

73

JUNE 1967

60¢

AMATEUR RADIO

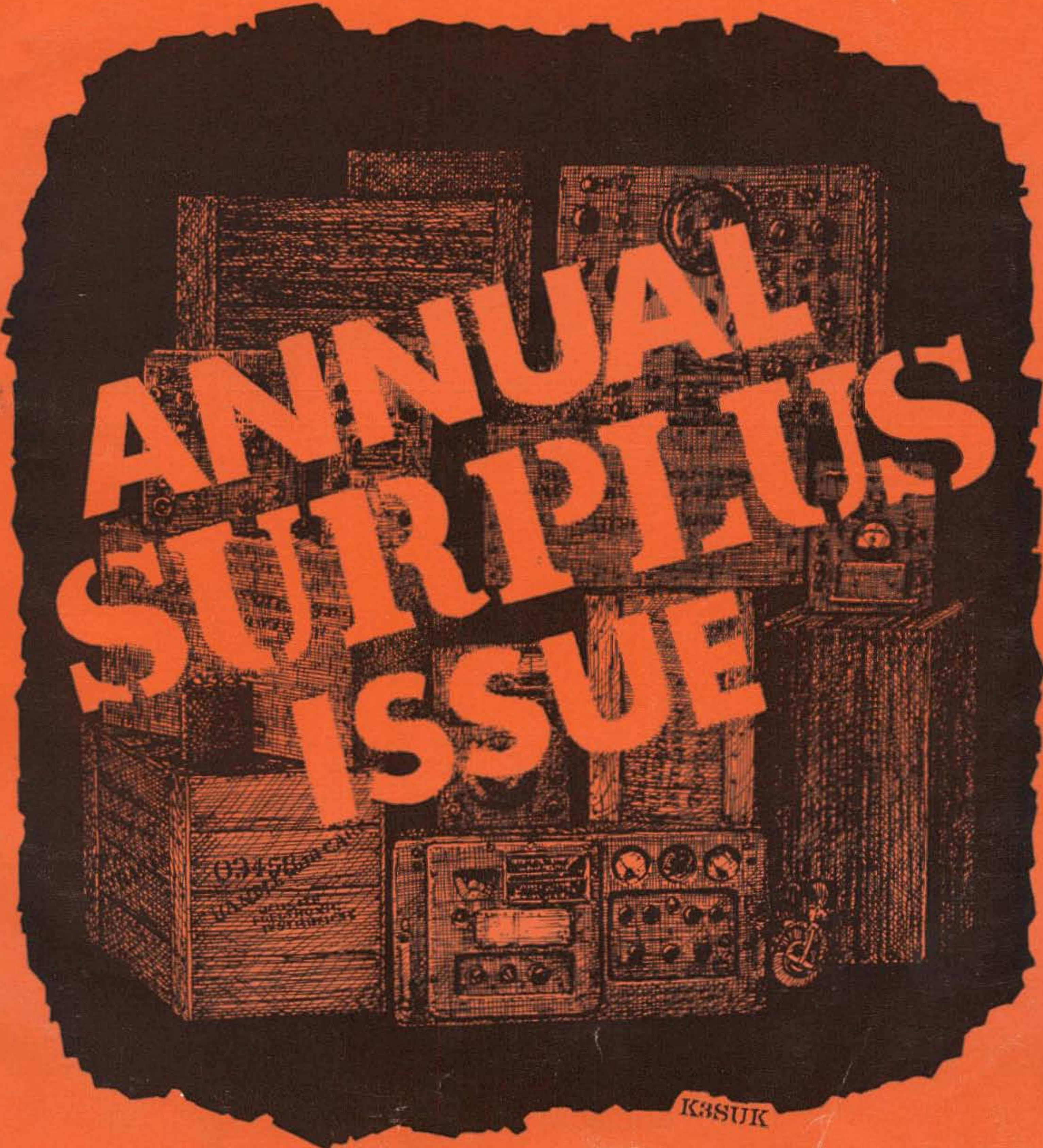

ANNUAL
SURPRISE
ISSUE

IC3SUK

Amateurs! Experimenters!

SEND FOR FREE COLOR BROCHURE!

READ WHY

VESTO

Yes! I'm Interested in a Vesto Tower. Please RUSH complete information!

Name _____

Address _____

City _____ State _____

Call Letters _____

IS "THE TOWER THE AIRPORTS USE!"



These Are Standard VHP-50 Towers with B 200 Safety Platforms

SMALL DOWN PAYMENT!

24-MONTH TERMS!

Pick the Tower You Want! Vesto Will Arrange Terms If You Need 'Em!

22'	\$192
28'	\$243
33'	\$288
39'	\$343
44'	\$395
50'	\$468
55'	\$529
61'	\$596
77'	\$898
100'	\$1392

"Mage" Magers, WØOJI, says

"Old Timer or Novice—it will pay you to choose the lifetime steel tower the airports and many leading hams use! It's fun to erect this tower yourself. Just dig 4 holes, set anchor posts in place, and bolt the pieces together. 5½-foot ladder sections make it easier to assemble as your tower goes up! Let me send you all the dope today!"

HURRICANE PROOF! NO VESTO HAS EVER FAILED!

HERE'S WHY:

- 4-Post Construction for Greater Strength!
- Completely Self-Supporting—No Guy Wires to Break or Stumble Over!
- Completely SAFE—Ladder to Top!
- Hot-dip Galvanized Steel Lasts a LIFETIME!
- Tower Shipped Complete—Ready to Assemble!

"VESTO TOWERS ALL OVER THE WORLD"

VESTO CO., Inc.

20TH & CLAY NORTH KANSAS CITY, MISSOURI

"Mage" Magers, President WØOJI

73 Magazine

June 1967

Vol. XLVI, No. 6

Jim Fisk WIDTY
Editor

Jack Morgan KIRA
Advertising Manager

ADVERTISING RATES

	1X	6X	12X
1 p	\$298	\$281	\$264
1/2 p	155	147	139
1/4 p	80	76	72
2"	42	40	38
1"	23	22	21

No extra charge for second color (red, usually) or bleed on full page ads. If you're interested in advertising to hams, get our full rate card and other information from Jack Morgan KIRA.

Cover by Wayne Pierce K3SUK

73 Magazine is published monthly by 73, Inc., Peterborough, N.H. 03458. The phone is 603-924-3873. Subscription rate: \$5.00 per year, \$9.00 for two years, \$12.00 for three years. Stop reading this fine print and turn to the surplus catalog starting on page 79. Second class postage is paid at Peterborough, New Hampshire and at additional mailing offices. Printed in Pontiac, Illinois, U.S.A. Entire contents copyright 1967 by 73, Inc. Postmasters, please send form 3579 to 73 Magazine, Peterborough, New Hampshire 03458.

The Whole of the Doughnut.....	W4BRS.....	6
Toroidal coils for kilowatt amplifiers.		
A 1296 Grid Dipper.....	WIDTY.....	16
1050 to 1320 MHz with a converted APX-6.		
Using FET's in the Command Set Transmitter.....	K3LCU.....	23
Results in a very stable VFO.		
The Dichotomy of a Tube Man.....	W5SOT.....	26
Putting an FET in the BC-906 frequency meter.		
Converting the Swan 120 to 6 Meters.....	K6RIL.....	28
Be prepared for the six-meter openings this fall.		
Military Quartz Crystals for the Radio Amateur.....	WØHYB.....	36
A survey of surplus crystals.		
Converting the BC-728.....		38
A fine superhet for 160, 80 and 40 meters.		
Photographing Your Electronic Gadgets.....	VE3DAN.....	42
Must reading for authors.		
Panoramic Display from the AN/APA-38 Indicator.....	W6JTT.....	46
Low-cost panoramic reception.		
RDR Receiver Conversion.....	K3HIL.....	48
Crystal controlled channels on 220 MHz.		
Build a 40-Meter Rotable Dipole.....	WB2GZL.....	50
Maximum effectiveness on 40 meters with a shortened dipole.		
Operating the BC-611 Walkie-Talkie.....	WIMEG.....	55
Great for short distances over flat terrain.		
A Poor Man's Transmitter Cabinet.....	WA4RHT.....	56
Using old TV cabinets.		
Micro-logic for Non-logical Users.....	W6GXN.....	58
How to use digital integrated circuits in ham projects.		
Proportional Transistor Control of AC Circuits.....	Ives.....	66
Solid-state replacement for a variable transformer.		
Phone Patching—More Light in a Gray Area.....	K8BLL.....	69
From the legal point of view.		
The Heathkit SB301 Receiver.....	W2JDL.....	76
One of Benton Harbor's newest releases.		
Face-Lifting the TS34/AP Oscilloscope.....	K6GKX.....	110
A great scope for less than twenty dollars.		
Climbing the Novice Ladder: Part VII.....	W70E.....	111
Judy and Joe take the written test.		
Ham Public Service and Broadcast Stations.....	K4HKD.....	117
Another approach to better public relations.		
Gus: Part 24.....	W4BPD.....	119
Sir Gus tours ZS-land.		

The View from Here.....	2	WTW Report.....	72
Letters.....	4	What's New.....	74
Why Fight Ohm's Law.....	44	New Products.....	130
Heathkit Transistor Tester.....	52	Caveat Emptor.....	137
The Vacationer Portable Antenna.....	54	Propagation.....	142
AC Ammeter.....	54	Ad Index.....	144

The View from Here . . .

With all the technological advancements that have been made in amateur radio in the past few years, there's no reason why we must perpetuate antiquity by using AM on any of the high-frequency bands.

I'm sure this will evoke a few cries from isolated corners, but the fact is, if you listen in on the bands below 30 MHz at any time of the day or night, AM stations in the American phone band are few and far between.

Ten years ago it was the other way around—sideband stations were in the minority. Even five years ago the gentlemen's agreement on twenty meters was useful—now it is ridiculous. The two or three AM stations operating between 14200 and 14250 do a lot of complaining about the sidebanders' violation of this archaic agreement, but they're the only AM stations on the band. Everyone else has gone to more efficient and compatible sideband.

When king spark was outlawed in favor of CW and modulated oscillators were eliminated from the high-frequency bands, there were cries of anguish from a few who had fallen behind the times. The same thing is true today. There are always a few who fail to keep the pace.

The spectrum that we have available is limited and there's not a chance in the world that it will be enlarged. There's even a good possibility that we'll lose part of it. At the very best we'll have to contend with more and more intruders. Therefore, it's incumbent upon us to use the space we do have available to the best advantage. Maximum utilization of the bands available, cannot, within any stretch of the imagination, include the use of Ancient Modulation. Most amateurs are aware of this and have switched to sideband.

Not only do AM transmitters require much more bandwidth, they are inefficient and in many cases, ineffective. This has been proven many times in the past, both theoretically and practically. If you can copy a station Q5 on CW, about 90% of the time you can make a successful contact on sideband. Don't try it on AM—90% of the time you won't make it.

Although spectrum utilization and interference are the two big arguments against AM, there is one other important consideration—state-of-the-art. In years past, amateurs

donated much to the advance of the radio art. As our technology sky-rockets forward, there doesn't seem to be an awful lot that the backyard experimenter and amateur can contribute. However, we can use the best techniques that are available—this doesn't include AM; it went out with 872 rectifiers, general coverage communications receivers and swinging links.

A lot of the AM procrastinators will holler about the high cost of sideband. Bunk! You can buy a high-frequency sideband transceiver today from five or six prominent manufacturers for about the same thing you paid for a good communications receiver a decade ago. If you don't like transceive operation, remote VFO's are available from most of the same manufacturers for less than a hundred dollars.

Kilowatt power amplifiers are no problem either—if it will work on AM, a few modifications will turn it into a linear. In most cases all that is required are a few changes in bias. While all tubes were not designed for linear operation, most of them will perform pretty well when properly biased.

Furthermore, the conversion of an AM transmitter to double sideband is a relatively easy operation. Although double sideband uses twice the bandwidth of single sideband, it has at least the same efficiency and the troublemaking carrier is eliminated. The widespread use of single sideband has pretty much inhibited any serious experimentation with double sideband, but it appears to offer at least one advantage—synchronous detection. When a properly designed double sideband system with synchronous detection is used, QRM free QSO's are apparently the rule rather than the exception. Not that I'm advocating double sideband—I just think it deserves more investigation.

It doesn't really make a great deal of difference whether we use one sideband or two—either system is compatible with the other. Actually, there is little danger that double sideband will ever be very popular; single sideband equipment is too readily available.

None the less, AM is not compatible. It's not compatible with sideband, nor spectrum utilization, nor state-of-the-art. It's inefficient and ineffective. Isn't it about time we eliminated it from the high-frequency bands?

Jim, W1DTY

NOW

A low cost Crystal for the Experimenter

International

- LOW COST
- MINIMUM DELIVERY TIME

3,000 KHz to 60,000 KHz



type "EX"

\$3.75

Postage Paid

SPECIFICATIONS: International Type "EX" Crystal is available from 3,000 KHz to 60,000 KHz. The "EX" Crystal is supplied only in the HC-6/U holder. Calibration is $\pm .02\%$ when operated in International OX circuit or equivalent.

CONDITIONS OF SALE: All "EX" Crystals are sold on a cash basis, \$3.75 each. Shipping and postage (inside U.S. and Canada only) will be prepaid by International. Crystals are guaranteed to operate only in the OX circuit or its equivalent.

MINIMUM DELIVERY TIME We guarantee fast processing of your order. Use special EX order card to speed delivery. You may order direct from ad. We will send you a supply of cards for future orders.

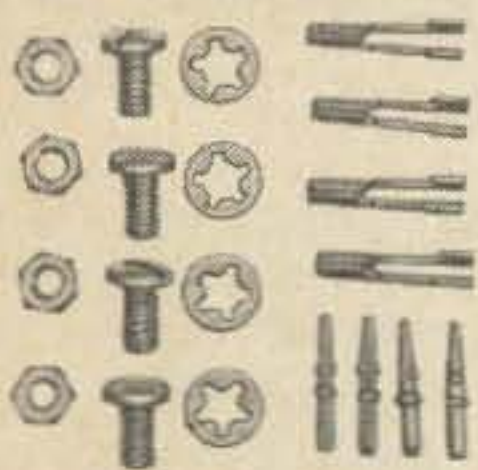
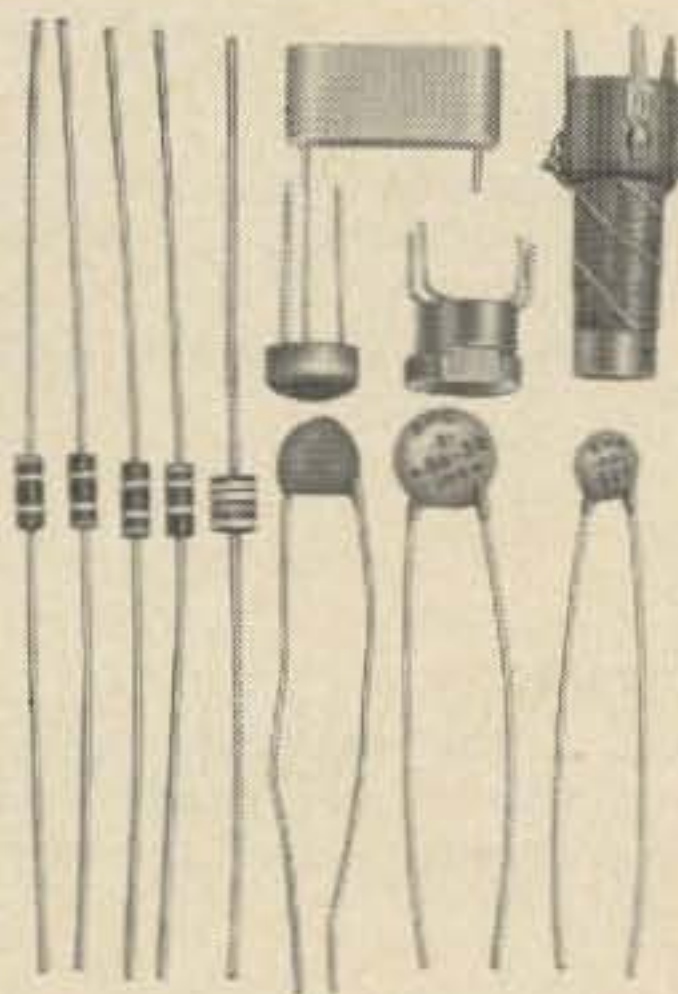
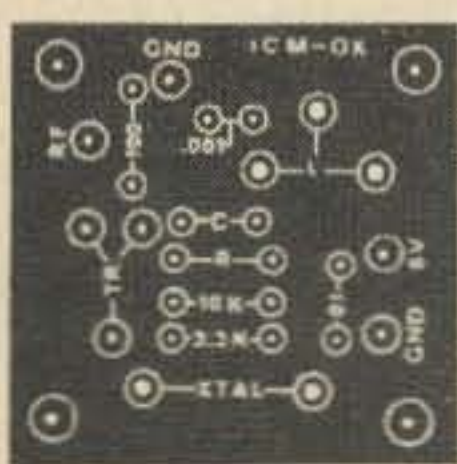
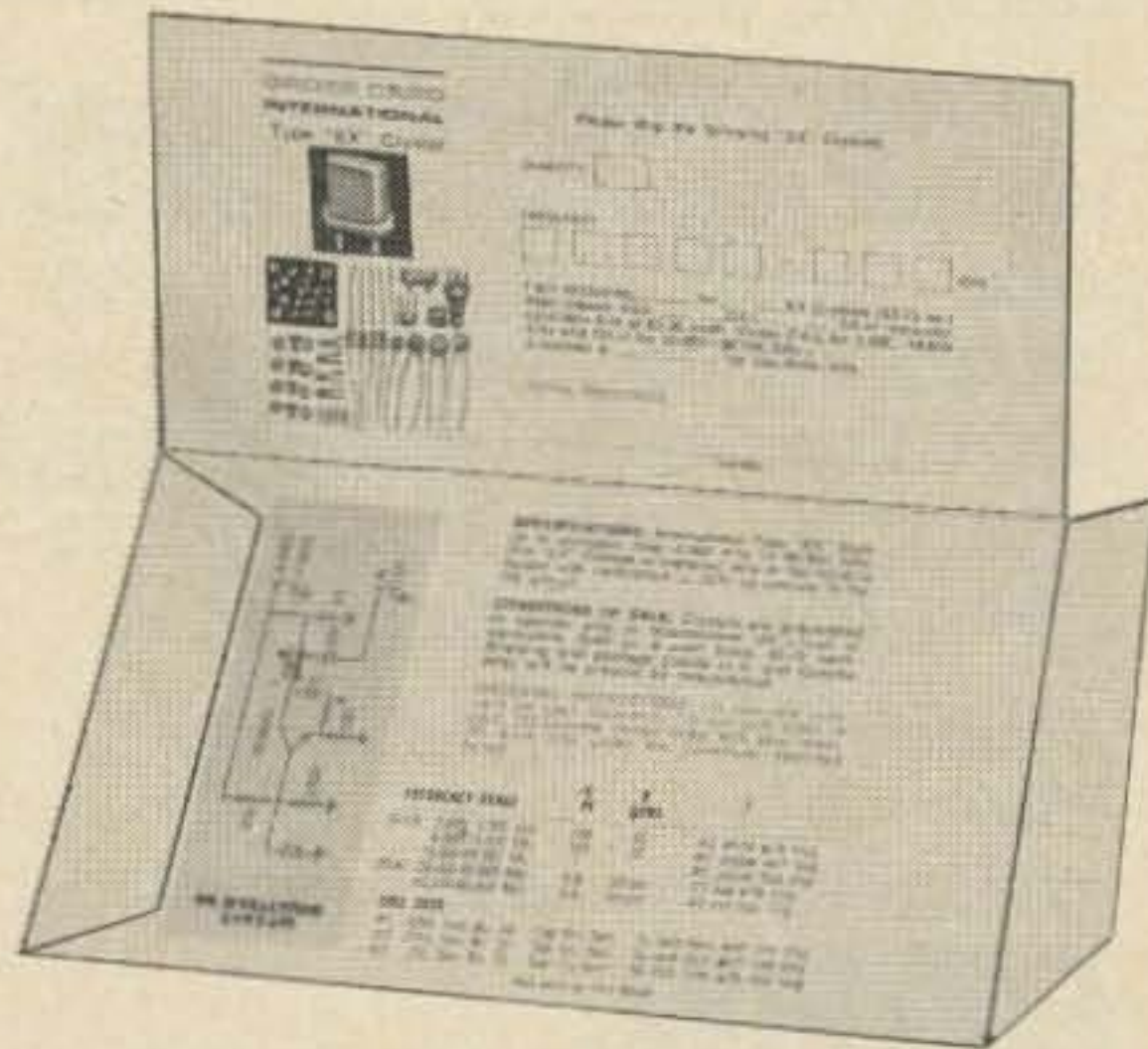

COMPLETE OX OSCILLATOR KITS

Everything you need to build your own oscillator. Two kits available. "OX-L" kit 3,000 to 19,999 KHz. "OX-H" kit 20,000 to 60,000 KHz. Specify "OX-L" or "OX-H" when ordering.

\$2.35

Postage Paid

ORDERING INSTRUCTIONS

- (1) Use **one** order card for each frequency. Fill out both sides of card.
- (2) Enclose money order with order.
- (3) Sold only under the conditions specified herein.



CRYSTAL MFG. CO., INC.
10 NO. LEE • OKLA. CITY, OKLA. 73102

ROHN®

Mighty big in towers

CATV • Microwave • Communications • Broadcast • Home TV • Amateur • Specialty Towers

The dominant position ROHN enjoys in the tower industry has its foundations established on a concept of providing the customer with more than he expects to get. The built-in extra quality factor begins with:

ENGINEERING AND DESIGN — computer-assisted for exactness

MANUFACTURING — vast, modern, custom-designed facilities and methods

FINISHING — hot-dipped galvanizing after fabrication and continues with . . .

ROHN SERVICE — strategically located warehousing, worldwide representatives, turnkey tower erection service and complete lines of towers, lighting, microwave reflectors, accessories and equipment.

Representation and Distribution Worldwide

For further information contact

ROHN®

Home Office
P.O. Box 2000, Peoria, Illinois 61601
Ph. 309/637-8416 TWX 309/697-1488



Letters

The Price of Progress

Dear 73:

. . . A few months ago I subscribed to 73 and had a rude awakening. I did not know the language well enough to read half the articles. Progress had run ahead of me and I was in bad shape. Since that time I have been trying to catch up and it's rough . . .

Just wanted you and your associates to know that you are greatly appreciated and I think you are doing a great job for the fraternity. Maybe some of the youngsters like to buy ready-to-operate, but there are still some of those left around that like to experiment and build our own. Again, thank you very much for the fine job you are doing. Keep up the good work.

Emery White, Sr. W4TQD
Glasgow, Kentucky

Dear 73:

. . . Your magazine is getting better all the time and you may yet make a technician out of a mathematician. Hi.

John Bauer
Kanata, Ontario, Canada

QRP

Dear 73:

The following might be of interest to younger hams and perhaps refresh the memories of some of the old timers. The following input powers were taken from QSL cards received from stations worked on 28 MHz in 1948. My call was then KZ5RS: OZ8J—12 watts; ZL1DW—70 watts; ZS1CG—25 watts; OQ5HL—60 watts; GM3BON—35 watts; and VK3PG—50 watts. My reports to these stations were 57 or better.

R. W. Stewart WA4EKF
Warner Robins, Georgia

The sunspots do make a difference.

Transistor Circuits

Dear 73:

Congratulations on your article by W1DTY—too bad you cut off the "T" in his call on the front cover of the March 73. His 73 transistor circuits are going to be a big help to this ham and a lot of others I am sure.

S. R. Gross W9OJI
Wheaton, Illinois

Dear 73:

. . . the transistor circuits article in the March issue was a real dandy and received a lot of favourable comment from the boys around here.

George Cousins VE1TG
Nova Scotia, Canada

Dear 73:

Only two tubes in the March issue—what did you do, fire the drawer of tube diagrams? If so, FB. Promote Fisk for his solid state jewel!

Ev Taylor W6DOR
Sacramento, California

(turn to page 126)

KNOW... *your rig is running right!*

(keep it in constant check)

Waters



DUMMY LOAD • DUMMY LOAD/WATTMETERS

DUMMY LOAD/WATTMETERS

MODEL 334A . . . Reads power output to 1000 RF watts over 2 to 230 MHz. 4 calibrated scales for accurate readings. THE wattmeter if you operate through VHF!

MODEL 374 . . . Indicates RF power to 1500 RF watts from 2 to 30 MHz. Has 4 calibrated scales. Specifically designed for the 2KW PEP Linears to 30 MHz.

DUMMY LOAD

MODEL 384 . . . Handles up to 1500 RF watts from DC to 230 MHz. Combined with Waters Reflectometer operates as a Dummy Load/Wattmeter — and a VSWR Meter.

You'll transmit a consistently better signal with your rig kept under constant operating surveillance. And a Waters Dummy Load/Wattmeter will help you do just that! Even more . . . you'll know with every transmission your precise power output measured directly in RF watts. Dummy Load/Wattmeters are available in two models to handle either 1000 or 1500 RF watts.

Send for your copy of Waters new Catalog.

CANADIAN HAMS: Order direct from M. J. Howard & Co., Ltd., 1300 Carling Ave., Ottawa, Canada.

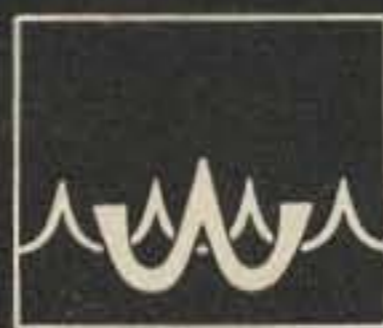

WATERS
MANUFACTURING INC.
WAYLAND, MASSACHUSETTS

E. L. Klein W4BRS
6814 Criner Road, S. E.
Huntsville, Alabama

The Whole of The Doughnut

How to use toroidal tank coils in high power amplifiers for increased efficiency with reduced size. Practical inductors are shown for 100, 500 and 1000 watts.

Toroid rf tank coils have brought a new era of construction technique to the amateur builder as well as commercial manufacturers. Spurred on by modern requirements for compact construction, the toroid has seen recent applications in DC to DC power converters, interstage audio transformers, and many other uses. Indeed, the largest single application of the toroidal coil is the television fly-back transformer which has been taken for granted for years in the home TV set. Recent articles have described toroidal coil applications in VFO's,^{1,2,3} low power transmitters,⁴ VSWR meters⁵ and multi-band tuners⁶. Now, for the first time, the outstanding advantages of toroids have been realized in higher power transmitter rf tank circuits.

The impact of toroids upon modern electronic equipment design has been of first order importance. Not since the advent of transistors or SSB itself, has so important an advance in construction technique been available to the electronics industry. Significant reductions in size, ease of packaging and improved efficiencies lead the list of reasons why toroids have emerged as the currently favorite tool of electronic designers.

Advantages of toroids

The most significant feature of the toroidal coil is that its magnetic flux is almost entirely contained within the coil itself. This means that generous spacing

of the coil from adjacent components, panels and chassis need not be provided. Further, by virtue of using a powdered iron core within the coil, an adequate inductance can be achieved with fewer turns, smaller diameters and resultant smaller physical sizes. When fewer turns are used for the coil, larger gauge wire can be accommodated. Also, if the flux is restricted within the coil, greater Q and improved power transfer efficiency are achieved. These factors add to accomplish less heating loss within the tank coil assembly itself, resulting in more power output.

In rf tank circuits for example, we are able to achieve a volumetric size reduction of better than 8 to 1. Part of this is due to the fewer turns and smaller diameter winding which is possible. More importantly, however, less spacing is required around the coil to accommodate its magnetic flux, because this flux for the most part is contained within the toroid. Therefore, a favorably high Q is achieved without spacing the coil at least one diameter away from the chassis as would normally be required with conventional construction. While toroids promise many desirable features, several new design considerations must be recognized. The higher Q presented by a toroidal coil makes its tuning relatively sharp. This is particularly true when tuning an unloaded or lightly loaded tank circuit. There-

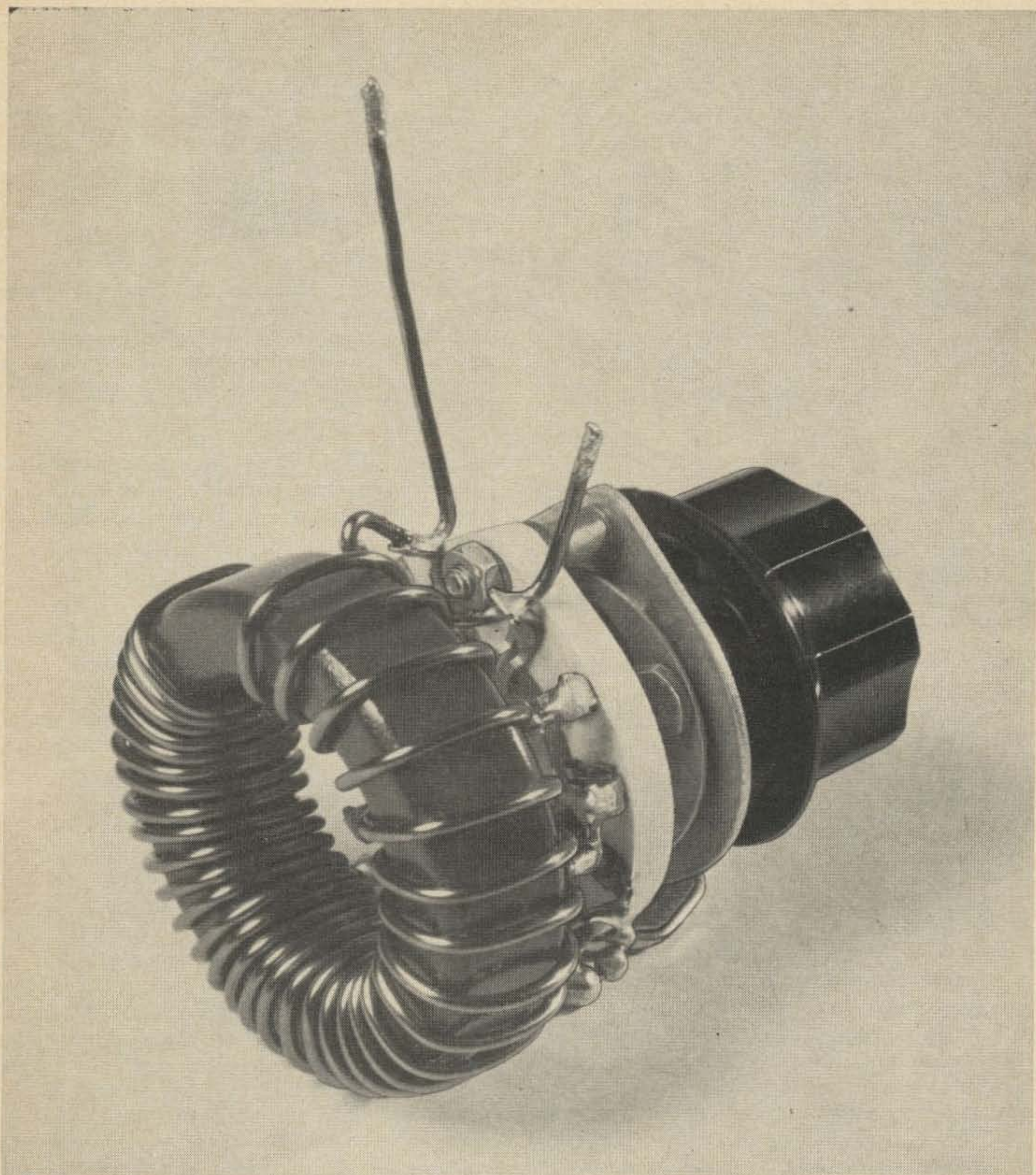

Fig. 1. Toroidal rf tank coil for use in a 100 watt transmitter. The powdered iron core provides High-Q and therefore, good energy transfer. Compact construction results in a tank coil only a fraction of the size normally encountered in conventional designs. The core is given several coats of epoxy cement prior to winding so as to prevent flash-over from the winding to the core.

fore, when a toroid is used in a transmitter final tank circuit, it may be necessary to "re-dip" the final more often than a conventional circuit when changing from one operating frequency to another. Also, when the quasi-conductive powdered iron core is placed within a high power rf tank coil, some tendency toward flash-over to the core is experienced. However, with proper precautions

and adequate spacing as described later, this tendency can be eliminated.

The toroidal core

Cores for the toroidal tank coils described in this article were obtained from Ami-Tron Associates, 12033 Otsego Street, North Hollywood, California. Their model T-200-2 was selected for its large size (2 inch out-

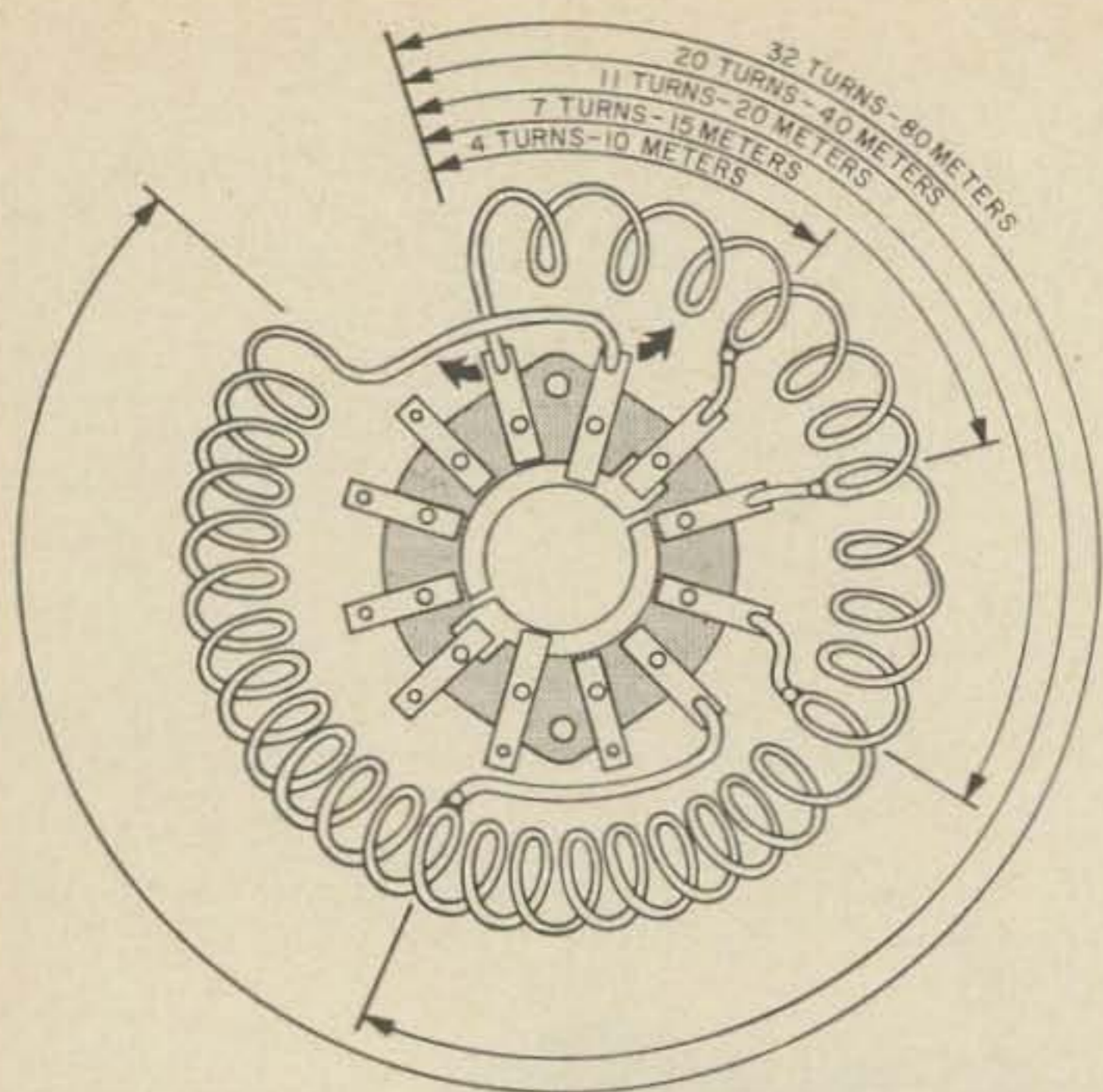

Fig. 2. Winding data is given here for the 100 watt coil. Enamelled copper wire (#14 AWG) is used. Windings have a greater spacing at higher frequencies in a manner typical of multi-band tank coils.

side diameter) and 2 kW PEP rating from 500 kHz thru 30 MHz. This same core is used in the *Ami-Tron Signal Antenna Balun Kit*.

Powdered iron cores are manufactured from iron ore by a process called "sintering". While several special proprietary processes enter into their fabrication by different manufacturers, the essential process requires a thorough dehydration by baking and pulverizing of the iron ore. The resultant iron granules are then compacted or sintered in a properly shaped mold under extreme pressure and high temperature. Organic binders are generally not used. Rather, a mechanical inter-granular adhesion is achieved which produces a solid mass with each iron granule being electrically quasi-insulated from the rest. This is needed, as we know, to prevent hysteresis losses and is analagous to the

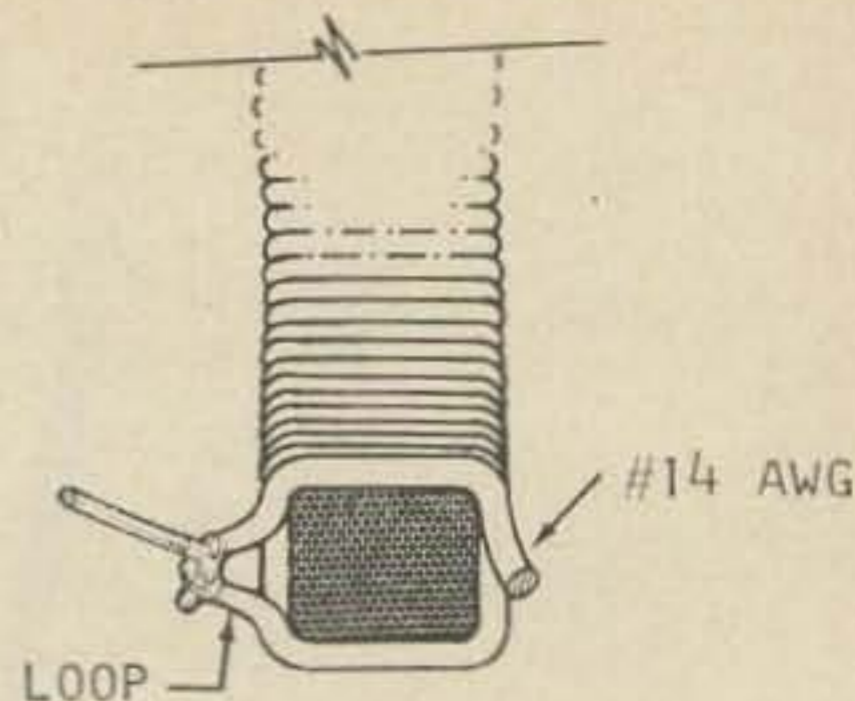

Fig. 3. Taps for connecting to the band change switch are made to small "U" shaped loops in the wire. These loops are placed on the edge of the coil facing the switch and leads are only about 1/2 inch long. The switch is a Mallory ceramic wafer switch.

insulated laminations in a conventional power transformer or choke coil. Higher frequency applications require smaller granule sizes.

The 100 Watt toroid

In our experimentation with toroids in rf tank circuits, three different sizes were selected to satisfy three different power ranges; 100 watts, 500 watts and 1000 watts. The builder might well use somewhat higher or lower powers in connection with the physical sizes of the coils illustrated here.

Corona flash-over to the iron core mass is eliminated by first coating the T-200-2 toroid core with several coats of epoxy cement. Teflon, vinyl or fiberglass tape may also be used for this purpose. Fig. 2 gives the winding data and shows the placement of taps which are connected to a ceramic wafer band change switch. Number 14 AWG enamelled copper wire is used. The windings for the 10, 15 and 20 meter portions of the coil are spaced out at the center of the toroid equal to the wire diameter. The remaining 40 and 80 meter portions of the coil are close spaced at the toroid center.

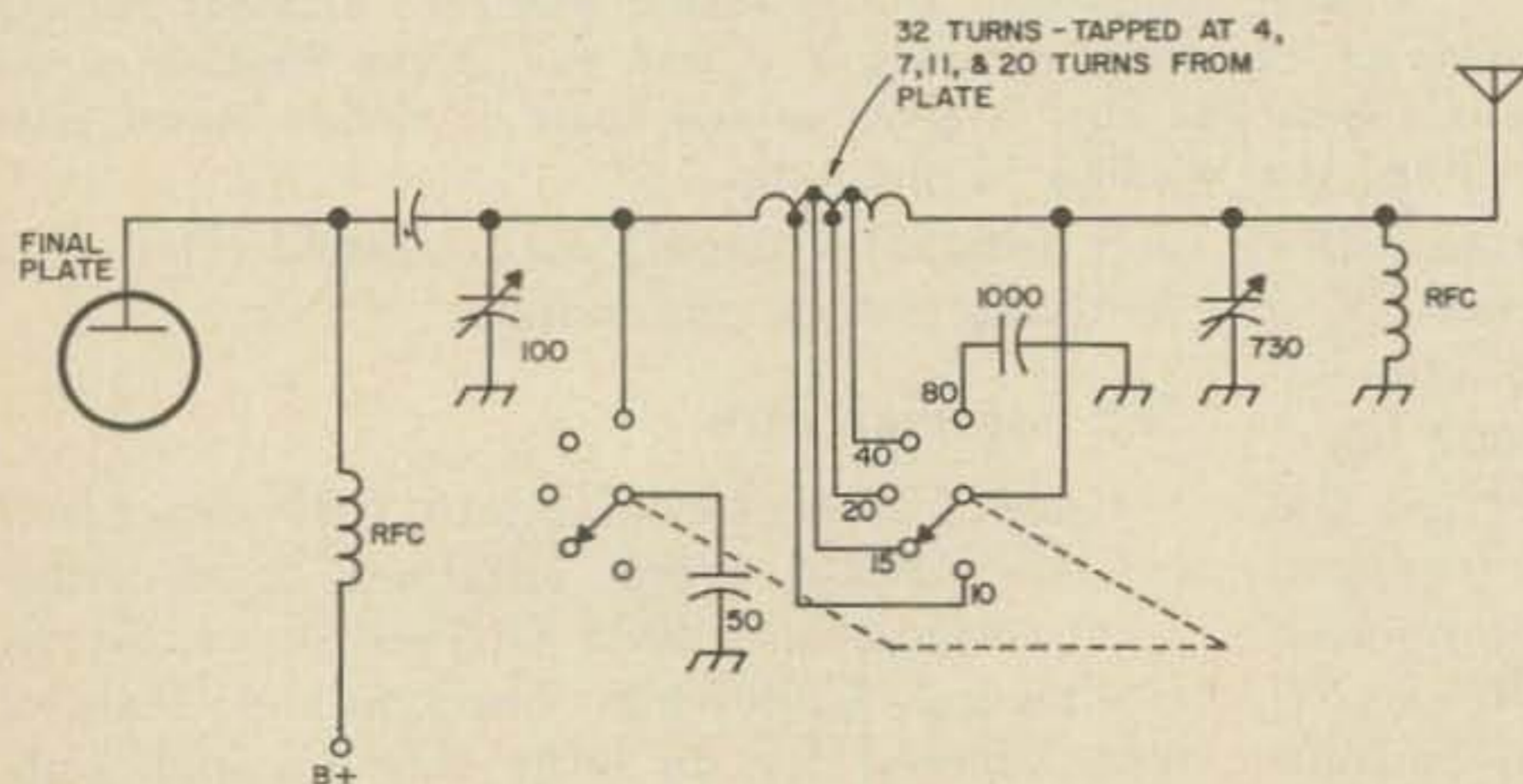

Fig. 4. Schematic of a typical pi network. Additional fixed capacitance is provided at both the input and output in the 80 meter position. This permits smaller tuning capacitors to be used.

Taps to the toroid tank coil are made by forming a small loop in the winding as shown in the cross-section, Fig. 3. Stout needle-nose pliers are used for this purpose. After all windings are completed, the enamel is scraped from the loop and short sections of the #14 buss wire are soldered on, completing the connections to the band change switch. These short sections provide a rigid mounting of the coil to the switch and permit the completed assembly to be panel mounted.

The reader will note that a double pole wafer switch was selected for the 100 watt toroid tank coil. This permits the switching in of a fixed 50 pF padder capacitor on the 80 meter band as shown in Fig. 4. Consequently, the smaller 100 pF variable tank capacitor can be used, resulting in further space and cost savings. In the 80 meter position, a switch tap is also available for padding the output or antenna loading capacitor.

Winding toroids

When winding toroids commercially, specialized machines are used. Large numbers of turns are made by passing a bobbin of wire thru the toroid on a circular guide ring. Winding rf tank coils with heavy gauge wire presents a whole new family of problems. The toroids in this article were all wound by hand with a pre-determined length of wire.

The builder's first inclination is to hold the core in a bench vise and pull the turns taut with pliers as shown in Fig. 5. Don't do it! A broken core is bound to result. The core should be held by hand and each turn is pressed into place. While this is a challenge to the strength and endurance of one's fingers, it is necessary for successful toroid construction. Powdered iron cores are fragile and if one happens to be dropped or otherwise broken, it can be cemented together again as shown in Fig. 6. Remember, that insulation between the iron granules of the core is fundamental to its design. Avoid use of organic cements which deteriorate with heat or age.

The following are a few pointers which will ease the task of designing and winding toroids employing heavy gauge wire:

1. If the proper number of turns is not known, wind the coil first with small size bare wire. It will be easier to wind, easier to space out the turns and more con-

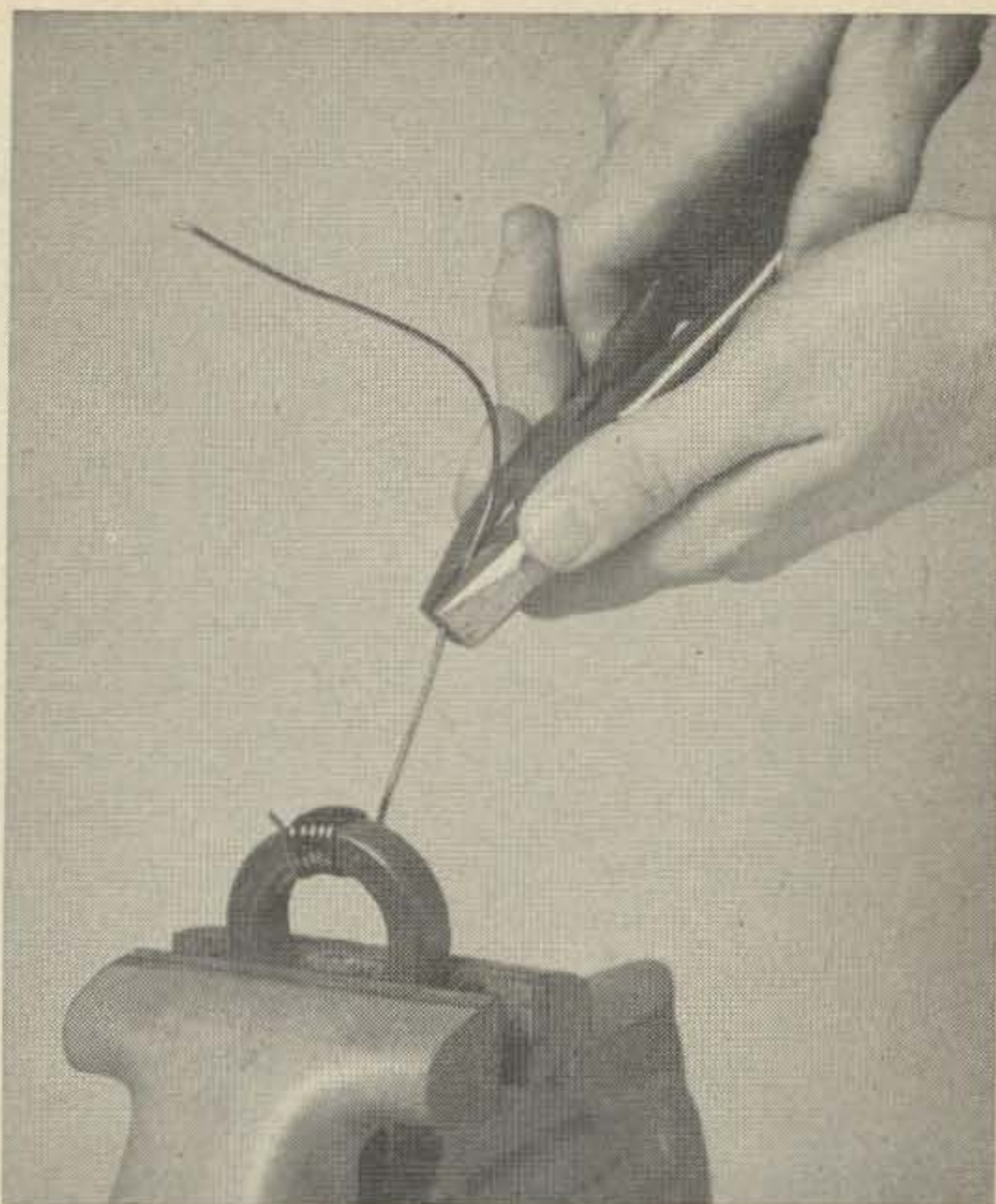

Fig. 5. How not to wind your toroidal coils! The fragile core is sure to break if heavy wire is pulled taut with pliers. When winding toroids, the core should be hand held, and the wire pressed into place with your thumb.

venient to solder on taps to verify where they should be placed. After making the necessary electrical measurements, the small wire can be clipped loose, discarded and replaced with wire of the proper size.

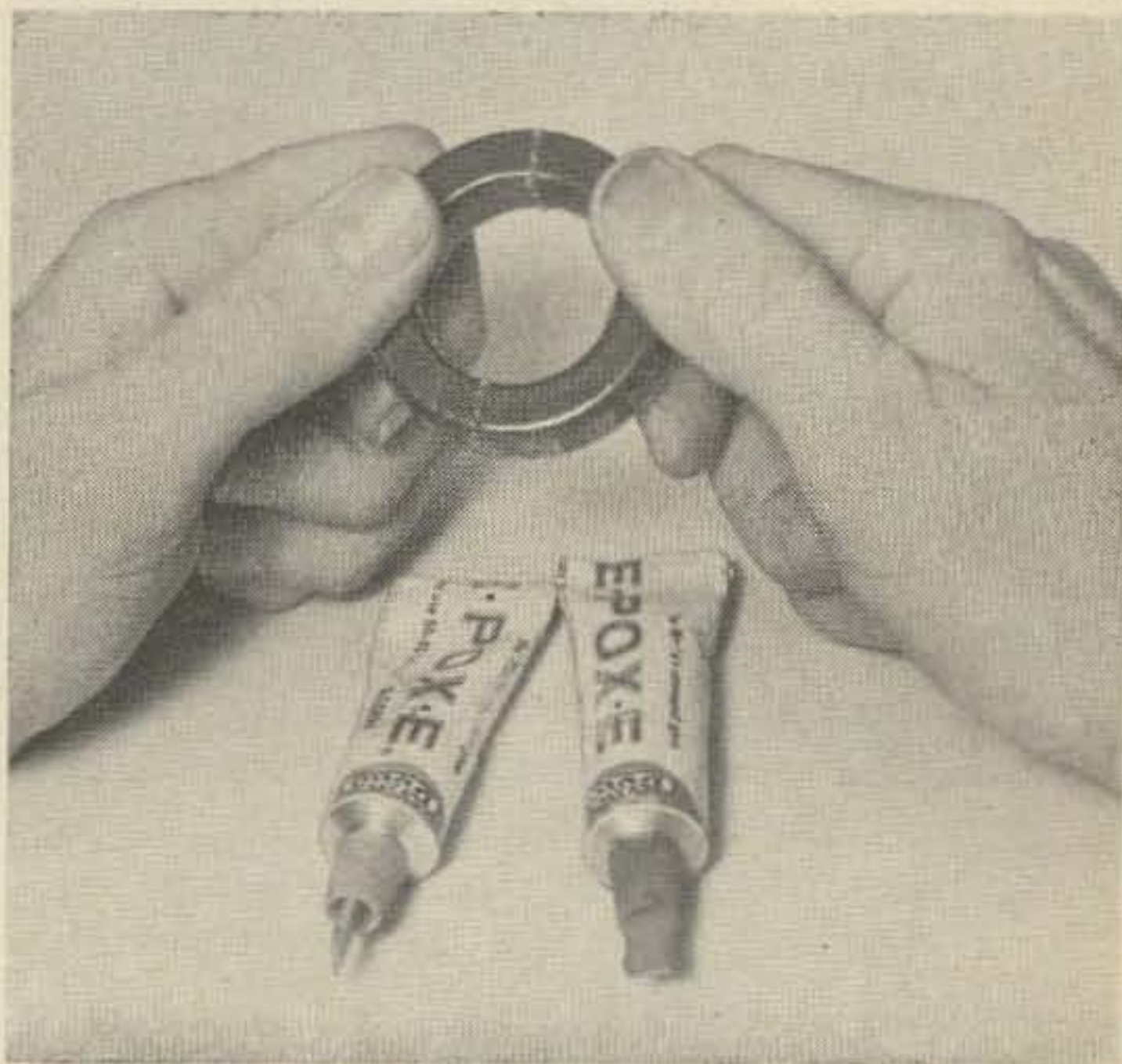

Fig. 6. Broken powdered iron cores may be repaired with epoxy or household cement. Core material is a quasi-insulator and electrical contact between the broken pieces is neither required nor desired.

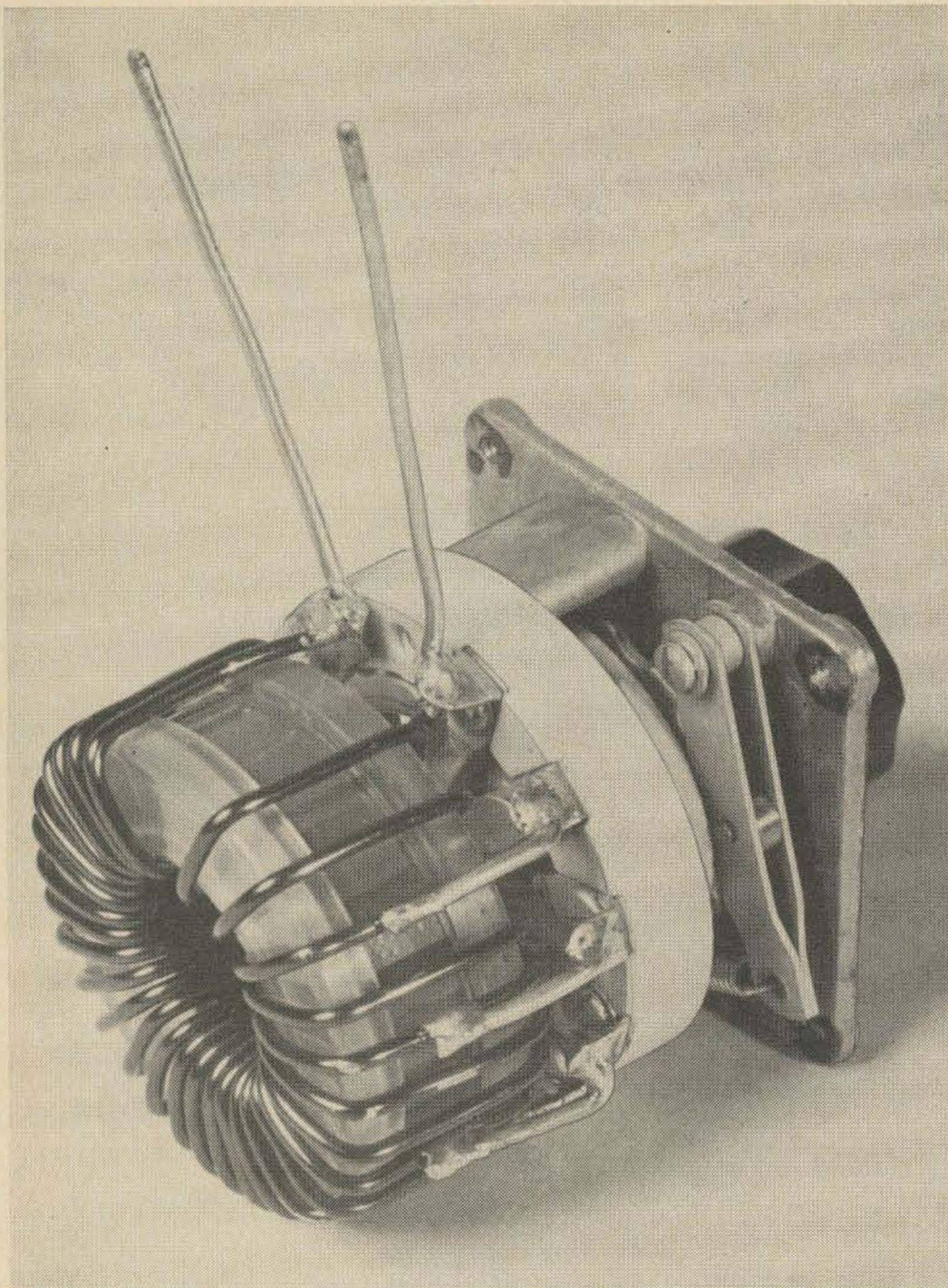

Fig. 7. Medium power (500 watt) toroidal tank coil employs one powdered iron core. The polystyrene end-spacers prevent flashover from the winding to the core. Coil taps for the various amateur bands are made to the outside of the windings that bridge across the two end spacers.

2. The length of heavy gauge wire required should first be calculated or simulated with string. This will avoid the inconvenience of threading an excessive length of wire through the toroid and will eliminate wastage when cutting off the surplus after the proper number of turns are reached.

3. Note the direction to which the windings advance; left to right. Determine the proper winding direction so that taps for the various bands proceed from left to right when viewing the band switch from the front panel.

4. Prior to starting the winding, straighten the wire and remove kinks. This can be done by holding one end in a bench vise and jerking the far end with a pair of pliers. Alternately, the far end can be

twisted an equal number of turns to the right and then to the left with a hand drill. Avoid excessive working of the copper which causes it to harden and become more difficult to handle.

5. Start winding from the center of the measured length of wire and work toward each end. This eliminates passing the total length of wire through the toroid core on each turn. It also minimizes work-hardening of the wire and kinking due to excessive handling.

6. Press wire firmly in place on each quarter-turn so that tight windings and neat right angles are obtained on each turn.

7. Prior to passing the free end of the

wire thru the core, unwind the last quarter turn slightly. This permits the wire to thread through parallel to the axis of the core and avoids kinks.

8. When spaced turns are called for, first wind them close spaced. After the proper number of turns are in place, space them out to the desired locations. This results in neater windings and tends to tighten them upon the core.

500 watt toroid coil

Fig. 7 shows the 500 watt toroid. An Ami-Tron T-200-2 core is also used with this coil. The band change switch pictured with the coil is the husky tap switch taken from a surplus BC-375 antenna tuning unit. These are still available for little cost from surplus dealers who advertise in this magazine. If a new switch is to be purchased for this purpose, the Ohmite power tap switch model 111 or 212 will work very well.

The reader will observe that insulating end spacers have been employed to hold the wire away from the powdered iron core material. About one-eighth inch of space is thus provided and has served well to prevent flash-over from the coil to the core. This spacing is about equal to that usually used between the rotor and stator of a tank capacitor selected for this power level.

Enamelled copper wire of #12 AWG size is used for the 500 watt toroid coil. It is wound using the same general instructions as used with the 100 watt unit. Because a larger coil diameter results from use of the end spacers, fewer turns can be employed. This is a welcome advantage due to the smaller inner diameter of the end spacers and less space which is available for the windings. Fig. 8 gives the winding data and tap information for the amateur bands from 80 to 10 meters inclusive.

1000 watt coil

Fig. 9 illustrates the high power coil which is suitable for 2 kW PEP on single sideband. The 10 meter portion of the coil has been externally wound. This was done to provide further isolation of the high impedance or highest voltage end of the coil from the powdered iron core. Copper tubing of 3/16 inch diameter is used for the 10 meter coil and #10 AWG tinned copper buss wire is used for the remainder of the coil within the toroid core.

In the 1000 watt coil, two Ami-Tron T-200-2 toroid cores are used to minimize the possibility of core saturation and "flat-topping". Prior to winding, the two cores as well as the end spacers are cemented together with epoxy cement. This makes winding of the coil much easier. Alternately, the two cores and two end spacers could be temporarily clamped together or lashed with string until the initial windings are in place.

The heavy duty band change switch is again used as previously described. Even with the greater mass presented by the two cores and heavier wire, no problem was encountered in making the complete assembly rigidly panel mounted by short pieces of #10 AWG copper buss connecting the taps to the band change switch. Fig. 10 provides the winding data for the high powdered coil. This spacing is ensured by placing small 1/4 inch by 2 inch pieces of 1/16 inch aluminum or plastic between the turns at the center of the coil. After proper and uniform spacing is achieved the individual turns are secured to the end spacers with epoxy cement. The temporary spacers can then be removed.

End spacers

Polystyrene sheet 1/4 inch thick is used to

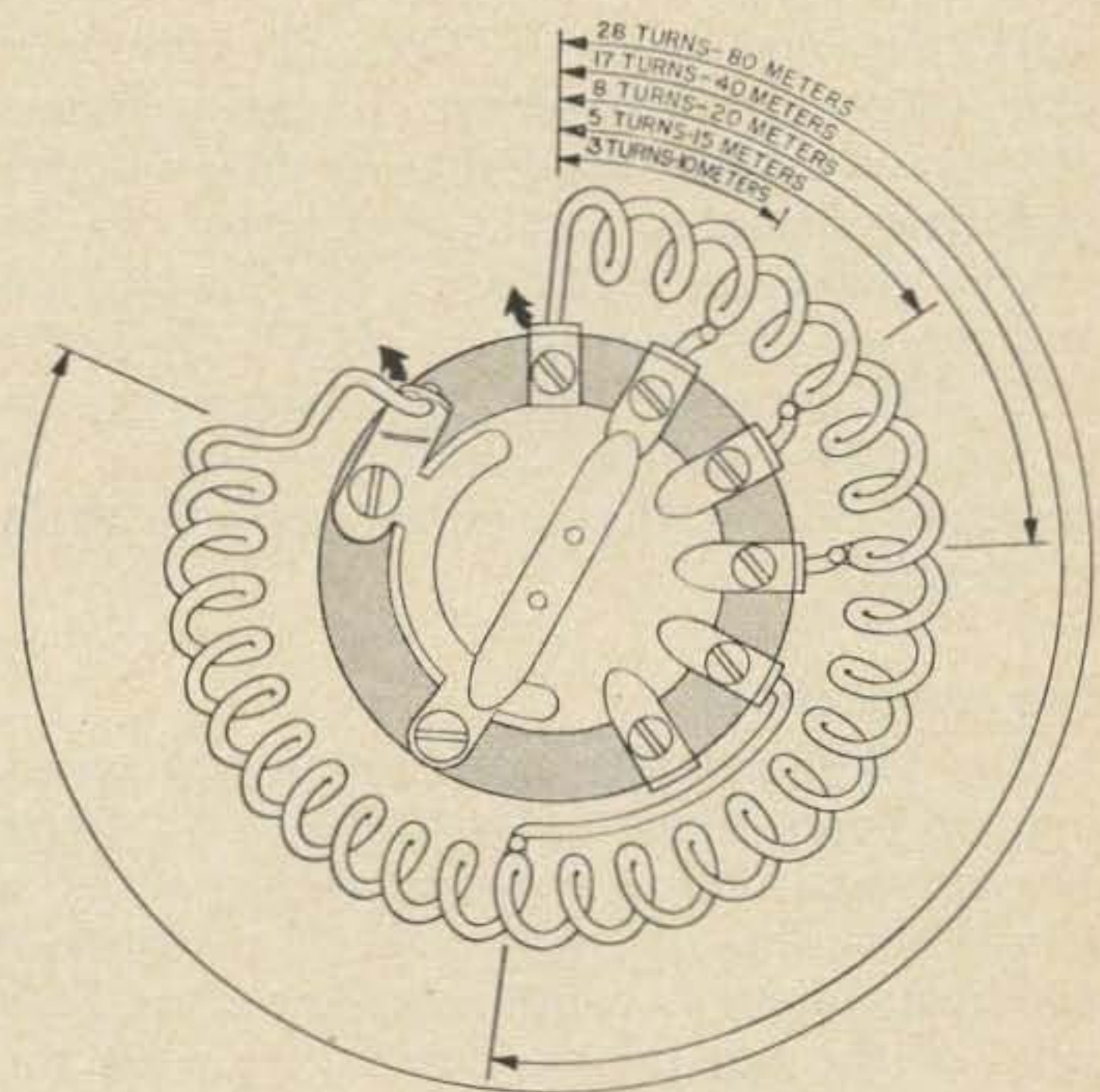

Fig. 8. The medium power toroid tank coil uses a surplus switch from a BC-375 Antenna Tuner. Windings are made with #12 AWG enamelled wire. Fewer turns are required when the end spacers are used due to their producing a larger effective coil diameter. The 10 and 15 meter windings are spread out slightly more than the rest of the coil.

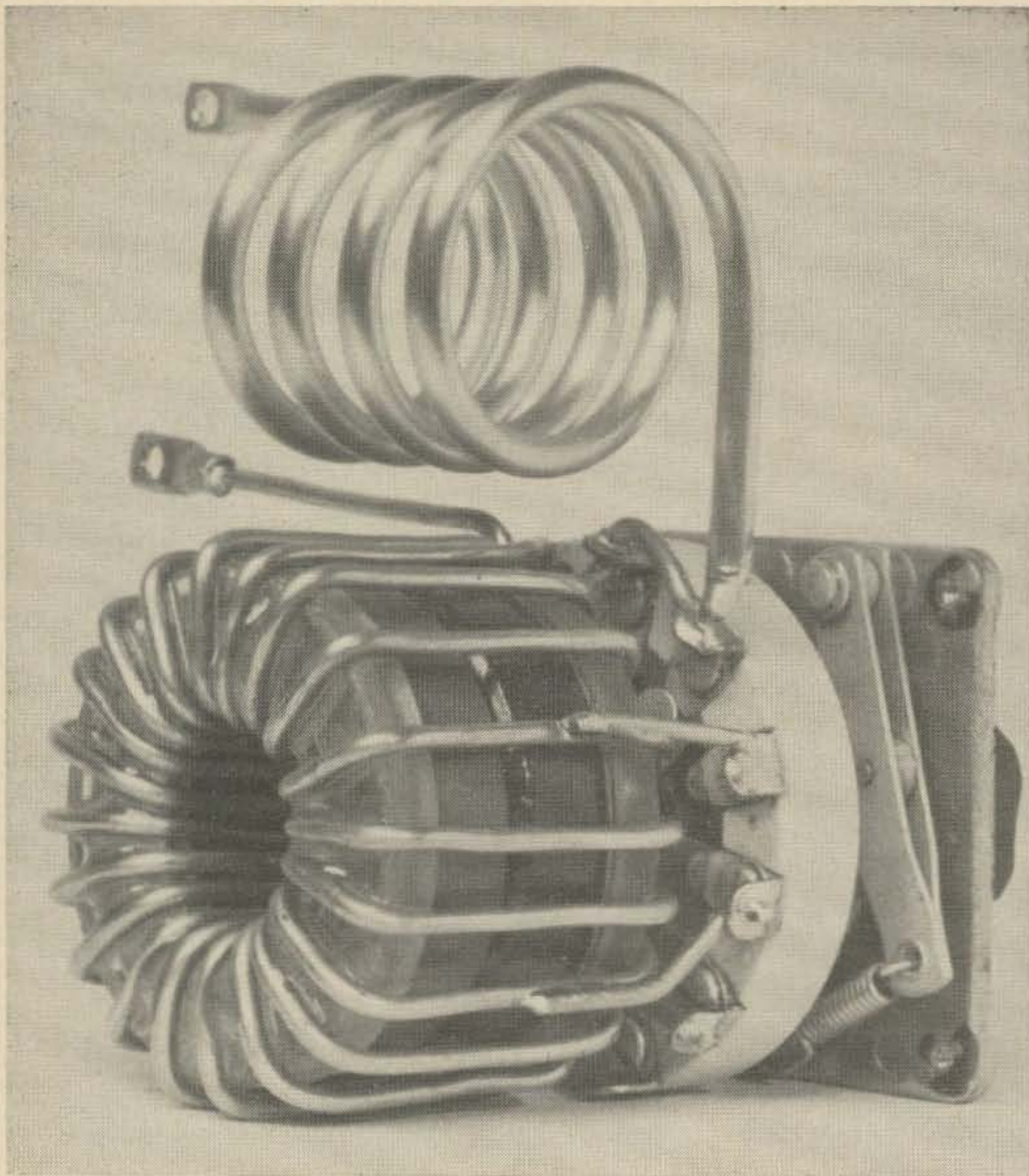

Fig. 9. High power tank coil for 1 kW operation. Two cores are stacked to lessen the possibility of core saturation. Larger wire (#10 AWG) is used in this model. The same heavy duty band change switch is used for this and the medium power version.

make the end spacers. Fig. 11 gives the dimensions of these pieces. Lucite or bakelite should not be used due to their inferior dielectric strength. The end spacers can be readily made on a lathe or can be cut out and recessed by means of a chassis fly-cutter in a drill press. If the end spacers are to be cemented to the toroid core, it is not necessary to cut the circular recess in them as pictured.

Tap connections

Fig. 12 shows alternate methods of securing tap connections to the toroid coils. Good success was achieved by providing about a ½ inch overlap of the tap lead on the coil winding. Solder is cautiously flowed on both sides of the tap taking care not to melt the polystyrene end spacer material. When assembling the coil to the band change switch, it is desirable to first form and solder the two major coil ends to their proper terminals on the switch. This serves to position the coil and makes it more convenient to form the taps and solder them in place.

Coil measurements

A Boonton Q Meter is invaluable in the empirical design of coils. However, such an instrument is not generally available to the amateur constructor. In lieu thereof, a grid-dip meter and calibrated capacitor will serve for frequency determination. A recent article in *73 Magazine*⁷ described this method. The three toroid tank coils were measured on a Boonton Q-meter and the following unloaded Q values were recorded:

Band	100 watt	500 watt	1000 watt
80	310	360	332
40	177	200	190
20	160	205	188
15	132	186	190
10	128	146	250

The lower Q values measured at the higher frequency bands are due to the coil being "bunched-up". That is, the small number of turns occupy only a fraction of the total core length. To achieve maximum Q for any given number of turns, those turns should be spaced out evenly over the whole core

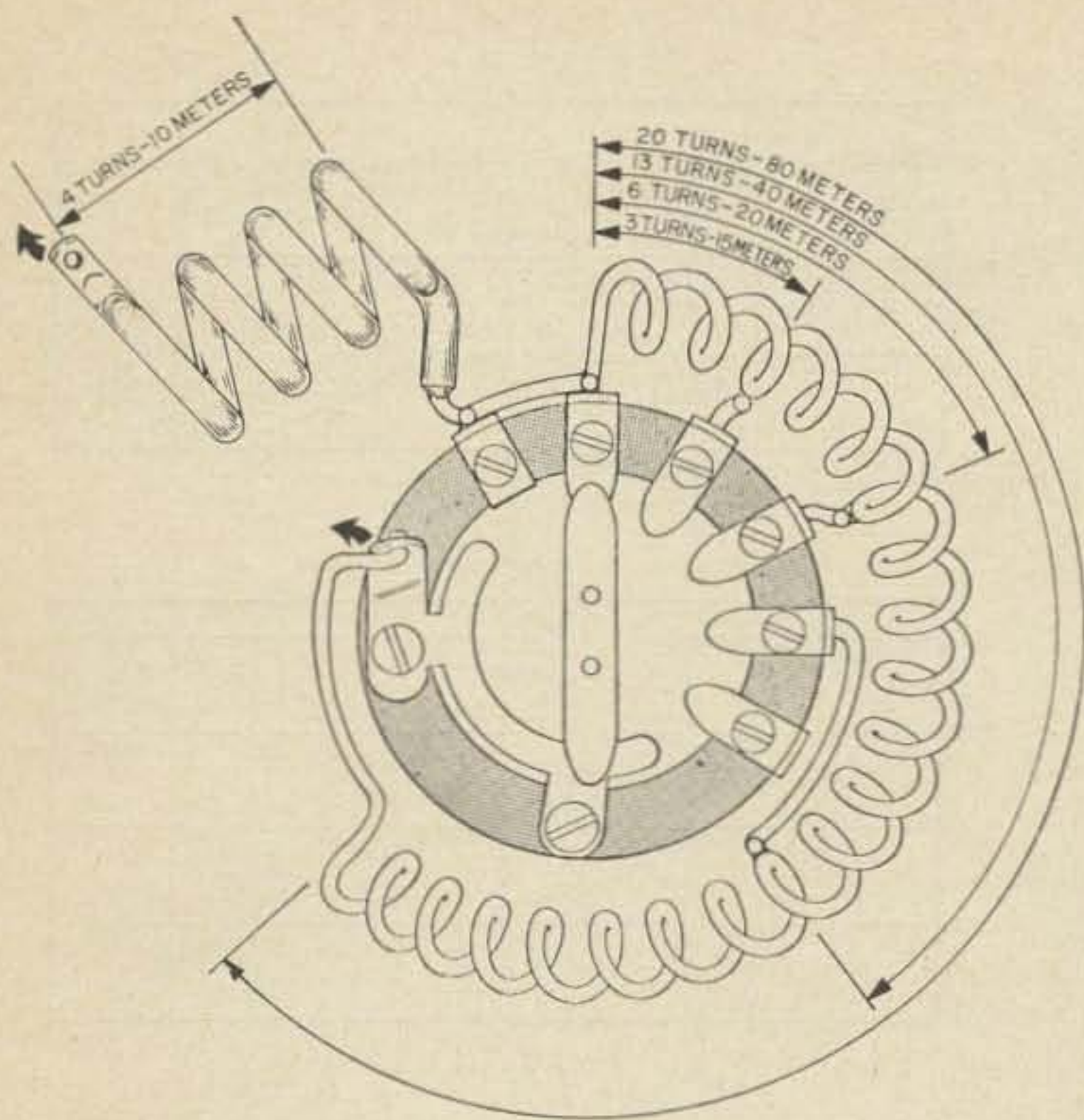

Fig. 10. The high power coil utilizes two powdered iron cores whose larger winding cross section requires that still fewer turns be used than for the medium power coil. While it is optional with the builder, in this case, the 10 meter section of the tank was externally air-wound. This is desirable because it reduces the electro-potential stress between the "hot" end of the coil and the core. Four turns of 3/16ths inch diameter copper tubing are wound on a 1 1/4 inch diameter form and spaced out to 1 3/4 inches long.

length (or circumference). This situation is always encountered with a multi-tapped coil. It is interesting to note that the high power 10 meter coil has a relatively high Q. This is obviously due to its heavy construction, optimum length/diameter ratio and the fact that it is self-supporting, external to the toroid.

Fig. 13 provides a handy guide in determining the value of tank capacitance to be used in resonating these coils. Of course, the first step to be taken when designing a resonant tank circuit for your transmitter is to select the proper L/C ratio to match the tubes output impedance. The toroid coils described in this article are suitable for most tubes in common use today. However, if several amplifier final tubes are paralleled as is frequently done, the reader should be guided by the references on this subject in one of the amateur radio handbooks to obtain a proper L/C ratio.

The future of toroids

Having already gained wide spread use in

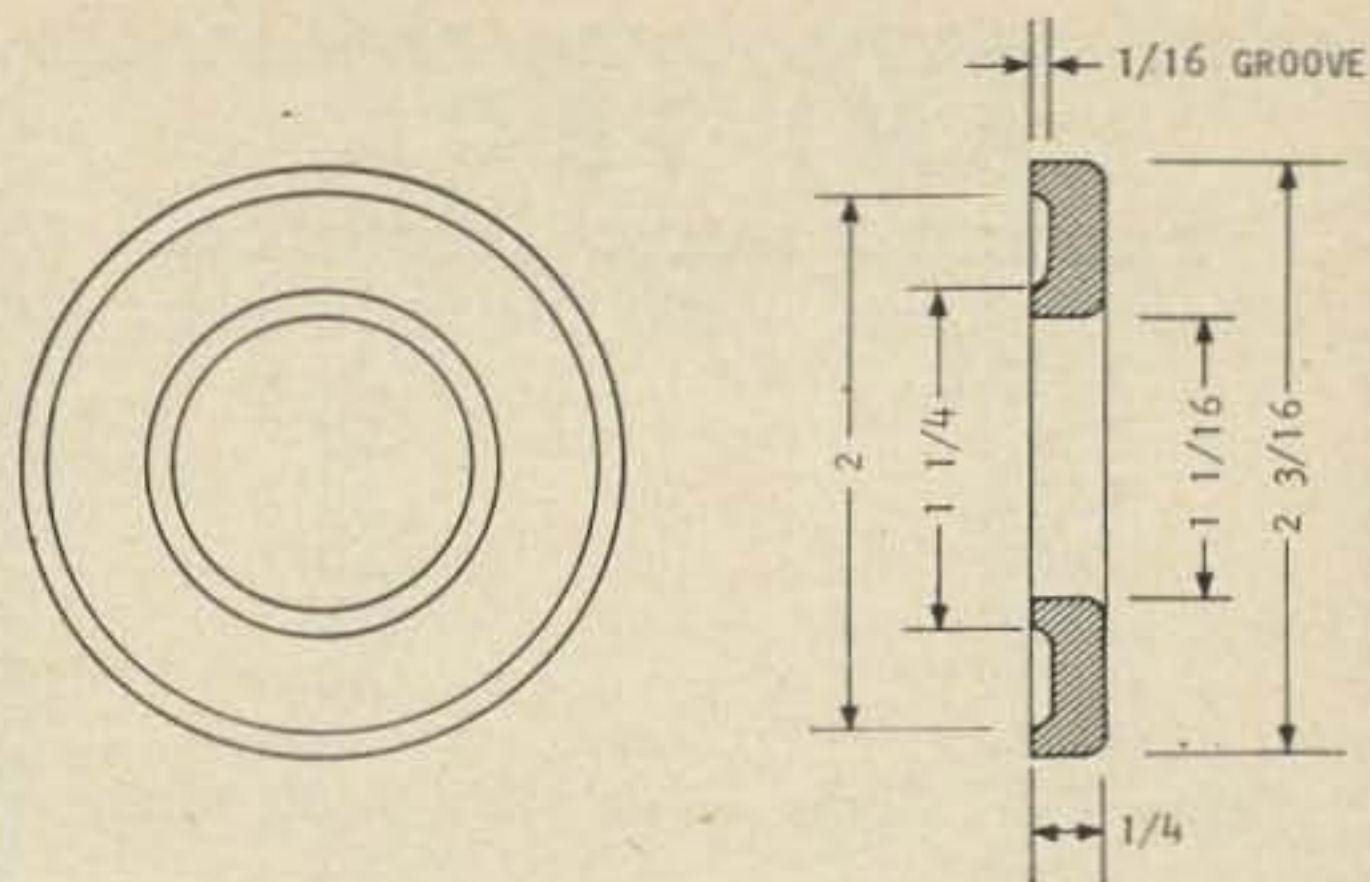

Fig. 11. Drawing showing dimensions of end-spacers used on both the medium and high power toroidal tank coils. Polystyrene, 1/4 inch thick is used to make the end-spacers by means of a chassis fly-cutter mounted in a drill press. Wire tension and friction hold the end-spacers in place.

many lower power applications, toroids can now be used to great advantage in high power transmitters. Perhaps before long, commercial transmitters will be using toroids. In the meantime, the amateur may avail himself of their superior compactness and efficiency and thereby continue the pioneering heritage which has earned the amateur radio operator and constructor his place of respect today.

Acknowledgement

Mr. Joe Williams, W6SFM, of Ami-Tron Associates was most helpful in furnishing toroid core material, technical advice and encouragement in developing the coils described here. To Mr. Paul Sellers, W4EKO, goes thanks for early design criteria and the pioneering approach to high power toroid rf coils. The assistance of Mr. Frank Emens, W4HFU, was invaluable in making coil measurements, and Mr. Jim Bauman and

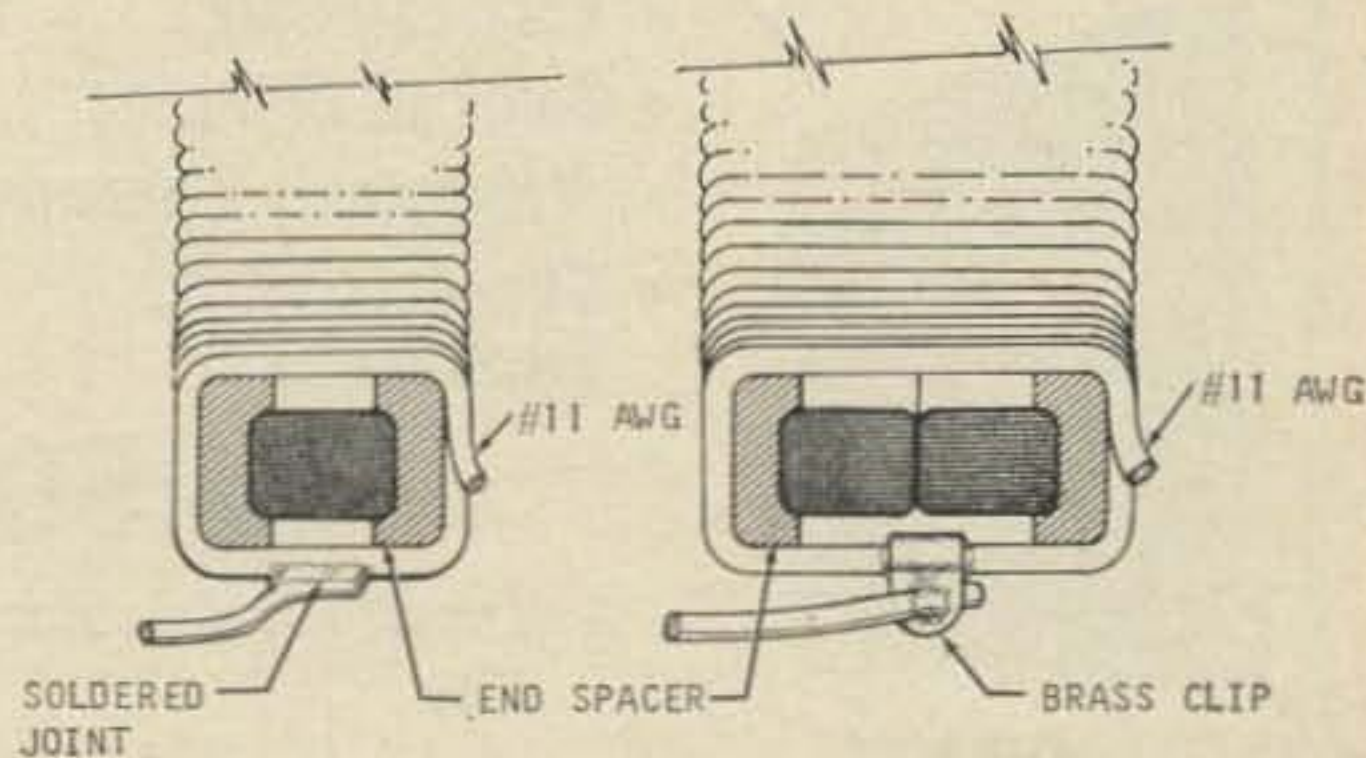

Fig. 12. Details of alternate methods for making the tap connections to the toroidal tank coils. Care must be taken to prevent solder from bridging over to the core, thus promoting a flash-over. Excessive heat must be avoided when soldering near the end-spacers so as to prevent their being melted.

AMI-TRON

Ferromagnetic Products

Red "E" Cores — 500 kHz to 30 MHz:

T-200-2	\$3.00
T-94-2	.75
T-80-2	.60
T-68-2	.50
T-50-2	.45
T-37-2	.40
T-25-2	.30

Yellow "SF" Cores — 10 MHz to 90 MHz:

T-94-6	.95
T-80-6	.80
T-50-6	.50
T-25-6	.35

Black "W" Cores — 30 MHz to 200 MHz:

T-50-10	.60
T-37-10	.45
T-25-10	.40

FERRITE BEADS: Package of 12

+ Spec Sheet: \$2.00

KILOWATT TOROID BALUN KIT: \$5.00

EXPERIMENTER'S 2 CORE

TOROID KIT: \$1.50

Minimum Order: \$1.00

Please add 25c per order
for packing and shipping.

Ami-Tron Associates

12033 Otsego Street

North Hollywood, Calif. 91607

Courtesy To Distributors

the NEW "Vacationer"

PORTABLE ANTENNA with Non-Shatterable Base

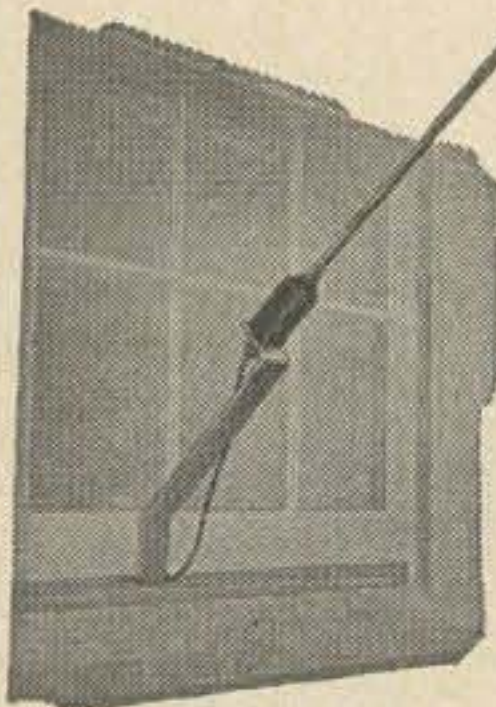

Patented

- 20-15-10-6-2- Meters
- Very Low SWR
- Folds to 19 inches
- Weighs only 2 pounds
- Complete for 5 Frequencies

\$24.50

ask your local dealer
or

DPZ CORPORATION

P. O. BOX 1615

JUPITER, FLORIDA 33458

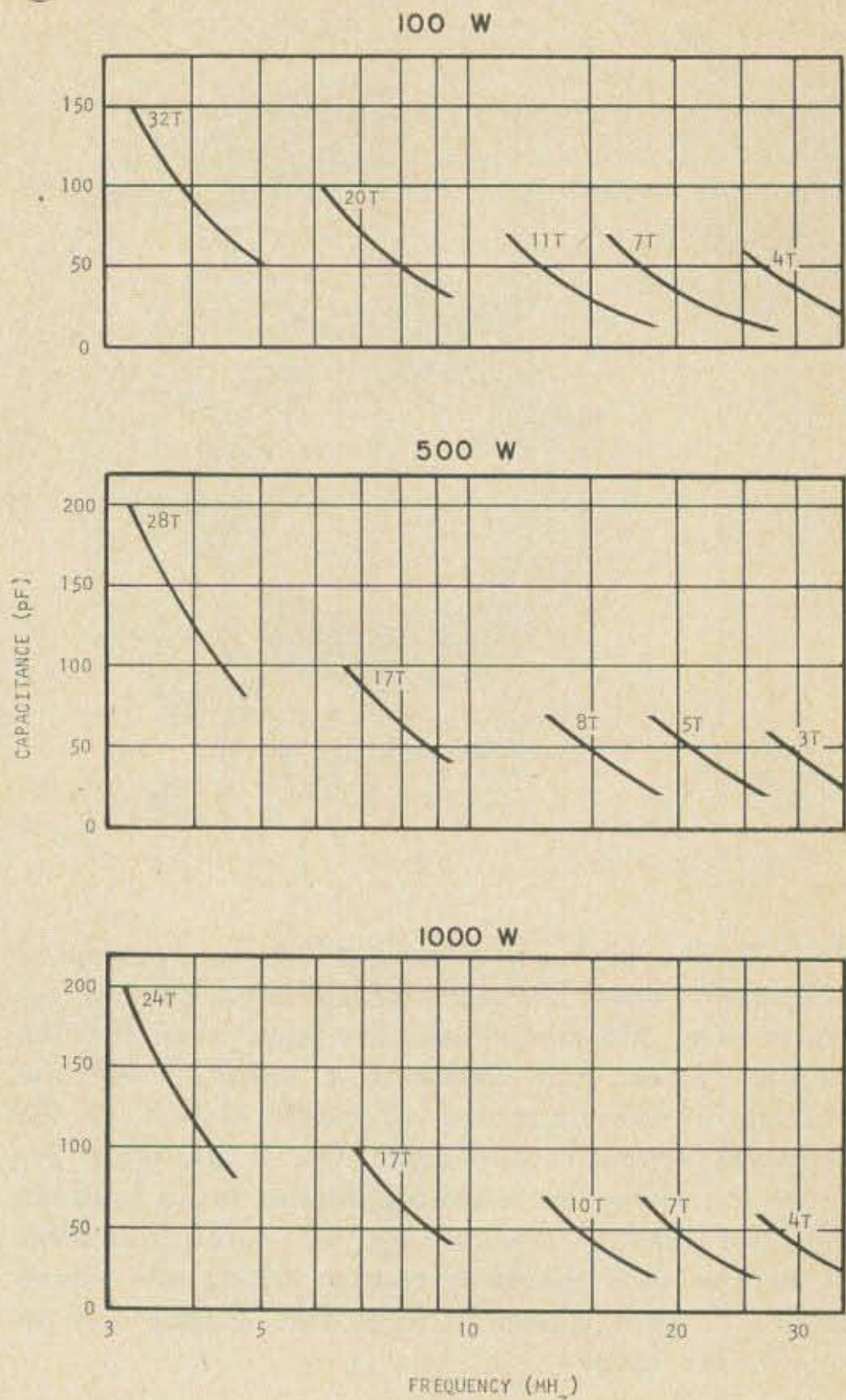

Fig. 13. Charts showing the capacitance required to resonate the three toroid tank coils on the five amateur bands. The L/C ratios obtained on each band match the tube impedances most frequently used today. If a very low tube output impedance is encountered, such as found in paralleling of many TV tubes, a much lower L/C ratio would be called for.

Mr. Jack Hood of RCA, Huntsville, Alabama deserve credit respectively for the model shop work and art work used in this article.

... W4BRS

References

1. "A Stable VFO for VHF or HF," Del Crowell, *73 Magazine*, November 1966.
2. "Toroidal VFO," E. L. Klein, *73 Magazine*, April 1967.
3. "An FET VFO for 80 Meters," J. Fisk, *73 Magazine*, May 1967.
4. "Practical Tips on Building Transistor Transmitters," P. Burbank, *73 Magazine*, February 1967.
5. "A Directional Wattmeter," H. C. Sherrod, *CQ Magazine*, December 1966.
6. "Toroidal Multiband Tuner," J. Williams, *73 Magazine*, August 1966.
7. "Semi-Precision Capacitor," J. Fisk, *73 Magazine*, February 1967.

Performers appreciate the Broadcast Engineer's skill. He makes an important contribution to a smoothly-produced program.



HOW TO Get an Exciting Job "Inside" Radio or Television...as a Broadcast Engineer

No college or high school diploma needed—just a Government FCC License. Here's how you can prepare in your spare time

LOOKING FOR A JOB with more money and more excitement? Become a Broadcast Engineer!

When you work at a radio or TV station, you're where the action is. You're in on news as it breaks. You hear new records before they're released. You often know the behind-the-scenes stories of important events. You rub shoulders with famous people in show business, athletics and politics. And you may get to announce news or music and become a local celebrity yourself.

There are deeper satisfactions too. In emergencies you help save lives and restore order. During the great power blackout of 1965, radio helped prevent widespread panic.

Yes, broadcasting is exciting. And breaking into it is easier than you might imagine. Right now, there's a desperate shortage of broadcast engineers—a job that pays from \$185 to

\$215 a week at big-city stations once you have a little experience under your belt.

All You Need Is a License

You don't need an engineering degree to qualify. You don't need a high school diploma. All you need is a Government 1st Class FCC License. If you have one, most stations will welcome you with open arms. In fact, *Radio-Electronics* magazine says: "If you can't get a good job with one...you'd starve to death in a candy store."

For some men, getting an FCC License is easy. For others it's hard. It depends on how much electronics you know when you take the licensing exam.

Our specialty is making it easy. For over 30 years, we've been teaching men electronics in their homes. No lost income—no classes to attend. Yet our graduates learn their electronics so well, 9 out of 10 pass the FCC exam. Without our training, two out of three men fail! For this reason we can back our license-preparation courses with our iron clad Warranty: Upon completion of your course, you must be able to pass the FCC exam...or your tuition will be refunded in full.

What makes our course so good? For one thing, we use AUTO-PROGRAMMED™ lessons. You build your knowledge of electronics the way you'd build a brick wall—one piece at a time. Each "piece" is small and easy to handle. And it rests securely on the pieces that came before it. It's easy to learn this way, even if you once had trouble with your studies.

And you get more personal attention than you might in a busy classroom. Your instructor doesn't merely correct and grade your

work—he analyzes your thinking to make sure you are staying "on the right track." Then he mails back your assignment the same day he received it, so you can read his notes and corrections while everything is still fresh in your mind.

These 2 Free Books May Change Your Life

If you itch for a better-paying, more interesting job, the two books we offer may have your answer. One tells how to qualify for the many fabulous career opportunities in electronics. The other tells how to get your FCC License and break into broadcasting. Both are free. No obligation—just mail the coupon. It may be the turning point of your life.

ENROLL UNDER NEW G.I. BILL

All CIE courses are available under the new G.I. Bill. If you served on active duty since January 31, 1955, or are in service now, check box in coupon for G.I. Bill information.

"I GIVE CLEVELAND INSTITUTE CREDIT FOR MY GOVERNMENT 1ST CLASS FCC LICENSE,"



says Matt Stuczynski, senior transmitter operator, Station WBOE. "Even though I had only six weeks of high school algebra, CIE's AUTO-PROGRAMMED™ lessons make electronics theory and fundamentals easy.

After completing my CIE course, I took and passed the 1st Class FCC Exam. I now have a good job in studio operation, transmitting, proof of performance, equipment servicing. Believe me, CIE lives up to its promises. I really enjoy my work and I'm on my way up."

CIE **Cleveland Institute of Electronics**
1776 E. 17th St., Dept. ST-12, Cleveland, Ohio 44114

Cleveland Institute of Electronics

1776 E. 17th St., Cleveland, Ohio 44114

Please send me without cost or obligation:

1. Your 40-page book "How To Succeed in Electronics" describing job opportunities in electronics today, including those in broadcasting, and how your courses can prepare me for them.
2. Your book on "How To Get A Commercial FCC License."

Name _____
(Please Print)

Address _____

City _____ State _____ Zip _____

Occupation _____ Age _____

Check here for G.I. Bill information

Accredited Member National Home Study Council.
A Leader in Electronics Training... Since 1934

ST-12

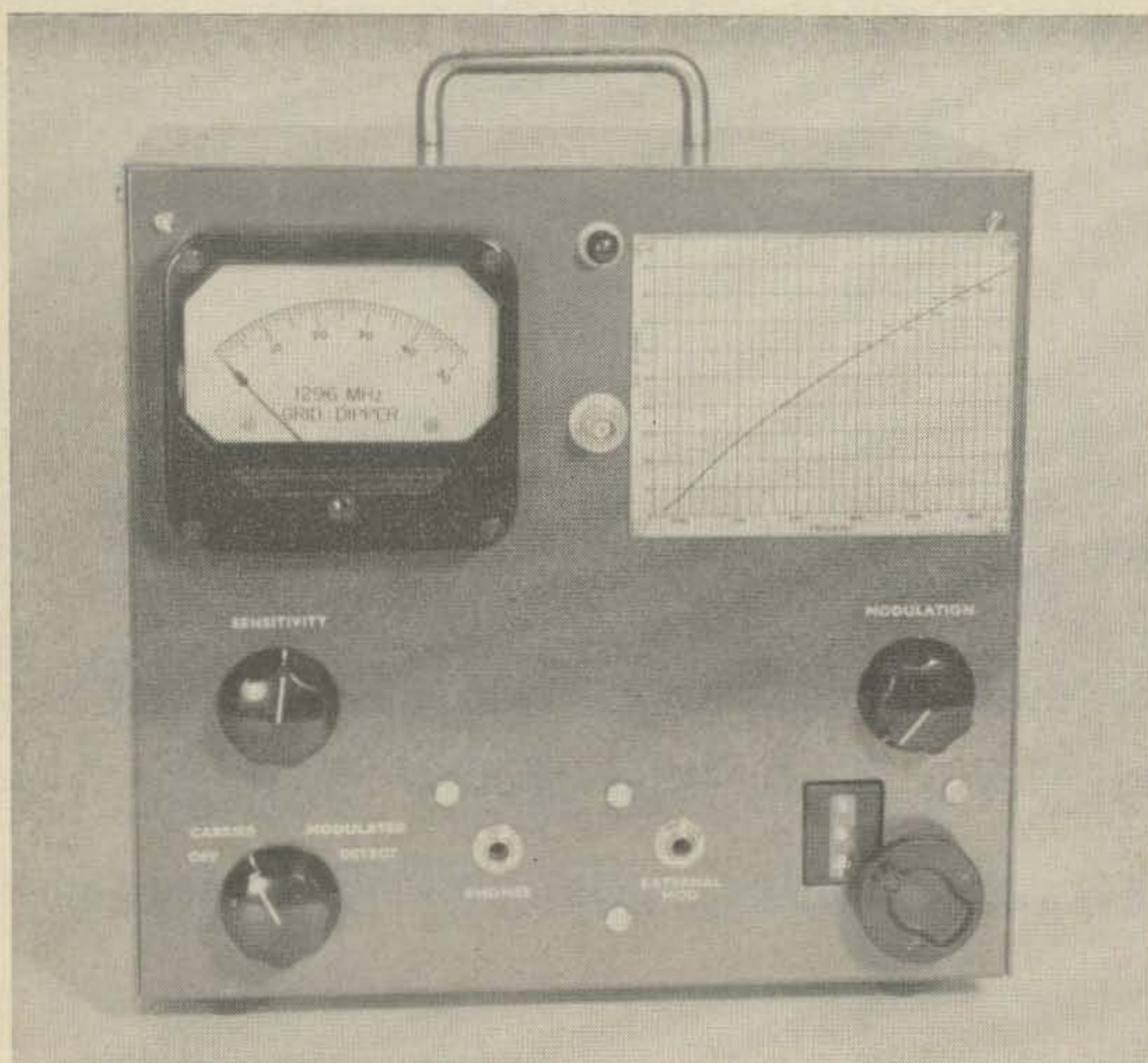

Jim Fisk WIDTY
RFD 1 Box 138
Rindge, N.H. 03461

A 1296 Grid Dipper

Conversion of the APX-6 transponder to a grid-dip oscillator that covers from 1050 to 1320 MHz.

One of the big problems with operating on 1296 MHz is locating the operating frequency of your equipment. Not only is the newcomer faced with this problem—any longtime resident on 1296 will attest to the many checks he has made to ascertain operating frequency and band edges. Some UHF amateurs have been able to obtain signal generators that cover the 1215 to 1300 MHz band, but many must resort to the time-proven lecher-wire system for any meaningful frequency measurements on this band.

Each of the systems commonly in use suf-

fer from one disadvantage or another. Moreover, there is no commercial grid dip meter on the market, to my knowledge, which will cover this range. Most of them stop at 1000 MHz or so. This conversion of the APX-6 is not difficult and results in a very versatile grid-dip meter. Like its lower frequency counterparts, it may be used for dipping resonant circuits, detecting rf energy or as a signal source. The built-in Veeder-Root counter provides excellent frequency readout and the internal gear system ensures repeatability.

The only part of the APX-6 you need for

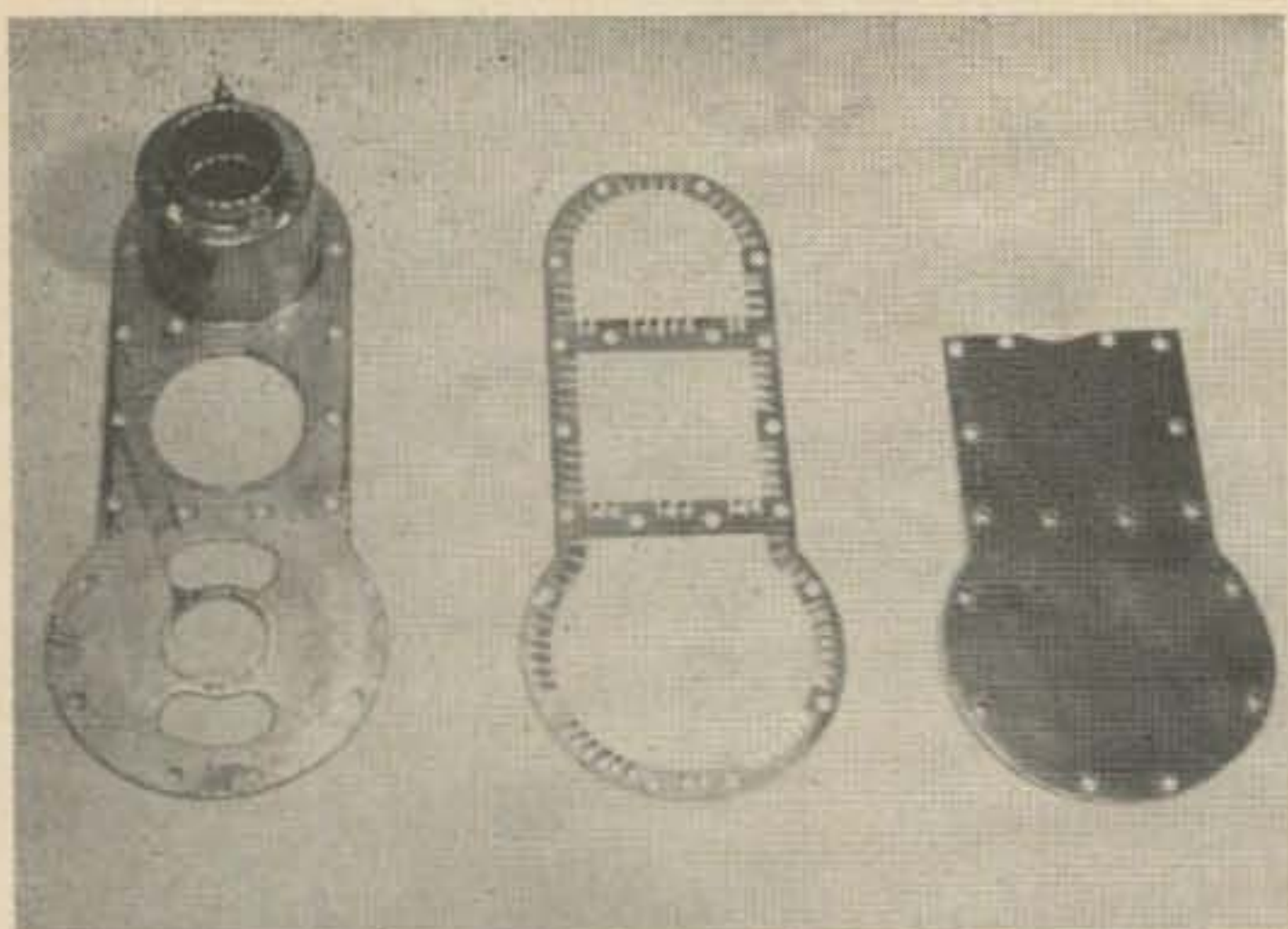

The three pieces of the cathode cavity plate—the modified plate to the left, the serrated contact ring in the center and the new plate cover on the right.

plished on a lathe. Handle the plunger very carefully so the surface is not scratched. If it is damaged, the diplexer plunger may be used as a substitute.

While the plungers and gears are out of the housing, remove the shoulders around the transmitter and diplexer drive shafts on the front of the casting. If these shoulders are not cut off with a hack saw or filed down, the completed unit won't sit flush against the new front panel.

After the piece is cut off the tuning plunger, screw it on the gear drive assembly and push it through the contact fingers on top of the gear housing. Set the Veeder-Root counter to 000 and put the bottom cover in place. Now you have to do a little juggling. Adjust the plunger so it just protrudes through the contact fingers. Now mesh the drive gears so that the *stop* tabs engage. Usually you'll have to move the gears a few teeth each way to get the shaft to stop with the counter on 000. When the gears are all lined up, install the screws in the bottom cover.

The first step in the conversion of the cavity body is to remove the large coaxial connector. Remove the screw from the split collar which holds the connector on the front of the cavity. When the screw is removed you should be able to rotate the connector in the collar. The center contact is soldered to a pickup loop which is located in the wall between the diplexer and transmitter cavities. When this joint is unsoldered the connector may be easily removed. Remove the collar by unsoldering it from the front of the cavity.

Cut out a piece of copper 1-23/32 inches wide by 2-1/4 inches long. This will be used

as a partition in the center of the old diplexer cavity. If you cut this partition a little larger than required and form lips at the edges, it may be force-fit into the diplexer cavity and no soldering is required.

Look down inside the receiver cavity. You will note that the plate voltage is applied through a feedthrough capacitor (C403) to a piece of wire which winds spirally around the plate line. Unsolder this wire from the capacitor, remove the three retaining screws and pull out the plate line. This line must be shortened by 1/8 of an inch. This is most easily accomplished with a tubing cutter.

In the unmodified APX-6 the local oscillator energy from the receiver cavity is coupled into the crystal mixer with the small loop adjacent to the aperture in the cavity wall. Somewhat heavier coupling must be provided for grid dip service. Cut a strip of copper 1/4 inch wide and about 2 1/2 inches long. Form a short tab on one end of this strip and solder it to the bottom of the receiver cavity about 1/4 inch out from the wall. Put a "Z" bend in it as shown in Fig. 2. and solder it to the contact on the crystal mixer. After the new coupling loop is in place, put the modified plate line back in place and reconnect the B plus line to the feedthrough capacitor.

Unscrew the connector from the crystal mixer and pull out the diode. Remove the crystal retaining fingers from the BNC connector with a pair of pliers and push an awl through the ceramic capacitor which is built into the connector. Remove the pieces of ceramic and pull out the center contact.



Front view of the cavity assembly and gear housing before installation of the cathode cavity plate.

Save this female pin. If the ceramic capacitor is not removed, all of the 1200 MHz oscillator energy will be bypassed to ground.

If you look closely at the back end of the mixer assembly you will see a round cover plate which is soldered in place. You will also see that a small hole has been drilled through this plate. Form a small hook in the end of a piece of #16 buss wire and hook it through this hole. Heat the cover plate with a small torch and when the solder is softened, pull the plate free with the buss wire. Solder a two inch length of #18 wire to the center contact of the mixer assembly and run it up through the connector body—cut it so it extends 13/16" above the threaded shoulder. Solder the female connector pin to the end of this wire and replace the BNC connector. Replace the round cover plate on the rear of the old mixer assembly and solder it in place. Modifications to the cavity body are now complete.

Unsolder the diplexer cavity from the cathode cavity plate and discard it. Discard the transmitter cathode cavity and saw off the grid contact fingers which extend above the plate at the transmitter end. Using the cathode cavity plate as a guide, cut out a piece of thin aluminum as shown in the photographs to cover up the holes. This cover serves no functional purpose, but it does make a neater looking unit. All that is left are the modifications to the receiver cathode cavity.

If you look inside the receiver cathode cavity, you will see that the grid contact is suspended from the top of the cathode cavity with three wires. These wires are soldered to both the cathode cavity and the grid ring. Carefully unsolder the support wires from the top of the cavity and pull out the grid ring; remove the three wires. Enlarge the three holes in the top of the cavity with a reamer, install three 500 pF feedthrough capacitors (Erie X5UO 501M or equivalent), and solder them in place. These feedthroughs consist of a coaxial shell and are actually only half a capacitor—when you run a wire through the center, the capacitor is formed. If you can't locate this type of capacitor, you can make your own by unsoldering and removing the center conductor from a conventional feedthrough capacitor.

Solder three 1½" lengths of #16 buss wire to the grid ring and put it back in the cathode cavity with the new support wires going through the feedthrough capacitors.

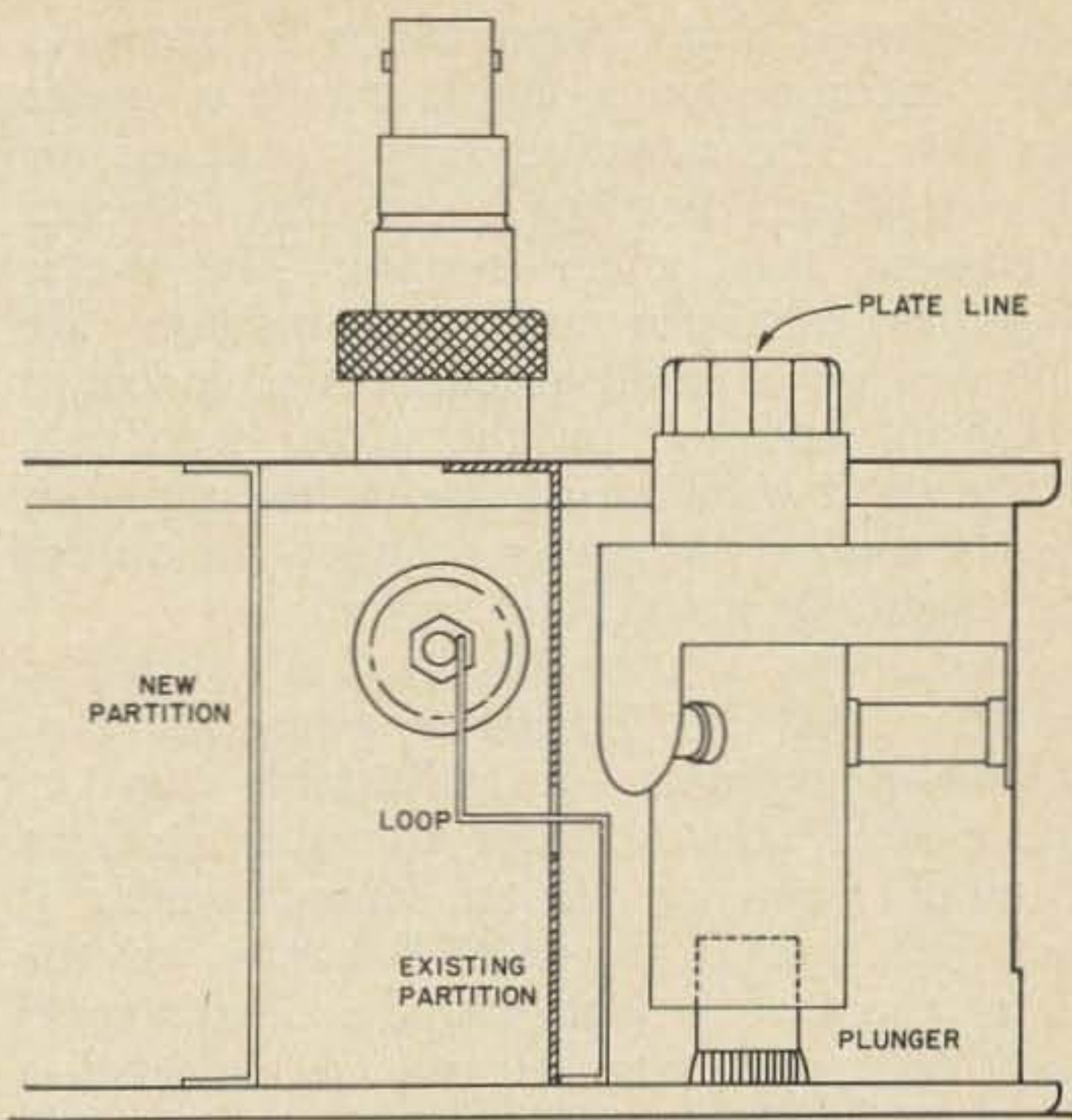
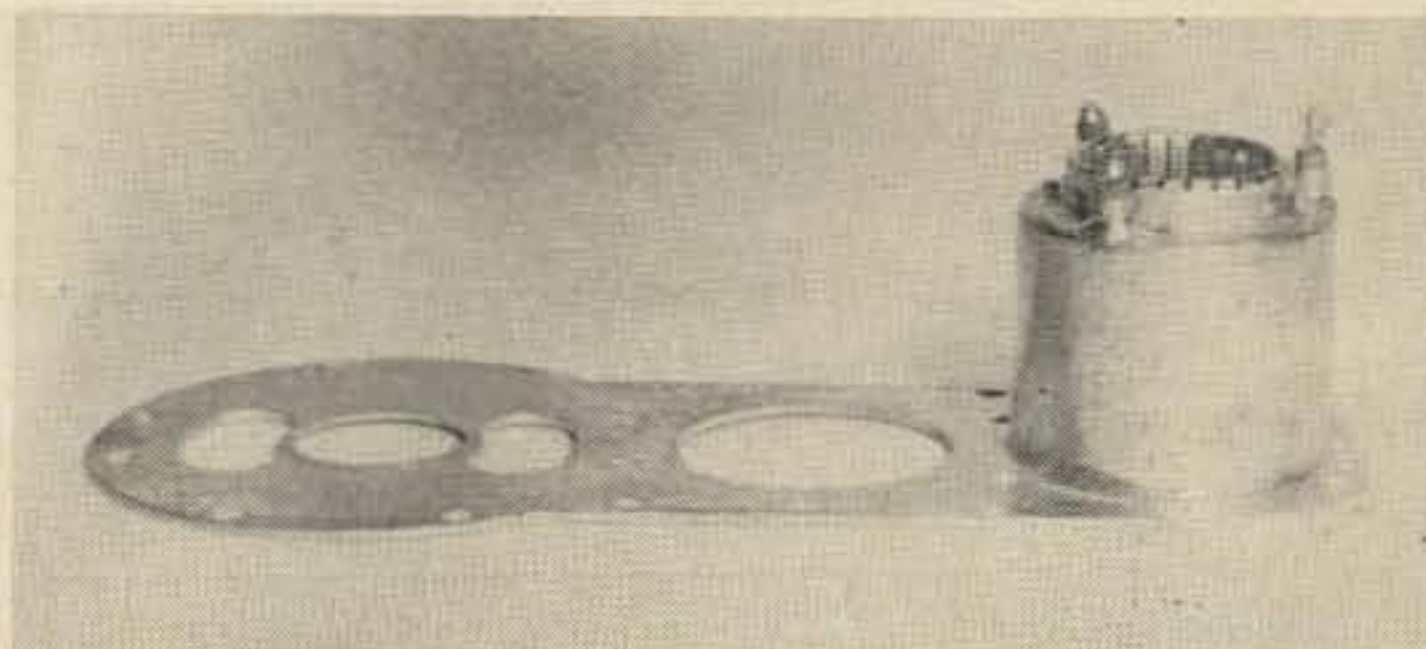

Fig. 2. Cutaway view of the APX-6 receiver cavity showing the location of the new pickup loop.

Place the 2C46 in the cathode cavity and use it as a gauge for placing the grid ring in the proper position. When you have everything all lined up, solder the three supporting wires to the feedthrough capacitors. It's a good idea to check for shorts between the grid ring and the cathode cavity before soldering everything down—they should be electrically isolated for dc.

The APX-6 cavity modifications are now complete. It will tune smoothly from about 1050 MHz to well over 1300 MHz and grid current may be monitored in the modified cavity. All that is left is the power supply and modulator.

For maximum stability the power supply is regulated with a zener diode. The ninety volt supply is more than adequate for this purpose—when the grid is shorted to ground the grid current is nearly 1 mA. With the 10,000 ohm grid resistor, grid current is on the order of 150 A. A 200 microampere meter



Closeup view of the modified APX-6 local oscillator cavity showing the installation of the grid-ring feedthrough capacitors.

is ideal for this grid dipper, but since I had a large 1.5 mA meter which I wanted to use, I incorporated a simple transistor meter amplifier. The negative supply voltage for the amplifier is developed across the 330 ohm resistor in the power supply. The meter amplifier transistor and bias resistors are mounted on a small piece of Vector board which is mounted on the meter terminals. If you don't want to use the meter amplifier, simply connect the meter between the arm of the sensitivity control and ground.

Modulation of the oscillator is provided by the 1000 Hz transistor phase-shift oscillator—modulation is adjustable up to about 90%. The oscillator is constructed on a small piece of Vector board which is mounted behind the APX-6 cavity on the main chassis. A jack on the front panel may be used for external modulation—a three to four volt audio signal will provide 90% modulation.

I built the chassis for my APX-6 grid-dipper from sheet aluminum, but a standard 12" x 11" x 8" utility cabinet can be used if you don't like to bend aluminum. My chassis is 11" wide, 10½" high and 5½" deep and consists of two U-shaped pieces. Bracing is provided by two brackets across the top and bottom as shown in the photographs. These brackets are made up from do-it-yourself aluminum angle and actually

serve two purposes. In addition to strengthening the chassis, three tapped holes in each bracket accept the cover retaining screws. The front panel is laid out as shown in Fig. 3. Even if you don't use this type of chassis construction, it is recommended that you use this panel layout.

The parts placement was chosen to provide a balanced layout. This means that all the available space is used. In fact, the two phone jacks occupy space previously taken up by the discarded counters in the gear housing. If they are moved to any great extent, they will interfere with the gear housing. The layout for the square counter cutout and five cavity mounting holes are not shown in Fig. 3—these are best obtained by using the old APX-6 door as a template.

Construction is quite straightforward and no problems should be encountered. Note, however, that the phone jack in the grid lead must be isolated from ground—this is easily done with fiber washers. Since the jacks are hidden by the gear housing when the cavity is attached to the front panel, wiring to them is run through the small screw holes drilled in the bottom of the housing. These holes were originally used to hold the counters in place.

The output of the oscillator is connected to the front panel connector with a short

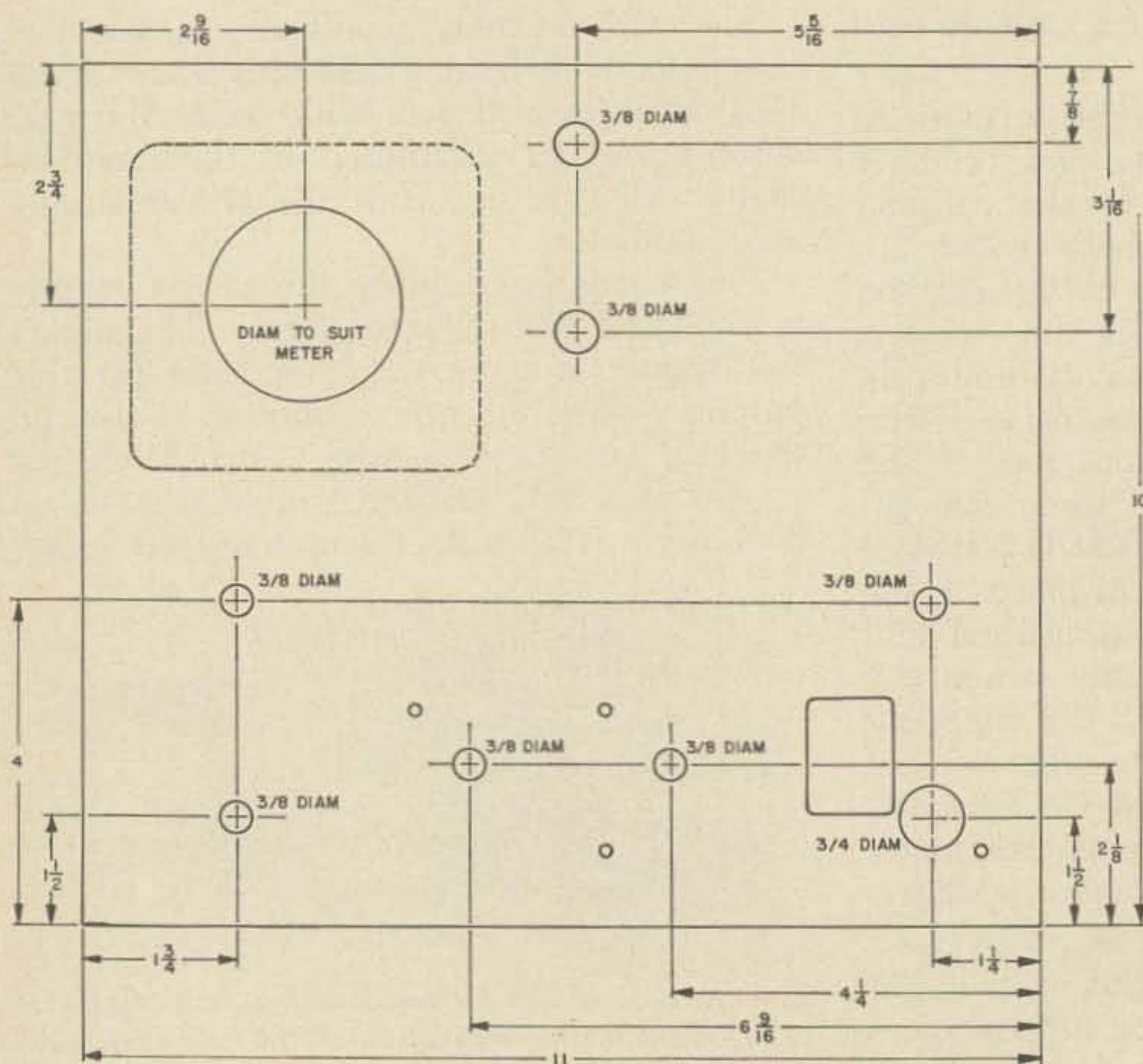
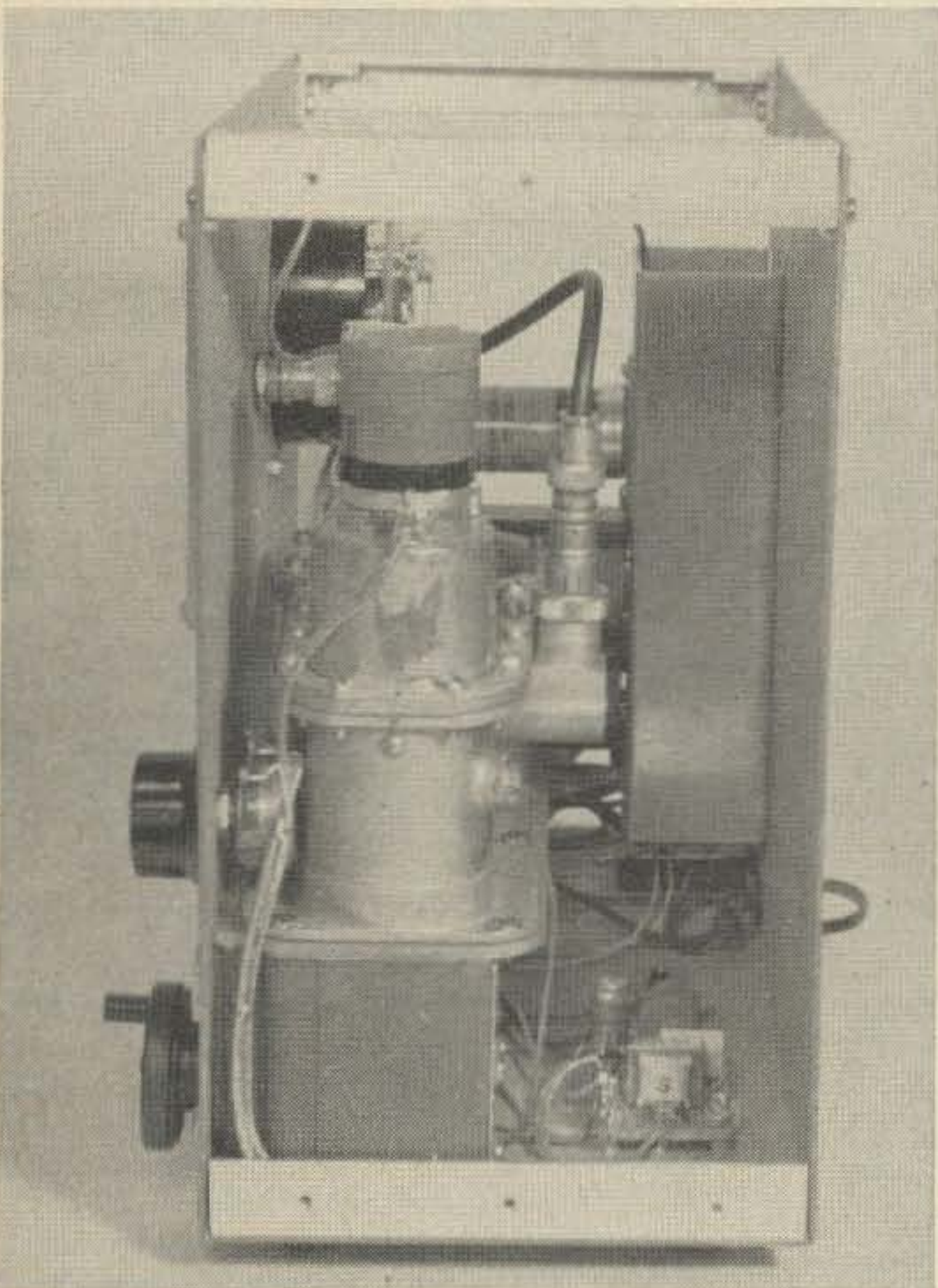

Fig. 3. Front panel layout for the APX-6 grid dipper. The locations of the square counter cutout and cavity mounting holes are not shown—they are best determined by using the old APX-6 door as a template.

length of coaxial cable. One of the newer Teflon insulated cables would be ideal for this purpose, but RG-58/U is perfectly adequate—that's what I used. Mismatch losses at the BNC connectors may be minimized by using the connector assembly diagrams in 73°.

Although a 2C46 was used in this cavity in the original APX-6, I found that it would not *always* oscillate in the modified cavity when power was applied. Substitution of the 2C42 from the old transmitter cavity solved this problem. An added bonus was the extra power output available with the 2C42.

Since there is a considerable difference in grid current between the oscillator and detector modes, be sure to turn down the sensitivity control before switching from one mode to another. If you don't, the needle will slam against the pin. It's also a good idea to turn the modulation control down when modulation isn't required. Since the meter indicates the relative magnitude of the modulating signal, less meter sensitivity



Inside the APX-6 grid dipper. The phase-shift modulator is in the right foreground, the power supply chassis is mounted on the rear panel. The cover is held with screws through the tapped holes in each of the four corner braces.

*"Coaxial Connector Handbook", WA6BSO, 73, August 1966.

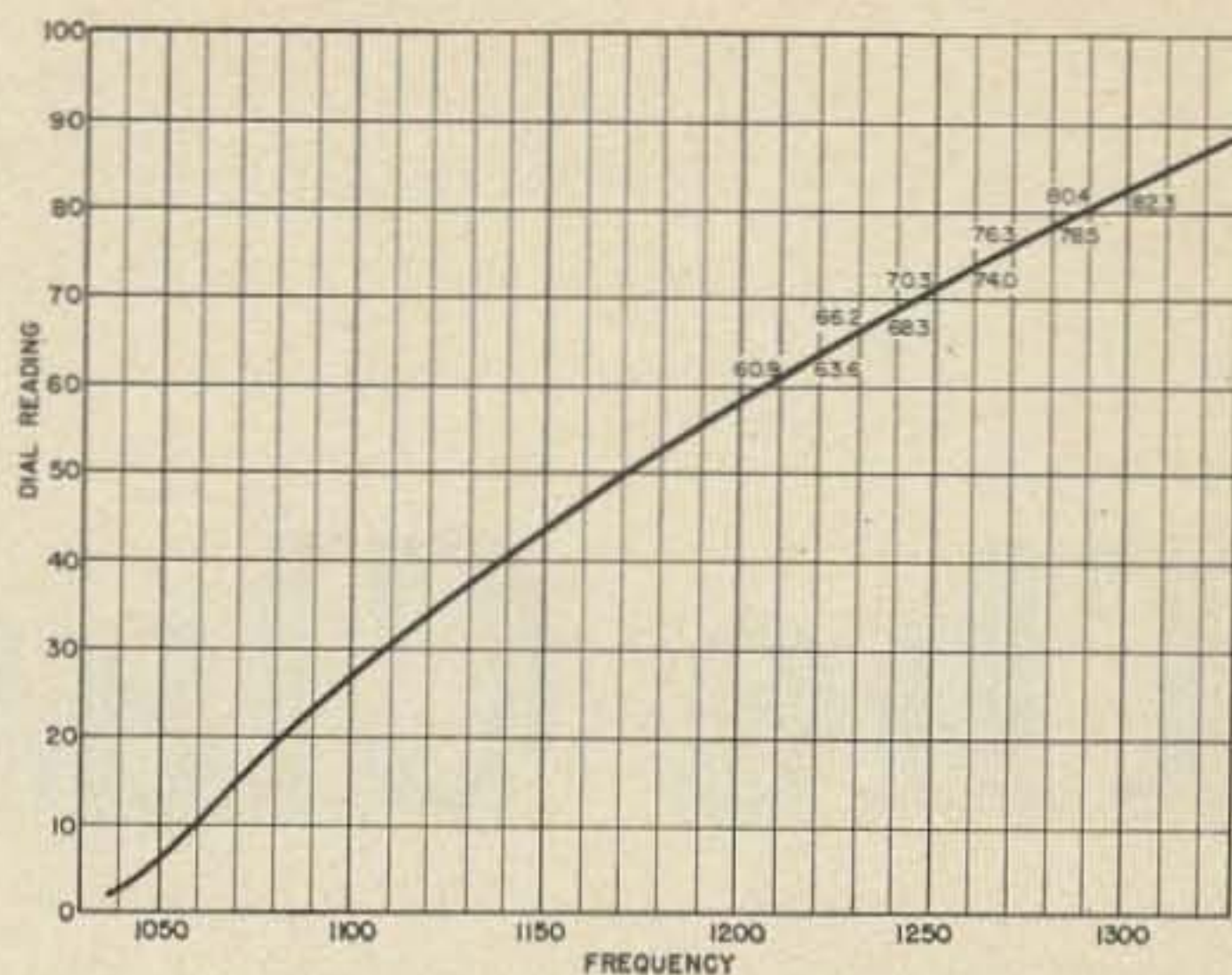

Fig. 4. Calibration curve of the APX-6 grid dipper. Counter readings for each 10 MHz point in the 1215 MHz band are included for accurate interpolation.

is required when the oscillator is modulated. If the modulation is turned up when you switch from carrier to detector through the modulated position, a bent meter pin is inevitable.

After you have completed the unit, all that is left is calibration. There are several approaches at this point, depending upon the type of equipment you have or can borrow. Lecher wires are the most straight forward but not necessarily the easiest. I used a General Radio 1140A wavemeter and an old surplus echo box and then made a double check with an LAE signal generator which covers this range. The calibration curve (Fig. 4) was then mounted on the front of the grid dipper for easy reference.

The completed unit tunes very smoothly through its range with no jumps in frequency. A few false dips in grid current appear around 1100 MHz, but in the main range of interest, 1200 to 1300 MHz, there are no false dips. In the detector mode, rf signals down to several millivolts provide an upswing on the meter. When used as an oscillating detector with headphones, significantly lower magnitude energy may be readily detected.

For the amateur who is interested in operating on the 1296 band, this grid dipper is a very useful piece of equipment. It may be used for tuning up converters, dipping out filters, detecting parasitics, determining transmitter frequencies and in tuning up frequency multipliers. In a pinch it may even be used as a low power transmitter by plugging in an external modulator.

... WIDTY



The Classic 10-15

Mosley *TRAP*
MASTER

The New 'CLASSIC' Approach
To The Hot Bands
... 10 & 15 Meters.

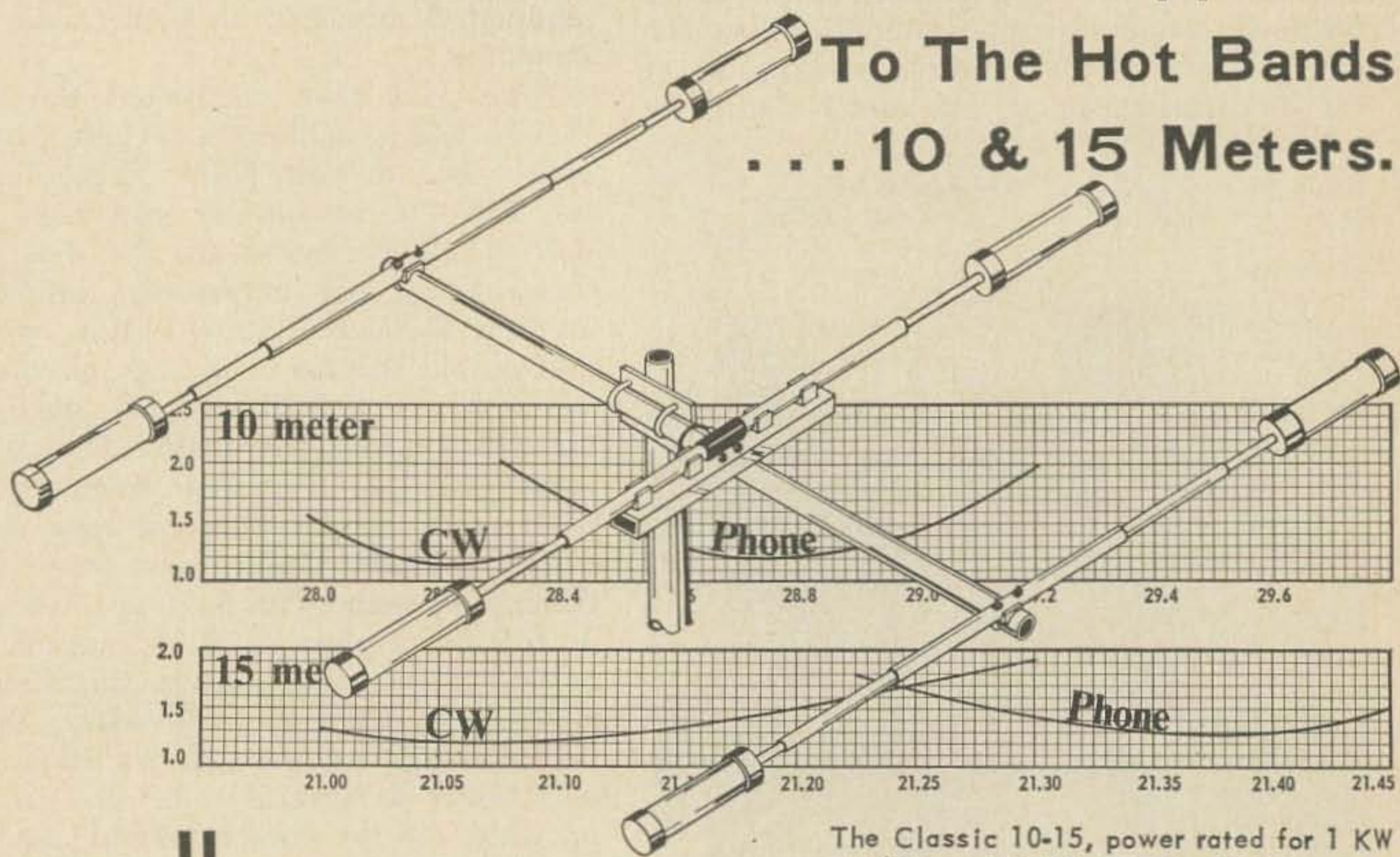

Have you tuned 10 and 15 meter bands recently? They'er quite active again! The 15 meter band is now considered the best daytime DX band and 10 meters is gaining more ground every day. An All New approach to these bands is the Classic 10-15. The newest addition to the Classic Trap-Master beam family. Incorporating the very latest in matching systems, Broad Band Capacitive matching (Pat. Pend.), first introduced last year in the now famous Classic 33.

Mosley Electronics, Inc. 4610 N. Lindbergh Blvd., Bridgeton Mo. 63042

The Classic 10-15, power rated for 1 KW AM/CW and 2 KW P.E.P. SSB input to the final. Gain, a FULL 8 db. compared to reference dipole or 10.1 db. over isotropic source. Incorporates durable metal encased traps made famous by the Trap-Master TA-33. Maximum front-to-back. And so lightweight (only 27.5 lbs. assembled weight) it may be easily stacked with your present 20 and/or 40 meter beam.

The Classic 10-15 . . . another reason why you select quality when you specify Mosley. Write for more information.

Write Dept. No. 131

Using FET's in the Command Set Transmitter

How to build a very stable VFO using a Command Set and three transistors—one FET and two conventional types.

Do you need a good stable VFO that's quite easy and inexpensive to build? Well I did, and after discarding many possibilities I came back to the old reliable Command

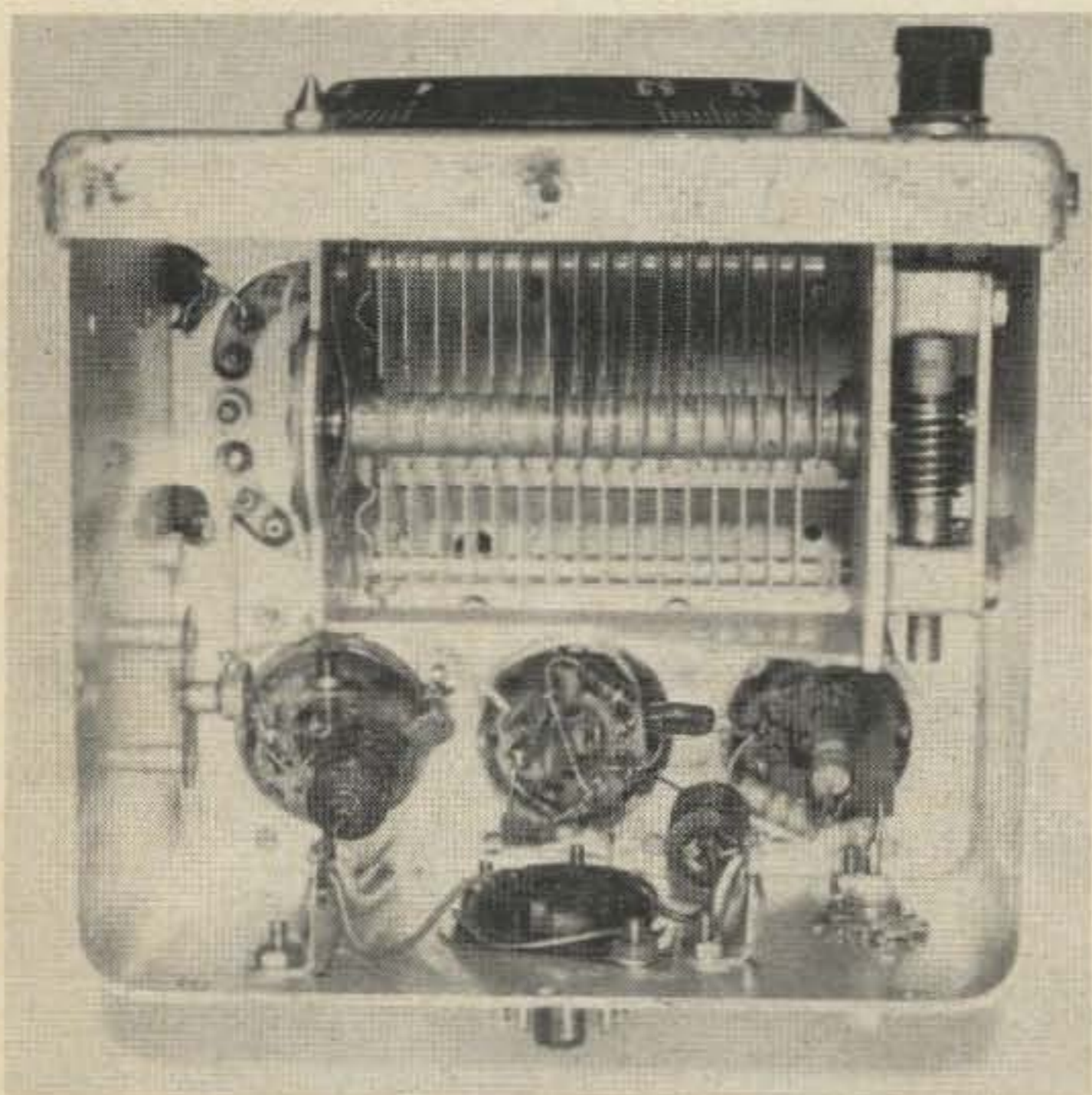

Bottom view of the transistorized Command Set. The oscillator section of the original Command Set is located on the rear of the chassis. In this conversion the chassis was cut in half and the rear part attached to the front panel.

Set. Tubes were definitely out—after all, who needs them with so many types of semiconductors to choose from. Besides, the FET is supposed to behave like a tube, why not use it.

Hastily I attached an FET to the cathode, grid and plate pin of the oscillator tube. Boy, was I surprised—the oscillator took right off when voltage was applied without any component changes.

Enthusiastically, I began to remove everything from the chassis and decided to cut down its size as detailed in the *Command Set*[®] book. All parts except those associated with the oscillator were removed. The set was then rewired as shown in Fig. 1. The first transistor after the FET oscillator is operated as a class A buffer amplifier to isolate the oscillator from the output transistor and to build up the small signal to drive the next stage. The output stage is a broadband class C amplifier and only draws current when the oscillator is operating. No tuned circuits are used except the original circuit so the output is constant across

*"Command Sets," Copyright 1957 by Cowan Publishing Co., Port Washington, L. I., N. Y.

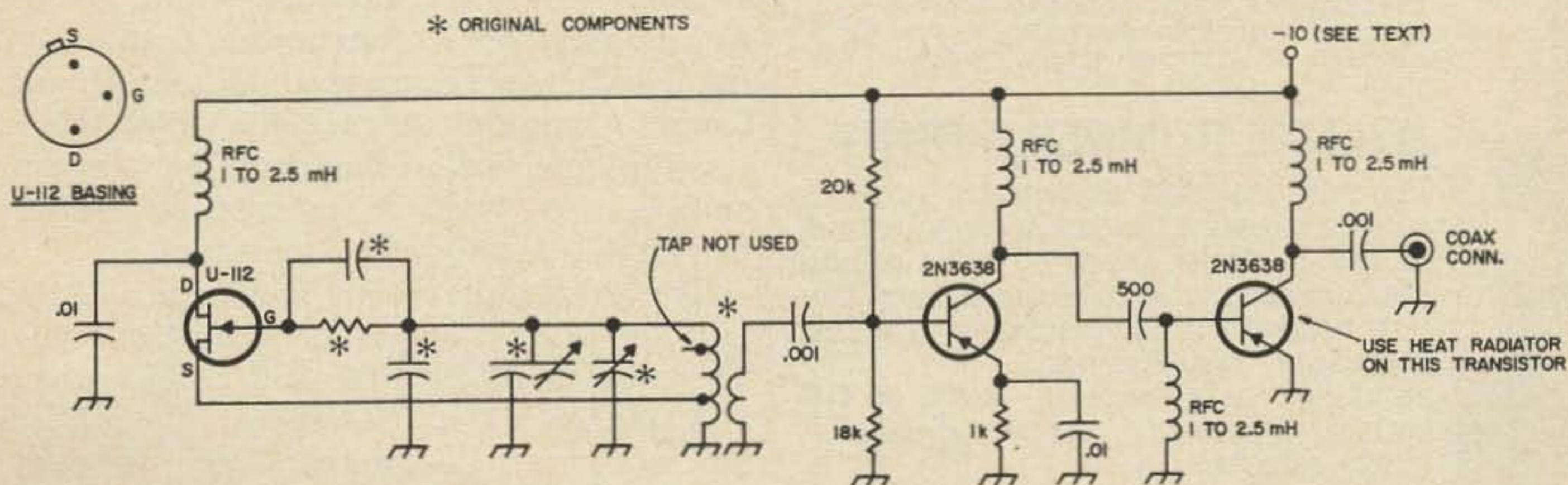

Fig. 1. Schematic of the transistorized Command Set transmitter. All components marked with an asterisk are original Command Set parts. The use of an FET in the oscillator circuit permits a simple and direct conversion from vacuum tube circuitry to semiconductors.

**NO
MORE
COIL
CHANGING**

with the new improved
SWANTENNA

The only remote controlled
band switching mobile
antenna on the market.

5 BANDS-500 WATT
POWER RATING

We are pleased to offer the new band switching deluxe Swantenna as part of the Swan line. Two of the major improvements are the use of GE Lexan® in the center coil support that makes it virtually unbreakable, and the new light weight stainless steel whip. The higher Q of the Swantenna and the gold plated switching contacts provide greater radiation efficiency and field strength than most coil changing designs. Thus with the new improved Swantenna you achieve the ultimate in mobile operation; a high efficiency antenna system plus band switching while driving.

MODEL 55 remote controlled **\$95**

MODEL 45, same antenna as Model 55, but with manually operated coil switch **\$65**

***Original KWIK-ON**
Antenna Connector

Disconnect your antenna from bumper mount in seconds. Made entirely of stainless steel. Noise free. **\$3.25**

DELUXE BUMPER MOUNT

The most important development in mobile antenna mounts in years. No chain to break, no clip to stretch. Made of highly polished cast aluminum. Complete instructions illustrate how to fit this deluxe mount to the exact contour of your bumper, providing the strongest, best looking mount for your mobile antenna. **\$24⁹⁵**

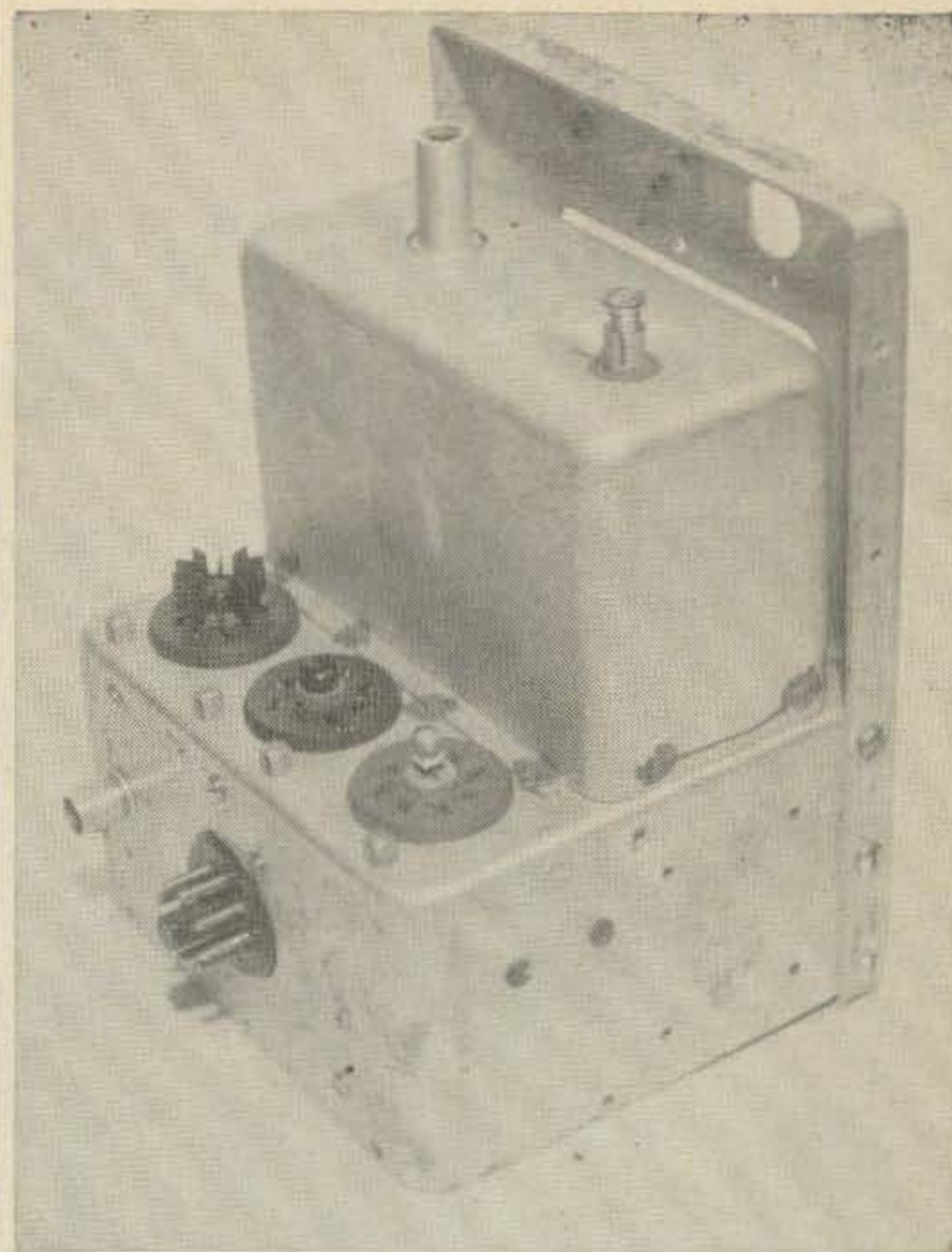
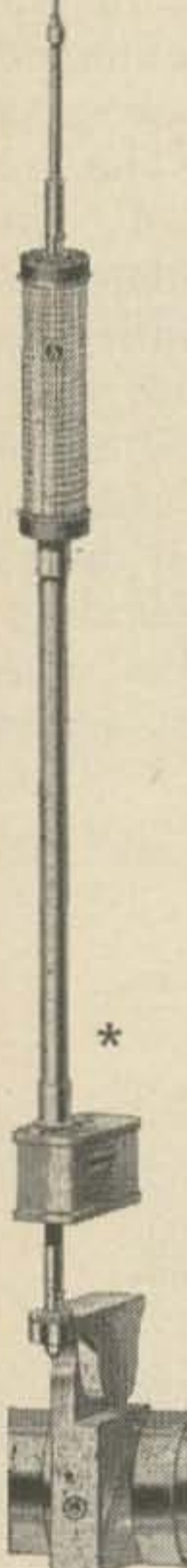

The shortie, transistorized Command Set. The transistor sockets are mounted in the center of the old octal tube sockets.

the band. With a 10 volt supply you get a full watt of input power to the final transistor. This is plenty enough to drive any crystal controlled transmitter.

All the HF Command sets were tried and the oscillator functioned perfectly. I won't attempt to give any of the basic data on converting the Command Sets. This information is quite readily available and would only bore most readers.

To keep the heat dissipation of the final transistor within safe limits, 10 volts is used for the supply voltage. Even with 10 volts a cap type heat radiator should be used. An increase of 2 volts more than doubles the power so be careful. When driving a Gonset Communicator III, for which this unit was designed, I find that dropping the supply voltage to 6 volts is more than ample to drive the transmitter to full output.

The transistors really carry a nice price tag, and should appeal to almost everybody. They are made by Fairchild Semiconductors and sell for about 62c apiece. The FET is a Siliconix unit. If another type is used it should have a transconductance of 1000 or better. If you really like pleasant surprises try this conversion.

... K3LCU



SWAN
500

KING OF THE ROAD

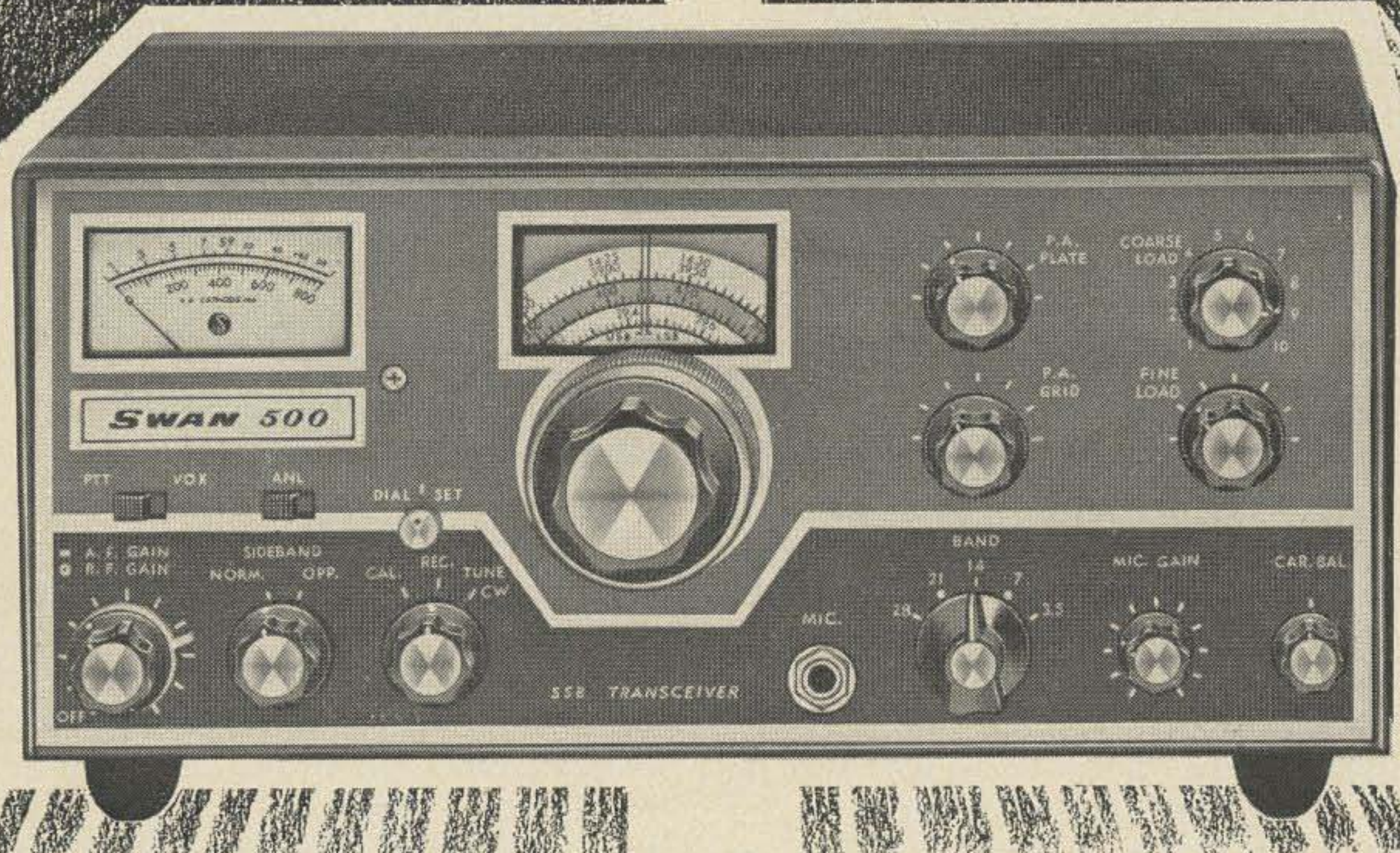

SWAN 500

**5 BAND—480 WATT SSB TRANSCEIVER
FOR MOBILE—PORTABLE—HOME STATION**

It won't take long for the new Swan 500 to establish itself as "King of the Road." 480 watts of solid power, improved circuit efficiency, and Swan's excellent audio quality combine to give you home station performance while operating mobile.

At the top of the Swan line, the 500 offers many extra features: Automatic noise limiter, selectable upper and lower sideband, 100 kc crystal calibrator, and provision for installation of an internal speaker.

The new 500 is equipped with the finest sideband filter used in any transceiver today. With a shape factor of 1.7 ultimate rejection better than 100 db, and a carefully selected bandwidth of 2.7 kc, this superior crystal filter combines good channel separation with the excellent audio quality for which Swan transceivers are so

well known.

Frequency coverage of the five bands is complete: 3.5-4.0 mc, 7.0-7.5 mc, 13.85-14.35 mc, 21-21.5 mc, 28-29.7 mc. (In addition, the 500 covers Mars frequencies with the 405X accessory crystal oscillator.)

Along with higher power, improved styling and many deluxe features, the new 500 has the same high standards of performance, rugged reliability and craftsmanship that have become the trademark of the Swan Line. Backed by a full year warranty and a service policy second to none, we feel that the Swan 500 will establish a new standard of value for the industry.

So if you'd like to hear a VK, ZS or UA say "stand by, the mobile station," put a Swan 500 in your car this summer!

ACCESSORIES:

- 12 Volt DC Supply, for mobile operation.
- Model 14-117\$130
- Matching AC Supply, Model 117XC\$ 95
- Plug-in VOX Unit, Model VX-1\$ 35

- Full Coverage External VFO, Model 410\$ 95
- Miniature Phone Band VFO, Model 406B\$ 75
- Crystal Controlled Mars Oscillator, Model 405X ...\$ 45
- Dual VFO Adaptor, Model 22\$ 25

SEE IT AT YOUR
SWAN DEALER



ELECTRONICS
Oceanside, California

The Dichotomy of a Tube Man

Including the use of a FET in the BC-906 frequency meter.

It is hard to resist a winning combination, particularly when that combination happens to be articles and ads in 73 magazine. The spell-binders referred to are, "Field Effect Transistor Primer" by Jim Fisk¹ and "Two Transistor Testers" by Frank Jones.² Couple these with advertisements such as Poly-Paks and Meshna in which you find almost unbelievable semi-conductor and transistor bargains and you are lost.

When such a powerful coalition causes an old died-in-the-wool tube man to become a transistor enthusiast, that is an accomplishment. Would you believe a fellow who buys *two assortments* of 50 new, unused, 20-24 year old tubes for \$2.95 per assortment*, just to have them on hand in case? Hold on now, consider what electronic miracles *you* might perform with an orbital beam, hexode uhf amplifier, type 1630, Army Signal Corps Tube VT-128! Just to hold it in your hand and look at it is inspiring. It looks like a grown-up 955 acorn tube, except that it has 12 radial electrode wires instead of five. Into this world of dreams came WHAM, POW, SOT-Fisk and Jones et al.

After the order of solid state goodies arrive, you find yourself impressed by how few identifying marks are on the TO-5 and other style cases. In fact, you reminisce and recall that at least you could peek inside

* 1964 Catalog, McGee Radio Company, Kansas City, Missouri.

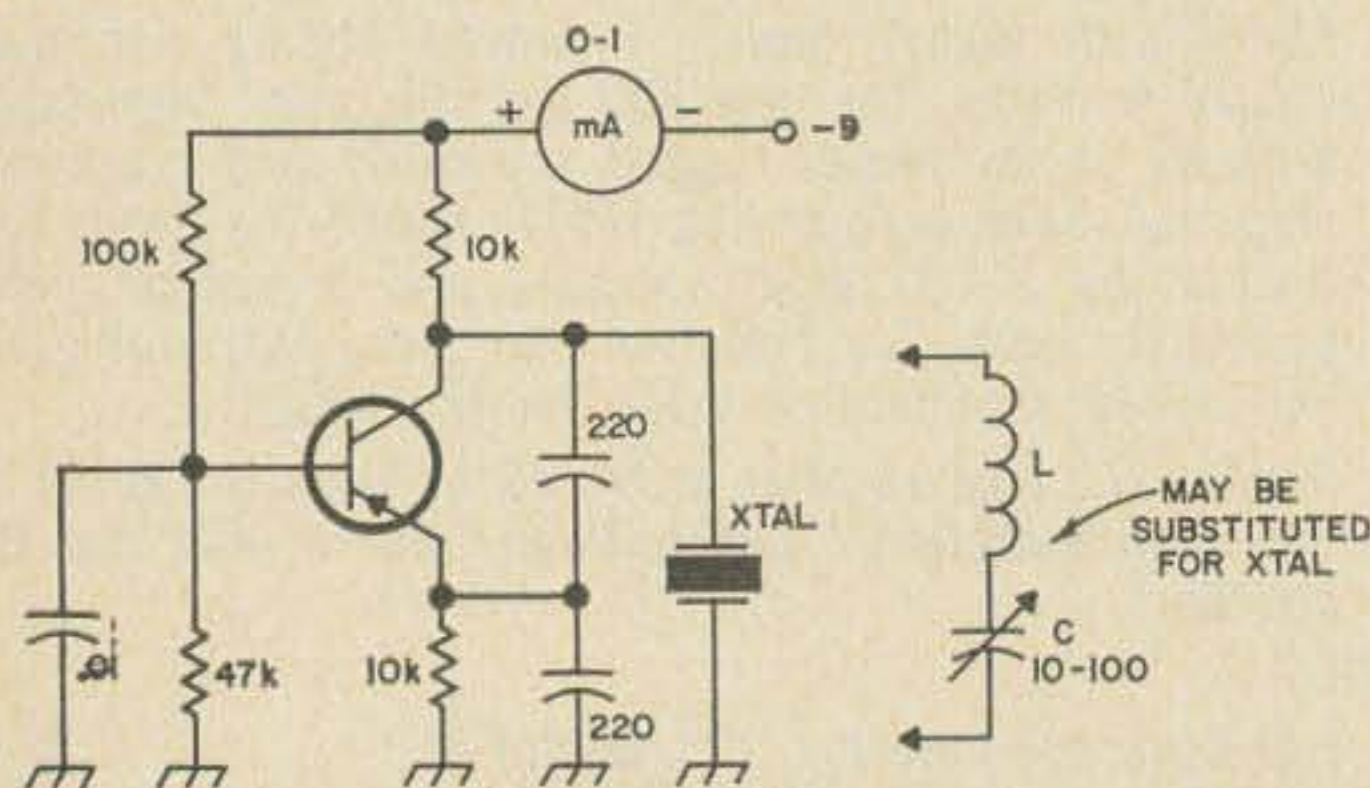

Fig. 1. Circuit for testing the oscillating characteristics of unmarked transistors. This circuit is shown with a negative supply for PNP transistors—for NPN units reverse the meter and use a positive supply.

the orbital beam hexode glass envelope and try to guess which is the grid, filament and cathode lead. At this point enter Frank Jones. Build up and use one of his transistor testers and the door of knowledge is opened. No longer do you care if you can't see inside. Everything becomes orderly. PNP's go into one box and NPN's into the other. The duds are set aside for Psuedo-Zener use. The sorting process turns into an exhilarating game. Plug them in, test, pull 'em out. You don't mind that after squeezing the three little wires between thumb and forefinger for the hundredth time, you have an excruciating cramp in the thumb! But wait; now that these wonderous things are sorted, how do you know which of them is "Power", "RF", "IF", "Audio", "Switching" and no test? Frantic thumbing through all issues of 73 from January 1962 forward was of little help for a solution to this new dilemma. In fact it was a hindrance. You find far too many tube articles which you remember wanting to try! Anyway, after having invested so heavily—at least \$10 so you can take advantage of the double bonus—it is incumbent upon you to take the next step to find out which of these little three-pronged rascals will oscillate. A circuit to help sort the unmarked transistors further is shown in Fig. 1.³

This is a Clapp transistor oscillator, either crystal or series L-C resonated. As shown, the battery and meter are set up for PNP's. Change the polarity to check NPN's. By using several crystals, for example, 450kHz, 2MHz, 3.5MHz and 7MHz or higher, you can learn which of the 100 or more bargain transistors in your possession will oscillate. It sure takes a lot of plugging but it's worth it. Imagine the thrill that shivers through your frame as you hear that crystal clear note in the station receiver. It takes you back to the days when—for old-timers—after you sawed two hacksaw slots at right angles across the bakelite base of a type 76 triode, between the four prongs, so as to decrease the dielectric shunting, you got the

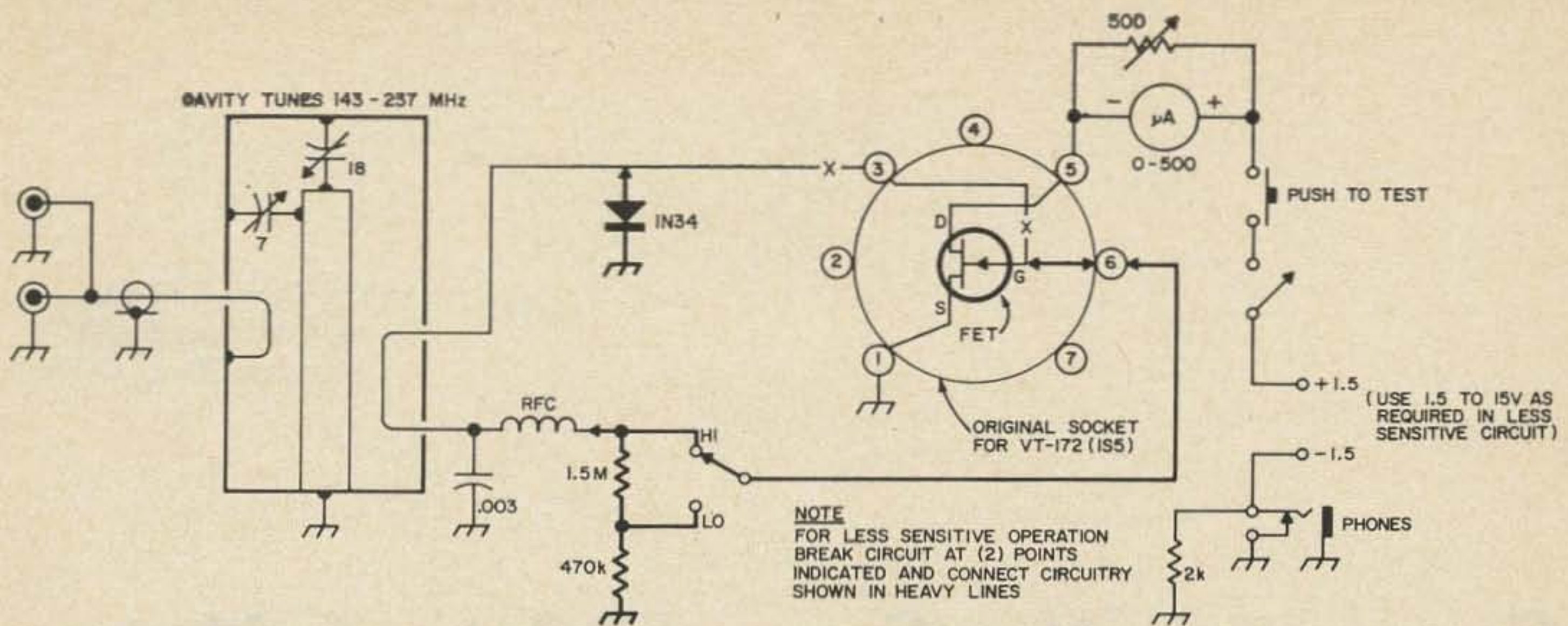

Fig. 2. Conversion of the BC-906 frequency meter to detect rf signals down to a 100 microvolts or so and

will tune through both the 2 and 1 1/4 meter bands.

tube to work at 2 1/2 meters! For the younger man the occasion might be similar to uncorking his first 807 on 10 meters. At any rate, the yield of good oscillators from the packet of 100 bargain items is surprising. Many were vigorous to 7.3MHz. How well they will work in other circuits remains to be learned. It may be safe to assume that some of them will perform as rf amplifiers; how noisy they are can be learned from trial and error unless one uses the more modern transistor testers which are available at much greater cost than the simple ones referred to in this work.

The field effect transistors are indeed fascinating. It boggles the mind to think what would have happened to the radio-radar-sonar systems had the solid state version of the tube arrived first. We'd probably be discovering the vacuum tube about now and that would be a blessing to those of us who need bi-focal glasses in order to work with these miniature components. Jim's FET Primer caused me to try the FET's offered by Poly-Paks. Again, the ones received are unmarked except that one is painted an ominous black. The advertisement seems to say that mine are low noise FET's made by Crystalonics. The package has a nice re-print from 73 and also some data which leads me to believe that one of the FET's is a C-610. Since my surplus BC-906E Frequency Meter had a 1S5 tube which went west, it was a logical choice to go FET. The original and modified circuits are shown in Fig. 2.

The FET can be plugged into the tube socket for experimentation, then later soldered in if you so desire. The schematics show the tube socket pin numbers in which to plug the FET leads. It is necessary to

remember that when looking at the bottom of the FET, the *base* lead is where the collector lead normally is located on a standard transistor. (*Not on all FET's. Consult manufacturer's data sheet if in doubt. Ed.*)

The absorption wave-meter with the FET performs much the same as the original tube version. One less battery is required and the battery voltage will depend upon the FET used. The FET which I assumed to be a C-610 works well with 1.5 volts. When the meter reads 500 micro-amperes full scale, the measured drain current is 1.5 milliamperes. As the cavity is tuned through a two meter rf field, the drain current will dip just as it did with the vacuum tube in the circuit.

The sensitivity may be improved by leaving out the 1N34 diode and disconnecting the 1.5 megohm resistor from the end of the radio frequency choke nearest the Hi-Lo switch. These modifications are indicated in Fig. 2 by the heavy lines. Then, with the rf lead from the cavity connected to the gate of the FET, the field effect transistor will act like an old-fashioned vacuum tube with a floating, leaky grid.

With this modification the frequency meter will respond to 100 microvolt signals fed into the cavity by way of the plug-in antenna. The fact that the FET will perform in this manner is a measure of compensation and a bit of solace to a hard vacuum tube man.

. . . W5SOT

1. WA6BSO, "Field Effect Transistor Primer," 73, December 1965.
2. W6AJF, "Two Transistor Testers," 73, September 1966.
3. M. S. Kiver, "Transistors," 3rd edition, 1962, McGraw-Hill Book Company, New York.

Del Crowell K6RIL
1674 Morgan Street
Mountain View, California

Converting the Swan 120 to 6 Meters

With the continued upswing in sunspot activity, inter-continental DX on 6 meters is just around the corner. This simple and inexpensive conversion will provide a complete SSB transceiver for six.

This conversion makes a complete 180 watt PEP six meter transceiver with more features than the original 20 meter unit and compares favorably with commercial 6 meter units at much less cost.

General description

With the Swan single band transceivers consistently appearing on the used market,



Part of K6RIL's shack. The six meter Swan 120 is in the right foreground. The rack on the left contains a kilowatt and transverter for 432 MHz, a 2 kW PEP rig for six and a 2 kW amplifier and transverter for 144.

the SW 120 models may be purchased for a very reasonable price. This inspired me to investigate the possibility of converting one into a 6 meter transceiver. The investigation seemed to prove that this was entirely possible.

I noticed that the Swan people left a lot of chassis room in the right hand side around the final section, so I decided to take a chance. A SW 120 was purchased for \$85.00 and the modification was started. I was quite amazed at how simple the modification appeared. As described previously, there is a lot of empty space under the chassis for adding extra parts.

New transmitter circuit

The transmitter conversion consists mainly of changing the original driver stage to a second conversion mixer and removing the original driver plate coil and all of the final circuits. The new driver, a 6CL6, operating in class A, and new final with 6146's operating in AB1 were added. In addition, a local oscillator with buffer was installed. These added parts fit into the empty space very nicely. When checking out the transmitter, two major problems were encountered. First,

Fig. 1. New circuit of the SW 120 for six meters. L4 and L5 are 8 turns number 26 on a 3/8" form. Relocate L5 and wire as shown. L6 and L7 are 5 turns number 20 closewound on a 3/8" form—use a white slug. L8 consists of 3 1/2 turns of 1/4" copper tubing—1 1/4" inside diameter, 2 3/8" long. Parasitic chokes PC1 and PC2 are 2 turns number 22 wound around a 470 ohm, 1/2 watt resistor. PC3 and PC4 consist of one turn number 14 wound around a 47 ohm, 2 watt resistor. RFC3 is the original choke with 1/4" removed from each end.

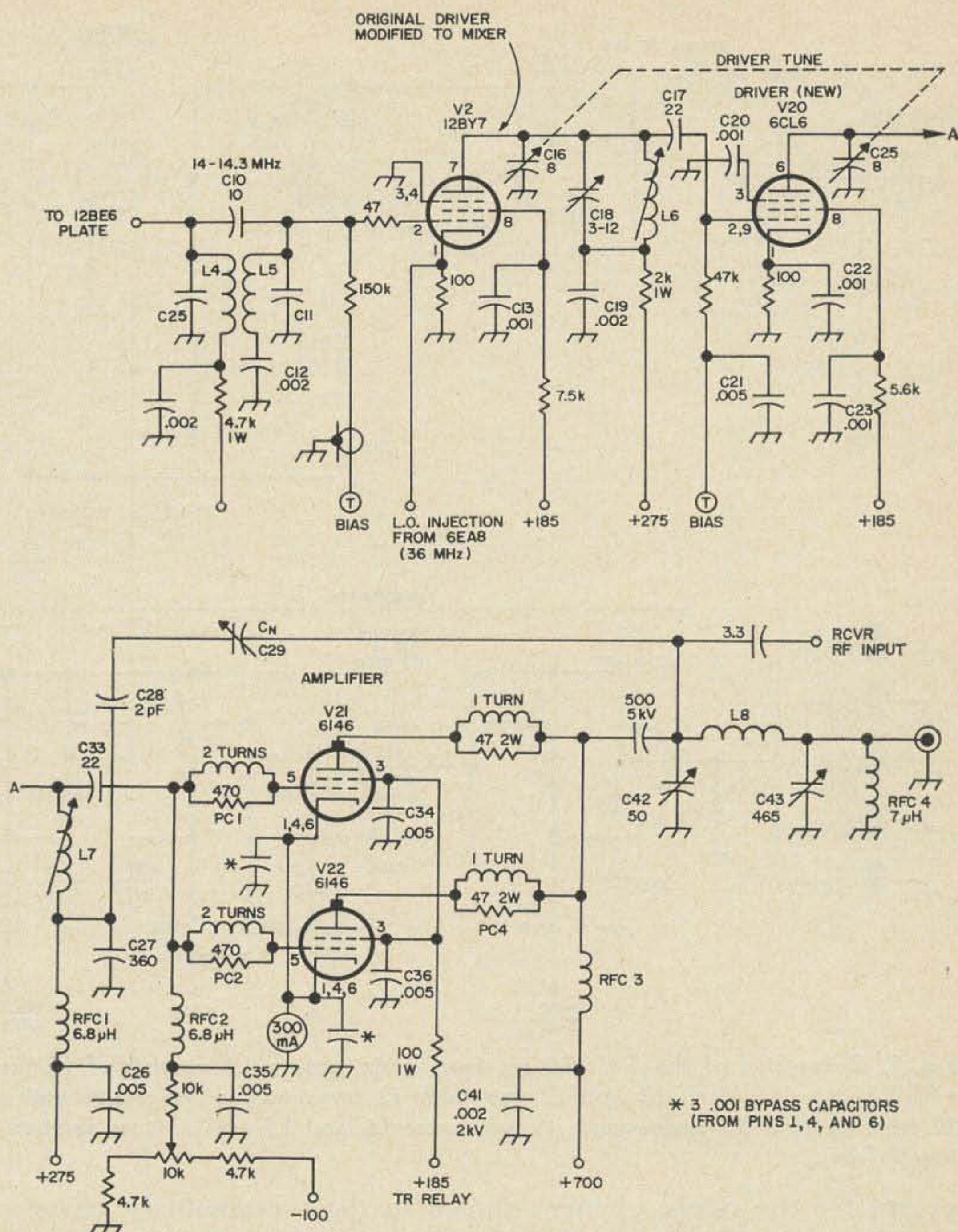

the final showed signs of instability even after neutralizing. This proved to be parasitic oscillations—parasitic chokes in the plate leads cured this problem. The driver was also unstable—the original 11 pF butterfly driver capacitor was used to reduce the cost of modification, but this capacitor produced too much feed back due to the configuration so a new double section capacitor had to be used. Since a small capacitor with low capacity was not available on the market, a small bracket was fabricated and two Johnson type 160-140 capacitors were ganged for this job. This arrangement provides good isolation, takes up a minimum of space and gives more than adequate tuning range.

New local oscillator circuit

A new local oscillator and buffer were installed using a 6EA8. The triode section oper-

ates as a standard crystal oscillator with low voltage applied to the plate and the pentode section provides a small amount of gain and acts as a buffer to prevent frequency shift. A crystal switch and five sockets were installed to give additional coverage in the band. The crystal switch also has additional contacts to resonate the buffer coil when the oscillator frequency is changed—this adjusts the buffer output to maintain a constant injection level.

The crystal switch mounts in the hole where the tune switch was originally mounted; this tune switch was completely removed and the wires disconnected. The 12AV6 that was used as an audio oscillator is converted to an AGC amplifier.

Other transmitter changes

The basic exciter was left as original

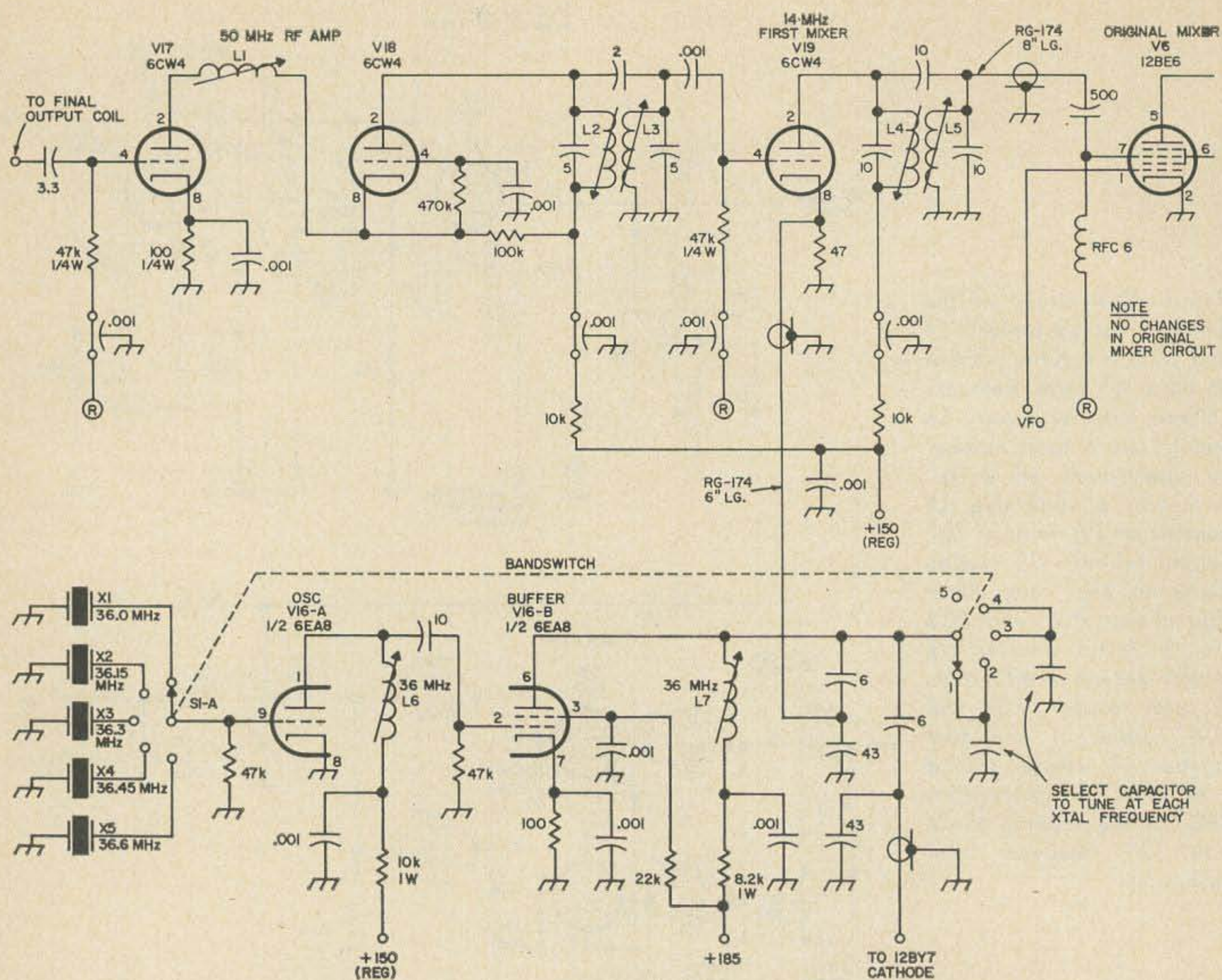

Fig. 2. Conversion of the SW 120 receiver to six meters. L1 consists of 10 turns number 26 closewound on a 1/4" slug-tuned form. L2 and L3 are both 12 turns number 26 closewound on a 1/2" form; L4 and L5 are 30 turns number 30 closewound on 1/4" form; L6 and L7 are 11 turns number 26 closewound on a 3/8" slug-tuned form.

except for the minor changes shown in the carrier balance control and transmit-receive switch. Also, the VFO was adjusted to cover 14.0 to 14.150 MHz to the 12BY7 mixer. This was only done to use a crystal that was available. The original dial calibration was used with the 20 meter markings removed with a pencil eraser (don't use paint thinner). New markings were made to indicate 0-100 kHz and 150 kHz. When calibrated, the dial now can be read to 1 kHz and crystals can be selected to cover any 150 kHz range in the band.

The original driver plate coil with associated capacitors is now installed under the chassis and connected to the grid of the 12BY7 mixer. A 10 pF capacitor is connected between the two coils—this forms a 14 MHz bandpass coupler for added rejection.

Transmitter modification

Before starting the conversion to six, a

preliminary check of the transceiver should be made to insure proper operation on the original band. Disassembly is accomplished by first removing all covers and the front panel. Mark any wires that may be disconnected. Follow these steps for removal of the unused parts:

1. Remove the final tube and all parts in the final compartment; leave only the plate and load capacitors and the two stand-off insulators.
2. Remove the 6DQ5 socket, disconnect wires and mark each with the pin number as it is removed. Pull the wires back through the chassis, but leave the meter wires in place.
3. Remove the driver plate coil and the associated wiring from pin #7 of V2 (12BY7) and driver tune (butterfly) capacitor.
4. Check to see that all parts from the driver plate and final grid are removed.

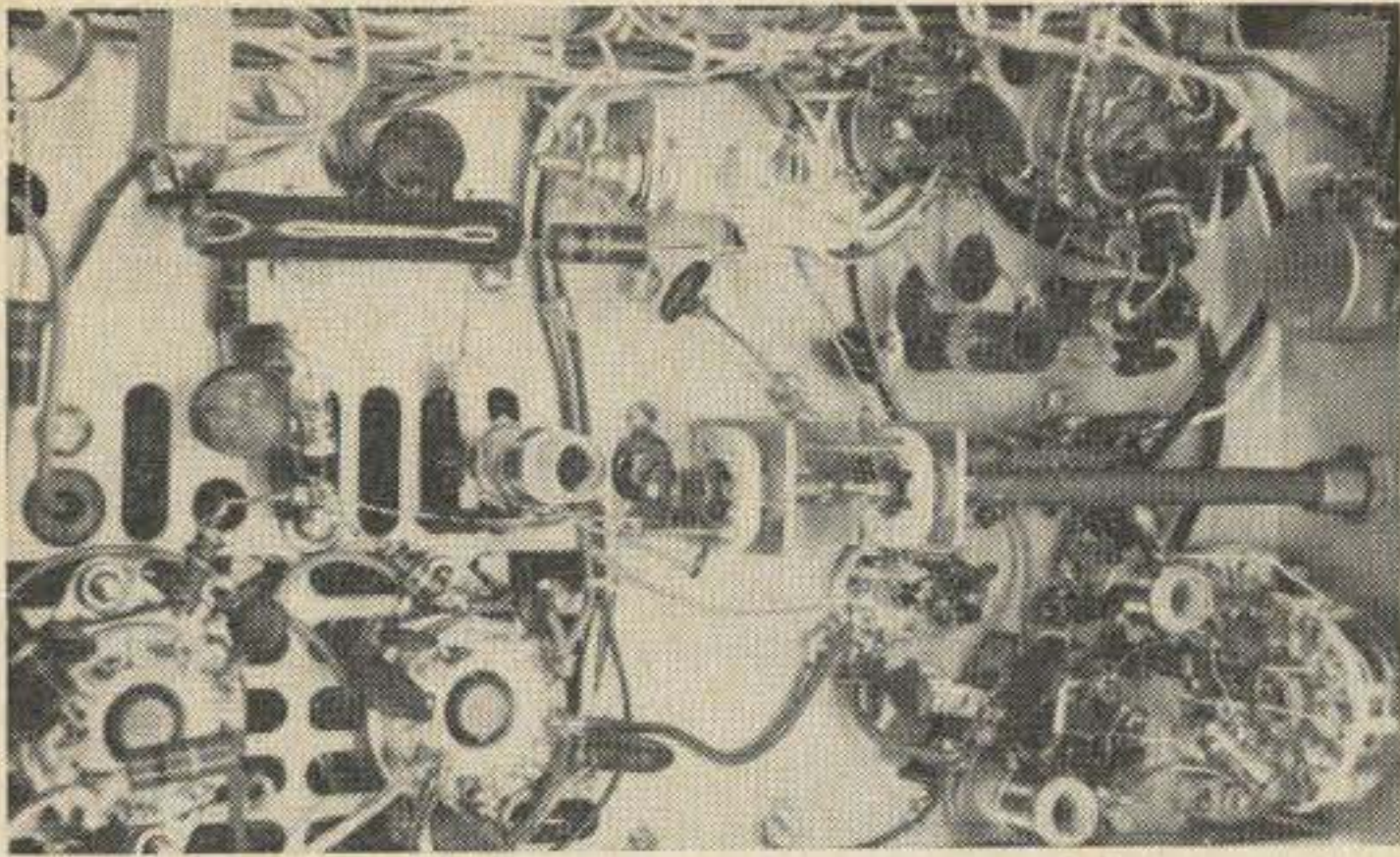

Closeup view of the new transmitter wiring.

The plate meter should also be removed before holes are drilled.

Mark the chassis for new holes by referring to the photos. Holes should be drilled with a small drill before enlarging for the chassis punch; use care when drilling so you don't damage parts left in the chassis. Holes for the crystal sockets require careful layout or much filing will be needed. New holes for the 6146 final tube sockets will have to be cut in the ventilation holes in the bottom of the final compartment. The tubes will now be mounted in the vertical position. Several stand off terminal strips must be installed for assembly of the new circuits; these holes should also be drilled before any parts are installed. When the holes have been deburred and all chips removed, the chassis is ready for installation of new parts.

Transmitter assembly and wiring

The new sockets can now be installed. If the 6146 sockets have no ground lugs, extra lugs will have to be installed. Install the mixer and driver coils as shown in photo—the new mixer coil is mounted under the chassis on an L-bracket. Position the terminals for direct connections. Wiring of the new mixer plate, driver, local oscillator and buffer should be done in sequence starting with the 12BY7 mixer plate. Be sure to leave room for the new driver capacitor and bracket. This capacitor should be installed last—refer to the photos and circuit diagrams for connections and layout. The new crystal switch mounts in place of the tune switch. Assembly of the final output circuit will require installation of a new coil with a better blocking capacitor. Start by installing the original neutralizing capacitor, modified plate choke and original dc bypass capacitor; position the parts as shown in the photo.

Modify the large loading capacitor by dis-

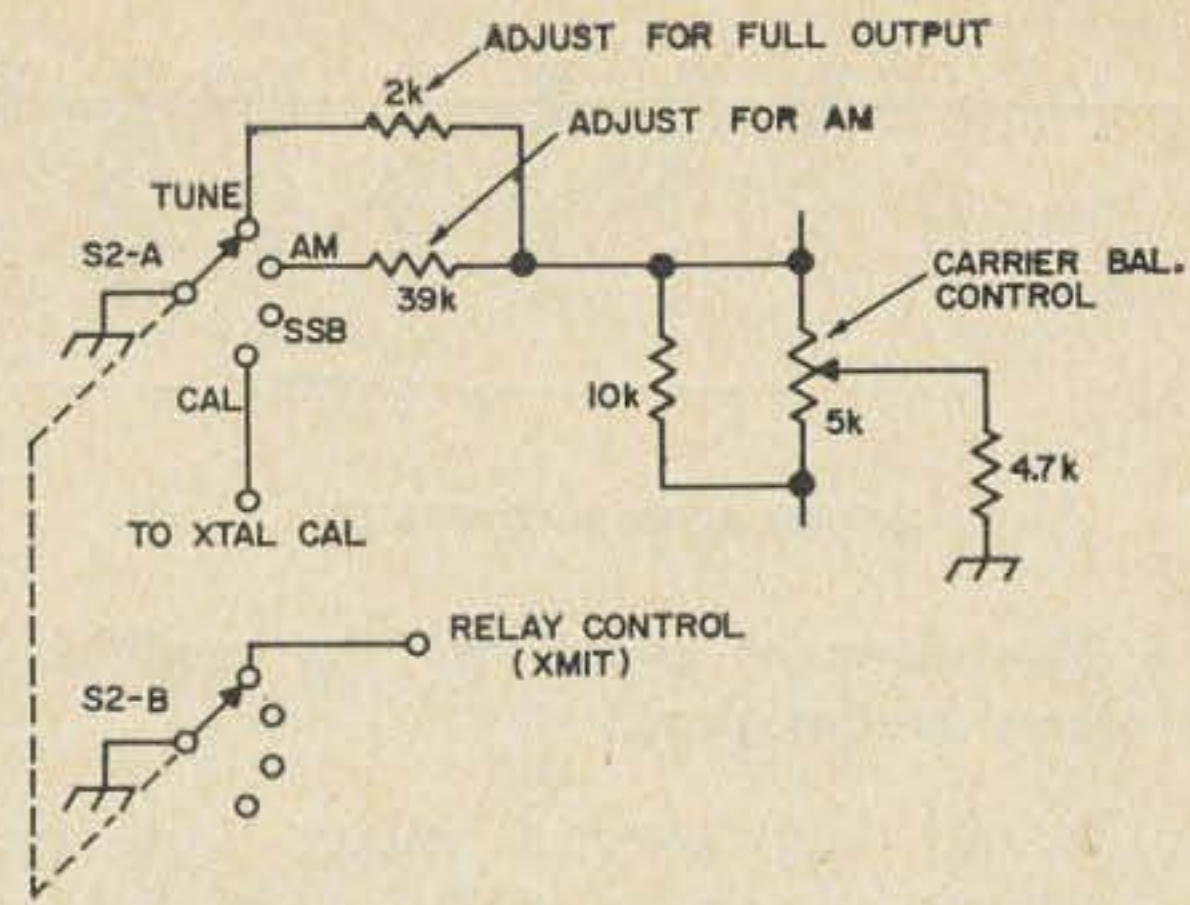
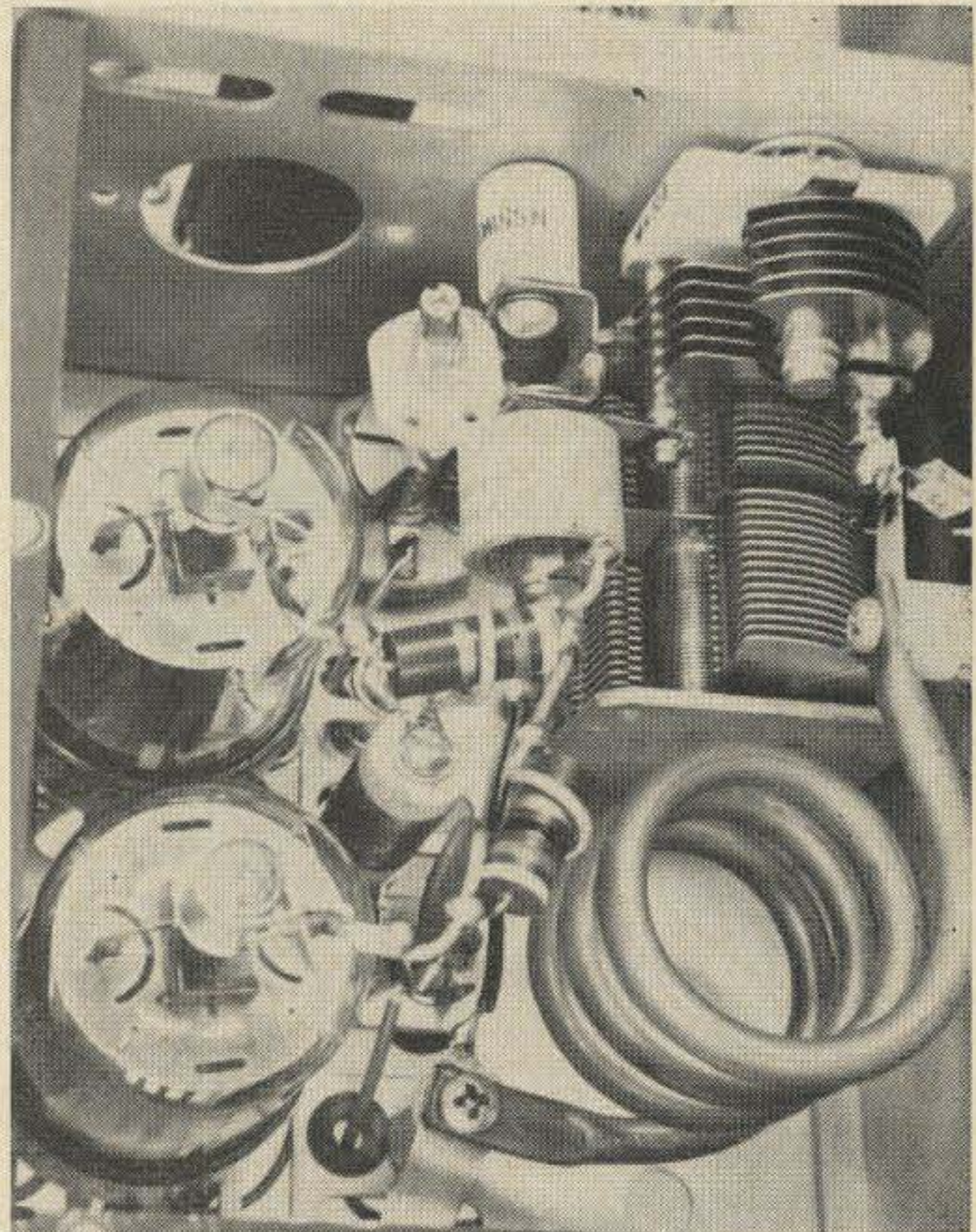

Fig. 3. Wiring the new function switch. S-2 is a double pole, four position rotary switch.

connecting the front half of the dual section. Use only the rear section. Remove two plates from the rotor and stator of the plate tuning capacitor and install the final tank coil. Use a brass strap from the stand-off to the plate tuning capacitor. Bend a "U" in the blocking capacitor bracket and install the new blocking capacitor. Also use a strap from the plate tuning capacitor as before.

Parasitic chokes must be used in the plate leads or the final will be unstable. Check back through all the wiring to insure that no wiring errors have been made. Be sure all bypass capacitor leads and socket pin grounds are very short. Use neat workman-



The new 50 MHz final amplifier showing placement of parts including the relocated rf choke. The small variable capacitor is connected in series with the original neutralizing capacitor.

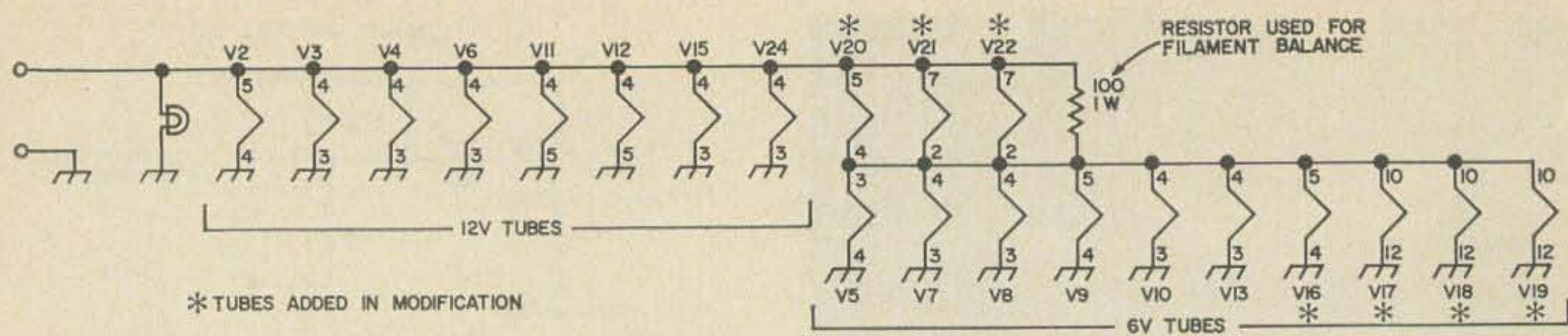

Fig. 4 New filament circuit for the modified SW 120. The tubes indicated by an asterisk are added—all others are original.

ship. Install the second mixer and driver plate tuning capacitor with a bracket, connect leads to the proper coils and install the front panel.

Receiver modifications

Since no room was available on the main chassis for the new rf and mixer stages, the 6 meter front-end and mixer were built on a small sub-chassis and attached to the VFO housing. This front-end consists of a 6CW4 cascode rf amplifier and a 6CW4 mixer. The local oscillator energy is injected into the 6CW4 cathode across a 47 ohm resistor. A double tuned output feeds the grid of the original 12BE6. The 6BA6 was originally used, but I found that the receiver had too much gain and excessive background noise. By eliminating the 6BA6 (V5) and feeding the first mixer directly to the 12BE6 mixer, the overall receiver gain is ideal. A very weak signal can be copied as well as on the more elaborate equipment I have available. The 14 MHz bandpass coupler must still be used between the two mixers for rejection of

unwanted signals. A length of 50 ohm coax is used to couple the local oscillator injection and *if* output. The final output tank also serves as the receiver input. Coupling to the 6CW4 grid is provided by two 3 pF capacitors. On transmit the 6CW4 is cut off by switching bias to the grid as is done in the original circuit.

By referring to the chassis layout and circuit diagram, the new front-end can be built and checked out prior to installation. This completes the receiver changes except for the AGC and audio modifications.

AGC and audio modification

As most persons know, the single band Swan has no AGC circuit or audio level control. With no control to hold the audio level at a pleasant volume, a loud signal blasts the operator out of his shoes before he can get the rf gain turned down. After using the transceiver a few days like this, I decided something had to be done.

In the original SW 120 the 12AV6 (V15)



The new local oscillator and driver tubes and crystal sockets are mounted below the meter. The extra hole in the foreground was evidently punched by a previous owner. Hole in the final compartment wall was for the original final socket.

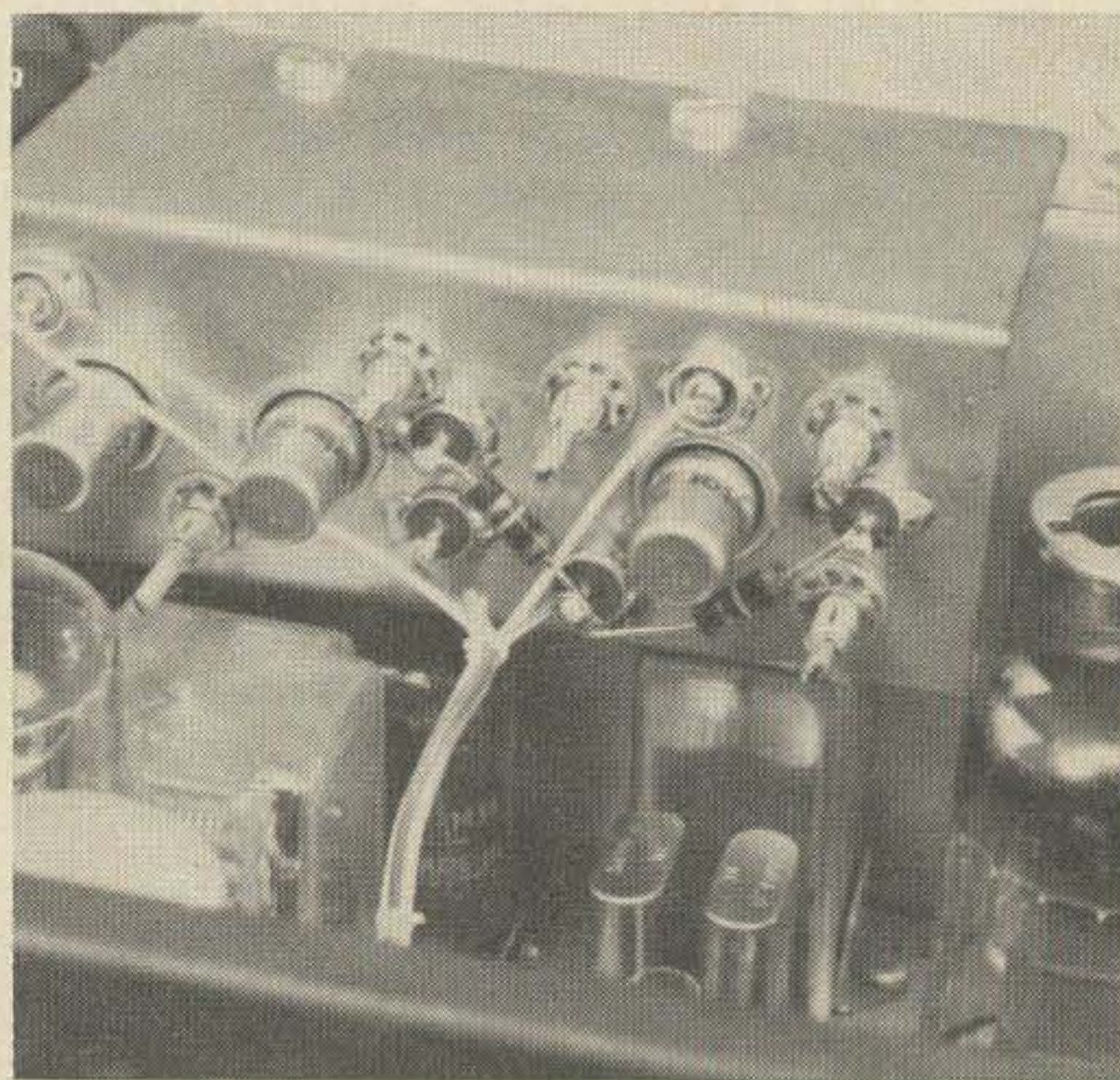

The 50 MHz front end. The two tubes on the left are the cascode rf amplifier. A 3 pF capacitor connects from the feedthrough on the final compartment to the grid of the rf stage.

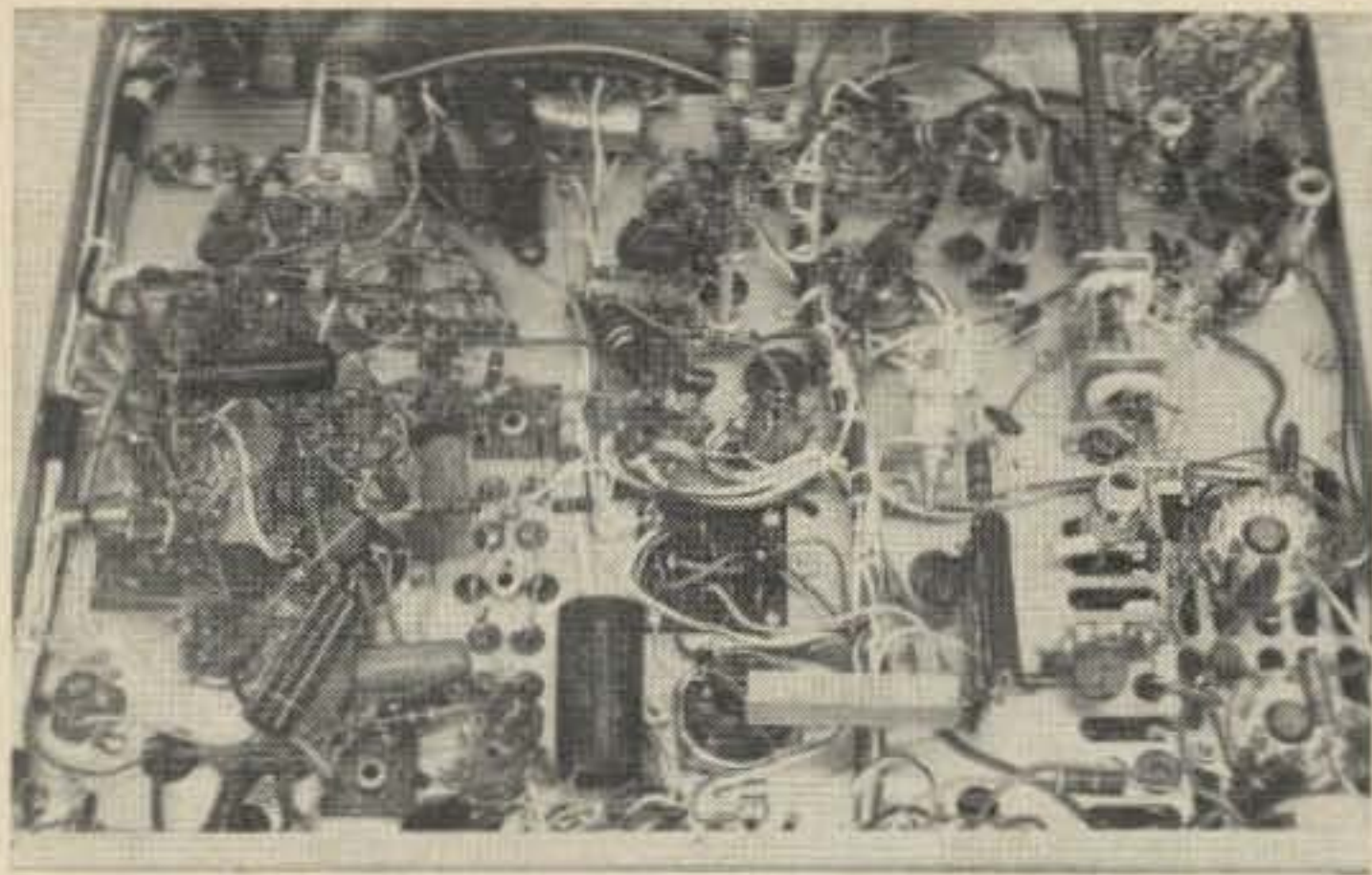

Under-chassis view of the modified transceiver. The local oscillator is in the upper right-hand corner, final sockets bottom right and mixer plate and driver center right. The new driver socket is partially hidden by the double tuning capacitor. The AGC circuit is next to the VFO dial plate. The new volume control and power switch are in the upper left-hand corner.

is a tune-up oscillator which generates a lot of excessive noise when tuning. This stage was converted to an AGC amplifier. Some early transceivers didn't have this oscillator.

The AGC system used is an audio derived method. The audio signal is sampled from the plate of the product detector and amplified. Finally, it is converted to a minus dc voltage which is proportional to the audio level. This voltage is then fed to the grids of the tubes to be controlled.

In this case the first rf and second if stages are controlled with the AGC loop. This allows the rf gain to be run full open. An audio volume control must now be used to adjust the audio level. The original rf gain control was moved to the hole which was occupied by the on and off switch. The new volume control with power supply

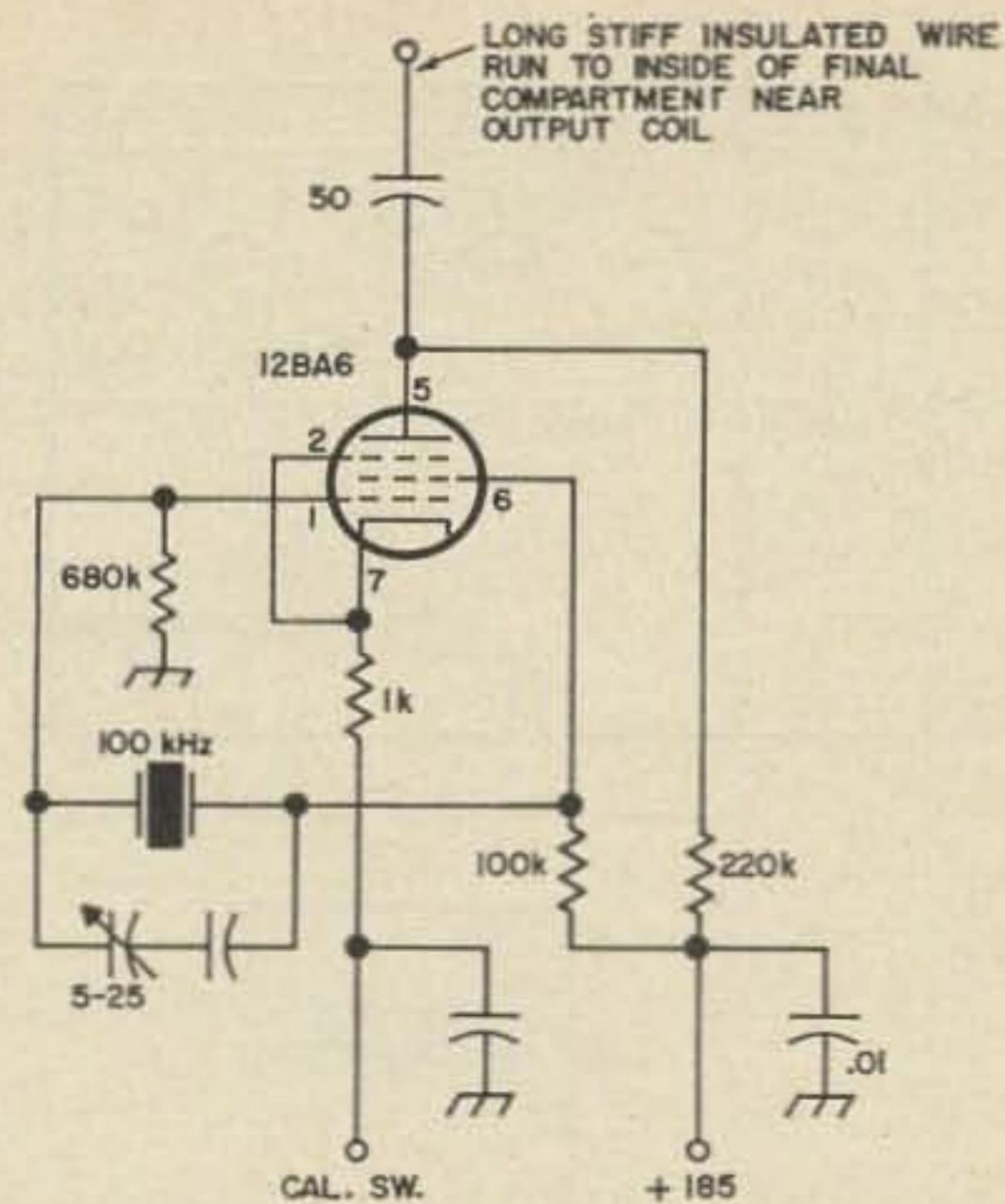

Fig. 5. Circuit of the 100 kHz crystal calibrator for the six meter Swan 120.

switch is now in the space left by the rf gain control. Two signals with extreme variations in strength now sound the same level in the speaker and very little popping or distortion is noticed even on loud signals.

The 50k pot marked AGC threshold should be adjusted with the antenna connected—adjust the control to give a residual voltage of -0.3 volts and a little kick on background noise from autos or static.

This AGC circuit works much better than any other version that I tried. I find it hard to give signal reports because most signals now sound the same strength. As stated previously, the quality of the stations received are still very good regardless of the signal level and I wouldn't be without AGC control. This circuit can be adapted to all the single band Swan transceivers whether modified to 6 meters or not.

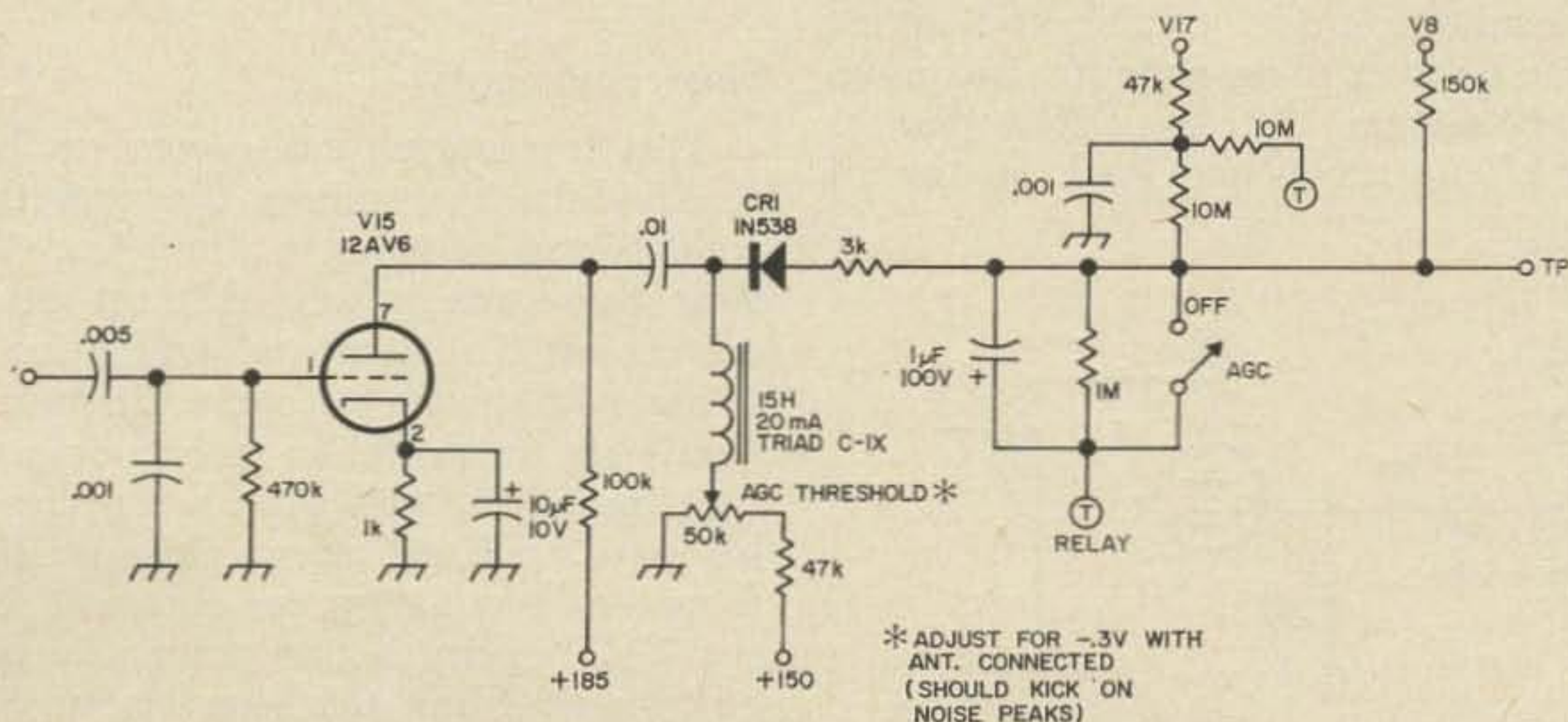

Fig. 6. Audio derived AGC system for the SW 120. This circuit is equally applicable to other single-band Swans.

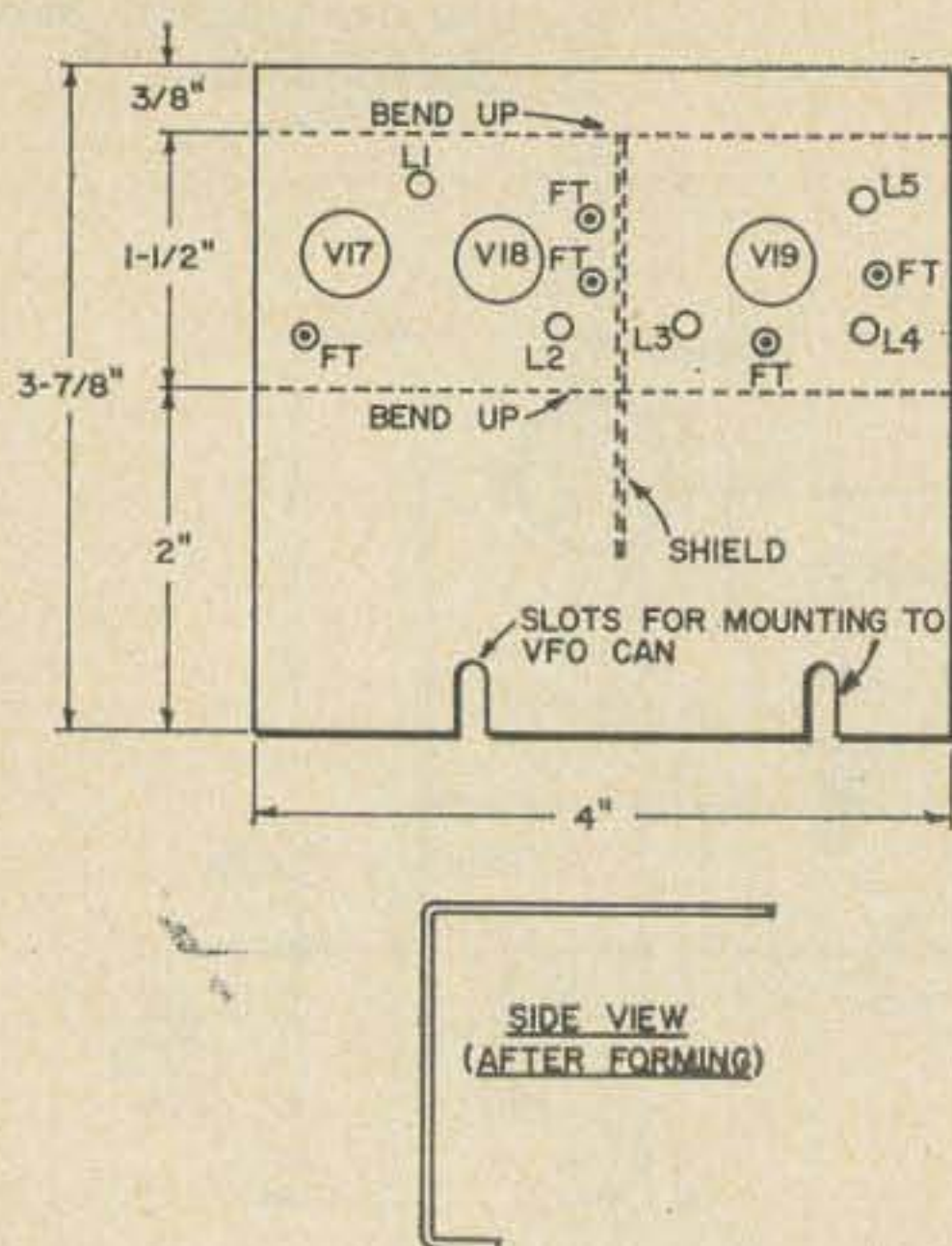

Fig. 7. Chassis for the 6-meter cascode rf amplifier and mixer circuitry.

Miscellaneous changes

A new function switch is shown in the circuit diagram. This will allow the operator to insert carrier for different modes by simply turning the switch. Fixed resistors are selected for AM and tuneup modes.

A calibrator was installed for checking calibration. This switch is mounted in place of the old transmit-receive switch.

Adjustment and operation

Transmitter section

Preset all coils with a grid dip meter, disconnect the final screen and plate voltages, and check to be sure there are no short circuits and wiring is complete. Apply power and with the grid dip meter in the diode position, tune the local oscillator and buffer for maximum output indication. Turn on the transmitter, insert carrier and adjust the mixer and driver plate coils for maximum output at 6 meters. Set the VFO dial to the center of the range and peak up the 14

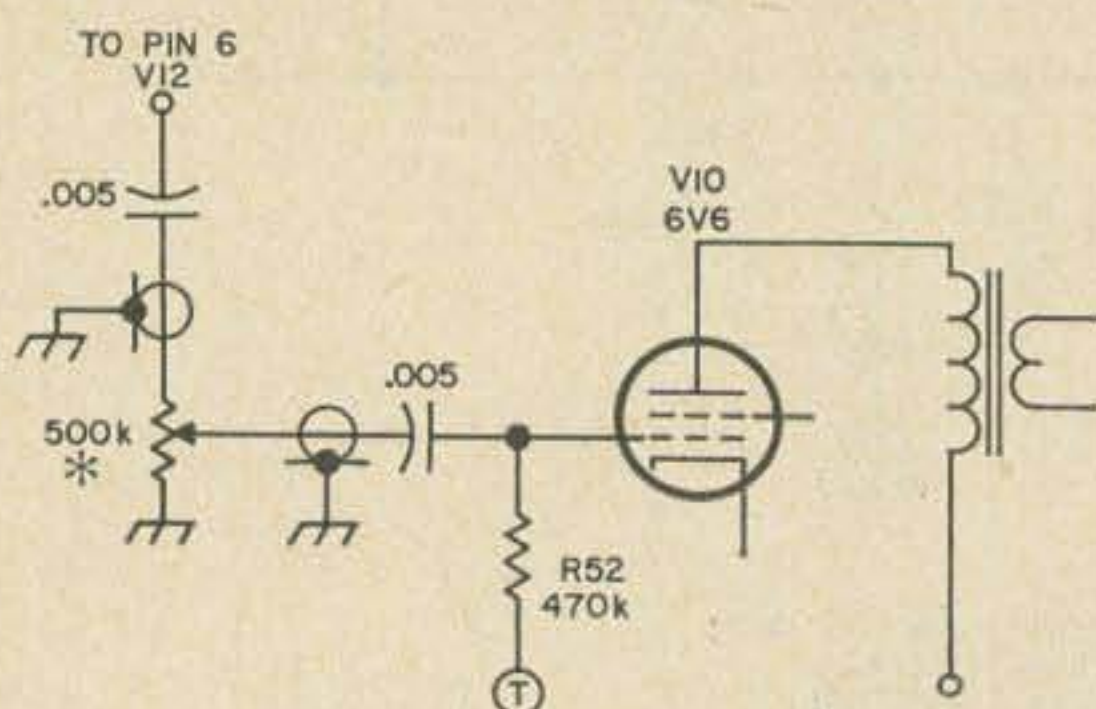

* MOVE RF GAIN TO OFF-ON POSITION
MOUNT CONTROL IN HOLE MARKED VOLUME

Fig. 8. New audio volume control circuitry.

MHz bandpass coupler for highest level at 6 meters. Connect a voltmeter across the 10k bias resistor feeding the grids of the final tubes and again adjust all coils for maximum voltage on the meter.

Check to be sure the output is on 6 meters. The driver tuning capacitor should be set at near maximum capacitance for the low end of the band—this will allow coverage of 2 MHz or greater range. All coils should be peaked several times to make sure maximum output is obtained.

Neutralization

Connect a detector probe and VTVM to the final output jack. With the screen and plate voltages disconnected apply drive to the final and adjust the final plate and output capacitors for maximum reading. Next adjust the neutralizing capacitor for minimum output. Check to make sure the capacitor is not completely open or closed—it should be in the center range and the output reading low in relation to the original level. Now the screen and plate voltages can be applied and carrier inserted. Peak the driver tuning, connect the output into a good load, and tune up the final to about 230 mA with full drive.

Receiver

The new front-end should be adjusted for maximum gain before mounting to the VFO housing. Only slight peaking is needed for final adjustments.

The crystal calibrator is wired with a lead run into the final compartment and positioned about one-half inch from the final tank coil.

Final comments

This transceiver has proved to be a very worthwhile investment; the reports are excellent and it does a fine job. The final runs the same power as most other transceivers on 6 meters and will drive a 2 kW linear with power to spare. It makes a very handy rig for portable, mobile or just general use, and the Swan power supplies can still be used for fixed or mobile operation. With 6 meters looking up for the next few years, the VHF operator can get ready for lots of enjoyment from this conversion. Get your tools out and get to work.

... K6RIL

LS *LINEAR SYSTEMS* all Solid-State Power Supplies □ are built by the company most experienced in designing mobile power supplies for the amateur □ provide higher transmitter power output at all input voltages □ have multiple output voltages to operate all transceivers □ are used by the military without added ruggedization □ have

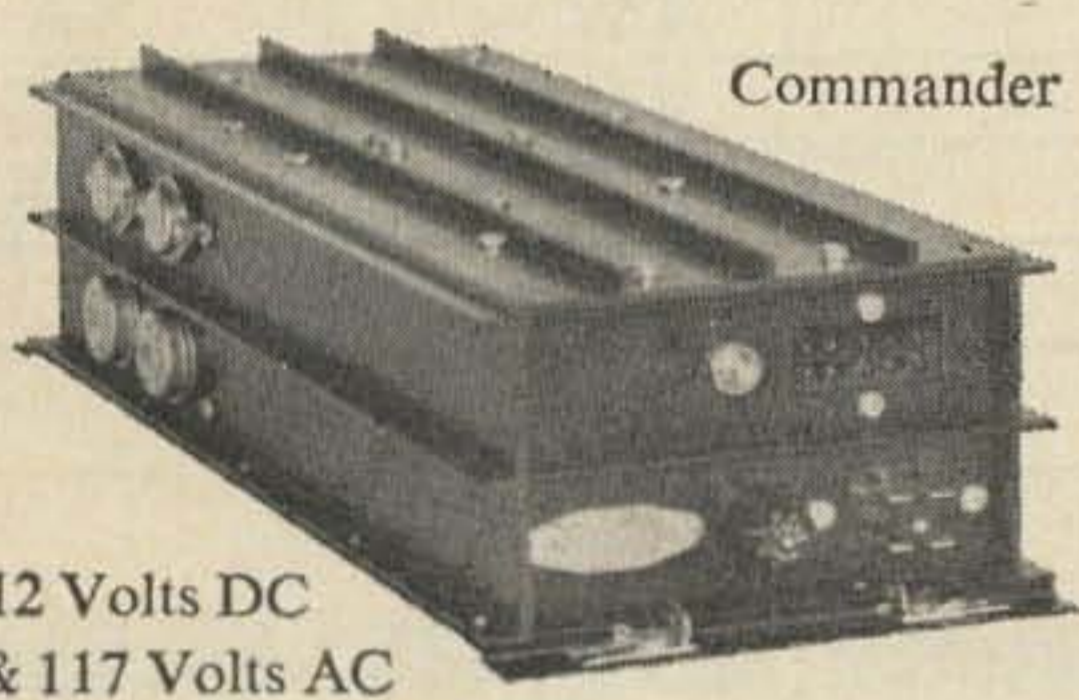

the highest efficiency of any mobile power supply on

the market □ come complete with cables □ available from

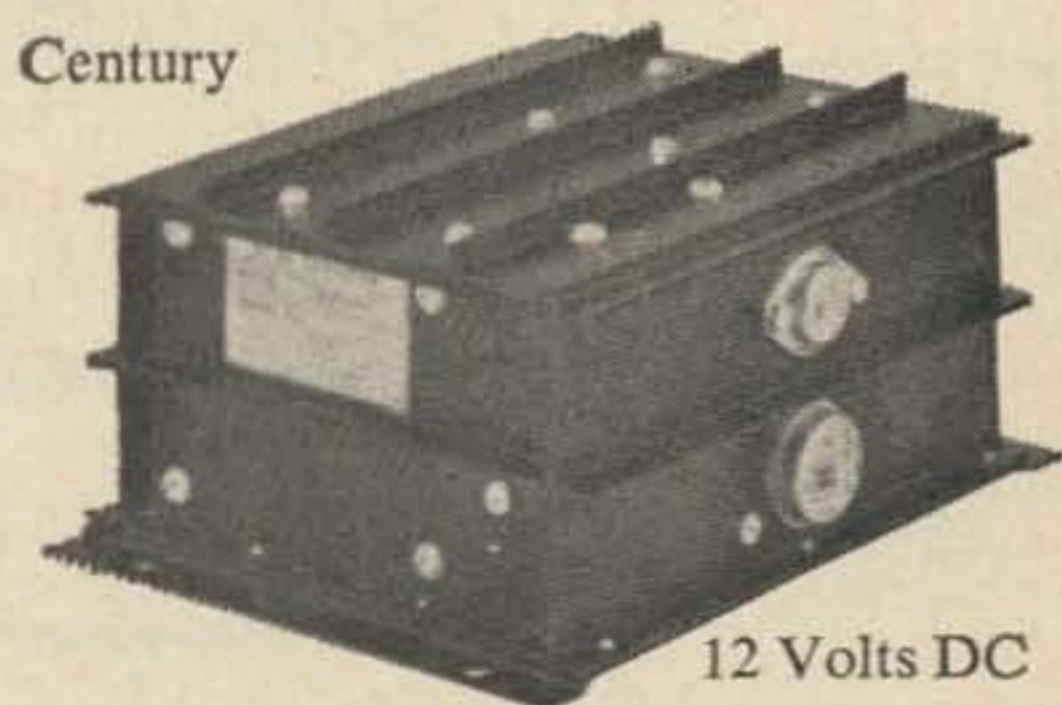

dealers throughout the country □ □ □

Commander Model \$189.50 □ Century Models \$124.50 — \$149.50 — \$249.50

LS *LINEAR SYSTEMS INC.*
220 Airport Boulevard, Watsonville, Calif. 95076 Tel. (408) 722-4177

Maurice J. Shumaker WØHYB
3077 South Hurley Circle
Denver, Colorado 80227

Military Quartz Crystals for the Radio Amateur

How to find crystal bargains

Surplus military quartz crystals are available at just about any frequency throughout the low and high frequency portion of the radio spectrum. These crystals can be very useful to hams and are available at modest prices from many electronic surplus houses or through some crystal manufacturers and dealers. Surplus crystals can be put to many good uses including transmitter and/or receiver frequency control, band pass filters, frequency standards and many others.

The writer has gathered together a lot of useful data on military quartz crystals and has presented it in tabular form (Tables 1 and 2). The information contained in the tables was derived from the "D" revision of the Military Specification MIL-C-3098, *General Specification for Quartz Crystal Units*. The table does not reference all of the 69, yes I said 69, types of quartz crystals used by the military. Rather, only the more common types frequently found in the surplus markets are discussed.

Military Quartz Crystal Holders					
Holder Type	Pin Dia.	Pin Spacing	Holder Height	Holder Thickness	Holder Width
HC-5/U	0.156	0.812	2.205	1.817	1.594
HC-6/U	0.050	0.486	0.775	0.317	0.725
HC-10/U	0.062	N-A	1.055	0.560	N-A
HC-13/U	0.050	0.486	0.775	0.317	0.725
HC-18/U	0.017	0.192	0.530	0.150	0.402

Note: All dimensions are in inches.

Table 1. The dimensions of popular military crystal holders.



— with a MATERIAL DIFFERENCE!

Use, is one of the most dependable testimonials of endorsement, and Telrex products are in use in 139 Lands

"Beamed-Power" ANTENNAS, "BALUNS" I. V. KITS and ROTATOR SYSTEMS!

Most Technically-Perfected, Finest Communication Arrays in the World! Precision-Tuned-Matched and "Balun" Fed for "Balanced-Pattern" to assure "TOP-MAN-ON-THE-FREQUENCY" Results

Enjoy, World renown TELREX performance, value and durability! Send for PL67 tech. data and pricing catalog, describing professionally engineered communication antenna systems, rotator-selsyn-indicator systems, "Baluns", I.V. Kits, Towers, "Mono-Pole", "Big-Berthas", accessories, etc., etc.

COMMUNICATION SYSTEMS SINCE 1921

Communication Engineering
telrex Laboratories

ASBURY PARK, NEW JERSEY 07712, U.S.A.

Military Quartz Crystal Types

Item	Military Type	Holder Type	Frequency Range	Oscillating Mode	Freq. Tolerance (%)	Resonance	Drive Level (mW)	Temperature Range (degrees C)
1	CR-15B/U	HC-5/U	80-200KC	Fundamental	±.01	Parallel	—	-40 to +70
2	CR-16B/U	HC-5/U	80-200KC	Fundamental	±.01	Series	—	-40 to +70
3	CR-17/U	HC-10/U	15-25MC	3rd Overtone	±.005	Series	—	+60 to +80
			25-50MC	5th Overtone				
4	CR-18A/U	HC-6/U	0.8-20MC	Fundamental	±.005	Parallel	5-10	-55 to +105
5	CR-19A/U	HC-6/U	0.8-20MC	Fundamental	±.005	Series	5-10	-55 to +105
6	CR-23/U	HC-6/U	10-52MC	3rd Overtone	±.005	Series	—	-55 to +105
			52-75MC	5th Overtone				
7	CR-24/U	HC-10/U	15-25MC	3rd Overtone	±.005	Series	—	-55 to +105
			25-50MC	5th Overtone				
8	CR-25A/U	HC-6/U	200-500KC	Fundamental	±.01	Series	—	-40 to +85
9	CR-26A/U	HC-6/U	200-500KC	Fundamental	±.002	Series	—	75 ± 5
10	CR-27A/U	HC-6/U	0.8-20MC	Fundamental	±.002	Parallel	2.5-5	75 ± 5
11	CR-28A/U	HC-6/U	0.8-20MC	Fundamental	±.002	Series	2.5-5	75 ± 5
12	CR-29A/U	HC-5/U	80-200KC	Fundamental	±.002	Parallel	—	75 ± 5
13	CR-30A/U	HC-5/U	80-200KC	Fundamental	±.002	Series	—	75 ± 5
14	CR-31/U	HC-6/U	1-10MC	Fundamental	±.005	Parallel	—	-55 to +90
15	CR-32A/U	HC-6/U	10-52MC	3rd Overtone	±.002	Series	—	75 ± 5
			52-75MC	5th Overtone				
16	CR-33A/U	HC-6/U	10-25MC	3rd Overtone	±.005	Parallel	2.5	-55 to +105
17	CR-35A/U	HC-6/U	0.8-20MC	Fundamental	±.002	Series	2.5-5	85 ± 5
18	CR-36A/U	HC-6/U	0.8-20MC	Fundamental	±.002	Parallel	2.5-5	85 ± 5
19	CR-37A/U	HC-13/U	90-250KC	Fundamental	±.02	Parallel	—	-40 to +70
20	CR-38A/U	HC-13/U	16-100KC	Fundamental	±.012	Parallel	—	-40 to +70
21	CR-42A/U	HC-13/U	90-250KC	Fundamental	±.003	Parallel	—	75 ± 5
22	CR-43/U	HC-16/U	80-860KC	Fundamental	±.01	Parallel	—	-30 to +75
23	CR-44/U	HC-6/U	15-20MC	3rd Overtone	±.002	Parallel	—	85 ± 5
24	CR-45/U	HC-6/U	455KC	Fundamental	±.02	Series	—	-40 to +70
25	CR-46A/U	HC-6/U	200-500KC	Fundamental	±.01	Parallel	—	-40 to +85
26	CR-47A/U	HC-6/U	200-500KC	Fundamental	±.002	Parallel	—	75 ± 5
27	CR-48/U	HC-6/U	800-3000KC	Fundamental	±.008	Parallel	—	-55 to +90
28	CR-50A/U	HC-13/U	16-100KC	Fundamental	±.012	Series	—	-40 to +70
29	CR-51A/U	HC-6/U	10-61MC	3rd Overtone	±.005	Series	20.0	-55 to +105
30	CR-52A/U	HC-6/U	10-61MC	3rd Overtone	±.005	Series	2-4	-55 to +105
31	CR-53A/U	HC-6/U	50-87MC	5th Overtone	±.005	Series	20.0	-55 to +105
32	CR-54A/U	HC-6/U	50-125MC	5th Overtone	±.005	Series	2.0	-55 to +105
33	CR-56/U	HC-18/U	17-61MC	5th Overtone	±.005	Series	2.0	-55 to +105
34	CR-56A/U	HC-18/U	50-125MC	5th Overtone	±.005	Series	2.0	-55 to +105

Table 2. Operating characteristics of popular military quartz crystals.

The next time you visit your local surplus store on a crystal buying spree, bring along the tables. You will find that they will be very useful as you rummage through the bins.

Table 1 can be used when selecting the crystal type to match a particular socket

and vice versa. Table 2 provides much needed information for designing the oscillator circuit of a receiver or transmitter or when trying to select an appropriate crystal oven.

. . . WØHYB

Converting the BC-728

A low frequency superhet receiver for 160, 80 and 40 with a very attractive price.

One of the items you can sometimes find on the surplus market is the BC-728 receiver, a six tube superheterodyne battery operated unit for shoulder carrying. This unit is advertised by several dealers for the amazing price of \$7.95!

It is possible, for a bit extra, to buy the units complete with antenna, wet battery and charging cable. This antenna is a good deal if you are going to use the unit for portable use, the most logical application. This plugs into the antenna jack on one side, has a heavy cable with shoulder strap on it and the antenna fastens to the other side of the case. Thus the antenna feedline is used for the shoulder carrying harness. The antenna is telescoping for easy portability.

The case is rugged and most units are waterproof. If you have a selection you might pick out one with a sliding cover over the loudspeaker which would be very handy should you leave it out in the rain on Field Day.

The receiver has four pushbuttons inside to select the received channel. Channel one tunes from 2.0 to 2.6 MHz, channel two from 2.6 to 3.5 MHz, channel three from 3.5 to 4.5

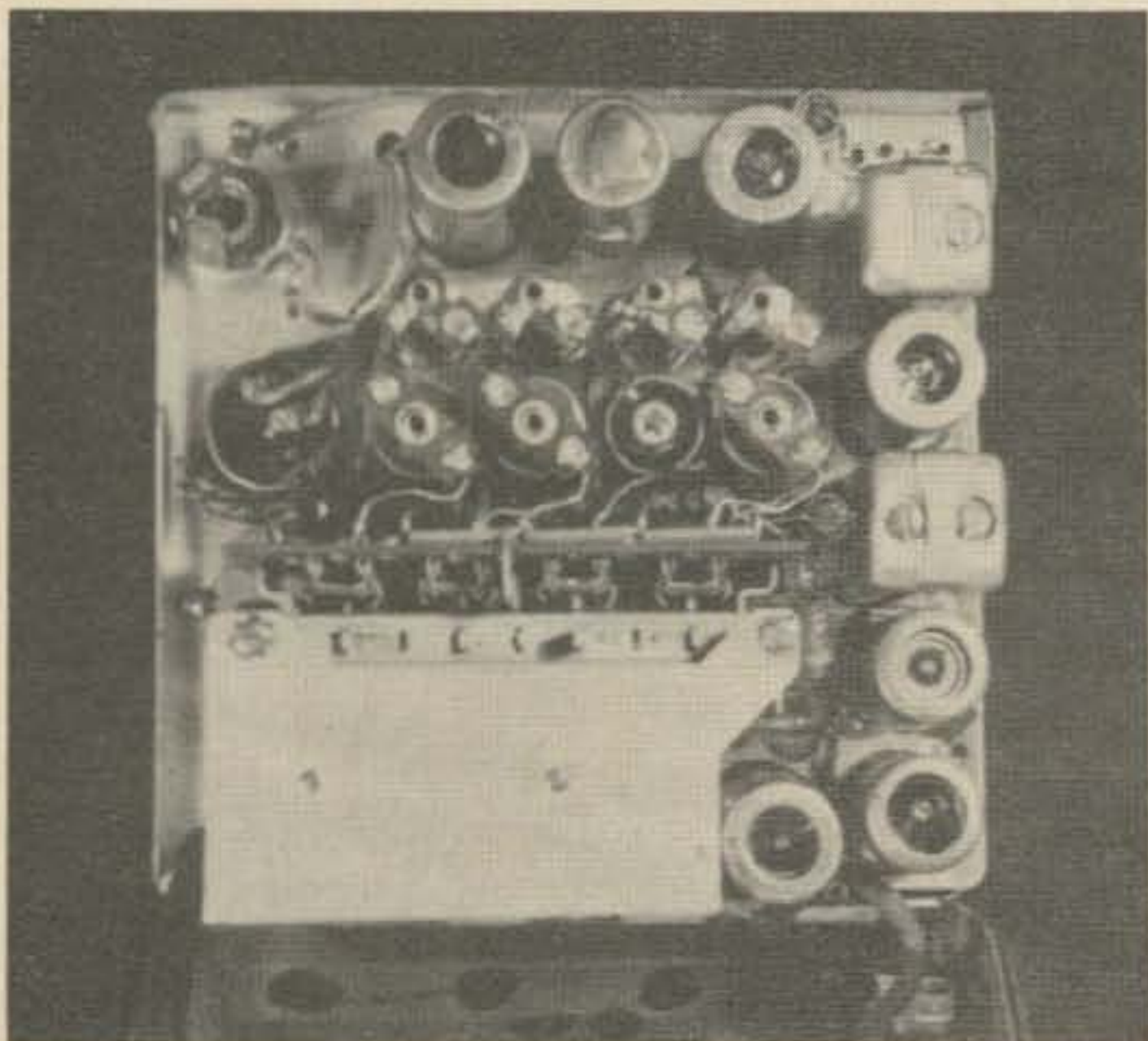

Inside the BC-728. Note the large amount of elbow room. No crowding like most surplus gear!

MHz, and channel four from 4.5 to 6 MHz. While this was designed as a fixed channel receiver, you will find that there are tuning knobs right below each push button for tuning the channel. Thus, if you want to use the receiver for amateur use you can tune channel one, with a little padding, to the 160 meter band. Once you have peaked up the antenna and rf knobs you only have to tune the oscillator knob to cover the band.

Applications

For amateur band reception it is simple to slightly retune channel one for 160 meters. Channel three covers 75 meters as it stands, and channel four can be retuned to cover 40 meters quite easily.

Boating enthusiasts (or friends of boating enthusiasts) will find channel one worth more than the price of the whole unit for it covers the ship-to-shore bands and really brings them in with a wallop.

People having an interest in time and frequency standard signals (astronomy, piano tuning, watch adjustment, event timing, etc.) will find the receiver ideal. Channel one brings in WWV on 2.5 MHz, channel two tunes CHU on 3335 kHz, channel four tunes WWV on 5 MHz, and channel three can be retuned to bring in CHU on 7335 kHz. At least one of these should be available at all times of the day or night.

Conversion

Unless you are interested in wet nursing a wet battery it is a good plan to forget the beautiful vibrator power supply built into the case. This is designed to work with a 2 volt midget wet battery ("Keep upright when charging"). There is also a charging circuit with an external plug to go to a six or twelve volt battery. If you get the charging cable it should come with the battery clips.

Should you agree that dry batteries are

far better than wet (when one is inclined to forget about charging) then you can follow the next instructions. If you are planning to use the receiver for long periods then the wet battery would be a better deal, but for short periods of use dry batteries are ideal.

Step one: remove the power unit. Unscrew all of the bolts you can see coming through the outside case, bottom, top, back, and sides. Open the case and unscrew the knurled screw holding the antenna plug. This plate is also held by two small knurled knuts which will probably take a pliers to loosen. Lift the plate out and let it dangle. Unplug the power plug and gently lift the whole power supply, easing it out of the compartment. There is a little finger that extends into the power supply from the back of the case which will keep the unit from slipping out easily. You will have to work it out. Par for getting the unit out, counting all the screws and antenna plate, is six minutes.

The power unit can be relegated to the "junk box" for possible ravagement on future construction sprees. There are a lot of real nice goodies in it so don't give it the heave-ho.

Power cable

Your choice: remove the power connector socket from the power unit and connect the batteries to this or else remove the plug from the wires and connect them directly. If you decide to deplug the power line then keep track of the wires and connect them the same as you would with the plug.

Batteries

A number 6 dry cell is best for the filaments. They draw 300 mA at 1.5 volts, which will run down a flashlight cell pretty fast. And besides, there is plenty of room for the larger cell. A small 67½ volt portable radio battery will give more power than you need for the B plus and the drain is only 7 mA, so even the small #VS-016 batteries will give good life. You will also need a bias supply. Since there is no current involved here you can use small transistor radio or photoflash batteries. You will need about 7 volts, so a 7½ or 9 volt battery will do fine. Penlight cells, soldered in series are excellent and inexpensive.

Retuning the channels

Once you have gotten the receiver working and have checked out all the channels you are

ready to retune. Let us take one specific channel and go through the process. For instance, if we want to move channel three so it will cover the 40 meter band, here is what we will have to do.

Since you will be about doubling the frequency of the channel you will have to remove about half of the windings from the three coils in that channel. Remove the shield can over the antenna coils and cut the connections to coil 3. The four small tongues can be bent back from the bottom of the coil form to release the coil. It is easier to remove turns when you have the coil right out there in your hand. Unwind half of the turns from the terminal end of the coil. Don't be afraid, make it a good generous half or you may have to pull it back out and pull off some more. Resolder the wire end of the coil to the terminal and put the form back into the set. Once the coil is soldered back in the circuit you can make sure you hit the right spot by checking it with a grid-dip meter and tuning the slug to both extremes to find out the new range of the antenna circuit.

Be very careful of the bottom end of the coil for if you should break the wire going from the terminal to the bottom of the coil you will have problems. The coil is wound with every other turn overlapped so that it is extremely difficult to unwind a turn or two from the bottom of the coil in order to give you enough wire to reach back up to the terminal. Better careful than sorry, to coin a phrase.

Step two is the rf stage. This is just as easy as the antenna coil. Do it the same way. There are not as many turns on this coil so you will only have to pull off about 30 turns instead of 40; run it down half way. Dip this one too if you have the instrument. Order a dipper if you don't have one so you'll be in better shape for the next conversion you try. Every ham shack should have a dip meter.

Now comes the p-d-r (piece de resistance), the oscillator. This coil is well shielded and, short of major surgery, you haven't a prayer of getting the coil out to work on. So? So work on it in the set. Warning: be careful. But don't worry, even if you louse everything up you can get back out of the predicament in a few minutes. Clip the wires going to the coil terminals from the set. Then clip the terminal board so that the two terminals are free. Next pry out the circular piece

NEW callbooks

**GET
YOUR
COPY
NOW!**



Over 60% of listings changed in only a year!
QSL Managers Around the World in every issue!
Plus many other interesting features!

Over 275,000 QTH's in the U.S. edition \$5.95
Over 127,000 QTH's in the DX edition \$3.95

See your favorite dealer or order direct (add 25c for mailing in U.S., Possessions & Canada. Elsewhere add 50c).

Radio Amateurs Reference Library of Maps—Order Your Set Today!



WORLD PREFIX MAP—Full color, 40" x 28", shows prefixes on each country . . . DX zones, time zones, cities, cross referenced tables postpaid \$1.00

RADIO AMATEURS GREAT CIRCLE CHART OF THE WORLD—from the center of the United States! Full color, 29" x 25", listing Great Circle bearings in degrees for six major U.S. cities; Boston, Washington, D.C., Miami, Seattle, San Francisco & Los Angeles postpaid \$1.00

RADIO AMATEURS MAP OF NORTH AMERICA! Full color, 29" x 25" — includes Central America and the Caribbean to the equator, showing call areas, zone boundaries, prefixes and time zones, FCC frequency chart, plus informative information on each of the 50 United States and other Countries \$1.00

WORLD ATLAS—Only Atlas compiled for amateurs. Polar projection, six continents, prefixes on each country . . . full color, 16 pages postpaid \$1.50

Complete reference library of maps—set of 4 as listed above postpaid \$3.00

See your favorite dealer or order direct.

**WRITE FOR
FREE
BROCHURE!**

RADIO AMATEUR



callbook INC.

Dept. B, 4844 W. Fullerton Ave.
Chicago, Ill. 60639

that keeps you from seeing down into the coil. Watch yourself on this move for you can break off one of the wires of the coil which come through the two holes in the circular piece. The upper terminal (on the rf coil side) is the bottom end of the winding. Lay that over the coil shield out of the way. Now reach down with a midget screwdriver and pull off the tape from the top of the coil. With that off you can unwind the coil turns freely. Pull off 35 turns. If you lose count don't worry about it. You can stop at any time and resolder the wires into the circuit and see where the oscillator is perking by turning on the set. A dipper won't give you much indication due to the coil shield.

When checking for oscillator range it is handy to have a signal generator on hand. This is another pretty basic piece of test equipment for the well run ham shack. Lacking this basic unit you can always tune in a distinctive signal and hunt for it on your regular all-wave receiver. Good heavens, don't you even have that?

When you are all through pruning the coils it wouldn't hurt any to paint on a bit of coil dope to hold them together.

What's that Elmer? You say you broke the wire on the oscillator coil and don't know what to do. Well, in that case you can pull off all the wire from this coil and scrape the form as clean as you can. Then you wind up a new coil for yourself out of #31 enamel covered wire (or #29, 30, 32 etc.) and slip it over the form, holding it in place with the aforementioned coil dope. About 35 turns should do.

Antenna

The AN-75-C antenna, which was designed for the BC-728, is the best deal, but you may have some trouble locating it. For some obscure reason the antennas seem to have gone one way and the receivers another, though both are available in quantity. Should you decide for one reason or another to do without the AN-75-C you can get fine results by connecting a short length of wire to a Motorola type plug. Fifteen feet works well. You can coil this up and carry it inside the set when not in use and then fling it up into a nearby tree or house for operation. Or you can put a clip on the end of the wire and connect onto more ambitious wires. When changing antennas remember to open up the set and retune the antenna circuit for maximum volume. ■

MOBILE CEIVER

get rolling!

WE NEED
TRADE INS!



COLLINS KWM-2	\$1150.00
516F2 AC pow/sup	153.00
MP-1 DC pow/sup	198.00
351D-2 mobile mount	120.00

DRAKE TR-4	\$ 599.95
AC4—AC p/s	99.95
DC3—DC p/s	149.95
MS4 Speaker	19.95
MMK-3 mobile bracket	6.95

EICO 753 Kit	\$ 189.95
EICO 753 wired	299.95
(Mobile brackets inc.)	
751K AC pow/sup (Kit)	79.95
751W pow/sup (Wired)	109.95
752K DC pow/sup (Kit)	79.95
752W DC pow/sup (Wired)	109.95

HALLICRAFTERS SR500	\$ 399.95
P500 AC pow/sup	119.95
P500 DC pow/sup	149.95
MR-500 mobile mount	14.95

NATIONAL 200	\$ 359.00
(Mobile brackets inc.)	
AC-200 AC pow/sup	75.00
PS150-12 DC pow/sup	99.50

SWAN 350	\$ 420.00
(Mobile brackets inc.)	
117XC AC pow/sup	95.00
14-117 DC pow/sup	130.00
14X DC Module	65.00
SWAN 250 6Meters	325.00
(Uses same p/s as 350)	

I will ship to you freight free! Write to me for top trade-in allowance!

MISSION HAM SUPPLIES

3316 Main Street
Riverside 3, California 92501
Phone 683-0523 (area code 714)



**LINEAR
AMPLIFIER**



Complete with
Eimac 3-1000Z

\$79500

RF section only,
with tube \$495

Power Supply,
separate \$300

Full power input of 2 KW PEP SSB—1000 DC Watts CW-AM-RTTY. More than 20 important advanced features. New HD tank gives more output, especially on 10 meters. More TVI suppression. Most any exciter can drive to full output. 220/115 VAC operation.

**ORDER
TODAY**

MISSION HAM SUPPLIES

3316 Main Street, Riverside, Calif. 92501

- Send spec sheet on BTI Linear.
- QUOTE trade allowance and terms.
- Please send latest HAM flyer.
- Put me on your mailing list.

NAME _____ Call _____
(please print)

Address _____

City _____ State _____ Zip _____
(Calif. orders add 4% tax)

W. R. McCullagh VE3DAN
McCullagh Studio
73 Simcoe Street
Toronto, Ontario, Canada

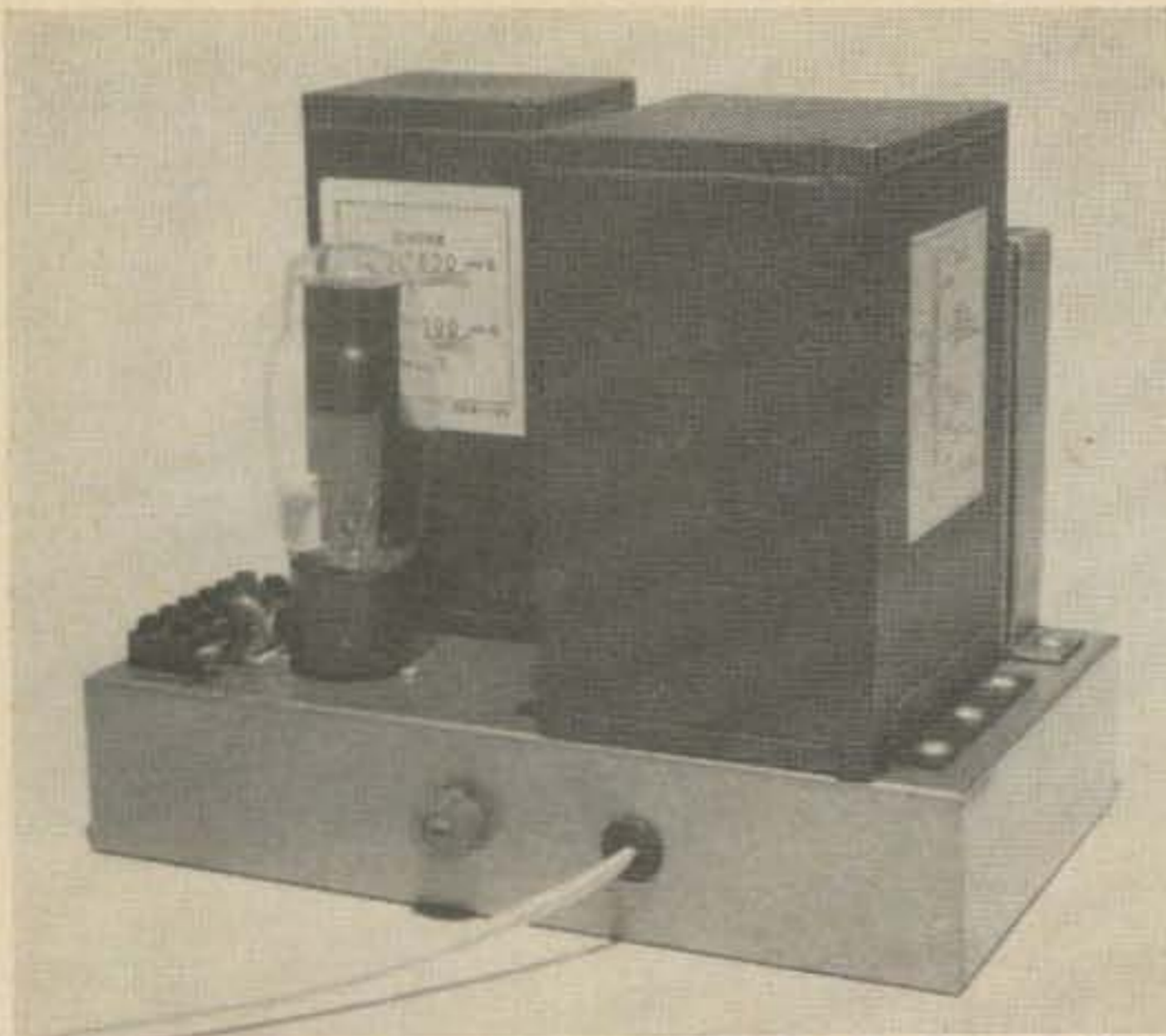

Power supply. The picture was taken with Ilford Pan F film in the 4 x 5 inch camera. There was one spotlight overhead.

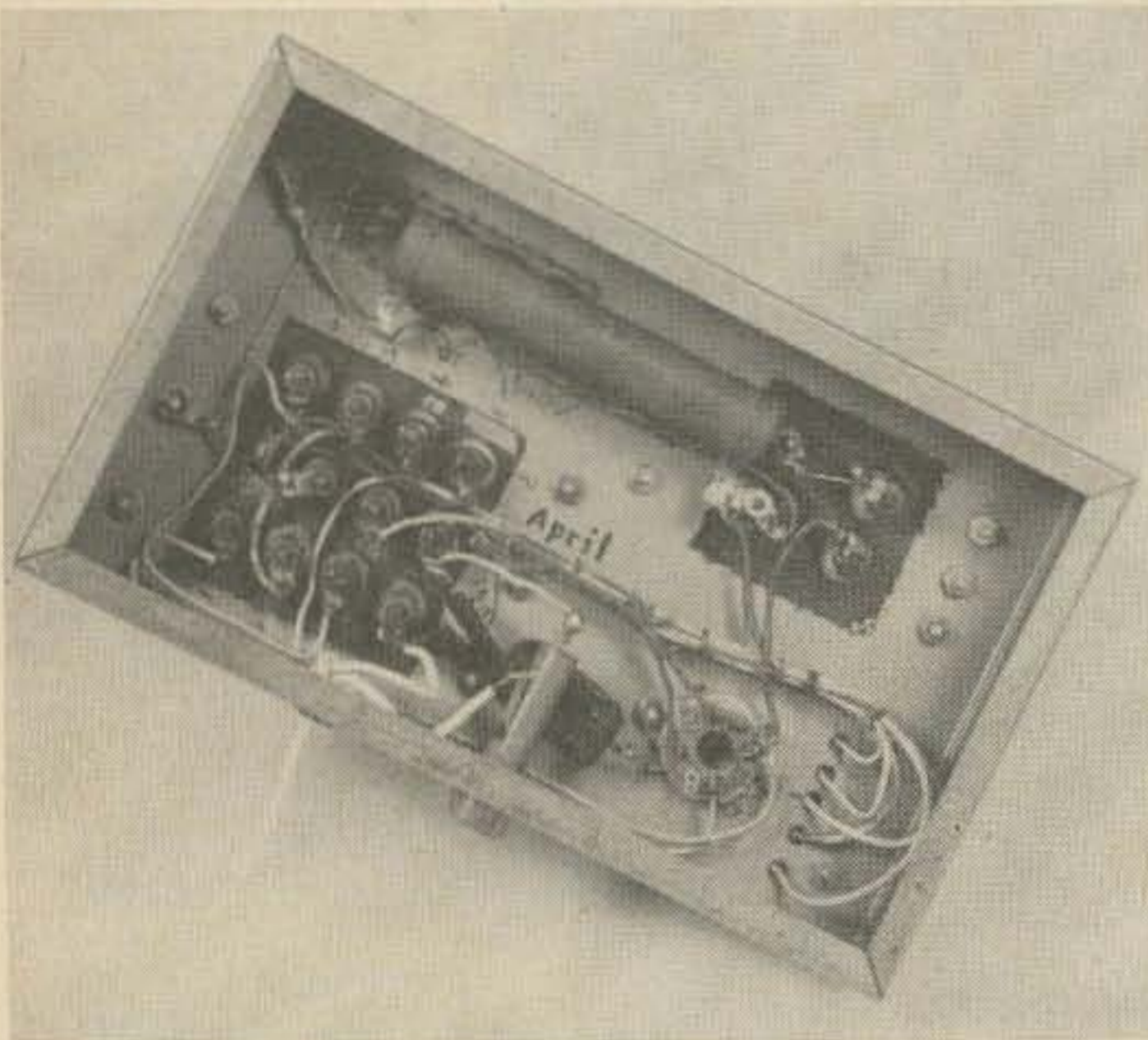

Bottom view of power supply. The camera used was a Cannon FX with a 50 mm lens. Photofloods in reflectors, no diffusion. Tri X film.

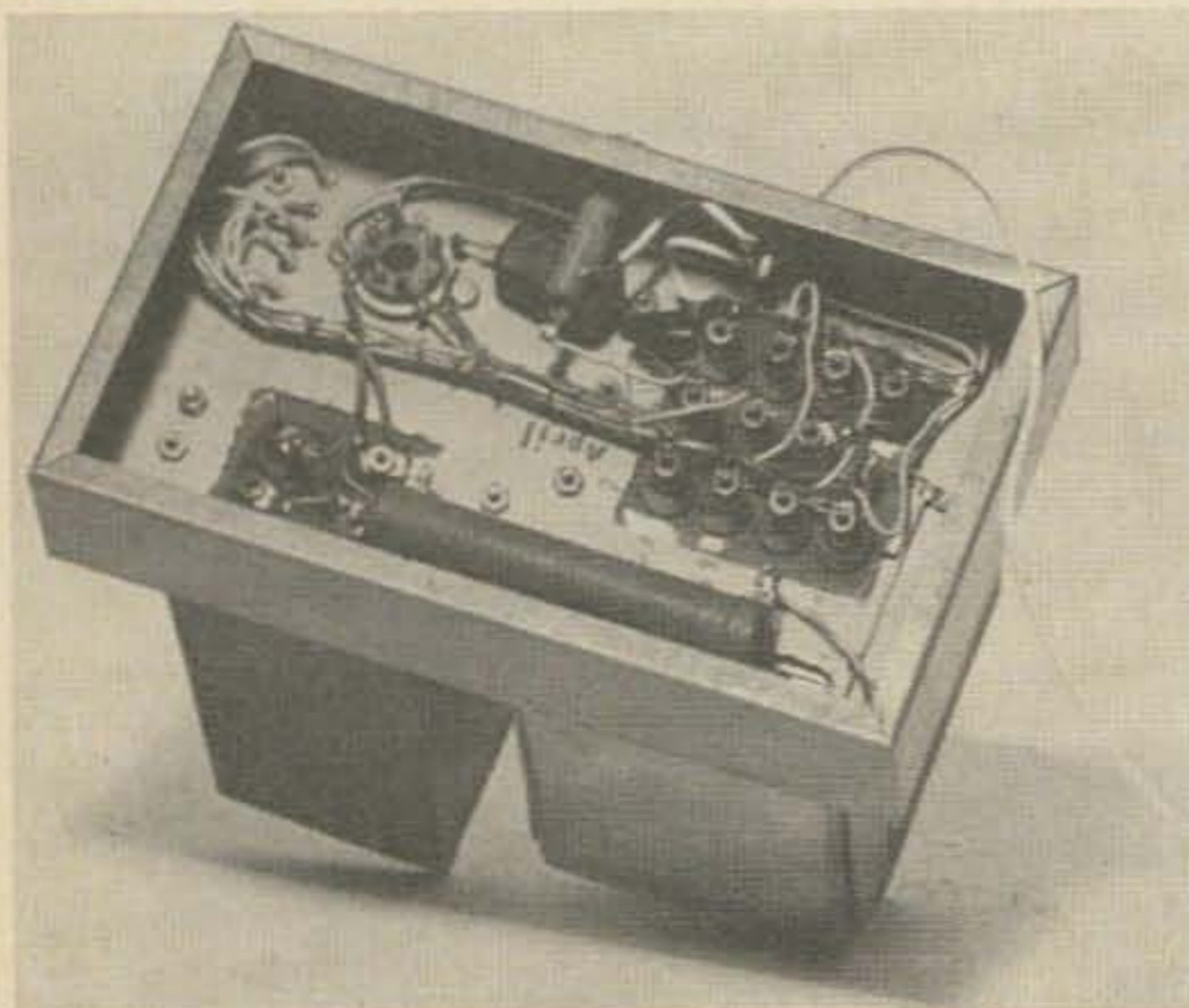

Underneath the power supply. The 4 x 5 inch camera was used, with diffused lighting.

Photographing your Electronic Gadgets

Practically every article in radio publications uses at least one photograph. Some of these are good, some are excellent—but a lot of them are poor. Yet I have never seen an article on how to photograph equipment properly, so here goes.

The amateur writing about his electronic gadgets is naturally going to use whatever camera equipment he has. If he did have a choice of equipment what would be best? A large view camera with tilting front and back, even if it is an old one, is tops; with this he is able to correct converging verticals.

The professional photographer uses a 4 x 5 or 8 x 10 inch camera, but it is possible to take good photographs with a box camera. A tripod or camera stand is a must, the heavier and sturdier the better.

Almost any lens will take a good photograph when closed down, as it should be to get everything in focus. For the small camera a long focus lens is best, except for detailed close-ups.

Lights don't need to be elaborate; photofloods in reflectors, reflector floods and even an ordinary lamp hand held is quite usable, as is the ordinary room lighting. Flash lamps



Balanced transistor amplifier for photovoltaic cell light meter. This shot was taken with a 4 x 5 inch camera.

aren't very good and electronic flash isn't much better unless you really know what you are doing.

As the camera should be on a stand or clamped to something solid, fast film isn't necessary. For a small camera slow, fine grain film usually makes a better enlargement, although some of the newer fast films, such as Kodak Tri X, are excellent. Don't forget the exposure meter; most camera users have one and should know how to use it.

If you are using a view camera, don't forget that a close-up photo requires more exposure. See your camera manual regarding this. This is needed because of the additional bellows extension.

For a background, use a white card or unwrinkled white paper available from art supply houses.

Most editors like a large print, preferably 8 x 10 inches, so an enlarger is needed unless a friend or drug store is making the prints.

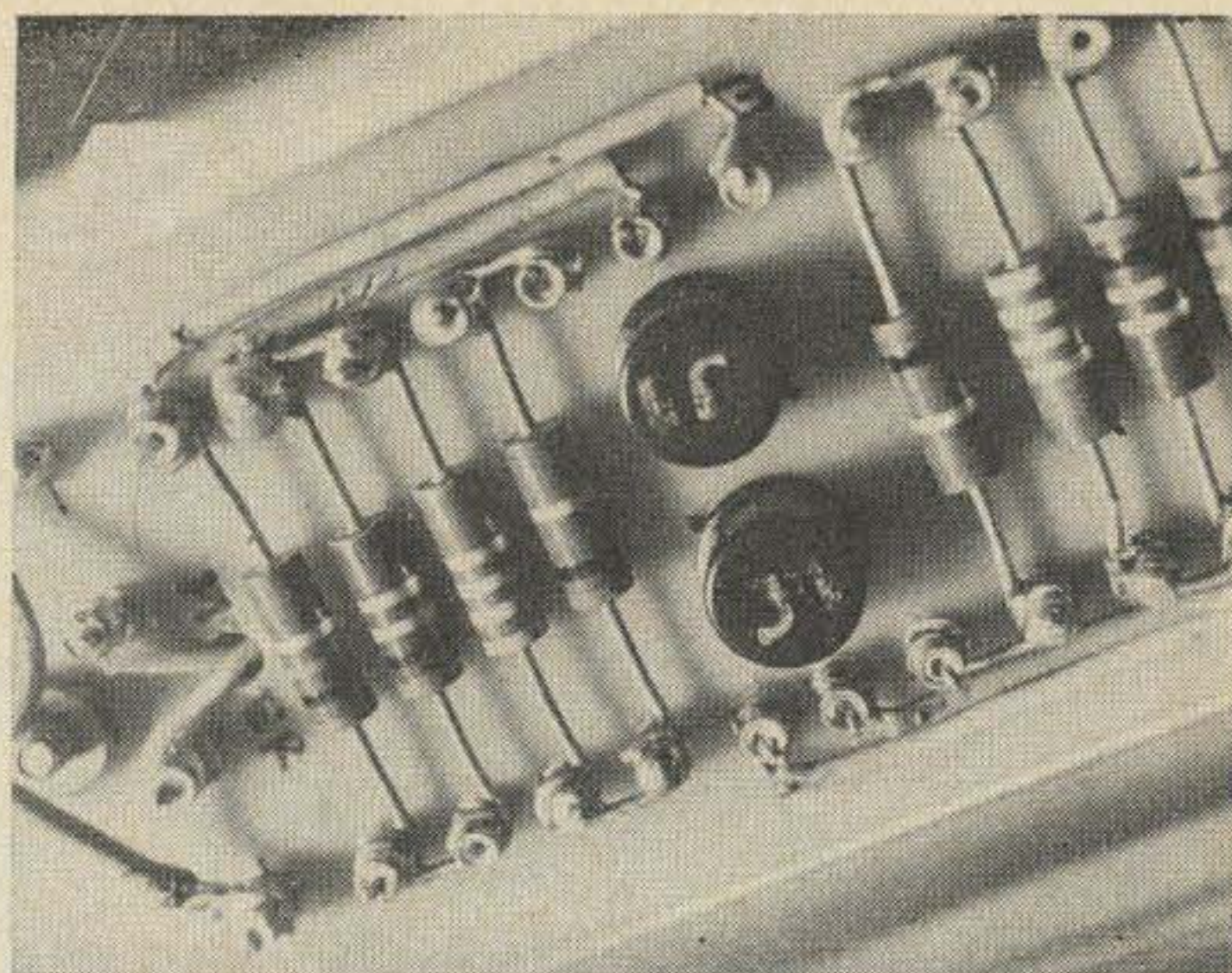

Closeup of a balanced transistor amplifier. The camera—Edixa reflex, with a Novoflex 35 mm lens. Tri X film.

Reflectors to lighten up shadow areas may be white cards or even a newspaper and some diffusing material such as tracing paper or cloth, although glass cloth is the preferred material.

Looking over a number of radio magazines the most common faults in the photographs seem to be blurring, probably due to improper focusing or movement of the camera; and burnt out faces, due to having a flash on the camera too close to the subject. We mustn't rule out poor engraving and printing, over which the photographer has no control. However, if the prints submitted aren't overly contrasty or soft and mushy, but are sharp and have a full range of tones from lights to darks, the chance of good reproduction is good.

Which brings up to the subject of process-

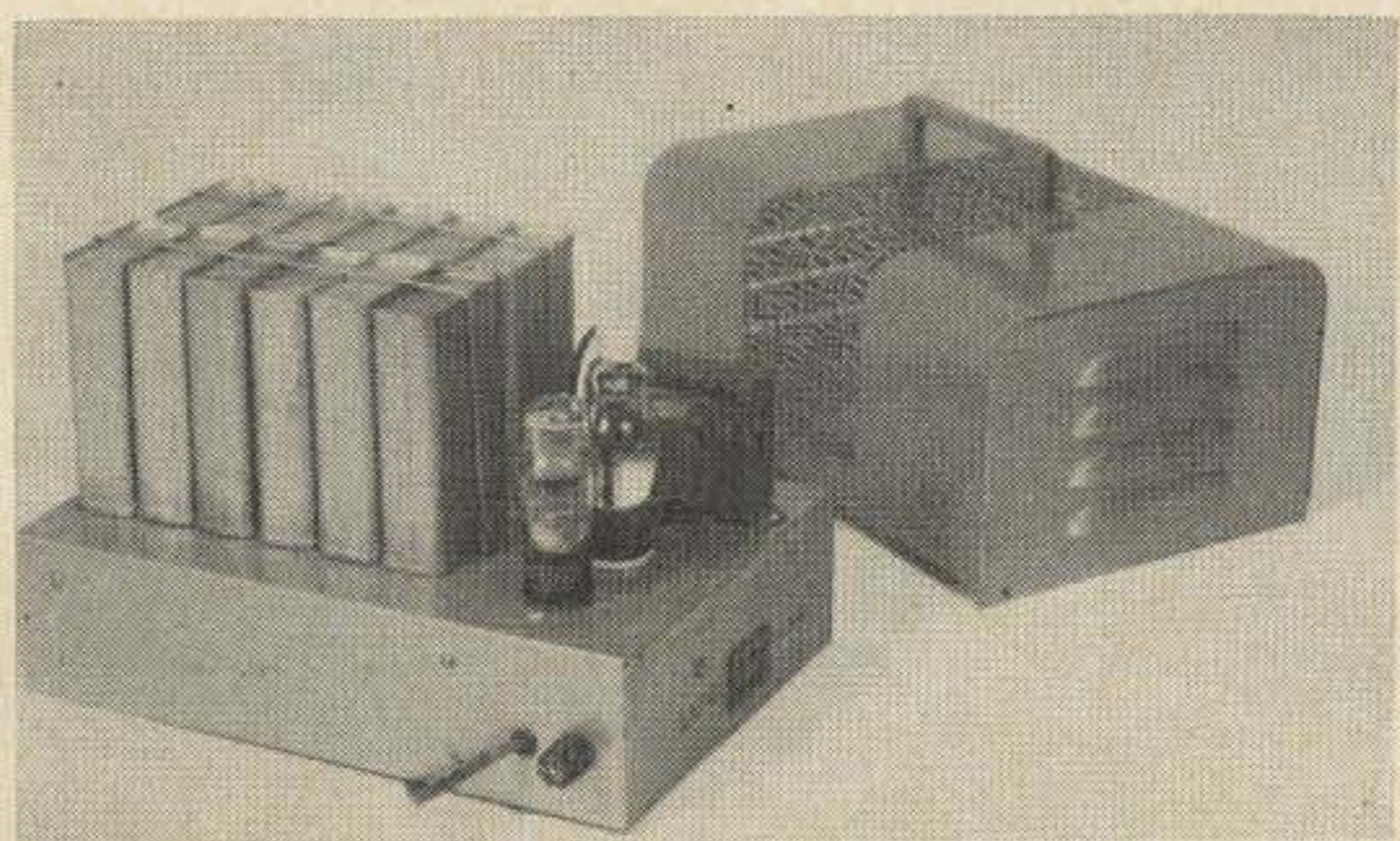

High voltage flash unit, with protective cover. A 4 x 5 inch camera with two diffused lights was used.

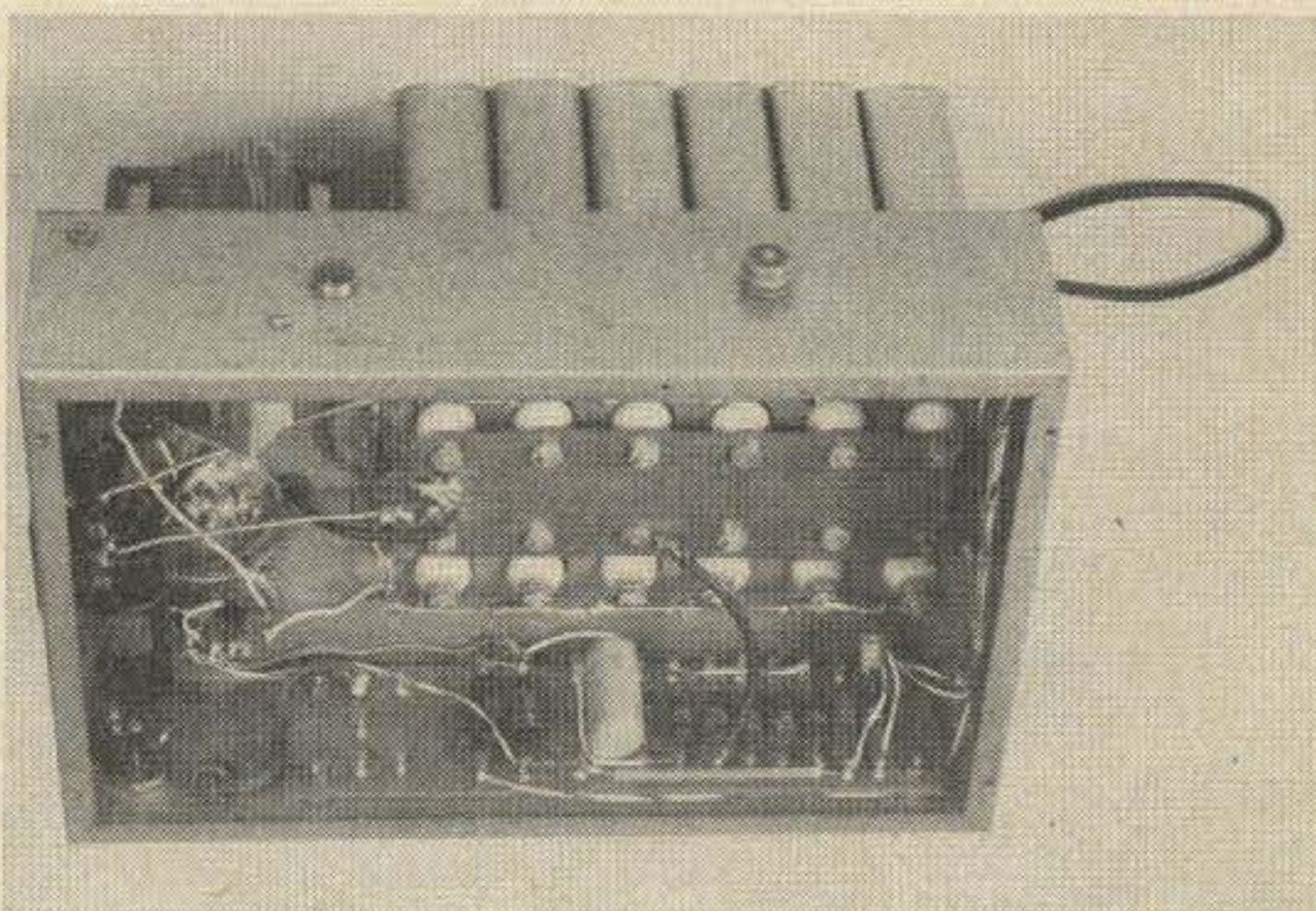

Inside view of the high voltage flash unit. The large connector is used because of extremely high currents which may peak at 800 amperes at 2500 volts. Definitely not for the beginner.

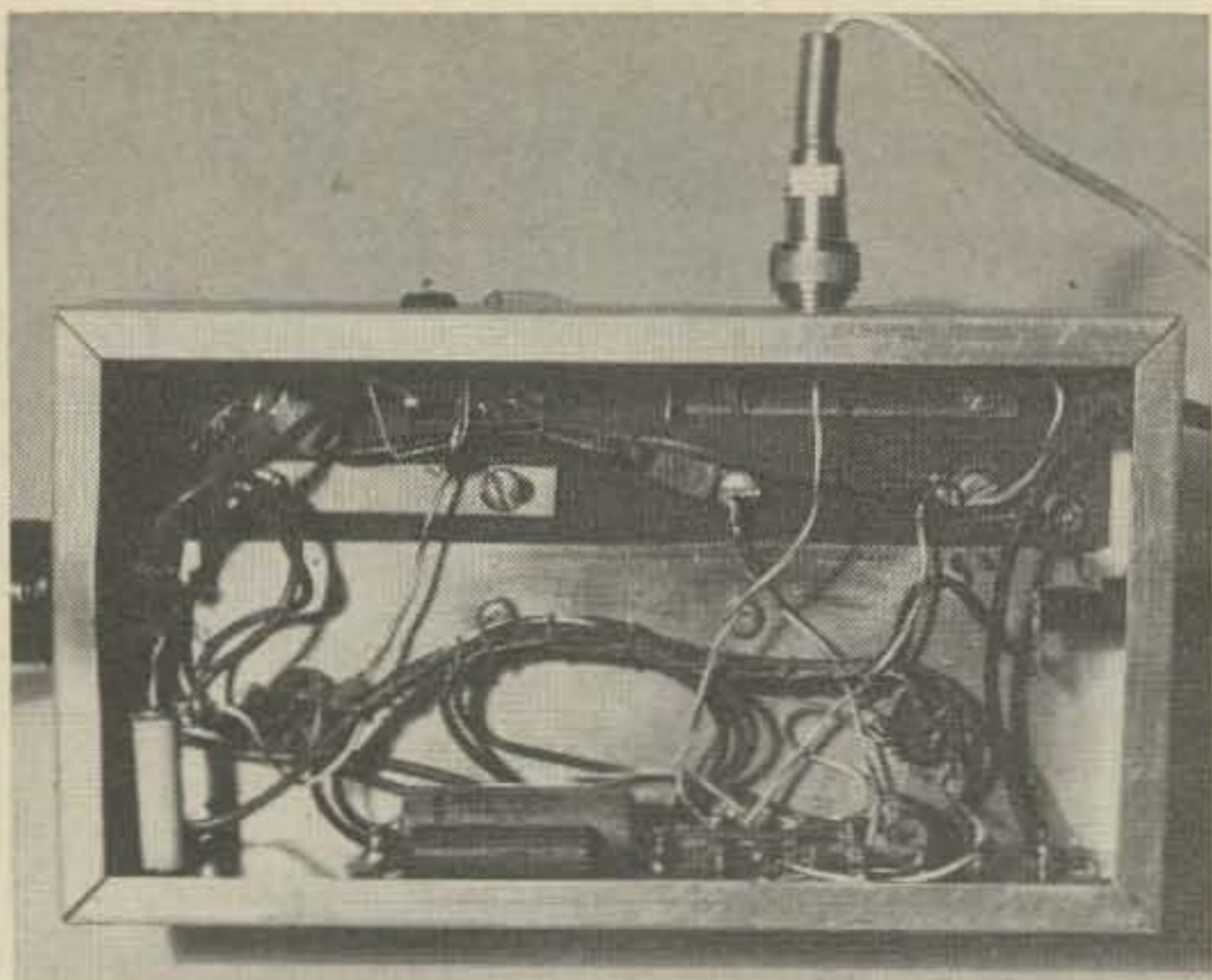

Inside the 50 watt second power supply. This supplied the power to take this photograph. The light was harsh, undiffused.

ing. The film and paper manufacturers have spent large sums of money working out the proper processing for their materials, and are anxious to have you get the best results possible. They should know what's best for their products, so it's a good idea to follow the instructions in the package.

To sum up. First, have a good solid support for the camera. Take the time to arrange the subject. Try a number of angles. To be sure of the best exposure; take a few extra shots at different speeds—film is cheap.

If possible use a lens of longer than "normal" focal length to get better perspective and possibly a short focal length lens for very close up shots. Use a small aperture for greater overall sharpness and use fine grain film if you are using a small camera.

Avoid harsh lighting, and over or under development of the film. Make a print on



The flash for this photograph was provided by the low voltage power supply pictured. 4 x 5 inch camera used.

glossy paper with full tonal range. The editor likes lots of pictures.

As the great majority of my work is done with large cameras, and as they were available and I feel more at home with them. I used a couple of Speed Graphics, one with a 127 mm Ektar lens, the other with a 135 mm Zeiss Tessar lens. There is no discernible difference in results. I also used a Cannon FP Reflex with a 50 mm and 135 mm lenses and an Edixa Reflex with a Noflexar 35 mm lens, which will focus down to about two inches from the object.

For the 4 x 5 cameras I used Ilford FP3, a fine grain film; for the 35 mm cameras I used Kodak Tri X film and Ilford Pan F, an extremely fine grain film. I imagine the editor would find the Tri X acceptable, although fairly grainy. I doubt if this would show when printed. ■

Why Fight Ohm's Law and Lose?

An article by K5HPT in the October 1963 issue of 73 described a simple phone patch. The title was "Why Fight Ohm's Law?" Well, I did—and lost. It was a big hum of a mess. So John WA4CUA and I experimented and came up with the circuit shown. I used two transformers back to back and added rf bypassing. I have had several requests for a drawing of the patch by those who have heard it on the air.

. . . Roger Williams WA4KWC

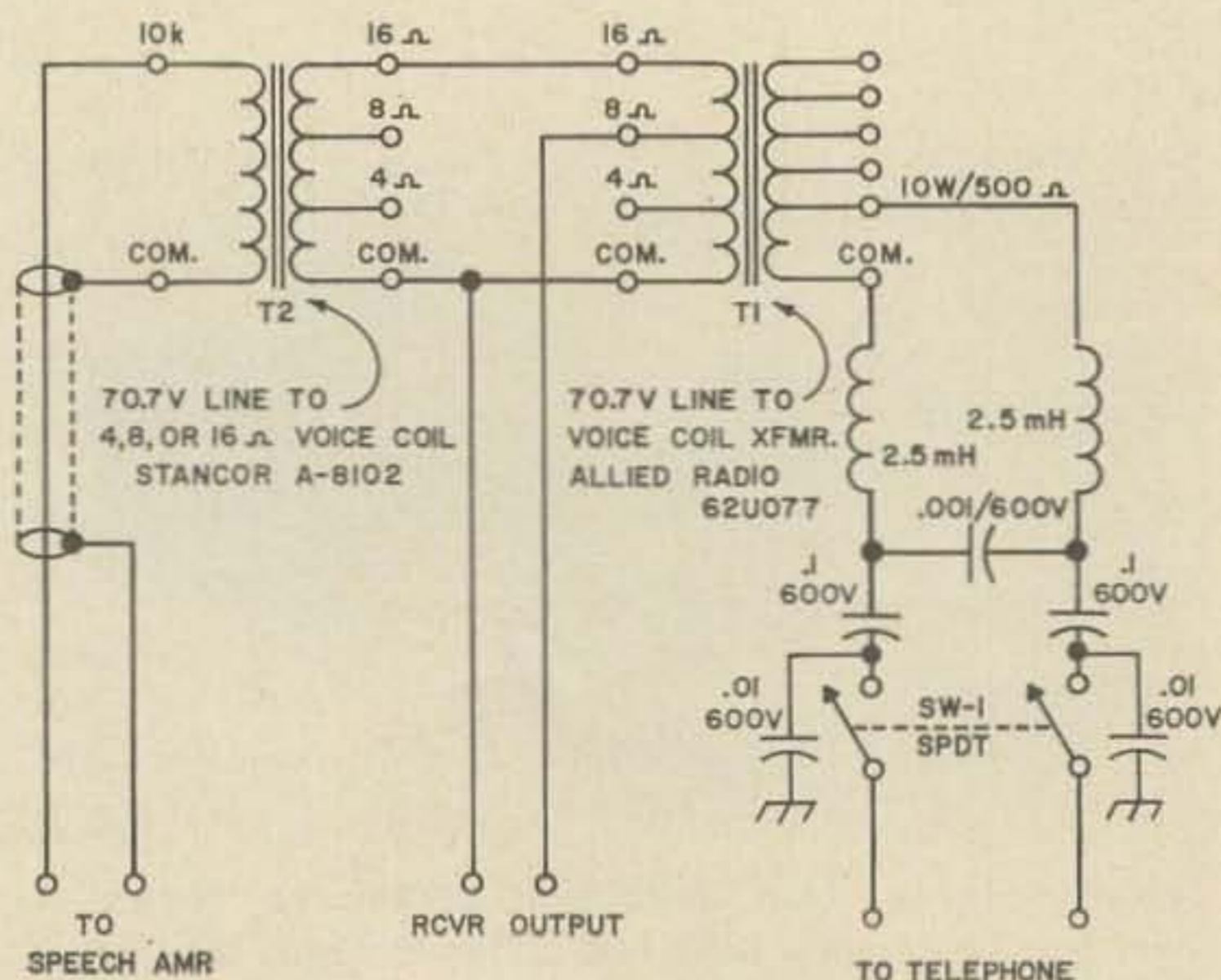



LOOK at your low Monthly Payment
AFTER JUST \$5⁰⁰ DOWN

SWAN 350 80-10m Transceiver.....	(14.98)	\$420.00
SWAN 400 80-10m - No VFO.....	(14.98)	420.00
SWAN 500 80-10m - Deluxe.....	(17.69)	495.00
SWAN 250 6m Transceiver.....	(11.55)	325.00
Mark I 10-80m Linear - less tubes ...	(16.79)	475.00
Mark 6 6m Linear - less tubes	(16.97)	475.00
Two 3-400Z Tubes for Mark I or 6.....		68.00
117XC AC Supply for 350/250.....		95.00
117XB AC Supply for 400.....		75.00
14-117 12v DC Supply w/cable.....		130.00
405X MARS Oscillator - less crystals		45.00
406B Small Phone Band VFO		75.00
410 Full-Coverage VFO.....		95.00
210 6 Meter VFO.....		120.00
VX-1 Plug-in VOX for 350 & 400		35.00
SSB-2 Selectable Sideband kit for 350		18.00
22 Dual VFO Adaptor for 350 & 400.....		25.00
100kc Calibrator kit for 350.....		19.50
500kc Calibrator kit for 250.....		19.50
RC-2 Remote Control kit for 400.....		25.00
45 Swantenna - Manual		65.00
55 Swantenna - Remote Control.....		95.00
Custom Contour Bumper Mount.....		24.95
Kwik-On Antenna Connector		3.25

NOTE: Above are listed the "Standard - Everyday" Swan products - Below are listed some Special Purpose items:

14X 12v DC Module w/cable.....	\$ 65.00
14XP As above, but Positive Ground.....	70.00
117X Basic 117v AC Supply ONLY.....	65.00
230X Basic 230v AC Supply ONLY.....	75.00
117 or 230vac Line Cord (specify)	5.00
8' Cable w/plug (Supply to Transceiver).....	3.00
Cabinet w/Speaker & AC Line Cord.....	30.00
230XC 230v AC Supply for 350/250.....	105.00
14-230 12v DC Supply w/230v Basic	140.00
230XB 230v AC Supply for 400.....	85.00



AMATEUR ELECTRONIC SUPPLY

4828 West Fond du Lac Avenue
Milwaukee, Wisconsin 53216
Phone (414) 442-4200

MILWAUKEE STORE HOURS: Mon & Fri - 9 am to 9 pm;
Tues, Wed, Thurs - 9 am to 5:30 pm; Sat - 9 am to 3 pm

IMPORTANT! - Be sure to send all Mail Orders and Inquiries to our Milwaukee store, whose address is shown above. VISIT - Please do not write the following Branch stores - they are set up to handle walk-in trade only.

CHICAGO, ILLINOIS
6450 Milwaukee Avenue
Phone (312) 763-1030

ORLANDO, FLORIDA
19 Azalea Pk. Shpg. Ctr.
Phone (305) 277-8231

CHICAGO & ORLANDO STORE HOURS: Mon, Wed, Thurs - 12 to 9 pm; Tues & Fri - 12 to 5:30 pm; Sat - 10 am to 4 pm



SAVE \$50

Purchase any new Swan transceiver or linear at the regular price with no trade-in and you may take a \$50.00 Credit toward the purchase of any other merchandise.

Order Today direct from this ad!



Terry Serman, W9DIA
Proprietor

TRADES ??
GET OUR
DEAL TODAY!
Use Handy
Coupon
Below



Ray Grenier, K9KHW
Mgr. Mail Order Sales

To: **AMATEUR ELECTRONIC SUPPLY**
4828 West Fond du Lac Avenue
Milwaukee, Wisconsin 53216 #7

I am interested in the following new equipment:

I have the following to trade: (what's your deal?)

Ship me the following New Equipment.

I enclose \$ _____, I will pay balance (if any)
 COD 1 year 2 years 3 years

Name _____

Address _____

City _____

State _____ Zip _____

SEND YOUR NEW 1967 CATALOG.

Panoramic Display from the AN/APA-38 Indicator

A simple, low cost approach to panoramic reception.

A very attractive item for the VHF enthusiast is the AN/APA-38 panoramic indicator. It is an earlier version of the IP-69/ALA-2 indicator whose conversion was described in the June 1964 issue of *73 Magazine* and is currently available for under \$20.

The APA-38 was originally used with the APR-1 and APR-4 receivers for identifying radar signals. Basically it is a superheterodyne receiver whose output is a video signal applied to the vertical plates of a cathode ray tube. The input center frequency at 30 MHz is heterodyned to the 6.5 MHz *if* by a sweep oscillator. The frequency limits of the sweep oscillator are controlled by the sweep width control—at its maximum position the indicator will display the spectrum ± 5 MHz of the center frequency.

In addition to the conventional panoramic display, two sweep positions are provided. These sweep ranges (PRF-1 and PRF-2) cover 30 - 1500 hz and permit using the indicator as an oscilloscope for analyzing the modulation of the incoming signal.

Since the indicator was originally designed to operate from a 400 Hz supply, it must be converted to 60 Hz operation. To do this remove the following components: power transformer T-104, high voltage rectifier V-

105, low voltage rectifier V-110, and choke L-101. While you are at it, remove the front panel and the power supply cage.

The 60 Hz supply could be built in the space made by removing the 400 Hz components. However, building it on a separate chassis not only makes construction simpler, it reduces the AC coupling problem and shortens the unit so that it will fit into a 16 inch deep rack.

Build the supply as shown in **Fig. 1**. The need for a special oscilloscope transformer was eliminated by using a voltage doubling circuit for the CRT negative high voltage supply.

Replace the old front panel with standard 8-3/4 inch rack panel. The CRT viewing hole is easily cut with a saber saw. The power supply should be mounted to the panel with a bracket and supported with a shelf. The rf input connector is replaced with a BNC type mounted on the rear of the power supply chassis.

After wiring the power supply, check the indicator for proper operation. Allow it to warm up and advance the brilliance control until a trace is visible. Set the function switch to PAN. Turn the gain control fully clockwise and position the trace along the base line using the horizontal and vertical position controls. Sharpen the trace with the focus control. Couple the output of your signal generator (or grid dip oscillator) to the input connector. With the sweep width control fully clockwise, tune the signal generator from 25 - 35 MHz and observe the pip. Set the signal generator at 30 MHz and center the pip using the center control frequency. The height of the pip should be reduced with the signal generator attenuator until it is not over-loading the display.

Modulate the signal generator with a 400

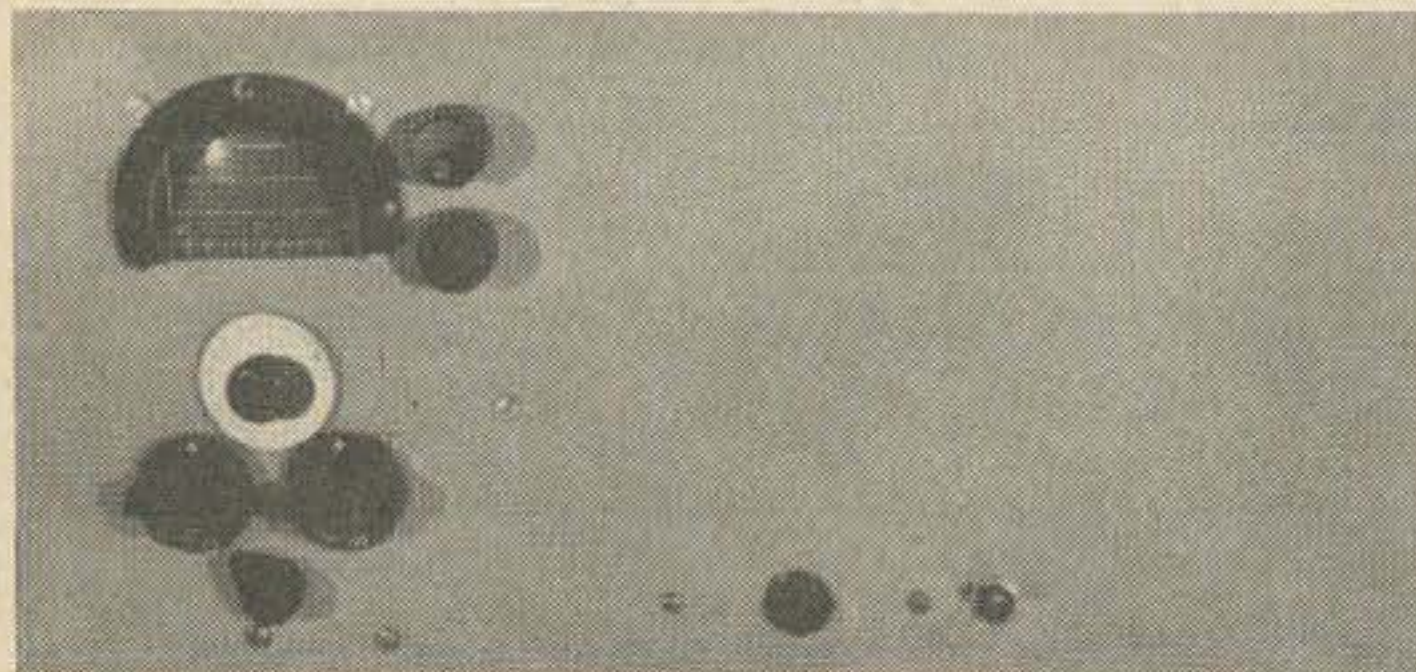

Sam's neat rack-mounted panoramic indicator. Although the center frequency of this unit is 30 MHz, other *if* frequencies may be used with a simple heterodyne converter.

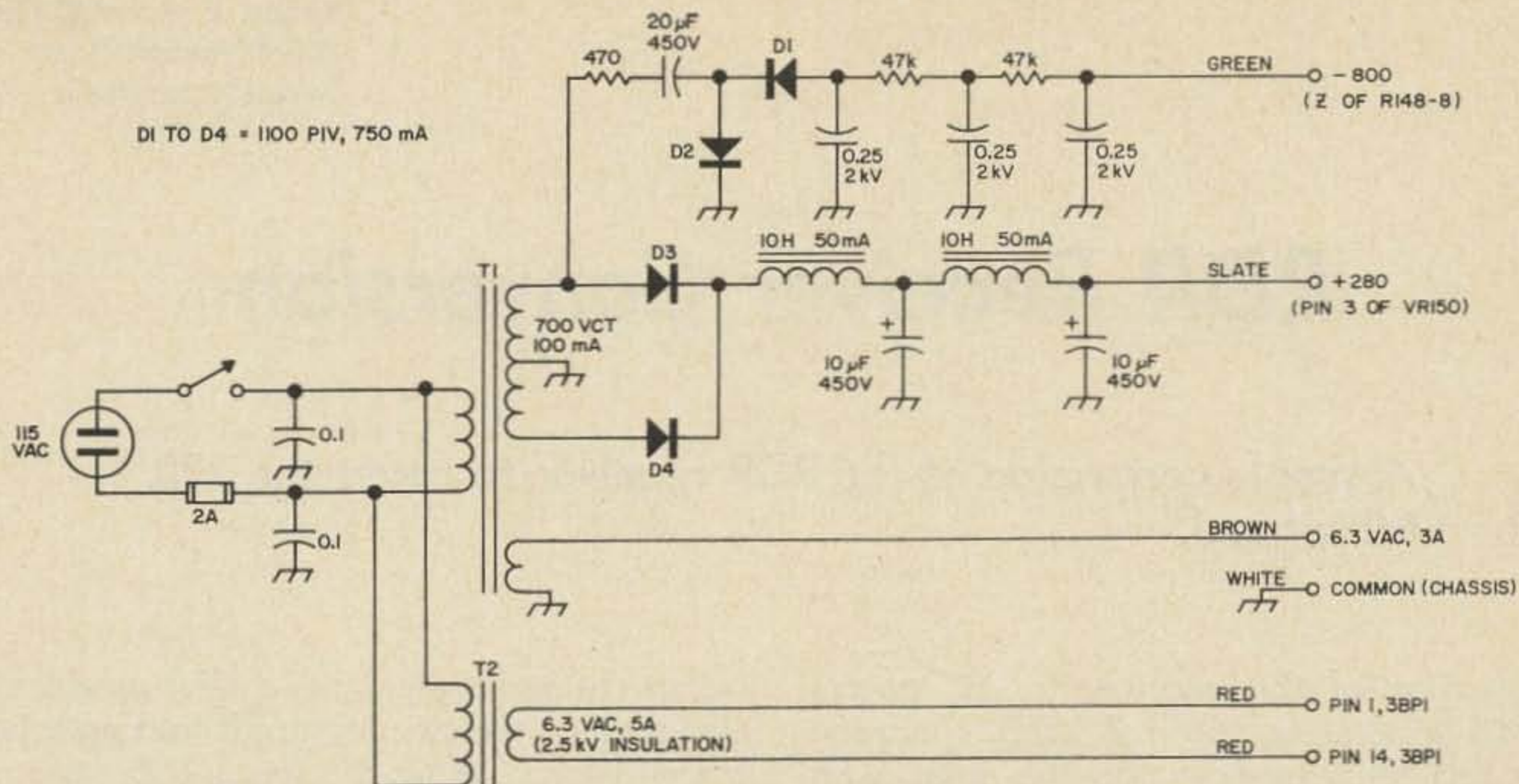

Fig. 1. An AC power supply for the converted AN/APA-38 indicator.

Hz signal. Place the function switch in the PRF-1 position and adjust the sweep control until the signal locks in, and the modulating sine wave is stationary on the CRT.

The indicator is now ready for use. Couple the 30 MHz *if* of your receiver into it and you are ready to go. If you have an *if* other than 30 MHz you can construct a simple heterodyne converter to convert it to 30 MHz.

On the air experience is the best way to become familiar with the operation and uses of a panoramic display. The following is a brief guide to signal identification:

1. A CW or unmodulated carrier appears as a pip of fixed height. If it is a keyed CW signal the pip will appear and disappear with the keying. With a little practice you can copy CW visually!
2. AM signals will appear as a pip of fixed height when no modulation is present. With low frequency modulation the waveform will look like a broad response curve. As the frequency of modulation increases you can observe the sidebands moving away from the carrier.
3. SSB two tone test signals appear as two carriers of slightly different frequency. If the tones are closely spaced they will generally appear as a single deflection varying in height.
4. An MCW signal will appear like a CW signal, varying in height as the transmitter is keyed. If the modulating

frequency is high it will be possible to distinguish the sidebands.

5. An FM signal appears as a multitude of discrete pips. The amplitude of the pips is a function of the modulation index. The spacing between pips is a function of the modulating frequency.

... W6JTT

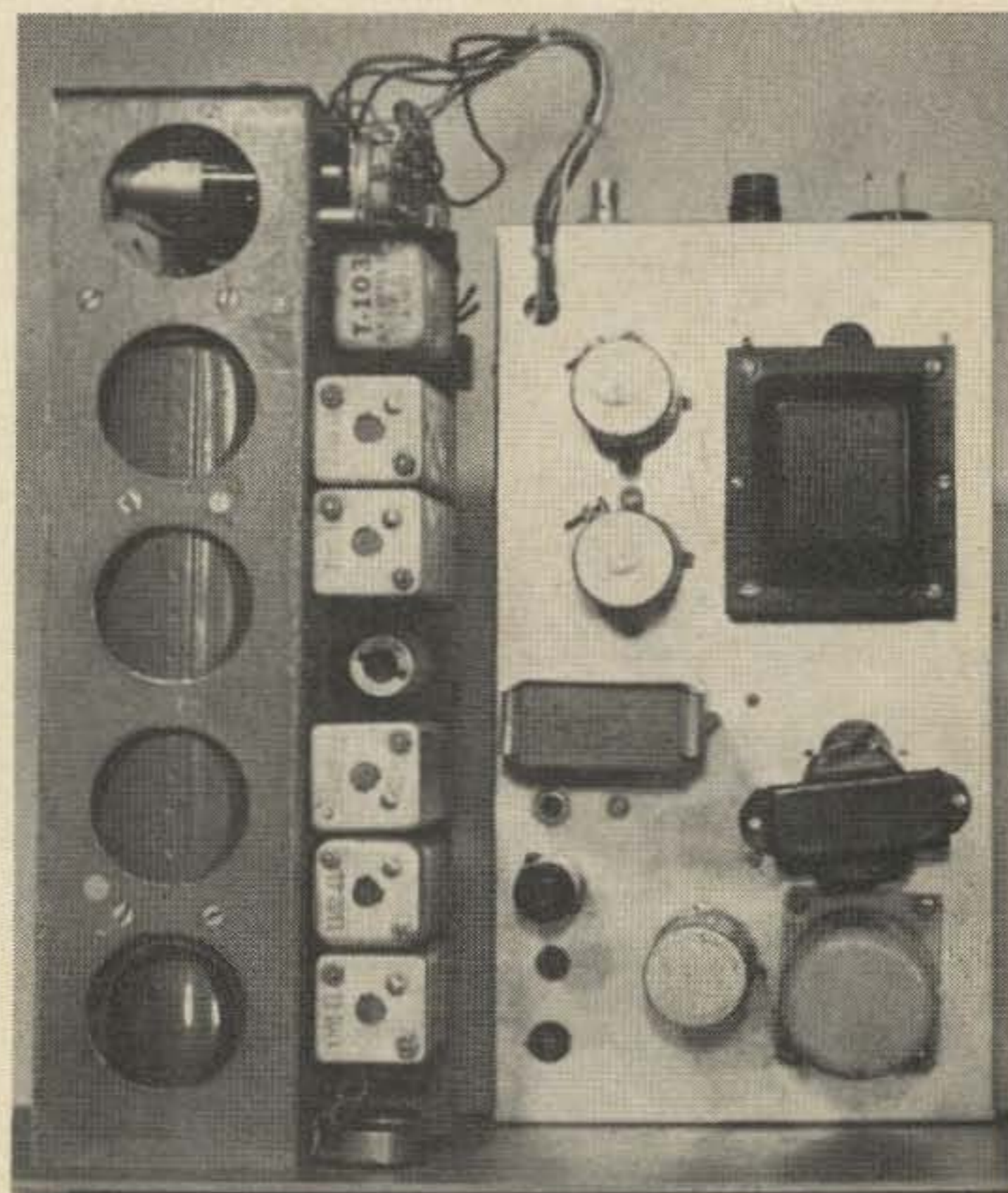

Top view of the converted, rack-mounted AN/APA-38 panoramic indicator. The surplus unit is on the left, and the new 60 Hz power supply is on the right.

RDR Receiver Conversion

A simple conversion of the RDR receiver to cover the 220 MHz band.

Conversion of this receiver to AC operation with crystal or external VFO operation is a worthwhile project for the ham who wants to listen in on the 220 MHz amateur band.

Remove the chassis from the cabinet by loosening the twelve screws around the front edges. Pull out the chassis and by depressing the tabs on the sides, completely remove it from the cabinet. Now, remove everything from the dynamotor compartment, including all wiring, the fuse holder and base by removing four screws along the outside edges. Remove the cover from the crystal and inter-control compartment by removing fourteen screws. Pull out the crystal oven and oven socket, leaving the two heavy wires as long as possible.

Remove all the automatic tuning system

except the multiplier and rf dial mechanism. Also remove the two long rods and associated gears that run along the top and bottom rear of the compartment—this has a short shaft coming straight out the front in the middle of the compartment. Add a coupling to this shaft so it will protrude through your new panel and you will be able to tune both the multiplier and rf controls simultaneously.

Cut out a 5 by 12½ inch panel to mount where the former oven, rf and multiplier cables were covered. Cut out holes for the multiplier and rf dials—also the tuning control, crystal socket, B+ switch, AC switch, pilot light and speaker. Cut a panel 6⅞ by 10 inches to fit the dynamotor compartment; this is for the new power supply. Wiring is simple, as all parts are labeled. Cut out R112 on top behind the front panel. The transformer filament windings go to terminal

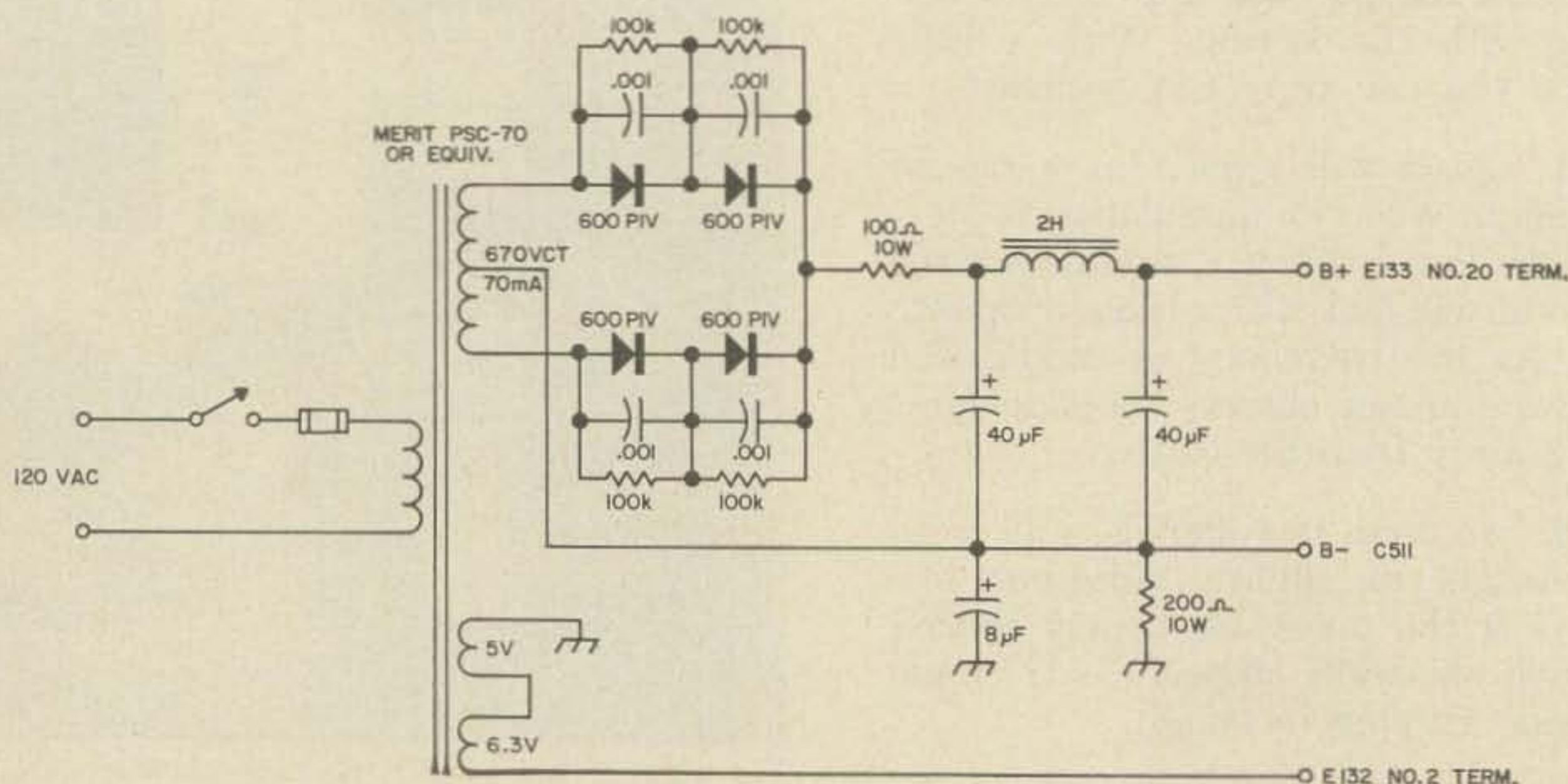
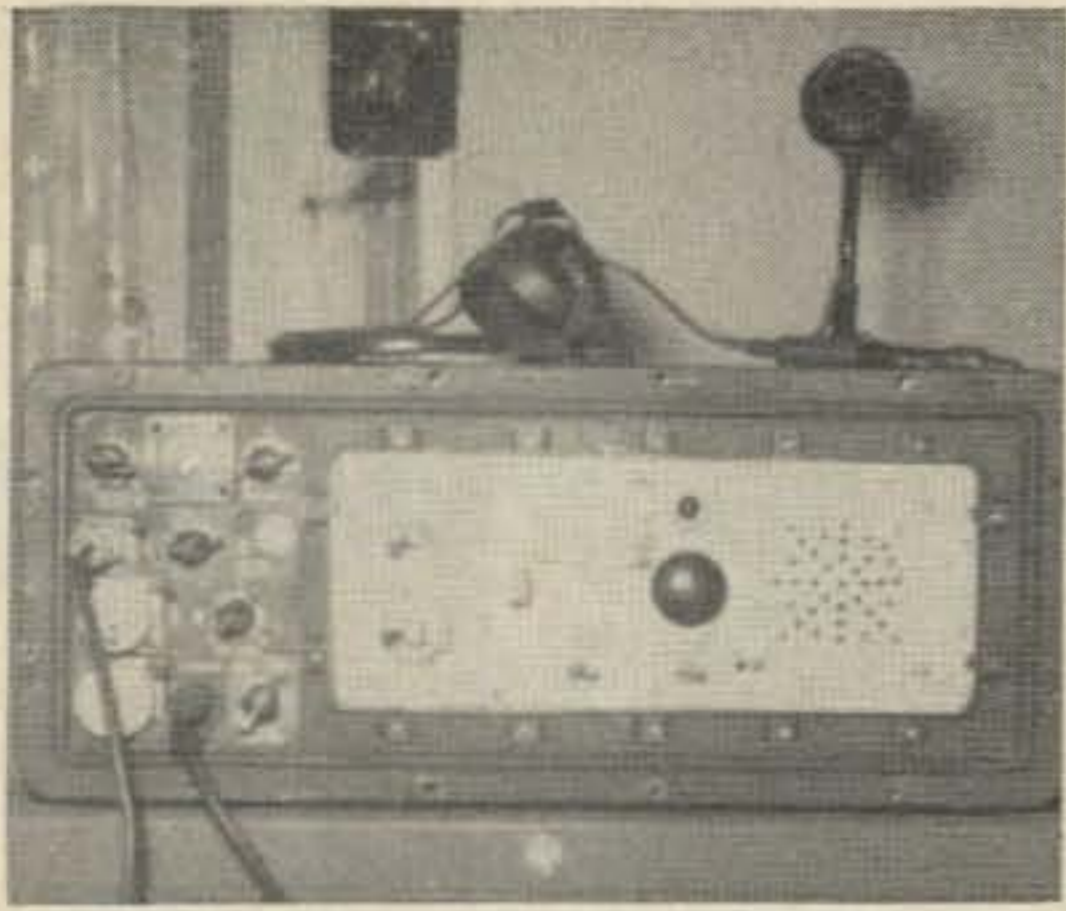

Fig. 1. AC power supply for the RDR receiver. The completed supply is mounted on a small panel which is mounted in the original RDR dynamotor compartment.



K3HIL's converted RDR receiver. Bob used a 4937 kHz crystal to cover the Gemini astronaut's 296.8 MHz communications frequency.

number 3 on terminal strip E132. The other end of the wiring goes to ground.

Label original pilot light connections for future reference. The B+ connects to terminal number 20 on terminal strip E133. The B- is connected to C511 on the back end of the multiplier section. The speaker and output transformer are connected across the phone jack terminals under the *if* strip cover. Install a crystal socket (FT243) on the front panel and connect it to the two heavy wires going into the multiplier stage. Install the switches, pilot light and speaker on to the panel—now you're ready for the smoke test.

Tune the receiver as follows: insert the crystal, rotate meter switch to position 1, unlock multiplier dial and adjust for a reading of 5 to 7 on the meter. Turn the meter switch to position 2, readjust multiplier slightly to obtain a reading of at least 4 on the meter. At position 3 unlock the rf dial and rotate for maximum noise and a minimum reading of 7. Position 4 is the plate voltage of receiver—normal reading 7; position 5, filament voltage, normal reading 7.5. The other positions are not used.

Crystal control was desired in my case but the multiplier tuning capacitor has a rather large range which can be used to tune the oscillator. The crystal frequency is doubled, then tripled 3 times—a total multiplication of 54. The *if* frequency is 30.2 MHz.

To determine what crystal frequency you require, subtract 30.2 MHz from your desired receive frequency and divide the result by 54. For example, to receive 222.5 MHz, $222.5 - 30.2 = 192.3$ MHz. Dividing by 54: $192.3 / 54 = 3.561$. A 3561 kHz crystal would be required.

... K3HIL

Thousands Sold!

S.W.R. BRIDGE and FIELD STRENGTH METER

9⁹⁵

EACH
Allow 50c for packing and shipping.
California residents include 4% sales tax.

MAY BE LEFT IN LINE, UP TO 2000 WATTS.

GOOD THROUGH 2 METERS



THE BEST VALUE WE HAVE EVER OFFERED!

SWB-4

QUEMENT ELECTRONICS

1000 SOUTH BASCOM SAN JOSE, CALIFORNIA

"Northern California's Most Complete Ham Store"

SINCE 1933

Build a 40-Meter Rotatable Dipole

This shortened dipole is little longer than a 20-meter quad.

A few months ago I built a wooden tilt-over tower, which to my amazement, worked very well. After I completed that project, I worked a few more weeks looking for parts for my "Triband Quad" to put on top. Up to this time I had been using, and very successfully, an all-band antenna.

With the erection of my "Triband Quad" I found that I could not keep the all band antenna up anymore, because there was some interaction with the quad and I could not get the SWR down when the quad was pointed in the direction of the other antenna.

I had to come up with something that I could put up that would not interfere with the quad. My property is not too wide, but it is long. If I put up a dipole it would run in the wrong direction to be effective. To put a half wave rotatable dipole up was out because I could not get past a nearby tree, mostly in my neighbor's yard. Hence, this shortened version of the 40 meter dipole.

I needed a plate to attach my quad to the mast, and I knew where there was one, which I bought for five dollars. The owner also threw in the rest of the antenna which had come down in a wind storm. After careful observation I noticed that the driven element was in good condition, and that it could pos-

sibly be placed in between the quad.

I figured that by placing a bamboo pole into either end and by taping a wire along the pole, it would work but again it could not be over 30 feet. The commercially built four band beams have a 40 meter section close to 39 feet.

Electrical

Fig. 1 shows the idea of the dipole. It consists of a ten meter section of an old driven element—a coil attached to the end of it, and a length of wire attached to the coil, that will resonate at 7.1 MHz.

There are several ways to construct the antenna at the mast. It may be done as seen in Fig. 2, or a dowel may be used as an insulator and the aluminum may be placed over the dowel. Any other way may be incorporated as long as there is a space between one side of the antenna and the other; also one must remember to keep it electrically insulated from the mast.

The length of the wire was 19 feet at the beginning. I also started with 20 turns of 3" coil. My first job was to get the one leg to resonate at 7.1 MHz. This was done by winding four turns of soft drawn wire around a grid dip meter and finding the right spot on

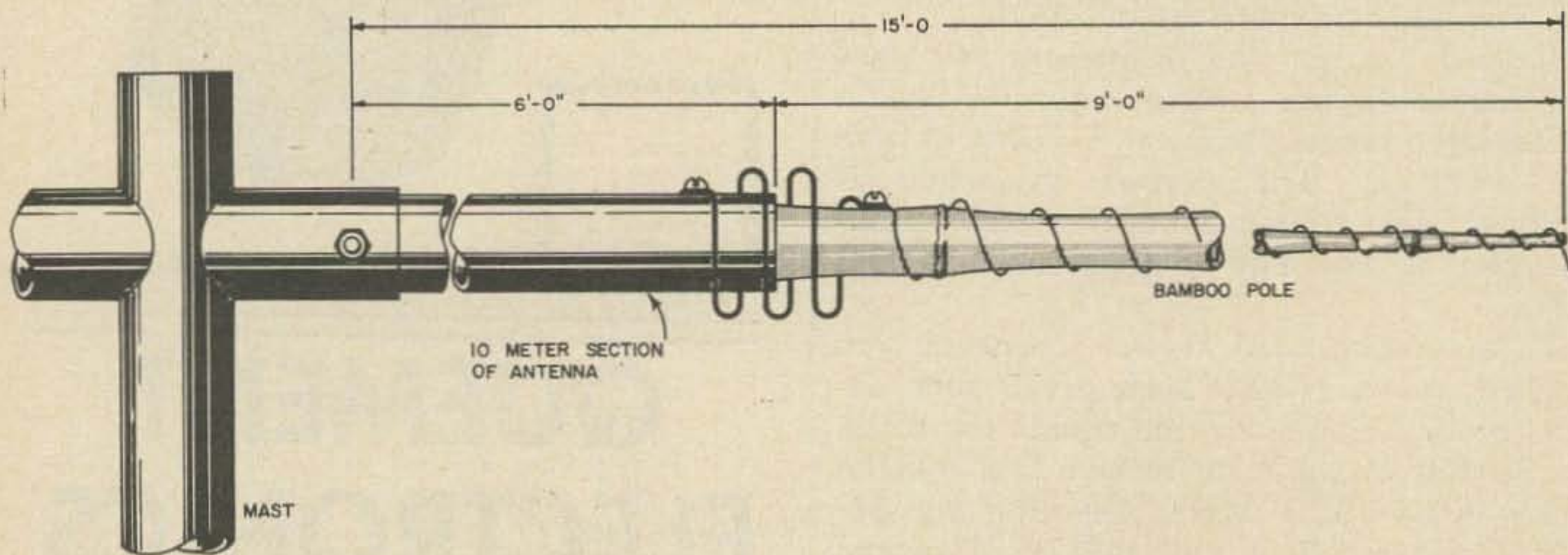

Fig. 1. Construction of one arm of the shortened 40-meter rotatable dipole.



Here's the dipole in place between the two elements of the quad.

the coil. See Fig. 3 The next step was to wind the wire very carefully around the bamboo pole so that each turn was about 1" apart. I did this until the 19' were completely used up. I checked the grid dip meter again to make sure that there was no change in resonance, and there was none.

At the coil I began moving the tap so that I would add two or three turns to the coil, while I snipped the wire at the other end to resonance. You may leave the 19' of wire on the pole. You may also make it shorter by adding more turns to the coil than I did.

Attach the coil with two stand off insulators so that the bamboo pole is approximately in the center of the coil. After I found the length of the dipole I wanted, I soldered the wire to the coil, and I drilled a hole at the end of the bamboo pole, and put a small nut and bolt through it. To this I attached the other end of the wire.

That being completed I did exactly the same thing to the other leg. Knowing the

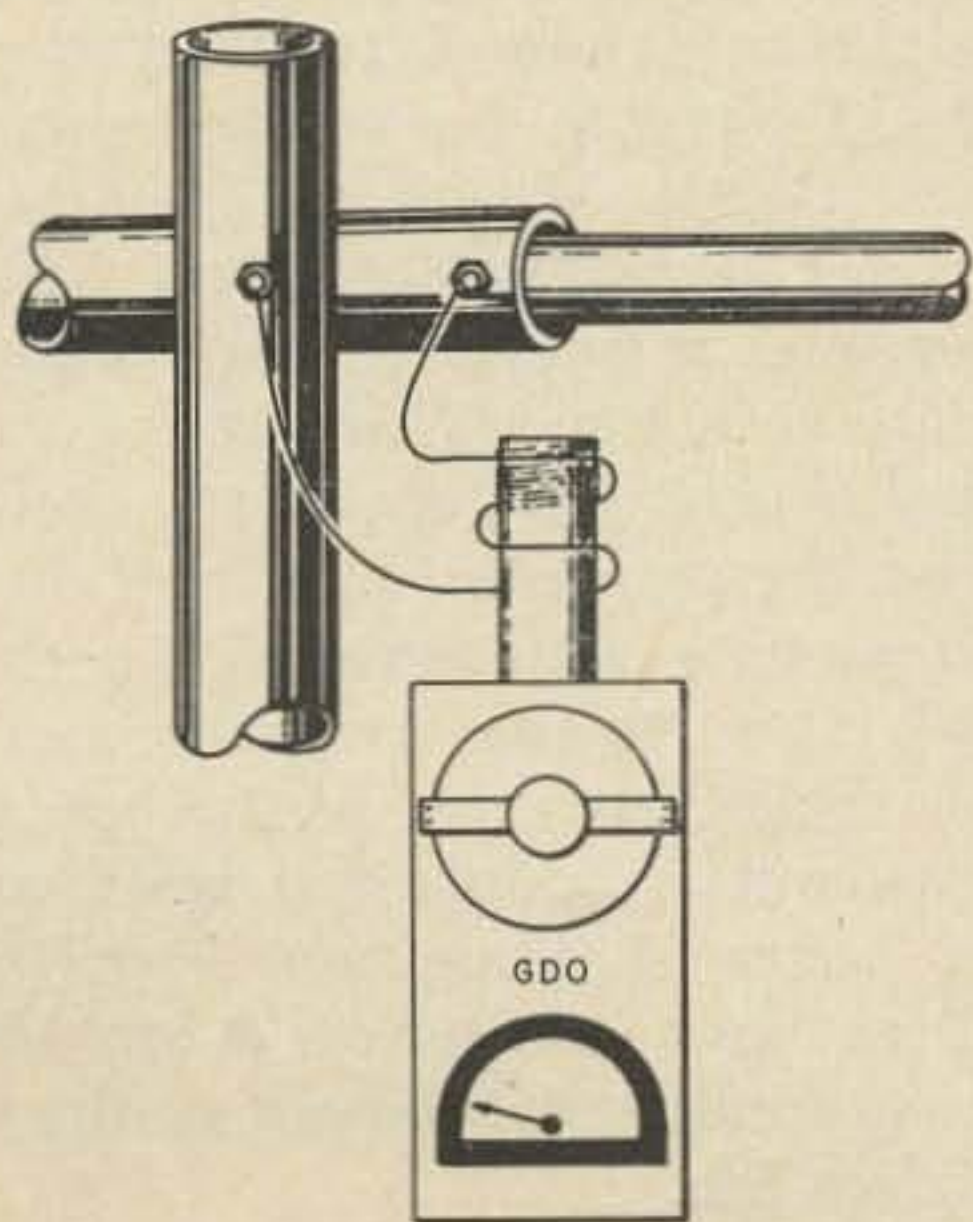

Fig. 3. Getting one arm to resonate at 7.1 MHz.



Fig. 2. One way to connect the antenna to the mast.

approximate number of turns on the coil, and the number of turns on the bamboo pole it took half the time to fix the second side. After completing the second side I put two coats of varnish on the bamboo poles and over the wire, I coiled over the bamboo pole.

Now that I had both sides completed, I again checked resonance by placing the coil around the grid dip meter, but this time the wire was attached to either side. See Fig. 4 The meter should dip as you move it through the coil without any further adjustments.

Feeding

Feeding the dipole may be done three ways. One, feeding it with balanced twin lead as I did; two, feeding it with 72 ohm coax; or three, any other feed line with a balun. Make sure the feed line runs away from the antenna at a right angle as much as possible. I have mine running right to the ground, a total of 38' before it comes into the shack, where I tune it with a match box.

The SWR seems to rise sharply toward

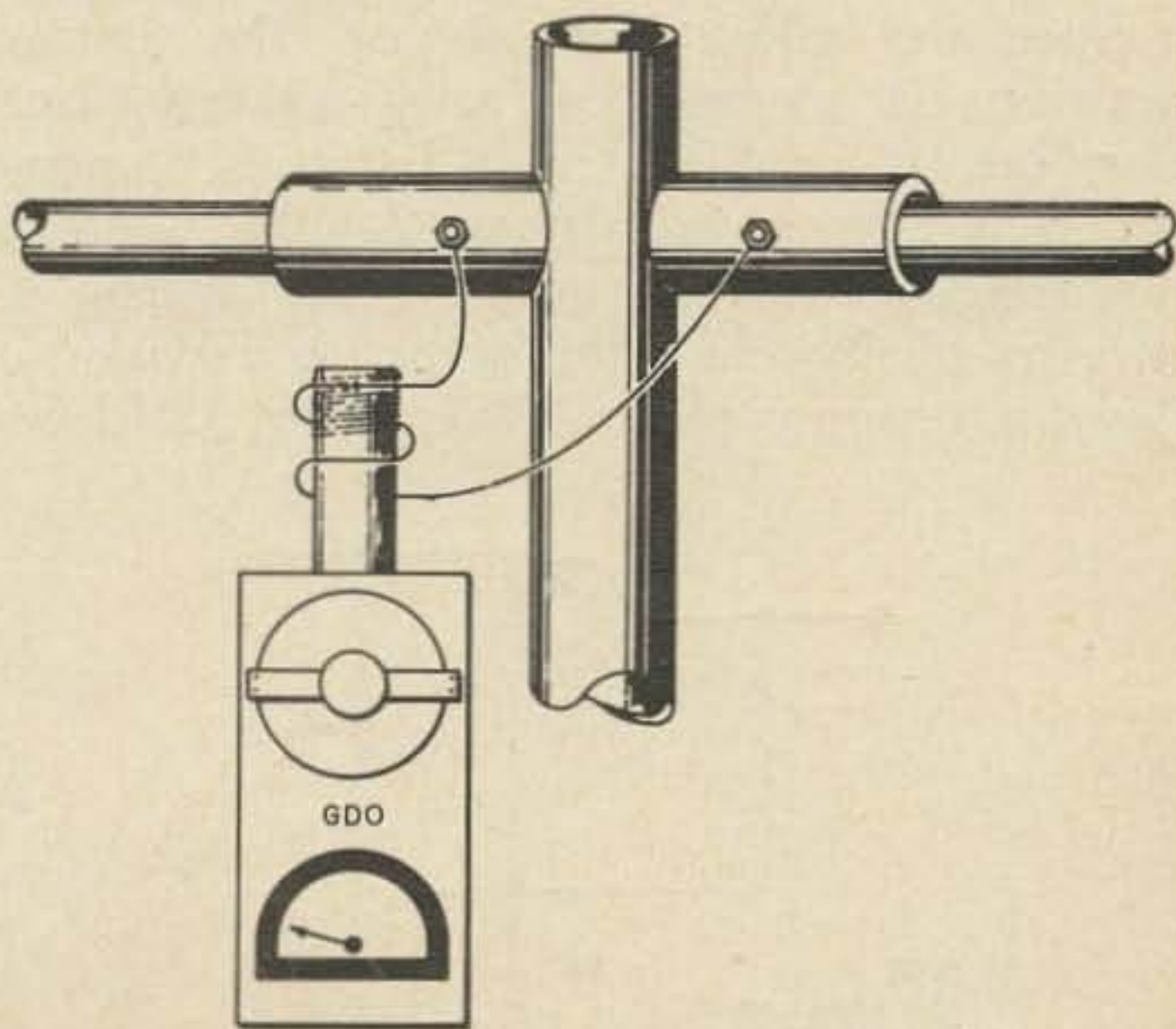

Fig. 4. Checking the resonance of the whole dipole.

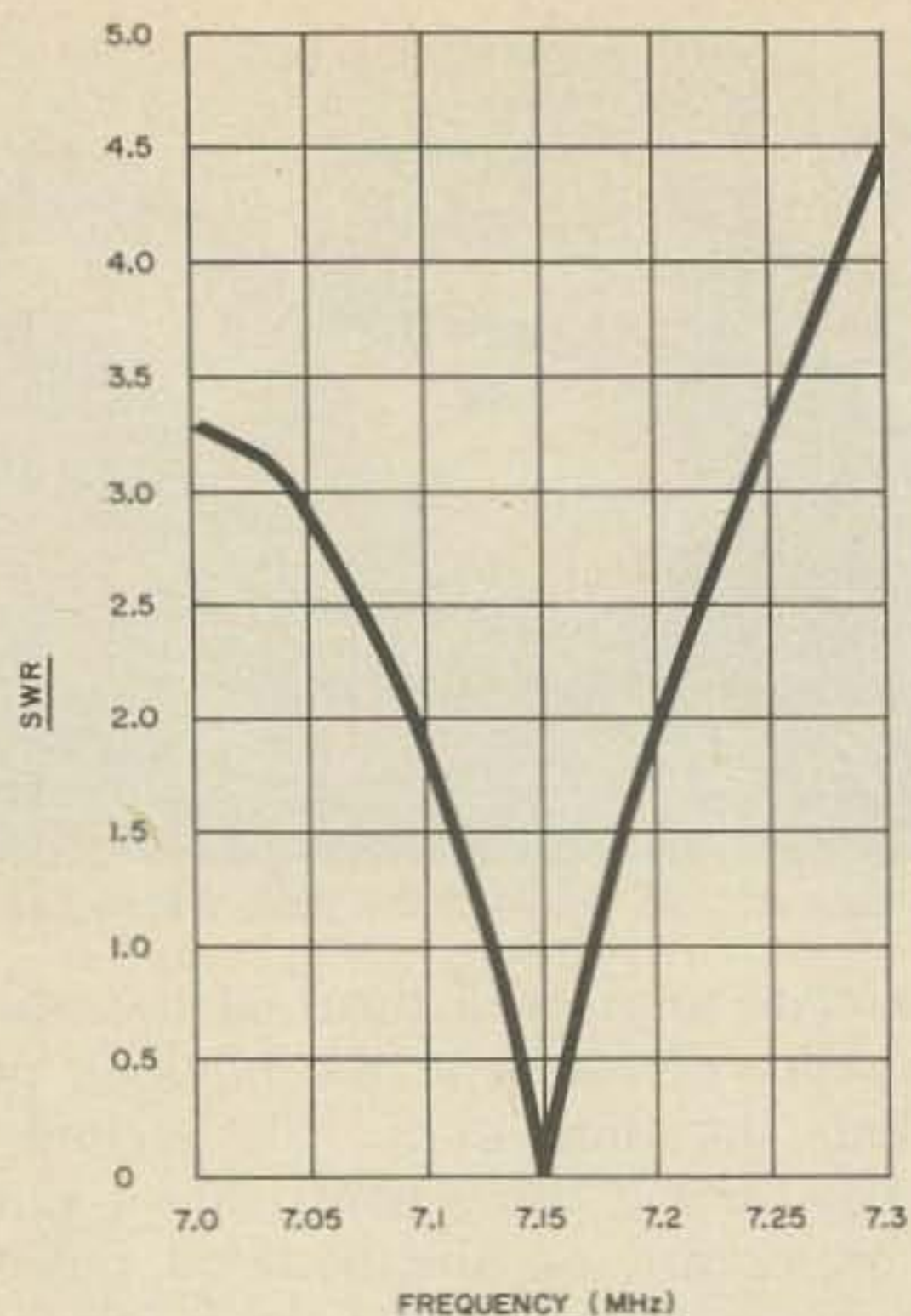
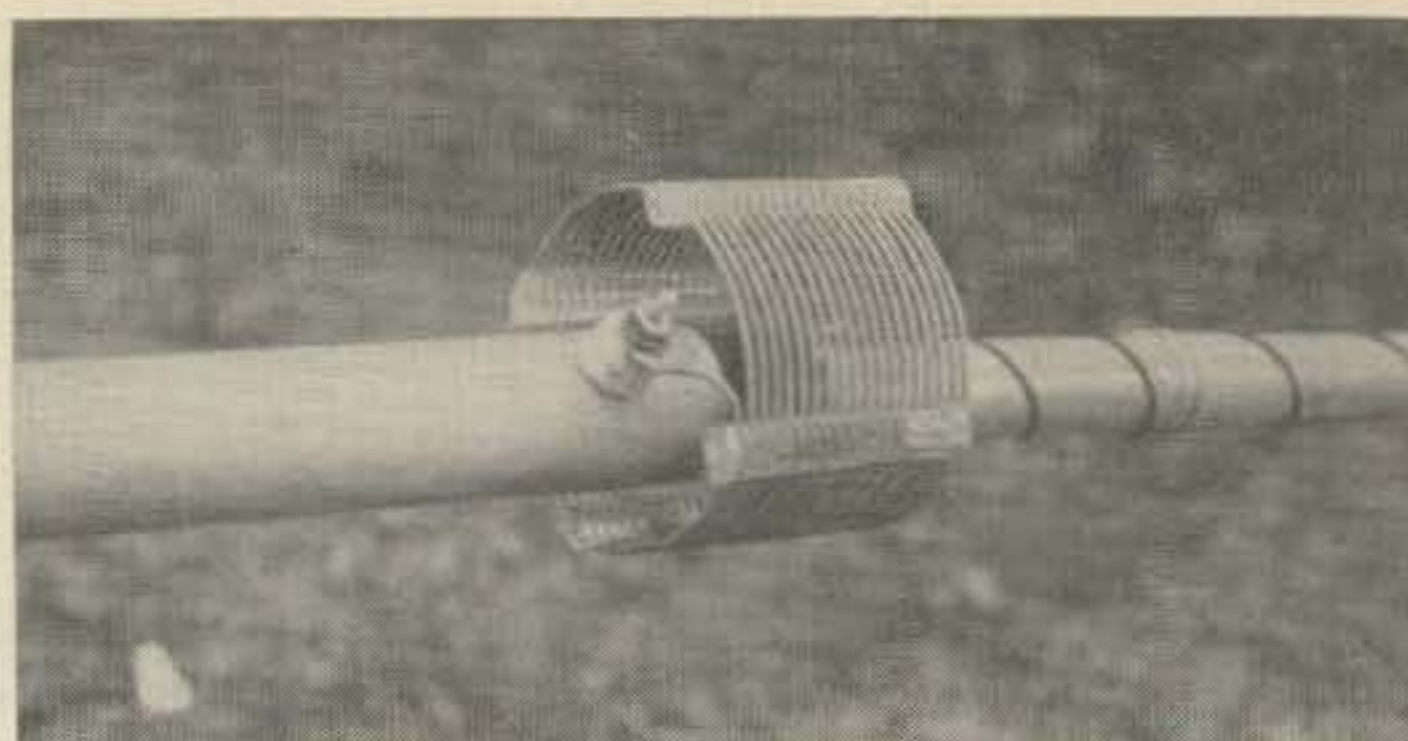

Fig. 5. SWR of the antenna fed with balanced twin lead through a Matchbox tuned at 7.15 MHz and the transmitter frequency varied.

the high end of the band. See Fig. 5 I have found that I can get a one-to-one reading at the transmitter using RG86/U 205-ohm balanced line.

Performance

I found that the quad works perfectly without any interaction between it and the



Here's what the coil between the ten meter section and the bamboo pole.

dipole. Don't try to feed the dipole with the same feed used with the quad; it will not work. You must use a separate feed line.

I also found that there seems to be a slight gain in strength when the dipole is at a slight angle to the person you are working. I have had one DX contact in Venezuela with a 5 x 7 report. I have held my own through the QRM on 40 meters. It's not a cure-all by any means, but it beats not having any antenna at all on forty. Also you can rotate it along with your quad. Its weight is relative to the weight of the quad. As you can see, I have it up on a wooden tower and it seems to be holding up fine. All in all, I would say it should cost you about \$5.00 at the most to build.

Good luck and hope to hear from you on 40 meters.

Is Your Heathkit Transistor Tester Running Wild?

The scene was an industrial electronics laboratory, not so long ago. Our Heathkit Transistor Tester Model IM-30 had been absorbing a considerable amount of skilled engineering talent for almost the entire morning. It seemed perfectly healthy, but gave erratic readings on a batch of expensive new silicon transistors. As the general atmosphere was becoming rather warm, a little bit of the old light began to dawn . . . Do you suppose this XXXX thing could be

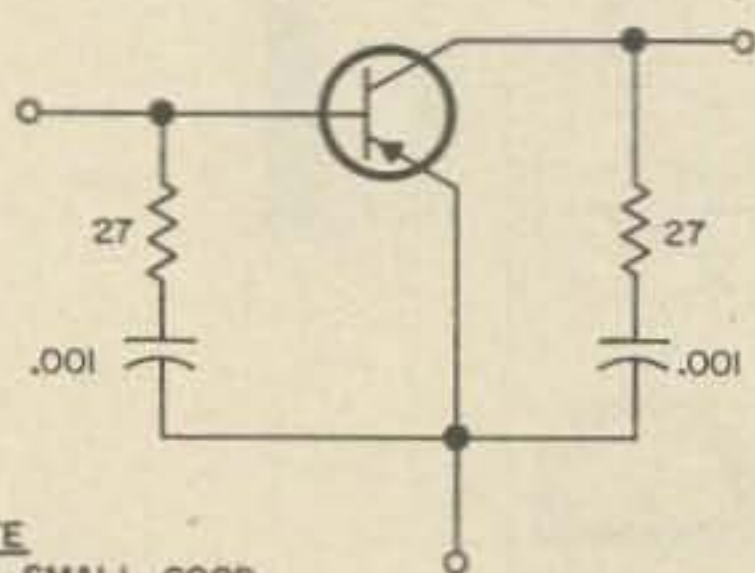

NOTE
USE SMALL, GOOD
QUALITY DISC
CERAMIC CAPACITORS

oscillating? It turned out the oscillations could be stopped by applying a fingertip to one transistor lead. The tests were rapidly completed and with a loud roar the focus of attention turned elsewhere.

Recently, I almost failed to recognize this same problem while checking some surplus 25c transistors. Then I realized the difficulty would have to be worked out. Using my James Dandy Mixer (73, August 1966) I spotted the oscillation at about 130 MHz. And after one or two false starts I found an appropriate circuit modification.

Fig. 1 shows how I stopped the oscillations by loading the transistor at rf but not at dc. The components are installed in the best VHF style close to the transistor socket. An extra test socket on short leads required the same treatment although it is used with the modified tester. I hope you'll put in the emitter-base and emitter-collector branches first time around! It takes both of them to do the complete job.

. . . James Ashe W2DXH

"HAM" BUERGER'S

June Specials . . .



Astatic GD-104 desk type push-to-talk microphone and stand. Regular price \$51.20.

Special price \$25.00

Volt - Ohm - Milliammeter. 20,000 ohms per volt DC, 10,000 ohms per volt AC. DC voltages: 0-0.6-6-30-120-600-1200-3000-6000 V. AC voltages: 0-6-30-120-600-1200 V. Resistance: 0-0K-600K-6 meg-60 megohms (30-3K-30K-300K at center scale); plus DC current, dB and capacity. With leads and batteries. 6" H x 4" W x 1 3/4" D. Regular price \$19.95.



Special price \$12.95

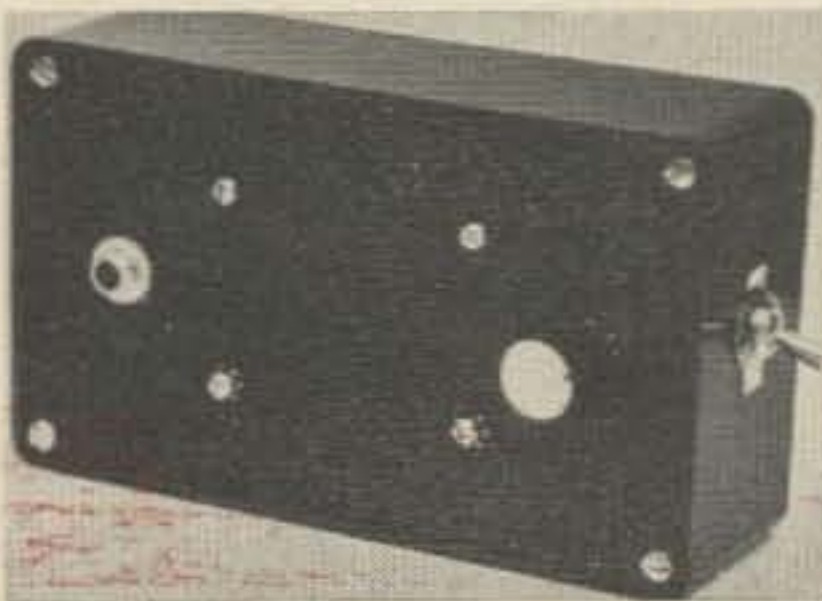

AJ-1 Audio Filter. Ideal for CW and SSB transceivers. Variable audio range. 28 dB down at 100 cps — peaks 200 cps. 4 ohm input and output impedance, built-in in

and out switch. 6 1/4" L x 3 3/4" W x 2" D.

Special \$7.95

Astatic mobile ceramic microphone. Super talk power. Regular price \$12.75.

Special price \$6.50

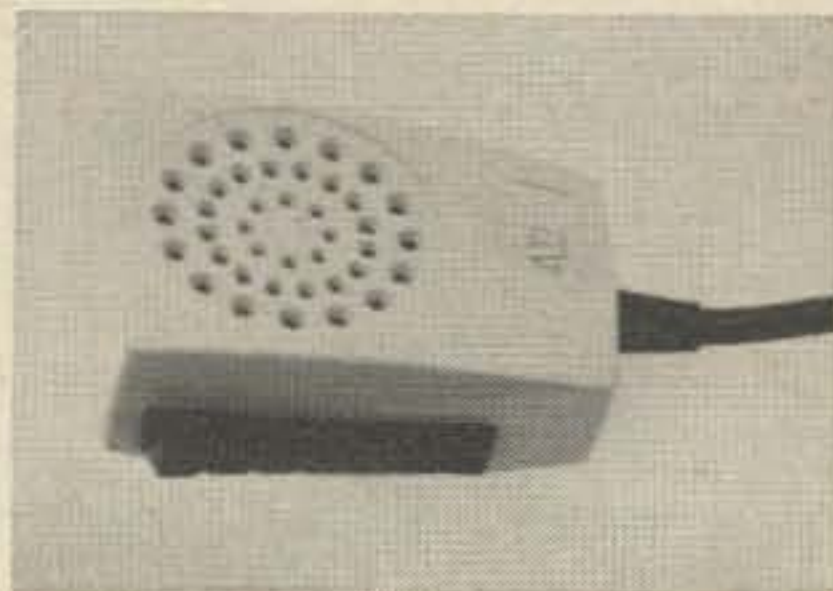

CO-4 4 Position Coaxial Antenna Switch. Uses low loss connectors and a ceramic switch. Complete with knob. Regular price \$9.95.

Special price \$6.95

CO-2 2 Position Coaxial Antenna Switch. Same construction as the CO-4 switch to the left. Used for switching linear amplifier in and out of the antenna line. Regular price \$8.95.

Special price \$6.95



QSL Cards

2 color chromekote cards



\$2.95
per
100 cards

All prices plus postage • Pa. residents add 5% state tax.

Open evenings — Monday, Wednesday, Friday; 9 AM to 9 PM.

Saturday, 9 AM through 5 PM.

"HAM" Buerger

Amateur Radio W3BAH

432 York Road • Jenkintown, Pa. 19046 • Phone 215-887-7350

The Vacationer Portable Antenna

How often when checking into a hotel or motel for the night, or if you live in a non-cooperative-landlord apartment, have you wished you could get on the air without causing an upheaval? Well now you can: The Vacationer Portable Antenna is the answer.

The Vacationer Antenna is unique in the fact that this base loaded whip becomes a center-loaded antenna with very low SWR due to the simple wire counter-poise that is clipped onto the window mount and extends inside the room. Places are indicated on the counter-poise wire for the best match on each band. If an SWR meter is inserted into the line, it is possible to get a 1:1 ratio easily.

For use on 20, 15 and 10 meters, suitable loading coils are provided, and are attached to the base of the whip with removable screws. For two and six meters a shorting bar is furnished. The Vacationer is ruggedly constructed. The base is of molded unshatterable nylon; the machined parts are made of nickel-plated brass, and the window mount is weather resistant aluminum.

With this portable antenna, going together quickly and easily, one can be on the air in less than 5 minutes. It is de-

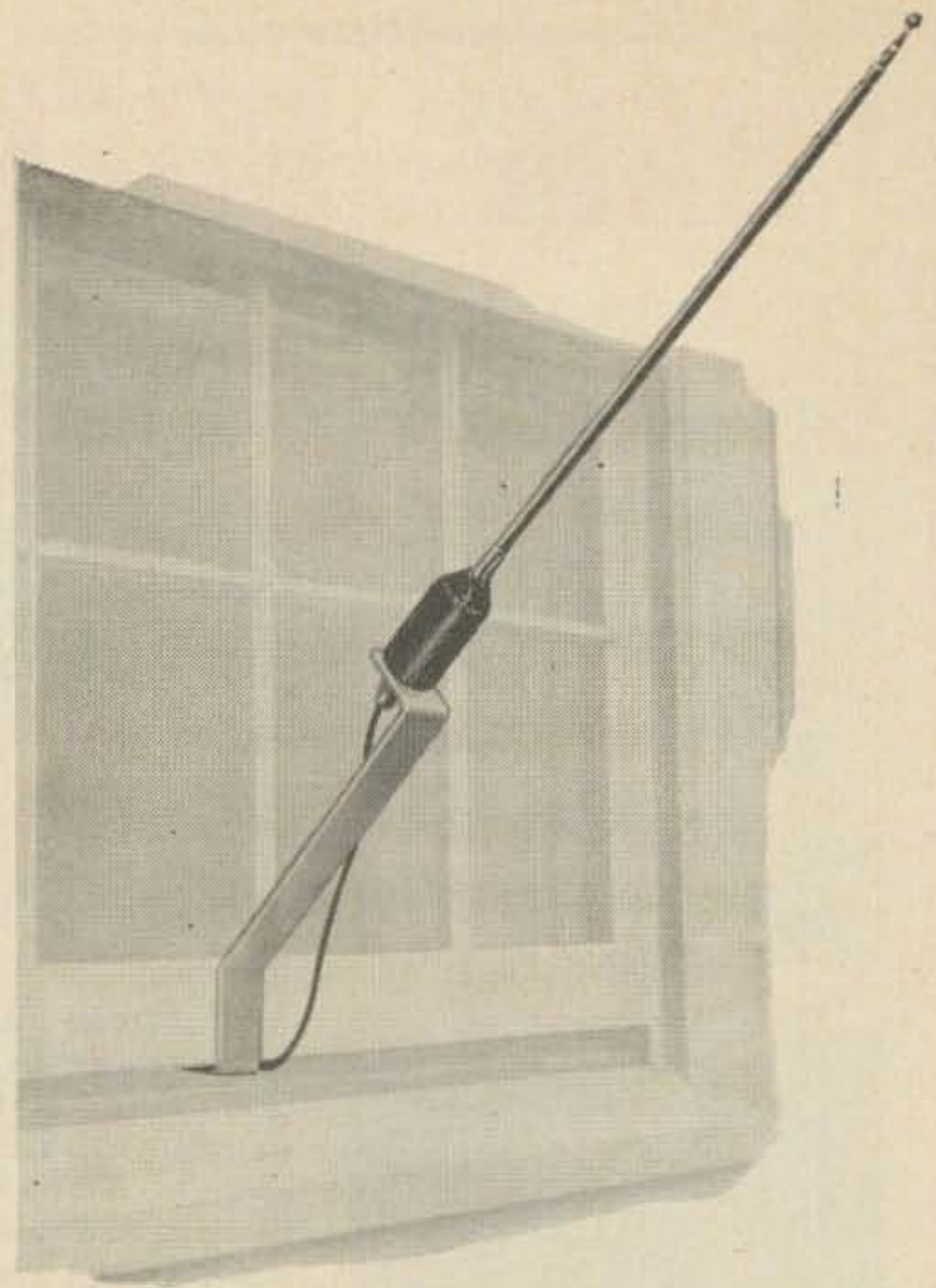

signed to handle any of the 300-watt PEP transmitters, or 180 watts AM or CW.

Come hurricanes, sleet or ice storms, when beams and outside dipoles collapse, The Vacationer, as an emergency antenna, will keep you on the air; very economical insurance. The Vacationer folds down to 19 inches, so it can be packed in a suitcase, it is sold by the DPZ Corporation, P.O. Box 1615, Jupiter, Florida, 33458, and retails for \$24.50.

. . . K1RA

AC Ammeter

Have you ever wondered just how much current that transmitter is pulling from the 120 Vac line, but don't want to get into the expense of a good AC wattmeter? Here is a low cost adapter for making such power measurements with an AC voltmeter. The voltmeter should have a sensitivity rating of at least 1000 ohms per volt. Almost any vom or vtm in the shack should meet this requirement.

The adapter consists of an accurate 1 ohm power type resistor mounted in a ventilated housing provided with terminals for connection to the AC line, voltmeter, and power consuming device. This resistor converts the voltmeter into an AC ammeter. At any deflection of the voltmeter the reading is

directly in AC amperes. To convert to watts drawn by the load, multiply the deflection by the line voltage. Example meter reads 0.65 volts and line voltage is 120 Vac. $0.65 \times 120 = 78$ watts. This is only accurate for a resistive load, but will give a relative reading on others.

Above 500 watts the voltage drop across a 1 ohm resistor becomes large enough to reduce the voltage applied to the device under test. If higher power levels are to be measured, the resistor should be reduced to .5 or .25 ohm.

DC power drain can be measured by substituting a DC voltmeter in place of the AC voltmeter.

. . . Don Marquardt K9SOA

Operating the BC-611 Walkie-Talkie

BC-611's are now available and are very useful for short-haul communications and locating sources of interference.

The BC-611 is a press-to-talk portable radiotelephone designed to transmit and receive signals over the frequency range 3.5-6.0 MHz. Its range is short because of its low power ($\frac{1}{4}$ watt output), and could be anything from 100 feet to one mile. Over salt water, a three mile range might be obtained. These units are currently available and are being used for short haul work in the MARS circuits.

Power requirements are 1.5 Vdc for the filaments and 103.5 Vdc for the B plus. Originally, the batteries were designated as BA-37 (1.5V) and BA-38 (103.5V). Either the Burgess XX69 or the Eveready W361 are commercial equivalent B batteries but the 1.5 volts may be obtained from two flashlight C cells in parallel and an FT-501 adapter.

Extension of the telescopic antenna to its full length actuates a toggle switch to energize the unit. The receiver is a superhet circuit and contains a crystal controlled local oscillator. The transmitter section consists of a crystal oscillator, power amplifier, speech amplifier, and plate modulator. All of the tubes except one serve double purposes. Tube VI (3S4) serves as the rf amplifier in the receiver and as the power amplifier in the transmitter, tube V2 (1R5) functions as the converter-oscillator in the receiver and as the oscillator in the transmitter, tube V4 (1S5) operates as the second detector-avc-af amplifier in the receiver and as the microphone amplifier in the transmitter, and tube V5 (3S4) serves as the output amplifier in the receiver and as the modulator in the transmitter. Tube V3 (1T4) operates as the *if* amplifier in the receiver.

The push-to-talk switch is a 7-section, double-pole, double-throw switch. Some of the surplus units may be received with broken switch handles. It is possible to fashion a new switch handle made from a piece of plastic.

The transmitting frequency is determined by the particular crystal used; to receive stations operating on the same frequency it is necessary to use a receiver crystal 455 kHz higher than the transmitting crystal frequency.

To tune the receiver for maximum performance on a specific frequency, adjust C7 and L2 for best reception of a received signal. There are two methods for tuning the transmitter's output. The best way is to use a field strength meter and adjust C12 for maximum meter deflection. The second method is to insert a milliammeter in the plate circuit of the rf power amplifier (remove jumper inside bottom cover and insert meter) and adjust C12 for maximum meter deflection (dip).

The BC-611 is part of Radio Set SCR-536-A, -B, -C, -D, -E, and -F and the technical manual is TM 11-235. The test set for the SCR-536 is designated as Test Unit I-135. Loop antenna AN-190 (not supplied with the unit) is a directional loop antenna with a built-in sensing device and can be used for homing purposes in conjunction with the BC-611. When equipped with the loop antenna the BC-611 should make an excellent unit for tracing down local interference sources and should appeal to amateurs possessing fixed direction finding equipment.

... WIMEG

A Poor Man's Transmitter Cabinet

Judging by the appearance of some ham shacks, proper packaging of the equipment presents a major problem to the roll-your-own amateur. Many transmitters sound wonderful on the air, but look like something the junior operator dragged in from the junk yard. These eyesores can be dangerous to the operator and to any visitors to the shack.

After putting up with poor packaging at my station for a time, I decided to act. This article describes how the problem was solved; the finished transmitter cabinet meets the following requirements:

1. Complete enclosure to keep children out of the wiring.
2. Adequate TVI shielding.
3. Pleasing appearance.

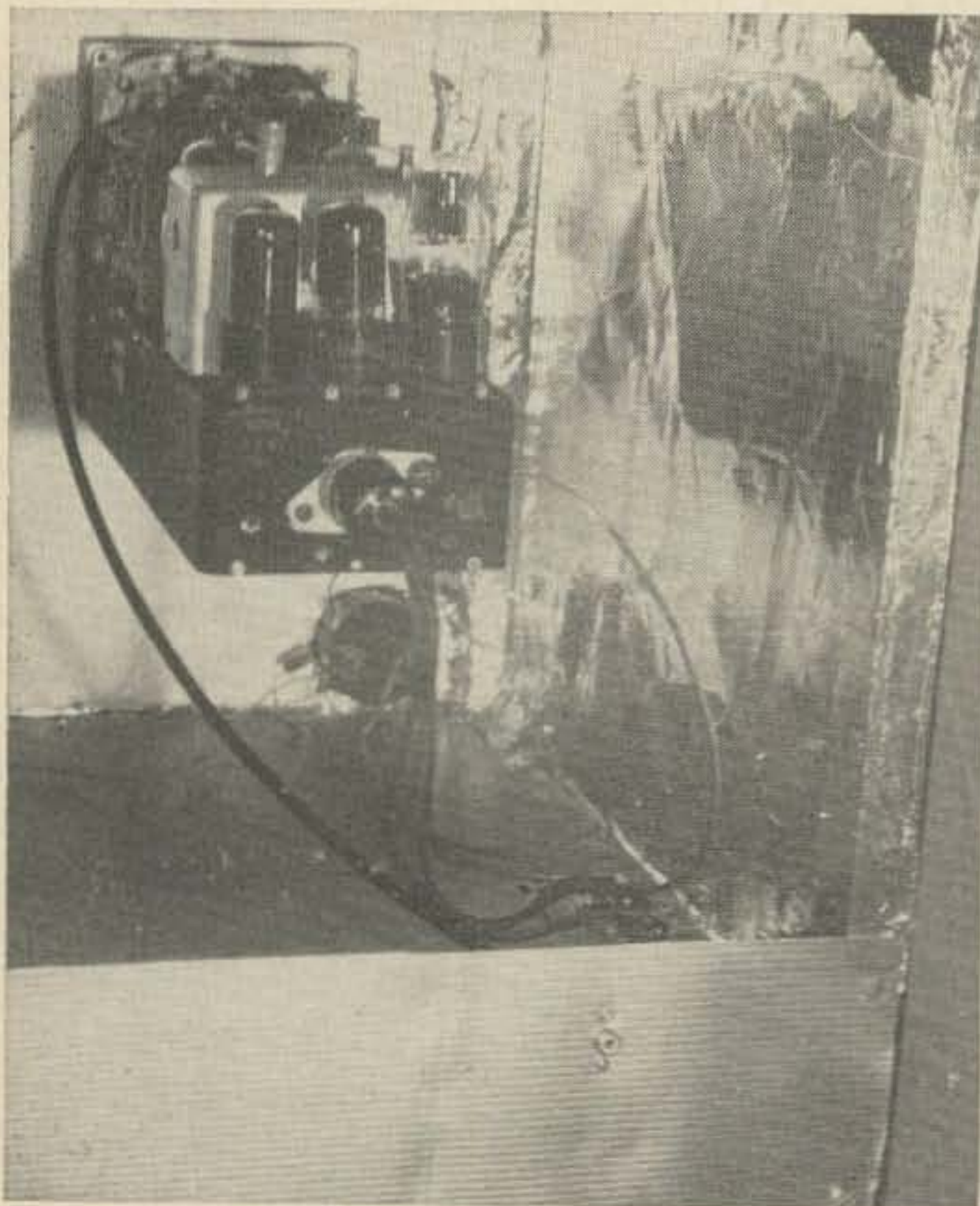

Inside view of the TV cabinet showing the aluminum foil shielding and the Command Transmitter mounted on the front panel. Note that the foil extends over the back of the cabinet to the edge of the wood frame; this overlap provides generous metal to metal bonding when the rear shield is in place.

4. Adequate space for a complete medium power transmitter.

5. Construction possible with only simple tools.

6. Low cost.

My transmitter cabinet provides 7.5 cubic feet of usable space for less than five dollars; with a little effort the average amateur can duplicate this in a modest workshop. The finished product will adequately house an AM transmitter of several hundred watts or a SSB transmitter running the legal limit.

The basis of this project is a used floor model TV cabinet. Many enterprising amateurs find a wealth of usable parts in old junked TV sets; why not use the cabinet too? There are many old TV sets around with large wooden cabinets available for the asking. A friend gave me the one I used. A plastic cabinet might be usable, but wood is easier to work with. A table model cabinet would be excellent for a small transmitter.

Here's how I converted my cabinet. I lined the cabinet with a heavy grade of aluminum foil on the inside top and sides and a piece of sheet aluminum on the bottom and front. The front panel must be heavy enough to support the weight of any attached equipment. A better job, though more expensive, could be done with lightweight sheet aluminum throughout. In any case, allow generous overlap and metal to metal bonding at the joints. A long crack lets out quite a bit of rf energy. I attached the foil with glue and staples.

The back of the cabinet has a door which is easily removed. In the cabinet shown in the photograph, copper window screen was stretched over a thin wood frame, but a sheet of thin aluminum sheet perforated with small holes would be better. In any case the material must preserve the shielding and permit free circulation of air; for high power transmitters, the use of a blower should be considered.

The best shielding in the world will not

prevent TVI if the leads leaving the shielded enclosure are not filtered. A simple length of shielded hook-up wire bypassed at both ends *might* provide adequate filtering, but I used the more elaborate filter shown in Fig. 1. I built a metal box from an old tin can with tin snips, pliers, and a propane torch. Although not attractive, it cannot be seen when mounted in the cabinet.

The bypass capacitors might work better inside the box than out, but they perform well in this unit and were more easily mounted on the outside. I mounted them with very short leads close to the point where the coil lead passes through the box. Ceramic feed-through insulators should be used for circuits carrying high voltage.

The coils must be wound with wire adequate to carry the current. The only place where this might present a problem is in the heater leads. The coils were wound on a section of $\frac{3}{16}$ inch rod; they are self supporting when used with very short leads. About one inch of close wound number 26 wire was used for all coils except the one carrying heater current; this coil was wound with number 18.

The bypass capacitors were disc ceramics salvaged from old TV receivers, except as a safety precaution I used new capacitors for the high voltage leads. The photograph shows the filter mounted in the cabinet with five leads rated at below 1000 volts. A high voltage filter will be mounted immediately in front of the present filter when the medium power final is completed.

I feel that I have met all six requirements set forth in the beginning of this article; the transmitter is completely enclosed and quite safe from contact with high voltage. At the present time this cabinet is pretty large for the command transmitter and its power supply, but there is room to expand; I am working on an 813 final for more power.

No trace of TVI is observed on any of the area television stations located 40 miles away. My own TV receiver has no high pass filter and is several years old. When the transmitter was operated outside the cabinet and without lead filtering I experienced severe TVI to both sound and picture.

Do not let the do-it-yourself urge be suppressed by the lack of a proper cabinet. Find an old TV cabinet and package that rig!

... WA4RHT

6 METER TRANSCEIVER

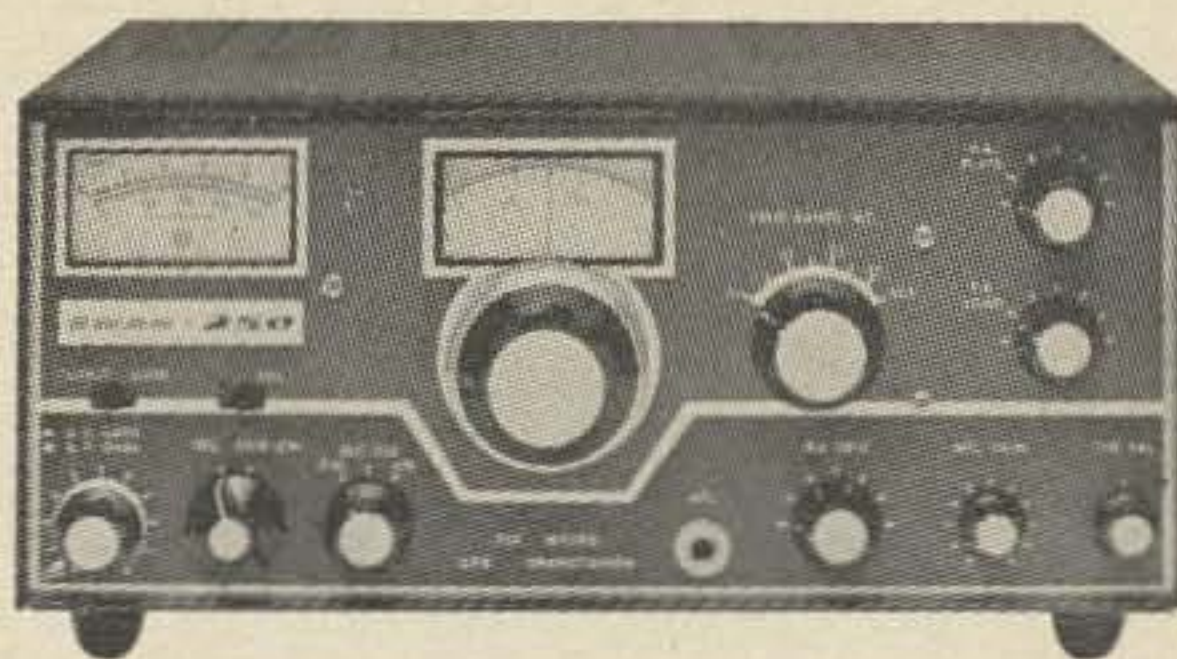

SWAN 250 \$325 PREPAID IN USA

FREE

LIST
\$42.50

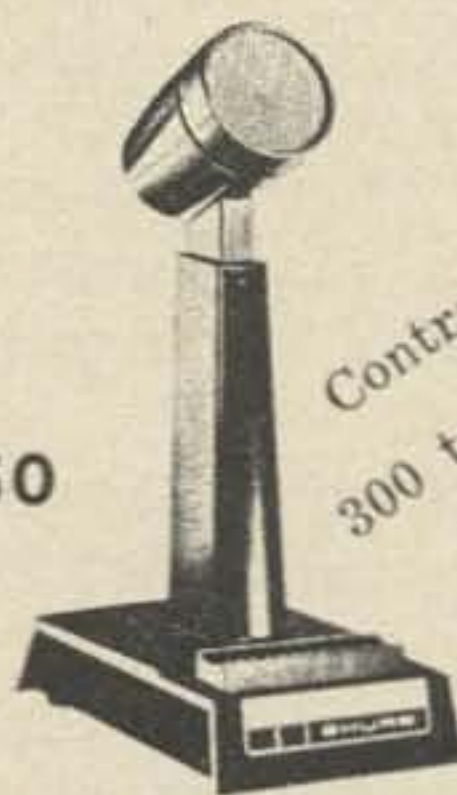

Controlled Magnetic
300 to 3,000 cps

SHURE 444
SSB MICROPHONE WITH
EVERY SWAN TRANSCEIVER

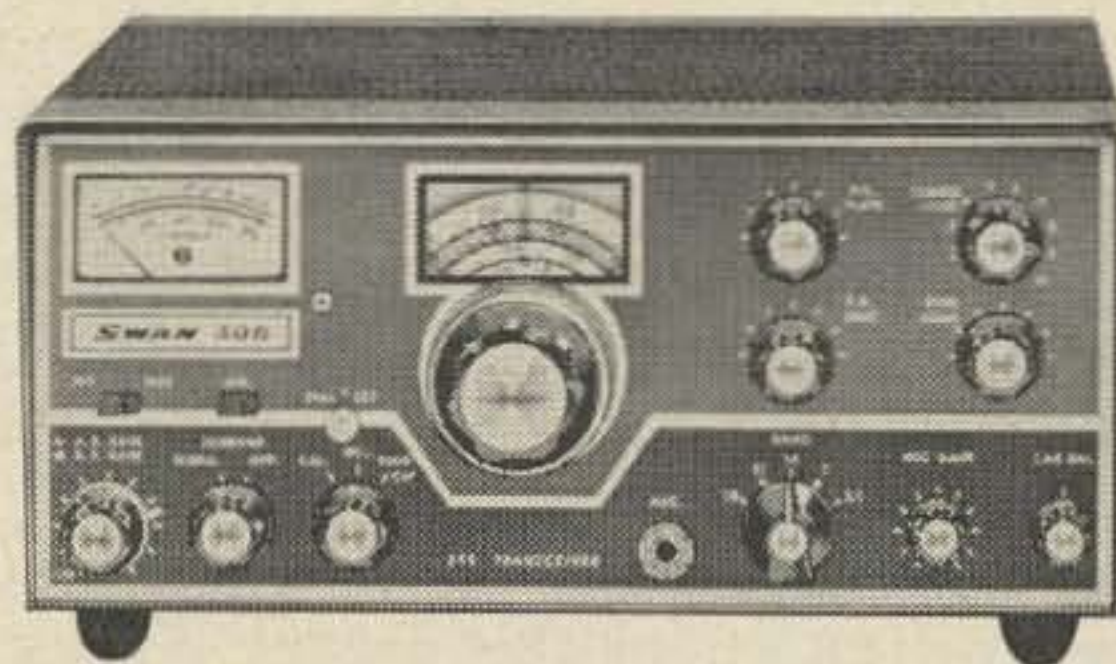

SWAN 500 \$495 PREPAID IN USA

IN STOCK AT

QUEMENT ELECTRONICS

1000 SOUTH BASCOM SAN JOSE, CALIFORNIA

"Northern California's Most Complete Ham Store"

Micro-logic for Non-logical Users

The title is not meant to imply that amateur operators are *illogical* in any way, but rather to identify this article as one in which integrated circuit (IC) logic elements are used in ways for which they weren't specifically designed. That is, it will attempt to show some of the many ways that amateurs can use digital IC's in circuits that are non-computer oriented.

Historically, there are two reasons why the digital IC (micro-logic) became readily available at low cost before the linear IC. One of these reasons was the rapid growth of the digital computer industry; increasing both individual computer size and the number of computers in production. Size, cost, and reliability requirements of the new digital computers offered a rich prize to the semiconductor industry if it could come up with an IC to suit computers. The second reason digital IC's came first is the fact that logic circuits are easier to make than linear circuits. Logic circuits generally require only that their transistors be in one state or another (for instance, "on" or "off") and this requirement is relatively easily met by mass production units.

Out of all the research that was poured into the realization of the digital IC for the computer industry, several "logic families"

of IC's emerged. These logic families have all made successes in computer use to one extent or another and no *one* family has yet obtained a clearcut advantage over the others on all counts.^{1,2} The present major logic families are: Resistor Transistor Logic (RTL), Diode Transistor Logic (DTL) Transistor-Transistor Logic (TTL), and Emitter Coupled Logic (ECL).

RTL Integrated Circuits have become the

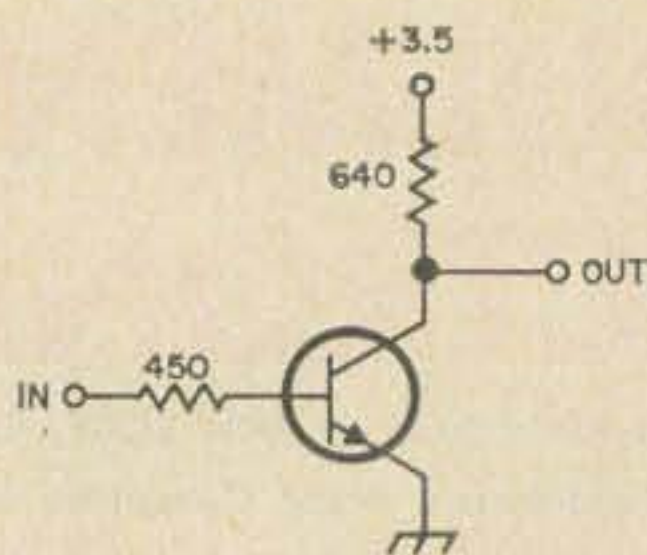

Fig. 1. The basic transistor gate.

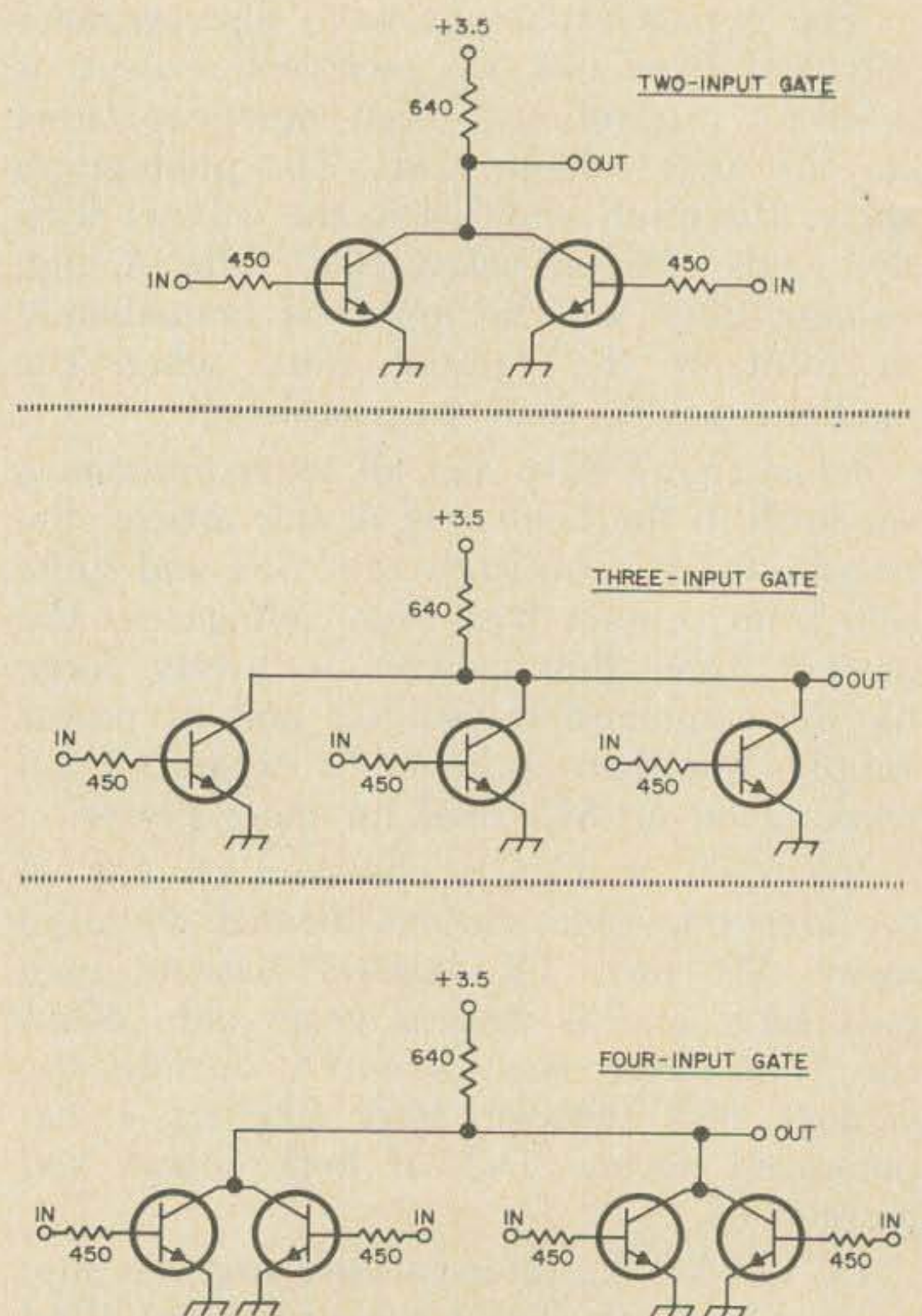
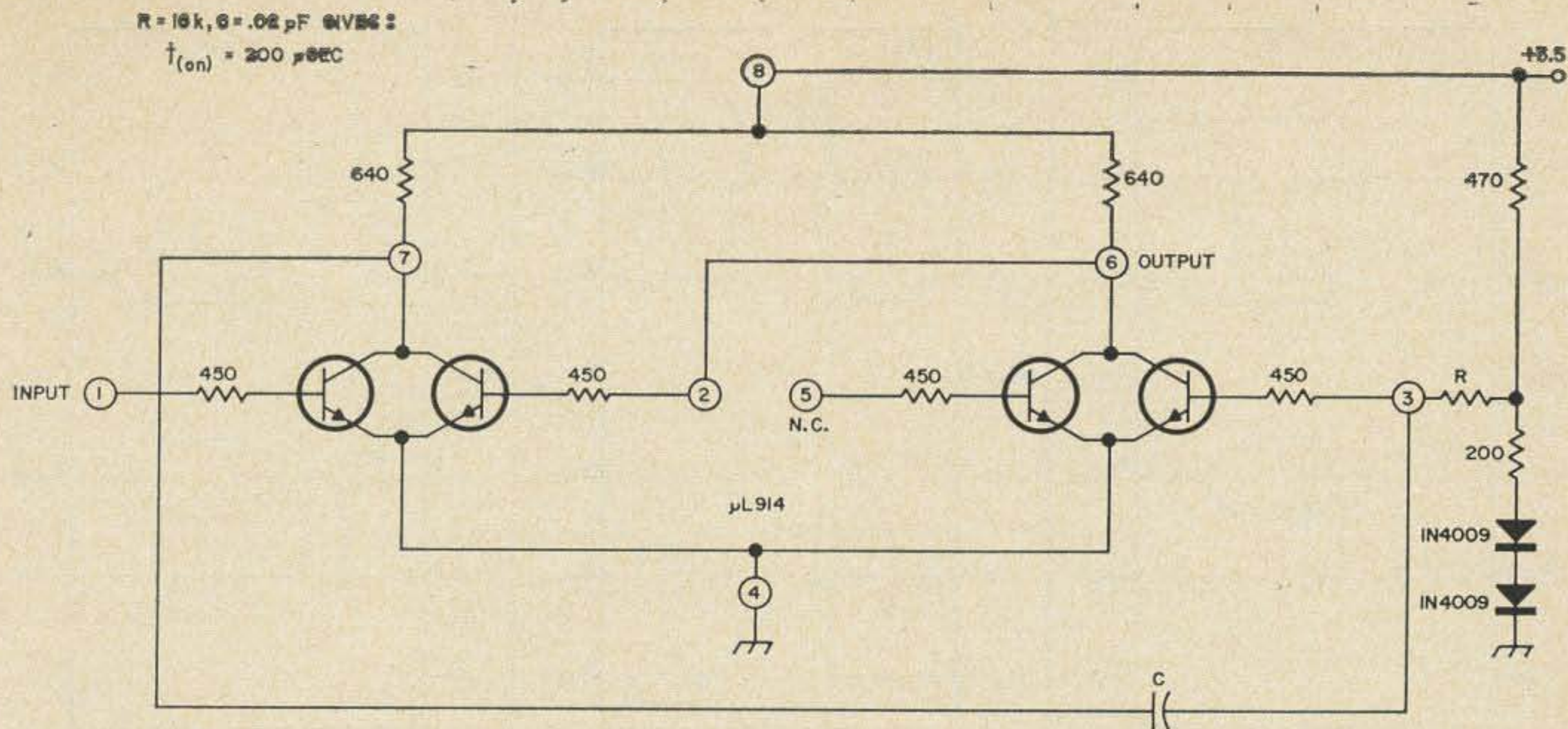

Fig. 2. Various gate arrangements—two input, three input and four input.



MONOSTABLE MULTIVIBRATOR

Fig. 4. A monostable multivibrator using the $\mu L914$.

least expensive, most available IC's on the market. In small quantities (1-99) the price of a simple J-K flip-flop has dropped to \$1.35 and that of a dual two-input gate to \$.80. A number of semi-conductor manufacturers, Motorola, Fairchild, Sperry, Texas Instruments, and others all make the RTL line; and at least between *some* units, voltages are compatible. There are two mainly-used packages, the TO-5 can with 8 or 10 pins and the "Dual-Inline Package" (DIP) with 14 pins.

The basic building block of the RTL family is the gate shown in Fig. 1. This gate can be expanded into two, three, and four-input types as shown in Fig. 2. In the gates shown in Fig. 1 and 2, a +1 volt input to *any* input will saturate a transistor and pull the output down from the +3.5V supply level to saturation.

One of the least expensive and most ver-

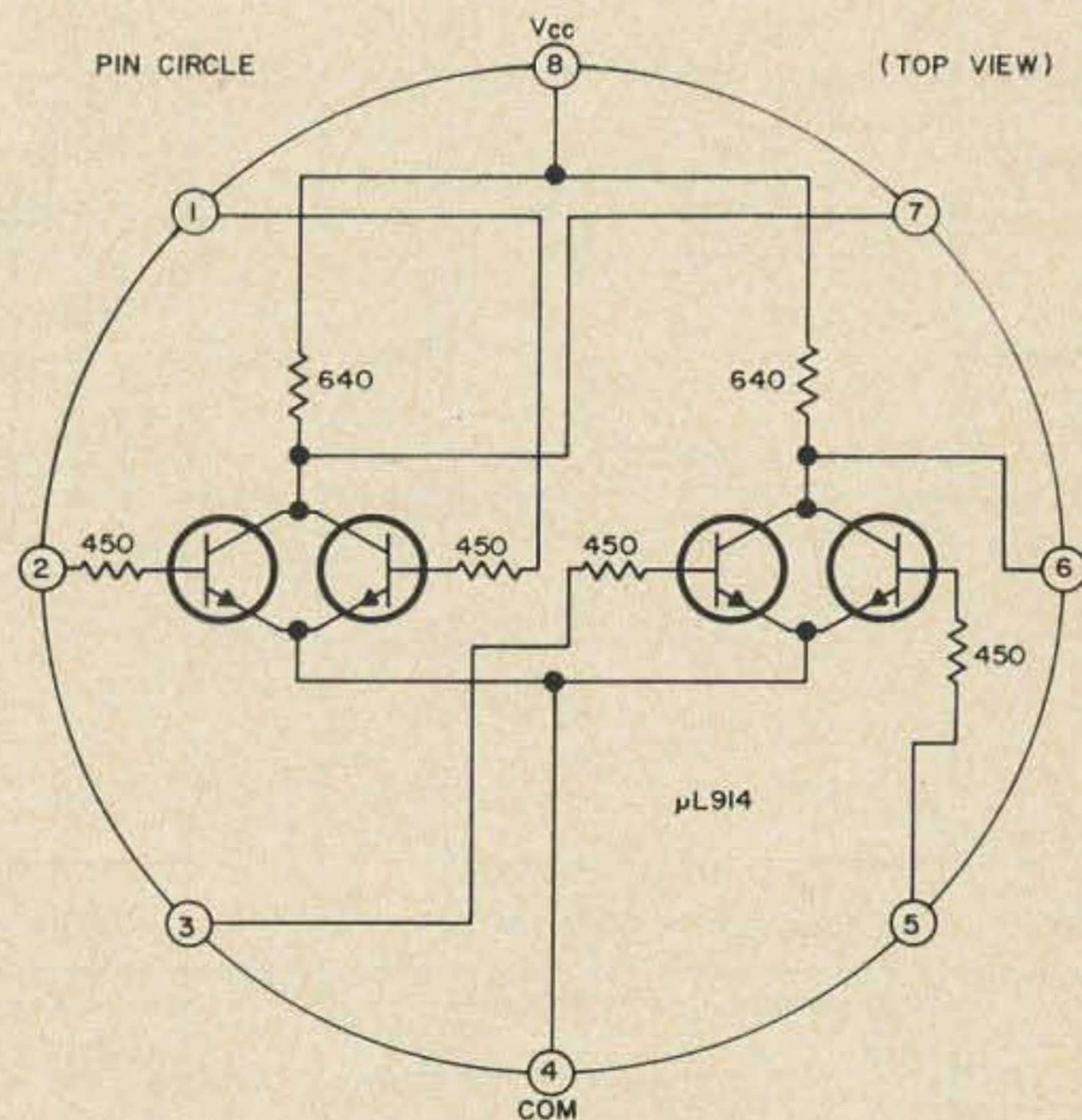
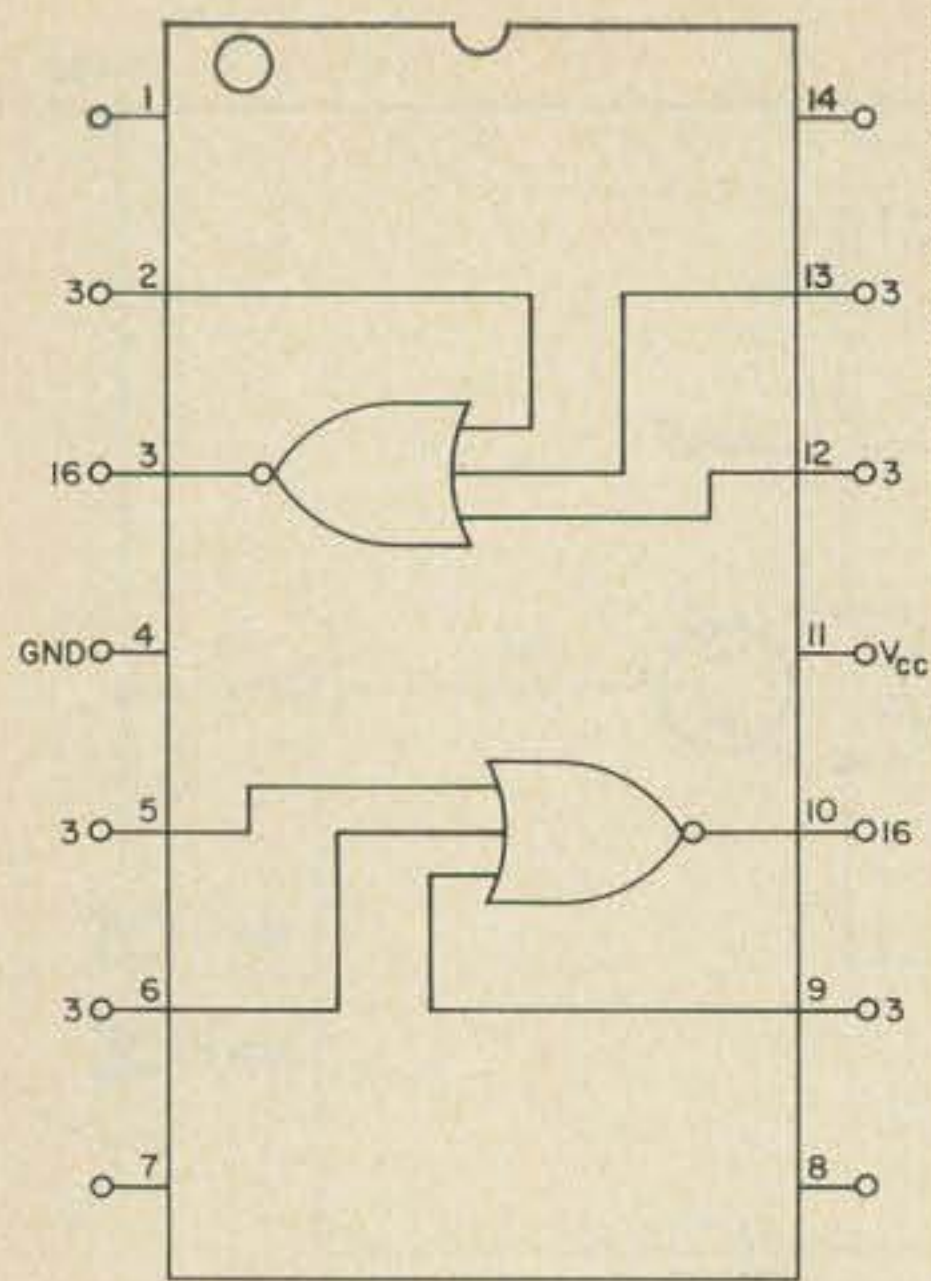

Fig. 3. Basing diagram and circuit of the Fairchild $\mu L914$ RTL gate.

HEP Number	MC-Number	Description	Amateur Use (other than logic)
553	303	Half-adder	
554	304	Bias-driver	Regulator
556	306	Three-input gate	Schmitt trigger, free-running multivibrator, amplifier
558	308	J-K flip-flop	Divider, one-shot multivibrator

Table 2. Comparison of the Motorola HEP line to their MC300 IC elements.



MC715P DUAL 3-INPUT GATE

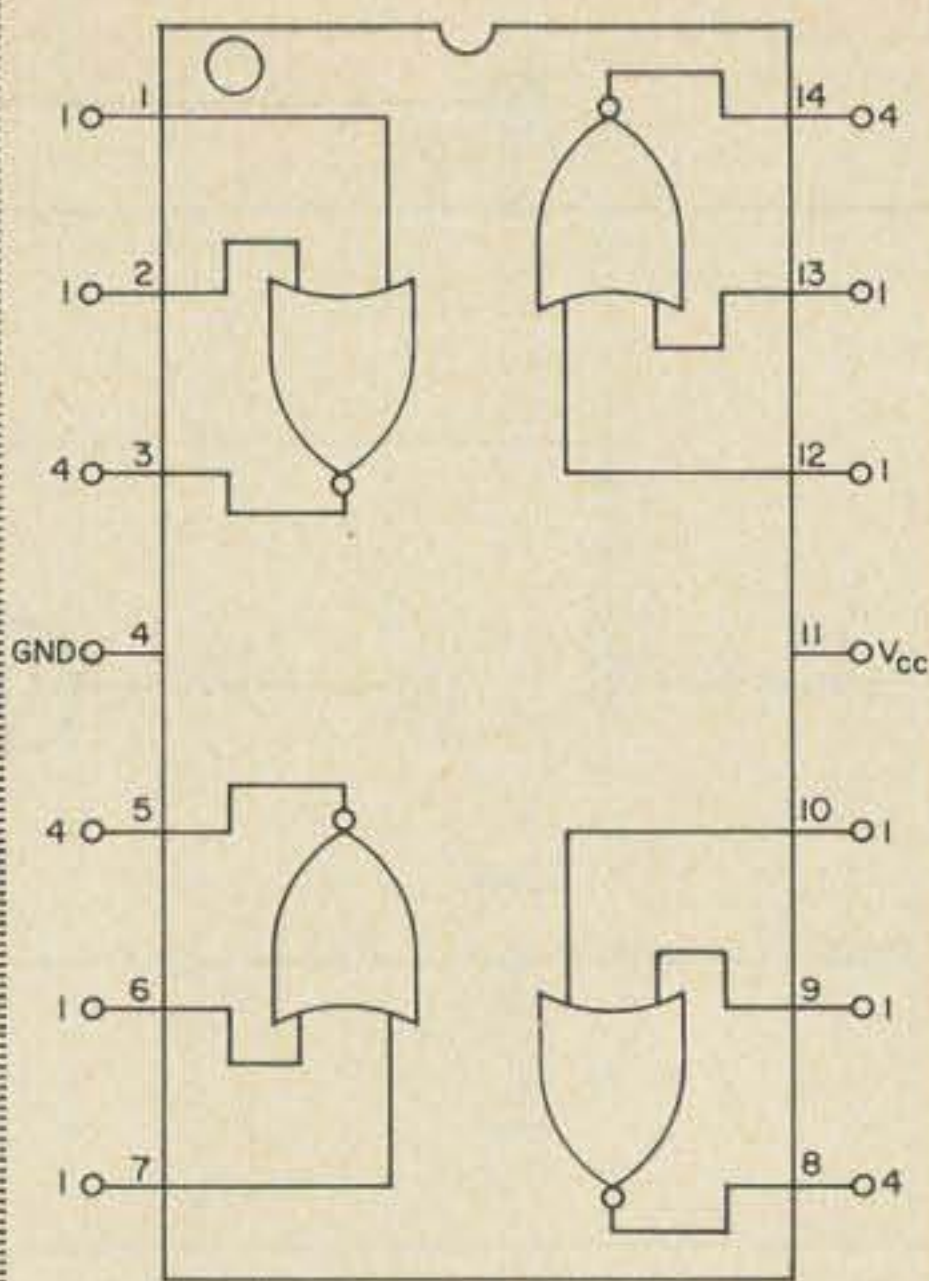

MC717P QUAD 2-INPUT GATE

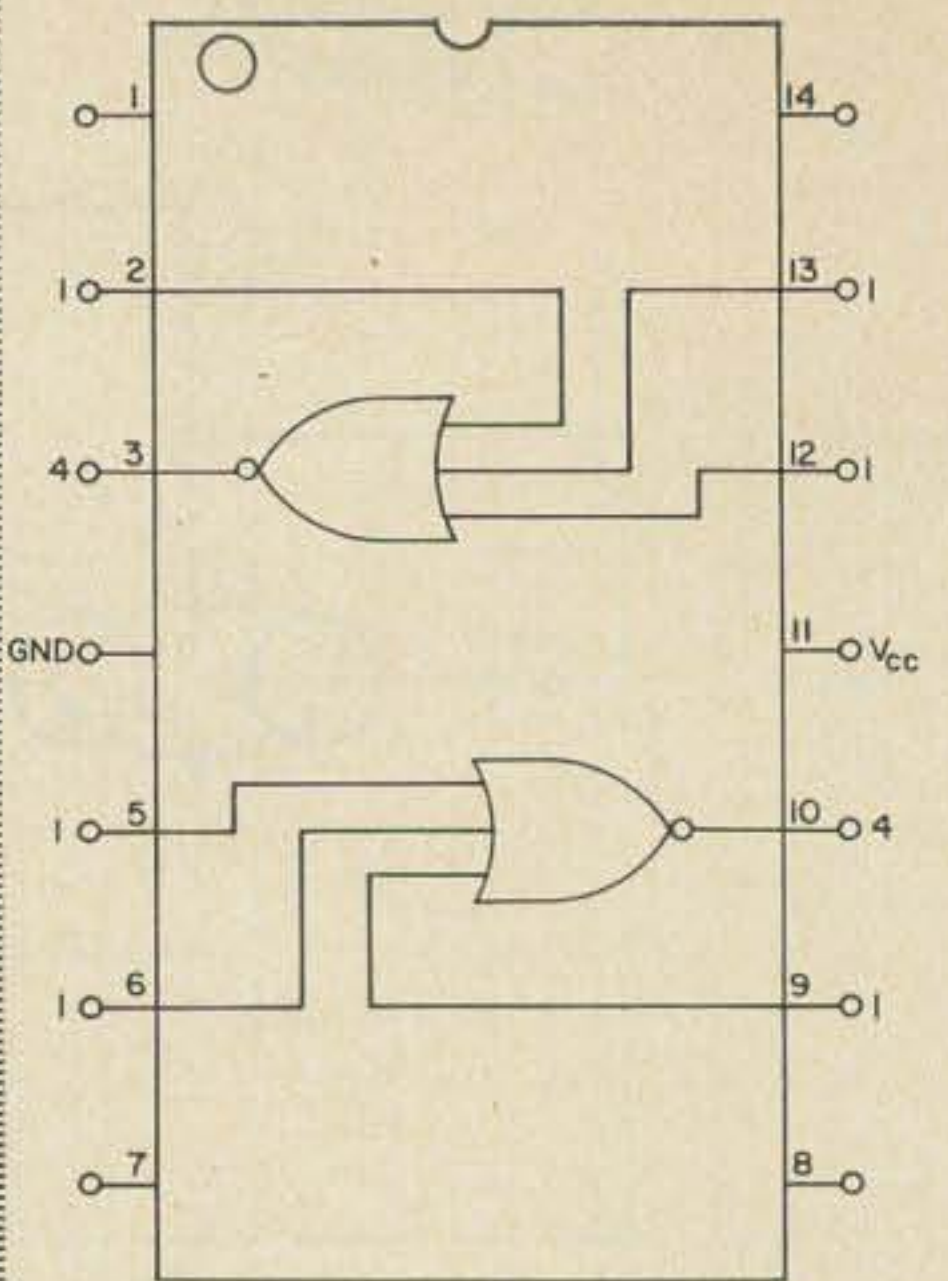

MC718P DUAL 3-INPUT GATE

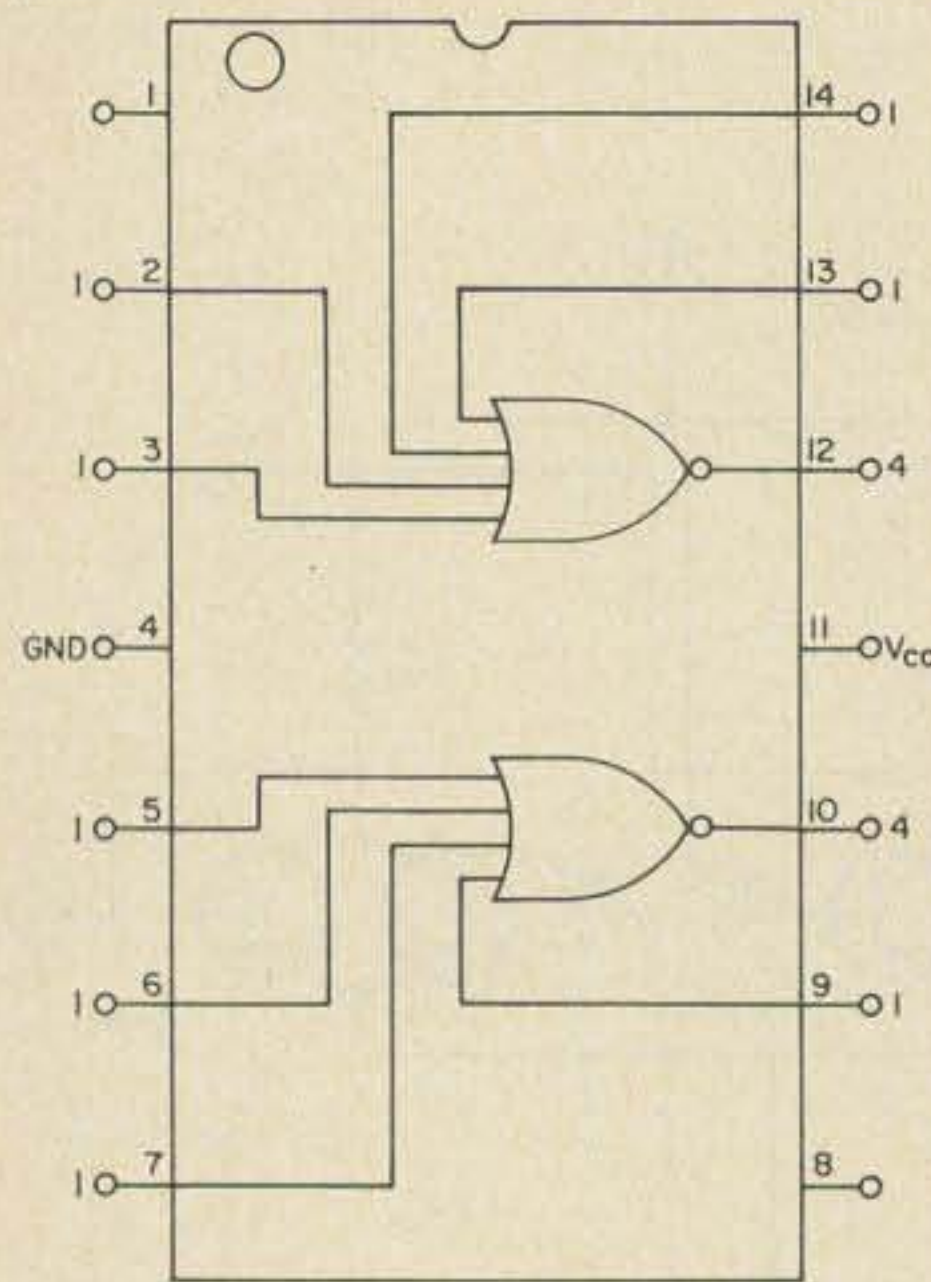

MC719P DUAL 4-INPUT GATE

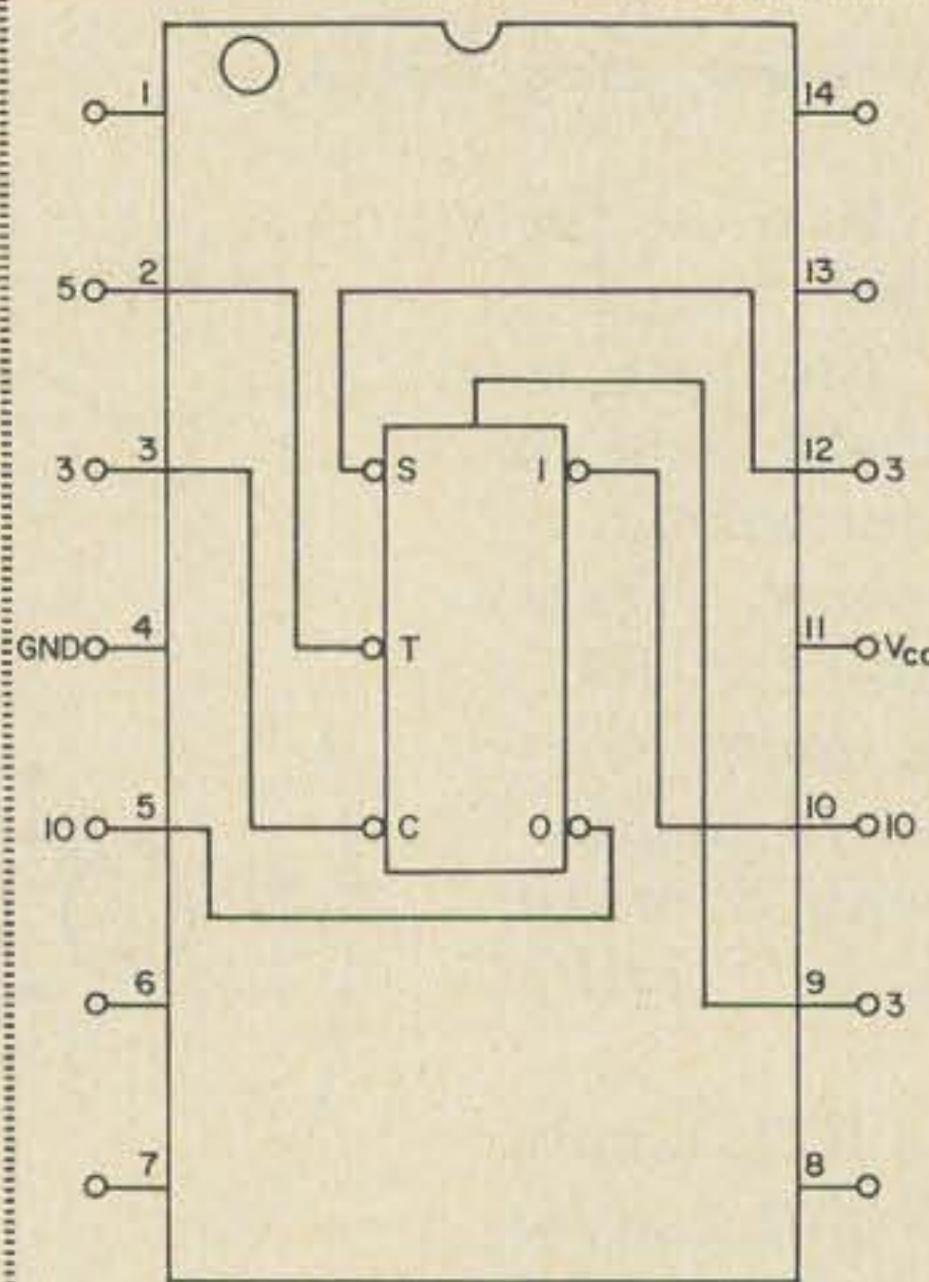

MC723P J-K FLIP-FLOP

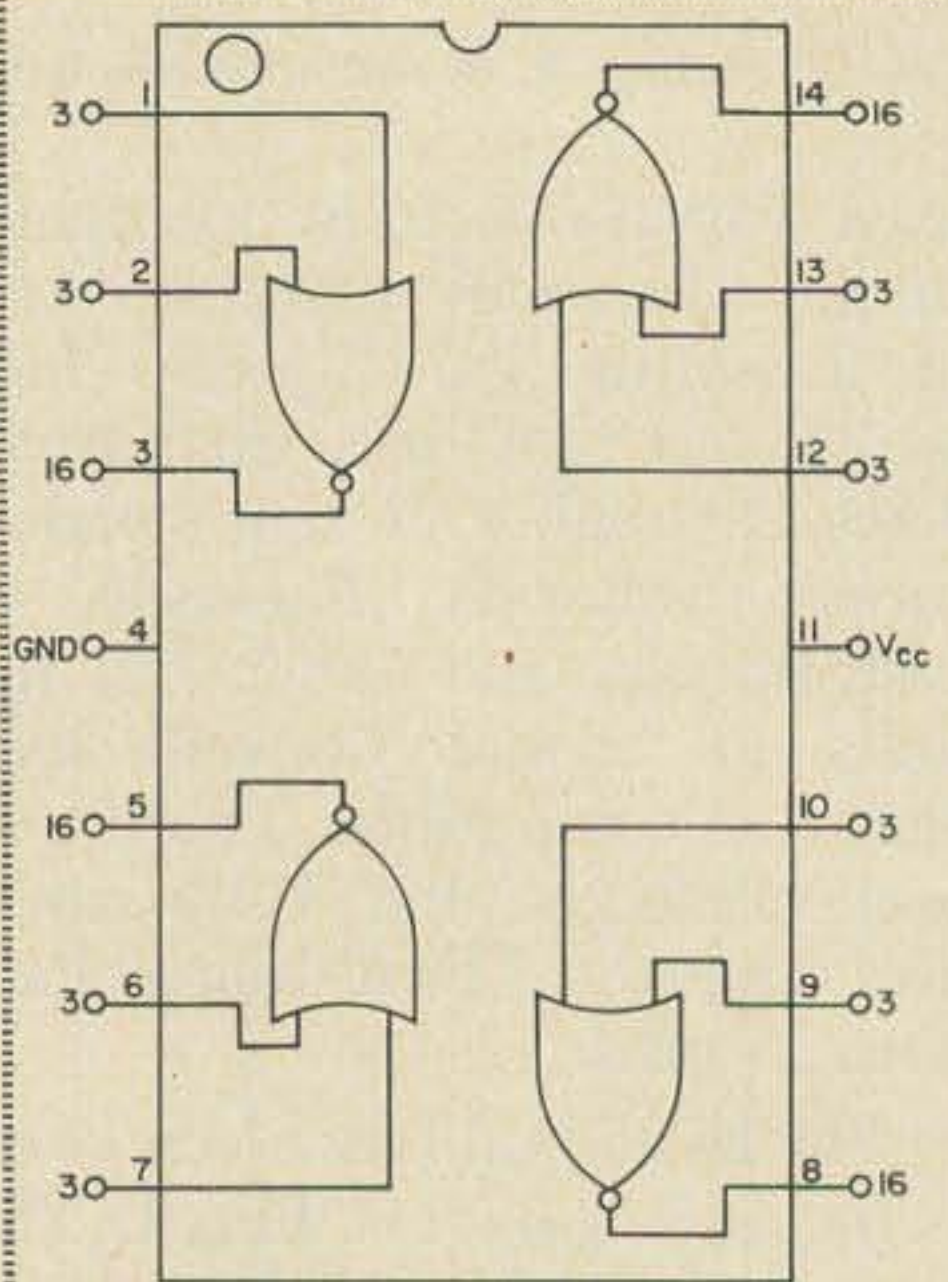

MC724P QUAD 2-INPUT GATE

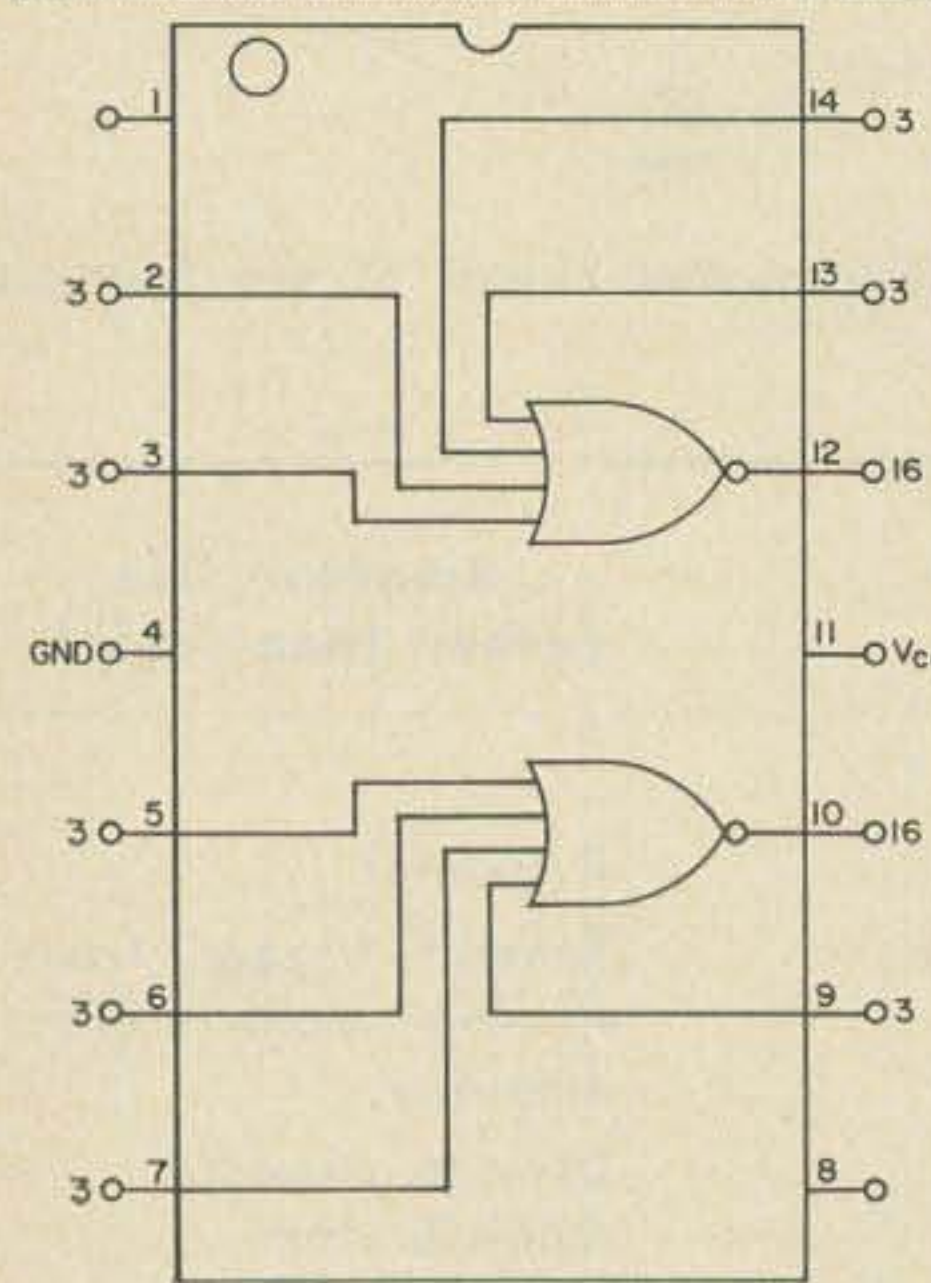

MC725P DUAL 4-INPUT GATE

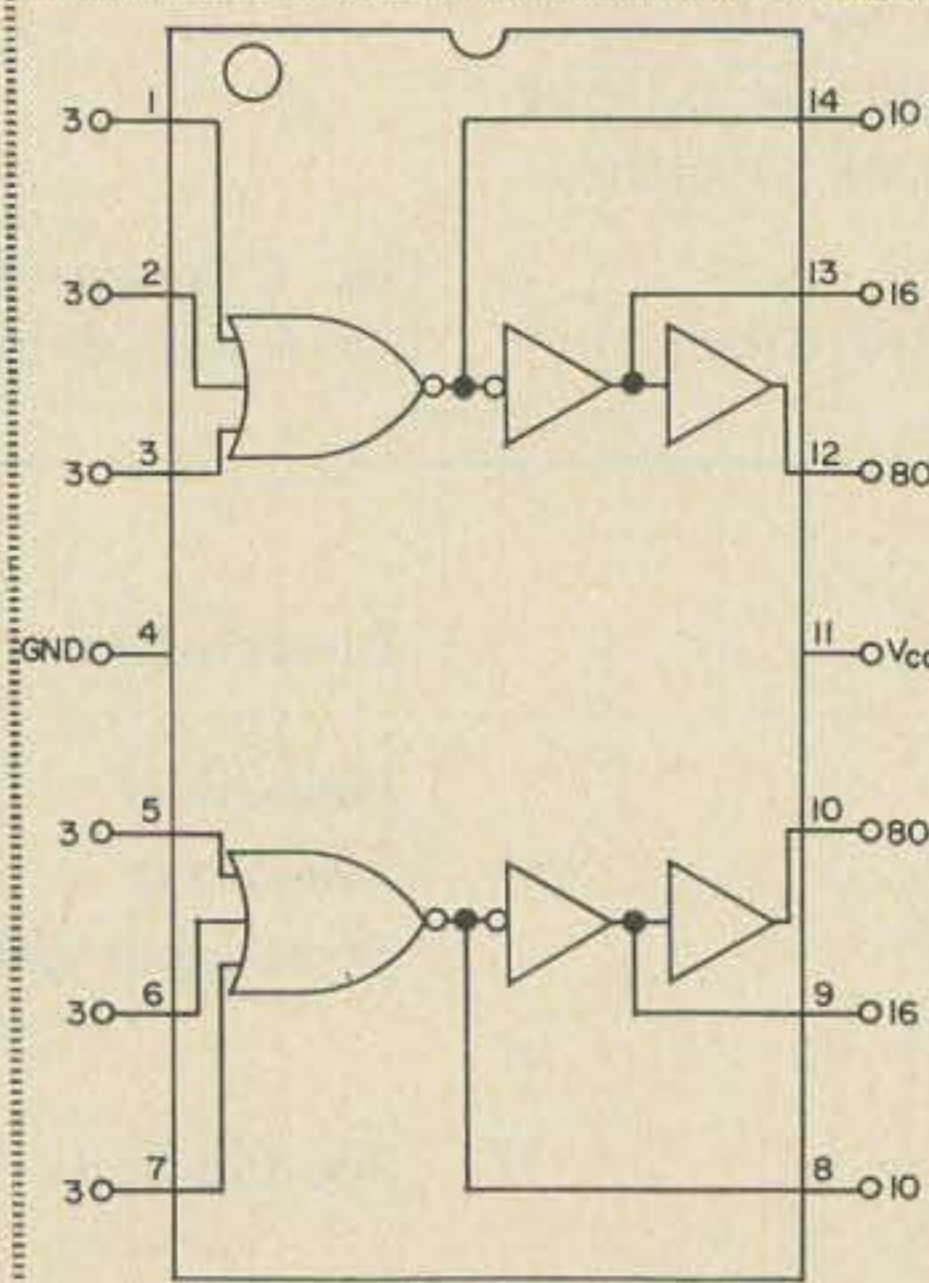

MC788P DUAL BUFFER

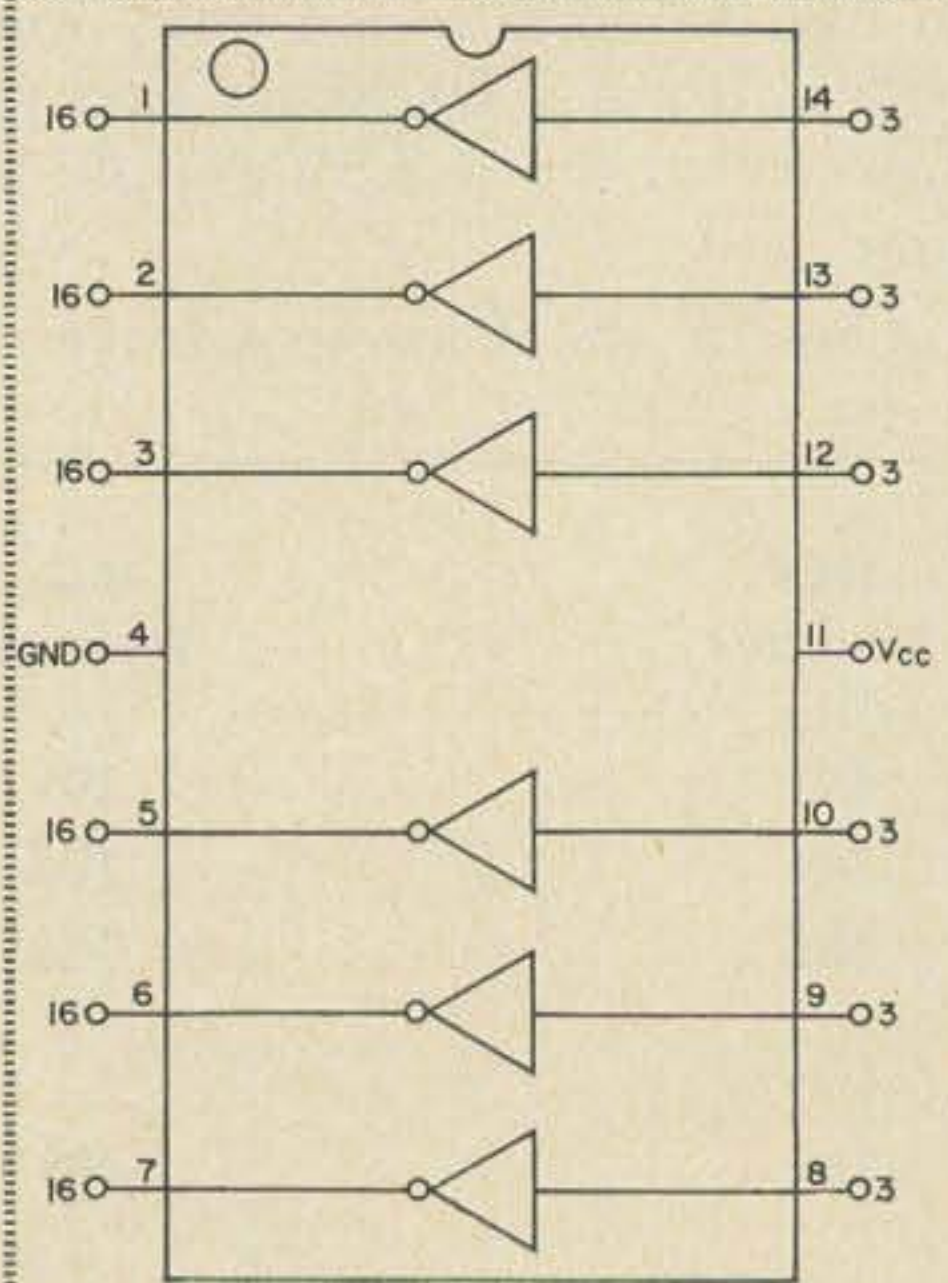

MC789P HEX INVERTER

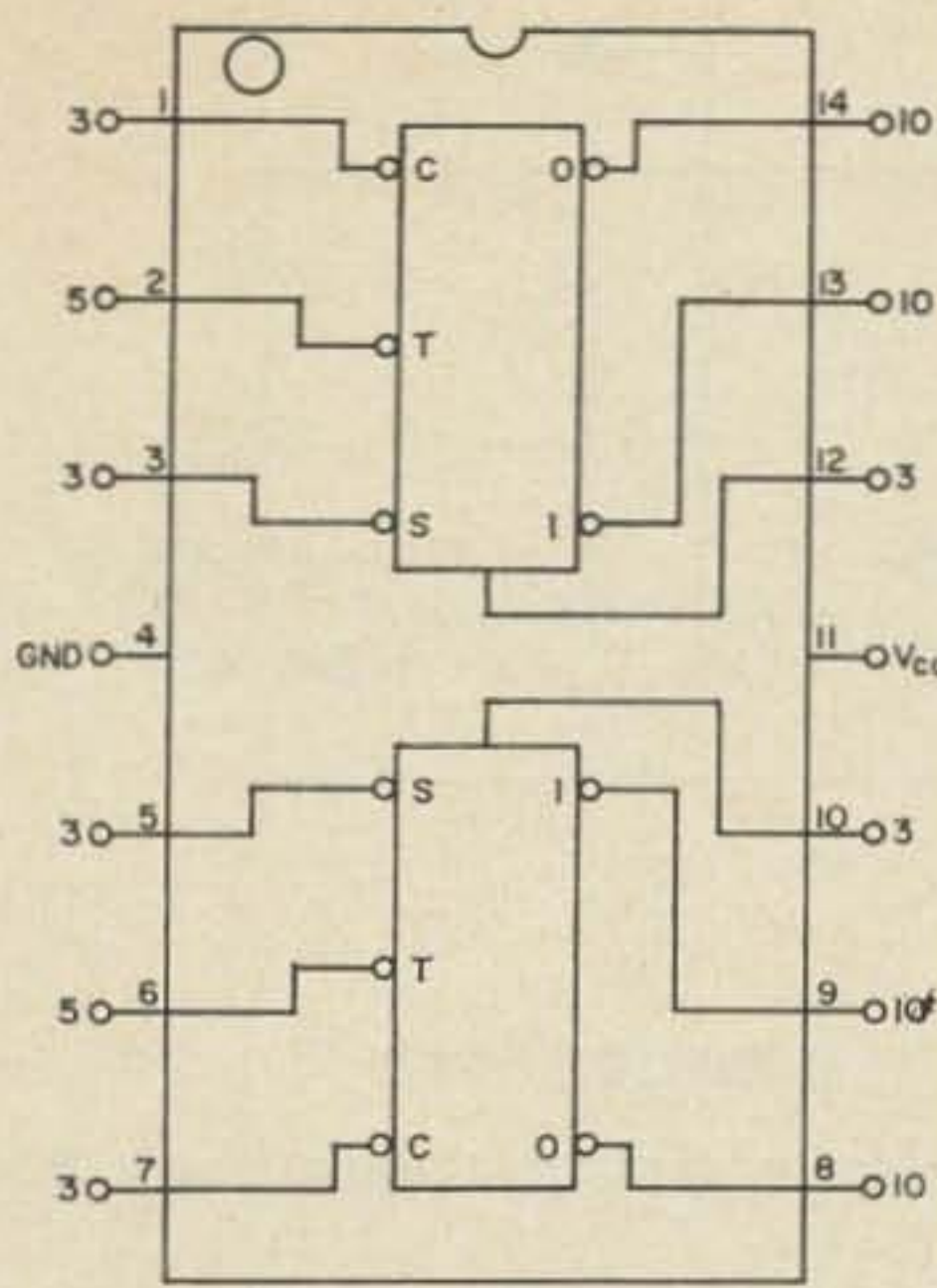

MC790P DUAL J-K FLIP-FLOP

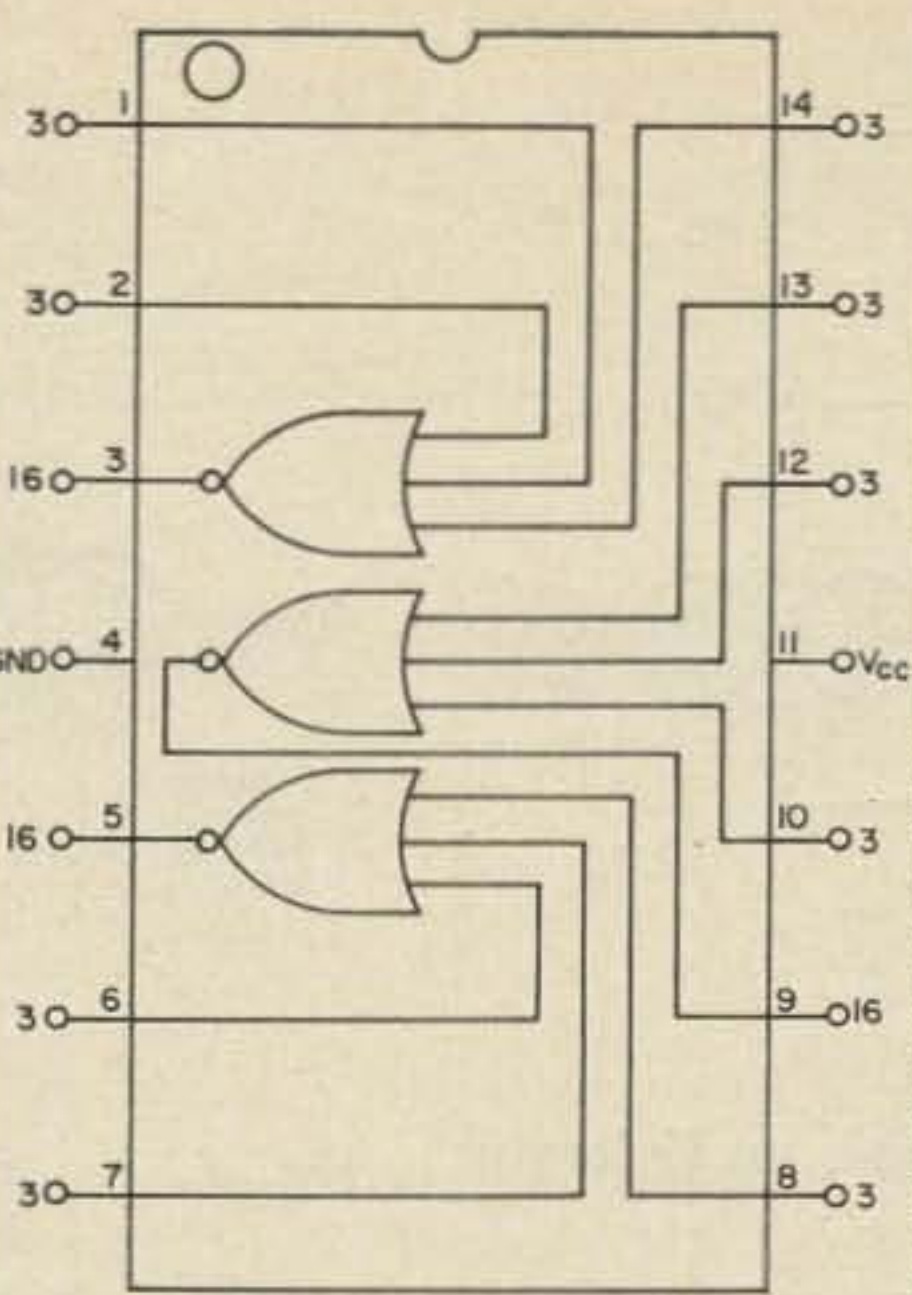

MC792P TRIPLE 3-INPUT GATE

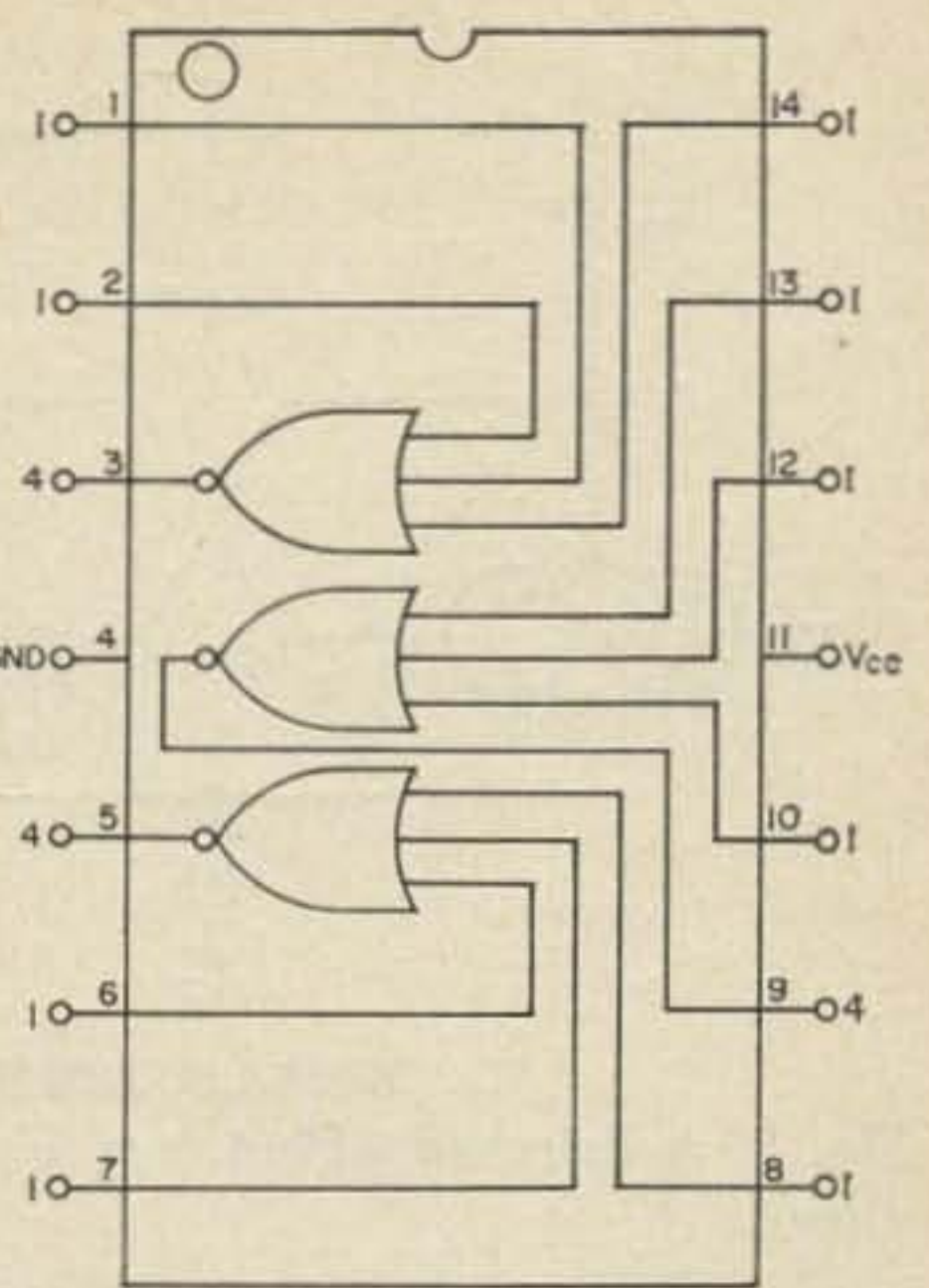

MC793P TRIPLE 3-INPUT GATE

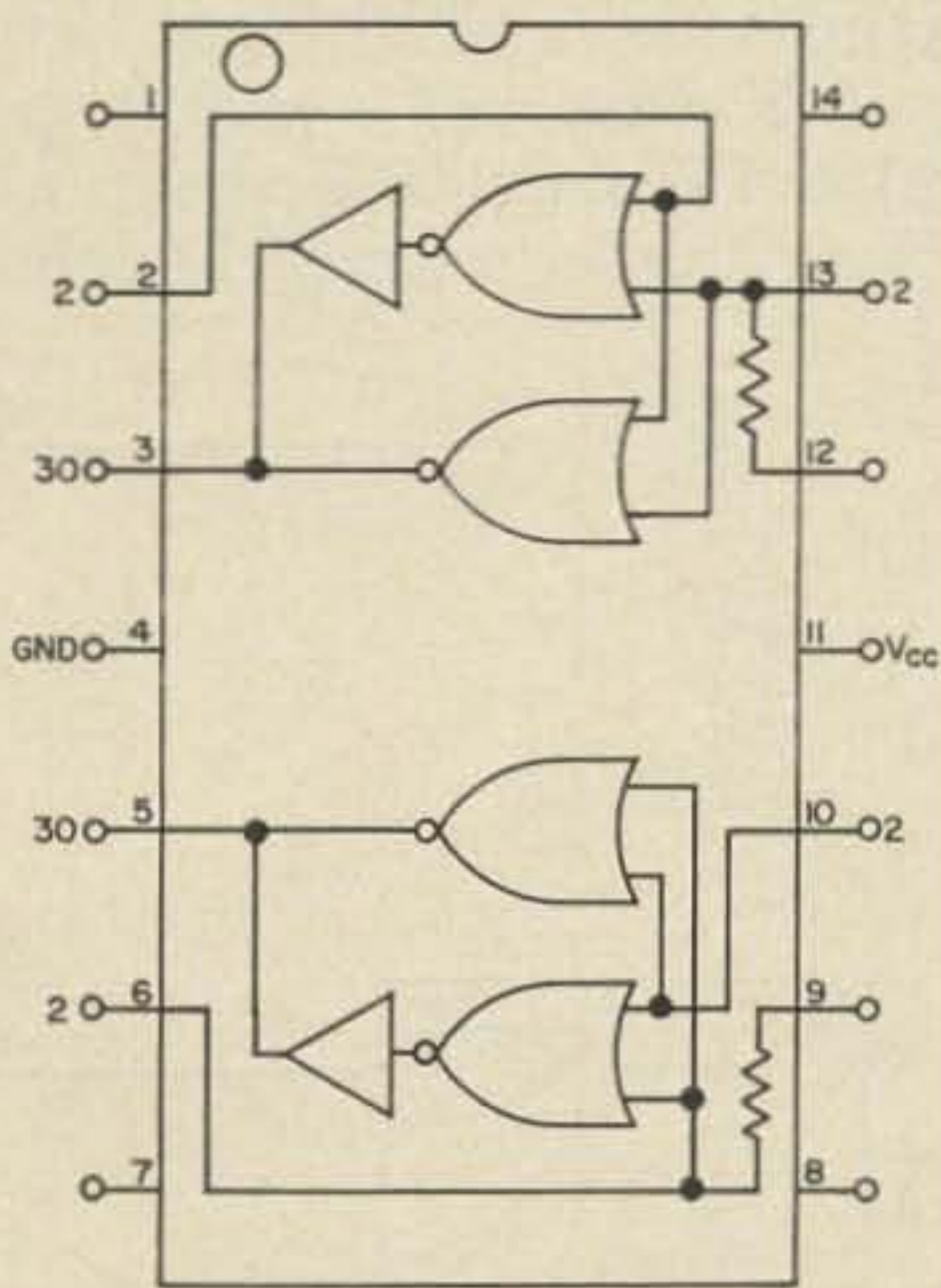

MC798P DUAL BUFFER

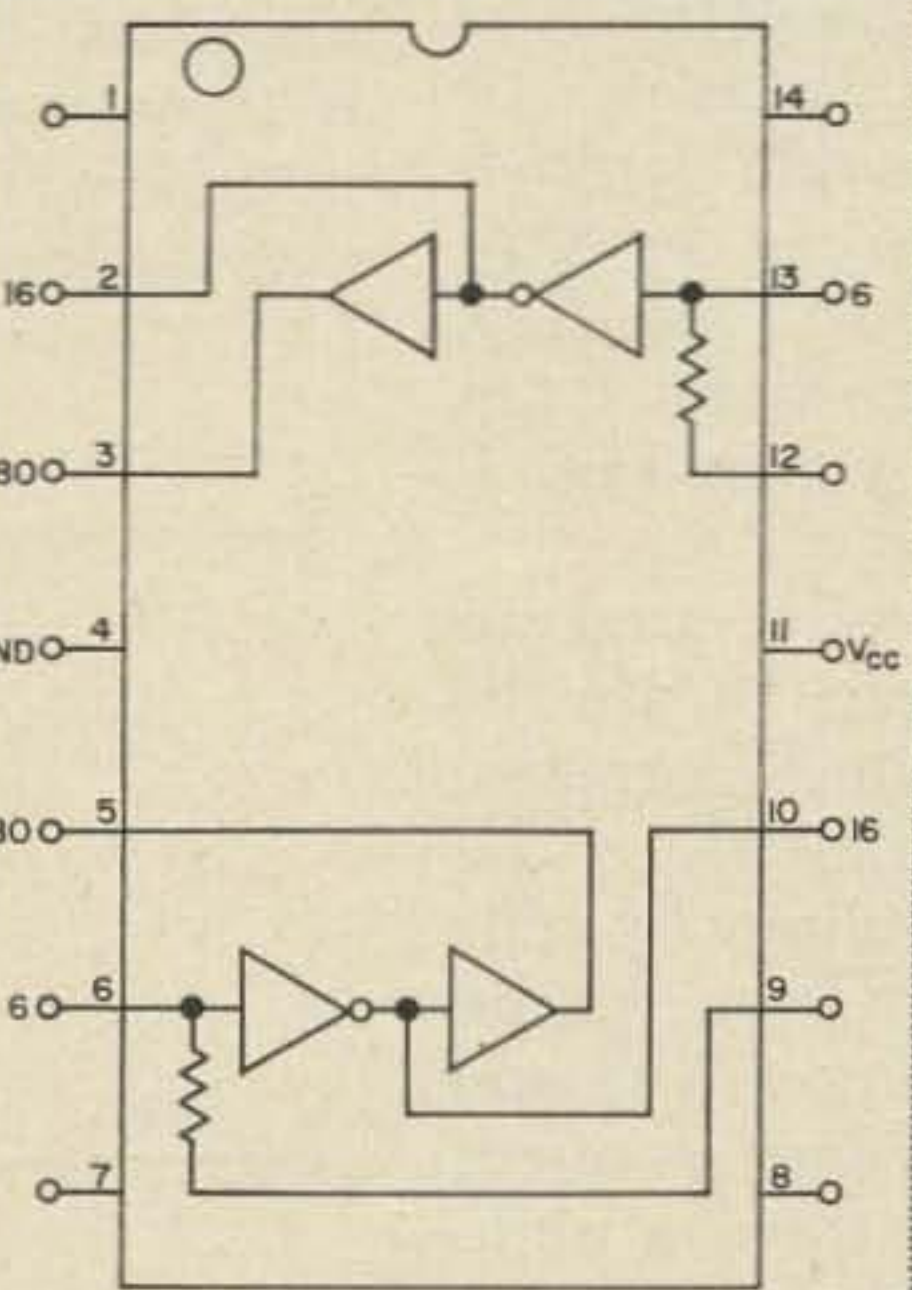

MC799P DUAL BUFFER

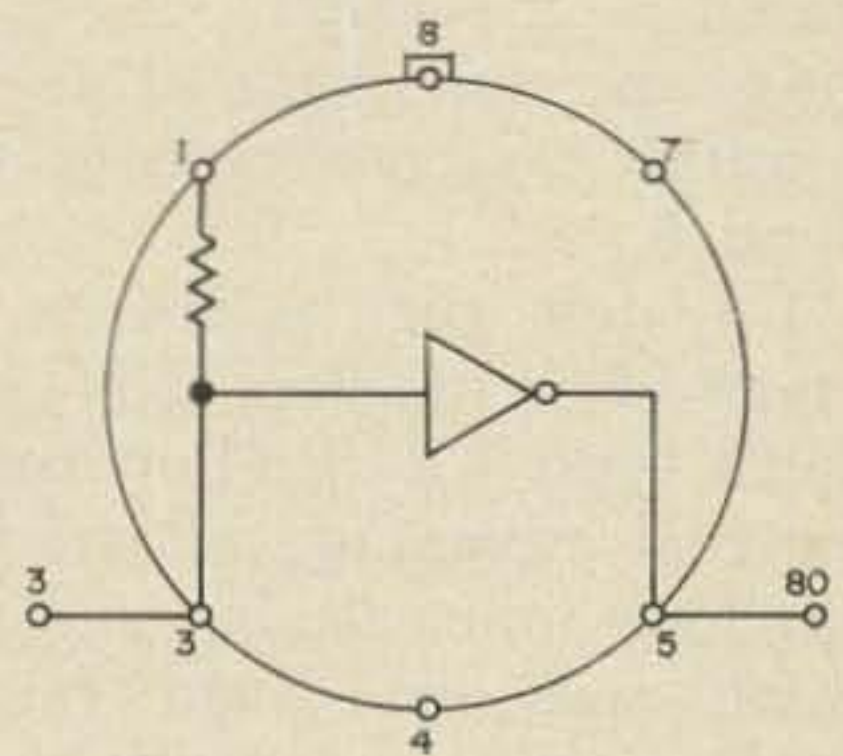

μL900

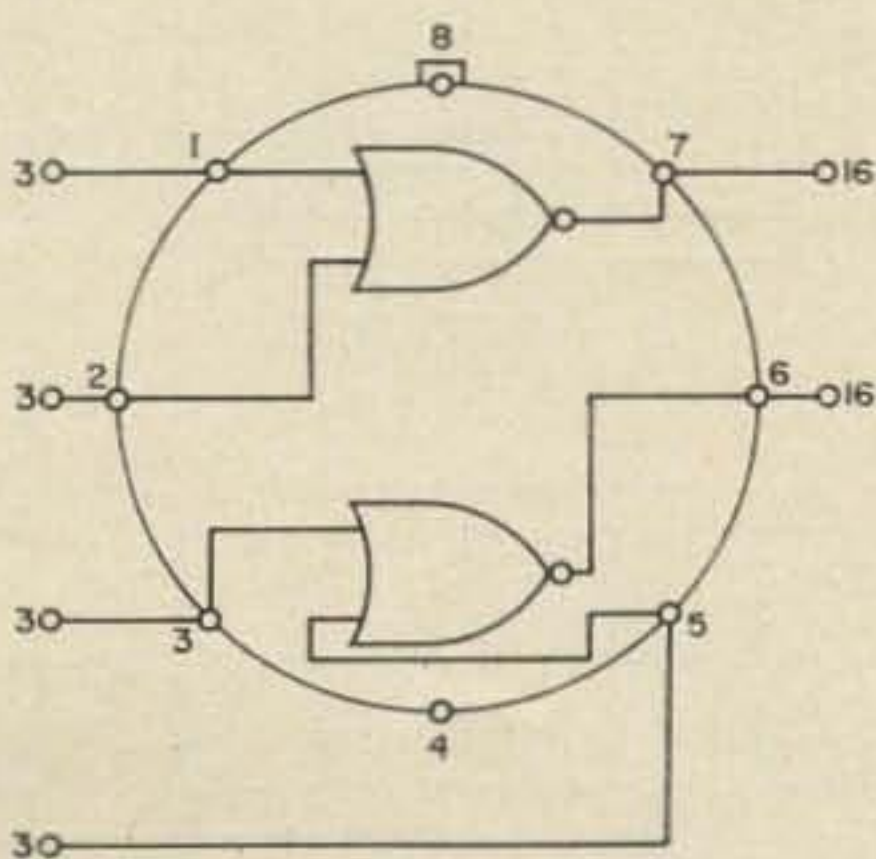

μL914

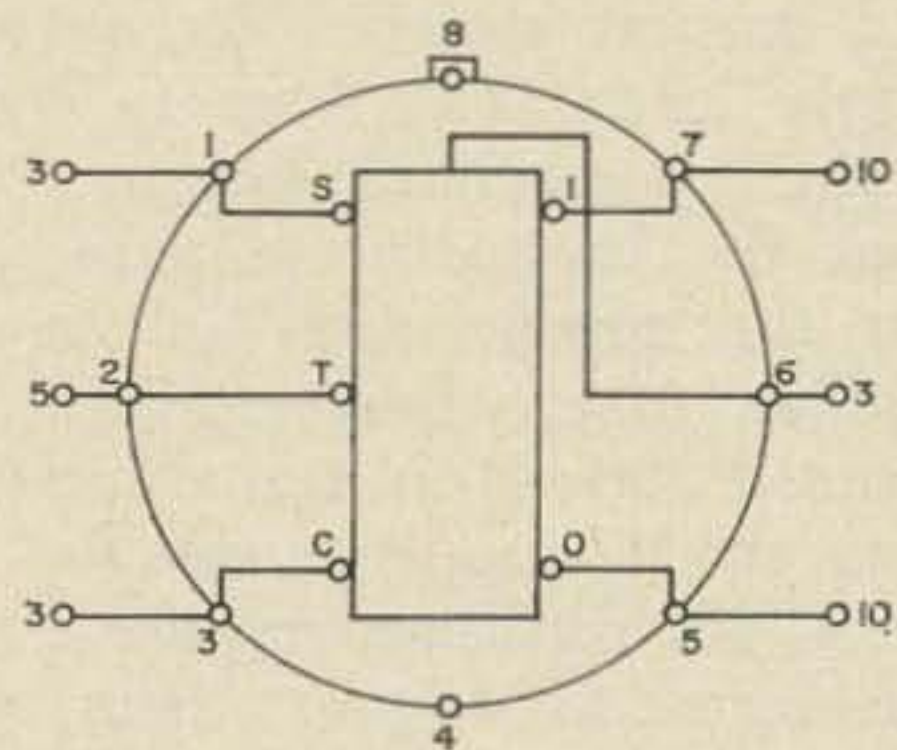

μL923

Table 1. Basing diagrams, circuit logic and load factors for popular IC packages. The MC-numbered units are manufactured by Motorola; μL-units by Fairchild.

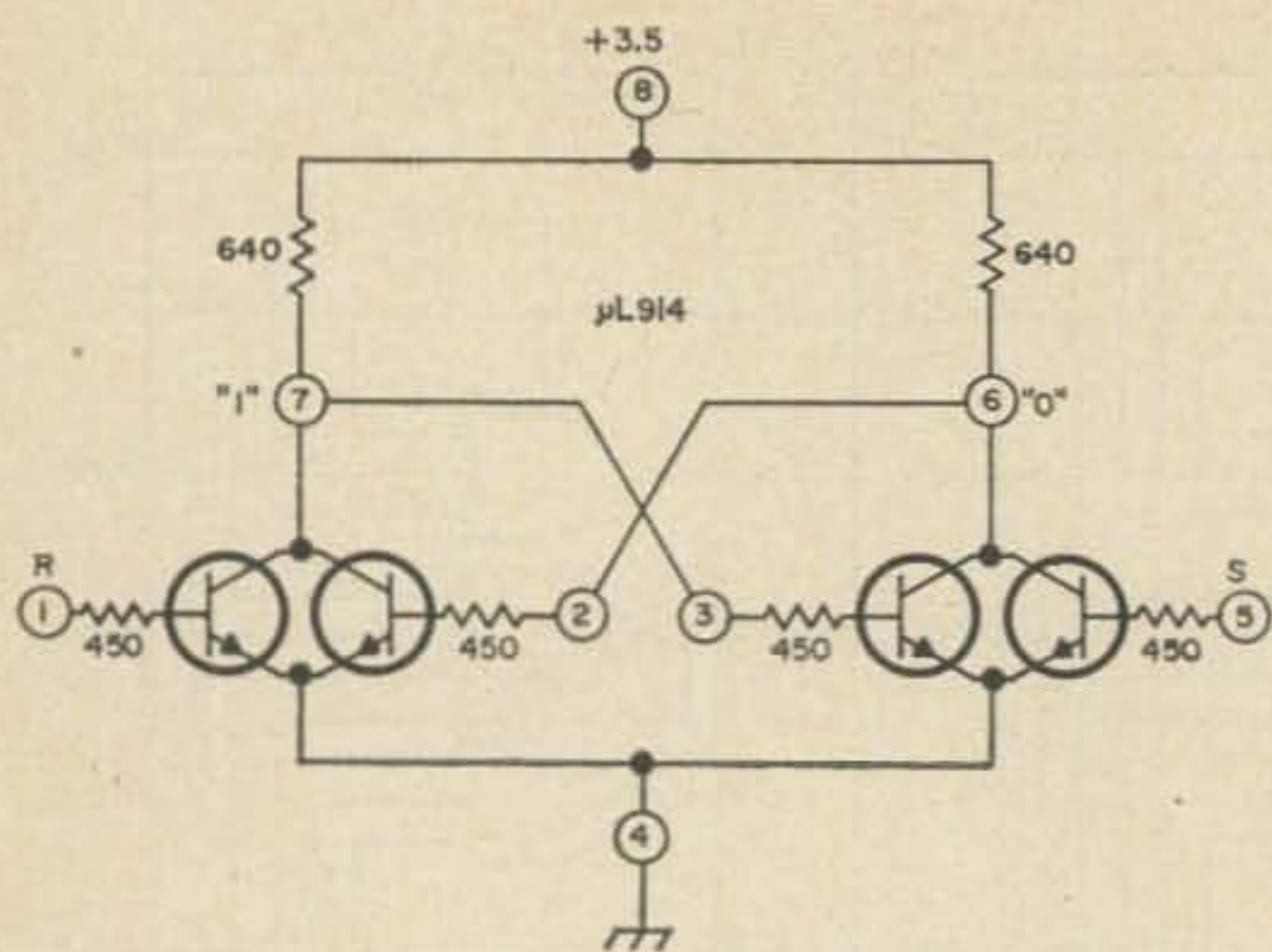

BISTABLE MULTIVIBRATOR

Fig. 5. A Fairchild μL914 in a bistable multivibrator circuit.

satellite RTL gates that is in general use is the Fairchild μL914 . This is shown in Fig. 3. It can be used (in addition to its normal use as a gate) as a monostable, bistable, or astable multivibrator. The bistable multivibrator connection of this chip can be purchased as the μL902 , a type "RS" flip-flop. The connection of the μL914 in various types of multivibrator circuits is shown in Fig. 4, 5 and 6.

Although the μL914 is easily used as a type "RS" flip-flop, it is simpler to use the μL923 type J-K flip-flop for most purposes. The real advantage of using the J-K is the simplicity one attains in dividing by different numbers. Even fairly large prime numbers may be divided using J-K's, and no critical feedback capacitors are required. Since the J-K has many ports, there are a number of ways to divide most numbers. Some examples of dividers using J-K's are shown in Fig. 7.

There are some points of care which must be observed when using these RTL IC's. The individual J-K will draw between 20 and 25 mA of current at 3.6 volts, so use good "fat" supply leads. This care in buss (and ground) lines is essential, because the RTL family has the lowest noise immunity (for spikes on the supply line) of any of the logic families. Also, when in doubt, it never hurts to put a 330 μF -6V tantalitic capacitor right across the IC supply terminals.

The RTL J-K flip-flops require a fast rise-time waveform to trigger them properly. Try to keep your rise-time to less than 1 μsec if possible. For instance, the $\div 5$ circuit of Fig. 7 was unreliable when the input rise-time approached 3 μsec .

The convention in the Motorola and Fair-

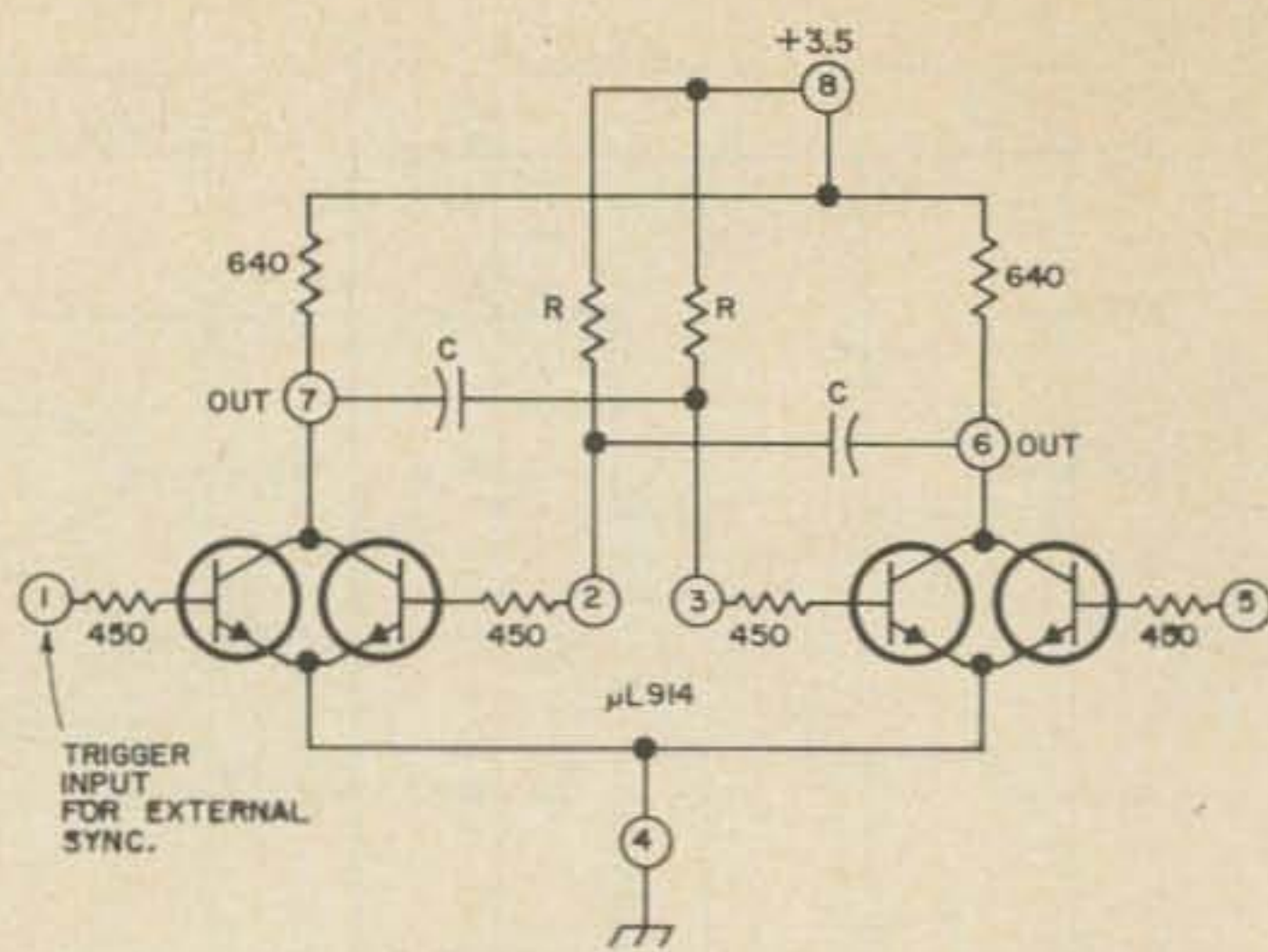

ASTABLE MULTIVIBRATOR

Fig. 6. An astable multivibrator using the μL914 .

child RTL family is to add load factor numbers adjacent to the pin numbers of the IC diagrams. For instance, a μL914 gate input is *three* units of loading and a μL914 gate output will drive *16* units of loading. This load factor scheduling is completely consis-

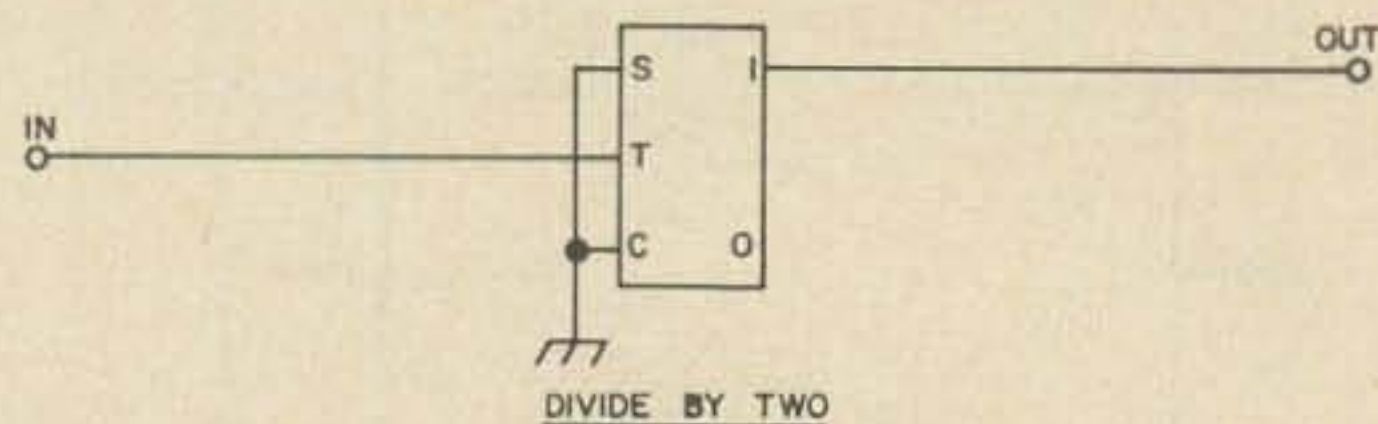

DIVIDE BY TWO

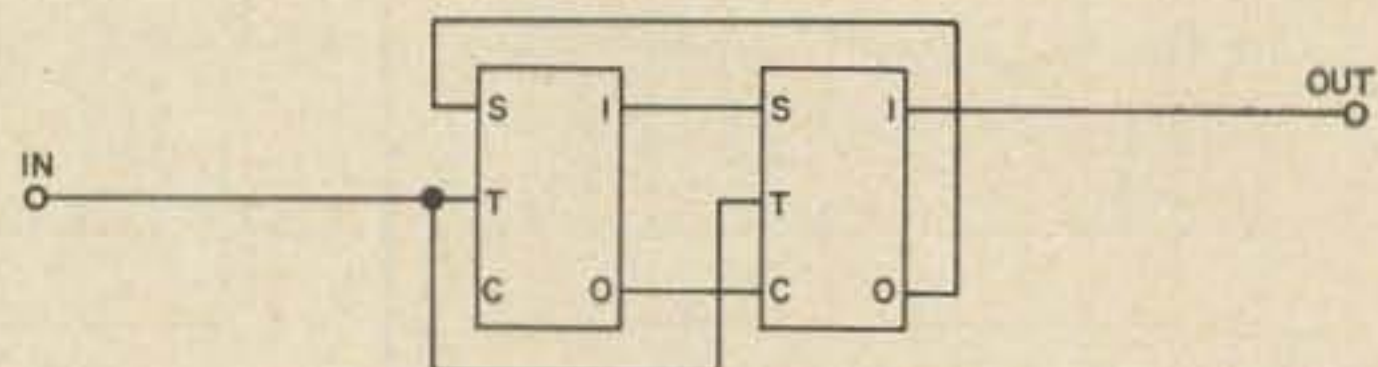

DIVIDE BY THREE

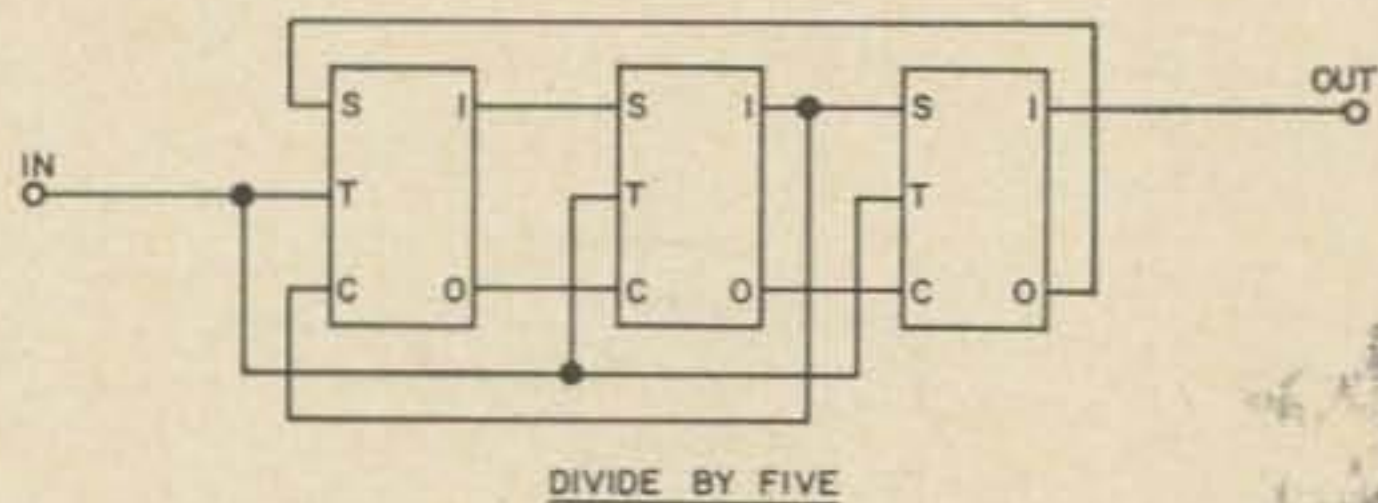

DIVIDE BY FIVE

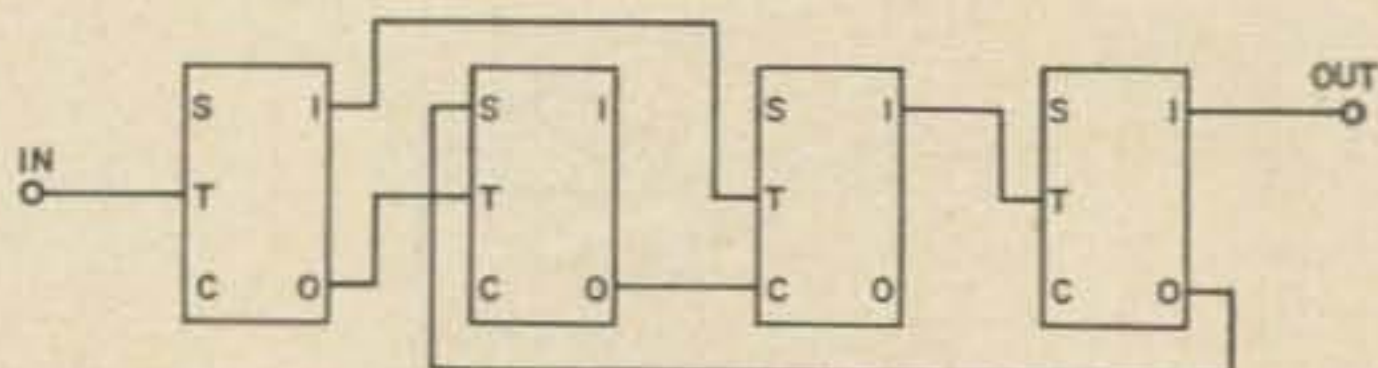

DIVIDE BY TEN

Fig. 7. J-K flip-flop divider circuits; divide by two, three, five and ten.

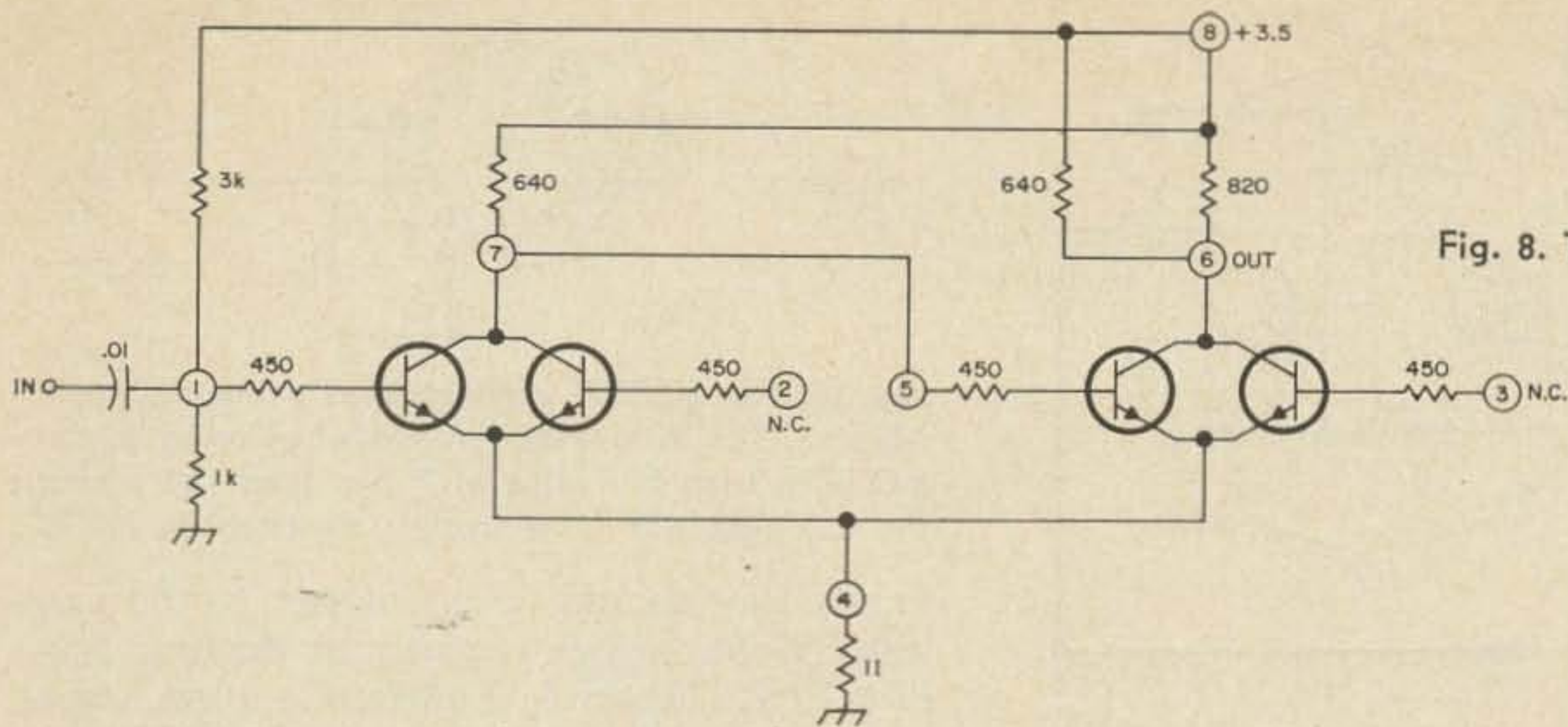

Fig. 8. The Schmitt trigger.

tent within the Fairchild μ L900 series, even though some members of this family are lower power units than others. The Motorola

MC-700P series uses the same supply voltages and logic voltage levels; and the load factor designations are also compatible with

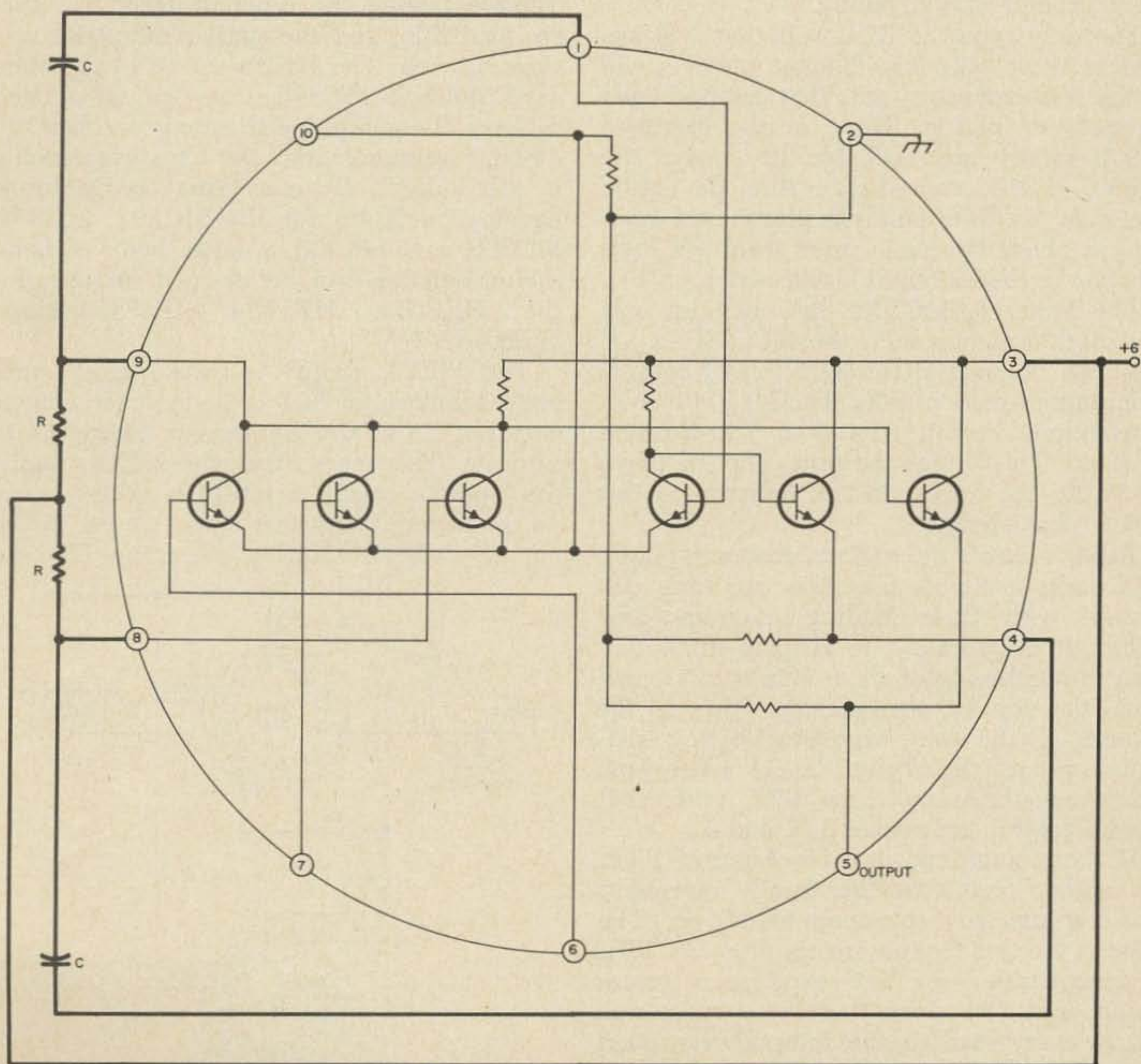

Fig. 9. The HEP 556 connected as a free-running multivibrator. For an output frequency of 1200 Hz, $R = 100k$ and $C = 0.01 \mu F$. For greater output level at the expense of waveform distortion, pins number 2 and 10 may be shorted together.

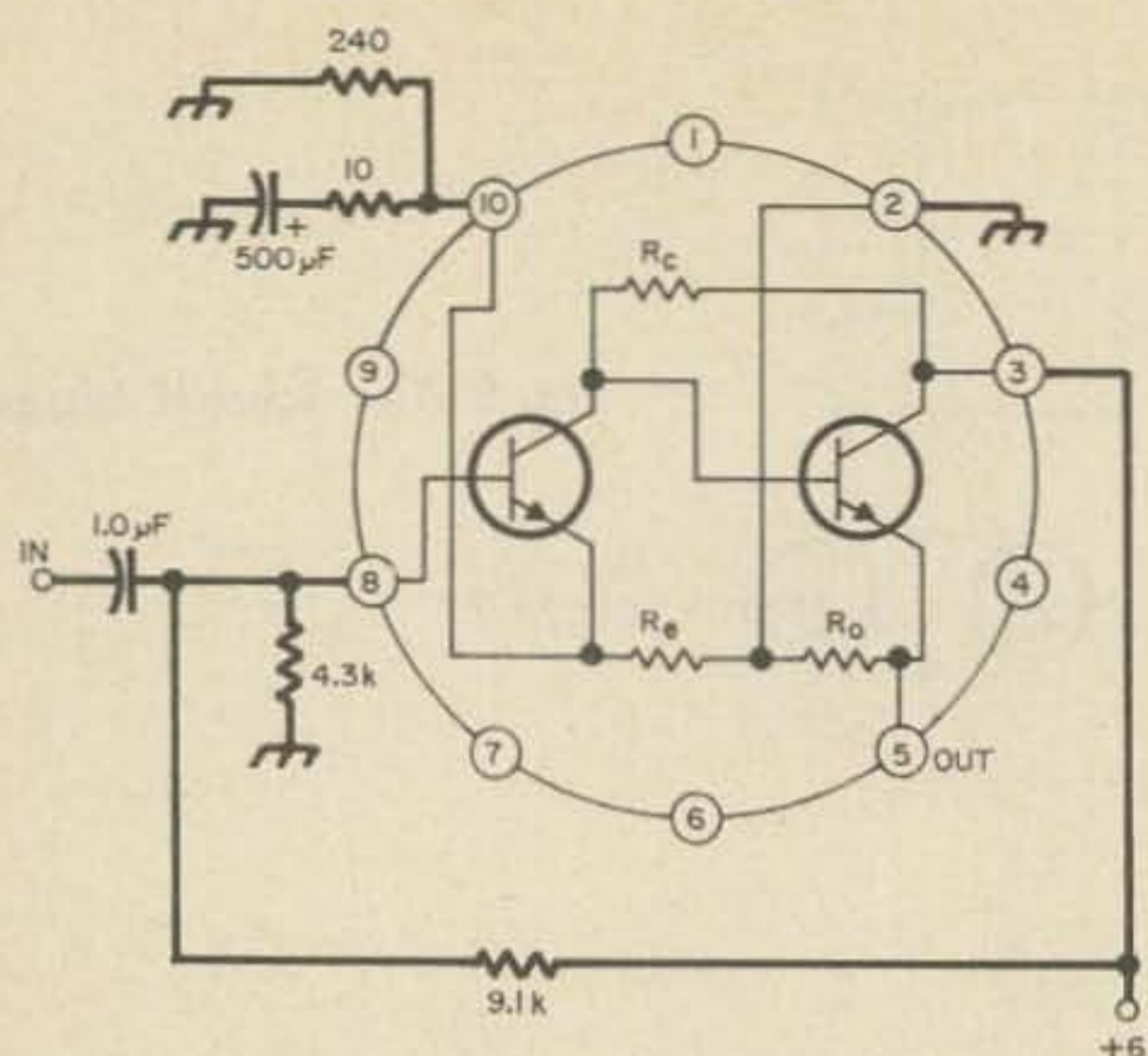

Fig. 10. Using the HEP556 as a low input impedance, low-level amplifier. The voltage gain of this circuit is approximately 20.

the Fairchild μ L900 family.

The only types of RTL IC's that will appeal to those with low budget projects will be the less-expensive units that are packaged in epoxy or plastic. Three of the Fairchild μ L900 family are available in epoxy: the μ L900, μ L914, and μ L923. Also the entire Motorola MC700P family is plastic and available at about the same price level *per logic function* as the Fairchild μ L900 series.

The Motorola MC700P line includes only one single function unit, the MC723P—a J-K flip-flop. The rest of this DIP family consists of multiple function units. The MC790P is an outstanding one; it is a dual J-K flip-flop at \$2.00. This brings the price per J-K down to \$1.00, the lowest in the industry to this author's knowledge.

Table 1 shows the various economy-plastic RTL units available from the two lines discussed, with their loading diagrams and prices. It is important to keep in mind that the pin-numbering of *these* IC's is as viewed from the top of the package; this is the reverse of the way transistor basing diagrams are usually shown. There are several articles available on these RTL units that can be helpful: references 3, 4, and 5.

Without sounding biased in favor of RTL, the author feels that this family represents the best one to "cut one's teeth" on. The reasons for this feeling are simple: (1) RTL is inexpensive, so first experience comes cheap, and (2) since there is a resistor in nearly every lead to the internal transistors of the IC chip, your mistakes are not likely to destroy the units.

ECL (Emitter-Coupled Logic) is another

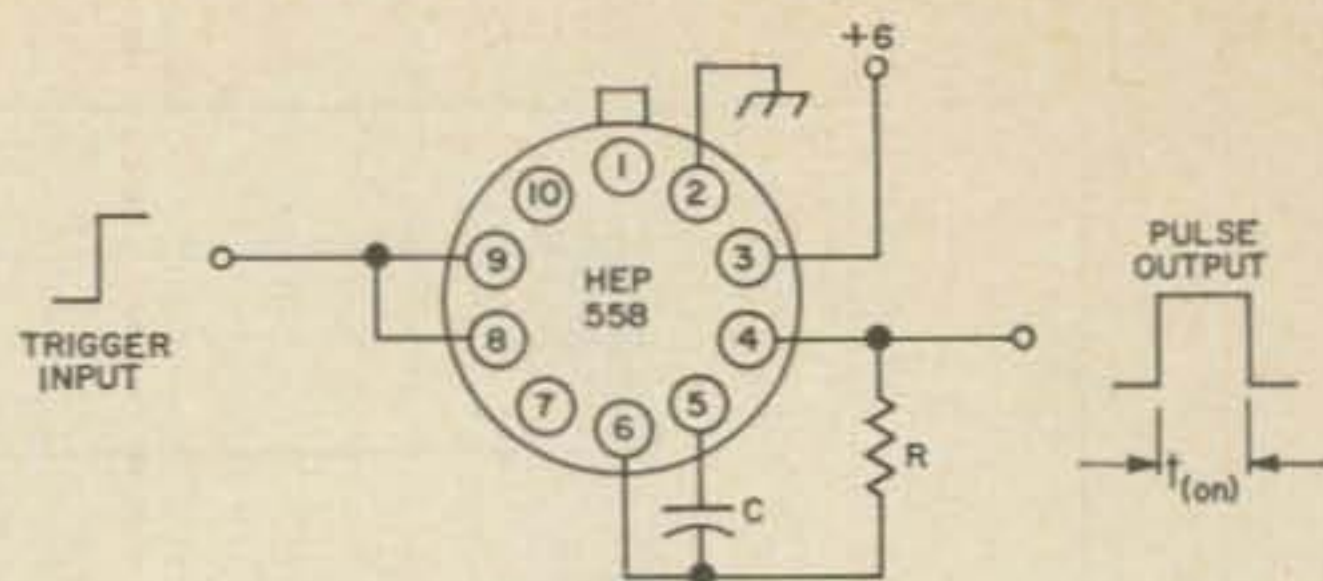

Fig. 11. The HEP558 connected as a one-shot multivibrator. The main consideration when using this circuit is to keep the value of R less than 160 kilohms; the $t_{(on)}$ time will be approximately equal to $1.4 RC$.

family that should be of interest to the amateur. Motorola has recently made four types of MECL (Motorola Emitter Coupled Logic) available in their HEP line. This HEP line has the distinct advantage of being available nearly anywhere in the U.S. and also through mail order firms such as Allied Electronics. Table II shows the types of HEP IC's that are available, and the similar industrial versions of each. The HEP versions of the standard Motorola MC300 series are not obliged to have the same specifications as their industrial versions, but the cross-referencing is still helpful. By consulting the Motorola Application Notes for the MC303, MC304, MC306, and MC308, a large body of helpful information can be gleaned on uses for the HEP553, HEP554, HEP556, and HEP558.^{6, 7, 8}

The MECL family is unlike most other logic families in that a logic level change does not cause any component transistors to saturate. This means that the MECL family can operate much faster than others, since no saturated transistors have to be pulled out of saturation during switching. The in-

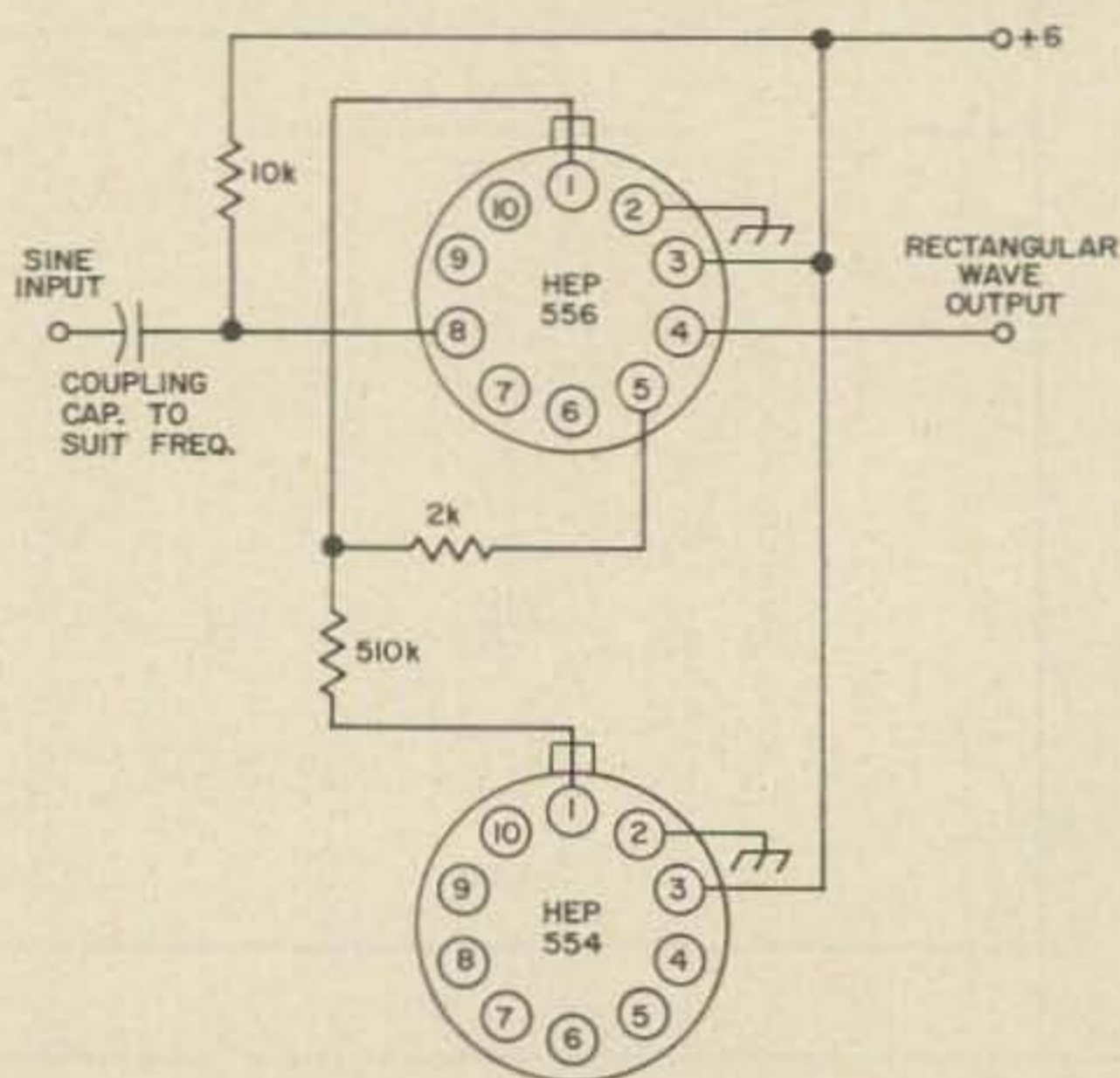

Fig. 12. Using the HEP554 and HEP556 as a Schmitt trigger. The 510k resistor should be 510 ohms.

time through counting elements. This allows us to build serial dividers of *large* prime numbers, like 17, at fairly high frequencies.⁹

Fig. 9 through 13 show several uses for the HEP integrated circuits. The applications to which these circuits are put, will be left to the readers' needs and ingenuity. Some of the units which can be built using HEP integrated circuits are described in detail in a booklet by Motorola.¹⁰

... W6GXN

Bibliography

1. Keelan, R., "Switching to Integrated Circuits", Motorola Monitor: Vol. 4, #3—p. 4-11.
2. Keelen, R., "Comparison of Seven Digital Integrated Circuit Logic Lines", Motorola Application Note AN-255.
3. Fairchild, "RT μ L Composite Data Sheet" SL 218, June 1966.
4. Motorola, "Technical Data, MC700P Series" DS-9055, May 1966.
5. Lancaster, D., "Using New Low Cost Integrated Circuits", Electronics World, March 1966, p. 50.
6. Garrett, L., "The MECL Line of Digital Integrated Circuits", Motorola Application Note AN-244.
7. Renschler, E., "MECL IC Schmitt Triggers", Motorola Applications Note AN-239.
8. Renschler, E., "Design of Monostable Multivibrators Using MECL Integrated Circuits", Motorola Application Note AN-233.
9. Landers, G., "Designing Integrated Serial Counters", Motorola Application Note AN-194.
10. Motorola, "Integrated Circuits Projects", HEP 407, May 1966.

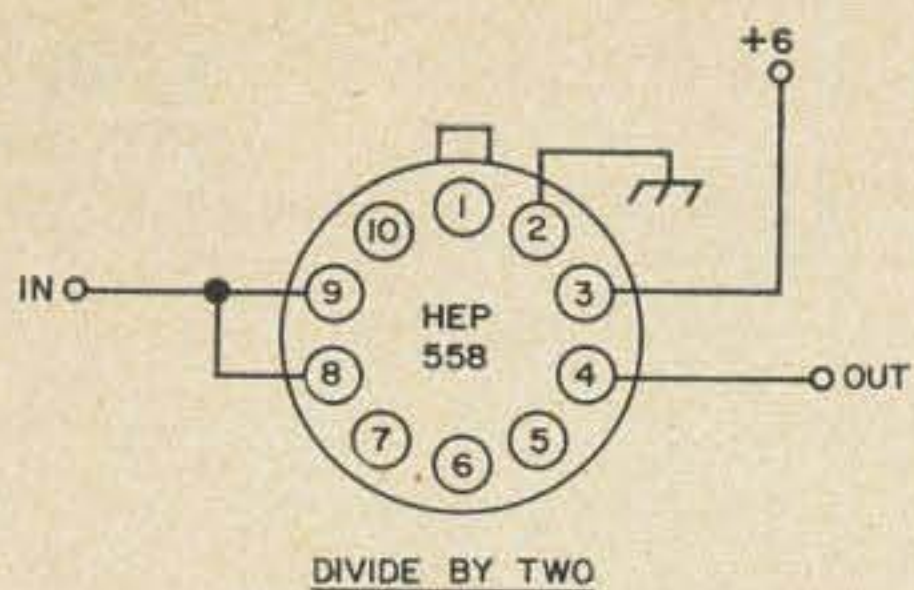

DIVIDE BY TWO

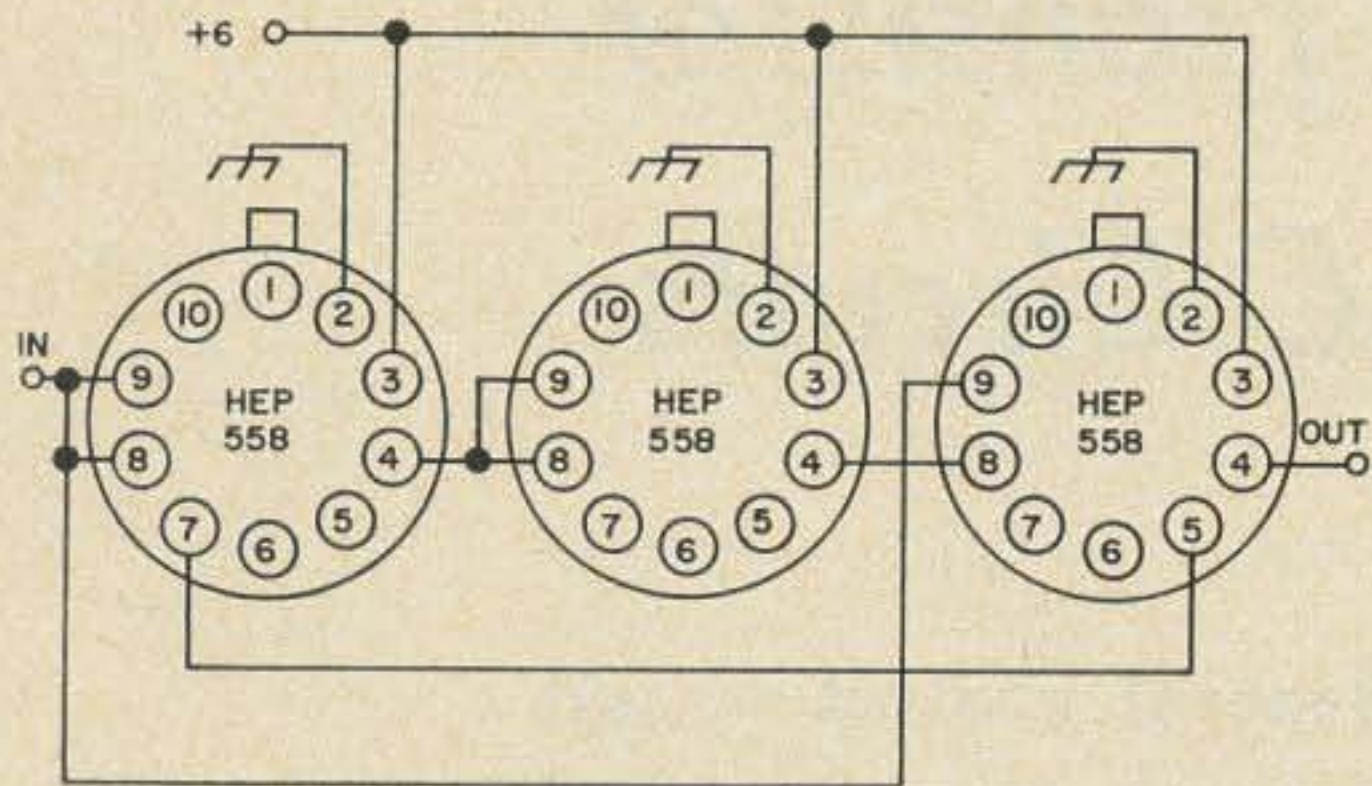

DIVIDE BY FIVE

Fig. 13. Connecting the HEP558 IC as a divider—divide by two and divide by five.

dustrial MC300 units can be used up to 30 MHz switching rates, so, we can expect to find *some* of the HEP units that will approach this rate, too. This inherently faster operation is reflected in small propagation

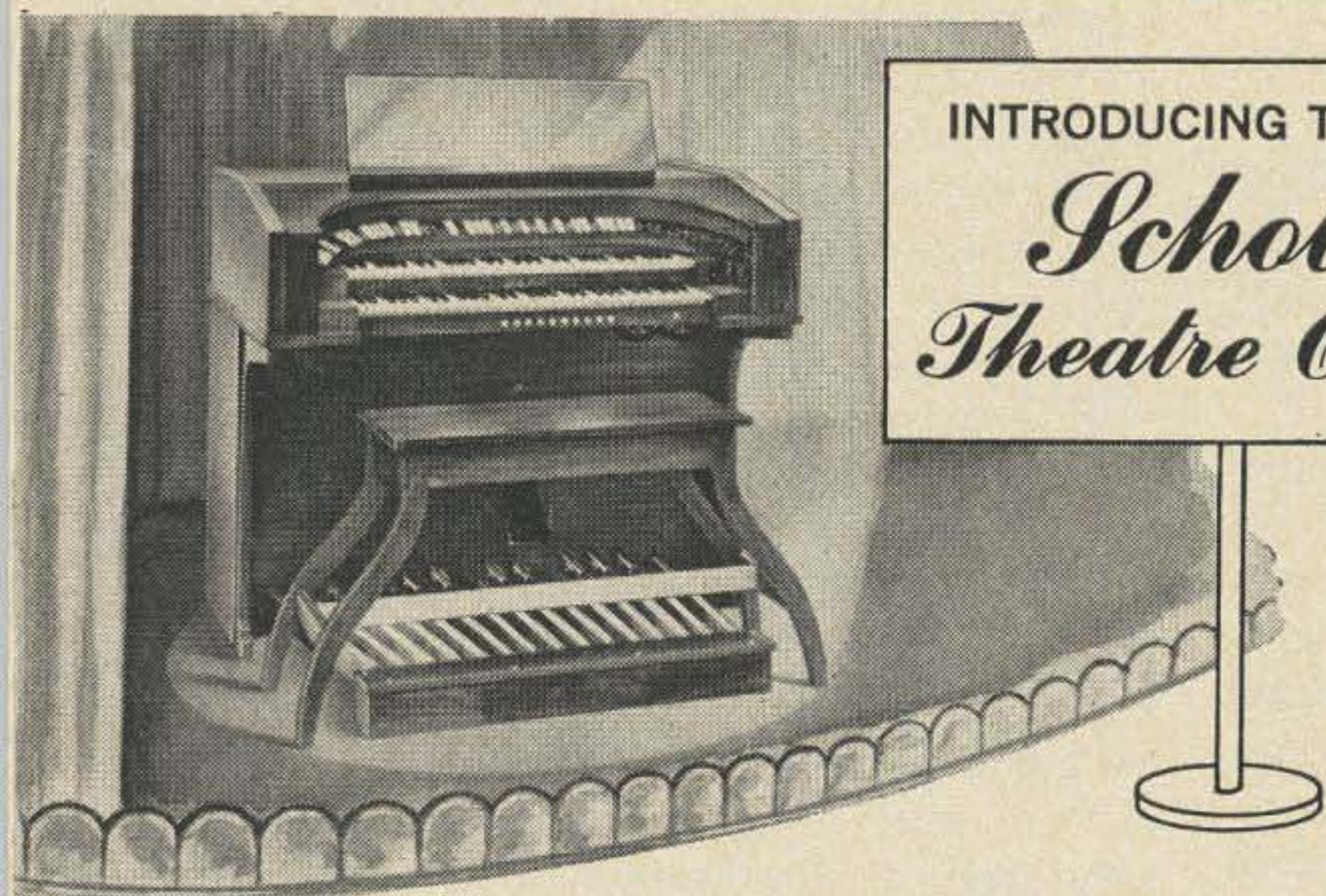

INTRODUCING THE NEW

Schober Theatre Organ

The only
Theatre Organ
available in kit form
—for only \$1350.

Build it yourself and
save over 50%

Combination Action Ten buttons select preset combinations of stops — actually move the stop tablets as in pipe organs.

Percussion Eight percussion stops provide exciting realism. Celesta, harpsichord, piano, mandolin, xylophone, chrysoglott, orchestral bells, single or reiterating, are played just like the real thing — and sound that way — alone or along with regular organ stops.

Free Information. Send today for your copy of Schober's 16-page full-color booklet—plus free 7" recording.

THE *Schober Organ* CORPORATION
43 West 61st Street, New York, N.Y. 10023

The Schober Organ Corp., Dept. D-2
43 West 61st St., New York, N. Y. 10023

- Please send me Schober Organ Catalog and FREE 7-inch "sample" record.
 Enclosed please find \$2.00 for 12-inch quality LP record of Schober Organ music. (\$2.00 refunded with purchase of first kit.)

Name.....

Address.....

City.....State.....Zip No.....

You've asked for it and here it is — the NEW Schober THEATRE ORGAN that you assemble yourself. For the first time in kit form, a real Theatre Organ with that rich, full, old time theatre pipe organ sound. You create the organ, then you create the music!

The Theatre Organ features special voicing, curved console design, two 61-note keyboards, 2-octave radiating pedal clavier, 8 octaves of tone distributed over 5 pitch registers (including a 1-foot register), 35 speaking organ stops, 8 realistic percussion stops, 4 couplers, and vibrato tablet—48 tablets in all. And all at a truly remarkable low price...you save over \$1,500 (*well over 50%*) from comparable theatre organs.

Just follow easy step-by-step instructions written in everyday language which anyone can understand. You'll have an unequalled pride when you're finished that only can come from assembling it yourself.

The Theatre Organ starts at \$1,350. This price includes a beautiful walnut console or you can save further by building your own from plans. Options available include combination action, genuine reverberation, percussion, and amplifiers and speakers.

Proportional Transistor Control of AC Circuits

Proportional dc control of ac circuits has been one of the sticky problems in electronics since the days of the slop-jar rectifier and the "Edison" storage B battery. Most of the successful circuits take the form of a good amplifier, in which the gain is varied by the dc control voltage. Until recently, this was an effective, but highly uneconomical, control method, and was usually limited to low powers.

Since the end of WW II, the situation has been improved by magnetic amplifiers, thyristors, and "back-to-back" configurations of transistors. All of these systems work, and some work very well, but their cost and bulk, not to mention procurement difficulties and delays, usually confine them to large-scale industrial and governmental use.

Relatively recent commercial availability of high-voltage transistors and of silicon bridge rectifiers of high current capacity has simplified high power rectification and control greatly, and has reduced prices enormously. A bit of cogitation, followed by some experiments, indicates that proportional control of any ac circuit by a small dc control voltage, using only rectifiers and transistors, in a simple configuration, is entirely possible.

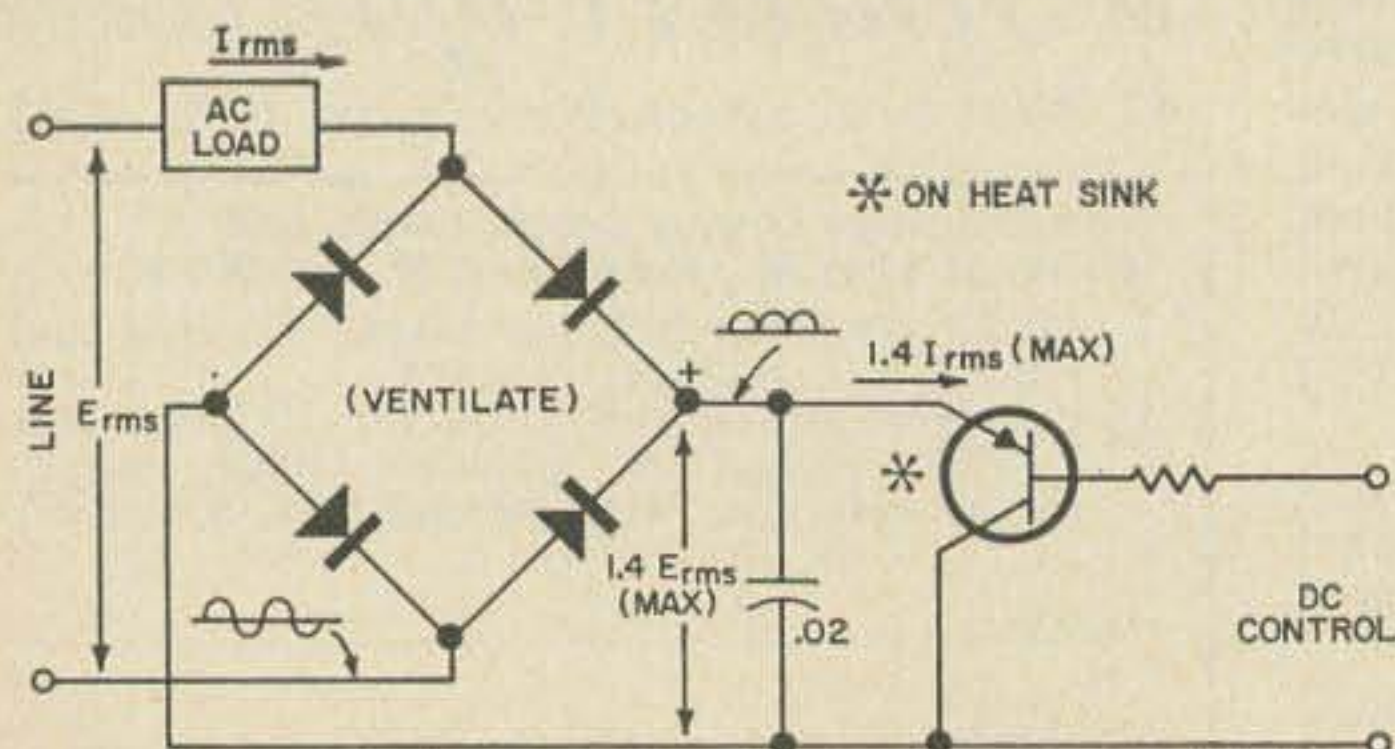

Fig. 1. General control circuit.

General control circuit

Circuit for controlling any ac load by means of a dc control voltage, using only a bridge rectifier and a transistor, is shown in schematic form in Fig. 1, with approximate voltage and current values.

In this circuit, everything to the left of the bridge is ac, from the line or other source. Everything to the right of the bridge is pulsating dc, resulting from the full wave rectification of the line power. With the bridge output shorted, current through the ac load is determined by the line voltage and the load reactance (less the very small losses in the bridge). With the bridge output open, voltage across the bridge output is approximately 1.414 times the line RMS voltage.

If a variable resistor is connected across the bridge output, the current through the load can be varied by varying the resistor. If the resistor is replaced by a suitable transistor (note voltage and current relations in Fig. 1), current in the ac load can be varied by varying the dc bias on the transistor. This current is at maximum when the transistor is saturated, at minimum when the transistor is cut off, and at various intermediate values determined by base bias when the transistor is between saturation and cutoff. With a single control transistor, controlled power is from 30 to 50 times controlling power. With a Darlington pair in the control position, control ratios of considerably better than 1,000 to 1 are easily obtained.

Specific circuit data

Using standard and easily-obtained parts, a specific circuit, much like the general circuit of Fig. 1, was constructed and tested.

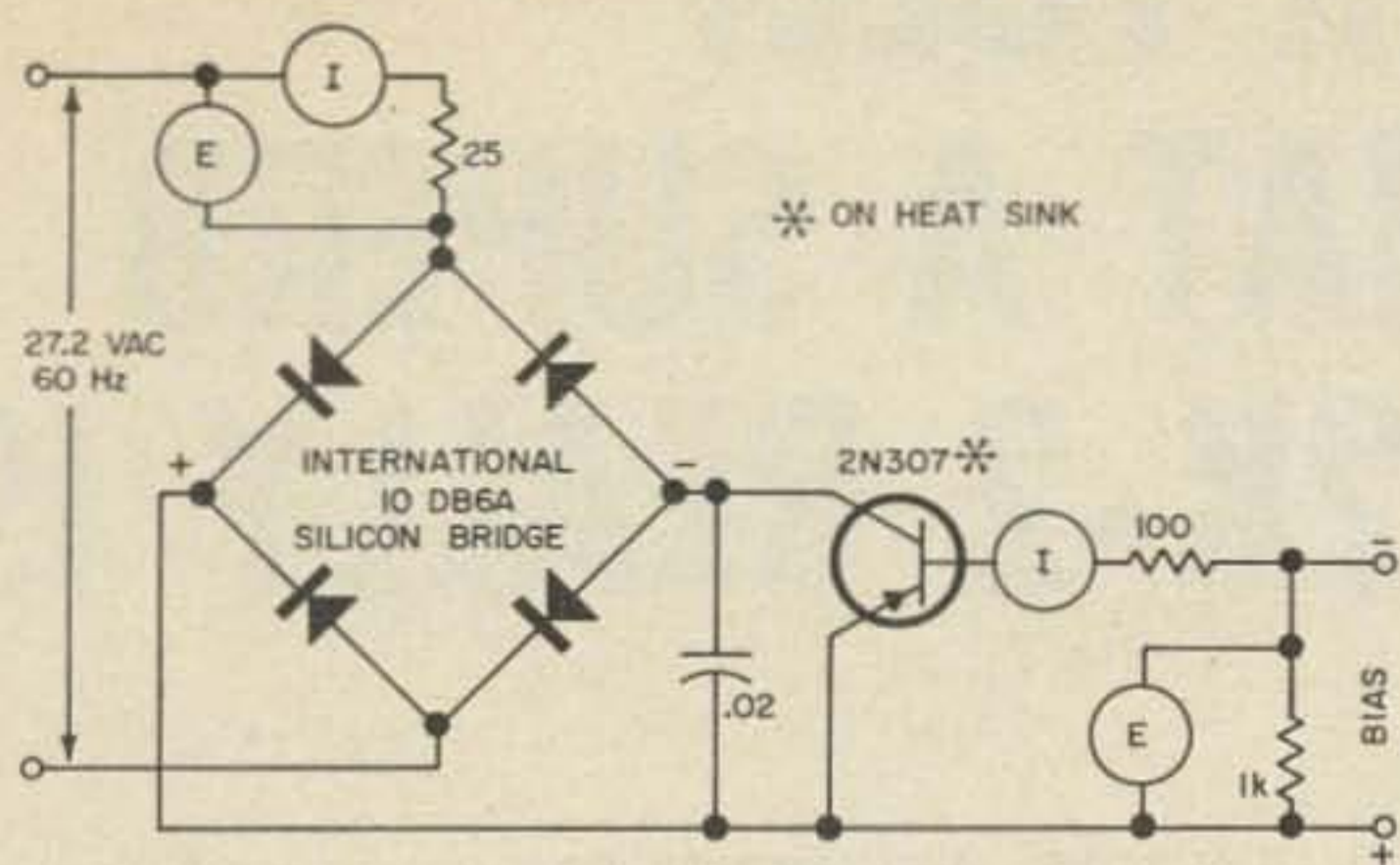

Fig. 2. Specific test circuit, with constants.

Results with this circuit, shown in Fig. 2, are tabulated in Table I. Note that in this circuit, polarity of both the bridge and of the transistor have been reversed, so that, in event of failure of the bias source, the load is deenergized.

As will be noted from Table I, performance of the circuit is smooth, there being no serious "boobles" in the control characteristic. It is quite important that the transistor have an adequate heat sink, or its characteristics will change with use—usually not for the better. A 4" x 4" by 1/16" sheet of copper, exposed to free air circulation, was found adequate for the 2N307 here used. The small capacitor shunted across the bridge is a hash filter. Its value depends in part upon the characteristics of the load, and may be anything from .01 to .1 μF per ampere of current without impairing circuit operation.

Extension to higher power

The test circuit shown in Fig. 2 has a power handling capability of 25 volt-amperes. Theoretically, the same circuit can be used for any power by suitable choice of bridge rectifier and transistor. In practice, we are now limited to about 400 volt-amperes because of the limitations of available transistors, the upper limit being attainable with the Delco DTS 423 transistors. By using an elevated line voltage, (above 115), we can squeeze out some more volt-amperes. Watch out for polarity when changing transistor types.

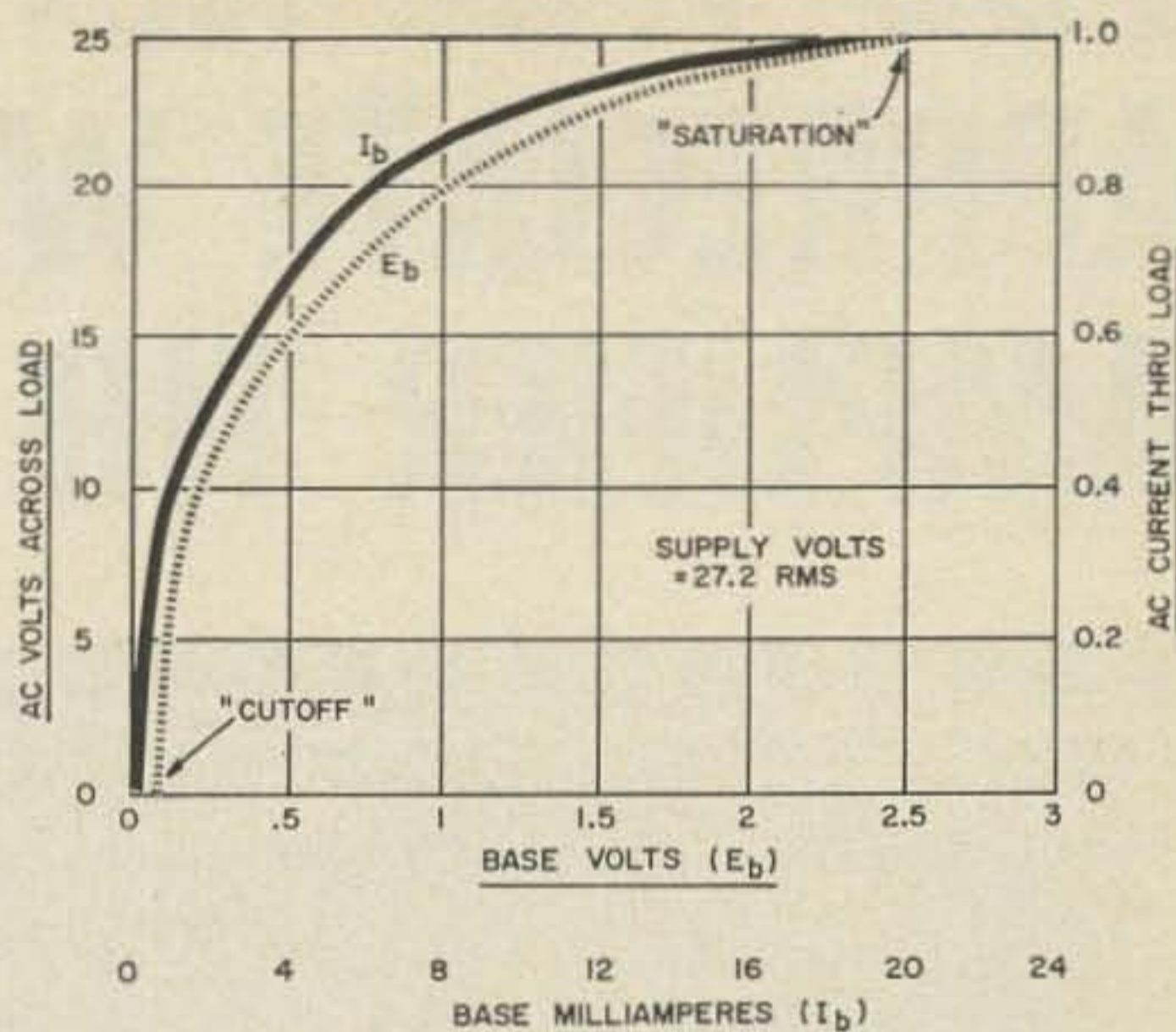

Table I. Performance of the circuit shown in Fig. 2.

When the new 10 and 20 ampere high-voltage transistors, now reportedly being developed by at least three manufacturers, appear on the market, we will be able to control more than 2,000 volt-amperes of ac by means of a relatively small dc control power.

Applications

This control circuit is an excellent replacement for a Variac within the presently-existing power limitations. As the control power is low voltage low current dv, the main elements (rectifier and transistor) can be placed near the load, and the control element, such as an Ohmite AB pot, mounted at any convenient place on the panel.

This circuit permits convenient primary control of power supplies, either manual or automatic, and has a number of possible protective applications, such as shutting off plate power when bias voltage fails.

Life of components, when properly cooled, is problematical, but very long. Silicon bridge rectifiers have service lives measurable in years (5 or more); and modern power transistors, either germanium or silicon, seem to be equally dependable. ■

THIRD ANNUAL LONG ISLAND HAMFEST

Sponsored by the Federation of Long Island Radio Clubs. A day out for the entire family. Swimming, sunbathing, playgrounds, boardwalk, barbeque grills, tables for picnicking, games, prizes. **Contests, auction, swap shop, mobile activity • Talks by prominent radio amateurs**

Sunday, July 16th. 9:00 A.M.

Write F.L.I.R.C., Box 304, Long Beach, N.Y. 11562, for further information.
Hempstead Town Park, Lookout Point, Long Island

YOU WILL NEVER FULLY APPRECIATE WHAT A SUPERB AMPLIFIER THE 2K-2 REALLY IS

**That is... until you own one!*



THE 2K-2 FLOOR CONSOLE OR DESK MODEL \$675.00

It's true. We keep telling you about the inspired simplicity of the 2K-2 design, about its rugged reliable mechanical construction. We've told you many times about the 2K-2's high quality components, its enormous power output, its exceptionally low distortion figure and attendant signal sharpness. Other amateurs have been telling you these same things too! And you have been hearing those BIG, BIG 2K-2 signals on the air. But it's still true, you will never fully appreciate what a superb amplifier the 2K-2 really is until you have owned one for yourself.

And now good news! The 2K-2 is available for immediate delivery. We have expanded production and have amplifiers in stock. Pick up your telephone today. Find out how easy it is for you to own the 2K-2. If you live near a metropolitan area air freight can deliver one to you by tomorrow. Of course if you live in the country you may have to wait an extra day.

If you are still not sure let us send you our descriptive brochure. Remember you are dealing with the world's oldest and most reliable amateur distributor. You can count on the same responsible merchandising program that amateurs all over the world have been relying on for forty years.

ATTENTION! Military, commercial, industrial and scientific users . . . please write for information on our custom line of high power communication linear amplifiers and RF power generators.

6% FINANCE CHARGE • 10% DOWN OR TRADE-IN DOWN • NO FINANCE CHARGE IF PAID IN 90 DAYS • GOOD RECONDITIONED APPARATUS • Nearly all makes & models. Our reconditioned equipment carries a 15 day trial, 90 day warranty and may be traded back within 90 days for full credit toward the purchase of NEW equipment. Write for bulletin.

Henry Radio Stores

CALL DIRECT . . . USE AREA CODE

Butler 1, Missouri, 64730	816 679-3127
11240 W. Olympic, Los Angeles, Calif., 90064	213 477-6701
931 N. Euclid, Anaheim, Calif., 92801	714 772-9200
6116 N. 27th Ave., Phoenix, Ariz., 85017	602 AM 4-3895

East Coast Rep.: Howard Laughrey, 2 Elizabeth St., Chappaqua, N.Y. 10514, (914) CE 8-3683

"Worlds Largest Distributors of Short Wave Receivers"

C. A. Robertson K8BLL
Product Manager, Communications
Heath Company
Benton Harbor, Michigan

Phone Patching-

More Light in a Gray Area

Litigation presently in the courts may clear up the legalities of phone patches.

More than seven years ago, an eloquent plea for legalizing amateur radio phone patches was made by Mr. C. D. Ehinger, a ham, K9IVY, and also a prominent member of the telephone industry, in an article which appeared in the December, 1959 issue of *Electronics World*. The article was symptomatic of the controversy that has surrounded the "gray area" of amateur radio phone patching for years and which, at last, appears headed for legal resolution.

A phone patch is, in essence, a device which interconnects the facilities of the telephone company with a two-way radio system. Tariffs filed with the Federal Communications Commission by AT&T and other telephone companies prohibit such interconnections unless the equipment, with a few exceptions, is provided by the telephone company. From the telephone company viewpoint, this restriction is necessary to prevent possible interference to telephone service resulting from the direct or indirect connection of a "foreign attachment" to a telephone line. This viewpoint is defended on the basis of the responsibility of the telephone company to provide dependable land-line communications under federal regulation in return for being granted a monopoly for telephone service in a certain area.

Over a year ago, the Carter Electronics Corp., of Dallas, a manufacturer of a phone patch device called *Carterfone*, filed an anti-trust suit against AT&T, Southwestern Bell, and General Telephone Company of the Southwest. Carter Electronics seeks compen-

sation for damages resulting from an alleged loss of business due to threats by the defendant telephone companies to discontinue service to individuals and firms using the *Carterfone*. The courts, before handing down a decision in the *Carterfone* case, have asked the FCC to resolve the question of the "justness, reasonableness, validity, and effect" of the current tariff regulation. Thus, the FCC, which has in the past indicated that phone patches do not violate FCC radio service rules but has avoided the issue of the validity of the telephone company tariffs, must now come to grips with the problem. A hearing before an FCC examiner is scheduled within the next few months.

The arguments in favor of legalizing phone patches are reasonable and persuasive. From the predominant commercial viewpoint, properly designed and effective phone patches can be produced at prices well below the usually prohibitive cost of telephone company equipment offered to provide a similar service. The installation of such phone patches result in more efficient and increased use of telephone facilities. In the non-commercial area of amateur radio, if phone patches were

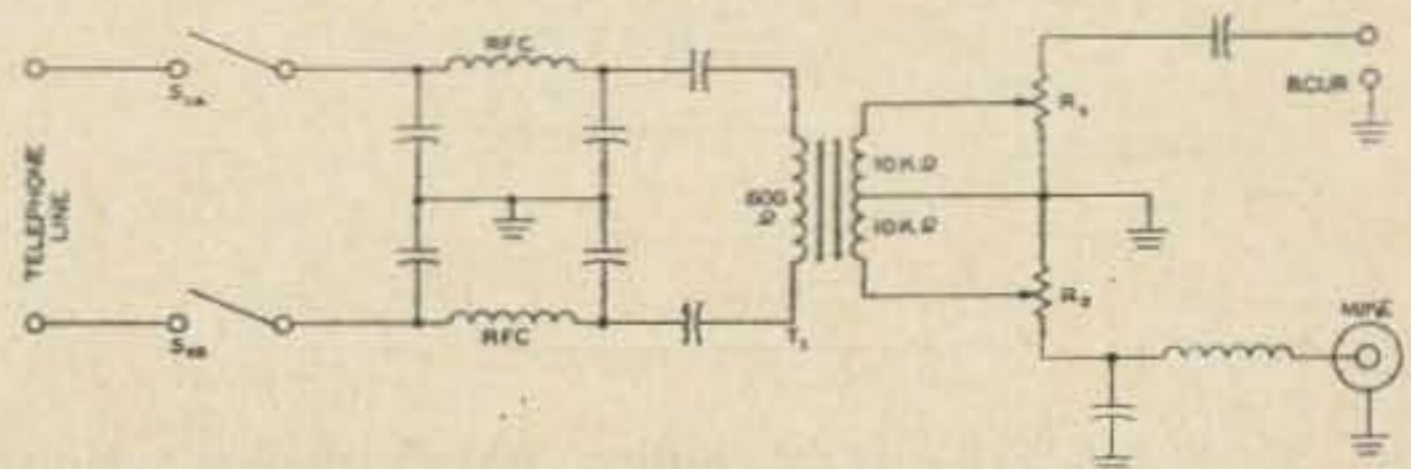

Fig. 1. Typical "home-brewed" phone patch which was widely used with AM transmitters.

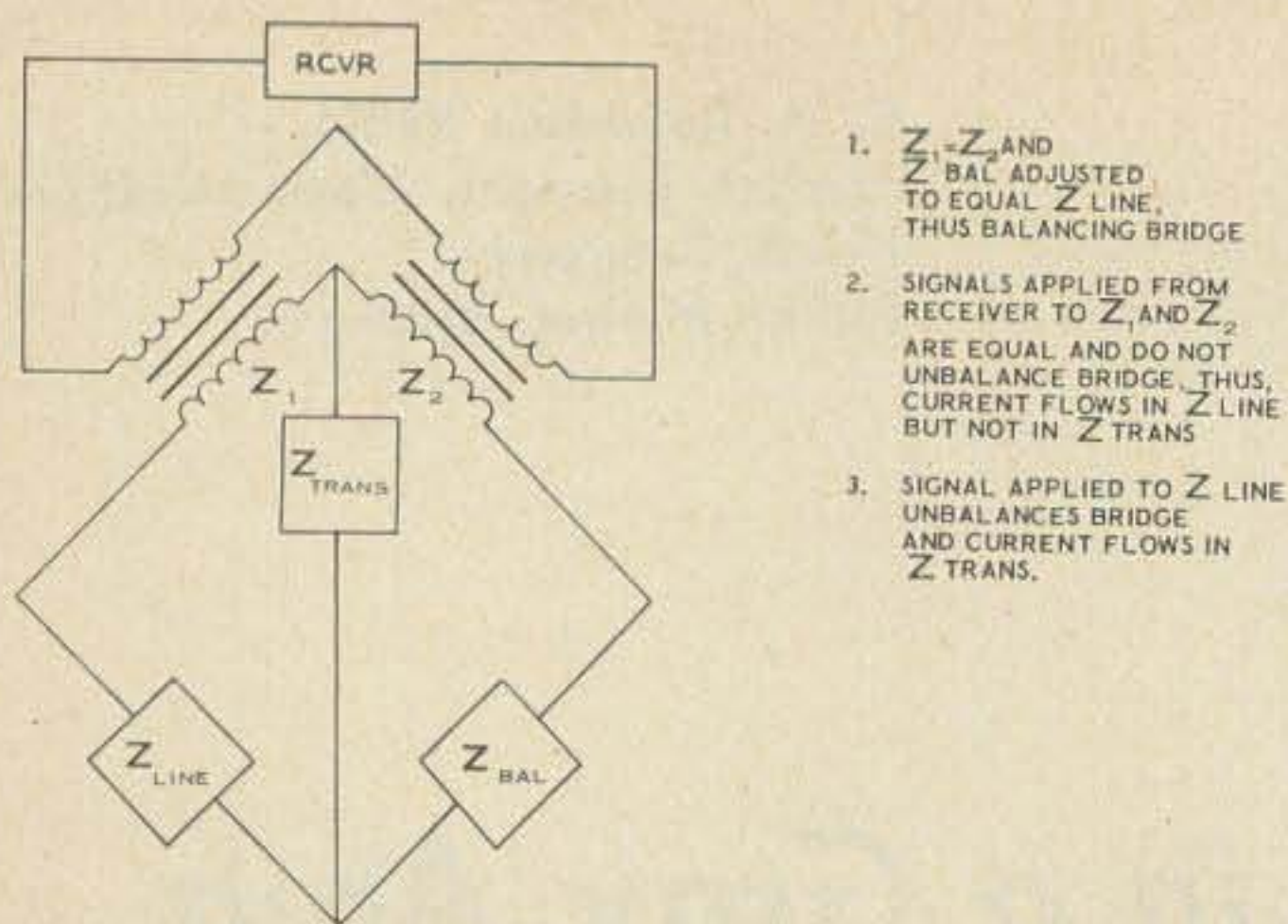

Fig. 2. The Wheatstone bridge is the basis for modern hybrid phone patch circuits employed with VOX operated SSB transmitters.

to be removed from the "gray area", a marked increase in public service phone-patch traffic, particularly with overseas military personnel, would ensue. Telephone companies have in the past indirectly indicated the usefulness of the phone patch by turning their heads the other way concerning amateur radio use of these devices. Nevertheless, the "gray market" has forced all but two amateur radio equipment manufacturers, Heath Company and Waters Manufacturing Company, out of the ham phone patch business. Heath Company reports that despite the "gray area" and to the best of their knowledge, their patch has never been the cause for a complaint by a telephone company against a user. Adequate performance and low-cost therefore appear to be compatible in today's phone patch designs.

Adequate performance was not always the case with amateur radio phone patches. The type of patch illustrated schematically in Fig. 1 was considered fairly sophisticated fifteen years ago but provided what could be termed only satisfactory performance with AM rigs at that time. This design employed

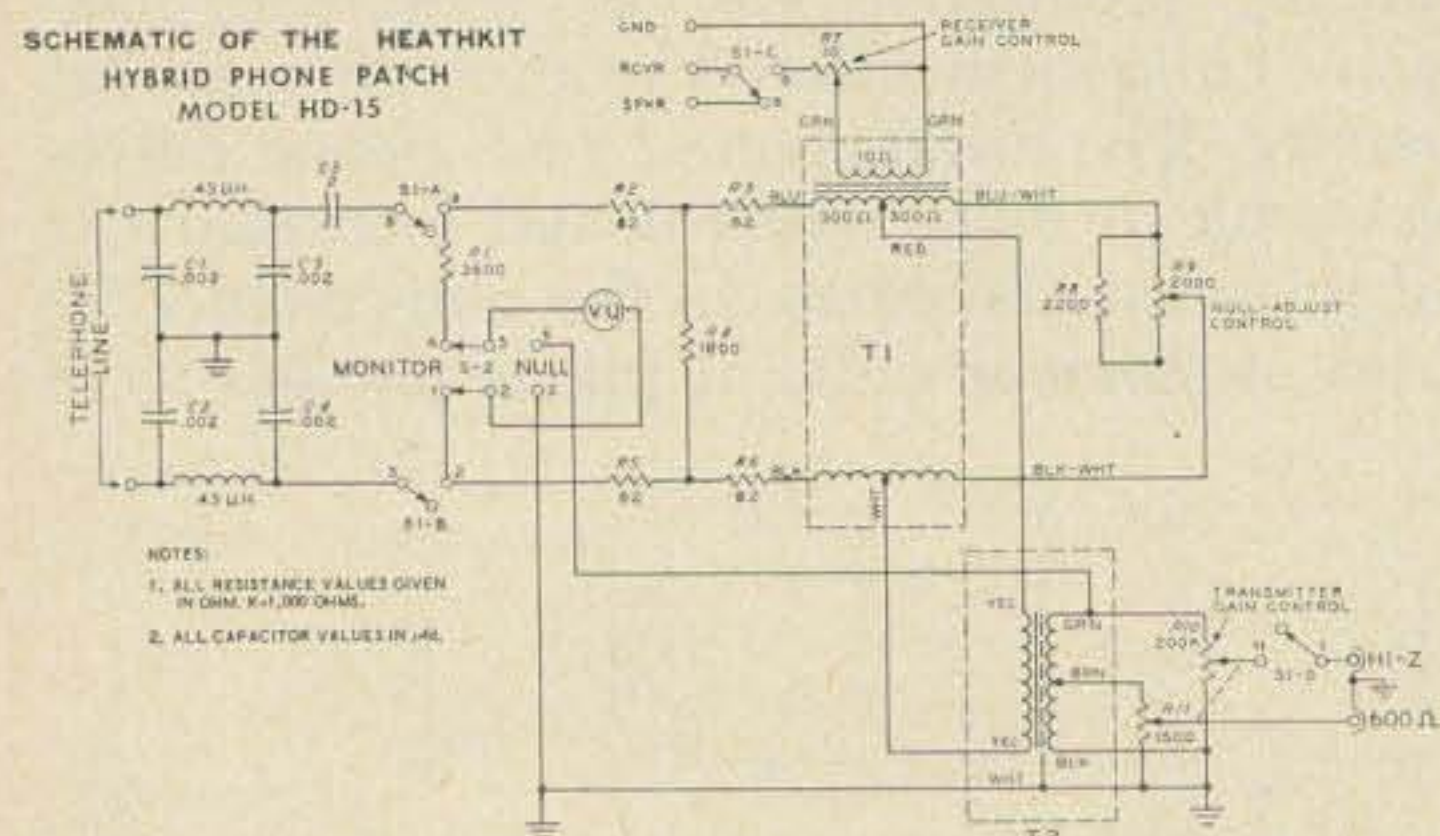

Fig. 3. A typical hybrid phone patch design using special transformers for optimum energy transfer and impedance matching.

an audio output-to-line transformer which at least approximated a match to the telephone line impedance. The center-tapped high impedance winding helped reduce hum pickup which was a real problem in early home-brew patches. Most of us can also recall phone patch circuits which employed power transformers in crude designs which were matched by equally crude performance. One can only imagine the detrimental effect these devices had on telephone service. The circuit in Fig. 1 was, with its attention to impedance matching, hum reduction, and rf filtering and bypassing, at least a step in the right direction.

With the increased popularity of SSB by the early sixties, phone patch design was forced to take a giant step forward to satisfy the demand for patch operation consistent with the VOX capability found on most all SSB transmitters. To eliminate the need for manual transmit-receive switching during phone patch operation with VOX equipped SSB rigs, true telephone-type hybrid circuitry was required in patch designs. Thus, more accurate telephone line impedance matching was a necessity and telephone quality transformers were employed. Also about this time, the need for monitoring the input level to the telephone line was realized and VU meters, as employed by the telephone industry, became standard equipment on most hybrid phone patches.

The operation of a hybrid phone patch can best be understood by referring to Fig. 2. The basic requirement of the circuit is to passively couple audio from the receiver into the telephone line without energy being delivered to the transmitter audio input at a level which will cause the VOX circuit to operate. As described in Fig. 2, our old friend, the Wheatstone bridge, provides an effective means of satisfying the basic patch requirement outlined above.

A practical embodiment of this circuit is illustrated in the hybrid phone patch design presented in Fig. 3. In addition to the normal hybrid circuit components, on-off switching functions and appropriate rf filtering, several other significant circuit techniques are evident here. A 600 ohm resistive H pad is provided to isolate the telephone line impedance, which can vary from installation to installation, so that a simple balance network can provide maximum transmit-receive isolation at every installation. The VU meter can be switched from its normal line level



Fig. 4. The Heath HD-15 Hybrid Phone Patch employs a VU meter for monitoring input level to the telephone line and indicating correct null adjustment.

monitoring function to a null indicating function to permit accurate adjustment of the balance, or null, control. A strong heterodyne is tuned in on the receiver and, with the patch on and a telephone call actually placed, the balance control is adjusted for a null on the VU meter which is measuring the voltage developed across the transmitter input level control. Once set, the balance control usually needs no further adjustment. Notice also that this patch design also employs transformers which match the impedance of the receiver output and transmitter input as well as those of the telephone line to provide maximum overall energy transfer.

Mr. Ehinger's 1959 article suggested several requirements for the design and use of legal phone patches. These were use only with radio equipment and by operators having valid FCC licenses, use only on a private telephone line, location of the telephone at the radio operating position, patch provision for monitoring input level to the telephone line, and payment of a nominal, monthly fee to the telephone company. All requirements, except the last, still seem to be reasonable. If the tariff is revised to permit phone patching, it does not appear that the telephone companies would be justified in charging a fee for use of equipment that belongs to an individual. Phone patches supplied by the telephone company, should they be made available, would be a different matter.

Whatever the outcome of the *Carterfone* litigation, it is encouraging that the question of phone patch legality is finally being scrutinized. At least it indicates that there is a growing interest in legalizing phone patches and that a demand exists for reasonably priced phone patch equipment. Let's hope a decision favorable to hams will be handed down and result in complete illumination of the "gray area". . . . K8BLL

NEW! IMPROVED! SOLID STATE FREQUENCY CONVERTERS



Priced from only **\$14.95** to \$39.95

OVER 5000 FREQUENCY COMBINATIONS FROM
.45 MC TO 475 MC AVAILABLE FROM STOCK.

MANY NEW MODELS TO CHOOSE FROM OFFERING A TOTAL OF THE FOLLOWING: Crystal control, variable tuning, UHF epitaxial transistors, FET transistors, noise figures as low as 2.0 db, full wave varactor diode transistor protection, sensitivity better than 2/10 microvolt, fully shielded oscillators and band-pass filters to eliminate spurious frequencies, zener diode voltage regulation, 6 to 12 volts positive or negative ground, slug tuned coils, double tuned R.F. stages, tuned mixer stages, wide band I.F. amplifiers. All this plus the highest quality components carefully assembled, tested, and guaranteed.

We have exactly what you want at a lower price and better quality than you can obtain elsewhere. See our new multiple oscillator converters for monitoring two or more frequencies simultaneously!

24-hour special delivery service available on many models.

Send for your free 1967 converter catalog.

VANGUARD LABS

Dept. H

196-23 Jamaica Ave.

Hollis, N. Y. 11428

WTW Report

WTW is picking up faster all the time now. If the requests for our new WTW country list/tally sheets are any indication, things will be rolling in high gear for sure in a few months from now. I have been sending out these sheets at the rate of six a day. It seems as if many fellows are interested in WTW—a lot more than I ever thought.

The new WTW country list/tally sheets consist of four pages printed on both sides. Spaces have been allowed so that you can use them for ten years. About every fifth line has been left blank for additions as they turn up or corrections as they are discovered. I will take full blame for the various mistakes that are on these sheets—they were laid out, made up and printed by me so these mistakes cannot be blamed on anyone other than myself. They are free for the asking provided you send along a manila envelope (9 by 14 inches or larger) self addressed and with 10c worth of stamps on it. This will pay the postage for 3 or 4 sets of these forms depending upon the weight of the envelope. One set of these forms must be filled out and sent in with your first batch of cards. We retain this form and file it away to add the countries as you send them in to us. One form is required for each mode on each band. This may seem like a lot of work but later on it will simplify our task of keeping the records straight. This will be especially true when the 5 year period has passed and you begin to lose the countries you worked 5 years ago.

If you are considering trying for WTW, by all means get yourself a set of these forms. It will make your record keeping a lot easier I am sure. A complete list of WTW countries is included so you know what counts and what doesn't. A few of them may surprise you if you have not seen our list recently. Send along a large envelope for your copies and it will be sent out pronto.

We have received many suggestions from different DXers regarding WTW. At this moment we have not decided what changes, if any, will take place. Right now we are "mulling over" the idea of accepting cards

in multiples of less than 100. This would keep everyone informed as to how others are doing in their WTW work.

There will be a column in each issue of 73 from now on that's devoted to the progress of WTW. We think it will be of interest to all DXers because competition will become keener as more fellows qualify. The day may come when we will keep a running record of the top 10 or 20 or even 30 who are battling it out for top position. I have had many letters suggesting this and it seems that this would make things more interesting to the fellows. What do you think Mr. DXer?

At this time we still need a DX Club to check WSL cards for these call areas: W/K 1, W/K 2, W/K 5, W/K 8, and W/K Ø. We need one or two such check points for Africa, one in the southern part and one in the north. Two are still needed in Asia too—one around Hong Kong or Japan and the other somewhere around western India, Tehran or thereabouts.

Do we have any volunteers for these check points? We furnish the necessary blanks needed for proper record-keeping. We want every checkpoint to use the same kind of record keeping so that we will have a uniform system. The work involved is not too great, at least not at this time, but we hope it will grow as WTW interest grows.

The address of each of the current WTW QSL check points is as follows:

W/K 3—Western Pennsylvania DX Society, John F. Wojkiewicz W3GJY, 1400 Chaplin Street, Conway, Pennsylvania 15027.

W/K 4—The Virginia Century Club, P.O. Box 5565, Virginia Beach, Virginia 23455.

W/K 6—Orange County DX Club, James N. Chavarria, 3311 Stearns Drive, Orange, California 92666.

W/K 7—Western Washington DX Club, Inc., William H. Bennett W7PHO, 18549 Normandy, Seattle, Washington 98166.

W/K 9—The Montgomery County Amateur Radio Club, Scott Millick K9PPX, Litchfield, Illinois 62056.

Canada—The Edmonton DX Club (VE6GX), 12907 136th Avenue, Edmonton, Alberta, Canada.

Oceania—The New Zealand Association of Radio Transmitters, Jock White ZL2GX, Contest and Awards Manager, 152 Lytton Road, Gisborne, New Zealand.

South America—Venezuela Amateur Radio Club, P. O. Box 2285, Attention of YV5CHO DX Committee, Caracas, Venezuela, South America.

Europe—Via R.S.G.B.

Hawaiian amateurs send their cards to the W6 check point.

All others send your cards to: Gus M. Browning, Route 1, Box 161-A, Cordova, South Carolina 29039.

Each group of cards sent to any check point must be accompanied with a remittance of \$1.00 to cover costs of certificates and handling—*plus* postage to cover the return of your cards. Please specify method of shipment and enclose a large addressed envelope. Otherwise your cards will be returned to you via third class mail.

Notice that W5KUC, W4NJV and W3DJZ have qualified for the 200 country certificate for 14 MHz phone. Mind you, these fellows have worked and received QSL cards from 200 countries in less than one year. As you know, WTW only started at 0001 GMT May 1st last year. This should prove to you that it's possible if you make up your mind that you are going all out. I bet these fellows had a ball working DX all over again. I know these fellows and they are the type who get things done when they make up their mind to do it. We wish to congratulate them on a job well done. They are presently working hard on their WTW-300—WOW—I sure hope they make it. That's it for this month. If you have any questions please write me and I will try to answer. Please send along a sase. Thanks.

... Gus

Genuine

TEXAS

"BUG-KETCHER"®

KILOWATT

80 THRU 10

MOBILE

ANTENNA

You've heard them on the air . . . Now . . . Available for the first time!!!

The Texas "Bug Ketcher" has been one of the best radiating antennas on the air for years . . . and yes, low power rigs can increase effective radiated power with this high "Q" coil.

"Bug Ketchers" are custom made of top quality materials, engineered to withstand abuse where other antennas fail . . . **Send For Yours Now** . . . Be ready for a full season of mobile fun!

BUG-KETCHER

COIL ONLY **19.95**
COMPLETE MOBILE PACKAGE INCLUDING

. . . base extension, whip, gutter clip, extra heavy duty ball mount and spring (your option, bumper or deck mount).

. . . **A \$46.05 VALUE FOR ONLY . . .**

\$39.95 COMPLETE

BIG "D" HAMBOREE—DALLAS MARKET HALL—AUGUST 4-5

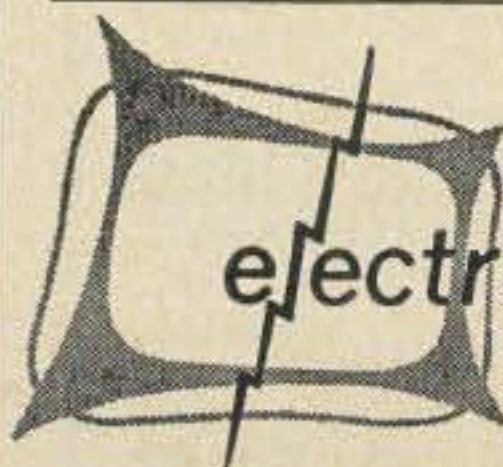

electronics center, inc.

2929 N. HASKELL
DALLAS, TEXAS 75204
214-LA6-2023

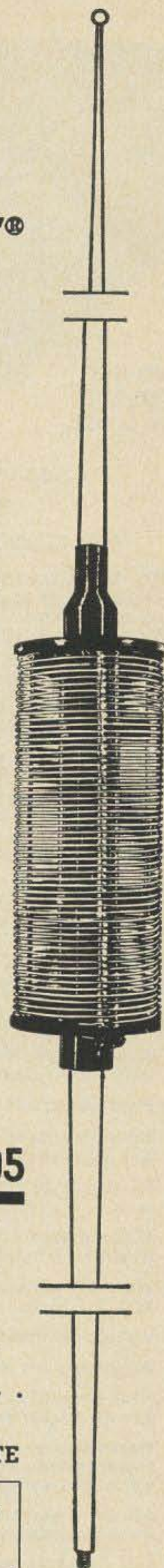



VANGUARD
MODEL 501
Made In USA.

\$279.95

SHIPPING COLLECT
COMPLETE WITH LENS

SUB-MINIATURE SOLID STATE
TV CAMERA

FOR CLOSED CIRCUIT OR AMATEUR TV

THE VANGUARD 501 is a completely automatic closed circuit television camera capable of transmitting sharp, clear, live pictures to one or more TV sets of your choice via a low-cost antenna cable (RG-59U) up to a distance of 1000 ft without the need for accessories or modifications on the TV sets. The range can be extended indefinitely by using line amplifiers at repeated intervals or by using radio transmitters where regulations permit.

There are hundreds of practical uses in business, home, school, etc. for any purpose that requires you or anyone chosen to observe anything taking place anywhere the camera is placed. Designed for continuous unattended operation, the all-transistor circuitry of the 501 consumes only 7 watts of power.

SPECIFICATIONS:

- Measures 2 $\frac{3}{4}$ " x 4" x 7" (excluding lens and connectors).
- Weighs 3 $\frac{1}{2}$ lbs.
- Operates on 100-130 volts 50 or 60 cycles, 7 watts.
- Tested at 10° to 125° F.
- Advanced circuitry utilizing 35 semi-conductors most of which are silicon.
- Field effect input circuit for minimum video noise.
- Resolution guaranteed to exceed standards set by 525 line TV receivers.
- RF output 30,000 microvolts adjustable for channels 2 to 6.
- Video output 1.5V p-p composite with standard negative sync (random interlace).
- Viewable pictures obtainable with illumination as low as 1 ft. candle.
- Vidicon controlled light compensation; 150/1.
- Adjustable iris on lens enables use in bright sunlight.
- New long life, sub-miniature vidicon with spectral response similar to Type 7735A.
- Electronically regulated power supply and thermally compensated circuits eliminate change in picture quality when line voltage and temperature fluctuate.
- All parts guaranteed for 1 year (except for open filament on vidicon or breakage).
- Fast, low-cost service always available from our factory in Hollis, N.Y.

Pre-set adjustable controls include the following: Video gain, video compensation, pedestal level, target voltage, beam voltage, beam alignment, electrical focus, horizontal frequency, horizontal size, vertical frequency, vertical size, vertical linearity, modulation and RF frequency output.

Send your order direct to our factory

VANGUARD LABS

196-23 Jamaica Ave. Dept. 5 Hollis, N.Y. 11423

What's New for You?

This column is set aside for short technical notes, comments on 73 articles, information about new and useful components and surplus, and announcements about technical nets and technical clubs. If you've come across something that you think would interest 73 readers, but don't think it's worth a full article, send it along. We'll give you credit in the column. Send your contributions to Paul Franson, 38 Heritage Road, Acton, Massachusetts 01720.

Don't forget that we're looking for a new name for the column, a name that fits the content a bit better than the present one. I've heard two suggestions so far, but I'm not sure whether they're serious: Technical Trash, and Electronic Eclecticism.

New FET's

There are several new field effect transistors on the market which should appeal to the amateur experimenter. The most exciting of these is probably the 2N4416 from Union Carbide. This device is still somewhat expensive (about \$6.00), but displays excellent noise characteristics on 144 and up. Pre-amplifiers built for 432 MHz with the 2N4416 for example, exhibit noise figures on the order of 2.5 dB: gain is 12 dB. On 144 the noise figure is about 2 dB with 18 dB gain. Next month 73 will have a construction article using this FET in both 144 and 432 preamplifiers.

A low cost plastic encapsulated FET which looks quite interesting is the new Motorola MPF-102. This transistor is designed for VHF amplifier and mixer applications and features guaranteed parameters at 100 MHz. Forward transconductance at 100 MHz is 1600 μ mhos minimum. The input capacitance is 7 pF and the reverse transfer capacitance is 3 pF. Maximum drain-source voltage is 25 volts.

73 Transistor Circuits

Trouble with FET diagrams *again!* In WIDTY's article in the March issue there are several errors in the schematics using field effect transistors. The thing to remember here is that the N-channel FET requires a positive drain supply, the P-channel FET, a negative supply. P-channel FET's include the 2N2607, 2N4360, TIM12 and U112. N-channel types are the 2N2943, 2N3819, 2N3820, HEP-01, MPF-103, -104, -105 and TIS34.

Diagrams to watch in the circuits article are Fig. 11, 17, 39, 40, 47 and 71.

Transconductance Tester Troubles

WA4UZS reports that he had a little trouble with transients in the FET Transconductance Tester he built from WIDTY's article in the January 73, but cured it with a 0.047 μ F capacitor across each of the push button switch contacts.

I-177B Schematic

A manual, schematic and updating information for the I-177B tube tester is available from the Engineering Department, Daven Division of the Thomas A. Edison Industries, Grenier Field, Manchester, N.H. 03103 for \$2.50, reports WIDKG.

Slide Rule Error

The conversion of $\pi/2$ radians in the article on slide rules in the March issue is wrong. It should be 90° instead of 1.57° . If you put 2 on the C scale over π on the D scale, the answer is read on the D scale under R on the C scale. The basic formula for these conversions is $\pi \times R = 180$, where R stands for 1 radian. Thanks to WA8LQS for this.

Product Detector Circuit Board

The connections on the right side of the circuit board on page 34 of the March 73 are reversed. The board is for a solid-state product detector. Gregory Perreault of Glen Rock, N.J. caught this one.

RTTY Translator Error

There is an error in the schematic of the RTTY encoder on page 37 of the January issue. The 0.033 and 0.038 μ F capacitors in the frequency-determining network are reversed. The component reference numbers were also omitted from the schematics and pictorials, but not the text, causing some confusion. On page 35, R1 and R2 are the 6.8k Ω resistors in the emitters of Q2 and Q3. R12 on that page is the resistor shown in series with the magnet. On page 37, reference is made to an R10 and R12 in the encoder circuit. These two resistors are the 100 k Ω and 6.8 Ω resistors attached to the base of Q4. The author of the article, W6AYZ, sent us these notes.

... Paul

VALUABLE books from E. & E.

NEW

SINGLE SIDEBAND: THEORY AND PRACTICE



by Harry D. Hooton, W6TYH. The

one-source guide to ssb. Covers the origin and principles of ssb, derivation of ssb signals, carrier suppression techniques, sideband selection, carrier generators, speech amplifiers and filters, ssb generators, balanced mixers and converters, low-power ssb transmitters, linear r-f amplifiers, ssb communications receivers, transceivers, tests and measurements. Includes chapters on how to build air-tested linear amplifiers. 352 pages. Hardbound. Order No. EE-350, only... \$6.95

NEW 17TH EDITION OF THE FAMOUS RADIO HANDBOOK

Tells how to design, build, and operate the latest types of amateur transmitters, receivers, transceivers, and amplifiers. Provides extensive, simplified theory on practically every phase of radio. Broadest coverage; all original data, up-to-date, complete. 816 pages. Order EE-167, only... \$12.95



RADIOTELEPHONE LICENSE MANUAL

Helps you prepare for all commercial radio-telephone operator's license exams. Provides complete study-guide questions and answers in a single volume. Helps you understand fully every subject you need to know to obtain an operator's license. 200 pp. Order EE-030, only. \$5.75



LEADING BOOK ON TRANSISTORIZED COMMUNICATIONS EQUIPMENT

TRANSISTOR RADIO HANDBOOK, by Donald L. Stoner, W6TNS, Lester A. Earnshaw, ZL1AAX. Covers a wide range of communication uses for both amateur and commercial applications. Includes audio and speech amplifiers, VHF transmitting and receiving equipment, SSB exciters, and complete SSB transceivers. 180 pages. Order EE-044, only... \$5.00



Order from your electronic parts distributor or send coupon below.



EDITORS and ENGINEERS, Ltd.

P.O. Box 68003, New Augusta, Ind., Dept. 73-E6

Ship me the following books:

- No. EE-350 No. EE-030
 No. EE-167 No. EE-044 \$_____encl.

Name _____

Address _____

City _____ State _____ Zip _____

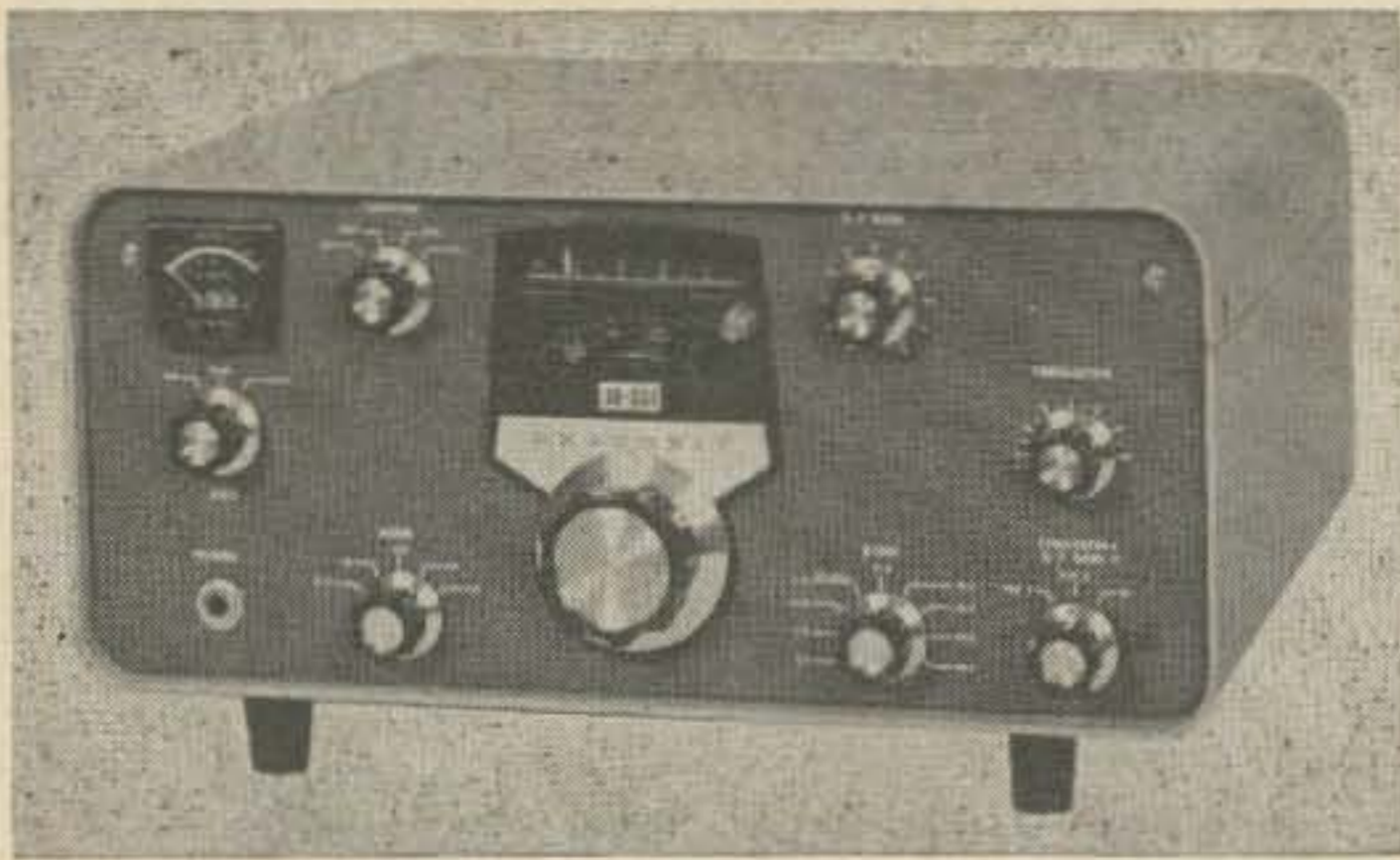

Mort Waters W2JDL
82 Boston Avenue
Massapequa, L. I., N. Y.

The Heathkit SB301 Receiver

The Heathkit SB301 is an updated and improved version of the older SB300 which, in its short history has already earned a well-deserved niche in ham radio. The 301 is a ham-bands-only SSB/AM/CW/RTTY receiver with coverage from 3.5 MHz through 30 MHz, easily extendable to the 2- and 6-meter bands with accessory converters, both of which mount neatly on the receiver's rear apron. A front panel switch concentric with the rf gain control selects either converter and simultaneously switches the input of the receiver from the normal antenna to the converter outputs on 10 meters. Frequency coverage with the converter crystals supplied is from 144 to 146 MHz and 50 to 52 MHz—the tuning range can be increased with accessory crystals.

Power for the converters flows only to the converter which is selected by the panel switch mentioned before. When the receiver is operated on the low bands, no voltages reach the converters.

CIRCUITRY

The incoming signal is amplified by a 6BZ6, the rf stage and capacitance coupled to the grid of the first mixer, a 6AU6, which receives the local oscillator signal from the crystal-controlled 6AB4 heterodyne oscillator. The latter's coils have a small pickup winding which feeds the oscillator output to a jack on the rear apron, where it is available for transceiving with the matching transmitter, the SB401.

The 6AU6 mixer stage mixes the signals, with the sum and difference frequencies being applied to a bandpass coupler having a passband from 8.359 to 8.895 MHz. Emerging from the coupler, the wanted signal is then applied to the grid of the second mixer, an-

other 6AU6. At the same time, the 5.0 to 5.5 MHz output of the LMO is coupled to its cathode. For transceiving, the LMO output is also fed to a jack, through a .01 capacitor.

The second mixer's output at the *if* frequency of 3.395 MHz passes through a crystal filter to the *if* stages (you get one filter with 2.1 kHz bandwidth with the kit; AM and CW filters are available as extra cost accessories).

The *if* amplifiers, 6BA6's are both high gain voltage amplifiers, tuned for maximum gain. The S-meter is connected between the screen of the first *if* and the cathode of the second, with a chassis-mounted zero-adjust potentiometer providing precise settings.

A new feature of the SB301 that didn't appear in the 300 is a self-biasing, full-wave, shunt-type noise limiter which automatically adjusts itself to the degree of modulation of the incoming signal. This system has the advantage of moving the point where limiting begins up and down along with the signal level. The limiter is either in or out of the circuit, depending on a push-pull switch integral with the AF gain control. The degree of limiting cannot be controlled manually. The system operates in all modes and performs effectively.

AGC voltage is obtained by rectifying a portion of the *if* output signal, then passing it through a capacitor-resistor network which applies the voltage to bias the rf amplifier and the *if* amplifiers. This system is of the instantaneous attack type; one of two decay "speeds" is switch selected—slow for SSB, fast for CW and AM. An "off" position is also provided for maximum gain when digging for the weak ones.

A three-section Compactron, a 6AS11, combines the product detector, BFO, and BFO amplifier in one envelope. The BFO oscillates at one of three crystal-controlled frequencies, selected by the mode switch. In the RTTY position, the crystal frequency is 3392.110 kHz, placing the detected signals of 2125 and 2975 kHz in the center of the band pass frequency range of the SSB crystal filter. Narrow band RTTY operation can be had in the CW position of the mode switch. If you're operating SSB and want to change sidebands, here's what happens: the crystal that is switched into the circuit increases the BFO's operating frequency by 2.8 kHz. At the same time, the LMO is automatically shifted 2.8 kHz lower by a diode switch so you've changed sidebands without having to move the dial—you continue to read frequency right off it.

The mixed *if* and BFO frequencies obtained from the product detector are capacitor-coupled to the grid of the first audio stage, one-half of a 6HF8, which drives the second audio; either high impedance headphones or 8-ohm speaker operation is available. Negative feedback from the output transformer to the cathode of the first audio stage provides low distortion audio.

For AM reception, the BFO is switched off and the *if* output is coupled to a diode detector instead of the product detector and thence to the audio stages.

The lineup is completed by a 100 kHz calibrator that can be zeroed against WWV's

15 MHz signal. The band switch has a special position for receiving WWV—another new and welcome feature that was missing from the 300.

Assembly

No unusual problems were encountered in building the receiver except one of my own making. I did not observe the cardinal rule of kit building—read the instructions first, and follow them exactly. In blind confidence, I unpacked all the parts and sorted them out, but when I began to check them off against the parts list, I discovered that Heath had made another important advance. There were separate numbered "parts packages" that were called for individually as you begin each stage of assembly. The advantage is, of course, that you don't have a lot of small parts floating around long before you need them. Had I read the manual carefully I would have known this. Take warning, do as I say, and not as I do!

Total assembly time was about 24 hours, and alignment with the built-in crystal calibrator and S-meter went very rapidly. Not a single operating difficulty was found, a testimony to the good design, careful engineering and superb manual that makes it possible for anyone who can solder to build this kit successfully.

In case of difficulty, extensive troubleshooting procedures are carefully outlined in the manual, and complete voltage and resistance charts are included. According to Heath, 90% of the troubles that do arise

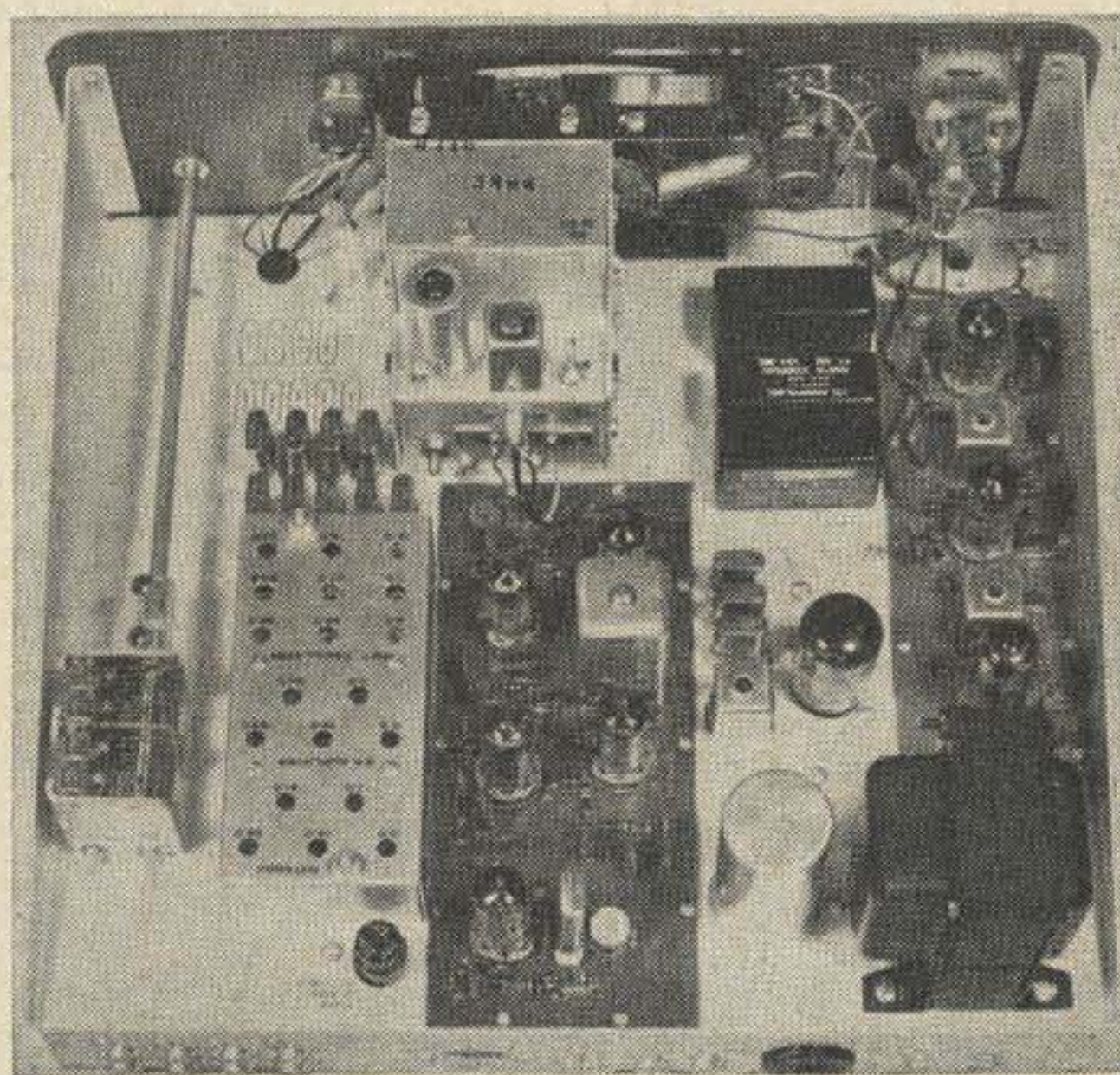
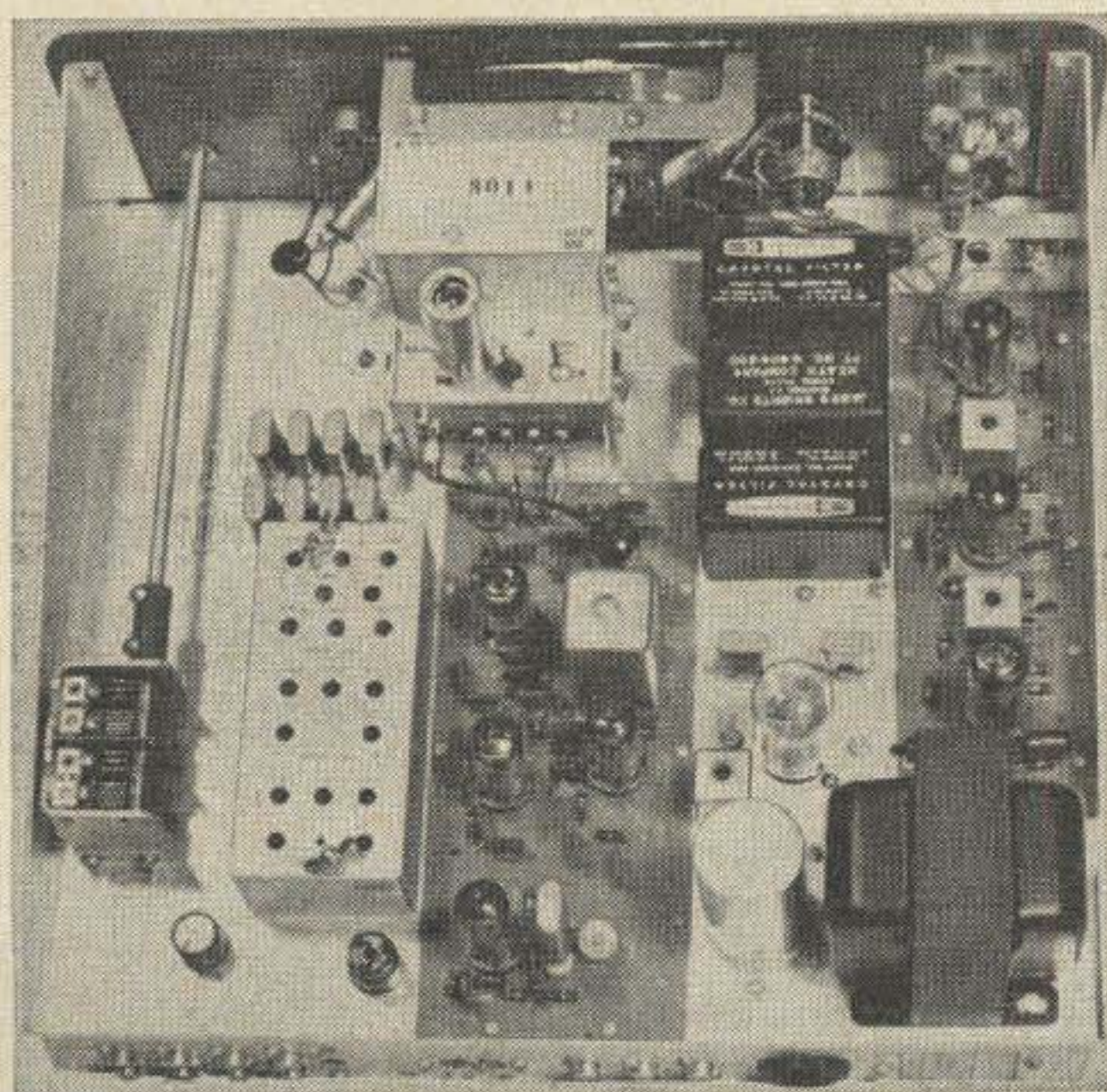

This bird's eye view shows several differences between the SB300 and SB301. The SB301 on the right has an additional heterodyne oscillator crystal and coil—immediately to the left of the large board. The converter switch which was located on top of the chassis in the SB300 is now located on the front panel. The three crystal filters of the 301 are somewhat smaller; the 6AS11 Compactron (below crystal filters) has been moved a little and is now adjacent to three crystals instead of the two that were used in the SB300.

are traced to poor soldering, so check that first.

Comparing the SB301 to the SB300

Owners of the older model will be interested in the differences between the two; physical changes are quickly apparent. On the front panel, the function switch and the AF gain control have been moved nearer the top. The AF gain knob also pulls out to turn on the ANL. The mode switch now has RTTY position and the band switch, its opposite number in location, includes the WWV 15 MHz position. At the bottom of the panel the converter switch is concentric with the rf gain control. It was formerly located on the top of the chassis and you had to open the lid to get at it.

Examine the top view photos of the two receivers; the holes in the coil cover indicate two things—coil locations have been shifted and an additional heterodyne oscillator coil appears. It is, of course, for the 15 MHz WWV position.

Three crystals appear in the chassis area of the 301 forward of the power transformer, where the 300 had only two. The extra one is for RTTY reception. Further forward in the same area, the three crystal filters are

located. The new ones are not only smaller—but better. The 400 Hertz CW filter is now only 2 kHz wide 60 dB down, compared with 2.5 kHz in the old one.

The VFO in the receiver, which Heath calls the LMO (linear master oscillator), is a slightly modified version of the original model. An industrial grade 6BZ6 has been substituted for the original 6AU6, and there are some minor changes in the values of one or two parts. Its stability is excellent; drift is completely unnoticeable from a cold start.

Operation

One of this receiver's outstanding characteristics is its quiet operation, but don't make the mistake of thinking this means it's dead. Far from it—it's got sensitivity to spare. Tuning is smooth and the degree of tension on the dial is adjustable to your own tastes. With the receiver properly calibrated, frequency readout and resetability are outstanding, within a fraction of a kilohertz.

When you wrap the whole works up in the neat two-tone green cabinet Heath favors, you've got a receiver that's an impressive package for the money.

... W2JDL



NUVISTOR LOW NOISE PREAMPLIFIER

For 27 (CB), 28, 50, 144 or 220 MC. (Also available for 150-170 MCS)



Add this Ameco Nuvistor Preamplifier to your receiver (or converter) to improve the sensitivity and noise figure. Two tuned circuits also improve rejection of image and spurious frequencies. Compact, easily connected and low power requirements, wired and tested with tube.

Model PV 27 \$11.95
Models PV 28, 50, 144 & 220 \$13.95

Write for details on 150-170 mcs and others.

Ideal for improving performance of surplus FM Two-Way equipment for "NET" operation on the 2 and 6 meter bands.

MANUFACTURERS OF FM AND AM TWO-WAY RADIO, SSB AND ISB COMMUNICATIONS, CONTROLLER FUEL CONTROL AND DATA EQUIPMENT, AMECO* HAM, CB AND SHORT WAVE LISTENING EQUIPMENT.

AMECO EQUIPMENT CORP.

A SUBSIDIARY OF AEROTRON, INC. ■ P. O. BOX 6527 ■ RALEIGH, N. C. 27608

HEAVY DUTY POWER KIT FOR SSB EXCITERS



I am always on the lookout for electronic components or assemblies which possess potential ham value. I have also been interested in any item which makes it possible for more hams to enjoy sideband. You can, therefore, understand how happy I was when on a recent western trip I found one lot of 225 watt core power transformers and in another area a batch of computer grade electrolytic condensers. Immediately, I felt that we could put out a darned good universal transceiver power supply and when I got back, the boys in the shop confirmed this.

I say universal because with two of these power transformers and two 500 mil chokes, 12 diodes, assorted resistors and other com-

ponents, we were able to make up a supply which met the requirements of the latest Swan, Collins, Drake, Hallicrafters, Heath, and National transceivers. Talk about value! We can offer this complete assortment of parts including a 16 gauge steel chassis and bottom plate, a good PM speaker and mating plugs for your particular transceiver for just \$50. The transformers in this set weigh 17 lbs. and altogether the completed supply will weigh close to 40 lbs. This is what I call meat and potatoes. The filtering is excellent; the regulation is extremely good, and we have schematics and a printed story to be supplied with each kit, giving detailed information as to how to make the connections for your rig. You will have to tell us what model you own.

This is what the power supply will do:
800-1000 V at up to 400 mils on peak
285-320 V at up to 300 mils
bias of up to 125V at 100 mils
12V DC at 1 ampere
12.6V AC at 6.5 amps

Remember, this is an assembly of parts.

We do not furnish a drilled chassis; we do not furnish the hardware; we do not furnish the solder and the wire but literally everything else is supplied.

Please allow for 45 lbs. shipping weight or otherwise be prepared to accept Railway Express or motor truck shipment.

HIGH VOLTAGE PLATE TRANSFORMER



We pulled a booboo in our January catalog issue. We did not accurately describe a particularly good plate transformer and the result was that few people bought them. Actually one of the best items we have in stock, this plate transformer provides for 2850V either side of center, is rated for 500 mils of continuous duty, and is insulated for 4286V. The primary is intended for 207, 220, or 225V. This transformer will coast and run cool even with condenser input and a peak demand of your final at close to 4000V and upwards of one ampere. In other words, you can run 4KW PEP. It measures 9½" w. x 7¾" d. x 9½" h. and weighs 60 lbs. Check the price of copper and steel today and see if this isn't

a value. Only \$35 f.o.b. Harvard. This is brand new merchandise.

DON'T RUN OUT OF NUTS AND BOLTS

We have 500 boxes of 5/8" 6-32 thread nuts and bolts for \$1.95 a box. These are heavily plated steel oval head bolts with square nuts to match. Used all the time in ham construction projects. Each box weighs 3 lbs. Please allow for postage.

Herbert W. Gordon Co.

Woodchuck Hill, Harvard, Mass. 01451

Telephone: 617-456-3548

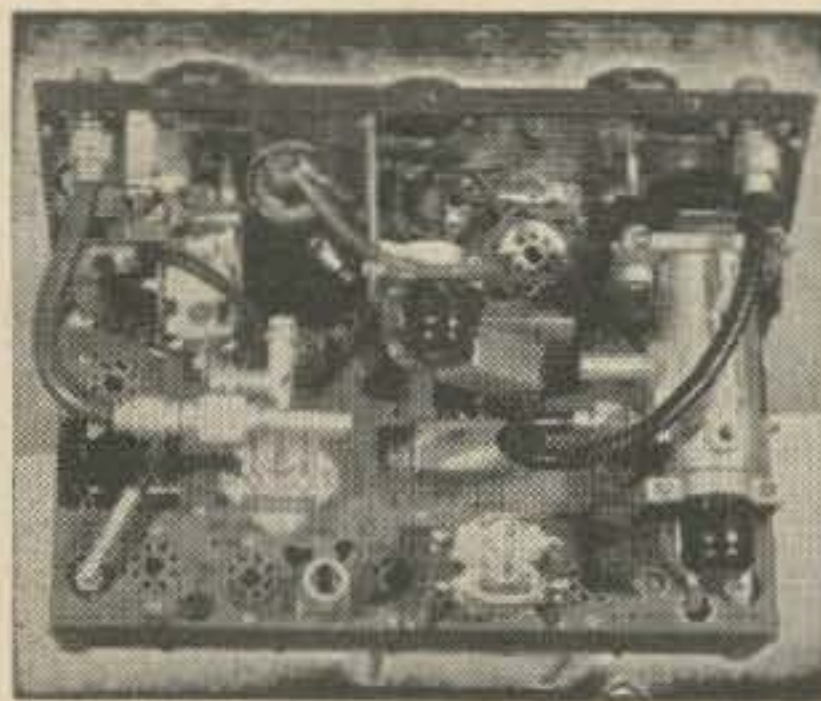

S Band Transponder. RT-21/APN-21XR Measures 13"W x 13"H x 10"D and weighs 21 lbs. Supplied less tubes. A veritable wealth of S band components—pulse transformers and generally useful components. Basic cavity may be used in amateur microwave work around 3000MC and uses light house tubes. A Shepard McNally Klystron 707B used in 2nd cavity. 12 or 24 VDC and 400 cycle 115V AC single phase. Bargain priced at \$15.00.



X-Band Radar. An early airborne radar set for X band includes receiver and pulse magnetron. Allow 100 lbs. \$50.00 each. Here's your chance to have your own radar trap or weather eye. Requires 115V 400 cycles and 28V DC.

Loading Capacitor Here is a two-section loading condenser each section varying between 20 and 600 pf so that the sum of the condenser will extend up to 1200 pf which is more than adequate for most high-powered finals. The spacing is excellent. The condenser measures 3 3/8" behind the panel. Its width is 3 1/4" and its maximum height with the condenser open is 2 3/4". This is straight line frequency. A particularly good value at \$3 each. 1/4" shaft. 2 lbs.

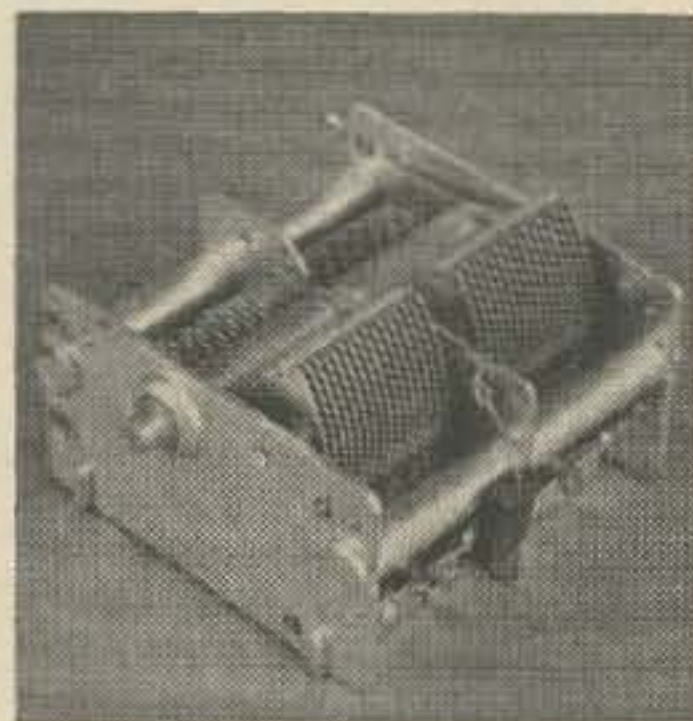

Bridge Rectifier Transformer suitable for solid state application. Capable of furnishing 600V at .5 amp; 115V primary; secondary rated at 545V at .455 amps. 5 1/4" square x 5" high. \$7.25. 15 lbs.

Solid State or selenium rectifier transformer made by Raytheon, their #UX9115A; primary 60 cycles; secondary tapped, from 28 to 48V; rated 2 amps but good for 4 amps. 4 1/2" high by 3 1/2" wide. \$4 each. 7 1/2 lbs.

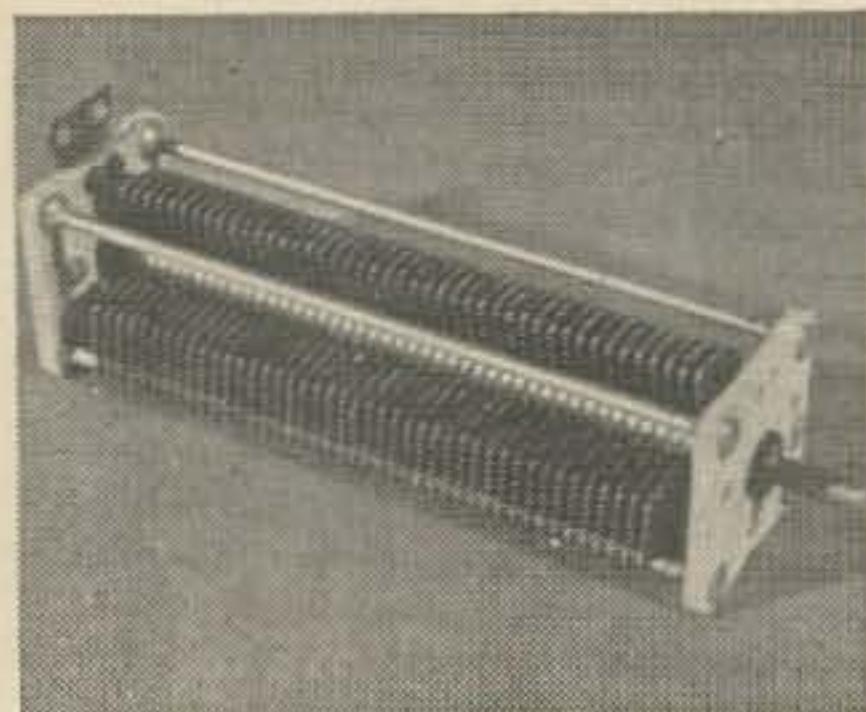

G.E. Air Capacitor. 20-140 pf, 7" long x 2" x 2" ceramic end caps with 1/4" shaft. Heavy brass construction, .015 spacing. Excellent as a loading capacitor or for general purpose work. \$4/ea. 1 1/2 lbs

Dual Bearing Hammarlund Capacitor. 100 pf straight line capacity. Excellent for a variety of general uses. 90c each, 10/\$7.50. 4 oz. each.

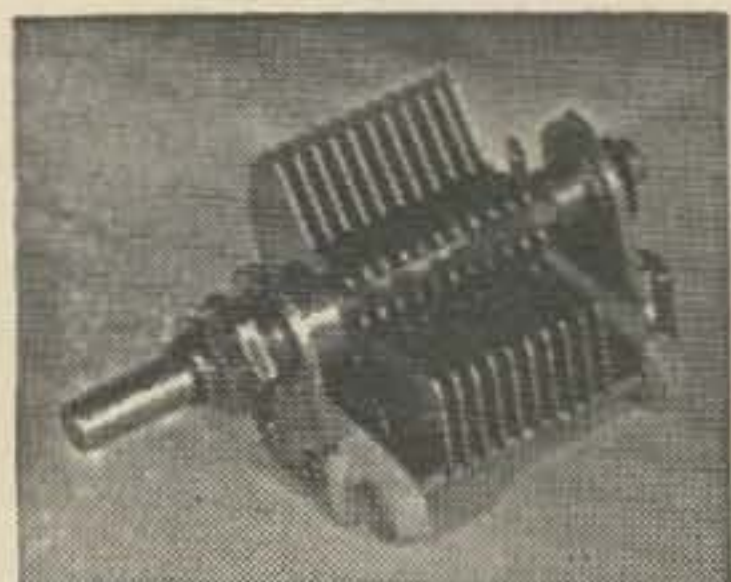

Collins RF Plate Choke—good for high-powered final; capable of at least 1/2 amp and suitable for 80-10 meters. \$4/ea. 1/2 lb.

Herbert W. Gordon Co.

Woodchuck Hill, Harvard, Mass. 01451

Telephone: 617-456-3548

PHONE PATCH KIT ONLY \$5.95

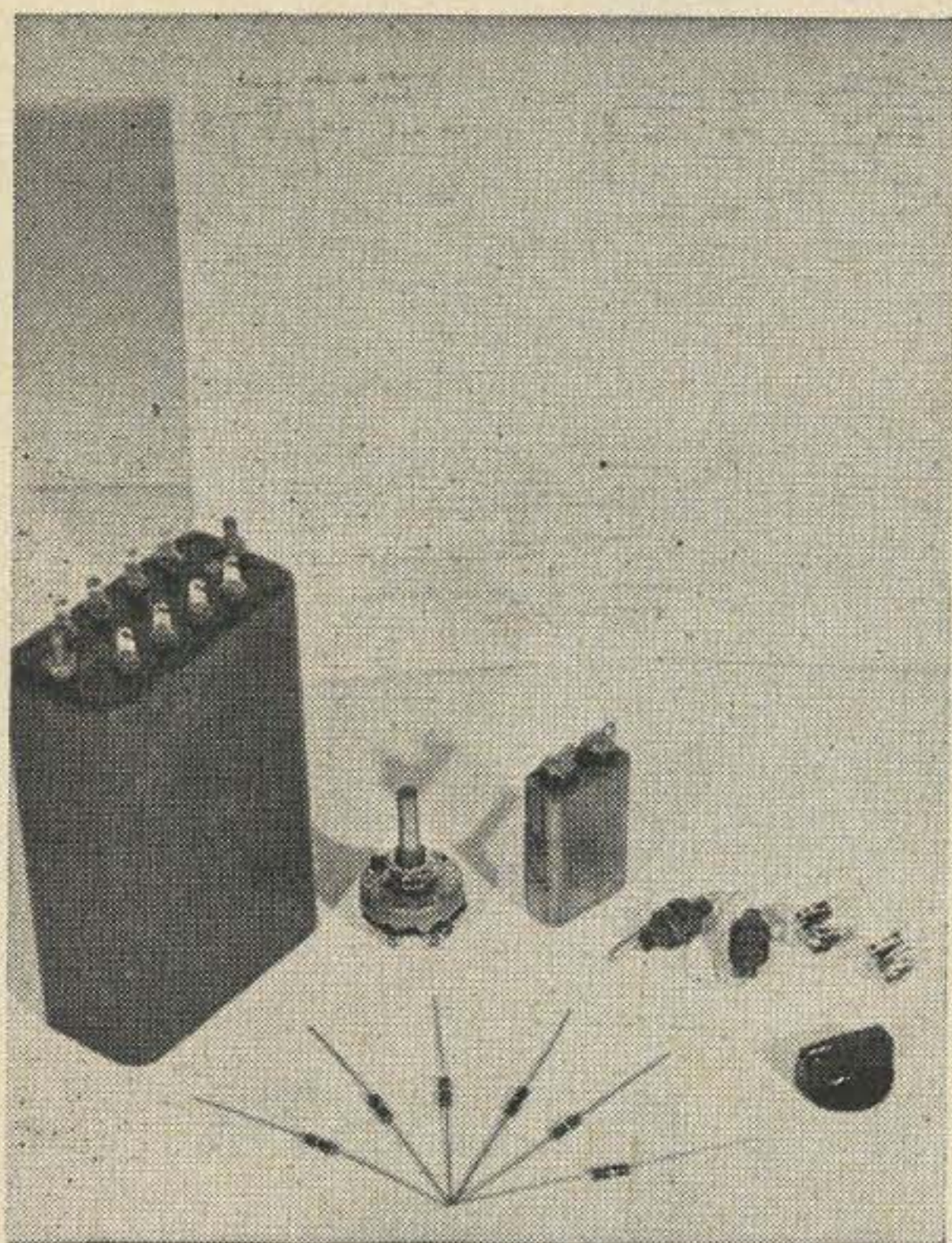

The most popular item that we have ever produced for the ham is our inexpensive phone patch kit. We have received literally hundreds of orders and many hams have taken the trouble to voluntarily write us to describe how pleased they were with the performance of the kit. The electrical values of this kit have been chosen for average volume and average telephone line conditions. Each kit is fashioned around a very expensive Western Electric repeating coil transformer. The transformer has four 600-ohm windings and is toroidally made with a great amount of shielding. Even when purchased in large quantities, the price of this transformer is over \$40 and no contemporary phone patch made in this country includes a transformer doing more or costing more than this transformer. Besides the transformer, I supply a 4-pole switch and knob, six half watt resistors, two RF chokes, a blocking condenser, four ceramic capacitors and, naturally, an instruction sheet.

The patch is designed to work from the 500-ohm output of your receiver into a 500-ohm input on your transmitter. If you use a modern trans-

ceiver, we can supply two auxiliary transformers that will enable you to use this kit. One of them is a small 500-ohm to grid transformer priced at \$2.50. You wire this into the microphone input circuit of your transceiver. The second transformer is a 500-ohm to voice coil transformer and it is used to contact the 3.2 to 8 ohm from your receiver output into the phone patch transformer. Price: \$1.50.

A typical transceiver would normally require \$9.45 worth of parts—\$5.95 plus \$2.50 plus \$1.50. If you have an older type transmitter such as a Johnson, B&W, or Hallicrafters, you would very likely need only the kit itself. The kit, when packed with the auxiliary transformers, weighs 5 lbs. Those on the West Coast should add \$1.70 for postage; those in the midwest, \$1.30; those on the East Coast, \$1.20.

AMERICAN BEAUTY 100 WATT SOLDERING IRON—\$4.95

This famous iron has been standard in our trade for over 25 years. It will operate year in and year out without failure for it is built like the proverbial battleship. Especially well balanced for heavy use. Heavy enough to solder to a chassis and light enough for all general work. The soldering tip is iron plated which greatly reduces pitting and redressing and saves you time if you work with an iron all day long. The casing and body are of one-piece seamless steel. The shatter-proof wooden handle is coated with a durable rubberoid for personal handling comfort. Has a cooling baffle; uses an extra-flexible cord which withstands repeated kinking, and bending. Supplied with tip and stand. One of the most useful and best values I have ever offered. Absolutely new. \$12.50 value—my net is \$4.95. Allow postage for 2½ lbs. Only 275 available.

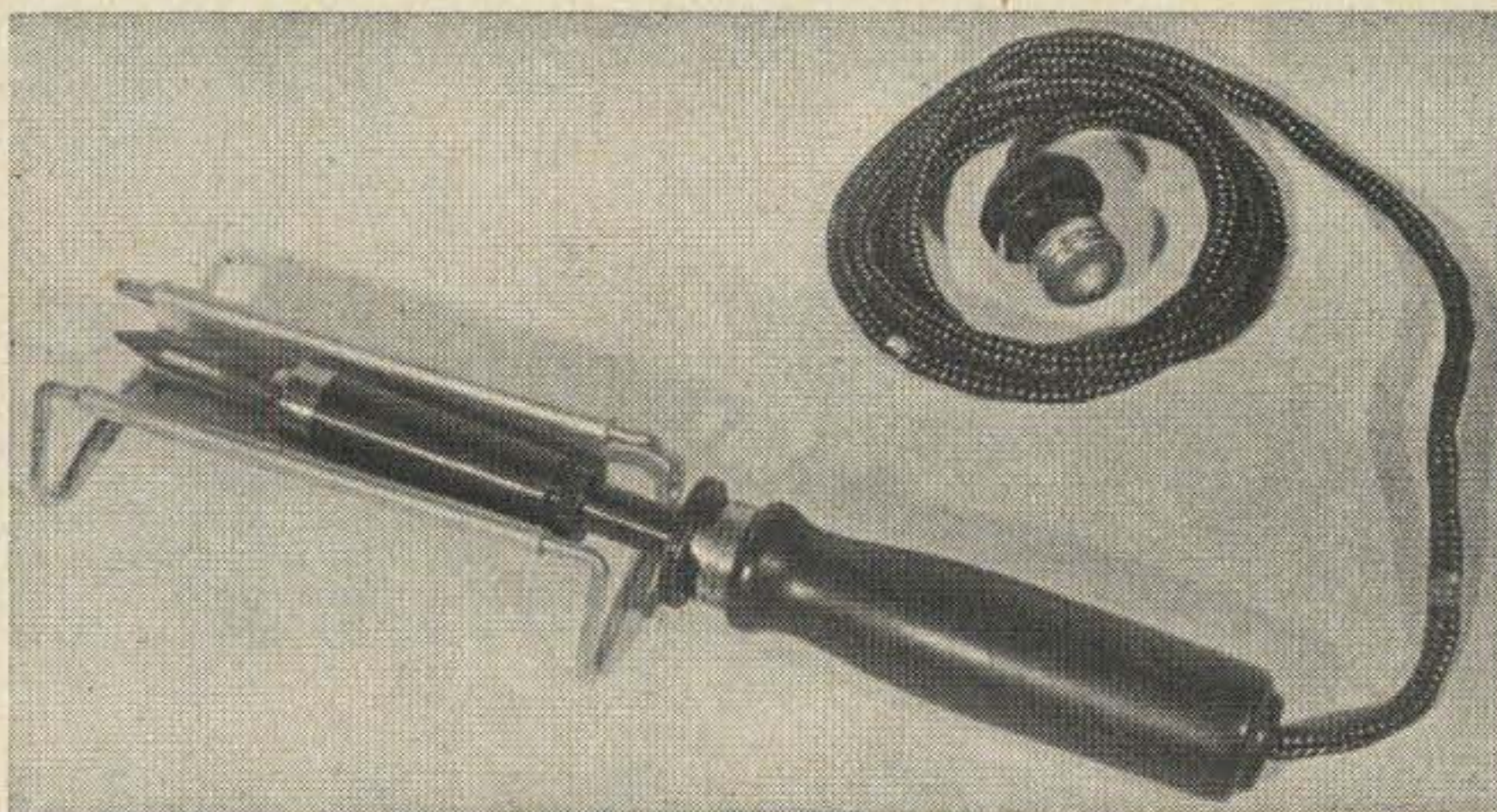

The soldering tip is iron plated which greatly reduces pitting and redressing and saves you time if you work with an iron all day long. The casing and body are of one-piece seamless steel. The shatter-proof wooden handle is coated with a durable rubberoid for personal handling comfort. Has a cooling baffle; uses an extra-flexible cord which withstands repeated kinking, and bending. Supplied with tip and stand. One of the most useful and best values I have ever offered. Absolutely new. \$12.50 value—my net is \$4.95. Allow postage for 2½ lbs. Only 275 available.

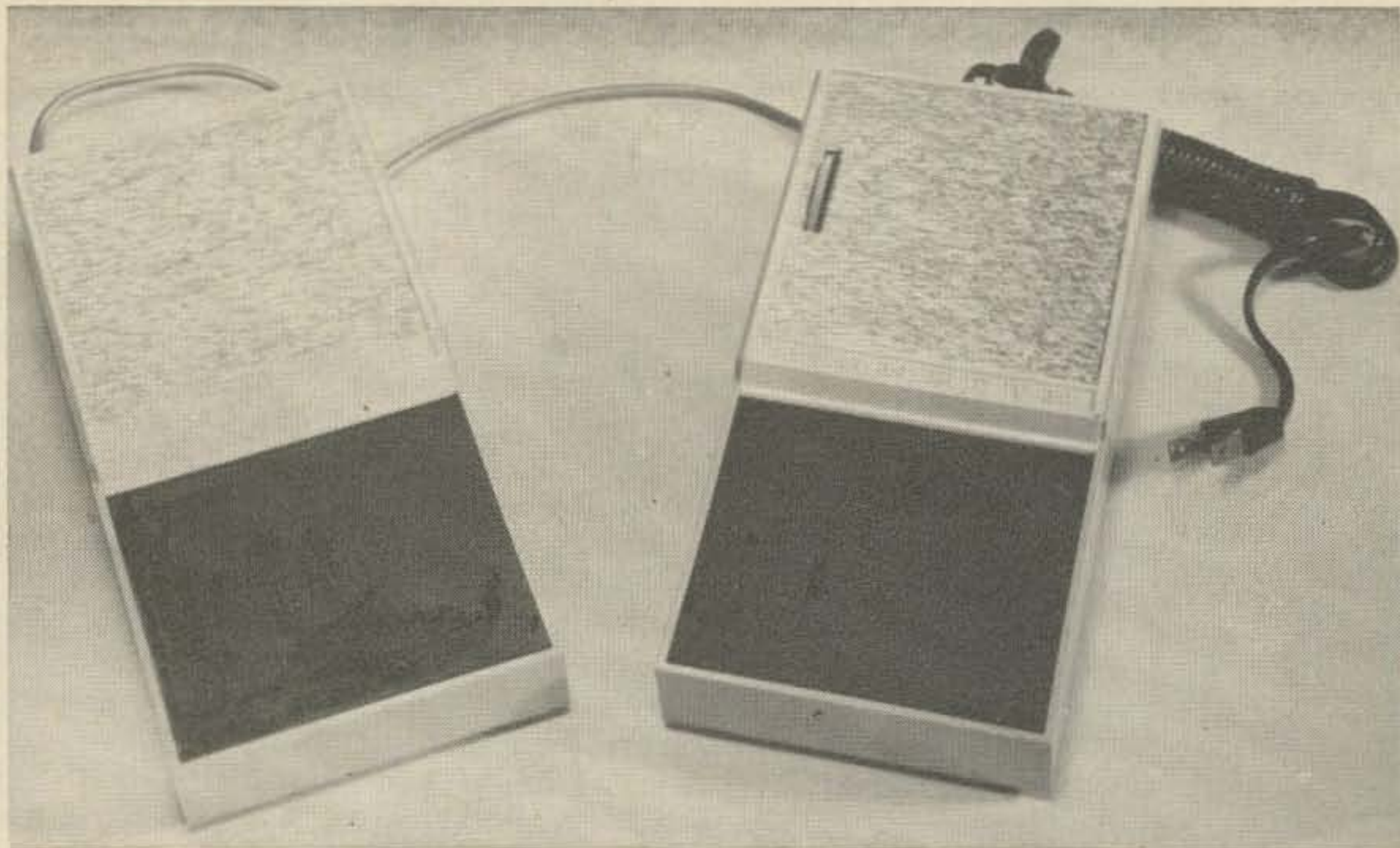

SIGNETTE LOUDSPEAKING INTERCOM

(Master, Remote and 50' of wire — only \$20.00)

One of the surprise offerings made me in the past sixty days and which I have accepted for sale, is the small, solid-state intercom powered from the AC lines and made by General Dynamics in Rochester, New York. We offer our ham friends a truly worthwhile item which can be used in a variety of ways. Most hams set their shacks apart from their living quarters—in attic, garage, or basement. A big advantage of this little, inexpensive but high-quality, device is in having the XYL be able to reach you for dinner—or in reverse, during one of those contests when you want another pot of coffee, wouldn't it be nice just to reach over, push the



Radar Echo Box AN/UPM-30. A coaxial type resonant cavity used to monitor radar systems operating in the range of 1150-1350MC Decdy 3.5 lb per micro second. Sensitivity 1 db. power loss for 50 yard ringtime. Temperature coefficient .105% ringtime/degree F at 68°. Uses 3-IN21B diodes. New Weighs 25 lbs. Cost uncler \$2000.00. Your Cost \$70.00.

Oscillator 0-12. This is a signal generator operating between 155 and 235 MHz with a built-in attenuator assembly accurately calibrated to more than 100 db, below 1 volt. It employs a remote cutoff piston attenuator. These oscillators normally provide pulsed RF output but can easily be employed for CW with a simple change. \$9.70. 7½ lbs.

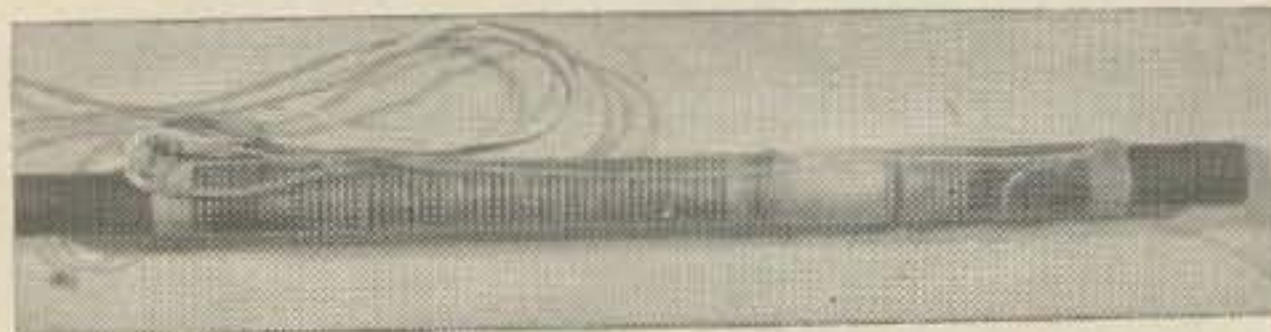
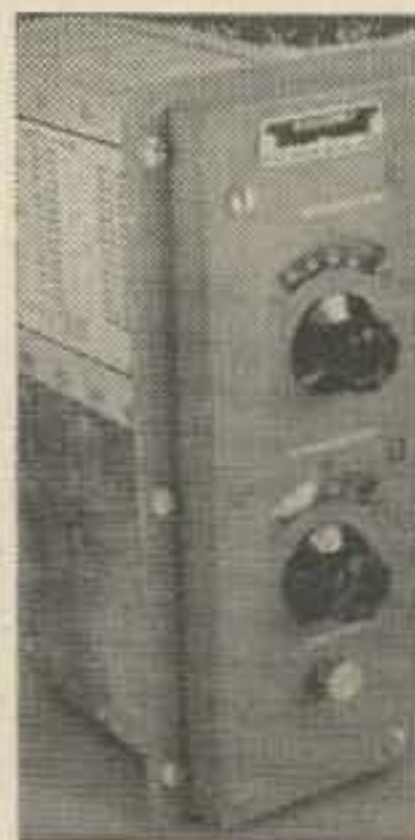

Ferrite Antenna Coil: 6⁵/₈" long x 5/16 diameter. I bought these at a very low price and found them to be particularly attractive when bunched together as a core for winding filament chokes. Use 4 of them wound with electrical tape as a core for 4-1000. 59¢ each. 4/\$2.00. 4 oz. each.

Herbert W. Gordon Co.

Woodchuck Hill, Harvard, Mass. 01451

Telephone: 617-456-3548

button, and ask for some Java without having to get up and lose your chance in the pile-up?

Another interesting application is using this as an automatic babysitter. If you wish, you can wire one through the walls of your home in such a way that people approaching your front door can have verbal entree to the kitchen where the XYL usually hangs out.

These little intercoms are ideal for stores, professional offices, small business, restaurants, grilles, garages or other office applications. The Master and substation units may be used in a variety of combinations. Instant operation and very low current consumption are features.

We offer, for \$20, to supply one 1M Master and one 1R Remote. Also included will be 50' of 3-conductor triplex wire. You can use this little intercom at distances up to 225' as long as the interconnecting cable is made up of at least #22 wire. Technically, each Master comprises two transistors in cascade with a push-pull transistorized output stage. A 45-ohm dynamic speaker serves as a microphone on transmit. A small negative 12V power supply is obtained from a full wave rectifier and a tiny line transformer. The residual hum is negligible; the units are surprisingly clear, and sensitive enough so that a person speaking in a low voice four to five feet from a unit can be heard at comfortable volume at the other end of the line.

A Multi-Master intercom is available using the Model 7M which permits the selection of six stations, either Master to Master, or Master to Remote, or mixed Masters and Remotes. The 7M was originally priced at \$50. We offer it for only \$22.50. The little Remotes originally sold for \$14.50 but when purchased on our special they are available at \$6.75 each. The 1M and 1R combination which we sell for \$20 can be wired for privacy mode or hands-free operation. In the hands-free position, you have an automatic listening device useful, for example, if you want to monitor the sounds coming from your baby's room.

Each unit measures 4-3/16" w. x 7-25/32" d. x 2-5/16" h. There is a volume control on the master unit. Operation from either unit is effected by depressing the talk-listen plate or, in the case of the model 7M, by first selecting the remote and then depressing the plate. You may leave them plugged in and turned on all the time since they draw only 2 watts for the complete system. The transistors used are two pieces of 2N1414 and two of the 2N1415. The weight of the 1R and 1M when packed and shipped together is only 6 lbs. Remember to allow enough for postage and please give your street address in the event we can make shipment by United Parcel Service.

Just over 500 sets are available. These should go fast considering their quality and usefulness and the reputation of the original manufacturer. Remember this is new merchandise.



Matching transformers: Here is a very high quality line-to-grid transformer. Primary either 200 ohms or 500 ohms impedance and secondary 30,000 ohms grid-to-grid with a center tap. It may also be used as a low-level plate-to-multiple line transformer. UTC-4050 \$2.50. 1/2 lb.

Sockets: RCA 9935 7 contact socket with built in capacitors. Semi-shielded for use with 829B, 3E29 and 832. Price \$1.80. 100 available.

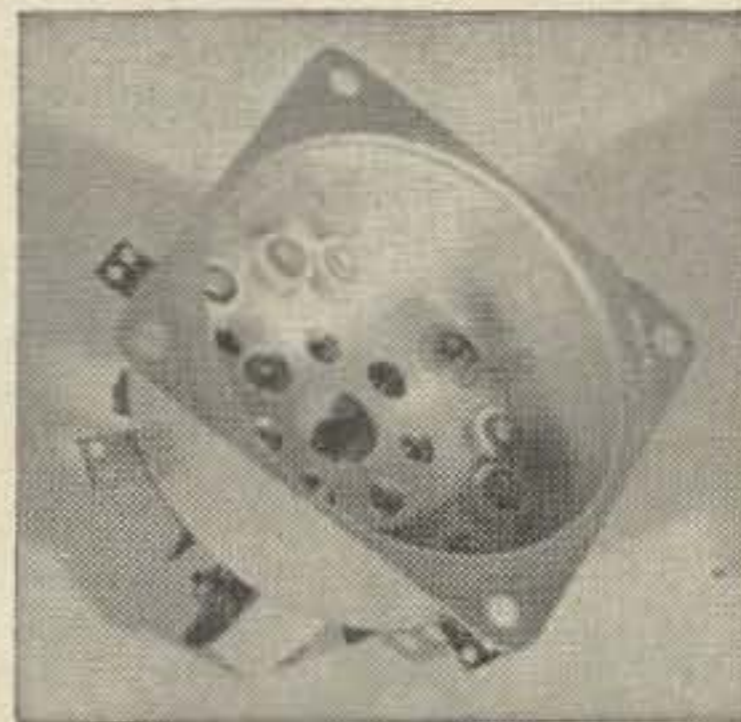

Toroidal Filter Assembly for RTTY. These new Humphrey units measure only 1 3/4" x 2". We have them complete with their sockets in matched sets tuned to 2125 cycles and 2975 cycles. \$8.50 per set. 1/2 lb.

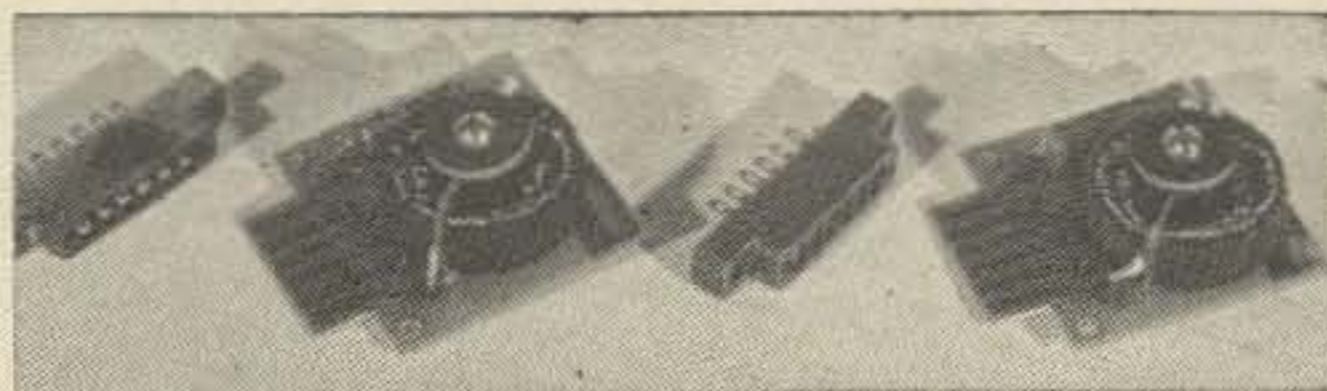

Herbert W. Gordon Co.

Woodchuck Hill, Harvard, Mass. 01451

Telephone: 617-456-3548

INTEGRATED CIRCUIT SALE

GOOD STUFF YOU CAN AFFORD

IC's, Choice, TO-5 or TO-46 case, RTL Mostly 6 & 8 lead. Includes Gates, Buffers Flipflops, etc. 50 assorted\$5.95

Buy 2 asstd. packs & get 8 pin test socket free.
IC's Flat Packs, DTL, Gates, Flipflops, Buffers, etc. 40 assorted\$5.95
 100 asstd.\$12.95

All IC's sample test over 50% good, unmarked. Schematics, identification & test info included.

IC's TO-5 or TO-46 Similar to 903 3 input NAND-NOR Gates. Tested.6 for \$2.95

Same as above, Sample tested over 50% good.50 for \$5.95

IC's Flat Packs sim. 931 RS/JK Clocked Flipflop, tested10 for \$12.502 for \$2.95

FOLLOWING HAPPY PACKS WILL RESTORE YOUR FAITH IN SURPLUS DEALERS. All \$2.95 each. Buy 10 and get #11 free. Some tested, some sample tested (ST), but include extras.

Hi-Gain (Darlington) Amplifiers TO-18 similar 2N998, 2N999. 4 lead. Tested6 each

P Channel Field Effect Trans. similar 2N3277, 2N3278, TO-5, 4 lead. Tested3 each

NPN Power Trans. HV Amplif. 20 MHz, 30 watts Tested, Beta 25 to 75. TO-59 stud.....6 each

Same Pwr. Trans. Tested Beta 75-100 plus, 4 each.

NPN Pwr Trans. HV Choice TO-3 diamond, 15 watt or TO-66 Small diamond 5 watt test 21-50 Beta, 6 ea.

Pancake Trans. tiny TO-46, choice all PNP or NPN, tested30 each

Fast Switch Trans. sim. 2N914/NPN, TO-52, tested12 each.

NPN TO-5 or PNP TO-5. Various types test, 35 ea.

NPN TO-18 or PNP TO-18, Various types including UHF. Tested35 each.

Asstd. NPN-PNP sample tested, choice, all TO-18 or all TO-5over 45 each.

Dual Trans. 6 lead. Choice. All TO-5 or TO-18 NPN, or PNP. Choice. Dif. Amp. types tested 6 each.

Dual Trans. Choice All TO-5 or TO-18, mixed PNP & NPN (ST)20 each.

Power Trans. NPN Asstd. TO-59 Stud, TO-3 and TO-66 Diamond Tested, low Beta15 each.

Dual Computer Diodes, 3 lead, TO-18 case, mostly fast. Common Anode. (ST)75 each.

Signal Diodes, mostly fast, Asstd. Glass & Tiny black dot (ST). Few Zeners100 each.

Above Devices all new, unmarked, all silicon.

SCR's, tested for PIV, PRV & Gates. Your choice TO-5 1.2 to 1.5 amp. TO-66 Diamond, 5 ampere TO-59 Stud, 8 amp. All packs\$2.95

Choice all one type:

50 to 100 PRV6 each.
 100 plus to 200 PRV4 each
 200 plus to 300 PRV3 each
 300 plus to 400 PRV2 each

Silicon 10-32 Stud Diodes Tested\$2.95 pkg.

PIV	5 Amp.	10 Amp.
50 plus to 100 PIV	12 each	
100 plus to 200 PIV	10 each	6 each
200 plus to 300 PIV	8 each	5 each
300 plus to 400 PIV	6 each	4 each
400 plus to 500 PIV	5 each	3 each

We include some Rev. Polarity.

Germanium Diodes, IN-270, 100 PIV, 90 ma. all purpose type50 each.....\$2.95

Germanium Transistors, TO-5\$2.95 pkg.

Sprague, 2N1754, PNP, RF10 each

Gen. Inst. 2N604 PNP, 50MHz SW10 each

Tex. Inst. 2N1303 PNP HI Gain10 each

Above new marked long leads.

TEX. Inst. 2N1304 NPN GP, new20 each

TEX. Inst. 2N1305 PNP GP, new25 each

Asstd. Marked PNP, NPN (ST)50 each

Last 3 items have short leads PC bd. or socket length.

Assorted types of Goodies\$2.95 pkg.

Miniature Trimpots by Bournes, Dale, Daystrom, etc. Mixed new and used pull-offs.

20 ohm to 500 ohm10 asstd.

1000 ohm to 10,000 ohm10 asstd.

20,000 ohm to 1 meg ohm10 asstd.

Slug tuned coils, wired, from Gonset, 7 varieties25 asstd.

Disc Capacitors top grade, Erie, 600V 5% 80 to 320 mmf. 7 varieties60 asstd.

Dipped Micas (Hershey Bars) mostly 100, 220, 330 mmf 100 V new trimmed for PC boards, 125 asstd.

Good—All subminiature Mylar Capacitors 200 V precision, 2% ratings.

.026, .047, .055 mf

30 asstd., 10 of each or 30 of a type\$2.95

Precision Resistors, 2% 1/2 watt

All marked 47 ohm thru 470K ohm short leads. 300 asstd.\$2.95

88 mhy Toroid coils 1" diam

Excellent re-wind cores10 for \$2.95

Ferrite Cores for Pulse Xfmr windings. 1/4" x 1" rods, 3/8" x 5/8" round toroids and 3/8" x 3/4" E cores. 25 asstd.\$2.95

Some memory cores included free.

NE-2 Neon Lamps, 300 each mounted in 8" x 12" Micarta Panel. Removable. 4 lbs.\$4.95

Nicad Rechargeable battery 1.25 V mounted in reject Elect. Toothbrush with motor, some usable units. 1/2 lb each\$1.00

Buy 10 and get free battery charger

Memory Plane, 5" x 8" with 4096 wired toroid bits, \$9.75 each. Complete 8 plane unit\$75.00

Memory Plane, 10" x 10" with 10,000 wired toroid bits. Perfect condition. 1 lb. each\$15.00

Same Memory Plane slightly damaged, 2 for \$15.00

Same Memory Plane badly damaged each\$ 5.00

2"x3" 10x10 (100 bit) Matrix boards..... \$2. each

MIKE QUINN ELECTRONICS

Building 727, Langley Street

Oakland Airport, California 94614

Computer Grade Elect. Capacitors. 2" x 5"
by Mallory, Sprague and G.E. each **\$1.25**, 1/2 lb.
36,000 mfd 4 VDC 4,500 mfd 55 VDC
25,000 mfd 6 VDC 2,500 mfd 80 VDC
19,000 mfd 6 VDC 1,250 mfd 180 VDC
3,500 mfd 55 VDC 500 mfd 310 VDC

Transistor Ignition Systemless coil **\$2.95**
with 3"x5" finned heat sink, 2 power trans.
TO-3 & TO-36 plus control trans. fully wired.
with by-pass capacitor & res. for 6 or 12 VDC,
Including Heathkit Ignit. Manual, 36 pg, 1 lb.

Dialco or Eldima 10 V 14 ma. Tiny 1/4"x1" stove-
pipe panel lights with mount clip. Ok for 12 to
28 volts **15 for \$2.95**

Grayhill Minn. Rotary Switches, both new and
used. Nice assortment of 10 **\$2.95**

Jumbo Silicon Trans. Assortment. 450 asstd. **\$9.95**
Includes PNP & NPN in TO-18, 46, 52 & TO-5. A
few Power Trans. Darlingtons, 6-lead dual Trans. and
a few FETs, SCRs & Integ. Circuits and about 50

diodes. These are sample tested, and will run from
50% to 90% good depending on type. This is good
stuff and we get many re-orders on this mixture.
Buy 2 assortments and get a Pomona flare top trans-
istor test socket free. 1 lb.

WEIRD-O EXPERIMENTER ASSORTMENT.
Over 100 **\$4.95**

We get loads of odd types of special products
like resistor arrays or diode arrays in multilead
TO-5 cans. Tiny flatpack dual transistors, flatpack
single trans. & other multi-lead pkgs. A real nutty
assortment containing some mighty good stuff.

Brand New Selenium Rectifier Stacks. 8 plate to
50 VDC 3 to 4 amp., \$3.95. 4 to 5 amp, **\$4.95**, 1 lb.
each. 15 amp., \$6.95, 3 lbs. All FWB.

G.E. Germanium FWB Stacks 2"x4" long., 5.2 amp
to 40 VDC or 4.2 amp to 70 VDC, each **\$2.95**

New Copperclad PC Boards. Easy Etch
3"x6"—5 for **\$1.00** 4"x6"—4 for **\$1.00**
4"x8"—3 for **\$1.00** 6"x8"—2 for **\$1.00**

IC TESTER

Here's simple little tester capable of testing or id-
entifying a wide variety of logical integrated circuits.

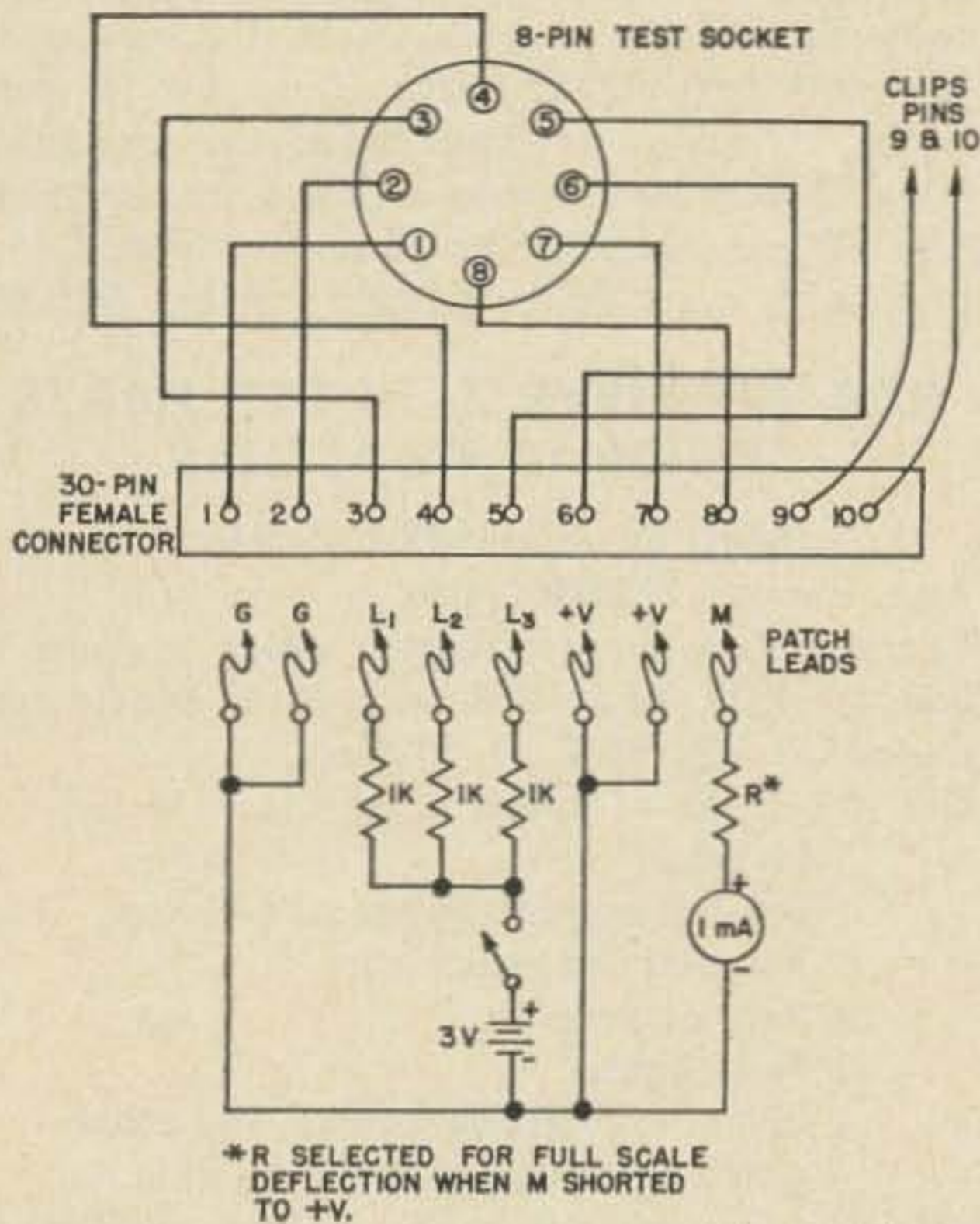

While this was built to test TO-5 RTL units, it can
easily be extended to DTL or TTL by increasing the
supply voltage (especially with flip-flops; these fam-
ilies require 5 or 6 volts). The use of the "patch
board" is the factor that makes this tester so ver-
satile: resist the temptation to use push buttons or
switches!

The best way to sort TO-5 cans is to separate them
first according to lead configuration, then go through
each set of similar appearance. This minimizes re-
connections. A good procedure is to connect +V to
pin 8, and ground pin 4, (This is for 8-lead units. For
10-lead cans put +V on pin 10 and ground pin 5.),
then with the M lead explore for likely voltages on
pins 7, 6, 5, 3, 2 and 1, in that order. When you
find a voltage of about 0.2 or a voltage over 1.3,
watch the voltage on that terminal while applying
one of the L leads to the blank pins. If you see
no change, try applying two L leads at the same
time to various combinations of free terminals. Gen-
erally, once you get the hang of it, the right (most
probable) connections seem fairly obvious. Every
now and then a unit requires the use of both +V
leads; in this case try one on pin 8 and the other
on pin 6.

Most TO-5 cans sold unmarked seem to be the 8-
lead cans, although several valuable types come in
10-lead cans. Ten pin test sockets are not necessary
if you use separate clips, as in the diagram.

For a complete discussion of the various families of
integrated logical circuits, see Electronics Magazine
for 6 March 1967 and 73 Magazine for March and
June 1967.

In surplus business 21 years now. We guarantee satisfaction on all sales. Please add approximate
postage where weight is shown. On other assortments add 10¢ to each price and we will make up
any difference. Minimum cash order \$5.00. Minimum COD with \$5.00 deposit is \$20.00. Minimum
School or Company purchase order is \$20.00. Minimum foreign order \$20.00. California orders, add
4% Sales Tax. Most of our semiconductors are silicon.

We're working on a new catalog and hope to have it ready soon. Send for it; postage
appreciated.

In ordering, you can list the items you want or if you wish tear out these sheets, mark them and we
will return them with your order.

MIKE QUINN ELECTRONICS

Building 727, Langley Street

Oakland Airport, California 94614

PREMIUM SILICON REPLACEMENTS

5R4 Ratings 4000V. PIV 1 AMP 5R4WGY
IMMEDIATE AND DIRECT PLUG-IN!
INSTANT OPERATION

NO: REWIRING NECESSARY
**NO: FILAMENT TRANSFORMERS
NEEDED**

—PROPERLY COMPENSATED—

Our tubes are UNAFFECTED by VIBRATION
or HUMIDITY

Potted in HYSOL Electrical Epoxy
All our tubes are power tested at 1 AMP av-
erage current.

END Vacuum Rectifier Tube REPLACEMENTS.
Price: \$6. Quality prices on request.

Other tube replacements available.

OUR S/A SILICON DIRECT TUBE REPLACEMENTS

Replaces the following tube types: 5Y3, 5U4,
5Y3GT, 5V4, 5V4GT, 5AU4, 5T4, 5W4, 5Z4,
5AW4, 5V3, 5AS4, 5AX4, 5AZ4. Rates 1800
P.I.V. at 1 amp.

Price \$1.95 each or 10 for \$16.00.

FLANGELESS SILICON DIODES

All rated at 1.5 amps.

50-200 volts	6¢ each.....	20/\$1.00
200-400 volts	9¢ each.....	15/\$1.00
400-600 volts	12¢ each.....	10/\$1.00
600 plus	15¢ each.....	7/\$1.00

RACK CABINET AND BLOWER

BRAND NEW 19" desk top rack cabinets that
contain a NEW Rotron muffin fan with at-
tached cord and plug for 115V 50-60cy,
mounted on the rear door. There is also a top
door, 2 drawer rails with ball bearing rollers
(removable), 3 alignment tools and 2 Allen
wrenches. Front panel space is 19" wide x 14"
high with a 13½" clear behind panel depth.
The outside measurements are 16" high x 21"
wide x 15" deep. There are four rubber feet
on the bottom, and the color is dark gray.
Price\$14.95 each

ARC-5 TRANSMITTER LIKE NEW 3-4 mHz

Complete with all tubes. One of the most
versatile pieces of surplus equipment ever.
Get yours now—not many of these left. Guar-
anteed excellent. Price\$12.95

HAMMARLUND VARIABLE CAPACITORS

Brand new in original cartons
All have 3/8" bushing with standard 1/4" dial
shaft:

Butterfly type	Price each
BFC-25	\$.75
BFC-50	1.00
Single type	Price each
HF-50	\$1.25
HF-100	1.50

NEW INSTRUMENT OR RECEIVER TRANSMITTER CABINET

Panel space 19" wide x 12½" high with a clear
depth of 13". Outside depth is 14½". Partial
rear panel. Painted black crackle.

Price:\$3.95 each

NEW CRYSTALS

100 crystals in a case originally for type MAR
equipment. These crystals cover the range of
4844.44 kHz to 7778.78 kHz. There are 16 units
in the 40 meter amateur band, and an addi-
tional 7 units are usable in the 6 meter band.
Also 17 are usable in the 10 meter band. Com-
plete with case. Price: \$12.95 2 for \$25.00

RDR RECEIVER & SPARE PARTS WITH 10 CRYSTALS

Mfg. by RCA BRAND NEW

Freq. range: 225-390 mHz.

You get two wooden crates which include:
Box #1 RDR RECEIVER with 13 V dynamotor.
Output is 385 VDC at 500 ma.

Box #2 1 set of spare parts which include:

- 1 Headset
- 1 Set of operating tubes (spares).
- 1 Headset extension cord
- 10 Sets of fuses
- 2 Pilot lights
- 1 Set of connecting cables, and other
parts too numerous to mention.

All this in original military boxes, receiver
packed in aluminum waterproof case, manual
included. Easily converted to 200 mHz ham
band, or use as they are for UHF aircraft
band. You get all that is required to operate
except the 12 V DC source and the antenna.

BRAND NEW

Price: \$34.95 ea. while they last FOB our ware-
house.

SELECTRONICS

1206 S. NAPA STREET, PHILA., PA.
HO 8-7891 HO 8-4645

DESK TOP RECEIVER OR TRANSMITTER CABINET

A modern design desk top cabinet with a top lid and rounded corners and painted a light gray. These cabinets are made of perforated steel on side and top for adequate ventilation. The panel space is 8³/₄" H x 18" W with 15" depth behind panel. Also, a bottom chassis cover is supplied. These units are BRAND NEW. PRICE:\$2.95 ea. or 2/\$5.00

SUPER DELUXE CABINET RACK

These cabinets are a blue-gray finish with front and rear doors and a complete filtered air blower system in the base with suitable duct on the rear door to distribute air as required throughout the cabinet.

The outside dimensions are:

Height approx. 93"
Width " 24"
Depth " 24"

The panel space is 19" x 76" with approx. 15¹/₂" behind the panel.

USED, EXCELLENT CONDITION

PRICE:\$79.95 F.O.B.

PANEL METERS ALL NEW

2¹/₂" round, 30 amps AC Tripplett, ea. \$3.95
3¹/₂" round, 1 amp RF G.E.,ea. 4.95
3¹/₂" round, 3 amps RF Simpson,ea. 4.95
0-400 feet, but easily changed,
Weston,ea. 2.95
3¹/₂" round, 1.5 amp AC Weston,ea. 2.95
2¹/₂" round, 35 VDC Bruno Ind.ea. 2.50

MINIATURE POWER SUPPLY KIT

A set of electronic parts to build a small power supply useful for transistor work.

Input: 117 VAC 60 cycle
Outputs: 12.5 VDC at 630 ma
100 VDC at 8 ma
55 VDC at 31 ma

Parts supplied:

1 transformer
5 diodes
2 filter capacitors (1 ea. 40 mfd & 100 mfd.)

Schematic with directions supplied.

Price:\$3.95 each, or 2 for \$7.00

TELETYPE DEMODULATOR UNIT

Northern Radio type 104 model 3

11 tubes

115 or 230 V 60 cy operation

GOOD CONDITION

Price:\$49.95 Shipping wt. 50 lbs.

TDA-2 RTTY—TEST SCOPE

The Stelma Telegraph Distortion Analyzer type TDA-2 is a self contained portable unit designed to measure bias and distortion of telegraph start-stop signals. Distortion is indicated by vertical pips displayed in a rectangular pattern on the face of a cathode ray tube. Measurements can be made while the machine is operating. Measurements can be made on circuits operating at 60, 75 or 100 OPM on 20 or 60 ma neutral circuits or 30 ma polar circuits. Distortion measurements from zero to 50 percent with an accuracy of plus or minus two percent can be made. The set is patched in series with the loop and direct measurements made. No special skills required to make measurements after a few minutes practice. See your distortion, then adjust and watch it disappear. Price:\$49.50 F.O.B.

POWER TRANSFORMER STANCOR #PC-8412

Primary: 117 VAC 60 cy

Secondaries:

Plate: 400-0-400 VDC at 200 ma
Fil.: 5.0 V at 3 A AC
6.3 V at 5 A AC
Upright mounting base
area 4" x 4"

Price:\$3.95

PLATE TRANSFORMERS

Input: 110/220 60 cy 1 ph

Secondary: 2500-0-2500, 500 ma

Size: 11¹/₂" H x 7" D x 9" W

Price: \$19.95 or 2/\$35.00 Ship. Wt. 100 lbs

TRANSFORMERS

1000-0-1000 or

1200-0-1200

200 ma, CCS

110 or 220 volts

Price:\$9.95

WESTON R.F. AMMETERS

A brand new 3¹/₂" round panel meter with external thermocouple unit calibrated for 200 R.F. amps. Full scale with the lowest scale reading 20 amps. Weston model 1533 meter and thermocouple. These units are of particular interest to broadcast stations, and induction heater users. There is negligible frequency error up to 30 mHz, and approx. 2% error up to 75 mHz.

Price:\$24.95 Shipping wt. 5 lbs.

SELECTRONICS

1206 S. NAPA STREET, PHILA., PA.

HO 8-7891

HO 8-4645

READ CAREFULLY ABOUT JAN CRYSTALS

All JAN Crystals listed were manufactured for the Armed Services and were made by America's leading crystal manufacturers to the rigid specifications of the government. The specifications in most cases call for .005% or better tolerances over a temperature range of -55° to $+90^{\circ}$ Centigrade. This means that the crystals must be cut at the proper X-rayed angles and processed to all specifications, many of which are more rigid than those required for commercial crystals.

Every crystal listed has passed these government tests and was accepted by inspectors. You are assured of a quality product when you buy JAN Crystals. We receive crystals in the original packing, unused, as they are released from time to time as excess to the government's needs. Every JAN Crystal is tested for output and frequency using the latest type frequency counters. Many persons do not understand that a crystal may be changed in frequency by adding or subtracting capacity to the oscillator circuit. Unless otherwise stated

the crystals listed were designed for a circuit of 32 mmfd capacity and when operated in such an oscillator JAN Crystals will be on frequency.

This chart shows how far a crystal will change frequency with a change of capacity in the oscillator circuit.

MEASURED CRYSTAL FREQUENCY IN KC

	STANDARD			
	10 MMFD	20 MMFD	32 MMFD	50 MMFD
2000.200	2000.060	2000	1999.950	
3000.600	3000.200	3000	2999.800	
4001.000	4000.400	4000	3999.700	
7003.300	7001.200	7000	6999.200	
14008.1	14003.1	14000	13998.0	



HC18/U

Wire Leads

1 1/2" for soldering

\$1.60 EA.

4 for \$5.00

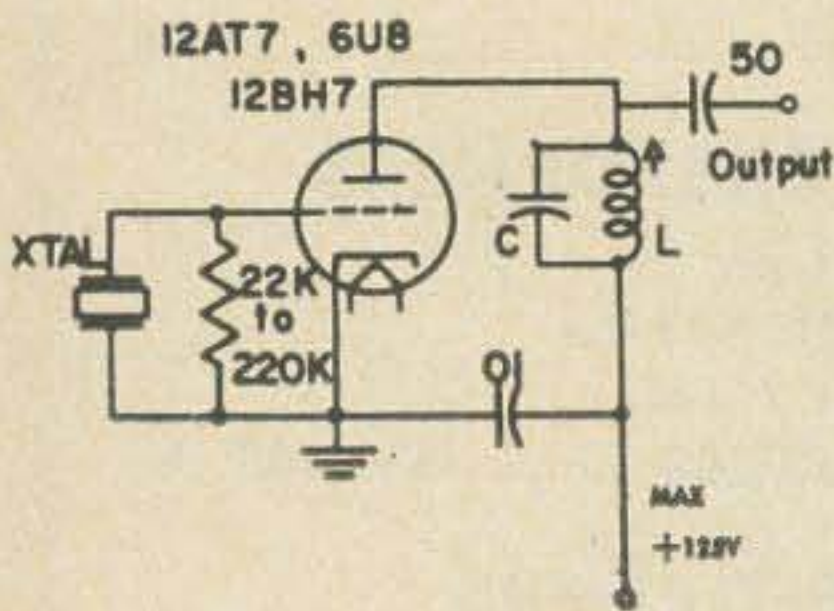

FREQ. IN MC	14.950	28.000	36.850	40.6296	42.1480	53.2070	57.8500	80.9925
16.000	28.250	36.900	40.6666	42.2500	53.2575	58.0500	81.0000	
16.250	28.750	36.950	40.8888	42.3333	53.3070	58.3830	81.9925	
16.500	29.000	38.1481	41.0000	42.4000	53.3833	59.0500	82.0000	
16.750	29.250	38.3333	41.0500	42.4500	53.3575	59.3830	82.9925	
16.950	29.500	38.4814	41.1000	42.5185	53.4070	59.7160	83.0000	
17.000	29.750	38.6296	41.1111	42.5500	53.4420	60.0000	83.9925	
17.050	30.000	38.7375	41.1500	42.6500	53.4575	60.0500	84.0000	
17.100	30.250	38.9250	41.2000	42.7500	53.5075	60.3830	85.0000	
17.150	30.750	38.9629	41.2222	42.8500	53.5575	60.9875	86.0000	
7.255	17.200	31.250	39.0000	41.2500	42.9500	53.6070	61.0500	87.0000
7.280	17.250	31.750	39.0740	41.3000	44.7400	53.6575	61.6750	88.0000
8.230	17.350	33.000	39.1111	41.3333	45.5000	53.7075	62.1500	89.0000
11.666	17.400	33.100	39.1851	41.3500	46.2400	53.7160	64.9920	90.0000
14.000	17.450	33.200	39.2222	41.4000	46.4000	53.7575	65.9925	94.5000
14.050	17.500	33.300	39.2591	41.4500	48.3750	53.7920	66.9925	96.0000
14.100	17.550	33.400	39.2963	41.4814	48.3833	53.8075	67.0250	97.0000
14.150	17.600	33.500	39.4074	41.5000	48.4666	53.8575	67.1250	98.0000
14.200	17.650	33.600	39.4814	41.5500	48.7160	53.8920	67.9920	99.0000
14.250	17.750	33.700	39.5555	41.6000	48.9675	53.9075	68.9920	99.8667
14.300	17.850	33.800	39.6296	41.6500	49.0500	53.9575	69.9925	103.0600
14.350	18.000	33.900	39.6666	41.6666	49.3833	53.9590	70.7375	103.2600
14.400	18.250	34.322	39.7777	41.7000	49.7166	54.0500	70.9925	103.4600
14.450	20.4983	34.444	39.8148	41.7500	50.0500	54.3833	71.9925	103.6667
14.500	20.500	36.100	39.8500	41.8000	50.7500	54.7160	72.9925	103.8600
14.550	20.750	36.200	40.0370	41.8518	52.5000	55.0500	73.9925	104.1667
14.600	23.750	36.300	40.1111	41.8888	52.9000	55.3830	74.9925	104.2600
14.650	24.750	36.350	40.1851	41.9000	52.9920	55.7160	75.9925	104.4600
14.700	24.900	36.400	40.2222	41.9500	53.0070	56.0500	76.9925	104.6600
14.750	26.250	36.650	40.2963	42.0000	53.0500	56.7160	77.9925	111.0000
14.800	26.750	36.700	40.3703	42.0500	53.0570	57.3830	78.9925	111.2500
14.850	27.250	36.750	40.4074	42.0740	53.1070	57.7160	79.9925	112.0000
14.900	27.500	36.800	40.4444	42.1111	53.1570	57.8000	80.0000	132.7500

NOTICE

Due to the shortage of quartz we will buy all type HC6/U crystals or miniature crystals with 1 1/2" leads at 15c each, or we will allow you 25c each, credit on your orders, for any crystals listed in our catalog.

Send unusable crystals to:

Jan Crystals
2400 Crystal Drive
Fort Myers, Florida 33901

HOW TO ORDER...

**ADD 5¢ PER CRYSTAL FOR POSTAGE
OR 10¢ PER CRYSTAL FOR AIRMAIL**



Order your crystals by type and frequency... enclose check or money order (No C.O.D.)... add 5¢ per crystal for postage, 10¢ per crystal for airmail... make check or money order payable to JAN CRYSTALS, 2400 Crystal Drive, Fort Myers, Florida.
PHONE AREA 813 WE 6-2397



CR1A/AR
Pressure type
crystal used in
SCR-522, etc.

75c EACH
3 for \$2.00

The following frequencies are in stock for immediate delivery, frequencies guaranteed ± 1 KC as listed in kilocycles.

5620	6510	7340	7745	8103	8264	8361	8436	8570
5645	6511	7370	7785	8114	8269	8367	8446	8575
5690	6520	7372	7850	8133	8270	8368	8449	8580
5700	6522	7380	7855	8138	8272	8378	8446	8592
5710	6527	7405	7860	8146	8278	8389	8449	8598
5780	6539	7438	7910	8148	8284	8383	8452	8622
5820	6550	7440	8001	8154	8285	8385	8463	8630
5835	6627	7505	8002	8162	8301	8389	8464	8645
5950	6633	7516	8006	8170	8306	8395	8465	8650
5960	6680	7520	8007	8177	8307	8405	8476	8660
6040	6694	7540	8008	8185	8310	8407	8477	8686
6050	6727	7550	8029	8192	8315	8408	8486	
6160	6750	7565	8030	8198	8320	8409	8492	
6180	6860	7570	8036	8200	8328	8410	8494	
6200	7030	7580	8037	8212	8330	8416	8512	
6240	7033	7600	8045	8224	8344	8423	8530	
6250	7083	7620	8046	8225	8345	8428	8541	
6260	7210	7660	8050	8228	8353	8430	8547	
6440	7230	7695	8086	8236	8350	8431	8550	
6460	7300	7705	8092	8262	8357	8435	8560	

LOW FREQUENCY PRESSURE TYPE CRYSTALS



TYPE 243

\$1.05

EACH

FREQUENCIES ARE
IN KC. ORDER BY
FREQUENCY

FREQUENCIES LISTED
ARE IN STOCK FOR
IMMEDIATE DELIVERY

1150	1355	1930	2045	2155	2265	2375	2485	2595	2705	2815	2925	3035	3145
1170	1360	1935	2050	2160	2270	2380	2490	2600	2710	2820	2930	3040	3150
1220	1365	1940	2055	2165	2275	2385	2495	2605	2715	2825	2935	3045	3155
1225	1370	1950	2060	2170	2280	2390	2500	2610	2720	2830	2940	3050	3160
1235	1375	1955	2065	2175	2285	2395	2505	2615	2725	2835	2945	3055	3165
1240	1380	1960	2070	2180	2290	2400	2510	2620	2730	2840	2950	3060	3170
1245	1390	1965	2075	2185	2295	2405	2515	2625	2735	2845	2955	3065	3175
1250	1395	1970	2080	2190	2300	2410	2520	2630	2740	2850	2960	3070	3180
1260	1400	1975	2085	2195	2305	2415	2525	2635	2745	2855	2965	3075	3185
1265	1405	1980	2090	2200	2310	2420	2530	2640	2750	2860	2970	3080	3190
1270	1420	1985	2095	2205	2315	2425	2535	2645	2755	2865	2975	3085	3195
1275	1440	1990	2100	2210	2320	2430	2540	2650	2760	2870	2980	3090	3200
1285	1460	1995	2105	2215	2325	2435	2545	2655	2765	2875	2985	3095	
1290	1470	2000	2110	2220	2330	2440	2550	2660	2770	2880	2990	3100	
1300	1830	2005	2115	2225	2335	2445	2555	2665	2775	2885	2995	3105	
1305	1870	2010	2120	2230	2340	2450	2560	2670	2780	2890	3000	3110	
1310	1900	2015	2125	2235	2345	2455	2565	2675	2785	2895	3005	3115	
1320	1905	2020	2130	2240	2350	2460	2570	2680	2790	2900	3010	3120	
1325	1910	2025	2135	2245	2355	2465	2575	2685	2795	2905	3015	3125	
1330	1915	2030	2140	2250	2360	2470	2580	2690	2800	2910	3020	3130	
1335	1920	2035	2145	2255	2365	2475	2585	2695	2805	2915	3025	3135	
1350	1925	2040	2150	2260	2370	2480	2590	2700	2810	2920	3030	3140	

PLEASE SPECIFY YOUR SECOND CHOICE IN CASE WE DO NOT HAVE FREQUENCY ORDERED.

SUB-MINIATURE CRYSTALS IN
HC-18/U TYPE HOLDERS
MOUNTED ON A WAFER SWITCH
ASSEMBLY. HIGH QUALITY
CLOSE TOLERANCE CRYSTALS.
MANUFACTURED FOR AVIATION
TRANSCIVER USE. ALL
CRYSTALS MOUNTED ON A
PRINTED CIRCUIT COMPACT
SWITCHABLE UNIT. ALL
CRYSTAL FREQUENCIES LISTED
IN MEGACYCLES.



CRYSTAL WAFER ASSEMBLY # 1	CRYSTAL WAFER ASSEMBLY # 2	CRYSTAL WAFER ASSEMBLY # 3	CRYSTAL WAFER ASSEMBLY # 4	CRYSTAL WAFER ASSEMBLY # 5	CRYSTAL WAFER ASSEMBLY # 6	CRYSTAL WAFER ASSEMBLY # 7
88.00	98.00	108.00	88.00	98.00	82.00	91.00
89.00	99.00	109.00	89.00	99.00	83.00	92.00
90.00	100.00	110.00	90.00	100.00	84.00	93.00
91.00	101.00	111.00	91.00	101.00	85.00	94.00
92.00	102.00	112.00	92.00	102.00	86.00	95.00
93.00	103.00	113.00	93.00	103.00	87.00	96.00
94.00	104.00	114.00	94.00	104.00	88.00	97.00
95.00	105.00	115.00	95.00	105.00	89.00	98.00
96.00	106.00		96.00	106.00	90.00	99.00
97.00	107.00		97.00			
28 crystals - \$ 35.00	19 - \$ 25.00	18 - \$ 24.00				

ORDER BY ASSEMBLY NUMBER

CRYSTAL ETCHING AND GRINDING KITS

	Kit #1	Kit #2	Kit #3
Crystals in misc. holders	12	20	35
Assorted crystal blanks	6	12	15
Pkg. ammonium bifluoride flakes	1	2	3
Packet grinding compound	1	2	3
Plastic containers	2	3	5
Wooden crystal blank holders	2	4	6
Instructions	\$ 3.95	\$ 7.50	\$12.50

HIGH QUALITY CRYSTAL OVENS

THE OVENS LISTED ARE NEW AND FULLY GUARANTEED, PRICED AT A FRACTION OF THEIR ORIGINAL COST.

STOCK NO. IA-1	LAVOIE OVEN FOR BASE STATIONS 115 VOLTS AC 60 TO 1000 CYCLES DIMENSIONS- 4" HIGH X 1 7/8 X 1 1/2 FITS OCTAL SOCKET. 75° C. REGULAR PRICE \$ 35.00	\$ 10.00 EA.
STOCK NO. JK-2	JAMES KNIGHTS 75° C. OVEN 6.3 V AC OR DC. FITS OCTAL SOCKET. FOR ONE CRYSTAL	\$ 2.50 EA.
STOCK NO. BU-3	BULOVA 55° OVEN C. 117 V AC FITS OCTAL SOCKET	\$ 2.00 EA.
STOCK NO. BU-4	BULOVA 70° OVEN C. 12 V DC FITS OCTAL SOCKET	\$ 2.00 EA.

Send 25¢ for 68 page RELAY SALES catalog
2400 Crystal Drive
Fort Myers, Florida 33901

THIRD OVERTONE CRYSTALS — HC6/U HOLDERS



\$1.50 EA.

4 for \$5.00

The CR23/U is a third or fifth overtone crystal designed to operate in a series overtone circuit, 3rd overtone from 10 to 52 MC, 5th overtone 52 to 75 MC, .005% tolerance, from -55° to +90° C. Maximum drive 5 milliwatts. Listing in MC.

IN STOCK FOR IMMEDIATE DELIVERY

NON-OVEN TYPE HERMETICALLY SEALED CRYSTALS MADE TO ORDER

Gold or Silver plated. Plating acts as electrodes. Spring mounted, sealed under vacuum or filled with inert gas. Max. current capacity 10 milliwatts (5 for overtone type). Very high frequency stability. Conform to military specifications. When ordering for G.E., Motorola, Link, etc. split channel operation, send sample of Xmtg and Rcvng crystal known to be correct and specify exact frequency desired. We will correlate and return samples with your order. All are .005% tolerance. Fundamental type supplied at 32mmfd load capacity and overtone supplied for series resonance unless otherwise specified.

15MC to 50 MC Third Overtone



\$3.00
EACH

11.3562	24.911	30.625	33.225	36.444	39.666	42.900	44.814
11.4310	24.922	30.644	33.250	36.450	39.703	42.916	44.850
11.4566	25.266	30.666	33.325	36.481	39.740	42.925	44.888
11.4810	25.533	30.675	33.300	36.518	39.777	42.962	44.925
11.5812	25.692	30.688	33.333	36.555	39.814	43.000	45.000
11.6812	25.700	30.700	33.350	36.592	39.851	43.037	45.275
12.4777	25.711	30.725	33.375	36.629	39.888	43.074	45.700
15.3250	25.861	30.775	33.400	36.666	39.907	43.111	45.850
15.4350	25.945	30.822	33.425	36.703	39.925	43.185	45.883
15.5060	26.120	30.825	33.444	36.740	40.037	43.148	46.083
16.5060	26.162	30.866	33.450	36.777	40.074	43.222	46.275
16.9999	26.220	30.875	33.600	36.814	40.148	43.259	46.850
17.0060	26.241	30.925	33.625	36.851	40.185	43.277	46.895
17.4000	26.533	30.955	33.700	36.888	40.222	43.296	47.187
17.5060	26.666	30.975	33.750	36.925	40.259	43.407	
18.1500	26.703	31.075	33.800	36.936	40.296	43.444	47.700
18.4278	27.006	31.100	33.850	36.962	40.333	43.481	47.812
18.4350	27.120	31.111	33.900	37.000	40.370	43.518	47.850
18.5500	27.158	31.125	33.950	37.037	40.407	43.555	47.888
18.5833	27.220	31.133	34.000	37.074	40.444	43.592	47.900
19.0060	27.319	31.175	34.200	37.111	40.445	43.629	47.927
19.9350	27.455	31.200	34.300	37.148	40.481	43.703	47.937
19.9999	27.629	31.225	34.400	37.185	40.518	43.740	48.012
20.0060	27.666	31.275	34.488	37.222	40.555	43.750	48.187
20.316	27.700	31.375	34.511	37.259	40.583	43.777	48.700
20.435	27.725	31.525	34.555	37.266	40.592	43.814	48.850
20.533	28.555	31.575	34.588	37.296	40.629	43.850	48.958
20.555	28.620	31.666	34.688	37.333	40.666	43.888	49.611
20.616	28.700	31.675	34.700	37.370	40.703	43.900	49.700
20.700	28.725	31.700	34.722	37.407	40.740	43.925	49.730
20.777	28.888	31.888	34.866	37.444	40.778	43.962	49.850
20.803	29.000	32.222	34.888	37.481	40.814	44.037	49.888
20.935	29.525	32.225	34.922	37.500	40.833	44.074	49.900
20.977	29.575	32.250	35.629	37.518	40.851	44.111	49.906
21.030	29.600	32.275	35.666	37.555	40.888	44.148	49.958
21.133	29.625	32.300	35.692	37.592	40.925	44.185	50.850
21.253	29.700	32.350	35.703	37.627	40.962	44.222	52.208
21.300	29.725	32.375	35.740	37.629	41.037	44.259	52.910
21.403	29.800	32.400	35.777	37.666	41.250	44.275	53.500
21.503	29.875	32.450	35.814	37.695	41.625	44.296	53.850
21.553	29.925	32.550	35.851	37.703	41.666	44.300	54.550
21.577	29.975	32.600	35.888	37.740	41.833	44.333	54.650
21.603	30.000	32.650	35.925	37.777	41.850	44.370	55.000
22.155	30.025	32.675	35.933	37.814	41.923	44.407	55.250
22.200	30.066	32.700	35.962	37.851	42.250	44.444	55.275
22.511	30.125	32.822	35.977	37.862	42.333	44.500	56.918
23.577	30.175	32.850	36.074	37.888	42.500	44.518	57.275
23.788	30.222	32.950	36.111	37.925	42.592	44.555	70.600
23.825	30.225	32.975	36.148	38.000	42.629	44.592	75.000
23.833	30.275	33.000	36.185	38.148	42.666	44.629	82.333
24.033	30.325	33.050	36.222	38.166	42.703	44.666	82.833
24.188	30.375	33.100	36.259	38.200	42.740	44.700	83.125
24.200	30.500	33.150	36.296	38.244	42.814	44.703	83.333
24.413	30.525	33.195	36.370	39.537	42.850	44.740	110.000
24.700	30.575	33.200	36.407	39.592	42.888	44.777	

MINIATURE CRYSTALS

HC18/U

Available in following Frequencies



\$1.55 EA.

4 for \$5.00

MINIATURE CRYSTALS
WITH PINS
FREQ, IN MC

		12.7025
		20.8000
		22.3000
		24.7000
		29.4000
		32.3500
		37.7777
3.525	4.680	57.59405
3.800	5.850	58.2940
3.980	6.305	103.9547
4.060	7.050	104.2547
4.207	7.505	104.5547
4.2585	8.476	104.7547
4.293	8.931	104.8547
4.294	9.750	104.9547
4.515	12.2475	

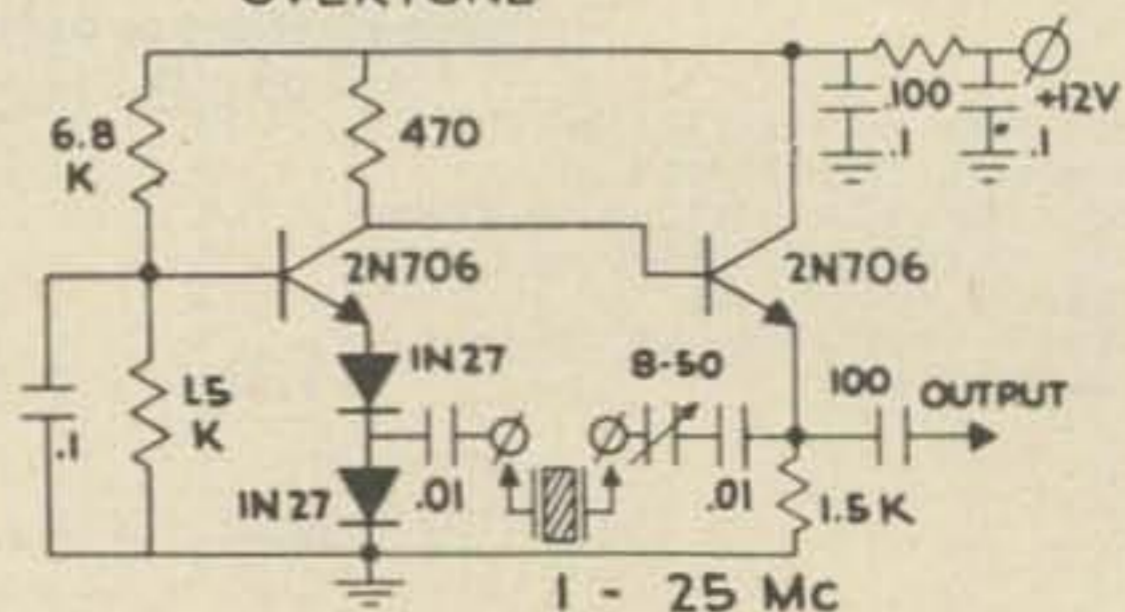
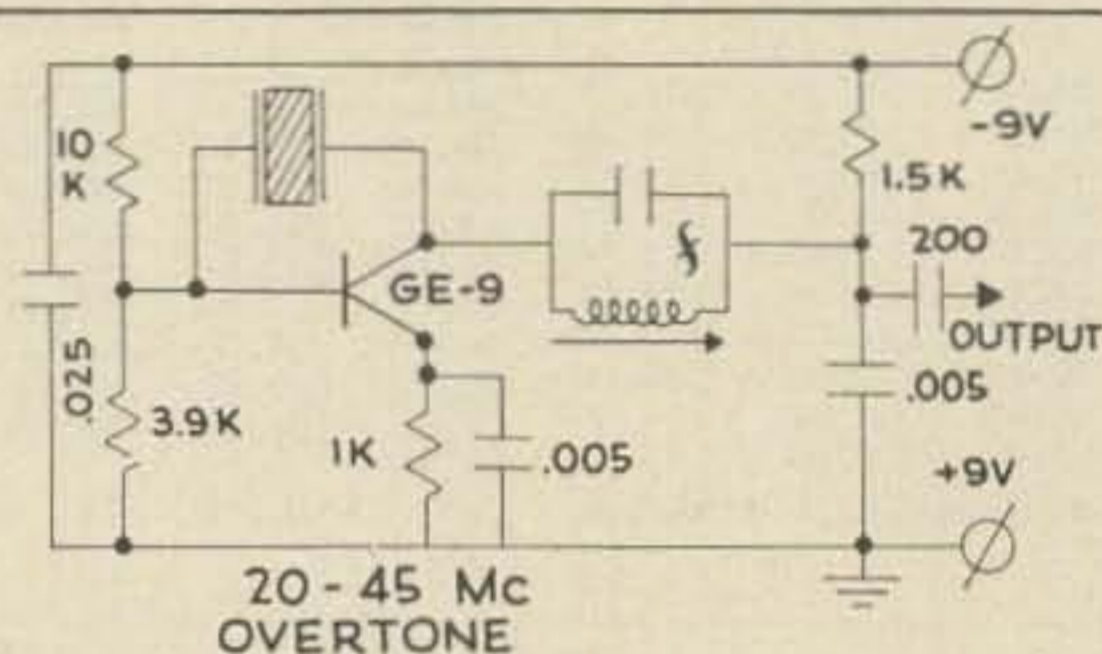

HOW TO ORDER...

Order your crystals by type and frequency... enclose check or money order (No C.O.D.)... add 5¢ per crystal for postage, 10¢ per crystal for airmail... make check or money order payable to JAN CRYSTALS, 2400 Crystal Drive, Fort Myers, Florida.

PHONE AREA 813 WE 6-2397



DIVISION OF BOB WHAN & SON ELECTRONICS, INC.

SEND US YOUR REQUIREMENTS... WE ARE RECEIVING NEW FREQUENCIES WEEKLY... WRITE FOR LISTINGS



PRESSURE TYPE CRYSTALS

75c TYPE 243 EACH

3 for \$2.00

Type FT-243. A most rugged type having .093 pins and .486 pin spacing (1/2"). Designed to operate on frequency in 32 mmfd oscillator circuit. The quartz crystal in this holder is either .5" x .5" or .5" x .6" and is held between two stainless steel electrodes by spring pressure. It is by far the most popular crystal of its type in use. Some of the government sets in which the FT-243 is used are: (Maximum drive 50 milowatts) BC620, BC659, BC611, BC1335, RT111/TRC20, R415/FRC20, R19/TRC-1, RT77/GRC9, BC1306, RT30/PRC1, AN/AMT3, BC1000, AN/PRC5, T87/TRT1, R397/TRL1 and many others. The following frequencies are in stock for immediate delivery, frequencies guaranteed ±1 KC as listed in kilocycles.

4035	5040	5852	6450	7314	7464	7766	8290
4046	5070	5860	6423	7316	7466	7770	8291
4080	5080	5873	6475	7323	7470	7773	8300
4095	5090	5875	6497	7325	7473	7775	8306
4115	5127	5880	6500	7327	7475	7783	8308
4135	5140	5900	6506	7328	7483	7790	8310
4140	5150	5906	6516	7337	7491	7791	8316
4162	5165	5907	6520	7338	7500	7800	8320
4175	5205	5925	6525	7340	7506	7806	8325
4190	5230	5940	6528	7341	7525	7808	8330
4200	5235	5950	6540	7350	7530	7810	8333
4215	5248	5955	6550	7351	7533	7816	8533
4255	5250	5973	6573	7358	7540	7818	8541
4270	5295	5975	6575	7361	7541	7820	8550
4280	5300	5995	6600	7363	7548	7825	8558
4295	5305	6000	6606	7365	7550	7830	8560
4300	5312	6006	6618	7366	7558	7833	8566
4310	5327	6025	6625	7370	7560	7840	8570
4330	5333	6040	6630	7371	7566	7841	8575
4340	5335	6042	6640	7372	7570	7850	8580
4390	5360	6050	6645	7373	7573	7858	8583
4395	5370	6073	6650	7375	7575	7860	8590
4397	5385	6075	6660	7377	7580	7863	8591
4410	5397	6100	6663	7379	7583	7866	8600
4445	5410	6106	6673	7381	7590	7870	8603
4450	5435	6125	6675	7383	7591	7873	8608
4490	5437	6130	6690	7386	7600	7875	8610
4495	5456	6140	6700	7388	7606	7880	8616
4520	5460	6142	6706	7390	7608	7883	8620
4535	5480	6150	6708	7391	7610	7886	8625
4600	5485	6173	6725	7393	7616	7890	8630
4610	5500	6175	6733	7394	7620	7891	8633
4620	5540	6185	6740	7396	7625	7900	8640
4630	5545	6200	6750	7397	7630	7906	8641
4635	5582	6206	6773	7399	7633	7907	8650
4640	5620	6210	6775	7400	7638	7908	8658
4655	5622	6225	6790	7401	7640	7910	8666
4695	5633	6235	6798	7403	7641	7916	8670
4700	5645	6240	6800	7405	7650	7920	8675
4710	5655	6250	6806	7406	7658	7925	8680
4725	5660	6273	6815	7408	7660	7930	8683
4735	5675	6275	6825	7410	7665	7933	8690
4740	5677	6278	6826	7414	7666	7940	8691
4760	5687	6285	6831	7415	7670	7941	8700
4780	5695	6300	6833	7417	7673	7950	8710
4790	5700	6306	6835	7418	7675	7958	8716
4810	5706	6308	6837	7421	7680	7960	8720
4830	5715	6315	6840	7422	7683	7970	8725

FT-243 AMATEUR BAND CRYSTALS UNCONDITIONALLY GUARANTEED



\$1.50 EACH

4 for \$5.00

40-meter general	7000 to 7300	fundamental	7000-7300
40-meter novice	7151 to 7199	fundamental	7151-7199
20-meter general	14,000 to 14,350	double	7000-7175
20-meter general	14,000 to 14,350	triple	4667-4780
15-meter general	21,000 to 21,450	triple	7000-7150
15-meter novice	21,100 to 21,250	triple	7034-7082
10-meter general	28,000 to 29,700	X4	7000-7425
6-meter gen. & tech.	50 MC to 54 MC	X6	8334-8900
2-meter general	144 MC to 148 MC	X18	8001-8221
2-meter novice	145 MC to 147 MC	X18	8056-8166
2-meter tech.	145 MC to 147 MC	X18	8056-8166

CRYSTALS IN STOCK FOR IMMEDIATE DELIVERY LISTING IN KILOCYCLES

3525	7075	7203	8033	8120	8186	8408	8508
3735	7088	7206	8035	8125	8190	8410	8510
3800	7100	7225	8036	8126	8191	8416	8516
3825	7106	7240	8040	8128	8200	8420	8518
3830	7108	7250	8041	8130	8206	8425	8520
3840	7113	7262	8045	8133	8208	8430	8525
3885	7123	7273	8047	8140	8220	8433	8530
3920	7125	7275	8050	8141	8225	8440	
3950	7136	7278	8073	8150	8230	8445	
3970	7140	7300	8075	8155	8340	8450	
3980	7150	7306	8088	8160	8341	8458	
3990	7170	8000	8090	8164	8350	8460	
3995	7173	8006	8091	8166	8358	8470	
7006	7175	8007	8092	8170	8360	8475	
7023	7152	8008	8100	8171	8370	8480	
7025	TO	8030	8106	8173	8375	8483	
7040	7198	8020	8108	8175	8380	8485	
7050	EVERY	8021	8110	8178	8385	8491	
7068	1 KC	8023	8111	8180	8391	8499	
7073	7200	8025	8116	8183	8400	8500	

4840	5722	6320	6845	7425	7690	7973	8730
4845	5725	6325	6850	7426	7691	7975	8733
4850	5730	6330	6852	7428	7700	7980	8750
4852	5733	6335	6856	7429	7706	7983	8797
4860	5740	6340	6858	7431	7708	7990	8820
4880	5750	6350	6860	7433	7710	7991	9022
4890	5760	6362	6873	7435	7716	8240	9067
4900	5773	6373	6875	7436	7720	8241	9090
4925	5775	6375	6888	7439	7725	8250	9135
4930	5780	6388	6900	7440	7728	8258	9175
4950	5782	6400	6906	7441	7730	8260	
4960	5800	6405	6925	7444	7733	8266	
4970	5805	6406	6940	7445	7740	8270	
4980	5806	6422	6950	7448	7741	8272	
4995	5820	6425	6973	7450	7750	8273	
5000	5825	6437	6975	7455	7751	8275	
5030	5840	6440		7458	7758	8280	
5035	5850	6444	7308	7460	7760	8283	



A REAL CRYSTAL BARGAIN IN SEALED METAL HOLDERS

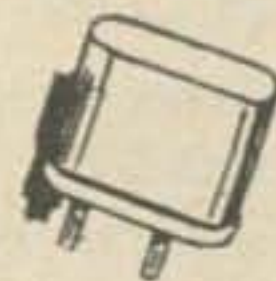

For experimentors and labs. These type CR7/U crystals are mounted in hermetically sealed cans similar to type HC6/U except can is only 1/2" high, pins are .050 1/2" spacing — made especially for Navy type "MAR", TDZ, and RDZ sets. All crystals are fundamental frequencies and are so stamped on side of can.

All frequencies listed are in stock for immediate delivery. * denotes frequencies we have in quantities of 50 or more each. Every crystal tested and guaranteed to .01% tolerance.

Special price type CR7/U

75¢

3 for 2.00

Order by frequency and specify
2nd choice if possible.

4285.19	5202.08	*5614.82	5900.00	6239.06	6618.75	*7051.85
4329.63	5203.70	*5629.63	5901.56	6251.56	6625.93	*7052.08
4344.44	*5214.82	5633.33	5902.08	*6251.85	6637.04	*7070.37
4374.07	5235.42	5635.42	5914.06	6252.08	6640.74	*7081.48
4403.70	*5248.19	5639.06	*5925.93	6255.56	*6652.08	*7085.42
4500.00	*5259.26	*5644.44	5926.95	6264.06	6655.56	7096.30
4625.93	5268.75	5651.56	5929.63	6268.75	*6666.67	7100.00
4640.74	5277.78	5652.08	5935.42	6276.56	*6668.75	7114.82
*4655.55	*5288.89	*5659.26	5951.56	*6281.48	*6681.48	*7125.93
4700.00	5292.59	5662.96	5952.08	6285.19	*6685.42	*7140.74
4727.63	*5303.70	5685.42	*5955.56	6289.06	6700.00	7144.44
4729.63	*5333.33	*5688.89	5968.75	*6311.11	*6714.81	*7155.56
*4774.07	*5339.06	5692.52	5976.56	6314.82	*6718.75	7159.26
4774.40	*5348.15	5701.56	5988.89	6326.56	*6725.93	7170.37
4788.89	*5364.06	5702.08	5989.06	*6340.74	6729.63	*7185.19
4844.44	*5366.67	*5703.70	6002.06	*6344.44	6744.44	*7200.00
4862.96	5377.00	5714.06	6014.06	6352.08	*6752.08	*7214.82
4877.78	*5389.06	5722.22	6018.75	*6370.37	6755.56	7218.52
4888.88	*5401.56	*5733.33	*6026.56	*6374.07	6774.07	*7244.44
4892.00	*5422.22	5739.06	6035.42	6377.08	*6785.16	*7259.26
*4903.70	*5437.04	5748.15	*6039.06	6385.42	*6785.42	*7274.07
4907.06	*5439.06	5751.56	6048.15	6400.00	6803.70	*7288.88
4922.22	*5451.85	5776.56	6052.08	6403.70	6814.82	*7303.70
*4933.33	5464.06	5781.48	*6076.56	6418.52	6818.52	*7333.33
*4951.85	*5466.67	5785.42	6077.76	*6429.63	*6818.75	7362.96
*4962.96	*5481.48	*5789.06	6085.42	*6459.26	*6844.44	*7377.78
4966.66	5489.06	5801.56	6102.08	6462.96	6848.15	*7407.41
*4996.30	*5511.11	5802.08	*6103.70	6477.78	*6852.08	*7422.22
5011.11	5514.80	5807.41	6107.41	*6488.89	6862.96	
5025.93	5518.93	5811.11	6122.22	6492.59	*6874.07	7437.04
5055.56	*5525.93	*5814.06	*6133.33	*6785.16	6877.78	*7481.48
5070.37	5535.42	5818.00	6135.06	*6518.52	*6885.42	*7629.63
5085.19	5539.06	*5826.56	6152.42	6522.22	*6903.70	7659.26
5100.00	5544.44	5835.42	*6162.96	6537.04	*6918.75	*7662.96
5102.08	5552.08	5837.04	6166.67	*6548.15	*6922.22	*7674.07
5129.63	*5555.56	5839.06	*6192.59	6552.08	6933.33	*7688.89
5135.42	5564.06	*5840.74	6196.30	6566.67	*6952.08	*7703.70
5144.44	5570.37	*5851.56	*6201.56	*6577.78	*6962.96	*7718.51
5174.07	5574.00	5852.03	*6207.41	6581.48	*6977.78	*7733.33
*5185.18	5589.06	5870.37	6218.75	6585.42	*6985.42	*7777.78
5185.42	*5589.19	5876.56	*6222.22	6596.30	*7018.75	
5188.89	5602.08	5885.42	6225.93	*6607.41	*7022.22	
*5200.00	5603.70	*5889.06	*6226.56	6611.11	*7037.04	

HOW TO ORDER...

ADD 5¢ PER CRYSTAL FOR POSTAGE
OR 10¢ PER CRYSTAL FOR AIRMAIL

Order your crystals by type and frequency... enclose check or money order (No C.O.D.)... add 5¢ per crystal for postage, 10¢ per crystal for airmail... make check or money order payable to JAN CRYSTALS, 2400 Crystal Drive, Fort Myers, Florida.

PHONE AREA 813 WE 6-2397



LOW FREQUENCY CRYSTALS in HC6/U HOLDERS

ORDER BY FREQUENCY



For Lattice Networks—Single Sideband—
Low Frequency Oscillators—Markers—
Etc. Frequency is fundamental in KC.

371 to 540KC 3.95

730 to 1000KC 3.55



CRYSTAL TYPE FT-164

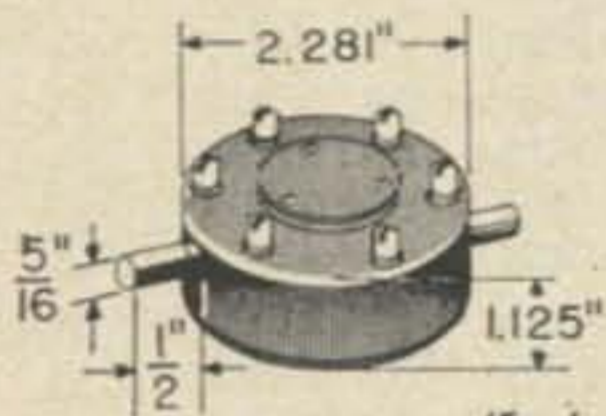

This rugged type crystal was designed for the U. S. Navy and uses a 1" x 1" AT blank. We can furnish in frequencies from 200KC to 7000KC.

(Fundamental Frequency .005% tolerance)

ORDER BY FREQUENCY

1601KC to 7000KC 7.50 ea.



TYPE FT249 HOLDER
(Pin Spacing Standard — Diameter .125)

CRYSTALS Made to Order

This 3 pin Holder can be supplied with either one or two crystals. When ordering specify if crystal is to be used for Transmitter or Receiver or Both.

FT249 with Single Crystal 3.50 ea.
FT249 with Duo Crystals 6.50 ea.
2001KC to 8000KC 3.50 ea. 2001KC to 8000KC 6.50 ea.

MARKER — FILTER SPECIAL USE CRYSTALS

3579.545 KC T.V. Color Burst HC6/U WIRE LEADS 2.50

Metal tube octal base

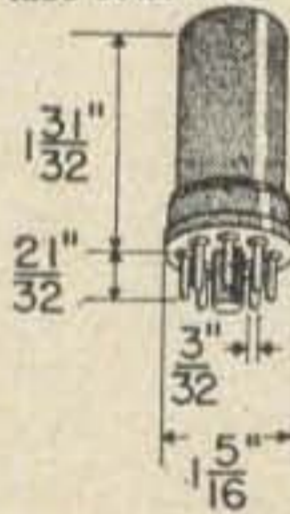

3500 KC Marker in metal tube octal base used in ARC/5 1.50
4600 KC Marker in metal tube octal base used in ARC/5 1.50
6200 KC Marker in metal tube octal base used in ARC/5 1.50
8000 KC Marker in metal tube octal base used in ARC/5 1.50

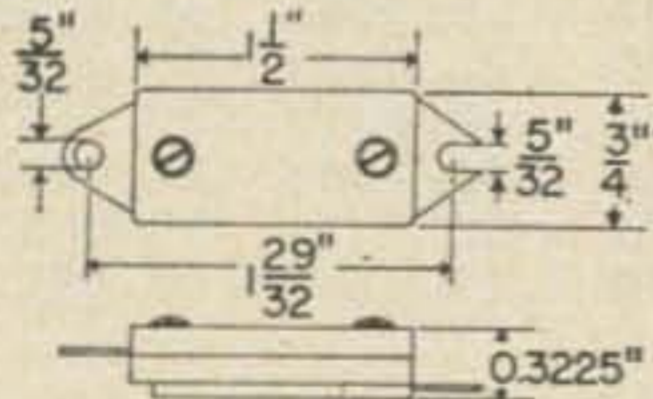

DC-6-A

470 KC Filter Crystal DC6A for BC342 & BC312 1.50

FUNDAMENTAL CRYSTAL OSCILLATOR CIRCUIT FREQUENCIES 800KC TO 20,000KC

B - voltage may vary from 100 volts for HC6/U crystals to 250 volts for FT243 and MC7 crystals or other pressure mounted types.

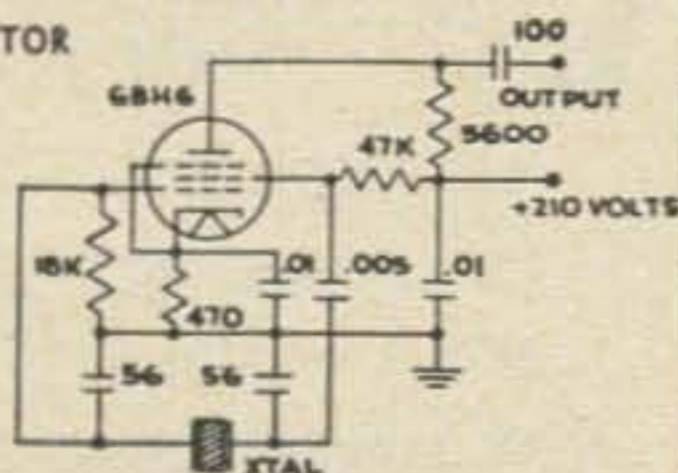

PRESSURE-TYPE CRYSTALS Made to Order



TYPE 243

\$2.00 EACH

All Crystals
.005% tolerance

Available in all frequencies
from 2000KC to 8650KC



FT-171

For BC-610, etc.

\$2.00 EACH

Available in all frequencies
from 2000KC to 5000KC.

MC7 CRYSTALS

\$2.00 EACH

1/8" pins, 3/4" pin spacing,
available in 2182, 2638,
2003, 4755 KC and all
marine frequencies.



CR1A/AR

Pressure type
crystal used in
SCR-522, etc.

\$2.00 EACH

All frequencies from 4000KC
to 8650KC available with
1/2" pin spacing and 1/8" pin
diam. Specify frequency de-
sired.



THIRD OVERTONE
TYPE FT 243

IN STOCK FREQ.

IN MC

\$2.00 EACH

14.310	15.953	16.913
14.420	16.000	16.953
14.580	16.040	16.973
14.593	16.080	17.0933
14.687	16.133	17.150
14.800	16.240	17.173
14.833	16.4933	17.295
15.200	16.533	17.413
15.353	16.573	17.600
15.753	16.5933	17.750
15.840	16.800	

CR24/U
(BARREL TYPE)

\$2.00 EACH

CRYSTALS IN STOCK FOR IMMEDIATE DELIVERY

\$2.00 EACH

CRYSTALS



CR24/U

Designed for the Armed Services the CR24/U is a Pressure Type "AT" Crystal which will accommodate more current than the plated crystal. From 15 to 25MC the crystal is a third overtone—From 25.001 to 60MC the crystal is a fifth overtone.

	20.9500	22.2833	23.3417	24.1800	26.2833	28.8250	30.6925
	20.9583	22.2900	23.3500	24.1833	26.2917	28.8750	30.7000
	21.0300	22.2917	23.3583	24.2833	26.4167	28.8833	30.8167
	21.0333	22.3583	23.3833	24.2917	26.4250	28.8917	30.8250
	21.1000	22.3500	23.3917	24.3000	26.5500	28.9333	30.8833
	21.1500	22.4333	23.4300	24.3500	26.5583	29.0833	30.8917
	21.1583	22.4833	23.4333	24.5166	26.6000	29.0917	30.9500
	21.2666	22.4917	23.5166	24.5333	26.6200	29.1500	30.9583
	21.2833	22.5000	23.5200	24.5583	26.6833	29.1583	30.9666
	21.2916	22.5500	23.5500	24.7416	26.6917	29.2167	31.1000
	21.3500	22.5583	23.5583	24.7500	26.8167	29.2250	31.1500
	21.3583	22.6167	23.5667	24.7800	26.8250	29.3000	31.1583
	21.3667	22.6250	23.5800	24.8400	26.8667	29.3500	31.6250
	21.3833	22.6500	23.6167	24.9333	26.9500	29.3583	31.6333
	21.4166	22.7000	23.62500	24.9166	26.9583	29.4167	31.8166
	21.4833	22.7500	23.6700	24.9333	26.9800	29.4250	31.8250
	21.4417	22.7583	23.7000	24.9500	26.9666	29.5500	31.9500
	21.4917	22.7700	23.7500	24.9583	27.0833	29.5583	31.9583
FREQ. MC	19.8250	21.5500	22.8000	23.7583	24.9833	27.0917	29.6173
	19.8500	21.5583	22.8166	23.7600	25.0416	27.1000	29.6250
16.505	19.8900	21.8500	22.8250	23.7666	25.0833	27.1667	29.6666
18.400	19.8917	21.8833	22.8300	23.7700	25.0917	27.2250	29.6833
19.0583	20.0000	21.8917	22.8833	23.7666	25.1167	27.3375	29.6971
19.2833	20.0666	21.9500	22.8917	23.7900	25.1500	27.3500	29.7500
19.2917	20.1167	21.9583	22.9500	23.8167	25.1917	27.3583	29.7583
19.4833	20.2500	22.0166	22.9583	23.8800	25.2167	27.4600	29.8167
19.4917	20.3700	22.0250	23.0400	23.9000	25.2250	27.4833	29.8250
19.4917	20.6000	22.0500	23.0833	24.0000	25.3000	27.4917	29.8333
19.5500	20.6700	22.0833	23.0917	24.1000	25.3200	27.5500	29.8833
19.5583	20.8167	22.0916	23.1300	24.1166	25.3583	27.5583	29.8971
19.6500	20.8250	22.1100	23.1500	24.1200	25.3500	27.6375	29.9500
19.6833	20.8333	22.1500	23.1583	24.1500	25.3583	27.7500	29.9583
19.6916	20.8833	22.1583	23.2833	24.1583	25.3667	27.7583	29.9666
19.8167	20.8917	22.2000	23.2917	24.1600	25.3900	27.8833	30.0833
					25.4167	27.8917	30.0916
					25.4250	28.0000	30.1500
					25.4833	28.0166	30.1583
					25.4917	28.0250	30.2167
					25.6167	28.1500	30.2250
					25.6250	28.1583	30.2833
					25.7000	28.2833	30.2917
					25.7500	28.2917	30.3375
					25.7583	28.3833	30.3500
					25.8250	28.4167	30.3583
					25.8833	28.4250	30.3750
					25.8917	28.5500	30.4375
					26.0167	28.5583	30.4833
					26.0200	28.6833	30.4917
					26.0250	28.6917	30.6167
					26.1500	28.7583	30.6250
					26.1583	28.7666	30.6833
					26.2300	28.8166	30.6917

CITIZEN BAND CRYSTALS

MINIATURE CRYSTALS WITH PINS FOR TRANS. AND RECEIVING FREQUENCIES LISTED ARE IN STOCK. ORDER BY FREQUENCY.

TRANSMIT CHANNEL	REC +455IF	REC +1680IF
1 26965	27420	28645
2 26975		
3 26985		
4	27460	
5 27015		
6 27025		
7 27035	27490	28715
8 27055		28735
9 27065	27520	
10 27075		28755
11 27085	27540	28765
12 27105		28785
13 27115		
14 27125		
15 27135	27590	
16 27155	27610	28835
17 27165	27620	28845
18 27175		
19 27185		28865
20 27205	27660	
21 27215	27670	28895
22 27225		

\$1.75
EACH
OR
3 CRYSTALS
for \$5.00

THE FREQUENCIES LISTED ARE FOR CADRE MODELS C-60, C-75, C-100, C-500, C-501, C-510, C-515. SINGLE CRYSTALS \$ 1.75 EA. OR THREE FOR \$ 5.00. MATCHED PAIRS TRAN. AND RECEIVE \$3.00 PER PAIR OR FOUR PAIRS FOR \$10.00. THESE CRYSTALS ARE NEW AND WERE MANUFACTURED FOR CADRE CB SETS.

★
QUALITY CRYSTALS
For Every Purpose

SPECIAL CRYSTALS IN STOCK



\$3.50
EACH

1000 KC FREQ.
STANDARD IN
HC6/U HOLDER
NEW MANUFACTURE



\$4.50
EACH

100 KC
FREQUENCY
STANDARD
HC13/U HOLDER
NEW MANUFACTURE

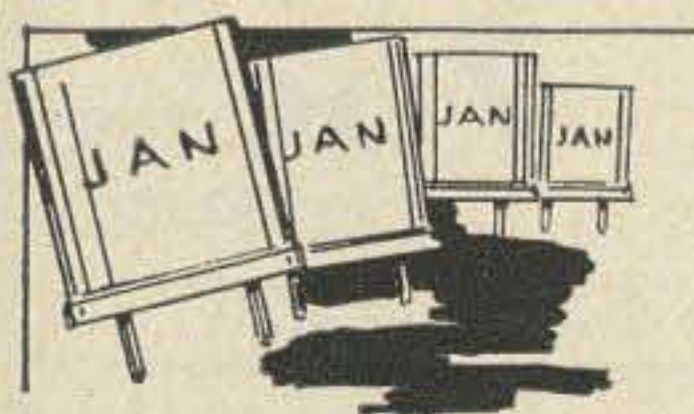

\$1.50 EA.

4 for \$5.00

The CR18/U is a hermetically sealed plated crystal fundamental frequency to be used in parallel oscillator circuit of 32 mmfd. Tolerance is .005% from -55° to +90° Centigrade. It may be used to double, triple, or quadruple, to any desired frequency. Maximum drive is 10 milowatts.

CRYSTALS LISTED ARE FUNDAMENTAL FREQUENCIES. WE WILL MAKE TO ORDER ANY FREQUENCY FROM 2000KC TO 12000KC IN HC6/U HOLDER .005% TOLERANCE AT

\$2.55 EACH

BE SURE TO SPECIFY EXACT FREQUENCY AND CIRCUIT IT IS TO BE USED IN TO INSURE CORRECT CORRELATION.

DELIVERY ON SPECIAL FREQUENCIES CAN BE MADE IN 48 HOURS AFTER RECEIPT OF ORDER.

FUNDAMENTAL FREQUENCY
HERMETICALLY SEALED CRYSTALS
 in HC6/U HOLDERS ORDER BY FREQUENCY

FREQUENCIES LISTED ARE IN KILOCYCLES

1400	2382	2855	3768	6258	6753	7375	8199	8786	11877
1753	2388	2868	3775	6261	6758	7383	8200	8791	12358
1763	2391	2877	3777	6298	6761	7385	8215	8887	12365
1843	2394	2887	3805	6316	6765	7390	8216	8950	12366
1845	2418	2900	3814	6332		7400	8221	9044	12373
1848	2436	2910	3851	6343	6776	7415	8223	9045	12379
1849	2437	2931	3870	6354	6805	7428	8228	9050	12380
1925	2442	2945	3900	6365	6850	7435	8233	9088	12383
1927	2449	2957	4200	6366	6872	7450	8236	9108	12397
1932	2453	2966	4280	6376	6877	7458	8240	9150	12400
1937	2460	2971	4835	6487	6883	7473	8242	9322	12403
1939	2467	2980	4843	6398	6888	7515	8246	9327	12405
1945	2494	2987	4854	6400	6894	7516	8248	9337	12412
1994	2561	2998	4860	6404	6900	7537	8250	9397	12441
2052	2594	3000	4889	6410	6905	7548	8253	9412	12564
2055	2617	3008	4910	6411	6922	7561	8258	9500	12568
2072	2618	3023	4993	6415	6925	7575	8261	9537	12573
2075	2622	3060	5108	6421	6927	7585	8268		12575
2085	2625	3067	5131	6425	6933	7591	8273		12579
2090	2628	3105	5147	6432	6938	7600	8285	9579	12580
2096	2632	3127	5156	6443	6940	7638	8292	9604	12597
2101	2647	3139	5157	6450	6944	7651	8294	9636	12600
2110	2650	3142	5171	6455	6950	7660	8296	9637	12604
2126	2654	3144	5205	6470	6955	7665	8300	9683	12625
2135	2658	3151	5275	6476	6961	7683	8302	9697	12629
2144	2667	3154	5335	6487	6966	7715	8307	9750	12716
2146	2674	3156	5416	6500	6972	7740	8317	9777	12718
2148	2677	3163	5421	6510	6977	7750	8320	9787	12793
2150	2681	3166	5437	6516	6983	7758	8338	9794	13012
2151	2684	3181	5555	6528	6986	7775	8340	9888	13016
2155	2688	3199	5569	6550	6988	7822	8347	10125	13023
2161	2694	3203	5580	6555	6994	7833	8350	10131	13037
2163	2695	3207	5610	6559	7005	7838	8353	10195	13272
2165	2699	3211	5632	6566	7010	7850	8376	10300	13320
2169	2710	3216	5730	6572	7011	7867	8380	10367	13376
2172	2715	3231	6043	6577	7016	7886	8385	10515	13485
2174	2716	3233	6060	6583	7022	7894	8392	10626	13655
2176	2726	3236	6071	6589	7027	7925	8407	11111	13817
2179	2730	3238	6091	6591	7038	8016	8415	11175	13910
2185	2732	3240	6093	6605	7061	8021	8419	11400	13985
2194	2737	3242	6098	6611	7083	8035	8435	11490	14316
2198	2744	3248	6104	6616	7091	8040	8450	11250	14777
2202	2751	3251	6109	6618	7100	8050	8452	11356	14818
2208	2757	3255	6130	6626	7105	8091	8469	11381	15318
2209	2760	3261	6132	6627	7111	8114	8471	11390	15680
2214	2762	3263	6137	6638	7120	8140	8488	11478	19683
2215	2767	3268	6142	6641	7122	8142	8541	11496	19850
2217	2773	3276	6148	6650	7150	8146	8547	11500	
2219	2782	3327	6152	6655	7172	8148	8550	11518	
2226	2788	3400	6159	6671	7250	8152	8572	11526	
2237	2794	3432	6164	6683	7256	8160	8584	11540	
2240	2805	3450	6181	6694	7258	8164	8625	11557	
2253	2810	3566	6183	6705	7270	8167	8637	11562	
2275	2813	3579	6187	6708	7277	8169	8650	11651	
2293	2817	3650	6193	6716	7278	8171	8666	11657	
2320	2820	3683	6198	6727	7305	8176	8686	11696	
2344	2835	3691	6203	6733	7338	8183	8750	11707	
2362	2840	3742	6243	6738	7345	8185	8775	11835	
2375	2854	3759	6248	6750	7350	8192	8783	11861	



PHONE AREA 813
 WE 6-2397

ADD 5¢ PER CRYSTAL FOR POSTAGE
 OR 10¢ PER CRYSTAL FOR AIRMAIL

**SEND US YOUR REQUIREMENTS . . . WE ARE RECEIVING
 NEW FREQUENCIES WEEKLY . . . WRITE FOR LISTINGS**

2400 CRYSTAL DRIVE • FORT MYERS, FLORIDA 33901

COLUMBIA CLOSEOUT SPECIALS

COMMAND RECEIVERS

195-550 Kc.	Good condition	\$ 14.95
550-1500 Kc.	R-22 Exl. cond.	14.95
1.5-3 Mc.	Like new	19.95
3-6 Mc.	Like new	14.95
6-9 Mc.	Good condition	14.95

COMMAND TRANSMITTERS

2.1-3 Mc.	New	\$ 9.95
3-4 Mc.	Excellent	9.95
4-5.3	Excellent	4.95
5.3-7 Mc.	Good cond. No xtal	4.95
5.3-7 Mc.	Good. No tubes, xtl	2.95

TRANSCEIVERS AND TRANSMITTERS

RT-18/ARC-1 Transceiver 100-156 Mc	Good	\$ 24.95
T-47/ART-13 Transmitter 100W		
2-18 Mc less tubes	Good	24.95
BC-640 Transmitter 50W 100-156 Mc.	Good	150.00

RECEIVERS

R-105/ARR-15 Collins 1.5-18 Mc	exelnt.	\$ 49.95
ARB 195-9000 Kc.	Good condition	24.95
RBS 2-20 Mc. No pwr sup.	Good cond.	49.95
RAK 15-600 Kc. No P/S	Good cond.	49.95
RDZ 225-400 Mc	Good cond.	39.95
RBA 15-600 Kc 110VAC	Excellent	99.50
RBB 600-4000 Kc same	Excellent	99.50
RBC 4-27 MC same	Excellent	99.50
R-444/APR-4Y AM & FM	Like new	49.95
RDO Less plug-in tuners	Excellent	149.50
CV-253/ALR Plug in tuner for		
APR-1, 4, 4Y and RDO Receivers,		
38-1000Mc, 4 bands	xInt.	199.50
BC-683 27-40 Mc AM & FM	Excellent	39.95

COLUMBIA ELECTRONIC SALES INC.

4365 W. Pico Blvd.
 Los Angeles, California 90019
 Phone (213) 938-3731

COLUMBIA TEST EQUIPMENT SPECIALS

TEK 511AD 5cps to 10Mc	Excellent	\$ 225.00
TEK 514D DC to 10 Mc	Excellent	325.00
TEK 513D	Excellent	400.00
DuMont 303A	Excellent	150.00
DuMont 322	Excellent	200.00
DuMont 322A	Excellent	275.00
TS-34/AP Look good	sold unchecked	25.00

SIGNAL GENERATORS

Meas. Corp. Model 65B	Like new	\$ 500.00
Meas. Corp. Model 80	Excellent	350.00
Meas. Corp. Model 82	Excellent	350.00
Meas. Corp. Model 84	Excellent	250.00
TS-497/URR Mil. Model 80 2-400Mc	XInt.	300.00
General Radio 1001A	Like new	600.00
General Radio 805C	Excellent	600.00
TS-419/U 900-2100Mc	Excellent	350.00
Navy LP 9.5-50Mc	Excellent	200.00
TS-413/U 75Kc-40Mc	Excellent	275.00
H-P 608A 10-500Mc	Excellent	500.00
H-P 212A Pulse generator	Excellent	200.00
H-P 210A Sq. Wv. Gen.	Excellent	85.00
H-P 202B Low Freq. Audio Osc.	XInt.	175.00
H-P 201B Audio Oscillator	Excellent	100.00
A.R.C. H-14A Omni Generator	Excellent	P.U.R.
SG-1/ARN Omni generator	Excellent	P.U.R.
MD-83A/ARN Omni Generator	Excellent	P.U.R.
SG-2/GRM Boonton 232A Glide slope	xnt.	P.U.R.

FREQUENCY METERS

BC-221 125-20,000 Kc	Excellent	\$ 75.00
LM 125-20,000 Kc	Excellent	50.00
TS-174/U 20-280 Mc	Excellent	150.00
TS-173/U 90-480 Mc	Excellent	150.00
TS-175/U 85-1000 Mc	Excellent	125.00
TS-323/U 20-450 Mc	Excellent	200.00
TS-186/U 100-10,000 Mc	Excellent	200.00
AN/URM-32 125Kc-1000Mc	Excellent	400.00
H-P 524B Counter with 100 Mc plug-in	Gd.	1250.00
FR-4/U 100Kc-20Mc	Excellent	400.00

MISCELLANEOUS SPECIALS

IP-69A/ALA-2 Panadapter 30 Mc in- put with schematic & conversion information for 60 cy use	Like new	\$ 24.95
---------------------------------------------------------------------------------------------------------	----------------	----------

PLUG-IN TUNERS FOR APR-1,4, 4Y & RDO

TN-1/APR-1 38-90 Mc.	New	\$ 29.95
TN-3/APR-1 300-1000 Mc	Excellent	29.95
TN-18/APR-4 300-1000	Excellent	49.95
TN-19/APR-4 975-2200 Mc.	Excellent	59.95

TUBES AND ACCESSORIES

Eimac socket & chimney for 4-400A	New	\$ 14.95
Socket for 4x150A	New	3.95
4-400A tubes	New	29.95
4CX300A tubes	New	19.95
RA-62 AC P/S for SCR-522	Good	17.95

If you don't see what you want, send us a note with your exact requirements. Columbia has one of the world's largest inventories of surplus military, communications and test equipment.

COLUMBIA NEEDS YOUR SURPLUS EQUIPMENT

WE PAY MORE, WE PAY FREIGHT, AND YOUR MONEY IS SENT OUT AIRMAIL IMMEDIATELY.

CALL US COLLECT OR WRITE US YOUR BEST OFFER AND WE WILL TOP THAT OFFER. WE ALSO MAKE TRADES FOR ANY GEAR YOU MAY NEED.

WE NEED THE FOLLOWING EQUIPMENT:

AN/ARG-27, 34, 38, 44, 45, 52, 55, 58, 73, 84, etc. AN/ARN-14, 21, 59, 67, 70. AN/APS-42, 81, 85, etc. AN/TRC-1, 24, 35, TRC equip. AN/PRG-8, 9, 10, 25, R-108, 109, 110/GRC. RT-66, 67, 68/GRC. AN/APR-9, 13. AN/URR-13, 27, 35. VRC equip. TED, AN/URT-7, AN/URC equipment. Test equip. with ARM, SG, URM UPM, APM, TS, GPM and other prefixes.

Also Tektronix, Hewlett-Packard, Boonton and General Radio equipment. Aircraft instruments and radio and navigation equipment

COLUMBIA ELECTRONIC SALES INC.

4365 W. Pico Blvd.
Los Angeles, California 90019
Phone (213) 938-3731

SOLID STATE SALES

P.O. BOX 74,
SOMERVILLE, MASS. 02143

INTEGRATED CIRCUITS

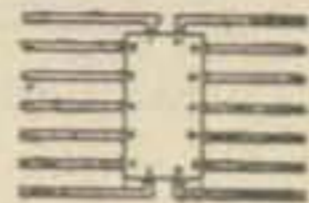

SR Clocked Flip Flops	\$1.15
JK Flip Flops	\$1.15
SRT Flip Flops	\$1.15
Dual Nand Nor Gates	\$1.00
Dual 4 Input Or Gate	\$1.00

TO-85 flat pack guaranteed to work. They come complete schematic, elect characteristic sheet & some typical applications. \$9.00—\$15.00 value from original manufacturer. We have other types of IC's in these categories available, send requests.

Silicon Controlled Rectifiers

PRV	7A	20A
50	.50	.80
100	.70	1.35
200	1.05	1.90
300	1.60	2.45
400	2.10	2.85
500	2.80	3.50
600	3.20	
700	3.50	
800	4.00	
900	4.50	
1000	5.00	

PRV	1A	350 MA
30		.30
60	.70	.50
100	.90	.70
200	1.10	.90
300	1.25	1.00

Top Hats and 1.25A. Glass Epoxies 750 MA Amp. Diode

PRV	
100	.07
200	.09
400	.12
600	.20
800	.25
1000	.50
1200	.65
1400	.85
1600	1.00
1800	1.15

PRV	
100	.12
200	.17
400	.25
600	.40
800	.50
1000	.65

Silicon Power Rectifiers

PRV	3A	20A	40A	240A
100	.10	.40	1.00	5.00
200	.20	.60	1.50	7.50
400	.25	.80	2.00	15.00
600	.35	1.20	2.50	20.00
800	.45	1.50	3.00	
1000	.65		4.00	35.00

A controlled avalanche rectifier in which the rated PRV may be exceeded without the rectifier breaking down.

OUR TRANSISTORS AND RECTIFIERS ARE GUARANTEED TO WORK

All transistors are checked for minimum voltage and gain, insuring our customers a good transistor within the category we advertise. All rectifiers costing over 10c are checked for forward voltage and leakage, as well as PRV. The gates on our SCR's are also checked. All non-operable units will be refunded or exchanged immediately. We stand on our reputation for quality products and service.

DO NOT CONFUSE OUR PRODUCTS WITH THOSE OF SOME OF OUR COMPETITORS

A defective semiconductor is worthless or worse.

Large quantity users of the above items send us your specifications. We feel we can meet them at a competitive price.

SOLID STATE SALES

POST OFFICE BOX 74
SOMERVILLE, MASS. 02143

TRANSISTORS

- A) Similar to 2N2185 (PNP). A silicon epitaxial low leakage transistor in TO-18 package, to 30 volts at 150 mw. **3/\$1.00**
- B) Similar to 2N329A (PNP). A general purpose silicon epitaxial transistor in a TO-5 package, low leakage, to 30 volts and β of 30-80. Compare with \$9.00 value. **3/\$1.00**
- C) Similar to 2N3060 (PNP). A 60 volt silicon transistor in a TO-46 pack with a β of 30 at .4 w dissipation. These transistors are used in DC amplifiers, audio systems and in high voltage work. **3/\$1.00**
- D) Similar to 2N1640 (PNP). A bi-directional transistor in which the emitter and collector are interchangeable. This is a silicon unit in a TO-5 package. **\$.75 ea.**
- E) Similar to 2N339-2N341 (NPN) etc. A high voltage, medium power (5 watts) silicon (NPN) transistor. **5/\$1.00**
- F) Similar to 2N547A, B and C, etc. A silicon transistor in a TO-5 package mounted in its own heat sink. **3/\$1.00**
- G) Similar to 2N728 (NPN). A high frequency silicon unit in a TO-18 package extending to the UHF range. **3/\$1.00**
- H) Similar to 2N995 (PNP) silicon unit with 1.2 w dissipation in a TO-18 package. This transistor has cut-off frequencies to 180 mc. **3/\$1.00**
- I) Similar to 2N699 (NPN). A 5 watt silicon, high voltage transistor in a TO-5 package used for fast switching. Ultra high frequency. **3/\$1.00**
- J) Similar to 2N2875 (PNP) silicon 20 watt power transistor with a cut-off frequency to 30 mc. **\$.75**
- K) Similar to 2N1648 (NPN) silicon high voltage, 20 watt unit used in output stages and power transistor drivers. **\$.75**
- L) Similar to 2N2885 (NPN) and TMT-8035 (PNP) microtransistors, they are high frequency transistors which dissipate 75 mw. of power **Both units \$1.00**
- N) Similar to 2N155 (PNP), a 20 watt germanium power transistor in a TO-3 package used in audio work. **4/\$1.00**
- O) Similar to 2N327A (PNP) silicon transistor in a TO-5 package used in audio work. **4/\$1.00**
- P) Similar to 2N519 (PNP), a TO-5 germanium transistor used in RF circuits. **6/\$1.00**
- Q) Similar to 2N389, 424 (NPN) etc., an 85 watt, 60-100 volt transistor with many high voltage power applications. **\$.75 ea.**
- R) Similar to 2N1209, 2N1212, etc. These transistors have the same electrical characteristics as the 2N389's, but are stud mounted. **\$.75**
- T) Similar to 2N497 (NPN), a silicon transistor in a TO-5 package for general purpose use. **5/\$1.00**
- S) FET's, N channel type similar to C610 used in amplifiers, switches, and choppers—very high input impedance. **\$1.50**
- U) NPN dual transistors. A TO-5 package (2N2060) which contains 2 NPN silicon transistors. **\$1.50**
- V) PNP dual transistors. This package (2N2807) contains 2 PNP transistors in a TO-5 can. **\$1.50**
- W) Similar to 2N117 (NPN), a silicon transistor, used as a small signal transistor in a flat package. **4/\$1.00**
- X) Similar to 2N1131 (PNP) silicon TO-5 transistor used for VHF, oscillator, audio and DC work. **3/\$1.00**
- Y) High Voltage 150V VBCBO at 2.5A High HFE in TO-66 Pack **\$.75**
- Z) High Voltage 200V VBCBO at 2.5A High Gain in TO-66 Pack **\$1.00**

RECTIFIERS

- A) 10 watt ZENERS. 2-180 volts. STATE DESIRED VOLTAGES. **\$.75 ea.**
- B) COLOR CODED GLASS DIODES. Si. **20/\$1.00**
Ge. **30/\$1.00**
- C) Similar to 1N251, a high frequency diode used to 1000 Mc. PIV. of 20 volts. **10/\$1.00**
- D) Similar to S284. A 30 PIV unit with characteristics similar to 1N251. **10/\$1.00**
- E) Silicon bilateral switch. Replaces SCR's by firing in either direction when the breakover voltage is exceeded. It is used as a light dimmer, etc. with schematic. **\$.75**
- F) 1N429. A 6 VOLT DOUBLE ANODE REGULATOR, 2 WATTS **5/\$1.00**
- G) SV176. A 7 VOLT REFERENCE DIODE, 2 WATTS. **5/\$1.00**
- H) High Voltage Assemblies. 6000V at 200 mils. These Silicon Assemblies may be put in Series to Achieve Higher Voltages. **\$1.50**
- I) Microdiodes, similar to MD27, etc., up to 200 PIV at 100 μ a. These are switching diodes with a short recovery time. The size of the body is only .05" in diameter. **6/\$1.00**
- J) GA AS VARACTORS, SIMILAR TO AP-1, AP-6, etc. 70 KMC at 160 mw. **\$4.00 ea.**

SOLID STATE SALES

POST OFFICE BOX 74
SOMERVILLE, MASS. 02143

RECEIVERS - TRANSMITTERS

- ARR-15**—Collins receiver, manual or auto tune, covers 1.5 to 18 MHz, has built in crystal calibrator also permeability tuned oscillator\$49.50
- APR-4 Receiver**—11 tube superhet, uses tuning units to cover 38-4000 MHz. Receiver less tuning units\$59.50
- AMT-4** Weather balloon transmitters, compact and light, new\$3.95
- ART-13 Transmitter**—100-watt with 813 final, 2 to 18 MHz\$29.50
- ARC-1 Transceiver**—100-156 MHz, uses 832A in final\$29.50
- BC-1000 Transceiver**—18 tube portable, 2-way radio, 40-48 MHz, can be used on 6 meters, less tubes\$29.50
with tubes\$39.50
- ARR-26**—FM receiver, 152-174 MHz not mounted in case. Some with tubes, Has 30-MHz IF strip. Will make good 2-meter receiver. In as is condition\$4.95
- URC-19**—Mobile FM in two bands, 25 to 50 MHz and 152 to 174 MHz. Good for 6 and 2 meters. Comes in 3 separate units: transmitter, receiver and power supply. Beautifully constructed and delivers 30 watts. Can be converted to A.M.\$49.50
- TSC Receiver & Transmitter Set**—Includes TSC remote control, 12 VDC power supply and antenna loading coil. Covers 1500 to 12,000 MHz. All for\$149.50

TUBES

- 3C22**—new boxed. \$2.95 each or 2 for \$5.00
- 100TH**—new boxed, each\$4.95
- 1625**—new boxed3/\$1.49
- 807**each 97c
- 707B**—1200 MHz klystron3/\$1.00
- 717A**—Direct replacement for 6SK7, 6SH7, 6SJ7, 6AK7, 6SG7, also used for octal 6AK5. Good for reduction in noise level, and IF gain10/\$2.95
- Bulk Packed—
- 5814**—Same as 12AU75/\$1.00
- 6J6**3/\$1.00
- 6H6**3/\$1.00
- 6AC7**3/\$1.00
- 902A**—Scope tube 2" with octal base new, each\$2.95
- 1P28** Photo multiplier tube, each\$3.95

TEST EQUIPMENT

- URM-26**—Navy version of Model 80 or TS-497. More compact and later style. Covers 2-400 MHz\$250.00
- TS-148**—Spectrum analyzer, X band, \$129.50
- TS-186**—Freq. meter 100-10,000 MHz \$149.50
- UPM-8**—Signal generator, 980-1230 MHz. Also used as pulse generator\$39.50
- TS-13**—X band signal generator\$49.50
- I-222**—Signal generator, 8-15 MHz & 45-77 MHz\$39.50
- TS-14** Signal generator 3200-3370 MHz \$39.50
- Binary Radiation Counter** for research\$29.50
- TS-35**—X band signal generator\$34.50
- TS-345**—Noise and gate generator\$24.50
- TS-250**—Altimeter test set\$12.50
- TS-155**—Signal generator 2700-3400 MHz for testing receivers and transmitters and for supplying trigger pulses\$97.50
- TS-230**—Power meter. Designed to measure frequency of unmodulated and pulsed signals in the range of 85-9700 MHz. New, with fittings\$49.50
- TS-573/UP**—Radar range calibrator, portable used calibrating pulse radar systems used for tracking or automatic signal. Range strobe output. Variable from 100 yds. to 200 miles\$97.50
- OS-8/U** Oscilloscope, has 3" cathode ray tube. Compact sweep circuit osc. 3 Hz to 50 KHz. Weight approx. 15 lbs.\$97.50
- Tektronic 511 Scope**—Good for wide range wave shape observance\$195.00
- UPM-4**—Precision scope, 3" tube type, and can be triggered internally or externally, and can be delayed by either. Has high voltage supply but needs additional voltages for operation. Complete with tubes\$22.50

TELETYPE

- Model 14 reperf** with sync motor less base and cover, as is condition, Each\$19.95
- 88 mH coils**, potted for easy mounting, 5 for\$1.49
- Paper, model 15**, carbon type, 10 rolls to a case, per case\$9.95
- Paper, model 14**, 11/16", 40 rolls to case, \$7.95 per case, or 2 cases for\$15.00
- Special Power Supply** for model 15 and model 19, mfgd by Teletype, Each ...\$9.50

J. J. Glass Electronics Co.
1624 S. Main St.
Los Angeles, California 90015
Phone: 213-749-1179

Terms: All items subject to prior sale. FOB our warehouse, Los Angeles, Calif. 25% deposit with COD order. Calif. buyers add 4% sales tax. Minimum order \$5.00

POWER SUPPLIES

- RA-62**—Used with SCR 522, 110 V 60 cy input. Can easily be adjusted to operate ARC-5,3,4 etc. Each\$19.95
- TCS**—12 volt dynamotors assym. 4 transmitter & receiver. Completely filtered, can also be used to operate SCR-522, ARC-3, 4, 5 etc. New, each\$9.95
- Converter-Rotary type**—12-24 volts to operate 24 volt equipment without any internal changes in the equipment. Will deliver 24 volts at 4 amps. Each\$9.95
- PE-125**—12 volts, 15 amps input. Output 425 volts DC at 200 ma. Has starting relay, fuses and completely filtered, Each,\$9.95
- 24-Volt generator** at 25 amps, new\$8.95
- Laminated core** for 275 watts power supply. Stack 2 for 375 watts. (QST Dec. 1964 for details), Each\$1.95
- Power Supply** for BC-603 or BC-683, 110 VAC, Each\$9.95
- RA-43** Power Supply. Input 110 volts 60 cycle Output 110 volts 525 watts, in excellent condition. Weighs 165 lbs, Each\$14.95
- RA-94** Power Supply, for Super-Pro receiver, New, each\$14.95

MANUALS

- ARC-27** transceiver\$7.50
- ARC-1** transceiver 4.95
- BC-604 & 603** 2.50
- BC-611** Walky-talky 1.50
- SCR-625** Mine Detector 1.25
- GRC RT-66, 67, 68** 2.95
- PRC-6** 1.95
- Special Model 15** 7.50
- BC-191** Trans. 1.95
- BC-342** Rec. 1.95

CRYSTALS

- 200 KHz** metal holder\$1.95
- 200 KHz** 241 holder 1.25
- 9050** metal crystal used for marker 1.95
- 10,000** metal holder 1.95
- 13,000** metal holder 1.25
- 500 KHz** 241 holder97
- 1000 KHz** metal holder 2.95

COMMAND EQUIPMENT

SPECIAL

- 4-5.3** MHz transmitters, as is. Most are complete with tubes, Each\$1.95
- 3-4** MHz transmitters, Each\$9.95
- ARC-5/VHF** transmitters, 100-150 MHz, new condition, with tubes, Each\$14.95
- 3-6** MHz receivers, exclnt cond, Each \$12.95
- 6-9** MHz receivers, good cond. Each \$9.95
- BC-459** ARC-5 modulators, Each\$5.95
- BC-442** Antenna relay, new\$2.25

MISCELLANEOUS

- Acrylic Spray:** Supplies a protective cover for equipment, diagrams, maps, meters, etc. Brings out luster and makes sprayed area look like new. Case of 12 cans, \$3.95/case
- Stereo Phones:** Mfgr. by Monarch. New \$9.95
- Dial telephone** For extension or 2-way use, each\$4.95
- TSC Remote speakers:** Ideal for tweeter, flat to 16,000 cy\$4.95
- Geiger Counter:** Compact type, uses Geiger-Mueller tube, New\$4.95
- 2 Volt Rechargeable Battery:** New, \$2.49
- Counter:** for use with computer electronic counters etc. 12 VDC coil, counts 0-9 in large 1-inch figures\$1.95
- Styrene Tubing:** 48" corrugated 2" diameter. Can be used to cover fluorescent bulbs for indirect lighting, or to wind coils, or antenna loading or ant. mast. 5 tubes\$2.49
- Navy Beam Filter:** 1020 cy, same as FL-8 Neweach \$1.95
- Grey Aluminum boxes:** Beautifully constructed lined with sponge rubber. 8½" square by 3¼" thick, new, onlyeach \$1.95
- RM-52 Phone Patch Special:** Comes complete with UTC83719 transformer\$1.95
- RM-53 Phone Patch Special:** A more elaborate unit with sensitive 4 ma plate relay. This unit can be used for phone patch as is, without any changes\$2.95
- Technical manual for above\$0.49

J. J. Glass Electronics Co.
1624 S. Main St.
Los Angeles, California 90015
Phone: 213-749-1179

Terms: All items subject to prior sale. FOB our warehouse, Los Angeles, Calif. 25% deposit with COD order. Calif. buyers add 4% sales tax. Minimum order \$5.00

SELL YOUR OLD GEAR TO GET BIG CASH DOLLARS NOW

We have immediate customers for your old equipment in any condition. We'll pay guaranteed highest price, shipping, insurance, etc. We'll pay in 24 hours, write or call collect for our high offer. P.S. We'll trade or swap equipment too.



MILITARY ELECTRONICS, CORP.

DIVISION OF SPACE ELECTRONICS CO.

4178 PARK AVENUE • BRONX, NEW YORK 10475

212-299-0300

Please rush me a quote on the following gear that I have to sell:

Name

Address

Zip Phone

GET HIGHEST PRICES

NAVY "TED" TRANSMITTERS AN/URR-13,27,35 etc.; AN/URA-6,8,17; AN/SPA-4,8,9.

AN/GRC-3,4,5,6,7,8,9,10, 19,26,46; RT-66,67,68,69, 70,77; AM-65/GR, T-368/UR, PP-112/GR, RT-174/PRC-8, R-108,9/GR, RT-175/PRC-9, R-110/GR, RT-176/PRC-10, T-195/GR, AN/PRC-25, R-125/GR, T-217A, T-235/GR, R-278B, SB-22/PT, MD-129A/GRC-27, AN/VRC-12, etc.

AN/TRC-24:

T-302A, AN-912,3
R-417A, AM-914,5, PP-685A & accessories.

AN/TCC-3: AM-682, TA-219

COMMERCIAL AIRCRAFT COMMUNICATIONS:

Collins: 17L-4,7, 51X2, 51V3, 618S, 618T, 18S-4, 621A3, 860E-2, 618M, 51R3, 578D, 578X, 479S-3, 479T-2; ARC: R-30A, R-38A, R-34A, RT-11A, T-27A, T-25C, R-31A,

T-27A, T-25C, R-31A, 21A system, IN-12,13,14. Test Sets: H-14, H-14A, etc.

INDICATORS: ID-250,1, ID-387, ID-257, ID-663, ID-1103, ID-637, etc.; all Collins, Weston, and A.R.C. indicators and control units.

TEST EQUIPMENT

SG-12A/U
AN/URM-25
AN/URM-26
SG-1A/ARN
SG-2A/GRM
AN/URM-80
SG-13/ARN
AN/URM-81
AN/ARM-8
AN/URM-32
AN/ARM-25
AN/ARM-68
AN/URM-48
AN/ARM-22
AN/ARM-66
AN/USM-26
AN/ARM-65
SG-66A/ARM-5
AN/URM-43
AN/UPM-98
AN/ARM-68
MD-83A/ARM
AN/UPM-99
AN/USM-16

TS-723/U
OS-8E/U
TS-757
TS-330
AN/UPM-32
TV-2C
TS-621
TV-7
TS-710
AN/URM-44
TS-683
TS-510A
AN/URM-52
AN/USM-44
AN/TRM-3
SG-24/TRM
ME-30C/U
AN/PSM-68
AN/GPM-15
TS-505D/U
AN/PSM-48

We also buy all H-P, Boonton, ARC, GR, Bird, Measurements, TEK, etc.

RECEIVERS: AN/APR-13,

14, 17; R-388, R-388A, R-390, R-390A, R-391, R-392, R-220, R-389, R-1125, R-1051, CV-253/ALR, 51J-2,3,4, AN/URR-, AN/FRR-, etc.

AIRCRAFT EQUIPMENT:

AN/ARC-27,33,34,38,44, 45,52,54,58,73; AN/ARN-14,21,54,56,59,65,67,52V.

MILITARY ELECTRONICS, CORP.

Division of **SPACE ELECTRONICS, CO.**

4178 Park Avenue, Bronx, New York 10475 • (212) 299-0300

"TAB" * SILICON ONE AMP DIODES

Factory Tested & Guaranteed

Piv/Rms 50/35 .05	Piv/Rms 100/70 .07	Piv/Rms 200/140 .10	Piv/Rms 300/210 .12
400/280 .14	600/420 .21	800/560 .30	900/630 .40
1000/700 .50	1100/770 .70	1700/1200 1.20	2400/168 2.00

**All Tests AC & DC & Fwd & Load!*

1700 Piv/1200 Rms @ 750 Ma. 10 for \$10
2400 Piv/1680 Rms @ 750 Ma. 6 for \$11

Silicon Power Diodes Studs & P.F.**

D. C. Amps	50Piv 35Rms	100Piv 70Rms	200Piv 140Rms	300Piv 210Rms
3	.10	.15	.22	.33
12	.25	.50	.75	.90
** 18	.20	.30	.75	1.00
45	.80	1.20	1.40	1.90
160	1.85	2.90	3.50	4.60
240	3.75	4.75	7.75	10.45

D. C. Amps	400Piv 280Rms	600Piv 420Rms	700Piv 490Rms	900Piv 630Rms
3	.40	.50	.60	.85
12	1.20	1.50	1.75	2.50
** 18	1.50	Query	Query	Query
45	2.25	2.70	3.15	4.00
160	5.75	7.50	Query	Query
240	14.40	19.80	23.40	Query

5U4 Silicon Tube ...\$2@, 3 for \$ 5
5R4 Silicon Tube ...\$5@, 2 for \$ 9
866A Silicon Tube ...\$14@, 2 for \$24

SCR-SILICON-CONTROL RECTIFIERS!

PRV	7A	25A	PRV	7A	25A
100	Q	Q	500	2.50	3.75
200	Q	Q	600	3.25	4.25
300	1.80	2.25	700	4.00	5.00
400	2.00	2.90	800	4.75	5.65

Untested "SCR" Up to 25 Amps, 6/\$2
Glass Diodes IN34, 48, 60, 64, 20 for \$1

2 RCA 2N408 & 2/IN2326 Ckt Bds
IN2326 Can Unsolder5 for \$1

MICA MTG KIT TO36, TO3 TO10
30c@4/\$1
ANODIZED TO INSULATOR5/\$1
ZENERS 1 Watt 6 to 200V\$1 Each
ZENERS 10 Watt 6 to 150V...\$1.25 Each
STABISTOR up to Ten Watt ..10 for \$1
GLASS DIODES Equiv IN34A, 20 for \$1

Wanted Test Sets (TS) & Equip.

*** TRANSISTORS * SCR'S * ZENERS!!!**
Full Leads Factory Tested & GTD!
PNP100 Watt/15 Amp HiPwr TO36 Case!
2N441, 442, 277, 278, DS501 Up To
50/VCBO \$1.25@, 5 for \$5
2N278, 443, 174. Up to 80V \$3@, 2/\$5

We Buy! We Sell! We Trade!

PNP 30 Watt/3A, 2N115, 156, 235, 242
254, 255, 256, 257, 301, 392, 40c@ 3 for \$1
PNP 2N670/300MW 35c@5 for \$1
PNP 2N671/1 Watt 50c@4 for \$1
PNP 25W/TO 2N538, 539, 5402 for \$1
2N1038 6/\$1, 2N10394 for \$1
PNP/TO5 Signal 350MW 25c@, 5 for \$1
NP/TO5 Signal IF, RF, OSC
25c@5 for \$1
Finned Heat Sink 180 SQ". \$1.50@, 4/\$5
Finned Sink Equiv. 500 SQ"2/\$7
SILICON PNP/TO5 & TO18 PCKG
2N327A, 332 to 8, 474 to 9, 541 to 3,
935 to 7 & 1276 to 9, 35c@4/\$1

Send 25c for Catalog

Discaps .001@1000WVDC 10c@, 20/\$1
Discaps 2x .004@1000WVDC 15c@, 10/\$1
Discaps .03@1000WVDC 15c@, 10/\$1
Discaps .01@2000WVDC 18c@6/\$1
Discaps .001@5KVWDC 20c@6/\$1
Discaps .005@5KVWVDC 25c@5/\$1
Discaps 130mmg / 6KV 20c6/\$1
6 or 12VAC Minifan & Blade\$1
TO3/PIN LUGS for B & E15/\$1

TOP \$\$\$ PAID FOR 304TL TUBES

18 Pressfit Diodes to 100 Piv5/\$1
MICRO-MUSWITCH 35A AC/DC, 5/\$1
2N408 RCA SHORT LEADS, 5 for \$1

Wanted Transistors, Zeners, Diodes!

"TAB"

Band Pass Filters 60, 90, 150 cys., 3/\$5
"SPERRY" Wattmtr Meas. LoPwr RF
Self-Calib/50MuW to 10MW\$10
Synchro Differentials C78249/115AC 60
Cycles Less Back Plate\$2
Bendix Auto Syn's "AY" Series2/\$1

2.5MH Piwound 500MA Choke3/\$1
Knob Spin-Crank BC348 \$1 each ..3/\$2
MiniFan 6 or 12 VAC \$1.50 each....4/\$5
Beam Indicator Selsyns 24VAC2/\$7
Teletype TLI47 Feeler Relay Gage ...\$1
Fuse 250MA/3AG50/\$1, 300/\$2

DON'T C-WRITE & SEND ORDER!

Mini-Rectifier FWB 25MA/115VDC
Output3/\$1, 20/\$5

THERMISTOR-VARISTOR - W.E.

40A and/or 41A4/\$1
D171631 Varistor4/\$1
D97966 Varistor\$2 each, 3/\$5
D170396 HF Pwr Meas.\$2 ea., 6/\$5
IC Bulb Time Del.2/\$1, 15/\$5
38/C/20259 DB/MTR Bridge \$2 ea., 3/\$5
Octal Sockets Ceramic & Molded ..20/\$1
Scope Sockets, Assorted4/\$1
304TL or 829 Johnson Socket\$1

I-177 Hickok Type Tube Checker ...\$39
GE YYZ-1 Decade Sealing Counter ..\$35
Pirani Vacuum Gages\$39
"ESC" Var. Pulse Ten Step Delay Net-
work TD. 5uSEC/Z100 & .05 to .5, \$25
AM-TIME PROD 500cy Fork & Amp. \$30
"VFC" Vibrator Feeder Controlled
Type 5—(Shake Table)\$75
Black Light Lamps&UV Sylvania ...\$2
Osram XB0450W/P Lamp\$35
GE 190T3/CL-60V/Q-InfraR Lamp ..\$10

BC746 Bantam 1 watt less Coils3/\$2
Welch Duo-Seal 1402B Lg Cap HiVacuum
140 Ltrs/M & Mtr. Mint & LN\$150
Consolidated Vac. Corp PMC115A Diff-
sion "ION" Pump, Mint & Like New, \$90
HiVac Valve CVC#VCS21, Like New \$60
Temescal VAC Valve, New\$10
Electronic VAC Deposition JAR less
Glass Bell 6" ID\$50

W.E. #293 Spring Relay Tool2/\$1
CD307A/6 ft Ext Cord PL55 & JK26 \$1
Carborundum Fine 6" Stone2/\$1
5-way Red & Black Binding Posts, 5/\$1

WANTED TUBES ALL TYPES

We Buy, Sell & Trade As Well

Line Filter 200A/230VAC, \$20 ea., 2/\$30
Weston 0-130VAC 3" Rd, \$6 ea., 2/\$10
Elapsed Time Meters 115VAC/3" Rd \$10
Variacs 0-120VAC/10A & K&D, LN \$16
Variacs 0-135VAC/7.5A & K&D LN \$15
Minifan 6/12VAC/60cy & Blade ..3/\$5
Untested SCR 25AMP6/\$2
Untested SCR 7.5AMP4/\$1
Untested 35AMP Silicon Pwr Studs 4/\$1
Untested 12AMP Silicon Pow Studs 8/\$1

Leece-Neve 100A/12V3PH Sil Rect ..\$16
250MFD@450WVDC/SSB Electro-
lytic\$3
500MFD@200WVDC/SSB Electro-
lytic\$2 ea., 8/\$10
.012@25KV "CD" Hy/Capacitor \$4, 3/\$9
Vacuum RF/50MMF/20KV, \$4 each, 3/\$10
Mica .01MFD/8KV RF/XMTG,
\$3 ea.4/\$10

Weston #45/0.5%/150VDC Lab Meter \$27
Wileox F3&CW3 coils (set)\$3
WE #150/LowFreq Carrier Coils ..3/\$1
Pulse XFMRs 1:1/1W.E. & Others 7/\$5
WSTGHS/Scope 10KV/Pulse &
HV Test\$90
SPERRY RF Lab Scope\$35
"AB"/POTS ASSTD SDS & Shafts 20/\$5
Delay Lines ASSTD/ESC/.4 &
CTClms2/\$1
Insulation Test/0-1500VDC nonDES \$30
MTRS/AN 30/60/120/240/480 amps
N/S\$3
Relay INTRLOK/Pulse/115VDC
\$3 ea.3/\$5
Resistor Bleeder 50K/100W \$1 ea., 8/\$5

Wanted Tubes All Types

WE BUY, SELL & TRADE AS WELL!

"TAB"

TERMS: Money Back
Guarantee! Our 23rd
Year. \$5 Min. Order
F.O.B., N. Y. C. Add
Shipping Charges.
111 HJ LIBERTY ST., N.Y.C. 10006 N.Y.
PHONE 732-6245

Send 25c For Catalog

Silicon 200AMP Power Rectifier Re-
places 90% of Gas Station Fast
Charger Selenium *C.T./Forced-Air
Stacks. Sealed & Non-ageing! BC200P
or BC200N/NEG. Output,
\$16 each2/\$30
With Auto/Klixon 125A Breaker
ADD\$2

X-Formers All 115V-60Cy Primary—

2500V@ 1CMA & Fil \$2@,3/\$5
1100VCT@ 300Ma, 6v@ 8A, 5V @ 3A &
125V Bias, abt 1200VDC\$5@, 4/\$15
2.5V@ 2A \$1@3 for \$2
6.3V@ 1A \$1.50@,4 for \$5
20VAC & TAPS/8, 12, 16, 20V@ 4A \$2@
32VCT/1A or 2X16V@ 1A \$3@
880V Vet @ 735Ma for SSB \$12@, 2/\$22
480 Vet@ 40Ma & 6.3@ 1.5A CSD \$1.50
10 Vet@ 5A & 7.5 Vet @ 5A\$5
6.3 Vet@ 15.5A & 6.3Vet@2A.....\$5

"VOLT-TAB" 1000 Watt Speed Control
115VAC \$8@,2 for \$15

Bandswitch Ceramic 500W 2P/6Pos \$3@
5Hy-400Ma Choke \$4@2/\$5
6Hy-500Ma \$5@2/\$6
250Mfd @ 450 Wv Lectlytic 4/SSB \$3@
Cndsr Oil 10Mfd x 600VDC \$1@.....4/\$3
Cndsr Oil 6Mfd @ 1500V \$4@, 5 for \$10
Line Filter 200 Amp/130VAC \$5, 5/\$20
DC 3 1/2" Meter/RD/800Ma \$4@, 2/\$7
DC 2 1/2" Meter/RD/100 Ma \$3@,
DC 2 1/2" Meter/RD/30VDC \$3@, 2/\$5
DC 4" Meter/RD/One Ma/1% \$5@, 2/\$9
Socket Ceramic 1625 Tube ...3/\$1, 8/\$2
Socket Ceramic 866 Tube ...4/\$1, 10/\$2
Socket Ceramic 4X150/Loktal4/\$2
XMTTG Mica Cndsr .006@ 2.5Kv 2/\$1
Mini-Rectifier 25Ma/115VDC/FWB, 5/\$1
W.E. Polar Relay#255A \$5@, New 2/\$9
W.E. Socket for #255A Relay\$2.50

RUSH YOUR ORDER TODAY.
QTYS LIMITED

Toroids 88Mhy New Pkg ...\$1@, 6/\$5
200 KC Freq Std Xtals \$1.50@, 2 for \$2
2 Side/cu Printed Ckt Bd New 9x12" \$1
Klixon 5A Reset Ckt Breaker \$1@, 10/\$5
2K to 8K Headsets Good Used \$3@, 2/\$5
Finished Piezo Xtal Blanks ..25 for \$1

SILICON TUBE REPLACEMENTS

OZ4 UNIVERSAL\$2
5U4 1120 Rms/1600Inv \$2@, 3 for \$5
5R4 1900 Rms/2800Inv \$5@, 2 for \$9
866 5Kv/Rms-10.4Kv\$10

Line Filter 4.5A@115VAC 5 for \$1
Line Filter 5A@125VAC3 for \$1
Boat Filter 400 Ma@28VDC8 for \$1
Boat Filter Input/3A@30VDC ..6 for \$1
866A Xfmr 2.5V/10A/10Kv/Insl\$2
Ballentine #300 AC/Lab Mtr.\$45
Choke 4Hy/0.5A/27Q \$3@4/\$10
H'sld Stevens Precision Choppers\$2
Helipots Multi Ten-Turn@\$5
Helipot Dials\$4@, 3/\$10

866 C.T./2.5V/10A FILAMENT
XFMR 10 Ky Insltd SPECIAL \$2

"Bruning" 6" Parallel Rule@\$1
PL259A & SO239 CO-AX M&F Pairs 3/\$2
Phone Patch Xfms Asstd3/\$1
FT243 Xtal & Holder, surplus4/\$1
Insltd Binding Posts "EBY"20/\$1
Sun-Cells Selenium Asstd6/\$1
TO36/100W Untested Transistors ..4/\$1
Tube Clamps Asstd20/\$1
.01 Mica 600Wv/1kv test6/\$1
.001 to .006 Mica/1200 WV/2.5Kv
test4/\$1

D. C. Power Supply 115V/60 to 800
Cys. Output 330: Tap 165V up to
150 Ma. Cased, 5@2 for \$9

SELENIUM F.W. BRIDGE RECTIFIERS

DC AMP	18VAC 14VDC	35VAC 28VDC	72VAC 54VDC	130VAC 100VDC
1/2	\$1.00	\$1.90	\$3.85	\$5.00
1	1.30	2.00	4.90	8.15
2	2.15	3.00	6.25	11.10
3	2.90	4.00	8.60	13.45
6	4.15	8.00	18.75	31.90
10	6.10	12.15	26.30	41.60
12	7.75	14.90	30.95	43.45
20	12.85	24.60		
24	15.00	29.45		

One Year Gtd!

Write For Rectifier Catalog

WE BUY! SWAP & SELL
TRANSISTORS, DIODES, ZENERS

Send 25c for New Catalog



G.E. PROGRESS LINE, 30-54 mc 6/12 volt mobile transceivers. 60 watts RF output. Absolutely mint condition. These were removed from service in Jan. 67 in perfect operating condition. They are complete in every respect except for the antenna. Narrow Band. FCC type ET23A. Now on 47mc. Tunes to 54mc with no modifications. Your purchase price refunded if not satisfied for any reason! This is the lowest price anywhere.

Single freq. trans. & rec. **Only \$100.00**

*Two freq. trans. & rec. **Add \$ 10.00**

*Four freq. trans. & rec. **Add \$ 30.00**

*Limited quantity, give 2nd & 3rd choice

MOTOROLA 150mc mobile transceivers FMTRU5V, with case, control head, cables. Some small tubes missing, dirty, but apparently in good cond. Only \$29.00 ea.

RCA 150 mc Transistorized pocket receivers good cond., complete less on batt. (RCA VS320) \$25.00 ea

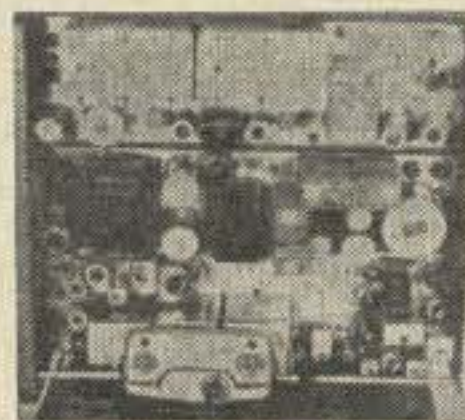

G.E. 450MC 6/12v mobile transceiver 20 watts output. Rec. sens., less than 1 uv. trans-

mitter tunes to 432.0 with no modifications, rcvr requires 2 padders in osc. section. Complete with all acc., guaranteed in A-1 cond. Only \$65.00 ea

For complete list of FM equipment and accessories, send large sase. WE WILL PAY CASH OR TRADE FOR FM EQUIPMENT, LATE MODEL MILITARY & COMMERCIAL COMMUNICATION EQUIPMENT, AND TEST EQUIPMENT. Motorola, G.E.-RCVRS, R220, R5200, R389. Also any facsimile equipment, parts, acc. made by Electronic Comm. or Stewart-Warner. If you have equip. to sell or trade, please name your cash or trade price.

MIN. order \$5.00 .25% deposit on COD orders. Prices subject to change without notice. Prices are FOB Trenton, Mich. Res. add 4%. Include postage for parcel post items only.

NEWSOME ELECTRONICS

Hours: by appointment only

2670 Pinetree, Trenton, Michigan 48183

Telephone 313-676-7460

RECEIVE PICTURES FROM APT WEATHER SATELLITES

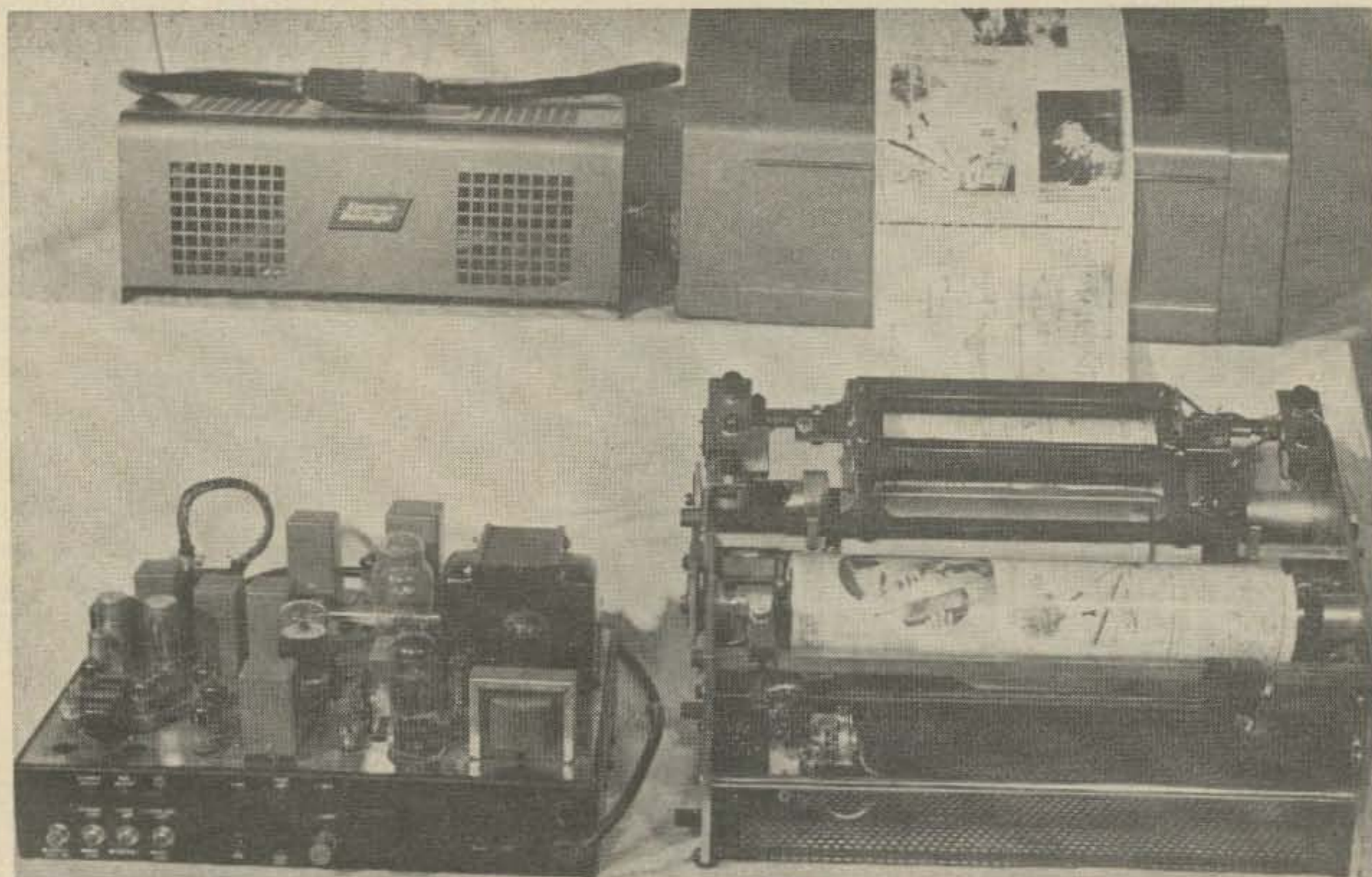

Late model commercial facsimile transceivers. The finest available on the surplus market. Commercial units, not military. Employs electrolytic method, which is the type of reception used in modern AP & UPI machines, replacing the older photographic equipment. These machines are like new and in perfect condition. Ideal for the reception of pictures from the various weather satellites. Pictures received from the

BERKLEY ELECTRONIC COUNTER

Freq. range—0-99,999 cps. Time base 1/10 sec & 1 sec. We have about a dozen of these. All are clean and in excellent operating condition. Only \$150.00 ea

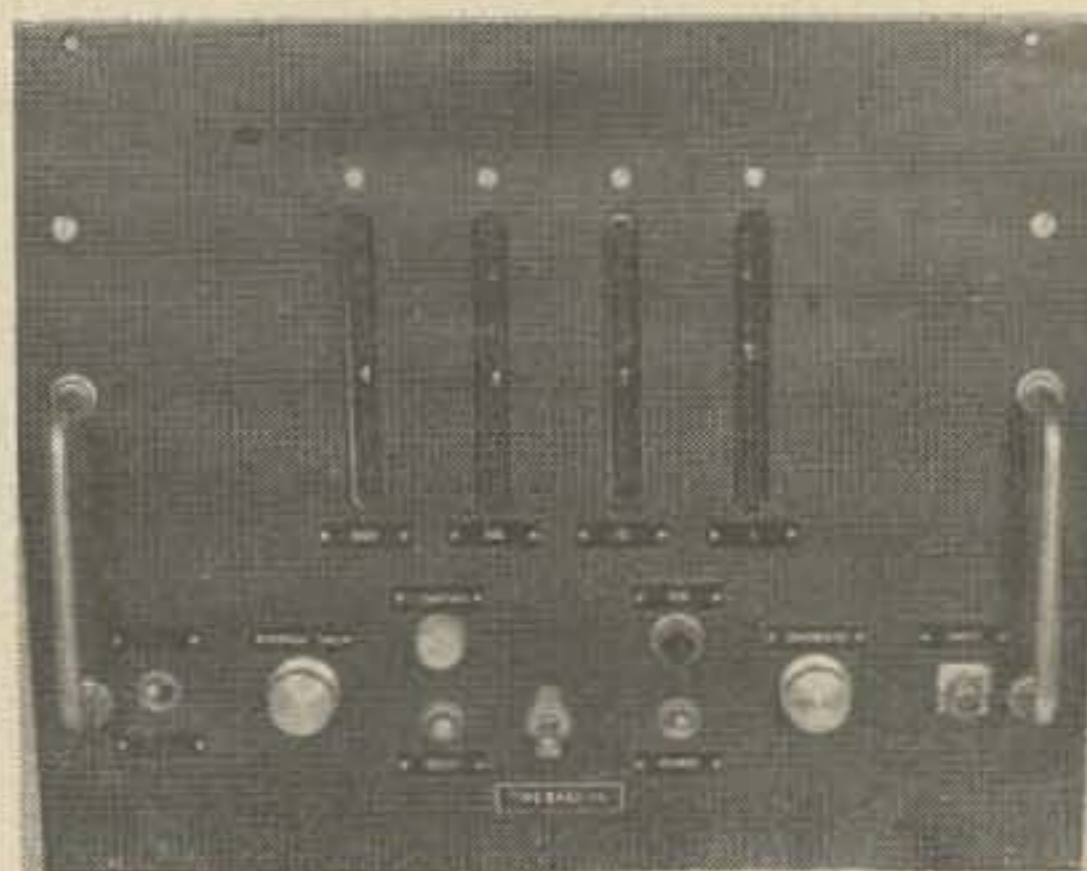

CAVITY, silver plated brass, brand new, lots of uses. For two meters & up. 2x12". \$2.95 ea



CARTER 6/12 volt Dyna-motor, brand new-unused. output is 400-vdc at 400ma. \$17.50 ea

NEWSOME ELECTRONICS

Hours: by appointment only

2670 Pinetree, Trenton, Michigan 48183

Telephone 313-676-7460

satellites are 8 x 8.5 inches. For additional information on receiving pictures from the Automatic Picture Taking satellites, see: QST, Nov. 65, p. 11. CQ, Sept. 66, p. 44. Electronics World, March 67, p. 23. CQ, Aug. 66, p. 25. Electronics, July 27, 1964 p. 81 & 99. These machines will send and receive pictures, schematics, etc., up to 8.5 x 14". They can be used on the 2 meter band and up without any additional equipment other than your AM or FM receiver and xmtr. When transmitting, it provides a monitor copy which is an exact reproduction of the picture being transmitted. 100Ft rolls of recording paper are readily available at a cost of less than 2 cents per picture!

SPECIFICATIONS

Drum speed	— 240 RPM	Received	— 85 Lines/
Subcarrier	— 2400 cps	Horizontal and	inch
freq.		Vertical	
Modulation	— VSB—AM	resolution	
	carrier	Phasing	— Automatic
White	— 26 DB below	Receive AGC	— 20DB
	black level		Dynamic
Input/output	— 600 ohms (Audio)		range
Recording	— 100 ft.	Bandwidth	— 900-2700 cps
paper capacity	continuous	Carrier freq.	— 2400 cps
Receiving level	— No less than	Black signal to	— 26DB At
	—35 DBM	noise ratio	receive term.
Start/stop	— Automatic	Power req.	— 115vac, 60
	(auto-start)		cps

Additional information and prices available on request.



TOROID power transformers. (2) in mini-box. Wind your own primary. Toriod dim: 2⁵/₈ OD x 1¹/₄ ID x 1/2". 2 stud type rect. Brand new. \$2.95 ea

MOTOROLA fully transistorized 150mc pocket transmitters, 1/2 watt output. less batt. \$25.00 ea

MEASUREMENTS model 58 field strength meter, 15 to 150-mc. A-1 cond. \$95.00

COLLINS R425B UHF receiver, on 420mc, brand new, unused! \$60.00

LAMPKIN 205 A FM modulation meter, ser. no. 2018. Excellent cond. \$175.00

NEWSOME ELECTRONICS

Hours: by appointment only

2670 Pinetree, Trenton, Michigan 48183

Telephone 313-676-7460

Face-Lifting the TS 34 / AP Oscilloscope

The TS 34/AP Oscilloscope is one of the best buys on the surplus market today but, due to its World War II vintage, it is sometimes by-passed for other equipment. When you look at a TS 34/AP it reminds you of the old kaleidoscopes found in penny arcades at amusement parks—the kind you squint into to see the girlie pictures. The TS 34/AP is something on that order but a face lifting will make it look like a million dollars.

This oscilloscope is a real fine instrument and has many excellent operating characteristics. It's light weight and small size make it an excellent portable or fixed station scope. The TS 34/AP operates from 110 volts at 50 to 1200 Hz and draws 90 watts. The sensitivity is .1 to 100 volts and sine waves are observable from 30 Hz to 1 MHz.

The first job is to bring the 2AP1 tube up forward. This simple modification makes better viewing of the cathode-ray tube from all angles so you don't have to squint into the scope to view the test pattern. Remove the top cover of the cabinet and take out the long black Armco-iron shield over the CRT. Save the small shield which is inside the long one. Next measure $7\frac{1}{8}$ inches in from the socket end (rear) and cut off the shield with a hack saw. This short shield will be used when the tube is moved to the front.

Next we work on the front end of the top cover to prepare it for insertion of the 2AP1 tube. The eye-shade or hood should be removed, leaving an oval hole. This hole must be enlarged to take a round meter bezel, 2 to $2\frac{1}{4}$ inches in diameter. I used a meter bezel which I found in the junk box. Prepare a new sub-panel 7 x $3\frac{1}{4}$ inches which is to be fitted over the enlarged hole. Do-it-yourself aluminum was used here. Cut out the hole in the center of this panel for the bezel; fasten panel and bezel to the top cover.

The top cover needs more surgery, so cut out a hole 10 x 5 inches right in the center. Start $2\frac{3}{4}$ inches from the front edge. This hole will be used later for adjusting the in-

stallation of the 2AP1 tube. You will also need it to replace tubes. Next make a cover or lid to fit over this hole using do-it-yourself perforated aluminum and fasten it with self-tapping screws. Allow at least a one inch margin around this lid so it will be secure when fastened to the cover. When this is finished, paint the new and old parts of the top cover with a spray-can.

Our next job is to move the 2AP1 tube forward by lengthening the wires going to the tube socket. The present socket will be moved forward about seven inches. Allow enough wire when splicing the additional wire to the original leads. To get an idea of the length of the required splices, place the 2AP1 temporarily in the bezel and measure the additional wire length to each pin of the socket. It is a good idea to lace and bind these wires together when splicing is completed. A bracket must be made to hold the shield, similar to the original bracket at the rear of the chassis. It can be made from a small piece of aluminum shaped like the letter Z. It is then fastened to the screw just in front of the 6AG7. This screw and washer hold down the phenolic tie point board. The bracket should have a nut and screw attached to it so that the little fork on the rear of the shield fits down on it and holds secure.

Now the final adjustment of the face lifting. Fasten the socket into the Armco-iron shield. Take the small shield and insert it inside the larger one. The 2AP1 tube is then pushed down through the shield until it fits into the socket. Then the tube and shields are placed through the bezel. The small fork on the outer shield is fastened to the screw and nut on the bracket. To keep the tube rigid, put a piece of rubber around the edge of the 2AP1 tube.

If you have followed these simple instructions you will have a scope of modern design and you can enjoy the capabilities of this \$1,000 instrument—that's what the government paid for it.

. . . K6GKX

Howard S. Pyle W7OE
3434 74th Avenue, S.E.
Mercer Island, Washington 98040

Climbing the Novice Ladder

Part VII: Judy and Joe take their written exams and report on their transmitter hunt.

By the following Saturday neither FN nor Larry had received the sheets for the written portion of the novice exam for Judy and Joe from FCC but the two youngsters had not wasted any time during the week. In addition to cramming for the exam they had made the rounds of the local ham stores and accumulated some ideas for their transmitters. FN had accordingly invited them to drop out and discuss what they had found, so early that afternoon they peddled out to his shack.

Judy opened the discussion; "Gramps, we saw quite a bit of some pretty nice gear down-town but those we think we'd like to have were way out of our price class. Joe starts working at the supermarket on Saturdays right after school opens and with what he'll make there and what he has saved from his paper route, he figures he can go about \$60 for a rig. Me, I'm not quite so flush; I don't have any job prospects except occasional baby-sitting and I don't have *too* much left in my piggy bank . . . about \$20 is all." Joe then chimed in with "Well, I'm luckier than Judy as I already had a receiver and didn't have to buy one; what I saved there can go on the transmitter. I saw a couple of jobs I'd like to have but they're a bit complicated for me. Jim Turner has a Viking Ranger for \$65.00 but it's priced that low because the modulation section is burned out. Larry took a look at it with me and said, from the looks of it quite

a bit of work would be necessary and I'd have to buy a new modulation transformer and maybe both tubes. I'd like to have phone after I get my General ticket but Larry advised against tackling the repairs on the Ranger; what you think?"

"I think Larry is right, Joe. If the modulation section is gone it's very possible that you'll find more trouble in the rf portion. Generally, when the major portion of a transmitter goes out, it carries other things along with it and you may bite off quite a frustrating job if you go for that one.

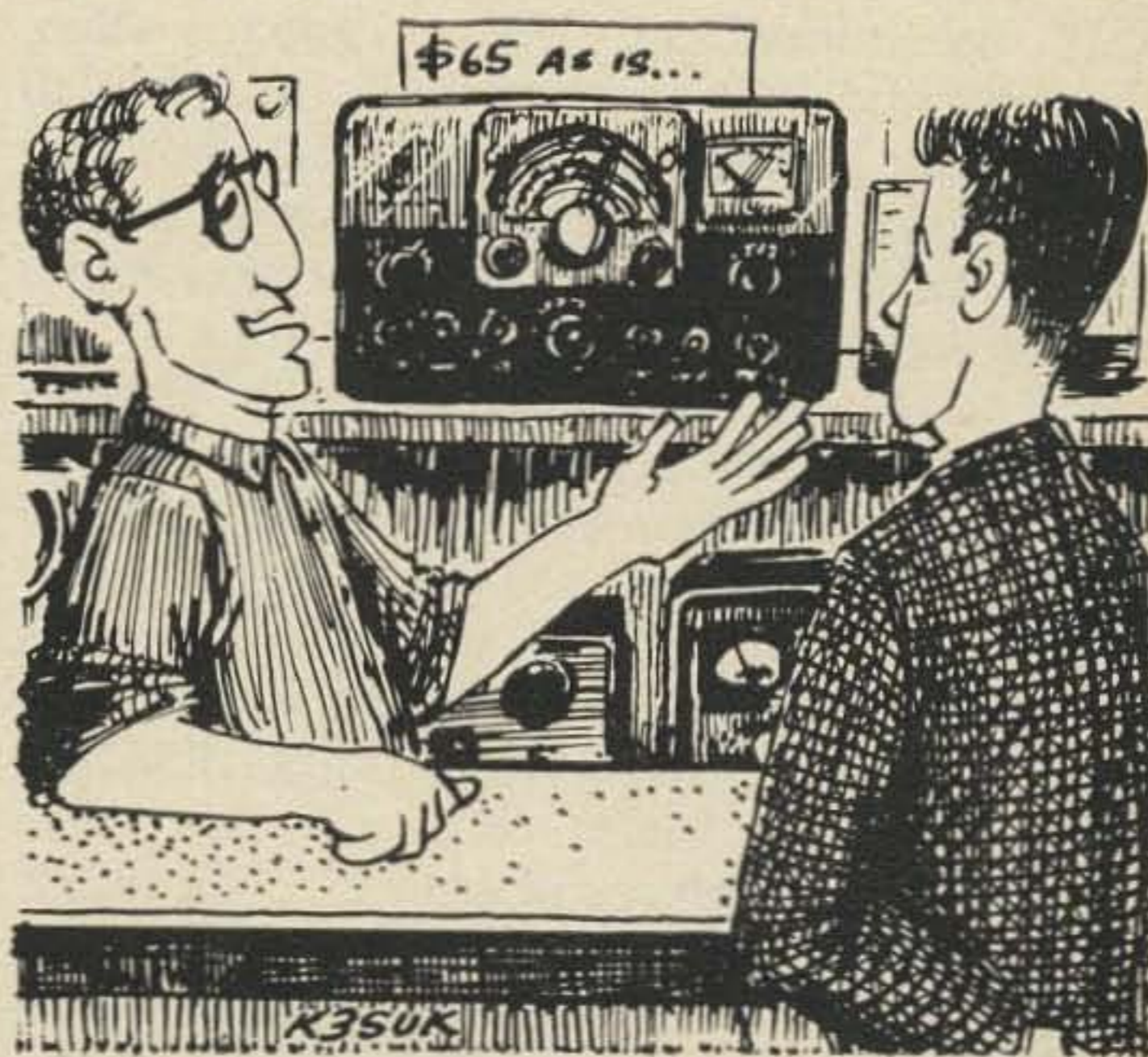

Joe considers a Ranger in need of repair. "Dad . . .

A Ranger is a swell little job when it's operating normally but if it has been abused, it isn't exactly child's play to restore it; I believe I'd forget it if I were you. What was the other one you saw Joe?" "Well, it was a military surplus job . . . a TCS with an AC power supply and it had been modified and fixed up so it would handle 20, 40 and 80 OK . . . no 15 though. Jim was asking \$45 for it which Larry says is a good price but he wasn't too keen about it. The modifications weren't too well done and the power supply was a home-brew job and kinda sloppy although Jim said the set-up worked very well; he tried it out before he took it in on a trade. I might be getting a bag of lemons though if I bought it off the shelf".

"Neither the Ranger nor the TCS sound like very good bets to me Joe," FN replied, "I think you can do better than that. What about a new kit job? You've had enough electronic building in school so that you shouldn't run into any great amount of trouble putting one together and then you'd have something modern and new so you shouldn't experience any grief there. Did you look over the kit catalogs?" "Yes, FN, I did" Joe returned, but I just kinda thumbed through 'em . . . didn't really come up with anything; I thought I'd see what you thought about the Ranger or the TCS first". "All right, Joe; suppose you take a *good* look at what Heath, Knight, Eico and others have to offer. Read the dope thoroughly on each one and drop back in a few days and we'll talk about it. Now Judy, \$20 isn't going to get you much of a transmitter although if you want to, you can get a time payment deal on something pretty good." "No, Gramps, my little income is too unstable to sign up for something maybe I couldn't pay for. I don't think Dad would want me to either; he'd have to guarantee it you know at my age" she laughed. "Joe and I are going to the club with Larry tonight though and they're going to have an auction; maybe something will turn up there for both of us . . . let's wait and see Joe, OK?". "Sure" said Joe, "another day or two won't hurt us and I'd rather get something I want than take a chance". "Good idea kids" FN put in, "sometimes these club auctions offer some pretty fair pieces of gear . . . it's worth a try". "OK Gramps, we'll take in the auction and I'll let you know tomorrow how we made out. Larry said he'd pass on anything that looked good before we went for

it" and with those parting words, Judy mounted her bike and led off with Joe following on his Honda.

The following day Judy's family made the trek out to FN's place where they were joining the older folks for Sunday dinner. Judy immediately cornered FN and said somewhat dubiously but with obvious excitement, "Do you know Gramps, there was only *one* transmitter offered at the auction and it was a six and two meter transceiver; nice looking job but it was nothing for Joe and me to start our novice career with; it went for \$85 to the highest bidder which was out of our class anyway. "But" and Judy glowed but still looked a bit dubious, "one of the hams at the club told me that he just got the latest "Blue Book" listing of re-conditioned equipment from World Radio Labs and as there was nothing that he wanted this time, he gave it to me as it had several nice little transmitters on it. I brought it along Gramps; there's one that sounds pretty good to me but it's \$35. Dad said though that if you approved it, he would give me the other \$15 I'd need, for a birthday present . . . I'll be 17 Wednesday you know!" "Let's have a look Judy; maybe you've hit a jack-pot; WRL generally have a pretty good assortment and you can't go wrong dealing with them . . . they're good people. Ah, there's seven transmitters on here; four of those you could use . . . the others' are kinda in the money; which one were you thinking of?". I kinda like that little Viking Adventurer; Larry had one once and said it's a dandy little rig and an FB novice transmitter; has all of the bands and is crystal controlled . . . runs about 50 watts. Larry gave me a catalog sheet on it and I read it over . . . here it is . . . what do you think of it?" "Judy, maybe you *have* hit a jackpot here. As I remember, those little jobs cost about \$65 or \$70 as an unassembled kit and WRL is offering it completely wired, reconditioned and tested for \$35. Not bad . . . not bad at all. Let me read this description sheet to refresh my memory; I knew these little rigs once but some of the details escape me now. Uh, huh, crystal control for your novice start and when you get to be a General you can build or buy a VFO to plug into it; fine. Also, if you want to take a crack at radiophone, a simple little modulator is not hard to build for a rig of this power. The circuit is conventional, the keying is clean and it has band switching . . . no

plug-in coils to monkey with. Here's something too that I bet you overlooked on WRL's list; your Dad won't have to put up as much dough as he thinks . . . you get a 10% discount if you don't offer a trade-in to partly pay for it; costs you only \$31.50 that way!" "Gee Gramps, I *did* miss that . . . it sounds better yet . . . what do you say?" FN took a couple of deep drags on his pipe, removed it from his mouth and said, "OK Judy; I'll give you a green light on that one; don't see how you can go wrong. I'd move fast though for someone may snap it up if you delay. If WRL pronounces it OK, that's good enough for me and they're not very far from here . . . just over in Iowa . . . so your parcel post cost won't be very great. Let's talk to your Dad now".

Bubbling over with excitement, Judy shouted to her Father, "Wait up Dad; we've got something to talk to you about". Tom Mansfield, who was examining a new colt in the corral, turned and smiled as he saw Judy's eager approach. "I know," he said, "and I'll bet it'll cost me money". "Remember Dad, you said you'd pay off what I needed if FN said I should get that transmitter. Well he did and it's not going to cost you so much either; we get 10% off as long as we don't have anything to trade in on it". Laughingly Tom turned to FN and

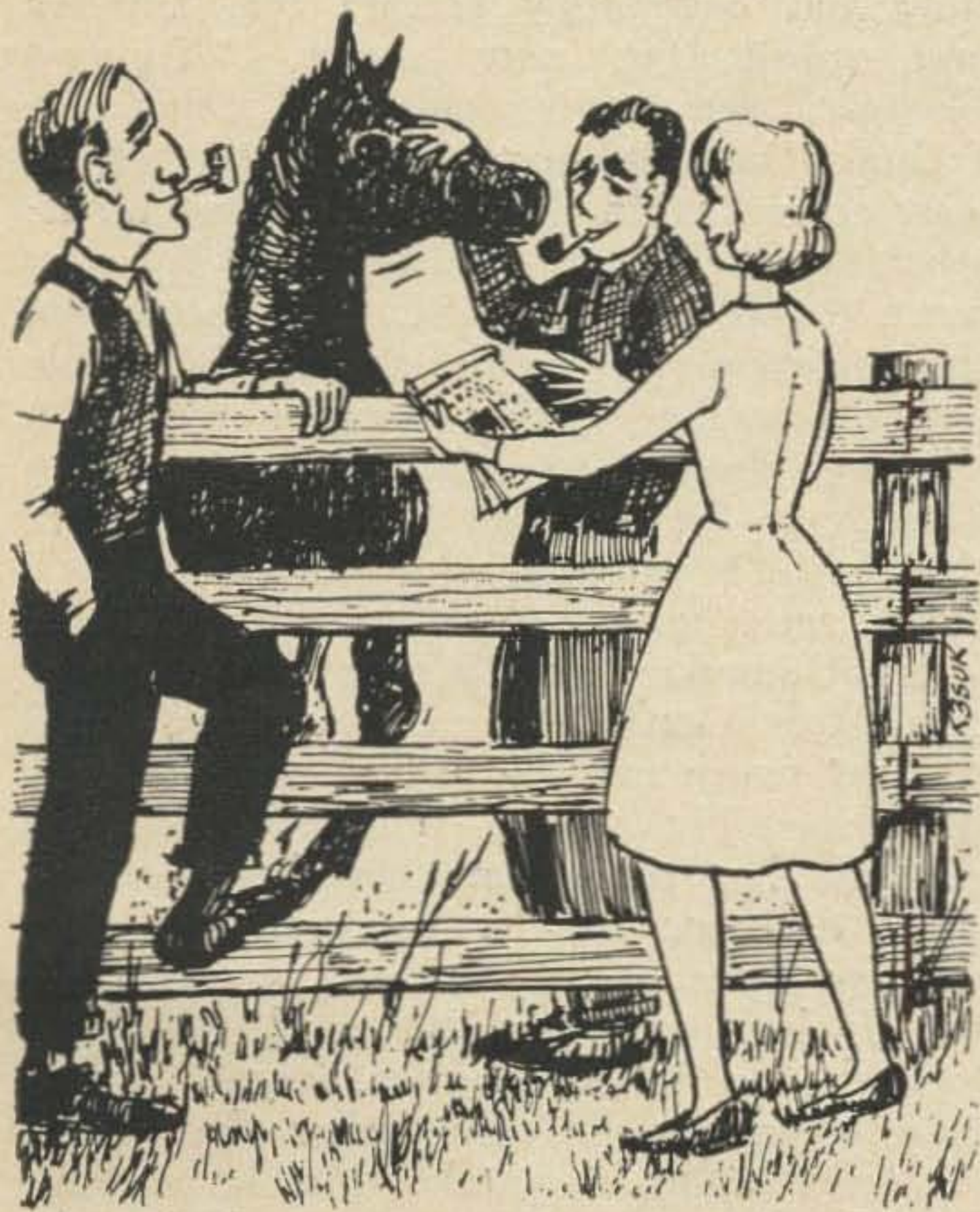

we've got something to talk to you about . . ."



The neat little re-conditioned transmitter which Judy chose for her initial station.

said, "I knew you'd scheme between the two of you to take me to the cleaners but I'm a man o' my word you know. You think it's OK for her to buy this little transmitter then, eh FN?" "Yes, Tom", his Dad replied, "it's a good little rig made by a well-known and reliable manufacturer and offered by an equally reliable mail order firm. It's really a good buy and I'd say go for it. "OK" replied Tom, "we'll make out an order tonight Judy and I'll mail it in town first thing in the morning." With stars in her eyes Judy exclaimed, "Well, that takes care of me; I beat Joe to it anyway . . . wonder what he'll come up with".

The morning mail brought Judy's FCC examination papers to FN and he phoned to let her know that he had received them. Naturally anxious to get her license as soon as possible Judy asked, "Gramps, would it be OK if I peddled over this afternoon and you gave me the exam?". FN chuckled, realizing her eagerness but replied, "I'm sorry Judy but I've got a man coming out to figure an irrigation deal for me this afternoon. I'll be free in the morning though and you'll be fresher; why don't you come out then?" "OK Gramps, I'll be there at 9 o'clock . . . OK?". FN assured her that it was and then asked, "Do you know if Larry got Joe's papers this morning too?" "Oh yes" replied Judy, "I nearly forgot; Joe phoned and said Larry called him and said he had his papers now but he is going to examine Joe right at home this evening; Larry works weekdays you know until college starts". "Fine" said FN, "we'll each examine our own candidates separately then; you be out here in the morning and I'll put you through the hurdles." "OK Gramps, bye-bye and '73' "

★ SALE ★

MODEL 400 AND 501

TV CAMERAS

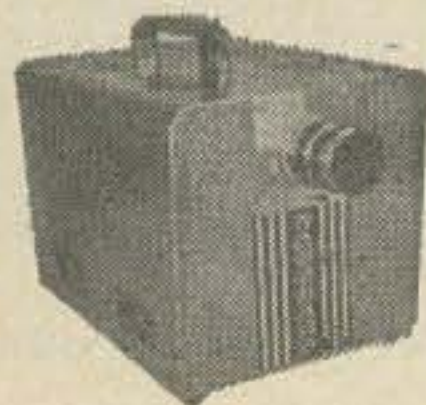

From \$125.00

Each month we have a limited quantity of used TV cameras which we make available to hams at greatly reduced prices. Some cameras were used as demonstrators by our salesmen; others like our Model 400 were traded in for our 501. A few are back from being rented out on special temporary surveillance jobs. Some were modified slightly to fit the particular job and may have extra holes or vary slightly in appearance from the photos. All have been checked out and are guaranteed for 90 days. Complete with vidicon and lens.

Model 400 sale price \$125.00 FOB Hollis

Model 501 sale price \$160.00 FOB Hollis

These used cameras are for sale to radio amateurs only. Include call letters with your order.

DON'T DELAY. ONLY A FEW ARE AVAILABLE EACH MONTH.

For specifications on the 501 see our other ad elsewhere in this issue. For specifications on the 400 see 1965 issues of 73.

VANGUARD LABS

196-23 Jamaica Ave.

Hollis, N. Y. 11423

and Judy hung up.

When she arrived next morning, FN told her that Joe had called and said that Larry had examined him the previous evening. Joe hadn't found it too difficult and Larry told him that while he could not give him an official opinion it appeared to him that Joe had made the required percentage nicely and probably with some to spare; the real decision would come from FCC of course. Joe had also discussed kits with FN and seemed to have more or less settled on one and would be out the next day to talk with him about it.

FN, complying with the instructions on the examination paper envelope, opened it and passed the contents to Judy, asking her first to read the envelope instructions which were directed to the applicant and to follow them to the letter. After doing so, Judy carefully read over the questions, pondering a few of them with furrowed brow and then carefully marked off what she considered the correct answer on the formal answer sheet supplied. She had completed all of the answers in little more than half an hour while FN read the morning paper and smoked his faithful briar. Being a thorough-going youngster, Judy carefully went over all of her answers, pausing at two points to do a bit of deep thinking and then carefully and *completely* erasing two answers and substituting new marks. "There Gramps," she finally announced, "that's it; I think I've got most of them correct, at least according to the way I understand it; what now?" "That's all of it girl; the rest is up to me and the FCC. I have to sign the statement on the back, stick the whole business in the envelope you brought with you and drop it into the post-office when I go down for the mail this evening. From then on it's waiting game for you. You'll either get a notice of failure from FCC or a brand-spankin' new license and a set of call letters. Don't be in a dither though until you get word; may be in two weeks, maybe three, possibly six or eight. The FCC is efficient but remember they have lots of other divisions besides amateur and they are far from overstaffed. It is anybody's guess when you'll get the word. *Don't* try to rush 'em by sending an inquiry; you'll more than likely delay rather than help, whatever action they take. Just be patient; FCC has just recently mechanized their license processing which should speed up the

issues but you'll not be a licensed operator until you get that all-important little card in the mail. Meanwhile, you're waiting for your transmitter to arrive too so why don't you just go play with your dolls or make mud pies or whatever you girls do to pass time!" "Oh Gramps, "dolls . . . mud-pies . . . what you think . . . I'm still five years old?" she laughed. "Don't worry, between Dad and Mom they'll dream up enough chores around home to keep me occupied. What do *you* think I did with the exam though?" "Well Judy," FN replied, "I'll give it the once-over but just as Larry told Joe, there can be nothing official about what I say . . . all I can do is express a *personal* opinion; the FCC will give you the answer straight across the board; just a minute now". FN then carefully ran his eyes down the question sheet mentally checking each answer as he went. In a few minutes he said, "I'm going to say that I'm pretty sure you'll make it. There were a couple of places where I think you could have done a bit better but to me it appears that you have more than an adequate number of correct answers to make the grade. We'll just seal it up now so I can mail it this evening and wash our hands of the whole biz till the magic word arrives". Judy was already atingle with hopeful anticipation as she mounted her bike and peddled swiftly homeward.

The next morning Joe appeared at FN's place ready to discuss his thoughts on a transmitter. He lost no time in announcing, "FN, I think I've found it. The more I studied



"... What do you think about it, FN?"

AMI-TRON

R. F. TOROID KIT: Two iron-powder cores, wire, LCF nomograph, inductance chart and application notes. This kit is very popular with experimenters and R & D Engineers.	\$1.50
KILOWATT BALUN KIT: 2" Core and #14 wire. Illustrated inst. sheet. Works from 80 thru 6 Meters. Ideal for correcting coax cable imbalance in Ham and CB rigs. 4:1 or 1:1 ratio.	\$5.00
FERRITE BEADS: Modern Slip-On ferromagnetic chokes. Recommended for R. F. Decoupling, Parasitic Suppression, R. F. Shielding. Excellent for treating stubborn forms of RFI and TVI. Package of 12 Beads plus Spec Sheet.	\$2.00
BURR-QUIK Swivel Action deburring tool set. Anodized chuck handle and 3 different tool steel cutting blades. If you own an electric drill you need this fine tool.	\$3.25
E-Z ETCH PC KIT #140: Contains one 4" x 6" copper/glass laminate board, one page of Rub-On resist, one etchant package and complete instructions.	\$3.45
E-Z ETCH PC KIT #240: Contains two 4" x 6" copper/glass boards, three pages of resist, two etchant packages and instructions.	\$5.95
E-Z ETCH Circuit Board: One 4" x 6" Military Quality copper/fiberglass circuit laminate. 2ounce Foil.	\$1.00
E-Z ETCH Etchant: Etching crystals in plastic etching bag. Makes one pint. This will etch a 4" x 6" 2 Oz. circuit board.	\$1.00
E-Z ETCH Rub-On resist: Three 4" x 6" pages of PC images. One sheet with 1/8" width lines and two sheets with 1/16" lines. This resist works with all types of etchant.	\$2.00
AMI-CAL Ward Set: Over 1000 'dry transfer' words and symbols. For panels, etc. Looks like silk screen work when applied. Available with Black or White lettering.	\$2.95

Many of these products are available at your local electronics store. When ordering direct from AMI-TRON, please allow enough payment for packing and postage. We refund any overpayment. California customers please add 4% Sales Tax to all prices. As a service to Mail Order customers all over the world, AMI-TRON offers a wide selection of R. F. Toroid Cores. We invite you to write for our latest Toroid Core Catalog.

*AMI-TRON Associates • 9033 OTSEGO STREET • NORTH HOLLYWOOD, CALIF. 91607

WE BUY . . .
TUBES FOR CASH
UNITY ELECTRONICS
 107 Trumbull St., ELIZABETH, N.J. 201 - FL 1-4200

SPACE AGE KEYS

Only
\$67.50



- Planar epitaxial *integrated circuits* for reliability. No tubes—No separate transistors.
- Precision feather-touch key *built-in*.
- Fully digital—Dot-dash ratio always perfect.
- No polarity problems—Floating contacts switch $\pm 300\text{-V}$ @ 100-ma.
- Rugged solid construction—will not walk.
- Send QSL or postcard for free brochure.

PALOMAR ENGINEERS
 BOX 455, ESCONDIDO, CAL. 92025



**CAMP ALBERT BUTLER INVITES
HAM RADIO ENTHUSIASTS OF ALL AGES
TO TRY FOR YOUR
GENERAL CLASS TICKET
THIS SUMMER! OUR 8th SEASON**

**NOVICES, TECHNICIANS AND C.B.'ers
ESPECIALLY TAKE NOTE**

This co-ed Amateur Radio Camp, Y.M.C.A. owned and operated, can accommodate 60 campers. There is no age limit. We have had campers from 7 through 74 years of age. It is very helpful if you can copy 5wpm or have a Novice or Technician ticket, but it is not necessary. Time is divided between radio classes in code and theory and the usual camp activities, such as swimming, archery, riflery, hiking, etc. Gold privileges are included at the beautiful New River Country Club course. Entire staff consists of licensed hams who are instructors in electrical engineering in some of our finest colleges and universities. Camp opens August 5 and closes August 19. Tuition of \$175.00 includes all camp expenses: room, meals, notebooks, textbooks, and insurance. Send for our brochure.

C. L. Peters, K4DNJ

General Secretary

Gilvin Roth Y.M.C.A., Elkin, North Carolina

Please send me the Booklet and Application Blank for the Camp Albert Butler Radio Session.

NAME
CALL
ADDRESS
CITY STATE ZIP

SPRING DEMO SPECIAL

SAVE SAVE SAVE

Drake TR4	\$489	Swan 250	\$289
Drake R4A	\$330	Ham/M w/c	\$ 95
Drake TX4	\$330	D104 Mike	\$ 24
Swan 350	\$340	Heights Towers	
Galaxy MK2	\$340	40% off list	
Galaxy 2000	\$395	Mosley TA33	\$100

See Bill Ogg WA9RMO or Dave Clarke WA9RFK

EVANSVILLE AMATEUR RADIO SUPPLY

1306 E. Division St., (812) 422-4551
Evansville, Indiana 47717

MACO QUAD — FOR 10-15-20

Uses SHAKESPEARE FIBERGLAS WONDER-SHAFT® Optimum spacing—.15 on all bands—
(1) RG-8/U quad complete—\$99.95—WRITE FOR FREE BROCHURE

Maco Products

915 E. Cornell Ave., Springfield, Illinois
See our previous ads in April, May and June 1966 73's.

RADIO TELETYPE EQUIPMENT

TELETYPE MODELS 28 ASR, 28 KSR, 28 LPR, 28 LARP, 28 LXD, 28 LBXD1, 14, 15, 19, Page printers, Perforators, Reperforators, Transmitter-distributors, Polar Relays, Collins Receivers 51J-3, R-388, 51J-4, R-390A. Hammarlund SP-600JX. Frequency Shift Converters.

ALLTRONICS-HOWARD CO.

Box 19, Boston, Mass 02101 Tel: 617-742-0048

the catalogs the more I kept coming back to the little Knight-Kit T-60. Lots of kits were pretty keen deals but the Knight-Kit seemed to hit me just about right. Larry says I can't go wrong on that . . . what you think about it?" "Well son, Larry is right; the T-60 is a neat little package and not too difficult to put together and get on the air. You know of course that it also has modulation in it which involves a bit more work than just a straight CW kit assembly but not at all beyond you. You'll probably want to work a bit of phone after you get your General license so you're that much ahead. About all you'll need to add when you get the higher grade ticket is a VFO and you can pick one up at a modest cost or you can build one if you're so inclined. I'll go along with you on the T-60 and I'm sure you'll find it a dandy little rig. I'm sure you won't have any trouble putting it together and wiring it but if you need any help, drag it out here and we'll both get on it". "Thanks FN," replied Joe, "but you've already done a lot for us kids and Larry has offered to give me a hand if I need it so I think I'll tackle it on my own and bring it out for you to look over and test when I'm through with it. The little thing is just within my budget so I'm going to order it from Allied tonight as long as you've OK'd it. It only has to come from Chicago so I should have it in a week or less". "OK lad, go ahead and buy it; I've seen and tested quite a few of those little rigs and if you do a reasonably good job in putting it together and follow the book right to the dot, you'll have yourself a nice piece of gear. Like I told Judy, I'd like both you kids to let me know two things; tell me when you get your transmitters and let me know when you hear from FCC. You probably will both be ready to go on the air by the time your license is in your hands. Larry told you I suppose, that it takes more than a few days to hear from FCC?" "Yeah, FN; waiting will be a bit rough but nothing we can do about it; we'll let you know when word from FCC and our transmitters shows up". So saying. Joe hopped his Honda and took off, stopping at Judy's on his way home to compare examination reactions. As their session lasted all afternoon, obviously it was not *entirely* concerned with electronics!

W7OE

Next installment: Judy and Joe reach the top of the novice ladder!

Ham Public Service and Broadcast Stations

Ross Sheldon
3313 Avery S.W.
Huntsville, Alabama 35805

In any major town there is certain to be a broadcast station specializing in spot news. Such stations have both phone patch and phone recording equipment. They welcome phoned-in tips and recorded news stories.

Here in Huntsville, Alabama, as a part of the Huntsville Amateur Radio Clubs program of public relations and public service, spot broadcasts giving hurricane news picked up by ham radio are broadcast regularly during the hurricane season. If other clubs decide to do this, here are some tips:

Care should be taken to confine broadcasts to specific hurricane information, omitting names and reports of damage, injuries and other such "scare" items. Such items are usually exaggerated and often completely false. Leave that type information to the news gathering agencies.

Following is the script of one of the broadcasts made here, which others may use as a guide:

(BACKGROUND MORSE CODE ON RECEIVER LOUD THEN FADE)

"This is Ross Sheldon, an amateur radio operator, relaying to radio station WAAY the latest hurricane Alma information as received by amateur radio from amateurs in the Carribean area.

"The amateurs from Puerto Rico to the Canal Zone and along our gulf coast report that Hurricane Alma is now 230 miles SSW of Ft. Myers, moving at 16 miles per hour in a northerly direction. It should pass abreast of Ft. Myers, moving at 16 miles per hour in given as to when or where it will strike the central gulf coast.

"Winds at the center are 110 mph with gale force winds spreading out 250 miles in all directions.

"Shortwave listeners wishing to hear up-to-the-minute information on the hurricane should tune to the amateur radio hurricane net now in operation on 14,325 kHz where tape recorded weather bureau reports and other hurricane information is being relayed to isolated areas by amateur stations engaged in hurricane duty.

"This is amateur radio station K4HKD re-

turning you to WAAY."

(BACKGROUND CODE UP AND OUT)

Note the favorable publicity given amateur radio by these broadcasts which are a public service to the people in the threatened area and to relatives and property owners outside the area.

To get information, tune to, but do NOT transmit on, the hurricane net frequencies. Relay stations will repeat weather bulletins several times, so you do NOT have to ask for fills. PLEASE DO NOT TRANSMIT!! Note the stated time of the weather bulletin. If it is an hour old and the hurricane is traveling 20 mph, the center is obviously 20 miles farther along. Correct for this in your report. WARNING! Do NOT forecast the eventual route the hurricane will take. Hurricanes change direction quickly and unpredictably, hence even the weather bureau will not predict the complete path. Damage suits from those claiming the wrong forecast lulled them into a false sense of security are possible. Just stick to the facts and DON'T SPECULATE OR TRY TO INTERPRET.

Lay your groundwork in advance by finding out which stations will accept information by amateur radio. (Showing them this article might be a good idea.) Ask whether they just want the information, or wish to tape broadcasts by phone. If they have a teletype which gives them the same information you hear the hams passing on the air they will be interested primarily in the "color" of the spot broadcast from a ham, plus whatever additional information you may pick up.

Type up a complete broadcast, leaving blanks to fill in with the changing data in pencil. (distance and direction from what city, wind velocity, direction and speed of travel, etc.). Read it aloud at least twice at newscast speed to see how it sounds and times before calling the station to record the tape. The shorter the tape, the better. I aim for 50 seconds with a minimum of 30 and a maximum of 90 seconds.

It's a public service—and darn good public relations. If you can swing it.

. . . K4HKD

THE R. & C. WILSON COMPANY

THE LM FREQUENCY METER . . . AN UNUSUAL VALUE. Why pay more for the army's version (BC-221) when this will do the same thing, is smaller, and has modulation unit built in? The unit contains an accurate two-frequency oscillator which covers from 125 kHz to 20 MHz or more. The basic frequencies are 125-250 KHz and 2-4 HMz. Calibration charts may be made by simple interpolation according to instructions we will send you if you need them. Power supply requirements are broad: fil. 12 or 24 volts, B+ from 200 to 475 volts according to internal taps. Also contains two internal voltage regulator tubes. Works well on battery or AC power supplies. Let us pick you out a unit from the large stock . . . the sooner the order the more plush the unit. Complete with universal calibration chart . . . \$34.50

NOW . . . A SCOPE AND RECEIVER COUPLED FOR THE MOST EXACTING FREQUENCY CALIBRATIONS!

A receiver which is crystal controlled on 2.5, 5, 10, 15 and 20 MHz allows instant selection of the National Bureau of Standards station WWV on the optimum frequency. Output of the receiver is coupled to a scope which allows a local crystal standard to be set not just to "zero beat", which may be 20 Hz off, but to "zero phase" with the Bureau of Standards. In addition there are filters for the one-second ticks, 440 Hz standard, 600 Hz standard or voice announcements. Rack mounted, 5 inches tall, contains speaker, scope controls, receiver controls, Collins filter, AC power supply and more. Made by Specific Products, model WWVC . . . \$148.95
BUY AN ARC-1 AT THIS LOW PRICE. 100-156 MHz, easily converted for ham use. Lots of space to build in power supply. Uses heterodyne exciter. A single crystal or VFO tunes both transmitter and receiver . . . \$25.00

SAVE YOURSELF ABOUT \$2000 ON A PRECISION FREQUENCY METER.

The Lavois LA-6 meter is a rugged heterodyne-style unit that covers from 100 to 500 MHz with an accuracy of 0.001% or better. It contains a very accurate crystal in a high quality oven for a reference source. Dial read-out is a new style tape dial. Calibration tables and instructions are

built in. Reference frequency is 4 MHz and interpolation frequency is 166 to 340 MHz; modulation frequency is 800 Hz; RF out is 50 microvolts or more; sensitivity in the receive mode is 10,000 microvolts; power required 115/230 volts @ 50 to 1000 Hz. Has full complement of 25 tubes: 6X4W, OA2, OB2, 6BN6, 6BA6, 5814, 12AT7, 6AU6, 6AH6, 6AQ5, and a CR-28/U crystal. NOW REDUCED TO OUR LOWEST PRICE EVER . . . \$445.00

AN ELECTRONIC FAVORITE: DUMONT 340 SCOPE, Universally popular, requires 115 V, 60 Hz, 100 Watts. Tubes: 2-6BK7A, 1-12AT7, 5-12AU7, 1-12AX7, 1-OA2, 1-1X2A, 1-5AQP11, 1-5Y3GT. Fairly recent design and manufacture (about 1955) and are not World War II surplus . . . \$84.50

UNIVERSALLY POPULAR TOP GRADE SCOPE!!! Tektronix 514D is the finest available for this price range! Contains well known features such as DC to 10 MHz operation; scope picture is delayed 1/4 microsecond so that the start of a fast pulse may be viewed; well calibrated as only Tektronix scopes are; gain may be set so that true voltage measurements may be made; sweep speed is widely adjustable; has a flat faced tube, two inputs, internal calibrator and so on. It is said that this unit has the best triggering circuit of any Tektronix ever made. Fine for any type of service shop, industry, school or home lab . . . \$225.00

TOP QUALITY SHORTWAVE RECEIVER, UP TO DATE DESIGN ARR-36 covers high frequency bands, about 2 to 18 MHz, with frequency synthesizing oscillator control and digital tuning systems; uses 45 modern subminiature tubes which are easily replaceable. Weight about 100 lbs. We are selling at this low price because we don't have a manual on this piece of late equipment. Very few have ever been placed on the market, so order now while they last . . . \$295.00

RCA 9 kHz MECHANICAL FILTER, FREQUENCY 300 kHz, resonating capacity is internal; ripple less than .9 dB; 3 dB points 8 to 9 kHz; 50 dB points 17 KHz; coil resistance about 18 ohms. Perfect for use where 10 kHz channels are used such as CB band. Cuts out the interference from adjacent channels and crud from wide selectivity skirts. . . \$5.95

Stamped, self-addressed envelope brings latest LIST. Our guarantee: If you are not satisfied, return the equipment within 10 days in its original condition, unmodified, and receive your full money back. Simply pay only the shipping charges. (What could be more fair than that?) We buy and sell quality surplus.

THE R. & C. WILSON COMPANY

Box 393, Littleton, Colorado 80120 Phone 303-798-2629

Gus: Part 24

At the end of the last chapter I had just entered the Union of South Africa from Bechuaniland, one of the most desolate spots I have ever seen—or at least the portion I saw. At least the good roads I found in South Africa made the rattley old bus a lot easier to ride on and I could again open my mouth without fear of my upper plate falling out, and *this was good!*

We stopped at the little Customs House at the border and in we all went, me and those genuine Africans (I was the only European on the bus, and I did look sort of “out of place”). I guess I had even soaked up some of the usual “aroma” that the Africans have. I noticed that the Customs Officials did not get too close to me for some reason; I guess that “aroma” caused it. I guess he had me tagged as some crazy American, poor as a church mouse, riding that African bus (he had me tagged right too). He must have figured that it was not possible for someone like me to have anything of real value since the questions he asked went something like this: where were you born, what nationality and color were my mother and father, (maybe I had gotten a little suntan by this time making me look somewhat off-color to him), did I have any fire arms, any ammunition, any transistor radios, or political affiliations and with whom? He made a few tick marks on the customs forms and said sign here—this I did gladly. As there was no inspection of anything on the bus, the Africans and I piled back on and away we went for what they call Jo-burg (Johannesburg to you fellows).

I was met by ZS6IF, Lamberth; everything was loaded in his car, and away we went for his QTH. I headed to the shower to change my color and smell; I really needed that shower and when I emerged from it I felt like a changed man. Boy, it was wonderful! We went to Lamberth's shack to the rear

of his garage. Lamberth is a Dutchman who QSYed to ZS land some years ago; I think he said about 1955 or so. By the time I arrived he had changed 100% from being a Dutchman to a South African.

His was just about the cleanest, smoothest, slickest ham shack I have ever seen. Everything was home built and I mean beautifully built. Everything looked as if it was just finished, cleaned up and polished yesterday—it might have been too. Lamberth was one of those typically thorough Dutchmen in his job and you could see it was finished by a master craftsman right down to each screw being tightened up so the screw slots were even lined up; each solder connection was one of the wiped jobs, the kind most hams don't have the time or inclination for anymore. His keyer, key lever, etc. were all home constructed. It made me glad to know that there are fellows in the ham world who still go to all the pain and strain to do such masterful work as Lamberth had done there.

We sat in his ham shack and had one of those fine business eye-ball QSO's—the kind any of you fellows would like to have with some of the DX stations in distant parts of the world. He wanted to know about any number of W/K DXers he had heard and been working all these years and all about their rigs. He wanted to know the type of bottles, plate voltage, and current they used; also, all about the kinds of antennas the top boys were using in the States. Luckily, I think I personally knew every fellow he asked me about and I even knew something about many of their rigs. I could never be sure of the exact plate voltage or current they ran; most of them did use a kilowatt more or less when I visited them, but at that time nothing rare was coming through—you might say the going was not on the rough side at that moment

MESHNA SURPLUS BARGAINS

REFLEX CAMERA American made, takes 16 pics 127 film\$1.50

GEIGER COUNTER complete w/meter, 550 volt transistor supply, less probe tube. #410....\$4.00

ANALOG TIMER w/sync motor, DC motor, 8 hr. input to 10K output via gear train. Made by Veeder Root. #VR\$1.50

POLICE-FIRE converters. Kit when wired makes your car radio into short wave receiver. High band 100-200 mc or low band 25-100 mc. Either kit \$5.00 or both kits\$9.00

FET transistors w/spec sheets. "N" channel junction FET\$1.00 ea 6/\$5.00

240 AMP SILICON DIODES 100 PIV\$5.00

MICROAMP METER, brand new 100 microamps GE. #435 \$1.50

METER w/thermocouple & sun cell demonstrates electricity from sun or heat. #435K\$3.00

COMPUTER PC Salvage Boards 6/\$1.00

IC INTEGRATED CIRCUITS TO-85 flat pack with special sheet.....\$1.00 ea. 2 for \$1.75

NI-CAD battery cell 1.25 volt 6 amp hours\$2.00

POLAROID FILTER, demonstrate polarizing theories 2 sheets 5x5 inch\$1.00

BATTERY CHARGER kit, 3 amps 6 & 12 volt output. #207 \$4.00

FAIRCHILD CAMERA F-56, 20 inch focal length. In trunk w/film mags, cables, viewfinder, etc. Manual or electric. Package weighs 150 lbs., cost Gov't \$2,500.00 each.\$100.00

POWER SUPPLY KIT output 6-12-24 volts DC 6 amps from 115 volt house current. Used for powering surplus gear, plating, charging....#340 12.00

GUN CAMERA, standard Air Force AN-6. Takes 50 ft. 16 mm. XInt. #447\$17.50

MEMORY FRAMES, wired core frames from computers, xInt condition, w/specs
180 core \$4.00 * 1,000 core \$10.00
 4096 core \$12.50 * 8192 core \$15.00

SNIPERSCOPE M-3, complete, operational, less battery. See in dark\$225.00

LENS KIT, 12 Eastman Kodak cells with experimenters sheet, #222\$1.00

PUSH BUTTON tuner assembly from Car Radios w/osc.— RF—Ant coils2/\$1.00

REED SWITCHES, triggered by magnet or coil, used in burglar alarms6/\$1.00

SNOOPERSCOPE TUBE see in dark, late model 6032 w/spec sheet\$6.50

SUN CELL, make electricity from the sun, jumbo size w/leads & sheet75¢

FIRE ALARM HEAT SENSOR, any setting from 50 to 300 F. Make your own alarm system for fire alert.75¢ ea. 6/\$3.00

EXPERIMENTERS RELAY package, 4 relays with instructions using as RF noise gen., telephone ring-blink indicator, AC buzzer.....#418 1.00

The above listing shows only a few of the hundreds of bargains available in our 84 page catalog crammed with fantastic & unusual electronic & optical equipment purchased from govt. and other sources. We have a most unusual & varied stock for the photo-bug, R & D lab, amateur radio, etc.

All material shipped FOB Lynn, Mass. (you pay shipping). Minimum order \$5.00

JOHN MESHNA JR.
 19 ALLERTON ST. LYNN, MASS. 01904

29 VOLT 50 AMP DC REGULATED

Operate on 115 volt 60 cycle input with output of 29 volts DC 50 amps filtered and regulated. Solid state components with standard 19 inch rack panel mounting. Excellent condition. Shipping wgt. 175 lbs.\$75.00

29 VOLTS DC 35 AMPS REGULATED

Same type power supply as above with lesser output of 35 amps.\$65.00

1600 VOLTS DC 1.8 AMPS REGULATED

Solid state circuitry. 115 volt 60 cycle input, rack panel mounting, filtered with 0.5% ripple. Only a few of these on hand. Shipping wgt. 175 lbs.\$75.00

5 VOLT FILAMENT XFMR 12 KV INSULATED

Unused government surplus. 120 volt 60 cycle input with 2 isolated secondaries. 5.1 volt at 43 amps and 5.1 volts at 14.5 amps. Use them back to back for a high powered line isolating transformer.\$5.00
 4X250 TUBE, used, OK\$5.00
 4X250 SOCKET w/chimney & plate ring\$4.00

One only . . . COLLINS KINEPLEX RCVR/XMTR TE-202F-5 & TE-202E-1. \$200 takes all. Don't have any info on this but it's racks of transistorized equipment & with power supplies. If you know what it is you can steal it for\$200.00

IBM WIRED MEMORY FRAMES

Removed from high priced computers. ExInt condition.
 4,000 core\$12.50
 8,000 core\$15.00
 16,384 core\$35.00

LIGHT ACTIVATED SCR (LASCR)

Function of an SCR triggered by light thru the glass window top of the TO-18 unit. Various applications in tape readers, character recognition, logic circuitry, relay replacement, night lighter brain. Offered at a fraction of list price . . . only small quantity available.

25	PIV	\$.75	200	PIV	\$2.30
50		1.00	300		2.70
75		1.35	400		3.20
100		1.60	500		4.00
150		2.00	Under 25 V		.50

New winter catalog hot-off-the-press. We keep no mailing lists. Send 25c for the best 80 page catalog we have ever printed. More bargains than ever before.

—so just one kilowatt. You can't be too sure of what might happen to the voltage and currents later on!

Lamberth and I sat there and yakked away, drinking some wonderful Dutch coffee his wife brought in to us every now and then. Lamberth still had some of that Dutch accent and his wife's accent was very strong. His children spoke perfect English and I think all of them spoke the native language they call Afrikans, which is a combination (I think) of Dutch, English, Flemish and maybe even a few other European tongues mixed with some native South African dialects. They say it's a very difficult language to learn. I don't know because I don't think I ever learned more than two or three words of this complicated, tongue-twisting way to speak.

The next morning we went out in his back yard and looked over his beam—I think it was a quad. He showed me the moon bounce dish he was constructing—it was a real beauty, absolutely perfectly built. I hear now that Lamberth's interest is moon-bounce or tracking satellites and other UHF activity; since I have not been hearing him on the bands, I suppose this may be true.

Lamberth and his wife were very FB hosts to me. Lamberth drove me around Jo-burg quite a bit, showing me the various sights there. One of the oddest things to be seen are those huge mountains of earth in and around Jo-burg. We stopped beside one of them and I got out of the car to look at it closely. It seemed as if it was almost as hard as cement—not a blade of grass was seen growing on these hills. I asked Lamberth why this was and he told me the chemical process they used to extract the gold made it impossible for anything to grow.

I talked to a ZS station a few years after my visit there and he told me that some chemist had found that it was now possible for grass to be grown on this rock by some kind of treatment to the soil. I think he also said that a special grass seed was used to seed the tops of some of these mounds. He told me that someone had built a drive-in theatre on top of one of them, so I I guess they won't be absolutely useless from now on.

Lamberth drove me out to spend the night with Brian, ZS6ANE (America North East as he calls it). He lived all the way across town from Lamberth. Brian is a young married chap with one little girl who was about

3 years old. He is a very likeable fellow with a wonderful wife. We went to his hamshack and sat up quite late having a good eyeball QSO; there were even Cokes in the Fridge, which made the stay with them that much better. The next few days were spent visiting a number of ZS6 fellows and seeing their ham shacks. All were very well equipped and had good antennas; they all seemed to be good operators.

Oh yes, Lamberth asked me if I had declared my gear to Customs when I had entered the country; I told him I had not. That's when he said that it was going to be very difficult trying to get it out of the country when I was ready to depart. I told him I had never had any trouble getting things out—getting them in yes, but not getting them out. He said, "Well, you have never tried getting things out of South Africa yet." I did find a solution to this problem later on but that's another story and will be dealt with in full at the point where it enters the story. It worked out quite well in the end.

I really got to see some of the country around Johannesburg, spending about 5 or 6 days there, sort of biding my time for the departure date of the ship to Tristan, Gough and Bouvet Island. I found I had a few more days to spend between Jo-burg and Capetown so I got in touch with Sid, ZS4MG, in Kroonstaid (about one-third the distance from Jo-burg to Capetown). I gave him a DX phone call and made arrangements for him to meet me when I arrived there via the train from Jo-burg.

The train arrived in Kroonstaid about 1 AM and there was Sid at the railway station in his little car—with his little goatee and all. When he arrived at his home his very sweet wife was still up—she even had a big supper on the table for me. I could see immediately that my stay with them was going to be one of the stops where I could pull off my shoes, roll up my pants, and dive into the Fridge when I wanted to.

They told me to make myself at home while there and that's exactly what I did, every minute of my stay. I was even allowed to operate from his station—up to then I had not done very much operating from ZS land. I had a number of FB rag chews with Gus Watchers, as some of them called themselves. I told them how things were progressing towards my forthcoming trip to the islands. I always believe in keeping the

"Your Friendly Supplier"

FROM STOCK!

OFFERS

A COMPLETE SELECTION OF ANTENNAS AND BEAMS: BOTH FIXED STATION & MOBILE, PLUS ALL ACCESSORIES . . .

Cush Craft

Mosley *hy-gain*

HI-PAR

WATERS

Webster

NEW-TRONICS

SWANTENNA
BY SWAN

antenna
specialists

W2AU QUADS

W2AU BALUNS

WE ALSO HANDLE
Tristao **CRANK-UP TOWERS**

CHECK WITH US FOR YOUR REQUIREMENTS!

TIME PAYMENT PLAN AVAILABLE

WE MAINTAIN THE LARGEST STOCK OF USED EQUIPMENT IN THE NORTHEAST
WRITE FOR LATEST COMPLETE LIST

Evans RADIO

P. O. BOX 312

CONCORD, N. H. 03301

FONE 603-225-3358



SMALL BUT POWERFUL

**DON'T BE FOOLED BY
IMITATIONS!**

Get the **ORIGINAL**

SYDMUR SOLID STATE "CD" IGNITION SYSTEM!

High Quality Components used throughout. Fiberglass Printed Circuit Board. Unitized Construction. Simplified Kit Assembly. Reduces ignition interference.

ORDER yours TODAY!

COMPAC Assembled \$34.75*

COMPAC KIT 24.95*

* Add 75c for mailing and handling
N.Y. State Residents add Sales Tax.

SYDMUR ELECTRONICS SPECIALTIES

1268 E. 12th St.

Brooklyn, N.Y. 11230

Go Commercial - - -

That's right. Get your FCC commercial operator's license, and then work, at good pay, in your "hobby" field—radio and electronics. We prepare you by **correspondence**, under our "get your license or your money back" warranty. Get full details in our free "FCC License Course Brochure". Write:

Grantham School of Electronics, Dept. R.
1505 N. Western Ave., Hollywood, Calif. 90027

fellows back home well informed so they can be on the air when you arrive at a rare country.

I knew all about some of the fellows taking days off from their work to contact me. I knew many of them would want to know which day they should play sick. I had even heard of one of them flying back to his home in Ohio from his Texas vacation spot just to work a new one. There is, I am told, a doctor in NYC who will leave his patient on the examination table when one of the fellows gave him the land-line buzz that I was on the air. Bill Eitel of Eimac told me that so many of his crew got sick on the first day I landed at some spot and got going, that their production was very drastically cut! Of course, I think he was pulling my leg.

I can't see any real reason why, under normal conditions, a fellow can't tell you where and when he will be at such and such a spot, provided he knows when it will be. You go on a DXpedition to work as many fellows as possible and this is one way to make sure you get plenty of callers when you get going from a "gud one". Sometimes I know it's not a good policy to announce too far in advance where you are planning on going; there is the possibility of some eager beaver beating you there or maybe getting telegrams or air mail letters to London to stop you. Under these circumstances it's always best to play it cool and keep your mouth shut. I learned this the hard way on the Chagos trip. This might explain why Don Miller stays real quiet most of the time as to where he is going or planning on going.

Sid had a very nice peach orchard right in his back yard, the peaches were about one to two months from being fully ripe, and that's when I told him and his wife I most certainly would stop by and see them on my return from the islands. I told them about my being from the part of the USA where peaches and watermelons grew the best and how I loved to wrap my lips around peaches and whipped cream (um umm). He said he would hold a few treefuls just for me to eat upon my return.

I sure hated to leave Kroonstaid with all that fine home cooking and the real friendship that both of them extended to me, but I kept looking at the calendar and saw "D" day for the ships departure from Capetown creeping up on me.

Late one evening I boarded the train for Capetown; Sid and his wife and daughter saw me off, and away I was for Capetown. A really smooth ride all the way down. Those South African trains are very plush and smooth riding and the food in the dining cars is very good and reasonably priced. The cost of the fare was reasonable too. Arriving in the vicinity of Capetown at sunrise the next morning I could see that it was quite hilly around the country and city.

Marge and Jack—ZSIRM and ZSIOU—met me at the railway station. They had the mayor of the city along with them, and after a very fine welcome, they insisted we stop at a cold drink bar for a Coke (it took practically no convincing, I must say). As usual when we sat down and ordered the drinks, (we all ordered Cokes) I told the waitress to be sure to bring mine in the bottle, please. She said OK, and as is usual, she brought it to me in a glass.

I refused the drink and told her I wanted it in the bottle; with a half frown she then brought me another, this time in the bottle. The mayor said, "There is no difference," and that's when I said, "Oh, yes there is, I am a connoisseur of Cokes, I know when they are best." He and Jack and Marge had theirs in a glass, then they all ordered another Coke in the bottle. Right there in the drink bar they had a sip and smack test of Cokes—they would sip a little from their glass, then take a swig from the bottle; after a little of this testing all three decided that there is a difference. They all said it was much better directly from the bottle!

If I did nothing else in South Africa, I converted three people to drinking Cokes the right way—directly from the bottle! After this little episode the mayor departed, I guess for his office, and Jack, Marge and I departed for The Strand where they lived in an upstairs apartment overlooking the beach. The Strand of Capetown is a beach-side resort area, a sort of holiday spot, where everyone goes on the week ends to swim, fish, golf, etc. Marge works in a beauty parlor and Jack sells insurance. They are not in the wealthy class at all; they are regular down to earth kind of people and their's is not a fancy apartment. They had held a bedroom especially reserved for me, and their Fridge was jammed full of Cokes, fresh figs, Cape grapes, cantelopes, watermelons, and other goodies.

QUAD AND BEAM BREAKTHRU

QUADS: PROVEN SENSATIONAL! All metal (except spacing insulator dowels); full size; two element; absolutely complete with steel boom; all hardware; wire and fittings; terrific gain and directivity; one man installation; no bamboo or fibreglass; all quads use single 52 ohm coaxial feedline: 10-15-20 Quad, \$35; 15-20 Quad, \$32; 10-15 Quad, \$30; 20 Meter Quad, \$25; 15 Meter Quad, \$24; 10 Meter Quad, \$23.

BEAMS: new complete with boom and hardware; SWR 1:1; handles 5 KW; adjustable entire band; 7/8" and 1" alum. alloy tubing; single coaxial feedline:

4 EI 20	\$32.*	2 EI 15	\$12.
3 EI 20	22.*	6 EI 10	28.*
2 EI 20	16.	4 EI 10	18.
5 EI 15	28.*	10 EI 6	32.*
4 EI 15	25.*	4 EI 6	15.
3 EI 15	16.	*Has 20' steel boom	

ALL BAND VERTICAL V80 (6 thru 80)\$16.95

ALL BAND VERTICAL V160 (6 thru 160) 18.95

Remit with order; shipped charges collect.

GOTHAM, 1805 Purdy Ave., Dept. 73, Miami Beach, Fla. 33139

GUARANTEED RECONDITIONED



HAM GEAR

Phone: (415)
DI 2-5757

ELECTRONICS

WRITE NOW
FOR MONTHLY
FLYER.

999 HOWARD AVE-BURLINGAME, CAL.

VHF-UHF

Converters and Preamps for 50 thru 432 Mc.
Write for literature.

Send for a sample copy of the VHF'er, the only magazine for VHF and UHF hams.

Parks Electronics, 419 S.W. First Beaverton, Ore.

LEARN RADIO CODE



\$9.95

Album contains three 12" LP's 2 1/2 hr. instruction

THE EASY WAY!

- No Books To Read
- No Visual Gimmicks To Distract You
- Just Listen And Learn

Based on modern psychological techniques—This course will take you beyond 13 w.p.m. in LESS THAN HALF THE TIME!

Also available on magnetic tape. See your dealer now!

EPSILON [E] RECORDS

206 East Front Street, Florence, Colorado

DXERS and DXERS-TO-BE

Want to keep up to the minute of what's happening DXwise? Subscribe to Gus Browning W4BPD's new weekly DXERS MAGAZINE. 16 pages of DX events, coming up DXpeditions, QSL info, pix, etc. Rates, US surface \$8.50. US air mail \$10, West Indies \$16.50, S. America and Europe \$19, rest of world \$28.

The DXERS MAGAZINE

c/o W4 BPD

Route 1, Box 161-A,
Cordova, S.C., U.S.A.

WANTED

SALES ENGINEERS

EARN

\$20,000 per year

Based on commission from sales and installation of just 3 Vanguard TV cameras per week!

Full or Part Time

Closed circuit TV is recognized as a definite necessity for many businesses to combat rising costs. Thousands of factories, office buildings, banks and schools will welcome your demonstration.

Using our list of applications as a guide you will be able to show how any establishment can use several cameras and how each one can save thousands of dollars through the resulting increase in efficiency and security.

If you are over 21, have a working knowledge of TV and are financially responsible, we need you as a sales engineer to demonstrate our Model 501 in your area. To receive your application and additional details, send us a resume of yourself and include a self-addressed, stamped envelope.

VANGUARD LABS

196-23 Jamaica Ave.
Hollis, N. Y. 11423

They took me into the radio shack (which is not unusual you know) and I was shown how to turn on the rig, turn the beam, and they said, "Gus, the rig's yours as long as you are here with us. Make yourself right at home and sleep as late as you wish." After a good many hours of eye-balling they departed for bed, leaving me in the shack. I immediately went on the air, getting on 14065, my DXpedition frequency; called a CW CQ and had quite a ball working the boys in the States, telling them that Tristan da Cunha and Gough and Bouvet were getting closer and closer all the time.

I stayed up until about 3 AM having myself quite a ball I must say. I dragged myself away from the pile-up that was still calling me and slept until 10 AM the next morning. When I got up, Marge and Jack had left a note on the rig, so I would be sure to see it I suppose, telling me to go right ahead and fix my own breakfast; they had to go to work. This was really making me feel right at home—they had turned the whole house over to me and they again said I could use the rig as much as I wanted to.

I had a very leisurely breakfast of coffee, cantelopes, even ate a big slice of watermelon—for breakfast. Man, this was like being back in South Carolina eating watermelon for breakfast. I did miss my grits and sausage and eggs and Peggy's cooking though.

W4BPD

VK7TR

VK7TR, Ray Conrad of Hobart, Tasmania, was completely burned out in the great fire which recently swept the South Australian Island. His home and all contents including all his radio gear, QSL's and logs were completely destroyed. Ray and his XYL escaped in their car from the fire which descended on their home at 75 mph. If those to whom VK7TR owes QSL's will send new cards to his old QTH or to VK7CK, he will attempt to QSL from memory. Ray and his XYL are leaving April 22 for an extended trip stateside via England. He expects to hit New England and Pennsylvania after August 20, then on west across the USA and back home. Don't be surprised to hear his melodious accent from G3LSF, W1BCR and W3CES and others.

ELECTRONIC SURPLUS BARGAINS

SAVE UP TO 90%

BLACKLITE KIT FOR ULTRA-VIOLET FLUORESCENCE

For qualitative work in laboratory or shop for mineral identification and display. The long-wave ultra-violet light produced by the 4-watt or 8-watt lamps is in a range of from 3500



to 3600 Å. The tubes contain a high-emission phosphor in the above range. Lamps are of the blue-glass type for filtering out most visible light. KIT CONTAINS: Ultra-violet tube, brackets, ballast, starter, wire, plug, and wiring diagram. (110-VAC operation, long-wave). 4-WATT KIT (5 1/4" tube) .. \$3.50 Kit. 8-WATT KIT (12" tube) \$4.50 Ppd.

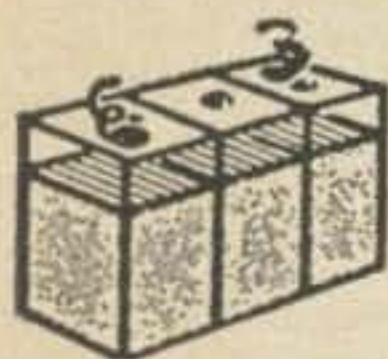

NT-6 WILLARD 6-VOLT STORAGE BATTERY

Rated 2.4 amp. hr. Approx. dimensions: 3 1/2" l. x 1 1/4" w. x 2 1/8" h. Weight: 1 lb. 3 oz. (plastic case) Dry-charged. \$2.50

POTTER & BRUMFIELD RELAY

#SM5LS SPDT 8,000 ohm 11/16" dia. x 1 11/16" long. Approx. weight 1 oz. Hermetically sealed. Standard 7-pin miniature base. \$2.00



MINOR SWITCH

10-position, 3-pole with stopper coil and reset coil 6-12 volts D.C. off-normal non-bridging wiper approx. dimensions: 4" long x 4 1/2" high x 1 1/4" wide. weight: 1 lb. \$9.95



OIL CAPACITORS

1 mfd. 25,000 V. DC Westinghouse Interteen Type FP Style 1313854. \$39.95 each. 10 or more, \$35.00 each.

GENERAL ELECTRIC FULL WAVE BRIDGE GERMANIUM RECTIFIER

input 117 volt AC, output 115 volt DC at 10 amperes approximate dimensions: 4 3/4" x 4 3/4" x 7 1/2" long weight: 3 1/2 lbs. PRICE \$9.95 each

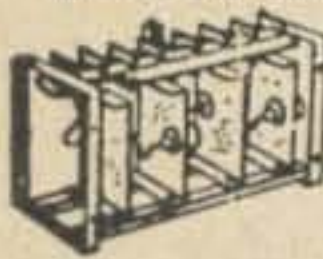

TEST SCOPE—SYNCHROSCOPE—PULSE ANALYZER

ID-59/APA-11. Late production. Modular subassembly construction. Video amplifier is flat to 4 mc. 3BP1 presentation. Test-scope sawtooth 25-20,000 cy. Has all normal test-scope controls. As synchroscope and pulse analyzer, accepts positive or negative pulses. Video delay circuit permits leading edge of pulse to be seen. Calibrated-dial horizontal shift measures pulse durations from 0.5 to 100 microseconds. Sinewave-oscillator measures recurrence rates from 200 to 6000 pps accurate within 0.4%. Built-in power supply requires 115v, 400 cy, 196 watts. External 60 cy power supply may be made to furnish plus 350 and -1300 vdc and 6.3 vac. In excellent condition, with all 19 tubes, schematic with parts values, parts-location pictures, operating instructions, theory explanation, and maintenance charts. Shipping weight 60 lbs. Used, good. Price each \$19.50



X-BAND POWER LEVEL TEST SET, TS-36/AP

Brand new, in original packing, has accessories. Measures 10 to 30 dbm. 8700-9500 mc. \$14.95

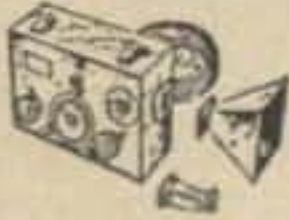

RG 58A COAX CABLE

52 OHM, 100 ft. lengths\$3.95

NICKEL CADMIUM BATTERY 1.2 VOLTS



Rechargeable thousands of times. Alkaline storage battery sintered-plate. Flat voltage curve during discharge. Will hold charge for long period of time. High discharge rate up to 50 amps. Still-proof, may be used in any position. Approx. 6-ampere-hour capacity. Dimensions: 6" high; 2" wide; 1/2" thick. Approx. wt. 6 oz. Uses potassium hydroxide (30% Electrolite) \$1.95

8-DAY AIRCRAFT CLOCK

24-hr. dial and civil date indicator. Center sweep second hand, luminous figures and hands on black face. Case is made of black plastic 3 1/2" mounting. Manufactured by Waltham Watch Co. \$20.95 Postpaid



2 3/4" x 4 1/4". Wt. 3 1/4 pounds. POWER TRANSFORMER Output: 12, 24, 36 volts. Input: 100 volts, 60 cycles, single-phase. Will handle 2 1/2 amps. Steel case is hermetically sealed, 3 1/2" x \$2.95



DIRECT-READING MAGNETIC COMPASS

Full-floating card, compensating magnets, and dial light avail. in 6- or 12-v. bulb. Luminous dial. Mfgd. by Bendix-Pioneer. 3 1/4" x 3 1/4" x 3 1/2". 1 1/4 lbs. \$8.50 postpaid.



TCS DYNAMOTORS

12 volt D.C. input, 9.9 amps; output 440 volt D.C. at 200 ma new \$7.95

12 volt D.C. input, 3.6 amps; output 225 volt D.C. at 100 ma new \$2.95 each

RADIO COMPASS RECEIVER

B5/ARN7 Frequency 100 to 1750 KC Price \$17.50 R5A/ARN7 Price \$27.50 Loop LP21 LM Price \$12.50 Control Box C4/ARN7 Price \$ 7.50 Indicator 181A Price \$ 4.95

BC683 FM RECEIVER, 27-39 MC continuous tuning and 10 preset push-button channel selector with sensitive squelch and volume controls 2 watt output to self-contained speaker; used, good condition\$39.95

DM34 dynamotor for 12 volt DC operation of the above receiver\$3.95

R/C SERVO MOTOR DRIVE ACTUATOR

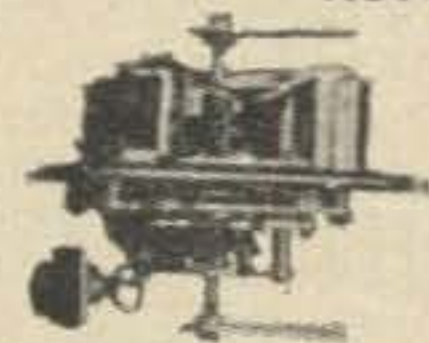

Contains 2-6 volt permanent magnet motors. Current consumption approx. 100 MA. 2-6 volt DPDT Relays. Many gears. Unit completely enclosed in aluminum housing\$4.00

ARC RADIO EQUIPMENT



ARC receiver #R13B: VHF, 108-135 mc \$19.95 ARC receiver, R10A/ARC 520-1500 KC\$22.50 ARC transmitter T366A: 28 volt DC, 160-132 mc\$19.95 B-10A converter \$24.95 D-10A 28VDC dynamotor used w/above receiver\$5.00 Controls: C-18, C-22, C-37 and C984. Ea.\$7.50 CV-265/ARN-30A Converter\$29.50 E-13B/ARN-30 Rack 7.50 A-13A Antenna 35.00

TS-102/AP RANGE CALIBRATOR

This crystal controlled pulse generator produces a square-topped, 50-volt synchronizing pulse of .8 microsecond, at a prf of 400, 800, 1600 or 2000 cps, and a triangular marker pulse of 0.4 microseconds duration at a prf corresponding to a pulse-echo distance of 1500 ft. The phase between the marker and sync. pulses is continuously variable from -180 to +180 degrees. PRICE\$12.50 each



TYPE AN/ARN-6 RADIO COMPASS

Receiver R/101/ARNN-6, 100-1750 kc. in 4 bands. Excellent condition. Price \$34.50 Loop AS13-B. Excellent Condition. Price \$27.50 Indicator ID91B/ARN-6 Excellent Condition. Price \$ 9.95 Mounts MT-273 or MT-274 Excellent Condition. Price Ea. \$15.00 Control Box C-149A. Price \$20.00



MANUAL

Handbook of operating instructions, general installation adjustment plus 5 pages of diagrams and Schematics. Price \$ 3.50

250-WATT SOLDERING IRON

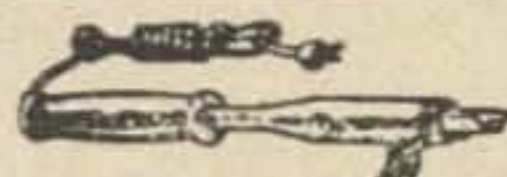

Mfg. VASCO, 110-volt AC, 60-cycle, single-phase. U.L.-approved. Brand new \$3.95 including stand.

12 FT. TELEPHONE STRETCH CORD

3 conductor wire with JK-53 and a U31/GT plug. PRICE \$1.49 ea.



RT-82/APX-6 TRANSCEIVER

Easy to convert to 1215 Mc Ham Station. Good Condition. Less Tubes\$9.95

U. S. NAVY 145-DAY TIMER

This unit was used by the Navy to activate and de-activate mines at sea. Has a setting from 1 to 145 days. Unit contains a 12 volt D.C. permanent magnet motor, precision clock movement, switches, approximately 30 brass precision gears; enclosed in a metal case with inspection window. Approximate dimensions: 3 1/4" dia., 4" long. Unused condition. Cost Government hundreds of dollars. Our price: \$3.95 each, postpaid.



POWERSTAT TYPE 20

input 120 volt AC, 50/60 cycle output range 0-140 volts AC, 3 amperes. 7.95



POWERSTAT TYPE 116

input 120 volts, 50/60 cycle output range 0-140 volts AC, 7.5 amperes. PRICE\$16.95 each

COAX CABLE RG59A/U

50 ft. roll complete with coax fittings. PRICE \$2.49 ea.



All prices FOB Pasadena unless otherwise noted. No COD's.

C & H SALES CO.

2176 E. Colorado St., Pasadena, Calif. Murray 1-7393

MORE TALK POWER

WITHOUT DISTORTION



SPEECH COMPRESSOR CSPII

A New and novel design provides instantaneous peak limiting with no distortion. The unit installs in microphone leads and provides an effective average power gain of 10 dB relative to the peak output. Its usefulness applies to all forms of voice transmissions including and especially single sideband.

Price: \$111.00 Postpaid in U.S.A.

(Add 3% Tax in Mass.)

Write For Free Brochure

COMDEL, INC.

218 Bay Rd., Hamilton, Mass. 01982

10 - 15 - 20 METER MONOBEAMS

FOR
MORE
DX PUNCH

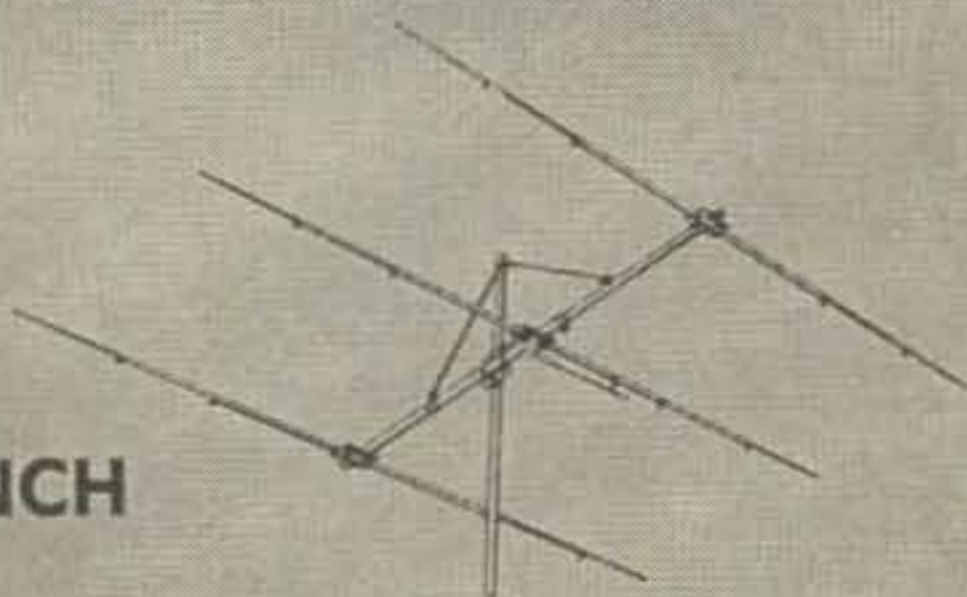

Cush Craft Monobeams combine superior electrical and mechanical features with the best quality materials and workmanship. They will provide reliable day to day amateur communications and that extra DX punch, when needed, for contest work or emergency communications.

A28-3 10 Meter, 3 Element, Boom 10'	\$31.95
A28-4 10 Meter, 4 Element, Boom 18'	42.95
A21-3 15 Meter, 3 Element, Boom 12'	39.95
A21-4 15 Meter, 4 Element, Boom 22'	59.95
A14-2 20 Meter, 2 Element, Boom 10'	49.95
A14-3 20 Meter, 3 Element, Boom 20'	77.50

SEE YOUR DEALER OR WRITE FOR CATALOG.

**Cush
Craft**

621 HAYWARD STREET
MANCHESTER, N.H. 03103

Letters

(cont'd from page 4)

Dear 73,

Your March issue of 73 Magazine with the 73 transistor circuits is by far the best issue I've ever received . . . I work the Air Force MARS CW Transcon Net and used the audio passband filter described in Fig. 14 between the headsets and the receiver. It sure does the trick at 7332 kHz which is close to the CHU time signals. It completely eliminated CHU and brings CW signals up no end—hence I am figuring on setting the thing between the first audio and second detector of my receiver. This way I won't have to wear a set of "cans" all the time.

With this filter in my receiver I am able to give all the fellows a QSA5 QRK5 signal report, but when I take it out there is so much crud on the darned frequency that it knocks 'em down to 2/2 for sure.

Charlie Holstrom WA 0 GYK
Fairbury, Nebraska

Dear 73:

I am particularly interested in transistors and while all 73's are good, this one is the *goodest*—uh huh. So send 3 copies of March please. I have some kids I'm getting started in transistors too.

Walt Burdine W8ZCV
Waynesville, Ohio

Unhappy

Dear 73:

I have just one fault to find; the magazine gets here very late . . . very fine on everything else. I think you are putting out a fine magazine and I will support it all I can.

Glen Wilson WA6ORZ
San Pablo, California

This issue was mailed on May 20th. The July issue will be mailed on the 10th of June. After that all magazines will be mailed by the 10th of the preceding month.

Kudos

Dear 73:

I just had to sit down and write you a letter. What about? Many things, —first of all, about the quality of 73's articles. Superb! In the past eleven years of hamming I know of no mag that equals yours.

Scanning a typical issue of 73, the transistor articles immediately catch my attention—I usually spend at least an hour on these gems—next a quick trip to the back, the best place to begin reading any mag, plus I always find something interesting in New Products and Books.

Whenever Jim Fisk describes some phase of hamming through his high quality booklets—he receives my vote every time! More of the same Jim! The technicians up here found the Coaxial Handbook invaluable, but myself—being a solid state nut—devoured "73 Useful Transistor Circuits".

Roy Schoonover 3C8AG/VE8
Winnipeg, Manitoba, Canada

Dear 73:

More than 50 years ago I purchased my first ham radio equipment. The receiver was slider tuned with an electrolytic detector using a Wallaston spring wire contacting an acid solution in a carbon cup. The transmitter used a spark gap.

Today I'm still enthused as I read your selected articles on new equipment and how to build one's own.

Phil Shigley WB6SJA
Redding, California

Dear 73:

For the past several years now, I have enjoyed receiving my copy of "73 Magazine". I look forward to seeing many new and different approaches to construction articles and feel that this magazine keeps me more than adequately supplied.

Incidentally, I also write a weekly column for one of the local newspapers and find this very rewarding with respect to the interest generated in 'the hobby'.

Hoping to build up the Transistorized Digital Identification Generator and have already written to Barry Todd regarding the diode matrix. Last summer I got "hooked" on the integrated circuit keyer, and can only say that it works like a champ.

RTTY is my chief interest these days, would sure like to see more articles in this vein. Possibly I can add my two cents worth at some future date.

James H. Sayer, VP9BY
Smiths Parish, Bermuda

Dear 73:

I saw a March 1967 issue of 73 magazine last night at our ham meeting and it sure did impress me. All those real interesting transistor circuits. I don't see how you can put so much good information in one publication.

I have been taking the ARRL QST, but my subscription is up and I am going to take 73.

You may be interested to know that one of our ham friends who is well educated in electronics made the statement last night at the ham meeting, "I have been taking QST magazine, and I am so far behind I was unable to read 73." That is how much he has been missing my not subscribing to your magazine earlier.

Please start my subscription with the March 1967 issue—I sure do want that book.

Levy Belcher K4TSX
Glasgow, Kentucky

Dear 73:

Congratulations on the February 73 which arrived here today. I have been a subscriber of 73 from issue number one and have written publicly about it in our Break-In—you have now hit the jackpot with the new binding. Of the material inside, there is always much of interest for me so I continue to rate the magazine number one . . .

Jock White ZL2GX
Contest and Awards Manager
New Zealand Association of
Radio Transmitters

Dear 73:

I've been wanting to tell you how much I, a non-ham, enjoy much of 73. I'm not qualified to comment on the technical articles (my husband says at least once a month, "73 sure has it beat over the other two"), but I certainly find the overall magazine much more appealing than CQ or QST. I've taken a "beginning beginner's" course in electronics and absorbed quite a bit by osmosis (what wife could avoid that when her husband is afflicted with the disease of ham radio!) and occasionally I even find a technical or general information article I can muddle through.

I don't want to ramble on, so I'll just say that in this household 73 is considered tops.

Mrs. Heather Jorgensen
XYL of K1DCK

**MORE RANGE . . .
with NO NOISE**

**FOR ALL
MOBILE UNITS**

ENGINEERING
★
ESTES
COMPANY

**ELECTRO-
SHIELD**

CUSTOM SYSTEMS
KITS • ACCESSORIES

ELIMINATE IGNITION NOISE
ELECTRO - SHIELD®
YOUR ENGINE

FROM \$44.95

ESTES ENGINEERING CO.
1639 W. 135th St. Gardena, Calif. 90249

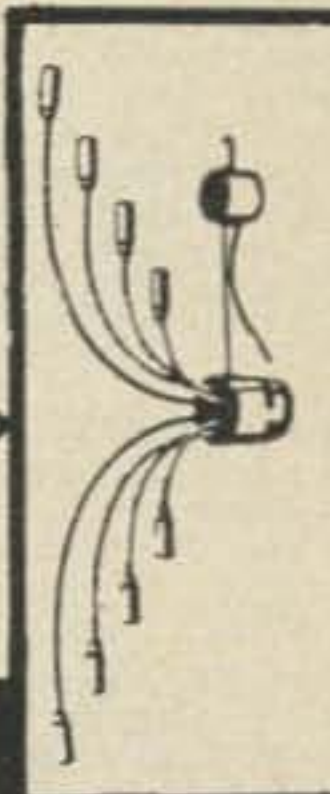

ALUMINUM TOWERS

ALL KINDS

- WON'T RUST
- NO GUYS
- TILT OVER — CRANK UP

Write Postcard

GATEWAY TOWER CO.
7530 Big Bend
St. Louis, Missouri-63119

73 Magazine CUMULATIVE INDEX

October 1960-December 1966

Now available for 25¢

73 Magazine
Peterborough, N.H. 03458

GET IT from GOODHEART!

EVERYTHING UNCONDITIONALLY GUARANTEED!

(C) means with Cert. of Calib. traceable to N.B.S. If item isn't already cert., we can get it done at request. **TIME PAY PLAN:** Buy anything over \$149.00 with 10% down.

Aeronautical Radio-Shop Eqpt.

Collins Radio "ZIFOR" Test Set brand new #478A1..\$475.00
A.R.C. H-14, UPM-6B, Tacan Testers, ILS &
Omni, etc. P.U.R.

Amplifiers, DC thru Microwave

Too many to list here; send for list or ask for needs.

Audio Test Equipment

Jackson #655 Oscillator 20-200,000 cy\$49.95
Hewl-Pack #202B Osc. 1/2-50,000 cy, 2%, flat 1 db179.50
Hewl-Pack #205AG Osc. & Gain Set 20-20,000 cy.....195.00
Hewl-Pack #650AR Osc. 10 cy to 10 mc flat, accurate..295.00
Hewl-Pack #330BR Distortion Analyzer like new350.00
Hewl-Pack #300A Harmonic Wave Analyzer (C)195.00
Gen Radio #736A Wave Analyzer (C) \$1275 value295.00
Gen Radio #783A Audio Wattmeter 2 mw-100 w.
40 Z's199.50

Bridges & Other Precision Eqpt

Boonton #160A Q-Meter 50 kc to 75 mc495.00
Boonton #190A Q-Meter 20 to 260 mc395.00
Decade Boxes for R, C & L: Too many to list here..P.U.R.
Galvanometers: Pointer, Light-Beam, Electronic.....P.U.R.
Gen. Radio #821A Twin-T Imp Bridge 0.46-40 mc....275.00
Other Gen. Radio, Freed Kintel, Marconi BridgesP.U.R.
Gen. Radio & Leeds & Northrup Precision V-Dividers..P.U.R.
Gertsch Ratio Tran .001% accuracy AC volt. Dividers..P.U.R.
L&N #4230 Wheatstone Bridge. 01% (Anthony Pattern).475.00
L&N #4285 Kelvin Bridge w/galvo, .0001 to 26.6 ohm..250.00
L&N #7552 (K2) Potentiometer (C)350.00
L&N #7591 Volt Box (sold only with Potentiometer)87.50

Communications Receivers

SWL NEWS DXer of the Month uses Hallic. R45/ARR-7
revr; 550 kc-43 mc contin. crank tuning 2 RF & 2 IF.
Separate mixer w/VR regul, 3 xtl, 3 non-xtl. Select choice
Has S-Meter, AVC/MVC, AF/RF Gains, CW/MCW, Pitch,
ANL. New or like new, aligned, grtd, (needs 260vdc, 6.3vac)
With book149.50

Pwr Sply w/cord, plug...\$30.00. If we add SSB, add...20.00
R-23/ARC-5 Command Revr 190-550 kc. Q-5'er. Checked 14.95
#12 R-22 Command Revr 540-1600 w/tuning graph17.95
DZ-1 Superhet Lo-Freq. Revr 15-70 & 100-1500 kc, New 89.50
RBL-5 TRF Lo-Freq. Revr 15-600 kc exc., w/book125.00
SP-600JX for rack mtg exc., w/book, .54-.54mc.....249.50
R-44/ARR-5 AM/FM 27-143 mc modif. for better sens..149.50
R-54 & R-444/APR-4 w/CV-253 or TN's, 38-4000 mc..P.U.R.

Communic. Xmtrs & Pwr Supplies

AN/FRC-6A 30-40 mc FM 50 W revr/xmtr, 115 v,
60 cy59.50
TDQ Xmtr 115-156 mc AM, 45 W Po, 115 v 60 cy pwr.P.U.R.
TDZ Xmtr 225-400 mc AM, 30 W Po, 115 v 60 cy pwr.P.U.R.
TCM Pwr Sply furnishes both HV's for ART-13. New ..49.50
RA-62 furnishes all voltages for SCR-522. Checked17.95

Counters

Hewl-Pack #522BR Universal (freq. & Period) 120 kc..395.00
Berk. #736OR or CMC #226A universal, to 1.2 mc....450.00
North. Engrg, like HP #524C, nixie readout, 10 mc ..1150.00
Plugins for above extend to 100 & 220 mc, each (C)...200.00
H.P. #540A Trans. Osc. extends 200 to 5000 mc (C) ..175.00

Direction Finder

DU-1 Loop w/preamp/phaser .2-1.6 mc, unidirectional ...29.95

Frequency Meters

LM: .125-20 mc, .01% xtl, checked, grtd, w/data.....57.50
TS-323: 20-480 mc, .001% xtl, OK grtd, w/data169.50
PRD #504 100-10,000 mc better than .03%, w/data ...395.00

Leak Detector

Beckman Mod. 140 #14,000 Mass Spectrometer,
Helium\$1000

Meggers

Hand-Crank & 120 v 60 cy, too many to list here...P.U.R.

Meter Calibrators, Precision Pwr Splies

Fluke, Kintel, etc., DC, sq-wave, too many to list ..P.U.R.

Meters, Digital

Switching & Integrating, DC & AC, too many list....P.U.R.

Meters: Phase, Multi-, Precision

Acton #320AB Phase Meter 1-100,000 cy w/book, exc...89.50
Weston #432 Wattmeter 1/2% 1 ph DC to 1 kc,
to 1500 W149.50
Sens. Res. #HS .02-50 VDC, 1/2% D'Arsonval 50K
ohms/V99.50
Sens. Res. Electrostatic DC-300 kc, to 5 KV, 1%130.00
Greibach 1/2% 50 uA de, hairline shadow, no parallax ..99.50
Weston 341/370, GE P3, 1/4% dynam., ac/dc
v,ma,w. (C)P.U.R.

This page shows only a small part of our inventory, and our entire inventory keeps changing . . . so Catalogs of Surplus are Silly . . . Write for your Specific needs! WE ALSO BUY! TELL US WHAT YOU HAVE!

SELL IT to GOODHEART!

WE PAY HIGHEST AND FASTEST!

Meters, VTVM

Millivac RM-27D 0-250 μ V to 1 KV, 1 to 4%.....150.00
Millivac MV-18C w/probes 0-10 mv-1 kv ac, 50 mv dc..149.50
Hewl-Pack #400D 0-1 mv -300 v ac w/book, OK grid..160.00
Hewl-Pack #410B all-purpose VTVM w/probe &
T Adapter160.00
Sierra Car. Freq. #101C: 20-500 kc; -80 to +40 dbm..135.00

Noise & Field Strength Meters

Stoddart, Ferris, AN/ types, too many to list here....P.U.R.

Oscilloscopes, Scope Camera

DuMont 401: Identical X, Y mp's; dc-100 kc; 10 mv..175.00
Hewl-Pack 120A: 1 us/cm; 10 mv/cm; dc-200 kc.250.00
Analab 1120R/700: 2-Trace, precision calib., 0-1 mc. .300.00
Tekt. 512: 3 us-.3 sec/cm; 5 mv/cm; dc-2 mc295.00
Tekt. 511AD: .1 us/cm; .25 v/cm; 5 cy-10 mc275.00
Tekt. 514AD: .1 us-.01 sec/cm; 30 mv/cm; dc-10 mc ..350.00
Tekt. RM-45 is rack-mtg #545. Less plugins. (C)850.00
Tekt. C-A 2-trace plugin (C) ..\$200. 53/54C 2-trace..150.00
Tekt. 53C 2-trace\$87.50. 53B hi-gain wide-pass....60.00
Fairchild Polaroid #302 with f/1.9 lens like new149.50

Panoramic Analyzer

LP-IAZM w/PS-1C pwr sply, exc., w/book, sonic anal..495.00

Power Supplies, Regulated DC

Milro 2226-1: Solid state, 5-36 v, 0-30 amps225.00
Dres. Barnes 5-300F: 0-500v, .3A & 0-300v, .15A139.50
NJE Solid-state 900-1300 v, 1.5A. 208-220 v 1 ph in. .175.00
And 45 other types from \$17.50 and up!P.U.R.

Power at 400 cy. Electronic

TIC 400AR: 380-420 cy, 90-130 Vo 1 ph. 100 VA125.00
Behlman Invertron 503C6: Output is 3 phase, 500 VA..595.00

Power at 400 cy, Rotary Machine

1 ph 6.25 KVA 120/240v. Input 416 v 3 ph 60 cy ...395.00

Pulse & Delay Generators

Tekt., Hewl-Pack, Datapulse, etc., too many to list ..P.U.R.

Radar, Tacan, Transponder

APA-39, UPM-6B, Hi-V Dividers, too many to list..P.U.R.

Recorders, Graphic

Brush, Esterline-Angus, etc., too many to list here....P.U.R.

Regulators, Line Voltage

Sorenson 1000S: 0.1% regul., 3% max. harm., 1 kva...89.50
Sup. Elect. IE-5102: same as above, up to 2 1/2 kva199.50
Sup. Elect. IE-20060: Same but rugged. MIL, 3 kva279.50
Sup. Elect. IE-5105: Same but 5 kva (1 ph 110-120v)..350.00
Sor. 5000-2S: Same, 5 kva, but 230 v 1 ph in & out..350.00
Sup. or Gen. Radio 1570AL 6 kva electromechanical...279.50
Sup. EM-4115 elect-mech 15 kva 1 ph; 120 v in & out..395.00
Sup. EM-4228: 27 1/2 kva 1 ph, 230 v in & out495.00

Semiconductor Tester

Baird GP-4 w/socket Adapter, NPN & PNP, \$475
value195.00

Servo, Synchro Tester

Servoscope Mod. 1100-H: 0.1-20 cy v p-p, 1%225.00

Signal Generators, Microvolt Calibrated

LP: 9 1/2 kc-50 mc, cw/am. Up to 1 v open ckt199.50
Boonton 203/207: 0.1-25 mc by het. a VHF generator..150.00
TS-606: .085-40 mc cw/am, up to 15 v to 20 ohms!...995.00
TS-608: 40-400 mc cw/am, up to 23 v to 50 ohms! ...695.00
Meas. #80: 2-400 mc cw/am, up to 0.1 v to 50 ohms ..265.00
Hewl-P. 608A: 10-500 mc cw/am, to 1v 50 ohms. (C) ..595.00
Boont. 202E/207E: 0.1-216 mc cw/am/fm .2 v (C) ...550.00
Boon. 225A: 10-500 mc cw/am, 130-500 mc fm, (C) ..550.00
B-W #75: 10-440 mc cw/am/fm/pm, xtl cal. & reset; has
AFC; grtd to outperform H.P. 608D for FAA demo. .795.00
Hewl-Pack #614A: 0.8-2.1 gc, 0 dbm 50 ohms (C) ..995.00
Hewl-Pack 616A: 1.8-4 gc, 0 dbm 50 ohms550.00
And 26 other types! Write for list or tell needs!

Sonar Test Sets

OAX-1, OCP-(*): Send, receive, measure; w/transduc..P.U.R.

Teletype

TT-4A, CV-89, #14's, #19, Books; write for list..P.U.R.

Transformers

SP-600 Revr plate/fil: 610 vct. .15A, etc. New.....4.95
Scope: 1490, 1100, 780 ct. many 2 1/2's & 6.3's, new6.95
Isolating stepup/down: 115/230/tapped 125 v; 7 1/2 kva..49.50

Tuning-Fork Oscillators

62 1/2 cy to 10,000 cy: phenomenal accuracy! Send for list.

Wattmeters, RF

Complete Water Calorimeters, \$295! and other types...P.U.R.

R. E. GOODHEART CO., INC.

P. O. Box 1220

BEVERLY HILLS, CALIFORNIA, 90213

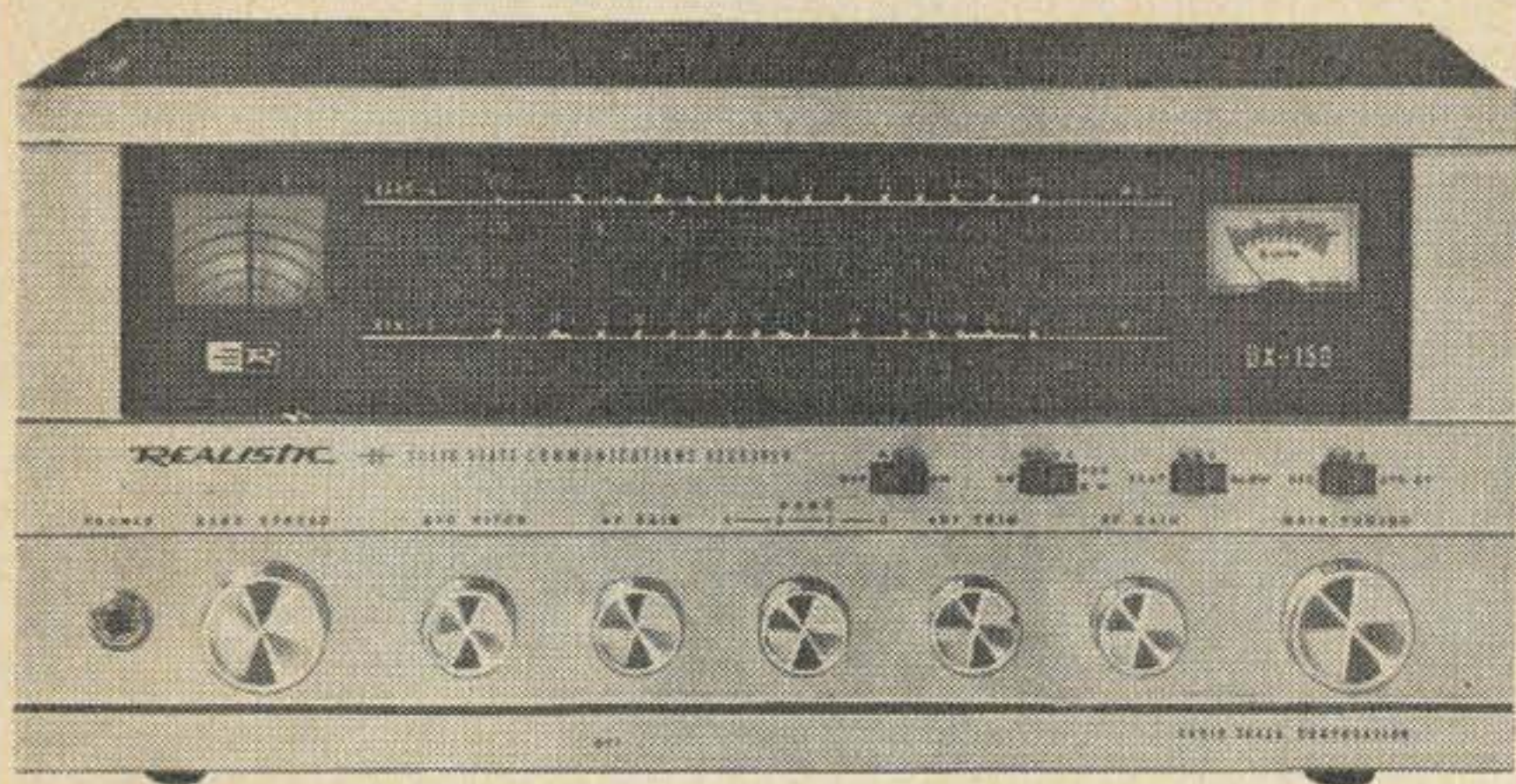

RADIO SHACK
BREAK THRU!!!
 ALL
 SOLID STATE

The World's First 117V/12V All-Transistor Communications Receiver Is Available Now In 150 Radio Shack Stores Coast to Coast!

THE *REALISTIC*® DX-150

- Over 30 semiconductors — no tubes, no nuvistors — the DX-150 is 100% solid state!
- SSB/CW/AM reception, covering 535KC through 30MC in 4 slide-rule bands!
- Product detector for SSB/CW, plus fast and slow AVC; variable-pitch BFO!
- Illuminated electrical bandsread fully calibrated for the Amateur and CB bands!
- Cascade RF stage; ANL for RF and AF; zener-stabilized; OTL audio; illuminated "S" meter!
- Built-in monitor speaker plus front-panel jack for external (optional) matching speaker!

ONLY
119⁹⁵

New, big, exciting, professional — the Realistic DX-150 obsoletes tube receivers and warm up, banishes forever your dependence on house current to stay in operation. For example: the DX-150 will run 100 hours on 8 D-cells if current fails, or isn't available, or on field day. Additionally, it will operate from a car's cigarette lighter or any other mobile or base 12VDC source! Of course a 117VAC power supply is built in. DX-150 is a husky brute: 14¹/₈ x 9¹/₄ x 6¹/₂", with a massive silver extruded front panel, solid metal knobs, grey metal cabinet, 14 pounds of quality.

A NEW STANDARD OF RECEIVER VALUE!

Priced Radio Shack's way (factory-to-you) the DX-150 saves you about \$100 off traditional pricing methods. Yet it offers 11 front controls; dual power supply; 12¹/₄" slide-rule dial in 5 colors; continuous coverage from 535KC through 30MC, including 160 through 10 meters; separate detector circuits for AM (diode, and SSB/CW (4-diode bridge); sensitivity good to 0.5 μ v at 30MC. Nobody but nobody but 44-year-old Radio Shack could have created this unique product for \$119.95. You better believe it!

THERE'S A STORE NEAR YOU!

- | | |
|---------------------------------------------------------------------------------------------------------------------------------------------------------------------------------------------------------------------------------------------------------------------------------|--------------------------------------------------------------------------------------------------------------------------------------------|
| ARIZONA — Phoenix | MICHIGAN — Detroit |
| ARKANSAS — Little Rock | MINNESOTA — Minneapolis, St. Paul |
| CALIFORNIA — Anaheim, Bakersfield, Covina, Downey, Garden Grove, Inglewood, La Habra, Long Beach, Los Angeles, Mission Hills, Mountain View, Oakland, Pasadena, Pomona, Reseda, Sacramento, San Bruno, San Diego, San Francisco, Santa Ana, Santa Monica, Torrance, West Covina | MISSOURI — Kansas City, St. Joseph, St. Louis |
| COLORADO — Denver | NEBRASKA — Omaha |
| CONNECTICUT — Hamden, Manchester, New Haven, New London, Orange, Stamford, West Hartford | NEW HAMPSHIRE — Manchester |
| FLORIDA — Jacksonville, Orlando | NEW JERSEY — Pennsauken |
| GEORGIA — Atlanta | NEW MEXICO — Albuquerque |
| ILLINOIS — Chicago | NEW YORK — Albany, Binghamton, Buffalo, New York, Schenectady, Syracuse |
| KANSAS — Wichita | OHIO — Cincinnati, Cleveland |
| LOUISIANA — New Orleans | OKLAHOMA — Oklahoma City, Tulsa |
| MAINE — Portland | OREGON — Portland |
| MARYLAND — Langley Park | PENNSYLVANIA — Philadelphia, Pittsburgh |
| MASSACHUSETTS — Boston, Braintree, Brockton, Brookline, Cambridge, Framingham, Lowell, Medford, Natick, Quincy, Saugus, Springfield, Waltham, West Springfield, Worcester | RHODE ISLAND — Providence, East Providence |
| | TENNESSEE — Memphis, Nashville |
| | TEXAS — Abilene, Arlington, Austin, Brownsville, Corpus Christi, Dallas, Fort Worth, Houston, Lubbock, Midland, San Antonio, Sherman, Waco |
| | UTAH — Salt Lake City |
| | VIRGINIA — Arlington, Virginia Beach |
| | WASHINGTON — Seattle |

REALISTIC DX-150 CUSTOM ACCESSORIES

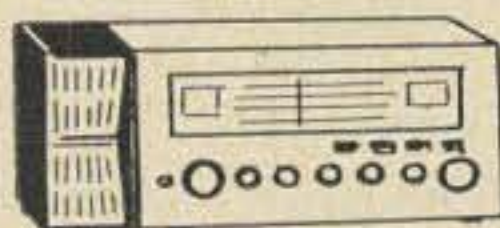

Exact-match external Voice-Frequency speaker cuts out built-in monitor, includes lead and plug. 20-1500: \$7.95 (4 lbs.)



12VDC portable pack with all cables, plugs, 8-long-life batteries; includes plug-to-plug and plug-to-lighter cord sets. 20-1501: Only \$7.95 (wt. 4 lbs. w/batteries)

ORDER BY MAIL! IN PERSON! FREE FOLDER!

RADIO SHACK

East: 730 Commonwealth Ave., Boston, Mass. 02215
 West: 1515 So. University Dr., Ft. Worth, Tex. 76107
 Dept. RX

Please rush me the item I've checked below.

I enclose \$ _____, plus 50¢ for postage and handling:

- | | |
|------------------------------------------------------|-------------------------------------------------------------|
| <input type="checkbox"/> FREE 1968 Catalog | <input type="checkbox"/> Matching Speaker, 20-1500, \$7.95* |
| <input type="checkbox"/> FREE DX-150 Folder | <input type="checkbox"/> 12 VDC Power Set, 20-1501, \$7.95* |
| <input type="checkbox"/> Receiver, 20-150, \$119.95* | * Plus Shipping Cost:
14 lbs., 4 lbs., 4 lbs. |

Name (print) _____
 Street _____
 City _____ State _____ Zip _____



NEW PRODUCTS

Heathkit SB-301



The new Heathkit SB-301 Amateur Band Communications Receiver is an improved version of an already famous pacesetter, the SB-300. Some of the new features of the SB-301 are increased sensitivity, full RTTY provisions, 15 to 15.5 MHz coverage for WWV, built-in automatic noise limiter, and front panel switching of the optional six and two meter converters.

The SB-301 covers 80 through 10 meters with provisions for AM, CW, upper and lower sideband and RTTY. It has a crystal-controlled front-end which provides the same tuning rate on all bands. The pre-assembled and calibrated Linear Master Oscillator (LMO) features linear tuning and excellent stability. The sensitivity of this new receiver is better than 0.3 microvolts for 10 dB signal-plus-noise to noise on all bands. The built-in crystal filter exhibits selectivity of 2.1 kHz at the 6 dB points for SSB and RTTY. Optional filters are available for AM (3.75 kHz) and CW (400 Hz).

The SB-301 is fully capable of transceive operation when operated as a companion to the SB-401 transmitter. When the optional six and two meter converters are plugged in, the SB-301 provides full amateur band coverage from 80 through 2 meters complete with front-panel switching. Look for a complete review of this versatile new receiver in this issue. For complete specifications and the schematic diagram, write to the Heath Company, Benton Harbor, Michigan 49022.

Heathkit SB-401



The new Heathkit SB-401 80 through 10 meter SSB Transmitter is an improved version of the widely chosen SB-400. The engineering department at Heath has added many new features to this rig to make it even more versatile than its predecessor. The new SB-401 offers a front-panel control to switch from independent to transceiver operation when used with the Heathkit SB-301 (or SB-300) communications receiver. This control and the allied circuitry that go with it also enable the SB-401 to be operated as an independent transmitter with any communications receiver—all you need is the Heath SBA-401-1 crystal group.

One of the amazing things about this new transmitter is its cost—it is forty dollars less than the preceding model! Even with the optional crystal group installed the new SB-401 is ten dollars less. The specs of the new SB-401 are just about the same. It still runs 180 watts PEP on SSB on 170 watts CW. Linear tuning is provided by the Linear Master Oscillator and the 1 kHz dial calibration permits frequency repeatability within 200 Hz. It features a built-in antenna change-over relay, a relative power meter, VOX and PTT control, and LSB, USB or CW.

In addition, Heath has changed their assembly plan to "sub-pack" packaging. Now basic portions of the transmitter are assembled as individual units. The builder opens only the packages of components necessary for that part of the SB-401 he is about to assemble. Unit by unit he progresses toward completion. In this way, the number of components involved at any sequence is cut down and there is less chance for error. Besides, it's easier.

For more information on this new transmitter, and a complete set specifications and the schematic, write to Heath Company, Benton Harbor, Michigan 49022.

(Turn to page 132)

Beautiful Binders

Keep your valuable copies of 73 neat and easy to find with inexpensive custom-made binders. These binders are sturdy, attractive and easy to use. Each holds twelve issues, a full year of your favorite ham magazine. Years available: 1960-61 (holds all of 1961 and the three issues we published in 1960), 1962, 1963, 1964, 1965, 1966, 1967.

Only \$3 each.

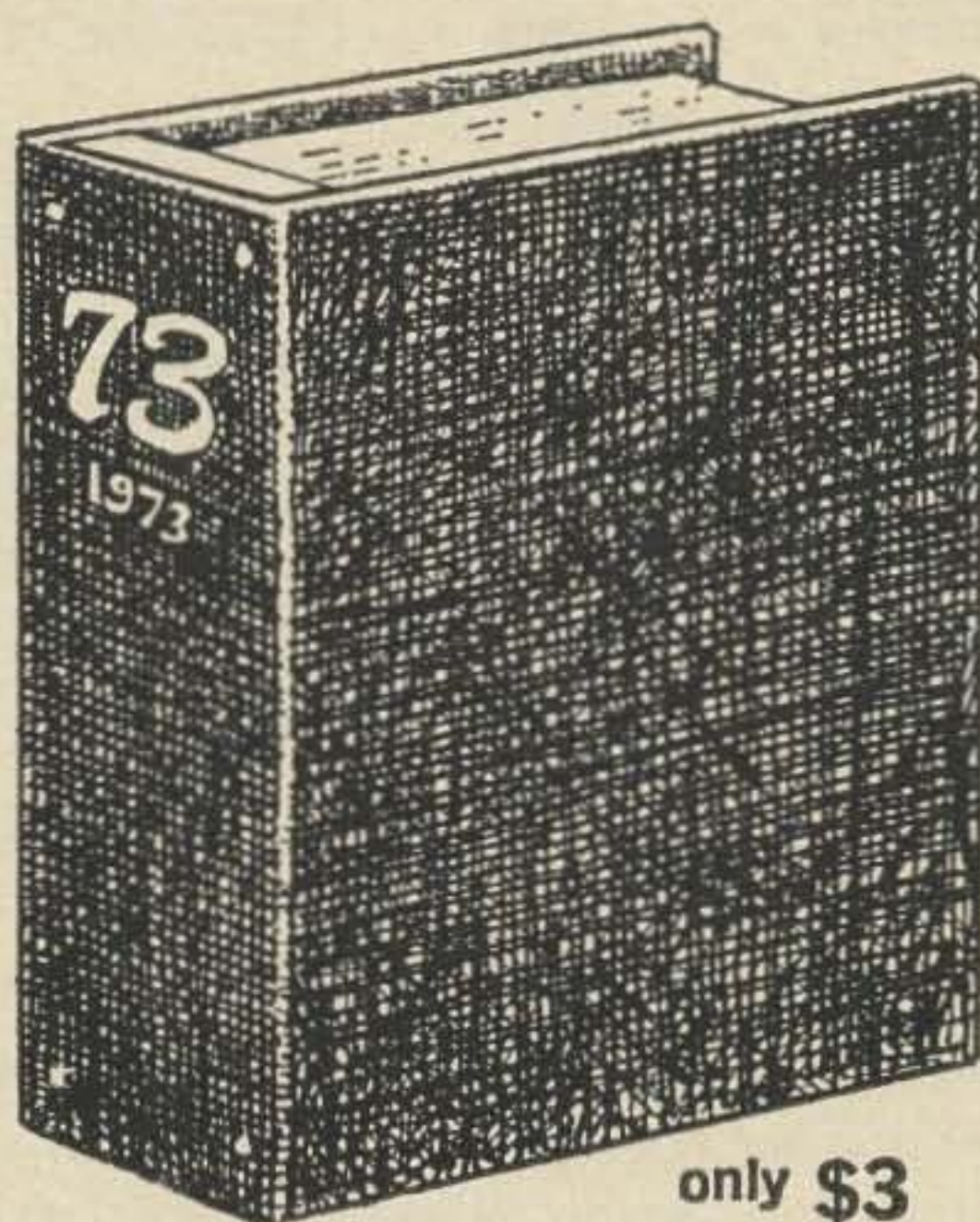

only \$3

Fantastic Full Years—\$3.50

Missed any full years of 73? Like a new set of any years to replace those old, worn-out, ragged, dog-eared 73's you keep using for reference? We can supply all 12 issues of 1962, 1963, 1964, or 1965 in good, unused condition at less than 30¢ per copy when you buy all 12. We reserve the right to substitute if any issue runs out. The price for one year, 12 issues, is only \$3.50.

Special Sales! Binders and Back Issues! Save!

Buy both a beautiful binder and beaucoup back issues and save! Normally a binder and 12 issues (a full year) of 73 costs \$9. Now buy them for \$7 and save \$2. Years available: 1962, 1963, 1964, 1965, 1966. \$6.25 per year.

Back Issue Special—20 issues for \$5

We're offering a special on back issues: 20 good back issues of 73 (our choice) from before 1965 for only \$5.

Individual Back Issues—50¢

All back issues of 73 are still available except January 1961. They cost 50¢ apiece except October, November and December 1960, which are \$1 each.

PLEASE INCLUDE POSTAGE ON ALL ORDERS.

73 Magazine

Peterborough, N. H. 03458

ALL BAND TRAP ANTENNA!



Reduces Interference and Noise on All Wave Receivers. Makes Short Wave Reception Stronger. Clearer on All Bands!

For ALL Amateur Transmitters. Rated at 1000 Watts AM 2000 SSB PiNet or Link Direct Feed. Light, Neat, Weatherproof.

Complete as shown total length 102 ft. with 96 ft. of 72 ohm balanced twinline. Hi-impact molded resonant traps. You just tune to desired band. Excellent for ALL world-wide short-wave receivers and amateur transmitters. For NOVICE AND ALL CLASS AMATEURS! Eliminates 5 separate antennas with excellent performance proven. Inconspicuous for Fussy Neighbors! EASY INSTALLATION! Thousands of users.

75-40-20-15-10 meter bands. Complete\$19.95
40-20-15-10 meter. 54 ft. (best for swl's). Complete ..\$18.95
SEND ONLY \$3.00 (cash, ch., mo) and pay postman balance COD plus postage on arrival or send full price for postpaid delivery. Free information.

MIDWAY ANTENNA • Dept. A7-1 • Kearney, Nebr. 68847

Interested in VHF?

Then why not send for a free sample of the VHF'er Magazine. It's devoted entirely to serious VHF and UHF hamming. It contains articles by well-known and capable VHF'ers. All who want to improve their knowledge of VHF are invited to subscribe.

The VHF'er

Parks Laboratories
419 SW First, Beaverton, Oregon

HERE IT IS!



THE EXCITING XT-1A TV CAMERA KIT

26 SEMICONDUCTOR CIRCUIT (17 pnp transistors, 8 silicon diodes and 1 zener) 6 STAGE HIGH GAIN, LOW NOISE VIDEO AMPLIFIER • SELF-CONTAINED ELECTRONIC REGULATED POWER SUPPLY • 1 PIECE PRINTED CIRCUIT BOARD CONSTRUCTION • RF (ch. 2-5) or VIDEO OUTPUT

KIT CONTAINS: Anodized aluminum cabinet, printed circuit board, lens, lens mount, focus and deflection coils, power transformer, transistors, resistors, capacitors, small coils, switches, pots, knobs, vidicon tube socket, coax output connector, diodes, hardware, wire PLUS OUR LARGE, EASY-TO-FOLLOW CONSTRUCTION PLANS.

In addition to this camera we have a complete line of tube model STARTER and MAJOR COMPONENTS KITS starting as low as \$18.95! For detailed info on all our kits PLUS block diagrams and off-the-rcvr photos send 10¢ for our information packed 1966 catalog. DON'T BUY UNTIL YOU'VE COMPARED our UNBELIEVABLE PRICES with our competitors! Low cost x Quality = an ATV RESEARCH kit.

Post Office Box 396-S **ATV RESEARCH** So. Sioux City, Nebr. 68776

New Products

(from page 130)

Poly Quad Antenna Kits

The Polygon Plastic Company has entered the amateur radio field with a unique fiberglass cubical quad antenna kit. Already a nationally known manufacturer of industrial fiberglass products and the "Glas-Lite" fiberglass sporting goods line, Polygon has adapted a three piece tube with strength equal to, or even greater than, the best 13 foot continuous length pole.

The entire kit is mailable, thus reducing shipping cost and time. Most important is the sky-blue epoxy paint used on the standard kit spreader. This paint protects the fiberglass from weather and ultra violet ray deterioration adding years to spreader life. It also tends to make the mounted antenna less conspicuous and therefore, less objectionable to neighbors. The most advanced and economical feature of the kit is the spreader mount—called the Starmount. Using only a wrench and screwdriver, the amateur can adjust the Starmount to fit booms from 2 to 3 inches in diameter. He can go from dual to multi-element arrays without buying all new hardware. The Starmount is diecast of proven corrosion-resistant, high strength aluminum alloy. The boom-to-mast adapter is also fabricated from a high quality aluminum alloy.

A comprehensive and illustrated 28 page manual offers simple instructions enabling the average Ham to construct the Poly-Quad in a matter of hours. Selection of boom, wire and reflector tuning methods is left to the individual customer. Kits are available with 2, 3 and 4 elements in tri and duo-band series. Components are also sold separately. For more information, write to Polygon Plastic Company, 7 Industrial Park, Walkerton, Indiana 46574.

Amperex Linear IC's

Amperex has announced the availability of five new linear monolithic IC's. The most advanced type in the line is the TAA320, an optimum performance audio frequency semiconductor device. Trade-named the 'BiFET', it is the world's first bipolar/mosfet integrated circuit amplifier. This new design concept enables the unit to take 100 volt transients, features a G_m of 40,000 μ mhos and has an input resistance of 10,000 megohms.

The new model TA310 is designed specifically as a record/playback preamplifier. It provides 100 dB gain with less than 4 dB noise. The TAA293 features complete accessibility to all internal connections to provide wide application flexibility. It is ideally suited for audio and *if* applications, or as an amplifier, oscillator and multivibrator in other low-frequency functions.

The new Amperex TAA103 is the smallest linear integrated circuit amplifier presently available. The plastic flat-pack in which it is packaged measures a scant 0.002 cubic inches. This IC features 75 dB gain and is ideally suited for amplifier applications from dc to 600 kHz.

For more information on this new line of integrated circuits, write to Amperex Electronic Corporation, Semiconductor Division, Slatersville, Rhode Island 02876.

Aerovox RF Suppression Filters

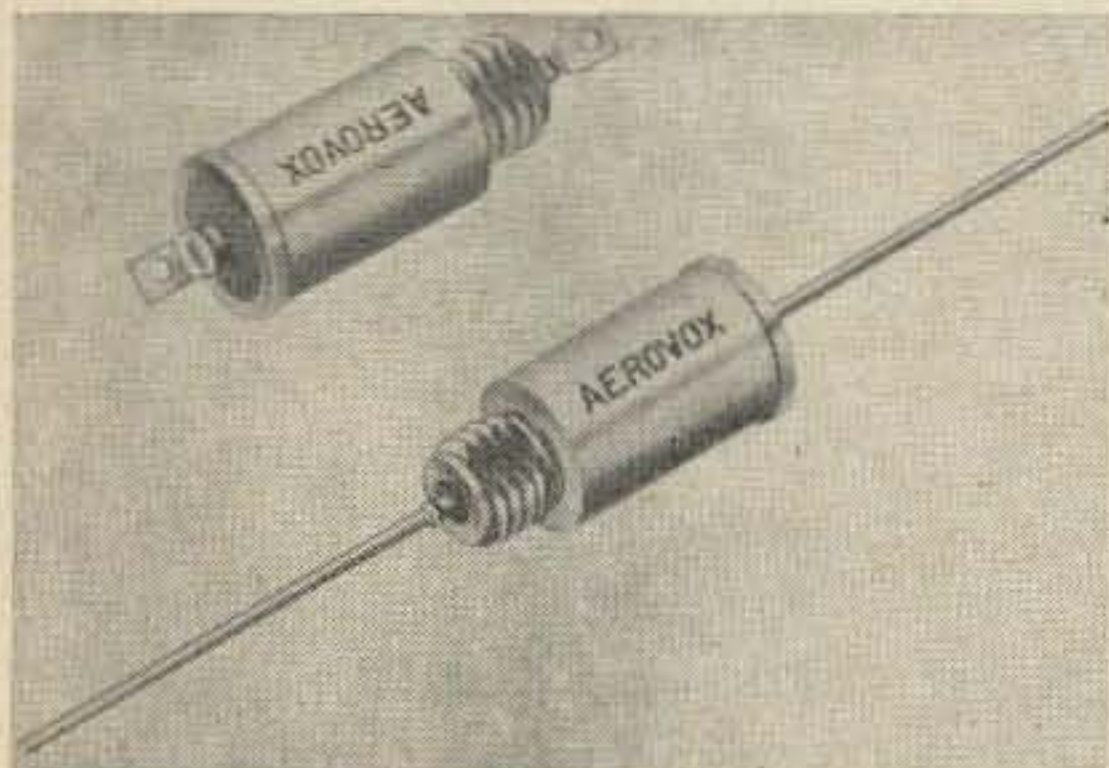

Although these filters were designed for the military market, they should find use in amateur equipment where severe rf suppression requirements exist. These miniature ceramic filters come in twelve different models for rf suppression from 150 kHz to 10 GHz (10,000 MHz). For more information write to Aerovox Corporation, Olean, New York.

WRL 1967 CB Catalog

Although this new catalog from World Radio Labs was put together specifically for the citizens band operator, there are many items included which are of interest to the amateur. Test equipment, antenna accessories, feedline, rotors, tools and components are included as well as a full line of CB gear. For your free copy write to World Radio Laboratories, 3415 West Broadway, Council Bluffs, Iowa 51501.

(Turn to page 134)



TUNAVERTERS!!
160 to 2 Meters for HF & VHF AM-SSB-CW-FM Marine, SW, and Police! Tunable RF converters.

For all auto and home radios! Transistor & 6-l tuning!

(See Complete listing in Apr. '67 '73 ad, page 107.)
Dept. 75, Woodboro, Texas 78393

HERBERT SALCH & CO.

— Special Purchase — COPPER CLAD LAMINATES

VHF & UHF Circuitry G10 Epoxy Glass 1 oz. copper, 1 side						General Purpose XXXXP 1 oz. copper, 1 side	
Pkg. Quantity	3/64"	1/16"	5/64"	3/32"	1/8"	Pkg. Quantity	1/16"
1 9" x 12"	N/A	\$3.00	\$3.50	\$4.00	\$5.50	2 9" x 12"	\$1.50
2 6" x 9"	N/A	3.00	3.50	4.00	5.50	4 6" x 9"	1.50
4 4 1/2" x 6"	2.50	3.00	3.50	4.00	5.50	8 4 1/2" x 6"	1.50
6 3" x 4 1/2"	2.50	3.00	3.50	4.00	5.50	12 3" x 4 1/2"	1.50

Postage prepaid. Every order unconditionally guaranteed.

Limit, 5 packages per order (enclose cash or M.O.) No sales to dealers.

TRI RIO

Electronics

2614 Lake Shore Dr. LaCrosse 1, Wis. 54601

ARNOLD'S ENGRAVING

ARNOLD
WA2ZHA
AMATEUR RADIO CLUB

BLACK WITH WHITE LETTERS, 1 1/4 x 3/4"

AMATEUR CALL PINS \$1.25

ARNOLD LINZNER

2041 LINDEN ST. RIDGEWOOD, N.Y. 11227

oscillator/monitor

- a sensitive broadband RF detector gives audible tone signal in the presence of any RF field from 10mw to 1kw and 100kc to 1000mc
- a CW monitor with positive "RF" switch uses only 8" pickup antenna and NO connection to rig or key
- a code practice oscillator with adjustable tone & built in speaker
- high gain 4 transistor circuit powered by long life AA pencil
- 16 gauge aluminum cabinet in white & black epoxy finish, 3 1/2" by 2 3/8" by 1 1/4", weight 8 ounces
- 100% US made and guaranteed



1295 (batt incl)
ppd usa & can
send cert ck or m.o.
ny res add 5% tax

the James research company
11 schermerhorn st., brooklyn n.y. 11201

CONVERTER SALE

6 METER SOLID STATE RF CONVERTERS

2 db NF, .2 μ v for 6 db signal to noise ratio, mil. spec. epoxy glass printed circuit board, variable forward gain control, built-in power supply available for all models. 2N3823 FET front end available for 1.5 db NF and reduced cross-modulation effects.

THESE CONVERTERS CAN REALLY PULL IN THE DX!

Model	Input M Hz	Output M Hz	Price
SS610	50-54	14-18	\$21.95
SS610F	Same as above but FET rf amp.		39.95
SS611	50-54	7-11	21.95
SS611F	Same as above but FET rf amp.		39.95
SS510	50-54 MHz rf pre-amplifier		9.95
SS511	50-54 MHz FET rf pre-amplifier		29.95
SS600X	Special IF (.6-30 MHz)		24.95
SS660XF	FET special IF (.6-30 MHz)		42.95
	For built-in power supply, add		5.00

For prompt shipment of stock models include postal money order or cashier's check. Special models shipped within six weeks. Personal checks must clear before shipment. Include 20% deposit for COD.

Unconditionally guaranteed.

Southwest Semiconductor Specialists

P.O. BOX 12312, SAN ANTONIO, TEXAS 78212

150 MC BASE STATIONS

30 watt excellent condition now narrow banded Bendix MRT8 \$59 F.O.B. Ft. Worth. Send M.O. or cashiers check with order. For info send stamped envelope.

F. M. HAM SALES

P.O. Box 1574 Ft. Worth, Texas 76100

FREE ARCTURUS CATALOG

A Trusted Name in Electronics Since 1925

Electronic parts, tubes. Wholesale.

Thousands of items. Unbeatable prices.

ARCTURUS ELECTRONICS CO.

502 - 22nd St., Union City, N. J. 07087



Master Code

the sure and easy way

TELEPLEX METHOD Code Instruction gives you training that makes you proud of your accomplishment. The greatest pleasure derived from any hobby is an exhibition of your

skill. Shaky speeds of a few words per minute may be gained in most any haphazard, hit-or-miss system. Professional skill will be gained only from professional training. Brochure 7-5 is free—it gives you the facts.

TELEPLEX COMPANY

739 Kazmir Court, Modesto, Cal. 95351

New Products

(from page 132)

Top Tuning Piston Capacitor

The Components Division of the JFD Electronics Company has just announced a universal top tuning assembly which adapts all JFD piston capacitors for top tuning and vertical mounting. These units are ideal for applications in equipment where space is at a premium and top tuning is required.

These components are available in two wire and pin or four wire configurations for printed circuit use. The unit shown here has a range from 2 to 25 pF, a working voltage of 500 Vdc, and Q of 600 at 20 MHz. For further information, write to JFD Electronics Company, Components Division, 15th Avenue at 62nd Street, Brooklyn, New York 11219.

Amperex Semiconductor Catalog

Amperex has just announced the latest edition of their condensed Semiconductor Catalog. This new catalog contains the basic specifications and related material on the full line of Amperex semiconductors. It serves as a quick reference guide and includes specification lists and associated applications references on transistors, diodes, audio amplifier assemblies, integrated circuits, heats sinks and audio kits. In addition, there is a list of Amperex Application Reports. Free copies may be obtained by writing on your company letterhead to Amperex Electronic Corporation, Advertising Department, Hicksville, Long Island, New York 11802.

1967 EICO Catalog

EICO has just announced publication of their new 1967 catalog. This new catalog features EICO's complete line of 200 electronic kits and factory assembled instruments for hams, electronic technicians, hobbyists, CB'ers and audio buffs. Among the new EICO items included in this catalog are their 717 Electronic Keyer, 711 Short-wave Receiver, 888 Engine Analyzer and "Cortina" solid-state stereo. Also included are the EICOCRAFT Solid State electronic kits—seventeen different units for many applications. For your copy of this new catalog, write to Electronic Instrument Company, Inc., 131-01 39th Avenue, Flushing, New York 11352.

WANTED!

YOUR MILITARY SURPLUS EQUIPMENT BUY - SELL - TRADE

Airborne: ARN-14C, ARN-21C, ARN-30D, ARN-52, ARN-59, ARC-21, ARC-27, ARC-34, ARC-38, ARC-44, ARC-51, ARC-52, ARC-73, ARC-84, APX-6B, APN-70, APN-133. Collins 17L-6, 17L-7, 51X-2, 51R-3, 51V-4, 51Z-3, 618T, 618F, 618S-1, 618M-1.

Ground Equipment: PRC-8A, PRC-9A, PRC-10A, PRC-25, AN/GRC-3 thru 85, RT-66 thru RT-70/GRC, UPX, UPA, APR-14.

Receivers: R-220, R-274C, R-388, R-389, R-390, R-391, R-392/URR, SP-600JX, RBL, SP-600VLF, R-836/ARN, BC-348, AR-88D, 75S-3, 75A4, 51J-4, 51S-1.

Test Equipment: Surplus with ARC, ARM, SG, GPM, GRM, URM, UPM, USM, MD prefixes. Commercial H-P, GR, Tektronix, Boonton, Measurements.

Tubes: New boxed receiver and transmitter types, buy and sell.
Tech Manuals: We Buy, sell and trade.

TRADE YOUR GEAR FOR THE FOLLOWING

Ameco TX-62, 6 & 2 mtr transmitter	\$ 149.95
Ameco VFO-621, 6 & 2 mtr VFO	59.95
Drake R-4A, receiver	399.95
Drake T-4X, transmitter	399.95
Drake T-4X, AC power supply	99.95
Drake TR-4, transceiver	599.95
Drake AC-4, TR-4 AC power supply	99.95
Drake DC-3, TR-4 DC power supply	149.95
Drake MS-4, speaker	19.95
Drake RV-4, TR-4 remote VFO	99.95
Drake 2-C, receiver	229.00
Drake 2-NT, CW transmitter	129.00
Drake L-4, linear amplifier	695.00
Drake SW-4, general coverage receiver	289.00
Eimac 3-400Z tube	34.00
Eimac SK-410 socket for 3-400Z	6.50
Eimac SK-416 chimney	6.50
Eimac 3-1000Z tube	78.00
Eimac SK-510 socket for 3-1000Z	6.50
Eimac SK-516 chimney	12.00
Eimac, send your needs; others in stock.	
E-Z Way towers, write for prices.	

Gonset 900A (GSB-II) SSB-AM-CW 2-meter transceiver	\$299.50
Gonset 903A 500-watt 2-meter amp.	256.00
Gonset 910A (GSB-6) SSB-AM-CW 6-meter transceiver	299.50
Gonset 913A 500-watt 6-meter amp.	256.00
Gonset 2/6 mtr xcvr DC power supply	55.00
Gonset 2/6 mtr xcvr AC power supply	61.00
Gonset GSB-201 all-band linear amp.	299.00
Gonset GA-138, 108-138 MHz air-to-ground transceiver, 12V/117V	489.95
Hammarlund: write for prices.	
Hy-Gain: write for prices.	
Ham-M rotator	119.50
Linear Systems: DC mobile power supplies, write for prices.	
National 200 all-band transceiver	359.00
National NCX-5 all-band transceiver	549.00
National NCX-A, AC power supply/speaker console for transceivers	110.00
National HRO-500 receiver	1675.00
SBE SB-34, SSB transceiver with built in 115V/12V power supply	419.00

Other manufacturers in stock. Send your needs. Also lists of what you have to trade.

Surplus Special: Jennings vacuum variable capacitors, UCS 10-300 mmfd, 7.5 kV, complete with gear drive train, mounting bracket, brand new, \$27.50 postpaid, insured.

Write, wire, phone 813-722-1843, Bill Slep, W4FHY

SLEP ELECTRONICS COMPANY

Drawer 178P, Highway 301
ELLENTON, FLORIDA 33532

Hundreds of Bargains

...SO WHY PAY MORE FOR THE BEST!

Instant Credit, Instant Shipment On Time Payments & Cash Orders

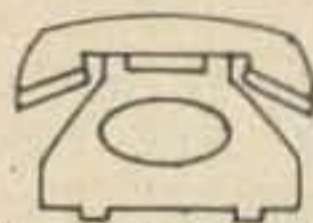

Trigger Electronics is as near as your phone



...or your mailbox

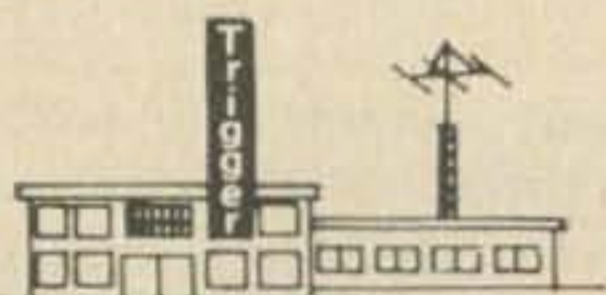

Trigger—for the most complete inventory of amateur and CB equipment. Everything in stock for your convenience!

Trigger has cut the red tape of time-consuming credit delays. Just pick up the phone and call us (no collect calls, please) and your goodies will be on their way—usually the same day!

another important TRIGGER service:
WE BUY USED HAM GEAR FOR CASH
 PROMPT SERVICE...
 PROMPT CASH!



No company processes foreign orders and inquiries with greater dispatch than Trigger

TRIGGER Attn: W9IVJ
 7361 North Avenue
 River Forest, Illinois
 RUSH THE FOLLOWING: Amount Enclosed

NAME _____
 ADDRESS _____
 CITY _____ STATE _____ ZIP _____

ORDER BLANK TO: trade ur present gear, order equipment, sell ur gear for cash.

STORE HOURS Weekdays 11:00 A.M.—8:00 P.M.
 (CENTRAL TIME) Saturdays 9:00 A.M.—3:00 P.M.

ALL TELEPHONES (312) 771-8616

WHY IT WILL PAY YOU TO DEAL WITH TRIGGER

- Amazing Trades
- No Down Payment Required
- Low Budget Terms
- Midwest Bank Credit Cards Accepted
- Fast, Efficient Service
- No Waiting
- 20 Minutes From Downtown Chicago Or O'Hare Airport
- Near Junction Of Routes 64 & 43
- Plenty Free Parking
- Open Weekdays Until 8:00 PM
- COME IN, BROWSE AND GET ACQUAINTED, AND SEE THE MOST COMPLETE INVENTORY OF HAM AND CB GEAR—ATTRACTIVELY DISPLAYED.

NEW EQUIPMENT ON LOW BUDGET TERMS

Ameco	Hallicrafters	Numechron
Astatic	Hammarlund	Regency
B & W	Hy-Gain	S B E
C D R	Johnson	Shure
Cush-Craft	Mark Mobile	Swan
Dow Key	Millen	Trimm
Drake	Mosley	Vibroplex
Eico	National	Waters
Finco	New-tronics	Weller

and many other major brands

LIKE-NEW EQUIPMENT ON LOW BUDGET TERMS

- Ten-Day Trial
- 30-Day Guarantee

Tops in performance and appearance, thoroughly and beautifully reconditioned, and clean as a pin. Alignment, calibration as good as new, and frequently better. Listed below are but a few of the hundreds of items and accessories currently available. Write for complete listing and prices.

LIKE-NEW BARGAIN SPECIALS FOR JUNE

COLLINS 75A4...\$429	AMECO TX62...\$119	GONSET G77A...\$ 77
DRAKE TR4... 519	AMECO VFO621... 47	GLOBE HG303... 47
DRAKE RV4... 79	S85... 67	GALAXY 111 AC, SPKR, VOX... 249
DRAKE R4A... 349	S120... 39	HQ100AC... 134
DRAKE T4X... 319	SX110... 87	HQ170AC... 259
DRAKE AC4... 79	SX111... 149	SP600JX... 399
SWAN 350... 357	SX130... 129	EICO 753... 139
AC SUPPLY... 74	SX140... 77	HW29A 6ER... 39
SBE34... 349	HT46... 259	HEATH HR10... 67
SB2LA LINEAR... 219	HA1 KEYSER... 59	SB300... 229
CLEGG 99ER... 89	HRO500... 1350	DX100B... 99
CLEGG 22ER... 177	NC60... 39	SENECA VHF1... 179
INTERCEPTOR... 257	NC109... 79	HX10... 199
ALLBANDER... 69	NC125... 89	HW12... 79
ZEUS... 267	NC303... 257	HA14 & HP24... 149
RANGER... 99	NCX3... 189	MP1... 24
VALIANT 11/FW... 249	NCX5... 429	HP23... 39
CHALLENGER... 57	NCXA... 79	SWR BRIDGE... 12
KNIGHT VFO... 27	NCL2000... 549	

A SMALL DEPOSIT WILL HOLD ANY UNIT ON LAY-AWAY.



TRIGGER Electronics
 7361 NORTH AVE. • RIVER FOREST, ILLINOIS 60305
 (WEST SUBURBAN CHICAGO)

SUNDAY TELEPHONE SERVICE
 11 A.M.—3 P.M.

Caveat Emptor?

★ Price—\$2 per 25 words for non-commercial ads; \$5 per 25 words for business ventures. No display ads or agency discount. Include your check with order.

★ Type copy. Phrase and punctuate exactly as you wish it to appear. No all-capital ads.

★ We will be the judge of suitability of ads. Our responsibility for errors extends only to printing a correct ad in a later issue.

★ For \$1 extra we can maintain a reply box for you.

★ We cannot check into each advertiser, so Caveat Emptor . . .

WANTED IP-501 receiver write box 77 Savannah, Georgia, 31402.

WANTED SW-3 receiver write box 77, Savannah, Georgia, 31402.

NEW T-4X, \$325, AC-3, \$65, unopened factory cartons, warranty, new, sealed. 3-400Z tubes, pair \$55, singles \$28, warranty. W4HKQ, Don Payne Box 525, Springfield, Tenn. 37172.

NEW SWAN 500, 117XC speaker, supply unopened factory cartons, warranty, \$478. HQ-170, clock, manual, mint condition, \$115. W4HKQ, Don Payne, Box 525, Springfield, Tenn. 37172.

TRANSFORMERS: Filament-transistor power supply: 6.3 VAC at 1.5 A, 115 VAC, \$1.00 each pp anywhere in U.S. No minimum order. Electro Systems, 3496 Zisch Dr., San Jose, Calif. 95118.

RECORDING TAPE: Name brand splice free. 1.5 mil mylar, 1200 ft, \$6.50 for 5 reels; 1.0 mil mylar, 1800 ft, \$9.00 for 5 reels, pp anywhere in U.S. Electro Systems, 3496 Zisch Dr., San Jose, Calif. 95118.

ANTENNA FOR SALE! Mosley A-315 15 meter mono bander. Never used. \$25. You pick up or pay delivery. Russel Appleyard, 16 Coolidge St., Larchmont, N.Y. 914-834-3470.

ALUMINUM TOWER, never rusts. Easy to erect. Crank up, tilt over. Mail postcard to Ralph, Gateway, Exeter at Big Bend, Shrewsbury, Mo. 63119.

NCX-3 & NCX-D supply both in very clean and good operating condition, package deal \$275. Ed Baldus, 5365 Dockweiler Pl., L.A., Calif. 90019, tel 213-933-0485.

RF SIGNAL GENERATORS: I-122, \$24; LAE, \$8; HB superhet, \$18; TS-34 scope, \$20; uncalibrated LM-14, \$21; also have CQ, QST, books, TM's, parts and other test equipment. Send for free list. John R. Yurcik, K2EMF, 510 Conklin Place, Linden, N.J., 07036.

SWAN 350 & AC power supply, \$300. In mint condition. Will ship prepaid on receipt of check. C. Cowles, K9KNG, 831 N. 8th, Manitowoc, Wisc.

SIMPSON MULTIMETER, (VTVM) model 266, \$19; Heathkit signal generator, \$18; Heathkit VTVM, \$18. Good working condition. H. Goldman, 43 Clinton Ave. Rockville Center, N.Y., 11570.

HEATH SB-300 with filters, \$250; SB-400, \$295; SB-301-3, \$19; Table top KW linear, \$125; others write. Shideler, 2812 Tenth, Arcadia, Calif.

VIKING-1 6146's PA TVI'd VFO PTT filter RCA AR88LF 60KC-30MC all \$150. Buyer inspects/collects. K2BJB, 25 Tudor Ave. Pine Beach, N.J. 08741.

VIKING VALIANT, \$170. HRO-50 with crystal calibrator and 5 coils, \$125. Central Electronics 10-B, \$45. Albert Thomson, W8DTI, 2645 Forest Grove S.W., Wyoming, Michigan 49509.

HEATH solid state multiplex twins, AA 14 and AJ 14 with bookshelf speakers, all in oiled walnut. Ranger 1 and Vanguard 6 mtr conerter w/10 meter out. Sell or trade for transceiver. Robert F. Cann, W4GGB, 815 Ben Franklin Dr. Sarasota, Florida 33577.

SWAN 120 with mike, \$120. Topaz mobile 800 V power supply, \$50. Will ship. H. A. Hindert Star Route 2, Fischer, Texas 78623.

HEATH SB-300 receiver, cleanly wired, excellent operation, like new condition, used 6 months during novice period. Will ship FOB for \$175. D. W. Frye, WA3CKZ, 328 Castlegate Rd. Pittsburgh, Penna. 15221.

HQ-170-C, \$175; DX-60, \$55; HG-10 vfo, \$25; 10-D mike, \$15; HM-11, \$10; Matching speaker for 170, \$10. Also key, etc. First certified check for \$260 takes all. Singly as listed. D. Callaway, Rt. 1, Box 303, Durango, Colorado 81301.

BACK ISSUES: 73-CQ-QST-Radio. Write, for list. W. Conant, 15424 Chase St., Sepulveda, Calif. 91343.

DUMMY LOAD 50 ohms, flat 80 thru 2 meters, coax connector, power to 1 KW, kit \$7.95, wired \$11.95, pp Ham Kits, Box 175, Cranford, N.J.

CLIFF DWELLER 75/10 meter rotatable dipole. First owner, not rusty, \$50; HT32A immaculate condition, \$250. Want transceiver. Marty WB6-NWW, 5349 Abbeyfield, Long Beach, Calif. 90815.

SWAN 250 AC SUPPLY, Mark VI Linear, many extras, Johnson 6N2, National VFO, Tapetone WTC-1300; best offer. Richard Solomon, 25 Regina Rd. Dorchester, Mass.

FOR SALE: Swan 350 w/AC power supply, \$375.00; SB-200, 1200 W PEP linear, \$175.00; HA-650 6-meter portable xceiver, \$100.00. All equipment mint, perfect working order. Ken Feldman WB6FRP, 705 Gayley Ave., Los Angeles, Calif. 90024.

SELECTRONIX AUDIO FILTER, use between receiver and speaker or phones, cuts monkey chatter and narrows band pass to about 1000 Hz. Some QSO's possible only with this in circuit. \$24.95 pp. W0RA/1 Box 115, Greenfield, N.H. 03047.

NATIONAL NCX-3 and NCX-A power supply, mint condition, \$290. Electro-Voice mike and PTT stand, \$20. Randy Brook, WA2PPE, 534 W. 114th St., N.Y.C. 212-662-0232.

GONSET G-76. Transceiver. Both factory power supplies and mike. Very good condition, \$175.00. Will ship, you pay charges. D. Frahm, 714 San Miguel, Sunnyvale, California 94086.

A. R. C. Sales

Variable Capacitor. Four section. 7.5-425 mmf. per section. 30-1700 mmf. overall. 3½" w x 1½" h x 6½" long plus ½" for ¼" shaft. Wt. 3 lb.\$4.95
Filament and Bias Transformer. 115v. 60 cyc. pri. Sec. 1—12.6v C.T. @ 7.5 amp. Sec. 2—185v @50 ma. Wt. 7 lb.\$4.50
Plate Transformer. Pri. 117v. 60 cyc. Sec. 690v @ 450 ma. No C.T. Will double to 1700 volts. Wt. 19 lb.\$3.95
Plate Transformer. Pri. 117v. 60 cyc. Tapped Sec. 1200v C.T. @ 200 ma. and 740v C.T. @ 235 ma. Wt. 12 lb.\$3.25
Heavy Filament Transformer. Tapped Pri. 115-125v. 57-63 cyc. Sec. 1—6.3v C.T. @ 15 Amp. Sec. 2—6.3v C.T. @ 5 Amp. Wt. 10 lb.\$3.50
 All items are new and F.O.B., Worthington, Ohio

A.R.C. Sales

P. O. Box 12, Worthington, Ohio 43085

PLATE TRANSFORMERS—\$39.95

3600-0-3600 VAC @ 1000 Ma., CCS, with 120/240 VAC 60 cps primary. Commercial quality units manufactured by Wagner Electric Co. measure 13" high, 12" wide, and 9" deep. Net weight is 85#. Price \$39.95 F.O.B. Minneapolis. One year unconditional money back guarantee. Terms: Check or M.O. with order. Immediate delivery. Write or phone:

PETER W. DAHL CO.
 3314 Diamond Drive El Paso, Texas

TWO-WAY COMMUNICATION CRYSTALS

AMERICAN CRYSTAL CO.
 PO BOX 2366 KANSAS CITY, MO.

CQ de W2KUW

5% BONUS!!

Paid over any top offer for any piece of aircraft or ground radio units, also test equipment. All types of tubes. Particularly looking for 4-250 • 4-400 • 833A • 304TL • 4-1000A • 4CX5000A et al. 17L • 51X • 390A • ARM • GRM • GRC • UPM • URM • USM units.

TED DAMES CO. • 310 Hickory St., Arlington, N.J.

COLLINS VFO's

Units are less Dial Assembly with leads ready to install in your equipment. These are new units or like new, carefully checked and satisfaction guaranteed.

See Schematic and pictures in Collins Receiver Handbooks.

Type	Used In	Tuning Range	Dimensions	Price
70E-24	75A-4	1.95 to 2.955 MHz	5 x 2½" diam	\$49
70E-23	KWS-1	2.75 to 3.75 MHz	5 x 2½" diam	\$39
70K-1	KWM-1	3.445 to 3.545 MHz	2½W x 2H x 2½D	\$29

Terms cash, full refund if you are not satisfied within 10 days.

RICHARD E. MANN

430 Wilmoat Road, Deerfield, Illinois 60015

MILITARY TEST EQUIPMENT DATA HANDBOOKS

Published 1961 by Frederick Research Corp. Vol. 1. Volt/Current Meas. Equip. Vol. 2. Freq. Meas. Equip. Vol. 3. Waveform (Oscilloscope) Equip. Vol. 4. Signal Gen. Equipment. Four Bound Books (10 pounds) NEW. \$5.50 postpaid, payment w/order. We Also buy for Cash, Surplus Testsets, Transmitters, Receivers, Etc. Especially Airborn Collins.

RITCO Electronics, Box 156, Annandale, Va. 22003. Phone (703) 560-5480.

TRANSISTORS. Had baby so he took over shack. Have transistors plus many associated parts. Send for list. Ralph Miller, 15 Arbutus St. Dorchester, Mass. 02124.

HY-GAIN 18-AVQ, brand new in original box. Going for full size 80-meter vertical. Delivered prepaid, \$39.50. W0RA/1, Box 115, Greenfield, N.H. 03047.

PIPE SMOKERS: Three 1½ oz. sample pouches of the world's finest pipe tobaccos. \$1.50 plus 50¢ handling charges. SMOKE RISE, W4ANL, 13118 Thompson Rd., Fairfax, Virginia 22030.

HAMFEST AND PICNIC, sponsored by Tri-State College Amateur Radio Club, Sunday, June 11th, 1967, at 1200 EST, Steuben County 4-H Park. Prizes, swap-shop, transmitter hunt, etc. For information write: Tri-State College Amateur Radio Club, Angola, Indiana 46703.

WANTED: TEST EQUIPMENT, laboratory quality such as Hewlett-Packard, General Radio, Tektronix, etc. Electronicraft, Box 13, Binghamton, N.Y. 13902. Phone: (607) 724-5785.

RTTY GEAR FOR SALE. List issued monthly. 88 or 44mH toroids, five for \$1.75 postpaid. Elliot Buchanan, W6VPC, 1067 Mandana Blvd., Oakland, California 94610.

WANTED—Teletype 28s, parts, what have you. SELL—machines, parts. Fred Schmidt, W4NYF, 405 NW 30th Ter., Ft. Lauderdale, Fla. 33311. 305-583-1340 (9 P.M. EST.)

TOOOOBES: 811A—\$4.25; 7094—\$26.90; 6146A—\$2.25; 6CW4—\$1.40; 5894—\$15.50; Extra power 6146B—\$4.00; 6360—\$3.45; 8236—\$9.50. All new, boxed, guaranteed. FREE catalog. VANBAR Distributors, Box 444Y, Stirling, N.J. 07980.

SOUTHERN NEVADA AMATEUR RADIO CLUB thanks participants and exhibitors who made "SARCO", the "FUN-CONVENTION", such a success in 1967. Stellar Industries, E G & G, Southern California Edison Company, Brad Thompson Industries, Mission Ham Supplies, California Highway Patrol, Henry Radio, Tistao Towers, Weatherbie Electronics Center, Swan, Tri-Ex Towers, Collins, Hallicrafters, Superior Engraving, Hy-Gain, Radio Products, Linear Systems, Hotel Sahara, MARS, Raytheon, United States Airforce, WCARS-7255, W7SAI, "SAROC" 1968 "FUN-CONVENTION" will be centered in the heart of the entertainment capital of the world at Hotel Sahara, Las Vegas, Nevada, January 4-7. QSP, QSL-card, ZIP and telephone number for details to Southern Nevada Amateur Radio Club, Box 73, Boulder City, Nevada 89005.

WANT: R278/GR, or R278B/GR: Also R391 receivers. Thompson, 5 Palmer, Gorham, N.H.

WANTED: Tubes, transistors, lab instruments, test equipment, panel meters, military & commercial communications equipment and parts. Bernard Goldstein, Box 257, Canal Station, New York, N.Y. 10013.

FREE CATALOG—Loads of Electronic Bargains, R. W. Electronics, Inc., 2244 South Michigan Avenue, Chicago, Illinois 60616.

DUMMY LOAD 50 ohms, flat 80 thru 2 meters, coax connector, power to 1 kW. Kit \$7.95, wired \$11.95. pp HAM KITS, Box 175, Cranford, N.J.

PLASTIC HOLDERS—each display 20 QSL cards. 3 for \$1.00 or 10 for \$3.00 prepaid and guaranteed. Free brochure of other ham goodies included. Tepabco, Box 198N, Gallatin, Tennessee 37066.

SIX ASSORTED ISSUES at ATV Experimenter, circa. '64-'65, \$1 from 73 Magazine, Peterborough, N.H. 03458.

SCHEMATICS FOR either the ARC-508, or the ARR 15, both described in June '65 issue of 73, only 50¢ each. 73 Magazine, Peterborough, N.H. 03458.

1963 BOUND VOLUMES OF 73. \$15 each from 73, Peterborough, N.H. 03458.

25 WORDS FOR \$2. Sell or buy through these want ads, a terrific bargain. Caveat Emptor, 73 Magazine, Peterborough, N.H. 03458.

NOVICE AND TECHNICIAN HANDBOOK by W6SAI and W6TNS. Limited quantity for only \$2.50 each. 73 Magazine, Peterborough, N.H. 03458.

COMPLETE CONVERSION instructions for the AN/VRC-2, just \$1 while the supply lasts. 73 Magazine, Peterborough, N.H. 03458.

HALLICRAFTERS HT-32B like new \$280.00; Teletype Model 19, fine shape, \$95.00; Model 15 with table, \$75.00, both Bell units with sync. motors. No ship. New TT63A, \$25.00; GBS-201 Linear, \$140.00; Scope HQ-10, \$45.00. Hy-Gain 18HT vert., \$50.00. WA6VBO, Redlands, Calif., (714) 792-7037.

COMPLETE STATION—must sell. Heathkit DX-60 transmitter with HG-10 VFO; Hallicrafters SX-71 receiver with matching speaker; Hy-Gain 14-AVS four-band vertical and tripod roof mount; Turner 22X microphone, and Dow-Key coaxial relay. \$200 takes all. Maurice Blais, 170 Spruce St. Burlington, Vermont 05402.

QSL CARDS???? "America's Finest." Samples 35¢. Sakers Printery, W8DED, Holland, Michigan.

PRINTING PRESS for sale. Excellent for QSL printing. Write Box 218, Holland, Michigan.

CHRISTIAN HAM FELLOWSHIP now being organized for Christian fellowship among hams and for gospel tract efforts. Christian Ham Callbook \$1 donation. Free details. Write Christian Ham Fellowship, Box 218, Holland, Michigan 49423.

JOHNSON KILOWATT MATCHBOX. In like new condition. First certified check for \$85.00. You pay shipping. Cecil E. Menold, WA8HLD, 915 Garfield St., Struthers, Ohio 44471.

AMATEUR EQUIPMENT REPAIRING SPECIALIST. Transmitters-receivers-kits wired. Custom building-alignment-calibration; product detectors added. John Roache, W1SOG, broadcast chief engineer 20 years. Prop. J-J Electronics, Windham Road, Canterbury, Conn. 06331.

SELLING OUT—SB-400, SP-600JX, Mobile supply, QST's, much more. Stamp for list. W3CNS, 21 Terrace La., Elizabethtown, Penna. 17022.

BC-221-P, AC and book, \$60.00; SX-100 & spkr., \$125.00; DX-60 & HG-10, \$65.00. FOB. W9JOX, Box 65, Avoca, Wisc. 53506.

APR-4 WITH TU's, \$175.00; UR8A RTTY converter, \$150.00; 450TH, 450TL, each \$15.00; Trade. Want TR3, linear, rotor, G-76, TA-33. K4UEB, 7807 N. Davis, Pensacola, Fla. 32504.

AVC AUDIO AMP. AM 447 A/G, input 600 ohm split primary output 600 ohms split secondary and 15 K for phones. Constant +37 dbm output for -20 to 0 dbm input. 115V 60cy AC. Brand new. \$14.95 each. Shipping weight 20 lbs. Bertsche Electronics Laboratory, 1475 Bush, San Francisco, Calif. 94109.



SALE

New!

FROM THE SPACE PROGRAM

ONE AMP 'GLASS AMP' SILICON RECTIFIERS



- ★ Outperforms Top Hats and Epoxies!
- ★ Handles 2 Amps
- ★ Encapsulated in Glass!
- ★ High Output, Temperature Reliability!
- ★ Only 5/16 x 1/8" Diameter!
- ★ Worth Many Times Our Sale Prices!

PIV	Sale	PIV	Sale	PIV	Sale
50	<input type="checkbox"/> 9c	400	<input type="checkbox"/> 19c	1000	<input type="checkbox"/> 51c
100	<input type="checkbox"/> 12c	600	<input type="checkbox"/> 27c		
200	<input type="checkbox"/> 15c	800	<input type="checkbox"/> 39c		

General Instrument

★ Handles 2 Amps

1 AMP
800 PIV
3 For \$1

ONE AMP 'GLASS AMP' SILICON RECTIFIERS

New!

SILICON CONTROLLED RECTIFIERS

85 WATT

PRV	3 AMP	7 AMP	16 AMP	25 AMP
50	<input type="checkbox"/> 30	<input type="checkbox"/> 48	<input type="checkbox"/> 70	<input type="checkbox"/> 80
100	<input type="checkbox"/> 50	<input type="checkbox"/> 70	<input type="checkbox"/> 1.05	<input type="checkbox"/> 1.20
200	<input type="checkbox"/> 80	<input type="checkbox"/> 1.05	<input type="checkbox"/> 1.30	<input type="checkbox"/> 1.70
300	<input type="checkbox"/> 1.05	<input type="checkbox"/> 1.60	<input type="checkbox"/> 1.90	<input type="checkbox"/> 2.20
400	<input type="checkbox"/> 1.60	<input type="checkbox"/> 2.10	<input type="checkbox"/> 2.30	<input type="checkbox"/> 2.70
500	<input type="checkbox"/> 2.10	<input type="checkbox"/> 2.80	<input type="checkbox"/> 3.00	<input type="checkbox"/> 3.30
600	<input type="checkbox"/> 2.50	<input type="checkbox"/> 3.00	<input type="checkbox"/> 3.30	<input type="checkbox"/> 3.90

NPN 10 mc
Like
SILICON 2N424



2 For \$1

SILICON POWER STUD RECTIFIERS

AMPS	Factory Tested	50 PIV	100 PIV	200 PIV
3	<input type="checkbox"/>	<input type="checkbox"/> 7¢	<input type="checkbox"/> 11¢	<input type="checkbox"/> 17¢
15	<input type="checkbox"/>	<input type="checkbox"/> 22¢	<input type="checkbox"/> 40¢	<input type="checkbox"/> 65¢
45	<input type="checkbox"/>	<input type="checkbox"/> 75¢	<input type="checkbox"/> 90¢	<input type="checkbox"/> 1.25
AMPS	400 PIV	600 PIV	800 PIV	1000 PIV
3	<input type="checkbox"/> 22¢	<input type="checkbox"/> 31¢	<input type="checkbox"/> 40¢	<input type="checkbox"/> 59¢
15	<input type="checkbox"/> 90¢	<input type="checkbox"/> 1.35	<input type="checkbox"/> 1.59	<input type="checkbox"/> 1.79
45	<input type="checkbox"/> 1.59	<input type="checkbox"/> 1.90	<input type="checkbox"/> 2.50	<input type="checkbox"/> 2.95

DC MICROAMMETERS



2 1/4" 0-100

ZENERS

Volts	Volts	Volts	Volts
<input type="checkbox"/> HALF WATT29			
<input type="checkbox"/> 1-WATT45			
<input type="checkbox"/> 10 WATTS65			
● 5.4	18	43	100
● 6.4	20	47	110
● 8.0	22	51	120
● 9.1	24	56	130
● 10	27	62	150
● 12	30	68	160
● 13	33	75	180
		82	200
● 12 W top!		91	



1-Amp SILICON RECTIFIERS

PIV	Sale	PIV	Sale	PIV	Sale
50	<input type="checkbox"/> 5¢	600	<input type="checkbox"/> 19¢	1400	<input type="checkbox"/> 69¢
100	<input type="checkbox"/> 7¢	800	<input type="checkbox"/> 25¢	1600	<input type="checkbox"/> 89¢
200	<input type="checkbox"/> 9¢	1000	<input type="checkbox"/> 45¢	1800	<input type="checkbox"/> 99¢
400	<input type="checkbox"/> 11¢	1200	<input type="checkbox"/> 59¢		

10¢ FOR OUR "SUMMER" BARGAIN CATALOG ON: **10¢**
 Semiconductors Poly Paks Parts

TERMS: include postage. Rated, net 30 days. CODs 25%

POLY PAKS

P.O. BOX 942 A
LYNNFIELD, MASS.

"ARCTURUS" COLOR TV SPECIALS

- * Original Color Flybacks for RCA, GE, Emerson, Magnavox, Muntz, Olympia, Philco, Silvertone, Sylvania, etc. List price \$24.00. Our price\$9.95. Cat. #CTVF
- * Original Color Yokes for all makes of color TV. 70 degree for all round color CRT's. Cat. #XRC70; 90 degree for all rectangular 19 to 25 inch CRT's. Cat. #XRC90. List price \$50.00. Our price\$12.95 each
- * Color Focus Rectifiers, 6.5 M.V., Cat. #CFR5\$1.95
- * Color Silicon Rectifiers, 1-5 amps, 2000 p.i.v. Cat. #CFR10\$1.19
- * Color picture tubes. Write for special low prices.
- * Color TV Receiving Tube types. Listed in our catalog at very special prices.
- * Color TV CRT sockets. Cat. #CSO 19.79c each
- * Other Specials: #5965, #6211 Tubes—replace 12AU7, 12AT7, 12AV7, etc. 39c each, 3 for \$1.00. #5844, #5964, #2033—ruggedized 6J6 tubes, 39c each, 3 for \$1.00. 1AX2—replacement or substitute for 1X2, 1X2A, 1S2, 49c each, 5 for \$2.00. 25L6, 3 for \$1.49. #5751—ruggedized low noise 12AX7, 59c each, 2 for \$1.00. 2C40 lighthouse tube, usually \$14.00, special99c ea.
- * Black and white TV yokes—Order by Thordarson or Merit #. Any "Y" number from Y40 to Y106, any MDF number from 106 to 143, in stock, complete with hook-up instructions—price \$4.95 each. Black and white TV 119 degree yokes, original equipment for most models of Admiral, Emerson, Dumont, Magnavox, Motorola, Philco, Silvertone, Westinghouse, Zenith, RCA. Order by set maker's number. Price\$7.50 each
- * Stromberg-Carlson Transistorized Intercoms, AC only. Seven station master \$12.95. Cat. #SCT11. Remote stations for SCT11, \$4.95 each. Cat. #SCTR2. With hook-up instructions.
- * Transistorized UHF Tuners, used in 1965, '66, '67 TV sets by Admiral, Dumont, Magnavox, Motorola, RCA, Philco, Olympic, Sylvania, Silvertone. Only difference from one to another: removable gearing may differ. Easy replacement. No filament voltage required. Needs only 15 VDC to function. Cat. #UHFT1\$4.95
- * Kit of 30 tested germanium diodes. Cat. #10099c
- * Kit of subminiature tubes, Cat. #2999c
- * Silicon Rectifier long-life replacement for 5U4, 5V3, 5AS4, 5AU4, 5T4, 5V4, 5Z4. Octal based, with diagram: Cat. #RECT1, 99c each. OZ4 long life silicon rectifier replacement, octal based, Cat. #RECT299c each

Send for free catalog listing thousands of similar items at lower-than-fair prices. We thank you now—you'll thank us later.

ARCTURUS ELECTRONICS CORP.

502-22nd St., Union City, N.J. 07087,
Dept. ST-6. • Phone 201-864-5568

TN128/APR9 Tuning Unit 1000-2600mc. W/Tubes..EX 32.50
PP336 Main Power Supply for APR9 Receiver. EX 14.75
PP337 Klystron Supply for TN130 and TN131/APR9..EX 7.50
ID226/APR9 Panoramic Indicator. W/Schematic ..EX 10.50
ID169C/APN12 Scope. 3JP1 CRT. DPDT Coax Switch EX 12.75
IP30/APQ31 Scope Indicator w/3JP7 CRTEX 8.75
SN36B/APS31 W/5-807s, 46 other tubes, 2 blowers..EX 9.25
Battery Charger. 115V 60cy to 8VDC @ 20 Amps. NEW 7.50
Scope Xformr 1950V @ 3ma, 6 Fil windings, 60 cycle New 4.75
SA325/U Coaxial Switch SP4T 28VDC MotorEX 4.50
AM581 3-stage, 60mc IF Amplifier. W/TubesNEW 3.75
AS313B/ARN6 Station Seeking Loop. 100-1750kc ..EX 4.75
R8/ARN8 75mc Recvr w/7 Tubes, 8000 ohm Relay ..EX 4.50
C45 Control Box for ARC1 and ARC12 Receivers ..EX 1.25
3JP1 CRT w/Mount, Shield, Socket, Intensifier Plug .. 6.25
Control Amplifier w/11 Tubes. A Parts ValueEX 3.50
Weston Meter Model 843, 3 1/2", 500-0-500ua scale ..EX 3.50
Marion Meter Model 36W, 3 1/2", 0-100ua scaleLN 4.75
Marion Meter 3 1/2", 100ua movement, arbitrary scale EX 2.75
Simpson Meter Model 25, 3 1/2", 0-200ua scaleLN 4.25
UPM11A AFC Unit w/8 Tubes & Wiring Diagram NEW 4.50
Tripler Cavity, 1200mc w/5876 UHF TriodeEX 3.75
Demodulator Cavity, 1200mc w/5675 UHF Triode ..EX 3.50
Precise HV Probe 500 Megohm 50KV Insulation..NEW 2.50
Right Angle Drive w/Gears, Universal, 1/4" Shaft ..EX 1.75
PL259 on coax. GOOD 5/1.25....PL259 boxed. NEW 5/1.75
Coax 6" long w/BNC Plug each endEX 4/1.00
Coax 8" w/1 BNC Plug & 1 BNC Panel Socket..EX 3/1.00
SO239 Socket. GOOD 4/1.00. Type N Panel Socket LN 3/1.00
RG9A/U Coax 10 feet long with two Type N Plugs
NEW 2.75
Ohmite Z50 RF Choke 7/1.00. RF Choke, 2.5mh, 3 pi 8/1.00
Universal for 1/4" rod 7/1.00. Fiberglass Rod 1/4" x 7" 5/1.00
Teflon Insulating Coupling. 2000V Test. 1/4" Rod. EX 6/1.00
Capacitor. Feed-thru. 15 on Panel.....Three Panels/1.00
Sprague Filteral-2. Line Filter. 10A 115V 60cy. NEW 4/1.50

E. C. HAYDEN Box 294, Bay Saint Louis, Mississippi, 39520
Prices: FOB Bay Saint Louis. Terms: Net, Cash.

SURPLUS MANUALS, \$3.50 each; ARC-27, CV-116/URR, ARN-6, ARN-30. Many others. Model 28 TTY manuals \$2.00. S. Consalvo, W3IHD, 4905 Roanne Drive, Washington, D.C. 20021.

WANTED MILITARY, COMMERCIAL, SURPLUS: Airborn, Ground, Transmitters, Receivers, Test-sets, Accessories, Especially Collins. We pay freight and cash. RITCO Electronics, Box 156, Annandale, Virginia. Phone (703) 560-5480 Collect.

COLLINS 3251, 7551, Waters Q multiplier, 500 cycle filter, 312B4, 516F2 all FB. Trade for 350 or TR3 and \$450. K5DZP, San Angelo, Texas 76901.

COMPLETE STATION: HT-32, SX-101-A, Warrior, Monitor scope, HAM-M, Keyer, Quad, Tower. Good condition and at bargain prices. K1IQB, R. Allaire, 35 Weymouth St., Holbrook, Mass., Phone 617-963-3530.

SONAR 80-10 METER TRANSMITTER: with matching VFO. Uses efficient 5894 in final. \$75 with power supply. 73 Magazine, Petersborough, N.H. 03458.

HALLICRAFTERS HT-45 linear 2 KW excellent, \$275. W3CEX, 301-761-7119 Baltimore, Md.

WANTED HEATH MARAUDER. Will pay depending on condition. Call after 6 PM or write: Judd Goodman, WB2VOG, 101 Hillwood La., Plainview, L.I., N.Y. 11803. 516-935-5726.

BACK ISSUES 73 March 1963 to March 1967, except December 63 \$10.00 Postpaid. John Catron, W5DZA, 826 Ranchitos, Santa Fe, N.M. 87501.

SELL OR TRADE COLLINS 30L-1. Trade RCA WR-99A marker generator for Q meter like value. WB6BLF 1036 Carol Lane, Lafayette, Calif. 94549.

FT-243 CRYSTALS: 3500 to 8700 kHz, .01% setting \$2.00 each. Novice \$1.00 each ±2 kHz. Denver Crystals, 776 S. Corona, Denver, Colo. 80209.

LATEST SWAN 350. Sideband selector VX-1, 117XC. Mint condition, \$465. Richard Stalls, K4KYO-DL5OL, 475 S. Perkins Rd., Apt. 406, Memphis, Tenn. 38117.

CE-20A \$95. BC-458 VFO \$15. Bandhopper VFO \$60. Drake 2B 2BQ \$195. PHLA400C \$95. Sixer & DC supply \$40. Millen HD Transmatch \$95. With manuals, all operating. W2QH, 92 Genesee St., Greene, N.Y. 13778.



HAM TUBE SPECIALS BRAND NEW—GUARANTEED

3C24	\$ 5.50	416B	\$20.00
4CX250B	20.00	417A	3.75
4X150A	9.50	811A	3.50
4-65A	8.50	866A	1.50
4-125A	19.00	872A	4.75
4-250A	26.50	5881	1.75
4-400A	30.00	5894	14.00
4-1000A	85.00	6360	3.00
FG17	4.50	6939	5.00
404A	3.80	8008	5.50

G-E 12BA6-50C5 Kit (5 tubes) \$1.50

Sell, trade your new tubes
FREE—Ham tube catalog



120 W. 18th St., New York, N. Y.
10011 212-242-7400

RTTY

TS 2/TG



WESTERN ELECTRIC POLAR RELAY

\$2.95

\$2.95

WESTERN ELECTRIC SOCKET for above \$1.25

I-97A Bias meter 7.95

GH 1203-2H Lionel transf. 1.49

P/O CV89A/URA-8A

Discriminator sub-unit part of frequency shift converter CV89A/URA-8A. This unit cost the Navy \$330.00 and is brand new in original export packaging complete with tubes. Schematic and connector arrangement for input and output is furnished with order. Shipping weight 15#

\$49.50

SILICON POWER STUD RECTIFIERS

TOP HAT AND EPOXIES

SCRS!



800 PIV	1.5 Amp	Epoxy	69¢	5 for	\$3.00
800 "	1.5 "	Tophat	59¢	5 "	2.50
600 "	1. "	"	39¢	5 "	1.75
400 "	1. "	"	29¢	4 "	1.00
100 "	6. "	"	39¢	5 "	1.75
100 "	.2 "	"	15¢	8 "	1.00
50 "	150. "	Stud	\$2.95	4 "	10.00
50 "	6. "	"	98¢	5 "	4.50
50 "	.5 "	Tophat	15¢	8 "	1.00

SCR Gen. Elec. C40B (2N685) 200PIV 25A 2.95

COAX RELAY

S P D T Relay has 2-12 volt coils wired in series for 24 V operation Parallel these for 12 V. 3 S0239 connectors for standard VHF use at 300 watts. New \$3.95

With 3 PL259 connectors \$4.95

Coaxial Cable FOR LESS THAN 3c Per Foot! RG-54 A/U CABLE-



58 OHMS 1/2" OD.

70 Feet \$1.95

370 Feet \$9.75

COAXIAL CABLE



RG 8/AU (52 ohm) 15 foot patch cord with PL259 each end. New \$1.49

RG 9/U (50 ohm) 18" patch cord with 2 PL259 \$.98

RG 9/U 7 foot patch cord with 2 PL 259 \$.98

AUDIO FREQUENCY GENERATOR



TUNING FORK FREQUENCY STANDARD

500 cycle-- .001% accuracy--operates from 24VDC at .18A Removed from new equipment. \$7.50

Nickel-Cadmium BATTERY



Considered a life time battery, they may be re-charged indefinitely and may be left charged or discharged with no ill effects. Rate of discharge is many times the rated AH and is almost flat at rated AH.

Four sizes presently available all in excellent guaranteed chargeable condition. All are 1.2 volts.

80 AH \$7.50 50 AH \$5.95
32 AH \$3.95 4 AH \$1.75

Panoramic Indicator

IP-274/ALA-



This panoramic adapter was written up in the June 1964 issue of "73" Magazine. It is a 14 tube scope using one or more of each of the following tubes: 3BP1A, 6BE6, 6BA6, 6AL5, 6J6, 6SL7, 6SN7, 6AC7, 884, 0D3, 1B3, and 6X5.

A. R. C. TYPE 12

RECEIVERS

R 10 - 520 to 1500 KC	\$19.50
R 11 - 190 to 550 KC	24.50
R 13 - 108 to 135 MC	29.50
R 19 - 118 to 148 MC	35.00

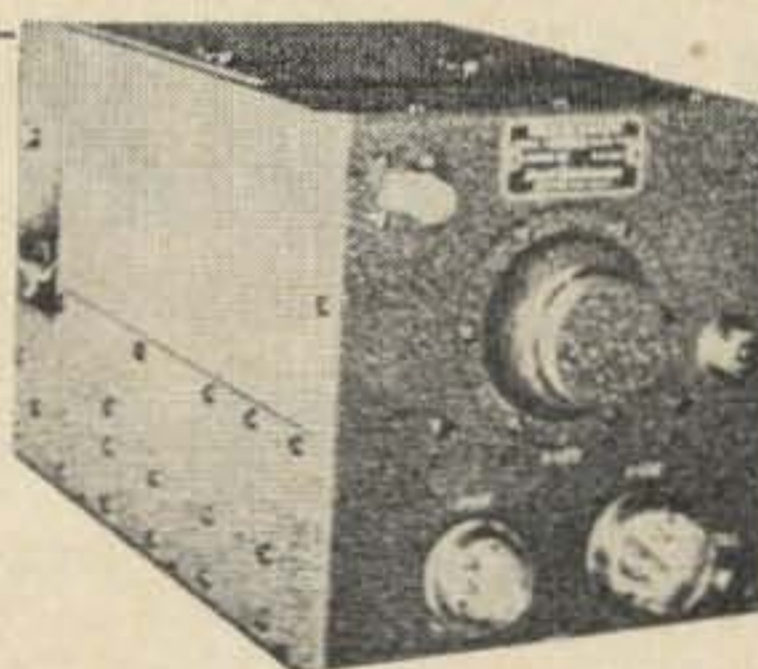

These receivers are continuously tunable over the ranges indicated and are furnished with tubes in either new or very good condition.

DAVEN Frequency Meter

Direct indicating frequency meter covering 25 to 5000 cycles in four ranges --- .1 KC, .5 KC, 1 KC, @ 5 KC.

Exc. cond. \$37.50

OIL-FILLED CAPACITORS

2 Mfd.	2000 VDC	\$ 1.95
2 Mfd.	3000 VDC	\$ 2.95
2 "	4500 "	3.95
2 "	10000 "	29.95
.0008	15000 "	3.50
.06 "	15000 "	9.95
1 "	16000 "	29.95
2 "	20000 "	49.95

ARROW SALES-CHICAGO, INC.

2534 South Michigan avenue,

Chicago, Illinois. CA 5-4750

TCS EQUIPMENT

NAVY TCS RECEIVER AM



1.5 MC to 12 MC in two (2) bands. Variable freq. oscillator & crystal control on four (4) preset channels in the entire freq. range. Audio output 1.5 watts into 500 ohm load; uses tubes 12SK7 RF A., 12SA7 converter, 2/12SK7 IF A., 12SQ7 detector BFO, 12A6 oscillator, 12A6 audio Amp. 456 KC IF Freq. Large vernier & spin dial, audio gain, AVC, BFO and all

controls on the front panel. Voltages required: 12 VDC & approx. 220 VDC 100 MA. Size: 11 3/4 x 11 3/4 x 13 3/4". Wt.: 37 lbs. **USED: \$44.95**

NAVY TCS TRANSMITTER AM—

1.5 MC to 12 MC in three (3) bands, CW 40 watts, voice modulation 20 watts, master oscillator variable and crystal control on 4 preset channels in the entire freq. range. Uses 3/12A6 in oscillator & buffer-doubler, 4/1625 in modulator & power amplifier stages, 2 1/2" meters for PA Plate 0-200 DC RF meter 0-3, all tuning and operating controls on front panel. Voltages required: 12 VDC & 400-440 VDC 200 MA. W/tubes. Sizes: 11 3/4 x 11 3/4 x 13 3/4". Wt.: 41 lbs. **USED: \$34.50**

- Antenna Loading Coil #47205 **Used: \$ 6.95**
- Remote Control Box w/Speaker #23270 **Re-New: 9.95**
- Dual Dynamotor Power Supply 12 V. #21881 **Re-New: 14.95**
- D-401 Transmitter Dynamotor 12 V. **New: 6.95**
- D-402 Receiver Dynamotor 12 V. **New: 4.95**
- CABLE—Receiver to Power Supply **New: 2.75**
- CABLE—Transmitter to Power Supply **New: 2.75**
- Connector Plugs for Remote Control Box **New: 1.50**
- A C POWER SUPPLY—115 V. 60 cycle (Not Government Surplus). Receiver: \$20.00—Transmitter: \$35.00.
- Shock Mounting for Receiver or Transmitter.... **Used: 2.95**
- Noise Limiter Conversion Kit—W/6H6 tubes **2.00**

Parts available for Rec. and Trans. Advise us of your needs!
Prices F.O.B. Lima, O.—25% Deposit on COD's—BIG CATALOG—Send 25c (stamps or coins) & receive 50c CREDIT on your order.

FAIR RADIO SALES

DEPT. 73 — P. O. Box 1105 — LIMA, OHIO 45802

WE PAY CASH FOR TUBES

Lewispaull Electronics, Inc.
303 West Crescent Avenue
Allendale, New Jersey 07401

TRANSCEIVER SALE

"while they last"

- SWAN 350's\$395 NCX-5's, Mark II\$495
- KWM-2 795 HRO-60 225
- 75S-1 295 SW-120 125
- 32S-1 375 NC-300 149

SWAN 500's NOW—IN—STOCK, \$495

FRECK RADIO & SUPPLY CO. INC.

38 Biltmore Ave., Asheville, N.C. 28801. Phone 704-254-9551. Closed Saturdays. We trade.
T. T. Freck, W4WL Sandy Jackson, WN4AAL

Propagation Chart

JUNE 1967

ISSUED APRIL 15

J. H. Nelson

EASTERN UNITED STATES TO:

	GMT: 00	02	04	06	08	10	12	14	16	18	20	22
ALASKA	14	14	14	7A	7	7	7	7A	14	14	14	14
ARGENTINA	14A	14A	14A	14	14	14	14	14	21	21	21A	21
AUSTRALIA	14	14	14	14	7B	7	7A	7A	7	7	14	14
CANAL ZONE	21	21	14	14	14	14	14	14	14	21	21	21
ENGLAND	14	14	7A	7A	7A	14	14	14	14A	14A	14A	14A
HAWAII	14A	21	14	14	7	7	7A	14	14	14	14	14
INDIA	14	14	14	7B	7B	7B	14	14	14	14	14	14
JAPAN	14	14	14	14	7	7B	14	14	14	14	14	14
MEXICO	14A	14A	14	14	7	7	14	14	14	14	14A	14A
PHILIPPINES	14	14	14	7A	7B	7B	7A	7A	14	14	14	14
PUERTO RICO	14	14	14	7A	7	7	14	14	14	14	14	14A
SOUTH AFRICA	7B	7B	7B	14	14	14	14A	14A	21	21	14	14
U. S. S. R.	14	14	14	14	7	14	14	14	14	14	14	14
WEST COAST	14A	21	14	14	7	7	7A	14	14	14	14A	14A

CENTRAL UNITED STATES TO:

ALASKA	14	14	14	14	7A	7	7	7A	14	14	14	14
ARGENTINA	14A	14A	14A	14	14	7	14	14	21	21	21A	21
AUSTRALIA	21	21	14	14	14	14	7A	7A	7	7	14	14
CANAL ZONE	21	21	14	14	14	14	14	14	14	21	21	21
ENGLAND	14	14	7A	7A	7	7	14	14	14	14	14	14
HAWAII	21	21	14	14	14	14	7A	14	14	14	14A	14A
INDIA	14	14	14	14	7B	7B	7B	7B	14	14	14	14
JAPAN	14	14	14	14	7A	7	7	7A	14	14	14	14
MEXICO	14	14	14	14	7	7	7	14	14	14	14	14
PHILIPPINES	14	14	14	14	7A	7B	7B	7A	14	14	14	14
PUERTO RICO	21	14A	14	14	7	14	14	14	14	14A	14A	14A
SOUTH AFRICA	7B	7B	7B	14	7B	14	14	14	14	14A	14	14
U. S. S. R.	14	14	14	14	7	7	14	14	14	14	14	14

WESTERN UNITED STATES TO:

ALASKA	14	14	14	14	7A	7	7	7	7A	14	14	14
ARGENTINA	21	21	21	14	14	7	14	14	21	21	21A	21A
AUSTRALIA	21	21A	21A	21	14	14	14	14	7A	7	14	21
CANAL ZONE	21A	21A	21	14	14	14	14	14	14	21	21A	21A
ENGLAND	14	14	14	14	7	7	7	7A	14	14	14	14
HAWAII	21	21A	21A	21	14	14	14	14	14	21	21	21
INDIA	14	14	14	14	14	7B	7B	7B	14	14	14	14
JAPAN	14	14	14A	14	14	14	7A	7A	14	14	14	14
MEXICO	14A	14A	14	14	14	7A	7A	14	14	14	14A	14A
PHILIPPINES	14	14	14	14	14	14	7	7	14	14	14	14
PUERTO RICO	21	21	14A	14	7	7	14	14	14	14A	21	21
SOUTH AFRICA	7B	7B	7B	14	7B	7B	14	14	14	14	14	14
U. S. S. R.	14	14	14	14	14	7	7	14	14	14	14	14
EAST COAST	14A	21	14	14	7	7	7A	14	14	14	14A	14A

A. Next higher frequency may be useful this hour.

B. Very difficult circuit this hour.

Good: 1-8, 10-13, 15-17, 19-21, 23-30

Fair: 9, 14, 18, 22

VHF: 5-7, 10-13, 15, 20, 24-27

TELEMARINE CLEARANCE BARGAINS!

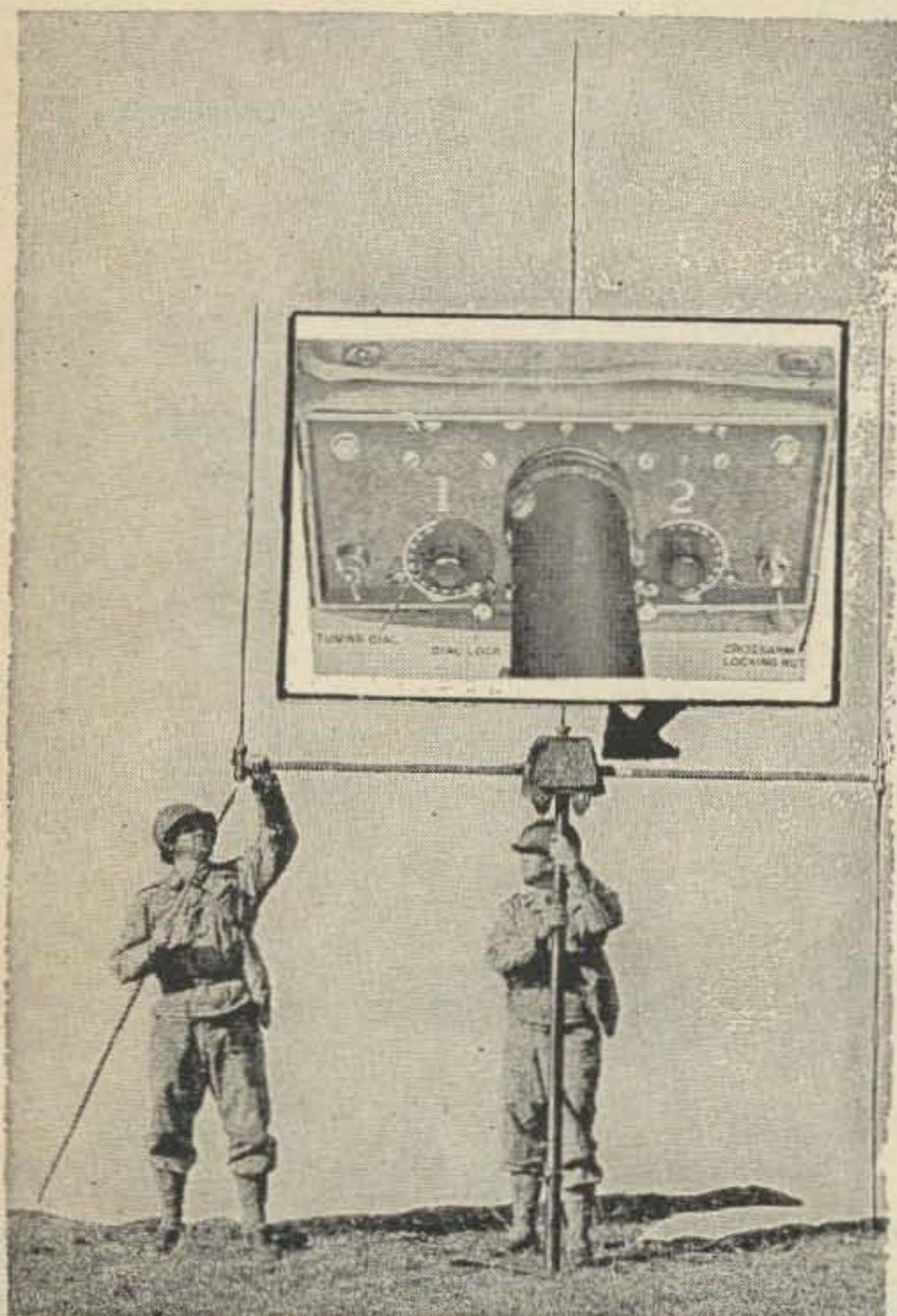

PRICE, \$14.95

TELEMARINE discovered this outstanding 3-element Adcock type beam antenna in Army surplus. It includes a vertical dipole and a phase-load tuning box which permits tuning and phasing in the radiator and director elements, and phasing out the reflector element so that an unusually high front-to-back ratio results along with exceptionally high forward gain. Plug-in inductors permit use of this antenna over a frequency range of 20 to 40 MHz. Operates with 52 or 72 ohm transmission line. Sturdy, weather-resistant construction. Operates satisfactorily with CDR-AR-22 beam rotator, or equivalent. New, unused, with instruction book which covers complete equipment for which antenna was intended, and provides full installation and tuning-up data. Net wt. of beam 39.5 lbs. Shipping wt. 102 lbs. Supplied with 2 plug-in inductors to cover 25-30 MHz installed in phase-load box. **COILS**, (2 required) for 20-22.5 MHz, 22.5-25 MHz or 30-40 MHz, **PER PAIR** **\$4.95**

BC-611 WALKY-TALKY

BC-611 WALKY-TALKY: Range approximately 1 mile. Used, fairly good condition, not tested. Pre-set for 1 frequency with 3.5-6 MHz, no selection of frequency, with tubes, antenna, but less batteries. Shipping wt. 15 lbs. **EACH** **\$14.95**

BC-611 WALKY-TALKY CHASSIS: New excellent spare chassis for above, priced so low that in the event of trouble it would be cheaper to insert a new chassis. Also excellent for the amateur or technician who prefers to make his own style of walky-talky. Supplied less tubes (1-1R5, 1-1S5, 1-1T4, 2-3S4 tubes required, and less plug-in osc., RF & ant coils, and less crystals. Supplied with schematic wiring diagram. Shipping weight 8 lbs. **EACH** **\$6.95**



FOB our address.

—TELEMARINE COMMUNICATIONS—

142 West Broadway, New York, N. Y. 10013
Phone: 212-267-5444

POWER TRANSFORMER FOR 12V DC TRANSISTORIZED POWER SUPPLY 450 VDC at 200 MA. From 12.0 VDC

Build your own transistorized mobile power supply for less than \$15.00, and cut down battery drain 60% or more. Power transformer employs powdered iron core (approx. 1000 cps), with feedback winding, and at 300 ma load still delivers 410 volts. Dim: 2½" L x 2½" H x 2½" D. We furnish diagram and construction details. New units, shipg wt. 1½ lbs. **EACH** **\$6.95**

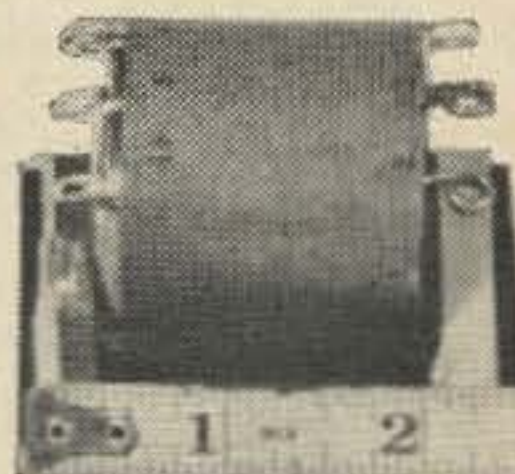

LIMITED QUANTITY BARGAINS

BC-652 RECEIVER, excellent for marine use. Two tunable bands covering 2-3.5 MHz and 3.5-6 MHz with contained dynamotor for 12 VDC operation. 20 KHz and 100 KHz calibrator insures precise dial calibration and frequency checking. Like-new units, compact and rugged. **\$29.95**
Shpg wt. 55 lbs. **EACH**

BC-1335 FM TRANSCEIVER 18 tube transmitter-receiver operates 28.9 to 40 MHz. Has 6/12 VDC power supply, and crystal control of both sections. Dim: 11½" L x 10½" D x 6¼" H. Compact and ideal for mobile. Very good condition. Less tubes. Shipping wt. 45 lbs. **\$10.95**
EACH

GO-9 TRANSMITTER: 125 watts output, low and high frequency (200-500 KHz, 1.5-18 MHz), consists of 3 sections: low freq. unit, high freq. unit and 800cy AC power supply, which are assembled into one piece. All-aluminum construction, with 7 meters (including RF), xmitting var. capacitors, ceramic coil forms, dials, vernier gears, etc. All new units, ideal for modification or for parts for new transmitter. Shipping wt. 250 lbs. **\$59.95**
EACH

951 PHOTOMULTIPLIER TUBE complete with wired circuit, and encased in mu metal shield. Ideal for flying spot scanning TV. **\$6.95**
Shpg wt. 5 lbs. **EACH**

BC-604 FM TRANSMITTERS. 10-channel, push button selection, 20-28 MHz. Complete with tubes, excellent for mobile conversion. Less Dynamotor. Used, very good, **\$6.95**
Ship wt. 75 lbs. **Each, only**

PHILCO 30-40 mHz FM MOBILE TRANSMITTER. Model PRT-336T. Single channel, crystal controlled, with power output tube, and 6 VDC dynamotor power supply output of which is 600 VDC at 175 ma. Excellent for conversion for ham, CB emergency and other applications. Used, good condition, with tubes, but less accessories. Ship wt. 30 lbs. **Bargain Price, only** **\$9.95**

TYPE VRC-2 FM TRANSMITTER 30-40 mHz, power output 45 watts. Crystal controlled, single channel unit, with built in 6 VDC power supply. Can be used for NBFM amateur transmissions, or may be applicable to fire, police or other use. Used, excellent condition units, with schematic. Ship wt. 65 lbs. **EACH** **\$10.95**

TG-34 CODE PRACTICE SET

Learn to copy code or improve your speed with this unit. For individuals, schools, etc. Complete, portable automatic unit for reproducing audibly (built-in loud speaker) code signals recorded in ink on paper tape. Pre-recorded tapes, lessons 1-15 (on 15 reels) available from many other surplus houses. Also usable for practicing "sending" by means internal oscillator, keyed by external hand key. Operates from 90 to 120 V or from 190 to 240 V 60 cy AC. Units are used. Very good condition. Ship wt. 54 lbs. **SPECIAL** **\$15.95**

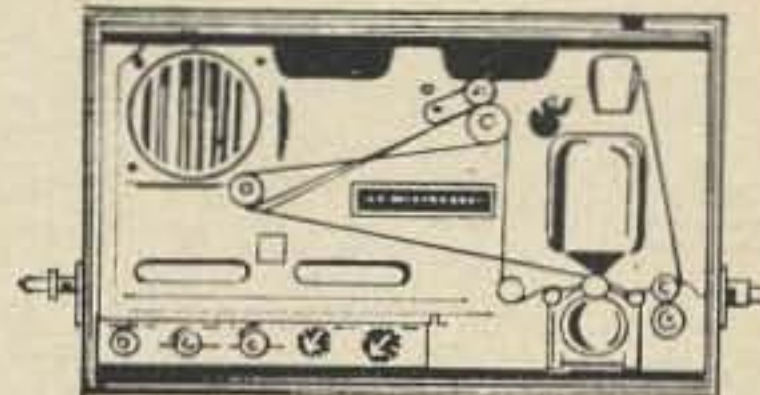

PLEASE!! DO NOT REQUEST CATALOGS! MATERIAL LISTED IS "HERE TODAY, GONE TOMORROW", AND CATALOGS WOULD BE USELESS.

All above material subject to prior sale. 25% minimum deposit on all CODs. Minimum order \$5.00. All prices

LIBERTY ELECTRONICS WANTS TO BUY FOR CASH

Electron tubes and semiconductors

Most any type or quantity
Receiving, transmitting, special
purpose, magnetrons, klystrons
We will make you an immediate
offer in cash.

Special sale

HP-200BR audio
oscillator \$65

Surplus communication and test equipment

AN/GRC-3, 4, 5, 6, 7, 8, 10, 19, 26, 27, 46, VRC-12

AN/PRC-8, 9, 10, 25

Test equipment with ARM, SG, URM, UPM, USM, and TS prefixes

Communications: AN/TRC-1, 24, 35, 36

Receivers: AN/APR-9, 13, 14, R-388A, R-274, R-390A, R-391, etc.

Indicators: ID-250, 251, 387, 257A, etc.

Aircraft: AN/ARC-27, 34, 38, 44, 52, 55, 57, 73, 84

AN/ARN-14, 59, 67, 70

AN/APS-42, 81

AN/APN-1, AN/GPN-2A

Also: Tektronix, Hewlett Packard, Boonton, and General Radio
equipment, etc.

Liberty Electronics, Inc.

548 Broadway, New York, New York 10012, Phone 212-925-6000

PRICE BREAK

RIIA	Latest type 190 to 550 KC, receiver, with 85 KC IF. Very excellent used, with all tubes, internally complete, less dynamotor. Extremely excellent used. See Sept. 1963 issue, of 73, "Q-5er, Reborn".	\$15.95
EFJ # 152-852	Dual 300 pf/sec. 4500v variable capacitor. 4 1/4" w x 7 1/2" h x 12" l, plus 1 1/2" for two 1/4" shafts. Has 50:1 right angle drive, easily removed. 11 pounds, shipping weight. NEW.	\$8.00
EFJ # 160-308	2.3 to 14.2 pf differential, miniature. 3/16" shaft. NEW. 4 for \$3.00	79c ea.
ERIE NPO	5.5 to 18 pf, miniature trimmer. 1/4" dia., 1/4" thick. Two solder terminals. NEW.	5/\$1.00

Hamfest schedule: Starved Rock, Ottawa, Ill., June 4. Tri-State, Angola, Ind., June 11.

All orders, except in emergency, or I'm at a hamfest, shipped same day received. For the "GOODIE" sheet, send self-addressed, stamped envelope—PLEASE, PLEASE include sufficient for postage, any excess returned with order. I carry private (Travelers) parcel post insurance for domestic parcel post. For items too heavy, or too large for parcel post, I suggest bus parcel express. Please advise name of bus line, and city, where you can pick up the shipment.

B C Electronics

Telephone 312 CALumet 5-2235

2333 S. Michigan Avenue Chicago, Illinois 60616

INDEX TO ADVERTISERS

Alltronics.-Howard, 116	Lewispal Electronics, 142
Amateur Electronic Supply, 45	Liberty Electronics, 144
Ameco, 78	Linear Systems, 35
American Crystal, 138	Maco, 116
Ami-Tron Associates, 14, 115	Mann, R. E., Co., 138
Amrad Electronics, 123	Meshna, 120
A. R. C. Sales, 138	Midway Antenna, 132
Arcturus Electronics, 134, 140	Military Electronics, 104, 105
Arnold's Engraving, 133	Mission Ham Supplies, 41
Arrow Sales, 141	Mosley Electronics, 22
A. T. V. Research, 132	National Radio Co., Back Cover
B C Electronics, 144	Newsome Electronics, 107-109
Camp Albert Butler, 116	Palomar Engineers, 115
CeCo, 140	Parks Electronics, 123
C&H Sales, 125	Poly-Paks, 139
Cleveland Institute, 15	Quement, 49, 57
Columbia Electronics, 97-99	Quinn, Mike, Electronics, 84, 85
Comdel, Inc., 126	Radio Amateur Callbook, 40
CushCraft, 126	Radio Shack, Inc., 129
Dahl, Peter W., Co., 138	Riteo Electronics, 138
Dames, Ted, Co., 138	Rohn Mfg. Co., 4
DPZ Corp., 14	Saleh, Herbert, Co., 133
DX'er Magazine, 123	Schober Organ Co., 65
Editors & Engineers, 75	Selectronics, 86, 87
Electronic Center, 73	Slep Electronics, 135
Epsilon Records, 123	Solid State Sales, 100, 101
Estes Engineering, 127	Southwest Semi-Conductors, 134
Evans Radio, 122	Swan Electronics, 24, 25
Evansville Amateur Radio Supply, 116	Sydmur Elect. Spec., 122
Fair Radio Sales, 142	T A B, 106
Federation of L. I. Radio Clubs, 67	Telemarine, 143
F M Ham Sales, 134	Teleplex, 134
Freck Radio, 142	Telrex, 36
Glass, J. J., Co., 102, 103	Trigger Electronics, 136
Gateway Tower, 127	Tri Rio, 133
Gordon, H. W., Co., 79-83	Unity, 115
Goodheart, R. E., Co., 128	Vanguard, 71, 74, 114, 124
Gotham, 123	Vesto, Cover 11
Grantham Schools, 122	VHF'er Magazine, 132
"Ham" Buerger, 53	Waters Mfg. Co., 5
Hayden, E. C., 140	Wilson, R. & C., Co., 118
Henry Radio, 68	World Radio Labs, Cover 111
International Crystal, 3	73 Magazine, 127, 131
James Research, 133	
J A N, 88-96	



“Just found out how much I could have **SAVED** by buying a WRL **Duo-Bander 84!**”

THREE Great Package Options!

ECONOMY FIXED STATION PACKAGE

INCLUDES

DUO-BANDER 84
AC48 Power Supply

\$199⁹⁵ 10 DOLLARS MONTHLY

FIXED STATION PACKAGE

INCLUDES: WRL Duo-Bander 84; Model AC-384 Power Supply; WRL 3N1 Mike w/stand; WRL 80-40 Meter Doublet; (100') RG58/U Coax; All plugs.

\$265⁰⁰ 14 DOLLARS MONTHLY

MOBILE PACKAGE

INCLUDES: WRL Duo-Bander 84; DC Power Supply with cables; WRL 3N1 Mike; Body Mount; New-Tronics RSS2 Spring; MO-1 Mast and 40 & 80 Resonators; (25 ft.) RG58/U Coax; all plugs.

\$305⁰⁰ 15 DOLLARS MONTHLY



NOT A KIT!

WIRED — Ready for Operation

Designed for the Amateur who's interest is 80 and 40 meter SSB. Power and high-performance at a very reasonable cost! Power to make good contacts...a selective Receiver, Stability and Compactness! (5x11¼x10") Smaller by far than anything in its power class!

LOOK AT THESE FEATURES: 300 Watts PEP/SSB • 2 Kc Dial Calibration • Rugged Reliable Printed Circuitry • Stable-Transistor VFO • Dual-Speed Vernier VFO Tuning • Built-in Speaker • Mounting Bracket • Combination "S" Meter and Output Meter • Sharp 4-Crystal Lattice Filter.

\$159.95

Why wait? Enjoy it now for only \$8.00 monthly!

WORLD RADIO LABORATORIES

73-18N

3415 West Broadway, Council Bluffs, Iowa 51501

Please ship me the following:

- Duo-Bander 84 — \$159.95
- Information on Duo-Bander 84
- Economy Fixed Station Pkg. — \$199.95
- Fixed Station Package — \$265.00
- Mobile Package — \$305.00
- Check or Money Order Attached
- Free 1967 Catalog
- Charge it.

Name _____ Call _____

Address _____

City _____ State _____ Zip _____

“The House the HAMS Built!”

Join the National 200 club



Own the most versatile 5-bander on the market ...priced even lower than a kit rig!

National's new 200 is fast becoming the most popular 5-bander on the market . . . and it's no wonder! Here's an ideal rig for mobile, portable, or home operation . . . the fastest way to move up from single band or triband. The price? . . . an amazingly low \$359! Performance? . . . here's what Jim Fisk WIDTY said in a recent issue of a noted amateur radio publication: "When National came out with their new model 200 transceiver a few months ago at a lower cost than any other five band transceiver on the market, I just couldn't believe that it would perform as well as the more expensive models. But — after using it for several weeks in chasing DX, I find that they have done a superb job and it performs right along with the best of them. The sensitivity is fine, the selectivity afforded by the steep-sided crystal filter is excellent, and the audio reports, if I am to believe the fellows on the other end, have all been good. Reports of, 'tremendous audio quality,' 'really sounds good,' and 'very clean and crisp,' have been normal reports during the time I have had the 200 on the air."

Feature this for \$359! ■ Complete coverage of the 80 through 10 meter bands. ■ 200 Watt PEP input on SSB, plus CW and AM. ■ Separate product and AM detection plus fast-attack slow-release AGC. ■ Crystal-controlled front end and single VFO for high stability, and identical calibration and tuning rate on all bands. ■ Crystal lattice filter for high sideband suppression on transmit, and rejection of adjacent QRM on receive . . . plus solid-state balanced modulator for "set-and-forget" carrier suppression. ■ Operation from new low-cost AC-200 supply or from NCX-A or mobile power supplies. ■ ALC. ■ 45/1 planetary/split gear tuning drive. ■ Automatic carrier insertion in AM and CW modes. ■ Panel meter automatically switched to S-units on receive. ■ Universal mobile mount included.

\$359.
ONLY
with National's full
One-Year Guarantee



National Radio Company

37 Washington Street, Melrose, Massachusetts 02176