

AMATEUR RADIO 73

Fast Scan Vidicon for SSTV
Selective Audio Filter
The Unijunction Transistor

SPECIALS

The Life of Nikola Tesla
Master of electrical energy
Part I — Getting Your
Extra Class License



NOW—GALAXY PROUDLY UNVEILS

**NEW Power!
NEW Features!
NEW Beauty!**

**THE EXCITING NEW
GT-550
TRANSCEIVER**

**5 BAND
SSB**
Mobile or
Fixed
Station

☆ AND A COMPLETE LINE OF HANDSOME
MATCHED ACCESSORIES!



The New Galaxy
Wattmeter/Antenna Selector

The Powerful New Galaxy
GT-550 TRANSCEIVER

The Beautiful, Matching
Galaxy Speaker Console

"HOT," Husky, and Handsome!

You asked for it...now it's here! The new GALAXY GT-550 and a complete line of handsome matching accessories!

Your suggestions made it possible. We took your ideas—added some of our own and went to work. We built in new power, new conveniences—such as a 25 kHz calibrator option, and no frequency jump when you switch sidebands. Then we hired the best designers in the business to give GALAXY a distinctive "New Look"!

Our new GT-550 has all those great qualities of the famous Galaxy V's...and then some! It has new POWER...550 watts SSB, making it the hottest transceiver made! A new single scale VFO Dial makes frequency interpolation child's play...the new skirted knobs make tuning and band-changing a split-second job...and, that slick, king-sized finger-tip tuning knob works like a dream! *Still the most compact—only 11¼ x 12¾ x 6"!*

P.S. Sounds unbelievable but it's an even HOTTER receiver than our previous Galaxy V's!

Space prevents telling you all about the handsome, matched accessory line. Write for a free brochure that's loaded with exciting news!



GALAXY ELECTRONICS

"Pacesetter in Amateur/Commercial Equipment Design"

10 South 34th Street • Dept. 73-AA38 • Council Bluffs, Iowa 51501

73 MAGAZINE

February 1969
Vol. LXIX No. 2

STAFF

Kayla Bloom W1EMV
Editor

Wayne Green W2NSD/1
Publisher

William Beatty
Advertising Manager

Cover Photo: The new Hallicrafter's SR-400 Transceiver with companion HA-20 External VFO. The little robot in the foreground is "Ampheham," built almost entirely of Amphenol connectors of various types. See story on page 76. This could lead to all kinds of projects to keep those spare connectors busy!

Editorial Comment: Postal regulations require that a postcard insert in a magazine must be assigned page numbers. In this issue there is a card between pages 32 and 35, so don't panic after you tear out the card and assume there are two missing pages in your issue.

Contents

6	A Fast Scan Vidicon in Slow Scan Camera More on ATV	K7YZZ
10	A Cheap and Simple Linear Amplifier More watts per dollar	WB2PTU
12	The Beatnote Basher A selective audio filter	WB6JXU
14	The Unijunction Transistor What they are, and what they do	VK3ZRY
24	What's Out There Probing the universe for life	WIEZT
32	Velcro A new material with ham potential	K3AQH
36	TVI Suit Ham sued for one million . . .	Staff
38	Nikola Tesla The master of electrical energy	Elkhorne
58	Go Mobile Some pointers for new mobileers	WB6ACM
60	Getting Your Extra Class License Part I—AC-DC Theory	Staff
74	Is it Cold Down There? A common question in the Antarctic	K6GKX
76	Ampheham Building project for odd connectors	Staff
80	Be a Good Ham, Not a Bad Egg The fine art of lending and borrowing	W5NQQ
82	73 Visits FAA Center The electronic complex for aircraft control	Staff
90	CW Only Here, OM CW can be fun	W6EKN

Departments

Editorial Liberties	2	Propagation	88
de W2NSD/1	4	Caveat Emptor	94
New Products	70	Index to Advertisers	98

73 Magazine is published by 73, Inc., Peterborough, N.H. 03458. Subscription rate: \$12.00 for Three years, \$6.00 for one year. Second-Class Postage paid at Peterborough, New Hampshire, and at additional mailing offices. Printed at Pontiac, Illinois, U.S. Entire contents copyright 1969 by 73, Inc. Postmasters, please send form 3579 to 73 Magazine, Peterborough, New Hampshire 03458.

Editorial Liberties

They say "Imitation is the sincerest form of flattery". Apparently, one of the other magazines likes our cover format and copied it for their December issue. However, the advertisers must be delighted that their Xmas ads arrived on the scene after Christmas!

The illness which seems to have hit amateur radio recently is disturbing, to say the least. We hear obscene language (and I don't mean an occasional "damn" or "hell"), music, tape recordings, and a multitude of violations of both amateur rules and *just plain ethics*.

These are sick people! Incentive licensing is not the answer to this kind of problem. Personality defects can't be cured by knowing more about electronics, or being able to copy faster CW. There must be a form of screening for new hams. Obviously, FCC can't have a Psychologist in each office to decide whether a potential ham is going to create problems on the bands.

The thought occurs to us that perhaps the ham club could participate in the decision.

What would happen if a potential ham was required to have character references from a minimum of three other amateurs before he was permitted to take the exam? Taking it a step further, these references would be checked against the OO files at ARRL, to see if the references themselves were clean. If all seems in order, ARRL would recommend that the applicant be allowed to take the exam. If not, the request would be denied.

Even with Incentive Licensing, we make it entirely too easy to obtain a ham ticket, and very hard to lose it. FCC does not have sufficient personnel to monitor the amateur bands with any degree of efficiency. We are pretty much left to police our own bands and unless FCC receives a complaint, they don't take action. The ARRL Official Observer system is a good one, but has no real authority for action.

The ham clubs have been complaining for

a few years that interest has been waning. Here might be the opportunity to give the club a real purpose. I think it might be a good thing to have every ARRL OO report be directed to the attention of a committee of the nearest affiliated local ham club for investigation. If the ham in question has a bad record with his local hams, ARRL could then recommend that FCC take action. We have a lot of housecleaning to do in our ranks.

It was once said, "Let he who is without sin cast the first stone." I have, and I'm sure most of us, have, on occasion, violated some of the rules. I once, while mobile, called CQ out of the band. We all, at some time or other, inadvertently, make mistakes. These isolated violations would not need to be included. However, where deliberate infractions of the regulations were involved, a hearing would be called by the local club. The results of this hearing would be forwarded to ARRL and FCC.

This month, I have taken the liberty of devoting a good portion of 73 to an article on Nikola Tesla. If this name means nothing to you, you would be well advised to read the article. Tesla's AC theory probably advanced the state of the art of electricity and electronics by at least twenty years. This article, lengthy as it is, tells only a part of the story. The reference list which follows, is one worthy of attention.

Also, this issue begins the Extra Class theory course. This follows the same format as the Advanced theory which has run in 73 for the past year. Apparently people *do* want to learn, rather than memorize. The response to this series is overwhelming! We will continue to devote space to tutorial articles as long as the demand is present. Maybe I'm wrong, but it seems to me the role of the ham magazine is not just "How to do it," but "Why it happens."

. . . Kayla-W1EMV

For The Experimenter!

International EX Crystal & EX Kits

OSCILLATOR / RF MIXER / RF AMPLIFIER / POWER AMPLIFIER

Type EX Crystal

Available from 3,000 KHz to 60,000 KHz. Supplied only in HC 6/U holder. Calibration is $\pm .02\%$ when operated in International OX circuit or its equivalent. (Specify frequency)



\$3.95

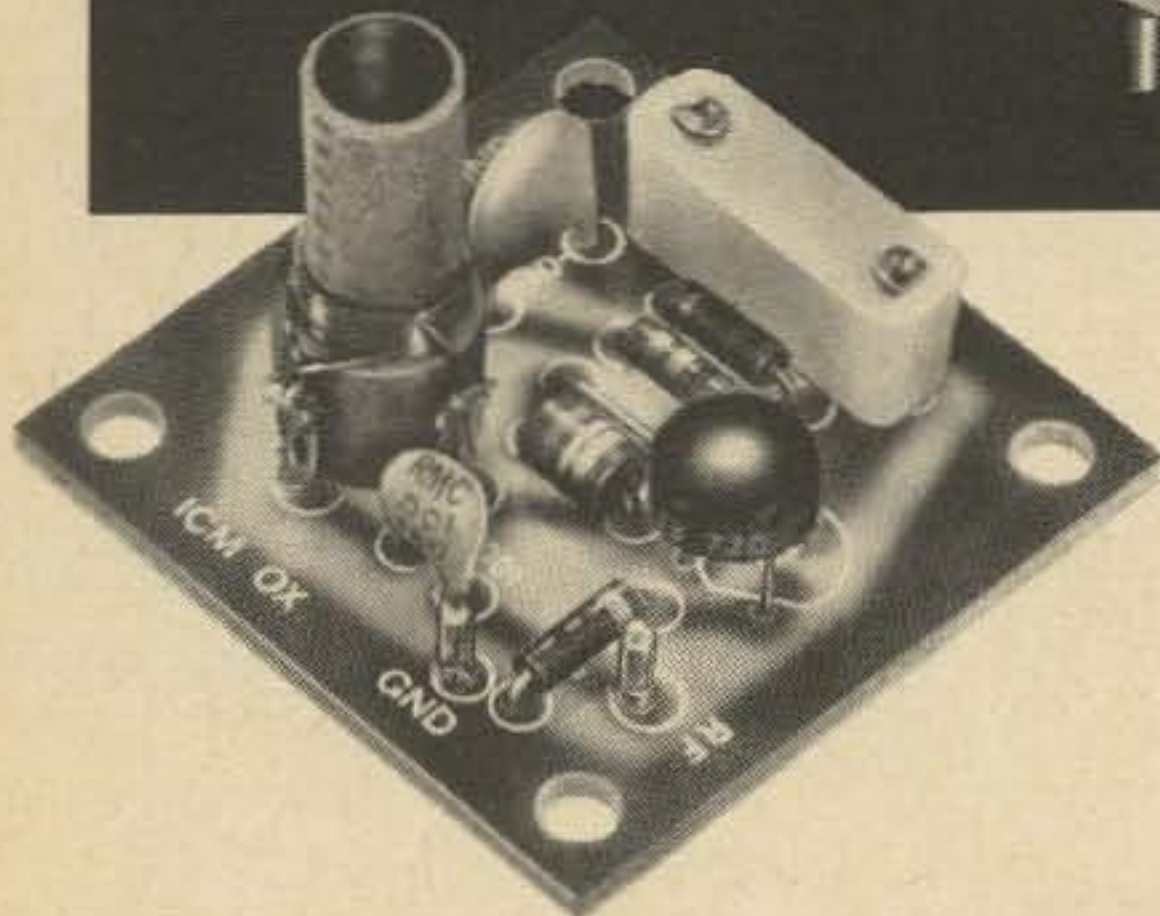

OX OSCILLATOR

Crystal controlled transistor type.
Lo Kit 3,000 to 19,999 KHz
Hi Kit 20,000 to 60,000 KHz
(Specify when ordering)

\$2.95

MXX-1 Transistor RF Mixer

\$3.50

A single tuned circuit intended for signal conversion in the 3 to 170 MHz range. Harmonics of the OX oscillator are used for injection in the 60 to 170 MHz range.

Lo Kit 3 to 20 MHz
Hi Kit 20 to 170 MHz
(Specify when ordering)

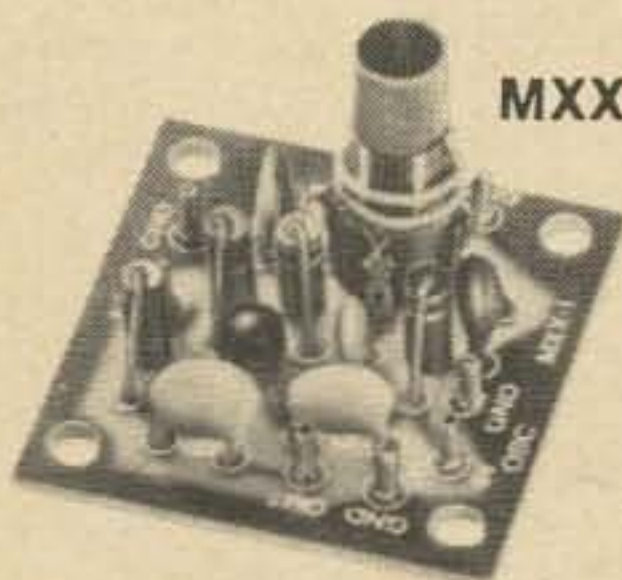

MXX-1

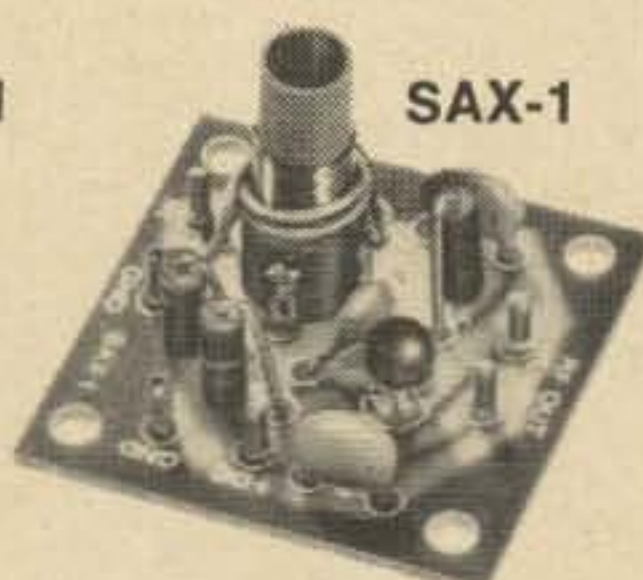

SAX-1

SAX-1 Transistor RF Amplifier

\$3.50

A small signal amplifier to drive MXX-1 mixer. Single tuned input and link output.

Lo Kit 3 to 20 MHz
Hi Kit 20 to 170 MHz
(Specify when ordering)

PAX-1 Transistor RF Power Amplifier

\$3.75

A single tuned output amplifier designed to follow the OX oscillator. Outputs up to 200 mw can be obtained depending on the frequency and voltage. Amplifier can be amplitude modulated for low power communication. Frequency range 3,000 to 30,000 KHz.

BAX-1 Broadband Amplifier

\$3.75

General purpose unit which may be used as a tuned or untuned amplifier in RF and audio applications 20 Hz to 150 MHz. Provides 6 to 30 db gain. Ideal for SWL, Experimenter or Amateur.

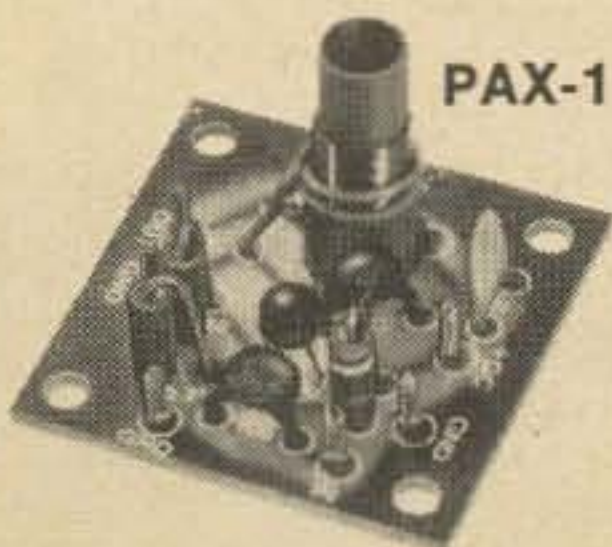

PAX-1



BAX-1

Write for complete catalog.



CRYSTAL MFG. CO., INC.

10 NO. LEE • OKLA. CITY, OKLA. 73102

.....de W2NSD/1

The proof of the pudding is in the eating, if I may coin a phrase, and the proof of the value of incentive licensing is in the results that it brings to amateur radio. The incentive licensing rules were announced over a year ago and there certainly has been time enough for a pattern of response to the new rules to emerge.

The new allocations for the Extra Class license came as a shattering blow to most DX hunters and contest fans. With the bottom 25 kHz now the exclusive Extra Class country this meant that virtually all of the DX hunting grounds were out of bounds for the other classes. The letters column in QST gave clear evidence that the amateur reaction to this was one of enthusiasm and determination. Everyone was buckling down and going to pass the new license exams.

Now that the facts are in we can see that the new licenses were met with massive apathy and resignation. There is little sign of any enthusiasm. Let's take a close look at the curve of the FCC released license figures and see what has happened.

As early as 1963, when the ARRL central Committee started the incentive licensing ball rolling, it was obvious that there were going to be some advantages to having the Extra Class license. Yet during 1966 and 1967 we

see the number of EC's growing at about 500 a year, with a total of only 5000 at the end of 1967; many grandfathered into the license. Then, with the release of the new allocations, the curve changed and some 2000 new EC licenses were issued during 1968. This is about 1500 over the normal growth of the license, or about 1/2 of 1% of the 260,000 licensed amateurs.

It would be hard to envision a more devastating rejection. Amateur radio has flatly turned thumbs down on incentive licensing so far. Now that the new allocations have actually gone into effect we may see more of a rush for the EC license. Let's hope so, because our EC bands are just sitting there largely unused except for the DX stations now and our experience is that while nature abhors a vacuum, the commercials love it and are quick to fill in any blank spots we leave in our bands. And once in, it is almost impossible to get them back out again.

Why has the Extra Class license been turned down by the amateurs so far? The letters we receive indicate that most amateurs are put off at having to take what seems to them to be a professional exam for an amateur license. The theory part of the exam is quite comparable to the theory part of the First Phone Commercial License exam and the 20 wpm code test also seems "com-
ADVANCED

EXTRA

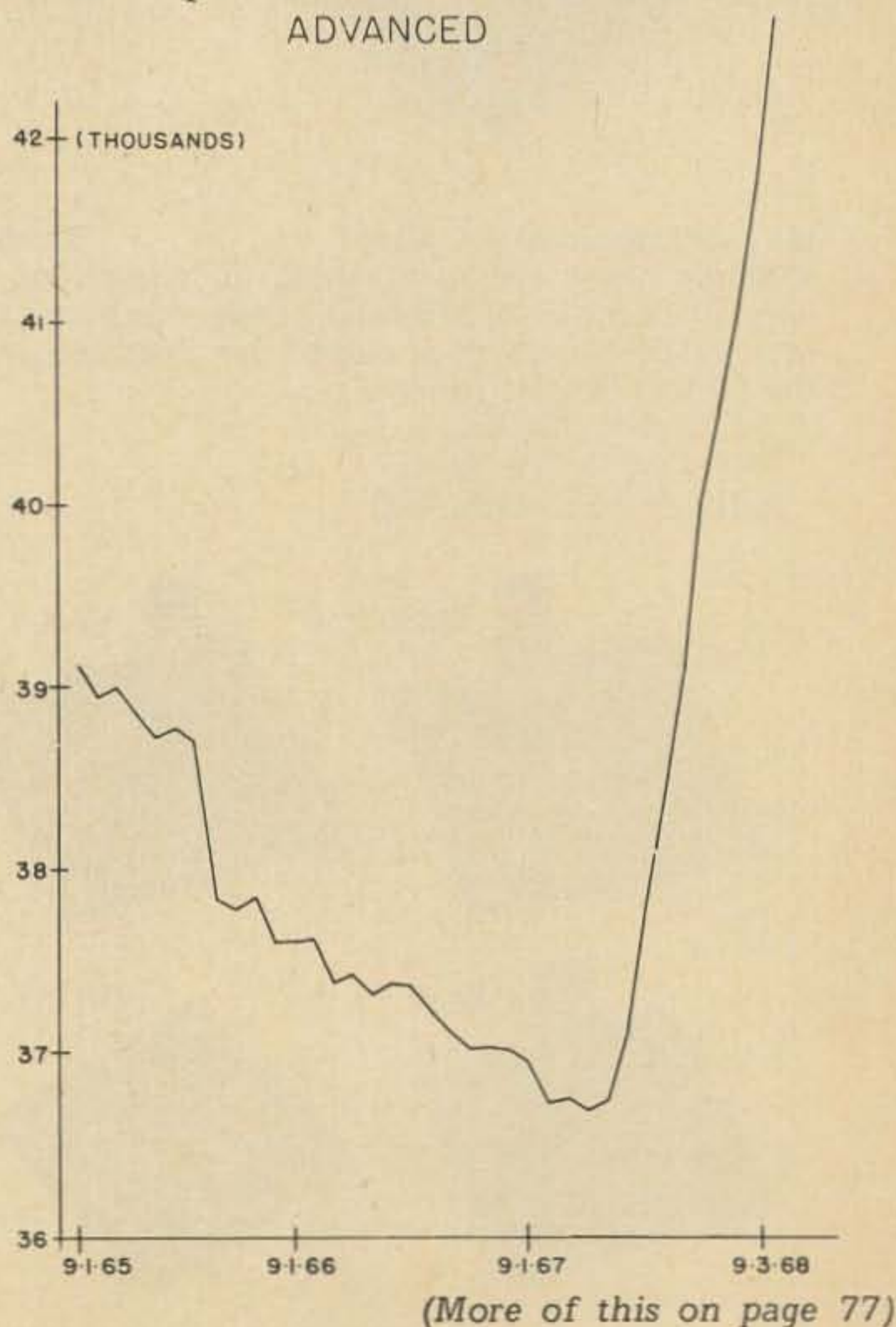
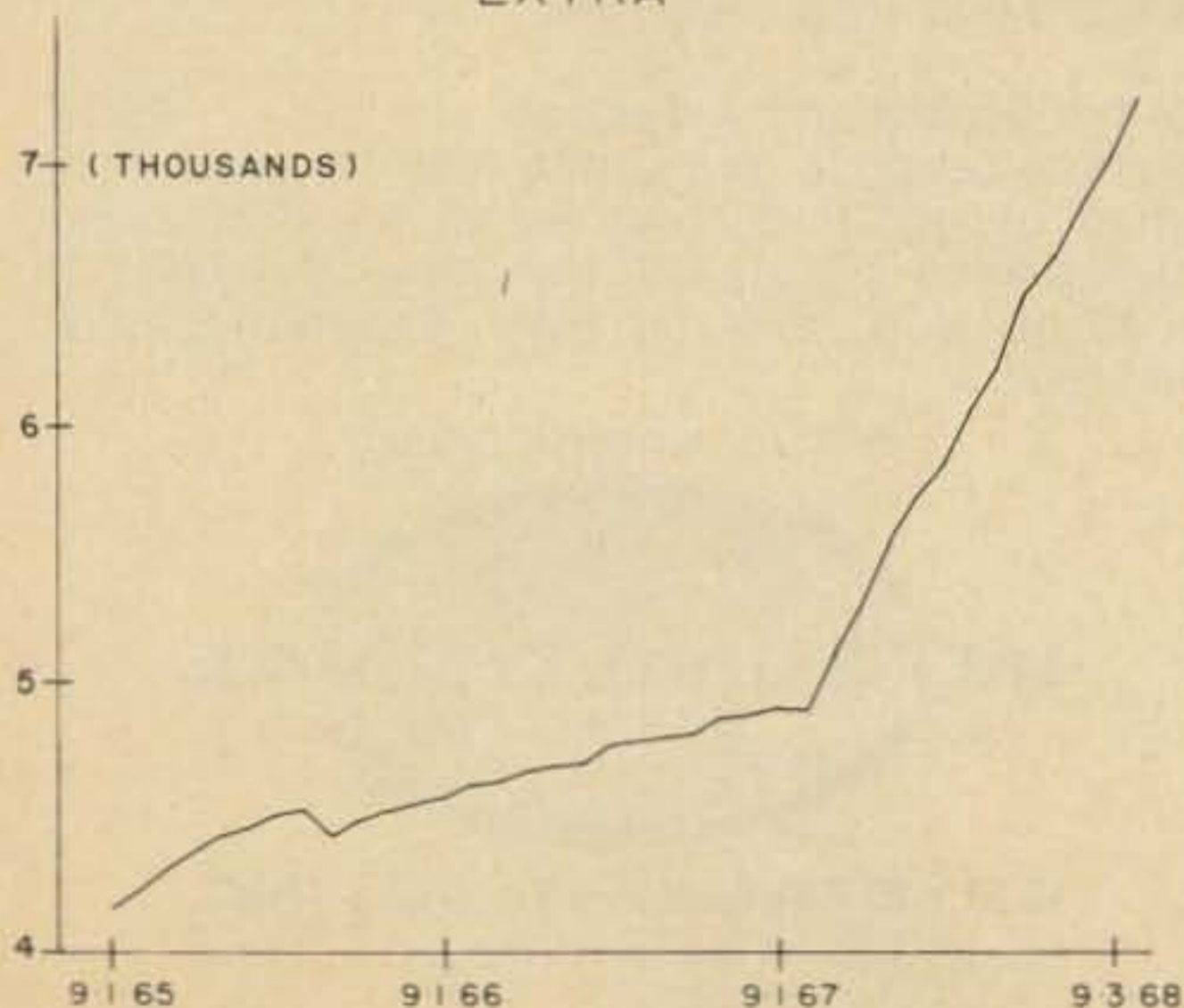

a complete amateur radio station



in one portable package

SWAN *Cygnet*

A 5 BAND 260 WATT SSB TRANSCEIVER WITH BUILT-IN AC AND DC SUPPLY AND LOUDSPEAKER **\$395**

The new Swan Cygnet is a complete SSB transceiver, with self contained AC and DC power supply, microphone and loudspeaker in one portable package. The Cygnet features full frequency coverage of the 10, 15, 20, 40 and 80 meter bands with a power input rating of 260 watts P.E.P. in single sideband mode, and 180 watts CW input. A crystal lattice filter at 5500 Kc is used in both transmit and receive mode, and provides excellent selectivity with a 2.7 Kc bandwidth at 6 db down. Superior receiver sensitivity of better than $\frac{1}{2}$ microvolt makes it easy to pull in those DX signals, and with the Cygnet, if you can hear them, you can work them. Audio fidelity is in the well known Swan tradition of being second to none; providing smooth, natural sounding voice quality. The Cygnet is temperature compensated on all bands, featuring solid state oscillator circuitry with zener regulation which permits wide variation in supply line voltage without frequency shift.

Unwanted sideband suppression is 45 db, carrier suppression 60 db, and distortion products are down approximately 30 db.

The new Cygnet is designed to provide efficient, high quality communications in the 5 most commonly used amateur bands. Its low cost is a tribute to Swan's well known techniques in value analysis, and simple, direct circuit design. Above all, these techniques lead to a high degree of reliability and foolproof performance. Dimensions are: 13" wide, 5 $\frac{1}{2}$ " high, and 11" deep. Weight is 24 lbs.

The transceiver comes complete with AC and DC input cords, and carrying handle; thus making it the most versatile and portable set on the market, and certainly the best possible value.

Amateur net **\$395**

P.S. Yes, for our customers who require some of the extra features, there will be a deluxe version of the Cygnet coming soon, which will sell for approximately \$495

ASK THE HAM WHO OWNS ONE



SWAN
ELECTRONICS
OCEANSIDE, CALIFORNIA

A Subsidiary of Cubic Corporation

A Fast-Scan Vidicon In The Slow-Scan TV Camera

Louis I. Hutton K7YZZ
12235 SE 62nd St.
Bellevue, Wash. 98004

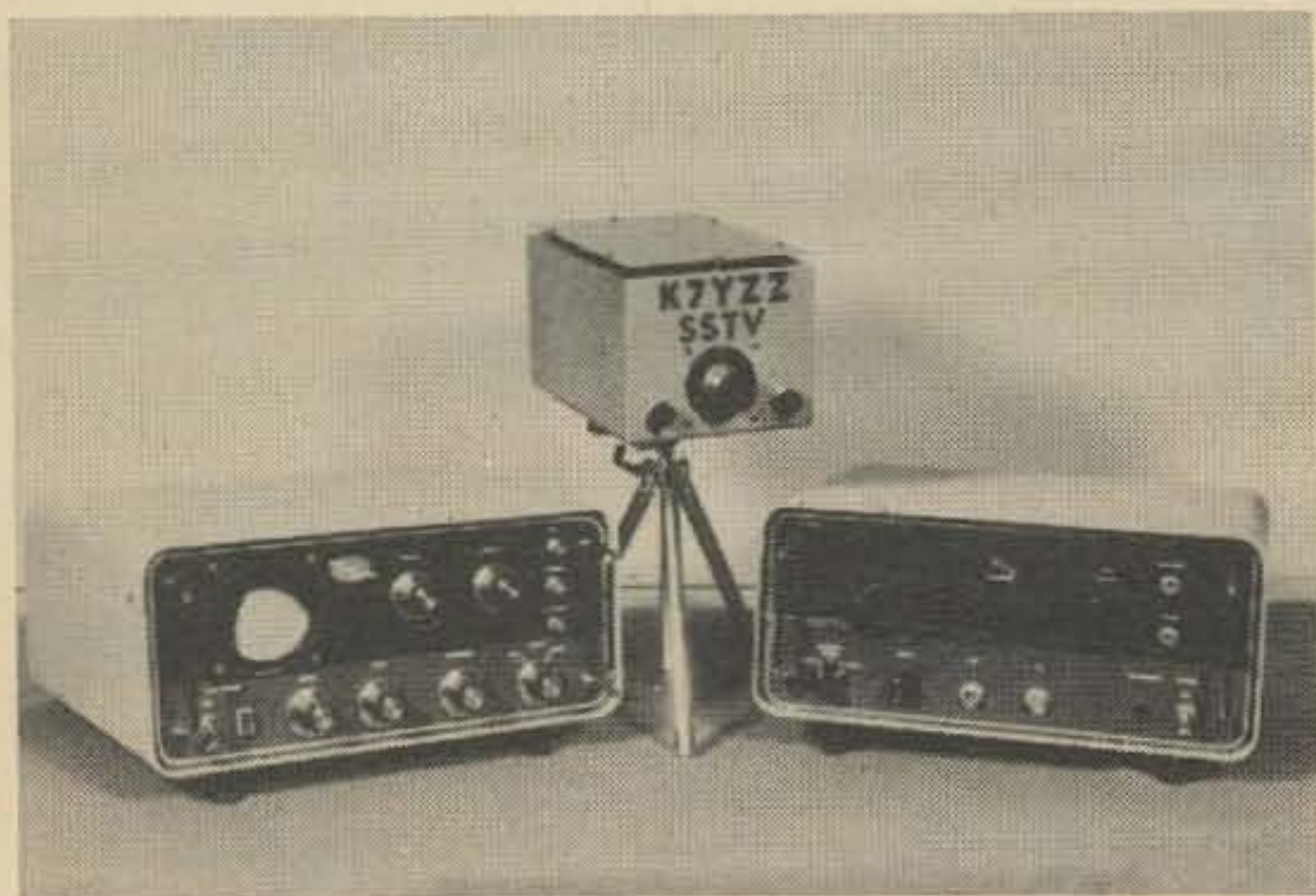

With the successful construction of the Slow-Scan TV (SSTV) Picture Generator described in 73 magazine,¹ I decided to try my hand at building a SSTV Vidicon camera. I had previously built a conventional TV Vidicon camera of the type described in ATV Anthology.² I soon found that Slow-Scan Vidicons are expensive and scarce on the surplus market. Since I am not able to locate an available economical source of this type of Vidicon I decided to try to use a fast-scan Vidicon in the slow-scan mode. The camera described in this article is based on the design by Macdonald WAØNLQ,³ but incorporates extensive circuit redesign of the video amplifier to permit the use of a standard fast-scan Vidicon operating in the shutterless slow-scan mode. The camera consists of two units, one the camera head, and the other the power supply, sweep circuits and sub-carrier modulator/oscillator.

¹"A Slow-Scan TV Picture Generator", K7YZZ, 73, October 1967.
²"ATV Anthology", 73.
³"A Slow-Scan Vidicon Camera", Macdonald, QST, June, July, August 1965.

Camera head

To minimize stray magnetic field pickup the Vidicon, deflection coil assembly, 10 kHz video amplifier and detector were mounted in a steel cabinet 5" x 6" x 9". The shutter mechanism was omitted and a spacer made from sheet brass was installed between the cabinet front panel and the focus coil to provide the proper focus distance (25mm in my camera) between the lens and the face of the Vidicon. A fixed focus 16mm lens, Bausch and Lomb F2.7 to F16 - FL 25mm, was mounted to the front of the camera head. This lens was purchased from Burstein-Applebee and is their part number 61A78 in the 1967 catalog. The "Beam", "Video", and power plug are mounted on the rear of the camera head. The box lid is spaced one quarter inch from the box by metal standoffs to provide adequate cooling.

Comparing the circuit diagram of the camera head with the circuit of the Macdonald SSTV camera the reader will note the change of V13 and V14 to more common tube types and the addition of a tuned circuit to limit the bandwidth of the

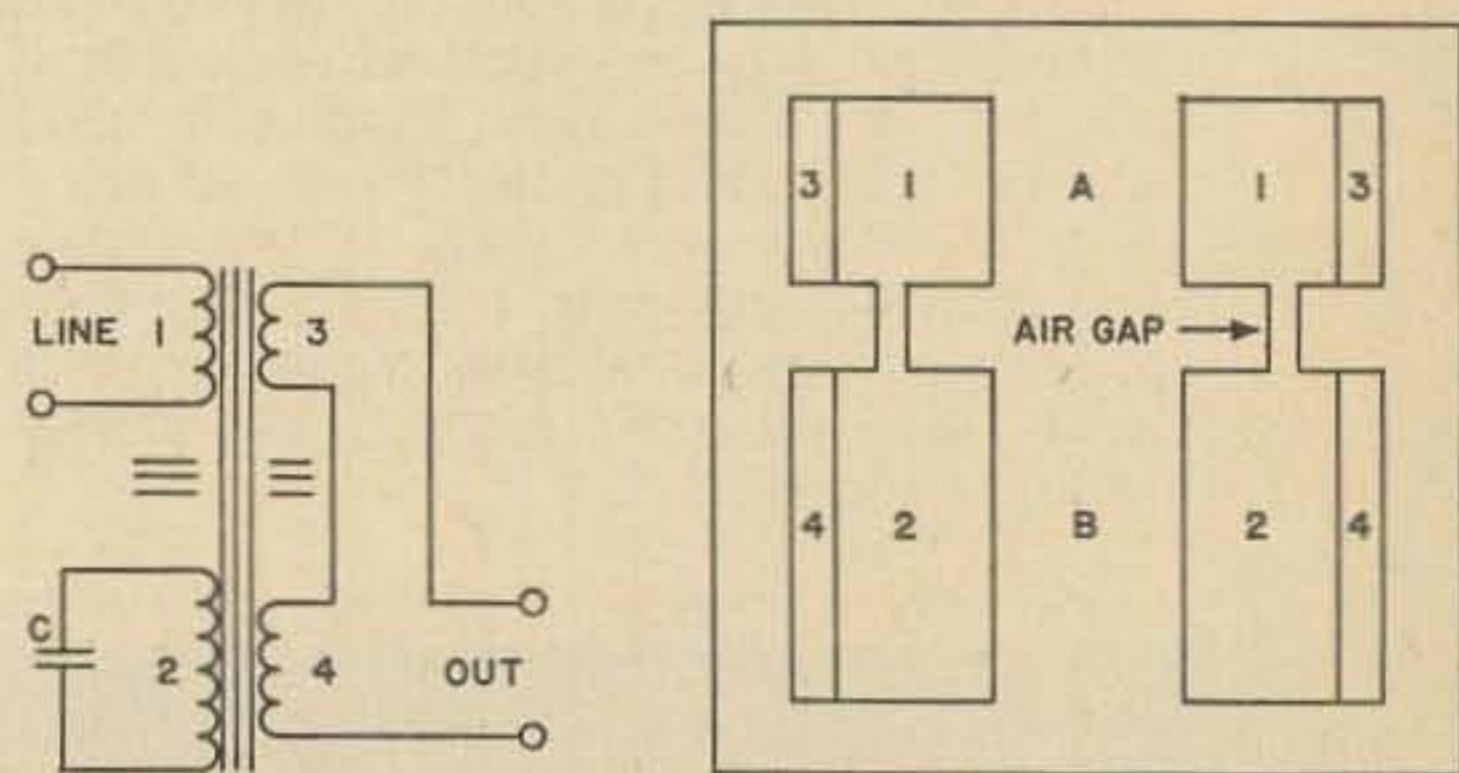

Fig. 1. Driving and control circuits mounted in the camera box.

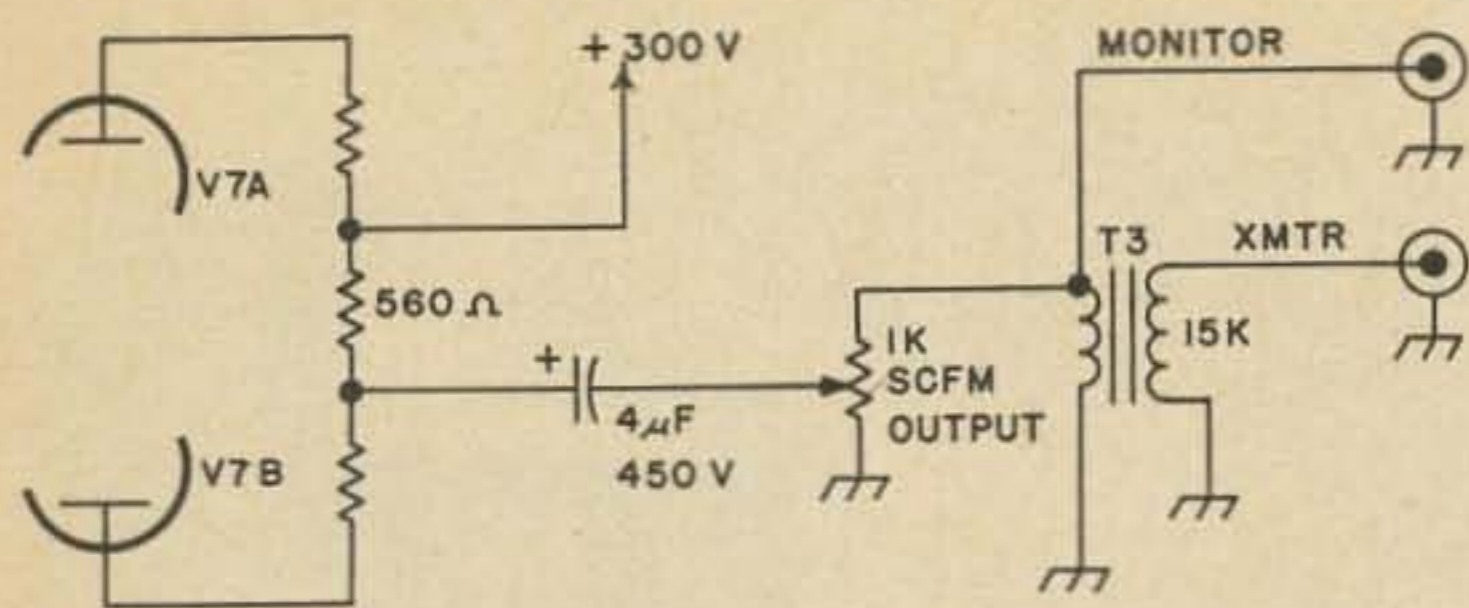

Fig. 2. Audio output control circuit.

10 kHz video amplifier. Several other component values were changed to optimize the new amplifier design.

The deflection yoke and focus coil assembly were handmade. Information on the techniques of making Vidicon deflection components may be found in the ATV Anthology. The focus coil was wound with #32 wire and has a dc resistance of 420 ohms.

Due to the lower vertical and horizontal sweep frequencies used in SSTV the deflection coils contain many more turns of wire than those used in fast-scan TV. The vertical deflection coils series dc resistance is 360 ohms, using a coil form window spaced of $1\frac{1}{16}$ " x $\frac{3}{4}$ " x .050" thick, with #36 wire. The horizontal deflection coils series dc resistance is 270 ohms, using a coil form window spacer of $1\frac{1}{16}$ " x $\frac{3}{4}$ " x .035" thick, with #36 wire. For those individuals not interested in winding their own coils, a kit of prefabricated deflection components for SSTV cameras may be purchased from ATV Research advertised in 73 magazine.

Main chassis

The remaining portions of the SSTV camera were built on a hand formed chassis housed in a Heath cabinet. The shutter control circuitry (V8a and V8b of the QST schematic) may be deleted if the builder does not plan to acquire the 7290 SSTV Vidicon. The 1200 Hz phase setter (V15) was also deleted as suggested by Macdonald. A 1000 ohm potentiometer was added to control SCFM audio output (Fig. 2).

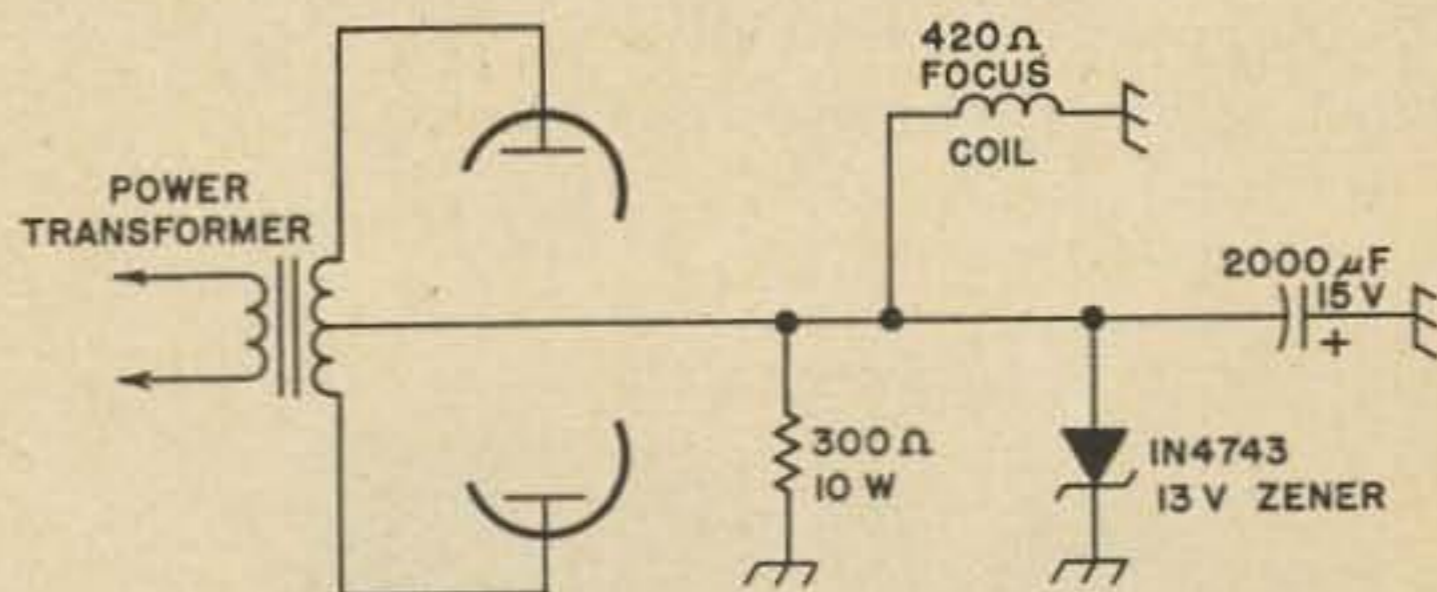

Fig. 3. After some experience with the focus coil circuit, a zener regulator was added as shown here.

The focus coil was wired as shown in the original schematic but has since been changed as shown in the schematic of Fig. 3. A 1000 ohm potentiometer connected in series with a 470 ohm resistor was wired across the horizontal output deflection coils terminals to provide for control of horizontal sweep width.

A test point was brought out accessible from the top of the chassis from pin #7 of V6b to aid in camera tune up and adjustment.

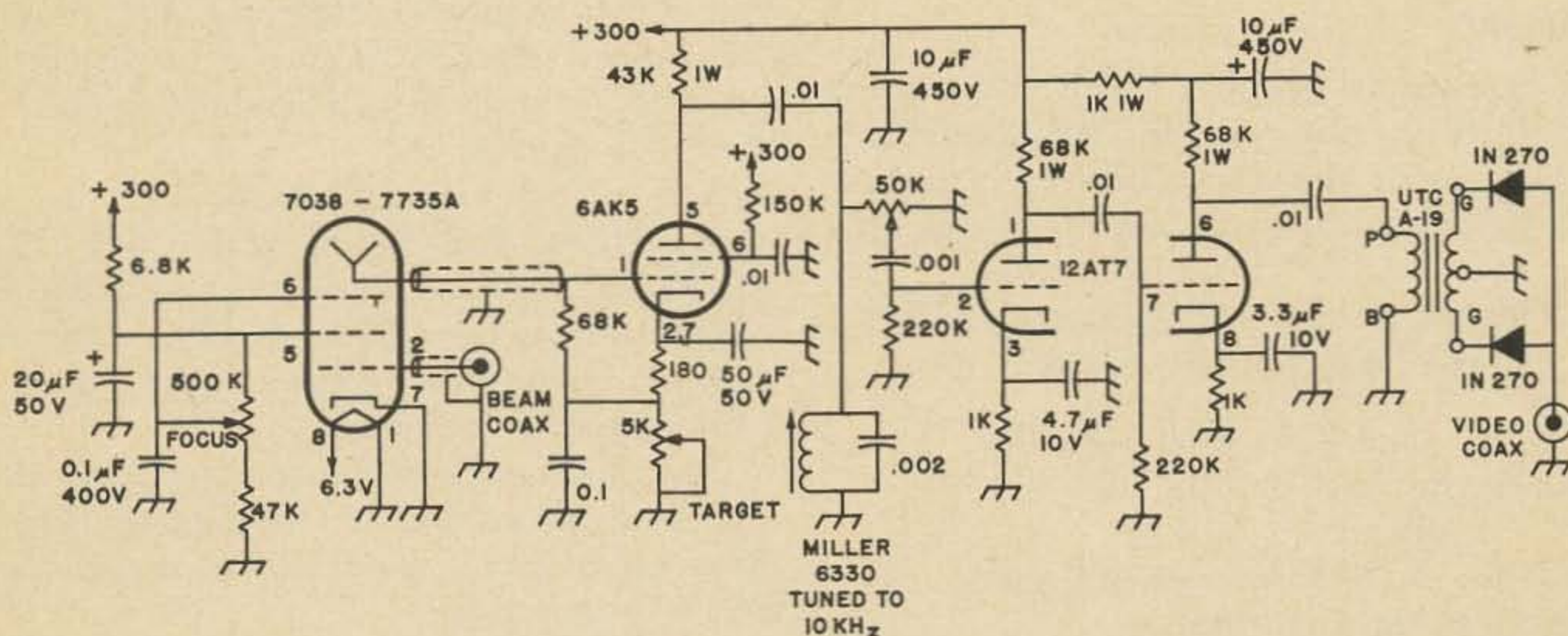
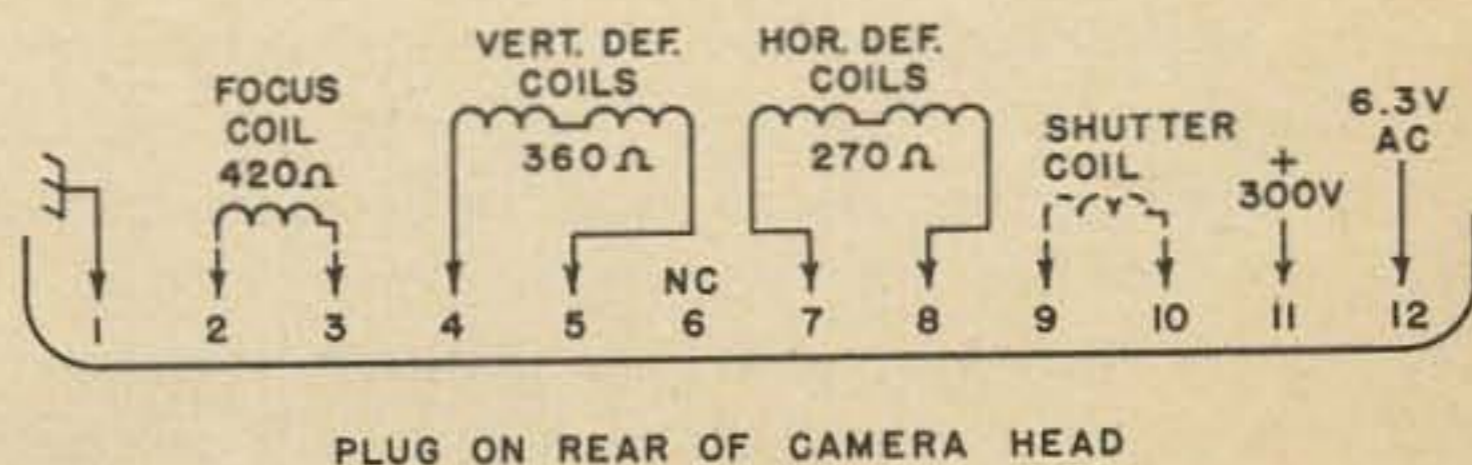
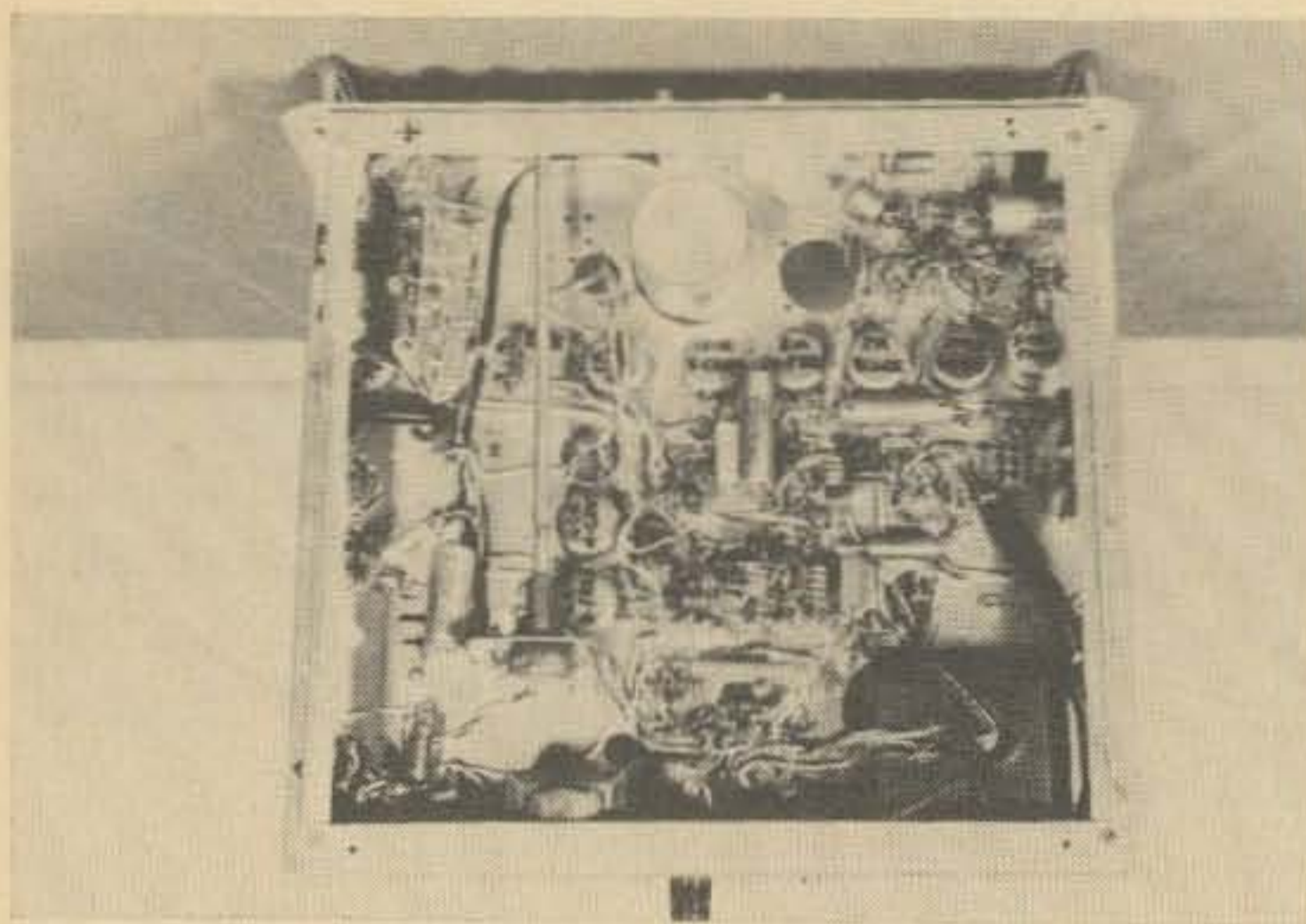

Fig. 4. Complete wiring diagram of the SSTV camera head. Note: pins 9 and 10 blank if shutter deleted on camera using standard vidicon.



PLUG ON REAR OF CAMERA HEAD



Bottom view camera power and sweep.

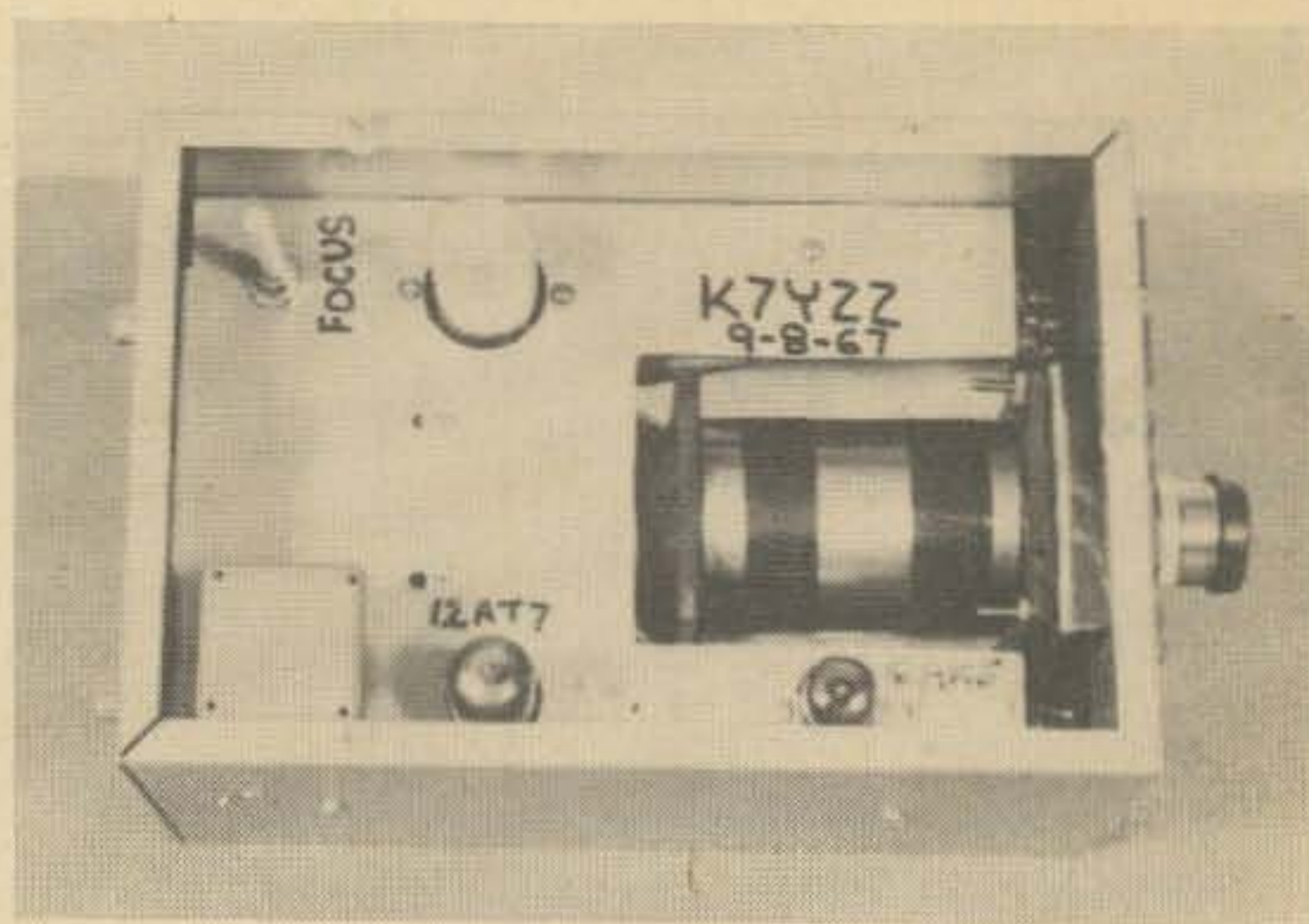

Top view of camera head.

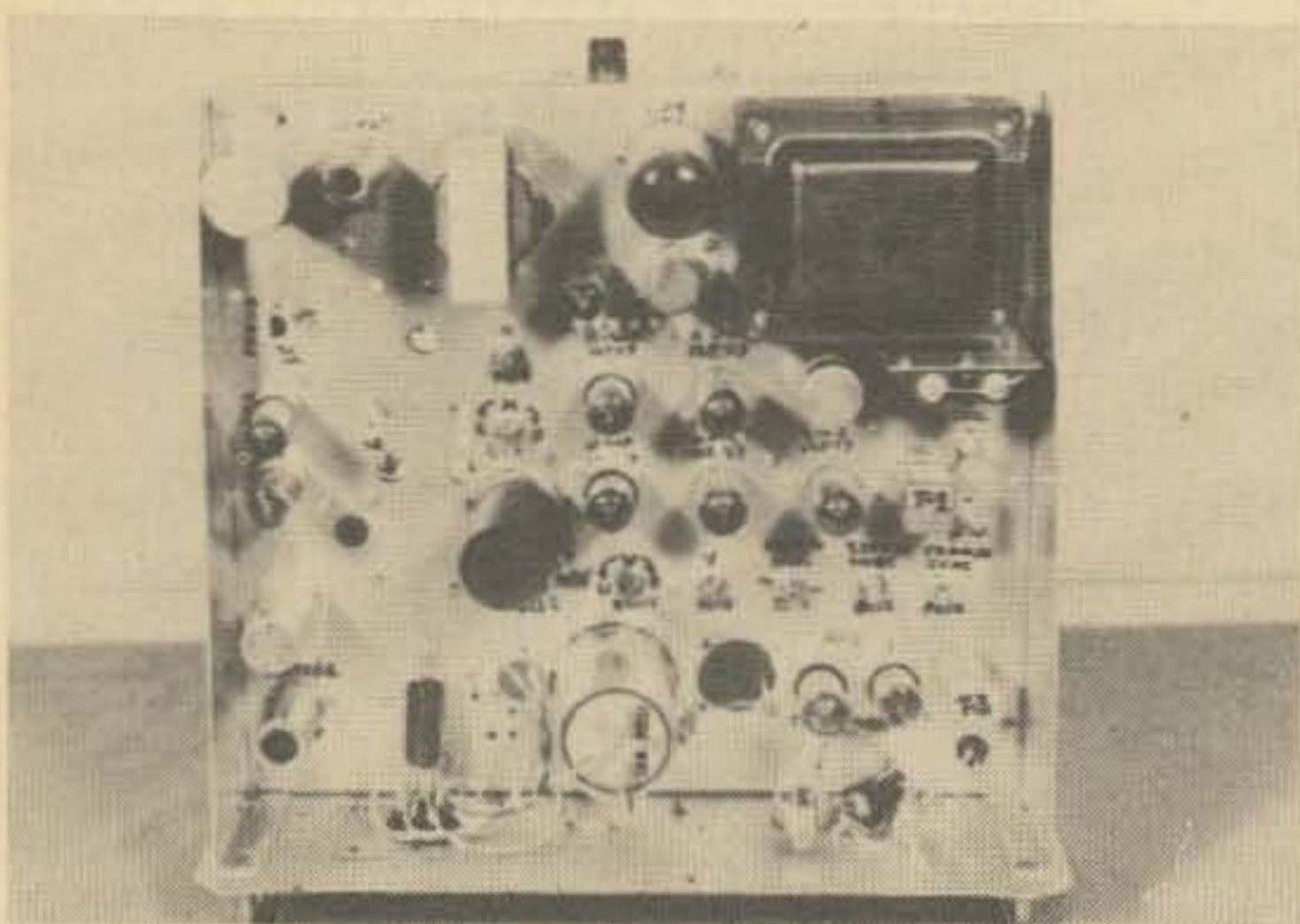

Top view, camera power and sweep.

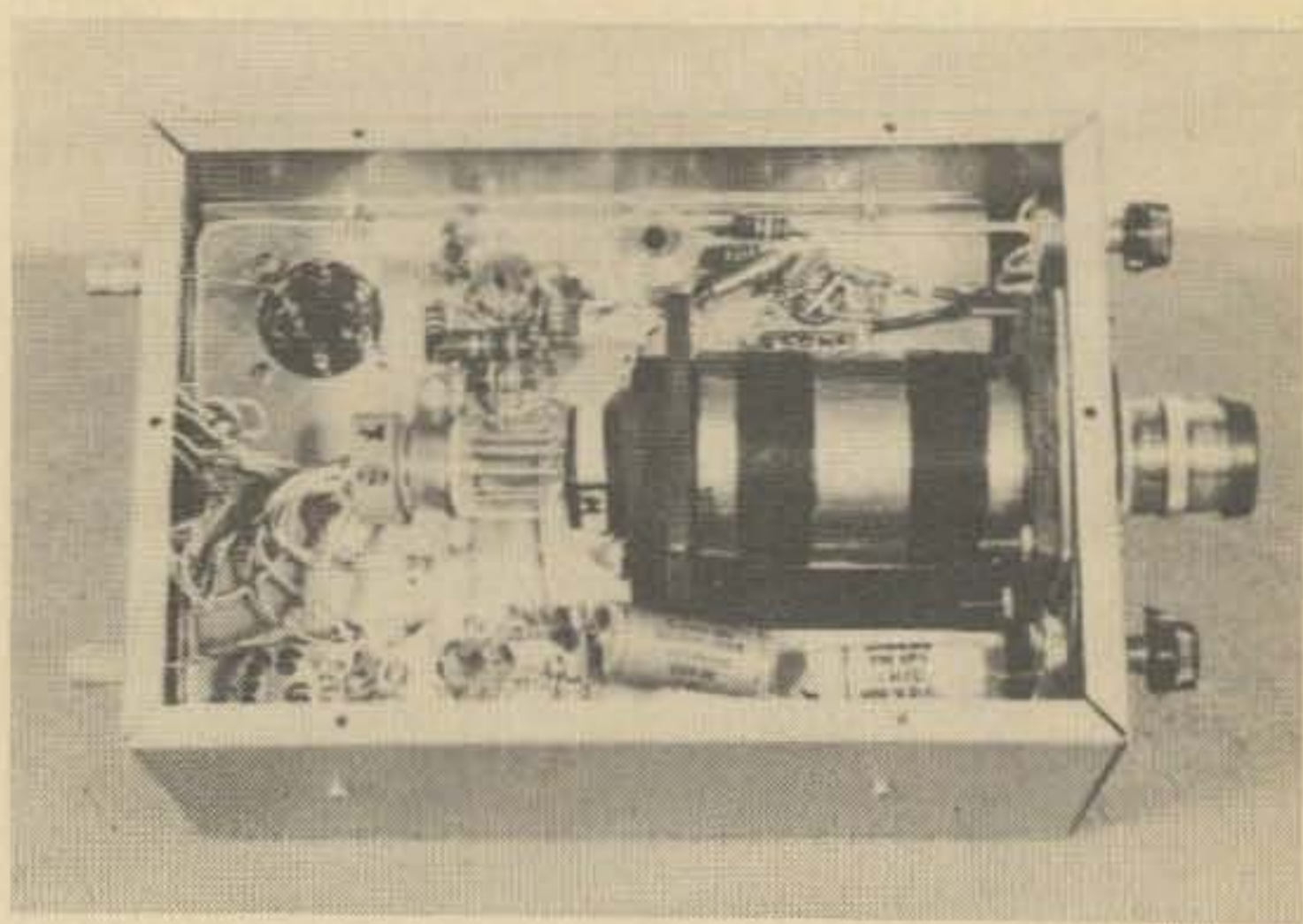

Bottom view of camera head.

Adjustment

The detailed adjustment of a SSTV camera is described in the original Macdonald article. Of course those portions referring to the shutter operation do not apply to this camera.

Typical operational voltages on the 7735A SSTV camera head are as follows:

- Target: plus 9 to plus 15 volts
- Beam: minus 87 volts
- Focus: plus 160 volts
- #5 pin on 7735A: plus 300 volts
- Contrast: mid rotation

The first recognizable picture observed on the camera was reversed. This was corrected by reversing the horizontal deflection connections at the camera head power plug. The deflection yoke also required some minor rotation to level the picture. Optical focusing

of the camera is accomplished by changing the position of the Vidicon. With the fixed focus lens referred to earlier in this article I am able to view objects in focus from around 2 feet to 20 feet.

For station identification titles I use a movie titler. This Sears catalog #3 G9350C Magic Master Letters for titling, uses white plastic letters on a black background, and is held approximately three feet from the camera for full coverage.

Live subjects may be scanned, but the individual should remain motionless for about 24 seconds for a good clear picture on the SSTV monitor.

I wish to express my thanks to Copthorne Macdonald, WAØNLQ, for his verbal assistance during the construction of the camera, and to Bob Gervenack, W7FEN, for his cooperation in the on-the-air tests of the camera.

... K7YZZ

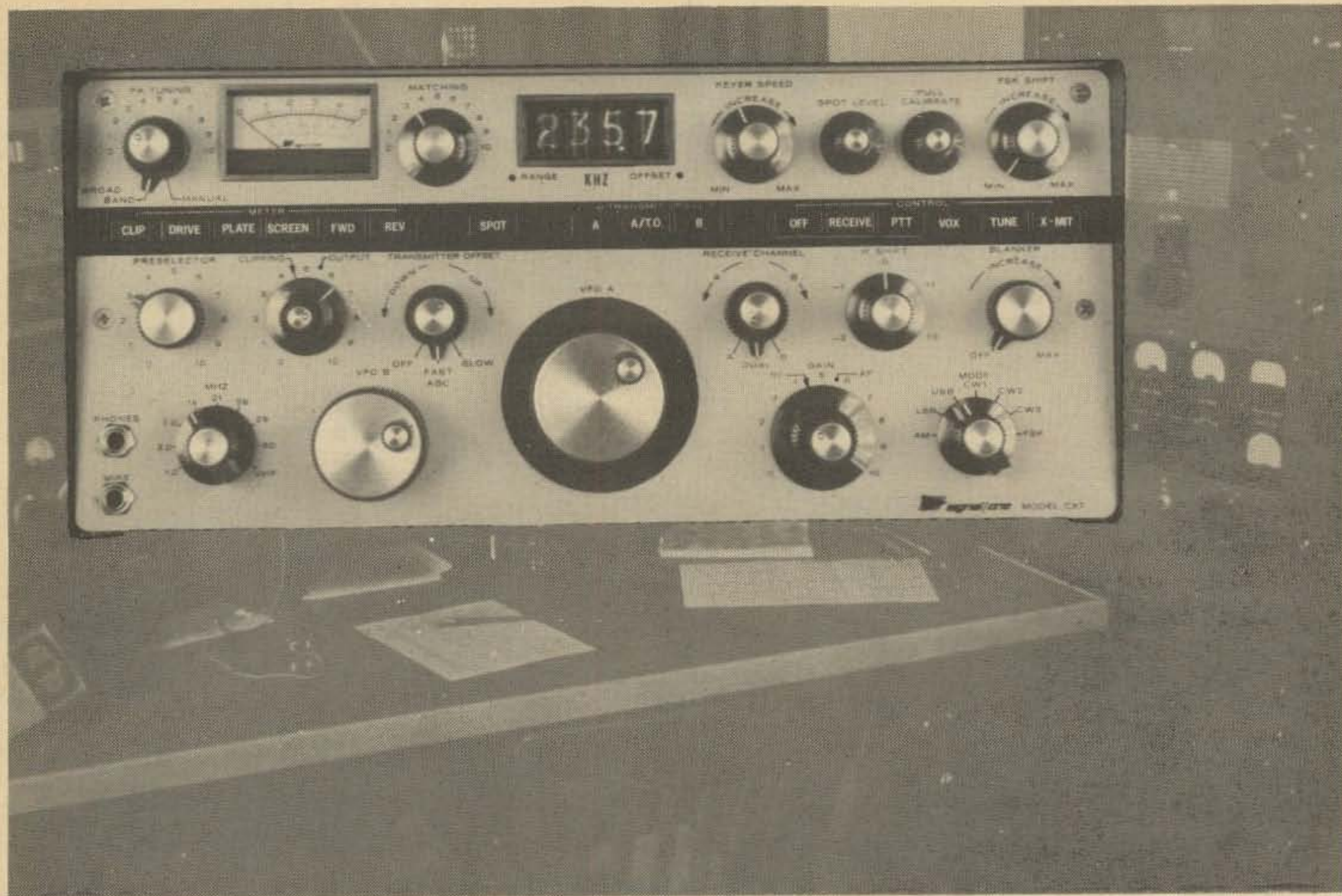

THE STATE of the ART

(YOU'LL NEVER MISS THE GOOD OLD DAYS)

It will transceive... it's compact and light... AND... 30 minutes with SIGNAL/ONE's DELUXE INTEGRATED STATION WILL MAKE YOU FORGET ALL ABOUT THE GOOD OLD DAYS *including yesterday*...

NOW YOU CAN HAVE YOUR DREAM RECEIVER... with

- spectacular skirt selectivity and ultimate rejection from two cascaded crystal lattice filters...
- ELECTRONIC IF SHIFT to exploit those razor-sharp skirts and slice away QRM...
- dual-gate MOSFET front end for superb sensitivity and overload resistance...
- variable-threshold pre-IF blanking to wipe out noise before it can do its dirty work...
- true "second receiver" convenience built in—CONTINUOUSLY-VARIABLE CHANNEL MIXING makes it handier than a separate extra receiver...

AND THE TRANSMITTER delivers

- clean, crisp SSB with the penetrating talk power that only RF clipping can provide...
- more than 150 watts of continuous output into a matched load without tune-up—yet the high-linearity broadband

power amplifier is easily adjusted to compensate for mismatch, too—and is conduction-cooled for rugged dependability...

- true CW break-in keying ...
- no compromise transceive convenience for the serious CW man with SIGNAL/ONE's new VARIABLE TRANSMITTER OFFSET system plus instant "spotting" off, near, or dead-on your receive frequency...

AND BOTH OF THEM

- cover all of 10 through 160 meters in full megahertz bands, continuously displaying frequency directly to 100 Hertz absolute accuracy...
- are integrated behind a single, sleek front panel... human engineered to provide the ultimate in operating pleasure. (Write for a detailed brochure)

BUT NOBODY'S PERFECT...

...you still need a mike and key, an antenna and a power outlet!

Performance... Convenience... Quality...



"It Speaks for Itself"

SIGNAL/ONE

A Division of ECI (An NCR Subsidiary)

2200 Anvil Street N. • St. Petersburg, Florida 33710

A Cheap and Simple, Tri-Band, Linear Amplifier

Allan H. Matthews WB2PTU
R.D. 1,
Waverly, N.Y.

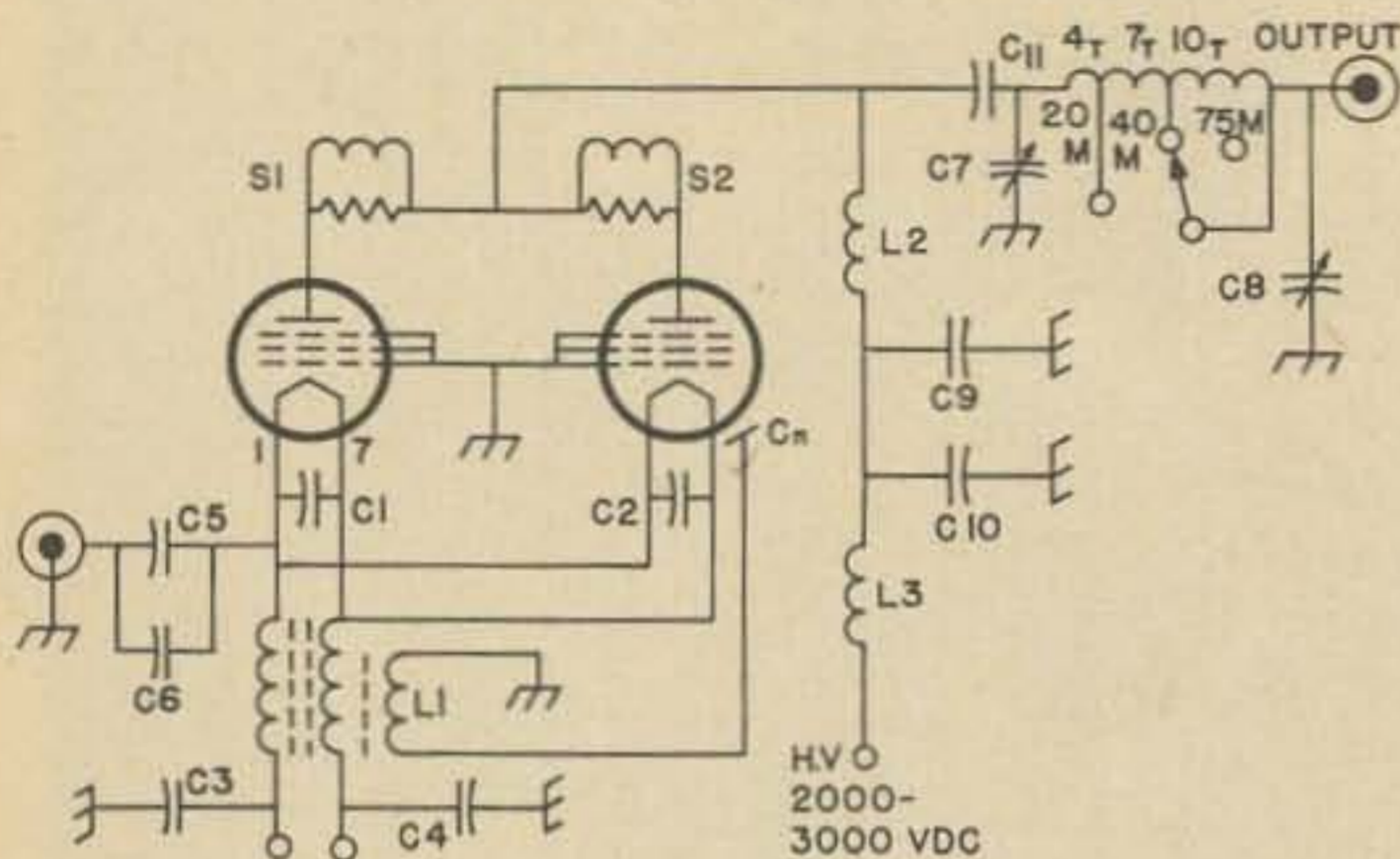

Fig. 1. Schematic diagram of the "Cheap and Simple Tri-band Linear Amplifier."

This article is not for the ham who buys all new commercial gear. He can go out and purchase a nice, new, shiny, chrome-plated linear amplifier for a few hundred bucks and be on the air fast with his 2000 watts PEP. If you are the type of ham, however, who believes in a little elbow grease and ham ingenuity, read on friend, and save some money. 80, 40, and 20 meters are covered because these are the bands most transceivers cover.

I had recently traded all of my gear and purchased the SB 34. This left me with no money for ham gear but with a desire for a higher power, at least for 75 meters. I decided that the linear amplifier must have the following specifications:

1. No screen voltage supply.
2. No bias voltage supply.
3. 500 to 1000 watts dc input.
4. Low cost.

My choice of tubes was a pair of 813's. These are available as surplus from many sources and many amateurs have a few kicking around. Some commercial stations use them for drivers and the ART-13 also used one, so look around. The tube socket is cheap and no fancy blower is needed. Since the SB 34 would deliver 135 watts PEP I decided on the grounded grid circuit. I realize that some commercial ampli-

fiers use 813's in grounded-grid with a bias voltage, but, believe me, they work very well with all grids tied together and strapped to ground. This also saves a few capacitors and a bias supply. The schematic pretty much explains things, but don't be afraid of substitutions. The filament transformer can be a rewound television power transformer. 10 volts at 10 amperes is what is needed if you wind your own. Don't forget the center-tap.

The filament choke is used to block rf from getting into the filament transformer and to ground. You can purchase one for about \$18 or wind your own for about 25c. I wound my own. The core is ferrite from the core of a burned out television fly-back transformer. Grind the U shaped piece until you have a straight bar of the material, then give it a coat of Scotch #33 tape to smooth it off. Next, wind one layer, 12 turns, of #12 wire, the wire arranged to be two windings wound simultaneously. To do this fold the wire in the center, clamp it into a vise, stretch it and then wind the choke using both strands, side by side. It requires about ten feet of wire. Use Formvar insulated wire if you can get it. Motor rewinding shops have it on hand. After you have wound the core full, give it another layer of tape. Then wind a single strand of anything from # 16 to # 26 in the same direction directly over the tape, using the same number of turns as you used on the first winding. This will be used for neutralizing. Cover this winding with plastic tape also.

The next expensive item is the kilowatt tank coil. I wound my own, using 15 ft of $\frac{1}{8}$ in. copper tubing. My coil is $2\frac{3}{4}$ inches inside diameter because that's the size can I had on hand. Some pieces of plastic and some plastic cement were used to space the

Parts list

C1, C2, C3, C4	.01 mfd., 600 V. ceramic
C5, C6	.006 mfd., 1200 V mica
C7	240 pF, 1/8 inch spacing
C8	1000 pF
C9, C10	500 pF TV doorknob
C11	.0024 pF 5000 V.
Cn	See text.
L1	See text.
L2	P & H kilowatt plate choke, or equivalent.
L3	20 turns #26 on 3/8 inch dowel, close spaced.
S1, S2	5 turns #16 on 47 ohm 2 W resistor.

windings at about 1/16 inches apart. The coil I wound has 21 turns, but 18 would be plenty, as I tried a second tap for 75 meters but it didn't make any difference. Total cost for the coil was under two dollars. The L/C ratio is probably not exactly right but with 1000 watts of dc input, who cares if we lose a watt or two. Besides that, the coil runs cool. So much for the purists.

The amplifier was built for 75 meters but a rugged rf switch from an old tuning unit was in the junkbox and since the SB 34 covered four bands, I decided to make the unit bandswitching. I used a grid dipper to find taps on the coil so the linear would operate on 75, 40, and 20. Taps are as follows:

- 40 meters . . . 11 turns from the plate end of the coil
- 20 meters . . . 4 turns from the plate end of the coil

The power supply is conventional and since mine is rack mounted, the power supply control panel contains the 0-500 mA meter and the 3.5 kV plate voltage meter. That way, if I build another linear, I save the price of two meters. I use a variac in the plate transformer primary, but light bulbs in series will work as well to get tune up voltages.

Earlier I mentioned substitutions and here are a couple you will probably make. The plate tuning capacitor is a 240 pF Cardwell but a 150 pF would do the trick. The loading capacitor is another ancient Cardwell (I think it is 1000 pF but I'm not sure) and you might do better with a three gang broadcast variable. This would be about 1100 pF.

Tune up procedure is to warm up the

tubes and apply about 1000 volts to the 813's. Tune the exciter and the linear for maximum output. This will be about 300 mA of plate current at 1000 volts. Then take out the carrier and raise the voltage to whatever is available. Operate the linear at 2800 volts at 320 mA for an input of 900 watts dc. Adding the driving power of 90 watts dc of the SB 34 we wind up with very close to the legal limit. Idling current of the two tubes runs about 60 mA.

Neutralization is not critical and perhaps not necessary. C_N is an antenna connector from an Arc-5 but a piece of stiff wire would work as well. There is no need for adjustment.

In closing, let me say that I scrounged most of the parts for this linear amplifier, and what I didn't scrounge, I built. So can you. I have much less than \$20.00 in the amplifier itself. The signal reports are gratifying (about 10-12 dB above the barefoot exciter) and this unit can be heard nightly at 3955 kHz where I will be in QSO with K3ABC . . . Break in and join us.

. . . WB2PTU

NEW!

1969 EDITION— WRL ELECTRONIC EQUIPMENT CATALOG

FREE

Brand New!
Filled with amazing
buys in electronic
equipment includ-
ing dozens of new
and exclusive
items you can't
buy anywhere
else!

Anything in the
book on easy
credit terms,
100!

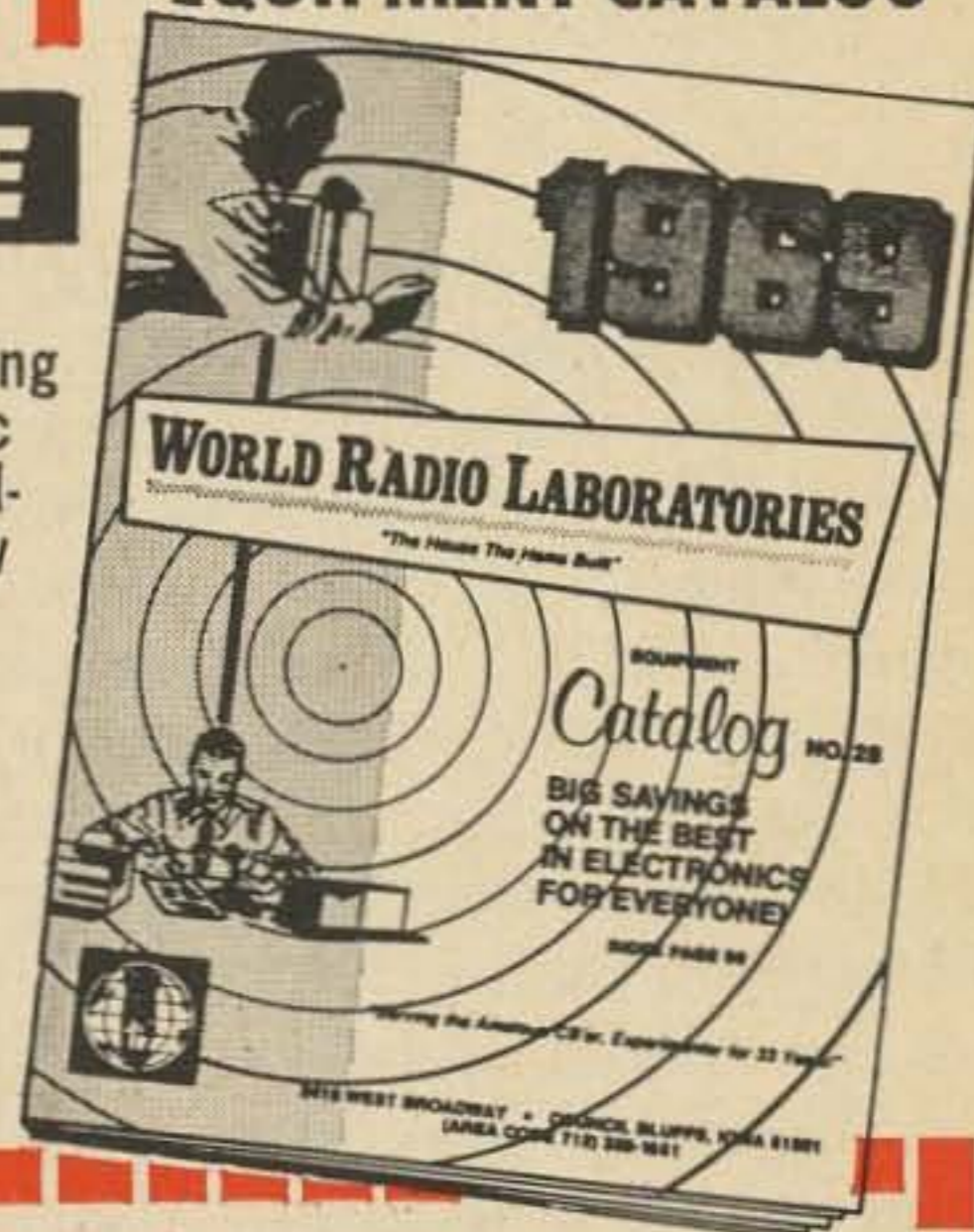

World Radio Laboratories
3415 West Broadway
Council Bluffs, Iowa 51501

73-r38

Gentlemen:

Please send me your Free 1969 Catalog.

Name _____

Address _____

City _____ State _____ Zip _____

The Beatnote Basher

Roger Melen WB6JXU
Rt. 2, Box 486-M
Chico, Calif. 95926

A Selective Audio Filter

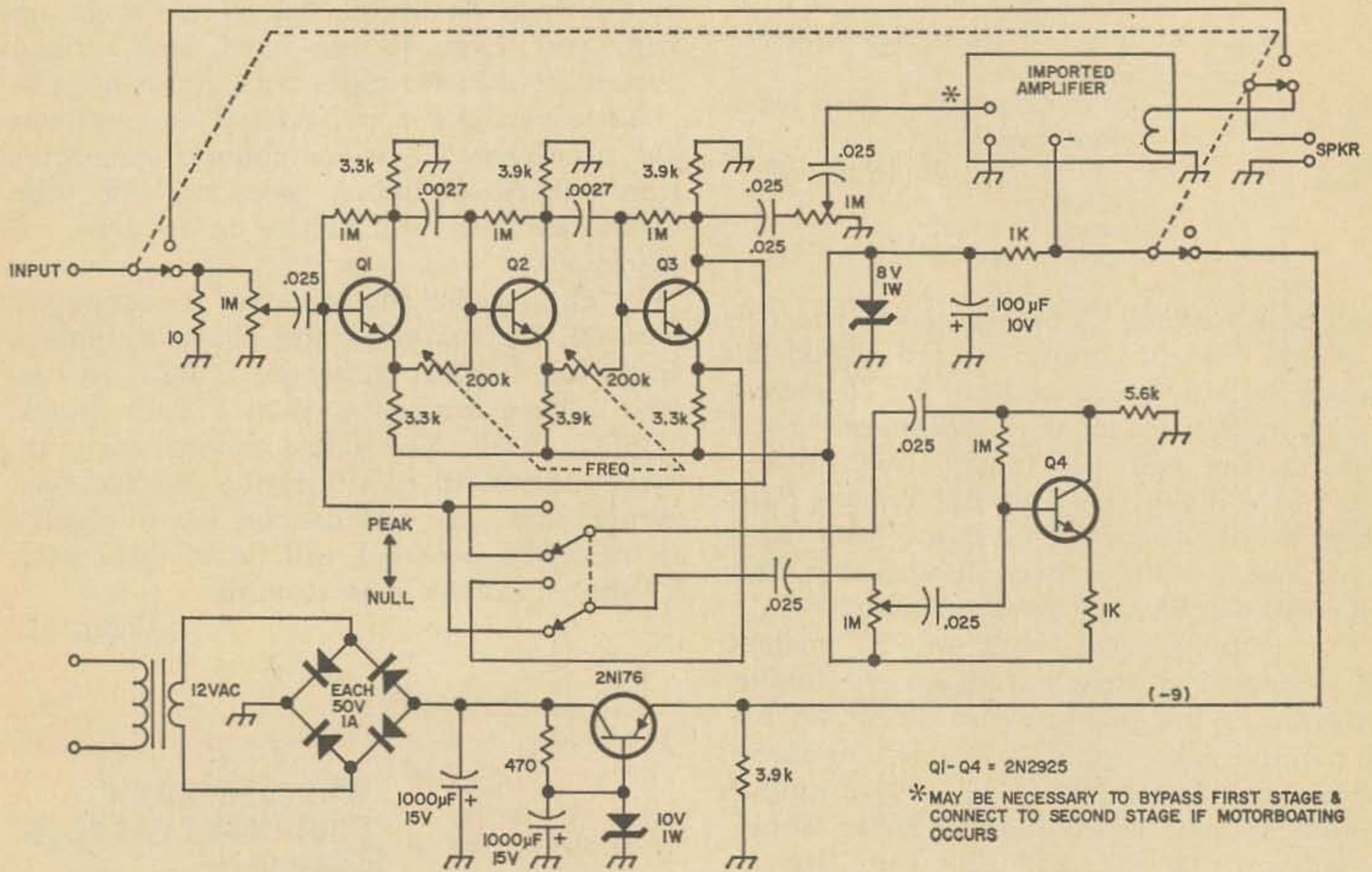

Today's crowded amateur bands require selective receivers. Heterodynes, ignition noise and other interference can wreck a good QSO. Unfortunately, some modern SSB transceivers don't have a notch filter, and aren't selective enough for good CW reception. The "Beatnote Basher" is not a cure-all, but it does offer, in the "reject", mode an audio notch that will knock an undesired heterodyne almost out of the picture. In the accept mode, it proves an extremely sharp passband allowing you to pull a single station out of a pile-up. Also, the installation requires no modification of your present equipment. It is simply installed in the speaker lead of your present receiver, or transceiver. It works with all *ifs*, and receivers and transceivers.

Basically, the idea is not new. The "selecto-ject"¹ and others are based on the same principal. An audio amplifier is constructed so as to have a phase shift of zero degrees at just one frequency. Q₁, Q₂, and Q₃ comprise

such an amplifier. An ordinary amplifier, Q₄, is placed in parallel with before-mentioned amplifier when the "accept-reject" switch is placed in the reject mode. The ordinary amplifier, which has a phase shift through it of 180 degrees, will have an output which is identical to the phase shifting amplifier except for a phase difference of 180 degrees at the frequency which is to be rejected. If the selectivity control is adjusted so that the gain of both amplifiers is identical at the frequency which is to be rejected, the two signals will add out, while allowing all others to pass through.

In the reject mode, the "Beatnote Basher" acts as an amplifier with feedback, but the feedback is at the optimum phase at just one frequency. The system has greater gain at this frequency than at all others, so that only the desired frequency is heard at the speaker.

Most circuits of this sort utilize a tube type amplifier. Warm-up time, heat dissipation and size were the main factors which

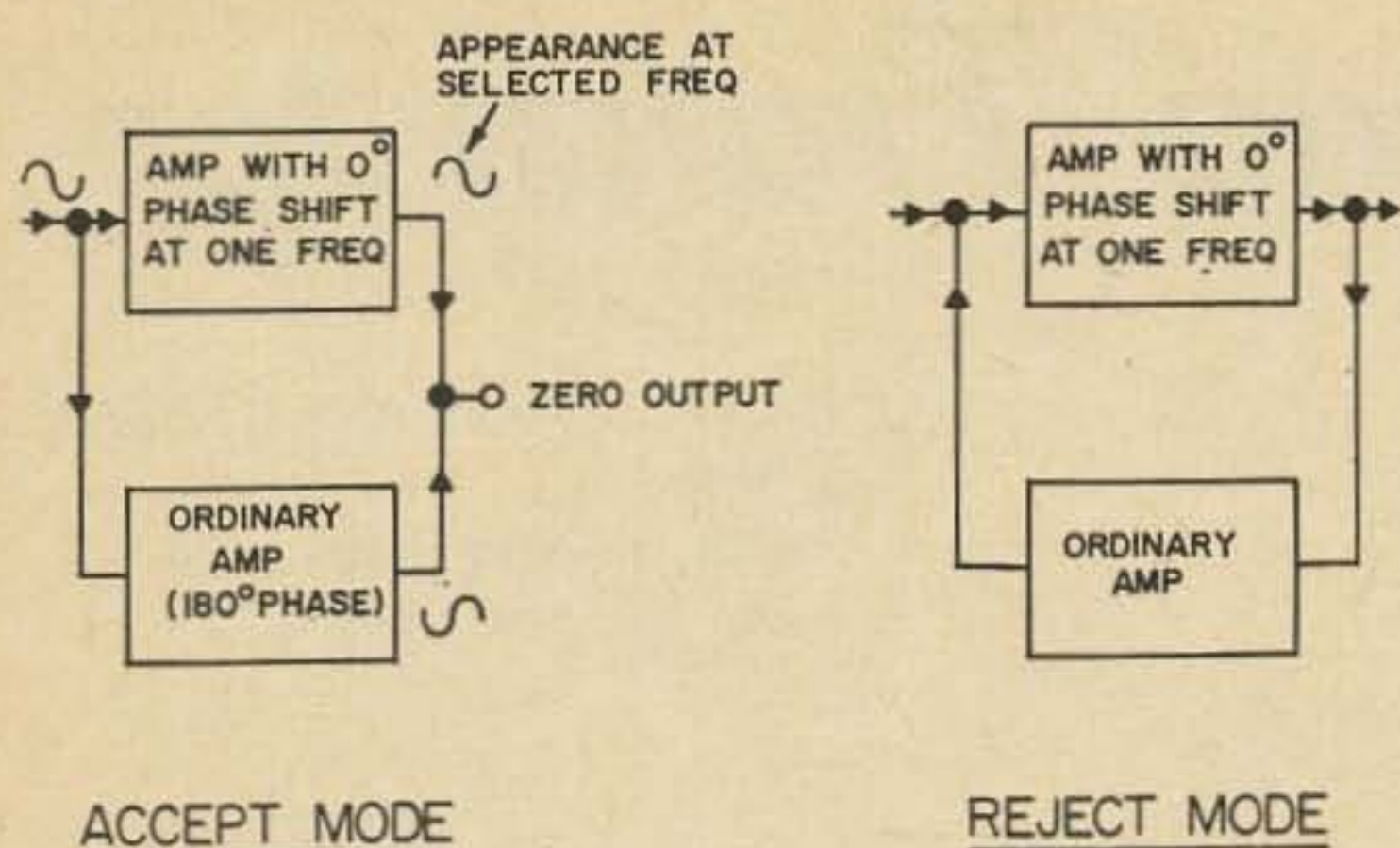

discouraged the use of tubes in the author's circuit. The transistor which should be used is rather important. Impedance matching, gain and other consideration point to a high beta transistor. The General Electric 2N2925 has a typical beta of 215 which is excellent for our purpose, and they're only 60c each.² Bargain transistors of dubious type are not recommended. The audio amplifier may be any of the 1 watt or 3 watt imported jobs which are presently on the market.³ The author attempted to homebrew an amplifier, but turned to an imported model when inter-stage and output transformers were found to be going for the same price as the complete imported amplifier. Any suitable power supply can be used, as long as it is capable of being hum free at currents up to a half an amp or so, depending on the power output of the imported amplifier obtained. Without the amplifier, the current consumption is about 4 milliamperes.

Construction technique varies with the builder, and nothing is extremely critical, although good wiring technique is always advisable. The unit in use here is constructed on a vectorboard with flea clips. Sockets are recommended for the transistors. Presently, the power supply and filter are in separate mini-boxes, but plans are being made to fit the whole thing in one 7" x 5" x 3" mini-box. The front panel controls are: power, in-out, reject-accept, frequency and selectivity. The two gain controls may be put on the back panel, or once the desired values are found replaced by fixed resistors. The filter should be in a shielded box in order to void picking up *rf*.

Once the unit is built, the input should be connected to the speaker jack and the output to a speaker. With the selectivity control set for maximum gain and both gain controls set for maximum gain and the "accept-reject" switch put in the accept mode, the unit

should oscillate quite loudly (tuning the frequency may be needed) and it is not recommended that this be done when others are sleeping). Backing down on the selectivity control should stop the oscillation.

The gain control for the imported amplifier should be adjusted so that the amplifier is not distorting badly. With audio fed into the filter, the selectivity control backed all the way down, the gain control on the input of the filter should be backed down below where distortion occurs. If output is lacking, gain control on the imported amplifier may be adjusted for more gain. For most shacks a 1 watt amplifier is sufficient, but the 3 watt model may be preferred. When finished, the gain controls should be set so that when the filter is put in it has no gain or loss when the selectivity is all the way down and it is in the accept position.

With the filter "in" a signal may be notched out by putting accept-reject switch on "reject" and tuning the frequency until the heterodyne is nulled. The selectivity control should be set about half or two-thirds of maximum for this operation. Once the null is achieved, the selectivity control should be tuned for maximum null.

A signal may be peaked by putting the accept-reject switch on accept and advancing the selectivity control to the threshold of oscillation. The frequency control is turned to peak the desired frequency. The selectivity may have to be readjusted some while turning the frequency control. The operation of the unit is very similar to a Q multiplier except that it operates at audio frequencies in the speaker lead.

The unit may be built into a receiver and then the imported audio amplifier could be omitted, and the output of the filter hooked to the input of the receiver's audio.

If properly wired the unit should give no difficulty and serve as a useful receiving accessory. It can also be useful as an audio oscillator when the selectivity control is advanced in the "accept" position. Oscillator output can be taken at the input to the imported amplifier.

. . . WB6JXU

¹1963 *The Radio Amateur's Handbook* page 129

²Newark Electronics Corporation, 500 Pulaski Road, Chicago, Ill. 60624

³Lafayette Radio Electronics, 111 Jericho Turnpike, Syosset, L.I., New York 11791

The Unijunction Transistor

Roger L. Harrison VK3ZRY
1 Mary St.
North Balwyn 3104
Victoria, Australia

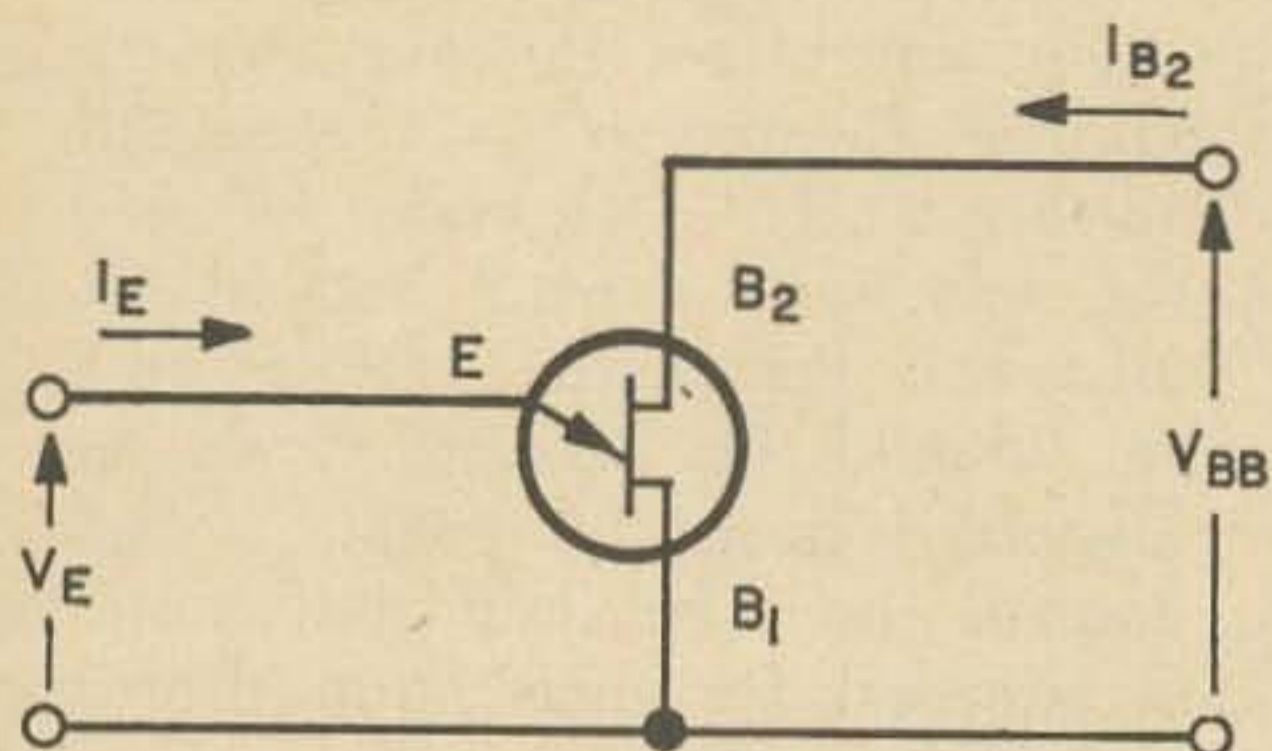

Fig. 1. The symbol and conventions for current flow in the Unijunction transistor.

Perhaps you have seen this rather unusual name in technical journals. Perhaps you have seen an odd-looking symbol (see Fig. 1) in a circuit in those very same technical journals. Perhaps you have wondered what this little device does—with its symbol that vaguely resembles that of a conventional transistor but actually behaves much differently. The thing looks (and behaves) like some weird paradox—it has an emitter in the wrong place and *two* (yes two) bases—which incidentally gives us its other name—“The Double-Base Diode,” which tends to confuse matters even further.

Well, what is this little device and what can you do with it? Read on, and all shall become clear (or more confused).

The unijunction transistor (hereinafter referred to as UJT) is a semiconductor device possessing quite unusual electrical characteristics. Its construction and operation is markedly different from the conventional two-junction transistor.

Characteristics

Fig. 1 shows its symbol and the conventions for current flow in the device. Fig. 2 gives a simplified equivalent circuit. Now, referring to Fig. 2, R_{B2} plus R_{B1} represents the resistance between B_2 and B_1 . This is known as the interbase resistance, R_{BB} , and is generally in the range 4K and 12K ohms. This is the resistance of a bar of N-type silicon with two contacts at either end. Now another contact of P-type material is placed somewhere between B_2 and B_1 on the N-type silicon bar and this forms a rectifying or diode contact called the emitter (E).

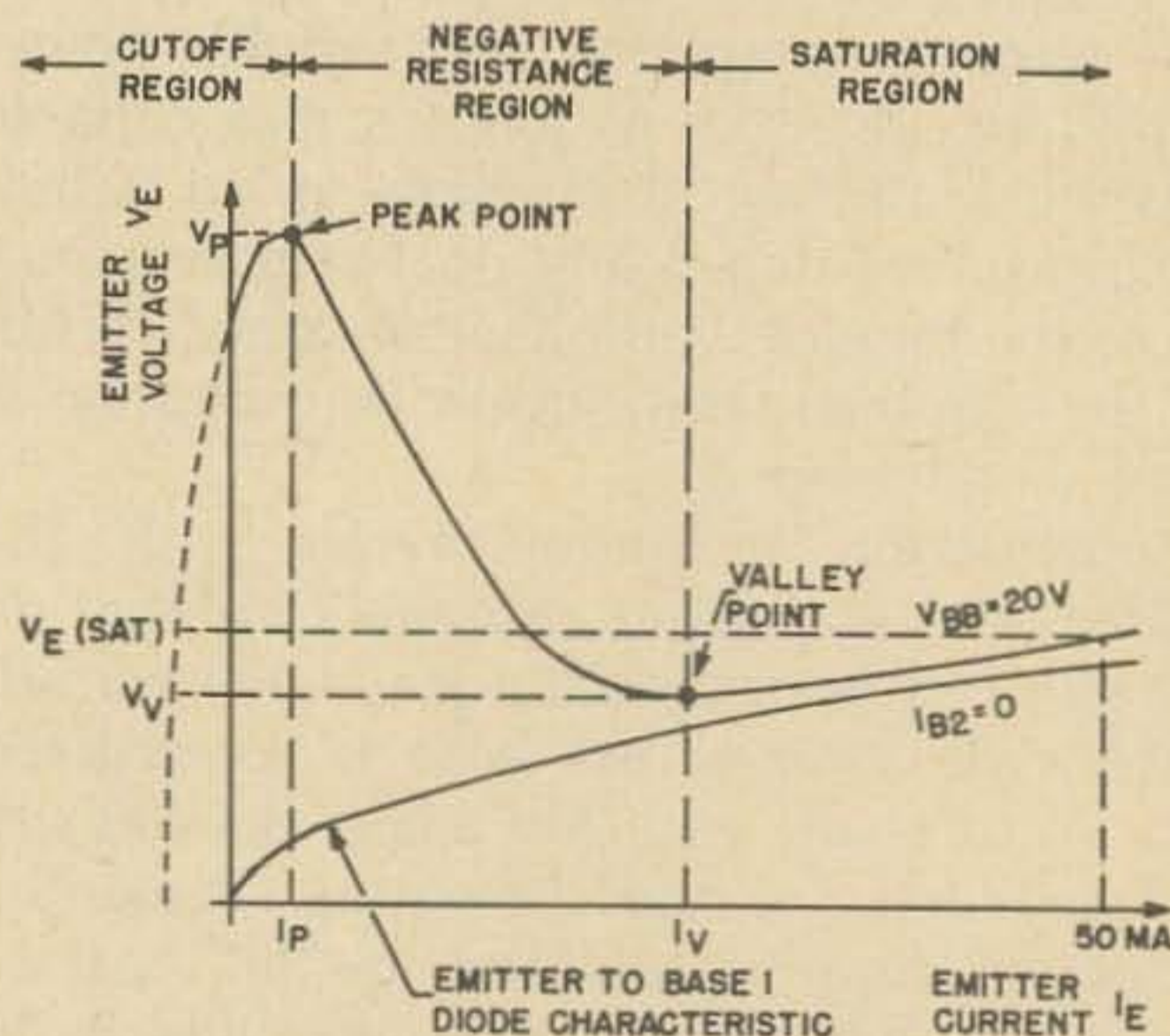

Fig. 3. Plotting the interbase characteristics.

Intrinsic standoff ratio

If a variable potential is connected between B_2 and B_1 , with the positive on B_2 and the negative on B_1 (E not connected to anything) the device acts just like a voltage divider and a certain fraction, will appear at the emitter (E). This fraction (η) is called “the intrinsic standoff ratio”. The ratio is approximately 0.5 to 0.8 for all types of UJT’s. Mathematically the following equation will accurately define η .

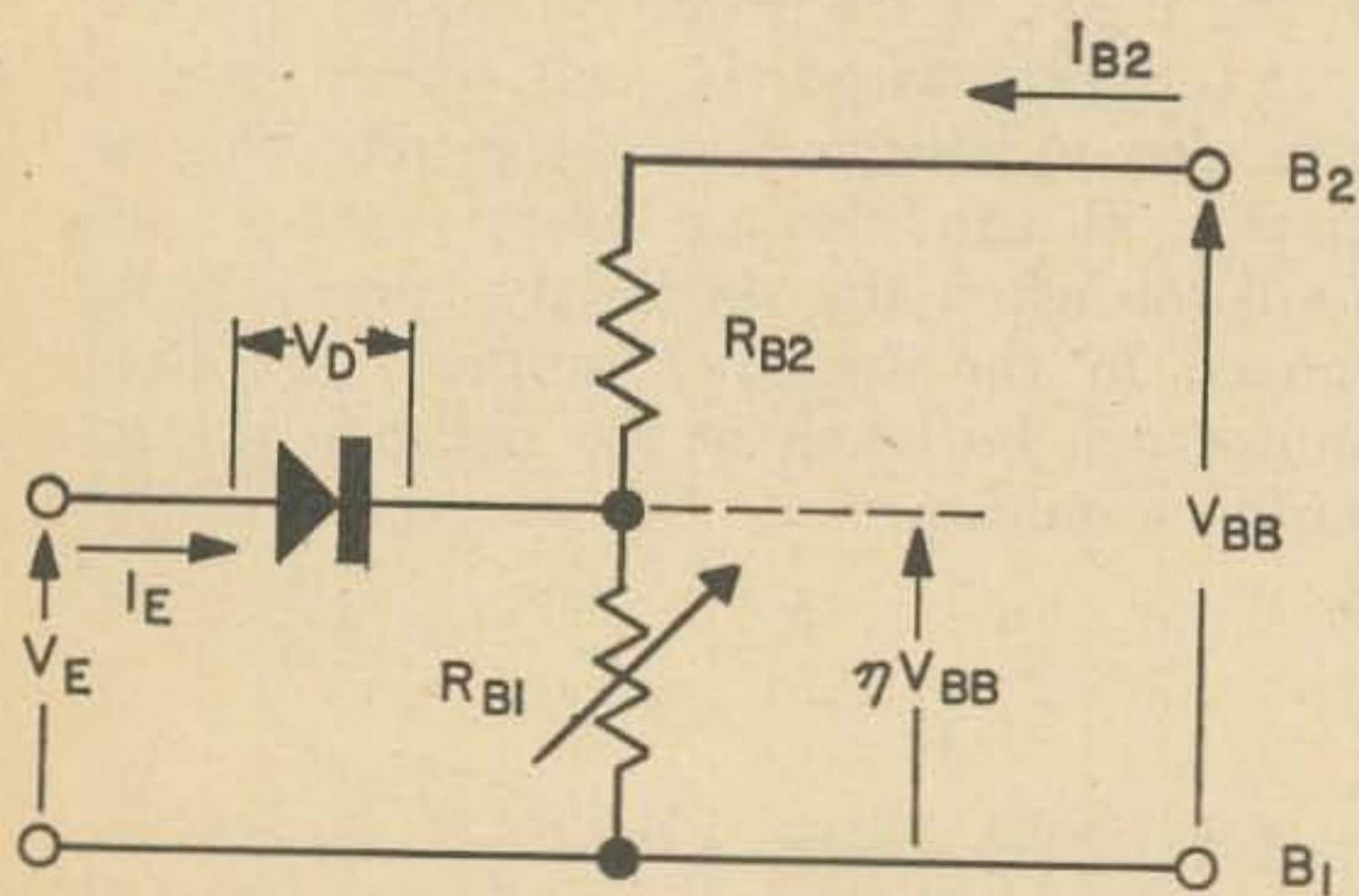

Fig. 2. A simplified equivalent circuit where R_{B2} plus R_{B1} represents the resistance between B_2 and B_1 .

$$\eta = \frac{R_{B1}}{R_{B1} + R_{B2}}$$

Peak point emitter voltage

If the emitter Voltage, V_E , is less than V_{BB} , the emitter diode is reverse biased and only a small leakage current will flow. As V_E is raised towards V_{BB} and just above, emitter current will flow as the emitter diode becomes forward biased. The result is that R_{B1} will suddenly decrease its resistance. Consequently I_E will suddenly increase and V_E will drop.

The point at which R_{B1} suddenly decreases is called the "peak point" and the emitter voltage at this point is called the "peak point emitter voltage" and is labelled V_p .

The diagram in Fig. 3 illustrates the peak point and V_p a little more clearly. These are the static emitter characteristics and you will note that V_p is dependent on V_{BB} (the interbase voltage.) The lower curve ($I_{B2} = 0$) is the emitter to B_1 diode curve when B_2 is disconnected. These curves can be plotted for any UJT by breadboarding the circuit in Fig. 4. Set V_{BB} to convenient voltage in 5V or 10V steps and for each setting of V_{BB} vary the emitter pot. to find V_p first (sudden increase in I_E) and then vary I_E in suitable steps (about 1 or 2 mA steps), reading V_E at each step. You can then plot the static interbase characteristics like those in Fig. 3. Disconnecting B_2 will allow you to plot the curve for $I_{B2} = 0$.

From these curves an approximation to η can be calculated very easily. Simply divide V_p (for a certain value of V_{BB}) by the value of V_{BB} for that curve—

Now $V_{BB} = 30$ V, lets say $V_p = 16$ volts. at this point

$$\eta = \frac{V_p}{V_{BB}} = \frac{16}{30} = 0.534$$

To be more accurate at lower values of V_{BB} use the equation—

$$\eta = \frac{V_p - V_D}{V_{BB}}$$

where $V_D =$ emitter diode voltage,
 ≈ 0.6 volts

Peak point current

This is marked as I_p in Fig. 3. I_p is the minimum current necessary to trigger the UJT. It can be measured using Fig. 4 with some changes. Disconnect the meter (VTVM etc.) reading V_E . Replace the meter reading I_E (0-50mA) with a 0 to 50 microammeter. At each setting of V_{BB} slowly increase the emitter potentiometer until the meter jumps suddenly. The point just before the jump in emitter current is the value of I_p .

Valley voltage

This is marked as V_v on Fig. 3. It is the emitter voltage at the valley point. V_v increases with increase in V_{BB} you may notice.

Valley current

This is marked as I_v on Fig. 3. It is the value of emitter current at the valley point, this also increases with increase in V_{BB} .

Static interbase characteristics

These characteristics are a series of curves that relate V_{BB} and I_{B2} . They can be plotted by breadboarding the circuit in Fig. 5. With the emitter disconnected at first, a reading of I_{B2} for every step in V_{BB} is taken. The steps in V_{BB} should be at 5V intervals. Then, connecting the emitter, increase the emitter pot. until the UJT fires and set I_E at

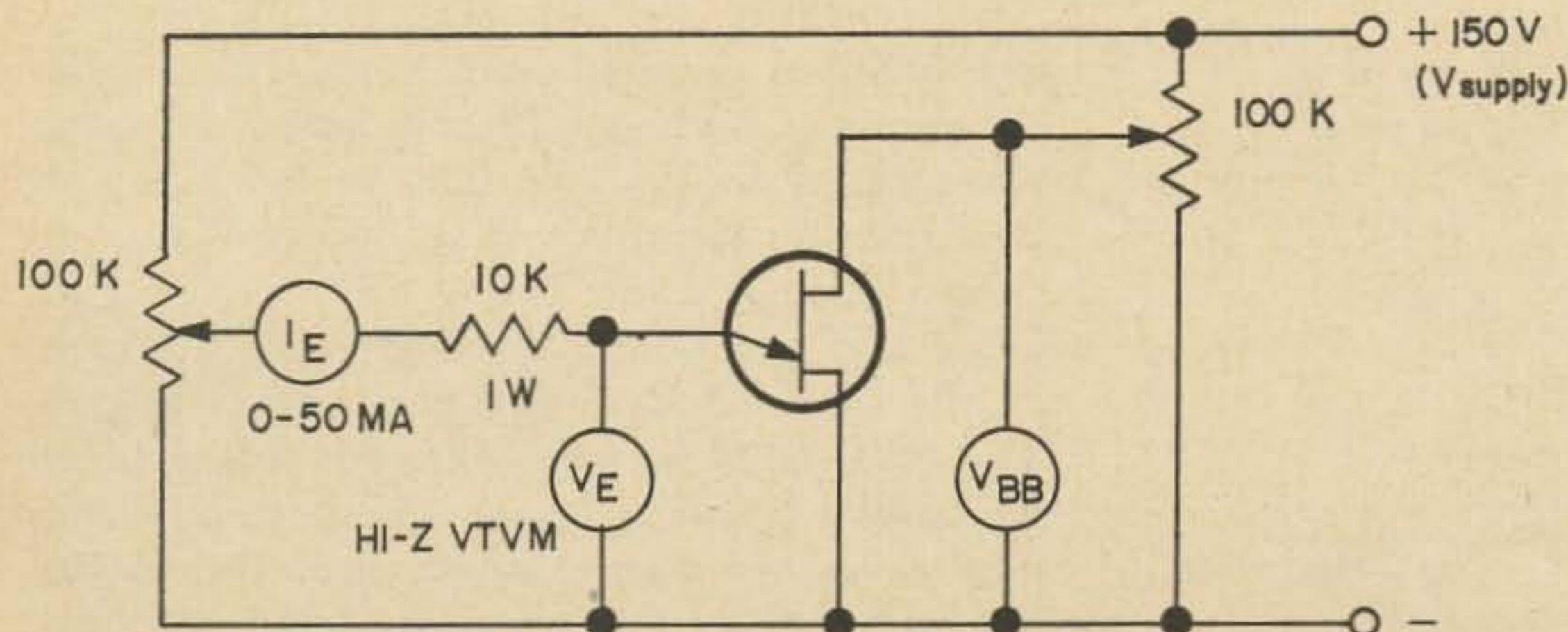

Fig. 4. The minimum current necessary to trigger the UJT can be measured. Keep V_{BB} constant at each step for variations.

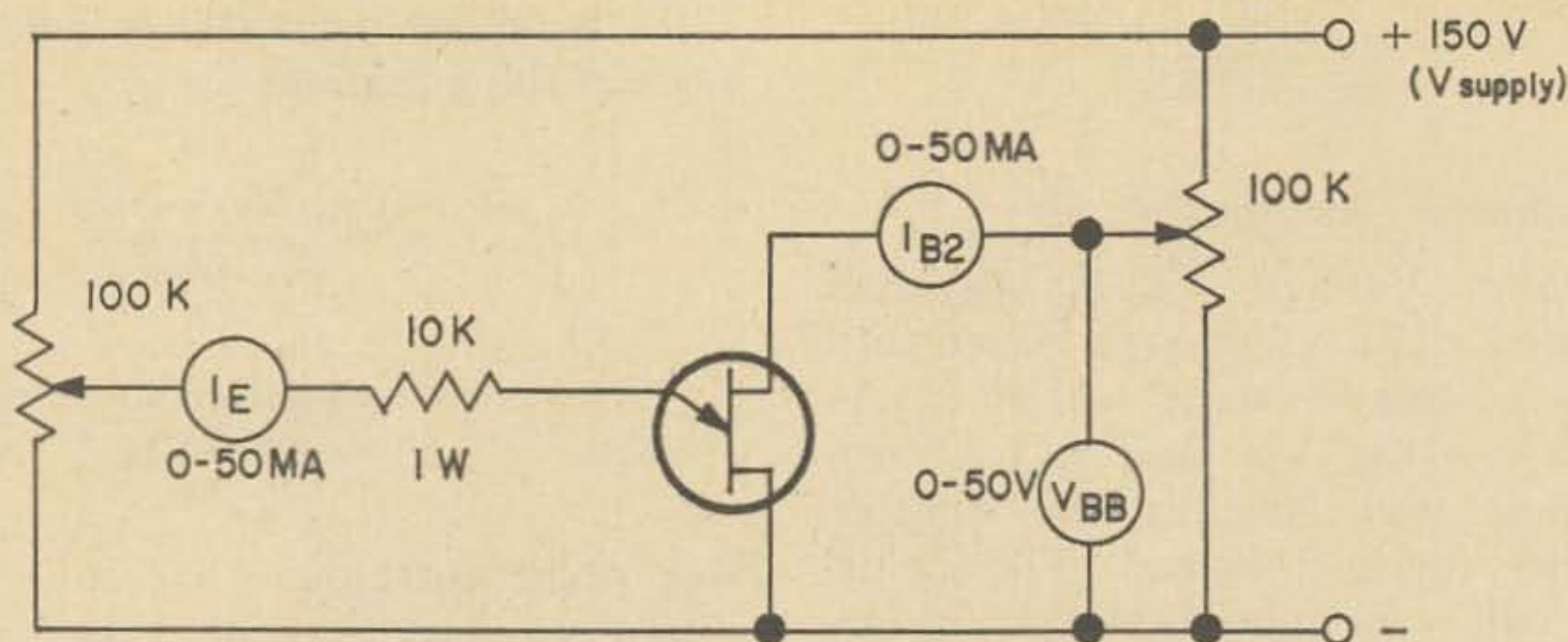

Fig. 5. Static interbase characteristics can be plotted by breadboarding this circuit.

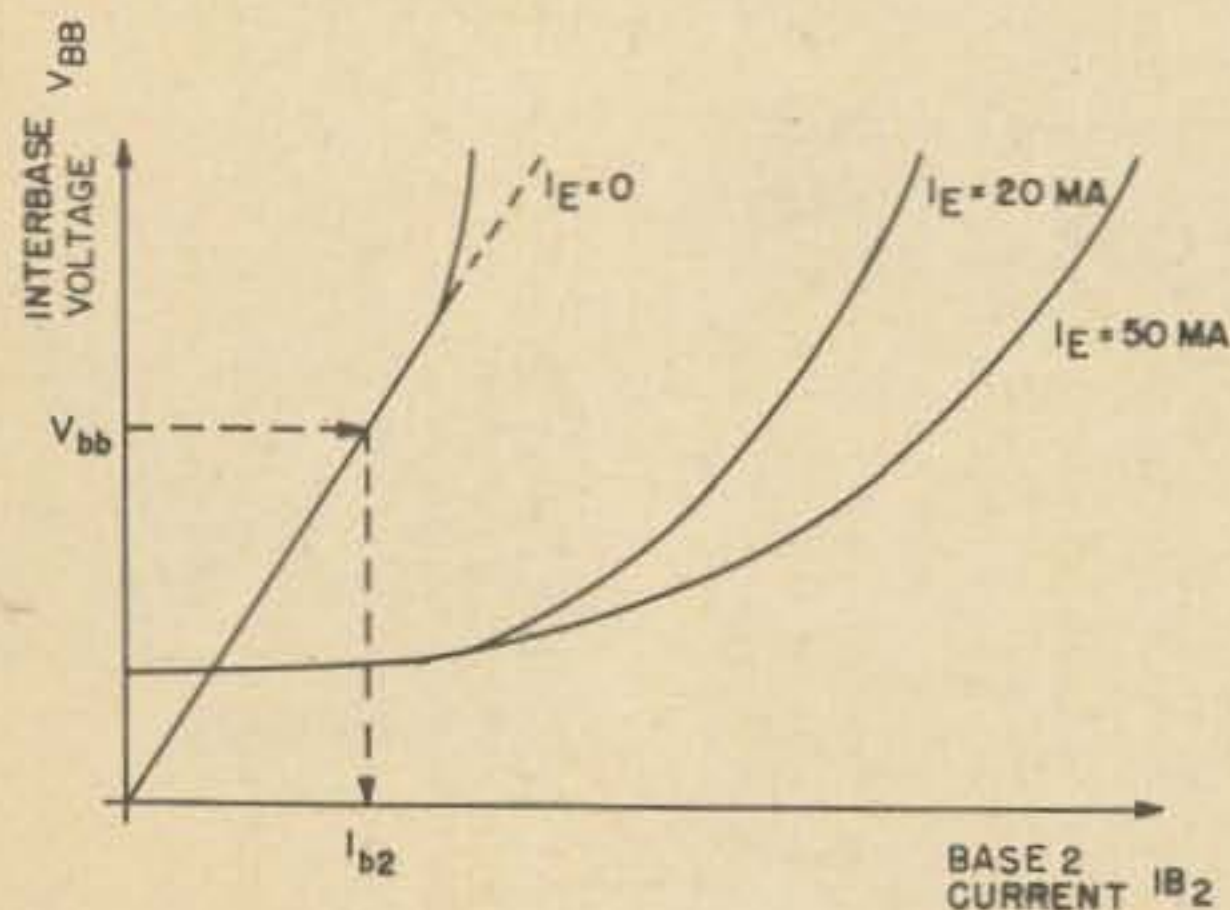
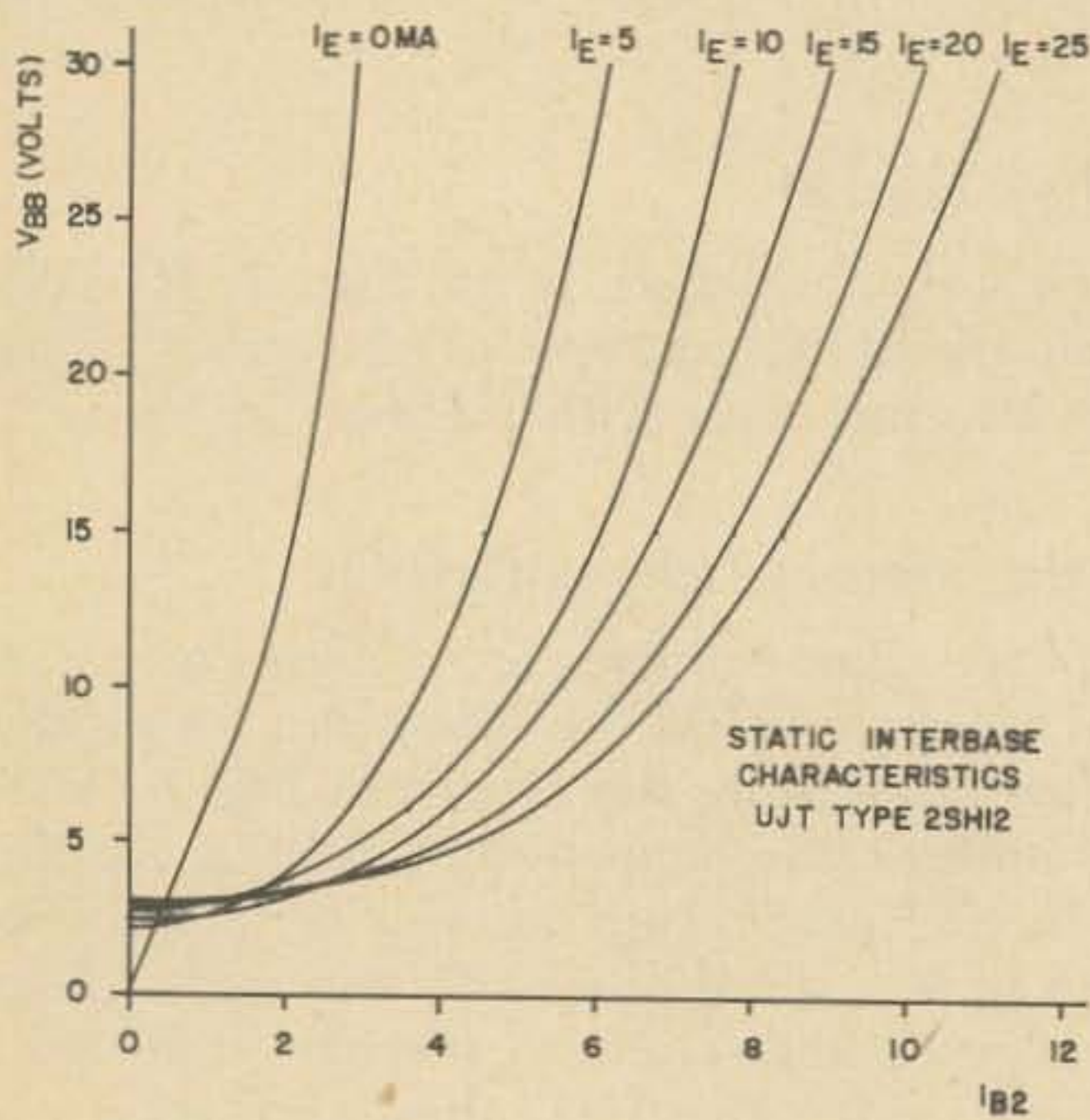
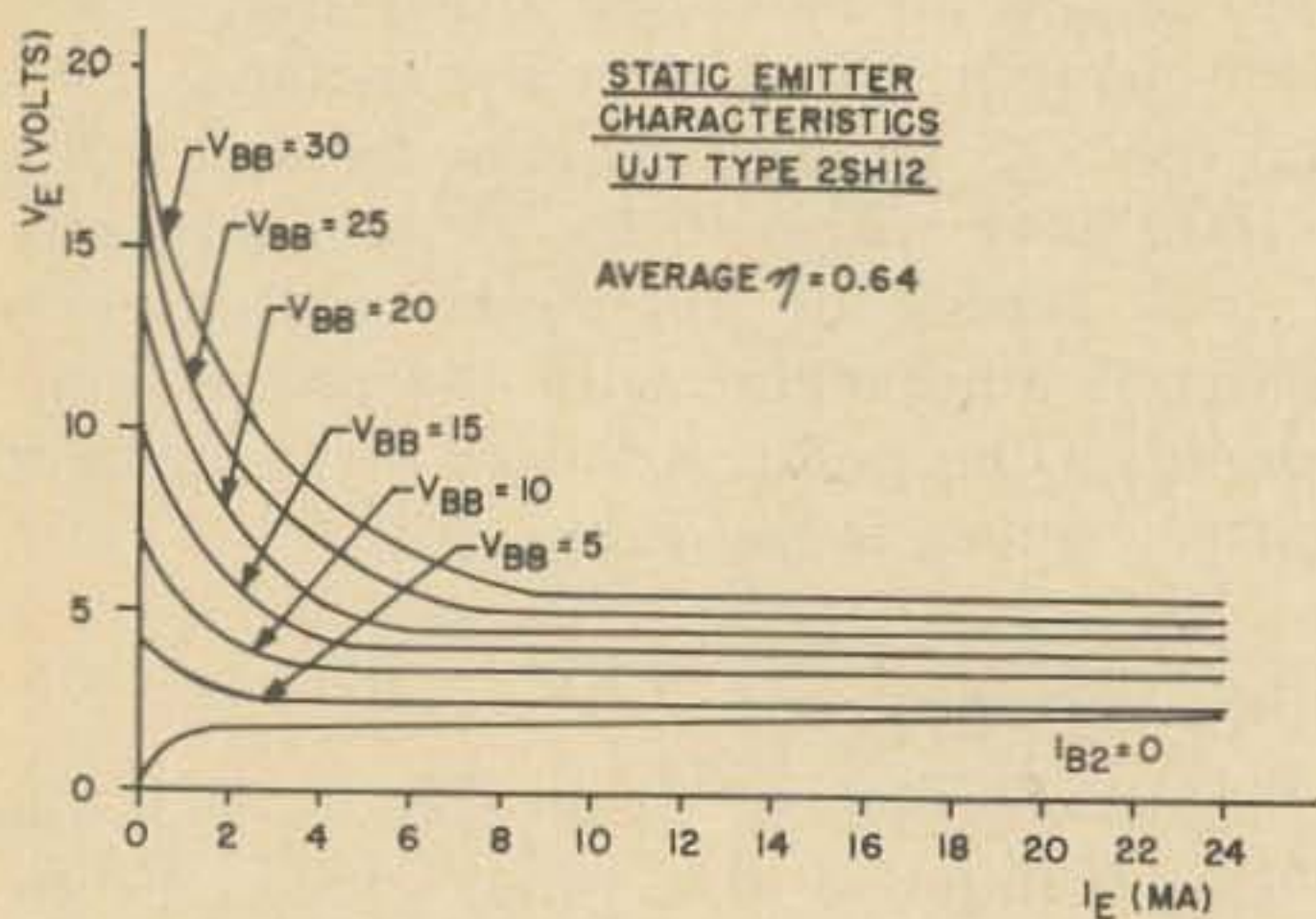

Fig. 6. Resultant curves from plotting by Fig. 5.

5 mA or 10 mA and keeping this constant, take readings of I_{B2} at every step in V_{BB} . Take another set of readings for I_E at say 10 or 15 mA. Continue this for steps of I_E at 5 or 10 mA intervals stopping at $I_E = 50$ mA. Plotting the results will give a set of curves like those in Fig. 6.

A set of curves was plotted, using the above methods, for a type 2SH12 UJT.

Construction

The UJT is constructed in two basic forms known as the bar and cube structures. Most UJT types are of the bar construction form.

The bar construction is shown in Fig. 7. A small bar of silicon has two ohmic contacts (not junctions) implanted at opposite ends of the bar. A junction (the emitter)

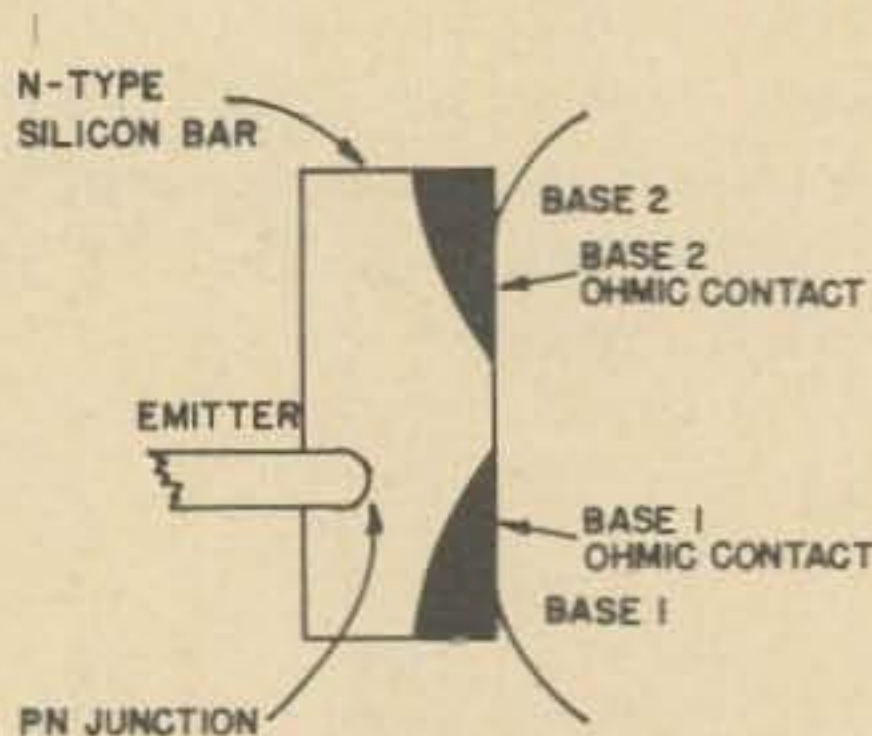

Fig. 7. Bar construction of most UJT types.

is implanted on the opposite side of the bar between B_1 and B_2 . This junction is somewhat closer to B_1 than it is to B_2 . The unit is generally mounted on a ceramic disc inside a TO - 5 or TO - 18 case and all leads are electrically isolated from the case.

The cube construction is shown in Fig. 8. The cube of N - type silicon is mounted on its base-two contact and the base-one contact is a thin wire alloyed into the top of the cube. The emitter is alloyed into the

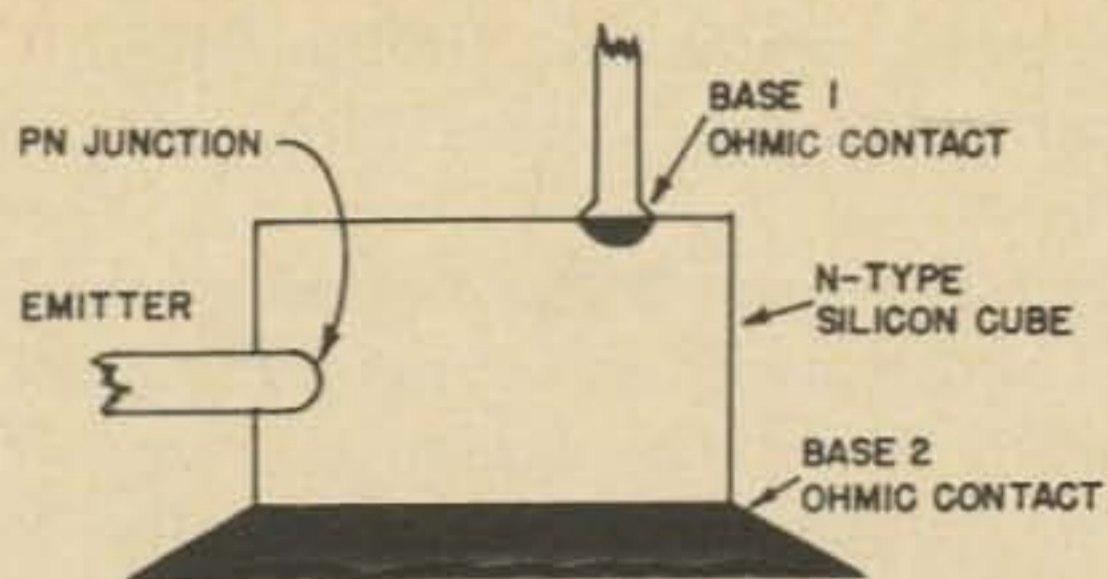

Fig. 8. Cube construction. This type is usually mounted in a TO-18 package.

side of the cube and a PN junction formed. This type of construction is usually mounted in a TO-18 package.

This type of construction gives different characteristics to the bar type. Owing to the small contact area and shape of B_1 a higher intrinsic standoff ratio (n) can be achieved with much smaller spacing between E and B_1 . This produces a lower I_p , short turn-on time, lower valley voltage, and permits operation at reduced voltages. Unfortunately cost is generally higher. Fig. 9(a) and 9(b) illustrates the different static emitter characteristics of typical bar and cube structure UJT's.

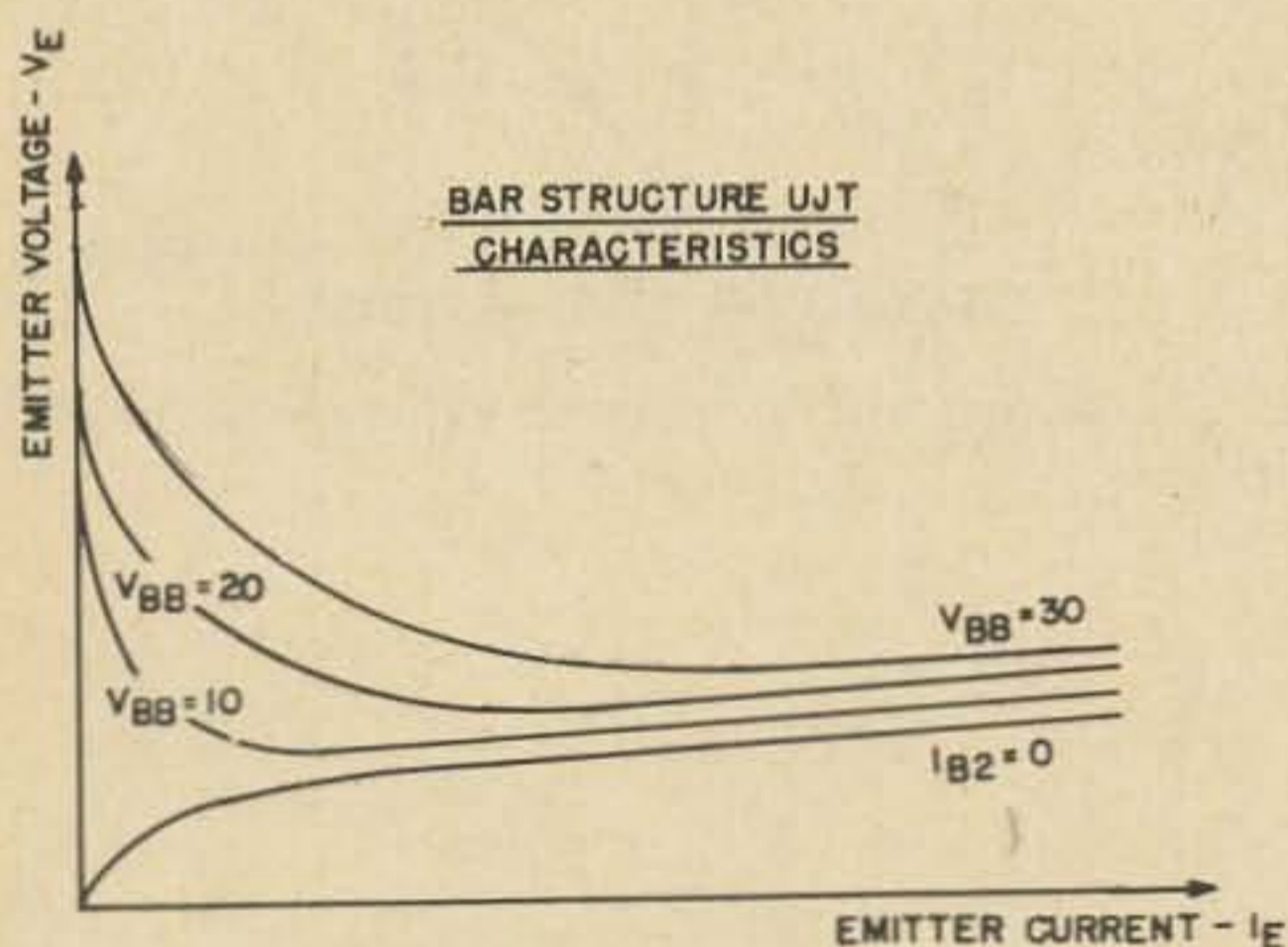

Fig. 9A. Characteristics of a bar type UJT.

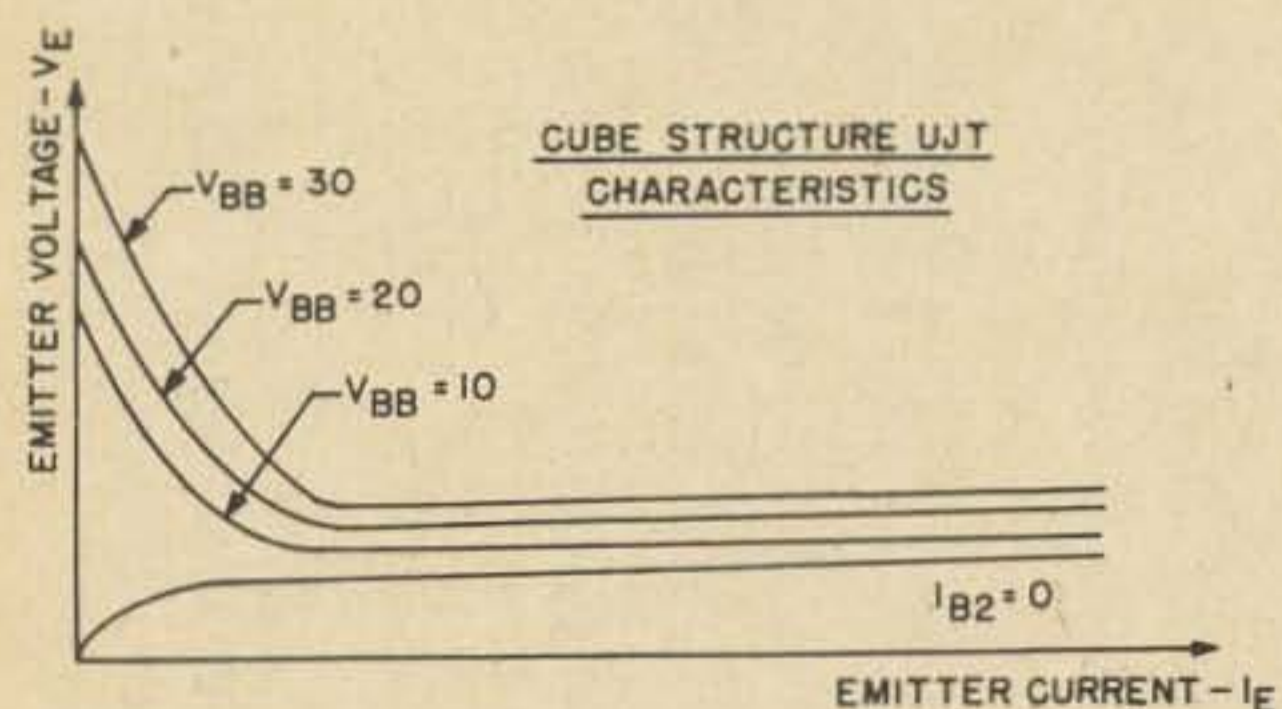

Fig. 9B. Characteristics of a cube structure UJT.

UJT circuits

Seeing as most types of available UJT's are of the bar construction type I will only consider these in the following discussion.



FEBRUARY CLEARANCE RECONDITIONED HAM GEAR

RECEIVERS

CLEGG Zeus 2-6 M 185 watts XMTR	\$319.00
COLLINS 75A4 (early Model) RCVR 75A4 (Late Model) 5000+ 75S-1 RCVR 516F2 Power Supply	\$349.00 449.00 295.00 \$110.00
DRAKE 2B Φ Multiplier Drake 2A RCVR Drake 2-C RCVR	\$ 29.00 \$149.00 195.00
GALAXY Galaxy III Galaxy V	\$229.00 319.00
GONSET Gonset Comm. II 2M XCVR Comm. III 6M XCVR GSB 100 XMTR	\$119.00 99.00 179.00
HALLICRAFTERS SX99 RCVR SX96 RCVR SX110 RCVR SX115 RCVR HT 37 XMTR HT32A	\$ 79.00 129.00 99.00 369.00 229.00 295.00
HAMMARLUND HQ 110C RCVR HQ145X RCVR HQ170C RCVR	129.00 179.00 189.00
HEATH HR-20 RCVR MR-1 w/p.s. HW12 80 meter XCVR	\$ 69.00 29.00 89.00
JOHNSON Valiant XMTR Thunderbolt 80-10M Linear Ranger II XMTR Ranger I 1 KW Match Box (No bridge)	\$159.00 295.00 149.00 79.00 69.00
NATIONAL NC183D RCVR NCX-5 XCVR NCL-2000 Linear	129.00 385.00 385.00
SWAN SW175 XCVR 75 meters Swan 240 (75-40-20) XCVR with TCU VFO Swan 420 VFO 400 XCVR Swan 350 117C AC Power Supply 210 VFO 6M	\$129.00 269.00 79.00 339.00 329.00 69.00 95.00

ALL CASH ORDERS SHIPPED FREE IN THE 48 STATES

MISSION HAM ELECTRONICS

3316 Main Street, Riverside 3, California 92501
Phone 683-0523 (area code 714)

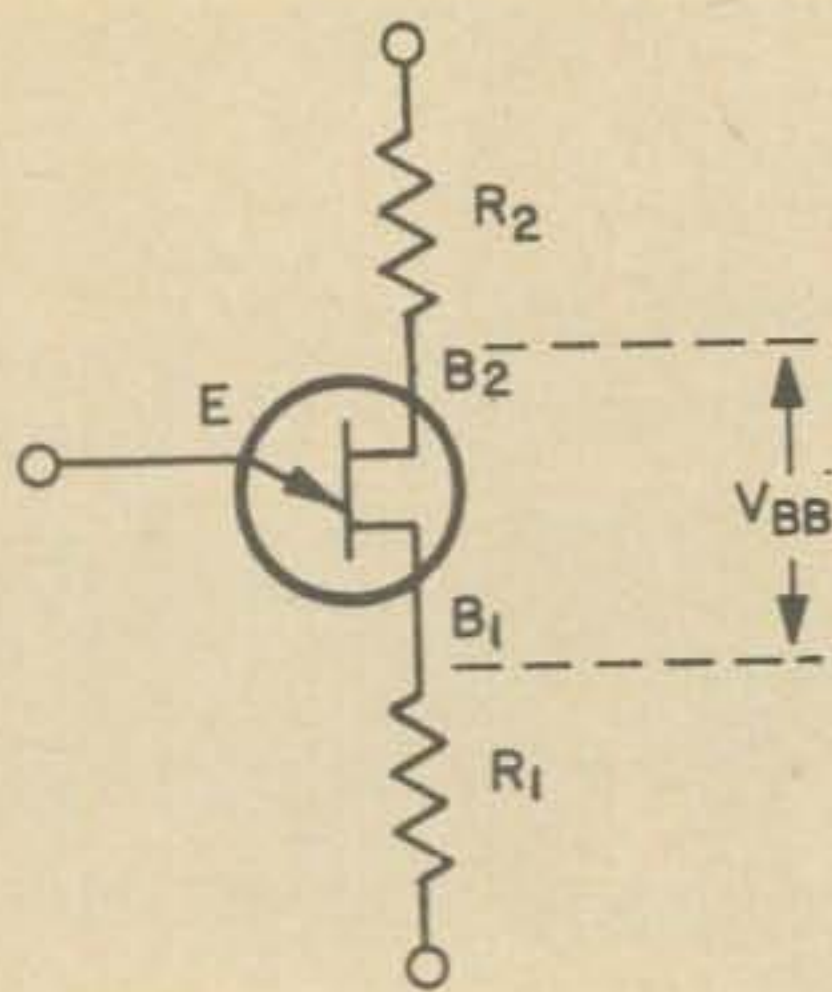

Fig. 10. Resistor R_2 compensates for temperature variations.

Bias circuits

The various parameters and characteristics of a UJT are subject to temperature variation; some more so than others. Now V_p will vary with temperature and is principally due to variation in V_D (see Fig. 2). This effect is usually compensated for by a resistor, R_2 , in Fig. 10. As the temperature increases so will R_{BB} ; V_{BB} will increase owing to the voltage divider action of R_2 , R_{BB} and R_1 .

The resistor R_2 can be chosen from the following equation

$$R_2 = \frac{R_{BB0}}{2 V_1} \quad (\text{for } R_{BB0} \text{ see Fig. 6})$$

this equation is only approximate and some juggling of R_2 might improve the compensation, but generally it will be close enough for a wide range of UJT's. Also, for the circuit in Fig. 10 V_p is given by: $-V_p = V_1$.

The resistor R_1 should generally be kept below 100 ohms as it controls the Valley Voltage (V_v) and Valley current (I_v) (see Fig. 3). Use what you have on hand.

Relaxation oscillators

The relaxation oscillator shown in Fig. 11 can be used for many applications. For ex-

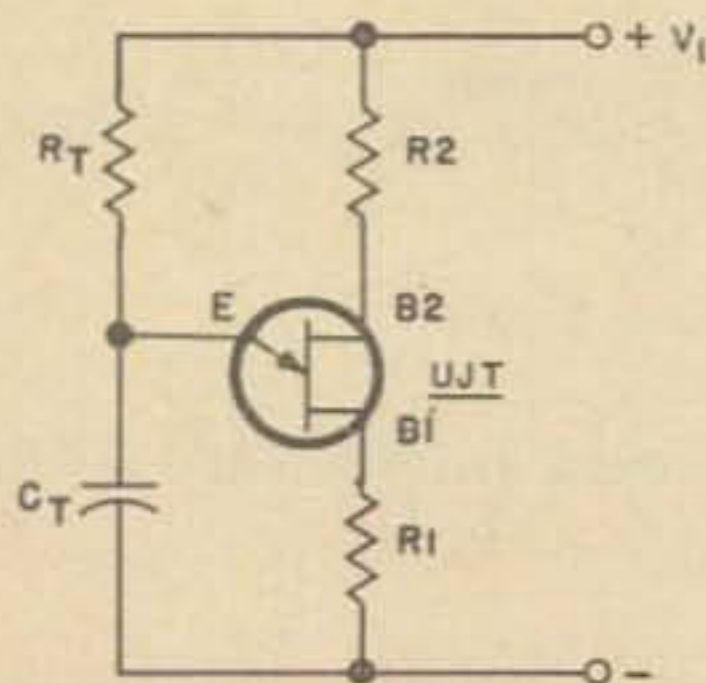

Fig. 11. The relaxation oscillator may be used for many purposes.

ample; tone oscillator, timing circuit, pulse generator, sawtooth generator or a trigger circuit.

When V_1 is applied C_T appears as a short circuit and thus E is reverse biased and does not conduct. As C_T charges through R_T the emitter voltage rises exponentially towards V_1 . When the voltage reaches V_p the emitter suddenly conducts and C_T discharges through E and B₁ via R_1 .

The emitter then ceases conducting and the whole process begins again. The waveform produced is shown in Fig. 12.

The approximate frequency of oscillation is given by:

$$\frac{1}{R_T C_T I_n \left(\frac{1}{1 - \eta} \right)} \text{ Hz}$$

the equation holds providing R_1 and R_2 are small i.e. $R_1 \leq 100$ and R_2 from previous equation but less than 1000 ohms.

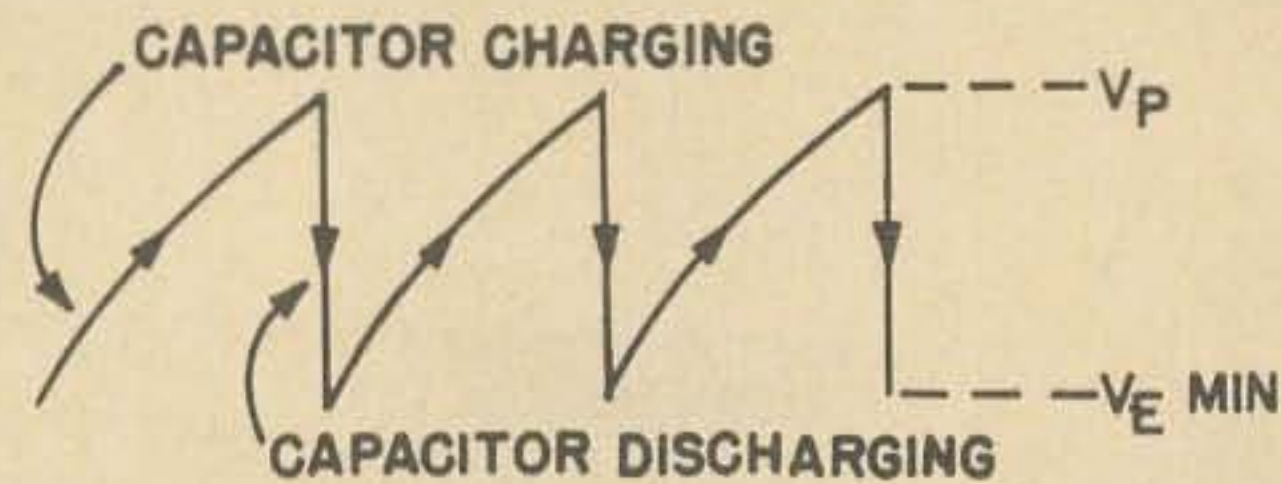

Fig. 12. Waveform produced from the relaxation oscillator.

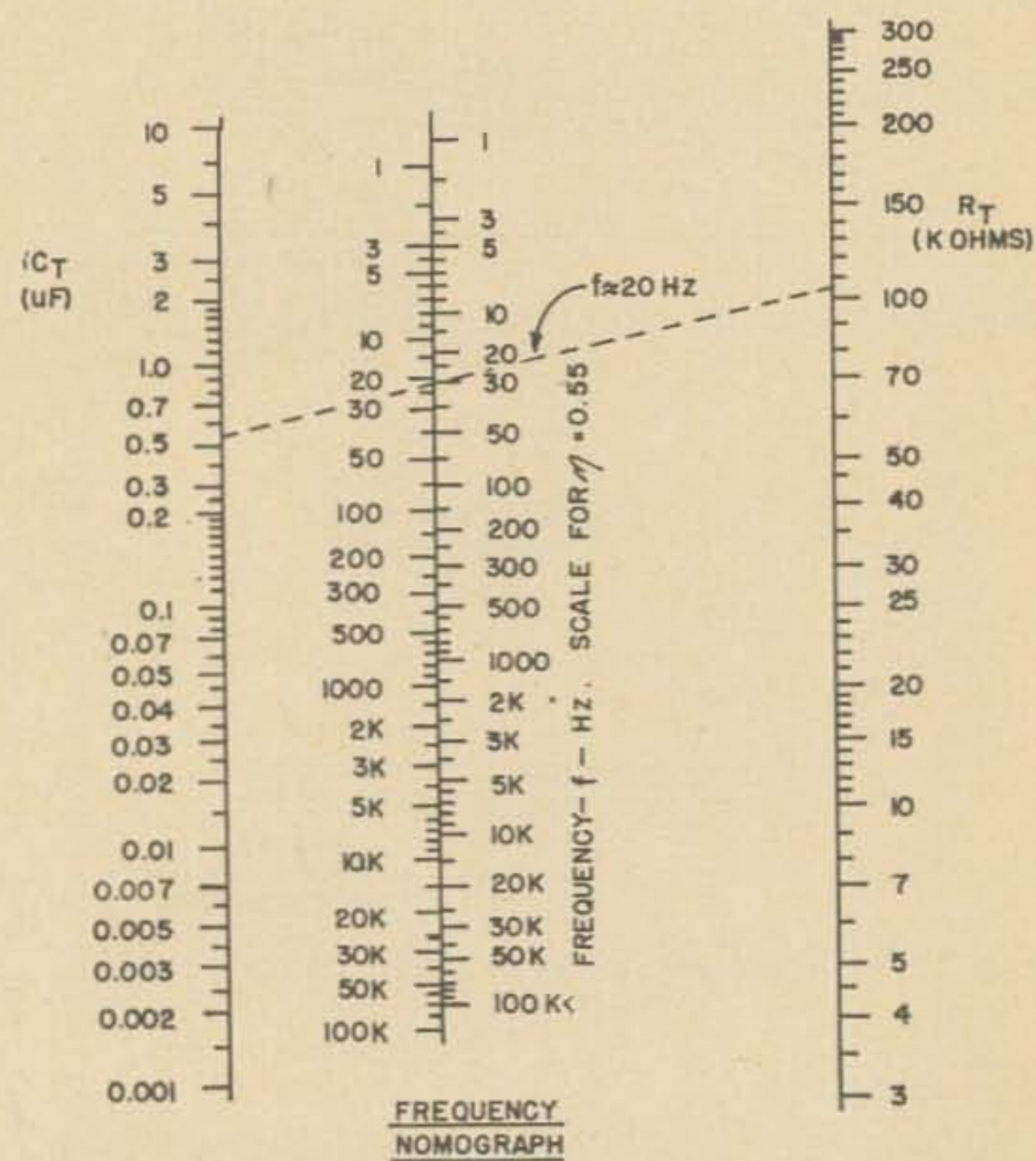

Fig. 13. Nomograph to assist in the design of a relaxation oscillator.

To save calculation in many instances a nomograph (Fig. 13) will assist in the design of a relaxation oscillator using a UJT.

Two frequency scales have been given. One for a value of $\eta = 0.55$ and another for a value of $\eta = 0.65$. Use the scale appropriate to the value of η for the UJT you are going to use. An example for a practical circuit is given later. (see Fig. 16.)

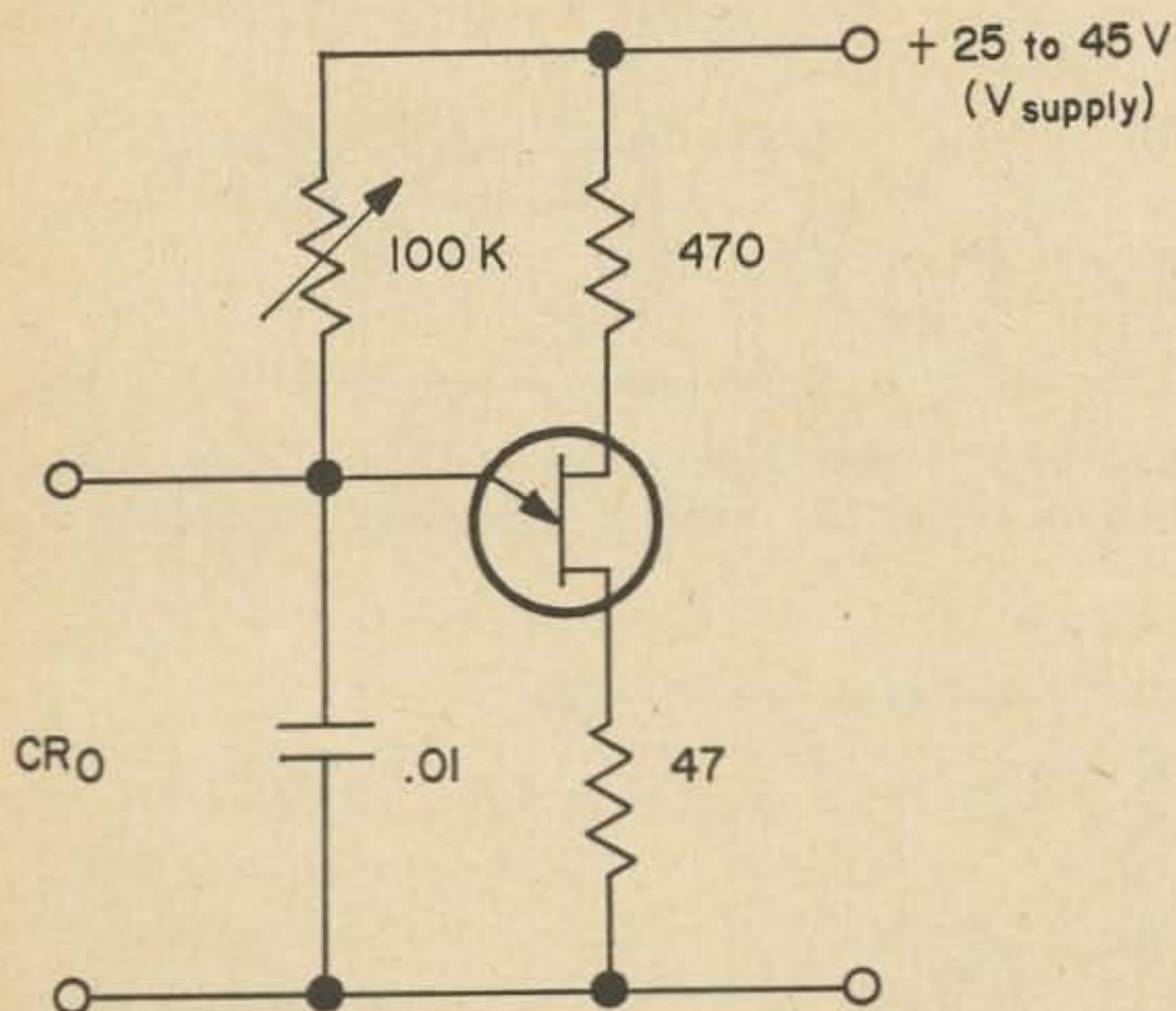

Fig. 14A. A practical circuit built and tested by the author.

A wide range relaxation oscillator

The circuit in Fig. 14(a) shows a practical circuit built and tested by the author. I used a Japanese UJT, the NEC-2SH12. It performed very well, the frequency range being 500 to 1. I inspected the waveforms with a Hewlett-Packard CRO and the results are shown in Fig. 14(b) and 14(c). The circuit would not oscillate below 1kHz as the timing resistance R_T was too great to allow the emitter to "fire". The frequency is easily lowered by increasing C_T .

This circuit has great potential for the sweep generator in a CRO, rf sweep generator or Panaramascope. Unfortunately the output has a non-linear rise as can be seen in Fig. 14(b) and (c). This can be overcome in two ways. Fig. 15(a) shows R_T returned to a higher voltage supply. This is OK and gives reasonable linearity providing a higher voltage supply is available. It suffers from a disadvantage though—the frequency is not as stable as it would be with a single supply.

In Fig. 15(b) a transistor, connected in a common-base circuit, uses the high output impedance of the circuit to maintain a relatively constant charging current for the timing capacitor C_T .



GSB 201 MK III

10-80 METER LINEAR AMPLIFIER

...THE WORK HORSE



Exceptionally compact—only 8½" high, 12⅝" wide and 17" deep—the GSB 201 lends itself readily to table top mounting.

- Four (not two) type 572B tubes for a full 2000 watt P.E.P. SSB input.
- Full wave solid state power supply.
- Universal rear of cabinet circuitry may be connected for transceiver or receiver-transmitter use without internal modification.
- Plus many, many more features.

AMATEUR NET\$375.00

Also available: GSB 201 MK II — employs four type 811A economical triodes for 1500 watt P.E.P. input.

AMATEUR NET\$325.00

See your favorite distributor
— Write for brochure

GONSET® ANOTHER DIVISION OF AEROTRON, INCORPORATED
P. O. Box 6527 / Raleigh, North Carolina 27608

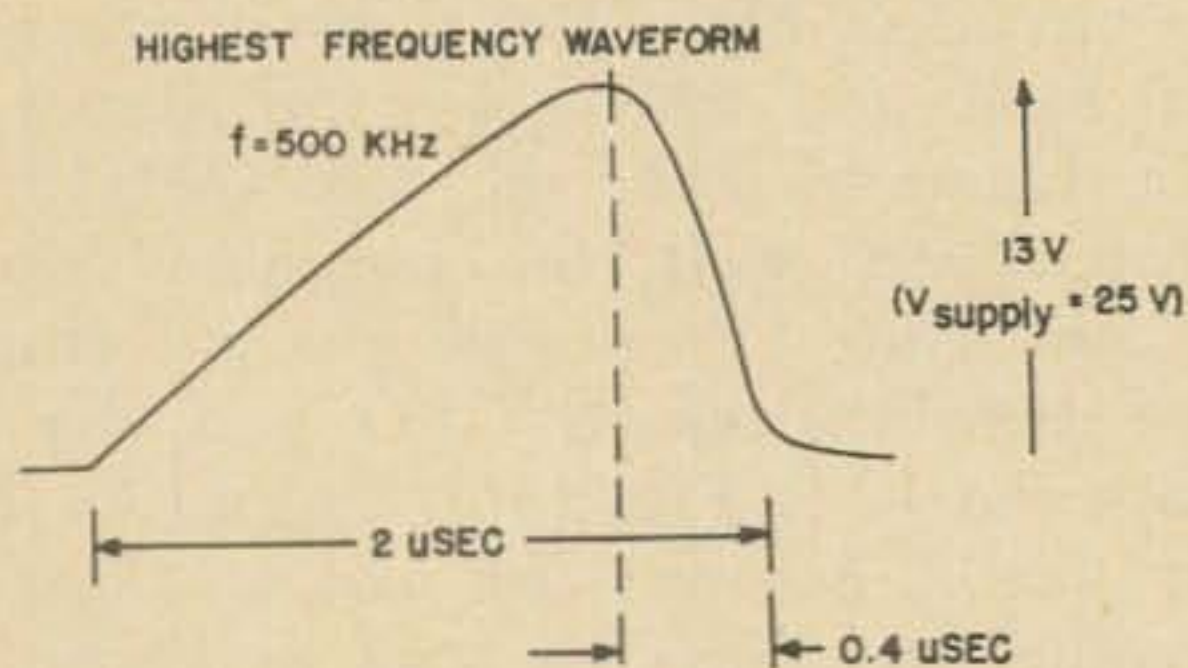

Fig. 14B. Highest frequency waveform.

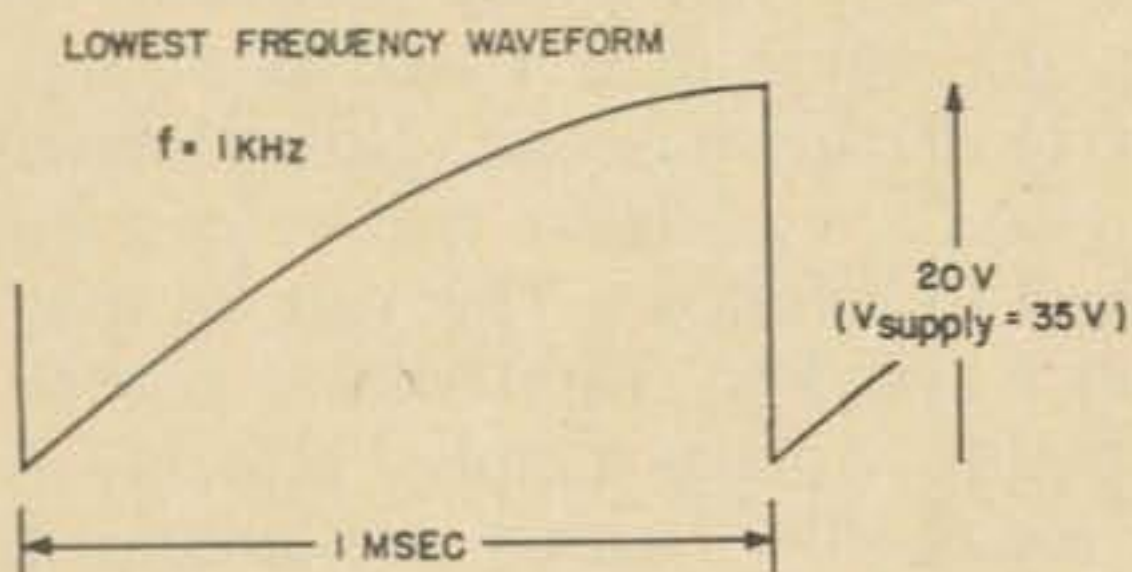

Fig. 14C. Lowest frequency waveform.

Pulse generators

A current pulse will flow in the emitter, base-one, and base-two circuits each time the UJT "fires" in a relaxation oscillator. Thus, a relaxation oscillator can be used as a very efficient pulse generator giving either positive or negative output pulses at various impedance levels. Several circuit configurations are shown in Fig. 16(a) (b) and (c).

The output pulse from these circuits has a relatively fast rise time and quite a slow fall time compared with the length of the pulse. A significant improvement in this state of affairs can be made by using an inductance in the B_1 circuit. A transistor can be used to invert the output pulse. (See Fig. 17).

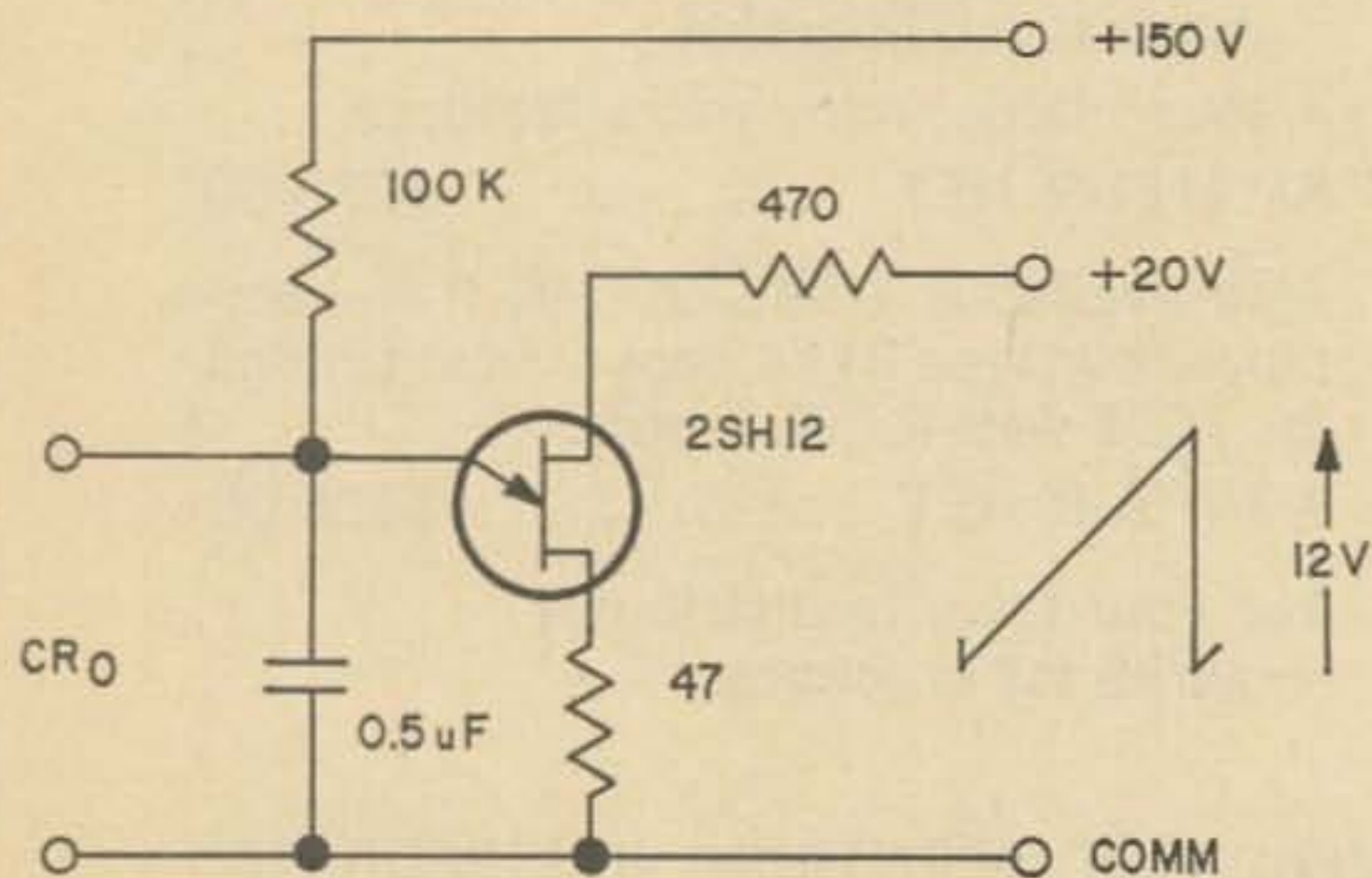

Fig. 15A. R_T returned to a higher voltage to give better linearity.

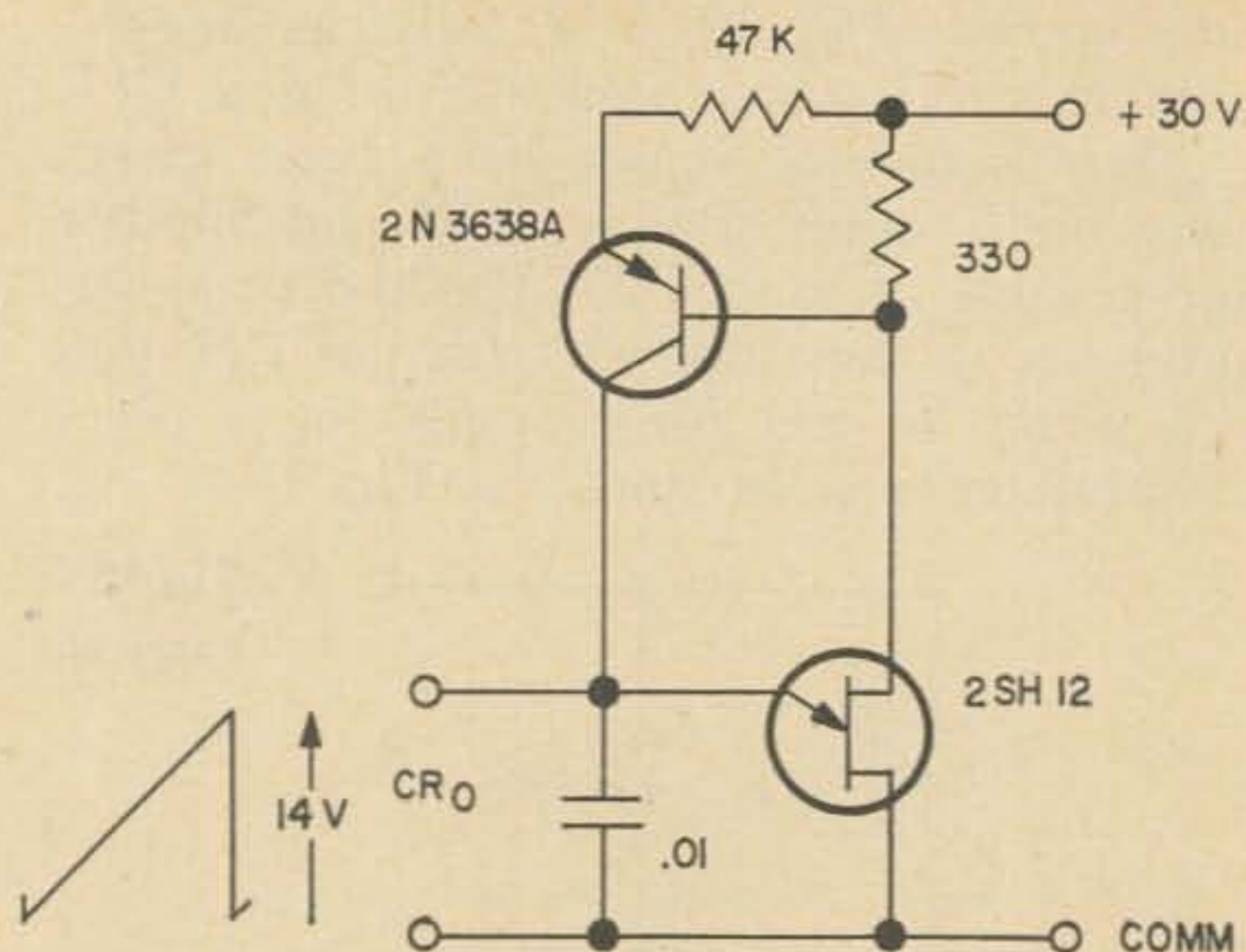

Fig. 15B. Using high output impedance to maintain a relatively constant charging current.

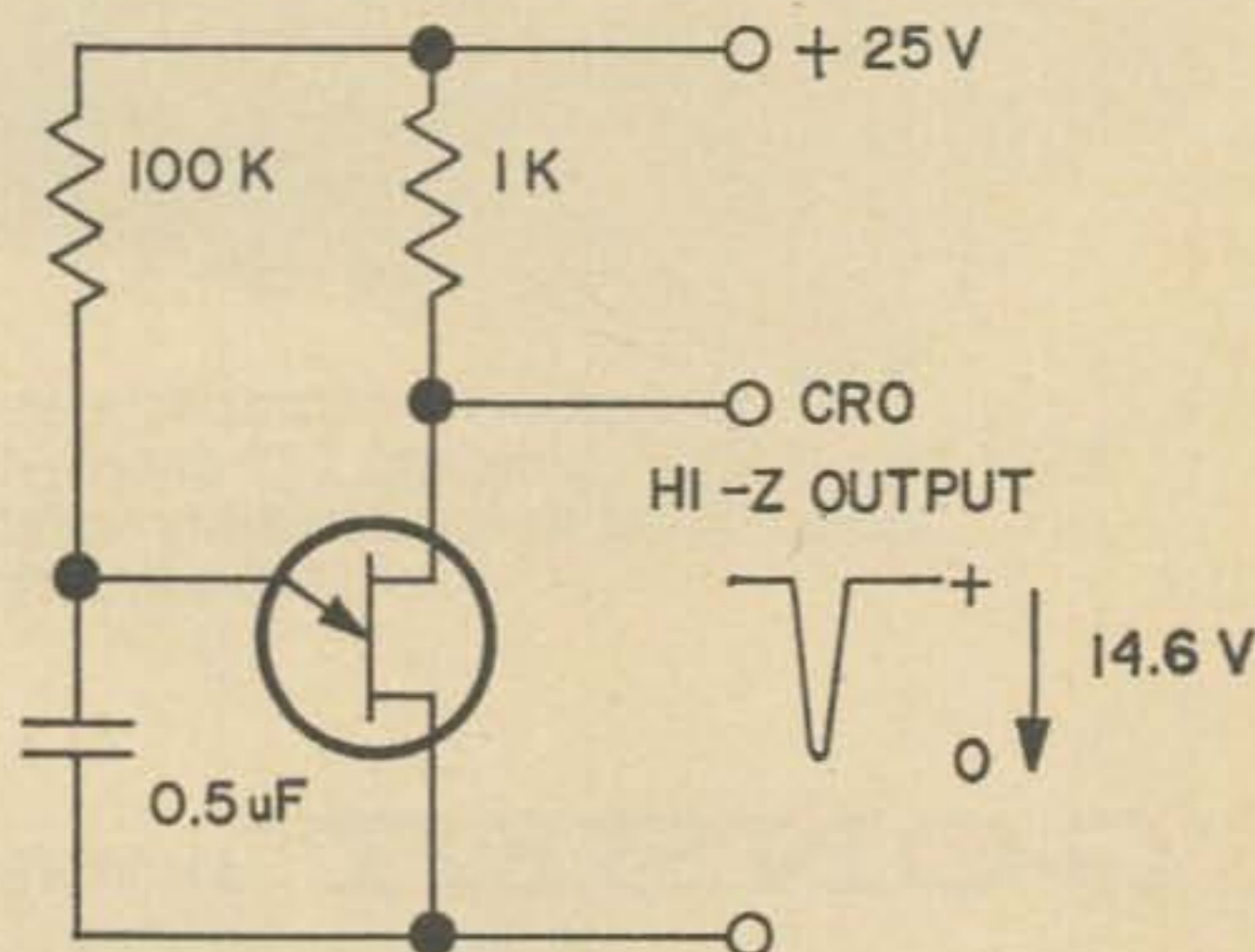
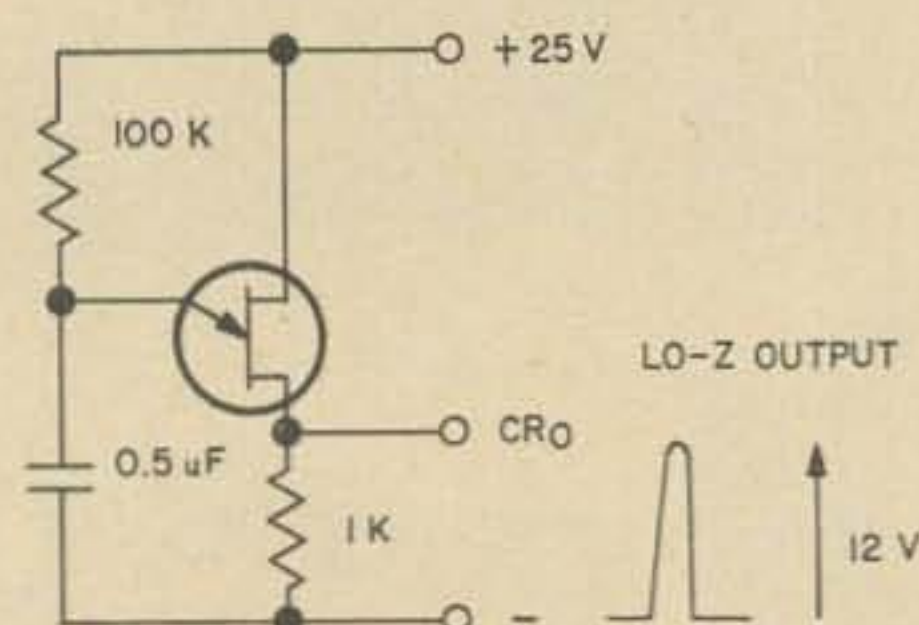
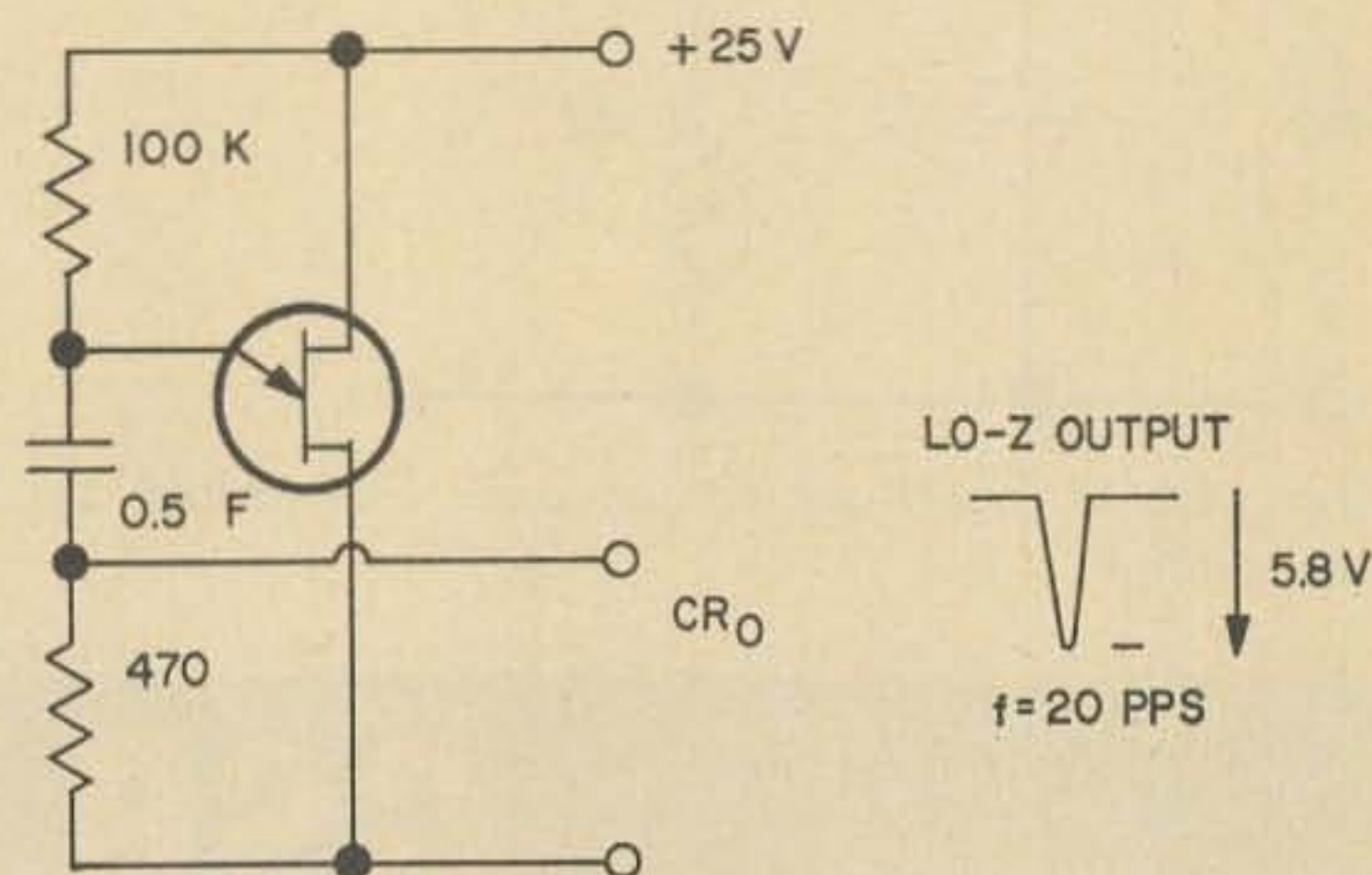

Fig. 16A., B., and C. Several circuit configurations.

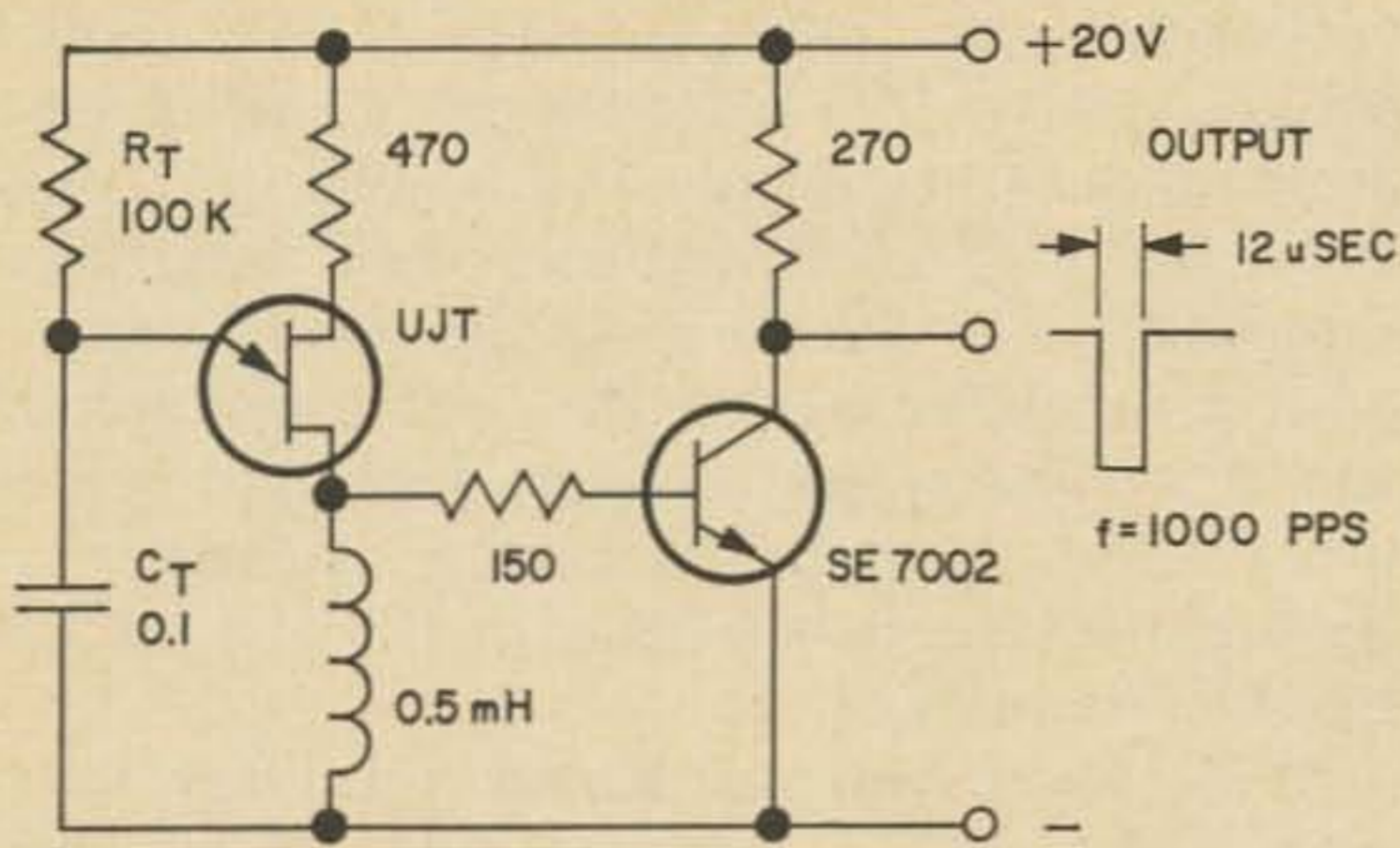

Fig. 17. Inverting the output pulse by use of a transistor.

A pulse generator can be designed by using the nomograph of Fig. 13 and picking the circuit configuration you desire from Fig. 16. The resistor R_T shown in the circuits (a), (b) and (c) of Fig. 16 can be chosen by the "um-now-let-me-see-what-have-we-got" method. Juggle its value and the supply voltage to obtain the output voltage you want.

For more critical applications the circuit in Fig. 17 can be used. The width of the pulse is determined by the inductance in the emitter (L). The frequency of the pulses (or number of pulses per second) is determined by R_T and C_T . The rise and fall times will be quite short, typically 1/20th to 1/50th of the pulse width "t".

UJT timers

A timer can be designed using the relaxation oscillator principle. Referring to Fig. 18, when S_1 is closed, C_T charges to the peak point voltage at which time the UJT "fires" and the capacitor C_T discharges through the relay which closes. One set of

((changeover) contacts holds the relay closed. Opening S_1 returns the circuit to its original condition. This circuit is useful for periods up to 15 or 20 seconds.

The best way to design a circuit like this is to haywire it together and juggle R_T and C_T until you achieve the desired result. I found this method reasonably fast and calibrating the pot. is easy. Note that the relay should be physically small so that it has low operating power. A huge 600 or 3000 type relay just won't work (I tried).

Have a look in the G.E. Transistor Manual for more timer circuits.

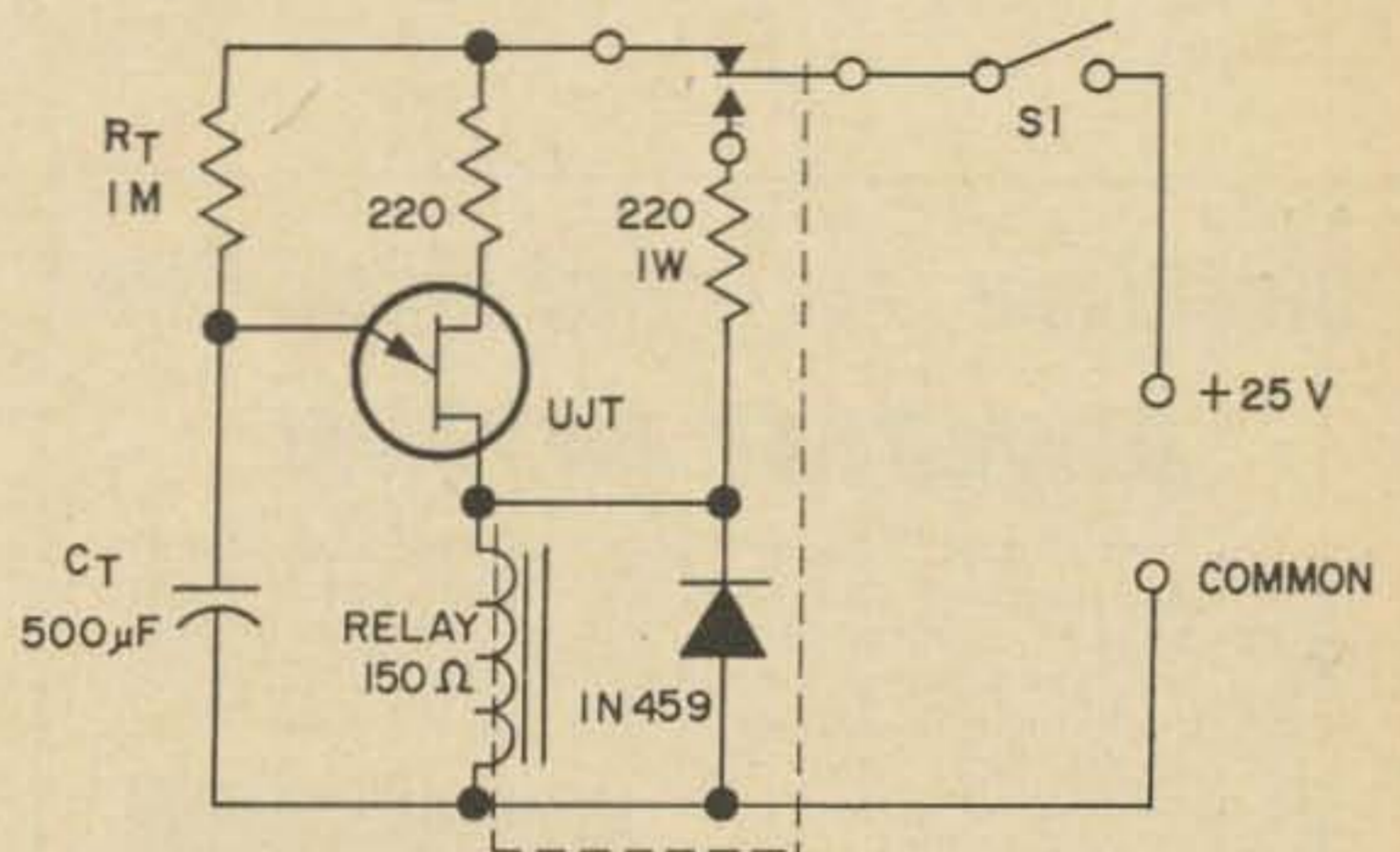

Fig. 18. The relaxation oscillator principle used for a timer circuit.

Sweep generators

Fig. 19 gives the circuit of a very handy little sweep generator. The coils can be switched if you like. It will work from about 60 kHz to about 60 MHz, depending on the transistor used for SC2. If you don't want to go really high in frequency an OC45N will work admirably.

The circuit is fairly non-critical and some

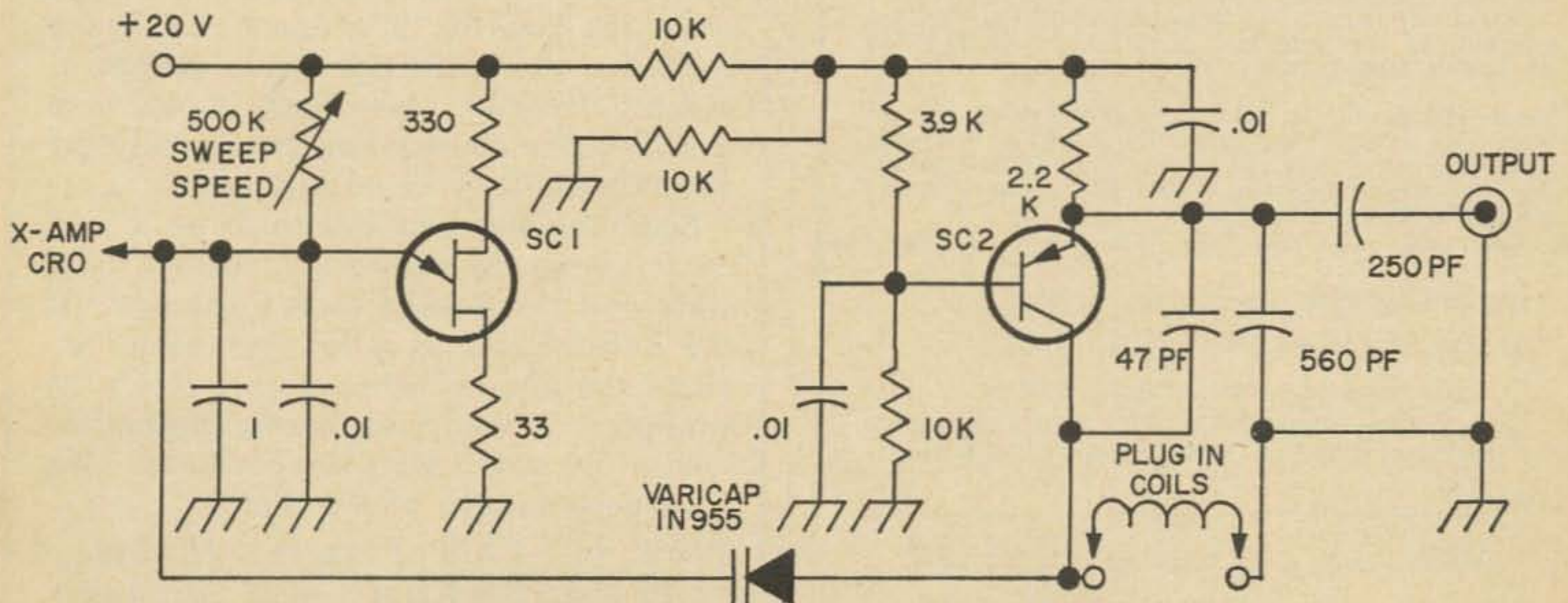
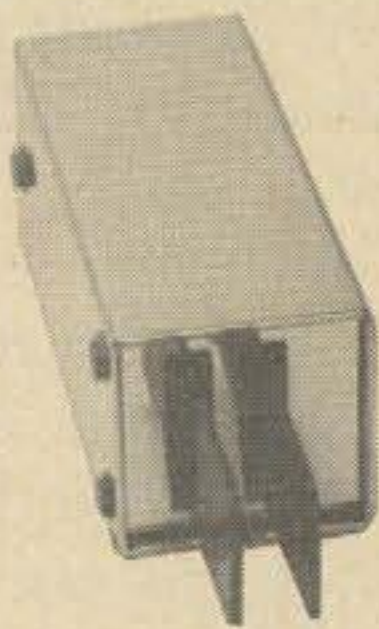

Fig. 19. The circuit of a very handy little sweep generator.

the permaflex key

- both a twin lever & straight hand key in a pivotless 2 paddle design.
- gives instant choice of automatic semi-automatic & straight hand keying.
- use directly with any transmitter or through an electronic keyer.
- 8 amp. gold diffused silver contacts adjust from 0-.060" & 5-50 grams.
- distinctive blue paddles are of rugged G-10 fiberglass epoxy.
- cabinet is 16 gauge polished chrome steel: 1.95" sq. x 3.75", paddles extend 1.25", weight app. 1 pound.
- silicone rubber feet for stability.
- 100% US made & guaranteed for 1 yr.



1995 complete,
ppd usa & can.
send a check or m.o.
sold by mail only

**James Research company, dep't: AR-K
11 schermerhorn st., brooklyn n.y. 11201**

Build New Schober Music Kits

DYNABEAT RHYTHM

If you want rhythm Schober's got it—10 real trap sounds in a small carrying case. Add bass drum, snare drum, cymbals, and 7 other great rhythm effects to your combo, piano, or organ playing, each at the touch of a button the instant you want it—or have a ball playing traps along with records and radio! The Schober Portable Dynabeat connects to any guitar, hi-fi, or p.a. amplifier, makes you an instant drummer. Kit \$139.50, all built \$169.50. Special Dynabeat for all Schober Organs (not other brands) synchronizes the sounds you want with manuals and pedals. \$150 for the kit.

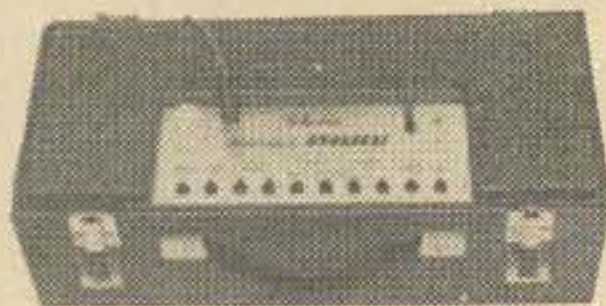

TUNESMITH MELODY INSTRUMENT



The Schober Tunesmith makes the one-finger artist an instrumental soloist. Produces one note at a time on the 2½-octave keyboard while you control tone color (6 voices), vibrato, pitch, volume, as you play. Carry the melody for a combo or play with piano or organ accompaniment—or along with records and radio. Easily portable (13 lbs.), connects to any amplifier. Easy to build kit \$149.50; assembled, ready to plug in and play \$189.50.

Send **right now** for the full-color Schober catalog, with all details on Dynabeat and Tunesmith as well as Schober's five kit organ models and unique reverberation system. No charge, no obligation. If you like music, you owe yourself a Schober instrument!

THE *Schober* ORGAN CORP., Dept. D-5
43 West 61st Street, New York, N.Y. 10023

- Please send me a Schober Organ Catalog.
 Enclosed is 50 cents for 7-inch LP demonstration record of DYNABEAT and Portable TUNESMITH.

NAME _____

ADDRESS _____

CITY _____ STATE _____ ZIP _____

variations are permissible. The supply could be two 9V batteries in series. Coils are found by experiment. For 455 kHz the coil from an *if* transformer (with capacitor removed) is ideal. To limit the sweep range add a capacitor across the coil and retune the slug. The output is quite high and some attenuation may be necessary. Connect a high resistance in series with the output to effect a reduction.

Well, there we are. Knock up a few circuits and find out about UJT's. I think you may find a useful circuit in this article. For more ideas look up the references mentioned below.

... VK3ZRY

References

- 73 Magazine* Jan '66 (UJT Keyer p.12)
Dec '66 (Ipps generator p.23)
Mar '67 (sawtooth generator p.29A)

Electronic Fundamentals & Applications

—J. D. Ryder

Transistor Manual—G.E. Company.

Please Use Your Zip Code When Writing 73

CLUB SECRETARIES NOTE

Your club can round up some extra funds by imploring, cajoling, convincing, or forcing your members to subscribe to 73 Magazine. Never mind the cries of anguish, just remember that you are doing what is best for them—and the club.

Subscriptions to 73 are normally \$6 per year. The special club rate is exactly the same: \$6. The only difference is that the club treasury holds 25% of the loot and sends the rest to 73. Send us \$4.50 for each one year subscription, in groups of at least five subs. Just think, if your club has 10,000 members you can quickly get \$15,000 for the club on this deal!

Send the subscriptions to us on 3"x5" cards, giving the name, call, address, city, state and zip code of each subscriber. If the subscription is a renewal please include the address label from a recent 73 wrapper. Indicate all renewal subscriptions so we won't start a second sub. We have been known to do that.

**Send to: Club Finagle, 73 Mag.
PETERBOROUGH, N.H. 03458**

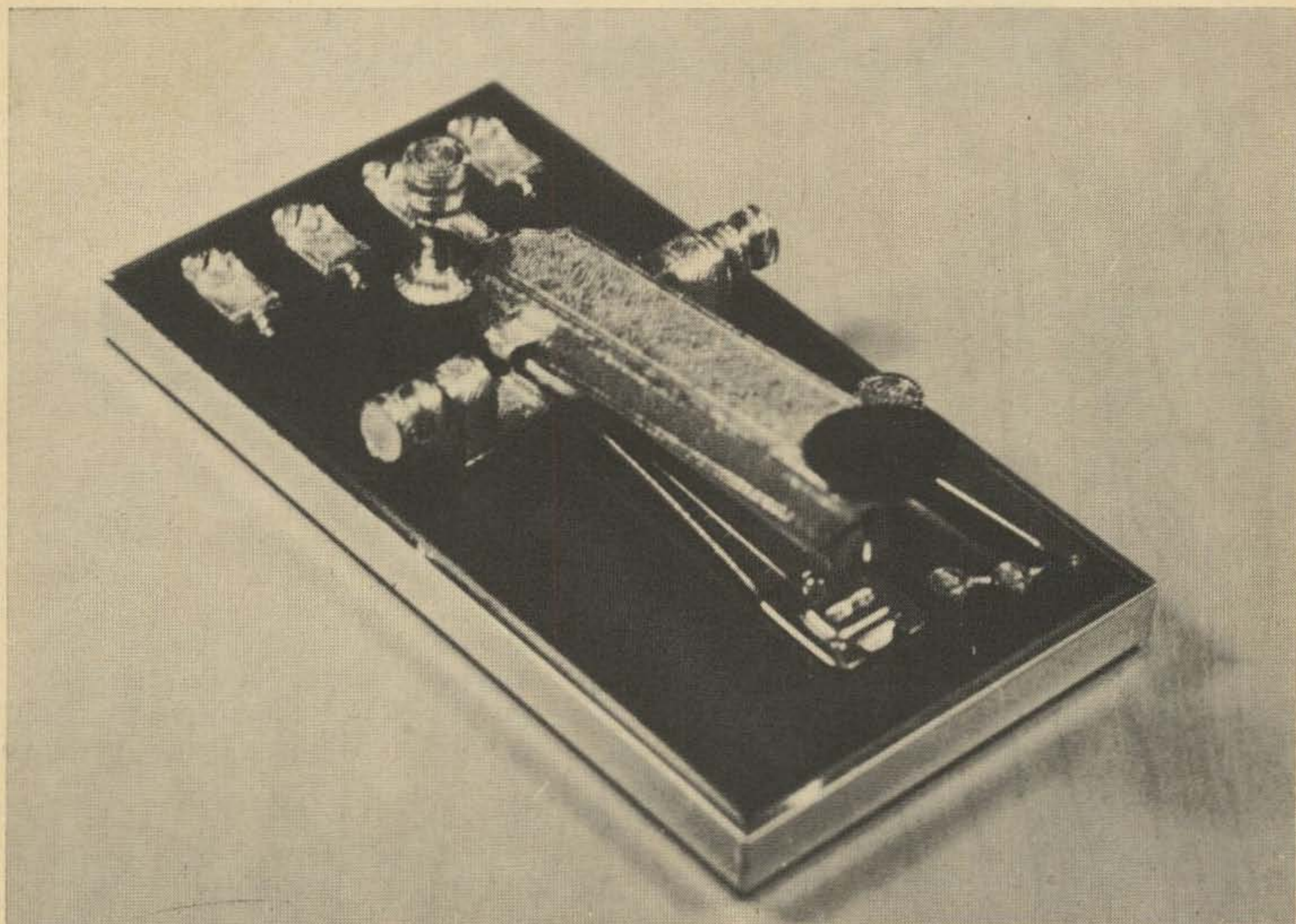

TELEGRAPH KEY STAPLER

Handsome reproduction of antique telegraph key
This Morse Code Telegraph Key cleverly functions as a
stapler. Bostitch stapling mechanism. The rheostat is a staple
remover. Antique gold finish on black metal with Chinese-
red velvet base. 6 1/2 x 3 1/2. Ideal for an original gift for
the office or the radio shack.

Built to last

\$10.59 + 80¢ Postage

10 Days money back guarantee

Sorry no C.O.D.

Please send _____ key stapler(s) to

NAME _____

STREET _____

CITY _____ STATE _____ ZIP _____

please print

HUGO H. ROUSSEAU & SONS

210 Post Street • Suite 915

SAN FRANCISCO

CALIF. 94108

What's Out There?

Jim Ashe W1EZT

P.O. Box 343

Peterborough, N.H. 03458

The Universe is out there, and men go into it for short visits. Maybe one day they will live in space and we can sit down here and talk to them at distances of hundred-thousands or ten-millions of miles. Is it possible there are other intelligent beings out there already, who have never seen our sun except as a distant star?

Within recorded history people not very far removed from us believed the world extended a few miles from top to bottom, and maybe as many as several hundred from one edge to the other. They thought this little area was provided for raising people, as we might grow radishes or bugs in small dishes. The sun, moon, and stars were ornaments or maybe a part of the machinery of the Gods, but nothing more.

One Greek philosopher had a ready reply to a question of "Which is most important, the sun or the moon?" "The moon," he said. "The sun shines in the day when it is light anyway."

All through history men with new ideas have had to be careful. You could get killed that way, or at least written off as a useful member of society. Evidently you still can, if news reports are to be accepted. Yet there has been a slow trend to decreased reliance upon dogma in favor of science and technology, which really works. And just a very few years ago some scientists met (quietly) to assess the chances there might be life on other worlds.

Their question was, "Are there intelligent beings on other planets who would be interested in talking with us?" They had all of human knowledge to work with (it doubles every few years now) and while they could not come to a definite yes/no result they could estimate at least 40 and perhaps fifty million planets interested in communication, *right now*. And there could be about ten times as many worlds with intelligent life.

We'll have to make considerable progress in exploring space before we come upon grounds for a more definite opinion, or for one with a narrower margin of error. Perhaps

we will discover a surprise: an explorer's camp left on the Moon. And scientists are very puzzled over some points about the two moons of Mars, which act like artificial satellites.

But the strongest chance seems to be that somehow we'll overhear a conversation or intercept a message aimed at somebody else. SWL's in space? Most probably, and radio amateurs too. Ham radio is in a doldrums now, but may be facing a greater opportunity than was open to it in the early 1900's. We'll have to enlarge our perspectives considerably to meet that challenge.

Are there worlds out there?

This is an excellent question because if there are no worlds in space other than ours we hardly need look for people living on them. A world in space without a nearby sun would be too cold to live on, and so if we want to find worlds we start by looking for stars.

What do we see if we look up at the skies late at night from some clear hill? We see a tiny bit of the universe, and several thousands of stars. I have always felt it is a splendid sight, and very thought-provoking. Except for a few wandering lights now known to be planets and some others that are specially interesting to astronomers, these stars are suns. Each one of these suns—just think! Each one *might* have a planet something like our own. If this is a possibility why haven't astronomers increased the magnification of their telescopes so we can see those stars close-up and observe any possible planets?

The uncompromising laws of nature intervene. The stars are too far away, and there is a practical limit to the magnification any optical device can achieve. There is another limit too, set by the erratic jiggly nature of our atmosphere. We cannot look to see if there are planets circling the stars.

Yet if we want to discover life on other worlds, we have to sort out the worthwhile stars from all the stars we might look at.

If we cannot see planets how do we even know they exist? Not so long ago most astronomers felt it was quite likely our own world was something of an accident, and others must be so rare it would not be worthwhile to look for them.

A simple observation finally terminated that line of thought. Our sun does not rotate very fast. Our sun has planets—we live on one of them. Is there any connection between the planets and the sun's slow rotation? Yes, and the modern theory of magnetohydrodynamics explains how the sun could have lost some of its rotation to its planets. Now we know why the planets go in the same direction the sun turns, and about the same axis.

Looking outward we discover some stars that rotate rapidly, and many that do not. Very probably the slow ones are slow because, as our sun did, they gave up that energy of rotation to their planets. Current thinking is that nearly 70% of all stars have planets, and each one may have two or three that might bear life. Our own system has three planets and a moon (ours) that might have life, and Mercury, Jupiter and Saturn are less certain prospects.

Life

Modern research into the question of how life originated is complicated, interesting, and not yet complete. We can be certain there was no life in the universe at its creation about 26 billion years ago. What happened since then to bring life into the scene? What happened here?

Well, the current trend in thinking about this question is that life appeared naturally here about 4 billion years ago. The earth was very different from the earth we know, and a number of chemical processes were going on that we can only observe in sealed experimental chambers now. The chambers have to be sealed because if we left them open bacteria and insects would enter to consume any life-like chemicals we might produce.

It turns out we do produce complex chemicals identical with those of life by simple heating and mixing processes together with electrical discharges and radiation similar to what we think were found on earth about the time life originated. Researchers are convinced this process, going on naturally for a few millions of years, would generate

Announcing another exciting "FIRST" ...SOLID-STATE TV MODULES!



BUILD A VIDICON TV CAMERA IN A JIFFY!!
PREVIOUS TV KNOWLEDGE NOT REQUIRED.

- Totally encapsulated for trouble-free operation.
- Compact size; 1 3/4" x 2 1/2" x 1" approx. 3 oz. average weight.
- Each module replaces entire camera section...i.e., complete video amplifier, vertical sweep, horiz. sweep, RF osc., etc.
- Perfect for amateurs, experimenters, students, industry, etc.
- Assemble complete camera in a few hours! Only 5 modules required. Designed to work with standard 1" vidicons and focus-deflection kits.
- Each module complete with hook up instructions. Fully guaranteed 90 days from date of purchase!
- Build completely modularized camera or replace trouble sections of existing cameras with as many modules as needed.

Video module - \$20 Vert. module - \$15 Horiz. module - \$15
RF Osc. module - \$10 HV module - \$10

Send for complete details on these new vidicon camera modules plus our latest catalog fully describing our extensive line of TV camera kits, plans, coil kits, vidicons, lenses, etc. It's FREE.

ATV Research

13TH & BROADWAY, NORTH DAKOTA CITY, NEBR. 68731

radio amateur

callbook



GET YOUR NEW ISSUE NOW!

Over 283,000 QTHs
in the U.S. edition
\$6.95

Over 135,000 QTHs
in the DX edition
\$4.95

See your favorite dealer or order direct (add 25¢ for mailing in U.S., Possessions & Canada. Elsewhere add 50¢).

These valuable EXTRA features included in both editions!

- QSL Managers Around the World!
- Census of Radio Amateurs throughout the world!
- Radio Amateurs' License Class!
- World Prefix Map!
- International Radio Amateur Prefixes
- Radio Amateurs' Prefixes by Countries!
- A.R.R.L. Phonetic Alphabet!
- Where To Buy!
- Great Circle Bearings!
- International Postal Information!
- Plus much more!

WRITE FOR
FREE
BROCHURE!

RADIO AMATEUR

callbook INC.

Dept. B, 4844 W. Fullerton Ave.
Chicago, Ill. 60639



PRESENTING THE ALL NEW AMECO PT ALL BAND TRANSCEIVER PREAMPLIFIER



- 6 THRU 160 METERS
- FEEDS 2nd RECEIVER

Model PT, with built-in power supply, transfer relay, connecting cables, wired and tested.

Amateur Net **\$49.95**

- A frame grid pentode provides low noise figure with ability to handle strong signals, greatly improving the sensitivity of the receiver section of a transceiver.
- A unique built-in transfer circuit enables the PT to by-pass itself while the transceiver is transmitting. The PT also feeds the antenna input of a 2nd receiver as well as muting it.

AMECO

DIVISION OF AEROTRON, INC. ■ P. O. BOX 6527 ■ RALEIGH, N. C. 27608

a molecule that could duplicate itself. The rest of the story of life would be evolution, not creation. Could this process take place elsewhere?

Best results indicate it certainly could, and probably would. And other studies indicate that once life appears it is extremely hard to destroy. Experimenters thinking about life on other worlds have tested some of their ideas by looking for unusual kinds of life on our own world and they have found it in environments so harsh and unusual as to qualify "extraterrestrial, just

happens to be here." For example, bacteria live in the cooling water of nuclear piles, an environment once regarded as absolutely lethal. Some insects found in the arctic will cook to death in the palm of a man's hand. Other insects can be dessicated—as dry as old seeds, and will live again when placed in water. Seeds thousands of years old, and some bacteria sealed in salt crystals for millions of years have come to life again in the laboratory. And some plants are known to live naturally in water at 194 degrees F., and others have survived higher tempera-

Fig. 1. Temperature and other conditions in some known parts of space are within extremes known to be habitable here on earth.

	EXTREME	EARTH (life zone)	MOON	MARS	VENUS	ELSEWHERE
Temperature		-100° F To +212° F	-210° F To +212° F	-210° F To +80° F	? Very Hot	All Extremes or Lack of Them
Pressure		Vacuum To 8 Tons/in ²	Vacuum on Surface	1/8 Earth Pressure	?	
Radiation		To Nuclear Pile Intensity	Moderate	Low	Low	
Life?		Yes— Everywhere	Possible Under Surface	Possible on Surface	Maybe in Atmosphere	Almost Certainly

tures than that. Lab studies have shown bacteria can thrive in jars pumped and cooled to the conditions known to exist on Mars.

Apparently, once life appears it can adapt to gradually harshening conditions fast enough to continue in the face of anything short of a cosmic disaster. If there ever was life on the moon, on Mars, Venus, or elsewhere there probably still is. Few people will be surprised if the first men visiting the moon bring back fossils, or even small plant-like things that live safely a few feet under the moon's surface.

Extraterrestrials

Once life has appeared, intelligent life is likely. The continual generation, survival and destruction of living beings wherever we see life tends to emphasize the development of the ones most able to survive. If there are many different environments there will be many kinds of beings, and the odds favor the development of intelligence sooner or later. And, once it appears, it wins over all the competition almost instantly, on a cosmic time scale. And then by degrees we have science, technology and engineering, and finally interest in other worlds.

Of all the risks involved, the interest in other worlds seems to be the greatest. It seems ten times more likely that intelligent races exist elsewhere in space than that they will be concerned about what is outside their skies. Our own history bears this out.

But if we are interested and they are there and interested too, how will we find them?

Some thinkers suggest they may have found us. I'm not referring to the flying saucer reports, which seem rather faddish to me. Some historians suggest we must have had a real visit at least once in recorded history and maybe we can find a description of it somewhere. Others suggest we already have the records but we don't understand them, and point to various odd legends of supernatural beings or visitors.

If we have had visitors from other star systems we are likely to find traces on the moon. Our moon, handy to the most interesting planet in the Solar System (from our own viewpoint at least) would offer an excellent base for observing a possibly dangerous planet (it's safe to suppose *all* planets are dangerous if they are as ours was hundreds of thousands of years ago) while simultaneously mining nuclear fuels for a re-

DUAL GATE MOSFET PRE-AMPS



to 175 MHz. **\$19.95** ppd.
to 300 MHz. **\$23.95** ppd.
to 400 MHz. **\$27.95** ppd.
to 450 MHz. **\$31.95** ppd.

- Available from 5 MHz. to 450 MHz. Bandwidth is approximately 3% of frequency.
- Voltage gain 30 to 40 DB depending on frequency.
- Two **Dual Gate** MOSFET amplifier stages with each having a tuned input and tuned output. Each Dual Gate MOSFET is actually an integrated cascode circuit thus giving you 2 cascode circuits equivalent to 4 triodes.
- Exceptionally low noise (2.5 DB at 175MHz.), greatly reduced cross modulation and 10 times the dynamic range (signal handling capability) of the best bi-polar transistors. Also superior to preamps using junction FETs and Single Gate MOSFETs.
- Internal connections for high impedance AGC or manual gain control if needed.
- Type BNC input and output receptacles for minimum loss at UHF. Standard impedance is 50-75 ohms.
- Carefully tuned at our laboratory with sweep generator and oscilloscope for the best bandpass characteristic.
- Full wave UHF diodes protect input transistor.
- Operates on 6 to 16 volts DC, 5 to 15 Ma.

VANGUARD LABS

Dept. H

196-23 Jamaica Ave., Hollis, NY 11423

YOUR CALL

Please check your address label and make sure that it is correct. In cases where no call letters have been furnished we have had to make one up. If you find that your label has an EE3*&* on it that means we don't know your call and would appreciate having it.

USED MODEL 501 TV CAMERAS



MADE
IN U.S.A.

\$160.00 FOB Hollis

Each month we have a limited number of used TV cameras which we make available to hams at greatly reduced prices. These cameras were rented out for temporary surveillance jobs on construction sites, county fairs, conventions, etc. All have been checked out and are guaranteed for 90 days. Complete with vidicon and lens.

**Used Model 501 sale priced
\$160.00 FOB Hollis**

Don't delay. Only a few used cameras are available each month. For specifications send for our illustrated catalog.

VANGUARD LABS

Dept. H, 196-23 Jamaica Ave., Hollis, N.Y. 11423

FOR THAT

"Extra Class"
YOU NEED THE



Listen for the hundreds of LK-2000 linears now on the air and judge for yourself. Write for free illustrated brochure or send \$1.00 for technical and instruction manual.

BTI LK-2000 LINEAR AMPLIFIER

For SSB, CW, RTTY
Maximun legal input
Full loading 80-10M
Rugged Eimac 3-1000Z
Dependable operation
Easy to load and tune
No flat topping with ALC
Distinguished console
Instant transmit
High efficiency circuit
Designed for safety
Fast band switching
Real signal impact

Price \$795.00
READY TO OPERATE!

BTI AMATEUR DIVISION

Hafstrom Technical Products
4616 Santa Fe, San Diego, Ca. 92109



turn trip. If any traces have been left over the past few hundred-thousands of years they are probably still there. The Moon has no weather to obliterate footprints and engineering structures.

Looking a little farther out we come to Mars, interesting in itself, and its two moons. Phobos, the inner moon, behaves like a hollow shell in space and both Deimos and Phobos are in orbits unlike those of any other satellites except our artificial ones. And astronomical records suggest both moons *may* have appeared in space between our years 1862 and 1877. Several other observations about Mars are interesting, and it will probably be visited by humans next after our moon. That expedition may bring back a bundle of news!

But the most probable way we can discover any other people is by their radio communications. We have some idea how many planets might be interested in communicating with us, but what are the odds one is both interested and near enough? How near is near enough? And how will they go about it?

Right here the question becomes one of most fascinating things we can find to think about. Here we are at the sea shore, as we were once before in this same century. We can guess, we can conjecture, and while the experts are working like made on the problem there are thousands of amateurs per expert. The odds for success favor the men with two-hundred and thousand-foot reflectors and yet simply because their gear is so powerful and cumbersome they cannot try all possibilities with it. Only the best. Can ham radio jump off again, as once before, and find a place in the future

. . . WIEZT

REFERENCES

1. Allen, Tom: *THE QUEST*. Chilton Books, 1965.
2. Asimov, Isaac: *THE UNIVERSE*. Avon Books (paperback) 1968.



**Moving? Please
Let Us Know!**

many have tried

but SWAN SUCCEEDED

a complete station
for only

\$395⁰⁰ Just hook the Model 260 to an antenna and you're on the air.



Its that simple! There is nothing else on the market comparable to the 260. Look what you get for \$395.00.

- ★ Complete frequency coverage on all five bands
- ★ 10 meters
- ★ 260 watts PEP
- ★ Built-in power supply . . . AC and DC
- ★ Portable . . . only 26 pounds, complete with handle, built-in speaker and mike
- ★ Designed and built with the same ruggedness, reliability and craftsmanship that has made Swan a household name the world over.

And coming very soon will be another star in the Swan line, the 270 deluxe. Everything that the 260 has, plus many additional features for those who can pay a little more. The 270 will sell for \$495.00, still a low price for a complete station.

And if you need an antenna, Henry Radio can make that a simple matter with its cost saving Antenna Package Program.

We know its hard to believe, but come on in to a Henry Radio Store for a demonstration. If you can't come in . . . write or phone. We'll give you more information, terms, and will ship anywhere.

EASY FINANCING • 10% DOWN OR TRADE-IN DOWN • NO FINANCE CHARGE IF PAID IN 90 DAYS • GOOD RECONDITIONED APPARATUS • Nearly all makes & models. Our reconditioned equipment carries a 15 day trial, 90 day warranty and may be traded back within 90 days for full credit toward the purchase of NEW equipment. Write for bulletin.

TED HENRY (W6UOU)

BOB HENRY (WØARA)

WALT HENRY (W6NRV)

CALL DIRECT . . . USE AREA CODE

Henry Radio Stores

Butler, Missouri, 64730

816 679-3127

11240 W. Olympic, Los Angeles, Calif., 90064

213 477-6701

931 N. Euclid, Anaheim, Calif., 92801

714 772-9200

"World's Largest Distributor of Amateur Radio Equipment"

BUY 73 BOOKS

73 USEFUL TRANSISTOR CIRCUITS

If you've been looking for a transistor circuit to do a special job, chances are there is a circuit in this book that will give you a head start. It covers circuits for audio, receivers, transmitters and test equipment. **\$1**



VHF ANTENNAS

This handbook by K5JKX is a complete collection of information about VHF and UHF antennas, with design hints, construction and theory. If you've been wondering what array you need, this book will give you enough background to make the right decision. **\$3**



INDEX TO SURPLUS

Do you have a piece of surplus equipment that you want to convert but can't find an article? If so, this is the book you need. It lists all of the surplus articles and conversions in popular electronic and amateur magazines from 1945 to 1966. **\$1.50**

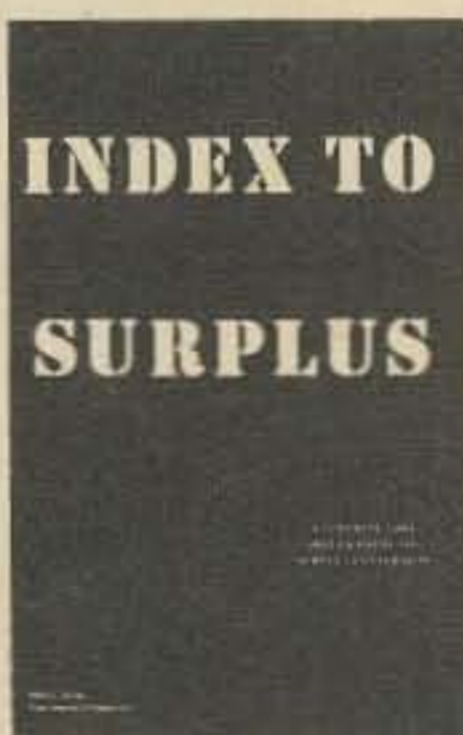

SIMPLIFIED MATH

Does math scare you? It shouldn't in this easy-to-understand book K8LFI explains the simple exponential system of arithmetic, simple formulas, logarithms, and their application to the ham shack. **50c**



PARAMETRIC AMPLIFIERS

For the ham who wants to work DX on the bands above 432 MHz, there is nothing that can beat the gain and noise figure of a paramp. This book shows you how they work and how to build and use them. Lavishly illustrated with photographs and drawings. **\$3**

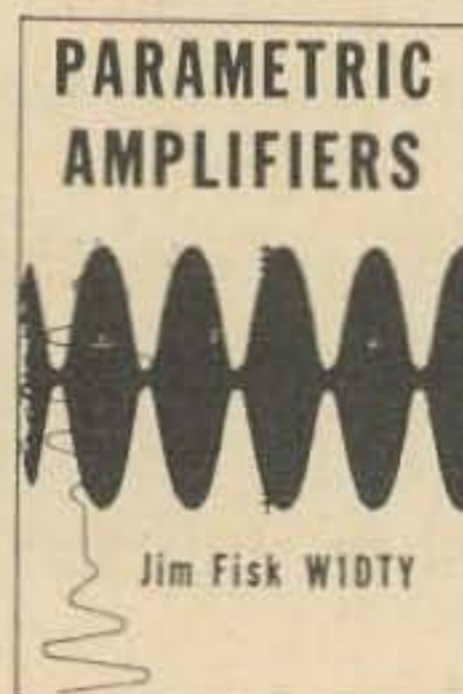

HAM TELEVISION

The Amateur Television Anthology is a collection of the technical and construction articles from the **ATV Experimenter**, edited by WØKYQ. If you're interested in ATV, this is the book for you. It covers the gamut from the simple to the complex in amateur television equipment. **\$3**



HAM RTTY

More and more hams are joining the RTTY crowd every day. This 112-page book gives you all the basics and tells you what you need to know to get started and get on the air. Written by W2NSD and W4RWM. **\$3**

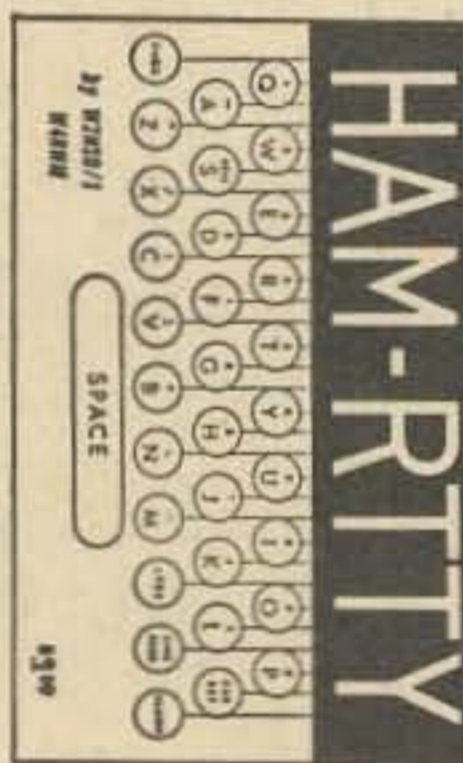

DIODE CIRCUIT HANDBOOK by WA1CCH. Will drive you right out of your mind. **only \$1.**

CW by W6SFM explains code and how to learn it. **50c**

MILITARY SURPLUS TV EQUIPMENT by W4WKM is a necessity to the surplus-scrounging ATV addict. **\$1**

CUMULATIVE INDEX lists all the articles in 73 up through December 1966. **25c**

- Transistor Circuits\$1.00
- Index to Surplus\$1.50
- Parametric Amplifiers\$3.00
- Ham RTTY\$3.00
- VHF Antennas\$3.00
- Simplified Math\$.50
- ATV Anthology\$3.00
- CW\$.50
- Military TV\$1.00
- Cumulative Index\$.25

Please send me the books checked at left:

Name Call

Address

City State Zip

Books shipped prepaid in US and Canada.

73 Magazine

Peterborough, N. H. 03458



**52 Ohm 1 KW
SWR Meter**

- Simple
- Inexpensive
- Effective

\$14.95

Model SE-405

**TRANSISTOR
DC SUPPLY**

This power supply will operate transistor radios and other devices under repair or where batteries are a drag to replace. Voltage range: 0-20 vdc continuously variable. Meter ranges: 0-20 vdc, 0-20 mA, 0-200 mA. Maximum current capacity: 150 mA/20 v or 200 mA/10 v. Pilot lamp. AC ripple: less than .25 mv rms. Fused. Has built in power transformer and 30 watt power transistor. Built for continuous duty.

Model SE-100

ONLY \$16.95



MINI-LAB

Here is a complete test laboratory all in one package! A modern miracle of electronics. This one unit contains an AC-DC Voltmeter: 50, 150, 500 volts; 0-500 mA; 10K, 100K, 1M ohms; resistance and capacitance substitution; 9 vdc battery supply; RF Signal generator 455 kHz (and up to 700 kHz); plus an audio generator at 400 Hz. You can service just about anything with this lab. You can signal trace and align receivers and trace audio systems, speech equipment, hi-fi and tape recorders. This is probably the single most useful piece of test equipment ever to come along.

Model SE-400

SPECIAL \$24.95

SIGNAL TRACER

Here is an exceptional value. This solid state signal tracer will make servicing of your receiver, AM/FM and TV very easy. Comes complete with shielded prod and clip cord. Self-powered. Six transistors, four diodes and one thermistor. Built in speaker and 200 uA meter. Attenuator 20-40-60 dB. Gain over 70 dB. Outputs for 8 and 600 ohms. You can track down the trouble in a receiver in minutes with this little unit.

Model SE-350



ONLY \$22.50



**RF
Field
Strength
Meter
1-400 mHz**

Comes with 5-section antenna and earphone for modulation checking. Invaluable for tuning any transmitter. Magnetic base for mobile use.

Model FL-30

only
\$8.95

SEE YOUR LOCAL DISTRIBUTOR

(Distributors and Reps please write as several areas are still open for distributing these fine products)

MAIL ORDER SALES

Include \$1 for packing and mailing and send to **REDLINE** Company, **JAFFREY, NEW HAMPSHIRE, 03452**. Money back guarantee on all DGP equipment!

CO. P.O. box 231 JAFFREY, N. H. 03452

A New Material—VELCRO

R. Bailey, K3AQH
326 Hoffnagle St.
Philadelphia, Pa. 19111

In this space age new things are coming along all the time, sometimes at a pace that is hard to keep up with. Some of these new ideas may be of use to hams, and a specially good one is VELCRO.

VELCRO is that stuff used on your family doctor's blood pressure cuff. If your wife does a lot of sewing, she may already know about it, and maybe there is some in her sewing box. It is a rather ordinary looking product, but when you look closely, you see it comes in two types: one with a forest of tiny nylon hooks and the other with a surface resembling felt.

When you press the two pieces together the hooks engage the felt, and if you press the attachment becomes stronger. The force necessary to separate the pieces is that required to bend one hook times the number of hooks. Since there are many hooks and the nylon is "kinda" stiff, the holding power becomes quite useful.

Applications

After thinking about this a number of ideas come to mind. For mobile operation, for instance, you can cement a piece of VELCRO to the mike and a mating piece to the dash; now the "right" spot is a general area rather than a precise mechanical point. No fumbling in traffic.

You can make up a strap of VELCRO to go around your mobile log, with some elastic or a rubber band to complete the loop. After opening your log to the correct page you slip this loop over it; the mating piece of VELCRO is located on the appropriate shelf

or surface. When you put the log down there, it won't slide. Put another piece of VELCRO around the pencil and it won't dance around either!

If there is a fairly wide base area in your car, you can use some VELCRO to hold your rig in place. Three or four strips on the bottom of the rig (use low-profile bolts, rivets, or cement) against mating strips on the mounting surface will provide a surprisingly strong mounting arrangement. In the same way you can hold your rig, or parts of it, very nicely in place if you are thinking of a tilted shelf to improve panel visibility.

VELCRO will hold small, light chassis in place on top of larger, heavy ones, too. This idea has very good possibilities in view of the trend to smaller, lighter electronic components. Use noncritical pieces of VELCRO in place of harder-to-assemble (and more expensive) mechanical mounting assemblies.

When you put up your mast, wrap a piece or two of VELCRO near the top. When you are up there with test gear it can serve as a third hand holding your field strength meter or whatever.

If you are experimenting with VHF yagis, lay out a strip of VELCRO along the boom. Wrap a mating piece around the center of each element, and when you press the element down onto the boom it will stay put yet is easily moved.

Other suggestions are a bulletin board with some VELCRO for semi-permanent mounting of clip boards, pens, charts, even a small card file. Some tools might be hung on VELCRO, too, in the workshop.

... K3AQH

ALL BAND TRAP ANTENNA!

Reduces Interference and Noise on All Makes Short Wave Receivers. Makes World-Wide Reception Stronger. Complete

with 96 ft. 72 ohm feedline. Sealed resonant traps. For novice and all class radio amateurs! Eliminates 5 separate antennas with better performance guaranteed. 80-40-20-15-10 meter bands. Complete 102 ft. \$19.95. 40-20-15-10 meter bands. 54 ft. (best for world-wide short wave reception) \$19.95. Send only \$3.00 (cash, ck, mo) and pay postman balance COD plus postage on arrival or send full price for post-paid delivery. Complete instructions included.

WESTERN ELECTRONICS Dept. A Kearney, Nebraska 68847

For ALL Amateur Transmitters. Guaranteed for 1000 Watts Power. Light, Neat, Weatherproof.

73 BINDERS

Are your magazines falling down all the time? Our bright red binders will hold them on the bookshelf. Stamped in gold. Specify year. Only \$3 each, but going up before long. Order.

73 PETERBOROUGH NH 03458

More than 5 million two-way transmitters have skyrocketed the demand for service men and field, system, and R & D engineers. Topnotch licensed experts can earn \$12,000 a year or more. You can be your own boss, build your own company. And you don't need a college education to break in.

HOW WOULD YOU LIKE to earn \$5 to \$7 an hour... \$200 to \$300 a week... \$10,000 to \$15,000 a year? One of your best chances today, especially if you don't have a college education, is in the field of two-way radio.

Two-way radio is booming. Today there are more than five million two-way transmitters for police cars, fire trucks, taxis, planes, etc. and Citizen's Band uses—and the number is growing at the rate of 80,000 per month.

This wildfire boom presents a solid gold opportunity for trained two-way radio service experts. Most of them are earning between \$5,000 and \$10,000 a year more than the average radio-TV repair man.

Why You'll Earn Top Pay

The reason is that the U.S. doesn't permit anyone to service two-way radio systems unless he is licensed by the FCC (Federal Communications Commission). And there aren't enough licensed experts to go around.

This means that the available licensed expert can "write his own ticket" when it comes to earnings. Some work by the hour and usually charge at least \$5.00 per hour, \$7.50 on evenings and Sundays, plus travel expenses. Others charge each customer a monthly retainer fee, such as \$20 a month for a base station and \$7.50 for each mobile station. A survey showed that one man can easily

maintain at least 15 base stations and 85 mobiles. This would add up to at least \$12,000 a year.

How to Get Started

How do you break into the ranks of the big-money earners in two-way radio? This is probably the best way:

1. Without quitting your present job, learn enough about electronics fundamentals to pass the Government FCC License. Then get a job in a two-way radio service shop and "learn the ropes" of the business.

2. As soon as you've earned a reputation as an expert, there are several ways you can go. You can move out, and start signing up your own customers. You might become a franchised service representative of a big manufacturer and then start getting into two-way radio sales, where one sales contract might net you \$5,000. Or you may be invited to move up into a high-prestige salaried job with one of the same manufacturers.

The first step—mastering the fundamentals of Electronics in your spare time and getting your FCC License—can be easier than you think.

Cleveland Institute of Electronics has been successfully teaching Electronics by mail for over thirty years. Right at home, in your spare time, you learn Electronics step by step. Our AUTO-PROGRAMMER® lessons and coaching by expert instructors make everything clear and easy, even for men who thought they were "poor learners."

Your FCC License... or Your Money Back!

By the time you've finished your CIE course, you'll be able to pass the FCC License Exam with ease. Better than nine out of ten CIE graduates are able to pass the FCC Exam, even though two out of three non-CIE men fail. This startling record of achievement makes possible our famous FCC License Warranty: you'll pass the FCC Exam upon completion of your course or your tuition will be refunded in full.

Find out more. Mail the bound-in post-paid card for two FREE books, "How To Succeed In Electronics" and "How To Get A Commercial FCC License." If card has been detached, use coupon below.

ENROLL UNDER NEW G.I. BILL

All CIE courses are available under the new G.I. Bill. If you served on active duty since January 31, 1955, or are in service now, check box on card for G.I. Bill information.

CIE Cleveland Institute of Electronics

1776 East 17th Street, Cleveland, Ohio 44114

Please send me without cost or obligation:

1. Your 44-page book "How To Succeed In Electronics" describing the job opportunities in Electronics today, and how your courses can prepare me for them.
2. Your book on "How To Get A Commercial FCC License."

Name _____ Age _____

(PLEASE PRINT)

Address _____

City _____ State _____ Zip _____

Accredited Member National Home Study Council ST-19

How to get into one of today's hottest money-making fields—servicing 2-way radios!



He's flying high. Before he got his CIE training and FCC License, Ed Dulaney's only professional skill was as a commercial pilot engaged in crop dusting. Today he has his own two-way radio company, with seven full-time employees. "I am much better off financially, and really enjoy my work," he says. "I found my electronics lessons thorough and easy to understand. The CIE course was the best investment I ever made."



Business is booming. August Gibbemeyer was in radio-TV repair work before studying with CIE. Now, he says, "we are in the marine and two-way radio business. Our trade has grown by leaps and bounds."

\$1,000,000 TVI SUIT FILED

Grid, W4GJO, the well-known VHF pioneer, is being sued for \$1,000,000 for causing TVI. His case, if lost, could mean the end to amateur radio. Please read this incredible case.

It is the purpose of this letter to set forth in as factual a manner as possible the events which have taken place in the subject TVI case.

This case was first brought to the attention of the Sarasota Amateur Radio Association in April 1968 when Mr. Ansel Gridley W4GJO requested the assistance of the TVI Committee. Mr. Gridley, who resides at 2439 Goldenrod Street, Sarasota, had received a TVI complaint from Mr. Lee H. Eggers, whose address is 2451 Goldenrod Street, next door to Mr. Gridley. Mr. Gridley explained that his neighbor had complained of interference on his TV set on two other occasions during the last ten years and each time the interference had been eliminated by the addition of high-pass filters at the TV sets. This time, however, Mr. Eggers had refused to consider the installation of a filter or to cooperate in any way. At that time Mr. Gridley wrote to Mr. Eggers to the effect that he would be happy to investigate the cause of the interference at Mr. Eggers' convenience. A copy of this letter was filed at the FCC office in Miami. As a result of Mr. Gridley's request, Mr. Larry Loper, W4WHF, of the TVI Committee contacted Mr. Eggers, who again declined to discuss the situation.

On August 1, 1968, an advertisement appeared in the Sarasota Herald Tribune. This ad was placed in the newspaper by Dixie Lee's Bar and Package Store and contained an "editorial" ostensibly written by the proprietor, Lee Eggers. The object of the editorial, of course, was Mr. Gridley.

As a matter of interest, Mr. Gridley is the owner of Tel-Appliance, Inc., one of the larger TV and stereo sales and service stores in Sarasota. As part of this operation, Mr. Gridley also handles the most complete line of amateur radio equipment and supplies on the west coast of Florida. Mr. Gridley, known as

"Grid", has been a licensed amateur for over 30 years and is well known in VHF circles throughout the country.

I personally met with Mr. Eggers at his place of business on August 3 to discuss his complaint. He said that he had experienced interference in varying degrees with various TV sets and other appliances during the past 10 years. He said the interference to his new color set was unacceptable and that he would seek to prevent Mr. Gridley from operating. The possibility of a lawsuit was mentioned. Reluctantly, he consented to allow the TVI Committee to investigate the nature of the interference in his home.

On the evening of August 8, Mr. William Quigley, also of the TVI Committee, Mr. Harry Hartnup, owner of Harry's TV from whom the TV set was purchased, and myself were admitted to Mr. Eggers' home. By telephone, Mr. Gridley was asked to begin transmitting. The 28.5 MHz. band was used for the test since this has been the band most frequently used in recent months. Severe interference to both picture and sound was apparent on all channels including UHF channel 38. Several orientations of the transmitting antenna were tried as well as power levels of 100 and 1000 watts average. The degree of interference remained substantially the same throughout the test. Single-sideband transmission was employed in all cases. It was determined that an antenna mounted pre-amplifier was being used by the TV set. When this device was disabled by disconnecting its power supply, the degree of interference was reduced significantly. This concluded the initial test at Mr. Eggers' home.

The TVI Committee also inspected the amateur station of Mr. Gridley. The transmitter in use is the Drake Model T4X followed by the Drake L-4 Linear Amplifier. A Drake Model TV-1000LP low-pass filter and a Johnson Match Box antenna coupler are used at all times. The antenna used on the 28.5 MHz. band is connected to an earth ground. To all appearances, the station is installed, maintained and operated within the norms of good engineering practice. Mr. Gridley also has several TV sets in his home. These sets are fed from an outside TV antenna and through a high-pass filter and a distribution amplifier. It was witnessed by the committee that no trace of interference occurred on these sets under any conditions of operation of the amateur station.

It was the committee's opinion at this time that the interference was principally due to

overloading of the single-transistor pre-amplifier which is located at the TV antenna and in a high intensity RF field. This overloading and consequent crossmodulation is producing spurious signals throughout the entire television spectrum. Under these conditions, rejection of the interfering signals within the TV set is not possible. The installation of a high-pass filter ahead of the pre-amplifier was considered but disregarded due to the weather-proofing problem. It was the recommendation of the committee, therefore, that the offending pre-amplifier, a Bonder-Tongue U-V Amp-2, be removed entirely. It was recommended that a Jerrold Model TA-66 amplifier be installed at the TV set and that a high-pass filter be installed at the amplifier input. The TA-66 is generally intended to be used as a four set coupler. It does, however, have approximately the same gain as the Blonder-Tongue amplifier, and some amount of input tuning is provided. The TA-66 operates on VHF channels only.

Mr. Eggers, his attorney, Mr. Jack Windt, and Mr. Hartnup were informed of the results of the committee's investigation and the above changes were proposed. It was also stated that the new amplifier and high-pass filter would be supplied at no expense to Mr. Eggers. The possibility of subscribing to the cable TV service which is available in the neighborhood was also discussed. It was stated that this service had been tried but that the results were unsatisfactory for reasons not related to this problem.

During the first week of September, the recommended changes were accomplished by Mr. Hartnup. Shortly thereafter, Mr. Hartnup and myself repeated the original tests at the Eggers' home. With Mr. Gridley transmitting under the same conditions as previously, there was no trace of video interference except on channel 3. Channel 3 exhibited a very slight variation in intensity on peaks of modulation. Audio interference was present on all channels, however, and to a degree approximately equal to that of our first visit. This interference was recognized as being due to audio rectification or detection in the audio amplifier stages of the TV set. The elimination of this type of interference is generally difficult and dependent upon trial and error methods. The first step would be to bypass or shield any long leads associated with the audio stages. It was proposed to Mr. Eggers that the TV set be removed to Mr. Hartnup's TV store and that the necessary work be performed. This proposal was re-

fused. Mr. Eggers also stated that he was not satisfied with the quality of the reception with the new amplifier and that he wanted it removed and his original pre-amplifier re-installed.

It should be mentioned that Mr. Eggers is an avid television viewer and expects to receive signals reliably from stations other than the principal stations in the area. These principal stations are WTVT-TV, channel 13, and WFLA-TV, channel 8, both in the Tampa-St. Petersburg area, a distance of about 50 miles over flat terrain. The other stations which he expects to receive include several lower power stations in the Tampa-St. Petersburg area, one in Ft. Myers, a distance of 65 miles, and one in Orlando, over 100 miles away. Even in the case of the principal stations, Sarasota is considered to be a fringe area.

Also during the month of September, Mr. Hartnup contacted the RCA factory in an effort to obtain their assistance on this problem. Their suggestions were essentially the same as those of the TVI Committee. As a matter of interest, the set uses the RCA CTC 30 color chassis.

During the latter part of September, Mr. Eggers and Mr. Gridley were advised that on October 2, 1968, Electronics Technicians Robert Ritchie and William McCrimmon of the Tampa FCC office would arrive in Sarasota to investigate the complaint. This investigation was apparently the result of a letter written by Mr. Eggers' attorney to the FCC. Upon their arrival, Mr. McCrimmon inspected Mr. Gridley's station. He also observed the absence of interference to a TV set just a few feet from the transmitter. After approximately an hour and a half, Mr. Ritchie entered. He said that he had visited every house within two blocks of the Gridley residence, and that while a few isolated cases of interference were reported to him, in every case Mr. Gridley had quickly provided the necessary filters. Mr. Ritchie stated that "Mr. Gridley's cooperation in this matter appears to be outstanding". Tests were then conducted with the FCC inspectors observing Mr. Eggers' interference. Finally, a test was made with the FCC inspectors monitoring a TV set in their automobile located approximately 75 feet from Mr. Gridley's beam. With Mr. Gridley operating with the maximum legal power, there was no evidence whatsoever of interference on any channel. Upon leaving, Mr. Ritchie said that he could not make an official recommendation at that time and that

(More TVI suit on page 89)

Nikola Tesla

Master of Electrical Energy

"Give me a lever long enough, and a fulcrum on which to rest it," Archimedes said, "and I will move the Earth." Nikola Tesla, a nearly forgotten man from a forgotten country, who was perhaps the greatest scientific genius in human history, needed no such prerequisites as Archimedes. Tesla succeeded in resonating the globe as though it were only a child's toy.

This man, who dared presume his power as significant as a God's, had humble beginnings. As the night of July 9, 1856 was drawing to its end, Nikola was born, the second son of a Serbian Orthodox clergyman in Smiljan, Lika, Croatia. (Croatia is now one of the six republics of Yugoslavia.) Djouka Tesla, Nikola's mother, was unable to read or write, yet had an excellent memory and literary facility. She could recite long passages from the Bible and thousands of verses of Serbian national poetry and was an accomplished seamstress. Nikola's father, Milutin, had had an excellent education, though, and had started a career in the military, only to enter the ministry shortly after he married.

Tesla forebears had given a long line of sons either to the military or the Church and Tesla's father intended Nikola to become a minister. The elder son, Dane, had a brilliant mind and the family expected him to bring them honor as a scientist or engineer. But Dane died when he was twelve years old, as the result of an accidental fall. It has been speculated by some writers that Nikola had to succeed in his brother's stead, perhaps because he felt guilty. This author thinks rather that Tesla's choice of vocation was the inevitable result of natural ability.

Young Nikola had an inherent mechanical aptitude which evidenced itself many times in his early years. When he was only four years old, he built a water wheel for the creek which flowed near his home. During

his childhood he made many curious devices. One such was a popgun which fired a ball of wet hemp. He built and sold these to his fellow children until a rash of broken windows ended this enterprise. He turned to archery and went from bow-and-arrow to crossbow and then arbalest. He was fascinated by the idea of flying and when he was twelve years old, made an unsuccessful parachute jump from the barn using an umbrella.

He evidenced an original turn of mind from his earliest days. Once he noticed that after lightning struck from the dark masses of clouds that torrents of rain would fall, and decided that one might be able to control rainfall by controlling the lightning. Years later he had succeeded in producing artificial lightning, but was never able to convince the U.S. Patent Office that weather control might be possible.

In school his talents quickly led him to the head of his class, particularly in mathematics, a subject he favored. He detested resorting to paper and pen when it was so easy for him to solve any problem in his mind almost as quickly as the teacher had given it. This ability led to his being suspected of cheating and he was not given a passing mark. Nikola went to the director of the school and demanded an examination. The test was duly given and in the presence of the director and the teacher, Tesla solved problems far beyond his years. Suspecting that he had somehow gotten the answers to the standard examination, the officials departed from it to throw even more difficult problems at him, which he solved equally well. The astonished men could only acknowledge that Nikola Tesla possessed an astounding ability and passed him.

At fifteen Tesla continued his education at the Higher Real Gymnasium in Karlovac, Croatia, which corresponds to our college

level training. He completed the four year course in three years. During this time, he was living with an aunt and her retired army officer husband. The woman felt that Nikola was of delicate health and that heavy meals would have a bad effect on him. Tesla remembered this as the hungriest period of his life. While he was at Karlovac, he took many hikes along snow covered mountain trails. One day, he began rolling snowballs down a slope, trying to see how big he could get one. He succeeded too well and sparked an avalanche which roared down the mountainside and diverted itself harmlessly in a field, only just missing some farm buildings. Tesla was horrified at the near disaster he had created but wise enough to recognize that the tremendous power of Nature could be harnessed by relatively small applications of Man's power.

When he had completed his studies at the Gymnasium, his father had written urging him to take a hunting trip rather than return home. Tesla impulsively disregarded his father's advice and went home to find the area in the grip of a cholera epidemic. Worse than this was the elder Tesla's desire to see his son study for the ministry. Milutin Tesla was not wholly autocratic, however. He knew that if his son did not enter the church, he would be required to serve three years in the army. Nikola felt he was caught between Scylla and Charybdis, about to be crushed by alternatives he could not stand. Three years as a soldier seemed to him three years as an unthinking robot, compelled to the mindless disciplines of drill and routine. And a life in the ministry would leave him no time to learn Nature's secrets. Nikola had decided that he wanted to be an engineer.

The three years of undernourishment and the spiritual anguish he faced now so weakened him that he succumbed to cholera. For months he lay ill, one sinking spell leading to another. The family doctor finally announced that he could do nothing more for the boy and the family should prepare themselves for his imminent death.

Now the elder Tesla was facing his own crisis. One son had already died. He had pledged Nikola to the church, but if the boy died, the pledge would be unfulfilled. In anguish the father asked the dying son what he could do. Nikola whispered that he could get well if only he could study

engineering and the despairing father quickly agreed. The deathbed crisis passed, Nikola's will strengthened and he began to recover. Tesla wrote in later years that no magical event had taken place, but rather his recovery had been because of a distasteful but potent medicine his mother prepared.

Subsequently the army declared the convalescing Nikola unfit for service and he was now free to pursue his goals. The elder Tesla's influence with other members of the family in the military for this decision has been suggested but is not definitely known. It is a fact that the father sent Nikola away for a year while the decision was being rendered. During this year Nikola amused himself with such fanciful projects as a proposed subterranean tunnel between Europe and America through which containers could be propelled by water pressure. Tesla quickly realized that drag would make the project unworkable, but nevertheless enjoyed such pursuits as a stimulus to his imagination.

In 1875, nineteen-year-old Tesla entered the Polytechnic Institute at Graz, Austria. In his effort to prove himself worthy of his father's reconsidered decision, he took twice the normal number of subjects and limited himself to less than four hours' sleep a night. At the end of the year, he returned home with the highest possible marks, fully expecting his father's praise. Instead his father disregarded the effort his son had made and criticized him for endangering his health. It was only years later that Tesla discovered that the dean of the technical faculty had written Milutin Tesla to say that Nikola was "a star of the first rank but will kill himself from overwork."

In his second year at the Institute, Tesla limited his studies to physics, mechanics and mathematics. During a demonstration of a Gramme motor/dynamo, Tesla remarked that the commutator sparking indicated power loss. His instructor, Professor Poeschl, patiently explained that the commutator was necessary to provide a direct current output. Tesla responded that by discarding the inefficient commutator and using the natural alternating current from the rotating armature, far greater efficiency could be attained. A hail of invectives greeted Tesla's conjectures, comparing them with such foolishness as perpetual motion machines. Since early experimental motors would not run,

it was assumed that the positive and negative cycles were cancelling one another. Some ac generators were used about this time, but only for resistive loads, such as street lamps. Everyone knew you could never get a motor to work on ac!

Though Tesla bowed before the authority of his professor, he could not get the concept out of his mind. Plan after plan was imagined and discarded. Tesla had had, for his earliest childhood memory, an amazing ability to visualize objects. When he thought of something it appeared before him, as real to him as any object in the external world. It took some time for the child to realize that other persons could not perceive these visualizations of his. The adult Tesla always said that he perfected his models in his mind, and that there they were so real that he could see signs of wear, and in the case of rotating machinery, could actually tell whether or not it might be out of balance. His visualizations were accurate to the thousandth of an inch; the piece parts he required did not need any trial-and-error machining. Years later, in America, the staff he had in his laboratory had a hard time keeping up with him. If his precise verbal instructions did not seem clear to a workman, Tesla would make a small, neat sketch on the handiest piece of paper. It is said that no matter what size paper Tesla picked up, his sketch was sure to be no more than one inch across, yet perfectly detailed.

This uncanny visualization, coupled with his amazing mathematical ability, certainly aided his inventive efficacy. Tesla had what we would call a photographic memory, and was able to quote—from beginning to end—Goethe's *Faust*, as well as a good deal of Shakespeare, and other classics. He committed the logarithm tables to memory, so that he would not have to waste computation time in reference.

Since he had heeded his father's advice for his second year at the Polytechnic Institute and had not taken as many classes, he rounded out his activities with billiards, chess—and poker. As he could visualize many moves ahead on the chessboard, it was only a short time before he had conquered all his fellow students. He then set about organizing a chess team which challenged other schools—the first known example of intercollegiate activities. His first poker game was a memorable one—the companion

who took him to the game had promised a lamb for the shearing. By the end of the evening, the lamb had won everything. Then he amazed everyone by returning, to the cent, what each player had lost. For Tesla it was only a means of relaxation, not a profit-making venture. Many times he returned to the card table, and it was the same. Then one night luck or his own ability let him down. He calmly bet the tuition money he had received for the next year's study, and it was quickly gone. The game was over—but no one offered to return the money as Tesla had. This was a painful lesson about the nature of men and Tesla was deeply shamed that he had lost his parent's careful savings. Yet he could do only one honorable thing, and that was to confess all. He returned home, found his mother, and told her what had happened. Djouka Tesla sagely understood. Where his father would have scolded him for immoral activities, the mother knew that her son was obsessed. She gave him what little remained of their savings, telling him that he had yet to learn a lesson. When Tesla returned to the card sharps, they expected only more loot. Instead, Tesla, playing with steel determination, won everything. When the game was finished the players expected their money to be returned. This time, Tesla kept it. He had regained his tuition, and the money his mother had advanced him was returned. He made a solemn oath never to play cards again.

When he had completed his studies at the Institute, Tesla took a job at nearby Maribor with a tool-and-die works which was manufacturing electrical equipment. The money he saved enabled him to study a year at the University of Prague. Upon graduation, he travelled to Budapest, where a telephone central office was being built. The excellently-educated engineering graduate found that no responsible engineering position was open to him. Ironically, the job he was able to accept was that of draftsman with the Hungarian Government Telegraph Office. Some forty years later, he wrote that it was "at a salary which I deem it my privilege not to disclose!" He also recalled that, "By an irony of fate my first employment was as a draughtsman. I hated drawing; it was for me the very worst of annoyances." Yet Nikola Tesla could not do a job poorly and it was not long before his

ability was noticed and he was promoted to more responsible work and finally made chief electrician to the telephone company. At only twenty-five years of age, he found himself engineer-in-charge of an entire system.

It was to his liking. He found himself fully occupied during the day, limiting himself to a five-hour rest period, in which he tried to keep up with current technical journals, sleeping only two hours a night. At this time he invented the first "speakerphone", a loudspeaker apparatus with which a roomful of people could hear a telephone conversation. Tesla never bothered to patent it, though the company put it into service. Thirty years later, he remarked that it compared favorably with then-current loudspeaker designs.

All the while, his mind was constantly working on the concept of alternating current, but he had not yet solved the basic problem. Then the long hours of toil, welcome though they were to him, took effect and Tesla had a breakdown. Chief symptom of the unique nervous disorder he developed was a highly abnormal sensitivity. Tesla wrote: "I could hear the ticking of a watch with three rooms between me and the time-piece. A fly alighting on a table in the room would cause a dull thud in my ear . . . In the dark I had the sense of a bat and could detect the presence of an object twelve feet away by a peculiar creepy sensation on the forehead." Doctors pronounced the malady incurable, though they did not know what it was. As quickly as it had come, it went. While he was convalescing, his assistant, Szigeti, went with him for a walk in the park one afternoon. Tesla was pleased that the illness had not affected his memory and, looking at the sunset, began an appropriate quote from Goethe. Suddenly, before him, was the alternating-current apparatus he had thought about for so long. "Watch me reverse it!" he cried, throwing an imaginary switch. Szigeti feared that his boss had gone 'round the bend. Tesla calmed himself enough to explain. Evidently his mind had unconsciously completed the assigned task while he was ill. Tesla picked up a stick and sketched the circuit diagrams on the dirt path, explaining each detail to Szigeti. Tesla would use a two-phase ac in the field coils of his motor, which would produce a rotating magnetic field. This mag-

netic whirlwind would—by induction—pull the armature around with it. The armature would have wound coils closed on themselves, requiring no external electrical connection. Thus, in a blinding flash of inspiration, Tesla had grasped the answer. There would be no commutator to cause power loss; the only wear point of the motor would be the mechanical bearings.

Years later, a president of the American Institute of Electrical Engineering said: "The work of Nikola Tesla in his great conception of his rotary field seems to me one of the greatest feats of imagination which has ever been attained by the human mind."

The rotary magnetic field was more than an invention. It was a basic discovery, and it was this ability to perceive new insights into nature's wonders that set Tesla apart from other men. While those such as Edison made improvements on existing theory, Tesla forged ahead into an uncharted wilderness, where Man had not gone before. It was Tesla's gift that he could discover—but the gift contained tragedy, in that other men could not, or would not follow.

It was in February, 1882, that Tesla grasped the answer to the alternating-current problem. It would be six years before he would convince men that this was a revolutionary, wonderful new system. His immediate problem was more mundane—the job he had held was ended, as his employer had sold the business. Puskas, the employer, wrote a letter of recommendation for Tesla, which enabled him to get a job with the Continental Edison Company in Paris.

Tesla felt that the cosmopolitan city of Paris would give him the opportunity he needed and he swiftly took the job. Even more swiftly, he found that his employers were not interested in any "crack-brained schemes". Tesla tried to interest businessmen in his alternating-current system. Friends warned him that someone would steal his discovery, but that was hardly the case. Tesla could not even give it away.

In the meantime, his position with Con. Edison had been done in the usual flawless manner. Tesla was assigned as a roving trouble-shooter, and in 1883 was sent to Strasbourg, Alsace, then part of Germany, to straighten out an embarrassing situation. A new power plant had been built and Emperor William I was present at the dedication ceremonies. Unfortunately, the plant

had been wired by men who were less than adept at their job and when the master switch was thrown to activate the new lighting system, a short circuit blew out one wall, showering bricks and debris on the dignitaries. The Germans understandably would not accept the plant in its present condition and Tesla was dispatched to the rescue.

He soon put matters right, even in the face of German bureaucratic bungling. He writes of the "efficiency" of a simple matter of placing a hall light, in which the whole chain of command had to be consulted before the light could be installed at the very spot Tesla had suggested to begin with. When he was not taking time in matters of this sort, however, he was free to work on his own. He had brought some materials with him, and rented the facilities of a machine shop near the railroad station for evening work. There he built his first induction motor. Because he could visualize the final design so accurately, he did not need blueprints. He was a fussy worker, however, and the precise machining and polishing of the parts took time. The individual parts did not need cut-and-fit partial assembly but went together into a finished product the first time.

It was a dramatic moment. Tesla had thought the idea through in his mind, but it was new, it had never been tried before. Perhaps he had deluded himself, maybe it was only wishful thinking. He could only find out one way—he threw the switch. The motor hummed, the armature turned. Almost instantly, it had built up full speed. Tesla threw the reversing switch. The armature stopped, began to revolve in the opposite direction. It was clearly a success.

Tesla had made many friends in Strasbourg, impressed many people because of his efficiency and knowledge. Now he went to the mayor and various businessmen. Perhaps the sight of a working model would suffice where words had failed. But it was the same. No one seemed interested in what was the most significant commercial development in electrical engineering.

The despairing inventor returned to Paris, where another disappointment awaited him. He had been promised a substantial bonus on successful completion of the Strasbourg project. He had delivered. Now the managers of the works sent him on a wild-goose

chase. The treasurer would pay him, only the treasurer said he did not have the authority to issue a draft; the operations manager understood, but he had not authorized the trip, etc., etc. Tesla gave his resignation in disgust.

Charles Batchellor, one of the company administrators who had been friendly toward Tesla advised him that he would have a better chance of achieving success in America. Batchellor was a close personal friend of Thomas Edison and gave Tesla a letter of introduction.

Once the idea was in Tesla's mind, it didn't take long for him to settle his affairs. He sold his possessions and books and bought a steamship ticket. On the way to the station where he would catch a train for the seaport, he was robbed. He managed to get to the docks but the steamship officials would not let him board without a ticket. He persuaded them that if no one showed up before departure to claim the reservation that they should accept his story as true. He arrived in America with four cents in his pockets, a book of his own poems, a couple of technical articles, some notes on a mathematical problem and on the design of a flying machine—and a wealth of inventive genius in his mind.

He presented himself to electrical wizard Edison quickly and angered the great man immediately by telling him of his alternating-current system. Yet Edison was quick to recognize the ability of the young immigrant and impressed by the letter Batchellor had written. Never one to ignore the knock of opportunity, Edison hired the well-educated and experienced engineer for eighteen dollars a week—hardly more than he paid the average mechanic in the shops.

Tesla was impressed on their initial meeting by Edison's forceful personality and recognized that the practical man had done quite a lot with no formal training. He wondered if his own educational process had been a waste of time. He was quick to learn, however, that it had not. Edison firmly believed in the trial-and-error approach to all things and much later Tesla wrote that "a little theory and calculation would have saved him ninety percent of his labour."

Tesla was initially assigned minor routine work but when he showed his talent and his dedication by working eighteen hours

a day, Edison soon trusted him with important tasks. One of the most significant concerned the steamship *Oregon*. Edison generating equipment had been installed on this most up-to-date liner of the day and worked well for many months but eventually broke down. Edison sent his lesser lieutenants to make repairs but they failed. The *Oregon* did not sail as scheduled and Edison was faced with financial and personal embarrassment because of his equipment. In desperation he sent hardworking Tesla to try his luck. Working throughout one night with the assistance of a willing crew, Tesla rewound the armatures which had short-circuited. Leaving the ship in the early morning, Tesla met Edison and Batchellor, who had returned from Paris. When Tesla reported success, Edison remarked to Batchellor that Tesla was good as Batchellor had said, and "indeed, he's even as good as he thinks he is!"

But their good relationship was soon at an end. Tesla was already discomfited by Edison's refusal to consider an alternating-current plan. It is true that Edison had made a \$2 million investment in New York City on a dc distribution system. Naturally he did not want to see this expenditure threatened.

The final blow came as the result of a statement Edison made to Tesla concerning some research problems. Edison told him it would be worth fifty thousand dollars if he could come up with the answers. In all, Tesla's improvements led to twenty-four new dynamo designs utilizing highly efficient short field-core magnets, some new automatic controllers, and several patents taken out in Edison's name. Tesla had delivered the goods and eagerly awaited the promised bonus. When it was not forthcoming, he asked the great man and was told: "Tesla, you just don't understand our Yankee humor."

It was Spring, 1885, and he had been with Edison less than a year, but he could no longer go on. As Con. Edison had cheated him in Europe, so he was led down the garden path in America by Edison himself. Tesla's reputation had developed well, and some promoters approached him with the idea of starting a street and factory lighting company under his name. Tesla offered his alternating current system to them, but they rejected it in favor of quick profits

in this utility venture. Tesla agreed to develop a practical arc lamp for shares in the company. For about a year he worked at a very small salary, producing all the equipment the businessmen had asked for, and taking out several patents. When the system was well under way, Tesla was given stock shares and was quickly manipulated out of the company. He found that his share certificate was worth very little. The United States was undergoing a depression and Tesla was without income. His former associates, not content with having eased him out of the company, now made spurious claims about his unreliability. And Edison certainly had nothing good to say about him.

Tesla underwent such a period of hardship during the next year that he would never discuss it in later life. It is known that he did occasional electrical repair jobs, when he could find them, and that he worked as a common laborer. During the winter of 1887, Tesla was working as a ditch digger. The crew foreman, a former stock broker who had lost everything in the market, became interested enough in Tesla's theories to introduce him to A. K. Brown of Western Union Telegraph. Brown and an associate financed a laboratory for Tesla, and organized the Tesla Electric Company in April, 1887. Tesla's lab was at 33-35 old South Fifth Avenue (later West Broadway) and not far from the Edison works. The models Tesla now built were identical to the designs he had conceived five years before. In all this time he had made no notes—the concepts were firmly locked in his memory. By October of that year, Tesla had filed for a patent. He wanted a single patent for the discrete elements which comprised his system. The U.S. Patent Office was horrified at the idea of such a sweeping omnibus approach. They insisted on a breakdown to seven separate sections. By the end of the year he had filed for and received thirty basic patents.

The scientific world which had ignored Tesla for so long now could not contain its amazement. As the import of his system was grasped, he was praised as the scientific genius of the age. The lecture he delivered on invitation to the American Institute of Electrical Engineers on May 16, 1888, is a classic of the electrical engineering field. The theory and practise he presented are the basis of the system we still use today.

In one stroke he accomplished an engineering breakthrough of such magnitude that no comparable development has been presented since. Tesla was on the crest of an inventive wave that would last for thirty years.

Fortunately for Tesla—and for the world—the man of commerce who could bring this scientific feat out of the laboratory and into the everyday world of engineering practice approached. This was George Westinghouse, inventor in his own right, and head of his own company. Westinghouse was not committed to direct current as Edison was. In Tesla's system, he saw the revolutionary means of long-distance power transmission that would reap profits such as Edison's plant could only wish for. Westinghouse offered Tesla one million dollars for the rights to the group of patents, which now numbered forty. Tesla agreed, provided that a royalty based on equipment produced was also paid. A conservative estimate was later made that Tesla should have received an additional \$12 million in royalty payments.

This dynamic duo was the worst possible threat to the Edison system. What Tesla—the man of vision—lacked in financial awareness, Westinghouse—the successful entrepreneur—could supply. The United States was leaving a phase of depression and entering one of explosive capitalistic growth, in which giant industrial empires were born. Westinghouse, in his eagerness to make the most of the Tesla system, expanded his corporation by consolidating a number of smaller companies and also by attracting much outside capital. The time came, however, when Westinghouse's board of directors overruled him on the matter of royalty payments to Tesla. Even though there was a legal contract in which the payments were stipulated, the board argued to an unwilling Westinghouse that such payment would seriously endanger the stability of the corporation. Further, if Westinghouse insisted on honoring the contract, much of the outside capital would be withdrawn. As an inventor himself, Westinghouse understood the justice of the royalty payment; as a businessman, he could not bear the thought of the empire crumbling. He went to Tesla and explained the situation. Tesla had become a close personal friend of Westinghouse and understood the problem. Further, he was more interested

in seeing his system operating on a successful basis than in collecting a payment legally his, which would wreck any chance of that system's development. Tesla tore up the contract and the Westinghouse empire was saved.

Tesla had had to give half of his million dollar initial payment to Brown and his associate, but the half which was left served well enough to maintain the most splendid research establishment seen in America at that time. Tesla embarked on a program of research that would have broken most men. He began his monumental studies into high-frequency phenomena, and at most fortunate time.

The Edison faction had not been inactive during this period and in a calculated campaign to destroy the alternating-current disciples, began a whirlwind of adverse publicity. Edison and his friends gave Sunday afternoon demonstrations on the evils of ac by electrocuting cats and dogs for the edification of visitors.

Edison wrote: "Just as certain as death Westinghouse will kill a customer within 6 months after he puts in a system of any size. He has got a new thing and it will require a great deal of experimenting to get it working practically. It will never be free from danger."

A propaganda campaign of immense proportions arose. Most of the so-called scientific proof of the horrible dangers of ac erupted from Edison's laboratory in West Orange. Misleading statements were issued to the press. Pamphlets were distributed, warning the people that it would soon be a matter of taking one's life in his hands to merely walk the streets, constantly at the mercy of the lethal high-tension wires. A further suspicious fact is that a former laboratory assistant at West Orange, H. P. Brown, began lobbying and lecturing for the passage of a bill in the New York state legislature for the provision of death by electrocution.

Such a bill was passed in 1888 and H. P. Brown, now a consultant to the state, authorized the purchase of three Westinghouse alternators to be installed at Sing Sing Prison. George Westinghouse protested this particular use of his equipment, but the authorities pointed out blandly that dc generators could hardly provide the high voltages necessary. On August 6, 1890, con-

a Great one from NRCI



New 500-Watt 5-Bander from NRCI

You can't buy a more potent package than the new NRCI NCX-500 transceiver. This versatile 5-bander is packed with the performance extras that give you the sharpest signal on the band, plus an enviable collection of QSL's. Check it out!

- 500-Watt PEP input on SSB, grid-block keying on CW and compatible AM operation.
- Receive vernier, with tuning range greater than $\pm 3\text{kHz}$.
- Separate product and AM detection.
- Sidetone monitor, plus built-in code practice oscillator.
- Fast-attack slow-release AGC in all modes.
- Rugged heavy-duty 6LQ6's.
- Crystal-controlled pre-mixing with single VFO for effective frequency stability, plus identical calibration rate on all bands.
- Crystal lattice filter for high sideband suppression on transmit, and rejection of adjacent-channel QRM on receive . . . plus solid-state balanced modulator for "set-and-forget" carrier suppression.
- Universal mobile mount included.

AC-500 power supply available

Great things are happening at NRCI



NATIONAL RADIO COMPANY, INC.

NRCI

37 Washington St., Melrose, Mass. 02176
617-662-7700 TWX: 617-665-5032

victed murdered William Kemmler was to be put to death in a secret ceremony. The engineers who had installed the electric chair had been perhaps more frightened of it than was necessary. It was reported that the power was insufficient to cause death. Repairs had to be made and the execution repeated, resulting in "an awful spectacle, much worse than hanging . . ."

Meanwhile, Tesla had not been idle. He had, of course, selected 60-Hertz operation as best for commercial power applications. Indeed, he had opposition from Westinghouse engineers at the Pittsburgh plant where the new apparatus was being developed. They preferred a 133-Hertz system, partly because of decreased cost of core materials needed at the higher frequency. Tesla left in disgust, even though Westinghouse was able to offer him \$24,000 a year salary. Shortly thereafter, the engineers did select our familiar 60-Hertz system as the standard. Tesla remarked that the year he spent in Pittsburg was wasted in minor design problems and that he was not free for creative work. In the next four years, he was granted 45 additional patents on polyphase current distribution.

His researches into higher frequencies had led him to the discovery that as the frequency increased, less and less iron was necessary in transformer cores. Utilizing conventional rotary dynamo technique, he built devices which produced up to 10,000 Hertz. The next step was the production of even higher frequencies and the development by him of the air-core high-frequency transformer known and loved by all as "the Tesla coil". Two decades later, F. W. Alexanderson was developing high-frequency ac dynamos for high-power wireless transmitters for the government along the same lines.

Incidentally, Tesla's choice of 60-Hertz operation made possible cheap electric clocks, driven by synchronous motors, a fact he pointed out freely.

Along with the high frequencies Tesla was now producing, were also high potentials, so much so that conventional insulating methods were ineffectual. It was at this time that Tesla produced the technique of oil immersion, which had great commercial importance. He had soon reached the practical limits of frequency from rotary dynamos. Now he was exploring the field of

resonance phenomena. He developed the technique of electrical tuning in 1890, one of the basic principles of radio.

Utilizing Lord Kelvin's theory of the damped oscillation wave of a discharging condenser, Tesla developed means of charging a condenser by low voltage, then using the "disruptive discharge" through the primary of his air-core transformer, deriving very high-frequency oscillations and extremely high potentials in the output. He discovered the heating effect in the human body of the high frequency currents and thereby laid the principles for medical diathermy. Here was another pioneer discovery for which he took no patents nor credit.

He lectured once more before the American Institute of Electrical Engineers in May 20, 1891, on the subject of high frequency currents, and demonstrated a variety of phenomena. With apparatus then, he was able to achieve a spark discharge of over five inches, indicative of a potential in excess of 100,000 volts. The induction coil he used was energized from a generator of his own design working at 20,000 Hertz. He described the various discharge phenomena exhibited under varying conditions of potential and frequency. In his research he had discovered that the nerves of the human body could not react to currents higher than 700 Hertz. He recognized that high voltage as such was not lethal, as he had taken the high-frequency discharges of his larger apparatus many times without ill effect. Partly it is because of "skin effect", in which the high frequency tends to travel across a surface of a conductor. Also the output of Tesla's apparatus had a low current density. He wrote that slight changes of potential, current, and frequency could work together to form a lethal shock.

He said that the surest way to electrocute a person was to subject him to sustained direct current, but that the most painful means of killing would be to use a low-frequency alternating current. It is conceivable that a high-power, high-frequency current could kill swiftly and painlessly. But his demonstrations before the Institute were clear proof that alternating currents, as such, were quite harmless. Tesla repeatedly put himself into the high voltage secondary circuit of his coil, in the process of lighting bulbs of his own design, with no discomfort.

550 Big Watts!



The GT-500 by GALAXY

Based on the proven Galaxy V Mk 3 design . . . the GT-550 comes on stage with an entirely new look. And under this beautiful new exterior Galaxy has packed 550 watts . . . the highest powered unit in its field. Henry Radio, always the first with the best, is proud to introduce this fine piece of equipment along with an equally fine line of accessories.

Come on in, look them over. Or write or phone. We'll send you detailed specifications.

GT-550,	550 watt transceiver	\$449.00
AC-400,	AC Power Supply, 110/230 VAC, includes cables	\$ 89.95
G-1000,	DC Power Supply, 12/14 VDC, Neg. Ground	\$125.00
RV-550,	Standard Remote VFO provides dual frequency control for GT-550 only	\$ 75.00
RF-550,	3000/400 watt Wattmeter/Antenna Selector (Available after April 1)	\$ 69.00
SC-550,	Standard Speaker Console, 5 x 7 speaker 8 ohm, (AC-400 will mount inside)	\$ 19.95

Henry Radio has a great antenna package program . . . big savings. Write for literature.

EASY FINANCING • 10% DOWN OR TRADE-IN DOWN • NO FINANCE CHARGE IF PAID IN 90 DAYS • GOOD RECONDITIONED APPARATUS • Nearly all makes & models. Our reconditioned equipment carries a 15 day trial, 90 day warranty and may be traded back within 90 days for full credit toward the purchase of NEW equipment. Write for bulletin.

TED HENRY (W6UOU)

BOB HENRY (WØARA)

WALT HENRY (W6NRV)

CALL DIRECT . . . USE AREA CODE

Henry Radio Stores

Butler, Missouri, 64730

816 679-3127

11240 W. Olympic, Los Angeles, Calif., 90064

213 477-6701

931 N. Euclid, Anaheim, Calif., 92801

714 772-9200

"World's Largest Distributor of Amateur Radio Equipment"

Part of the awe-inspiring show was the fact that the forms of illumination Tesla was demonstrating had never been seen before. Instead of the ordinary Edison bulb for light, Tesla was using ordinary wires in normal atmospheric pressure to demonstrate luminosity effects. He had vacuum lamps, lamps with other gases, lamps with extremely high internal pressure—and most of the above had but one terminal. Others had none at all!

The production of a practical means of commercial power and now the development of a whole new spectrum of alternating currents—both within three years—established his reputation firmly with the scientific community. All at once he had more offers for lectures, after-dinner speeches, demonstrations and consultations than he could cope with. One of the problems was that his high sense of intellectual honesty and originality required him never to duplicate the material in a lecture; thus each appearance of this prodigal genius before the public was a unique event.

He was invited to lecture before scientific bodies in England and on the Continent. In February, 1892, he gave another lecture on high-frequency currents before the Institute of Electrical Engineers in London. Sir James Dewar asked Tesla to repeat the lecture before the Royal Society. Tesla had other plans and demurred, but Sir James took him to Michael Faraday's chair and plied him with the remaining private stock of whisky which had belonged to that earlier genius of electrical invention. After such a singular honor, Tesla could do no less than agree.

While he was touring Europe he received word that his mother was gravely ill. He arrived at her home in time and was able to talk with her that day. She died during the night. The strain of rushing to her deathbed caused a patch of hair on his head to turn white overnight, but a month later it had regained its natural color. His father had died years before, while he was still a student.

When Tesla returned to America he realized that his social success had cut into his research time tremendously and he turned away from all such engagements in the future, preferring to devote himself to useful work in the laboratory. During this period he experimented with such diverse

items as high-frequency currents, mechanical oscillators, X-rays, and astronomical studies. He prepared a large exhibit for the 1893 Columbian Exposition, where Westinghouse had won the contract to furnish power and lighting equipment. During frequent demonstrations at this World's Fair, Tesla passed one million volts of high-frequency electricity through his body, to turn copper plates molten or to light special bulbs of his own exotic design. The public was thoroughly convinced that ac was not the danger Edison and his followers claimed.

The final blow the dc faction received was the harnessing of Niagara Falls. The child Tesla, having seen a picture of Niagara and perhaps influenced by that first toy waterwheel, prophesied that he would someday make the falls work for him. Now that dream was to come true. A charter for developing power at the Falls had been granted in 1886 and in 1890 Edward Dean Adams, head of the Cataract Construction Company, organized the International Niagara Commission. Lord Kelvin, the famous British scientist, was made chairman of this body, which was to determine the best method. A prize of \$3,000 was offered for the best plan submitted. Tesla was frantic to toss his hat in the ring but George Westinghouse pointed out that the prize would be insufficient payment for value received and persuaded Tesla to persevere. A further complication was that Kelvin favored direct current. However, in 1893, when none of the major manufacturing concerns had submitted plans to claim the prize, the commission asked for bids. By now the Edison faction had capitulated and paid for the rights to utilize the ac patents. Westinghouse's bid for the generating plant was accepted on May 6 and the by-now General Electric Company, Edison's empire, was chosen to build the transmission line to Buffalo, twenty-two miles away. After the completion of this project, which was described as the "most tremendous event in all engineering history," Kelvin admitted that alternating current had many more advantages, and further stated that "Tesla has contributed more to electrical science than any man up to his time."

Ironically, during this period of commercial development of the polyphase ac system, Tesla was referred to as an imitator by the British press, which claimed that he

2-METERS FOR \$129⁹⁵



HEATHKIT[®] HW-17 AM TRANSCEIVER — make your move now

Another Heathkit Transceiver . . . this time it's a solid-state 2-Meter AM job that's just right for local ragchewing, NETS, DX, as well as CAP, MARS, and Coast Guard Auxiliary use . . . reasonable power output, sensitive receiver, easy-to-use features, and a low price tag.

The Heathkit HW-17 in detail. It's really a separate receiver and transmitter in one compact, versatile package (the only common circuitry are the power supply and the audio output/modulator). Frequency coverage is 143.2 to 148.2 MHz. The solid-state dual conversion, superheterodyne receiver with a pre-built, pre-aligned FET tuner has a lighted dial with 100 kHz calibration, automatic noise limiter, squelch, and 1 uV sensitivity. Selectivity is 27 kHz at 6 dB down, a figure that's consistent with band occupancy and easy receiver tuning. The front panel meter indicates received signal strength and relative power output. A 3-position switch on the front panel has a "Spot" position for finding the transmit frequency on the tuning dial, a Receive/Transmit position, and a Battery-Saver position that comes in handy during those long periods of monitoring while mobile (the receiver draws only 8 watts during this time). A 3" x 5" speaker is built in.

On the transmitting end is a hybrid circuit in-

cluding transistors and tubes with a 25-30 watt power input and an AM power output of 8 to 10 watts. Modulation is automatically limited to less than 100%. A front panel selector switch chooses any of four crystal frequencies or an external VFO (the Heathkit HG-10B VFO at \$39.95 is perfect for this job).

Front panel controls include Final Load, Final Tune, Crystal-VFO switch, Main Tuning, Squelch with ANL switch, Battery Saver-Receive/Transmit-Spot switch; rear panel has S-meter Adjust, Headphone jack, Power socket, VFO power socket, VFO input, and Antenna connector (50-72 ohms, unbalanced).

The 15 transistor, 18 diode, 3 tube circuit is powered by a built-in 120/240 VAC supply. Circuit board construction averages 20 hours. It's all housed in a low-profile Heath gray-green aluminum cabinet measuring 14¹/₈" W x 6¹/₈" H x 8¹/₂" D with everything in place. A ceramic PTT mic. and a gimbal bracket for mobile mounting are included.

Move up to 2 meter 'phone operation this low cost way with the Heathkit HW-17.

Kit HW-17, 2M Transceiver, 18 lbs. \$129.95

Kit HWA-17-1, Transistorized DC supply for negative gnd. systems only, 5 lbs. \$24.95



FREE '69 CATALOG

Describes these and over 300 other Heathkits. Save up to 50% by building them yourself. Use coupon and send for your FREE copy!

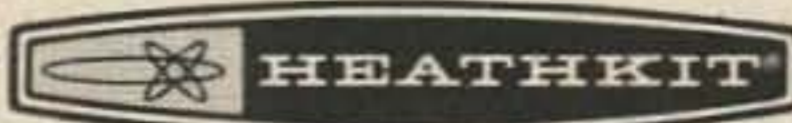

HEATH COMPANY, Dept. 11-2
Benton Harbor, Michigan 49022

Enclosed is \$ _____, plus shipping.

Please send model (s) _____

Please send FREE Heathkit Catalog.

Name _____
(Please Print)

Address _____

City _____ State _____ Zip _____

Prices & specifications subject to change without notice. AM-211

had used as the basis of his system the apparatus of a physicist at the University of Turin, Professor Galileo Ferraris. It has been proven that Ferraris first presented a paper on "electrodynamical rotation" in 1888, six years after Tesla's discovery of the rotating magnetic field, and indeed, several months after Tesla's application to the U.S. Patent Office. Ferraris had developed an alternating-current device as a demonstration of circularly polarized light and stated specifically that the principle behind his model could never be developed as a practical power unit. Yet chauvinistic English publications, which had received notice of the Tesla system, ignored it.

In 1891, another pretender to the throne arose, in the person of Dolivo Dobrowolsky, at the Frankfurt Industrial Exposition of 1891. Dobrowolsky claimed the invention of the first practical ac motors, and later reduced his assertions to a greater efficiency of his three-phase motor than that of the original two-phase Tesla induction motor. However, the chief engineer of the project, C. E. L. Brown, completely smashed Dobrowolsky's claims by writing to the *Electrical World* that "the three-phase current as applied at Frankfurt is due to the labors of Mr. Tesla and will be found clearly specified in his patents."

Part of the problem during this period of massive technological change was that the lines of communication and publication of new inventions were very slow. And there were those that put forth fraudulent claims, so that they could reap the rewards. But at the same time, errors of fact have been made by writers too lazy to do proper research.

Finally and unequivocally, Tesla was granted the credit due him, by scientists, engineers, and editors throughout the world. It is certain that the many persons who saw Tesla's demonstrations at the Columbian Exposition would not soon forget him. By 1900 there were many usurpers and infringers on the Tesla patents. The Westinghouse Co. took about twenty suits to the courts and the Tesla patents were upheld in every case. Judge Townsend of the U.S. Circuit Court of Connecticut in September, 1900, wrote: "It remained to the genius of Tesla to capture the unruly, unrestrained and hitherto opposing elements in the field

of nature and art and to harness them to draw the machines of men . . . he first conceived the idea that alternations might be transformed into power-producing rotations, a whirling field of force.

"What others looked upon as only invincible barriers, impassable currents and contradictory forces he seized, and by harmonizing their directions utilized in practical motors in distant cities the power of Niagara."

After his European and American lecture tours and his triumph at the World's Fair, Tesla withdrew from public and social life. The next two years were full to bursting. Induction coils had led him from the curious phenomena of high-frequency to the realization of the nature of electrical resonance. He planned to develop wireless communication through the earth by means of his air-core transformers. Soon he progressed to the notion that power itself could be transferred. Even working eighteen hours a day, he had not enough time for the ambitious program he undertook. During this period he discovered, independently, X-ray phenomena of the type that Roentgen would soon announce. But Tesla never claimed his system was similar to Roentgen's. All he noted at this time was a type of "very special radiation". With it, he was able to get shadowgraph pictures through a human head—at a distance of 40 feet!

He turned his attention to atmospheric phenomena and declared that the *aurora borealis* was caused by expulsion from the sun of particles of high electrical charge. Professional astronomers laughed at such an idea; after all, they knew that the sun was 93 million miles away. He further convinced them of his eccentricity with a casual statement about the "dozen or so" planets of the solar system. Then he announced his detection of mysterious rays bombarding the earth, of hundreds of millions of volts in energy. A decade later, in 1909, W. H. Pickering announced the probability of a trans-Neptunian planet. In 1930, such a planet was discovered photographically and named Pluto. Robert Millikan announced the existence of cosmic rays in 1926 and thereby won a Nobel Prize in physics.

The above were merely side interests. His main curiosity was in resonance phenomena. Aside from electrical oscillations, Tesla had developed several interesting mechanical

Unique opportunity to own one of the world's finest all-band receivers. 500 kc to 32 mc!



R-390A/URR
Radio Receiver

Limited quantity of famous R-390A/URR radio receivers . . . brand new. Original manufacture, 1968 production . . . fully tested to meet U.S. Government specifications. Range 500 kc to 32 mc, 30 1-mc bands, digital readouts. Original pack, includes two instruction books, complete set running spares. New low price \$1,700* . . . fully guaranteed.

* Continental U.S.A. only.

WRITE OR CALL FOR DETAILS

EAC Industries, Inc., 20 Bridge Avenue, Red Bank, N.J./201/747-5100, Ext. 51.

resonators, testing their low frequency mechanical vibrations and their effect on the human body and on various materials. Noticing the invigorating effect of the vibrations, he was induced to construct a small massager for the barber of one of his assistants—the ancestor of the same massager the barbers of today use. Another of his vibrating machines consisted of a platform on which one could stand. The platform was connected to a large motor which could be adjusted for different rates of vibration and which created invigorating sensations in the human body. Author Sam Clemens had become a close friend of Tesla and visited the inventor's laboratory many times. Tesla admired Clemens and claimed that one of "Mark Twain's" books had hastened his recovery from a youthful illness. One day, Clemens tried the platform and found it so refreshing that he would not get off, even at the urging of his friend, Tesla. Suddenly he stepped down and demanded petulantly to know "where it was". Smothering a smile, Tesla pointed the way to the rest room, where Clemens hastened. At certain rates, the curious platform had an irresistible laxative effect.

Another of Tesla's mechanical oscillators had more serious ramifications. Tesla had noted that gentle application of power at the natural resonant frequency of a material would set up strong vibrations within it, just as it is possible for an opera singer's voice sustaining one note to sometimes shatter glass. Tesla attached his puny device to a strong vertical steel girder in the laboratory. It seemed improbable that any significant action would occur. He activated the device, which was described later as small enough to slip into one's pocket. It was automatic in operation, in that it would "hunt" for the natural frequency of the substance it was attached to and then lock in step and reinforce the resonant wave. At first, nothing could be noted in laboratory. However, in other parts of Manhattan Island matters were quite different. The strata of sand beneath the surface transmitted the vibrations exceeding well, whereupon they reflected from the granite layer of bedrock. Since the vibrations were sustained by the mechanical oscillator, the power of the waves constantly grew. Shortly, windows were cracking, plaster falling, furniture

moving wildly about. The man-made earthquake began at some distance from the laboratory and slowly moved in toward the source centre. By the time the shock wave impinged on Tesla's building, local police were deluged with reports. Officers were sent to the laboratory. When they entered, they found Tesla smashing the oscillator with a sledge hammer. He had realized what must be happening and taken the swiftest action necessary to cease his experiment. The police had been right in believing Tesla to be involved—after all, anyone who could make lightning in the laboratory must be responsible for other strange occurrences.

Tesla later calculated that his innocent-appearing device was capable of much greater damage. He never released specifics on its construction, prudently, and never resumed such experiments. Later he claimed that with it he could have destroyed the Brooklyn bridge within an hour, or "could now go over to the Empire State Building and reduce it to wreckage in a very short time." At least one published estimate of the time necessary was fifteen minutes! Lest someone think this an idle boast, recall that soldiers break step when marching across a bridge. Further, the infamous "Gallopig Gertie", a bridge across the Tacoma Narrows built in 1940, showed all too clearly the result of destructive vibration. When completed, it was the third longest suspension bridge in the country. Four months after its completion, a wind storm, with gusts to 42 mph, well within the calculated safety limits, started erratic vibrations in its span. After four hours, waves of thirty feet were passing along. Then it began undulating from side to side. Four more hours saw 600 feet of the centre span plunge into the Narrows. The 1000-foot side spans followed. Anyone who has seen the film of this bridge swinging from side to side in a mad dance will acknowledge the effects of internal vibration.

On the night of March 13, 1895, catastrophe of another sort hit the Tesla laboratory. A fire razed his building, destroying several years' work, most of Tesla's awards and momentos, what notes he did keep. Fortunately his prodigious memory kept the loss to a minimum, but almost all his experimental equipment was lost. He opened a new laboratory at 46 E. Houston Avenue

in July of that year and went on with his work.

By September of 1897, he had filed and received U.S. Patents 645,576 and 649,621—which have been called the fundamentals of radio broadcasting. He was now ready to demonstrate for the public his new wonders. Always the showman, he booked Madison Square Garden and put on a demonstration of what we would refer to as a radio-controlled boat. He called his remotely-controlled devices "telautomatons". Thousands of people saw a small craft with antennas which could be ordered about at will. Tesla had had constructed an immense tank, in which the boat was placed for the demonstration. The model craft was controlled by a Tesla wireless transmitter and could follow its orders even under water, for it was also a submarine!

This alone would have been sufficient to win him undying fame, had he pursued it monomaniacally. But for Tesla it was not yet enough. His idea of good transportation was a vessel which did not have to take its fuel along, but could receive it as electric power via a broadcast system. Once he had achieved the means of sending signal power, he believed that he could transmit power enough to drive ships and eventually aircraft.

Tesla had advanced in his research to the point where he was able to build a 5 million volt oscillator in his New York laboratory. He was already using lower-potential oscillators as a drive for wireless fluorescent lamps which lighted the laboratory. The big job was used to test his theories of energizing the earth to transmit power by conduction. He recognized that he had reached the limits of safe operation within the confines of the city and proceeded to set up a new laboratory near Colorado Springs. Local entrepreneur, Leonard E. Curtis had promised land and all the electric power he needed, reasoning that a great scientific name such as Tesla's would bring a good deal of attention to the community.

The new laboratory was at an ideal location. Colorado terrain is a great producer of natural lightning and Tesla was able to devise equipment which would record the magnitude of the blasts. He determined that standing waves were set up by the lightning bolts—as storms moved further away, the recorder invariably showed peaks and troughs in the received energy. This further

**now
off
the**

presses! ONLY \$3.00

CHARTS AND DATA ON EVERY TYPE OF COAX
KNOWN TO MAN.

INVALUABLE (VALUABLE) BOOK FOR THE HAM - THE LAB - INDUSTRY
And everyone else that doesn't want to have to keep a whole library on hand for reference. Or even worse, have to write to the manufacturer for coax specifications.

SEND ORDER TO: 73 MAGAZINE - PETERBOROUGH - N.H. - 03458

Dear 73,

You are absolutely right. No reasonable person can stand being without your invaluable (valuable) Coax Handbook. Please drop everything else and fill my order. Note: I have friends in high places and wish to have copies of your epochal book for them. See below.

Name _____ Call _____

Address _____

City _____ State _____ Zip _____

\$3.00 enclosed for one Coax Handbook, postpaid.

\$3.00 apiece enclosed for extra copies of the Invaluable Coax Handbook for my influential friends. Send to the addresses attached ___ Send to me ___

73

special

- * cables
- * connectors
- * accessories
- * applications



COAX
handbook

substantiated his theory of earth conduction. The additional data he obtained aided his production of artificial lightning, perhaps with a view to controlling the weather, as he had fancied long before. However, his present interest was the development of practical wireless transmission of power in commercial quantities. Tesla's apparatus depended for its effect not on electromagnetic radiation, as some have mistakenly believed, but on massive electrostatic action. Indeed electromagnetic dispersal of power was wasteful, in Tesla's system. His system used a "magnifying transmitter," which was a gigantic Tesla coil, driven by thousands of horsepower. The secondary was a quarter-wavelength coil, one end grounded, the aerial portion attached to an immense copper electrode. Once the generator attained full power, the aerial electrode acted as one plate of an artificial condenser, the ground point being the other. In this way, Tesla pumped enormous quantities of electricity into the earth. Some 200 kw was the rating of his Colorado installation.

While weeks of labor turned into months, and the barn-like building he had had erected became stuffed with equipment, his workers had no clear idea what exactly was to happen. At last all was complete and Tesla explained to them; there was a nervous exodus for the door. Only one old assistant dared to stay. Tesla stood outside, conveying his orders to Czito, the assistant, by hand signals. At first, the generator, which drew its power from the commercial ac mains, was only energized a little. Then the power was slowly increased. With each step up in power, changes occurred at the copper aerial electrode. First there was only a violet corona discharge. Then, as more power was fed to the system, sparks began to snap and hiss. At the half-power point, bolts of raw electricity leapt from the electrode. As the system neared full power, artificial bolts of lightning, thick as a man's arm, snapped forth, fifty, a hundred, then almost two hundred feet in length. This secondary effect was natural, a sign that the electrostatic equilibrium was being disturbed. When the system stabilized, the lightning would end. Then, as they reached full power, all activity ceased. Tesla ran inside, saw that he was no longer receiving power from the commercial lines. He called the power company.

"You've ruined my experiment," he told them.

"And your experiment has ruined our station," was the reply. "You overloaded the generator and it caught fire."

Humbled, Tesla took Czito to help him set things right at the power station.

It has been stated that Tesla failed in his attempts to transmit power, but this writer believes that other factors became predominant. There are pictures extant of Tesla's apparatus in operation. In one instance, he demonstrated for the press the new system. A receiving circuit was set up twenty-six miles away from the "magnifying transmitter" and 200 50-watt incandescent bulbs were lighted to full power; this, with the transmitter at a low output. Tesla claimed a 95% efficiency for the new equipment.

Tesla was fully satisfied with his results and evidently the U.S. Patent Office concurred, as they issued a number of patents on wireless power transmission. However, when Tesla returned to New York to raise capital for a commercial system, he was unable to. Investors could not see what profit they could make from a system where anybody anywhere could use the power fed into the earth. Let it be said that practical financial considerations of this type were never Tesla's strong suit. The single greatest flaw of this scientific Jove was complete lack of a hard-headed business sense. He further compounded his errors by an overly generous nature.

Those who infringed on his patents were never attacked by him personally, as he considered time taken in such undertakings as wasted. He believed he could never run out of new ideas and inventions. He preferred the wealth of discovery in the laboratory. Also, his great goodwill led him to the naive expectation that, when he had produced a means of improving the human condition, he would be appropriately rewarded by a grateful humanity. His poly-phase power distribution system had already improved man's lot by substituting cheap electrical power for manual work in many areas. His new system would make electrical power available in the most remote, inaccessible and impoverished places.

Tesla, returning to New York City in the summer of 1900, found himself in the same situation he had been in in 1882—he had

a wondrous discovery, but could not interest anyone in it. The financiers asked if he had not something else they could capitalize on. He stated that he could adapt his system as a "world broadcast plant". With it, he asserted, he could provide "interconnection of existing telegraph and telephone exchanges *all over the world*; establish a secret and non-interferable government communication service; maintain universal distribution of news; establish a worldwide system of musical distribution; maintain accurate time signals to clocks everywhere; provide full facsimile transmission; send accurate navigational signals"—among other possibilities.

"A cheap and simple device, which might be carried in one's pocket, may then be set up somewhere on sea or land, and it will record the world's news or such special messages as may be intended for it," wrote Tesla, concerning his "World-system".

The men of money were skeptical; Tesla promised much. Still, he had delivered on his claims before; the polyphase ac system in general use now was silent testimony to this man's genius. Then J. P. Morgan made a gift to Tesla of a sum which was never disclosed, but estimated to be from \$150,000 to twice that amount. James S. Warden, manager of the Suffolk County Land Company made available to Tesla two hundred acres of his company's tract at Shoreham, Long Island, about sixty miles from New York City.

A large brick building was soon erected and a great, wooden tower was being built. An all-wood structure was specified, because of the enormous voltages the plant would handle. Stanford White, the eminent architect of government buildings of that era, provided the plans for such a structure. The tower was some 187 feet high, and many people snickered, because they knew such a wooden tower could not stand, or if it did, would not be able to resist high winds. A torus-shaped copper electrode of copper, 100 feet in diameter, was to top the tower. This was later changed to a hemispherical shape. Needless to say, the equipment being installed—most made to order—the tower itself, and the cost the copper electrode and changes engendered took all the money Tesla had. The smaller investors stood by, waiting to take their cue from Morgan. That financial baron had

the key to hospitality

Del Capri

HOTEL and APARTMENT SUITES

On world famous Wilshire Blvd. Newest and finest accommodations. California contemporary styling. Every room equipped with TV and AM - FM radio. **FREE PARKING.** Completely air - conditioned. Large swimming pool and plenty of patio for lounging in the sun just outside your door.

Luxurious comfort combined with all modern conveniences. **THE BEST ADDRESS in**

10587 Wilshire Blvd.
Los Angeles 24, Calif.
GRanite 4-3511

LOS ANGELES
CALIFORNIA

radio amateur
callbook

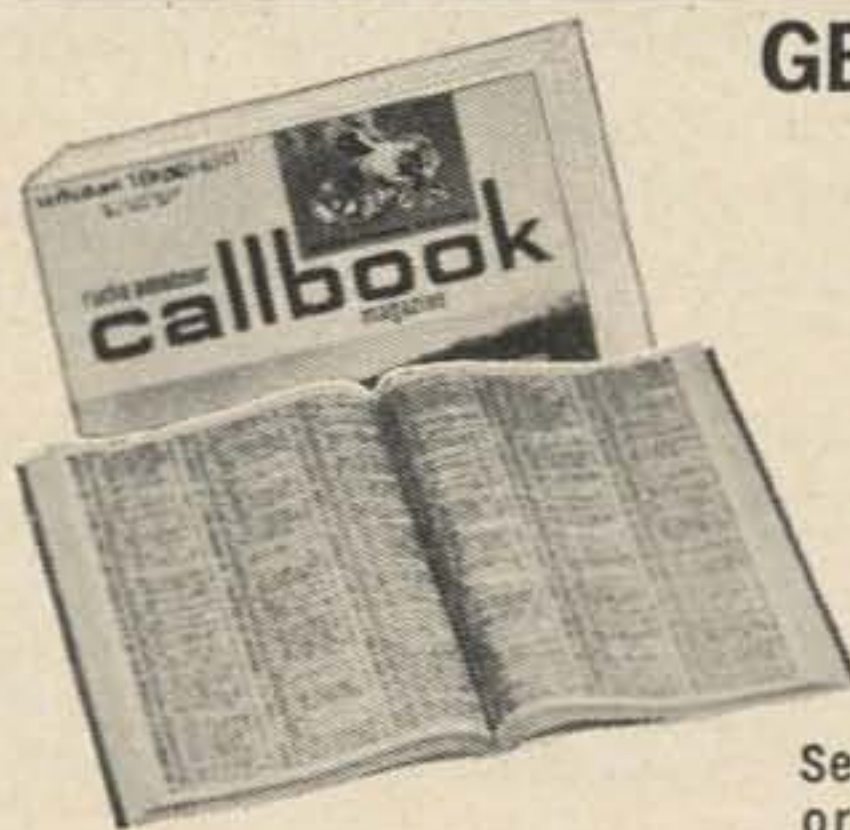

GET YOUR NEW ISSUE NOW!

Over 283,000 QTHs in the U.S. edition
\$6.95

Over 135,000 QTHs in the DX edition
\$4.95

These valuable EXTRA features included in both editions!

- QSL Managers Around the World!
- Census of Radio Amateurs throughout the world!
- Radio Amateurs' License Class!
- World Prefix Map!
- International Radio Amateur Prefixes
- Radio Amateurs' Prefixes by Countries!
- A.R.R.L. Phonetic Alphabet!
- Where To Buy!
- Great Circle Bearings!
- International Postal Information!
- Plus much more!

See your favorite dealer or order direct (add 25¢ for mailing in U.S., Possessions & Canada. Elsewhere add 50¢).

WRITE FOR FREE BROCHURE!

RADIO AMATEUR
callbook INC.
Dept. B, 4844 W. Fullerton Ave.
Chicago, Ill. 60639





HAM V-O-M 20,000 OHMS/VOLT

The only low priced
V-O-M with a 5000
vdc range!

dc volts: 2.5, 10, 50, 250, 500, 5000
ac volts: 10, 50, 250, 500 @ 1K/volt

Name _____
QTH _____
City _____ State _____ Zip _____

REDLINE - JAFFREY - NH - 03452

ORDER TODAY

Ohms: 12K, 120K, 1.2M, 12M
dc mA: .05, 5, 50, 500
dB: 0, 14, 28, 34, 40

ONLY \$9.95

No taxes anywhere Plus 90¢ shipping

made a good deal of money on the General Electric Company, whose financing he had accomplished, and the others reasoned that if he was backing Tesla again, they would follow. They did not know that the sum was a personal gift, not a business investment. When Tesla ran into financial difficulties and Morgan did not rescue him, rumors arose that Morgan had withdrawn his support in dissatisfaction. Tesla was unable to raise further capital and the "World-system" went down the drain. A couple of personal friends extended sums, which Tesla used to pay off creditors.

It may be argued that the system was a technological failure, that Tesla was unable to produce the results he had claimed. However, his earlier experiments in Colorado had been sufficiently practical to win him U.S. patents. It is hardly necessary to say that the Patent Office does not grant patents on conundrums such as perpetual motion machines.

Tesla wrote of this failure: "My project was retarded by the laws of nature. The world was not prepared for it. It was too far ahead of time. But the same laws will prevail in the end and make it a triumphal success."

Nevertheless, Tesla did not regain his stature as creator after this episode and his twilight years were taken up with ever smaller practical projects and ever more grand dreams and theories. His next major enterprise was the successful development of a bladeless turbine, another revolutionary idea. The Tesla turbine used a rotor composed of a series of smooth discs. Steam entered through center porting and flowed in spiral lines around the discs, dragging them along by virtue of viscosity and adhesion. The first experimental model, built

in 1906, was six inches in its largest measurement, weighed about 10 pounds, and developed 30 horsepower. But it was another case of being too much ahead of time and revolutionary. Though the high cost of machining the conventional turbine bladed rotor made the Tesla approach attractive from a cost viewpoint, the conventional turbine was already highly developed and accepted.

In 1911, Tesla adapted the radio-control apparatus he had developed for his 1898 submarine demonstration to an airplane and presented his plans to the War Department, where the scheme was laughed at. Of course, this was the same period when Robert Goddard, the American father of modern rocketry, was ridiculed as a crank by the military savants of this country. By 1936, the aging Tesla had completely recanted in his idea that devastating weapons would make Mankind turn away from war; he claimed that he had conceived a 'death ray,' but would not give his calculations to the government. Fantasy, some say. Yet it is a fact that the Federal Bureau of Investigation impounded his papers when he died in 1943, and for all this writer can discover, still has them. The death ray would have been only a defensive weapon, because it required staggering amounts of electrical power. It would have secured a country against enemy air attack. As early as 1917, Tesla had thought about this problem and had described the possibility of apparatus which could broadcast short-wave impulses and receive reflected waves which would be displayed on a fluorescent screen—radar, in short.

Fortunately, Tesla wrote a good deal in later years. Gernsback's "Electrical Experimenter" published a series by the scientist starting in 1919, which gives some valid

biographical data and a good review of his discoveries and plans. Tesla also wrote on diverse subjects: van de Graaf generators, Servian poets and translations of their works, the compass, the moon's rotation, woman's role in future society. Perhaps the writing that caused the greatest reaction from the public was "The Problem of Increasing Human Energy," in Century magazine, June, 1900. Instead of a dry scientific dissertation, Tesla took a philosophic approach, derived in part at that time of a mechanistic view of Man. In this massive article, he discussed such topics as public health, morals, diet, the outlawing of war, his telautomatics and their potential use, harnessing solar energy, the iron industry, the coming age of aluminum, new power sources and prime movers, wireless and the secret of tuning, and the practical possibility of interplanetary communication.

Concerning the latter, Tesla had claimed that he had received radio-type signals which could only have come from outer space. Conventional people, both scientists and laymen, laughed. Marconi claimed the same results. Many years later, Project OZMA's radio telescope began probing the stars for intelligent signals. And the recent International Astronautical Congress in Rome heard a paper which reviewed the findings of Tesla, Marconi and the Scot, David Todd.

In 1912 the Nobel prize in physics was awarded jointly to Tesla and Edison. Though he could have sorely used the \$20,000 prize money, he refused the honor. Tesla called himself a discoverer and Edison an inventor.

"Placing the two in the same category would completely destroy all sense of the relative value of the two accomplishments," he wrote. By a great irony, a few years later friends persuaded Tesla to accept an honor presented by the American Institute of Electrical Engineers—the Edison medal. In 1936, the Yugoslav government awarded an honorarium of \$7,200 a year to the aging scientist.

On January 7, 1943, Tesla passed away, ignored by the world he had helped to energize. He had once written: "The opinion of the world does not affect me. I have placed as the real values on my life what follows when I am dead." A prophetic statement—for less than a year after his death, the United States Supreme Court rendered a decision that the Marconi radio patents were invalid, on the basis of prior work by Tesla and others. Had this significant decision been reached during Tesla's lifetime, he might not be all but forgotten today. Every school child knows of Edison. Most people have heard of Marconi—but the name "Tesla" raises blank stares. Of course, much has been written about Tesla concerning his eccentricities, his strange beliefs and habits—sensation-mongering that has led attention away from his accomplishments. However, the summation must be that his was a brilliant career—he led the way for the world during the peak of his abilities, and as his influence ebbed, he pointed to future realizations for others. His successes are beyond dispute. His failures may yet yield practical results. ■

ATTENTION

Last minute news! W3EFI and WA5AXW/3 are sending up a balloon containing a 1/2 watt transmitter sending a series of dits. The unit will go to 50,000 ft. and will be launched February 26th. Frequency will be 28.250. Send signal report and time/date heard to: Ken Hollan, W3EFI, Fairhaven, Maryland, 20796. Future balloons will include telemetry and more sophisticated equipment. Hopefully we will hear more from these enterprising hams.

LEARN RADIO CODE



\$9.95

Album contains three 12" LP's 2 1/2 hr. Instruction

THE EASY WAY!

- No Books To Read
- No Visual Gimmicks To Distract You
- Just Listen And Learn

Based on modern psychological techniques—This course will take you beyond 13 w.p.m. in LESS THAN HALF THE TIME!

Also available on magnetic tape. See your dealer now!

EPSILON RECORDS

206 East Front Street, Florence, Colorado

Go Mobile!

Joe Hannigan WB6ACM
887 Islay 3
San Luis Obispo, CA93401

So you've decided to go mobile. Have you considered the problems you may face when it comes time to put the rig in the car?

Have you decided on your equipment? Let's think about it for a while.

High power is not too practical for mobile operation. A medium powered transceiver will work around the world. Also, the lower power adds a challenge to the game, and saves batteries and generators as well.

Unless you have one of the larger luxury cars or have no family, you'll want a unit that takes up as small a space as possible (some 300 watt units take up less than a cubic foot).

If you're not a VHF'er, you'll want a rig that will work on 80 through 10 meters and an antenna that covers those bands. Long whips may cause a problem with mounting and can be dangerous when you go around a corner (it might wrap around something or someone)!

Now, let's see what problems lurk ahead.

The first step in the installation is to mount the antenna. A body mount should be used, because it will give greater efficiency by providing added height. Place the mount on the top of the left rear fender. This position will give a good radiation pattern. A better pattern can be achieved by mounting the antenna in the center of the roof, if you have the courage.

A bumper mount can also be used, but a poorer ground may result.

The coaxial cable should be run from the antenna mount to the position chosen for the transceiver, usually be under the dash.

Take care to protect the cable from fraying when it passes through holes in the body of the car by installing grommets.

The transceiver should be mounted as far toward the firewall as possible to give the passengers as much room as possible. This saves the equipment from being kicked when they enter the car.

Make sure the installation is as vibration proof as you can make it so that the printed circuit boards won't be broken and other parts shaken loose.

The power supply is next. It should be placed as far in front of the engine and radiator as possible. Power transistors generate a large amount of heat, and need to be kept cool. Position the supply so it will be in an area of maximum air flow. It unit should be mounted flush with the body of the car to insure a good ground, and to allow the body to act as a heat sink.

Run the cables from the power supply to the transceiver, but be sure to remember the grommets! Keep the leads as short as possible.

Remove the fuse from the power supply and connect the battery cables. These cables should be as short as possible (no more than three or four feet), or poor voltage regulation will result. Put the fuse in the supply, and you're almost ready to go on the air.

You still need a speaker, but most cars have one mounted for the car radio. Clip the speaker's hot lead and install an spdt toggle switch. Attach one lead from the car radio and one lead from the transceiver, and use a common ground for both.

Don't turn the rig on yet!

Check your job of wiring. A little precaution now can save time and money. If you're sure everything is wired correctly, throw the switch.

Run tests at low power first and check



The advantages of a collapsible whip antenna are many. You may want to reinforce the whip to halt wild swaying when cornering by using an insulated brace mounted on the car body.

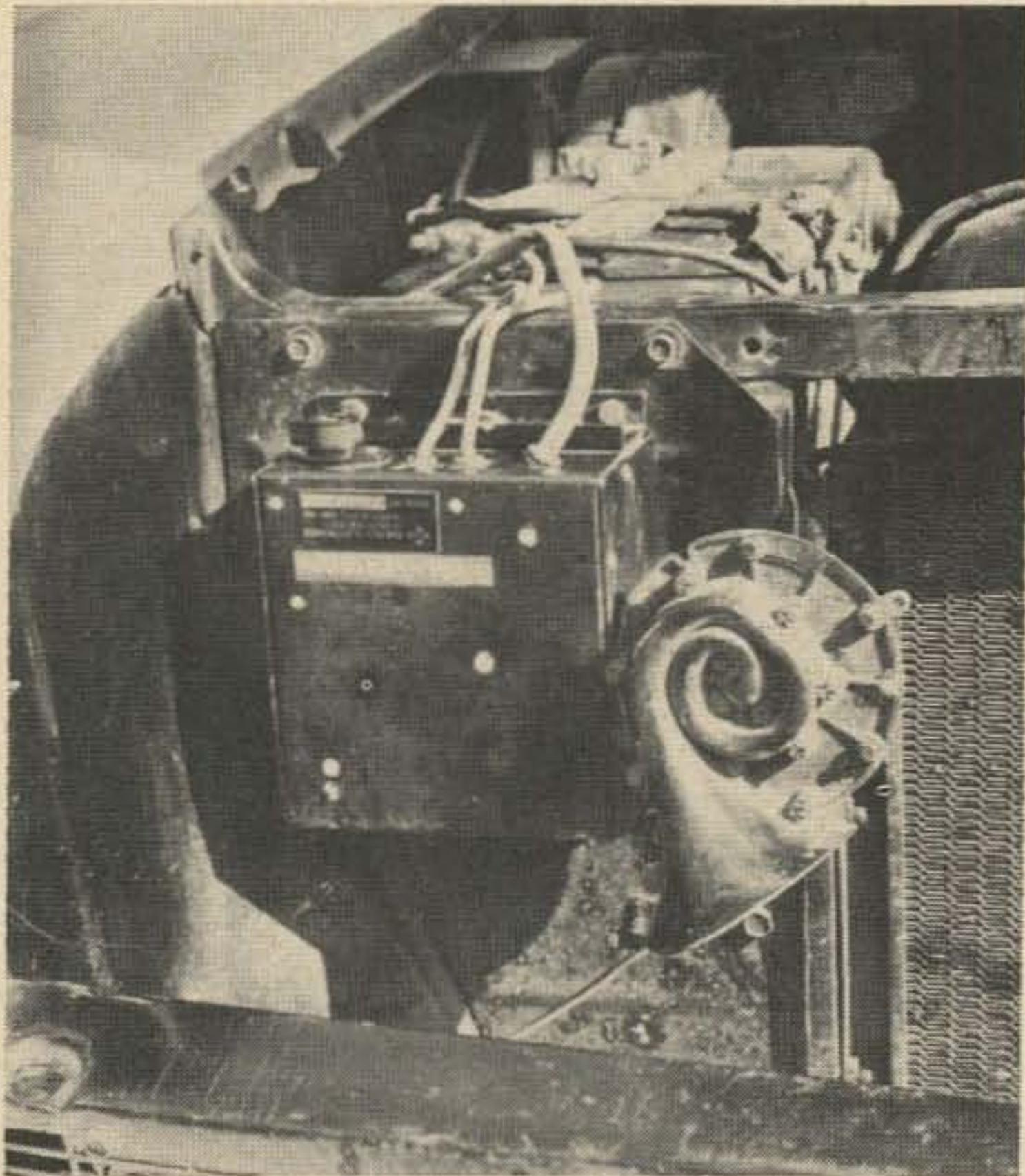

Special attention should be given mounting the power supply. Be sure plenty of air reaches it and make it as water tight as possible. Keep all cables as short as is practical.

the standing wave ratio by inserting an SWR bridge in the antenna line. An SWR of 2:1 is reasonable.

Now try full power, and have a friend listen to your signal, checking for clarity, strength and frequency drift (which could be caused by having too long a cable from the battery to the dc supply!)

That about does it. The pleasures of mobile operation await you.

With the current sun spot activity, world wide communications are possible using low power on 20 meters. If you like DX (who doesn't), now you can enjoy it while you take a Sunday drive, or while you're caught in a traffic jam on the freeway.

If you can't hear the weak DX stations because of the ignition noise, try one of the commercially made suppression kits.

I work the VK's and ZL's regularly from California with S9 plus signals and DXCC is about 50 countries away. You can enjoy mobiling, too, and share the adventure. But be sure you do a good job when you install the rig. It'll pay off. . . . WB6ACM

THE BEST 2 METER CONVERTER

Model 407
\$34.95
ppd.

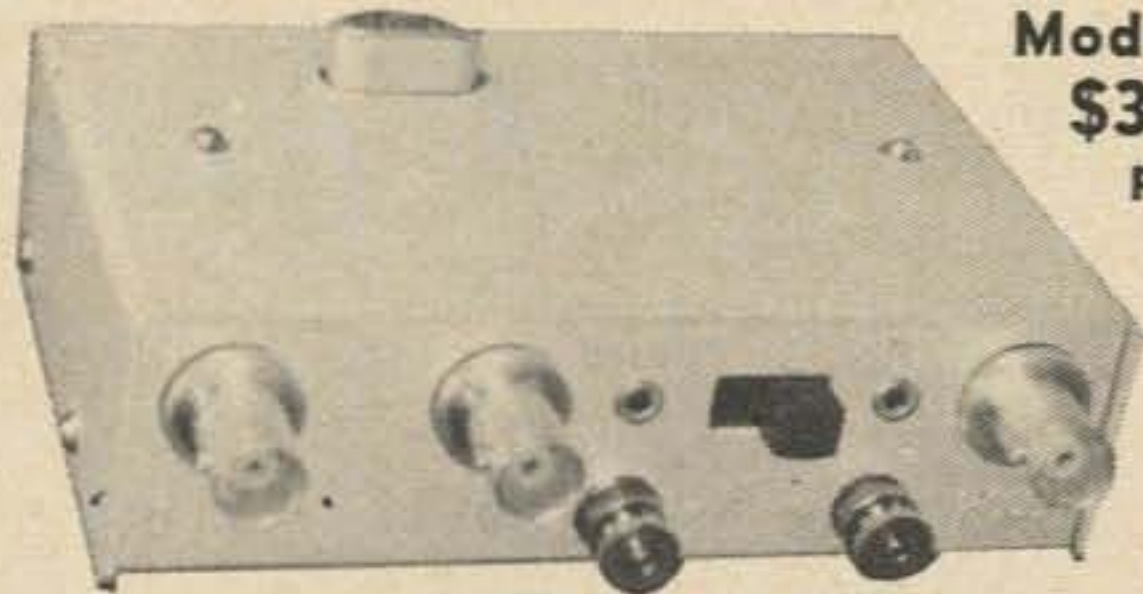

144-146 MHz in. 28-30 MHz out
or 146-148 MHz with a second crystal

A full description of this fantastic converter would fill this page, but you can take our word for it (or those of hundreds of satisfied users) that it's the best. The reason is simple—we use three RCA dual gate MOSFETs, one bipolar, and 3 diodes in the best circuit ever. Still not convinced? Then send for our free catalog and get the full description, plus photos and even the schematic.

Can't wait? Then send us a postal money order for \$34.95 and we'll rush the 407 out to you. NOTE: The Model 407 is also available in any frequency combination up to 450 MHz (some at higher prices) as listed in our catalog. New York City and State residents add local sales tax.

VANGUARD LABS

Dept. H, 196-23 Jamaica Ave., Hollis, N.Y. 11423

ENGINEERING DEPARTMENTS OF UNIVERSITIES AND COLLEGES

ARE YOUR COSTS TOO HIGH FOR REPAIRS AND CALIBRATION?

Better check with Leger Labs...we have reasonable prices and prompt service.

We can repair, align and calibrate:

- Gertsch FM7 and FM9
- General Radio 1606A
- General Radio 916AL
- General Radio 1601A
- Empire Devices equipment
- RF Voltmeters
- RF Ammeters
- Stoddard Field Intensity meters
- Narrow band
- High band — low band FM

We do authorized warantee repairs for:

Julie Research Laboratories, Datapulse, Micro-Power, Power/Mate, National Radio, Wavetek, Data Technology Corp. (digital voltmeters), Singer Metrics.

LEGER LABORATORIES

Groton Street, East Pepperell, Mass. 01437
Phone: 617-433-2721

To get here from Harvard take 495 north to 119 and then 111 into Pepperell. From Concord NH take the Everett Turnpike to route 3 to 111 to Pepperell. Come see our new building. Come buy a beam or a tower . . . or get just about anything fixed.

Getting Your Extra Class License

Part I — AC-DC Theory

Having completed the study course for the Advanced Class examinations, let's turn our attention to the Extra Class ticket and its technical requirements.

The official FCC study list to prepare for the Extra Class exam includes 79 questions, most of which appear much more forbidding than do the 51 for the Advanced Class license. However, if you've stuck with us this far you may be amazed at how much of the required information you already have!

We'll tackle the Extra Class just as we did the Advanced, by selecting several questions from the study list which deal with the same general subject, and then exploring that subject in detail. We'll also continue to paraphrase the official questions into broader queries, to assure that we get all the necessary information rather than just enough for memorization.

At times, we'll refer back to the Advanced Class articles; in several cases, our broader questions covered not only the data needed for Advanced tickets but that for Extra Class as well.

To kick off this course, let's take the group of questions dealing with ac and dc theory. We covered much of the information needed to answer these questions last time out, in the final installment of the Advanced Class course, and so this is a good time to get the rest of it.

The FCC study list questions included in this group are (all numbers, as always, are from the study list):

10. What is the meaning of the time constant in a resistance-capacitance circuit?
16. What are inductive and capacitive reactance? How are their phase angles related?
25. How do mica and paper dielectric

bypass capacitors compare at different frequencies?

26. How do filter capacitors made of mica and paper compare at different frequencies?
30. What does the term "power factor" mean in reference to electric power circuits?

All of these questions deal with characteristics of capacitors and inductors—even number 30. Last time out we went into great detail concerning reactance, so we'll refer you back to that one so far as question 16 is concerned. The rest of the group can be covered by posing four questions:

First would come "How do capacitors and inductors work?" With that settled, we can ask "What are time constants?" to get a handle on question 10. While we find out how the devices work we'll meet the term "dielectric" and so a natural successor in our list of questions would be "What is a dielectric?" There, we'll find answers which apply to questions 25 and 26. Finally, we'll ask "How about power factor?", and dispose of the final question from the original list for this month.

Ready? Let's get on with it.

How Do Capacitors and Inductors Work?
Both capacitors and inductors are, essentially, energy-storage devices. Each of them works by storing energy, but they do so in opposite ways.

Energy may be stored in many different ways. A living creature, for example, stores heat energy by chemical action which transforms the energy already stored in its food into another class of compounds more suitable for storage in its body. Both the food and the body itself are basically chemical structures—but the energy which is stored,

and which powers the creature, is that of heat.

Similarly, a storage battery or storage cell stores electrical energy by chemical action. The electrical energy causes chemical changes within the storage cell. These changes turn the electrolyte of the cell from its original chemical compound into another. When, sometime later, the electrical energy is needed, the second compound is transformed back into the first—and in the process, the electrical energy is made available to an external circuit.

The energy storage action of capacitors and inductors is somewhat more direct in that no chemical transformation occurs. The capacitor stores electric (sometimes called electrostatic to distinguish it from “electricity”) energy by creating a temporary “electric field”, while the inductor stores magnetic energy by forming a magnetic field. Since “electricity” always involves *both* electric and magnetic fields, storing either kind of energy in its own field is a direct storage of “electricity”.

A capacitor consists simply of two conductors, of any sort at all, separated by an insulator known as the “dielectric” of the capacitor.

An inductor, on the other hand, consists of only one inductor, surrounded by its magnetic field.

You can see from these definitions that *any* wire carrying an electric current must be an inductor, and any two wires which are not connected to each other must form a capacitor. This is absolutely correct.

In fact, this “stray” capacitance and inductance which is present in every electrical circuit is one of the biggest problems the VHF or UHF worker must battle. The inductance of a 2-inch length of hookup wire is not very large; normally you can merely ignore it, but when the frequency gets high enough it may be *more* inductance than the design calls for. Similarly, the capacitance from one pin of a tube socket to an adjacent pin is usually less than $\frac{1}{2}$ pF, which again is a very small value—but when the frequency is far enough up there, this may be more than the maximum allowable for a circuit.

In the rather unrealistic world of “pure” theory, though, we can *imagine* such things as perfect resistors which have no capacitance or inductance, perfect inductors with

no capacitance, and the like. And even in the more realistic world we live in, most of the time we can consider all the capacitance in a circuit to be contained in those components called capacitors, and all the inductance to be in the inductors.

These “normal” capacitors usually have plates and dielectric made out of thin, rather flexible material, and rolled into a cylinder or similar shape to occupy the least space. We’ll look at the physical details of the various types of capacitors in more detail when we examine the properties of the dielectric, a bit later in this session.

The “normal” inductor usually has its single conductor wound into a coil, so that the magnetic field tends to be concentrated in a single region. This permits the field to store more energy in the same space, than would be the case if the conductor were stretched out straight. Inductors for *rf* use frequently use nothing at all to strengthen the field, but you will often find ferrite slugs used as “cores” in the inductor. The same current can create a stronger field in the ferrite core than it can in air, thus increasing the inductance of the coil. Audio inductors almost invariably use either ferrite or soft iron cores.

Brass slugs are also used in *rf* coils; they serve a purpose opposite to that of the ferrite. Where the ferrite core increases inductance of the coil, the brass slug decreases it. Effectiveness of either type of core depends upon how much of the field is occupied by the core; this permits adjustment of inductance by moving the core in or out of the coil.

Capacitors and inductors store energy without regard to whether ac or dc is flowing in the circuit which contains them. However, their energy is “polarized”; that is, a capacitor charged with dc will retain the polarity of its charge. In an ac circuit, the polarity reverses every half-cycle, and as a result the capacitor discharges at every reversal and re-charges with opposite polarity. This effect is the cause of phase shift, which we went into in such detail last time.

Both capacitors and inductors store energy by converting it from a moving “wave” into a stationary “field”; just exactly *how* this is accomplished is still not known, but the theoretical boys are pretty well certain that it’s somewhat similar to the stretching of a rubber band which converts energy of

motion—kinetic energy—into energy of tension—potential energy.

The capacitor works on voltage, and stores it in an electric field, while the inductor works on current and stores it in a magnetic field.

Either kind of field is unstable, once energy is stored there. The energy, like the stretch of the rubber band, is eager to get out. That's what makes the whole idea practical.

The energy-storage aspect of capacitors and inductors is most apparent in some of their non-radio, dc applications. For example, a photographer's strobe-light unit uses large capacitors to accumulate a high-voltage charge. This charge is measured in watt-seconds, and a typical strobe operates at 50 to 100 watt-seconds, with anywhere from 250 to 2500 volts. The charge accumulates over a period of several seconds; some units take as long as a minute to re-charge after each shot. This means very little power is necessary. The discharge, however, happens in a very few thousandths of a second, so that during that time you have the equivalent of a 50-kilowatt light.

Another example, using an inductor rather than a capacitor, is the Kettering auto ignition system, which was standard equipment on all autos from the days of the magneto until the rise of transistorized ignition and is still widely used. Here, the ignition points are closed most of the time and a current of several amperes flows through the ignition coil primary. This is a rather sizeable inductor, and a large magnetic field results which stores much energy. When the points open, the primary circuit is broken. The current no longer flows, which releases the "stretch" holding the field in place, and the magnetic field collapses. This collapse releases the stored energy of the field, which reappears as high-voltage pulses at both the primary and the secondary windings.

The purpose of the whole thing is to produce a 25000-volt pulse at the secondary winding; the 250 to 500-volt pulse in the primary circuit is an unwanted side effect. That's the purpose of the capacitor known to mechanics as "the condenser" across the points; it stores the energy of the primary pulse and returns it to the circuit.

These examples bring out one of the fundamental differences between energy storage in a magnetic field and in an electric

field. A capacitor is charged by application of voltage, and the electric field will remain there—stretched—until you discharge it. The inductor is "charged" by applying current, but the magnetic field remains only as long as current flows and "snaps back" as soon as current stops.

What Are Time Constants? It would appear, from what we've seen so far, that any capacitor could store as much energy as any other capacitor. If you qualify this by adding to it the words "of the same capacitance", the statement is true. The only factor affecting the amount of energy which a capacitor can store is its capacitance, which is determined by the *area* of its conductors or "plates" and the thickness of its dielectric.

Practical capacitors, of course, have a few other limitations such as voltage rating and self-inductance, but we'll get into these later. The essential point at this stage is that the size of the field is limited only by physical characteristics of the capacitor itself and not by any other component in a circuit.

In most if not all applications of capacitors, though, we must consider not only the capacitor but also the rest of the circuit—and the other parts of the circuit *do* affect the size and strength of the field at any specific instant.

For instance, let's look at the capacitor as being something like a large water glass. It can hold a pint, let's say. We can fill it up from a gallon bucket in a hurry, or we can trickle water in from a dripping faucet. The glass will still fill to its pint capacity—but it will take longer.

A capacitor being charged with dc reacts in just the same way. If we connect it directly to a battery, it will charge rapidly until it reaches approximately the same voltage as the battery. If we connect it to the battery through a large resistor, which reduces the current flow to a mere trickle, it will take longer to charge—but it will eventually reach the same voltage, if we leave it connected long enough.

That's the whole meaning of the term "time constant". As it turns out, we can connect a 1-mfd capacitor in series with a 1-megohm resistor to a 12-volt battery, and the capacitor will have reached a voltage of about 8 volts after 1 second. If we connect a 2-mfd capacitor in series with that same 1-megohm resistor, it will take twice

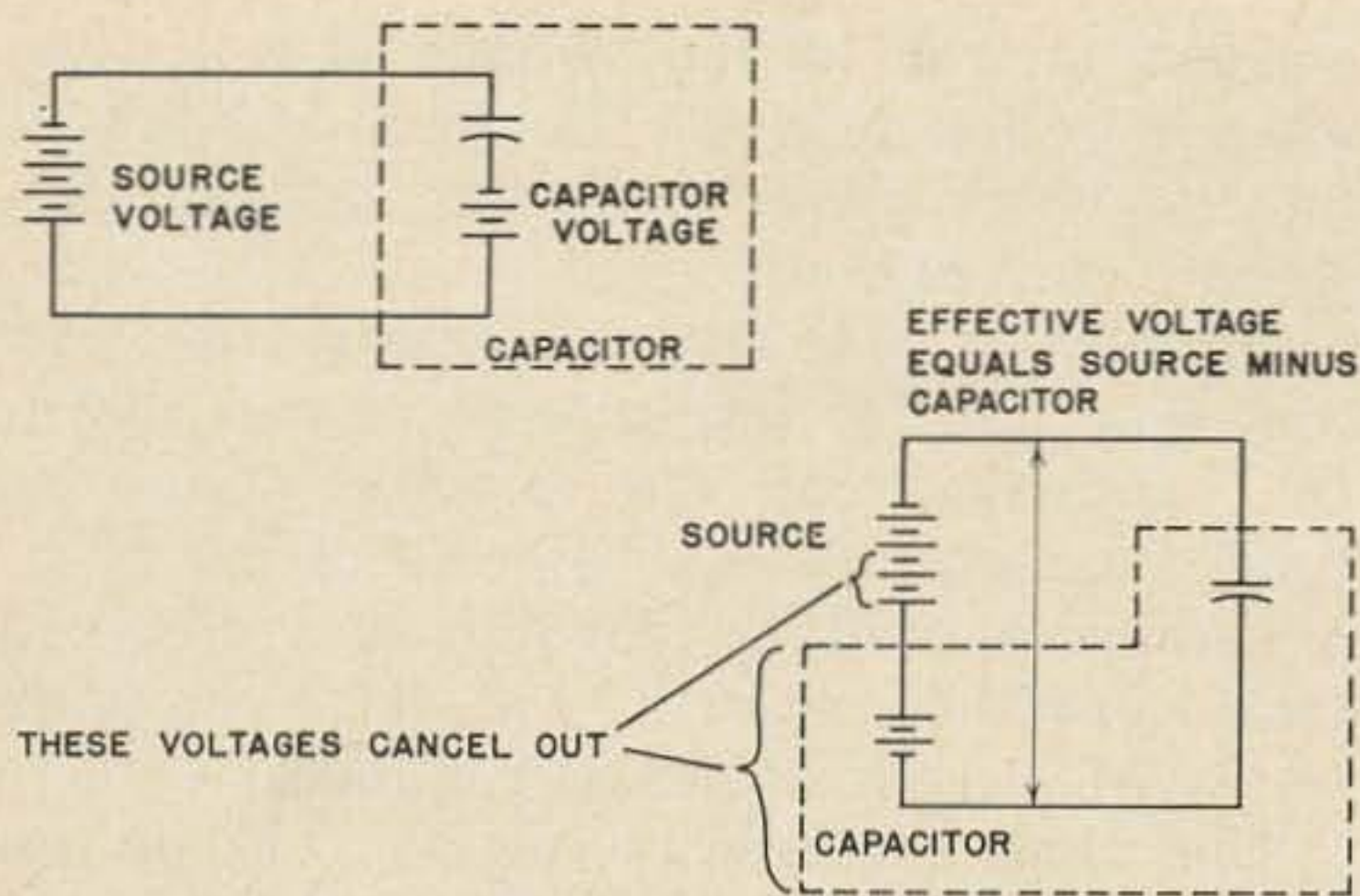

Fig. 1—When a capacitor is charging, three voltages must be considered. The obvious one is the voltage of the source from which the charge comes. However, as charge accumulates on the capacitor it takes on a voltage which acts to oppose the source voltage; the effective voltage available to keep charging action going is then the source, minus the voltage on the capacitor. This is why charging slows and eventually apparently stops when a capacitor is connected to DC.

as long to reach the same voltage since the capacitor is twice as large. However, if we use a 2-mfd capacitor and a $\frac{1}{2}$ -megohm resistor, the time will remain constant.

For capacitors, time constant is defined as the product of resistance in ohms times capacitance in farads. Resistance in megohms times capacitance in microfarads gives the same result, and the resulting time constant is measured in seconds. In our examples, 1 megohm \times 1 microfarad = $\frac{1}{2}$ megohm \times 2 microfarads = 1 second time constant.

The same rules apply to inductors, but the R-L time constant is not nearly so widely used as is the R-C time constant. We'll concentrate on the R-C case.

You probably noticed that in our examples above the capacitor had charged only to about 8 volts, rather than to the full battery voltage, after 1 time constant's worth of time had elapsed. Why?

The reason is a little tricky, and most texts resort to differential calculus to explain it. Let's see if we can't make it clear by using only simple arithmetic.

When we set out to charge a capacitor, it may look as if there's only one voltage to worry about—but actually there are three. The *source* voltage (our 12-volt battery) is the obvious one. The hidden ones are the *capacitor* voltage and the *effective* voltage. The schematic in Fig. 1 shows what they are.

The capacitor voltage can be thought of as a battery inside the capacitor. Actually, it's the voltage of the charge which we have *already* stored, and since in the series circuit which the charging current must traverse it's opposing the source voltage, it makes the circuit act as if the source voltage were continually decreasing.

For instance, when we have the capacitor charged to 8 volts in our earlier examples, the capacitor voltage is 8 and the source voltage is steady at 12. So far as the capacitor alone (without regard to its already-existing charge) is concerned, the situation is the same as it would be if source voltage were (12 - 8) or 4, and capacitor voltage were zero.

This difference between source voltage and capacitor voltage is what we call "effective" voltage. It's the only voltage available to *add* to the existing charge.

When we started, capacitor voltage was zero and the effective voltage was the same as the source voltage, or 12. As soon as the capacitor had charged any at all, though, the resulting capacitor voltage opposing the source voltage began reducing the effective voltage.

When the capacitor reached 1 volt, the effective voltage was down to 11; when capacitor voltage reached 2, effective voltage was down to 10. By the time capacitor voltage was 8, effective voltage was only 4.

It's like an ant crawling up the side of a wall, who covers half the distance between where he is and the top in any given period of time. During the first period, he makes it half-way up. During the next, he gets half-way up the remaining half, or a total of $\frac{3}{4}$ of the way up from the start. In the next period, he gets half-way up the remaining quarter, or $\frac{7}{8}$ of the total distance.

The higher he gets, the slower he goes. Also, you may notice, he will *never* make it to the top of the wall. No matter how high he gets, he can only make half of the remaining distance in the next period of time.

The same thing's true of a charging capacitor. No matter how long you charge it, it can never reach the full source voltage.

In practice, though, it will get so close—within a few million-billionths of a volt—that you can't tell the difference. And the

longer you leave it connected, the closer it will get.

Our R-C time constant, ohms times farads, is simply a convenient and easy-to-use measure of that "time period" in which our poor ant was climbing. There are good mathematical reasons why it works out this way, but for our purposes it's only necessary to know that a capacitor will charge to 63.2 percent of the source voltage during one time constant, and to know that the speed of its charge is always changing as the voltage changes.

Fig. 2 tabulates the three essential voltages at selected time periods between 0 and 10 time constants, for a capacitor being charged from a 100-volt source.

All this time, we've been talking about voltage only—but whenever we have voltage in action, we must have current too. What happens to the current in this circuit?

Initially, when the capacitor voltage is zero, the capacitor acts just like a short circuit so far as the power source is concerned. Theoretically, the current at this instant is infinite; in practice, it's limited only by the resistance of the wires in the circuit and the capability of the power source.

But as soon as the capacitor begins to charge, the capacitor voltage opposes the source voltage as we have seen and shown in Fig. 2, and so the current drops to a smaller value. The higher the capacitor voltage, the less current flows to charge it.

And as a matter of fact, you can use the figures listed in Fig. 2 to determine the

Time (Time Constants)	Source	Voltages Capacitor	Effective
0.0	100.00	0.0	100.00
0.1	100.00	9.5	90.5
0.2	100.00	18.1	81.9
0.3	100.00	25.9	74.1
0.4	100.00	33	67
0.5	100.00	39.3	60.7
0.6	100.00	45.1	54.9
0.7	100.00	50.3	49.7
0.8	100.00	55.1	44.9
0.9	100.00	59.3	40.7
1.0	100.00	63.2	36.8
1.5	100.00	77.7	22.3
2.0	100.00	86.5	13.5
3.0	100.00	95.02	4.98
4.0	100.00	98.17	1.83
5.0	100.00	99.326	0.674
6.0	100.00	99.752	0.248
10.0	100.00	99.9955	0.0045

Fig. 2—This shows how effective voltage goes down while capacitor voltage goes up. After 5 time constants, capacitor is so close to full charge that it can be considered "charged", but charging continues indefinitely. You can use this for any source voltage by reading the voltage values as being "percent of source voltage".

current as well as the voltage at any time after charging begins. The same column of figures which shows "effective voltage" applies to current flow.

Initially, at 0.0 time constants, the current flow will be 100 percent of that which the external circuit can provide. After $\frac{1}{10}$ time constant, only 90.5 percent of the available current will be flowing, and after 10 time constants, current will have dropped to just $\frac{45}{10000}$ percent of that available.

The time constant of an R-C circuit has many effects, not all of which are obvious. One of the more apparent is the possibility of using the effect to provide a means of timing events—and this provides the horizontal sweep timing signal for most oscilloscopes. Less apparent is its application to bypass and filtering action.

But in the circuit of Fig. 3, for example, if the input signal consists of pulsating dc such as you would get from a full-wave rectifier, and no current were being drawn from the output of the circuit, the capacitor would eventually charge to approximately the peak value of the input signal voltage. Having reached that peak, it would retain that voltage level because the time constant of the R-C network R1-C1 is so long that the capacitor voltage cannot change greatly in the time between the peaks of the input signal.

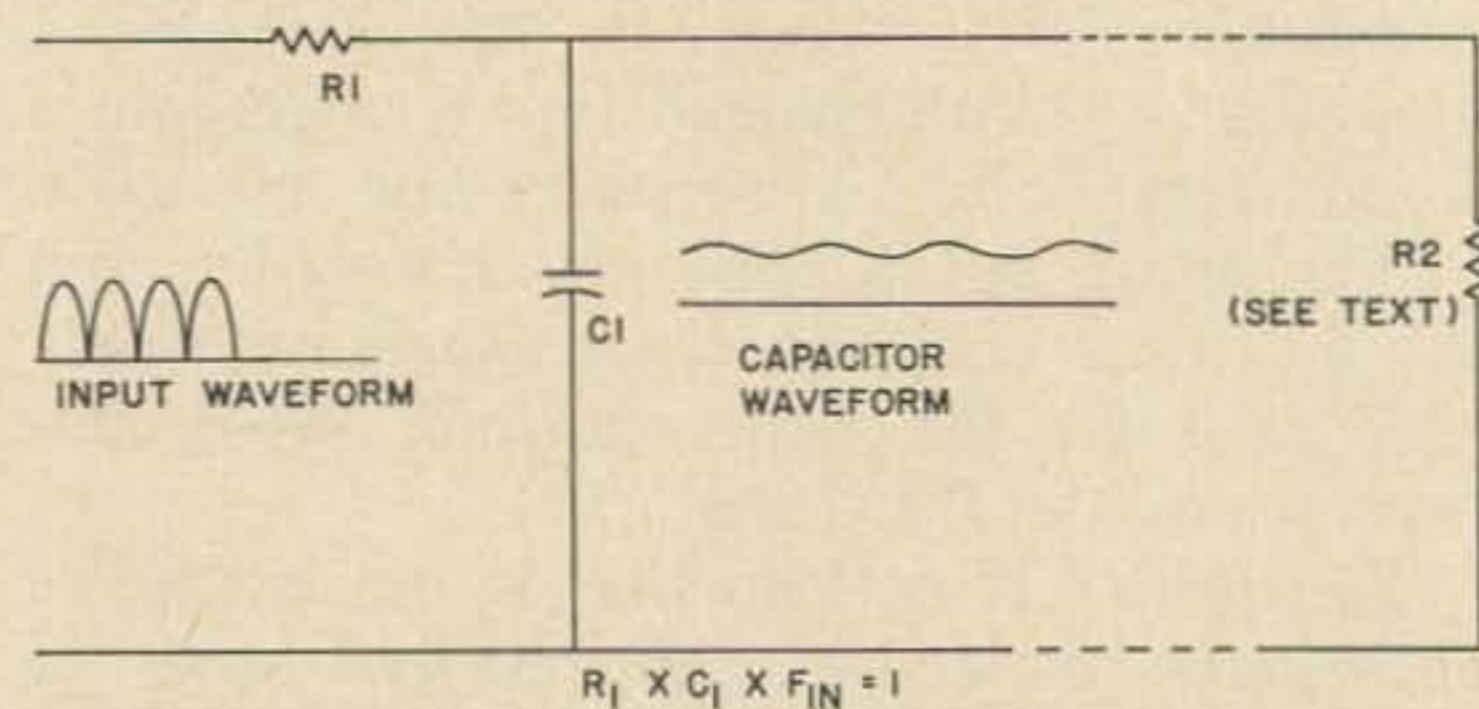

Fig. 3—Time constant of a resistance-capacitance circuit can be used to filter out low-frequency signals, by proper choice of time constant with respect to input frequency and output loading. See text for discussion of resistor R2 which represents load on the filter and affects actual resistance and capacitance values for any practical circuit.

If the value of R1 is reduced, shortening the time constant, the output signal level would have time to fall back in an attempt to follow the input signal. If R1 were reduced to zero, the output signal might be able to follow the input signal almost exactly and no filtering action would occur.

When a load is applied to the circuit, it acts just as if resistor R2 were connected (unless the load is itself an inductor or a capacitor, and we're not considering that kind of load at this point). Now the charge on C1 is bled off through R2 during the time between peaks, and the output level may tend to follow the input signal.

Increasing C1 or R1, either one, will lengthen the time constant and keep the output level more constant. If R1 is increased, though, less current may be taken from the output; if the time constant is lengthened by increasing C1, the available current will not be reduced.

The exact relationship between time constant of a filter or bypass circuit such as that shown in Fig. 3. and the lowest frequency at which bypass or filtering action is effective, is complicated greatly by the variables always present in practice. These variables include the waveform of the signal to be bypassed or filtered, the current through R1 and that through R2, and a number of other quantities.

A useful rule of thumb, however, is to always make the time constant at least equal to one full cycle of the lowest frequency to be filtered or bypassed. For a low-frequency cutoff of 100 Hz, for instance, the time constant should be at least $\frac{1}{100}$ second. This would work out to be a 0.1 mfd capacitor for C1 and a 100 K resistor at R1, or a 10-mfd capacitor at C1 and a 1K resistor at R1, or possibly a 100-mfd capacitor and a 100-ohm resistor. All three of these combinations provide a 0.01-second time constant and would have equal filtering action; the choice between them would depend upon power requirements and impedance of the circuit being filtered.

What Is A Dielectric? We noted several pages back that a capacitor consists of two conductors, known as "plates", and an insulator separating them, called a "dielectric". This implies that any and all insulators are "dielectrics", and in fact this is true. However, when an insulating material is used primarily as the dielectric of a capacitor several characteristics of the material assume considerable importance. They not only help determine the capacitance of the resulting capacitor, but its useful frequency range of operation, the voltage levels at which it may be used, and the temperatures at which it may be employed.

To help us see just how the characteristics of the dielectric determine all these properties of the capacitor, let's take a rather oversimplified look at the way in which a capacitor stores energy.

All materials, of course, are composed of atoms, and atoms, in turn, are composed of protons, neutrons, and electrons. Only the electrons concern us in this view.

The major difference between an insulator and a conductor is in the way in which the electrons are held to the atoms which compose the material. In a conductor, many of the electrons are "free"—that is, they are able to migrate from one atom to another. Since each electron is a minute negative electric charge, this migration or "drift" of the free electrons is what we generally call an "electric current" in the conductor. The greater the pressure, or voltage, which we apply to the material, the more electrons move—and the larger the current.

In an insulator, on the other hand, the electrons are "bound" to their parent atoms more firmly and are not free to drift. While they can, and do, travel comparatively long distances from their "home positions", the binding forces remain to pull them back into place once any pressure is removed. It's very much as if they were attached to the atoms by rubber bands of various thicknesses.

When we apply a voltage to the conducting plates of a capacitor, the pressure from the voltage source pushes a large number of free electrons onto the negative plate.

Since charges of like polarity repel each other, the combined negative charge of all these free electrons pushes the neighboring "bound" electrons in the insulating dielectric away from the negative plate.

The push away provided by the repulsion force is opposed by the binding forces within the dielectric, but in all cases the repulsion force is the strongest and it overcomes the binding forces.

As a result, the electrons of the dielectric, although still bound to their original positions, are pushed out of place and pile up near the positive plate. There, they repel the free electrons in the conducting positive plate, which in turn drift on out of the capacitor into the remainder of the circuit.

The total effect is that a current flows "through" the capacitor—but in so doing,

the binding forces within the dielectric have been stretched to permit the current to flow through.

This tension of the binding forces is usually called "stress", and is the stored energy. So long as the binding forces remain stretched, the energy remains stored within the capacitor. It would be just as accurate to say that so long as the capacitor retains its charge, the binding forces remain stretched.

When a discharge path is provided from one plate to the other, then the binding forces within the dielectric pull the bound electrons back into place. This creates a shortage of electrons at the positive plate and an excess of electrons at the negative plate—but the excess electrons flow through the external discharge path back to the positive plate to make up the deficit there. In the process, their energy is released as electric energy.

As we said, this is an oversimplified view of the process and makes no mention of the "electric field" associated with a capacitor. The oversimplifications lie in the area of "What keeps the binding forces stretched out?", and any attempt to answer *that* one accurately would lead us far into the depths of solid-state physics and beyond the scope of this study course.

But it may be a bit clearer now just how the physical and atomic characteristics of a dielectric can determine so many of the properties of the complete capacitor, since the dielectric is the place in which the actual energy storage occurs.

For instance, some materials have stronger binding forces than others. The stronger the binding force, the more pressure will be required to put in the same amount of "stretch" or stress. This means that the material with the stronger binding force must require a larger electric charge, if physical sizes are the same, than one with a weaker binding force. Its capacitance, then, must be smaller.

This characteristic is normally called the "dielectric constant" of the dielectric, and is also a measure of its insulating capabilities. The dielectric constant is a number which provides a comparison of the dielectric in question with clean, dry air. That is, air has a dielectric constant of 1. Any material whose dielectric constant is greater than 1 will permit greater capacitance for the

same thickness than will air. For instance, a material with a dielectric constant of 2 will make a capacitor having twice the capacitance of one with air as a dielectric, all other things remaining equal, and another material whose dielectric constant is 10 will provide 10 times as much capacitance as air or 5 times as much as the first material.

While the binding force can be stretched over a considerable distance, it cannot be stretched indefinitely. Like a rubber band, it eventually reaches a point at which it snaps. The dielectric material is then permanently damaged. This effect is measured by a characteristic called "dielectric strength", which is usually rated in volts-per-mil. The volts-per-mil is the voltage necessary to cause permanent breakdown in a $\frac{1}{1000}$ -inch-thick sample of the dielectric.

Very few, if any materials, are either perfect conductors or perfect insulators. The most perfect insulators known still retain a few free electrons and so can act as partial conductors, while the most perfect conductors (at normal temperatures) still retain some resistance. This provides a third factor in the dielectric which affects the capacitor greatly—one called "volume resistivity" and measured in ohms per cubic centimeter. The higher the resistivity, the better the insulating qualities of the dielectric. Surprisingly, some popular dielectrics have rather poor insulating qualities; it all depends upon the particular application!

The fourth major characteristic of the dielectric which has large effect upon the properties of the capacitor is the "dissipation factor". Like everything else, the stretch-and-release action of the dielectric is far from perfect. Not all the energy stored when the binding forces are stretched is turned back when the stress is released. Some of it is dissipated as heat within the dielectric.

The "dissipation factor" is the ratio of energy released to energy lost, and like dielectric constant is measured by comparison to air. Air has a dissipation factor of 0.0; most if not all other dielectrics have higher factors. In most, it is also frequently sensitive, with losses increasing as the signal frequency goes up. This is the principal reason why some types of capacitors are suitable only for use at dc or audio frequencies, while others work well up into the UHF spectrum.

A perfect dielectric for an all-purpose capa-

citor, then, should have a high dielectric constant to keep the capacitor small; very high dielectric strength to permit its use with high voltages; high volume resistivity to prevent loss of the stored energy by internal leakage; and a low dissipation factor so that most of the stored energy will be returned to the external circuit upon demand.

Few dielectrics meet all these requirements—and that's why we have so many different types of capacitors available. Of all the various insulating substances available for use as dielectrics, only six major types have found wide use, with a seventh (not usually considered to be an insulator) coming into popularity for special applications.

The classic dielectric is, of course, air. Its dielectric constant is so low, however, that air capacitors of practical physical sizes are limited to small values of capacitance.

A substance even better than air as a dielectric in most of the critical factors is ruby mica. Again, though, the dielectric constant is relatively low and so mica capacitors of any appreciable capacitance are extremely large.

The most popular dielectric for general purpose use through the years has been paper. The paper is almost always treated with special materials to modify the critical factors, but dielectric constant is always high. The principal problem with paper as a dielectric is threefold—the dissipation factor, while reasonable at low frequencies, becomes excessively high in the *rf* region; the dielectric strength is not always great enough to get adequate capacitance and voltage ratings at the same time; and the physical construction, being so much like a coil, introduces undesirable self-inductance.

Despite these limitations, paper capacitors are still the most widely used in moderate capacitance ratings for dc, audio, and low-frequency *rf* applications—and their only serious rivals are members of another very similar class.

These rivals are the plastic capacitors, which use any of a number of types of plastic as the dielectric. The qualities of the plastic can almost be tailored to the needs of the capacitor designer, permitting near-perfect capacitors for any specific purpose, but the physical limitations remain.

Similar to plastic capacitors in some ways,

and vastly different in others, are the capacitors which use ceramic dielectrics. Most of us tend to think of ceramic capacitors as relatively recent devices. Yet glass is a ceramic material—and the very first capacitors, the venerable Leyden jars which date from before the invention of the electric battery, used glass as their dielectrics.

Like plastics, ceramics can be made with almost any characteristics. "Ceramic" capacitors fall into two broad classes, though. One of these—which includes glass—is similar in most ways to mica. It offers extreme precision of manufacture, excellent stability of characteristics over wide temperature ranges and humidity conditions, and moderate values of dielectric constant. The other is not so stable, but has the highest dielectric constant of any type of insulator in wide use except one. This type of ceramic is used in the popular disk bypass capacitors and other units which feature high capacitance in small size. Unfortunately, its resistivity and dissipation factor prevents its use in general applications and limits it to bypassing and filtering.

The sixth type of dielectric provides the highest dielectric constants of all, but at the cost of having the lowest dielectric strength and resistivity, together with polarization effects which restrict its use to dc circuits. This is the electrolyte dielectric, used in electrolytic capacitors.

An electrolyte dielectric is a chemical solution which, in the presence of voltage stress, produces an ultra-thin oxide coating on one face of one plate of the capacitor. This oxide coating is the actual dielectric, and the electrolyte actually serves as the other plate of the unit.

When an electrolytic capacitor is manufactured, its dielectric is "formed" by operating it for a specified time at specified voltages. The unit should never be used at higher voltages than it is rated for—and likewise should not be allowed to stand idle for excessive periods of time, or the oxide coating may go back into solution and cause failure of the unit when voltage is applied.

Because of its unique characteristics, the electrolyte dielectric is used mainly for filter capacitors where the need is for largest possible capacitance values with moderate physical size, and comparatively large amounts of leakage can be tolerated.

Material	Dielectric Constant (relative)		Dielectric Strength (Volt/mil)	Volume Resistivity (ohm/cm ³)	Dissipation Factor (relative)	
	60Hz	1 MHz			60Hz	1 MHz
AIR	1	1	1200	very high	0	0
(standard for comparison of dielec. constant & dissipation)						
MICA						
from	5	5	3800	5×10^{13}	.005	.0003
to	9	9	5600	5×10^{13}	.005	.0003
PAPER						
plain		3.3	2.8	202	not rated	.01
waxed		14.2	5.4	—	abt. 10^6	.12
PLASTICS						
from	1.03	1.03	200	10^7	.00005	.00007
to	11.4	7.0	2000	10^{18}	2.0	.140
PRECISION CERAMICS (including glass)						
from	3.78	3.78	200	7×10^7	.0006	.00001
to	29.5	29.5	410	10^{19}	.03	.0075
OTHER CERAMICS (bypass only)						
from	168	167.7	75	10^{12}	.006	.0002
to	1250	1143	.100	10^{14}	0.56	.0105
ELECTROLYTES						
	(not rated specifically; approximate values)					
Alumin	45	—	450 V max	very low		very high
Tantal	140	—	150 V max	very low		very high

Fig. 4—Key characteristics of the various types of dielectric materials are listed above. Note that all have comparatively high resistivity and most have small dissipation factors.

Fig. 4 lists the four key characteristics for the six types of dielectrics we've examined so far. The figures come from the fourth edition of "Reference Data for Radio Engineers", but in most cases have been modified to cover an entire range of materials rather than specific dielectrics. (The plastics entry, for instance, condenses two pages of reference data into a single line covering the entire range.)

In general, the dielectrics with the larger dielectric constants are used more frequently at dc and low frequencies where larger capacitance values are more frequently needed. The critical factor so far as frequency is concerned is that of dissipation—this is a measure of internal losses, and dielectrics with excessive internal losses are not usable at higher frequencies.

For bypassing, for instance, either a paper or a mica capacitor can be used at low frequencies, but paper would be the more normal choice because of its higher dielectric constant. A physically smaller capacitor could be used, if paper were chosen. As frequency goes up, though, losses in paper increase more rapidly than do losses in mica—and at the same time the capacitance values required for effective bypassing go down. This makes the dielectric constant less important, and the preference would switch to mica somewhere in the neighborhood of 1 MHz.

The high-capacitance ceramic units, however, would be preferable to either so long as capacitance values of 0.1 mfd or less would suffice, since the unit would be smaller than an equivalent-capacitance paper unit, and would perform at least as well as mica up through the UHF spectrum!

In a tuned filter, on the other hand, the mica unit would be preferable in all cases. In a filter, the self-inductance of the capacitor would become an important factor, and that of a typical paper unit would vary widely from manufacturer to manufacturer because of differing construction techniques. All mica capacitors, however, are made in the same layer-cake fashion because mica is brittle, and so the variations would be held to a minimum.

How About Power Factor? Quite a ways back there, in looking at the low-pass R-C filter circuit of Fig. 3, we said that a load on this circuit would look like a resistor, unless the load had either inductance or capacitance—and we begged that question at the time. It's time for it now.

Obviously, any electric circuit could be put into a solid black box with nothing exposed except the terminals, and it would be rather difficult to tell what was inside.

When we're looking at the power circuitry of any device, we can forget all about the signal terminals and look only at the power terminals on that black box. Most of the time, we'll find that the innards of the box cannot be distinguished from a large resistor.

That is, if the gadget operates on dc, it takes both voltage and current, and replacing the black box with a resistor which draws the same current at the same voltage would put the same load on the power supply.

Sometimes, though, that resistor representing the circuit's power usage might appear to have a capacitor in parallel with it—or an inductor in series. If it draws heavy current when it's first connected, which comes down as time passes, that's the same action we would expect from a capacitor. On the other hand, if it draws less current at first than it does after it's been connected for a while, that's the action an inductor would produce. In the first case, we would call it a capacitive load, and in the second, an inductive load.

On a dc circuit, the inductance or capaci-

tance of the power loads is of little importance except at the instant of switching power on. When the power circuit uses ac, though, the inductance or capacitance appearing at the power terminals of a device can wreak havoc with other gadgets on the same line, because of the phase shift introduced on the main power lines by these reactances.

That's what "power factor" amounts to; it's just another way of measuring the apparent capacitance or inductance of a load on an ac power line. Any normal resistive load has a power factor of 0. This means that it is effectively a pure resistance to the power line, free of either inductance or capacitance.

A completely reactive load, having no real resistance in it but composed exclusively of either inductance or capacitance, would have a power factor of 1.0. If it were capacitive, it would be a *leading* power factor, and if it were inductive, the power factor would be said to be *lagging*.

In other words, the term "power factor" refers to the percentage of reactance in the load. The whole thing is almost identical to the "Q" factor we normally apply to coils and tuned circuits, but power engineers use the "power factor" approach instead.

Many "normal" devices used on ac lines have some reactance in them, which reflects to the power line as a power factor. Among these are electric motors, which reflect large inductive power factors when they are coasting, and are highly capacitive loads when power is first applied. The capacitive nature of the motor's load on the line is the reason most motor circuits use slow-blow fuses; these fuses will carry the "charging current" required by the reactive load without blowing, yet still provide protection if the current drain continues for an excessive length of time.

Transformers may reflect either inductive, resistive, or capacitive loads, depending upon the type of circuit connected to the secondary.

In general, power factors of any type of load can be corrected to the ideal 0.0 figure by deliberately introducing the opposite kind of reactance to cancel out that present in the load itself. For instance, "synchro motors" (commonly known as selsyms although this term is actually a trademark) usually appear to be inductive loads to their power

sources. Correcting capacitors are connected across the lines supplying primary power to these devices, to "tune out" the power factor and keep the main power line itself at a power factor of 0. The amount of capacitance required to do this depends upon the power factor present in the load, which in turn depends upon the number of devices and their exact operation conditions.

In most ham power wiring, it's safe to assume that the power factor is always zero and not attempt to adjust it. Normal household wiring is quite tolerant of reactance, as are most devices used with it.

The term "power factor" is also used, in somewhat different surroundings, to describe the "dissipation factor" of a capacitor which we examined in the previous question. This usage, however, is not in reference to electric power circuits. When applied to a capacitor, the power factor is similar to the dissipation factor, and indicates the amount of loss to be expected within the capacitor at power-line frequencies. The higher the power factor, the greater the internal losses.

Next Session. The Extra Class exam is more loaded with theory than is any other amateur examination. While we're working with the basics and some of their finer points, let's stay with them a while longer and examine the details of amplifier operation. Even if you're not interested in the higher ticket, you may find it nice to know how an amplifier works! ■

**Your ad in this space
will reach 65,000 paid
readers (an honest Fig-
ure!). Plus all their
friends who are too
chintzy to buy their own
copy.**

**Call or Write for
Ad rates today
73 Magazine
Peterborough, N.H.
03444
Phone 603-924-3873**



NEW PRODUCTS

MODEL MCQ-3B

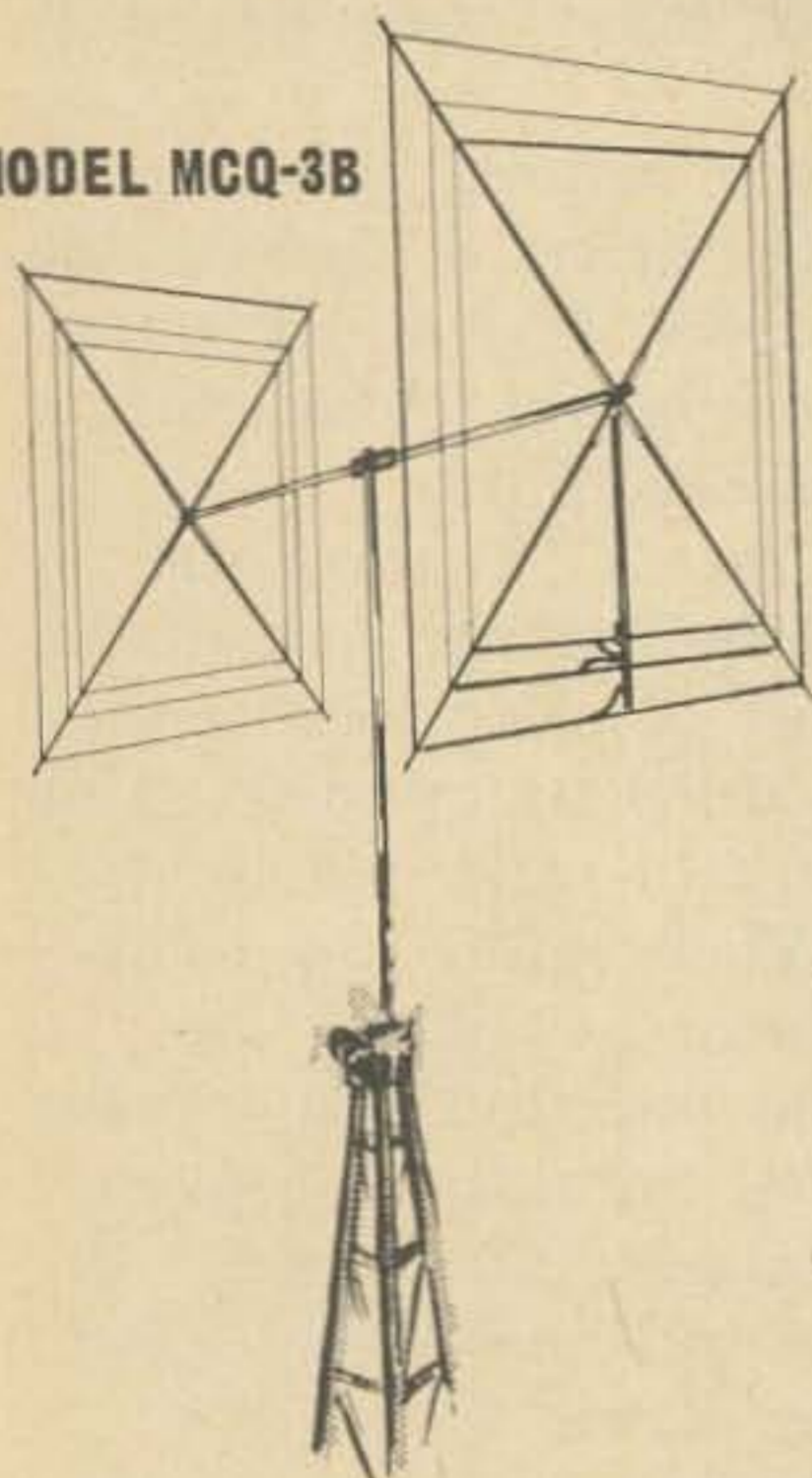

Mosley

Amateur Radio
Cubical Quads

Single Bands

MCQ-10 for 10 meters

MCQ-15 for 15 meters

MCQ-20 for 20 meters

Tri-Band

MCQ-3B for 10, 15 &
20 meters

Mosley Amateur Radio Cubical Quads

Mosley's newly released MCQ Cubical Quad Antennas are available in single-band form for 10, 15, or 20 meters, or as a tri-band quad for all three bands. The antennas feature Mosley's rugged boom-to-mast mounting assembly with stainless steel clamps, 52 ohm coax feed to wire elements, and a Gamma Match coupling arrangement that maintains an SWR of 2.2:1 or better across the entire amateur band. Shipped with boom, spreaders, wire, hardware and instructions. For further data write to Mosley Electronics Inc., 4610 N. Lindberg Blvd., Bridgeton, Missouri 63042.

TAB Book Catalog

If you're in ham radio as a game, or one of the electronics fields for life and advancement, there is a TAB book that you will be interested in. A recently published catalog describes over 100 current and forthcoming books, dealing with broadcasting, servicing, basic technology, electric motors, audio and hi-fi, test gear, transistors, and several other subjects. The catalog is available free upon request, from TAB BOOKS, Blue Ridge Summit, Pa. Ask for their 1968 catalog.

VHF Converter

The performance of 1957's elaborate vacuum-tube receiving converters is considerably improved upon by today's inexpensive solid-state models. Prices are lower, too. For instance, here is a 432 MHz to 14 MHz converter, typical noise figure of 3.6 db., at a kit price of \$29.95. Hams who have been around for a while will realize how remarkable this really is. The circuit requires about 4.5 mA from a 9 to 12 volt battery. Kit available from VHF Associates, PO Box 22135, Denver, Colorado 80222. Since they are an active company, you might ask for their catalog, too.



Varactor Multiplier

Sometimes it is easier to generate radio frequency power at a relatively low frequency, and then to use a simple circuit to generate a much higher frequency output. This possibility is a relatively new arrival in amateur electronics, using a key component now known as a varactor diode.

Varactor diode circuits can handle considerable amounts of power. For example, here is a varactor multiplier that will take up to 40 watts input on 144 MHz to generate about 24 watts output at 432 MHz. Unlike ordinary multipliers, varactors will take AM or sideband inputs as well as CW, without generating unacceptable distortion of the signal.

Several models are available. The one shown here, is priced at \$54.95, from VHF Associates, PO Box 22135, Denver, Colorado 80222.

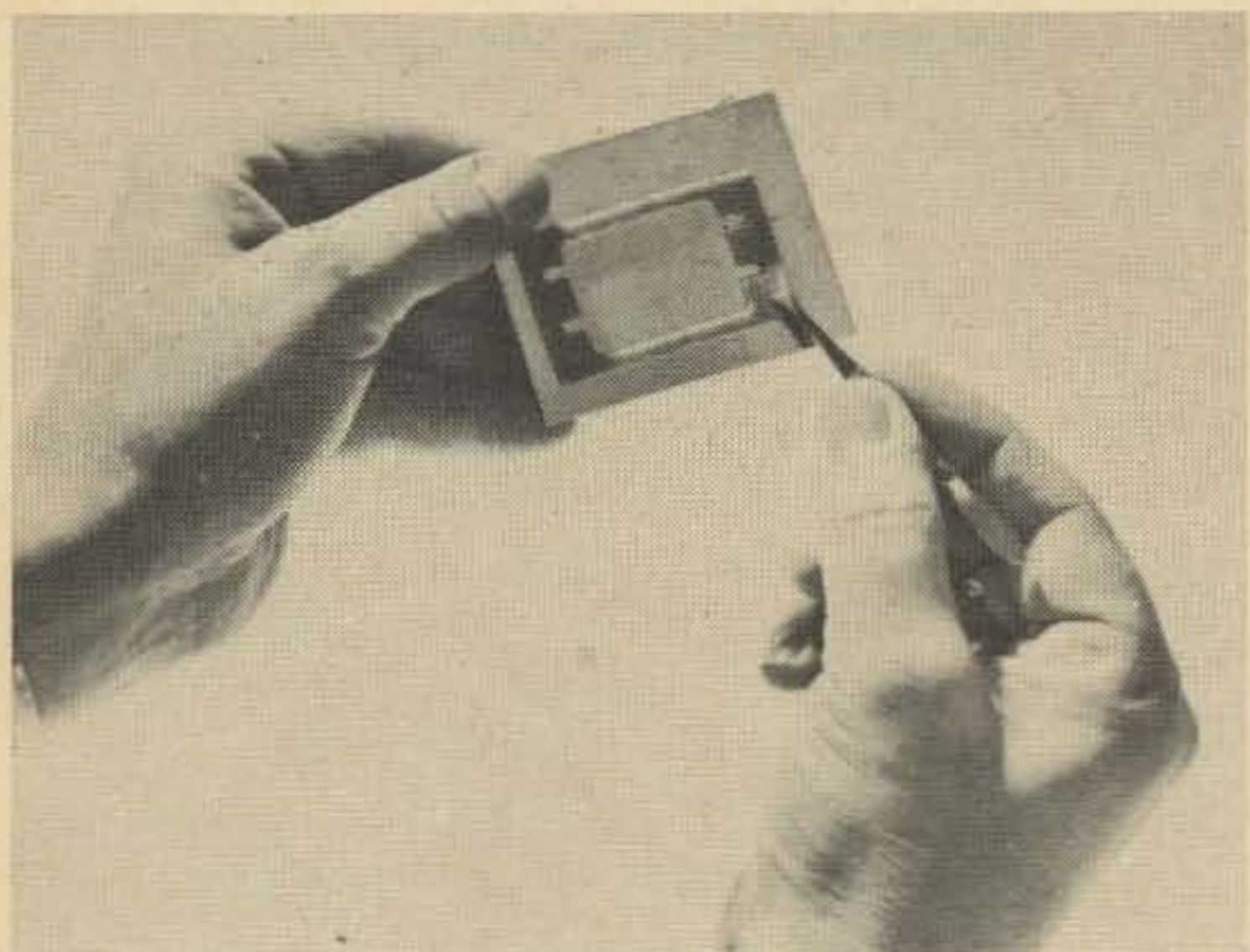

Metex Polastrip

If you are facing shielding or TVI problems, some modern ideas for interference shielding materials may interest you. For instance, how about POLASTRIP, a material provided with tiny wires in elastomer? Under pressure, the wires bite through dirt and oxides to complete connections between two parallel metal surfaces. If the POLASTRIP will not stay in place, you can ask for some POLASTICK. This is a special adhesive which will not interfere with the electrical properties of the strip material. For further information write to the Sales Manager, Metex Corporation, 970 New Durham Road, Edison, N.J. 08817.

Noise Suppressors

Mobile ham radio sounds like a lot of fun, but there are some hard technical problems to get over first. The car builders don't expect their buyers to have ears for electrical noise, but it turns out good ham radios are very sensitive, and respond strongly indeed to the electrical noises cars generate. Very often you can tell, without any technical knowledge at all, that your car is generating excessive noise, by hearing the noise change with the road or engine speed. Is there something you can find that will help stop this noise? Yes, and the Estes Engineering Co. is very active in this field. For a minimum job try their Ignition Suppression Kit #6415 at \$8.95. Or for a more complete treatment their Universal Suppression Kit goes for \$14.95 to reduce noise from spark plugs, distributor, generator, and other parts of the car. From Estes Engineering Co., 543 West 184 St., Gardena, Calif. 90247.

BACK ISSUE GUNSMOKE*

*some..other..unmentionable
publication has used Bonanza

30 (THIRTY) 30 count 'em 30 tremendous stupendous fascinating enormous devastating incredible enervating back issues

ONLY

\$5 (WOW!)

postpaid worldwide

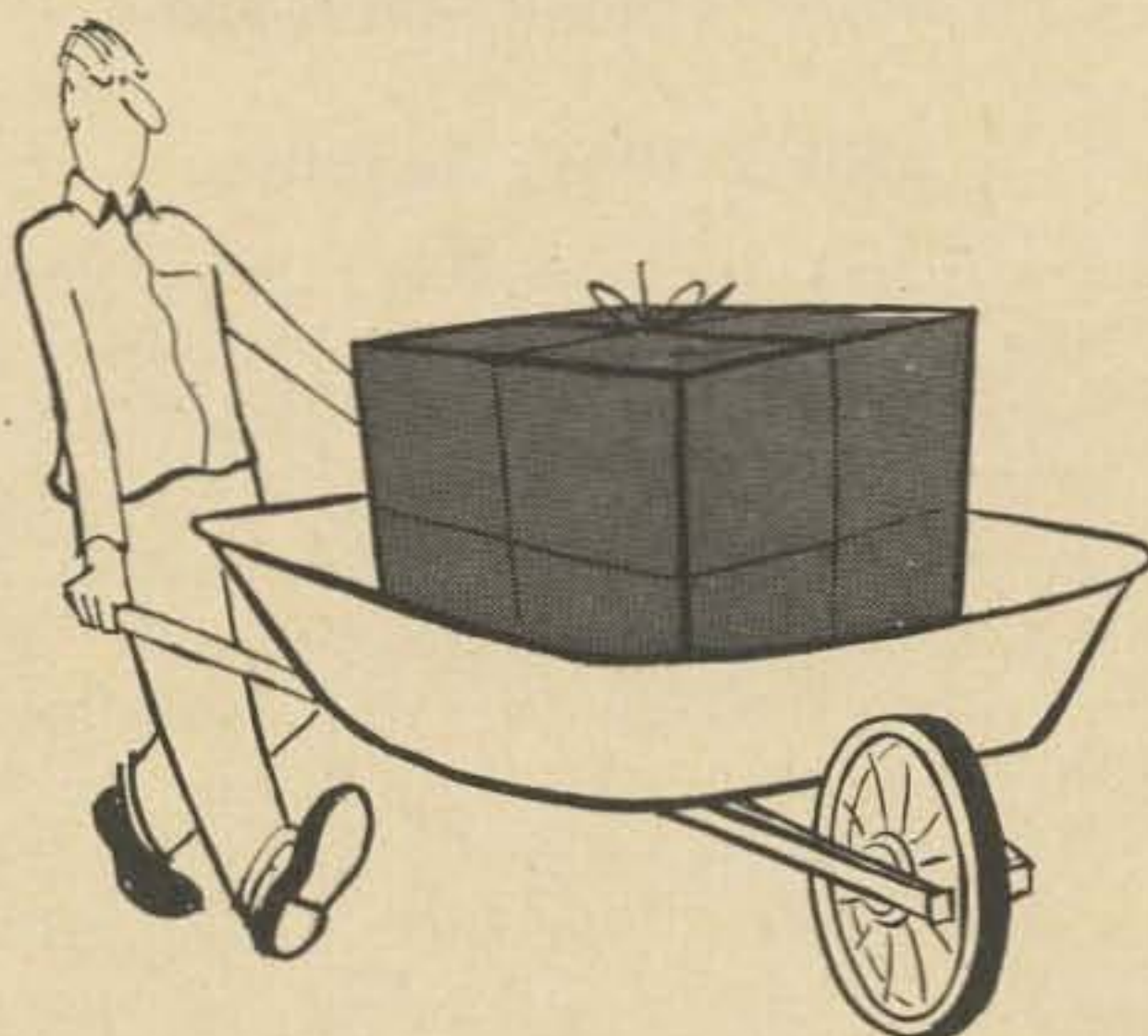

Yes...yes...yes...here is your opportunity to blow your mind on back issues of 73. You send us \$5 in cash, check or negotiable securities and we will send you an unbelievable miscellany of thirty different (all different) back issues from the 1960-1966 era. These are all rare collectors items. Every one could very likely be worth a fortune to you. Who knows, you might even find a rare January 1961 in this pile! We don't even know what is in the packages. To keep costs down we have had these magazines packed into sloppy bundles by the chimps from Benson's Animal Farm. Watch out for banana skins.

If you want specific issues of 73 they are available at the low low (high) price of 75c each. Unless we don't have them, in which case the price is higher.

How about sending a bundle to a DX friend? Back issues are worth their weight in unicorn dung in most countries. Remember your friends with a nice bundle of 73 magazines.

Money received without a shipping address will be used for beer.

73 MAGAZINE
PETERBOROUGH,
NEW HAMPSHIRE 03458

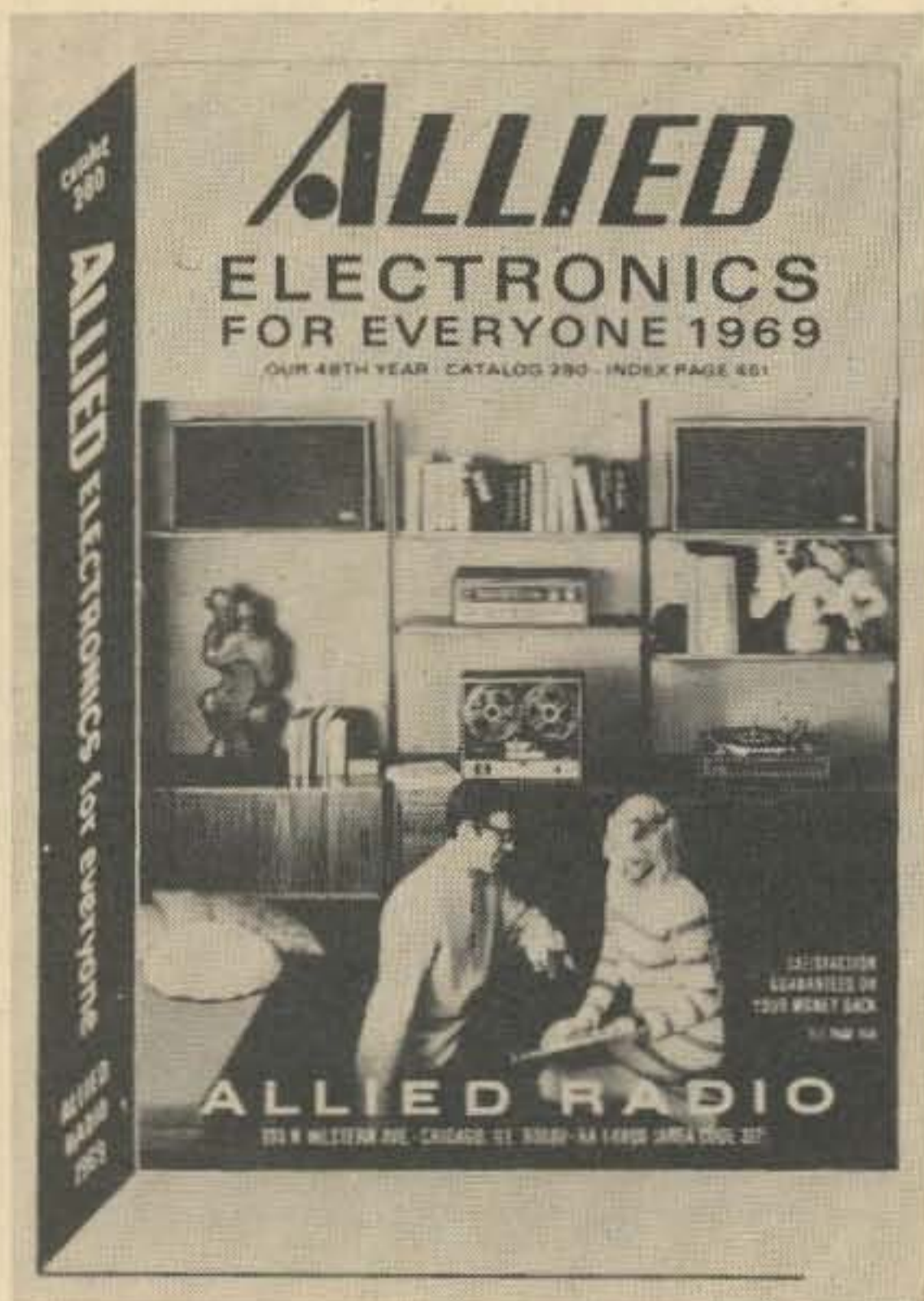

Allied 1969 Catalog

Allied Radio, perhaps the nation's largest consumer electronics distributor, has just published their #280 Electronics-for-Everyone, with 536 pages. This is a very large catalog, full of hi-fi gear, TV cameras and monitors, radios, phonographs and turntables, right through to test instruments, electronics components, and a line of kits. This line includes Allied's recently introduced KG-2100 Triggered Sweep Scope kit, and a variety of other test instruments. For all these details, the catalog is free on request from Allied Radio Corporation, PO Box 4398, Chicago, Ill. 60680.

Model 830 Transistor Commander

Weight: 3 lbs. Portable. Luggage type case is 9¼" x 6¾" x 6⅜". That's Amphenol's new service oriented transistor tester. It can also check diodes, zeners, and circuit supply voltages up to 100 volts.

Provided with color-coded meter scales for simplified tests, the Model 830 tester will measure the DC beta of small-signal or power transistors without their removal from the circuit. Out-of-circuit tests include I_{CBO} measurement. The tester is protected against accidental burn-out of transistors and diodes, or of the instrument itself.

Available from Amphenol Distributor Division, 2875 South 25th Ave., Broadview, Ill. 60153. Price, \$79.95 net.

Semiconductor Handbook

Semiconductor Handbook, by Robert Tomer. From Howard B. Sams & Co. Inc., 1968

The good old days of small transistor handbooks are long past, but a coverage of the general principles along with illustrative applications can still be packed nicely between two covers that are not too far apart.

It takes 13 chapters and three appendices to do the job, but the field is covered from basic physics ideas through circuit fundamentals, component ratings, industrial and power applications, communications applications, advanced devices in general, FET's in some detail, and at last about 20 pages on micro-circuits and integrated circuits.

The coverage is improved by many small diagrams, located at frequent intervals through the text where they are handy to the appropriate paragraphs. This is a second edition, written by an experienced field engineer. His experience shows in the close relevance of the writing to readers' requirements. From Howard B. Sams & Co., Inc., \$5.75.

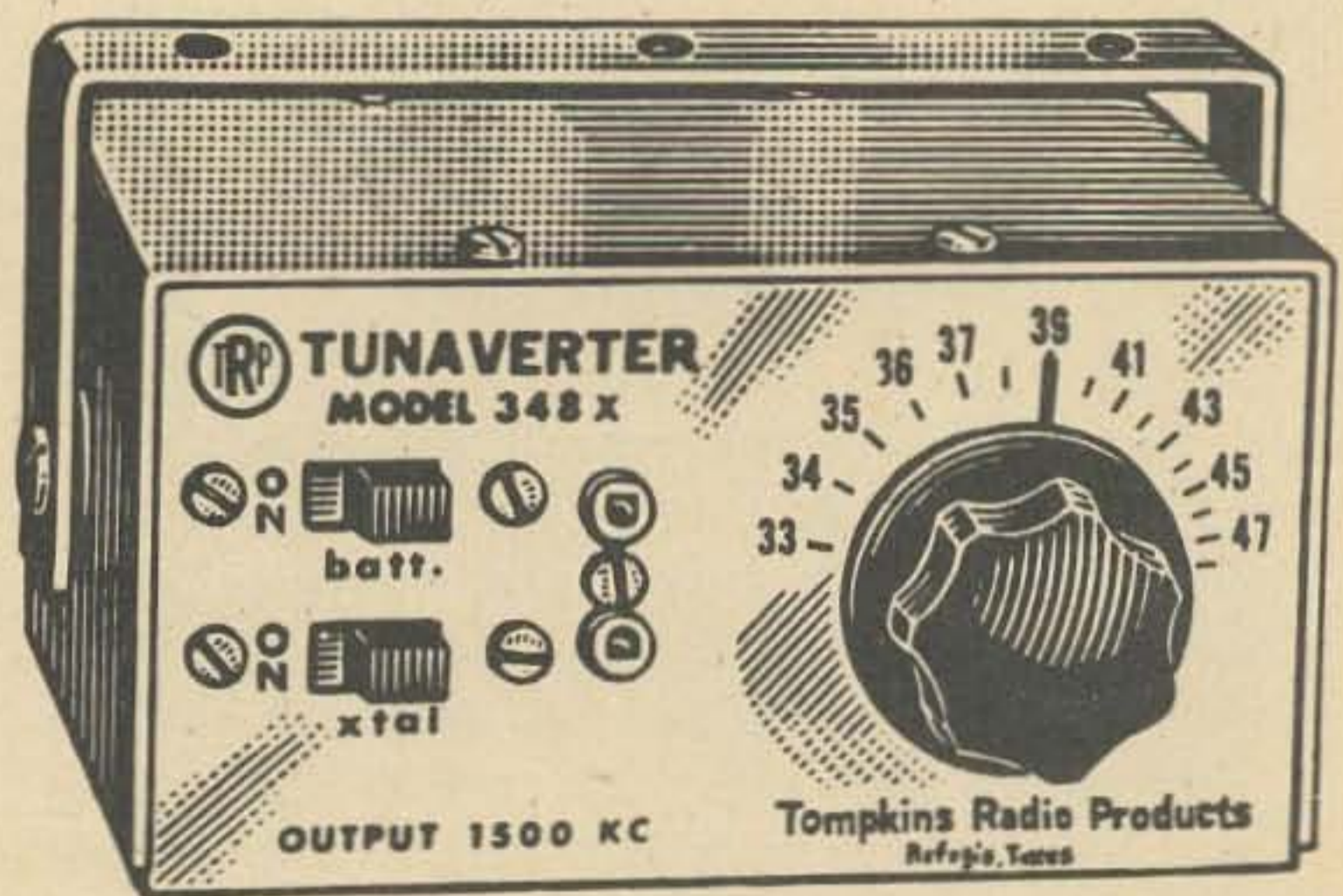

RF Converter

Tompkins Radio Products has developed new models versatile *rf* converter line. Their new TUNAVERTER X line can tune over a range of frequencies, and then monitor drift free with crystal control by simply flipping a switch. Another channel may be monitored by changing crystals. Priced at \$32.95 each less crystal from Tompkins' marketing division, Herbert Salch & Co., Woodsboro 73M, Texas 78393.

Dictionary of Electronic Terms

If you have not been working in electronics for very long, or if you have, for that matter, sometimes you need to find out what some new term means. A remarkably complete collection of old and new terms has just appeared on the market.

Allied's dictionary supplies definitions of power line, coil form, Citizens' Band radio, radio receiver, etc., which will be very useful to the beginner who wants to understand what the basics are all about.

But like any complete dictionary, it also meets requirements for the advanced worker. For instance, what is a ferrosphenel? Triad? (a color TV term) or how about gamma ferric oxide?

The print in this 112-page dictionary is a bit small, but it is a good visible type face, offering a lot of material between two low-priced covers. A really complete book, and the definitions are not too short to be useful. From Allied Radio Corporation, Chicago, Ill., and the price is a remarkable one dollar.

Application Notes Catalog

If you're thinking about that next project, or the one following, maybe you can find some ideas in Motorola's new Application Notes Catalog. It is industrially oriented, but many of the entries should be interesting to non-engineers and amateurs. There are 130 entries, each describing the design and application of a circuit (or circuits), using Motorola components. A Selector Guide section at the beginning of the catalog lists the entries by applications categories.

Titles include "20 Watts at 1 GHz with Step Recovery Varactors," "An Integrated Circuit RF-IF Amplifier," "Using Shift Registers as Pulse Delay Networks," and "Unijunction Transistor Timers and Oscillators." Several reference guides, two catalogs, and the Semiconductor Data Book are also listed, in the back of the catalog.

For your copy of this handy guide, the Motorola Application Note Catalog, write Department TIC, Motorola Semiconductor Products Inc., Box 20924, Phoenix, Arizona 85036.

DANGER

73 Transistor Circuits has driven hundreds of amateurs right out of their minds with joy. Do not send \$1 for this dangerous book. Do not send it to: 73 Magazine, Peterborough NH 03458.

SUBSCRIBERS

We want to make absolutely sure that no one is using our 73 mailing list. We do not rent this list out as do other magazines. If your address label from 73 is distinctive and you find that you are getting any mail addressed in the same distinctive way please let us know immediately and send us the envelope or wrapper that you received so we can take appropriate action. Your help in this will be very much appreciated.

HAVE YOU A PERFECT FIST? M&M'S NEW ELECTRONIC KEYS CAN PERFECTIFY YOUR CW TO 40 WPM!



- Trouble free solid state circuitry.
- Every letter perfect: self completing dah's and dits, 3/1 perfect ratio.
- AC powered: no batteries to die.
- Isolated relay output works with any rig.
- Built in monitor.
- Works with your present key or bug.

M&M Electronics Dah-Ditter model EK-1 only \$34.95 postpaid in USA and possessions

Send your order direct to:

M & M ELECTRONICS Keyer Dept.
6835 Sunnybrook, N.E., Atlanta, Georgia 30328

SURPLUS ELECTRONICS

ARC-3 TRANSMITTER 100-156 MC	EX	\$24.95
SK-980 PHANTOM ANTENNA	NEW	\$ 6.50
GO-9 TRANSMITTER 300 KC-18MC	NEW	\$75.00
GP-7 TRANSMITTER 800 KC-9 MC	NEW	\$37.95
BC-604 FM TRANSMITTER 20-27 MC	EX	\$ 7.50
BC-924 FM TRANSMITTER 27-38 MC	EX	\$12.95
BN IFF SET 150-180 MC 110VAC 60CY	NEW	\$59.95
BC-456 ARC-5 MODULATOR	NEW	\$ 3.75
T-28/APT-1 RADAR TRANSMITTER		
90-200 MC	NEW	\$19.95
RT-45/ARQ-1 TRANSCEIVER-JAMMER		
14-50 MC	NEW	\$34.95
BC-617 FM RECEIVER 30-50 MC	EX	\$24.95
BC-1158 AM TRANSMITTER 50-90 MC	EX	\$29.95
BC-605 INTERPHONE AMPLIFIER 12VDC	NEW	\$ 5.95
T-61/AXT-2 TELEVISION TRANSMITTER	NEW	\$42.95

PRICES: FOB INDIANA, PA. NO C.O.D. ORDERS
MIN. ORDER \$5.00 NOT INCLUDING POSTAGE.

PENNSYLVANIA ELECTRONICS
P.O. BOX 127
INDIANA, PENNSYLVANIA 15701

Ralph Steinberg, K6GKX
110 Argonne Ave.,
Long Beach, Calif. 90803

Is it Cold Down There?

A common query when the men on the "ice" at McMurdo Station in the Antarctic receive phone patch calls from home. Invariably the answer is "It's always cold and the temperatures are below zero in summer or winter."

Phone patching and teletype traffic to the Antarctic stations is a *must* every day of the year, band conditions permitting. The morale of the men depends on the communication link with their loved ones. The isolation in this remote part of the world is easier to take knowing there are dedicated radio amateurs ready at all times to serve them.

In former years the phone patching and traffic handling was done by any stations that would oblige in meeting schedules with KC4USV, McMurdo Station. However on May 11th, 1967 a new Navy MARS net began operations and now has a membership of thirty-seven stations that represent coverage of every part of the United States. Appropriately the net control station at McMurdo was assigned the Navy MARS call NØICE.

With the transition to Navy MARS, the Antarctic Network has become more effective in the handling of phone patches and teletype messages. In the first year of operation, the net handled 3,536 phone patches and 287 messages from McMurdo. Since April of this year, 2,433 phone patches and 2,503 messages have been completed and by the end of this year these figures will far exceed the totals of last year. During the winter over period (March to September) most of the teletype messages are of one hundred word personal letter text as mail service is non-existent during the Antarctic winter season. Also phone patches are not limited to five minutes due to the isolation of the men and the net is tailored for their welfare.

Operations on the net begin each night on the east coast at approximately 0100 GMT, the midwest at 0300 and the west coast at 0430 GMT on the Navy MARS frequency of 13,975.5 MHz. To expedite the handling of phone patch calls, numbers are assigned



Operator at NØICE/KC4USV at McMurdo Station running a phone patch through the Navy MARS Antarctic Network. Official Navy photograph.

to the families of the men stationed at McMurdo. Each net member has a copy of these numbers with the name of the party to call, town or city and phone number. The net control need only pass the number to the net station for the phone patch call. At times there may be as many as ten to fifteen calls placed with some of the net stations to complete in his or her area.

In the summer season, September to February, the population increases at McMurdo Station with the arrival of the scientists and more military men. During this period, traffic to the states is at its peak and sometimes it is necessary for the net to work around the clock, especially on Christmas and Mother's Day. Usually the net control station at McMurdo has several operators working in shifts and the net stations frequently have extra operators to man their stations. With McMurdo Station as the communications center for the outpost stations (South Pole, Byrd, Palmer and Plateau) this also adds to the traffic load.

The members of the Navy MARS Antarctic Net not only handle the phone patches and messages but in many cases shop for gifts

at Christmas, weddings, anniversaries and birthdays for the men in the Antarctic and have them delivered to their families. Such service by the net members are not forgotten and when the men return to the United States they make personal visits to these members to thank them for this service.

Recently during the operations of Project Facsimile Antarctic¹ the net was used as the liaison frequency between McMurdo and southern California. This was arranged for by Chief Navy MARS and assistance was given by MARS Director, Lloyd Madison of the 11th Naval District and MARS Director Terry Swartz who succeeded him. The net manager, Kenneth Nokes, NØRYE, arranged the operations schedules with the facsimile operators at McMurdo Station and thru the several months of the facsimile project did help to keep things operating smoothly on the net while transmissions of pictures were beamed to McMurdo.

Words of praise are offered to the net members of the Navy MARS Antarctic Net for their continued efforts to keep up the morale of our servicemen who do duty in remote parts of our world. The net roster lists the following stations associated with the Antarctic Net: NØAAJ, NØAJN, NØAJO, NØAYT, NØEJH, NØEQH, NØEQZ, NØEYX, NØFMO, NØFPG, NØFQP, NØFXQ, NØHFO, NØIDH, NØIFH, NØILN, NØIMK, NØITS, NØJBF, NØJRT, NØJVG, NØKMR, NØKWS, NØRLX, NØRTR, NØRUH,

NØRWL, NØRYE, NØUSM, NØVAE, NØVQJ, NØWCK, NØWNN, NØXRO, NØYNK, NØYQJ, NØZFF, NØZHP, NAV 8 and NAV 11.

The contribution and dedication of these Navy MARS members can be expressed by the following letter addressed to the net manager, Kenneth Nokes, NØRYE, from Chief Navy MARS, LCDR. Robert E. Mickley:

"I would like to take this opportunity to express my appreciation to you and your fellow Navy MARS Antarctic Network members regarding the accomplishments of your operations during the wintering-over period.

Through your untiring efforts and those of your associates, you have succeeded in breaching the communication gap between personnel serving their country in the bleak Antarctic wastelands and their families and friends in the United States.

The record messages, radiotelephone calls and radio-teletypewriter letters handled by the Navy MARS Antarctic Network provided an outstanding service and exhibited a high degree of communication readiness. This accomplishment has brought significant acclaim to yourselves as individuals and to Navy MARS specialty operations.

Please express my appreciation to the members of network for a task "Well Done."
 . . . K6GKX.

References

1 . . . 73 Magazine, November issue, 1968, Page 86.

ARE YOU PAYING 75c A COPY OR 30c?

Righto . . . that's 30c a copy for 73 when you buy it in three year batches. Figure it out. 36 lovely issues of 73 for \$12. 30c. Send cash, check, MO.

All subscriptions will start with the February issue unless otherwise specified.

Name _____ Call _____

Address _____

City _____ State _____ Zip _____

I prefer to be a subscriber\$12 for three years

I am a cheap microscriber\$ 6 for 1 very short year.

These rates are valid world-wide until we wise up.

73 MAGAZINE PETERBOROUGH, NEW HAMPSHIRE 03458

Creative Interconnections: the "Ampheham"



John Gove, product specialist for Amphenol Industrial Division of The Bunker-Ramo Corporation, Chicago, is shown above constructing a new "Ampheham," which, when completed, will look identical to the five-inch-high mechanical ham shown in lower left-hand corner. The Ampheham is constructed almost entirely of those types of microphone connectors, power connectors and tube sockets found in most hamshacks, manufactured by the division. The "ama-

teur's" body, only exception to this rule, consists of a high-wattage projector lamp socket, also made by Amphenol. A close look at the photograph also reveals John's "Amphepup" (foreground), a tiny dog fashioned from miniature-type Amphenol microphone connectors and tube sockets.

Incidentally, John's craftsmanship can also be seen on our December cover (the Amphepup and colorful, specially-designed "Ampheclaus"). ■

(...de W2NSD/1, continued from page 4)

mercial" to many amateurs. The widely reported failures at passing the Extra exam (possibly around 50%) also have tended to discourage fellows from taking the time and expense of trying for it.

Up until 1968 the Advanced Class license was closed to newcomers and we see the gradual drop off in licensees as cigarette cancer and apathy ate into the ranks. It was dropping off about 1000 a year or so. Then, when the license was opened again last year, it trooped the troops. About 5000 new Advanced Class licenses were issued.

Considering that the most choice twenty-meter phone frequencies are now restricted to Advanced and Extra Class licensees, the number of new licenses is piddling.

Most of the new Advanced and Extra came up from the General Class license, as we can

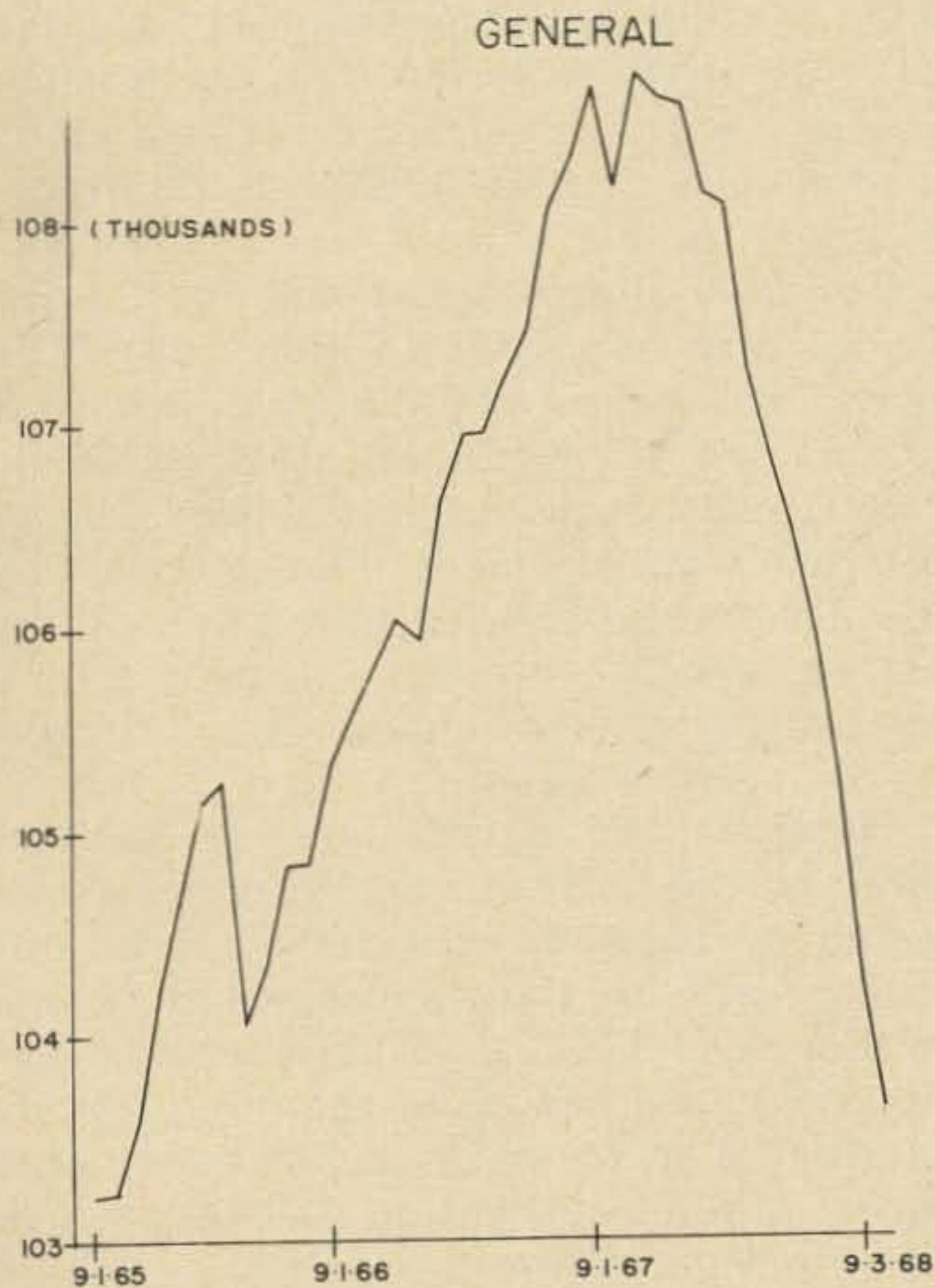

see from the graph. There is a loss there of about 5000, pretty much the same number that turned up in the Advanced category. 5000 out of 108,000 Generals is not exactly a tumult. It is more like a 4.6% response. Less than one in twenty! Perhaps this helps to explain the enormous vacuums in the new Extra in Advanced Class band segments.

This class of license has been dropping off ever since the FCC rewrote the rules and virtually did away with the class. Now, as renewals come up, the old Conditionals either drop out or become Generals. As you can



see, the incentive deal did not change the picture in the slightest. There is not any indication whatever of the Conditionals going for a higher license.

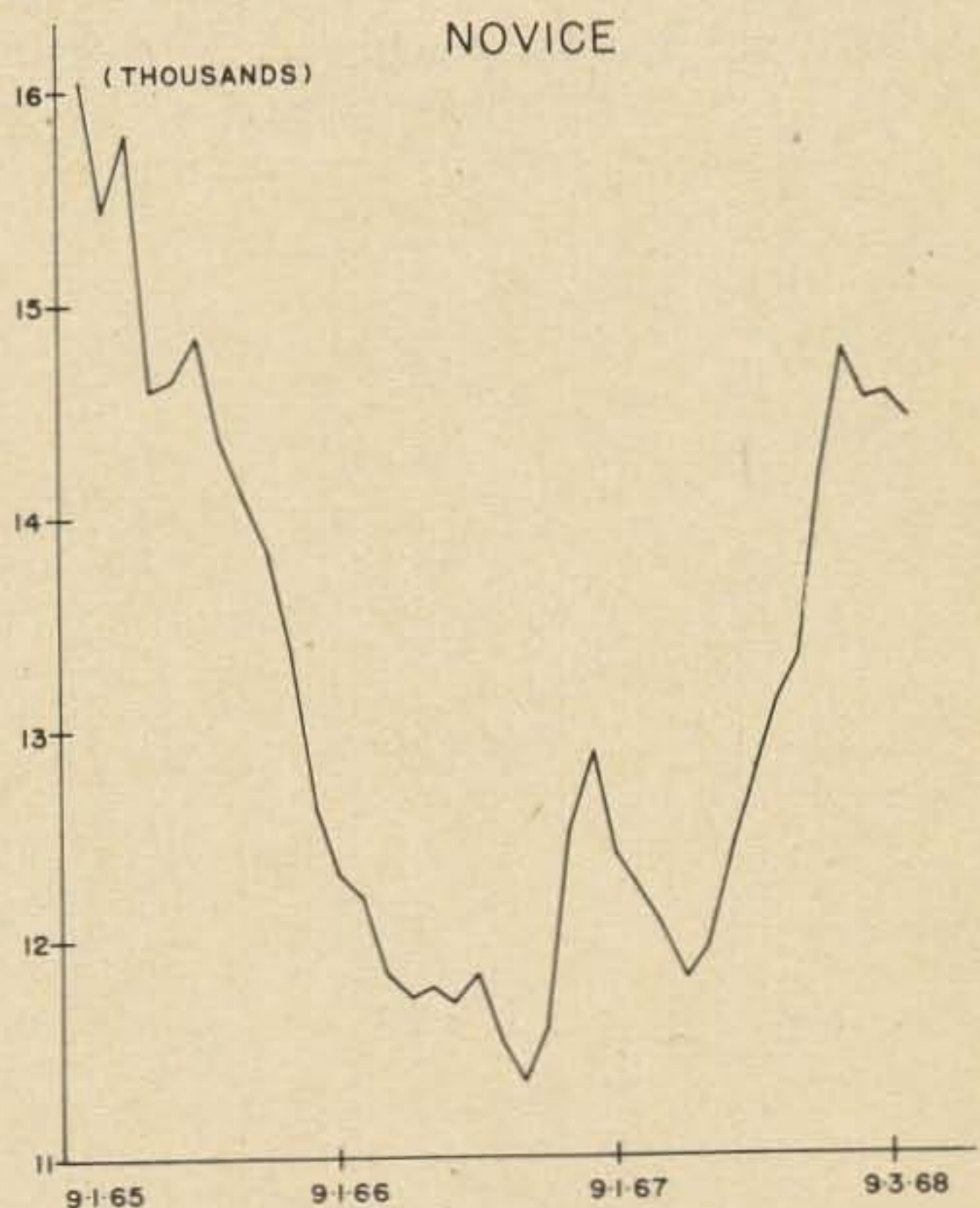

The interest of the newcomers reached bottom a couple of years ago and now is building up again. We really should make a major effort to get more and better hams into our hobby through a program of public relations.

The drop-off has been steady for the last

two years. $2\frac{1}{2}\%$ a year is not a reason to panic, but just the same I'd be interested in any ideas on where the Techs have gone.

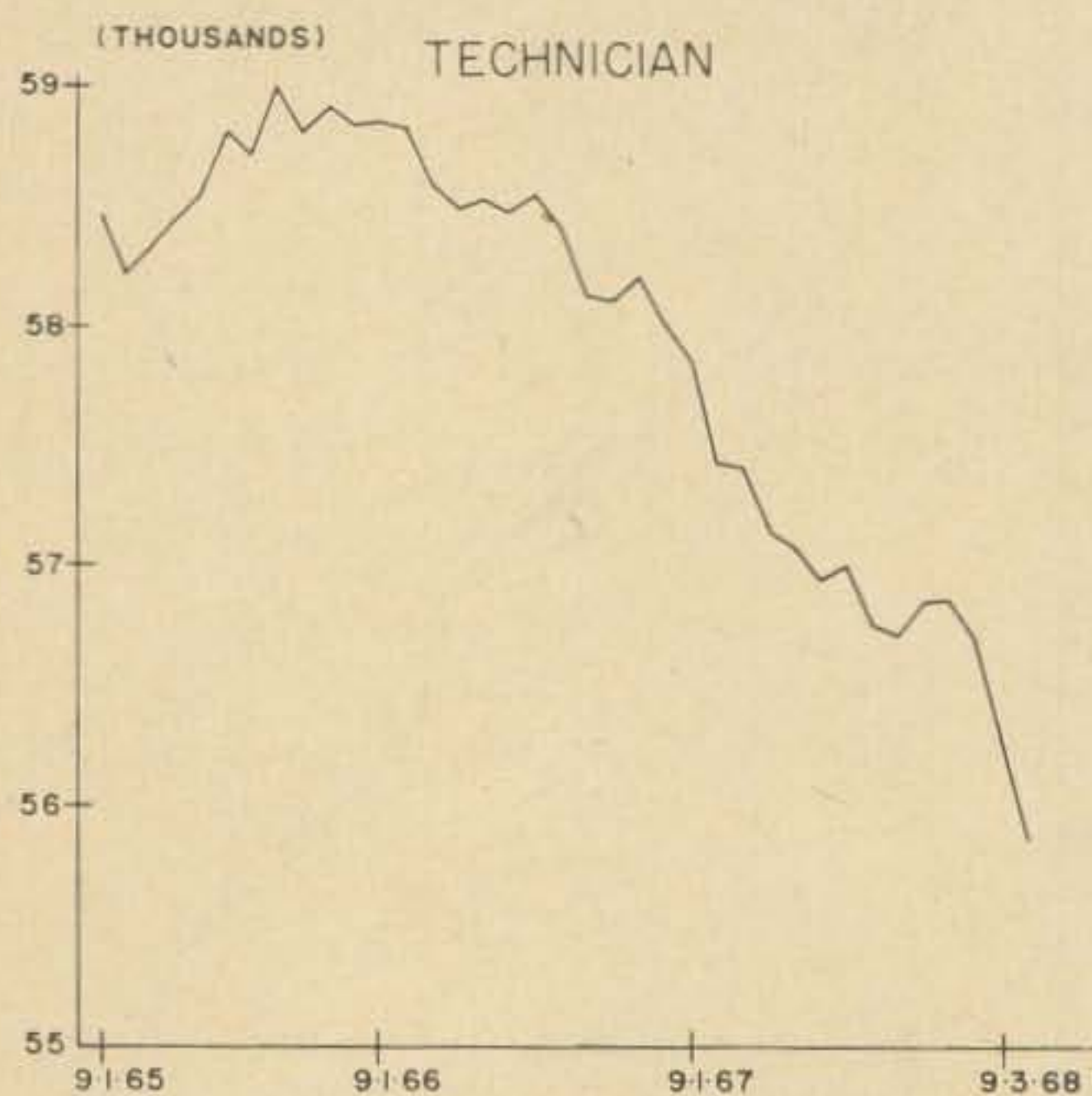

That large drop-off in 1966 is probably more of a computer correction than a real change in licenses. In the last two years the number of hams has been very slowly growing, perhaps averaging out at about a thousand a year. It certainly isn't much like the good old days when our ranks were growing at about 10% a year! Perhaps we need new management?

Perhaps we should recognize that whether

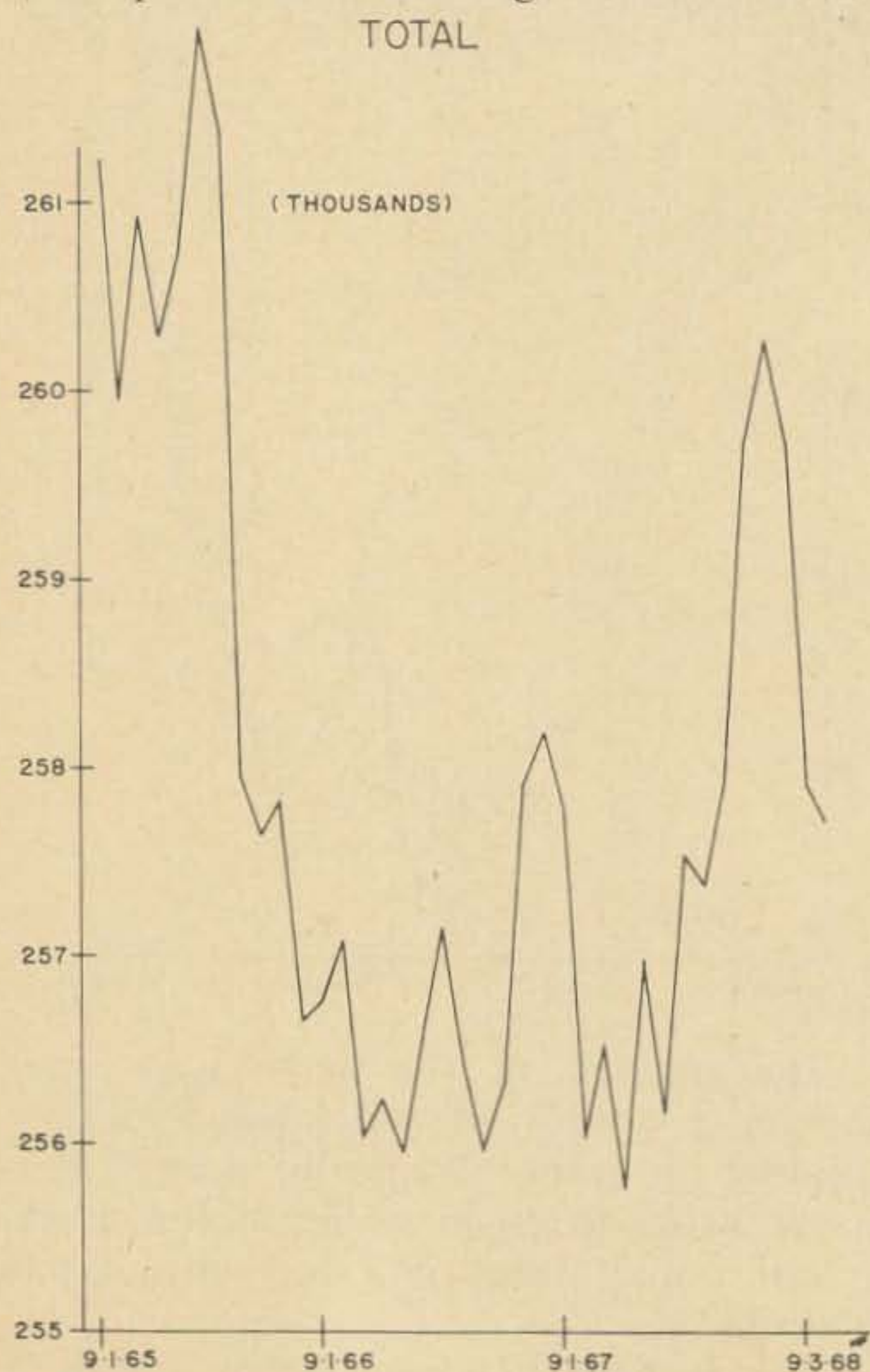

we approve of the new regulations or not is besides the point now. They are the law and apparently will remain the law for some time to come. Our job now is to fall into line and get our higher class license as soon as we can. It is the responsibility of the ham magazines to make the transition as easy as possible. It is the responsibility of the radio clubs to encourage and assist members in getting their new licenses. We at 73 are doing everything we can think of to make it simple to pass the new exams.

Hamfests and Conventions

Hamfests and conventions, despite what you may have read recently, can be a ball and I try not to miss any more than I have to. During the last year I managed to get to the Long Island Hamfest, the Swampscott Convention, the National in San Antonio, the Sarcoc in Las Vegas, the Sideband in New York, the VHF in New Jersey and the Rochester Hamfest. Kayla managed to get to a lot that I had to miss, such as the Dayton Hamvention and many others.

Perhaps I should also count the 73 Hamfest up here in July. We didn't outpull the ARRL National as we did back in 1965, when we ran our last hamfest, but we did have quite a crowd and we had a lot of fun. I suspect that Hemisfair was more of an attraction than New Hampshire and its mountains. I enjoy New Hampshire a lot, but I do have to admit that I had a whale of a good time at Hemisfair and I'm glad I went.

Hamfests and conventions are important, I feel, to the spirit of amateur radio. Here we can all get together with the top hams of the country who are there demonstrating ham-TV or slow scan TV, ham-RTTY, ham facsimile, moonbouncing and all of the other special interests that go to make up our hobby of ham radio. A good convention will keep you hopping from one interesting session to the next.

How many contests have you entered at a hamfest? Code speed contests are simple to put on and are fun. Mobile operating contests are simple too. Fox hunting is great—it is the primary amateur radio activity for thousands of amateurs in Russia and several iron curtain countries. And how about working up some special contests, say perhaps one for the phone men with twenty telephones connected in parallel and a given time for all to exchange short messages or even just call letters with as many as possible. They will be yelling their heads off, if it works out any-

thing like a DX pile-up. I'm sure that an enthusiastic hamfest committee will be able to work out a number of events that will make their hamfest memorable—and will bring back even more the next year.

If the committee coddles the speakers they will get them back again too. All too often a guest speaker is left to just stand around until his speaking time comes. Some committees make sure that speakers are welcomed. The Swampscott committee puts on a special dinner for them, gives them badges and makes them feel glad they came.

Most hamfests don't rely too much on exhibitors as a drawing card for their hamfest, but convention committees know that the exhibits can make or break a convention. Every manufacturer in the ham field gets letters constantly asking him to come and exhibit at this or that convention. Some letters give the impression that the convention is doing the manufacturer a big favor by letting him display his wares. I realize that a good many amateurs have a basic feeling that everything in ham radio should be entirely home made and that manufacturers are an unnecessary evil. Without our manufacturers I fear that much of ham radio would still be hung up in the Tri-Tet Crystal Oscillator days and running 200 watts to a 6L6.

I get to talk with most of the manufacturers in our field and I think I know all of them pretty well. The best of them may be making a profit of 10% on his ham sales. That is, unfortunately, the exception. This means that any additional expenditure that he makes must be able to bring in ten times that expense in sales volume. A \$100 magazine ad must bring in \$1000 in sales. A convention booth must bring in \$10,000 in sales just to break even, at the least. By the time you add the cost of the booth space, shipping the exhibit from the factory and back, plane fare, hotel, and etc., it costs more like \$2000 for a convention.

How valuable is a convention to the manufacturer? Well, if you figure that he can talk to about two or three hundred prospective customers during the show, he has to do a powerful lot of selling to make it profitable. The average affair runs for about eight hours on two days, a total of 960 minutes. One customer every three minutes would total 320

Are there solutions to these problems? Of course. The convention committees that organize their club members to help make life easy for the exhibitors will find that they have a lot more displays. Show them the town,

buy them a dinner, help them set up and pack their displays, offer them accommodations in members' homes. Spell them at their booth so they can see the convention, attend some of the talks, and get a snack. Most manufacturers have an interesting story to tell about their product and you could do worse than offer them a little time in front of an audience to talk and answer questions.

The secrets of putting on good conventions have been pretty well worked out. Hamfest and convention chairmen could do a lot worse than get in touch with the fellows who manage the Swampscott and Dayton conventions every year. These are the two most successful conventions year after year because they are well planned and are fun.

Lots of Prizes

There is much to be said for displaying all of the prizes prominently, complete with a commercial message beside each product. The winners can then come up and pick their own choice of a prize. This matches the needs of the winners to the prizes available and helps to cut down the discount selling of unwanted prizes after the hamfest, a process which is distressing to both the prize winners and the manufacturers.

Perhaps some publicity in the hamfest program could be given to the prizes. Also, as the prizes are picked out by the winners the announcer could read off the commercial message. If you show the manufacturer that it is to his advantage to give prizes for hamfests, there will be a flood of prizes.

Letters to the Editor

When I visit ham clubs I get asked a lot of good questions about ham radio, the ARRL, Don Miller, CQ, Incentive Licensing, the ITU, the IARU and other matters of general interest. The club members tell me that they enjoy knowing more about these things. Yet we hardly ever get any letters here at 73 asking about these things.

You might keep in mind, when you read something rotten about 73 elsewhere, that other publishers have a very good reason for hating us. 73, as far as we know, is the only ham magazine that is in the black. It will take more than name calling and cover immitating to change the pattern.

While I don't put much stock in editorials in other magazines calling me a scoundrel, you may and perhaps you feel that there are some questions that need answering. Ask away and we'll bring out the true facts.

Let's see them cards and letters, folks.

Carole H. Allen W5NQQ
308 Karen Drive
Lafayette, La. 70501

Be a Good Ham and Not a Bad Egg!

The mailman just delivered a small white envelope from the Federal Communications Commission and at last you're a ham radio operator! As you open the envelope and see your call letters for the first time, you join thousands of other hams in a new world of adventure. And, of course, dozens of these amateurs are probably right in your own hometown or area. If you want to enjoy the hobby to the fullest and form the most lasting friendships, resolve right now to be a good ham and not a bad egg!

Make a few rules for yourself about borrowing and loaning—and stick to them! It may seem a trivial subject but you'd be surprised how serious it can be.

For instance, imagine what happens to a budding friendship between two hams if one borrows an expensive tube tester from the other and then returns it several weeks later not working properly. Or what if the ham down the street says he desperately needs your jin pole to put up an antenna that weekend but lets it lie in his yard long enough to rust before bringing it back!

Oh, you'd never do anything like that, but who would have thought these fellows would either? They probably wouldn't dream of borrowing your car, camera, or lawn mower, but when it comes to ham radio, anything seems to go. Some hams feel that since we're all members of a great fraternity, they want to make sure they get the most from their memberships!

But what can you do about people who borrow? Of course, you can refuse to loan anything at any time and quickly become known as a sorehead. Yes, you may always have your possessions at hand, but you'll make it almost impossible to ever borrow anything yourself no matter how great your own emergency.

There are a few other tactics that are worth a try. In the first place, don't borrow anything yourself if you can possibly avoid it. You really ought to own a soldering iron, screwdrivers, wrenches and an assortment of nuts and washers, so don't pester some other fellow for these items. You'll be asking for return requests.

And if you want to look over a schematic in a current issue of an electronics magazine, for heaven's sake, cough up the 75 cents and buy it on the newsstand. Let the guy who subscribed to the magazine keep it on his desk. If you find you must borrow a back issue of a magazine, make a copy of what you're interested in and return it before the sun sets.

If you need an ohmmeter, voltmeter or equipment that will be beyond your budget for a long time to come, try to use it at the owner's home. Call him first and make sure you're welcome. If you're checking out a cumbersome kilowatt rig or something else extremely hard to move, ask the owner of the test gear if he would have time to come over and help you with the measurements. Chances are he would be tickled pink to bring his equipment and help you solve the problem right in your hamshack. This way there is no doubt how his property is handled and you'll probably learn a lot in the process.

If you do borrow a tube tester or anything else, don't ask for it until you're ready to use it, and then return it immediately. If you're delayed and can't take it back when you said you would, call the owner and tell him. Don't just keep it indefinitely. This is a sure way to make an enemy.

And another important rule of the game—don't ever loan anything you have borrowed to anyone else! It just isn't yours to loan; and believe me, if something is going to be

damaged or lost, it will happen when you have relented it. Then you really are in a pickle—you're still responsible for the borrowed article and you must explain that you had loaned it to someone else!

But what is the worst should happen while you're checking out your mobile rig with Tom's grid dipper and you drop it on the concrete driveway. Replace the dipper or fix it but don't returned a damaged article. If you take the broken dipper back as it is, the owner may say, "Oh, there probably isn't too much wrong with it," while gnashing his teeth, or he might give you a black eye.

If you have an accident with a borrowed item, even if an old tube flickers out, fix it first and then return it with explanation and apology.

On the other side of the coin, you'll be asked to loan things too. Put your name and call letters on a small tag and fasten it to tools or other items that might easily get lost in someone else's garage or shack. Label your magazines with your call letters and this will serve as a good reminder to the borrower that you want them back. There may be a lot of people you will loan to freely, but if you're approached by someone with a reputation for misusing borrowed gear, you can insist on accompanying whatever he borrows and then bringing it right back home. Or you can tell the little white lie that you just hap-

pen to be using what the fellow wants to borrow and just can't let it go.

After you have been on the air for several years, you will have scrimped, saved, and accumulated a fine inventory of test equipment and tools for your shack that will make a beginner blink with envy. He may have nothing more at home than a homebuilt CW rig and an imported key and you will be the first person he thinks of when needing to borrow something. No one objects to loaning equipment or tools to a beginner who needs a boost, but everyone's personal goal should be to accumulate what he or she needs to operate his equipment independent of another fellow. After all, John Smith saved his pennies for that \$75.00 safety belt so if a sudden wind blows a limb across his beam antenna 80 foot up on a tower in his back yard, he can take care of it immediately. He didn't buy it for someone else to borrow and stack in his closet for a month or two.

The Golden Rule is just as applicable in ham radio as anywhere else. If you absolutely must borrow something, treat it as you do your own property and don't keep it one minute longer than necessary.

If you follow these suggestions carefully you'll never have to worry about being a bad egg—you'll be known by your friends as a real good ham!

. . . W5NQQ



— with a MATERIAL DIFFERENCE!

Use, is one of the most dependable testimonials of endorsement, and Telrex products are in use in 139 Lands

telrex "Beamed-Power" ANTENNAS, "BALUNS" I. V. KITS and ROTATOR SYSTEMS!

Most Technically-Perfected, Finest Communication Arrays in the World! Precision-Tuned-Matched and "Balun" Fed for "Balanced-Pattern" to assure "TOP-MAN-ON-THE-FREQUENCY" Results

Enjoy World renown TELREX performance, value and durability! Send for PL68 tech. data and pricing catalog, describing professionally engineered communication antenna systems, rotator-selsyn-indicator-systems, "Baluns", I.V. Kits, Towers, "Mono-Pole", "Big-Berthas", accessories, etc. etc.

COMMUNICATION SYSTEMS SINCE 1921 **telrex** Laboratories

ASBURY PARK, NEW JERSEY 07712, U.S.A.

73 Visits the Federal Aviation Control Center at Nashua N.H.

What are radio amateurs doing in the world of modern technology? One prominent public service business is air travel, and as we think about airplanes and public transportation we may remember a time, maybe thirty years ago, when airplanes were known human accomplishments but you did not see one very often.

A real, loud, amazing, *two-engine* airplane could upset anybody's schedule, if it passed over low enough. Some of them did. We all knew these were built and flown by men, but the thought of actually entering one and going up in the *air* with it seemed very unlikely.

I recall some magazine stories about Stratoliners, and it was believed that someday commercial flights at altitudes as high as 20,000 feet might be practical. This, men thought would be well above most atmospheric disturbances, and air travel would be very comfortable. That was in the days before jet engines, radar sets, and Clear Air Turbulence. Since then I have flown in

passenger aircraft as high as 40,000 feet, and experienced the curious sensation of somebody hitting the plane with big soft hammers. Looking out the window I have seen other planes traveling with tremendous velocity in the opposite direction, and I have sat watching the wing (whose tip I could not see) while the pilot worked his way down through a stack in zero visibility, to land at last in a snowstorm.

Electronics in Air Travel

When you consider the problems, you may feel some surprise at the relative ease and reliability exhibited by airliners departing for some distant point, and getting there. The worst difficulties seem to be on the ground, getting to the airport, and from there to your destination. Some newspaper reports appear about those flights that don't make it, but think for a moment—there is an awful lot of air traffic. If all the successful trips were reported in any detail at all the newspapers could not publish very much



A general view of the many electronics consoles where flight controllers are observing and tracking aircraft.



Looking at some of the more complex electronics gear. This is a system that adds maps to the radar display, and transmits the appropriate part of the resulting image to one of the radar repeated consoles.

else. Air travel has its hazards, but on the average it is a safe and very fast way to make long trips. If you avoid bad weather and those times when many other people are traveling you can get from New York City to San Francisco more comfortably than you can make a 300-mile bus journey, and, in about the same time. The air travel business has become a remarkable, huge industry.

A key part of this industry is electronics, appearing as data processing, telephone and radio communications, and radar observation and mapping. Are there radio amateurs in this work? Why not look for radio amateurs at the nearby Air Traffic Control Center? We came up with the name of Eli Nannis, W1HKG, and after a telephone call I went up for a visit. I expected to find something like a control tower or other conservative if slightly odd airport-type structure.

The Boston Air Route Traffic Control Center

A bit of careful navigation (following road signs) brought me to the Center. Isn't

DX-ARRAY

NEW 20 ELEMENT ANTENNAS

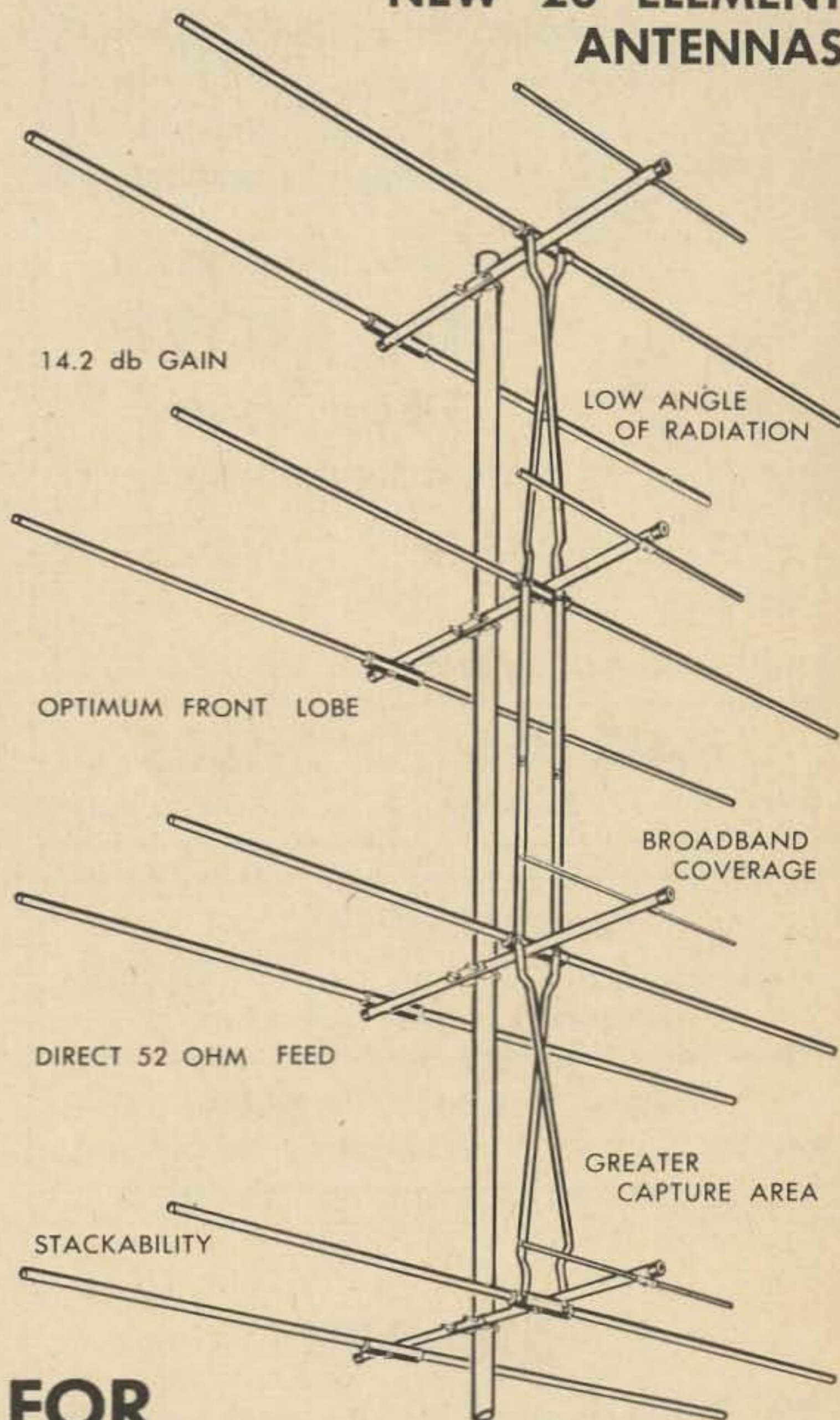

FOR

144 mhz 220 mhz 432 mhz

A breakthrough in VHF/UHF Amateur antennas! The new Cush Craft DX-Arrays combine the best yagi and colinear features into the World's most advanced amateur communication antennas.

Realizing that the antenna is the most important part of your station, Cush Craft engineers have devoted two years of intensive development and testing to perfect DX-Array. DX-Arrays have already established new records in Dx-ing and moon-bounce programs.

Whatever your interest may be, ragchewing, contests, DX, or moonbounce, get in on the excitement of VHF hamming today with DX-Array.

DX-120 — 144 mhz	\$29.50
DX-220 — 220 mhz	22.50
DX-420 — 432 mhz	17.50

See your local distributor or write for complete specifications on these exciting new antennas from the world's leading manufacturer of UHF/VHF Communication Antennas.

621 HAYWARD STREET
MANCHESTER, N.H. 03103

FREE Catalog

OF THE WORLD'S FINEST
ELECTRONIC GOV'T
SURPLUS BARGAINS



Now **BIGGER**
And **BETTER**
Than Ever!

MAIL COUPON NOW

NAME:

ADDRESS:

CITY: STATE: ZIP:

FAIR RADIO SALES

Dept. 73 • Box 1105 • LIMA, OHIO 45802

Epoxy DIODES

1000 PIV 1.2A	.25ea	\$21.00/100
800 PIV 1.2A	.20ea	\$18.00/100

Minimum Order \$5.00 Postage Paid

Money Back Guarantee—Write For Cost Per 1000

Pete Fragale, W8AEN

Box 585

CLARKSBURG, W.VA. 26301

DANGER

73 Transistor Circuits has driven hundreds of amateurs right out of their minds with joy. Do not send \$1 for this dangerous book. Do not send it to: 73 Magazine, Peterborough NH 03458.

MOTOROLA FM EQUIPMENT SCHEMATIC DIGEST

91 pages (11½" x 17") of schematics, crystal information, alignment instructions, service hints and specialized information. \$3.95 post paid.

TWO-WAY RADIO ENGINEERS, INC.

1100 Tremont Street
Boston, Massachusetts 02120



Eli Nannis, W1HKG, is pointing out some of the characteristics of the New England area.

that odd? No airport, I thought. Seems to be no airport anywhere near here. Just this big block of a building with a microwave tower nearby, and some dipoles or long-wire antennas. Looks like a manufacturing plant of some kind.

Walking up to this building, I rang the buzzer and shortly Eli Nannis came to the door. Going inside we walked down a short corridor and into a large room. It was more than that: it was a *huge* room! I was appalled. I was going to write something about this? Seeing that I might be approaching a state of shock, Eli considerably conducted me along one wall (I felt like a mouse invading an auditorium) and we went into the Center's amateur station, WA1HOB

It turned out the Center has a rather large and quite active ham radio club. There are hams from all parts of the Center, which employs about 400 people and is in business 24 hours per day, every day. The ham station consists of a Galaxy transceiver, some test gear, and of course an SWR bridge. The setup there can be operated from mains power, the Center's emergency power, or from car batteries, and can double over for emergency communications if necessary. An educational program is continuing for the improvement of hams' technical and communications backgrounds, and several new amateurs are expected to receive their tickets shortly.

After we visited the station, and I had recovered slightly from my shock at seeing the size and complexity of the Center, we discussed the work that is done there. Basic-

ally, its purpose is to oversee all air traffic, except a few light planes, within the area between northern Maine south nearly to New York City, and west to slightly beyond Syracuse. Air traffic within five miles or so is controlled from the airport control towers, and is not a responsibility of the Center.

There are four technical areas in the Center, reflecting the four general kinds of work carried on there. They are communications, display preparation, data processing, and the flight control area.

I was very surprised to find the Center has no radar or other direct connections with the outside world of air traffic. All radio gear and radar systems used by the Center are situated at appropriate places over the control area, and linked to the Center by microwave or telephone systems. For instance, a flight controller handling traffic near Syracuse uses a radar display that is generated at Syracuse, not in New Hampshire. Since any controller can talk with as well as observe any plane in his area, and there are many areas and controllers, the Center has a communications system that certainly appears large enough for a fair-sized town.

The equipment that generates the displays used by the flight controllers is on the same lower level as the communications system. Several large cabinets contain some rather unusual gear that combines incoming and locally generated displays, and prepares them for use by the controllers on the floor above.

At one end of the building, on a large raised platform, there is a large Univac computer. It is to be replaced by a larger



Here Eli Nannis is following an aircraft on one of the many radar repeater consoles.

Ver-r-r-y Inter-r-r-esting Bar-gains!!!

Send for our ver-r-r-y Inter-r-r-esting 68 page catalog!!! 25¢ (Free with an order!!!)

MINI-BOX HEAT SINKS

Made of gold anodized aluminum. Designed for transistor ignition systems. It is the very best. Inside dimensions are 1 1/4 wide x 2 5/8 long x 2 3/8 high. 2 shelves inside for mounting transistors & diodes. Brand new with hardware. Use it in your next project to give it that professional look.

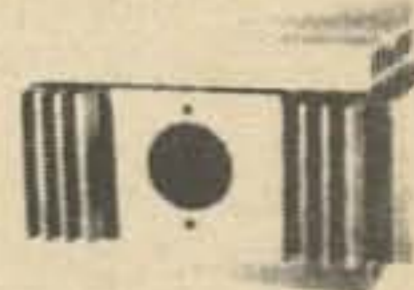

MHBS.....\$2.00 postpaid.

GYROSCOPE—WORLD WAR II FAMOUS



Drift Meter Gyro— Use it as a Camera Stabilizer or for a Science Fair project — has a high momentum. Gyro wheel 4" Dia. & turns @ 11,500 RPM. AC input 110V @ 400 Hz, but will run on 12 V-DC with a 400 Hz power supply. A similar Gyroscope Camera Stabilizer is sold at over \$800.00 in large camera stores. Has on off switch & a caging provision to lock movement when required. Has a machined mount to attach to item to be stabilized. Power Supply Kit for this unit \$2.50 when with Gyro.

4K Gyro.....\$10.00 postpaid.
Power Supply P.S. Gyro.....\$2.50 postpaid.

1000 MFD TANTALUM CAPACITOR

Buy a brand new high capacitance Tantalum capacitor for less than the price of an equivalent aluminum foil unit. You gain the advantages of small size, high reliability, infinite life, and high temperature operation. Don't let the Electrolytic Capacitor be the largest size and least reliable component in the next home project or replacement. Regular net price of these units is \$72.00. Brand new Tantalum Capacitors:

1000 Mfd @ 50 VDC—TC1000.....\$2.00 postpaid.
400 Mfd @ 75 VDC—TC 400.....\$2.00 postpaid.

B & F Enterprises, Box 44, Hathorne, Ma 01937

Brand New GOVERNMENT SURPLUS

F1.	Connector SO-239, New.....	\$.45
F2.	Connector PL-259, new.....	\$.45
F3.	Adapter UG-175/U, new.....	\$.12
F4.	Hardware. 2 lbs nuts & bolts.....	\$1.00
F5.	Capacitors, 1 lb grab bag.....	\$1.00
F6.	Rotary Switches, 1 lb grab bag.....	\$1.00
F7.	Lever switches, 1 lb grab bag.....	\$1.00
F8.	Precision resistors, 1 lb grab bag.....	\$1.00
F9.	Mica capacitors, 2 lb grab bag.....	\$1.00
F10.	SPST switch A&H83001, 3 for.....	\$1.00
F11.	DPDT Rockette type switch.....	\$.50
F12.	Subminiature 8 pin socket, 20 for.....	\$1.00
F13.	829 tube socket.....	\$.75
F14.	7-8-9 pin sockets, 10 for.....	\$1.00
F15.	7 and 9 pin shields, 10 for.....	\$1.00
F16.	Acorns—954, 955, 957, 959, 10 for.....	\$1.00
F17.	GE 3C22, new.....	\$2.00
F18.	Toroid 40 hy.....	\$.50
F19.	CAC Toroid 23.3 mH.....	\$.50
F20.	CAC Toroid 430 mH.....	\$.50
F21.	Xfmr 115vac — 6.3 @ 1.2A, 1#.....	\$1.00
F22.	Sprague 10/10 mfd 450vdc, 3 for.....	\$1.00
F23.	Dumont 2 mfd 1000vdc cap.....	\$.50
F24.	TLA6040, 4 mfd 600vdc cap.....	\$.50
F25.	Cap., 20/20 mfd 300vdc.....	\$.50
F26.	Cap., 20/20/20 mfd, 450vdc.....	\$.50
F27.	Cap., 40/40 mfd 150 vdc.....	\$.50
F28.	Micamold 60 mfd 400vdc.....	\$.50
F29.	Oil cap., Pyramid 1 mfd 1500vdc.....	\$.75
F30.	Oil cap., Pyramid 16 mfd 400vdc.....	\$1.00
F31.	Oil cap., Sprague 8 mfd 1500vdc.....	\$2.00
F32.	Var. cap., National 7-100uuf 1kv.....	\$1.00
F33.	Var. Johnson 50-1050uuf 2.5kv.....	\$7.00
F34.	Var. Johnson 3.5-14.5uuf 1.2kv.....	\$.50
F35.	Var. dual section 470uuf 4.5kv.....	\$7.00
F36.	Var. Cardwell 2.8-6uuf 1 kv.....	\$.50

Minimum order \$5. Please include sufficient postage in your money order or cashiers check. Ohio residents add 4% tax.

MENDELSON ELECTRONICS CO.

516 Linden Avenue, Dayton, Ohio 45403
Phone: 513-252-9911

CASSETTE TAPE RECORDER

After testing a dozen different makes of cassette tape recorders we found that the Valiant was by far the easiest to use. The fidelity is good and the push button system outstanding. Has battery level meter, recording level meter, jack for feeding hi-fi or rig, operates from switch on mike. Great for recording DX contacts, friends, at the movies, parties, unusual accents, etc. Use like a camera. Comes with mike, stand, batteries, tape.



SPECIAL, ONLY \$33.00 Postpaid

24 HOUR CALENDAR CLOCK

This beautiful clock reads the day, the date and the time in large, easy to read numbers. Set this on GMT and never make a mistake again on logging time or date. 8x3½x3½, brushed aluminum case. Synchronous self-starting movement, 115v 60 cy. Make your operating desk look outstanding with this new type of clock.



24 HOUR CLOCK, \$41.00 Postpaid

12 HOUR CLOCK, \$41.00 Postpaid

TRAVEL-CLOCK RADIO

Eight transistor clock radio, complete with clock, radio alarm and slumber setting! Weighs less than 1½ lbs. Great gift for traveling friend or relative. Batteries included. Tray opens to hold change, etc.



SPECIAL, ONLY \$24.00 Postpaid

AM-FM DIGITAL CLOCK RADIO

Here is something new—a digital clock (reads numbers directly) plus sensitive AM-FM radio with AFC! Compare with \$60 Sony.



This is a wonderful radio for the bedroom or kitchen. Transistorized radio. Antenna built in for local stations. Use outside antenna for distance.

SPECIAL, ONLY \$38.00 Postpaid

DESK NAME-CALL PLATE

Your name and call on a walnut grained desk plate 10" long by about 1" high. Up to 20 letters and spaces. You can have your full name or your first name and call letters. Sorry, no zero available.



Identify your station with a beautiful desk plate.

SPECIAL, ONLY \$2.00 Postpaid

Send order to:

REDLINE Co. Box 431, Jaffrey NH 03452

() Tape recorder () Digital clock radio
() 24 Hour clock () 12 Hour digital clock
() Travel clock radio () Desk name plate

Name _____

Address _____

City _____

State _____ Zip _____

one, I understand, within a year or two since it is having some difficulty keeping up with the work. This computer prepares flight information by use for the controllers, and reads it out on the machines visible in the lower RH corner of the large photo. This computer can accept information from other computers in adjacent flight control zones, without human assistance, so that controllers are promptly informed of flights entering their areas or passing over on long trips.

And at the other end is the actual flight control area, consisting of many small consoles, each manned by a group of two or three workers. The consoles at the left hand side of the room are operated by men controlling flights above 20,000 feet, and those on the right are for flights below 20,000 feet. Each console displays only a rather small part of the overall picture of the entire area.

How the Center Works

All commercial and military pilots, and many private pilots, file flight plans with the FAA shortly before takeoff. These list take-off and landing times and places, and proposed schedule in flight. Fed to the Center's computer, these figures are checked against other flight plans, and changed if necessary to avoid hazardous interference possibilities. Finally, the computer prints out information slips for the flight controllers, carrying the data each one needs to follow that flight across his screen.

The controller sees the plane as a blip on his screen. He notes the plane's designation, bearing, speed and altitude on a small piece of plastic (called a shrimp boat) which he pushes across the radar display to follow the appropriate blip. If he wants to talk with the pilot he is able to communicate through the elaborate phone and radio system, and can ask the pilot to activate a transponder in the plane. This generates a brief but prominent change in the blip, and the test is regarded as most successful if the appropriate blip flashes, and most needed if some other blip flashes. Positive identification is made very quickly in this way.

Each controller is responsible for the safe flight of up to ten (or 20, in emergencies) aircraft across his area. He gets about sixteen months of training, on special simulated displays, before he goes to work as a controller.

As Eli was explaining this to me, something was gaining my attention. I looked at one of the displays close up and finally it struck home: These looked like PPI displays, and they were green as you would expect, but they seemed to show TV scanning lines. In fact, they appeared to be TV displays, not radar displays. I asked Eli about this. What was the purpose of it?

Some Very Practical Electronics

That explanation took some time, and we visited some parts of the building again as the various parts and functions fell into a clearer picture.

The incoming radar displays are not very good for flight control work. For instance, beacon sites and airways are simply places on the map and there is little or nothing to serve as accurate reference for radar navigation control. Airways do not reflect radar waves. And so the map is added at the Center. A flying spot scanner does that job.

A sharply focussed spot moves across the face of a fast-phosphor tube (the trace is quite blue, almost violet) in synchronism with the radar trace. A map is placed over this display. Since the map is drawn on transparent material, its lines appear as positive or negative lines when added to the incoming radar picture. Very little electronics is required to do this job, most of it serving to keep the flying spot trace and the map in synchronism with the radar display. The combined signals are presented on the face of a special image memory tube, but this picture is off-center so that only a portion of the area visible to a given radar set appears on the memory tube phosphor.

This is because the same big display can be fed to several memory tubes simultaneously, each tube getting an area that is interesting to one flight controller. A TV pickup tube assembly then reads off the image for use in one or more flight control consoles. Since there are several of these systems, a data processing system, and many communications systems, it is evident there is a lot of electronics installed in the BARTCC.

The Future

Hams thinking about their future in electronics should be very interested in the FAA's work in aircraft safety and navigation. The field is rapidly developing in com-

NEW G&G CATALOG! MILITARY ELECTRONICS



24 PAGES crammed with Gov't Surplus Electronic Gear—the Biggest Bargain Buys in America! It will pay you to

SEND 25¢

for your copy—Refunded with your First Order!

BC-645 TRANSCEIVER, 15 tubes, 435 to 500 Mc. Easily adapted for 2 way voice or code on Ham, Mobile, Television Experimental and Citizens' Bands. With tubes, less power supply in factory carton.
Brand new **\$16.95**

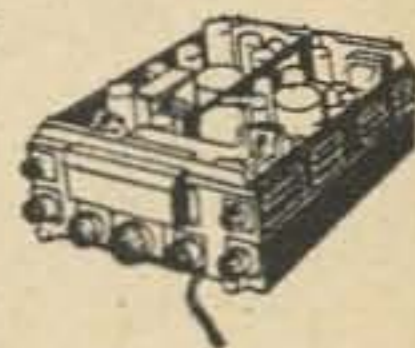

SPECIAL PACKAGE OFFER: BC-645 Transceiver, Dynamotor and all accessories, including mountings, UHF Antenna Assemblies, control box, complete. **BRAND NEW** **\$26.95**

AN/APR-4Y FM & AM RECEIVER "FB" FOR SATELLITE TRACKING!

High precision lab instrument, for monitoring and measuring frequency and relative signal strength, 38 to 4000 Mc in 5 tunings ranges. For 110 V 60 cycle AC. Built-in power supply. Original circuit diagram included. Checked out, perfect, **LIKE NEW** **\$88.50**
All Tuning Units Available for Above

SCR-274-N, ARC-5 COMMAND SET HQ!

Freq. Range	Type	Exc. Used	Like New	BRAND NEW
RECEIVERS, Complete with Tubes				
190-550 Kc	BC-453	\$18.95	\$23.50	
3-6 Mc	BC-454	\$16.50	\$21.50	
6-9.1 Mc	BC-455	\$14.95	\$19.95	
1.5-3 Mc	R-25	—	\$21.50	
TRANSMITTERS, Complete with Tubes				
4-5.3 Mc	BC-457	\$ 6.95		\$11.95
5.3-7 Mc	BC-458	\$ 6.95		\$12.95
7-9.1 Mc	BC-459	\$17.95		\$22.50
2.1-3 Mc	T-18	—		\$10.95
3-4 Mc	T-19	\$10.50		\$14.95

BC-929 3-Inch Scope, with all tubes, **EXC. USED, Like New** **\$16.95**
Conversion instructions, with diagram, for 110 V AC operation. **\$.65**

TERMS Either 25% Deposit with order, balance C.O.D.—OR—Remittance in Full. Minimum Order \$5.00. All shipments F.O.B. our warehouse, NYC. All merchandise subject to prior sale and price change.

G & G RADIO SUPPLY COMPANY

(Tel: (212) CO 7-4605
77-B Leonard St., New York, N.Y. 10013

plexity and sophistication, and although it's pretty elaborate right now it was my impression that you'd really be getting in on the ground floor. Right now, electronics technicians get about \$9,000 worth of training over a period of six months before they are qualified, and this can be expected to be worth more and take longer as proposed new gear and systems are installed and made operational. ■

GATEWAY ELECTRONICS

6150 Delmar Blvd., St. Louis, Mo. 63112

RCA 12 Volt 85°C Crystal Ovens—for RCA-GE-Aerotron-Comco FM Radio Equipment. Octal base—slight modification to some radios for proper connections. Shipping weight 1 lb..... **\$3.50**

Facsimile paper for WestFax Machines—2¢ each or \$12.00 per 1000 sheets. Shipping weight 5 lbs. per 1000 sheets.

Transformer—12 volt center tapped @ 70 amps (input 115 vac). Ideal for battery charger, two way radio supply, etc. Size 6½x7x5. Shipping weight 30 lbs..... **\$9.95**

Transformer—28 volt @ 8½ amps & 12 volts @ 1 amp (input 115 vac). Excellent for regulated supply or low voltage power supply. Size 5½x5x4½. Shipping weight 16 lbs..... **\$5.95**

12 volt DC to 115 volt AC 60 Cycle Transistorized Inverter Kit—complete with all parts, instructions and case. Shipping weight 25 lbs..... **\$18.95**

Sealed Mercury Wetted Polar Relays (direct replacement for WE255A). RTTY'ers dream. Shipping weight 4 lbs..... **\$4.95**

Ni-Cad Batteries, 1.3 volt @ 4 amp/hr. Excellent condition. Shipping wt. 1 lb.... **\$2.25**

Minimum Order \$5.00. Sorry, no catalog at this time. Write for specific items. Watch for our future ads in 73 Magazine. Happy Valentine's Day!



TRANSKEY(TM)



\$34.95
Postpaid

Electronic Keyer and Monitor

- +Transistorized; relay output.
- +Key built-in; wired, ready to operate.
- +Continuously variable speeds 5-50 WPM.
- +Penlight cells or 6V external source.
- +Key contacts adjustable.
- +Push switch on back, automatic or semi-automatic operation.
- +Dot-space ratio adjustable.
- +Variable tone control on monitor.
- +Keyer 3½x5½x1¾. Weight 2 lbs.
- +Unconditional one year guarantee.

W6PHA — GLOBAL IMPORT CO.
BOX 246, EL TORO, CALIF. 92630



25KC MARKS!

Locate New Sub-Bands

Accurately! Four wires connect IC-3 Divider to your 100KC calibrator to give 25KC marks. Circuit board 1¼" x 1½". Specify supply voltage — 3-300, 10 ma. (Lowest is best.) Send for IC-3, \$5.95, + 30¢ postage.

PAXITRONIX INC. BOX 1038 (B) Boulder, Colo. 80302

NO "FREE" CATALOG!

Our new policy is to send "FLYERS" only on a free basis: and there may be no follow up mailing unless you order from the flyer. We have a large catalog of electronic parts & equipment (over 100 pages) that will be supplied to those ordering over \$10.00 from the flyer. Catalog deposit is \$1.00 (mdse certificate issued)

BIGELOW ELECTRONICS

Dept. 73, P.O. Box 71, BLUFFTON, OHIO 45817

Propagation Chart

FEBRUARY 1969

ISSUED DECEMBER 1

J. H. Nelson

EASTERN UNITED STATES TO:

	GMT: 00	02	04	06	08	10	12	14	16	18	20	22
ALASKA	21	14	7	7	7	7	7	7	7A	14A	21A	21A
ARGENTINA	14	7A	7	7	7	7	14A	21	21	21	21A	21A
AUSTRALIA	21A	14	7B	7B	7B	7B	7B	14B	14B	14	21	21A
CANAL ZONE	14	14	7	7	7	7	14	21A	2B	2B	21A	21
ENGLAND	7	7	7	7	7	7	14	21A	21A	21	7A	7
HAWAII	21	14	7B	7	7	7	7	7B	14	21A	21A	21A
INDIA	7	7	7B	7B	7B	7B	14	14	7B	7B	7B	7
JAPAN	14	7A	7B	7B	7	7	7	7B	7B	7B	7B	14
MEXICO	14A	14	7	7	7	7	7	14A	21A	21A	21A	21
PHILIPPINES	14	7A	7B	7B	7B	7B	7	7B	7B	7B	7B	7B
PUERTO RICO	14	7	7	7	7	7	14	21A	21A	21	21	21
SOUTH AFRICA	14	7	7	7	7B	14	21A	21A	21A	21	21	14
U. S. S. R.	7	7	7	7	7	7B	14A	21	14	7B	7B	7
WEST COAST	21	14	7	7	7	7	7	14	21A	21A	2B	21A

CENTRAL UNITED STATES TO:

ALASKA	21	14	7	7	7	7	7	7	7	14A	21A	21A
ARGENTINA	21	14	7	7	7	7	14	21	21	21	21A	21A
AUSTRALIA	21A	14	14	7B	7B	7B	7B	7B	14	14	21	21A
CANAL ZONE	21	14	7	7	7	7	7A	14A	21A	2B	2B	21A
ENGLAND	7	7	7	7	7	7	7B	14	21A	14	7A	7
HAWAII	21A	14	7B	7	7	7	7	7	14	21A	21A	21A
INDIA	7B	7B	7B	7B	7B	7B	7B	7	7	7B	7B	7B
JAPAN	21	14	7B	7B	7	7	7	7	7	7B	7B	14
MEXICO	14	7A	7	7	7	7	7	7A	21	21	21	21
PHILIPPINES	21	14	7B	7B	7B	7B	7	7	7	7B	7B	14
PUERTO RICO	14A	14	7	7	7	7	14	21A	21A	21A	21A	21
SOUTH AFRICA	14	7	7	7B	7B	7B	7A	14A	21A	21A	21	14
U. S. S. R.	7B	7	7	7	7	7B	7B	14	14	7B	7B	7B

WESTERN UNITED STATES TO:

ALASKA	21	14	7	3A	3A	3A	3A	3A	7	14	21	21A
ARGENTINA	21A	14	14	7	7	7	7	14	21	21	21	21A
AUSTRALIA	2B	21A	14	14	7	7	7	7	14	14	21	21A
CANAL ZONE	21	14	7	7	7	7	7	14	21A	21A	21A	21A
ENGLAND	7B	7	7	7	7	7	7B	7B	14	14	7B	7B
HAWAII	2B	21	14	7	7	7	7	7	14	21A	2B	2B
INDIA	7B	14	7B	7B	7B	7B	7B	7	7	7	7B	7B
JAPAN	21A	21	14	7B	7	7	7	7	7	7B	7B	14
MEXICO	14A	14	7	7	7	7	7	7A	21A	21A	21A	21
PHILIPPINES	21A	21	14	7B	7B	7B	7	7	7	7B	7B	14
PUERTO RICO	21	14	7	7	7	7	7	14	21	21A	21A	21A
SOUTH AFRICA	14	14B	7	7	7B	7B	7B	14	21A	21A	21	14
U. S. S. R.	7B	7	7	7	7	7B	7B	7B	14	7B	7B	7B
EAST COAST	21	14	7	7	7	7	7	14	21A	21A	2B	21A

A - Next higher frequency may also be useful.
B - Difficult circuit.

Good: 3-6, 11-14, 18-21, 23-25.
Fair: 1, 2, 7, 8, 15-17, 22, 28.
Poor: 9, 10, 26, 27.

(\$1,000,000 TVI Suit from page 37)

their findings would be reported to the Miami office of the FCC which has jurisdiction in this case.

On October 25, I spoke with Mr. Gilbert, the Engineer in Charge of the Miami FCC office, to see if a determination had been made in the case. He said that the FCC could find no cause to limit Mr. Gridley's operation and that Mr. Eggers' attorney had been notified to that effect. He said that he considered the case closed inasmuch as the FCC no longer had jurisdiction over what is in essence a dispute between two neighbors.

On October 26, the original pre-amplifier was re-installed at the TV antenna upon the insistence of Mr. Eggers. The Jerrold amplifier and the high-pass filter were removed. This TV set is, therefore, in its original configuration, which exhibited the maximum amount of interference.

On October 31, a suit was filed in the Circuit Court of Sarasota County against Mr. Gridley. Among other things, the suit states:

"That said radio station was erected and is maintained in a negligent and unskillful manner, and by reason of this negligence and want of care in the construction, operation and maintenance of said radio station since the year of 1958, Defendant still does maintain a nuisance, causing much discomfort and vexation to your Plaintiff by not allowing him to enjoy his radio and television sets because of this constant and considerable interference, and this aforesaid nuisance constitutes an electronic invasion of privacy in the home of the Plaintiff."

The suit asks that Mr. Gridley be restrained by injunction from maintaining or using his amateur station and that Mr. Eggers recover \$1,000,000 damages.

Mr. Richard V. Harrison, attorney for Mr. Gridley, has contacted the ARRL General Counsel in Washington and has requested support in this matter. Mr. Harrison has also moved that the case be heard in the Federal Court in Tampa, and that Mr. Eggers be enjoined from publishing in the newspapers any material referring to Mr. Gridley or to "ham operators." A total of five advertisements containing "editorials" have appeared in the newspaper since the start of the case.

It is understood that a hearing on this case will be held in the Federal Court in Tampa on January 8, 1969.

The TVI Committee believes it has exhausted all possible methods to effect a solution to this interference problem. However, a final solution cannot be effected until the

complainant agrees to cooperate by allowing the necessary corrective action to be performed. Nevertheless, the committee will continue to monitor the events as they occur and stands ready to assist if requested.

A note from Grid points out that there never has been a precedent set in a suit of this type in ham radio and that an adverse ruling, no matter how unlikely, could mean the end of amateur radio as we know it today. Grid needs help, legally and financially, to see him through this nightmare.

A.E. Gridley W4GJO
1966 Hillview Street
Sarasota, Florida 33579

"THE COMPLETE HAM STORE" WHERE YOUR DOLLAR BUYS THE MOST

All leading lines of amateur gear:
We give best trade-in allowance
for your gear on new equipment:
Call us for the best deal:

**WE PAY CASH FOR HAM & CB RADIOS
CALL OR WRITE**

BOB'S AMATEUR ELECTRONICS

927 N.W. 1st. St., OKLA. CITY, OKLA. 73106
Phone 405-CE-5-6387

SURPLUS WANTED

Equipment with prefixes ARA, ARC, ARM, ARN, APA, ASN, ASA, APN, APR, ARR, ASQ, GRR, GRC, GRM, GPM, VRC, UPX, URA, URR, URM, USM, UPM, SG, MD, PRM, PSM, PRC, TMQ, TRM, TED, SPA, SRT, CV, Commercial equipment by: ARC, BIRD, BOONTON, BENDIX, COLLINS, MEASUREMENTS, H-P, NARDA, GR, SPERRY, etc.; **TOP CASH DOLLAR PAID OR TRADE. WE STOCK NEW HAM GEAR.** Write-Wire-Phone (813) 722-1843, Bill Slep, W4FHY. SLEP ELECTRONICS COMPANY, 2412 Highway 301 N., Ellenton, Fla. 33532

WE PAY CASH FOR TUBES

**Lewispaul Electronics, Inc.
303 West Crescent Avenue
Allandale, New Jersey 07401**

Roy Ferren W6EKN
131 S. Anita Ave.
Los Angeles, Calif. 90049

CW Only Here, OM

As a true believer of the delicate art of CW, I used to wonder since World War II, if I was still living in the age of high button shoes and buggy whips, but I no longer do, and here is why:

I made my conversion at a tender age from the life of a normal, red blooded American boy to a strange character who spent long night hours listening to weird noises from the 201A's in a super-regen receiver. The sheer joy of first copying completely a message from start to end has seldom (I siad "seldom") been equaled to this day. I was a superior being—I was in an esoteric society of superhumans who had their own language, and greatest of all—I was privy to secret conversations coming through the night in fair weather and foul.

Since 1928 (my "ticket" year) I have steadfastly held my head high and refused to be seduced by the "phone" boys—or as we now say the "SSB" types. "Lips that touch liquor shall never touch mine" were mild compared to my firmness that, "A hand that caresses the bug shall never hold a mike." My rationalization for this attitude was a thing of beauty and joy forever. I said, in my pristine purity, "I talk all day on the telephone, so why should I spend my precious time shouting into a mike!" For this I have suffered the opprobrium, slurs, and downright insults of my fellow hams, but I have resolutely turned my cheek.

Now after 38 years of "CW only" (I

started young—so none of that "Old Timer" stuff) I feel my lonely stand against the ubiquitous "phone man" is slowly being vindicated. I am sort of a strange breed that can best be described as a "DX ragchewer" or a "Ragchewing DX'er." I do this by sitting quietly in front of my 75A4 watching the heat waves rise from the Henry 2K final and slyly swinging around the wide spaced single band Yagi to those directions wherefrom the sweet and pure sigs come for me to snare. When this occurs I then subtly start questioning the victim in English, French, or Spanish to encourage him to break the deadly pattern of the "RST, QTH, QSL, 73" hackneyed QSO's heard constantly on 14 MHz. Sometimes I succeed, sometimes I don't, but when I do I get some interesting answers. Among these answers comes forth the fact that a number of dedicated phone men are reluctantly deserting the ranks of SSB for the honorable art of CW. Why? Mainly, because they are bone tired of the incessant flow of chatter, endless repetition, and the use of "cute" phrases. They want to again enjoy the crisp, clear interchange of ideas, thoughts, and information through the use of CW which by its nature forces clear thinking into few words. Objectively, I think this is good for amateur radio. It gives a healthy transfusion between disciplines and keeps alive that spark of uniqueness in amateur radio of "Let's do it differently, and better."

... W6EKN



\$14.95

1" VIDICON Magnetic Deflection Yoke

Brand new 1" VIDICON DEFLECTION YOKES, either tube - no. 19,168 or transistor type no.1809 (Please specify). Complete with "How to Build a TV Camera" instructions, etc. Only \$14.95 + post.
No.4760 Crystals for 15.750 kc.....\$14.95
No.4761 Crystals for 31.5 kc.....\$14.95

PAGE AFTER PAGE OF VALUES LIKE THESE are listed in our catalog 967A1. If you have mislaid your copy a new one will be mailed upon request. With the exception of our flyer 968M1 we will not have a new catalog available until the Spring of 1969. WATCH FOR IT! Occasional flyers only.

TV CAMERA TURRETS

ONLY \$7.95

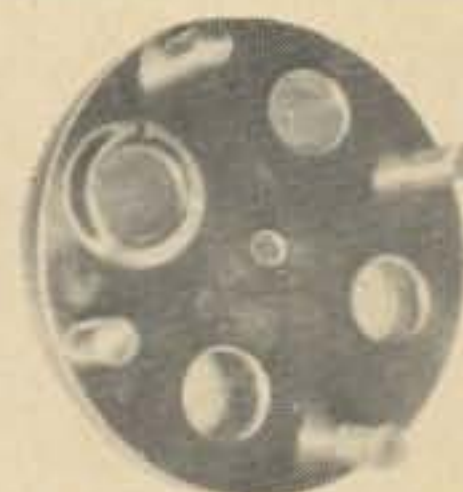

No.19,172—Sylv. brand new 4 lens turret 5 3/4" dia. w/mounting hole in center (1 mounting hole is forward of the other 3 for using close-up lenses) & all are threaded for a std. 16mm "C" lens.
EXTRA SPECIAL only \$7.95 plus postage.
VIDICON SOCKETS—no.2100—brand new - for 1" electromag. Vidicons type 7038, 6198, etc. \$2.95.

THE DENSON CORP. Rockville CT 06066
POST OFFICE BOX 85 Phone 203-875-5198

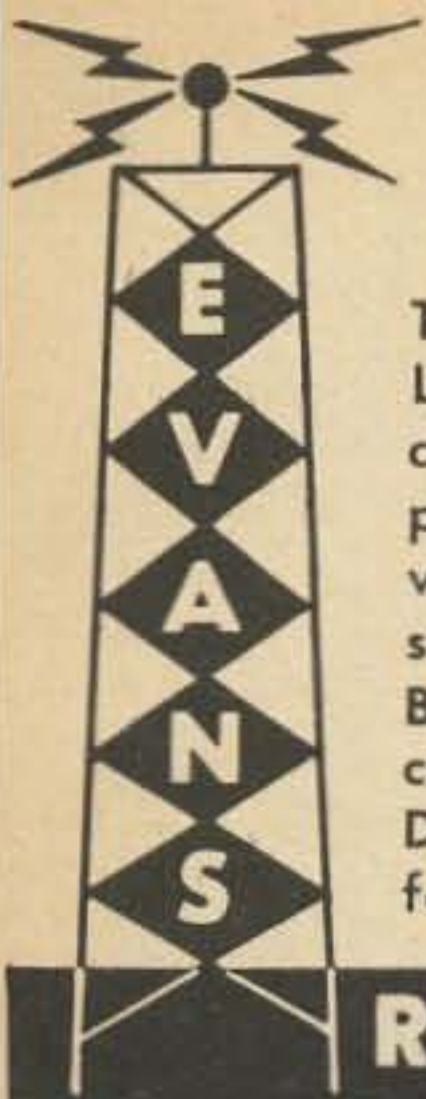

IN STOCK!

THE DRAKE R-4B RECEIVER



The Drake R-4B offers many fine features . . . Linear permeability tuned VFO with 1 kc dial divisions. Covers 80, 40, 20, 15 meters completely and 28.5 to 29.0 Mc of 10 meters with crystals furnished. Four bandwidths of selectivity, .4 kc, 1.2 kc, 2.4 kc, and 4.8 kc. Built-in Notch filter, Noise Blanker, and 25 KC crystal calibrator. Product detector for SSB/CW, Diode detector for AM . . . Plus many other features . . .

R-4B Receiver _____ \$430.00

ALSO IN STOCK:
 T-4XB Transmitter \$449.00
 AC-4 AC Supply 99.95
 and other Drake Accessories

We also have a large selection of used equipment — Write for Latest Complete List.

RADIO, INCORPORATED • ELECTRICAL SUPPLY CO.
 BOX 893 CONCORD NH 03301 TEL. 603 225-3358

HI-HO-HUM

Are you getting signal reports that you have a sixty cycle hum and your modulation is distorted, when you use your vfo? Is it possibly a leaky pair of electrolytic condensers in the power supply of your transmitter? Or, could it be a broken shield on your mike cord? Nine times out of ten the vfo is causing the hum.

How come it is the vfo? In commercial radio amateur or "home brew" transmitters, the cathode of the oscillator tube sometimes has a choke or a choke and resistor to ground. Now this is fine if you use a crystal but if you use a vfo with the choke or choke and resistor still in the cathode circuit, you are above ground and there is the hum.

To cure this problem, the cathode must go straight to ground eliminating the choke when you use the vfo. A DPDT switch (see Fig. 1) will make it easy for you to use a xtal or a vfo without any hum.

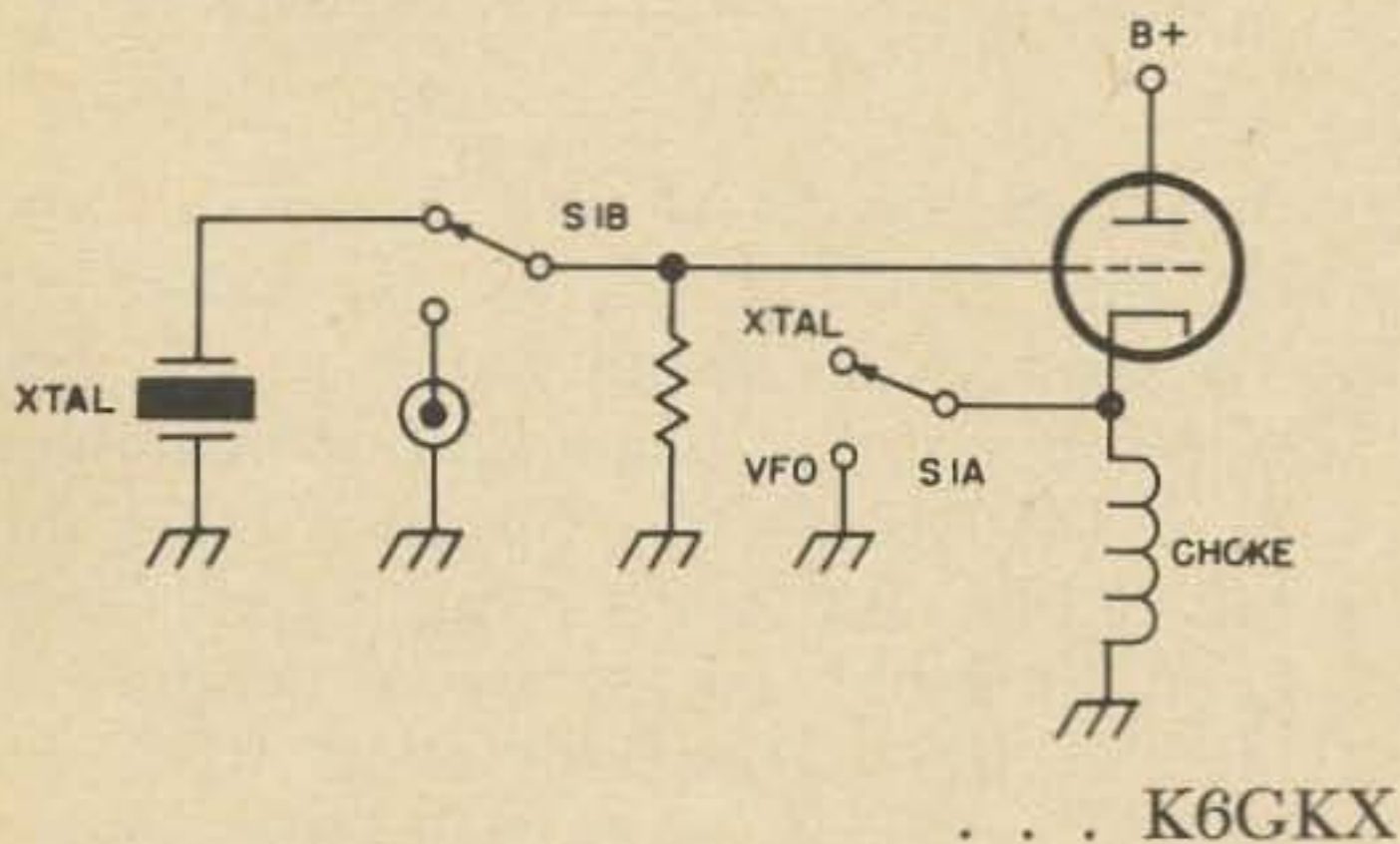

**HELP STAMP OUT
 MENTAL HEALTH
 SUBSCRIBE TO 73
 NOW**

CUSTOM TRANSFORMER DESIGN & MANUFACTURE

Write today for a free quotation on any transformer, choke, or saturable reactor. Each unit will be designed and manufactured to your exact specifications. Standard E-I and tape wound "C" cores are available. Quantities from single units to production runs may be accommodated.

PETER W. DAHL CO.
 5325 Annette Ave., El Paso, Texas 79924
 Tele: 915-751-4856

VIBROPLEX

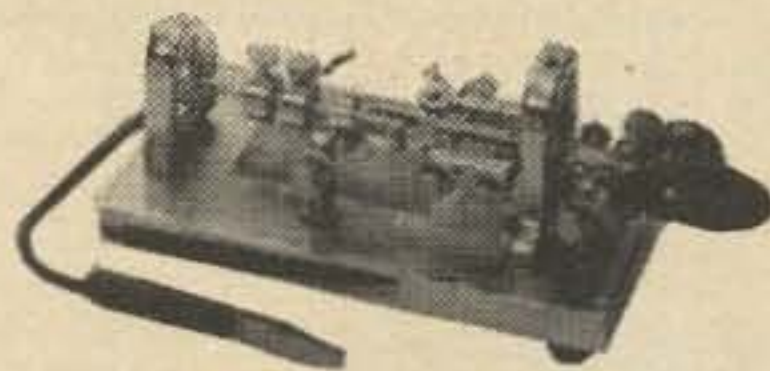

**ENJOY EASY,
 RESTFUL KEYING**
 \$21.95 to \$43.95
**THE VIBROPLEX
 CO., INC.**
 833 Broadway,
 N. Y. 3, N.Y.

**CONVENTION 69
 ARRL NATIONAL**

**Des Moines, Iowa
 June 20, 21, 22
 P.O. Box 1051, 50311**

**LARGEST SELECTION in United States
 AT LOWEST PRICES—48 hr. delivery**



Thousands of frequencies in stock. Types include HC6/U, HC18/U, FT-241, FT-243, FT-171, etc. SEND 10¢ for catalog with oscillator circuits. Refunded on first order. 2400B Crystal Dr., Ft. Myers, Fla. 33901

- ARC-I Transceiver 100-156 Mc, 25 Watts AM, with tubes, schematic, conversion info for 2-meters. Used, good. 50 lbs. \$20.00
 ARC-I only, less tubes, \$12.00
- BC-221-AK with AC Power, Calib. Book & Xtal. \$95.00
- TS-174, 20-250 Mc. Freq. Meter, on rack panel with AC Power, Calib. Book & Xtal. \$95.00
- Brush BL-202 2-channel oscillograph, Used, Exc. \$90.00
- Sorensen 3000S AC Line Voltage Regulator, 3000 V.A. Used, Exc. \$125.00
- Non-Linear-Systems 451 Digital Voltmeter. P.U.R. Send 10c for flyer listing surplus equipment, test equipment, new and used ham gear.

JEFF-TRONICS
 4252 Pearl Rd. Cleveland, Ohio 44109

HEY THERE! YOU WITH THE GEAR IN YOUR SHACK!

Don't clutter up your home with all that stuff! Better to clutter up our warehouse -- and get paid in the bargain. Don't waste time asking us for prices. Tell us exactly what you want for your Gen Radio, H-P, Tektronix, ARC, GRC, TED, PRC, VRC, ARN, URR, APN and other military/commercial gear. Write Today!

Will pay Hi, unreasonable, fan-
tastic price for Navy 10 W. Audio Amplifier...in cast aluminum cabinet. Urgently need Models AM-215A, -B, -C, -D/U. What have you?

COLUMBIA ELECTRONICS, Dept. 7

4365 W. Pico Blvd., Los Angeles, Calif. 90019
Phone: (213) 938-3731 Cable: COLECTRON

ARNOLD'S ENGRAVING Personalized

ELECTRIC
**ON-THE-AIR
SIGN**
WITH CALL



Works on
110 VAC
\$12.95



Metallex Lapel Bar - \$1.50 Metallex Tie Clip - \$2.25

ARNOLD'S ENGRAVING

2041 Linden St.

Ridgewood, N.Y. 11227

ANTENNAS • TOWERS • ROTORS NEW • USED • SURPLUS

Hy-Gain Mosley CDR Newtronics
Tristao Kreco

Mylar rope insulators Coax baluns
One-piece to Complete Antenna
Systems

Also Deal in Surplus—

Write for latest list

ANTENNA MART

BOX 7

RIPPEY, IOWA 50235

*Tell Our Advertisers
You Saw It in 73*

Superslingshot for Stringing Antennas

Hams have often used trees to support antennas. Unfortunately, the trees could not always support the ham as well. The casualty rate is somewhat lower for those who put the antenna in the tree by the bow and arrow method, but a suitable bow may run ten or twenty dollars and there's all those arrows too. You can always try throwing something, but if you're fat and forty or just plain out of shape, you may find that heaving a chunk of stone almost straight up feels harder than it looks.

My solution is better than a wrenched elbow and cheaper than a good bow. Buy a package of rubber bands, size 16 should do, and link fifty of them in a row as shown in the figure. You must loop the end ones as shown or the string will come apart.

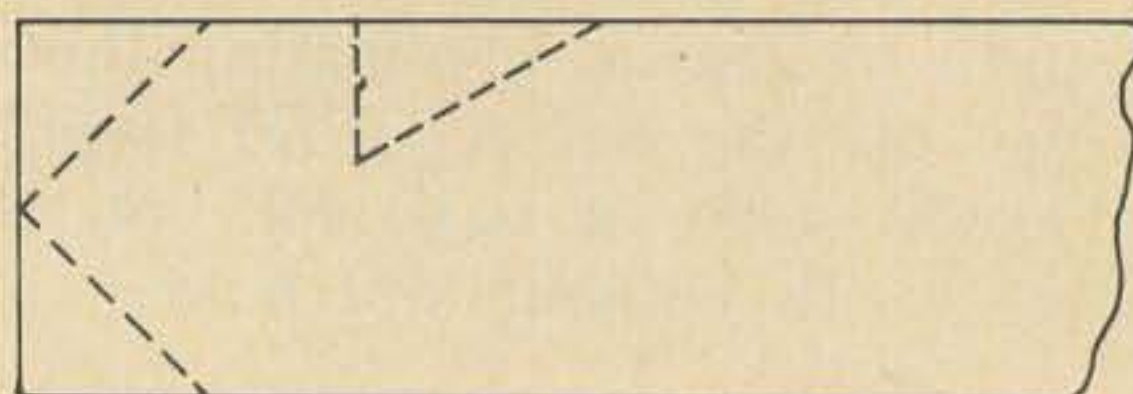

Take 18 inches of 1x2 wood or broomstick and cut the head as shown. Lay out a light nylon string 2½ times the height you want in large loops and attach the top end to the tail of the "arrow". Now, using a tall ladder and the rubber band string as a giant slingshot, notch the arrow, pull back as far as the bands will allow (3-5 feet), aim and let fly. If more power is needed to put the arrow over the limb of the tree, heavier bands will give your arrow more fling. So what if the neighbors think you're crazy, they know you're a ham.

... WA4VQR

Warning!! If the bands should break, the backlash could be severe. Draw to the chest, not to the eye! Ed.

104 Easy Transistor Circuits You Can Build, by Robert M. Brown

A hundred and four useful circuits, ranging from really simple or novel devices such as a light-activated oscillator to receivers, transmitters, and test instruments. There is something for any interest, or any wallet, in this book, and many of the circuits are of the extremely uncritical variety that can be assembled easily from junk-box parts if other materials are not available.

For instance, a power supply circuit described in the introduction, uses a simple current-regulating circuit in place of a zener which may be hard to get, and works very well with almost any available transistors of the correct polarity. The introduction also contains several paragraphs on substitution of available transistors for those listed in various projects.

Specially noted in the book were projects for several code practice oscillators, some CB gear, VHF as well as HF circuits, several test generators, and an efficient battery charger that will automatically switch over from charge current to a small trickle current as soon as the battery reaches full charge.

"104 Easy Transistor Circuits You Can Build" is available from your distributor or from Tab Books, Blue Ridge Summit, Pa., 17214, for \$6.95 in hardcover (recommended) or \$3.95 in paper.

99 Ways to Use Your Oscilloscope

If you have a 'xx 'scope, this book will be invaluable to you. If you don't have a 'scope then get one. Also get the book. It shows you how to test just about any circuit you are liable to run into, complete with the waveforms that you should find. Servicing color? Here is the info. What to do with an IC circuit? Transistors? All right here, with waveforms. Curve tracing for transistors? Diodes? Zeners? Here too. TAB Books, Blue Ridge Summit, PA 17214. Probably available from your local distributor for \$6.95 hardbound (best) or \$4.95 in paper. This book will give new life to your 'scope.

FEBRUARY 1969

R13B. Command receiver, 108-132 mc AM, 9 tube, 2 uv sensitivity. No dial. We give knob, tuning graph, technical data. Needs power supply & controls as other Commands.

NEW..... 27.50

R22. Command receiver 540-1600 kc, with knob and tuning graph & technical data. OK..... 17.95

R23/ARC-5 Command revr (Q-5'er) 190-550 kc, has dial, w/knob & tech. data. OK..... 14.95

R-392. Compact version R-390. Digit tune by kc & mc. 0.5 to 32 mc. Select pass 2, 4, or 8 kc.

Ready to use with power supply and book..... 525.00

AN/ALR-5. Tunes 38-1000 mc with ONE tuning unit CV-253 included.

Brand new, w/revr late type converted to 60 cy (R-444) also new or like brand new, with book..... 275.00

LM-14 freq. meter .125-20 mc, .01%, w/ser.-matched calib. & tech. data. 100% OK..... 57.50

TS-323 freq. meter 20-480 mc w/chart to approach .001%. Tech. data. 100% OK..... 169.50

TS-175 Gertsch FM-3, 3AM, 6, 9 freq. meters, also Deviation Meter.....

..... Ask for List #11b

WANTED: GOOD LAB TEST EQUIPMENT & MIL COMMUNICATIONS

We probably have the best inventory of good lab test equipment in the country, but please do not ask for a catalog! Ask for specific items or kinds of items you need! We also buy! WHAT DO YOU HAVE?

R.E. GOODHEART CO inc, Box 1220 GC, BEVERLY HILLS, CA 90213
Phones: area 213. Office 272-5707. Messages 275-5342.

JENNINGS VACUUM VARIABLE CAPACITOR. Type UCS-500. 25-500 pf at 10 kv. Includes panel mounting bracket. BRAND NEW. Factory boxed. (5 lbs.).....\$39.95

HAMMARLUND AIR VARIABLE CAPACITOR. Type TCD-240-J. Dual section transmitting type. 31-250 pf per section at 4250 volts. 10-3/16" L x 4 3/8" W x 2 5/8" H. BRAND NEW. (10 lbs.).....\$9.95

STANCOR POWER SUPPLY CHOKE. Type C-1001. 10.5

Henries at 110 ma, 3000 volt insulation. BRAND NEW. Factory boxed. (3 lbs.).....\$1.00

Quantities are limited. Include sufficient for postage and insurance—any excess will be refunded with your order.

KAPTAINS KOMPONENTS

2225 Albion St., Denver, Colorado 80207 • (303) 355-3680

TEST EQUIPMENT

and

IBM COMPONENTS

SEND FOR FREE CATALOG

GADGETEERS, inc. 5300 Vine Street
CINCINNATI, OHIO 45217

RADIO TELETYPE EQUIPMENT

Teletype Models 35, 33, 32, 29, 28 ASR, 28 LPR, 28 LARP, 28 LXD, 28 LBXD1, 14, 15, 19, Page Printers, Perforators, Reperforators, Trans-Distrib. polar relays, tape winders, cabinets, Collins Receivers, 51J-3, 51J-4, R-388, R-390A, SP600JX, Frequency Shift Converters, D.C. Power Supplies.

ALLTRONICS-HOWARD CO.

Box 19, Boston, Mass. 02101 Tel: 617-742-0048

YOUR SURPLUS WANTED BY
THE FASTEST GUN IN THE EAST



No horsing around, we pay fast . . . in 24 hours . . . and we pay more. We'll swap or trade new equipment too . . . We quote fast too. We also pay for shipping, insurance, etc. You call fast, now, collect, for fast quote.

SPACE ELECTRONICS

div. of MILITARY ELECTRONICS CORP.

11 Summit Ave., East Paterson, N.J. 07407, (201) 791-5050

NOW TUNAVERTER X WITH SQUELCH!

Tunable and crystal controlled RF converters for monitoring Police, Fire, Amateur, CB, CD, VHF weather, etc., on your broadcast radio economically.

See listing of models in Jan. issue of 73, page 27.

Or write for details to:

HERBERT SALCH & CO, Woodsboro 7, TX 78393



SPACE PROBLEMS SOLVED WITH

JOYSTICK

VARIABLE FREQUENCY ANTENNA SYSTEMS

With ATU's for 10-160 Meters Under \$50

SHORTWAVE GUIDE

414 Newcastle Rd.

Syracuse, NY 13219

**TOROID POWER TRANSFORMERS
THESE ARE NEW AND UNUSED**

T-2—This toroid was designed for use in a hybrid F.M. mobile unit, using a single 8647 tube in the RF amp. for 30 watts output. Schematic included. 12 VDC pri. using 2N1554's or equivalent. Sec. #1 500 volts DC out at 70 watts. Sec. #2 —65 volts DC bias. Sec. #3 1.2 volts AC for filament of 8647 tube. Sec. #4 C/T feed back winding for 2N1554's. 1 1/4" thick. 2 3/4" dia. ..\$2.95 ea.—2 for \$5.00
T-3—Has a powdered iron core and is built like a TV fly back transformer. Operates at about 800 CPS. 12VDC Pri. using 2N442's or equivalent. DC output of V/DBLR 475 volts 90 watts. C/T feed back winding for 2N442's. \$2.95 ea.2 for \$5.00

Transformers

P4—105-115-125 v 60 cy pri. 6.4v @ 11A, 205v @ 1/2A, 17v @ 45mA (relay power). Wt. 10 lbs.\$2.95
P-5 Pri. 117 VAC/12 DC. Sec. #1 295 VDC (V. DBLR) @ 85 ma. Sec. #2 12.6 VAC 2.6 A. & C.T. winding for Vibrator. Double Half Shell. Wt. 2 1/4 lbs. \$2.25—2 for \$4.00
P-6 Pri. 117 VAC/12 VDC. Sec. #1 275 VDC (V. DBLR) @ 150 ma. Sec. #2 12.6 VAC & C.T. for Vibrator winding. Wt. 4 1/4 lbs.\$2.95 ea.2 for \$5.00
SR 42—46 Type\$2.75—2 for \$5.00
P-7 117 VAC Pri. Sec. #1 185 VAC @ 120 ma. Sec. #2 6.3 VAC @ 4A. Double Half Shell Mail Box Type. SX 146 type\$2.75—2 for \$5.00
P-8 117 VAC Pri. Sec. #1 470 C.T. DC out of Bridge 660 V 300 ma. Max. Sec. #2 100 VAC @ 10 ma. Bias Sec. #3 12.6 VAC @ .75 A. to 6.3 VAC @ 6A. Half Shell HT 46 type. Wt. 7 1/4 lbs.\$3.50
P-9 117 VAC Pri. Sec. #1 900 VAC @ 300 ma. Sec. #2 100 VAC @ 10 ma. Bias. Sec. #3 12.6 VAC @ 2 AMP. Wt. 16 1/2 lbs. Double Half Shell\$4.50
P-10 117 VAC Pri. Sec. #1 960 VAC C.T. @ 160 ma. Sec. #2 425 VAC C.T. and tap at 100 VAC 10 ma Bias. Sec. #3 12.6 VAC @ 4.5A. Double Shell Mail Box type. Wt. 8 1/4 lbs.\$3.75
Output transformers, all types59 cents or 3 for \$1.50
OT-1 transistor TO-3 Power Diamond. Imp. 50 ohms to 3.2 ohms DC Res. Pri. .6 ohm. Sec. .3 ohm.
OT-2 Pri. imp. 7000 ohm. Sec. 3-2 and 500 ohm for Phones or 70 volt line 3 watts. full shielded Double Half Shell.
OT-3 Pri. imp. 5500 ohms. Sec. 3.2 ohms. SX122 type.

All prices F.O.B. All weights listed are net. Please allow for packaging. Please allow enough for postage. We will return any extra.

TOWER COMMUNICATIONS
924 Elm St., Racine, Wis. 53403

GO VHF

Go VHF the easy VHF Associates way. Send for descriptive Technical Bulletins describing our complete line of TRAN-SISTOR RECEIVING CONVERTERS and VARACTOR FREQUENCY MULTIPLIERS for 50, 144, 220, 432 and 1296 MHz.

VHF ASSOCIATES, INC.

P.O. Box 22135, DENVER, COLORADO 80222

FOR SALE TELETYPEWRITER LO-15A send-rec., mfg. Lorenz for Teletype Corp. HERE IS attachment to set up identification (answer-back). Most parts interchangeable with Model 15, parts available from us. W/steel table with electrical box, light green color, used excellent \$105.00, w/o table \$85.00.
FRXD-10 or 20 Combo typing reperf. & TD w/synch. motor. Used with a Model 15 page printer it will provide all the functions of a Model 19, with much more flexibility. Used excellent \$32.50 each. Send for our catalog on Teletype.
Atlantic Surplus Sales, 300 7th St., Brooklyn, NY 11215

**WE WANT TO CELEBRATE OUR 40TH
ANNIVERSARY WITH YOU
1928 - 1968 - IN BUSINESS
ANNIVERSARY SPECIAL**

All used equipment advertised in December issue offered at an additional discount of 10%. Be sure to check this list—over \$20,000 worth of good used Receivers, Transmitters and Transceivers offered at these reduced prices! While the stock lasts — let us serve you?

**We Stock SWAN Transceivers
Try Us for Best Trades**

Doug Jones WB4IHO mgr — T.T.Freck W4WL
FRECK RADIO & SUPPLY COMPANY
38 BILTMORE AVENUE
ASHEVILLE, NORTH CAROLINA 28801

Caveat Emptor?

- ★ Price—\$2 per 25 words for non-commercial ads; \$10 per 25 words for business ventures. No display ads or agency discount. Include your check with order.
- ★ Deadline for ads is the 1st of the month two months prior to publication. For example: January 1st is the deadline for the March issue which will be mailed on the 10th of February.
- ★ Type copy. Phrase and punctuate exactly as you wish it to appear. No all-capital ads.
- ★ We will be the judge of suitability of ads. Our responsibility for errors extends only to printing a correct ad in a later issue.
- ★ For \$1 extra we can maintain a reply box for you.
- ★ We cannot check into each advertiser, so Caveat Emptor . . .

ANNUAL W2-DX ROUND-UP Saturday, March 22, 1969 (Saturday prior to IEEE Convention) at Holiday Inn of Newark, 430 North Broad Street, Newark, New Jersey. Starts 1 P.M. Ticket basis—afternoon program only, or total package with prime rib banquet. Afternoon program will include talks on speech processing, antenna performance, DX panel on "How To". Door prizes. Conveniently reached by train, subway, auto, and bus. Further details call W2LA. Also call 201-226-4545 or 212-344-2997 both daytime.

500 GREAT CIRCLE bearings, return bearings, distances, time differences, zones, computerized to your QTH. \$3.00. Samples, 25¢. Bearings, 122 Lockhart, Princeton University, Princeton, N.J. 08540.

HALLICRAFTERS HT-37. \$210, good condition, clean, no rust spots, and low mileage. Bob Koepke, W9IHI, 344 Oriole Lane, Madison, Wisc. 53704.

ALL HAMS, particularly college students, interested in pure physics and physics-philosophy, are invited to join Die Physik Gruppe, a group which will get on the air regularly and ragchew physics, especially pure physics and physics-philosophy. Please write Aron Faegre, WA9FJG/7, Box 318, Reed College, Portland, Oregon 97202. Discussions will not be in German!

3 PLASTIC HOLDERS will frame and protect 60 cards, \$1.00—or ten holders \$3.00. Prepaid & guaranteed. Patent 3309805. Tepabco, Box 198N, Gallatin, Tenn. 37066.

RECEIVER BAND changing switch 25¢ postpaid. Send for our surplus electronics parts and equipment flyers. Bob-Frank Electronics, PO Box 1327, Harrisburg, Pa. 17105.

ORIGINAL CONDITION, 1923 RCA radio. Has oscillator, wave length, loop regeneration knobs, tubes and transformers. Excellent condition for age. Best offer over \$100. W. C. Smith, 8679 45th St., Glen Avon, California 92509.

19 ASR TELETYPE for sale. A-1 mint condition, factory reconditioned. \$150. C. Vinson W2GJJ, Larkspur St., Yorktown Heights, New York 10598.

REGULATED POWER SUPPLIES, without transformers, .6-4 AMP, \$2.75 to \$8.50. Zeners, thermistors, \$.25. 10A Triac, \$1.75. Diodes, \$.05. Nixies with driver, Burroughs #B6091, \$9.50. Catalog. Murph, 204 Roslyn Ave., Carle Place, New York 11514.

LONG RANGE TV reception easy! Booklet outlines methods to receive distant TV stations using inexpensive materials. \$1.50 postpaid. PRACTICAL PLANS, Box 56-K, Killeen, Texas 76541.

WANTED: 1/2" paper tape for Boehme CW keyer. Send your price and amount available to Robert R. Smith WB6ODR, 13209 Idyl Drive, Lakeside, California 92040.

COLLINS: 51J4 w/3kc filter, excellent condition, \$700; KW-1 transmitter, excellent condition but needs bias transformer available from Collins for \$53, \$700. Shipping paid. Paul Reid, 405 4th Place, Merritt Island, Florida 32952.

VHF GEAR. Three Clegg 22'ers, \$160 for one, 10% off for two or all three. 6 Meter Gonset Communicator III, \$130. No personal checks. Barrie C. Hiern, K5SGP; 1506 Cross Lake Blvd., Shreveport, Louisiana 71109.

FOR SALE: 6 meter Hallicrafters AM SR-46 transceiver w/HA-26 VFO and Mobile kit. Mint Condition, \$100. Joel Eschmann K9MLD, 2036 Erie Street, Racine Wisconsin 53402.

WRL'S USED GEAR has trial—guarantee—terms! HW22—\$89.95; Swan 350—\$279.95; Galaxy 300—\$139.95; V—\$249.95; Vmk2—\$299.95; HX500—\$269.95; HT37—\$199.95; NCL2000—\$449.95; SB300—\$229.95; NC155—\$119.95; RME6900—\$149.50; Collins #312B5—\$199.95; hundreds more. Free "blue-book" list. WRL, Box 919, Council Bluffs, Iowa 51501.

RUSSIAN AMATEUR TRANSMITTER type CCCP-SVIAZ for sale, best offer accepted. George WA4NQR, 102 Willow Rd., Savannah, Georgia 31407.

25 YEAR COLLECTION electronic sound equipment, tape recorders, speakers, microphones, parts, technical magazines, collectors' items. Los Angeles 383-8718 after 8 P.M.

RUSSIAN TYPE CCP VSIEM amateur transmitter for sale. Best offer. W4MQU, Jacksonville, Fla., 1563 San Marco Blvd.

RTTY GEAR FOR SALE. List issued monthly, 88 or 44 MHy torroids 5 for \$2.00 postpaid. Elliott Buchanan & Associates, Inc., 1067 Mandana Blvd., Oakland, California 94610.

DAYTON HAMVENTION April 26, 1969: Sponsored by Dayton Amateur Radio Association for the 18th year. Technical sessions, exhibits and hidden transmitter hunt. An interesting ladies' program for XYL. For information watch ads or write Dayton Hamvention, Dept. S, Box 44, Dayton, Ohio 45401.

FACTORY NEW INTEGRATED CIRCUITS



Manufacturer's name withheld, but you will find it marked on every unit. Manufactured to Fairchild 900 RTL Series. All first grade, spec sheets included. A really amazing buy. Never previously offered by anyone at these ridiculous prices.

\$1.00 each or \$10.00 dozen

Buffer	900
Dual Input Gate	2-903
JK Flip Flop	923
Dual JK Flip Flop	2-923
Dual 2-Input Gate, Dual Expander	1-914, 1-925
Dual 2-Input Gate Expander	925
Quad 2-Input Expander	2-925

FAIRCHILD

711 Dual Comp. Amp.	2.00 ea, 12/20.00
926 JK Flip Flop, hi speed 923 (20MHz)	1.50 ea, 12/15.00
910 Dual 2-Input NOR	1.50 ea, 12/15.00

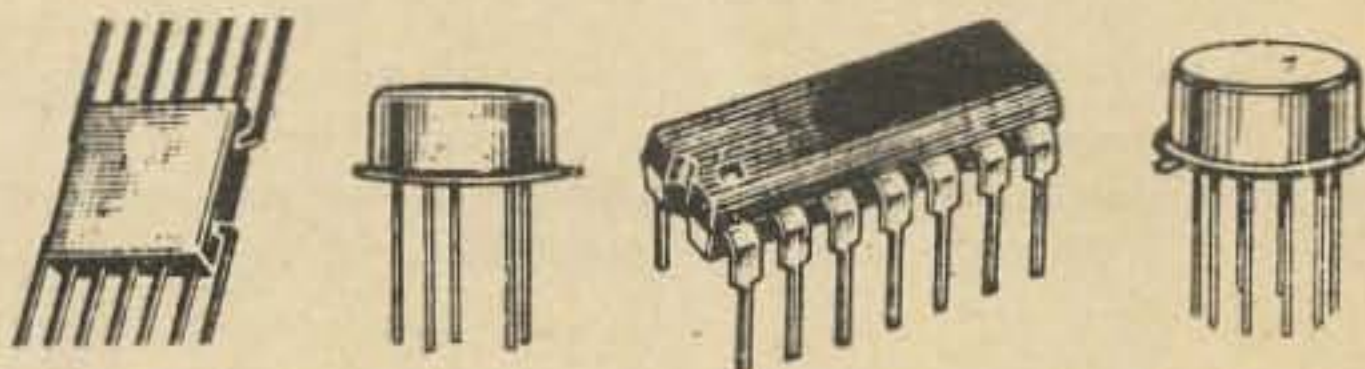

IC GRAB BAG \$2.00 DOZEN

Mixture of one dozen units, some marked, untested. 10 pages of RTL & DTL specs to aid in identifying. All configurations, TO-5, TO-85, Flat-Pack, Dual Inline. At this price you can't lose. 12 for \$2.00

VARACTOR sim to MA 4060 \$5.00

Note from Meshna:

You have only yourself to blame if you are procrastinating on sending for our 84 page catalog of super-stupendous bargains, the choice of the surplus market, all hand picked by Meshna himself. With today's shrinking dollar, you want all your shrunken buck will buy. We have a helluva job keeping up with catalog requests now. But we want our mailing dept. to keep sweating and we want you to have an opportunity of selecting the choicest bargains you ever found in the surplus market. Send 25¢ for our latest catalog #69-1 now in preparation. The 25¢ you send does not cover costs but does show a sincere interest on your part. As soon as 69-1 is printed, you'll get one.

JOHN MESHNA JR.

19 ALLERTON ST. LYNN, MASS. 01904

**HAMS! DON'T BUY USED TUBES
COMPARE OUR PRICES
FOR NEW TUBES
RCA-GE-EIMAC-AMPEREX-ETC.**

811A-4.75, 4-125A-28.00, 4-65A-12.00
5R4GY-1.75, 807-1.75, WE350(807)-1.25
4-400A-37.50, 813-20.95, 4X-150A-19.95
4-250A-36.50, 4-1000A-80.00, 4PR60B-\$55
4CX250B-21.00, 8236-12.95, 2E26-2.50
1625(807-12v fil)-1.10, 417A-2.25, 404A-2.25
6146-2.50, 6360-3.00, 2X2-.50, OD3-OC3-.75
5879-1.75, 5881-3.25, WE-CV677 1000 WATT
TETRODE-5.95, EIMAC-MACHLETT VT-158
1200-3000 WATT BOTTLE-READ MARCH
1969 ISSUE 73 HOW GREAT THIS IS-9.95!
12V 20AMP DIODE POWER SUPPLY (LESS
XFORMER)-4.95. SEND FOR OUR LIST OF
OVER 3000 TYPES OF AMERICAN, BRITISH
AND EUROPEAN IMPORTED TUBES. LAR-
GEST STOCK OF XMITTING TUBES IN THE
WORLD. SEND FOR OUR LARGE PARTS
CATALOG (OUR PRICES ARE THE LOWEST
IN THE USA).

**UNITED RADIO COMPANY
56-A FERRY STREET
NEWARK, NEW JERSEY 07105**

WANTED: Military, commercial, surplus Air-
borne, ground, transmitters, receiver, testsets ac-
cessories. Especially Collins. We pay freight and
cash. Ritco Electronics, Box 156, Annandale, Va.
Phone 703-560-5480 collect.

300 V @ 3μF brand new GE Pyronal oil capaci-
tors \$3 each. Can mail, 3-lbs. each shipping wt.,
FOB. P. Wandelt, RD # 1, Unadilla, New York
13849.

HAM AUCTION, Feb. 16, 14th Annual by Toledo
Mobile Radio Ass'n, at the Lucas County Recrea-
tion Center, 2901 Key St., Maumee, Ohio. \$1.00
Registration, open table sales, map and further
info. write Ron W8STA, 1939 Cone, Toledo, Ohio
43606.

TEST EQUIPMENT WANTED: Any equipment
made by Hewlett-Packard, Tektronix, General
Radio, Stoddart, Measurements, Boonton. Also
military types with URM-(), TS-(), SG-() and
similar nomenclatures. Waveguide and coaxial
components also needed. Please send accurate
description of what you have to sell and its
condition to Tucker Electronics Company, Box
1050, Garland, TX. 75040.

LINEAR BUILDERS: 100 MFD @ 3000 VDC Con-
densers, \$30 each. Basil J. Weaver, 1821-C Ave. M.,
Lubbock, Texas.

SWAN 120, 20 meter transceiver with Power Pack.
In perfect condition. \$135.00. J. Alkire, 1054 Linden
Ave., Akron, Ohio 44310. Ph. 614-929-3713.

SCR-SILICON-CONTROL RECTIFIERS!

PRV	16A	25A	PRV	16A	25A
50	.50	.75	400	1.60	1.90
100	.95	1.20	600	1.95	2.75
200	1.15	1.30	800	2.85	3.60
300	1.40	1.65	1000	3.70	4.50

5U4 Silicon Tube ..\$1.50@, 5 for \$5
5R4 Silicon Tube\$4@, 3 for \$9
866A Silicon Tube ..\$10@, 2 for \$18

MICA MTG KIT T036, T03, T010, 4/\$1
ANODIZED T036 INSULATOR ... 5/\$1
ZENERS 1 Watt 6 to 200V ..80@, 3/\$2
ZENERS 10 Watt 6 to 150V \$1@, 6/\$5
STABISTOR up to Ten Watt, 20 for \$1

Wanted Test Sets (TS) & Equip.

*** TRANSISTORS * SCR'S * ZENERS!!!**
Full Leads Factory Tested & GTD!
PNP150 Watt/15 Amp HiPwr T036 Case!
2N441, 442, 277, 278, DS501 Up To
50/VCBO\$1@, 7 for \$5
2N278, 443, 174. Up to 80V \$2@, 4 for \$5
PNP150 W/2N1980, 1970 &
2N2075, 2079\$2@, 3/\$5
PNP 30 Watt/3A, 2N115, 156, 235, 242
254, 255, 256, 257, 301 40e@3 for \$1
PNP 2N670/300MW 35e@5 for \$1
PNP 2N671/1 Watt 50e@4 for \$1
PNP 25W/TO 2N538, 539, 540 ..2 for \$1
2N1038 6/\$1, 2N10394 for \$1
PNP/T05 Signal 350MW 25e@, 5 for \$1
NPN/T05 Signal IF, RF, OSC 5 for \$1
Finned Heat Sink 180 SQ", \$1@, 3/\$2
Finned Sink Equip. 500 SQ". \$3@, 2/\$5
SILICON PNP/T05 & T018 PCKG
2N327A, 332 to 8, 474 to 9, 541 to 3,
935 to 7 & 1276 to 9, 35e@4/\$1

866 C.T./2.5V/10A FILAMENT
XFMR 10 Ky Insldt \$2@,3/\$5

Bandswitch Ceramic 500W 2P/6Pos, \$2@
5Hy-400Ma Choke \$4@2/\$5
250Mfd @ 450 Wv Lectlytic \$3@, 5/\$10

Send 25c for New Catalog

"TAB"

"That's A Buy"

"TAB" * SILICON ONE AMP DIODES

Factory Tested & Guaranteed

Piv/Rms	Piv/Rms	Piv/Rms	Piv/Rms
50/35	100/70	200/140	300/210
.05	.07	.10	.12
400/280	600/420	800/560	900/630
.14	.21	.30	.40
1000/700	1100/770	1700/1200	2400/168
.50	.70	1.20	2.00

**All Tests AC & DC & Fwd & Load!*

1700 Piv/1200 Rms @ 750 Ma. 10 for \$10
2400 Piv/1680 Rms @ 750 Ma. 6 for \$11

Silicon Power Diodes, Studs & P.F. **

D. C.	50Piv	100Piv	200Piv	300Piv
Amps	35Rms	70Rms	140Rms	210Rms
** 12	.25	.50	.75	.90
** 18	.20	.30	.75	1.00
45	.80	1.20	1.40	1.90
160	1.85	2.90	3.50	4.60
240	3.75	4.75	7.75	10.45
D. C.	400Piv	600Piv	700Piv	900Piv
Amps	280Rms	420Rms	490 Rms	630Rms
** 12	1.20	1.50	1.75	2.50
** 18	1.50	Query	Query	Query
45	2.25	2.70	3.15	4.00
160	5.75	7.50	Query	Query
240	14.40	19.80	23.40	Query

We Buy, Sell & Trade As Well!

"TAB"

56 DX PEARL ST., BKLYN, 11201 N.Y.

PHONE 212-522-7300

Send 25c For Catalog

TERMS: Money Back
Guarantee! Our 24th
Year. \$5 Min. Order
F.O.B. N. Y. C. Add
Shipping Charges.

DC 3 1/2" Meter/RD/800Ma \$3@, 2/\$5
Socket Ceramic 866 Tube5/\$1
Socket Ceramic 4X150/Loktal4/\$1
W.E. Polar Relay#255A \$4@, ...3/\$10
Toroids 88Mhy New Pkg 75e@,4/\$2
200 KC Freq Std Xtals4/\$2
2 Side/cu Printed Ckt Bd New 9x12" \$1
Finished Piezo Xtals Blanks50/\$1
Line Filter 4.5A@115VAC 6 for \$1
Line Filter 5A@125VAC 3 for \$1
Choke 4Hy/0.5A/27Ω \$3@4/\$10
H'sld Stevens Precision Choppers ... \$1
PL259A & S0239 CO-AX M&F Pairs 3/\$2
Phone Patch Xfms Asstd 4 for \$1
FT243 Xtal & Holder, surplus .. 5 for \$1
Insldt Binding Posts "EBY" 25/\$1
Sun-Cells Selenium Asstd 10/\$1
Band Pass Filters 60, 90, 150 cys. .3/\$3
2.5MH Piwound 500MA Choke3/\$1
Beam Indicator Selsyns 24VAC2/\$5
Fuse 250MA/3AG50/\$1, 300/\$2
Oil Cndsr Strobe, Photoflash 25MFD
2000V G.E./Pyronal, \$7@2/\$10
Resistor Bleeder 50K/100W3 for \$1

Send 25c for Catalog

Discaps .001@1000WVDC 10e@ ..20/\$1
Discaps, 2x .004@1000WVDC 15e@, 10/\$1
Discaps .03@1000WVDC 15e@10/\$1
Discaps .01 @2000WVDC 18e@6/\$1
Discaps .001 @5KVWDC 20e@6/\$1
Discaps .005@5KVWVDC 25e@5/\$1
Discaps 130mmG/6KV 20e6/\$1
.02@50WVDC25 for \$1
6 or 12VAC Minifan & Blade\$1

X-Formers All 115V-60Cy Primary—

2500V@ICMa & Fil \$2@4/\$5
1100VCT@ 300Ma, 6v@ 8A, 5V @ 3A &
125V Bias, abt 1200 VDC \$4@ ...3/\$12
480 Vet@ 40Ma & 6.3@ 1.5A CSD \$1.50
10 Vet@ 5A & 7.5 Vet @ 5A\$5
6.3 Vet 15.5A & 6.3 Vet @ 2A\$4
7.5 Vet@ 12A \$3@2/\$5



PENNY SALE!

include uses as described in

73 **QST** RADIO ELECTRONICS,
ELECTRONICS WORLD,

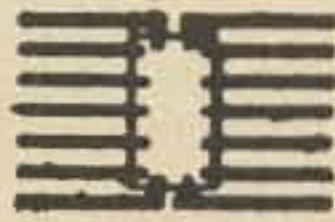

By far the biggest Integrated Circuit Sale in our history. **NOBODY!** That's right **NOBODY** under-sells Poly Paks. Imagine — buy 1 Integrated Circuit at our bargain price and get the 2nd one for **ONLY 1¢** . . . that's right **ONE CENT!** **NO LIMIT PER ITEM!** Every item guaranteed as advertised. All include data on Integrated Circuits, schematics, and or hookups, and as much as 40 circuits. **THIS OFFER IS LIMITED!**

\$100,000
"EYE SEE"
INTEGRATED
CIRCUIT
BONANZA BY
POLY PAK
FOR 1969

Fairchild No.		EACH	1c MORE
<input type="checkbox"/> 900	Buffer	1 for 1.49	2 for 1.50
<input type="checkbox"/> 902	R-S Flip Flop	1 for 1.49	2 for 1.50
<input type="checkbox"/> 903	3 In. Gate Nand/Nor	1 for 1.49	2 for 1.50
<input type="checkbox"/> 903-903*	3 Input gate Nand/Nor	1 for 1.49	2 for 1.50
<input type="checkbox"/> 904-904*	Half adder	1 for 1.49	2 for 1.50
<input type="checkbox"/> 910	Dual Two Input Gate	1 for 1.29	2 for 1.30
<input type="checkbox"/> 914	Dual Two Input Gate.....	1 for 1.29	2 for 1.30
<input type="checkbox"/> 914-914*	Dual Two Input Gate	1 for 1.49	2 for 1.50
<input type="checkbox"/> 915	Dual 3 Input Gate Nand/Nor	1 for 1.49	2 for 1.50
<input type="checkbox"/> 923	JK-Flip Flop	1 for 1.49	2 for 1.50
<input type="checkbox"/> 923-923*	JK Flip Flop	1 for 1.69	2 for 1.70
<input type="checkbox"/> 925	Dual 2 Input Gate, Expander	1 for 1.49	2 for 1.50
<input type="checkbox"/> 927	Quad Inverter	1 for 1.49	2 for 1.50
<input type="checkbox"/> 930	Dual 4 Input Gate Nand/Nor	1 for 1.49	2 for 1.50
<input type="checkbox"/> 933	Dual Input Gate, Expander	1 for 1.49	2 for 1.50
<input type="checkbox"/> 944	Dual 4 Input Power Gate	1 for 1.49	2 for 1.50
<input type="checkbox"/> 945	Clocked Flip Flop	1 for 1.69	2 for 1.70
<input type="checkbox"/> 946	Quad 2 Input Gate Nand/Nor.....	1 for 1.49	2 for 1.50
<input type="checkbox"/> 948	Clocked Flip Flop	1 for 1.69	2 for 1.70
<input type="checkbox"/> 950	AC Binary	1 for 1.98	2 for 1.99
<input type="checkbox"/> 952	Dual 2 Pinout Inverter Gate	1 for 1.29	2 for 1.30
<input type="checkbox"/> 954	Dual 4 Input and Gate	1 for 1.29	2 for 1.30
<input type="checkbox"/> 955	8 Input and Gate w 2 output	1 for 1.29	2 for 1.30
<input type="checkbox"/> 956	Dual 2 Input Buffer	1 for 1.29	2 for 1.30
<input type="checkbox"/> 957	Dual Rank (hold) Flip Flop	1 for 1.98	2 for 1.99
<input type="checkbox"/> 961	Dual 4 Input Gate w/expander	1 for 1.49	2 for 1.50
<input type="checkbox"/> 962	Triple Gate	1 for 1.49	2 for 1.50
<input type="checkbox"/> 963	Triple Gate	1 for 1.49	2 for 1.50

* Two identical IC's in one package

LINEAR AMPLIFIERS with circuits & data

- 709C HI-GAIN OPERATIONAL\$3.69
- 711C DUAL COMPARATOR\$1.98

SILICON POWER STUD RECTIFIERS

PIV	3A	6A	12A	55A
50	<input type="checkbox"/> .06	<input type="checkbox"/> .16	<input type="checkbox"/> .20	<input type="checkbox"/> .50
100	<input type="checkbox"/> .07	<input type="checkbox"/> .22	<input type="checkbox"/> .25	<input type="checkbox"/> .75
200	<input type="checkbox"/> .09	<input type="checkbox"/> .30	<input type="checkbox"/> .39	<input type="checkbox"/> 1.25
400	<input type="checkbox"/> .16	<input type="checkbox"/> .40	<input type="checkbox"/> .50	<input type="checkbox"/> 1.50
600	<input type="checkbox"/> .20	<input type="checkbox"/> .55	<input type="checkbox"/> .75	<input type="checkbox"/> 1.80
800	<input type="checkbox"/> .30	<input type="checkbox"/> .75	<input type="checkbox"/> .90	<input type="checkbox"/> 2.30
1000	<input type="checkbox"/> .40	<input type="checkbox"/> .90	<input type="checkbox"/> 1.15	<input type="checkbox"/> 2.70

MICROMINIATURE SILICON RECTIFIERS

1. Actual Size

AMP

PIV	Sale	PIV	Sale
50	<input type="checkbox"/> 5¢	600	<input type="checkbox"/> 19¢
100	<input type="checkbox"/> 7¢	800	<input type="checkbox"/> 21¢
200	<input type="checkbox"/> 9¢	1000	<input type="checkbox"/> 32¢
400	<input type="checkbox"/> 12¢	1200	<input type="checkbox"/> 45¢

SCRs CONTROLLED RECTIFIERS

PRV	3A	7A	20A
50	.35	.45	.70
100	.50	.65	1.00
200	.70	.95	1.30
300	.90	1.25	1.70
400	1.20	1.60	2.10
500	1.50	2.00	2.50
600	1.80	2.40	3.00

★ Handles 2 Amps

2 AMP
800 PIV

TOP HAT
RECTIFIERS

6 \$1
for

EPOXY SILICON TRANSISTORS

- 3-FK-4046, 1W, 0.5A, npn, 250MC \$1.00
- 3-2N3568, 350MW, 200MC, 200BVC, NPN \$1.00
- 4-2N3563, NPN, 600MC, 200MW \$1.00
- 3-2N3683, NPN, 1000MC, 5MA, 200MW .. \$1.00
- 3-14 WATT, B-5000, npn, 3A \$1.00
- 4-2N4313, PNP, 600MC, 200MW \$1.00
- 4-2N3565, 500HFE, npn, 200MC \$1.00

GLASS FIBER OPTICS 3 Ft. per \$1

Well, these light guides plastic jacket; transmit light from one point to another much as copper wire transmits electrical energy.

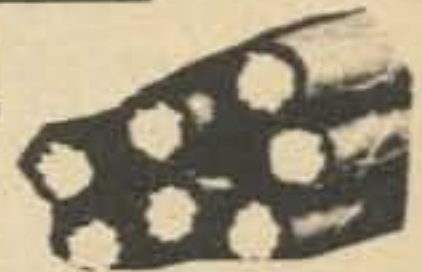

Cuts Like Wire



1 AMP TOP HAT AND EPOXIES

PIV	SALE	PIV	SALE	PIV	SALE
50	<input type="checkbox"/> .05	800	<input type="checkbox"/> .19	1800	<input type="checkbox"/> .87
100	<input type="checkbox"/> .07	1000	<input type="checkbox"/> .31	2000	<input type="checkbox"/> 1.05
200	<input type="checkbox"/> .08	1200	<input type="checkbox"/> .44	3000	<input type="checkbox"/> 1.60
400	<input type="checkbox"/> .11	1400	<input type="checkbox"/> .62	4000	<input type="checkbox"/> 1.90
600	<input type="checkbox"/> .16	1600	<input type="checkbox"/> .72	10000	<input type="checkbox"/> 4.80

Terms: add postage. **Rated:** net 30, cod's 25%
Phone Orders: Wakefield, Mass. (617) 245-3829
Retail: 211 Albion, St., Wakefield, Mass.

GIANT SPRING CATALOG ON: Parts, Rectifiers, **10¢**
 Transistors, SCR's, I.C.'s, Equipment, Etc.

POLY PAKS

P.O. BOX 942 A
LYNNFIELD, MASS.
01940

**LIBERTY
PAYS**

MORE!

**WILL BUY
FOR CASH
ALL TYPES**

- **ELECTRON TUBES**
- **SEMICONDUCTORS**
- **Military Electronic Equipment**
- **Test Equipment**

WIRE, WRITE, PHONE COLLECT! WE PAY FREIGHT ON ALL PURCHASES WE MAKE

Liberty Electronics, Inc.

548 Broadway, New York, New York 10012, Phone 212-925-6000

**LIBERTY
OFFERS**

MORE!

PRESTEL FIELD STRENGTH..METER

(Model 6T4G)

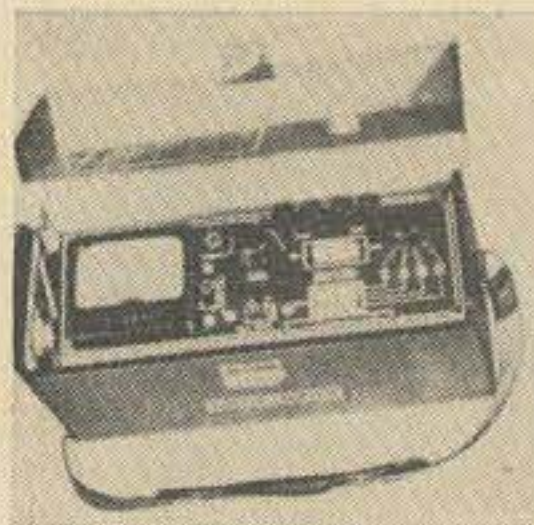

Frequency Range: 40 to 230 and 470 to 860 Megahertz. Calibrated outword from 10 to 50,000 Microvolts. Nothing makes it easier to properly and speedily find the correct place to install TV, FM and Communication Antennas. You can measure and hear the signals

with this 4 1/2 volt battery economically powered unit. There is nothing else like it!

Only \$120.00

"ARCTURUS" SALE

1700 transistor types at 39¢ each.

40 watt germanium power transistor, same as Delco 501, 2N278 (etc), Cat: 349, 59¢ each.

Color TV cartridge focus rectifier 6.5 kv. Used in every color TV. Cat: CFR-20, 79¢ each.

Motorola 2500 ma. at 1000 piv, high voltage/current epoxy silicon rectifier, axial leads. Cat: HEP-170, 49¢ ea.

2 Printed circuit I.F. transformers, 4 lug, 455 kc input and output, Cat: 1909P4, 99¢ each.

RCA UHF transistor type TV tuners, KRK-120 (long-shaft) cat: UHF-20; KRK-120 (short shaft) cat: UHF-21, each \$4.98.

RCA VHF transistor type TV tuners, KRK-146, cat. VHF-74, \$9.99 each.

Transistorized U.H.F. tuners used in 1965 to 1967 TV sets made by Admiral, RCA, Motorola, etc. Removable gearing may vary from one make to another. Need only 12 volts dc to function. No filament voltage needed. Easy replacement units. Cat: UHF-567, \$4.95.

U.H.F. Tuner original units as used in TV sets such as RCA, Admiral, etc., covering channels 14 through 82, as part no. 94D173-2. Complete with tube. Drive gearing is removable. Can be used in most sets. Cat: UHF-3, \$4.95.

Color yokes. 70° for all around color CRT's. Cat: XRC 70, \$12.95. 90° for all rectangular 19 to 25" color CRT's, Cat: XRC-90, \$12.95.

Kit of 30 tested germanium diodes. Cat: 100, 99¢.

Silicon rectifier, octal based replacement for 5AS4-5AW4-5U4-5Y3-5T4-5V4-5Z4. With diagram. Cat: Rect-1, 99¢ ea.

7", 90° TV bench test picture tube with adapter. No ion trap needed. Cat: 78P7, \$7.99.

Tube cartons 6AU6 etc., size \$2.15 per 100. 6SN7 etc., size \$2.55 per 100. 5U4GB size \$2.95 per 100. 5U4G size \$.03 each.

Send for complete free catalog. Include 4% of dollar value of order for postage. \$5 MINIMUM ORDER. Canadian check, 8% dollar differential.

ARCTURUS ELECTRONICS CORP.
502-22nd St., Union City, N.J. 07087 Dept.M73
Phone: 201-UN 4-5568

INDEX TO ADVERTISERS

Alltronics-Howard, 93
Ameco, 26
Antenna Mart, 92
Areturus, 98
Arnolds, 92
ARRL Hamfest, 91
Atlantic Surplus, 94
ATV, 25

B & F Enterprises, 85
Biglow, 88
Bobs Amateur, 89
BTI Hafstrom, 28

Cleveland Institute, 33, 34, 35
Co-Ax Hand Book, 53
Columbia, 92
Cushcraft, 83

Dahl, Peter H. Co., 91
Densen, 90
Del Capri Hotel, 55
DGP, 99

Electronics Assistance Corp., 51
Epsilon, 57
Evans Radio, 91

Fair Radio, 84
Fragale, 84
Freck, 94

Gadgets Inc., 93
Galaxy, Cover 11
Callbook, 25, 55
Gateway, 88
G & G, 87
Global Imports, 88
Gonset, 19
Goodheart, 93

Hallcrafters, Cover III
Heath, 49
Henry, 29, 47

International Crystal, 3
James Research, 22
Jan Crystals, 91
Jeffronics, 91

Leger Labs, 59
Lewispaal, 89
Liberty Electronics, 98

Meshna, 95
Mendelson, 85
Mission, 17
M & M Electronics, 73

National Radio, 45
Newtronics, Cover IV

Paxitronix, 88
Pennsylvania Electronics, 73
Poly Paks, 97

Redline, 56, 86
Rousseau, 23

Salch, 93
Schober Organ, 22
Short Wave Guide, 93
Signal One, 9
Slep Electronics, 89
Space, 93
Swan, 5
73 Magazine, 22, 30

TAB, 96
Tower Communications, 94
Telrex, 81
Two-Way Radio, 84

United Radio, 96

Vanguard, 27, 28, 59
VHF Associates, 94
Vibroplex, 91

Western Electronics, 32
World Radio Lab, 11

When Hallicrafters says "dual receive" we mean **SIMULTANEOUSLY!** **SIMULTANEOUSLY!**



That's right—*simultaneous dual receive!* Unlike any other transceiver/VFO combination, the SR-400 Cyclone and HA-20 VFO lets you "Double-Team" the competition in any DX contest. You can "Band-Scan" for a second contact while you are working another. You can set VFO's on two separate DX stations, receive both simultaneously, and be instantly ready to "Tail-End" on either station. And of course, Hallicrafters' winning performance features don't stop here. Get in front of this rig and you'll know. Hallicrafters has built another "great one" in the fine tradition of the HT-32 and HT-37.



PS: Want simultaneous dual receive with 2 KW on SSB? Put an SR-2000 in your shack.

the hallicrafters CO.

A Subsidiary of Northrop Corporation

600 Hicks Road, Rolling Meadows, Illinois 60008



Designed
to be a
Hustler

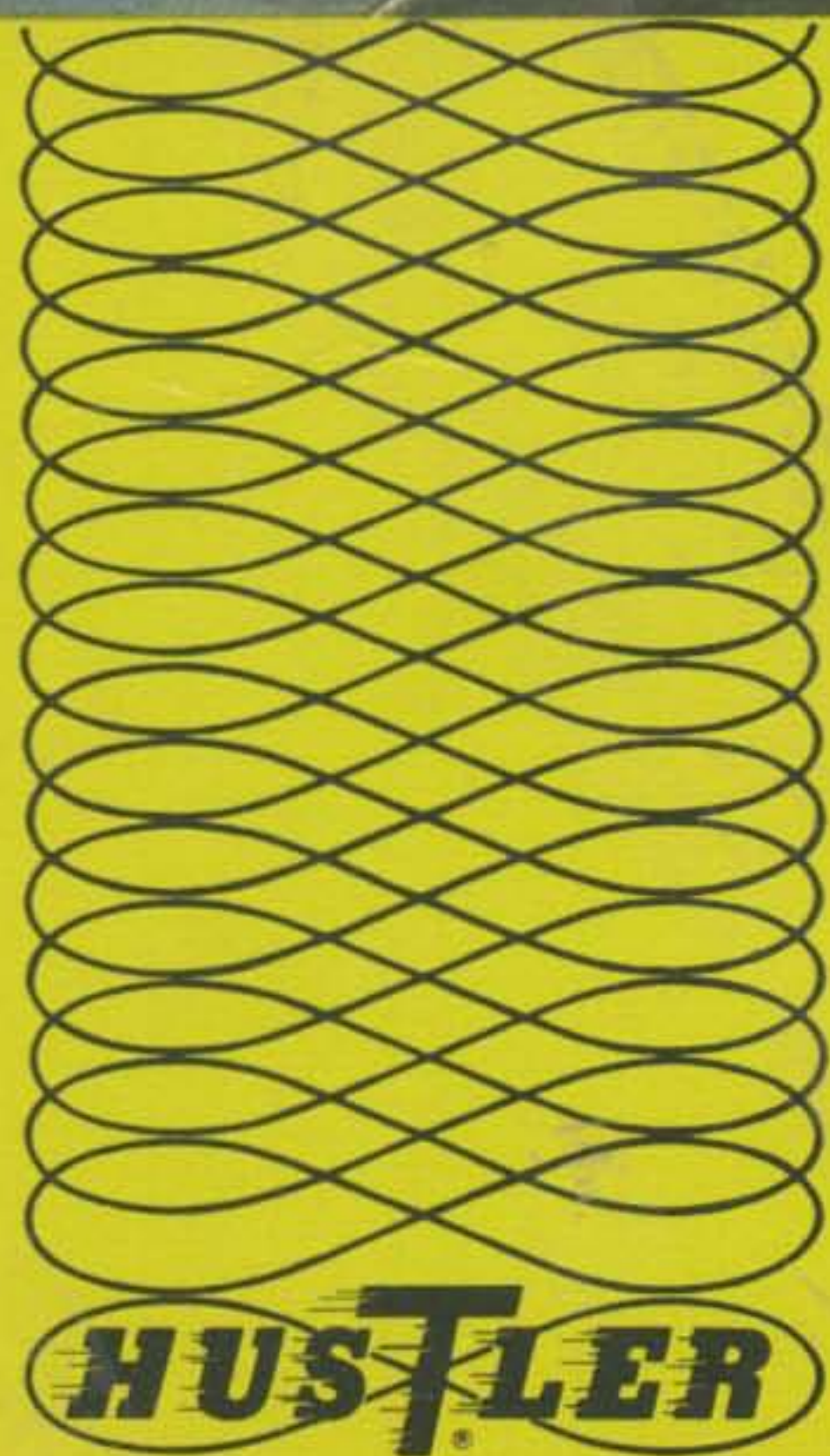

Yes, our new facilities were specifically designed for, and devoted exclusively to, the manufacture, engineering and testing of antennas and allied products. All from one Hustler to many Hustlers, New-Tronics now offers more than any other manufacturer of amateur, auto, citizens band, and commercial antennas and accessories. Whatever you may require, check first with New-Tronics.

NEW-TRONICS CORP.

15800 COMMERCE PARK DRIVE
BROOK PARK, OHIO 44142