

# amateur 73radio

A  
CE

#120

One Dollar  
September 1970

ID Unit Sends Your Call  
Using ICs

MOSFET 2M Converter  
Best yet!

A Great AGC Circuit  
Would we lie?

Using Bargain ICs  
Simple testers

Beer Can Antenna  
Drink to a good signal

GENERAL CLASS LICENSE  
Study Course

MORE? Yes!

EMPHASIS:  
SOLID STATE

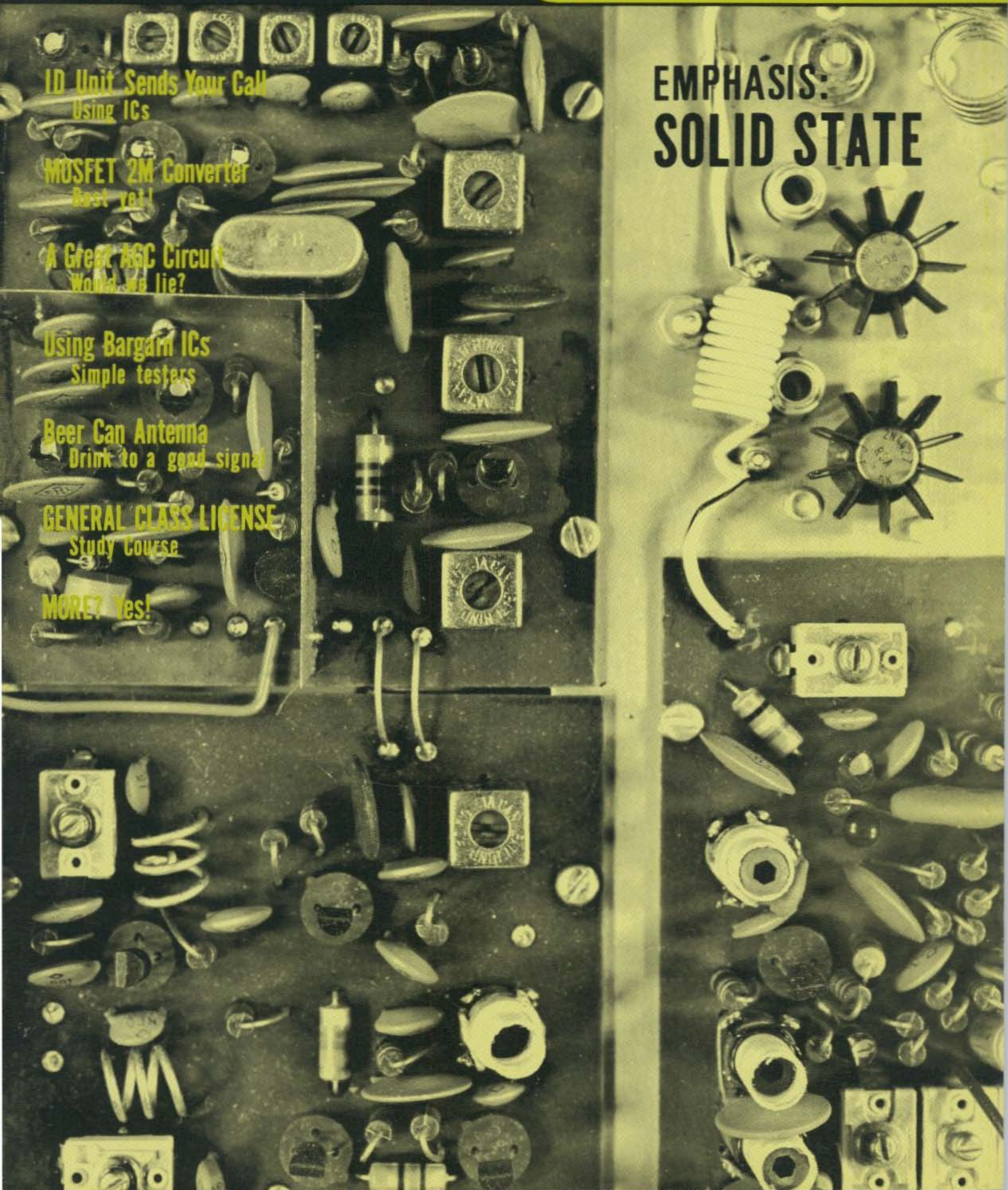

# INTRODUCING THE NEW SWAN-1011

*Designed especially for the serious 10 meter operator  
Optimized for highest standards of sensitivity,  
selectivity and all-out performance.*

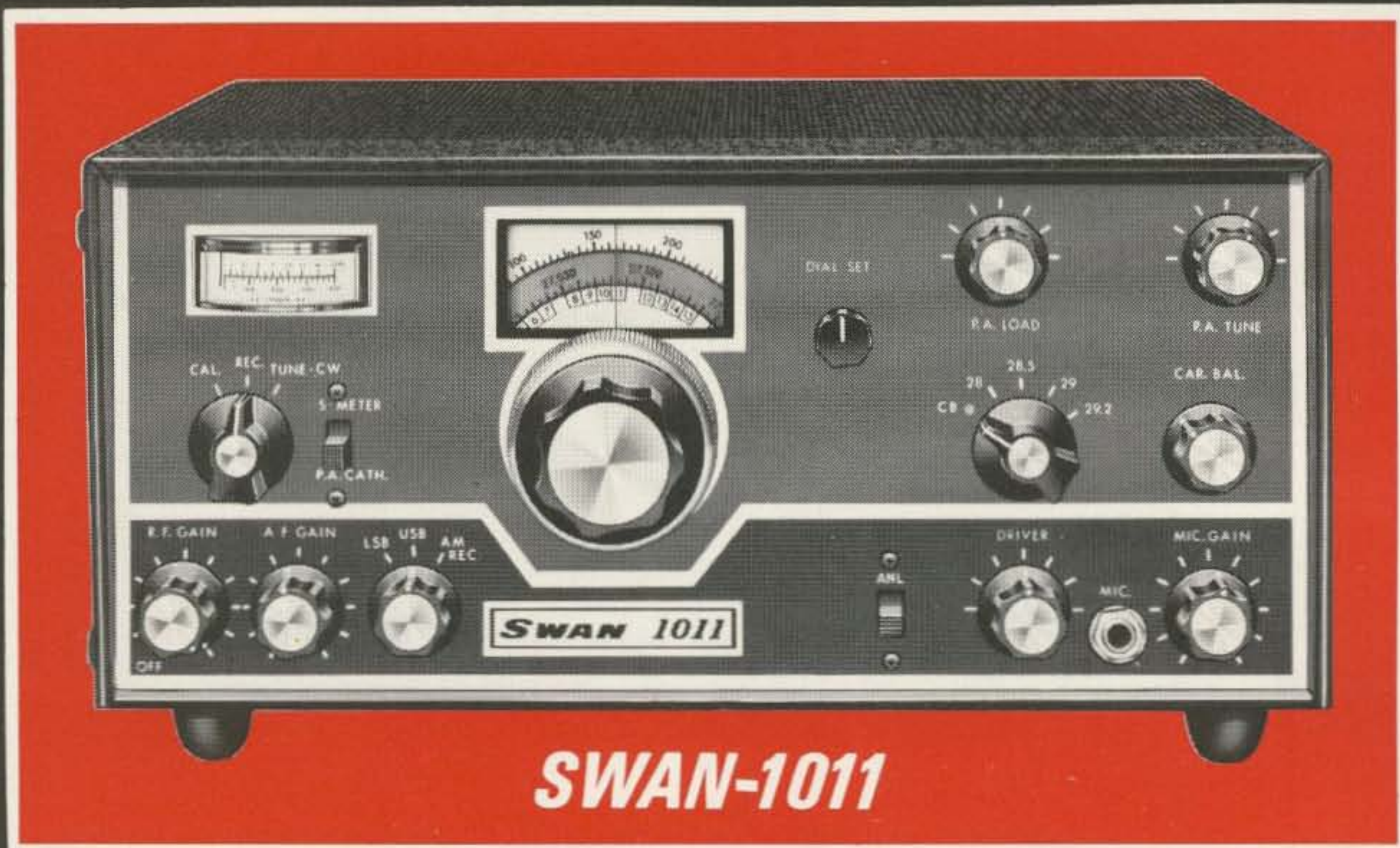

**A 260 watt 10 meter SSB/AM transceiver,  
complete with built-in AC power supply,  
loudspeaker, plus tunable receiver coverage  
of the 11 meter Citizen's Band.**

## SPECIFICATIONS:

- Power rating: 260 watts P.E.P. input, 180 watts CW input, 60 watts AM input.
- Frequency Range: 28.0 — 28.5, 28.5 — 29.0, 29.0 — 29.5, 29.2 — 29.7, plus a special 26.96 — 27.23 mc receiving range for monitoring the Citizen's Band. \*(Note) In the Citizen's Band position the transmitter relay circuitry does not function.
- Voltage input: 117 volts AC or 12-14 volts DC.
- Velvet smooth, Dual-Ratio tuning system, provides exceptionally smooth, zero backlash tuning with 5 kc calibration increments.

- Selectivity: 2.7 kc bandwidth with shape factor of 1.7 and ultimate rejection more than 100 db.
- Sensitivity: Less than 1/2 microvolt at 50 ohms for signal-plus-noise to noise ratio of 10 db.
- Unwanted sideband suppression: 50 db. Carrier suppression: 60 db. Third order distortion down approximately 30 db.
- Built-in AC power supply plus loudspeaker.
- Selectable upper and lower sideband
- 100 kc crystal calibrator

Model 1011 Transceiver ..... \$499

Model 14-A plug-in converter  
for 12 volt DC operation ..... \$39.50



See your Swan dealer today.

**SWAN**  
ELECTRONICS

305 Airport Road  
Oceanside, California 92054  
A Subsidiary of Cubic Corporation

# amateur 73Radio

## Features

- 2 Radio Amateur News Page
- 8 Caveat Emptor
- 10 Never Say Die
- 12 Mr. Virgo Himself
- 14 Leaky Lines
- 73 ACTION COUPON
- 100 Letters
- 112 Propagation Chart
- 112 Advertiser Index

## Editor-Publisher

Wayne Green W2NSD/1

## Managing Editor

Ken Sessions K6MVH/1

## STAFF

### Associate Editor

Jim Kyle K5JKX

### WTW Editor

Dave Mann K2AGZ

### FM Editor

Mike Van Den Branden

### Advertising

Diane Shaw

### Art Director

Roger Block

### Graphic Arts

Jeanne Caskie

Nancy Estle

Gay Salter

### Composition

Jane Tracey

Debi Mercier

### Drafting

R. K. Wildman W6MOG

Wayne Peeler K4MVW

T. M. Graham W8FKW

### Subscriptions

Dorothy Gibson

### Circulation

Phil Price

Bing Hawes

Roxanne Billings

### Comptroller

John Henne

### Traffic

Jeff Parsons

### Propagation

John Nelson

## Contents

- 16 Integrated Circuit CW ID Generator ..... W7PUG  
Automatic identification for your station.
- 26 Six Volts From Twelve Volts .....K3GSY  
Six buck solid state voltage dropper.
- 29 The Indicating Oscillator ..... KH6AF  
Another dipper circuit, 1-400 MHz.
- 32 Tuning VHF Receivers .....K1CCL  
Clever infinite attenuator and oscillator unit.
- 35 Code Practice a la Baby Talk ..... W9PXA  
Everybody's doing it...
- 38 Using Those Bargain ICs .....WA2IKL  
Three testers will test most ICs you will encounter.
- 45 Repeater Antenna Separation ..... K6MVH  
One of the easiest ways to improve repeater range.
- 54 Diode Stacks ..... W2BDG  
Replacing those high-power rectifier tubes.
- 56 Deluxe Receiver Gain Control .....VU2JN  
Using one transistor and a zener.
- 60 A New Approach to Communications Equipment .... K9ALD  
A call for manufacturer standardization.
- 64 Reed Relays for Coaxial Switching ..... W7CRY  
Work very well for UHF low-power applications.
- 66 File Box Resistance Decade .....WB4ITN  
First in a series of file box test gear.
- 70 The DyComm VHF-FM RF Amplifier .....Staff  
Transistorized, 15 watts out.
- 74 General Class License Study Course .....Staff  
Part II, Alternating Current.
- 82 What Really Happened to Hamdom? ..... W9HBF  
The horrible truth about CB.
- 86 Beer Can Two-Meter Coaxial Antenna .....WA0RWQ/6  
Drink your way to a good signal.
- 88 Converting 24V Relays to 115 VAC ..... Douglas  
... using a couple of cheap diodes.
- 90 Versatile 2m MOSFET Converter ..... WB6YVT  
Low noise, high gain, ultra stable.

73 Magazine is published monthly by 73, Inc., Pine St., Peterborough, New Hampshire 03458. Subscription rate: \$12.00 for three years, \$6.00 for one year. Second Class Postage paid at Peterborough, New Hampshire, and at additional mailing offices. Printed at Menasha, Wisconsin 54952, U.S.A. Entire contents copyright 1970 by 73, Inc., Peterborough, New Hampshire 03458. Phone: (603) 924-3873.

We do not claim that subscribing to 73 will make you wealthy, yet we cannot overlook the many reports we have received from our subscribers telling us that soon after subscribing to 73 they found buried treasure, fell heir to a fortune, or discovered a pearl in their oyster. It is difficult to overlook the strange coincidence that the magnitude of their windfall seems to always be in direct proportion to the length of the subscription taken to 73. Is a subscription to 73 really a money magnet? Can you afford not to make sure about this? Turn to page 98 please.

# Amateur Radio News Page

September XIXLXX

Monthly Ham News of the World

73 Magazine

## HAM SATELLITE FUTURE BRIGHT

Amateur satellite Australis—Oscar 5 has contributed significantly to plans for future satellites in the amateur service. It was the first OSCAR satellite to be launched by NASA; this is an important milestone since secondary payload space is expected to be available on future Thor-Delta launches as the payload capability of that rocket continues to be upgraded. Thus, the next OSCAR satellites under development by AMSAT are being designed specifically to interface with Delta launch vehicles.

The precedent of the command capability proven in the AO-5 mission is very significant, particularly in planning for long-life, solar-powered satellites in the amateur service, and in preparation for the 1971 ITU World Administrative Radio Conference on Space.

The use of command systems should prove a feasible alternative to the adoption of absolute power flux density limitations, so that satellites in the amateur service can be turned off upon command in the event of interference to other services operating in the shared amateur bands. The success of the Magnetic Attitude Stabilization



Members of the Antique Wireless Association admire a rare de Forest radiophone made in 1920 and used by many pioneer stations. WWJ at Detroit used this model when it first went on

the air in September 1920. The rig's input power was about 20W. Left to right: K2NP, W2NSD, W2QY, L. Peckham, and K2BX. (Photo courtesy W2KE.)

## FCC Steps Up Drive To Nab Violators

Paul J. Bedoian W1HRJ, of Newington, Connecticut, was cited by the Federal Communications Commission for "repeated violation of Amateur Rules, Section 97.7(b)." According to an FCC public notice, Bedoian operated his station "on a frequency not authorized." The FCC report listed the fine at \$100, but gave the amateur 30 days in which to respond to the allegation.

In Monroe, Michigan, Richard Brown WA8YDZ was also cited for the same violation, as was Paul Angelides WA2YHK, of Middle Village, New York, and George White W1MPW, of Waterbury, Connecticut. In all cases, the fine was listed as \$100.

The FCC doesn't just issue notices

System demonstrated that this technique is a most attractive one for future satellites.

The precedents established in international group cooperation among amateurs, and the training and educational benefits derived from the design, construction, testing and flight of AO-5 will also be of great usefulness in future radio amateur satellite projects. (Material furnished by AMSAT Newsletter.)

### American Radio Club Formed

A small group of active amateurs gathered recently to see if they could provide the nucleus for action that seems needed to further the interests of amateur radio in the U.S.

A group of basic goals was agreed upon:

1. To work toward getting more amateurs in the U.S.
2. To recommend band allocations relevant to current use.
3. To protect the future of our hobby in Washington.
4. To protect the future of our hobby in the ITU.
5. To encourage discovery and development by amateurs.
6. To work with all other clubs and groups to strengthen amateur radio.

It was decided that the editorial policy of 73 Magazine best reflected the nonpartisan approach to amateur politics and that this magazine would be designated as the official club bulletin, providing this was agreeable with the publisher (it is . . . pub.).

The American Radio Club will accept bids from groups of amateurs interested in establishing Chartered Regions of the Club. A list of the founding members, the area included in the Chartered Region, the proposed Club, c/o 73 Magazine, Peterborough, N.H. 03458.

## US Ham Mag Wanted by Reds

73 frequently gets letters from the Iron Curtain countries saying that it is impossible for the amateurs there to send money for subscriptions to 73, yet they find the magazine of tremendous interest and each copy is almost read to pieces it goes through so many hands.

If you would like to sponsor a subscription for a club please drop us a note and include \$10 for each three-year gift subscription. We will start down our list of requests and go as far as we can. We will also drop a note to the club telling the amateurs who you are so they can let you know that the issues are coming through and are appreciated. While they can't send money, they can send through some really great phonograph records,

records completely unavailable here, and things like that as gifts of appreciation.

If you already have a club or individual you would like to sponsor, send along that name and address for us. They must be in a controlled-currency country such as Poland, Czechoslovakia, Hungary, Russia, etc.

Speaking of which, just to give a little political zing to anyone who thinks of the U.S. as being imperialist, it is interesting to note that the U.S. has gotten out of every one of the 21 countries it has occupied since the beginning of the war, while our friends in Russia have left only one, Austria, and that one under a great deal of political pressure. So much for the capitalist imperialists.

## Unlicensed Radar Brings Challenge

A California resident, irate over a traffic citation, told city council this week he is going to enlist the aid of the Federal Communications Commission in his battle with the local police department.

Dale Rohde, of Cypress, claimed the city's police were operating radar equipment without a federal license when he was issued a speeding ticket July 3.

Unless all the traffic citations obtained in this method are dismissed, he said a federal warrant would be sought against the city for violation of a section of FCC regulations, which governs the operation of public safety radio equipment.

The maximum penalty for each violation, Rohde said, is a two-year sentence and a \$10,000 fine.

"I hope you gentlemen realize a municipality in the San Francisco area wound up paying \$28,000 in an instance similar to this," Rohde said.

City Administrator Robert Huntley said the unit is presently inoperative and "it did not have a license."

Huntley added that Chief Conner Collacott, however, was "under the impression" the unit had been licensed.

Rohde asked council what action it intended to take.

"What do you want us to do?" asked Councilman Frank Fry.

"I don't think it is unreasonable for all these citations to be dismissed," said Rohde.

Nevertheless, Deputy Dist. Atty. Richard Beacom indicated the DA's office is planning on prosecuting the cases whether "the unit was illegal or not."

and forget. A number of amateurs are now getting nailed for failing to respond to Commission letters. Dennis Mitchell WA8ROJ, of Milan, Michigan, has been ordered to "show cause" why his license should not be revoked. His violation: failure to reply to official communications. And Martin Higgins WA6AGX, of La Crescenta, California, simply failed to give the FCC some information that had been requested. He, too, has been ordered to show cause why his license should not be revoked.

The Commission has at long last begun to act on the many cases of on-the-air jamming taking place in the ham bands. Robert Brickey, of Orem, Utah, who is holder of licenses for W7QAG, W7ABU, and WA7BTS, has been ordered to show cause why all his licenses shouldn't be revoked for "willful and malicious" violation of Sections 303(m) (1) (E) of the Communications Act of 1934 and Part 97.125 of the Amateur Rules. According to the FCC report, Brickey's stations were used "to interfere with" radio communications or signals of another radio station.

### RADIO ANTENNA SUIT

An injunction suit is on file in Superior Court in which the City of Fresno seeks to force Patrick C. Fennacy to shorten a crank-up tower from 71 ft to a maximum of 25 ft and to obtain a building permit for the structure. According to an item in the Fresno Bee, the suit alleges Fennacy built the tower after the Fresno City Planning Commission turned down his request to erect it so high. The suit says the tower is a public nuisance. The amateur who submitted this report to 73 also said that "ARRL is reported as being uninterested."

# WORLDWIDE DX NEWS

## INTERNATIONAL DX ASSOCIATION FORMED

If you have been listening on 14220 at about 2330Z for the past several months you have heard reference made to a new international DX organization currently in the formative stage. The history of this effort goes back over several years and is long and involved. Let it suffice to say for now that Aubrey Spear WA5REU, Arden Hopple W3DJZ, and Eva Perenyi PY2PE, are more or less at the bottom of the deal.

During the past several weeks a few ideas have begun to jell and we now have a rudimentary organization still subject to change on short notice. The dues are to be \$2 per year, also subject to change on short notice. In my possession is a document which was formulated by Aubrey and about a dozen other well-known DX'ers last April at the Dayton Hamvention. This document proposes certain aims and objectives of the organization. Such things as international goodwill, promotion of camaraderie, and good fellowship among amateurs (and other such hogwash) are mentioned.

However, the real meat of the thing is Objective II, which states "To finance DXpeditions, to furnish radio equipment to deserving amateurs throughout the world who are unable to do so for themselves for one reason or another." In short, the objective is to place radio equipment where it will

the address shown below. In any case, join the PRS gang (Pandemonium Reigns Supreme) on 14.220 MHz at 2330Z any night in the week. You can get the latest DX rumors for free. For example, I worked ZA1C at 1643Z on 21275 kHz July 5, 1970 and he is for real (maybe).

## CAN THE FEDS SEIZE YOUR GEAR ?

Yes, they can. And sometimes they do. As in the case of CB "skipper" George Bennett, for instance. George, better known to the local CB crowd as "Unit 909," had all his radio equipment confiscated by order of the government.

The Detroit man had been convicted of violating a U.S. District Court injunction against operating an unlicensed CB station, and received a six-month suspended sentence and a

## CW PRACTICE BROADCASTS?

One of the ARRL services that is helpful to virtually every prospective amateur is the Morse Code broadcasts by W1AW and W6OWP. There is really no reason why these two stations should have a corner on the code practice market.

Just as we have established a Technical Aid Group in the pages of 73 (TAG) for answering technical questions from readers, we would like to establish a Code Practice Group. If you are set up for sending code practice sessions with your station and are willing to establish a fixed and rigidly unchangeable schedule for broadcasting, please let us know your time, frequency and code speed to be trans-

mitted.

CPG stations should have automatic means for sending code and a substantial signal. While we think that the best bands for code practice are the 80 and 40 meter bands, there obviously is a need for some service on 20, 6, and even 2 meters. We ask that all CPG stations register with 73 so their schedules can be published and that when they come on the air, they check the scheduled frequency for activity and settle in plus or minus enough to avoid jamming contacts or nets in progress.

We suggest that code practice sessions consist of both plain language and coded groups.

## MICHIGAN HAM WORKS GERMANY ON VHF

*Fourth-of-July F2 conditions permit intercontinental QSO on 6 meters*

When George Kerr (W8QNY), of Jackson, Michigan answered a CQ on the 4th of July, he thought he was making contact with South America. It took a little beam-spinning before he discovered he'd made an F2 contact with an amateur in the northern part of Germany.

"His signal was weaker to the south," George said, "so I worked my three-element Telrex toward the east . . . He got my call straight when I was beamed southeast."

George said he learned the fellow, Peter, was transmitting from Keil, Germany, and talked with him "for about 30 minutes before the band dropped out."

## ONCE AROUND THE WORLD... W2NSD/1

C31AH (Gaston), gets on now and then from Andorra, but he has so far neglected to contact me. C31, what kind of nonsense is that? That's worse than that old CR10 prefix. Gaston, by

full year's probation. Then they came and took away his rig.

The reason his station was unlicensed, by the way, was because his license had earlier been revoked. The reason: "... flagrant violations of FCC rules." But despite the revocation, the severe warnings from the Fed, and the court injunction, Bennett just couldn't keep his hand off the switch. Now he doesn't even have a switch.

expect to zip on down there for the awards banquet October 22nd. Hope you can make it too; there should be quite an interesting bunch there. FW8BO has been on recently around

do the most good to eliminate the word "rare" in rare DX. Considerable satisfaction can be derived from helping individuals like Sid (ST2SA) get on the air with SSB equipment. As a matter of fact, an HW-100 is on the way to Sid at this moment. Several projects which are currently in the works are: (1) An antenna is being sent to Africa in a TY/TZ effort; (2) the such discussed equipment for ZK1AJ has finally been located in Christchurch and is again on its way to Manihiki, Niue, and Tokalaus; (3) assistance was furnished for the recent highly successful Zanzibar operation; and (4) the Albania effort by OH2BH was supported.

It is quite obvious that, should this organization hold together and become productive, the demand will far exceed the supply. An HW-32 plus accessories plus AC/DC power supply costs about \$200, not to mention the devastating cost and problems of getting it where it will do some good. Obviously, it will take support from large numbers of DX'ers to handle many such projects. Herein lies the main reason for the formulation of this group. If, for example, 2000 DXers want to contribute \$2 per year, several stations could be sprinkled around the globe. Substantial contributions could be made to other individuals and groups planning DXpeditions of their own. Then, when the bite is put on you, you can say you are a member of "International DX Association" and have already contributed.

A final charter, ground rules, officers, etc. are being worked. However, it will be several months before such a final document is ready for distribution. In the meantime, useful and interesting projects are under way. If you feel that you would like to join such an effort, send your \$2 to me at

the way, is QSL'd via REF.

EP2DX is on fairly regularly from Tehran. QSL to W3HMK for Rick.

Funny about some of the phonies...1A1A came on and immediately every smart op knew that this was a lead balloon, yet some of the thicker oldtimers continued to create pileups for this sickee for days. Ambrosia Island, good grief!

Biu, PY4AP, points out that he is not the QSL manager for PY7AWD/Ø. This station is now operating as PYØ Box 2, Fernando de Noronha and should be QSL'd direct. He speaks no English, so good luck. The Bermuda contest was hurt a bit by poor conditions, though VP9's AT, BY, CP, DL, FU, GD, GE, and MI were very busy anyway. Everything being equal, I

1200Z on 250. AX9KY on Cocos can be heard about the same time. 4S7AB is on 15 these days. FG7AC has been busy with all those DX'ers who need Guadaloupe, and there are thousands. VR5LT, Bill, Box 49, Tonga, South Pacific, was listing it up with W5GG doing the honors and gladdening a lot of hearts at 0330. There hasn't been much on from there since the old Miller daze. A CQ directed at the Middle-East brought an answer from 7X2SMA In Algiers (P.O. Box 2), where Boualem is doing his best with low power AM. 5R8AP (Buddy) has been on often recently, working the pileups by the prefixes. Nice signal and QSL to WB4GQH. By the way, when you are in Bermuda you can look up the local amateurs in the Yellow Pages under "Ham Radio."

## OF LISTS AND SUCH...

The International DX Association meets nightly at 2230 on 14.220 for an orgy of list-working rare ones or else an orgy of boasting. Either way it is fun. They also get in a little time to scheme up new DXploits, figure where they can send a rig that will do some good, etc. Check in with K3RLY or PY2PE. Eva puts a horrendous signal into the entire U.S., so you can't really miss her charming voice and wry wit.

The other night the list featured a quickie with CE9AT down in the South Sandwich Islands. There are a few spots rarer than that, but only a few. The night before they were making the same scene with XT2AA, another beaut.

Lists are the order of the day for working 5R8AS, Chet Cunningham,

down in Tananarive on Monday nights. He'll be there until December if you need a 5R8. Check in with Herb W6FQ at 0400 on 14.220. Chet is the director of the NASA tracking station down there.

Some ops are discourteous enough to get on the list, wait their turn, and then take the time of those still waiting to tell the DX op that they don't like lists. Bad manners. Boorish. Ugly. Okay, there are several ops that find their ego offended by having to get in line with the ordinary run-of-the-mill DX'er. They would much rather smash through a pileup to get their rare ones. It satisfies their need for prestige and proves their superiority to themselves and everyone else.

It all makes the list seem more worthwhile when you think it over.

# ALBANIA ACTIVATED

Martin, OH2BH, operated for several hours from inside Albania in mid-July, giving some 700 enthusiastic DX'ers a contact with this rarest of countries.

Amateurs have been trying for many years to get permission to operate from Albania, but there have been no legitimate operations for at least 25 years. The few clandestine operations were short-lived, though they have been accepted by the ARRL for country credit.

There is some question about the validity of the OH2BH operation as far as official permission is concerned, with some interested parties being quite convinced that this operation, like its predecessors, was clandestine.

The cables received by amateurs in Finland and Sweden were short and perplexing: "Demonstration over, rig lost." The fact that Martin was able to return to Finland from Albania lends credence to the opinion that this might have been a legal operation. Word has it that, legal or illegal, credit will be given for ZA by ARRL to the 700 lucky ones who got through the pileup.

### Foreign 73 Agents!

Please include call letters on all inquiries about subscriptions. 73 files subscriber names according to ZIP codes, but since foreign countries don't use ZIP, the only logical file system is by ham call. A mention of the call will save a tremendous amount of time in the troubleshooting department.

Thanks.

# FCC-APPROVED ID FOR CONTESTS

by James E. Barr  
Chief, Safety and Special  
Radio Services Bureau

Since the fall amateur contest activity will soon be here, a number of amateurs may be interested in a resume of a recent explanation of what the Commission considers to be an acceptable station identification, as follows:

For compliance with rule Section 97.87(a), the last transmission of the exchange of transmissions with another station must include the "other" station's callsign. For example, "BK 589 CAL TU DX1DX de W6XYZ K" would be in compliance with §97.87(a). When there is a need for identification of the "other" station in an exchange for the benefit of our monitoring facilities, it is most likely to be heard if it is in the last transmission or at the end of a long single transmission.

Where the transmissions of an exchange are very brief, such as the

typical contest exchange, if it is less than 30 seconds duration, the entire last transmission is considered the "end of the exchange" for the purpose of compliance with §97.87(a). Provided there is no mistaking which is the transmitting station's callsign, the callsigns may be anywhere in such last transmission. While the rule no longer gives examples, continuation of the traditional practice of placing the transmitting station's callsign last or preceding it by "de" is acceptable for this purpose.

Examples of acceptable end-of-exchange transmissions of less than 30 seconds are:

"CS1DX de W6XYZ 589 CAL BK"  
"DX1DX W6XYZ 589 CAL K"  
"DX1DX 589 CAL de W6XYZ K"  
"DX1DX 589 CAL W6XYZ K"  
"589 CAL DX1DX W6XYZ K"

For telephony, the voice equivalent of the foregoing examples may be used, substituting "this is" or "from" for "de," etc.

## PRESS LETTING HAMS DOWN?

The Society of Wireless Pioneers has expressed concern at the failure of the press and all media to mention or recognize the vital part radio officers play in the saving of lives and property during emergencies.

A case in point, according to an SOWP news release is the sinking of the S.S. *Badger State* Dec. 26, 1969, in which radio officer William Lafay-

## "Trader Jim" Suffers Fatal Heart Attack

James S. Sommerville, (W9WHF), known to thousands of amateur radio and Citizens Band operators the world over as "Trader Jim," died recently of a heart attack.

Mr. Sommerville was a senior technical correspondent for Allied Radio Shack, Chicago. He acquired the nickname "Trader Jim" during the years that Allied was active in the trade-in communications equipment business through the mail.

An active Ham for more than 33 years, he had an earnest desire to help young people get started in amateur radio.

# ATV MOUNTAINTOPPING



Three enterprising television amateurs — Dick Nickel (W6PCQ), Chuck Phillips (WB6WPQ), and Dan Fix (WA6DNY) — escorted their portable television and radio gear to the top of Santa Monica Mountains as a project of the ATV Club of Southern Calif. The reason for this tiring trip was

to create wider interest in amateur radio through the modern concept of amateur television.

Mountaintopping is a standard for amateur radio activity on Field Day. However, amateur television is another story. Aside from the normal problems, there are sync pulses and video scanning, all of which must be generated or must be compatible with the 60 Hz commercial electrical line frequency.

The only source of electrical power used was a 12V electrical system from the 1969 Dodge van which was their only transportation. A 300W 12V-to-110V inverter furnished the end power source to the radio and television equipment. This supplied enough power to alternate between the available equipment.

## A FAREWELL TO A PIONEER

by Mrs. Patricia Armstrong

In a geriatric home in Melfort, Saskatchewan, Canada, an event occurred that in one way was not important outside a small family circle, but in another was important to all hams everywhere. This was the death, in his seventy-third year, of Oscar Olson, a radio ham of forty years standing. Like the majority of his fellows, he was known locally by his name to only a few people, but internationally to many by a set of letters and figures. (Oscar's were VE5DS.) Is his passing not an occasion for North American hams to lay aside their microphones, hush the clatter of their code keys, and pay a moment's silent tribute to members of a fast-disappearing group: the pioneers of our own profession?

## Okinawa Award Rules Change

The Okinawa Amateur Radio Club has recently revised requirements for the Okinawa Award, as follows: 25 QSLs are required for applicants from KR6 and KR8; 10 QSLs are required for BV, CR9, DU, HL/HM, JA/KA, KG6, VS6, W/K applicants. For the best of the world, 5 QSLs.

KR6 & KR8 applicants must submit cards for verification. For all others, send only a logbook extract with signed confirmation that required QSL information had been reviewed and verified by two licensed amateur radio operators, or by an official of a recognized radio club or society.

Send all applications, together with \$1 (U.S.) or 10 International Reply Coupons, to QSL & Awards Manager, Okinawa Amateur Radio Club, Box 465, APO, San Francisco CA 96331.



ette lost his own life but was able to send the SOS which resulted in rescuing 14 members of the crew, including the captain.

Checking into the matter, the Society found that Officer Lafayette carried out his duties in an outstanding manner and he was complimented by all who worked with him in the handling of this emergency. However... not one word of this man's heroic devotion to duty found its way into press releases. Nor did any of those rescued give him recognition in their press interviews.

The Society suggests "monitoring" of press releases in newspapers, magazines, and other media, and contact the editor in the event of such omissions. The anonymous spokesman for the Society of Wireless Pioneers said. "We are proud of our heritage and the many brave and valiant men who have lost their lives in carrying out their duty." *What more can one ask?*

### *New Transistor Runs 90 W OUTPUT on 2m FM*

A new silicon rf power transistor from Motorola (type MM1552), is rated at 90W peak output power, with an rf input of 18W, according to Jack Jaques, engineering director at Motorola Semiconductors, of Phoenix, Arizona.

Intended for use as high-power Class C amplifiers for 100-175 MHz frequencies, the transistors have the high peak power capabilities and breakdown voltages required for AM service. The MM1552 permits close to 100% modulation with a 25W carrier at  $V_{CC}=13.5$  Vdc. In FM or CW service, the new transistor is capable of a continuous 75W output at 150 MHz. The 65 V  $BV_{CES}$  of the MM1552 permits high level modulation with a 13.5V power supply or series modula-

### *New Mexico Hamfest To be Biggest Yet*

The Albuquerque Amateur Radio Club and Caravan Radio Club of New Mexico will sponsor the New Mexico Hamvention at Albuquerque, New Mexico on September 18, 19, and 20. This will coincide with the New Mexico State Fair which is being presented from the 17th through the 27th of September.

The Hamvention headquarters will be at the Holiday Inn East, East Highway 66. There will be a banquet on Saturday night (September 19) in the main ball room of the Holiday Inn. There will be lots of door prizes, Gabfest, flea market, and lots of fun. Technical sessions will be presented in the areas of VHF, FM, SSB and other subjects. There will be MARS meetings and the VHF FM Society of New Mexico will have its first formal meeting. Planned guests include Ken Sessions (Repeater Handbook) and Bill Orr (Radio Handbook).

Talk-in frequencies will be: 3990, 7293, 14345, and 29600 kHz (AM and FM), 146.34-146.94 MHz (Repeater), and 146.94 MHz (direct) NBFM.

For further information and registration, contact Ray Hill, W5SDM, 9016 Los Arboles Ave. NE, Albuquerque, New Mexico 87112, (505)299-1719.

tion with a 27V supply. The transistor derives its electrical ruggedness from "balanced emitter" construction - it can withstand all conditions of load mismatch in AM service, from short to open circuit. Much of the fine broadband performance of the transistor comes from its low-lead inductance stripline package. The price is \$43.50 each. An application note describing at 25W, broadband, amplitude-modulated transmitter employing the MM1552 may be obtained by writing Motorola directly.

Ham radio is a quiet hobby, little known beyond its own warm circle, but persistent, and limited to no one nation. Oscar Olson was rather like that himself. Born in Sweden on December 1, 1897, he was transported at the age of seven by ship, train, and finally horse-and-buggy to a homestead near Stenen, Saskatchewan. There he grew to young manhood, working on his father's farm and exploring, in his free time, the scientific marvels of a dawning age. For forty years he was a ham operator. He left behind a stack of yellow radiograms and logbooks dating back to the 1920s. To browse through them is to recapture the history of the humble community in which he spent his life.

In 1926, when Oscar was formally licensed as a ham operator, radio was in its infancy. Enthusiastic amateurs were building their own crystal sets, straining breathless to hear through the crackling static of headphones, undaunted by the envious jeers of less-skilled neighbors.

What goes into the making of the 300,000 licensed amateurs of the North American continent? They are ordinary men and women who patiently learn Morse code, who sit for endless hours fiddling with dials, sorting out beep-beeps from every country in the world, discussing reception, frequencies, trivialities hour after hour, day after day, week after week. Suddenly, perhaps, one may leap into the spotlight of public acclaim at a time of national emergency like a flood or a cyclone. Most live and die "unwept, unhonored, and unsung." What starts them on their dedicated path? What spell holds them to it in spite of daily tedium?

Of course no two hams are identical. Yet surely all of them must share one common trait - the love of tinkering. Most of them originally construct at least a part of the equipment with which they work. In the early days

that we are remembering just now, perhaps they constructed all of it.

Oscar belonged to a type that is disappearing in this day of standardized technical education. He was a self-taught enthusiast, a man who developed a natural skill without the help of formal education.

Today one turns the leaves of those logbooks that record the daily radio contacts of forty years, and marvels at the neat script which would put to shame most high school students of our own day. One gazes at the painstaking sketches of mechanical apparatus that apparently interested him - sketches that, to an untrained eye at least, look like the work of a professional draftsman. For many years Oscar kept a radio sales and repair shop in Sturgis. He also farmed with his brothers Andrew and Eric. Oscar was the one who repaired things - radios, farm machinery, whatever in the neighborhood broke down. The boy who put his clocks back together never gave up until he found what kept the radio or the tractor from functioning.

Oscar is survived by a wife and four sons. His ham equipment sits in his Sturgis home, dismantled now, awaiting the time that one of the boys will, perhaps, establish a permanent home and take up his father's hobby.

During the two and a half years after the stroke that ended his days at radio and key, who knows what Oscar thought or what he remembered? But we remember him - and the thousands like him who put their bits of scrap together when the country was young, and started, for good or ill, man's conquest of the airwaves. Let's pause a moment now, and toast them all. Ladies and gentlemen, I give you the pioneer hams of North America. May God bless those who still live, and the memory of those who, like Oscar Olson, have passed beyond the reach of key and code!

## Classified

### Caveat Emptor?

Price — \$2 per 25 words for non-commercial ads; \$10 per 25 words for business ventures. No display ads or agency discount. Include your check with order.

Deadline for ads is the 1st of the month two months prior to publication. For example: January 1st is the deadline for the March issue which will be mailed on the 10th of February.

Type copy. Phrase and punctuate exactly as you wish it to appear. No all-capital ads.

We will be the judge of suitability of ads. Our responsibility for errors extends only to printing a correct ad in a later issue.

For \$1 extra we can maintain a reply box for you.

We cannot check into each advertiser, so Caveat Emptor. . .

**ELECTROMECHANICAL TIMER** — A reader recently wrote 73 asking where "veeder root" type counters could be obtained. We got the info but lost the writer's letter. Counters are available from J. Meshna, 19 Allerton St. Lynn MA 01904. Order No. 68-38, \$1.75 postpaid.

**CINCY STAG HAMFEST:** The 33rd Annual Stag Hamfest will be held September 27, 1970 at Stricker's Grove, Compton Road, Mt. Healthy, Cincinnati, Ohio. Door prizes each hour, raffle, lots of food, flea market, model aircraft flying, and contests. Identify Mr. Hamfest and win prize. \$5.00 cost covers everything. For

**TECH MANUALS** — R-390A/URR, BC-639A, OS-8C/U, SP-600-JX, R-274/FRR, Ted, \$6.50 each; TX-175/U, TX-323/UR TS-173/UR, \$5.50 each. Hundreds more. S. Con-salvo, 4905 Roanne Drive, Washington DC 20021.

**73 IS AVAILABLE** to the blind and physically handicapped on magnetic tape from: SCIENCE FOR THE BLIND, 221 Rock Hill Road, Bala Cynwyd PA 19004.

**RBB-RBC MANUALS:** New \$5. Used \$4. OS-8 Oscilloscope manual \$3. Some QST 1929, 30, 31 etc., Radio 1939, 40, 41 etc. Write for list. James W. Holloway W6LFL, 2027 Harton Rd., San Diego CA 92123.

**SAROC:** January 7-10, 1971, Flamingo Hotel Convention Center, Las Vegas, Nevada. Sponsored by Southern Nevada ARC, Inc., Box 73, Boulder City, Nevada. Advance registration \$14.50 per person accepted until January 4, regular registration at door, includes Flamingo Hotel late show and drinks, Sunday breakfast, cocktail parties, technical seminars and meetings, ARRL, DX, FM, MARS, QCWA, WCARS-7255, WPSS-3952 and WSSBA. Ladies program. Flamingo Hotel SAROC room rate \$12.00 plus room tax, per night, single or double occupancy January 3 thru 12, 1971. Mail accommodations request to Flamingo Hotel. Mail advance registration to SAROC. W7PRM, Club President. W7PBV, SAROC Convention Chairman.

**"TOWER HEADQUARTERS!":** 11 Brands! Heights aluminum 35% off! Strato crank-ups-low cost! Rotors, antennas and gear discounts. Phone patch \$11.95. Catalog-20¢ postage. Brownville Sales Co., Stanley WI 54768.

**END CARD PROBLEMS:** Frame, protect, store or display 200 QSL's in 20 card plastic holders for \$3.00, prepaid and guaranteed. Tepabco, Box 198, Gallatin TN.

HT-37, \$169.00: R4-A, \$279.00: Ham-M Rotor, \$79.95: HQ-180, \$225.00. Moory Electronics, Phone 501-946-2820, P.O. Box 506, Dewitt AR 72042.

**DECIMAL INDICATOR TUBES:** 1/2" characters 0-9, no decimal point. Similar "Nixie" B5750. Brand new, guaranteed, \$3.50 ppd. SASE full information. W1DMU, box 1, Corinth VT 05039.

**6-METER STATION:** Clegg 99er transmitter, matching VFO, Hy-gain 3-element beam. All excellent condition. WB2MRJ Mark Freedman 67-IOC 190 Lane, Fresh Meadows NY 11365. 212-GL4-8194.

**RG8U or RG11U:** Low loss foam coax 10¢ foot PL259-SO239 40¢ each, 15/\$5.00. Jacketed 1/2 inch aluminum 50 ohm foamflex 20¢ foot. New factory sealed Ham-M Rotor \$95.00. Everything new! Monte Southward Co. RD. 51, Upper Sandusky OH 43351.

**SURPLUS GOODIES** — Two radio remote control units RM-39: \$7.50 each; two EE-8 telephones: \$7.50 each; BD-72 Switchboard (12 lines): \$10; five BC-611 walkie-talkies: \$10 each; two BC-745 AM 80 meter portable transceivers with rechargeable pwr supplies: \$10 each; 60 watt GE rcvr and xmtr, 30-40 mc., 6/12 volt, FM: \$17.50; Metal detector SCR-625: \$25. All items FOB. Will answer all replies. William S. Weir Wb4GEW, 322 Forest, Berea KY 40403.

**FOR SALE:** best offer DX 100, SX100, DX 40, DX 60, Globe 90, TBS

50, BC 348, RCA 88LF, ip501, Marconi LF, omega 4 x 5 enlarger, HT40 RCA 8506B, ARR 8503, all in working condx. Write Box 8352, Savannah GA 31402.

**NOVICE CRYSTALS:** 40-15M \$1.38, 80M \$1.83. Free Flyer. Nat Stinnette Electronics, Umatilla FL 32784.

**POWER/MATE MODEL:** UNI88 precision 0-34 volt power supply at 1.5 amperes equipped with controls and metering arrangement 27.50 W2TJZ 101 Christie St., Tenafly NJ 07670 07670. Phone 201-568-1267.

**RECORD GRAB-BAG,** from personal stock, 10 new 45 rpm records, variety music, \$1.00 postpaid USA. Don Whitney K5GKN, Box 249, Osceola AR 72370.

**FOR SALE:** CE20A with QT1, CE458 VFO \$85.00, 2A with xtal calibrator \$135.00. Both \$200.00. Don Whitney K5GKN, Box 249, Osceola AR 72370.

**DRAGON FLY.** . . antenna, for 20-40-75 meters. . . no traps. . . no compromise. . . eight months in development. . . one feed line. . . SWR one to one guaranteed. Construction drawings \$5.00 Box 423, Wakefield, RI 02880.

**NATIONAL 1000,** one kilowatt transmitter, 80-10 meters, brand new, used for short test for 73. Cost \$1100. Send check for \$900 and it is yours. Factory guarantee. 73 Magazine, Peterborough NH 03458.

## Hamfests and Other Happy Occasions

### Oklahoma

The annual hamfest at Lake Texoma Lodge on Lake Texoma, near Kingston, Oklahoma will be held this year November 13, 14, and 15th.

All the programs will be indoors

### California

The 9th Annual Greater Bay Area Hamfest will be held at the Edgewater Hotel in Oakland, California on October 18-19th of this year. For the 10,000 amateurs in the San Francisco



NEVER SAY DIE

...de W2NSD/1

EDITORIAL BY WAYNE GREEN

The FCC jammed through its contribution to inflation, the rule that increases the cost of an amateur license from \$4 to \$9 for five years. I suppose this isn't so bad in the context of \$2 movies (how many of you can remember those Saturday afternoon matinees with two main features, one western, two serials and six cartoons for 10¢?) and teensy 25¢ ice cream cones.

The argument against raising the ham tax was that we need to turn every stone we can to get more hams, and anything that could possibly slow down the entry or continuance of amateurs should be avoided. Like more than doubling the tax. It probably wouldn't have bothered many of us so much if there had been a raise in the tax on the commercial licenses, the permits to make money.

At any rate, starting immediately you will have to pony up \$9 and there doesn't seem to be much to be done about it. A good lobbyist for amateur radio in Washington undoubtedly could have stopped this, but we don't have a good lobbyist in Washington, only a part time unpaid cheapskate who doesn't even have the fare to get to Washington half of the time. You got what you paid for.

#### ARRL National

Newington hated it, but they grudgingly permitted 73 to exhibit at the Boston ARRL National this time. Last time they turned thumbs down and 73 was not permitted to have a booth. They did remain adamant that none of the 73 staff be permitted on the program so (unless some special arrangements can be made) you will miss hearing about FM and repeaters from Ken and miss seeing my slides of King Hussein and Jordan. Too bad about that, but that's the way it is with ham politics.

#### W2NSD/1 Nightly Sked (wife permitting)

Last month I set up a schedule on 14.300 MHz nightly at 0200Z, plus whatever time after that it takes me to remember the schedule, and providing my wife hasn't yanked me out to the movies or something. After a few nights on 14.300, I want to publicly express my sympathy with the 141,000 General and Conditional licensees who are stranded in that unbelievably crowded band segment. Normally I operate down around 14.210 or so, and while there is QRM

there most of the time, it is usually on the order of S8 or so. On 14.3 the QRM is seldom below +10 over 9, and frequently squashes any signal below +30.

At first I was going to set up shop on 14.280, but after a couple nights of trial I gave up the idea of trying to work in between all of the nets that are set up there. 14.300 seemed better in that at least there did not seem to be any organized activities there.

Try me on 14.300 if you have any traffic. I have a big signal and will try and pave a way for you to get through. I'm looking for any information that might be of interest for the news pages, things like DX news, emergencies, medicine to save babies, or whatever you think might be of good general interest. Please do not call in about subscriptions, advertisements, JY1 cards, or anything commercial.

#### Anecdota Wanted

Jean Shepherd K2ORS called the other day to say that he has started work on a book about amateur radio aimed at the youngsters. He would like to hear from any amateur who has had an unusual experience that might be worth including in the book. Have you been involved in anything unusual or exciting which might be worthy of inclusion in a book about our hobby? Send the particulars to us to pass on to Shep. Send the stories to Shep, c/o 73 Magazine, Peterborough, N.H. 03458.

#### Mideast Perspective

Though I try to keep up on worldwide current events, and probably do more than most people, I found myself woefully short on anything more than generalities when I went to Jordan. The impression I had from the usual flow of Mideast news in the U.S. was that Israel had made just about every concession possible in an effort to get the fiery and intransigent Arab leaders to sit down and try to work out a peace arrangement.

While I was in Jordan I naturally heard quite a bit of the other side of the story. The rather extensive report by Newsweek, a magazine that I have come to trust down through the years, was strikingly similar to the evaluation of the situation I had been hearing in Jordan and this cast some doubt in my mind about the objectivity of

(cont. on page 108)

further info, contact, John Bruning, W8DSR, 6037 Fairhurst Ave., Cincinnati OH 45213.

**WANTED:** SP4OOX Chassis with Tuner. Ralph M. Williams, Box 372, Dixfield MA 04224.

**HAMVENTION:** Albuquerque, New Mexico on 18, 19, 20 Sept. 1970. Lots of door prizes. Gabfest, Flea Market, Technical sessions. MARS, VHF, SSB, DX meetings. For information and registration contact Ray Hill, W5SDM, 9016 Los Arboles Ave. NE, Albuquerque NM 87112, Phone area code 505-229-1719.

**FM GEAR:** P/O AN/TRC-28. 50W 150 MHz Base. T-416/GR, R-394/U, PP-804/U, C-844/U, CY-122/G cabinet. 115/230 VAC. Xceive, 2W Remote, Repeater options. W/Books, Handset. 1 ea. L/N \$45. 1 ea. Unused \$55. 1 ea. Remote (C-845/u) Unused \$10. 1 ea. Base plus remote on 146.34/146.94T, 146.94 W/1800, 1950, 2100, 2250, 2400, 2805 burst built into remote unit, unused \$95. Freight collect or you P/u. SASE for list of Hiband and UHF FM gear. Jack Krause WA6OBH, 8513 Don Ramon Drive, Stockton CA 95207.

**CRYSTALS AIRMAILED:** Novice — all bands, all frequencies, accurate-active — \$1.50 airmail 10¢/crystal, 1st-class 6¢. Free amateur experimental general frequency price-order bulletin. Your crystal shop since 1933. WØLPS, C-W Crystals, Rt. #2, Marshfield MI 65706.

**VIKING INVADER:** 2000 perfect clean condition with electronic tr. switch and factory fitted RTTY, need space, bargain \$350 K8UBG, 1137 Cedar Point, Sandusky OH 44870.

**COLOR ORGAN KITS:** Home/Auto \$7.50. IC power supplies \$2.75 to \$8.50. Computer grade electrolytic capacitors \$.35. XMTR transistor TRW PT3690 \$4. Catalog. Murphy, 204 Roslyn Ave., Carle Place NY 11514.

**ELECTRONIC ORGAN,** solid state, spinet, send SASE for particulars; Lloyd G. Hanson W9YCB, RR 2 Box 52A, Angola IN 46703.

**GREENE:** center dipole insulator with ... or ... without balun ... see November 73, Page 107.

**WORLD RADIO's** used gear has trial-terms-guarantee! KWM2, \$695.00; Duobander 84, \$104.95; Galaxy 5 mk2, \$259.95; 5 mk 3, \$279.95; GT550, \$379.95; 2NT, \$119.95; Valiant, \$129.95; SB2LA, \$149.95; R530 receiver & 3 filters, \$649.95; Interceptor 6/2, \$199.95; 75S1, \$299.95; HQ170C, \$179.95; Drake 2A, \$159.95; F455B60, \$19.95; GC104, \$19.95; Swan TV2(20M), \$199.95. Free "blue-book" list for more. 3415 West Broadway, Council Bluffs IA 51501.

**SURPLUS CRYSTAL FILTERS,** dime for list. Over 50 types, 80 kHz to 36 MHz. See Aug. 73 ad. ESELabs, 301 Augustus, Excelsior Springs MO 64024.

**TWO INCH TOROID CORES,** popular T-200-2. Make balun, fil. choke, tapped tank. PPD \$2.75 each, 3 for \$7.00. ESELabs, 301 Augustus, Excelsior Springs MO 64024.

**"HOSS TRADER ED MOORY":** says he will not be undersold on cash deals! Shop around for your best price and then call or write the "HOSS" before you buy! Swan 500C, \$449.00; Swan 270 Cygnet, \$419.00; Drake T4-XB, \$395.00; R4-B, \$379.00; TR-4, \$559.00; TH6-DXX, \$139.95; GT-550, \$415.00. New Rohn 50 ft. Foldover tower prepaid, \$199.95; New Mosley Classic 33 and Demo Ham-M Rotor, \$198.00; New Gonset GSB 201 MkIV Linear, 2000 Watts, (\$495.00), CASH PRICE \$349.00; New Swan 350C, (\$420.00), CASH PRICE \$329.00; Reconditioned Equipment: L4-B, \$549.00; 75A-4, \$319.00;

and there will be entertainment for all. There will be the customary program of technical discussions, swap and shop, and there will be display tables provided free if you are registered at the lodge.

### New Jersey

The South Jersey Radio Association will hold its 22nd annual hamfest on Sunday, September 13th at Molia Farms, off Route 47 at Malaga Lake, Malaga, N.J. 1000-1700 hours, EDST Talk-in and hidden station hunt on 2, 6, and 10 meters. Registration is free but modest fee for prize-drawing tickets. Swap shop, swimming, children's games, snack bar and lots of contacts. Additional detail from Jack Koch K2MZZ, 1529 Dogwood Dr., Cherry Hill, N.J. 08034, 609-429-2642.

### New York

The annual Syracuse VHF Round-up will be held at the Three Rivers Inn, Route 57, 10 miles north of Syracuse, N.Y., Saturday, October 10. Reservations and information from Charles Sellwood, W2RHQ, 902 1st North Street, Syracuse, New York 13208.

### Illinois

The Peoria Area Amateur Radio Club, Inc. will hold its 13th annual hamfest Sunday, September 20, 1970 at Exposition Gardens (same place as last year), located on the northwest edge of Peoria, Illinois. Lunch will be available. There will be plenty of activities for the entire family, beginning with the campsite opening the preceding evening. Free coffee and donuts from 9:00 to 9:30 a.m. CDT. Free swap section, parking, contests, and cartoons for the kiddies. Advance registration \$1.50, (\$2 at the gate). For further details and advance registration, write Ferrel Lytle W9DHE, 419 Stonegate Road, Peoria, IL 61614.

Bay Area, this promises to be the biggest hamfest ever.

With the interest that amateurs have displayed in previous years in mind, this year's hamfest will emphasize quality presentations of seminars and exhibits. In 1969 there were more than 1000 amateurs at the hamfest and visiting the exhibits. It is expected that the attendance this year, moving closer to the center of the amateur population in the Bay Area, will surpass this mark.

### Illinois

The Chiburban Radio Mobileers announce the 3rd annual 160 meter reunion, Sunday, September 20, 1970 at the Joliet Beach Club, Joliet, Illinois.

There is no admission charge, and no formal activities are planned. The reunion is a chance to get together with other enthusiasts to discuss equipment, operations, noise problems, DX, use of frequencies, etc. Last year's mobile efficiency contest evoked so much discussion that it may be repeated with revised rules. Slides and snapshots of various 160 layouts will be shown.

The Joliet Beach Club is located on Rowell Avenue, immediately adjacent to Interstate Route 80. For those who wish to stay over, there is a Joliet Holiday Inn, and a Howard Johnson motel nearby. Talk-in on 1810 kHz.

### Ohio

The 33rd annual STAG hamfest sponsored by the Greater Cincinnati Amateur Radio Association will be held on Sunday, September 27, 1970, at Stricker's Grove on Compton Road, Mt. Healthy, Cincinnati, OH.

The "Cincy" STAG hamfests have grown in popularity each year; last year's attendance was over 2300 hams.

# For The Experimenter!

## International EX Crystal & EX Kits

OSCILLATOR / RF MIXER / RF AMPLIFIER / POWER AMPLIFIER

### Type EX Crystal

Available from 3,000 KHz to 60,000 KHz. Supplied only in HC 6/U holder. Calibration is  $\pm .02\%$  when operated in International OX circuit or its equivalent. (Specify frequency)



# \$3.95

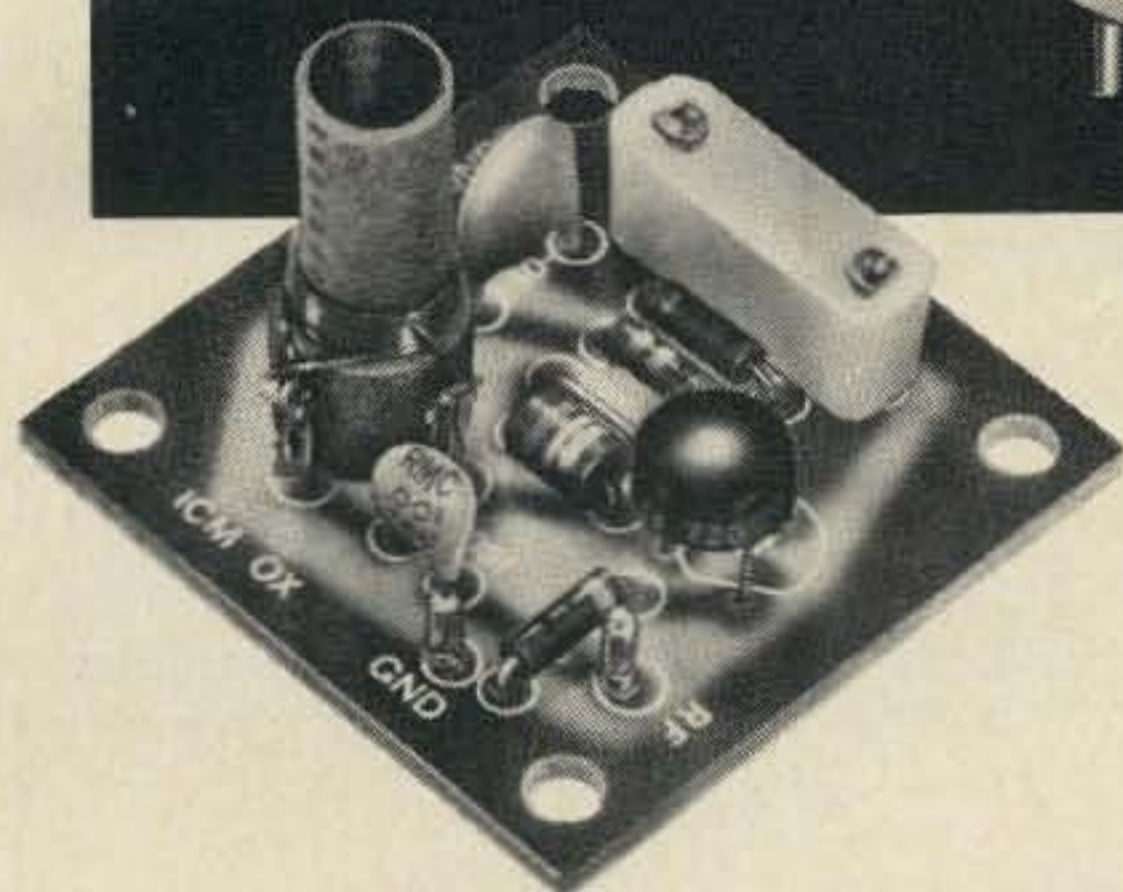

#### OX OSCILLATOR

Crystal controlled transistor type.  
Lo Kit 3,000 to 19,999 KHz  
Hi Kit 20,000 to 60,000 KHz  
(Specify when ordering)

# \$2.95

#### MXX-1 Transistor RF Mixer

**\$3.50**

A single tuned circuit intended for signal conversion in the 3 to 170 MHz range. Harmonics of the OX oscillator are used for injection in the 60 to 170 MHz range.

Lo Kit 3 to 20 MHz  
Hi Kit 20 to 170 MHz  
(Specify when ordering)

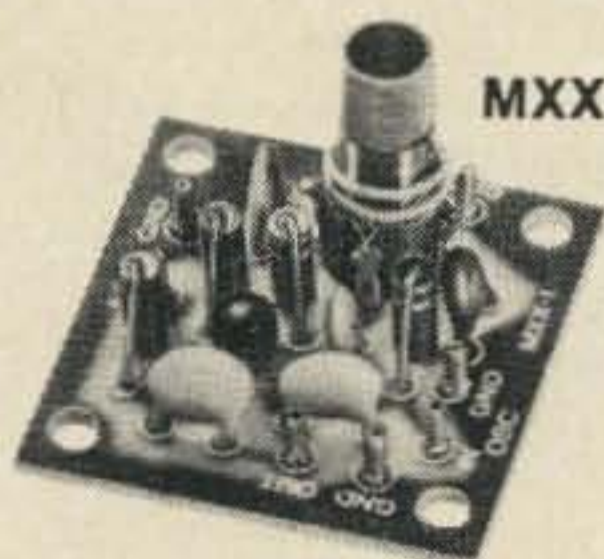

MXX-1

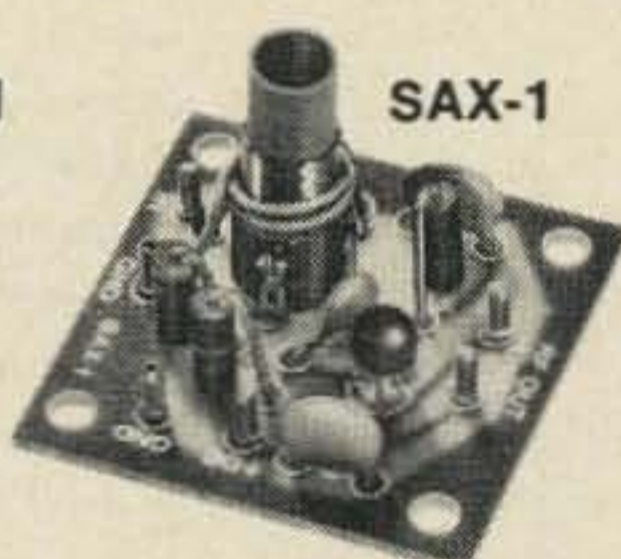

SAX-1

#### SAX-1 Transistor RF Amplifier

**\$3.50**

A small signal amplifier to drive MXX-1 mixer. Single tuned input and link output.

Lo Kit 3 to 20 MHz  
Hi Kit 20 to 170 MHz  
(Specify when ordering)

#### PAX-1 Transistor RF Power Amplifier

**\$3.75**

A single tuned output amplifier designed to follow the OX oscillator. Outputs up to 200 mw can be obtained depending on the frequency and voltage. Amplifier can be amplitude modulated for low power communication. Frequency range 3,000 to 30,000 KHz.

#### BAX-1 Broadband Amplifier

**\$3.75**

General purpose unit which may be used as a tuned or untuned amplifier in RF and audio applications 20 Hz to 150 MHz. Provides 6 to 30 db gain. Ideal for SWL, Experimenter or Amateur.



PAX-1

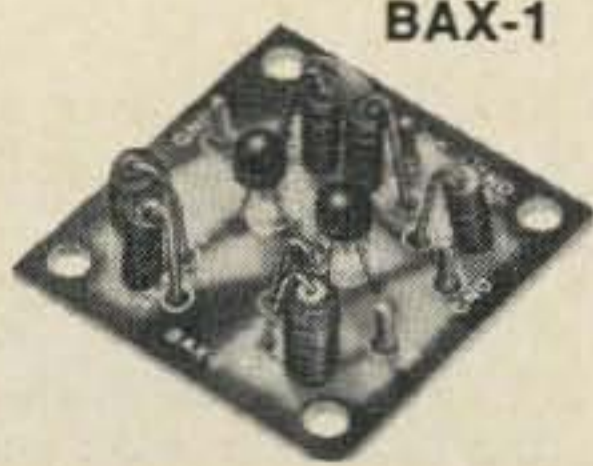

BAX-1

Write for complete catalog.



**CRYSTAL MFG. CO., INC.**  
10 NO. LEE • OKLA. CITY, OKLA. 73102



### Long-Range Planning for a "Biggie"

If plans continue on course, the next SAROC Las Vegas convention should top all existing ham convention records. Leonard Norman (W7PBV), chairman for the event, says that two charter flights are being negotiated with Chicago- and New York-based airlines. The deal, says Norman, will allow hams near these big cities to come to SAROC at a package price. For less than "normal airline fare," the package will include a champagne flight, transportation to and from the Flamingo Hotel (where SAROC's being staged), tickets to a major stage show, registration and drawing tickets, the annual SAROC breakfast banquet, cocktail parties, seminars, a complimentary casino "free money" packet, and heaven knows what else.

The way things look now, you'll be able to charge the whole thing on your regular credit card (Carte Blanche, American Express, Diners Club, etc.). As far as I can tell, there's just one big hitch: There will be only one charter plane leaving from Chicago and one leaving from New York. Those who make reservations early can be accommodated, but if you wait, you'll end up being left out. To be safe, better drop a card to Leonard Norman now and let him know if you plan to be on either of the two flights. (His address is Box 73, Boulder City NV 89109.)

SAROC is always a big thing for everyone, but this next one should rank particularly high with the FM crowd.

For one thing, both Chicago and New York are FM strongholds, so the number of FM'ers on the flights will probably be disproportionately high. For another, the affair at SAROC will be FM's fourth annual national convention.

The tentative FM schedule so far includes as speakers: Wayne Green of 73 Magazine (and me, of course); Dr. Phil Dater (WA5JDZ), key man behind the chain of interconnected New Mexico repeaters; Art Housholder (K9TRG), general manager of Spectronics, Incorporated; Pat Devlin (K5BPS), from Tulsa Repeater fame; and Gary Hendrickson, renowned author and principal of the Baltimore repeater.

On the regular SAROC agenda (non-FM), the scheduling of speakers is still under way, but I'm sure the lineup will include Wayne Green's slide presentation of his recent visit with King Hussein in Jordan.

At any rate, the Flamingo is making some advance preparations. It has blocked off 600

rooms for the exclusive use of SAROC attendees, who qualify for the special \$12 room rate. The advance registration price for those not making the charter flights is \$14.50 per person, which includes — among lots of other things — a late show at the Flamingo, a couple of drinks (at Flamingo or Desert Inn), breakfast, cocktail parties, etc.

### Repeater Cliques

It's still a little early to call it a trend, but more and more reports are coming in that repeaters are turning "unfriendly." More open repeaters are turning inward, closing to "outsiders"; more member-supported groups are hiking their dues to lock out would-be users.

These are bad signs indeed. Most of the "old salt" FM'ers remember the first couple of years of repeater growth, where the situation was reversed. Repeater owners wanted to encourage as much activity as they could. Then, AM "neighbors," threatened by the big loud band-dominating machines, fought by jamming, boycotting, maligning, and just about every other tactic they could think of.

Repeaters are an accepted part of our way of life, now, but a lot of the "good guys" of yesterday are turning into the "heavies" of today with the techniques some of them are adopting to inhibit further development.

The first step is an innocent one: A club forms for the purpose of providing a means of support for a repeater. The club will usually include a few officers with enough technical talent to keep a repeater percolating and enough members to keep the thing financed adequately.

W 4 B O C

**Alford Memorial Radio Club**  
2271 White's Mill Road  
Decatur, Georgia, 30032

July 13, 1970

Dear OM,

Your application for membership was considered at the last regular meeting of the Alford Memorial Radio Club. Unfortunately, no sponsor was present to support your petition and the members present therefore could not act favorably on your application. Should you desire to re-apply for membership at a later time, please be sure a sponsor is present to support your petition. In addition, please include a short sketch of your activities as a Radio Amateur and state the reasons you would like to join this repeater organization.

We will be pleased to reconsider your application at a later time if you so desire.

Yours very truly,

Taylor F. Whitmire, Sect./Treasurer  
Alford Memorial Radio Club

*A ham in Decatur, Georgia wanted to operate through the local "open" repeater, operated by the Alford Memorial Radio Club. This letter to him from the club secretary speaks for itself.*

The next step is the dangerous one: setting up two price lists that serve to factionalize the repeater users. This sets up an "inner group" of a few individuals who think of themselves as an elite caste.

A concerned amateur in one of the biggest cities in Georgia called me recently to tell of a repeater there that will not accept new members. He said transient use of the repeater was discouraged, full membership in the repeater organization was closed, and that operation through the repeater resulted in boycotts or insults. Yet, he said the repeater is referred to (by its management) as being "open," it is set up on nationally accepted channels, and it does not require sub-audible continuous tone (PL) for activation.

An amateur in New England called with essentially the same complaint about another repeater. And my letter file includes numerous such reports. It is clear that someone should do something before the situation gets out of hand.

I don't think for a moment that these cases are all one-sided. In some cases, certain individuals are being discouraged because they do not respect the local traditions of repeater use. In others, individuals are discouraged for long-windedness, excessive activation of the repeater, or simply bad operating habits.

However, if the locked-out individuals begin to grow in number; if the repeater takes on the aspect of a "closed" setup; if transients are ignored or discouraged; or if PL is put to use to limit the number of users — then it's time for some giving on the part of the repeater groups.

I have always held that closed repeaters do not belong on national repeater frequencies. A closed repeater on either the .34-94 or .34-.76 pair is an open invitation to unrestricted use by anyone who buys an FM unit. Let the closed repeaters function, but let them function where they do not impose on the rights of others. The simple fact that most ham FM units come equipped with crystals for .34 and .94 makes those frequencies "public," and it is certainly within the rights of a newcoming FM'er to operate using the crystals that came with his rig.

Also, a closed repeater using .34, .76, or .94 prevents the establishment of an open repeater in the area on those channels. The result is that if an open repeater is to evolve, it is forced to happen on a nonstandard frequency pair — the only alternatives being a direct conflict for the national channel or no open repeater at all.

Repeater organizations are necessary, of course, and dues are necessary if the repeater is to be maintained. But all of us should remember that amateur radio is a fraternity traditionally characterized by the "ham spirit." If we let factions and cliques gain a solid foothold in an area as important as FM repeaters, our now-excellent reputation will be threatened in the eyes of the rest of the amateur world. And our image of friendliness and fellowship will decay and crumble.

... K6MVH ■

# New Subscription Rates? YOU BET

With this issue of 73 we close out our first ten years of publication. In an era of unprecedented inflation we have done well, we think, to keep our subscription rates as low as we have. We started out at 37¢ a copy, went to 40¢ when the newsstands protested the odd figure, then went to 50¢, 75¢, and finally a dollar. Our subscription rate started at \$1 a year, and went to \$12 for three years back in 1966.

If congress and the administration would try and cut expenses down we suspect that the inflation would stop. As long as they keep the Bureau of Engraving busy three shifts a day printing more money, we can't have anything except inflation, and (as has been proved rather clearly) curbing consumer credit only makes the situation worse by adding a recession to the inflation.

Suffice it to say, we must inch our subscription rates up a little bit more just to stay in one place. The new subscription rates will take effect with the next published issue of 73, thus giving you time to repent over dawdling on sending in your money.

Term	Current U.S.	After Oct. 1, 1970	
	& Foreign	U.S.	Foreign
1 yr	\$6	\$6	\$7
2 yrs	\$11	\$10	\$12
3 yrs	\$12	\$14	\$16
LIFE	\$50	\$73	\$73

## LAST CHANCE!

73 Inc., Peterborough NH 03458

Name \_\_\_\_\_

Call \_\_\_\_\_

Address \_\_\_\_\_

City \_\_\_\_\_ State \_\_\_\_\_

Zip \_\_\_\_\_

3 yrs \$12

LIFE

1 yr \$6

\$50

Isn't it time someone did something to relieve the problem of unrestricted use of the entire HF spectrum on such activities as Field Day? The 1970 edition of this annual exercise presented a perfect example of the utter futility of any effort to utilize the bands for any other purpose. From the low CW end to the top of the phone portions of each band there was bedlam. It was just about impossible to get through the crud without being interrupted by FD participants looking for extra contest points.

There is nothing wrong with contests, if you happen to like them, SO LONG AS THEY DO NOT PREEMPT THE ENTIRE AMATEUR SPECTRUM. There seems no logical reason why some portion of each band should not be inviolably secured from contest activity, so that normal use of the bands for standard operation and ordinary ham activity may continue unimpaired.

The ultimate in tactlessness, rudeness, and plain old-fashioned crust was noted when both parties on a phone patch were interrupted and requested for a Field Day contact by some eager beaver in the Fourth District. I would not have believed it possible if I had not heard it myself. The most ridiculous part was, this was an overseas patch to South America, dealing with some missing persons in the earthquake sector of Peru. To say that the operators of the patch were miffed would be the rankest understatement.

Nobody is compelled to participate in any activity he does not fancy. But there has developed a certain breed in recent years, who do not try to understand this. These characters think they have a perfect right to interpose their unwanted presence at will; to ask for reports, audio checks, S-meter readings, opinions about . . . "this microphone I just bought, and what do you think of the quality, Old Man?" This goes on all the time, ad nauseum, without a single thought whether it is right or wrong. That he may be an unwelcome intruder never enters this type's mind, it seems.

And when these people get what they deserve — either total disregard, polite refusal, or an out-and-out reading of the riot act — they feel that they are being sorely put upon. In this scribe's humble view, any imbecile who would interrupt an overseas phone patch to request a contest contact ought to get his head handed to

him, or ought to be rewarded with a good, swift kick in his "sitzfleischl."

It would be extremely helpful if certain segments would be declared out of bounds by sponsoring groups of contests, so that participants would understand clearly that any contest activity therein would be proscribed. In the regularly scheduled CD parties, a very small segment of each band is recommended, and to the best of my knowledge, very few noncontesters are inconvenienced by these popular contests. The various other contests which have

not yet seen fit to emulate this example could certainly profit by doing so.

\* \* \*

In recent months, on 3997 kHz, a powerful AM station has been operating every evening, starting at 2330 GMT. This is the recently established RSA, the outgoing service of the South African Broadcasting Corporation, in Johannesburg. During the course of their broadcasts, it has been next to impossible to use the adjacent frequencies, due to their big signal. On my receiver they

AN  
EDITORIAL  
by  
DAVE MANN K2AGZ

## Leaky Lines

1 DANIEL LANE, KINNELON NJ 07405

are usually about 30 to 40 dB over S9.

By fortunate happenstance, I happened to hear them playing a recording of one of my songs, and I seized the opportunity to write and thank them for the performance, and incidentally to get in some licks about the interference to amateur operations. They sent me a prompt reply, consisting of a Manila envelope about an inch thick, containing, among other things, their broadcast schedule, times, and frequencies.

There is absolutely no mention of 3997. Their frequencies are announced as 9705, 9695, and 5980. There is no way by which these can be beat together or combined to produce a beat of 3997. However, in a compendium of AM stations of the world, issued by our own government, and available at the Printing Office, the frequency is mentioned as being allocated to RSA.

So I sat down and wrote again. I explained that it would be extremely unlikely that they would garner any sizable group of SWLs on that frequency, since it is occupied solely by amateurs, with whom, unfortunately, they were interfering. Their 250 kW, I added, was being wasted on this particular segment, and might they not reconsider and curtail the use of 3997 in the evenings. I closed the letter with a polite request for further information, if any, and for

(cont. on page 109)



# the NEW ONE

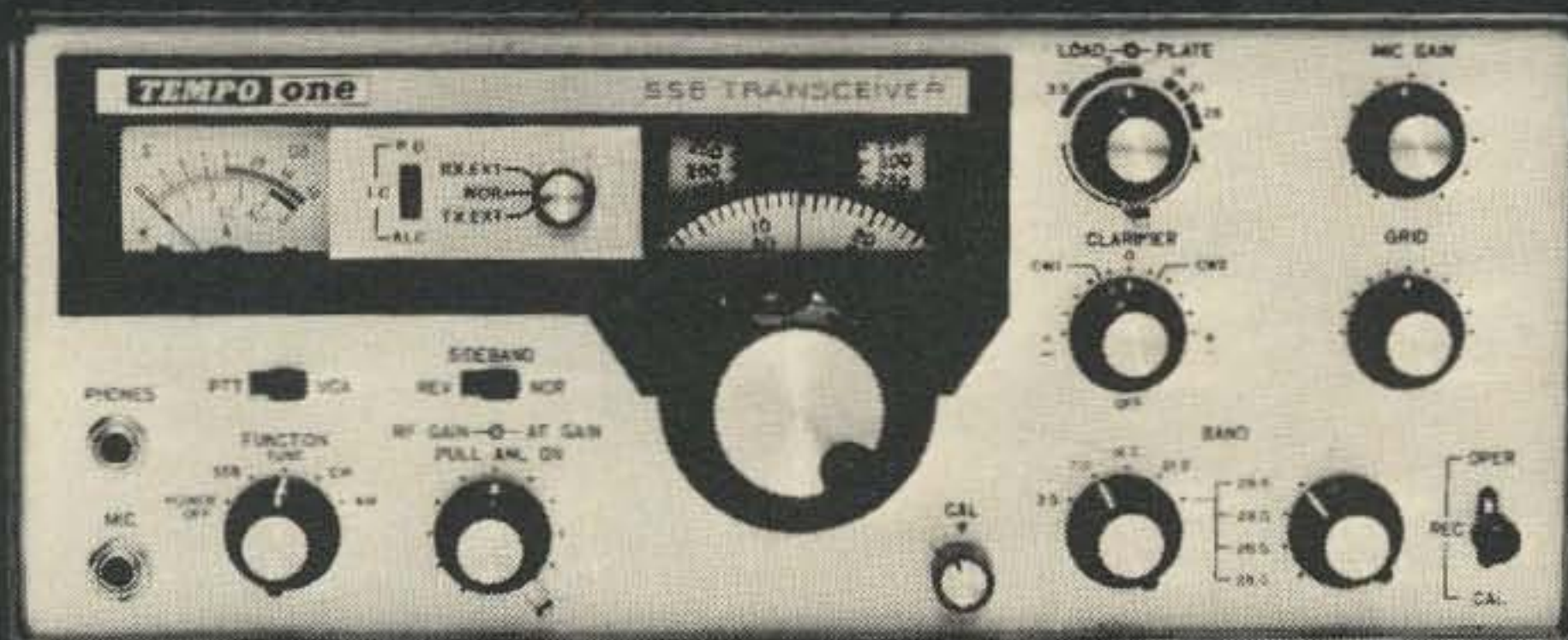

## **TEMPO one**

AN OLD FRIEND (HENRY RADIO) INTRODUCES A NEW NAME . . . A NEW VALUE . . . A NEW TRANSCEIVER. THE TEMPO 'ONE' SSB TRANSCEIVER REPRESENTS THE CULMINATING ACHIEVEMENT OF MANY YEARS OF EXPERIENCE IN THE AMATEUR RADIO FIELD. MODERN DESIGN, SUPERB PERFORMANCE, HIGH STYLING, STURDY CONSTRUCTION, OUTSTANDING RELIABILITY, EXCEPTIONAL VALUE — ALL THESE FACTORS COMBINED FOR THE FIRST TIME IN AN AMATEUR SSB TRANSCEIVER MAKE THE TEMPO 'ONE' THE OBVIOUS CHOICE IN TODAY'S AMATEUR MARKET.

Five Band Coverage: 80 thru 10 meters • Power Input: 300 watts PEP • Selectable Upper and Lower Sideband • Built-in VOX • Built-in Calibrator • ALC • AGC • ½ Microvolt Receive Sensitivity • Receiver Off-set Tuning • All the features you want at an unbelievably low price . . . only **\$298.00**

AC/one, 110-220 volt 50/60 cycle power supply . . . \$99.00

DC/one, 12 volt DC power supply . . . \$107.00

TED HENRY (W6UOU)

BOB HENRY (WØARA)

WALT HENRY (W6ZN)

# *Henry Radio*

11240 W. Olympic Blvd., Los Angeles, Calif. 90064 213/477-6701  
 931 N. Euclid, Anaheim, Calif. 92801 714/772-9200  
 Butler, Missouri 64730 816/679-3127

*"World's Largest Distributor of Amateur Radio Equipment"*

# AN INTEGRATED CIRCUIT CW ID GENERATOR

P. J. Ferrell W7PUG  
6021 S. 119th St.  
Seattle WA 98178

A project to develop an automatic, solid-state CW ID generator was recently initiated by members of the Seattle repeater group. Although there have been a number of recent articles concerning such devices,<sup>1-2-3-4</sup> our starting point was the FM Magazine article by Woore.<sup>2</sup> The outcome of this project must be classified as an engineering overkill. The resulting CW identification generator features a clocked character generator (for flawless CW with variable speed), inexpensive RTL integrated circuitry, and a computer-designed diode read-only memory matrix. Also included are "pulse" starting, a discrete "hold" voltage available during ID execution, and a continuously adjustable keying speed (from far too slow to far too fast). Not only are these generators ideal for repeater identification, but they may be used to identify any amateur station such as RTTY, ATV, etc.

The block diagram in Fig. 1 shows the major divisions of the ID generator. Many excellent articles covering RTL logic design

have appeared in amateur literature<sup>5-6</sup> and the reader is referred to them for background material.

### Program Counter and Start/Stop Flip-Flop

This six-stage ripple counter consists of three dual JK flip-flops. The first five cascaded stages are the program counter and count from 0 to 31. The last stage is employed as the start/stop flip-flop. Each stage of a ripple counter is arranged to toggle (change state) on the output of the preceding stage. A five-stage program counter has 32 distinct stages ( $2^5=32$ ).

(number 32) resets or clears the first five stages, but toggles the start/stop flip-flop to the "stop" or set position, thereby halting the character generator.

A positive pulse into the "preclear" input of FF6 clears the halt and allows the character generator to run, thereby initiating a cycle of operation. A five-stage program counter was chosen since virtually all amateur calls can be encoded in 32 characters worth of dots, dashes, and blanks. RTL JK flip-flops are adversely affected by capacitive output loads, and

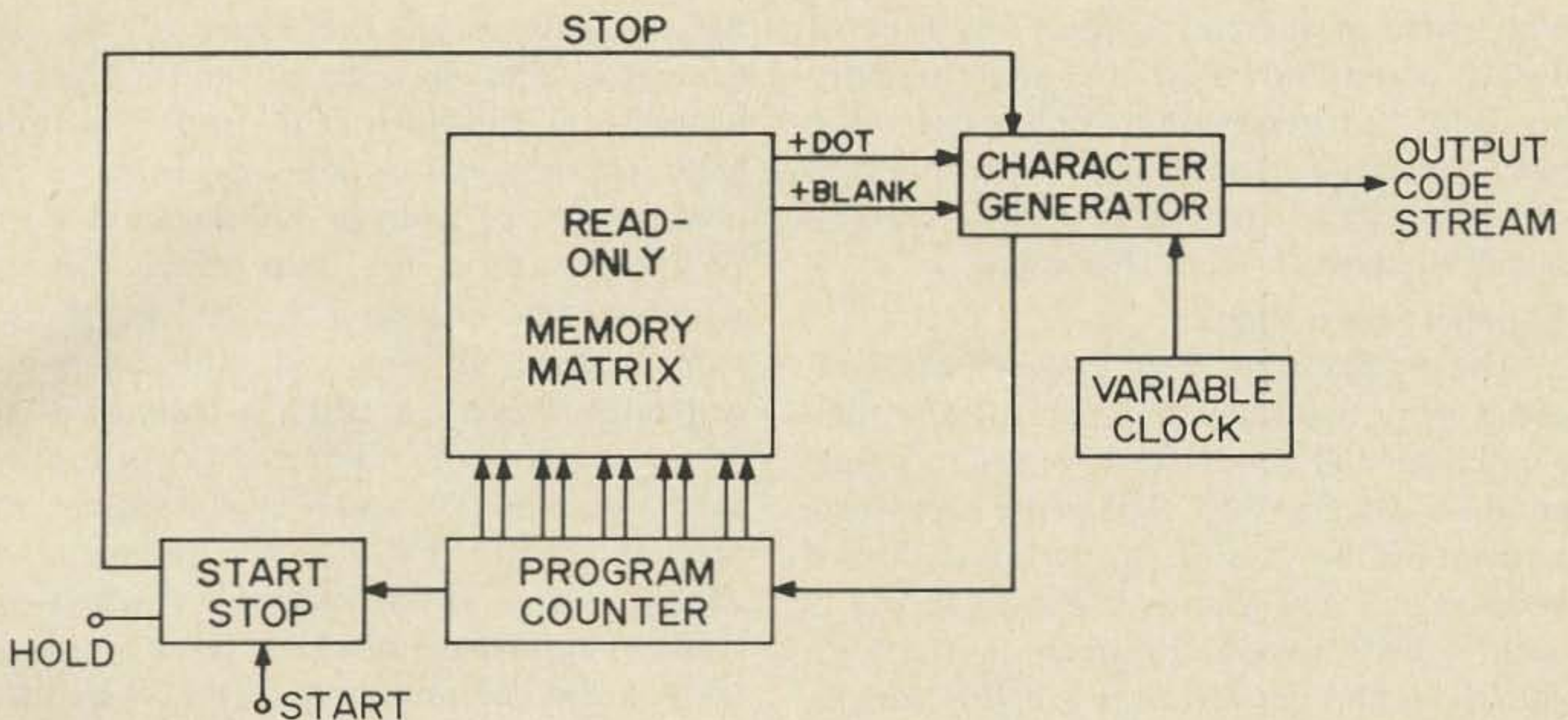

Fig. 1. CW ID generator block diagram.

When arranged as shown in Fig. 2, the program counter advances under the control of gate G1 which derives its input from the character generator. Each dot, dash, or blank character advances the program counter by one count. The last character

will not toggle reliably if the capacitance is too high. This fact precludes the use of silicon diodes in the *and* portion of the diode memory.

If the program counter output lines were buffered (isolated from the flip-flops

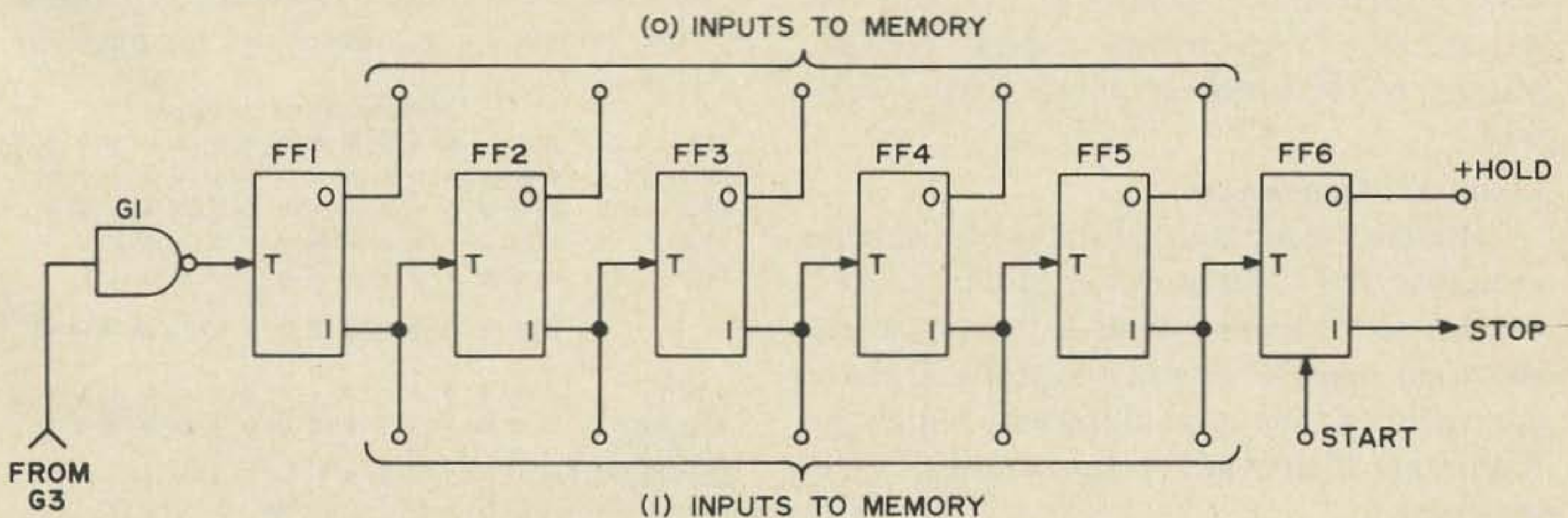

Fig. 2. Program counter.

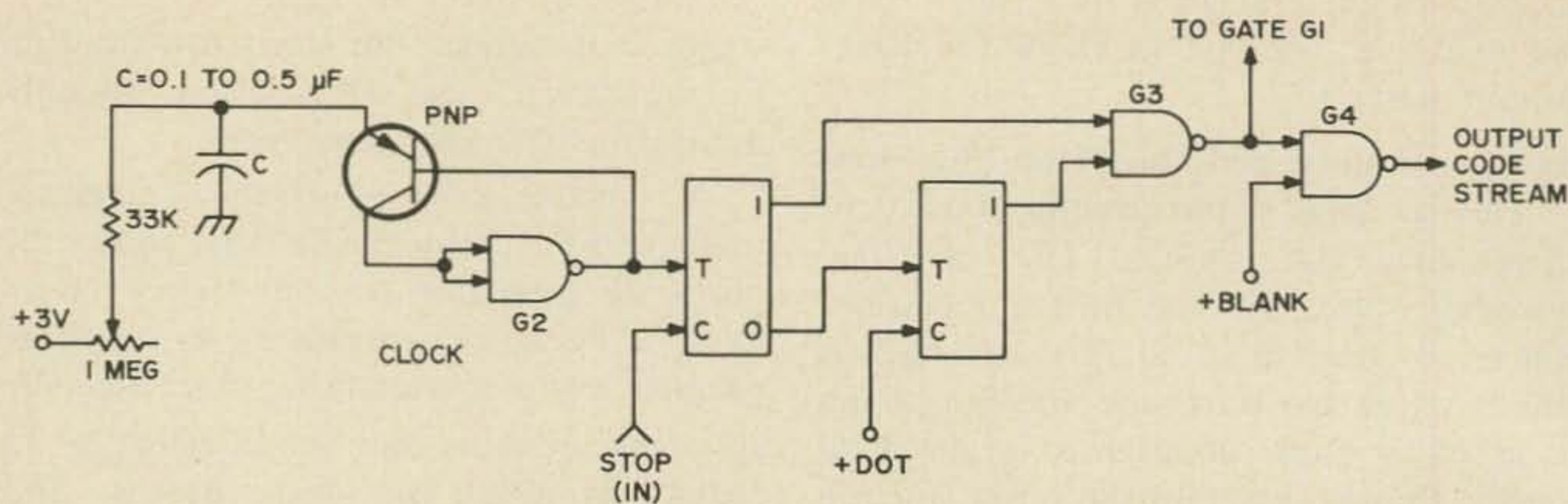

Fig. 3. Clock and character generator.

with gates or inverters), then any type of diode could be used in any memory position; but germanium diodes have very low capacitance and may be connected directly to the flip-flop outputs, thereby saving the cost of 10 buffer stages.

### Variable Speed Clock

The clock circuit must deliver a negative-going pulse with leading edge of less than a microsecond duration in order to toggle an RTL JK flip-flop. The pulse repetition rate should be variable to permit choice of code speed. The circuit is shown in Fig. 3 with a PNP silicon transistor paired with gate G2. The net effect is a PNP switch. Capacitor C charges to about 2V and then discharges through the gate with a leading edge which is very abrupt.

Nearly any of the new PNP silicon transistors will work in this circuit. The minimum value for R is about 33 kΩ else sufficient current is available to hold the switch in conduction (just like a neon relaxation oscillator). For R much above 1 MΩ insufficient current is available to initiate the regenerative "snap" action. Values of R between these limits work well.

### Character Generator

The electronic generation of Morse code requires the creation of dots, spaces, dashes, and blanks which have a precisely specified relative length. The dot and space are each of one unit duration, while the dash and blank are each of three units duration.

An extremely clever character generator was borrowed from the Micro-Ultimatic

Keyer<sup>7</sup> and forms the heart of the ID generator. The character generator consists of two JK flip-flops (FF7 and FF8) and gates G3 and G4 as shown in Fig. 3. A positive (stop) voltage on terminal C of FF7 holds it in the clear state, thereby stopping the character generator. If the stop voltage is removed, the character generator toggles in such a manner as to produce a string of dashes at the output of gate G4. If a positive (+DOT) voltage on terminal C of FF8 changes the string of dashes into a string of dots. A dash (or blank) requires four clock pulse intervals while a dot requires two. Gates G1 and G4 each invert the output of gate G3.

The output of gate G1 must be either a dot or dash character (never a blank), and is used to advance the program counter at the end of each character. The second input to gate G4 will blank out the output code stream, and is used to produce a blank character. If a blank is required, then a positive "+BLANK" input from the diode memory causes the dash generated by the character generator to be blanked

	polarity of the (I) output															
FF5	o	o	o	o	o	o	o	o	o	o	o	o	o	o	o	o
FF4	o	o	o	o	o	o	o	+	+	+	+	+	+	+	+	+
FF3	o	o	o	o	+	+	+	+	o	o	o	o	+	+	+	+
FF2	o	o	+	+	o	o	+	+	o	o	+	+	o	o	+	+
FF1	o	+	o	+	o	+	o	+	o	+	o	+	o	+	o	+
	0	1	2	3	4	5	6	7	8	9	10	11	12	13	14	15
+DOT	o	+	+	o	+	o	o	+	o	o	o	o	+	+	+	+
+BLANK	o	o	o	+	o	+	+	o	o	o	+	o	o	o	o	o
CHARACTER	-	.	.	x	.	x	x	.	-	-	x	-	-	.	.	.
				D		E			W							7

Fig. 4. Diode memory inputs and outputs.



each one, then a total of 24 decoders would be required: 15 would be paralleled to give the +DOT signal and the remaining 9 would be paralleled to provide the +BLANK signal. Each decoder requires 6 diodes for a grand total of 144 diodes to build a straightforward read-only memory using this technique.

Fortunately for us, the English philosopher George Boole published his *Investigation of the Laws of Thought*, in which he resolved the ambiguity of the words *and* and *or* by means of a kind of algebra. In 1938, eighty-four years later, Prof. D. E. Shannon (the *Information Theory Shannon*) put Boole's algebra or Boolean Algebra to use in the *Symbolic Analysis of Relay and Switching Circuits*. This classic paper has revolutionized switching design, and has led to the development of minimization techniques which can dramatically reduce the diode count of our ready-only memory. The details of these methods and the underlying theory are beyond the scope of this article, but for those who are

fascinated by this stuff, standard texts are available which will quickly dispel the aura of "black magic" that seems to surround this area.<sup>8</sup>

For our purpose, a graphical reduction technique known as a *Karnaugh map* will be employed. Figure 6 illustrates the process for the code stream *DE W7DBF*. The polarity of the 1 output levels of flip-flops FF1 through FF5 are shown as the program counter steps from 0 (all FFs clear) to state 31 (all FFs set). The sample code stream begins with a blank and has three blanks separating the *DE* from the *W*

A Karnaugh map organization of program counter states is presented, flanked on the left by the DOT map and on the right by the BLANK map for the desired code stream. Reduction is accomplished by "folding" the map about any of the dividing lines and pairing the marks (dots or blanks) which overlap. For example, folding the DOT map about the vertical centerline pairs dot 5 with dot 21, and dot 9 with dot 25, and dot 15 with dot 31.

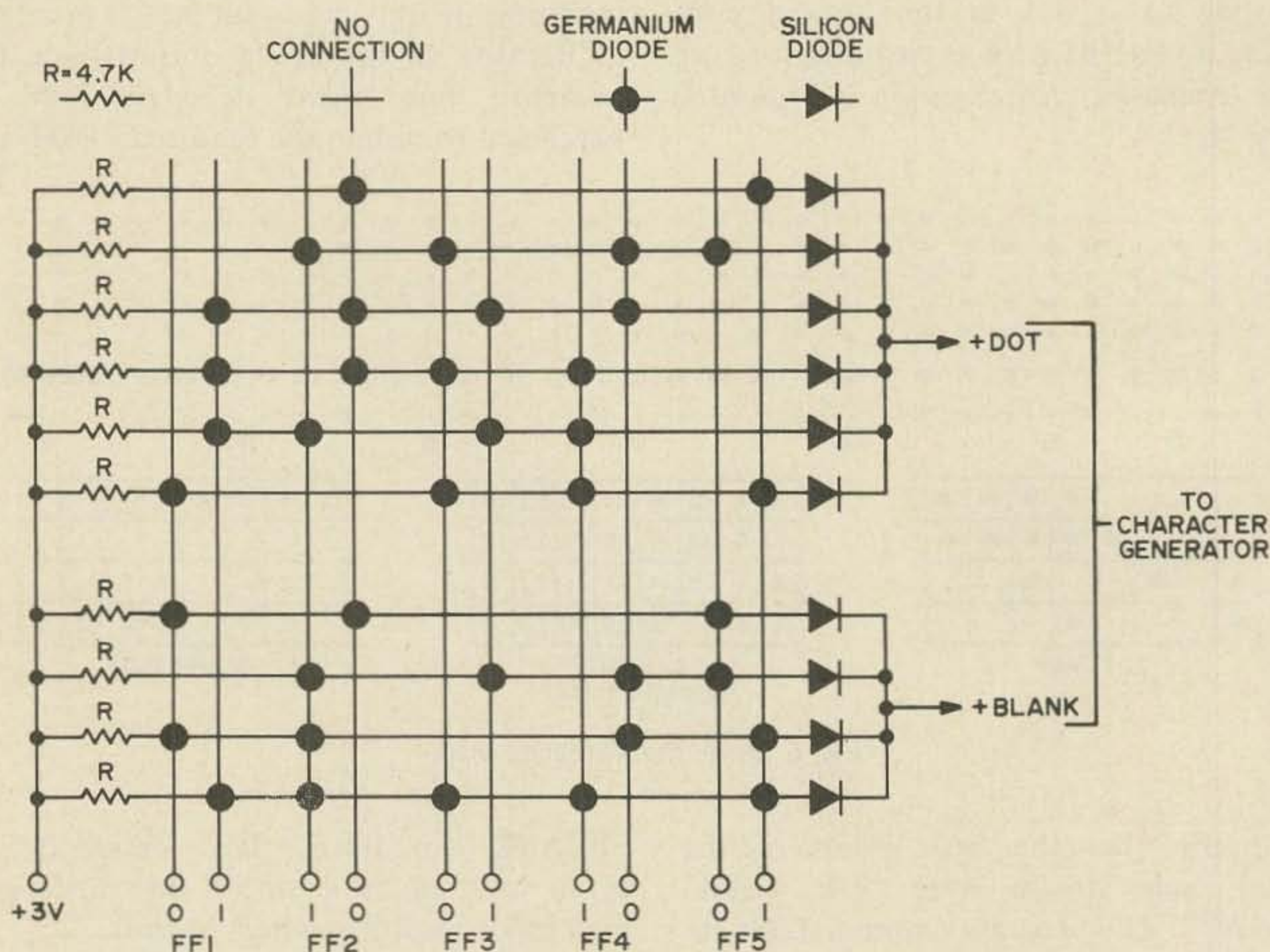

Fig. 7. Diode read-only memory matrix for "DE W7DBF."

# WHEN IT COMES TO ANTENNA SYSTEMS... IS YOURS

a space problem? a budget problem? an applications problem? an installation problem?  
or simply a problem of where to buy?

Your one-stop solution is ANTENNAS, INC.

Exclusively specialists in radiating systems, complete systems or any component part.

Arrays—complete or in kit form, quads, yagis, dipole assemblies, verticals—fixed or mobile, towers, masts, rotors, guy and control cable, transmission line, coax relays and switches, connectors and adaptors, test gear, technical publications, corrosion resistant hardware, corrosion proofing chemicals, insulators, installation and wiring hardware, aluminum tubing and plate, wire, and much, much more.

If your requirements are for a complete system, major components, or the smallest yet important piece of hardware—

*Our prices and deliveries are hard to beat . . . anywhere.*

## ANTENNAS, INC.

Dept. B, 512 McDonald Road  
Leavenworth, Kansas 66048.

ANTENNAS, INC. can be your one-stop,  
single-source. Write today for our catalog,  
\$2.00, refundable, first order.

Successive pairing, then pairing pairs, etc. allows a reduction from the original 144 diodes to a total of 48 diodes arranged as shown in Fig. 7. Note that in Fig. 7, the 0/1 flip-flop lines are reversed for FF2 and

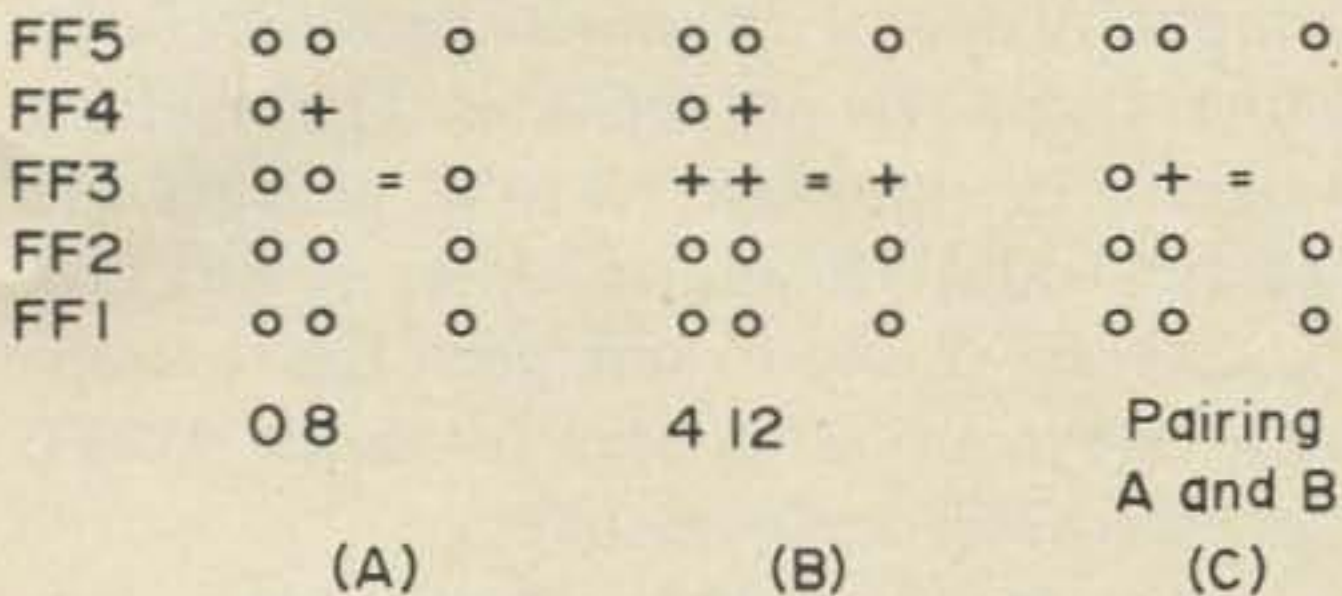

Fig. 8. Actual reduction procedure.

FF4. This reversal materially simplifies printed circuit construction.

As an example of pairing, consider the blanks in positions 0, 4, 8, and 12 of the BLANK map of Fig. 6. If the map is folded about the second vertical line (the one separating positions 4 and 12), then blank 4 pairs with blank 12, and blank 0 pairs with blank 8. If we fold again, then all four blanks coincide

is illustrated in Fig. 8. In part A, the program counter states for positions 0 and 8 are compared. They differ in exactly one FF position (FF4) as all pairs must. A single diode decoder of the type shown in Fig. 5 could get both blanks simply by neglecting to connect to FF4. It even saves one *and* diode.

Part B of Fig. 8 presents the same comparison for blank 4 and blank 12, and again they differ only in FF4. In part C, a comparison of the 0/8 with the 4/12 pairs shows that these differ only in FF3. Thus, if a three-input diode decoder of the type presented in Fig. 5 were connected to FF1 (0), FF2 (0), and FF5 (0), it would give a +BLANK for all four desired program counter states (0, 4, 8, and 12). Without this reduction, 24 diodes (six for each blank) would have been required rather than the four actually required. This diode decoder may be found in Fig. 7 as the first line in the +BLANK group.

The foregoing example illustrates the use of a Karnaugh map. The states which

**wow!**

**AN/SSQ-23A**

**Sonobuoy**

Only \$14.95

Include \$2.00 for postage and handling

$$\frac{20}{2+2+2} = \text{FN/FM}$$

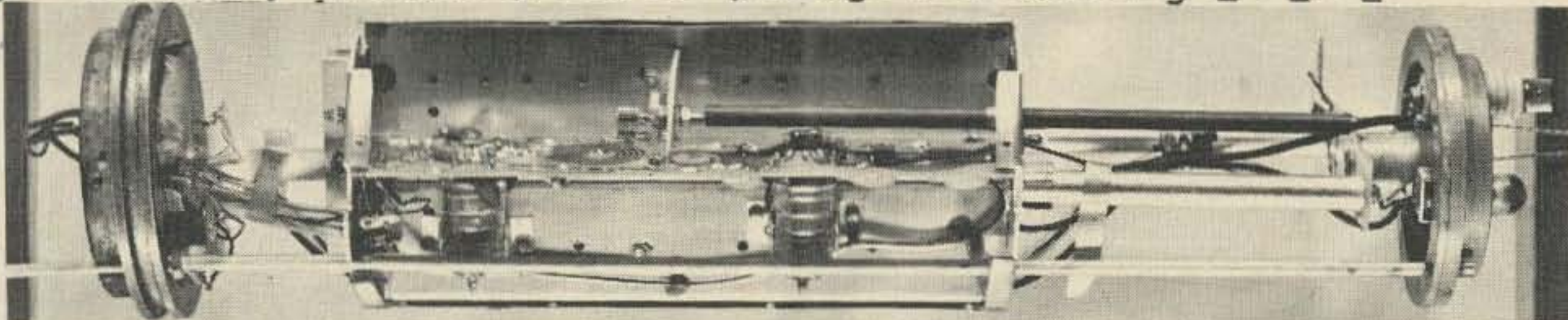

New AN/SSQ-23A Sonobuoy for a quick & easy 2 meter Fun FM Transmitter.

New — with tubes — less Hydrophone, Battery & Antenna, with original instruction book.

Giant 25th anniversary flyer out September—Write for your copy.

PO Box 85, Longview St.

**DENSON ELECTRONIC CORP.**

(203) 875-5198

Rockville, Conn. 06066

map, and then the actual reduction is performed as in Fig. 8. It should be noted that some states will not pair at all, such as blank 27 in Fig. 6. To pick up this blank, a full five-input diode decoder is required. From Fig. 6, we see that for blank 27, the program counter is in state “++0++” and the resulting diode decoder can be found in Fig. 7 as the bottom diode line.

The rule when pairing states is that the two program counter states can differ in exactly one flip-flop position. All other positions must agree, including any omitted connections as in Fig. 8, part C. If there is disagreement in more than one FF position, then these two states do not pair.

After completing the reduction process, check to make sure that every necessary state has been covered at least once by one of the final decoders; otherwise, you may be surprised at the resulting code stream. This type of calculation, once understood, is not particularly difficult, but it certainly is tedious and has lots of room for errors. Slight changes in the desired code stream (even position) can have a huge impact on the diode count.

For example, the diode count for the code stream in Fig. 6 is 48. If just the *DE* is slid one count to the right, a new code

stream is formed which starts with two blanks, and has two blanks between the *DE* and *W*. The diode count for this new stream is 55. If this new stream is shifted two positions to the left, so that the two leading blanks become trailing blanks, then the diode count becomes 85. These effects are unpredictable, and for complete optimization each code-stream version must be reduced separately, and the results compared. This greatly increases the already great tedium of such calculations.

#### Computer Optimization

In order to minimize the pain of diode memory design, the task was subcontracted to a digital computer. The Seattle repeater group is extremely fortunate in having remote access to the University of Washington Computer Center's Burroughs B5500 computer, one of the nicest hardware/software systems ever put together. The resulting program in extended ALGOL accepts the desired code stream (in dots, dashes and blanks) as an input and performs a complete Boolean reduction for both +DOT and +BLANK diode decoders.

If the specified code stream is less than 32 characters (more than 32 characters are not allowed), then the computer assigns the necessary trailing blanks and performs

EXECUTION BEGINS...

CODE STREAM [ - . . . . . . - - - . . . . . - . . . - . . . . . . . - . . ]  
REQUIRES 48 DIODES AND 10 RESISTORS.

PLACE SILICON DIODES (S), GERMANIUM DIODES (G), AND 4.7K RESISTORS (R) IN THE FOLLOWING POSITIONS:

D	B	0	1	2	3	4	5	6	7	8	9	+
S					G						G	R
S				G		G			G	G		R
S			G		G		G		G			R
S			G		G	G		G				R
S			G	G			G	G				R
S		G				G		G			G	R
	S	G			G					G		R
	S			G			G		G	G		R
	S			G					G		G	R
	S		G	G		G		G			G	R

Fig. 9. Computer printout.

EXECUTION COMPLETE...



the required reductions, and repeats the process for each shift of the code stream until all the trailing blanks have become leading blanks. The code stream version having the smallest diode count is printed out along with diode and resistor counts and an actual map of the entire diode read-only memory matrix. Examples of the

digital computer printout are shown in Fig. 9.

### Construction

The four dual JK flip-flops are Motorola MC790P (or HEP 572) and the quad 2-input gate is a Motorola MC724P (or HEP 570). Virtually any PNP silicon tran-

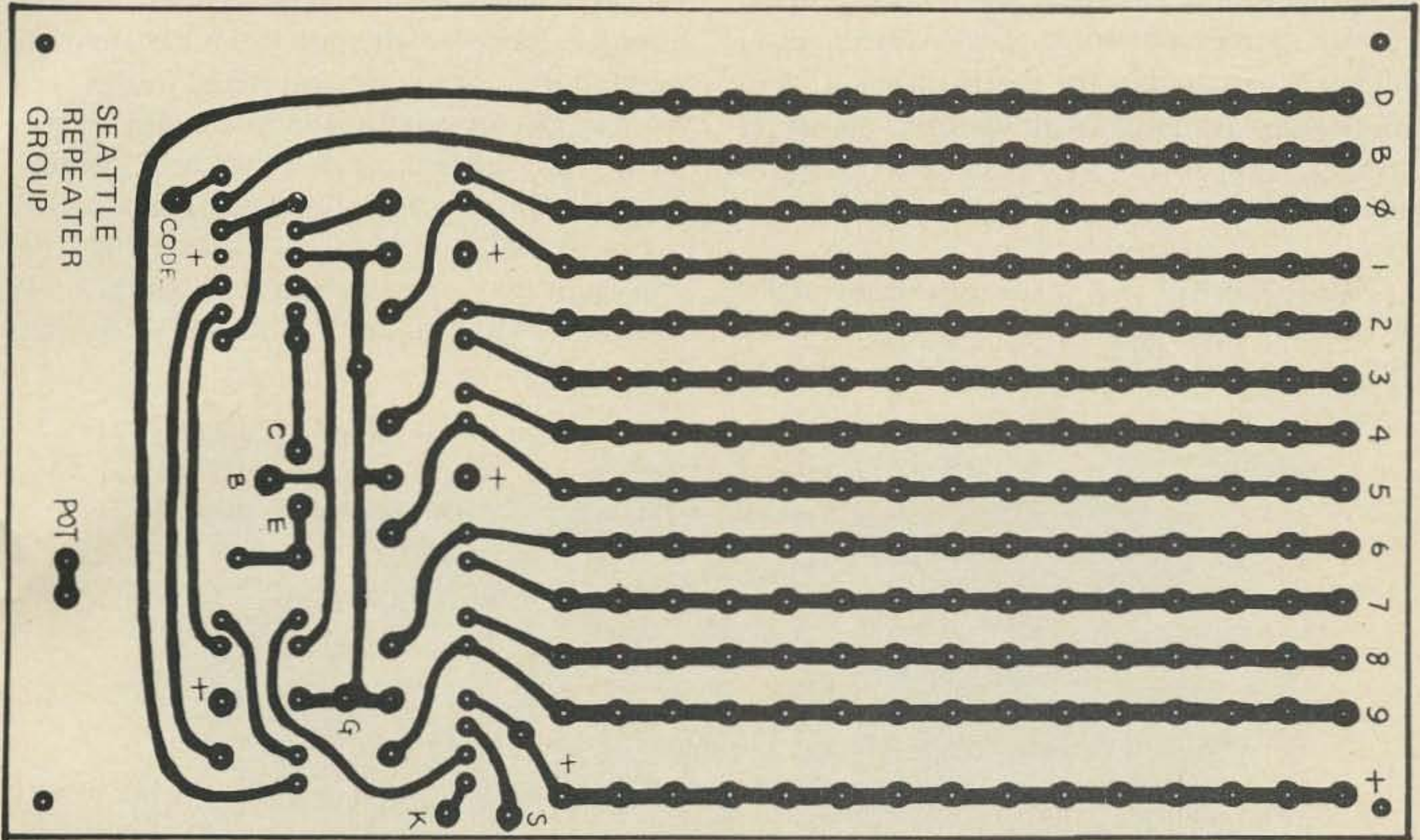

Circuit board (bottom).

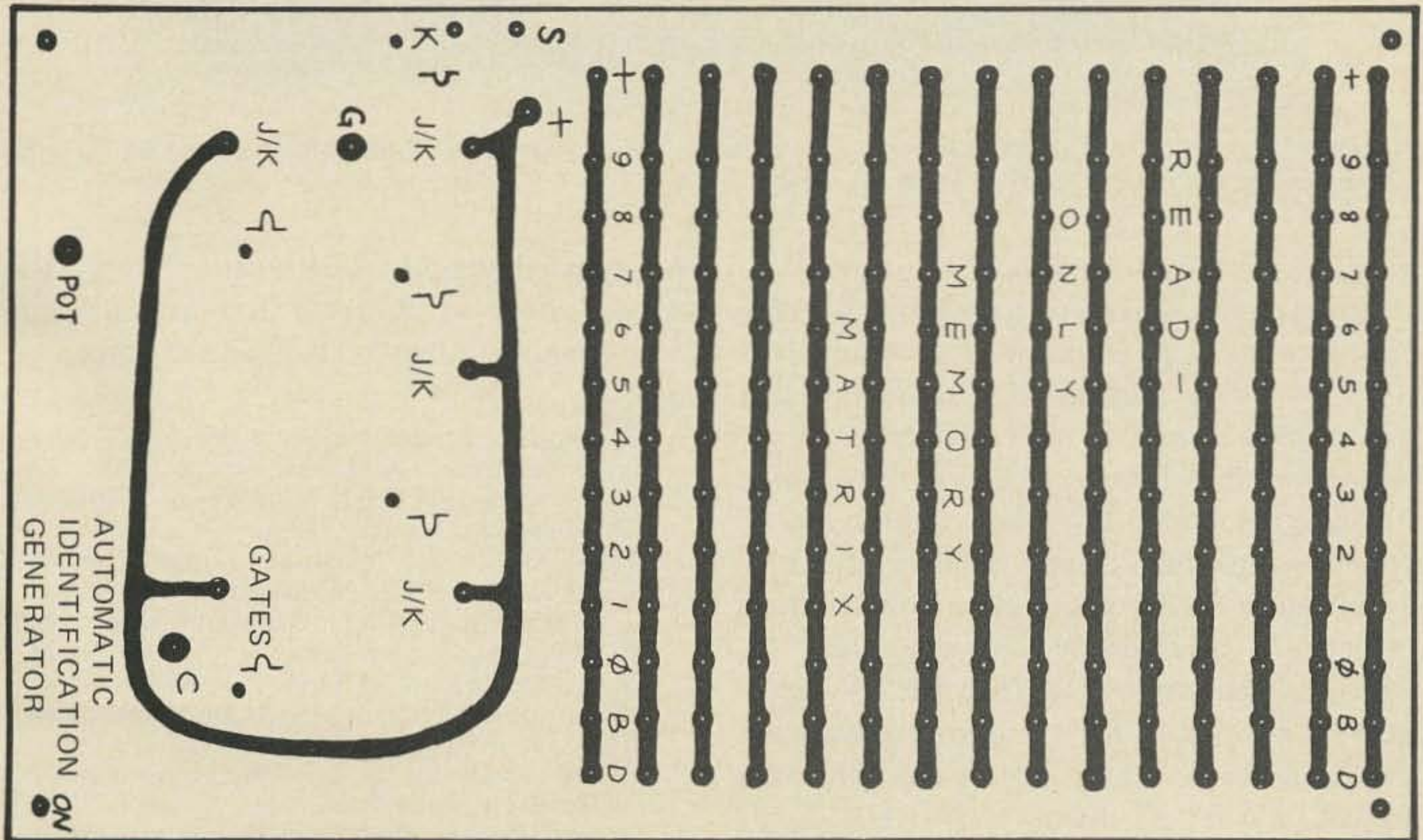

Circuit board (top).

Fig. 10. Full-size reproductions of PC board.



# STEP UP TO TELREX

## Professionally Engineered Antenna Systems

### Single transmission line "TRI-BAND® ARRAY"

By the only test that means anything . . . on the air comparison . . . this array continues to outperform all competition . . . and has for two decades. Here's why . . . Telrex uses a unique trap design employing 20 HiQ 7500V ceramic condensers per antenna. Telrex uses 3 optimum-spaced, optimum-tuned reflectors to provide maximum gain and true F/B Tri-band performance.

#### ONLY TELREX GIVES YOU ALL THESE FEATURES . . .

- Power rating 4 KW PEP . . . rain or shine
- Wind rating survival 110 MPH
- Patented broad-band coaxial Balun
- Heavy-duty steel gusset mounting plate
- Aluminum boom 2 in., 2½ in. O.D. x 18 ft.
- Large diameter, .058 wall taper-swaged dural elements for minimum

weight and exceptional strength to weight ratio

- Stainless steel electrical hardware

With a Telrex Tri-band Array you get 49 lbs. of educated aluminum engineered and built to provide many, many years of performance unmatched around the world by any other make. Longest element 36 ft. Turning radius 20 ft. Shipping weight 65 lbs. Shipping container 13 in. x 5 in. x 13 ft.

Note: If not available from your dealer, order direct. You'll get fast, personal service.

Telrex Labs are design engineers, innovators and manufacturers of the world's finest ¾ to 160 meter communication systems and accessories priced from \$25 to \$25,000.

For technical data and prices on complete Telrex line, write for Catalog PL 70.

TB5EM/4KWP  
formerly TC99D

**\$298**

FOB Asbury Park, N.J.

1 KW peak  
Model TB5EC

**\$198 similar structure**

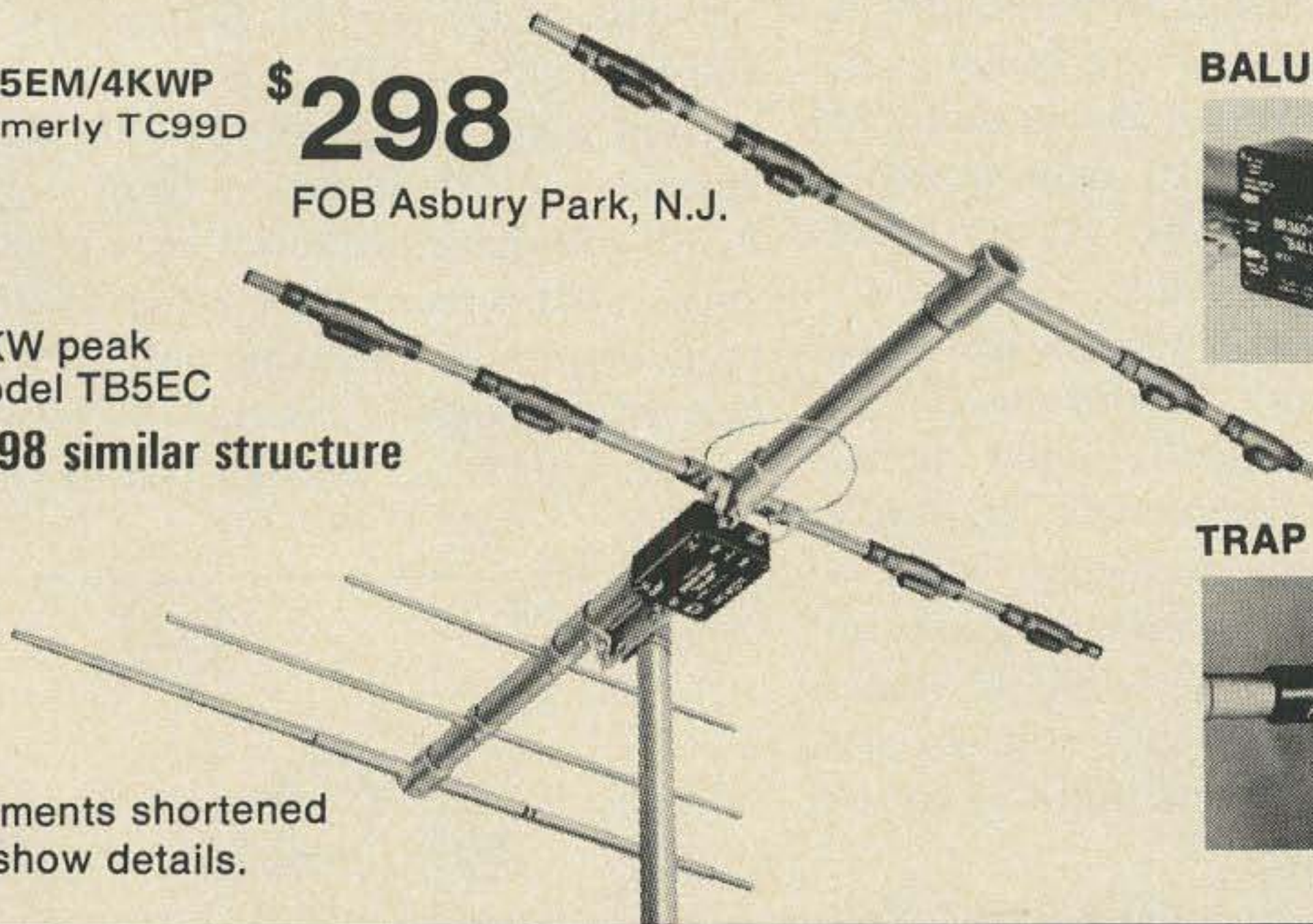

Elements shortened to show details.

BALUN

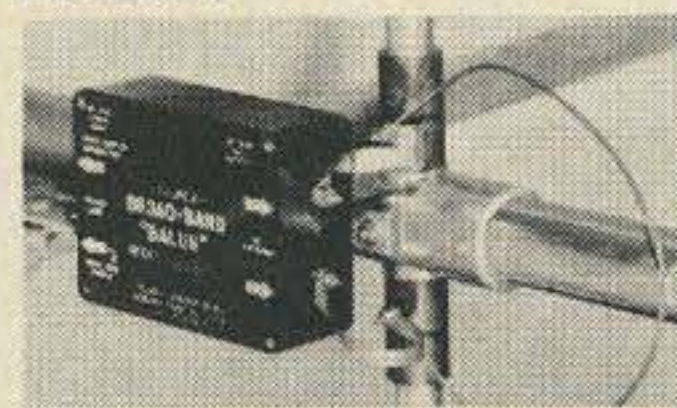

TRAP

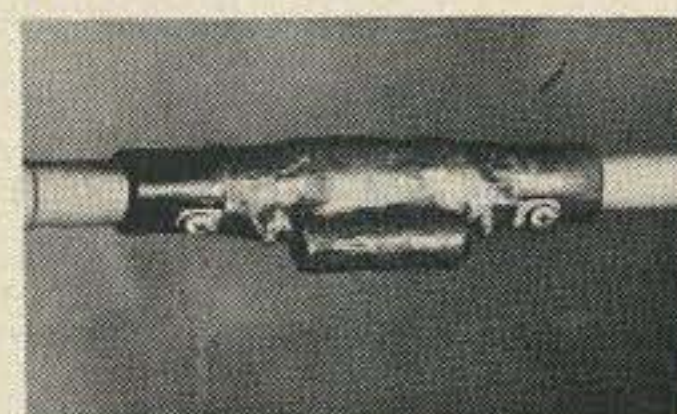

#### Some thoughts from Mike Ercolino, P.E. — W2BDS, Telrex Chief Engineer . . .

"I've been in the game over 50 years (pounded brass for 25) and found out a long time ago that antennas were the weak link. We changed all that."

"Good antennas such as those we build can be ruined in two minutes by a tinker. So put 'em up and leave 'em up the way we make 'em."

"Our 'Big Bertha' systems cost more than a Rolls Royce. Three of our customers have bought two of them . . . that's living."

**telrex**

**COMMUNICATION ENGINEERING LABORATORIES**

TV And Communications Antennas Since 1921

Asbury Park, New Jersey 07712 201-775-7252

Dept. A



# 6 volts from 12 volts the Easy way

Thomas J. Warnagiris K3GSY  
118 Waupelani Drive  
State College PA

**M**obile gear designed for 6V batteries is often sold at a bargain price simply because 6V electrical systems are not as common as they once were. I recently bought a 6V transceiver suitable for 2 meters FM. At the time, I had visions of doing a little tinkering to change the internal supply to 12V. Unfortunately, the internal supply turned out to be almost as complicated as the rest of the transceiver. Instead of a little tinkering it was going to be a lot of hard work. One possible alternative was to somehow get 6V from my car's 12V electrical system.

The classic method of using a dropping resistor wouldn't work in this case. Like most transceivers this one required almost ten times as much current while transmitting as it did when receiving. With a dropping resistor this meant providing the proper current and voltage while receiving, then upping the source so I still got 6V when I tried to draw ten times as much current for transmitting.

The solution was to build a device that would deliver a constant voltage under all conditions. This device would also have to handle currents of from 1 to 15A and yet be cheap enough to make buying 6V gear still seem attractive. A little investigation pointed to a solid-state regulator as probably the best answer. True, it would be as inefficient as a dropping resistor power-wise, but for my purpose, simplicity and low cost were more important than power efficiency. So with these requirements in

mind I came up with the circuit shown in Fig. 1. It worked so well that I thought others with 6V gear and 12V vehicles would like to try it.

## Operation

When I switch from transmit to receive, the current to my transceiver jumps from 1.5 to 12A. As this happens, the current to the base of Q1 changes from a few microamps to only a few milliamps due to the current gain of the transistors. The base current for Q1 is drawn from a point at 8.2V; voltage is produced by a zener diode and a 68Ω resistor. The zener diode maintains essentially the same voltage when the current through it changes. So with about 100 mA flowing through the diode, little

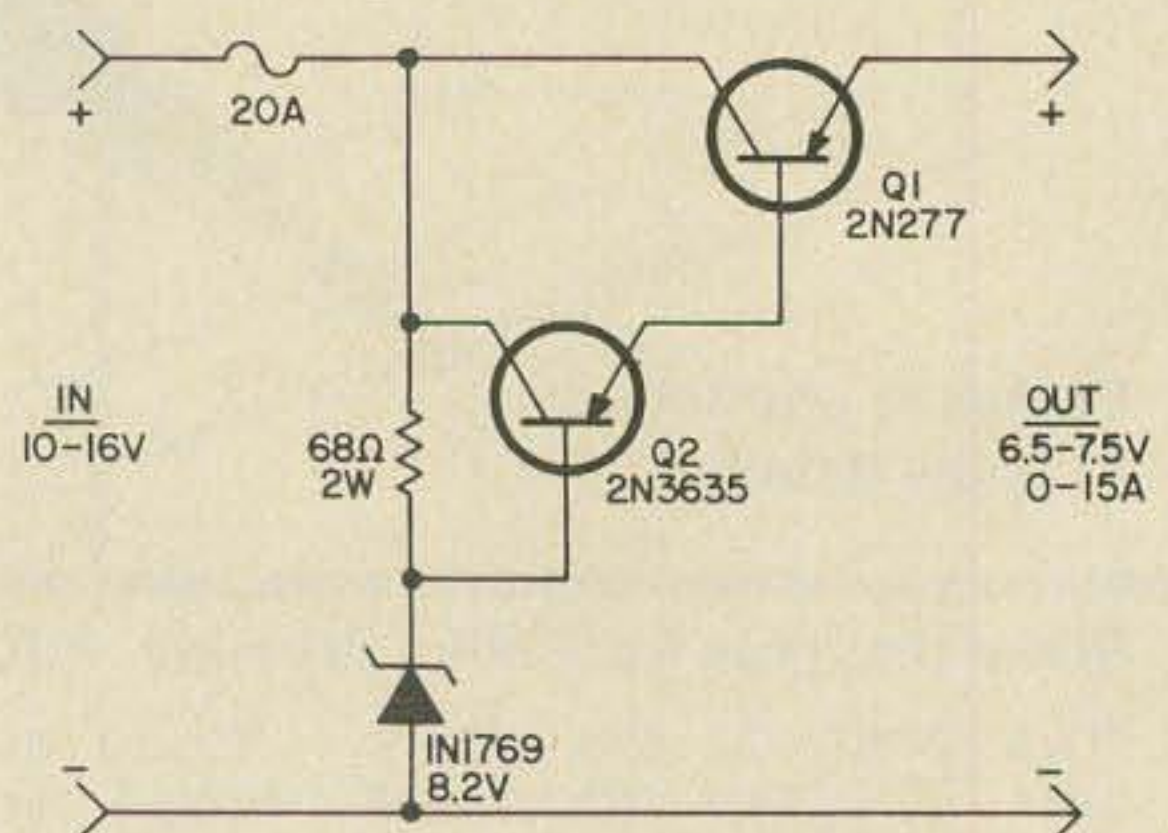

happens to the 8.2V when a few milliamps are diverted from the diode to the base of Q1. Q1 and Q2 have only current gain and no voltage gain due to the way they're connected. This means that the 8.2V of the zener appears across the load. Actually, there is a small voltage drop through each

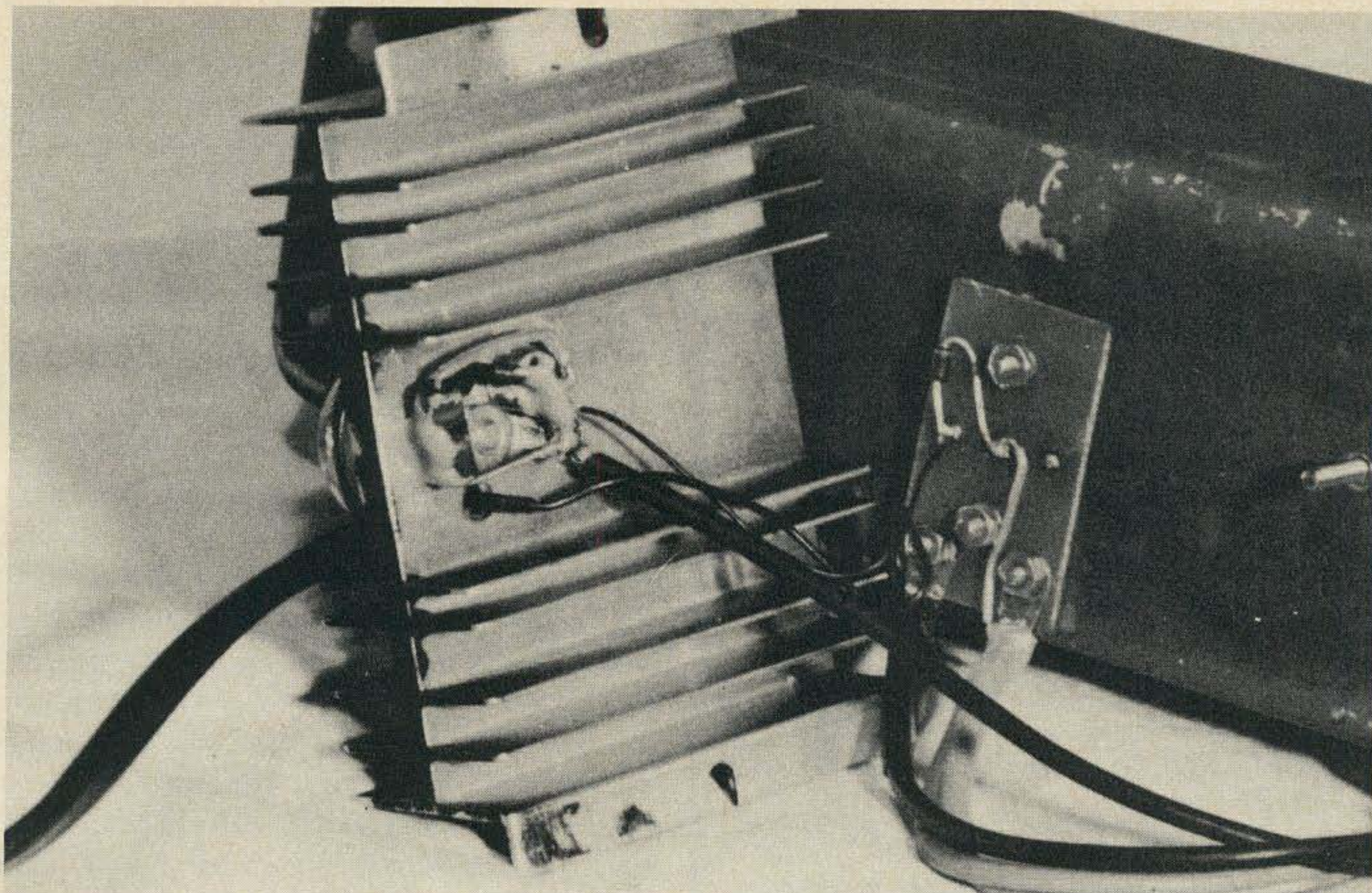

*Inside view of the regulator. All components except a zener diode are epoxied to the heatsink. The small fiber glass board holds the zener and acts as a strain relief for the heavy wires.*

transistor, and the voltage to the transceiver is about 6.5V.

#### **Parts and Construction**

When I first began collecting parts from my regulator I bought a bargain power transistor and a heatsink from a mail order surplus dealer. The rest of the parts I scrounged from my junkbox. Unfortunately, a 2N3635 happened to be the only transistor I had on hand with the right characteristic to drive the power transistor. I say "unfortunately" because a 2N3635 carries a rather high price. Luckily, there's a large group of cheap transistors (2N2147, 2N4314, 2N3613) that will work as well. If you don't use a 2N3536 you'll find that the regulator parts are low cost, easily found items. You can buy everything necessary from any large electronic distributor at a cost of about \$6 or less.

The parts you end up with and the space available will determine the exact layout. Placement of parts is not critical, but try to put the regulator in a spot where heat will not be trapped. For best heat removal, mount the regulator on a large metal surface, with the heatsink fins open to the air.

I mounted mine on the back of my transceiver as shown in the photo. This allowed the chassis to carry away most of

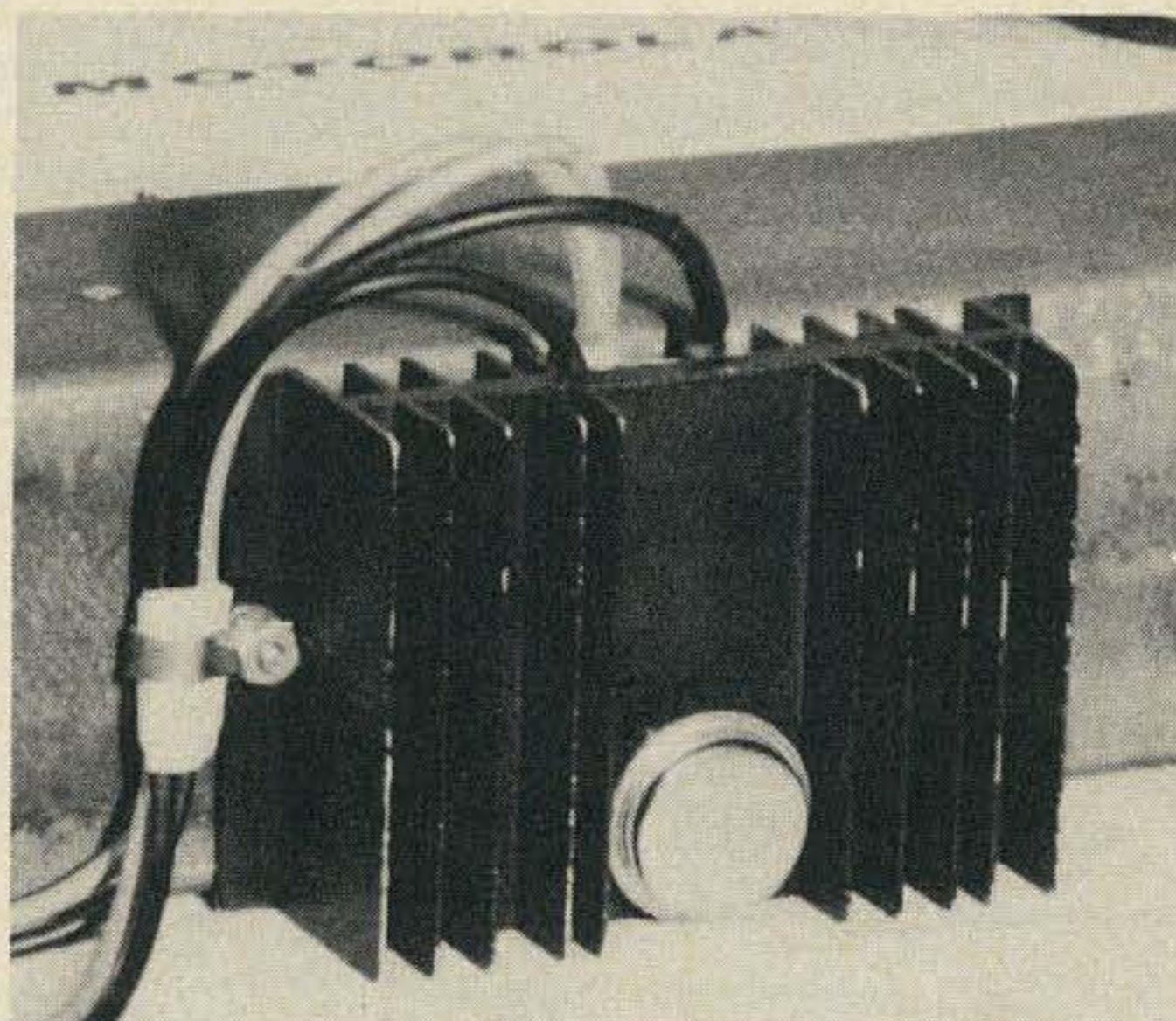

*Top view of the regulator showing input and output lines. All other circuitry is located under the heatsink.*

the excess heat. The 2N3635 and the 2W resistor normally run warm, too, so I epoxied both to the underside of the heatsink. To hold the zener and serve as a strain relief for the heavy wiring, I made a small fiberboard card. The card fit nicely

# Incentive Licensing Is Here!



**Brush up – Tone up – Shape up with AMECO Technical Books and code practice records.**

## EASY-TO-UNDERSTAND BOOKS

- # 16-01 Advanced class license guide ..... .50
  - # 17-01 Extra class license guide ..... .75
- Radio amateur theory course. Latest edition is ideal for brushing up.
- #102-01 (over 300 pages) .....3.95

## THE FASTEST AND SIMPLEST WAY TO INCREASE CODE SPEED. . . AMECO CODE PRACTICE RECORDS (33 1/3 RPM)

- #104-33 Contains material to increase code speed from 13 wpm to 22 wpm .....3.95
- # 106-33 19 to 24 wpm supplement to above .....3.95

## AND FOR THOSE OF YOU WHO ARE A BIT RUSTY

- #103-33 Contains material for 8 to 18 wpm .....3.95
- #105-33 supplement to above .....3.95

AT LEADING  
HAM DISTRIBUTORS



**DIVISION OF AEROTRON, INC.**  
P. O. BOX 6527 • RALEIGH N. C. 27608

under the center section of the heatsink despite having some of the space taken up by the epoxied parts. From the card I ran 14 AWG stranded wire through a 20A fuse to a plug designed to fit a cigar-lighter socket. With everything except the fuse enclosed by or mounted on the heatsink, the regulator proved to be both compact and rugged.

### Checkout and Alignment

When the regulator is completed it will require some simple tests before it's ready for operation. Carefully check all the wiring before connecting it to a 12V supply. Because of the high current involved, a wiring mistake could be dangerous. As a check on the output voltage, connect about a 10Ω 10W resistor to the output and a 12V supply (or car battery) to the input. Measure the voltage across the 10Ω resistor (should be about 7.5V). This will be the output voltage under light load. When the current drain is raised to 15A, the voltage will drop by about a volt. The drop is usually all right since most 6V gear will work from a 6–8V supply. If you feel that the output voltage is too high for your application, change the 8.2V zener diode to a 7.5V diode. This will drop the output voltage by 0.7V.

### Comments

Once testing and alignment are completed, the regulator should be in good working order. The output voltage will stay almost constant even if the supply voltage goes as low as 10V or as high as 16V. And currents of 1–15A can be drawn with only a small change in output voltage. I don't recommend applying more than 16V to the regulator or drawing more than 15A through it; such conditions exceed the ratings of the power transistor. Also, don't try to draw maximum current continuously if your heatsink is not capable of dissipating at least 150W. If you don't intend to draw high current or you draw high current intermittently, a smaller heatsink can be used.

*Author's note:* Thanks to Nevin Davis, Pine Groves Mills, PA, for the photos used in this article.

... K3GSY ■

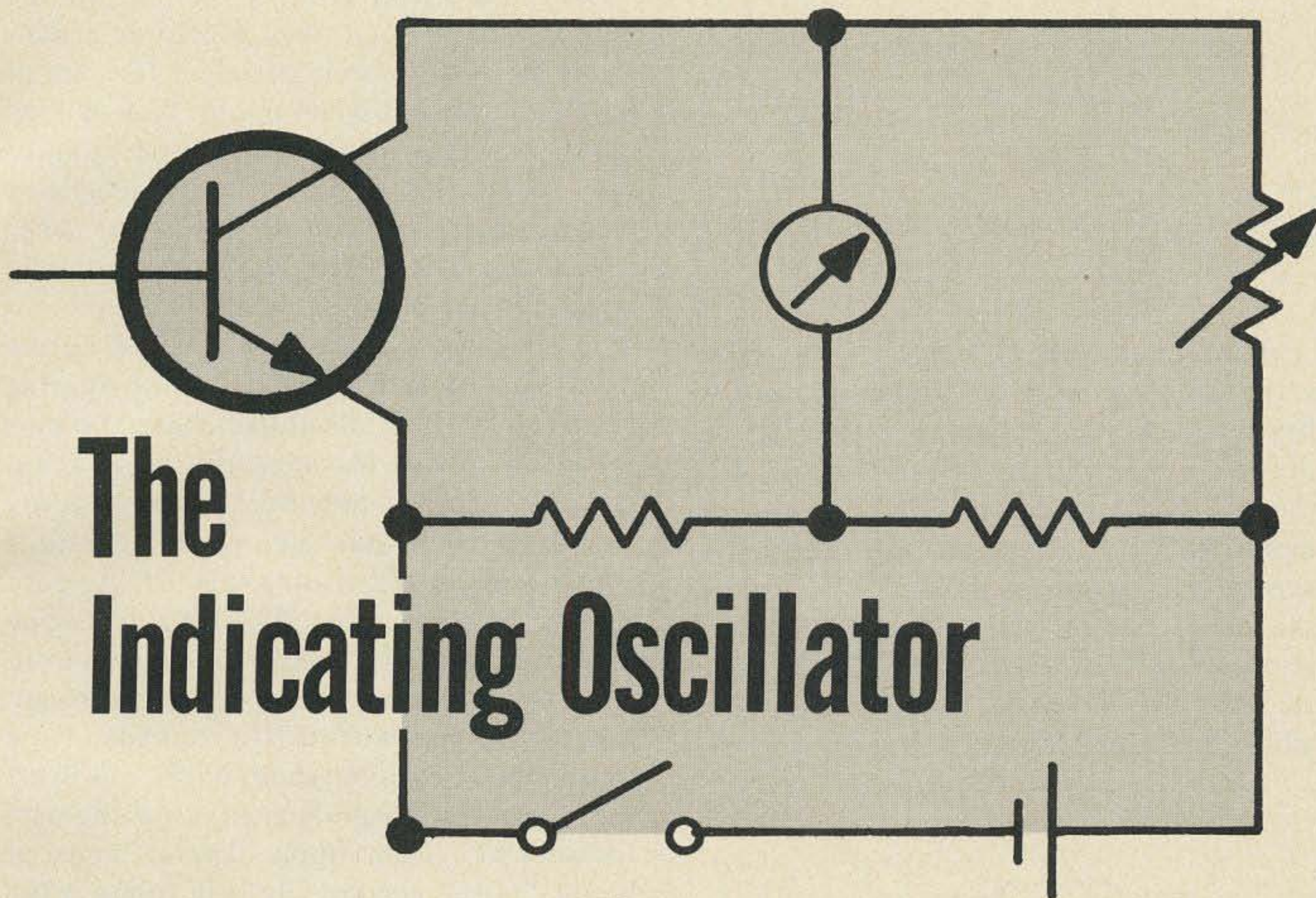

# The Indicating Oscillator

**R**elatives of this little gadget have been around a long time! Even the transistorized versions, which usually leave something to be desired. With an FET, however, we are back in business as with tubes, but with many advantages.

The range of this oscillator is fantastic. That is, without any circuit tricks or special handling. The low frequency end was carried down to the 1 MHz in order to cover the lowest ham band. The high end takes care of 250 MHz easily. This can be extended with a little more effort.

Use of a field-effect transistor (FET) allows operation more nearly like the tubes with which we are, perhaps, more familiar. However, we are not tied to the power lines, which alone makes it worthwhile.

A 2N4221 FET was used in this indicating oscillator. Very likely other FETs will work also. The MOSFETs also should

be as good, if not better. The new ones with built-in diode protection would be much easier to handle.

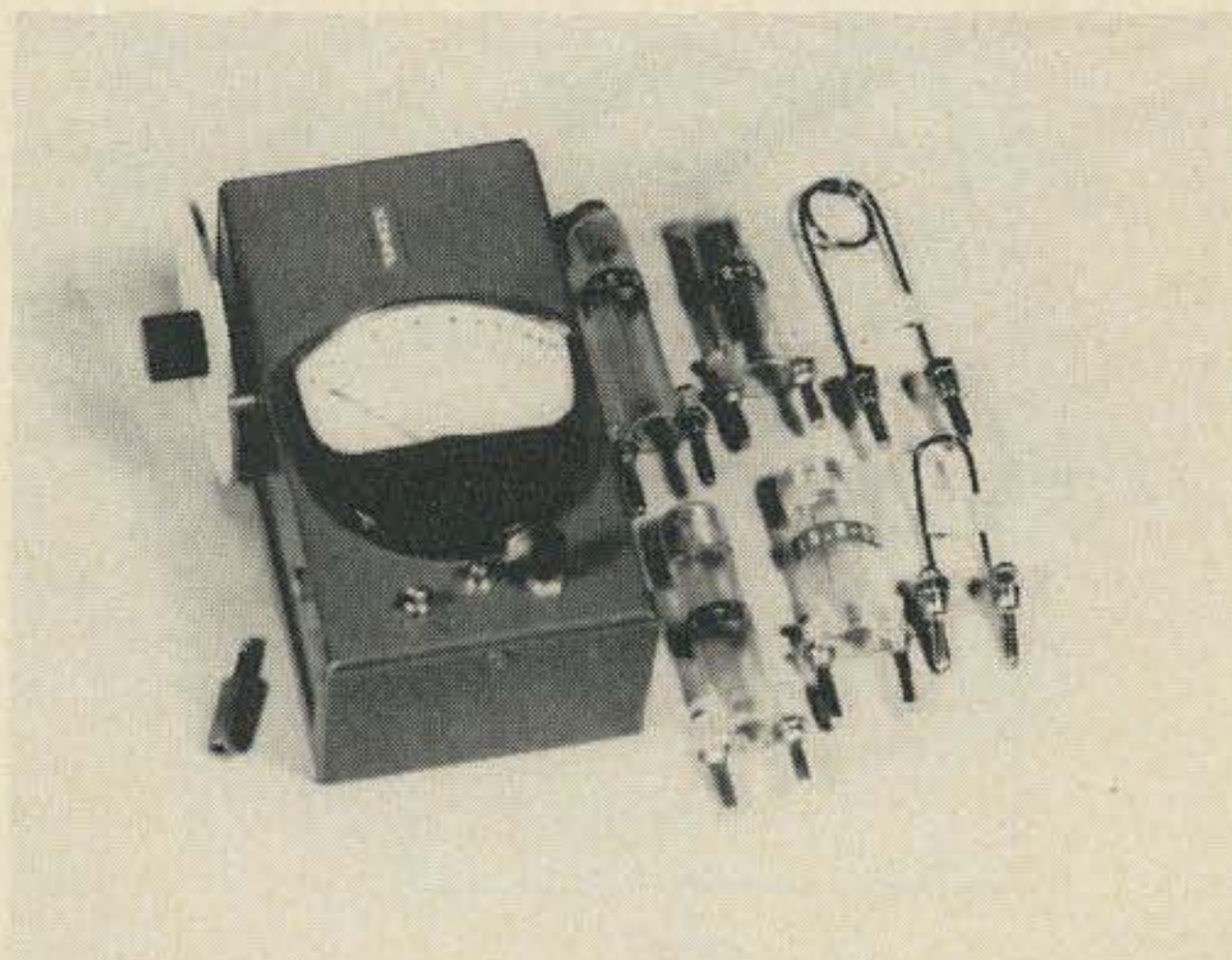

*Standard banana plugs spaced  $\frac{3}{4}$  in. make ideal bases for the coils. The lower frequency coils are wound on polystyrene forms.*

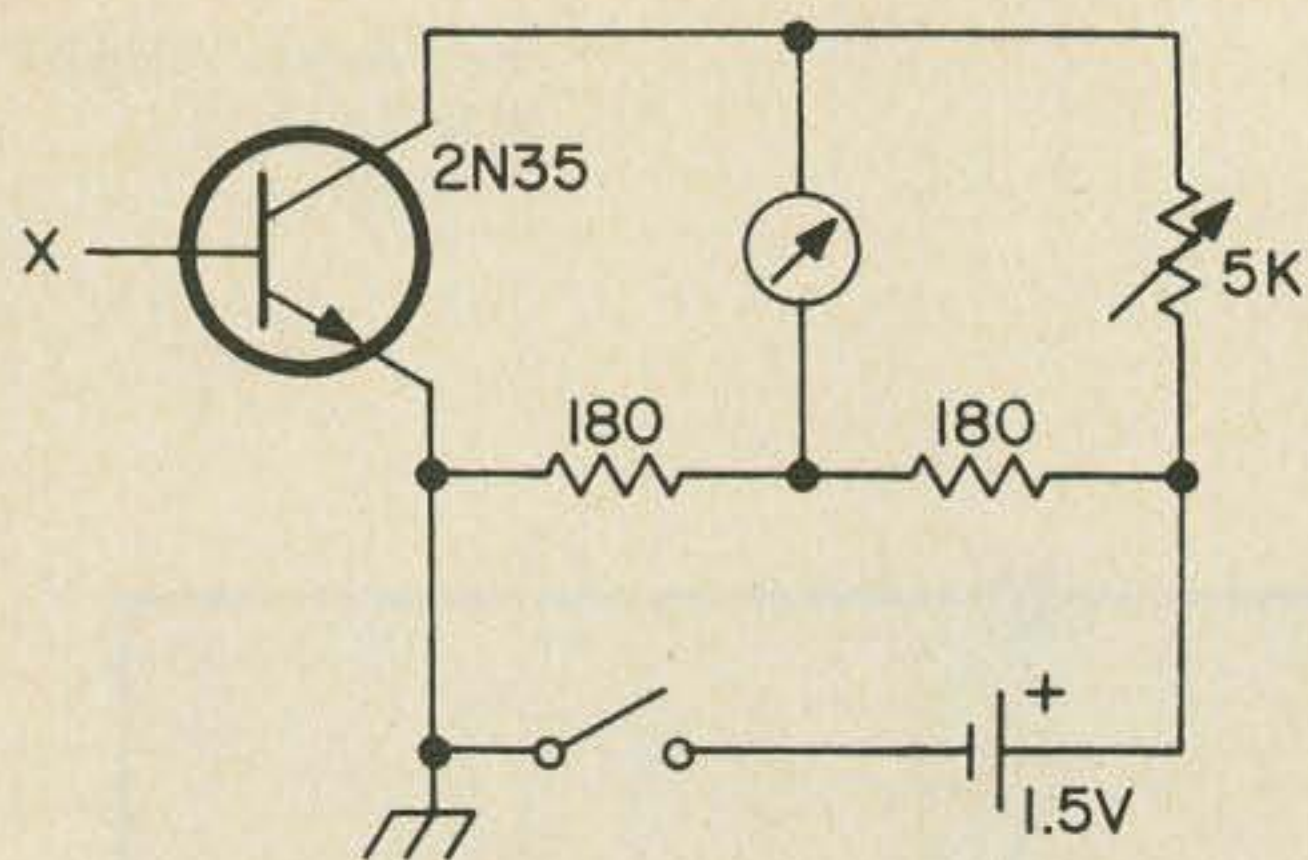

Fig. 1. Indicating oscillator circuit diagram.

The circuit (Fig.1) is not critical. However, the sensitivity control should not be bypassed. Layout could possibly be improved with a slightly larger box, allowing the dial to be placed on the face with the meter. It is a good idea to keep the layout symmetrical as far as possible, particularly the tuned circuit. This can be seen in the photo of the inside view. The box used was an LMB 532 EL with the cover reversed to allow for coil mounting insulator (poly-

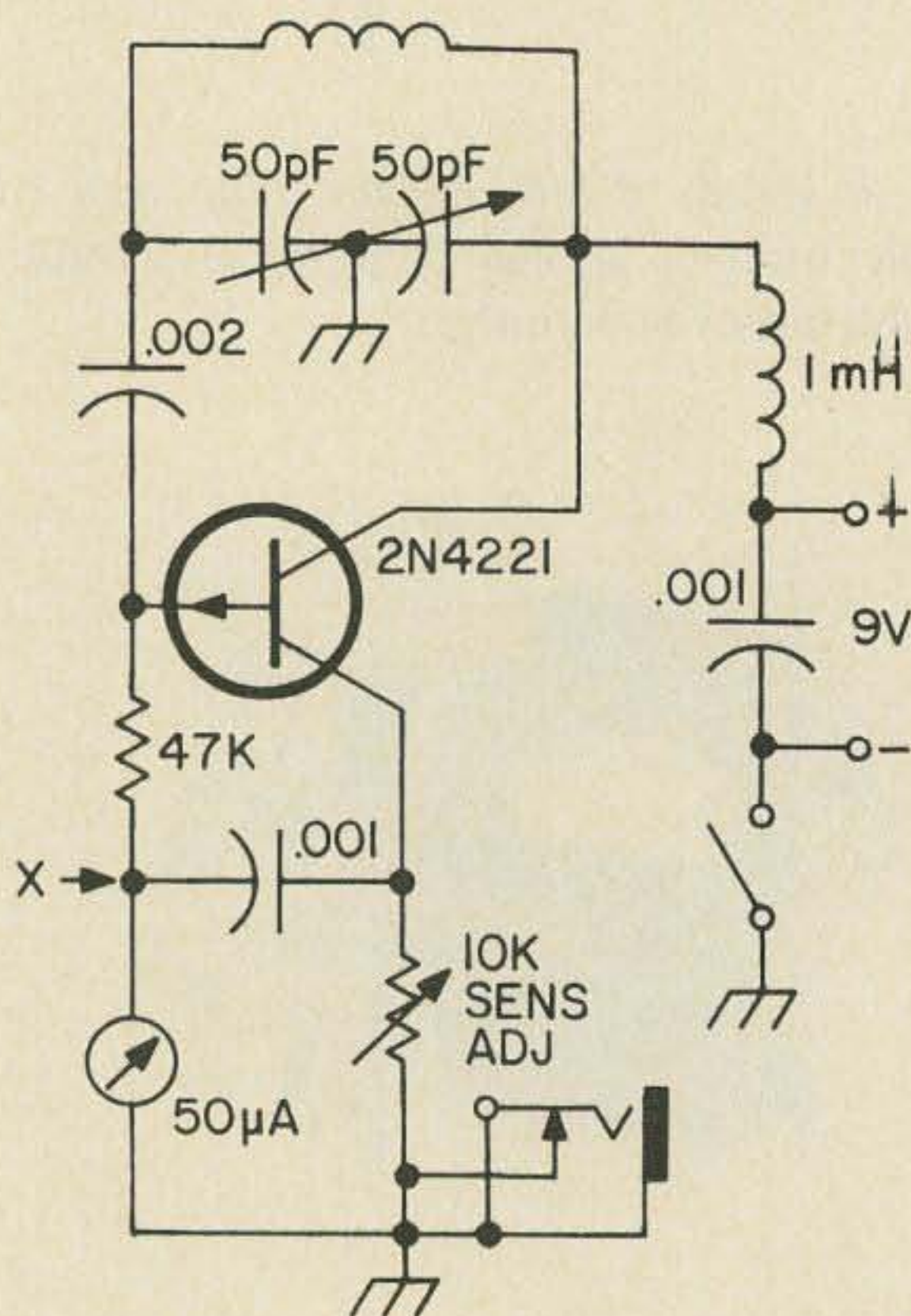

Fig. 2. This meter amplifier will increase the level of the signal so that a less-sensitive meter than 50  $\mu$ A may be used.

styrene or other good rf insulating material). The meter should be a 50  $\mu$ A movement; otherwise, a meter amplifier such as the one shown schematically in Fig. 2 will be necessary. This is no problem, as there is room for this amplifier on the circuit board.

A thumbwheel from a BC-375 tuning unit could be used very nicely as a dial. Three sides have been left clear for ease in placement of unit when in use. Plug-in coils makes for easy bank change and application to the job at hand. Standard-spaced banana pins allow for use with other accessories. Use 5/8 in. polystyrene tubing and stud-type banana pins.

A dual banana plug can be used during construction for setting the spacing accurately. The coils shown have the pins wired in place for stronger mechanical assembly. Drill a hole for about 24 AWG copper wire on each side of the pin studs which will lie along each side of the poly tubing. Use a number 59 or 60 drill. One wire is enough on each pin. Form a hairpin with about an inch of wire, push it through the drilled holes from the outside. Now twist tightly with longnose pliers, cut it off short, but not so short as to allow the wire to untwist! Then apply several coats of liquid "poly" cement. Be sure to move the coils frequently during the hardening period to make sure the liquid "poly" flows evenly over the stud and forms a slight fillet with the tube. Epoxy doesn't seem to work well with polystyrene. Neither Allied nor Newark list liquid polystyrene any longer, but your neighborhood hobby shop should be well stocked.

The lowest frequency coil (number 1, 0.95–2.2 MHz) was made from a Miller 951 ferrite 0.5 mH choke with 6 or 8 turns removed – just enough to slip inside the poly tubing. Some reaming may be necessary. The number 2 coil (2.2–5.4 MHz) was made from a Miller ferrite antenna unit with the slug permanently installed in the top end and all lugs and mounting hardware removed. This coil was also mounted inside the poly tubing. The number 3 coil (5.4–13.5 MHz) consists of 32 turns of 28 AWG enameled wire, close-wound on the outside of the poly tubing. All coils are 2½



# FM'ers!

GET THESE  
EARLY ISSUES  
OF FM  
BULLETIN,  
BOUND INTO A  
SINGLE  
VOLUME

**\$3** WHILE  
THEY  
LAST



Only 500 copies of this collector's edition have been printed. The material consists of FM bulletin's rarest issues, and is reproduced in its original form by lithography. Contains FM Bulletin, Volume I (Feb. 1967 to Feb. 1968).

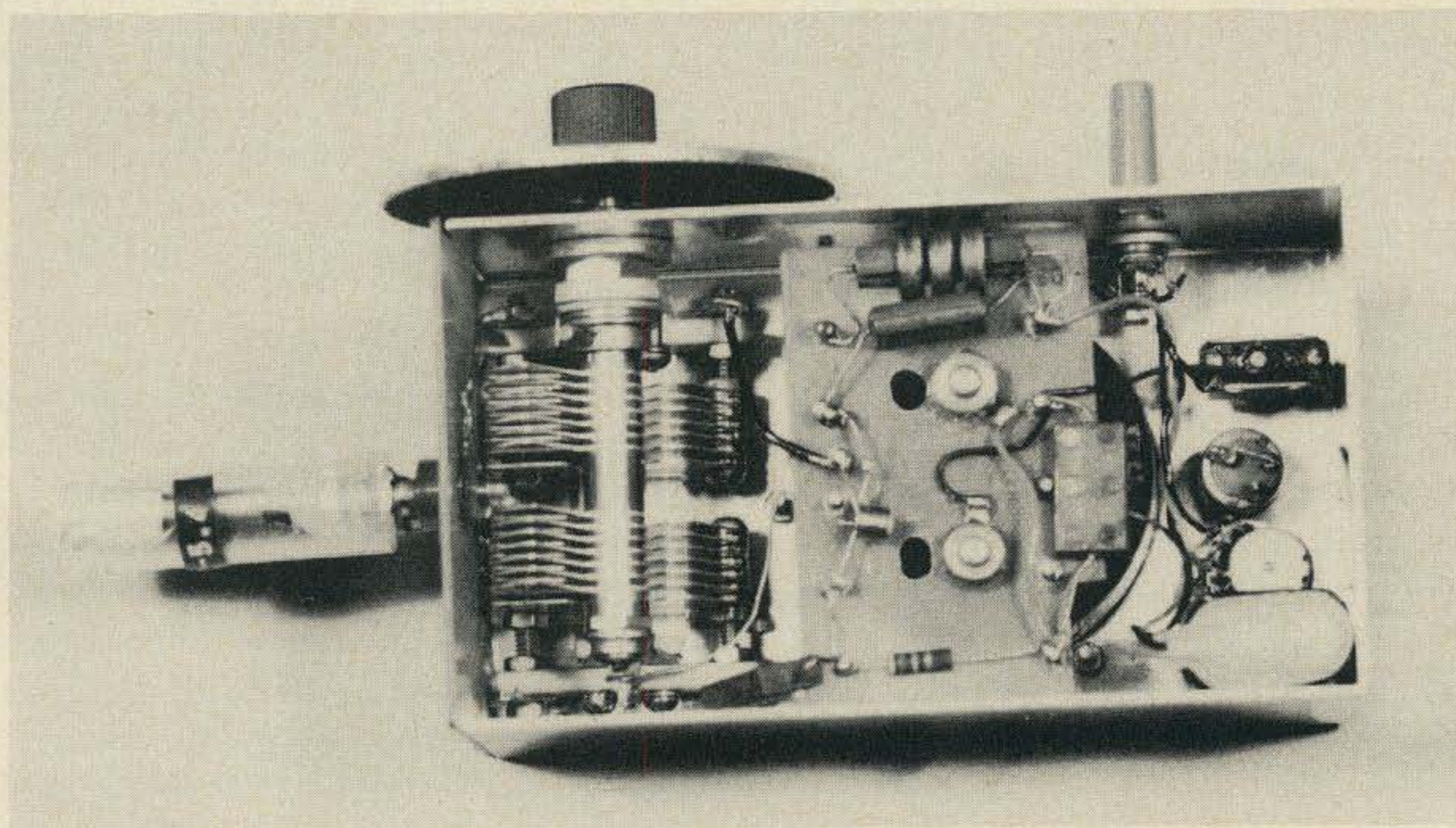

*Interior view of oscillator with coil attached shows construction of the author's version.*

in. long with windings as near the end as practical. The number 4 coil (27–50 MHz) consists of 10 turns of 24 AWG enameled wire, close-wound. The number 5 coil (45–100 MHz) consists of 2 turns of 14 AWG enameled wire, self-supporting. The number 6 coil (60–270 MHz) is one

hairpin loop 3/8 x 1 in.

A jack is provided for headphone use. The screwdriver-adjusted miniature pot is for zero adjustment of the meter amplifier. It can be seen in the photograph.

... KH6AF ■

Bill Hoisington K1CLL  
Far Over Farm  
Peterborough, N.H.

LOW A  
COST N  
OSCILLATOR D

# INFINITE ATTENUATOR

## FOR TUNING VHF RECEIVERS

One of the most useful test-equipment gadgets the homebrewer can build is a signal generator. The one described here is of commercial quality and it can be completely contained inside a waveguide. Positioning, by sliding along the waveguide, provides a variable-strength stable signal of one millivolt, one microvolt, one nanovolt, or less, dropping down gradually to a true zero. It does this in a perfectly smooth fashion without steps or jumps so that every fraction of a decibel in lower noise figure shows immediately on the slide dial. What's more, the slide can be calibrated so that FM'ers can use the device for directly measuring receiver sensitivity in tenths of a microvolt.

In building a 6 meter receiver recently for maximum absolute sensitivity I naturally had to check especially on the first-stage rf transistor and circuit for minimum noise figure. (For this type of work you *must* have a signal generator capable of being attenuated out of sight with any receiver you can buy for any money.) The usual generators on the market under \$100

do not do this. And many of the very expensive generators get so leaky that they have to be used 200 ft from the receiver. At any rate, the generator described here can be made up quickly and at low cost, and it *is* stable, reliable, and infinitely variable.

### Waveguide

The only possible difficulty might be in obtaining the piece of waveguide needed. The piece I used is 4¼ in. wide by 2 1/8 in. high, and is 24 in. long. If you have a choice, get a piece a little longer. You could make up this item out of brass or copper if you had to, because in this case it is not used to *carry* energy but to *attenuate* it, so the worse you make it the better!

The waveguide *must not* have any holes in it and should be reasonably smooth inside; otherwise your dial would not read smoothly in attenuation. You *could* use copper or aluminum drain pipe, although I have not tried them yet. Working directly on the rf, this attenuator is good for any kind of modulation, including SSB, FM, pulse, or what have you.

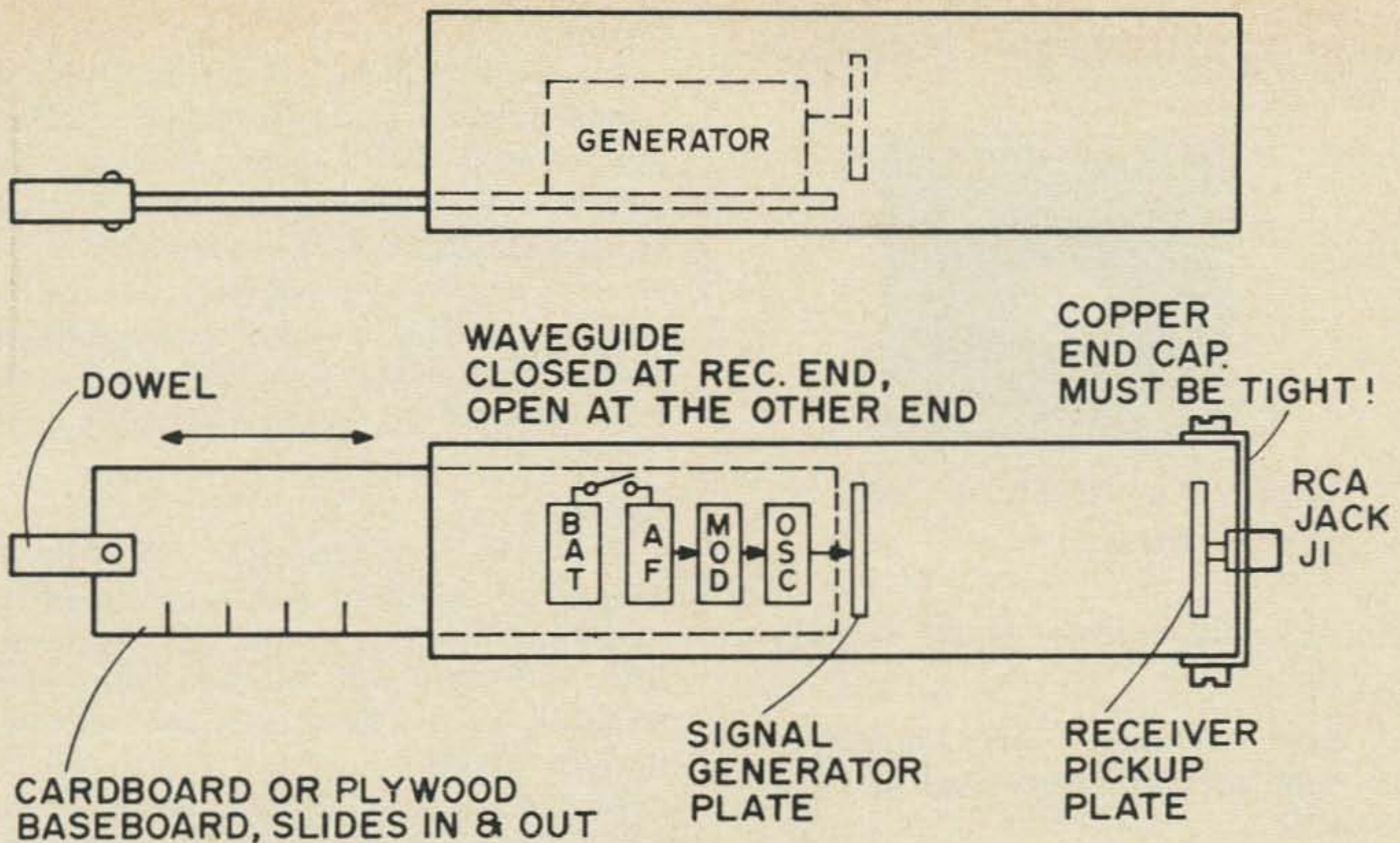

Fig. 1. Sketch shows plan-view layout of unit inside waveguide attenuator. The oscillator unit is mounted on a flat wood or cardboard strip that can be calibrated to give accurate indications of output signal.

### Construction

Figure 1 shows the basic idea. When the signal generator plate is close to the receiver pickup plate, you can get about 100 mV of signal into the receiver, and it is handy for checking diode receivers. When the two plates are about 8 in. apart, the signal is just detectable on a good receiver. Additional spacing between plates amounts to "waveguide beyond cutoff." I do not believe that there is any receiver in the world that can pick up the signal much beyond the 8<sup>3</sup>/<sub>4</sub> in. point.

Pretty soon in your receiver "peaking" work you get to that signal that may be but a tenth of a microvolt or so, and you begin dreaming about cryogenic front ends,

masers, and such. As mentioned, every fraction of a decibel lower in noise figure, every improvement in sensitivity comes out rigorously and relentlessly on that slide dial. You can easily check which of your low-noise transistors is really low, whether that MOSFET will do a better or worse job for you, and in which circuit.

As you go up in frequency you may have to make smaller and smaller oscillators in order to fit in smaller waveguides to get the cutoff effect. (That will not be a problem if you read 73; the May issue described a "postage-stamp-sized" rf generator that is an ideal candidate for the signal source.)

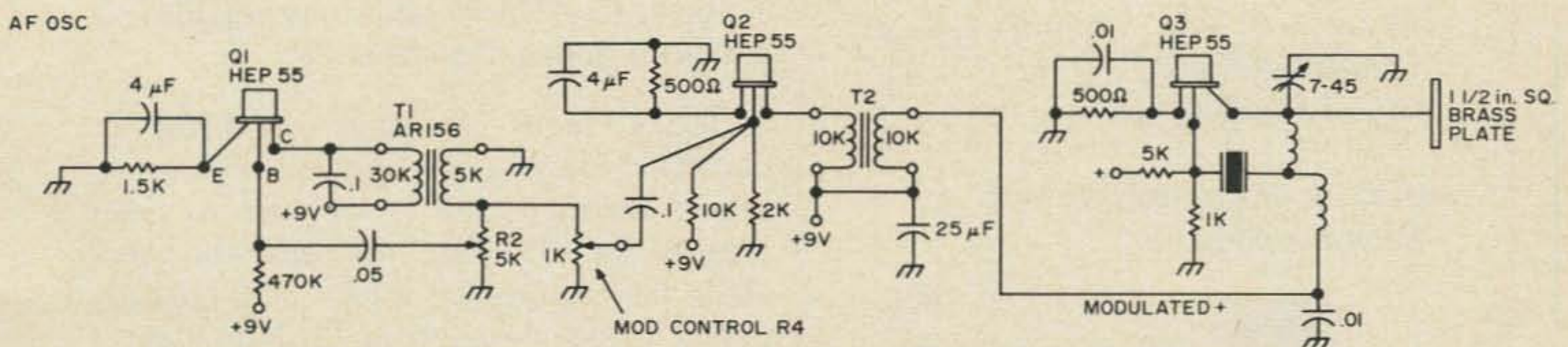
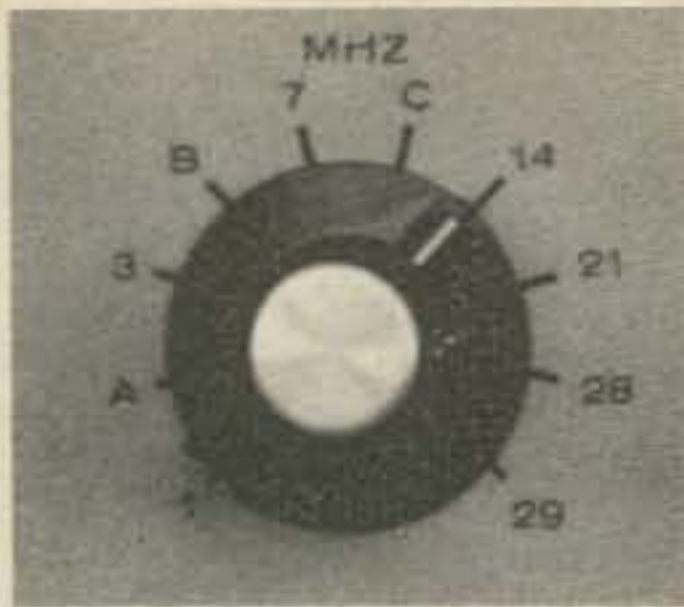

Fig. 2. Schematic of generator. This entire assembly about 3 x 4 in. including small 9V battery and switch must be entirely inside the waveguide. No wire or metal of any kind can be brought outside.

# Feature This



## SIGNAL/ONE'S CX7 gives you...

ALL the coverage you're looking for.

Cost, clutter and operating confusion are eliminated by the CX7.

ALL HAM BANDS from 160 through 10 meters in full 1 MHz ranges plus overlap for MARS, WWV.

ALL POPULAR MODES of operation . . .

- Upper and Lower sideband
- True break-in CW
- Compatible AM for VHF convenience
- FSK MODULATOR PLUS IF Shift\* allows use with popular 2125/2975 Hz frequencies

STANDARD "BUILT-INS" are yours . . .

- Heavy duty AC power supply
- RF clipper
- Second Receiver capability
- CW keyer
- Precision frequency meter/calibrator
- Even a folding bail!

Write for illustrated brochure.

\*Patent applied for



A Division of ECI (An NCR Subsidiary)  
2200 Anvil Street No.  
St. Petersburg, Fla. 33710

## Circuit

A crystal oscillator, an af oscillator, and a simple class A modulator do an excellent job to start with. Figure 2 shows the present unit as used on 6 meters. It must be stressed again that no wire or other piece of metal may be allowed to reach the outside from this assembly. I'm making up another for 2 meters soon (still my favorite band) and will try one on 450 a little later.

## Audio

A controlled-feedback transformer-coupled af oscillator does a good job in furnishing a sine wave. A Motorola HEP55 is used for the oscillator, with feedback to the base from the collector through transformer T1, controlled by resistor R2. Audio output is taken off the 5 k $\Omega$  winding of T1, is fed through R4 the modulation control, and then to the base of af modulator Q2. Transistor Q2 is set up for low-power class A operation because not much modulation is needed for the signal generator. Transformer T2 is an old 5W unit from "tube-type portable" days. The secondary of T2 feeds a modulated +9V signal to Q3, the crystal-controlled 50 MHz oscillator.

This rf oscillator is one of my negative-feedback jobs with phase reversal in the crystal. A 1½ in. square plate is tied onto the collector, radiating energy to the receiver pickup plate facing it inside the waveguide. This energy is rapidly attenuated as you move the plates apart, and should be impossible to detect after some 9 or 10 in. of separation.

Once again, do *not* bring any wires or any other metal or conductor out from the oscillator assembly. If you want an outside controlled switch or other control, bring it out as a wooden dowel handle.

That's about it. Tune everything up outside the waveguide on the bench; when you're satisfied, plug your best 6 meter receiver into J1, push the oscillator plank along the waveguide (or rather I should say pull it along) away from J1. You'll get a surprise! Hope this helps you with your low-noise receiver work. It did a lot for me.

. . . K1CLL ■

# Code Practice a la Baby Talk



I was reading the mail on 20 when I let out a groan that brought my wife, Margie, running into the shack. "What's with you?" she demanded. "And don't say it's my cooking."

"Look," I said, waving a hand toward my brand new ham receiver and transmitter built from kits, "Here I got this fine ham gear and I can't talk back to those guys because I haven't a license."

"So what else is new?"

I knew what she meant. It wasn't the first time I'd moaned over my licenselessness. I squared my shoulders, stuck out my chin. "This time I'm really going to learn the code. The theory I know. It's that goshdarn code!"

"That reminds me. You know that ham at the end of the block?"

I groaned again. "Sure I know him. He just got his Extra class ticket. He can copy twenty words a minute and I can barely copy four."

"Well, maybe you could do just as well if you used his method."

My head snapped up. "What method?"  
"I met his wife in the supermarket the other day and she said that he learned code by dah-ditting everything he read."

"Dah-ditting?"

"That's right — dah-ditting. At breakfast he'd sound off labels on breakfast food in Morse code. Then on the way to work, he'd do billboards and car licenses in code. She said it was this idea that made it possible for him to pass the code test"

I thought this over for awhile, and then said, "Dah-dah-dah, dah-dit-dah."

"What's that supposed to mean?"

"OK. I'm going to try it."

And I did, the very next morning. As usual, I poked my head into the baby's room. The little tyke looked up, and said "Dah dah."

"Hey," I yelled to the wife, "the kid knows one letter already — dah dah. That's M!"

I heard a dish drop in the kitchen, then my wife's excited voice. "I hope you're not thinking that. . ."

"Well, the thought did occur that Junior and I could talk in code."

"No! Absolutely no! I want my son to talk, not dah-dah throughout life."

I could see her point. I'd be guilty of creating a human oscillator. I apologized and sat down at the breakfast table. Instead of the usual small talk, I vocalized in code the advertising material on cereal packages. I even included the recipes. At one point, I said, "Pass the dit-dah-dah-dah, dit-dah, dah-dah."

Margie's eyes went heavenward. "Oh, what did I start by giving you this dit-dah idea!"

"I only asked you to pass the jam." I chuckled. "It's a great idea. I've got a feeling I'm going to pass the thirteen-word requirement for a General license."

On the way to the office I had a great time translating billboard ads into code. Never before had I been so fascinated by car, beer, milk, and bank outdoor advertising.

When the billboards weren't in view, I'd work on car licenses and speed limit signs. It was while sounding off on a 25 mph speed limit sign that I became aware of a motorcycle cop at my left, obviously wanting me to curb my car.

I stopped, and then as the cop approached I did something out of force of habit. I dah-ditted the officer's badge number in code. He looked at me oddly. "Sorry, officer, I forgot myself. I'm studying the code for a ham license. Those dah-dits were your badge number."

He seemed more than mildly interested. In fact, I believe I detected the very faintest smile. "You were doing 30 in a 25-mile zone." He started to write. "May I see your operator's license?" Then, as if he'd just heard: "Studying for a ham license, eh? Me too."

My spirits soared. "Well, well, well! It's a small world, isn't it?"

He agreed, but went on writing.

"You'll know it's the code that stops most of us," I said. "I just learned about this method of sounding out the code while driving and thought it'd be a great idea. Maybe," I added, "you'd like to try it." I looked at him expectantly.

"No, that'd come under inattentive driving."

I groaned inwardly as he continued to write. "Glad to hear you're going to be a ham," I tried again in a different vein. "What I like about the hams is their great fraternal spirit. . . Nothing they wouldn't do for each other."

The cop nodded and went on writing. Maybe I was being too subtle. "Hey," I said, "I bet if we were hams right now we'd be slapping each other on the back and wishing ourselves good DX."

"Yeah." Just yeah, that's all he said and handed me the ticket. I shoved it in a pocket without a glance.

I was in a bad mood all day and to top it off that evening the wife greeted me with a cheery, dit-dit-dit-dit dit-dit. "That's hi," she said, obviously proud that she'd learned two letters.

"Hi to you too," I said, handing her the ticket and at the same time relating what had happened, adding, "I can't understand it. For one thing, that speed sign wasn't there yesterday, and I was only going five miles above the limit. Furthermore, there aren't any pedestrians there, and. . ."

I stopped. Margie was laughing. I became sarcastic. "How would you like to laugh all the way down to the police station and pay the fine?"

She continued to laugh. "Silly! This isn't a speed ticket. It's a warning. And the officer must like you."

"Like me?" I recalled the ice-water treatment.

"Sure. Look."

I grabbed the official form and for the first time noticed that it wasn't a speed ticket. Scribbled in a strong hand were the words:

"Suggest you use your vocal code practice method when not driving. Hope to work you on 80 CW soon. 73."

I read it once, twice, three times, and then danced around the room, singing, "Dit-dit-dit-dit dit-dit" over and over. Margie looked puzzled. "Oh," I said, "I should explain. . . dit-dit-dit-dit dit-dit is what the CW operator sends when he means "ho ho ho."

. . . W9PXA ■

# AMATEUR ELECTRONIC SUPPLY

*is the Best Place to purchase your new  
**SWAN** gear for the following reasons-*

SWAN 260 Cygnet 80-10m AC/DC (\$50 Bonus)	\$435.00
SWAN 270 Deluxe Cygnet . . . . . (\$50 Bonus)	525.00
SWAN 350C 80-10m Transceiver. (\$50 Bonus)	420.00
SWAN 500CX 80-10m - Deluxe .. (\$50 Bonus)	565.00
SWAN 250C 6m Transceiver . . . . . (\$50 Bonus)	450.00
NS-1 6m Noise Silencer . . . . .	36.00
TV-2B (Specify 14 or 50mc if) .. (\$30 Bonus)	350.00
CYGNET 1200W Linear . . . . . (\$25 Bonus)	295.00
Mark II 80-10m Linear - w/tubes (\$50 Bonus)	395.00
Mark 6B 6m Linear -w/tubes . . . (\$50 Bonus)	395.00
Power Supply for Mark II & 6B . . . . .	265.00
117XC AC Supply w/spkr. in cabinet . . . . .	105.00
14-117 12v DC Supply w/Cable . . . . .	130.00
510X MARS Oscillator - less crystals . . . . .	55.00
508 Full Coverage VFO . . . . .	145.00
210 6 Meter VFO . . . . .	120.00
VX-II Plug-in VOX . . . . .	35.00
100kc Calibrator for 350 . . . . .	19.50
100kc Calibrator kit for 350C only . . . . .	19.50
500kc Calibrator kit for 250 or 250C . . . . .	19.50
FP-1 Phone Patch . . . . .	48.00
AF-800 Audio Filter . . . . .	28.00
14C 12v DC Module/cable . . . . .	\$ 65.00
14CP As above, but Positive Ground . . . . .	75.00
117X Basic 117v AC Supply ONLY . . . . .	65.00
230X Basic 230v AC Supply ONLY . . . . .	75.00
117 or 230vac Line Cord (specify) . . . . .	8.00
8' Cable w/plug (Supply to Transceiver) . . . . .	6.00
230XC 230v AC Supply, speaker, cabinet . . . . .	115.00
14-230 12v DC Supply w/230v Basic . . . . .	140.00
Universal Mobile Mounting kit . . . . .	12.00
SS-16 Custom Crystal Lattice Filter . . . . .	95.00

<b>SWAN HORNET TRI-BAND BEAMS (2kw P.E.P.)</b>	
TB-2 2 Element (standard) . . . . .	\$ 99.00
TB-3 3 Element (standard) . . . . .	119.00
TB-3H 3 Element (Heavy Duty) . . . . .	139.00
TB-4H 4 Element (Heavy Duty) . . . . .	169.00

1040 10-40m Trap Vertical . . . . .	59.95
<b>"MODEL 35" SINGLE BAND MOBILE ANTENNAS</b>	
5' top section with kwik-on . . . . .	\$ 11.95
15m coil with kwik-on . . . . .	21.95
20m coil with kwik-on . . . . .	23.95
40m coil with kwik-on . . . . .	25.95
75m coil with kwik-on . . . . .	27.95
18" Base Section . . . . .	8.50
36" Base Section . . . . .	8.95
48" Base Section . . . . .	9.50

<b>80-10m MOBILE "SWANTENNAS"</b>	
Model 45 (Manual Bandswitch) . . . . .	\$ 79.50
Model 55 (Remote Bandswitch) . . . . .	129.50
Custom Contour Bumper Mount . . . . .	24.95
Kwik-on Antenna Connector . . . . .	5.95

- ★ TOP TRADES for your good clean equipment
- ★ STAY-ON-THE-AIR PLAN - Enables you to keep your trade-ins until your new gear arrives - Lose no operating time!
- ★ Convenient Revolving Charge Plan
- ★ PERSONAL SERVICE from fellow hams who understand your problems
- ★ SAME DAY SERVICE on most Orders and Inquiries from our Centrally Located Modern Facilities
- ★ Top Notch Service Department
- ★ UP TO \$50 CREDIT may be taken towards other merchandise when on a unit that indicates a Bonus is purchased without trade-in and at the regular price.



Terry Sterman, W9DIA  
Proprietor



Ray Grenier, K9KHW  
Mgr. Mail Order Sales

**GET OUR  
DEAL TODAY!**  
Use Handy  
Coupon  
Below

To: **AMATEUR ELECTRONIC SUPPLY**  
4828 West Fond du Lac Avenue  
Milwaukee, Wisconsin 53216

I am interested in the following new equipment:

I have the following to trade: (what's your deal?)

Ship me the following New Equipment:

I enclose \$ \_\_\_\_\_ I will pay balance (if any)  
 C O D (20% deposit)  Revolving Charge Plan

Name \_\_\_\_\_

Address \_\_\_\_\_

City \_\_\_\_\_

State \_\_\_\_\_ Zip \_\_\_\_\_

## AMATEUR ELECTRONIC SUPPLY

4828 W. Fond du Lac Ave.; Milwaukee, Wis. 53216  
Phone (414) 442-4200

STORE HOURS: Mon & Fri - 9 am to 9 pm; Tues, Wed & Thurs - 9 am to 5:30 pm; Sat - 9 am to 3 pm

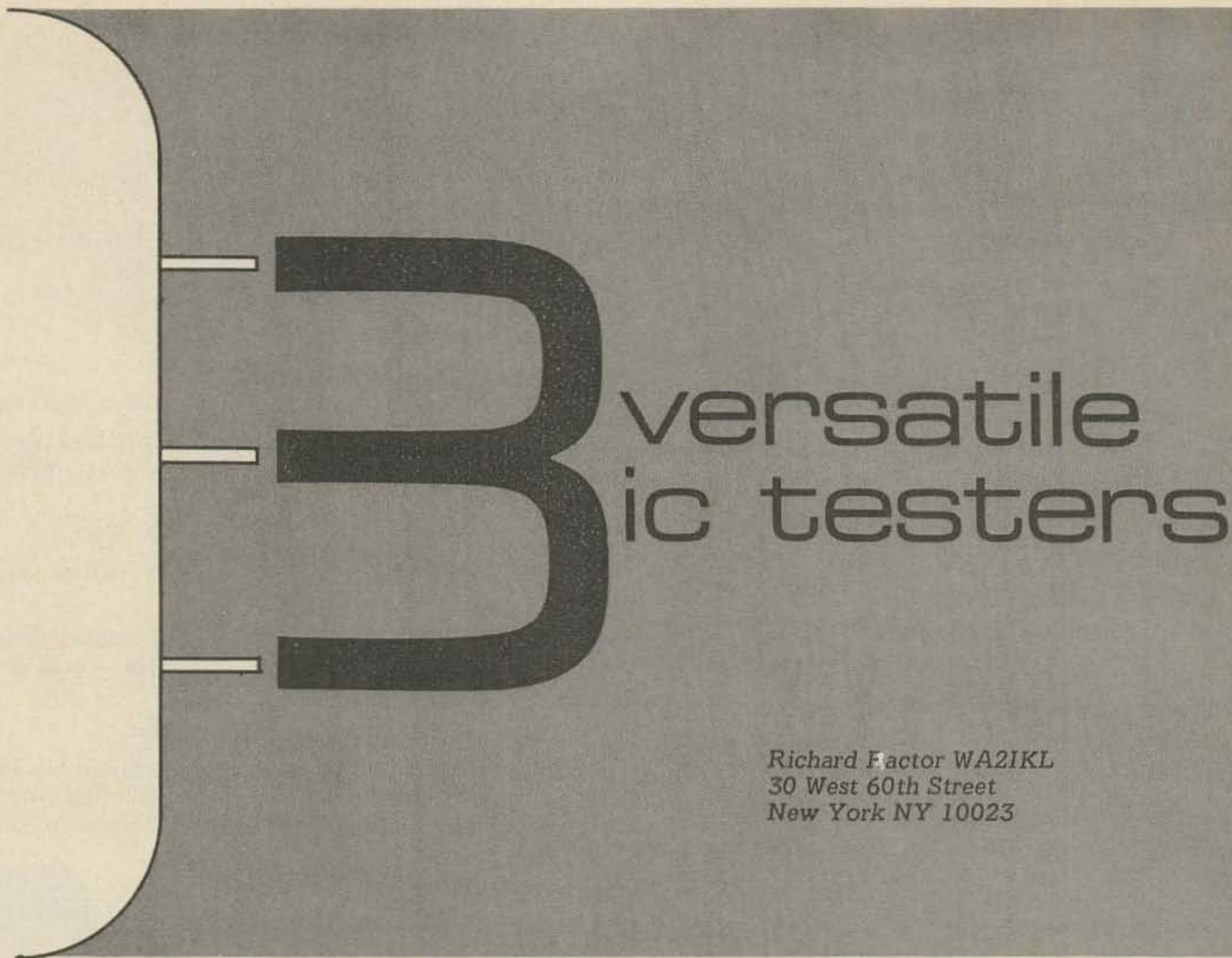

# B versatile ic testers

*Richard Factor WA2IKL  
30 West 60th Street  
New York NY 10023*

**A**s integrated circuits become widely used in industry, large numbers of them find their way into the surplus market, often at prices of a few cents each. The cheaper assortments contain many rejects and are frequently unmarked. With transistor assortments, this is not a problem, since transistors generally have three leads, and only a few trials are necessary to find out if they still "transist."

ICs compound the problem, since they not only have many more leads, but they don't all do the same thing. Figure 1 shows just a few of the many configurations available. With three simple IC testers, you can test and identify virtually all of the ICs a ham is likely to come across (including those of Fig. 1).

After the sweeping claims above, I should clarify some of the things the testers won't do: They will not rapidly and automatically test all the static and dynamic parameters of ICs. They will not automatically check such complex function units as 256-bit read-only memories

and other MOS circuits. They will not test the vast assortment of rf and video amplifiers available. They will give no measurements good to 0.1%. But all three can be built for under \$20; so if you don't expect the impossible, you can make up a very handy item to have around.

What the testers will do, and do quite nicely, is test RTL, DTL, and TTL digital logic circuits, decade counters, Nixie drivers, and assorted operational amplifiers and comparators, and tell you whether or not they work. And believe me, that's all you really care about.

### Testing Philosophy

To test an IC, the simplest thing to do is to regard it as a black box. You apply power to it, connect an input to the proper pin, and observe whether the output is as expected. The procedure for doing this to an unmarked IC is as much an art as a science. I will describe my procedure for going through a batch of ICs. Bear in mind that this is only a representative method —



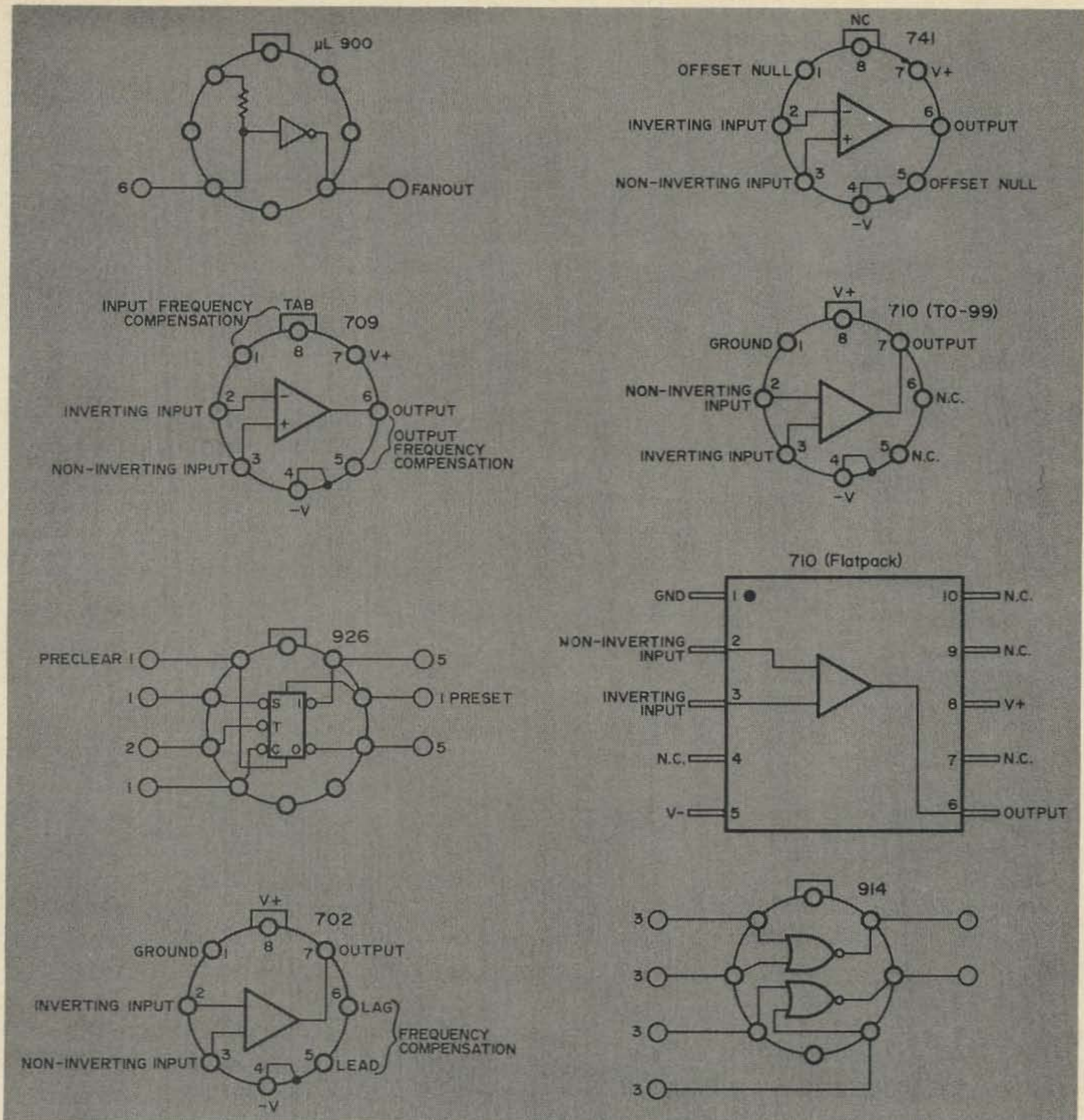

Fig. 1. Connection diagrams for some common ICs. All are shown from top view.

you might hit on one that works better for you.

Assume you have latched onto a handful of unmarked TTLs known to belong to the SN7400N series. This family has gates, flip-flops, and assorted complex functions. Since gates are the most common function, it is best to start by looking for them. Connect the patch cords so that pin 7 is grounded, and pin 14 goes to the +5V terminal. One advantage of looking for the gates first is that these power supply connections cannot damage any flip-flops or counters.

It is a very good idea to have the manufacturer's literature handy so that once you identify an IC, you can label it with a number rather than writing a truth table for it, and so you can avoid pitfalls like improper power supply connections. Insert the ICs into the socket and watch the output current of the supply. When it increases (about 5–10 mA), you have reason to believe that the IC is a gate.

The next step is to look for outputs. The easiest way to do this is to connect the scope successively to each pin while holding the tip of the patch cord. Holding the

cord puts 60 Hz on the scope input. Inputs have very high impedance, and thus the signal will not disappear when the scope is connected to one. Outputs have either saturated transistor outputs in either state (TTL), or low-resistance pullups (DTL or RTL), and will effectively short out the 60 Hz current picked up by the body. Once an output is identified, connect a pulse input to the other pins and find out which ones give an inverted output. This is now sufficient to identify the IC.

Frequently an IC will be perfectly good except for one input. If it has only a minor defect (one of four gates bad, a defective reset on a flip-flop, or such), you can break off the pin corresponding to the defect. This is much more economical than discarding the unit.

Now that we have identified the gates, let's try some other possibilities. Connecting pin 11 to ground and pin 4 to +5V is appropriate for the SN7473N flip-flop. Again, identify the outputs as above and connect the scope to one of them. Connect the pulse generator to the other pins. If you truly have a flip-flop, you should see the pulse waveform divided down to a square wave at half its frequency.

Similar procedures can be followed for almost any digital IC. Some of the newer functions are sufficiently complex to make a data sheet necessary for testing, or you

may never hit on an appropriate combination of inputs and outputs. In such a case the digital tester of Fig. 2 can still make valid operational tests, although it will be of little use in identification.

### Decade Counters, Nixie Drivers

Counting circuits and readout tube drivers are becoming more popular as their prices decrease. While the SN7490N decade counter can be tested by the above method, it is rather tedious, and the driver cannot be since it is designed to interface with a high-voltage device. To simplify testing of the counter and SN7441N Nixie driver, a special unit was built (Fig. 3) which simulates decade counter operation. Half of an SN7400N (or any other 2-, 3-, or 4-input dual, triple, or quad gate) is used to produce a single pulse each time the SPDT switch is closed. This steps the decade counter, and the Nixie tube is observed for proper operation. Obviously, it is necessary to have a working Nixie driver in the socket when testing the counters, and vice versa.

The 22 kΩ resistor in series with the Nixie is for current limiting. This resistor value depends on the B+ supply and the particular tube used. A rule of thumb is to select a resistor which insures that all of each digit is lit up when the corresponding cathode is grounded. The value is not particularly critical.

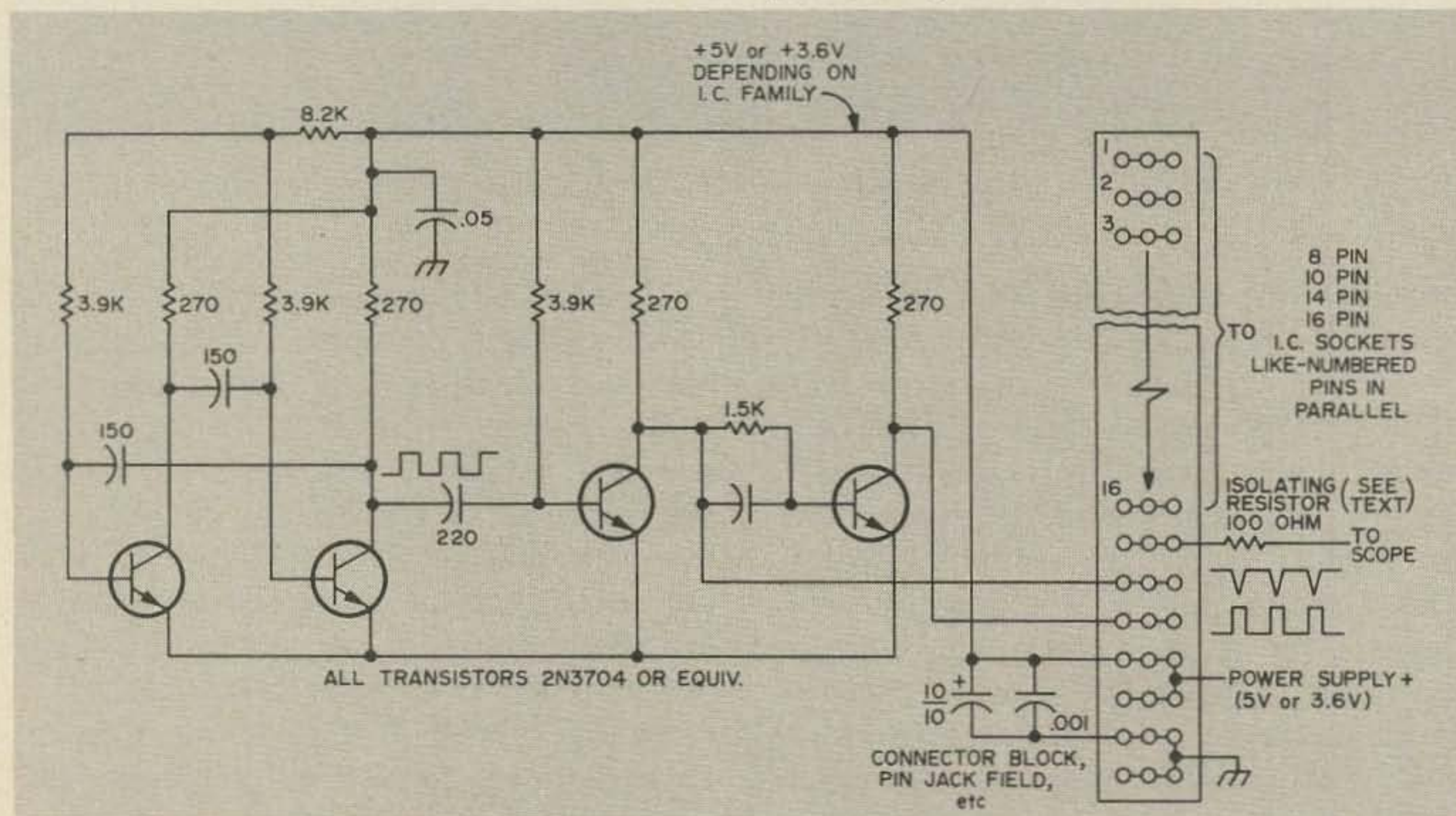

Fig. 2. General purpose digital IC tester.

YOUR HUNT'S OVER for  
**VHF SEMICONDUCTORS**

for 2-METER, 6-METER and  
 10-METER USE . . . They're at Your-  
**MOTOROLA-HEP Supplier**



**HEP-S3001**

RF Power Transistor for 2 Meter use — Power in 500 mW, Power out 5W at 150 MHz — Power in 500 mW, power out 1W at 400 MHz

Suggested Net . . . only **\$3<sup>75</sup>** ea.

**HEP-75 & HEP-76**

Complimentary Pair — VHF RF Power Transistors for 6 Meter use — HEP-75 is NPN, Replaces 2N3866, Power in 50 mW, Power out 1.25 W at 200 MHz (class C). HEP-76 is PNP, Replaces 2N5160, Power in 50 mW, Power out 1W at 300 MHz (class C).

HEP 75 Suggested Net only **\$2<sup>95</sup>** ea. HEP 76 Suggested Net only **\$4<sup>95</sup>** ea.

**HEP-S9100 & HEP-S9120**

DARLINGTON Amplifiers — NPN — for Preamp inputs Requiring Hi Gain, Hi Input Impedance, Low Noise — HEP-S9100 useable up to 200 MHz with 20,000 minimum gain — HEP-S9120 useable to 175 MHz with 50,000 minimum Gain.

HEP-S9100 Suggested Net only **79<sup>c</sup>** ea. HEP-S9120 Suggested Net only **89<sup>c</sup>** ea.

**HEK-3**

RADIO AMATEUR IC KIT — Contains Two RF-IF Linear Hi Freq. Amplifiers, one RTL Quad 2-Input Positive Logic NOR Gate, and Brochure of Ten Specially Selected Amateur Radio Project Circuits.

Suggested Net only **\$5<sup>95</sup>** per Kit



ASK for them! Look for them! Make "Tracks,"  
 to your Local MOTOROLA HEP Supplier!

Write for LIST of HEP  
 Suppliers in your area.

get **HEP** with

**MOTOROLA Semiconductor Products Inc.**

5005 E. McDowell Rd., Phoenix, Arizona 85008

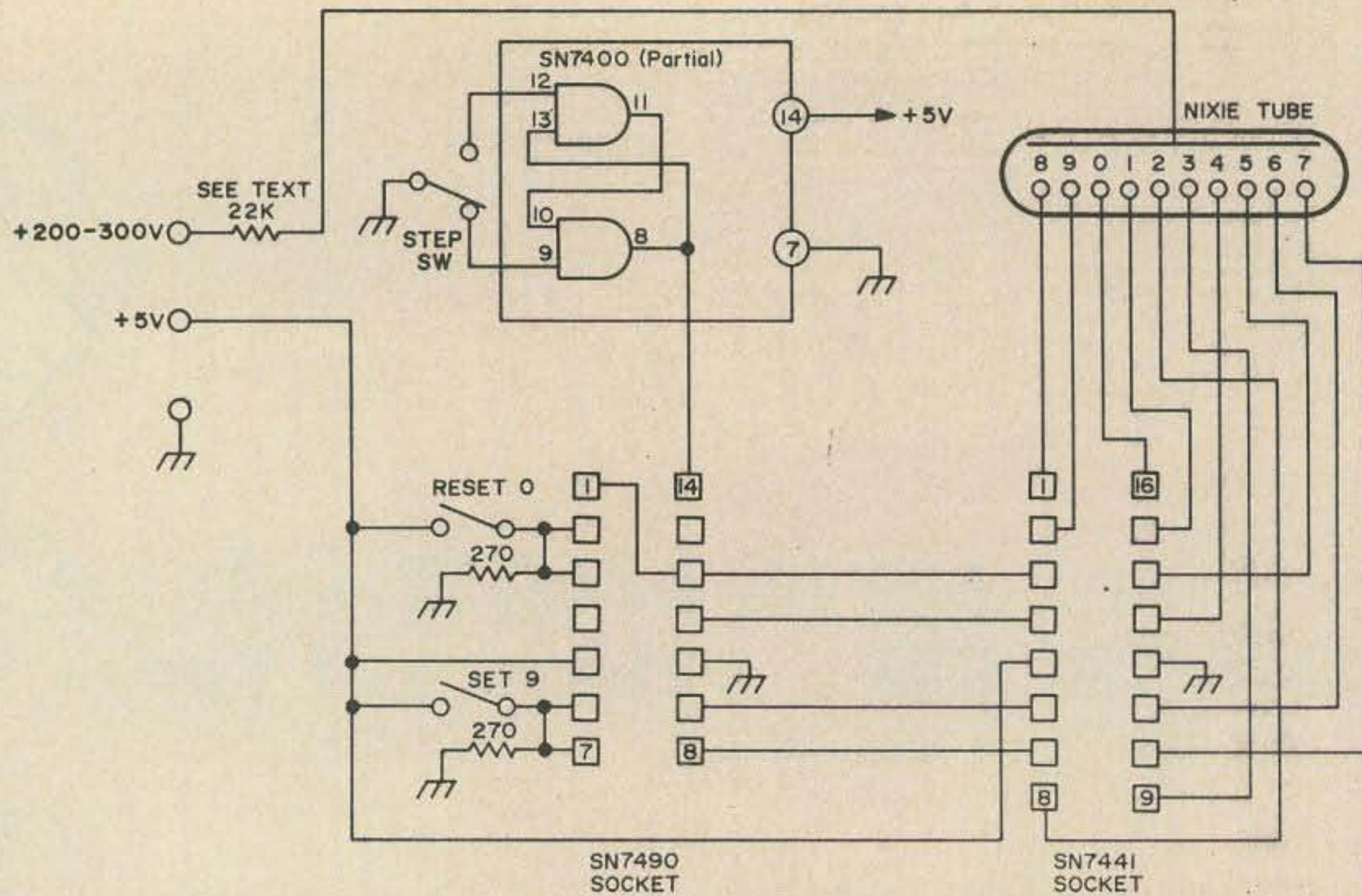

Fig. 3. Decade counter and nixie driver tester.

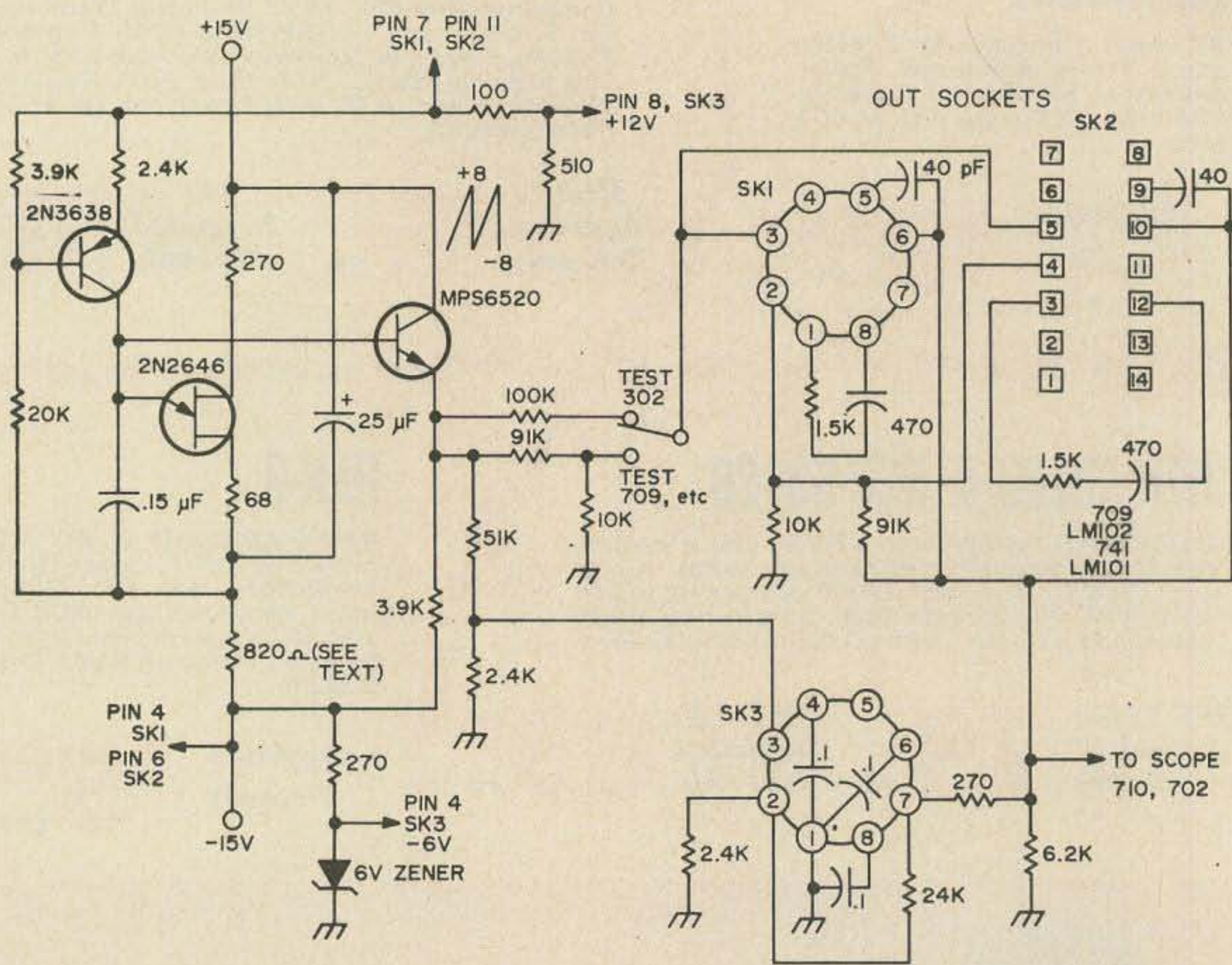

Fig. 4. Linear IC tester.

### Linear ICs

Compared to digital ICs, linears are a horse from a different stable. If you have no idea what type you have, you are quite likely to destroy it during the testing procedure. They are designed for a wide variety of positive and negative voltages,

and pin connections are quite nonuniform. The most useful type of linear IC is the operational amplifier, or opamp, and the most popular of these is the type 709. They are so popular that the price has plummeted from over \$50 to under \$2 in

reasonable quantities, and are available from numerous sources. The linear tester (Fig. 4) was designed primarily for 709 and the 710 comparator. It will also test other opamps, such as the LM101, the 702, the  $\mu$ A 741, and the LM102 voltage follower. The diagram showing the test-circuit equivalents (Fig. 5) gives the appropriate output waveforms to look for. The tester doesn't test for parameters such as dc offset and open-loop gain, but does provide a go/no-go test.

The unijunction and current-source transistors generate a linear sawtooth of about 16V amplitude. The approximately 820 $\Omega$  resistor is adjusted so that the voltage swing is symmetrical about ground when measured at the emitter of the MPS 6520 buffer. This signal is then appropriately attenuated and applied to the device input. The 709 output should be a symmetrical linear sawtooth of 16V amplitude. The 302 output should be similar, but without attenuation. Testing the 709 without attenuation will show its peak-to-peak output swing, without delivering enough current to damage the input. A tester switch is used to control the attenuation.

### Building the Testers

The diagrams are more or less self-explanatory. The only special component used in any of the testers is the patching arrangement for the digital IC tester. I used some sort of connector block into which small conical pins fit. It had been lying around for so long that I forgot where I got it. If you can't find something like this, you might try an arrangement of terminal strips and alligator clips, or perhaps a field of pin jacks. Also, while it is not shown on the diagrams, it is a good idea to bypass the power supply connections to ground as near to the IC sockets as possible, especially in the linear IC tester.

Unless you're an old pro with ICs, testing them is not as boring a job as it may seem. It is impossible to describe a complete test procedure for all digital ICs, since they fail in as many ways as there are internal components. It is highly instructive to test the ICs with both the pin diagrams and the internal schematics in

**CB'ERS  
POLICEMEN  
FIREMEN  
EMERGENCY  
GROUPS  
HAMS**

**KEEP IN TOUCH!  
LISTEN TO NEWS AS IT HAPPENS!  
MONITOR POLICE-FIRE CALLS  
ON YOUR BROADCAST RADIO WITH  
TUNAVERTER S  
KING of the CONVERTERS!**

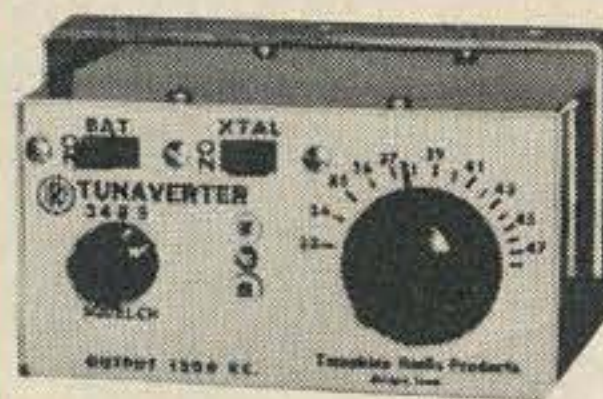

**OUTSTANDING  
PERFORMANCE**  
with  
**MORE FEATURES**  
plus  
**EASY Installation**  
and 100% American  
made dependability

**Crystal & Tunable** by the flip of a switch! It's getting TWO converters for the price of ONE!

**Extra Sensitivity & Selectivity** with unique 3 gang tuning capacitor! It is signal peaker on crystal control!

**Changeable Crystals** for Versatility & Usability. Change channels at will! Never obsolete!

**Squelch** built in for NOISE FREE monitoring!

**\*2 WEEK MONEY BACK GUARANTEE!**

- \* 12 volt powered!
- \* Includes coax, mount
- \* 6:1 Gang Tuning!
- \* 1 year guarantee
- \* Size 2 1/2" x 3 1/2" x 4 1/4"
- \* OUTPUTS 1500kc

"I am very pleased with this unit. I have picked up the Highway Patrol as far away as 75 miles. L. Moore, Calif.

### TUNAVERTER S

Models for AM & FM Tunable & Crystal! (less crystal)  

BAND	MODEL	COVERS	ONLY \$44.95 each
Police, fire	348s	33-48mc	No crystal needed for tunable use.
Weather, etc.	1564s	150-164mc	
Aircraft	1828s	118-128mc	

**TUNAVERTER X** No squelch-9 volt powered  

BAND	MODEL	COVERS	ONLY \$32.95 each
6 meters	504X	50-54mc	No crystal needed for tunable use.
2 meters	1450X	144-150mc	

**TUNAVERTER T** Tunable only .9volt powered  

Marine	Marine	2.0-2.85mc	550kc	\$19.95ppd.
SW&WWV	SWL	9.5-16mc	1500kc	\$19.95ppd.
SW&CHU	SWL	2.7-3.3-16mc	1500kc	\$24.95ppd.

**SQUELCH FOR YOUR TUNAVERTER**  
 Noise free monitoring with adj. electronic squelch! No wires to Radio or Converter! Just plug in coax! For all 1500 kc outputs. 9 or 12V. 1"x4"x2". \$17.50ppd.

**Mobile Battery Eliminator, 12Vto9V \$4.95ppd.**  
**Crystal Controlled models available—1 & 2 channels—with or without Squelch—26-250mcs. —12 volt neg. grd. \$19.95 to \$44.95. Write for details!**

Coupling Loop & Ext. Antenna for use with home and Transistor Radios \$3.95ppd.  
 Crystals—State Exact Listening Freq. \$5.10ppd.  
 Order from: **AIR MAIL** add \$.85 ea

**HERBERT SALCH & CO.** Marketing Division  
 of Thompkins  
 Woodsboro 46 Texas 78393 Radio Products

PLEASE MODEL \_\_\_\_\_ TOTAL \_\_\_\_\_  
 SEND MODEL \_\_\_\_\_ ENCLOSED \_\_\_\_\_  
 TO C LOOP \_\_\_\_\_  
 NAME: \_\_\_\_\_  
 ADDRESS: \_\_\_\_\_  
 CITY \_\_\_\_\_ STATE \_\_\_\_\_  
 SEND C.O.D.—I WILL PAY POSTAGE ( ) 46 \_\_\_\_\_

# HEY! HOW ABOUT THAT

## S.W.R. BRIDGE

- MODEL SWB-2
- READS FORWARD AND REFLECTED POWER SIMULTANEOUSLY
- "EASY READ" METERS
- USE FOR REFERENCE POWER METER
- DUAL 100-MICROAMP METER MOVEMENTS
- LOW INSERTION LOSS
- SIZE-5"X2"X2"

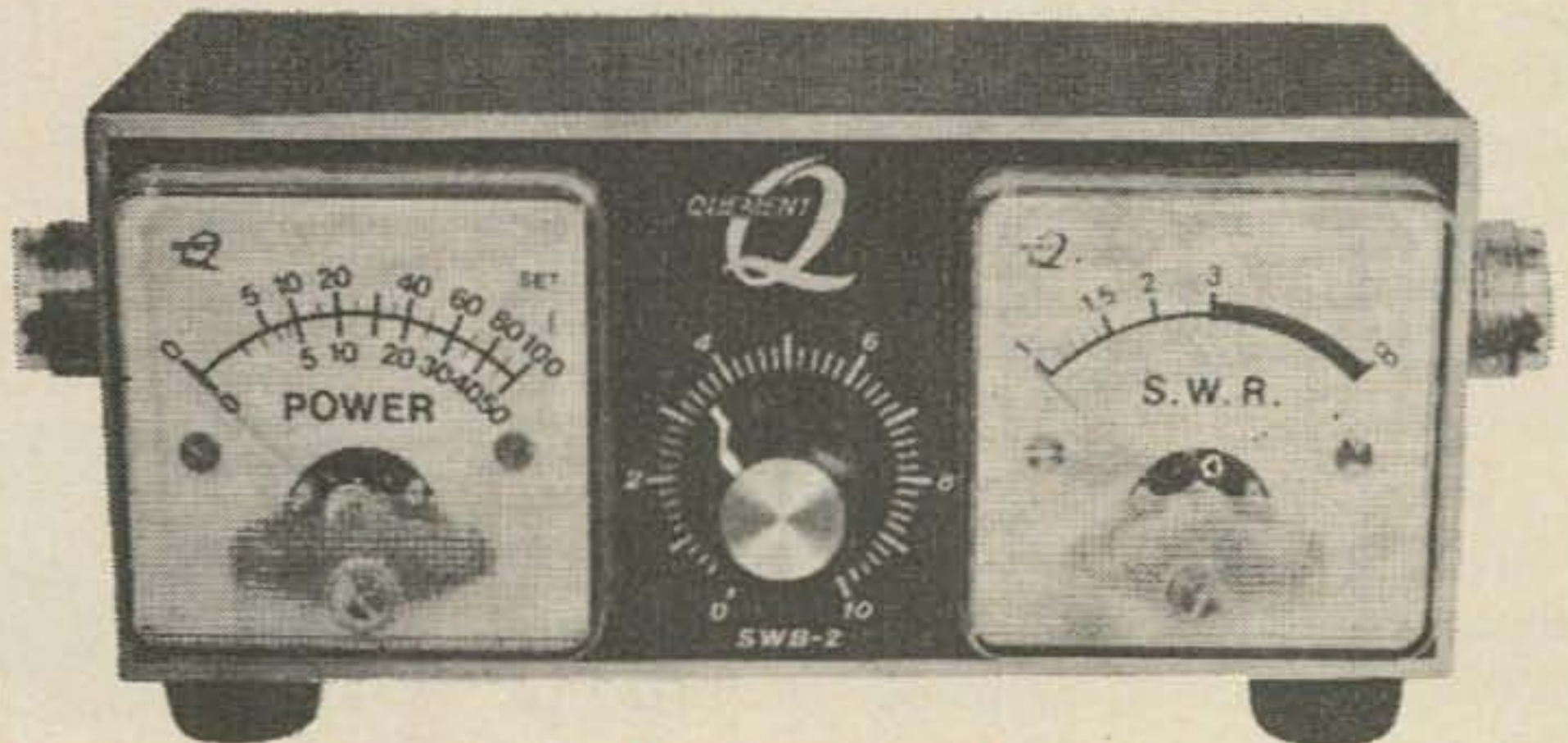

# \$15.95

ALLOW \$1.00 FOR PACKING & SHIPPING. CALIFORNIA RESIDENTS INCLUDE SALES TAX.

THE BEST VALUE WE HAVE EVER OFFERED!

MAY BE LEFT IN LINE, UP TO 2000 WATTS.

GOOD THROUGH 2 METERS

SINCE 1933

FAST SERVICE

Phone 408-294-0464

# QUEUMENT ELECTRONICS

1000 SOUTH BASCOM AVENUE

SAN JOSE, CALIFORNIA

"Northern California's Most Complete Ham Store"

95128

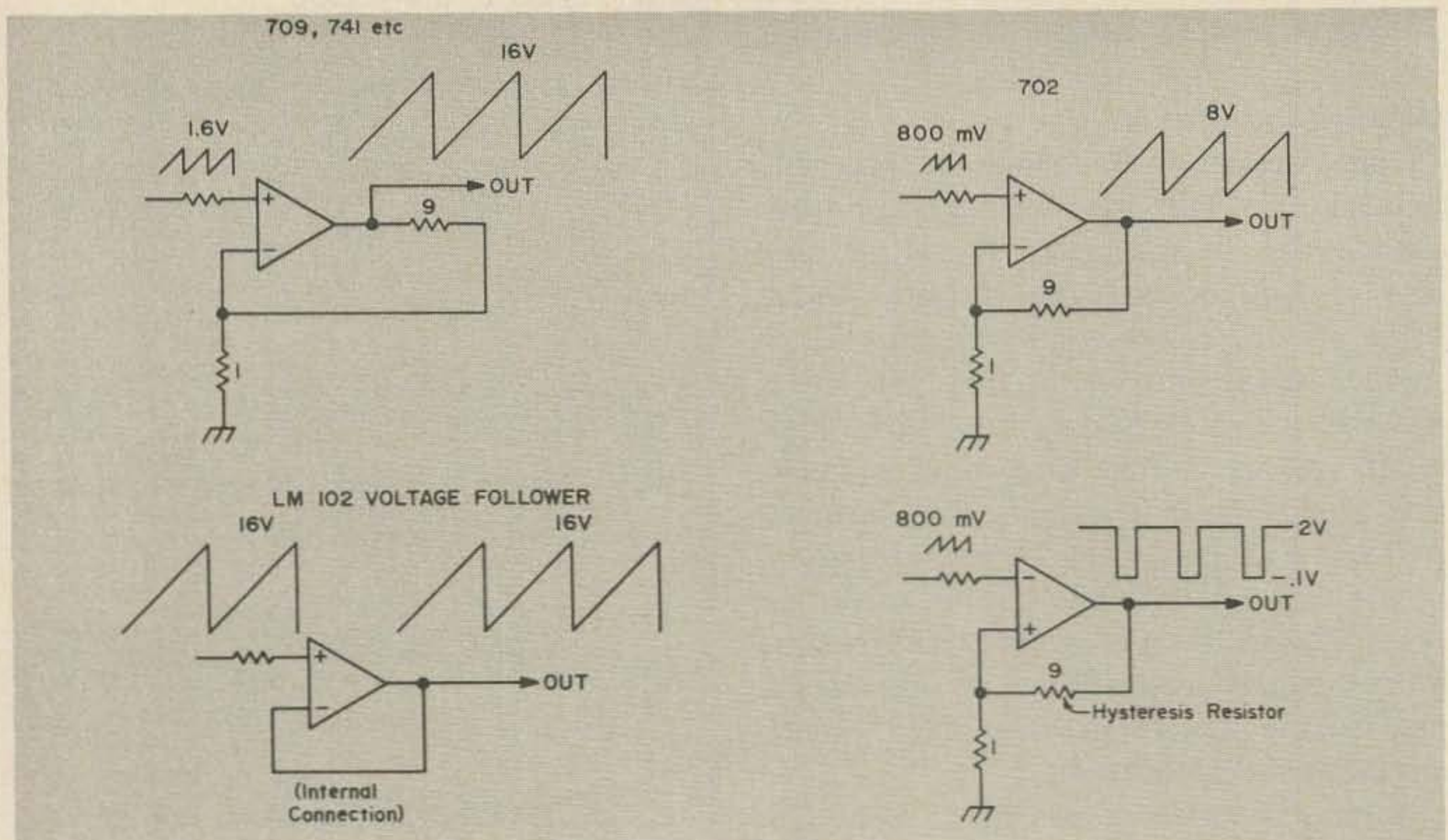

Fig. 5. Simplified test circuit equivalents.

front of you. It will give you insight into IC operation and a better knowledge of logic functions than can be obtained from the literature. And the money you save

from salvaging just a few ICs can equal the cost of the testers.

...WA2IKL ■

# OPTIMIZING ANTENNA DESENSITIZATION ANTENNA SEPARATION IN FM REPEATERS

by Ken W. Sessions, Jr. K6MVH

*If the receiving range of your repeater can't match the output capability, the problem could be desensitization. And chances are you can solve the problem by as simple a step as moving the antennas around a bit at the site.*

**I**t was a long trip and it had seemed like an eternity since I left the last metropolitan area and all the concomitant repeater activity. I was looking forward to driving through the next big city, which I knew to be a highly populated repeater stronghold. I kept watching the road signs so that I could get some idea as to the coverage in miles I could expect from that famous repeater. And every so often I would key my .34 transmitter and listen for a telltale squelch indication on .94.

Just when I thought I was going to fall asleep from fatigue, I got the squelch tail I had been looking for — 68 miles out of the city! With new vigor, I hit the button and put out a call. No answer. It was only 10:30 at night, so I was pretty sure there must be at least one lonely soul more interested in chatting than in watching the evening lineup on TV. After a few more miles, I called again. No answer.

Strange. Who would think that such a renowned repeater would be so forsaken this early on a Friday night? I passed the 50-mile marker and tried again. The squelch tail was not full quieting; the delay was long enough so that I could be absolutely sure that I was making it in, however. There was still no answer.

Not one to give up easily, I tried again and again — past the 54- then the 42-mile markers. Eventually chagrined, I reached over to change my transmitter to .94 — and the first signs of life began to appear on the repeater.

From the repeater came, "Why don't you knock it off, fella...you're not disturbing anybody."

I gave my call again and tried to make contact with the voice.

"So keep it up," it said. "All you're doing is wearing out your finals."

Was the guy drunk? Was he talking to me?

"Hello, there," I said into the microphone. "Are you copying me?"

Then another voice came on. "Hello, Jack...what's up?" (Squelch tail.)

"Same old thing, Ray," the first voice said. "The lid is back playing with the repeater again." (Squelch tail.)

"Break," I said. And there was no squelch tail because Ray was talking.

"...ignore him long enough and he'll just go away." (Squelch tail.)

"Break," I said. And a squelch tail followed.

"Go ahead the break." (Squelch tail.)

I had just passed the 35-mile marker.

"What's going on, fellows?" I said. "I've been hitting your repeater for the last 35 miles but all I've been getting is the brushoff. I thought something had gone wrong with my audio. This is K6MVH mobile – does my audio sound okay?"

"Better try again, old man. You're not quite making it into the repeater. We'll stand by for you." (Squelch tail.)

"Not making it in? Are you kidding? I've got a 15-watt rig here and I've been keying the repeater for more than a half-hour. How could I not be making it in?" I dropped carrier and heard the distinctive kerchunk.

"Did you get any of that, Jack?" Ray said.

"Yeah. . . I think it was a mobile. Hang on till you get in a little closer, old man, you're still too far out for good copy."

I was incredulous, but obedient. I drove on, listening to the two carry on their conversation. At the 21-mile mark, the road inclined for a few hundred yards, so I pulled to the side at the top and gave another call. This time they heard me, but I wasn't much out of the noise.

There was nothing wrong with my audio, I learned. And there were no problems with my transmitter or mobile antenna system. The repeater was merely experiencing a "little" desensitization. The repeater owners had put up the machine but had not yet found the cure for their desensitization problems; nonetheless, they wanted as much range on the repeater as they could get, so they set the receiver squelch to its threshold point.

The result was that the repeater users were being driven right up the walls from signals they had been attributing to "lids" and "troublemakers." They could hear the repeater being keyed frequently, but since they couldn't hear anything but garbage, they assumed each unintelligible input was a local clown.

If the anecdote sounds all too familiar, don't blush. Desensitization is far more common than you might think. It's just that when you hear about the wonders of someone else's repeater, the fellow who tells you about it generally has a way of

overlooking some of the less attractive aspects of it. The truth is, the repeater I described could be any one of a dozen in the West, several in the Midwest, and a few in New England. The "mile markers" might have been different, but the situation – the lack of parity between input and output and the horrendous degree of desensitization – is strikingly uniform from one repeater to another.

There have not appeared too many articles on defeating desensitization – virtually nothing in the major journals. The measures that have been taken in most instances have been the result of dogged determination and untiring experimentation on the part of the amateurs who build the repeaters. Moreover, in the majority of installations, the problems don't seem serious enough to warrant the often rather dramatic and time-consuming effort described by the scant literature on the subject.

To minimize receiver desensitization in a typical repeater, some means must be employed to attenuate the transmitter signal at the receiving antenna location. The degree of attenuation required for any given repeater application can be predicted, however, with a fairly high reliability if certain key parameters are considered as "constants." And, since

REPEATER OPERATING FREQ		HORIZONTAL SEPARATION												
		51.0	51.25	51.5	51.75	52.0	52.25	52.5	52.75	53.0	53.25	53.5	53.75	
VERTICAL SEPARATION	51.0													
	51.25													
	51.5	115												
	51.75	90	112											
	52.0	70	90	108										
	52.25	62	70	89	105									
	52.5	55	61	69	88	103								
	52.75	47	54	60	68	87	100							
	53.0	42	46	53	59	68	86	99						
	53.25	36	40	45	52	58	68	85	98					
	53.5	32	34	38	44	50	57	67	84	97				
	53.75	28	30	32	36	43	48	56	67	83	95			

Fig. 1. Tabular listing of required antenna separation in feet for various 6 meter repeater frequency combinations. The gray area shows separation requirements for horizontally spaced antennas; the white triangle shows distances for vertically separated antennas (tip-to-tip).



**IF YOU'VE  
EVER  
USED  
A  
REPEATER,**

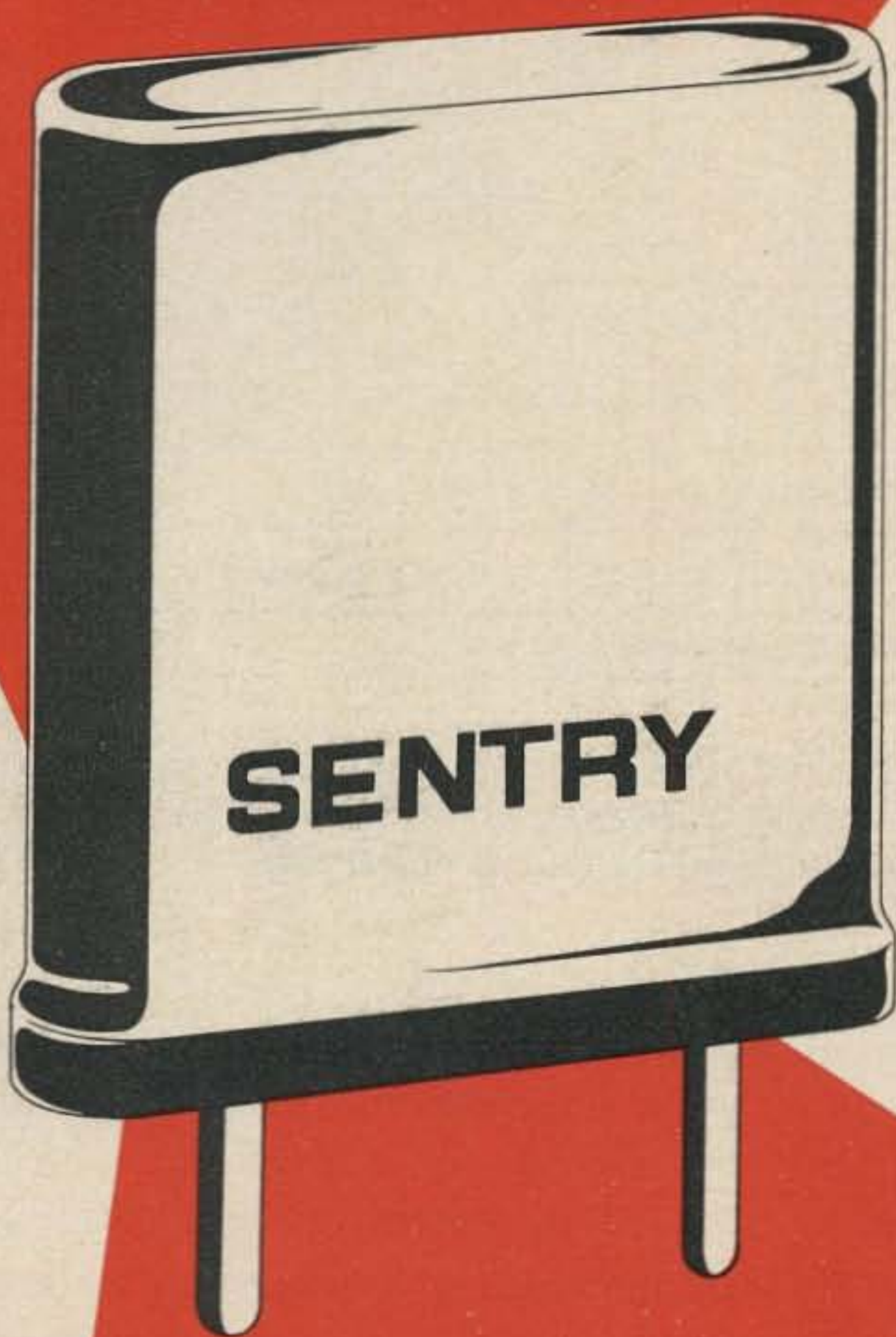

**YOU'VE USED A  
SENTRY CRYSTAL**

If you haven't  
already received  
a copy of our **NEW**  
**1970** Catalog of Precision  
Quartz Crystals & Electronics  
for the Communications Industry,  
**SEND FOR YOUR COPY TODAY!**

Somewhere along the line, in virtually every ham repeater in the world, you'll find a couple of Sentry crystals.

Repeater owners and FM "old-timers" don't take chances with frequency—they can't afford to. A lot of repeater users depend on a receiver to be on frequency, rock stable...in the dead of winter or the middle of July. The repeater crowd took a tip from the commercial "pros" a long time ago—and went the Sentry Route.

That's one of the reasons you can depend on your local repeater to be there (precisely there) when you're ready to use it. FM'ers use the repeater output as a frequency standard. And for accuracy, crystals by Sentry are THE standard.

**IF YOU WANT THE BEST,  
SPECIFY SENTRY CRYSTALS.**

*"Ask the Hams and Pros  
Who Build Repeaters!"*

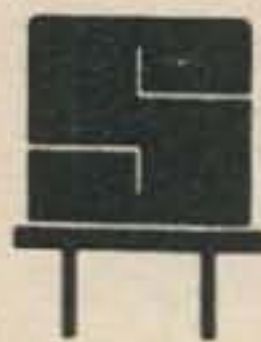

**SENTRY MANUFACTURING COMPANY**  
Crystal Park, Chickasha, Oklahoma 73018

PHONE: (405) 224-6780

TWX-910-830-6425

REPEATER OPERATING FREQUENCIES		HORIZONTAL SEPARATION																ATTENUATION REQUIRED, dB
		146.04	146.10	146.16	146.22	146.28	146.34	146.40	146.46	146.52	146.58	146.64	146.70	146.76	146.82	146.88	146.94	
VERTICAL SEPARATION	146.04	1156	1043	938	840	749	665	588	518	455	339	290	248	213	185	164	150	53 54 55 57 58 60 62 64 66 69 72 76 80 86 100
	146.10	160	1144	1032	827	830	738	653	578	506	442	336	288	245	211	183	163	
	146.16	133	156	1132	1021	916	820	727	642	567	494	429	333	285	242	209	182	
	146.22	120	130	152	1120	1009	905	809	717	631	555	482	416	329	281	240	207	
	146.28	107	120	126	148	1108	997	894	797	707	620	543	470	404	326	278	238	
	146.34	95	106	117	123	144	1096	985	882	785	694	608	531	458	391	322	275	
	146.40	84	90	104	113	120	140	1084	973	870	773	682	596	519	446	379	318	
	146.46	74	83	88	101	110	117	136	1072	961	858	761	670	584	507	434	367	
	146.52	65	72	81	86	98	107	114	132	1060	949	846	749	658	572	495	422	
	146.58	57	63	70	79	84	95	104	111	128	1048	937	834	737	646	561	483	
	146.64	50	56	62	68	77	82	92	101	108	124	1036	925	822	725	634	549	
	146.70	44	49	54	60	66	75	80	89	98	105	120	1024	913	810	713	622	
	146.76	39	43	48	52	58	64	73	78	86	95	102	116	1012	901	798	701	
	146.82	34	38	42	47	50	56	62	71	76	83	92	99	112	1000	889	786	
	146.88	30	34	38	41	46	49	55	60	67	74	80	88	96	108	987	877	
	146.94	27	30	33	37	41	45	48	54	59	67	72	78	86	93	104	975	
147.0	25	27	30	33	37	40	44	48	53	58	65	70	76	83	90	100		

Fig. 2. Minimum tip-to-tip spacing (in feet) required between transmit and receive antennas to achieve various attenuation values. Shaded area is for horizontal separation; white area is for vertical. Diagonal lines represent attenuation level attained by tabulated separation in typical case.

most amateur repeaters are similar in many respects, the constants aren't difficult to nail down. As rules of thumb, then, these can be considered to be: a transmitter output power of 50W or less; a receiver sensitivity of 0.5  $\mu$ V (for 20 dB quieting) under normal, nontransmit conditions; use of conventional omnidirectional antennas, receiver selectivity typical of modern commercial two-way FM units, use of a well-matched antenna for both transmit and receive; and installation of high-quality, low-loss coaxial cable.

The cheapest and easiest method of minimizing desensitization is through careful separation of the repeater antennas. Assuming all the constants cited above apply to your own VHF repeater setup,

you can readily determine how far apart your transmit and receive antennas must be placed by consulting the charts of Figs. 1 (6 meters) or 2 (2 meters).

#### Understanding Attenuation Requirements

It is easy to see from examination of the tabulated figures that the closer the repeater operating frequencies are to one another, the greater the attenuation required. With 500 or 600 kHz of spectrum between the two frequencies — as with most of the 2 meter repeaters — some means must be employed to attenuate the transmit signal by about 60 dB (shown by diagonal line on Fig. 2). If no other method is used to obtain this isolation, it can be effected by placing the two antennas some 50–60 wavelengths

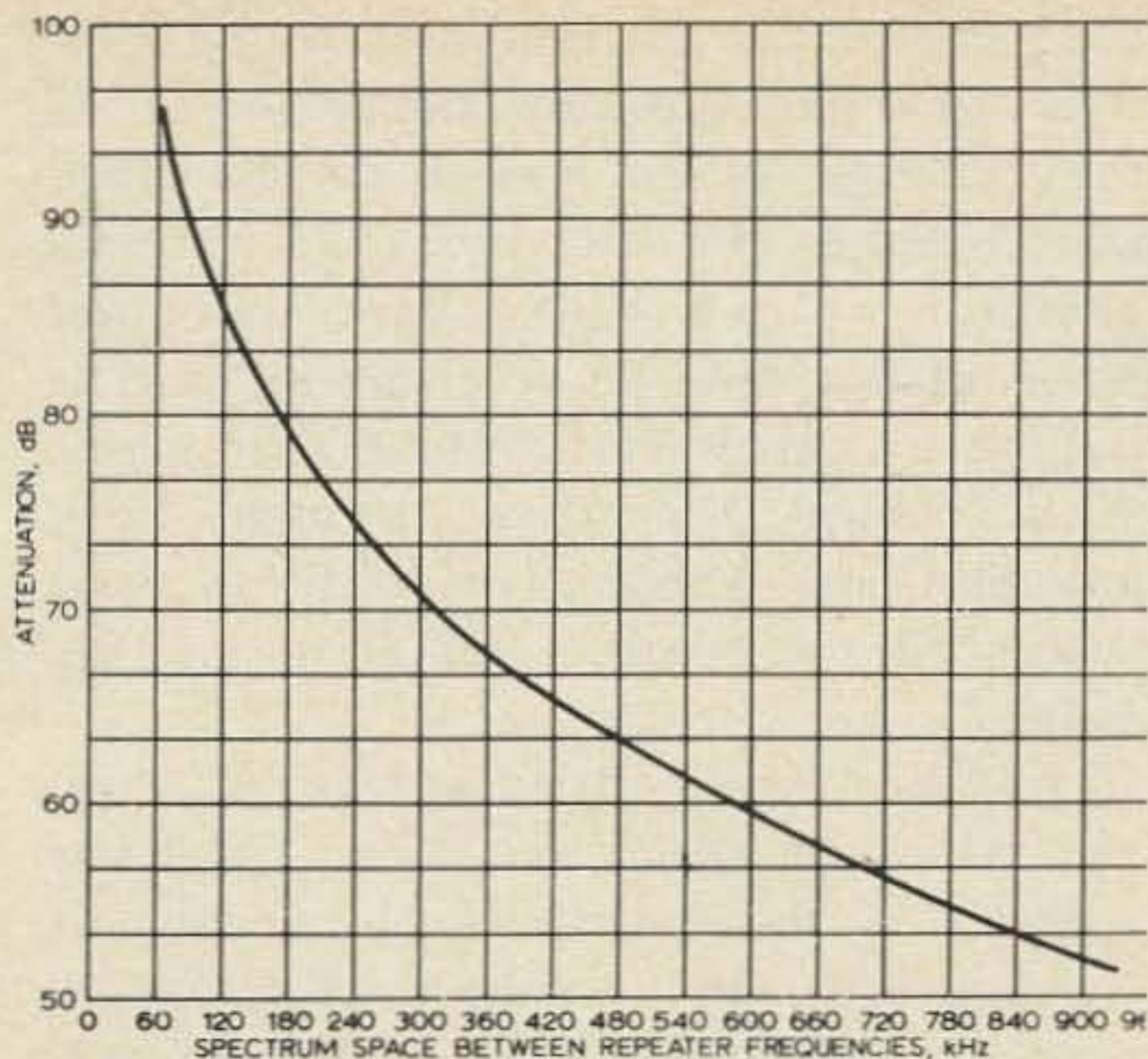
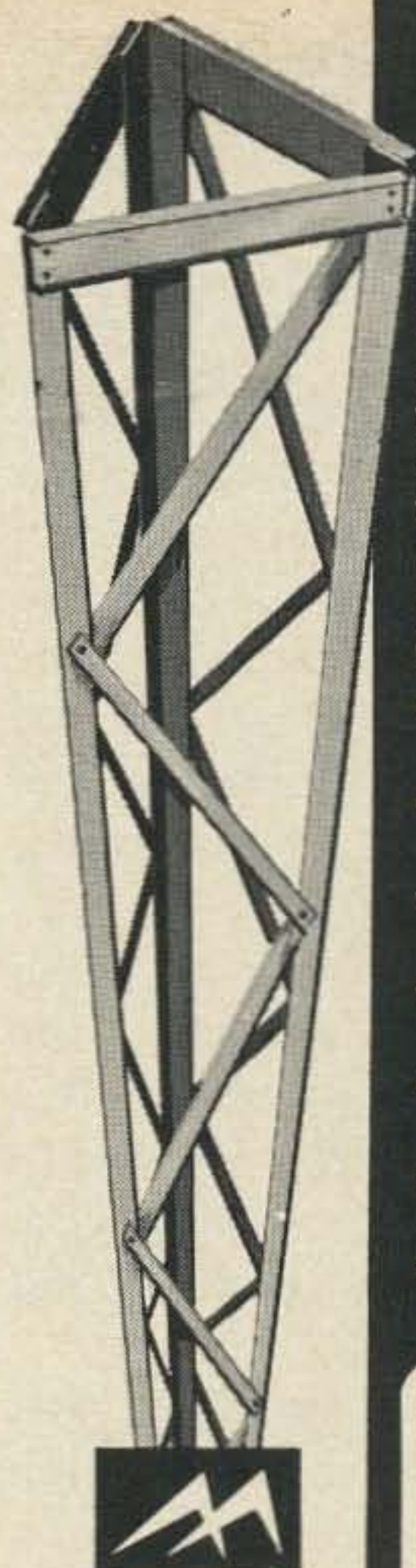

Fig. 3. Attenuation curve shows how isolation problems can be simplified by providing more spectrum between the repeater operating frequencies. As shown, the attenuation requirement gets extremely severe with close-spaced channels.

apart horizontally or by spacing them about 8 wavelengths vertically.

Since the spacing is directly proportional to wavelength, the higher frequencies require less distance between antennas to achieve a given isolation value. It is easier, for example, to isolate 146.94 from a 147.00 MHz transmitter than it is to isolate 146.70 from 146.76 MHz, even though the spectrum between the two sets is the same (60 kHz). From Fig. 2, 100 ft of vertical separation is needed between the antennas on the top end of the spectrum, and 116 ft is required to give the same degree of attenuation for the lower set.

The curve of Fig. 3 shows the attenuation required as a function of spectrum spacing between the two repeater operating frequencies. When you consider that each 6 dB of attenuation represents halving the field strength (in measurable voltage) at the receiving antenna, it is not too difficult to see why repeater owners keep the transmit and receive frequencies as far apart as possible. Consider the attenuation requirement for a 60-kHz-separated repeater, for example, as compared with a repeater system with operating frequencies spread by 600 kHz. As the frequencies are brought together, the



## AL SERIES ALUMINUM TOWERS for uhf - vhf

Ideal for mounting industrial, commercial, citizens band, amateur, or television receiving antennas. Exceptional strength in proportion to weight qualities. Easy access to equipment mounted on the Microflect top mast extension.

Other features are:

- 10 to 120 feet high in easy to erect 10 foot sections.
- Available factory assembled or in kit form.
- Lightweight all aluminum 10 foot sections weigh only 12½ lbs.
- Low maintenance, will never rust or require painting.
- Staggered ladder treads for easy climbing.
- Can be used for direct radiator at HF.
- Wide variety of mounting brackets and accessories available

DISTRIBUTOR INQUIRIES  
INVITED

**MICROFLECT**

3575 25th STREET  
SALEM, OREGON 97302  
AC 503-363-9267 TWX 510-599-0107

## THE BEST 2 METER CONVERTER

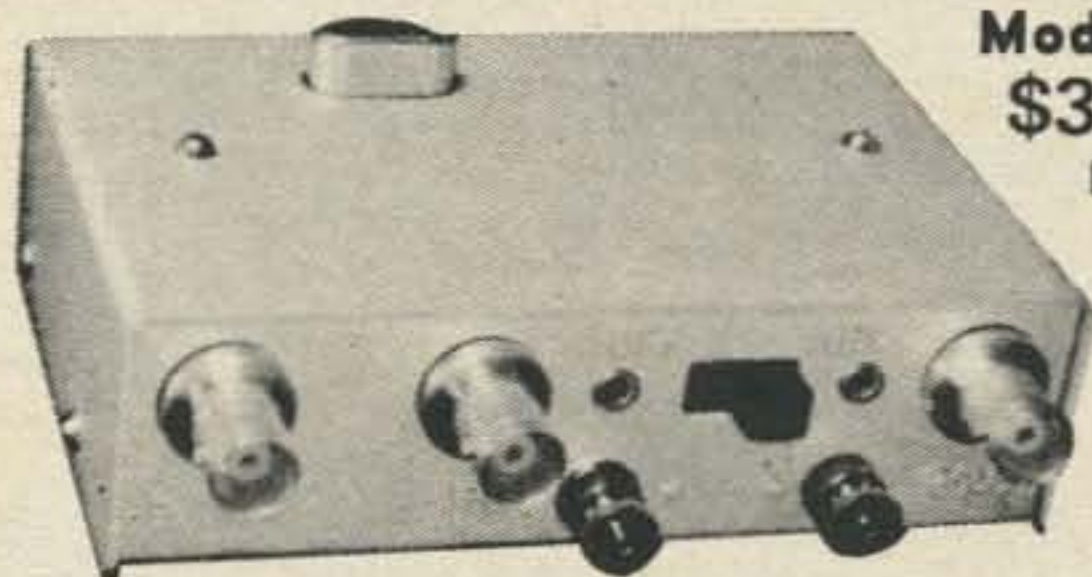

Model 407  
\$39.95  
ppd.

144-146 MHz in. 28-30 MHz out  
or 146-148 MHz with a second crystal  
Available at \$4.95 each.

A full description of this fantastic converter would fill this page, but you can take our word for it (or those of thousands of satisfied users) that it's the best. The reason is simple—we use three RCA dual gate MOSFETs, one bipolar, and 3 diodes in the best circuit ever. Still not convinced? Then send for our free catalog and get the full description, plus photos and even the schematic.

Can't wait? Then send us a postal money order for \$39.95 and we'll rush the 407 out to you. NOTE: The Model 407 is also available in any frequency combination up to 450 MHz (some at higher prices) as listed in our catalog.

\*New York City and State residents add local sales tax.

**VANGUARD LABS**

Dept. H, 196-23 Jamaica Ave., Hollis, N.Y. 11423

attenuation requirements get downright formidable.

If your tower will not permit the minimum separation distance as determined by the charts, you will have to plan on either more spectrum between the transmit and receive frequencies or incorporation of additional isolation measures, such as cavities or hybrid rings. The only other alternatives are placing the receiver site physically at some distance from the transmitter or separating the two antennas horizontally by mounting them on two different towers.

It should be understood that an isolation factor of 60 dB (which the 600-kHz-spread figures are based on) is a minimum, and it results in a desensitization level of about 2 dB — a value considered acceptable by most amateur and professional repeater men.

Horizontal separation is usually a last resort because it may take as much as ten

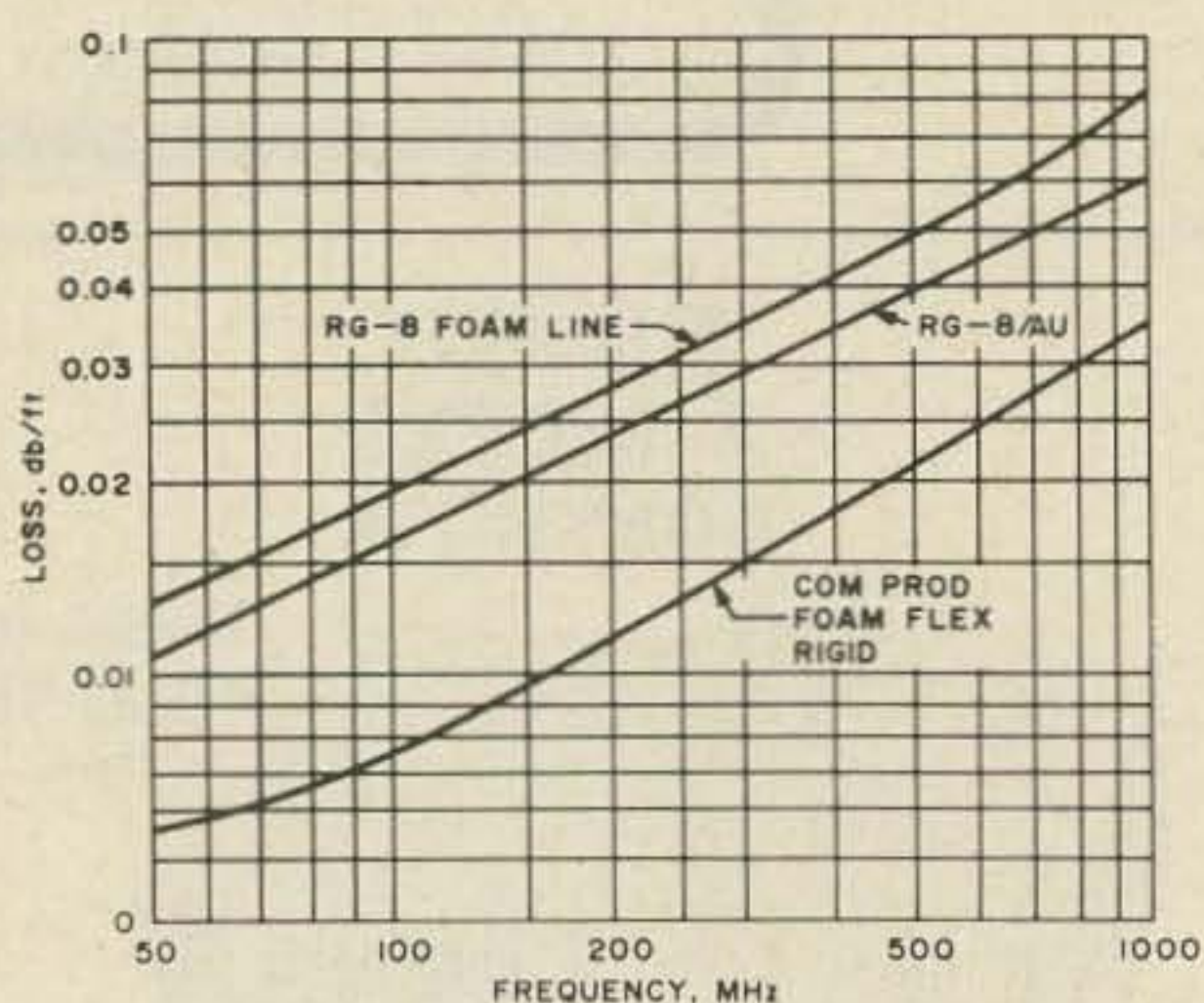

Fig. 4. This chart shows the superiority of foam line over conventional RG-8A/U cable. For a 100 ft run there is 0.5 dB less loss with their "equivalent" foam line at 150 MHz, and only 1 dB of total loss with ComProd's rigid foam line.

times the distance horizontally that it takes vertically to achieve a given attenuation level. In the 60 dB attenuation example above, for instance, a vertical separation of only 45 ft does the job. If the antennas are to be separated horizontally, however, the physical spread between the two antennas must be increased by no less than 322 ft. This

characteristic is attributable to the fact that antennas typically radiate most of their energy in an almost perfect horizontal plane. Not only does the transmit antenna pump out more radiation horizontally, but the receiving antenna is pulling in signals better along that plane. With vertical separation, though, both antennas are placed in a position least susceptible to direct radiation of the other.

Another major disadvantage of horizontal separation with a single-site repeater is the excessively long runs of transmission line usually required. No matter what type of coaxial cable is used, a 400 ft run means plenty of signal loss — particularly at the higher frequencies. Figure 4 shows just how much loss you can expect with RG-8A/U and foam-line equivalents at the various VHF and UHF frequencies of interest to amateurs. At moderate power levels, extremely long runs of conventional coax would seem almost prohibitive, even at 150 MHz. A figure of 0.025 dB/ft for signal attenuation may not seem like much, but it results in a 10 dB loss with a 400-ft length of transmission line — which is a power loss of a full order of magnitude, turning fifty watts into a measly five.

Use of a very high grade of line, such as Communication Products' rigid Foam-Flex, will cut the loss to about 1 dB per hundred feet; a better alternative, of course, but still a significant loss. And consider the cost of a 400 ft length of this "good stuff." It isn't cheap!

Clearly, horizontal separation of antennas is not a sound solution from a single site under ordinary conditions, particularly on the lower VHF frequencies.

All this discussion is not meant to be a course in repeater planning; the object is merely to help you determine the best possible way of providing good solid repeater coverage using only the facilities that you have available.

#### Tricks You Can Do

If you looked at the vertical separation charts of Figs. 1 and 2 and decided that there was not enough room on your

# GOOD NEWS FOR CANADIAN AND LATIN AMERICAN HAMS...

Now you can enjoy the fabulous  
Varitronics line of amateur  
VHF FM equipment too!

Like the IC-2F . . .



completely solid state,  
2 meter FM transceiver,  
20 watts, 6 channels  
with a super hot receiver

And other transceivers and accessories, too.

Get full particulars on the  
equipment that has swept the  
U.S. For your nearest  
distributor write . . .

## CANADA

Marathon Agencies, Inc.  
4105 11th Street S.E.  
Calgary 24, Alberta

## LATIN AMERICA

Carvill International Corp.  
P.O. Box 4039  
Foster City, California 94404

## UNITED STATES

See your local distributor  
or

# VARITRONICS INCORPORATED

2321 E. University Drive  
P.O. Box 20665  
Phoenix, Arizona 85036

tower to accommodate both your repeater antennas, don't resort too soon to going the horizontal route. There are still a few more aces you can play.

Many service specialists – both commercial and amateur – are surprised to learn that when “gain” antennas are spaced vertically, one or the other of the two may be moved a few inches *horizontally* to yield an *effective* increase in separation distance and a positive improvement in signal isolation by as much as 3 dB. This interesting phenomenon can be explained on the basis of the radiation-pattern peculiarities of individual antennas (though virtually all of the collinear omnidirectional antennas are similar). From the typical pattern of Fig. 5, you will notice that a collinear omnidirectional gain antenna produces lobular “spikes” below the radiator and along the same axis. Most antenna manufacturers publish typical patterns (as in Fig. 5a) that show a symmetrical placement of these minor lobes. In practice, however, these lobes are not necessarily symmetrical, even though they are always present. Their appearance will depend on such factors as antenna placement, distance from tower, size of mast, etc., and they will rarely form the symmetrical arrangement sketched in Fig. 5a. The measured pattern will form a hodgepodge of lobe spikes as pictured in Fig. 5b.

If the lower antenna is positioned at the null between these spikes, maximum attenuation will result. If the lower antenna is centered on one of the lobes, however, adequate isolation may be very difficult to achieve. A few inches to a foot laterally may make all the difference in the world!

One excellent way to determine the best position for the second antenna is to take actual field-strength measurements at various candidate locations on the tower while the transmitter is pumping a signal into the first (mounted permanently). For vertical-separation checks, load the transmitter into the upper antenna (even though it may eventually become the receiving antenna), then do a thorough job of checking the field strength of the

signal at various positions lower on the tower. When an optimum location is found, mount the antenna there loosely, then connect it directly to the field strength measuring device. While monitoring for a null, move the antenna as much as possible within its confines. Then secure it when the reading is optimum.

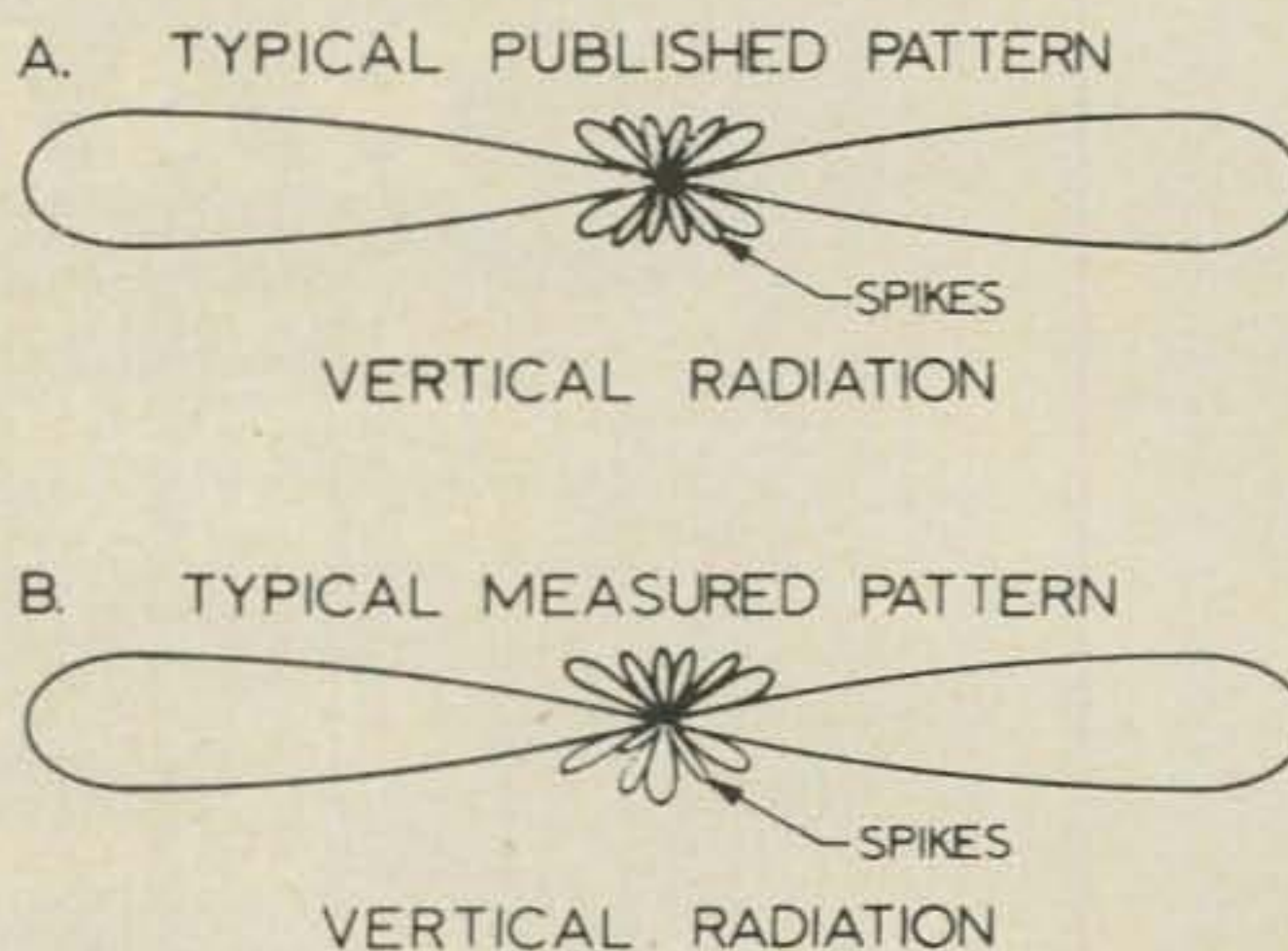

Fig. 5. The measured radiation characteristics of an antenna will often differ from that specified, particularly with the minor lobes directly above and below the radiator. Published patterns show symmetrical minor lobes with a null directly above and below the antenna. Actual measurement may show nulls slightly off-axis from the radiator. Experimentation with one of the repeater antennas will quickly show where the null points are.

Another trick in common use is the inversion of one of the two vertically separated antennas. With gain antennas, this procedure may not offer some of the fallout advantages to be realized with groundplanes because most gain antennas have a characteristic radiation in an almost perfect horizontal plane. So there is rarely an actual signal improvement when a gain antenna is inverted, but the reduction in desensitization can certainly make it worthwhile. If the vertical lobes of the upper gain antenna (that is, the spikes extending directly below the upper antenna) are difficult to avoid with the lower, turning the *top one* upside-down and jockeying for position will almost certainly cure the problem, *provided the tip-to-tip spacing between the two antennas can be preserved*. If the tip-to-tip spacing must be compromised by invert-

ing the higher of the two antennas, it might be wisest to try inverting the lower one. This tends to increase tip-to-tip spacing, but could cause problems of interference with other structures if the lower antenna is mounted in the vicinity of a rooftop, the ground, etc. Individual installations will have to be made on the basis of these considerations.

*An important note:* When a gain antenna is inverted, great care must be taken to insure that *absolutely no moisture* gets into the fiber-glass casing. A little water and you can kiss your expensive antenna goodbye.

Groundplanes make particularly good antennas for inversion because they characteristically have a very high angle of radiation (generally about 23 degrees above the horizon). Inverting the *lower* one will provide the highest degree of signal isolation, and will probably get you a little extra gain on the low horizon because of the change in primary radiation angle. Inverting the upper one may or may not help your desensitization, but it will certainly improve your radiation angle. Your best bet is to try it both ways — first the lower antenna, then the upper one. At least with groundplanes, there is no need to fear compromising the tip-to-tip spacing between antennas.

### The Last Step

There is still one other repeater improvement technique that can be employed, but it is the one least used by repeater people. It takes practically no effort, and results in a system that is greatly improved in terms of actual usefulness. The trick? Nothing more complicated than a simple adjustment of the repeater squelch. But for some reason — no doubt intrinsically involved with ego in some way — repeater owners are all too frequently quite reluctant to do it.

The rule is this: Don't set a loose (sensitive) repeater squelch unless the transmitter can reproduce a weak input signal without degrading the performance of the receiver. The problems I incurred during my trip could have been avoided completely if the local repeater talent had

adjusted the repeater squelch to a realistic level. When my signal was too weak into the system to overcome the desensitization problem, it should have been kept from being repeated and providing an annoyance to the local stations who monitor the frequency. Repeater owners should bear in mind that even if a repeater can be activated by a weak station, this is not necessarily a guarantee that the output signal will be copyable by the users. And there is nothing so disconcerting as a repeater being constantly keyed by unintelligible signals.

Many convention-goers found this out at the recent Orlando hamfest when a hastily installed repeater was set to retransmit threshold signals. A number of walkie-talkies were turned off because of the annoying and unintelligible garbage that was being relayed the first night. A flick of the wrist at the receiver on the second morning of the FM convention, however, cured the problem, and the repeater was once more the useful and enjoyable communications medium that it was designed to be.

In short, if the range of the receiver doesn't match that of the transmitter, look for excessive desensitization. If you seem to have that problem whipped and the range imbalance still exists, try lowering the transmitter power. This will achieve the dual purpose of dropping whatever desensitization that may still exist and effectively bringing the range of the transmitter in to more closely approximate that of the receiver. Finally, set the squelch on the receiver so that those signals too weak to be copied do not even get repeated.

The result? Your repeater will be as busy as ever, but with cleaner signals — and you'll find more people monitoring more often during the inactive periods. But most important, your repeater may get the reputation for having input and output coverage that is ideally balanced. What better compliment to your system than to have people say, as they do of the Buffalo repeater, "If you can hear it, you can use it!"?

. . . K6MVH ■

# More Notes on Diode Stacks

While reading K6KA's excellent article on diode stack power supplies (73 Magazine, September 1969), I thought of a recent experience I had where I replaced two 3B28's with silicon rectifier stacks. The particular power supply used was a 3 kV centertapped transformer, 8  $\mu$ F oil-filled capacitors, and a 50 $\Omega$  current-limiting resistor. A relay in the primary of

the transformer is connected to the push-to-talk relay in the transceiver and push-to-talk operation is normally used.

I obtained some GE rectifier modules (Part A1423) rated for 5 kV at 300 mA and substituted them for the tubes. The only special precaution I took was to keep the leads short. No special transient suppression circuits were used and the power

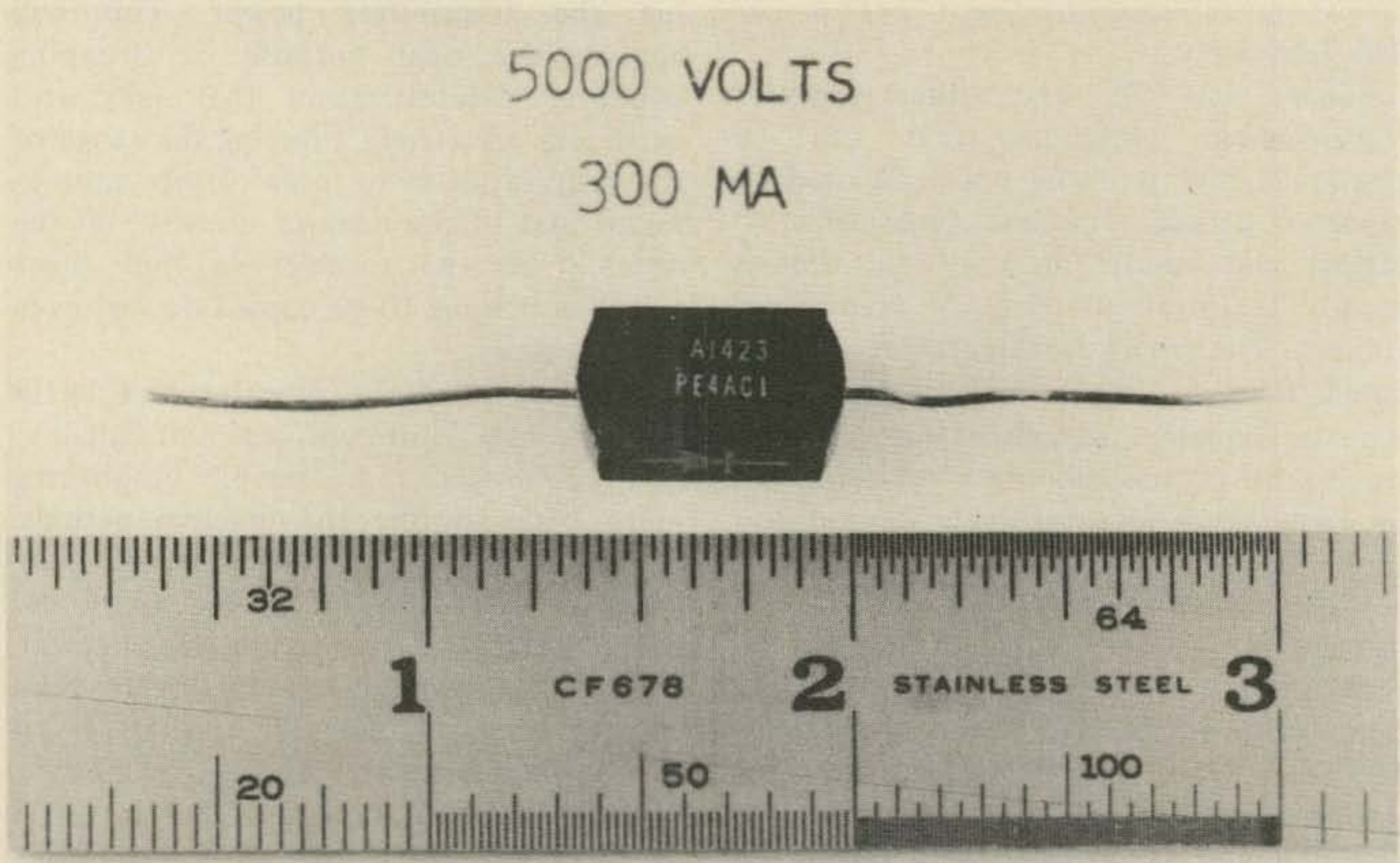



GRUNDIG

## SATELLIT-AMATEUR 210

# Yes, it copies Sideband and CW too!

**FOR SHORTWAVE** A highly sensitive receiver whose selectivity can be switched to wide or narrow for optimum results on sideband or AM. And for serious DXing, just plug in an external antenna.

**FOR FM** Hi-fi quality through broad bandwidth, high-power audio, and multiple speaker arrangement.

**FOR SWL** Easy tuning on a number of selectable bands. This receiver is sensitive enough to pull in even the weak stations without an external antenna.

*Operated by Hams  
... for Hams*

# Dymond

**ELECTRONICS**

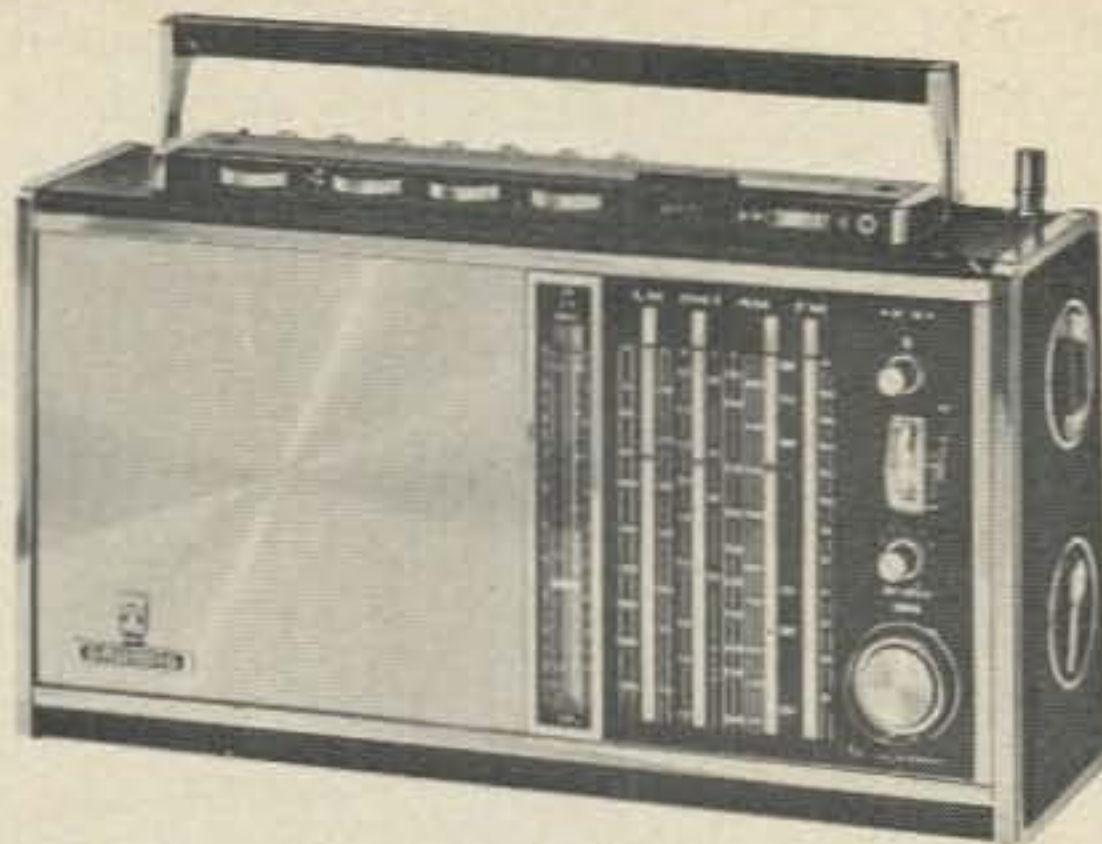

Function	Band (MHz)	
Bandspread	28.3-29.8	Longwave
Tuning	26.9-28.3	150-450 kHz
(includes CB)	20.9-21.7	
	13.8-14.5	
(includes CHU)	7.0-7.35	Broadcast Band
(SW Broadcast)	5.95-6.25	510-1650 kHz
	3.5-3.8	
	1.7-2.0	HiFi FM (Wideband)
(includes 75m)	1.6-5.0	88-108 MHz (AFC)

AC OR BATTERY - S-METER  
BUILT-IN ANTENNA

\$225.00 PREPAID  
Anywhere in the Continental USA  
Certified Check or Money Order

501-515 Blackstone - Fresno, Calif. 93701  
209-266-9644

supply has been operating satisfactorily for about six months. The photo of the rectifier module shows its small size.

Higher voltage stacks are available from GE in the same package; however, I recommend using two of the 5 kV stacks in series to obtain higher voltage ratings, as necessary. Use of a voltage rating considerably above the peak voltage to be expected will insure a long trouble-free life.

The units are relatively inexpensive (about \$4 each) and are advertised to be avalanche-protected. As with any semiconductor rectifier, the factor limiting the current rating is the heating of the junction, which is caused by the forward current and the voltage drop across it.

In order to safely exceed the current rating of a rectifier or module, the heat must be removed. The easiest way to do this is using short leads to a heatsink; other ways are by heatsinking the body of the unit, by blowing cold air past the unit, or by adding radiating fins.

Most rectifiers are rated at a temperature above room ambient and this adds a little leeway in the current rating. For ex-

ample, the 300 mA rating of the 5 kV module referred to earlier is at 50° C and ½ in. lead length, at 25° C the rating is over 350 mA. With single sideband equipment, rectifiers get a chance to cool between voice peaks and most power supplies are full-wave, which reduces rectifier heating somewhat.

The usual cause of failure in low-current silicon rectifiers is loss of blocking capability rather than forward current overload. Loss of blocking capability is often caused by voltage transients exceeding the rating of the rectifier - hence, the recommendation for a large voltage safety factor.

Avalanche- or transient-protected rectifiers will usually handle a small amount of power in the reverse direction, where small voltage pulses may be higher than the rating; however, it is much safer not to operate close to the voltage rating.

I have had good luck with these rectifier modules even though I'm probably not using them as the manufacturer intended.

...W2BDG

R. Jayaraman (Engg.) VU2JN  
Assistant Professor  
College of Engineering  
Trivandrum-16  
India

# DELUXE RECEIVER GAIN CONTROL

**I**t is well-known that for obtaining optimum gain and noise figure, the front-end of a tube-type high-frequency communications receiver should employ a high-transconductance sharp-cutoff pentode run at maximum gain without agc. However, most commercial receivers use a variable- $\mu$  pentode for the convenience of easy gain control.

When I pulled out the 6SG7 amplifier in my receiver and directly substituted a 6SH7 sharp-cutoff pentode, the improvement in the sensitivity and noise figure of the receiver was truly remarkable. The plate voltage was 250V and the screen voltage 100V. A cathode bias resistor of 100 $\Omega$  was provided and agc was disconnected from the first stage.

This improvement in performance,

however, is accompanied by a drawback. With strong signals, there is overloading of the mixer, resulting in distortion and audio splashing. This can be eliminated by inserting a separate gain control in the form of a potentiometer in the cathode line of the rf amplifier. Although the range over which the gain of a sharp-cutoff pentode can be varied without curtailing its signal-handling ability is limited, sufficient variation in gain does occur to prevent overloading of the mixer with strong signals.

When using a sharp-cutoff pentode in the front end, the ideal way of controlling the receiver gain is therefore to run the rf amplifier at full gain on all but very strong signals, and reduce the gain just to the extent necessary on strong signals. Figure 1 shows a circuit in which the rf gain of the

# Important E & E Amateur Books from SAMS

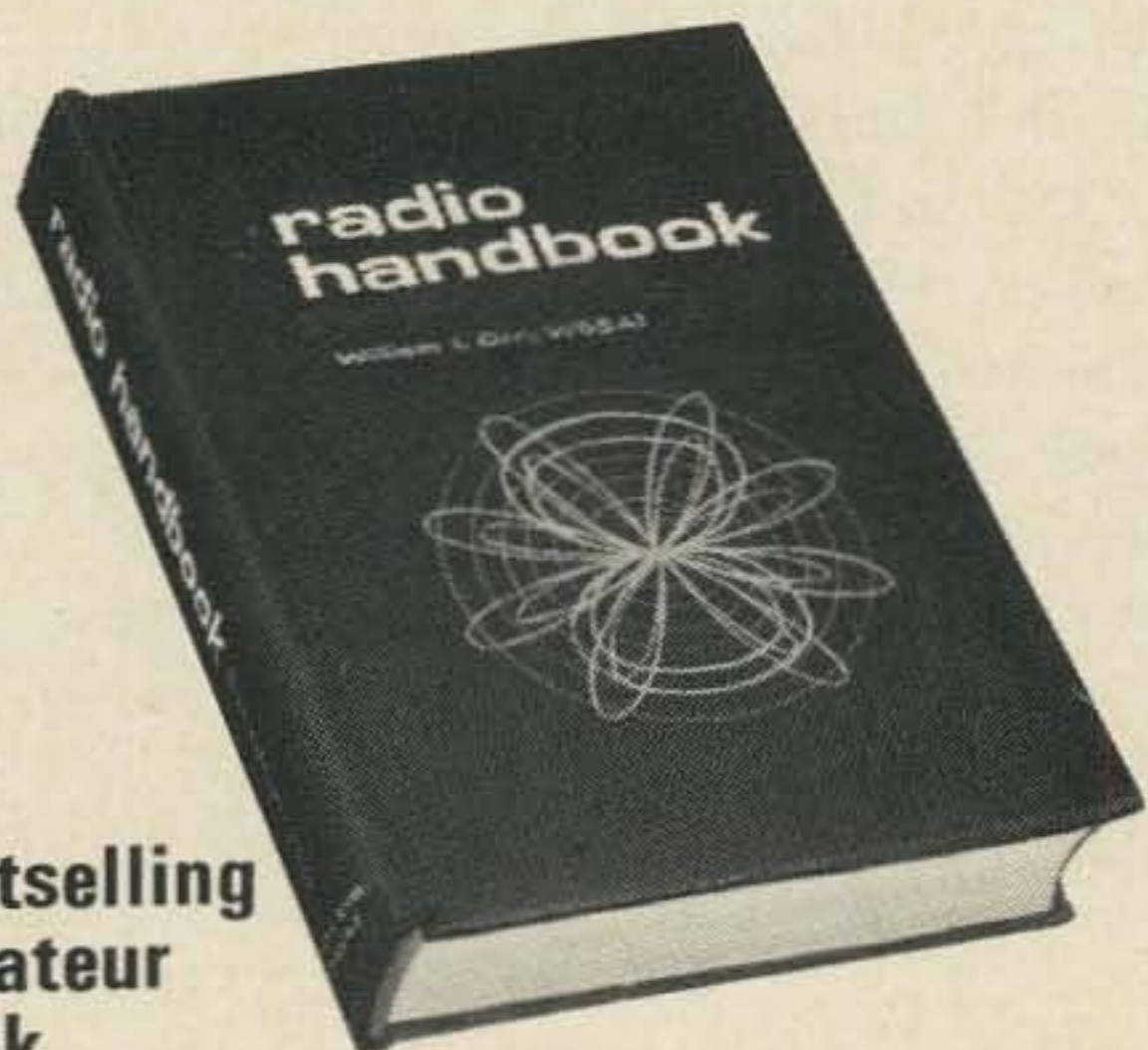

the  
bestselling  
Amateur  
book

## New 18th Edition of the famous E & E RADIO HANDBOOK

by WILLIAM I. ORR, W6SAI

Completely updated edition of the famous communications handbook which is the electronics industry standard for engineers, technicians and advanced amateurs. Explains in authoritative detail how to design and build all types of radiocommunications equipment. Includes SSB design and equipment, RTTY circuits, latest semiconductor circuits and IC's, as well as special-purpose and computer circuitry. 896 pages; hardbound. Order **24020**, only... **\$13.50**

latest E & E title

## The Radio Amateur's F-M Repeater Handbook

by KEN SESSIONS, JR., K6MVH

This is the definitive work on the momentous and challenging subject of amateur f-m repeaters, a vital new development which has been virtually undocumented. Chapters

include: Preparing and Obtaining Sites for Repeaters; How to Build a Repeater; Repeater Applications. Includes an F-M Repeater Directory. There is no other comparable book available. 228 pages; hardbound. Order **24008**, only... **\$6.95**

## 73 Vertical, Beam, and Triangle Antennas

by EDWARD M. NOLL, W3FQJ

Describes the design and construction of 73 different antennas used by amateurs. Each design is the result of the author's own experiments with various antenna configurations; each has actually been built and air-tested by the author. Includes appendices covering the construction of noise bridges and antenna line tuners, as well as methods for measuring resonant frequency, velocity factor, and standing-wave ratios. 160 pages.

Order **24021**, only... **\$4.95**



## Single Sideband: Theory and Practice

by HARRY D. HOOTON, W6TYH

This one-source guide emphasizes basic principles and circuitry of ssb. Covers the origin of ssb, the derivation of ssb signals, carrier-suppression techniques, sideband selection, and a complete analysis of all types of ssb equipment. Order **24014**, only... **\$6.95**

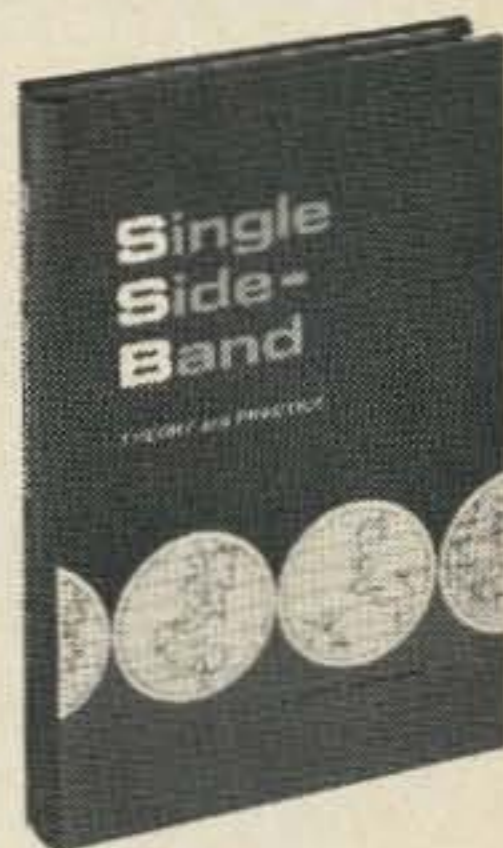

## 73 Dipole and Long-Wire Antennas

by EDWARD M. NOLL, W3FQJ

This is the first compendium of virtually every type of wire antenna used by amateurs. Includes dimensions, configurations, and detailed construction data for 73 different antenna types. Appendices describe the construction of noise bridges, line tuners, and data on measuring resonant frequency, velocity factor, and SWR. 160 pages. Order **24006**, only... **\$4.50**



**EDITORS and ENGINEERS**

Howard W. Sams & Co., Inc. Dept. 73-080  
4300 W. 62nd St., Indianapolis, Ind. 46268

Send the following books: Nos. \_\_\_\_\_

\_\_\_\_\_ \$ \_\_\_\_\_ enclosed

Send FREE 1970 Sams Book Catalog

Name \_\_\_\_\_  
PLEASE PRINT

Address \_\_\_\_\_

City \_\_\_\_\_ State \_\_\_\_\_ Zip \_\_\_\_\_

Order from your electronic parts distributor or send coupon at right.

front end is electronically locked to the i-f gain and tracks with it in the desired manner. The circuit needs just one transistor, a zener, three resistors, and a bypass capacitor. The values of the three resistors shown in the figure should be taken only as a rough guide; for every receiver, the proper values of the resistors are to be determined experimentally, as explained below.

To start with, a 10 kΩ potentiometer is temporarily used as a separate rf gain control. A very strong signal is tuned in

and the gain control is backed up until all traces of front-end overloading disappear. The resistance of the potentiometer then gives R1. The corresponding cathode bias will be of the order of 4–6V.

R2 determines the cathode bias at full gain. Its value depends on the tube and transistor characteristics and should be determined experimentally so that the cathode bias at full gain is the recommended value for the tube (–1.0V for 6AU6 and 6SH7; –2.0 volts for 6AH6 and 6AC7).

**V1: 6AH6, 6AU6, 6AC7 OR 6SH7.**

**V2, V3: 6BA6, 6SG7 OR 6SK7.**

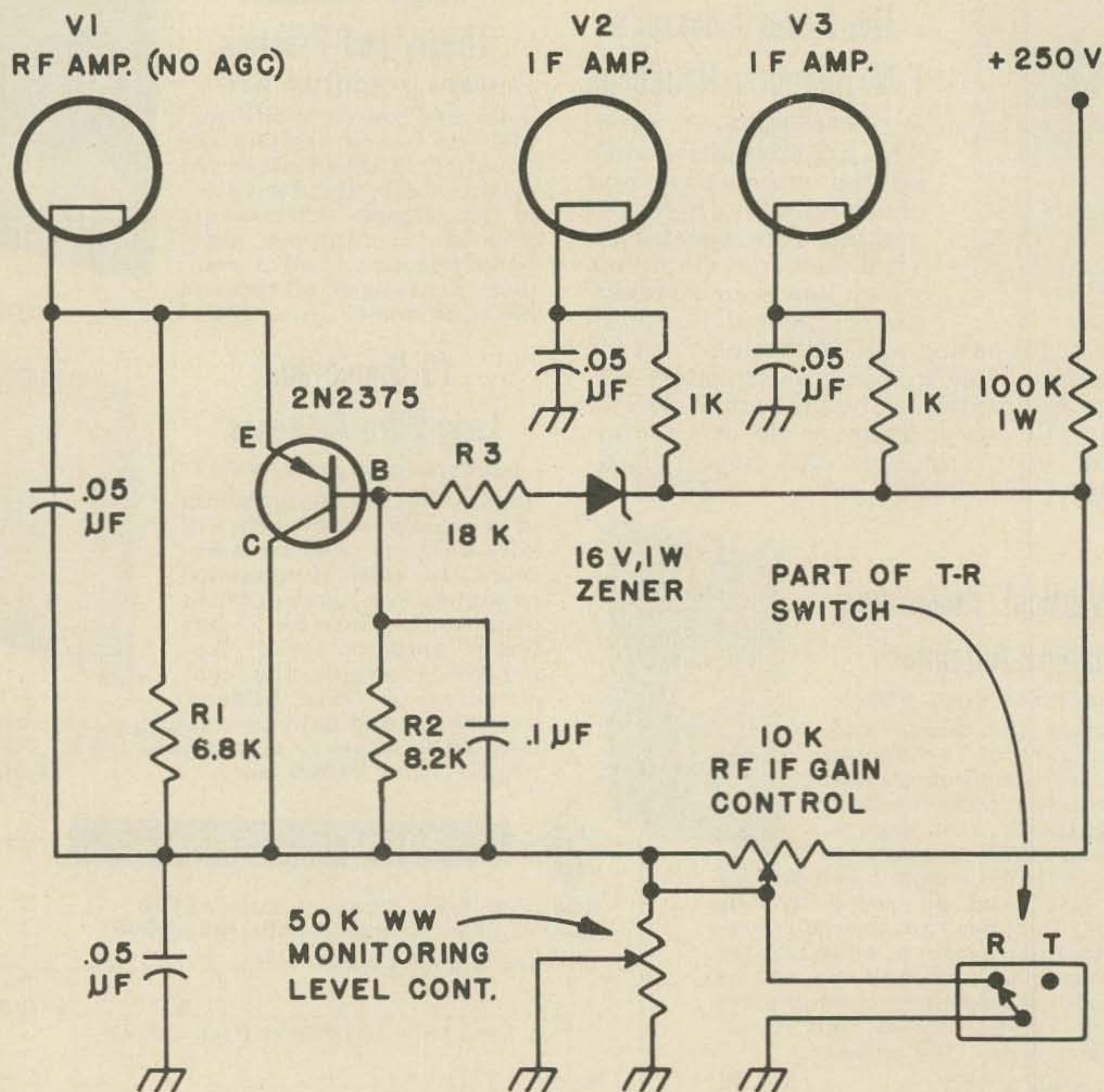

Fig. 1. In this circuit the front-end gain is "locked" onto the i-f gain and tracks with it.

The zener determines the bias voltage at which the rf gain begins to track with the i-f gain. Zeners in the voltage range of 16–22V will be in order. I did not encounter any noise or avalanche problem in using the zener. As the bias voltage of the i-f stages rises, the zener current increases the base voltage of the transistor and lowers its conduction, thus raising the cathode bias of the rf amplifier.

R3 governs the tracking of the rf gain with the i-f gain. Its value should be such that with the gain control at minimum, the cathode bias of the rf amplifier just approaches the maximum usable bias determined at the outset.

The transistor used should be a low-leakage high-gain PNP germanium transistor. The 2N2375 which I used showed an  $I_{ceo}$  of less than 100  $\mu A$  and a beta of 100 under normal test conditions. Since the transistor has practically negligible collector dissipation, it is able to survive in the very unfavorable surroundings inside the receiver chassis!

In the transmit position, the 50 k $\Omega$  monitoring level control comes in series with the rf gain control. This overbiases the i-f stages while the rf amplifier, in view of its sharp-cutoff characteristic, gets completely cut off. This permits comfortable monitoring of the transmitted signal.

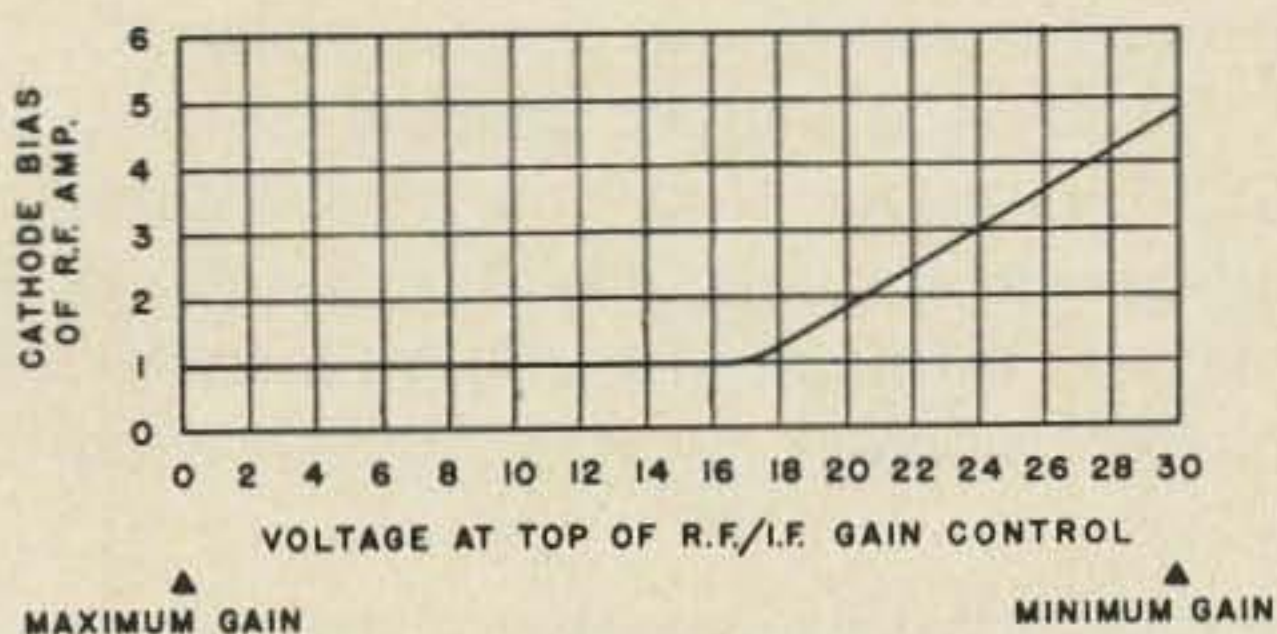

Fig. 2. Tracking curve shows smooth voltage transition with increased voltage bias.

Figure 2 shows the observed smooth tracking of the rf stage bias with the i-f stage bias. Flattening of the right end of the curve due to the transistor getting cut off can be avoided by increasing the value of R3. The performance of this gain control leaves little to be desired.

... VU2JN ■

## MORE RANGE . . . with NO NOISE

**FOR ALL  
MOBILE UNITS**

**ESTES ENGINEERING COMPANY**  
ELECTRO-SHIELD

CUSTOM SYSTEMS  
KITS • ACCESSORIES

**ELIMINATE IGNITION NOISE  
ELECTRO-SHIELD®  
YOUR ENGINE**

FROM \$44.95

**ESTES ENGINEERING CO.**  
543 W. 184th St., Gardena, Calif. 90247

Getting a  
QRP  
complex?

**Boost your ego  
AND your talk-power  
for \$25.00**

Install the fully-guaranteed  
**RPC-3 SPEECH COMPRESSOR**  
in your HW-100, SB-101, SB-401  
or any other rig.

SEND YOUR ORDER OR INQUIRY TO  
**R<sub>P</sub> ELECTRONICS**  
BOX 1201, CHAMPAIGN IL 61820

MODEL RPC-3                      \$24.95 ppd.

# *A New Approach to* Communications Equipment

New amateurs are aware of the cost to develop new pieces of amateur equipment. This cost can sometimes run into millions of dollars. Most amateurs are aware of the high cost of quality equipment with all the features they might want. The three traditional methods of beating this high cost: buying used equipment, building your own, or modifying surplus; each leaves something to be desired. Additionally, improvements in circuits and various other changes tend to leave the amateur with the choice of extensively modifying complex equipment or buying new gear. This need not be. There is an approach to designing communications equipment that can significantly reduce these

problems, while providing almost infinite flexibility.

In my field of high energy physics, experiments are controlled and results recorded by racks and racks of electronic modules. Since each experiment is quite different from any other in logic and control, this equipment is assembled from small plug-in modules of simple logic functions which can be connected in an infinite variety of ways. This same approach should be used in communications equipment.

Figure 1 is a block diagram of a typical SSB transceiver. Note how it can be broken down into a simple group of functions. By placing different functions in different plug-in modules, a very flexible piece of

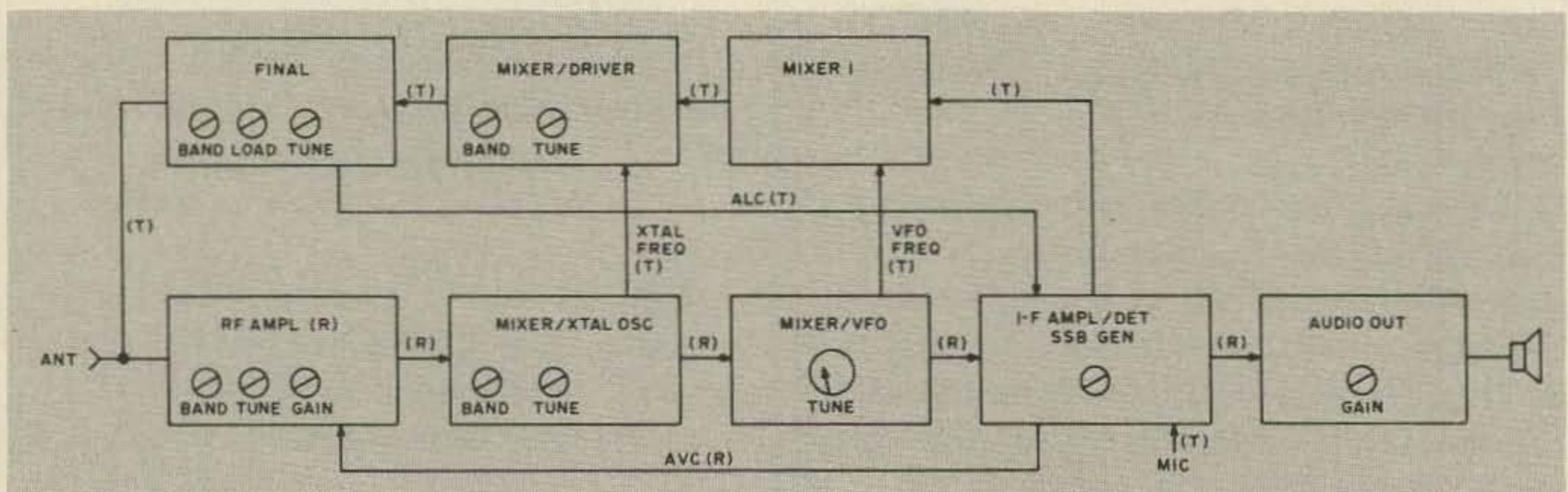

Fig. 1. Block diagram of a typical SSB transceiver.

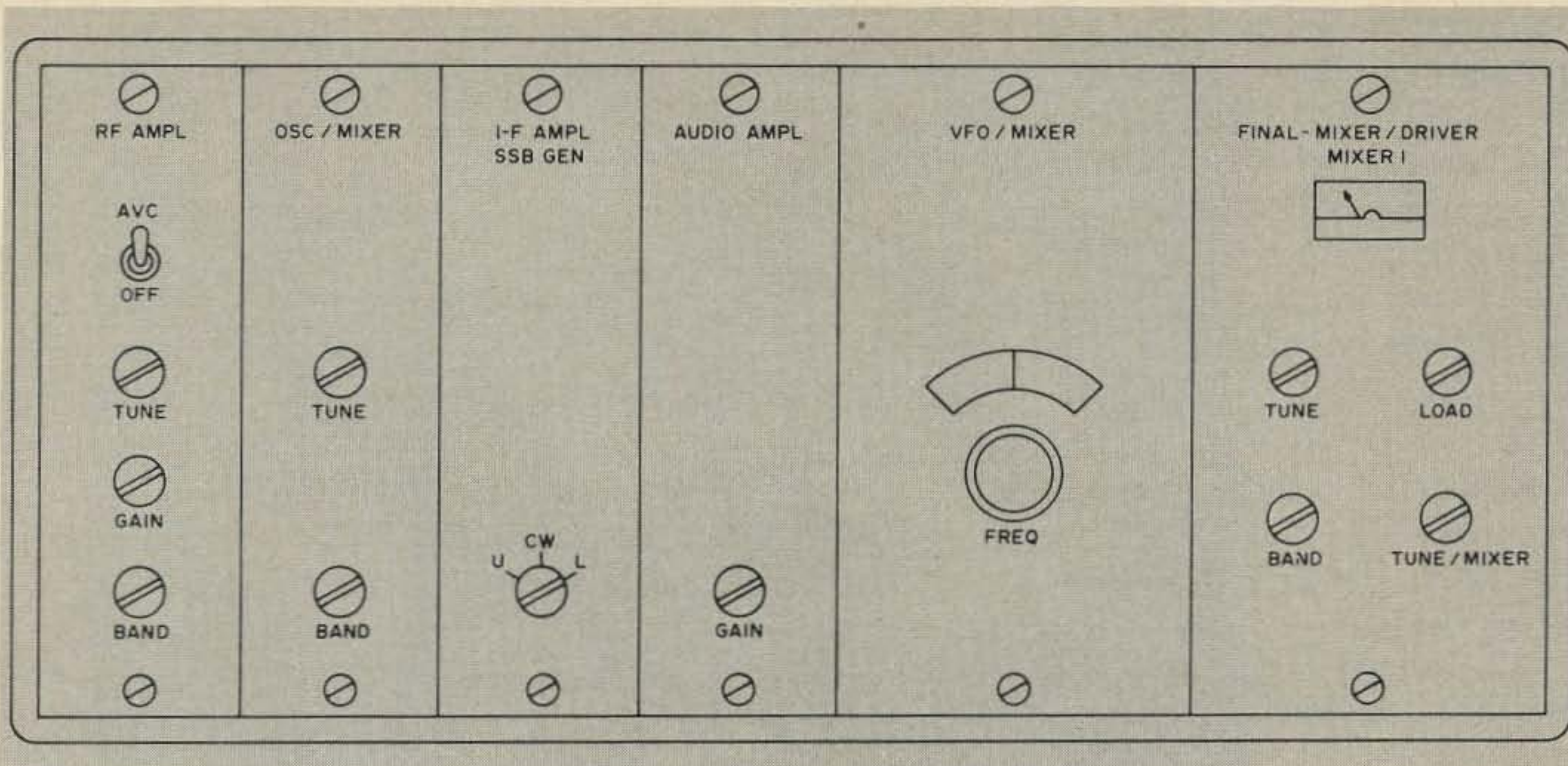

Fig. 2. Front view of a typical SSB transceiver.

equipment emerges. Figure 2 is a front view of such a transceiver. Several functions are combined in some of the modules to fit into one chassis. If separate chassis are used for transmit and receive, some of the modules would need to appear in only one and serve both chassis if desired. If the chassis design, connector, and signal specifications are standardized among various manufacturers, then any module purchased from any manufacturer or one made at home can be used interchangeably. The user can purchase only those functions he wishes to use and not be required to pay for undesired capabilities. He may choose to purchase each module from a different manufacturer or build his own, depending on which is most appropriate for him. Men who like to experiment may easily replace a module such as the rf with his own creation instantly for direct comparison. This standardization would drastically re-

duce the development costs of new equipment. Manufacturers could concentrate on building better and less costly modules to perform the many different functions various hams desire. It would drastically reduce the problem of converting to other uses, such as MARS, military, RTTY, TV, or whatever, simply by plugging in the appropriate modules.

Figure 3 is a block diagram of a crystal-controlled 3–30 MHz transceiver for AF MARS presently under construction with this approach. As an example, Fig. 4 is a photograph of the component side of a complete 9 MHz SSB transceiver on a small printed circuit board. One LM-173 integrated circuit serves as a complete SSB/CW receiver with 9 MHz input and audio output with avc. The other LM-173 integrated circuit is an SSB/CW generator with 50 mV audio input and 9 MHz SSB output with alc. A McCoy filter is mounted on the

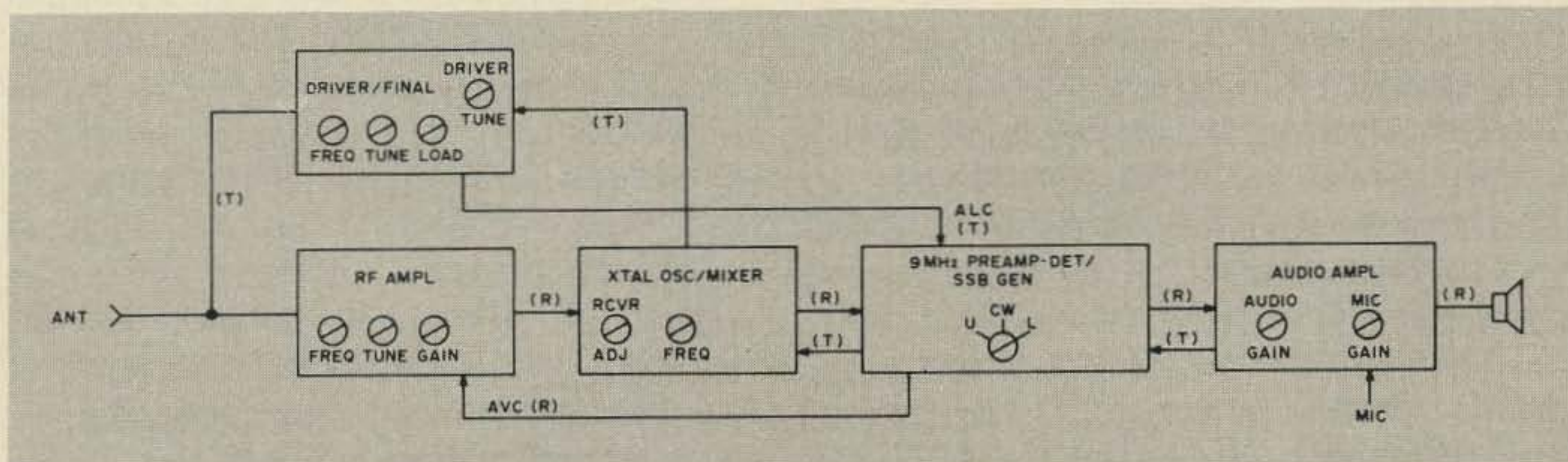

Fig. 3. Block diagram of A. F. Mars transceiver.

other side of the board for maximum isolation. The board could have been made much smaller, but I like lots of room between components for better isolation in such circuits. With the use of ICs and functional isolation, small, compact, and inexpensive modules may be constructed.

In order to make this approach work,

some agreements must be reached. I might suggest the following: Although most of these circuits will be solid state, room should be left for those who prefer tubes. Actually, most of the space requirements are dictated by control functions and connectors, not the circuits themselves. In order to prevent the need for expensive, complex controls, a fair amount of front panel space should be available. At any rate, for what they are worth, here are my recommendations:

- Front panel space: 16" wide x 6" high.
- Module width: 2" single, 4" double, etc.
- Power connectors: Blue Ribbon 24 pin every 2"
- Module depth: 6" — Rack depth: 8"
- Rf signal connectors: BNC
- Power supply connections:

Pin: 1 ground	13 alc
2 +24 vdc	14 avc
3 +12 vdc	15 ground
4 ground	16 ground on transmit
5 6.3 ac	17 ground on receive
6 6.3 ac	18 receiver audio
7 ground	19-24 spares
(6.3 ac return)	
8 -100 vdc	
9 ground	
10 +150 vdc	
11 +250 vdc	
12 ground	

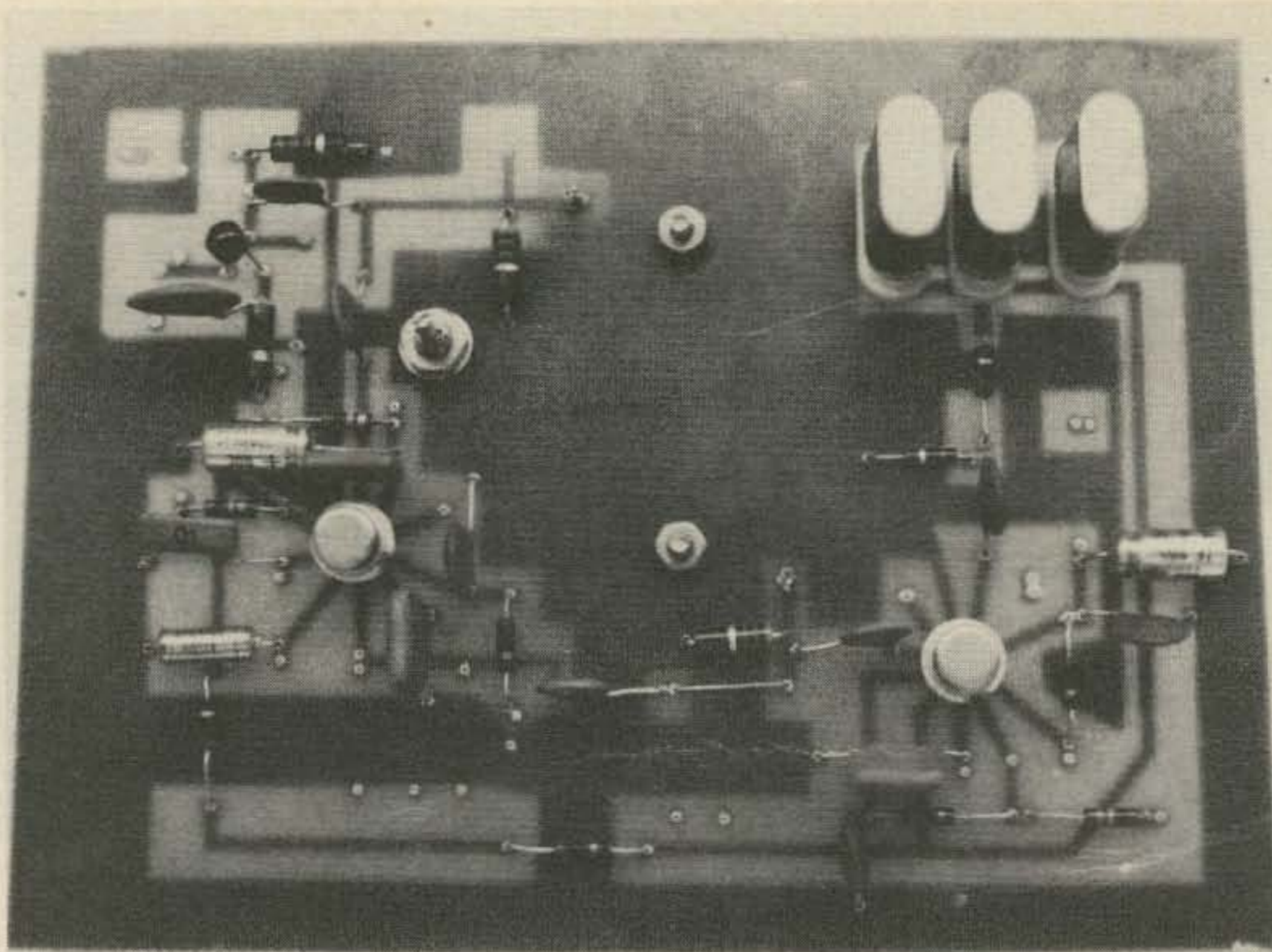

*Component side of a 9 MHz SSB transceiver.*

These pins are simply "reserved" for these voltages. They need not be supplied if not needed. For all solid state units, it is recommended that only the +12V be used so mobile operation may be used easily. Final high voltage to final (+750V) is supplied to that mobile on a separate connector.

Anyone could get into the communications equipment business by simply producing the racks first. Then they could add module chassis, power supplies, and modules as they grew. Fierce competition would drive prices down eventually, however, and should result in high quality, very flexible equipment at much more reasonable prices. System design costs would virtually disappear. Testing costs would also be reduced drastically, and fault isolation for the average ham much easier.

All in all, I feel it is the ideal approach to low cost, high quality, communications equipment, which can be assembled simply to perform any desired functions within the desires and budget of each user. It should also stimulate a lot of interest in homebrew to see if we can better the commercial boys and build a better "mousetrap" without undertaking a whole major project at once, thus improving our technical ability piece by piece.

... K9ALD ■



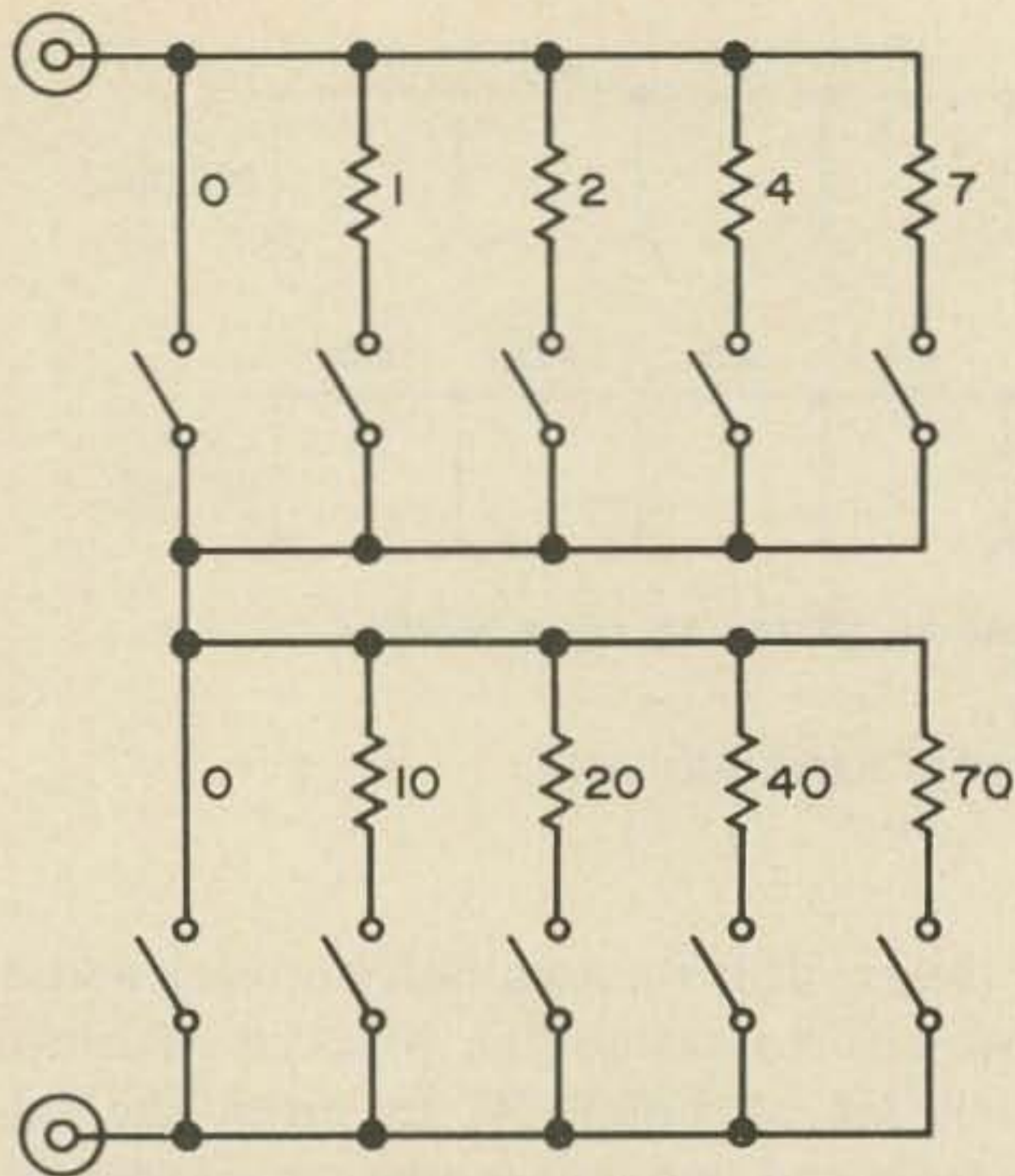

Fig. 3. Toggle switches and additional resistors extend the H decade.

Place panel on brackets in box and spot bracket holes. Remove panel and drill holes and tap with 6-32 tap. Eventually, attach panel to box with 6-32 x 1/4 in. machine screws.

#### Finishing the Box

The schematic and the operating instructions should now be attached under the box and inside the lid. The box should

be identified on the outside front with the name of the test equipment it houses, and the builder's call letters placed in the lower right corner.

Figure 1 shows a basic series resistance decade. It is made up of nine identical values of resistance, each of which can be calibrated to a single high-accuracy resistance. It is easy to build, as all the resistors can be soldered directly to the rotary switch. However, since it does require a greater quantity of resistors throughout, it could double the cost.

Another type of resistance decade is the H configuration of Fig. 2. This uses only four resistors mounted on a small subpanel. Note that the R1, R2, R4, and R7 values are used individually, but the other values are combinations of two resistor values. The connections are marked A to E; wires run between these points and the switching shown in Figs. 3 and 4. Figure 3 shows a dual decade resistance which uses ordinary toggle switches.

You will note that we have not talked about what the specific resistance values should be and what wattage resistors should be used. If you use composition resistors, it is suggested that 2W types be

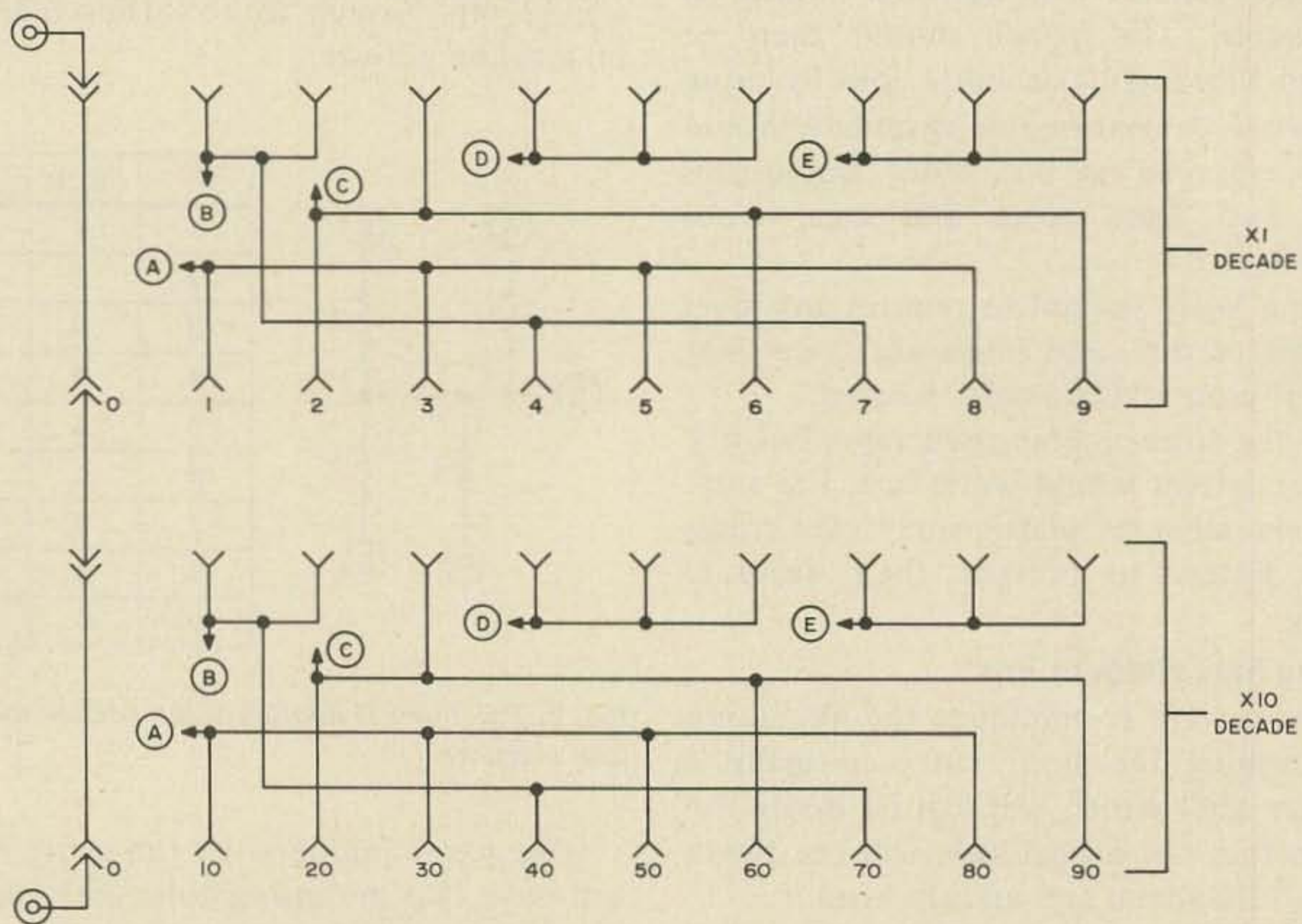

Fig. 4. Rotary switch connections for a dual decade.

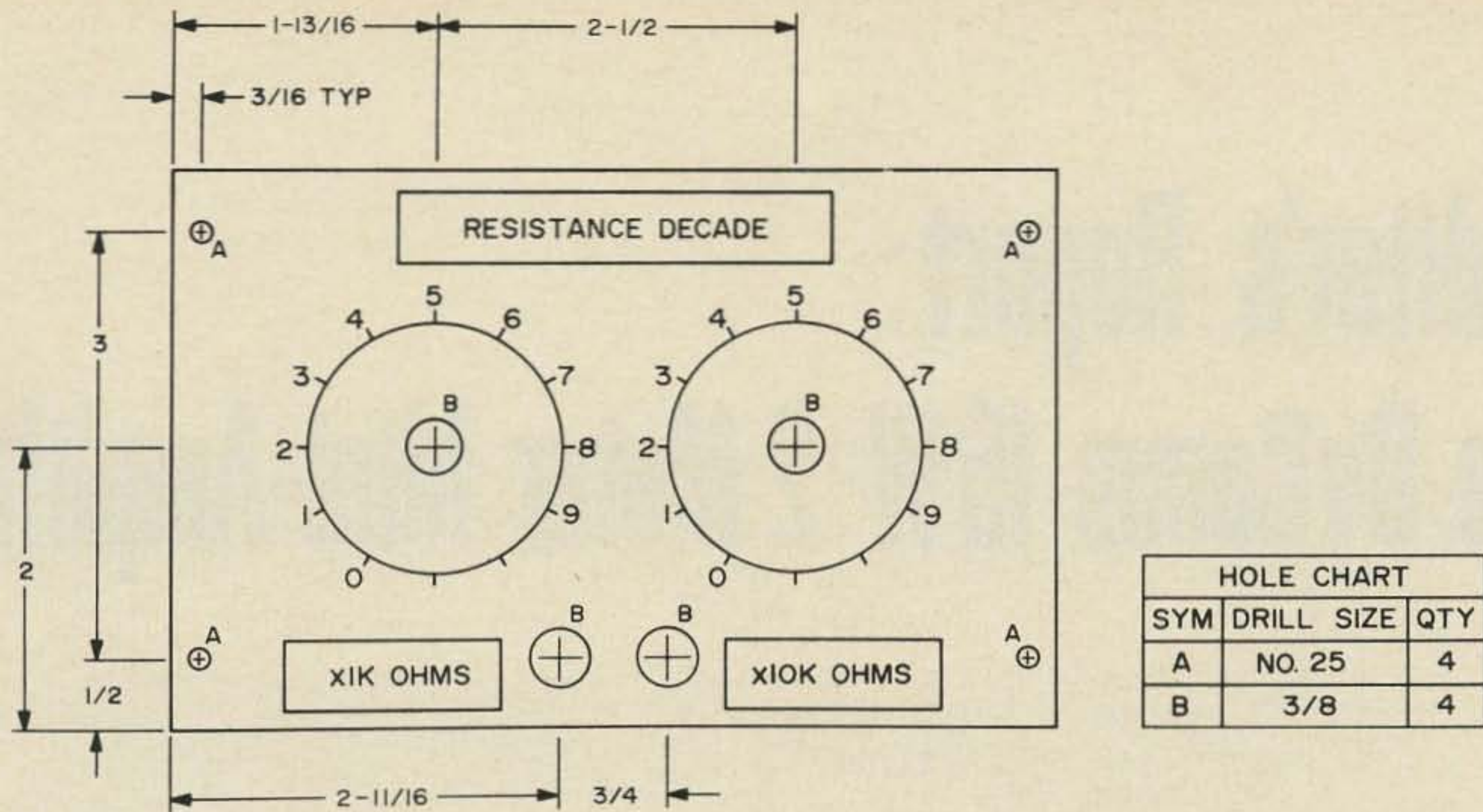

Fig. 5. Panel layout for the file box unit.

used. As far as the resistance values are concerned, they will depend upon the total resistance required of the decade. For instance, a 100 k $\Omega$  decade would be composed of a 10 k $\Omega$ , 20 k $\Omega$ , 40 k $\Omega$ , and 70 k $\Omega$ .

It is suggested that you make up your first dual decade file box with 10 k $\Omega$  and 100 k $\Omega$  decades. Then build another with 100 $\Omega$  and 1 k $\Omega$  decades. This should cover the largest part of the resistance requirements. Other values, of course, can be used, but watch the added circuit resistance with low decade resistances.

The second switching method for the H configuration is the rotary switch shown in Fig. 4. This is the configuration shown in the photo. A panel layout is shown in Fig. 5. The panel markings shown for the various switch positions on the panel can be accomplished with metal escutcheons, as shown, or with dry transfers such as obtained from Datamark.

#### Accuracy

It is self-evident that resistors should be as precise as your pocketbook can afford. Why not start out with 5% composition resistors and when you run across more accurate values, just substitute them. One way to get the accuracy better, and by as much as an order of magnitude is to use paired resistors of twice the value, and in parallel.

If you can beg or borrow the use of a good resistance bridge, you can calibrate the resistors quite accurately by taking two resistors in parallel, and by picking the resistors, come out with rather good accuracy. First calibrate each resistor on the bridge, separating them into two piles, those plus and those minus the resistance value which is just twice the desired value. Then set the bridge to the final desired value and match plus and minus values until you get two that hit the correct value.

Just one caution: When you solder composition resistors, treat them as you would a transistor. They can permanently change value due to too high applied heat. Use a pair of pliers as a heatsink between the resistor and the hot soldered joint.

When you have installed the panel in the specially worked file box, attached the schematic to the bottom and any information, such as calibration dates and accuracies, you will have a compact, useful test instrument that can help you a great deal in your ham building.

#### File Box Parts List

- (1) file box
- (2) pieces of 1/2 in. aluminum bracket (4 in. lengths)
- (4) rubber feet with 6-32 mounting screws and nuts
- (1) panel, aluminum (6-1/8 x 3-15/16 x .030 in.)

... WB4ITN ■

# Editor's Report:

## The DyComm 15 W 2 Meter Mini-Amplifier

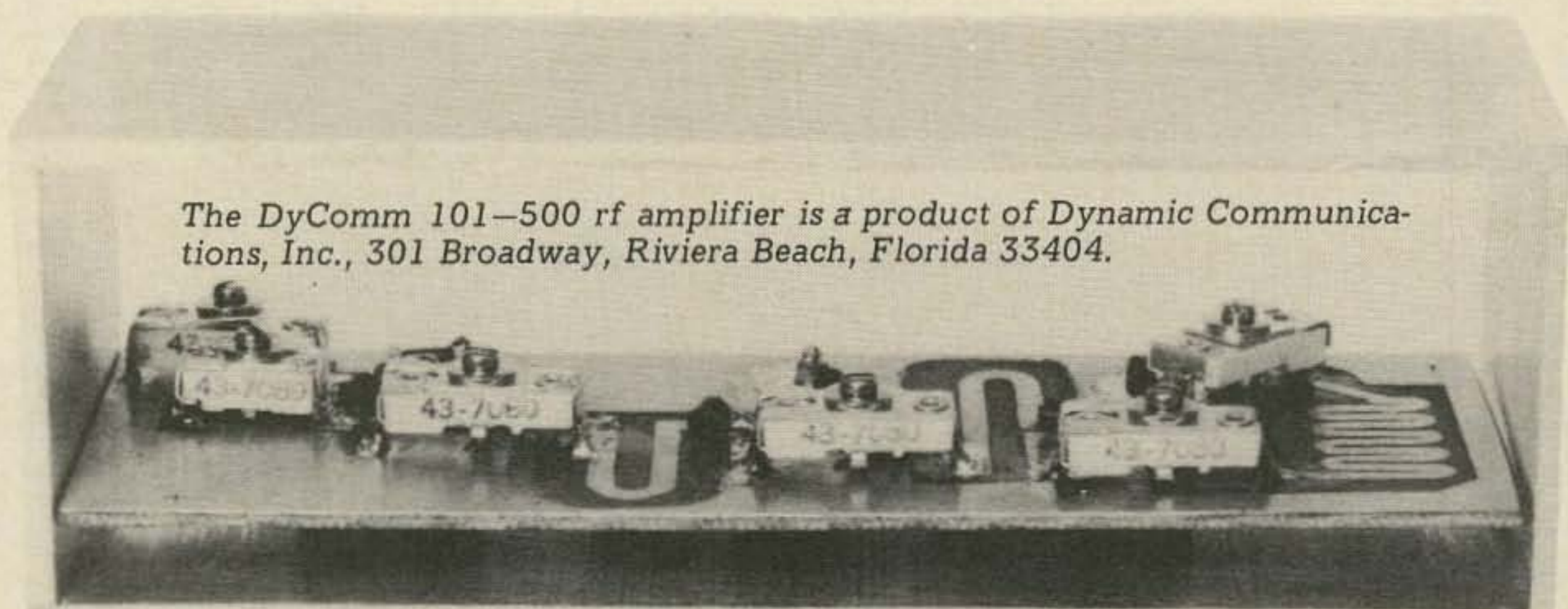

There's a brand new miniature rf amplifier being marketed that should be of considerable interest to both builders and the QRP boys alike. The unit is small enough to fit into your pocket, and can whack out a signal of up to 15 watts with less than 80 mW of drive. For FM applications in particular the tiny amplifier should prove extremely popular. To get it going, all that is required is to apply a 12V dc power source and feed in a low-power FM signal. Then presto, a 50 mW handie-talkie becomes a full-powered mobile.

### General

This sophisticated little piece of machinery is called the DyComm 101-500. It was originally developed as a module of a compact commercial radio-telephone unit, and it is currently in use in that service. Considering the fact that the rf amplifier designed for the commercial application was reliable, efficient, self-contained, and extremely broad-banded, someone got the bright idea of making the

units available to amateurs.

Not that the frequency of operation can't be changed; it can — by the simple expedient of adjusting a few variable capacitors. But as it comes from the factory, the amplifier is tuned to the center of the 2 meter band. The curve of resonance is so broad that the half-power points (without tuning) are a full three megahertz either side of the center frequency.

According to the manufacturer, the DyComm's main claim to fame is its remarkable cleanness of signal. Harmonic content is so low that no feedback coupling was used in the design. This exceptional performance is partially attributable to the low-Q coupling used in the collector and base circuits between stages. With a sufficient number of stages to assure high efficiency and plenty of gain without excessive drive, each stage's input level is limited by very low-Q rf chokes. The philosophy seems to be "the lower the drive, the less the chance of harmonic radiation."

The unit that was submitted to 73 for evaluation was reportedly right off the production line. All I needed was a low-power rf source and an auto battery of some other source of dc. I just happened to have an HT-100, a pocket sized transceiver made by Motorola that puts out 100 mW of rf on 2 meters FM. For power, I used an Eico 10A variable dc power supply.

Since the DyComm requires only 20 mW to drive it, I coupled the Handie-Talkie's signal into the unit with nothing

within the confines of a heatsink "surround." Large-signal impedance values were used in calculating input-output matching requirements, and L-type matching networks are employed in coupling. The result, according to the manufacturer, is optimum transfer of signal at the stated input and output impedances ( $50\Omega$ ), and maximum stability.

Another factor adding to the units' stability is the minimizing of unwanted inductances through multiple emitter con-

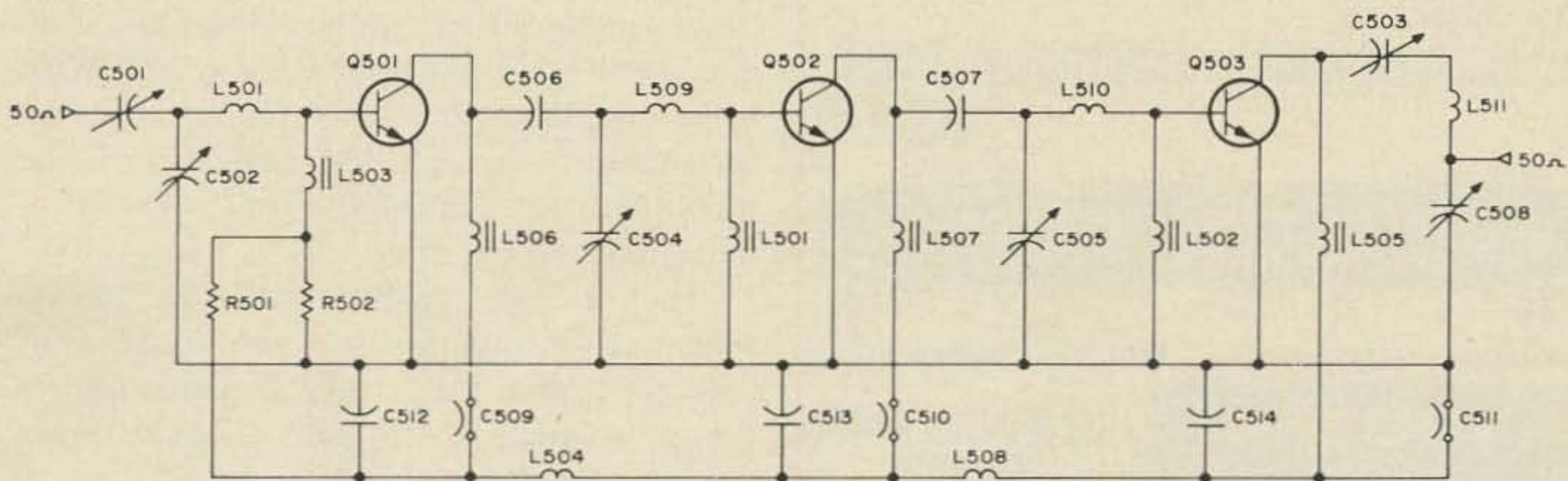

Fig. 1. Complete schematic of the DyComm 101-500 rf power amplifier. Total gain of the three-stage unit is 25–30 dB, depending on drive and supply voltage.

more than a clip lead attached to the telescoping antenna. I connected the DyComm output through a Bird Thru-Line wattmeter to a 2 meter groundplane, hooked up the dc power, and pressed the push-to-talk switch. Immediately, the Bird indicated a power output of just under 12W. I increased the dc supply voltage to 15V and trimmed the final a bit and the output climbed to 15W.

I don't know how much rf power I was putting into the DyComm, but the manufacturer's specifications stated that the input range should be somewhere between 20 and 50 mW. I can assume I was in the general ballpark because my HT is only rated for 100 mW at best and there was bound to be a substantial signal loss because of my hokey coupling method.

### The Circuit

As shown in Fig. 1, the circuit consists of three rf stages connected in cascade. The complete amplifier is built onto an epoxy-fiber-glass circuit that is nestled

tact on the driver and final transistors. The emitters in these stages are internally connected to the semiconductor case. Thus, when the transistors were inserted into the circuit board, a solder connection was made to the transistor case as well as to the emitter lead itself. This may seem like a small thing, but many engineers have gone through many hair-pulling hours trying to solve problems that could have been solved with the same simple technique.

The overall gain of the amplifier is about 28–30 dB. The first stage gain is 12 dB; the balance is equally divided between the second and final stages. If signals greater than 20–50 mW are to be coupled into the amplifier, the first-stage gain can be reduced by lifting R502. If signals greater than 500 mW are to be amplified, the signal should be coupled directly into the second stage.

### Performance

Figure 2 shows how the DyComm rf amplifier is interconnected in actual use.

# LEARN RADIO CODE



**\$9.95**

Album contains three 12" LP's 2 1/2 hr. Instruction Available on magnetic tape, \$9.95 Cassette, \$10.95

## THE EASY WAY!

- No Books To Read
- No Visual Gimmicks To Distract You
- Just Listen And Learn

Based on modern psychological techniques—This course will take you beyond 13 w.p.m. in LESS THAN HALF THE TIME!

# EPSILON [E] RECORDS

508 East Washington St., Arcola, Illinois 61910

## 10 AMP. FILAMENT CHOKE KIT \$2.00

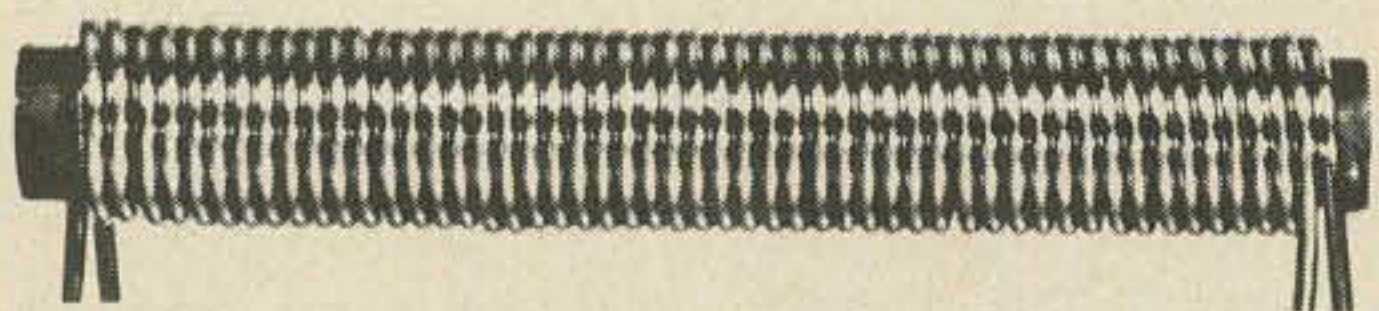

COMPLETE INSTRUCTIONS FREE ILLUSTRATED FLYER

**AMIDON Associates**

12033 OTSEGO STREET  
NORTH HOLLYWOOD, CALIF. 91607

**12X100 MM ROD \$1.25**

## RF MULTIMETER, RFM-1



Simplifies construction and testing of solid state circuits, antennas and transmission systems.

—MEASURES—

- 1 mv to 100 v DC  $\pm 3\%$
- 1 mv to 1 v RF to 1 Ghz  $\pm 5\%$
- VSWR 1.35 and 3.0 fs to 2 Ghz
- 0 to 60 Decibels

Many more features — Write for detailed brochure  
**RADIATION DEVICES CO.**  
Box 8450, Baltimore, Maryland 21234

## ARNOLD'S ENGRAVING Personalized

ELECTRIC  
**ON-THE-AIR SIGN**  
WITH CALL



Works on 110 VAC  
**\$12.95**



Metallex Lapel Bar - \$1.50 Metallex Tie Clip - \$2.25

## ARNOLD'S ENGRAVING

2041 Linden St.

Ridgewood, N.Y. 11227

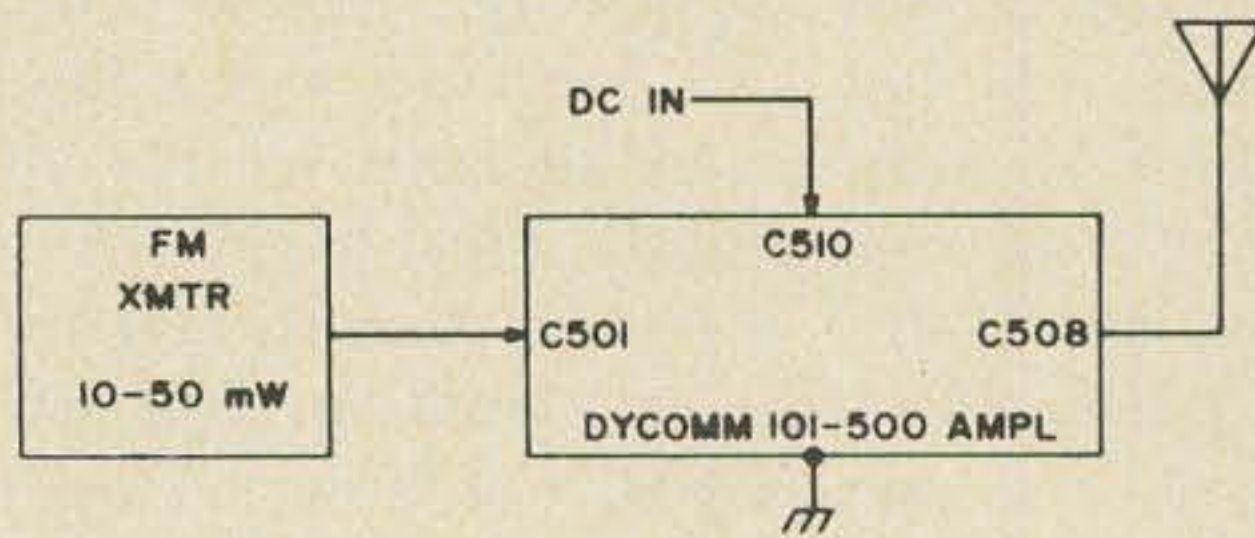

Fig. 2. This sketch shows how the DyComm rf amplifier is interconnected for operation. The capacitor numbers depicted are tie points.

Since the amplifier can be classed as a class C type, it accepts CW or FM directly. With some modification, the circuit can be linearized to accept AM signals, too; the manufacturer can supply all the information necessary to do this.

The tables below list the actual measured output power at various dc input voltages. Table I gives performance figures for an rf drive of 25 mW. Table II shows performance with 35 mW of drive.

Table I. DyComm Performance Values at an RF Input of 25 mW.

Supply, VDC	Primary Current, A	RF Output, W
10	0.35	0.4
12	0.5	1.4
14	0.8	3.0
15	0.9	4.4
16	1.1	6.0
17	1.25	8.3
18	1.45	11.0

Table II. DyComm Performance Values at an RF Input of 35 mW.

Supply, VDC	Primary Current, A	RF Output, W
6	0.55	1.5
8	0.80	3.0
10	1.0	5.4
12	1.25	8.0
13	1.45	10.5
14	1.5	12.0
16	1.8	16.0
18	2.1	20.0

... K6MVH ■

# PAGE SEVENTY-THREE

## ACTION COUPON

THE FCC WANTS TO KNOW

What *YOU* think about Incentive Licensing!

Here is your chance to speak up and be counted, pro or con, on this most important matter. Fill out the ACTION COUPON and send it to us . . . we will total up the response and send it to the FCC for their information.

1. *Are you in favor of the principle of incentive licensing wherein progressively more difficult technical exams allow the use of restricted segments of our bands?*

2. *Do you feel that the 20 wpm code test requirement for the Extra class license should be kept? Some amateurs feel that code is becoming irrelevant. Other feel that it should be everyone to his own bag. Still others find the 20 wpm a valuable incentive. How about you?*

3. *Do you feel that it would have been better to provide an incentive to get the higher grade licenses by offering new band allocations rather than taking away bands from licensees who do not get a higher license?*

4. *Do you feel that the 50 kHz CW allocation for Extra is more than it should be?*

5. *Do you feel that the 20 meter General class phone segment is too small now for practical use?*

6. *Would you like to see the whole matter of incentive licensing and band restrictions opened for reconsideration?*

Send to 73 Magazine, Peterborough, NH 03458

	yes	no	?
1. Incentive Licensing principle?	<input type="checkbox"/>	<input type="checkbox"/>	<input type="checkbox"/>
2. 20 wpm code test for Extra?	<input type="checkbox"/>	<input type="checkbox"/>	<input type="checkbox"/>
3. New bands for incentive?	<input type="checkbox"/>	<input type="checkbox"/>	<input type="checkbox"/>
4. 50 kHz too much for Extra?	<input type="checkbox"/>	<input type="checkbox"/>	<input type="checkbox"/>
5. 20m General band too crowded?	<input type="checkbox"/>	<input type="checkbox"/>	<input type="checkbox"/>
6. Reconsider Incentive Licensing?	<input type="checkbox"/>	<input type="checkbox"/>	<input type="checkbox"/>

Name \_\_\_\_\_ Call \_\_\_\_\_

Address \_\_\_\_\_

City \_\_\_\_\_ State \_\_\_\_\_ Zip \_\_\_\_\_

## PART IIB

In the first half of this part of the study course we determined that *resistance* and *reactance* could be considered as forms of *impedance* – which helps us understand why the ohm can be the common unit of measure.

But what about the effects of impedances, such as rf resistance, skin effect, and other resistive and inductive phenomena? In the first part of this series, we mentioned a definition of inductance based on the “number of flux lines” encircling the current flow, to show what happens.

Consider a piece of straight copper wire, such as that sketched in cross-section view in Fig. 10. (The figure numbers are continuations of those in Part IIA.)

If we push dc through this wire, from a battery, current flow will be approximately the same throughout the cross section of

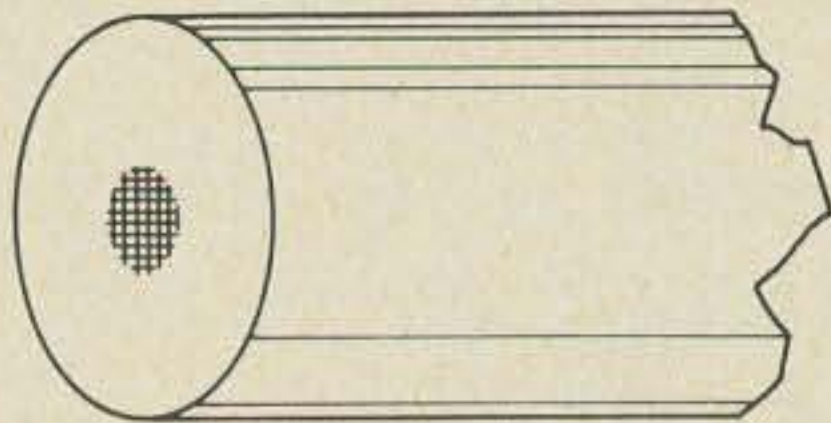

Fig. 10. Cross-section view of copper wire shows how center portion of wire is surrounded completely by conductor, while surface region has conducting material only on one side of it. This causes center to have more inductance than surface, which will in turn force ac current to seek the surface and avoid the center. The higher the frequency of the ac, the less effective will be the interior of the wire. At sufficiently high frequency, all current travels on the “skin” and almost none flows in the interior. This is called “skin effect.”

the wire. Just as much current will flow near the center as flows in the same cross-sectional area near the edge.

That current in the center is surrounded by the magnetic field associated with itself, and also by the magnetic field associated with all the current in the outer parts of

the wire, while the current on the wire’s surface is surrounded by magnetic field from only itself and adjacent currents.

This means that there will be, inherently, more inductance in the center of the wire than on its surface. With dc, it makes no difference, because inductance is a factor only when current flow is changing.

With ac, the resulting inductive reactance means that the wire’s impedance is lower on the surface than it is in the center. So long as signal frequency is low enough, the effects are not noticeable. At radio frequencies, though, the effect becomes appreciable. Virtually all the current is flowing near the surface of the wire, and the center might as well not be there. This variation of impedance between the surface of the conductor and its interior is what is known as “skin effect,” because the rf current seems to flow on the “skin” of the conductor and avoid the interior.

No harm is done by the copper on the inside of the wire, but in high-power circuits it’s often more economical to use hollow tubing rather than solid rod, and because of the skin effect one works as well as the other. It’s not unheard-of to find really high-power rf coils being cooled by water pumped through the hollow cores of the conductors!

One way in which “skin effect” is minimized at moderate frequencies is by using “litz wire,” which consists of many individual conductors, each insulated from the other, and woven together in such a manner that each individual conductor spends as much time in the high-inductance center of the combined strand as it does on the surface. This equalizes the inductance for all conductors, and effectively connects all of the reactances in parallel so that it does actually reduce the rf resistance. At high frequencies, however, the principle breaks down because the variation of conductor position cannot be made to happen

within a short enough distance as compared to the signal wavelength.

Litz wire, like all the other combining of reactances we've touched upon so far, involves the combination of the same type of reactance. What happens when we combine the two different types of reactance? That's our next subject.

*What Is Resonance?* Back near the beginning of our preceding discussion, we mentioned in passing that it was possible to use a little reactance of one kind – say inductive – to cancel out some of the other kind – in this case, capacitive.

Now let's take full advantage of this fact, with the series circuit shown in Fig. 11

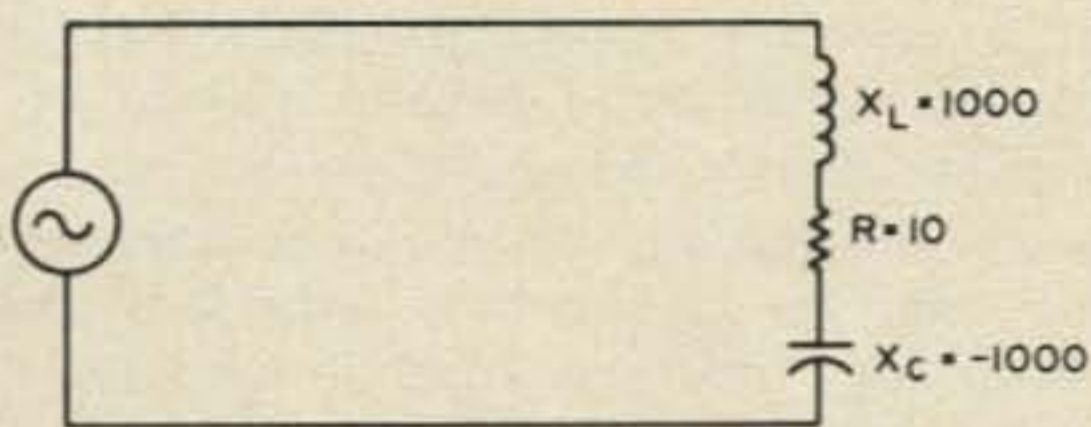

Fig. 11. Series L-C-R circuit illustrates effects of resonance, which is possibly the most important single phenomenon aside from energy propagation itself so far as radio operation is concerned. Resonance permits "tuning" of equipment to select one frequency and reject all others, which in turn makes it possible for more than one transmitter to be used at one time. Without tuning, radio as we know it would not be possible.

which contains an inductor, a capacitor, and a resistor, all in series with each other.

We know already that the resistance of the resistor will be the same at all frequencies, and that the reactances will change as the frequency changes. Let's plug in some specific figures to see how this circuit can be expected to behave. For instance, let's make the resistor 10 ohms. Reactance of the inductor will vary with frequency, being much less than 10 ohms at frequencies near zero Hz, and being in the megohm region at extremely high frequencies. Similarly, the capacitor's reactance will vary from a very high value at low frequencies, to only a few ohms at high frequencies.

Notice that where the inductor's reactance is small, at the low frequencies, that of the capacitor is large, and vice

versa. It stands to reason, then, that at *some* frequency within the infinite range possible, their reactance must be equal.

Let's assume that we have picked proper values for both capacitor and inductor to make this happen when the inductor's reactance is +1000 ohms; the capacitor's reactance is then -1000 ohms.

But since the reactances are equal in value and opposite in sign, they cancel each other out completely – and the resulting circuit impedance is that of the resistor alone, or 10 + j0 ohms (10 ohms at 0°, if you prefer the single-value method of rating impedance).

This might be only mildly interesting, except that the opposite kinds of reactance both tend to keep circuit impedance high at other frequencies. Take for example the frequency which is only 1/10 that at which the values cancel at 1000 ohms each. At this new frequency, the inductance is only +100 ohms, and the capacitor is up to -10,000 ohms, which gives us a net reactance of -9,900 ohms. Circuit impedance is 10 - j9900 ohms, or in the single-value method, 9900.5 ohms at -89.5° approximately.

Going in the other direction, at the frequency 10 times that at which the values cancel, the inductance is up to +10,000 ohms and the capacitor is down to -100 ohms, which gives a circuit impedance of 10 + j9900 ohms or, in single values, 9900.5 ohms at +89.5 degrees.

If our circuit is fed by an ac source which provides the same voltage – say 99 volts – at all frequencies, then at either the high or the low frequency only about 1/100 ampere of current will flow through the circuit. But at the single frequency where the reactances cancel, current will be limited only by the resistance and in this case the current flow will be 9.9 amperes. That's 990 times as much as at either the high or the low frequency.

In this manner, the series L-C-R circuit of Fig. 11 selects current at a single specific frequency and permits it to flow through, while tending to block current at all other frequencies either higher or lower.

And that's the particular function which is necessary in order for us to be able to



choose a signal at one frequency and reject those at other frequencies. For this reason, this circuit and its close relatives are among the most fundamental circuits in all of radio.

The condition in which reactance is completely cancelled out of the circuit is known as "resonance," and a circuit in which all reactance is cancelled out in this manner is called a "resonant circuit." The particular resonant circuit shown in Fig. 11 is known as a "series resonant" circuit, because its driving source is in series with all circuit elements.

The impedance of a resonant circuit depends upon a number of factors, but they are lumped into two general headings. One is the frequency of the applied signal, and the other is the "Q" factor which we will be examining shortly. Figure 12 is a

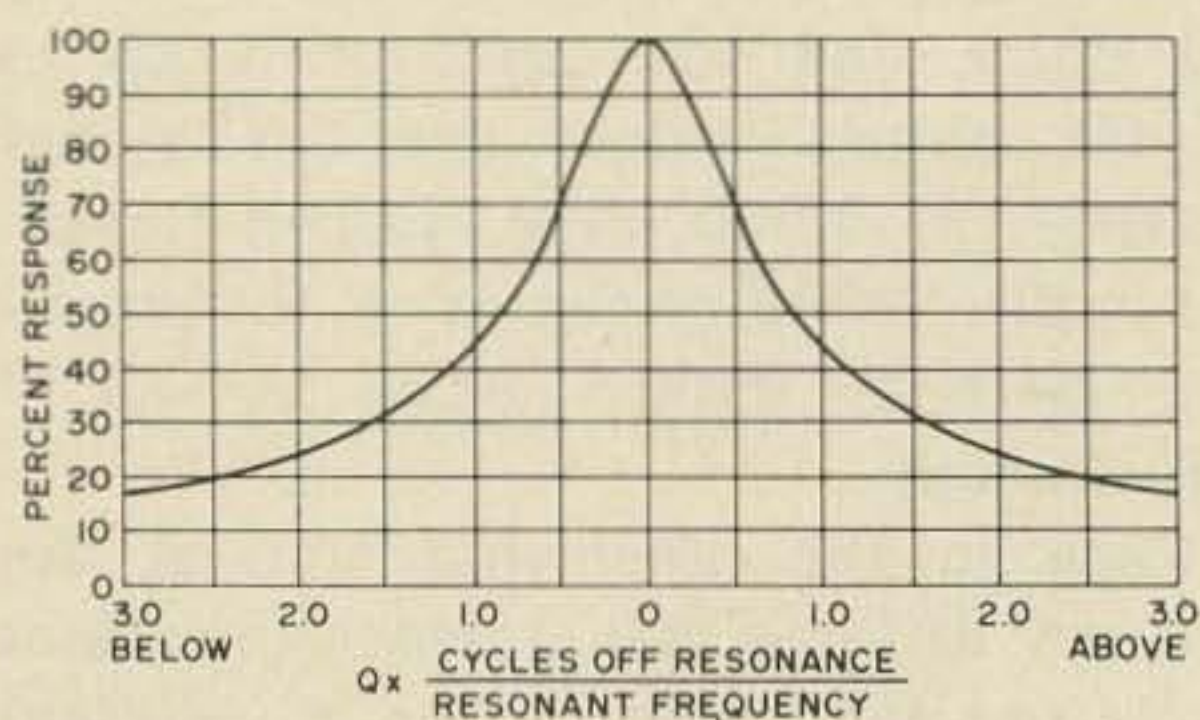

Fig. 12. Response curve of any resonant circuit is shown here. Horizontal scale is dependent upon two factors, "Q" and "resonant frequency," which makes this graph universal. For example, a resonant circuit with a Q of 100 and a resonant frequency of 10 kHz would make the horizontal scale come out to be 100/10000 times cycles off resonance, or 0.01 times cycles. At a frequency of 10.01 kHz, 100 cycles above resonance, the value to use on the horizontal scale would be 0.01 times 100 or 1.0, and response would be 45 percent of that at resonance.

graph of a "universal" resonance response curve; the solid line can be thought of as representing current flow through the circuit of Fig. 11 as compared to maximum current flow at resonance.

In addition to the series resonant circuit, we also make use of "parallel resonant" circuits. Parallel resonance was at one time called "antiresonance," but this word

is rather rapidly fading from use. Figure 13 shows a parallel resonant circuit.

If we ignore the power-source connections in Fig. 13 we will see that the reactances and the resistance are still in series with each other. The difference between parallel resonant circuits and

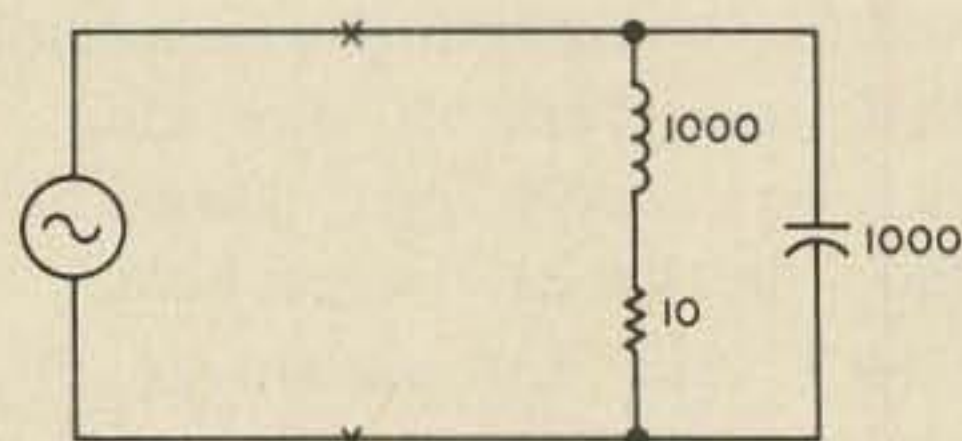

Fig. 13. Schematic of typical parallel-resonant circuit. If power source is disconnected at points marked "X" and circuit is then opened at any point, it becomes same as series-resonant circuit of Fig. 11. Resistance is shown here in series with inductor because in practice, inductors usually have more stray resistance than do capacitors and circuit behaves as if all resistance were in the inductive leg. See text for details of circuit action.

series resonant circuits depends on the way in which the power or driving source is connected. If the source is in series with the reactances, it's series resonant. If the source is in parallel, it's parallel resonance.

The impedance characteristics of a parallel-resonant circuit are markedly different from those of series resonance. In series resonance, circuit impedance is high except at the resonant frequency. In parallel resonance, though, the reactances are in parallel so far as the power source is concerned, and this means that rather than cancelling out reactances, we must combine "susceptances." High reactance means low susceptance, and vice versa.

At low frequencies, the inductor has low reactance and high susceptance, while the capacitor has high reactance and low susceptance. The capacitor's low susceptance cancels out its corresponding amount of inductive susceptance, but the remaining susceptance is still high which makes net reactance low.

At high frequencies, it's just the other way around, and net reactance is still low.

At the resonant frequency, the two susceptances are equal, and so they do cancel each other out. But a susceptance of zero is equivalent to an infinite impedance. This means that at its resonant frequency, a parallel-resonant circuit must have very high impedance. At other frequencies, the impedance depends upon the reactance left over after cancellations.

Why is the impedance so high at resonance? This happens because each reactance, individually, enforces a phase shift between voltage and current. The capacitor puts voltage  $90^\circ$  behind current, or current  $90^\circ$  ahead of voltage. The inductor puts current  $90^\circ$  behind voltage. Since the circuit is parallel, voltage across both reactances is identical at all times. But since current in the capacitor is  $90^\circ$  ahead of this voltage while current in the inductor is  $90^\circ$  behind, the phase difference between the two currents is  $180^\circ$  — and this amounts to a complete cancellation of current flow.

The "cancellation" is effective only so far as the power source is concerned. In each reactance, its own current is flowing. However, this current cannot get out of the circuit — and so it circulates between inductor and capacitor. It's known as "circulating current," and is very real indeed as anyone who has watched the output coils of his transmitter melt from its effects can testify!

The circulating current is, in fact, as much *larger* than the current which either reactance alone would permit to flow, as the actual current flow is smaller. Both are related to the circuit's "Q" as we shall shortly see.

Because the circulating current *is* larger, a closed resonant circuit in which circulating current flows can act as a voltage amplifier. The circulating current through each reactance will produce a voltage drop determined by the amount of current circulating and by the reactance value. If the driving power is coupled into the circuit by means of a tap on the inductor, it can force large circulating currents, and an output voltage much larger than the input voltage can be obtained. This isn't something for nothing, because no *power*

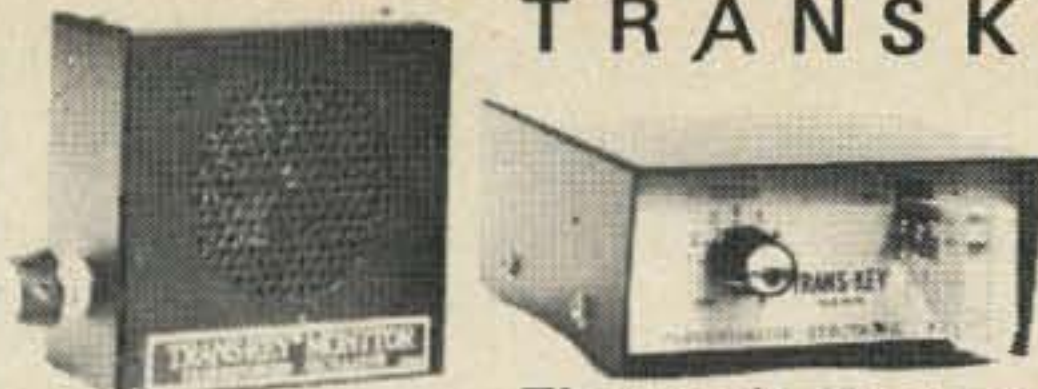

## TRANSKEY<sup>(TM)</sup>

**\$34.95**  
Postpaid

**Electronic Keyer and Monitor**

- + Transistorized; relay output.
- + Key built-in; wired, ready to operate.
- + Continuously variable speeds 5-50 WPM.
- + Penlight cells or 6V external source.
- + Key contacts adjustable.
- + Push switch on back, automatic or semi-automatic operation.
- + Dot-space ratio adjustable.
- + Variable tone control on monitor.
- + Keyer 3½ x 5½ x 1½. Weight 2 lbs.
- + Unconditional one year guarantee.

Calif. dealers: Scott Radio, Long Beach;  
Wireless Shop Inc., Vallejo, Calif.

**DEALERS WANTED**

**W6PHA — GLOBAL IMPORT CO.**  
**BOX 246, EL TORO, CALIF. 92630**

... for the Ham

## GREAT "MINI MAST"

**NEW**

### Self Supporting Crank-up Masts

High strength tubing — 6 square feet of antenna with adequate margin of safety in 50 mph winds — easy 2 step installation.

Available with the  
**Exclusive new Rotor Base Accessory**

Installation details, other models and accessories available

**TRISTAO TOWER CO.**

Box 115 Hanford CA 93230



**NOW! FOR UNDER TWENTY BUCKS**

## A COMPUTER FOR BEAM SETTINGS

A PRODUCT OF MECHANICAL COMPUTER TECHNOLOGY  
GLOBE PLOTTER INSTANTLY READS OUT ROTOR SETTINGS  
IN DEGREES TO THE TOUCH OF YOUR FINGERS.

SMALL — IT FITS INTO THE WORK AREA EASILY; WITHOUT  
HINDERING RIG ADJUSTMENTS... FAST — IT COMPUTES  
WHILE YOU TALK. AVERAGE TIME 3 TO 5 SECONDS!!!  
ACCURATE — WELL WITHIN YOUR ROTOR'S CAPABILITIES.

ACTUALLY SEE YOUR SIGNAL'S PATH PLOTTED ON A WORLD  
SPHERE FROM YOUR QTH TO ANY OTHER IN THE WORLD....  
WHEN YOU MUST BE SURE, GLOBE PLOTTER KNOWS-AND TELLS.

**SATISFACTION GUARANTEED**  
WRITE TODAY FOR COMPLETE INFORMATION

**GLOBE PLOTTER** BOX 2097-F1  
DES MOINES, IA 50310

# FM Schematic Digest

A COLLECTION OF  
MOTOROLA SCHEMATICS  
Alignment, Crystal, and Technical Notes  
covering 1947-1960

136 pages 11½" x 17" ppd \$6.50

S. Wolf  
1100 Tremont Street  
Boston, Massachusetts 02120

gain is achieved. The higher voltage can only be obtained if little or no current is taken from the circuit. Many receiver input circuits make use of this fact to help overcome effects of tube and circuit noise, by stepping up signal voltage ahead of any amplifier stages.

To determine the exact frequency at which any specific pair of inductance and capacitance values will be resonant, we just combine the inductive-reactance and the capacitive-reactance formulas and come up

$$F = \frac{1}{2\pi \sqrt{LC}} \qquad F^2 = \frac{25,330}{LC}$$

*Fig. 14. Equations for resonant circuits. Version at left is basic formula, with frequency in hertz, inductance in henries, and capacitance in farads. That at right is practical version with frequency in megahertz, inductance in microhenries, and capacitance in picofarads. For any value of inductor, some capacitor exists to make it resonant at any desired frequency. In practice, choices are also limited by effects upon circuit Q and feasibility of actually obtaining desired values.*

with the equations shown in Fig. 14. As before, one is exact and the other is more practical, having all the conversion factors and the "pi" constant built into a single magic number. While any specific pair of values will have only one resonant frequency, in theory any inductor can be resonated at any desired frequency by simply choosing the proper capacitor value, and vice versa. In practice, "Q" is also a factor to be reckoned with and tends to limit the choice of L and C values.

All through this discussion we've had to refer to "Q" from time to time. Let's find out now just what this strange factor is, and what its effects are.

*What Is Q?* "Q" is a symbol which shows up in radio theory just about as often as do the "R" which stands for resistance, and the "E" for voltage, the "I" for current, the "L" for inductance, or the "C" of capacitance. You'll meet "Q" as

part of the description of nearly any coil, many capacitors, and all tuned circuits. It is used to describe the characteristics of quartz crystals, and of antennas. But what is it?

The symbol "Q" originally stood for "quality factor," and almost all textbooks define it in the same way — as the ratio of inductive reactance to total resistance in a circuit ( $X_L/R$ ). But very few texts bother to show why the ratio of reactance to resistance should be of much importance, and only a couple of the more than a dozen we studied in preparing this discussion bothered to give any other definition of Q.

Nevertheless, Q is important, and it has many definitions, all are equally true in every case, but for any special case, some are easier to apply than others.

So let's try to see first why the ratio  $X_L/R$  affects behavior of a resonant circuit, and then explore some alternate definitions of Q. We'll begin by returning to our series-resonant circuit shown in Fig. 11, with the same component values used before. That is, 10 ohms resistance and 1000 ohms reactance for each reactance.

We discovered already that if this circuit is driven by a power source which delivers 99 volts peak, a peak current of 9.9 amperes will flow through each of its three elements.

What we failed to say before is the fact that we can determine the voltage across either the coil or the capacitor alone, either by Ohm's Law or by actual measurement with a good VTVM. Here, we'll do it with Ohm's Law in the form  $E = IZ$ .

Since it's a series circuit, I is the same for all three elements, or 9.9 amperes with our 99-volt source. Impedance of the coil is 1000 ohms at  $90^\circ$ , and so the voltage across the coil must be 9.9 times 1000, or 9,900 volts at  $90^\circ$ . Impedance of the capacitor is also 1000 ohms at  $-90^\circ$ , so its voltage must be 9,900 volts also, but at  $-90^\circ$ . Since these two high voltages are  $180^\circ$  out of phase with each other, they cancel each other out and cannot appear to the external circuit — but inside the circuit, measured across each element by itself, they're present.

Some authorities call this action the

## FET CONVERTER KITS FOR 50, 144 AND 220 MHZ

Basic two-meter converter described in February 1969 issue of VHF COMMUNICATIONS. The most popular VHF converter in Europe! Hundreds already in use in North America.

Kit contains: Glass-epoxy p.c. board (silverplated), crystal, coil forms and trimmers. Requires additionally: Three FET's (TIS 34, MPF 107, etc.), two bipolar transistors (TIS 45, etc.), coil wire, fixed capacitors and resistors. IF 28–32 MHz. 12 VDC/16 mA. Noise figure (attained with MPF 107's) 50 MHz: 2, 144 MHz: 2, 220 MHz: 2.5.

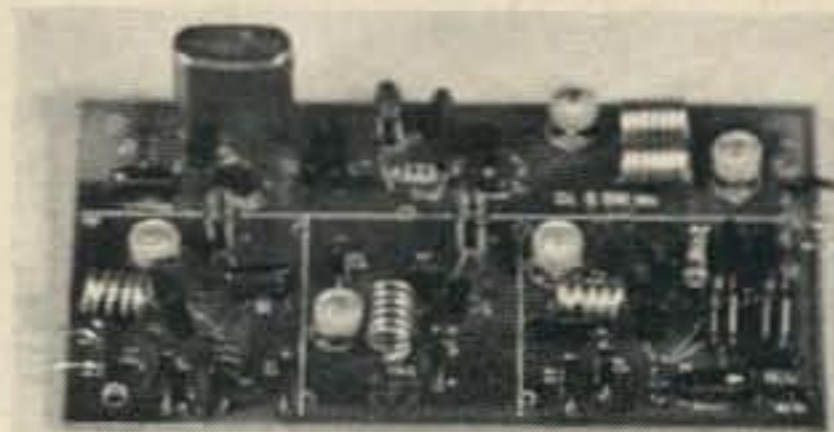

Kit price \$10.20 each.

## DUAL GATE MOSFET CONVERTERS FOR TWO METERS

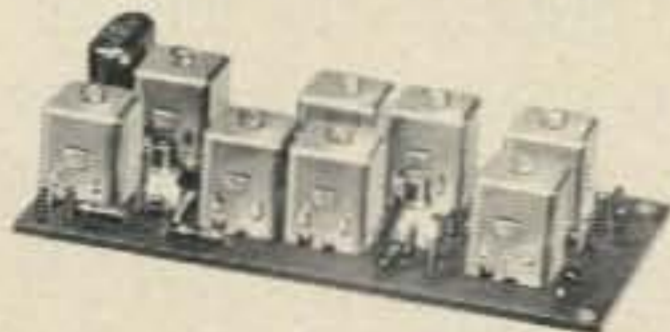

Low noise figure ( $<2$ ). Excellent cross modulation and image rejection (116 MHz xtal oscillator). IF 28–30 MHz. 12 VDC/20 mA. Silver-plated, glass-epoxy p.c. board. All inductors shielded. Fully assembled and aligned. By Braun.

Model DGTC 22, \$35.00

Highly compact converter (3" x 2" x 1"); can be mounted in existing receiver or transceiver cabinet. Electrical characteristics as above, except any IF between 14 and 32 MHz can be selected by simple plug-in of the appropriate oscillator crystal. (116 MHz crystal furnished with converter). Oscillator-emitter follower output for use with transceiver.

Schilling Model HS 1000 Jx, \$ 39.50



**si**

**SPECTRUM INTERNATIONAL**

BOX 879 TOPSFIELD MASSACHUSETTS 01983

**si**

“voltage magnification” of the resonant circuit, and speak of the 9900/99 ratio between reactive voltage and applied voltage as the “magnification factor.”

Others call the ratio the “quality factor” or merely “Q.”

The relation between this “magnification factor” and the definition of Q as being  $X_L/R$  is not overly obvious. It comes about because each of the voltages — that across the reactance and that across the total circuit — is related to the same series current by Ohm's Law. In both cases,  $E = IZ$ , where Z is the impedance and I is the current.

For the reactance, the Z is equal to  $X_L$  or  $X_C$ , and at resonance they're the same absolute value. For the total circuit, both reactances cancel out and the impedance is simply R. The voltage ratio  $E_x/E_t$  then becomes  $IX_L/IR$ ; the I cancels out of the calculation since I/I is always “1,” leaving us only  $X_L/R$  to define the magnification factor or Q.

Now let's see why “Q” should be such an important factor in the first place.

One of the most important uses of “Q” is as a measure of the effectiveness of a resonant circuit. That is, it measures how effectively the circuit can separate two signals of different frequency. We can demonstrate the relation between Q and selectivity in two ways, one of which is easy to see and the other of which, though much more accurate, requires more thought. Let's try both, the simpler one first.

Recall that the selection capability of a series resonant circuit comes about because at the resonant frequency, current flow is limited only by the R of the circuit, while at frequencies far from resonance, the X is the limiting factor and the R has very little effect.

This means that if the resistance is very small compared to the reactance at the resonant frequency, the current flow at resonance will be very high compared to current at those frequencies where the reactance is the limiting factor.

If we increase the resistance and leave reactance alone, it will have little effect on current at the extreme frequencies, but will

reduce the current flow at resonance. Thus the ratio between current at resonance and current far from resonance will become smaller, and the circuit is therefore less selective.

Since  $Q$  goes down as resistance goes up, if  $X$  is constant, this means that a high- $Q$  circuit must be more selective than one with low  $Q$ .

While this explanation shows how circuit  $Q$  affects selectivity in general, it unfortunately does not tell us much about what happens at frequencies near resonance. To find out how  $Q$  works in this region — which, after all, is the one in which we are most often really interested — we must go to the more detailed explanation. It takes a little arithmetic to illustrate.

We define  $Q$  by looking at the “magnification factor” — the ratio between the voltage across either reactance, and the total voltage applied to the circuit.

At frequencies near resonance, the reactances will not vary greatly from their values at resonance. If our inductor has 1000 ohms reactance at 10,000 Hz, then at 10,010 Hz its reactance will be 1001 ohms, and at 9,990 Hz it will be 999 ohms. The capacitor will behave similarly, with reactance values of -999 ohms at 10,010 Hz and -1001 ohms at 9,990 Hz.

Because of the mutual cancellation of opposite types of reactance, the net reactance of the circuit will be the difference in reactance values. At 10,010 Hz, net circuit reactance would be 1001 - 999, or 2 ohms inductive.

If our circuit had a  $Q$  of 100, this would mean a resistance of 10 ohms (and with a 100-volt-peak source, 10 amperes current flow at resonance). Impedance of the circuit at 10,010 Hz, then, would be  $10 + j2$  ohms, or about 10.19 ohms at a very small phase angle. Current flow at this frequency ( $E/Z$ ) would be  $100/10.19$  or about 9.84 amperes, nearly as much as the 10 amperes at resonance.

If we leave the reactances alone, but reduce the resistance to only 2 ohms, we will raise circuit  $Q$  to 50 ( $1000/2$ ). Current flow at resonance would be 5 times as great, or 50 amperes with a 100-volt source.

At 10,010 Hz, however, circuit impedance would not be  $2 + j2$  ohms, or 2.83 ohms at  $45^\circ$ . Current at this frequency would be  $100/2.83$  or 35.4 amperes. This is only  $35.4/50$  or 70.8% of the current at resonance, while with a  $Q$  of 100 the currents at the two frequencies were almost equal.

The same thing happens at all other frequencies, whether near to or far from the resonance point of the circuit. The result is that a high- $Q$  circuit is “sharper” than one of low  $Q$ . Figure 15 shows this by

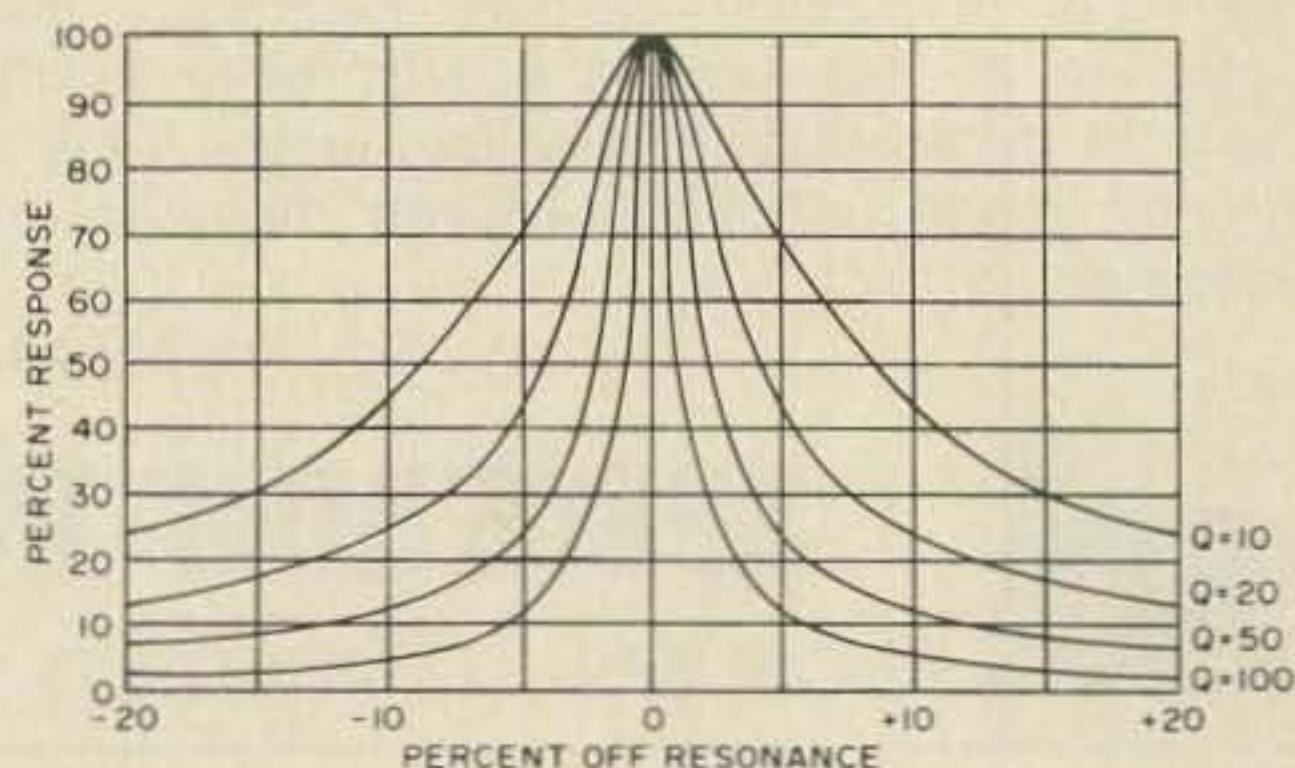

Fig. 15. Effect of  $Q$  upon circuit selectivity is shown graphically. This is similar to Fig. 12, except that factor “ $Q$ ” has been removed from horizontal scale and different curves have been drawn for different  $Q$  values. The greater the  $Q$ , the sharper the selectivity. Notice that effects are greatest in regions near resonance, but very little difference exists at frequencies almost exactly on the resonant frequency.

comparing relative currents for circuits with  $Q$ 's ranging from 10 to 100, for frequencies from 20 percent below resonance to 20 percent above.

Of course, instead of measuring current flow through the circuit directly, we could take the voltage developed across either reactance, because this voltage is developed by the current flow through that reactance. And, in practice, this is exactly the way in which a receiver makes use of resonant circuits. The output of the circuit is usually the voltage developed across the capacitor.

The ratio  $X_L/R$  is the most commonly encountered definition for  $Q$ , but it's not by any means the only one nor is it even the most descriptive. Our own favorite is

one which defined  $Q$  as being proportional to "the ratio of peak energy storage to average power loss" in any circuit.

This definition is directly related to the more familiar one, because the circuit's reactance is a measure of peak energy storage while the resistance includes any factors which actually *lose* energy.

However, thinking of  $Q$  as a ratio of energy stored to energy lost makes it apply to many non-electrical things, such as a swinging pendulum or a vibrating tuning fork, while the terms "reactance" and "resistance" are limited by definition to electrical actions.

$Q$  is sometimes defined as being the inverse (or reciprocal) of the "power factor" of a component or circuit. The "power factor" is the ratio of power consumed to apparent power, which boils down to being a ratio of resistance to reactance. Since this is the inverse of the ratio which defines  $Q$  in the most common definition, defining  $Q$  as the inverse of power factor is simply a second-hand way of providing the same definition.

$Q$  is also sometimes defined – and frequently measured – by its effect on bandwidth of a circuit. In resonant circuits having  $Q$ 's in the normal range (from 10 to 1000,) the number of Hz between the half-power points (the two frequencies, one above and one below the resonant frequency, at which power transfer falls to half of that transmitted at resonance) are related to the resonant frequency by a factor which is roughly  $1/Q$ .

That is, for a  $Q$  of 10, the lower half-power point will be  $f/10$  Hz below the upper one, if "f" is the resonant frequency in Hz. If  $Q$  is raised to 20, the separation or "bandwidth" will be  $f/20$  Hz, and with a  $Q$  of 100, it will be  $f/100$  Hz.

All of our discussion of "Q" so far has been in terms of series resonant circuits. It applies equally, though, to parallel-resonant circuits by making proper substitutions. The net result after these substitutions are made is that the circuit impedance, rather than voltage, is multiplied by  $Q$ . That is, in a parallel-resonant circuit each of whose reactances is 1000 ohms at resonance and having a  $Q$  of 100, the imped-

ance at resonance will be 100,000 ohms at  $0^\circ$ .

If such a circuit is then "loaded" by connecting a perfect 100,000-ohm resistor across it, the net impedance will be reduced to 50,000 ohms. The same result would be produced by raising the internal resistance from 10 to 20 ohms and so lowering  $Q$  to 50. In most radio theory the effects of such "loading" are accounted for by assuming that the load is "transformed" into the equivalent series resistance. In this case, the 100,000 ohm resistor's value would be transformed to 10 ohms, and its effective connection point would be changed from being in parallel with the resonant circuit to being in series with the inductor inside the circuit.

This is what is meant by the "impedance transformation" effects of a tuned circuit, and transmitters make use of tuned circuits in this way to large degree.

We said way back at the beginning of this discussion that  $Q$  is applied to such things as quartz crystals and antennas, as well as to conventional resonant circuits. In these cases, the "energy stored/energy lost" definition is the most meaningful one.

A crystal, for instance, will vibrate for some time after receiving a single impulse, and this vibration will in turn return electrical energy in the form of mechanical vibrations and returns it with little loss. This means that the "Q" of a crystal is remarkably high (around 25,000 for most ham units).

An antenna, on the other hand, is intended to radiate or lose as much energy as possible, so that low  $Q$  is desirable for any antenna. Many designs, however, will radiate effectively only over a narrow range of frequencies, and at all other frequencies will store the energy rather than radiating it. This means that the  $Q$  goes up, and the designer must find ways of lowering the antenna  $Q$ .

*Next Time.* Now that we have fairly firm foundations established both for ac and dc circuit theory, we can go into the superstructure. Our next installment will examine power, decibels, and harmonics.

... Staff ■



# What Really Happened To Hamdom?

Robert M. Brown W9HBF  
5611 Middaugh Avenue  
Downers Grove IL 60515

**I**ncentive programs or not, this article is hardly expected to endear the writer to the hams in this country—nor, perhaps, to the policy-making editors of 73. It is designed instead to inform hamdom of some serious problems that have been all but ignored in recent years. Let it be stated now that what follows are the impressions and opinions of the author, combined with known facts gleaned from the general public, the electronic industry, and from current legislation and trends in Washington, D.C.

We challenge readers to dispute these truths; we implore readers to reexamine themselves and make an honest effort towards maintaining the open-mindedness this hobby needs.

The draft for this diatribe began as an article devoted to informing our meager readership of the pros and cons of QRP. Before I realized, however, I had struck a tender root of one of the most serious problems American amateurs face today. But we are getting ahead of our story.

In an attempt to get a truly objective perspective regarding the state of ham radio today, I stumbled across an item of profound implication in the foreign ham press. Smatterings of information on low-power and QRP associations have appeared from time to time in the recent past in this country, but there remains the fact that a great deal of amateurs here don't even know what QRP means, much less the thinking behind it. So what?

Shortly after the last war, amateurs in almost all other countries began to seriously investigate the advantages of running on reduced power. In London the QRP Society, Inc., was formed to keep Europeans abreast of flea-power military surplus bargains while at the same time serving to further awaken hamdom to the exciting world of QRP. What caused this interest in "half-hearted" hamming? Economics. The flow of surplus equipment into European markets meant that with the proper knowledge, an SWL could get on the air without investing large sums of

money. In short, the expense of becoming a ham had been substantially lowered, and with it came a remarkable increase in the number of foreign amateurs on the air. Understanding this important factor, it is relatively simple to see why the QRP trend caught on like wild fire overseas.

While progressive European countries experimented with single-tube transmitters and later developed transistorized 144 MHz transceivers, Americans built kilowatts. Today the foreign journals referred to earlier, such as the *RSGB Bulletin*, *Das DL-QTC*, and *UKW Berichte*, carry an amazing array of flea-power projects surrounded by advertisements offering transistorized low-frequency and UHF stations. Our magazines, on the other hand, are saturated with linear amplifiers and 2000-watt band blasters, while our advertising seems to cater to the conventional big-station buyer. Somehow we have adopted the mistaken idea that power is everything.

The real truth of the matter, though, is that the American ham is generally in a better economic situation than his European comrades. He can afford the "best." Ham radio in this country has clearly degenerated to the point where status in many circles is determined by income. Not so?

A good example is found at six meters, a band that this writer feels more than qualified to talk about. Rather than generate interest in experimenting with narrow-band FM, sideband techniques, and almost interference-free CW, the 50 MHz band is presently presided upon by the DX-happy. Who can snag the most states? When will Puerto Rico slip in again to be pounced upon by 912 East or West Coast snoopers? And they are almost all doing it with AM phone. Nobody builds here anymore. It "isn't necessary." Others feel that "commercial competition has made it cheaper to buy 6 meter rigs." Hogwash. Of course I'm not talking about the dedicated Technicians who are there for legitimate reasons; I'm calling out the 85% whose goal is to buy bigger and better equipment as they can afford it. Naturally, with a philosophy like this prevailing on a ham band, new-

comers are apt to feel that unless they can afford to buy the best they just won't be "in it." And the sad truth is that they aren't.

### Smashing the Price Barrier

So fervent is the struggle for power on the ham bands today that thousands do not realize just how little they are buying for the hard-earned dollar. The real difference between 75W and a full gallon is inconsequential when compared open-mindedly to the economic ratio of either building or purchasing a three-element beam to replace a folded dipole. Or when compared to spending even one-quarter that amount for a good preselector or Q-multiplier.

Communications — *true* communications — is an art. If DX is your forte, working stations others can't even hear should prove extremely exciting. Yet I'll wager you could do it by properly investing but a fraction of what you have already spent into refined necessities. Don Stoner W6TNS has WAC on 15 CW running 80 milliwatts. ZL1AAX works regularly into the states with 20 milliwatts. K1CRD in Connecticut sets his own 50 MHz records using but a 27 milliwatt transceiver he built from combining various transistor circuits in current electronics journals. Interested?

Offering an answer to the long-standing price barrier facing even American amateurs, the transition to QRP is just beginning to catch. And to the avid exponents of the sport, a challenge is there to be delved into, examined and explored to the hilt. What is there for people interested in flea-power today?

Plenty. Although the London QRP Society folded in the early fifties, in something short of four years the new QRP Amateur Radio Club (headed by K8DZR in Ohio) has snowballed into one of ham radio's largest fraternities. With members all over the world, the QRP ARC sponsors contests, proves the truths of low-power hamming every day, and publishes a handsome quarterly brimming with interesting case histories and construction projects.

Since the high power stigma has begun to alleviate, QRP'ers are striving for cheaper and cheaper rigs. QRP ARC chap-



ters offer prizes for the best units built for under \$10. Now circulating are circuits for low-frequency receivers (less than \$4) and AM transmitters for 20 meters (perhaps \$12). And then there are all those slightly used CB transceivers that can be modified by a child for 10 meters. . .very cheaply. And I could go on and on.

### The Ugly American

But by and large, high power still has a long way to go before it is completely abolished. As long as the law says Americans can run 1kW input to the final, even though most foreigners are restricted to under 100W, the DX man's toy will remain. What happens?

In all truth, the amateur's status symbol is his cherished homebrew gallon, more often than not a brilliantly conceived jumble of war surplus tubes and a power supply capable of pumping at least a thousand watts to the final. With a gleam in his eye the operator seeks out his prey (frequently a poor Belgian with 40W), zeros in for the kill and then, along with 74 others, calls him frantically. Silence follows. If I only had more power, our friend thinks to himself. But alas, he came back to an Englishman.

With the staggering number of postwar hams that put signals on the air as amateur radio developed into a modern-day mania, the high-power struggle seems to have intensified. By 1958 literally hundreds of illegal *California Kilowatts* were relieved of their licenses for power levels often up to 5kW and beyond.

What have we really accomplished in this high-power battle? Presently the supposedly sophisticated U.S. hams have literally saturated the spectrum, clobbering each other and the rest of the world as they swish their vfo's to clear the frequency before kicking in the linear. We have out-populated our allotted frequency space 25 years earlier than the best authorities estimated just a few decades ago. We have imposed American-made pandemonium on the worldwide DX bands.

German hams can't hold decent conversations with the English because some operator in Tuscaloosa is using his kilowatt to talk to New York. Frequency alloca-

tions being what they are, *more power means more QRM!*

The status-seeking "Ugly American" is heard round the world — regardless of whether or not anyone *wants* to listen. Today a good number of foreign hams have decided not to QSO the states and to ignore as best they can the innocuous U.S. kilowatts. Own up to it or not, a ham radio "cold war" is on. The cause: the power-mad DX-happy American ham.

### Some Day We'll Pay the Penalty

The time is rapidly approaching when the rest of the ham world will have a substantial voice in declaring what the U.S. hams can and cannot do. Or to put in more bluntly, a growing number of previously friendly countries are fed up. They want to return amateur radio to the pioneer spirit that once led the art.

We have, admittedly unknowing, stepped on a great deal of tradition, destroying in our path to bigger and better things the very foundation of what the rest of the world still clings to in its interpretation of amateur radio. We can expect the worse, and accept (without further embarrassing ourselves by stupid on-the-air remarks) whatever Geneva comes up with.

### The Horrible Truth About CB

Ask your typical coworker at the office what he thinks of when he visualizes a ham radio operator. Chances are he vaguely remembers visiting a boyhood friend who demonstrated his rig, talking gibberish to Rangoon while the coworker looked on fearfully at his homebrew monster flickering in its chassis.

Or more realistically, he remembers last Saturday night, when Lawrence Welk was all but obliterated by the youngster next door.

The point is simply that the impression is not good. Ask a friend the difference between a ham and a CB'er and he'll reply with the best of intentions that the ham uses radio as a toy, whereas the CB'er has a definite purpose in putting his set on the air. The public is not aware of the fact that we are supposed to be technically better informed than the CB'er.

The horrible truth is that we *are* competing with the CB'ers whether we want to

recognize it or not. The same legislative body that gave experimenters frequencies they could use for furthering the art awarded a mere 250 kHz of the 11 meter band to citizens. And what have they done with it?

To be perfectly frank, the accomplishments of CB fall just short of miraculous and something hams will have to reckon with sooner or later. Putting aside the reams of anti-CB material we publish (the more opinionated referring to them as morons\*), we should at least admit the facts:

- There are literally thousands of CB clubs throughout the country cooperating with local officials to aid in emergencies.
- The press has treated CB most favorably, publicizing in newspapers and magazines the strength and power they have added to ambulance squads, police departments and highway patrols.
- The public is not plagued by nearly so much CB TVI as we would like to believe. Improvements in equipment design and the 5W power limitation do much to hold this down.
- In numbers, CB'ers are expected to top one million this year.
- Sales of CB equipment hit \$54 million in 1966.
- CB offers more to the public (tangibly, at least) than amateur radio.
- America now has an emergency radio force of citizens exceeding that anywhere on earth at this time.
- At least 70% of CB units are installed for "emergency power" — under the dash.
- Detroit's leading automobile manufacturers appear anxious to arrange for CB as optional equipment in the near future.
- The FCC has already given the go-ahead for a mass program for an automobile emergency corps on CB channel 9, and has restricted channel 9 for emergency use only.
- CB can be effectively and profitably

\* *Auto-Call, February 1965 edition*

used in business — whereas ham radio cannot.

Like it or not, the above points are cold, hard facts. And they are darned tough to argue with.

So who cares about CB? Every amateur should be vitally interested in all that occurs on 27 MHz if he values his hobby. In the learned eyes of the electronics industry, the FCC and the general public, CB is accomplishing the very thing that amateur radio was founded to do.

A great number of us are under the dangerous misconception that amateur radio is primarily an exciting hobby, offering something that can be found nowhere else. The sad truth is that this is but a byproduct. To quote the FCC in an age-old phrase: "*Amateur radio exists because of the service it renders.*" And exactly what service *do* we render that CB does not?

We spend a great deal of our time studying award requirements and calling directional CQs. We pride ourselves additionally in keeping abreast of advances in electronic communications. We try to out-guess the experts by coming up with new ideas and effective techniques that the country can use. We are constantly building and improving in an effort to develop ourselves as communications specialists, or amateur engineers, as it were. We admit only the scientifically minded and those eager to learn more about electronics. Or do we? Are we really as technically advanced *individually* as our forebears? Can we honestly state that we have superior motives that will help America stay ahead technologically in the electronics race? *Can we?*

.. K2ZSQ/W9HBF ■

***Tell our  
Advertisers  
You Saw it  
in 73***

# BREW 1 on 2

## A TWO METER COAXIAL

**I**t was an ordinary Saturday afternoon, as I sat in my garage hamshack drinking a cold brew. What I needed was a good 2 meter antenna. With one sterling qualification: it must be cheap, cheap, inexpen-

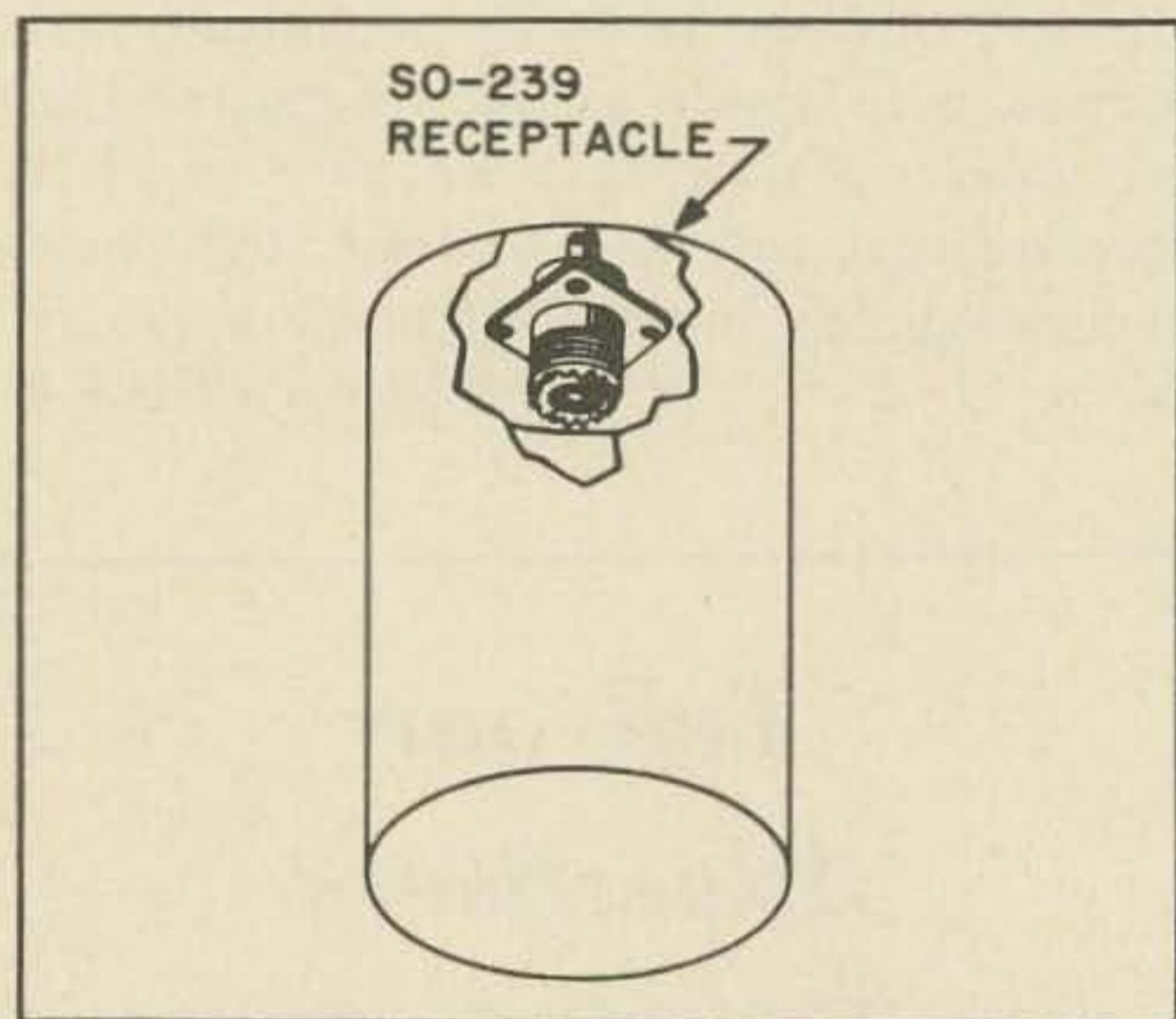
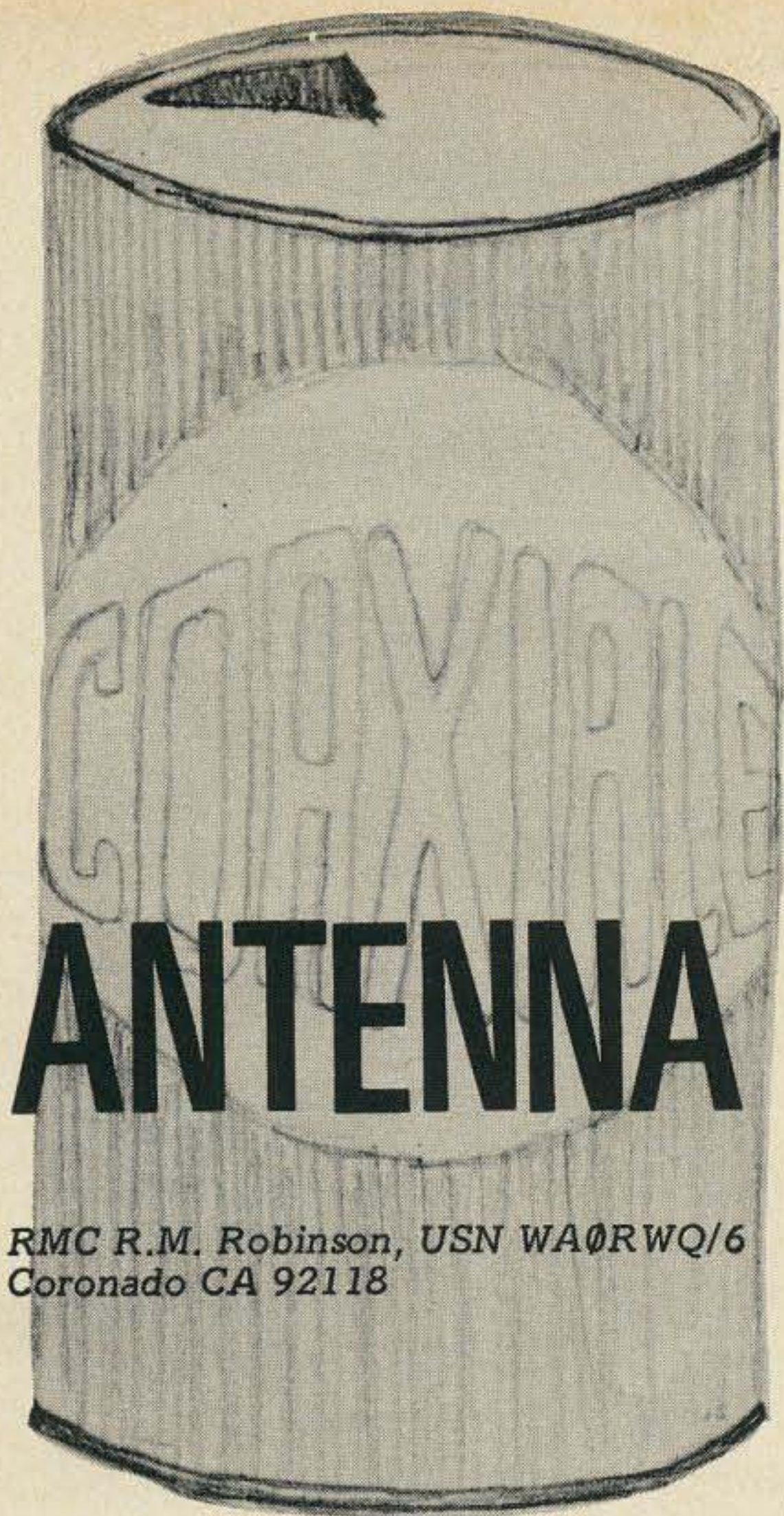

*Fig. 1. Cutaway view of top can shows SO-239 inside can. The transmission line will have to be connected before the connector is attached, unless you have very, very small hands.*

sive. I rolled the brew can around in my hands and the idea struck me — why not make a coaxial antenna with the empty beer cans; I'd heard of beer can verticals — why not a beer can coaxial?

So, I broke out the ruler and found that four empty beer cans measured just over 19 in. With haste, I dug out the soldering gun, solder, and tin snips. First, I cut the tops and bottoms out with a can opener (I left the bottom in one and drilled it to accommodate an SO-239 connector). (See Fig. 1.) When this was completed, I made up a piece of coax (RG-59 or RG-9) 38 in. long with a PL-259 at each end. I connected one end to the SO-239 on the top can. This was easy at this point, but would be practically impossible later.

Then I slid that piece of coax through the center of the remaining three cans and soldered all four as shown in Fig. 2. I used a piece of 19 in. stiff wire for the radiator, and soldered it to the end of the SO-239 sticking out of the top can. If you duplicate the antenna, you'll find welding rod, coathangers, etc. quite satisfactory. Mounting is up to the builder; also, I would suggest spraying the cans with antirust



RMC R.M. Robinson, USN WAØRWQ/6  
 Coronado CA 92118

paint. I mounted my antenna on an old broomstick with electrical tape. Swr can be changed by shortening or lengthening the 19 in. vertical.

To trim the antenna, it is better to bend the top over a bit at a time rather than cutting it. This is so that when you pass resonance your vertical won't be too short, and you can straighten out the bent portion, rather than to have to replace it.

I used a Heathkit Twoer with about 2W output. Swr at resonance was about 1.2:1 at 145.5 MHz. I found it was quite broad, QSYing nicely without a drastic increase in swr. My antenna is about 20 ft off the ground and about 4 ft from the roof on its broomstick mast.

My first contact was with WB6YO1 in Fallbrook, Calif., about 25 miles away. I also noticed I could receive stations I never could hear before, and those I could hear were much stronger than on my old groundplane. Not bad for two hours work and no cash outlay.

I won't go into the problems associated with trying to solder aluminum. If the brew you drink comes only in aluminum cans, you'd better be good at silver-

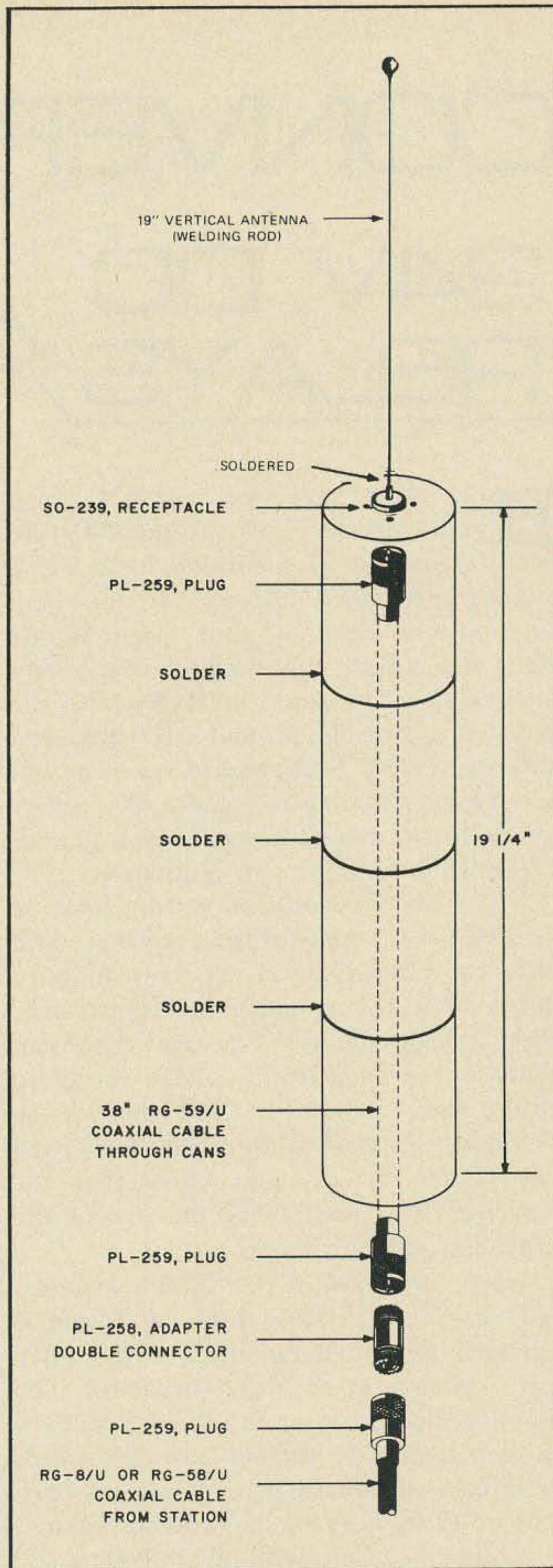

Fig. 2. Sketch shows connector required and overall construction of the beer-can coaxial.

soldering; otherwise it might be wise for you to change brands for one evening.

... WAØRWQ ■

# CONVERTING

## 24V DC RELAYS TO 115V AC

Alan Douglas  
Box 225  
Pocasset MA 02559

**H**ow often have you pawed through your shoebox of surplus 24V dc relays, looking for something for a 115V project, and wished you could change them over with a wave of your magic wand? Well, it's almost that simple; nearly any such relay will operate on 115V with the addition of two diodes and a resistor. And how many 48V telephone relays have you salted away, waiting to build a 48V power source to run them? They are even simpler to use; all it takes is a pair of diodes.

The classic circuit for getting 24V dc consists of a transformer, rectifier, and filter capacitor (Fig. 1). You can simplify this a little by replacing the transformer with a dropping resistor, providing you increase the capacitor's voltage rating to 150V, since without a load the voltage would rise to that value. If you have used this circuit before, you know that the capacitor is at least twice the size of the relay, and probably as expensive.

Now throw away the filter capacitor, and replace it with a diode. Filtering is provided by the inductance of the relay coil, instead of by the capacitor. To simplify basic theory, an inductor will try to keep steady the current flowing through it. If half-wave-rectified ac is applied, current flows in short bursts of 60 per second; in a relay it causes the familiar 60 Hz buzz. The diode provides a path for the current to flow between ac cycles, so that the coil current remains fairly steady, instead of being cut off abruptly 60 times a second.

This circuit works fine with most surplus relays which have a high coil inductance. The newer "crystal can" miniature

relays are about the only exceptions. The 48V telephone relays are a snap to use because only a very small dropping resistor, or none at all, will operate them. Note that since the relay will tend to hold on after the power is removed, it cannot be operated as fast as a conventional relay. This is likely to cause trouble only in a keyer circuit.

No additional arc suppression is needed, since the shunt diode eliminates the transient voltages normally produced when a relay is turned off. This is, in fact, a very common arc-suppression arrangement in conventional dc circuits.

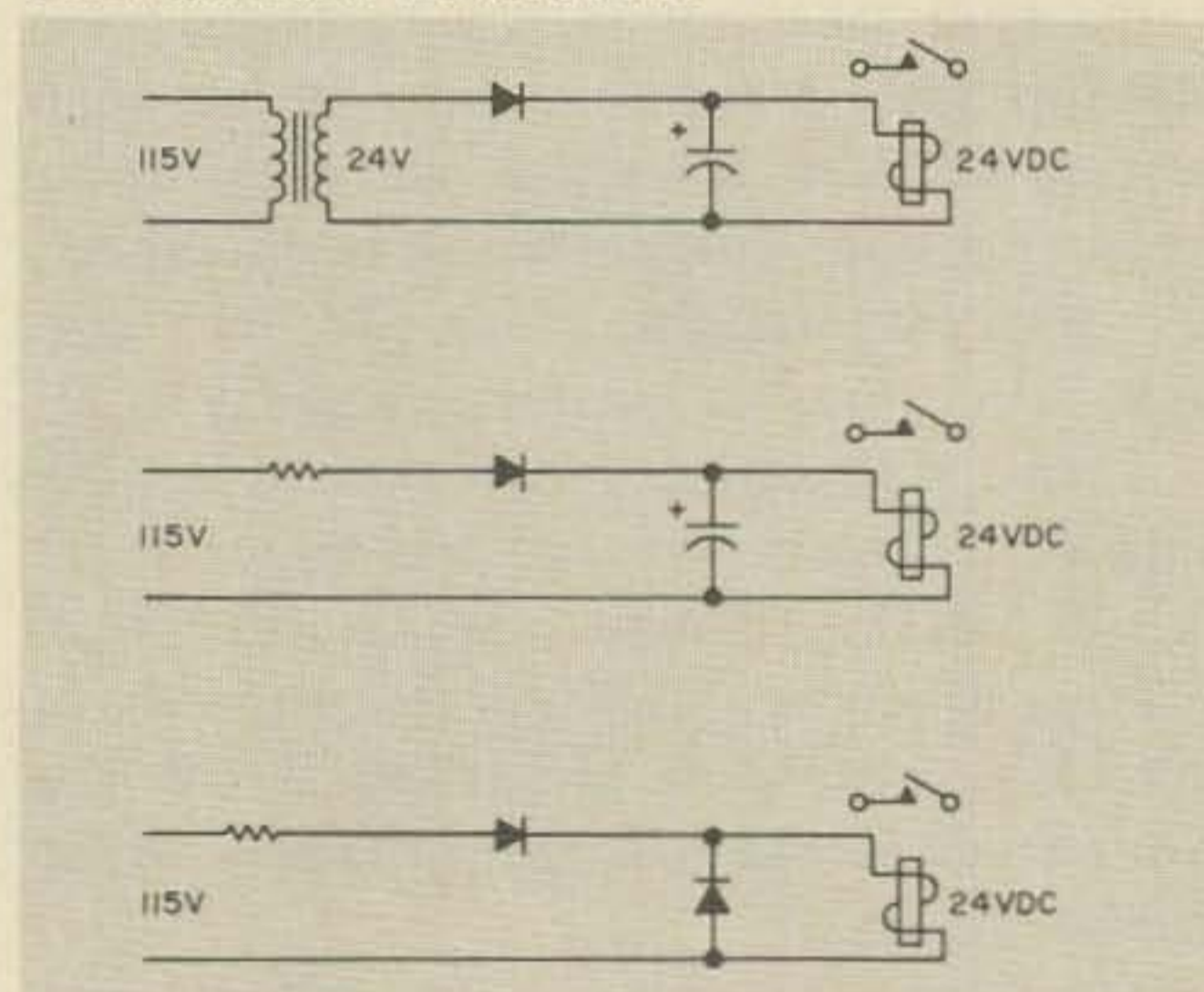

Fig. 1. In these three circuits, the result is the same. Circuit C is the simplest, though, with just one resistor and two diodes. Diode ratings should be at least one-half the relay coil current, and 200 PIV. The dropping resistor should be equal to the relay coil resistance.

Now, rush to your nearest surplus dealer and pick up a supply of relays before he reads this and ups his prices.

... Douglas ■



# 73 BOOKS FOR HAMS

## VHF ANTENNAS

This handbook is a complete collection of up-to-date information about VHF and UHF antennas, with design hints, construction and theory. If you've been wondering what array you need, this book will give you enough background to make the right decision. \$3

## ADVANCED CLASS STUDY GUIDE

128 pages of up-to-the-minute simplified theory, written with the beginning radio amateur in mind. This unique book covers all aspects of the theory exam for the Advanced Class license and has helped hundreds of hams to sail through the exam. . .nothing else like it in print. \$3

## DIODE CIRCUITS HANDBOOK

An invaluable reference book. Covers rectifiers, mixers, detectors, modulators, FM detectors, noise limiters, AGC, BFO/Q-multiplier, AFC, Varicap tuning audio clippers, balanced mods, field-strength meters, RF probes, zeners, control circuits, etc. 111 different circuits. \$1

## COAX HANDBOOK

Invaluable book for the ham or the lab and for everyone else who doesn't want to have to keep a whole library on hand for reference. . .or even worse, have to write to the manufacturer for coax spec. \$3

## 73 USEFUL TRANSISTOR CIRCUITS

If you've been looking for a transistor circuit to do a special job, chances are there is a circuit in this book that will give you a head start. It covers circuits for audio, receivers, transmitters and test equipment. \$1

## INDEX TO SURPLUS

Do you have a piece of surplus equipment that you want to convert but can't find an article? If so, this is the book you need. It lists all of the surplus articles and conversions in popular electronic and amateur magazines from 1945 to 1966. \$1.50

## DX HANDBOOK

Includes giant world country-zone wall map. Articles on QSL design secrets, winning DX contests, DXCC rules, DXpeditions, reciprocal licensing and many more. World postage rates, WAZ record lists, time charts, propagation, etc. Special ham maps and bearing charts. A must for the DXer. \$3

## SIMPLIFIED MATH

Does math scare you? — It shouldn't. This easy-to-understand book explains the simplified exponential system of arithmetic, simple formulas, logarithms, and their application to the ham shack. 50¢

## FM ANTHOLOGY

Vol. I. This book is largely a collection from FM Bulletin, edited by K6MVH and WA8UTB. The material is taken from the editions of February 1967 through February 1968.

**NOW AVAILABLE FOR ONLY \$3**

VHF Antennas . . . . . \$3.00  
 Advanced Class . . . . . \$3.00  
 Diode Circuits Handbook . \$1.00  
 73 Transistor Circuits. . . \$1.00  
 Index to Surplus. . . . . \$1.50  
 DX Handbook . . . . . \$3.00  
 Simplified Math . . . . . \$ .50  
 Coax Handbook. . . . . \$3.00  
 FM Anthology . . . . . \$3.00

Please send me the books checked at left:

Name ..... Call .....

Address .....

City ..... State ..... Zip .....

Books shipped prepaid in US and Canada.

# 73 Magazine

Peterborough, N. H. 03458

Robert D. Morrison WB6YVT  
1590 De Leon Way  
Livermore CA 94550

## A VERSATILE

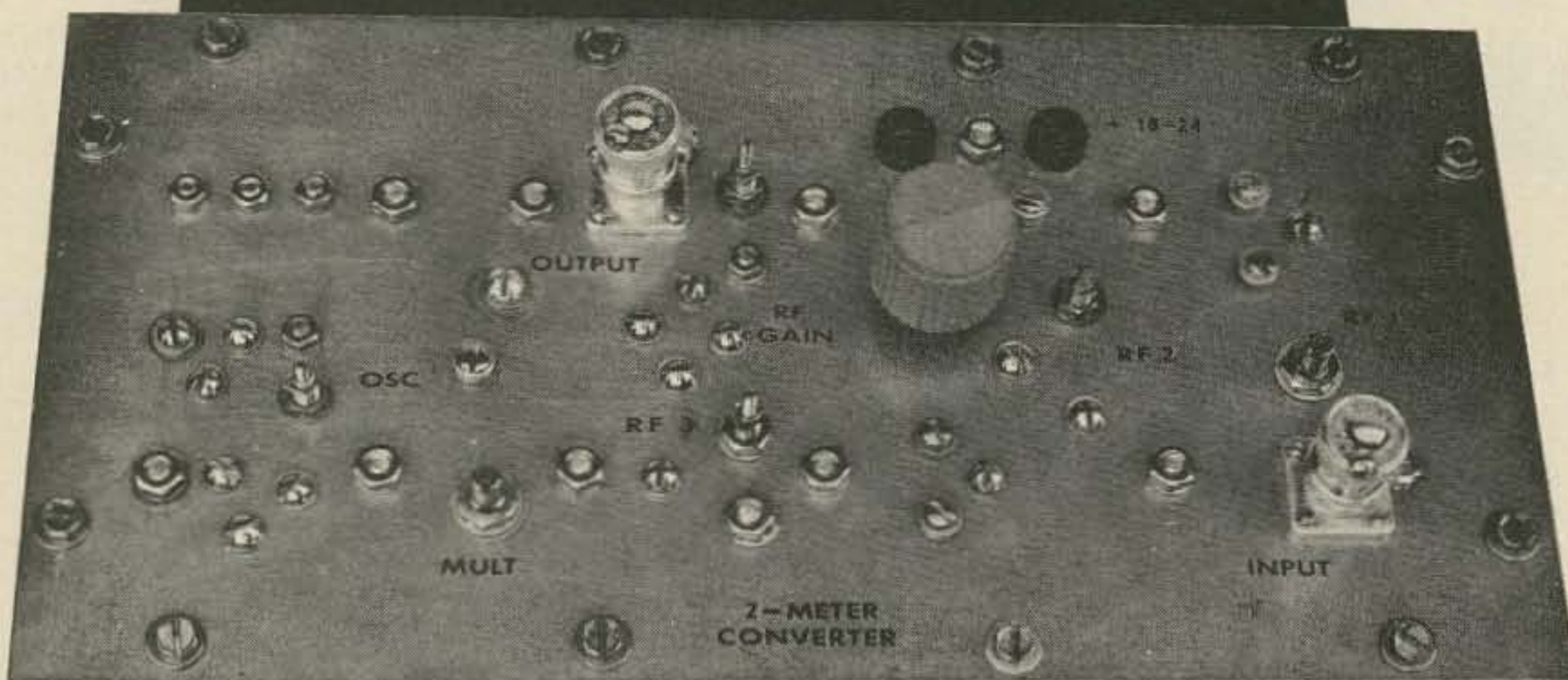

## and STABLE MOSFET CONVERTER for 144 MHz

**H**ere is a converter which offers just about the optimum in tube and solid-state performance. Its characteristics include the following.

- Low noise figure.
- Excellent cross-modulation performance, dynamic range, and overload control.
- No neutralization, stagger-tuning, or reduced gain operation is required to prevent rf oscillations.
- Complete stability. The rf stages of this converter have never oscillated

under any conditions of tuning or antenna source impedance. In addition, the local oscillator has high amplitude stability and has never required any readjustments.

- High gain with a very effective rf gain control.
- Wide bandwidth, which allows operation over the entire 144–148 MHz range with no repeaking of the converter required.

### Circuit Description

The dual-gate MOSFET appears to be the new darling of the front-end designers.

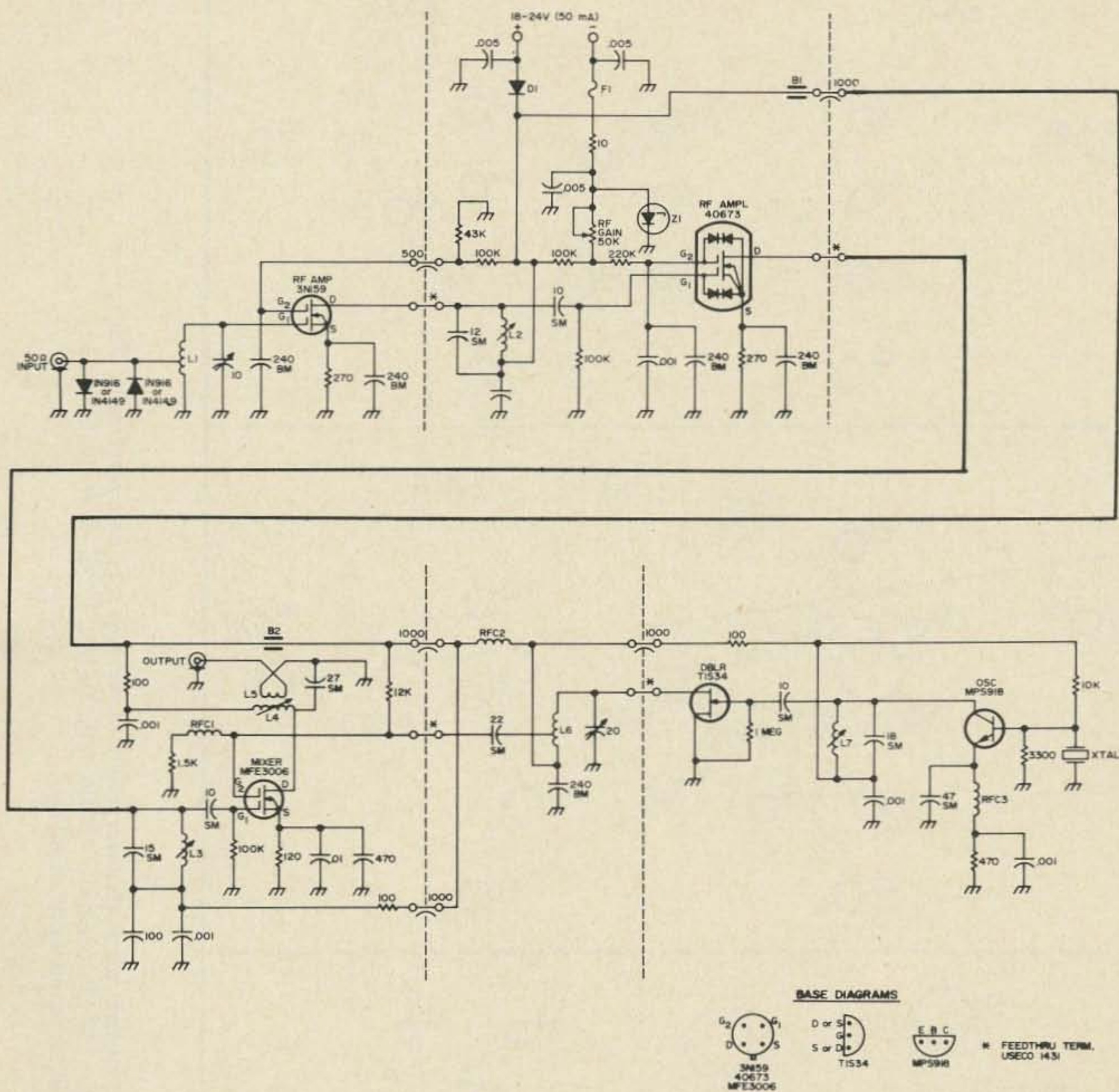

Fig. 1. Schematic diagram of the converter. Any one of the MOSFET types 3N140, 3N159, or MFE3007 may be substituted for any of the MOSFETs in the schematic. However, a 3N159 will give the lowest noise figure in the first stage. A 40673 should give the best protection against any rf spikes in the second stage. And a MFE3006/MFE3007 should give the best protection against steady, high-voltage rf signals in the mixer stage. All resistors are  $\frac{1}{2}$ -watt carbon, 5%. All fixed capacitors other than SM, BM, or feedthrough types are disk ceramic.

It has surpassed the performance of tubes, bipolar transistors, and junction FETs with but one exception. This exception is that the junction FET gives about a 1 dB lower noise figure in the VHF range. This extra decibel of sensitivity may be useful to moonbouncers and those who live in remote areas, but if you live near populated areas, the sensitivity of the MOSFET is more than adequate to get you down into the atmosphere noise.

An important advantage of the dual-gate MOSFET is that, unlike the "triode" tran-

sistors, it does not require neutralization. Of course, if the builder uses second-rate shielding and bypassing techniques, even the dual-gate MOSFET will oscillate.

The key to the stability of the new present converter is that the rf MOSFET gate 2 source leads are soldered directly to button mica bypass capacitors. In addition, there are shields between each stage, and the rf MOSFET drain leads are soldered directly to the shield feedthroughs. Something to remember is that the series-resonant frequency of a bypass capacitor



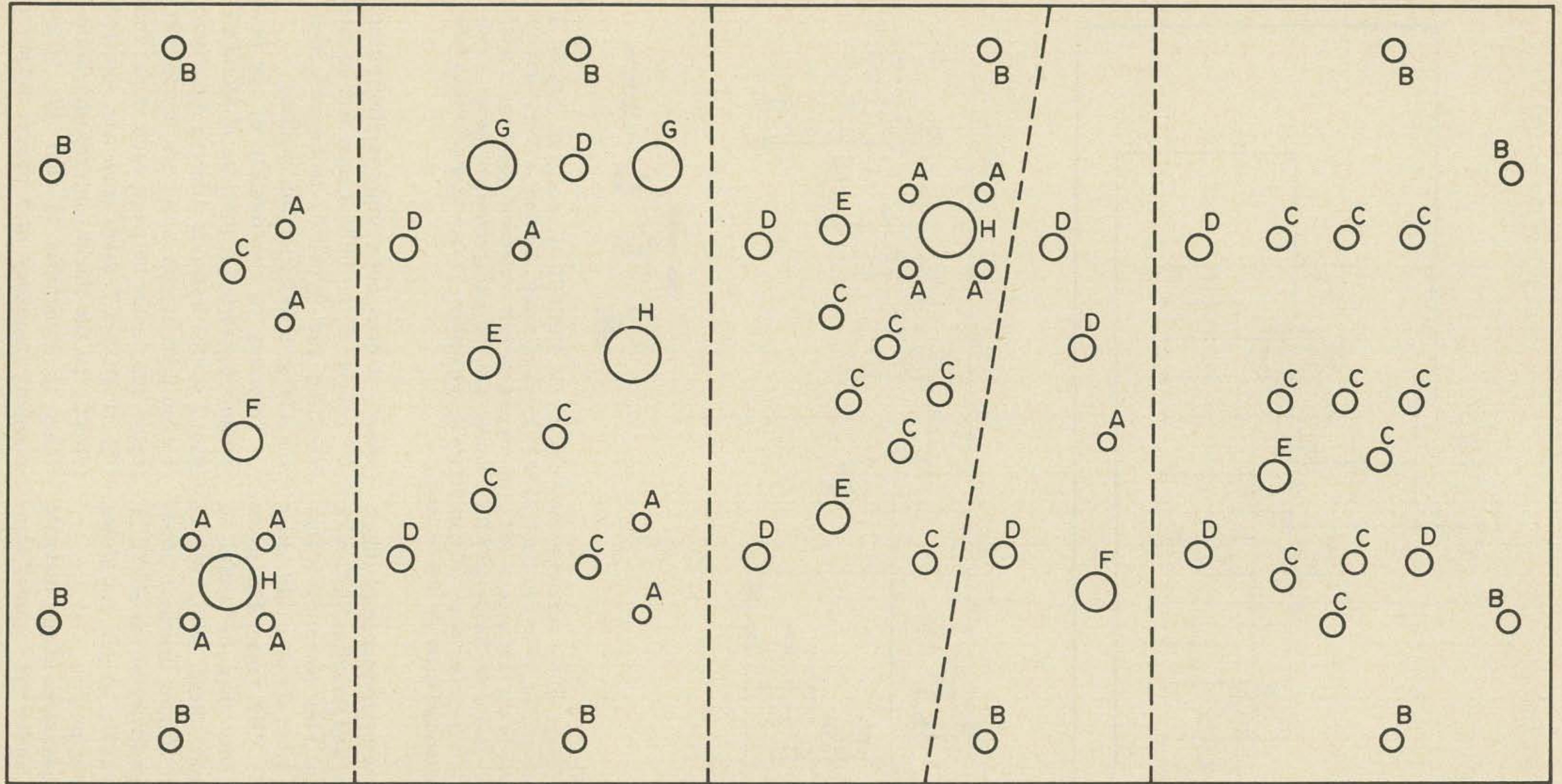

Fig. 2. Reduced-size template of chassis plate (bottom view) shows hole size and placement. The letters indicate drill sizes: A—No. 37, B— $5/32$  in., C—No. 26, D—No. 17, E— $3/16$  in., F— $1/4$  in., G— $5/16$  in., H— $3/8$  in. The broken lines represent shielding.

should equal or exceed the frequency to be bypassed.

Figure 1 shows the converter circuit. The first rf stage uses an RCA 3N159. At the time of this writing, this transistor has the lowest 200 MHz noise figure of all dual-gate MOSFETs on the market. This stage is biased to run at "wide-open" gain for best sensitivity. The input tank has a fairly wide bandwidth so that a low noise figure is maintained over the entire 144-148 MHz band with no repeaking of the converter.

Silicon high-speed diodes are used at the antenna input. These diodes have a negligible effect on the input circuit. Germanium diodes conduct at about 0.1V so that signals above this value will be distorted. Silicon diodes, on the other hand, conduct at about 0.5V. The MOSFET, with its insulated gate, has a higher gate voltage tolerance than the J-FET whose gate will conduct at 10.5V bias. As a result, the silicon diode-MOSFET input has considerably greater overload tolerance than the germanium diode-J-FET input combination. For extreme overloads, each silicon diode may be replaced by two silicon diodes in series.

The second rf stage uses an RCA 40673. This MOSFET has integrated back-to-back diodes from each gate to the source. These diodes protect the silicon dioxide insulation from breakdown by the high-voltage spikes of static discharge. Unlike unprotected MOSFETs, these transistors require no special handling techniques.

The linear pot and 4.7V zener network provides an adjustable gain range of about 50 dB from full on to full off. The 100 k $\Omega$  resistor connected to the pot provides a gate 2 voltage of about 1V at maximum gain. This 100 k $\Omega$  may be reduced to give a higher bias and a slightly higher maximum gain but the gain control action may become more abrupt and possibly bothersome.

If the converter is to be used with a good antenna and high-gain receiver, one rf stage probably will provide adequate performance. If desired, the gain control could be applied to the first stage. To avoid parasitic oscillations, it is important to

## DUAL GATE MOSFET PRE-AMPS



to 175 MHz. \$21.95 ppd.  
to 300 MHz. \$25.95 ppd.

NEW FOR 1970!

The above models now have rf gain control.

For 300 to 470 MHz

See Model 202 in our catalog.

- Available from 5 MHz. to 450 MHz. Bandwidth is approximately 3% of frequency.
- Voltage gain 30 to 40 DB depending on frequency.
- Two Dual Gate MOSFET amplifier stages with each having a tuned input and tuned output. Each Dual Gate MOSFET is actually an integrated cascode circuit thus giving you 2 cascode circuits equivalent to 4 triodes.
- Exceptionally low noise (2.5 DB at 175MHz.), greatly reduced cross modulation and 10 times the dynamic range (signal handling capability) of the best bi-polar transistors. Also superior to preamps using junction FETs and Single Gate MOSFETs.
- Internal connections for high impedance AGC or manual gain control if needed.
- Type BNC input and output receptacles for minimum loss at UHF. Standard impedance is 50-75 ohms.
- Carefully tuned at our laboratory with sweep generator and oscilloscope for the best bandpass characteristic.
- Full wave UHF diodes protect input transistor.
- Operates on 6 to 16 volts DC, 5 to 15 Ma.

New York City and State residents add local sales tax.

## VANGUARD LABS

Dept. H

196-23 Jamaica Ave., Hollis, NY 11423



## GUNSMOKE?

Blow your mind on our back issue bargain bunch, 30 (count 'em) assorted (we hope) back issues, all before 1968, for the incredibly low price of \$6 post-paid (hardly pays for the postage). These are packed by slave labor (to cut costs) so please ignore notes calling for help, etc. that may be slipped into the bundles. 73 Gunsmoke, Peterborough NH 03458. Send cash, check or negotiable securities.

keep the gate 3 dc bias resistors out of the first-stage compartment.

Undoubtedly, the dual-gate MOSFET is the best of the transistor mixers. With the signal input at gate 1 and the oscillator input at gate 2, the problem of oscillator feedthrough to the rf circuits is greatly reduced. Also oscillator detuning by the rf circuits is minimized. The mixer presents a high impedance to the oscillator circuits, so that the oscillator drive requirement is low. The square-law response of the MOSFET greatly reduces cross-modulation distortion. The MOSFET is also very resistant to overload, which is a highly prized characteristic for mixer operation.

A Motorola MFE 3006 silicon nitride passivated dual-gate MOSFET is used for the mixer. The gate breakdown voltage ratings of  $\pm 35V$  are considerably greater than the ratings of the unpassivated MOSFETs. Because very high steady rf voltages may appear across the mixer terminals, the higher breakdown voltages of this transistor are deemed more appropriate. This transistor is still quite vulnerable to voltage spikes so that handling precautions are necessary. (The Motorola MFE 3007, by the way, is an improved version of the MFE 3006.)

The present *mixer-local oscillator* injection voltage is 2.5 peak (1.8V). Higher injection voltages will produce more gain, while a somewhat lower injection voltage should produce slightly less mixing distortion. Distortion control and gain are both excellent at the present 2V peak oscillator injection level.

The 14–18 MHz mixer output coil has a fairly wide bandwidth so that no readjustment of the converter is required during operation over the entire 144–148 MHz range. For receivers with input impedances other than  $50\Omega$ , the turns ratio of the mixer output coil should be adjusted to give a suitable bandwidth.

By the time this article appears in print, some manufacturer will probably be marketing a dual-gate MOSFET which has the low noise figure of the RCA 3N159, the protective diodes of the RCA 40673, and the silicon nitride passivation of the MFE 3006. This could possibly be the ultimate

in silicon channel MOSFETs. Of course, a second manufacturer may later one-up the first by marketing a gallium arsenide channel MOSFET, and then later still, a third may bring out an integrated circuit that has... There is nothing like free enterprise to keep the manufacturers sharp and the ham builders happy.

The fifth-overtone oscillator circuit is excellent. It has exceptional amplitude stability, adequate frequency stability, good output power, and low output impedance. It was suggested by Bill Carver K6OLG, who believes it may be a variation on an original design by Frank Jones W6AJF.

The TIS34 J-FET doubler has a fairly high input impedance, a high output voltage, and is very simple to construct. The 65 MHz fundamental is better than 20 dB down from the 130 harmonic in the doubler output. This ratio is not earth-shaking, but it is adequate for the application.

The oscillator-doubler combination produces a strong, stable output, and can operate over a dc range of 5–25V.

The converter is designed to be used with a  $50\Omega$  antenna and a receiver of approximately  $50\Omega$  input impedance.

#### Construction

A 5 x 10 in. brass sheet of 40 mils thickness serves as the chassis plate. The shields are made of 30-mil brass plate and are bolted to the chassis plate. The brass plate on my unit (pictured) has been tin-coated for appearance and contact resistance stability. The tinned brass plate is held to an inverted 5 x 10 x 3 in. aluminum chassis by sheet metal screws. Aluminum and tin are more galvanically compatible than aluminum and brass. Of course, any two dissimilar metals in contact can produce corrosion if the conditions are right. The tin-aluminum combination used here should give no problem. Figure 2 is reduced-size template showing hole positioning, shield placement, and relative hole sizes.

Transistor sockets are not used. The leads are soldered directly to button mica bypass capacitors, shield feedthroughs, or to ceramic standoffs. All ground lugs are

soldered directly to the chassis plate.

Ceramic slug-tuned coils are used throughout with two exceptions. Air-core coils, with their higher Q values, are used for the antenna input coil and the doubler output coil. (A complete parts list appears in Table I.)

The ferrite beads are novel and may be replaced by  $33\Omega$  resistors, if desired. Ferrite beads have the advantage that they have zero dc resistance — a disadvantage is that their ac resistance is significant only above about 50–100 MHz.

This converter probably should not become a first VHF project. At 2 meters, capacitors can look like inductors and inductors can look like capacitors, regardless of what is stamped on the outside of the component.

The oscillator should be built and tested first. A 2N918 or MPS 918 must be used in this circuit. When the oscillator is performing well, the doubler can be added. A TIS34 or 2N3823 should be used. A TIS88 (2N5245), MPF107 (2N5486), or 2N4416 with their higher gain may cause undesired oscillations.

When the oscillator–doubler chain is working, add the mixer. Use an RCA 40673 protected MOSFET for experimentation at this point since the other MOSFETs are too easily damaged by constant insertion and easily interchanged.

Any problems in the oscillator–doubler–mixer chain should be solved before installing the two rf stages. The second rf stage should be added and made stable. Then the first rf stage can be put in. All dc bias resistors of the first rf stage except the source resistor should be kept out of the first rf stage compartment.

After the converter is completely stable, the top on the antenna input coil should be adjusted for minimum noise figure. This should be done with a noise generator, but a weak 2 meter signal should also suffice.

The builder may find that the capacitor values needed in the tank circuits differ from those given on the schematic. This is to be expected, since slight geometrical changes can affect the frequency response of tuned circuits at 2 meter frequencies.

Unprotected MOSFETs are easily

## 10 WATT 2M AMPLIFIER

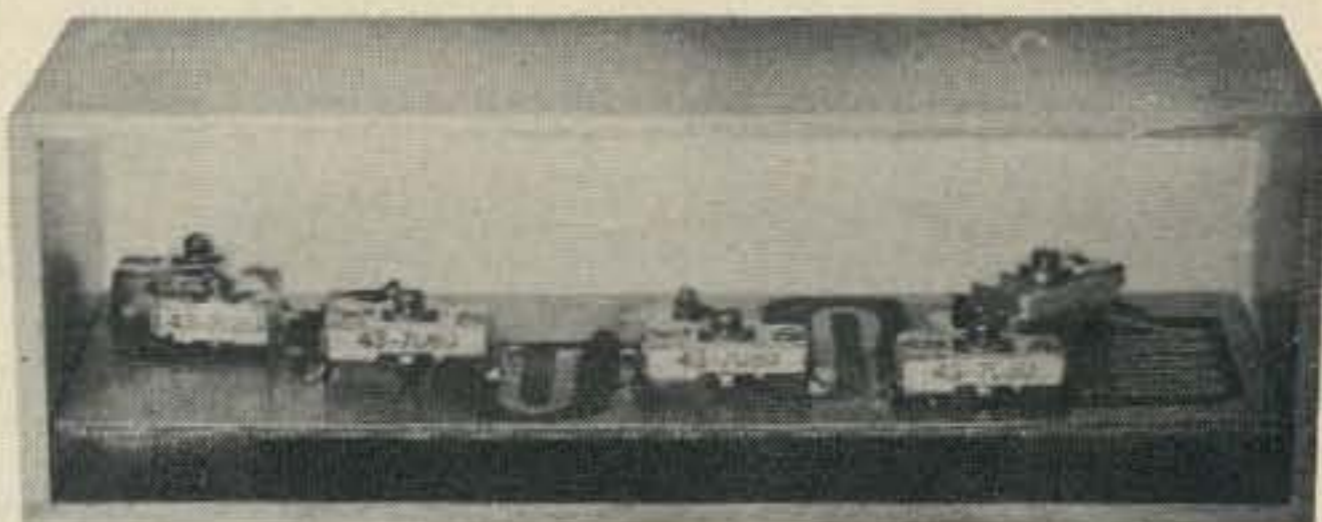

DyComm 101-500

30 mW drive (or more), 12V dc powered.

FM — CW — AM — Etc.

ONLY **\$59.95** postage prepaid

SOLD? ORDER NOW!

NOT SOLD? Send for information.

**DYNAMIC COMMUNICATIONS**

301 BROADWAY

RIVIERA BEACH FL 33404

## \*TWO-WAY\* COMMUNICATION CRYSTALS

AMERICAN CRYSTAL CO.

PO Box 2366 Kansas City, MO 64142

(816 - 842 - 5571)

## HATRY ELECTRONICS

500 Ledyard St., Hartford, Conn. 06114

203-527-1881

(1 Block East of Wethersfield Ave. off  
Airport Rd., Rte 6)

See **CORKY, W1KXM** or **WARD, W1WRQ**

### ANTENNA STUFF

In 100 foot rolls only

450 ohm open wire. Per 100 feet .....\$ 4.95  
300 ohm open wire. Per 100 feet ..... 4.65  
Standoff-Mast or Screw-In ..... .19

In 100 ft. interconnected coils

18 Copperweld. Per 100 feet .....\$ 1.19  
14 Copperweld. Per 100 feet ..... 2.95  
12 Copperweld. Per 100 feet ..... 3.99  
14 Copper-Solid. Per 100 feet ..... 4.29  
12 Copper-Solid. Per 100 feet ..... 5.79  
Times T4-50 L/Loss 8U. Per foot ..... .18  
Times T5-50 L/Loss 58U. Per foot ..... .10  
Times Solid Sheath Alumafilm in stock  
Kits with connectors 50/100 ft  
Glass Line-guy wire. Per 100 feet 500 lbs Test 3.79  
Glass Line-guy wire. Per 100 feet 1000 lbs Test 5.85  
Hy-Gain Balun. Each .....14.95  
W2AU Balun. Each .....12.95  
Blitz Bugs. Each ..... 4.95

All major lines of Amateur gear • Rohn #25 towers and accessories • Waters Protax switches • Dow Key relays • Greene Baluns • New-Tronics Hustler Mobile • All antenna insulators in stock.

(Canadian Amateurs Send U.S. Funds Only)

F.o.b. Hartford

Please Include Postage

CONNECTICUT'S OLDEST HAM STORE

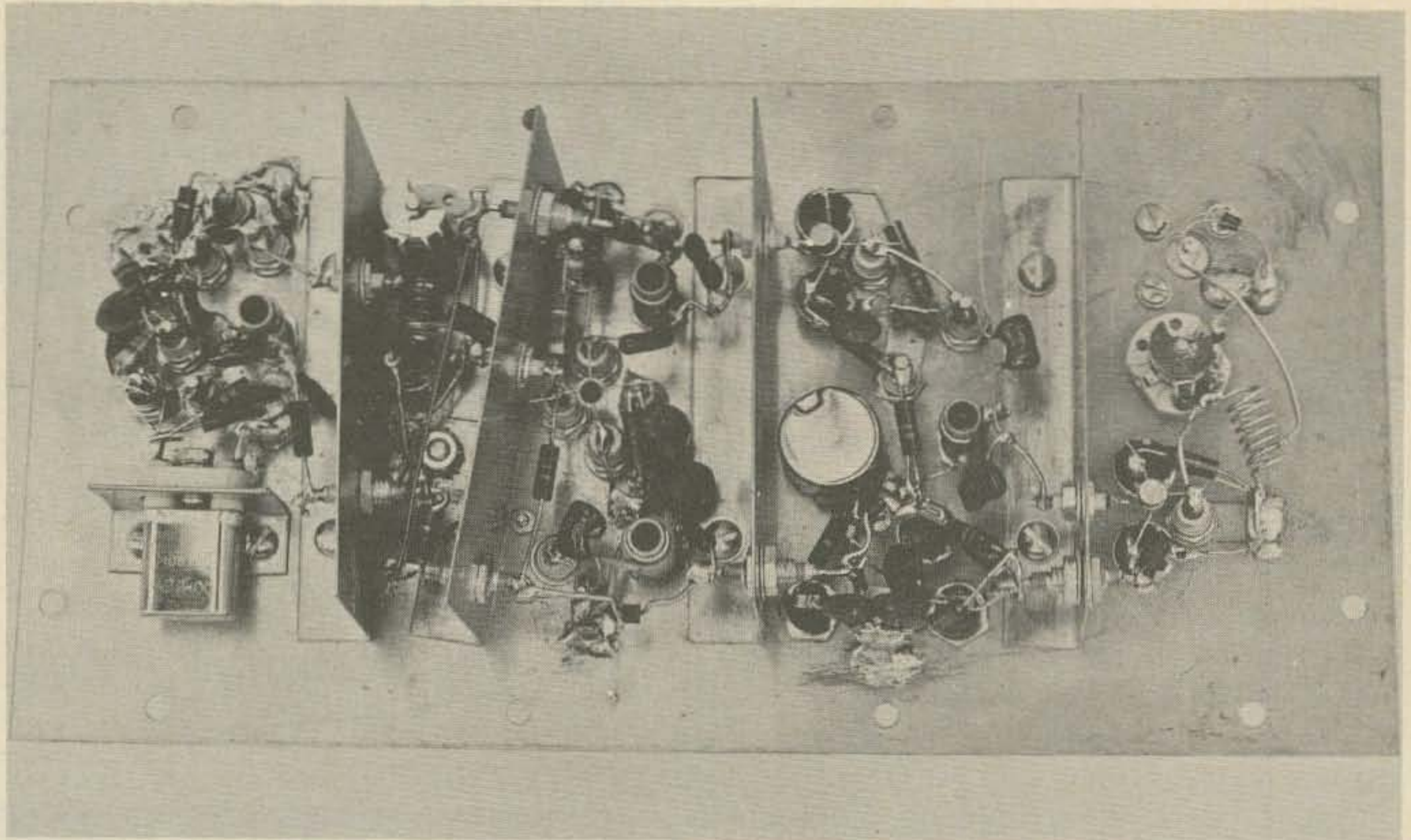

Construction details and component placement are clearly shown in this head-on view of the segmented converter.

damaged by improper handling procedures. Adequate procedures to prevent damage are as follows.

1. The soldering iron tip should be grounded to the converter chassis.
2. The lead to be soldered (or the lead that is connected to the point to be soldered) should be grounded to the chassis with a clip lead.
3. The metal ring supplied with the transistor can be replaced with a ring of solder if the solder firmly contacts all four leads.

Once the MOSFETs are in place and the converter is working properly, there should be no more concern about damaging the MOSFETs.

#### Performance

The following results were obtained with the antenna coil tuned to 146.0 MHz, the second rf coil tuned to 144.5 MHz, the third rf coil tuned to 147.5 MHz, and the mixer output coil tuned to 16.0 MHz. Other combinations may work better with a different antenna and receiver.

1. The measured noise figure is about 3 dB.
2. The measured gain is about 50 dB.
3. The measured gain control is about 40 dB for a 0.1V rms signal, and

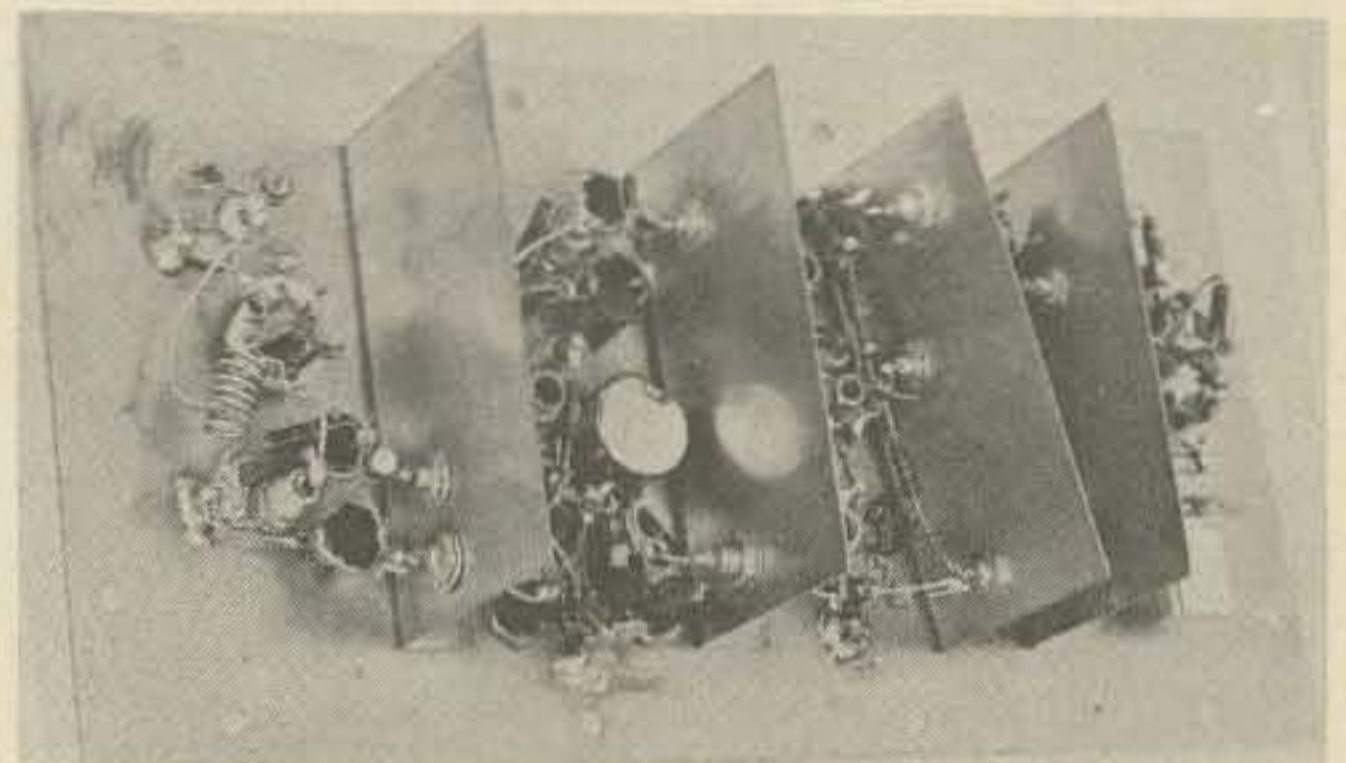

The shielded compartments are (left to right) first rf stage, second rf stage, mixer, doubler, and oscillator. The crystal can be seen against the chassis plate in the oscillator compartment.

about 60 dB for a 10 mV signal.

4. The bandwidth is wide enough that a 3 dB noise figure and a fairly constant gain persist over the entire 144–148 MHz range with no readjustments on the converter.
5. A 0.1V rms antenna signal produced no significant distortion in the converter; however, a strong signal may produce distortion in the receiver mixer, since the converter can put several volts of rf into the receiver mixer. In this case the converter gain control or the receiver rf gain control should be used to attenuate the

strong signal. At no time during initial operation of my unit did the converter gain control require any decrease from the maximum. The receiver gain control did require downward adjustment on very strong signals, however. Incidentally, it was observed during this test that the converter front-end noise was negligible compared to the atmospheric noise. The test location was in the Livermore valley 30 miles east of San Francisco.

6. The converter is completely stable. The local oscillator has never required any adjustment. The two rf stages have never oscillated, but they have remained stable and broadband under all conditions of operation.

Table I. MOSFET 2m Converter Parts List and Symbol Explanations

- SM — Dipped silver mica.  
 BM — Button mica (Erie).  
 L1 — 7t 18-gage tinned wire, air-wound ½ in. long on 7/32 in. inside dia. Tapped approx 1 5/8 turns from cold end.  
 L2, L3 — 2¼t 18-gage enam. wire, closewound on ¼ in. dia slug-tuned ceramic form (Miller 4500-4, white core).  
 L4 — Slug-tuned, 3.1–4.8 μH (Miller 4504).  
 L5 — 4t 220gauge insulated wire wound around L4.  
 L6 — 6t 18-gage enam. wire, air-wound ½ in. long on 7/32 in. inside dia. Tapped approx. 1½t from cold end.  
 L7 — 4¼t 24-gage enam. wire, closewound on ¼ in. dia. slug-tuned ceramic form (Miller 4500-2, red core).  
 RFC1, RFC2 — 2.2 μH molded rf choke (Miller 9320-14).  
 RFC3 — 1.5 μH molded rf choke (Miller 9310-16).  
 Z1 — 4.7V zener, 1W (Motorola 1N4732).  
 D1 — Silicon diode, 100V PIV min, 300 mA min.  
 F1 — Standard fuse, 1/8A.  
 XTAL — 65.000 MHz, fifth-overtone, series-resonant crystal.  
 B1, B2 — Ferrite beaded (Ferroxcube, Stackpole), or 33Ω resistor.  
 Air capacitors are Hammarlund MAC-10 and MAC-20.  
 2 BNC receptacles, 2 banana jacks, 15 ceramic standoff insulators.

The experienced VHF builder will find this converter to be a satisfying construction experience. The 2 meter operator will be quite happy with its stable, all-around performance.

... WB6YVT ■

## WHAT IS THE BEST ANTENNA HEIGHT FOR DX'ING?

70 feet  
(for 20-15-10M)

## WHAT IS THE BEST WAY TO GET THERE?

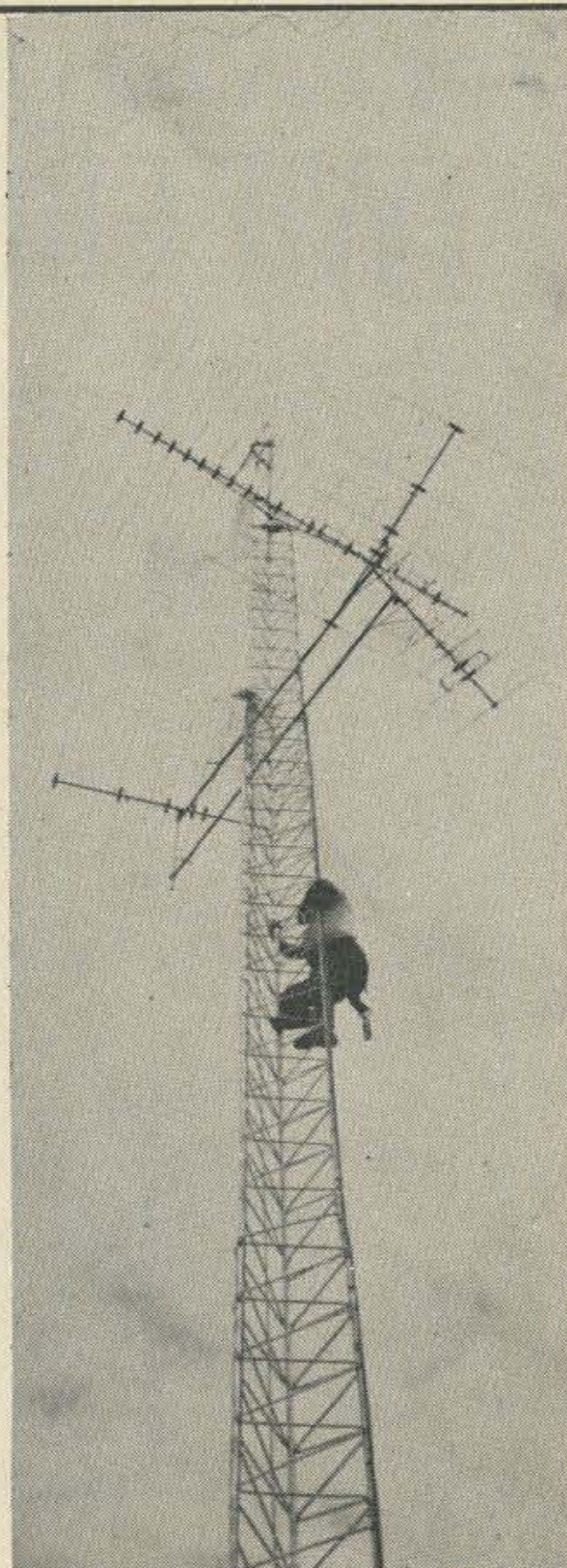

### The HEIGHTS

Aluminum Tower	+	hinged base
*so light you can	+	fits any rotor
put it up all by	+	costs under \$350
yourself! No	+	no painting
climbing, no jin	+	no rusting
poles, no heart	+	doesn't depreci-
attacks.		ate like steel.

\*A 64 foot tower  
weighs only 140 #

SEE YOUR LOCAL DISTRIBUTOR  
OR WRITE

FOR COMPLETE INFORMATION

*NOW In New Larger Facilities  
to expedite your orders.*

**HEIGHTS  
MANUFACTURING CO.**

Almont Heights Industrial Park  
4516 North Van Dyke  
Almont, Michigan 48003

**Direct from 73**

# TWO GREAT E&E HANDBOOKS

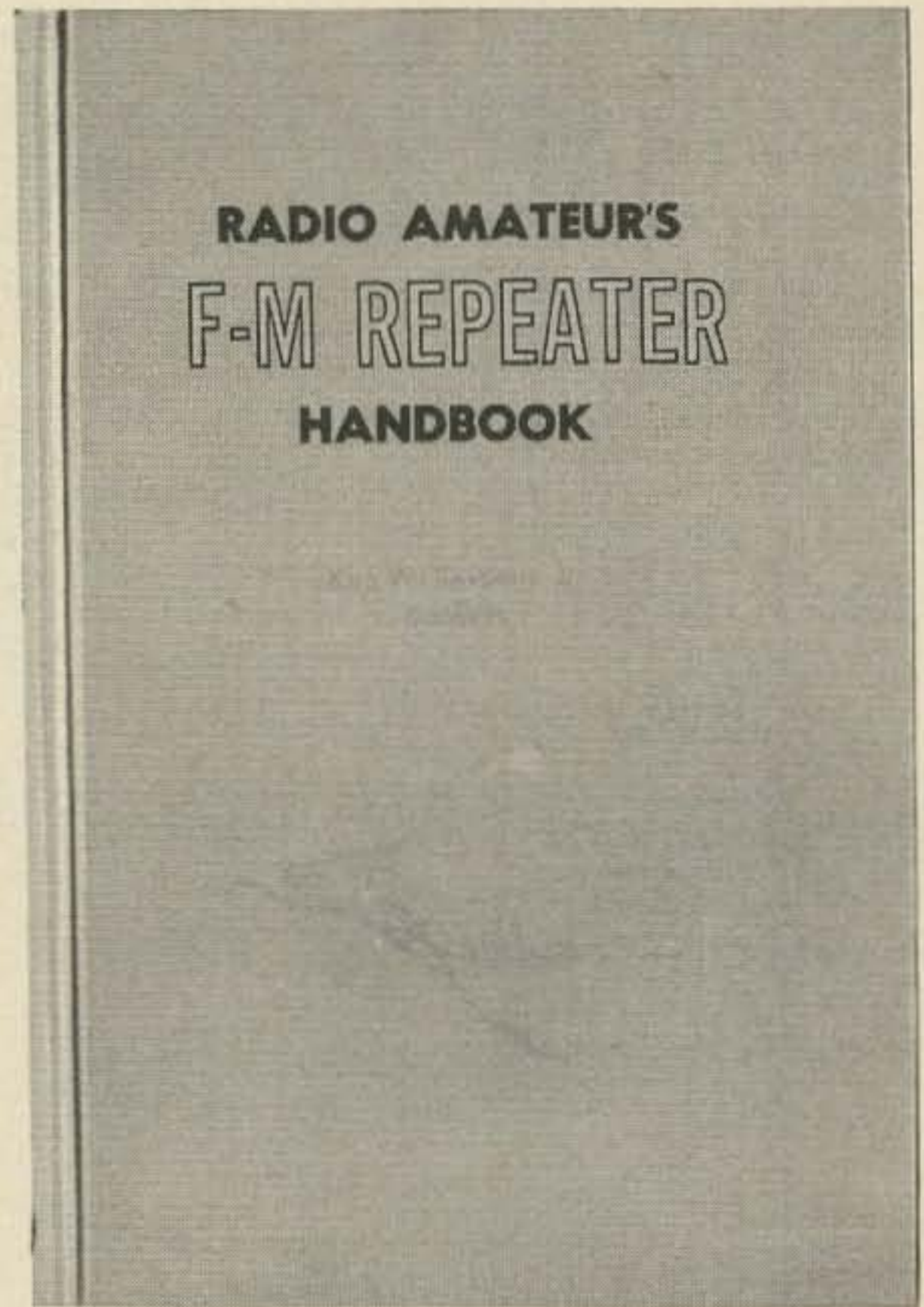
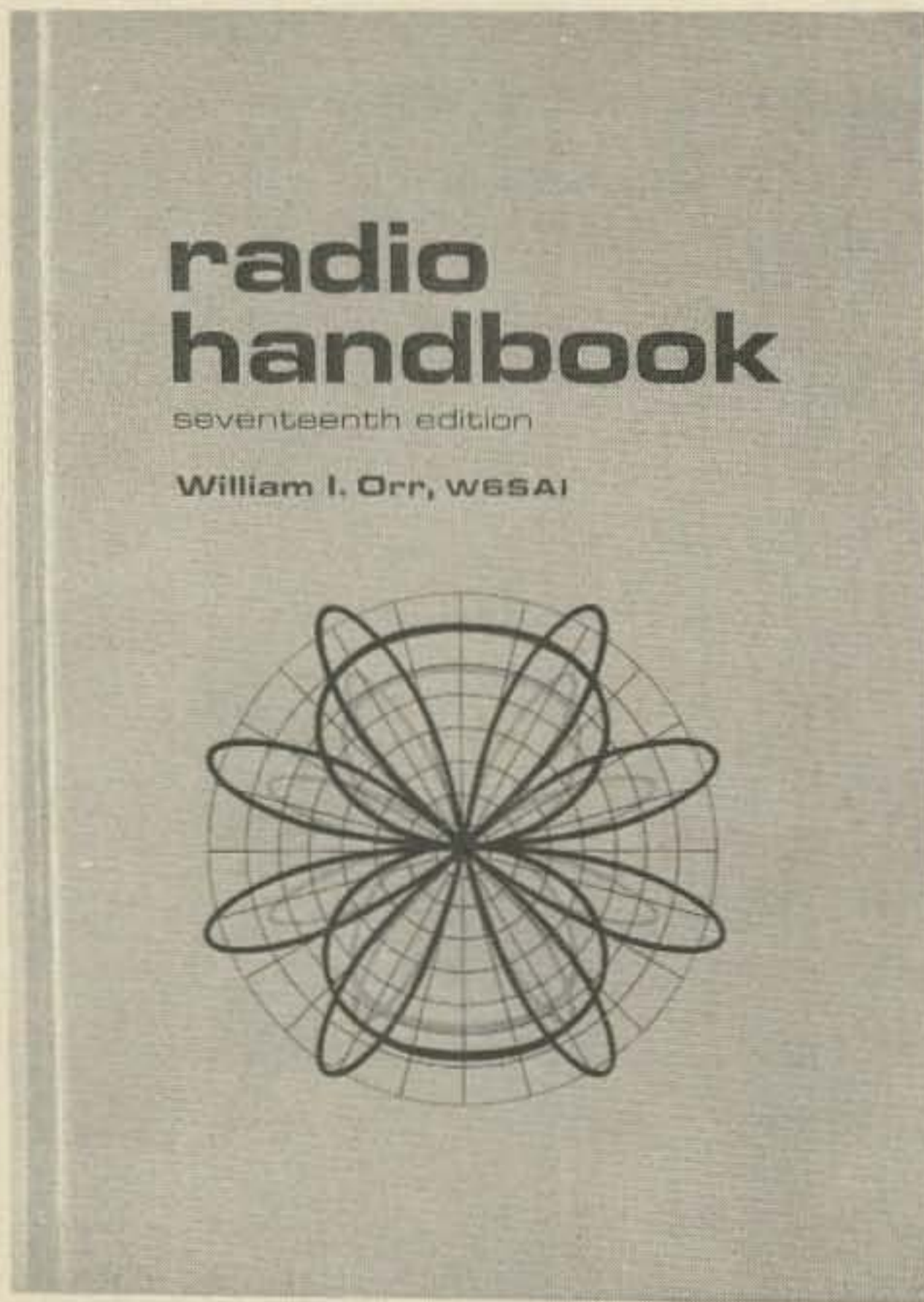

Regularly...\$ 12.95 / **A STEAL at \$ 10.**

The Radio Handbook is by far the biggest and the best handbook in print. Here is your chance to get this great book at a substantial discount, if you act fast. We have a limited quantity on hand and when they are sold that will be the end of the bargain.

The Radio Handbook is the *only* handbook that has all original material rather than just reprints of magazine articles. The hundreds of construction projects were built specially for this handbook by top amateur radio builders. Hardbound, with some 850 pages of theory, construction projects, and reference data covering every aspect of amateur radio.

... a sellout

at radio stores from coast to coast!

Want to build a repeater?

Or improve your existing site?

Whether you're a newcomer or an oldtimer, you'll find "The Radio Amateur's FM Repeater Handbook" to be the most valuable repeater aid you can get.

The Repeater Handbook contains 208 pages of useful, hard-to-come-by information, and it's written in an interesting, personal vein.

## GET BOTH OF THESE GREAT HANDBOOKS — ONLY \$15.00

Use the coupon to order the Radio Handbook, the FM Repeater Handbook, or the special two-book package.

MAIL TO 73 HANDBOOKS, PETERBOROUGH NH 03458

NAME \_\_\_\_\_ CALL \_\_\_\_\_

ADDRESS \_\_\_\_\_

CITY/STATE \_\_\_\_\_ ZIP \_\_\_\_\_

Radio Hndbk I enclose \$10     FM Repeater Hndbk I enclose \$6.95     Both Hndbks I enclose \$15

# AHA! YOU THOUGHT GOTHAM

made run-of-the-mill ordinary antennas. No, no, no. Our materials are the best, and our design superior. WA1JFG won the New England Round-Up championship with our 3-element 15meter beam by a margin of 5,982 points!

**QUADS** Worked 42 countries in two weeks with my Gotham Quad and only 75 watts...

**W3 CUBICAL QUAD ANTENNAS** — these two element beams have a full wavelength driven element and a reflector; the gain is equal to that of a three element beam and the directivity appears to us to be exceptional! **ALL METAL** (except the insulators) — absolutely no bamboo. Complete with boom, aluminum alloy spreaders; sturdy, universal-type beam mount; uses single 52 ohm coaxial feed; no stubs or matching devices needed; full instruction for the simple one-man assembly and installation are included; this is a fool-proof beam that always works with exceptional results. The cubical quad is the antenna used by the DX champs, and it will do a wonderful job for you!

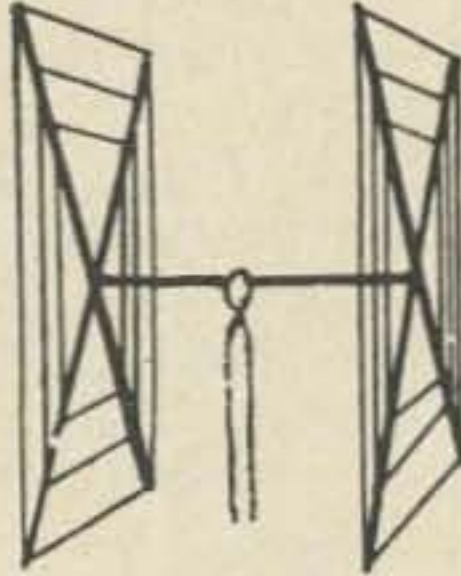

**BEAMS** The first morning I put up my 3 element Gotham beam (20 ft) I worked

YO4CT, ON5LW, SP9-ADQ, and 4U1ITU **THAT ANTENNA WORKS!** WN4DYN Compare the performance, value, and price of the following beams and you will see that this offer is unprecedented in radio history!

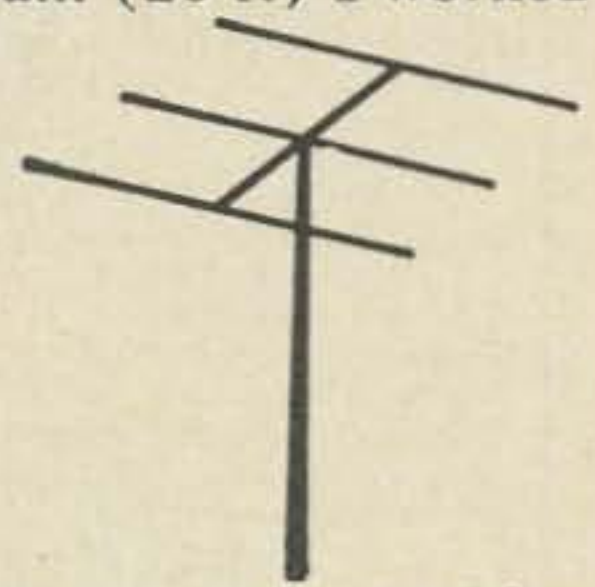

Each beam is brand new; full size (36' of tubing for each 20 meter element, for instance); absolutely complete including a boom and all hardware; uses a single 52 or 72 ohm coaxial feedline; the SWR is 1:1; easily handles 5 KW; 7/8" and 1" aluminum alloy tubing is employed for maximum strength and low wind loading; all beams are adjustable to any frequency in the band.

## 10/15/20 CUBICAL QUAD SPECIFICATIONS

Antenna Designation: 10/15/20 Quad  
 Number of Elements: Two. A full wavelength driven element and reflector for each band.  
 Freq. Covered: 14-14.4 Mc. 21-21.45 Mc. 28-29.7 Mc.  
 Shipping Weight: 28 lbs. Net Weight: 25 lbs.  
 Dimensions: About 16' square.  
 Power Rating: 5 KW.  
 Operation Mode: All  
 SWR: 1.05:1 at resonance  
 Gain: 8.1 db. over isotropic  
 F/B Ratio: A minimum of 17 db. F/B  
 Boom: 10' long x 1 1/4" O.D.; 18 gauge steel; double plated; gold color  
 Beam Mount: Square aluminum alloy plate incorporating four steel U-bolt assemblies. Will easily support 100 lbs. Universal polarization.

Radiating Elements: Steel wire, tempered and plated, .064" diameter.

X Frameworks: Each framework consists of two 12' sections of 1" OD aluminum 'hi-strength' (Revere) tubing, with telescoping 7/8" tubing and short section of dowel. Plated hose clamps tighten down on telescoping sections.

Radiator Terminals: Cinch-Jones two-terminal fittings

Feedline (not furnished); 52 ohm coaxial cable

Now check these startling prices—note that they are *much lower* than even the bamboo-type:

10-15-20 CUBICAL QUAD .....	\$37.00
10-15 CUBICAL QUAD .....	32.00
15-20 CUBICAL QUAD .....	34.00
TWENTY METER CUBICAL QUAD .....	27.00
FIFTEEN METER CUBICAL QUAD .....	26.00
TEN METER CUBICAL QUAD .....	25.00

(all use single coax feedline)

2 EL 20 .....	\$21	4 EL 10 .....	20
3 EL 20 .....	27	7 EL 10 .....	34*
4 EL 20 .....	34*	4 EL 6 .....	20
2 EL 15 .....	17	8 EL 6 .....	30*
3 EL 15 .....	21	12 EL 2 .....	27*
4 EL 15 .....	27*		
5 EL 15 .....	30*		

## ALL-BAND VERTICALS

"All band vertical!" asked one skeptic. "Twenty meters is murder these days. Let's see you make a contact on twenty meter phone with low power!" So K4KXR switched to twenty, using a V80 antenna and 35 watts AM. Here is a small portion of the stations he worked: VE3FAZ, T12FGS, W5KYJ, WIWOZ, W2ODH, WA3DJT, WB2FCB, W2YHH, VE3FOB, WA8CZE, K1SYB, K2RDJ, K1MVV, K8HGY, K3UTL, W8QJC, WA2LVE, YS1MAM, WA8ATS, K2PGS, W2QJP, W4JWJ, K2PSK, WA8CGA, WB2KWY, W2IWJ, VE3KT. Moral: It's the antenna that counts!

**FLASH!** Switched to 15 c.w. and worked KZ5-IKN, KZ5OWN, HC1LC, PY5ASN, FG7XT, XE2I, KP4AQL, SM5BGK, G2AOB, YV5-CLK, OZ4H. and over a thousand other stations!

V40 vertical for 40, 20, 15, 10, 6 meters .....	\$14.95
V80 vertical for 80, 75, 40, 20, 15, 10, 6 meters .....	\$16.95
V160 vertical for 160, 80, 75, 40, 20, 15, 10, 6 meters .....	\$18.95

"HOW TO ORDER: Send money order (bank, store, or United States) in full. We ship immediately by REA Express, charges collect. DEALERS WRITE."

**GOTHAM**  
**1805 Purdy, Dept. 73,**  
**Miami Beach, Fla. 33139**



## HARDBOUND BOOK SALE!

	Price	Special
TV Servicing Guide Book	\$6.95	\$3.95
Semiconductors: From A to Z	7.95	4.95
Troubleshooting the Solid State Chassis	7.95	4.95
Radar Detection	18.95	11.95
Handbook of Transistors, and Microelectronics	20.00	11.95
Radio News Handbook	6.95	2.95
Transistor Circuits & Applications	10.95	6.95
Modern TV Circuit & Waveform Analysis	7.95	4.95
Electromechanical Devices for Energy Conversion and Control Systems	20.00	9.95
IBM Electronic Circuit Analysis Program	18.00	11.95
Guide to Professional Broadcast Announcing	9.95	5.95
On the Color TV Service Bench	6.95	3.95
Managing Today's Radio Station	12.95	7.95
Electronics Reference Databook	7.95	6.95
The Transistor Radio Handbook	5.00	2.95
Audio Systems Handbook	7.95	4.95
Working With Semiconductors	7.95	4.95
64 Projects for Home and Car	6.95	4.95
Installing and Servicing Home Audio Systems	7.95	5.95
Single Sideband, Theory and Practice	6.95	4.95
Tape Recording for Fun and Profit	7.95	5.95
How to Fix Transistor Radios	7.95	5.95
CB Operator's Guide	6.95	4.95
The Oscilloscope	7.95	5.95
Frequency Modulation Receivers		9.95
Modern Electronic Circuit Design		9.95
Electronic Tests & Measurements	15.00	9.95
Electric Circuits, Alternating Current	9.95	6.95
Electric Circuits, Direct Current	9.95	6.95

### SALE of Softbound Books

Electronic Hobbyist's IC Projects Handbook	3.95	1.95
Integrated Circuits, Fundamentals & Projects	.75	.50
Semiconductor Power Circuits Handbook	3.95	.95
Interpreting FCC Broadcast Rules	6.95	3.95
Radio Sales Promotions	10.00	4.95
Working with the Oscilloscope	4.95	2.95
Engineering Conference Technical Papers	10.00	4.95
Semiconductor Handbook	5.75	2.95
Solid State Projects from Motorola		.50
NAB 1967 Engineering Conference Proc.	10.00	3.95
Pin Point TV Troubles	4.95	2.95
Your Citizens Radio Station	1.00	.50
ABC's of Citizens Band Radio	1.95	.95
Better Short Wave Reception	2.85	.95
Antennas for Citizens Radio	1.00	.50
How to Install TV Antennas	.50	.20
RCA Linear Integrated Circuits	2.00	.95

Prices are postpaid in USA. Closeout of stock, one of a kind, first come, etc.

**RADIO BOOKSHOP Peterborough NH 03458**

## Fabulous DX Map of the World



### SHOW VISITORS DX YOU'VE WORKED

- ONLY \$1.00 POSTPAID USA**
- Wall sized (23" x 31")
  - Shipped flat in mailing tube
  - Suitable for framing
  - Most complete map available
  - Up-to-date world prefixes shown
  - Color in countries as worked
  - Shows islands, reefs, rare DX spots
  - Use colored map pins for different bands
  - Dresses up the DX shack

### MADE ESPECIALLY FOR DX'ERS

Buy lavishly! Order today from:

**73 MAP, Peterborough NH 03458**

advised by my lawyers that  
ou goons don't ever proofr  
lasy m...  
**LETTERS**  
branch of books...  
you ignored my comments in  
I insist that you print ev  
should be boiled in oil ov

### 2-Channel Search-Lock

Several questions and comments have arisen concerning the 2-channel search-lock article (July 1970).

In Fig. 1, the capacitor connected from the emitter of the unijunction transistor (Q1) should be 0.47  $\mu$ F. Transistors Q2, Q3, Q8 and Q9 can be 2N3641, 2N706, GE-17, Motorola HEP 50, or any similar type.

The waveforms of Fig. 6 should be labeled as follows:

Top left: emitter of unijunction transistor Q1.

Top right: base 1 of Q1.

Bottom left: collector of either Q2 or Q3.

Bottom right: base of either Q2 or Q3.

The pin numbers listed for IC-1 in Fig. 1 are for the standard 8-pin TO-5 package. If a dual-inline or a flatpack is used, the pin numbers will have to be changed accordingly.

In the picture of Fig. 2, the two lamps mounted adjacent to the upper main power toggle switch are the active channel indicators. I used Dialco subminiature series 252-9951-XXX lamps which are quite small.

I have been asked how this circuit can be modified to provide for more channels. This can be done by replacing the flip-flop (Q2 and Q3) with an appropriate ring counter circuit. I hope to develop such a circuit and present it in an article in the near future. A kit of all the semiconductors required for the 2-channel project is available (\$8.88) from Poly-Paks, Box 942, South Lynnfield, Mass. Specify article title, 73, July 1970.

**R. Gary Hendrickson W3DTN**  
1510 Jupp Road  
Glen Burnie MD

### Computer Comparison

The other month I wrote a series of complex "macros" (I teach computer programming) to serve as a class example. The outgrowth was that I created a little system that could be used to extract data from a data base by a logical combination of keywords. For example, "Extract the record if the keywords *antenna* and *vertical* are present." The next step was to (and what a step) convert the tables of contents of the major ham magazines into punched card form to serve as the data base. My idea was to be able to take all of the technical articles appearing in 73, CQ, and QST for the past 5 or 10 years and get them collected so that surveys could be easily generated. Something interesting happened...I kid you not...the ratio of technical articles became most apparent! 73 was way out in front. Then I decided to do the same thing (or try to do it) for articles of interest to FM nuts like myself. Again, but even more dramatically, 73 was out in front.

**Thomas R. Yocom WA0ZHT**  
1530 Country Club Dr  
Marion IA



## A HAMSHACK WITHOUT A GLOBE? *Ridiculous!*

Particularly when these fabulous Hammond globes (the best in the biz) are available at our **LOW PRICE**.

13" inflatable globe (guaranteed, by the way), regularly selling for \$15, now special, while they last, **ONLY \$10**.

13" lighted globes, regularly \$25, now **ONLY \$15**. We have a few of these in stock and when they are gone, that is it.

**RADIO BOOKSHOP**  
Peterborough, New Hampshire 03458

### Autopatches

I can assure you that the "Autopatch" you have described in 73 Magazine is illegal. I know. I just spent three days per month for the last seven months in Washington as a member of the Academy of Sciences panel engaged in a study of the effects of interconnection to the telephone lines. The present tariffs *permit* interconnection of voice or data information through a coupler which acts to isolate foreign voltages, capacitance unbalances, grounds, etc., from the lines.

The tariffs *prohibit* any signaling or control functions from being done by the customer which includes dialing, on hook-off hook controls, and ringing. There are indeed many more considerations than meet the eye in this latter category. Dialing at 10 pulses per second isn't all that is required. The percentage make/break is a more stringent requirement at 61% nominal with 58-64 min/max limits. Maintaining capacitive balance on the lines is essential, otherwise crosstalk will ensue. The possibility of foreign voltages being placed on the lines is another serious concern.

No, I don't work for the telephone company. I am just a member of the electronics industry that was called upon to objectively evaluate the interconnection issue. The panel's recommendation has just been presented to the FCC and I understand the report is available from the Academy of Sciences for \$4.50.

Being a ham, I am emotionally torn towards allowing free interconnection but also being a technical consultant, I can see the dangers in allowing free and uninhibited interconnection. Our panel recommendation is to open up the present "telephone company only" approach by allowing *certified* manufacturers and personnel to interconnect. So, there is hope for the future.

**Herman Lukoff W3HTF**  
506 Dreshertown Road  
Fort Washington PA

*As we interpret the tariff, signaling with foreign equipment through a phone line is indeed illegal, unless a specific phone company authorization is obtained. But dial-type autopatches do not involve phone line transmissions of externally generated tones, even though touchtone patches, of course, do.*

*Your wrap-up of the make-break-ratio importance is quite correct, but most amateur repeater builders are aware of this. Most use ordinary phone dials for pulsing and adjust the dials as*

## ARROW SALES New Address

7049 W. ARCHER AVE.  
CHICAGO IL 60638  
Phone: 586-7441

### Opening Special!

R19/ARC Receiver - 118 to 148 MHz  
**\$19.90**

radio amateur

# callbook



### GET YOUR NEW ISSUE NOW!

Over 283,000 QTHs  
in the U.S. edition  
**\$7.95**

Over 135,000 QTHs  
in the DX edition  
**\$5.95**

These valuable EXTRA features  
included in both editions!

- QSL Managers Around the World!
- Census of Radio Amateurs throughout the world!
- Radio Amateurs' License Class!
- World Prefix Map!
- International Radio Amateur Prefixes
- Radio Amateurs' Prefixes by Countries!
- A.R.R.L. Phonetic Alphabet!
- Where To Buy!
- Great Circle Bearings!
- International Postal Information!
- Plus much more!

**WRITE FOR  
FREE  
BROCHURE!**

RADIO AMATEUR



**callbook** INC.

Dept. B. 925 Sherwood Drive  
Lake Bluff, Ill. 60044

# Thousands of Parts

Good Business for sale  
**DOW TRADING CO., INC.**  
ELECTRONIC PARTS & EQUIPMENT  
1829 E. HUNTINGTON DRIVE  
DUARTE, CALIFORNIA 91010 357-3763

**432 MHZ CONVERTER**  
MODEL 432CA  
ONLY \$64.95 pp.



Low Noise Silicon Circuitry • Attractive Metallic Green Styling • Built-in ac Power Supply • Silver Plated Cavities • Write for detailed literature or order direct, specifying i-f frequency.

**JANEL  
LABORATORIES**

P.O. Box 112, Succasunna, NJ 07876  
Telephone 201-584-6521

## ALL BAND TRAP ANTENNA!

Reduces Interference and Noise on All Makes Short Wave Receivers. Makes World-Wide Reception Stronger. Complete with 96 ft. 72 ohm feedline. Sealed resonant traps. For novice and all class radio amateurs! Eliminates 5 separate antennas with better performance guaranteed 80-40-20-15-10 meter bands. Complete 102 ft. \$19.95. 40-20-15-10 meter bands, 54 ft. (best for world-wide short wave reception) \$18.95. Send only \$3.00 (cash, ck, mo) and pay postman balance COD plus postage on arrival or send full price for post-paid delivery. Complete instructions included.  
**WESTERN ELECTRONICS Dept. A Kearney, Nebraska 68847**

### PROFESSIONAL REPAIR AND CALIBRATION SERVICE

Specialist in the maintenance and calibration of school's electronic laboratory equipment, test equipment and amateur equipment. Prompt service by holders of amateur and commercial FCC licenses. Write for shipping instructions.

**PANTRONICS OF VIRGINIA, INC.**  
6608 Edsall Rd.  
Alexandria, Virginia 22312

### FT 243 CRYSTALS

3000 to 8500 Khz.

± 2 Khz. \$1.25

± .01 % 2.50

Surface mail 6c, Air Mail 10c extra

### DENVER CRYSTALS

Rt. 1, Box 357 Parker, Colorado 80134

### SCHEMATICS AVAILABLE FROM 73 \$1.00 each

ARR-15 from June 1965 73, page 78.

ARC-27 2M Guard Channel Receiver.

SSB Transceiver, Nov. 1961 73, page 23.

R508/ARC, June 1965 page 48, before & after.

73 Magazine, Peterborough, N.H. 03458

CQ de W2Kuw

## 5% Bonus

Over best offer for any tube, transmitter, receiver or test gear.

Fair trading since 1937.

**The Ted Dames Company** | 308 Hickory Street  
Arlington, New Jersey 07032  
(201) 998-4246

necessary to comply with requirements. Amateurs are also sensitive to maintaining good isolation between their circuits and those of the phone.

Nonetheless, strictly speaking, the phone companies do require a terminal unit (officially installed) between foreign attachments and the phone, although no ham repeater has ever been known to be reprimanded for illegal interconnection.

The whole tie-in business will eventually be dealt with in specific terms for amateurs, but right now the tariffs appear to be aimed for the manufacturer of interconnect devices and the mass-scale user.

... Ken

### Free Speech

It is such articles as K2AGZ's "Free Speech for Hams" which is assisting our enemies to mutilate and destroy our American heritage of freedom.

His attack on Vice President Agnew is a good example.

Recently Pope Paul VI said "Too many papers use the press to defame instead of to inform."

This is exactly what K2AGZ has done in his article. Either he has never read or listened to the Vice President's speeches, or he has made up this defamation of VP Spiro Agnew from enemy infiltrations in the press.

President Jefferson once said that if our country was ever destroyed, it will be by infiltration by enemies who will use our freedoms to destroy us.

The checks and balances and criticisms which Vice President Spiro Agnew speaks of, are simply and purely self-defense of democracy and freedom.

**Myron R. Fox**  
45 McKinley St.  
Brookville OH

Pleased and surprised by K2AGZ's views in "Free Speech." Hope for more of the same!

**Ken Cole**  
Box 3  
Vashon VA

I have subscribed to 73 for a number of years and think the magazine is great for the radio information it contains. However, there are many times recently that I think its EDITORIALS stink. It appears to me that you - the editor - can't make up your mind: You express a belief that violators of the regulations should be punished, but not if their breaking the rules helps them maintain their freedom.

You say you are for law and order. Perhaps you are, but you sure show a leaning towards those who want to "burn it down" because it is their right under the First Amendment.

I still believe that 73 is a good amateur publication. But its editorials stink! Maybe a new editor would improve them.

**W T McAninch**  
2137 Grayson Place  
Falls Church VA

I would like to say that if 73 Magazine is pressing for free speech on the air - the use of obscene, indecent, and profane language - and

that whether it is that type of language to be determined by the one using it - 73 should start closing its doors!

Wayne E. Herron W0MI  
1301 Church St  
Scott City KS

You must be a new reader to 73 and thus not understand that 73 has no opinions, that opinions expressed in the magazine are signed and are the opinions of the writers only. Some we agree with, many we don't, but it is dishonest to censor out ideas because we don't happen to agree with them.

We reported that the FCC chairmen are having trouble with words and the interpretation of what is obscene, etc., in light of supreme court decisions. On a strictly pragmatic level one might ask what harm a four-letter word is going to do on the air... we are seeing it regularly now in books and magazines, and hearing it in the movies. Many people are beginning to believe that there is a possibility that some of our population is becoming adult enough not to be stricken by mere words. It takes more maturity than is generally available to be able to dismiss "dirty" words. Of course, once the emotional impact is gone, they will fade from such prominent use. (We may not notice it, since they won't bother us any more!)

... Wayne

#### FM

Just wanted to tell you that I have been enjoying your recent FM articles and the thicker magazine. I hope you run a reprint of "Chronicles of an Amateur FM Channel." I sure would like to have a copy of that in my library.

Skip Hansen WB6YMH  
3614 Homeway Dr.  
Los Angeles CA

"Chronicles" appears in the FM Anthologies, Vols. I and II, in its entirety.

... Ken

Appreciated the report on the Orlando Hamfest and FM Convention. Also, the mobile phone and search-lock FM articles were FB. Keep up the good work for at least three years (the length of the enclosed renewal).

Charles Durst WA4WTX

On May 26th I sent you a check for \$15.00 for a three year subscription to 73 and the "FM Anthology." So far I have received the magazines but not the book. Being new to 2 meter repeater operation I need all the information I can get.

Thanks very much for all the FM articles being printed in 73 and for the special issue. I've been almost completely inactive for years and 73 has done more than anything else to revive my interest and get me back on the air.

Ray F. Caldwell W4VFC  
525 Hall's Lane  
Madison TN

Sorry about the FM Anthology hang-up. We're having printer problems, and the orders exceeded the initially printed quantity. Another week or two at the latest.

... Ken

#### Ham "Hobby" License

I find this newly proposed class of radio amateur license an interesting topic for discus-

**BUILD YOUR OWN TV CAMERA!!**  
Imagine transmitting amateur TV pictures over the air...or watching the kids on the living room TV...or monitoring some remote area, such as a driveway, swimming pool, nursery, etc! Select from a variety of starter or complete kits. Also, plans available separately.  
DETAILED CATALOG FREE.  
**ATV RESEARCH**  
13th & Broadway N. Dakota City NB 68731

## WORLD QSL BUREAU

5200 Panama Ave., Richmond CA USA 94804

**PLAN 1.** We forward your QSLs (please arrange alphabetically) to any place in World, including all foreign countries, and to or within USA, Canada, and Mexico, for 4¢ each.

**PLAN 2.** You use our special log form and send us a copy. We supply QSL—make out QSL—deliver QSL, all for 8¢ each.

## LARGEST ASSORTMENT of BRAND NAMES

You can save enormous amounts of money while choosing from a complete line of transceivers, receivers, transmitters, etc.

**WE HAVE EVERYTHING IN HAM GEAR  
SAVE MONEY ORDER BY MAIL**

**CB Radio Co., Inc.** 89 Aspen Rd.  
Swampscott, Mass. 01901 617-598-9700

## HAL DEVICES

Hot Carrier Diodes: HP2800..... 90¢, 12/\$10.00 Matched by HAL.... 4/\$4.25  
IC's: fµL 900, 914..... 60¢ fµL 923..... 90¢  
MRTL MC790P, MC890P..... \$2.00, 10/\$19.50  
MC724P, MC789P, MC792P, MC725P..... \$1.05, 10/\$9.50  
Also Available: MC788P, MC880P, MC767P, MC9760P.  
OP AMP: SN72709N (DIP)..... \$1.75, 7/\$10.00  
TOROIDS: Indiana General CF102-06, CF102-Q1, CF101-Q2..... 50¢  
CINCH IC sockets, 14-DIP, 8-ICS..... 60¢ **HAL DEVICES**  
Add Postage, send for complete list. Box 365 L, Urbana, Illinois 61801

## VIBROPLEX

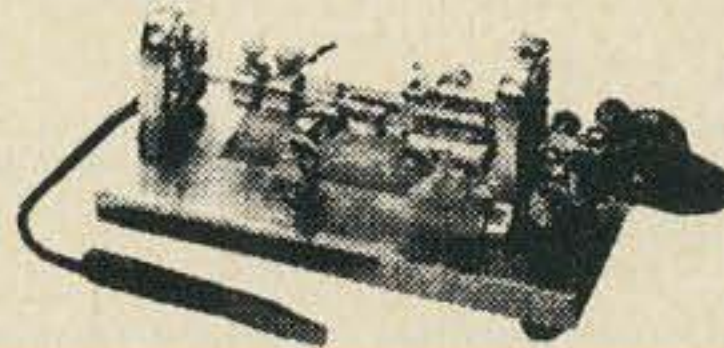

**ENJOY EASY,  
RESTFUL KEYING**

\$21.95 to \$43.95

**THE VIBROPLEX  
CO., INC.**

833 Broadway,  
New York, NY 10003

## CUSTOM TRANSFORMER DESIGN & MANUFACTURE

Write today for a free quotation on any transformer, choke, or saturable reactor. Each unit will be designed and manufactured to your exact specifications. Standard E-I and tape wound "C" cores are available. Quantities from single units to production runs may be accommodated.

**PETER W. DAHL CO.**

5325 Annette Ave., El Paso, Texas 79924

Tele: 915-751-4856

**WE PAY HIGHEST CASH PRICE**  
for Electron Tubes & Semiconductors  
Immediate Payment on Unused Tubes

**H & L ASSOCIATES**

Elizabethport Industrial Park

Elizabeth, New Jersey 07206

(201) 351-4200

## the permaflex key

- both a twin lever & straight hand key in a pivotless 2 paddle design.
- gives instant choice of automatic semi-automatic & straight hand keying when used through an electronic keyer.
- use directly with any transmitter
- 8 amp. gold diffused silver contacts adjust from 0-.060" & 5-50 grams.
- distinctive blue paddles are of rugged G-10 fiberglass epoxy.
- cabinet is 16 gauge polished chrome steel: 1.95" sq. x 3.75", paddles extend 1.25", weight 10 oz.
- silicone rubber feet for stability.
- 100% US made & guaranteed for 1 yr.

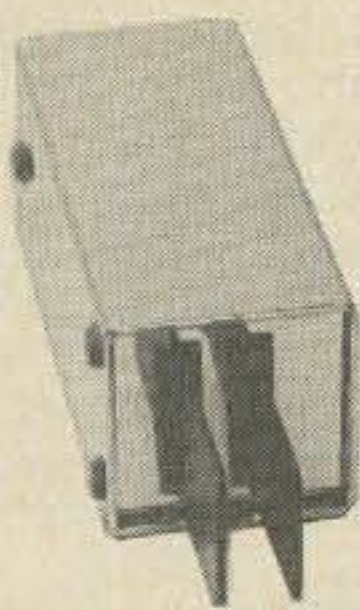

**1995** complete,  
ppd usa & can.  
send a check or m.o.  
sold by mail only

**James Research company, dep't: AR-K**  
20 willits road, glen cove n.y. 11542

## WE PAY CASH FOR TUBES

**Lewispaul Electronics, Inc.**  
303 West Crescent Avenue  
Allandale, New Jersey 07401

## NEED CRYSTALS?

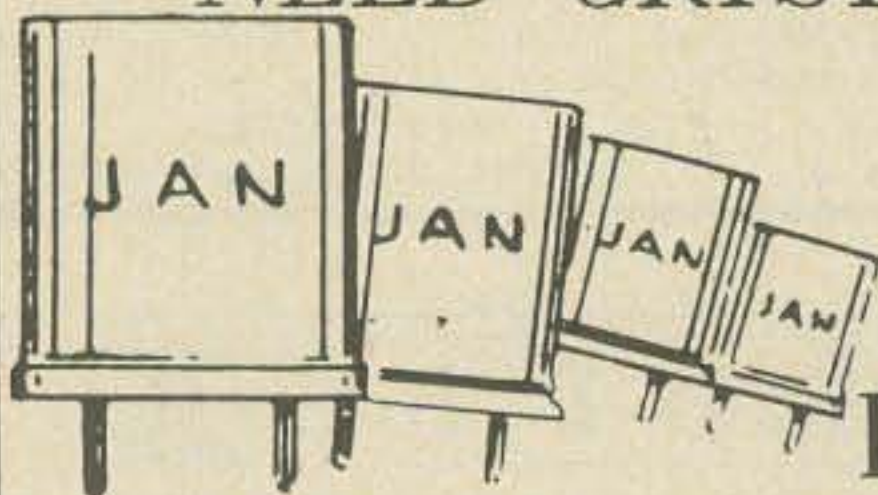

**48 hr.**  
**DELIVERY**

### SPECIALS

Color TV crystal (3579, 545KHz) wire leads	\$1.60 4 for 5.00
100 KHz frequency standard crystal (HC 13/U)	4.50
1000 KHz frequency standard (HC6/U)	3.50
Any CB crystal, trans. or rec. (except synthesizer crystals)	2.25
Any amateur band crystal in FT-243 holders (except 80-160 meters)	1.50 4 for 5.00
Any marine frequency (HC6/U)	2.85
80 meter crystals in FT-243 holders	2.50

We have in stock over six million crystals which include types CR1A/AR, FT243, FT241, MC7, FT249, HC6/U, HC13/U, etc. Send 10¢ for our 1970 catalog with oscillator circuits, listing thousands of frequencies in stock for immediate delivery. (Add 10¢ per crystal to above prices for shipment 1st class mail; 15¢ each for air mail.)

**JAN**  
**CRYSTALS**

**ORDER DIRECT**  
with check or money order to  
Special Quantity Prices  
to Jobbers and Dealers

2400B Crystal Dr., Ft. Myers, Fla. 33901

sion. The hobby license would be beneficial for cleaning up the overcrowded conditions and irresponsible operating practices found on 27 MHz. It would also serve to increase amateur activity on VHF. This class of amateur license could be beneficial for amateur radio, providing these newcomers were responsible to the spectrum they would be using. This responsibility develops into a need for the knowledge of basic radio theory because this knowledge provides for the appreciation of radio. The theory these radio users need to know is the propagation characteristics of the band they would be occupying plus the general principles of what frequency modulation is (since this is the type of modulation they would be using). They should also know why FM is advantageous over other ways of supplying information to a signal carrier. The basic radio theory I have mentioned here as well as the rules and regulations already proposed, is essential to upholding the quality of amateur radio.

**Paul Leary, Jr. WA4WUN**  
3302 Natchez Lane  
Louisville KY

*How about a minimum-code requirement, too; say 5 wpm?*

You have just sprouted an excellent idea to eliminate the citizen band dilemma, now how about putting your genius to work on this one.

**Stanely W. Pugh O. D.**  
2521 North Proctor  
Tacoma WA

I tend to favor the "Hobby" license as described in 73, with reservations on: (1) getting a foot in the door, and (2) code should be retained for all classes except "Hobby." The code is the only prestige we hams have and we must retain it.

**Mal WA2CDE**  
Box 321  
Hyde Park NY

Yep, I'm all in favor of "Hobby" on 220. We hardly use the band, even in the major population areas—but think of what would happen when and if you could buy a five-channel solid state 1 watter for \$69.95!!!! If they can be made and sold for this price for 11 meters, it is not that big a step to 220 MHz, as far as design and manufacture is concerned. Smart people, these Japanese! We are just around the corner from the \$100 VHF FM rig, and after that is the \$50 walkie-talkie!

**Fritz Hervey WB4MSJ**  
Box 336  
Indian Trail NC

... So now we call everyone a ham. Why not call CB'ers hams ... what's the difference? Take 220, but give us more room on 14 or 21 MHz. Don't take only! And keep commercial interests away from ham radio — that's how we lost 27 MHz.

**W8AWN**

We lost 27 MHz the same way we stand liable to lose any sparsely populated spectrum. Some bright fellow said, "... Well, we can place the band for this requirement down on 27 MHz. This frequency is allocated to amateurs, but it's not used much."

... Ken

### Crooked QSLing

VK4SS's article on QSLing really put it in black & white (73, July 1970). I get so disgusted with DXing that I hardly ever do it, preferring a nice domestic contact to working any DX. Reasons:

1. Pileups. I am too impatient waiting for a 20-second contact, fighting it with people who in all probability are using somewhat in excess of legal power.

2. Discourtesy. With all the break-break-break business it sounds like a bunch of CB'ers. One man in Fiji who used to live here can hardly hear his scheduled contact with the QRM aimed his way.

3. QSLing. The article says quite a bit. Personally, I like receiving and sending cards, and would gladly do it on every contact. Anybody who sends or asks for a card gets it from me.

So many of these people say, "QSL 100% by bureau" or some such trivia; or "Will QSL direct for IRC." So what happens? Maybe 50% come through. I went through a bunch of logbooks and made a list of stations who have not QSLed after a reasonable time (3-4 months). Maybe if a bunch of us made lists some of us could refer to the list before wasting a stamp.

One of my friends in Modesto is making up a "lid" list with a similar intention. He is going to award a "lid of the year" award with call letters engraved in a used toilet seat to the worst operator in the area. Already two or three are in mind - these guys who bumble in on a QSO with a linear, hollering "Can you read me?" while the guy they want to contact is transmitting.

Paul Schuett WA6CPP  
14472 Davis Road  
Lodi CA

Just finished reading VK4SS's written word about QSL "con games," and must express my approval. I'm probably not the best myself in the category of QSL WN QSLed - I just don't QSL unless requested and I don't work that much DX any more. I have been DX in the past and I can remember what it cost me after one weekend in '65 for a United Kingdom Scout Jamboree on the air and I looked over the log: 126 sent, 4 rcvd from KJ6!!

'Nuff said!

K2DAK/WA6DEK

### Wha' Happen?

I received my July 1970 issue of 73 incomplete; pages 33 through 48 are missing. I enjoy your magazine very much (even with 16 pages missing).

Please don't fall into the rut the other magazines have and print a bunch of meaningless junk about contests and the like.

I would appreciate another July issue or at least those 16 mysterious pages.

W T Glenn  
Rt. 1  
Levelland TX

The 16 pages contained meaningless junk about contests and the like.

... Ken

### Nets, Nets, Nets, Nuts!

One big problem on the various bands, is this "net" business.

## oscillator/monitor<sup>mark 2</sup>

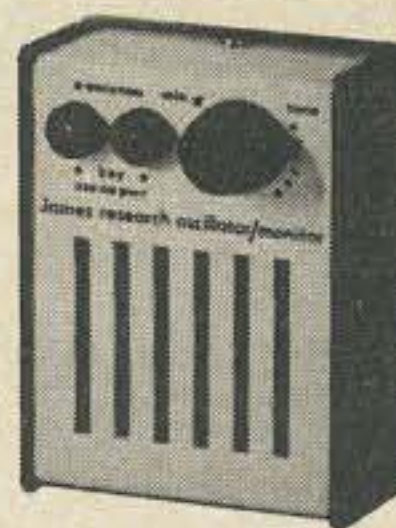

- makes an audible tone to monitor the RF of any CW transmitter from 10Mw to 1 Kw & 100Kc to 1000Mc, using only an 8" pickup antenna.
- can be self-triggered for code practice or the testing of solid state components and circuits.
- aids in tuning up & testing RF oscillator and power circuits.
- 4 transistor, 2 diode circuit, speaker, tone adjust, AA pencil, test tips, 8" ant., & magnetic base.
- cabinet is 16 gauge black & clear anodised aluminum, 3.4 x 2.3 x 1.2" US made & guaranteed for 1 year.

14.95 complete,  
ppd usa & can.  
send a check or m.o.  
sold by mail only

James Research company, dep't: AR-M  
20 willits road, glen cove n.y. 11542

## SUMMER SPECIALS

CA3008 RCA OP AMP	\$1.50
<b>MOTOROLA DUAL INLINE IC's FACTORY MARKED, NEW</b>	
MC724P Quad 2 input NOR gate	\$1.00
MC725P Dual 4 input gate	1.00
MC790P Dual JK flip flop	1.50
MC792P Triple 3 input gate	1.00
MC799P Dual Buffer	1.00
MC826 JK flip flop	1.00
<b>MOTOROLA TRANSISTORS-FACTORY MARKED</b>	
JAN 2N2907A 1.8 watt 60 volt 125mc	3/1.00
2N2218A 3 watt 40 volt 250 mc	2/1.00
<b>7400 SERIES IC GRAB BAG</b>	
Pack of assorted dual inline (10 units) unmarked untested. Schematics included. Package of 10 IC's	\$1.00
SOCKET for DUAL INLINE IC	50¢
Add 25¢ postage on above orders. New catalog now out.	

## JOHN MESHNA JR.

19 ALLERTON ST., LYNN, MASS. 01904  
P. O. BOX 62; E. LYNN, MASS. 01904

RG 196 AU 50 ohm teflon coaxial cable. Outside diameter .080" RF loss .29 db per foot at 400 Mhz. Silver plated shielding and conductor. Used for internal chassis wiring, antenna coupling, RF coupling between stages, etc. Random lengths from 35 foot to 150 foot. Colors: black, red, brown, blue, grey, orange. Regular price- 23¢ per foot. Our price 5¢ per foot \$3.00 per 100 ft.

455 Khz ceramic filters type BF-455-A. These filters will help to sharpen the selectivity of most sets using 455 Khz IF's. Use across cathode bias resistor in place of a capacitor, or in transistorized sets, across the emitter bias resistor. Impedance is 20 ohms at 455Khz., DC resistance is infinite. Impedance increases rapidly as you leave 455 Khz. Plan your own LC filter circuits at very low cost.  
10 for \$1.00 25 for \$2.00

### TOROID POWER TRANSFORMERS

# T-2 This toroid was designed for use in a hybrid F.M. mobile unit, using a single 8647 tube in the RF amp. for 30 watts output. Schematic included. 12 VDC pri. using 2N1554's or equivalent. Sec. #1 500 volts DC out at 70 watts. Sec. #2 .65 volts DC bias. Sec. #3 1.2 volts AC for filament of 8647 tube. Sec. #4 C/T feed back winding for 2N1554's. 1 1/2" thick. 2 3/4" dia. \$2.95 ea. -2 for \$5.00

# T-3 Has a powdered iron core and is built like a TV fly back transformer. Operates at about 800 CPS. 12V DC Pri. using 2N442's or equivalent. DC output of V/DBLR 475 volts 90 watts. C/T feed back winding for 2N442's \$2.95 ea. -2 for \$5.00

### TRANSFORMERS

P-7 117 VAC Pri. Sec. #1 185 VAC @ 120 ma. Sec. #2 6.3 VAC @ 4A. Double Half Shell Mail Box Type. SX 146 type. \$2.75 ea. -2 for \$5.00

P-9 117 VAC Pri. Sec. # 900 VAC @ 300 ma. Sec. # 2 100 VAC @ 10 ma. Bias. Sec. #3 12.6 VAC @ AMP. Wt. 16 1/2 lbs. Double Half Shell \$4.50

P-10 117 VAC Pri. Sec. #1 960 VAC C.T. @ 160 ma. Sec. #2 425 VAC C.T. and tap at 100 VAC 10 ma Bias. Sec. #3 12.6 VAC @ 4.5A Double Shell Mail Box type. Wt. 8 1/2 lbs. \$3.75

Output transformers, all types 59 cents or 3 for \$1.50

OT-1 Transistor TO-3 Power Diamond.. Imp. 15 ohms to 3.2 ohms DC Res. Pri. .6ohm. Sec. .3 ohm.

OT-2 Pri. imp. 7000 ohm. Sec. 3-2 and 500 ohm for Phones or 70 volt line 3 watts. Full shielded Double Half Shell.

OT-3 Pri. imp. 5500 ohms. Sec. 3.2 ohms. SC122 type.

All prices F.O.B. All weights listed are net. Please allow for packaging. Please allow enough for postage. We will return any extra.

# TOWER COMMUNICATIONS

1220-22 Villa St., Racine, WI 53403

## SLOW SCAN TV

Now for the first time an S. S. monitor designed for your own custom installation. Available in 3 economy kits.

KIT 1	P.C. BOARDS ONLY (2 req.)	\$9.95 ea.
KIT 2	P.C. BOARDS (Both) & all parts (unwired)	\$80.00
KIT 3	BOARDS Wired & tested	\$125.00

All kits tube type with instructions.

CRTs, Power Supplies, and cabinets not included.

CRT PRICES ON REQUEST

Power Supply Kit - No chassis	\$54.95
Complete monitor - In handsome cabinet	\$298.00

E.K.Y. VIDEO VISION CO.  
BOX 15, STOCKHOLM NJ 07460

## NOW AVAILABLE

COPIES of TECH MANUALS or ANY PORTION THEREOF, and FULL LENGTH COPIES of FOLD-OUT or PAGE SIZE SCHEMATICS.

LARGEST STOCK of HARD TO GET PUBLICATIONS. WRITE US YOUR NEEDS FOR PRICE and AVAILABILITY.

SID GLASS & CO.

P.O. BOX 788

BEVERLY HILLS, CALIF. 90213

(div. of J. J. Glass Elect., Los Angeles CA RI9-1179)

## JEFF-TRONICS

### GUARANTEED USED EQUIPMENT

Central Electronics 200	\$325.00
Drake R-4B	300.00
Collins 62S1 w/ AC power supply	550.00
Hewlett-Packard 212-A pulse generator	75.00
Hewlett-Packard 400-B AC VTVM	60.00
General Radio 650-A Impedance Bridge	100.00
G-R 667-A Inductance Bridge	100.00
G-R 1217-A Unit Pulser	50.00
Hallicrafters HT-37 SSB xmtr	150.00
Collins R-388 Receiver	325.00
BC-221-N Freq. meter.	60.00
BC-348 Receiver with AC power	75.00
Johnson Challenger Xmtr.	45.00
Vectron SA-25 microwave spectrum analyzer with X-band plug-in.	100.00

### BRAND NEW.

DRAKE TC-6 TRANSMITTING CONVERTER, 6-meters.	190.00
TC-2. for 2-meters.	230.00

Send 25¢ for catalog of surplus parts & equipment, new & used ham gear. Free with order.

## JEFF-TRONICS

4252 Pearl Rd. Cleveland, Ohio 44109  
749-4237

It seems that there ought to be some brain-busting on this, by those who claim to have brains. Some of us have been successfully driven off some bands, by the preponderance of nets.

As a kind of last resort, I am down on 21 MHz now and most of my friends are there also. However, the Peruvian Disaster Net, on 21.423, asked for and got 5 kHz on either side of that frequency. Two other nets asked for the same, also working Peru stations. All this was in the General segment of the 21 MHz phone band.

Someone suggested that all work be shifted to the section from 21.200 to 21.350, but it was vetoed. I took a look down there and found about six stations working.

Nearly everyone honored the request by the Peruvian net, as handled by W2AIM, who did a great job hour after hour.

I do not think any authority would hinder such emergency work if it was done in the blank sections of the various bands. And believe me, there are some terribly blank sections.

Now please don't give me that incentive jazz; I am far too old and feeble to compete with the young smart guys running around loose these days. So let's hear from some of the brain power up there in New Hampshire, about this NET business, and how best to handle it from now on.

Martin M. Hellman K2TAJ  
61 Scott Ave.  
Staten Island NY

The other evening I ventured up into the General part of 20 meters and, as usual, tuned for a blank spot (well, relatively blank) and asked if anyone was using the frequency. Yes, indeed, please QSY off the Missionary net, OM. Okay, glad to oblige, but when does the net close? In a half-hour, but then the Doctor's net will be using the frequency. I tried another channel... no, please QSY, this is the Maritime Mobile net. Another... please QSY, this is the YL net. Another... please QSY, this is the International Sideband net. This is the County Hunter's net. This is the Intercontinental Phone net. This is MARS, you're out of band...

Obviously, quite a problem has developed now that all of the nets that were scattered through the phone band a couple years ago are now jammed into the 75 kHz left for the Generals. I think this tells us why more and more phone patches are blooming in the hitherto DX part of the band around 14.200-.250.

During the prime evening hours there seems to be some sort of organized net just about every 10 kHz (it only takes seven nets to fill the band). Now, while I think that the whole idea of nets is excellent, I can see that somehow something has to give. Nets, with 10-50 stations all on one frequency, are obviously a very efficient way of providing activity for a maximum number of stations in any given band. And the pursuit of a special interest by a group obviously makes amateur radio more fun for those involved, another plus. Some of the nets provide fine public service (such as the Eyebank net) and emergency help (WCARS, etc.) But it is getting like the old prewar 80M band where there is room for nothing but nets (Postoffice net, Airport net, Broadcast Engineer's net, etc.) and there would seem to be a rapidly growing need for someone to provide a net registry service

which would stagger the nets by time and channel for the maximum use of the few General frequencies still left.

... Wayne

#### International Crystal PC Modules

The little PC boards made by International are more fun than anything but girls: they go together fast, work right the first time, and they are cheap. I think they are one answer to the problem of getting kids to tinker. Some of them may be overwhelmed by the complexity of today's gear and are scared off. These little boards are the easy way to learn fundamentals and we need an article about them.

F. C. Hervey  
Rt. 1 Box 336  
Indian Trail NC

#### Not Guilty!

I have delayed sending in my renewal so that I might add a comment as to my opinion of the makeup of your little book. Personally, I find it tops in its line — in particular, the brief but complete and detailed articles on the projects that a person can still find time to knock together. I had been a captive to the "Hartford Clique" for 15 years and finally woke up. As a consequence, I did not subscribe to any ham magazines until I saw a counter copy with an interesting article 73. So after a period of 10 years as a nonbeliever I am reading again. I have 35 years in advanced electronics with broadcasting, commercial, and industrial and the last few years in space electronics. Therefore, I resent my hobby being turned into something that only high-level electronic plants can produce. The big plants manufacturing ham equipment must love Hartford for the part they played in pushing SSB. (Yes, I am an appliance operator on the lower bands.) Let's build on two meters and up and try to keep it a hobby.

John B. Kihm  
17203 Haas Ave.  
Torrance CA

If your reference to "Hartford" implies that the League is responsible for encouraging side-band initially, I think your wrath is misdirected. The ARRL was one of the last to advocate SSB.

... Ken

#### Something for Everyone

I have had an amateur ticket for almost 9 years now, and I have seen all kinds of Amateur Radio magazines.

Most are fair in some areas, but not all areas. 73, in my opinion is great in all areas. Best amateur magazine on the market at any price.

Every amateur can find something of interest in 73 and that is what the amateur radio magazine business is all about, something for ALL amateurs.

I operate 40, 20, and 15 meter CW exclusively. You may say CW is oldfashioned, but if you become proficient at it, it is just as enjoyable as AM, SSB, FM, or any other mode. That is what I like about amateur radio; everyone has an opinion as to what he enjoys. As for the code test of 20 wpm for the extra, it ain't all that hard to learn if you apply yourself.

# GATEWAY ELECTRONICS

6150 DELMAR BLVD., ST. LOUIS, MO 63112  
314-726-6116

6326 A VIDICON — RCA-new in sealed cartons. Shipping wt. 1 lb. ....	\$ 50.00
455 Khz CRYSTALS Shipping wt. ¼lb. ....	1.25
100 MFD — 3000 VDC CAPACITOR 14" x 6" x 8" Shipping wt. 40 lb. ....	25.00
30V CENTER TAPPED TRANSFORMER 115 volt pri. 24 to 30 volt sec. 10 amps or 20 amps a24 to 15 volts. Shipping wt. 15 lb. ....	10.00
1000 FOOT ROLLS #22 Plastic-tinned HOOK-UP WIRE. Shipping wt. 5 lb. ....	4.50
TD2 MICRO-WAVE GENERATOR includes all tubes 416B etc. Shipping wt. 50 lb. ....	35.00
6.3 volt - 10 AMP TRANSFORMER 115 volt primary. Shipping wt. 2 lb. ....	3.95
JOHNSON INVADER 2000 TRANS-MITTER — 2000 watts PEP — excellent condition. Shipping wt. 150 lb. ....	275.00
UCS 300 VACUUM VARIABLE CONDENSER — 10 to 300 mmf with motor drive — new. Shipping wt. 15 lb. ....	35.00
WESTON METER 40-0-40 Micro amp 2½ inch — ideal for 2 way FM radio alignment. Shipping wt. 2 lb. ....	.95
3600-0-3600 volt @750 MA PLATE TRANSFORMER — ideal for the linear amp. 115 volt or 230 volt primary. Shipping wt. 75 lb. ....	25.00

Minimum order \$5.00. Sorry, no catalog at this time. Write for specific items. Watch for our ads in 73. Stop in and see us when you're in St. Louis.

## PEP's SPECIAL! CIRCUIT BOARD COLLOSSAL

Loaded with components up to \$100.00 value. Bought out one supply house—FIRST come—FIRST served!

All Different! All Complete! First Line Units!

If you don't feel that you got your money's worth—full return guaranteed.

3 DIFFERENT GROUPINGS TO CHOOSE FROM

GROUP A — Actual Value \$15.00 — PEP Price \$1.25

SAMPLE A-1: 200 diode — 7 transistors — over 50 resistors — complete with board.

SAMPLE A-2: Four I. C. Mounting Blocks — 3transistors — over 25 resistors — complete with board.

GROUP B — Actual Value \$20.00 — PEP Price \$1.75

SAMPLE B-1: 8 I. C. Mounting blocks — over 50 resistors — 32 transistors — over 30 diodes — complete with board.

SAMPLE B-2: 32 transistors — over 100 resistors — capacitors — over 15 diodes — complete with board.

GROUP C — Actual Value \$50.00 — PEP Price \$4.50

SAMPLE C-1: 22 in-line I.C.s — over 75 diodes — 20 trans. — over 50 resistors — capacitors — complete with board.

SAMPLE C-2: 22 in-line I.C.s — over 50 diodes — over 50 resist — capacitors — complete with board.

LIMITED SUPPLY! Hurry and place your order for the best buys!!!

NO SALES TAX—WE PAY POSTAGE

**PARK ELECTRONIC PRODUCTS**  
P.O. Box 99, N. Salem, N.H. 03073



### Special-Purpose Receivers, Panadapter

**RAK-7** complete, w/dwg, 15-600 khz TRF . . . . **125.00**  
**RFI** (Noise & Field Strength Meters) are basically radio rcvrs. TS-587/U (no ant. accessories) somewhat modified as an RFI Meter, OK as rcvr, 15-400 mhz, \$195.00, Ferris #32A, 15-20 mhz, complete, OHC, w/charts & book, \$175. #32B is later model, \$275. Navy **OF1**, 15-17½ mhz, OHC, with book, \$75. **MORE PROFESSIONAL** setups, to \$4000.00, Stoddart and Empire Devices: **ASK!** Also ask about **SPECTRUM ANALYZERS**, if interested.

**455 khz Panadapter**, various models, all 100% OK, all with instruction books . . . . . **57.50**

**WWV Comparator Rcvr** has meter to zero-beat your signal with WWV switched tuning at 2½/5/10/15/20/25 mhz. **Beckman #905R** sold for \$650. From us, OHC and with book . . . . . **175.00**

### Hi-Sensitivity Wide-Band AM/FM RCVR

**38-1000 MHz:** AN/ALR-5 consists of brand new Tuner/Converter DV-253/ALR in original factory pack and an exc., used, checked OK & grtd. main rcvr R-444 modified for 120 v, 50/60 hz. Packed with each tuner is the factory checkout sheet. The one we opened showed **SENSITIVITY:** 1.1 uv at 38.3 mhz, 0.9 at 133 mhz, 5 at 538 mhz, 4½ at 778 mhz, 7 at 1 ghz; w/book & pwr-input plug, all for . . . . . **275.00**

**R-390/URR Rcvr:** Collins xtl-zero-beating, driftless receiver, grtd 100% perfect . . . . . **795.00**

**R-390A/URR** has mech. filters, grtd perfect . . . **995.00**

### Regul. Pwr Sply for Command, LM, Etc.

**PP-106/U:** Metered. Knob-adjustable 90-270 v up to 80 ma dc; also select an AC of 6.3 v 5A, or 12.6 v 2½A or 28 v 2½ A. With mating output plug & all tech. data. Shpg. wt 50 lbs . . . . . **19.50**

**Bargains which the above will power:**  
**LM-(\*) Freq. Meter:** .125-20 MHz, .01%, CW or AM, with serial-matched calib. book, tech. data, mating plug.  
 Shipping wt. 16 lbs . . . . . 57.50  
 Same, less calib. book . . . . . 27.50  
**A.R.C. R11A:** Modern Q-5'er rcvr 190-550 khz. . . 2.95  
**A.R.C. R22:** 540-1600 khz rcvr w/tuning graph . . 17.95  
**A.R.C. R32:** 108-132 mhz rcvr . . . . . 32.50

**IF YOU DON'T SEE IT HERE, ASK FOR IT!** But don't ask for a general catalog. . . we believe that is nonsense in surplus. . . we get new things in almost every day! **WE ALSO BUY!** So tell us what you have, condition, and your asking price!

**R. E. GOODHEART CO., INC.**  
 Box 1220-GC, Beverly Hills, Calif. 90213  
 Phones: Area Code 213, Office 272-5707



**FREE Catalog** Of The **WORLD'S** FINEST GOV'T SURPLUS ELECTRONIC BARGAINS

Now **BIGGER** and **BETTER** Than Ever!

MAIL THIS COUPON NOW

NAME: .....

ADDRESS: .....

CITY: ..... STATE: ..... ZIP: .....

For your **FREE** copy, fill out coupon and mail. Dept. 73

**FAIR RADIO SALES**  
 1016 E. EUREKA · Box 1105 · LIMA, OHIO · 45802

Enjoy your study guide very much and I know many others do, too. Thanks for a fun magazine, keep up the good work.

**Bill Weaver WA6UPC**  
 6642 Varna Ave.  
 Van Nuys CA

### DX'er's Complaint

Greetings from Monte Limbara, Sardenia, 4500 ft above sea level on the northwest coast of the island, overlooking the beautiful Mediterranean, home of IS1DFO.

Just finished reading about JY1 and agree completely about just how discourteous some hams are in this world. I can understand just how King Hussein feels trying to have a QSO with someone about various subject without some clown getting in there and hollering. . "Break-A, break-A, break-A," and for the most part never identifying properly, going over it several times - not only to irritate you but to let you know without a doubt that they are on your frequency with their harmonic-rich distorted modulation and to impress you with the fact that they aren't gonna shut their mouths or turn off that international homebrew jammer until you acknowledge them. I enjoy being able to talk to guys and gals all over the world and really feel privileged to share part of the limelight in being able to pass on signal reports good and bad to those desiring contact with this island . . . but there should prevail certain tact on radio, and the few who do ignore the basic rules of being polite and waiting just cause hard feelings. We make the most of it and am sure that the many we have worked enjoyed working us because we make it a point to say a few words to make it more meaningful than just a normal signal reports.

**Joe (John) Johnston W5AOE**  
 Jacksonville AR

(W2NSD cont. from page 10)

the past reporting I had read on the subject from our newspapers.

After returning home I paid a lot more attention to the Mideast, reading every news item or article that I could find, plus watching all special television reports. One of the most fascinating television programs on the subject was on NET, called "The Advocates." They argued the Arab side of the problem one week and the Israel side the next. They mentioned that the Quakers had produced a booklet on the subject called "Search for Peace in the Middle East." I sent for one.

The Quaker book is exhaustively nonpartisan and, for a small book, does a beautiful job of putting everything into perspective. They cover the Arab arguments and problems as well as the Israeli.

If you are at all interested in an objective history of the situation, complete with an espousal of both sides' problems and complaints, you should read this booklet. It certainly is an eye-opener. To make this easy for you I have arranged for our book department to have some of these on hand. Send \$1 (75¢ plus handling charges, etc.) for the Quaker book to Radio Bookshop, Peterborough, N.H. 03458. Why not know the whole story? . . . W2NSD/1 ■

(Leaky Lines cont. from page 14)

any mailings they might care to send me. They have informed me that they are placing me on their mailing list, and will take the matter under advisement.

I am hoping that these inquiries will bear fruit, and will keep you abreast of the matter via Leaky Lines. Lest anyone get the idea that nothing will come of it, I might remind him that in at least two similar instances, offending signals were dealt with through the determined efforts of amateur operators. One, a high powered teleprinter operated by NSS at Annapolis, was cleared up through the talents of W4UMC, principally. The other, a terribly troublesome Teletype in Bogota, Colombia, some years ago, was halted through the use of the telephone. A very cordial call to the office of the head of the Colombian mission to the UN resulted in the prompt cessation of the interference. Sometimes simple solutions are the best. In any case, all we can do is to try.

\* \* \*

Now that the amateurs of practically every country in North and South America have pitched in unstintingly to render assistance to beleaguered Peru in its hour of travail, it will be interesting to observe the future attitude of that nation toward the United States. U.S. hams have been most dedicated; some of them have even stayed away from their jobs and have lost sleep, continuing to man their stations, so that the lines of communication could be kept open. I'll not go into details concerning the actual operation, since there are certain to be many articles on that subject. Let us simply state that if it had not been for all these dedicated hams, plus the presence of the U.S.S. Guam, practically converted into a hospital ship, many lives would have been lost that were saved.

In the recent past, of course, the property of some of our compatriots had been seized by Peru. Fishing vessels were interned... oil company installations had been expropriated. It seemed that our stock in Peru had fallen mighty low. It is a source of great pride to me, and I am sure to all Americans, that such cavalier treatment at the hands of this small country did not deter us from our willingness to offer all our resources in order to ameliorate the terrible tragedy which struck without warning.

... K2AGZ ■

*Tell our  
Advertisers  
You Saw it  
in 73*

## NEW G&G CATALOG! MILITARY ELECTRONICS

24 PAGES, crammed with Gov't Surplus Electronic Gear - the Biggest Bargain Buy\* in America! It will pay you to SEND 25c for your copy - Refunded with your first order.

**BC-645 TRANSCEIVER** 16 tubes, 435 to 500 Mc. Easily adapted for 2 way voice or code on Ham, Mobile, Television Experimental, and Citizens Bands. With tubes, less power supply in factory carton, BRAND NEW..... **\$16.95**

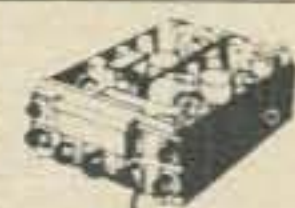

**SPECIAL PACKAGE OFFER:** BC-645 Transceiver, Dynamotor and all accessories, including mounting, UHF Antenna Assemblies, control box, complete set of connectors and plugs. Brand New ..... **\$26.95**

**AN/APR - 4Y FM & AM RECEIVER** "FB" for Satellite Tracking!

High precision lab instrument, for monitoring and measuring frequency and relative signal strength, 35 to 4000 Mc. in 5 tuning ranges. For 110 v 60 cycle AC. Built-in power supply. Original circuit diagram included. Checked out. Perfect. LIKF NEW..... **\$88.50**



### DUAL AMPLIFIER

Has two input circuits, each feeding a single 6SN7GT twin triode amplifier. 115 V 60 cy. power supply. Finest components. Size: 5 1/2" x 2 1/2" x 4 1/2". Weight 11 lbs. Brand new, SPECIAL ..... **\$7.95**

### WILLARD 2-VOLT STORAGE BATTERY

Rated at 20 Amp.-Hours. Model 20-2. Rechargeable. Compact nonspill construction. Lightweight polystyrene container, 3x4x5 1/2". Shipped dry, uses standard electrolyte. Shipping Weight 3 lbs. NEW, each ..... **\$2.79**



### BC-605 INTERPHONE AMPLIFIER

Easily converted to home or office intercom system! Uses pair of 1619 tubes, delivering 10 watts of audio power. Massive construction, suitable for shops, factories. Finest parts used. Conv. diagram and instr. included. BRAND NEW ..... **\$2.45**



### HEADSET

Low impedance. With large chamois ear cushions. 4-ft. cord and plug. Reg. \$12.50. OUR SPECIAL PRICE ..... **\$2.95**



### SCR-274-N, ARC-5 COMMAND SET HQ!

Freq. Range	Type	Exc. Used	Like New	BRAND NEW
RECEIVERS, 190-550 Kc.	Complete with Tubes			
3-6 Mc.	BC-453	\$16.95	\$23.50	\$27.50
6-9.1 Mc.	BC-454	\$16.50	\$19.50	\$22.50
1.5-3 Mc.	BC-455	\$14.95	\$17.95	\$21.50
	R-25		\$19.50	\$21.50

ARC-R11A Modern Q-5 Receiver 190 - 550 KHz ..... **\$16.50**

ARC-R22 540 - 1600 KHz Receiver with tuning graph ..... **\$24.50**

R-4/ARR-2 Receiver 234-258 Mhz, 11 tubes, NEW..... **\$ 9.95**

TERMS: 25% Deposit with order, balance C.O.D. -or- Remittance in full. Minimum order \$5.00 F.O.B. NYC. Subject to prior sale and price change

## G&G RADIO ELECTRONICS COMPANY

47 Warren St., (2nd Fl) New York, N.Y. 10007 Ph. 212-267-4605

## Wanted! Dead or Alive!

WE PAY HIGHEST CASH PRICES  
PLUS ALL SHIPPING CHARGES

NO QUANTITY TOO SMALL OR TOO LARGE:

AN/SPA-4A	Navy Radar Indicator
RT-77/GRC-9	Army Radio Transceiver
DY-88/GRC-9	Army Power Supply
RT-176A/PRC-10	Army Radio Transceiver
AN/SGC-1	Navy Teletype Terminal
AN/URC-32	Navy Radio Transceiver
MD-522/GRC	Army Teletype Terminal
AN/VRC-24	Army Radio Transceiver
AN/TRC-68	Army Radio Transceiver
RT-524/VRC	Army Radio Transceiver
RT-246/VRC	Army Radio Transceiver
AN/URC-9	Navy Radio Transceiver

WRITE OR CALL COLLECT  
(213) 764-9030 (213) 875-2970

## COLUMBIA ELECTRONICS

P.O. BOX 9266, 7360 ATOLL AVE., NORTH HOLLYWOOD CA 91609

## CIRCUIT BOARD SPECIAL



HONEYWELL COMPUTER BOARDS 4½" x 11"; loaded with transistors, zeners, diodes, precision res.  
A9098 (all different) . . . . . 3/1.00

Transistors		
A4000	2N277	Motorola PNP Germanium Power 55 Watts . . . . . 75 3/2.00
A4001	2N1183B	RCA PNP Germanium Power 7.5 Watts . . . . . 75 3/2.00
A4002	2N1204	Motorola PNP Germanium General Purpose . . . . . 5/1.00
A4003	2N231	PNP Germanium General Purpose . . . . . 5/1.00
A4018	2N1907	Texas Inst. PNP Germanium Power 150 Watts . . . . . 1.75
A4022	2N1546	Motorola MP1546 High Reliability 90 Watts . . . . . 1.00
A4023	#108	Motorola or Delco Similar to 2N1100 40 Watts . . . . . 3/2.00
A4024	2N3567	Fairchild NPN Silicon General Purpose . . . . . 5/1.00
A4025	MADT	Sprague . . . . . 4/1.00
A4027	2N706A	Sylvania NPN Silicon VHF 1 Watt . . . . . 5/1.00
A4028	2N1011	Motorola PNP Germanium Power 35 Watts . . . . . 3/2.00

A4016	FET Field Effect Transistor To-18 25 Volt Source to Gate N Channel	.50 5/2.00
A4017	Tunnel Diode Similar to 1N3717	.50 5/2.00

Lots of other items — send for free flier; All merchandise fully guaranteed. Please include postage; excess will be refunded.

### Miscellaneous Items

A8010	2000 Ohm Multiturn trimmer . . . . .	75
A9004	TO-3 Power Transistor Sockets . . . . .	8/1.00
A9040	Fan Motor 110 AC . . . . .	1.00
A9001	Sub-miniature slide switches . . . . .	3/1.00
A9003	Fuse Holders (Panel type) . . . . .	6/1.00
A9032	Dialco 28 Volt pilot light bulb and Assembly . . . . .	3/1.00
A9076	Mercury Wetted Relay Clare HGP 1059 . . . . .	1.00
A9067	Isolation Transformer Triad N-51X . . . . .	2.00
A9062	D.C. Servo Motor, 24V, 4.2 Amps . . . . .	9.95
A9063	Nickel-Cadmium Batt., 1.25V, 4AH . . . . .	1.25
A9075	Reed Switch & 24V Coil SPDT (Removed from equipment) . . . . .	75..3/2.00
A8013	Delay Line, 10-40 usec, Imp. 20000 Ohms . . . . .	2.00
A2031	Miniature var. Capacitor 3-75 pF . . . . .	3/1.00

### Zener Diodes

A4010	1N751A	5.1 Volts, 400 mw . . . . .	5/1.00
A4011	1N3039A	62 Volts, 1 Watt . . . . .	3/1.00
A4012	1N3822	3.6 Volts, 1 Watt . . . . .	5/1.00
A4013	1N3000B	62 Volts, 10 Watts . . . . .	2/1.00
A4014	1N3048B	150 Volts, 1 Watt . . . . .	3/1.00
A4015	1M3.0	3 Volts, 1/2 Watt . . . . .	4/1.00
A4029	1N429	5.6 Volts, 1 Watt . . . . .	4/1.00
A4038	1N961B		
A4040	1N3048	150 Volts, 1.7 ma (Matched pair) . . . . .	75

### Integrated Circuits

Stk. No	Type	Case	Function	Price
A3000	907	TO-5	Four input gate . . . . .	75
A3001	914	TO-5	Dual 2 input gate . . . . .	1.00
A3008	914	FP	Dual 2 input gate . . . . .	1.00
A3002	915	TO-5	Dual 3 input gate . . . . .	1.00
A3003	923	TO-5	JK Flip Flop . . . . .	1.00
A3007	3M4-923	FP	JK Flip Flop . . . . .	1.00
A3005	1M4-925	FP	Dual 2 input gate exp. . . . .	1.00
A3004	926	TO-5	Buffered JK Flip Flop . . . . .	1.00
A3006	926	FP	Buffered JK Flip Flop . . . . .	1.00

(FP - Flat Pack)

**SPECIAL** With every order of ten dollars or more, choose two more dollars FREE.



## DELTA ELECTRONICS CO.

BOX 1, LYNN, MASSACHUSETTS 01903

## Equipment For Trade!

1000 Watt, 200 to 400 MC Transmitter—Receiver. Water Cooled final tubes. Semi transistorized, very late model (Trade Value \$1000.00)

UTA-68: 2 meter SPECIAL: 115 to 152 MC 10 channel, 10 watt, crystal controlled transceiver, compact, complete with dynamotor and schematic. Close out at \$14.95 each or AS IS, less tubes at \$7.50 each.

HEADPHONE & BOOM MIKE COMBINATION: Aircraft type \$7.50 ea.  
Tank type 3.95 ea.

HYCON COLOR BAR GENERATOR: complete with most tubes and crystals \$24.50  
Less tubes and crystals 9.95

2 METER ANTENNA — tubular brass with extended whip that can be trimmed to other frequencies \$2.95 ea.

VARIACS: 0—250 volts AC, 60 cycles at 6 amps. \$29.50 ea.

### TRADE:

Model 551, dual Beam Tektronic in excellent condition  
(Trade value \$595.00)

**J. J. GLASS ELECTRONICS CO.**

1624 S. Main Street, Los Angeles, Calif. 90015  
Telephones: 749-1179 749-1170

## TECH MANUAL SALE

SCR-658	\$3	MN-26	\$2
SCR-508, 528, ANVRC5	3	BC-610	1
BC-375	2	BC-189	1
AN/AIC-4	1	RBL	3
BC-733A	1	AN/APN-12	3
AN/SAR-4 Snooperscope	2	DAE	2
RAX-1	2	1-177 data cardsq	1
BM-1, 2	2	Teletype #141, #14	3
SCR-284, BC-654-A	3	Teletype #162 Reperf	3
ASB-4	2	Teletype Regen Rep	1
ASB-5	2	Teletype Mod 12 printer	2
AN/AXT-2	3	Teletype Mod 15	2
AN/APA-38	3	Teletype #15 Adj., etc.	10
RAL-7	3	Teletype TT4/TG	4
RBH-2	1		

SEND CASH, CHECK or IOU to:

**73 MAGAZINE Peterborough NH 03458**



Buy 73 binders and win the love of a beautiful girl. Now only \$4.00!

# Sale

3 AMP  
1000 PIV

SILICON  
RECTIFIERS  
4 for \$1



1 AMP  
800 PIV

SILICON  
RECTIFIERS  
7 for \$1



- ★ Avalanche Type
- ★ Micro Miniature
- ★ Up to 2 Amps



HAM  
SILICON  
TUBE  
SPECIALS

(Replaces) Sale  
5U4GB) ..... 2.39  
5R4) ..... 4.39  
866A) ..... \$8.50

## HIGH VOLTAGE

1 AMP EPOXY

PIV	SALE
<input type="checkbox"/> 2000°	.1.00
<input type="checkbox"/> 3000	1.35
<input type="checkbox"/> 4000	1.65
<input type="checkbox"/> 5000	2.25
<input type="checkbox"/> 6000	2.96
<input type="checkbox"/> 8000	3.50
<input type="checkbox"/> 10000	3.95

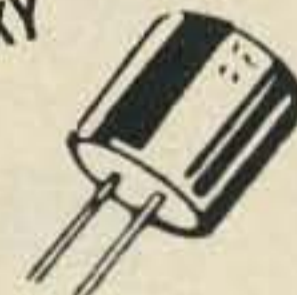

SILICON  
RECTIFIERS

## NOW! FIRST TIME IN U.S.A.!

### "ONE PRICE" SCRS!

Imagine 7-amp, 16-amp and 25-amp at one price! Just check the proper amp and PRV blocks.

7-Amps		16-Amps		25-Amps	
PRV	Sale	PRV	Sale	PRV	Sale
<input type="checkbox"/> 50	.45	<input type="checkbox"/> 150	.80	<input type="checkbox"/> 300	1.75
<input type="checkbox"/> 100	.70	<input type="checkbox"/> 200	1.15	<input type="checkbox"/> 400	2.25
		<input type="checkbox"/> 250	1.35	<input type="checkbox"/> 500	2.50
				<input type="checkbox"/> 600	2.95

## General Instrument

Full  
Wave  
Bridge

\$2.25

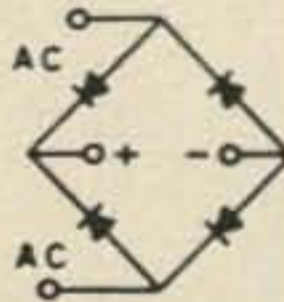

5 AMP  
1500 PIV

## 709C OP AMPLIFIER



Guaranteed! With Spec.

TYPICAL USES:  
\* AC AMPLIFIER  
\* RIAA PHONO PREAMP  
\* INTEGRATOR \* MULTIPLIER

1.49



UHF HIGH POWER  
TRANSISTORS

2.99 ea

400 mc

2N3632 23W, 3A.

## BRAND NEW! RTL-TTL 'ICS'

ALL GUARANTEED! With Spec Sheets!



79c EA.

3 for \$2

### Description

Part Number	Description	Logic
<input type="checkbox"/> SG43SD	Dual 4 Input Nand/Nor Gate	TTL
<input type="checkbox"/> W215F	JK Flip Flop	DTL
<input type="checkbox"/> W266F	Quad 2 Input Gate	DTL
<input type="checkbox"/> 320T	JK Flip Flop (fastest logic)	ECL
<input type="checkbox"/> 900FF	Buffer	RTL
<input type="checkbox"/> 908TU	Full Adder	RTL
<input type="checkbox"/> 909TU	Buffer	RTL
<input type="checkbox"/> 912TU	Half Adder	RTL
<input type="checkbox"/> 913TU	Shift Register	RTL
<input type="checkbox"/> 914TF	Dual 2 Input Gate	RTL
<input type="checkbox"/> 923TF	JK Flip Flop	RTL
<input type="checkbox"/> 960TU	Dual Buffer	RTL
<input type="checkbox"/> 7470FX	JK Flip Flop (35mhz)	TTL

Give 1st, 2nd, and 3rd choices on case styles,

## EPOXY SILICON TRANSISTORS

5 for \$1

Type	Sale
<input type="checkbox"/> 2N706	5 for \$1
<input type="checkbox"/> 2N2222	5 for \$1
<input type="checkbox"/> 2N2368	5 for \$1
<input type="checkbox"/> 2N2711	5 for \$1
<input type="checkbox"/> 2N3396	5 for \$1
<input type="checkbox"/> 2N3565	5 for \$1
<input type="checkbox"/> 2N3638	5 for \$1
<input type="checkbox"/> 2N3641-3	5 for \$1
<input type="checkbox"/> 2N3645	5 for \$1
<input type="checkbox"/> 2N3662	5 for \$1
<input type="checkbox"/> 2N3683	5 for \$1
<input type="checkbox"/> 2N3692	5 for \$1
<input type="checkbox"/> 2N3793	5 for \$1
<input type="checkbox"/> 2N4140-1	5 for \$1
<input type="checkbox"/> 2N4248-9	5 for \$1

## TEXAS! NATIONAL! FAIRCHILD COUNTING "IC's"

Guaranteed! W/Spec Sheets

Any 3 -

10% Discount!

<input type="checkbox"/> 958 Decade Counter	\$4.95
<input type="checkbox"/> 959 Quad Latch	3.95
<input type="checkbox"/> SN7493 4 Bit Counter	4.95
<input type="checkbox"/> SN7490 Decade Counter	5.50
<input type="checkbox"/> SN7475 Quad Latch	4.50
<input type="checkbox"/> SN7441 BCD Decoder	6.50

1 AMP 5  
1000 PIV for \$1  
SILICON RECTIFIERS

## GE PA-237 2-WATT AUDIO AMPLIFIER



\*Lowest Prices \*Brand New! \$3.95

2 watts continuous 9 to 27 volt supply, 8 mV sensitivity, includes 11 circuits, for phono, tape recorders, dictating, TV, FM, movie.

## SOLID STATE 1970 WINNERS

<input type="checkbox"/> Westinghouse Voltage Regulator 0 to 40 VDC Positive	\$1
<input type="checkbox"/> Shockley Diodes, 4 layers	3 for \$1
<input type="checkbox"/> Neon & Nixie Driver 2N4410	4 for \$1
<input type="checkbox"/> SCR/Triac Trigger Diodes	4 for \$1
<input type="checkbox"/> 1-TUNNEL DIODE, 1N3716 for amps-osc	\$1
<input type="checkbox"/> 2-UNIUNCTION TRANSISTOR,	\$1

## 741C AMP



\$2.59

3 for \$6

• Similar to 709 but  
frequency compensated

1.5 AMP PIV 1.5A

EPOXY  
SILICON  
RECTIFIERS



'XMAS'



## POLY PAKS

P.O. BOX 942 A  
Lynnfield, Mass.  
01940

Terms: add postage. Rated: net 30, cod's 25%  
Phone Orders: Wakefield, Mass. (617) 245-3829  
Retail: 211 Albion, St., Wakefield, Mass.

### 73 Reader Service Coupon

Now we don't say that every single reader must buy every last product advertised in 73. We believe that, but we don't say it. The very least every reader can do is to put on a show of interest in the products herein advertised. To make this a simple task, even for the laziest reader (now there is a contest for you!), we have cleverly arranged the advertising index to double as a readers service coupon. All you have to do is tear it out (or photocopy it) and send it in with the appropriate boxes marked. (We have a prize for the most boxes marked... a silent prayer of thanks from the publisher). We'll accept postcards, slips of paper, or almost anything else that lists the companies you want to hear from and your address.

No one likes to go into a store without buying something, right? It is the same with these information requests. You will be expected to buy something. Oh, it doesn't have to be a \$50,000 antenna system, but it should be something modest... a transceiver... a linear... you know. We'll leave the decision up to you, knowing that we can trust you to do the right thing.

And we are definitely not saying that the use of this service coupon has any curative powers, but we cannot but notice that many readers report remarkable relief from simple backache, headaches, lumbago, and acid indigestion after sending in their coupon. Why take any chances?

#### Advertiser Index

- |   |   |
|---|---|
| <input type="checkbox"/> Amateur Electronic 37    | <input type="checkbox"/> Megart 77            |
| <input type="checkbox"/> Ameco 28                 | <input type="checkbox"/> Meshna 105           |
| <input type="checkbox"/> American Crystal 95      | <input type="checkbox"/> Microfect 49         |
| <input type="checkbox"/> Amidon 72                | <input type="checkbox"/> Mosley IV            |
| <input type="checkbox"/> Antennas Inc. 21         | <input type="checkbox"/> Motorola 41          |
| <input type="checkbox"/> Arnolds Engraving 72     | <input type="checkbox"/> National III         |
| <input type="checkbox"/> Arrow Sales 101          | <input type="checkbox"/> Pantronics 102       |
| <input type="checkbox"/> ATV 103                  | <input type="checkbox"/> Park 107             |
| <input type="checkbox"/> CB Radio 103             | <input type="checkbox"/> Poly Paks 111        |
| <input type="checkbox"/> Columbia 109             | <input type="checkbox"/> Quement 44           |
| <input type="checkbox"/> Dahl 103                 | <input type="checkbox"/> Radiation Devices 72 |
| <input type="checkbox"/> Dames 103                | <input type="checkbox"/> Radio Callbook 21    |
| <input type="checkbox"/> Delta 110                | <input type="checkbox"/> RP Electronics 59    |
| <input type="checkbox"/> Denson 21                | <input type="checkbox"/> Salch 43             |
| <input type="checkbox"/> Denver Crystals 102      | <input type="checkbox"/> Sams 57              |
| <input type="checkbox"/> Dow Trading 102          | <input type="checkbox"/> Sentry 47            |
| <input type="checkbox"/> Dymond Electronics 55    | <input type="checkbox"/> Signal One 34        |
| <input type="checkbox"/> Dynamic 95               | <input type="checkbox"/> Spectrum Int. 79     |
| <input type="checkbox"/> EKY Video Vision 95      | <input type="checkbox"/> Swan Electronics II  |
| <input type="checkbox"/> Epsilon 72               | <input type="checkbox"/> Telrex 25            |
| <input type="checkbox"/> Estes Engineering 59     | <input type="checkbox"/> Tower 105            |
| <input type="checkbox"/> Fair Radio 108           | <input type="checkbox"/> Tristao 77           |
| <input type="checkbox"/> Gateway 107              | <input type="checkbox"/> Two Way 77           |
| <input type="checkbox"/> G&G 109                  | <input type="checkbox"/> Vanguard Labs 49, 93 |
| <input type="checkbox"/> JJ Glass 110             | <input type="checkbox"/> Varitronics 51       |
| <input type="checkbox"/> Sid Glass 106            | <input type="checkbox"/> Vibroplex 103        |
| <input type="checkbox"/> Global Imports 77        | <input type="checkbox"/> Western Radio 102    |
| <input type="checkbox"/> Goodheart 108            | <input type="checkbox"/> World QSL 103        |
| <input type="checkbox"/> Gotham 99                |   |
| <input type="checkbox"/> HAL Devices 103          | <input type="checkbox"/> 73 Stuff             |
| <input type="checkbox"/> Hatry 95                 | Bookshop 89                                   |
| <input type="checkbox"/> Heights 97               | Repeater Handbook 98                          |
| <input type="checkbox"/> Henry 15                 | E&E Handbook 98                               |
| <input type="checkbox"/> H&L 103                  | FM Anthology 31                               |
| <input type="checkbox"/> Hy-Gain 63               | Subscriptions 91                              |
| <input type="checkbox"/> International Crystal 11 | World-Globe 101                               |
| <input type="checkbox"/> James Research 104, 105  | Bookshop Clearance 100                        |
| <input type="checkbox"/> Jan Crystal 104          | DX Map 100                                    |
| <input type="checkbox"/> Janel 102                | Tech Manuals 110                              |
| <input type="checkbox"/> Jefftronics 106          | 73 Binders 110                                |
| <input type="checkbox"/> Lewispaul 104            | Back Issue Gunsmoke 93                        |
|   | Schematics 102                                |

MAIL TO 73 Inc., Peterborough NH 03458

Name \_\_\_\_\_  
 Call \_\_\_\_\_  
 Address \_\_\_\_\_  
 Zip \_\_\_\_\_

## PROPAGATION CHART

J. H. Nelson

Good  Fair (open)  Poor

### September 1970

SUN	MON	TUES	WED	THUR	FRI	SAT
		①	②	③	④	⑤
⑥	⑦	⑧	⑨	⑩	⑪	⑫
13	14	⑮	⑯	⑰	⑱	⑲
⑳	21	22	㉓	㉔	25	26
㉖	㉗	㉘	㉙	㉚		

#### EASTERN UNITED STATES TO:

	GMT: 00	02	04	06	08	10	12	14	16	18	20	22
ALASKA	14	14	7A	7	7	7	7	7	14	14	14	14
ARGENTINA	21	14	14	14	7	7A	14A	21	21A	21A	21	21
AUSTRALIA	21	14	7B	7B	7B	7	7	14B	14B	7B	14A	21
CANAL ZONE	21	14	14	7A	7	7	14	21	21	21	21A	21
ENGLAND	7	7	7	7	7	7A	14	14	14A	14A	14	14
HAWAII	21	14	14	7	7	7	7	14B	14	21	21	21
INDIA	7B	7B	7B	7B	7B	7B	14	14	14	14	14	7B
JAPAN	14	14	7B	7B	7	7	7	7B	7	7	7B	14
MEXICO	21	14	7A	7	7	7	14	21	21	21	21A	21
PHILIPPINES	14	14	7B	7B	7B	7B	7B	14B	14	14	14B	14
PUERTO RICO	14	7A	7	7	7	7	14	14	14	14	21	21
SOUTH AFRICA	14	14	7	7	7B	14	21	21	21A	21A	21A	21
U. S. S. R.	7	7	7	7	7B	7B	14	14	14	14	14	7B
WEST COAST	21	14	7A	7	7	7	7A	14	21	21	21	21

#### CENTRAL UNITED STATES TO:

	GMT: 00	02	04	06	08	10	12	14	16	18	20	22
ALASKA	14	14	14	7	7	7	7	7	14	14	14	14
ARGENTINA	21	14	14	14	14	7	14	21	21	21A	21A	21
AUSTRALIA	21	21	14	14	7B	7	7	14B	14B	7B	14A	21
CANAL ZONE	21	14	14	14	7A	7	14	21	21	21	21A	21A
ENGLAND	7	7	7	7	7	7	7A	14	14	14A	14A	14
HAWAII	21A	21	14	7A	7	7	7	14	14	21	21	21
INDIA	14	14	7B	7B	7B	7B	7B	14	14	14	14	14B
JAPAN	14	14	14	7B	7	7	7	7	7	7	14	14
MEXICO	14	14	7	7	7	7	7	14	14	14	21	21
PHILIPPINES	14	14	14	7B	7B	7B	7B	7	14	14	14B	14
PUERTO RICO	21	14	7A	7	7	7	14	21	21	21	21A	21
SOUTH AFRICA	14	14	7	7	7B	7B	14	21	21	21	21A	21
U. S. S. R.	7B	7	7	7	7	7B	7B	14	14	14	14	7B

#### WESTERN UNITED STATES TO:

	GMT: 00	02	04	06	08	10	12	14	16	18	20	22
ALASKA	14	14	14	7	7	7	7	7	7A	14	14	14
ARGENTINA	21	21	14	14	14	7	7A	21	21	21	21A	21A
AUSTRALIA	28	21	21	14	14	14	7	7	7A	7	14A	21
CANAL ZONE	21	14	14	14	14	7	7	14A	21	21	21A	21A
ENGLAND	7B	7	7	7	7	7B	7B	7B	14	14	14	14
HAWAII	21A	21A	21	14	14	14	7	7	14	21	21	21
INDIA	14	14	14	7B	7B	7B	7B	7B	14	14	14	14B
JAPAN	14	14A	14	14	7	7	7	7	7	7	14	14
MEXICO	21	14	7	7	7	7	7	14	21	21	21	21A
PHILIPPINES	14	21	14	7B	7B	7B	7	7	14	14	14	14
PUERTO RICO	21	14	14	7	7	7	7	14	14	21	21	21A
SOUTH AFRICA	14	14	7	7	7B	7B	7B	14	21	21	21	21
U. S. S. R.	7B	7B	7	7	7	7B	7B	7B	14	14	14	7B
EAST COAST	21	14	7A	7	7	7	7A	14	21	21	21	21

A = Next higher frequency may be useful also.  
 B = Difficult circuit this period.

# NCX



1 kw Solid State  
TRANSCEIVER  
( 80-10 Meters )

# 10000

Here's a transceiver designed for the amateur who would rather spend his hard-earned radio dollar on performance than frills. The NCX-1000 is built to meet the demands of the operator who needs and desires a high performance SSB-AM-CW-FSK rig with solid-state dependability and plenty of power. Add to this the convenience of having your transmitter (including linear amplifier), receiver, power supply, and monitor speaker in a single, compact, smartly styled 59 pound package.

So let's look at the NCX-1000, starting with the double-conversion, solid state receiver. After the received signal is processed by a double-tuned preselector, a stage of RF amplification, and another preselector, it is applied to the first mixer for conversion to the first IF frequency. The first IF contains passband filters and a stage of amplification. A second mixer then converts the signal to the second IF frequency for additional processing by a 6-pole crystal-lattice filter and four IF stages. Finally, the signal is detected and amplified by four audio stages. The unparalleled high dynamic range lets you tune in weak stations surrounded

by strong interfering signals. The result? High performance for SSB, AM, CW, and FSK. Sensitivity of 0.5 EMF microvolt (for a 1Q db S-N/N ratio).

In the transmitter you'll find three stages of speech amplification followed by a balanced modulator, a crystal-lattice filter, a filter amplifier, and an IF speech processor (clipper). A mixer converts the signal to a first IF frequency for processing by two crystal passband filters, and two IF amplifiers. A second mixer converts the signal to the transmitting frequency where it is amplified in five RF stages before it gets to the grid of the 6BM6 driver. Final power amplification takes place in a forced-air-cooled 8122 ceramic tetrode which feeds the antenna through a pi network. Other features? You bet! Grid block keying for CW. Complete metering. Amplified automatic level control (AALC).

So here's a package that can give you 1000 watts PEP input on 80 through 10 meters, 1000 watts on CW, and 500 watts for AM and FSK. The speech processor lets you double your SSB average power output with minimum distortion. No frills with the NCX-1000. Just top performance.

For complete (and impressive) specifications and details, write:



**NATIONAL RADIO COMPANY, INC.**

**NRCI**

37 Washington St., Melrose, Mass. 02176



**the MAXI-mini-beam**

Now the Mosley CB Mini-Beam packs more muscle than ever on its sturdy miniature frame. Deluxe coils assure the maxi-performance of the new Model GA-3D. With high-impact polystyrene coil forms and molded covers, these coils are built to take a powerful beating and come out on top.

The deluxe Mini-Beam (GA-3D) saves you money and space, like all the Gamma 323 antennas. It is lightweight enough for an inexpensive TV antenna mount and rotor. Its mini-size takes less room and makes it easier to handle, easier to stack (Model GA-33D offers two beams with stacking hardware). It saves you time too because assembly is simple with preassembled parts, solid-state gamma match, and color-coding.

Some vital statistics:

MINI-size

Boom Length: 9'

Max. Element Length: 11' 5"

Turning Radius: 7' 3"

Assembled Wt.: Approx. 6 lbs.

Shipping Weight: Approx. 7½ lbs.

via P.P. or U.P.S.

MAXI-performance

Forward Gain: 9.6 db over isotropic source, 7.5 db comp. to ref. dipole

Front-to-back Ratio: 25 db

SWR: 1.5/1 or better

Bonus Feature: GA-3, the original CB Mini-Beam, can be converted to GA-3D with a Conversion Kit (Model GA3-3DCK).

Get the Mini-Beam with Maxi-Performance at your nearest Mosley dealer. Write factory direct for detailed brochure. Dept. 183A

**Mosley Electronics Inc.**

4610 N. LINDBERGH BLVD., BRIDGETON MO. 63044