

# amateur 73radio

**A**  
#126  
One Dollar  
March  
1971

**ANNUAL SURPLUS ISSUE**

**TRAP-TYPE VERTICALS for 2m  
IC AUDIO FILTER**

**To The REPEATER  
- on SKIS!**

page 54

**AMATEUR RADIO LICENSE  
STUDY COURSE**

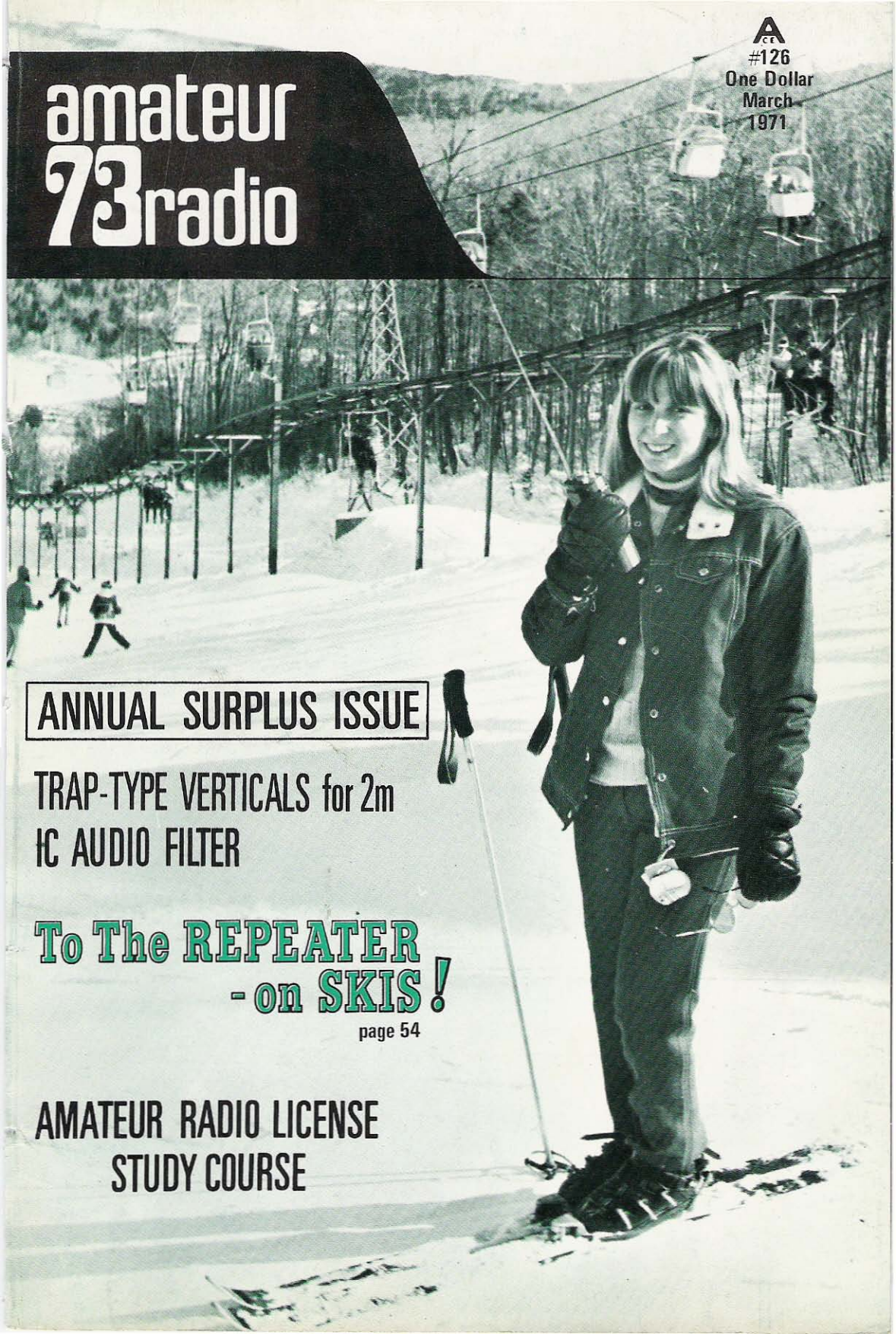

Editor-Publisher: Wayne Green W2NSD/1  
 Managing Editor: Ken Sessions K6MVH/1

## STAFF

Associate Editor: Jim Kyle K5JKX

WTW Editor: Dave Mann K2AGZ

Advertising: Aline Coutu

Art Director: Roger Block

Graphics: Nancy Estle  
 Jan Wozmak  
 Jane Ehrlich

Composition: Ruthmary Davis  
 Karen Mellor

Subscriptions: Dorothy Gibson

Circulation: Phil Price  
 Barbara Block

Comptroller: Georgiana Sage

Publications: Biff Mahoney  
 Venn Mellor

Traffic: Douglas Stivson WB2MYU  
 Taylor Sage

Propagation: John Nelson

Drafting: R.K. Wildman W6MOG  
 Wayne Peeler K4MVV  
 T.M. Graham W8FKW

## CONTENTS

- 12 Integrated Circuit Audio Filter ..... W2EEY  
 Clean up that dirty audio with a filter.
- 16 Integrated Circuit Six Meter Converter ...WB4KMB  
 Not for bigots with six unconverted meters.
- 18 Trap-type Vertical Antennas ..... W2EEY  
 Adding stubs for two meters, FM article.
- 22 Resurrecting Granddaddy ..... K6BIJ  
 Fun with a 1925 parametric amplifier.
- 26 Digital Counters ..... W6LMD  
 Five digit.
- 37 Identifying Surplus Electronic Equipment W6DOB  
 Military marking system.
- 40 The Horizontal-Output Linear ..... W2A00  
 A 850 kilowatt amplifier?
- 43 DX America First ..... K10XX  
 DXpedition to Maine.
- 49 Phone Patch: No Cost, No Wires ..... WAZEAW  
 Phone patching is illegal in Rwanda. Too bad.
- 54 Mt. Snow: To the Repeater - On Skis ..... K6MVH  
 Our cover feature. An FM article.



...de W2NSD/1

NEVER SAY DIE

## SAROC 1971

These being days of impoverishment, I had not intended to make the scene at Vegas. At the last minute Ken put on the pressure and, with the hopes of perhaps selling a page or two of ads to help balance the books, I hopped on down there.

Just after taking off from Boston I had a short contact with WITNO through the W1ALE repeater in Concord, N.H. No answers at Schenectady... some short contacts in western New York... Cleveland was kept busy with long-winded nonlistening talkers... ditto Detroit... contacts in Chicago... no one around in Urbana... and so it went. Omaha was not open to breakers. About ten minutes out of Vegas I picked up their repeater and talked with the gang the rest of the way in, while waiting for baggage, and during the limousine ride to the hotel. One mobile pulled up alongside, waved, and then broke in to say hello.

It was colder in Vegas (15°) than in New Hampshire so I grabbed my camera and went across the street (watching out for any possible ARRL-driven cars) and took pictures of the ice-encrusted fountains at Caesar's Palace. Art Housholder W9TRG, arriving on a Frontier Airlines plane, came through the repeater at this time and I talked with him as he flew over Lake Mead and later while he was waiting for his baggage at

and every mobile within 100 miles of town. My last contact was from the airport as I went to get on the plane and I said goodbye to Ken, who was just that minute getting out of bed back at the hotel. TWA shut me up from there until I landed in Boston. I have this black curse to put on TWA: May the board of directors eat one meal a week in the tourist section of their planes. That'll hold 'em.

## FM/Airborne

Yes, I use my little two meter FM hand transceiver while I'm a passenger on the airlines! It works out beautifully, too. About the only serious problem I have with it is trying to get a word in edgewise on the repeaters I fly over. All too few of the fellows talking over repeaters ever give even one second for a passing-through breaker.

On the way to Saroc I tried to get through a number of repeaters, but just couldn't break the big signals with my hand transceiver. Oh, there were several that I did get into and it was fun to talk for the few minutes I was within range.

How about the plane, you ask? Many of the FM'ers who have hand units have tested them to make sure that no interference is caused to the plane radio or instruments and none has occurred. Considering the use of FM, the frequency and the low power involved, I would not expect to find any interference. Most of the FM'ers

## THE WORLD OF FM

Editorial by Ken Sessions K6MVH

## THE FM SCENE

SAROC was great fun this year. The Flamingo Hotel provided excellent accommodations and Las Vegas provided the atmosphere. I didn't hear a single complaint from so much as even one ham this time.

Times are a'changin', too. A few years ago, gamblers and hotel officials got uptight at the sight of individuals carrying hand-held transceivers through the casinos. But with literally hundreds of 2m FM units protruding from the pockets of so many hams this year, the hotel people apparently grew accustomed to it. No one reported any problems at all - except for the fact that the hotel security people reportedly complained that the hams had newer and better equipment



Dr. Phil Dater, representing the New Mexico repeater chain, gave a slide presentation showing repeater progress in the midwest.



Pretty Linda Mueller, wife of WB6IGZ, tended bar in Room 1031A, a spur-of-the-moment hospitality suite.



The lovely Sharon La Traille, of Varitronics, Incorporated, demonstrated 2m transceivers, amplifiers, and antennas.

57 Repeater Audio Mixer	W1ELU
Another great FM article.	
61 Something New in PC Construction	WA1EJU
Building with scissors.	
65 Switching Remote Linears	W0HFK
Like in the car.	
66 Digital RTTY Accessories	K5ZBA
Regenerative repeater, stunt box, speed conversion.	
72 The Coathanger Groundplane	K6MVH
Two meters (FMI)	
74 General Class Study Course	Staff
Part VII. Power and how to get it.	
93 Reading 5 Code RTTY in Binary	WB2MPZ
Just what you've been waiting for.	
118 Petitions to FCC	Staff
220 MHz proposals.	

## FEATURES

- 1 Radio Amateur News Page
- 1 Never Say Die
- 1 The World of FM
- 6 Letters to the Editor
- 8 Caveat Emptor
- 8 Leaky Lines
- 128 Propagation Chart
- 128 Advertiser Index

### On The Cover:

Lin Green talks home via two meters while skiing on Mt. Snow in Vermont, checking on daughter Sage, being minded by Ken. The 110-mile path is via K1ZJH repeater about 60 miles away. (Where's Wayne, you say? Who do you think took the picture?)

73 Magazine is published monthly by 73 Inc., Peterborough, New Hampshire 03458. Subscription rates are \$6 for one year in North America and U.S. Zip Code areas overseas, \$7 per year elsewhere. Two years \$10 in U.S. and \$12 overseas. Three years \$14, and \$16 overseas. Second class postage paid at Peterborough, N.H. and at additional mailing offices. Printed at Menasha, Wisconsin 54952 U.S.A. Entire contents copyright 1971 by 73 Inc., Peterborough NH 03458. Phone: 603-924-3873. Usually reliable sources inform us that continued reading of one of our competitor magazines is a positive mental health hazard. We are not at liberty to divulge the name of the alleged magazine, however we will give you one guess. Be on the safe side and read only 73.

the airport... I was just walking around taking pictures all the while.

SAROC was an FM convention this year. The ARRL Forum pulled about a dozen while the FM Forum next door was jammed with hundreds. Ken Sessions organized the FM program and it certainly was the hit of the convention. Most of the exhibitors were FM oriented... Regency was there en masse... Varitronics displayed their mobile IC2F, their hand unit, and lovely Sharon LaTraille (you saw her in the "Ham's Wide World")... Drake had their sideband gear there, but the attention was on their Marker Luxury FM rig and the brand new TR-22 walkie-talkie unit... Walt Henry proudly displayed his Tempo FM rig... Galaxy was there with their FM-210... Standard displayed a new transceiver and a mini-repeater. Lou Tristano had a tower that he feels FM'ers will like... Swan was showing their new FM rig from Japan... Ross & White showed their line of tone encoders and decoders... Sentry took orders for a lot of crystals from their interesting booth... and so it went.

A few non-FM manufacturers were present too... Dick Ehrhorn was showing his new all-band linear amplifier... Collins was there, but with nothing new for the amateurs and no FM plans whatever in the foreseeable future... Carl Mosley was there... Robot had a nice demonstration of slow-scan television. Spectronics brought a bunch of FM Motorola hand transceiver modules and the building crowd cleaned him out... ComSpec had its new gain vertical 2m antenna on display as well as their new 2 meter 50W amplifier... the Pierce-Simpson FM unit made its first appearance at SAROC.

My HT-220 hand unit was with me day and night and I have to admit to having a lot of fun. I kept in constant communication with Ken, the FM hospitality suite, dozens of friends, in the convention, the exhibits, the talks,

ask the plane captain for permission to use their rig while flying and, though permission can be refused on the basis of a regulation against using receivers in a plane, usually there is no hitch.

Sad to say, TWA has been one of the least cooperative with amateurs. Alas, I've been riding with TWA since they were Transcontinental Western Airlines, over 40 years ago, but I will choose alternative travel in the future where possible since I do enjoy operating while traveling. It wouldn't hurt them any to be nice... there is a lot of competition... and a growing number of amateurs with hand transceivers. The new little Drake unit (1½ watts) would be ideal for this!

Perhaps I should be in more awe of the complicated electronics in these planes, but my experience as a pilot, my tenure with Airborne Instruments Laboratories, and other background has lessened the mystery. Add to that several trips with no interference reported, even with a 5W unit, and similar reports from a dozen or other amateurs.

So look fellows, when you are talking through a repeater about something of earth-shaking importance, like how many 6SN7s you have left from the old days, won't you be nice enough to at least take one breath between transmissions so I can break in for a minute or so and say hello as I pass over on some other airline than TWA? You can't imagine how frustrating it is to hear you down there talking without being able to ever break you!

### New Repeater Bulletin

Mike WA8UGT has announced that he is planning on starting a repeater bulletin later this year. I am sure that all of us who remember the fine FM Journal that Mike and Ken Sessions published will be pulling for him to make it this time. With all but one amateur magazine reported to be in the red this is a particularly difficult

than they themselves had been issued. *C'est la vie!*

Some nice surprises were in store for convention-goers. Mr. Everett Henry, FCC officer in charge of amateur and CB policy-making, showed up and agreed to answer questions from FM'ers. He drew a bigger crowd

Mr. Henry's evasiveness was understandable, in view of the fact that the FCC does not plan to get deeply involved with repeater legislation until after the "phone band expansion" issue is settled. The notorious docket (18803) as well as my own petition (RM-1725) are both stacked neatly on



The whole staff of Regency Electronics showed up. They were kept busy demonstrating the company's growing line of equip.

in the FM room than any other speaker on any other subject in any other quarter. He was peppered with questions about repeater rulemaking, unofficial sanctions, and such matters, and managed to sidestep all major issues with the adeptness of a politician.



Walt Henry, of Henry Radio, showed his company's new high-performance, low-cost Tempo FM transceiver, which was itself a smash success at the convention.

the desk of FCC's Bill Grenfell, who will get going on them some time before midyear.

SAROC's display area looked pretty much "FM," too, with manufacturers proudly showing their latest FM transceivers, rf amplifiers, and other related hardware. Art Housholder showed slides of Spectronics to a packed house. The fact that he did it in the "hospitality suite" contributed to its popularity; the room was stocked with free beverages.

For me, SAROC was a stepping stone to a tropical vacation. When the convention was over, I flew to Los Angeles for a week in the sun and smog. Thanks to the hospitality of my California friends, the week was not as expensive as it could have been.

But I'm glad the week ended when it did. My California friends all know that I flip over Mexican food, and that Mexican food is just not available in New England. So each of my contacts in California went overboard to serve

# VK HAMS HELP "LA BALSA" MAKE LANDFALL

by Alan Shawsmith

In an effort to prove a 1000 year old theory, that the early peoples of South America could have drifted to Australia, by making use of the Equatorial currents and winds, four courageous young men, one of them being a ham, HC9EBP, left Ecuador on May 29 1970, on a 45 ft raft made basically of seven large balsa logs. Appropriately, they named it La Balsa. Filled with the challenge of adventure, they hoisted a square mainsail and with hopeful hearts, turned their primitive ship and faces westward. After a drift of more than 8500 miles across the Pacific, they arrived safely at a small boat harbor named Mooloolaba, 80 miles north of Brisbane.

This incredible sea journey, in a nonpowered craft, must rank as one of the greatest ever by modern man. Others before this have set out from the west coast of South America, but none have come so far or been so long at sea (161 days) in one single hop. They survived the tropical heat, sickness, many severe storms in which all but one were washed overboard at one time or another, including the cat Minette, and by a mixture of skill and good fortune, managed to avoid the numerous coral reefs and shoals along the way.

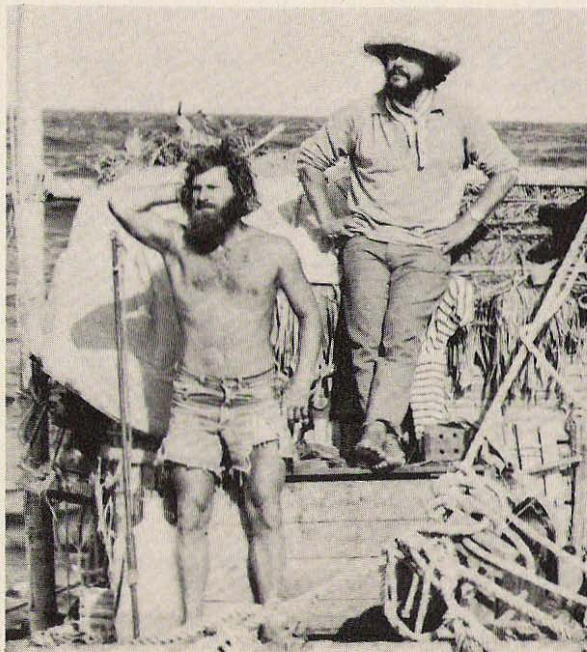

## IARU REGAINS OBSERVER STATUS

The International Amateur Radio Union, an organization of national amateur radio societies run by the ARRL, was removed from the list of organizations permitted to send observers to the International Telecommunications Union meetings by an action of the ITU Administrative Council in 1966.

IARU representatives have never been permitted to participate as other than silent observers at the ITU conferences. Even amateurs sent by their national societies have been unable to be accredited by their own country delegations (except for the U.S.) with the result that radio amateurs have had virtually no say whatever on the frequency allocations set up for them. As a result, amateur frequencies have been constantly eroding at these conferences. The services best represented have been able to hold or gain in frequencies and those least represented have lost the most.

Now the ITU Administrative Council has reconsidered its decision and again will permit the IARU to send observers to the ITU conferences. While this is better than nothing, the real action will come when amateurs are permitted to join their country delegations.

## TURKISH HAM NEEDS U.S. SPONSOR

Selim Canbeken TA2SC, 19, would like very much to come to the U.S. and learn about electronics. There just isn't any good education in this field available in Turkey and Selim knows what he wants.

Amateur radio has not been legal in Turkey for citizens since 1937 so the 150 or so active amateurs have operated quietly and in fear. Radio equipment is almost nonexistent and generally has to be built from what can be scrounged. There are no radio stores or manufacturers as in the U.S. Even so Selim was able to build a sideband transceiver, a linear amplifier and even a slow scan television flying spot scanner!

On April 28, 1970 the police came and confiscated everything . . . antennas, test equipment, a pre-war National 100XA receiver, logs, QSL cards, parts, transceiver, linear . . . everything. This was a cruel turn of events for this avid amateur.

Selim writes, "Now I am a Tone Maister for the famous Turkish singer Zeki Getin. We are working every night at night clubs. This life isn't good for me. Last year I finished my school. I want to go to the U.S.A. for an electronic education. I can work

Approaching Australia, they faced their greatest danger, the treacherous thousand-mile-long Barrier Reef. It was at this point in their voyage that the VK hams began to play a vital part in this Norse-like saga of the sea. Amateur radio operators in Queensland and New South Wales were first alerted by Gus, ZM1RO, in New Zealand, that an unidentified vessel, possibly *La Balsa*, was approaching Barrier Reef. XE1EEI, in Mexico, who had attempted to follow and plot the course of the raft, had passed the message across Oceania that, according to calculations, the raft should soon be within radio range of the east coast of Australia.

During the period the raft was in mid-Pacific, the 100W transmitter it carried became inoperative, due to a faulty microphone — all that *La Balsa* could send was a series of clicks (not Morse). This raised the problem of positive identification and caused many who were listening to proclaim the signals as a hoax. The first ham to pick up these faint clicking signals, on 28 October 1970, was Sid Molan, AX2SG. Others then reported them. The unidentified vessel was asked to send a certain number of clicks, if it was, in fact, the *La Balsa* raft. This it did and regular daily schedules were then maintained at 0400 GMT on 14100 MHz.

Many still refused to believe the signals were genuine. They insisted no raft could remain afloat for this length of time, especially as other ships in the area had reported no sightings. So the mystery deepened as the still unidentified boat approached the East Coast of Australia. At first it appeared to be on a collision course with the Swain reefs, one of the most treacherous areas of the Coral Sea. However, a wind change enabled the raft to bypass this dangerous area. Keith Schleicher, AX4KS, and Les Bell, AX4LZ, were now both receiving the clicking sounds very clearly. With Sid

acting as controller, an intense daily vigilance was maintained. A varying code of clicks was devised and in this way much information was exchanged between the raft and the three hams. For example; Sid would request them to send four clicks if all four men were fit and well. A group of two or three clicks would indicate the number of knots drifted during each 24 hours. Their position in Lat. and Long., the state of the weather, the barometric pressure, and much other vital information was transmitted in this manner.

The raft was now in a busy Australian sea lane and all ships alerted but still no report came through. Excitement reached fever pitch. News papers ran headlines, "LA BALSAL OR HOAX? — INCREDIBLE JOURNEY" — and so on. On the morning of November 4th the raft indicated it may soon need some assistance. A strong on-shore wind was carrying it close to the coast of Queensland. A plane and boats were dispatched to search in the given area, but by darkness no sighting had been made and the affair remained as mysterious as ever. The skeptics still insisted it was nothing more than an elaborate hoax. Then, at 2300 GMT on the next day a searching plane radioed it had located *La Balsa* twelve miles off the Australian coast. The frequency came to life as many hams who had been listening quietly for days now briefly broke with congratulations. Air and sea emergency rescue services directed a boat to the scene and the raft was taken in tow to the nearest harbor, some 20 miles away. Capt. Alsar, HC9EBP, and his crew, triumphant and smiling, were taken ashore to a thunderous Australian welcome.

Without the VK hams' timely vigilance and direction — and most of all, their insistence that *La Balsa* was real — it is possible that the raft could have found itself in difficulties, handi-

capped as it was with no phone or CW transmission, and no one would have known. It might have been wrecked on Great Barrier Reef or struck by a passing ship or crashed in bad weather on some inhospitable part of the coastline.

At the official welcome on Australian soil soon after *La Balsa* crew had landed, Captain Alsar proffered his thanks and gratitude to all the hams who had monitored his transmissions right across Oceania. They were Raphael XE1EEI, Joe HC2OM, Gus ZM1RO, Sid AX2SG, Keith AX4KS, Les AX4LZ, and many others. Well done, chaps!!

## RM PRICES STYMIE PROSPECTIVE BUYERS

W5PGG was interested in getting a copy of the RM's on file with the FCC listed on page one of our October issue. He wrote to the FCC and asked for copies of the RM's. No dice. They suggested he get in touch with a company that specializes in that service. Orville wrote to them, giving his list, and got back a quote for the service of \$98.46 for the copies of the nine RMs. This cooled him.

for enough money to pay my way while I'm in school. Perhaps I can stay for one year and live with an American family, then I can select a good way for my future. Perhaps I can select to be an American citizen. I have my high school diploma so I can join a school to be an electronic engineer or an electronic technician. This is my ideal for my future."

Are there any ham families near a good school who might have room for this amazing youngster? Write to this fine boy... Selim Canbeken, P.O. Box 106, Adapazan, Turkey.

## HIS MAJESTY OPERATES PORTABLE IN LONDON!

### Uses Ham Radio to Relax While Recuperating from Heart Attack

King Hussein was hospitalized in London for about three weeks, possibly recovering from a mild heart attack brought on by his extended visits to a number of countries during the preceding few weeks. Within a few days he was on the air using a Drake station operating primarily on 15 meters with the call of G5ATM, keeping his schedule with WA3HUP and other friends. While in the U.S. the king visited New York and Washington, staying at Blair House. A number of amateurs that had contacted JY1 visited with him during his stay in Washington. Hallcrafters presented HM with an SR2000 transceiver during his Washington visit. Hopefully we will be hearing this unit from Jordan one of these days.

Many interested amateurs had an opportunity to see the king at length during a one hour interview on the David Frost show. HM acquitted himself well on this show and those that watched it were able to learn a good deal about the Mideast problems.

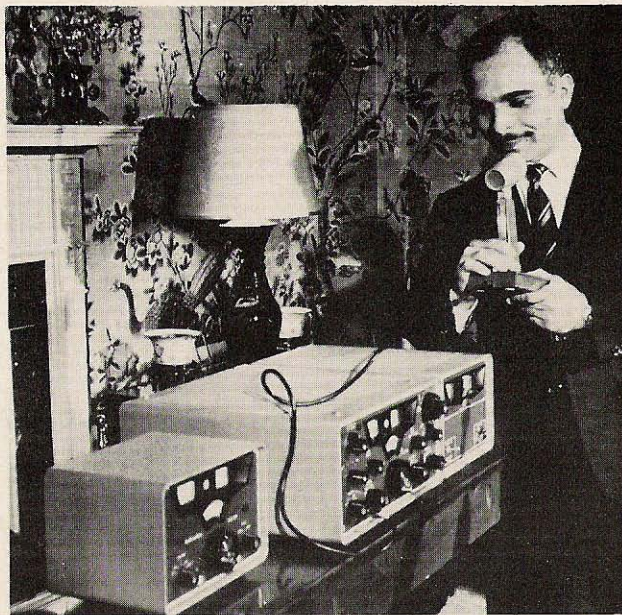

# WESTERNERS ACTIVE IN SLOW-SCAN TV

by W7SAB

The Western SSTV net has grown to quite a few members (principally on the west coast and middle west areas, though check-ins continue over the whole USA and anyone wishing to check in is certainly welcome). Technical information and experience with various equipments are available and more especially availability of hard-to-get parts for those unable to locate them. New stations are always welcome and in fact such stations as KH6BAS in Hawaii have been practically developed with information over the air from W7SAB and K7YZZ, who have spent many hours in getting him set up and operating. Also stations KL7FHN and KL7DRZ in Alaska have received assistance and hard-to-get parts from the group. IILCF in Bologna, Italy has drawn heavy support and parts in getting his station in operation. ZS6ASR and ZS6PP have also received assistance. Likewise for ZL1DW, ZL1AOY, and ZL1NH (who has actually visited the group). Some contacts have also been made with UW6LC.

Normally the net is conducted by W7SAB with W7FEN, K7YZZ, W7VEW, W7ABW, WA7MOV, K6STI, K6IV, WA7LQO, WB6OMF acting alternate net control. For some time the net has been formalized as the Western SSTV Net and on 5 May the 40 meter division of the Western SSTV Net was opened on 7220 at 9:30 local time. Some attempts have been made to interest our Canadian friends in SSTV and in fact a demonstration has been given recently at the University of British Columbia with 55 Canadian amateurs present in which slides, equipment, lecture and actual live demonstration was conducted. Demonstrations and lectures have been given throughout the NW at various radio clubs and K7YZZ has had sev-

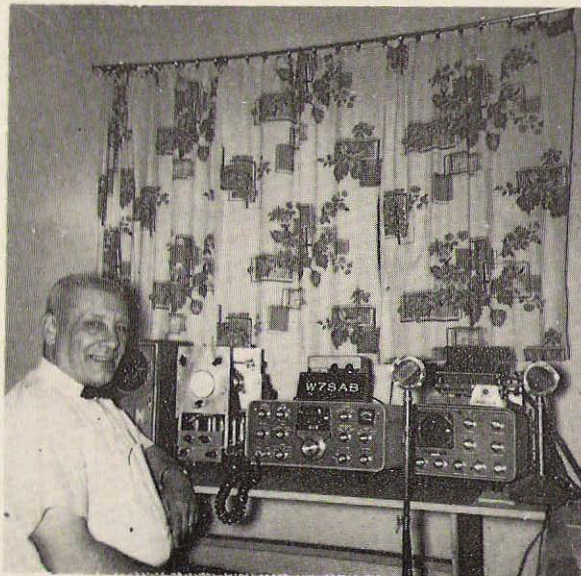

eral articles presented in 73 Magazine, and W7FEN and W7ABW have an article in June 1970 QST.

Early developments in SSTV have been thoroughly covered by our several amateur publications and a complete bibliography is quite comprehensive and of great help in getting started in SSTV. As much of the equipment must be designed and built by interested parties I would consider this activity a great incentive for advancing amateurs in the state of the art and general performance.

The above information about covers the activities and organization of

the Western Slow Scan Television Net and I hope this will be of some help to you. I will again list the times and frequencies of the nets for your information.

3845 kHz 9:00 p.m. (PST) nightly  
7220 kHz 9:30 p.m. (PST) nightly

## HAM POPULATION EROSION

### VE COUNTRIES BANNED

By special edict dated 14 October, 1970, the Department of Communications has requested that all Canadian Amateurs be alerted to new regulations covering communications with various foreign countries. As a result the fifteen countries are now on the banned list under the authority of: ITU, annex 2, to operational bulletin No. 55, dated 13 July, 1970.

A list of the forbidden countries is as follows:

Burundi 9U5	
Cambodia XU	
Cyprus ZC4	
Gabon TR8	
Greece SV	
Indonesia 8F	
Iraq YI	
Jordan JY	
Laos XW8	
Libya 5A	
Pakistan AP	
S. Yemen 4WI	
Syria YK	
Turkey TA/TC	
Vietnam 3W8	

## INDIAN NEWS

### VU2GV

*New Delhi.* We are happy to advise you that we have been successful in getting a favourable response from the Government to our proposals for utilizing the radio amateur network for handling traffic in emergencies. We are also hopeful that some arrangements can be worked out for establishing an emergency net for simulated emergency tests by the authorities. This will give adequate opportunity for both sides to get acquainted with emergency procedures.

In order to enable this to be properly organised it is proposed to

## DX NEWS

### TOKELAUS

The ZM7-Tokelaud effort looked ready to roll, then it foundered. Initially VE7HE and VE8RA had planned to stay at the home of the Catholic priest on the Tokelaus. However, with Pope Paul VI visiting Pago Pago, the padre locked up and took off to serve on the reception committee. Then the captain of the vessel they were to use began to worry about the typhoon season and the rhinoceros beetle and soon both the housing and the transportation had evaporated.

Apparently there is no docking space at these islands and ships have to lay offshore. The rhinoceros beetle infests the palms and ships have to get beyond three miles at night when the beetle is prowling about in order to avoid becoming a host for the beetle. So with the typhoon season around the corner and the beetle problem, the vessel was not available. It seems that one must have definite accommodations to be allowed on the Tokelaus and the captain of the vessel was not for laying off the island for any length of time.

So this effort did not jell just about the time when everything seemed ready to go. VE7HE and VE8RA spent the week in Western Samoa signing 5W1AG and 5W1AR. They had a good signal and their Tokelaus efforts, which came close to being accomplished, certainly would have gone well.

### NIUE

ZK2AG, Trevor, reported as active. Was at 14210kc at 0415Z - with an HW-32 and using a dipole 15 feet up in a palm. Home call said to be ZM3TV. ZM4NH to handle QSLs. Mail service intermittent from the island... about once monthly. Said

# ANNOUNCEMENTS

## Columbus, Georgia Hamfest

The annual Columbus, Georgia hamfest will be held on March 21, 1971 at the Fine Arts Building behind the Municipal Auditorium at the Fairgrounds. For information, write John Laneby, K4VGI, 1905 Iris Drive, Columbus, Georgia 31906.

## CONNECTICUT QSO PARTY April 3-5, 1971

The Candlewood Amateur Radio Assn. invites hams throughout the world to take part in The 8th Connecticut QSO Party. Rules: 1) The contest period is from 2300 GMT April 3 to 0400 April 5. Each station may be worked once on each band and mode. The general call is "CQ CONN" on cw and "CQ CONN QSO PARTY" on phone. 2) Conn stations send QSO number, RS(T) and county. All others send QSO number, RS(T) and ARRL section or country. 3) Score one point per QSO. Out-of-state stations multiply total contacts times the number of countries worked (maximum of 8). Conn stations multiply contacts times the number of ARRL sections and countries worked. 4) Certificates will be sent to the high scorer (6 or more contacts) on each ARRL section and country, also the two highest scorers in each Conn. county. Novice certificates will also be awarded. 5) Suggested frequencies are 3540 3925 7040 7275 14040 14300 21050 21300 28040 28880 kHz. Novices try 3740 7175 and 21125 kHz. 6) Logs must show dates, times in GMT, band, mode, QSO numbers, RS(T) and QTH. Send all logs before May 20 to the Conn QSO Party, c/o Tom O'Hara, W1DDJ, 7 West Wooster St., Danbury, Conn. 06810. Include an SASE for results.

## OOTC QSO PARTY

The Old Old Timers' Club will hold its 1971 QSO party April 2nd through April 5th starting and ending at 2300 GMT. Suggested frequencies for locating the gang are plus or minus the following: 3520, 3530, 3820, 3830, 7020, 7030, 7240, 7260, 14279, 14290, 21021, 21030, 21270 and 21280. Participants should avoid any possible interference on any of these frequencies which may be used for net operations.

**NO NEWS IS BAD NEWS • MAIL YOUR  
STORIES, PIX, AND NEWS TO 73 NOW.**

## ARRL GREAT LAKES DIVISION CONVENTION

MUSKEGON COMMUNITY COLLEGE  
QUARTERLINE RD,  
MUSKEGON, MICHIGAN.  
LARGE SWAP & SHOP, MEETINGS  
FOR ALL MARS PROGRAMS, VHF  
REPEATER PROGRAM, NET &  
TRAFFIC MEETINGS, RTTY FOR-  
UM, HAM TV, RACES-CD, MID-  
CARS, QWCA MEETING, AND  
MANY MORE. COMPLETE LUNCH-  
EON FACILITIES, PARKING FOR  
OVER ONE THOUSAND CARS,  
EASY ACCESS VIA INTERSTATE  
196 & US-31 TO MUSKEGON,  
JUNCTION OF US-31 & MICH. 46.  
COMPLETE NEW AND COM-  
FORTABLE FACILITIES AT THE  
NEW MODERN COLLEGE. MAIL  
ADDRESS: P.O. BOX 691, MUS-  
KEGON MI 49440

The FCC figures show that the total number of licensed amateurs dropped 683 during 1970. That isn't much of a drop, assuredly, but when compared with the 40,000 gain that we should have had, it is not encouraging.

During the month of December we gained 29 Extra class licensees and 102 Advanced class licensees. All other classes dropped. Somehow 29 Extras out of 264,000 has a message in it somewhere for the incentive licensing enthusiasts who still believe that punishment is better than rewards for getting results.

## NEW PRODUCTS

### Callbook Supplement

The Radio Amateur Callbook Magazine has come up with a new and valuable service . . . a quarterly supplement. Now, instead of having to buy a complete new Callbook every quarter if you want to be sure and have the latest addresses, you can update your most recent book with this supplement.

The supplement even has some advantages over the regular Callbook listings in that it lists all call letter changes when amateurs move from one call area to another and also lists all deceased amateurs as such. This is valuable information that we've missed in the past.

The Spring 1971 Supplement will sell for \$3.50. That compares favorably with the \$8.95 for the U.S. book and \$6.95 for the DX edition. The Supplement covers U.S. listings and U.S. possessions only.

form an All India net at 2030 hrs. IST daily on 14130 kHz. The net will commence operation with VU2KV as the Net Control but we require volunteers to act as alternatives for net control.

We are expecting some teletype machines to be released at reasonable prices. Though these are not in a working condition they can be cannibalised and a few made workable. We would like to know who all would be interested in getting these and get on RTTY. RTTY would greatly facilitate traffic handling in emergencies and would make this easy and fast.

# DX FOOTNOTES

Rio de Oro. Justo EA9EJ is the only active station in this rare spot. Four other amateurs are presently in the country, but no licenses for operation are being issued by the Spanish authorities. Only Justo may operate his rig and no one else. Justo is usually active on Fridays and Saturdays on 14130 from 0600 GMT.

East Pakistan ON5DO/AP2, 14206, over there on hurricane relief mission. QSL to ON5KL.

Sikkim AC3PT, Namu, 1230Z, 1429Z, coming back to looong calls.

Arabic Net, 7Z3AB net control, Fridays 0830Z 21300, 0600Z 14200. You can work nice ones such as YK1AA, SU1MA, ST2SA, MP4BHH, 7X2's, 9K2's, etc.

Caribbean Net, 3804 @ 1000-1100Z. Canton Island K6AZB/KB6 Norm 0200-0500Z 14325.

Marcus Island, 2200Z 28550, Dick, QSL JA1BA.

he would be on nightly when possible but on Saturdays especially from 0200-0400Z in the 14220-14240kc area. Wally, SK2AF, presently on leave.

## ST. BRANDONS

Alex, 3B8DA, who operated as 3B7DA from St. Brandons, advises that his gear...both the transmitter and receiver...suffered damage on his return to Mauritius from St. Brandons. This was gear donated by the Southern California DX Club and Alex is looking for some assistance to get the gear operating again. His present plans call for him to go to Rodriguez in 1971, possibly signing 3B9DA. Home address is 39 Brown Seaward Ave, Vacoas, Mauritius. The damage was done by sea water dousing the gear. Alex also interested in stamp collecting.

## CHAGOS

VQ9SM said to be on pretty much of a regular schedule. 14233kc at 0200Z daily; 14030kc at 1400Z. Sometimes this rotation is reversed and he may appear at 14233kc at 1400Z. Reported to be crystal controlled at these frequencies. QSLs go to JA0CVU/1... Tack Kumagai, Post Office Box 22, Mitaka, Tokyo.

Oman MP4MBB 1230Z 14235, John, QSL G3LQP.

Trucian Oman MP4TDK 1530Z 14078, Dave, QSL RSGB.

Sudan ST5AD 0730Z 14247, Alban. Pitcairn Island VR6TC 0600-0700 14185 Sunday, 0500Z 14230 Wednesday, Tom.

Rodrigues Island 3B9BZ Bert 1400Z 14200, QSL 3B8AD.

Laccadives VU5KV, QSL Box 3031, New Delhi with 5 IRC's.

Vietnam XV5HH 1230Z 14169, QSL W9JT.

# LETTERS

## Gray Matter

These photographs refute a statement which Wayne made in the January issue in the discussion of the EKY Video SSTV gear. Wayne stated that the SSTV pictures are composed of blacks and whites with no gray shades. The SSTV standards presently in use provide for a continuous gray scale between black and white as the photographs certainly show. To be frank, the lack of gray values in the gear that Wayne was observing was

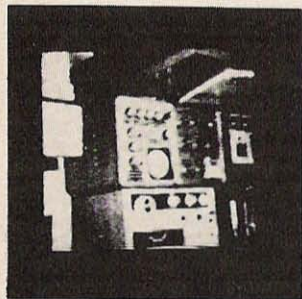

probably a function of improper construction or adjustment in that particular piece of gear. Improper setup of the video discriminator will decrease the dynamic range of the monitor and result in an overly contrasty picture. SSTV pictures of normal well-lit scenes, whether televised with a vidicon camera or flying spot scanner, have excellent gray-scale rendition and I am sorry that EKY's gear gave the impression that this wasn't so. There are enough constraints required with the SSTV system that I tend to be perhaps overly sensitive to comments that impart still more

patches worth? Is a human life expensive enough?

At about 0330 EST on Christmas Day, 1970, I was driving home from a party at a friend's house in Miami. As I pulled up at a light on a deserted street, I saw that the car on my right was smashed in in the front, the door was open, and a person was sitting on the seat with a smashed face, losing blood, and in shock. At this time of the morning, when very few persons are awake to answer a radio call, the Miami autopatch enabled me to have the police and an ambulance on the scene within three minutes.

The ability to contact the police, while not necessarily instrumental in saving this person's life, has undoubtedly been so in the past, and will undoubtedly be so again in the future.

To the opponents of FM and the repeaters, I would like to ask another question. How would you feel if you became involved in an accident on a deserted road late one night? Would you still be so opposed to that conglomeration of black boxes, antennas, and telephone lines if the ham who happened along procured an ambulance for you? You know, it's happened in the past, and it could happen again.

Amateur radio is very much a hobby of public service. If a repeater and an autopatch provide this particular service only once in five years, what is the price of a human life?

Jeffrey R. Harrow WA4RLG

## FM Correction

We have read your article regarding the Regency HR-2 2 meter FM transceiver in the December issue with great interest. We were disappointed to see that the chart contained in the article had one significant error and one significant omission with regard to our unit.

First, our SR-C806MA sells for \$335.00 not \$349.00. It also comes complete with 4 channels, not just 146.94 as indicated. I am sure these

clarified to avoid misleading your readers.

Virtually all DTL IC's available from any source are in the so-called "930" family which requires a supply of +5V ±10% rather than the +4V mentioned in the article.

Your definition of an inverter talks about "+ and - logic." In fact, an inverter has nothing to do with positive and negative logic or positive and negative voltage. An inverter merely inverts the logic signal put into it: a 0 becomes a 1 and a 1 becomes a 0.

Figure 4 has two Jotic symbols called 2-input *nand* gates. The one labeled "most common form" is correct, but the other is one representation of a 2-input *nor* gate. The correct symbology is shown below:

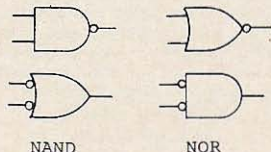

The "typical buffer with gated input" in Fig. 5 is simply two *and* gates with their inputs and outputs in parallel to increase the drive capability. This is possible with RTL, but is more complicated with DTL and TTL.

The "flip-flop" in Fig. 5 is not a flip-flop unless *nand* gates are substituted for the *and* gates shown.

The paragraph which says that you can make a 3-input gate from a 4-input gate by grounding one of the inputs is true for the *nor* gates used in RTL but not for the *nand* gates used in DTL and TTL.

The existence of a clock input has nothing whatsoever to do with a flip-flop being RS or JK. An RS flip-flop is defined by its response to the R and S inputs, as shown below:

R	S	Q
0	0	no change
0	1	0
1	0	1
1	1	unknown

that I ask my friends to write a short letter indicating what we ham experimenters have accomplished and how my activity has influenced or helped their progress. I'm sure anything that could be truthfully said will aid the city officials in understanding more about ham radio and its benefits.

If your local newspapers have written up ham activities or accomplishments, include the clippings with your letter. Be sure to include any specific association and activity with me.

Please address your letter to:

San Jose City Council  
801 N. First Street  
San Jose CA

Letters should be mailed as soon as possible.

Mike Staal K6MYC

## HELP!

I recently came into some good fortune by being handed three wide band amplifiers, Instruments for Industry Model 500A, without tech data. Since I am a Novice and very limited in my electronic background I would like to know how and where I might use these beautiful pieces of electronic gear. And if it's not asking too much, how about where I might pick up a schematic and some additional tech data, as the corporation is now defunct.

Ted Onyszczak WN30IP  
302 Red River Ave.  
W.S.M.R., NM 88002

## Thumbs Down

I am not renewing my subscription for the following reasons:

1. I don't like FM, much less repeaters which monopolize frequencies. (Maybe 10 years of Uncle Sam with FM & repeaters gave me this negative attitude.)
2. The condoning of amateur radio to support alien causes.
3. Lack of articles etc. for an old brasspounder like myself.
4. The constant lambasting of

I thought you were exceptionally kind to the ARRL in your writeup of the Boston Convention. Personally, I thought it (except for 73's room, of course) a waste of time. I left after three hours of the first day and enjoyed some flying out of Hanscom AFB.

Bob Lauzon WB2NSD  
Drawer G  
Pittsford NY 14534

## CW/Phone Split

The continuous battle between the phone and CW boys (I am of the latter group) could be solved (hopefully) by exactly splitting all ham bands - half for phone, half for CW. Those who can't hack the code could flap their lips all day at a mike, and those of us who can't talk could wear out our fingers on our hearts' content.

Of course, on the CW half, code proficiency would remain the criterion as determining just how much of a band a feller could use. But what would the phone boys do? See who could talk the fastest?

William S. Cronan III WA6NPB  
9056 Willowgrove Ave.  
Santee CA 92071

*50/50 split seems a little unfair considering phone users outnumber CW men by more than 20 to 1.*

...Ken

## More FM

Just a note to let you know I appreciate your magazine very much. I don't always agree but we're not all perfect. Too bad the "boys" in Connecticut don't know when to leave well enough alone, e.g. Incentive Licensing, Repeater Rules. How about some more FM articles, I'm new in the FM game. Already have Ken's great book.

Larry Godek W6KQL

Larry Godek W6KQL

*Watch our smoke in April!*

...Ken

## Pro 1L

The monkeys who pack your Gunsmoke evidently have been opening the mail for you. Almost a year ago I wrote with my comments supporting incentive licensing, but I noticed it was not included in the "sum total" of supporting statements that you allegedly received.

Paul Schuett WA6CPP

*We printed only those letters received after the ACTION coupon was published (which trailed your alleged letter by 9 months). Since last issue we have received additional letters, both pro and con - but those published last issue are still representative, and the mail runs heavy against incentive licensing.*

...Ken



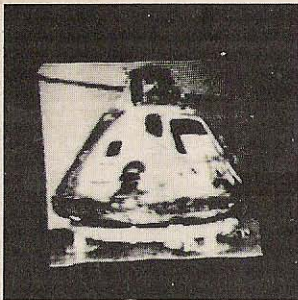

things were simple oversights or errors as our ad in the same issue calls these things out correctly.  
**STANDARD COMMUNICATIONS CORP.**

**Thomas L. Fischer  
 Vice-President - Engineering**

*We understand the SR-C826MA is now available, which supersedes the 806 and surpasses it in performance as well. An operational repeater at SAROC using 826 components was impressive indeed.*

...Ken

shortcomings to the pictures. We have to put up with a 120-line picture, but these pictures are certainly crisp and well-rendered within these limitations.

**Ralph E. Taggart**

Ever since I have gotten my first 73 Magazine I have thought of it to be the greatest publication for the hams. If you don't think I am an old stinker I would like to make one suggestion - don't print articles "side-ways" in the 73, such as the news page, editorial, Cavert Empior and others. This is not only awkward but detracts from the good image 73 has ...

Charles D. Stoffel  
 78 Haverwood Drive  
 Rochester NY 14622

*Is that better?*

**Score 1 for Autopatch**

During the past several years, there has been some rather strong protest from various sides against repeaters and autopatches. I am a commercial pilot and carry my HT with me whenever I fly. I've worked into repeaters across the entire United States and I can't say I can agree with very many of the objections for these two technological devices.

However, I have a question for the opponents of this form of progress. What price are the repeaters and auto-

On page 96 of the December issue of 73 Magazine, you list specifications for several FM transceivers. Some of the information on the Standard SR-C806MA is in error.

We are a dealer for Standard products and would like to see the errors corrected if possible.

The price of the SR-C806MA is \$335 not \$349 as listed in the chart. The SR-C806MA comes with crystals for three channels in addition to 146.94 not just crystals for 146.94 as indicated in the chart.

I wish to thank you in advance for your cooperation.

Very truly yours,  
 ELKO Electronics Specialties  
 Thomas E. Doyle

*The Standard is now being supplied with crystals for .94 direct, .76 direct, .34, .94, and .34/.76. Sorry about the errors!*

...Ken

**Hooray!**

You really started off the New Year right with the FB January 1971 issue. I enjoyed every article in the magazine, including the front cover! Hope to see more articles on the humorous side, and the same type of cover in issues to come!!

**Gordon Bello WA1JWQ  
 16 Beals St.  
 Brookline MA 02146**

**Get HEP!**

Your article *Getting HEP to IC's* in the January '71 issue contains several errors. I suspect that these may be primarily the result of trying to simplify and condense a lot of material into a short article, but they should be

If the RS flip-flop has a clock or trigger input, it may be called a clocked RS flip-flop, or an RST flip-flop. It behaves exactly the same as an unlocked RS flip-flop except that the inputs are ignored until a clock pulse occurs. A JK flip-flop is just like an RS flip-flop except that the output (Q) inverts when both J and K inputs are 1's. A JK flip-flop may or may not have a clock, but usually does.

Again, the +2 and +4 circuits assume RTL flip-flops since grounding the S and C inputs will not work with DTL and TTL flip-flops.

Let me close by saying that 73 remains my favorite ham magazine, both technically and editorially. Right on! (Write on!)

**E. Douglas Jensen W50GJK4DAD  
 Senior Digital Systems Engineer  
 RECOGNITION EQUIPMENT Inc.  
 Dallas TX 75222**

**Ham in Trouble**

For several months now my ham radio activity has been jeopardized by a local ordinance in San Jose limiting antenna height to 35 ft above the ground.

I have applied to the city for variances to allow for my TH6-DX at 70 ft and my 2-meter collinear array to stay up at 40 ft. The variances have been denied. But at the last appeal the city indicated that I might be right about the fact that sometimes ham antennas should be higher than 35 ft. The city officials suggested I attempt to change the local ordinance limiting tower height. This is what I am working toward now and that is why I need your help.

City officials have stated what my best course of action should be to influence the city council. Of course, the modification of the 35 ft local ordinance will benefit all of the San Jose hams, so I am enlisting their support.

Since I have so many outstanding friends all over the world whom I've experimented with, it was suggested

ARRL without any constructive and active solutions.

**Joe W6RPX**

**Stars 'n' Stripes**

73 and CQ are the only ham magazines carried by the Stars and Stripes newsstands; all other magazines are only available by subscription.

Under separate cover I am sending you a picture of the new repeater location here in Stuttgart, Germany. Wayne Green once spent an evening in the restaurant above the site.

Hanne Knorr 552-56-1321  
 Boebblingen AYA SAC-N-21  
 APO New York 09046

**Death of a Rig**

I knew very little about the Swan 1011 before reading Ken's editorial in the November issue. It is shocking to hear that a group of "worried" amateurs could talk Swan out of the production of the 1011. Maybe if enough of us who use 20 meters write back to Swan in favor of their rig they will consider putting it back into production. Swan puts out some very fine rigs, and I think that we should encourage them to bring up new ideas instead of tearing apart whatever new that comes out. I'd like to commend "73" and Ken for taking a stand on this issue. Thanks for keeping us informed.

**Warren Watson WA0POL  
 3456 Perry Ave. N.  
 Minneapolis MN 55422**

**Optometrist's Conspiracy?**

73 has been the only radio ham magazine allowed in this rumpus room of W6VVF for a long time.

It now appears that you are in league with the optometrists to foster sales of eyeglasses to read 73.

To top it off, you have included a comprehensive index to 1970 articles that my trifocal glasses just can't read without the use of an additional magnifying glass!

Having once been a printer's devil, I don't understand why such an important index has to be set up in such fine print when a couple more pages would have made the index easy to use.

I'll continue to read that portion of 73 in the future that I can see but be assured, I am not going to dig through these microscopic ads for goodies. I can read the telephone directory without my glasses so don't prescribe stronger lenses. Try the next size font - larger, not smaller!

**W. E. Nichols A/W6VVF**

*We get a lot more articles in an issue when we reduce the size of indexes and directories. Some advertisers feel they need to use every square inch of space, too. It must pay off for them, though, or they wouldn't keep advertising in 73. We'll see what we can do for you about increasing the type size of the news pages. Fair enough?*

**Lobbying**

QST has a December editorial saying that a lobbyist is not necessary because - look what has been accomplished by Barry Goldwater as a senator.

Now it strikes me that QST, by pointing to the accomplishments of Barry, has actually defeated its own contention that a lobby is not needed.

If we had a lobbyist, he would attempt to get Congress to do just what Barry has done and more for ham radio. On the other hand, if there is no lobby and no Barry Goldwater in Congress, what would the ARRL have been able to point to in support of their opposition to a lobbyist.

What I am trying to say is that the QST editorial argument supports a lobby.

On the subject of licensing of hams, I go back to the late thirties and later where I argued at RCB meetings that I do not favor more than one type license for amateurs other than Novice because of divisions it would cause among hams. It was bad enough then. I feel very sad at the bickering going on today about who is a lid, who can use what part of what band, etc.

**Dave Korpus W2BKP  
 773 East 46 St.  
 Brooklyn NY**

*QST's editorial was indeed contradictory. We have Barry Goldwater, they say, so who needs a lobby? They don't seem to realize that Barry's actions on behalf of ham radio are the actions of a lobbyist. Curious, no? ...Ken*

**WVW via R-4**

Keep up the good work with 73. I've been reading it since the first issue. I thought that other hams with Drake R-4 rcvrs might profit from this discovery. To receive WVW without extra crystals:

1. Set rcvr to tune 7.133 AM
2. Rotate preselector to 2.4 on the inner scale.

That's all there is to it! WVW clear as a bell.

**Laird Simpson W7AWB/0  
 8120 Bloomington Ave. S.  
 Minneapolis MN 55420**

**Unhappy New Year!**

All those who have worked AS3B on CW and have sent their cards to his manager, K2PJG, please take note: You have been taken. No such call as AS3B and K2PJG is not his manager. He cannot possibly write to all those who have sent him a QSL because he is crippled severely by cerebral palsy, and writing is a task for him. And to the person who claims the call AS3B and has caused PJG some trouble, I along with Bob's other friends wish him a miserable New Year.

**Dr. G. Schwartzbard WB2IWH  
 213 Dayton Ave.  
 Clifton NJ 07011**

con't on page 5

## Caveat Emptor?

Price — \$2 per 25 words for non-commercial ads; \$10 per 25 words for business venture. No display ads or agency discount. Include your check with order. Deadline for ads is the 1st of the month two months prior to publication. For example: January 1st is the deadline for the March issue which will be mailed on the 10th of February. Type copy. Phrase and punctuate exactly as you wish it to appear. No all-capital ads. We will be the judge of suitability of ads. Our responsibility for errors extends only to printing a correct ad in a later issue. For \$1 extra we can maintain a reply box for you. We cannot check into each advertiser, so Caveat Emptor. . .

**TRADE, SELL:** used receivers. Trade for new amateur equipment. Available HQ-180C, R-4A, HQ-200, NC-190, SX-110, 2B, HW-16, GPR-90, SX-130, Eimac 4-1000A, PL 8160/4-1000A, S-Line, Nems-Clarke 1456A, S-36. Send for current list. Steven Kullmer, Evergreen Hatchery, Dysart, Iowa 52224.

**"1971 TESTS-ANSWERS"** for FCC First and Second Class License. -plus "Self-Study Ability Test." Proven! \$9.95. Satisfaction guaranteed. Command, Box 26348-S, San Francisco CA 94126.

**2 PORTABLE TRANSCEIVERS** for two meters F.M. One on 146.34-146.76. WABCO 24H82C, 2 Channels. Input 10-18 VDC, 7W RF Output at 18 VDC. 0.5 W audio output, 14 diodes, 30 transistors, triple conversion receiver, like new with manual - \$135.00 each. Please send for Brochure. B. Dickerson, 1200 Johnston St., Philadelphia PA 19148.

**MANUALS**--R-390/URR, R-390A/URR, USM-24C, BC-639A, SP-600JX, BC-348JNQ, URM-25D, UPM-45, UPN-12, OS-8C/U, CV-591A/URR, BC-779B, TS-186D/UP, FR-5/U, USM-26, \$6.50 each. S. Consalvo, 4905 Roanoke Drive, Washington DC 20021.

**HELP WANTED:** Experienced ham, background in military electronics, to run surplus house in Northern New Jersey. Warehouses full of surplus gear waiting for the right man. Salary and commission basis or participation with small capital investment. Send resume to P.O. Box 2129, South Station, Newark, NJ 07114.

**SELLING OR SEEKING HAM, CB, or H.F. EQUIPMENT?** Get "Electronic Peddler," 2810 Caledon, Cincinnati OH 45244. \$1.75 yearly. Your ad .08 per word per insertion.

**VOICE COMMANDER 11 watt G.E. FM Transceiver.** 34-94 crystals, manual Works FB. Needs batteries. \$45. Brad Rehm, W9LYK, 858 W. Chalmers Pl., Chicago IL 60614.

**WANTED:** Name and address of Sec./Treas. of "Ten-Ten Net of Southern California". John D. Brannon, GMAT, Box 20, APO, S.F. 96263.

**HEALTH HW-100 xcvr, HP-23A supply, SB-600 spkr, mike, key, good condition.** \$280. Bert O'Connor, 16 Smithshire, Andover MA 01810.

**73 MAGAZINES** 13 issues from Oct. 1960 thru Dec. 61 including January 1961. Sell or swap. Make offer. K8UHX, 4212 Fulton Pkwy, Cleveland OH 44144.

**RED HOT! SRK Delta Tri-bander** - Sensational breakthrough in Delta Loop design. Proven outstanding DX ant. Highest quality - also heavy duty high performance quads. Check our low prices. Island Electronics, 4103 Ave. S, Galveston TX 77550.

**COLOR ORGAN KITS \$7.50.** IC Power Supplies \$2.75 to \$8.50. Computer Grade Electrolytic Capacitors \$.35. XMTR Transistor TRW PT3690 \$2. Used Variacs. Nuvistors. Catalog. Murphy, 204 Roslyn Ave., Carle Place, New York NY 11514.

**150 WATT SALA MODEL 20-13-115** type CV constant voltage transformer, output 118V at 1%, New \$18.00. Taut band 1% lab, multimeter D.C.

## Leaky Lines

I got a brainstorm recently and wrote a letter to the office of U Thant, Secretary General of the United Nations. The thought had occurred that since ham radio is an international activity which promotes amity and good will, that perhaps it might be possible to establish a working station at UN Headquarters in New York, with operational privileges for visitors with current licenses. Since the UN constitutes a legitimate international enclave within New York City, as does the ITU within the city of Geneva, I reasoned that perhaps this station might achieve separate country status in the same manner as 4U1ITU, and might be acceptable for DXCC credit. The latter part was an afterthought, to be discussed at some subsequent date. My main target was to get permission from the UN authorities to establish the station.

I pointed out that since this year marks the 25th anniversary of the signing of the Charter in San Francisco, it would be an auspicious occasion for the initiation of such a station. And I asked the Secretary General if we might not be favored with a prompt reply.

The answer came in less than a week, not from Mr. U Thant, but from Josef Nichols, First Deputy Chief of the Communications Section of the Secretariat. He relayed cordial greetings from the Secretary General, and stated that Mr. Thant had expressed warm enthusiasm for the many contributions of the world's amateurs toward world peace and friendship. He en-

Then, of course, the idea hit me, square in the middle of my dumb skull. I have about as much chance of getting any League Committee to agree to a proposal of mine, as Spiro T. Agnew has of being elected Honorary Chairman of the S.D.S.

But I still think the thought has merit, and I still intend to try to get the station established . . . with or without separate country status. It would be a marvelous accomplishment to have a ham station operating at the UN, where the face of amateur radio could be observed by visitors from all over the globe, doing what it does best; establishing and maintaining international camaraderie, good will and peaceful co-operation among all the peoples of the planet. That's more than all the so-called statesmen and all the political geniuses have been able to do.

\* \* \*

Over the last six months or so, ever since one of my close friends popped off that the code requirements ought to be scrapped because they are obsolete, I have conducted a private survey among about 1500 amateurs, selected at random, more or less. My poll consisted of a short series of simple questions, unlike some well-known political polls, not loaded nor designed to result in a predetermined conclusion. I wanted to learn the true facts concerning CW, let the chips fall where they might. And without wishing to appear immodest, I am happy to say that I anticipated the result. By an overwhelming majority

by Dave Mann K2AGZ

There has been a good deal of discussion pro and con concerning these list-type operations and frankly, I have mixed feelings about them myself, even though I go along with them as a sort of half-a-loaf.

To a great extent these are like the little girl with the little curl in the middle of her forehead. When the net control station succeeds in maintaining his chairmanship effectively, reducing the confusion to a modicum, the hubbub is neutralized, and a surprisingly large number of QSO's is the happy result. But in a number of instances, where the control station has been incapable, either through ignorance or inexperience, of handling the job properly, the ensuing chaos has been horrific. I am sure that these nets, while they may be unpalatable to many, have certainly served a useful purpose to those DX chasers who are not blessed with strong signals by virtue of extravagant antenna systems and ideal locations. From their standpoint the lists have made the difference between a contact and total failure. They could never hope to compete on an equal basis with the big guns on our DX bands.

Perhaps the next time you are tempted to belittle these lists, you might give a charitable thought to all of those who, but for this method, would have precious little chance to realize their hopes of working rare DX. And then, you may enjoy the knowledge that more people are experiencing the satisfaction which ordinarily would come only to those few who are fortunate enough to be able to compete fairly with each other. View it as you would view your golf handicap, and it begins to make more sense.

**SWAN 270B** with SS-16 filter (shape factor 1.28:1!) factory installed, with Electrovoice 600E mike, \$450. Curtis electronic keyer factory wired with relay \$50. All absolutely mint, with manuals, in factory packaging. Marty Barrack WA7PUE, 505D East Country Club Drive, Yuma AZ 85364.

**FACSIMILE** machines Transmitting and receiving model. 110vac units in operating condition wt. 30 lbs. \$16.95 ea. Facsimile paper 500 for \$4.25. Send check or M.O. with sufficient postage, excess refunded to R. C. Anderson, 1733 W. Ellen St., Chicago IL 60622.

**ELECTRONIC ORGAN**, basic spinet kit, transistorized, known make. limited supply, send SASE for particulars. W9YCB, L. G. Hanson, RR 2, Box 52A, Angola IN 46703.

**WEST COAST HAMS** buy their gear from Amrad Supply Inc. Send for flyer. 1025 Harrison St., Oakland CA 94607. 451-7755 area code 415.

**DERRICK ELECTRONICS HAS ANTENNAS.** We'll give the best deals on Hy-Gain, Mosley, Cushcraft, Rohn, Tri-Ex, Easy-Way, Tristao. Box 457, Broken Arrow OK 74012.

**MOTOROLA FM** - 2 meters; U43GGT, 40 watts output, transistor supply, very clean, with cables and control head, less crystals - \$145.00. 80D Transmitter strip - \$15.00. Sencison A Receiver - \$20.00. Complete 80D, Dynamotor supply with cables and head - \$40.00. WA1INO, P.O. Box 587, Manchester CT 06400.

**MILITARY SURPLUS.** All new. Electronics, devices, components. Compare and save. Catalog 10¢ (stamps or coin). Electronic Systems, P.O. Box 206, New Egypt NJ 08533.

**MODEL 19 TELETYPE**, good operating condition, for sale or trade. (202)-234-4678, P. S. Richter, K1SDX/3, 2727 29th St. N.W., Washington DC 20008.

ranges: 3, 15, 30, 150 volts and .06, .6, 3.30 Amperes, Gulston model VAR-101. \$24.50, 100 Megacycle vacuum type crystal \$5.00. 6 ampere 200 volt Motorola silicon rectifiers 75 cents each. 1 ampere 400 volt, 10 cents each. 100 M.A. 2 inch panel meter D.C. to 50 Megacycles \$7.50. 240 volt primary, 24 volt secondary at 10 amps, Barber Colman \$6.00. SASE for more items. RHC, 2425 Bradley Road, Rockford IL 61107.

**HAM-M ROTOR:** Used 1 season, like new. First \$59 takes it. D. Steele VE7BCX, 1732 Brookshire, Tustin CA 92680. 714/878-3495.

**HT-2 VARITRONICS HANDIE-TALKIE:** Unused, perfect, complete. First \$159 takes it. D. Steel, VE7BCX, 1732 Brookshire, Tustin CA 92680. 714/878-3495.

**FACSIMILE TRANSCEIVERS** Mod. TXC w/110 V.A.C. - P.S. Good cond. \$175. each. Facsimile Rec. Mod RD-92/UX w/110 V.A.C. - P.S. Good Cond. \$100. each. News Clark Telemetry Rec. Type 14-12 New & Unused. Timefax electrostatic rec. paper \$5./roll. Charles Moss, Rt 1, Box 411, Mt. Shasta CA 96067.

**THE SPRING AUCTION of the ROCKAWAY** Amateur Radio Club will be held Friday evening April 23rd at 8 P.M. at the American Irish Hall, Beach Channel Drive at Beach 81st Street, Rockaway Beach, N. Y. Come to the best Auction in the New York area. For further information write to Al Smith, WA2 TAQ, P.O. Box 341, Lynbrook NY 11563.

**WANTED, MAN WITH 2nd CLASS PHONE TICKET** or better to work in 2 Way radio sales & service with option to buy business. Am Distributor for E. F. Johnson F.M. & Motorola Service Station. No smoking habit preferred. Walt Fairbrother, 29 Alden St., Greenfield MA 01301. Ph. 413-773-5063.

dorsed the spirit of international cordiality which has always been so marked a part of amateur radio. Unfortunately, the letter went on, they could not consider establishing such an operation at this time, since the expected visits of many heads of state would tax their security facilities to the limit. My proposal was highly acceptable at some time in the near future, but, regrettably, it must be declined for the period of the celebration. Hence, the door to such an operation has been flung open, to be acted upon when the time is more propitious.

In mentioning the matter to other hams, I discovered a great deal of skepticism concerning ARRL DXCC Committee's willingness to consider granting any separate country status to such an operation. This puzzles me, for several precedents have been established which leave the way clear. United Nations Headquarters is certainly no different than ITU, Geneva, or even HV, the Vatican, both enclaves within larger political entities. If there were a refusal to grant status, it would be highly inconsistent. In what possible way does New York differ from Geneva or Rome?

**HOBBYISTS** - Electronic components at huge savings. Transistors, 2N3566 and 2N3567, 6 for 25¢ 2N3638, 4 for 25¢ capacitors 10¢ carbon resistors 5¢. Thousands of components. Catalogue free. SASCO Electronics, 1009 King St., Alexandria VA 22314.

**TRANSCEIVER SR-150** and power supply P-150 AC, complete with crystals for five bands and calibrator, excellent condition. Turner SSB mike, new. \$300 plus shipping. McFolin, WA4WRU, 710 Dellwood Rd., Huntsville, AL 35802.

the continued use of code is endorsed wholeheartedly. Even confirmed phone men who rarely, if ever, use telegraphy, expressed what I like to think was a sentiment, rather than merely an opinion. They would not care to see CW fade into limbo like the horse and buggy or the old fashioned waltz.

One thing I noticed almost universally among those who had to 'fess up that they hadn't been on CW for years. They all vowed solemnly that "One of these days I'm gonna get out the old bug and get back on CW, because the phone frequencies are starting to become a real rat race." It seems that even those who suggest that less emphasis on CW is now in order, invariably add, somewhat wistfully, "There was a time I could copy forty per minute without any trouble at all." Somehow all hams seem to find a source of real pride in that accomplishment, and are a bit ashamed to admit that they have allowed their skill on CW to atrophy.

Yes, my little survey clearly shows, despite all arguments to the contrary, that far from being ready for the boneyard, CW is a lusty, healthy, living part of our hobby, still very much utilized both for its usefulness, and in a way even more importantly, for the sheer fun and pleasure of it.

\* \* \*

I am an enrolled, card carrying member (what am I saying?) of three or four of those recently organized nets which have been formed for the purpose of facilitating DX contacts, so that those foreign operators who are intimidated or otherwise frustrated by horrendous pile-ups will be able to minimize their difficulties and work a few QSO's.

## Letters can't from page 4

A comment on the formulas on page 28 of your November issue for calculating electrical lengths.

The formula used in both cases by W6AJZ is one which has already been corrected from the free space calculation by some 5%, for length/diameter, and end effect. It is the one commonly used for wire antenna dimensions. To apply velocity factors, which are a ratio to the free space dimension, is therefore incorrect, in this case.

Correct formulas are  $369/f$  (MHz) x V for the 3/8 wavelength, and  $492/f$  (MHz) x V for the 1/2 wavelength.

Owen Jackson OA4MS.

I confirm that the formulas should read: for the 3/8 wave stub =  $369/f$  (MHz) x V; and for the coupling line =  $492/f$  (MHz) x V x m, where "m" equals the multiples of half-waves required to reach from antenna to operating position. The "m" was typographically misplaced in the first formula in the printed article.

I think the fact that some local W6s successfully applied the erroneous formulas is accounted for by the short line length they used... only 1/2 wavelength, which minimized the affect of error. Longer line multiples of "m" would undoubtedly lead to grief.

Ring up one shameful boo-boo to W6AJZ, and my thanks to OA4MS for showing me the error of my ways.

W6AJZ



What do you suppose they're up to now?

# EDITORIALS CONT.

## W2NSD/1 cont. from News Page 1

time to start a new publishing effort so Mike will need all the help and cooperation he can get.

When you consider that Mike is undertaking this all on his own with no support beyond good wishes from any of the amateur magazines you can see that he has his work cut out for him.

### THAT QST EDITORIAL

In December the unsigned QST editorial defended the ARRL position that amateur radio needs no lobby in Washington to protect the hobby. They attributed my concern about this to an effort to build up the circulation of 73. That allegation ill befits them.

Amateurs who took the time to read the QST editorial carefully and thoughtfully may have recognized the illogic of their argument. Actually they made an extremely strong case in favor of a Washington lobby for amateur radio. In essence, they said that since we have Goldwater in Congress, a lobby is not needed. It was Goldwater who broke the ice with the reciprocal licensing bill. . . Goldwater who was responsible for the effort to license aliens. . . etc.

Senator Goldwater is providing some of the functions of a Washington lobby for amateur radio. . . true. But Senator Goldwater has been sent to Congress by the people of Arizona and it is to them that he owes his primary efforts, not to us. If he has time left over, we are benefited. . . if not, well, too bad.

We have but to remember back to the years that amateurs worked toward getting that reciprocal licensing bill into Congress . . . to no avail. Without Senator Goldwater I doubt seriously if we would be any further along in getting reciprocal licensing today than we were ten or fifteen years

would irritate congressmen shows a profound misunderstanding of the lobby function. Their insistence that Congress has little power to help amateur radio is downright appalling.

The fact is that the FCC recently jammed through a 125% increase in the amateur radio license fee and the ARRL was completely powerless to stop it. They demonstrated that they have no clout where it counts. The increase was unreasonable and should never have happened. You can bet that the AOPA would never let anything like this happen to the pilots or the NRA permit such a catastrophe to hit their members.

Read that editorial again when you get a chance and see what you think of it now. Maybe you will join the "Drumbeaters."

Is 1971 the year when ARRL members will start taking an interest in amateur radio and will vote in some new directors? That is where you have to start if you are going to make a dent in the conservative core at HQ.

### NEW FCC FORM 610

The FCC has announced that effective July 1, 1971 they will no longer accept 610 forms which are dated July 1970 or later. The form 610 is for applying for an individual amateur radio station and/or operator license.

### NEW THREAT TO 220

The Electronics Industries Association is petitioning the FCC to take the 222-224 MHz amateur band and turn it over to CB, removing it entirely from amateur use. They further are asking that the amateur frequency allocation be changed so that one class can use 220-222 and another class use 224-225 MHz!

The following companies are financially supporting the EIA program:

## K6MVH cont. from News Page 1

me tacos or enchiladas. It was tacos for supper with WB6AOF, tacos for lunch with W6NOS; enchiladas for

respect to VHF operation. The hottest thing on the calendar right now is the First Annual Southwest Regional



*The fellows at Standard Communications (both hams) showed their new superselective transceiver and demonstrated a repeater made from Standard transceiver parts.*

lunch with WB6IGZ, then an enchilada dinner with WA6BOF and K6VBT. When I visited my mother in Boulder City, I was going to tell her about my "forced" Mexican food diet, but I didn't have the heart. When I walked into her house, a surprise party was under way for me. In case you haven't already guessed, the "party" was in the form of a taco feed.

It's a real pleasure to be home again, here in Peterborough. And clam chowder never looked better!

### A Big One in Texas

It looks like it's getting to be convention season; particularly with

ly what's on tap for the conference program, but I will be there as either speaker or "open-forum" participant.

According to Paul Storm (WA5RAG), president of the Midland club, door prizes will be awarded at the dance and the swapfest. In addition, prizes will be awarded for CW, frequency guessing, homebrew equipment (no kits), etc. Talk-in frequencies will be 7270 SSB and 146.94 FM. (The local repeater is .34/.94.)

Advance registrations may be sent to MARC, Box 967, Midland TX 79701.

### Speaking of Conventions

Wayne and I are occasionally invited to speak at conventions or hamfests, and we nearly always accept. But invariably, we attach a string to it so that 73 doesn't go broke paying air fares. What we require is sufficient guaranteed subscription sales to cover expenses for the trip. That way 73 picks up the tab, but the money comes from the area we visit. The whole thing generally works out quite satisfactorily for everyone.

## NEW PREFIXES IN GERMANY

In addition to the existing call sign prefixes the German postal authorities now issue the prefixes DA, DB, and DF. There are now the following call signs:

ago. Someday I hope that John Barrows, (W6ECS) the chap who spent more time than anyone else in the world trying to get reciprocal licensing enacted, will write a history of that effort. His major opponent in this was none other than ARRL HQ which was, at the time, vigorously fighting anything that they did not originate. I will leave it to your objectiveness as to whether they have changed in this attitude.

I have talked with Senator Goldwater about the importance of our lobbying for amateur radio and he has been most helpful in suggestions to this end. We do need to make sure that all congressmen know what amateur radio is and how it differs from the citizens band and other services. Amateurs are making enough news for us to get congressmen to enter items in the Congressional Record frequently. This is one paper that every congressman reads every day. Mail and handouts seldom get through the assistants, but the Record does.

The CBers have begun to find out how important congressmen can be to their efforts to get the FCC to listen. At the November 20th confrontation between the FCC and representative CB groups in Washington I doubt if the FCC representatives would have done more than politely listen to the CB pitch for more frequencies, more power, higher antennas, and legal hamming. But there were a number of congressional representatives there and the FCC *did* listen. I was there to watch that important meeting. Amateurs have never held such a meeting with the FCC, have they?

As of mid-January the powerful Electronics Industry Association still intends to petition the FCC to follow the CQ Magazine plan and turn 146-148 MHz over to CB. This is in addition to their 222-224 MHz petition for CB channels. Can we hold our frequencies against this formidable combination of a well funded and experienced Washington lobby plus a large number of cooperating CB groups who have the ear of their congressman? Senator Goldwater has his work cut out for him and I hope Arizona doesn't need anything serious soon.

The QST editorial is slanted. The use of such emotional terms as major clinker...pointless idea...expensive...dangerous...with reference to the proposed Washington lobbyist is scarcely honest rhetoric. Their inference that a lobbyist

Amphenol  
Antenna Specialists Company  
B & K Division of Dynascan  
Browning Laboratories, Inc.  
CTS Knights, Inc.  
Courier Communications  
Demco Electronics  
Echo  
E. F. Johnson Company  
Hallett Manufacturing Company  
Hallcrafters Company  
Heath Company  
Hy-Gain Electronics Corp.  
Kaar Electronic Corp.  
Lafayette Radio Electronics  
Midland International Corp.  
Moseley Electronics  
Olson Electronics  
PACE Communications Corp.  
Raytel Division of Raytheon  
Regency Electronics  
Rohn Electronics  
Squire Sanders, Inc.  
Texas Crystals  
Turner Microphone Company  
World Radio Lab

The above companies are CB manufacturers, though a few are also in the amateur field. In all it is a formidable group backing this proposal.

Keep in mind that the EIA is centered in Washington and knows its way around when it comes to lobbying. Keep in mind that amateur radio has no lobby whatsoever and thus has no way to effectively oppose any pressures that can be brought to bear. What will the outcome of this one-sided pressure to completely take away this amateur band? Since you have nowhere to turn for help, if this is of any importance to you, you are forced to do something about this yourself. But what can you do?

First of all you must understand the issue and what is at stake. The complete text of both the EIA proposal and RM-1633, the only alternative so far filed with the FCC, will be published at the end of this editorial so you can judge for yourself the factors involved. 1633 asks for the establishment of a new class of amateur license, requiring only a knowledge of rules and regulations, which would use the middle 4 MHz of the 220 band. This was proposed as a plan for bringing more new amateurs into our hobby via the VHF FM route. The band would still remain open to all amateurs and no frequencies would be

# VERON

## 25th ANNIVERSARY

The Dutch national society, VERON, celebrated 25 years of service to the radio amateur at a "Day of the Amateur" held on 15 November 1970 at Philips Ontspanningscentrum (recreation center) at Eindhoven.

After opening speeches by the president of VERON, A. H. J. Claessen, PAØCLA, and the president of the Eindhoven district club, members heard a lecture by Dr. J. A. Saxton, president of the RSGB, entitled *Amateur Radio and Propagation Research*. Dr. Saxton, who is director of the UK Radio and Space Research Station, spoke of the past achievements of amateurs in the field of propagation research and emphasized the need for continuing vigorous work in the future.

Nearly 300 members attended during the day and the success of the meeting was assisted by the excellent facilities of the Philips center.

taken away from amateur radio.

While many amateurs may not agree 100% with the proposals of 1633, some feeling that the new class of license should demonstrate at least 5 wpm code ability, others feeling that a Novice level of theory should be required, the entry of the EIA proposal would appear to virtually eliminate the possibility of such options, and reduce the problem facing the amateur to choosing one or the other of the two alternatives. There is a good possibility that even if amateurs are in 100% agreement (which would be historic) that they still would not be able to stop the EIA juggernaut.

Practically speaking, your choice would seem to be either a support of the EIA proposal through your silent submission, or an active fight to put through RM-1633.

		License Class
DA 1 AA	- DA 2 ZZ	Amateurs of Foreign Armed Forces A + B
DA 4 AA	- DA 4 ZZ	Amateurs of Foreign Armed Forces C
DB 1 AA	- DB 9 ZZ	German amateurs C
DC 0 AA	- DC 0 EZ	German amateurs C
DC 0-FA	- DC 0 JZ	Foreign civilians C
DC 0 KA	- DC 0 ZZ	German amateurs C
DC 1 AA	- DC 6 ZZ	German amateurs C
DC 7 AA	- DC 7 ZZ	German amateurs in West Berlin C
DC 8 AA	- DC 9 ZZ	German amateurs A + B
DF 1 AA	- DF 9 ZZ	German amateurs A + B
DJ 1 AA	- DJ 0 ZZ	Foreign civilians A + B
DJ 1 AA	- DJ 9 ZZ	German amateurs A + B
DK 0 AA	- DK 0 ZZ	German club stations, special call signs A + B
DK 1 AA	- DK 9 ZZ	German amateurs B
DL 0 AA	- DL 0 ZZ	German club stations, special call signs A + B
DL 1 AA	- DL 6 ZZ	German amateurs A + B
DL 7 AA	- DL 7 ZZ	German amateurs in West Berlin A + B
DL 8 AA	- DL 9 ZZ	German amateurs A + B

## USSR PREFIXES

Prefix Club Stations	Prefix Individual Stations	Prefix Individual vhf Stations	
UK1	UA1	RA1	European USSR
UK2	UA2	RA2	Kaliningrad
UK2	UC2	RC2	Byelorussia SSR
UK2	UQ2	RQ2	Latvian SSR
UK2	UP2	RP2	Lithuanian SSR
UK2	UR2	RR2	Estonian SSR
UK3	UA3	RA3	European USSR
UK4	UA4	RA4	European USSR
UK5	UO5	RO5	Moldavian SSR
UK5	UB5	RB5	Ukrainian SSR
UK6	UG6	RG6	Armenian SSR
UK6	UD6	RD6	Azerbaijan SSR
UK6	UK6	RF6	Georgian SSR
UK6	UA6	RA6	European USSR
UK7	UL7	RL7	Kazakh SSR
UK8	UH8	RH8	Turkmen SSR
UK8	UJ8	RJ8	Tadzhik SSR
UK8	UM8	RM8	Kirgisk SSR
UK8	UI8	RI8	Uzbek SSR
UK9	UA9	RA9	Asiatic USSR
UK0	UA0	RA0	Asiatic USSR

A view of an encased WM3A filter and one with part of the casing removed to show the internal hybrid integrated circuitry. The encased filter measures only 3/10" x 7/10" and is about 3/16" thick. Photo courtesy Western Microwave, Los Gatos CA 95030.

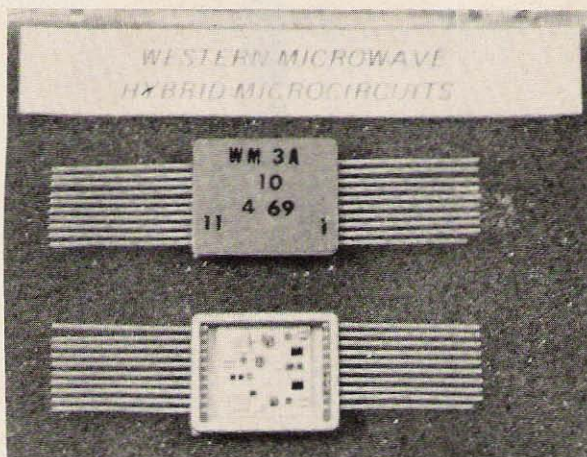

## INTEGRATED CIRCUIT AUDIO FILTER

*The development of complicated multi-inductor filters and multi-transistor rc filters is culminated in a new type of integrated circuit audio filter. The filter should have many applications in amateur radio equipment designs.*

One item that has been used in innumerable pieces of amateur equipment and accessories over the years is an audio filter. Such filters, particularly if they were used for audio selectivity purposes, could get to be very elaborate and large with multiple section designs. It was probably only inevitable that the current stream of progress toward the micro-miniaturization of electronic components would also reach audio filters. However, the miniaturization

of audio filters that has been achieved is not just simply a miniaturization of inductors and transformers. None of these components are used in the audio filters to be described, and these integrated circuit filters offer adjustment versatility that could never be achieved with inductors. Such filters open up the possibility for the construction of numerous compact pieces of accessory equipment that can be used to improve the operation of receivers and transceivers.

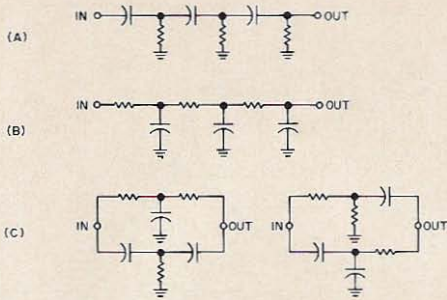

Fig. 1. Basic RC networks allow filter circuits to be built without the use of inductors. High-pass circuit (A), low-pass circuit (B), and notching and peaking circuits (C).

### Background

Many attempts have been made to do away with the use of inductors in filters both because of size and cost factors. Some of these attempts date back quite a few years and all revolve about the use of RC networks in place of inductors. For instance Fig. 1(A) shows an RC high-pass filter. As the frequency of the input signal increases, the reactance of the capacitors decrease and more voltage appears across the output. Fig. 1(B) shows a low-pass filter that works in a similar manner. If you combined the filters, using an amplifier for each, you could form a bandpass filter. You could also combine various forms of RC networks to form notching or peaking filters, as shown in Fig. 1(C). Such filters by themselves, of course, are crude and provide poor selectivity. Usually such filters are used together with amplifier stages to compensate for the filter attenuation and also in feedback arrangements so the filter

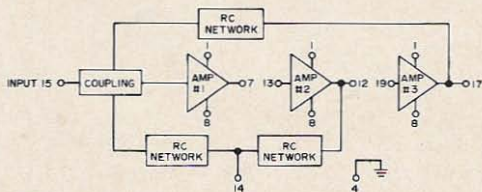

Fig. 2. Block diagram of the Western Microwave WM3 filter. ALL of the blocks shown are contained in the single filter unit shown in the photograph. Each amplifier is, in fact, a separate integrated circuit amplifier. The numbers refer to the terminal connections.

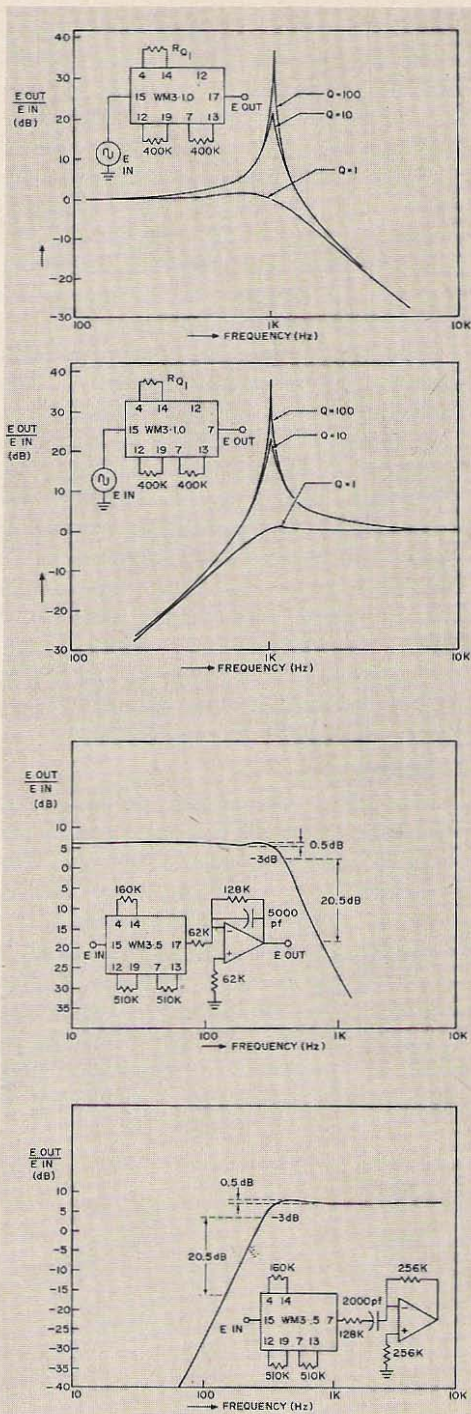

Fig. 3. The WM3 filter can be used alone [(A) and (B)] to function as a low-pass or high-pass filter or in conjunction with a postamplifier [(C) and (D)] to produce a steeper slope at the cutoff frequency.

circuits are not loaded down. Unfortunately, by the time you combine sufficient discrete component rc networks and transistor amplifier stages to have the rc filter duplicate the performance of an inductor network, the rc filter can be as large and as costly as the latter. The advent of integrated circuits has changed all that, however. High gain amplifier circuits and multiple rc networks can be incorporated in one physically compact unit.

The block diagram of the integrated circuit filter is shown in Fig. 2. Three multi-transistor operational amplifiers and the necessary rc networks in a feedback arrangement are combined in the hybrid filter unit. Three external resistors are used and can be manipulated to change the operational characteristics of the filter. One can see some of the filter components in the unencased view of the filter in the photograph. The encased filter measures 0.8 inches x 0.65 inches x .15 inches thick. The surface area is about that of a 25 cent piece, and it is hardly any thicker.

#### Performance

The filter really begins to shine when one investigates its performance possibilities. It can be used as a high-pass filter, low-pass filter, peaking filter, notching filter, etc. The center frequency can be adjusted as desired by an external potentiometer as well as the Q if desired. The unit can also be set up so you can switch select a variety of different filter effect outputs.

Graphs portray the performance of this type of filter best. Fig. 3 illustrates the

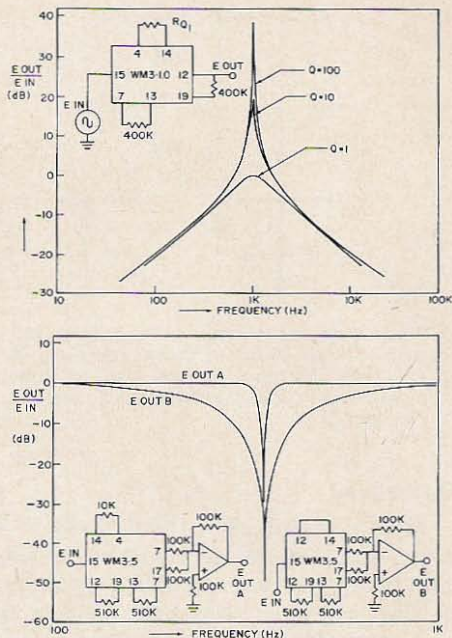
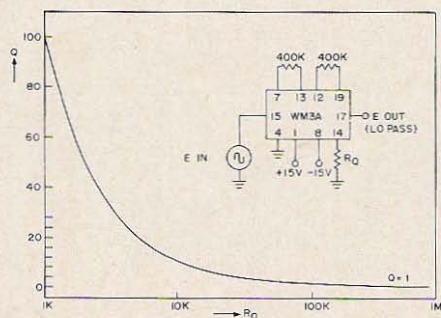

Fig. 4. The extremely sharp peaking and notching characteristics of the filter make it ideal for use as a cw selectivity device. The peaking and notching frequencies can be tuned from 500 to 1500 cycles.

output versus frequency characteristic of the filter in several low-pass and high-pass circuits. The filter can be used alone for these functions, or its output used to drive another ic operational amplifier power stage to further increase the slope of the frequency response at the cut-off frequencies.

Fig. 4 shows the filter used as a peaking or notching filter. Note the extreme

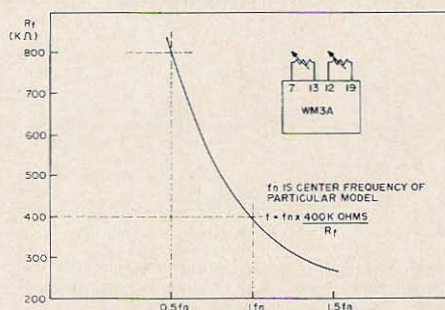

Fig. 5. The above graphs indicate how by simple external potentiometer control, the frequency as well as the Q of the filter can be varied.



sharpness of the response at the nominal center frequency of 1 khz. Actually, both the center frequency as well as the sharpness of the filter response can be tuned by making various of the external resistors variable as shown in Fig. 5. Thus, the center frequency of a nominal 1khz filter can be tuned from about 500 to 1500 cycles. The Q can be varied from about 1 to a maximum of 100.

As might be imagined from looking at the arrangement of the external resistors and the output terminals used for each specific application of the filter, you can devise various switching arrangements to select different outputs, different specific center frequencies, etc. The possibilities in this direction are pretty well limited

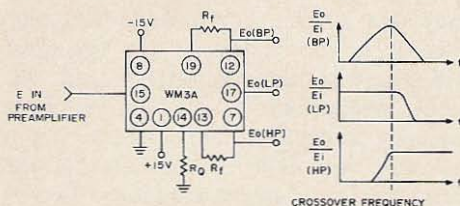

Fig. 6. The above diagram illustrates how the filter can be used to simultaneously produce different output characteristics.  $R_f$  and  $R_q$  are chosen according to Fig. 5.

by your imagination. Fig. 6 shows one simple circuit which provides simultaneous or switch selected different output possibilities.

### Summary

The type of filter described is available now from firms such as Western Microwave. The price of such a filter—about \$30 depending upon the type of casing used—will restrict its use in amateur equipment until greater sales will invariably bring the price down to that of regular integrated circuits. However, even though one may not be using such a filter tomorrow, such filters will be the type of component that will become common in amateur equipment as the micro-miniaturization of components for use in communications circuits continue.

... W2EY

# War On Poverty!

You can help fight a really serious poverty pocket in New Hampshire by sending in your subscription today to 73. Not only will this give you the warm feeling deep inside knowing that you have helped someone in need, but it will also bring you bounteous blessings.

1. You will save tremendously on the highly overpriced individual-copy cost of \$1.
2. You will not have to worry about your dealer running out of copies just before you get there.
3. Many other blessings too numerous to mention.

### Tax Deductible

A subscription to 73 is such an extraordinary act of generosity that it should be deductible. Unfortunately, it isn't. It is generous to yourself, bringing you unfettered joy and enthusiasm for an entire year, spread out just enough to whet the etc. It is generous to the poor underprivileged employees of 73 who are eking out their lives, anxiously awaiting each and every subscription with grasping fingers. It is generous to the State of New Hampshire, for the only taxes in this fine state are on profits and, there is always the distant possibility that your subscription might be the one which would edge 73 out of the red and into the tax-paying bracket. This, unfortunately, is a slim possibility.

Name \_\_\_\_\_

Call \_\_\_\_\_

Address \_\_\_\_\_

City \_\_\_\_\_

State \_\_\_\_\_ Zip \_\_\_\_\_

New subscription

\$6 One year

\$14 Three years

Renewal

\$10 Two years

Foreign: add \$1 per year.

73 Magazine • Peterborough NH 03458

# INTEGRATED CIRCUIT 6 METER CONVERTER

At the present time, amateur 6-meter converters are built around nuvistor tubes or field-effect transistors. The former requires a b-supply in the order of 100V and filament power; both types usually require neutralization, which is tedious and requires additional components.

The 6-meter converter described in this article uses an integrated circuit in the front-end, eliminating the need for neutralization and yielding far better gain characteristics than the nuvistor or all-FET counterparts.

The amplified 6 meter signal is mixed at the gate of a 2N3819 FET mixer with the local oscillator signal, generated by a crystal controlled 2N3819 FET overtone oscillator operating at 49.5 MHz. This produces a difference frequency of 1.0 MHz which is in the middle of the broadcast band, making the converter ideal for mobile applications. If a 7 MHz difference frequency is desired, a 43.5 MHz crystal is used and the 3900 pf capacitor in the mixer drain tank circuit is changed to 100 pF.

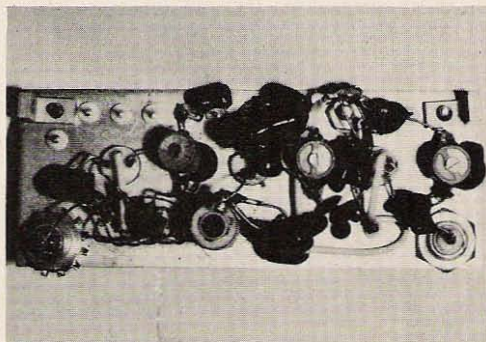
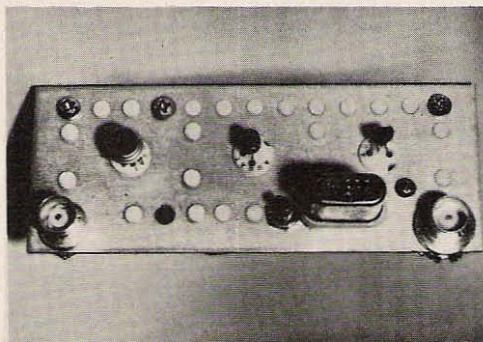

## Circuit Description

This converter uses a CA3028A integrated circuit in the rf amplifier, which is connected in cascode configuration. The cascode circuit behaves as a pentode tube, and thus prevents tendencies toward oscillation. These tendencies are further reduced by using toroidal coils, which prevents generation of stray magnetic fields and eliminates the need for shielding the input from the output tank circuits.

The converter has a gain of 36 dB up to the mixer drain tank circuit. However, since the tank circuit is high impedance, a link coupling must be used to match to the receiver input impedance, which is usually in the order of 50 ohms. The link consists of three turns of no. 22 wire around the mixer drain tank coil. Matching losses are unavoidable, but a gain of 24 db can be achieved without much difficulty. Typical bandwidth is 100 kHz.





# Trap-Type Antenna

V  
E  
R  
T  
I  
C  
A  
L

*The addition of a few stubs can add effective 2 meter operation to most trap-type vertical antennas without degrading the regular performance of such antennas and without requiring any change in transmission line connection.*

John Schultz W2EY  
1829 Cornelia St.  
Brooklyn NY 11227

Usually one erects a trap-type vertical antenna for use on the lower frequency bands because of antenna space restrictions. When carefully adjusted, such antennas are capable of reasonably good performance. Many operators who use such antennas would also like to have some antenna facility for operation on a vhf band—particularly 2 meters—and look fondly at the trap vertical structure trying to visualize how advantage might be taken of its height, etc., for use on 2 meters without erecting a completely separate antenna installation for the latter band. One could mount some small two meter antenna, such as a ground plane, on top of the trap vertical, but structural problems are involved with the relatively thin upper section of the trap vertical, a separate transmission line required (or a changeover relay to the trap vertical transmission line), and the basic trap vertical performance may be affected. A much better solution to the problem, of course, is to somehow utilize the trap vertical antenna itself as an antenna array with a low loss transmission line, such as RG-8, if it has been properly installed. So, there is no problem with the basic transmission line run to the antenna for use on two meters. The problems which do exist are with the trap vertical antenna itself as to how it can be modified into a useful antenna form on 2 meters that will correctly match the transmission line.

This article presents an easy method of modification that can be used with most trap verticals which permits use of the antenna on 2 meters while operation of the antenna on its basic design frequencies is not affected.

## Basic Antenna Considerations

The usual trap type vertical can be electrically represented as shown in Fig. 1(A). The various tuned circuits isolate sections of the antenna on different bands such that the basic antenna structure always remains a  $\frac{1}{4}\lambda$  vertical. Above their resonant

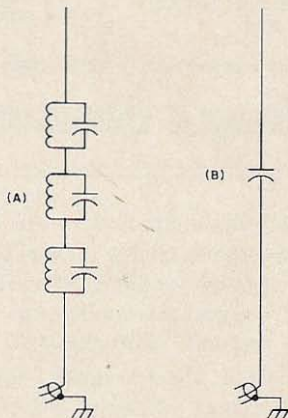
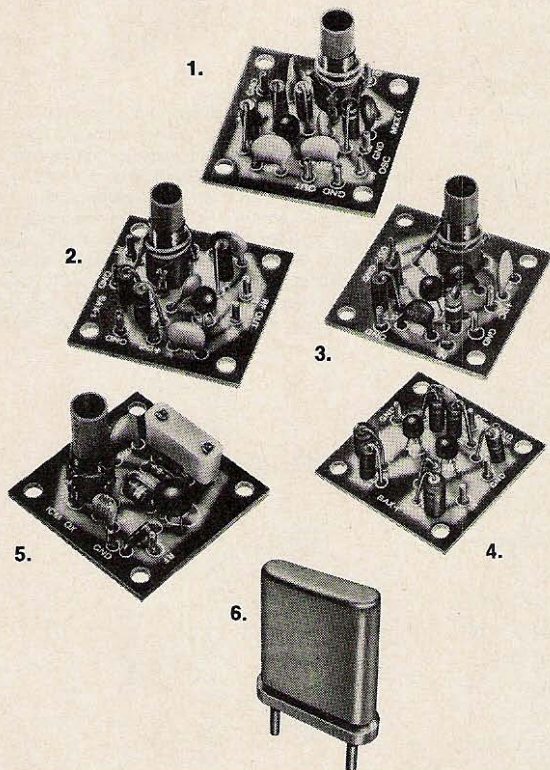

Fig. 1. Multiband trap type vertical antenna (A) forms a vertical antenna which can be represented as at (B) when operated on a frequency which is several times higher than its highest normal operating frequency.

frequencies, each tuned circuit would present a capacitive reactance. Thus, if the antenna were operated on a frequency several times higher than the resonant frequency of the highest frequency tuned circuit trap, the antenna could be electrically represented as shown in Fig. 1(B). The capacitive reactance still present would be very small because of the frequency being considered, although the series effect of the equivalent capacitors from the individual tuned circuits works to increase the total reactance on 2 meters. The total reactance

# for the experimenter!

**INTERNATIONAL EX CRYSTAL & EX KITS**  
 OSCILLATOR • RF MIXER • RF AMPLIFIER • POWER AMPLIFIER



**1. MXX-1 TRANSISTOR RF MIXER**

A single tuned circuit intended for signal conversion in the 3 to 170 MHz range. Harmonics of the OX oscillator are used for injection in the 60 to 170 MHz range. Lo Kit 3 to 20 MHz, Hi Kit 20 to 170 MHz (Specify when ordering).....**\$3.50**

**2. SAX-1 TRANSISTOR RF AMP**

A small signal amplifier to drive MXX-1 mixer. Single tuned input and link output. Lo Kit 3 to 20 MHz, Hi Kit 20 to 170 MHz (Specify when ordering).....**\$3.50**

**3. PAX-1 TRANSISTOR RF POWER AMP**

A single tuned output amplifier designed to follow the OX oscillator. Outputs up to 200 mw, depending on the frequency and voltage. Amplifier can be amplitude modulated. Frequency 3,000 to 30,000 KHz.....**\$3.75**

**4. BAX-1 BROADBAND AMP**

General purpose unit which may be used as a tuned or untuned amplifier in RF and audio applications 20 Hz to 150 MHz. Provides 6 to 30 db gain. Ideal for SWL, Experimenter or Amateur.....**\$3.75**

**5. OX OSCILLATOR**

Crystal controlled transistor type. Lo Kit 3,000 to 19,999 KHz, Hi Kit 20,000 to 60,000 KHz. (Specify when ordering).....**\$2.95**

**6. TYPE EX CRYSTAL**

Available from 3,000 to 60,000 KHz. Supplied only in HC 6/U holder. Calibration is  $\pm .02\%$  when operated in International OX circuit or its equivalent. (Specify frequency).....**\$3.95**

## for the commercial user

**INTERNATIONAL PRECISION RADIO CRYSTALS**

International Crystals are available from 70 KHz to 160 MHz in a wide variety of holders. Crystals for use in military equipment can be supplied to meet specifications MIL-C-3098E.



**CRYSTAL TYPES:** (GP) for "General Purpose" applications  
 (CS) for "Commercial Standard"  
 (HA) for "High Accuracy" close temperature tolerance requirements.

WRITE FOR CATALOG.



**CRYSTAL MFG. CO., INC.**  
 10 NO. LEE • OKLA. CITY, OKLA. 73102

present on 2 meters depends upon the number of traps used in the antenna and their specific parameters, but it can be as low as 30 ohms in a typical antenna.

For the moment, it can be considered that the series capacitive reactance on 2 meters is insignificant, and the antenna acts as a straight rod. If the antenna were excited on 2 meters, a situation similar to that shown in Fig. 2(A) would result. If the total length of the antenna happened, by chance, to be correct, it might still match the transmission line impedance. The chances of such an event taking place are rather small, however. Even if it were to occur, the total length of the antenna would be such that a number of current reversals (one every  $\frac{1}{2}\lambda$ ) could take place. Since the currents in different sections would be out of phase, the resultant radiation pattern would split into a number of lobes in a manner similar to that for a long wire antenna. The result would be radiation and useful for little more than communicating with an aeronautical mobile station directly overhead.

### Stub Placement

The use of a few simple  $\frac{1}{4}\lambda$  stubs on 2 meters can provide both proper matching of the antenna to the transmission line and correct phasing of the antenna currents. This situation is illustrated in Fig. 2(B). Note that the stub on the bottom of the antenna is connected differently than the other stubs. The "closed" end is connected to the ground terminal (shield of the transmission line) and not to the antenna (center conductor of the transmission line). Calling it a "stub" is actually a misnomer since it functions on 2 meters as a quarter wave transmission line transformer to match the low impedance of the transmission line to the high impedance of the first  $\frac{1}{2}\lambda$  section of the antenna. The operation is the same as the well-known "J" antenna. The other stubs cause a phase reversal between the  $\frac{1}{2}\lambda$  sections so that the currents in each section line up properly. The result is that a radiation pattern is produced which is omnidirectional in the horizontal plane and also which has several db of gain with low angle radiation in the vertical plane.

Fig. 3 shows an example of how the scheme of Fig. 2(B) was used with a 14AVG

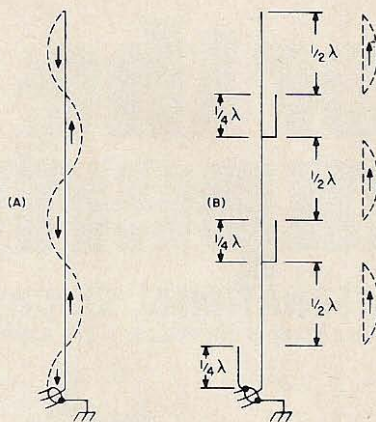

Fig. 2. Exciting a multiband antenna on 2 meters without any modifications being made to the antenna may produce some useful radiation but usually the antenna will not impedance match the transmission line and the current distribution on the antenna (A) will produce mostly useless high angle radiation. Both correct impedance matching and correctly phased current distribution for effective low angle radiation can be achieved by the use of a few simple stubs (B).

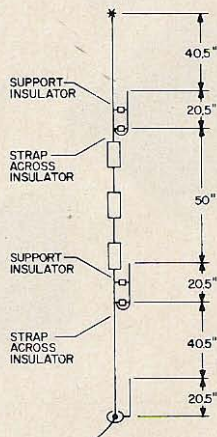

Fig. 3. Dimensions of stubs and placement for two meter operation of a typical hf multiband trap vertical antenna.

trap vertical (remove the rf choke in the base connector). The matching stub is simply ground end connected to one of the mounting bolts on the antenna base connector. A standard pillar insulator (Birnbach 440F) with pipe clamps on each end is used to support and insulate the other end of the stub. The other stubs are mounted in a

similar manner but using two insulators with a shorting strap across the bottom insulator. The photograph illustrates the construction used. The spacing of the stub is not critical nor is the diameter of tubing used for the stub. In the example shown, a center to center spacing of about  $3\frac{1}{2}$ " was used and  $\frac{3}{4}$ " aluminum tubing for the stub.

The second stub (first phasing stub) is placed  $\frac{1}{2}\lambda$  above the end of the matching stub. This stub can be placed below the first trap on almost all trap verticals which are designed for use down to 10 meters. The second  $\frac{1}{2}\lambda$  section will encompass the physical length of all the traps in the usual 2 or 3 trap antenna, since these traps are placed relatively close together. As was mentioned before, however, the traps will still act to present some capacitive reactance on 2 meters. Therefore, in order to effect an electrical  $\frac{1}{2}\lambda$  section, the physical length between the first and second phasing stubs must be made longer. In the example shown, the length required was about 50" which placed the second phasing stub just above the top trap. The last  $\frac{1}{2}\lambda$  section above the last phasing stub is formed by the remainder of the antenna. Usually, the necessary length can be secured by slight adjustment of the top section length or adding to the capacity top-hat on the antenna. A slight adjustment of this length does not affect the antenna performance on the hf bands, since the length is not effective except on the lowest frequency used. The stubs themselves are insignificant electrically when the antenna is used on the hf bands. The physical placement of the small stubs does not in any way affect the mechanical strength of the antenna structure.

The only question about adjustment that may arise is the spacing to use between the first and second phasing stubs in order to allow for the capacitive reactance of the traps. Probably the easiest way to determine the correct length is to temporarily remove the section of the antenna above the top trap. Then using a field strength meter placed at a height equal to about the middle of the antenna and as far away as possible, the antenna is excited and various lengths of top section tried for maximum field strength indication. The regular top section is then

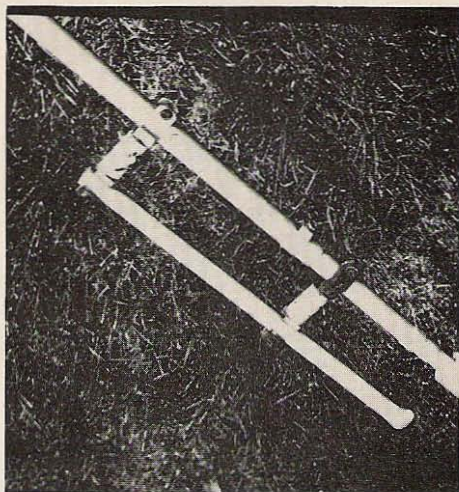

Two standard pillar insulators are used to support the  $\frac{1}{2}\lambda$  stub. Note the shorting strap across the lower insulator. The spacing of the stub from the antenna is not critical and is shown as being about  $3\frac{1}{2}$ ".

replaced and the bottom of the second phasing stub placed a distance above the top trap equal to length just found necessary to peak the field strength reading. The last  $\frac{1}{2}\lambda$  section above the top phasing stub is determined by direct measurement. In case the dimensions of a trap antenna are such that a stub would fall between traps, the same procedure as just described using a field strength meter should be followed to peak any  $\frac{1}{2}\lambda$  section which contains a trap.

#### Summary

Most trap verticals can be modified at minimum expense into very effective 2 meter antennas by the method described. The performance will easily equal or exceed that which would be effected by placing a ground plane antenna at a height equal to the top of the trap antenna. The swr will remain reasonably low over most of the 2 meter band but can be dipped in any desired portion of the band by adjusting the length of the matching stub on the base of the antenna.

... W2EEY

# RESURRECTING A GRANDDADDY

## Part One: Granddaddy

A page in an old notebook, with a couple of circuits and the words "Crystadin" and "Losev," brought a few memories and forced me to plug in a soldering iron and run a few experiments.

Time—middle 1920's; Place—Moscow, Russia; Time of the day—just after midnight; Picture—15 year old ham (later K6BIJ), sleepy, but determined, trying to adjust *two* catwhiskers on *two* crystals at the same time, while listening to weird sounds emanating from *two* earphones.

This was "Crystadin," a circuit introduced by a Russian ham Losev, a "temporary" invention — something to get by until the industry (in ruins after the WW1 and the Civil War) started to produce tubes. Somehow the circuit was able to produce regener-

ation, and also worked as an rf amplifier<sup>1</sup>, using "Zincite"<sup>2</sup> crystals and steel wire catwhiskers. Looks like it was one of the granddaddies of some semiconductor devices "invented" later.

I will not attempt to explain the theory of the Crystadin — I do not know how it works, but it looks like a mixture of regeneration and parametric amplification. The semiconductor junction, dc bias, and the pump frequency are all there.

Crystadin was used for reception of Euro-

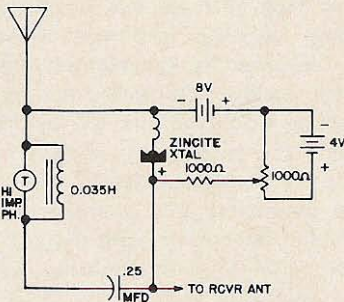

Fig. 1. RF amplifier.

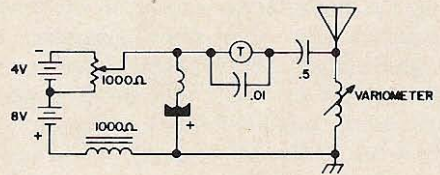

Fig. 2. Receiver

pean BC stations; there was only one Russian BC station (in Moscow) at the time, and we hams had to wait till midnight for it to quit, before we could start fishing for DX. Very little was known at the time about short waves; there were no ham transmitters (no tubes), and a "ham" was just a guy that built his own crystal receivers, spent a lot of his spare time on the roof, and was generally responsible for the absence of what you place on the hook in a telephone booth.



The poor granddaddy died at the age of three, killed by a "micro tube" (micro referring to a low filament current of 60 mA) that appeared on the market in the late 1920's. The death was very premature.

Passing (too briefly) through the regenerative circuits<sup>3</sup> – the tubes made possible a monstrosity called "superhet," the Supreme Ruler of the receiver world, still being worshipped by the hams and engineers alike. Like anything else, being worshipped, it did not improve any since its invention (only the components did), and is still a contraption to bury weak signals in the noise and hiss generated by it.

1. See "RF Q Multiplier," 73, May 1962, page 80.
2. Zincite-ZnO, a zinc ore (mineral), melted and cooled to produce a lump covered with red crystals.
3. See "Superhet or Regenerator," 73, March 1964, page 58.

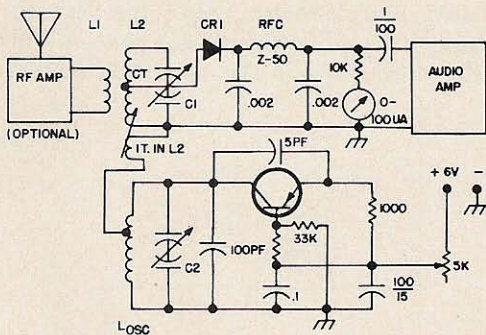

Fig. 3. Schematic.

## Part Two: Resurrection

The circuit shown in Fig. 3 can be visualized as a superhet with local oscillator removed from the receiving frequency only just enough to produce an i-f that is, at the same time, your audio (this is true also in

case of a regen, only there the oscillator and detector functions are performed by the same tube or a transistor). Let us compare a block diagram of Fig. 3 with that of a conventional six meter superhet. We can see that to produce the same gain, the audio section of the Fig. 3 must have as much gain as the two mixers, two i-f's, and the audio of the superhet combined. This means quite an audio amplifier, but it also means quite less

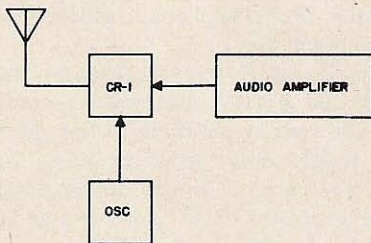

Fig. 4. Block diagram of receivers.

noise generated in the receiver because mixers are notorious noise generators and because transistors are much less noisy at lower frequencies than at high.

You probably saw in some manual that a certain transistor has a noise figure (nf) of let us say "4" at 200 MHz, but only "2" at 100 MHz, etc. In the audio range the nf is of course still lower. This, coupled with a complete absence of images, birdies, and all the other byproducts manufactured within any self-respecting superhet, explains the low internal noise of the Fig. 3 circuit.

Certain deficiencies of the K6BIJ engineering department, coupled with a complete inability to penetrate the semiconductor jungle existing in this country, and viewed through a large hole in the pocket-book – resulted in working, but far from perfect, audio amplifier. It consists of Fig. 1, WIDTY's article, March, 1967, in 73, followed by Fig. 14 (operated at 6 volts and

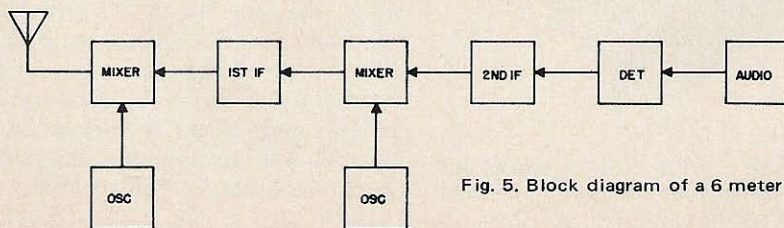

Fig. 5. Block diagram of a 6 meter superhet.

with the filter centered around 800 cycles), and followed by an existing amplifier designed for crystal microphone input and one watt output. Transistors were PNP units marked 033, and taken from IBM surplus boards (disregarding the "0" — if the number is less than 50 it is PNP, if over 50 it is NPN). Failure to produce a quiet audio amplifier naturally will defeat the purpose of the project; in this case I suggest that you temporarily retain the rf amplifier — it will be a step backward, but a much simpler audio unit will do.

Normally regenerative receivers are stable, selective and sensitive, but you can wreck all this if you overcouple them to the antenna or try to get more "gain" by using higher voltage and current through the regenerating tube or transistor. The "gain" should be in the audio amplifier. The ARC-5 receivers, that are supposed to be "as broad as a barn door," are broad only because they have practically no audio, and hams are trying to compensate for this by cranking up the rf i-f gain wide open. Result — the "barn door." I added two stages of audio (also transistor bfo) and am using it on 80 meters SSB and CW without any "barn door" effects.

Now comes CR-1; I connected twelve diodes of all kinds to a twelve position switch, and just tested them in the circuit. Some of the diodes were transistor base-emitter junctions. Those that did not work were replaced by other "unknowns," and so on. As a result it was found that 1N21 always performed fairly well, but some of the glass encapsulated catwhiskers from the

IBM surplus boards outperformed the 1N21 quite a bit. Using an ohmmeter to choose the diodes resulted in a failure; my best diode has 30% reverse leakage, and the second best has practically none.

What takes place at the junction in CR-1? I do not know, but whatever it is, it makes possible a darn good receiver for really weak signals. Whether it is a regen, parametric amp, or a superhet with low internal noise, it works. And if someone will tell me that the three circuits are just variations of one and the same principle, I will not be surprised.

Further improvement can be made by using a vxo instead of a vfo (Fig. 49, page 21-A, 73, March, 1967; a search for a better diode should bring some results, and, of course, there is no limit in improving the audio system.

Variable condensers *must* be of the split-stator, insulated-rotor type, otherwise the noise produced by the rubbing contacts will split your eardrums. The meter shown in the

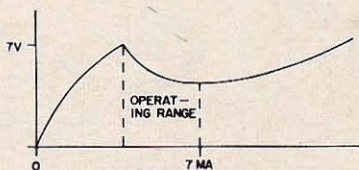

Fig. 6. Voltage/current in crystal in receiver. (see Fig. 2)

circuit is useful only as an indicator of oscillations in your oscillator circuit, and also for tracking (just tune the trimmer condensers and adjust the coils for maximum reading on the meter). Minimum voltage should be used on the oscillator just enough to start it.

The circuit outperformed on six meters a usual converter (rf FET 2N3819—mixer 2N3819—crystal oscillator—RCA SK 3006) followed by an average receiver; it had less internal noise; therefore, weak signals were received much better. It worked best on SSB and CW; AM was somewhat difficult to tune unless the station was fairly strong.

...K6BIJ

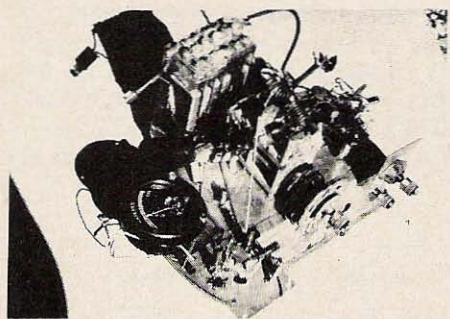

Photo of audio amplifier inside the chassis. The nicad battery pack at the rear of the unit supplies about 7.2V.

a new name  
a new value

...the great new team by **TEMPO**



TEMPO "ONE" SSB TRANSCEIVER



TEMPO "2000" LINEAR AMPLIFIER

The TEMPO "ONE" SSB transceiver represents the culminating achievement of many years of experience in the amateur radio field. Modern design, superb performance, high styling, sturdy construction, outstanding reliability, exceptional value . . . all these factors combined for the first time in an amateur SSB transceiver make the TEMPO "ONE" the obvious choice in today's amateur market. Power input: 300 watts PEP SSB, 240 watts CW. Five band coverage: 80 through 10 meters. VFO range: 500 khz. Complete with: Selectable Sideband, Crystal Calibrator, VOX, Receiver Off-set Tuning. Price: \$298.00. AC/ONE power supply 117/230 volt 50/60 cycle . . . \$99.00 DC/ONE power supply 12 volts DC . . . \$107.00

The TEMPO "2000" is the smallest self-contained, full legal-limit kilowatt amplifier in its price range. It has an entirely self-contained, solid-state power supply that makes it fully operational within three seconds from turn-on. The "2000" provides full kilowatt input on all modes, band-switched 80 through 10 meters, and grounded-grid input for maximum compatibility with modern transceivers and transmitters. Look at the price . . . look at the features . . . you can't do better for only \$395.00.

■ Henry Radio has a great antenna package program . . . big savings. Write for literature. ■

EASY FINANCING • 10% DOWN OR TRADE-IN DOWN • NO FINANCE CHARGE IF PAID IN 90 DAYS • GOOD RECONDITIONED EQUIPMENT • Nearly all makes and models. Our reconditioned equipment carries a 15 day trial, 90 day warranty and may be traded back within 90 days for full credit toward the purchase of NEW equipment. Write for bulletin. Export inquiries invited.

TED HENRY (W6UOU)

BOB HENRY (W0ARA)

WALT HENRY (W6ZN)

# Henry Radio

11240 W. Olympic Blvd., Los Angeles, Calif. 90064  
931 N. Euclid, Anaheim, Calif. 92801  
Butler, Missouri 64730  
New York area: John Richardt W2W1Y  
Houston area: Jan Carman W5SBX

213/477-6701  
714/772-9200  
816/679-3127  
201/637-4107  
713/464-0419

"World's Largest Distributor of Amateur Radio Equipment"

# 7 5 3 3 4 DIGITAL COUNTERS

"Your frequency is 3637.490 kHz, OM. Would you please move 10 Hz higher to get on the teletype auto-start frequency?"

You'll never hear this on the ham bands? Wait 'till you contact me!

Ever dream of building a receiver/transmitter, or maybe an rf signal generator that would give a digital readout of frequency to the nearest hertz? Well, just you read this article about the digital indicators, and put a little tin on your dream rig.

In building such a project as this, there are 4 main considerations that must be kept in mind:

- 1) Usages, actual and possible.
- 2) Reliability (bulb burnout, etc.).
- 3) Component availability (readout Indicators, transistors, integrated circuits, resistors).
- 4) How complex; number of parts, amount of wiring (transistors vs integrated circuits).

Having come this far, I now wish to show you the different ways you can get a 0-9 number, then discuss various driver circuits to light up your chosen indicator.

## Numbered Light Bulbs

The simplest of all digital displays would be those of either Fig. 1a or 1b. Fig. 1a is merely a piece of clear plastic painted black on the front except where the number is. Lamps are placed behind each number, and shielded from showing through to the adjacent number.

Fig. 1b shows a similar method, only the light bulbs were encapsulated in plastic and little plastic letters were glued over the top of the appropriate bulb. Other arrangements,

such as bulbs in a circle, etc., are also a possibility in this general type.

**Advantages:** Low cost—only the ten bulbs and a little plastic need be bought. Simplicity.

**Disadvantages:** Relatively short bulb life; small image, necessitating close reading; Out of line reading of long numbers, making the reading slower.

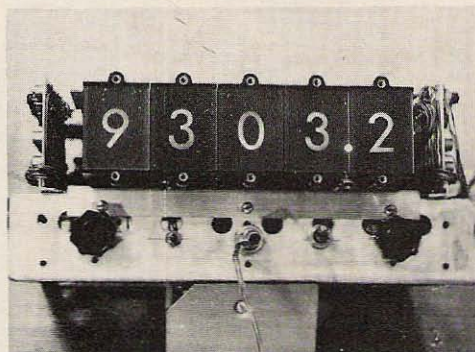

Front view of my digital frequency counter with a range of 50 Hz to 100 kHz and beyond, with a readout of 1/10 of a cycle. Projected image type of readouts are shown, driven by 5 digital decoder #2's.

## Light Bar Matrix

Fig. 1c shows a system used by the Simpson III digital voltmeter and others, which presents several advantages while adding a few disadvantages too.

Seven lights are placed so as to form 10 distinct numbers by lighting up various combinations of light bars. To get a "1", bar

C & F are lit; "2" has bar A, C, D, E, & G lit to give 2; "3" has bar A, C, D, E, F, & G lit to give 3; "4" has bar B, C, D, F, & G lit to give 4; "5" has bar A, B, D, F, & G lit to give 5; "6" has bar A, B, D, E, F, & G lit to give 6; "7" has bar A, C, & F lit to give 7; "8" has all bars lit; "9" has all bars lit except E to give 9; "0" has all bars lit except D to give 0.

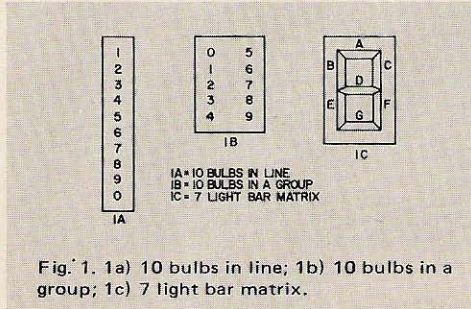

These lights may take a number of forms. They may be a piece of plastic backlighted to give a bar on the front. Another possibility is to use long lamps similar to those used in car dome lamps, only with low amperage. Even NE-2 neon bulbs may be used, along with high voltage switching transistors.

**Advantages:** Larger Number  
 Brighter number  
 Inline reading of long numbers  
 Cheaply made in comparison with commercially available readouts.

**Disadvantages:** Proper lamps difficult to find.  
 More difficult assembly as compared to simple numbered lights.  
 Brightness varies according to number of bulbs lit.  
 More current is drawn due to a number of lamps being lit.  
 Electronic driver circuit is more complex, though not much more expensive.

#### Edge Lighted

Some manufacturers have produced digital readouts which consist of 10 concentri-

cally placed pieces of plastic, each with a number placed on it which is edge lighted to show the desired number. An example of this type is the readout sold by Radio Shack Corp. for \$9.95.

**Advantages:** Very compact  
 Well formed number  
 Inline reading of long numbers.

**Disadvantages:** Dimmest of all displays.  
 Small angle of viewability.

#### Projected Image

This system consists of 12 light bulbs, 0-9 and + and -, which are projected on the back of a ground glass screen. Various bulbs may be used to achieve different levels of illumination. A #44 bulb will give the most brilliant display, but it requires a rather high current from the switching transistor, 250 mA. On the other hand, an 1819 bulb @ 40 mA is rather easy on the transistor, but is

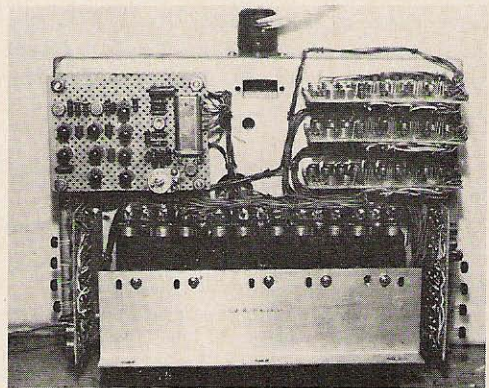

Top view, showing how I mount the various decoders. Section at back left is the crystal oscillator and gating circuitry. Not shown, but beneath this section are the 24 flip-flops in the 'divide by one million' section.

quite dim, having a relative character brightness of 15 as opposed to 145 for the #44 bulb.

By reducing the voltage 10%, bulb life of 3000 and 1000 hours, respectively, will be increased 5 times, for 15,000 hours for the #44. Relative brightness will be cut in about half. The popular #47 at 150 mA will perform at about 1/2 the brilliance of the #44.

Cost of these units varies considerably. New ones run in the neighborhood of \$30

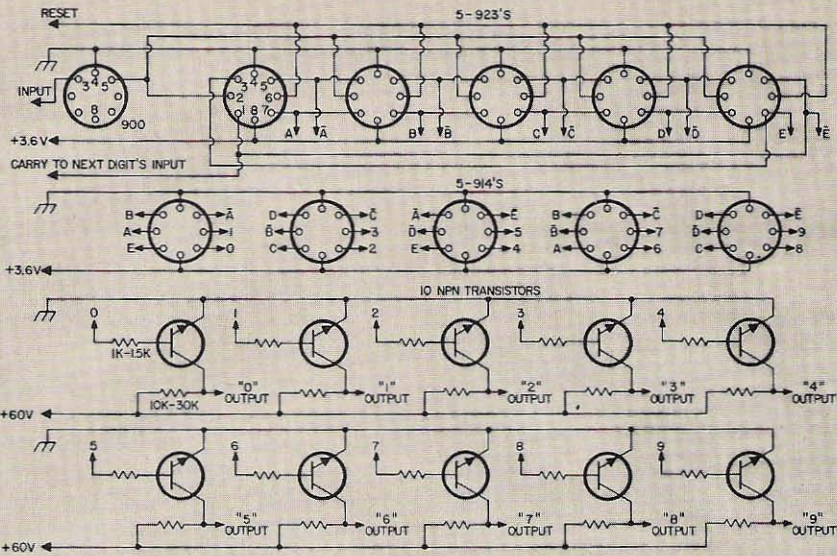

Fig. 2. Digital decoder #1. Reset to 0 by momentarily placing +3.6 v on reset line. All resistors of a similar function are the same value.

RESET TO ZERO BY MOMENTARILY PLACING 3.6V ON RESET LINE.  
ALL RESISTORS OF A SIMILAR FUNCTION ARE THE SAME VALUE.

each. However, various surplus stores do have them at prices from \$6 to \$10, the former being about the most that I would pay. At that price, a bank of 5, as I myself use, makes a very attractive display unit for \$30.

- Advantages:
- Nice looking image
  - Ease of mounting
  - Simple and cheaper driver circuits
  - Low cost (if surplus)
  - Inline reading of long numbers
- Disadvantages:
- Bulb burnout
  - Bulky

### Nixie Tubes

These readouts are a gas filled, cold cathode type tube. They are somewhat similar in basic idea to a vr tube or a neon tube, only they display a given number depending on which of a number of cathodes is hooked up to negative voltage. When this happens, the gas around this element ionizes and glows. Prices on these devices vary according to size and construction. Units of interest to amateurs run from \$8 to \$30 in price, the \$8 one looking like a miniature tube, giving numbers .6" high. These units require special sockets running about \$1 apiece. I have seen Nixie tubes on

the surplus market as low as \$3 apiece. For information, write to: Burroughs Corp., Electronics Components Division, Plainfield NJ 07061.

Advantages: \ Very long life (200,000 hours)

- Bright and easy to read
- Compact
  - Wide angle of viewability
  - Simple driver circuit
  - Different sizes available

### Disadvantages:

- Require power supply of about 200V
- Special circuit needed for dimming
- (I don't like their red colored number.)

### Pixie Tubes

These are units similar to the Nixie, but instead of seeing a relatively large number lit up, a small number is visible through a perforated plate above the lit-up cathode. The advantage of these units over the more common Nixie lies in the fact that they are much cheaper, costing only \$5 new, and much less surplus. The main disadvantage is that the number images are so small, about 3/16", that it is very difficult to read them at a distance greater than 6 feet. Besides this,

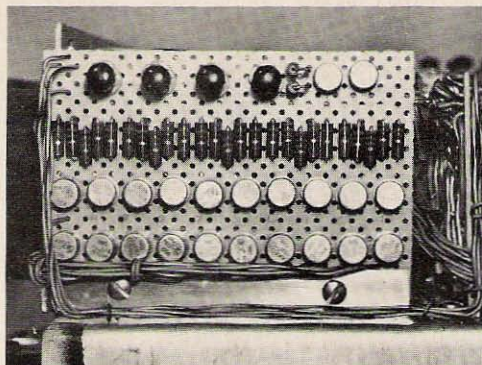

Top view of digital decoder #2. At the top are the IC and 2 transistor gates. In the middle are the other gates. At the bottom are the drivers.

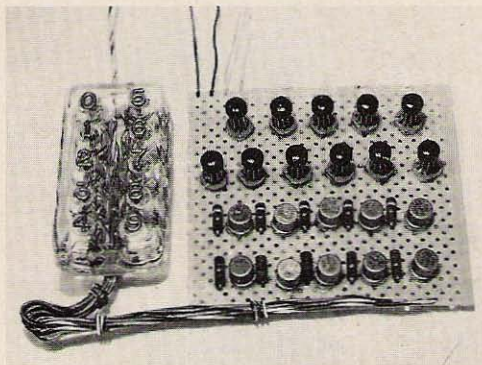

Top view of digital decoder #1. At the top are the 5 flip-flops. The 2nd row has the 900 driver at the left, and the other 5 IC's are the 914's. The other transistors are the drivers. At the left is a digital display which consists of 10-#49 light bulbs encapsulated in plastic.

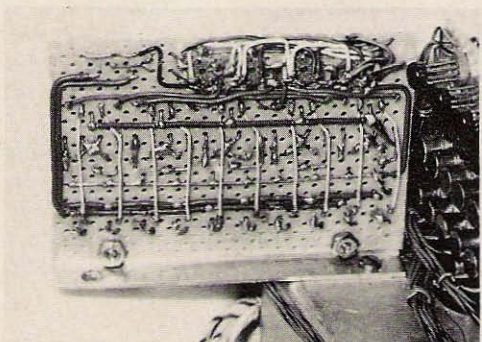

Bottom view of digital decoder #2.

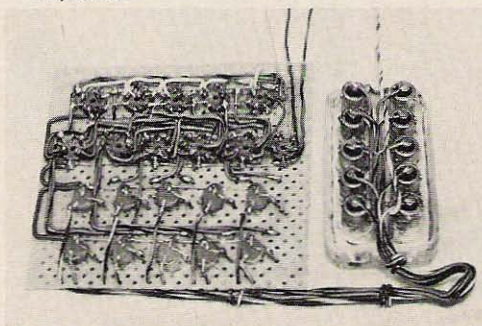

Bottom view of #5.

a long number would be read slower due to the individual digits out of line.

### High Vacuum Readouts

Though similar to a Nixie, these are tubes which project an image quite similar to the way a CRT works. For more information, write to: Industrial Electronic Engineers, Inc., 7720 Lemona Ave., Van Nuys CA 91405. This company can also give you more information on the projected image type readouts, which they make.

- Advantages:
- Long life if brilliance reduced
  - Other advantages of the Nixie
  - Can be dimmed by a simple circuit

- Disadvantages:
- Hv supply of 1-3 kV required, plus 1.1V filament supply
  - Smaller image and slightly higher cost than the Nixie.

### Digital Drivers

So that you can arrive at the desired digital signal to your selected type of readout, you have 3 items to consider now.

First, you must have a set of flip-flops which will have 10 different states, and then start over. There are a number of different ways to hook up 4-6 flip-flops and additional gating transistors to achieve this. In this article, I have selected 2 ways as being the simplest to work with.

Secondly, you must select the outputs of the flip-flops and steer the proper voltage to the driver stage, which comprises the third part of the whole digital decoder.

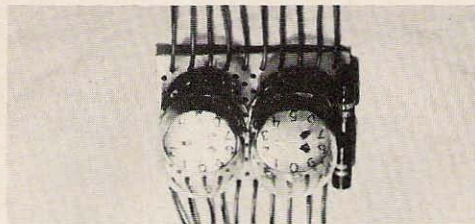

Two Pixier indicators, mounted on some keyboard.

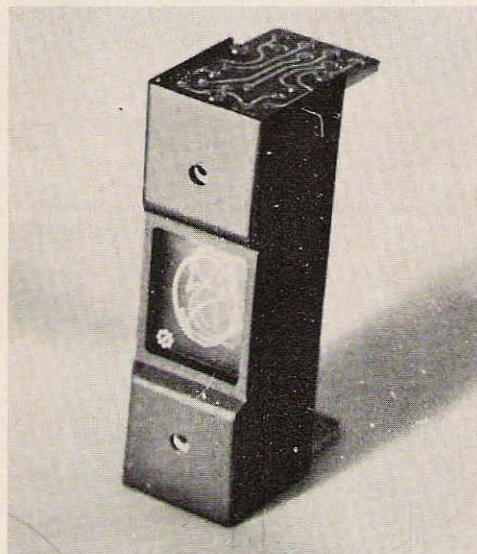

An edgelit indicator showing internal construction.

### Digital Decoder #1

This decoder needs 31-41 parts: 5-JK flip-flops (Fairchild 923 IC); 1-Driver/Buffer (Fairchild 900 IC); 5-Dual 2 input gates (Fairchild 914 IC); 10-1K-1.5K ½ watt resistors; 10-10K-30K ½ watt resistors (only if Nixie/Pixies used); 10-Driver xstrs (Surplus NPN, or, if Nixie/Pixie used, hv xstr as Fairchild 2N3568)

Cost: \$20 if you use Nixie/Pixies and buy the resistors; \$12 if you use lamps and have the resistors.

Wiring time: about 6 hours from start to finish.

To build this circuit, a great deal of care is necessary to avoid errors. The way that I wire them is to put all of the ICs in the order shown in the diagram, then wiring the common pins, 4, 8, and 6 of the 923's. Next, wire the common pins of the driver and gating transistors and ICs. After this, put in the resistors and complete the wiring except

the wiring of the 914 decoding gates which is the last to be wired and the most prone to error.

As you can see in the parts list, there are a few different ways to build this decoder. If you plan on using the Nixie/Pixie type of indicator, then you will need to use such transistors as the Fairchild 2N3568 or others with a 60V or more collector-to-emitter voltage rating. The 60V line and 10 resistors to the driver transistors is only necessary when Nixie/Pixies are used also. Fig. 3a shows how to hook up lamps to the decoder, and 3b shows how to hook up Nixie/Pixies.

### Digital Decoder #2

This is the unit which I use in my present digital counter. It has only 4 ICs, so cuts down on the cost of the unit, but uses 22 NPN computer transistors, which, while cutting down on the cost, adds to the complexity.

Parts used are as follows: 4-JK flip-flops (Fairchild 923 IC); 22-NPN switching transistors (Surplus computer); 2-2.7K ½ watt resistors; 5-470-680Ω ½ watt resistors; 10-4.7K-6.8K ½ watt resistors; 10-1K-2K ½ watt resistors.

Cost: Well under \$10.

Wiring time: About 6 hours.

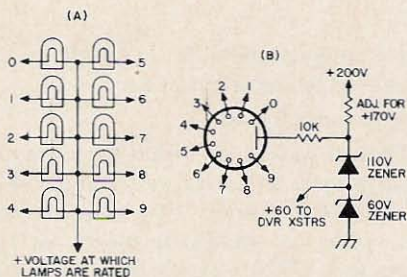

Fig. 3. 3a) How to hook up lamps to the decoder; 3b) How to hook up Nixie/Pixies.

As you can see, there is a definite cost advantage to decoder #2, if you can come by the transistors and resistors cheaply. I find the wiring of decoder #2 easier, due to less wires in the decoder, which is the most confusing part. Should you desire to use decoder #2 with Nixie/Pixie readouts, then change the driver transistors to hv types, and add a 10-30 kΩ resistor to each driver's



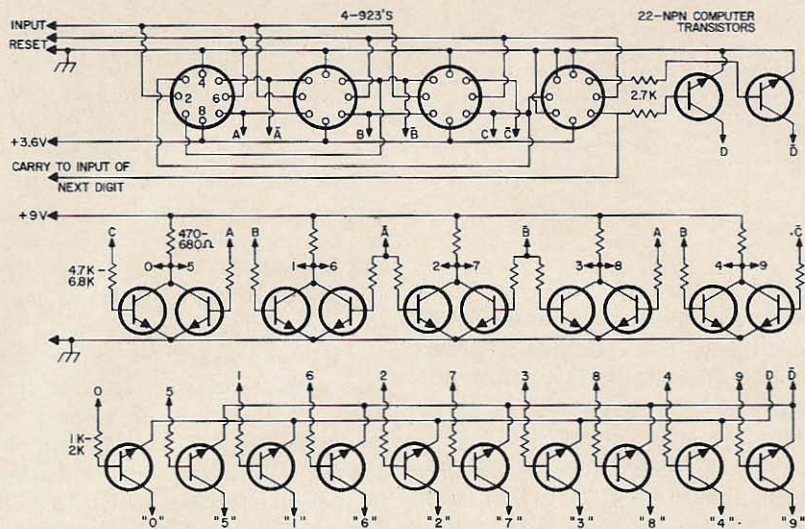

Fig. 4. Digital decoder #2. All resistors of a similar function are the same value. To reset to 0, place +3.6 v on reset line momentarily.

RESET TO ZERO BY MOMENTARILY PLACING 3.6V ON RESET LINE.  
ALL RESISTORS OF A SIMILAR FUNCTION ARE THE SAME VALUE.

collector from a +60V source, as in decoder #1. Please note on the decoder #2 diagram, Fig. 4, that the outputs are not in numerical order. This is due to the fact that the ICs are in a biquinary count configuration, which means that they count to 5 twice to reach 10, then start over.

### Digital Decoder #3

This particular unit is made up of either of the two preceding decoders plus a diode

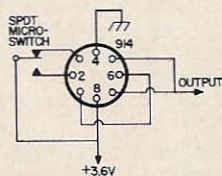

Fig. 5. A simple count checker.

matrix to drive the 7 light bars. As it is rather involved, I am not including it here, but those interested may obtain the schematic by sending me a SASE. The cost will approach \$15 to \$25, depending on parts availability, and the construction time will be about 10 or more hours.

### Count Checker

A simple count checker which can be used to see that everything is counting correctly is shown in Fig. 5. Before you

hook up the counter to read a multidigit number, make sure you have each digit counting correctly!

### Improved Input Sensitivity

Fig. 6 shows the addition of an emitter follower to my original input circuit; this considerably improves the low frequency performance.

### Digital Frequency Divider

As many have mentioned to me regarding the binary counter, it would be a shame to depend on the 60 Hz line frequency for a timing standard for such an accurate instrument as a digital counter. Therefore, I am now using a 100 kHz crystal as the standard. Fig. 7 shows that I am using one of Jim Fisk's little crystal circuits into a 914 monostable pulse shaper. This in turn drives 24

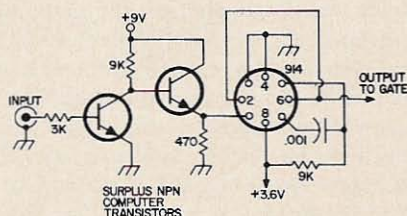

Fig. 6. Addition of an emitter follower to original input circuit of the binary counter.

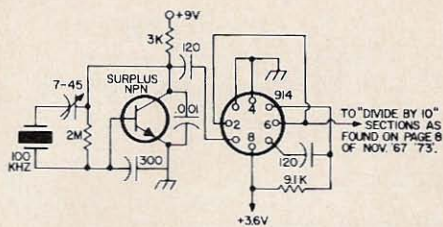
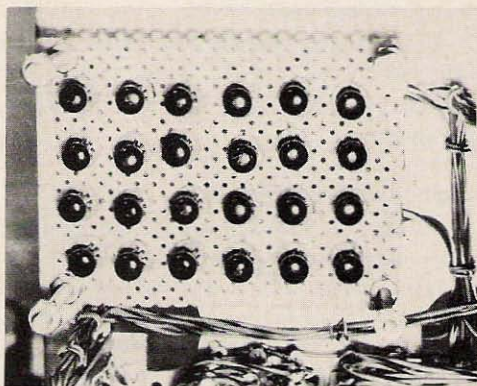

Fig. 7.

923 flip-flops hooked up as 6 "divide by 10" frequency dividers. This results in a "divide by one million," giving me a final output frequency of one hertz in ten seconds. Using this to trigger the count controller and gate, I take a count of all pulses in 10 seconds, thereby giving me an accuracy to one tenth of a hertz. The decimal point is inserted as hertz. The decimal point is inserted as shown in the picture. Various other frequencies are tapped off the divide by one million set of flip-flops to achieve other values of counts. This is described in my previous article.



Top view of the 24 923's in the "divide by one million" section.

### Flip-flops

A number of people have inquired about other types of ICs which might be used. Suppose that you wanted to count up higher in frequency. To do this, you would have to change the time constant of the input shaper by putting in a smaller condenser, and then using higher frequency ICs. Say you wanted to read the output of a 7 MHz vfo. Simple. Use Fairchild 926s (freq. to 8 MHz as opposed to 2 MHz of the 923). Make a

frequency divide section which will give you the desired accuracy, say 100 Hz. This will require a divide-by-1000 section, or 12 flip-flops. Now you can read out the frequency of that vfo to, say, 7034.8 Hz. How about 20, 15, and 10? Simple too! for 20 meters, add one more flip-flop to the 1000 divider to get 50 Hz. This way, you get double the count, or 14069.6 Hz. For 15, add a divide-by-3 to the divide-by-1000 to get 21,104.4 Hz. For 10 meters, add two divide-by-2 for a divide-by-4. Exciting? Certainly is! Accurate? Just as accurate as when you zero that 100 kHz crystal with WWV. Of course you don't have to read out the whole number, but can read out the last 3 or 4 only, since you should know your frequency to within a megahertz. Where do you do from here? Well, I've given you some ideas on the fundamentals. The rest I leave to you.

... WØLMD

### Bibliography

For those people who are interested in the theory behind digital readouts and decoders, I would like to recommend the following free literature.

Nixie/Pixie tubes: Bulletin 1104A  
Bulletin 1095  
#616E (General Catalog & Applications).

Write: Burroughs Corp., Electronic Components Div., Plainfield NJ 07061.

High Vacuum/Projected Image readouts: Request information from:

Industrial Electronic Engineers, Inc., 7720 Lemona Ave., Van Nuys CA 91405.

Fairchild IC's: Applications brief 36 on 9960 series  
Circuit Notes RTL 1 through 5.  
App-120/2, App-118/2 & SL-218

Write: Fairchild Semiconductor, 313 Fairchild Dr., Mountain View CA.

Fairchild parts and information: Request "Designing with Integrated Circuit Components"

Write: Hyer Electronics Co., Denver Technological Center, PO Box 22227, Denver CO 80222.

General Digital information:

Write: Interstate Electronics Corp. 707 E Vermont Ave., Anaheim CA—Request S-139A and Updates. Digital Equipt Corp., Technical Publications Dept., 146 Main St., Maynard MA 01754—Request "Logic Handbook."

**IF YOU'VE  
EVER  
USED  
A  
REPEATER,**



**YOU'VE USED A  
SENTRY CRYSTAL**

If you haven't  
already received  
a copy of our **NEW**  
**1971** Catalog of Precision  
Quartz Crystals & Electronics  
for the Communications Industry,  
**SEND FOR YOUR COPY TODAY!**

Somewhere along the line, in virtually every ham repeater in the world, you'll find a couple of Sentry crystals.

Repeater owners and FM "old-timers" don't take chances with frequency—they can't afford to. A lot of repeater users depend on a receiver to be on frequency, rock stable...in the dead of winter or the middle of July. The repeater crowd took a tip from the commercial "pros" a long time ago—and went the Sentry Route.

That's one of the reasons you can depend on your local repeater to be there (precisely there) when you're ready to use it. FM'ers use the repeater output as a frequency standard. And for accuracy, crystals by Sentry are THE standard.

**IF YOU WANT THE BEST,  
SPECIFY SENTRY CRYSTALS.**

*"Ask the Hams and Pros  
Who Build Repeaters!"*



**SENTRY MANUFACTURING COMPANY**  
Crystal Park, Chickasha, Oklahoma 73018

PHONE: (405) 224-6780

TWX-910-830-6425

The most powerful antennas under the sun!



# Hy-Gain's ALL NEW HAMCAT

## Now The Best Is Even Better!

- More power capability with lower VSWR
- Higher Q plus broad band performance
- Higher radiation effectiveness
- Lightweight, super strength construction
- Shake-proof sleeve lock folds over for garaging
- Lightweight precision wound coils sealed in an indestructible epoxy-fiberglass sleeve
- Swivel base for quick change from band to band
- Nominal 52 ohm impedance on all bands—no special matching (any length coax will work)
- Coil sleeve is distinctive white with heavy chrome plated brass fittings
- Turn-over mast is hefty 3/8" dia. heavy wall tubing of highly polished heat-treated brite dipped aluminum
- All connections are standard 3/8 x 24 thread
- Mast folds over, swivels, turns over—mount it on bumper or deck
- Swivel lock base is stainless steel
- Coil and tip rods are a one-piece assembly. Coil diameters are constant, only lengths change

No. 252

Order No. 257 All new design 5' long heavy duty mast of high strength heavy wall tubing	<b>\$16.95</b>
Order No. 252 75 meter mobile coil	<b>\$19.95</b>
Order No. 256 40 meter mobile coil	<b>\$17.95</b>
Order No. 255 20 meter mobile coil	<b>\$15.95</b>
Order No. 254 15 meter mobile coil	<b>\$12.95</b>
Order No. 253 10 meter mobile coil	<b>\$10.95</b>

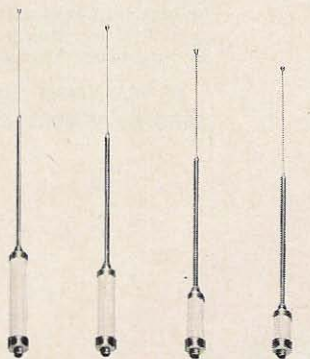

No. 256    No. 255    No. 254    No. 253



SHAKE-PROOF SLEEVE LOCK releases fold-over hinge.

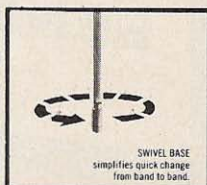

SWIVEL BASE simplifies quick change from band to band.



Order No. 492  
Price \$2.80

Coil and tip rod SPRING also available. Shpg. Wt. 0.2 lbs.



COIL ASSEMBLY CUT-AWAY  
A. Chrome plated brass fittings.  
B. Inner fiberglass core.  
C. Precision coil.  
D. Outer fiberglass shield.  
All permanently assembled and completely impregnated with special moisture-proof compound.

### Hy-Gain Heavy Duty Bumper Mount

- Rugged stainless steel construction • Handles full size heavy whip
- Clamps to most car bumpers

Order No. 415

**\$8.95**

## HY-GAIN ELECTRONICS CORPORATION

P.O. Box 5407-GC, Lincoln, Nebraska 68505



No. 257

The most powerful antennas under the sun!



## NOW... A GREAT NEW WIDE BAND VERTICAL for 80 through 10 Meters

# HY-GAIN'S 18AVT/WB

Take the wide band, omni-directional performance of Hy-Gain's famous 14AVQ / WB, add 80 meter capability plus extra-heavy duty construction—and you have the unrivalled new 18AVT/WB. In other words, you have quite an antenna.

- Automatic switching, five band capability is accomplished through the use of three beefed-up Hy-Q traps (featuring large diameter coils that develop an exceptionally favorable L/C ratio).
- Top loading coil.
- Across-the-band performance with just one furnished setting for each band (10 through 40).
- True 1/4 wave resonance on all bands.
- SWR of 2:1 or less at band edges.
- Radiation pattern has an outstandingly low angle whether roof top or ground mounted.

CONSTRUCTION...of extra-heavy duty tapered swaged seamless aluminum tubing with full circumference, corrosion resistant compression clamps at slotted tubing joints...is so rugged and rigid that, although the antenna is 25' in height, it can be mounted without guy wires, using a 12" double grip mast bracket, with recessed coax connector.

ORDER NO. 386

**\$59.95** SUGGESTED RETAIL PRICE



*Take a look at that price...then see the best distributor under the sun  
...the one who handles all Hy-Gain products.*

**HY-GAIN ELECTRONICS CORPORATION**

P. O. Box 5407-GC Lincoln, Nebraska 68505





AMERICAN MADE

## Mobile 2 Meter FM Transceiver

Here is what the 2 meter, FM Ham World has been asking for.

Specifications: 90 day warranty

### RECEIVER

The HR-2 receiver is a double conversion, superhetrodyne with highly selective ceramic filter.

Frequency Range...144-148 MHz  
Sensitivity.....0.35  $\mu$ v (nom.) 20DB Quieting  
Selectivity.....6DB Down  $\pm$  16KC  
50DB Down  $\pm$  32KC

Audio Output  
(3-4  $\Omega$  Speaker)....3 Watts 10% Distortion  
5 Watts Maximum

Channels.....6 Crystal controlled with provision for adding an additional 6 channels

I.F. Frequencies.....10.7 MHz & 455KHz

### TRANSMITTER

The HR-2 transmitter uses phase modulation for the ultimate in carrier stability. Built in SWR load mismatch circuitry provides protection against open and shorted antenna conditions.

Frequency Range...144-148 MHz  
Power Output.....10 Watts (min.) @ 13.6 VDC  
Modulation.....Phase Modulation with

Deviation.....Automatic deviation limiting  
Automatic Limiting with internal adjustments from 0-15KC deviation

Microphone.....Plug-in, hand held, high Z Ceramic supplied

Channels.....6 Crystal controlled with individual trimmer capacitors for Frequency netting

### GENERAL

Power Requirements 13.6 Volts (nominal)  
Receive (Squelched) 180 MA.  
Receive (Max. audio output).....800 MA.  
Transmit.....2.5 Amps (max.)

### STANDARD EQUIPMENT

Built-in 4" Speaker  
Mobile Mounting Bracket  
SO-239 Antenna Connector Socket  
T & R Crystals for 146.94 MHz  
PTT Ceramic Mike

only \$229<sup>00</sup> Amateur Net

**Regency**

ELECTRONICS, INC.

7900 Pendleton Pike, Indianapolis, Indiana 46226

This is actual size and shape of our radio. Cut it out and place it under your dash to see how compactly it fits.

# DRAKE TC-2&6

## 2 and 6 Meter TRANSMITTING CONVERTERS



TC-2 Full 2-Meter band • 180 Watts **\$300<sup>00</sup>**

TC-6 Full 6-Meter band • 300 Watts **\$250<sup>00</sup>**

**General:** All switching from front panel • For any 20 meter exciter or TR-6 Transceiver • Oscillator injection from Drake SC-2 or SC-6 receiving converter • Transmit AGC • Plate current and relative output meters • Built-in antenna relay • 5½"H x 7¾"W x 11½"D, weight 9 lbs.

Available at your local distributor.

**R. L. DRAKE COMPANY**



540 Richard Street  
Miamisburg, Ohio 45342

**IDENTIFY  
INGSURP  
USELECT  
RONICEQ  
UIPMENT**



by Bill Welsh W6DDB

Most hams are vaguely familiar with the two- and three-letter prefixes used on military electronic equipment. The JAN (Joint Army-Navy) designations have been expanded upon and superseded by the Joint Electronics Type Designation System (JETDS). JETDS designations apply to all Air Force, Army, Marine, and Navy electrical/electronic equipment.

The following tables provide information which permits quick classification of any military electronic item which bears

the customary letter identification. Table I shows the three-letter classifications used with the complete systems, sets, and groups. Table II shows one and two-letter classifications used with units and components which are basically parts of the systems, sets, and groups detailed in Table I.

The information shown in Tables I and II is primarily extracted from MIL-STD-196B (Joint Electronics Type Designation System), dated 7 April 1965.

Table I. System/Set/Group Classifications

First Letter (Installation)		Second Letter (Equipment Type)		Third Letter (Equipment Purpose)	
A	Piloted Aircraft	A	Invisible Light, or Heat Radiation	A	Auxiliary Assembly (Not Complete Operable Sets)
B	Submarine or	B	Pigeon (Obsolete)	B	Bombing
C	Air Transportable (Obsolete)	C	Carrier	C	Communications (Receiving and Transmitting)
D	Pilotless Carrier	D	Radiac	D	Direction Finder, Reconnaissance and/or Surveillance
		E	Nupac	E	Ejection and/or Release
F	Ground-Fixed	F	Photographic (Canadian only)		
G	Ground-General Use	G	Telegraph or Teletype	G	Fire Control or Searchlight Direction
				H	Recording and/or Reproducing (Graphic, Meteorological, or Sound)
		I	Interphone or Public Address		
		J	Electromechanical or Inertial-Wire Covered		
K	Amphibious	K	Telemetry	K	Computing
		L	Countermeasure	L	Searchlight Control (Obsolete - use G)
M	Ground-Mobile	M	Meteorological	M	Maintenance and/or Test Assemblies, including tools
		N	Sound in Air	N	Navigation - including Altimeter, Beacon, Compass, Depth Sounder, Landing & Approach, and Racon
P	Portable	P	Radar	P	Reproducing (Obsolete - Use H)
		Q	Underwater Sound and Sonar	Q	Special or Combination of Purposes
		R	Radio	R	Receiving-Passive Detection
S	Water-Surface	S	Special Types, such as Magnetic or Combination of Types	S	Active Detection and/or Range and Bearing
T	Ground-Transportable	T	Telephone (Wire)	T	Transmitting
U	General Utility				
V	Ground-Vehicular	V	Visual and Visible Light		
W	Water-Surface and Underwater Combinations	W	Armament, Not Otherwise Covered	W	Automatic Flight or Remote Control
		X	Facsimile or Television	X	Identification or Recognition
		Y	Data Processing		

As an example, the AN/APS-80A(V) is (first letter A) installed in a piloted aircraft, (second letter P) is a Radar type equipment, (third letter S) is used for search purposes, is Model number 80, is modification A, and consists of a variable grouping. Model numbers and modification letters are used in sequence. The T, V, X, Y, and Z suffixes respectively indicate Training, Variable Grouping, Voltage Change, Phase Change, and Frequency Change in the basic equipment.

The two-letter unit/component identi-

cation is commonly identified to the system/set it is designed for by suffixing a slant bar and the identification of the system or set. As an example, the AM-3474/APS-80A(V) is a synchro signal amplifier designed as part of the APS-80A(V) airborne search radar system.

Identification	Unit or Component	Typical Description
AB	Antenna Support	Antenna mounts, mast base, mast section, tower, etc.
AM	Amplifier	Audio, electronic control, frequency, interphone, power, radio, video, etc.
AS	Simple or Complex Antenna	Array, dipole, loop, mast head, parabolic, reflector, telescopic, etc.
BA	Primary Battery	Non-rechargeable battery, batter pack, etc.
BB	Secondary Battery	Rechargeable battery, storage battery, etc.
BZ	Audible Signal Device	Buzzer, gong, horn, etc.
C	Control	Control box, remote tuning control, etc.



Table II. One- and Two-Letter Unit/Component Classifications

CA	Sonar Commutator Assembly	All types	OX*	Coder, Decoder, Interrogator, or Transponder Group	All types and composites
CB	Capacitor Bank	Power Supply, etc.	OY*	Radar Set Group	Where applicable, use a more definitive indicator such as OE, OR, OT, etc.
CG	RF Cable Assembly	RF cable, waveguide, transmission line, etc., with connectors	OZ*	Radio Set Group	Where applicable, use a more definitive indicator such as OE, OR, OT, etc.
CH	Drawer/Door Chassis	Framework which accepts (but does not include) plug-in modules. Circuitry and/or receptacles may be included. This is not a storage facility or blank chassis.	PD	Prime Driver	Diesel motor, electric motor, gasoline engine, synchro, etc.
CK	Crystal Kit	Kit of crystals with holders	PF	Pole Fitting	Cable hanger, clamp, protector, etc.
CM	Comparator	Compares two or more signals	PG	Pigeon Article (Obsolete)	Container, loft, vest, etc.
CN	Compensator	Electrical and/or mechanical compensation, regulation, or attenuation	PH	Photographic Article (Obsolete)	Camera, projector, sensitometer, etc.
CP	Computer	Electronic and/or mechanical mathematical computing device	PL	Plug-in Module	Where applicable, use a more definitive indicator such as AM, R, T, etc.
CR	Crystal	Crystal, in a crystal holder	PP	Power Supply	Non-rotating type such as vibrator pack rectifier, thermoelectric, etc.
CU	Coupler	Impedance matching device, directional coupler, etc.	PT	Plotting Equipment	Rotating power equipment other than dynamotor or motor generator
CV	Converter	Electronic device which changes phase, amplitude, or frequency; or changes from one medium to another	R	Receiver	All types except telephone
CW	Cover	Bag, cap, cover, nacelle, radome, roll, etc.	RC	Reel	All types (See RL)
CX	Non-RF Cable Assembly	Cable with terminals, test leads, or composite cable with non-RF and RF conductors	RD	Recorder-Reproducer	Disc, facsimile, film, graphic, magnetic, mechanical, sound, tape, wire, etc.
CY	Case or cabinet	Rigid or semi-rigid structure for enclosing or carrying equipment	RE	Relay Assembly	Electrical, electronic, etc.
D	Dispenser	Bomblet, chaff, flare, leaflet, napalm, etc.	RF	Radio Frequency Component	Composite component of an RF circuit. Where applicable, use a more definitive indicator.
DA	Electrical Dummy Load	RF or non-RF test load	RG	RF Bulk Cable	RF cable, transmission line, waveguide, etc., without terminals
DT	Detecting Head	Hydrophone, magnetic pickup, search coil, etc. (see RF)	RL	Reeling Machine	Mechanism for dispensing and rewinding antenna wire, field wire, recording wire, recording tape, etc.
DY	Dynamotor	Power supply	RO	Recorder	Disc, facsimile, film, graphic, magnetic, mechanical, sound, tape, wire, etc.
E	Hoise	Sonar hoist assembly, etc.	RP	Reproducer	Disc, facsimile, film, graphic, magnetic, mechanical, sound, tape, wire, etc.
F	Filter	Bandpass, noise, telephone, wave trap, etc.	RR	Reflector	Confusion, target, etc., but not antenna reflector (See AS)
FN	Furniture	Chair, desk, table, etc.	RT	Receiver-Transmitter	Composite radio/radar receiver and transmitter
FR	Frequency Measuring Device	Frequency meter, tuned cavity, etc.	S	Shelter	House, tent, etc.
G	Power Generator	Electrical power generator without prime mover (see PD and PU)	SA	Switching Device	Impact, manual, motor-driven, pressure, etc.
GO	Goniometer	All types	SB	Switchboard	Fire control, panel, power, telephone, etc.
GP	Ground Rod	Ground rod, stake, etc.	SG	Signal Generator	Noise generator, test oscillator, etc. (See O)
H	Handset, Headset, or Chestset	Includes earphone	SM	Simulator	Aircraft, flight, signal, target, etc.
HC	Crystal Holder	Crystal holder, less the crystal	SN	Synchronizer	Device to coordinate two or more functions
HD	Environmental Apparatus	Cooling, dehumidifying, heating, pressure, vacuum, etc.	ST	Strap	Harness, etc.
ID	Non-CRT Type Indicator	Calibrated dial, calibrated meter, indicating light, etc.	ST	Optical Device	Bore-sighting scope, periscope, projector, telescope, etc.
IL	Insulator	Feedthrough, standoff, strain, etc.	T	Transmitter	All types, except telephonic
IM	Intensity Measuring Device	Field intensity meter, noise meter, slotted line, SWR gear, etc.	TA	Telephone Apparatus	Miscellaneous telephone equipment
IP	CRT-Type Indicator	Azimuth, elevation, panoramic, etc.	TB	Towed Body	Boat, fish, paravane, target, etc.
J	Junction Device	Jack box, junction box, terminal box, etc.	TC	Towed Cable	Articulated towing strut, faired cable, etc.
KY	Keyer	Coder, electrical keyer, electronic keyer, interrupter, mechanical keyer, etc.	TD	Timing Device	Electronic gate, electronic timer, mechanical timer, multiplexer, range device, etc.
LC	Line Construction Tool	Cable plow, etc.	TF	Transformer	Separate identification only when used as a separate item
LS	Loudspeaker	Intercommunication station, enclosed loudspeaker, etc.	TG	Positioning Device	Tilt and/or train assembly
MA	Magazine	Magnetic tape, magnetic wire, etc.	TH	Telegraph Apparatus	Miscellaneous telegraph equipment
MD	Modulator, Demodulator, or Discriminator	Device to vary amplitude, frequency, or phase	TK	Tool Kit	Miscellaneous tool assemblies
ME	Meter	Multimeter, power meter, VOM, VTVM, etc.	TL	Tool	All types, except line construction (LC)
MF	Magnet or Magnetic Field Generator	Electromagnet, magnetic tape or wire or other permanent magnet, etc.	TN	Tuning Unit	Antenna, receiver, transmitter, etc.
M1	Microphone	Hand, radio, telephone, throat, etc.	TR	Transducer	Magnetic head, phono pickup, sonar transducer, vibration pickup, etc. (See H, LS, and M)
MK	Miscellaneous Kit	Maintenance, modification, etc., except crystal (CK) and tool (TK) kits.	TS	Test Set	Test and measurement equipment not otherwise categorized
ML	Meteorological Device	Barometer, hygrometer, scale, thermometer, etc.	TT	Teletype or Facsimile	Miscellaneous facsimile, tape, teletype and similar equipment
MT	Mounting	Frame, mount, rack, stand, etc.	TV	Tube Tester	All types
MU	Memory Unit	Otherwise unclassified equipment.	TW	Tape and Recording Wire	Electrical tape, insulating tape, recording tape, splicing tape, recording wire, etc.
MX	Miscellaneous Equipment	Otherwise unclassified equipment, including subassemblies. Use a definitive indicator instead of MX, if possible.	U	Audio or Power Connector	Adapter, plug, receptacle, socket, tee, union, etc.
O	Oscillator	Blocking, master, multivibrator, etc. (See SG for test oscillator)	UG	RF Connector	Adapter, choke coupling, elbow, flange, plug, socket, tee, union, etc.
OA*	Miscellaneous Group	Otherwise unclassified group. Use a definitive indicator instead of OA, if possible.	V	Vehicle	Cart, dolly, trailer, truck, etc.
OB*	Multiplexer and/or Demultiplexer Group	All types and composites	VS	Visual Signalling Equipment	Flag set, serial panel, signal lamp, etc.
OC	Oceanographic Device	Bathythermograph, etc.	WD	Two-Conductor Cable	Non-RF, cable and cordage in bulk (See RG)
OD*	Indicator Group	All types	WF	Four-Conductor Cable	Non-RF, cable and cordage in bulk (See RG)
OE*	Antenna Group	All types	WM	Multiple-Conductor Cable	Non-RF, cable and cordage in bulk (See RG)
OF*	Adapter Group	All types	WS	Single-Conductor Cable	Non-RF, cable and cordage in bulk (See RG)
OG*	Amplifier Group	All types	WT	Three-Conductor Cable	Non-RF, cable and cordage in bulk (See RG)
OQ*	Simulator Group	All types	ZM	Impedance Measurement Device	Measures C, L, Q, R, power factor, etc.
OJ*	Console or Console Group	All types			
OK*	Control Group	All types			
OL*	Data Analysis or Data Processing Group	All types and components			
OM*	Modulator and/or Interconnecting Group	All types			
ON*	Power Supply Group	All types			
OP*	Test Set Group	All types			
OQ*	Receiver Group	All types			
OS	Oscilloscope	Scopes for general test use			
OT*	Transmitter Group	All types			
OU*	Converter Group	All types			
OY*	Generator Group	All types except power-generation			
OW*	Terminal Group	Radio, telegraph, telephone, etc.			

\*Represents a collection of items which are part of (or used with) a system/set or a series of system/sets.

The two-letter unit/component identification is commonly identified to the system/set it is designed for by suffixing a slant bar and the identification of the system or set. As an example, the AM-3474/APS-80A(V) is a synchro signal amplifier designed as part of the APS-80A(V) airborne search radar system.

# The Horizontal

## Output Linear

Warren L. MacDowell W2A00  
11080 Transit Road  
East Amherst NY

Many amateurs who are not fortunate enough to be wealthy will find this article of interest. Many of us desire higher power so as to cut through the QRM present on 20 meters but do not have the spare cash to purchase exotic tubes such as the 4-1000, 4-400, etc.

It has long been known that it is possible to parallel various tubes such as the 807 or 1625 and create an operable linear. This linear is merely a modern version of this paralleling circuit which works well and is simple and inexpensive to construct. In addition to this, the unit exhibits no instability.

With a well stocked junkbox, the average amateur should be able to construct this amplifier for under \$20.

I concentrated the design of the linear shown in Fig. 1 about the 6JE6 tube, which is commonly used as the horizontal output tube of many of the present color television receivers on the market. The specifications of the 6JE6 from tube manuals do not show it as a powerhouse. When looking at the size of the plate on the 6JE6, it becomes apparent that it must be capable of a good amount of dissipation. Also, as a pentode, it would have the necessary isolation between cathode and plate that is required for unneutralized operation. We are grounding all the grids, so essentially the tubes are working as triodes for this application.

Six of the 6JE6s are paralleled in the final. All of the grids are grounded directly to the shell of the 9-pin socket. It is

essential that these grids are grounded as close as possible to the shell or instability will result. Simply bend down the socket pins and solder them directly to the shell.

I attempted to operate the cathodes at ground potential; however, the resting current of the linear was in the neighborhood of 225 mA — which, of course, is excessive. The choke that isolated the cathodes from rf ground is wound on a half-inch piece of ceramic stock 4 in. long. Fill the entire length of this with 26 AWG enamel wire. It was necessary to bias the cathodes of these tubes to lower the resting current to 80 mA. This was done with the use of two 75Ω, 160W wirewound resistors in series with the cathode choke to ground.

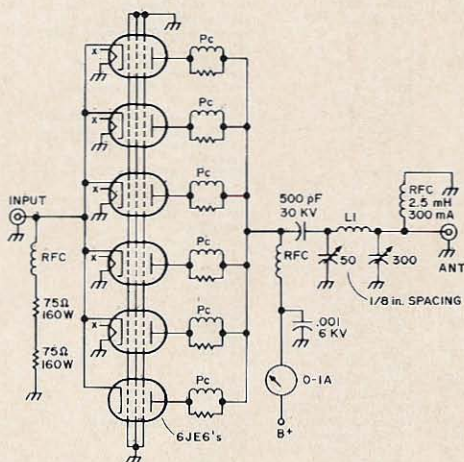

Fig. 1. Schematic diagram of the "horizontal-output" linear amplifier.

(These large resistors are only \$2.50 each.)

At this point, you may think that it would be easier to bias the grids. I tried this but instability resulted. Also, it is easier to solder in two large resistors than build an entire bias supply. In operation, these two resistors run very cold even at 500 mA instantaneous current.

It was necessary to use parasitic chokes in the plate lead of each of the tubes. These are constructed from 5 turns of 14 AWG copper wire ( $\frac{1}{2}$  in. diameter coil) around a  $92\Omega$ , 1W resistor. With these chokes in the circuit, there is no trace of parasitics.

The plate rf choke is also homebrew. In fact, it is identical to the cathode rf choke. This is mounted at a central point in the group of tubes and is bypassed to the chassis with a  $0.001 \mu\text{F}$ , 6 kV disk ceramic capacitor. The dc blocking capacitor (rf coupling) is merely a TV "doorknob" capacitor rated at 500 pF, 30 kV.

The final tank coil is constructed from 5 turns of  $\frac{1}{4}$  in. copper tubing,  $2\frac{1}{2}$  in. in diameter. This is resonated in a pi-network configuration with a 50 pF variable for resonance and a 300 pF broadcast variable for antenna loading. Make sure that the 2.5 mH choke going from the output lead to ground is in the circuit or a brilliant display of fireworks will occur in the test stages of this rig.

The power supply (Fig. 2) uses a 1 kV secondary, 500 mA power transformer. You probably could use two identical TV power transformers phased in parallel to achieve the necessary current capability. We were fortunate enough to have this transformer lying about from a military regulated supply. With 1 kV going into the diode rectifier bridge, the output voltage will fall at approximately 1.3 kV with 80 mA of resting current and will drop to 1 kV when the linear is drawing 500 mA. Of course this represents 500W dc input, or 1 kW sideband power.

The bridge consists of bargain silicon diodes which are rated at 600 PIV, 500 mA each. In each leg of the bridge, four of these diodes are in series and equalized, which gives each leg a 2.4 kV rating. Each diode is voltage equalized and protected from surge and transient spikes by paralleling  $470 \text{ k}\Omega$ , 1 watt resistors and  $.001 \mu\text{F}$ , 600V disk ceramic capacitors about the diode. The high voltage is activated by grounding the negative side of the bridge with a toggle switch. Filtering is achieved through two  $8 \mu\text{F}$ , 1.5 kV oil-filled capacitors and an 8H, 500 mA filter choke.

It may sound surprising but each of the 6JE6s draws 2.5A of filament current at 6.3V ac. When you consider that there are 6 of these, it takes 15A at 6.3V to keep these bottles heated. Make sure that the filament transformer is adequate to handle this current.

When tuning up the linear, apply drive to the input and resonate it as with any final. There should be no current drawn above 80 mA with no drive applied. Do not hold the linear at 500 mA for any length of time as it will overheat the finals. The linear is designed for CW or sideband operation where the average will be much lower than 500W dc. Of course the rf peak will be 1 kW in this mode.

I have been driving this linear with a DX-35 in CW mode and have had fine reports with a clean signal. This indicates that 50W drive will excite the linear nicely.

The simplicity and performance of the linear will make it well worth the time and effort of construction.

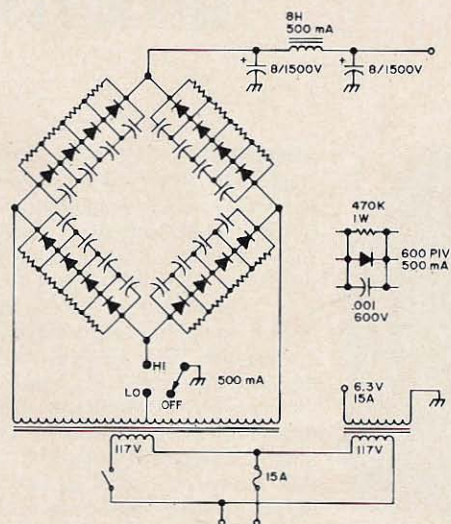
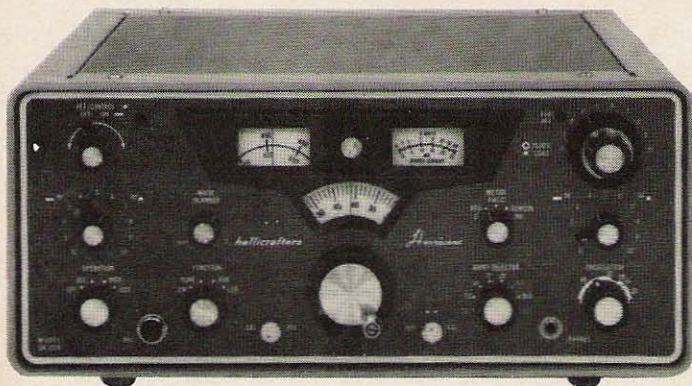

Fig. 2. Linear power supply.

... W2A00 ■

# watts up?

SR-2000 that's what. **the Hallicrafters SR-2000 transceiver is packed with watts. 2000 watts. that's WATTS** of power. you can buy it today.



**FEATURES:** < 1 KC readout • exclusive RIT (Receiver Incremental Tuning) • AALC Amplified Automatic Level Control • built-in Noise Blanker • 100 kHz crystal calibrator, VOX, PTT, Break-in CW • < 1 uv sensitivity for 20 db S: N/N • compact rugged cabinet • 2000 watts SSB, 1000 watts CW in a package only 7¾ x 16½ x 15 inches • P-2000 AC power supply including built-in speaker, final amplifier plate metering, 110/220 VAC • See WATTS UP at your local Hallicrafters distributor today.

*the hallicrafters co.*

A Subsidiary of Northrop Corporation



600 HICKS ROAD  
ROLLING MEADOWS, ILLINOIS 60088

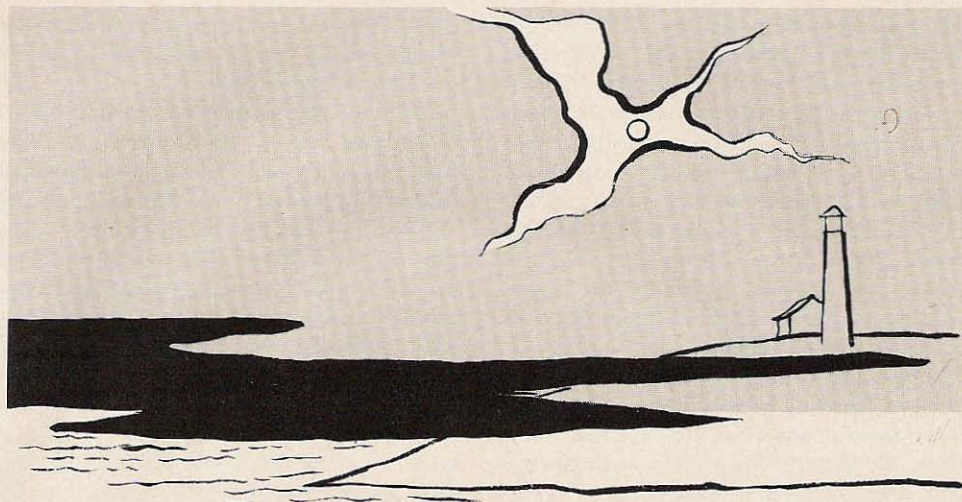

## DX AMERICA FIRST

Rev. Robert O. Gardiner W6LZJ  
595 E. Pacific Coast Highway  
Long Beach CA 90806

One of the real thrills offered to the licensed amateur radio operator is the opportunity to work DX. That thrill is trebled when the DXing is done from some exotic out-of-the-way place. Unfortunately, most of us have neither the time nor the money to travel extensively . . . crossing oceans to far-flung islands or dense jungles. We may never visit the other continents nor hope to ham from the moon. However, there is nothing to prevent any ham from sharing in the thrill of a DXpedition within reach of simple transportation, in short vacation periods, and best of all, within the range of the billfold.

The wife permitting, the rig usually accompanies the family on every summer vacation. Installing the antenna and rig is as important as setting up the tent and preparing the first meal. The working of DX is fairly simple if the equipment includes the low frequencies. If you have never taken 6 and 2 meter equipment as your only station on a DXpedition you have missed one of the most exciting and interesting pleasures in all of ham radio.

Because of the short distances normally

covered by VHF rigs, a good antenna is recommended. On the other hand, the smaller dimensions make this an easier antenna to pack along with all the other gear. Having decided what is to go, it is well to talk over with the rest of the family where the vacation is to be spent. If you are fortunate enough to live near a large lake or on either coast, an island makes an ideal hideout for the family and for hamming.

Recently, we made such a decision; and since we lived in New England, we decided to visit the island of Matinicus, 25 miles off the coast of Rockland (Maine). The old Merc was laden with clothes, the Clegg Zeus, Interceptor, a borrowed 40 ft mast, miles of stranded aluminum guy wire and coax, a CDR rotor, all the tools I could pack, and a 1.25 kW alternator manufactured under the name of Zeus. We had written ahead to the skipper of the *Mary A* making reservations for the 7:45 a.m. departure on August 1.

On the ferry next morning, I heaved a real sigh of pleasure when I noted all our things safely loaded on deck. Paint cans, a

live chicken or two, and tons of fresh foods were stacked between piles of building materials, plumbing supplies, and the raw materials for lobster traps and floats. When the morning sun came out through the fog, an island appeared on our starboard. Up to then we had been aware of an occasional bit of something floating in the grayish water, but with the clearing fog, we could make out literally hundreds of multi-colored lobster floats bobbing in the cold blue water of the Atlantic.

What before we had only heard as a chug, chug, chug now turned out to be the lobstermen's boats as they visited their traps. We were to learn more of these men and their adventures later in our stay on the island. I was told that each lobsterman makes and paints his own floats and unerringly travels to each one marking a lobster trap baited and lying on the sea bottom. For the life of me, I could never tell how he knew where each was placed as he looked for the trap in the fog. I was told they never lose one except to a storm.

By this time we had become accustomed to the fascinating accent of the other passengers. They were mostly natives of Maine who lived on Matinicus or who were visiting their families and friends on the island. Our skipper was apparently too busy avoiding the rocks which began to appear more numerous as we neared our destination. The island is approximately three miles long and about a mile across. The skipper brought us deftly through the maze of other boats in the harbor, and at last — three hours from the time of our departure — we arrived at the dock. I immediately learned that if I was to have assistance in getting my freight off the ferry, I would have to pitch in and help unload the boat. After the restful trip and the invigorating air clear of all man-made impurities, I was ready to work and joined in the line relaying the cargo from hand to hand until all was now dockside.

Our letter affirming our desire to rent a small cottage, the only one then being offered to let, had brought an accommodating fellow, Mr. Bunker, down to the dock with a pickup truck. He helped me load our gear, and with the family riding in

front with him, I hopped into the back and bumped along over the dirt roads taking in the view of land and sea.

One of the things we learned about vacationing on a small island in New England is the importance of buying all necessary provisions for the larder at the local store. We had heard of those who came up from New Jersey and Long Island in the summer time bringing cases and boxes of canned goods with them. This not only alienated the local people whose economy depends on the local store, but was also costly as by the time the food was carried on the ferry the price of it was higher than at the local store. Also, the local people were unhappy to the point of refusing transportation to the outlying camp. All our goods were hauled free by our landlord, Mr. Bunker, and he took us back to town so that we could do our grocery shopping, and later delivered it for us.

We were now safely established in our vacation cottage on the shore of a small cove with a northeast exposure allowing us to see nearby Birdrock better known as Gull Rock, Cannonball Island, and Ragged Island. We had a late lunch, had the freezer section of the refrigerator (which ran on bottled gas) well stocked, the ham gear set up in one corner of the front room near the fireplace, when Mr. Bunker drove up with a five-gallon can of gasoline and two quarts of motor oil for the alternator. We were all set to begin our DXpedition except for installing the antennas.

News travels fast in New England, and it travels even faster on Matinicus. I was wondering how one man, one woman, and a lad of fourteen would get the 40 ft telescoping mast erected, guyed, and sporting two beams without accident. Ed, the junior op, mentioned that there was a man coming along the shore and into our cove. In that delightfully informal way that the people of Maine have, he introduced himself and then said, "I hear you have some radio equipment with you."

Not being short of words myself, I quickly introduced him to the family and then the ham gear. He was Charlie Pratt, the local telephone man on Matinicus. He



# NOW...you can have the complete line of Swan amateur equipment at **FACTORY DIRECT PRICES**

Our value engineering and advanced methods of production are not restricted to our manufacturing efforts alone. One of the bases for our success has been our ability to market products equal or superior to other makes, at a lesser cost to the amateur.

The introduction of foreign made products, sold on a direct basis, has offered an interesting new challenge to our marketing department, and we believe they have developed the ideal solution.

## Introducing Swan's new **SALES PROGRAM**

You can now buy any Swan equipment

direct from our factory at substantially reduced prices. If you wish to trade, or desire individual financing, purchase your Swan equipment from one of our authorized Swan dealers, at a price slightly higher than the factory price. Either way, you are now able to have proven, American made amateur radio equipment, at prices competitive with any foreign made products.

Write for our 1971 Swan catalog. It contains photos, descriptions, specifications, and the new Factory Direct Prices for every piece of equipment we make. (Did you know Swan manufactures over 50 different pieces of amateur radio equipment?)



# **SWAN** ELECTRONICS

A Subsidiary of Cubic Corporation

**SWAN Factory**  
305 Airport Road  
Oceanside, CA. 92054  
Phone: (714) 757-7525

**Eastern Office**  
P. O. Box 151  
Freehold, N.J. 07728  
Phone: (201) 431-0707

**SWAN Electronics, 305 Airport Road,  
Oceanside, CA. 92054 Phone: (714) 757-7525**

**Gentlemen:**

**Please send me the 1971 Swan catalog.**

Name \_\_\_\_\_  
Street \_\_\_\_\_  
City \_\_\_\_\_  
State \_\_\_\_\_ Zip \_\_\_\_\_  
Call \_\_\_\_\_

# Versatility plus!... in a 2 Meter FM Transceiver

... IN THE FIELD  
IN THE CAR  
IN THE HOME ...

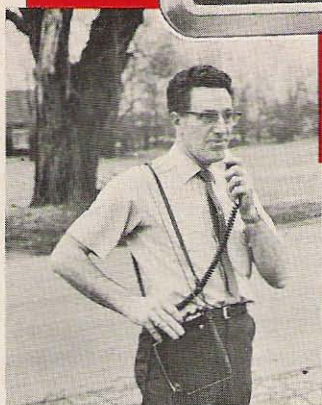

## DRAKE MODEL TR-22

**\$199<sup>95</sup>** Amateur Net\*

The TR-22 is a 2-meter VHF-FM completely transistorized, compact, portable transceiver with capacity for six channels. It can be used over the shoulder, mobile, or in your home. Has a built-in telescoping antenna, and SO-239 connector provided for external antenna. May be used barefoot or with accessory two-way amplifier. Operates on external 12 VDC or on internal rechargeable nickel-cadmium batteries. Has built-in 120 VAC 50-60 Hz battery charger.

### SPECIFICATIONS

**GENERAL** • Frequency Coverage: 144-148 MHz • 6 channels, 3 supplied: (1) Rcv: 146.94 MHz, Xmit: 146.34 MHz; (2) Simplex: 146.94 MHz; (3) Rcv: 146.76 MHz, Xmit: 146.34 MHz • Frequency modulation • Push-to-talk Xmit Control • DC Power Drain: Rcv: 45 mA, Xmit: 450 mA • Power Source: 12 VDC  $\pm$  20%; 120 VAC 50-60 Hz (for recharging nickel cadmium batteries only.) • Size: 5 $\frac{3}{8}$ " x 2 $\frac{5}{16}$ " x 7 $\frac{1}{8}$ ", Wt: 3 $\frac{3}{4}$  lbs.

**RECEIVER** • Completely transistorized crystal controlled double conversion superheterodyne circuit. • 1st IF 10.7 MHz • 2nd IF 455 KHz • Antenna Input Impedance: 50 ohms • Sensitivity: 1 microvolt or less for 20 dB S+N/N ratio • Audio Output: 0.7 watt at 10% or less distortion • Built-in speaker.

**TRANSMITTER** • RF Output Power over 1 watt • Frequency Deviation adjustable to 15 kHz maximum; factory set to 5 kHz.

\*PRICE OF TR-22 INCLUDES: Dynamic Microphone, Over-the-Shoulder Carrying Case, 120 VAC and 12 VDC Power Cords, Speaker/Headphone Plug, and 10 Nickel-Cadmium Batteries.

AT YOUR DEALER'S!

**R. L. DRAKE COMPANY**



Model AA-22 Accessory Amplifier \$149.95. Improves receiver sensitivity and rejection of undesired signals. Provides at least 25 watts output with  $\frac{1}{2}$  to 3 watts drive. Fully automatic.

Model MNK-22 Mobile Mount for TR-22 \$6.95



540 Richard Street  
Miamisburg, Ohio 45342



had singlehandedly installed telephone wires throughout the island to all the residents who for a small sum per month could keep in touch. In the meantime, the telephone company on the mainland had installed a microwave telephone station on the island and employed Charlie to take care of the power generators and make periodic checks by radio with the home office. He also was the designated Civil Defense contact for the island and the CD net on the mainland. His interest in ham radio had led him to visit us and glad I was to see him. He said he would help me get the antenna up; and with Bette, Ed, and me on the three guy wires, Charlie did what I have never since seen done. He stood on the next to the top rung of a small ladder which in turn was leaning untied against the mast. We had guessed the approximate lengths of the remaining guy wires which were fastened at the top of each 10 ft section except the last one. The 2 meter beam was at the top and spaced below was the 6 meter "hilltopper."

Charlie, although short of stature, is sturdy and his years of pulling up his lobster lines have developed muscles I don't even have. He would give a tug on a 10 ft section of mast, hauling along the antenna; guy wire, and coax. And up it went!

It still is hard to believe as I think back on it, but there it stood, and well guyed too, as it turned out. We had one whale of a summer thunderstorm with wind and lightning during our stay one memorable afternoon.

Our first contacts were strictly local Maine coastal stations, and evoked some comment since Matinicus had neither electric power nor licensed amateurs. Every expedition is subject to minor irritations and difficulties, and ours was no exception. About the second day on the air the Clegg Zeus went dead without a sputter. Charlie again proved himself a ham's best friend. When he came over after his day out in the lobster dory, he learned of my problem and asked if I could use a VOM. I traced my difficulty to one of two ballast tubes in the modulator power supply. Since the

ferry makes its trip to the island on Tuesday, Thursday, and Saturday, sending and receiving an order by mail would mean at least a week off the air.

The island's 6 meter rig was connected to our antenna, the beam pointed southeast, and attempts were made to make a contact with one of my buddies, K1WPS, Murray of Marblehead, Massachusetts, who knew I was on the island and would be looking for my signals. As it turned out, I heard two of my friends in New Hampshire. It was difficult to break them as they lived on opposite hills from one another and I was not giving them more than a few watts of antenna power. Before they did sign off, I managed to get through with my order for replacement tubes and asked them to pass the traffic on to Murray.

The very next ferry had a package addressed to me with the necessary ballast tubes. Needless to say, we had no more technical difficulties for the rest of our stay. I was able to get into Massachusetts regularly several times a day and with no trouble each evening except one. I learned that every ham with any kind of gear on 6 meters was trying to raise K1OXX/1 on Matinicus Island. The QSLs began to come in from Long Island, New York, Connecticut, Rhode Island, Maine, New Hampshire, Vermont, and with some partial openings customary in August I worked North and South Carolina and several other southern states.

The real thrill of the DXpedition came one night as I was in QSO with a fine YL camping with her father in southern Maine when I heard a breaker calling me from W2-land. I had several contacts with other 2s and 3s on what appeared to be a very effective aurora. Suddenly, they were gone and I was in contact with the midwest. In short order I was working stations at the rate of four or five every two or three minutes. Each time that I signed over it was like turning on the switches on ham rigs all over the country. In a matter of moments every ham who could copy my signals was calling: "Hi Bob, do you copy WAØXXX?"

I had to do what you have heard Wayne

# WHEN IT COMES TO ANTENNA SYSTEMS... IS YOURS

a space problem? a budget problem? an applications problem? an installation problem?  
or simply a problem of where to buy?

Your one-stop solution is ANTENNAS, INC.

Exclusively specialists in radiating systems, complete systems or any component part.

Arrays—complete or in kit form, quads, yagis, dipole assemblies, verticals—fixed or mobile, towers, masts, rotors, guy and control cable, transmission line, coax relays and switches, connectors and adaptors, test gear, technical publications, corrosion resistant hardware, corrosion proofing chemicals, insulators, installation and wiring hardware, aluminum tubing and plate, wire, and much, much more.

If your requirements are for a complete system, major components, or the smallest yet important piece of hardware—

*Our prices and deliveries are hard to beat . . . anywhere.*

## ANTENNAS, INC.

Dept. B, 512 McDonald Road  
Leavenworth, Kansas 66048.

ANTENNAS, INC. can be your one-stop,  
single-source. Write today for our catalog  
\$2.00, refundable, first order.

Green and all those other fellows do who go on rare DXpeditions. I began looking up and down the band 20–30 kHz to find one voice among the many that could be copied. You will readily imagine my surprise the following morning when I learned that Massachusetts had had no opening on six meters that eventful night. It was the only night I didn't keep schedules with my friends in Massachusetts.

I hesitate to close this account without telling you that we witnessed the fiery results of what appeared to be a feud on the neighboring Ragged Island. It seems that whenever there are *claim jumpers* or perhaps more appropriately trap robbers, all *hades* breaks loose on their Maine Islands. Whole families have been known to disappear and never be heard of again on their home island. It was one of those beautiful clear days with a soft breeze blowing across our cove. I could hear the ignitions of the engines on the lobster boats buzzing in my speaker sometime before they crossed into sight of the cottage. I looked out the window to see if the lobsterman was going to enter our cove and spotted instead a wisp of smoke where I thought there shouldn't be any. I rushed out to the bank which protected us from the storm's high waves during inclement weather, and caught a good view of what by now was obviously a great fire burning on Ragged Island. What I had thought was a boat's ignition proved to be the Coast Guard plane flying back and forth observing the blaze at Creehaven.

Later that day we learned at the general store that one of the residents of the neighboring island had somehow made

enemies who took advantage of his absence from the island to burn his house down. So you see fellows, and gentle readers, all is not always sweetness and light, calm and peace, even twenty-five miles out in the Atlantic. Should you care to walk the trails among the blue spruce, pick wild blueberries, and strawberries, and apples, and feast on Aunt Lizzy's homegrown vegetables, I think that I should warn you. Today you don't need to take your own generator for there's power on the island now. Right, you guessed it; Charlie Pratt, the telephone magnate and lobsterman supreme, the CD chief, and antenna installer, is the new utility expert. He has installed power lines to each home and no longer do the residents have to run gasoline powered washing machines nor generate power for their color TV. I had the honor of being the first ham ever to have his signals read on a color TV on Matinicus Island. Fortunately, the owner of the TV was more intrigued by the situation than the ones I have met with at home. (Besides, if I remember correctly, he was Charlie's uncle — and Charlie could square anything.)

We had planned to return to our cove the next year, but our inquiries about the cost of such a cottage led to an unanticipated early purchase by the judge who had been renting it in all the previous years. We can't go back to that cottage, but I know we shall never forget how we spent an August "down Maine" and met one wonderful lobsterman trying out our own version of *DX America first*.

... W6LZJ■

R. L. Morgenstern WA2EAW  
141-60 73 Avenue  
Flushing NY 11367

# PHONE PATCH NO COST NO WIRES

**I**n the past I have read many articles about phone patching. All of these had some form of actual wire attached to the telephone company lines. Similar attachments are needed for the commercial patch, either in kit form<sup>1</sup> or purchased as a complete and finished piece of gear<sup>2</sup>. Another point which was hammered at, was the impedance matching to the telephone lines, which seemed to scare me away more than anything else. Then there was the fact of a \$20 to \$30 outlay for the patch (I always found something better to do with the \$20 or \$30).

In my travels along the shelves of used-book stores, I came across an article<sup>3</sup> which seemed, with a little revision, to be just what I wanted in the way of a patch without any of the bugaboos I had read about in the past. The cost turned out to be not a single red cent and nothing was wired into the precious lines of the telephone company. I will attempt to go

through my construction of the patch as I revised it and present the problems that showed up and what I did to clear them up.

The construction is simple, straightforward and noncritical. The heart of the patch as I constructed it was a used automobile ignition coil. New, an ignition coil can cost about \$9 or more. This cost can be avoided by asking a local service station operator for a used, discarded ignition coil. Maybe I was fortunate in the first coil I tried. A few may have to be checked out. The coil that was given to me was grease covered. I wiped it clean and used steel wool to clean the 3 terminals. One binding post terminal is primary positive, one is common negative, and the third is the "tower" secondary positive. The continuity of the primary and secondary coils are tested with an ohmmeter to see if it is shorted beyond use. The primary

positive to common negative was about  $1.5\Omega$ . The tower secondary to common negative was about  $10\text{ k}\Omega$ . The remaining needed parts for the patch came from the overflowing junkbox. These were:

1. About 40–50 ft of thin enameled wire. I used 24-gage because I had a spool of it, but any small-size wire can be used if it is insulated and not so fragile that it breaks with a small amount of abuse.
2. Two-conductor shielded wire about 18 in. long.
3. Two alligator clips.
4. A two-conductor coiled cable, the kind that contracts when not in use and can be pulled out to a length of 3–4 ft on extension. I took this from an old telephone. This was used only as a matter of neatness. The patch will work just the same without it.
5. Assorted nuts, bolts, washers, tape, etc.

### Construction

Clean up the ignition coil, check it out, and set it aside. Using the 40–50 ft of enameled wire, I left a lead of about 2 ft and started to wind the remainder of the wire around the earpiece of the telephone. I found that if I confined my turns to the screw-on cover of the earpiece and not let my turns work their way on to the handpiece, it was much easier to remove and tape the turns together. I made about 60 turns of wire around the earpiece rim and left about a 2 ft lead when I finished.

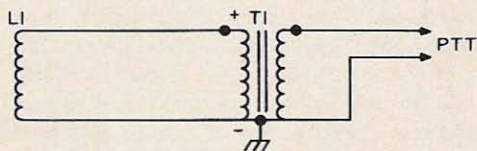

Fig. 1. Schematic representation of induction patch.

I had pre-cut four pieces of tape about 1 in. long and as I lifted part of the formed loop from the earpiece I bound that portion of turns together with the tape. This was repeated at four spaced intervals; as the wire loop was completely removed from the telephone it retained its shape. I

was now able to replace this loop back on the earpiece with slight pressure.

The phone patch works even with this induction loop held about  $\frac{1}{2}$  in. away from the earpiece. So do not worry if the loop will not go back onto the earpiece and fit as it did before removing it.

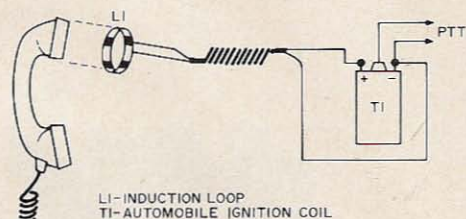

Fig. 2. Pictorial schematic shows patch connections.

If the coiled cable is used, the following steps should be taken. The coiled cable I used had four conductors: two white, one pink, and one black. This was great because I only needed two of these and this meant I had a built-in color code. I removed the insulation from both ends of the pink and black wires. The ends of both white wires were cut short to be out of the way. After removing the insulation from the wires I discovered that these wires are special in that they are multistranded and that every two strands were braided with a thread. This thread was unraveled by rolling the two wires between the fingers. The freed thread is cut away.

After all the ends were ready for soldering I found out I could not solder these wires. In order to secure the induction loop to the coiled cable I first cut the lead lengths on the induction loop down to about 4 in. and steel-wooled the enamel of the last 2 in. A homebrew binding post was made to secure the induction loop leads to the coiled cable leads. Two such binders were needed. These consisted of a small bolt, long enough to accommodate two washers, the two leads to be united, and a nut.

One washer was slipped on the bolt up to the head of the bolt, the two wires were wound on the shaft of the bolt up close to the washer, one lead from the induction loop and one lead from the coiled cable. (It

does not matter which lead goes to which wire of the loop.) The second washer is slipped on and the nut follows this and is tightened to clamp the two wires between the washers. The remaining lead from the induction loop and the remaining wire from the coiled cable were united in the same way.

We now have, if you used the coiled cable, one induction loop attached to the end of a coiled cable. If the coiled cable was not used, you have an induction loop with 2 ft leads, cleaned of insulation for about 2 in. at the ends.

The free ends of the coiled cable or the ends of the induction loop leads are now attached to the ignition coil binding posts. It does not matter which lead goes to which of the following binding posts. One lead to the primary positive and one lead to the common negative. The primary positive post can have its nut tightened at this time, but leave the nut on the common negative loose. Prepare a 2 in. length of insulated wire with an alligator clip on one end and no insulation on the other for about ½ in. This bare end is placed around the binding post of the common negative and the nut is tightened.

Remove the tower terminal and clean it with the steel wool. Prepare another insulated wire as just done. I soldered this wire to the inner portion of the tower conductor and I replaced the conductor inside the tower. These last two leads that are from the tower terminal and the common negative I elected to connect to my mike PTT switch because this saved me the trouble of going into the rig and it also provided me with an extra control switch in addition to the PTT switch on the rig.

The preparation of the mike to the ignition coil is the final step in completing the patch. On the breadboard circuit I used two separate wires for this step without any problem.

The PTT switch on my mike is on the upright hand grip. The hand grip is hollow, so this is ideal. I unscrewed the PTT switch and pulled it away from the hand grip to expose the switch tie points. At this time both ends of the shielded cable were

prepared. One end of the shielded cable was slipped up the hollow center of the hand grip from the bottom of the open base and fished out the hole of the PTT switch. My PTT switch has two tie points, and one of the leads was soldered to each tie point. It makes no difference which wire goes to which tie point. I did not solder the braid of the shielded cable to anything. It was cut back close to the insulation to get it out of the way, because I found that if I touched it when the rig was on VOX my rig went into the transmit mode. The PTT was replaced after making sure that there were no shorts and solder bridges.

The remaining end of the shielded cable coming out of the bottom of the mike has the end prepared as follows; about 3 in. of outer insulation and the shielding braid were removed. The remaining insulated wires were cleared of insulation for about ½ in. These ends were each given a coating of solder to keep the strands from wandering and to give it some strength. Some 1/8 in. spaghetti from the junkbox was cut to give me two pieces each about 2½ in. long. These were slipped over the soldered tips of the shielded cable conductors and pushed back far enough so that the bare wire was exposed. Do not connect the leads from the shielded cable to the ignition coil at this time.

I turned on the rig and while it was warming up I placed the induction loop over the earpiece of my telephone. This was a real live telephone. I replaced the telephone handpiece to its cradle to kill the dial tone. I tuned to an unoccupied frequency and tuned up the rig. I placed the PTT switch on the rig in the OFF position and the PTT switch on the mike in the ON position. I then attached the two alligator clips from the ignition coil to the leads from the shielded cable just installed in the mike.

I advanced my mike/CW level just a bit more than I usually have it during normal voice operation. I now placed the rig PTT switch in the active position which is VOX on my HW-100, and I heard a hum in the speaker which was never there before. I will get back to the hum later. I lifted the

**MORE RANGE . . .  
with NO NOISE**

**FOR ALL  
MOBILE UNITS**

**ENGINEERING  
ESTES  
COMPANY**

**ELECTRO-SHIELD**

**CUSTOM SYSTEMS  
KITS • ACCESSORIES**

**ELIMINATE IGNITION NOISE  
ELECTRO-SHIELD®  
YOUR ENGINE**

**FROM \$44.95**

**ESTES ENGINEERING CO.**

**543 W. 184th St., Gardena, Calif. 90247**

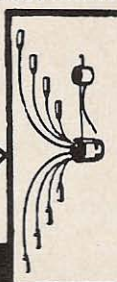

handpiece of the telephone from the cradle and the dial tone activated the rig into the transmit mode. I replaced the telephone handpiece and the rig went into the receive mode.

If the dial tone does not activate the rig to transmit, raise the mike/CW level. If this does not make the dial tone activate the rig then replace the handpiece and reverse the alligator clips to the shielded cable. Lift the handpiece again and the rig should go into transmit when the dial tone starts. Make a note of which lead goes to which clip.

The patch is now ready to transmit through your rig from the telephone. In fact, that is all this patch does: It lets the telephone earpiece activate the rig and whatever is coming into the earpiece is transmitted. So how is the signal received by the rig sent over the telephone? This I have done by the very simple method of plugging in my earphones and placing the earphone over the mouthpiece of the telephone. It may not be the latest in circuitry but it works.

You can also place the mouthpiece of the telephone near the speaker, but since

all transmissions from my station are my responsibility I monitor all patches. This was simplified by fashioning a retaining ring that slips over the mouthpiece of the telephone and holds the earphone in place. In this way, I can hold the telephone as in normal use or I can rest it on my shoulder, leaving both hands free. If your hearing is better than mine, you can leave the whole thing on the operating table in front of you.

As this phone patch now stands it must be worked on a PTT basis. The mike is active on my circuit and I can break in by use of the mike or the telephone mouthpiece.

Now about that hum I heard: I found that it was dependent on where the ignition coil was placed on the operating table, so I kept moving the coil around until I found a spot where the hum went away and this is where I place the ignition coil whenever a patch is to be made. When not in use, the induction loop is removed from the telephone and hung over the tower terminal. That takes care of all the attachments to the telephone. The alligator clips are removed and clipped together and the patch is put away.

Now for the two leads coming from the bottom of my mike stand: The spaghetti pulled over the exposed ends of the two wires and the wires are bent back on themselves and tucked up the hollow mike stand.

### Summary

My ignition-coil phone patch is shown in Fig. 1, and the deployment is pictured in Fig. 2. There are no interconnecting wires to the telephone lines. Since the audio introduced into the telephone lines is nothing more than audio there is no worry about adding any voltages to the telephone lines. I wonder what would happen if I cascaded a few ignition coils?

... WA2EAW ■

1. Heath kit.
2. Johnson phone patch.
3. QST, July 1969 "Ductopatch."

# STEP UP TO TELREX

## Professionally Engineered Antenna Systems

### Single transmission line "TRI-BAND® ARRAY"

By the only test that means anything . . . on the air comparison . . . this array continues to outperform all competition . . . and has for two decades. Here's why . . . Telrex uses a unique trap design employing 20 HiQ 7500V ceramic condensers per antenna. Telrex uses 3 optimum-spaced, optimum-tuned reflectors to provide maximum gain and true F/B Tri-band performance.

#### ONLY TELREX GIVES YOU ALL THESE FEATURES . . .

- Power rating 4 KW PEP . . . rain or shine
- Wind rating survival 110 MPH
- Patented broad-band coaxial Balun
- Heavy-duty steel gusset mounting plate
- Aluminum boom 2 in., 2½ in. O.D. x 18 ft.
- Large diameter, .058 wall taper-sawed dural elements for minimum

weight and exceptional strength to weight ratio

- Stainless steel electrical hardware

With a Telrex Tri-band Array you get 49 lbs. of educated aluminum engineered and built to provide many, many years of performance unmatched around the world by any other make. Longest element 36 ft. Turning radius 20 ft. Shipping weight 65 lbs. Shipping container 13 in. x 5 in. x 13 ft.

Note: If not available from your dealer, order direct. You'll get fast, personal service.

Telrex Labs are design engineers, innovators and manufacturers of the world's finest ¾ to 160 meter communication systems and accessories priced from \$25 to \$25,000.

For technical data and prices on complete Telrex line, write for Catalog PL 71.

TB5EM \$395

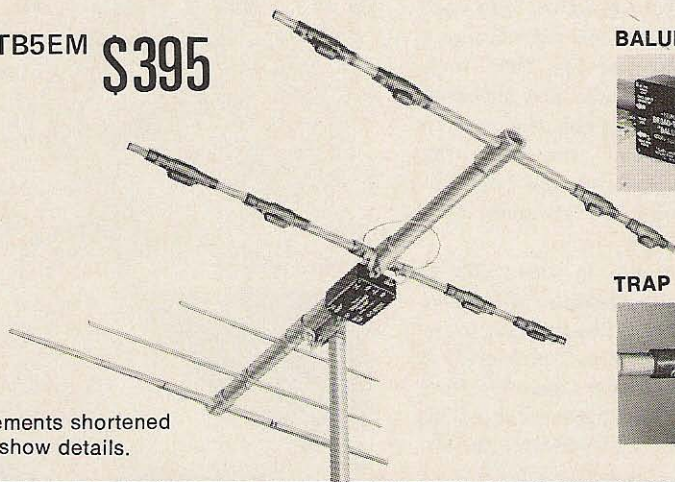

Elements shortened to show details.

BALUN



TRAP

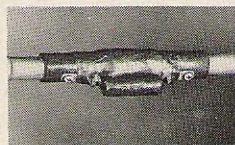

#### Some thoughts from Mike Ercolino, P.E. — W2BDS, Telrex Chief Engineer . . .

"I've been in the game over 50 years (pounded brass for 25) and found out a long time ago that antennas were the weak link. We changed all that."

"Good antennas such as those we build can be ruined in two minutes by a tinker. So put 'em up and leave 'em up the way we make 'em."

"Our 'Big Bertha' systems cost more than a Rolls Royce. Three of our customers have bought two of them . . . that's living."

**—telrex** COMMUNICATION ENGINEERING LABORATORIES  
TV And Communications Antennas Since 1921  
Asbury Park, New Jersey 07712 201-775-7252

With 81 miles of ski trails, serviced by 16 aerial lifts, Mt. Snow is now ranked as the world's busiest ski resort. Where the trails come together at the summit, the W1KFX machine reliably repeats FM signals from 146.31 to 146.88 MHz, month in and month out, in weather where zero is considered warm.

# To The Repeater - ON SKIS!



**I**nstalling and maintaining a repeater on an isolated mountaintop usually means a lot of lonely hours for the fellow who does the work. But at least one repeater man feels it doesn't have to be that way. Gordon Pugh, W1JTB, who has probably set up more repeaters along the eastern seaboard than any other amateur in the country, makes it a point to select his sites so that he can combine his "business" with his pleasure.

Gordon's "business," in this case at least, is setting up repeaters that have greater coverage than other systems in his area of the country. The "pleasure" is skiing. And Gordon's most laudable effort recently has been the deployment of his 146.31/146.88 MHz FM repeater at Mt. Snow, Vermont.

Mt. Snow is an extraordinary place. Europeans and Americans alike might find it difficult to believe that Mt. Snow is actually the largest ski area in the world — but it really is! With as many as 10,000 visitors on a good skiing day, Mt. Snow goes unchallenged as "biggest." Not even those renowned resorts in Switzerland can compete with Snow in terms of human traffic.

The mountain is not particularly high — at least not by worldwide standards. But at its 3600 ft perch atop Mt. Snow's

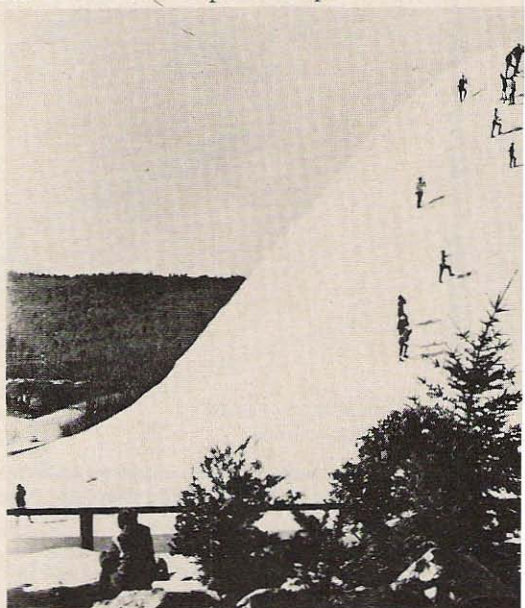

The glacier towering above the pool is called Fountain Mountain, and it was created by the snowy fallout from a geyser jet of water shot at tremendous pressure from underground. Fountain Mountain takes nearly two months to build; but it "happens" every year.



famous *North Face*, the .31/.88 machine, licensed under the call of WAIKFX, provides effective automatic relay coverage in five states — New York, New Hampshire, Massachusetts, Connecticut, and, of course, Vermont.

When Gordon Pugh services his Mt. Snow repeater — which is curiously nearly every weekend in winter and virtually never during summer months — he arms himself with all the tools he's likely to use and myriads of items he's not; then he packs up his skis and vacation gear, and off he goes — sometimes for days at a time.

If things really need fixing at the repeater site, Gordon's first day is usually spent in earnest. He's been known to spend as much as seven hours on the top of a tower at one sitting. He makes a marathon of the repeater repair job, staying with it until the task is done. In the unheated, open area where the WAIKFX repeater is installed on Mt. Snow, the temperatures frequently drop to the uncomfortable side of zero and remain there for long periods. But Gordon simply plugs in a 1 kW bulb

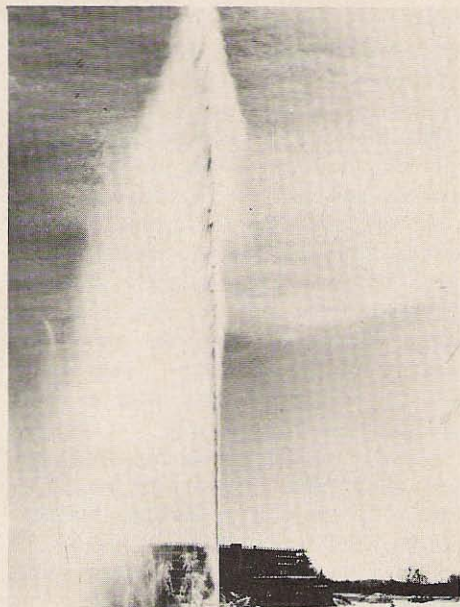

(for heat more than light) and hacks away at the problem. When it's licked, the funtime starts.

From the top of North Face, Gordon has a wide choice of trails on which to descend. An expert skier himself — and a part-time ski instructor, Gordon usually chooses one of the brisker slopes — like Snow's *Jaws of Death* or the *Challenger* both carefully marked, "For experts only."

If there's still daylight left when the repeater is once again operational and he's descended to the Snow Lake lodge area, Gordon will take maximum advantage of the remaining hours. With no less than 16 lifts to choose from, and 42 descent trails, he'll spend the day tackling the Main Mountain, with its thousand acres of ski facilities.

"The trip to the top is almost as much fun as the race down the mountain," Gordon says. And he's not kidding. There aren't many thrills equaling that of scaling the mountain in one of Mt. Snow's "skis-on," enclosed gondolas. The gondola lifts you high above the tree-studded mountain side and offers a breathtaking panorama of scenery.

"What I like about Snow," says Gordon, "is the solitude. The 80-odd miles of ski trails are sufficient to accommodate the hordes of visitors without crowding.

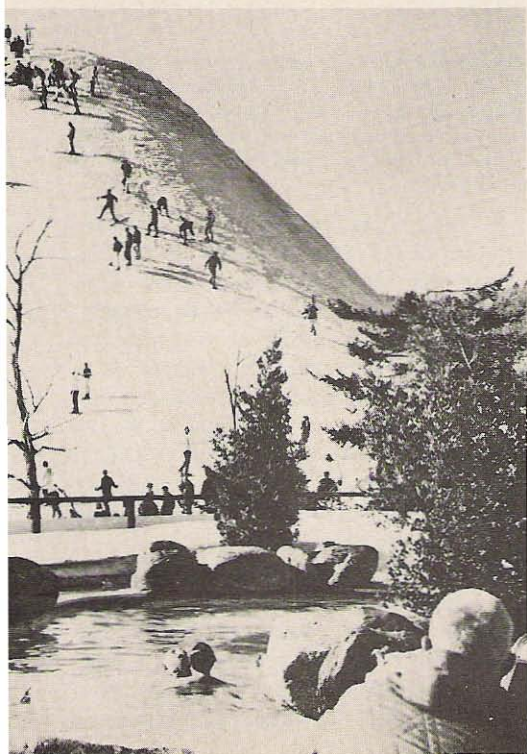

There's something about a solitary trip down the mountain that puts you in pretty close contact with Nature." With an almost reverent, poetic tone, Gordon added, "When the wind isn't blowing too hard, the only sounds you hear are the swishing of your skis and the rustle of the trees."

At the lodge, Gordon always winds up his day with a swim in the heated outdoor pool. It doesn't look comfortable when the air temperature is in the low teens, but Gordon insists that it is. The water temperature in the winter is rarely below 100° F, he says, and a swim is more refreshing than a hot shower.

Some of us conservatives remained skeptical about the comforts of swimming outdoors in below-freezing weather, though. And it didn't help a bit to see Gordon's hair freeze into brittle spikes when his head came out of the water.

It certainly made an interesting picture, if nothing else. What is more incongruous than a photo of swimsuit-clad bathers with bundled-up skiers gliding over a snowy slope in the background?

That "slope in the background" is one of Mt. Snow's more interesting attractions. The hill, called *Fountain Mountain*, is a glacier made as a cooperative enterprise by man and nature. The management at Mt. Snow provide the geyser-fountain — tons of water jetting nearly 400 ft into the sky. Nature provides the water-to-snow conversion. The result is a glacier that takes several months to build.

The water geyser gets turned on when low-temperature season comes around — usually late in November. For a month or two, the geyser continues, day and night, while the glacier grows and grows. When the water is finally shut off, the glacier, with its ski-able snowlike surface, stands a full 200 ft. Skiers can then negotiate the miniature mountain until well into April.

Mt. Snow is an ideal repeater site, as the coverage performance of the WA1KFX machine will attest. It towers high enough above the surrounding countryside to make the .31/.88 machine accessible from even flea-power units like hand-held transceivers and battery-operated portables. But there

are FM'ers who use Mt. Snow for communicating on frequencies other than those of the Snow system. Wayne Green, for example, likes to take his Motorola Handie-Talkie down the slopes of Snow, talking to distant amateur stations on a "direct" basis.

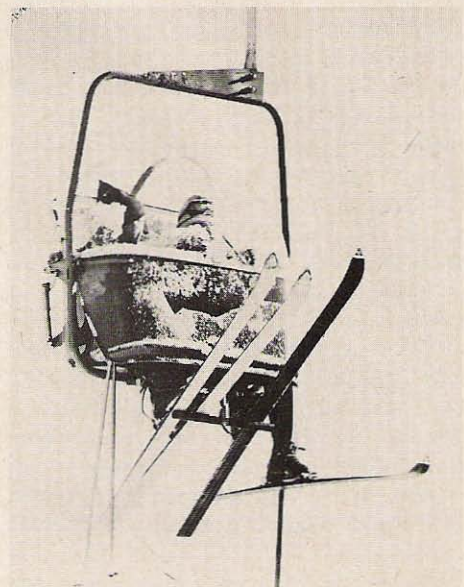

*When Gordon makes a repair trip to the repeater site, he does it in style. During summer, he'd have to walk up; but in winter, it's easy going all the way — in an enclosed skis-on gondola that offers warmth as well as a panoramic view of the mountain.*

Wayne also noted that other New England repeaters are accessible from Mt. Snow's *Main Mountain*. Heading down on skis at a neckbreaking clip, Wayne managed to combine two hobbies in one, and was able to talk through a number of New England repeaters during the course of one trip. Transmitting on 146.34 MHz, Wayne communicated through W1ABI, W1KOO, W1ALE, K1ZJH, W2NSD/1, and probably other repeaters that weren't active during the minutes of his descent.

For people who question Gordon Pugh's frequent trips to Mt. Snow, he offers a two-edged answer. If the query comes from a skier, he'll say, "There's more to snow resorts than skiing." And to curious amateurs, he says, "There's more on Mt. Snow than a repeater."

# REPEATER AUDIO MIXER

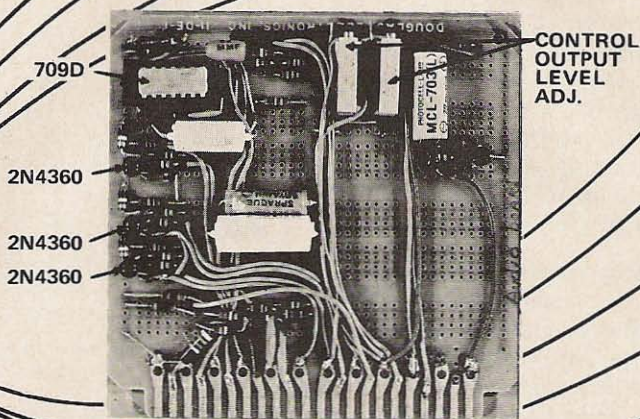

Paul Hoffman W1ELU  
169 Millham St.  
Marlboro MA 01752

Ray Pichulo W1IRH  
172 Dent Street  
West Roxbury MA 02132

The audio mixer described in this article, although designed primarily for repeater use, can be used anywhere it is desired to mix a number of audio inputs with a high degree of isolation between inputs. The mixer is adaptable to almost any configuration which may be required to suit the individual's requirements. The number of inputs can be increased by a factor of two or three to suit the user's needs. The isolation between individual inputs of over 40 dB makes it possible in repeater operation to have tone command information on one channel not be affected by another input. The mixer shown in this article is the one designed for use in the WA1KFY repeater. It has eight inputs — three of them squelched, the other five continuously on.

## Operation

The amplifier uses a single 709D opamp plus one FET for each squelched input. The audio inputs as shown in Fig. 1 are

applied to the opamp's inverting input. The output is fed back through 150 k $\Omega$  resistor R1. Notice that the signal from each input is applied through 150 k $\Omega$  also. The resultant voltage at the input terminal of the opamp is the combination of the input signal plus the out-of-phase feedback voltage. Since both are applied through equal series resistances, the resultant voltage is zero. This condition results in the opamp's having an extremely low (almost zero) input impedance. This resultant low impedance, together with the high series resistance on each input, accounts for the high degree of isolation between inputs. The squelched inputs use a FET across each input as a switch. With zero volts on the gate, the FET exhibits a drain-to-source resistance of about 350 $\Omega$ , effectively shorting its associated input to ground. When +15V is applied to the gate, the FET switches off, enabling the input channel. The 75 k $\Omega$  resistors between each FET and the input bus prevent the input bus from being shorted by the FETs.

The gain of the opamp is determined by the ratio of the feedback resistance to the input series resistance. In this case, the gain on all the inputs is unity. If more gain is desired on a particular channel, the input resistance can be lowered to change the ratio (and therefore the gain). For example, it was found necessary to increase the gain from the main channel receiver when the phone patch was connected in order to increase the level into the phone line. (The phone patch does not load down the output; rather, the gain had to be raised in order to properly drive the line.) The gain change is accomplished by a photocell-lamp assembly, with the photocell in series with a second 150 k $\Omega$ .

The frequency response of the amplifier is essentially flat from dc up to about 8 kHz. Beyond that point, it rolls off. The 22 pF capacitor across the feedback resistor determines the rolloff frequency characteristic. The audio output voltage swing can go as much as  $\pm 10V$ . This is more than ample to drive 10 or more high-impedance inputs. The audio amplifier in WA1KFY is presently used to drive three transmitters, a phone patch, and a monitor earpiece. The number of inputs can be expanded to suit individual requirements. The unswitched inputs require only an additional 150 k $\Omega$  series resistor and load resistor for each leg. The switched inputs each require an additional FET switch in addition to the load resistor and series resistors.

The opamp requires 15V (positive as well as negative) to operate it. The current requirements are approximately 30mA. The components shown in the detail schematic (1.5 k $\Omega$  0.005 mF, and 200 pF) are used to compensate the amplifier against instability. The 100 $\Omega$  resistor, 30  $\mu F$  capacitor and 0.1  $\mu F$  capacitor on the +15V line form a decoupling network.

Two trim pots at the top edge of the board (see photo) are used to provide audio outputs for tone-operated command functions. They are connected across the load resistors of the six meter receiver and the main-channel two-meter receiver as shown in Fig. 1. The arms of both pots connect to pins on the edge connector and

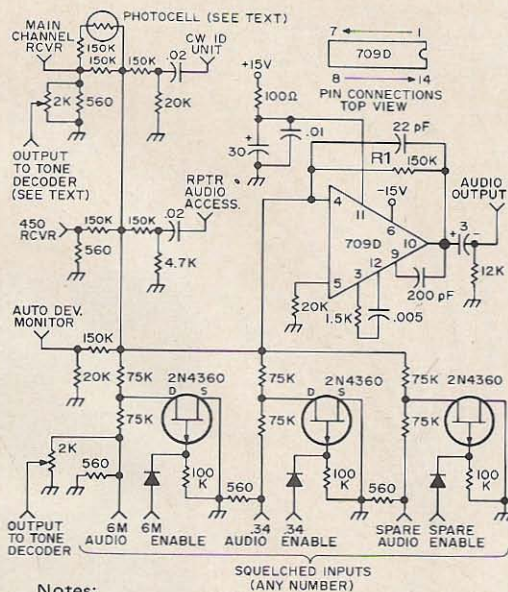

**Notes:**

1. Resistance values in ohms, capacitance values in microfarads unless otherwise noted.
2. Diodes are 1N457'S.

Fig. 1. Audio summing amplifier.

go off the board to their associated tone decoders on another board. These pots are mounted on the audio mixer board as a matter of convenience and would not be used if it is not required to bring audio to another point in the system for tone command or other functions. The photocell-lamp assembly for gain changing on the main channel input is on the right side of the board. Similarly, it could be deleted if this feature is not required.

**Summary**

This audio mixer provides the repeater owner a high-quality audio mixer system which has minimal space and power requirements. It is especially attractive for use in more sophisticated repeater systems where several receiver/transmitter combinations are used. However, if the same construction techniques as those described in this article are used, it is just as good to use with a simpler repeater system because there is more than adequate room for expansion at a later time.

...W1ELU,W1IRH

# NOW

## The Quality Leader In Amateur FM

### At A Competitive Price



#### *Deluxe 2 Meter FM Transceiver*

Always the quality leader, (see December and January 73 Magazine, and reviews in January QST and March CQ) the IC-2F remains the same — superb performance, deluxe features, 1 year warranty . . .

**TRANSMITTER:** RF input power — 20 watts; RF output — 10 watts minimum; maximum frequency deviation — 15KHz (adjustable); Automatic Protection Circuit (APC) — NEW! Not offered in any other transceiver on the market. Absolute assurance of final PA protection from shorted or high VSWR antennas by instantaneous transmitter disabling; Electronically switched — no relays; Sealed low pass filter to eliminate spurious radiation.

**RECEIVER:** Double conversion superheterodyne; Sensitivity better than  $0.4\mu V$  @ 20 db of quieting; FET front end; ceramic filters for excellent bandpass shaping; Integrated Circuit IF; built-in speaker on front panel.

**GENERAL:** Six channels (six transmit and six receive crystals) selectable from the front panel; large RF/"S" meter and easier to read controls; power requirements 12 to 15 volts DC.

The Deluxe IC-2F comes complete with high impedance microphone, three-position chrome mobile mounting bracket, crystals installed for two channels (Ch. 1, 146.34/146.94; Ch. 2, 146.94/146.94), power cables and plugs and manual. **Amateur Net \$299.95**

Optional AC Power Supply with built-in Discriminator Meter, Model IC-3P. **Amateur Net \$42.50**

PA-50A 50 watt solid state AFTERBURNER for more power mobile. **Amateur Net \$129.95**

*Available at your dealer*

# VARITRONICS INCORPORATED

2321 EAST UNIVERSITY DRIVE • PHOENIX, ARIZONA

# **NEW** 12 vhf-fm channels all solid state



## **6m and 2m models**

AGC circuit at the front end

3 TRANSMITTING POWER positions.

REAR panel has provision for 25w unit,  
TONE squelch, and MULTIPLIER unit.

CHANNEL SELECTION by diode switch.

Remote control possible

34/94, 94/94, MIKE included. \$289<sup>95</sup>

**TELECOMM ELECTRONICS**  
**P.O. BOX 461. CUPERTINO, CA. 95014**

Ken Sessions, Jr. K6MVH

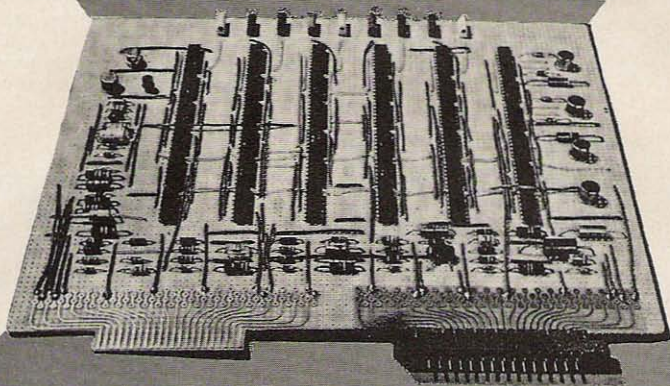

## SOMETHING NEW IN PC CONSTRUCTION

One of the nice things about being associated with a major ham magazine is that I get a chance to preview a lot of interesting products. Some of the things I get to see are obviously gimmicks that will never take hold. Others are reasonably new good ideas, most of which are doomed to oblivion because the cost exceeds the ultimate value to the user. But once in a while – not often, mind you – but just on rare occasions, I get the chance to see something that smacks of real greatness.

Such is Circuit-Stik, an item that I think is the most important development in the history of printed-circuit construction. I think this item is important because it will permit any amateur to make even the most complex circuit boards without any art, camera work, photoresist exposure, or etching. And that's really something!

You can get Circuit-Stik in a kit that includes everything you need to make professional circuit boards, but I haven't the faintest idea what the price is. A quick letter to the manufacturer will get you that information in no time, I would imagine. It's the *process* itself that I'm excited about. The trouble is, it's extremely difficult to describe it adequately, even with pictures.

I'll try explaining it anyway: The kit includes a fairly large sheet of perforated board with very close-spaced holes (on 100-mil centers). From this sheet, you can cut your basic circuit board to whatever size your project might require. But rather than etching circuit paths onto a copper-clad layer, you can lay the circuit paths down onto the board with already-

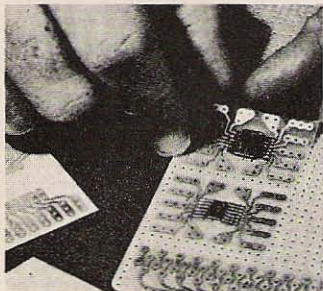

A wide variety of circuit-element patterns are available allowing the user maximum flexibility in his selection.

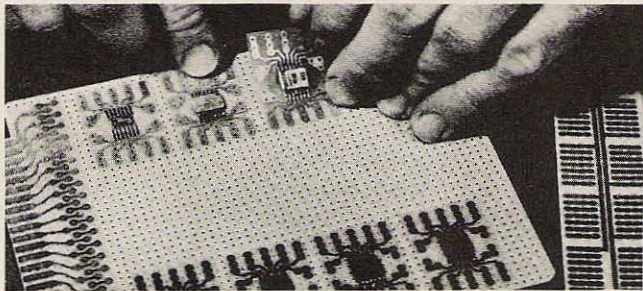

When MSI or LSI components are pre-lead bonded to Circuit-Stik subelements, (as the "flat-pack" units have been in the photos), they can be immediately tested in a circuit or become part of a permanent circuit board in minutes.

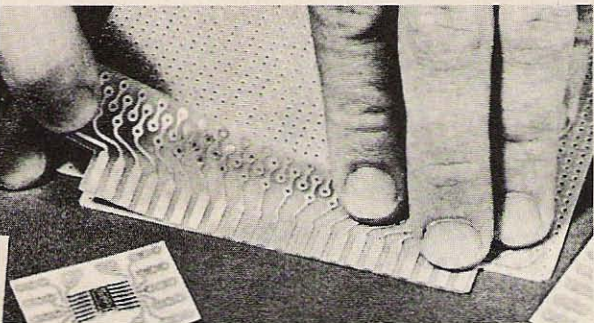

Circuit-Stik subelements are pressure sensitive and the adhesive formula offers exceptionally good adhesion strength, withstands soldering temperatures and yet may be removed for easy circuit design modifications.

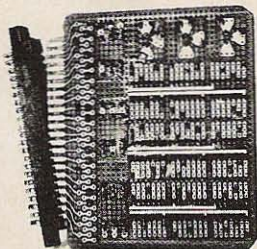

Circuit-Stik "1000-series" subelements are designed "on-grid," are pre-drilled, and when used in conjunction with .100 inch punched board, require no drilling

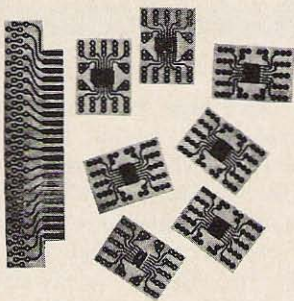

All subelement conductors are preplated and ready for soldering

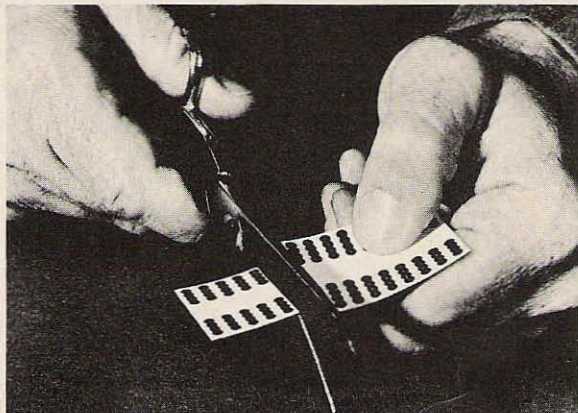

CUT FOR NUMBER OF COMPONENTS REQUIRED

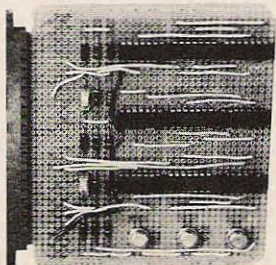

No terminals are needed as active circuit components are soldered directly to the subelements and resulting circuit boards made from Circuit-Stik materials are as durable and reliable as conventional printed circuit boards.



# Motorola HEP Semiconductor Devices

## NEW FUNCTIONAL ICs

C6004	1-W Audio Power Amp.	\$2.60
C6005	2-W Audio Power Amp.	\$4.35
C6006	4-W Audio Power Amp.	\$5.60
C6010	W-band Amp-RF-IF-Audio	\$1.59
C6001	FM IF Diff. Amp.	\$2.09

**HEK-3 RADIO AMATEUR KIT**  
Contains (2) HEP-590, (1) HEP-570 plus book with 10 Ham Projects. .... \$5.95

**HEK-2 FET EXPERIMENTERS KIT**  
Contains HEP-801, HEP-802, HEP-50, HEP-51 and Instructions for 9 Projects. .... \$3.95

## DIGITAL INTEGRATED CIRCUITS

HEP-556	MECL 3-input Gate	\$1.79
HEP-558	MECL J-K Flip-Flop	\$2.39
HEP-580	RTL Dual 2-input gate	.95
HEP-582	RTL Dual Buffer	.99
HEP-583	RTL J-K Flip-Flop	\$1.49

## ECONOMY ZENER DIODES

Z0214	6.2 V 500 mW	.70
Z0219	9.1 V 500 mW	.70
Z0220	10 V 500 mW	.70
Z0222	12 V 500 mW	.70
Z0230	20 V 500 mW	.70
Z0234	27 V 500 mW	.70

## RF POWER

FOR THAT FM XMITTER		
HEP-75	P out 1 W	\$2.95
S3001	P out 5 W	\$3.75
S3005	P out 3 W	\$9.55
S3006	P out 10 W	\$19.90
S3007	P out 25 W	\$24.95
S3008	P out 1.5 W	\$2.18

## SILICON TRANSISTORS

HEP-50	NPN TO-18 250 MHz	.79
HEP-51	PNP TO-5 150 MHz	\$1.29
HEP-53	NPN TO-5 200 MHz	\$1.15
HEP-56	NPN TO-92 750 MHz	\$1.44

**Popular HEP-590 High Freq. Amp.**  
for RF-IF-Mixers Direct Conversion Rcvr-Balanced Modulator-Product Detector-VFO-etc. .... \$3.99

## JUNCTION FETS

HEP-802	N-channel RF	\$1.59
HEP-801	N-channel Audio	\$1.59

## DUAL-GATE FETS

F2004	VHF RF Amp-Mixer	\$2.50
F2007	VHF RF Amp-Mixer; Diode Protected LOW- NOISE 2.6 dB @ 200 MHz	\$1.65

## FREE PROJECT BOOKLETS

HMA-32 IC Projects  
HMA-33 FET Projects  
HMA-36 Ham Projects  
HMA-37 Handyman Projects  
Send self-addressed stamped envelope for free project booklets... or request with your HEP order

## HEP BOOKS

HEP-400 Solid State Projects ... .50  
HEP-407 IC Projects ..... \$1.00  
HEP-408 FET Projects ..... \$1.00  
HEP-414 Power Circuits Book \$2.00

## WE CAN SUPPLY ANY HEP DEVICE

PLEASE INCLUDE 25¢ FOR POSTAGE WITH ORDER

## CIRCUIT

## SPECIALISTS CO.

BOX 3047  
SCOTTSDALE, AZ. 85257

FACTORY AUTHORIZED  
HEP DISTRIBUTOR

prepared patterns that are gold-plated or tinned copper on thin adhesive sheets of epoxy-glass.

The adhesive-backed conductive patterns are called "subelements," and they are available for virtually any transistor or IC package you could dream up. There are even subelements for all conventional card-edge connectors. The beauty in the system is that the subelements are all predrilled, and the holes fall directly over the holes that already exist in the perf-board. So making a complete board for any project is nothing more complex than laying out the board with a pencil and paper, then dropping the subelements onto the board in their proper positions.

I don't know what kind of adhesive is used on these superthin patterns, but it certainly does hold. And no matter how much you solder to the patterns and paths, they stay down. If you place a sharp knife under a pattern or circuit path, you can lift it without sacrificing any of its holdability, then reposition it anywhere else on the board.

...K6MVH

## THE BEST 2 METER CONVERTER

Model 407  
\$42.95  
ppd.

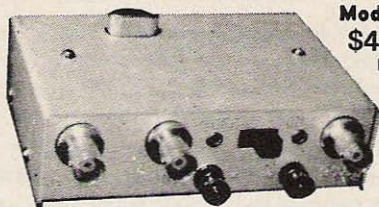

144-146 MHz in. 28-30 MHz out  
or 146-148 MHz with a second crystal  
Available at \$5.95 each.

A full description of this fantastic converter would fill this page, but you can take our word for it (or those of thousands of satisfied users) that it's the best. The reason is simple—we use three RCA dual gate MOSFETs, one bipolar, and 3 diodes in the best circuit ever. Still not convinced? Then send for our free catalog and get the full description, plus photos and even the schematic.

Can't wait? Then send us a postal money order for \$42.95 and we'll rush the 407 out to you. NOTE: The Model 407 is also available in any frequency combination up to 450 MHz (some at higher prices) as listed in our catalog.

\*New York City and State residents add local sales tax.

## VANGUARD LABS

Dept. H, 196-23 Jamaica Ave., Hollis, N.Y. 11423



Ray Grenier, K9KHW, Mail Order Sales Manager at  
**AMATEUR ELECTRONIC SUPPLY**, says:

"Operating all bands (160 thru 2 Meters) is a real pleasure with my **DRAKE 4 LINE** setup. You, too, can eliminate all of that extra gear and mess usually needed for that much frequency coverage. Let me help you go the same route. . . . all the way, as I have done - or just one unit at a time.

Visit our store or write me at **AMATEUR ELECTRONIC SUPPLY** for the best Trade or No-Trade Deal on new **DRAKE** equipment. You will be surprised how little per month it would cost you to own new **DRAKE** equipment when you use our convenient Revolving Charge Plan.

Remember, too! When trading with **AMATEUR ELECTRONIC SUPPLY** you can use our **STAY-ON-THE-AIR PLAN**, which means you can keep your trade-ins until your new equipment arrives. - Lose no operating time! **CU on the air!**"

The **BIGGEST** - The **BEST** - In the **MIDWEST**

**AMATEUR ELECTRONIC SUPPLY**

4828 West Fond du Lac Ave. Milwaukee, Wis. 53216

Phone (414) 442-4200

STORE HOURS: Mon & Fri 9-9; Tues, Wed & Thurs 9-5:30; Sat 9-3

# READING 5 CODE RTTY in BINARY

000 000 111 011 000 000

Anthony Sperduti WB2MPZ  
4740 Newton Road  
Hamburg NY 14075

**E**ver try and read the tape that you just printed off your Model 19? Here is an interesting way of reading it, using the binary system. Look at the tape from the top with two holes to the left of the sprocket and three holes to the right of the sprocket. Group the two to the left, to read 2-1 and the three to the right to read 4-2-1. Now all you have to do is add up all the holes that are punched to the left as one digit and all the holes punched to the right as one digit. This will give you two digits which can be converted to a function on the machine.

*Example 1.* If all holes are punched, add up the two weights on the left ( $2+1=3$ ). Now add up all the weights on the right ( $4+2+1=7$ ). You now have two digits which put together is 37. Look on the table and

you find 37 would be the LTRS function.

*Example 2.* No. 1 hole on the left with a weight of 1, and the No. 2 hole on the right with a weight of 2. Put together, this is 12. Look on the table and you find 12 is the function R.

*Example 3.* No. 2 hole on the left with weight of 2 and the number 4 and 1 hole on the right summed is a weight of 5. Putting the two digits together gives 25. Look on the table and find 25 is the Y function.

TABLE

01 = T	20 = E
02 = CAR RET	21 = Z
03 = O	22 = D
04 = SPACE	23 = B
05 = H	24 = S
06 = N	25 = Y
07 = M	26 = F
10 = LINE FEED	27 = X
11 = L	30 = A
12 = R	31 = W
13 = G	32 = J
14 = I	33 = FIGS
15 = P	34 = U
16 = C	35 = Q
17 = V	36 = K
00 = BLANK	37 = LTRS

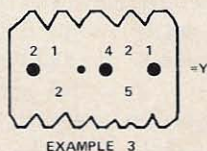
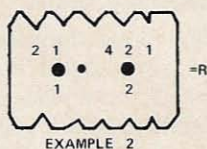
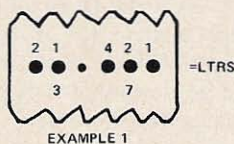

If you study the table you can see that there is no wasted functions. There is a possible combination of 32 functions. If you add the 26 upper case operations we have 58 different possibilities. When reading the tape you should know if the tape is in upper or lower case. This should not create any problems. You could add one more function which is the blank.

Anthony Sperduti WB2MPZ ■



# Unique Digital TTY Accessories

*J. A. Murphy K5ZBA  
4105 S Pittsburg  
Tulsa OK 74135*

**T**his article describes three accessories for the RTTY station. The first is a regenerative repeater; you put highly distorted, biased signals in one end and get nice, clean, properly timed signals out the other. The second forms the basis of an electronic stunt box; it performs the "cleaning up" function of the first, plus converting the serial TTY signal to a 5-line parallel signal which can be used to perform various functions on receipt of a specified group of characters. The third performs all the functions of the first two plus speed conversions; with this little goodie you can put 100 wpm gears in your machine for copying the commercials and use the speed conversion function to operate at 60 wpm on the ham bands.

In order to understand the operation of these three devices, let's take a moment to review the manner in which a TTY printer decodes a signal. The start element of the code drops the selector magnet, initiating a

mechanical timing cycle. Five times during this cycle the machine mechanically "samples" the condition of the selector magnet and positions the code bars accordingly. In a 60 wpm machine these samples are 22 ms apart and about 4.4 ms long. The length of time between the beginning of the start element and the first sample can be varied with the range adjustment. With the range control set at 60 the samples occur 33 ms, 55 ms, 77 ms, 99 ms, and 121 ms after the beginning of the start element. The Regenerative Repeater

### **The Regenerative Repeater**

The repeater electronically samples the TTY signal in much the same manner as the printer. A start element initiates a series of seven sampling pulses. The input signal is sampled in the middle of the start element, in the middle of the five signal elements, and 11 ms into the stop element. The condition of the signal at the time of each sample is loaded into a flip-flop memory where it is stored until the next sample is taken. Thus, the output of the

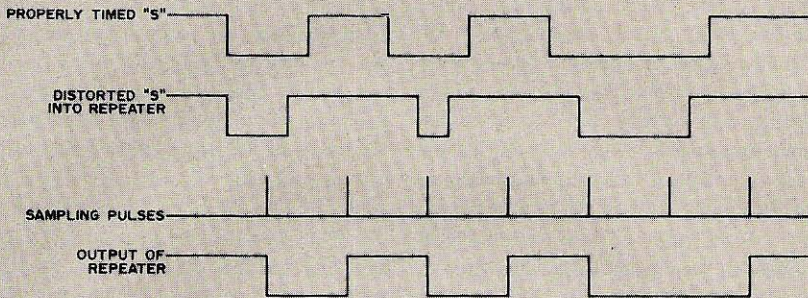

Fig. 1. Simplified timing diagram for regenerative repeater.

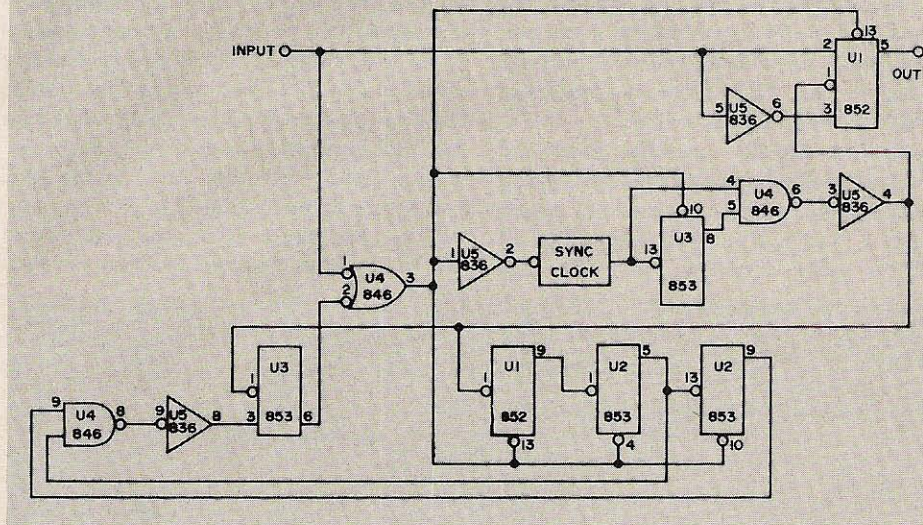

Fig. 2. Logic diagram for regenerative repeater.

flip-flop is a perfectly timed TTY signal, delayed 11 ms from the input signal, with signal elements corresponding to the condition of the input at the time of sampling (see Fig. 1). After the stop element is sampled, the circuit resets and waits for the next start element.

The logic required to perform these functions may be implemented in many different ways. The diagrams included here show 803 series DTL integrated circuits. It should be noted, however, that the same functions could just as well be accomplished with RTL, TTL, ECL, or HTL ICs, discrete transistors, or even tubes or relays, to name a few! with this series of DTL a high logic level is approximately +5V and a low logic level is approximately ground.

Referring to the logic diagram of Fig. 2

and the timing diagram Fig. 3, a start element (space) puts *nor* gate U4 input pin 1 at a low level, forcing output pin 3 and inverter U5 input pin 1 high. Output U5 pin 2 goes low, starting the 91 Hz synchronous clock.

"Synchronous clock" is simply a high-powered term for an oscillator that can be turned on in an orderly fashion; that is, the first cycle after the start command has the same period as all the following cycles. A simple oscillator of this type is shown in Fig. 4. It produces a series of narrow positive-going pulses at 11 ms intervals, the first occurring 11 ms after the input goes low.

The clock output drives divider flip-flop U3, the output of which is a square wave with a period of 22 ms. *Nand* gate U4 picks

out every other clock pulse and drives inverter U5 input pin 3. The signal at U4 pin 4 is the string of positive going sampling pulses. The first of these pulses causes JK flip-flop U3 output pin 6, which has been high until now, to go low. As long as the K input, pin 3, of this flip-flop remains low the following sample pulses will have no effect on its output. The low output at pin 6 goes to *nor* gate input U4 pin 2, causing the timing cycle to continue regardless of the signal at the input. Note, however, that this happens only after 11 ms of continuous spacing signal. This means that a spacing condition must exist at the input for at least 11 ms to initiate a timing cycle. This provides protection against noise on the signal line.

The first sample pulse also loads the start element into output flip-flop U1 pin 5 and causes the counter outputs, U1 pin 9, U2 pin 5, and U2 pin 9 to step from all (lll), the reset condition, to (Hll). The

second sample pulse loads the first signal element into the output flip-flop and steps the counter to LHL. This process continues for pulses three through six. At this time the last signal element has been loaded into the output flip-flop and the counter outputs are LHH. This makes both U4 pin 9 and U4 pin 10 high, so U4 pin 8 and U5 pin 9 go low. Inverter output U5 pin 8 JK flip-flop U3's K input, pin 3, go high. The next sample pulse, which loads the stop element into the output flip-flop, also causes JK flip-flop output U3 pin 6 to go high. This, together with the condition on the signal line, causes *nor* output U4 pin 3 to go low, stopping the clock, resetting the counter to LLL, and forcing the output flip-flop to remain in the mark condition until the next start element initiates a new timing cycle. Just add some simple level converters to make your TU, printer, keyboard, and keyer DTL compatible and you're all set to clean up distorted received

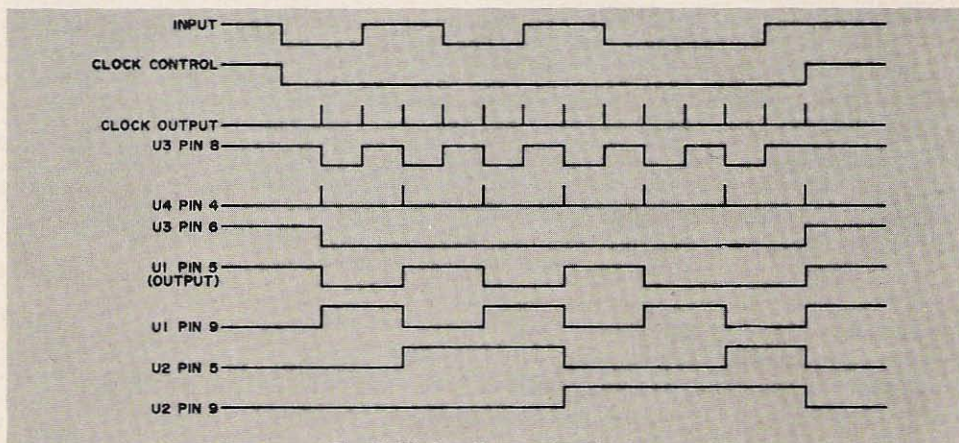

Fig. 3. Timing diagram for Fig. 2.

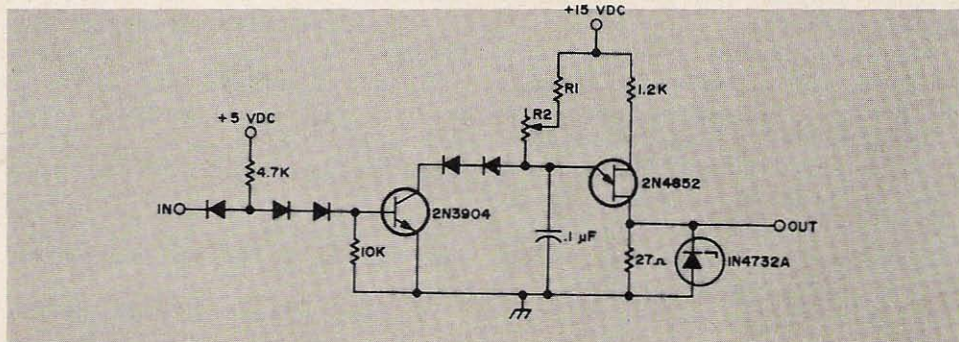

Fig. 4. Synchronous clock.



# New FM for '71 Standard's SR-C826M

**professional quality, solid state, two-way radio,  
designed and sold exclusively for amateur use  
in the United States and Canada.**

Standard Communications Corp., the world's largest manufacturer of marine V.H.F. equipment, has just developed a new industrial quality, high performance 2-meter unit. This rugged, compact transceiver is available only in the U.S. and Canada thru an authorized Standard dealer. The "826" is so compact that it makes mobile installation practical in almost any vehicle or aircraft, it becomes fully portable with the addition of Standard's battery pack.

#### GENERAL

Freq. Range — 143 to 149 MHz, 2 MHz spread  
Supply voltage — 11 to 16 VDC. Negative Ground  
13.8VDC nominal  
Current Consumption — .15 amp receive standby. 2.4 amp transmit  
Number of channels — 12-  
Supplied with 4 channels  
1) 146.94 Simplex  
2) 146.34/94  
3) 146.76 Simplex  
4) 146.34/76  
Microphone — Dynamic  
Dimensions — 6 $\frac{7}{8}$ " w x  
2 $\frac{1}{2}$ " h x 9 $\frac{7}{8}$ " d

Weight — 4 $\frac{1}{2}$  lbs. max.  
Frequency stability — .001%  
(-10 to +60°C)

#### TRANSMITTER

RF power output — .8 or  
10 watts  
Output impedance — 50  
ohms nominal  
Deviation — Internally  
adjustable to  $\pm 10$  kHz min.  
factory set to  $\pm 7$  kHz  
Spurious and harmonic  
attenuation — 50dB below  
the carrier power level  
Type of modulator — Phase  
**RECEIVER**  
Sensitivity — .4 or less  
microvolts for 20 dB quieting

Squelch sensitivity —  
Threshold — .2 microvolts  
or less

2 MOSFET RF Amplifiers  
1 MOSFET Mixer

Deviation acceptance —  
Up to  $\pm 15$  kHz deviation  
Spurious and image  
attenuation — 65 dB below  
the desired signal threshold  
sensitivity

Adjacent channel selectivity  
(30 kHz channels) — 60 dB  
attenuation of adjacent  
channel

Type of receiver —  
Dual conversion  
superheterodyne

Audio output — 5 watts  
For external speaker

\$339.95 (complete as shown with  
microphone, built-in speaker and  
external alternator whine filter.)



**STANDARD  
COMMUNICATIONS CORP.**

World's largest manufacturer of marine V.H.F. equipment  
P. O. Box 325, Wilmington,  
Calif. 90744 (213) 775-6284

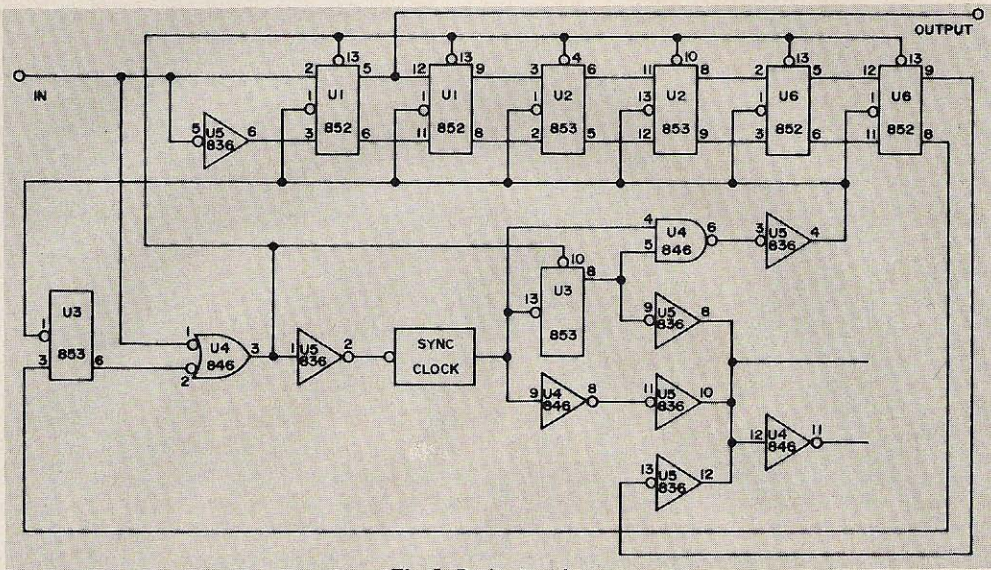

Fig. 5. Basic stunt box.

signals and to transmit perfectly clean signals from your aging keyboard!

### The Stunt Box

The stunt box is a relatively simple expansion of the repeater, requiring only a few more parts and the rerouting of a few wires. Comparing the stunt box (Fig. 5) and the repeater, (Fig. 2), we find three differences: First, the output flip-flop is now the first stage of a six-stage shift register; when the first signal element is loaded into U1 pin 5 the start element moves to U1 pin 9, and so on until after the sixth sample, when the start element is present at U6 pin 9 and the five signal elements are stored in the first five stages of the register.

Second, instead of counting out seven sample pulses with a counter, we now wait for the start element to move into the last stage of the register, causing U6 pin 8 and U3 pin 8 to go high. Now, as before, the seventh pulse samples the stop element and resets the whole works.

Third, 11 ms after the sixth pulse we find that U5 pin 9, U5 pin 11, and U5 pin 13 are all low, allowing U5 pin 8, 10, and 12, and U4 pin 12 to go high and forcing U4 pin 11 low. Thus, we get both a positive and a negative strobe pulse which occur once each character, and at a time

when the entire character code is stored in the register. This is all the information we need to decode a character.

A simple stunt box decoder is shown in Fig. 6. This decoder is set up to respond to the two character sequence ZB. When the positive strobe pulse occurs the two flip-flops sample the *nand* gate outputs U7 pin 6 and U7 pin 8. If the character in the register is anything other than a Z, U7 pin 6 will be high when strobed and U8 pin 6 will remain low. A Z forces U7 pin 6 low and U8 pin 6 goes high after the strobe pulse. If the next character is anything other than a B, U7 pin 8 and U7 pin 6 will be high at the time of the strobe pulse and U8 pin 8 will remain low. If, however, the character after the Z is a B, U7 pin 8 will go low and U8 pin 8 will go high and remain high until the next character is received. Using this decoder as a starting point, much more complex decoders can be built to respond to any number of character sequences of any length and used to set and reset latches to turn your printer, tape unit, or coffee pot on and off on command.

### The Speed Converter

Now that we have taken a 60 wpm TTY signal and shifted it into a register where we have it temporarily stored, all that



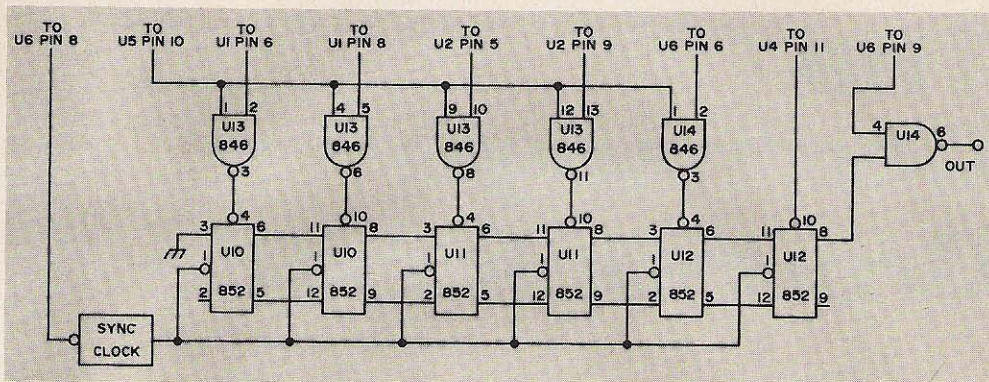

Fig. 6. Simple stunt box decoder.

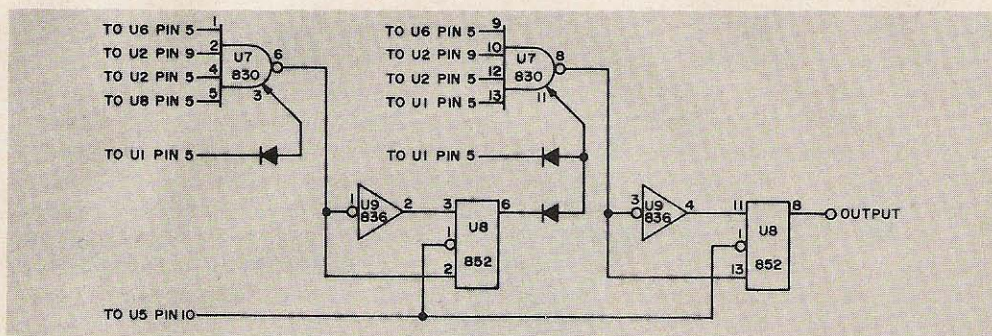

Fig. 7. Speed converter adapter for stunt box.

remains to be done to make it print on a 100 wpm machine is to load it into another register, in parallel form, and shift it out to the printer with shift pulses that occur every 13.5 ms. The hardware required to accomplish this is shown in Fig. 7.

Before a character is received U6 pin 8 and the input to the 74.2 Hz synchronous clock are low, the clock is running, and the register is shifting. But since the input to the first stage of the register, U10 pin 3, is held low and the output to the printer, U14 pin 6, remains high, or marking. When the start element of a character shifts into the last stage of the first register U6 pin 8 goes high and the 74.2 Hz clock stops. When the strobe pulse occurs, 11 ms later, U5 pin 10 goes high, loading the five signal elements into the first five stages of the second register. At the same time U4 pin 11 goes low, forcing a space, or start element, into the last stage of the second register. The output to the printer remains in the marking condition, however, since U6 pin 9 is holding U14 pin 4 and the

input to the output *nand* gate at a low level. When the stop element has been sampled and the first register resets, U6 pin 9 goes high, allowing the start element in the last stage of the second register to appear at the output to the printer. At the same time U6 pin 8 goes low, restarting the 74.2 Hz clock and allowing the character to shift out of the register to the printer. As the character shifts out the register fills up with marks so that 13.5 ms after the last signal element is sent to the printer the output goes to a marking condition and stays there until the next character arrives.

To convert the 100 wpm output of the keyboard to a 60 wpm input for your keyer it is only necessary to reverse the input and output leads of the converter and switch the clock frequencies from 91 Hz and 74.2 Hz to 148.4 Hz and 45.5 Hz. Of course, the keyboard may only be operated at typing speeds up to 60 wpm, but that shouldn't cramp the typing style of too many of us!

...K5ZBA ■

# The Coathanger Groundplane

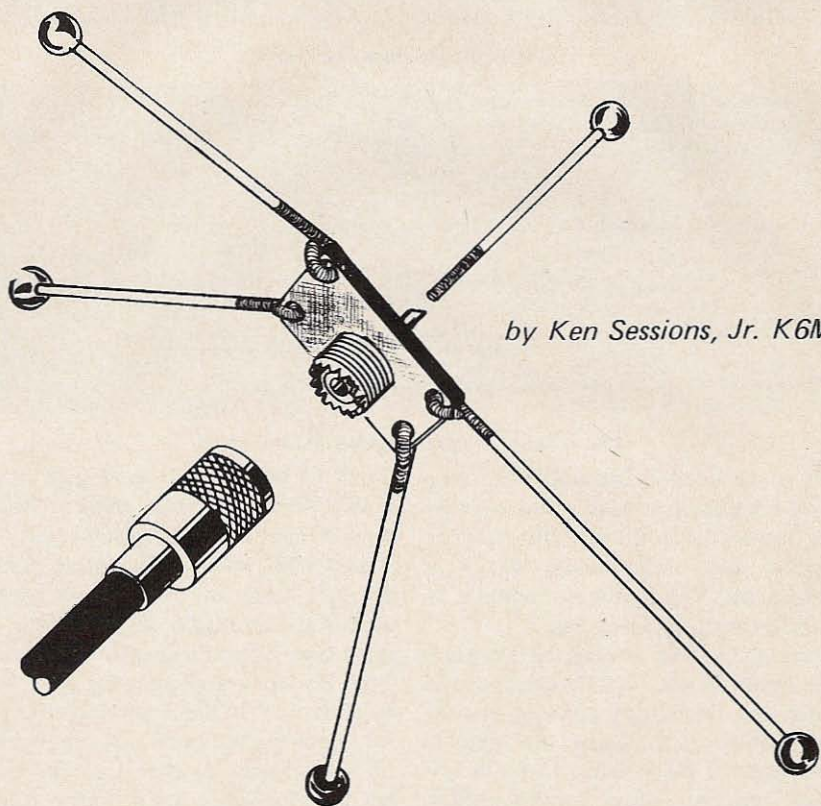

by Ken Sessions, Jr. K6MVH

**F**or UHF and VHF applications in particular, the groundplane is perhaps the most utilitarian of all antenna types. It is simple to build and offers effective performance for both receiving and transmitting. The most economical of the groundplanes is the "coathanger" type, where the elements are cut from wire coathangers or some other stiff conductor (such as 10 AWG type TW copper wire).

With a little imagination on the part of the builder, the coathanger groundplane can be made into a very professional-looking antenna.

To build up a quickie 2 meter groundplane, you'll need five coathangers, five toy plastic beads, a chassis-mounting UHF connector, and some silicone grease.

The first step is cutting. Refer to the cutting chart to determine the lengths of

the radials and the radiator, then straighten the wires and cut accordingly.

When the elements have all been cut to length, sand the protective coating from the coathanger wires for  $\frac{3}{4}$  in. at one end of each piece. Most coathangers are coated with a heavy varnish-like compound to retard rust and corrosion. The sanding operation removes this coating and prepares the wire to accept solder.

The beads will be affixed to the unsanded ends of the elements. The beads offer an added measure of safety and give a professional appearance to the antenna. To attach the beads, heat the unsanded end of a wire on the kitchen stove for a few seconds; then, while the conductor is still very hot, press the bead down firmly over the wire end. The heat melts the plastic of the bead so that the stiff wire bores its own hole. Now, as the wire and bead cool, the plastic bead hardens and becomes securely attached to the end of the element.

The four screw holes in the chassis UHF connector will be the "solder lugs" for the radials. Using a pair of long-nose pliers, bend a "U" in the sanded end of each of the four longer pieces. (The shorter piece is the upright radiator, and requires no bend.) Allow no more than  $\frac{1}{2}$  in. for each bend, and be sure to keep each piece the same length.

Hook each bend into the UHF connector as shown in the sketch on the preceding page, then compress the joints with pliers. Try to keep each radial positioned so that it maintains a 90-degree interval from adjacent elements.

Before soldering, adjust the positions of the radials precisely so that a symmetrical cross is formed by looking directly down onto the antenna from the top. Then solder all connections with a heavy iron or gun. The chassis connector requires a considerable amount of heat to keep the solder flowing, and insufficient heat will mean cold solder joints.

When the radials have been soldered, insert the shorter upright piece into the "center conductor" soldering point of the chassis connector. Twirl the radiator in the tube as you solder to make sure it is tinned

completely, but don't allow excess solder to build up to the point where it exudes onto the dielectric. The characteristic impedance of the connector is determined by the dielectric material as well as the radial distance from the center conductor to the shield. If this distance is shortened in any way — as from a blob of solder — the characteristic impedance will be lowered and a mismatch will result.

When the joints have cooled, carefully bend the radials downward about  $30^\circ$  from the horizontal. This will lower the radiation angle of the antenna and will result in a better match for a  $50\Omega$  input impedance. Spread a generous amount of silicone grease over all connections to prevent corrosion and minimize the chance for water entry.

That's all there is to it; the antenna is ready to use. And in appearance, it's "just like downtown."

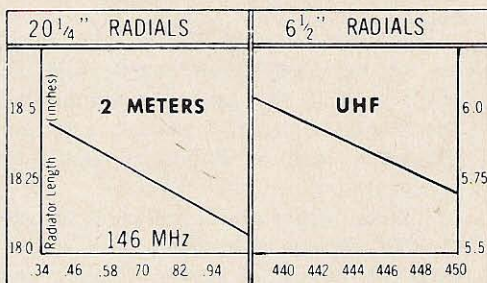

If you're thinking of building up this antenna to use in conjunction with a repeater or remote installation, there's one other trick of interest: Mount the thing upside down! Of course, this type of an installation would not be beneficial at all in run-of-the-mill applications, but it could mean the difference between "hearing" and "hearing nothing" on a mountaintop.

The groundplane characteristically has a very high angle of radiation. This problem is not too evident when the antenna is put into service in the lowlands; but when it is part of a mountaintop station, a high angle of radiation gets less and less tolerable. By mounting the groundplane so that the vertical radiator is suspended, the angle of radiation can be put to work for you. Try it! It really works!

... K6MVH ■

# STUDY GUIDE GENERAL CLASS LICENSE

## Part VII Power and How to Get It

To operate any radio equipment, whether transmitting or receiving, you've got to have power — and it has to be just the right kind. While receivers can get by with a mere thimbleful of energy, transmitters have healthy appetites. The more potent the signal output, the heftier the rig's gulps of power.

So every different kind of equipment has its own power requirements, and the result is that the art of providing the proper power structure to keep a station simmering isn't as simple as might be expected.

Like all other aspects of radio theory, the FCC expects its licensees to be familiar with the theory of power supplies, and devotes a number of questions in the General examination to that subject. This time around in our study course, we're going to take a look at them. The specific questions are numbers 2, 10, 12, 18, 26, 28, and 34 on the official study list:

2. Of what use is a bleeder resistor in amateur equipment?

10. What is meant by the ripple frequency of an ac power supply voltage?

12. How does a zener diode operate and of what use is it in amateur equipment?

18. How do electrolytic capacitors operate and why are they widely used in power supply circuitry?

26. Why is a centertap return connection employed on the secondary of a transmitting tube's filament transformer?

28. Describe ways of equalizing the reverse voltage drops across series connected silicon diodes.

34. How does an ac power supply produce a dc voltage? Distinguish between a choke-input and a capacitor-input filter and compare their operating characteristics. What is dynamic regulation and how can it be improved? How do the output voltages of a full-wave centertapped and a full-wave bridge rectifier compare?

Following our usual practice, we'll recast these questions into more general ones which will, we hope, cover the subject more completely.

For openers, we'll try to learn "How is ac converted to dc?". We can then address ourselves to the question, "How is our new dc made usable?" and find out how filters operate. Next, we will ask "How is power supply performance rated?" to gain some definitions of necessary terms. Finally, we'll see "How can power supply performance be improved?" and look into methods of regulating voltage and current.

*How is AC Converted to DC?* Most electronic equipment operates from direct current. FCC rules require "pure dc" for the plate supply of any transmitter operating below the VHF region, and good operating practice requires it up into the microwaves. Yet dc of the proper voltage and power level doesn't come out of the wall outlet on demand. We must have circuits which take the ordinary ac available in any home, and convert it to the required dc. Such circuits are known as "power supplies," and they're the subject of our discussions in this installment.

In general, any power supply is composed of three distinct functions as shown in the block diagram of Fig. 1. These are (1) the voltage-determining portion, (2) the rectification portion, and (3) the filter. Operation of each depends upon the characteristics of the other two, yet many choices are possible for each block of the circuit.

The voltage-determining portion usually consists of one or more transformers which step the household ac from its 115 or 230V value up or down as required. For most power supplies, a step up is necessary, although filament supplies normally involve a step down.

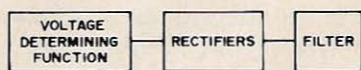

Fig. 1. Any power supply must include these three functions. Voltage is usually determined by transformer, which may step input ac either up or down. Vacuum tubes require step up, usually, while transistors require step down. Rectifiers change ac output of voltage-determining function into pulsating dc, and filter smooths out the ripple in the rectifier output to produce "pure dc."

The amount of step-up required depends both upon the desired output voltage and the rectifier arrangement, as well as upon the type of filter employed. The

transformer itself, however, is essentially the same as those employed for impedance matching and examined in our previous installment, except that power transformers need operate at only one frequency and so are somewhat simpler to design.

The stepped-up ac goes from the voltage-determining block to the rectifiers, and there's where wide choice comes into play. At least three different rectifier arrangements are in common use with single-phase power supplies; all three are shown in Fig. 2.

The half-wave rectifier is the simplest of the three, but is also the least efficient since it throws away half the ac cycle. This circuit is seldom used for circuits which are intended to deliver any appreciable amount of power, although it finds frequent application in bias supplies and other low-current uses.

The centertapped full-wave rectifier is probably the most commonly used circuit. While it requires a centertapped transformer capable of supplying twice the voltage desired at the output, it makes full use of the input ac cycle and places no severe demands upon any circuit components. When virtually all rectification was accomplished by vacuum tubes or mercury-vapor bottles, this circuit was almost universal.

The full-wave bridge rectifier, like the

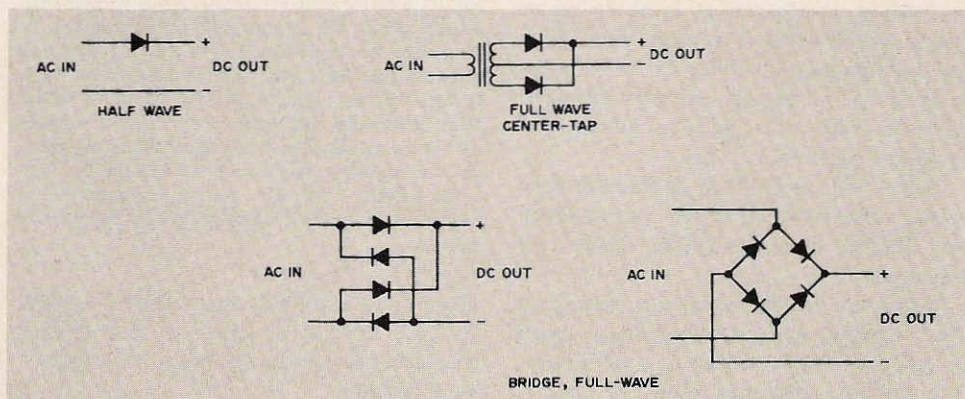

Fig. 2. These three circuits represent the only rectifier hookups in common use. Half-wave circuit is used only in ac/dc receivers and extremely lightweight gear. Full-wave centertap circuit is functionally just two half-wave circuits back to back, with transformer providing two-phase ac. Bridge circuit uses four diodes, but steers ac input through to output without need of transformer while retaining full-wave advantages.

centertapped circuit, makes full use of the input ac cycle, but with some rather significant differences. The centertapped circuit is, essentially, just a pair of half-wave circuits of opposite phase operating in parallel. The bridge, however, is a completely different kind of circuit, in that its diodes "steer" the incoming ac in the proper direction so that it always comes out at the same output terminal regardless of the input terminal it entered.

Because of this steering effect, the bridge does not require a double-voltage transformer. If used with the same transformer as a centertap full-wave circuit, the bridge will produce twice the output voltage — and this arrangement is often used to produce a 100W power supply operating from ordinary TV-replacement power transformers.

The bridge circuit does, however, place additional requirements upon some of its diodes, which limit its attractiveness if tube-type diodes are to be used. Full output voltage appears between cathodes and filaments of the "off" diodes; most tube-type diodes are not rated for this stress. With solid-state rectifiers, though, the bridge is not limited by this difficulty — and since the advent of silicon rectifiers, the bridge circuit has gained wide popularity.

All three of these rectifier circuits involve diodes, which are electronic one-way valves. Diodes come in three major flavors, with subflavors in some cases. They may be high-vacuum tubes, of either high, medium, or low impedance; mercury-vapor tubes; or solid state, such as silicon, germanium, or selenium stacks.

Tubes are used when extremely high reverse voltages are involved, but in many new designs only solid-state diodes are employed.

Tubes are usually rated for maximum direct current per plate, maximum peak current per plate, maximum peak inverse plate voltage, and maximum rms supply voltage per plate.

Solid-state diodes may be rated for peak inverse voltage (PIV), rms supply or input voltage, average forward current, peak one-cycle surge current, peak forward

current, forward voltage drop, and thermal resistance. Of all these, the most important are those which correspond to the tube ratings: PIV, average forward current, and peak one-cycle surge current.

PIV is the maximum voltage which can be applied "in reverse" to the diode before it breaks down and permits current flow "against the stream"; when exceeded instant destruction of the diode usually results. If the diode is connected to a capacitor, diode PIV should be at least twice the peak value of applied ac voltage; otherwise, PIV should be at least equal the peak of the applied ac.

Two or more diodes can be connected in series to increase their PIV ratings, provided that equalizing resistors are connected in parallel with each as shown in Fig. 3. These resistors assure that each

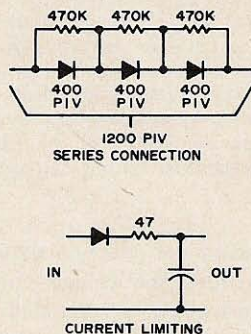

Fig. 3. Semiconductor diodes require their own special tricks. To extend PIV of diodes, two or more can be connected in series, but resistors must be paralleled with each to assure that back voltage divides equally among all units rather than piling up on unit with highest reverse resistance. When capacitor-input filters are used, current through diode must be limited by low-value resistor, to stay within one-cycle surge ratings of 10 to 50A. Value of  $47\Omega$  at 1W usually suffices.

diode gets only its share of the applied voltage; otherwise, most of the voltage would appear across the diode with highest back resistance.

Average forward current is the maximum current which the diode can pass without overheating, on a steady basis.

Peak one-cycle surge current, usually at least 10 times greater than average current,

is the maximum current which can be tolerated on a "one-time" basis without destruction of the unit. Surges occur each time the power supply is turned on, as the filter capacitors charge, and if this rating is ignored with semiconductors, diodes will behave like expensive (and rapid) fuses every time.

While surge current limitations appear more often in connection with solid-state diodes, they apply to all rectifiers. However, tube-type diodes normally have such high internal resistance that they automatically limit themselves to surge currents too small to cause damage. Solid-state diodes, on the other hand, have much less internal resistance and at the same time are much more prone to damage by surges. For this reason a current-limiting resistor capable of holding maximum current within the "surge" rating even in case of a dead short should always be included in series with solid-state diodes as shown in Fig. 3.

Regardless of the type of rectifier used, the output of the rectification part of the power supply is dc rather than ac. This dc is, however, not yet usable because it is "pulsating" rather than "pure." The waveform of the dc at this stage, were it to be fed into a resistive load, would look like Fig. 4 which shows both half-wave and full-wave rectifier-output waveforms. The continual change in level of this power makes it unusable for our purposes; that's why our power supply contains the final block, the filter.

#### How is Our New DC Made Usable?

When our dc emerges from the rectifier circuit, it's pulsating as shown in Fig. 4,

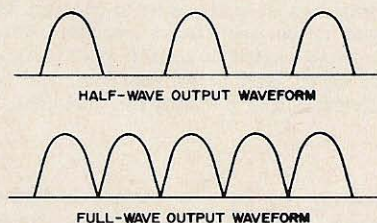

Fig. 4. These waveforms are produced by the rectifier circuits shown in Fig. 2. Half-wave circuit "wastes" half the input ac cycle; full-wave circuit makes use of both halves to produce higher output voltage, and also produces double the ripple frequency which makes filtering easier.

and cannot be used. The filter circuit evens out the voltage and current waveforms, turning it into "pure" dc required by FCC regulations.

Filters are composed of capacitors and inductors, with the capacitors being connected in parallel with the output of the power supply, and the inductors in series. This arrangement makes possible two different layouts for the filter's input circuit, as shown in Fig. 5. Either the series

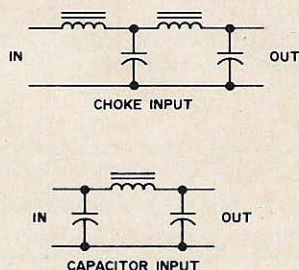

Fig. 5. These schematics show the two types of filter circuits most often encountered in ham equipment. Choke-input filter produces better regulation but lower output voltage; capacitor-input filter is harder on diodes and transformer but produces higher output voltage. Capacitor input is widely used at low power levels but choke input is almost exclusively employed at high power.

inductor can be the first component encountered at the input or the parallel capacitor can be first. If the inductor appears first, the circuit is known as a "choke-input" filter, while if the capacitor appears first, the filter is called a "capacitor-input" type.

Choke-input and capacitor-input filters have very different characteristics, caused by the differences between inductors and capacitors. Compared to a choke-input filter, a capacitor-input filter will produce a higher output voltage at light current drains, but with poorer voltage regulation since at heavy current loads, output voltage for both types is similar. The capacitor-input filter requires higher voltage ratings for the rectifier diodes, and imposes a heavier current load on the transformer.

Because of these differences, capacitor-input filters are most often used for re-

# SLOW SCAN TV

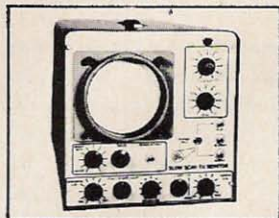

Now for the first time an S.S. monitor designed for your own custom installation. Available in 3 economy kits.

KIT 1 P.C. Boards only (2 req.) ea.	\$9.95
KIT 2 P.C. Boards (Both) & all parts (unwired)	\$80.00
KIT 3 P.C. Boards Wired & tested	\$125.00
Power Supply Kit - No chassis	\$54.95
Complete Monitor - In handsome cabinet	\$298.00

All kits tube type with instructions. CRTs, Power Supplies, and cabinets not included.

**E.K.Y. VIDEO VISION CO.**

Box 15, Stockholm NJ 07460

# DUAL GATE MOSFET PRE-AMPS

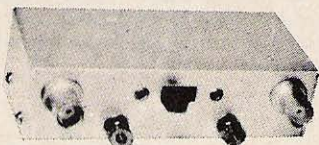

to 175 MHz. \$21.95 ppd.  
to 300 MHz. \$25.95 ppd.

- Available from 5 MHz. to 300 MHz. Bandwidth is approximately 3% of frequency.
- Voltage gain 30 to 40 DB depending on frequency.
- Two Dual Gate MOSFET amplifier stages with each having a tuned input and tuned output. Each Dual Gate MOSFET is actually an integrated cascode circuit thus giving you 2 cascode circuits equivalent to 4 triodes.
- Exceptionally low noise (2.5 DB at 175 MHz.), greatly reduced cross modulation and 10 times the dynamic range (signal handling capability) of the best bi-polar transistors. Also superior to preamps using junction FETs and Single Gate MOSFETs.
- Panel mounted manual gain control.
- Type BNC input and output receptacles for minimum loss at UHF. Standard Impedance is 50-75 ohms.
- Carefully tuned at our laboratory with sweep generator and oscilloscope for the best bandpass characteristic.
- Full wave UHF diodes protect input transistor.
- Operates on 6 to 16 volts DC, 5 to 15 Ma.

New York City and State residents add local sales tax.

# VANGUARD LABS

Dept. H

196-23 Jamaica Ave., Hollis, NY 11423

ceivers and test equipment, where current loads are not likely to vary widely. Transmitters, on the other hand, use choke-input filter circuits more frequently.

The differences between the choke-input filter actions and the actions of the capacitor-input filter are best understood by looking at the waveforms which show what happens inside the power supply during a single cycle of ac input. The waveforms for a capacitor-input filter are shown in Fig. 6. Full-wave rectification is assumed; half-wave rectification merely emphasizes the differences.

Waveform A in Fig. 6 merely shows what the full-wave ac would look like across a resistor, in the absence of any filter.

When the filter capacitor is connected, with a moderate load current being drawn,

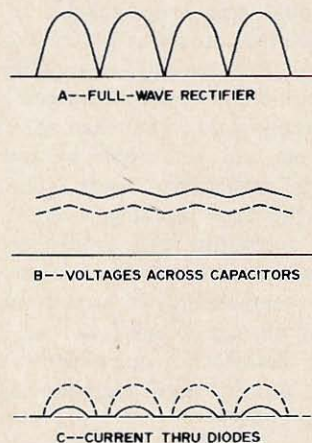

Fig. 6. Waveforms encountered in capacitor-input filter with both light (solid) and heavy (dotted) load currents. Note how both voltage and current waveforms vary as load current is changed. With zero load current and perfect capacitors, output voltage would be pure dc equal to peak voltage of rectified signal; with actual capacitors and light load current, output is slightly less than peak.

the voltage across the capacitor follows waveform B; from point B1 to B2 the capacitor is charging, and from B2 to B3 it is discharging. Current through the diodes, however, flows only during the time from B1 to B2 because the transformer voltage is less than the capacitor voltage for the



remainder of the cycle, so the rectifier current waveform follows that shown as C.

With very little current being drawn, the discharge portion of the capacitor-voltage waveform (that from B2 to B3) becomes almost horizontal, and the entire waveform shown at B rises toward the peak of the rectified waveform. Waveform C then becomes smaller and smaller, until it disappears at the limit of zero load current, with output voltage becoming equal to ac peak input voltage.

Under heavy current load, the discharge curve (B2 to B3) steepens, pulling the entire waveform toward the "zero" line and increasing the amplitude and duration of the pulses in waveform C. These current pulses eventually become so large as to limit the performance of the power supply.

The ac component remaining in wave-

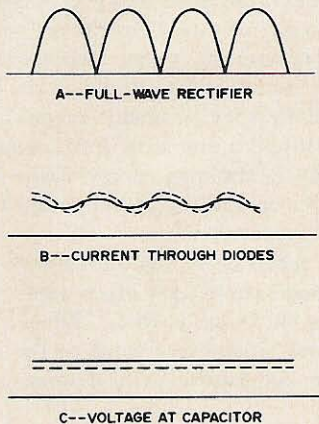

Fig. 7. Waveforms found in choke-input filter are very different from those of capacitor-input circuit. Input choke maintains current through diodes essentially constant, so capacitor voltage does not vary widely between light (solid) and heavy (dashed) load conditions. With half-wave rectifier, output voltage would be only half as great as with full-wave; this difference does not show up nearly so much with capacitor-input filters.

form B is known as the "ripple" frequency of the power supply, and is determined by the timing between voltage peaks in waveform A. In a half-wave circuit, the ripple frequency is the same as the frequency of the input ac, while in a full-wave circuit, the ripple frequency is twice that of the ac

RF MULTIPLIER — 1 mv. to 1v. D-C and RF to 1 Ghz.; VSWR 1.35 & 3.00 full scale; 0 to 60 dB.; many other features: Model RFM-1.

VSWR BRIDGE SET — Precise swept frequency or cw VSWR measurement to 2 Ghz.; includes bridge, termination, and mismatches: Model RCS-1.

BROADBAND RF AMP — 30 dB. gain minimum 10 to 15 MHz.; 10 dB. gain minimum to 500 MHz.; noise figure is 6 dB. maximum: Model BBA-1.

PREMIUM RF AMP — Same as above but with low noise transistors and selected components; noise figure is 3 dB. maximum: Model BBA-1P.

BROADBAND DETECTORS — Coaxial RF detectors in BNC type male and female; high efficiency; 1 MHz. to 1 GHz.  $\pm 1$  dB. Model CRD-1,2.

PEAK-N-NOTCH FILTER — Tunable by front panel control from 100 to 2500 Hz.; 25 dB. peak or notch selectable by switch; unity voltage gain; will drive phones or small speaker: Model PNN-1.

Write for More Information and Discount Prices  
**RADIATION DEVICES CO.**  
 P.O. Box 8450, BALTIMORE, MD. 21234

**ROTARY QSL FILE! \$8.00 ppd. in USA**

- Keeps QSL's always handy, clean, and easy to find in clear plastic pockets (size: 3 1/2 x 5 1/2 inches - Flip knob) to turn to new cards.
- Small enough to fit on smallest operating table.
- Swivel base permits viewing easily from any direction.
- Always at arm's length and handy to station operator.
- File will hold up to 500 cards with complete convenience, without mounting in pockets which can't fall off.
- Saves wall space for certificates.
- Ruggedly built with plastic base and knobs, completely assembled.
- Model HR-8 is shipped complete with pockets included for 160 cards in each file. File holds up to 500 cards. Refills are available at an additional low cost. A practical addition to any shack whether 'old timer' or beginner!

**M-B PRODUCTS & SALES** 1917 No. Lowell Ave. Chicago, Il. 60639

**UNIVERSAL ANTENNA BRACKET-MOUNT**

Rugged, corrosion resistant aluminum casting, with four 3/8"-24 studs, for 1 1/4" tube-mast mounting.

Accommodates up to 4 extra loading coils with Hustler 4-BTV trap vertical, for expanded bandwidth up to 240 KHz on 75/80 meters. (See article "Two on Top" by W6AJZ, 73 Magazine, May 1969). Or use to build your own 5-band vertical antenna (Article "1-2-3-4 On a Mast" by W6IEL, Popular Electronics, August 1970).

Excellent foundation for Ham and CB ground plane radials, or "spider" for mounting spreaders on small cubical quads.

Only \$7.95 postpaid anywhere in U.S. or Canada. Send postcard for detailed information, or order direct from —

**PAL Marketing** CALIF. RESIDENTS ADD 9% STATE SALES TAX  
 P.O. BOX 5187  
 SANTA MONICA, CALIF. 90405

**LEARN RADIO CODE**

**THE EASY WAY!**

- No Books To Read
- No Visual Gimmicks To Distract You
- Just Listen And Learn

Based on modern psychological techniques—This course will take you beyond 13 w.p.m. in LESS THAN HALF THE TIME!

Album contains three 12" LP's 2 1/2 hr. instruction \$9.95 Available on magnetic tape, \$9.95 - Cassette, \$10.95

**EPSILON RECORDS**

508 East Washington St., Arcola, Illinois 61910

input. Amplitude of the ripple is determined by the peak-to-peak excursions of waveform B, and so depends upon the current being drawn from a capacitor-input filter — the less the current drain, the lower the ripple amplitude!

In the capacitor-input filter, then, we have seen that current is drawn through the rectifier circuit only when the transformer voltage exceeds the capacitor voltage, and as a result flows in pulses.

The choke-input filter's waveforms are shown in Fig. 7. Again, waveform A merely repeats the full-wave ac waveform in the absence of any filter.

Since the inductance of the choke acts to oppose any change in current flow through the choke, it will tend to keep current flow out of the rectifier circuit steady, as shown in waveform B. This in turn provides a steady flow of current into the rest of the filter circuit, which produces a steady level of voltage across the output, as shown at waveform C.

Waveforms B and C are obtainable only with "perfect" chokes, and in practice, some ripple will be present just as in the capacitor input filter waveforms. This ripple is due to changes in the inductance of the choke as current flow through it changes.

Whether the choke or the capacitor appears first, the combination of a choke in series and a capacitor in parallel is called a "filter section" and most practical power supplies use at least two sections of filtering in order to reduce ripple to the desired low values. Occasionally, in receivers, the choke will be omitted from the second section, to produce a "pi-section" filter composed of two capacitors separated by a choke.

In addition to the chokes and capacitors, every power supply should include a bleeder resistor across its output.

One of the most important purposes so far as the individual user of the equipment is concerned is safety; the bleeder provides a path for eventual discharge of the filter capacitors, so that they cannot retain their possibly lethal charge for indefinite times. This, though important for safety, is not the primary reason for including the bleed-

er resistor, however — mere danger does not justify the expense of the components, nor the power required by their presence.

The electrical purpose of the bleeder resistor is to establish a minimum load upon the power supply, which will maintain current flow through the filter circuit at or above a certain critical level. This is necessary because the inductance of the chokes in the filter varies with the current through them; by maintaining a minimum current at all times, smaller values of inductance may be used.

Whether the filter uses choke or capacitor input, both the inductance and capacitance values required are very large in comparison to those required for radio-frequency circuits. Inductance values are usually measured in henrys rather than millihenrys or microhenrys, and capacitors are in the range from 2 to 200 microfarads. These large reactive elements are necessary both because the ripple frequency to be filtered out is low (120 Hz is the highest ripple frequency normally encountered in power supplies operating from commercial ac power), and the energy drain is high, which forces the circuit to operate at a low impedance level.

To achieve the high inductance values, "swinging" chokes are often used, particularly in choke-input filters. When a swinging choke is used, the value of the bleeder resistor becomes a critical item in filter design.

A swinging choke differs from an ordinary inductor in that it has a smaller-than-normal air gap in its core. This smaller air gap permits the choke's inductance to fluctuate as current through its winding varies; with low current, inductance is high, and as current increases, inductance drops. Typical swinging chokes vary over a 10-to-1 inductance range through their rated current range. Only enough copper and iron are necessary to provide the minimum inductance, in this design, which gets by because high inductance is necessary only at low current levels.

No such trick is available to help cut the cost of capacitors — but fortunately a special type of capacitor exists, which finds wide use in power supply circuits. Like all

# 20th Anniversary DAYTON HAMVENTION 24 April 1971

## Wampler's Hara Arena

Technical Session • Exhibits • Ladies Program • Hidden Transmitter Hunt • Flea Market • Awards • Banquet

Dept: S Box 44, Dayton, Ohio 45401

capacitors, it consists of two conductors separated by an insulating dielectric, but in this case the dielectric is a film of metal oxide formed chemically on the surface of one of the conductors, while the other conductor is the chemical solution which forms the oxide layer. Such a unit is called an electrolytic capacitor.

An electrolytic capacitor provides more capacitance in a given space and at a lower cost per microfarad than any other type, but it has several disadvantages which partially cancel this advantage. Since the capacitor is literally formed by the action of direct current upon a chemical solution, it can be used only on dc; any ac in the circuit must be kept small in relation to the dc present, or the capacitor will be shorted out. All electrolytics depend upon internal moisture for their action, even though they may be called "dry." The "dry" means merely that all the moisture stays inside, in contrast to early designs called "wet" which had grave tendencies to drip electrolyte all over everything.

In addition, the highest voltage rating seldom exceeds 500V peak, and any voltage in excess of this can cause instant punch-through. The resulting arc does two things immediately; it dries out the capacitor and vaporizes the chemical. A few milliseconds later, the former capacitor is a mess of sticky goo all over the interior of a once-clean chassis.

Unlike other capacitors, electrolytics have rather high leakage current ratings. This may be as much as 1 mA for every 4 mF of capacitance, but varies widely with temperature, age of the individual capacitor, operating voltage, and many other factors. The need to maintain polarization and the high leakage are the two factors which restrict electrolytics' main applications to power supply filters.

Electrolytics are manufactured in an assortment of voltage ratings from 3V up

## mark 2 oscillator/monitor



- makes an audible tone to monitor the RF of any CW transmitter from 10Mw to 1 Kw & 100Kc to 1000Mc, using only an 8" pickup antenna.
- can be self-triggered for code practice or the testing of solid state components and circuits.
- aids in tuning up & testing RF oscillator and power circuits.
- 4 transistor, 2 diode circuit, speaker, tone adjust, AA pencil, test tips, 8" ant., & magnetic base.
- cabinet is 16 gauge black & clear anodized aluminum, 3.4 x 2.3 x 1.2" US made & guaranteed for 1 year.

14.95 complete,  
ppd usa & can.  
send a check or m.o.  
sold by mail only

James Research company, dep't: AR-M  
20 willits road, glen cove n.y. 11542

See your  
**DEALER**  
for  
**DRAKE**  
products

Be a **PIONEER** in **HAM TV**  
...build your own camera!



**BRAND NEW KIT MAKES  
ASSEMBLY EASIER AND  
MORE FUN THAN EVER!**

THE ONLY KNOWN SOLID-STATE  
CAMERA KIT AVAILABLE.

**ONLY  
\$116.95\***

Model X-1A, series D

\*Special factory-discount  
price. Regular \$129.95.  
Vidicon priced separately  
\$36.00. Prices postpaid.

Dial 402-987-3771

VIDICON \* 400 line resolution \* AUTOMATIC  
light compensation \* Video or RF output ch. 2-6  
\* Connects without modification to any TV set

"Ham TV...the picturesque way to communicate!"

HOME TELECASTING is an exciting family type hobby.  
Write or call for FREE catalog of kits, plans, etc.

13TH & BROADWAY, N.

ATV Research

DAKOTA CITY, NB. 68731

to 525V (working ratings, with surge voltages of up to 10% higher permissible), and in capacitances from 1,000,000 microfarads (yes, that's one full farad) down to as small as 2 mF. In general, the high capacitance values are obtainable only at low voltage, and vice versa. Typical units

## • IMPORTANT •

Rochester location for  
WNY Hamfest and VHF Conference  
May 15th

*has been changed*

Send for map and program.  
Write WNY Hamfest  
Box 1388, Rochester NY 14603

## HAL DEVICES

### HAL FM REPEATER IDENTIFIER

TTL logic. Power line frequency counter for 3 minute or less timing and control. Easily reprogrammable diode ROM uses only 27 diodes (depending on call) to send DE "any call". Low impedance audio with volume and tone control. All circuitry including PS on small G10 glass PC board. Write for full details. **HAL DEVICES, BOX 365, URBANA, ILLINOIS 61801**

## HAL DEVICES

Hot Carrier Diodes: HP2800, . . . . . 90¢, 12/510.00 Matched by HAL, . . . . . 4/\$4.25

IC's: 1  $\mu$ L 900, 914, . . . . . 60¢ 1  $\mu$ L 923, . . . . . 90¢

MRTL-MC790P, MC890P, . . . . . \$2.00, 10/\$19.50

MC724P, MC789P, MC792P, MC725P, . . . . . \$1.05, 10/\$9.50

Also available: MC723P, MC788P, MC880P, MC767P, MC9760P.

OP AMP: SN72709N (DIP), SN72709L (TO-5), . . . . . \$1.25

TOROIDS: Indiana General CF102-06, CF102-01, CF102-02, . . . . . 50¢

CINCH IC sockets, 14-DIP, 8-ICS, . . . . . 60¢ **HAL DEVICES**

Add 50¢ Postage, send for complete list. Box 365 L, Urbana, Illinois 61801



## HAL DEVICES

### TTL INTEGRATED CIRCUITS

HAL is now stocking NEW 7400 series TTL IC's. Available are 7400, 7401, 7402, 7404, 7405, 7410, 7420, 7430, 7440, 7441, 7442, 7473, 7475, 7490, and 7493. Write for prices and complete catalog. **HAL DEVICES BOX 365L, URBANA, ILLINOIS 61801**

### VARACTORS and VVC'S

for Amateur Radio Service in Voltage Controlled Oscillators, AFC, remote tuning, variable filters. . . try the NEW WAY to TUNE.

write for data sheets

**EASTRON CORP.**

25 Locust St., Haverhill MA 01832

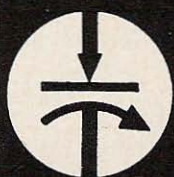

## ARNOLD'S ENGRAVING Personalized

ELECTRIC  
**ON-THE-AIR**  
**SIGN**  
WITH CALL



Works on  
110 VAC  
**\$12.95**



Mettalfex Lapel Bar - \$1.50 Metalfex Tie Clip - \$2.25

## ARNOLD'S ENGRAVING

2041 Linden St.

Ridgewood, N.Y. 11227

found in most power supplies range from 8 to 50 mF, at 350 to 450V. For low-voltage supplies, typical values might be 1000 mF at 15V.

When voltage is first applied to an electrolytic capacitor, leakage current is very high. The current "forms" the dielectric film, however, and leakage drops rapidly. This ability to form a new dielectric gives this capacitor a "self-healing" characteristic in case of momentary overvoltage, provided that the overvoltage doesn't start an arc which prevents the healing action.

Electrolytics are manufactured by wrapping an aluminum foil sheet and an electrolyte-soaked cathode material together, and applying dc with carefully limited current until the dielectric film is formed. The film tends to dissolve when the capacitor is idle, but usually re-forms when power is applied unless the power surge is too great and causes overheating. For this reason, it's advisable to keep power supplies in operation intermittently when equipment is to be shut down for extended periods of time, or alternatively to carefully re-form the filter capacitors before applying full voltage again.

*How is Power-Supply Performance Rated?* Performance of a power supply, like that of any other item of electronic equipment, can be measured only by comparison to known standards. The process of making such comparisons amounts to "rating" the performance of the supply.

Some of the obvious factors involved in such a rating are the output voltage and output current available from the supply, as well as the input voltage and current required. Not so obvious, however, are some nevertheless important factors, such as "regulation" and "ripple content" of the supply's output.

Let's start this discussion by defining our terms. Then we'll be in a position to find out how to fit values into the phrases, or interpret them should we encounter a statement such as, "This circuit offers a high degree of regulation but cannot tolerate input voltage variations."

One of the major terms, — and unfortunately, one with many contradictory meanings — is "regulation." All of its

meanings deal with *changes* of output voltage from a given power supply, but that's about all they have in common. A highly regulated supply maintains fairly constant output voltage, and a supply with poor regulation has an output voltage which can be expected to vary widely — but just what makes the output vary isn't too clearly defined.

One of the meanings often attached to "regulation" is a measure of the change in output voltage as the input ac voltage is varied. For instance, if a supply is designed to operate with 115V ac input and produces 2

One of the meanings often attached to "regulation" is a measure of the change in output voltage as the input ac voltage is varied. For instance, if a supply is designed to operate with 115V ac input and produces 250V dc output under its design conditions, and still produces approximately 250V dc, even when input voltage goes down to 100 or climbs to 130, that supply has good regulation in this sense.

A more commonly intended meaning for "regulation" deals with changes in output voltage as output current is varied, with input voltage held constant. Our well-regulated (for input variations) supply of the previous paragraph might produce its 250V dc output at a load current of 100 mA, yet drop to 200V at a current of 200 mA and climb to 300V dc if current drain is reduced to 50 mA. In this case, its regulation (in this sense) would be rather poor.

That's what we meant by "contradictory meanings," since we've given an example of a well-regulated supply (for input variations) which is poorly regulated (for load changes).

Compounding the situation is the addition of adjectives to the word "regulation," to create such phrases as "static regulation" and "dynamic regulation."

While the phrase "dynamic regulation" appears in the FCC study list as something you are expected to be able to define, we have not been able to find any mention of this phrase in the standard engineering texts and references, such as Terman's "Electronic and Radio Engineering," East-

man's "Fundamentals of Vacuum Tubes," the "Radiotron Designer's Handbook," "Electronic Designer's Handbook" by Landee, Davis, and Albrecht, or "Reference Data for Radio Engineers," all of which have extensive sections on power supply design and measurements. Neither could we find the phrase in three separate editions of the ARRL "Radio Amateur's Handbook," or two editions of the Editors and Engineers' "Radio Handbook." This makes it a bit difficult to provide a guaranteed definition of the phrase!

Some authors have attempted to separate the sometimes-contradictory meanings of "regulation" by attaching "static" to indicate changes caused by changes in input voltage, and "dynamic" to indicate changes due to variations in current drawn. The idea is that input-voltage variations are likely to occur more slowly, and to persist longer, than are current variations caused by circuit operation, thus justifying their being called "static" and using "dynamic" for the more rapidly varying current changes.

This does not, however, remove all confusion, because the idea of a "static change" is in itself a contradiction. And at least a few stubborn souls have reversed these conventions as well, using "dynamic" to mean input-voltage changes and "static" for changes of load.

Another meaning possible for "dynamic regulation" involves the reaction of the power supply to a rapidly changing load such as that produced by a class B modulator or an SSB final. Many supplies which exhibit good regulation under conventional testing go wild under such rapidly changing loads, because they are unable to keep up with the changes. In this context, *static* regulation would be that measured by imposing various loads for relatively long times while making measurements, and *dynamic* regulation would be that shown in action under loads which were continually changing — and this is *probably* the context meant by the FCC.

While we're compounding the confusion, it must be brought out that "regulation" as a general property of a power supply is one thing, confusing though it

may be – but “regulation” as a factor to be measured is something else. In the U.S., engineers measure power supply regulation in percent, and the regulation percentage is defined as the ratio between the difference of unloaded and loaded voltage, and the loaded voltage, all times 100. That is, a supply which delivers 250V without load, and 225V when loaded, has a regulation percentage of  $(250-225)/225$ , times 100, or  $25/225$  times 100, or 11.1%.

Regulation percentage doesn't necessarily mean the same thing everywhere. In other countries, it's sometimes figured as the difference over the *no-load* voltage, which would make that same example come out to 10% rather than 11.1, and occasionally it's figured as the loaded voltage over the no-load value, or 90%!

In short, about the only thing you can be certain of when the word “regulation” is used is that changes in the output voltage of a power supply are being discussed.

Hand-in-hand with regulation, but fortunately with much more precise meaning, is the term “output impedance” as applied to a power supply. The output impedance of a power supply is defined as the no-load voltage minus full-load voltage, divided by full-load current, and is expressed in ohms. If the power supply we used as an example to show the confusion possible with “regulation percentage” achieved that performance with a 100 mA current drain at full load, its output impedance would be  $250-225$  or 25V divided by 0.1A, or 250Ω.

The importance of the “output impedance” is that the power supply acts to any external circuit just like a short circuit in series with a resistor of the corresponding value. If 10 mA is drawn through a 250Ω resistor, the resulting voltage drop is 2.5V. Similarly, if 10 mA is taken from our example supply, the voltage should drop 2.5V from its no-load value, or to 247.5V.

Output impedance is especially important with regard to both “static” and “dynamic” regulation in the final context we examined. In both cases, good regulation demands low output impedance – well below 100Ω in most cases.

“Ripple frequency” is a term we've

already met, as is “ripple amplitude.” Ripple amplitude is usually specified as a percentage of ripple, which is the ratio of the peak-to-peak value of the ripple component only compared to the average value of the dc output voltage. A more meaningful way to rate ripple is directly in terms of peak-to-peak ripple voltage and frequency. In some cases, any ripple voltage over a microvolt or so is too much; in others, as much as 25 to 30V peak-to-peak of ripple may be acceptable. It all depends on what the resulting dc is to be used for.

Usual values of ripple percentage range from 0.1 to 5%; most charts for filter design appearing in the handbooks are calculated for 5% ripple, but if two sections of filtering are used the result will be 5% of 5%, or 1/4 of 1%, ripple.

Now that we have our terms defined, we can turn our attention to the performance factors to which they refer. The major factor is, as one might expect since it is surrounded by the most confusion, “regulation.” Ideally, a power supply should produce an output voltage which is constant, regardless of changes in either input voltage or load. This would be perfect regulation, or “zero” output impedance, and in general it cannot be achieved. But it *can* be attained over a surprisingly wide range of load currents, by use of some special circuitry we'll examine shortly.

Unless special regulator circuits or components are used, however, the regulation of the supply must necessarily be less than perfect. Just how much less depends upon the entire design of the supply. A choke-input filter provides better regulation over its range of operating current than does a capacitor-input one, but requires a higher-voltage transformer to achieve the same output voltage. Large filter capacitors produce better dynamic regulation than do small ones (it's difficult to get too large an output filter capacitor; 500 mF still leaves room for improvement on a 500V supply!) but may produce more loading of the transformer and rectifiers, and at any rate are more costly. A comparison of the output regulation for choke-input and capacitor-input filters appears as Fig. 8, and dynamic regulation of small and large

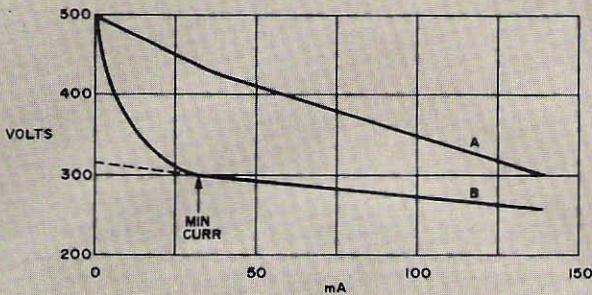

Fig. 8. This graph compares output voltage at various load currents for a typical power supply using (a) capacitor input filtering and (b) choke input filtering, with all other factors held constant. Note that minimum current drain is necessary in order to pull voltage of choke-input filter circuit down into "regulation" region, and that capacitor-input voltage is always higher than that from choke-input circuit.

output filter capacitors is illustrated by Fig. 9.

If better performance than that shown in Figs. 8 and 9 is necessary, then a fourth block must be added to Fig. 1 — a regulator circuit.

*How Can Power Supply Performance Be Improved?* When the utmost in performance is required from a power supply, some form of regulator circuit is usually included between the filter and the output terminals.

Regulator circuits may be as simple as a gas-tube (VR tube or neon bulb), or more

complex than many communications receivers. They may regulate the output voltage, the output current, or both. They may guard against changes in output with changes in load, with changes in input voltage, or both. In general, a wide choice of regulators is available.

The simplest voltage regulator for many purposes is a simple neon bulb. The neon gas which provides the bulb's glow has an unusual characteristic of maintaining constant voltage, regardless of current (within limits, of course) through it. In most cases, this is about 55V. A resistor must be

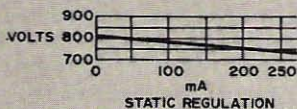
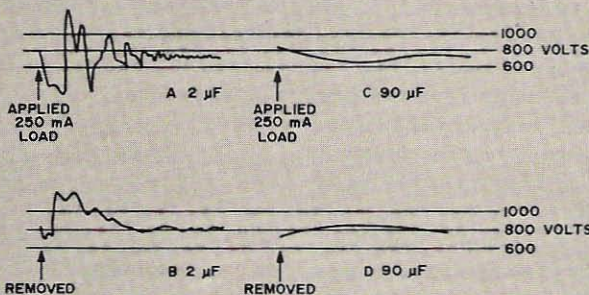

Fig. 9. These waveforms illustrate the meaning of "dynamic regulation" more effectively than could many words. The graph shows static regulation of the test supply, which remained the same for any value of output filter capacitor. Waveform A shows the transients which appeared on the power lead when full load was suddenly applied with 2 mF output capacitance, and B shows removal of load. C and D are the same, application and removal of full load, but with 90 mF output capacitance.

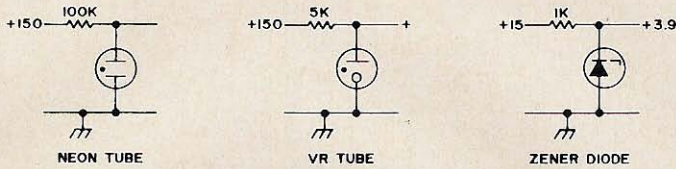

Fig. 10. Three different types of voltage references or simple regulators are shown here, drawn in such a way as to emphasize the similarity of their actions. Each of these produces a voltage which remains relatively constant over a wide range of current levels; so long as their minimum current requirements are met, the voltage is fixed by characteristics of the device. Neon tubes vary in voltage, from 50 to 70V. VR tubes come in specified sizes, as do zener diodes, but the choice is much wider with zeners.

placed in series with the bulb, to limit the current through it to the maximum for which the bulb is rated, as shown in Fig. 10. Output voltage remains constant at the bulb's "maintaining voltage" from zero current drain up to the point at which the current drain through the resistor reduces voltage below the maintaining level and the bulb goes out. So long as the bulb glows, output voltage is regulated.

The familiar VR tube is simply a variation of the same principle. A mixture of argon, neon, and xenon gas is used, and the electrodes in the tube are shaped to permit higher current operation, but the circuit remains the same. VR tubes come in ratings of 75, 90, 105, and 150V, and may be series-connected to produce additional values.

The semiconductor equivalent of the neon bulb or the VR tube is the zener diode. Any silicon diode operated beyond its PIV rating will exhibit the same constant-voltage effect, but zener diodes are especially processed to improve their performance, and to bring the PIV rating down to lower levels. Zener diodes are available to regulate voltages from 3.9 to 150V, and capable of dissipating anywhere from 0.1W to 50W or more of heat while doing so. Like VR tubes, they can be series-connected for "oddball" voltage values, and both VR tubes and zener diodes can be connected in the same series string if need be to achieve some unusual level.

Regulation of these devices is much better than that attained from a bare power supply, but is far from perfect. Output voltage across a VR tube may vary as much as 2V from the full-load to the

no-load condition, which is nearly 3% variation for a 75V tube. While this is better than triple the regulation of many bare supplies, it's not good enough for many purposes.

When better performance is required, the electronic regulator becomes necessary. This circuit, in general, combines a voltage reference source, an amplifier, and a control device (series pass vacuum tube or transistor in most cases), to continually compare the output of the power supply with the reference, and to change the output in such a direction as to drive the difference between output and reference toward zero.

Fig. 11 shows the block diagram of a typical simple regulator, while Fig. 12 shows a simplified version of the schematic (omitting such things as rf chokes, parasitic-suppression resistors, bypass capaci-

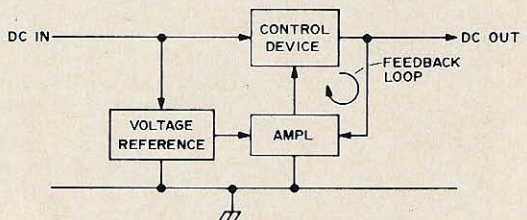

Fig. 11. This block diagram identifies the major functions within a typical electronically regulated power supply's regulator circuit. Input to this circuit is obtained from a conventional power supply. Output is controlled by a series control device, which is in turn controlled by an amplifier stage driven by the difference between the output voltage and an internal reference voltage. The result is that output voltage remains constant over a wide operating range.



tors, etc., which are required in practical regulators).

In this circuit, the voltage reference is a VR tube. Its regulation is much better when used as a reference, however, than when used directly as a regulator, because the load current on the reference remains constant. When near-perfect performance is required, special voltage-reference tubes guaranteed to maintain voltage within a fraction of a percent of rated levels are available.

The amplifier is a bit unusual in its hookup, because it must do the job of comparing output voltage with the voltage reference. In Fig. 12, it does so because the

er's bias decreases, which makes the amplifier draw more current and pulls down the output voltage. The output level thus stabilizes at whatever point produces an amplifier bias level capable of producing exactly the same output level. This is negative feedback in action, or what engineers call a "servomechanism."

The control device is an ordinary power tube or transistor. Fig. 12 shows a triode tube; tetrodes or pentodes require some special complications to keep the screen voltage at the right level. You can view the control tube as being a cathode follower, in which the cathode voltage "follows" the voltage applied to the grid, or you can look at it as being a variable resistance which forms the upper leg of a voltage divider, with the lower leg being composed of the load connected to the power supply.

The plate of the amplifier is connected directly to the grid of the control tube, so that whatever voltage appears at the amplifier is reproduced (except for a small offset voltage established by the tube's operating grid bias requirements) at the control-tube cathode, which is the output terminal of the circuit.

Now let's imagine that we have such a circuit, with all tubes warmed up and the VR tube glowing at a fixed voltage of +90V, but no power supplied to the amplifier and control-tube plates.

When we first apply power to the plates, the output voltage of the supply is zero, so the amplifier grid is effectively grounded. With the +90V from the reference applied to its cathode, the amplifier tube is effectively cut off and no current flows in its plate circuit. The voltage drop through the load resistor is thus zero, and full plate voltage is applied to the amplifier plate and the control-tube grid.

This full plate voltage is reproduced at the output terminal - but in order to rise from zero, where it started, to the full-voltage level, the output terminal must pass through every intermediate voltage level on its way, and as it does so this changes conditions inside the regular circuit in such a manner that the output voltage never climbs higher than the desired regulation point.

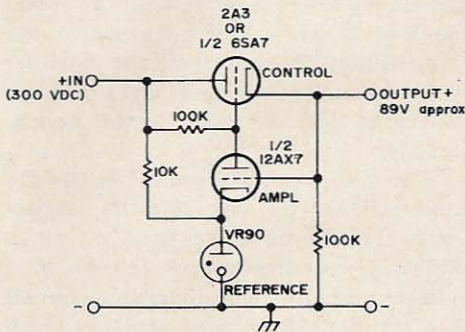

Fig. 12. Simplified schematic of regulator shown in Fig. 11. This circuit omits such items as parasitic suppressors, bypass capacitors, etc., to emphasize those parts which do the job of regulation.

output voltage is connected to the amplifier's grid and the reference voltage is connected to the cathode. This "clamps" the cathode permanently to the reference level.

So long as the output voltage is higher than the reference voltage, the grid of the amplifier is positive with respect to the cathode and the amplifier tube conducts heavy current. This causes a large voltage drop across the amplifier plate load resistor, and as we shall see shortly this in turn reduces the output voltage.

When the output voltage drops below the reference voltage, the difference between output and reference becomes the grid bias voltage for the amplifier, and plate current becomes less heavy. Output voltage rises. As output rises, the ampli-

... for the Ham

## GREAT "MINI MAST" NEW

Self Supporting Crank-up Masts

High strength tubing — 6 square feet of antenna with adequate margin of safety in 50 mph winds — easy 2 step installation.

Available with the  
Exclusive new Rotor Base Accessory

Installation details, other models  
and accessories available

TRISTAO TOWER CO.  
Box 115 Hanford CA 93230



See your  
**DEALER**  
for  
**DRAKE**  
products

### Over 250 Pieces of USED EQUIPMENT on SALE

Be sure to check this list—over \$20,000 worth of good used Receivers, Transmitters and Transceivers offered at these reduced prices! While the stock lasts — let us serve you?

We have Signal One CX7's  
in stock ready to ship

Sandy Jackson mgr — T.T.Freck W4WL

FRECK RADIO & SUPPLY COMPANY  
38 BILTMORE AVENUE  
ASHEVILLE, NORTH CAROLINA 28801

### ELECTRONIC COUNTERS!!

5 DIGIT READOUT WITH 8 DIGIT CAPABILITY — .0005% ACCURACY — PORTABLE

MODEL 5-30: 30 mhz multifunction counter. Frequency, period, ratio, scaling, markers. Frequency range — 10 hz to 30 mhz.

MODEL 5-60: 60 mhz frequency counter. Built-in 5 watt dummy load. Frequency range 100 hz to 60 mhz. 115 VAC or 9—12 VDC

PRICE: \$295 either model, postpaid. \$25 down for COD. Write for complete specs.



**PAGEL ELECTRONICS**

6742-C Tampa Ave., Reseda, Calif. 91335

Until output voltage approaches the VR-tube voltage, nothing much happens. As soon as the difference between output voltage and reference voltage is smaller than the cutoff voltage for the amplifier tube, though, current begins to flow through the amplifier tube, and this current flow through the amplifier load resistor reduces the voltage at the amplifier plate and control-tube grid. Remember that the output voltage of the regulator can never be higher than the voltage at the control-tube grid.

As output voltage continues to rise, the difference between output and reference voltages continues to decrease, reducing the grid bias on the amplifier and thus increasing current flow through the amplifier load resistor. This increased current flow reduces the voltage at the amplifier plate and control-tube grid, and so reduces the upper limit to which output voltage can rise.

This action continues until the control-tube grid voltage and thus the output voltage is reduced to the point at which difference between output and reference voltages is exactly right to maintain current flow through the amplifier at a level which will hold the control-tube grid voltage at that same point. Any additional rise in output voltage would then cause a fall in control-tube grid voltage, pulling output voltage back down, and so the action freezes.

The output voltage at which this "freeze" occurs depends upon the characteristics of the specific tubes used in the circuit, but is always a few volts lower than the reference voltage.

When a load is connected to the power supply output, the load current must flow through the resistance established by the control tube, and this increased current flow will cause output voltage to fall slightly. However, as soon as output voltage begins to fall, the difference between output and reference voltages increases, which means the the amplifier's grid bias increases and less current flows through its load resistor. This raises the voltage applied to the control-tube grid, which increases output voltage until the original level is



## IS IT EASY TO LEARN THE CODE?



Frankly, no. Neither was it easy to learn how to read without two things: Proper instruction, and practice. CODEMASTER tapes, proven in over five years of sales of thousands of tapes all over the world, give you that essential instruction. No other teaching system offers you a more proven method, more accurate sending, more complete guidance. Select your CODEMASTER tapes below!



**CM-1:** For the beginner. A complete course of instruction is on the tape. Practice material at 5, 7, 9 WPM. Prepares you for Novice exam. Includes code groups and punctuation.

**CM-1½:** An intermediate tape, especially for General Class exam study. No instruction; just practice. ½ hr 11 WPM; 1 hr 14 WPM; ½ hr at 17 WPM. Includes coded groups and straight text.

**CM-2:** For Extra-Class license study. Mostly straight text, some code groups. 1 hour at 20 WPM, ½ hour each at 25 and 30 WPM. For real QRO, play this tape at twice speed!

CODEMASTER tapes are 2-track monaural; available in two styles: 7 inch reel (3½ IPS) and cassette. Be sure to specify both the program (CM-1, etc) and the style (reel or cassette). Any tape, \$6.95 postpaid USA 4th class. Any two tapes, \$13.00; all three, \$17.00 PPD. For air shipment in USA add 50¢ per cassette or 80¢ per reel. Immediate delivery. Mastercharge and BankAmericard honored; give us your account number. CODEMASTER tapes are made only by Pickering Radio Company, P O Box 29A, Portsmouth, RI 02871. See your dealer or order direct. Satisfaction guaranteed.

restored. Action occurs so rapidly that the change in output level is usually not detectable – but the change *must* occur in order for the circuit to detect and correct it.

If the power supply load requires additional current, the same thing happens – whenever current drain from the output terminals tends to pull output voltage down, the control tube's grid voltage is automatically increased just enough to bring it back up again. If the current taken from the supply is reduced, the action works in reverse. Any tendency of output voltage to rise above the established "regulated level" causes the control-tube grid voltage to be reduced, pulling output level back down. The action is effective over a wide range of current. Only when the original supply is unable to deliver enough current, or the control tube is unable to pass it, can the output voltage fall.

A regulator circuit such as this normally acts to reduce ripple in the output, as well as to clamp voltage level constant regardless of variations in load current, because

any ripple which gets through is also detected as a variation in output voltage, and is canceled just as is any other output-level change.

A regulator circuit of this type acts to improve both the static and the dynamic regulation of the supply, and reduces output impedance of the supply to nearly zero.

A number of changes are possible to the basic circuit, which permit a circuit designer to choose any type of action he may desire. For instance, he may retain good static regulation and low dc output impedance, while deliberately introducing poor dynamic regulation and high ac output impedance, by placing low-pass filters in the amplifier circuit so that rapid changes in output level cannot cause changes in control-tube voltages, and so cannot be canceled. The simplest such low-pass filters are bypass capacitors from grid to cathode on both amplifier and control-tube stages. However, some bypassing is necessary to prevent oscillation, and so it's not safe to assume that the presence of capacitors at these points means that the designer has

**DOES DAYTON HAVE THE WORLDS LARGEST HAMVENTION? YES!**

20th Anniversary \* \* \* \* \* 24 April 1971

# DAYTON HAMVENTION

## Wampler's Hara Arena

Technical Session • Exhibits • Ladies Program • Hidden Transmitter Hunt  
Flea Market • Awards • Banquet

Dept: S Box 44, Dayton, Ohio 45401

chosen to degrade dynamic regulation.

Another modification which can be made permits the output impedance of the power supply to be made exactly zero, or even to be made negative. When output impedance is zero, a change in load current makes no change at all in output voltage. When output impedance is negative, output voltage actually climbs as current is drawn, and drops as current demand increases.

To achieve these effects, the designer need only include a low-value current-sensing resistor in the negative lead of the circuit, as shown in Fig. 13, and return the

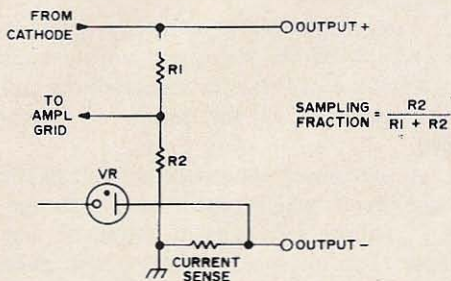

Fig. 13. Modifications to regulated power supply include voltage sensing network which permits output level to be higher than reference voltage, and series current-sensing resistor which allows output impedance to be reduced to (or even below) zero ohms.

negative end of the reference voltage source to the *load* side of this resistor while returning the voltage-sampling network to the *regulator* side.

As load current increases, the voltage across this current-sensing resistor also increases, and this change is added to the reference voltage "seen" by the amplifier. In effect, the reference voltage to which the output level is clamped is made to increase as load current increases, and the automatic clamping does the rest.

The size of the current-sensing resistor determines whether output impedance is zero or negative. The smaller the resistor's value, the less its effect. With a very low value, the effect can be made just enough to cancel the positive output impedance of the rest of the circuit, giving a net output impedance of zero. With higher values,

output impedance becomes negative.

Figure 13 also introduced the "voltage-sampling network," which is simply a voltage divider connected across the output of the supply, with the amplifier grid or base connected to its midpoint. This network permits output voltage of the supply to be higher than the reference voltage, because it establishes the voltage fed to the amplifier as a fixed fraction of actual output voltage, and the regulator circuit actually clamps the voltage fed to the amplifier at the reference level.

For example, with a 90V reference source and a sampling fraction of 2/3, the regulator would hold output voltage at something less than 135V. If the bias requirements of amplifier and control stages introduced a 10V offset, so that the circuit would clamp amplifier-input-voltage level to 80V, then output would be 120V (2/3 of 120 being 80).

To change the output voltage of this supply to 200V, all that would be necessary (if unregulated input voltage were 300V or above as noted below) would be to change the ratio of the resistors in the sampling network so that the sampling fraction changes from 2/3 to 2/5. Now, when output is at 200V, 2/5 of this output, or 80V, is applied to the amplifier, and action is just the same as before.

In practice, most regulated supplies use such sampling networks, and include a potentiometer at the junction point to

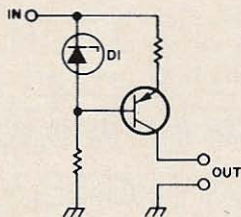

Fig. 14. Current regulator circuit uses two resistors, one zener diode, and a single transistor to regulate current to some maximum value set by design, over entire range from short-circuit to open-circuit load conditions. Naturally, design current cannot be made to flow through open circuit, but regulator assures that regulating level is never exceeded, and is achieved if input voltage is high enough to force that much current through load resistance.



permit variations of the actual output level by permitting small changes in sampling fraction. Some supplies have a wide adjustment range, while others permit only a narrow margin.

Note that a regulated supply of this sort requires an unregulated input voltage considerably higher than the desired output voltage. This additional voltage is necessary in order to provide operating voltage for the control device, and represents "wasted" power so far as the external load circuit is concerned. Current capability of the regulated supply is also limited by the control device. These two disadvantages are the major reasons why regulated power supplies are not more widely used. In ham gear, fully regulated supplies are found only in critical frequency-control circuits and low-current bias supplies, if at all.

While the term "regulated power supply" usually means a supply in which the output *voltage* is regulated, it's also pos-

sible to regulate output *current* so that it remains constant regardless of changes in load resistance. This is sometimes called "current limiting," as we did in discussing Fig. 10.

The need for current regulation occurs far less frequently than that for voltage regulation, however, and so in general use "regulation" has come to mean only "voltage regulation" unless specifically called out as applying to current.

Current regulation, when it is encountered at all, usually shows up the in voltage-reference portion of a regulated power supply, where the VR tube is supplied with constant current in order to hold its voltage more constant.

The simplest current regulator consists of a resistor, having a value from 10 to 100 times greater than the resistance of the expected load circuit, in series with a power supply which produces from 10 to 100 times the anticipated voltage requirement. Most of the voltage drops across the resistor, and current remains fairly constant.

For instance, a 300V supply connected through a 300 k $\Omega$  resistor will permit a maximum of 1 mA to flow, even if the output is shorted. With a load resistance of 30 k $\Omega$  the total series resistance is only 10% (9%, to be exact) less. If load resistance is not permitted to exceed 3 k $\Omega$  the resistance variation will be only 1%, and the current varies less than 1%. Voltage across the load ranges from 300 with no current flow down to zero with a short circuit.

For more effective regulation of current, a servo regulator such as that shown in Fig. 14 can be used. This circuit acts in much the same manner as the voltage regulator of Fig. 12, but combines the amplifier and control stages in a single transistor.

The transistor base is clamped to a voltage somewhat lower than the input voltage, by zener diode D1. Emitter voltage, however, varies with current flow through the circuit. With no current flow, the emitter resistor causes no voltage drop, the emitter is at input voltage, and since the transistor is PNP, this turns it on.

★ **INDUSTRIAL & GOVERNMENT**  
 FB PARTS **ELECTRONIC SURPLUS**  
 EQUIPMENT MONTHLY CATALOGS  
 AMATEUR RADIO ALL DIFFERENT  
 TUBES & SEMICONDUCTORS GET YOURS  
**STAR-TRONICS** NOW  
 P. O. BOX 17127 PORTLAND, OREGON 97217

**\* TWO-WAY \***  
**COMMUNICATION CRYSTALS**  
 AMERICAN CRYSTAL CO.  
 PO Box 2366 Kansas City, MO 64142  
 (816 - 842 - 5571)

**WORLD QSL BUREAU**  
 5200 Panama Ave., Richmond CA USA 94804  
**THE ONLY QSL BUREAU** to handle all of  
 your QSLs to anywhere; next door, the next  
 state, the next county, the whole world. Just  
 bundle them up (please arrange alphabetically)  
 and send them to us with payment of 4¢ each.

**VIBROPLEX**  
  
**ENJOY EASY, RESTFUL KEYING**  
 \$21.95 to \$43.95  
**THE VIBROPLEX CO., INC.**  
 833 Broadway,  
 New York, NY 10003

**WE PAY HIGHEST CASH PRICE**  
 for Electron Tubes & Semiconductors  
 Immediate Payment on Unused Tubes  
**H & L ASSOCIATES**  
 Elizabethport Industrial Park  
 Elizabeth, New Jersey 07206  
 (201) 351-4200

**160 METER ANTENNA**  
  
**MODEL 48MV MATCHVERTER WILL RESONATE ANY 40 OR 80 METER DIPOLE/INVERTED VEE ON 160 METERS**  
 ■ Handles 250W PEP (140W DC)  
 ■ Use coax or open feedline  
 ■ Use with any SWR bridge  
 ■ Made in USA—Guaranteed  
**\$3995 Ppd**  
**TOP BAND SYSTEMS**  
 5349 Abbeyfield, Dept. 8, Long Beach, Calif. 90815

**420 MHZ ATV CONVERTERS**  
 Our model 432CA crystal controlled converters are flat within about 1 dB over any 6 MHz channel in the 420 to 450 MHz band. Choice of Channel 2, 3, or 4 i-f. Noise figure 5.5 dB. A post card brings full details. Other converters available for 50, 144, 220, and 432 MHz.  
**JANEL LABORATORIES**  
 P.O. Box 112  
 Succasunna, N. J. 07876  
 TEL: 201-584-6521

Emitter-to-collector resistance is low and high current can flow, just as output voltage could skyrocket (initially) in Fig. 12.

As current flows, however, it produces a voltage drop across the emitter resistor, reducing the difference between emitter and base voltages, and so reducing the forward bias on the transistor. Emitter-to-collector resistance increases.

When enough current is flowing to bring the emitter voltage almost down to the base level (because of the voltage drop in the emitter resistor), the high emitter-to-collector resistance at this operating point prevents additional current flow. Thus, even with the collector shorted to ground, only enough current can flow through the emitter resistor to bring emitter voltage down to base level and turn the transistor off.

For any value of load resistance from zero to infinite (short circuit to open circuit), current flow through the collector is held at the value which develops approximately the zener-diode voltage across the emitter resistor. With a 3.9V zener and 3.9 kΩ in the emitter, current regulated at 1 mA; with 390Ω at 10 mA, and so forth.

Many variations of regulator design and action are possible. It's far beyond the scope of this series to go into any greater detail now, but if your interest in the subject has been whetted you can find much additional data in either of these two books:

"Silicon Zener Diode and Rectifier Handbook," Motorola Semiconductor Products Inc., Phoenix, Ariz. (\$2 when published in 1961).

"Electronic Designers' Handbook," edited by R. W. Landee, D. C. Davis, and A. P. Albrecht, McGraw Hill Book Company, Inc., New York, 1957.

Now that we know all about power supplies, or at least more than most of us really wanted to discover, we're ready to take a look at the subject of amplification.

...Staff ■

*Tell our advertisers you saw it in 73!  
 (Even if you didn't.)*

**FREQUENCY MODULATED  
TRANSMITTER. BC604**

Brand new government surplus in sealed cartons.  
 Power output 30 watts  
 Freq. Dev. 40 kc.  
 Freq. Range 20. to 27.9 Mc.  
 10Preset channels  
 Complete with tubes and spares.  
 Adaptable to ham band modification. Needs only  
 power supply, crystal and mike to get on the air.  
 Surplus Issue Special Price  
 Stock No. 5001 ..... \$22.50  
 Wt. 75 Lbs.

**LIGHT ACTIVATED SCRS**

STOCK	PRV	PRICE
H4116	60	1.00
H4117	100	1.75
H4118	200	2.50
H4119	300	3.50

**COMPUTER GRADE CAPACITORS**

Stock No.  
**S2040**  
 Sangamo or Pyramid 4 1/4 x 1 1/4. 4000 Mfd. 50  
 volts ..... .65 ea 5/3.00  
**S2049**  
 Sprague or Sangamo 4 1/4 x 1 1/4. 3500 Mfd. 55  
 Volts ..... .65 ea 5/3.00  
**S2062**  
 Sprague (Brand New) 3" x 4 1/2". 40,000 Mfd. 12  
 Volts ..... 1.25 ea 6/7.00

**PHOTO ELECTRIC ASSEMBLIES**

**S 7000**  
 Contains cadmium sulfide photo cell, potenti-  
 omer, relay, lamp & Fairchild 2N-2657, 1 5/8"  
 x 1 1/4". Original used as exposure meter control.  
 Complete with circuit diagram & application data  
 ..... \$1.25  
**S 7001**  
 Contains cadmium sulfide photocell, 2-500Ω  
 variable resistors & Fairchild 2N2240. Change in  
 light changes bias on transistor. Useful for all  
 types of light sensing & alarm devices. .... .75 ea.  
**SURPLUS ISSUE SPECIAL**  
 3 each S7000 & S7001 ..... 5.00

**FUSIBLE RESISTORS**

Protect your power transistors with one of these  
 in emitter circuit.  
**S8027** .27 Ohm 2 Watt ..... 6/1.00  
**S8028** .50 Ohm 5 Watt  
 Pos. Temp. Coef. .... 4/1.00

**COMPUTER BOARD SPECIALS**

**S9082**  
 Honeywell Computer boards, 4 1/2" x 12". Trans-  
 istors, diodes, zeners, capacitor, precision res-  
 istors, heat sink, trimmers, etc. 2 different  
 boards ..... 1.00  
**S9127**  
 Honeywell Boards 5 1/2" x 6". Loaded with late  
 no. transistors, diodes, resistors and capacitors 1.50

**MINIATURE RELAYS**

**S9130**  
 Operates from 12 to 24 volts. 3/4" x 3/8" x 3/8"  
 DPDT Printed Circuit or socket mount  
 .75 ea. 3/2.00 10/6.00

**SILICON CONTROLLED RECTIFIERS**

TO-5 1.5 AMP	STK. NO.	PRV	PRICE
	S4200	50	4/1.00
S4201	100	2/1.00	
S4202	200	3/2.00	
S4203	300	.80	
S4204	500	1.00	

TO-66 3 AMP	STK. NO.	PRV	PRICE
	S4206	50	.40
S4207	100	.50	
S4208	200	.65	
S4209	300	.85	
S4211	500	1.35	

**400 PRV 6 AMP TRIACS.**

Transitron TTD10 (RCA 40639) Comes mounted  
 on its own heat sink. S4128 .... 1.50 ea 6/8.00

**TO-5 HEAT SINKS**

Increase the power rating of your TO-5 trans-  
 istors. Adjustable for larger or smaller transistors.  
**S9109** ..... 15/1.00

**TUNNEL DIODES**

Similar to 1N3717  
**S4017** .60 6/3.00

**FIELD EFFECT TRANSISTORS  
(FETS)**

**S4016** N Channel Sim. to 2N3819 . .60, 6/3.00  
**S4129** P Channel Sim. to 2N3920 .. .60 6/3.00

**NIXIE DRIVERS  
NPN- TO-18**

**S4105** hfe .20 10/3.00  
**S4106** hfe .40 10/4.00

**\$1.00 FREE WITH \$10.00 ORDER**  
**MINIMUM ORDER \$3.00**

Lots of other items—send for free flier: All mer-  
 chandise fully guaranteed. Please include post-  
 age: excess will be refunded.



**DELTA ELECTRONICS CO.**

BOX 1, LYNN, MASSACHUSETTS 01903

**● SLEP ELECTRONICS COMPANY ● 2412 NORTH HIGHWAY 301 ● ELLENTON, FLORIDA 33532**

**RADIO RECEIVERS AND TRANSMITTERS:**

COLLINS R-648/ARR-41, tunes 190-550khz and 2 to 25mhz, digital readout, 28vdc, easy to convert to 115V/60cy, airborne R-390	\$275.00
COLLINS R-388/URR, military version of the 51J-3, tunes 500khz to 30.5mhz, a favorite	\$325.00
HAMMARLUND SP-600JX rcvr tunes 540khz-54mhz a pop RTTY CW & SWLrcvr	\$295.00
AN/URR-13 receiver, tuneable UHF 200-400mhz, popular for UHF ham bands, monitoring military and astronaut frequencies, best in UHF	\$85.00
T-593/TRC-47 VHF AM transmitter, 132-150mhz, single channel, xtal control	\$32.50
BC-645 transceiver, tunes 460-490mhz, 12/28vdc input, SEE past conversion articles for 420mhz conversion	\$21.50
COLLINS T-47/ART-13 transmitter, tunes 2-18mhz, 28vdc, autotune, 813A final	\$24.50
COLLINS RT-178/ARC-27 UHF 200-400mhz transceiver with control head	\$79.50
BENDIX RA-10 RDF receiver, tunes 150-1100khz and 2-10mhz, ideal for boats, weather, transmitter hunts	\$18.50
APX-6 transponder, the famous moonbounce set	\$21.50
TCS RECEIVER-transmitter, tunes 1.5mhz thru 12mhz, power output 20 watts voice, 49 watts CW, a popular unit	\$32.50
RBC with 115V/60cy power supply, 4 to 27mhz, A1, A2, A3 reception	\$65.00
AN/PRC-6 FM walkie talkie, 47 to 55.4mhz, 43 different operating channels, only one can be used at a time	\$39.50
2 ft. whip antenna, less battery and crystals	\$3.00
RT-66/GRC receiver-Transmitter, FM 20.0 to 27.9mhz, 16 watts	\$59.00
RT-67/GRC Receiver-Transmitter, FM 27.0 to 38.9mhz, 16 watts	\$85.00
RT-68/GRC Receiver-Transmitter, FM 38.0 to 54.9mhz, 16 watts	\$95.00
RT-70/GRC Receiver-Transmitter, FM 47.0 to 58.4mhz, 16 watts	\$79.00
R-109/GRC Receiver, 27 to 38.9mhz FM	\$65.00
R-116/GRC Receiver, 38.0 to 54.9mhz FM	\$65.00
AN/GRC-9 Transmitter-Receiver, 2 to 12mhz AM, CW, or MCW, 7 watts	\$119.00
R-278/GRC-27 Receiver, 225 to 400mhz, 10 preset channels, AM, 1750 selected channels	\$185.00
T-217/GRC-27 Transmitter, 225 to 400mhz, 100 watts, 1750 selected channels, AM/MCW	\$165.00
MD-129/GRC-27 Modulator, goes with T-217/GRC-27 transmitter	\$75.00
RCA AN/FRR-21 Receiver, A1, A2, F1 reception, 14-600khz tuneable, 115V/60cy	\$169.00
AN/APS-42 Receiver-Transmitter, Radar X-Band	\$65.00
BC-348 Receiver, tunes 200-500khz and 1.5 to 18mhz, 28vdc, unmodified	\$65.00
RCA SRR-13 Receiver, A1, A2, F1 reception, tuneable 2 to 32mhz, 115V/60cy, a Navy favorite	\$169.00
TBK-17 Transmitter, 2.0 to 18.1mhz, V.F.O., CW capable of relay keying speeds up to 100 WPM, 115V/220V, 60 cycle	\$95.00
TBL-7 Transmitter, 175 to 600khz and 2 to 18mhz, V.F.O., CW, MCW, 200 watts, keying speed 100 WPM, 220V/60 cycle	\$95.00

**TELETYPE EQUIPMENT:**

AN/UGC-40 Mitey-Mite page printer with 60, 75, 100 WPM gears, the miniature type printer, light grey color, 115V/60cycle, sync motor, looks good in any ham shack	\$119.00
TEST SET TS-2/TG teletypewriter signal distortion test set, transmits four test signals, R, Y, Space, or standard test message. A needed item for all RTTY operations	\$35.00
TT-4A/TG Teletypewriter, KSR, 115/60 cycle	\$69.50
RADIATION, INC. Model TDM5-5EB-R-2B teletype test transmitter, used to overhaul late type teletype systems	\$39.50

**MISCELLANEOUS EQUIPMENT:**

AN/PRS-3 Mine Detecting set in shipping case, the best portable system for battlefield, beach, and treasure hunting. Can be used around salt water and iron soil, the best	\$125.00
PANORAMIC INDICATOR IP-259/U, military version of SB-8A Type T-200, 400-600khz IF input, 5-inch CRT, complete with PS-8 115V/60 cycle power supply	\$145.00
NEMS-CLARKE TLM32-A Telemetry pre-amplifier	\$65.00
BOEHME TYPE 8-D automatic keying unit, 10-100 WPM	\$35.00
BC-709C Interphone amplifier, uses standard flashlight batteries, ideal for plane, car, camper, boat, house	\$3.00
RA-84 AC power supply for BC-779 Super-Pro receivers	\$18.50
C-626/ARC-27 control head	\$6.50
C-149/ARN-6 control head	\$12.50
C-2328/GRA-39 control head	\$12.50
RECORDER, WIND DIRECTION AND SPEED Type RO-14AN/GMO-20, goes with wind measuring set	\$37.00
GMO-20	\$37.00
COMBINE INDICATOR ARC IN-14-1, VOR/ILS Indicator for ARC-15 Omni	\$12.50
BENDIX IN-4D Indicator, left-right meter movement	\$3.50
C-996/ARN-14 control head	\$12.50
ID-91B/ARN-6 Radio Bearing Indicator, 360 degree rotation, ideal for antenna beam	\$6.50

**JUNK BOX NIGHTMARE:**

FOR THIS SPECIAL \$73 SURPLUS ISSUE WE HAVE PUT TOGETHER 50 POUNDS OF SMALL VALUABLE ELECTRONIC COMPONENTS CONSISTING OF SURPLUS RESISTORS, CAPACITORS, SWITCHES, CONNECTORS, CIRCUIT BOARDS, TRANSISTORS, SMALL SCREWS, KNOBS, VARIABLE CAPACITORS, CRYSTALS, TUBE SOCKETS, ETC., ETC. ALL SMALL COMPONENTS, NO HEAVY TRANSFORMERS, ETC. A TERRIFIC ONCE A YEAR BARGAIN. EACH BOX IS DIFFERENT. GUARANTEED TO SATISFY YOU. SPECIAL POSTAGE PAID DEAL \$18.00, TWO FOR \$32.50.

**AIRCRAFT PILOTS:**

SKYCRAFTERS Model AMT-9/AMR-4 VHF Transceivers, 24 channel with crystals, 118.1 to 123.0, Size 3-5/8" x 5 1/2" W x 7" D, choice of 12 or 24 transistorized power supply, size 2" H x 3" W x 4" D, total wt. 4.7 lbs., complete system with antenna and cables, BRAND NEW 1970 models, ready for installation \$285.00. Sells new for \$756.50.

**ATTENTION: LINEAR AMPLIFIER BUILDERS:**

B & W 850A Pi-Net Inductor, designed for 80-10 meter amateur bands, plate load impedance 2500-5000 ohms, used for single and parallel tubes series fed circuits, 813, 4-125, 4-400, 4-1000, rated 1000 watts, new boxed \$59.50  
 B & W 852 Pi-Net Inductor, designed for 80-10 meter amateur bands, plate load impedance 2000-4000 ohms, used for single or parallel tubes, series or shunt fed circuits, 3-400Z, 3-500Z, 3-1000Z, 4CX1000A, etc., rated 1000 watts, new boxed \$59.50  
 B & W 3902-1 Cyclometer, 100 turn counter, numbers increase with clockwise rotation of handle, a beautiful precision counter \$29.50

**NEW FACTORY EIMAC YELLOW BOXED TUBES, FACTORY GUARANTEED:**

Eimac 4002Z	\$32.00
Eimac 3-500Z	\$34.00
Eimac 3-1000Z	\$79.00
Eimac 4-400A	\$42.00
Eimac 4-1000A	\$119.00
Eimac SK-510 Socket, 3-1000Z, 4-1000A	\$10.50
Eimac SK-411 Socket, 3-400Z, 3-500Z	\$10.50
Eimac SK-650 Socket, 4X150A, 4CX250B, no screen by-pass	\$12.00
Eimac SK-620 Socket, 4X150A, 4CX250B, has screen by-pass	\$13.25
Eimac SK-800B Socket for 4CX1000A	\$59.50
Eimac SK-516 Chimney for 3-1000Z	\$12.00
Eimac SK-806 Chimney for SK-800B	\$13.50
Eimac SK-506 Chimney for 4-1000A	\$12.00
Eimac SK-416 Chimney for 3-400Z, 3-500Z	\$7.00
Eimac SK-626 Chimney for SK-650, SK-620, 4X150A, 4CX250B	\$1.50
Eimac HR-6 Heat Dissipating Plate Cap for 4-65, 4-125, 4-400	\$2.20
Eimac HR-8 Heat Dissipating Plate Cap for 3-1000Z, 4-1000A	\$2.85



• SLEP ELECTRONICS COMPANY • 2412 NORTH HIGHWAY 301 • ELLENTON, FLORIDA 33532

**TEST EQUIPMENT:**

OS-34/USM-32 Oscilloscope, 3WP1 tube, portable general purpose, 10cy to 4mhz	\$85.00
OS-8/U Oscilloscope, portable, 3RP1 tube, general purpose, DC to 2mhz	\$59.50
MICROLINE MODEL 555 Klystron signal source	\$29.50
ME-26D/U Multimeter, military version of H.P. 410B, same ranges	\$75.00
G.R. 869A Pulse generator, .3 to 70 microsec, 20-4000cy	\$29.50
LAVOIE LA-239A Oscilloscope, 10cps to 5mhz, square wave variable .1 to 1V peak to peak, high gain wide band 3" CRT	\$79.50
G.R. 1932A Distortion and noise meter, audio freq range 50cps to 15khz, distortion measurements 20 to 45,000cps, DBM range +20 to -60dbm	\$125.00
TS-375/U VTVM, AC-DC volts, freq range 40cps to 150mhz, the military favorite, with probes	\$32.50
G.R. 916AL RF Bridge, for measurements of antennas, line, networks, etc., range 400khz to 60mhz, resistance range 0 to 1000 ohms	\$145.00
SG-12A/U Signal generator, FM, 20 to 100mhz, used by military for alignment of GRC FM equipment	\$275.00
G.R. 762A Vibration analyzer, range 2.5 to 750cps	\$69.50
G.R. 805C Standard signal generator, 7 ranges, 16khz to 50mhz, a precision, high quality generator	\$175.00
TS-497/URR Signal generator, 6 ranges, 2 to 400mhz, MILITARY VERSION OF MEASUREMENTS MODEL 80, output 0.1 to 100,000mv	\$175.00
H.P. 430C Microwave power meter, reads direct, pulsed or CW power readings 10mhz to 40ghz	\$65.00
H.P. 524B Frequency counter with 525A plug-in, range 20 cycles to 100mhz	\$385.00
H.P. 525A Plug-in frequency converter for 524B, C, and D counters, FR-38 and Northeastern, can be adapted to other makes, range 10mhz to 100mhz	\$69.50
TS-175/U Frequency meter, 85 to 1000mhz, 0.05%, 20mv to 2V sens., 1000 cycle AM	\$55.00
BC-221 Frequency meter, 125khz to 20mhz	\$55.00
TV-10/U Tube tester, mutual conductance, checks old and late military receiver, transmitter and sub-min. tubes, with roll chart	\$65.00
H.P. 185B Oscilloscope with 187B dual trace amplifier, DC to 1000mhz, 10V/CM to 200V/CM, internal voltage calibrator, low noise, has X-Y recorder output. One of the best	\$475.00
TS-413/U Signal generator, 75khz to 40mhz in 6 bands, precise calibration from 1mhz crystal oscillator, has % modulation meter, CW or AM, 400/1000cps, variable 0-50% and RF level meters 0 to 1.0V, ideal for IF and receiver alignment	\$89.50
FREED 1140A Null detector amplifier, input impedance 1 megohm, gain 100db with 1 megohm load, 60/400/1000 cycle, 115V/60cy P/S	\$37.50
TS-282/U Audio oscillator, 0 to 200khz with 60 to 400 cycle reed meter, ideal for audio work	\$79.50
URM-91 Field strength meter, receiver range 18 to 125mhz, complete with antenna and power supply	\$95.00
G.R. 740B Capacitance bridge, range 5mmf to 1100mf in 7 ranges, reads direct from logarithmic dial and multiplier switch, accuracy within 1%, 115V/60cy, ideal for shops and labs	\$65.00
H.P. 400HR VTVM, .1mv to 300V, 10cps to 4mhz, 19" rackmount and metered	\$65.00
G.R. 1176-A Frequency meter, 25 to 60,000cps in 6 ranges, voltage input 0.25 to 150V	\$45.00
BRUSH BL-320 Universal strain amplifier, up to 100cps, used with Brush pen recorder	\$39.00
MEASUREMENTS MODEL 111B Crystal calibrator, range 0.1 to 1000mhz, accuracy 0.002%	\$42.50
TS-34/AP Portable oscilloscope, 2AP1 with 2X magnification lens, vertical amp flat 30cps to 1mhz, a good television scope	\$34.00
USM-24 Oscilloscope, vertical freq. resp. 1.5cy to 10mhz, horiz. 0.5cy to 1.5mhz, sweep time 1/24 to 125,000 microseconds, 115V/60cy	\$95.00
TS-505/U Multimeter AC/DC Volts, ohms, complete with probes	\$65.00
TS-11/AP Portable DC Milliammeter, 0-1 plus 0-25dcma ranges, mounted in nice wooden box	\$22.50
TEKTRONIX FM-122 low level preamplifier	\$18.50
USM-29 Frequency meter, 15khz to 30mhz, .001% accuracy, 115V/60cy	\$75.00
UPM-2 WAVEMETER test set, range 80-1220mhz, absorption type	\$37.50
URM-26 Signal generator, 4-405mhz, portable type in case, ideal for AM/FM work	\$225.00
SG-85/URM-25D Signal generator, 10khz thru 50mhz, 0.25%, portable type in case	\$265.00
SG-557/URM-52B Signal generator, 3800 to 7500mhz, 115V/60cy, military version of the H.P. 618-B	\$295.00
G.R. 1390B Random noise generator. This instrument generates wide band noise of uniform spectrum level, useful for noise and vibration testing in electrical and mechanical systems	\$185.00
BOONTON 250A RX METER Frequency range 500khz to 250mhz, measures equivalent parallel resistance and capacitance or inductance of networks, R-range 15-100,000 ohms, C-range 0-20pf, L-range .001uh-100mh	\$345.00
BIR-18890 Termaline R.F. dummy load, 2500 watt VSWR 1.1 max, DC to 1000mhz	\$129.50
AV/UPA-350 Color decoder, used with UPM-6 transponder test set	\$129.50
TS-186 FREQUENCY METER 100 to 10,000mhz, .01% accuracy, 115V/60cy	\$69.00
H.P. 335B FM MONITOR, has two panel meters to show carrier deviation and percentage of modulation with lamp to indicate peak modulation	\$225.00
G.R. 544B Megohm bridge, combination wheatstone bridge and VTVM, range 0.1 to 1,000,000 megohms, ideal for lab	\$65.00
TS-155/UP Signal generator, 2400 to 3750mhz	\$65.00
IE-19 TEST SET in chest, complete with 100-156mhz signal generator, field strength meter, ideal for one who wants a low price VHF test set-up	\$18.50
UPM-6B Transponder test set with probe, FAA approved	\$175.00
TS-251/UP Loran test set, used to calibrate all loran navigation equipment	\$79.00
TS-62/AP Hi-Q resonant cavity, 9320-9420mhz, 50 ohm	\$14.50
IE-36 test set, used to test VHF SCR-274N equipment	\$17.50
TS-419/U, same as H.P. 616A or ARC H-12, 900mhz to 2100mhz	\$125.00
IDEAL INDUSTRIES Type 41-001 Portable insulation tester, 500-2500V, complete with prods	\$22.50
T-5/NF-12 Empire Devices tuning unit, 10-15khz	\$65.00
TS-226A/AP Power meter, range 405 to 425mhz, 0-1000W, 115V/60cy, ideal for ham TV use	\$16.50
HOUSTON INSTRUMENTS HLVC-150 servo driven voltmeter and log converter, Has 13" mirror back scale, calibrated in RMS volts and DB, AC/DC 1mv-3.16v, 100mv-316v, DB scale movable from +75 db to -75db, eliminates adding or subtracting from 0 db reference	\$125.00
WATERMAN S-12-C, 3" rackmount oscilloscope, 1/2 cycle to 50khz	\$37.50
NARDA 440 Microwave power meter, 0.01 to 10mw, frequency range is any for which bolometer or thermistor detectors that are available	\$42.50
G.R. 783A Output power meter, used for direct reading measurements of power output in audio circuits, 0.2mw to 100 watts in 5 ranges, decibel range -10 to +10db above 1mw	\$95.00
COLLINS 478A-1 Zifor, FAA approved to check omni signal generators	\$195.00
ME-11B/U Termaline R.F. Wattmeter, military version of Bird 611, 60 watt dual range, 0-15/0-60, 30 to 500mhz, ideal for AM and FM work	\$65.00
SG-299D/U Squarewave generator, a wide range 1cps to 1mhz, used with any oscilloscope to determine the frequency response and phase shift characteristics of video and audio amplifiers, amplifier gain measurements can also be made	\$39.50

**STRIPPER SPECIALS:**

FOR THOSE WHO LIKE TO STRIP OUT EQUIPMENT FOR RESISTORS, CAPACITORS, TUBE SOCKETS, TRANSFORMERS, CHOKES, HARDWARE, WIRE, CHASSIS, CIRCUIT BOARDS, WE HAVE SELECTED A GOOD ASSORTMENT OF MILITARY SURPLUS EQUIPMENT LOADED WITH COMPONENTS FOR STRIPPING. YOU WILL HAVE MANY HOURS OF ENJOYMENT GUARANTEED TO SATISFY YOU. ORIGINAL COST IN THE THOUSANDS. 100 LBS. SHIPPED MOTOR FREIGHT PAID FOR \$32.50

ALL EQUIPMENT EXCELLENT CONDITION, F.O.B. ELLENTON, FLORIDA. SATISFACTION GUARANTEED OR MONEY REFUNDED! IMMEDIATE SHIPMENT. WRITE OR PHONE 813-722-1843, BILL SLEP OR AL JONES.

# MOTOROLA 2 METER POWER AMPLIFIER UP TO 700 WATTS OUTPUT!

TRUCKLOAD SALE! **BRAND NEW!** SPECIAL LOW PRICE!

Freq. range .....136 MHz to 174 MHz  
 Amplifier tubes ..... pair of 4X150A's  
 Input excitation .....2 watts to 15 watts  
 Power output ..... 250 watts to 700 watts \*  
 Type of operation ..... Class C, push-pull  
 Input/output impedance: ..... 50 ohms  
 A.C. power: ..... 115 or 230 vac

This is a completely self-contained power amplifier designed specifically to increase the power output of low power transmitters. It requires no modifications to operate on rtty, fm, mcw, etc. in the above listed freq. range. It will deliver 250 to 300 watts out when driven by a 2 or 5 watt handie talkie! The power output can be increased up to 700 watts with a very simple modification. (Change tubes to 4CX250B's, make minor change in power supply, instructions supplied with each unit.) Very compact (26 $\frac{3}{4}$  inches H, 20 $\frac{1}{4}$  inches W, 16 $\frac{1}{2}$  inches D.) Fully metered, antenna change over relay, blower motor. No

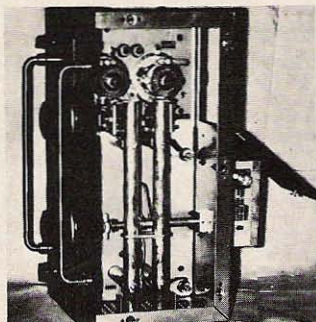

external keying circuits required. Amplifier keys automatically. (Just hook a piece of co-ax from your low power base or handie talkie and push the mike button!) Original cost: \$2,100.00. Our price, brand new, unused, complete with instruction manuals is only \$350.00 FOB Trenton, Mich.

**NEWSOME  
ELECTRONICS**

19675 ALLEN RD. TRENTON, MICHIGAN 48183  
 PHONE AREA CODE 313-282-6464

# NEWSOME ELECTRONICS

WE SELL MOTOROLA  
EQUIPMENT ONLY

SURPLUS  
CATALOG

ALL ITEMS MARKED (\*) ARE HALF PRICE UNTIL MAY 31st 1971.

**LOOKING FOR A CERTAIN MOTOROLA ITEM?  
LET US KNOW WHAT IT IS.  
WE MAY HAVE IT!**

Two wire remotes, 2 freq., intercom, tone osc. . . . .	\$29.95*
T51, 6/12 v, 40-50 MHz 50 watt mobiles . . . . .	\$39.95*
L44 450 MHz base stations . . . . .	\$125.00
D43 2 meter 6/12 v mobiles (30 watt) . . . . .	\$100.00
TU 588 transistorized pwr supplies w/heat sink . . . . .	\$40.00
FM Station Monitors, 40-50 MHz F4M24B1C . . . . .	\$85.00*
Dispatcher power supplies, 12 v NU 169 . . . . .	\$19.95
450 MHz receiver strips . . . . .	\$14.95
U44 BBT "T" power 12v 450 MHz mobiles . . . . .	\$75.00*
T43 GGV 150 MHz 6/12v 30 watt mobiles . . . . .	\$100.00
a.c. power supplies P846, for Motorola R-394 & 257 receivers, etc. . . . .	\$12.95*
VHF to UHF repeaters . . . . .	\$125.00
40-50 MHz receiver strips . . . . .	\$12.00
U43 GGT 150mc, 30 watt, 12 v mobiles . . . . .	\$149.00
150 MHz "HT" handi-talkies, like brand new, w/batt . . . . .	\$250.00
T41 GGV 6/12 v 30 watt, 40-50 MHz mobiles . . . . .	\$39.95*
450 MHz 20 watt transmitter strips . . . . .	\$12.50
T44 AAV 6/12 v 450 MHz mobiles . . . . .	\$24.95*

Above mobile equipment complete with acc. (less ant, Xtal ovens). Prices shown are fob Trenton, Michigan. We sell Motorola equipment only. Our terms are cash with order (25% deposit on c.o.d.'s). Mich. residents add 4% sales tax. We have a very large stock of Motorola equipment, tell us what you are looking for, we may have it. (Sorry, no catalogs or lists available.) Please give your amateur call with all inquiries. Our store hours are by appointment only.

# BRIGAR ELECTRONICS for INDUSTRY electronics

Offices & Warehouse: 10 Alice Street, Binghamton, New York 13904 - Tel.: 607-723-3111

**CB CASE**

**PANEL OPENING**

6- $\frac{1}{4}$ " X 3"

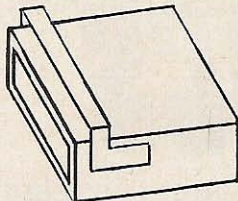

HAVE YOU EVER WANTED TO BUILD SOMETHING AND HAD TROUBLE FINDING THE RIGHT ENCLOSURE? HERE IT IS. WE HAVE CASES, (ORIGINALLY MADE FOR CB RADIOS) WHICH ARE CONSTRUCTED OF 22 GAUGE STEEL, ALL WELDED CONSTRUCTION. PANEL OPENING IS ROLLED FOR A NEATER APPEARANCE. SLOTTED VENTILATION OPENINGS ON EACH SIDE (NOT SHOWN). INCLUDED IS A SLIDE IN CHASSIS FOR MOUNTING EQUIPMENT. MOUNTING BRACKET IS FURNISHED FOR EASE IN MOUNTING UNIT UNDER BENCH, TABLE, DASH OF YOUR CAR, ETC. SIZE 8- $\frac{3}{4}$ " L X 7" W X 3- $\frac{3}{4}$ " H. SHP WGT 4 $\frac{1}{2}$  LBS. ORIGINAL COST \$9.95. OUR PRICE, THIS ADD ONLY..... \$2.95

**BELDEN # 8497 COILED MICROPHONE CORD, 3 COND 1 SHIELDED. NEOPRENE JACKET. RETRACTED LENGTH 11 $\frac{1}{2}$ " , STRETCHES TO 6 FEET**



PRICE EACH ----- 95¢

**TUNING METER TYPE 1-70-D**

G.E. TYPE DW-33  
DIAL CALIBRATED IN 7 DIVISIONS, WHITE ON BLACK FACE.  
METER READS TUNE FOR MAX. MOVEMENTS 0 TO 4.2 MA. BUILT IN SOCKET FOR DIAL LITE. SIZE 2- $\frac{3}{8}$ " DIA. FLUSH MTG. SHP WGT 1 LB \$ .90 EA



**PRINTED CIRCUIT COMPUTER BOARDS (SPECIAL SALE)**

BOARDS CONSIST OF DIODES, TRANSISTORS, CAPACITORS, AND RESISTORS. ALL BOARDS ARE DIFFERENT. SHP WGT 4 LBS. PRICE 10 FOR \$1.00

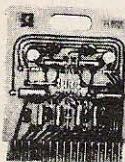

**HAMMARLUND AIR VARIABLE CAPACITORS 5 PF TO 50 PF. GEAR REDUCTION ON SHAFT FOR THAT FINE TUNING OF YOUR VFO ETC. SHP WGT 1 LB \$ .75 EA**

**INSULATED COMPUTER-GRADE ALUMINUM ELECTROLYTIC CAPACITORS**



MFD.	VOLT	SIZE
60,000	5	3 X 4-1/2
25,000	6	2 X 4-1/2
66,000	6	2-9/16 X 4-3/4
40,000	7	2 X 5
7,750	10	1-3/8 X 4-1/2
15,000	10	2 X 4-1/2
15,500	10	2 X 4-1/2
30,000	10	3 X 3-1/2
74,000	10	3-1/16 X 5
15,000	12	2 X 4-1/2
7,000	13	1-3/8 X 4-1/2
14,000	13	2 X 4-1/2
10,000	15	2 X 4-1/2
15,000	15	2-1/2 X 4-1/2
20,000	15	2-1/2 X 4-1/2
12,500	16	2 X 4-1/2
11,500	18	2 X 4-1/2
5,500	19	1-3/8 X 4-3/8
11,000	19	2 X 4-1/2
12,000	21	2 X 4-1/8
4,000	30	1-3/8 X 4-1/2
2,500	45	1-3/8 X 4-1/2
3,500	55	2 X 4-1/2
6,000	55	2 X 4-1/2
3,100	75	2 X 4-1/2
3,500	75	2 X 4-1/2
3,750	75	2 X 4-1/2
1,500	80	2 X 4-1/2
1,000	100	1-3/8 X 4-3/8
1,500	100	2 X 4-1/2
250	150	1-3/8 X 4-1/2
1,250	180	2 X 4-1/2
500	200	2 X 4-1/2

PRICE..... \$ .50 EA  
2,500 UF 275 VDC 2-7/8 X 6 \$2.45

**PLASTIC FILM CAPACITORS**



**GLASS CASE**  
GLASSMIKE ASG-503-2M. .05UF-2000VDC 3/4" D X 1-3/4". AXIAL STUD \$.35 EA  
SPRAGUE P51105. .01UF - 5000VDC. 3/4" D X 2-1/4. AXIAL LEAD \$.45 EA  
GUDEMAN GC-21R202K. .002UF-7500VDC 9/16" D X 1-3/16. AXIAL LEAD \$.50 EA  
GUDEMAN GC-246R202K. .002UF-7500VDC. 3/4" D X 2. AXIAL LEAD \$.70 EA

**SUB-MINIATURE TRANSISTOR AUDIO TRANSFORMER. IMPEDANCE-PR1 25K(TAPPED). SEC 3.2 OHMS. TC LEADS. LUG MOUNTING \$ .50 EA**



NO COD, FOB BINGHAMTON, N. Y.

MINIMUM ORDER \$5.00

# CQ de W2KUW

## TUBES PURCHASED

1P21	
2K25	3-1000Z
2K48	3CX2500
2K (any digits)	3CX3000
3-400	3CX5000
3-1000	3CX10,000
3B24	3E29
3B28	3K (any digits)
4-65	4CX350A
4-125/4D21	4CX1000A/8168
4-250/5D22	4CX3000A/8169
4-400A/8438	4CX5000A/8170
4-1000A/8166	4CX5000R/8170W
4X150A	4CX10,000/8171
4CX250B/8321	4X150G/8172
4CX250R/7580W	4PR60A or B
4CX300	4PR (any digits)
5-125B/4E27A	
5R4WGB	
6BL6	75TL
6BM6 or 6A	8D21
6L6	9C21
7D21	9C25
802	
805	TW (all types)
807	TWT (all types)
810	NL (all types)
811A	4000 series
812A	5000 series
813	6000 series
832A	7000 series
833A	8000 series
891	
304TL	450TH
VA (all types)	450TL
250TH	QK (all types)

**5% BONUS over highest offer.  
SHIP COLLECT FOR PAYMENT.**

**MILITARY AIRCRAFT RADIOS:** ARC 34, 38, 44, 51, 52, 55, 57, 58, 63, 65, 66, 70, 73, 74, 84, 85, 89, 90, 92, 97, 105, 108, 109, 115, 134  
ARN 14, 21, 59, 65, 67, etc.

## TEST EQUIPMENT

SG1A/ARN	TS330	UPM32
SG2A	TS505D	UPM66
SG12A/ARN	TS510A	UPM98
SG13/ARN	TS621	UPM99
SG24/ARN	TS683	UPM100
MO83/ARM	TS6684	AN/URM25
SG66/ARM5	TS710	AN/URM26
SG376	TS723	AN/URM32
AN/ARM8	TS757	AN/URM43
AN/ARM9	TS823	AN/URM44
AN/ARM22	TS1100	AN/URM48
AN/ARM25	TV2	AN/URM52
AN/ARM26	TV7	AN/URM80
AN/ARM29		AN/URM81
AN/ARM31		AN/USM16
AN/ARM68		AN/USM26
AN/GPM15		AN/USM44
AN/PSM4		AN/USM81
AN/PSM6		AN/USM117

**RECEIVERS:** R220, R274, R278, R388, R369, R389, R390, R390A, R391, R392, R1051, R1125, 51J3, 51R, 51J4, 51S1, SP600, JX17, APR13, APR14

**COMMERCIAL AIRCRAFT:** 17L4, 17L6, 17L7, 51X2, 51X3, 51V, 618M, 618S, 618T, 618Z, 621A, 860E, 51R3, 51R4, 578, 479S, 479T, etc.

All Hewlett Packard, Tektronix, Boonton, Bird, General Radio, CEC, Brown, etc.

## SYSTEMS PART OR ALL

AN/APN	AN/FRR	AN/SRR	UPM
AN/APR	AN/GRM	AN/UPA	URC*
AN/APS	AN/GRC*	AN/URR	URM
AN/ARR	AN/PRC*	ARN	URT
AN/ARC	AN/SLR	MRC	USM
AN/FRC	AN/SRC	TRC	VRC*

\*URGENT

Please send us your surplus inventory lists. We want to buy other tubes and Transceivers - Receivers - Test Equipment.

# The TED DAMES Co.

308 HICKORY ST. ARLINGTON, N.J. 07032  
Phone: 201 998-4246

# COLUMBIA

## TEST EQUIPMENT SPECIALS

All in excellent condition, recently calibrated by N.B.S. approved standards labs and supplied with calibration certificate.

HP 201C Audio Oscillator .....	150.00
HP 205A Audio Oscillator .....	250.00
HP205AG Audio Oscillator .....	275.00
HP400D VTVM .....	150.00
HP 400DR VTVM .....	130.00
HP 400H VTVM .....	175.00
HP 400HR VTVM .....	175.00
HP 400AB VTVM .....	125.00
HP 410B VTVM .....	150.00
HP 430C Microwave Power Meter ..	125.00
HP 430CR Microwave Power Meter ..	125.00
HP 415C SWR Meter .....	250.00
HP 524D Counter .....	650.00
HP 525A Converter 10-100 mc .....	150.00
HP525B Converter 100-220 mc .....	150.00
HP 683C Sweep Osc. 2-4 kmc .....	500.00
HP 684C Sweep Osc. 4-8 kmc .....	500.00
HP 211 A Sq. Wave Generator .....	200.00
HP212A Pulse Generator .....	250.00
HP-614A Signal Generator .....	1,000.00
HP-616B Signal Generator .....	800.00
HP-618B Signal Generator .....	1,000.00
Measurements 65B Signal Generator	500.00
SG-1A/ARN Signal Generator with	
PP-348 Power Supply .....	1,295.00
Bounton 212A Glide Slope Test Set	
Adapter for SG-1A/ARN .....	250.00
Tektronix 531 Oscilloscope .....	500.00
Tektronix 532 Oscilloscope .....	550.00
Tektronix 533 Oscilloscope .....	600.00
Tektronix 535A Oscilloscope .....	750.00
HP-160B Oscilloscope w/2 plug-ins ..	600.00
HP-170A Oscilloscope w/2 plug-ins ..	700.00
HP 120AR Oscilloscope .....	225.00
HP-200CD Audio Oscillator .....	165.00
HP 200AB Audio Oscillator .....	145.00
HP 608D Signal Generator .....	800.00
HP 612-A Signal Generator .....	900.00
HP 620A Signal Generator .....	1,000.00
Collins 497S-3 VOR Modulator ..	1,250.00

## NEW TUBES & SOCKETS

810 Tubes .....	\$14.95
5CP1 C.R.T. ....	4.95
5BP4 C.R.T. ....	4.95
4-1000A Eimac SK-500 Airflow	
Socket &	
SK-506 chimney.....	25.00
4X150A Tubes .....	15.00
4CX250B Tubes .....	20.00

## TELETYPE EQUIPMENT

M-15KSR Page Printer	Untested	Tested OK
w/Keyboard	\$115.00	\$170.00
M-14TD Tape Reader	50.00	75.00
M-14RO Tape Reperf.	50.00	75.00
M-28KSR Page Printer		600.00
M-28KSR Reperf. w/Keyboard		600.00
M-28ASR		1500.00

CV-89A/URA-8A RTTY Audio Type Terminal Unit. Good condition, less cabinet..... \$125.00

## COMMAND Receivers Transmitters

RECEIVERS	
190-550KC Q-5er Good Condition.....	\$14.95
1.5-3MC Marine Band Like New .....	\$19.95
6-9MC 40 Meters Good Condition .....	\$14.95
XMTRS	
2.1 3MC T 18/ARC-5 New .....	\$6.95
3-4MC T-19/ARC-5 Exl. Condition .....	\$6.95
4-5-3MC T-20/ARC-5 Exl. Condition. ....	\$3.95
4-5-3MC BC-475 New.....	\$8.95
MD-7/ARC-5 Plate Modulator For Above	
Xmtrs Exl. Condition.....	\$4.95

## IP-69/ALA-2 PANADAPTER

This compact unit can be used with most Ham Receivers after conversion. Complete with conversion info and schematic. Like new condition. .... \$19.95

## 2 METER AIRCRAFT MONITOR RECEIVER 130-150MC

R-748/TRC-47 single channel AM crystal controlled 110V 60CPS pwr supply & speaker built in, squelch, r-f gain, dual conversion modern design. Size 19"W x 5"H x 14"D for rack mtg. Supplied with schematic & hookup info. No conversion required. Exl condition. .... \$29.95

# MAYDAY \* URGENTLY NEEDED

Top prices for AN/VRC-24, AN/TRC-68, AN/ARC-51, 52, AN/PRC-10A, Collins 618T AN/URC-9, AN/SRC-20&21, plus all H.P., Tektronix, and lab grade test equip. Also all late model military electronic and radio gear.

Write or Call Collect for top offer ..... 213-875-2970

### XMTRS - TRANSCEIVERS - REC'RS

F-47/ART-13 2-18Mc transmitter Less	
tubes - Good condition .....	\$24.95
T-47/ART-13 with tubes Exl.	
Condition .....	49.95
RT-18/ARC-1 transceiver 100-156Mc	
Exl. Condition .....	\$39.95
ARC-3 transmitter 24 channel 100-	
156Mc Exl. Condition .....	19.95
BC 639 100 156 MC Tunable Receiver	
115/1/60 Reconditioned .....	99.50

BC 348 200 500KC & 1.5 18MC	
Reconditioned 24V DC .....	100.00
ARB 190-9000KC Good Condition	
with Control Box .....	24.95
R-444/APR-4Y AM & FM Excellent	
Condition .....	49.95
RBB 600-4000KC Reconditioned	
115/1/60 .....	100.00
RBC 4-27MC Reconditioned	
115/1/60 .....	100.00
ARC-3 Receiver 100-156MC 24 Channel	
Exl. Condition .....	19.95

# COLUMBIA ELECTRONIC SALES, INC.

P.O. Box 9266

7360 Atoll Ave., North Hollywood CA 91609 Tel (213) 875-2970 & 764-9030

# C&H C & H SALES WELCOMES 1971 WITH A TREMENDOUS TEST EQPT. SALE. NOW IS THE TIME TO BUY AND SAVE LOTS OF MONEY

Panoramic Sweep Gen. Model SG-1 40 CPS to 200 kc	\$250.00
Boonton 202G FM-AM Sig. Gen. 195-270 mc	\$295.00
Sierra H. F. Wave Analyzer Model 158A with two probes .5 to 10 mc	\$295.00
Donner Wave Analyzer Model 2102 0 to 50 kc	\$195.00
John Fluke 407D Power Supply	\$100.00
John Fluke 801 HR Differential Voltmeter	\$95.00
John Fluke 803 Differential Voltmeter AC-DC	\$100.00
Beckman Preset Eput & Timer Model 5311-1	\$125.00
Beckman Universal Eput & Timer Model 7350R-38	\$125.00
Beckman Universal Eput & Timer Model 7360C	\$125.00
C.M.C. Preset Counter-Timer Model 1213C	\$125.00
Ad-Yu Time Delay Standard Model 20A2	\$25.00
L & N K3 Pot	\$195.00
L & N 2430C Galvo	\$50.00
L & N 5300 Wheatstone Bridge	\$95.00
L & N 9834 DC Null Detector	\$75.00
L & N 8067 Mueller Bridge	\$195.00
Julie Research VOR 105 Voltage Divider	\$250.00
Shallcross 8285 Resistance Box	\$35.00
ESI SV 194B Voltage Calibrator	\$250.00
Rutherford B7 Pulse Gen.	\$150.00
Rutherford B7F Pulse Gen.	\$250.00
Ballantine 350 True RMS VTVM	\$150.00
Hathaway C-6B Resistance Meter	\$95.00

### SCOPE BARGAINS

TEK 502 Dual Beam Scope 1.2 mc	\$500.00
TEK 516 Dual Trace 15 MHz	\$500.00
TEK 533A Needs CRT 15 MHz	\$450.00
TEK 536 XY Scope 11 MHz with "T" plug in & scope cart	\$500.00
H.P. 130A DC to 100 kc	\$175.00
H.P. 130C DC to 500 kc	\$395.00

### TEK PLUG INS

TEK 80 Vertical Pre-amp	\$35.00
TEK 80 Vertical Pre-amp with probe	\$45.00
TEK TU-2 Test Load	\$45.00
TEK "P" Fast Rise Mercury Pulsar	\$40.00
TEK "K" Fast Rise Calibrated Pre-amp	\$75.00
TEK "N" Sampling Plug in	\$135.00
TEK "R" Transistor Rise Time Plug in	\$150.00

### TEK GENERATORS

TEK 105 Sq. Wave Gen.	\$75.00
TEK 111 Pre Trigger Pulse Gen.	\$75.00
TEK 121 Wide Band Pre-amp	\$25.00
TEK 162 Wave Form Gen.	\$65.00

R77/ARC3 Rcvr 100-156 mc	\$9.95
BC683 FM Rcvr 27-39 mc	\$25.00
DM-34 12 Volt Dynamotor for BC 683	\$3.95
A.R.C. R10A rcvr 520-1500 kc	\$19.95
Collins 70E2 PTO	\$15.00

### GENERAL RADIO TEST EQPT.

G.R. 107L Var. Ind.	\$40.00
G.R. 107M Var. Ind.	\$40.00
G.R. 716C Capacitance Bridge	\$150.00
G.R. 1021 P2 Sig. Gen. (250-920 mc— with P1 Power Supply	\$195.00

### G.R. 1105A FREQ. MEASURING EQPT. CONSISTING OF

1106A Freq. Transfer Unit	
1106B Freq. Transfer Unit	
1107A Interpolation OSC.	
1108A Coupling Panel	
1109A Comparison Bridge comes complete with Speaker & housed in 6 ft. Relay Rack	\$350.00
G.R. 1203B unit P.S.	\$25.00
G.R. 1219A unit Pulse Amp.	\$25.00
G.R. 1602B UHF Admittance Meter	\$75.00
G.R. 1750A Sweep Drive	\$75.00

### H.P. TEST EQPT.

H.P. 202A Function Generator	\$95.00
H.P. 219C Pulse Duration Unit	\$25.00
H.P. 350D Attenuator	\$75.00
H.P. 355B VHF Attenuator	\$50.00
H.P. 355C VHF Attenuator	\$75.00
H.P. 400 HR-VTVM	\$100.00
H.P. 410B-VTVM	\$100.00
H.P. 417A VHF Detector	\$125.00
H.P. 475B Tunable Bolometer Mount	\$25.00
H.P. 430 CR Microwave Power Meter	\$35.00
H.P. 428A Clip on DC MA. Meter	\$150.00
H.P. 525A Plug in 10 to 100 mc	\$100.00
H.P. 525B Plug in 100 to 220 mc	\$100.00
H.P. 526C Period Multiplier	\$100.00
H.P. 522B Counter	\$100.00
H.P. 151A High Gain Amp.	\$50.00
TS 403/U Sig Gen. same as H.P. 616A 1800-4000 mc	\$295.00
TS 429 Sig. Gen. same as H.P. 614A 900-2100 mc	\$295.00

ALL MERCHANDISE IN EXCELLENT CONDITION • MERCHANDISE SHIPPED FREIGHT COLLECT  
SEND CHECK OR MONEY ORDER WITH ORDER • CALIFORNIA RESIDENTS ADD 5% SALES TAX

# C&H Sales

2176 E. Colorado Blvd., Pasadena, California 91107  
213-681-4925

● JUST ARRIVED! MICROWAVE DEVICES, INC. Model 636NC Brand New Dummy Loads  
50Ω ● 0-3000 MC ● Maximum Wattage 600 ..... ONLY \$50.00

**TS-323/UR FREQ. METER**, portable crystal controlled heterodyne-type instrument. PRICE: \$74.95 Freq. range 20-450mc. With power supply, PRICE: \$90.00 EXCELLENT CONDITION. SHPT. WT. 35#

**R509 ARC RECEIVERS** freq. range 118-143mc with squelch. NEW. PRICE: \$14.95 ea. . . SHPT. WT. 9#

**T19 ARC RECEIVERS** freq. range 3-4mc. NEW PRICE: \$12.95

**WINTRONIX MODEL 850 INDUCED WAVE FORM ANALYZER**

This unit, in conjunction with your present oscilloscope, permits you to view wave forms in the range from audio thru MHz without any direct connection. The probe is simply placed over the tube in question and the wave form is displayed on the oscilloscope. It may also be used as a high gain amplifier to increase 'oscope sensitivity. Excellent for T.V., radio, amplifier, and transmitter repair and maintenance. BRAND NEW, WITH PROBE. PRICE: \$19.95 ea.

**HP 524 COUNTER** without plug in EXCELLENT CONDITION, checked out. PRICE: \$199.50. . . SHPT. WT. APPROX 125#

**AN/ASM-72 POSITION FIXING NAVIGATION SETS** freq. range 72-128kc.

This set includes:

- Mark V111 Receiver
- Computer
- Flight Log Control Display Unit (in form of a strip chart recorder)
- 3 Decometers
- 1 Lane Identification Meter
- Pre Amplifier
- Rec. Control Box

In the receiver there are 65 hermetically sealed-in glass crystals.

Operating tech. manual included. BRAND NEW PRICE: \$299.00. . . SHPT. WT. 100#

**TS497 (SIMILAR TO MEAS. MODEL 80)** Freq. range 2-400 mc. In 6 bands, checked out and GUARANTEED PRICE: \$175.00

**TORROID INVERTER POWER SUPPLY** with 22 stud diodes (1N256 & 1N254) 2 power transistors, 3 VR tubes, chokes, caps., res., etc. 300-150-240 VTC output. 12-24V input. PRICE: \$4.95

**1 MC XTALS** precision type for octal socket PRICE: \$4.95 ea.

**NI-CAD BATTERIES**

Nylon case kaplo 1.2V 95 amp. hour. 11 3/8" H x 5 1/4" D x 3" W. LIKE NEW.

PRICE: \$12.95  
5 batteries with connecting bracket \$39.95

**METERS**

Panel type Weston Model 1238, 0-500 microamps full scale calibrated .005 to 500 roentgens/hour. 270 degree scale, approx. 3" dia. Excellent for wavemeter, etc. NEW & IN ORIGINAL BOXES. PRICE: \$1.95 ea. or 3 for \$5.00

**PANEL METER** 0-100 microamps 2 1/2" round scale reads in %. NEW. PRICE: \$1.95 ea.

**TRANSFORMERS**

115/230 V input 60 cys.  
300 V 10 ma.  
12.6 VCT @ .5 A  
PRICE: \$1.00 ea. or 6 for \$5.00

**TRANSFORMERS**

115V-60 cy. input open frame. Sec. 24-24-24-24 @ 10 amp. ea. Can be used in parallel or series. PRICE: \$9.95 ea. . . SHPT. WT' 24#

**TRANSFORMERS**

115V 60 cy. open frame. Sec. 36-0-36 V @ 15 amps. PRICE: \$9.95 or 2 for \$17.00 SHPT. WT' 22#

**ARC 55-IF STRIP AND AUDIO AMP.** Unit NEW.

PRICE: \$4.95 ea.

**CONTROL HEAD C345U**

CONTAINS:

- 1 water proof 4" speaker
- 1 dB Meter
- 1 Audio Amp.

In OD color alum. case (8" x 12" x 10"). NEW. PRICE: \$6.95 ea. . . SHPT. WT. 27#

**OSM-80 (SIMILAR TO TEXTRONIX 535)** Excellent condition, checked out and GUARANTEED without plug in. PRICE: \$299.00

**GENERAL RADIO FREQ. STANDARD 1100A & 1105A.** 2 complete racks, EXCELLENT CONDITION, GUARANTEED. PRICE: \$795.00. . . SHPT. WT. 600#

**TAPE RECORD & PLAY BACK AMPLF.** Include bias osc., dB Meter, standard 19" rack mount, equalization switchable 3 1/4, 7 1/2, and 15 IPS.

PRICE: \$24.95. . . SHPT. WT. 50#

**DIODES**

1 amp. bullet type diodes with silver leads 600 piv @ 1 amp.  
10 for \$100 or  
110 for \$10.00

**HP 710B POWER SUPPLY** 100-360V @ 75 ma. 6.3. VCT  
PRICE: \$9.95

*All prices are F.O.B. our warehouse, Philadelphia, Pa. All merchandise described accurately to the best of our knowledge. Your purchase money refunded if not satisfied. Terms are cash and minimum order is \$5.00. All merchandise subject to prior sale.*

**1206 S. Napa St.  
Phila., Pa. 19146**

Phone: 215-HO2-5511

• or 215-HO8-7891

**SELECTRONICS**



# see the *Mann*

## for the best in USED FM communications equipment

Two-Way FM Units • Walkies • Repeaters  
Mobile Phone • Bases • Mobiles

Here are some of the great buys at Mann...

### MOTOROLA 6 METER MOBILES

- T41GGV 30W 6/12V Vibrator Supply in 10" housing, with acc. . \$60
- T51GGV 60W 6/12V Vibrator Supply in 15" housing, with acc. . \$70
- U41GGT 30W 12V T-Power Supply in 10" housing, with acc. . . \$125
- U51GGT 60W 12V T-Power Supply in 10" housing, with acc. . . \$145

### MOTOROLA 2 METER MOBILES

- T43GGV 30W 6/12V Vibrator Supply in 10" housing, with acc. . \$99
- X53GAD Two Separate 60W Transmitters, single receiver in 20" wide housing, 6/12V Dynamotor supply with acc. . . . \$66
- T53GKT Two Separate 60W Transmitters, single receiver in 20" wide housing, 12V T-Power Supply with acc. . . . . \$120

### MOTOROLA 450 MHZ MOBILES

- U44BBT 18W 12V T-Power Supply in 10" housing, with acc. . . \$115
- U44BBT-3100 Same as above i50,with Private Line, with acc. . . \$135

WRITE FOR FREE CATALOG

**Mann Guarantee**

Money refunded without question if equipment is returned within seven days from shipment, undamaged, freight prepaid.

**Conditions of Sale**

Unless otherwise specified, equipment is used, and is sold as-is. All items shipped FOB Tarzana, California. Crystals, ovens, antennas not included unless specifically stated in catalog. All equipment is sold on a first-come, first-served basis.

*Mann* COMMUNICATIONS  
P.O. Box 138, 18669 Ventura Blvd., Tarzana, Calif. 91356  
Phone: (213) 342-8297

**IF YOU'RE AN AMATEUR\*  
YOU QUALIFY FOR  
THE LOWEST PRICES  
THE SURPLUS INDUSTRY  
HAS TO OFFER!**

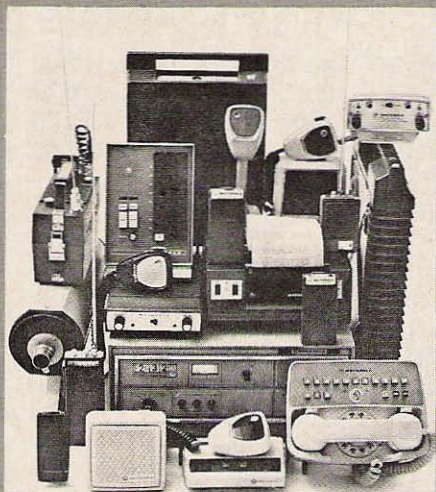

Handie-Talkies  
VHF and UHF Transmitter Strips  
VHF and UHF Receiver Strips  
Trunk-Mount & Dash-Mount Mobiles  
NI-CAD Batteries  
Base Stations, Remote and Local  
Complete Repeaters, VHF & UHF  
Plus Accessories of all kinds:

Tone Encoders  
Tone Decoders  
COR Parts

**PLUS PLENTY OF SPECIAL GOODIES**

**SPECTRONICS  
IS  
THE  
BIRTHPLACE  
OF  
REPEATERS**

\*AMATEURS ONLY. Include  
call letters with *all* inquiries  
and orders!

Phone: Area Code 312-848-6778

**SPECTRONICS**

**"The FM People"**

1009 GARFIELD AVE.

OAK PARK, ILL. 60304

**HYCON COLOR BAR GENERATOR:**  
Complete with tubes without crystals, un-  
checked .....\$19.95  
**TS-186 FREQUENCY METER:** 100 to 10,000  
 MC Accuracy  $\pm 0.1\%$ . 110VAC Power Sup-  
 ply..... \$75.00  
**TS-173 FREQUENCY METER:** 90 to 450 MC.  
 Accuracy .005. Only .....\$75.00  
**TS-174 FREQUENCY METER:** 20 to 250 MC  
 .....\$97.50  
**TS-175 FREQUENCY METER:** 85 to 1000 MC  
 .....\$75.00  
**LM FREQUENCY METER:** without book,  
 good condition. 125KC to 20 MC .....\$25.00  
**OS-8 SCOPE:** Portable, compact and light  
 weight .....\$49.50  
**TS-382 AUDIO OSCILLATOR:** 20 to  
 2000 00 cy .....\$75.00

**SPECIAL COLLINS R390A with mech. filter,  
 mint cond. ....\$895.00  
 will Trade????**

**TS 148 Spectrum Analyzer .....\$75.00**

**TS 659 Teletype Test Set for checking Teletype  
 by sending out signals, motor driven ...\$19.95**

**MODEL 14 REPERF with synch motor. As is  
 cond. ....\$14.95**  
**TELETYPE PAPER, WITH CARBON\*\*\***  
 Case of 12 rolls ..... per case/\$5.95  
**REPERF PAPER M-14**  
 Case of 40 rolls, ..... per case/\$6.95  
**TELETYPE RIBBONS**  
 Box of 12 each..... per box/\$2.49  
**88MH COILS ..... 5 for \$1.50**

**ASR TELETYPEWRITER, COMPLETE  
 MODEL 28 teletype .....\$1100.00**

**BC 348 Receiver, Complete unchecked. \$49.50**  
**VARIAC 0-250 V at 6 amps .....\$24.50**  
**LS 166 LOUDSPEAKER: A 4" square heavy  
 duty PM loudspeaker with an 8 ohm voice coil  
 housed in a steel case, complete with an 8 ohm  
 to 800 ohm transformer ..... \$3.95**  
**URA-8 Teletype: Converter, checked and work-  
 ing. Good cond. ....\$97.50**  
**AC RETRACTABLE CORD: 6 foot cord  
 mounted on spring loaded wheel ..... \$1.00**

**Walkie Talkie Citizen Band: Factory Seconds.**  
 Good cond. 2 for .....\$3.95  
**MUFFIN PAN: Funnel type, many uses. 110V  
 60 cy .....\$3.50**  
**WEATHER BALLOON MODULATOR: Com-  
 plete with built-in barometric pressure element.  
 New. ....\$2.95**

**RT-70/GRC TRANSCEIVER: Compact  
 14"x7"x5": Late type 46-58 MC FM ..\$49.50**

**RT-109/GRC RECEIVER: 270-390 MC FM  
 .....\$35.00**  
**RT-110/GRC RECEIVER: 380-550 MC FM  
 .....\$49.50**  
**STEEL ANTENNA WHIP: 8½ ft. long ..\$1.49**

**EARPHONES**

\*Low Impedance phones .....\$1.50  
 \*Phones and Boom Mike comb.  
 Aircraft type .....  
 \*Tank type .....\$3.95

**CRYSTALS**

\*100 KC .....\$4.95  
 \*200 KC .....\$1.50  
 \*1000 KC for LM or 221 .....\$3.95  
 \*1000 KC in FT-243 holder .....\$3.50  
**ARC 11 for 190 to 550 KC .....\$14.95**  
**URR-13, 200 to 400MC .....\$97.50**  
**2V rechargeable battery .....\$2.49**

**One Inch CRT Tube Mounted In A Plastic  
 Holder With Cable Lead. ....\$4.95**

**DIAL TELEPHONE can be used as extension  
 phone .....\$4.95**  
**BEAM FILTER .....\$1.95**

**JENNINGS VACUUM CAPACITOR: 125-250  
 at 7500 V. ....\$9.95**  
**10-85 at 35,000 V. ....\$29.50**  
**16 to 90 at 3000 V. ....\$7.95**

**URC-4 VHF COMPACT WALKIE TALKIE  
 good to line to sight. Makes good 6 or 2 meters  
 .....\$27.50**

**SUPER OSCILLATOR - Late Type. Consists of  
 18 crystals mounted on a turret with oven plus  
 the proper selector coils designed to select over  
 700 frequencies. Only .....\$14.95**  
**CONVERTER: 12 to 24 VDC at 4 Amps.  
 Rotary type .....\$7.95**

**Space prevents us from listing all items. Please  
 write us your needs and we will answer im-  
 mediately..**

**Terms: Remittance in full or 25% deposit on  
 COD orders. Minimum order \$5.00 FOB our  
 warehouse. L.A. Calif.**

**J.J. GLASS ELECTRONICS**

**1624 SO. MAIN ST.  
 LOS ANGELES, CALIF. 90015**

**CERAMIC FILTERS**

455 Khz ceramic filters type BF-455-A. These filters will help to sharpen the selectivity of most sets using 455 Khz IF's. Use across cathode bias resistor in place of a capacitor, or in transistorized sets, across the emitter bias resistor. Impedance is 20 ohms at 455 Khz. DC resistance is infinite. Impedance increases rapidly as you leave 455 Khz. Plan your own LC. filter circuits at very low cost 10 for \$1.00 ..... 25 for \$2.00

**TOROID POWER TRANSFORMER**

T3—Has powdered iron core and is built like a TV fly-back transformer. Operates at about 800 cps. 12 vdc pri. using 2N442's or equivalent. DC output of v/dblr 475 volts 90 watts. C/T feedback winding for 2N442's ..... \$2.95 ea, ..... 2 for \$5.00

**TRANSFORMERS**

P4-105-115-125 v 60 cy pri. 6.4 v @ 11 A. 205v @ 1/2 A, 17 v @ 45 mA (relay power). Wt. 10 lbs \$2.95 ..... \$5.00  
 P5—Pri. 117 vac/12 vdc. Sec. 1: 295 vdc (v/dblr) @ 85 mA. Sec. 2: 12.6 vac @ 2.6 A & CT winding for vibrator. Double half shell. Wt. 2 1/2 lbs \$2.25 ea. 2 for \$4. .... \$4.00  
 P6—Pri. 117 vac/12 vdc. Sec. 1: 275 vdc (v/dblr) @ 150 mA. Sec. 2: 12.6 vac & CT for vibrator winding. Wt. 4 1/2 lbs ..... \$2.95  
 SR-42-46 type ..... 2 for \$5.00  
 P7-117 vac pri. Sec. 1: 185 vac @ 120 mA. Sec. 2: 6.3 vac @ 4 A. Double half shell mail box type. SX-146 type ..... \$2.75 ea, 2 for \$5.00  
 P8-117 vac pri. Sec. 1: 470 CT. DC out of bridge 660 v 300 mA max. Sec. 2: 100 vac — 10 mA for bias. Sec. 3: 12.6 vac @ .75 A to 6.3 vac @ 6A. Half shell HT-46 type. Wt. 7 1/2 lbs ..... \$3.50  
 P9-117 vac pri. Sec. 1: 900 vac @ 300 mA. Sec. 2: 100 vac @ 10 mA bias. Sec. 3: 12.6 vac @ 2 A. Double half shell. Wt. 16 1/2 lbs ..... \$4.50  
 P10-177 vac pri. Sec. 1: 960 vac CT @ 160 mA. Sec. 2: 415 vac CT and tap at 100 vac @ 10 mA bias. Sec. 3: 12.6 vac @ 4.5 A. Double shell mail box type. Wt. 8 1/2 lbs ..... \$3.75

**OUTPUT TRANSFORMERS**

**59¢ each or 3 for \$1.50**

OT-2—Pri. imp. 7000 ohms. Sec. 3.2 and 500 m for phones or 70 volt line. 3 watts. Full shielded double half shell.  
 OT3—Primary impedance 5500 ohms. Secondary impedance 3.2 ohms. SX-122 type.

**TUBES**

New bulk packaged tubes made by RCA  
 6BA7 — \$1.00 ..... 6 for \$5.00  
 6CX8 — \$1.00 ..... 6 for \$5.00  
 12AU6 — \$ .60 ..... 6 for \$3.00  
 6BQ5 — \$ .85 ..... 6 for \$4.50  
 12AX7 — \$ .75 ..... 6 for \$4.00

**CABLE**

RG 196 AU 50 ohm teflon coaxial cable. Outside diameter .080" RF loss .29 db per foot at 400 MHz. Silver plated shielding and conductor. Used for internal chassis wiring, antenna coupling, RF coupling between stages, etc. Random lengths from 35 foot to 150 foot. Colors: black, brown, grey, orange. Regular price 23¢ per foot. Our price 5¢ per ft, \$3.00 per 100 ft.

All prices FOB Racine, Wisc. Orders under \$3.00 include 50¢ handling charge. Please allow enough postage, excess will be refunded. All weights are net weights.

**SEMICONDUCTORS**

S2—Amperex 2N671, 100 MHz FT. RF amplifier-mixer, 4 lead TO-5 case ..... \$.40 ea, 6 for \$2.00  
 S3—Amperex 2N2089 RF amp. mixer oscillator \$.35 ea. 12 for ..... \$3.00  
 S4—Delco DTS-413 Silicon NPN planar TO-3 case. 400 Vceo 100 mA continuous. Hfe 20 @ 5 v 500 mA. FT 12 MHz. Used as TV vert. output \$1.00 ea, 6 for ..... \$5.00  
 S6—RCA 1N3754 Silicon Diode 1.3 A 125 piv. Single ended TO-1 case. Used as biasing diode in power amp base to emitter circuit or general purpose ..... \$.15 ea, 8 for \$1.00  
 S7—Fairchild FD-100 ultra-high speed switching 2 nano sec. recovery time. Up to 500 MHz. 75 piv 10 mA. Used as general purpose rf and signal diode. Silicon planar type ..... \$.25 ea, 5 for \$1.00  
 S8—Texas Inst. 2N746 Zener diode 3.3 v 400 mw \$.50 ea. 3 for ..... \$1.00  
 S9—Sarkes-Tarzian 1N3020 Zener diode 10 v 1 w \$.60 ea. 2 for ..... \$1.00

**CAPACITORS**

C1—Aerovox transmitting capacitors for use in coupling power amps to Pi-nets. High amperage, high voltage (15 kv) type. HI-QHPA42BC axial screw terminals 1/2-20 with screws. Size: 1 1/4" by 5/8" long. All silver const. Heavy silver plated terminals and screws. 6800 mmfd \$2.00 ea. 3 for ..... \$5.00  
 C2—Plastic Cap Inc. Type "OF" high voltage glass capacitor. .005, 8000 v. Size: 1 1/2" x 3/4" x 8-32 screw terminals ..... \$1.50 ea, 4 for \$5.00  
 C3—Mallory computer grade electrolytic capacitors 1550 mfd 150 vdc. Fresh stock for use during 1971. Size: 2" x 4 1/4" with plastic insulating sleeve \$1.00 ea. 10 for ..... \$7.50  
 C4-PC mounting 900 mfd. 15 vdc. Size 5/8 x 1-7/8" high ..... \$.20 ea, 6 for \$1.00  
 C5—Axial lead 250 mfd. 40 vdc. Size 5/8 x 1 1/4" long ..... \$.20 ea, 6 for \$1.00  
 C6—Axial lead 15 mfd. 20 vdc. Tantalum Size 1/2 x 1/2" long ..... \$.25 ea, 5 for \$1.00

**RELAYS**

LR1—Potter & Brumfield latching relay SPST 115 v-24 v/12 vdc dual coils, horizontal mounting. 1 1/4" x 3" x 2" ..... \$.75 ea, 5 for \$3.00  
 LR2—Potter & Brumfield latching relay SPDT 115 v-24 v/12 vdc ..... \$.75 ea, 5 for \$3.00  
 RY1—Sensitive relay for use in transistorized circuits. 1000 ohms. Pull in 5 mA at 5 v. SPST. Can be used as SPDT. 1 1/4" x 1 1/4" x 1" \$.75 ea. 5 for ..... \$3.00  
 RY2-Sensitive relay for use in transistorized circuits. 2000 ohms. Pull in 5 mA at 10 v. SPST. Can be used as SPDT. 1 1/4" x 1 1/4" x 1" \$.75 ea. 5 for ..... \$3.00

Toroid core, reactor or inductor. Core size 3/4" thick 1" wide 2 3/8" od l 3/8" id. Silicon steel spiral wound plastic covered core. This toroid core now has 296 turns of #18 wire wound around core. Core weight 13 oz. wire weight 1/2 lb. total weight 1 lb, 5 oz. Room for additional 12 volt primary and feedback windings. CAN be used for powering FM with voltage doubling circuit. Approximate D.C. output 500 volts. Power input up to 200 watts. .... \$.90 ea, 3 for \$2.50

**TOWER COMMUNICATIONS**

1220-22 Villa St. Racine, Wisconsin 53403 632-9014

# IMPOSSIBLE?... BARGAINS IN SURPLUS ELECTRONICS (AND OPTICS)



**GOVERNMENT SURPLUS GEIGER COUNTER**  
 "USAF" radiation detectors are in like new condition, with instructions. Shirt pocket size, in gray plastic case. Requires one each 1.35 V and 5.4 volt mercury batteries, cost about \$3.00. Will operate fine from less expensive penlite batteries. Quantity limited.  
 ASAFGC ..... \$7.50 ppd.

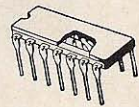

**DTL INTEGRATED CIRCUITS... 80% DISCOUNT**  
 This is the SP600 series of integrated circuits made by Sprague and Signetics. Compatible with other manufacturers integrated circuits. Each order will include circuits for decade counters, bi-directional counters, decoding circuits, shift registers, memories and many other circuits, in addition to data sheets. These I.C.'s represent one of the latest and most economical logic families for equipment design. Available are the SP620 J-K flip-flop, SP629A R-S flip-flop, SP631A quad 2 input gate expander, SP659A dual 4 input buffer driver, SP670A triple 3-input nand/nor gate, and SP680A quad 2 input nand/nor gate. Removed from new equipment.  
 SP616A, SP631A, SP670A, SP680A ..... \$0.50 ea. p.pd.  
 SP620A, SP629A, SP659A, ..... \$0.75 ea. p.pd.  
 Minimum order \$5.00 worth of logic. A 20% Discount on orders of 100 or more units.

**POWER SUPPLY KITS**

We have taken a select group of surplus components, and put together this bargain kit. The kit includes all components required to make a power supply as shown capable of supplying 24 volts at 2 amps, 12 volts at 4 amps or 6 volts at 8 amps. You couldn't build or buy this same supply at 4 times our low price of \$13.50. For an additional \$8.00, we supply the P.C. board and components to build an integrated circuit regulator for this supply, using a silicon power transistor and the I.C. regulator described elsewhere in this ad.

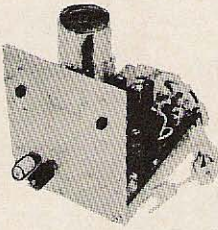

- Power Supply Kit, Unregulated ..... \$13.50
- Power Supply Kit, Regulated ..... \$21.50

**EXPERIMENTERS TTL LOGIC KIT**

This kit contains sixteen J-K flip-flop, eight dual four input nand/nor gates, eight quad two input nand/nor gates, eight triple three input nand/nor gates and three of our instant ultralarge logic cards with mating connectors. Full information on the integrated circuits, including circuits for counters, decoders, memories, shift registers etc. are included. The I.C.'s are made by T.I. Sprague or Signetics (no choice) and are new packaged in the flat-pak configuration. I.C.'s are or equivalent to 54/7400 series logic.  
 LOGIC EXPERIMENTATION KIT LEK ..... \$29.50 p.pd.



**SPECIAL INTEGRATED CIRCUIT VOLTAGE REGULATOR**

Latest type, Motorola MC1460G, RCA 3055 or equivalent. Range 3 to 30 volts at 200 MA, 4 amperes with external transistor. Foldback current limiting makes it short circuit proof. Complete with circuit diagrams and data sheets. MFGS price over \$6.00.  
 Our price ..... \$2.00 each

**NOISE CANCELLING MICROPHONE**

Carbon microphones used in high altitude Air Force G suits. Impedance, 40 ohms at 85 ma. dc. Uniform response 200 to 4,500 Hz. Construction is brass nivar and bakelite. Rugged blast-proof, sealed, altitude compensated. New with application sheet. Minimum order 5 units.  
 5NCM ..... 5 for \$2.00 p.pd.



**TTL INTEGRATED CIRCUITS**

TTL 7400 series I.C.'s need no introduction to the electronics experimenter. They are the latest most frequently used units. Our units are brand new, fully marked and are guaranteed to meet original manufacturers specifications. The low price needs no comment!

- 7400 Quad 2 input nand gate ..... \$ .50
- 7410 Triple 3 input nand gate ..... .50
- 7420 Dual 4 input nand gate ..... .50
- 7430 8 input gate ..... .50
- 7440 Dual 4 input driver ..... .50
- 7450 Dual 2 wide 2 input expandable ..... .50
- 7470 J.K. flip-flop ..... .75
- 7472 J.K. master-slave flip-flop ..... .75
- 7473 Dual J.K. flip-flop ..... 1.00
- 7474 Dual type D flip-flop ..... 1.00
- 7480 Full adder ..... 1.50
- 7490 Decade counter ..... 2.00
- 7492 Divide by 12 counter ..... 2.00
- 7493 4 bit binary counter ..... 2.00
- 7441 BCD to decimal decoder driver ..... 3.00

**DIODES BY THE FOOT!**

These diodes are packaged in rolls, for automatic machine insertion, spaced 0.2 inches apart, so there are 60 to the foot. They are TRANSITRON SG 2947 general purpose silicon fast switching diodes, 75 volt, 0.1 amps, in glass package. Buy a few feet and you should have diodes handy all the time. Pull them off the strip as you need them. At a BARGAIN low price.

- 1 Foot (60 diodes) ..... \$ 2.00
- 10 Feet (600 diodes) ..... 15.00
- 80 Feet (5000 diodes) Full Roll ..... 100.00

**PUSH BUTTON SWITCHES**

These high grade moulded bakelite push button switches were made to be used as a computer entry device. Uses are limited only by your imagination. Consists of seven sections, six double pole double throw and one four pole double throw. May be cut apart to make seven independent switches. Alternate action, similar to switches on professional audio equipment.  
 PBS-1 ..... \$1.25 each

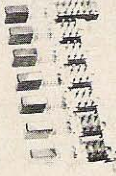

- T1 T1S43 Unijunction Xsistor ..... 2/\$1.00
- T1 2N3819 FET Xsistor ..... 2/\$1.00
- 1N3821A (3.3 volts) 1 watt, 1N3822A (3.6 volts) 1 watt, 1N429 reference or 12 volt 3 watt zener.  
 Your choice ..... 3/\$1.00
- Socket for 14 pin DIP integrated circuit ..... 3/\$1.00
- Integrated Circuits, TTL flat pak, new original packages... 5400 quad 4 input, 5410 triple 3 input, 5420 dual 4 input, 5440 power nand, 5470 J-K flip-flop.  
 Your choice ..... 3/\$1.00

- Hi-Fi Headphone Speakers, MFG G.E. Make your own Hi-Fi headset, lo z.  
 Price ..... 2/\$1.50

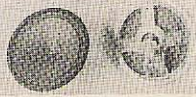

- GIANT 80 PAGE ILLUSTRATED CATALOG** jammed with BARGAINS in I.C.'s, Electronics, Optics, G.I. Watches, etc. Free with any order or send \$.25.  
 Price ..... \$ .25.

ALL ITEMS POSTAGE PAID IN THE U.S.A.  
 CHARGES WELCOME  
 BankAmericard - MasterCard - \$10.00 min.

## B. & F. ENTERPRISES

PHONE: 617 532-2323  
 P.O. Box 44, Hathorne, Massachusetts 01937

SURPLUS  
CATALOG

# FM SCHEMATIC DIGEST

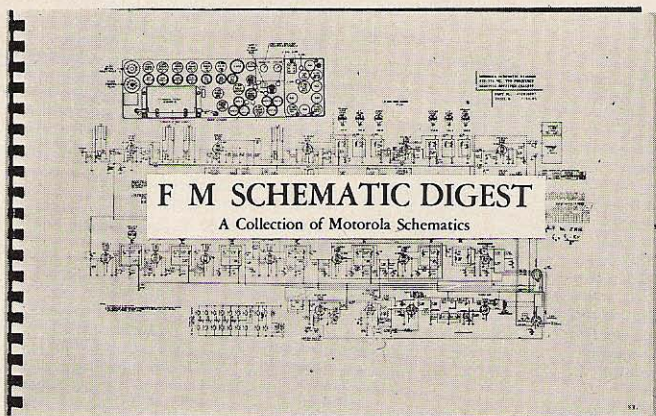

## FOR MOTOROLA OWNERS

Complete circuits,  
technical notes,  
and hard-to-get dope like  
alignment info and  
crystal-ordering data  
on Motorola FM equipment  
produced from 1947 to 1960.

136 GIANT PAGES — 11½ x 17 in.  
ALL THIS! And for less than the cost of a  
single crystal. Can you really afford not to have  
this valuable collection of facts and schematics  
for all the popular Motorola units?

**S. Wolf**

1100 Tremont Street  
Boston, Massachusetts 02120



**INTEGRATED CIRCUITS**  
**FACTORY FRESH — NO REJECTS**  
 W/SPEC. SHEETS

**FAIRCHILD — PHILCO — RCA**  
**MOTOROLA**

**YOU NEED IT —**  
**WE HAVE IT!**  
**RTL or TTL LOGIC**

UL 900 Buffer .....	80¢	10/5.50
UL 914 Gate .....	80¢	10/5.50
UL 923 JK Flip-flop .....	\$1.50	10/8.50
MC 790P Dual JK Flip-flop .....	\$2.00	10/18.95
MC 890P Dual JK Flip-flop .....	\$2.00	10/18.95
MC 789P Hex Inverter .....		
MC 724P Quad 2 Input Gate .....	\$1.00 ea.	10/9.25
MC 799P Dual Buffer .....		

MC 780P Decade .....	\$3.00
MC 767P Quad Latch .....	3.00
MC 9760P Decade .....	5.00
ONE EACH OF 3 ABOVE \$10.50	

7400 Quad 2 Input NAND Gate .....	75¢	10/6.95
7404 Hex Inverter .....	85¢	10/7.95
7441A Decimal Decoder/Driver .....	\$4.23	10/39.95
7473 Dual JK Flip-flop .....	\$1.60	10/14.95
7475 Quad Latch .....	\$2.30	10/21.50
7490 Decade Counter .....	\$2.70	10/25.50
709 Op Amp .....	\$1.75	10/16.50
741 Op Amp .....	\$3.10	10/29.95
CA 3035 Linear Amplifier .....	\$2.25	10/21.95
14 Pin Dual Inline socket terminals .....	25¢	10/2.25
16 Pin Dual Inline socket terminals .....	30¢	10/2.75

NEW NATIONAL Long Life Nixie tubes NL 940S 0-9 with two decimal points \$4.50 ea. 10/42.95

SOCKET for NL 940S .....	50¢ each
100 KC CRYSTAL NEW .....	\$3.95
88 MH TOROIDS .....	10/3.00

**DOOR KNOB CAPACITORS**

500 PF - 20 KV .....	75¢
600 PF - 12 KV .....	75¢
40 PF - 5 KV .....	50¢
50 PF - 7.5 KV .....	50¢



**R & R ELECTRONICS**  
 311 EAST SOUTH ST.  
 INDIANAPOLIS, IND.  
 46225

\$5.00 minimum order. FOB Indianapolis

**the all "NEW"**  
**CRYSTAL CALIBRATOR**

FROM



- 100 - 50 - 25 KC MARKERS
- ZERO BEAT TO W W V
- USES NEW 100 KC CRYSTALS (included in all units)
- GLASS EPOXY BOARDS
  - VERY COMPACT 2" x 3" x 1/2"
- 3.5 V. OPERATION

**\$12<sup>95</sup>** KIT  
 with  
**100 KC**  
**CRYSTAL**

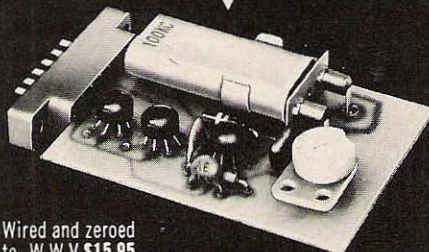

Wired and zeroed to W W V \$15.95

ARN-30 108-135 mc tunable receivers. High frequency version of the famous command receivers. Listen to local airport frequency or convert to 2 meters. Like New with schematic and operating instructions. 12 lbs. \$14.95

Western Union facsimile machines, send and receive pictures and memos. Works on 115 v 60 cycles. Shipped with auto-start, auto-phase pos-to-pos, conversion instructions. 20 lbs. \$19.95

Telfax paper .....2¢ each 1000 for \$12.95



# MESHNA'S KNOCKOUTS

## for thin wallets!

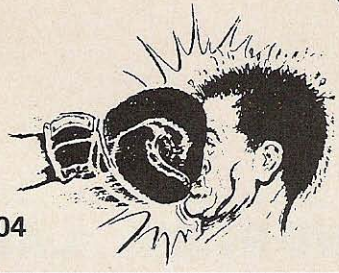

John Meshna Jr. PO Bx 62 E. Lynn MA 01904  
 Phone 617-595-2275 All material plus postage or shipping

### EXOTIC DISCRETE COMPONENTS

FET N-CHANNEL 2N3819 unused marked, TI	2/1.00
709C OP AMP	1.50
CA3008 OP AMP	1.50
TIS-43 UNIJUNCTION, TI, branded	2/1.00
TRIACS 600 PIV 6 AMP, TO-66 case	1.25
TUNNEL DIODE GE SMTD-760	1.00
TUNNEL DIODE GE TD-717	.75
LED VISIBLE	1.25
IR LED	1.25
LED DETECTOR	1.25
IR LED DETECTOR	1.25
2N918 TRANSISTOR NPNS VHF 300MW 15V 200MC	2/1.00
2N2218A TRANSISTOR NPNS 3 watt 40V 250MC	2/1.00
2N2907A TRANSISTOR PNPS 1.8 watt 60V 125MC	3/1.00
2N706 HI-FREQ TRANSISTORS	3/1.00
JK FLIP FLOP TEXAS INST S N5470F	3/1.00

### SYLVANIA DIP IC

Brand new dual inline package, factory marked, DTL series. Priced at a new Low, Low

	50¢ ea 1-25
	40¢ ea 25-100
	30¢ ea over 100

932 - Dual 4 input expandable buffer  
 930 - Expandable Dual 4 input - NAND/NOR gate  
 931 - JK/RS Flip-flop  
 933 - Dual 4 input expander  
 962 - Triple 3 input NAND/NOR gate  
 944 - Dual 4 input expandable power gate

### 455 KC IF ASSEMBLY

Complete miniature 455kc IF amp assembly. 1.5 inches long, little over 1/2 inch square. Ready to use w/schem. Sim to Miller 8902 . . . . . 2.50

### LM FREQ METER \$35.00

Lowest price yet. W/tubes, crystal and original calibration book. Look OK but unchecked. Typical schematic furnished.  
 8 lbs. . . . . #LM 35.00

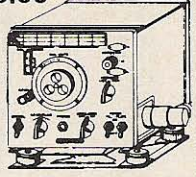

### RF VACUUM SWITCH

Made for the ART-13 good for 100 watts RF, no doubt handles much more due to being underrated for the military. . . #71-17 3/2.00

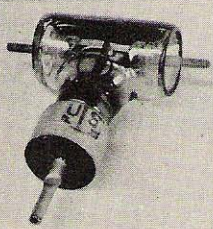

### UHF TRANSMITTER

One of the later designs being released. Superb workmanship by HUGHES. Utilizes 3 pencil triodes worth over \$46.00. Looks like a "natural" for 220 mc transmitter as it's on 264mc now. Simple to lower freq. W/tubes & schematic. Built-in power supply 400 cycle would have to be changed. Measures only 3x4x8 inches. Nice piece of scarce gear, easy to work on & first class condition.  
 4 lbs. . . . . #TA-401C 15.00

### NIXIE TUBES

Brand new BURROUGHS, 0-9 w/decimals. #B5441, with socket. List of \$8.40. #B5441 5.25

### 7400 SERIES IC GRAB BAG

Mix of 7400 series DIP, unmarked untested. Some schematics provided. . . . . 10 for 1.00  
 100 for 8.00  
 1000 for 60.00

### 70 AMP POWER SUPPLY KIT \$16.00

Runs on 115V 60 cycle. We include diagram, diodes, caps, resistors, transformer. Gives you a choice of 6V at 70 amps; 12V at 35 amps; 24V at 17 amps.  
 Ship wgt. 30 lbs. . . . . #PK-1 16.00

### OP AMP MODULES \$2.00

Mfgs' name withheld but you'll recognize them. Worth over \$10 each. Slightly below mfgs specs but tested OK & guaranteed. Any SA-1, SQ, SQ-1 or SQ-10 for \$2.00 w/diagram. Many others on hand, send for list.

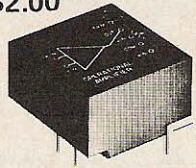

### PAMOTOR \$6.00

Brand new PAMOTORS for 115V 60 cycle, 115CFM, list of \$18.00 each. Mfr guarantee of 100,000 hours.

### TI SOLID STATE 3B28-866 REPLACEMENT

Brand new TI plug in solid state replacement for 3B28. Replaces 866. . . . . 9.00  
 2/17.00

### 6CW4 NUVISTA TUBES BRAND NEW 2/1.50

# WORLD'S LARGEST SELECTION OF NEW & USED TV CAMERAS & ASSOC. EQUIPMENT

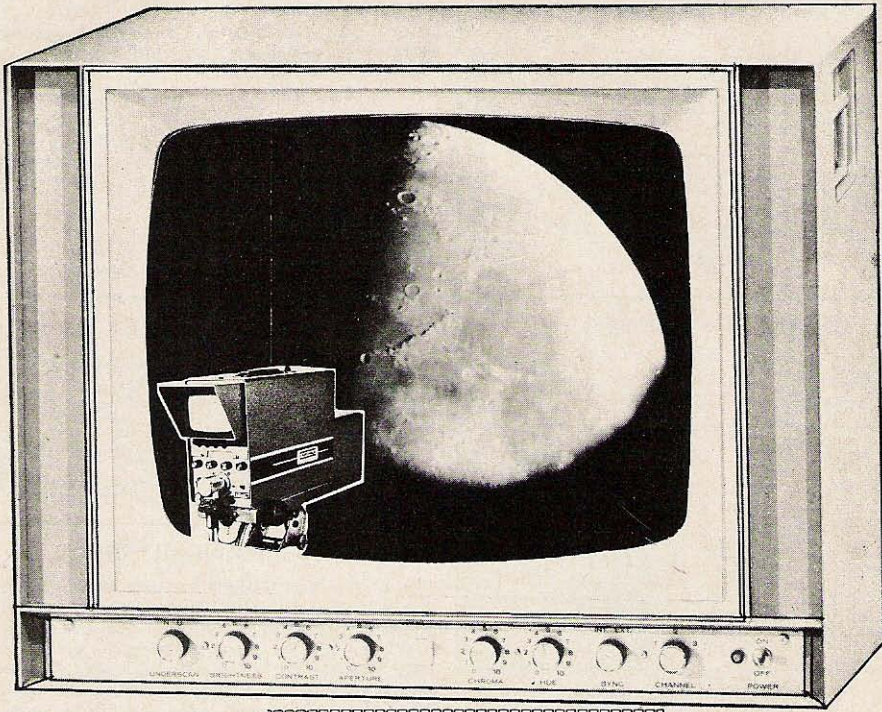

Broadcast & Closed Circuit TV  
Audio and Video Systems

**1971**  
INDEX PAGE 142

PRICE  
**\$1.00**  
ppd. \$2.00 foreign

*25<sup>th</sup> anniversary*  
**CATALOG # 971 A 1**

## THE DENSON ELECTRONICS CORP.

OFFICE Longview St. Tel. Area Code 203 / 875-5198

MAIL POST OFFICE BOX 85

### ROCKVILLE CONN 06066 USA



**FREE!**  
**1971**  
**EQUIPMENT**  
**CATALOG**

**Tucker Electronics Offers High Quality Reconditioned Equipment at Great Savings!**

Tucker Electronics specializes in the sale and servicing of all types of military and commercial test equipment such as oscilloscopes, signal generators, bridges, voltmeters, and similar instruments. Our experienced sales engineers can aid you in selecting quality test equipment for your specific requirements at a considerable saving in cost to you.

We maintain stock inventory of over 8,000 instruments by 250 different manufacturers. All our used equipment is reconditioned, calibrated, and fully guaranteed.

Tucker Electronics maintains a well-equipped repair and calibration laboratory. Calibration standards are traceable to the National Bureau of Standards, and services satisfy the requirements of Mil-C-45662A. Our customer list includes many nationally known electronic and aerospace companies, as well as many government agencies. Turn-around time on calibration work is kept to a minimum for quick service.

Write or Call today for FREE catalog.



P. O. BOX 1050 • GARLAND, TEXAS 75040 • 214/348-8800

*Our technicians constantly replenish an extremely wide inventory selection.*

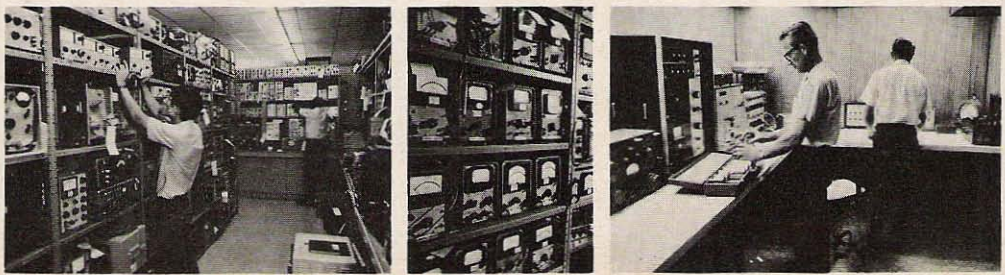

# ◆ JEFF-TRONICS ◆ TEST EQUIPMENT

**USED, CHECKED GUARANTEED IN GOOD WORKING CONDITION**

TEKTRONIX Plug-ins for 530-series scopes. Types B, D, E, K, L. . . . . \$60.00 each  
 FLUKE 801 Differential Voltmeter. . . . . \$125.00  
 FLUKE 101 VAW Meter with 3 shunts. . . \$125.00  
 DUMONT 304-A Oscilloscope, 5-inc. . . \$100.00  
 HEWLETT-PACKARD 524-B Counter, to 10 Mc. Can use plug-in units to count to over 200 Mc. Plug-ins not included. . . . . \$400.00  
 HEWLETT-PACKARD 523-B counter, to 1 Mc. . . . . \$250.00  
 HEWLETT-PACKARD 185-A Sampling Scope with 187-B dual-trace plug-in, . . . . . \$600.00  
 HEWLETT-PACKARD 415-A Standing Wave Ratio Indicator. . . . . \$45.00  
 HEWLETT-PACKARD 520-A High Speed Scaler for counter. . . . . \$75.00  
 KROHN-HITE UF-101-A Ultra Low-Distortion Power Amplifier. . . . . \$75.00  
 BALLANTINE 320 True RMS Voltmeter. \$80.00  
 BALLANTINE 302CS/2 Battery operated AC VTVM. . . . . \$35.00  
 ELECTRO-INSTRUMENTS A-12 DC Amplifier in portable case. . . . . \$50.00  
 KEPCO KR-2 Regulated Power Supply, 195-325 vdc. 125 ma. . . . . \$35.00  
 KEPCO KR-6 Regulated Power Supply, 195-325 vdc. 600 ma. . . . . \$50.00  
 BERKELY 5570 Digital Freq. Meter. 0-43 Megacycle. Counts to 1 cycle. . . . . \$250.00  
 G-R 736-A Wave Analyzer. . . . . \$100.00  
 TELETRONICS PG-200-AA Pulse Generator with extender. . . . . \$85.00  
 MICROLINE 123-B Wattmeter Bridge. \$35.00  
 PRD 650-A Universal Power Bridge. . . . \$35.00  
 ESE 270-R Capacitance Bridge. Rack mounting. . . . . \$100.00  
 ULTRASONIC INDUSTRIES Ultrasonic Generators. In small table-top cabinets. Model G4001P; 80 Kc., 80 watts. . . . . \$35.00  
 Model G80C1F, 80 Kc. 120 watts. . . . . \$45.00  
 G.E. "Volt-pac" variable voltage transformers. Input 120/240 v., output 0-240/480 volts, 35 Amps max. Shpg. Wt. 60 pounds. . . . . \$35.00

DIGITAL MECHANICAL COUNTERS:  
 3-digits 28 vdc relay operated. Thumb-wheel to reset. Counts backwards to zero. "Exposures remaining." 1 1/4" x 2 1/4". . . . . \$1.00  
 3-digit, uncased. 3/8" high numbers. Left-hand digit alternates 0-1-0-1. 3/16" diam. shaft. 1 1/4" x 1 1/4". . . . . \$1.00  
 WESTON #1524 0-500 AC Milliammeter. 2" round. . . . . \$2.95  
 POWER TRANSFORMER. 275 v. 125 ma. 12 v. 2 amps. Upright mounting. 8 pounds. . . . \$2.00  
 . . . . . \$4 for \$7.50  
 METAL-CASED PAPER TUBULAR CAPACITORS, mil spec.  
 100 vdc; .01, .047, .1, .22, .68, 1 uf.  
 200 vdc; .022, .033, .047, .056, .068, .1, .33 uf.  
 400 vdc; .015, .033, .047 uf.  
 600 vdc; .0022, .0047, .022, .047 uf. . . 10¢ each  
 200 vdc; .47 uf 400 vdc; .1 uf, .22 uf. . . 15¢ each.  
 200 vdc; 1 uf. 400 vdc; .47, 1 uf. . . . . 20¢ each.  
 SELENIUM RECTIFIER, Full-wave Bridge, 55 v. ac max. 3 1/2 amps. . . . . \$1.00 each  
 . . . . . \$6 for \$5.00  
 GENERAL RADIO POTENTIOMETERS:  
 #971-M 5000 ohms. . . . . 75¢  
 SELSYN DIFFERENTIAL GENERATOR, G.E. 2J1H1. 400 cycle unit, works well on 12 volts 60 cycles. for beam indicator, etc. New. . . . \$2.00  
 HUMIDISTAT . . . Honeywell type H46B1002-1 humidity controller. Contains a microswitch, closes the circuit on decreasing humidity. Dimensions: 1 7/8" x 1 1/8" x 3 1/2" deep. 1/4" diam. x 3/4" long adjusting shaft extends from the end. Brand new. Only 45¢ each. . . . \$2.00  
 WAVEGUIDE ASSEMBLY, X-band. Contains: 3 magic tees, 2 attenuators relay operated, 1 attenuator calibrated, xtal mount, klystron, angles, couplers, etc. Used, vry good. 30 lbs. \$15.00  
 COAX RELAYS, from MOTOROLA "MOTRAC" 12 vdc coil. 100 watts RF. Connections; 1 SO-239, 2 RCA plugs. . . . . \$3.00  
 OFFNER CHOPPER AMPLIFIER: model 190. with 12AU7 & 2 a2AX7 tubes, chopper. Used, appear good. . . . . \$4.50

**Prices are FOB our store. PLEASE include sufficient money for shipping. Any excess will be immediately refunded.**  
*Send 25¢ for our catalog of hundreds of items: Test equipment, parts, new and used ham gear. We will add your name to our permanent mailing list.*

# ◆ JEFF-TRONICS ◆

4252 Pearl Rd. Cleveland, Ohio 44109 749-4237

# FM 2 Meter UHF 6 Meter USED

**GENERAL ELECTRIC . . . RCA . . . MOTOROLA**

When it comes to great used mobile communications equipment, we wrote "the book" . . . Send for a free copy of "the book" (our new catalog).

Here are only a few of our **LOW PRICES:**

**2 METERS**

**GENERAL ELECTRIC MA/E33** 6 or 12 volts, 30 watts  
 Vibrator Power Supply with accessories ..... **\$148.00**

**MOTOROLA X43GGV**, New Low Price, Special Model in 10" case,  
 30 watt, transmitter narrow band, receiver wide band, vibrator  
 powered, 2 freq. transmitter, and transistor powered 2 freq. "Private  
 Line" receiver (single squelch), less reeds,  
 complete accessories ..... **\$108.** In quantities of ten .... **\$88.**

**6 METERS**

**MOTOROLA FMTR140D**, 6 or 12 volts, 60 watt, wide band.  
 Dynamotor Power Supply ..... **\$48.**

Transmitter Narrow Band ..... **\$58.**

Fully Narrow Band ..... **\$68.**

complete with accessories (less accessories deduct \$15)

**GENERAL ELECTRIC PRE-PROGRESS 4ER6 RECEIVER,  
 ET5 OR ET6 TRANSMITTER**  
 30 or 60 watts (as available), 6 or 12 volts,  
 including all accessories ..... **\$28.**

**UHF**

**MOTOROLA . . . T44A6A** with accessories ..... **\$38.**

T44AAV with accessories ..... **\$48.**

**RCA CMU15A . . . 15 watts,** minus accessories ..... **\$18.**

For Your Convenience **SCHEMATIC DIGESTS.** (Post Paid)  
**G.E. SCHEMATIC OUTLINE AND INTERCONNECTION DIAGRAMS  
 FOR GE 2-WAY FM RADIOS.**  
 Vol. 1 Pre-Progress Line ('49 - '55) 25-50 MHz 72-76 MHz  
 Vol. 2 Pre-Progress Line ('49 - '55)  
 150-170, 405-425 MHz, 450-570 MHz ..... each volume **\$4.50**  
**MOTOROLA FM SCHEMATIC DIGEST**  
 revised edition to 1960 ..... **\$6.50**



**GREGORY ELECTRONICS CORP.**

249 Route 46, Saddle Brook, N. J.

Phone (201) 489-9000

Dept. 73

# RADIO BOOKSHOP BIG DEALS

## BOOKS!

**ADVANCED CLASS STUDY GUIDE** Up-to-the-minute simplified theory, written with the beginning radio amateur in mind. This unique book covers all aspects of the theory exam for the Advanced Class license and has helped hundreds of hams to sail through the exam...nothing else like it in print.

1001.....\$3.95  
1001H.....Hardbound \$3.95

**EXTRA CLASS LICENSE STUDY COURSE BOOK** The Extra Class License Study Guide is now available in book form as a permanent addition to your radio library. This is the complete course that was published in 73, covering every technical phase of the new license exams for this highest class of amateur license. This also covers, in the easiest-to-understand form, just about every technical question likely to be asked on the First Class Radiotelephone exam. This is the first study course ever published that is written so the newcomer to radio can understand it. With this book you can face the FCC exams knowing that you understand the theory and with no fear of rewritten questions.

1002.....ppd USA \$4.95

**VHF ANTENNAS** This handbook is a complete collection of up-to-date information about VHF and UHF antennas, with design hints, construction and theory. If you've been wondering what array you need, this book will give you enough background to make the right decision.

1003.....\$3

**COAX HANDBOOK** Invaluable book for the ham or the lab and for everyone else who doesn't want to have to keep a whole library on hand for reference...or even worse, have to write to the manufacturer for coax spec.

1005.....\$3

**73 USEFUL TRANSISTOR CIRCUITS** If you've been looking for a transistor circuit to do a special job, chances are there is a circuit in this book that will give you a head start. It covers circuits for audio, receivers, transmitters and test equipment.

1006.....\$1

**SIMPLIFIED MATH** Does math scare you? It shouldn't. This easy-to-understand book explains the simplified exponential system of arithmetic, simple formulas, logarithms, and their application to the ham shack.

1007.....\$5.00



1004



1006

**AMATEUR TEST AND MEASUREMENTS** By W5REZ. Using VOM, Scope VTVM, dipper, SWR bridges, etc. Covers amateur users of test equipment in the ham station. 208 pages, softbound. Interestingly written, covers tuning receivers, all kinds of transmitters, etc. Invaluable for every hamshack.

1012.....\$5.50

**ELECTRONICS FOR THE AMATEUR** By W5REZ. Hardbound book, 272 pages. Covers entire theory needed for passing amateur licenses. Fine book for instructors, and for amateurs wanting a refresher course before exposing themselves to the FCC examiners. Handbook books look nice and last.

1013.....\$7.95

## NCX-1000

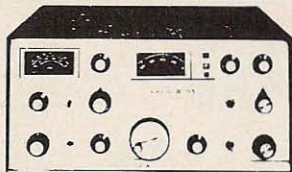

**NATIONAL NCX-1000 TRANSCEIVER** Transistorized transceiver (except for driver and final) runs 1000 watts, yet is just a bit larger than ordinary transceiver! Complete kilowatt ham station in one small, light unit. Tested by 73 staff and found to be a really great unit. The world of transistors and ICs makes it possible to have a complete kilowatt all band ham station in one small unit! Not much larger than normal transceiver yet runs solid 1000 watts. Extremely sensitive, processed speech for maximum umphs when wanted, everything you need in one little package. Only tubes are driver and final. The NCX-1000 lists for \$1100 and is an unusual bargain at that price. The 73 test unit, used a few days and under brand new factory warranty, is available to the first \$700 check received.

## GR 1105

**G.R. FREQUENCY MEASURING EQUIPMENT TYPE 1105A** This primary frequency standard will measure from 1 Hz to over 100 MHz with an accuracy of one cycle up to 10 MHz. This is a laboratory standard used primarily for calibrating other equipment. This is the last word in frequency standards. Send for details.

Special.....\$1995

## W2NSD/1

**MAGNETIC CAR SIGNS** Put this easy-to-read magnetic call sign on your car when you are on a trip and meet the hams along the way. Comes right off when the XYL drives the car, if she doesn't want to be bothered by hams tooting at her. Send \$4 along with your call letters today!

1201.....\$4

**LAPEL BADGES** Name and call identifies you at club meetings, hamfests, busted pot parties. Hand engraved by skilled New Hampshire craftsman with loving care. Only one lousy dollar. Send first name and call.

1202.....\$1



**A HAMSHACK WITHOUT A GLOBE? RIDICULOUS!** Particularly when these fabulous Hammond globes (the best in the biz) are available at our low, low price! 13" inflatable globe (guaranteed, by the way) regularly selling for \$15, now special, while they last.

1208.....only \$10  
13" lighted inflatable globe, regularly \$25 now

1209.....only \$15  
We have a few of these in stock and when they are gone, that's it!

## DX STUFF

**CUSTOM MADE DX CHARTS** When you need a DX bearing you need it immediately. You don't want to have to look it up on a map or fiddle with a globe. These Custom DX Charts are computer printouts for your exact shack location and give the bearing and mileage for every country in the world. They are printed out by call prefix for speed of location and the capital city is indicated.

Custom DX Chart, 1206ppd \$4



**FABULOUS DX MAP OF THE WORLD** Show visitors DX you've worked. Wall sized (23" x 31"); shipped flat in mailing tube; suitable for framing; most complete map available; up-to-date world prefixes shown; color in countries as worked; shows islands, reefs, rare DX spots; use colored map pins for different bands.

1207.....\$1

**DX HANDBOOK** Includes giant world country-zone wall map. Articles on QSL design secrets, winning DX contests, DXCC rules, DXpeditions, reciprocal licensing and many more. World postage rates, WAZ record lists, time charts, propagation, etc. Special ham maps and bearing charts. A must for the DXer.

1021...\$3

**DIODE CIRCUITS HAND-BOOK** An invaluable reference book. Covers rectifiers, mixers, detectors, modulators, FM detectors, noise limiters, AGC, BFO/Q-multiplier, AFC, Variac tuning audio clippers, balanced mods, fieldstrength meters, RF probes, zeners, control circuits, etc. 111 different circuits.

1004 ..... \$1

**"TRANSISTOR PROJECTS FOR THE AMATEUR"** A collection of 73's most popular ham projects, selected by you, the readers, and edited by Paul Franon (Mr. Semiconductor himself). This has got to be the best, most authoritative, most universally appealing collection of up-to-date circuits ever published.

1010 ..... \$3

## FM BOOKS

**FM ANTHOLOGY Vol. 1.** This book is largely a collection from FM Bulletin, edited by K67MVH and WA8UTB. The material is taken from the editions of February 1967 through February 1968.

1009 ..... \$3

**FM REPEATER HANDBOOK K6MVH.** Book is required for all repeater operators and must reading for all FM'ers. Only complete book on the subject. It is also one of the best selling books in amateur radio today.

1010 ..... Hardbound \$6.95

**"THE BEST OF FM"** A huge selection of FM Journal's finest technical and conversion articles, never before reprinted in any other magazine. The concluding segments of those controversial "CHRONICLES"! Selected FM editorials to show a broad view of the problems faced by FM'ers. This book comprises Volume II of the FM anthology, and includes an "Editor's Choice" selection of topflight articles from FM Journal, from March 1968 to May 1969.

1011 ..... \$4.95

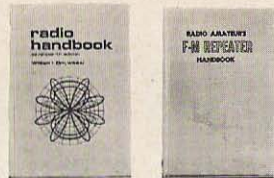

1019

1010

**EDITORS & ENGINEERS RADIO HANDBOOK** Hardbound. Latest (18th edition) by W6SAI. This is the most complete ham handbook ever published. Makes all other handbooks look like comic books. 896 pages.

1018 ..... \$13.50

**EDITORS & ENGINEERS RADIO HANDBOOK** Hardbound. W6SAI (17th edition) reduced for clearance, limited supply available for fast acting amateurs. Last chance to get this great book before it is gone forever.

1019 ..... \$10

**ELECTRONICS REFERENCE HANDBOOK** Hardbound. W6TYH handbook of basics and circuits. Complete analysis of all ssb equipment.

1015 ..... \$6.95

**HOW TO FIX TRANSISTOR RADIOS & PRINTED CIRCUITS.** Do you throw those little radios away when they stop? Wasted money! Easy to fix with this manual. Worth many times the low price. No serviceman or amateur should be without this tremendous book.

1016 ..... \$7.95

**SCHEMATICS AVAILABLE** \$1 each.

1101. ARR-15 from June 1965 73, page 78.

1102. ARC-27 2M Guard Channel Receiver.

1103. SSB Transceiver, Nov. 1961 73, Page 23.

1104. R508/ARC, June 1965 page 48, before & after.

Buy lavishly! Order today from: **RADIO BOOKSHOP**

Peterborough NH 03458

## GUNSMOKE

**GUNSMOKE?** Blow your mind on our back issue bargain bunch, 30 (count 'em) assorted (we hope) back issues, all before 1968, for the incredibly low price of \$6 postpaid (hardly pays for the postage). These are packed by slave labor (to cut costs) so please ignore notes calling for help, etc., that may be slipped into the bundles.

1204 ..... \$6

**SPECIAL! RARE BACK ISSUES** The back issue of 73 you need to complete your full set — or that has the continued article you only read the end of — can be yours for a mere pittance! Most issues are in stock and are available for \$1 each. The exceptions that prove the rule are listed below:

Dec.68, Nov.69, Feb.70, Oct. 70. .... \$2

Jan.65, Apr.65, Jan.66, Jan. 67. .... \$3

Jan.61, Dec.63, Jun.66, Jul. 66. .... \$100

## 73 BINDERS



**BUY BINDERS FOR YOUR 73** and win the love of a beautiful girl. Gorgeous red binders look great on your shelves and also keep the magazines from disappearing or breaking. Come with set of year stickers. Get enough binders to protect all those back issues too.

1205 ..... \$4

## DESK PLATE

**DESK CALL PLATE** Up to 20 letters on a desk plate, embossed white letters on walnut background; ebony stand. Looks great on rig with your name and call. Watch envy race through your neighborhood. Send along 20 well chosen letters (spaces count as letters too), include a nice fresh two dollar bill, and give us a strong hint on where to mail the exquisite piece of craftsmanship.

1203 ..... \$2

Latest Edition — **POPULAR TUBE & TRANSISTOR SUBSTITUTION GUIDE** Brand-new updated and revised edition! The most needed substitution data for both tubes and transistors all in one handy brand-new volume! No longer do you have to refer to one substitution manual for tubes and another for transistors — everything is here in one quick-reference guide. Lists 99% of the tubes and transistors you'll ever need to replace. Moreover, only readily-available and comparably-priced substitutes are listed. No longer do you have to search through lists of tubes and transistors you'll rarely see in use, or search through pages of irrelevant material to find a substitute. Why buy a \$10 switching transistor when a 89¢ popular type will do the job better? Contains 8 big sections — four devoted to tubes and four to transistors; Popular Receiving Tubes, Industrial and Commercial Tubes, American Substitutes for Foreign Tubes, Tube Base Diagrams, Popular Transistors, American Substitutes for Foreign Transistors, General Purpose Transistor Substitutes, Transistor Base Diagrams and Manufacturer Abbreviations. You'll find this guide to be one of the most practical everyday aids you've ever used. 224 pps., 8 Sections.

1022 ..... Softbound \$2.95

1023 ..... Vinyl Cover \$4.95

**WORLD'S FINEST LOG BOOK?** Designed and executed by W2NSD/1, this is the most relevant amateur radio log ever designed. This is a log for today. It has a column for the date, one for time and off of each contact, a small column to indicate whether you called the station contacted (or CQ) or not, a good wide space for the station call contacted, little columns for the reports, a good space for his location, a QSL column, and lots of room for notes! The log is the long way on standard 8½" x 11" paper and padded into pads of 125 sheets, with room for 20 contacts per page. The whole book of log sheets will carry you through 2500 contacts. There is a place to indicate on each sheet the brand being used and the power in case these change now and then. The log pages can be numbered for file card reference. Why use a log book designed in the 1920's? This one was designed for use in the 70's and is exactly right for the DX'er, and rag chews, or even the round-table denizen. It will work for RTTY, ATV or even slow scan television. Never has a log been made available which is as handy as this gem. Why keep struggling with those ring binders which get all bent out of shape? Get this first really modern log.

1210 ..... only \$2 ppd.

## RADIO BOOKSHOP

All books and items postpaid in U.S.A. unless otherwise indicated. Send cash, check, money order, etc., to:

Buy lavishly! Order today from: **RADIO BOOKSHOP**  
Peterborough NH 03458

# getting started

AMATEUR'S CORNER



# in Radio

by FRED J. MOCKING

Once upon a time there was a young boy who lived in a big city. He attended school during the day (he was in the sixth grade), but at home in the evenings he "fooled around" with his electrical experiments. Tom's teachers said he was lazy and inattentive. He did not study his textbooks like the other kids did. He had a poor memory and was unable to remember things the teacher had told him the day before.

He was so lazy that he never wrote out the details of his arithmetic problems. He had decided that it was much easier to memorize all the tables up to  $20 \times 20$ , than to calculate them every time.

He spent considerable time at the library, looking for books on electricity and radio. He was "friends" with the radio serviceman in his neighborhood and with a neighbor who worked for the telephone company. He also had a very special friend who was a ham radio operator.

His basement workshop was a mess, with parts of old radios, discarded appliances, tubes, meters and assorted miscellany all over. By the time he was in eighth grade, he had built several 1 and 2 tube receivers and his latest project which he was just finishing was a six-tube superheterodyne. He also had built a ham band transmitter and had been on the air for about six months.

He had acquired a number of basic skills using electrical and electronic instruments, troubleshooting all kinds of equipment and doing some simple design work, based mostly on Ohms law.

During high school he continued his ham activities, and did just average in his school work. His math teacher told him he would never learn math and should avoid technical subjects. His physics teacher, however, was impressed by Tom and encouraged him, provided opportunities for him to use school equipment.

As you might expect, Tom decided to study electrical engineering in college. Here again, his grades were average, and studies left little time for ham radio. But Tom picked up some spending money working part time in a radio repair shop and, in his last year, worked as a technical assistant to one of the professors in the EE department.

The professor was working on a project that involved using tube circuits to perform mathematical computations. There were no textbooks to refer to. Every aspect of the equipment was a step into an uncharted land. How do you represent numbers using electrical circuits? What circuits do you need to perform arithmetic operations? How do you get results out of the machine?



The professor didn't want to hire Tom at first, but some of the A students working on the project were completely lost when it came to troubleshooting. And, in designing circuits that weren't in the textbooks, they were rather confused. So Tom got the job. And strange as it seems, this indifferent scholar, with "no talent" and a "bad memory," became a leader and an outstanding engineer on a project that opened up a whole new vista in technology — the computer era.

Why do we spend time to review this thumbnail sketch about Tom? Because what happened here is happening to thousands of Toms across the country. There's a chasm between the world of school and the world outside of school, and considerable misunderstanding about what constitutes learning.

Tom didn't trust words, or textbooks, but he felt intuitively that his experiments were worthwhile. Some educators say "You learn by doing," which is somewhat of an oversimplification. Tom's teachers didn't trust the real world; they only felt comfortable with the world of words, which is to a large extent an unreal world. And what does this all have to do with a magazine?

If you want to learn electronics, you are going to learn about a lot of physical phenomena which exist without words, and which can be experienced and observed without words. This means that the equipment does the teaching.

If you want to argue, you can say "Wait! A magazine is nothing but words, so what gives?"

So here is the straight scoop:

The words can tell you what equipment to get and what to do with it. You have to *experience* how it works and that's *your* job. But afterwards, if you want to know *more*, people who have also experienced similar experiments and have written about them can communicate with you in the articles in this magazine.

This column will have comments on things to build, some techniques that help us understand the things we see, and some comments about learning, education, and communication.

for **MINIDUCTORS**  
select **B&W!**

send for spec sheet

**BARKER & WILLIAMSON**  
CANAL ST., BRISTOL, PA. 19007

## A 2M PREAMPLIFIER

12 vdc powered.

27 db gain (approximately)  
noise figure 2.5

will take Regency HR-2  
or Motorola to 0.1  $\mu$ v sensitivity  
without appreciable noise.

Metal case. ONLY \$17.95 ppd

**CRAWFORD ELECTRONICS**  
302 West Main, Genoa IL 60135

## WE PAY CASH FOR TUBES

Lewispaull Electronics, Inc.  
303 West Crescent Avenue  
Allandale, New Jersey 07401



**SALE!**  
**HEADSET**  
with. . . .

HEADBAND, CORD, PLUG, 2 RECEIVER  
UNITS WITH 2 CUSHIONS, 600 OHMS.

400 at \$1.75 each

Please include postage for 1 lb.

**TALLEN CO. INC.**

300 - 7th Street, Brooklyn NY 11215  
499-6300

# AT LAST A SPEECH COMPRESSOR THAT REALLY WORKS

- Low distortion circuit
- 5-10 dB improvement in TALK POWER
- Fully wired & tested not a kit
- Several models to choose from
- Works with phone patch

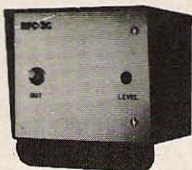

- Quality construction includes Silicon transistors, FETs, Glass circuit boards
- FULL WARRANTY - ONE YEAR

• Performance second to none

- INTRODUCTORY LOW PRICES - \$22.50 - \$34.95 (Illinois residents add 5% Sales Tax)

Write for specifications and information sheets (FREE)

Demonstration Tape cassette available (\$2.00 deposit)

**R<sub>P</sub> ELECTRONICS**  
BOX 1201B  
CHAMPAIGN, ILL. 61820



Radio Amateurs  
Reference Library  
of Maps and Atlas

**WORLD PREFIX MAP** - Full color, 40" x 28", shows prefixes on each country . . . DX zones, time zones, cities, cross referenced tables . . . . . postpaid \$1.25

**RADIO AMATEURS GREAT CIRCLE CHART OF THE WORLD** - from the center of the United States! Full color, 30" x 25", listing Great Circle bearings in degrees for six major U.S. cities; Boston, Washington, D.C., Miami, Seattle, San Francisco & Los Angeles. . . . . postpaid \$1.25

**RADIO AMATEURS MAP OF NORTH AMERICA!** Full color, 30" x 25" - includes Central America and the Caribbean to the equator, showing call areas, zone boundaries, prefixes and time zones, FCC frequency chart, plus informative information on each of the 50 United States and other Countries. . . . . postpaid \$1.25

**WORLD ATLAS** - Only atlas compiled for radio amateurs. Packed with world-wide information - includes 11 maps, in 4 colors with zone boundaries and country prefixes on each map. Also includes a polar projection map of the world plus a map of the Antarctica - a complete set of maps of the world. 20 pages, size 8 3/4" x 12" . . . . . postpaid \$2.00

**Complete reference library of maps** - set of 4 as listed above . . . . . postpaid \$3.50

See your favorite dealer or order direct.

WRITE FOR  
FREE  
BROCHURE!



RADIO AMATEUR  
**callbook** INC.  
Dept. B 925 Sherwood Drive  
Lake Bluff, Ill. 60044

Now, let's do some experimenting. I will assume that you own or can borrow a general purpose multimeter, also called a VOM (volt-ohm-milliammeter). If you have a VTVM (vacuum-tube voltmeter) you can use it as well for these experiments. You will also need some diodes and a few transistors.

There are many kinds of diodes that can be used. Rectifier diodes are usually readily available, and are often more clearly labeled than some others. Be sure the polarity is clearly shown. Transistors can be obtained as surplus or on surplus circuit cards. You should accumulate an assortment for experimenting. New transistors are fine but are usually somewhat more expensive.

Set the meter switch to the lowest OHMS scale, touch the prods together and "zero" the meter. Touch the test prods to the diode and read the meter. Now, turn

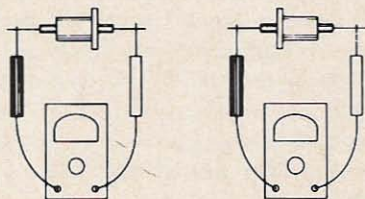

Fig. 1. Checking diode resistance in both directions.

the diode around and read the meter again. (see Fig. 1). One reading will be very low, as meter current flows through the diode in the "forward" direction. The other reading will indicate a high resistance (or open circuit) as the meter tries to "push" current through the diode in the reverse or blocking direction.

I have not given any numerical values of resistance because they would depend on many things, including the voltage of the dry cell in the meter, the diode being checked, and some other things. However, a good diode will read low in the forward direction and high resistance in the reverse direction.

Now, once more touch the meter prods to the diode with the diode in the forward or low resistance direction. Assuming that the diode is correctly marked, as shown,

and the prods are two different colors, usually red and black, two possibilities can arise, either A or B (Fig. 2). In A, "current" flows from the red prod, through the diode to the black prod. Knowing this, you can use the prod colors to help decide which way is forward for an unmarked diode. However, if B is the situation with *your* meter, then inter-

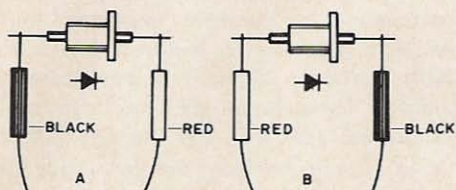

Fig. 2. The two possible arrangements that could give a "forward" reading, depending on the internal arrangement of your ohmmeter.

change the red and black leads at the meter. Now, to put current through the diode in the forward direction, your prods will match A, and you can still say that current flows from the red prod through the diode to the black prod.

When you are checking diodes or transistors, you can use the "reversed leads" trick described above. However, for voltage and current measurements, restore the leads to the proper positions. Incidentally, it is a good idea to label your ohmmeter

**POLARITY REVERSED ON OHMS, or...  
POLARITY CORRECT ON OHMS**

whichever applies to *your* meter. This can save you from trouble and goof-ups later on.

You have now acquired a "test set" (and some knowhow) that will permit you to do the following:

1. Determine the forward and reverse direction of an unmarked diode,
2. Check diodes for "opens" (high resistance both ways).
3. Check diodes for "shorts" (low resistance both ways).

In addition, this know-how can be directly applied to checking transistors, by testing between two terminals at a time and interpreting the readings as though

# GATEWAY ELECTRONICS

6150 DELMAR BLVD., ST. LOUIS, MO 63112  
314-726-6116

- 50 OHM NON INDUCTIVE LOAD RESISTOR — 7" long x 1/2 diameter ship wt. 1 lb. . . . . \$2.50
- CO-AX ANTENNA RELAY — BNC Connectors  
New packed ship wt. 1 lb. . . . . \$5.00
- NEMS CLARK TELEMETRY RECEIVER  
Model 1412 215 mhz-260mhz  
ship wt. 75 lb. . . . . \$200.00
- NEMS CLARK TELEMETRY RECEIVER  
Model 1671 175-260 mhz  
ship wt. 100 lb. . . . . \$250.00
- TRANSFORMER — 970 volt 200 ma center  
tapped with 6.3 @ 10A 5v @ 2A 5" x 5" x 6"  
115 vac Primary ship wt. 17 lb. . . . . \$7.00
- TRANSFORMER — 550 volt 200 ma center tapped  
with 6.3 @ 10A 5v @ 2A 5" x 5" x 4"  
115 vac Primary ship wt. 8 lb. . . . . \$5.50
- TRANSFORMER — 30 volt center tapped 30 volts  
@ 10 Amp or 15 volts @ 20 Amps.  
115 vac Primary ship wt. 15 lb. . . . . \$10.00
- VAC. VAR. COND. UCS-300 new with motor  
drive 10-300 mmf ship wt 22 lb. . . . . \$34.50
- MOTOROLA GOLD CRYSTAL OVENS 85 de-  
gree for two way radios ship wt. 1/2 lb. . . . \$1.00

See our IC prices in Jan. & Feb. Ads of 73 Magazine. Send for catalog available now. Minimum order \$5.00. Stop in and see us when you're in St. Louis.

RG 196 AU 50 ohm teflon coaxial cable. Outside diameter .080" RF loss .29 db per foot at 400 Mhz. Silver plated shielding and conductor. Used for internal chassis wiring, antenna coupling, RF coupling between stages, etc. Random lengths from 35 foot to 150 foot. Colors: black, red, brown, blue, grey, orange. Regular price-23¢ per foot. Our price 5¢ per foot \$3.00 per 100 ft.  
455 KHz ceramic filters type BF-455-A. These filters will help to sharpen the selectivity of most sets using 455 KHz IF's. Use across cathode bias resistor in place of a capacitor, or in transistorized sets, across the emitter bias resistor. Impedance is 20 ohms at 455KHz., DC resistance is infinite. Impedance increases rapidly as you leave 455 KHz. Plan your own LC filter circuits at very low cost.  
10 for \$1.00 25 for \$2.00

### TOROID POWER TRANSFORMERS

# T-2 This toroid was designed for use in a hybrid F.M. mobile unit, using a single 8647 tube in the RF amp. for 30 watts output. Schematic included. 12 VDC pri. using 2N1554's or equivalent. Sec. #1 500 volts DC out at 70 watts. Sec. #2 -65 volts DC bias. Sec. #3 1.2 volts AC for filament of 8647 tube. Sec. #4 C/T feed back winding for 2N1554's. 1W" thick. 2K" dia. \$2.95 ea. -2 for \$5.00  
# T-3 Has a powdered iron core and is built like a TV fly back transformer. Operates at about 800 CPS. 12V DC Pri. using 2N442's or equivalent. DC output of V/DBLR 475 volts 90 watts. C/T feed back winding for 2N442's \$2.95 ea. -2 for \$5.00

### TRANSFORMERS

P-7 117 VAC Pri. Sec. #1 18B VAC @ 120 ma. Sec. #2 6.3 VAC @ 4A. Double Half Shell Mail Box Type. SX 146 type. \$2.75 ea. -2 for \$5.00  
P-9 117 VAC Pri. Sec. #1 900 VAC @ 300 ma. Sec. #2 100 VAC @ 10 ma. Bias. Sec. #3 12.6 VAC @ AMP. Wt. 16 1/2 lbs. Double Half Shell \$4.50  
P-10 117 VAC Pri. Sec. #1 950 VAC C.T. @ 160 ma. Sec. #2 425 VAC C.T. and tap at 100 VAC 10 ma Bias. Sec. #3 12.6 VAC @ 4.5A Double Shell Mail Box type. Wt. 8 1/2 lbs. \$3.75  
Output transformers, all types 59 cents or 3 for \$1.50  
OT-1 Transistor TO-3 Power Diamond.. Imp. 15 ohms to 3.2 ohms DC Res. Pri. 6ohm. Sec. .3 ohm.  
OT-2 Pri. imp. 7000 ohm. Sec. 3.2 and 500 ohm for Phones or 70 volt line 3 watts. Full shielded Double Half Shell.  
OT-3 Pri. imp. 5500 ohms. Sec. 3.2 ohms. SC122 type.

All prices F.O.B. All weights listed are net. Please allow for packaging. Please allow enough for postage. We will return any extra.

# TOWER COMMUNICATIONS

1220-22 Villa St., Racine, WI 53403

## NEW G&G CATALOG! MILITARY ELECTRONICS

24 PAGES, crammed with Gov't Surplus Electronic Gear — the Biggest Bargain Buys in America! It will pay you to

**SEND 25¢** for your copy — Refunded with your first order.

**BC-645 TRANSCEIVER** 15 tubes, 435 to 500 Mc, Easily adapted for 2 way voice or code on Ham, Mobile, Television Experimental, and Citizens Bands. With tubes, less power supply in factory carton, BRAND NEW . . . \$16.95

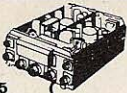

**SPECIAL PACKAGE OFFER:** BC-645 Transceiver, Dynamotor and all accessories, including mounting, UHF Antenna Assemblies, control box, complete set of connectors and plugs, Brand New . . . . . \$26.95

**TG-34A CODE KEYSER**, self-contained, automatic, reproduces code practice signals from paper tape. 5 to 12 WPM. Built-in speaker. Brand new with tech manual, takeup reel and AC line cord . . . . . \$24.50  
Code practice tapes for above P.U.R.



**AN/APR-4Y FM & AM RECEIVER "FB"** for Satellite Tracking!

High precision lab instrument, for monitoring and measuring frequency and relative signal strength, 38 to 4000 Mc, in 5 tuning ranges. For 110 v 60 cycle AC. Built-in power supply. Original circuit diagram included. Checked out, Perfect, LIKE NEW . . . . . \$88.50  
All tuning units available for above.



**HEADSET** Low impedance. With large chamois ear cushions. 4-ft. cord and plug. Reg. \$12.50. OUR SPECIAL PRICE . . . . . \$2.95  
High impedance adaptor for above . . . . . \$69¢



### SCR-274-N, ARC-5 COMMAND SET HQ!

Freq. Range	Type Complete with Tubes	Exc. Used	Like New	BRAND NEW
190-550 Kc	BC-453	\$16.95	\$23.50	\$27.50
3-6 Mc.	BC-454	\$16.50	\$19.50	\$22.50
6-9.1 Mc.	BC-455	\$14.95	\$17.95	\$21.50
1.5-3 Mc.	R-25		\$19.50	\$21.50

ARC-R11A Modern Q-5 Receiver 190-550 Khz . . . . \$10.95  
ARC-R22 540-1600 Khz Receiver with tuning graph \$15.95  
R-4 APR-2 Receiver 234-258 MHz, 11 tubes, NEW . . . \$8.95

TERMS: 25% Deposit with order, balance C.O.D. — or Remittance in full. Minimum order \$5.00 F.O.B. NYC. Subject to prior sale and price change.

### G&G RADIO ELECTRONICS COMPANY

47 Warren St. (2nd Fl) NYC, NY 10007 Ph 212-267-4605

See your  
**DEALER**  
for  
**DRAKE**  
products

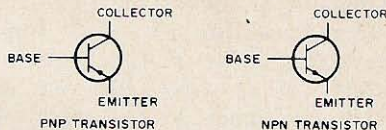

Fig. 3. Transistor symbols.

they were diode readings. Look at the transistor symbols in Fig. 3. The base and emitter form a diode, which can be checked just as we did before, with the ohmmeter. In the PNP transistor, "forward" is from emitter to base, while in the NPN transistor, forward is from base to emitter. These diodes can be normal, open, or shorted just as in any "regular" diode.

In a similar manner, the base-collector pair forms a diode, with polarity, for these tests, the same as the base-emitter diode. The "forward" polarities are:

PNP	NPN
Emitter-to-base	Base-to-emitter
Collector-to-base	Base-to-collector

In order to use this information, we need a guide that tells us which terminal is which on the physical transistor, since the leads are not marked. (See Fig. 4.)

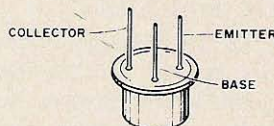

Fig. 4. Transistor lead identification.

You are now ready to take the ohmmeter and some transistors and check them to see if they are PNP or NPN. Then check for shorts and opens. Notice that there is no need to know how transistors "work" or how to design circuits, in order to perform these tests. Yet you will find yourself using this technique many times in the future. Even when you have much more elaborate test facilities you may want to run a quick check on a transistor or diode this way. So go to it, have fun, and the transistors, through the ohmmeter, will be happy to tell you about themselves.

... Mocking ■

Tell our Advertisers You Saw it in 73

# REDUCING MOBILE NOISE

Ward Stewart VE3FGS  
8 Church St.  
Penetang, Ontario

With the introduction of transistorized 2m FM transceivers and various amateur receivers for mobile use, there is a natural tendency to pick up the supply voltage from the ignition switch or the switched terminals on the fuse panel. Reduced current demands have rather obsoleted the old power relay . . . but not quite.

Because of the compactness of wiring harnesses, all kinds of voltages are induced into other wires in the same harness. It is quite possible for your receiver to get alternator, gage, and turn-signal noises induced on the supply line, and much of it will get past the receiver's filtering and appear at the speaker terminals.

The best way to eliminate this problem is to run the supply lead directly from the battery terminal, and route it away from other wiring while keeping it close to the metal chassis parts of the vehicle, which of course are at ground potential.

The battery itself is a big fat capacitor and a beautiful hash filter! But taking our A lead directly from it means we have to turn the rig on by hand for now it won't come on automatically with the turn of the ignition switch.

Here we come back to our old friend, the relay. Any relay with the current capacity for your rig and a 12V dc coil is okay. Your local two-way radio serviceman will undoubtedly have some old ones he would be glad to sell cheap (or he may even give them away). If you want a new one, ask for Motorola part number 59K813674. It looks like a horn relay off a car but it isn't! The illustration shows both the physical and electrical layout of this particular relay.

Use of this type of voltage supply will do much to reduce "local QRN" generated by the vehicle. Give it a try. . . .VE3FGS

## NEED CRYSTALS?

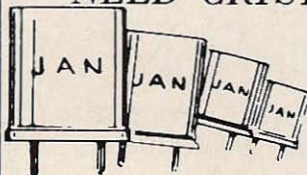

We can supply crystals from 2 KHz to 80 MHz in many types of holders.

### SPECIALS

Color TV crystal (3579, 545KHz) wire leads	\$1.60 4 for 5.00
1000 KHz frequency standard crystal (HC 13/U)	4.50
1000 KHz frequency standard (HC6/U)	4.50
Any CB crystal, trans. or rec. (except synthesizer crystals)	2.50
Any amateur band crystal in FT-243 holders (except 80-160 meters)	1.50 4 for 5.00
80 meter crystals in FT-243 holders	2.50

We have in stock over six million crystals which include types CR1A/AR, FT243, FT241, MC7, HC6/U, HC13/U, etc. Send 10¢ for our 1970 catalog with oscillator circuits, listing thousands of frequencies in stock for immediate delivery. (Add 10¢ per crystal to above prices for shipment 1st class mail; 15¢ each for air mail.)



**ORDER DIRECT**  
with check or money order to  
Special Quantity Prices  
to Jobbers and Dealers

2400B Crystal Dr., Ft. Myers, Fla. 33901

## radio amateur callbook

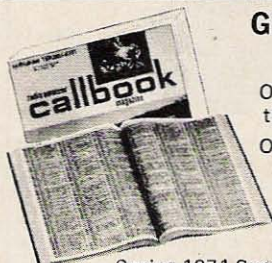

### GET YOUR NEW ISSUES NOW!

Over 285,000 QTHs in the U.S. edition \$8.95

Over 165,000 QTHs in the DX edition \$6.95

NEW EDITION EVERY:  
MARCH 1 — SEPT. 1  
JUNE 1 — DEC. 1

Spring 1971 Supplement, . \$3.50

These valuable EXTRA features included in both editions!

- QSL Managers Around the World!
- Census of Radio Amateurs throughout the world!
- Radio Amateurs' License Class!
- World Prefix Map!
- International Radio Amateur Prefixes
- Prefixes by Countries!
- Zips on all QTH's!
- A.R.R.L. Phonetic Alphabet!
- Where To Buy!
- Great Circle Bearings!
- International Postal Information!
- Plus much more!

See your favorite dealer or order direct (add 25¢ for mailing in U.S., Possessions & Canada. Elsewhere add 50¢).

WRITE FOR FREE BROCHURE!



RADIO AMATEUR callbook INC.

Dept. B 925 Sherwood Drive  
Lake Bluff, Ill. 60044

# SURPLUS TEST EQUIPMENT

Electronic Parts, Tubes, Radios  
New & Used Amateur Gear.

Send 25¢ for flyer listing hundreds of bargains, and we'll add your name to our permanent mailing list.

## JEFF-TRONICS

4252 Pearl Rd. Cleveland, Ohio 44109



# GUNSMOKE?

Blow your mind on our back issue bargain bunch, 30 (count 'em) assorted (we hope) back issues, all before 1968, for the incredibly low price of \$6 post-paid (hardly pays for the postage). These are packed by slave labor (to cut costs) so please ignore notes calling for help, etc. that may be slipped into the bundles. 73 Gunsmoke, Peterborough NH 03458. Send cash, check or negotiable securities.

## Standard Communications

New high performance 2-meter transceiver  
SR-C826M

**\$339.95**  
(Complete as shown with microphone, but in speaker and crystals for 146.94/94; 146.34/94; 146.36/76)



**Basic Features:** ■ All silicon semiconductors solid state circuitry ■ 12 crystal controlled channel capability ■ 4 channels factory installed ■ 10 watts of R.F. output power ■ Low power consumption ■ MOSFET R.F. Amplifiers and mixer ■ Noise operated squelch circuit ■ Hi/lo power switch ■ Illuminated dial ■ Self contained speaker (provisions for remote speaker included) ■ Metering of battery voltage, relative received signal strength and power output ■ .4 microvolt or better sensitivity

### SPECIAL CLOSEOUT!

Standard SRC-806MA two meter FM transceiver - 10 watts output, 12 channel capability. While they last - \$265.00 with 4 channels installed and full six month warranty. Regularly \$335.00

Write for brochure describing the SRC 826M and Standard's full line of accessories, including the SRC-851SH 25 watt 2 meter FM transceiver.

### ERICKSON ELECTRONICS

4657 N. Ravenswood Ave., Chicago, Illinois 60640  
Tel: AC 312 334-3200

**PETITION** filed by Wayne Green W2NSD/1, Peterborough, New Hampshire.  
The Federal Communications Commission has had considerable difficulty with the 27 MHz citizens band. Thousands of operators are using this band for hobby purposes even though this is prohibited by the regulations. Thousands more are using illegal antennas and illegal power amplifiers. Thousands are using the band even without a legal license. It seems obvious that there is a demonstrated need for a hobby band if the appropriate frequencies can be allocated. Such a band would provide a legal way for these operators to communicate and could therefore free the 27 band for its original purpose as a semibusiness band.

The drop in the number of the amateur radio service is reflecting along to the electronics and communications industries as a drop in the number of new workers entering this field. The needs of these industries are becoming more than ever as computers and space-age communications gradually involve more and more business and sectors of the economy. A drop in men coming into these fields can seriously hurt the future of these industries. In all, it would seem prudent to do everything reasonable to try and encourage the growth of amateur radio at this time.

The major factors influencing the growth of amateur radio would seem to be the discouragement resulting from the introduction of the "inactive licensing" program by the ARRL, the institution of \$4 license fee by the FCC, and the inderivable mess on the citizens band with 800,000 or so active stations using 23 channels, situation which has tended to discourage the most likely amateur radio prospects and divert them to other licenses.

The FCC in Docket 18802 has indicated that it is interested in making revenue meet expenses and has proposed that amateur license fees be raised to \$19. The result of this would seem to be even more problems for both services, with the raised fee right upon the issuance of amateur licenses possibly turned down again and the impressive increase in complete amateur license band operation becoming the rule rather than the exception. The Commission is asked herewith to consider an alternate source of needed income that might be derived from the increase of these two fees, thus eliminating at least the need for an increase in the amateur radio fees.

The Commission has been requested to establish a hobby-type license in the past several allocations in the amateur ten-x, and two-meter bands. Each of these requests has had serious drawbacks which have retarded their implementation. Basically, though none of these amateur bands are fully used, all of them are intensively in use and the resulting substantial range of frequencies for a new amateur license would inevitably cause a hardship to those now using the band and the amateur operators might want to use the band in the near future. This is one amateur band, however, that has been almost completely unused and which shows no signs of serious amateur development in the foreseeable future. This is the amateur 220-225 MHz band. It would seem important that this wide and valuable amateur band should be developed if it is to be retained at future international conferences. There are many practical reasons why this band has been skipped in the expansion of amateur radio into the microwave. The next band up is better for moon work, more commercial equipment is available for the 480 MHz band, repeater controls on this band, dish antennas become practical at the higher frequency, and television is allocated at 480 MHz.

**The Solution...**  
It is hereby proposed that the Commission institute a Hobby class amateur license which will have no code and no theory elements, only a rules and regulations examination which can be administered by any licensed amateur. General class or above, and which will permit the holder to operate with a power of up to 100 watts using nonreciprocal FM (15 MHz deviation) in the frequency range from 220.5 to 224.5 MHz. This license would be available for a fee of \$5 for a five-year term and would be renewable upon proof of use and a \$5 fee. The 220.5-224.5 and 224.5-225.0 MHz segments of the band would still be open to higher classes of license as presently authorized, thus preserving one MHz of the band for exclusive use of the higher classes of license.

This Hobby class license would provide the band that the citizens band operators need, one where hobby operation is legal, and would thus free the 27 MHz band for business and personal business use as originally proposed by the Commission. The large number of channels available in the 220 MHz band would provide relatively interference free communications for the operators, offering them the same reason for changing from the 23 channels on 27 MHz. The coming dropoff in use conditions on 27 MHz will result to the end of exceeding the transponder. This band, as with all other amateur bands, would be largely self-policing, thus removing a very expensive headache from the Commission.

It is suggested that the Hobby class license permit communication through repeaters, but that a higher class license be required for the installation and maintenance of a repeater, since technical knowledge is much more necessary for the installation than for the operation of a repeater.

It might be pointed out that the amateur 220 MHz band is above television channel 12 and that interference to television reception could be unlikely. Second harmonic radiation would be within the 480 MHz amateur band and would also be unlikely to interfere with television bands. The 500 kHz guard bands on each side of the proposed Hobby band would provide adequate isolation for errant operators to keep them from interfering with adjacent commercial bands.

The use of FM techniques would reduce the problems of heterodyne noise and interference so much to the frustrations of the 27 MHz band and would provide simple network systems with squelch as is now popular on the 146 MHz band. Though crystal control would not be required, it would probably be extensively used as it is for 146 MHz FM operation.

In order to indicate the class of license by the call letters it is proposed that a new set of call signs be established for the Hobby class

license using the regular amateur call areas, but starting with N1A1AAA and going through to N21ZZZ, a system which would provide for over 4,500,000 call signs to be issued. While the Hobby Class operator goes to a higher class of license, the last three letters could be passed along to the WA1AAA type of call letter, thus preserving the identity of the operator through this interpret call.

**Summary**  
The Hobby Class license would seem to fulfill a number of needs without taking anything away from anyone. It would provide a legal hobby license which is obviously needed. It would help the Commission solve the problems of the citizens band. It would provide activity on a virtually unused amateur band. It would encourage an influx of new amateurs. It would provide millions of dollars in fees to offset Commission expenses, with little overhead involved since all of the examinations would be given by volunteer radio amateurs. It would encourage the development of commercial narrowband FM equipment for the VHF bands which would benefit all amateurs as well as the users of adjacent commercial bands. It would encourage the development of fixed station equipment, mobile equipment, portable equipment and ham radio equipment. It would also give a number of manufacturers a very bright future.

Thus the Commission gains, the amateurs gain, the country gains, the manufacturers gain, and no one loses.

Before the  
FEDERAL COMMUNICATIONS COMMISSION  
Washington, D.C. 20554

In the Matter of  
Amendment of Part 95 and Part 15 of the  
Commission's Rules Concerning the Allocation and Assignment of Frequencies for the Unlicensed D Citizens Radio Service and a New Proposed Class E Citizens Radio Service

**PETITION OF PROPOSED RULEMAKING**  
There has been demonstrated a strong current and need for personal two-way radio communication for both safety and business purposes for individual citizens in conducting their daily activity of both a personal and business nature. This need was initially served by the establishment of the Citizens Radio Service in 1955, providing twenty-two channels of two-way radio communication with 10 KC spacing in the 27 MHz band. In the expansion of the Class D Citizens Radio Service, the Commission is requested to consider the need and right of individual citizens to have use of a portion of the R. F. Spectrum to conduct their affairs for convenience and safety via personal two-way radio. The technical limitation of 27 MHz and the limited number of channels made available have prevented the Class D Citizens Radio Service from meeting its total objective. We have learned much concerning the public's needs for personal two-way radio communication, even with these limiting factors. We can now more completely and more adequately serve this requirement for personal two-way radio service.

### I. CITIZENS NEED FOR PERSONAL TWO-WAY RADIO

In our mobile society today, we have an ever-increasing need for personal two-way radio communication from moving vehicles and in remote areas where land and communications facilities are not available. The primary need is for short range communications (within ten miles) for the greatest benefit to the greatest number of citizens. This service offers the greatest flexibility of use so that the citizen can use himself to this service in all his activities, whether he be in his home automobile or on a fishing or camping excursion.

The Class D Citizens Radio Service, with 800,000 active licenses and operations, has shown that low cost equipment owned and operated by the user provides the most satisfactory service.

### II. JUSTIFICATION FOR EXPANSION OF PERSONAL RADIO SERVICE

The benefits of personal ownership and operation of Citizens Two-Way Radio have been proved over and over again in the number of public assistance acts that have been performed on the Class D Citizens Radio Service throughout the country. The examples of assistance, both for safety and convenience, that have been rendered to the general public by Class D Citizens Radio operators is far greater per license holder than any other operator of the Public Safety Agencies themselves. There are countless examples of cooperation with law enforcement agencies and other agencies by the Class D Citizens Radio Operators in providing assistance in time of major and minor emergency that arise and occur in communities throughout the country. The cost of providing this benefit to our population could not possibly be met by any other means other than personal ownership and operation of Citizens Personal Two-Way Radio equipment.

### III. REQUIREMENTS FOR IMPROVING PERSONAL TWO-WAY COMMUNICATIONS SERVICE

Existing regulations must be simple to understand and easy to administer. Operating procedures must be established to provide a clear and concise set of rules and a minimum of cost is required for enforcement.

B. Equipment must be low initial cost and require a minimum of maintenance.

C. Flexibility of operation must be provided so the maximum utilization of frequency can be obtained. The maximum number of channels for local operation so that open channel space can be obtained for the user operator. Operating guidelines must be established so that maximum utilization can be obtained with the least confusion and interference.

D. Proper location in the frequency spectrum must be made to minimize the technical operating problem, short range communications in all types of terrain and populated areas must be accomplished with minimum interference due to man-made or natural interference.	36 road condition information only; power limit of 1 watt	222.875
E. Licensing procedures must be simplified to permit efficient handling of the large numbers of licensing that are required for this personal radio service.	37 TX audio call signs	222.900
The original establishment of the Citizens Radio Service by the FCC and subsequent establishment of the Class D Citizens Radio Service was to "provide the broadest possible public use and benefit of the frequency spectrum of necessary business and personal communications". The following factors concerning allocation of frequencies in the Class D Radio Service:	38 road condition information only; power limit of 1 watt	222.925
1. Technical atmospheric (skip) conditions make the Class D Citizens (27 MHz band more conducive to long distance amateur type operation than the short-range communications to which the operation is restricted.	TX audio call signs	222.950
2. R. F. noise, both man-made and atmospheric, coupled with low power and low antenna height restrictions, limit the range of Class D Citizens (27 MHz) band in metropolitan areas to the point of questionable operational effectiveness for its intended purpose.	39 road condition information only; power limit of 1 watt	222.975
3. Overcrowded conditions on the 23 channels of the 27 MHz Class D Citizens Radio Service, together with the above factors, has degraded the Citizens Radio Service to a level of ineffectiveness in many areas.	TX audio call signs	222.975
A new "Class E Service" is proposed as the best possible solution to provide the U.S. Citizens with properly regulated frequency spectrum for "personal communications".	40 road condition information only; power limit of 1 watt	223.000
A new Class E Citizens Radio Service is requested to be established between 222 and 224 MHz. The current Amateur Radio Service frequency allocation of 220 to 225 should be changed to 220 to 222 MHz for one class plus 224 to 225 MHz for another class.	TX audio call signs	223.000
This new Class E Citizens Radio Service should then be established by specified channels covering the 222 to 224 MHz range. As a guideline in establishing technical and operating parameters, it is recommended that the VHF Marine Region be referred to as an excellent example of providing the greatest use to the general public of the limited frequency spectrum available to satisfy the growing need for more short range "personal communications."	41 local traffic control use only; for a limit of 1 watt	223.025
The following regulations for operation are recommended with the basic objective of providing communications for the mobile public for convenience and safety up to a reliable range of ten to twenty miles.	42 local traffic control use only; for a limit of 1 watt	223.050
A. Power output to antenna limit of twenty-five watts with special "public service" license on base station allowed at one hundred watts output to antenna.	43 local traffic control use only; for a limit of 1 watt	223.075
B. Antenna height limit of twenty feet above the nearest man-made or natural object within in 500 yards; or sixty feet above the existing terrain (whichever is higher).	44 local traffic control use only; for a limit of 1 watt	223.100
C. Frequency assignments are requested as follows:	45 local traffic control use only; for a limit of 1 watt	223.125
Transmission of FM voice only with 25 KC spacing. Crystal controlled transmission only. 80 channels assigned as follows:	46 in plant use only; limit of 1 watt	223.150
	47 in plant use only; limit of 1 watt	223.175
	48 in plant use only; limit of 1 watt	223.200
	49 in plant use only; limit of 1 watt	223.225
	50 in plant use only; limit of 1 watt	223.250
	51 dual use of units with same call sign; limit of 1 watt	223.275
	52 dual use of units with same call sign; limit of 1 watt	223.300
	53 local use of units with same call sign; limit of 1 watt	223.325
	54 local use of units with same call sign; limit of 1 watt	223.350
	55 local use of units with same call sign; limit of 1 watt	223.375
	56 marine use only; limit of 1 watt	223.400
	57 marine use only; limit of 1 watt	223.425
	58 marine use only	223.450
	59 limited to units of same license, limited to contact only; units must change to alternate channel for message	223.475
	60 limited to units of same license, for business communications only	223.500
	61 limited to units of same license, for business communications only	223.525
	62 limited to units of same license, for business communications only	223.550
	63 limited to units of same license, for business communications only	223.575
	64 limited to units of same license, for business communications only	223.600
	65 limited to units of same license, for business communications only	223.625
	66 limited to units of same license, for business communications only	223.650
	67 limited to units of same license, for business communications only	223.675
	68 limited to units of same license, for business communications only	223.700
	69 limited to units of same license, for business communications only	223.725
	70 limited to units of same license, for business communications only	223.750
	71 for units of the same or different license; limited to contact only; units must change to alternate channel for message	223.775
	72 for units of the same or different license	223.800
	73 for units of the same or different license	223.825
	74 for units of the same or different license	223.850
	75 for units of the same or different license	223.875
	76 for units of the same or different license	223.900
	77 for units of the same or different license	223.925
	78 for units of the same or different license	223.950
	79 for units of the same or different license	223.975
	80 for units of the same or different license	223.975
	81 mobile to same license	222.000
	2 mobile to same license	222.025
	3 mobile to same license	222.050
	4 mobile to same license	222.075
	5 mobile to same license	222.100
	6 mobile to same license	222.125
	7 mobile to same license	222.150
	8 mobile to same license	222.175
	9 emergency use only per Class D Channel S	222.200
	10 mobile to same license	222.225
	11 mobile general calling for contact only; must change to alternate channel for message	222.250
	12 travel assistance use only mobile general calling permitted	222.275
	13 travel assistance use only mobile general calling permitted	222.300
	14 weather advisory use general calling permitted	222.325
	15 traffic advisory use general calling permitted	222.350
	16 mobile to unit of same or different license	222.375
	17 mobile to unit of same or different license	222.400
	18 mobile to unit of same or different license	222.425
	19 mobile to unit of same or different license	222.450
	20 mobile to unit of same or different license	222.475
	21 mobile general calling for contact only; must change to alternate channel for message	222.500
	22 mobile to unit of same or different license	222.525
	23 mobile to unit of same or different license	222.550
	24 mobile to unit of same or different license	222.575
	25 mobile to unit of same or different license	222.600
	26 mobile to unit of same or different license	222.625
	27 mobile to unit of same or different license	222.650
	28 mobile to unit of same or different license	222.675
	29 mobile to unit of same or different license	222.700
	30 mobile to unit of same or different license	222.725
	31 mobile to unit of same or different license	222.750
	32 mobile to unit of same or different license	222.775
	33 mobile to unit of same or different license	222.800
	34 mobile to unit of same or different license	222.825
	35 mobile to unit of same or different license	222.850
	36 mobile to unit of same or different license	222.875

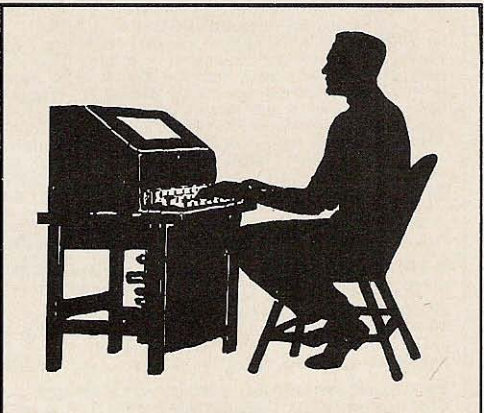

**TELETYPE!** Using tape for repetitive material such as station description, over-the-air QSL, and such? You should Model 7A tape transmitters \$9.

**RELAYS?** W.E. Model 215A polar relays, in fine shape, \$5 each; fair shape \$2.50 each. Poor shape \$1.

**TELETYPE DISTRIBUTORS.** Model 30A start-stop distributors for any printers requiring separate distributors, for tape equipment, etc. Includes both transmitting and receiving distributor, Westinghouse 1/75 hp, 115 V 60 Hz, 1800 rpm motor, \$17.50.

**TELETYPE TAPE GEAR.** Complete tape transmitter with built-in distributor, ac. \$32.75. These are compact units, ideal for setting up in a line with various tape loops for standard QSO information or messages.

**TELETYPE PERFORATOR.** Model 2A typing perforator, good shape, does not tie up your system when you are making tapes. \$35.

**TELETYPE TAPE DISTRIBUTOR.** Model 7A tape distributor (matches 7A tape transmitters) with plug-in jack for 7A tape head, \$14.90.

**TELETYPE DISTRIBUTOR.** Model 73 distributor (see page 100 of HAM-RTTY book) for use with tape transmitters, printers with no distributors, etc., \$10.

**TELETYPE PRINTER.** Strip printer for those interested in a compact unit, less than one cubic foot in size! Model 401. Allows you to copy signals off the air while cutting tape in answer without tying up your regular page printer. Prints on standard 5/32" tape. \$45 in good shape, \$25 not in good shape.

All units in short supply; first come, first served. All sold FOB N.H. Quality of the units varies from new to dirty and ugly. Early orders will get best gear. All units are priced at ugh condition price so if you get a new unit, be glad; if you get an ugh model, be thankful that you got one at all. Send check or money order to **Radio Bookshop, Peterborough NH 03458, USA only, please.** And include postage unless you want units sent collect by UPS or Railway Express.

### Hi-Sensitivity Wide-Band AM6FM RCVR

38-1000 MHZ: AN/ALR-5 consists of brand-new Tuner/Converter, CV-253/ALR in original factory pack and an exc. used, checked OK & grtd. main rcvr R-444 modified for 120 v, 50/60 hz. Packed with each tuner is the factory checkout sheet. The one we opened showed SENSITIVITY: 1.1 uv at 38.3 mhz, 0.9 at 133 mhz, 5 at 538 mhz, 4 1/2 at 778 mhz, 7 at 1 ghz. With book and pwr-input plug, all for ..... 275.00  
30 mhz Panadapter for the above ..... 97.50

R-390/URR Rcvr; Collins xtl-zero-beating, driftless receiver, grtd 100% perfect ..... 795.00

R-390 A/URR has mech. filters, grtd. perfect 995.00

### Regul. Pwr Sply for Command, LM, Etc.

PP-106/U: Metered. Knob-adjustable 90-270 v up to 80 ma dc; also select an AC of 6.3 v 5A, or 12.6 v 2 1/2 A or 28 v 2 1/2 A. With mating output plug & all tech. cata. Shpg. wt. 50 lbs. .... 19.50

**BARGAINS WHICH THE ABOVE WILL POWER:**  
LM-(\*) Freq. Meter: 125-20 MHz, .01%, CW or AM, with serial-matched calib. book, tech. data, mating plug. Shipping wt. 16 lbs. .... 57.50  
Same, less calib. book ..... 12.95  
TS-323 Freq. Meter: 20-480 mhz. 001% ... 169.50  
A.R.C. R22: 540-1600 khz rcvr w/knob + data 17.95  
A.R.C. R32: 108-132 mhz rcvr w/knob + data 13.95

### Versatile Plate & Filam. Transformer

Depot Spares for SP-600-JX: Pri. 95/105/117/130/190/210/234/260 v 50-60 hz. Sec. 1: 305-0-305 v 150 ma. Sec. 2: 5 v 3 A. Sec. 3: 6.3 v 5A. Sec 4: 7 1/2 v 1/2 A. Sec. 5: 7 1/2 v 1 1/4 A. Legend for pins is plainly marked. Herm. sealed. Add postage for 13 lbs 3.95

Our warehouses are bursting with good OSCILLOSCOPES, Digital Counters, Aeronautical Test Sets, Audio Test Sets, Oscillators, VTVM's Precision Meters, Pulse Generators, Signal Generators, Differential Voltmeters, Regulated Power Supplies, Ham Receivers, Wattmeters, Line-Voltage Regulators, etc. etc. We can't possibly begin to list everything in these ads. We have separate Catalogs for each Category of Equipment. . . so please ask for your needs by the type of equipment you need! THANKS!

**WE ALSO BUY! WHAT DO YOU HAVE?**

### R. E. GOODHEART CO., INC.

Box 1220-GC, Beverly Hills, Calif. 90213  
Phones: Area Code 213, Office 272-5707

## Thousands of Parts

ELECTRONIC PARTS & EQUIPMENTS

See us U Builders for Bargains (no fliers)

### DOW TRADING CO. INC.

1829 E. Huntington Drive  
Duarte CA 91010 - 213-357-3763



**FREE Catalog** OF THE WORLD'S FINEST GOV'T SURPLUS ELECTRONIC BARGAINS

Now **BIGGER** and **BETTER** Than Ever!

MAIL THIS COUPON NOW

NAME: .....

ADDRESS: .....

CITY: ..... STATE: ..... ZIP: .....

For your FREE copy, fill out coupon and mail. Dept. 73

### FAIR RADIO SALES

1016 E. EUREKA • Box 1105 • LIMA, OHIO • 45802

The manufacturer would be held responsible to include a short form: Class E Citizens license application with the owner's manual of each set and the dealer held responsible for assuring that an application is passed on to the purchasers of the transceivers at the time of sale of new and used equipment to a user.

To simplify licensing procedure in the case of individuals, a short form license application (included with each set) may be used to self-design call numbers which require no response from the Commission. A sample short form licensing procedure is attached.

Further control of illegal or improper equipment sale and operation is established by requiring the Manufacturer and Dealer to certify that the equipment, when sold, complies with the applicable regulation.

It is urged that the Commission move with haste to provide this much-needed rulemaking for the benefit of all citizens and their growing requirement for personal two-way radio communications for convenience and safety.

Very truly yours,

W. J. Thomas - Chairman  
Citizens Radio Section  
Industrial Electronics Division  
Electronic Industries Association



"A 30 to 50 megacycle rig? Why can't you walk to school like I did?"

*QRX QRL! No new repair jobs can be accepted until further notice.*

### PANTRONICS OF VIRGINIA, INC.

P.O. Box 209

Annandale, Virginia 22323

4-1000A FILAMENT TRANSFORMERS  
7.5 VCT @ 21 AMPS 117 VAC PRIMARY  
3 3/4" H, 4 1/2" W, 3 1/2" D. NET WT. 8 LBS.

\$14.95 PPD

### PETER W. DAHL CO.

5325 Annette Ave.  
EL PASO, TEXAS 79924 Tele: 915-751-4856

### LARGEST ASSORTMENT of BRAND NAMES

You can save enormous amounts of money while choosing from a complete line of transceivers, receivers, transmitters, etc.

**WE HAVE EVERYTHING IN HAM GEAR SAVE MONEY ORDER BY MAIL**

CB Radio Co., Inc. 89 Aspen Rd.  
Swampscott, Mass. 01901 617-598-9700

Blow Your Mind!  
AND ALL YOUR MONEY AT

## DAYTON SURPLUS

1001 East 2nd, Dayton OH 45403



## SPRAGUE- IC's



- 908 Full Adder
- 909 Buffer
- 912 Half Adder
- 913 Shift Register
- 915 Dual 3 In. Gate
- 921 Dual 2 In. Gate
- 940 JK Flip Flop
- 960 Dual Buffer

Your  
Choice  
3 for \$1

4,000 BIT MEMORY \$8.50

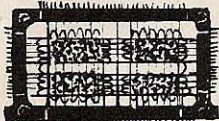

From IBM Computers,  
Guaranteed! W/Spec Sheets

## EPOXY RECTIFIERS



PIV	1Amp*	2Amp	3Amp
50	\$0.05	\$0.05	\$0.08
100	.06	.06	.12
200	.07	.07	.15
400	.09	.09	.22
600	.12	.12	.28
800	.16	.16	.39
1000	.22	.22	.59

\*microminiature

**1971 SPECIAL!**  
**FREE! SUBTRACT**  
**\$1 WITH EVERY**  
**\$10 PURCHASE**

## POPULAR "LINE LITERS"

- 10 — 1Amp 800 piv silicon rectifiers ... 1.00
- 8 — 1Amp 1000 piv silicon rectifiers ... 1.00
- 6 — 2 Amp 1000 piv silicon rectifiers ... 1.00
- 3 — 3Amp 1000 piv silicon rectifiers ... 1.00
- 10 — 3Amp 600V piv silicon rectifiers ... 1.00
- 40 GE 1Amp silicon rects, to 1000V ... 1.00
- 1-Watt Audio "IC amplifier" WC334 ... 1.49
- 1 Voltage Regulator, 0-40V pos "IC" ... 1.19
- 4 — 2N4409 Nixie tube drivers ... 1.00
- 1 — 6 Amp 200 PRV Triac ... .88
- 1 — 15Amp 200 PRV Triac ... 1.19
- 1 — 25 Amp 200 PRV Triac ... 1.49
- 1 Tunnel Diode 1N3717 ... 1.00
- 1 — 2N3632 400MC-3A.20W. npn sil ... 2.98
- 1 — 5U4 Raytheon silicon tube ... 1.49
- 3 — ER-900 Trigger diodes, triacs ... .99
- 2 — 2N2419 Unijunction transistors ... 1.19
- 2 N-Channel plastic Fets 2N3819 Texas ... 1.19
- 4 — 2N4409 Nixie tube drivers ... 1.00
- 10 — 1 watt zeners 5 to 12 volts ... 1.00
- 1 RTL-923 JK Flip Flop TO5 ... .69
- 1 RTL-914 Dual 2 Input gate TO5 ... .69

## FAIRCHILD IC "AMP"

Any 3 10% Discount!

Type	Description	Each
702	Wide Band DC	1.19
703	RF-IF Amp	1.19
709	Operational	1.19
710	Hi-Speed Diff.	1.19
2809	Dual 709's	1.98
2747	Dual 741's	2.98
741	Freq. Comp. 709	1.59

## HIGH VOLTAGE

### 1 AMP EPOXY

PIV	SALE
2000*	1.00
3000	1.35
4000	1.65
5000	2.25
6000	2.96
8000	3.50
10000	3.95

SILICON RECTIFIERS



### 6 AMP

PIV	SALE
50	\$0.88
100	.99
200	1.25
400	1.50
600	1.75
800	1.95
1000	2.25

FULL WAVE BRIDGE RECTS

## GIANT SALE ON NEW TTL TEXAS & NATIONAL ICs

Guaranteed! W/Spec Sheets  
Any 3 — 10% Discount!

TYPE	DESCRIPTION	SALE
<input type="checkbox"/> SN7400N	Quad 2-input NAND gate	\$.88
<input type="checkbox"/> SN7401N	Same as 7400 but with open collector output	.88
<input type="checkbox"/> SN7402N	Quad 2-input NOR gate	.88
<input type="checkbox"/> SN7404N	Hex inverter	.99
<input type="checkbox"/> SN7410N	Triple 3 input NAND gate	.88
<input type="checkbox"/> SN7420N	Dual 4-input NAND gate	.88
<input type="checkbox"/> SN7430N	8-input NAND gate	.88
<input type="checkbox"/> SN7440N	Dual 4-input NAND buffer	.88
<input type="checkbox"/> SN7441N	BCD-to-Nixie tube driver	4.95
<input type="checkbox"/> SN7442N	BCD-to-decimal-decoder	4.50
<input type="checkbox"/> SN7460N	Dual 4-input expander	.88
<input type="checkbox"/> SN7472N	J-K Master slave flip flop	.99
<input type="checkbox"/> SN7473N	Dual J-K master slave flip flop	1.19
<input type="checkbox"/> SN7474N	Dual D-type edge triggered flip flop	1.19
<input type="checkbox"/> SN7475N	Quad bistable latch	2.95
<input type="checkbox"/> SN7476N	Dual J-K flip flop	1.49
<input type="checkbox"/> SN7480N	Gated full adder	1.49
<input type="checkbox"/> SN7481N	16-bit MEMORY	4.50
<input type="checkbox"/> SN7482N	2-bit binary full adder	4.95
<input type="checkbox"/> SN7483N	4-bit binary full adder	5.50
<input type="checkbox"/> SN7490N	Decade counter	3.95
<input type="checkbox"/> SN7491N	8-bit shift register	4.95
<input type="checkbox"/> SN7492N	Divide-by-twelve counter	3.95
<input type="checkbox"/> SN7493N	4-bit binary counter	3.95
<input type="checkbox"/> SN7494N	4-bit shift register	3.95
<input type="checkbox"/> SN7495N	4-bit right-shift left-shift register	3.95

## COUNTING SYSTEM

Includes SN7490 decade counter, SN7441 BCD decoder-driver, SN7475 quad latch with hookups. instructions.

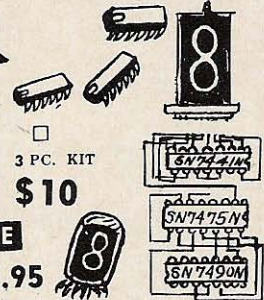

3 PC. KIT  
\$10

## NIXIE\* TUBE

- (0-9), wide angle \$5.95
- \* Similar to Burroughs

## LIGHT-EMITTING DIODES (LEDs)

\$1.50 Any 2  
2.69

- Visible LED "Brite Red"
- Visible "Brite Red" Detector
- Invisible "Infrared" Detector
- Invisible LED "Infrared"



## LIGHT ACTIVATED SCRS

Built-in lens transmits light energy, activates, triggers TO-18 case silicon control rectifier. A companion to our fiber optic light pipes. Requires as little as 30 uA.



For the 1st time anywhere

## 1 AMP

PRV	SALE
100	\$1.95
200	2.50
300	2.95
400	3.50

SPRING CATALOG  
10¢



## POLY PAKS

P.O. BOX 942 A  
Lynnfield, Mass.  
01940

Terms: add postage. Rated: net 30, cod's 25%  
Phone Orders: Wakefield, Mass. (617) 245-3829  
Retail: 211 Albion, St., Wakefield, Mass.

### 73 Reader Service Coupon

Now we don't say that every single reader must buy every last product advertised in 73. We believe that, but we don't say it. The very least every reader can do is to put on a show of interest in the products herein advertised. To make this a simple task, even for the laziest reader (now there is a contest for you!), we have cleverly arranged the advertising index to double as a readers service coupon. All you have to do is tear it out (or photocopy it) and send it in with the appropriate boxes marked. (We have a prize for the most boxes marked ... a silent prayer of thanks from the publisher). We'll accept postcards, slips of paper, or almost anything else that lists the companies you want to hear from and your address.

No one likes to go into a store without buying something, right? It is the same with these information requests. You will be expected to buy something. Oh, it doesn't have to be a \$50,000 antenna system, but it should be something modest... a transceiver... a linear... you know. We'll leave the decision up to you, knowing that we can trust you to do the right thing.

And we are definitely not saying that the use of this service coupon has any curative powers, but we cannot but notice that many readers report remarkable relief from simple backache, headaches, lumbago, and acid indigestion after sending in their coupon. Why take any chances?

#### ADVERTISER INDEX

- |  |  |
|--|--|
| <input type="checkbox"/> Amateur Elec. Supply 42                 | <input type="checkbox"/> Janel 92                |
| <input type="checkbox"/> American Xtal 92                        | <input type="checkbox"/> Jeffronics 114, 124     |
| <input type="checkbox"/> Antennas Inc. 48                        | <input type="checkbox"/> Lewispaul 119           |
| <input type="checkbox"/> Arnold's 82                             | <input type="checkbox"/> Mann 103                |
| <input type="checkbox"/> ATV 81                                  | <input type="checkbox"/> MB Products 79          |
| <input type="checkbox"/> B & F 107                               | <input type="checkbox"/> Meshna 111              |
| <input type="checkbox"/> Brigar 98                               | <input type="checkbox"/> National Cover III      |
| <input type="checkbox"/> B & W 119                               | <input type="checkbox"/> Newsome 96, 97          |
| <input type="checkbox"/> Callbook 120, 123                       | <input type="checkbox"/> Pagel 88                |
| <input type="checkbox"/> CB Radio 126                            | <input type="checkbox"/> Pal 79                  |
| <input type="checkbox"/> C & H 101                               | <input type="checkbox"/> Pantronics 126          |
| <input type="checkbox"/> Circuit Specialists 63                  | <input type="checkbox"/> Pickering 89            |
| <input type="checkbox"/> Columbia 100                            | <input type="checkbox"/> Poly Paks 127           |
| <input type="checkbox"/> Crawford 119                            | <input type="checkbox"/> Propagation 109         |
| <input type="checkbox"/> Dahl 126                                | <input type="checkbox"/> Radiation Devices 79    |
| <input type="checkbox"/> Dames 99                                | <input type="checkbox"/> Regency 36              |
| <input type="checkbox"/> Dayton Hamvention 81, 89                | <input type="checkbox"/> R P 120                 |
| <input type="checkbox"/> DaytDn Surplus 26                       | <input type="checkbox"/> R & R 110               |
| <input type="checkbox"/> Delta 93                                | <input type="checkbox"/> Selectronics 102        |
| <input type="checkbox"/> Denson 112                              | <input type="checkbox"/> Sentry 33               |
| <input type="checkbox"/> Dow 126                                 | <input type="checkbox"/> Sleep 94, 95            |
| <input type="checkbox"/> Drake Cover IV, 17, 37, 46, 81, 88, 122 | <input type="checkbox"/> Spectronics 104         |
| <input type="checkbox"/> Eastron 82                              | <input type="checkbox"/> Standard 69             |
| <input type="checkbox"/> EKY Video Vision 78                     | <input type="checkbox"/> Startronics 92          |
| <input type="checkbox"/> Epsilon 79                              | <input type="checkbox"/> Swan 45                 |
| <input type="checkbox"/> Erickson 124                            | <input type="checkbox"/> Tallen 119              |
| <input type="checkbox"/> Estes 52                                | <input type="checkbox"/> Telecom 60              |
| <input type="checkbox"/> Fair 126                                | <input type="checkbox"/> Telrex 53               |
| <input type="checkbox"/> Freck 88                                | <input type="checkbox"/> Top Band 92             |
| <input type="checkbox"/> Gateway 121                             | <input type="checkbox"/> Tower 106, 121          |
| <input type="checkbox"/> G & G 122                               | <input type="checkbox"/> Tristao 88              |
| <input type="checkbox"/> Glass 105                               | <input type="checkbox"/> Tucker 113              |
| <input type="checkbox"/> Goodheart 126                           | <input type="checkbox"/> Vanguard 63, 78         |
| <input type="checkbox"/> Gregory 115                             | <input type="checkbox"/> Varitronics 59          |
| <input type="checkbox"/> Hal 82                                  | <input type="checkbox"/> Vibroplex 92            |
| <input type="checkbox"/> Hallicrafters 64                        | <input type="checkbox"/> Western N.Y. Hamfest 82 |
| <input type="checkbox"/> Henry 25                                | <input type="checkbox"/> World QSL 92            |
| <input type="checkbox"/> H & L 92                                | <input type="checkbox"/> Wolf 108                |
| <input type="checkbox"/> Hy-Gain 34, 35                          | <input type="checkbox"/> Radio Bookshop 116, 117 |
| <input type="checkbox"/> Internat'l Xtal 19                      | <input type="checkbox"/> 73 Subscriptions 15     |
| <input type="checkbox"/> James 81                                | <input type="checkbox"/> Gunsmoke 124            |
| <input type="checkbox"/> Jan Xtals 123                           | <input type="checkbox"/> Teletype 125            |

MAIL TO 73 Inc., Peterborough NH 03458

Name \_\_\_\_\_

Call \_\_\_\_\_

Address \_\_\_\_\_

Zip \_\_\_\_\_

### PROPAGATION CHART

J. H. Nelson  
Good O Fair (open) Poor □

March 1971

SUN	MON	TUES	WED	THUR	FRI	SAT
	1	2	3	4	5	6
7	8	9	10	11	12	13
14	15	16	17	18	19	20
21	22	23	24	25	26	27
28	29	30	31			

#### EASTERN UNITED STATES TO:

	GMT: 00	02	04	06	08	10	12	14	16	18	20	22
ALASKA	21	14	7A	7	7	7	7	7	14	14	21	21
ARGENTINA	21	14	14	7	7	7	14A	21	21	21	21	21
AUSTRALIA	21	14	14	7B	7B	7B	7B	14	14	14	21	21
CANAL ZONE	21	14	7A	7	7	7	14	21	21A	21A	21	21
ENGLAND	7	7	7	7	7	7	7B	14	21	21	14	7B
HAWAII	21	14	7A	7	7	7	7	7B	14	21	21A	21
INDIA	7	7	7B	7B	7B	7B	14	14	14	7B	7B	7B
JAPAN	14	14	7A	7B	7B	7	7	7	7B	7B	7B	14
MEXICO	21	14	14	7	7	7	7	14A	21	21	21	21
PHILIPPINES	14	14	7A	7B	7B	7B	7B	14B	14B	7B	7B	7B
PUERTO RICO	14	14	7	7	7	7	7	14	21	21	21	14
SOUTH AFRICA	14	7	7	7	7B	14	21	21A	21A	21	21	21
U. S. S. R.	7	7	7	7	7	7B	14	21	14	14	14	7
WEST COAST	21	14	7A	7	7	7	7	14	21	21	21A	21

#### CENTRAL UNITED STATES TO:

	GMT: 00	02	04	06	08	10	12	14	16	18	20	22
ALASKA	21	14	14	7	7	7	7	7	14	21	21	21
ARGENTINA	21	14	14	7	7	7	7A	14A	21	21	21	21
AUSTRALIA	21A	21	14	7B	7B	7B	7B	14	14	14	21	21
CANAL ZONE	21	14	14	7A	7	7	7	14A	21A	21A	21	21
ENGLAND	7	7	7	7	7	7	7	7B	14	21	21	14
HAWAII	21	21	14	7	7	7	7	7	14	21	21A	21
INDIA	7	14	14	7B	7B	7B	7	14	7B	7B	7B	7B
JAPAN	21	14	14	7B	7	7	7	7	7	7B	7B	14A
MEXICO	21	14	7	7	7	7	7	14	21	21	21	21
PHILIPPINES	21	14	14	7B	7B	7B	7B	14B	14B	7B	7B	14
PUERTO RICO	14	14	7A	7	7	7	14	21	21	21	21	21
SOUTH AFRICA	14	14	7	7	7B	7B	14	21	21A	21	21	21
U. S. S. R.	7B	7	7	7	7	7	7B	7B	14	14	14	7B

#### WESTERN UNITED STATES TO:

	GMT: 00	02	04	06	08	10	12	14	16	18	20	22
ALASKA	21	14	14	7	7A	7	7	7	14	14	21	21
ARGENTINA	21	21	14	7B	7	7	7B	14	21	21	21	21
AUSTRALIA	21A	21	21	14	7A	7B	7B	7B	14	14	21	21
CANAL ZONE	21	14	14	7A	7	7	7	14	21	21A	21A	21
ENGLAND	7B	7	7	7	7	7	7	7B	14	21	14	7B
HAWAII	21A	21	21	14	7	7	7	7	14	21	21A	21A
INDIA	7B	14A	14	7B	7B	7B	7B	7	7	7B	7B	7
JAPAN	21	21	14	7B	7	7	7	7	7	7	7B	14A
MEXICO	21	14	7A	7	7	7	7	14	21	21	21	21
PHILIPPINES	21	21	14	7B	7B	7B	7B	7	7	7	7B	14
PUERTO RICO	21	14	14	7	7	7	7	14	21	21A	21A	21
SOUTH AFRICA	14	14	7	7B	7B	7B	7B	14	21	21	21	21
U. S. S. R.	7B	7	7	7	7	7	7B	7B	14	7B	7B	7B
EAST COAST	21	14	7A	7	7	7	7	14	21	21	21A	21

A = Next higher frequency may be useful also.  
B = Difficult circuit this period.