

# 73

**magazine**  
for radio amateurs

\$1.00  
April 1973  
26009

**A**  
CE

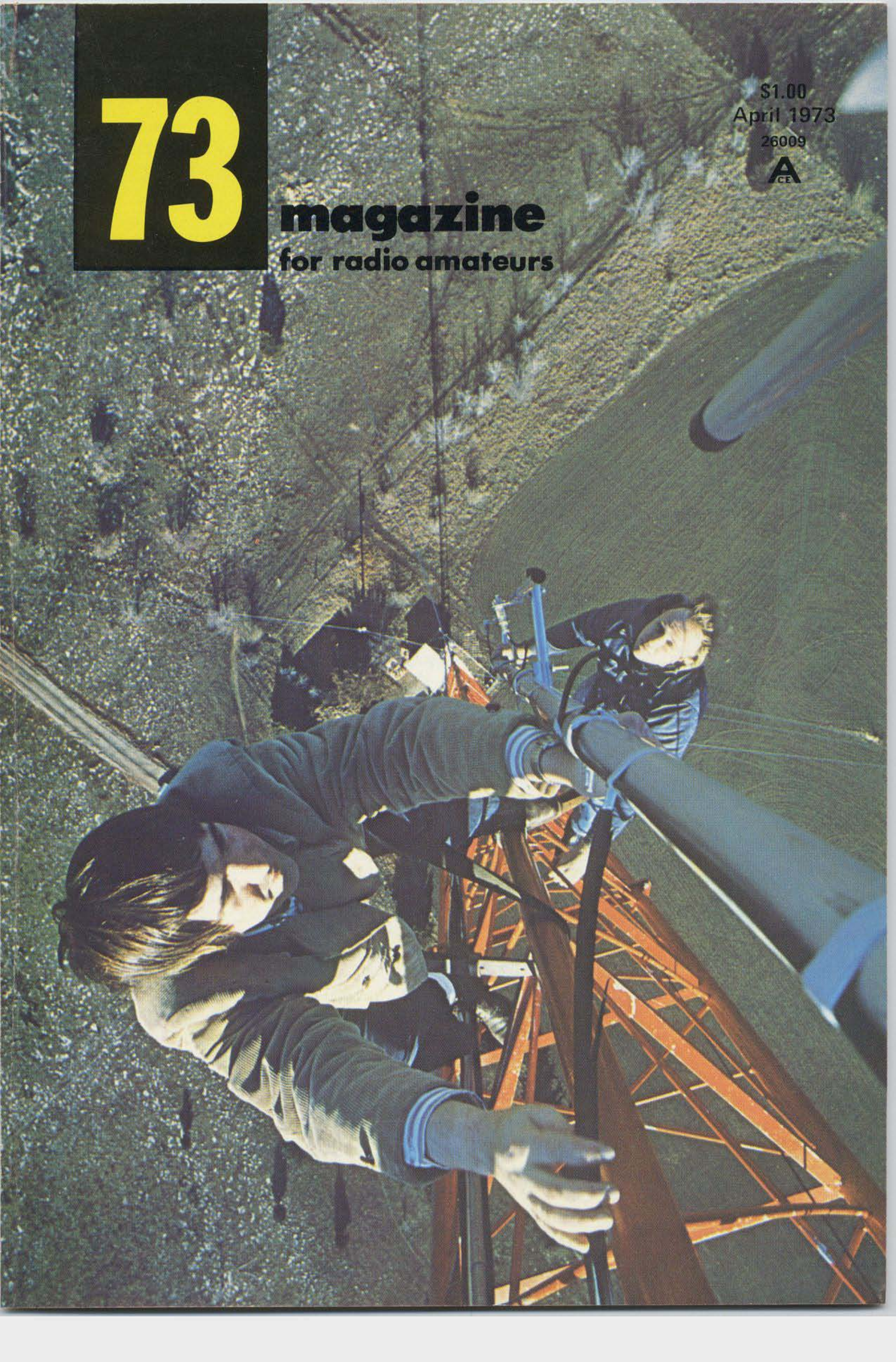

**for over 20 years we've  
been designing VHF-FM  
antennas for some  
pretty tough customers.**

**we know  
you're just as tough.**

A product in the amateur market gets a reputation very quickly. It measures up to what you expect in engineering, performance and quality — or else. That's why A/S amateur antennas are built to the identical design and construction standards as their commercial counterparts. Standards that have made them specified for more police and public safety vehicle installations than all other brands combined.

**HM-177  
2 Meters**

Features new high conductivity copper and nickel coated 17-7 PH stainless steel whip. Shunt fed coil encased in waterproof PVC jacket. All fittings chrome plated brass. Easy snap-in mounting. 3 dB gain.\*



**NEW! HM-223  
1 1/4 Meters  
(220 MHz)**

High performance 5/8 wavelength design for the new 220 MHz activity! Directly fed with low loss coil in new low-profile design. Spring and whip easily removable leaving only 1 3/16" high base for car wash clearance. 3 dB gain.\*



**HM-175  
3/4 Meters**

Collinear design with truly hot performance! Base fittings have silver plated contacts. Can handle 100 watts. Whip and phasing coil assembly is a one piece molded design to resist vibration and moisture. 5 dB gain.\*



**HM-4  
2 Meters**

Tough, virtually indestructible antenna for hand-helds. Completely insulated. Base fitting matches Motorola HT, E. F. Johnson, and Standard portables.



**HM-5**

Same as above but for Drake and other packset portables with SO-239 fittings.

**NEW ASCOM® TOWERS**

High strength, low maintenance aluminum towers for HF and VHF antenna installations. There is a complete line of ASCOM self-supporting towers — in heights from 30 to 90 feet — at attractive prices!

\*Measured over a 1/4 wavelength whip

WRITE FOR FREE AMATEUR ANTENNA  
and/or TOWER CATALOGS



**the antenna  
specialists co.**

Division of ORION INDUSTRIES, INC., 12435 Euclid Ave., Cleveland, Ohio 44106  
Export: 2200 Shames Dr., Westbury, L.I., New York 11590 Canada: A. C. Simmonds & Sons, Ltd.

### FEATURES

#### EDITORIAL STAFF

Wayne Green W2NSD/1  
Keith Lamonica W7DXX/1  
Ron Subka WA9FPP/1  
Yvette Grimes WA8ULU/1

#### ASSOCIATES

Jim Kyle K5JKX  
Mike Frye WB8LBP  
Bill Turner WA0ABI  
Jim Weir WB6BHI  
Harry Simpson A4SCF  
Dave Ingram K4TWJ  
Bill Hoisington K1CLL  
Gus Browning W4BPD

#### PRODUCTION AND ADVERTISING

Philip Price  
Lynn Panciera-Fraser  
Ruthmary Davis  
Bill Sundberg  
Janet Oxley  
Bill Suderman  
Karen Hebert  
Cynthia Schlosser  
Biff Mahoney  
Alexandra Schmidt

#### BUSINESS

Gigi Sage

#### CIRCULATION

Dorothy Gibson  
Barbara Block  
Ace Goodwin W1GRO  
Ginger Pettee

#### TRANSPORTATION

Kurt Schmidt

#### PROPAGATION

John Nelson

#### DRAFTING

R. K. Wildman W6MOG  
Bill Morello  
Wayne Peeler K4MVW  
T. M. Graham W8FKW

- |    |                         |     |                           |
|----|-------------------------|-----|---------------------------|
| 2  | Amateur Radio News Page | 17  | FCC News                  |
| 5  | Never Say Die W2NSD/1   | 17  | Social Events & Contests  |
| 6  | SSTV Scene              | 17  | Author's Correction       |
| 9  | DX Footnotes            | 18  | Cover Story               |
| 10 | Repeater Update         | 19  | New Products              |
| 12 | 50 MHz Band             | 100 | Letters                   |
| 12 | Novice                  | 120 | Caveat Emptor             |
| 13 | Hamburglar              | 122 | Curl Coil Forms WA2DDT    |
| 13 | Traveling Ham           | 125 | Willie and the SSTV W0LMD |
| 16 | Looking West            | 159 | Phase Lock                |
- 
- |     |  |       |          |
|-----|--|-------|----------|
| 21  | Low Cost FM Deviation Meter                        | ..... | W9HD     |
|     | Lest you deviate from the path of righteousness.   |       |          |
| 27  | Taming Those Hot 500 MHz FETS for 2m FM            | ..... | K1CLL    |
|     | Shrews you what you can do.                        |       |          |
| 31  | Two More Two Meter Amplifiers                      | ..... | WB4DBB   |
|     | Louder is better — right?                          |       |          |
| 35  | "Mini" Repeater Control System — Part I            | ..... | WA0ZHT/1 |
|     | This is the mini — the maxi is a whole book.       |       |          |
| 51  | Getting Your Repeater Licensed                     | ..... | W2NSD/1  |
|     | Difficult — but possible.                          |       |          |
| 55  | Low Temperature Techniques for Radio Amateurs      | ..... | W1GNZ    |
|     | Talk about solid state . . .!                      |       |          |
| 59  | Choosing Your FM Rig                               | ..... | W2NSD/1  |
|     | Stop missing all the fun.                          |       |          |
| 63  | Europe on 2 Meters a Day                           | ..... | W2EEY    |
|     | Europe is rife with repeaters.                     |       |          |
| 73  | Scanning Adapter for FM Transceivers               | ..... | WA4WTX   |
|     | Hear all — know all.                               |       |          |
| 79  | The RCA CMU 15 FM Transceiver                      | ..... | WB6BIH   |
|     | Getting on 450 el cheapo.                          |       |          |
| 83  | 2 Meter FM at 14,000 Feet                          | ..... | W7DXX/1  |
|     | How to be hated in six states simultaneously.      |       |          |
| 85  | Simple Lightning Detector                          | ..... | K2OAW    |
|     | Undetected lightning is bad stuff.                 |       |          |
| 87  | Citizens Band Alignment Aid                        | ..... | WA5SWD   |
|     | Is this an April Special?                          |       |          |
| 90  | Heath Desk Top Calculator                          | ..... | WA9FPP/1 |
|     | How did we ever do without it?                     |       |          |
| 93  | Transistor RF Power Amplifiers — Part II           | ..... | W9EGQ    |
|     | Only way to go.                                    |       |          |
| 105 | Repeater Economics                                 | ..... | K4ADL    |
|     | All that nice stuff costs money.                   |       |          |
| 109 | International Signal's 100 Milliwatt Rig Revisited | ..... | WB6QAM   |
|     | Hey, let's have more articles on this gadget!      |       |          |

**COVER:** A lack and a lass, the nude cover for this issue didn't materialize. We did have it all ready to go, when someone happened to notice that the hand unit the model was holding was backwards — so back to the studio. Eight subscribers cancelled after seeing the February cover — and the newsstands reported selling 2,800 extra copies. That's a fair trade off, for a good percentage of those new readers will subscribe during the next few months. Time magazine had a similar problem with their recent Last Tango cover which precipitated about 500 sub cancellations and sold 56,000 extra copies on the newsstands. We'll try to have that nude for you in May or June, so hold tight. And Gay Libbers, quit bitching. In its place we are substituting a shot (from the 600 foot level!) of the antenna installation at the W0EMU 16-76 repeater site in Winfield, KS. See page 18 for the complete story. Remember . . . this is an FM issue!

73 Magazine is published monthly by 73, Inc., Peterborough, New Hampshire 03458. Subscription rates are \$7 for one year in North America and U.S. Zip Code areas overseas, \$8 per year elsewhere. Three years, \$14, and \$16 overseas. Second class postage paid at Peterborough NH 03458 and at additional mailing offices. Printed at Menasha, Wisconsin 54952 U.S.A. Entire contents copyright 1973 by 73 Inc., Peterborough NH 03458. Phone: 603-924-3873. Microfilm edition of 73 available from University Microfilms, Ann Arbor, MI 48106. Magnetic tapes available from Science for the Blind, 221 Rock Hill Rd., Bala Cynwyd PA 19904.

# Amateur Radio

APRIL MCMLXXIII

Monthly Ham

## CHICAGO HAS VOTING MACHINE!



The Chicago FM Club recently tested a General Electric Voting System on their two meter 16/76 repeater. The voter selects one of four sites on the basis of "quieting." After six weeks of use, CFMC decided to purchase the comparator.

Shown here is the happy moment when the first commercially built voting system became part of an amateur repeater . . . the handing over of the check. From left to right: Don Coleman WA9DZS, tech committee chairman; Sid Cohen, local GE rep; Jim King WB9BDS, tech committee; Mike Krut K9BHM, licensing committee; and Rich Casey WA9LRI, CFMC president, happily holding the receipt.

## CANADIAN QSL BUREAU



The Canadian Amateur Federation Inc. is glad to make this new national bureau available to any QSL bureau in the world for cards coming into Canada. Canadian cards may be sent in bulk and will be promptly sorted and distributed to the ten provincial bureaus. There is no cost to anyone for this service. Cards are welcomed from individuals as well as bureaus. The address is: CARF National QSL Bureau, P.O. Box 66, Islington, Ontario, Canada M9A 4X1.

## HAMS AID CRASH VICTIMS

Last February radio and television shows were interrupted with a terse announcement that a plane had crashed into an Alameda CA apartment house. Details were so sketchy as to be non-existent. By 11 p.m. the news reported a Navy jet had screamed into a three-story building with the possibility that none of the occupants had escaped . . . that dozens may have perished.

Alert to the possible need by the American National Red Cross for emergency communications was Charlie Weber WA6RPK, a member of "The Repeater" Club, Mountain View CA. He contacted board member Roy Everhart WB6GWQ. Roy, in concert with trustee Al Nielson WA6AGA, discussed the situation and officially committed the resources of the club during the emergency. Adolph Kelly WA6CCG works in Alameda and was on his lunch break when the jet hit. His quick reconnaissance confirmed a need for the service amateur radio and Grizzly Peak could provide.

Forces quickly gathered with Don Smith W6NKF and Mach Myovich K6KAP at the scene with portables linking them to Betty Smothers WA6GCS at the Alameda Red Cross headquarters. Betty and her relief compiled a 17-page radio log before they finally secured operations some 3 days later.

Many reported to and remained at the scene throughout the night as the fire blazed. Still more made themselves available for uncounted hours during the gruesome cleanup and search for victims. Personnel were located at the scene, the Red Cross Alameda chapter office, and the Oakland ARC office. This provided the communications link needed to allow Red Cross staffers and volunteers to meet the emergency needs of the victims as well as to provide logistics support for the cleanup workers.

Col. Harrison and Mr. Harris, representing the American National Red Cross, expressed to the club that they were thankful that the hams arrived and so professionally assumed the significant role that they did. They felt the communications provided were the most professional they have utilized at any previous disaster. They were pleased with the accuracy of the traffic being handled, a fact important to them since the data included vital statistics of the rescued as well as the fatalities.

The ultimate compliment to the hams came when — as the phone link was being established — a request was made to have the radio operators continue their duties over the phones since they were so proficient as message handlers.

Members working any disaster or public service event are cautioned that persons not directly connected with the operation may assume incorrectly that you are an official spokesman for the group you are assisting. Therefore, be careful not to pass on traffic, requests, etc. unless originated by an official. Persons receiving such a message will assume it is from someone with authority to request or direct the action and will comply, not realizing the request is not "official." Organizations such as the Red Cross and Salvation Army normally designate a Press Representative who is knowledgeable of his group's press policies and who will provide releases to the media. The best thing to remember is that we are assisting by providing communications and not actually running the operation.

## SPECTRUM CHART

The FAA recently published a 32" by 34" radio spectrum chart showing usage from zero to 300 GHz. Copies are available at 40¢ each from the Government Printing Office, Washington, D.C. 20402. Request FAA Electromagnetic Spectrum Chart, No. TD 4.27:E12.

# News Pages

News of the World

73 MAGAZINE

## FREE COFFEE ALONG HIGHWAY

Reprinted from *Corvallis Gazette-Times, Corvallis, Oregon.*

That "Free Coffee" sign on weekends at the entrance to the Blalock rest area on Interstate 5 south of Wilsonville can be ignored for only so many trips. Then curiosity wins.

And, come to find out, the complete project is a volunteer effort by a band of radio hams from the Portland area. They group under the name of Mobile Communications Emergency Unit.

What's the idea? Because they're a bunch of nuts, the sign says, and the casual host behind the urns corroborates the claim. In that case, there should be more nuts just like them.

They're convinced that a break from driving puts the motorist back on the road more alert and less prone to make poor judgments resulting in accidents. The free coffee is just the gimmick to entice the driver to stop.

Most weekends they also operate four mobile units patrolling the freeway between Portland and Salem.

They assist stranded motorists, fetching gas, radioing for repair service or tow truck, aiding anyone who needs help in any way they can. Contributions deposited in a container at the coffee-tea counter pay for part of the expenses. These are Good Samaritans in action.

## Mobiles Check Freeway Conditions

KMPC, long the acknowledged leader in traffic coverage, has added more than 50 more freeway reporters each morning through a unique "Amateur Radio Network."

Headed by Frank Mead (WA6UJJ), the group, which is officially the WA6TDD Morning Network, utilizes the Mt. Wilson based transmitter of Burt Weiner (K6OQK) to augment reports by KMPC Airwatch helicopters and mobile units on Southern California freeway conditions.

These reports by the more than 50 work-bound hams are in turn monitored by Dave Glawson (WA6CGR) and Chris Williams (WB6HGW), who utilizes special phone lines to transmit the information to KMPC News.



OHIO-TENN. ATV QSO

Last Nov. 9, after extensive preparation, K4EJQ received the accompanying picture from W8DMR on 435.9 MHz. "Bunky" K4EJQ lives in Bristol TN and runs 500W into a 40 el. array. Bill W8DMR runs 100W into a 48 el. array in Columbus, Ohio. The estimated path between points is 250 miles.

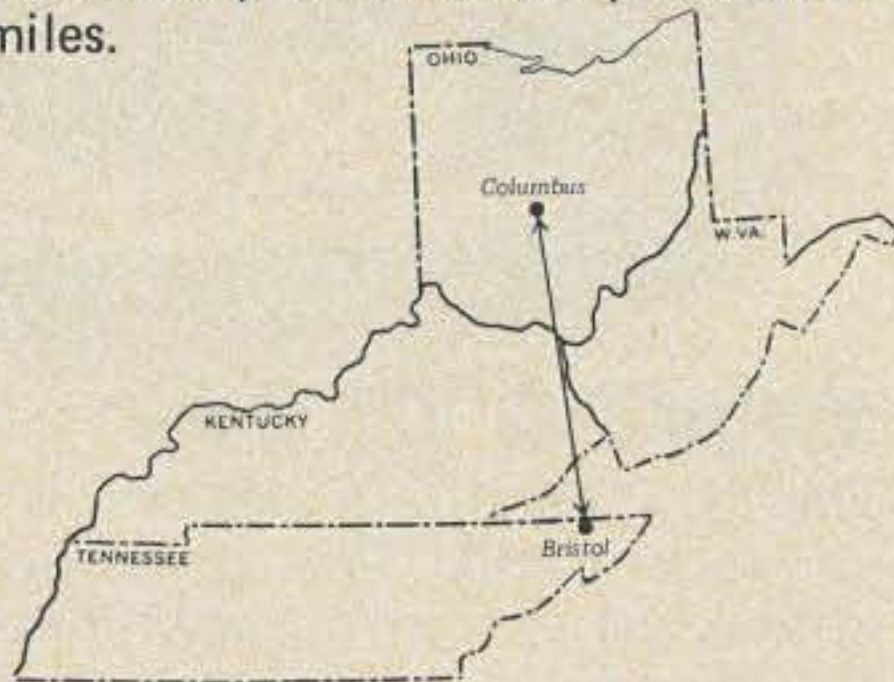

## EL2CI PROVIDES MEDICAL LINK

Zorzor, Liberia, Africa

An outbreak of Lassa Fever occurred in the Zorzor district March 1972. Spreading from an obstetrical patient, ill at the time of admission to the Curan Memorial Hospital in Zorzor, the epidemic affected seven staff members and two patients. A nurse, an aide, and two patients died. Two patients, two midwives and three midwifery students recovered.

Lassa Fever is a severe viral illness first identified in Northern Nigeria in early 1969 and recurring in epidemic form at a hospital there in early 1970, when 28 cases with 13 deaths were recorded, including the death of a physician who pricked herself during an autopsy. The complete history of the case and its consequences was reported to the Liberian Medical Association by Dr. Paul Martens who was then the physician-in-charge at

the hospital when the epidemic struck.

EL2CI, during the epidemic established radio communication between Zorzor and Monrovia and also between Monrovia and the Center for Disease Control in Atlanta, Georgia.

The communications made possible the rapid identification of the disease, and later permitted the coordination between Zorzor, Monrovia, and the CDC as extensive investigation was carried out by Dr. Patton, a U.S. citizen, resident cardiologist at the John F. Kennedy Medical Center, Monrovia. He took an active part in the epidemic by defining the information and putting it in medical terms for transmission to the Center for Disease Control. He was actually in EL2CI's QTH during most of the transmission.

## GIRL SAVED

Estele Maria Azar, an 18-year-old girl from Mendoza, Argentina, is recovering from a case of botulism which killed her 12-year-old sister when they ate a tainted can of beans. Argentine hams contacted American hams who reached Mount Sinai Hospital in New York, and they sent the required anti-toxin.



# tempo IS THE fm line

..THE finest quality.. THE best value

Tempo's Commercial Line VHF transceivers offer commercial performance at amateur prices. Compare these transceivers with any other available. Compare their performance, their quality of construction, their ease of maintenance, and then compare prices. Your choice will have to be Tempo.



## TEMPO/CL 146

The CL-146 offers operation on the 146 MHz amateur band. The price includes a microphone, power cord, mounting bracket and one pair of crystals. A full line of accessories is also available.

- 12 channel capability • 13 watts or a power saving 3 watts • All solid state, 12 VDC • 144 to 148 MHz (any two MHz without retuning)
- Supplied with one pair of crystals • RF output meter, S-meter, receiver detector meter
- Provisions for external oscillator • Monitor feature • Audio output at front panel • Internal speaker • The Price: \$279.00

## TEMPO/CL 220



As new as tomorrow! The superb CL-220 embodies the same general specifications as the CL-146, but operates in the frequency range of 220-225 MHz (any two MHz without retuning). At \$329.00 it is undoubtedly the best value available today.

## TEMPO/6N2

The Tempo 6N2 meets the demand for a high power six meter and two meter power amplifier. Using a pair of Eimac 8874 tubes it provides 2000 watts PEP input on SSB and 1000 watts input on CW and FM. Completely self-contained in one small desk mount cabinet with internal solid state power supply, built in blower and RF relative power indicator. \$595.00



## TEMPO/fmh

So much for so little! 2 watt VHF/FM hand held. 6 Channel capability, solid state, 12 VDC, 144-148 MHz (any two MHz), includes 1 pair of crystals, built-in charging terminals for ni-cad cells, S-meter, battery level meter, telescoping whip antenna, internal speaker & microphone. \$189.00



## TEMPO/fmp

Truly mobile, the Tempo/fmp 2 meter 3 watt portable gives amateurs 3 watts, or a battery saving 1/2 watt, FM talk power anyplace at anytime. With a leather carrying case included, this little transceiver will operate in the field, in a car, or at home with an accessory AC power supply. The battery pack is included. The price: \$225.00 (Accessory rechargeable battery available: \$22.00)

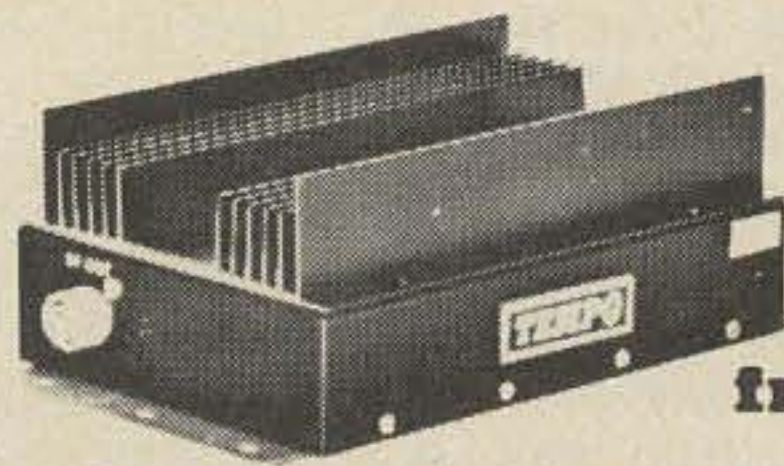

## TEMPO/TPL high power fm amplifiers

MODEL NUMBER	POWER INPUT	POWER OUTPUT (min)	BAND	PRICE
TPL1002-3	5 to 25W	100-135W	2M	\$220.00
TPL1002-3B	1-3W	80W	2M	\$235.00
TPL802	5W	80W	2M	\$180.00
TPL802B	1 to 3W	80W	2M	\$195.00
TPL502	5 to 15W	35-55W	2M	\$105.00
TPL502B	1 to 3W	45W	2M	\$130.00
TPL252-A2	1W	25W	2M	\$ 85.00
TPL445-10	1 to 2.5W	12W	440MHz	\$125.00
TPL445-30	4W	30W	440MHz	\$215.00
TPL445-30B	1W	30W	440MHz	\$235.00
TCP 12A Control Head . . .				\$32.00

Prices subject to change without notice.

# Henry Radio

11240 W. Olympic Blvd., Los Angeles, Calif. 90064  
931 N. Euclid, Anaheim, Calif. 92801  
Butler, Missouri 64730

213/477-6701  
714/772-9200  
816/679-3127

AVAILABLE AT SELECT DEALERS THROUGHOUT THE U.S.



NEVER SAY DIE

...de W2NSD/1

EDITORIAL BY WAYNE GREEN

**PETITION!**

The FCC has failed us utterly and completely with the repeater regulations, and we have to make this fact known to them. The principle of "least regulation" has been made a mockery by this over-restrictive set of rules.

Let's make our will known — with a petition. If we can present a petition with several thousand names and calls on it, they will have to listen — and give us relief.

Please make a copy of the below petition and get it signed by as many amateurs as possible — any class of license — and send it to 73 Magazine, Peterborough NH 03458. Please make sure that your petitions are in the mail to me by May 15th, at the very latest. I will make copies of the petitions and send them to the individual FCC Commissioners — to Barry Goldwater — and I will hand carry the originals to the Chief of the Amateur and Citizens Band division.

There are about 1000 repeater groups around the country, and I would hope that we would have 100% cooperation in this from them — which should mean that we could end up with 10,000 to 20,000 signatures. Please do whatever you can — with petitions for signatures in every radio store — at every club meeting, whether it be a repeater club or not. Let's do something this time and let the FCC know that we are interested and that it is important to us.

If we can make ourselves heard, we stand a much better chance of getting attention to our complaints on other legislative matters. If we never take a stand, we are as lost as sheep.

Copies of the petition form are available from 73 Magazine, Peterborough NH 03458 if you send a sase. Please use 8½ x 11 paper and sign on one side only. Please be sure to make the call signs readable.

When you read this, please call in on every repeater you can and see what you can do to organize petition signing meetings — get small committees to go to visit members who can't make the meetings — let's get out the vote using every strategem we can devise. Let's not have any slackers on this.

**FCC SHAME**

Repeater groups who discover a bootlegger in their midst may in the future think several times before appraising the FCC of this uncomfortable circumstance. The recent events at Phoenix are enough to convince any prudent person that perhaps the last people to be notified in case of such a difficulty is the FCC.

It seems that the trustee of the local repeater discovered that a well known local was a bootlegger when he applied for membership in the club. The first reply said essentially that he should mind his own business. He tried again and eventually the Commission sent two agents to look into the problem — which by the time they arrived had been solved.

The agents turned their attention to the repeaters and were able to find several aspects that weren't in line with the latest rules... so the club had to shut down the repeaters. This brought an eviction notice from the TV station — with the result that three two meter repeaters, one six meter repeater and a 450 repeater went off the air.

One repeater is on part time on 34-94, operating from the trustee's home, when he is home to control it. The 16-76 autopatch machine is on now and then too, but for the most part repeater operation has stopped in Phoenix.

The FCC should be proud of this. It certainly will stand out as a monument to the futility of trying to cooperate with the Commission.

**AMATEUR CD RESPONSIBILITY**

Not a few amateurs have wondered at the lack of enthusiasm exhibited by our government as far as civil defense is concerned. Talk about benign neglect! Recent information seems to indicate that this is quite intentional — that CD is being left to wither away on purpose.

Continued on p. 119.....

**PETITION**

I hereby petition the FCC to reconsider docket 18803.

Call	Name	Address	City	State	Zip
WIMUL	Paul Ramadan	3 Daniel Webster Dr	Hudson	NH	03051
WIDRP	John C. Tunell	164 Cypress Ln	Nashua	NH	03060
WIPVF	Sanford H. Cole, Jr	25 Pine St	Littleton	NH	03561
WAINYS	Herman Haberman	11 West Hill St	Nashua	NH	03060
KICKS	Hugo A. N. Semm	11 Glenhill Av.	Everett Mass	Mass	02149
WITG	A.P. Salbit	25 Park Hill Ave	Nashua NH	NH	03060
WIVK	John D. Kennedy	14 Bryant Rd	Nashua N.H.		03060
WIGQV	Patrick E. Paul	28 YARMOUTH DR.	NASHUA N.H.		03060
K1ZBJ	Kenneth Pelphrey	7 Depot St	MERRIMACK	NH	03078
WALNXI	Michael Whelpley	75 Belmont Dr	MERRIMACK	NH	03054
W1JOF	Allan R. Taitala	20 Spruce St.	Hudson NH		03051
WIBHD	Melvin H. DeMuth	30 Greenleaf St	Malden Mass.		02148
WAIQR	Charles Euse	42 Summit St	Milford N.H.		03055
WAIEDG	Richard P. Plummer	22 Wrentham St	Hudson NH		03051
KIDDE	Gary M. Stuyf	Devonshire Lane	London, N.S.		
WALERK	Roger L. Eaton	65 Linton St	NASHUA NH		03060
K1ALX	Harold J. Strout	R.F.D. 9, Box 165	Manchester NH		03102
WIFSM	CHET SEATON	7 DORRIS DR	CHARMSFORD, MASS		01824
WALJF	Eric W. Johnson	1 NEWBURN ST	NEWBURN ME		04810
K1GQZ	James L. Cianci	46 ROYAL CANTON DR	NASHUA N.H.		03060
WALGRH	Arthur J. Casariego	4 FOREST GLEN CIR	WOBURN MA		01801
WAIQEK	Walter R. Blanton	46 CROSCOW ST.	Lawrence, Mass.		01841
K1YCN	Bruce F. Moore	360 Kingsbury Avenue	Haverhill Mass		01830
WAIKRN	Michael A. Dean	5 Ridge Field Dr.	Milford, N.H.		03055
K1MNS	Harold J. Blount	Warner Hill Rd	Derry N.H.		03038
WAIWFK	John A. Blount	WARRIOR HILL RD	DERRY N.H.		03038
WAGFP/1	Ray Sulta	RTC 176	FRANCISTOWN N.H.		03043
W2NSD/1	Wayne Green	Peterborough	NH		03458
W1BRO	ROBERT GASCHEN	PO BOX 221	Peterborough	NH	03458
WAGLV/1	John Blount	Peterborough, New Hampshire			03458
W7OXX/1	Keith P. Lamonie	Peterborough, New Hampshire			03458

# U.S. AMATEUR FREQUENCY ALLOCATIONS

	CW Only	Phone & CW
Extra Class	3.500- 3.775	3.775- 4.000
	7.000- 7.150	7.150- 7.300
	14.000-14.200	14.200-14.350
	21.000-21.250	21.250-21.450
	28.000-28.500	28.500-29.700
	50.000-50.100	50.100-54.000
Advanced Class	3.525- 3.775	3.800- 4.000
	7.025- 7.150	7.150- 7.300
	14.025-14.200	14.200-14.350
	21.025-21.250	21.270-21.450
	28.000-28.500	28.500-29.700
	50.000-50.100	50.100-54.000
General Class	3.525- 3.775	3.890- 4.000
	7.025- 7.150	7.225- 7.300
	14.025-14.200	14.275-14.350
	21.025-21.250	21.350-21.450
	28.000-28.500	28.500-29.700
		50.100-54.000
Novice Class	3.700- 3.750	
	7.100- 7.150	
	21.100-21.200	
	28.100-28.200	

## SSTV Frequencies

	Suggested
3.775- 3.890	3.845
7.150- 7.225	7.220
14.200-14.275	14.230
21.250-21.350	21.340
28.500-29.700	28.680
50.100-54.000	

# SSTV SCENE

Dave Ingram K4TWJ  
Rte. 11, Box 499, Eastwood Vil. 50N  
Birmingham AL 35210

The big event this month, stateside, is the Dayton convention on April 28 and 29. This super fest is the major Slow Scan gathering of the year. There's a certain excitement around the SSTV booth created by recognizing "in person" the fellows you've seen and QSOed on the air, and usually some great ideas, information, and schematics are discussed by their



designers during the forum, often months before appearing in any magazine. Taggart WB8DQT, recently designed a nice, yet relatively inexpensive electromagnetically deflected monitor, and I understand he will have the monitor and information available on it. Three or four of the fellows are working heavily on Fast to Slow Scan converters, so these may be unveiled for the first time here also. And don't forget the flea market. Although used SSTV gear is still rare (who wants out... everyone wants "in"), there are usually some hard-to-find parts available.

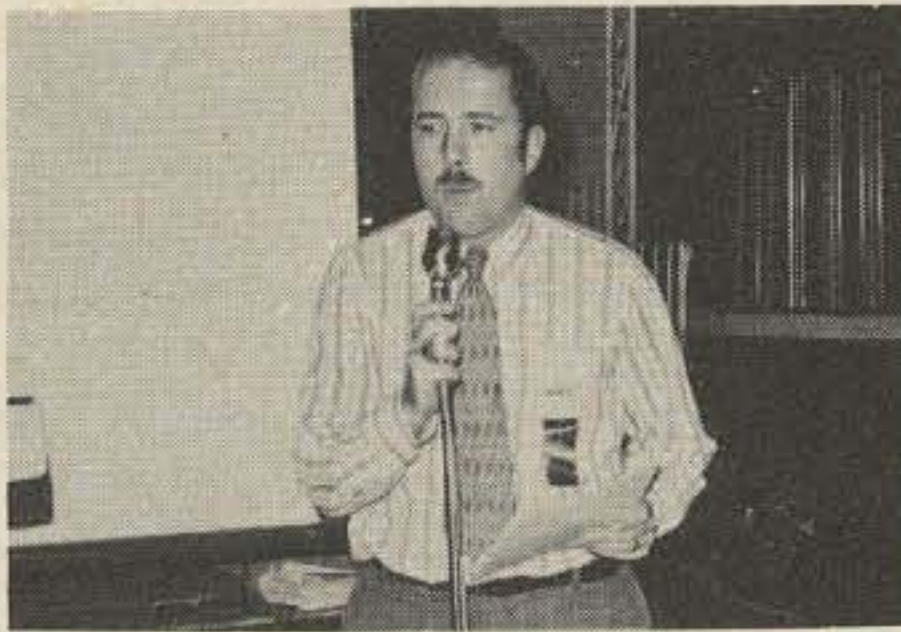

Ralph Taggart WB8DQT, emceeing SSTV Forum.



W0LMD/4 (Bob) and W4TB (Nick) make up after their "floor fight" on competing SSTV theories!

This month's pictures of the 1972 Dayton blast were snapped during the highly successful ATV forum by Gene W1VRK, who incidentally was also in the program.

Larry WA9MFF, sent along some pictures this month of his interesting Slow Scan monitor. The homebrew W6MXV/W0LMD type monitor is built in a Drake TR-4 cabinet, and looks professional. Circuitry is on six plug-in cards, and the bezel is hand-formed plexiglass. Larry may write a full article on his monitor in the near future.

This past winter 20 meters often "closed" quite early here. As an alternative I would switch to 40 meters, and was surprised to find so little Slow Scan activity. Maybe this is due to the recent frequency shifting, or the popularity of 80 meters; however don't underestimate 40. The static level is lower and skip conditions better, providing at least continental coverage. Before the recent frequency shift Slow Scan activity was

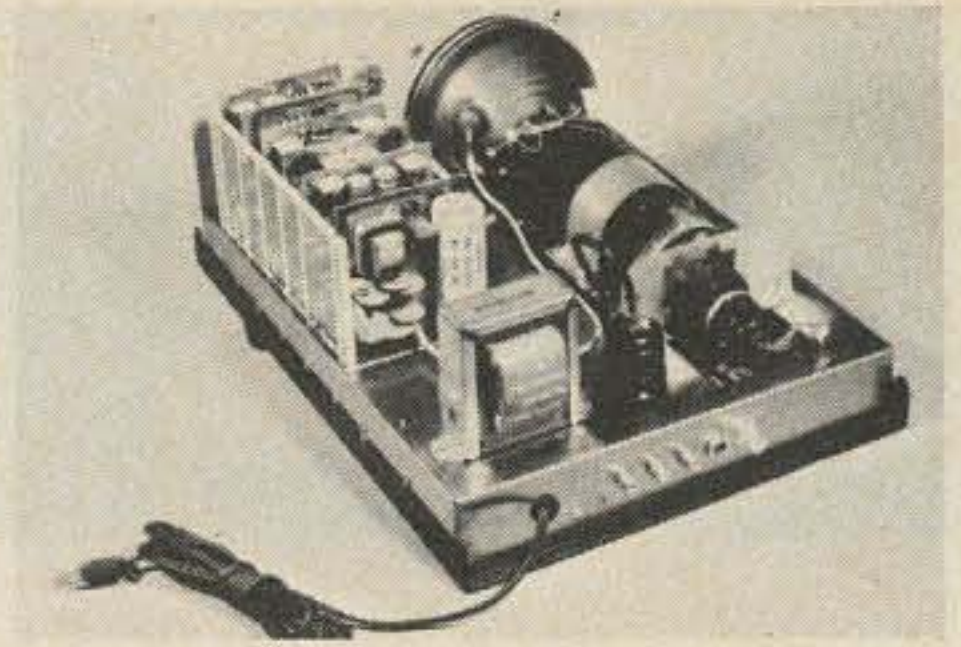

The W6MXV/W0LMD monitor built by WA9MFF.

on 7220 kHz. The new Advanced Class allocation is 7150 to 7225 kHz, thus we are still within the band and no frequency change was necessary. In fact, we now have room to stack back down the band as activity increases. "See" you on 40?

Robert Suding W0LMD has designed a nice 50 to 60 cycle line converter I am sure those of you overseas would like to build. We are hoping it will appear in print at least by this fall. If you are super anxious for the information and write either Robert or me, be sure to include sufficient IRCs to cover postage and copying.

9Y4VU recently joined our SSTV ranks. Frank presently uses a Macdonald monitor/tape recorder setup, and is building more. Watch for him on 20 meters. Let's see... that should put us up to about 70 countries now on Slow Scan.

The following circuit is a modification for the ever popular 'scope adapter, and compliments of Brooks W1JKF. A 4700 ohm resistor and any low level diode form a feedback path in the vertical sweep circuit (Q4 through Q9). This effectively closes the vertical circuit after its sweep pulse, until approximately time for the next pulse. The result is that QRM doesn't hold the initial trace at the screen top. Another modification for an already legendary circuit.

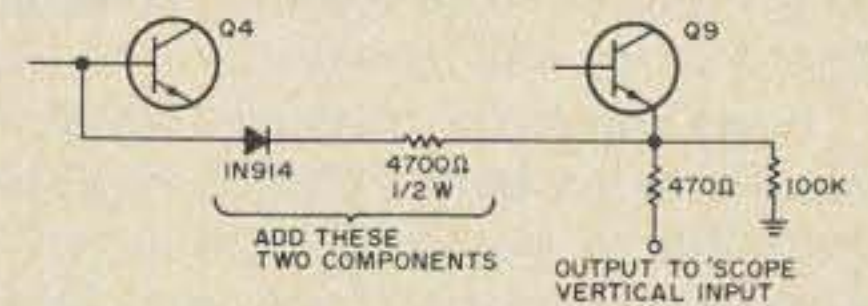

Word is just in from J&R Electronics on some late gear modifications. Their MXV-100 monitor now boasts an 8 inch crt for a larger picture, and a new oak cabinet. Nice, eh? And it works beautifully. (See the MXV-100 product report, 73 Magazine, Jan. 1972, pg. 5 & 8.) The automatic light compensated camera has an optional 1, 2, or 4 scans per 8 second frame capability. Thus in the "4 scan" mode, the top 1/4 of your picture will be displayed 4 times on the monitor screen.

73... Dave, K4TWJ





**73 MAGAZINE FM ISSUE**  
 — SPECIAL —  
**A JUGE EXCLUSIVE**  
**1 YEAR WARRANTY**

THIS MONTH ONLY . . . ON ALL SALES OF NEW FM EQUIPMENT DURING THE 73 MAGAZINE FM MONTH, JUGE ELECTRONICS WILL GIVE A FULL ONE-YEAR WARRANTY, WITH THREE OPTIONS:

1. We will repair in our shop free of charge, any defective unit returned to us freight prepaid.
2. Send your unit to the factory, prepaid, we'll pay their bill.
3. Have it repaired locally, send us the defective parts, and we will replace them to you. Sorry, we won't pay local labor charges.

Place your order today. Please send cashier's check or money order . . . for COD include 10% deposit. Mastercharge or BankAmericard accepted (send card number and expiration date. On Mastercharge send small "interbank" number shown above your name.) All in-stock items shipped the day your order reaches us.

Drake TR-22 6-channel transceiver . . . . . \$199.95	Regency HR-2A 15 watts out . . . . . \$229.00
MMK-22 mounting bracket for TR-22 . . . . . 9.95	HR212 . . . . . \$259.95
AA-22 Xmit/Receive amp for TR-22 . . . . . 149.95	
TR-22 . . . . . \$299.95	Standard SRC-826M12-channels . . . . . \$339.95
Dy-Comm "C" amplifier . . . . . \$59.95	SRC-146A "talkie" . . . . . \$289.95
"D" 10W in, 40-50 watts output . . . . . 99.95	
"E" 1-3W in, 20-30 watts output . . . . . 79.95	Swan VHF-150 . . . . . \$299.95
"ES" 1-3W in, 40-50 watts output . . . . . 99.95	Swan FM-1210A . . . . . \$359.95
"10-0" 10W in, 90-120 watts output . . . . . 195.00	Swan FM-2X . . . . . \$299.95
Power supply runs 10-0 on AC . . . . . 95.00	Clegg FM-27B . . . . . \$479.95
Crystals for Swan, Regency, Drake, Tempo . . . . 3.95	Linear Systems SB-144 . . . . . \$259.95

Our own 4 Amp unregulated power supply for any above 10 or 15 watt rig. \$19.95

"JUGE" rhymes with "huge," and that's the way we'd like to think of our service. We've been in the Amateur business now for eight years, and have built our reputation for service and assistance to our customers. Take advantage of this unusual offer . . . we bet you'll become a regular Juge customer.

**ED JUGE ELECTRONICS, INC.**

3850 SOUTH FREEWAY  
 FORT WORTH, TEXAS 76110

Phone: (817) 926-5221

Hours: 9:00-5:30 Tues. thru Sat.

# SBE

## feature after feature after feature

Been denying yourself all that great fun so many other amateurs are having with their rock-solid, through-the-repeater contacts?

**Delay no longer!** Hasten to your SBE dealer. Verify that the brilliant new **SB-144** has more channels---greater power output ---starts your enjoyment **now** by including three sets of crystals on popular repeater frequencies and a high quality, SBE exclusive dynamic microphone **without extra charge**. Add a sizzling, double-conversion receiver and a combo "S" and output meter with big **lighted** scale that also saves your battery by showing when the transceiver is ON.

Confirm the price then make the deal. Lose no time in securing this book-size beauty under your dash with the tiltable mounting bracket supplied. Then, **power on! ENJOY!**

## SB-144 2 meter FM TRANSCEIVER



10 WATTS  
OUTPUT  
ALL  
SOLID STATE



12  
CHANNELS.  
BACK LIGHTED  
NUMBERS



SUPPLIED  
WITH  
3 SETS OF  
CRYSTALS

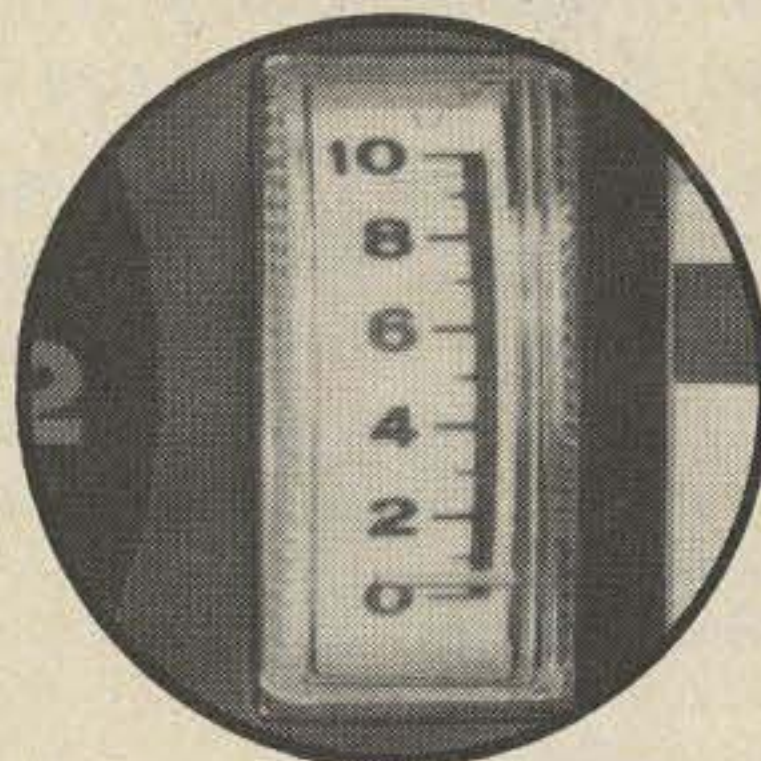

LARGE  
SCALE METER,  
COMBO,  
"S"/OUTPUT



SUPPLIED  
WITH  
DYNAMIC  
MIC.

# 259<sup>95</sup>

**SBE**

LINEAR  
SYSTEMS, INC.  
220  
Airport Blvd.  
Watsonville, CA  
95076



GUS M. BROWNING W4BPD

Well I see that good old summertime is around the corner, this means there will be some changes in the bands, and best of all the WX will be right to get your antennas "right"! I had a very FB "looking" 4 element, tri band quad, all put together, boom, elements and all. It was just tied down to the bottom of my 150 ft. tower, just high enough to clear the ground. I was trying to get it put on top of my tower and winter WX and a lot of rain and wind stopped me and then it turned cold and winter was upon us. I decided that I would just let it stay there until summertime came around again. I could see, getting this "thing" put on top of the tower was going to take a lot of "doing" and a lot of hand-shaking and back-slapping to convince someone to climb up and down that tower (the days of one of the neighborhood kids doing such things has passed, even "down-south"), well, like a few years ago we had one more of those ice-storms (we don't get snow-hi.) This one caused a lot of havoc, many thousands of trees fell and you should have seen W4WVF's FB quad. It looked like a very wet spider-wed and worst of all it looked like a wet spider-web that someone had than stepped on! This is the 3rd time his quad has suffered a calamity on account of ice-storms. It took the high winds all OK, but those ice-storms were "murder"! Mine even looked a mess down at the bottom of my tower I could see that I would have been in "big trouble" if it had been on top of my tower. To be truthful about the whole thing, I have "chickened-out" on putting it up, knowing that sooner or later there will be another ice-storm and it will crumble up and I would than have the whole thing to do over again. I would rather have a half loaf of bread than none! I am going to put up a multiple dipole for every band from 10 through 160 meters and feed it with RG17AU and accept what-ever SWR I happen to end up with. It might end up being broad-banded with all that wire up there and be non-directional. At least I think I will have up an antenna that will stay up and it will be "all-band". I will "worry" about putting up my 4 element, tri-band quad on a pole that I can put up and down by pulling a few ropes when there is the next ice storm coming this direction.

With the diminishing sun spots and conditions getting worse on the high frequency bands its about time to be looking into the lower frequency bands. The antenna is the first thing to get up and the best time is during the summertime, which is practically upon us right now. Those lower frequencies will be our "bread and butter" bands pretty soon now, so you had better start getting ready for them right now. The DX stations are getting more numerous on the lower frequencies and as the sun-spots get less and less the DX stations will get more and more.

Peggy (my XYL) and I are right now working on our "last" DXpedition which we hope to commence in March of 1974, we hope that it will last from one to two years, maybe even longer (as long as our money and donations permit.) Peggy is right now in the process of getting herself a license. We will dish-out YL and OM QSO's from as many countries as possible. The YL ISSB group is behind us on this trip, they will be helping with contributions to keep us on the road as long as possible. I told V. Mayree (K4ICA) that we had the time if they had the money! Their "contributions" "acceptor" is K5LIL. All this means that when Peggy and I get on the road you will be able to work us if you anchor your receiver on the YL ISSB System frequencies sooner or later you will hear us break in on them. Then you can work yourself a YL and OM in some DX spot - two QSO's without much trouble! We will be on all bands that are open after we attend to the YL's on their frequencies. Plenty of low frequency operation is planned since the higher frequencies are gradually going out. Get ready for us because we want plenty of "business" when we get on from "out there"!

Some of the DX coming through on 160 meters will surprise you if you stick it out and can battle the summertime QRN that will start pretty soon now. Some of the DX worked on this band since Jan. was some pretty good stuff, such as: 8P6DR, YV5CKR, LU5HFI, KH6RS, EP2BQ, VP8KF, PY1DVG, 4W1AE, HB9CM, JY9FOC, DL1FF, PJ2VD, OA8V, OE5KE, HR2HH and KP4DLW - All these between 1825 to 1830 kHz at all kind of hours of night. Some pretty good DX, even for higher frequencies. If this is a sample of whats being worked on 160 right now there certainly will be some real DX activity there when the sun spots get nearer the bottom of the 11 year cycle.

The operation of the Canadian World DX-pedition to Bhutan is off. They received a letter from the Bhutan

Ministry of Foreign Affairs informing them that the Government of Bhutan has standing orders that no visitors are to be allowed to enter Bhutan until the end of 1973 and even after that, only package tours of 6 to 10 persons will be allowed. So if you were waiting for them to go there to work your A51 country you can "forget it" for the present time.

MOUNT ATHOS - The ice was finally cracked in getting someone on the air from this rare spot in Greece. It's somewhat like Vatican City, which is located in Rome, Italy as you know, only Mount Athos is located in Greece. I can tell you from personal experience it took some "doing" to get permission for this operation. Many, many fellows including myself have been trying for years to do the "trick" without any success what so ever. NOW I guess the next rare spot to be cracked will be The Royal Order of The Knights of Malta set up which is one square block right smack in the center of Rome, Italy. I have heard that it has all the ear markings of being another "new one" if ever anyone gets "official permission" to operate from there. I WONDER when (if ever) will ARRL decide that there are TWO Viet-Nam's, TWO Germany's, TWO Korea's? I have not ever heard complaints that there are too many DXCC countries. In fact there are MORE DXERS that would like to see MORE countries on the DXCC country list than less. Far too many DXers have worked all the countries on the air and it seems to me like they want "something" to do. By this I mean real "DXERS", not the garden variety of DXer who thinks a G3 or DL is DX. I mean the serious DXER, the fellow that gets each "new one" as they come on the air. For him, the more DX there is the better he likes it.

WANNA WORK DX EASIER?

All you have to do is listen more and talk less. Listen what the DX station has to say. If he says W/K1's only, and you are not in the first district KEEP YOUR MOUTH SHUT, QRX until your district is called and then VERY SHORT calls, no need to mention his call much BUT give yours a few times (he knows his call, but not yours), use only STANDARD phonetics, or better yet if you know his language use it. When you get him, give him ONLY his signal report LET HIM indicate if he wants a rag chew. Lastly, if the deliberate QRM on him is someone YOU KNOW, be sure to get an immediate message or better yet a phone call to the nearest FCC monitoring station. I myself would call them if these shenanagins was being done my my own brother. See you on the "Low-End"-de *gus*

# 73 REPEATER ATLAS REGISTRATION

REPEATER CALL (WR only)		FORMER CALL		LOCATION (City)		STATE
INPUTS	OUTPUTS	TT Wh TB PL	FM AM RTTY	AUTO PATCH	ERP	USEFUL RANGE (RADIUS)
		Hz				
		Hz				
		Hz				
		Hz				
EQUIPMENT						ANTENNAS & HEIGHT <input type="checkbox"/> SPLIT SITE <input type="checkbox"/> DIPLEXER
REPEATER GROUP/SPONSOR		TRUSTEE		ID-TYPE OR MFR.		
<input type="checkbox"/> I certify that I have received no outside assistance while completing this form.						
DATE	SOURCE (NAME/CALL)		SPECIAL OR EMERGENCY FUNCTIONS			

## PHIL-MONT GOES FM

The Phil-Mont club, one of the larger in the country, is going FM, starting on 147.03 simplex and installing a Standard repeater for 147.63-03 later on. This should give quite a boost to FM in Philadelphia.

## NEW LICENSE ARRIVED?

When your repeater receives its new WR call, the second thing that you should do (after changing the identifier) is fill out the above form and mail it to 73. This will enable us to keep our repeater listing current and accurate. It will also make sure that the FM world doesn't forget you... for the 73 Atlas is recognized as the one complete listing of repeaters for the entire world.



## WR CALLS APPEARING

AZ	K7EIK	Kingman		16-76
			T1.8	34-94
GA	WB4RYQ	Griffin	Delete	28-987
IL	WR9AAA	Joliet		
	ex-WA9EAT			
MA	K1CRR	Webster		28-88
MA	K1A0I	Oxford	Delete	
MI	WB8CSU	Jackson		13-73
MN	K8PML	Mpls-St. Paul	T1.8	16-76
MN	W8PZT	Mpls-St. Paul		22-82
MN	WA8JCX	Mpls-St. Paul		28-88
MN	K2OPT/8	Albert Lea		34-94
MN	W8GVP	Duluth		34-94
MN	WA8ODF	Rochester		34-94
MN	K8RTU	Elk River		37-97
MN	WA8NPZ	Mpls-St. Paul		94-46
NC	WB4QGE	Winston-Salem		04-64
NJ	WB2ZQZ		Delete	
NJ	WB2ZWQ	South Jersey		22-82
NY	WR2AAA	Manhattan		13-73
	ex-WA2SUR			
PA	WA3KXD	Erie		34-94
				19-94
PA	WA3KXF	Lancaster		01-61
SD	W8BXO	Brookings	W1800	34-94
SD	WA8VVG	Sioux Falls	W1477	34-94
SD	K8RTD	Pierre		34-94
SD	W8OGS	Aberdeen		34-94
SD	WA8CPX	Rapid City		34-95
TN	W4SKH	Moved to Knoxville		28-88
TX	K5WPH	El Paso		28-88

As the April issue is nearing its deadline, word has been received that two WR repeater calls have been issued by the FCC - WR2AAA to WA2SUR in New York and WR9AAA to WA9EAT in Joliet IL. Note that both applications were for minimal, non-complex installations.

See the article on page 51 of this issue for details on how to insure that your application is processed quickly and with the least amount of problems.

## UPDATE THE UPDATE

Your new repeater, or your present machine with its new frequencies, is destined to remain practically unknown to the rest of the world unless you get the information to the Repeater Update... pronto!

All published updates are automatically compiled by our computer-like staff and added to the listings in the Repeater Atlas. While you can always (horrors) chop-up every issue and compile the new listings as they are published, an easier way is to send us a buck and a half for a copy of the brand-new-still-wet 1973 Repeater Atlas. It contains a listing for every repeater known, including maps, open or closed status and tone frequencies. See our ad on page 126 for that little extra bit of convincing.

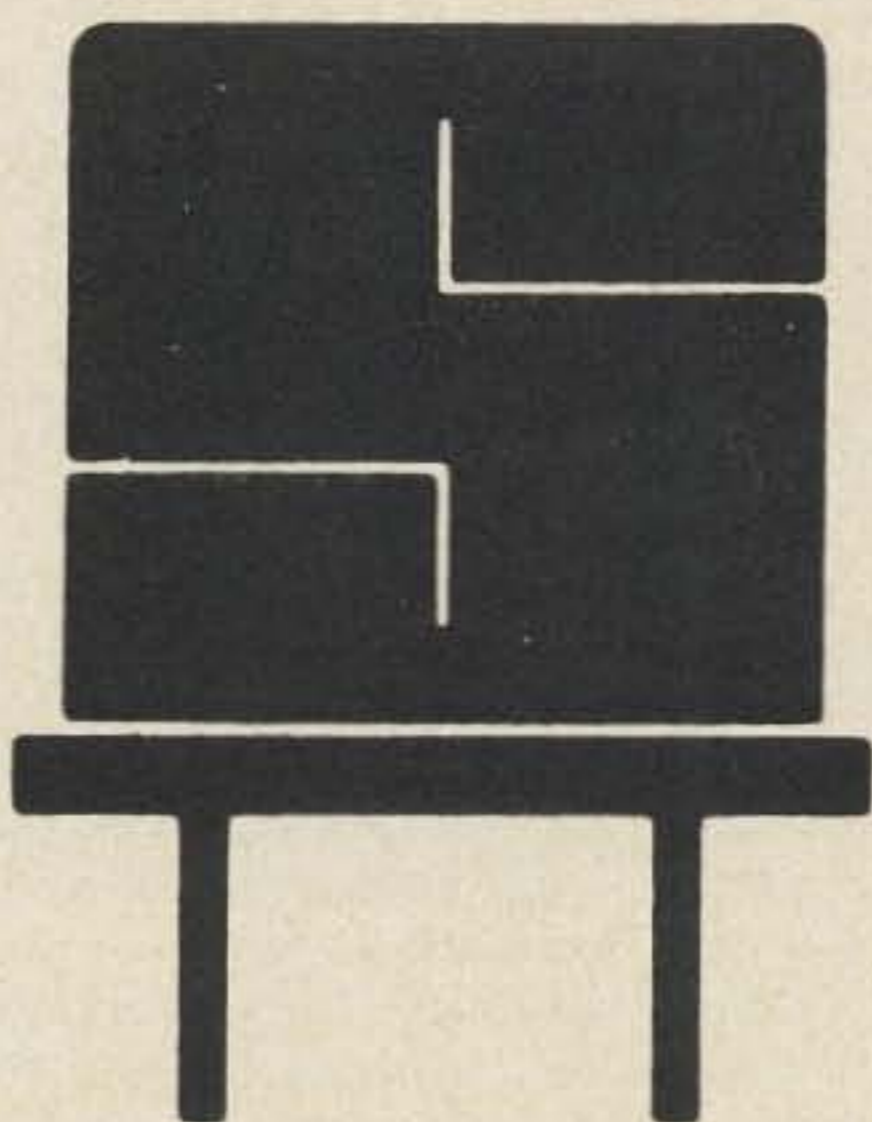

## REPEATER OWNERS

Don't Take Chances. SENTRY offers custom made crystals made exactly to your specifications. When it comes to crystals for your repeater, BUY THE BEST - SENTRY.

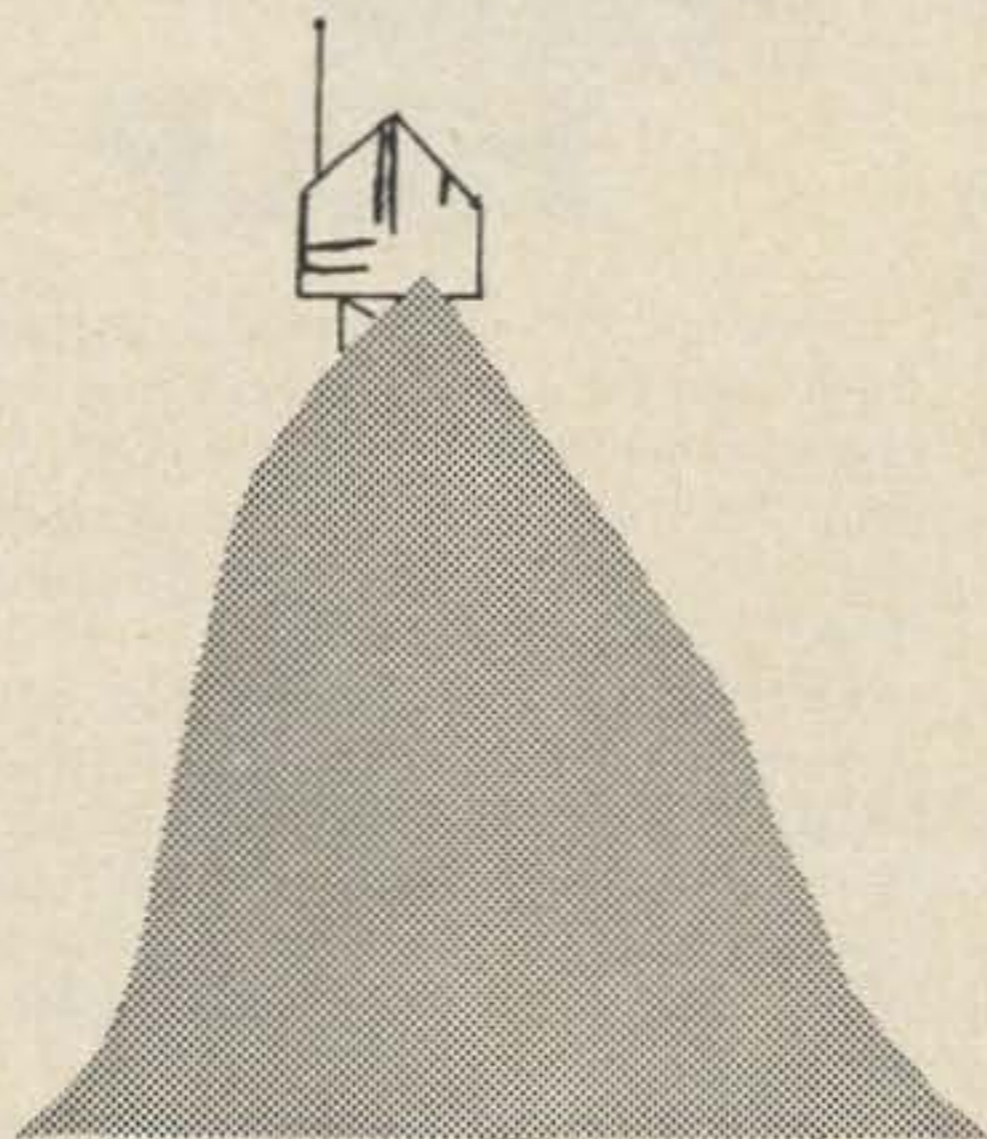

## REPEATER USERS

If you want reliable access to the repeaters in your area, you want and need SENTRY CRYSTALS. SENTRY CRYSTALS are custom made for your rig. We don't stock a large quantity of crystals for a certain frequency and hope you can tweak them to frequency in your rig. We do offer FAST service on crystals made especially for you and your rig. If you want reliable, on-frequency operation, INSIST ON SENTRY.

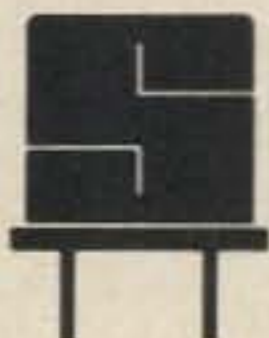

**SENTRY MANUFACTURING COMPANY**  
Crystal Park, Chickasha, Oklahoma 73018

PHONE: (405) 224-6780

TWX-910-830-6425

# 50 MHz BAND

Bill Turner WA0ABI  
Five Chestnut Court  
St. Peters MO 63376

Early February has been most unusual. There have been multiple E openings in many areas. Openings of this type and frequency are not normally expected until the beginning of the summer E season. The band has been open at least eight times during the first twelve days of the month. Areas heard include Maryland (WA3PNQ) to Florida and Louisiana (WA5UUD) in the south and west to New Mexico (W5TDZ) and Arizona (WA7FPO). I had a nice QSO with WA4CRK, Cary NC the other evening. Jim runs Johnson equipment and a four element beam on AM and does a nice job with it. I have seldom heard a more stable signal, the drift being essentially zero as copied on a SSB only receiver.

WB4BVT of Tateville, Kentucky, wrote and called to tell of an unusual occurrence the evening of February 4th. At approximately 7:05 EST David heard and recorded a station signing JA1SGY. Several replays of the tape confirmed the call which is not, however, listed in the Callbook. Has anyone heard or worked this station? David runs a Swan 250 and Mark 6 linear with a CushCraft beam.

Art WA1EXN, says "I thought I had publicized it pretty well on the band. However, I still hear of fellows having parasitic problems with the January 1969 QST modification of the SB-200 Heath linear. You might mention that all they have to do is replace the 47 ohm resistors in the plate choke with 100 ohms and it will cure it. The same coil form can be used. This in the (ARRL) Handbook, page 430, 1971 Edition. The original article fails to mention this and the uninitiated cremate the 47 ohm jobs and stink up their shacks for a week or so."

Hugh WB0HUP, has RTTY gear and is looking for contacts. Any takers?

Louis Ancieux WB6NMT/6, is looking for EME schedules. Anyone ready to go before mid-June (when he changes QTH) should drop him a line at NAVRADRECFAC, Scaggs Island, Sonoma, California 95476. Louis has a 28 dB rhombic at his end and suggests that those with a quad of 6 elements spaced one wave length should be able to make the grade. It might even be possible with a pair.

The SB-110 makes an excellent code practice set without internal changes — merely switch the function switch to "CAL" with the rig set up for CW. The sidetone works as usual providing aural indication of keying without transmitting a signal.

Some years back Telco produced a 6 meter linear utilizing four external anode tubes; can anyone supply a copy of the manual for this unit? Even a schematic would be helpful to the current owner.

Many thanks to those who contributed to the first year of "The 50 MHz Band." Your efforts and kindness are truly appreciated.

WA0ABI

## HAM HELP

Occasionally 73 receives letters from aspiring amateurs wanting to know if we can locate someone to help them get their license. Perhaps there are many more of our non-ham readers who also desire help.

Starting with this issue, we will publish names, addresses and telephone numbers of those desiring assistance. If you need help, don't be bashful about sending us your name...you do want your license don't you?

Each month, amateurs and clubs should look the list over and give a hand to those in their area. As new names come in, previous names will be removed from the list.

Earl L. Grove  
891 Commonwealth Ave  
Venice CA 90291  
213-396-7315

1Lt Olin L. Beall II  
530-34-9383  
Hq Co  
USA CCD  
APO San Francisco CA 96460

Oatley W. Wells  
RFD 1  
Concord NH 03301  
603-746-3916



Schley Cox WN9LHO  
219 Kilgore Avenue  
Muncie IN 47305

### THE RANK AMATEUR

Being a Novice operator is one of the broadest activities in ham radio. One of the problems with writing a column for Novice operators is that most of the ham columns are written for specialty areas like Oscar, 50 MHz Band, MARS and SSTV.

Novices do have one thing in common. We are almost all just beginning. Some of us have worked some DX, but haven't been able to get a QSO yet in the state just next door. Some of us have a code speed just at 5 wpm (unless there is QRM) and a few of us could shut down a lazy amateur Extra.

Most of us didn't have too much trouble getting our first ticket (that's hindsight talking!) but once on the air we usually start our operating experience trying to get our 50-watt loaded dipoles through the QRM of 40 meter band carriers from Moscow, Sofia, London and Rome.

Despite that 40 meter international snake pit and Novice band, the 80 meter summer static, that yet inexplicable interference some of our transmitters seem to cause the kitchen toaster, and the strange glances of family and friends who ask themselves, "What can anybody do with a radio all night long?", most of us will try to get our General license.

Those who have gone on already to the higher tickets tell me that what we are doing now is the most enjoyable time we will have in ham radio. Sometimes the technical competence of a few years' experience takes a little of the edge off what we're enjoying so much for the first time right now.

This column will be written for Novice ops who plan to make their first years in ham radio two of the most enjoyable and productive they will ever spend. Future topics include what to do when you get the telegraph operator's version of mike fright, how to improve your fist overnight, operating contests, DX, traffic, antennas, maybe something on the perfect solder joint, and most important, about the things you tell me are on your minds.



I have some strong opinions about what's right and wrong with the Novice bands and my fellow Novice ops. You'll read about them in this column from time to time. If you don't like my opinions, or if you do, let me know. I've been known to be wrong before, and I'm sure I will be again. I frequent 3.717, 7.110 and 7.1440 in the early afternoons and on week ends.

WN9LHO



### The Hamburglar STRIKES AGAIN!

The Hamburglar from Fun City has discovered FM! Barry Electronics has lost an FM 27B Ser. No. 27013-1141 to the devious scoundrel. Wouldn't he settle for a cheaper rig?

Anyone with information please contact Barry Gensler W2LNI, c/o Barry Electronics, 512 Broadway, New York NY 10012, 212-915-7000.

The following gear was taken from remote field site near Knolls, Utah between October and December 1972.

1. Kyokuto Denshi Model FM144-10L 2 mtr xcvr Ser. No. F459.
2. NPC Model 107M marine 12V power supply.
3. Onan generator, green in color, ser. no. 327885, Model 2.5AJ-IPL.

Contact Tooele County Sheriff, Tooele, Utah, or Peter T. Rowe WA6WOA, 316 Escuela #72, Mt. View CA 94040.

List from Past Issues:

Mfr., Model, Ser. No.	Owner	Issue
Coll., 62S1 No. 10728	MSU ARC E. Lansing MI	6/72
WRL Duo-Bndr 6010AT302	WA6FCY	6/72
HR-2A, 11 chan., 04-07152	WA1NVC	9/72
Swan Cygnet 270, No. 313022	K4ACJ	9/72
Collins Mic, Mod. MMs, No. 4294	K4ACJ	9/72
Heath HW-100 & AC PS	WA2JGP	10/72
Swan 270B, No. M-395430	W8HST	11/72
AF68 No. 10888	K5LKL	1/73
PMR8 No. 10918		
M1070 pwr supply		
Trio TR2200 No. 241969	WA2ZBV	1/73
Clegg 22er No. 1900-578	WIDHP	2/73
Standard 826M, No. 112007	WA8PCG	3/73

SNZG YKEDF BKVG VLF Z  
V F K D Y C G N Z Y Z  
XJTXEFKQKLY GL XDRDYGH  
GNFDD?

ZED BLLCSKY



Joe Kasser  
1701 East-West Highway, Apt. 205  
Silver Spring MD 20910

This month I have been taking a look at some foreign ham magazines. These, like "Radio Communication" from England and "Break In" from New Zealand, are the foreign amateur radio societies' equivalent of the ARRL publication QST.

The sections that make the most interesting reading are the advertisements, especially when the text is in a strange language. It seems that the Japanese are marketing their wares all over the world. There are plenty of advertisements for Yaesu and Trio (TR-22). Prices are such that the rigs are cheaper in some places than they are here in the USA. For example, a TR-22 costs the equivalent of about \$160 in England, including taxes.

These FM rigs sold abroad usually come fitted with the most used frequencies for the local area, so anyone intending to buy a rig to take on a trip might consider getting one abroad, already crystallized up for use, and then pick up crystals for the USA when they get back. The rigs come set up for 220V so a slight modification will have to be made upon returning to the USA. If you do decide to buy a rig abroad it would be advisable to arrange it beforehand with a store so that one will be available. There is nothing like going into a store and being told, "We'll have one in two weeks," when on a three-day visit. I have access to magazines from a number of countries and can possibly help out with copies of advertisements if anyone is interested (SASE please). I only have the ads - I know nothing about the stores.

If you intend to visit the locals when abroad, be sure to fill your pockets with goodies like \$1.00 bargain packs, IC's, (particularly linear IC's - LM 370, CA 3028, MC 1496, etc.) You wouldn't believe what they cost abroad.

Consider the Yaesu FT-101. In the U.S. it costs about \$560, in England it costs about the same in English pounds. Not much difference, is there? Well, consider this: When I came to the USA I would have had to save, say, two weeks' salary to buy an FT-101. In England I would have had to save two months salary to get the FT-101. That is just one case. In general salaries in the U.S. are two to four times as much as they are in

Europe in terms of actual currency. If that DX station says that he is using Drake, Collins or Yaesu gear, it probably cost him two to four times what it would have cost you in terms of "hours worked" to save up to pay for the rig. How would you like to have to pay \$1500 for an FT-101?

On an item like the FT-101 the currency was equivalent, but consider an IC that costs 25¢ here. In Europe it may cost 50¢ (current equivalent), so in terms of "hours worked" that would cost the equivalent of \$2.00.

Thus these goodies that you bring with you as gifts will be well received by the local homebrewers. These things are small, do not take up much space and may be tucked away in any convenient space.

Another useful thing to carry is a supply of mint U.S. twenty-one cent postage stamps. These will allow overseas amateurs to send SASE's to state-side QSL managers at minimal cost, because the air mail postage can be prepaid by those stamps.

The minimum rate for an air letter is roughly the same in all countries. There is an international agreement in effect between the countries in the UPU. If I want to send a QSL to any overseas ham and prepay the airmail postage, I have to send him three IRC's at about 22¢ each. The DX station operator gets three surface rate stamps for those IRC's which just about pays for the minimum air rate. So I spend 66¢ to prepay one air letter costing about 25¢. I'd feel much better if I could get a foreign stamp at about face value instead of all those IRC's. If you pass out 21¢ stamps overseas you will be bringing a useful gift. Any non-DX'ers could always mount them in a stamp album. You don't have to just take 21¢ air stamps - mixed commemoratives would be just as welcome.

A stamp exchange of mint foreign issues at face or near face value (say 28¢ a stamp) would be a useful thing to set up in this country. The Ex-G Club (a club made up of Britons and spouses of Britons domiciled outside the United Kingdom) is starting up such an operation for their members.



# Heathkit® 2-Meter FM gear is here!



NEW Heathkit  
2-Meter  
FM Transceiver

**179<sup>95</sup>\***

HW-202 shown above  
with Tone Burst  
Encoder installed.

• **All solid-state design** • **Can be completely aligned without instruments** • **36-channel capability** — independent push-button selection of 6 transmit and 6 receive crystals • **10-Watts Minimum Output** — designed to operate into even an infinite VSWR without failure • **Optional Tone Burst Encoder** — mounts inside, gives front-panel selection of four pre-settable tones

The Heathkit HW-202 compares with the best wired amateur 2M/FM rigs. Plus it has: 36-channel capability via independent selection of 6 transmit and 6 receive crystals. Solid-state circuitry with complete built-in alignment procedures using only the manual and the front-panel meter allow operation over a 1 MHz segment from 143.9 to 148.3 MHz. Removable front-panel bezel permits installation of the new Heathkit HWA-202-2 Tone Burst Encoder.

**10-15 watts transmission into an infinite VSWR** — indefinitely, with no failure! The HW-202 needs no automatic shut-down — it continues to generate a signal regardless of antenna condition. Transmitter deviation is fully adjustable from 0 to 7.5 kHz, with instantaneous deviation limiting. Harmonic output is greater than -45 dB from carrier. The push-to-talk ceramic microphone supplied has an audio response tailored to the HW-202.

**Excellent reception** — 0.5 uV or less produces 12 dB Sinad, or 15 dB quieting. Output at the built-in speaker is typically 2 watts at less than 3% total harmonic distortion. The receiver circuitry utilizes diode-protected dual-gate MOSFETS in the front end; an IC IF that completely limits with less than a 10 uV signal; dual conversion, 10.7 MHz and 455 kHz via a 4-pole monolithic 10.7 MHz crystal filter. Image response is -55 dB or better. Spurious response is -75 dB or better.

The Heathkit HW-202 comes with two crystals used in initial set-up and alignment, give you simplex operation on 146.94. Kit includes microphone, quick-connecting cable for 12-volt hook-up, heavy duty alligator clips for use with a temporary battery, antenna coax jack, gimbal bracket, and mobile mount that lets you remove the radio from the car by unscrewing two thumbscrews. The HWA-202-2 Tone Burst Encoder provides four presettable pushbuttons for instant repeater access. Fixed station operation is as easy as adding the HWA-202-1 AC Power Supply. The HA-202 2-Meter Amplifier puts out 40 watts for 10 watts in, and externally it's a perfect mate for your HW-202.

- Kit HW-202, 11 lbs., mailable ..... **179.95\***
- Kit HWA-202-2, Tone Burst Encoder, 1 lb. ... **24.95\***
- Kit HWA-202-1, AC Power Supply, 7 lbs. ... **29.95\***
- Kit HWA-202-3, Mobile 2-Meter Antenna, 2 lbs. .... **17.95\***
- Kit HWA-202-4, Fixed Station 2-Meter Antenna, 4 lbs. .... **15.95\***

**HW-202 SPECIFICATIONS — RECEIVER** — Sensitivity: 12 dB SINAD\* (or 15 dB of quieting) at .5µv or less. Squelch threshold: 3 µv or less. Audio output: 2 W at less than 10% total harmonic distortion (THD). Operating frequency stability: Better than ±.0015%. Image rejection: Greater than 55 dB. Spurious rejection: Greater than 60 dB. IF rejection: Greater than 75 dB. First IF frequency: 10.7 MHz ±2 kHz. Second IF frequency: 455 kHz (adjustable). Receiver bandwidth: 22 kHz nominal. De-emphasis: -6 dB per octave from 300 to 3000 Hz nominal. Modulation acceptance: 7.5 kHz minimum. **TRANSMITTER** — Power output: 10 watts minimum. Spurious output: Below -45 dB from carrier. Stability: Better than ±.0015%. Oscillator frequency: 6 MHz, approximately. Multiplier factor: X 24. Modulation: Phase, adjustable 0-7.5 kHz, with instantaneous limiting. Duty cycle: 100% with ∞ VSWR. High VSWR shutdown: None. **GENERAL** — Speaker impedance: 4 ohms. Operating frequency range: 143.9 to 148.3 MHz. Current consumption: Receiver (squelched): Less than 200 mA. Transmitter: Less than 2.2 amperes. Operating temperature range: -10° to 122° F (-30° to + 50° C). Operating voltage range: 12.6 to 16.0 VDC (13.8 VDC nominal). Dimensions: 2¾" H x 8¼" W x 9⅞" D.

\*SINAD =  $\frac{\text{Signal} + \text{noise} + \text{distortion}}{\text{Noise} + \text{distortion}}$



# ...and here!

**NEW Heathkit  
2-Meter Amplifier for cleaner  
FM copy on the fringe... 69.95\***

*40 watts nominal out for 10 watts in —  
requires only 12 VDC supply.*

*Fully automatic operation — with any  
2-meter exciter delivering 5-15 watts drive.*

*Solid-state design — all components  
mount on single board for fast,  
easy assembly.*

If you're regularly working from a fringe area, the new Heathkit HA-202 can boost your mobile output to 40 watts (nominal), while pulling a meager 7 amps from your car's 12-volt battery.

Install it anywhere...in the trunk, under the hood or dashboard. Use it with any 2-meter exciter delivering 5-15 watts drive. Features fully automatic operation. An internal relay automatically switches the antenna from transmit to receiver mode when you release the mike button.

All solid-state design features rugged, emitter-ballasted transistors, combined with a highly efficient heat sink, permitting high VSWR loads. Tuned input-output circuits offer low spurious output to cover the 1.5 MHz segment of the 2-meter band without periodic readjustment. All components mount on a single printed circuit board for easy,



4-hour assembly. Manual shows exact alignment procedures using either a VOM or VTVM. And installation is just as simple.

Kit includes transceiver connecting cable, antenna connector. Operates from any 12 VDC system — additional power supplies are not required. Add HA-202 power to your mobile 2-meter rig, and boom out of the fringe. **Kit HA-202, 4 lbs.**

**HA-202 SPECIFICATIONS** — Frequency range: 143-149 MHz. Power output: 20W @ 5 W in, 30W @ 7.5W in, 40W @ 10 W in, 50W @ 15 W in. Power input (rf drive): 5 to 15W. Input/output impedance: 50 ohms, nominal. Input VSWR: 1.5:1 max. Load VSWR: 3:1 max. Power supply requirements: 12 to 16 VDC, 7 amps max. Operating temperature range: -30° F. to +140° F. Dimensions: 3" H x 4 1/4" W x 5 1/2" D.

# ...and here!

**New Heathkit  
VHF Wattmeter/SWR Bridge ... 29.95\***



Perfect tune-up tool for your 2-meter gear. Tests transmitter output in power ranges of 1 to 25 watts and 10 to 250 watts  $\pm 10\%$  of full scale. 50 ohm nominal impedance permits placement in transmission line permanently with little or no loss. Built-in SWR bridge for tuning 2-meter antenna for proper match, has less than 10-watt sensitivity. **Kit HM-2102, 4 lbs.**

**HM-2102 SPECIFICATIONS** — Frequency range: 50 MHz to 160 MHz. Wattmeter accuracy:  $\pm 10\%$  of full-scale reading.\* Power capability: To 250 W. SWR sensitivity: less than 10 W. Impedance: 50 ohms nominal. SWR bridge: Continuous to 250 W. Connectors: UHF type SO-239. Dimensions: 5 1/4" W, 5 1/6" H and 6 1/2" D, assembled as one unit.  
\*Using a 50  $\Omega$  noninductive load.

**See them at your Heathkit Electronic Center —  
or fill out coupon for FREE Heathkit catalog**

#### HEATHKIT ELECTRONIC CENTERS

ARIZ.: Phoenix, 2727 W. Indian School Rd.; CALIF.: Anaheim, 330 E. Ball Rd.; El Cerrito, 6000 Potrero Ave.; Los Angeles, 2309 S. Flower St.; Pomona, 1555 Orange Grove Ave. N.; Redwood City, 2001 Middlefield Rd.; San Diego (La Mesa), 8363 Center Dr.; Woodland Hills, 22504 Ventura Blvd.; COLO.: Denver, 5940 W. 38th Ave.; CONN.: Hartford (Avon), 395 W. Main St. (Rte. 44); FLA.: Miami (Hialeah), 4705 W. 16th Ave.; GA.: Atlanta, 5285 Roswell Rd.; ILL.: Chicago, 3462-66 W. Devon Ave.; Downers Grove, 224 Ogden Ave.; IND.: Indianapolis, 2112 E. 62nd Ave.; KANSAS: Kansas City (Mission), 5960 Lamar Ave.; MD.: Baltimore, 1713 E. Joppa Rd.; Rockville, 5542 Nicholson Lane; MASS.: Boston (Wellesley), 165 Worcester St.; MICH.: Detroit, 18645 W. Eight Mile Rd. & 18149 E. Eight Mile Rd.; MINN.: Minneapolis (Hopkins), 101 Shady Oak Rd.; MO.: St. Louis, 9296 Gravois Ave.; N.J.: Fair Lawn, 35-07 Broadway (Rte. 4); N.Y.: Buffalo (Amherst), 3476 Sheridan Dr.; New York City, 35 W. 45th St.; Jericho, L.I., 15 Jericho Turnpike; Rochester, Long Ridge Plaza; OHIO: Cincinnati (Woodlawn), 10133 Springfield Pike; Cleveland, 5444 Pearl Rd.; PA.: Philadelphia, 6318 Roosevelt Blvd.; Pittsburgh, 3482 Wm. Penn Hwy.; TEXAS: Dallas, 2715 Ross Ave.; Houston, 3705 Westheimer; WASH.: Seattle, 221 Third Ave.; WIS.: Milwaukee, 5215 Fond du Lac.

HEATH <b>Schlumberger</b>	
HEATH COMPANY, Dept. 11-4 Benton Harbor, Michigan 49022	
<input type="checkbox"/> Please send FREE Heathkit Catalog.	
Enclosed is \$ _____, plus shipping.	
<input type="checkbox"/> Please send model(s) _____	
Name _____	
Address _____	
City _____ State _____ Zip _____	
*Mail order prices; F.O.B. factory AM-282	

Perhaps someone reading these lines is also a stamp dealer. If you are, here is a way of unloading your surplus stock. Think about it... you could make a profit *and* your customers would save by the difference between your charges and the cost of the IRC's. Everyone would come out on top except for the UPU and it serves them right for overcharging for IRC's!

G3ZCZ/W3



Bill Pasternak WA2HVK/6  
14732 Blythe Street #17  
Panorama City CA

At this time about the most important news out of this area concerns the recent FCC inspection of the Phoenix 34-94 repeater, under the new regulations. In a talk given February 3rd at the California Amateur Relay Council, Bob K7VOR of the Phoenix Repeater group explained how the situation began, and what has transpired since. According to Bob, this was not a planned inspection, but more a matter of coincidence. The FCC men were at the site on matters not related to amateur radio. (As with many other repeaters, this machine was located at a commercial broadcast site.) A chance meeting between two of the club members who were doing maintenance on the machine and the FCC personnel led to the inspection.

As an outcome of this inspection, the repeater was found to be in violation of the regulations regarding control. The inspectors apparently felt the system used (a timed carrier on 450 MHz) to control the two meter machine, did not meet the standards set in the new regulations. They felt



this type of control without any form of tone coding could not be accepted as positive control. However, though they have been informed that there was a violation of the regulations, as of this date they have not received an official citation from the FCC (I called Bob this evening and this is where the matter stands as of 2/8/73.)

In the meantime, all repeaters in the Phoenix area are off the air and only operate when there is positive control (i.e., operator on duty). At the time of the meeting, 34-94 in Phoenix was down, since Bob was not there to control it himself. I sincerely hope this is not a trend that the rest of the country will be forced to follow. Phoenix needs our support and backing, since it is apparent the FCC has decided on literal enforcement of the new rules. If this is true, then all repeaters will eventually be forced into a position of restricted operation. When I drove cross-country in some bad weather last October, having the rig in the car was quite reassuring to me. I was just about always within range of a two meter repeater, day and night.



Burt K6OQK doing maintenance on WA6TDD.

If the new repeater regulations force owners to curtail or restrict operating time due to the provisions on monitoring and control, then we will all be losers. I, like others, have come to depend on repeaters to communicate in time of emergency, as well as a place to chew the fat. I wouldn't like to be stuck some place deserted, only to find that the repeater I might be able to reach for help was off the air because no one was around to monitor and control it. Would you? My thanks to Bob WA6JGW and Chris WB6HGW for tape recording the meeting while Sharon and I battled the London Flu.

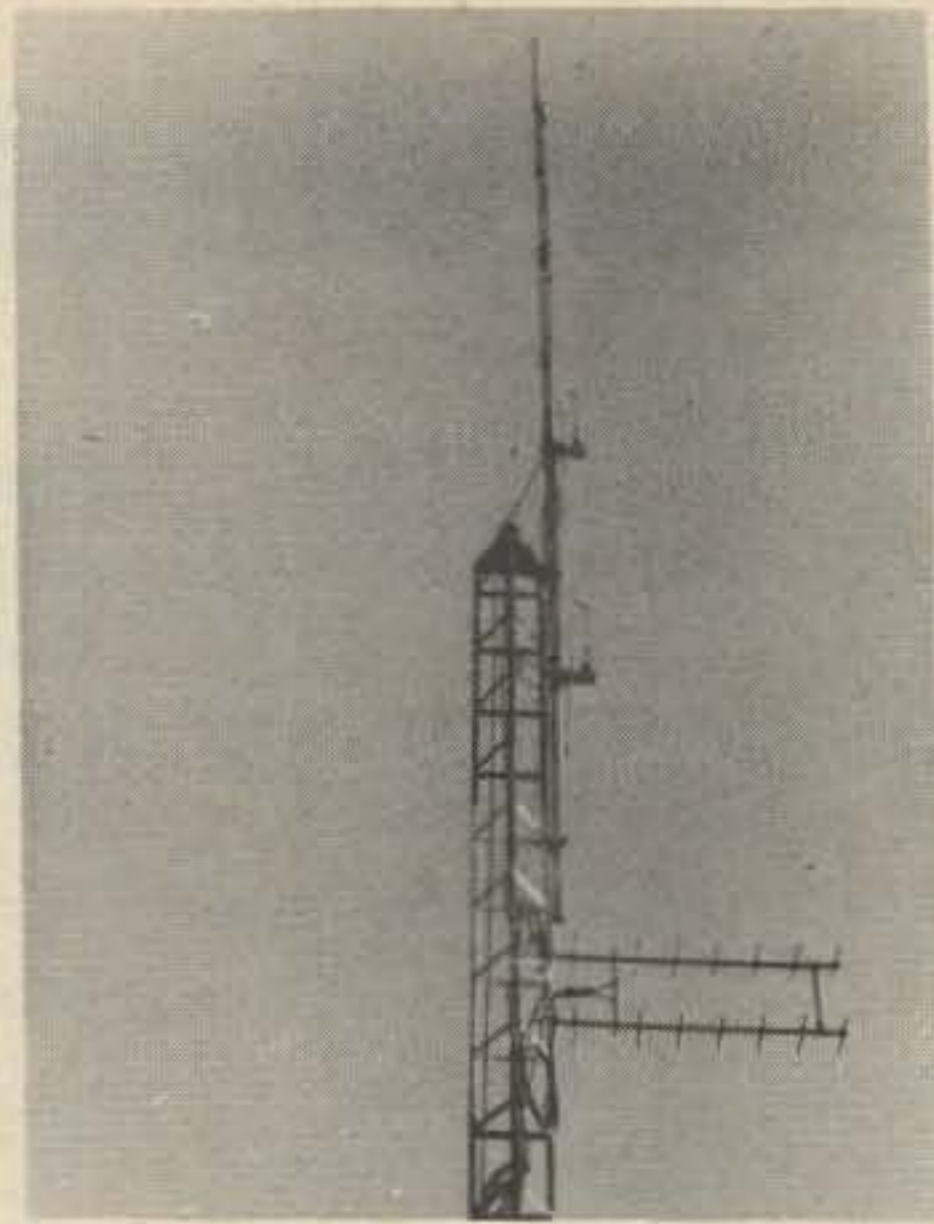

Transmit and 450 control antenna system of WA6TDD.

Since I became involved in FM a few years ago I, like many of you, had this dream of putting my own repeater high on some mountain. The closest I came was helping establish WA2ZWP on the Williamsburg Bank Building in Brooklyn. Well, it wasn't a mountain, but at least I did get a chance to fulfill part of my desire. I think that's why I was so enthusiastic about accepting an invitation from Burt Weiner K6OQK to drive up Mt. Wilson and visit the WA6TDD repeater site. WA6TDD is the only non-standard channel allocation in the L.A. area. Though the published input is 147.42, the input is actually split at 147.435 FM and 147.405 AM. The output is 146.40, FM. Though this is an odd combination of frequencies, Burt took the time to make the reason for it being this way clear. Simply, Mt. Wilson is not only the home of WA6TDD, but just about every major commercial broadcaster (TV and FM) serving the L.A. market. After years of trial, Burt found he had to keep his output at 146.40 to avoid any unwanted mixing and intermod with other services on the mountain. This output, coupled with a 145.195 input, worked fine until the new regulations forced TDD to move its input to where it is now. As to the AM input, retaining it was a decision that was left to the users of TDD, and they decided it would be in the best interest to keep it. Why? Well, while AM is slowly phasing itself out in most parts of the country, it is far from extinction out here. Most of the time I find it as easy to get an AM QSO as it is to get one through an FM repeater. An AM input affords the guy who has no FM equipment a chance to get involved in FM repeater operation and its benefits. At least that's my feeling. At the moment the AM input is out of service, but Burt tells me that it will go on again soon.

The system uses Motorola Sensicon A Receivers with a compression amp before the transmitter that keeps the output deviation at a stable 5 kHz even on under-deviated signals. Antennas are a pair of J poles with about 80 feet vertical separation. All this, combined with a site some 6700 feet above sea level, makes for better than average coverage. Oh yes, as an added bonus the view from atop Mt. Wilson is something to behold, even on a cloudy day. Come see for yourself.

...WA2HVK/6



## FCC NEWS

*Petition: To allow the use of topographic maps having the scale of 1:250,000, but having contour intervals of other than 50 feet, in applications for repeater stations in the Amateur Radio Service.*

It is hereby requested that section 97.41(f)(1) be amended to read:

Location of the station transmitting antenna, drawn upon a topographic map having the scale of 1:250,000.

It was the intent of the Commission in section 97.41(f)(1) that applicants for repeater stations in the Amateur Radio Service use the maps sold by the U.S. Geological Survey, of the scale 1:250,000. These maps are available with a contour interval of 50 feet for the portions of the country with relatively flat terrain; however, these maps do not have a contour interval of 50 feet for portions of the country with mountainous terrain. Since it appears to be extremely impractical to obtain maps that comply with 97.41(f)(1) for many portions of the country, and it does not appear to be contrary to the intent of the Commission, I request that this petition be approved.

Respectfully submitted,  
Robert R. Rule  
licensee: WA7EGK  
P.O. Box 1054  
Laramie, Wyoming 82070  
Telephone: 307-742-3369  
January 5, 1973

BYKW DVNBQMTVJL KW MHON J  
EKFCVWKM - JQVKO RMMO.  
NMX YJFC JOVCJEN WMOFCE  
BYC VCJO LCWWJTC.



### WORKED ALL BRITAIN CONTEST

The WAB phone contest will be held April 1, 1973, and WAB CW contest will follow the next Sunday. Times are between 0900-1200 GMT. Score 5 points for each contact. Operation on 160, 80 and 40m. Scoring multipliers are the number of different WAB areas worked. Exchange RST and Nr. Logs should be mailed within 50 days to WAB Contest Mgr., G2DSF, Norman Booth, 49 Baggrave St., Leicester, England.

### 5TH RTTY WAE DX CONTEST

The Deutscher Amateur Radio Club (DARC), has the honor to invite RTTY amateurs all over the world to participate in the 5th RTTY WAE DX Contest. Contest period is Apr. 28, 0000 GMT - Apr. 29, 2400 GMT. Call CQ WAE de... on all bands 3.5 through 28 MHz. Exchange QSO-Nr. & RST. Certificates to the highest scorer will be awarded. Logs must contain bands, exchanges sent and received, call signs, QTCs sent and received, points, multiplier. Use a separate log for each band. Enclose a summary sheet showing the scoring, rest period, classification, your name and address in BLOCK LETTERS. The deadline is June 10, 1973. Mailing address: WAEDC-Committee, D9-8950 Kaufbeuren, Postbox 262, West Germany.

### DAYTON

The 22nd Annual Dayton Hamvention will be held Saturday, April 28, 1973, at the Dayton Hara Arena. Technical forums, exhibits, flea market and 450 MHz transmitter hunt. For information write: Dayton Hamvention, Box 44, Dayton OH 45401.

## AUTHOR'S CORRECTION

K2OAW's Solid State Repeater Control in the March issue contained an error in Fig. 1 on page 36. Connections to pins 4 and 7 of the 741C were inadvertently reversed. The corrected portion of this circuit is shown below.

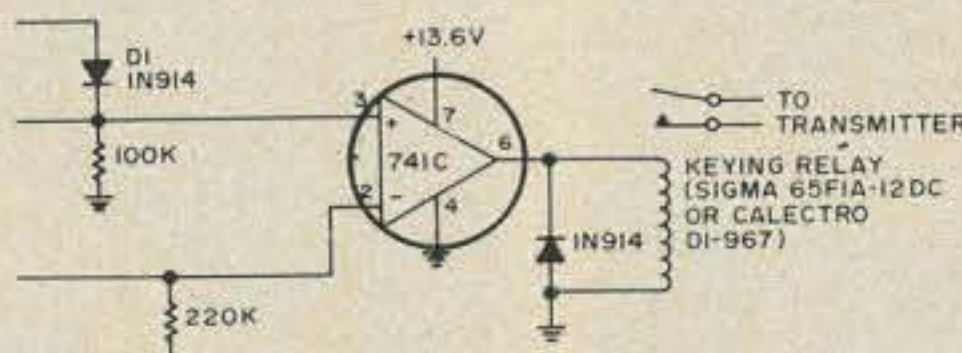

Fig. 1. Simple COR and timeout timer.

### FLORIDA QSO PARTY

FLORIDA SKIP, the all Florida Amateur Radio Publication, is happy to announce the 9th annual FLORIDA QSO PARTY to be held April 7th and 8th, 1973. All amateurs are invited to participate. Florida amateurs are urged to work as many out-of-state stations as possible as well as those within the state. Contest periods: Sat., 1500-2000; Sun. 0000-0500, 1400-2359. All times GMT. Exchange: Florida stations: RST and county. Non-Florida: RST and state, province or country. Trophies will be awarded to high scoring stations. Contact FLORIDA SKIP, Contest Chairman, P.O. Box 501, Miami Springs FL 33166 for further information.

### BIRMINGHAMFEST

The Birminghamfest Amateur Radio Convention will be held on May 5-6, 1973, at the Alabama State Fairgrounds Exhibition Hall in Birmingham AL. This event is sponsored by the Birmingham Amateur Radio Club, John A. Outland, WB4PJU, President. Those wishing to attend or exhibit can get information by writing to P.O. Box 603, Birmingham AL 35201.

### LOWER COLUMBIA CELEBRATION

Lower Columbia Amateur Radio Assn. announces its 25th anniversary celebration - Dinner - April 14th 1973. Prizes, contests, program, swap shop, CW contest, etc. For information write WA7NRQ, 355 Baltimore, Longview, Wash. 98632. \$3.25 per head.

### MATTOON HAMFEST

The Moultrie Amateur Radio Klub of Mattoon IL will hold its 12th annual hamfest at the American Legion Pavilion in Wyman Park, Sullivan IL on 29 April. For further info write Robert Boyer WB9AAV, Secretary of MARK, P.O. Box 327, Mattoon IL 61938.



Thanks to John K3SLJ

# IF YOU DON'T HAVE A MOUNTAIN

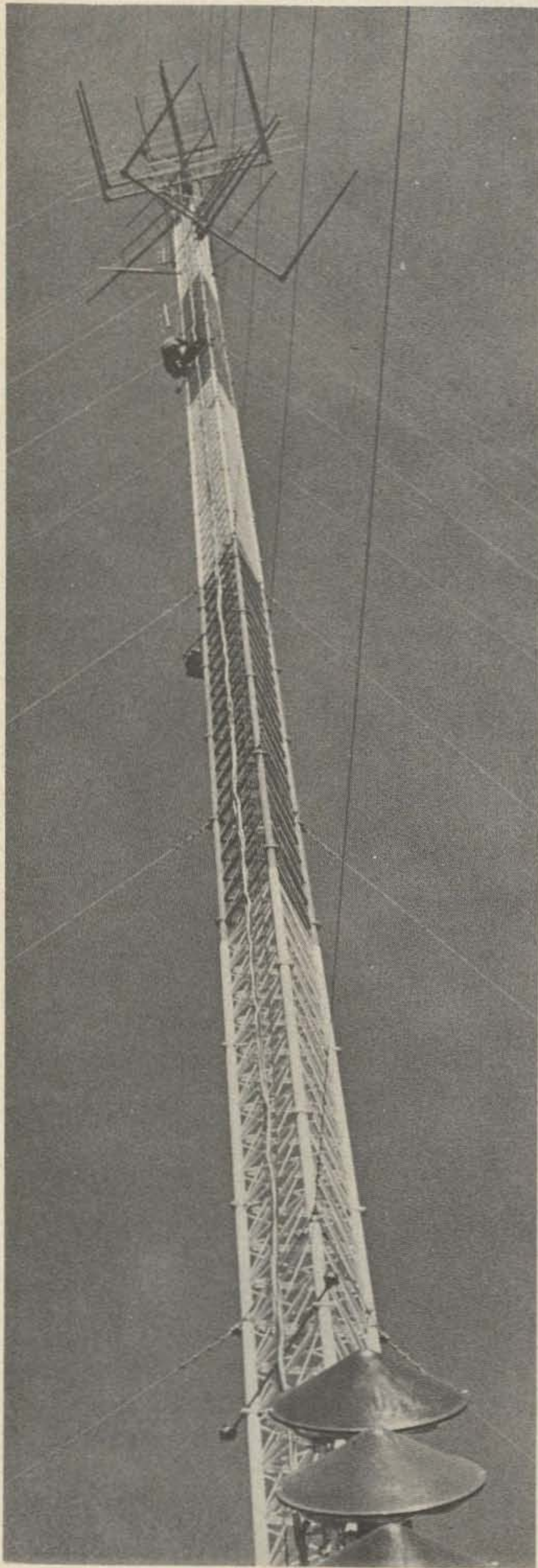

...there are other ways to get your repeater's antennas off the ground. Our cover photo this month shows intrepid alpinists Bill Stephens WBØCAB (in the tan coat) and Richard K. Brown WØEMU installing the feedline to one of two Cushcraft antennas for the WØEMU 16-76 repeater in Winfield, Kansas, at the 600 foot level of a commercial tower. The tower looks high enough in the groundhog's view at the left...but it must have tripled in height by the time the photographer swung out on the rigging at the top to take the cover shot.



The photo above shows WØEMU assembling the Cushcraft antenna and, below, WBØCAB and WØEMU are readying the coax for the long haul uphill.



### RALEIGH HAMFEST

The Raleigh NC Amateur Radio Society will hold their first annually scheduled hamfest on Sunday, April 15th, at Dorton Arena (indoors) on the State Fairgrounds in Raleigh. Indoor flea market, meetings (MARS, DX, FM, NETS), YL/XYL program, and prizes. Talk-ins Saturday night and Sunday morning on 3923 kHz and on 146.94 simplex, 146.28/146.88, and 146.04/146.64. Overnight camper parking available for \$2.00. For info write RARS Hamfest, P.O. Box 17124, Raleigh NC 27609.

### ROCK RIVER HAMFEST

The 7th annual Rock River Radio Club Hamfest will be held on Sunday, April 8, 1973 at the Lee County 4-H Center in Amboy IL. Advance ticket price is \$1.50 and gate price is \$2.00. Prizes — free coffee and donuts from 9-10 a.m. — indoor facilities. Talk-in will be on .94. Note: Absolutely no fire arms permitted!! Tickets are available from Carl Karlson W9ECF, Box 99, Nachusa IL 61057.

### ONTARIO CENTENNIAL STATION

The Burlington Amateur Radio Club VE3RAB is celebrating the centennial of the Town of Burlington, Ontario, by operating a centennial station for the duration of the 1973 year. The special call sign of VA3RAB will be used and acknowledgement of contacts will be with a colorful 3 section folding QSL card. Operation during all major contests will be part of VA3RAB activity.

### ROCKAWAY AUCTION

The Rockaway Amateur Radio Club will hold their Annual Spring Auction and FMers Get-Together on Friday evening, April 27th, at 8 p.m. Location will be Hall of Science Building, World's Fair Grounds, Flushing Meadow Park, Queens NY. Auction will be open for amateur radio gear. Doors open at 6 p.m. For further info write RARC Auction Committee, P.O. Box 341, Lynbrook NY 11563.

### JOHNSON CITY HAMFEST

The Fourteenth Annual Hamfest, sponsored by the Southern Tier Amateur Radio Clubs, is scheduled for 2:00 PM, April 14, 1973, at St. John's Ukrainian Hall, Johnson City, New York. Admission to lectures and flea market is free; awards and excellent dinner held to \$5.00. For tickets or further information, write STARC, P.O. Box 11, Endicott NY 13760. Advance ticket sales only by April 11, 1973.

### B.A.R.K. S.W.A.P.

The New Jersey Bergenfield Amateur Radio Klub's annual SWAP & SELL Sunday April 8, 1973, Bergenfield Recreation Center, Legion Drive, Bergenfield, N.J. For further information write Robert Winter WA2DZE, Bergenfield Amateur Radio Klub, 57 Clinton Park Drive, Bergenfield NJ 07621. Call 384-3232 9 a.m.—6 p.m.

### BALTIMORE HAMBOREE

The Greater Baltimore Hamboree will be held Sunday, April 8, 1973, at 10 AM at Calvert Hall College, Putty Hill and Goucher Boulevard, Towson MD (1 mile south of Exit 28 Beltway—Interstate 695), food service, flea market, prizes, REGISTRATION \$2.00. No table charge or percentage. Info: Joe Lochte, 5400 Roland Ave., Baltimore MD 21210.

### DEKALB HAMFEST

The Kishwaukee Amateur Radio Club of DeKalb, Illinois is having a hamfest on May 6, 1973, 8:00 AM—3:00 PM. Location is the Notre Dame Center, indoors, 3 miles south of DeKalb off Rte 23 — signs posted. Admission is \$2.00 at the door, \$1.50 advance sale. For details write Box 473, DeKalb IL 60115. Talk-in will be on 146.94 and 52 simplex, 13-73 and 7258 kHz.

### SHARON MA AUCTION

The Sharon Amateur Radio Association is planning an auction on the 29th of April 1973. It will be held at the home of David Fisher WA1LXE, 30 Ames Court, Sharon, Mass. Free coffee and donuts will be served! The auction will begin at 1:00 p.m. For information, please contact Robert Linsky WN1OWI, 21 Harold St., Sharon MA 02067.

### MARYLAND-POTOMAC HAMFEST

The Maryland-Potomas Area Hamfest will be held at Westminster, Sunday, April 29th, 9:00 to 5:00. Registration of \$2.00 also includes flea market or tail-gate sales. Professional food and beverage catering. Parking for 400 cars. All customary hamfest events. Information from K3DUA or K4LHB per Callbook address. Talk-in on 146.94.

### LICENSE FEES

Initial License .....	\$ 9
Renewal .....	\$ 9
New Class .....	\$ 9
Modification .....	\$ 4
Special Call Sign .....	\$25

Use FCC Form 610 and mail with appropriate fee to:

Federal Communications Commission  
Gettysburg PA 17325



### CLEGG 27B



When the Commission pulled the wraps off the 147 MHz segment of the FM band, the Clegg 27A was suddenly in need of a transmitting ability for this meg. It could already receive on either the 146 or 147 meg segments of the band, so there was no problem there.

The addition of one more crystal for the transmitter fixed the problem and presto: complete coverage of the entire two megs, transmit and receive. Owners of the A model can get info from Clegg on adding that extra crystal, which is simple.

The question that comes to a great many minds is this: why spend 490 clams for an FM rig when you can get one for half that which does pretty well? It is ever the question of price vs perfection. Why buy a Rolls when a VW will get you there?

If you live in a one repeater locality (does anyone live in a one repeater locality?) you don't need to worry much about saving money on crystals. Of course if you ever travel out of your area that is a different horse color. But if you live or visit some place like New York, New England, or even California, then you will begin to scratch your head over the crystal problem unless your name happens to be Valpey or Fisher.

Take New England, for an example — you need crystals for just about every 146 and 147 meg pair, plus some for the weirdos — a total of about thirty pairs of crystals if you want to be able to hit everything. That's sixty crystals. At \$3.75 each, you have blown \$225. Around New York you'll probably need even more, with about 35 pairs being par for the course. Ditto California. When you add in \$200 for crystals to the price of a rig, the 27B begins to appear to be much more of a bargain.

When you consider that even with that big handful of crystals, you can't come close to hitting all the channels that you can with the 27B, the economy grows ever clearer.

Continued on p. 114 .....

# FREQUENCY SYNTHESIZERS

IMMEDIATE  
"OFF THE SHELF"  
DELIVERY!

YOU'LL NEVER  
HAVE TO BUY  
CRYSTALS  
AGAIN!

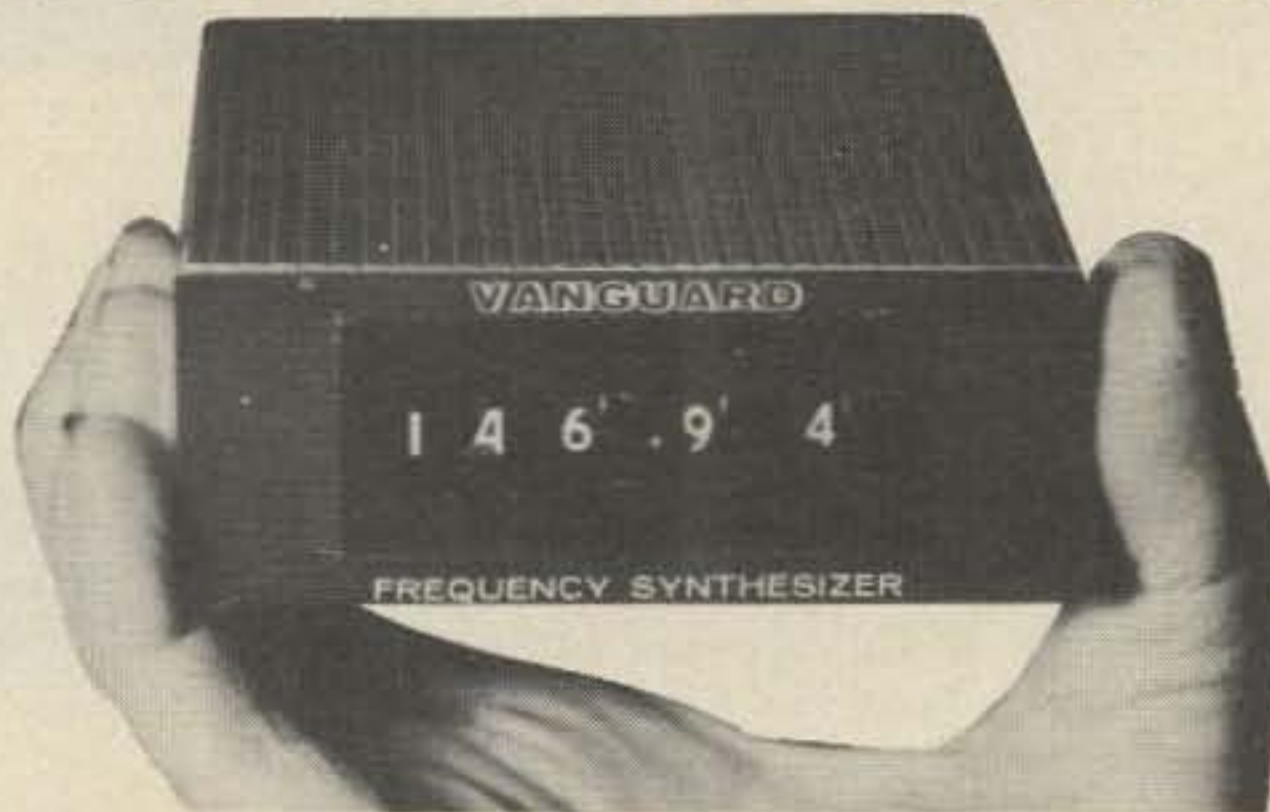

MODEL: ST-140

Price: \$129.95 ppd.

Tested, guaranteed and complete with mobile mounting bracket, tilt stand and transmitter matching kit.

NOTE: NY State residents add sales tax.

## CHECK THE ADVANTAGES OF A VANGUARD SYNTHESIZER OVER OTHER BRANDS...

- No microphonics. Can be used mobile over bumpy roads.
  - Reference frequency and spurious output down 70 dB. (excluding harmonics of output frequency which are used in the transmitter anyway.)
  - All output frequencies are generated directly from the VCO without the use of multipliers and are therefore free of sub-harmonics.
  - Now available with outputs in the 6, 8, 12 and 18 MHz. bands (corresponding to 144 MHz. dial reading) for direct substitution of transmitting crystals. More output frequencies are being made available. Call us if you don't see what you need.
  - Entire frequency appears in-line in clear digits. No guesswork or mental additions. Thumbwheel switches provide fast, accurate selection of 1000 channels in 10 KHz. steps from 140.00 to 149.99 MHz.
  - 50 ohm output and impedance transformer kit allows use at any distance from transmitter.
  - Maintains an accuracy of .0005% (5 parts per million) over the entire range of -10° to +60° C. with a precision temperature compensated crystal that requires no oven. Operates at 5 MHz. for easy checking with WWV and includes a zero trimmer for correcting long term aging drift.
  - Fast response time of only 3 milliseconds for a 10 KHz. step change in frequency and a remote control, gated output amplifier for push-to-talk operation.
  - No hunting or false locks as with some other synthesizers.
  - Operates from 10 to 15 VDC. 3 precision regulators eliminate input voltage fluctuations. Can also be used on 110 volts AC with a small 12 volt 1/2 amp power supply.
  - Smallest size of any commercial synthesizer. Only 1-3/8" high, 3-5/8" wide, 8" long.
  - All IC's are mounted in high quality insulated sockets and all parts are marked.
- Manufactured by VANGUARD LABS renowned for quality since 1952.

NOTE: Our 45 MHz. receive synthesizers may be ready by the time you read this. Call us for details.

IMPORTANT: When ordering be sure to state the output frequency you want.

### PRE-AMPS

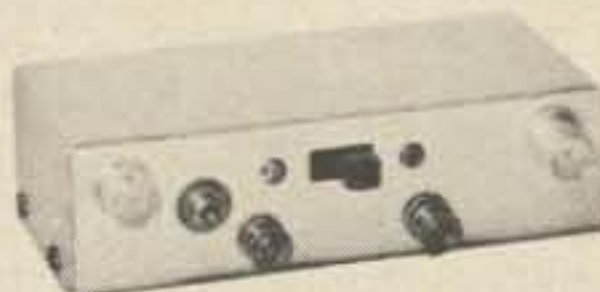

#### HIGH GAIN • LOW NOISE

35 dB power gain, 2.5-3.0 dB N.F. at 150 MHz, 2 stage, R.F. protected, dual-gate MOSFETS. Manual gain control and provision for AGC. 4-3/8" x 1-7/8" x 1-3/8" aluminum case with BNC receptacles and power switch. Available factory tuned to the frequency of your choice from 5 MHz to 350 MHz with approximately 3% bandwidth. Up to 10% B.W. available on special order.

Model 201 price:

5-200 MHz ..... \$24.95  
201-350 MHz ..... \$28.95

#### HOW TO ORDER:

All the items on this page are available only from Vanguard Labs. For receivers and converters, state model input and output frequencies and bandwidth were applicable. Remit in full, including sales tax if you reside in New York State, direct to Vanguard Labs. Prices include postage by regular parcel post. For air mail or special delivery include extra amount; excess will be refunded. Send money order or certified check for faster shipment.

### CONVERTERS



#### 40 dB GAIN 2.5-3.0 N.F. @ 150 MHz

2 RF stages with transient protected dual-gate MOSFETS give this converter the high gain and low noise you need for receiving very weak signals. The mixer stage is also a dual-gate MOSFET as it greatly reduces spurious mixing products - some by as much as 100 dB over that obtained with bipolar mixers. A bipolar oscillator using 3rd or 5th overtone plug-in crystals is followed by a harmonic bandpass filter, and where necessary an additional amplifier is used to assure the correct amount of drive to the mixer. Available in your choice of input frequencies from 5-350 MHz and with any output you choose within this range. The usable bandwidth is approx. 3% of the input frequency with a maximum of 4 MHz. Wider bandwidths are available on special order. Although any frequency combination is possible (including converting up) best results are obtained if you choose an output frequency not more than 1/3 or less than 1/20 of the input frequency. Enclosed in a 4-3/8" x 3" x 1-1/4" aluminum case with BNC receptacles, power and antenna transfer switch. Thousands of our converters are now in use by satisfied customers, many of whom are government agencies and universities.

Model 407 price:

5-200 MHz ..... \$49.95  
201-350 MHz ..... \$54.95  
Prices include .005% crystal. Additional crystals \$5.95 each.

### VHF FM RECEIVER

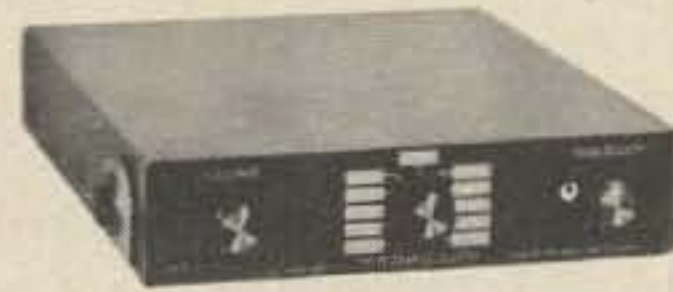

#### 11 CHANNELS • 135-250 MHz

• 11 crystal-controlled channels • Available in your choice of frequencies from 135-250 MHz in any one segment from 1-4 MHz wide • I.F. bandwidth (channel selectivity) available in your choice of ±7.5 kHz or ±15 kHz. • 8-pole quartz filter and a 4-pole ceramic filter gives more than 80 dB rejection at 2X channel bandwidth • Frequency trimmers for each crystal • .2 to .3 μvolt for 20 dB quieting • Dual-gate MOSFETS and integrated circuits • Self-contained speaker and external speaker jack • Mobile mount and tilt stand • Anodized aluminum case, 6" x 7" x 1-3/8".

Model FMR-250-11 price:

135-180 MHz ..... \$119.95  
181-250 MHz ..... \$129.95  
Price includes one .001% crystal. Additional crystals \$6.95 each.

# VANGUARD LABS

Call 212 468-2720 for fast C.O.D. shipment.

196-23 JAMAICA AVE. HOLLIS, N.Y. 11423

# LOW COST FM DEVIATION METER

**M**ost electronic experimenters have a lot in common. They like to own test gear, have limited funds, like to be original and have a hard time finishing one project before their mind wanders off to a new one. Another thing is that they may not really need the piece of gear they set out to build. Nevertheless, the junk box is usually raided (along with the bank account) and the curiosity is generally satisfied. With this kind of background it is little wonder that I set out to build an FM deviation meter without even owning an FM rig. The fascination provided by exploring different possibilities of design at minimum cost presented too much temptation to resist. The result of this madness is the following unit, a lot of lost sleep and a few more gray hairs.

The search for a low cost FM deviation meter started with the idea that the low cost hand held Public Service Band receivers might offer an approach to the problem. The possibility of easily retuning those 30 to 50 MHz and 146 to 175 MHz receivers to 6 and 2 meters evoked promise. Another possibility was by tuning to the frequencies of the multiplier stages of 220 and 450 MHz transmitters, frequency deviation at their output could be determined by multiplying the value by the same amount the signal would be multiplied in the transmitter.

Investigation showed that the 10.7 MHz i-f discriminator output voltage change was very small (as expected). In addition, the 1:1 receiver dial would make it hard to center the received signal at the crossover point of



*The deviation meter makes a neat portable package that is an invaluable aid to anyone on FM.*

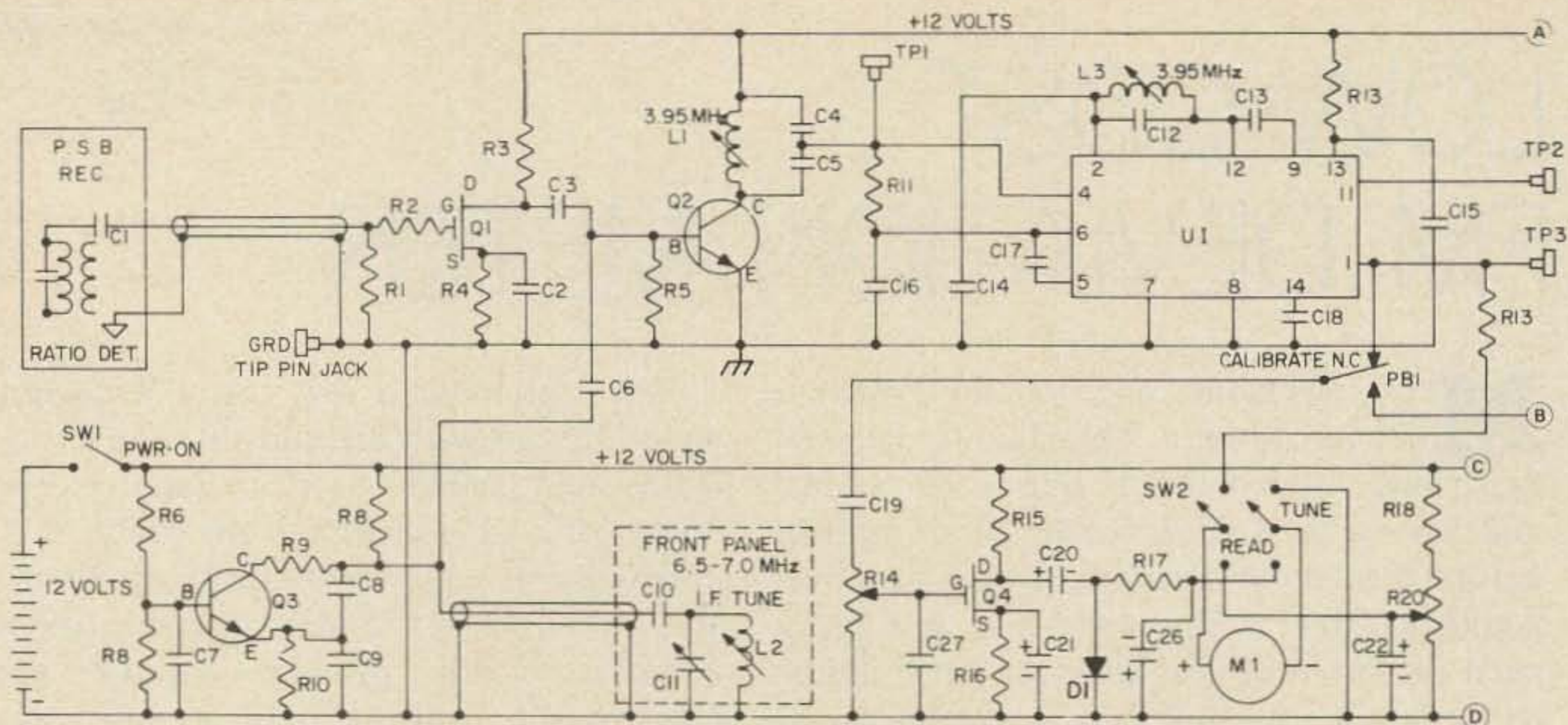

Fig. 1. Schematic of the deviation meter.

the ratio detector. This is important in order to get repetitive results. Even though the transmitter to be checked would be close by, the possibility exists that another nearby transmitter could upset the output of the ratio detector and upset the reading. The decision to add another tuneable converter after the 10.7 MHz i-f solved some problems with the following results:

1. Difficulty in tuning the signal was eliminated. Any signal heard through the receiver is heterodyned down to the 3.95 MHz range. The conversion oscillator tuning rate is much better.
2. Other signals which might appear in the 10.7 MHz range are attenuated.
3. By using an intermediate frequency inside an amateur band, the calibration is easier.
4. The output voltage per kHz deviation is much greater.

For the unit in Fig. 1, a 146 to 175 MHz P.S.B. receiver (usually found at hamfests) was used. The 10.7 MHz i-f signal is tapped off the primary winding of the ratio detector transformer through a small coupling capacitor and shielded lead. Due to the very small coupling capacitor the de-tuning effect is minimal. The signal is amplified by transistor Q1. Its purpose is to regain some of the signal lost by the capacitive voltage divider action of C1 and the shielded lead capacitance. In addition, it helps to isolate the vfo from the receiver and furnishes a low impedance source for mixer stage Q2. The vfo tuning range is 6.5 to 7.0 MHz to hetero-

dyne the incoming 10.7 MHz signals to 3.950 MHz. The ULN211A integrated circuit is a combination limiter amplifier and quadrature detector operating at 3.95 MHz. Transistor Q4 functions as an ac amplifier for driving the rectifier and meter circuit. Control R20 is used to provide a small forward bias voltage for D1. This greatly improves the linearity of the meter at the low end of its scale. Transistor Q5 functions as a 1 kHz audio oscillator. Its output is used to modulate the transmitter requiring adjustment. It is also helpful for checking the ac voltmeter section or whenever a low level 1 kHz signal is needed. The whole unit is powered by 8 C cell flashlight batteries. The current drain is approximately 30 mA. Smaller batteries may be used.

When using the meter it is only necessary to tune the signal on the receiver until it is heard in the speaker. Next, vary C11 (i-f tuning) and center the signal with meter M1 in the center of the "S" curve (see Fig. 3) with SW3 in the "tune" position. Switch SW3 to "read." By using the audio from jack J1 to modulate the transmitter, the clipping level may be read.

### Construction

The unit is built in a 6 x 9 x 5 in. Bud utility cabinet fitted with rubber feet and a carrying handle. The receiver is bolted to the front panel. The receiver can be removed for servicing by unsnapping it from its case. Black plastic tape around the seam of the



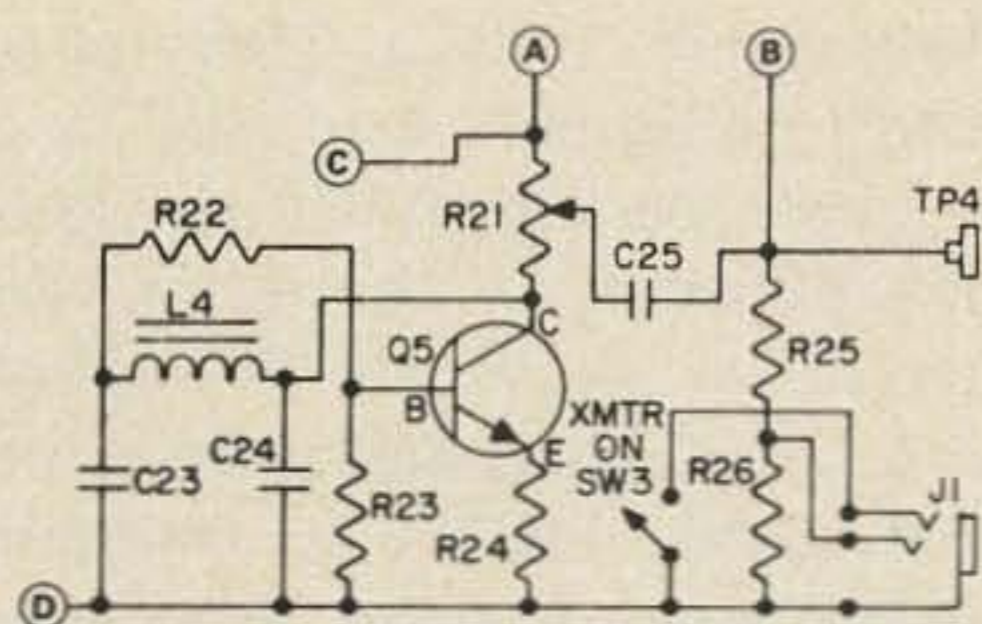

### PARTS LIST

R1, 13	100K
R2	100Ω
R3	1K
R4	150Ω
R5	47K
R6, 16, 17, 18	4.7K
R7, 8	1.5K
R9	27Ω
R11, 12, 23	330Ω
R12	47Ω
R14	1M pot.
R15, 24	10K
R20	1K pot.
R21	2K pot.
R22	2.2K
R25	470Ω
C1	10 pF
C2, 17	.01 μF
C3, 6, 10	50 pF
C4	1000 pF mica
C5, 8	250 pF mica
C9	470 pF mica
C11	100 pF variable
C12	200 pF mica
C13	4.7 pF
C7, 14, 15, 16, 17, 19	.1 μF
C20	10 μF 25V
C21, 23, 25	.47 μF 25V
C22, 26	100 μF 25V
C24	1 μF 25V non polarized
C27	100 pF
D1	1N34A
Q1, 4	HEP 802
Q2, 3, 5	2N706
L1, 3	40T no. 34 3/8" diameter (Miller 4406)
L2	22T no. 26 3/8" diameter (Miller 4405)
L4	88 mH toroid
SW1, 3	SPST toggle
SW2	DPDT toggle
M1	0-100 μA
U1	ULN2111A IC (Sprague)
GND	Black tip jack
TP1-4	Red tip jacks
PB1	N.C. pushbutton
J1	3 circuit jack

case prevents the receiver from accidentally coming apart. Prior to mounting the receiver to the front panel, the i-f output lead should be installed. This consists of capacitor C1 connected at the top of the primary winding of the 10.7 MHz ratio detector transformer. The opposite side of C1 connects to the center of a length of very small diameter shielded wire or coax. The shield is connected to the circuit ground in the receiver. Having a schematic of the receiver will help you locate the correct point at which to connect C1. Lacking this, it is possible to determine the correct point by using an rf probe or high frequency scope with a low capacity probe. Look for the point of highest signal level at the last i-f transformer when tuned to a nearby transmitter. Check that the signal disappears when the transmitter is turned off. Also check for dc collector voltage at this point to make sure you have the primary and not the secondary or tertiary winding of the ratio detector transformer. Drill a hole through the rear cover of the receiver just large enough to clear the small shielded lead. Control R21 and capacitor C11 are mounted to the front panel. All other controls are of the screw driver adjusted type and mounted on the circuit board. The meter, jack J1 and switches SW1, 2, and 3 are the only other components fastened to the front panel. Not having the patience to design PC boards, the circuit was built on vector board. The only precautions are that shielded leads should be only as long as necessary and that L1 and L3 be separated to reduce any tendency for the IC to oscillate.

### Testing and Alignment

Prior to applying power to the unit it is wise to check for shorts with the integrated circuit unplugged. Operate the power switch. Connect the common lead of an oscilloscope to the ground jack and TP4 to the vertical input lead. The output of the 1 kHz oscillator should be viewed when the audio control (R21) is advanced. Return the control to zero output.

In order to calibrate the meter it is necessary to make a new scale. At this point it must be decided what the maximum deviation will be. Should indications in

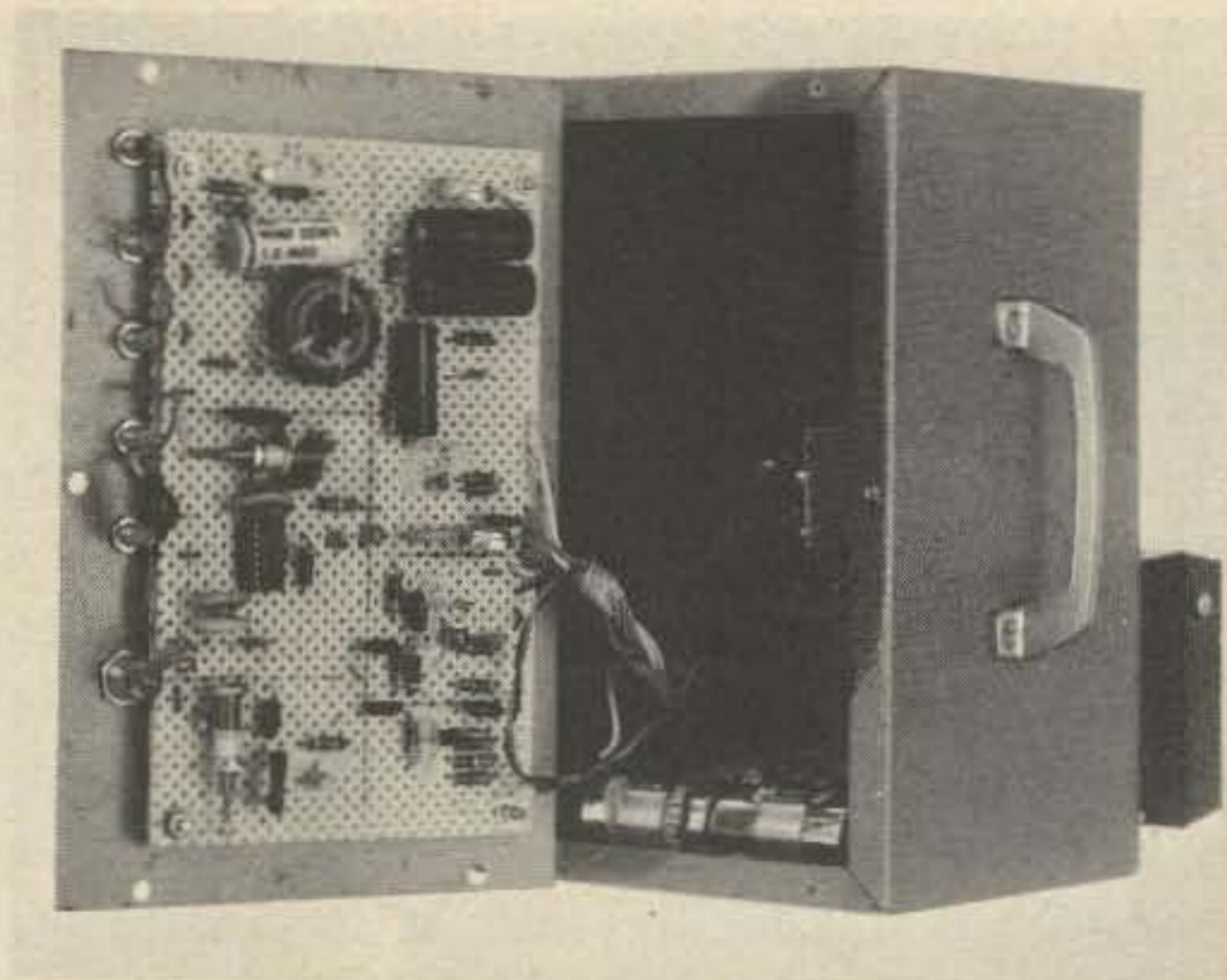

The circuit board is mounted on the back panel of the cabinet with the test jacks along the top.

excess of 15 kHz be desired, it will be necessary to check the linearity of the particular quadrature detector. This is good to do in any case. To increase the linearity it will be necessary to empirically shunt L3 with high values of resistance until the desired linearity is achieved. In my case I chose 15 kHz because the linearity is very good and most transmitters are adjusted to deviations within this range. With the deviation being proportional to the output voltage shift of the IC, it is only necessary to calibrate the meter as an ac voltmeter. This is done by feeding a known signal into the Q4 ac amplifier with SW2 in the read position. Before introducing the signal set control R20. (This is done by setting R14 toward its ground end. Slowly advance R20 until there is a barely perceptible movement off of mechanical zero.) Monitor the input of Q4 with an oscilloscope (or other suitable means). Use TP3 with an external oscillator at 1 kHz or TP4 with the calibrate push button held down, to introduce signal. Introduce a suitable signal (up to 2V peak to peak) as monitored on the scope. Set the scope gain so the signal occupies the same number of divisions on the scope as kHz you wish to indicate. Advance control R14 until the meter indicates full scale. By reducing the oscillator output and noting the scope readings, intermediate points on the scale may be calibrated. Next set the vfo to frequency by tuning a 40m receiver to 7.0 MHz. Set the oscillator capacitor C11 to approximately one quarter meshed. Tune

inductor L2 until the vfo is heard in the receiver.

In subsequent tests a 75m transmitter connected to a dummy load may be used as a signal source. An unmodulated rf generator may also be used. In the latter case, the introduction of signal to TP1 should be through a coupling capacitor. In either case the signal should always be maintained at the limiting level or above unless otherwise noted. When using the transmitter as a signal source, start with the drive control at minimum to avoid damage to the semiconductors. If you cannot get enough pickup with this method, attach a short radiator to the center lead of the coaxial cable feeding the dummy load. The 1 kHz oscillator output is adequate for setting the control R14 up to 20 kHz deviation on the meter. Should you desire the full-scale reading of the meter to read above this value, check at a lesser deviation (i.e., 5 kHz on the meter scale). If a wide band oscilloscope is to be used it may be necessary to bypass the input leads to keep rf patterns out.

Disable the vfo by shorting out capacitor C7. If the IC is not in its socket, temporarily remove power while it is installed. Set switch SW2 to the "tune" position. The meter should read approximately one-half scale. Connect a test lead or short piece of wire to TP1. Tune your transmitter up on 3.950 MHz in the CW mode so the output can be easily varied. Connect a VTVM with rf probe (or wideband oscilloscope) from the gnd jack and TP2. Using the lowest range on the VTVM, couple just enough energy from the transmitter to get a reading. Inductor L3 may now be tuned for maximum indication while keeping the input level below the limiting level of the IC. It will be noted that the meter in the unit behaves like a zero-

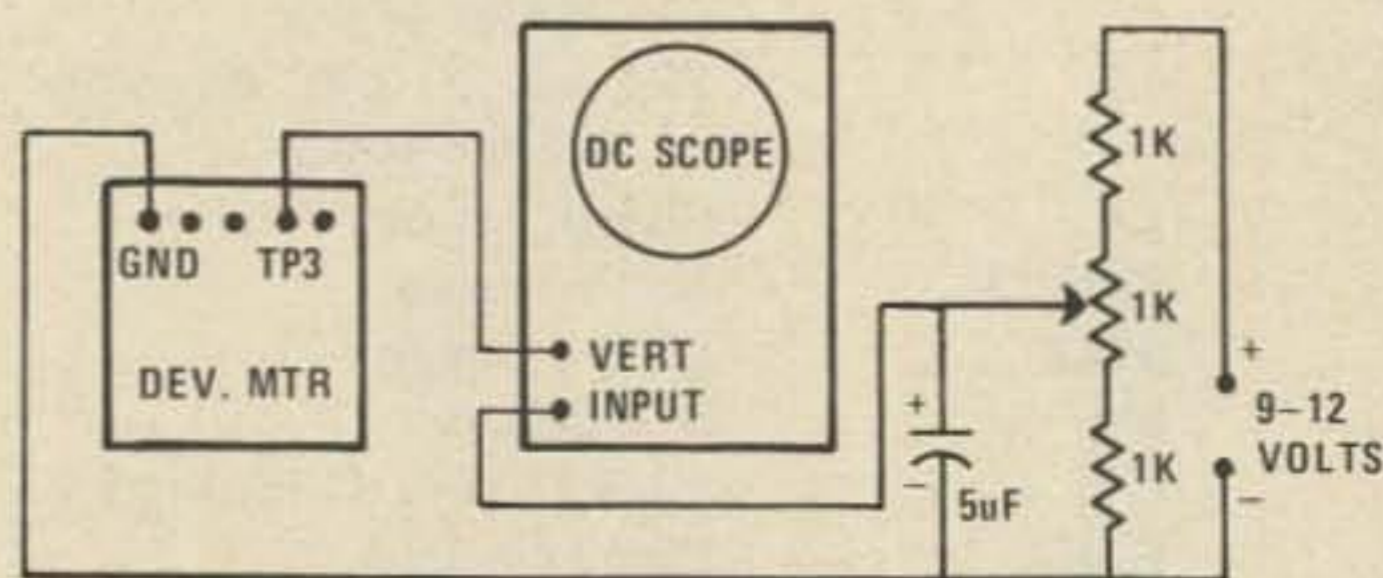

Fig. 2. Calibration circuit. Complete instructions are given in the text.

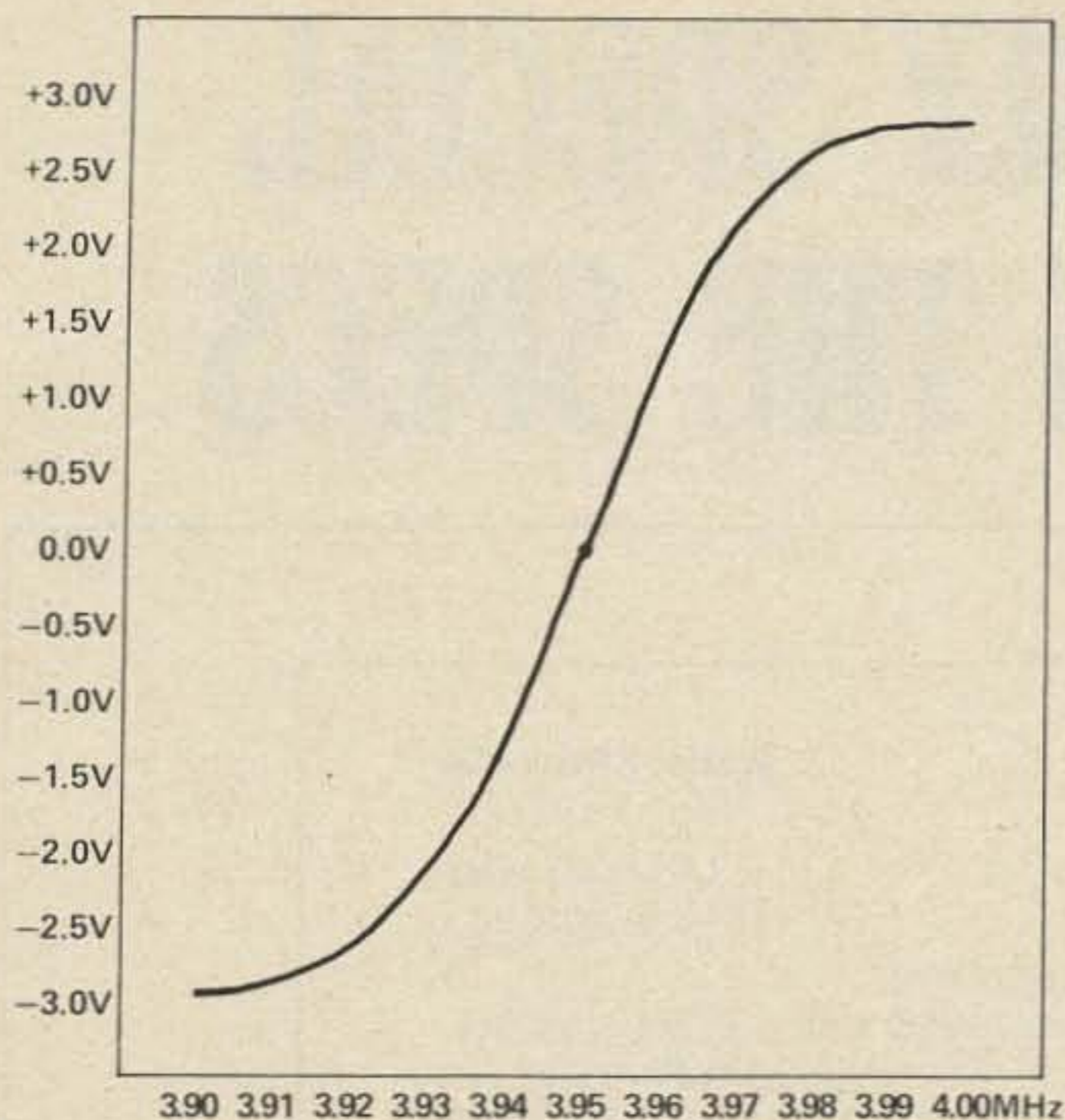

Fig. 3. Response curve of the quadrature detector without any resistance shunting coil L3. Zero voltage represents the quiescent state of the IC measured at TP3. This is the level to which all other points on the curve are referenced to.

center meter monitoring a discriminator "S" tuning characteristics. L3 should be tuned for the center of the "S" curve (same meter reading as before signal was introduced).

Remove the power and connect the test circuit shown in Fig. 2. The scope must have a dc vertical amplifier. Before applying the power again, set the oscilloscope trace to the zero line with the dc amplifier on and with no signal applied (transmitter on standby) operate the "power" and "read" switches of the deviation meter and apply power to the test circuit. The oscilloscope trace will probably move from the zero line. Return it by using the 1K potentiometer of the test circuit. Turn the transmitter on and slowly raise the output level until the rf voltmeter connected to TP2 indicates the limiting level has been reached. It may be necessary to retune L3 if the scope trace is not on the zero line. Vary the transmitter frequency above and below the center frequency the amount corresponding to the maximum frequency deviation you desire to read. It is desirable to set the scope vertical gain so this deviation moves the scope trace an even number of squares. Note the amount the trace moved. Without moving the scope

vertical gain adjustment and switching to its ac amplifier, the trace should again move to the zero line. Turn the transmitter off. Move the scope lead to TP4 and adjust the audio output control R21 so the negative and positive peaks coincide with trace excursions just noted. Depress the calibrate pushbutton and adjust R14 to read the deviation. Should the audio level be insufficient, adjust for a lesser deviation such as setting the audio level to one-half of what is required and calibrating the meter to one-half of full scale. Release the calibrate push-button and set switch SW2 to tune position. The meter should read somewhere in its mid-range. As a further check, the transmitter output can again be increased to the limiting level. The meter needle should move above and below the center as the transmitter is moved above and below 3.950 MHz.

All that is left to do now is to peak L1 to 3.95 MHz. With the output of the transmitter reduced to zero, connect one end of a test lead to the junction of R1 and R2. Slowly increase the transmitter output to get an indication on the rf voltmeter connected to TP2. Peak inductor L1. You can now remove all connections. The meter should be operational.

The term "calibrate" is a misnomer to some extent as the instrument does not contain a standard. However, if the value of signal was checked at TP4 with an ac VTVM and recorded when R14 was set, it should be easy to recheck M1 using the same ac VTVM (connected to TP4) calibrate pushbutton.

### Conclusion

No doubt the design could be changed to provide such features as peak deviation indication (instantaneous peak indication may be viewed with a scope at TP3) but the original intent was to construct an adjusting tool, not a monitor. As with all projects there is a lot of hindsight and plenty of second guessing. The fact this particular mixer used functions as a noise generator gives rise to this kind of thinking. Even though this does not present a problem (as the meter is used only on strong signals), I cannot help wondering if a Mark II model is not in the offing.

...W9HD

# CONSIDERABLY SPECIAL CONSIDERING THE SPECS

## 2 METER FM TRANSCEIVER

Model SRC-146A



Frequency . . . . . 143-149 MHz  
(2MHz spread)  
Number of channels . . . . . 5  
Supplied with 146.94 simplex,  
146.34 / .94 (same plug in  
crystals as SR-C826M)  
R.F. output . . . . . 2 watt minimum  
Sensitivity . . . . . better than 0.4  
uv / 20 DB Q.S.  
Audio output . . . . . 500 mw  
Meter . . . . . monitors battery voltage on  
Tx, S Meter on Rx  
Current drain . . . . . 620 ma Tx,  
15 ma Rx standby  
Size . . . . . 8<sup>3</sup>/<sub>8</sub>" high x 3" wide x 1<sup>5</sup>/<sub>8</sub>" deep  
Weight . . . . . 24 oz., less batteries

Options: *Private channel (CTCSS), external mic, or mic-speaker, stubby flexible antenna, desk top charger, leather case.*

# \$289 00

**Suggested  
Amateur  
Net Price**

## NEW 2 METER REPEATER

SCA-RPT-1

All solid state, 2M, 10W, FM  
REPEATER. Built-in C.O.R., adjustable  
carrier delay and time out timer.



*Write for complete specifications and cost.*



**Standard**  
COMMUNICATIONS CORP.

213 / 775-6284 · 639 North Marine Avenue, Wilmington, California 90744

The RCA insulated and protected dual-gate metallic oxide semiconductor field effect transistor type 40841 is quite a device. I don't work for RCA but I am quite fond of their products as you can gather. This device has up to 32 dB gain as an rf amplifier at 44 MHz and is useful up to 500 MHz without neutralization. It also features a low noise figure.

In the course of using them in the rf and mixer stages of a two meter FM receiver recently (see 73, December 1972) I encountered a few things which cannot fail to be of interest to the homebrewer. They were new to me, and I have lately turned the half century mark in my electronics experience.

In case you are not familiar with the 40841, here is some information: It is intended for use from dc to 500 MHz and has a wide dynamic range, which is good for busy channels crowded with loud signals and weak ones, and has low cross-modulation performance over the agc range, which is a good item if your neighbor has a KW. The gate no. 2 acts as a shield between gate no. 1 and the drain, similar to the screen grid effect in tubes, and helps eliminate the need for neutralizing. It requires negligible power for agc, its input impedance is high and is little affected by agc action and therefore the tuning doesn't change much. The back-to-back internal diodes clamp at about ten volts, protecting the gates and cutting off large noise transients too.

Their price is not what you might expect for all that performance, as they sell for under a buck in quantity!

You should probably order several when you buy, as they are only sample tested at that price, and you should then test them yourself. In spite of this, I have found no bad ones in about 50 so far. If you've got the money, buy 3N200's, which are a little better, and are all tested (but you'll have to pay four times as much). They are good for amplifiers, oscillators, mixers, video amps, dif-amps, frequency multipliers, and a lot more.

Figure 1 shows the rf amplifier in pictorial form in case you want to build a quickie. It will show a large gain right away, around 30 dB, or one thousand times in

Bill Hoisington K1CLL  
Farover Farm  
Peterborough NH 03458

# TAMING THOSE HOT 500MHz FETS FOR 2M FM

*Working with high gain FET's on 2 meters can be a problem unless you know what to expect. K1CLL provides good working knowledge.*

plain English. With reasonable bypassing, no self oscillation will occur at 147 MHz, and tuning will be good and straightforward. However, several small peculiarities were noted, one happening when C2 was operated quite a way from the 147 resonance point, a click being heard. Note that I like to measure, look, and listen to what goes on when I'm working on a new circuit. This takes an rf voltmeter, a small scope, an af amplifier, and a small speaker. It is well worth the trouble. Without listening, for example, this little demon wouldn't have shown up until later — probably the first time you turned it on after installing it all in

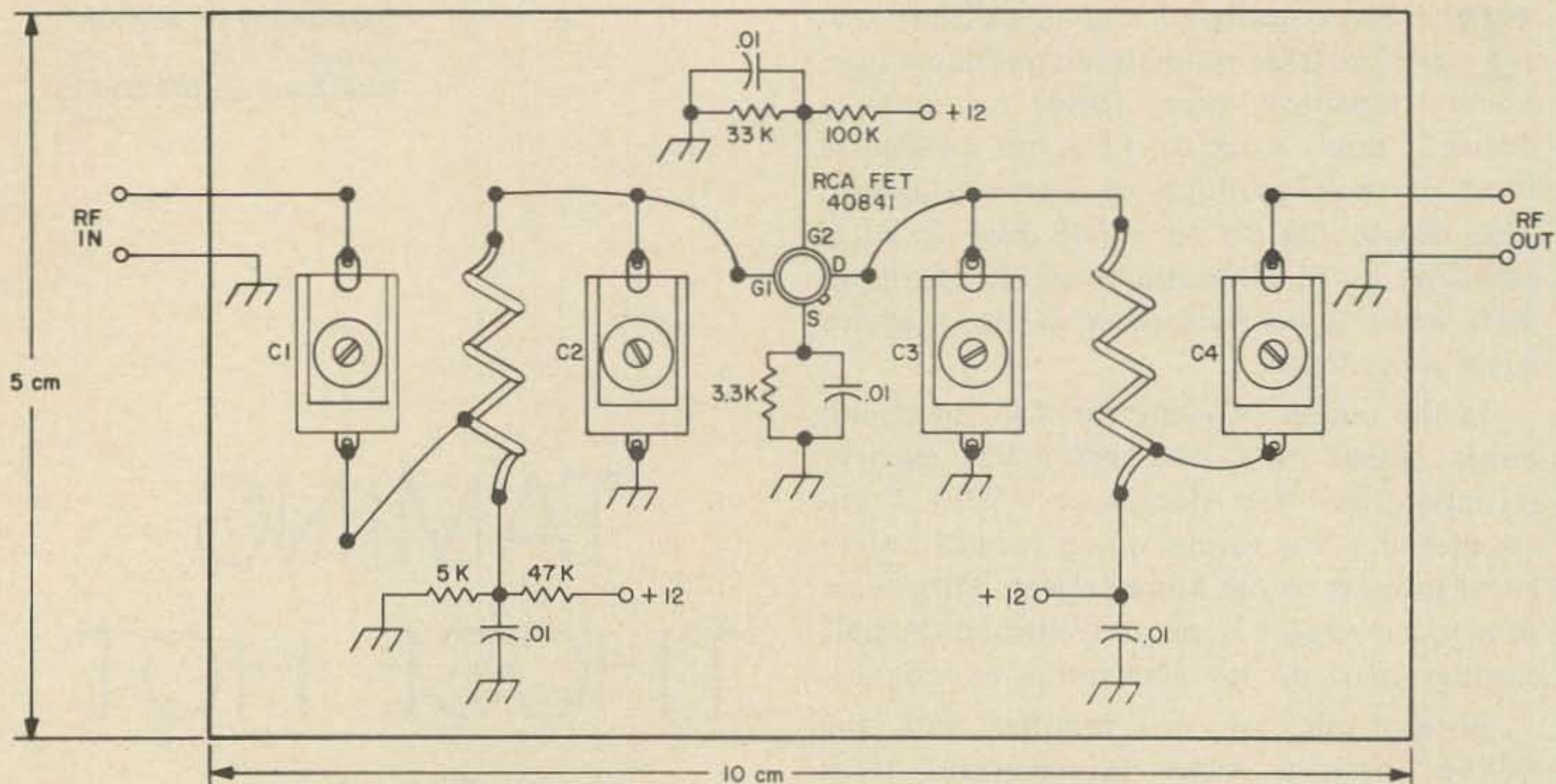

Fig. 1. Top view of the rf amplifier assembled on a copper-clad circuit board. L1 and L2 are 5 turns No. 18, 2 cm long, 1 cm diam., tapped at 1½ turns from cold end. Note: When installing C2 and C3, position adjusting screw at ground side. All trimmers 1–12 pF, ARCO 420.

a metal cabinet! Using these three facilities it was found that the “click” was in reality 600 MHz power being detected by L.O. harmonics as it swept by. UHF oscillation causes nasty things to happen. Your rf stage and mixer become noisy and unreliable and your i-f tuning meter takes off. This is very difficult to find and trouble-shoot, but well worthwhile getting rid of. You see, if you want really good filtering action, for 147 and against other frequencies, you should tune L1 and L2 to 147 in good style, which is done with C2 and C3. Elementary, of course, but then what happens? The same thing that I have seen in a good af amplifier, which oscillated at 200 MHz, and in my Gonset Communicator 3, which — brand new and straight from the factory — had 500 MHz oscillation in the plate circuit of the cascode stage. I cured that one with a 1 pF capacitor. Remember tubes? In this case C2 and C3 resonated the FET to 600 MHz, with L1 and L2 merely acting as rf chokes. This action was not easy to cure, and it took me most of a weekend, so I’m passing the dope on to you hoping it will save you time and trouble. If it gave me a headache after fifty years of electronics, I defy a newcomer to lick it easily, except maybe by luck, or compromise, which is not good.

After replacing the 147 MHz tuned diode detector testing unit I was using with a 400 to 600 MHz one, sure enough, lots of 600 MHz power was found. A zero to ten mA meter was put in the drain circuit and showed a rise from 8 mA up to 9.5 mA when watched carefully. I was pushing the mils to make the trouble show up more. Normally around 4 to 5 mils of current is used. With various sized small metallic probes, the short grounded portions of C2 and C3 were found to be very touchy at 600 MHz, a sure confirmation of UHF power being present. Unwanted in this case, to say the least.

You may have seen commercial circuits with a three hundred ohm resistor in the collector line going to the tuned circuit. This may stop spurious, but does that satisfy

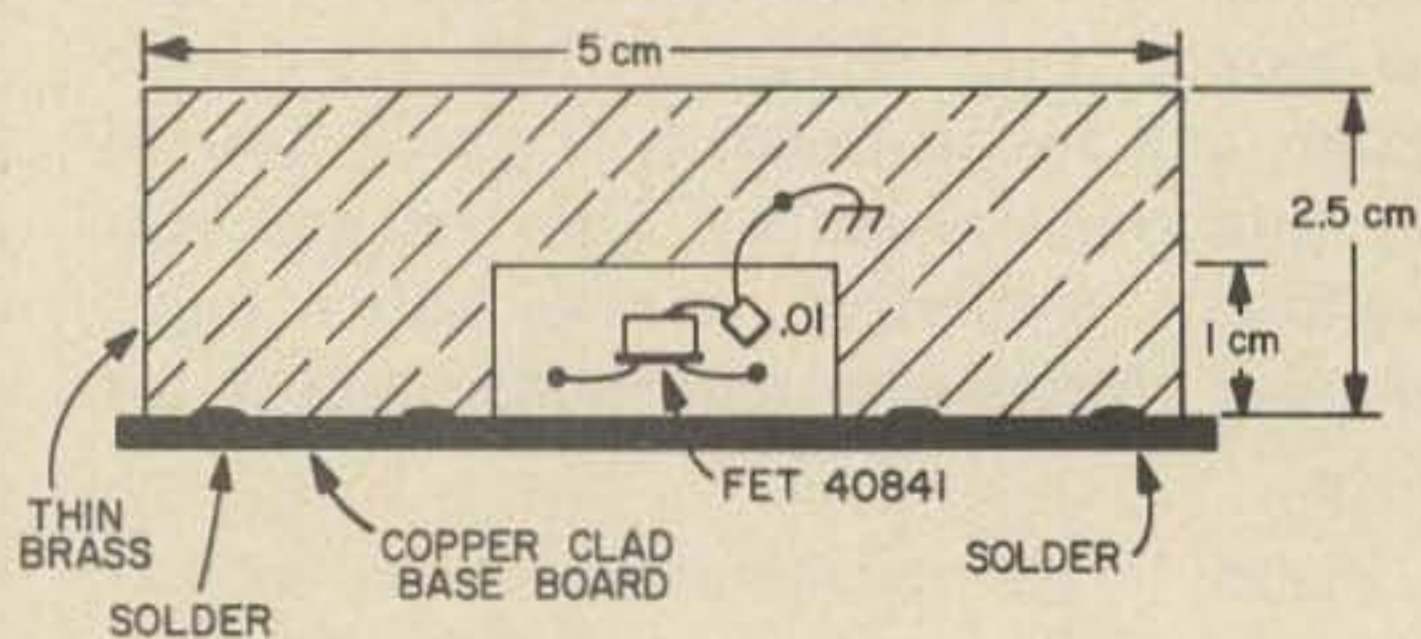

Fig. 2. Side view of the rf stage after the shield has been added.

you? If so, read no further. If you want to know the real dope, read on. It finally boiled down to the same old story, only more so. The source, which is the FET element corresponding to the emitter of an old fashioned bipolar transistor, or the cathode in days of yore, simply needed a lot more careful UHF bypassing, and C2 and C3 needed a little shielding from each other. A thin brass sheet ridged over the FET output lead (drain), as shown in Fig. 2, kept C2 from receiving feedback from C3. A small bypass (.01) was then soldered to the case of the FET and connected to the shield, as shown in Figs. 2 and 3. That was it! Luckily the FET is made mostly of silicon and also that the case is internally connected to the source. You can use a small homemade clamp, solder the .01 to it first, then put it on the case of the FET if you're the ultra-careful type. No UHF oscillation has been found since then in these amplifiers. On 147 there has never been any, so you are left with a good stable unit.

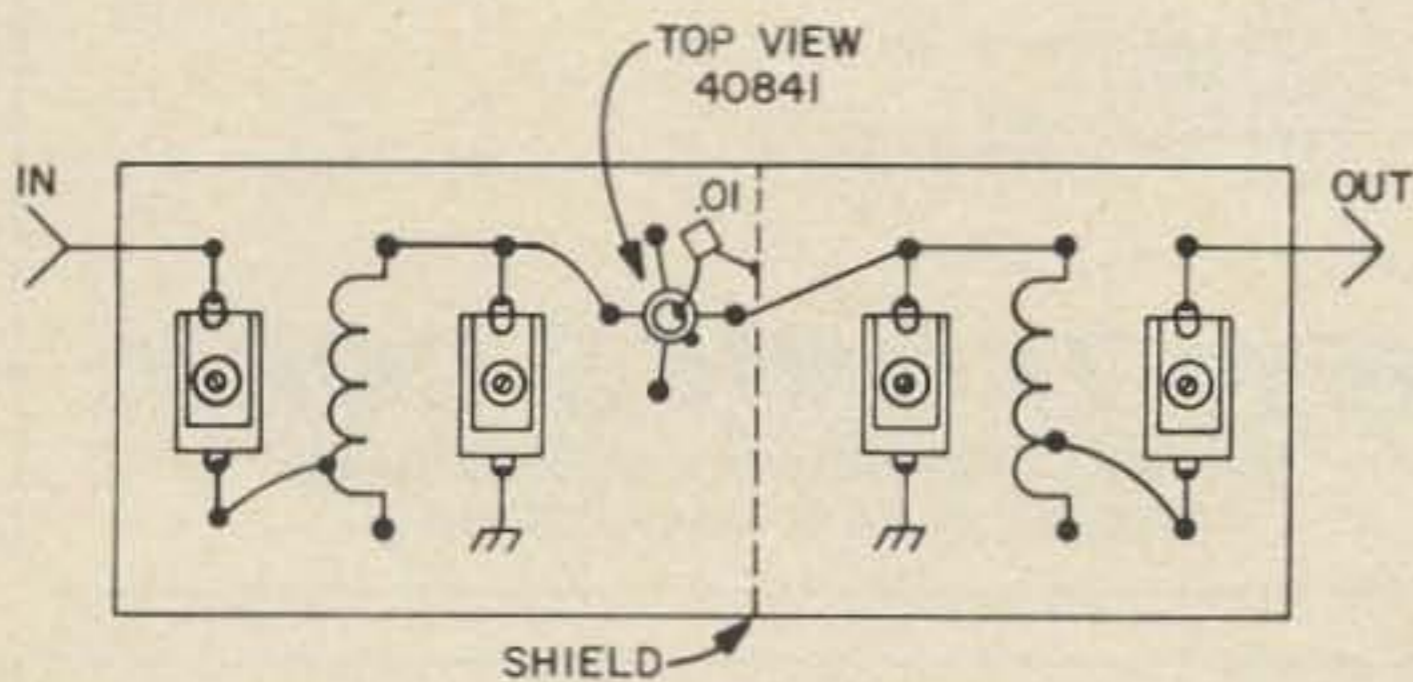

Fig. 3. Top view of the rf stage indicating the position of the shield and the .01 bypass.

Again, note that this effect is a particularly treacherous one. It does not show up on 147 as oscillation, but renders life miserable through its side effects of noise and on the i-f performance. There is an odd tunable rise on the tuning meter, excess noise, and BFO-like sounds in the output.

With two stages of this "battened-down" rf, the gain is terrific at 147 MHz, perhaps more than you may need. Just put in one of those little square trim pots (500 ohms or 1K) in the source lead and you can live happily with everything quiet, band-filtering action of 5 good tuned circuits on 147 MHz, and controlled rf gain.

...K1CLL



# Hobby Industry



DON'T FOOL AROUND -!  
Ask about my

HI-SAVINGS PLAN-SAVE \$

NO FOOLING! Real Bargains  
GREAT performance-521  
Astatic:Hi-Z ceramic &  
coil cord, PTT. \$5.95 post  
paid in the USA.



AMECO 2 meter  
filter reduces  
TVI and receiver  
cross-mod. A  
value at \$9.95  
p. paid.

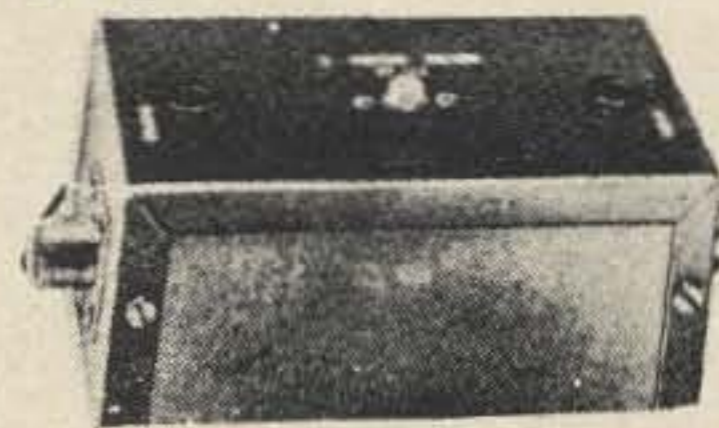

### NOVICE -VFO

Wired, solid-state modules  
to make a VFO/QRP Xmtr.  
As low as \$17.40, less case  
etc.

Especially for "hams"



CALL: Tues./Sat.-Noon/5PM  
Al McMillan WØJJK  
(712) 323-0142

WRITE: HOBBY INDUSTRY  
4ST Box 864  
Council Bluffs, Iowa - 51501

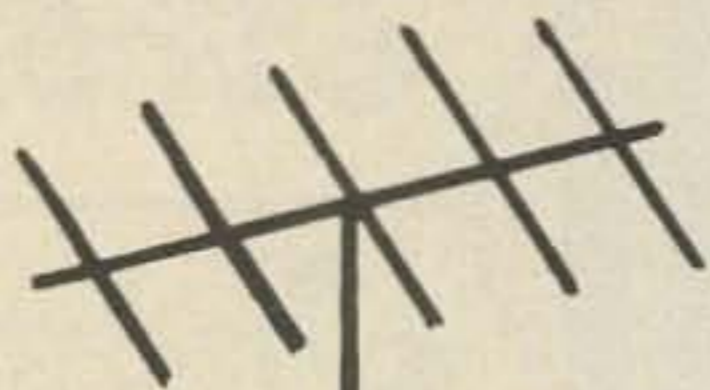

# THE HAM SHACK

**2 METER FM . . . .**  
Complete Stocks . . . All Major Brands  
We're Trading High . . . Get Our Quote!

## Two Meter—5.2 db Power Gain Colinear Mobile Antenna

- ! 5.2 db gain over 1/4 wave ground plane
- ! SWR at resonance . . . typically 1.1:1
- ! Bandwidth . . . 7 MHz for 1.5:1 or better SWR
- ! Power Rating . . . 200 watts FM
- ! Height, including mount . . . 78"
- ! Radiator . . . 17-7 PH stainless steel
- ! Field adjustable for lowest SWR

### CHOOSE FROM TWO VERSIONS

**MODEL CGT-144** (illustrated) antenna complete with trunk lip mount for easy, no holes installation on side or edge of trunk lip. 180° swivel included for adjustment of antenna to absolute vertical. Supplied operational with 17' MIL spec RG-58-U and PL-259 transceiver connector factory attached. Antenna is removable from mount. Shpg. Wt. 3.34 lbs. **\$36.95**

**MODEL CG-144**—Antenna only with 3/8"-24 base to fit all standard mobile ball mounts. Shpg. Wt. 1.84 lbs. **\$24.95**

Create a vast improvement in your two meter performance! Get the advantage of 6 db gain transmitting—6 db gain receiving. Both are yours in the Hustler Model G6-144, the antenna designed to establish who is who on two meters.

**MODEL G6-144 . . . \$39.95**

### ELECTRICAL:

- 6 db gain over 1/4 wave ground plane
- Omnidirectional radiation pattern
- 50 ohm feed impedance
- Field adjustable
- SWR at resonance — typically 1.1:1
- 6 MHz bandwidth for 1.5:1 or better SWR
- Power rating—250 watts FM

## **NEW-TRONICS CORP.**

15800 COMMERCE PARK DRIVE  
BROOK PARK, OHIO 44142

### CRYSTALS

Immediate Shipment on Crystals for  
Regency Drake SBE  
Standard  
**\$3.50 each**

*Nearly all frequencies in stock. Please add  
50¢ per total order for postage and handling.*

Florida residents add 4% tax.

Mail Orders Shipped Promptly  
Anywhere. LET'S TRADE!

Factory Authorized SALES &  
SERVICE All Major Ham Lines.

TOP TRADE-IN — MASTER CHARGE CREDIT  
"Buy it from Bill" at

# THE HAM SHACK

2116 BEE RIDGE RD. SARASOTA, FLA. 33579

Bill — WB4JFK (813) 921-4602



# TWO MORE TWO METER AMPLIFIERS

In the December issue of 73, I described an amplifier that would deliver 25 watts output when driven with 5 to 7 watts. In this article, I am presenting two more inexpensive amplifiers that, when used together, can take 100 milliwatts and amplify it to about 7 watts – enough to drive the 25 watt amplifier. If you want, you can eliminate the first stage and get 25 watts output when driving the last two stages with a 1 watt rig, such as the TR-22. All of the three amplifiers are suitable for loading into a 52 ohm antenna or another amplifier, so you have several options that you can take, depending on available drive and desired output.

Amplifier No. 1 is easy and very inexpensive to build. It takes 60 to 120 milliwatts and puts out from 1 to 1.6 watts. Be sure to keep the drive from exceeding 120 milliwatts. I built mine on a piece of single sided glass epoxy board. All parts go on the copper side except for Q, which mounts flat

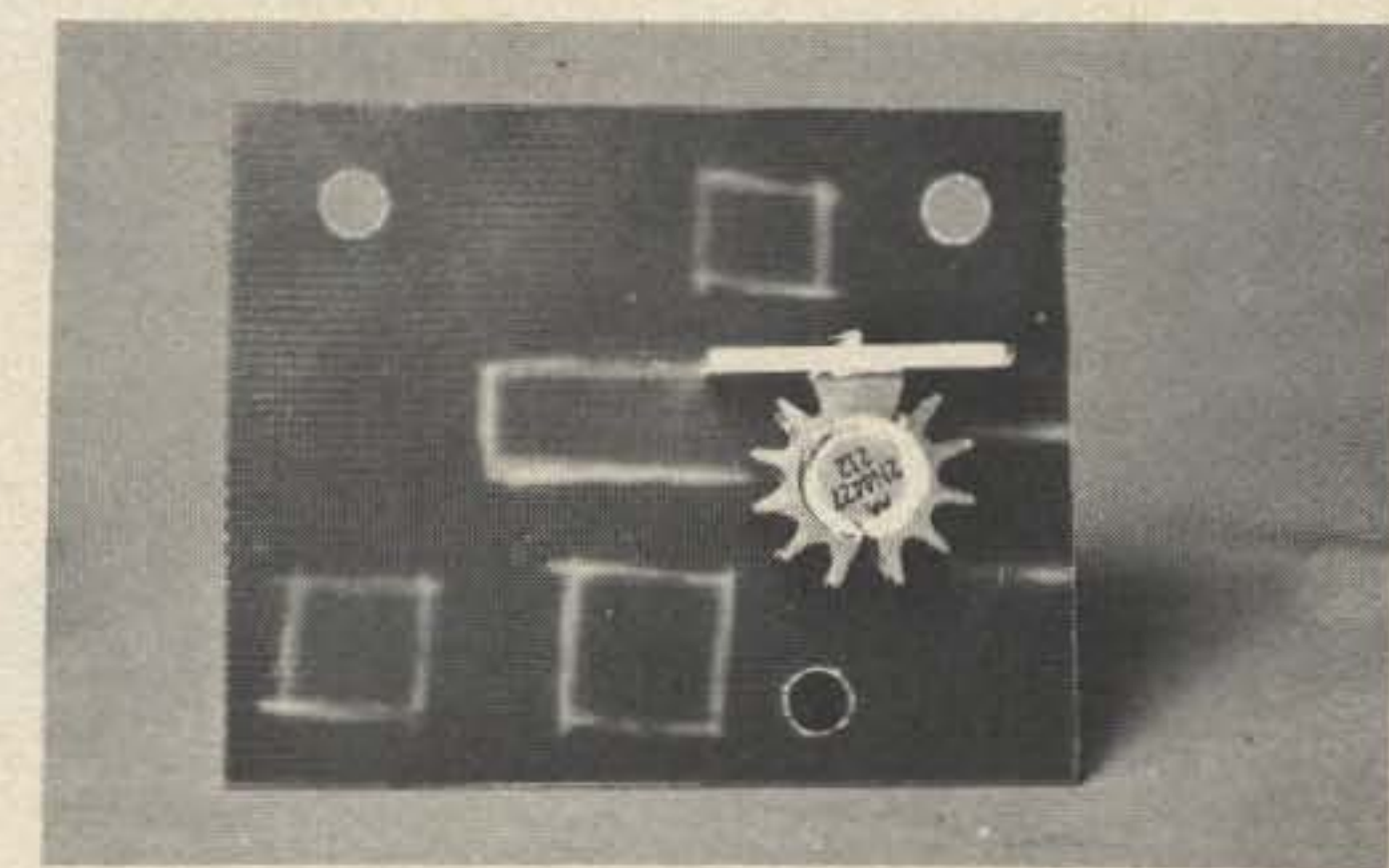

Bottom of the 1 watt amplifier showing the transistor and its heat sink.

against the other side with its heat sink. I used a HEP 502 heat sink. It kept the transistor cool enough after two hours operation, but I added a small strip of aluminum to be extra sure. The 2N4427 is a very rugged device, and is used as a driver in the HR-2, RMV, and several other transmitters. I must admit that I used some ideas from W9ZTK's article in the July issue of 73

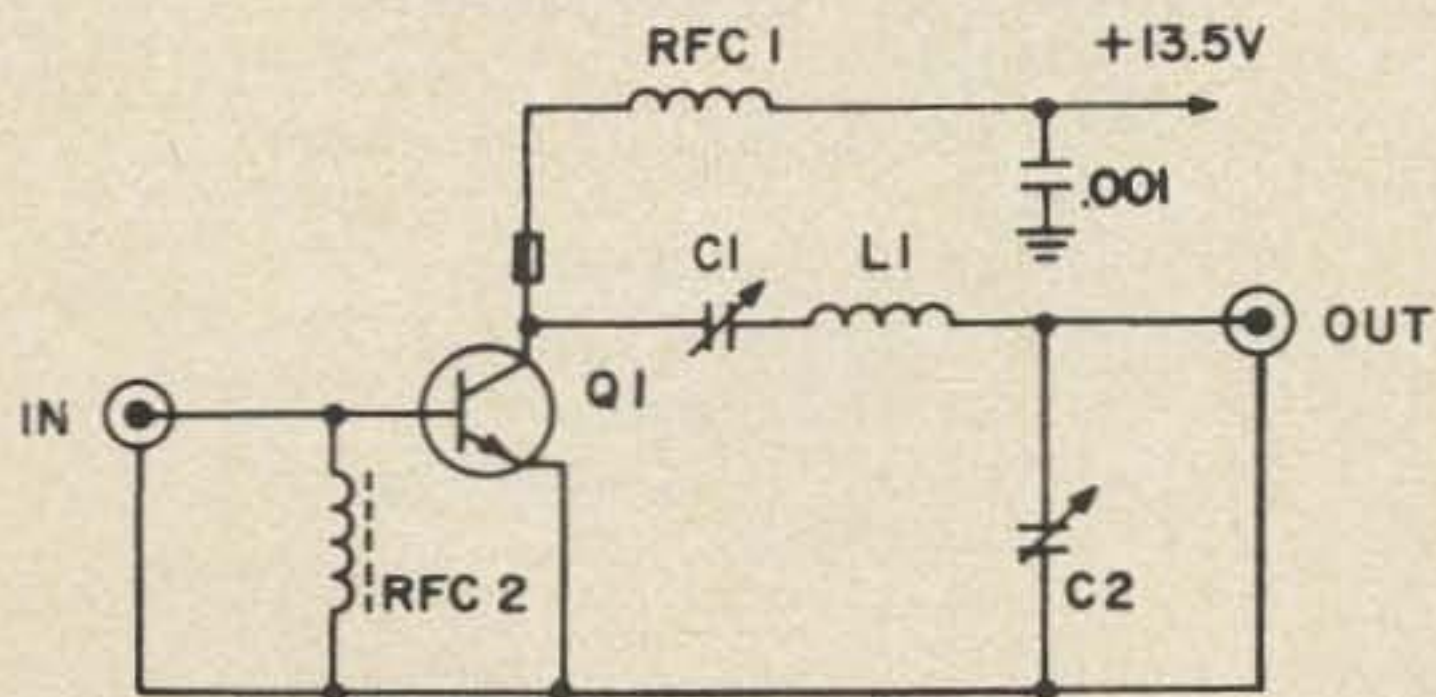
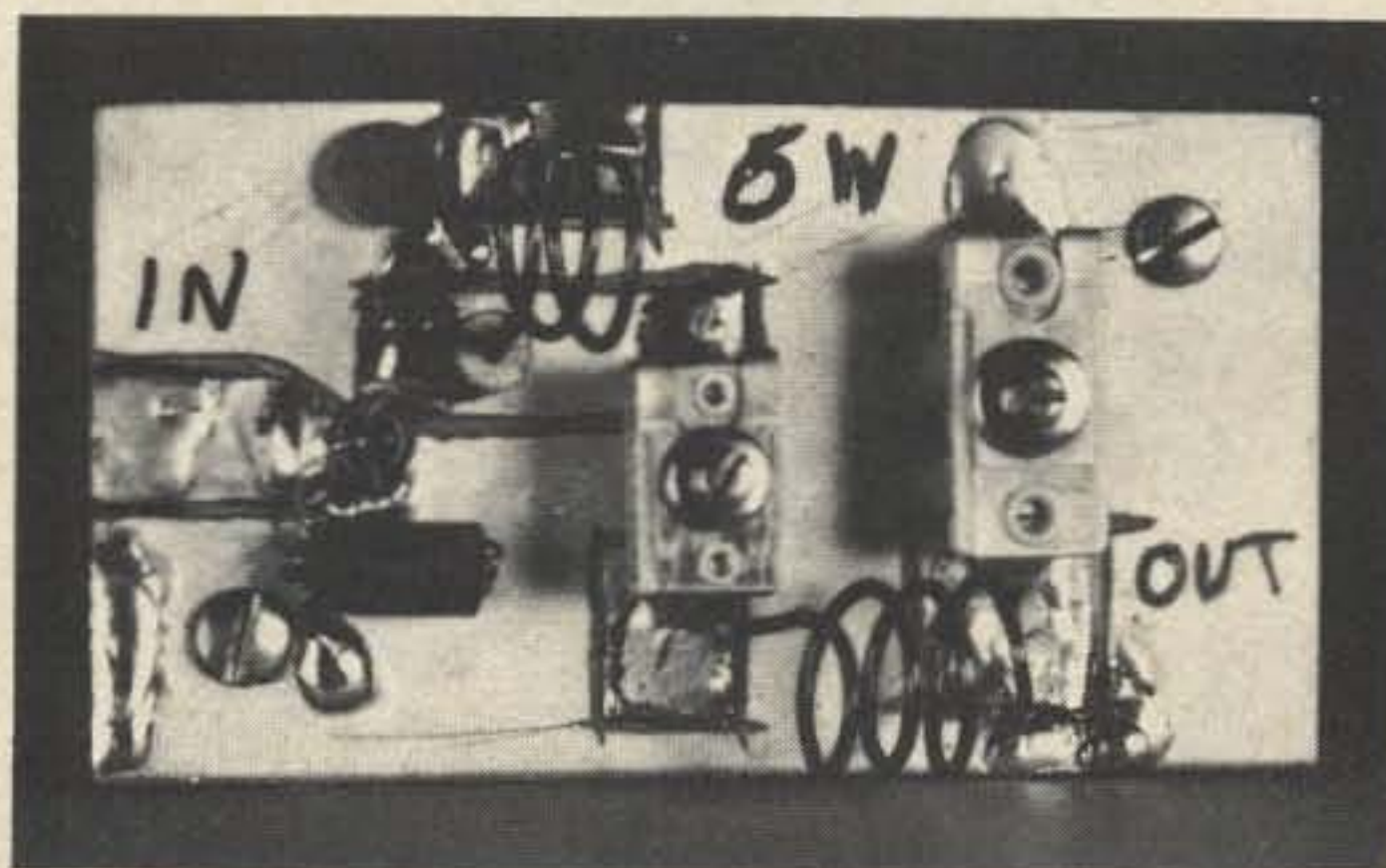

Fig. 1. Schematic diagram for both the 1 watt and 6 watt amplifiers. Refer to the respective parts lists for values.



Top view of the 6 watt amplifier.

# DRAKE AA-10

# Power Amplifier

Greatly increases transmitting distance covered by your 2-meter transceiver



**\$49.95**  
amateur net

**AC-10 Power Supply** provides a base for the TR-22. Powers AA-10 and TR-22. Charges TR-22 nicads. Supplies 13.8V up to 3A from 120 VAC 60 Hz input.

**\$39.95** amateur net

**FEATURES** Single stage solid-state power amplifier using balanced emitter VHF power transistor with VSWR protection. • Use with TR-22 or any transceiver with up to 1.8 watts output power. • 10 dB power increase • At least 10 watts output @ 13.8 VDC. • No relays — automatic transmit/receive switching • Small size

**SPECIFICATIONS** • Frequency Coverage: 144-148 MHz. • RF Output Power: 10 Watts minimum at 13.8 Volts DC and rated input power. • RF Input Power: 1 Watt nominal, 1.8 Watt maximum • Receive Loss: Fraction of 1 dB — unnoticeable • Antenna and Transceiver Connectors: Type SO-239 • 8 Semi-conductors. • Power Requirements: 13.8 Volts DC at 1.5 Amperes. • Size: 2"H x 2-1/16"W x 5-1/2"D. (51 x 52 x 140 mm)

**R. L. DRAKE COMPANY**



**DRAKE**

540 Richard St., Miamisburg, Ohio 45342  
Phone: (513) 866-2421 • Telex: 288-017

for part of the layout. The 2N4427 stage, when properly tuned, should give at least 10 dB of gain — which turned out to be a little better than the 2N3866 I tried.

Amplifier No. 2 is almost identical except for only two circuit changes. One is a slightly larger loading capacitor (which

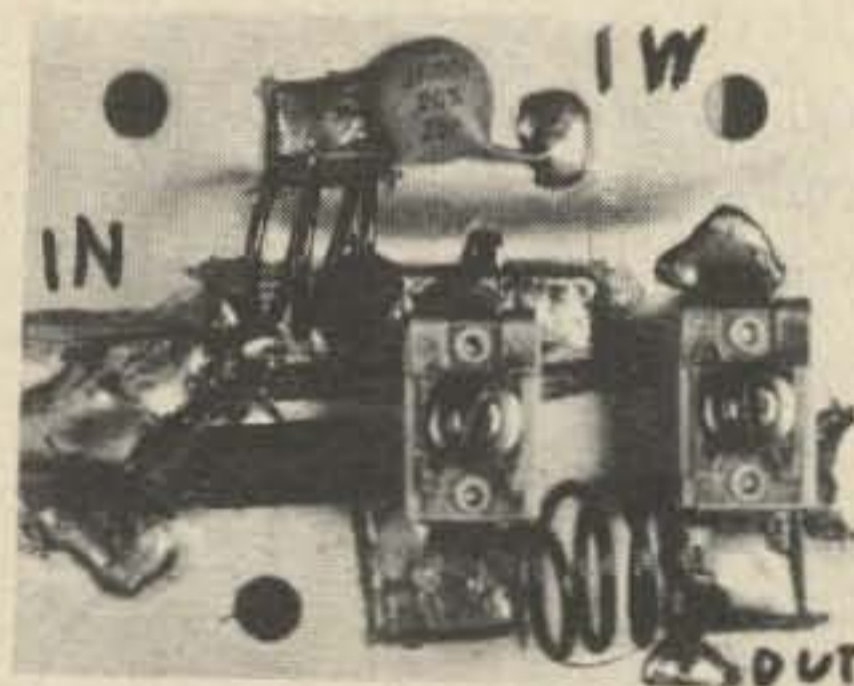

Top view of the 1 watt amplifier.

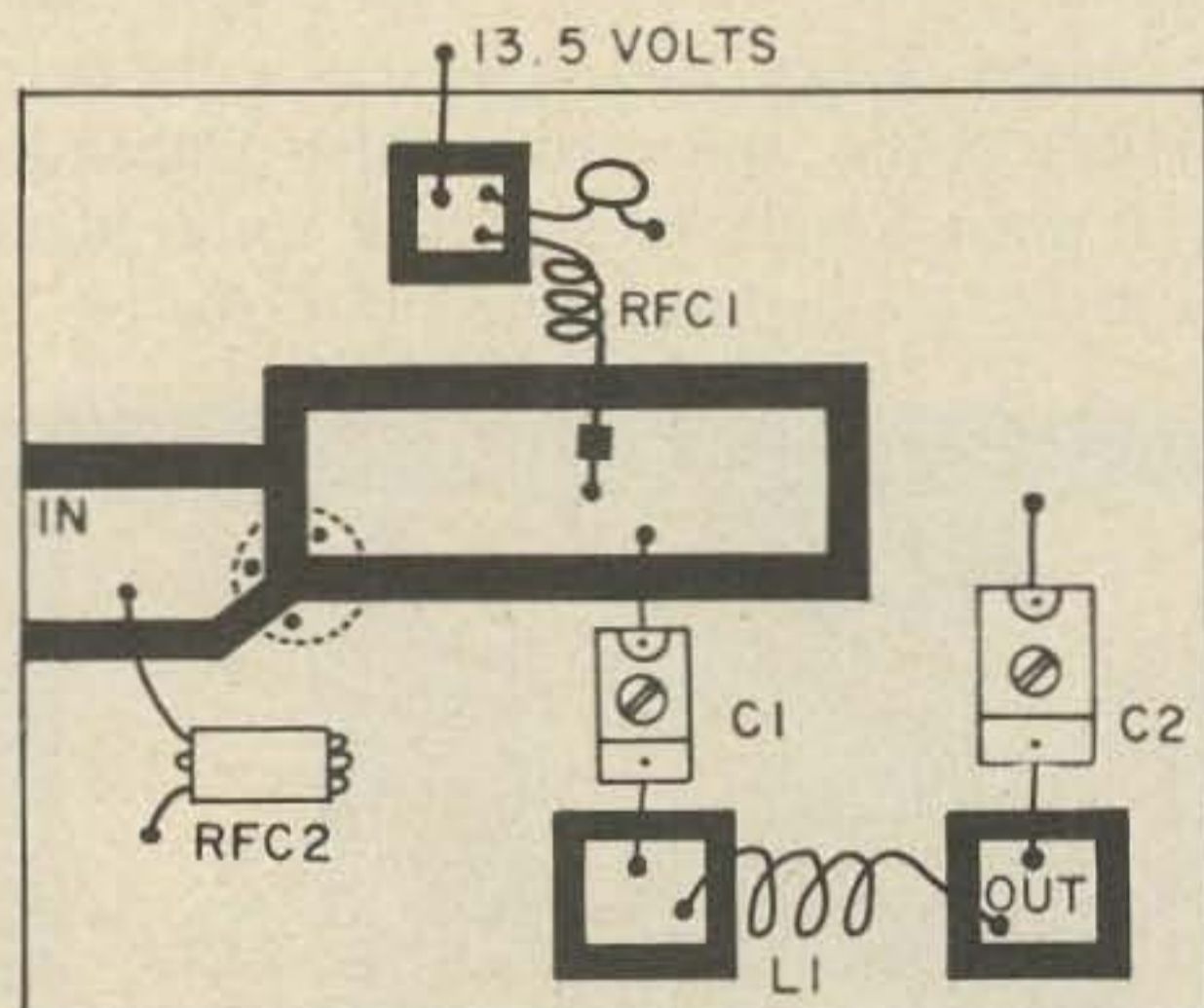
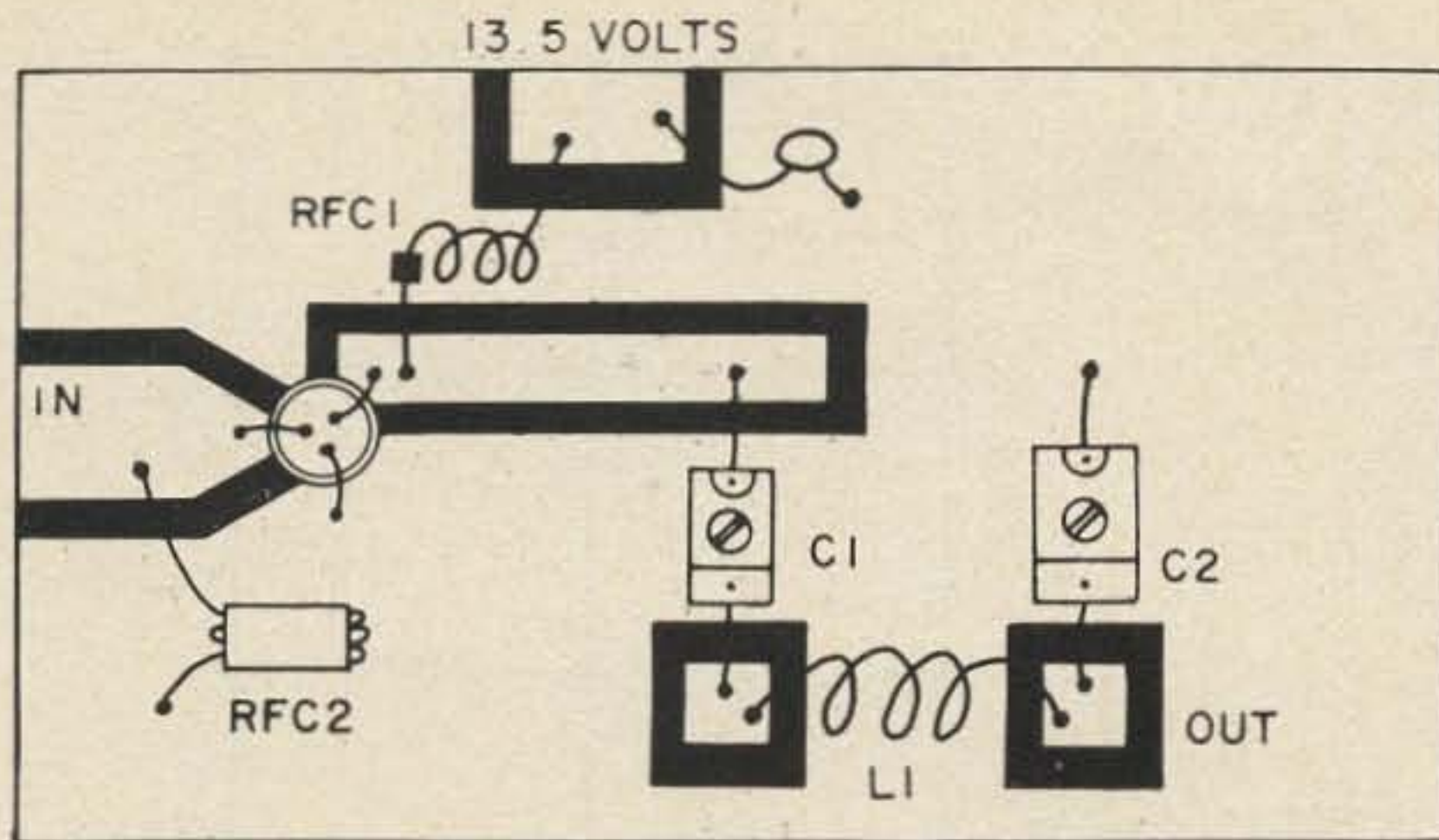

Fig. 2. Full size PC board layout (copper side) for the 1 watt amplifier. Black areas show where copper has been removed. All parts except transistor and heat sink are mounted on copper side. Be careful not to ground the transistor case or heat sink as it is internally connected to the collector.

**PARTS LIST 100 mW-1W AMP**

- Q1 — 2N4427
- L1 — 3½T no. 18, 0.7 cm I.D., 1.5 cm long
- C1,2 — 4-40 pF (ARCO 403)
- RFC<sub>1</sub> — 2½T no. 18, 0.7 cm I.D., plus ferrite bead
- RFC<sub>2</sub> — 3T inside 6 hole 200 MHz ferrite bead



- PARTS LIST 1-6W AMP**
- Q1 - 3N3925
  - L1 - 3½T no. 18, 0.7 cm I.D., 1.5 cm long
  - C1 - 4-40 pF (ARCO 403)
  - C2 - 7-100 pF (ARCO 423)
  - RFC<sub>1</sub> - 2½T no. 18, 0.7 cm I.D., plus ferrite bead
  - RFC<sub>2</sub> - 3T inside 6 hole 200 MHz ferrite bead

Fig. 3. Full size PC board layout (copper side) for the 6 watt amplifier.

happened to be in my junk box). The other change is the transistor, Q2. It is a Motorola 2N3925 which I chose for several reasons: (1) It isn't too expensive (\$5.35 in single quantities), (2) It is easy to mount and work with, and (3) It can put out 6 to 7 watts with 1.4-1.6 watts of drive. The board layout is somewhat different, because the device has a different package and requires a larger heat sink. For a heat sink, I mounted a piece of 0.7 (¼") aluminum under the board, using 0.7 cm (¼") spacers. The leads of the device all went through a 0.8 cm (7/16") hole in the board. The leads were

then bent over and soldered to their appropriate areas. Make sure the transistor nut and the spacer screws are secure before you solder the transistor leads. Also, don't let the case of the device (near the leads) touch anything, as the case is connected to the collector. The stud on the other end is electrically isolated from the elements inside, so it is not necessary to insulate it from the aluminum heat sink. Be sure to use a good quality heat sink compound here.

Tune-up of both amplifiers is straightforward - you tune for maximum output. If you build both of them, tune the low power

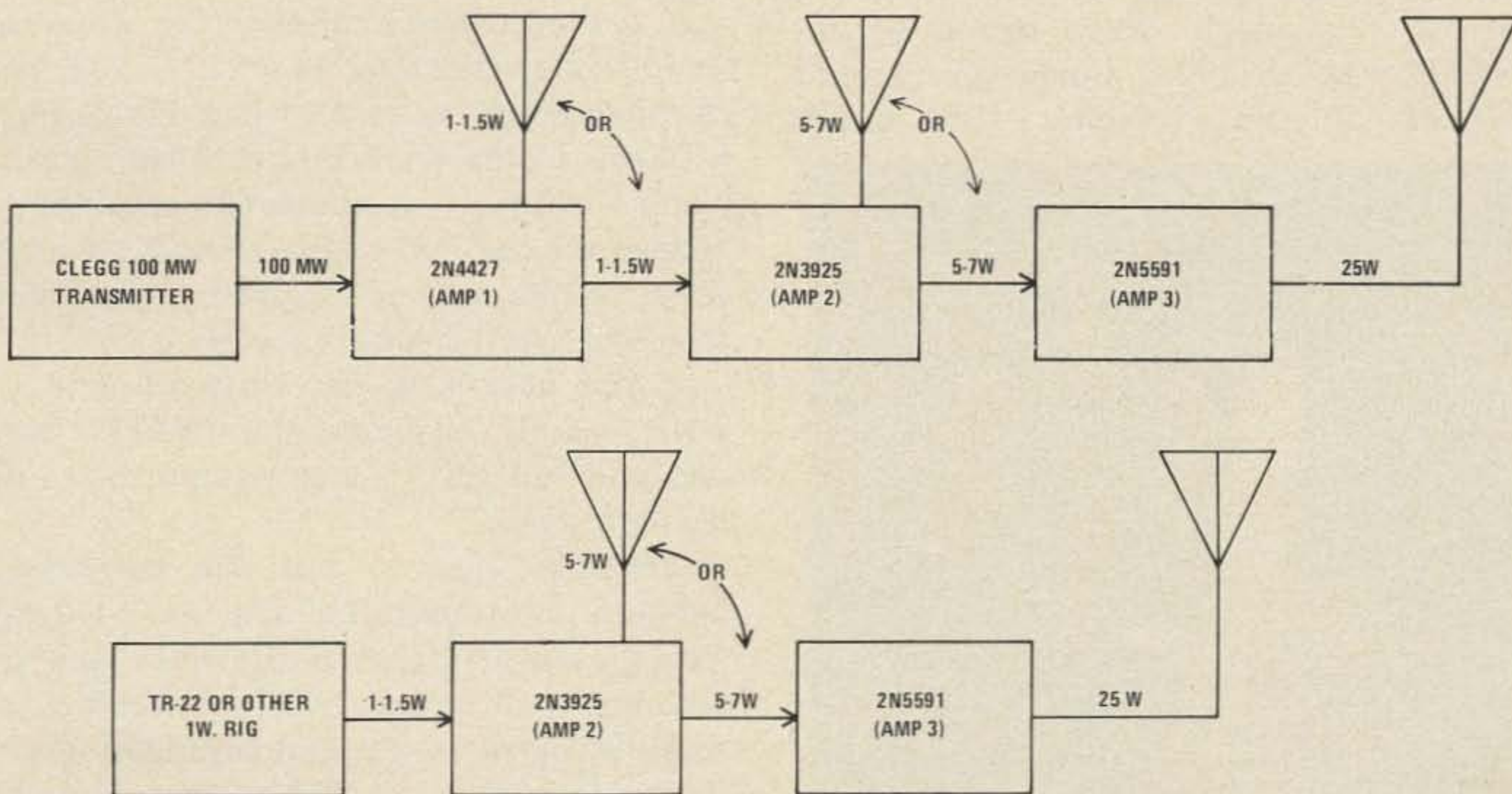

Fig. 4. Various methods of connecting the amplifiers for getting different power outputs. The amplifiers can all be built on the same board with shielding between sections or on separate boards connected via short pieces of coax.

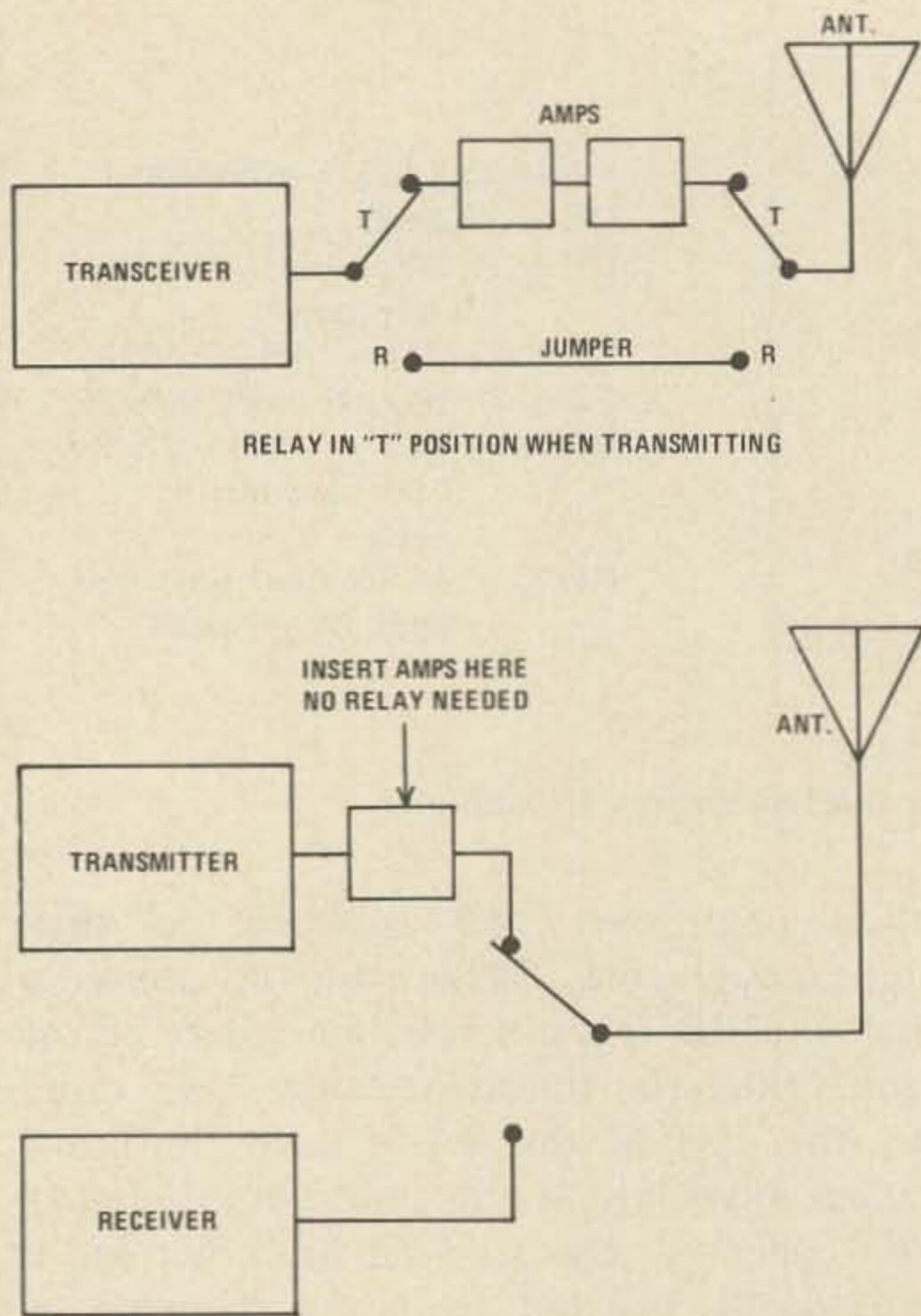
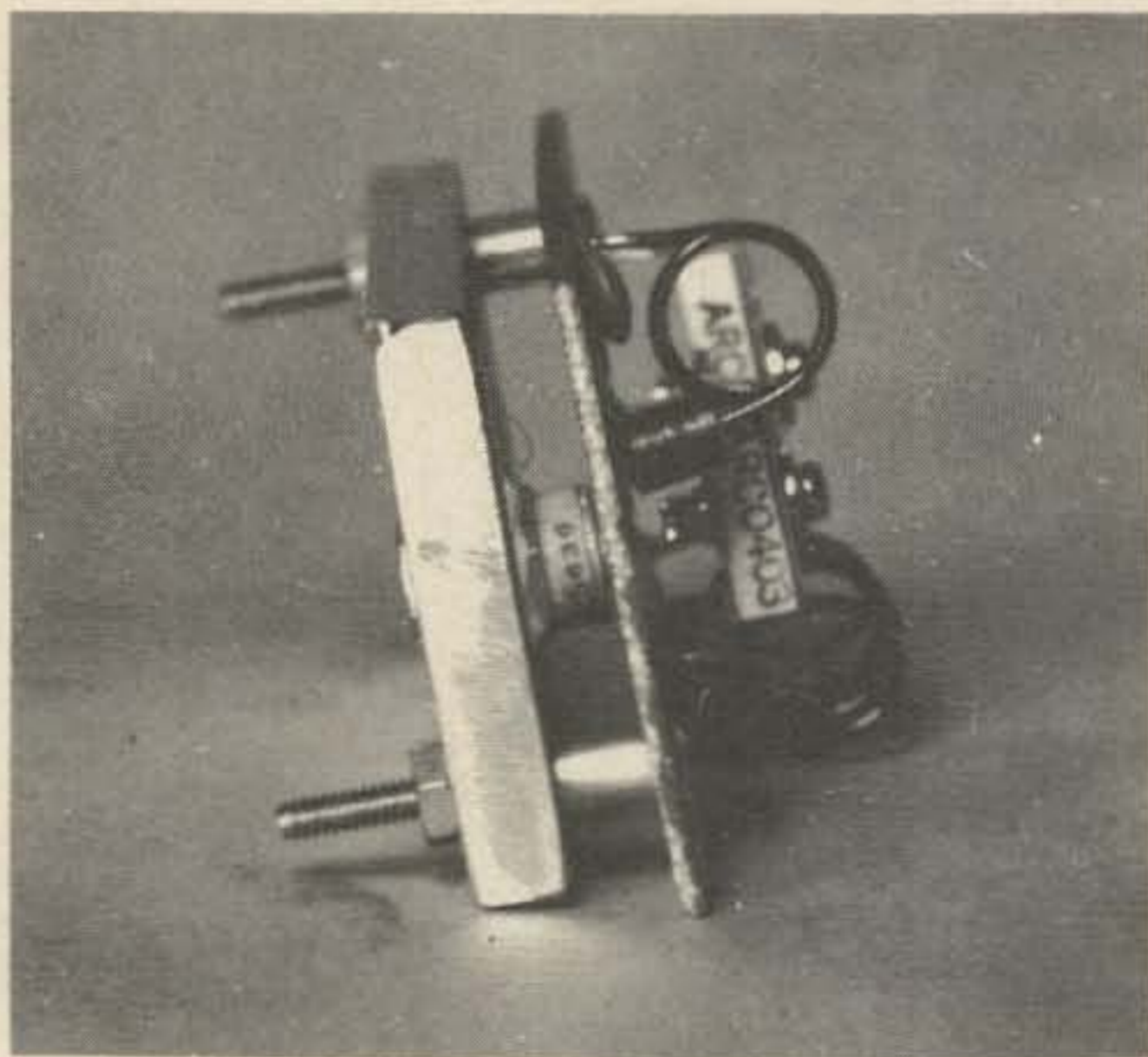
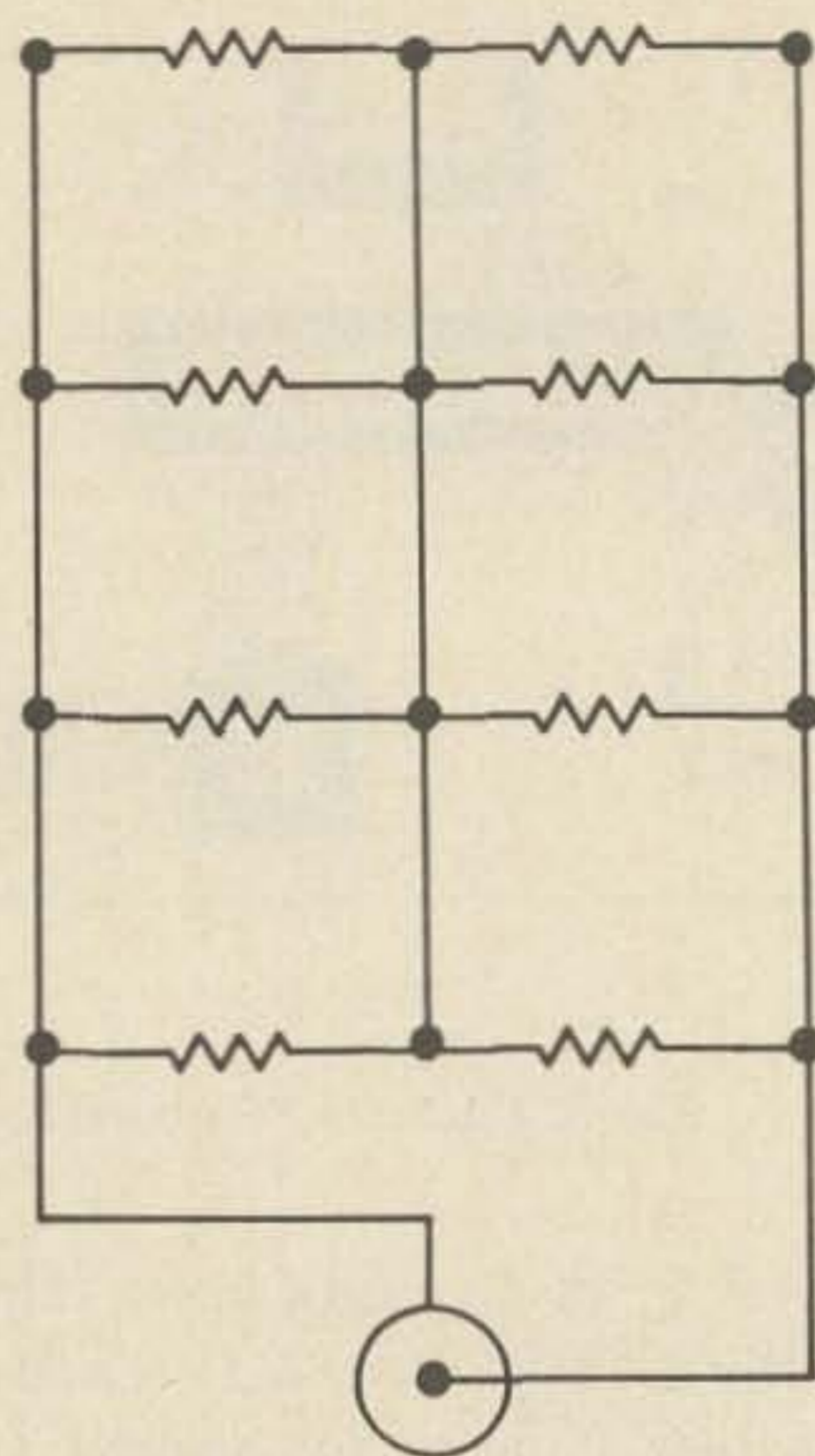

Fig. 5. Two ways to connect the amplifiers when using either a separate receiver and transmitter or a transceiver.

stage first. It should then be re-tweaked, after connecting it to the 7 watt amp. You may have to squeeze or stretch L1, but not by very much. When driven by the 2N4427, the 2N3925 should give around 6-7 dB of gain. Together, they should



Side view of the 6 watt amplifier showing heat sink details.



ALL RESISTORS 100Ω 2 WATT CARBON

Fig. 6. A simple dummy load for tuning the amplifiers. Keep tuneups short when running 25 watts.

deliver at least 15-16 dB gain. When tuning, it is advisable to use a good rf indicator, such as a Bird ThruLine or other VHF indicator. Also, be sure to use a 52 ohm non-inductive load.

If desired, these amplifiers can drive the 2N5591 amplifier (December 1972 73). You can then get 25 watts out when driving them with one of the small International Signal 2 meter boards. I recommend keeping the voltage on the ISC board around 10 to 11 volts, as the output transistor goes bad if anything over 12 volts is applied.

If you have a rig that puts out 1 to 1.5 watts, simply eliminate the 2N4427 stage, and you can get 25 watts output using the last two stages.

Also, be sure to put the amplifier(s) between the transmitter and the T-R relay. If you put it between the relay and the antenna, your receiver will not function as a received signal won't feed through them. If desired, you can use a DPDT relay to switch the amplifiers into the antenna line when transmitting, and out when receiving.

...WB4DBB

# "MINI" REPEATER CONTROL SYSTEM

## PART ONE

**A**fter designing and building a rather elaborate fully digital 2 meter repeater control system (a full description of this system has been published in book form by 73 Inc., Peterborough NH), it has been challenging to design and build a "Mini" repeater control system. The new system provides the most frequently desired repeater services, employs a minimum of parts, and furnishes reliable, trouble-free service. The resulting system is fully described here. The repeater control system was physically constructed in a way which allows it to be quickly removed from the normal interface circuitry. A companion diagnostic test set (DTS) was built to provide a way of verifying proper operation of the system logic. It will be described in Part II.

The control system is used in conjunction with a 2 meter transmitter and receiver and the following "support" circuits:

1. Carrier detector
2. Burst Tone Decoder
3. Touch Tone Decoders for three frequencies; 941, 1209, and 1477 Hz
4. Telephone Ring Signal Detector
5. Transmitter Keying Circuit
6. Tone Generator for identification
7. Audio Changeover

This combination of basic elements enables the system to provide two fundamental services:

1. A basic repeater function operating in either open or closed mode; closed mode means that a burst tone is required.
2. An automatic phone patch mode allowing incoming as well as outgoing telephone calls.

### The Repeater Mode

When operating in the repeater mode, access can be either open or closed. If closed operation is desired, either burst access, whistle-up, or continuous tone squelch can be employed. A 2-minute timer limits continuous transmissions to no more than two minutes; this provides a forced shutdown if a spurious signal persists on the input frequency.

### The Autopatch Mode

The autopatch mode is entered when a user transmits the Touch-Tone "\*" character. In this mode the transmitter is keyed continuously for the duration of the patch. The 2-minute timer is reset each time the input signal ceases — this prohibits a false shutdown. A 1-minute timer provides control of the telephone line; if the user fails to

transmit at least once each minute, the autopatch is released and the repeater mode is reentered. This timer provides system recovery in the event the user is unable to retain control (drives out of range, transmitter fails, etc.). The user terminates a telephone call by transmitting the Touch-Tone “#” character. The system then reverts to the repeater mode. The repeater mode is also entered if the 2-minute timer expires when the system is functioning as an autopatch. (This means that the user transmitted continuously for two minutes.)

In order to provide the user with control over the called party during those times when the radio party is transmitting, the control logic produces an “audio switch-over” signal which can be used to alter the audio input to the transmitter. This circuitry can be used to switch the transmitter’s input to a tone generator (“marker” signal) or another source of audio such as the receiver’s output. Such circuitry assures the system user that the telephone party will not “talk behind his back” and thereby broadcast profanity or other illegal transmissions. If such an undesirable transmission occurs while the user is listening, the called party can be silenced by the user keying his transmitter. If a “marker” signal is used, semi-privacy results since the user’s voice is not heard on the output frequency.

The system logic thus maintains control over the transmitter and telephone line under all conceivable conditions.

### Identification

The Federal Communications Commission requires that repeaters identify at five minute intervals during the period of usage. When use of the repeater ceases, it is desirable to have the repeater identify immediately. This presents a dilemma: each time the transmitter shuts down it *may* imply the end of a usage period; on the other hand, it may be the case that users of the system are not making quick exchanges. Three modes of operation come to mind:

1. Identify every three minutes
2. Identify every time the transmitter is about to shut down
3. “Anticipate” the end of a usage period and then identify

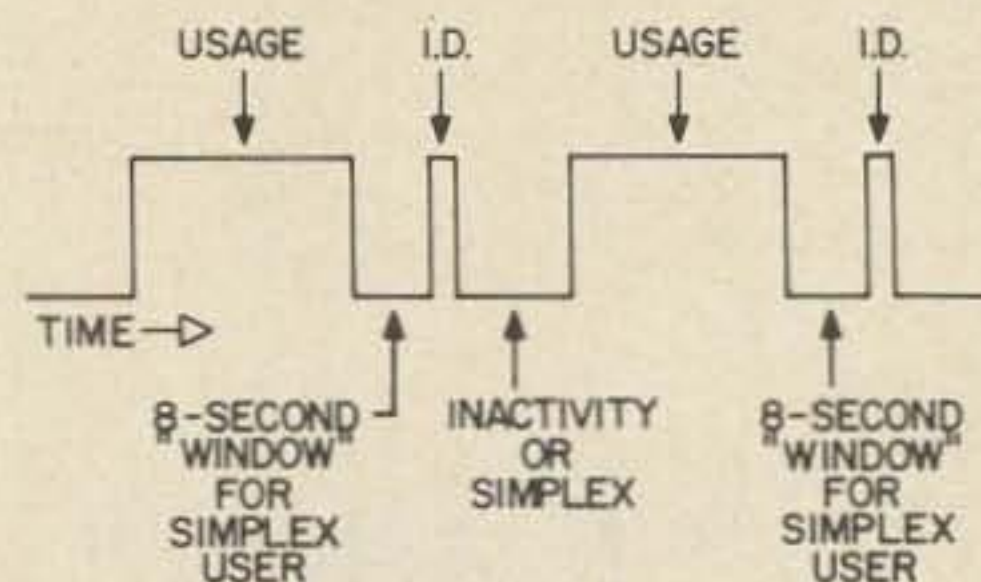

Fig. 1. Anticipator and identification scheme.

Each of these modes exhibits both desirable and undesirable characteristics. The third approach does not generate a large number of superfluous I.D.'s as does number 2 and does not generate an I.D. “out-of-the-blue” — as much as three minutes after the last period of usage — as does case 1. (Case 1 is particularly annoying if the repeater output is located on a popular simplex frequency. A simplex QSO may begin following a period of repeater usage and then be temporarily QRM'd during the final I.D. that the repeater generates.)

An anticipatory identification scheme is provided in the “Mini” repeater control system. The logic assumes that a lack of transmitter usage for 8 continuous seconds implies that the usage period has ended and that an I.D. is therefore appropriate. If the users tailend, or at least respond in less than 8 seconds, the repeater will identify only once every 3 minutes followed by a final I.D. at the end of the usage period.

By changing a single resistor, the anticipator’s time period can be adjusted to suit your own particular taste. If the time period is equal to zero seconds, the repeater will identify as in case 2; if the time period is greater than three minutes, the repeater will identify as in case 1. The anticipator discourages the use of the repeater by only a single user, i.e., one person going through the repeater and the other person operating simplex on the output frequency. With an anticipator, the simplex user must transmit through the “time window” that exists between the end of the repeater’s transmission and the start of the I.D. (See Fig. 1.)

Figure 2 shows how the anticipator and 3-minute timer work together during a period of repeater usage.

# DRAKE TR-22

## Versatility plus!...in a 2 Meter FM Transceiver



### Over-the-shoulder, mobile, or at home

Completely transistorized, compact, portable. Capacity for 6 channels. Built-in telescoping antenna, and connector for external antenna. Use barefoot or with accessory amplifier. External 12 VDC or internal ni-cad batteries, built-in 120 VAC battery charger.

Complete with: Dynamic Mike, O-T-S Carrying Case, 120 VAC and 12 VDC Cords, Speaker/Headphone Plug and 10 Ni-Cad Batteries.

**\$199.95**  
Amateur Net

AA-22 Amplifier \$149.95  
MMK-22 Mobile Mount \$9.95  
BBLT-144D Hustler Ant. \$27.95

**GENERAL:** • Freq. coverage: 144-148 MHz • 6 channels, 3 supplied • Push-to-talk Xmit • DC Drain: Rcv, 45 mA; Xmit, 450 mA • Size: 5-3/8" x 2-5/16" x 7-1/8", 3-3/4 lbs.

**RECEIVER:** • Transistorized crystal-controlled superhet • 1st IF: 10.7 MHz, 2nd IF: 455 kHz • Ant. Input Imped: 50 ohms • Sensitivity: 1  $\mu$ V or less/20 dB S+N/N • Audio Output: 0.7 W • Built-in speaker.

**TRANSMITTER** • RF Output over 1 W • Freq. Dev. adj. to 15 kHz max., factory set to 5 kHz.

**R. L. DRAKE COMPANY**



540 Richard St., Miamisburg, Ohio 45342  
Phone: (513) 866-2421 • Telex: 288-017

### Tone Access

The "Mini" repeater control system provides the circuitry necessary for correctly operating the system as a burst access, whistle-up, or continuous tone repeater. The logic associated with the access method includes a circuit that "remembers" that a tone has been received. A timer is used to govern how long the system remembers that a tone has been received. If the timer is set to 5 seconds, tailending is allowed for 5 seconds and the effective loss of signal due to flutter or chop is filtered out of the logic. A long time period, for example 5 minutes, would implement a "whistle-up" repeater

that would remain available, and open, for at least five minutes; continued use would cause the system to remain active indefinitely. Simple internal wiring changes will implement a continuous tone access system.

### System Logic

The "Mini" repeater control system was implemented using TTL logic devices because these devices are currently available at attractive prices. Whereas a more state-of-the-art approach to identification could have been used, e.g., use of ROM for identifier memory, TTL gates were used throughout because of their availability.

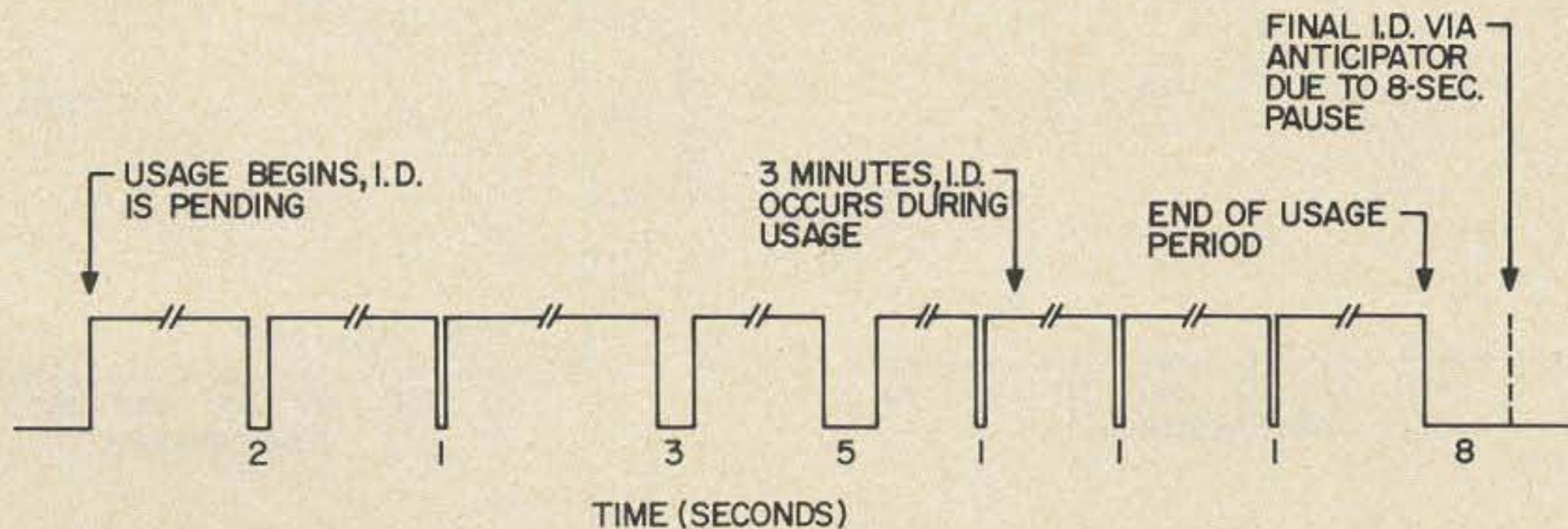

Fig. 2. Anticipator and 3-minute timer working together.

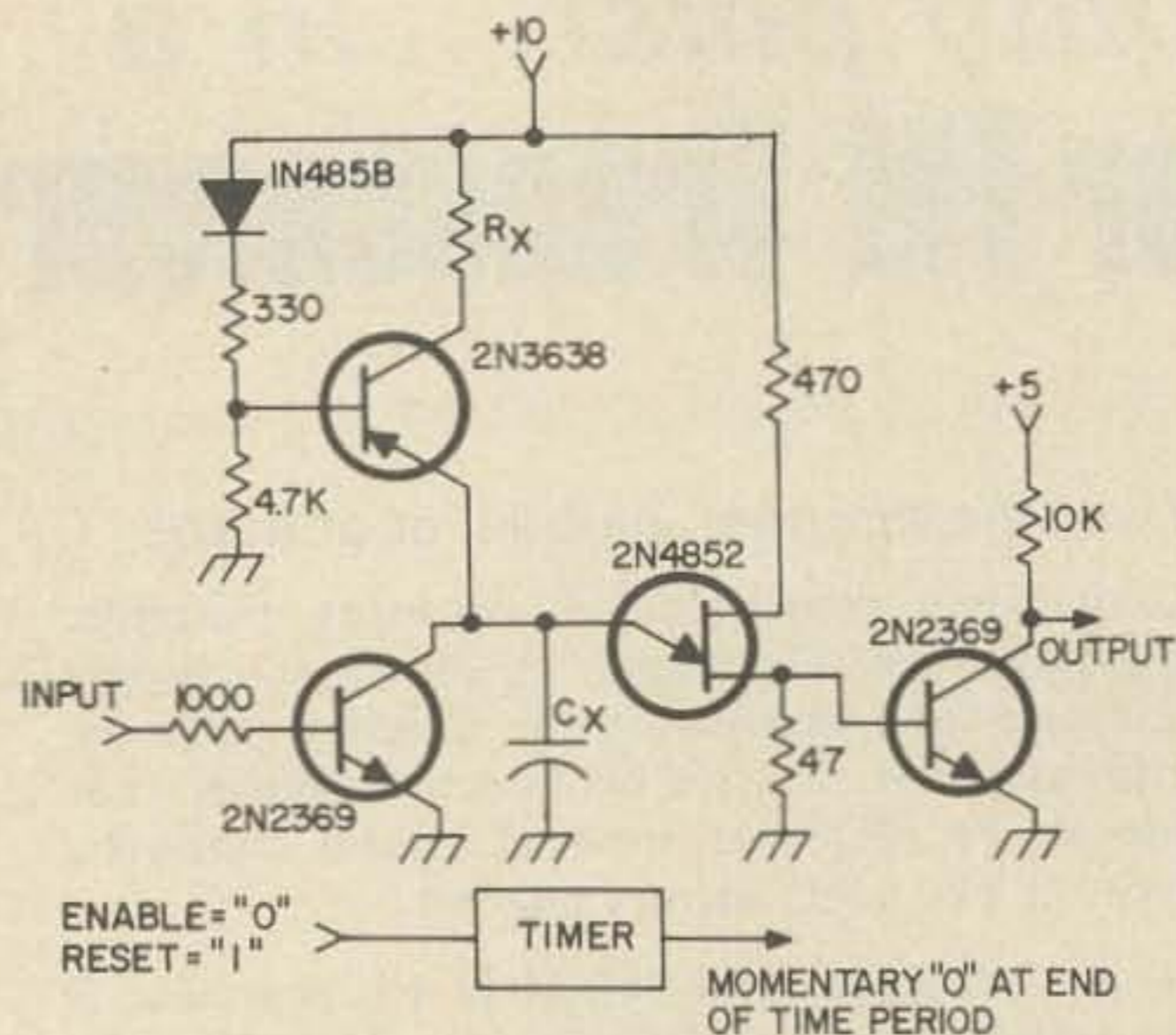

Fig. 3. Timer circuit.

The logic can be functionally broken into several sections:

1. *Timers* – A 5-second, 8-second, 1-minute, 2-minute, 3-minute timer and the clock pulse generator for the identifier.
2. *System Control* – The repeater and auto-patch functions.
3. *Identifier* – Character generator, character counter, and tone generator control.
4. *Decoding* – Generating a specific sequence of dots, dashes, and blanks.
5. *External Interfaces* – Formal inputs and outputs.

#### Timers/Clock

The timers and clock pulse generator were implemented using the "standard" circuit shown in Fig. 3. (The recent appearance

of the Signetics NE555 low-cost I.C. timer offers an economical source of accurate time signals. Such a device would represent a very significant improvement over the circuit used in this system. See *Electronics*, May 8, 1972, page 127.) In order to change the circuit's characteristics,  $R_x$  and  $C_x$  were appropriately chosen. The clock pulse generator used a value of 693K ohms for  $R_x$  and .1 microfarads for  $C_x$  to produce a comfortable I.D. speed. A "standard" 68  $\mu\text{F}$  capacitor was chosen for  $C_x$  for all of the timers. Experimental data was then plotted to generate the graphs shown in Figs. 4 and 5.

Figure 4 is used to select  $R_x$  for the anticipator and burst access timers, while Fig. 5 is used to select  $R_x$  for the 1, 2, and 3 minute timers. Using these graphs you can adjust the timers to the time periods you prefer for your particular repeater installation.

The basic unijunction timer circuit includes a constant current source for charging  $C_x$  to minimize the effects of voltage variations. Quality components should be used to minimize the effects of temperature changes. To evaluate the effects of temperature change, a "standard" circuit was constructed with a time period of 73 seconds. The circuit was then placed in the family deep freeze and finally in the oven. When operated in the deep freeze ( $<10^\circ\text{F}$ .) the time period was 84 seconds; the oven ( $145^\circ\text{F}$ ) yielded a time period of 77 seconds. Resistor  $R_x$  was a precision resistor and  $C_x$  was a 68  $\mu\text{F}$  tantalum capacitor. (Most of the noted time

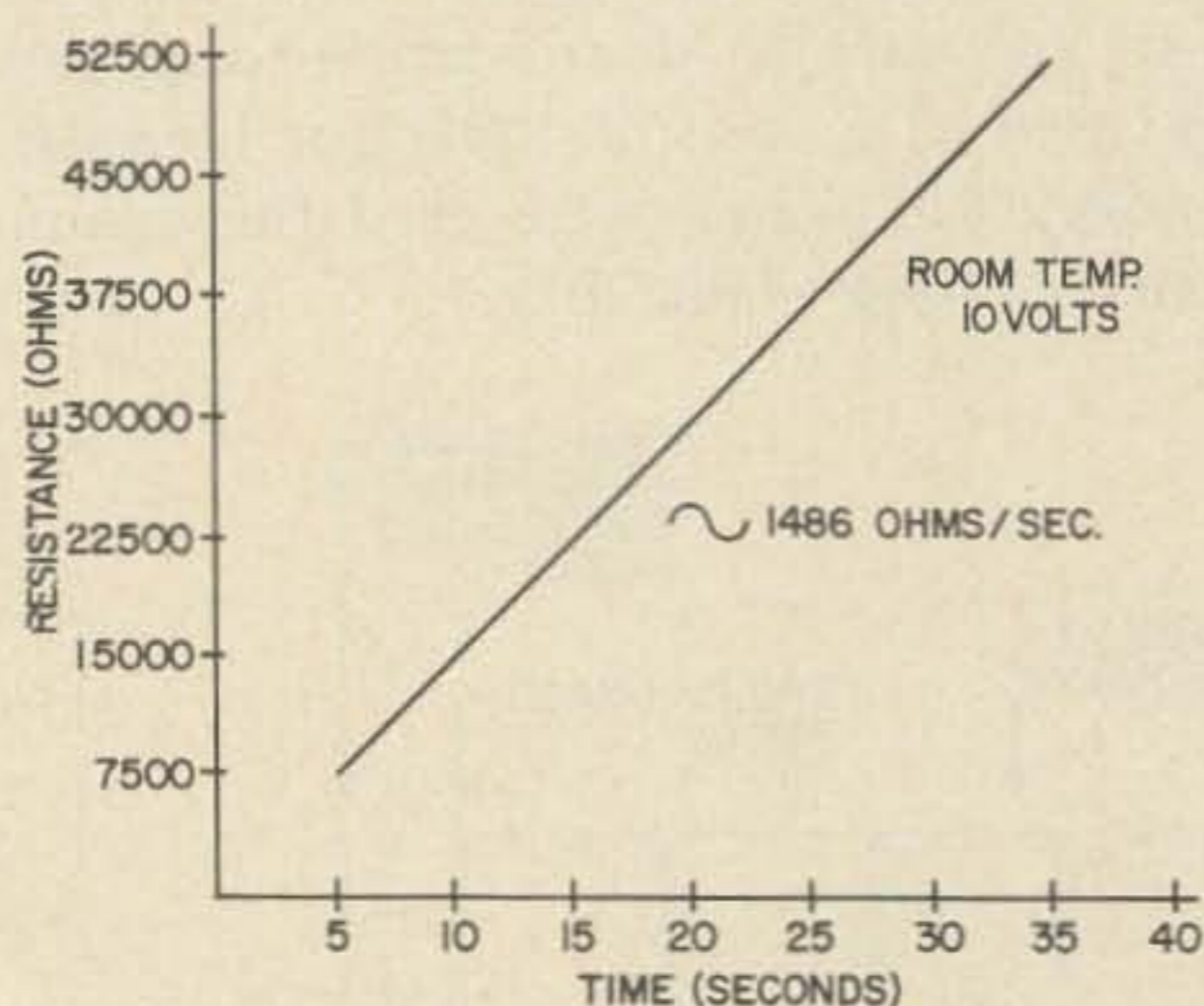

Fig. 4. Graph used to determine  $R_x$  for the anticipator and burst access timers.

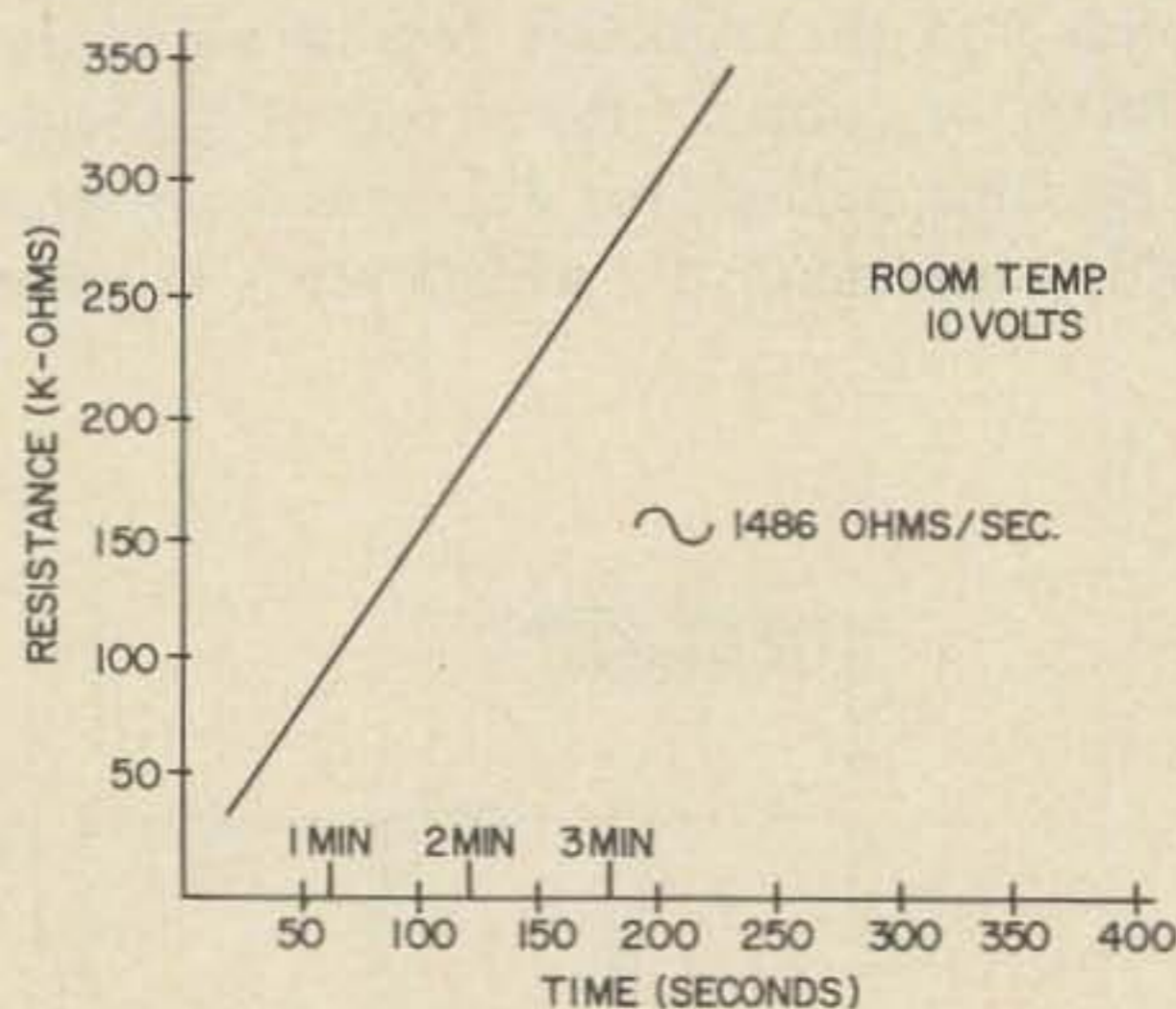

Fig. 5. Graph used to determine  $R_x$  for the 1, 2 and 3 minute timers.



period change can probably be traced to a change in the unijunction's intrinsic stand-off ratio).

From a logical point of view, the timer circuit has a single input and a single output. Time is accumulated when a logic 0 is applied to the input. A momentary logic 0 is produced at the output when the timer expires; e.g., if a continuous logic 0 is applied to the input of the 1-minute timer, a momentary logic 0 will be produced at the output one minute later.

### System Control

The system control logic was implemented using 9 integrated circuits. These nine IC's contain two 4-input gates, six 3-input gates, and twenty-four 2-input gates; 31 gates are used. Twelve of these gates are connected in a cross-coupled manner to implement simple set/reset flip-flops for the following memory functions:

1. Has an access tone been received?
2. Has a valid signal been received?
3. Is the system operating in the repeater mode or the autopatch mode?
4. Has a 2-minute timeout occurred?
5. Is an I.D. pending?
6. Is an I.D. in progress?
7. Has a "\*" been received?

Figure 6 shows the system control logic. Since the timers are all easily adjusted to suit an individual system's needs by selecting the value for Rx, Fig. 6 shows the timers in a general 2-terminal manner. Although various operational characteristics can be implemented by selecting time values different from those discussed in the text, for ease of discussion, the symbolic timers are interpreted as follows:

- Timer A 5-seconds
- Timer B 1-minute
- Timer C 2-minutes
- Timer D 3-minutes
- Timer E 8-seconds

NOTE: In the discussion that follows an I.C. pin will be referred to by an I.C. identifier followed by a dash and a pin number, i.e., E2-7; a flip-flop will be referenced by the identifiers of the two gates used to implement the flip-flop, e.g., A2/A3.

The memory flip-flops are composed of the following gates:

#### AA2 and AA3

This flip-flop is set when an access tone is received. It is reset 5 seconds after the carrier is removed from the input frequency. When the system is operating in the patch mode, the flip-flop is constantly set to nullify the need for a burst tone. Pins AA2-6 and AA2-7 are the set terminals and AA3-13 is the reset terminal.

#### A2 and A3

This flip-flop is set when a valid signal has been received; pin A2-5 is the set terminal and pin A3-8 is the reset terminal.

#### B4 and C1

This flip-flop specifies in which mode the system is operating; pin B4-12 is the set terminal and pins C1-1, C1-2, and C1-3 are the reset terminals. If the flip-flop is reset, the system is functioning as a repeater.

#### E2 and E3

This flip-flop is set when a 2-minute timeout occurs; pin E3-9 is the set terminal and pin E2-5 is the reset terminal.

#### G1 and F4

This flip-flop is set when a request for the transmitter is granted; the flip-flop thus indicates that an I.D. is pending, i.e., eventually required; pin G1-1 is the set terminal and pin F4-13 is the reset terminal.

#### D3 and G4

This flip-flop is set when an I.D. is in progress; pins D3-11 and D3-12 are the set terminals and pin GR-13 is the reset terminal.

#### BB2 and BB3

This flip-flop is used to prohibit the "\*" character from entering the telephone line when the patch is being accessed. The flip-flop is set at the end of the first "\*" character; additional "\*" characters are then allowed to pass to the telephone line. Pin BB2-5 is the set terminal and pin BB3-9 is the reset terminal.

NOTE: Flip-flops implemented using cross-coupled gates are set by applying a logic 0 to the set pin; they are reset by applying a logic 0 to the reset pin.

The remaining gates are used as conventional NAND gates (if any input is a logic 0, the output will be a logic 1; if all inputs are logic 1's the output will be a logic 0—). With TTL logic, "ground" is a logic 0 while the

power supply (through a suitable series resistor) is a logic 1.

Each of the logic gates performs an essential function in the total control system. The following paragraphs describe the detailed operation of the logic.

Gate A1 applies a logic 0 to the set terminal of flip-flop A2/A3 whenever a carrier is simultaneously accompanied by a logic 1 output from the access tone flip-flop AA2/AA3 decoder. If an access tone is not required, pin A1-2 can be connected to pin A1-1. When the carrier leaves the input frequency, the carrier signal becomes a logic 0 thus resetting flip-flop A2/A3 via pin A3-8. In this manner, flip-flop A2/A3 tells (via pin A2-7) whether an acceptable carrier is being received. In this implementation, the simultaneous presence of carrier and burst tone sets the flip-flop while loss of carrier resets the flip-flop. If a continuous tone squelch system is desired, pin A3-8 should be moved from A1-1 to A1-2. This change causes flip-flop A2/A3 to be reset when the tone is lost rather than when the carrier leaves (they would in fact normally leave at the same time). Connected in this manner gates A1, A2, and A3 perform a simple ANDing operation. The "access tone" signal applied to A1-2 is derived from the circuitry composed of timer A and gates AA1, AA2, and AA3. By appropriately selecting the time period of timer A, several modes of operation are possible. With gate A1 connected as shown in Fig. 6, the logic implements either a burst access or whistle-on repeater.

If the patch mode is not in progress, AA2-7 will be a logic 1; therefore, when ACCESS is a logic 1, indicating the presence of a tone, gate AA1 will apply a logic 0 to AA2-6 thereby setting flip-flop AA2/AA3. With AA2/AA3 set, gate A1 recognizes the presence of the burst tone until such time as AA2/AA3 is reset. Timer A functions as a "low pass filter" in that short duration interruptions of carrier will not cause AA2/AA3 to be reset. If timer A has a period of 5 seconds, AA2/AA3 will not be reset until 5 seconds after the input signal is removed. This allows for "tailending" by users not equipped with tone burst generators. If timer A were reduced to zero seconds (i.e., replaced by a single conductor)

tailending would not be possible; also, a momentary loss of signal, due to chop or flutter, would reset AA2/AA3 and thereby disable the transmitter. It is therefore evident that a non-zero value for timer A is appropriate.

If timer A were set to have a five minute time period, a carrier could leave the input for five minutes before flip-flop AA2/AA3 would be reset. When operated in this manner, the logic implements a "whistle-on" repeater; a user can whistle to generate a tone that in turn sets flip-flop AA2/AA3.

To implement a continuous tone access system (a tone must be present all the time) A3-8 is connected to A1-2 and the input to timer A is connected to AA1-1, AA1-2, and AA1-3. In this case, timer A determines how long a loss of tone will be tolerated; again a non-zero time is desirable to offset the detrimental effects of chop and flutter.

Flip-flop AA2/AA3 is permanently set when the patch mode is entered; this feature is provided by input AA2-7 being connected to the systems mode control flip-flop B4/C1. If this connection is omitted (AA2-7 then connected to AA2-6) burst tone will be required during patches. The presence of the tone may be annoying to the party on the telephone; on the other hand, the tone may be regarded as a way of informing the called party that he is talking on a radio circuit and that the radio party is going to speak. (NOTE: If continuous tone operation is employed, AA2-7 should be connected to AA2-6. Since continuous tone systems use nearly inaudible frequencies the tone would not be objectionable; furthermore, if AA2-7 is connected as shown in Fig. 6, flip-flop A2/A3 would *never* be reset since the output of gate AA1 would never go to logic 0!)

If the mode of operation (open or closed) is to be controlled on a selective basis by either a locally operated manual control switch or by a remote control facility (via UHF or landline), the ACCESS input to gate AA1 should be interfaced to the "outside world" through a suitable interface circuit (See Fig. 10) When tone access is desired, the output of the tone detector should be applied to AA1; when the repeater is "open," a logic 1 should be applied to AA1.

If pin A2-7 is a logic 1, then if the RPTR



escape from the **2** meter crowd

**The all new**  
**220 MHz Clegg FM-21 Transceiver**  
**puts you in tomorrow's channels today!**

220 MHz FM is *the* early solution to overcrowded 2 meter channels. Here's your chance to get in on the ground floor of the FM future. The new FM-21 all solid-state transceiver is an opportunity to "do it right" this time and start with the leader. The FM-21 uses only 1 crystal in any channel . . . one crystal gives you a separate transmit and receive frequency as well as automatic 1.6 MHz programming in the repeat mode. We call this unique triple-duty crystal feature Clegg Crystal Saver Frequency Control. For the complete story, see your Clegg Dealer or call or write us today for detailed data sheet and avoid the crowd.

**CHECK THESE FEATURES**

- 8-10 watts output (minimum).
- Speech clipping.
- Sensitive receiver—.25  $\mu$ V (max.) for 12 db Sinad.
- Selectivity—Adjacent channel (40 KHz) down 50 db.
- Each crystal does triple-duty, providing a transmit and receive frequency (Crystal Saver Frequency Control).
- Monolithic crystal filter.
- Compact, 7" x 2 $\frac{3}{4}$ " x 9"

**Amateur Net \$299.95**



**Clegg DIVISION**

3050 Hempland Road, Lancaster, Pennsylvania 17601

Tel: (717) 299-3671

Telex: 84-8438

ENABLE input is a logic 1, gate B1 will produce a logic 0 output. Gate C2 "gathers" transmitter requests; a request consists of a logic 0 supplied to any of C2's inputs. These inputs are termed "transmitter requests" since the transmitter is keyed only when the 2-minute timer has not expired.

Gate E4 processes the transmitter requests by simultaneously examining the outputs of gates C2 and E2. Pin E2-7 is a logic 1 unless a 2-minute timeout has occurred. If the two inputs to E3 are logic 1's, then the output of E4 is a logic 0. Gate D2 gathers valid transmitter requests; any logic 0 input will cause the transmitter to be keyed via the external interface circuit connected to pin D2-9. When gate E4 passes a transmitter keying request and applies a logic 0 to pin D2-8, it simultaneously sets flip-flop G1/F4 via the application of the logic 0 to pin G1-1; when flip-flop G1/F4 is set it indicates that an I.D. is pending. Note that the other inputs to D2 (pins D2-6 and D2-7) do *not* set flip-flop G1-F4. One of these inputs is from a local test switch while the other is from the identifier control flip-flop D3/G4. (Note that if the identifier's request for the transmitter *did* set flip-flop G1/F1 then the system would identify every 3 minutes whether the system was in use or not! The logic allows the identifier access to the transmitter even if a timeout has occurred. Thus, after a timeout, an identification will occur.

Gate E1 controls the 2-minute timer; if either input is a logic 0, the timer will be reset by E1's logic 1 output. Pin E1-2 is a logic 1 when the system is operating in the repeater mode since pin B3-9 will be constantly held at logic 0 when in repeater mode thereby holding the output of gate B3 at the logic 1 level. Consequently, when gate C2 receives a transmitter request, pin E1-1 also becomes a logic 1. With both inputs a logic 1, the output of gate E1 is a logic 0 and the 2-minute timer runs. If the 2-minute timer expires, its logic 0 output is applied to pin E3-9 thereby setting flip-flop E2/E3; with this flip-flop set, gate E4 blocks the transmitter requests normally passed to gate D2. When the system operates in the autopatch mode, the transmitter is keyed con-

tinuously for the duration of the patch but the 2-minute timer is reset each time the input carrier leaves.

Gate B3 samples the mode flip-flop B4/C1 and the signal flip-flop A2/A3. If a signal is not present (pin A3-11 is a logic 1) and the autopatch mode is in effect (pin B4-14 is a logic 1) then both inputs to gate B3 are logic 1's and the output is thus a logic 0. This resulting logic 0 is applied to gate E1 pin E1-2 which in turn generates a timer C reset signal (logic 1). Observe that at this point the transmitter is keyed and the 2-minute timer is *not* running. Although this initially seems to be incorrect, if the user fails to transmit within one minute, the 1-minute timer will cause the system to revert to being a repeater. When this occurs, the lack of input signal will result in no transmitter request and the transmitter will no longer be keyed.

The autopatch mode is entered when all of the inputs to gate D1 are logic 1's. This occurs when the AUTOPATCH ENABLE signal is a logic 1 and the two tones representing "\*" are detected. Under these conditions, the output of gate D1 becomes a logic 0 thereby setting flip-flop B4/C1. The autopatch mode is terminated when the proper two tones representing "#" are received which in turn apply logic 1 inputs to gate A4. The resulting logic 0 output from gate A4 resets flip-flop B4/C1; the system thus reenters the repeater mode. Pins C1-2 and C1-3 provide two additional ways to exit the autopatch mode: pin C1-2 is connected to the 1-minute timer while pin C1-3 is connected to the 2-minute timer. Thus the autopatch mode will be explicitly terminated when the "#" is received and implicitly terminated whenever a one or two minute timeout occurs. Figure 6 shows TONE1 and TONE4 strapped together since the "\*" and "#" have one tone in common, namely, 941 Hz.

The "\*" character is a convenient autopatch access character; however, transmitting the "\*" character into the telephone line will generally cause a "reorder" tone to be generated when the central office is expecting a series of digits. (Any of the 16 Touch-Tone characters may be sent after the

called party has answered.) The "Mini" repeater control system employs special circuitry to inhibit the connection of the patch until the access character has ceased. Gate BB1 and flip-flop BB2/BB3 assure that the patch will not be attached to the telephone line until *after* the "\*" character has been received.

If a "\*" is being received, pin D1-5 will be a logic 0 and pin B4-14 will be a logic 1. When the tone ceases, flip-flop B4/C1 is set and pin D1-5 is a logic 1. Consequently, both inputs to gate BB1 are logic 1's. The output of BB1 is therefore a logic 0 which sets flip-flop BB2/BB3. This flip-flop is interfaced to a transistor switch which operates the relay associated with connecting the patch to the telephone line. The flip-flop is reset when the patch mode is terminated — pin BB3-9 becomes a logic 0 and causes the flip-flop to reset. Note that while the first "\*" character is "blocked" from the telephone line, additional "\*" characters will be passed. This allows the user to place calls to automatically answered computer systems that might in turn require the caller to send special characters such as the "\*" and "#."

The 1-minute timer is controlled by gates F1 and F2. Gate F1 causes the timer to be reset whenever a valid signal is present and the system is in the repeater mode; when both of the inputs are logic 1's, the resulting logic 0 output is applied to gate F2 thereby causing pin F2-7 to assume a logic 1 which functions as the 1-minute timer reset signal. Gate F2 will also produce a logic 1 output if pin F2-5 is a logic 0; this is precisely the case when the system is in the repeater mode (pin B4-14 is a logic 0). This inhibits the 1-minute timer when it is not in use. Gate F3 is provided to invert the output of gate F1; gate F3 produces a logic 1 output when the system is in the autopatch mode and a carrier is present. The output of gate F3 is used to control external circuitry for selecting an alternate transmitter audio input signal during those times when the user is transmitting.

Gates G2 and G3 work in conjunction with the 8-second timer, timer E, to implement the anticipatory identification logic. The 8-second timer is enabled whenever the

transmitter is not keyed (gate D2's output is a logic 0). When the timer expires it produces a logic 0 which is inverted by gate G2 thereby applying a momentary logic 1 to pin G3-8. If an I.D. is pending, flip-flop G1/F4 is set (pin G1-3 is a logic 1) and so both inputs to gate G3 are at the logic 1 level; the result is a logic 0 output from gate G3. When the logic 0 output is applied to pin D3-11, flip-flop D3/G4 is set. With flip-flop D3/G4 set, pin G4-14 is a logic 0 and the I.D. clock pulse generator is enabled (see Fig. 7). When the I.D. is complete, a logic 0 is applied to pins F4-13 and G4-13 by the output of gate Z (see Fig. 9) thus resetting the I.D. circuitry.

Flip-flop D3/G4 can be set by the 3-minute timer's output and also by a local I.D. request switch; both of these signal sources apply a momentary logic 0 to pin D3-12.

### Enable Signals

It is significant to observe and understand the effect of the two enable signals on the system's operation. The AUTOPATCH ENABLE input only controls *entry* into the patch mode; removal of the AUTOPATCH ENABLE signal during a patch does not cause the patch mode to be terminated. The REPEATER ENABLE input causes the transmitter to be disabled for autopatch and repeater modes; telephone ring signals will continue to be broadcast (incoming calls can be ignored by disconnecting the ring detector from the telephone line).

### Identifier Character Generator

The identifier character generator logic was implemented using 6 integrated circuits. Four of the integrated circuits are dual J/K flip-flops (with separate clocks). One integrated circuit consists of four 2-input gates; two "half" I.C.'s are used — one 4-input gate and two 2-input gates.

Flip-flops H1 and H2 are used in conjunction with gates I1, I2, I3, and I4 to implement a character generator. Clock signals are generated by a unijunction oscillator circuit (see Fig. 3). The output of gate I4, pin I4-14, is the inverted form of the desired message. Gate Y2 inverts the signal and is in turn interfaced with an external tone generator via the open collector transistor; the transistor turns on when a tone is required.

Fig. 6A. System control logic. Also see Fig. 6B.

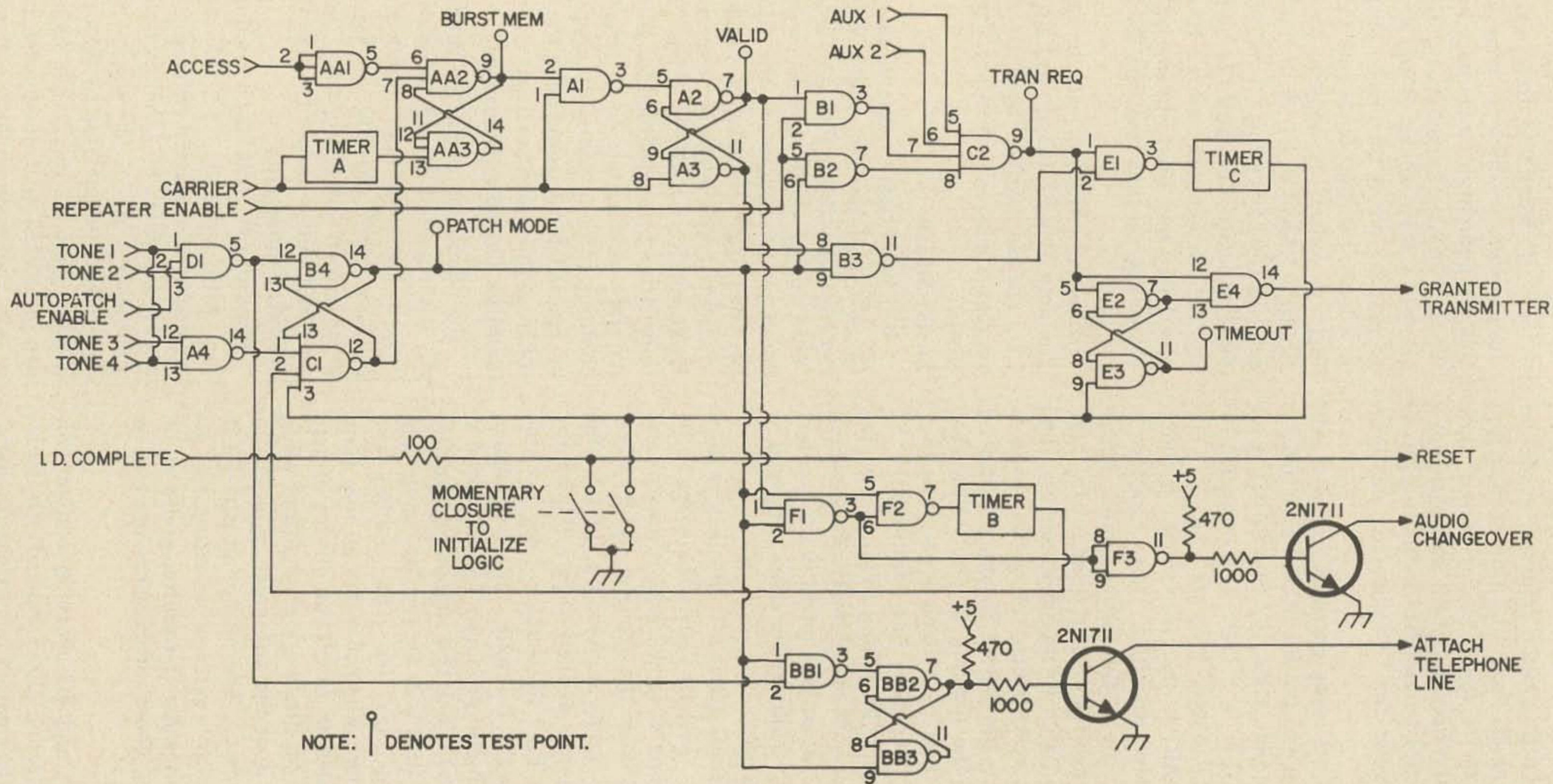

# "You asked for it"

## A low-cost 12-channel, 220 MHz FM mobile transceiver



### **MIDLAND 13-509**

*10 watts RF output power*

*Covers 220-225 MHz – crystals supplied for 223.0 MHz*

**SUGGESTED PRICE \$219.95**

Amateur users everywhere asked for it—Midland listened! And we've brought our years of experience as a top name in communication equipment to the amateur field with this new 220 MHz transceiver. Check the features: instantaneous final protection circuit prevents damage from excessive VSWR. Complete multiple FET front end coupled with high Q resonator filter, ceramic filters in IF gives excellent selectivity,

sensitivity and bandpass characteristics. King-size back-lighted S/RF meter and channel selector. Variable squelch, volume controls. Low power switch for short range (1-watt output). ADL circuit. Individual frequency trimmers for each receive and transmit crystal. Accessory connector for tone burst and discriminator meter. With mounting hardware and dynamic microphone.

Write for Midland's full-line  
amateur radio brochure: P.O. Box  
19032, Kansas City, MO 64141

DEALERS: inquire about an  
exclusive Midland amateur radio  
area franchise

**MIDLAND**  
ELECTRONICS COMPANY

*"Coming on Strong in Amateur Radio"*

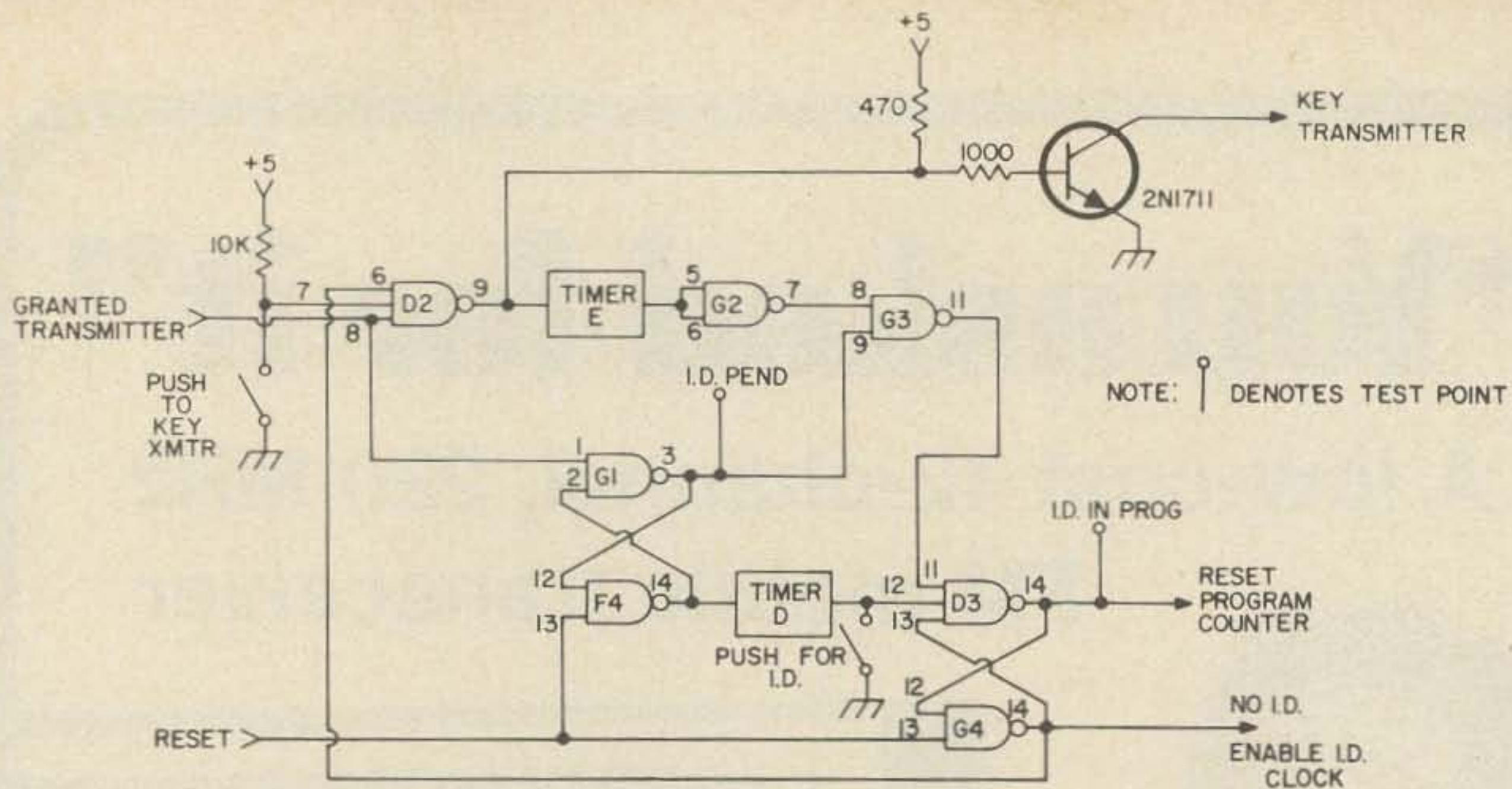

Fig. 6B. Continuation of system control logic.

The signal applied to pin Y2-5 is normally a logic 1 and therefore does not effect the generated Morse code message. Flip-flops J1, J2, K1, K2, L1, and L2 compose a 6-bit character counter. The 6-bit ripple counter is advanced at the completion of each dot, blank, or dash when the output of gate I3 (pin I3-11) goes from a logic 1 to a logic 0. (A discussion of this circuit was included in the article, "Integrated Circuit CW ID Gener-

ator," P.J. Ferrell, *73 Magazine*, September 1970.) With a 6-bit counter, large messages can be easily generated. When a logic 1 is applied to gate I1, a "blank" is generated; when a logic 1 is applied to gate I2, a "dot" is generated; when the inputs to gates I1 and I2 are both logic 0, a "dash" is generated.

Figures 8 and 9 show the decoding logic that was applied to only the first five flip-flops (J1 through L1). The decoding

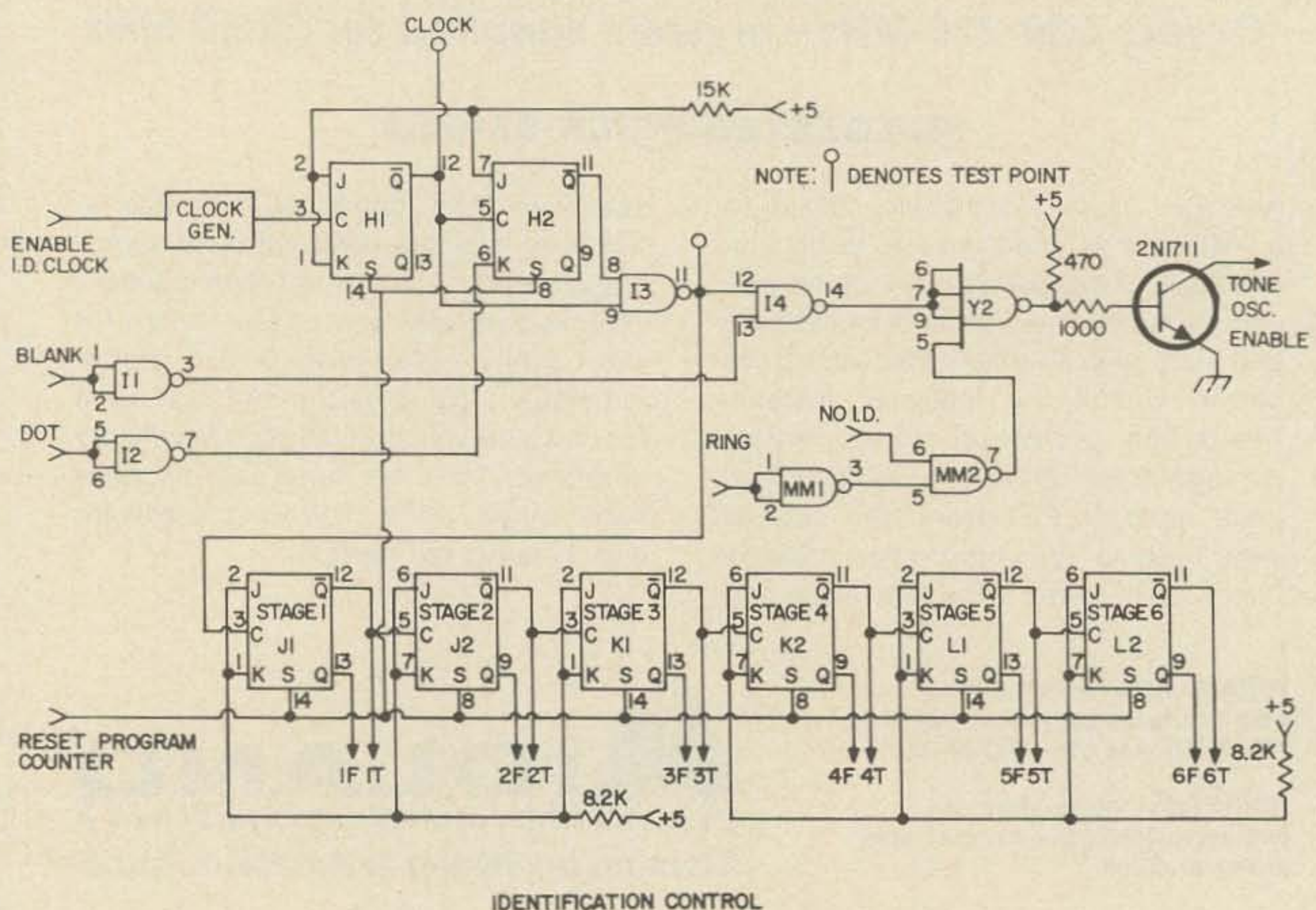

Fig. 7. Identification control.



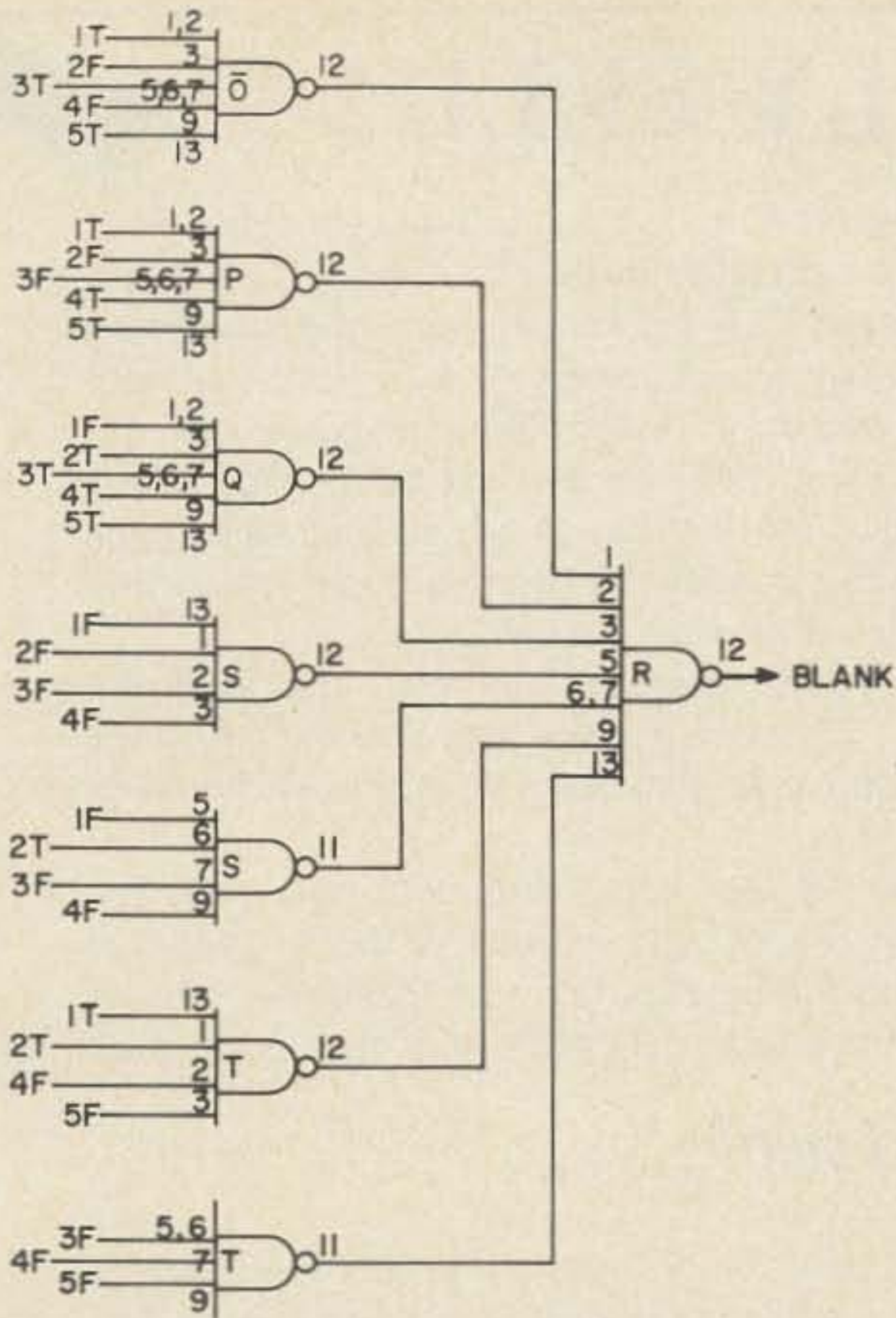

Fig. 8. Blank decoding logic.

logic shown produces the message:

S  
 bbbbbbWAØVWJ T  
 O  
 P

When the counter reaches the value 31, the output of gate Z goes to a logic 0; this is the signal applied to gates F4 and G4 (Fig. 6) to signal the end of the I.D. sequence.

### Call Letter Decoding

Various techniques exist for decoding the character counter and producing the "BLANK" and "DOT" signals; available methods include programmable read-only memories, diode matrices, and NAND gates. Figures 8 and 9 show the gate interconnects used for the WAØVWJ message. (One method for determining the proper minimal interconnects is given in reference 1).

The system control logic shown in Fig. 6 was designed to interface with either the logic shown in Figs. 7, 8, and 9 or with an I.D. mechanism of the user's choice. For example, if a tape recorded message is to be used, the output of gate D3 (pin D3-14) can be used to turn on a transistor switch that starts the tape playback unit; the tape player

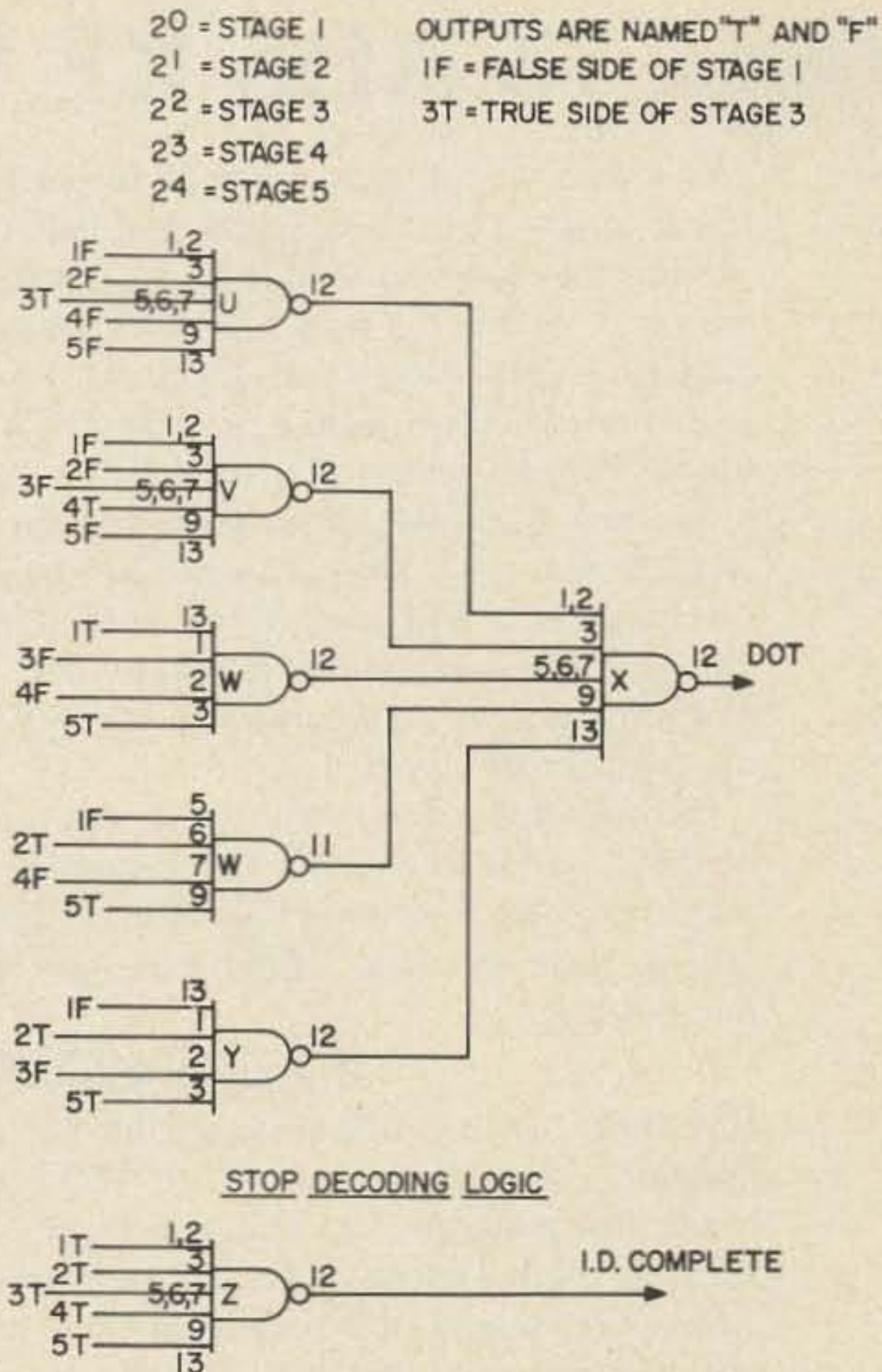

Fig. 9. Dot decoding logic.

need only supply a "stop" signal (logic 0) for gates F4 and G4 when the message has been completed. In a similar manner, the logic can be interfaced with a "code wheel" providing that a "stop" signal is returned when the message has been completed.

### Auxiliary Logic - Incoming Telephone Calls

Gate C2 contains two auxiliary inputs for transmitter requests. While the basic logic provides for repeater and autopatch operation, one of these two inputs can be used to implement a "call in" feature. When a telephone ring signal is received, an external circuit applies a logic 0 to pin C2-6; this produces a request for the transmitter. If the 2-minute timer has not expired, the transmitter is keyed. Simultaneously, gates M1 and M2 determine whether or not an I.D. is in progress. If an I.D. is not in progress; the output of gate M2 produces a logic 0 input to gate Y2 thus enabling the tone generator. Thus, whenever the telephone rings, a tone is broadcast for the duration of the ring signal providing that an I.D. is not in progress. If the time period of the anticipator (timer E)



# 73 ADS REALLY SELL !!



We don't claim that every 73 reader has a hand full of cash just looking for some place to spend it — but it sure seems that way when you advertise in 73.

You may have noticed how the number of ads in 73 has gradually increased, month by month — so that 73 now has more advertising — by a wide margin — than any other ham magazine. One thing is responsible for that, and one only: results. Phenomenal results.

Is the difference really that much? Judge for yourself — in the last six months 73 has run 61% more advertising than QST! That's right — 413 pages of ads to 256 pages. The other two ham magazines were not far from QST — with HR running about 11% more and CQ about 4%. Only 73 has moved way out in front. How come?

If you have a chance to talk with some of the advertisers, you'll know — talk with Bill Slep — with Press at Hamtronics — KA Sales — 73 seems to sell just about everything, from Signal/One transceivers to surplus IC's — and that includes FM, antennas, sideband rigs, and tons of parts.

Funny thing too — the more ads we run in 73 the more equipment and parts the readers buy. If you're thinking of selling the ham market, get in touch with 73 — ads cost about one third of what you would expect from a magazine this size (praise be the low rent section of New Hampshire where we have our offices) — and the results are outstanding.

## 73 ads work too well . . . . .

**Question:** "How do 73 ads work for you?"

**Answer:** "God! I average 75 to 100 orders per day. Now these are orders with cash in them, not inquiries. I pick up two huge mail sacks a day at the post office and average two to three thousand dollars a day. My only difficulties are in keeping up with the orders. If I have 500 pieces of a particular item I get orders for 600. I can honestly say that my 73 ads work too well. I'm thinking of running an ad to say that I have nothing to sell so I can have a day or two off." . . . Bill Slep.

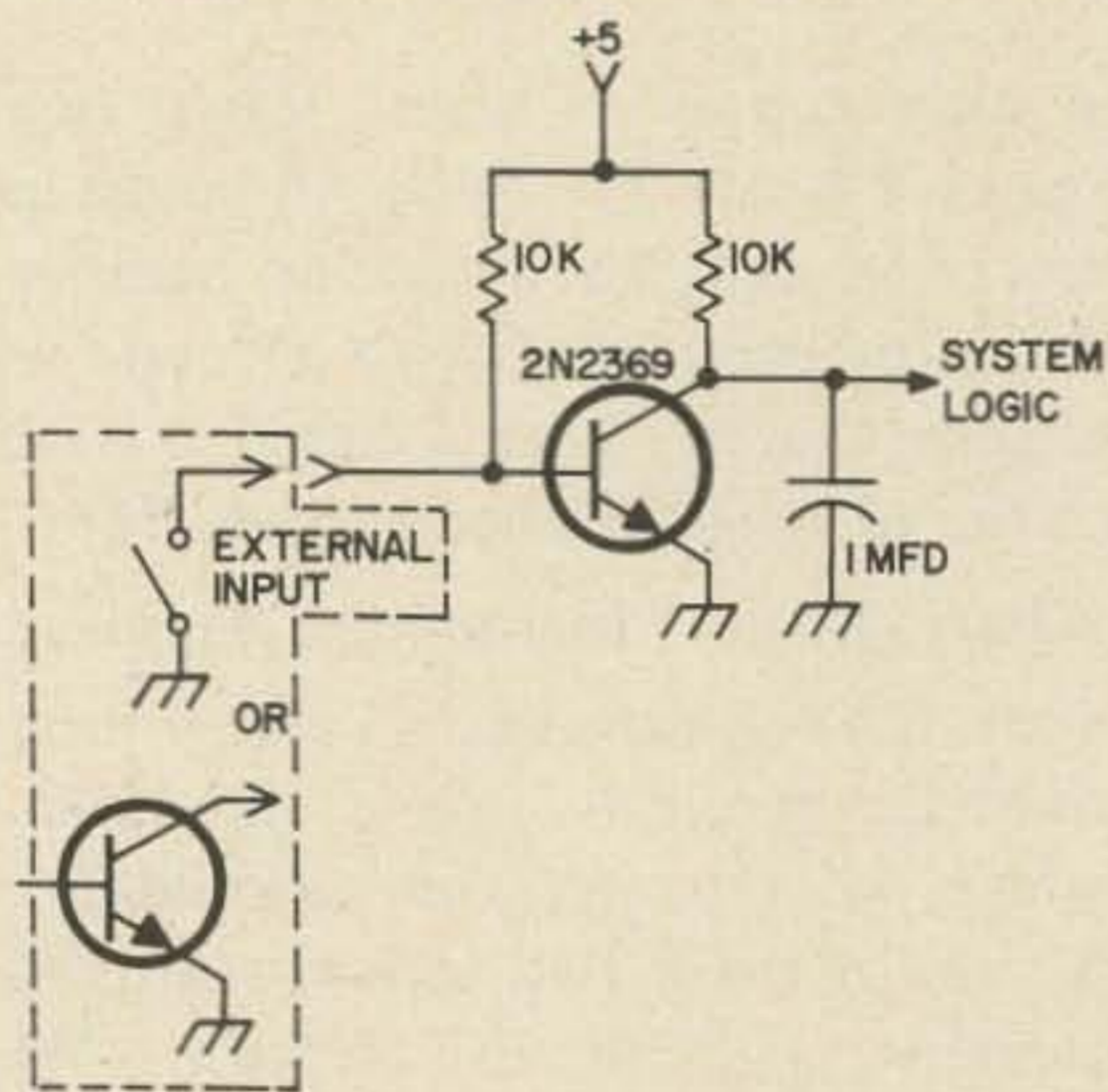

Fig. 10. "Support Circuits" apply a contact closure to ground when a logic 1 is to be generated (e.g., carrier present). This circuit produces a TTL logic 1 (>3.5 volts) which is applied to a specific TTL gate input pin.

is set longer than the time between telephone ring signals, an I.D. will follow the last ring signal broadcast. (If the ringing persists for more than 3 minutes, e.g., 5 minutes, an I.D. will occur at 3 minutes and then a terminal I.D. will occur at 5 minutes.) If the anticipator timer is too short, I.D.'s

will be initiated after *each* ring signal!

### External Interfaces

Two types of external interfaces were provided for the "Mini" repeater control system:

1. Input/Output signals to the system "support" circuits.
2. Input/Output signals and logic status points to a companion diagnostic and test unit.

The system inputs are buffered (to eliminate noise spikes) via discrete component circuits such as the one shown in Fig. 10. The TONE2 input circuit does not use the 1  $\mu$ F capacitor, use of the capacitor will seriously degredate the signal causing flip-flop BB2/BB3 to function improperly.

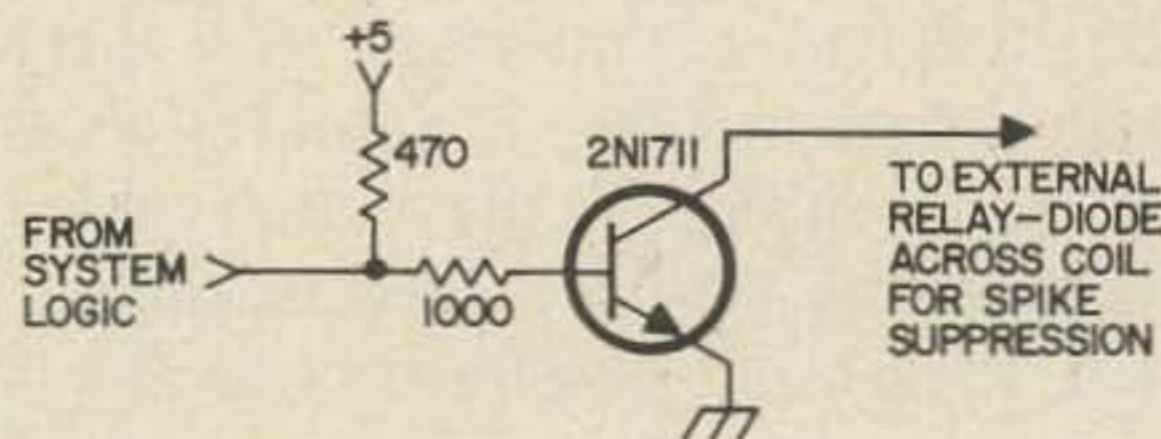

Fig. 11. Circuit of typical system output stage.

Ideally the "support" circuits should be included as an integral part of the control unit thus eliminating the interface circuit.

### Packaging Technique

The control logic and the diagnostic test set were individually constructed on a chassis cover plate. Each cover plate contains the logic, power supply (+12 to +5), and interface cable receptacles. Each chassis can support two distinct units — one on the "top" plate and another on the "bottom" plate. (The chassis was installed on its side; the top and bottom therefore become side panels.) Photo 1 shows the construction concept used. This unique packaging technique, devised by WAØVWJ's owner, Chuck Fenwick, performs very well, providing modularity, easy removal for testing and modification, and excellent shielding. The chassis containing the system logic is normally connected to the system's support circuits (receiver carrier detector, transmitter keying circuit, tone generator, telephone ring detector, etc.) via two cables fitted with 10 pin plugs.

When desired, or when necessary, the cable from the diagnostic test set is attached to the system logic subassembly. This configuration allows the diagnostic test set to monitor the system's operation via the lamp display. By connecting only the diagnostic test set, the control logic can be fully

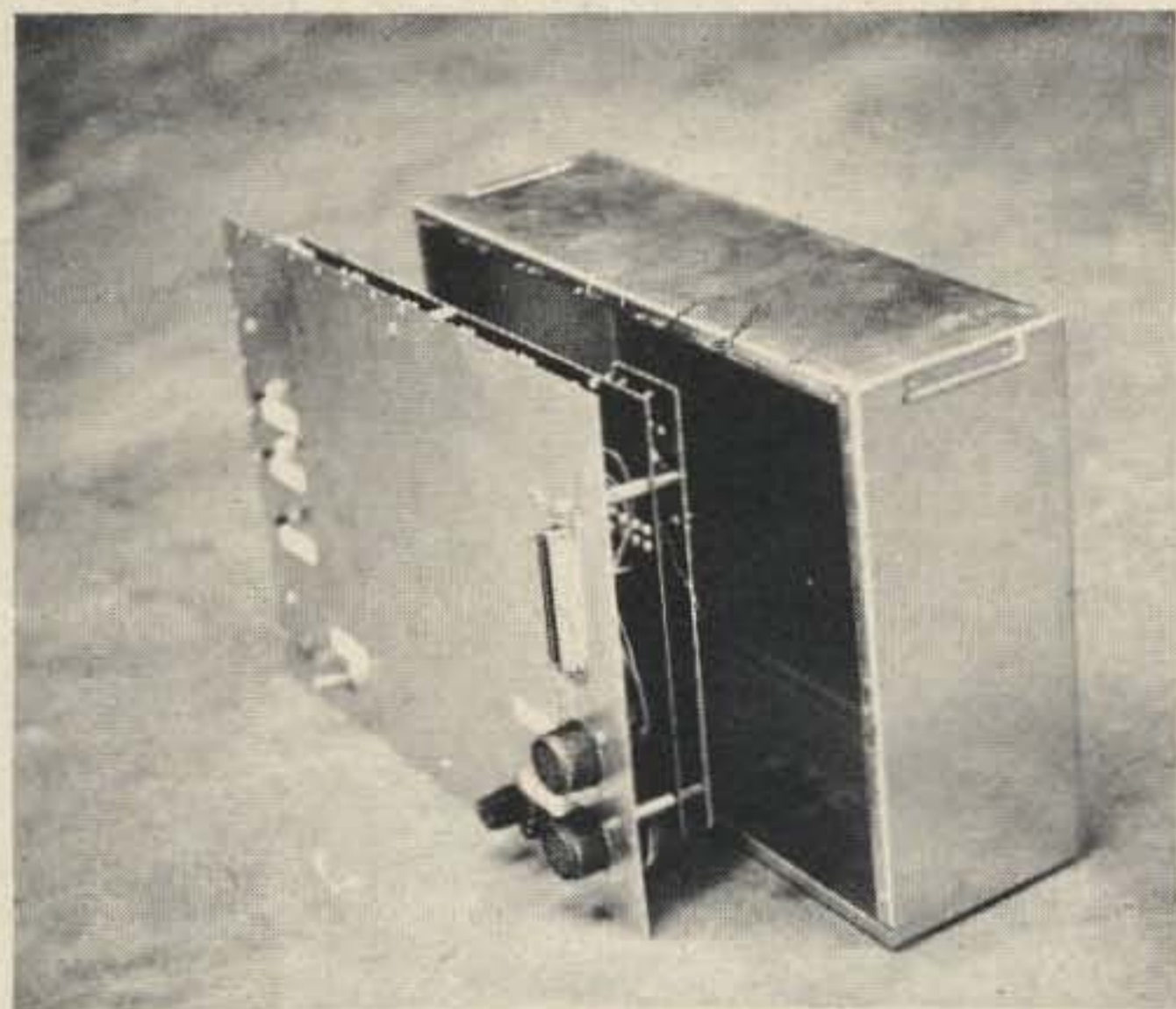

Photo 1. Main panel contains interface plugs, on/off switch, fuse, pilot light, local switches (i.e., key xmit, and logic initialization). Panel can be completely removed for easy servicing; when installed, shielding and dust proofing are automatic.

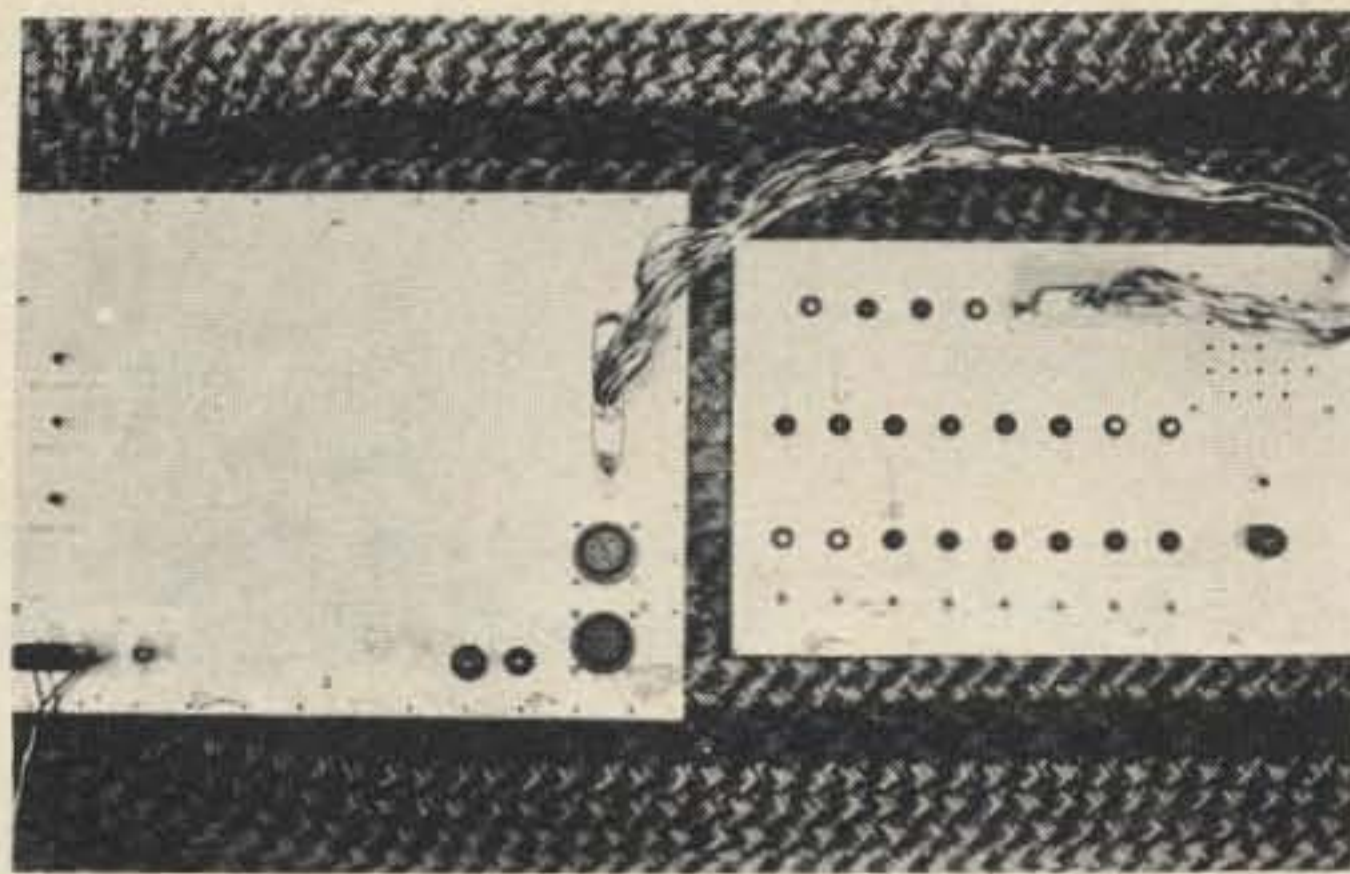

Photo 2. Operation in diagnostic mode. System interfaces have been disconnected.

exercised by manipulating the 8 input signal simulation switches. (See photo 2).

1. "Tailending" is generally incorporated in a repeater for at least one of the following reasons:

1. To allow stations not equipped with burst tone generators access to the system when a burst equipped user is on frequency
2. To minimize wear and tear on the transmitter keying circuitry

Timer A controls the amount of "open" repeater access time that will be allowed; the timer does not control the keying of the transmitter and therefore implements only the first of the above two reasons for tailending. (See No. 2 below)

The output of gate D2 is a logic 1 when the transmitter is to be keyed. This logic signal "follows" the input signal to the transmitter. If there is chop on the input signal, there will be discontinuities at the output of gate D2. In order to minimize wear and tear on the transmitter keying circuitry, the relay operated by D2's output should exhibit delayed drop-out — 2 or 3 seconds should be adequate. Delayed dropout can generally be implemented by connecting a capacitor in parallel with the relay's coil. A moderate amount of capacitance will work well providing the coil resistance is at least several hundred ohms.

...WAØZHT/1

### References:

1. "Designing Diode Matrix Units," T. R. Yocom, 73 Magazine, January 1972, page 45.

# 2 Rigs in one!

## THE COMCRAFT CTR-144



Made in U.S.A.

## The First AM-FM Solid-State Transceiver For Two Meters

No longer is it necessary to choose between AM and FM on two meters. Now you can have both in one compact unit. Join the gang on the new FM repeaters yet still be able to "rag chew" with old friends either AM or FM anywhere in the two meter band.

### compare these features...

#### TRANSMITTER:

- Built-in VFO (Frequency converted for stability)
- AM and FM both crystal and VFO
- Four transmit crystal positions (8 MHz)
- 12 watt input AM and FM
- High level transmitter modulation on AM
- Bandpass coupled transmitter requiring only final tune and load
- Three internal transmit crystal sockets with trimmers for netting
- One transmitter crystal socket on the front panel
- Deviation limiting
- 146.94 MHz crystal included

#### RECEIVER:

- Double conversion
- Crystal controlled first conversion
- MOS FET receiver front-end
- Integrated circuit limiter and discriminator for FM
- Envelope detector and series gate noise clipper for AM
- Built-in squelch for both AM and FM

#### GENERAL:

- Separate transmitter and receiver tuning
- Built-in 115VAC power supply
- Direct 12VDC operation for mobile or portable operation
- Optional portable rechargeable snap-on battery pack available
- "S" Meter also used for transmitter tune up
- Military style glass epoxy circuit boards
- Anodized lettering and front panel
- Baked epoxy finish on the cabinet
- 47 transistors, 22 diodes, 1 integrated circuit
- Dimensions: 10 $\frac{1}{4}$ "W x 6 $\frac{1}{4}$ "H x 7 $\frac{1}{2}$ "D

Warranty—90 Days Parts and Labor

The CTR-144  
is available at  
your DEALER

**\$489<sup>95</sup>**

# C

## COMCRAFT COMPANY

P.O. BOX 266—GOLETA, CALIF. 93017

Write for more information or use READER SERVICE

# GETTING YOUR REPEATER LICENSED

*the easy way . . .*

**A** single article — even a monthly column — is not enough to keep up with the developments in this grey area — you almost need a daily report. You see, the FCC (and when you see the term “FCC” these days, this generally is a euphemism for Prose Walker) is sailing full speed ahead into uncharted waters.

Many FMers are at a loss to understand how the FCC could possibly have come up with such an incredible set of regulations for repeaters. The fact is unless someone (Walker) changes, repeater operation has had its back broken and the fastest growing — the single largest ham activity — the most valuable emergency communications system we have ever devised — will be so hobbled that further growth is questionable. This is why the normally silent ARRL has, for the first time in its history, publicly chastised the FCC.

The reason that FMers are unable to understand how the new rules came about is their involvement with FM. There is a simple explanation for what happened — and once you think about it in this frame of reference, everything fits into place and makes sense. If you forget all about FM, repeaters, repeater councils who are coordinating frequencies, simplex channels, scanners, squelch, — just forget everything you know about FM entirely. Now, put yourself in the position of writing rules for repeaters for 75 meters and you will see that everything falls into place.

If you start with that basic premise, you end up with regulations which take into

Wayne Green W2NSD/1  
Editor-Publisher

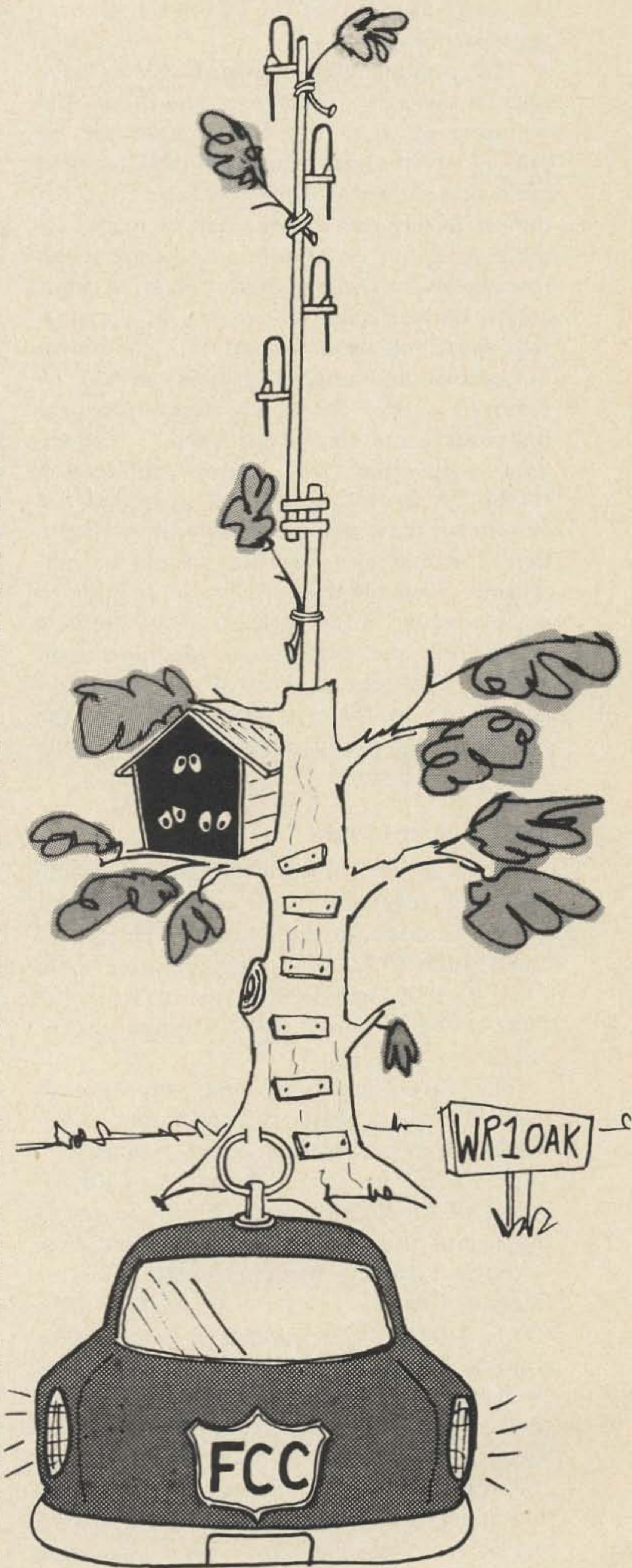

account the problem of simplex operation on the repeater input channel . . . and all of the other hassles that the FCC has built into the new rules.

The fundamental arguments FMers have against the new regulations are these: the requirement that a control operator be present at all times when the repeater is in operation will force many repeaters to go off the air during parts of the day or night . . . the restrictions on remote control are much too severe . . . the required timers to limit length of transmissions are not in the amateur spirit and are detrimental . . . the power limitations are unrealistic and should be removed . . . the frequency limitations are impractical and should be lifted . . . the antenna showings for license application should be deleted . . . the whole application system for repeater licenses should be simplified . . . crossband operation should be permitted . . . etc. It would take a large book to go into each of the deficiencies of the new regulations and present an adequate argument to back up the above. Much of this has been done in the past issues of 73 in the FCC columns, if you are interested in getting some perspective.

### Getting Your License

Okay, down to the nitty gritty of filling out your repeater license application. This should be done on the latest FCC form 610 dated July 1972. You can get these from your friendly area FCC office or from the FCC, 1919 M Street NW, Washington DC 20554.

The first special showing you have to make for the repeater license is one of the height of your antenna above average terrain. To do this you will have to send for copies of the correct maps. First you get an index and ordering information from U.S. Geological Survey, Washington DC 20242 or Federal Center, Denver CO 80225. You want to buy the topographical maps with a scale of 1:250,000 and a contour interval of 50 feet. No, the maps you now have are not the right ones — you have, in all probability, the 1:62,500 scale 20 foot contour maps and, unless the right maps are unavailable you must follow instructions. Word is that the correct scale maps may not be available

for California and a substitute will have to be made in this case. The maps cost \$1.50 each and the chances are good that your repeater will be in one corner so you may have to buy four maps.

Once you have the right map or maps — get a compass and draw circles around the repeater site at every two miles out to the ten mile circle. Then draw a vertical and horizontal line through the repeater site — and two at 45° and 135°. Now you're ready to get out the magnifying glass and read off the contours at the junction of all those lines and circles. If you didn't goof, you should have forty numbers. Average them. That means add them all up and divide by 40. This is a splendid time to have that Heath calculator. The number you end up with is your height of average terrain — unless you live in Death Valley, in which case it would be the depth of average terrain.

Now take that map and cut out an 8½ x 11 in. section of it which includes all of those terrain circles. This is your exhibit number one for the application. Show the forty numbers and the average — as well as the height of the repeater site and the antenna at that site. Put these numbers on a separate sheet of paper — also 8½ x 11 in. Make all of your exhibits on that same size sheet.

Next they want to know the effective radiated power in the horizontal plane. This means that you have to submit an antenna pattern on polar graph paper. If you don't have said polar graph paper you can buy it — or, if desperate, send a sase to 73 for a couple of sheets — we've printed up a bunch for this use.

Eventually the FCC (Walker) will have accepted radiation patterns for all of the commercially available antennas and all you will have to do is refer to the make and model — but for the present they want a lot more. The fact is that they have been rejecting some exhaustively prepared antenna submissions from manufacturers — and have refused to accept antenna patterns made by manufacturers even when these have been accepted by other divisions of the FCC.

This will probably change soon, but for the present the FCC seems to want you to set up your antenna and make field strength

measurements by driving around it as best you can. From this you can work out your horizontal radiation pattern. If you take the easy path and use a quarter wave ground plane on top of a tower — or a half wave dipole — the horizontal pattern will be circular and the gain one . . . 0 dB.

The effective radiated power is simple to calculate when the antenna gain is one. It is equal to the output of the transmitter (and tell them how you measured this — perhaps with a Bird wattmeter), less the losses in the coax cable, multiplied by the antenna gain. The *73 Coax Handbook* gives the coax cable loss vs frequency figures. If you're using RG-8/U foam, you can figure 2.3 dB loss per 100 feet at 147 MHz. So, if you have a ten watt repeater transmitter (measured with a Bird), and you lose 2.3 dB in the coax, and the antenna has a gain of one, your effective radiated power would be (according to the *Coax Handbook* again, page 13)  $10 \times 0.588 \times 1 = 5.88$  watts. Or perhaps you have 120 feet of coax, in which case you would have a 2.76 dB loss, or a power loss of .531 — so the ERP would be 5.3 watts. You're on your own.

Show your calculations of the loss of your feed line — in dB — and show how you determined the loss. If you used the *Coax Handbook* charts, reference them.

They want a polar coordinate graph paper radiation pattern of your repeater antenna as installed — showing true North — with the relative field strength indicated in voltage or dB and explain how this graph was prepared. They also want you to show the vertical field strength pattern. This may be a problem to measure — the FCC has suggested that you might turn the repeater antenna on its side and rotate it slowly, taking measurements every few degrees — or you might use a probe on a long stick — or you might get an airplane and fly around it at different altitudes. They will also accept, we understand, tests made on a model antenna at UHF, if you want to set up your own antenna laboratory.

Again, the easy way out is to use a quarter wave ground plane or a half wave dipole and get the pattern from a handbook (such as the *73 VHF Antenna Handbook*). They apparently will accept this.

The next hurdle is the remote control question. If there is any way to apply for your first license without remote control it will greatly simplify everything. Eventually we will have a body of literature of remote control systems which the FCC has accepted — but at present the ONLY known acceptable one is direct control of the repeater with no remote control.

It will not hurt you to show that your repeater has a three minute timer on it which will turn the repeater off when the transmitter has been on for three continuous minutes. This should be resettable only by the control operator. You can also have a timer set for less than three minutes on the input which is resettable by the users. The FCC would like to have a simple block diagram of the repeater system and you can indicate this control there. And don't forget to show the identifier too.

You should list the control operators, their calls and addresses, if any will be remotely controlling the repeater. We can't go into more details on remote control because it is just too complicated to handle in a short article and this will better wait until there have been some systems accepted.

So there you have it. If you follow the instructions given here you should be able to at least get your WR call in a reasonable time. Once you have it you can start work on getting remote systems accepted. There is much to be said for making the application as simple as possible and following "accepted" paths so you can get that WR call without a lot of correspondence with the FCC.

The latest reports are that the FCC has hired three more men to handle the repeater applications — the empire building has started. The overly complicated applications made it impossible for the existing staff to handle the paperwork. No reasonable explanation has been offered for the need for all this paperwork and it appears to many observers that no useful purpose is served other than expanding the FCC staff.

And don't forget the \$9 when you send in the application.

. . . W2NSD/1

# 2 METER FM HEADQUARTERS



Rigs for every use . . .  
for every pocketbook!

## STANDARD

HAND HELD  
STANDARD SRC-146-A

5 Channels — .94/.94 and .34/.94 supplied  
.3  $\mu$ V receiver — 2+W transmitter — PL available  
Compact — 8" h x 3" w x 1 1/2" d  
Full line of optional accessories includes external  
speaker-mike — desktop charger — "stubby" antenna — and more!

Available NOW! —

Only \$289.00



ALL PURPOSE

STANDARD 826MA

12 channels (4 with crystals)  
10 Watt output  
PL available

Hot MOSFET receiver, helical resonators

Only \$369.00

## NEW 220

## TEMPO/CL220

- 12 Channels
- 10 Watt xmtr — .5 $\mu$  Vrx
- Xtals for 223.5 MHz supplied
- Meter for Power Out, Signal Strength, and discriminator



Size: 2.36" x 5.9" x 7.66"

Only \$329.00

Antennas and 50W Power Amp. (TEMPO 522) Available!

### TEMPO SOLID-STATE POWER AMPS



U.S. Made

MODEL	DRIVE POWER	OUTPUT POWER	PRICE
1002-3	5-25 watts	100-135 watts	\$220
1002-3B	1-2.5 watts	120-130 watts	\$235
802	5-12 watts	70-90 watts	\$180
802B	1-2.5 watts	80-90 watts	\$195
502	5-15 watts	35-55 watts	\$105
502B	1-2.5 watts	45-50 watts	\$130
242-A2	1-2.5 watts	25-30 watts	\$ 85

And many more from SBE/Clegg/Gladding/Kenwood/Tempo/Antenna Specialists/Larsen



Make ERICKSON your headquarters for all your FM needs

SEND QSL FOR COMPLETE SPECIFICATIONS

**ERICKSON COMMUNICATIONS**

4653 N. Ravenswood Ave., Chicago, Ill. 60640 (312) 334-3200



# LOW TEMPERATURE TECHNIQUES FOR RADIO AMATEURS

Daniel L. Fox W1GNZ  
190 Upper County Road, RFD  
Dennisport MA 02639

One of the most effective techniques for the reduction of front-end noise in receivers has been completely overlooked by radio amateurs. The reason for this neglect is that the technique, until recently, has been far beyond the financial grasp of most hobbyists. I refer to the low-temperature design.

The low-temperature situation, I am happy to say, has changed. Recent research and experimentation at W1GNZ has resulted in a simple, effective method of constructing a low-temperature front end that is entirely within the reach of the average amateur's pocketbook.

Before going into actual design details, however, let us take a brief look at the history of low-temperature design, and the theoretical underpinning so important to the present presentation. The theoretical details may present a slight problem for the average amateur, but it is hoped that all readers will at least make an attempt to plow through the mathematics. Certainly an appreciation

of the *raison d'être*, as it were, of super-cooling will enable the average amateur to derive full benefit from the design to be described.

## Historical Significance

As most amateurs know, low-temperature techniques were first employed by radio astronomers in an effort to reduce thermal noise and attain the receiver sensitivity required to detect weak, extra-galactic sources. Authorities in this field have claimed overall sensitivities to the order of  $10^{-5}$  microvolts for a 10 dB S/N radio. Compare *that* to your present receiver, OM!

We are pleased to report that a technique has been devised which places the low-temperature theory and practice within easy grasp. This article demonstrates the technique, along with a brief theoretical background.

The research described here has resulted in some interesting spin-offs, including a

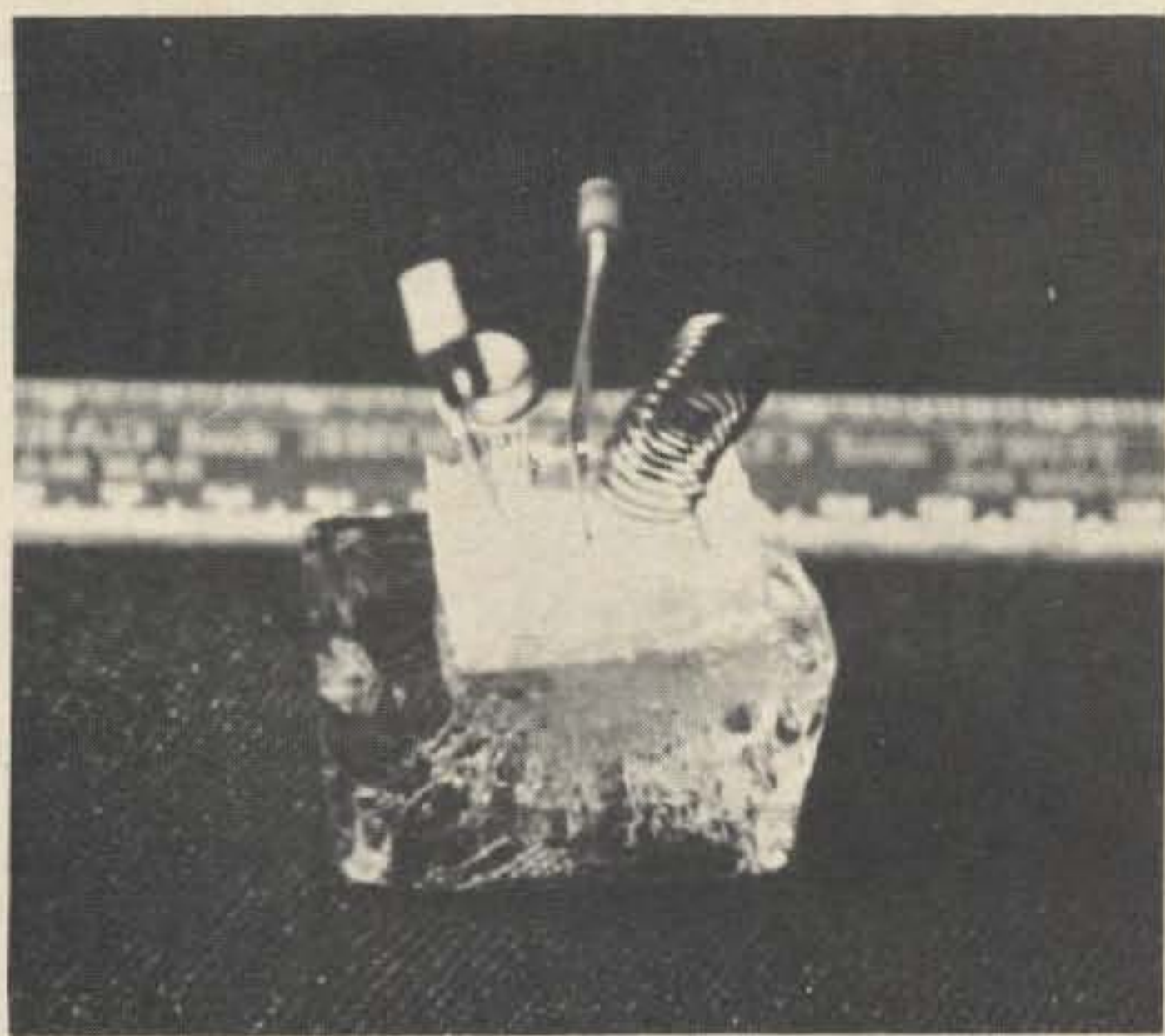

The low-temperature preamplifier, with anti-heat sink.

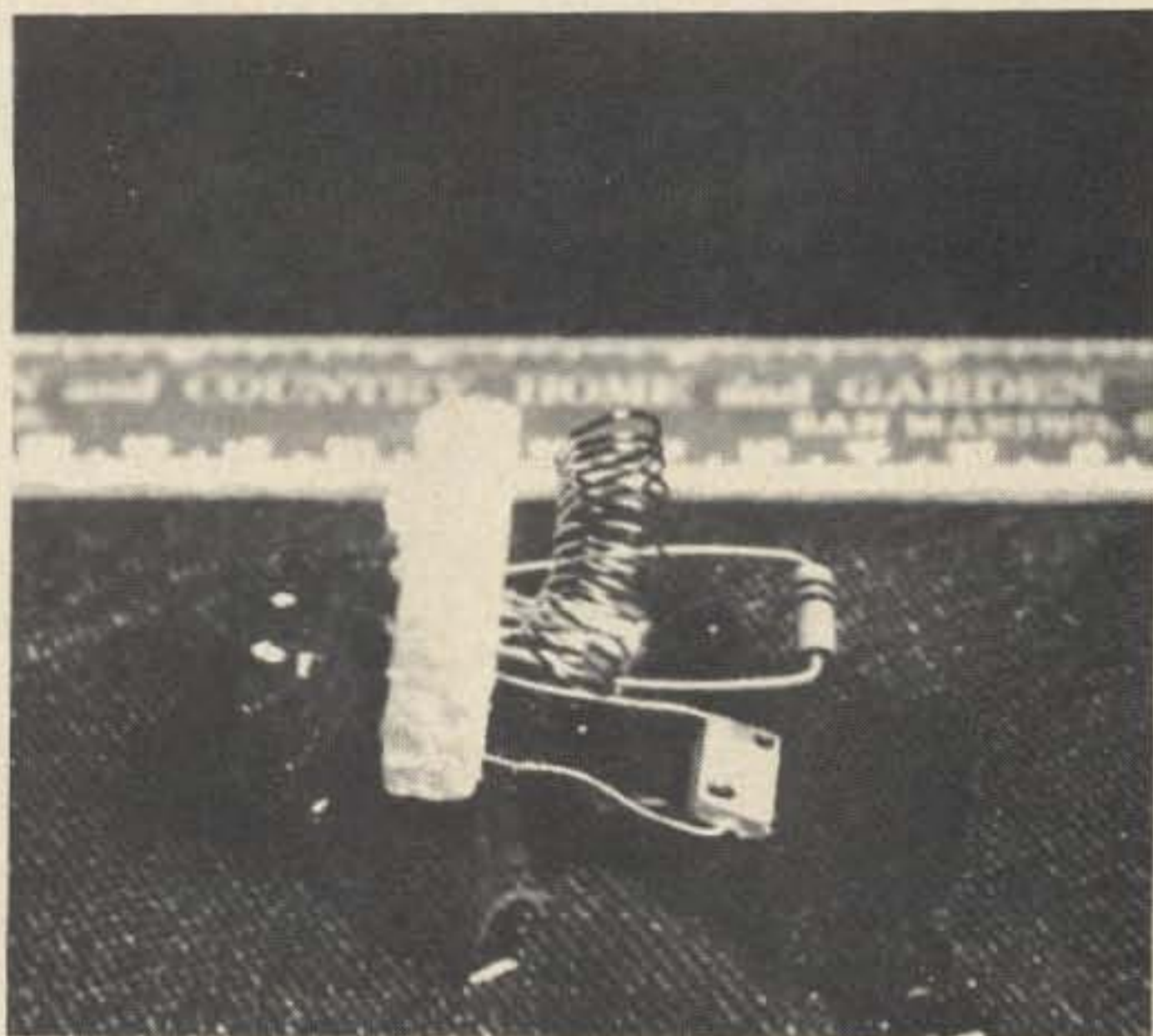

Effect of connecting the preamp to the linear. Note decreased sensitivity.

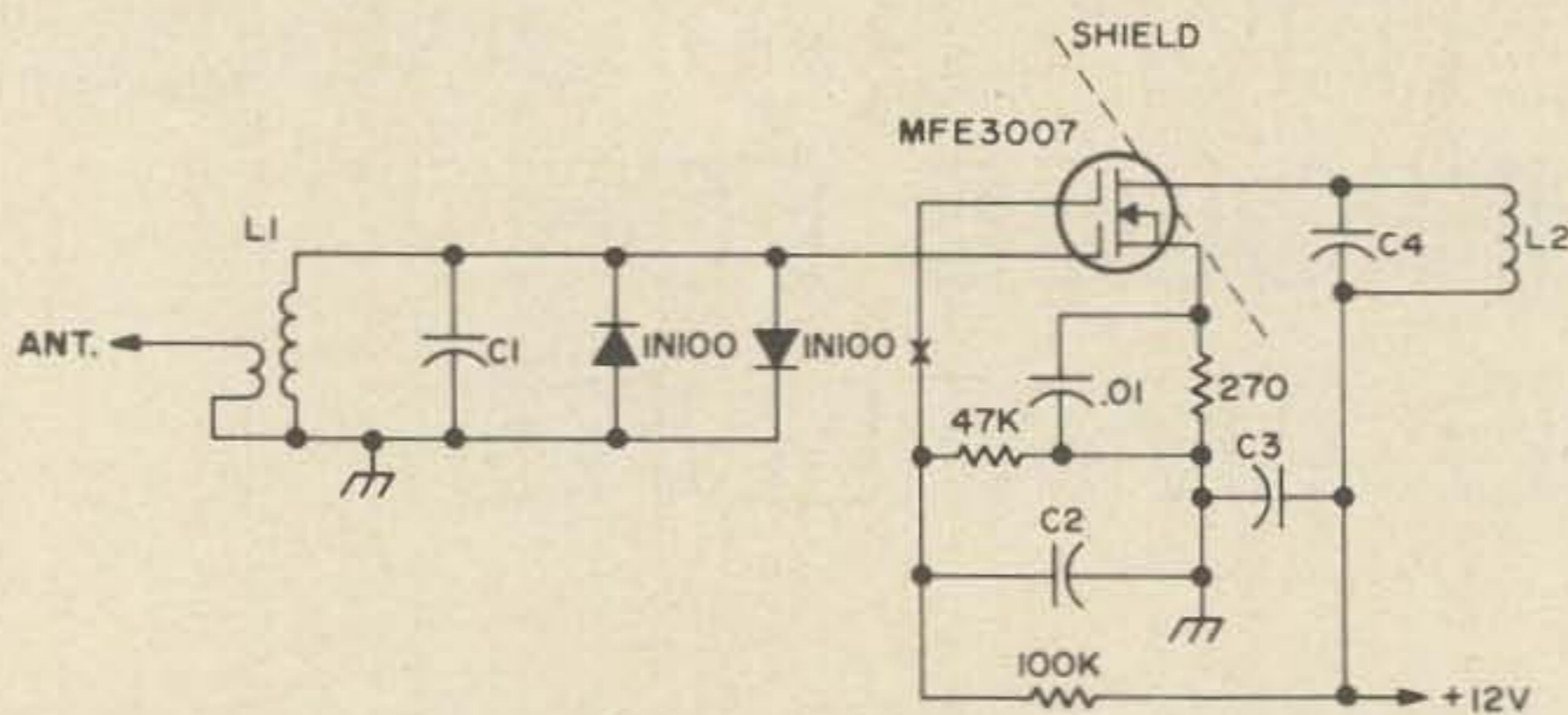

Fig. 1. A typical rf amplifier stage.

radical new organically-based i-f filter, which yields selectivity commensurate with the enhanced sensitivity. This will be described later.

### Theoretical Background

We apologize for the use of mathematics here, but the development is such that the average amateur should have no trouble understanding the equations if he will put forth a little effort.

That receiver sensitivity is limited by thermal noise has been shown by River.<sup>1</sup> OM River's development makes extensive use of wave functions, flow equations and bridge networks, but in simplified form it looks like this:

$$\int X^2 dx^2 = EdQd\theta dY$$

$$m \frac{d^2 y}{dt^2} + b \frac{dy}{dx} + ky = \begin{cases} 0 \\ 1 \\ \infty \end{cases} \text{ depending on sunspot cycle}$$

$$\left[ p(r) + \frac{Bx^2}{8\pi} + \frac{B\phi^2}{8\pi} \right]_{r_1}^{r_2} + \frac{1}{4\pi} \int_{r_1}^{r_2} \frac{B\phi^2}{r} dr = t_0$$

$$\frac{Ro \log \left( \frac{Ro}{R} \right)}{R} = \frac{1}{t_0} \int_0^t F(t) dt$$

Therefore,

$$C = Nk (te^x e^4 - he^x e^4) \text{ (the so-called "tee-hee" function)}$$

This result can be simplified to the form:  
 $a^2 + b^2 = c^2$

1. His research efforts just keep rollin' along.

In words, the significance of this formulation can be stated thus: At room temperature, there is considerable molecular vibration in every element of an electronic circuit. Conservation of energy demands that the rf energy used in making the molecules dance<sup>2</sup> is not available as signal and the overall sensitivity of the circuit is reduced drastically. (Incidentally, this line of thought has borne fruit in recent medical studies.<sup>3</sup>)

### Experiments

The stage is now set for low-temperature design. Here at WIGNZ, a method was desired that would enable us to construct a low cost front end incorporating the above considerations. A trip to the junk box and a phone call to the city dump provided the necessary equipment and the project was begun. An old Kelvinator refrigerator was acquired and its cold path rerouted so there was a compartment near the top that remained at a fairly constant, cold temperature. This compartment would house the new front end.

Now, it may be argued that freon, as supplied by an ordinary refrigeration device, is not sufficient for super-cooling. This was found to be incorrect, for reasons that will be shown.

Once the cooling chamber was readied (we dubbed it the "ice box"), attention was turned to the construction of a suitable preamplifier. The circuit of an ordinary

2. Most pronounced between 88-108 MHz.  
 3. Reuben, David. *Everything You Wanted to Know About Sex*, etc., Bantam Books. New York, 1969. See the chapter on sperm motility.



WIGNZ calculates a swr vs. cooking time plot for the unbalanced 10 meter cabbage.

preamp is shown in Fig. 1. Now, it must be remembered that at low temperatures resistance goes *down*, tending toward zero near zero degrees Kelvin<sup>4</sup>. The purpose of an rf stage transistor or tube is, of course, the amplification of the signal and the compensation for tuned circuit losses. A quick calculation of amplification factors and circuit losses revealed that, at low temperatures, the gain was high enough that certain simplifications could be made. The resulting low-temperature rf amplifier circuit is shown in schematic form in Fig. 2.

### Results

The first attempt to test the completed project was made with the rf amplifier in the ice box, connected to our transceiver by a length of RG8/U. It was soon found, however, that extra gain was to be had by installing the *entire transceiver* in the ice box

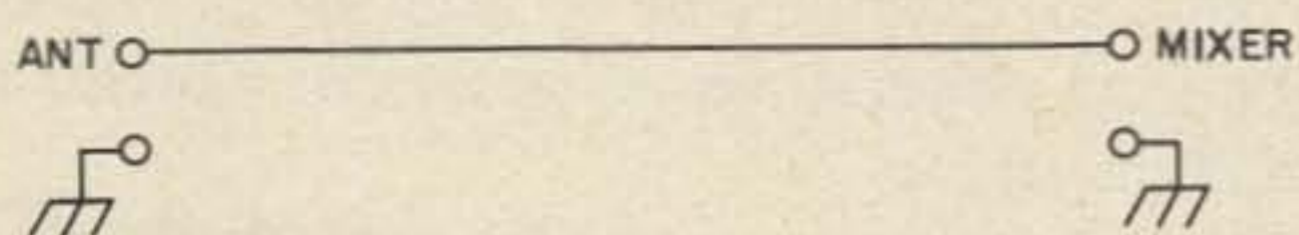

Fig. 2. The rf stage used with the low-temperature apparatus.

4. Absolutely.

and operating it by remote control. Gloves are recommended for changing bands.

We were very excited when the rig was fired up for the first time. Since the predicted gain is so high in this circuit, antenna considerations were minimal. We used a cabbage that happened to be in the refrigerator.<sup>5</sup>

A number of contacts have been made with this system, with S9+ reports every time. Stations worked report a certain amount of Doppler shift (probably caused by the rapid slowing down of electrons when they hit the ice), but so far it hasn't slid us out of the band. Receiver gain is variable, and seems to be greatest with the defrost timer set on 4.

### New Filter Discovered

As we mentioned at the outset, a spin-off of this research has resulted in the discovery of a radical, new organically-based filter.

After several hours of operation with the low-temperature system, it was noted that the selectivity had mysteriously improved. The observed bandwidth on SSB was indeed so narrow that only local bigots could be copied intelligibly. The device was opened

5. Peel off the outer leaves for a lower swr on ten meters.

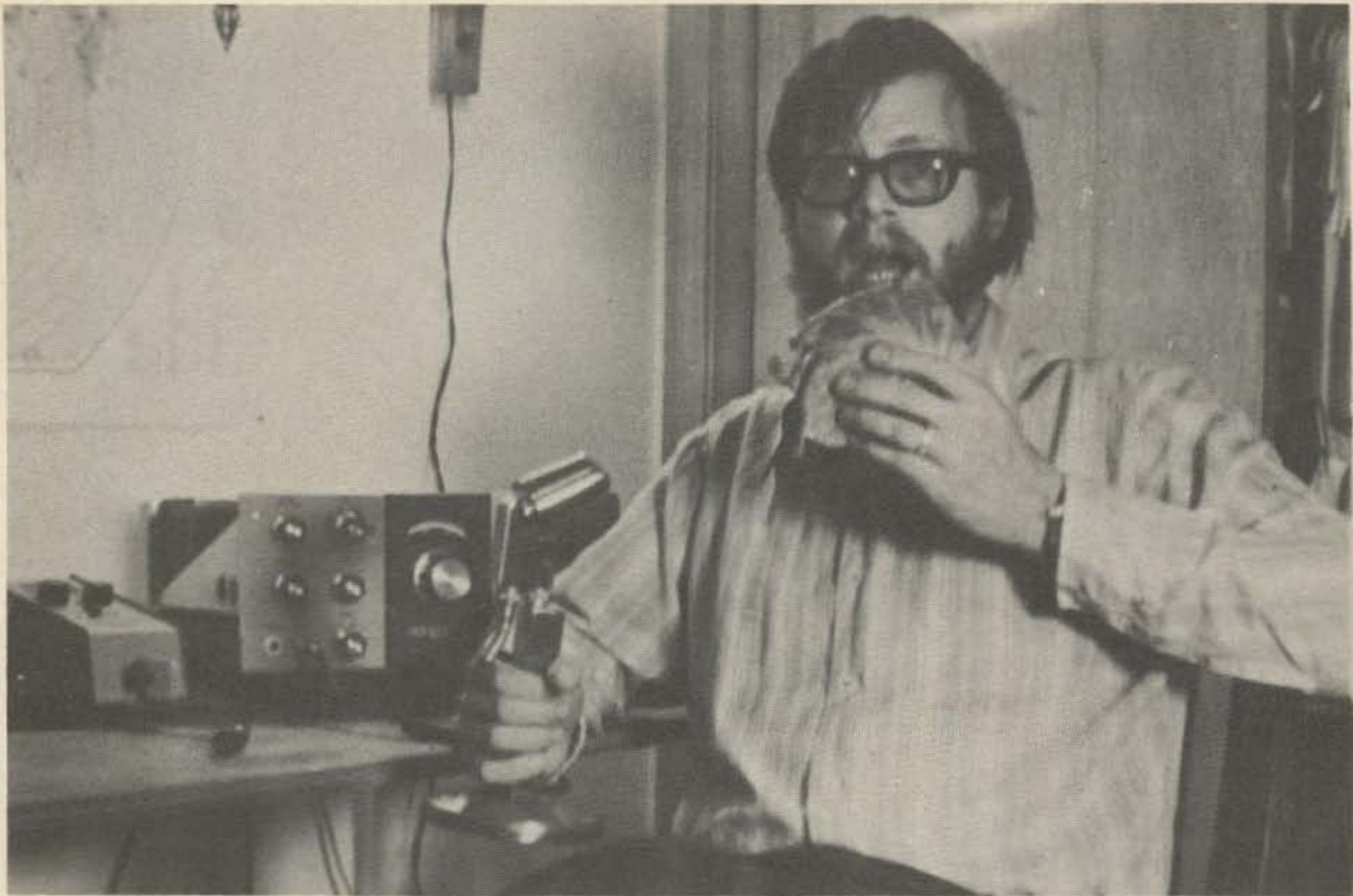

*5:1 is about right. Easy on the salt!*

up, the beer cans shoved aside, and it was discovered that a mouse had inadvertently become wedged between the i-f stages. The poor creature had frozen solid, and was oscillating at a handy 50 kHz. No wonder the selectivity curve had such a long tail!

After further "cut and try" experiments with our new filter, we settled on a large field mouse for SSB and a smaller rodent for CW. This data indicates that a hamster may have to be substituted for SSTV, but it hasn't been tried so far.



*An inside view of the complete installation.*

### Some Problems

No truly meaningful research is ever completed without difficulties of some sort. After a few weeks of operating we looked at the WIGNZ log and discovered that contacts had been made only with antarctic research stations; weak, extra-galactic sources, and an occasional VE8. Further investigation is indicated here. Additionally, the refrigerator needs to be defrosted about once a month and the mouse replaced. Failure to replace the mouse, we've found, results in a tremendous amount of "slop" in the received signal.

### Conclusion

We think this article shows that the average amateur is missing out on a lot in his hobby if he does not experiment and attempt new ways of doing things. The fun one can have with the equipment described here is limitless. For instance, the lower part of the refrigerator can be used to get rid of annoying operating distractions such as small children!

In a forthcoming article we will describe our recent venture into radio controlled mouse farming. Meanwhile, does anybody know a good cabbage wholesaler?

...WIGNZ

# CHOOSING YOUR FM RIG

The chart shows the basic specs of 32 different amateur two meter FM transceivers – and the question naturally arises: how do you decide which rig is the best for you?

This is a pretty tough order, frankly, and you'll find political and religious arguments about as easy to settle if you consult friends. This does not mean that it is impossible to apply rules of logic to your selection, only that it may appear that few FMers do.

One easy sort can be applied to the list if you have a need for a hand unit rather than a mobile rig – this takes you to the Standard

146A and the Tempo (Henry) FMH units directly, without passing go – and with the payment of \$200 or so. You may want to count in the price of fast charge nicad batteries with these units – plus a charger to keep the unit in when not in hand. This will bring the net cost of the hand units a bit higher.

Both of these units put out two watts, which runs down the batteries a lot faster than may make you happy. There is something to be said for the earlier SR-C146 unit which ran only one watt out – and lasted a lot longer. It might be prudent

to consult the importers, should you get one of these units, about reducing the power to one watt or a bit less. The results will not be noticeably different under most circumstances.

Perhaps you want to invest in a low priced unit which can be used both as a hand unit and a mobile rig – in which case you'd better check the three available portable units, the Drake TR-22, the Tempo FMP, and the new Gladding 660. The TR-22 has a built in charger, while the FMP has a socket to plug in the Johnson charger. The TR-22

	Model	Price	Power	Channels	S-Meter	First Year Sold
Clegg	27B	\$480	25	All		73
Comcraft	CTR144	\$490	8	All	X	71
Drake	P TR-22*	\$200	1	6	X	71
	TR-72*	\$300	10-1	23	X	73
Genave	GTX-2	\$250	30	10		72
Gladding	P 660	\$200	6-1	6		73
	25	\$250	25-1	6		71
Heath	HW202	\$180	10	6	X	73
Inoue	IC-20*	\$270	10-1	12	X	72
	IC-21*	\$359	10-1	24	X	72
	IC-22*	\$300	10	22	X	73
Midland	13-500*	\$250	15-1	12	X	73
Regency	HR2MS	\$319	15	8R,6T		72
	HR212	\$259	20	12		72
	HR2A	\$229	15	6		72
Ross & White	RW-BND*	\$240	10	12	X	71
SBE	SB144*	\$260	10	12	X	71
Simpson	B	\$250	25	12		71
	A	\$180	10	4		71
Sonar	3602	\$400	—	—		72
	3601	\$300	10	8		71
	H 2307	\$450	1	5		71
Standard	826MA*	\$370	10	12	X	72
	H 126A*	\$290	2	5	X	72
	14 *	\$595	10-3-1	22	X	72
Swan	FM2X*	\$260	10	12	X	71
	FM1210H*	\$330	10	12	X	72
Tempo	P FMP*	\$225	3-½	8	X	71
	FMV2*	\$200	10	11	X	72
	H FMH*	\$190	2	6	X	72
	CL146*	\$279	10-3	12	X	73
Yaesu	Auto FT2*	\$330	10-1	8	X	72
	FT2FB*	\$230	10-1	12	X	72

\* of Japanese manufacture

H = Hand-Held, P = Portable. All others mobile units.

runs one watt output, the FMP 3 or 1/2 watt, which can be handy. You normally run the low power and then have the ability to increase your signal by a bit over one S-unit if you need it. Either rig can be used with a mobile power amplifier to give you a combination shoulder rig and mobile rig. If you can't afford both hand units and mobile rigs, this is a money saver. And the chances are that you will find plenty of opportunity to use a hand unit — most of us do.

The mobile rigs can be divided up a bit. First there is the Clegg, which is in a category all its own. This is the only rig that will hit every channel from 146–148 MHz. The calibration is accurate enough for you to set the knobs and work simplex or through any repeater. It costs a bit more, but it is going first class.

The Comcraft is different. It is an AM-FM rig with a tunable receiver and a VFO for the transmitter. The dial calibration is not adequate for repeater use, though the spot switch permits simplex operation. You really need a frequency counter with this unit if

you are going to work through very many repeaters. There is a crystal socket on the front panel which can be used if you don't mind plugging in crystals to hit the repeaters. You still have to tune for the received signal. This is a terrific rig if there is much AM in your area — and with a counter it does about anything you could ask.

All the rest of the rigs are crystal controlled for both transmitter and receiver. In general you get about what you pay for — with higher prices generally indicating better receiver selectivity. It is possible to improve selectivity on most sets by buying a better filter for the i-f. This takes a bit of doing on some sets, but is worth the effort if you have a problem with adjacent channel spillover. Most of the newer sets are coming through with pretty good filters — the "D" at least, and some with the "E." These are by Murata.

Poor i-f selectivity makes it so receivers have a tough time rejecting a strong repeater in the next channel. Thus, a very strong signal on 146.91 can wipe out repeaters on 146.88 and 146.94.

Another factor which may be of importance to you is the number of channels in a rig. If you are in the northeast you may think in terms of one of the 20+ channel rigs such as the TR-72, the new Drake rig — the Inoue IC-21, or the Standard 14U. The IC-22 should be available in a short while, with its 22 channels.

If price is a major factor, you will be interested in the new Heath HW-202 at \$180 or, if there are still any left, the Simpson Model A at the same price — both remarkable buys. The Simpson boards, the last we heard, are being used as the foundation for the Dycomm repeater.

If power output is your turn on, then you may want to go the Genave GTX-2 with 30 watts output — the Gladding 25 with 25 watts — or the Simpson Model B with 25 watts — all priced at about \$250. Each has its pluses, with the Simpson and the Gladding having front speakers, which are generally a lot easier to hear in the car unless you plug in a separate speaker. The Simpson has 23 channels, the Genave 10, and the Gladding six.

...W2NSD/1

## FREQUENCY STANDARD



**Only**  
**\$32.50**  
(less batteries)  
POSTPAID USA

- Precision crystal
- Fully guaranteed

- Markers at 100, 50, 25, 10 or 5 kHz selected by front panel switch.
- Zero adjust sets to WWV. Exclusive circuit suppresses unwanted markers.
- Compact rugged design. Attractive, completely self contained.
- Send for free brochure.

**PALOMAR**  
**ENGINEERS**  
BOX 455, ESCONDIDO, CA 92025

## WALLER ELECTRONICS TEST EQUIPMENT SALES

P.O. Box 9913, Chevy Chase, Md. 20015

**Telephone 301-652-0996**

The "TESCO-PAD" has no tuned coils to go off frequency, no tuning necessary or even there! It's all in one "Black Box I.C." ready to go. The "TESCO-PAD" has a 1 second hold-up for your transmitter, complete P.T.T. operation, available with dual audio output levels, 12 or 16 tone combinations.

**KIT \$34.95      \$39.95 Wired**  
(Add \$1.00 for 16 tone version)  
(\$2.00 for dual output version)

*(Add \$1.00 for postage and handling.)*

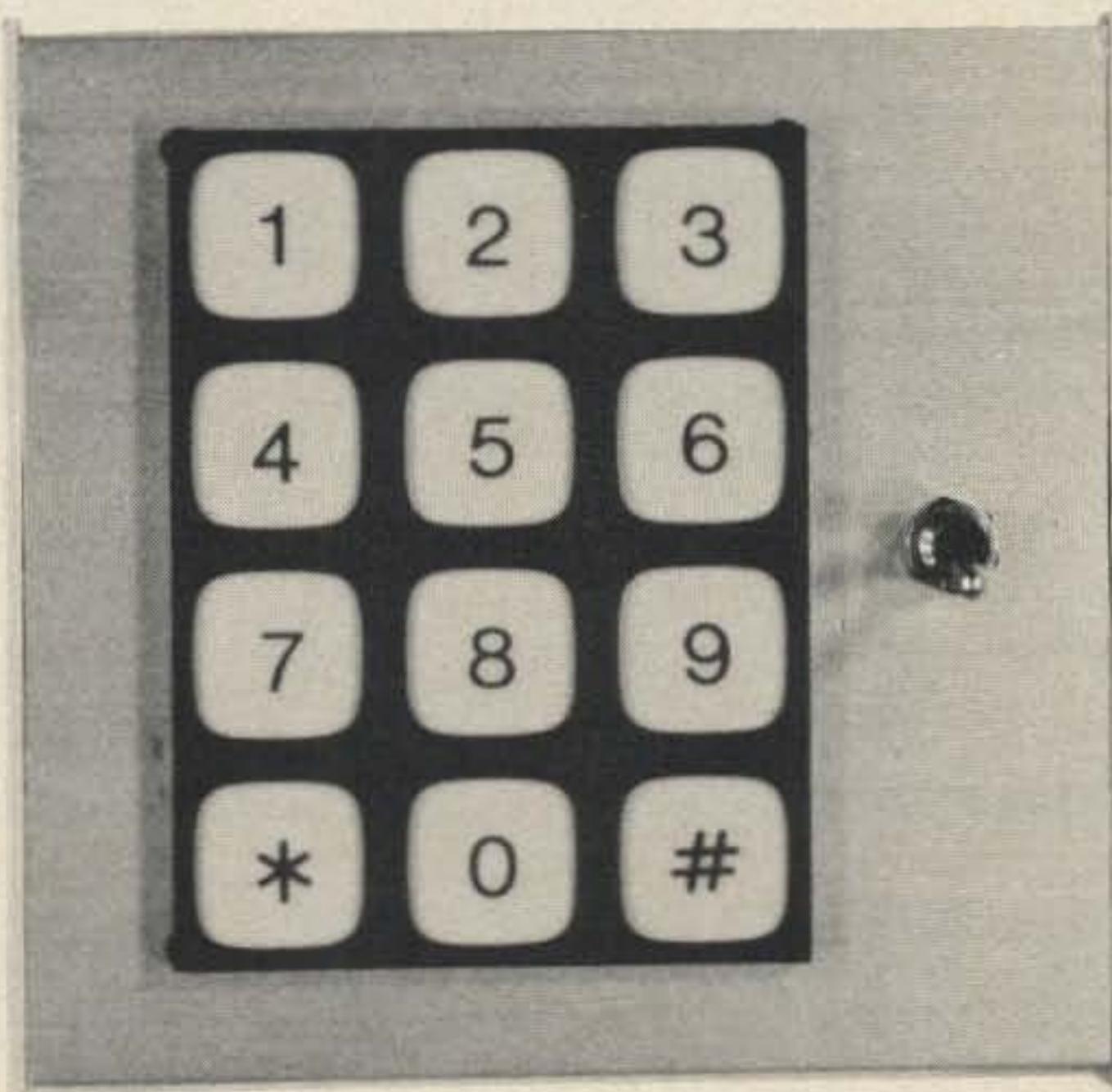

### NOW BRUTE FORCE IN A 12V BENCH SUPPLY – THE WALLER 60 AMP 12 VOLT SUPPLY!

A bench power supply for mobile equipment. This brute of a supply will run a mobile rig and even an amplifier from 110V ac. The output is a nominal 12V dc at 50 amps and is usable to a full 60 with a slightly lower output voltage. The heart of this supply is a constant voltage transformer rated at a constant output of 60 amps. The supply features built in voltage and current metering. The Waller 12 volt 60 amp supply is only ..... **\$100 in kit form or \$125 wired.**

*This unit shipped freight collect.*

Portable Tune Up Meter with cables to plug into Motorola, Link, GE, Standard, etc. This unit gives you the meter functions of the radio being tested. It also operates as a portable dc voltmeter with the following full scale ranges: 1.5, 5, 15, 50, 150, 500, 1 KV with a special 3 volt range for GE Progress Line equipment. The UT-1 can be set zero center for discriminator readings. Also featured in the UT-1 is a field strength meter. Place your order now. Kit form **\$42.50**. Wired **\$49.95**. Extra cables of your choice (specify rig) ..... **\$5.00 ea.**

*(\$2.00 for postage and handling.)*

## CALL OR WRITE WALLER NOW

# It's fun to build quality.



IC-2009  
**92<sup>50</sup>\***



IC-2108  
**79<sup>95</sup>\***

## Two new Heathkit Calculators.

At left is the totally new Heathkit IC-2009. It's first a self-contained portable, weighing in at 11 oz. and small enough to fit in your coat pocket. But it's a desk-top calculator, too. The internal Nickle-Cadmium battery gives five to eight hours use between charges. Or, the IC-2009 can be left connected to its charger for indefinite operation. And unlike other pocket calculators, the Heathkit IC-2009 is designed to be maintained by you. Plug-in keyboard and display boards, plus a complete troubleshooting section in the manual make it easy — and economical. Add up the features for yourself: 8-digit capacity. Four arithmetic functions. Full floating decimal. Constant key. Chain calculation capability. Clear entry key. Entry and total overflow indicators. Negative answer indicator. Battery-saver circuitry. Low battery indicator. Tactile-feedback keyboard for positive entry indication. Order your IC-2009 now. You'll have it built in two or three evenings. Mailing weight, 3 lbs.

The Heathkit IC-2108 on the right features a sleek, low-profile case with bright 1/2" read-

out tubes in an 8-digit display — one of the largest, most legible in the industry. The color-coded keyboard is human engineered to slope down to the desk so you can rest your arm while using. And the IC-2108 is loaded with features: Four arithmetic functions. Floating and fixed decimal. Constant key. Chain calculation capability. Clear display key. Entry and result overflow indicators. Negative number indicator. 120/240 VAC operation. In addition, the IC-2108 is amazingly simple to build. Two spare evenings will do it. 4 lbs. mailing weight.

HEATH	
<b>Schlumberger</b>	
HEATH COMPANY, Dept. 11-4 Benton Harbor, Michigan 49022	
<input type="checkbox"/> Please send FREE Heathkit Catalog.	
<input type="checkbox"/> Enclosed is \$_____, plus shipping	
Please send model(s)_____	
Name_____	
Address_____	
City_____ State_____ Zip_____	
*Mail order prices; F.O.B. factory.      GX-275R	



# EUROPE

## ON 2 METERS A DAY

*Complete details on reciprocal licensing and 2 meter repeater coverage.*

**T**aking along an amateur radio station on vacation, especially to a foreign country, used to be a luxury affordable only by a limited number of amateurs. However, the advent of reciprocal licensing with many foreign countries and the buildup of 2 meter repeaters have changed all that. With a compact transistorized 2 meter transceiver in your suitcase, you have a unique opportunity to quickly establish contact with the local amateurs in a foreign locale. The usage of a special call sign adds a bit of DX flavor to such operation, and local foreign amateurs — happy to hear an unusual call sign over their repeater — will usually extend a warm welcome. As long as you don't overdo it by forgetting that you are still a guest in a foreign country, you can have a great deal of fun and establish many new relationships.

Two items are obviously involved: securing the necessary license for operation in a foreign country and knowing the operating frequencies of the foreign repeaters. These items are covered in detail in this article, plus some general operating advice. Only the European area is covered because it offers the best possibilities for 2 meter repeater operation and most foreign travel is done there.

As part of the "homework" necessary to gather the information, letters were sent to all the licensing authorities from various countries as well as to many radio clubs. Many cordial replies were received in English as well as French, Spanish, etc. Obviously some administrations preferred to deal in

their own language, while others were kind enough to respond in the same language as the inquiry. Such a situation doesn't present too many problems, but you should be prepared to deal with forms where some translation assistance may be required. These situations are noted in the following material.

An alphabetical listing follows which discusses for each country the procedure for obtaining a temporary license and the 2 meter activity.

### Austria

Temporary licensing is very efficiently handled by Walter Nowakowski OE1WN. Walter is an official of the Austrian Association of Radio Clubs and handles matters dealing with temporary licensing with the government telecommunications authorities. To obtain a temporary license one has to fill out (in English) a simple form which he furnishes, supply a photostat of one's U.S. license and pay a nominal fee. The fee depends upon the maximum plate or collector dissipation (not the input power) of the final stage in the rig. For dissipations below 25 watts, the fee is a very reasonable 50 cents a month for the temporary license! Send 5 IRC's to cover mailing costs. The form for the application calls for an address in Austria and this must be supplied. There is no need to specify every address in Austria where one will be staying, but the main address should be indicated, as this will

# NEW

LOWEST PRICE  
HIGHEST QUALITY  
SUB-AUDIBLE  
TONE

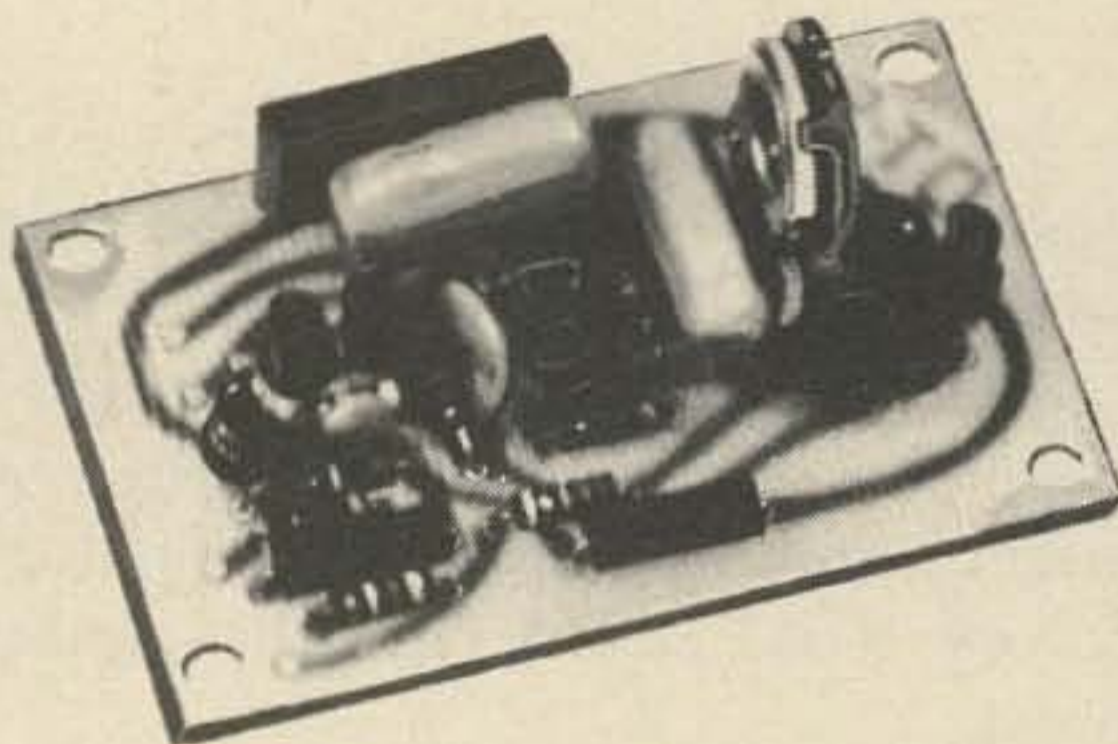

**COMPLETE—No reeds required!**

There's nothing else to buy, Alpha encoders and encoder/decoders are complete and ready to install. A free 32 page instruction manual is provided with each order, which includes helpful ideas on repeater applications and various tone uses.

Plug-in frequency modules are included. Specify frequency from 20 Hz. to 3,000 Hz.

## QT-5 Encoder only

ASSEMBLED **29.95**  
IN KIT FORM **22.95**

## QT-10 Encoder-Decoder

ASSEMBLED **45.00**

## PT-100 Burst Tone

ASSEMBLED **26.95**  
IN KIT FORM **23.95**

**ALPHA ELECTRONIC SERVICES**

8431 Monroe Ave., Stanton, Calif. 90680  
Phone 714-821-4400

REPUBLIK ÖSTERREICH  
POST- UND TELEGRAPHENDIREKTION FÜR WIEN  
NIEDERÖSTERREICH UND BURGENLAND IN WIEN  
ALS FERNMELDEBEHÖRDE I. INSTANZ

ZL 47053-158/1472  
2 Beilagen.

Wien, am 17. Mai 1972.

### Bescheid

Herrn

Ing. John J. Schultz  
1629 Cornelia St.  
11227 Brooklyn, N.Y.  
U. S. A.

wird gemäß § 3 Abs. 1 des Fernmeldegesetzes, BGBl.Nr.170/1949, und der Amateurfunkverordnung, BGBl.Nr.30/1954, in der Fassung der Verordnung BGBl.Nr.326/1962, über Antrag die

### Bewilligung

erteilt, in der Zeit vom 17. Mai 1972 bis 30. November 1972 in 1010 Wien, Johannesgasse 28 (Vienna Intercontinental) sowie beweglich im gesamten Bundesgebiet der Republik Österreich die von der US Federal Communications Commission Washington D.C. bewilligte Amateurfunkstelle unter den in Österreich geltenden Bestimmungen im Rahmen der Sendeklasse A zu errichten und zu betreiben.

Als Rufzeichen wird zugewiesen: OE 1 ZWA.

Für diese Bewilligung ist gemäß § 41 Z. 1 der Fernmeldegebührenordnung, BGBl.Nr.170/1970, eine einmalige Gebühr in der Höhe von US 70.-- zu entrichten, die mittels beiliegenden Erlagscheines bei einem Postamt in Österreich einzuzahlen ist.

Für den Präsidenten:



*W2EEY's temporary Austrian operating permit.*

determine the number in the call sign received (OE1, OE2, etc.). Contact:

Ing. Walter Nowakowski OE1WN  
Froebelgasse 46/18  
A-1160 Vienna, Austria

2 Meter repeaters in Austria have gotten off to a slower start than in neighboring Germany but have been growing steadily in number. The following should be in operation by mid-'73:

Input	Output	Location
144.15-145.75		Innsbruck
144.15-145.75		Gmunden
144.15-145.75		Vienna (city)
144.20-145.80		St. Poelten
144.20-145.80		Klagenfurt
144.20-145.80		Kufstein
144.25-145.85		Linz
144.30-145.70		Mattighofen
144.35-145.65		Schladming
Simplex 145.000 and 145.150		

### Belgium

Since 1964 Belgium has been granting temporary licenses to visiting amateurs even

if the country from which the visitor comes DOES NOT grant reciprocity to Belgium amateurs. This fine gesture is indicative of the warm welcome Belgium extends to visitors. To obtain a temporary license, write first to Rene Vanmuysen ON4VY for an information sheet which describes the application procedure to obtain a temporary ON8 call. There is no form to fill out but one has to supply the information requested on the sheet directly to the government telecommunications authorities at the address given in the sheet. In general, the information needed is the same as required in all temporary license applications (identification information, license photostat, temporary address, etc.). The only thing extra the Belgium authorities want is a circuit diagram (photostat from an instruction manual will do) of one's transmitter final stage showing the input voltages and current and type identification for commercial equipment. There is a license tax fee of about \$1.50 and a 30 cent/month fee for each month a license is desired (for up to 125 watts input). Contact:

Rene A. Venmuysen ON4VY  
 General Councillor of U.B.A.  
 Diepestreet 52  
 1970 Wezembeek - Oppem, Belgium

Repeaters on 2 meters have been planned for installation throughout the major areas of Belgium but are not yet in operation. The following is the planned 2 meter repeater network which hopefully will be in operation by mid 1973: 145.000 is the general simplex calling frequency but note there is also a simplex channel associated with each repeater!

Input	Output	Location	Simplex
145.050-145.650		Flandre et Liege	145.575
145.100-145.700		Namur et Flandre	145.625
145.200-145.800		Anvers et Luxembourg	145.550
145.150-145.750		Hainant et Limbourg	145.525
145.225-145.825		Brabant	145.600

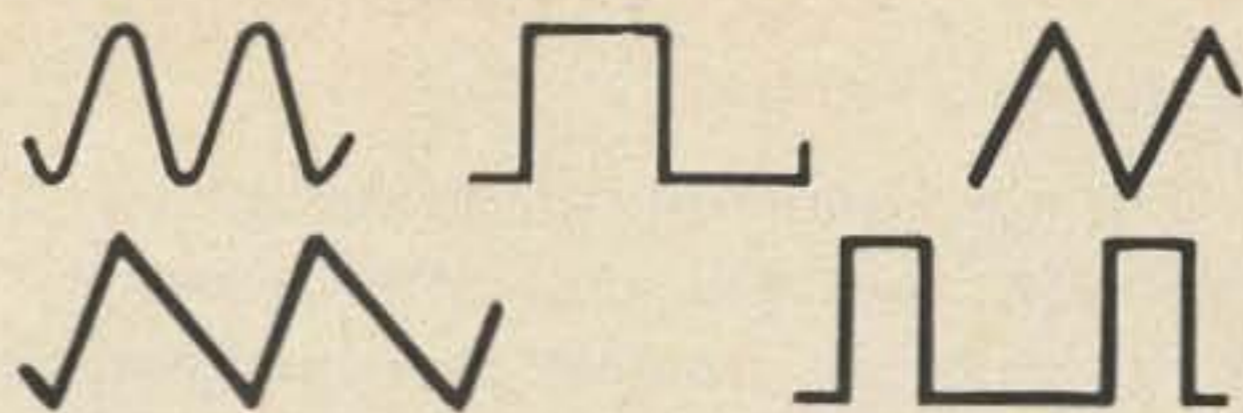

0.1 Hz. to 100 KHz.



For only \$39.95

Our new FG-2 Function Generator Kit gives you all five of the most useful waveforms for design and testing at one fourth the cost of previous similar instruments. Thanks to improved IC's the FG-2 now features amplitude stability of  $\pm 1$  dp over any range, Sine wave distortion of less than 1% from 20 Hz. to 20,000 Hz, and an output of 4.0 Volts peak-to-peak with adjustable offset. The offset selector lets you put the positive peak, negative peak, or the center of the waveform on DC ground. The DC coupled circuit keeps the waveforms in exactly the same position no matter what the level control setting.

Gray impact plastic case  $5\frac{1}{4} \times 6\frac{3}{4} \times 2\frac{1}{2}$ . 115 Volts 60 cycle power supply included.

FG-2 Function Generator Kit  
 shipping weight 3.0 lbs. \$39.95 + postage

*BankAmericard and Master Charge  
 Welcome*

Get our

## NEW 1973 CATALOG

listing this and other unique kits

**“ F R E E ”**

by simply checking our box  
 on the reader service card

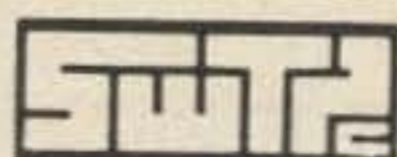

**SOUTHWEST TECHNICAL  
 PRODUCTS CORPORATION**  
 Dept. 73

219 W. Rhapsody, San Antonio, Texas 78216

## Denmark

The telecommunications authorities have responded that they are, unfortunately, "for the time being" unable to issue temporary licenses to U.S. amateurs. This situation is unlikely to change during 1973. For a quick check before departure, write to:

Ministry of Transport and Communications  
Telecommunications Services  
Farvergade 17  
DK-1007 Copenhagen K, Denmark

The above information is sad to report especially since Denmark has a fairly good network of 2 meter repeaters. At least 18 repeaters are presently licensed to give fairly complete geographical coverage of the country. The channels used are of two spacings, 600 kHz and 1600 kHz.

### 600 kHz spaced channels

144.950-145.550  
145.050-145.650  
145.150-145.750  
145.250-145.850

### 1600 kHz spaced channels

144.150-145.750  
144.250-145.850

For the 600 kHz channels, simultaneous tones at 1400 and 2200 Hz are necessary to open the repeaters. For 1600 kHz channels, a single tone of 1750 Hz is needed. At last report, Copenhagen was on 145.250-145.850.

## Finland

This country does issue temporary licenses to U.S. amateurs for periods of 1-3 months. However, mobile operation is not allowed with such a license. The details for securing the license are handled by the national radio club organization which apparently has a nice arrangement with the government since one has to join the radio club if a temporary license that is valid for more than one month is to be secured. The fees are quite nominal. If a license good for one month is secured, the cost is Fmk 15.20

plus Fmk 10.00 handling fee. For a longer term license the cost includes Fmk 10.00 handling fee, Fmk 15.20 basic license fee and Fmk 35.00 for a year's membership in the radio league! The application form for the license is easy to fill out with no complications, except that an exact address from which one will be operating in Finland must be supplied, and a photocopy of the identity information pages in one's passport. The call sign to be used is the home call plus suffix indicating the OH district in Finland (for example, W3EEY/OH2). 2 meter operation is carried on in Finland but there are no repeaters in operation at present. The radio league does hope to start a repeater network in 1973 but they could not supply any possible frequency information as yet. The address of the radio league is:

SRAL

Box 306

00101 Helsinki 10, Finland

## France

Two inquiries well over a month apart were made to the address the I.A.R.U. supplied as the authorities for reciprocal licensing matters. No reply was ever received. Perhaps the inquiry has to be made in French? In any case, it does not matter much as there are no known 2 meter repeaters in operation in France. For those who would like to try their luck in contacting the telecommunications authorities, the address is:

Direction des Services  
Radio Electriques  
5 Rue Froidevaux  
Paris 14, France

## Germany

The German Radio Club (DARC), via Diethelm Burberg DJ2YE, handles all details for the temporary licensing of foreign amateurs. There is no form to be filled out but the information requested on an information sheet supplied by DJ2YE must be supplied. A basic 3 month temporary license is issued for about \$3.50 even if the stay is for a shorter period. One uses his regular call

followed by /DL. Technician Class licenses can apply to operate on 2 meters and Novice licenses are not recognized. An English version of the German operating regulations which describes log keeping requirements, etc., is sent with the temporary license.

Diethelm Burberg DJ2YE  
P.O. Box 180  
D-4020 Mettmann, Germany

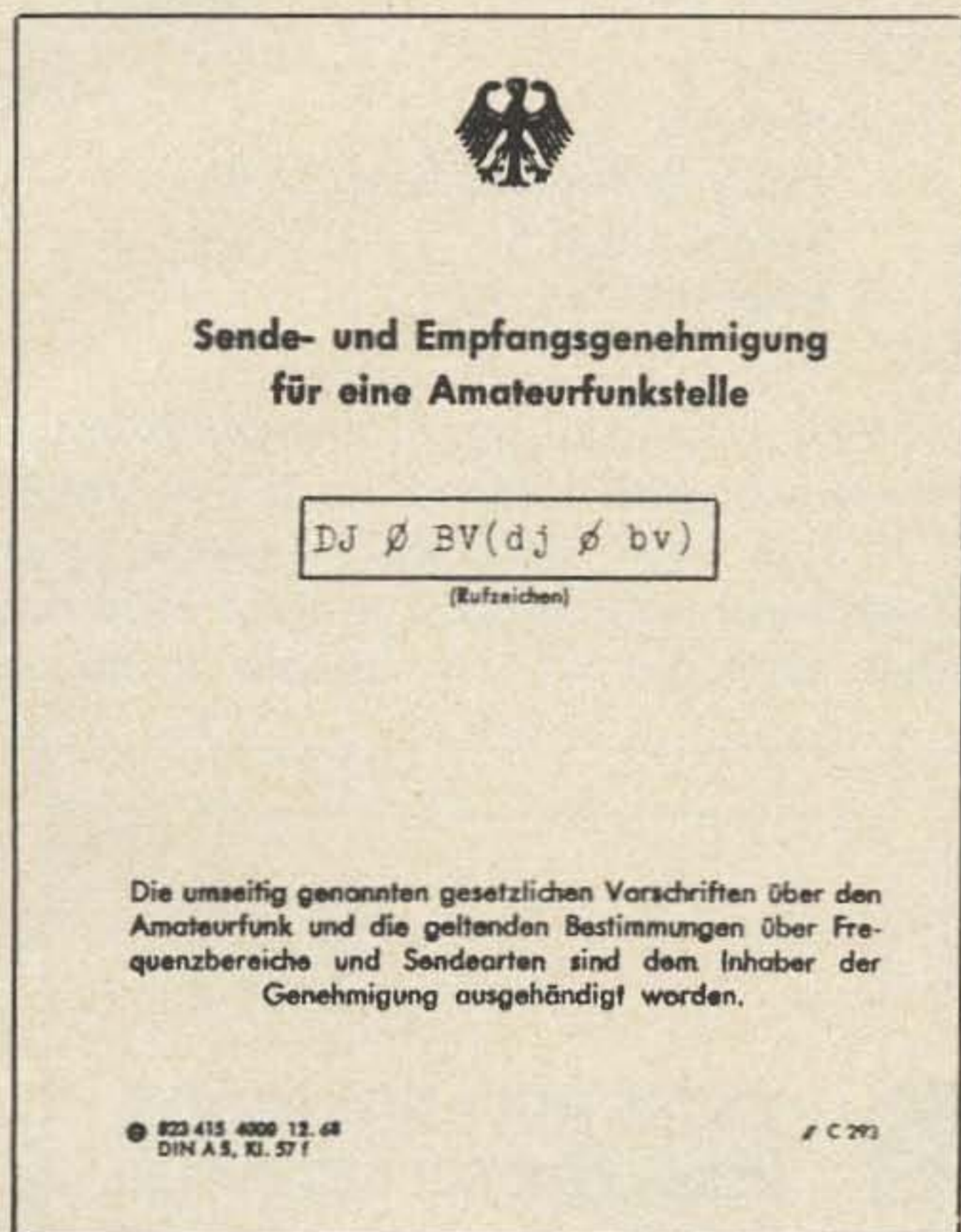

Standard amateur license issued by the West German authorities.

145.000 and 145.150 are in wide use as the simplex calling frequencies in Germany. Germany undoubtedly has the most developed 2 meter repeater network in Europe. Most of the repeaters operate with 1.4 or 1.6 MHz separation, although an eventual changeover to 600 kHz separation is planned. There will be no major changeover during 1973, although a few experimental repeaters will be operating on 600 kHz spacing (designed as "I" channels in the listing below). There first follows a listing of the in/out frequencies associated with each channel designation and then a listing of the repeaters by location.

Channel	Input	Output
I2	145.050	145.650
I3	145.075	145.675
R2	144.150	145.750
R3	144.175	145.775
R4	144.200	145.800
R5	144.225	145.825
R6	144.250	145.850
R7	144.275	145.725
R8	144.300	145.700

Channel	Location
I2	Feldberg/Taunus
I3	Nordhelle/Sauerland
I3	Hoechenschwand/Hochschwarzw.
R2	Berlin/Funkturm
R2	Cham
R2	Coburg
R2	Doerenberg/Osnabrueck
R2	Duisburg
R2	Feldberg/Taunus
R2	Hamburg
R2	Hannover
R2	Kaiserstuhl (Freiburg)
R2	Kassel
R2	Konstanz
R2	Muenchen-Stadt
R2	Nuernberg
R2	Oldenburg
R2	Stuttgart
R3	Bad Koenig
R3	Bocksberg (Harz)
R3	Bredstedt
R3	Fulda
R3	Goeppingen
R3	Hagen/Westf.
R3	Karlsruhe
R3	Koeln-Stadt
R3	Trier
R4	Aachen
R4	Augsburg
R4	Bad Hersfeld
R4	Baederstrasse (Ostsee)
R4	Bamberg
R4	Bentheim-Lingen
R4	Bremerhaven
R4	Darmstadt
R4	Deggendorf
R4	Deister
R4	Dortmund-Schwerte
R4	Dreilaendereck (Loerrach)
R4	Grab

R4	Greding
R4	Homberg-Kaiserslautern
R4	Koblenz
R4	Leer/Ostfriesland
R4	Lindau-Northeim (Hann.)
R4	Luechow/Elbe
R4	Siegen
R4	Triberg
R4	Weiden
R5	Berlin-Neukoelln
R5	Essen
R5	Frankfurt-Stadt
R5	Hoher Meissner
R5	Ochsenwang
R5	Pforzheim
R5	Pirmasens
R6	Aschberg (Rendsburg)
R6	Bergheim
R6	Bremen
R6	Detmold
R6	Goslar-Steinberg
R6	Heidelberg
R6	Hoechsten (Oberschwaven)
R6	Knuell
R6	Lahr
R6	Merzig/Saar
R6	Muenster/Westf.
R6	Ochsenkopf
R6	Winterberg
R6	Wuerzburg
R7	Zugspitze (Bavaria)
R8	Altenwalde
R8	Kalmit
R8	Ludwigsburg

#### Ireland

This country extends a friendly welcome to U.S. amateurs who can operate there on a reciprocal basis with a minimum of formality. No special application form is required for a temporary license. One only has to supply along with a photostat of the U.S. license a "listing of the frequency bands, power, modes of emission, duration of stay and exact location of operation." No fee is charged for a temporary license good for up to one month. All classes of U.S. licenses are recognized except for the Novice and Technician Classes.

Unfortunately, in spite of the relatively simple procedures for obtaining a temporary license in Ireland, there is not too much incentive for the 2 meter enthusiast to do so. There is very little activity in the 144-146 MHz 2 meter band there. The main VHF operation is confined to the 4 meter band with 70.26 MHz as the main calling frequency. On 2 meters, 145.11 is used as a calling frequency particularly for SSB, while 145.3 and 145.6 serve as less commonly used general calling frequencies.

The address to apply to for a temporary license is:

Secretary  
Dept. of Posts and Telegraphs  
Marlborough St.  
Dublin 1, Ireland

#### Italy

There is as yet no reciprocal licensing arrangement with Italy although it is rumored that in 1973 Italy will conclude some arrangement with other European countries (what happened to U.S. interest in taking



*Unique Italian "Patente" second-operator license is good for life.*

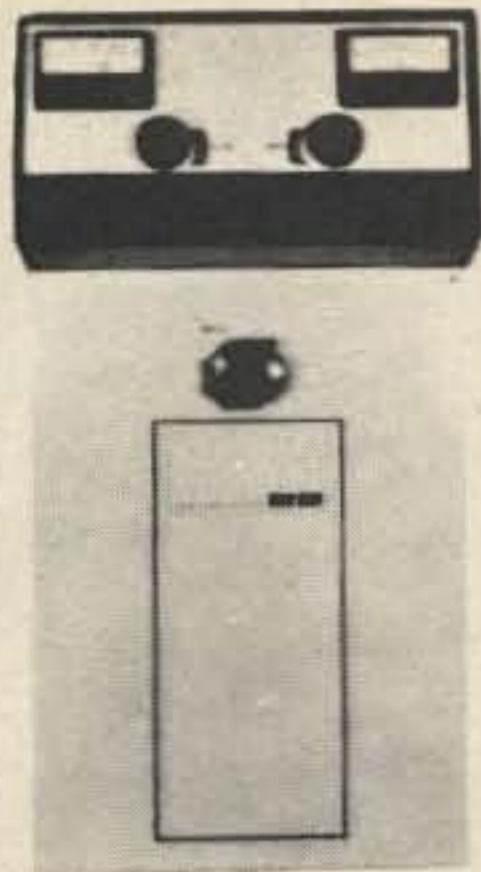

## HENRY 3K-A

Cool and Easy Max. Legal Power ★ SSB, CW, RTTY or SSTV through commercial ratings ★ 3.5 to 30 MHz ★ Continuous duty ★ Silver plated PI-L plate tank ★ DC relays ★ ALC ★ Built in SWR bridge ★ Output power 2 KW min. in commercial service ★

**. THE FINEST COMMERCIAL GRADE AMATEUR LINEAR AMPLIFIER AVAILABLE ANYWHERE IN THE WORLD AT ANY PRICE FOR ONLY \$1080— .THE HENRY 3K-A .THE LINEAR FOR THE CX-7A .**

*You will never know how little it costs to own THE incomparable CX-7A or Henry 3K-A until YOU write or phone us and let us know the trade in deal YOU WANT. We usually say yes! NO ONE ANYWHERE BEATS OUR DEAL.*



## signal/one CX-7A

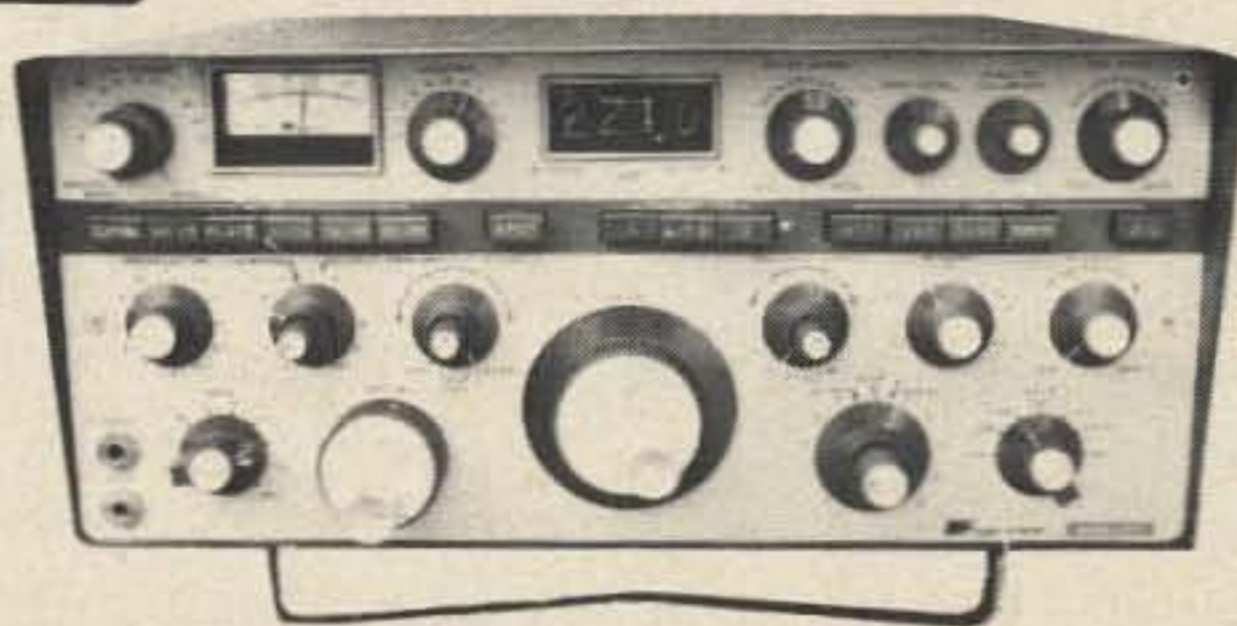

- ★ 160-10 Meters ★ 300 Watts ★
- ★ Transceive or split frequency with two built in VFOs ★ CW keyer built in ★
- ★ IF shift - new superior QRM remover ★
- ★ IF noise blanker ★ Digital nixie frequency readout ★ superb computer grade construction.
- ★ FSK keyer ★ adjustable output power ★ broadband tuning ★ output wattmeter and reflected power meter ★ **\$2395**



exclusive export agent for *signal/one* \*

### ★ FLASH ★ FLASH ★ FLASH ★

Look at what you get for NO REPEAT-NO EXTRA CHARGE. The GTX-2 now has a supersensitive Dual-Gate Mos Fet pre-amplifier BUILT IN the receiver front end for superb, less than .25 microvolt sensitivity. THE BEST receiver now even better!

## GTX-2



### 2 meter FM Transceiver

- (1) GTX-2 (with built-in DC PS) . . . \$249.95
- (2) AC POWER SUPPLY . . . . . \$49.95
- (3) 2 Extra crystals of your choice . . \$12.00

REGULAR \$311.90

**OUR SPECIAL PACKAGE PRICE! \$249.95**

30 WATTS OUTPUT. ALL SOLID STATE (no tubes). TRUE FM (not Phase modulation) for superb audio quality. 10 channels with 146.94/146.94 included. Three pole low pass filter on both transmit and receive. 1 watt low power position. Provision for tone encoder. Simple internal strapping provision allows multi-channel use of any crystal. Microphone and mobile mounting bracket supplied. Professional level construction by distinguished Avionics Mfg. - General Aviation Electronics, Inc. The finest amateur FM transceiver available at any price. Size: 9 x 6 1/2 x 2 1/2. Weight 5 lbs. Current Drain: Receive: .09 amps. Transmit: High 5.0 amps, Low: 1.7 amps.

Made in U.S.A.



- ★ Service Manual CX7-CX7A \$29.00 ppd.

## Marine/Master-25w 2-Way VHF-FM Marine Radio Telephone



- (1) MARINE MASTER - 25W
- (2) 6 1/2 Channels: WX, 6, 16, 68, 26, 28, 12.
- (3) 54" 3 db Gain lay-down white fiberglass antenna

REGULAR \$329.95

**OUR SPECIAL PACKAGE PRICE! \$259.95**

Please add \$35 for 8 ft. 6 db gain antenna.

Full 25 watts power. ALL SOLID STATE (no tubes) reliability. 10 channels with 6 1/2 pairs of crystals installed for calling and distress, weather, ship-to-ship, ship to coast and public and port operations. Complete with gleaming white fiberglass 3 db gain laydown deck mount antenna. Self contained, compact. Pre-tuned. Vinyl covered unit is splash proof - impact, humidity and fungus resistant. Can be mounted in panel, on bulkhead, on or below table top with universal mounting bracket included.

**JUST CONNECT TWO WIRES and YOU'RE ready to OPERATE!**

## AMATEUR-WHOLESALE ELECTRONICS

8817 S.W. 129 Terrace-Miami, FL 33156

Telephone - days (305) 233-3631 - nights and weekends - (305) 666-1347

\*Credit terms available on export orders to qualified firms.



part in these negotiations?). However, the country does make available to any foreign amateur a so-called "Patente" which is a rather unique second operator license good for life. With the "Patente" one can legally operate any licensed Italian amateur radio station much like the station licensee can. The form to apply for the "Patente" must be filed with the telecommunications authorities in Italian. The Italian Radio Club, through the good offices of Anacleto I2RCD, has volunteered to do the necessary paper work once the information and necessary fees (about \$7) are supplied to him. The information required is similar to that of other countries, with two exceptions. Two passport size photographs which have been authenticated by an "official" must be supplied. The official apparently can be the local police, State Dept., etc. One must also supply a copy of a birth certificate or similar document proving identity (a photostat of a passport is mentioned, but I don't think it is legal for U.S. citizens to make such a copy). I2RCD's address is:

Anacleto Realini I2RCD  
Via Rimini 13  
20142 Milano, Italy

#### Luxembourg

A temporary license can be obtained free of charge for periods of less than 30 days. One's U.S. call is used followed by the suffix /LX. The usual information must be supplied regarding personal identification, U.S. license status, etc. However, there is no application form as such and it appears that the correspondence with the authorities must be carried out in French. The maximum plate/collector dissipation allowed in the transmitter used is 100 watts.

Although 144 to 146 MHz is in use in Luxembourg, no information could be obtained regarding the existence of any repeaters.

For details of temporary licensing, contact:

Direction des Postes  
et Telecommunications  
Section Telecommunications  
8a, Avenue Monterey  
Luxembourg

#### Netherlands

It was rather surprising not to receive a reply to two inquiries about reciprocal licensing directed to the office listed by the I.A.R.U. Some two meter activity is definitely going on in the country but details could not be obtained. The office to write to is:

Radio Control Service, P.T.T.  
Kortenaerkade 12  
Gravenhage, Netherlands

#### Portugal

This country definitely issues reciprocal licenses to U.S. amateurs. I know several U.S. amateurs who have secured such licenses. However, in each case these amateurs were residing in Portugal at the time they secured the licenses. Two mail inquiries to the authorities in Portugal about reciprocal licensing produced absolutely no reply, although over two months was allowed for a reply to arrive. So the situation remains unclear. In any case, there is very little 2 meter activity in Portugal and no repeaters are in operation. The address of the reciprocal licensing contact office in Portugal is:

Rede dos Emissores Portugueses  
Rua D. Pedro V-7-4  
Lisboa 2, Portugal

#### Spain

There is as yet no reciprocal licensing agreement between Spain and the U.S., although Spain does have such arrangements with other countries. An inquiry to the U.S. Embassy in Madrid produced only the result that the matter is "under discussion." The main reason that seems to be given for the lack of temporary licensing of U.S. amateurs visiting Spain is that Spanish amateurs residing in North America are not accorded operating privileges. It would seem that a bit of a "push" in the right places could get this situation off dead center and secure temporary licenses for U.S. amateurs visiting this beautiful country. Spanish radio amateurs, judging from the few I have had contact with, are eager to extend a warm welcome to



visiting U.S. amateurs. Write your Congressman!

### Sweden

This country does issue reciprocal licenses to U.S. amateurs. No fee is charged for the issuance of a temporary license valid for 30 days or less. The call sign used would be the regular U.S. call followed by /SM and then followed by a digit indicating the region in Sweden from which one is operating. A listing of the regions is furnished with the temporary license. The application form for a temporary license is obtained directly from the telecommunications authorities and is quite easy to fill out (in English). It would appear that at least for 2 meter operation all classes of licenses are recognized except Novice class. There are only two "unusual" requirements imposed by the authorities which require a bit of advance preparation. One is that a copy be furnished of one's U.S. license if issued not more than six months ago, or if the license was issued more than six months ago, a certificate from the FCC stating the license is still valid. The second requirement is a certificate of "good conduct" issued either by one's "police authorities" or by the "applicant's amateur radio organization." So, I suppose that reads: be good to your local police chief or pay your club dues! Seriously, these are valid requirements and should be respected.

Sweden has a nicely developed network of 2 meter repeaters operating throughout the country. The following is a list of presently active repeaters:

Input	Output	Location
144.900-145.800		Stockholm
145.050-145.650		Stockholm
145.050-145.650		Bollnäs
145.200-145.800		Sundsvall
145.200-145.650		Göteborg
145.050-145.650		Helsingborg
145.200-145.800		Ystad
145.150-145.750		Karlskrona
145.200-145.800		Kalmar

A tone burst at 2172 Hz is necessary to activate some of the repeaters.

### Switzerland

U.S. amateurs may apply directly to the Swiss telecommunications authorities for a temporary license with a Swiss call sign. A simple application form has to be filled out (although it is written only in German, French and Italian) and returned with a photostat of one's U.S. license and a fee in Swiss Francs equivalent to about \$10. The temporary license is good for three months. Write for the application form to:

General Directorate of PTT  
Radio and Television Division  
CH-3000 Bern, Switzerland

Switzerland has only recently allowed the licensing of 2 meter repeaters and there will probably be a number of repeaters coming into service in the next year. The only repeater presently in operation is one near Lugano with in/out frequency of 144.150 and 145.750. A second will be in operation near Bern in 1973 although the frequencies have not yet been established. 145.000 is in common use as the 2 meter mobile calling frequency.

### United Kingdom

One must deal directly with the Ministry of Posts and Telecommunications to obtain a temporary license. An application form must be obtained and returned with the necessary information. Basically, temporary licenses are issued for up to a three month period and cost about \$7.50. Only Conditional, General, Advanced and Extra Class licenses are recognized for the issuance of a temporary license. The application form calls for details of one's passport number, etc., and so this must be obtained before making out the application. The address of the office to contact is:

Ministry of Posts and Telecommunications  
Radio Regulatory Division  
Waterloo Bridge House  
Waterloo Road  
London SE 1 8UA, England

145.000 is in common use as the country wide simplex calling channel. The only

repeater licensed to operate as yet is one near Oxford with in/out frequencies of 145.150 and 145.750. British amateurs are pushing hard for the establishment of other repeaters but the only thing that can be said with certainty is that the government has licensed this one 2 meter repeater to operate on an experimental basis until August 11, 1973. Other channels which may be of interest are:

144.350	Southwest and South Wales calling channel
144.480	FM calling channel, London area
144.800	FM working channel
145.200	FM working channel

### Overall Do's and Don'ts When Applying

Allow sufficient time for processing of the license. It would be best to apply several months in advance although some countries such as Switzerland indicate a month ahead is sufficient. Don't expect to arrive in a country and apply then for a license (unless a stay of several months is anticipated). Except for special events, the licensing authorities are not set up for "counter service" on license applications.

When dealing with amateurs who are contact personnel for their governments rather than with the government office directly, remember that postage costs come out of the treasury and pockets of the radio club. Enclose some IRC's.

When sending the fees required, try to send the exact fee in the currency of the country. This requires a bit more work on your part but will definitely speed the processing of your license. Especially when dealing directly with a government office, exact fee payments are necessary to keep their computers happy.

Don't apply for a license unless you have some serious intention of using it. The low fee requirements of some countries may tempt one to apply "just in case" but it is a disservice to those who have to process the paper work.

### Equipment and Operating Practices

Tone requirements for repeater installations have generally not been listed sepa-

rately because in practice tone is only needed for initial turn on and then the repeaters remain carrier operated. Good practice is to listen first to see what the operating procedures are on a given repeater, so a tone burst unit is not an absolute necessity. However, if such a unit is desired, one will find 1750 Hz to be the most commonly needed frequency. 2125 Hz is also used by a few repeaters.

Customs on a small transceiver being temporarily imported into a country is generally not a problem as long as one has a valid temporary operators license. One should, however, have either an original purchase bill for the equipment or a listing of the serial number, purchase price and other identification details. At the worst, one may be required to post a temporary import bond equal to 25 to 50% of the listed value of the equipment which is then later refunded upon leaving. Placing the transceiver in the checked baggage on an airline flight will avoid a lot of questions as compared to carrying the transceiver as carry-on baggage since the latter is usually still searched at European airports. European policemen also tend to be much more curious about people with radio gear since CB operation does not exist in most countries. When operating portable and in public be sure your licensing papers as well as personal identification papers are not back in the hotel room.

A small portable antenna is a great asset to any transceiver rather than relying on a whip. Some very handy forms of a portable ground plane and dipole can be built using properly cut up sections of a metal measuring band and a few banana plugs and jacks. RG 174 miniature coax is handy to use and the loss not excessive for runs up to 7 to 8 feet.

Finally, as a visitor, one will usually find a warm welcome on European repeaters and many of the local repeater users would like to collect a W QSL. Phone patches and message handling are not allowed on European repeaters. Don't monopolize the repeater time. Stop after every few QSO's and disappear for a while. Enjoy the repeaters as a visitor.

...W2EEY

# SCANNING ADAPTER FOR FM TRANSCEIVERS

**A** four channel commercial type FM mobile would be much more versatile if independent selection of transmit and receive frequencies were possible. However, if the unit is trunk mounted and connected by the cable supplied by the manufacturer, there probably are not enough wires in the cable for independent selection. Not wanting to run additional wires under the carpet and seats of the car, the circuit in Fig. 1 was designed to provide eight combinations of the four transmit and receive frequencies and in addition scan the receive frequencies. This can be done digitally with the four wires used for the four original channels. The same circuit could scan eight receive channels as well as enable manual selection of any channel.

## Basic Theory

The heart of the selection circuit is an SN7442 BCD to Decimal Decoder. A switch in the control head can be wired to count in Binary Coded Decimal format (see Fig. 2). For each count in BCD format a single output on the SN7442 goes to ground, "0," while all other outputs remain at 5 volts, "1." The outputs can be inverted and used to drive transistor switches which can ground cathodes or emitters for frequency selection.

## Scanning

It was readily apparent that a BCD counter could perform the same function as turning the channel selector switch, only much faster and easier. A unijunction tran-

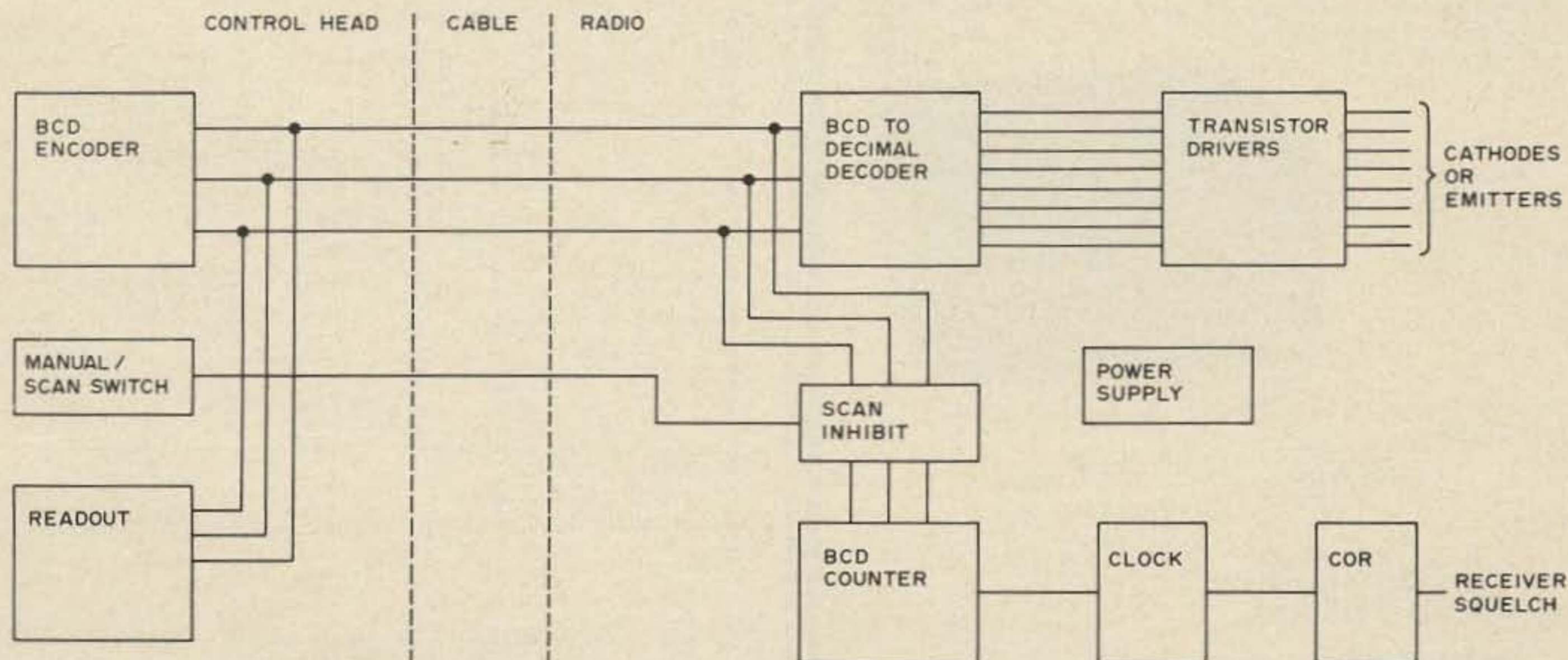
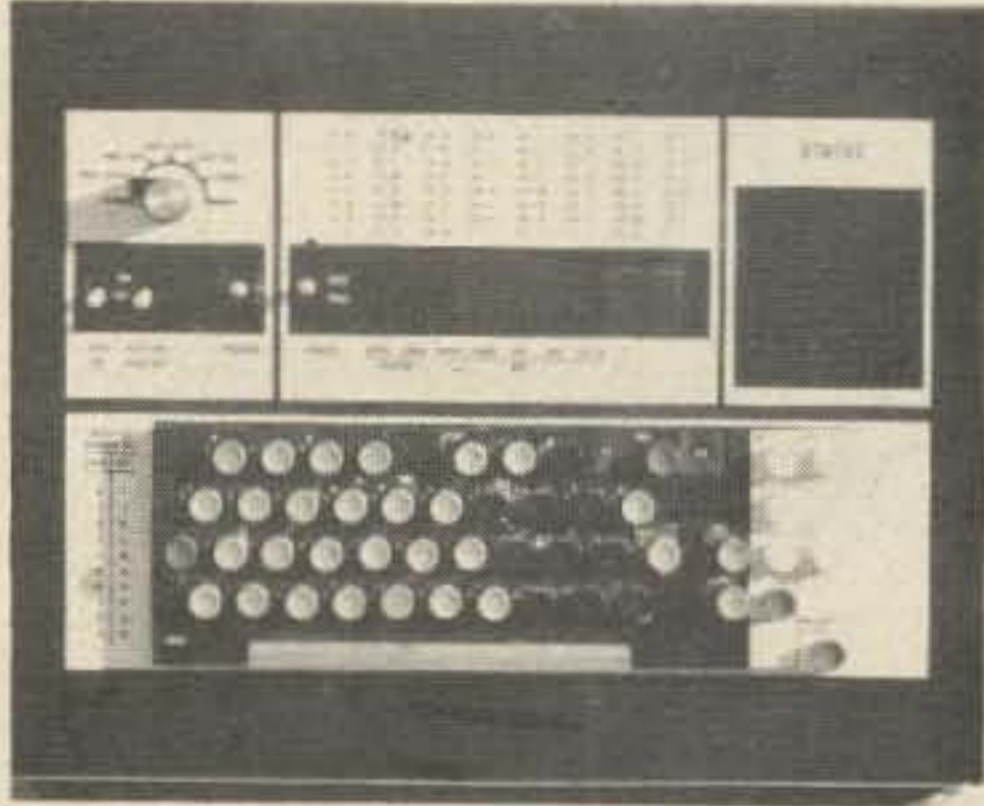

Fig. 1. Block diagram of channel selector - scanner.

# GATEWAY ELECTRONICS

8123-25 PAGE BOULEVARD  
ST. LOUIS, MISSOURI 63130

(314) 427-6116



**KEY-BOARD** - 48 key keyboard in modern sloping desk cabinet; overall size of case 15 1/2x12 3/8 - 1 5/8 high in front, 3 5/8 high in rear. Each key is SPST switch - included are 12 volt lamps in a lighted number field. ship wt. 21 lb. \$25.00

- L.E.D. 7 SEGMENT READOUT - MAN 1 TYPE - NEW \$2.75
- THUMBWHEEL SWITCHES - 0.5x2.125x1.78 - 10 position decimal \$2.75
  - 10 position BCD & compliment \$3.75
  - End Plates (per pair) \$1.00
- MINIATURE SIZE - 0.312x1.3x1.3 - 10 position decimal \$2.00
  - 10 position BCD & compliment \$2.75
  - End Plates (per pair) .50

## NEW!! 440 MHz PREAMPS



**\$29.95**  
postpaid  
Model 432PA

Two stage KMC Bipolar and MOSFET Preamp for DX, FM, ATV & Space Work. Typically 3.5 dB NF for excellent weak signal reception. 20 dB Gain, 20 MHz Bandwidth, 12V dc, with metal case, postpaid and guaranteed, Model 432PA Only \$29.95.  
Super sensitive Model 432PC - as above but very low noise K6007 input stage, 1.5 to 2.0 dB NF \$69.95.

**\$54.95**  
postpaid  
Model 432PA-1



Preamps with all the above features plus ac Power Supply and Die Cast Cabinet:

Model 432PA-1 (3.5 dB NF) \$54.95  
Model 432PC-1 (1.5 to 2.0 dB NF) \$94.95

**JANEL**  
laboratories

Write for our new catalog of  
VHF/UHF Converters and Preamps.

P.O. Box 112  
Succasunna NJ 07876  
201-584-6521

BINARY CODED DECIMAL CBA	Channel Count	DECIMAL Actual Count
000	1	0
001	2	1
010	3	2
011	4	3
100	5	4
101	6	5
110	7	6
111	8	7

Fig. 2. BCD to decimal conversion.

sistor clock steps the SN7493 BCD counter through its sequence to drive the BCD to decimal decoder. A COR type circuit stops the clock when a signal is received. Scanning is resumed when no signal is present.

### System Schematic

Figure 3 shows the complete schematic of the scanner and selection circuit. A description of each block of Fig. 1 will be related to the schematic in Fig. 3.

### BCD Encoder

An eight position, four section, shorting type rotary switch can be used to generate the BCD codes in Fig. 2. Ground can supply the "0" condition while 2K pull up resistors connected to 5 volts provide the "1" condition. A ground is applied to the

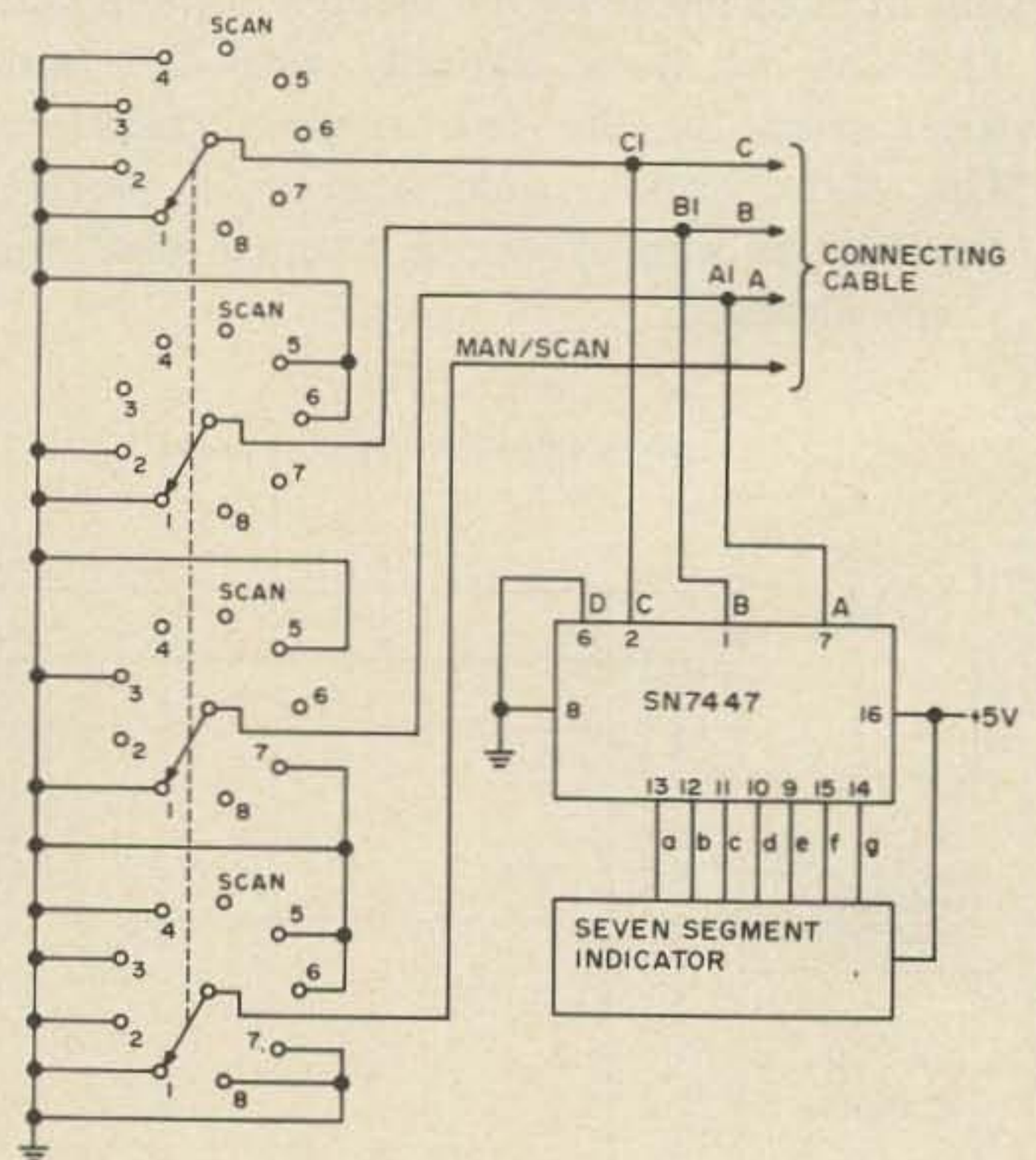

Fig. 3a. The scanner "control head" circuitry that connects to Fig. 3b via the connecting cable. See block diagram in Fig. 1 for its functions.

Scan-Inhibit line to manually select a channel. The channels are scanned when no ground is on the Inhibit line.

### Readout

Many methods are available for reading out the received frequency. In all cases the BCD format must be decoded to the desired output. In Fig. 3a, a BCD to seven segment decoder-driver operates a Numitron or similar seven segment readout device. This will indicate zero through seven. A BCD to Nixie decoder-driver could drive a Nixie tube to read one through eight. Alternately a BCD to decimal decoder could be used with transistor drivers to turn on a light bulb corresponding to the appropriate channel. See Fig. 4. Ultimately a matrix or program-

mable read only memory could drive two readout devices to indicate the frequency such as 52 or 94.

### BCD To Decimal Decoder

The SN7442 accepts Binary Coded Decimal format, and a single output goes to ground from 5 volts for the appropriate input. Only one output is at ground at a time; all others are at 5 volts.

### Transistor Drivers

The configuration of the transistor driver circuit depends on the number or combination of channels. The circuit in Fig. 3 creates eight different combinations of four transmit and four receive frequencies. The transistors could be wired to select any

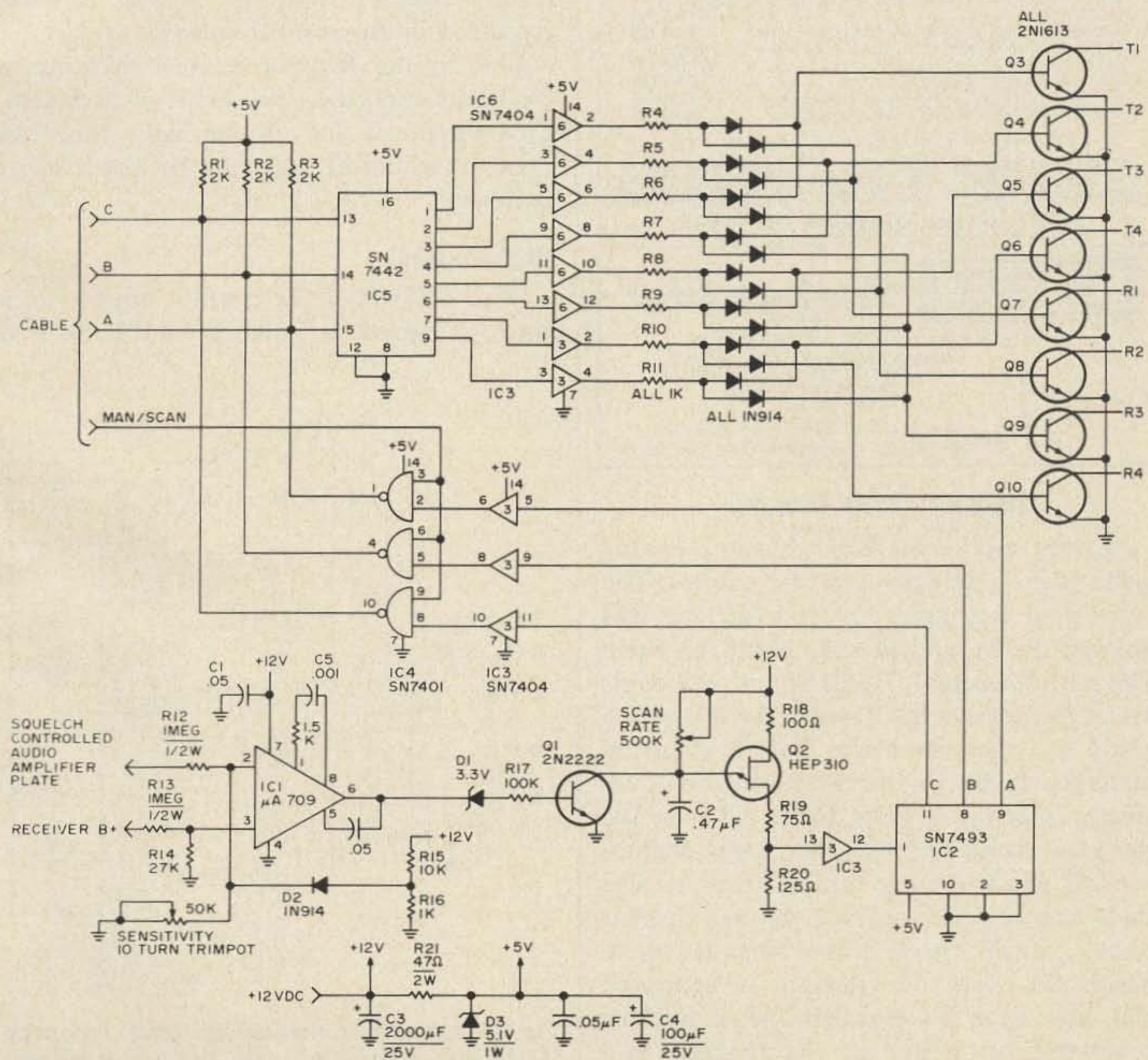

Fig. 3b. The main circuitry of the scanner. All resistors are 1/4 Watt except as noted.

**SINGLE CONVERSION  
2 METER FM . . . . .**

*PC Boards, Kits, AST Modules, (Assembled, Soldered and Tested) and Complete Sets. Send for Details.*



**HOISINGTON RESEARCH CO.**

Peterborough NH 03458

Phone: 603-924-6360

**TEST EQUIPMENT**

- Fluke 803 Differential AC-DC Voltmeter. \$150.00
- H-P 3526-A Tape Transport, for 1/2" or 1" tape; 15/16, 1 7/8, 7 1/2, 15, 60, 120 inches per second. Less heads. . . . . \$400.00
- H-P 561-B Digital Printer. . . . . \$85.00
- DATATOTAL 1141-8 8-digit printer. . . . \$25.00
- Keithley 150A Microvolt-ammeter. . . . \$100.00
- APR-4 receiver with CV-253 Tuner, 38-1000 MHz. 115 v. 60 Hz. . . . . \$175.00
- B & K 1076 Television Analyst (Flying spot scanner) . . . . . \$195.00
- Brush BL-202 2-channel chart recorder \$40.00
- Type C dual-trace plug-in for Tektronix (made by Hickok) . . . . . \$100.00
- Type K plug-in (Hickok) . . . . . \$40.00
- Tektronix type L wide-band plug-in. . . . \$60.00
- Tektronix type B wide-band plug-in. . . . \$50.00

*Send 25¢ for new 18 page catalog of surplus equipment & parts.*

**JEFF-TRONICS**

4252 Pearl Rd., Cleveland, OH 44109

**SBE** *feature line*

SB-36 • SB-144 • SB-450 • SCANVISION

**TEXAS TECHNICAL PRODUCTS**

AVAILABLE FROM:

Route 2, Box 324-D, San Antonio, Texas 78228 Telephone: 512/695-8430

**Junk Box Panel Bushing**

A very serviceable panel bushing can be made from a defective volume control. The conversion is simple. First, loosen the tabs holding the cover and slide it off the back. The switch assembly, if it has one, will come off at the same time. Remove the clip which holds the shaft in place. This is done by pulling outward on the shaft and simultaneously inserting a knife blade between the threaded shank and the clip. Twist slightly and the clip will come out of its recess. The shaft may now be removed through the rear of the control. Break off the fiber disc upon which the resistance element is deposited and you have an excellent panel bushing equivalent to the best on the market. Cost? NIX.

. . . . Bill Turner WAØABI

channel combination desired. The combinations in Fig. 3 are T1R1, T2R1, T1R2, T2R3, T3R2, T3R3, T4R4, and T4R3.

Figure 4 shows the circuit for scanning eight receive channels. The light bulbs are replaced by connections to the oscillator cathodes. The NPN transistors are used for grounding cathodes in tube type radios. In solid state radios in which a voltage is supplied instead of a ground to select the channel, a different transistor circuit will be required.

**Scan Inhibitor**

The clock and counter always run when no signal is being received. Manual selection is accomplished by inhibiting the outputs of the counter with the SN7401 Nand gate. The SN7401 was selected because it has open collector outputs. These can be grounded during manual selection with no ill effects to the IC. For manual selection, a ground is applied to one input of each gate. This forces all the outputs high. They can then be grounded manually by the selector switches.

**BCD Counter**

The SN7493 BCD counter counts from zero to seven in binary coded decimal

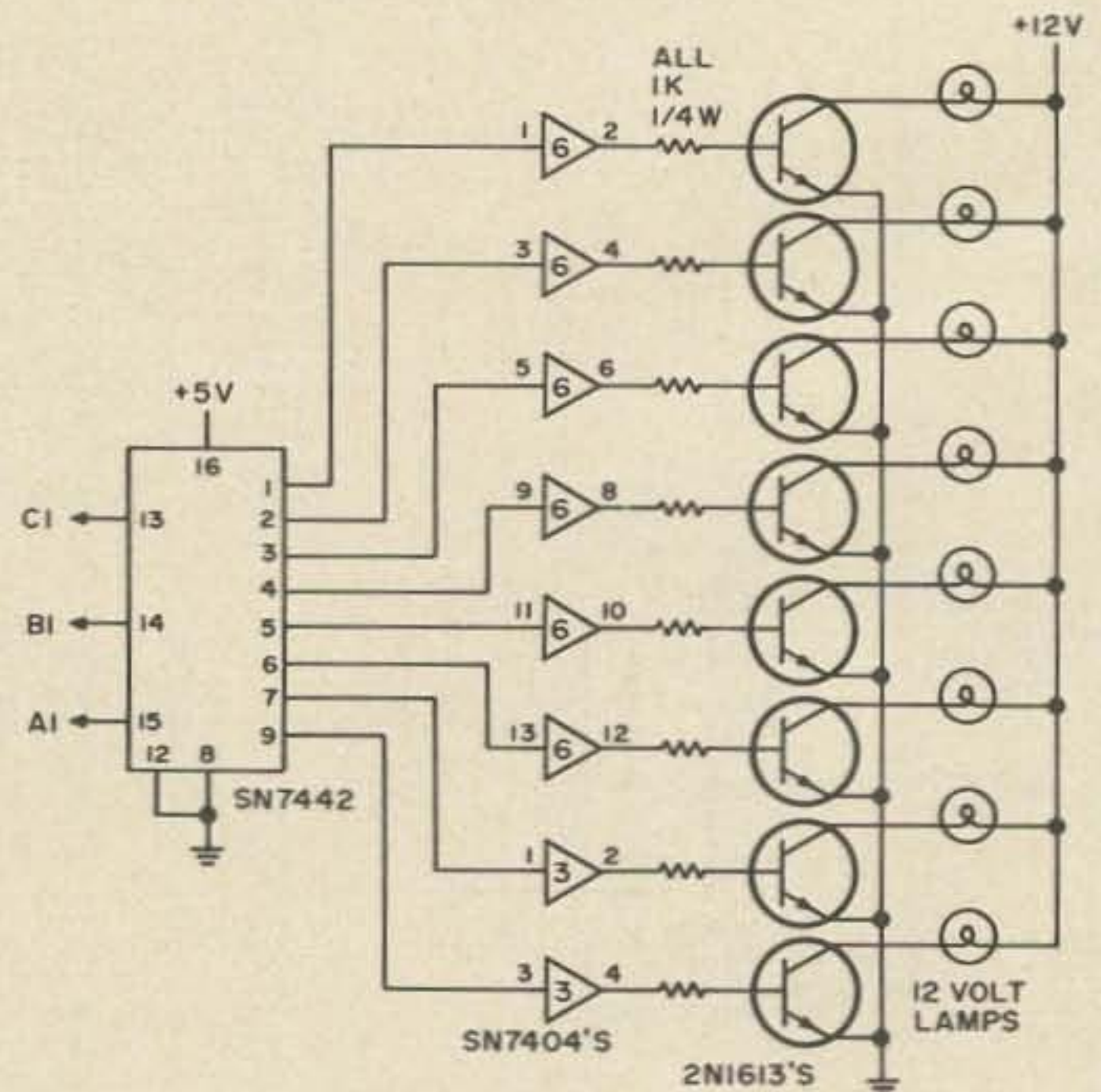

Fig. 4. Channel indication by light bulbs is possible if digital readout is not used. This circuit can also be used for scanning eight receive channels by modifying it as explained in the text.

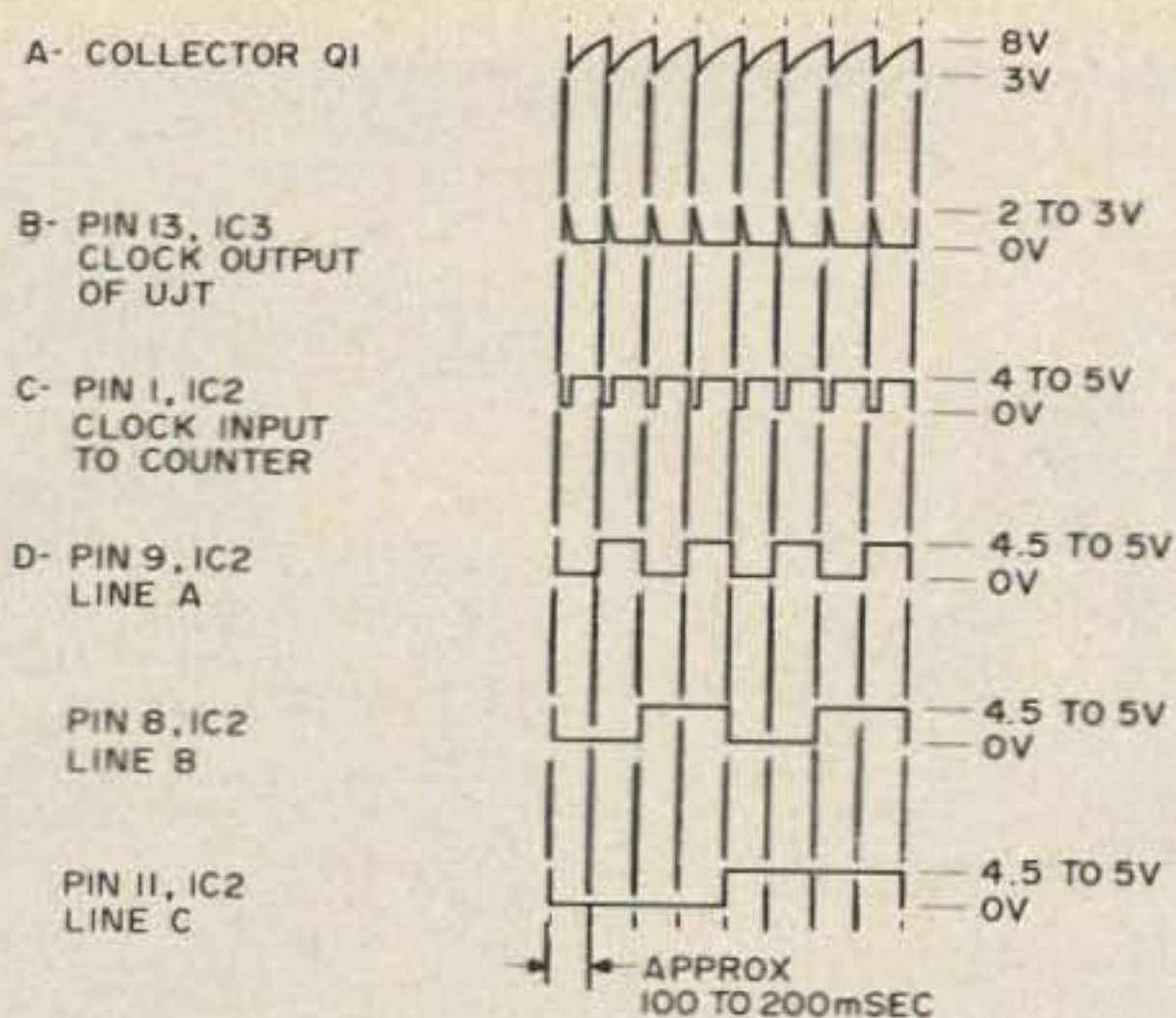

Fig. 5. The waveforms generated by Q1 as they are modified by the counting circuitry.

format (see Fig. 2). It advances one count waveforms are shown in Fig. 5.

### Clock

The clock is a standard unijunction transistor circuit. Clock rate is set by the .47  $\mu$ F capacitor and the 500K pot. Varying the pot changes the scanning rate. The inverter between the clock and the counter is used to square the clock pulse which is a very narrow spike coming out of the UJT.

### COR

The COR circuit was borrowed from a July 1970 article in 73 on a two channel

scanner by Gary Hendrickson, W3DTN. The operational amplifier in the differential input configuration is not affected by changes of B+ voltage. This is very useful in mobile installations. When no signal is being received, the squelch controlled audio amplifier plate is at the B+ potential. When a signal is received the voltage drops and forces the output of the op amp to 12 volts. This turns on transistor Q1 which stops the clock. As no clock pulses are seen by the counter, the receiver stays on the channel with the signal present. On the absence of signal, the op amp output goes to zero volts, Q1 turns off, clock pulses are generated, and the receiver scans.

### Power Supply

The unit requires +12 volts and +5 volts dc. For mobile installations 12 volts is available directly from the car's electrical system, and 5 volts can be obtained with a zener diode regulator. A similar circuit can be used for ac operation. The +5 volt source should be regulated by a zener diode because the IC's operate best on +5 volts  $\pm$  25 volts.

### Construction

The circuit can be built on any type of circuit board or vector board. Sockets are recommended for the IC's to facilitate removal if necessary. Parts layout is not

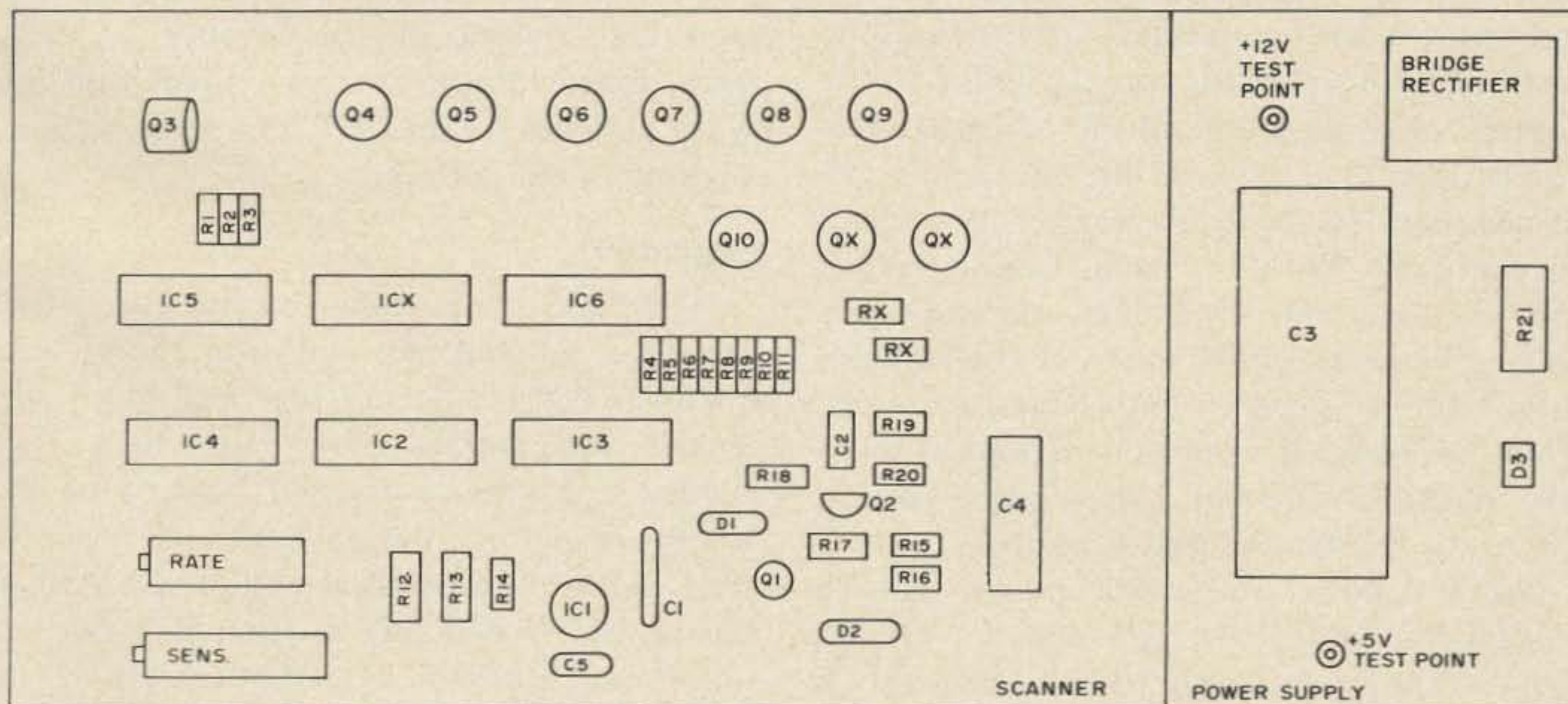
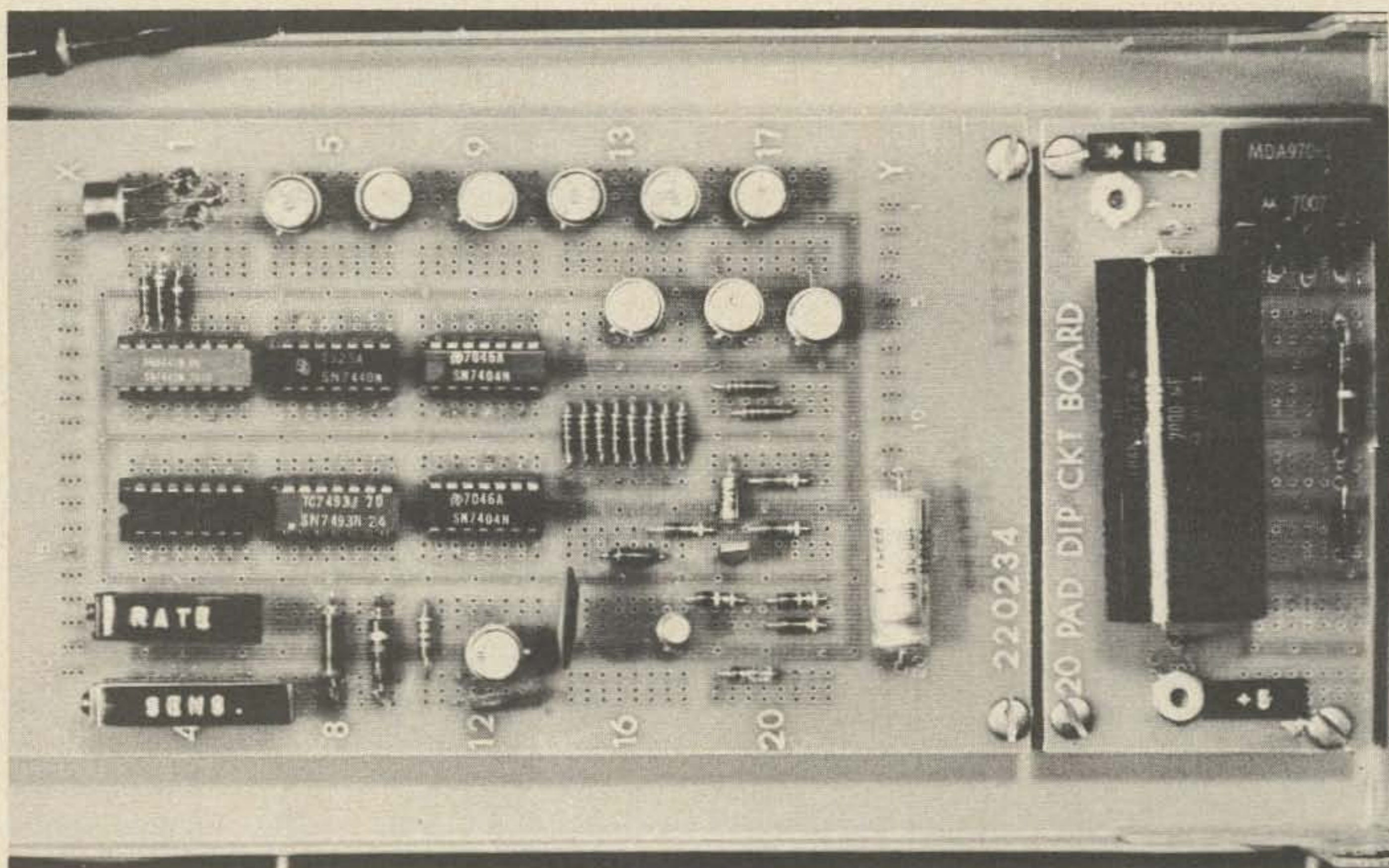

Fig. 6. Parts layout. Parts ICX, QX and RX which are not shown in Fig. 3 were added for additional switching. These parts are not required for the standard scanner. Some parts on the schematic are not on this board due to the use of a non-standard IC1. Q3 was mounted sideways in a field replacement of a defective transistor. Interconnecting wiring is on the bottom of the pc board.



Here is the completed scanning adaptor as it appears mounted next to its dual voltage power supply. See Fig. 6 for component identification.

critical. Bypassing and filtering of the 5 volt supply should not be omitted as the TTL logic is sometimes sensitive to noise.

### Testing

After inspection of all wiring, apply +12 and +5 volts. Manually select each channel and observe with a voltmeter or oscilloscope that only the transistor corresponding to the selected channel is on and the others are off. For proper operation of the scanner it will be necessary to adjust the Sensitivity control on the COR. With no signal being received and the receiver squelched, measure the voltage between pins 2 and 3 of the op amp. Adjust the sensitivity control for zero volts. When the squelch opens, the voltage at pin 2 goes negative, and the output pin 6 goes to +12 volts. Q1 should then turn on.

When Q1 is off, clock pulses can be observed at pin 12 of IC3 with an oscilloscope. The pulses will stop when Q1 is turned on by a received signal.

### Troubleshooting

If no oscilloscope is available, and the scanner fails to scan properly, measure the voltage at the collector of Q1 with a

voltmeter. If the charging and discharging of the capacitor is seen as in Fig. 5a, and the outputs in Fig. 5d are not seen on pins 8, 9, and 11 of IC2, either Q2, IC2, or IC3 are defective. The counter can be clocked manually by alternately applying +5 volts through 5 K $\Omega$  and then ground to pin 1. If IC2 is good the counter should advance on each clock pulse. Remove the connection between IC3 pin 12 and IC2 pin 1 for manual clocking of the counter.

### Conclusion

This circuit is very useful for either pairing four transmit and four receive frequencies with scanning or scanning eight receive frequencies. Only four wires are needed for remote manual control of the scanner/selector. Many variations are possible in the construction and application of the units. By utilizing integrated circuits, a minimum number of components is required. Since the price of TTL integrated circuits has become quite reasonable, the entire scanner can be built for a very small investment. By scanning four or more frequencies, one can be in on all the action.

...WA4WTX



# THE RCA CMU 15 FM TRANSCEIVER

**T**he RCA CMU15 450 transceiver is one of the most common rigs available recently from the commercial surplus market, and is probably the best buy. They are commonly available for less than \$20 complete, and their reliability and stability are superior to other rigs of similar age. However, retired equipment is generally not found in good condition, and will require service as well as alignment. To the amateur with limited experience and test equipment, getting one of these monsters to work on amateur frequencies can be a very frustrating experience.

This article will describe specific problems and their solutions, to be used as a supplement to the RCA instruction book. Several modifications and additions will be described that can improve the performance of these units.

## Take Your Pick

A group of hams will fight over a stack of radios to pick out the "cleanest" one. I have not found any indication that a clean radio works better than a "dirty" one. My base station transmitter is rusted and bent, and looks as if it has been sitting in water for

some time. It has not required any repair or cleaning except for replacing tubes. Perhaps the filthy radio from a service truck has had less on-the-air use because the driver spends most of his time working, while a clean radio from a supervisor's car is being talked on all the time. I have never found rust or corrosion to be the cause of a problem.

The major problem to look for is damage to the coil shields or adjusting screws. If a screw is bent, bending it back will usually break it. If a coil shield can break off it is possible to solder it back *very carefully*. The can material is soft, and a torch will melt a hole right through it! If the screw is broken off, the slug can be removed with a screwdriver through the hole in the bottom of the coil.

The power and control cables should be checked and taped up if the insulation is worn. Fuse holders or circuit breakers may be damaged or lost from the cables, but the system should *always* be protected from damage in case of a short. I had a bad vibrator get stuck and blow a fifty amp fuse instantly. Lack of proper protection may also void an insurance policy.

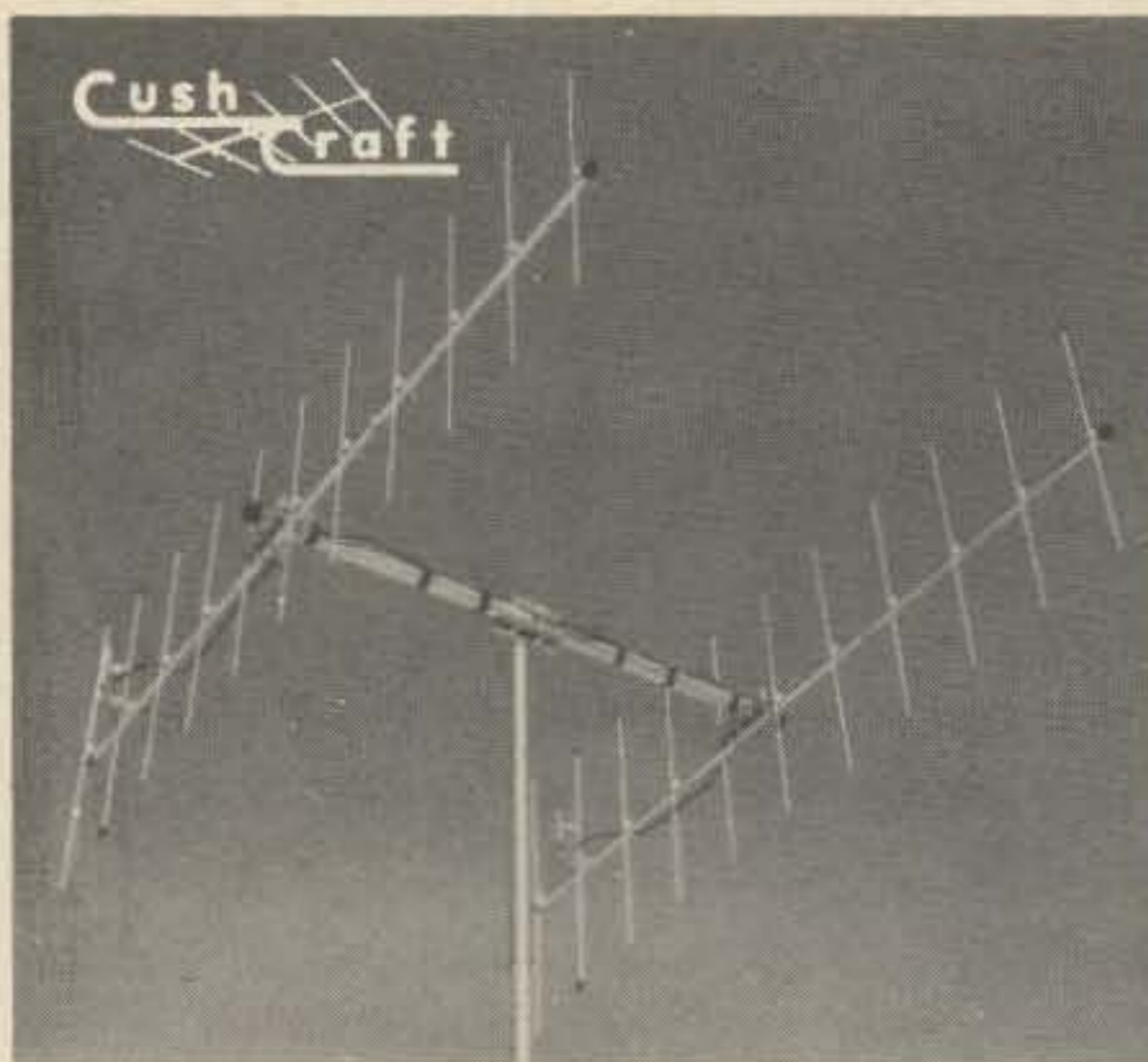

## FM POWER PACK

16 db GAIN      24 db f/b RATIO

- WORK DISTANT REPEATERS
- NULL OUT LOCAL INTERFERENCE

A quality Cush Craft array, complete with two 11 element antennas, harness, support boom and all hardware. Features direct 52 ohm feed, dimensions 144" x 80" x 40", turn radius 60", weight 15 lbs.

A147-22      146-148 MHz      \$49.50

**NEW** 450 MHz 6 ELEMENT REAR MOUNT  
11db GAIN      A449-6      \$10.95

IN STOCK WITH YOUR LOCAL DEALER



621 HAYWARD STREET  
MANCHESTER, N.H. 03103

Many amateur installations are lacking in two points. The radio should be bolted securely to the vehicle body in its cabinet. This will take advantage of the large mass of the vehicle to reduce sudden acceleration (mechanical shock). The steel cabinet will protect the radio from anything you could lift to throw on top of it. Cables should be tied securely to protect them from rubbing against anything that may damage them. Control head, cables, and microphone should be mounted so they are kept away from the driver's feet to prevent damage or interfere with operation of the vehicle.

### Tuning Up

The first step in alignment should be to check the tubes with a tube tester and replace the weak ones. In many cases this will be the only repair necessary. Further tube checks by substitution can be made after the radio is operating.

Receiver alignment is well described in the RCA instruction manual, but without a strong signal source aligning the front end is difficult. Lacking anything better, an

old Heathkit GD-1 grid dip meter can be used. The grid dip meter with its strong signal should be tuned to one half of the desired 450 frequency *very carefully*, and placed as near as possible to the desired stage. Once the approximate tuning point is found in each of the several front end coils, tuning can continue with a weak signal. Any alignment of the i-f frequency coils should be only slight peaking since the i-f does not change with receiver input frequency.

To aid in finding a starting point, I have made some measurements of the length of exposed adjusting screw on the tops of the coils. From the antenna connector back toward the mixer, the first three brown coils, (1L1, 1L4 and 1L5), should have about 1.7, 2, and 1.7 cm of thread exposed, respectively. The next two brown coils, 1L18 and 1L19, should both be extended about 2 cm. 1Z4, the coil with the green top next to 1L18 should be 2.3 cm. The screw on 1Z15, the green coil nearest to 1Z4, will extend about 1.5 cm. The screw on the green coil next to the chassis edge, 1Z14, will only extend 0.7 cm. The last green coil next

**SBE** *the feature line*  
SB-36 • SB-144 • SB-450 • SCANVISION  
**SUITLAND**  
**T.V. & ELECTRONICS**  
AVAILABLE FROM: 4712 Suitland Road, Suitland, MD. 20023  
Telephone: 301/735-4000

**PARTS! CORNELL TUBES!**  
FREE Send For FREE  
CORNELL'S New Color Catalog  
48 Pgs. New Items IN LOTS OF 100  
**33¢** per tube  
**36¢** per tube  
ORDER FREE IF NOT SHIPPED IN 24 HOURS!  
4215 S University Ave. San Diego, Calif. 92105

**Digipet-60** See Nov. '72 CQ Review  
**Frequency Counter**  
**1 KHz-60 MHz**  
(130-160 MHz with optional converter)  
**Reg. \$299**



A frequency counter with a range of 1 kHz to 60 MHz (or 130-160 MHz when used with our Digipet-160 converter). With a resolution of 1 kHz or 1 Hz (at 1 ms. or 1 s. gate times). It can be operated on either AC or DC, with complete overload protection. Plus a stability aging rate of 1 part in 10<sup>6</sup>/week. And the whole unit is a mere 7" deep by 2 1/2" high!

Superb precision quality at LESS THAN KIT PRICES. Call or write for literature and trade in or our **LOW INTRODUCTORY PRICE, 1 YEAR WARRANTY.**

NO ONE ANYWHERE BEATS OUR DEAL !!  
**AMATEUR-WHOLESALE ELECTRONICS**  
8817 S.W. 129 Terrace, Miami, FL 33156  
Days (305) 233-3631  
Nights-Weekends (305) 666-1347



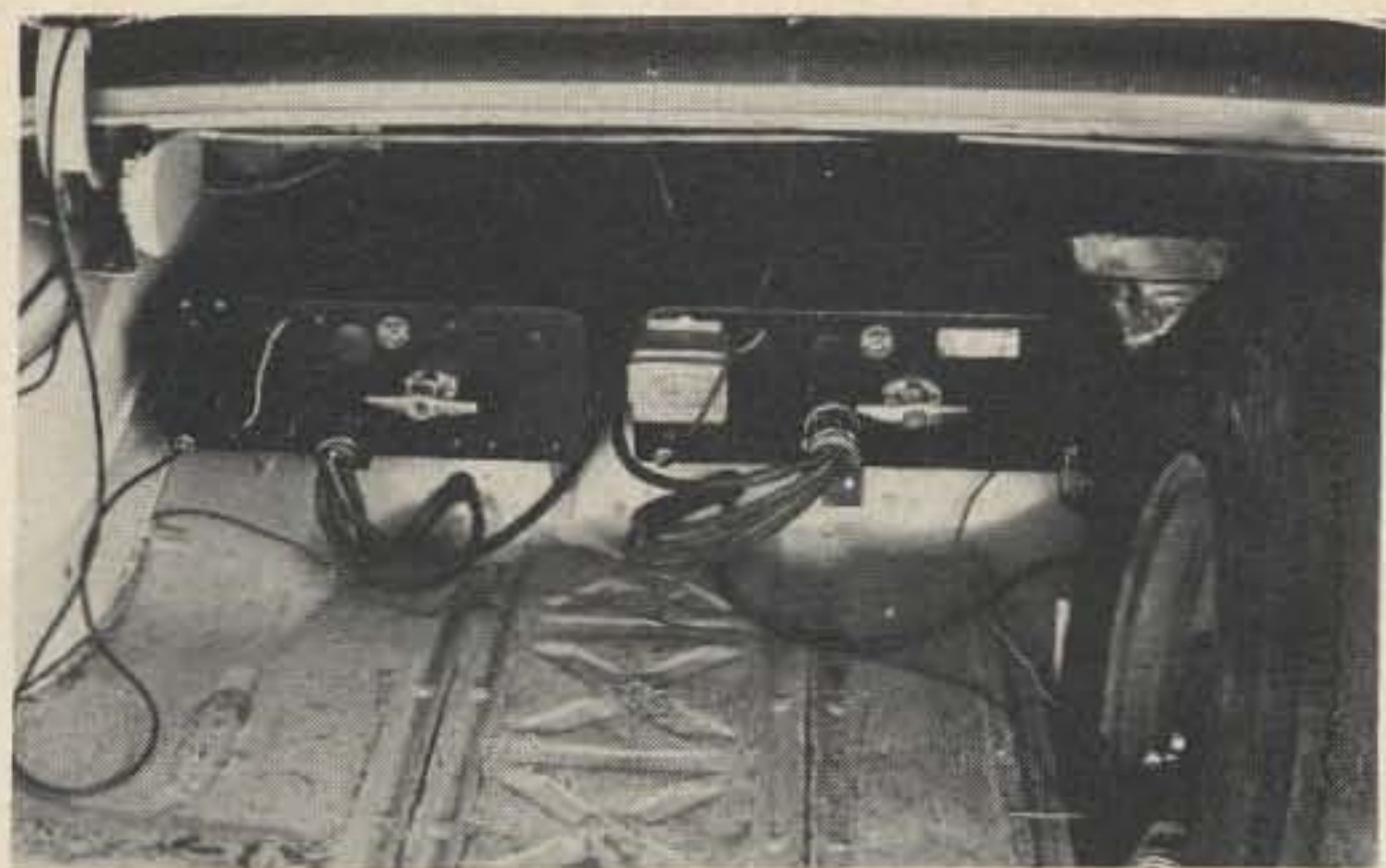

Here's an example of a sturdy trunk mounting arrangement that avoids the usual rat's nest of wires.

to the F2 oscillator tube (or hole in the chassis) will show about 1 cm of threads. The brass slugs will be coming up out of the coil while the iron slugs will go farther into the coil for lower frequencies. These measurements may vary as much as 0.5 cm between different radios, but will serve as a handy starting point for the most difficult part of alignment.

Some of the transmitter coils can be set approximately on frequency with a grid dip meter tuned to the appropriate crystal multiple. The second doubler plate and the second tripler grid coils may have to be bent to get them down to the 148 MHz frequency if the transmitter is to operate around 444 to 445 MHz. They will tune up without trouble, but if the capacitors peak at maximum capacitance, they may not have exactly reached resonance. Always be sure that no controls peak exactly at minimum or maximum where exact resonance is necessary. The 148 MHz circuits should show a smooth definite peak, and the first doubler plate and second doubler grid coils should also peak relatively sharply. These controls should be repeatedly readjusted since they do interact. Getting drive to the final 5894 is always the hardest part of alignment. The second tripler plate adjustment should peak near the top of its range, and the PA grid screw should be down in its hole near the bottom of its travel. These adjustments tune relatively broadly. In a case where drive to the final cannot be obtained this is usually indication that either or both 5894's are flat. The PA plate adjustment is *very critical*, and turning it will probably give the first indica-

tion of transmitter output. The other antenna tuning and loading controls show definite peaks, but the PA loading adjustment will be relatively broad. Readjust all of these several times to get maximum output since they interact. These adjustments alone may be the objective of a typical two hour tweaking program.

### Receiver Problems

As with the transmitter, the major cause of reduced performance is weak tubes. Even without a signal generator sensitivity check, if all the tubes are good and all the circuits tune properly, this alone is usually assurance that the receiver is working adequately.

Loss of overall sensitivity is usually caused by a weak 12AT7 in the first or second oscillator or multiplier. The 6AM4's in the front end or the 6BH6's in the first i-f need replacing less often. If the receiver seems to be sensitive enough, but is noisy, this usually indicates a weak 6BH6 in the low i-f, or occasionally a bad 12AT7 limiter. An open squelch can be repaired by replacing a defective 12AX7. In a rare occasion the glass on the 6AK6 output tube may crack.

Complete loss of audio output can be caused by a bad audio output transformer, a shorted .01 capacitor across the primary of the transformer, or a bad discriminator coil. The large .1 capacitor from the B+ line to ground may short out and cause a fuse or #43 lamp in the power supply to blow. This capacitor, 1C69, is located directly under the audio output transformer. It may be wise to replace this capacitor as well as the one across the transformer if you like to plan ahead, before they short out.

Improved receiver performance may be obtained by increasing the local oscillator signal. The  $22\Omega$   $\frac{1}{2}$  watt resistor on pin one of the oscillator 12AT7 should be shorted with a short piece of wire. The same may be done to the 33K 1 watt resistor directly under the bottom of coil 1Z15; it's the only 33K in this area. Modifications such as this in the i-f stages will cause instability and will not significantly increase performance.

Receiver performance can be improved by the addition of a small transistor power supply to power the receiver only. RCA

made a power supply for this purpose which is mounted on the front panel of the cabinet, or you could build your own from surplus parts. The vibrator wiring can be modified so that the vibrators only come on when the transmitter is keyed, thus eliminating vibrator noise from the receiver. With this modification it should be possible to break the squelch with as little as .2 micro-volt.

Approximately every six months it will usually be noticed that receiver performance has decreased. In this case receiver alignment and tube replacement should be made.

### Transmitter Tricks

Aside from replacing tubes, the greatest improvement in transmitter output power will result from removing the selenium rectifier stacks in the power supply and replacing them with 1000 volt 1 amp silicon rectifiers. With this modification the transmitter will put out as much as 18 watts. Removal of the old rectifiers also adds considerable space for a transistor power supply, single tone oscillator, PL oscillator, or rf preamplifier for the receiver.

Removing the output "trombone" filter from the transmitter will increase power output slightly. All the old RG58 can be replaced with Belden 8219, foam RG58, which should also be used for the antenna cable. A commercial antenna manufacturer offers a mobile gain antenna with higher than usual gain specs, achieved by simply using low loss coax instead of the usual RG58. Incidentally, a gain antenna will double the effective transmitter power as well as improving receiver performance by lowering the angle of radiation, and is worth the price.

Vehicle battery voltage always has a major effect on transmitter power, and low power output may be caused by a loose or dirty cable connection since very high battery current is drawn in the transmit mode.

Low power output can be caused by a "weak" vibrator, and replacement of the vibrators often will show an improvement. If a vibrator is inserted in the socket in the 6 volt position while connected to 12 volts, the power output will increase, but it may not last for very long!

In a homebrew base station the transmitter can provide as much as 30 to 40 watts output by simply increasing B+ voltages. Remember that the current required is around 300 mA, so relays used to break the B+ current should have large enough contacts and wide enough spacing to break the surprising arc that results when B+ is removed. A monster TV power transformer will make a good base station power supply for up to 30 watts output with about 350 volts. 400 volts makes a good repeater or remote base power supply, which is about the maximum voltage. Of course, in this situation for continuous operation, forced air cooling will be required. Two 75 CFM blowers bolted to the top of the final amp and tripler cage will cool the 5894's and the 5763's so they are cool enough to touch even after several hours of key down operation.

Service problems in the transmitter other than flat tubes are rare. The 5894's are quite reliable (which is fortunate considering their price) and do not go bad suddenly. A 5763 may go flat without warning, however, causing loss of output power. The antenna relay operates off the second tripler cathode current, and may not pull in if there is no drive to that stage or the tube is flat. It is not unusual to find a fifteen-year-old 5894 still putting out 10 or 12 watts, but new tubes are the key to maximum performance.

The bias supply in a homebrew power supply can be the source of trouble if it is not properly regulated. The combined grid current of the transmitter tubes can pull enough bias current to raise the bias voltage and cut off the final PA tube.

### Conclusion

The RCA CMU15 is probably the cheapest and easiest way for the beginner to get started in FM with a quality radio. With a good set of tubes and a little help getting started, service should not be a serious problem. The CMU15's good performance and low cost usually do not justify buying a later model tube radio at three or four times the cost, so the beginner may find himself keeping his CMU15 for a long time.

...WB6BIH

# 2 METER FM AT 14,000 FEET

**B**eing a DXer at heart and also very interested in 2 meter FM, I enjoy driving up to the 73 repeater site to fire up our base station to work DX during band openings. I find I can usually work up to two or three hundred miles or more during an opening. Now, since I am basically an experimenter and always want to improve on a situation, I decided there must be a better way to work 2 meter DX. The 73 repeater site is a twenty-minute drive from home, and during the winter months I have to hook up the snow buggy trailer to my Bronco and drive to the base of the mountain. The snow buggy trip up takes another forty-five minutes. After all the work of getting up the mountain, I usually lose some of my energy to work DX and just drink a couple of beers and come back down (a little faster than I went up).

Anyway, as I said, there must be a better way to work 2 meter DX. Second only to amateur radio is my big love — flying. I own a Cherokee 140D which — on the slightest suggestion — I'll fly almost anywhere. Why not install an FM transceiver in the airplane and combine both hobbies? Not a bad idea, I thought. My 140D is extremely well equipped with avionix equipment. The craft is completely IFR capable with the Genave (General Aviation) line, including their Alpha 600 with Glide slope, Beta 500 Transponder, Sigma 1500 ADF, 3 light marker beacons, and auto pilot. The point I make — as any of you who have seen the inside of a 140D can appreciate — is that panel space is at a premium. A quick measurement showed I had only 2½ inches

available in the 6½ inch wide panel. Since I did not want to modify the craft in any way, I had to find a transceiver to fit my space availability. After checking all the 2-meter units we have in the 73 offices with a tape measure, I began to feel a little discouraged. Maybe those snow buggy trips to the mountain weren't so bad.

Then it occurred to me, Genave had just announced their GTX-2 transceiver for 2 meter FM. I quickly checked the specs and found the GTX-2 was exactly what I needed. A telephone call to Genave produced the rig a few days later, along with an aircraft antenna cut to 2 meters. I flew the 140 down to New Haven Avionics, and in a couple of hours John Reiser had the unit installed and operating. With a flick of the switch I could transfer mike and speaker controls from the aircraft COMM to 2 meters.

When I got back to Peterborough I found a package from Sentry with extra crystals I had ordered. The GTX normally comes with 34/94 and 94/94. If you wish, they will supply any additional frequencies. I crystaled up the GTX-2 for 16-76, 19-79, 22-82, 28-88, 34-94, 52-52, and a couple of weird frequencies.

I decided the next Saturday night would be the best time for my little DXpedition. The 140D has a ceiling of about 14,000 feet, and after 10,000 feet supplemental oxygen is needed. A trip to the friendly ambulance company — and I had a small oxygen cannister on loan.

Saturday rolled around and the weather was CAVU (ceiling and visibility unlimited).

**NOW**

EXCLUSIVE 66 FOOT

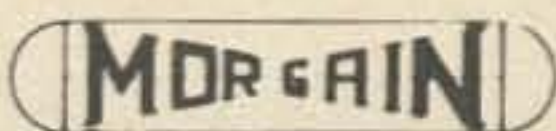

75 THRU 10 METER DIPOLE

**NO TRAPS — NO COILS — NO STUBS — NO CAPACITORS**

Fully Air Tested — Thousands Already in Use



**IS BACK**

#16 40% Copper Weld wire annealed so it handles like soft Copper wire—Rated for better than full legal power AM/CW or SSB Coaxial or Balanced 50 to 75 ohm feed line—VSWR under 1.5 to 1 at most heights—Stainless Steel hardware—Drop Proof Insulators—Terrific Performance—No coils or traps to break down or change under weather conditions—Completely Assembled ready to put up—Guaranteed 1 year—ONE DESIGN DOES IT ALL: 75-10HD—ONLY \$12.00 A PAND!

Model 75-10HD	\$60.00	66 Ft	75 Thru 10 Meters	Model 75-40HD	\$40.00	66 Ft	75 Thru 40 Meters
Model 75-20HD	\$50.00	66 Ft	75 Thru 20 Meters	Model 40-20HD	\$33.00	35 Ft	40 Thru 20 Meters
			Model 80-40HD	\$42.00		69 Ft	80-40-15 Meter (CW)

ORDER DIRECT OR WRITE FOR FULL INFORMATION

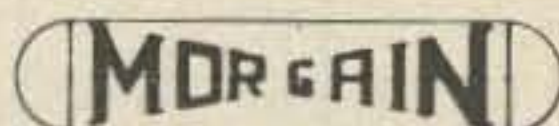

300 S. Shawnee  
Leavenworth, Kansas 66048

OR THRU YOUR FAVORITE DISTRIBUTOR

At 6 PM I took off from Keene airport and started a climb to 14,000 feet. On the way up I was listening to WA1KGO on 19-79. At 2,000 feet I started to hear WA1KGQ in Hartford CT (100 miles). At 3,000 feet I was hearing W2AKR in Paramus NJ (200 miles). At 5,000 feet I was hearing WA3CAG in Trevese PA (300 miles). I levelled off at 14,000 feet over Peterborough and started punching up different frequencies.

On every frequency I listened, there were at least two or three repeaters present. My first mistake was to key up 34/94. It took five minutes (or so it seemed) for all the repeaters to drop out. It soon became evident that operation on standard repeater frequencies was nearly impossible. I decided to try a couple of non-standard repeaters. I punched up W1DC which is 147.72 in and 147.12 out. Right away I heard a QSO in progress and decided to listen awhile. After a minute or so I realized it was not W1DC I was listening to, but WA4UAG in Huntsville AL (1000 miles). WA4UAG is a tremendous machine with an input on an off-channel which I just happened to have. A quick

crystal change and I was talking to K4YMB through the Huntsville repeater. After a short chat, I took a couple of deep breaths from the oxygen cannister and switched to 16-76. Fortunately there wasn't too much activity, and I was able to hear WA9ORC in Chicago with a full quieting signal. When I tried to call in, however, I keyed up a multitude of stronger 16-76 repeaters. 52 simplex proved rewarding with contacts to South Carolina, West Virginia, Tennessee and Canada made with ease. After about five or ten minutes there was so much activity on 52 that it was difficult to hear anyone.

Another two hours were spent checking different frequencies. Repeaters up to 1000 miles were heard consistently, but contacts were few on the common frequencies since I was keying up so many of them.

I have definitely found a new way to enjoy 2 meters and have also learned a few things. I have ordered reverse pair crystals for the common repeater frequencies and also for the simplex frequencies. Look for me on 2 meter FM some night. It's a blast.

...W7DXX/1

SB-144



SCANVISION





AVAILABLE FROM:

**KASS ELECTRONICS DISTRIBUTORS, INC.**  
Vince Barr, WA3ICS

2502 Township Line Road,  
Drexel Hill, PA. 19026 Phone: 215/449-2300

*the feature line*

SB-450



SB-36



# SIMPLE LIGHTNING DETECTOR

*For those remote repeater sites!*

The circuit shown in Fig. 1 wasn't really meant to be a lightning detector — originally it was part of a burglar alarm we built and installed some time back. But the first night we had a lightning storm all the bells and whistles went off and the neighbors . . . well, anyway, here we have a lightning detector that works quite well.

Not everyone *needs* a lightning detector, of course, but it is very handy for those stations that normally operate round the clock and unattended — repeaters, private repeaters, and remote control systems such as autopatches. In that case the lightning detector can temporarily disable the station and ground the antennas when a storm is in the vicinity.

Figure 1 shows the basic circuit. A small, sensitive SCR is in series with a relay coil. When a positive pulse appears on the SCR gate, the SCR turns on and energizes the relay. A 20 ft pickup wire attached to the gate and strung about the house works quite well to couple lightning-caused pulses into the diodes. Once the SCR latches, the circuit remains on until the power is removed.

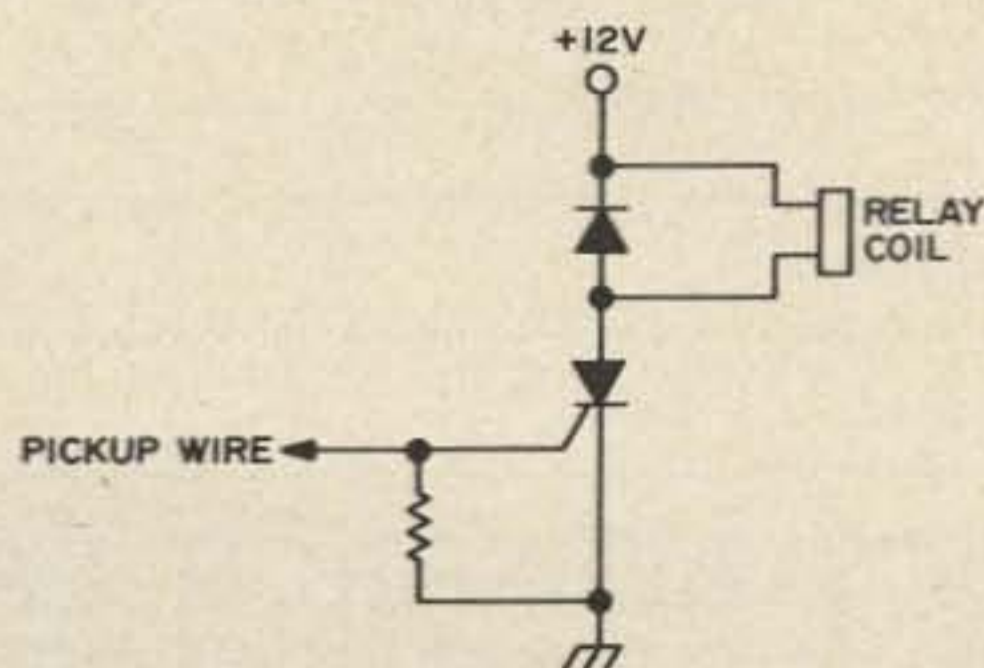

Fig. 1. Basic circuit of the lightning detector.

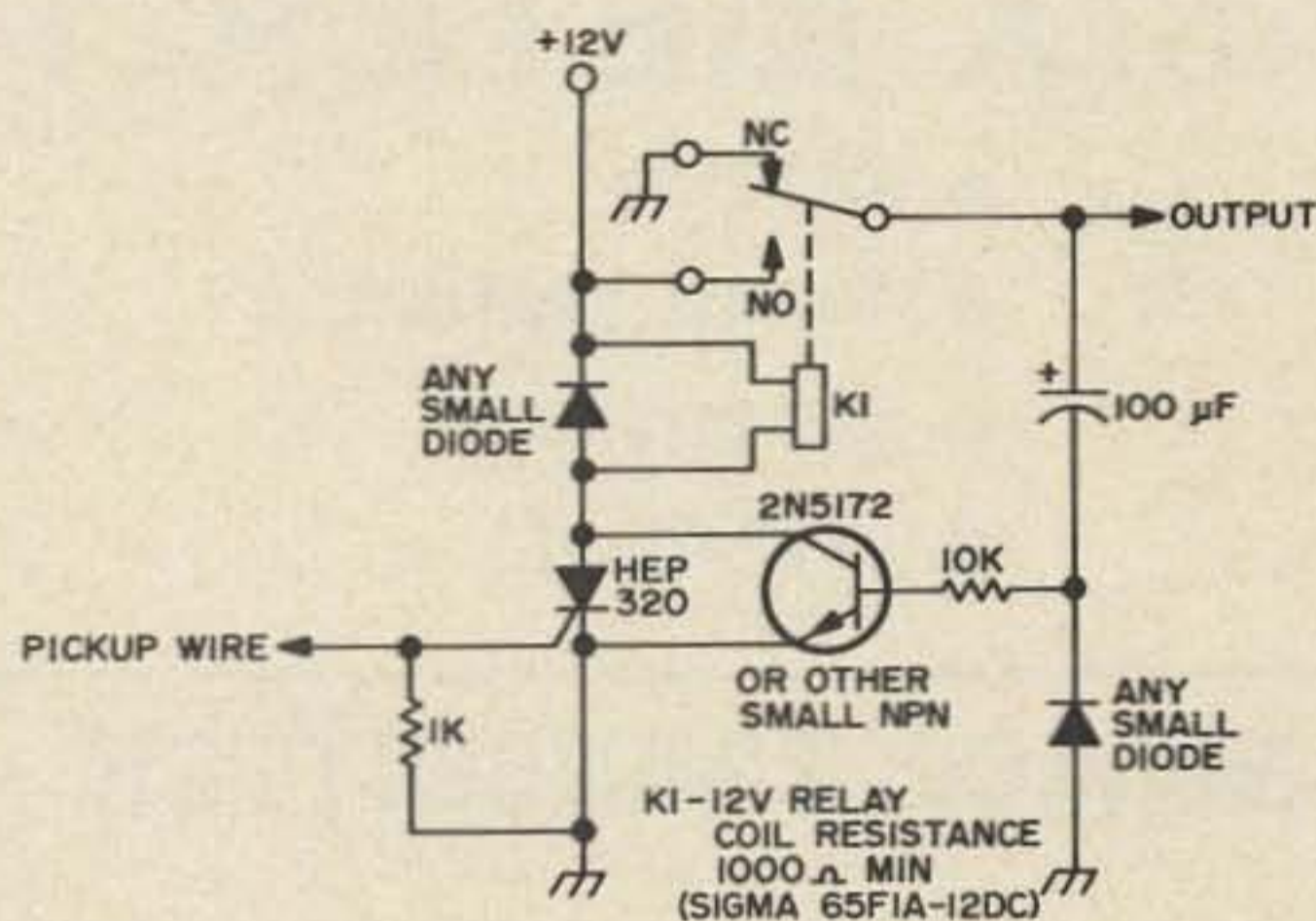
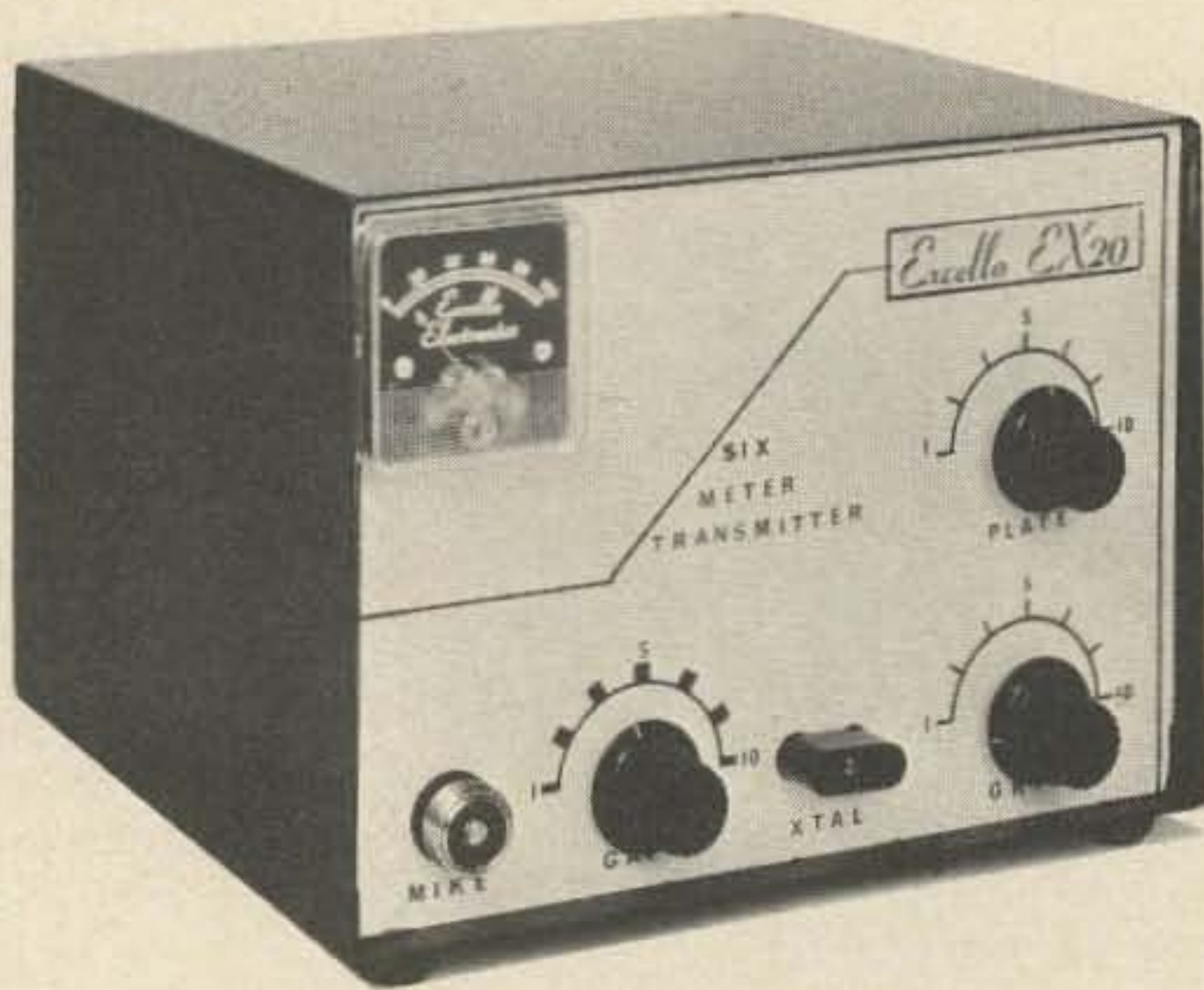

Fig. 2. Circuit with automatic reset.

Figure 2 shows an improved version which automatically resets itself after a while. The SCR works as before, but when the relay closes +12V is applied to the top of the capacitor, which then slowly discharges through the 10K resistor and the base of the transistor. The transistor is across the SCR and lets the SCR release immediately after the lightning stroke is over. The relay stays pulled in for a short time interval, depending on the gain of the transistor and the quality of the 100  $\mu$ F capacitor, and then opens.

In operation, make sure the pickup wire is far enough from your transmitter and antenna that it does not pick up rf energy from there. If any rf does get into the pickup wire, use a loop of wire whose far end is grounded. We haven't had any trouble in that regard, and the detector picks up any storms that are close enough to be seen and heard. If the sensitivity is too high, simply use a shorter pickup wire.

...K20AW



Price **49<sup>95</sup>**

Net to Amateurs  
Complete with Tubes  
Power Supply \$9.95

8MC. XTALS-8333-9000.  
Silk Screened Panel.  
18 Watts Output.

## SIX METER TRANSMITTER

- for
- Mobile
  - Fixed Station
  - Emergency
  - Aviation

### TUBE COMPLIMENT

6U8 Oscillator Multiplier  
12AX7 Speech Amplifier  
2E26 Final Amplifier  
6BQ5 Modulator

### NOVICE TRANSMITTER

**25 WATTS INPUT**  
BUILT IN POWER SUPPLY

#### TUBE COMPLIMENT

6AQ5 OSC.  
6L6 FINAL AMP

Price **49<sup>95</sup>**

Net to Amateurs,  
Complete with Tubes.

**NEW!** TWO METER  
TRANSMITTER  
**8 WATTS INPUT**

#### TUBE COMPLIMENT

6BA8 Osc-Mult  
6CX8 Final Amplifier  
6AQ5 Modulator  
12AX7 Speech Amp

Price **59<sup>95</sup>**

Net to Amateurs,  
Complete with Tubes.  
Power Supply \$9.95

### ORDER BLANK

SHIP TO \_\_\_\_\_

BILL TO \_\_\_\_\_

STREET NO \_\_\_\_\_

ADDRESS \_\_\_\_\_

CITY AND STATE \_\_\_\_\_

SHIP VIA \_\_\_\_\_

TOTAL PRICE \_\_\_\_\_

MODEL NO	QUANTITY	DESCRIPTION	PRICE



**EXCELTRONICS RESEARCH LABS**  
MANUFACTURERS OF ELECTRONIC DEVICES

217-24 121st. Ave. Cambria Heights, N.Y. 11411

Phone (212) 341-0096



# CITIZENS BAND ALIGNMENT AID

**T**he need for better tuneup aids for CB radios has been well documented by W2NSD/1. (See 73 Feb. '73, pages 5 and 6.) Well, FELLOW AMATEURS, I must admit to holding out on you, just a bit. I have been in possession of an excellent circuit for such a need for about seven years. I recently updated it with a more modern transistor and a Printed Circuit Board. A comment here, to explain that I also hold a First Class Radiotelephone License, and on occasion repair CB radios. Also remember that no license is required to tune the receiver.

It is obvious that the front end of a receiver should be tuned to respond equally well across the band, and thus have consistent sensitivity at any frequency in the band, if maximum usefulness is to be obtained. The usual method of insuring reasonable results is to tune at the middle, and check the ends. This is rather spotty, at best, as it would be better to check all channels. This is involved since you must set both frequency and amplitude 23 times in a single pass.

Naturally, a good sweep generator could be used, and the rf-mixer tracking set with it instead, but this was not available to me at the time. The circuit in Fig. 1 was originally a super-regenerative receiver taken from the GE Transistor Manual. These, as is well known, tend to spray a lot of rf back out the antenna. With this in mind, I listened with a

communications receiver and noted strong modulation products about 100 kHz above and below the "carrier." Deducing this to be caused by the quench frequency, I brilliantly decided to drop the quench frequency into the audio range, by increasing the capacitance across the base bias resistor. Lo and behold! Suddenly the entire Citizens Band was alive and jumping with a mass of "line noise," which at first appeared to be like natural noise. Then I turned on the BFO, which showed it to be many, many, many closely spaced "carriers." I presume the lower quench frequency develops a much larger bias swing on the base of the transistor, FM'ing it across the entire band. This stuff is concentrated in the region of 27

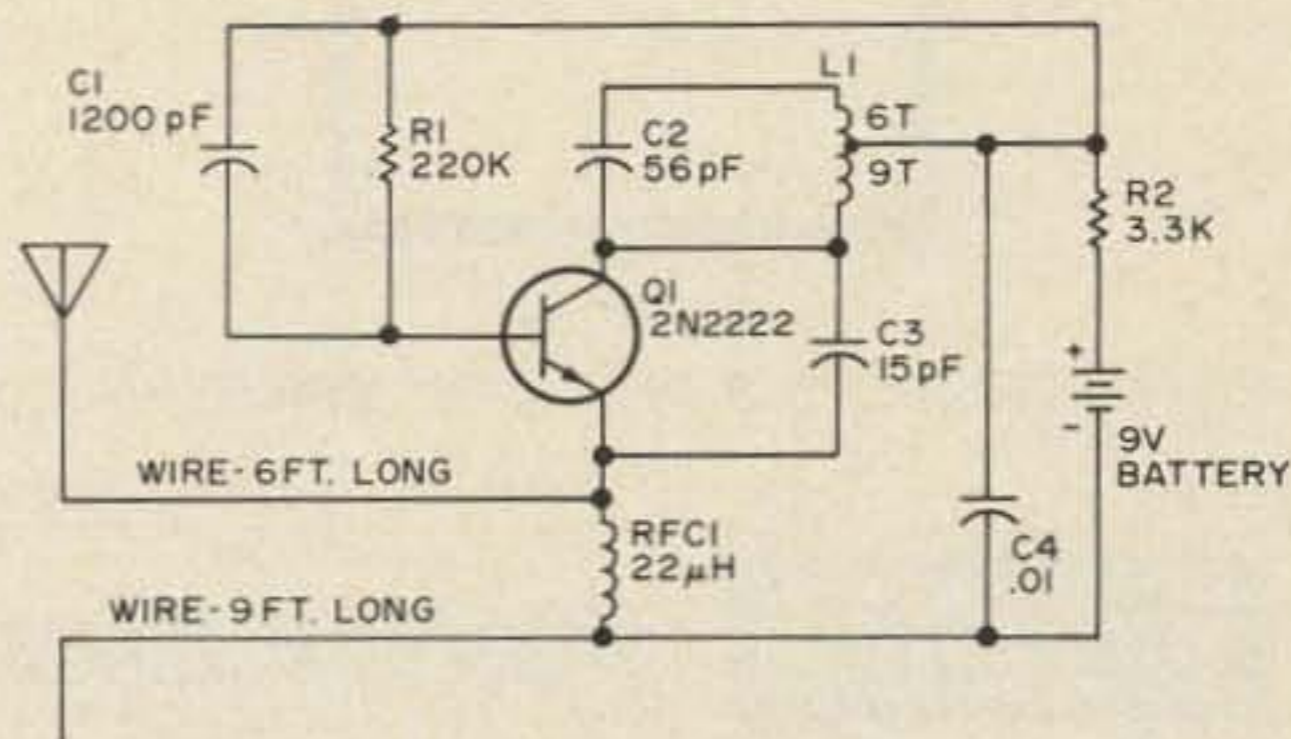

Fig. 1. Schematic of the alignment aid. L1 is 15 turns No. 22 tapped at 9 turns from the collector end. No switch is shown, so remove battery when not in use.

MHz, with very little spill-over into 10 or 15 meters, although the level across the design range is rather constant. The nearly constant rf level is what I needed to simplify tuneup of the front ends of the units I was working on.

Figure 2 is the layout of the P.C. board I made to facilitate reproduction of this useful circuit for a few interested friends and Fig. 3 is the component layout.

I used 6 ft of wire as an antenna connected to the emitter side of the rfc, with 9 ft of wire on the battery side of the rfc as a counterpoise. Since this made it a bit large, I carefully hung it vertically in a handy tree nearby. Of course, since this put a strong signal on every channel into every CB

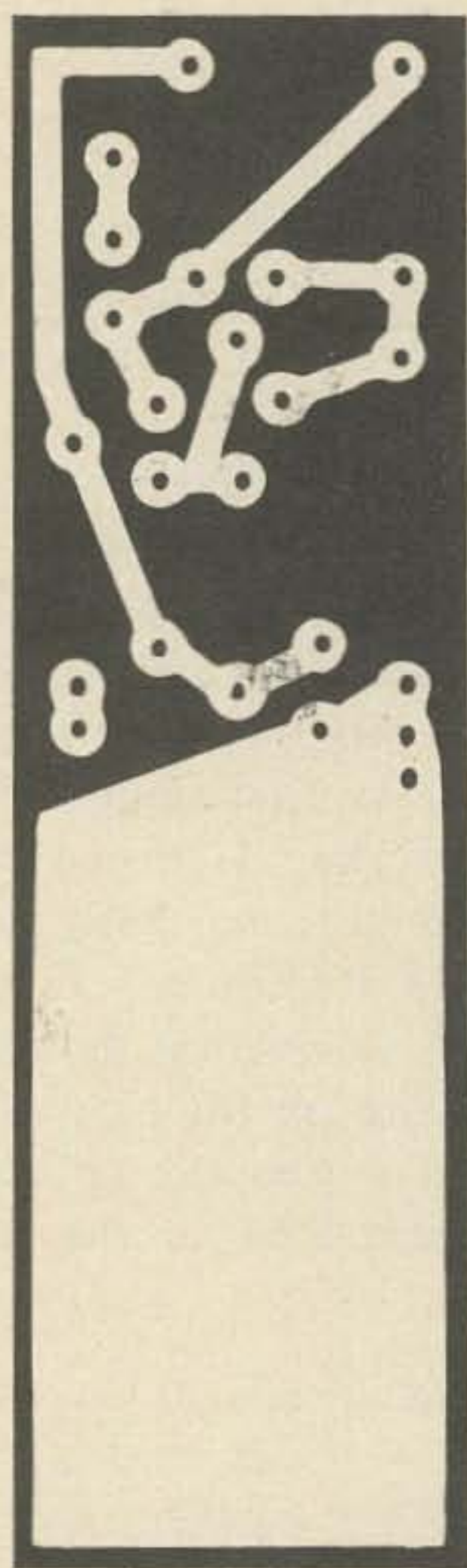

Fig. 2. Full size PC board layout (foil side).

receiver within 300 yards, I limited the use of this device to avoid unnecessary interference to the deserving users of the band. However, one fellow accidentally launched his into a tree too high to recover with an over-ambitious heave, and it ran for about a month in the dead of winter in a nameless northern city, helping every CBER for miles

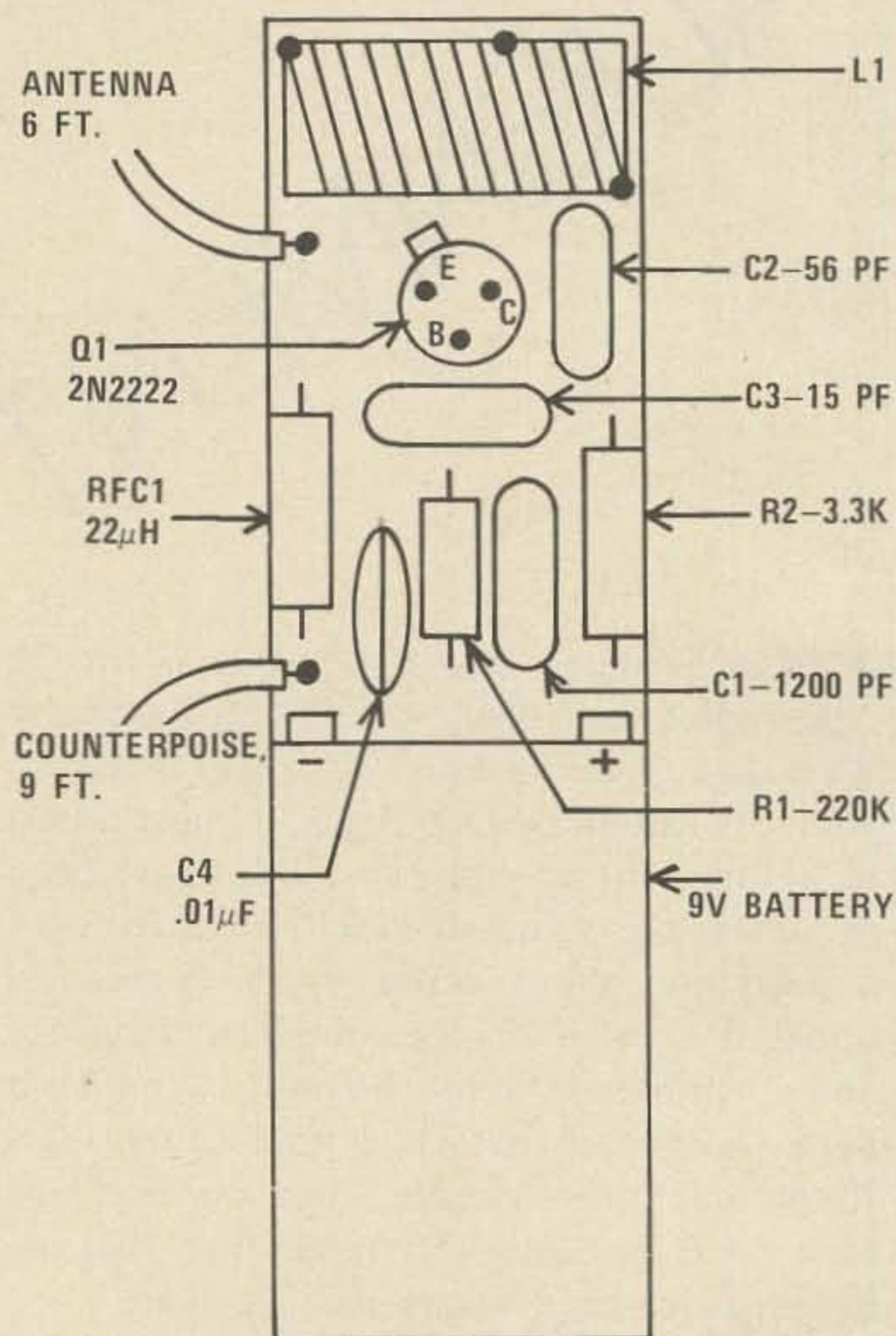

Fig. 3. Component side parts placement.

around align their sets! It only draws about half a milliamp from a 9 volt battery.

Since I am sure many others would like to align their 11 meter receivers for optimum results, I am presenting this circuit as a very low cost and worthwhile aid. If I receive enough inquiries, I could possibly have P.C. boards made up. These boards could also be used to make a compact super-regenerative receiver as per the original circuit. I am sure the changes required to put this on any other HF band are well within the scope of the readers of the magazine. I would estimate the cost to be about \$1.50 per P.C. board, plus shipping.

...WA5SWD

**SBE** *the feature line*

SB-36 • SB-144 • SB-450 • SCANVISION

**T & M ELECTRONICS  
SUPPLY, INC.**

472 East Main St., Patchogue, N.Y. 11772

AVAILABLE FROM:

# STEP UP TO TELREX

## Professionally Engineered Antenna Systems

### Single transmission line "TRI-BAND® ARRAY"

By the only test that means anything . . . on the air comparison . . . this array continues to outperform all competition . . . and has for two decades. Here's why . . . Telrex uses a unique trap design employing 20 HiQ 7500V ceramic condensers per antenna. Telrex uses 3 optimum-spaced, optimum-tuned reflectors to provide maximum gain and true F/B Tri-band performance.

#### ONLY TELREX GIVES YOU ALL THESE FEATURES . . .

- Power rating 4 KW PEP . . . rain or shine
- Wind rating survival 110 MPH
- Patented broad-band coaxial Balun
- Heavy-duty steel gusset mounting plate
- Aluminum boom 2 in., 2½ in. O.D. x 18 ft.
- Large diameter, .058 wall taper-swaged dural elements for minimum

weight and exceptional strength to weight ratio

- Stainless steel electrical hardware

With a Telrex Tri-band Array you get 49 lbs. of educated aluminum engineered and built to provide many, many years of performance unmatched around the world by any other make. Longest element 36 ft. Turning radius 20 ft. Shipping weight 65 lbs. Shipping container 13 in. x 5 in. x 13 ft.

Note: If not available from your dealer, order direct. You'll get fast, personal service.

Telrex Labs are design engineers, innovators and manufacturers of the world's finest ¾ to 160 meter communication systems and accessories priced from \$25 to \$25,000.

For technical data and prices on complete Telrex line, write for Catalog PL 71.

TB5EM **\$395**

Other Multi-Band Arrays Available

Elements shortened to show details.

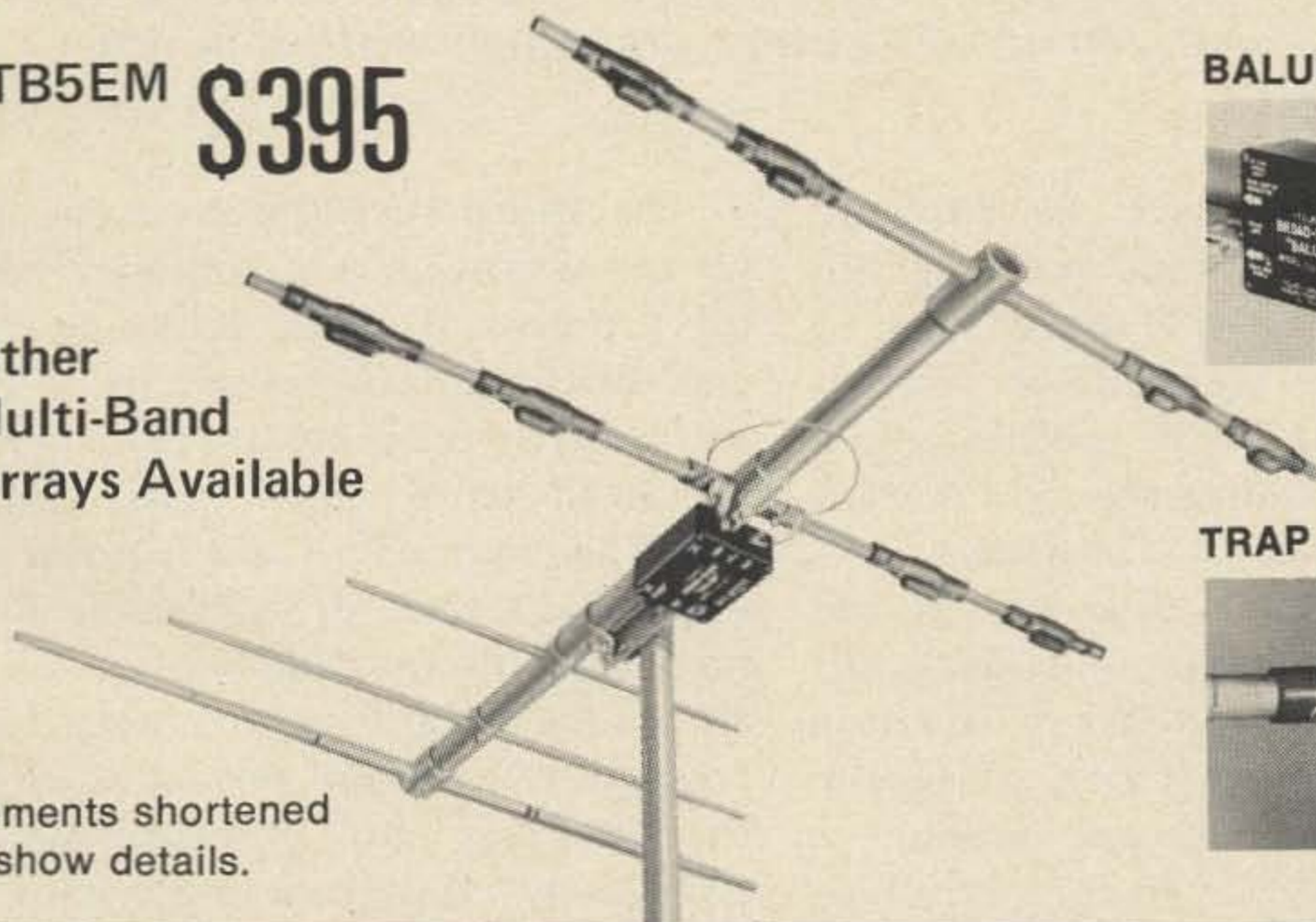

BALUN



TRAP

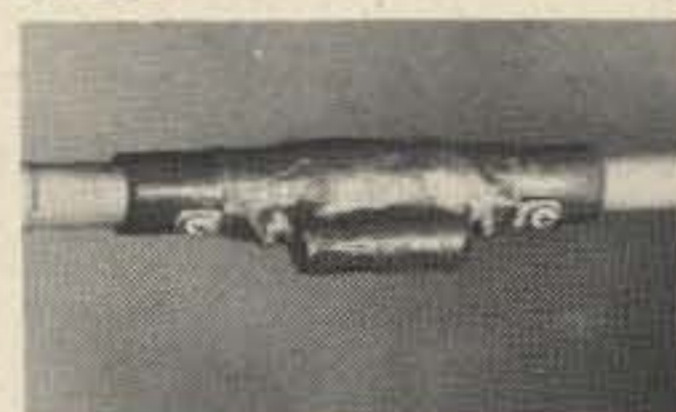

### TYPICAL TELREX "MONO-BAND" ANTENNAS

15M317	- "Monarch", 10 DBD, 3 El., 4 KWP, 2-1/2" O.D, 17' boom	\$175.00
20M326	- "Monarch", 10 DBD, 3 El., 8 KWP, 3-1/2" O.D, 26' boom	\$355.00
2M609	- "Monarch", 14 DBD, 6 El., 6 KWP, 1" O.D, 9' boom	\$ 39.95
2M814	- "Monarch", 16 DBD, 8 El., .8 KWP, 1.375" O.D, 14' boom	\$ 59.00
6M516	- "Monarch", 13 DBD, 5 El., .8 KWP, 1.5" O.D, 16' boom	\$ 63.95

and ----- many, many more! send for PL-71 Dept. C

**telrex** LABORATORIES

TV And Communications Antennas Since 1921  
Asbury Park, New Jersey 07712 201-775-7252

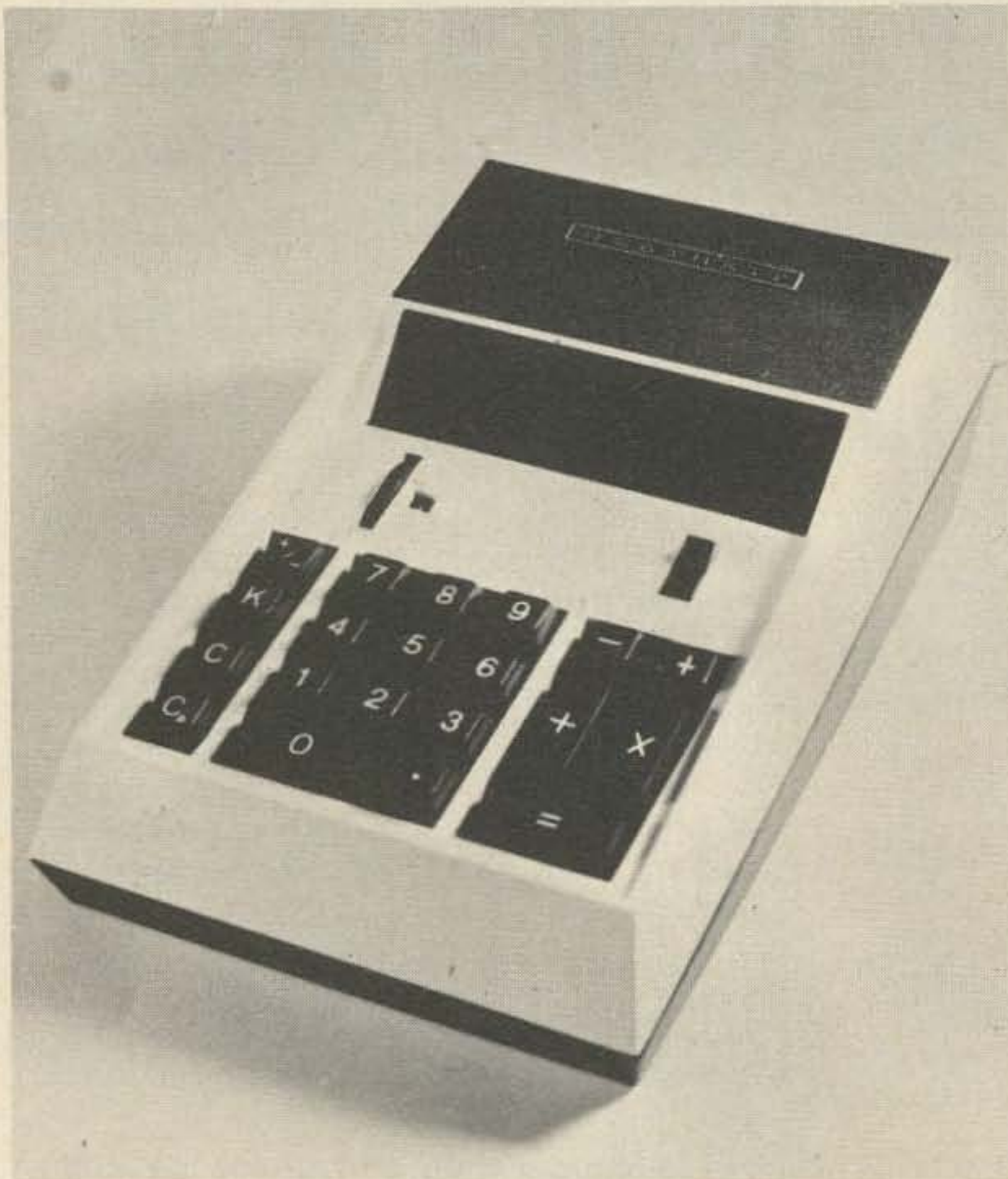

# HEATH DESK- TOP CALCU- LATOR

*A Ham-Convenience product of the Electronic Age. Once you have one you would betray your own mother in order to keep it!*

**T**his article should not be read by anyone who enjoys the manipulation of numbers from one side of a page to another. If you have ever noticed yourself even slightly smiling while performing a simple task such as finding the LC Constant for a particular frequency – Go Away!

Now, as the *rest* of us all know, the bad guy within those too-numerous electronic equations is the Algebra. In theory, equation solving is easy. Values are simply plugged-in for the variables and the end product is happily solved. (Ho!) In *practice* however, the easy part of equation solving is over more-and-more as the Algebraic calculations go on-and-on. Somewhere near the bottom of the second page, (where you neatly dropped a set of brackets) trouble usually begins. It is not immediately noticeable because of your search for that decimal point that was there just a minute ago . . . you are not even aware that you are moments away from rediscovering Avagadro's number.

The Heath IC-2008 electronic calculator kit can restore faith in anyone's mathematical prowess. It adds, subtracts, multiplies and divides faster than any living EE graduate, and is undoubtedly more accurate. It will read to 8 digits (with polarity and overrange indication) and features a floating or selectable fixed decimal point. Besides the numerals, addition and subtraction buttons, etc., it has buttons for polarity change, constant (K) storage, display Clear (to erase the last entry only) and machine Clear (to completely clear the calculator). The seven segment display tubes are neon filled and are large and bright enough to be read from across the room. The unit operates from 115V ac and sells for \$129.95.

## Assembly

The first thing I looked for in the pile of components was the heart of the unit, a Large Scale Integration (LSI) 40 pin IC. I took it out of its plastic box and examined it closely . . . quite an IC! Later, as I neared



*A few hours of assembly and those bags of parts start to look like . . . a calculator.*

completion of the calculator, I noticed a CAUTION notice warning the builder not to touch the pins on the IC as a measure against static damage. The notice was on page 32 of the assembly manual! Fortunately the IC received no damage but handling could have been avoided with a small caution sticker on the box that contained the IC.

The circuitry is assembled on two separate boards. The main board holds the power supply and calculator components. The smaller board holds the Sperry Rand SP-733 readouts and their associated driver transistors. Heath's instructions were excellent and no problem was encountered while assembling the boards. In most cases, eight or ten parts were mounted before a quick pass was made down the board with a soldering iron.

Care must be taken when mounting the big IC in its socket because 40 pins tend to go in 40 different directions all at once. A preliminary adjustment of the socket pins on the circuit board will help to avoid this problem.

The rear half of the unit contains the actual electronics while all available space to the front of the display tubes is filled with the push button switches. The buttons press-fit onto the switch stems.

The calculator was turned on after it was completed and the No. 8 button was pushed a few times to check the operation of the

display. One of the segments did not want to light and the problem was traced to its driver transistor. A slight tap on the transistor caused the segment to light, so a touch of solder was added to all three leads as a remedy for the mysterious bad joint. There were no further problems and the unit was tested.

The three pages of testing instructions are laid out well and are easy to follow. Tests take about fifteen minutes.

Operation is extremely simple. Just tap out the numbers you are working with while specifying to the machine the function it should perform. Complete operating instructions are included to help you become familiar with the various functions. The constant feature is really a bonus. This lets you store a preselected number in the calculator that will either multiply or divide into any number or series of numbers as fast as you can push the buttons. By entering 18 as a dividing constant you can get the 8 MHz crystal frequencies for the 2m FM channels by pushing the buttons for each 2m frequency followed by a quick push on the TOTAL bar. Receive crystals are just as easy. If you have a 10.7 MHz i-f, subtract 10.7 from the 2m frequency and divide by 3. A complete correlation chart can be made for any rig in just a few minutes. And of course that stock of weird crystals you have around the shack can be multiplied-up by entering each frequency as a constant and working up the keyboard to see if anything interesting shows on the display.

#### **Add One**

The Heath Calculator, besides being mathematical, can solve other problems (grief) as well. The time and energy saved while using this little machine is phenomenal. If a mistake is made part way through the problem you are working on, just erase everything and start over. You'll have the new solution in less time than it would take to find the mistake if you were working on paper. Even if you never particularly enjoyed working with formulas, this calculator will have you designing your own coils, filters and solid state rf amplifiers within a week.

...WA9FPP/1

**Now! Get all the advantages of Regency  
2 Meter FM...on the 6 Meter FM Band, too.**

# NEW HR-6

12 Channel  
Solid State  
6 Meter FM  
Transceiver

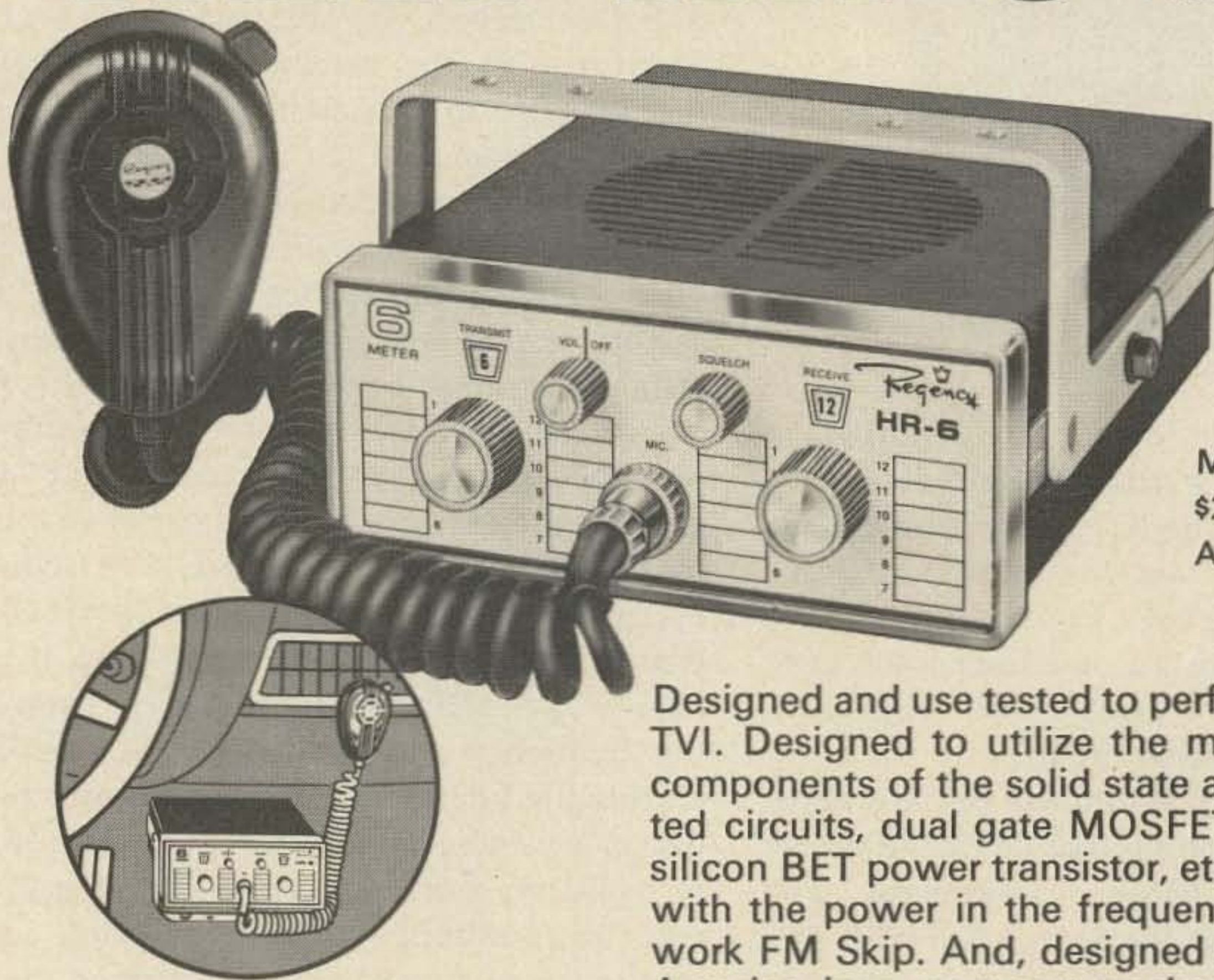

Model HR 6  
\$239.00  
Amateur Net

Designed and use tested to perform against TVI. Designed to utilize the most modern components of the solid state art—integrated circuits, dual gate MOSFET transistor, silicon BET power transistor, etc. Designed with the power in the frequency range to work FM Skip. And, designed and built in America in a compact package that will appeal to your taste and pride of ownership.

**Complete dash mount  
operation . . . does not  
require black box power  
hog in your trunk**

**25 Watts Out  
Long Range Signal Capability  
12 T and R Channels  
Independently Switched  
144 Frequency Combinations  
5 Watts Audio output  
Compact for Dash Mount.**

## SPECIFICATIONS

Power Output:	25 watts Min. @ 13V DC
Frequency Range:	52-54 MHz
Channels:	12 with independent switching
Sensitivity:	.35 $\mu$ V (nom) 20db quieting
Selectivity:	6db $\pm$ 16KHz
Audio Output:	5 watts max.
Size:	2 5/8" x 6 1/2" x 9 1/2"

State of the art receiver utilizes MOSFET mixer for superior front end overload and intermodulation performance.

 **Regency**

**ELECTRONICS, INC.**

7707 Records Street • Indianapolis, Indiana 46226

American Made

# TRANSISTOR RF POWER AMPLIFIERS PART II

Figures 2 and 3 depict the two forms of the L network – input resistance less than output resistance and input resistance greater output resistance, respectively. And Fig. 4 depicts the pi network. None of the equations governing these networks are overly complicated. Nevertheless, using them to design the input and output tank circuits of a practical rf amplifier does require quite a few calculations of little interest to readers not mathematically inclined. For convenience, therefore, we have put the equations and the calculations made in designing the 10 watt (nominal) rf power amplifier described below into the appendix of this article.

The illustrative calculations are made for a frequency of 145 MHz, but complete component data for all amateur bands between 3.5 and 148 MHz are included in Tables I, II and III.

## Designing a 145 MHz Transistor Power Amplifier

Let us design a 10 watt (nominal), 145 MHz booster amplifier to be driven by the output of a one or two watt FM transceiver. As developed earlier, for best results rf power transistors must be operated reasonably close to their design frequencies. We select the modern, balanced-emitter 2N5590. Its essential characteristics are:

Type	2N5590
VCC	13.6V dc
Dissipation	30 watts
Output Capacitance	80 pF <sup>1</sup>
Typical operation at 145 MHz	
Power Output	14 watts <sup>2</sup>
Driving Power	2 watts
Power Gain	8–9 dB
Input Resistance	2.5Ω

<sup>1</sup>Varies somewhat with frequency

<sup>2</sup>With two watts drive

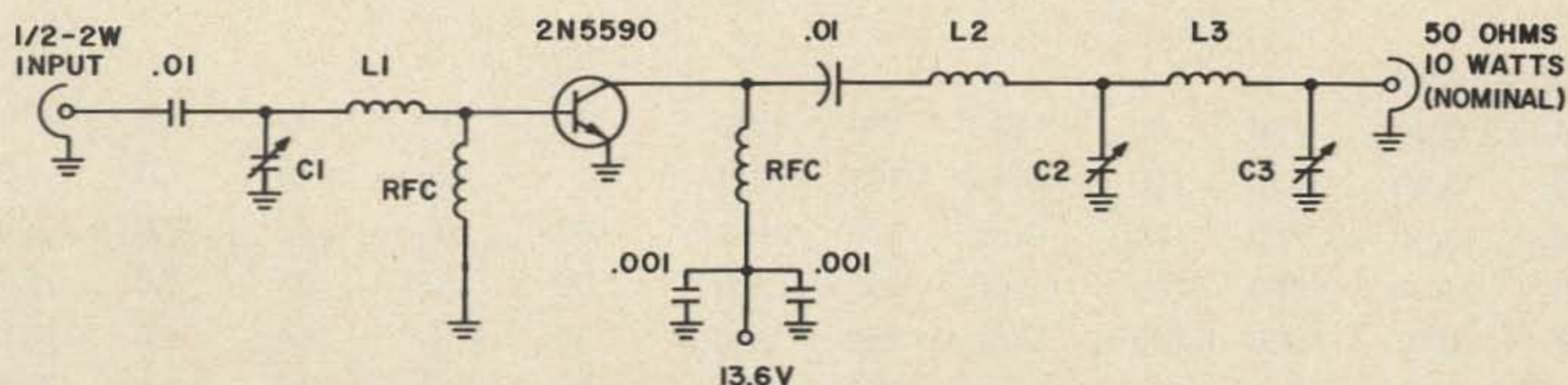

Fig. 1. Typical transistor rf power amplifier.

Solving equation 1 for a dc collector voltage of 13.6 and a power output of 14 watts gives a transistor output resistance of  $4.7\Omega$ . L network A would seem a logical choice to match this resistance to a  $50\Omega$  load. But, we note that the transistor output resistance is in parallel with the  $80\text{ pF}$  output capacitance of the transistor.

If network A had an input capacitor to ground, the simple way of compensating for the transistor parallel output capacitance would be to decrease the value of the input capacitor enough to compensate for the transistor capacitance. As L network A does not have an input capacitor, however, we use equations 12, 14, and 15 to transform  $4.7\Omega$  in parallel with  $80\text{ pF}$  to their equivalent values of  $2.8\Omega$  in series with a capacitive reactance of  $0.94\Omega$  (at  $145\text{ MHz}$ ).

Now solving equations 2 and 3 for input and output resistances of  $2.8$  and  $50\Omega$ , respectively, gives values of  $.012\ \mu\text{H}$  and  $90\text{ pF}$  for the L network. Adding  $.001\ \mu\text{H}$  to the calculated inductance to compensate for the  $0.94\Omega$  series output capacitance of the transistor brings the total inductance up to

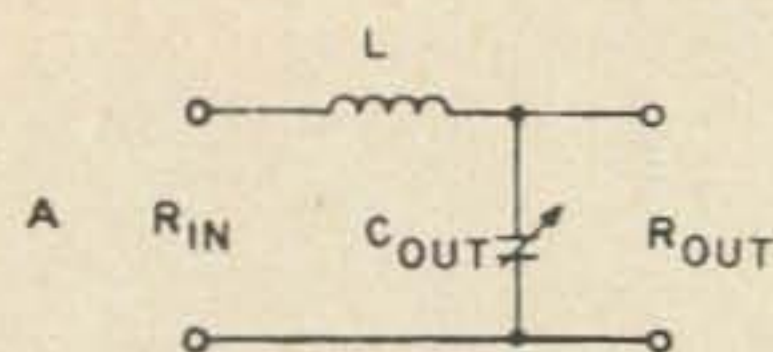

Fig. 2. L Network when input resistance is less than the output resistance.

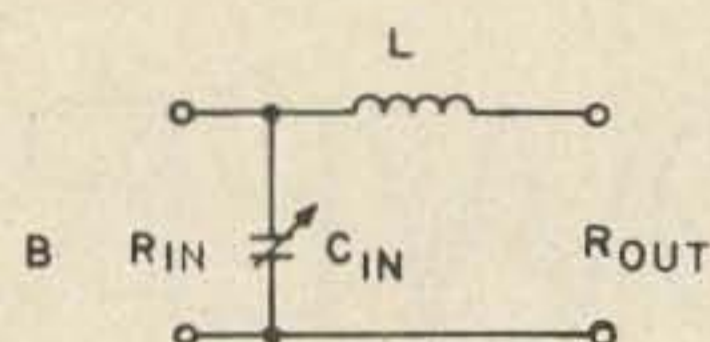

Fig. 3. L network when input resistance is greater than the output resistance.

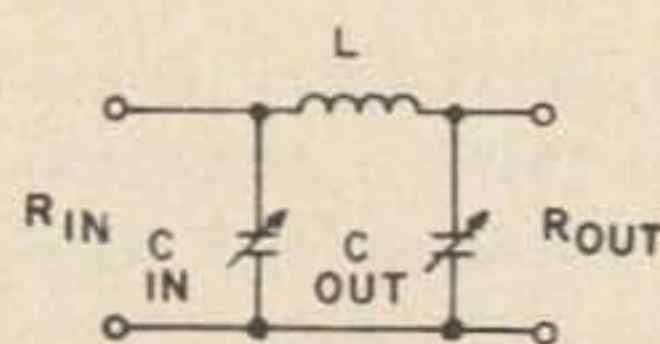

Fig. 4. Pi network.

TABLE I  
VARIABLE CAPACITOR AND INDUCTOR DATA  
POWER OUTPUT 10-15 WATTS, NOMINAL

VCC: 13.6 volts

Band MHz	C1 pF	C2 pF	C3 pF	C4 pF	C5 pF	C6 pF	L1 $\mu\text{H}$	L2 $\mu\text{H}$	L3 $\mu\text{H}$	RFC1 $\mu\text{H}$	RFC2 $\mu\text{H}$
145	Omit	150	50	50	100	50	.055	.062	.067	0.5	0.6
50	Omit	450	100	Omit	300	150	.1	.06	.2	1.0	2.0
28	Omit	750	Omit	Omit	500	250	.06	.125	.34	2.0	3.0
21	Omit	1000	Omit	Omit	750	375	.09	.18	.5	3.0	4.5
14	100	300	Omit	Omit	1000	500	.39	.27	.67	4.5	6.0
7	200	600	Omit	Omit	1300	1000	.78	.71	1.82	8.0	10.0
3.5	400	1200	Omit	Omit	2600	2000	1.56	1.42	3.74	12.0	14.0

VCC: 28 volts

144	Omit	150	50	50	100	100	.055	.1	.067	0.5	1.0
50	Omit	450	100	Omit	200	300	.1	.29	.19	1.0	3.0
28	Omit	750	Omit	Omit	125	150	.06	.64	.46	2.0	6.5
21	Omit	1000	Omit	Omit	150	200	.09	.82	.64	3.0	9.0
14	100	300	Omit	Omit	250	300	.39	1.3	.94	4.5	13.0
7	200	600	Omit	Omit	450	600	.75	2.6	1.85	8.0	26.0
3.5	400	1200	Omit	Omit	900	1000	1.56	5.0	3.6	12.0	50.0



.013  $\mu\text{H}$ . But calculating the Q of the network with the aid of equation 4 reveals a Q of only 4, certainly insufficient to prevent transistor distortion products from reaching the load.

An L-pi network between the transistor and the load will increase the circuit Q to a more satisfactory level. By stepping up the  $2.8\Omega$  input resistance to  $150\Omega$  in the L net for a resulting Q of 7.5 and designing the pi network for a Q of 3 to step the  $150\Omega$  back down to  $50\Omega$  at the network output terminals makes the overall circuit Q equal to 22. A Q of 22 is a reasonable figure for a transistor output tank circuit.

Referring to Fig. 1, the calculated L-pi network component values of 145 MHz are:

L2, .021  $\mu\text{H}$ ; L3, .067  $\mu\text{H}$ ; C2, 100 pF variable; and C3, 50 pF variable. (The output capacitance of the L network and the input capacitance of the pi network are combined in capacitor C2.)

L network B is selected to match the  $50\Omega$  driver resistance to the  $2.5\Omega$  transistor base resistances. Its calculated component values are: L1, .011  $\mu\text{H}$ ; and C1, 100 pF.

Unfortunately, attempting to construct a 145 MHz amplifier using the circuit diagram of Fig. 1 and the calculated values for coils L1 and L2 would probably result in failure. The inductances are so low that stray circuit inductances would reduce the physical size of the coils to the vanishing point. But refer to Fig. 5 and capacitors C1, C3 and C4.

TABLE II  
TRANSISTORS USABLE AS RADIO FREQUENCY POWER AMPLIFIERS  
IN AMATEUR TRANSMITTERS

Type	Band <sup>1</sup> MHz	VCC CW volts	IC Amps max.	Pwr Dis. watts	Pwr Out watts	Notes
2N1725	3.5	30	5	117		ft 10 MHz
2N2947	50	25	1	25	15	
2N2948	28	25	1	25	15	
2N2949	28	25	.32	6	3.5	2.5 watts out at 50 MHz
2N3295	2-100	15		2	.3 PEP	14-17 dB power gain
2N3296	28-50	30		6	3 PEP	16-19 dB power gain
2N3297	21-88	30	1.5	25	12	10-13 dB power gain
2N3375	144-220	28	1.5	11	6.5	7 dB power gain
2N3553	144	28	1	7	3.5	10-12 dB power gain
2N3632	144	28	1	23	14	7 dB power gain
2N3738	3.5	120	.14	20	10	ft 10 MHz
2N3818	50	28	1	25	15	Power out 15 watts at 15V
2N3927	144	13.6	3	23	12	6 dB power gain
2N3950	50	28	3	70	50	22 watts out at 13.6V
40082	1.8	13.8			35	Amplitude modulated
40444	1.8	13			20	Amplitude modulated
40340	50	13.5			25	
2N5161	144	28	1.5	20	8	PNP
2N5162	144	28	5	50	30	PNP
2N5346	7	30	7	60		ft 30 MHz
2N5589	144	13.6	1	15	4	10 dB power gain
2N5590	144	13.6	3	30	14	10 dB power gain

<sup>1</sup> Transistors may work on adjacent bands also.

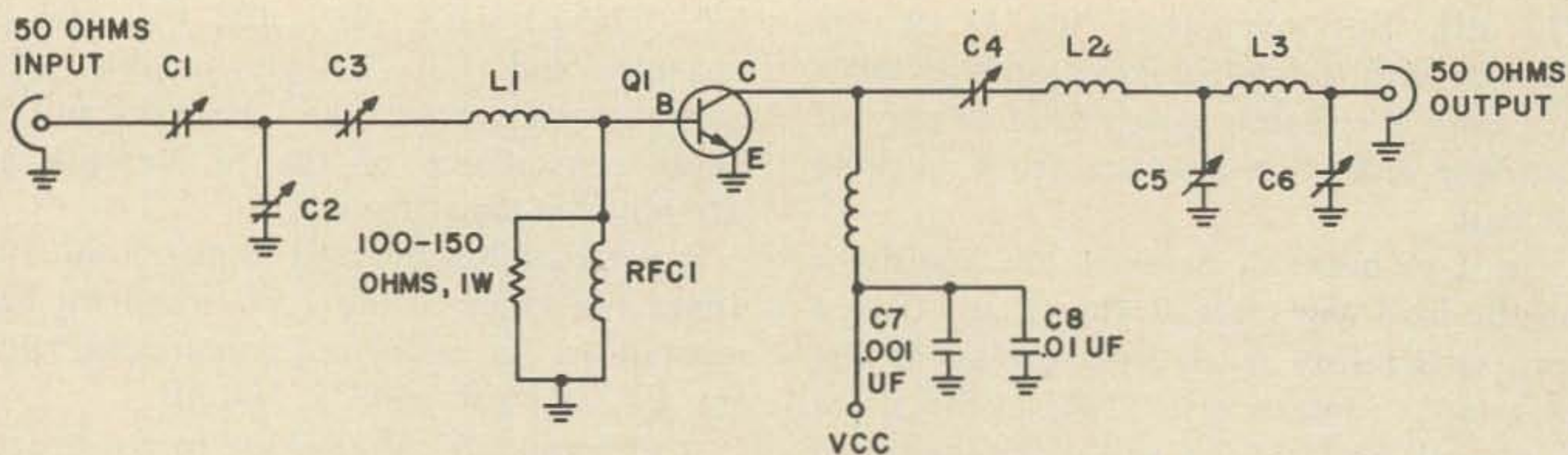

Fig. 5. Transistor "booster" rf power amplifier circuit. Component values for different frequencies and voltages are discussed in the text and tabulated in Tables I, II and III.

Assume for the moment that capacitor C1 is shorted out and that capacitor C3 in series with coil L1 has a capacitance of 25 pF, equivalent to a capacitive reactance of  $44\Omega$  at 145 MHz. Ignoring stray circuit inductances, the inductance of the coil will have to be increased from  $.011\ \mu\text{H}$  to  $.055\ \mu\text{H}$  to overcome the effects of the capacitor. Thus, adding capacitor C3 to the circuit permits making coil L1 a practical size. Capacitor C4 performs a similar function in conjunction with coil L2 in the output network.

Within limits, the series capacitors permit cancelling out any desired percentage of the

coil and circuit inductance. To be effective, they must have low minimum capacitances and very low self inductance. Such series capacitors are seldom required on frequencies below 50 MHz. On the other hand, the calculated capacitance values in low-impedance L networks become rather large at frequencies below 14 MHz.

At 7.2 MHz, for example, the input capacitor of an L network designed to match  $50\Omega$  to a  $2.5\Omega$  load would have a capacitance of over 2000 pF. But if the  $50\Omega$  can be made to appear as a higher resistance to the L network, the input capacitance (C2) can be decreased.

TABLE III  
DIMENSIONS OF SELECTED SMALL COILS

Estimated Inductance	Number of Turns	Coil dia.	Turns/inch or length	Wire size
5 $\mu\text{H}$	30	1/2"	32 t.p.i.	26
3.6 $\mu\text{H}$	24	1/2"	32 t.p.i.	26
2.6 $\mu\text{H}$	16	1/2"	32 t.p.i.	26
1.85 $\mu\text{H}$	13	1/2"	32 t.p.i.	26
1.3 $\mu\text{H}$	16	1/2"	16 t.p.i.	22
0.94 $\mu\text{H}$	13	1/2"	16 t.p.i.	22
0.82 $\mu\text{H}$	11	1/2"	16 t.p.i.	22
0.64 $\mu\text{H}$	9	1/2"	16 t.p.i.	22
0.46 $\mu\text{H}$	6	1/2"	16 t.p.i.	22
0.2 $\mu\text{H}$	4	1/2"	1/2" long	16
0.13 $\mu\text{H}$	5	1/4"	1/2" long	16
0.07 $\mu\text{H}$	4	1/4"	4 t.p.i.	16
0.05 $\mu\text{H}$	2	1/4"	3/8" long	16

Exact inductance of smaller coils is controlled largely by spacing between turns and lead lengths. Slug-tuned and toroidal coils may also be used in transistor rf power amplifiers.

As shown by the calculations in the Appendix, connecting a 150 pF capacitor (C1 of Fig. 5) in series with the amplifier input lead reduces the required capacitance of C2 from over 2000 pF to 485 pF at 7.2 MHz. At the same time, the inductance of L1 is increased from approximately 0.2  $\mu$ H to .78  $\mu$ H.

It is also possible to control the relative values of capacitance and inductance in L-pi networks by varying the value of the intermediate resistance chosen to calculate the L-pi component values.

These expedients were used in compiling Tables I and II. The tables list component values for nominal 10 watt output transistor rf amplifiers for the various amateur bands. Table III, in turn, lists winding data for suitable inductors for the amplifiers. Use the tables in conjunction with the diagram of Fig. 5.

Besides the obvious precaution to use good rf construction practices, such as keeping leads short and isolating input and output circuits from each other, probably preventing low frequency parasitic oscillations is a major requirement in building successful transistor rf power amplifiers.

Selecting rf chokes with the minimum usable reactance at the operating frequency helps control low frequency parasitic oscillations by bypassing them to ground before they start. Suitable rf choke values are listed in Table I. Also helpful in taming transistor rf power amplifiers to hold down the Q of the base rf choke to around five. One way of controlling its Q is to wind the choke around the body of a 100 $\Omega$ , 1 watt, non-inductive resistor. Terminate the choke leads at the resistor leads where the latter come out of the resistor. Bypass the "cold" side of the rf chokes with two different size capacitors in parallel. One should have a capacitance of approximately .001  $\mu$ F, and the other one should have a capacitance in the vicinity of 0.1 to 0.2  $\mu$ F. Finally, keep the base-to-emitter resistance and voltage as low as possible. This last precaution is most important when either the base or emitter are not directly grounded for dc.

Although the 2N5590 and a few other modern rf power transistors can survive

mistuning and operating into highly mismatched loads at rated voltages, most transistors are not so rugged. Consequently, first adjustments should be made at reduced voltages and drive. Once the amplifier is found to be stable and is delivering power to a load, dc collector voltage and rf drive to the base can be increased without exceeding rated currents. Watch for signs of instability and overheating in the process; an amplifier that may be stable at low voltages may become unstable at higher voltages. But a properly built and operated transistor rf power amplifier is a reliable piece of electronic equipment.

*Note: Different values of intermediate resistance were assumed in calculating the component values of the L-pi output networks on different frequencies; so that capacitors C5 and C6 are of reasonable capacitance. Their required capacitance can be built up by fixed mica capacitors in parallel with a variable capacitor for fine adjustment.*

## APPENDIX EQUATIONS

Output resistance of an rf power amplifier:

$$R_o = (V_{cc} - V_{min})^2 / 2P_o \quad (1)$$

Where  $R_o$  = output resistance in ohms.  $V_{cc}$  = dc collector voltage.  $V_{min}$  = minimum instantaneous collector voltage. And  $P_o$  = power output in watts. ( $V_{min}$  is approximately 2 volts for most rf power transistors. It is often ignored in routine calculations.)

L network equations:

A - Input resistance less than output resistance

$$X_c = R_{out} \sqrt{R_{in} / (R_{out} - R_{in})} \quad (2)$$

$$X_l = R_{out} \times R_{in} / X_c \quad (3)$$

$$Q = R_{out} / X_c \quad (4)$$

B - Input resistance greater than output resistance

$$X_l = \sqrt{(R_{out} \times R_{in}) - R^2} \quad (5)$$

$$X_c = (R_{out} \times R_{in}) / X_l \quad (6)$$

$$Q = R_{in} / X_c \quad (7)$$

Pi network equations:

$$X_{cin} = R_{in} / Q \quad (8)$$

$$X_{cout} =$$

$$R_{out} \sqrt{(R_{in} / R_{out}) / Q^2 + 1} - (R_{in} / R_{out}) \quad (9)$$

$$X_l = \frac{(Q \times R_{in}) + (R_{in} \times R_{out} / X_c^2)}{(Q^2 + 1)} \quad (10)$$

Where  $X_{cin}$ ,  $X_{cout}$  = capacitive reactance in ohms,  $X_l$  = inductive reactance in ohms.

# \$ale \$ale \$ale

## Solid State Tube Replacements

5U4/\$2.50, 5R4/\$3.25, 866A/\$7.50

Voltage Doubler—10KV Input/\$6.95

Send for FREE CATALOG  
Contains Over 300 Popular Devices  
Add 25¢ Postage

G. F. ELECTRONICS Box 14 Greenwood, Mass. 01880

$R_{in}$ ,  $R_{out}$  = resistance in ohms.  $Q$  = circuit "figure of merit." (Is automatically set by circuit values in L networks. May be predetermined in pi networks as long as  $X_1$  exceeds  $\sqrt{R_{in} \times R_{out}}$ ).

(11)

Most electronic handbooks contain charts for converting capacitive and inductive values into equivalent reactances at the desired frequency. The values may also be computed using the following equations:

$$X_c = 1,000,000 / 2 \pi FL \quad (12)$$

$$X_1 = 2 \pi FL \quad (13)$$

Where  $F$  = frequency in MHz,  $L$  = inductance in microhenries ( $\mu H$ ).  $C$  = capacitance in picofarads (pF).  $\pi = 3.14$ .  $X_c$  = capacitive reactance in ohms;  $X_1$  = inductive reactance in ohms.

Converting a resistance in parallel with a reactance to equivalent series values or vice versa:

$$R_s = R_p / [1 + (R_p/X_p)^2] \quad (14)$$

$$X_s = X (R_p/X_p) \quad (15)$$

$$R_p = R_s \times (1 + [X_s/R_s]^2) \quad (16)$$

$$X_p = R_p/(X_s/R_s) \quad (17)$$

Where  $R_s$  = series resistance.  $R_p$  = parallel

## Upgrade your 75S1 With a B&W Q-Multiplier/ Notch Filter Model 337-S1



Eliminates heterodynes and other unwanted signals in the IF bandpass. Tunable bridge T-network with a Q-Multiplier provides a deep null over 40db, tunable entire passband. Escutcheon plates and knobs matched to Collins receiver complete with simple installation instructions.

PRICE..... ONLY \$69.95

See your dealer or write:

Barker & Williamson, Inc.

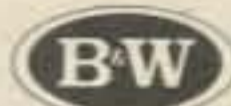

Canal Street, Bristol, Pa. 19007

resistance.  $X_s$  = series reactance.  $X_p$  = parallel reactance. All values in ohms.

### CALCULATIONS

Transistor output resistance from equation 1:  $R_o = (V_{cc} - V_{min})^2 / 2P_o$ .  $V_{cc} = 13.6$  volts, dc,  $V_{min} = 2$  volts,  $P_o = 14$  watts.  $R_o = (13.6 - 2)^2 / (2 \times 14) = 4.7 \Omega$ .

Converting  $4.7 \Omega$  in parallel with  $80$  pF into equivalent series form at  $145$  MHz: From equation 12,  $X_c = 1,000,000 / 2 \pi FC$ , where  $\pi = 3.14$ ,  $F$  = frequency in MHz and  $C$  = capacitance in pF:  $X_c = 1,000,000 / 2 \times 3.14 \times 145 \times 80 = 14 \Omega$  (capacitive). From equation 14,  $R_s = R_p [1 + (R_p/X_p)^2]$ , where  $R_p = 4.7 \Omega$ , and  $Z_p$  (calculated above) =  $14 \Omega$ :  $R_s = 4.7 [1 + (4.7/15)^2] = 2.8 \Omega$ . From equation 15,  $X_s = R_s \times (R_p/X_p)$ :  $X_s = 2.8 \times (4.7/14) = 0.94 \Omega$  (capacitive).

Solving equation 2, 3 and 4 for an input resistance of  $2.8 \Omega$  and an output resistance of  $50 \Omega$ :  $X_c = R_{out} \sqrt{R_{in} (R_{out} - R_{in})} = 50 \sqrt{2.8/50 - 2.8} = 11.5 \Omega$  (capacitive) which is equivalent to  $90$  pF at  $145$  MHz.  $X_1 = R_{out} \times R_{in} / X_c = 50 \times 2.8 / 11.5 = 13 \Omega$  (inductive).  $Q = R_{out} / X_c = 50 / 13 = 4$ .

Add  $0.94 \Omega$  inductive reactance to the calculated  $X_1$  to compensate for the  $0.94 \Omega$

SB-144



SCANVISION



*the feature line*

SB-450



SB-36

# SBE

AVAILABLE FROM:

## ARTCO ELECTRONICS

302 Wyoming Avenue, Kingston, PA 18704

$X_c$  in series with it:  $13 + 0.94 = 13.96\Omega$ , equivalent to  $0.14 \mu\text{H}$  at 145 MHz.

Calculating component values for L-pi network for matching  $2.8\Omega$  to a  $50\Omega$  load. Intermediate resistance,  $150\Omega$ . L network calculations:  $X_c = R_{out} R_{in} / (R - R_{in}) = 150 \times 2.8 / (150 - 2.8) = 20\Omega$  (capacitive), equivalent to  $50 \text{ pF}$  at 145 MHz.

$X_1 = R_{out} \times R_{in} / X_c = 150 \times 2.8 / 20 = 21\Omega$  (inductive), equivalent to  $.021 \mu\text{H}$  at 145 MHz.  $Q = R / X_c = 150 / 20 = 7.5$ .

Pi network calculations:

$Q = 3$ , selected so that total L-pi network  $Q$  would be between 20 and 25.

From equation 8,  $X_{cin} = R_{in} / Q = 150 / 3 = 50\Omega$  (capacitive), equivalent to  $22 \text{ pF}$  at 145 MHz.

From equation 9,  $X_{cout} = R_{out} (R_{in} / R_{out}) / Q^2 + 1 - (R_{in} / R_{out}) = X_c = 50 (150 / 50 / 9 + 1 - (150 / 50)) = 32\Omega$  (capacitive), equivalent to  $35 \text{ pF}$  at 145 MHz.

And from equation 10,  $X_1 = (Q \times R_{in}) + (R_{in} \times R_{out} / X_{cout}) = X_1 = (3 \times 150) + (150 \times 50 / 32) = 68\Omega$  (inductive), equivalent to  $.067 \mu\text{H}$  at 145 MHz.

Calculating input L network to match  $50\Omega$  to  $2.5\Omega$ . From equation 5,  $X_1 = (R_{out} \times R_{in}) - R^2 = X_1 = (2.5 \times 50) - 2.5^2 = 11\Omega$  (inductive), equivalent to  $.011 \mu\text{H}$  at 145 MHz.

From equation 6,  $X_c = (R_{out} \times R_{in}) / X_1 = C_x = (2.5 \times 50) / 11 = 11\Omega$  (capacitive), equivalent to  $100 \text{ pF}$  at 145 MHz.

Effects of connecting a  $150 \text{ pF}$  capacitor in series with input lead of amplifier at 7.2 MHz. From equation 12,  $150 \text{ pF}$  has a capacitive reactance of  $150\Omega$  at 7.2 MHz. And from equation 16,  $R_p = R_s \times (1 + [Z_x / R_x]^2) = R_p = 50 \times (1 + [150 / 50]^2) = 500\Omega$ .

From equation 17,  $X_p = R_p / (X_s / R_s) = R_p = 500 / (150 / 50) = 167\Omega$  (capacitive), equivalent to  $125 \text{ pF}$  at 7.2 MHz.

Calculation of component values for L network for  $500\Omega$  in and  $2.5\Omega$  out.

From equation 5,  $X_1 = \sqrt{(R_{out} \times R_{in}) - (R_{out})^2} = X_1 = \sqrt{(2.5 \times 500) - 2.5^2} = 35\Omega$  (inductive), equivalent to  $.79 \mu\text{H}$  at 7.2 MHz.

From equation 6,  $X_c = (R_{out} \times R_{in}) / X_1 = X_c = (500 \times 2.5) / 35 = 35\Omega$  (capacitive) equivalent to  $635 \text{ pF}$  at 7.2 MHz.

...W9EGQ

## DISTRESS SALE

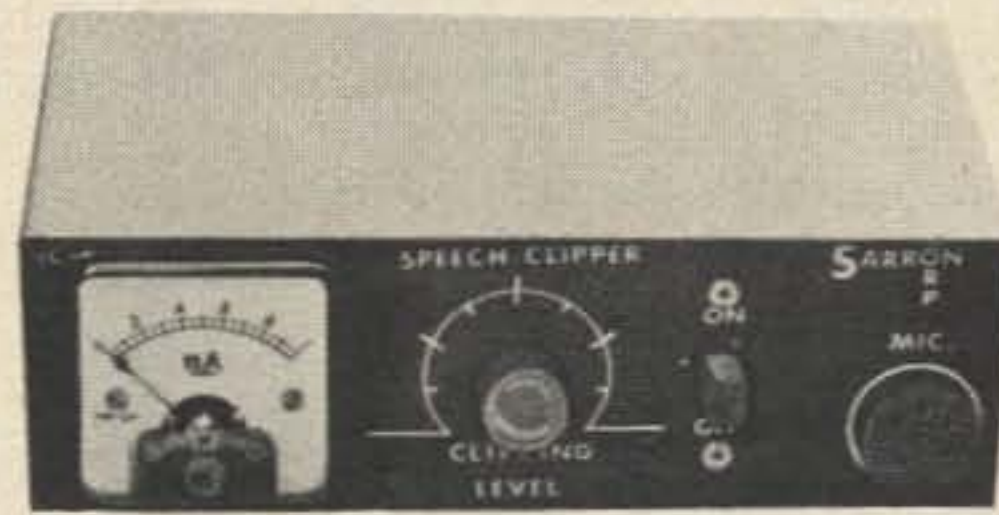

Famous Saron Speech Clipper. We bought entire manufacturing facility and we are selling a kit consisting of all the parts. Included are case - P.C. board - transistors - resistors - knobs - meter switch, etc. Everything needed to build this fine clipper at a fraction of the original cost.

Some of the features are;

- 1-Connects between mike and transmitter
- 2-Ample pre-amplification to assure full clipping
- 3-Meter indicator
- 4-All solid state
- 5-For all high or low level crystal, ceramic or dynamic mike phones.

Sale - kit of all parts \$10.00 each  
all parts less o-1 ma. meter \$6.00

Limited quantities

Sorry no guarantee at these low prices.

Please enclose \$1.00 for packing and shipping.

Send order to;

**HIRSCH SALES COMPANY**  
219 CALIFORNIA DRIVE  
WILLIAMSVILLE, NEW YORK 14221

## CRYSTAL BARGAINS

*Depend on . . .*

We supply crystals from 16KHz to 100MHz. Over 6 million crystals in stock.



DIVISION OF BOB  
WHAN & SON  
ELECTRONICS, INC.

2400 Crystal Dr.  
Fort Myers  
Florida 33901  
(813) 936-2397

Send 10¢ for new  
catalog with  
oscillator circuits  
and lists of  
thousands of  
frequencies in  
stock.

### SPECIALS! CRYSTALS FOR:

Frequency Standards	
100 KHz (HC13/U)	\$4.50
1000 KHz (HC6/U)	4.50
Almost All CB Sets, Trans. or Rec.	2.50
(CB Synthesizer Crystal on request)	
Any Amateur Band in FT-243	1.50
(Except 80 meters)	4 for 5.00
80 Meter Range in FT-243	2.50
Color TV 3579.545 KHz (wire leads)	1.60
	4 for 5.00

ou goons don't ever proofr  
loasy man scripps from bab  
bunch of rocks preting on  
you ignored my comments in  
I insist that you print ev

#### COVER

Upon receipt of the February issue I knew I could keep my silence no longer. WOW! That cover sure wins my seal of approval, and so does the stuff inside. Keep my 73's coming.

Jerry Johnson WA5RON  
Austin TX

#### UNCOVERED

I see from the numbers on the cover on the February issue that your name has changed from seventy-three to seven point three! A few more covers like this should bring up your circulation. It did mine.

T.L. Powell K0WNB  
Peyton CO

#### C.OVER

In the whole history of printing, you have published the nicest decimal point ever.

Jake WB2PAP  
Walden NY

73 IS using the metric system, you know . . .

#### ANTI-FETISH

My Gosh, man, use some taste. Never before have I seen a more unattractive pair of feet on the cover of a ham radio magazine.

D. M. Casselman WA0GSY  
Conway Springs KS

Those aren't feet . . . they're centimeters!

#### KINTS & HINKS?

You have a great magazine, but there are some things I would like to see. How about a small section each issue devoted to helpful gimmicks that we have found? I'm sure everyone would have a couple of unusual little hints that all would benefit from.

Buddy Wilkins WN4YIL

#### 220

I've been sitting idly by the last few months reading letters from interested parties on the subject of who should have the 220 MHz band, amateur radio or citizens band? In my opinion the question is not who is pushing the issue or why but rather do the CBers deserve additional frequencies? My answer to this is NO. They had their chance with the 27 MHz band and look what happened to that, with all the illegal activity going on! They should not be rewarded for operating illegally, but punished. Instead of giving them more room to operate they should take some frequencies away. If any CBers object to this letter I ask

that they seriously compare their band and its operating practices with that of amateur radio operating practices. They will see right off, if they are honest with themselves, that amateur radio is superior. Therefore amateur radio should be allowed to keep 220 MHz until they show that they DO NOT deserve it.

Tim Stickney WB6PRW  
Ft Bliss TX

*The question really IS who is pushing the issue, for this is a political (money) issue, not one of who deserves what band. Manufacturers believe that they will make a lot of money if 220 MHz is opened to CB and they are willing to gamble the money it takes EIA to lobby it through congress and thence the FCC. Morally the CBers deserve nothing at all since they are the worst lawbreakers in the history of radio. If a few law-abiding CBers take umbrage at being lumped with the dimwits, they have themselves to blame for not organizing against the Big Daddies.*

#### UPDATED LETTER

Reference "Letters" page 23 and "Repeater Update" page 12, February 73.

Maybe it is my handwriting, but the call of the South Jersey Repeater on 22-82 is NOT WB2ZQG but WB2ZWQ.

Sorry to cause a mess but I sure would like to get it straight!

I can see it now; now people will tell me I'm l'Ding our repeater with the wrong call!

Bruce Tiemann WB2RUH  
Woodlynne NJ

We're glad to see you've made up your mind!

#### PROTECTION PRECAUTION

Just noticed something in the Feb. issue of 73 that I felt had better be corrected before someone tries it and gets mad. The problem is with the article, "Protection for IC's" by Gene Brizendine W4ATE, on page 142. His basic idea is sound, and definitely a good idea, but his example was not correct. 7400 series TTL logic is rated at an absolute maximum supply voltage of 7.0 volts, says Motorola. Also, if the power supply is used to supply a logic "1" on any device input, the maximum voltage is limited to 5.5V.

With his 7.25 volt zener, the damage could very well already be done before the voltage rises high enough for the diode to conduct. I would suggest a 2.2k resistor in series

with the power supply +5 supply as a source of a logic "1" for the TTL logic (only one resistor is needed for up to 15 inputs). Then, use a 6.8V zener in place of the 7.25V one shown, and a fuse of approximately double the average total current in place of the resistor R. This keeps the maximum voltage supplied to the IC's below maximum, and at the same time will cut power before the zener diode can also fail from too high a power dissipation (for example, if the series pass transistor in the regulator shorts).

Keep up the good work. I especially like the idea of Circuits, Circuits, Circuits!

Lee A. Hart WB8DQN  
Houghton MI

#### WE NEED

Can anyone help our club with these items as they are particularly difficult to obtain here: New or recent Callbooks (USA and Foreign), working Vibroplex keys, any new or old radio books and magazines. Anything will be appreciated. Thank you very much.

Kushal Harvant Singh  
83 Aulong Road off Stephens Road  
Kampong Boyan  
Taiping, Perak  
Malaysia

#### 20 kHz/1 MHz

We have been among your stronger supporters because of a feeling that you are about the only quasi-official voice that 2m FM devotees have at the national level — in view of the absence of the likes of M. Van Den Branden and ARRL. However, we think you have gone bananas with your suggestion that 20 kHz spacing and 1 MHz splits even be *considered!*

The only force we have going for us in keeping 2m FM from being chaotic and utterly useless to everybody is CONSENSUS. The Texas Plan has just taken hold in most (not all!) areas and made it possible to use the band with reasonably harmonious relationships between and within metropolitan areas. Such harmony and standardization of this channelized operation are absolutely critical to the growth of 2m FM nationwide and to the practicability of this mode to the traveling ham. The degree to which the Texas Plan has been adopted reflects remarkable and unprecedented accommodations made by countless hams who have recognized the long-term benefits to all; this degree of consensus is an extremely rare and valuable development. You are apparently willing to ashcan it casually because you don't bother to even mention this factor.

The case that you have made for 20 kHz / 1 MHz is puny in comparison with the case for rededication to the

Continued on p. 128 . . .



# UNDERCOVER AGENT 00...



## MAKE YOUR QSLs PAY OFF!

*As Undercover Agent 0073 you can get up to \$100 for a \$1 investment.*

How would you like to make your QSLs start paying you? You can do this by signing up as an undercover agent for 73 Magazine — this is the key to being able to make a substantial side income. That's right, you can let your hobby help to pay for itself!

When you send out your QSL cards, all you have to do is include a special 73 subscription application with your card for the other operator to send direct to us. Your name as Undercover Agent 0073 will be on that card and you will receive one dollar for each one year subscription sent in.

You can sign up as an Undercover Agent 0073 and get 100 of these subscription applications — for only \$1 (to cover the cost of handling).

Most of the operators you contact would enjoy reading 73, if they knew about it. Your QSLs will help spread the word — and bring you a commission to boot.

### Bonus \$100

As a further bonus — the first 73 undercover agent who gets \$100 in commissions will receive an extra \$100.

***SIGN UP RIGHT NOW AND START THE MONEY ROLLING IN!***

APRIL 1973

## UNDERCOVER AGENT 0073 APPLICATION

*Ok — Send my cards and sign me up for this good deal.*

*My \$1 is enclosed to cover the cost of handling.*

Name \_\_\_\_\_ Call \_\_\_\_\_

Address \_\_\_\_\_ City \_\_\_\_\_ State \_\_\_\_\_ Zip \_\_\_\_\_

73 MAGAZINE PETERBOROUGH NH 03458 USA

# 73 BOOKS

**Slow Scan Television Handbook**, by Don C. Miller, W9NTP and Ralph Taggart WB8DQT.

This excellent book tells all about it, from its history and basics to the present state-of-the-art techniques. Contains chapters on circuits, monitors, cameras, color SSTV, test equipment, and much more. 272 pages, softbound \$5, hardbound \$7.



**Digital Control of Repeaters**, by Tom Yocom, WA0ZHT.

Here's a book for the FM'er who wants to design and build a digital repeater control system. Contains sections on repeaters, basic logic functions, logic circuit design, control systems, support circuits, mobile installations, touch-tone, plus special section on a "mini" repeater control system. 224 pages, softbound \$5; hardbound \$7.



**FM Repeater Circuits Manual**, by Ken Sessions

Contains almost every conceivable circuit that might be needed for use with a repeater. All circuits explained in detail and easily understood. All aspects covered, from the operator to the antenna. Also contains chapters on setting up a mobile station and many other articles for the use of the VHF and UHF enthusiasts. 305 pages, softbound, \$5. Hardbound, \$7.

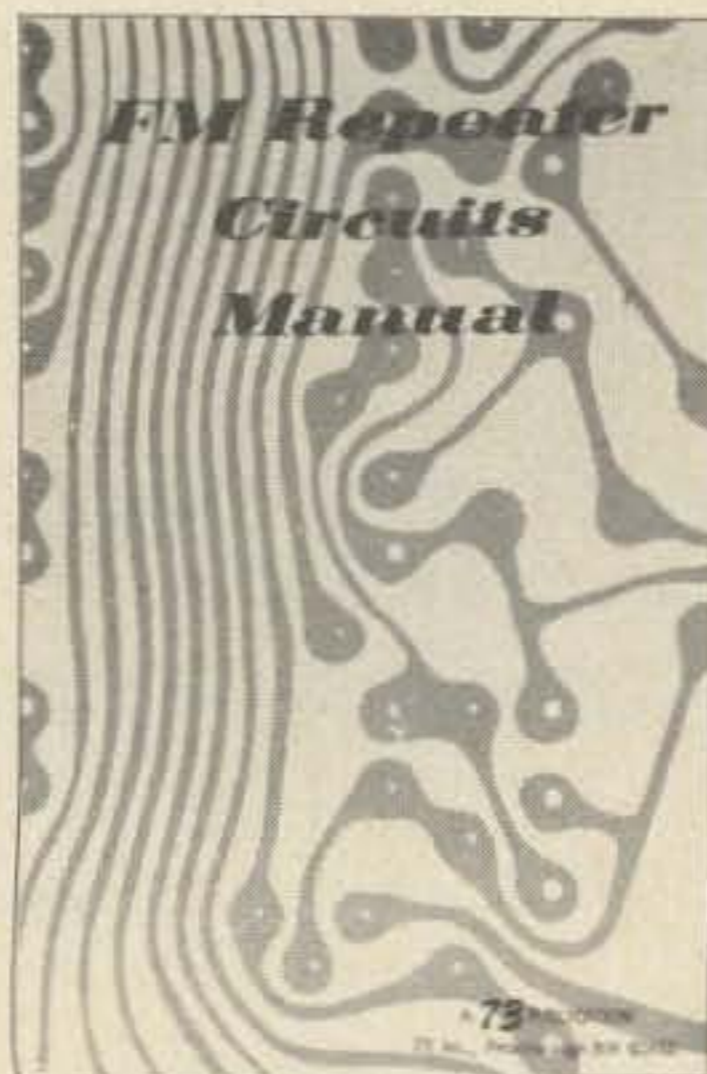

**RTTY Handbook**, Wayne Green, Editor.

A comprehensive book covering all areas of radio teletype, from getting started with the basic principles, what equipment to procure and how to make it work. The only up-to-date book available on the subject. Well written, easy to read and understand. 320 pages, softbound, \$6.

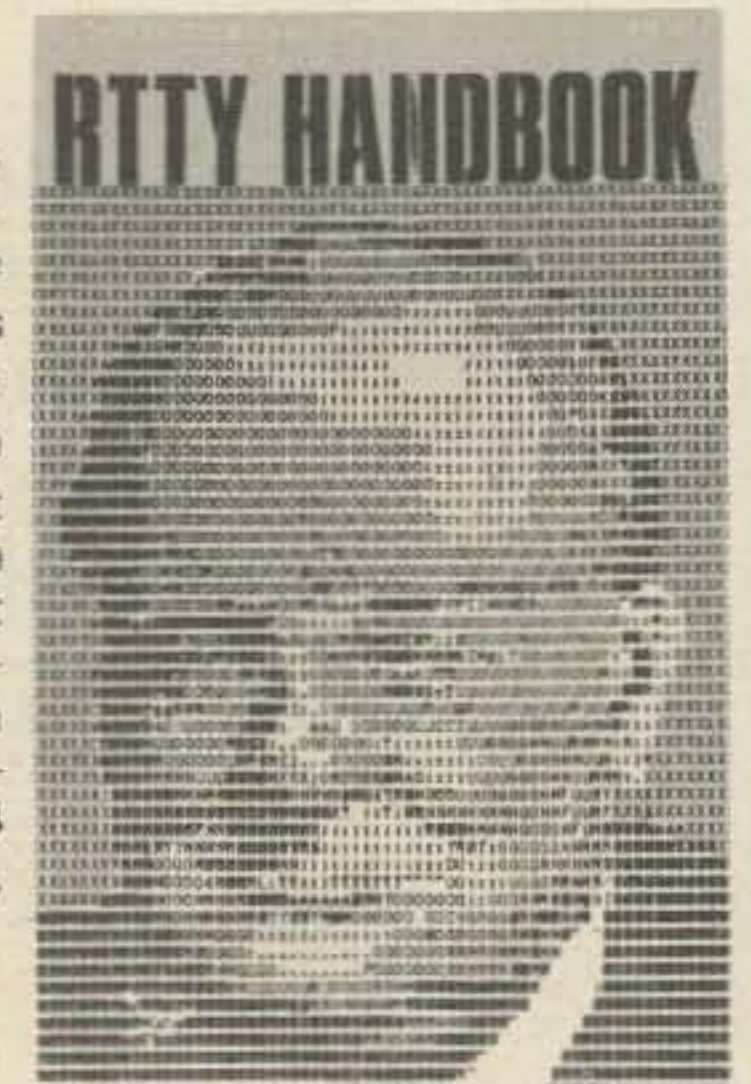

**Solid State Projects** Wayne Green, Editor.

Here are more than 60 projects of interest to anyone in electronics. The devices range from a simple transistor tester to an electronic counter — and from a capacity meter to a ham TV receiver. The idea of this collection is not only to provide you with interesting and practical projects to build, but also to help you become more intimately acquainted with such modern components as ICs, varactors and zeners. 224 pages, softbound. \$4.

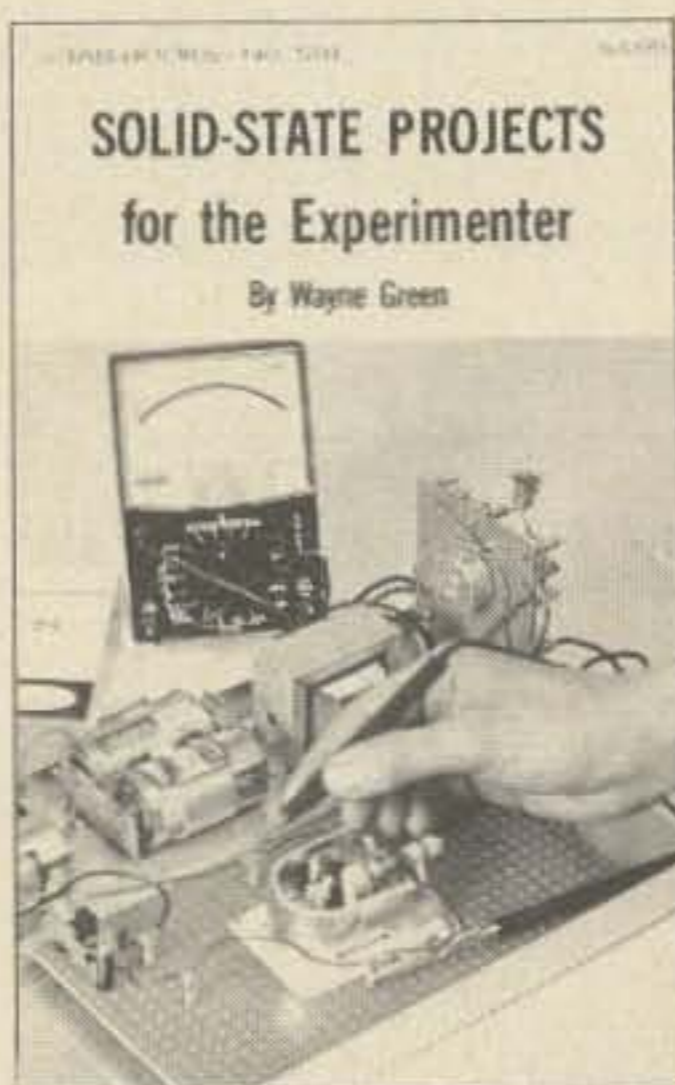

**IC Projects**, Wayne Green, Editor.

The transistor replaced the tubes in the 1960's, and soldering guns replaced the 100 watt soldering irons — but today in the 1970's, integrated circuits and soldering pencils are replacing transistors. This book tells how to understand and use ICs, with numerous construction projects.

For the ultra-modern home brewer. 189 pages, softbound. \$4.





# 73

# study guides

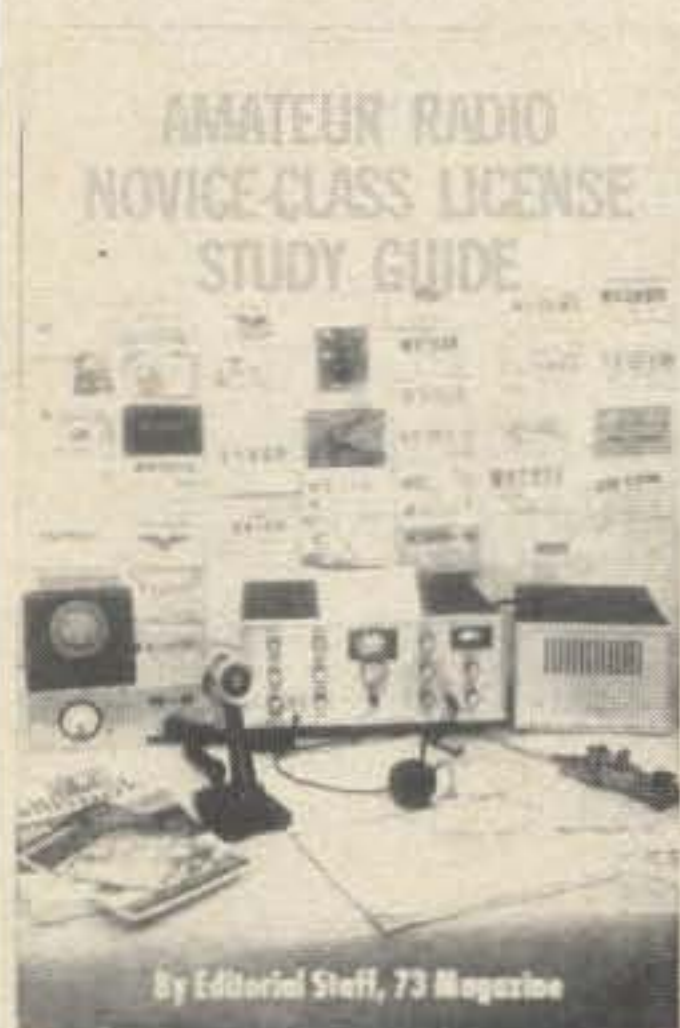

### Novice Class Study Guide, by Editorial Staff, 73 Magazine.

The world's easiest to understand book on the theory required for the Novice amateur radio license exam. Frustrated by fundamentals? Read this book. One simple reading should carry you through the exam. 154 pages, softbound. \$4.

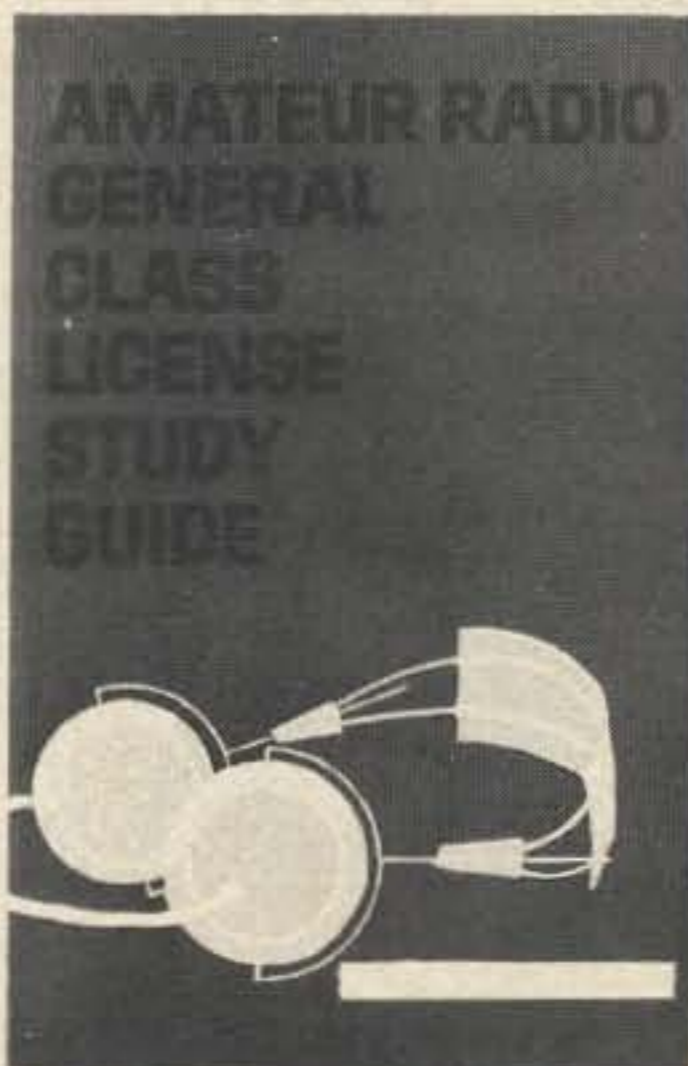

### General Class Study Guide, by 73 Staff

This book will help you to really understand the theory and enable you to easily pass the FCC exam. This is not a Q & A manual for memorization. Study this book and go into the exam with confidence. 317 pages, softbound. \$6.



### Advanced Class Study Guide, by 73 Staff

Considering the fee the FCC charges to take the exam, is it really worth the gamble to pass up this book? Thousands have used this book to help them breeze through the Advanced exam with no strain. This is the ONLY study guide published which covers ALL the material you will have to know. 189 pages, softbound, \$4.00. A limited number of hardbound editions available at \$2 more.



### Extra Class Study Guide, by Editorial Staff, 73 Magazine.

Does the theory required for the Extra Class exam panic you? No need, for this book reduces it to easy comprehension. Many amateurs find that a quick reading through this book is enough to get them through the tough Extra Class exam. It covers every aspect of the theory. Face that exam with confidence. 217 pages, hardbound \$7.

## BOOKS ORDER FORM

APRIL 1973

Name \_\_\_\_\_

Books wanted:

\$ \_\_\_\_\_ Enclosed.

Call \_\_\_\_\_

Address \_\_\_\_\_

City \_\_\_\_\_

State \_\_\_\_\_ Zip \_\_\_\_\_

73 MAGAZINE, Peterborough NH 03458 U.S.A.

# 73 SUBSCRIBE 73

## SUBSCRIPTION ORDER FORM

Apr 73

### 73 MAGAZINE

Peterborough NH 03458 USA

OK — I got the message: \$\_\_\_enclosed.

\$6,1yr \_\_\_ \$11,2yrs \_\_\_ \$15,3yrs \_\_\_ \$99,Life \_\_\_

NAME \_\_\_\_\_ CALL \_\_\_\_\_

ADDRESS \_\_\_\_\_

CITY \_\_\_\_\_ STATE \_\_\_\_\_ ZIP \_\_\_\_\_

## HOW TO HELP PAY YOUR INCOME TAX AND ENJOY 73 AT THE SAME TIME

For most of us, April 15th is the deadline for payment of our income taxes — and what a chore just to make out those forms, much less pay anything. Even the very thought of it is painful.

## SUBSCRIPTION ORDER FORM

Apr 73

### 73 MAGAZINE

Peterborough NH 03458 USA

OK — I got the message: \$\_\_\_enclosed.

\$6,1yr \_\_\_ \$11,2yrs \_\_\_ \$15,3yrs \_\_\_ \$99,Life \_\_\_

NAME \_\_\_\_\_ CALL \_\_\_\_\_

ADDRESS \_\_\_\_\_

CITY \_\_\_\_\_ STATE \_\_\_\_\_ ZIP \_\_\_\_\_

Nowadays, with the ever rising cost of living, it's hard to stay ahead and enjoy little luxuries like buying 73. Do you realize that by subscribing to 73 you could save \$6 per year? That's right.

At the current newsstand price of \$1 per copy, it will cost you at least \$12 per year to enjoy amateur radio with 73 — and since a 1-year subscription is only \$6, that's a savings of \$6.

## SUBSCRIPTION ORDER FORM

Apr 73

### 73 MAGAZINE

Peterborough NH 03458 USA

OK — I got the message: \$\_\_\_enclosed.

\$6,1yr \_\_\_ \$11,2yrs \_\_\_ \$15,3yrs \_\_\_ \$99,Life \_\_\_

NAME \_\_\_\_\_ CALL \_\_\_\_\_

ADDRESS \_\_\_\_\_

CITY \_\_\_\_\_ STATE \_\_\_\_\_ ZIP \_\_\_\_\_

How to help pay your income tax? Easy question — just apply the \$6 you saved by subscribing to it.

And for the lucky ones who are getting refunds — how about subscribing for 3 years or maybe life? What better way can you enjoy your good fortune?

AMATEUR RADIO  
is more fun with  
**73 — SUBSCRIBE NOW**

# REPEATER ECONOMICS\*

Andrew M. Cohn K4ADL  
Vice President  
Northern Virginia FM Assn. Inc.

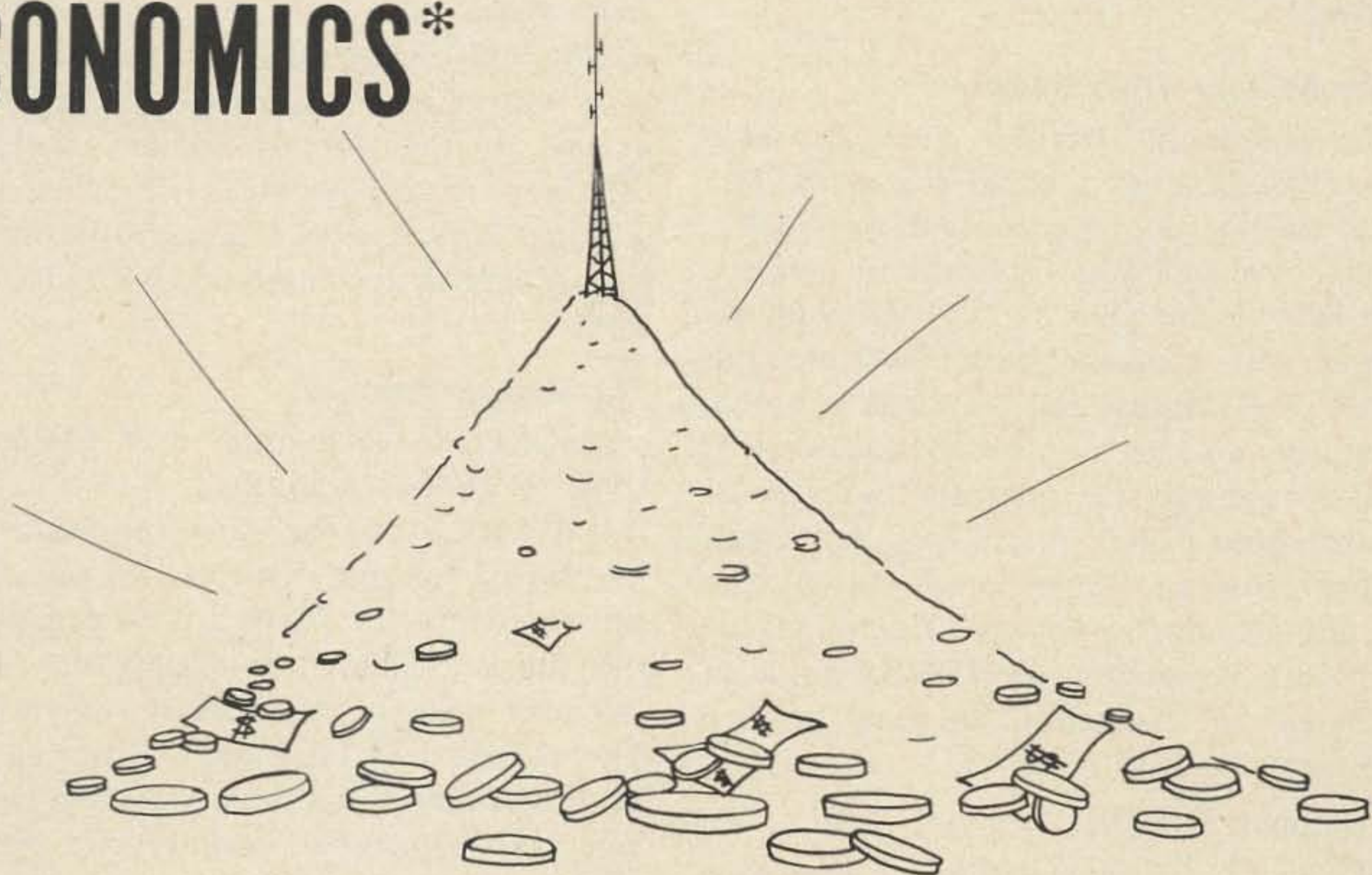

*\*or . . . "There's hills of them thar gold."*

In 1971 in Washington, D.C. there was but one two meter repeater to serve a vast metropolitan area saturated with FMers. Today, six repeaters are fully operational; five more are under construction.

Clearly, technical ability abounds — here and everywhere. Repeater groups become quite psyched up over their creations and perhaps let a very important element slip by: The organization itself. You know, that hopefully large group of members who annually contribute much-needed financial backing for the continued operation and improvement of their machine.

Admittedly, many effective repeaters are owned and operated by a mere handful, or less. Perhaps they want it that way. We say they must have remarkable wealth or uncanny scrounging ability. We also say it's quite nice to have a solid organization behind the repeater, and for those prospective repeater builders who might share our view, the ensuing discussion may prove helpful.

For a frame of reference, our Northern Virginia FM Association (NVFMA) was the third open repeater to spring up in the

Washington area. On the day our machine became operational, about fifty of our one hundred members were already on the roster. In short, we were able to secure a good portion of the necessary funds when we needed them most. While the repeater was under construction we put together an association to provide this backbone. Use the elements discussed to form your own group!

## Divide and Conquer

Someone in your group could care less about slaving over a hot iron. We'll pretend it's you. Let the technical wizards do their thing. Resign yourself to the fact that you must spend a little to make a little. And right now, you need a little. Your first step . . .

## . . .Up the Organization!

A repeater owned by individuals might be looked upon as risky by prospective members; there is always the possibility of someone packing up his personal bananas and going home. Repeaters and all associated equipment should be the property of the

organization. Then, no member will feel his contributions will be in the hands of one man's whimsy. Form an association and give it a name!

### **A Rose By Any Other Name**

We envied the Detroit Area Repeater Team. "DART" has a sharp ring to it. But here in the Fairfax area, most of us rejected a similar nomenclature for aesthetic reasons. Eventually we decided on NVFMA, only to discover our coverage extended into the District of Columbia and Maryland suburbs. In selecting a name for your association, it is useful to consider the potential coverage of your machine if you intend to solicit memberships from the entire area. Oh, by the way, any attempt to change or gimmick the name once it catches on will be quite an experience in frustration. A rose by any other name is a flop.

### **The Mailman Cometh . . .**

OK so you've picked a name, now how about an address? Your own mailbox may seem convenient, but how will you feel about it when the membership votes you out of office? You'll find just the right size slot for your organization at the local Post Office. The yearly rate for a P.O. box offers a better deal than the quarterly fee. We pay around \$10.85 per year for our box, but at least we know our address will outlast any of our officers.

### **To Inc or Not to Inc . . .**

We assume by this time you have drawn up your charter after having elected officers and directors for the association. Whether or not to incorporate is your next decision. NVFMA was fortunate to have on its team an attorney who donated his legal time to draft our application. Normally, he would have received a fee of approximately \$350.00. Instead, we simply paid the state's incorporation fee of \$48.00. Very likely you will find a lawyer/ham in town willing to do the same, in return, perhaps, for a free life membership in the association. Of course, it is possible to complete the papers without an attorney, but it won't be a picnic. Why incorporate in the first place? No, it's really not worth \$350. But it could be worth the \$48.00 (depending on where you live) when

you consider that in an unincorporated group, all members of record could be held personally liable for any negligent acts of the association. Now that we think about it, maybe \$350 is a bargain! Either way, talk it over with someone in the know before you decide. By the way, do not fail to obtain a "finding" from your local IRS office, if you wish to be taxed as a non-profit organization. This has nothing to do with incorporation.

### **The Membership Fee**

In keeping with other area FM associations, NVFMA established a yearly fee of five dollars, plus a one-time initiation fee of the same amount. This works out nicely, since most of the funds are needed early in the game. Decide immediately on either a calendar year or anniversary membership. The former is a bit unfair to the membership, particularly to those who join between July and December. Anniversary renewals keep your organization's secretary on his toes, but insure a steady, year-round income to meet recurring expenses, such as telephone lines, insurance, and so on. You should have no problem finding a local bank offering a non-charge, no-minimum-balance checking account for your organization.

With those formalities under your belt, you are now ready to embark on the biggest advertising campaign Hamville ever witnessed. With name, address membership fee and checking account established, the membership applications can now be printed. Unless you're a survey statistic nut, the forms should contain just enough blanks for name, address, date and telephone. The remaining space should contain at least 25 reasons for joining the association, unless, of course, you have the only football on the block. Whatever you use for selling points, do not promise anything you cannot fulfill.

If you think you can pull in 100 members, order at least 500 application forms. They'll disappear quite rapidly at hamfests, club meetings and radio stores. Most applications we've seen require a crime lab to decipher the faded blue mimeo ink. Try the photo offset process. Give the printer a neatly typed form, camera ready. Those rub-on instant lettering kits will pro-

duce a professional looking form, if you have the time and patience. You might also let the printer do the typesetting for you (for a few dollars more). Be sure he retains the negative or plate for future re-runs. Above all, remember that your application form may be the first contact the FM community will have with your organization. First impressions count.

### **Membership Cards**

Reward new members with a feeling of belonging. Your repeater might not be on the air yet, and the identity-seekers would appreciate any sort of fish you could toss out. Membership cards are usually abandoned in a dark corner of the wallet. Why not get some advertising mileage out of them? We recommend laminated, clip-on cards which can double as name/call tags at meetings and hamfests. The association's name should, of course, be readable at 1000 yards!

### **Letterheads?**

This item may appear to be a luxury. It'll add around \$100 to the expense list. Convinced of the necessity, we shelled out the cash personally. Our group did a lot of letter writing soliciting a free antenna site. We had to convince roof-owners we were not fooling around. The letterheads helped.

For the above goodies, you've made your printer \$24-36 richer. It will take 3 or 4 new memberships to amortize the cost of the forms, cards and stationery...well worth it in terms of organizational stature.

### **Public Relations**

Your promotional activities should serve two purposes: to assure current members that the association's work is progressing according to schedule; and, to lure non-members into the organization. Again, we are assuming you desire a vast roster to provide financial support.

On-the-air talkups are perhaps the most obvious and effective means of getting the word around. Posters and application blanks placed on the counters of local radio stores will help snare the low-banders not yet tuned up on FM. A few hours spent in the production of a massive sign to be displayed at a hamfest booth should pay off with a few more members, but don't get dis-

couraged when only a small percentage of the applications you hand out are returned with a check.

Once the repeater is operational you might want to make use of the "one-way-transmission" provision by putting out weekly info bulletins. This is an excellent way to keep members up to date on the organization's activities, and it's a whole lot cheaper than newsletters. Do not attempt to run opposite Flip Wilson, All in the Family, Laugh-In, etc.; we recommend you consult the TV Guide before scheduling broadcasts. In about 4 or 5 weeks of regular bulletins, most of the members will have caught on.

### **Dealing with Freeloaders**

It is impossible to deal with freeloaders. There is no such animal.

### **OK, then, Dealing With "Non-Members"**

That's better. Once you reach the 100 member mark, the inevitable group of non-member regular users won't bother you too much, until of course the association begins planning for those costly improvements such as split sites and autopatch. The most obvious course of action would be on-the-air and face-to-face pleas for support. You might also consider supplying each officer and director with a stack of membership applications to be mailed out - unsolicited - to these "potential members." Perhaps it will take more than one mailing to the same addressee, but sooner or later he'll take the hint. New stations appearing on the repeater - not knowing where to submit their memberships - would certainly appreciate the application forms.

### **A Final Suggestion**

We have found that the best public relations effort you can make is a friendly attitude toward all users of the repeater. You will come upon many stations who are off frequency, over-deviating, using incorrect procedures, monopolizing the machine, and so on. The biggest mistake you can make is not advising your fellow ham of these difficulties. The second biggest mistake you can make is attempting to correct the poor fellow by lecturing with harsh criticism. Keep it friendly, and you'll have everyone on your side.

...K4ADL

# SBE

## feature after feature after feature

There's a new enjoyment horizon waiting on 420-450MHz, an amateur band 7½ times wider than 144-148MHz! Here's wide open space for the ragchewer—paradise for the antenna experimenter. With half-wave antennas only about a foot in length, "dream beams"—the kind that literally **drip** with gain—become practical realities.

The highly knowledgeable repeater group has, of course, had equipment operating in this band for years. However, SB-450, SBE's exclusive, all-new FM transceiver gives the amateur something he has long needed, equipment with small size, convenience and performance characteristics considered to be indigenous to the "DC" bands. It is certain that repeater and 450MHz band activity will be given a big boost with this fine unit.

Beautifully constructed, book size, the SB-450 has 12 channel capability, delivers 5 watts FM output. It's all solid-state—no warmup—low drain from 12V car battery (operates on 115VAC for base station use with available accessory supply). Two sets of crystals are supplied for repeater and simplex operation.

Try UHF! Try SB-450! Enjoy!

## SB-450 UHF/FM TRANSCEIVER

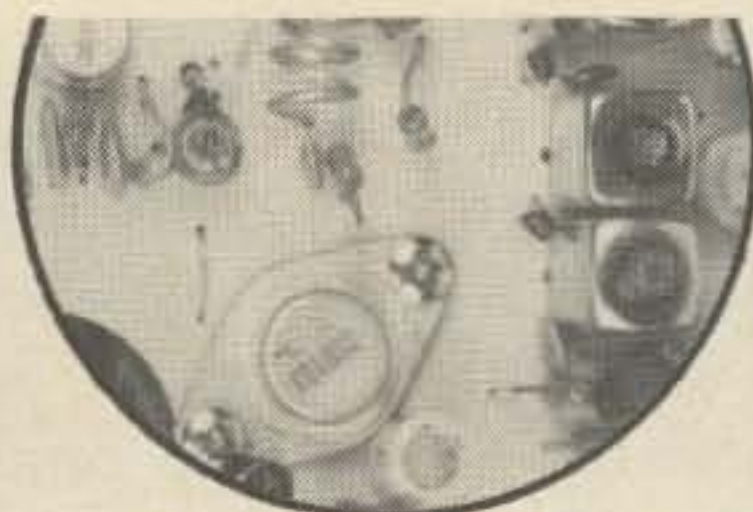

All solid state,  
1-SCR, 4-IC's,  
29 transistors



Panel meter  
shows relative  
response on  
receive — power  
output on  
transmit

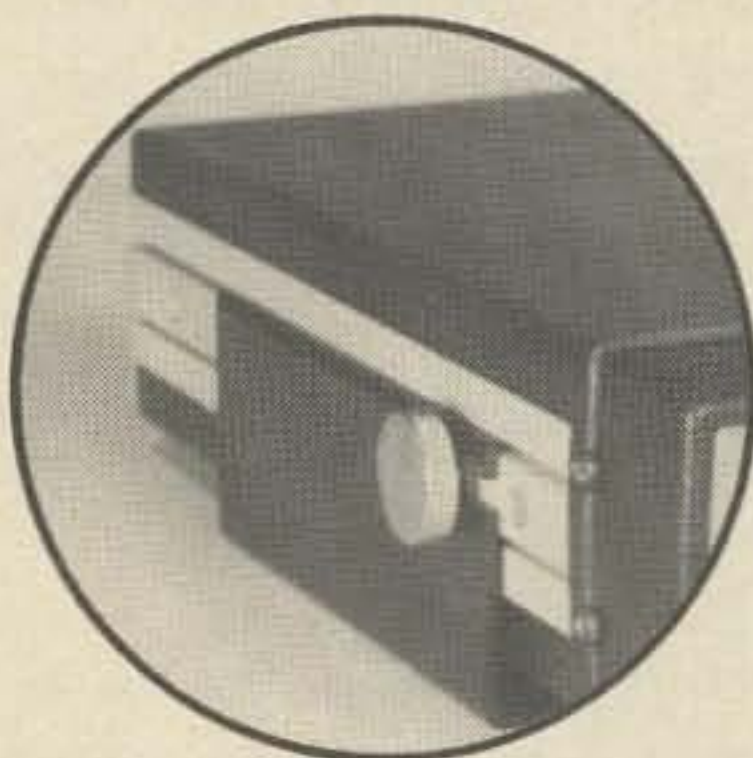

Housing slides in  
and out of fixed  
bracket, taper  
locks with  
knurled  
thumb screws.

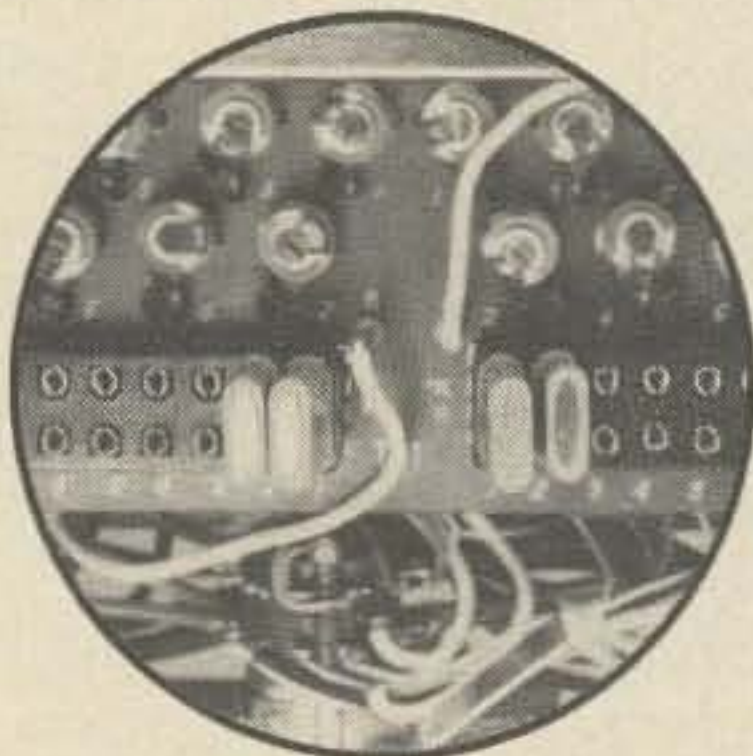

Two sets of  
crystals are  
supplied.  
Transmit and  
receive  
crystals have  
individual  
trimmers for  
exact frequency  
centering

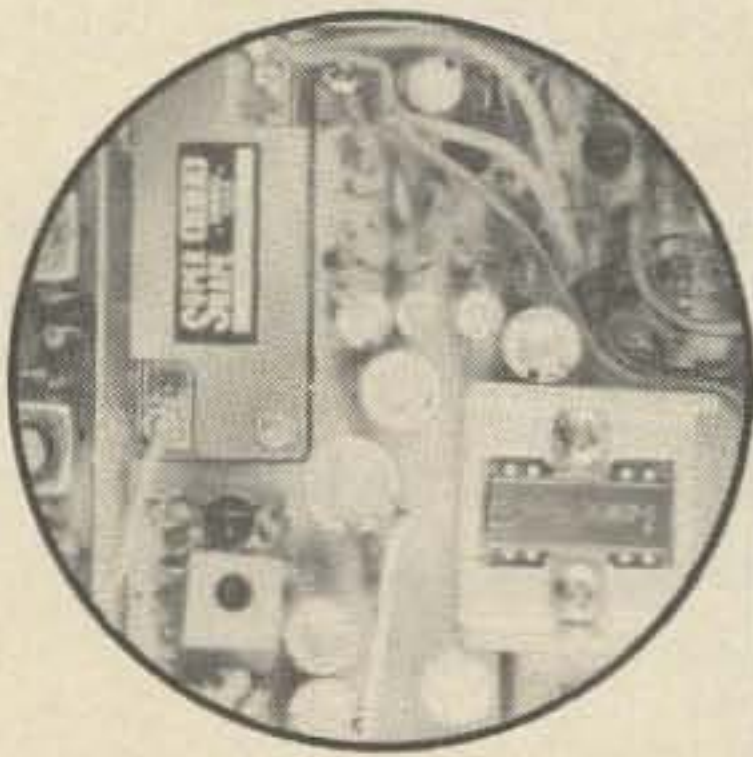

Uses exclusive  
SBE Super Shape  
crystal lattice  
BP filter

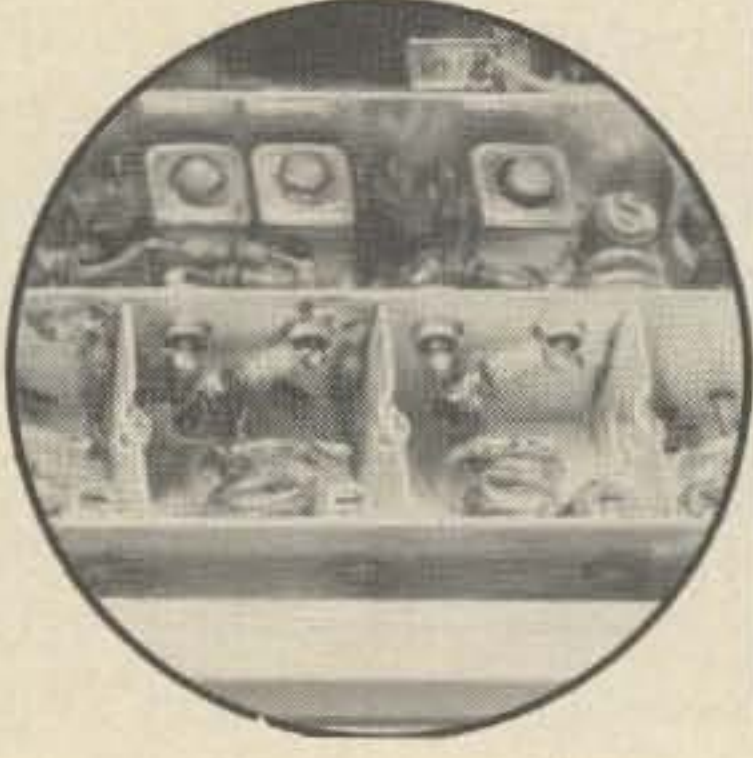

Silver plated  
brass shielded  
construction.

**SBE**

LINEAR  
SYSTEMS INC.,  
220 Airport Blvd.,  
Watsonville, CA  
95076

# INTERNATIONAL SIGNAL'S 100 MILLIWATT RIG REVISITED



I made a modification to the International Signal 100 mW rig that will be of interest to anyone who has one and would like to improve the power output. Several members of the *Naval Postgraduate School Radio Club* have made this modification and no one has experienced any trouble. The problem of the final blowing out at high voltage levels was the thing that got me to looking for a replacement that would stand more dissipation and get greater power out with the drive available from the board. After much searching I found that the 2N4427 (Fairchild) met the specifications except that the case was TO-39 versus TO-52 for the 40637. The new transistor dissipation was 1W at 25°C ambient, while the 40637 was only 0.3W.

The fit in the rig was tight, but the 2N4427 was installed and the rig tuned up. The power out was 250 mW. My batch of ten 2N4427's has a wide range of betas, so it was decided to see what effect the different values of beta would have on the power out. Several different 2N4427's were tried, and

the lowest power out was 200 mW and the highest 500 mW; however the average power out was 250 mW.

Since such improvement was made by just replacing the final, I wondered if the driver could be replaced and still more power out be had. This modification was tried with no improvement in power out, so the original driver was placed back in the rig.

Another modification has been made by one of the club members, but I have not tried this, so I can't say for sure how much the power out can be improved. This modification consisted of separating the final and driver stages from the rest of the board and running the final and driver on 12V, with the rest of the board at 8.1V.

The cost of the modification is \$1.80 for the new 2N4427 and about thirty minutes of time. I do not recommend using the HEP replacement for the 2N4427 since it is more costly, and from what information I could obtain, it appears that the HEP might require a bit more drive than the 2N4427.

...WB6QAM



## Go all the way into the **REPEATER**

There's nothing half-way about the new Hy-Gain *REPEATER LINE*. Designed for the man who demands professional standards in 2 meter mobile equipment, the *REPEATER LINE* is the 2 meter HAM's dream come true. It's got everything you need for top performance... toughness, efficiency and the muscle to gain access to distant repeaters with ease. Reaches more stations, fixed or mobile, direct, without a repeater.

The right antennas for the new FM transceivers...or any 2 meter mobile rig.

Rugged, high riding mobiles. Ready to go where you go, take what you dish out...and deliver every bit of performance your rig is capable of.

- 261 Commercial duty 1/4 wave, claw mounted roof top whip. Precision tunable to any discrete frequency 108 thru 470 MHz. Complete with 18' of coax and connector. 17-7 ph stainless steel whip.
- 260 Same as above. Furnished without coax.
- 262 Rugged, magnetic mount whip. 108 thru 470 MHz. Great for temporary or semi-permanent no-hole installation. Holds secure to 100 mph. Complete with coax and connector. Base matching coil for 52 ohm match. 17-7 ph stainless steel whip.
- 263 Special no-hole trunk lip mount. 3 db gain. 130 thru 174 MHz. 5/8 wave. Complete with 16' coax. Operates at DC ground. Base matching coil for 52 ohm match. 17-7 ph stainless steel whip.
- 264 High efficiency, vertically polarized omnidirectional roof top whip. 3 db gain. Perfect 52 ohm match provided by base matching coil with DC ground. Coax and connector furnished.
- 265 Special magnetic mount. 3 db gain. Performance equal to permanent mounts. Holds at 90 mph plus. 12' of coax and connector. Base matching coil for 52 ohm match. 17-7 ph stainless steel whip. DC ground.
- 269 Rugged, durable, continuously loaded flexible VHF antenna for portables and walkie talkies. Completely insulated with special vinyl coating. Bends at all angles without breaking or cracking finish. Cannot be accidentally shorted out. Furnished with 5/16-32 base. Fits Motorola HT; Johnson; RCA Personalphone; Federal Sign & Signal; and certain KAAR, Aerotron, Comco and Repco units.



2 meter mobile! with

**LINE** from **HY-GAIN**

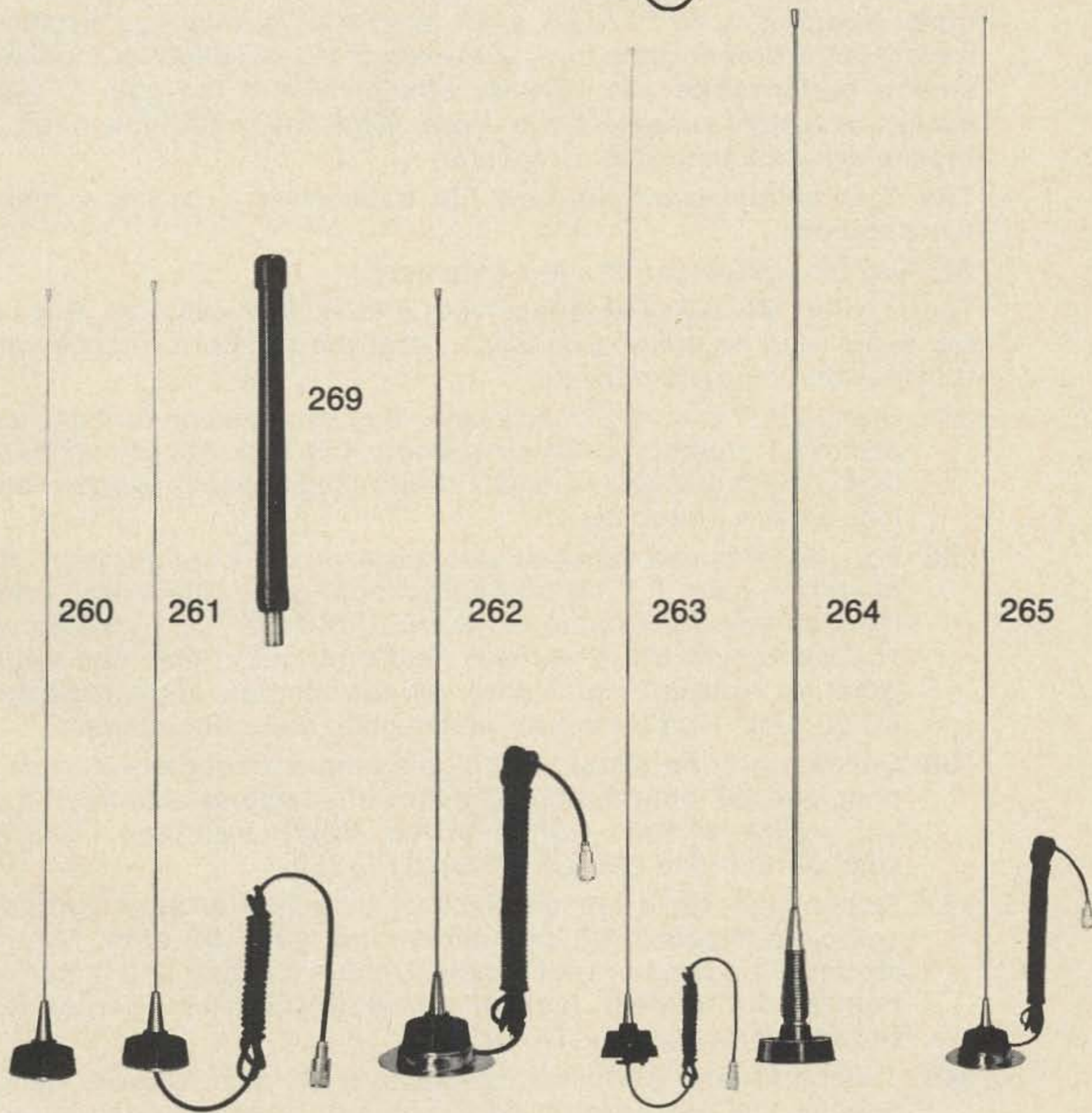

Top performance for 2 meter mobiles  
**THE REPEATER LINE**  
from

**HY-GAIN ELECTRONICS CORPORATION**

BOX 5407-WH / LINCOLN, NEBRASKA 68505

**WRITE FOR DETAILS**

For the most powerful antennas under the sun



# NEW REPEATER

## 2 Meter Fixed Station

Designed for the man who demands professional standards in 2 meter equipment. *REPEATER LINE* fixed station antennas are the 2 meter HAM's dream come true. With everything you need for top fixed station performance...toughness, efficiency and the gain to gain access to distant repeaters with ease. Work many stations, fixed or mobile, without access to a repeater.

The right antennas for the new FM transceivers...or any 2 meter fixed station.

### *REPEATER LINE* Fixed Station Antennas

Tough, high efficiency antennas with a long, low radiation. For the top signal and reception you want...and the top performance your transceiver's ready to deliver.

- 267 Standard 1/4 wave ground plane. May be precision tuned to any discrete frequency between 108 and 450 MHz. Takes maximum legal power. Accepts PL-259. Constructed of heavy gauge seamless aluminum tubing.
- 268 For repeater use. Special stacked 4 dipole configuration. 9.5 db offset gain. 6.1 db omnidirectional gain. Heavy wall commercial type construction. 144 thru 174 MHz. 1.5:1 VSWR over 15 MHz bandwidth eliminates field tuning. Extreme bandwidth great for repeater use. Center fed for best low angle radiation. DC ground. Complete with plated steel mounting clamps.
- 338 Colinear ground plane. 3.4 db gain omnidirectionally. Vertically polarized. 52 ohm match. Radiator of seamless aluminum tubing; radials of solid aluminum rod. VSWR less than 1.5:1. All steel parts iridite treated. Accepts PL-259.
- 362 SJ2S4 high performance all-driven stacked array. 4 vertically polarized dipoles. 6.2 omnidirectional gain. 52 ohm. May be mounted on mast or roof saddle. Unique phasing and matching harness for perfect parallel phase relationship. Center fed. Broad bandresponse. DC ground.
- 340 3 element high performance beam. 9 db gain. Coaxial balun. Special VHF Beta Match configuration. Unidirectional pattern. VSWR 1.5:1. 52 ohm impedance. Heavy gauge aluminum tubing and tough aluminum rod construction.
- 341 8 element high performance beam. 14.5 db gain. Coaxial balun. VHF Beta Match. Unidirectional. Boom length 14'. VSWR 1.5:1. 52 ohm feedpoint. Heavy gauge commercial type aluminum construction.
- 231 15 element high performance beam. 17.8 db gain. Coaxial balun. Beta Match. Unidirectional. Boom length 28'. VSWR 1.5:1. 52 ohm feedpoint. Extra-strength heavy wall commercial aluminum tubing.

# LINE from **Hy-gain** Antennas with real PUNCH!

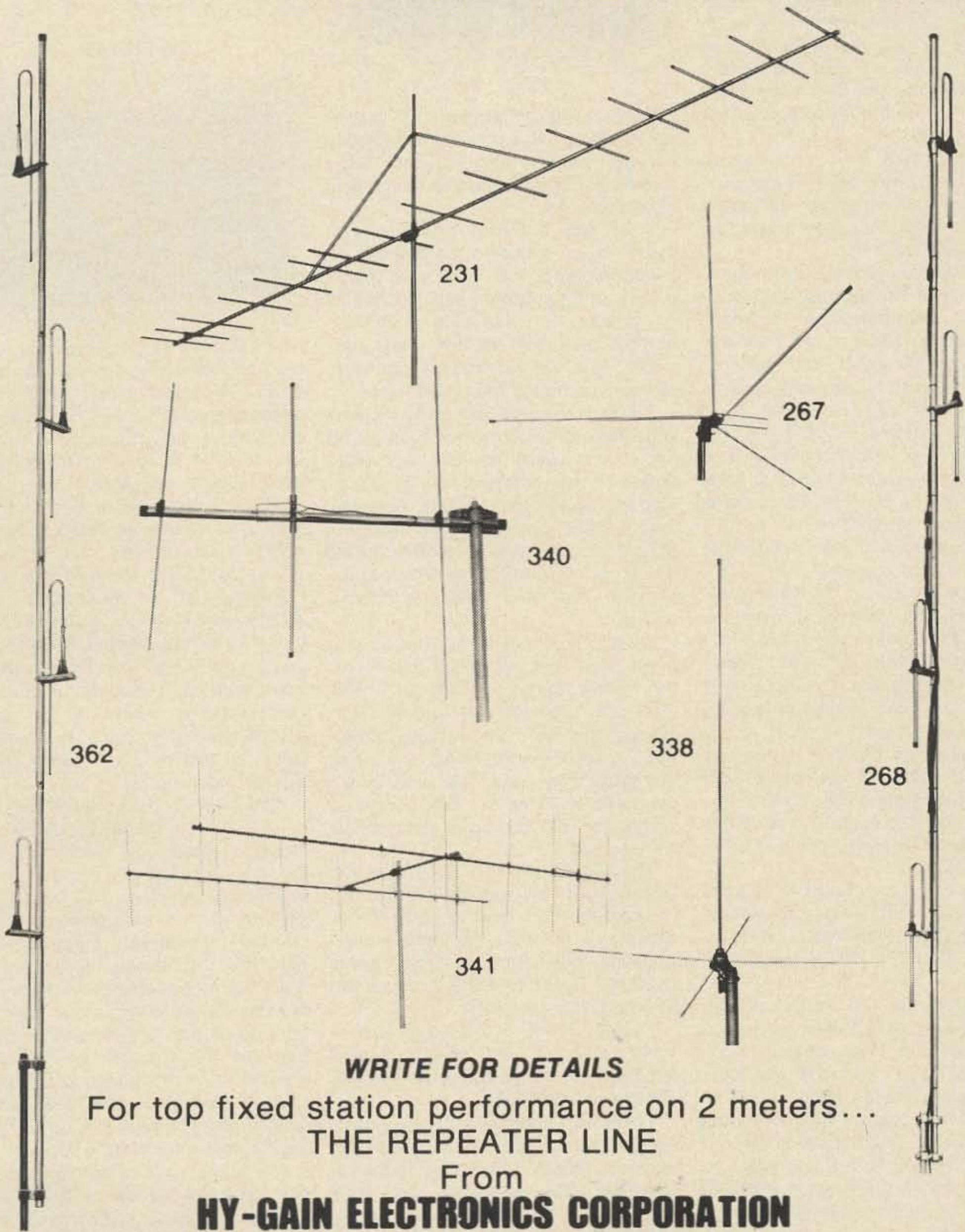

**WRITE FOR DETAILS**

For top fixed station performance on 2 meters...  
**THE REPEATER LINE**

From

**HY-GAIN ELECTRONICS CORPORATION**

P. O. Box 5407-WH Lincoln, Nebraska 68505

For instance — the other morning we tuned the band and heard a repeater locked on the air. Just for the heck of it we tuned down to the input channel — something we couldn't have done with a crystal rig — and sure enough, there was a signal on the input! A little work with the beam and we had one leg of a fix on the culprit. All we needed to do after that was find someone else with a Clegg 27B to give another fix!

There are many times when someone comes on a channel and is enough off so the repeater has a tough time with the signal. If you are within simplex distance you can tune down and listen in the input and help to get him on channel.

Now and then it is very helpful when you can work on a reverse pair, talking in private with someone who is coming through a repeater — and this is simple with the 27B.

The 27B has seven front panel controls — two for the receiver tuning and two for the transmitter — a switch to choose the 146 or 147 meg segments — squelch/on-off and volume/spot. One of the two tuning controls switches every 100 kHz of the band (there are crystals in the rig for this) — and the other control is a vernier for the intervening 100 kHz, calibrated every 10 kHz. The calibration is good enough to zip onto a repeater channel with about the same accuracy as most crystals.

In practice you can hit the channel very closely by zeroing it with the receiver tuning and then zeroing in the transmitter tuning on the "spot" position. This uses the repeater output as a standard, and if that isn't good enough, what's the difference?

Once you have the 27B in your car or at the home station you'll find yourself jumping around to all of the repeaters you can reach and widening your circle of friends. You'll skip 52 simplex a lot.

Heaven help us if the FCC sticks to its completely ridiculous concept of permitting simplex contacts on repeater inputs. The 27B makes this practical.

The 27B runs 25 watts output. While this isn't an awful lot more than the normal ten watt output, it is enough to give you the say over someone else with ten watts.

One other thing — the mounting bracket for the 27B has a nice lock on it, complete with key. But unless you make sure the whole bracket is bolted in firmly, you'd better keep your tape deck insurance paid up and the car alarm working, for many thieves just rip the whole works out — and a \$500 ripoff is a blow. Quite a few amateurs

slip the rig out of the bracket and into the trunk when they park — and most of them still have their rigs.

Remember, for a few dollars extra you can go first class. At \$490, the 27B is quite a bargain.

### A NEW ID

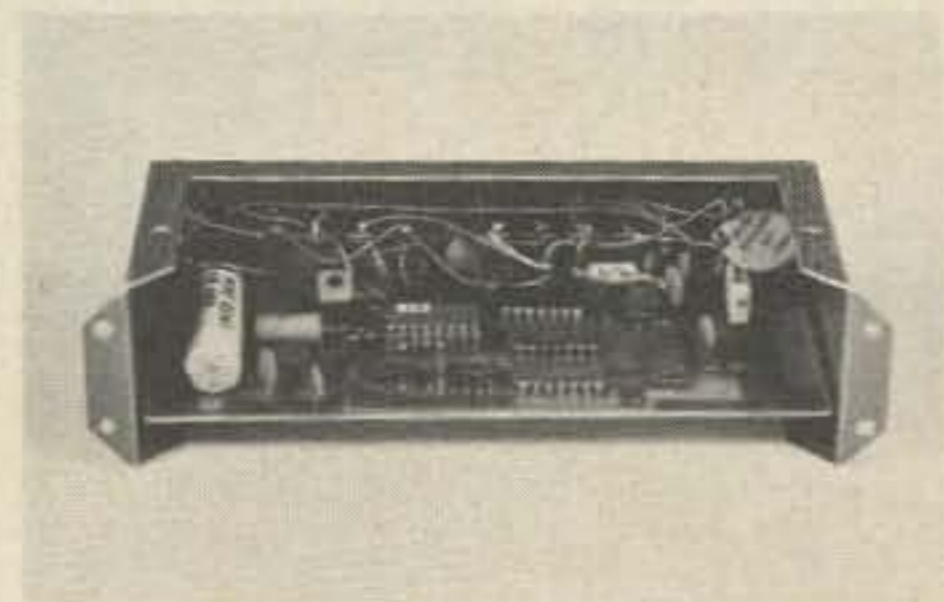

Control Signal Company of Denver has come up with a nice small identifier unit which sells for only \$65, completely programmed with the call of your choice.

There are a bunch of "not only that's" to be added to the above brief announcement. For \$65 you might expect to be getting a bare bones ID, or perhaps a kit. No such. This contraption not only is fully built and tested, but the factory sets up your call for you on the plug in IC unit.

The unit is small enough to be used with instant repeaters — or even in the car if you want to fake out your buddies with a professional CW identification while mobile — and who can pass up that eye opener? It operates from anything from 7.5 to 35 volts by virtue of a built in voltage regulator — so you could even use it on a walkie.

It has its own clock built in, so you don't need that old 60 Hz line to get the timing right. It comes set up for 20 words per minute, but you can change this by substituting another small resistor on the board and swing the speed from about five to 30 words per minute. Since the FCC seems to be hot for 20 per, this is a reasonable compromise.

The tone is set at 1020 Hz by the factory, but this too can be changed to anything from 200 to 1800 Hz by changing a resistor. Has anyone done anything about applying those surplus 1020 Hz filters to remove unwanted ID tones from receivers?

The CWID-50 is about 5-1/2" x 1-1/2" x 2-1/2" and weighs in at 8 ounces (how much is that in grams?). That's small and light.

There are three other parameters of the unit which can be modified by a resistor change: the time between identifications, which is set at 3 minutes by the factory, the delay before the ID starts, which is set at 3/4 second, and the length of the bauds, which is set for good copy at 20 per.

Control Signal also has models available for repeater installations which are built on a 19" rack panel and have a built in ac power supply, CW identification for RTTY stations, and etc.

This is quite an interesting development, getting away from the diode matrices which have been used heretofore.

For further information, write the company at 5964 West Columbia Place, Denver CO 90227. 73 sent you ... okay?

### CW FILTER

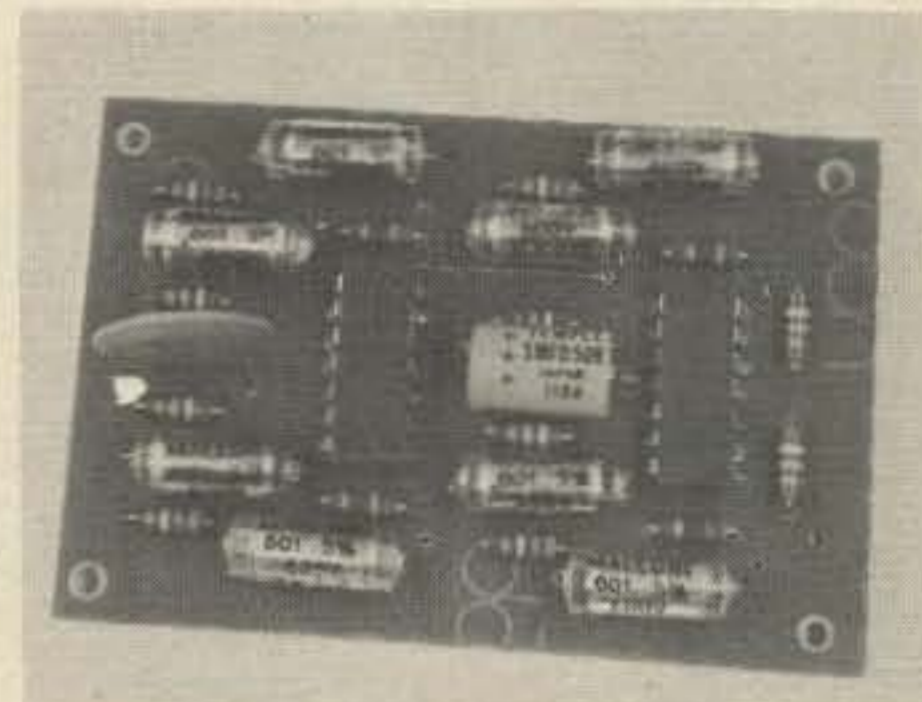

A CW filter is on the market that is hard to resist if you need help in the selectivity department. MFJ has a selectable, 80, 110, 180 Hz bandwidth audio filter that utilizes four op amps (2-dual 741's) in a modern design performance package. It will work with any voltage from 6 to 30V and does not require an internal connection to your receiver.

Packaged with the unit was a very complete set of instructions that makes sure you know exactly what you have just purchased, how it works and a number of ways to wire it into your receiver. Although it is noted that excellent results can be had by just plugging the filter into the phone jack, the test unit was wired into an SBE-34 sideband rig.

Since 40m is the only CW band that is covered by the SBE, things were tuned up there. The mechanical filter in the unit affords around 2 kHz selectivity, which is fine for general use but not on the novice band on a Sunday afternoon! Everyone was, naturally, clobbering everyone else. With the filter switched in there was a marked change. Signals that were very close were now individually readable. Even at the sharpest position there seemed to be no ringing as the signals popped through the QRM. A damned good filter! The peak frequency is 750 Hz and is comfortable to copy.

If you are a novice with an inexpensive receiver, or are a higher class licensee that needs optimum CW selectivity, the CWF-2 filter is probably the best buy on the market today. It outperforms filters costing twice its price. It sells for the amazingly low price of

**INTRODUCING: SUPER CRYSTAL —**  
**The New DELUXE DIGITAL SYNTHESIZER from**

**RP**

- TRANSMIT and RECEIVE OPERATION — SIMPLEX (transceive) and REPEATER MODES
- ACCURATE FREQUENCY CONTROL — .0005% accuracy
- STABLE LOW DRIFT OUTPUT — 20 Hz per degree C typical
- FULL 2 METER BAND COVERAGE — 144.0 to 147.99 MHz
- 10 KHz CHANNEL SPACING
- FAST ACTING CIRCUIT — 0.15 second typical settling time
- LOW IMPEDANCE OUTPUTS — 50 ohm output impedance both transmit and receive
- LOW SPURIOUS OUTPUT LEVEL — similar to crystal output

- Also Available:*
- COMPLETE STATIONS (WITH SYNTHESIZER)
  - PARTS AND KITS OF PARTS

SEND FOR FREE DETAILS & PRICES TODAY

Will Work With: STANDARD, REGENCY & OTHERS

\$30.00 will HOLD YOUR PLACE IN LINE for FASTEST DELIVERY

**GIFT IDEAS FROM RP — FAST SERVICE!**

**TONE BURST ENCODERS AND DECODERS**

- UP to 5 fixed tones (factory set)
- ADJUSTABLE —Duration —Output
- NO BATTERIES needed.
- FULLY ADAPTABLE
- EASY INSTALLATION
- CONTINUOUS TONE POSSIBLE
- FULL 1 YEAR RP Warranty

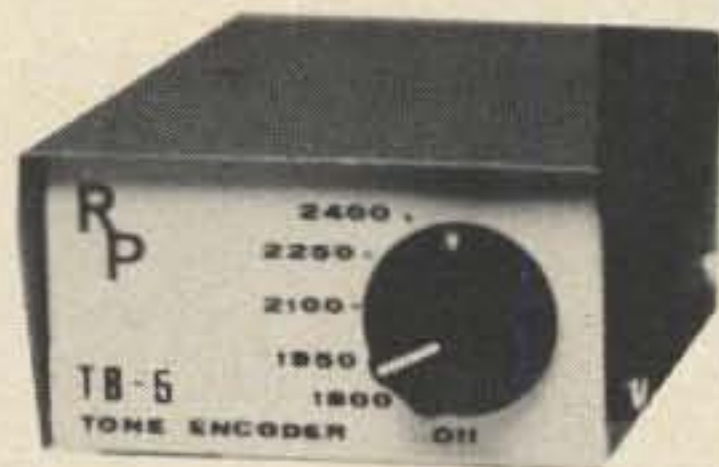

**PRICES:**

- TB-5 5 tone std. encoder ..... \$37.50 (1800, 1950, 2100, 2250, 2400 Hz.)
- ST-2 Single tone decoder ..... \$37.50 (Specify 1800, 1950, 2100, 2250, or 2400 Hz.)

Special tones -- inquire

Add \$1.80/unit for shipping (Ill. residents add 5% tax)

**A SPEECH COMPRESSOR THAT REALLY WORKS**

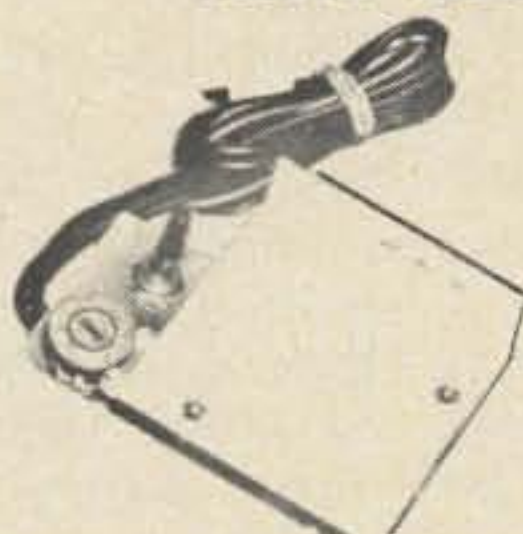

RPC-3,3U Internal Unit (\$24.95)



RPC-3C Cabinet Model (\$34.95)

- Low distortion circuit.
- Fully wired & tested. NOT A KIT
- Works with phone patch.

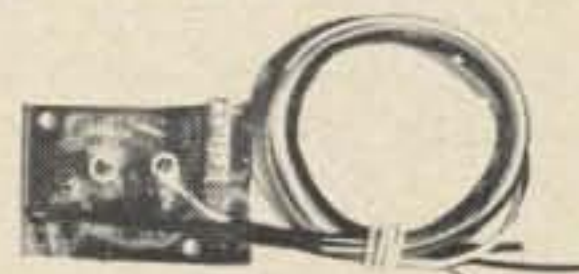

RPC-3M Module (ONLY \$22.50)

- Internal units & modules work mobile.
- FULL WARRANTY — ONE YEAR
- INTRODUCTORY LOW PRICES (Illinois residents add 5% Sales Tax)
- Add \$1.00/unit shipping (RPC-3, 3U, 3M)
- Add \$2.00/unit shipping (RPC-3C)

**RP**

**ELECTRONICS**

BOX 1201B  
 CHAMPAIGN, ILL. 61820

\$9.95 in kit form, and for \$12.95 it comes wired, tested and guaranteed!

For further information on the CWF-2 and other filters in the MFJ line, contact MFJ Enterprises, P.O. Box 494, Mississippi State MS 39762.

### CALCULATOR KIT



Aries, the kit division of B&F Enterprises, has taken the desk calculator business one step further and has a kit for a pocket device. It does everything that its larger brothers can do but does it with four AA cells instead of a dangling cord. Readouts are LED type so higher voltage is not required.

Inside the tiny case is a calculator chip and 40 transistors (27 are used as readout drivers). Packaging problems are taken care of by the use of well designed printed circuit boards. A large amount of space is saved through the use of an elastomer keyboard. Without it the size would probably double.

If calculators are great to use, a hand-held unit can only be better. (Just look what Handie-Talkies are doing to FM!) Take it with you and calculate everything!

The Pocket Calculator kit, complete with alkaline cells, sells for \$75. A companion charger with four nicads is available as a kit for \$17.50.

Aries Inc., 119 Foster St., Peabody MA 01960.

### REPEATER TONE PANEL

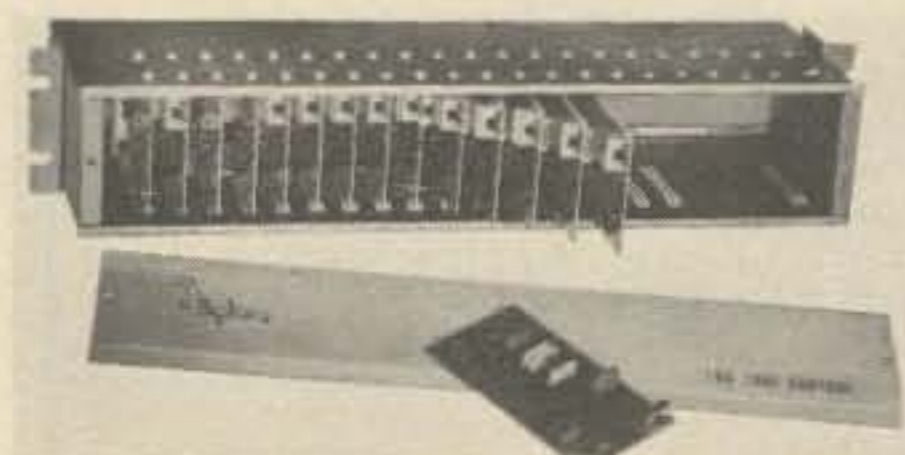

ALPHA announces its new RCP-780 multi-frequency repeater tone panel for use on community repeater systems, shared base station

systems or where tone control of numerous functions is required. The unit is capable of handling up to 18 separate tone controlled functions utilizing a modular plug-in card for each function.

All tone encoding and decoding circuits utilize ALPHA thick film hybrid chip modules that plug into the individual carrier cards making field repair or reconfiguration extremely simple. Each tone card plugs into mil spec gold plated connectors and all adjustments and indicator lights are at the front edge of the card for easy access. For additional information call or write ALPHA ELECTRONIC SERVICES INC., 8431 Monroe Ave., Stanton CA 90680 (714) 821-4400.

### PHONE PATCH



New from Radio Shack is the Realistic Phone Patch at a price which brings this useful accessory within the reach of any ham's budget. The Phone Patch is priced at \$19.95 and comes complete with 15 foot telephone leads, three foot transmitter lead and installation instructions. It features a built-in VU meter, gain control and locking push-to-talk bar. It is available at Allied Radio Stores and through Radio Shack Authorized Sales Centers.

### 100% SOLID STATE



Swan has come out with a high power 5 band all solid state transceiver. Goodbye mobile power supplies! Featuring no-transmitter tuning, the new unit has broadband transmitting circuits covering 80 through 10 meters. Ready to go by simply flicking a switch, the unit operates on

upper or lower sideband or CW modes.

Swan's new solid state transceiver comes in three different power ranges, 15, 100, or 200 watt P.E.P. and incorporated is full VSWR protection from an open to a short circuit.

Other features include front mounted controls for easy use and a built in VOX provided with variable VOX gain and Anti-trip controls. Standard with the units is a built-in noise blanker with a variable noise blanking control. They also have CW semi-break in with a CW monitor, a 25 kHz crystal oscillator and an external VFO connection with switching control.

Prices range from \$579 for the SS-15, while the SS-100 sells for \$699 and \$799 buys the SS-200.

The transceivers operate from 12V dc so two power supplies are available for 115V ac operation. The PS-10 will supply the SS-15 and SS-100 and sells for \$89. The SS-200 requires a bit huskier supply, the PS-20 which runs \$139. Both supplies are part of a companion speaker package.

For more information contact: Swan Electronics Corporation, 305 Airport Road, Oceanside CA 92054.

### THE RP SYNTHESIZER

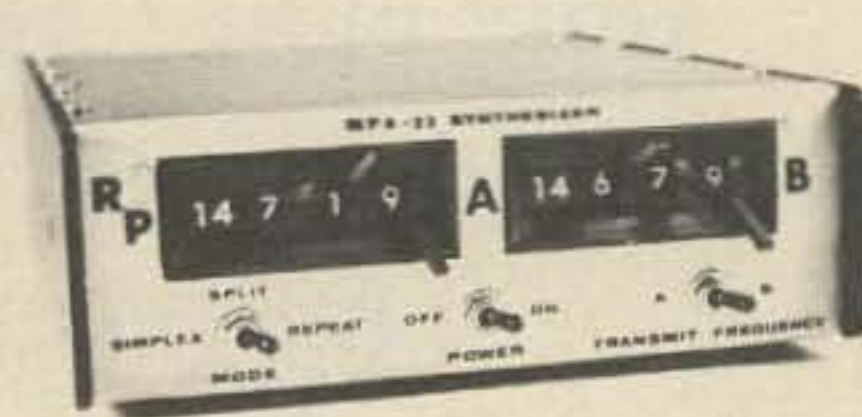

RP has done it. They've come out with the first two meter FM synthesizer for both transmit and receive that has the flexibility that most operators have been looking for.

The MFA-22 does just about everything you could want. First of all, it uses some brand new leverwheel dials — a dial that has the readability of a counter dial, and yet is operated with a small lever. The mobile operator will be able to flip this dial easily, even in the dark or with gloves on.

There are three basic modes of operation — simplex, split and repeat. In the simplex mode you transmit and receive on the same channel. You can

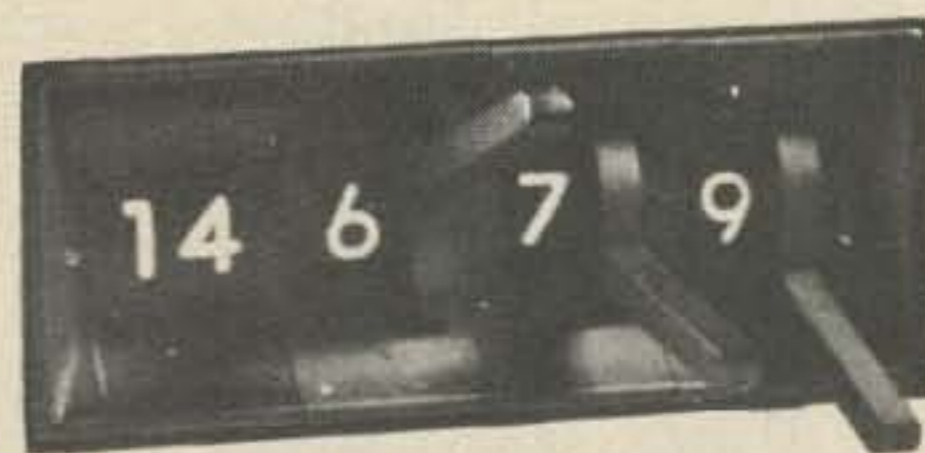

A close-up of the leverwheel dials.

# This will turn your repeater on



## Automatic Station Identifier **\$65**

The CWID-50 provides precisely timed identification of repeater stations in perfect international Morse code. When the CWID-50 is activated, the station identification is transmitted automatically at preset intervals. It also brings up the repeater for final ID after last use.

The heart of the CWID-50 is an IC memory that is factory programmed with your call sign. The unit employs 10 IC's; no more cumbersome diode matrices.

The CWID-50 is not a kit. It's ready to install and its small size allows mounting even behind the smallest rack panel.

The CWID-50 comes preset as follows (the user may adjust): code speed—20 wpm, ID interval—3 min,

audio frequency — 1020 Hz, and initial delay after activation before ID sequence—750 msec.

Inputs: COR contact closure, momentary contact for ID test, strap for continuous operation if desired, and DC power (7.5 to 30 VDC). Outputs: audio CW ID(0 to 5v), PTT switching transistor, (holds carrier on until after ID completed), and monitor output.

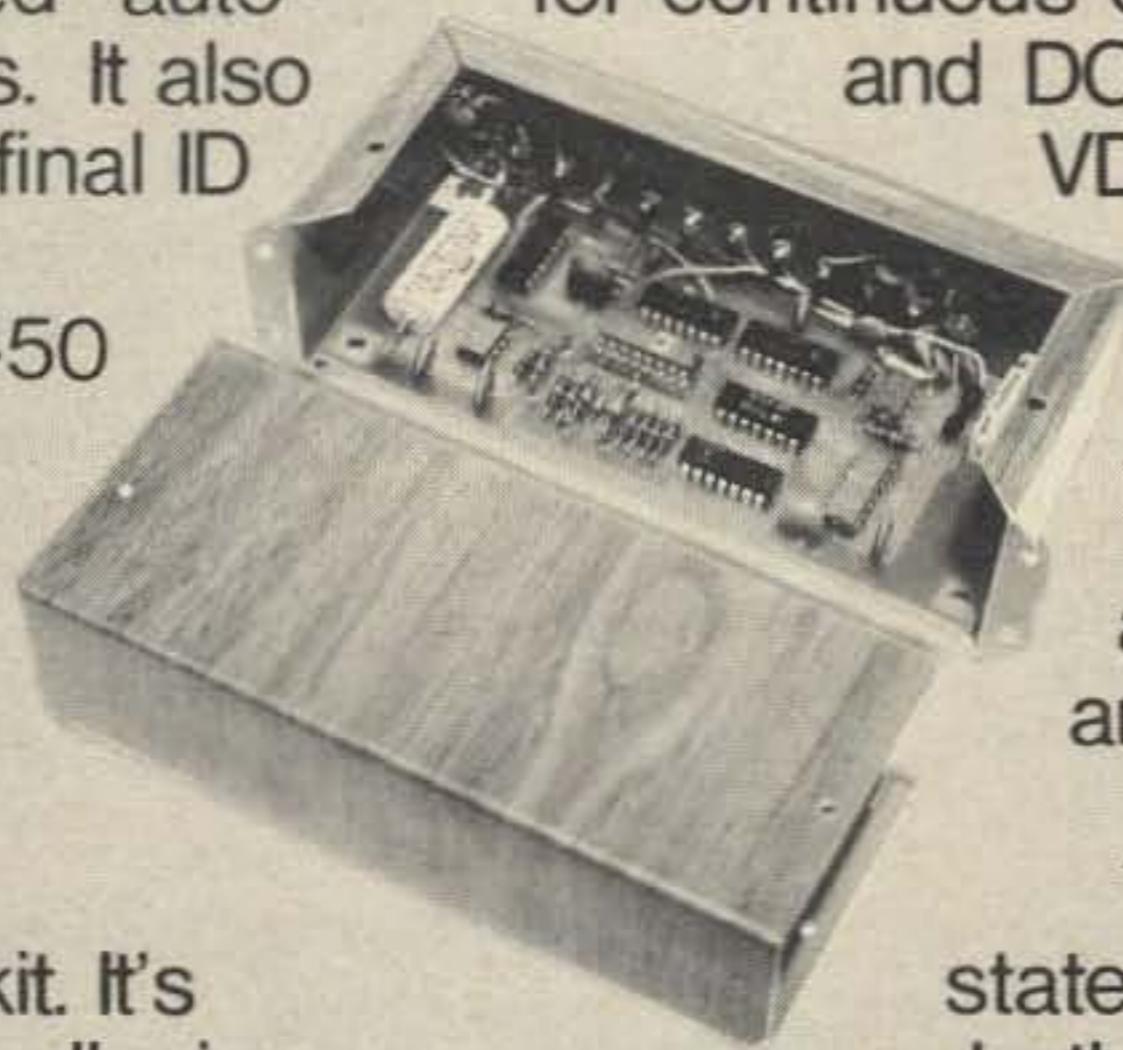

To order CWID-50 state your call sign and whether you desire 'de'. Enclose \$65 and we pay postage. Or remit \$10 part payment for COD shipment.

The CWID-50 is guaranteed fully for one year.

**CSC**

**CONTROL SIGNAL COMPANY**

5964 W. COLUMBIA PL., DENVER, COLORADO 80227

set up channel A and channel B and switch between the two, simplexing each. This gadget should certainly help to get the hordes off 94 simplex. There just is no need for ever having to put up with interference when you have flexibility such as this synthesizer affords.

The unit covers the entire two meter band, so the chances are that we may see more simplex operation moving down into the 145 segment — maybe even the 144 segment, a veritable desert in most areas of the country. This will also greatly simplify the use of remote base inputs in these lower segments of the band. Some repeater groups, faced with the new regulations, are thinking in terms of going remote base and moving the input down below 145 MHz to automatically limit the class of license required to use the station — and thus simplify problems of repeating into the lower phone bands where a higher license is required.

In the "split" position you transmit on one channel and receive on the other. If the repeater split is anything other than the standard 600 kHz with the receiver high, you can use the two channel selectors in this mode. This will enable you to instantly switch to the reverse pair, listening to the repeater input, should you desire. This does have advantages now and then. You can also work into repeaters using odd channel splits such as the WA1KGGK repeater in Connecticut with 147.49 in and 146.49 out. More and more repeaters with the 990 kHz and 1 meg spacing are being aired in the major metropolitan areas where the standard repeater channels have been filled up and only the old "simplex" channels are still mostly unused.

In the "repeat" mode you automatically receive 600 kHz higher than your transmitter is set. This is extremely handy when you are operating in the car and want to find out if you are in range of a repeater. You have only to switch the transmit channel and give a short call — if you hear the squelch tail coming back you know you can use the repeater. It would be difficult to drive and try the repeater channels if you had to operate both transmit and receive switches for every channel.

The MFA-22 will work with virtually any amateur FM transceiver, which includes 6, 8, 12, 16, 24, 48 MHz transmitters and receivers with i-f's on 8.7 — 10.7 — 11.7 — 16.7 MHz.

Interconnecting the unit is fairly simple, with a small hole having to be drilled in the transceiver rear apron to allow the two small coax lines and power wires to come in. The whole works shouldn't take over a couple of hours.

And how much does this lovely gadget cost? About the same as crystals for 35 channels — only \$275. You need this many channels just for repeaters in New England or around New York — and you need more than that if you want to operate both places. Likewise California. And, unless the FCC refuses to give decent repeater rules, you'll need lots more channels everywhere.

RP Electronics, Box 1201, Champaign IL 61820 will send you more info, unless you'd rather get a unit right now and read the info later.

### KEYER MEMORY



A large capacity programmable-reprogrammable CW message memory, designed as a plug-in accessory for the EK-420 keyer, has been released by Curtis Electro Devices. The standard MK-420 offers a solid state memory capacity of 100 Morse characters. A second optional, 1,024-bit plug-in memory doubles this capacity. The memory organization is switch selected to yield four different program arrangements so different programs may be stored in back quarter of the memory.

Programs are selected and started by pushbuttons; terminated by a message pause or by manual break-in. A 1–20 second repeat feature allows send and wait operation.

Memory programming is accomplished simply by sending the desired sequence in the "record" mode. Messages may be written as often as desired and stored indefinitely.

The MK-420 is priced at \$299.95. The optional extra memory is \$34.95. Contact Curtis Electro Devices, Inc., Box 4090, Mountain View CA 94040.

### CEI STANDARD TIME RECEIVER



Now you too can get automatic accurate time announcements from your repeater. The WA1KGO repeater

group had been looking for an easy way to have time announcements on the repeater. We wanted an automatic unit that would announce local time. However, the only unit we could find was a receiver with a built in recording that would announce the time when a button was depressed. The unit cost a staggering \$150 and it was subject to error should power fail. A quick telephone call to Hamtronics in Trevoze, Penn. gained us the new Caringella STR-1. It is a three channel solid state receiver for 5, 10, and 15 MHz for WWV. Or, the unit can be supplied for the 7 meg CHU frequency. A quick trip to the WA1KGO repeater site and we hooked up the STR-1 to the repeater so that it would announce the time on command through an 1800 Hz tone burst. After the time announcement the repeater returns to normal use. Naturally, the STR-1 has many other uses around the shack or office. At the 73 offices we have 11 digital clocks. When we lose power for a second or so each clock has to be reset. The STR-1 certainly makes the job easier.

The STR-1 is available either in kit form or wired from Hamtronics, 4033 Brownsville Road, Trevoze PA 29047. Be sure to specify WWV or CHU.

### SUPEREX HEADPHONES



A new low priced set of stereo headphones is being offered to the ham market by Superex. For \$19.95 you can forget those heavy uncomfortable cans and sit beneath something with a designed-in comfort factor.

Although the frequency response of stereo phones isn't by a long shot tailored for voice communications, most modern receivers have bandwidth filters and shaped audio sections that limit audio response and nullify the need for tuned phones.

One plus in the favor of these headphones is that the two phones are already electrically separate. Use one side to listen to a QSO in progress and connect the other to a second receiver and look for 20m DX. It's amazing how well the human ears can function independently of each other.

For more information on the "Newport," contact Superex Electronics Corp., 151 Ludlow St., Yonkers NY 10705 (914) Y05-6906.



The situation seems to be this: part of the nuclear standoff with the Russians appears to be an agreement not to even try to provide any defense measures for the citizens. In return for this, the Russians are expected to reciprocate. By leaving the populations of the two countries unprepared to cope with nuclear war, the standoff results, with each population being held as hostage by the other.

This system seems to work. At least we haven't had the war yet.

I don't recall being asked to agree to this system, and as an involuntary participant, I don't feel all that guilty if I hedge a bit on the agreement. If you feel the same way, perhaps the following may interest you.

Let's suppose the worst does happen. It could happen by accident — shades of Dr. Strangelove. It could come about through a third party such as China. Somewhere between 50% and 75% of our population would probably be wiped out — perhaps even more. These are the estimates that seem to be accepted by our government.

If such a disaster should come there would be little in the way of communications other than amateur radio. Some of the VHF services could handle purely local traffic, though (as we have found in our run of the mill disasters) each service would probably be too busy with its own communications to provide any help for the population. Even simple things like floods and earthquakes quickly show all existing communications systems to be virtually worthless. Only amateur radio is capable of providing both short and long range communications.

It seems to me that it behooves us to keep this in mind when we are setting up our repeaters and other emergency systems. How many of them will work if the chips ever go down? How reliable will they be? How well prepared are we to use the systems we have set up?

The recent FCC rules on repeaters will make our job of setting up emergency systems many times as difficult — for no obvious reason. This is unfortunate and perhaps we should build in some sort of "A Day" override for the hamstringing requirements of the new regs. Of course there have to be some tests of the full systems — it will be a little late if we wait for it to happen before we start trying to learn how to use things.

Reason dictates that FM repeaters should be able to interconnect with low band transceivers for combined short and long range traffic. Reason dictates that repeaters on the various VHF bands should be able to interconnect so six meter ops can talk with

two meter ops, and with 222 MHz ops — and even with 450 MHz ops. It seems to me to be irrational to have it any other way.

One of the main points where the FCC and I are at odds is that I feel we should be able to set up our repeaters with these systems right now and have them operational. I feel that if there is any pressure for holding down the number of channels in use that this will be felt and economy will follow, that it is not right for the FCC to limit our experimentation and development in the name of possible future channel congestion.

Now I do not suggest that the FCC is part of a conspiracy to prevent adequate civil defense, though they could hardly be much more effective in that direction even if they were consciously working toward inhibiting the development of amateur radio emergency systems. It is extremely unfortunate that the FCC has now set a pattern of turning a totally deaf ear to every plea and request for relief from their overly restrictive rules.

Should the ultimate emergency occur we will need every available aspect of amateur radio. We will need repeaters — every mobile and hand unit we can find — we will need emergency power — sideband rigs to interconnect communities and countries — RTTY for fast message handling — and we will need a measure of cooperation far beyond anything we have ever experienced.

Frankly I would like to see repeater clubs and radio clubs accept the responsibility for preparing for emergencies. I would like to see each club establish one man as an information center — a man who would inventory emergency equipment and personnel available — who would coordinate amateur radio with all other communications services in his community — who would know where to find emergency generators and gas — who would know who to see to interconnect with all other radio users — etc.

Very few repeaters are set up for true emergency operation and this should be remedied as fast as practicable. One of the first things to go in an emergency is commercial power — the other is telephone service. This means that repeaters dependent upon either are of little value in time of trouble.

Automatic gasoline generators are good, to be sure, but they are also expensive and they have to be fed. In a big emergency you might not be able to get to the repeater site to refill the tank — or you might find gas hard to get. Perhaps a better answer for this is to go solid state with the repeater and have it so it will work from 12 volt car or truck batteries when the

commercial power is off. This seems worth some thought and perhaps some articles for 73.

And how about windmill chargers? Maybe we're getting to the point where we might consider them for repeaters — at least as an auxiliary power source. They could help keep the batteries charged.

We could set up the repeaters to operate at about ten watts while on battery power, with the amplifier being connected to the commercial power.

My apologies for getting into nitty gritty aspects — the main idea of this was to communicate my idea about amateurs having a responsibility to provide emergency communications even though CD does not provide much help or encouragement. As I see it the only truly emergency system of communications that the country has is amateur radio — are we going to face up to this responsibility?

#### REPEATER COUNCIL SPEAKS

It has been reliably reported that at a recent meeting of a statewide repeater council the repeater groups represented agreed unanimously to keep their repeaters on the air should the FCC deadline of June 30th pass without the new call letters being issued. The identifier would be turned off, but the repeaters would continue.

Perhaps it is about time the Commission started reacting reasonably to the needs of amateur radio and stopped its dictatorial stance.

I predict that the pressures will build up to where the FCC must recognize them and modify some of the recent repeater rules . . . and the interpretations of these rules.

#### WAYNE vs IRS

Rumors have a way of spreading a lot faster than retractions or denials, so I assume that many readers have heard one or more of the Wayne Green fan club on the air giving a one-sided view of my latest battle with City Hall: the IRS.

The IRS is formidable. They have their own courts — judges — attorneys — and all the money in the world to hassle you. Milton Friedman in a recent *Playboy* feature interview compared the power of the IRS to that which the Russian leaders have over their people . . . "Or even compared in the United States with the power that an official of the Internal Revenue Service has over you. An official of the IRS can put you in jail. I doubt that there is a person in the United States who couldn't be convicted of technical violation of some aspect of the personal income tax."

Continued on p. 123 . . . . .

# Caveat Emptor?

Price — \$2 per 25 words for non-commercial ads; \$10 per 25 words for business ventures. No display ads or agency discount. Include your check with order.

Deadline for ads is the 1st of the month two months prior to publication. For example: January 1st is the deadline for the March issue which will be mailed on the 10th of February.

Type copy. Phrase and punctuate exactly as you wish it to appear. No all-capital ads.

We will be the judge of suitability of ads. Our responsibility for errors extends only to printing a correct ad in a later issue.

For \$1 extra we can maintain a reply box for you.

We cannot check into each advertiser, so Caveat Emptor . . .

**HELP WANTED** — Assistant Circulation Manager for 73 Magazine, male or female. Must be fluent in English, have proficiency in reading/writing Spanish, and have typing ability. Prefer ham or previous ham, domestic or foreign. Send resume c/o Circulation Manager, 73 Magazine, Peterborough, NH 03458.

**2 METER FM** — SR-C 145 Handie Talkie Transceiver brand new, complete with carrying case and American instruction booklet. \$190.00. Joe Gibson, 181 So. Orchard St., Wallingford CONN 06492.

**MOTOROLA HT220 FM Handie-Talkie**, factory modified for 2 meters crystals installed for 34/94, 10/70, 20/80, 94/94. Five watt output. Includes case, 5 1/4" "flex-whip" antenna, 2 rapid charge batteries, automatic charger, external antenna adapter, external speaker/PTT microphone with coil cord. Radio can be used as "miniature" base station from 110VAC. Other non-Motorola accessories included: Dycomm 101-500C 12VDC amplifier (mobile) Calrad 110VAC to 12VDC power supply for base. Will ship all. NO TRADES. Have manuals for all. \$700.00. Call daytime only or write: L.G. McFadden, WB6EJQ, 765 Geary St., #311, San Francisco, Calif., 94109, area code 415 474-1394.

**WA8TMR** deceased. Wife must sell Swan 500CX single sideband transceiver and Power Supply 117XC. Excellent condition. Mrs. John Sercia Box 144, Brookfield, Ohio 44403.

**ALL GEAR TOP CONDITION:** Hallcrafters FPM 300 SSB xcvr \$480. Heath IB-101 frequency counter with Vanguard scaler \$250. Heath SB200 linear 2 KW PEP \$330. GLB synthesizer, works with any rig, \$150. Also Galaxy V SSB xcvr w/p.s., accessory console and ext. VFO, \$350. Box 220, 73 Magazine.

**NEEDED . . . SWAN 406 VFO** (THIS IS THE SMALL PHONE BAND ONLY VFO). PLEASE CONTACT W7DXX/1 AT 73 MAGAZINE.

**COMPLETE** 36 page QSL catalog, 3rd edition. New "SPARKLING" QSLs. Hundreds of cuts, ten report forms, thirteen colored stocks, 25¢. Ten sample QSL cards. Corneilson's Quality QSLs, 321 Warren St., N. Babylon, N.Y. 11704.

**YAESU FTDX-560 Transceiver \$400.** Heath SB-220 2KW Amplifier \$320. Heath IM-102 Digital VOM \$150. New TR-44 Rotar \$50. Hal Keyboard Keyer \$75. Drake MN-4 Matchbox \$50. K4KY 3853 Garden Terrace, Owensboro, Ky. 42301, (502) 683-9871.

**EVANSVILLE** Indiana TARS Hamfest. Sunday May 6, 1973. 4-H Grounds, Highway 41 North 3 miles. For flyer contact Robby W9MKZ, 502 S. Lincoln Park Drive, Evansville, Indiana 47714.

**HR-2**, twelve channels, fully crystallized, pre-amp, A/C supply, nicad field pack, charger, antenna, \$280. 10w/50w Dycomm, \$70. Bruce Berg, 13 Lisa La., Cherry Hill, N.J. 08003.

**WANT HT-220's** — best prices paid — now's your chance to get enough to buy a six channel fast charge Japanese HT. Give details and price first letter. Box 95, 73 Magazine, Peterborough NH 03458.

**2 METER FM - YAESU FT-2F .8 and 10 watts**, good condition \$170.00 or swap for Drake TR-22 WA1JUV, 452 Livingston Drive, East Windsor, N.J. 609-443-1155.

**CANADIANS FREE** 120 page Electronics Catalog ETCO-B, 464 McGill Montreal.

**WANTED:** Parts for or cannibalized General Electric Voice Commander II's and III's; WA0JUM, Box 59, Mobridge, SD 57601.

**MOULTRIE AMATEUR RADIO KLUB**, 12th Annual Hamfest, Wyman Park, Sullivan, Illinois, April 29, 1973, Indoor-outdoor market. Ticket donation \$1.00 in advance — \$1.50 at the gate. For information write M.A.R.K. Inc., P.O. Box 327, Mattoon, Illinois 61938.

**YOUR CALL LETTERS.** Two sets, for windshield and rear glass. Smart white letters with red outline. Easily installed pressure sensitive decals. \$1.00, postage paid, anywhere. Satisfaction guaranteed. Lake Jordan Artists, Slapout AL 36092.

**6 MTR HA-460**, Squalo, Xtal, cables. 20 Watts, VFO, etc. \$115. Swap for 2mtr FM? Steven M. Hager WA2UBY, 45 Fleets Cove Road, Huntington, New York 11743.

**HERE'S YOUR CHANCE.** HR2MS 8 ch. scanner 15W \$255. TME-H-LMU 16 ch. scanning rcvr 6/2 3/4m \$255. Digital logiclock \$75. Tempo CL220 12 ch. \$265. Everything brand new. Box 310. 73 Magazine.

**DES MOINES HAWKEYE HAMFEST** will be held on Sunday, June 17, 1973 at the Iowa State Fairgrounds. Plenty of free parking. Flea Market, covered display booths available, small charge; open arena — no extra charge. Dealer displays, prizes, and XYL activities. Saturday night Auto races and camping — extra. Registration \$1.50 advance/\$2.00 at gate. Write Des Moines Radio Amateur Association, Box 88, Des Moines, Iowa 50301.

**ANTIQUE** radio equipment sale and swap session, dinner and program, A.W.A. Spring Meet, April 7, Canandaigua, N.Y. Write for details: Lincoln Cundall, W2QY, 69 Boulevard Parkway, Rochester, N.Y. 14612.

**PRINTED CIRCUIT NEGATIVES MADE.** SASE AND QUARTER FOR INFORMATION/PRICES. P-C NEGA SYSTEMS, 186 - 80th STREET, NIAGARA FALLS, NEW YORK 14304.

**HOOSIER ELECTRONICS** has the best deal around on the ham gear you want. Write us for a quote and try our fast, friendly Hoosier service. Factory-authorized dealers for Regency, Drake, Standard, Ten-Tec, Galaxy, Hy-Gain, CushCraft, Hustler, Mosley, Ham-M, Bowmar Pocket Calculators, plus many more. Orders for in-stock merchandise shipped the same day. Write or call us today for our quote and become one of the many happy satisfied customers of Hoosier Electronics, R.R. 25, Box 403, Terre Haute, Indiana, 47802. (812)-894-2397.

**2 METER FM CHEAP?** Will convert your 2mtr Gonset III for 2 meter FM — \$35.00 plus shipping. Jim Gysan W1VYB (617) 922-3850.

**22nd ANNUAL Dayton Hamvention** will be held on April 28, 1973 at Wampler's Dayton Hara Arena. Technical sessions, exhibits, hidden transmitter hunt, flea market, and special program for the XYL. For info write Dayton Hamvention, Dept. M, Box 44, Dayton, Ohio 45401.

**HT-220** two watt two channel with case — best offer over \$75. Box 12, 73 Magazine, Peterborough NH 03458.

**DESIGN** 1 to 300 MHz parallel resonant circuits. Find Q, inductance, capacitance, turns, etc. rapidly. 19 scales, durable plastic coated slide chart. Guaranteed. Send \$2.75 to ComRec Company, Box 93, Penacook, New Hampshire 03301.

## B & W Model 361 Codax Keyer



### improve your C.W. operation

The B & W Codax Keyer provides smooth rhythm keying. Automatic spacing and timing of any speed from 5-50 w.p.m. Built in double paddle key (one for dots, one for dashes) readily adjusts to any fist. Model 361 has a monitor built in in order to monitor your own keying.

PRICE.....\$69.95

See your dealer or write:

Barker & Williamson, Inc.



Canal Street, Bristol, Pa. 19007

# SBE

## feature line

SB-36 • SB-144 • SB-450 • SCANVISION

AVAILABLE  
FROM:

## ZACKIT CORP

1815 Sonoma Blvd., Vallejo, CA 94590  
Telephone: 707/644-6676

# VIBROPLEX

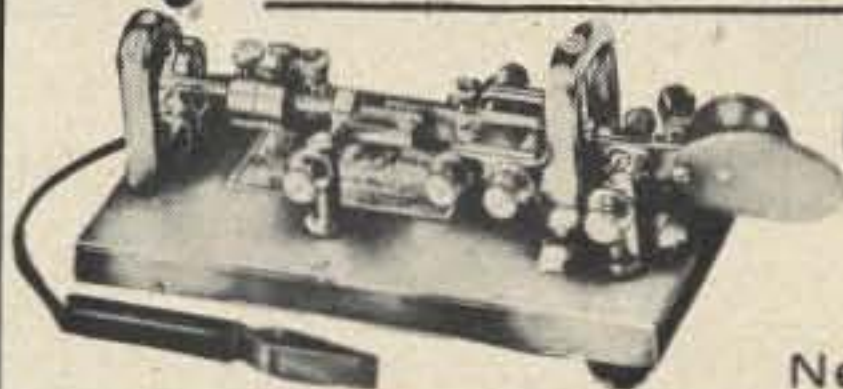

ENJOY EASY,  
RESTFUL KEYING  
\$21.95 to \$43.95  
THE VIBROPLEX  
CO., INC.  
833 Broadway,  
New York, NY 10003

# FREE Catalog

OF THE WORLD'S FINEST  
GOVERNMENT SURPLUS  
ELECTRONIC EQUIPMENT

And BETTER Than Ever!

Name \_\_\_\_\_

Address \_\_\_\_\_

City \_\_\_\_\_ State \_\_\_\_\_ Zip \_\_\_\_\_

Mail Coupon for Your FREE Copy, Dept. 73

## FAIR RADIO SALES

1016 E. EUREKA • Box 1105 • LIMA, OHIO • 45802

## ACTIVE AUDIO FILTERS

IC'S FOR SUPER HIGH PERFORMANCE

CW FILTER:

Get razor sharp selectivity. No impedance matching! BW (selectable) 180 Hz, 110 Hz and 80 Hz; Center frequency .F = 750 Hz. Skirts 60 db down at 1/2 F and 2F. 4 op amps, 2"X3" PC board. \$12.95 wired, tested, guaranteed.

LOW PASS FILTER:

Resistors set cutoff 500 Hz to 20. kHz. Factory set to 2.5 KHz. Rolloff max 48 db/pt. min 40. Input imp 1M; Load >2K, Gain = 1.5 op amps, 2"X3" PC board \$15.95 wired, tested, guaranteed.

\*\*Write for free spec sheets\*\*

\*Dealer inquiries invited\*



CW  
FILTER

9<sup>95</sup> KIT



LOW  
PASS  
FILTER

13<sup>95</sup> KIT

MFJ  
ENTERPRISES

P.O. Box 494, State College MS 39762

**CLEANING SHACK** - General Electric MA/E 36 w/4 frequency deck. Independent T & R frequencies, with 3 sets crystals and spare vib. P.S. \$125. Aerotron 6n100/MA Amplifier, 3--15 watts in - 80 to 110 out. With spare 5894 tube (new), \$75. Hammarlund FM-50a with 34/94 and 94/94 crystals ac/dc P.S. 25 watts out for only \$50. All items are in good working shape. Rob, WB2ATX (201)224-9659.

**WANTED: OLD RADIO TRANSCRIPTION DISCS.** Any size or speed. Send list and details to Larry Kiner, W7FIZ, 7554 132nd Ave N.E., Kirkland, Wash. 98033.

**SALE!** Pwr supply containing 105,110,115 in, 3200VCT@ 1a, Swinging, fixid chokes, filter caps, fil trans for 4 large Hg rect., mounted on a heavy steel frame. 1 extra plate trans as above. 28V@200A gen. 6 ft open rack. Dynamotors - all sorts - 6 to 28 in, 300 to 1000 out. ARC-5 transmitters. Model 15 and many spare parts. Motorola "coffins." Much hi-power supply parts. If you don't see what you want, ASK. W5EIX, 1224 Comanche, Richardson, Texas.

**DRAKE, T4XB, R4B, MN2000, AC4, MS4.** All excellent condition. \$600.00 for all or make offer on individual units. WB6CDU, 8302 Rathburn Av., Northridge, CA, 91324.

GE, Pocket Mate. 1W out on 146.94. Smaller than HT220. With nicads, antennas & manual. \$200.00 ppd. WB6CDU, 8302 Rathburn Av., Northridge, CA, 91324.

**HALLICRAFTERS SR-150 & PS-150;** \$275: Gonset 3212 2 Meter Power Amplifier; \$125: Poly-Comm 62-B; \$100: All in good condition with manuals. W2WRI J.A. Kammerer 23 New Street Katonah, N.Y. 10536 (914-232-8349).

**"DON AND BOB"** guaranteed goodies. SBE450 339.00; Gladding 25 212.50, with AC 255.00; Write quote Standard 836MA; Standard 146A; Cetron 572B 13.95; Mallory 2.5A/1000PIV Epoxy Diode 29¢; MOT MC1709CG OPAMP (709) TO5 39¢; K765 Code ID with plastic wheels 5.95; Calrad KW Dualmeter SWR Bridge 15.95; Write quotes Drake, Triex, Eimac, Midland, Hygain, Mosley. Used Collins 30L1 395.00; Collins 75A4 345.00; Prices FOB Houston, items guaranteed. Mastercharge, BAC. MADISON ELECTRONICS, 1508 MCKINNEY, HOUSTON, TEXAS 77002 (713)2242668.

**MODERNIZE FOR PEANUTS!** Frame & display QSL's with 20 pocket plastic holders. Two for \$1.00, seven for \$3.00. Prepaid, guaranteed. Universally used and approved. Order now. TEPABCO, Box 198S, Gallatin, Tennessee 37066.

**FOR SALE:** Swan 270 B, mint condition, with original shipping materials, \$250.00. Clegg Thor with A.C. supply, \$70. (615) 524-2693.

**WANTED:** authentic railroad telegraph key. Pay cash or swap antique radio items. WØHKF, 1212 Bellows St., St. Paul, Mn. 55118.

**TECH MANUALS** for Govt surplus gear, only \$6.50 each: R-388/URR, R-389/URR, R-390/URR, R-220/URR, R-274/FRR, CV-591A/URR, URM-25D, TT-63A/FGC, SP-600JX-17. W3IHD, 4905 Roanne Drive, Washington DC 20021.

\$45 COLLINS Model MBF xcvr. 6 meter SSB. David Ganezek, 2216 Camden Ave., L.A., Calif. 90064. WN6SQ6.

**GREATER BALTIMORE** Hamboree will be held Sunday, April 8, 1973, at 10 AM at Calvert Hall College, Putty Hill and Goucher Boulevard, Towson, Maryland (1 mile south of Exit 28 Beltway - Interstate 695), Food Service, Flea Market, Prizes, REGISTRATION \$2.00. No table charge or percentage. Info: Joe Lochte, 5400 Roland Avenue, Baltimore, Maryland 21210.

HW 100 mint condition with homebrew power supply, \$260. Will ship. Box 984, 73 Magazine, Peterborough NH 03458.

SEE YOU AT THE WORLD'S LARGEST HAMVENTION!

22nd ANNUAL

28 APRIL 1973

# Dayton Hamvention

WAMPLER'S HARA ARENA

DEPT: S Box 44 DAYTON, OHIO 45401

TECHNICAL SESSIONS • EXHIBITS • LADIES' PROGRAM • AWARDS  
FLEA MARKET • HIDDEN TRANSMITTER HUNT • BANQUET

## WORLD QSL BUREAU

5200 Panama Ave., Richmond CA USA 94804  
THE ONLY QSL BUREAU to handle all of  
your QSLs to anywhere; next door, the next  
state, the next county, the whole world. Just  
bundle them up (please arrange alphabetically)  
and send them to us with payment of 5¢ each.

GLADDING 25 \$249.95\*

\* 6 separately switchable transmit &  
receive channels • 2 meter transceiver. \*Suggested list price

**PEARCE-SIMPSON**  
DIVISION OF GLADDING CORPORATION  
P.O. Box 800 Biscayne Annex Miami, Florida 33152

## THE NOVICE MAGAZINE

THE NOVICE is a complete monthly (except Aug. &  
Sept.) publication for Novice ama-  
teurs. DX column, construction pro-  
jects, traffic, nets, theory, etc.  
We sponsor a Novice contest—join the  
fun. Don't miss another issue—send  
for your subscription today! Sample  
copy, 40¢. Package of 5 diff. back  
issues, \$1. Subscription, \$3 per yr  
(10 issues). Hurry!



THE NOVICE, 1240 21st St. Hermosa Beach, Ca. 9025L

# SBE

*the feature line*

SB-36 • SB-144 • SB-450 • SCANVISION

AVAILABLE FROM:

## B & J

### ELECTRONICS CO., INC.

1021 North Main St., Baytown, Texas 77520  
Telephone 713/427-8124

Peter J. Cacciotti WA2DDT  
530 Lee Drive  
Corapolis PA 15108

## CURLY

## COIL

## FORMS

**H**aving finally solved the problem of an inexpensive and readily available coil form, I thought I would pass on the idea to my fellow hams in the hope they too will find it useful. The procurement of these forms is not without its dangers, as they belong to the XYL. The forms of which I speak are my wife's hair curlers.

After having tried the usual coil forms, cardboard tubes, plastic pill bottles, and having tried "sewing" one together (a complete fiasco), I found the hair curler. They come in various diameters and lengths and are made of plastic. My wife's curlers have small teeth and these helped the spacing in the coil turns. They also have holes aplenty through which wires can be run.

When coupling coils are needed, the hair curlers work nicely, as they fit one inside the other. Unlike the ready-made store-bought coil form, there seem to be plenty of hair curlers around when they are needed, and — oh, yeah — if the XYL is deserving, you can let her do her hair up in your coil forms.

...WA2DDT

It all apparently stemmed from a little booklet that I wrote several years ago telling people how to make money, if that was their bag. Toward the end of the booklet there was a small section with ideas for tax loopholes to help you hold onto the money once you make it. This appears to have been a red flag to IRS.

Those of the readers who are company presidents understand that you hire bookkeepers and accountants — they prepare your tax forms and you sign them. The sticker here is that if they make mistakes you are the one who is threatened with jail, not them.

The first inkling that there were any serious problems came recently when the Manchester Union (you may have heard of this unusual paper) had a story of my being indicted for income tax evasion. Obviously I needed a lawyer. Some local FM friends recommended a man with experience in this field and he quickly asked for some sort of explanation from the IRS. The upshot was that the case was postponed indefinitely.

Eventually we may be able to find out what the IRS is griping about, but apparently some of my enemies have judged me guilty and have gone so far as to tell people I was in prison. I must give them credit for diligence, for copies of the newspaper article have appeared everywhere.

It is interesting to me that, contrary to the expectations of my competitors, the reaction has not been all that negative. Apparently the IRS is disliked — quite a lot.

I suppose that I should extend my thanks to those who have gone out of their way to PR us. My thanks to Skip Tenney of Ham Radio for an outstanding job. Dick Cowan of CQ deserves the highest praise. And Harry Dannals, the president of ARRL, should be congratulated for his untiring efforts on the air and off. What would I do without my fan club?

#### SUGGESTIONS SOLICITED

Recently, after having been on two meter FM for several months, I got the low band station working again and sat down for some twenty meter work. Down on the low end there were a few pileups. I shouldered my way into a couple — got my signal report and the call of the QSL manager — made a note on my DX log sheet of updated contacts with the countries involved — and tuned the band a bit more.

Is this it? Is this hamming?

I listened some more. I listened to the pileups and, time after time, I heard a frustrated DXer clobbering the channel to get through — then telling the DX station that this is the

second or third — or umpteenth — time he's worked him, that he is still using the same gear, he wishes him and his family well for whatever holiday is at hand or nearing — thanks for the QSL — 73.

Is this it?

Sure I realize that the DX hound who has never learned to talk on the air has to stick to working the pileups, and if he has already worked the object of the pileup, he still has to get through to gratify his ego — to do his thing. This is hard on the fellows who haven't yet worked the rare one — and it is hard on the DX operator too, for there is nothing whatever in such a contact for him. If he wants to give his rare country to needy ops, the DX hog frustrates him as well as those trying to get through. If he would rather have a more meaningful contact, he is still frustrated.

Have you any suggestions?

#### CB SOLUTION

Doesn't it seem reasonable that the FCC could solve the CB problem at any time it really wanted just by asking amateurs to step in and help? There are hundreds, if not thousands, of amateur clubs and groups which would be delighted to set up CB hunts and pinpoint the lawbreakers and bootleggers on 11 meters.

The CB line is beginning to be heard from the Commission halls in Washington — the line that citizens deserve to have frequencies for yacking. Perhaps this is why the Commission appears to be taking such an incredibly soft line with the illegal call signs — illegal power — illegal operation between channels — illegal language — illegal antennas — illegal skip contacts — illegal rag chewing.

#### CB CORRECTION

One reader called to point out that the piece about retuning CB rigs (Feb.) for better output neglected to mention that the slugs in the coils and i-f transformers often work themselves up and that a small hex wrench is most valuable for tightening these slugs down. These are in the centers of those little square cans and the little plastic round things — some have screwdriver notches, some hex holes. To bring in those skip signals, tighten all those loose slugs down.

#### GETTING RICH IN AMATEUR RADIO

Outside of going on commercial DXpeditions or publishing lucrative ham radio magazines, the main way to make amateur radio pay off is by getting into the manufacturing end.

Before you make that down payment on a new yacht, you will have to decide what marvelous product you

are going to make and be back ordered on for the next few years. Five kilowatt linear amplifiers might be a good item, except that the CBers would take all you could possibly afford to make and you wouldn't be able to even begin to supply the hams. Perhaps something in FM, since the CBers haven't discovered that yet.

The Fun Mode certainly seems like the way to go for 1973 . . . and 1974. The growth of interest (and sales) of FM equipment shows no sign of doing anything but going up. About 20% of the active amateurs are presently active on FM. By next year this could easily be up to 30% and, if even half of the possibilities of FM development are realized, this could eventually get up to 80% or better! Active amateurs are going for FM even faster than they went for sideband!

The manufacturing possibilities for FM are myriad. Hand units will be selling faster than they can be made for a long, long time. Soon you will see hand units sticking out of most of the ham pockets or slung on the belts at hamfests and conventions. Club meetings will be QRM pileups on the club repeater channels. It will all spell FUN.

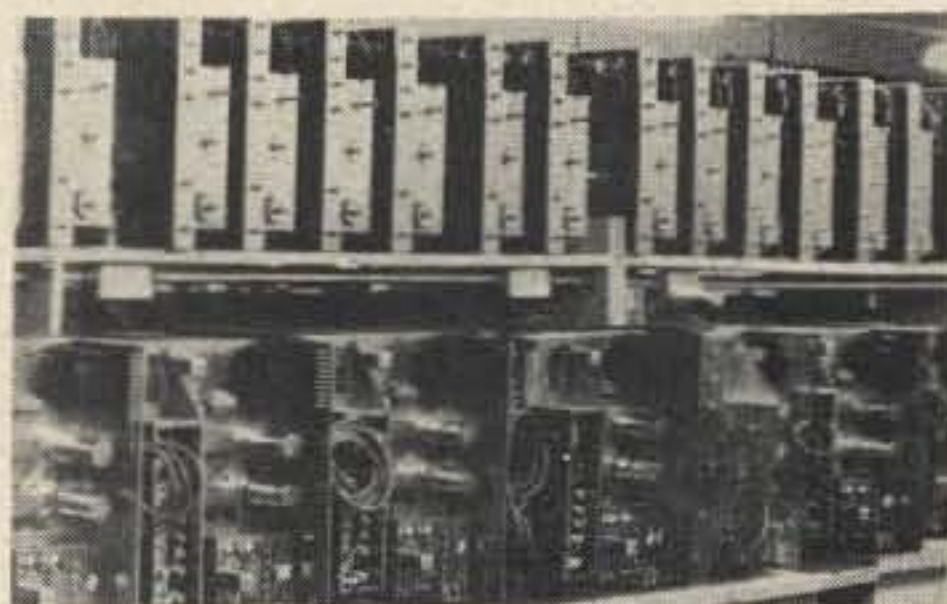

Ever envision your back-room workshop looking like this?

We need inexpensive solid state low power repeaters. I would suggest that they be made in two units with a 600 ohm line between for split site use or telephone line use. We need interface units for repeaters to phone lines, touchtone or dial. We need little touchtone pads to use in cars and even on hand units. We need synthesizers. We need channel-alert receivers to tell us which repeaters are in use. We need selective calling systems so we can call individual amateurs or be called through any repeater. We need shirt pocket transceivers and small booster repeaters. The list goes on.

Other areas of increased amateur interest are slow-scan television, QRP CW, repeaters for RTTY and ATV. Slow-scan holds great promise, in particular. Look for a lot more manufacturers of slow-scan equipment and accessories.

Okay, you've decided to try a new product . . . you've got a prototype and have gotten lots of encouragement from friends . . . you've priced it out and find that you can sell it at a

reasonable profit . . . you're ready to get going commercially. You'll need some expert advice on how best to merchandise, whether through distributors or via mail order.

The best of products can fail miserably if you don't advertise it right and in the right magazines. Is your item primarily of interest to Collins owners . . . the old-timers with money and not too much interest in newer things? There is a ham magazine ideally fitted to your products, one that will bring you the most sales per advertising dollar spent. Perhaps you have a cheapo gimmick and need a cut rate magazine read by kids . . . there is one! Maybe your item will be of major interest to super-technical engineers and fellows who believe in building instead of buying . . . there is a magazine. These are all exaggerations, of course, but not big ones.

If 73 looks like your best bet for introducing your product, give us a call. We'll help you with your marketing problems, with advertising, and try to help you get information on your product to as many amateurs as possible.

Who knows, perhaps you have something that I might like to try out personally and write about. As far as I know, I am the only publisher or editor of a ham magazine today who is on the air regularly and who is trying things out himself. I am on the air almost every day, as users of virtually every New England repeater will affirm.

#### DESK CALCULATOR

Long having been a big fan of the Monroe calculator — to the extent even of having had it at one time mounted in my car for use on rallies — it was only a question of time before I got into the new IC powered jobs which are turning up in all of the magazines — including 73.

The Heath unit seemed like an excellent way to go, so we tried that. You know, it's funny, but you can go along without something for years and never really suffer much — then, suddenly when you get it, you use it every day — often — and you wonder how in the world you ever got along without it.

The Heath frequency counter with Vanguard scaler is a case in point. A day doesn't go by that this combo doesn't get used. We whup transceivers onto the channels we want at the slightest whim now. Going to New York? Okay, let's put in 13-73, 40-00, and a couple other good New York channels. Boston? Fine, where are the 04-64, 07-67 and 39-99 crystals? Manchester? Hmmm, 34-94, 19-79, 25-85, 37-97. And etc.

The Heath calculator is used even more than that. Constantly. For all

sorts of things. For instance, a book just came in from TAB Books — nice one — "Handbook of Electronic Tables." It is a 223-page book (\$7.95 hardbound, \$4.95 paper) full of tables. But with the desk calculator all I need is the formula and I can get the same number without 223 pages.

It is difficult to figure just why I would want to know the area of the hole made by a 1/32'd inch drill — but there it is on page 203. A couple of quick punches with the calculator and I have the same answer. Wild.

Frankly, the ads for all the different calculators are a bit bewildering — with the big price differences there must be some advantages to the more expensive ones. Perhaps a reader will be able to write an article giving us some of the basic differences so we will all understand more about this. It is a little bit off of amateur radio — but it is IC technology and few of us do not have a need for calculators. And we also like to have the answers when talking with friends — they expect us to be knowledgeable when it comes to electronics.

A recent visit with SM7BOZ turned up a new midget calculator which will be selling for under \$75. I'll have to get a couple of those when they get to the U.S.

#### JORDANIAN FILM PROJECT

The response to the proposed project to make a film of the amateur radio program in the Jordanian schools has been good. This was mentioned in the February editorial

The plan is to use the schools of Jordan as an example for other emerging nations to encourage them to set up amateur radio stations as King Hussein has in Jordan. No nation can really develop without communications — and you need people for this — people interested in radio and communications — people to design — to build — to install — to operate and to service the radio and communications equipment.

And what is the best way in the world to get people interested in radio? Through amateur radio, obviously. This has sparked the idea of setting up ham stations in the high schools in order to attract teen-agers to the hobby — and to careers in electronics.

Jordan is the first country to try this idea and it is working very well there. In order to get this idea around to more countries it is important to make the results achieved in Jordan known — and to this end we want to produce a film which can be shown throughout the world. Dave Bell, the chap who has made the recent ARRL distributed films, has volunteered to work on this project as a labor of

love — which means that money is needed largely for film and processing costs — plus transportation.

The largest donation so far was received from Bernard Brink KØYSK/6, who sent in \$200. How about it fellows — here is an excellent opportunity to do something for the entire world — and to help amateur radio to boot.

#### WAYNE GREEN AS A SPEAKER?

There are far more requests for me to speak at dinners, hamfests and conventions than I can possibly handle and a general policy has evolved to cover my speaking engagements.

To keep personal expenses down, the costs of transportation and accommodations should be taken care of by the sponsoring club. To repay 73 Magazine for my lost time the sponsoring club should agree to pre-sell a minimum of 50 one year subscriptions to 73. To provide sufficient time for me to give a talk and answer questions, there should be at least two hours available on the program.

I will be delighted to talk on any or many subjects — you name it or leave it to me.

#### NOTIFICATION OF ADDRESS CHANGE

Recently we had occasion to cross check the latest FCC addresses with the addresses we are using for 73 subscriptions and we were surprised to discover that a substantial percentage of amateurs have moved without notifying the FCC. The Commission takes a dim view of this method of saving \$4 . . . and that would seem to be the logical explanation for so many not notifying.

When you move you are required by the amateur regulations to notify the Commission — and you have to do this on their 610 form — and this is a modification of your license and costs you \$4. You can renew your license and change address at the same time for the price of a renewal: \$9.

Also, if you are active on FM, or even might become active, it costs you nothing extra to also ask to be listed as a control station at the time you renew your license. If you do it as a separate modification, it's \$4.

#### ARE YOU REALLY INSURED?

Just because you have been paying premiums for insurance for many years does not mean that you have the insurance you think you have.

Take the case of one amateur who had his home broken into and had all of his ham gear, hi-fi, fur coats, silverware and appliances removed. It took a full year to get the insurance

*Continued on p. 128 . . . . .*

Robert Suding WØLMD  
189-3 Crenshaw Court  
Tallahassee FL 32304

## WILLIE AND THE SSTV

Is this a camera which I see before me,  
The lens towards my face? Come, let me  
activate thee.

I have thee ready, yet I see no light spot.  
Art thou not, cathode ray tube, sensible  
To wishes as to pulses? Or art thou but  
A camera of the mind, a wished-for FSS,  
Proceeding from the television-oriented  
brain?

I see thy pulses not, yet in acceptable gray  
scale,

With this slow scan camera now I scan!  
Thou marshall'st me the way I should be  
transmitting,

And such an instrument I am to use.  
Mine eyes are made weary of the flickering  
phosphorus,

And I would pull the plug: yet I see these  
still,

And on thy iridescent face dudgeon gout  
of P7 radiation,

Which I can do without. It is such a thing,  
This bloody scanning business which transmit  
Thus to the world. Now o'er my bleary eyes  
Sleep steals softly; yet incoming rasters  
abuse

The longed-for sleep; K4TWJ celebrates  
Pale WØLMD's offerings and W9NTP, etc.

Alarum'd by the qrm, the wretches,  
Whose hardsell or whose stealthy pace,  
With FM's ravishing strides, towards better  
solid state design

Moves like a ghost. Thou sure and firm set  
the status quo.

Hear not our splatter, which way they go,  
for yet

The very qrm'ers rally to us about,  
And take the present mystery from the  
"machine,"

Which now extends us so. While I scan, no  
other does,

And pictures to the heat of deeds too cold  
breath gives.

I input, and it is done; the distant pictures  
invite me,

Hear it, status quo: for it is the knell  
That summons thee to televise or to Hell.

...WØLMD  
(with apologies to Wm. Shakespeare)

# NEW!

how to use

# FM

wayne green

Editor and Publisher of 73 Magazine

**\$1.50**  
postpaid

This new 73 book, by W2NSD/1, gives you the basics of 2m FM operation...and gets you on FM quickly and easily. A fast reading of "How To Use FM" can help you avoid beginners' pitfalls...opens the door to a world of fun and friendly people. Order your copy today with the coupon below!

73 Magazine, Peterborough NH 03458

Enclosed is \$\_\_\_\_\_. Please rush \_\_\_\_\_  
copies (@ \$1.50) of "How To Use  
FM" to:

Name \_\_\_\_\_

Address \_\_\_\_\_

City \_\_\_\_\_ State \_\_\_\_\_ Zip \_\_\_\_\_

# NEW!

# 1973 REPEATER ATLAS

**\$150**  
postpaid

Complete up-to-date list of repeaters for the entire world! Maps pinpoint U.S. and Canadian repeaters and *all* listings contain call, location, frequency and access requirements. The Atlas features a concise history of 2m FM repeaters and a section on How To Use Repeaters by W2NSD/1. If you're using repeaters now... if you're planning to join the fun on FM... you need this book *now*! Send the coupon in today.

73 Magazine, Peterborough NH 03458

Enclosed is \$\_\_\_\_. Please rush \_\_\_\_ copies (@ \$1.50) of the 1973 FM Repeater Atlas to:

Name \_\_\_\_\_

Address \_\_\_\_\_

City \_\_\_\_\_ State \_\_\_\_\_ Zip \_\_\_\_\_





### CAMP ALBERT BUTLER RADIO SESSION

14th year - July 28-Aug. 10th

Courses Taught: General Theory and Code  
Advanced Theory and Code  
Amateur Extra Theory and Code

Golf privileges at New River Country Club; also fishing

**TRULY A VACATION WITH A PURPOSE!!!**

People attended from the following states and areas:

North Carolina, South Carolina, Missouri, Tennessee, Utah, Florida, Oklahoma, West Virginia, Alabama, New Hampshire, Iowa, District of Columbia, Vermont, Arizona, Indiana, Ohio, New Jersey, New York, Massachusetts, Maryland, Virginia, Illinois, Michigan, Georgia, Kansas, Mississippi, Nebraska, Maine, Kentucky, California, New Mexico, Arkansas, Texas, Wisconsin, Louisiana, Oregon, Connecticut, Minnesota, Pennsylvania.

**OUT OF STATE:** Puerto Rico; Saskatchewan, Canada; Ontario, Canada; Quebec, Canada; Granada, Spain; London, England; Geneva, Switzerland; Netherland, Antilles; St. Croix, Virgin Islands; Holland; Columbia; Thailand.

C.L. Peters, K4DNJ, *Executive Director*  
Gilvin Roth Y.M.C.A., Elkin, North Carolina

Please send me the Booklet and Application Blank for the Camp Albert Butler Radio Session.

Name \_\_\_\_\_ Call \_\_\_\_\_

Address \_\_\_\_\_

City/State/Zip \_\_\_\_\_

# SBE

## the feature line

SB-36 • SB-144 • SB-450 • SCANVISION

AVAILABLE FROM:

## EVANS RADIO, INC.

P.O. Box 893, Route 3A, Bow Junction,  
Concord, N.H. 03301 Phone: 603/224-9961

### SPACE-AGE TV CAMERA KITS & PLANS



BE A PIONEER IN HOME TELECASTING! Build your own TV CAMERA. Model XT-1A, Series D, \$116.95 pp. Solid-State. Step-by-step construction manual. High quality. Connects to any TV without modification. Ideal for hams, experimenters, education, industry, etc.

PHONE or WRITE for CATALOG.  
DIAL 402-987-3771

Many other kits, parts and plans available including starter kits, focus/defl. coils, vidicon tubes, const. plans, etc.

1301 N. BROADWAY **ATV Research** DAKOTA CITY, NEBR. 68731

### F.C.C. EXAM MANUAL

PASS FCC EXAMS! Memorize, study - "1973 Tests-Answers" for FCC First & Second class Radio-telephone licenses. Newly revised multiple-choice questions and diagrams cover all areas tested in FCC exams. - plus - "Self-Study Ability Test." \$9.95 postpaid.



COMMAND PRODUCTIONS P.O. BOX 26348 - S  
RADIO ENGINEERING DIVISION SAN FRANCISCO, CALIF. 94126

# 73's WORLDWIDE SALES REPRESENTATIVES

#### U.S. AREA REPRESENTATIVES

New Mexico/West Texas  
Ambrose G. Barry, W4GHV/5  
1010 Juniper Avenue  
Alamogordo, New Mexico 88310

#### DX REPRESENTATIVES

BCN Agencies Pty. Ltd.  
178 Collins Street  
Melbourne 3000, Victoria  
Australia

The Wireless Institute of Australia  
478 Victoria Parade  
P.O. Box 36  
East Melbourne, Victoria  
Australia

Carlos Rohden  
Caixa Posal 5004  
Sao Paulo, S.P.  
Brasil

Jim Coote  
56, Dinsdale Avenue  
Kings Estate  
Wallsend  
Northumberland, England

Radio Society of Great Britain  
35 Doughty Street  
London WC1N 2AE, England

Short Wave Magazine  
55 Victoria Street  
London, SW1, England

Bryan Fogerty  
Irish Radio Transmitters Society  
9 Wellington Street,  
Dun Laigoigha, Eire

Orion Books  
13-19 Akasaka 2-chome  
Minato-ku  
Tokyo 107, Japan

Sun Electron Corporation  
15-20 Takaban-1-chome  
Meguro-ku, Tokyo 152, Japan

Kushal Harvant Singh  
83, Aulong Road off Stephens Road  
Kampong Boyan  
Taiping, Perak, Malaysia

Gordon and Gotch Ltd.  
P.O. Box 584  
Auckland, New Zealand

G. H. Gillman  
Smarts Road  
Waikuku RMD  
Rangiora, North Canterbury  
New Zealand

New Zealand Assn. of Radio  
Transmitters  
P.O. Box 1459  
104 Hereford Street  
Christchurch, New Zealand

Harold C. Leon  
P.O. Box 61141  
Marshalltown, Transvaal  
South Africa

South African Radio Publications  
P.O. Box 2232  
Johannesburg, South Africa

South African Radio Relay League  
P.O. Box 3911  
Cape Town, South Africa

Julio Antonio Prieto Alonso, EA4CJ  
Donoso Cortes No. 58  
Piso 50, Letra B  
Madrid 15, Espana (Spain)

Eskil Persson, SM5CJP  
Frotunagrand 1  
194 00 Upplands Vasby  
Sweden

Francisco José Martin, YV5EBD  
Apto. 64 Prados del Este  
Caracas 108, Venezuela

... Letters continued from p. 100.

Texas Plan. Hundreds of functioning repeaters attest to the feasibility of 600 kHz splits... Probably one FM'er in a thousand has a synthesizer which you claim is a "reality." We have never heard of a crystal manufacturer offering to "shove" crystals that hams might send back to them. We are aware of no indications that good crystals are "much" cheaper nowadays. Commonly-used equipment WILL cover 1.5 MHz spreads with inconsequential performance penalties. 15 kHz spacing obviously provides more channels than does a 20 kHz plan for the relatively few severely congested areas of the country. There certainly is some truth in your claim that 15 kHz spacing creates problems for receiver designers, but isn't it just this sort of frontier that provides the element of technical challenge that is an important facet of ham radio? Simplex operation below 146 MHz, with repeaters up to 147.98, actually requires greater than 2 MHz spreads in transceivers - or are you assuming that these simplex types of hams are completely different people from repeater users? Multiple repeater outputs during changeover is illegal under FCC rules. Our observations (covering numerous areas of the country) indicate that, nationwide, simplex operation constitutes more like 40-50% than the 5% you guesstimate.

Terry A. Philpott KØEGW  
Charles A. Fenwick WØFTM  
Alvin H. Groff KØVQM  
Donald K. Grimm WAØWJM  
Cedar Rapids IO

While I have no desire to get into hassles over one meg splits and 20 kHz vs 30 kHz separation, I do feel a responsibility to bring these questions before the readers. When I have come to the point where I am deciding what everyone should do - and start censoring ideas and preventing their publication - then my usefulness will be diminishing. On this basis I am at odds with you, for I gather that you are opposed to anyone even thinking about ideas that you do not agree with.

Re ashcanning consensus - to the contrary - it appears to me that the consensus was arrived at by everyone considering all of the factors involved. Now, if we have other factors emerging, I see no reason why a new consensus cannot be reached. We've proven that we can agree - and we have no proof that we cannot introduce changes into our agreements.

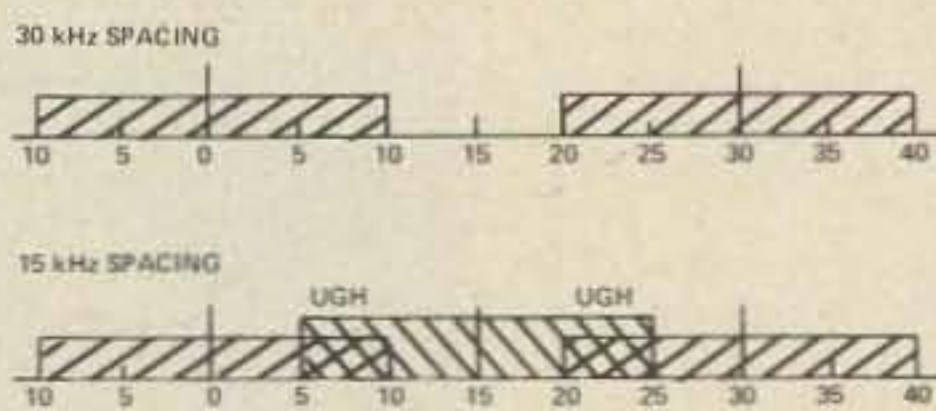

The pattern that I see emerging is one which will be straining the consensus - and this is what must happen when the consensus no longer is adequate. In areas where the 600 kHz channels are all occupied on a 30 kHz separation basis we see more and more 15 kHz splinters and more and more one meg splits. The fact is that the consensus was fine as long as it provided enough channels - and it

worked perfectly in most areas. Once the consensus no longer works it is ignored.

Now, on some of your other comments - synthesizers are beginning to arrive. We have two on test at 73 and more are coming - they will be a factor eventually. Crystals? Excellent crystals are available for virtually every ham transceiver for under \$4. The 15 kHz receiver problem will take more than new designs. Using the present 5 kHz deviation standard, this means that our signals are double that on each side of the zero frequency - 10 kHz each side. This results in a guard band of 10 kHz between channels if you are to have no interference from an adjacent repeater. It is possible at present to produce filters which will accept the 20 kHz wide FM signal, and still reject signals from beyond that, to the extent that even a strong repeater just 10 kHz outside of the desired passband is not heard. Fine - but now if we have the repeaters every 15 kHz this means that there will be an overlap of 5 kHz which is being transmitted within the receiver passband. If we changed to a 2.5 kHz deviation, we might be able to live with splinters. Simplex? It varies a lot. In hilly country it is almost nonexistent - in areas served by sufficient repeaters it is scant - but in flatland, away from the major urban areas, there is still a good deal of simplex - possibly the 40% you mentioned. I too oppose regression and chaos - and consensus is the answer - but we are getting away from consensus now and we need an exchange of information to get us back together, so please don't try to stop communication, even if you happen to disagree with some of the arguments... wayne.

... W2NSD/1 continued from p. 124.

company to settle for about one half of the cost of replacing the stolen stuff, even though the amount of the insurance far exceeded the claim.

It took several months to send for copies of the receipts for everything to substantiate that it had been purchased and for how much. The company tried to get out of the deal entirely by pointing to a fine print paragraph saying that the insuree had to be at least 80% insured, or else zilch. This required a complete inventory of all possessions and papers showing their value - to prove that the home was not under or over insured.

And so it went.

It may be a pain to sit down and read the fine print, but if you don't want to face years of weaseling, you'd better get out the magnifying glass. It can be most frustrating to find that you have been giving your premiums to the insurance company and have had no protection.

Many amateurs would like to know the least expensive way of covering

their ham gear - at home - in the car. Perhaps one of our more knowledgeable readers in the insurance business can pass along this information. I think we'd like to know about being protected against theft, floods, storms, and such.

A sudden windstorm can come along and whomp down your tower, demolishing the tower, beam, rotator, and perhaps pulling the coax enough to ruin the rig too, running the bill up to perhaps \$1000.

That puts me in mind of the time that a ham magazine editor, who shall remain nameless so I won't get sued, was out visiting a girl friend and his mobile rig was stolen. He didn't dare make a fuss because he was afraid that his wife would find out where he had been.

### 73 FEB COVER CONTINUED

I see where Time Magazine got into a hassle with a "sexy" cover and 350 of their 4 million plus subscribers cancelled in indignation. The newsstand sales for that issue increased by 54,000 copies. HmMMM.



Beware that circuit in the March issue of QST wherein the voltage on the phone line is used to hold in a relay. The phone companies are NOT going to like you doing this. They are not going to like it a whole lot.

Beware too the almost wholly misleading article in the January QST wherein there is a supposed explanation of how to calculate the antenna height above average terrain. The author, WA1NXG, could hardly be more misleading. Do NOT use the system in the article of getting FM broadcast station data as the FCC has specifically refused to accept this data. Instead, follow the ultra-simple instructions in the docket (see page 112, November 1972 issue of 73). Congratulations of some sort would seem to be due ARRL for not only publishing a totally misleading article, but then following it up with a subsequent award to NXG for the bum dope.

WAYNE

# 2 Meter FM THE BIG THREE FOR '73!

## GTX-10

10 watts output power nom.; accommodates 10 channels; rotatable frequency selector; adaptable for portable operation (with HamPak, below).

**\$199.95**

(Includes 146.94 MHz)



## GTX-2

30 watts output power nom.; accommodates 10 channels; push-button frequency selection; back-lighted for night operation.

**\$249.95**

(Includes 146.94 MHz)



## GTX-200

30 watts output power nom.; accommodates 100 channel combinations; features independent selection of transmit and receive frequencies, and switch for pre-selected pairing.

**\$259.95**

(Includes 146.94 MHz)



## HamPak

Battery pack for GTX-10 portable operation. Uses 10 D cells (not included).

**\$39.95**

(Includes portable antenna, carrying handle & mike clip)



**\$6.50**

Additional  
Crystals  
per crystal  
for Xmit or receive

Made in U.S.A.  
In Facilities Inspected by U. S. Gov't.



**VISIT YOUR LOCAL AMATEUR DEALER  
AND MEET THE "BIG THREE" IN PERSON!**

General Aviation Electronics, Inc., 4141 Kingman Drive, Indianapolis, Indiana 46226 — Area 317 - 546-1111

**MIDLAND**  
ELECTRONICS COMPANY

# What are we handing you?

**The most exciting  
2-meter, hand-held  
on the market...  
2-watt, 6-channel**

Now Midland—for years one of the top names in communication equipment—brings you a high performance hand-held transceiver with a suggested price of just \$229.95. What do you get? A full 2 watts output power with automatic deviation control. 6-channel capability with crystals installed for .16/.76, .34/.94 and .94/.94. High performance receiver with mechanical filters, IC and MOSFET front end. Built-in battery/S meter. Compact 9" x 3"

Write for Midland's full-line amateur radio brochure: P.O. Box 19032, Kansas City, MO 64141

DEALERS: inquire about an exclusive Midland amateur radio area franchise



x 1 7/8" size. Jacks for external speaker, microphone, antenna and charge/power. Operation on 8 "AA" cells, ni-cad battery pack or AC power supply (optional). With carrying case, less batteries. Model 13-520

**MIDLAND**  
ELECTRONICS COMPANY  
*"Coming on Strong in Amateur Radio"*

# Give your signals more "Sock - per - watt" ... WITH THESE ANTENNAS FOR 2 METERS from "HAM HEADQUARTERS, USA"® made by the antenna specialists co.

## FOR MOBILES

5/8 wave, for far greater gain over 1/4 wave whip! 56" overall. VSWR 1.5:1 or better over full 144-148 MHz range. Waterproof, shock resistant plastic encased base coils. 100 Watt rating. Stainless steel springs and whips, nickel over copper coated for higher conductivity, less heat loss of RF. Complete antenna unscrews for car wash, or stowing.

Prices include 17 foot 58/U coax cable with PL259 connector attached.

### Two easier-to-mount series:

**SNAP-IN** - Drill a 3/8" hole in roof, fender or trunk. Push mount into hole. A snap, and it locks permanently in place!

**NO HOLE** - The proven, practical answer to no drilling! Two concealed set screws securely fasten this mount to edge of trunk lid.

#### DELUXE

Shunt fed. Fittings chrome plated brass. Solderless coax connectors. SNAP-IN.  
HM-177 \$30.79  
NO HOLE.  
HM-178 \$34.29

#### NEW, LOW PROFILE!

Teflon insulated, aluminum plated steel mount. Only 1-3/16" high!  
SNAP-IN.  
HM-179 \$23.99  
NO HOLE  
HM-180 \$27.39

#### FOR HAND HELDS

Only 6-1/4" long. Rugged, for roughest handling! Bendable, completely insulated, cannot be shorted out.  
HM-4. With 5/16-32 base to fit Johnson and Motorola. \$6.09  
HM-5. With PL-259 base. \$6.09

#### CHARGE IT!

On your Master Charge, or Bank Americard  
Spread payments up to two years.

#### PROMPT ORDER DEPT.

We carefully pack and ship ham gear, accessories and parts to most any part of the world.  
Address your orders to:  
**18 SMITH STREET**  
Farmingdale, N.Y. 11735  
Or - Phone your orders to  
**(516) 293-7990**

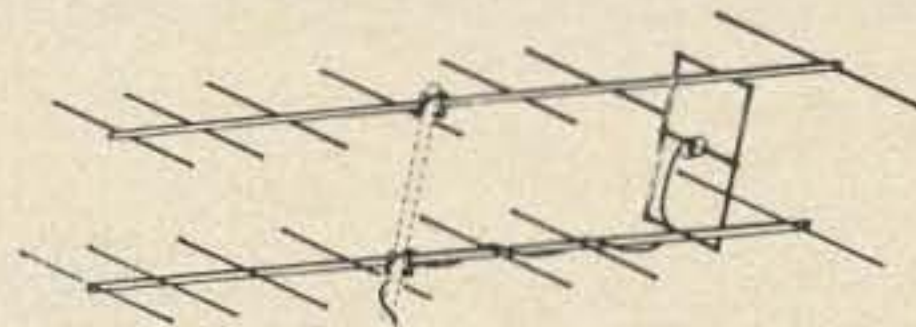

## FOR BASE STATION

Use these high performance beams, to concentrate your talk-power and squirt it for long haul! Covers full 144-148 MHz without retuning, with VSWR less than 1.5:1. Rugged construction, rated to 100 MPH winds. 2KW PEP. 50 Ohm for coax feed.

#### HM-172

4/4 element stacked Yagi.  
4'x4'x4'. 5.8 lbs. \$30.89

#### HM-173

8/8 element stacked Yagi.  
8'6" long x 3.4" x 3'10"  
9 lbs. \$41.19

### WANT VERTICAL POLARIZATION ?

Use HM-185 vertical mounting kit with either beam. \$7.45.

### GROUND PLANES

Rugged construction, for long life. Have stainless steel radials, to withstand heaviest ice loading. VSWR less than 1.5:1. Rated 100 Watts. Include mounting clamp for up to 1-1/4" OD masts.

#### STANDARD HM-7A

1/4 wave vertical is chrome plated brass + 2 MHz bandwidth \$9.29

#### HIGH GAIN HM-17

1/2 wave vertical, for greater gain. Stainless steel, with nickel over copper coating for greater conductivity, reduced heat loss of RF, Full 144-148 MHz bandwidth. Has receptacle for PL-259 coax plug. DC ground gives lightning protection. \$30.79

### HARRISON IS ANTENNA HQ!

Complete stocks of cable, rotators, filters, connectors, towers and sections, etc. Beams and verticals for all ham bands, commercial, CB, police, etc.

**IT PAYS TO DEAL WITH THE SPECIALIST!**

#### ORDER NOW!

Or, ask for literature

"HAM HEADQUARTERS, U.S.A."®

FARMINGDALE, L.I. ★ NEW YORK CITY ★ VALLEY STREAM

2265 ROUTE 110  
2 miles South  
of LIE exit 49S  
(516) 293-7990

OPEN NITES TILL 9 P.M.

8 BARCLAY STREET  
Near City Hall  
BARclay 7-7922

10 SUNRISE HWY.  
(At Rockaway Ave.)  
(516) 872-9565

OPEN NITES TILL 10 P.M.

# CIRCUITS, CIRCUITS, CIRCUITS...

The following circuits have appeared in the referenced books, magazines, application notes, etc. While we try to reproduce all of the information that should be needed by an experienced constructor, readers may want to avail themselves of the original sources for peace of mind.

Readers are requested to pass along any interesting circuits that they discover in sources other than U.S. ham magazines. Circuits should be oriented toward amateur radio and experimentation rather than industrial or computer technology. Submit circuit with all parts values on it, a very brief explanation of the circuit and any additional parts information required, give the source and a note of permission to reprint from the copyright holder, if any, and the reward for a published circuit will be a choice of a 73 book. Send your circuits to 73 Circuits Page, 73 Magazine, Peterborough NH 03458.

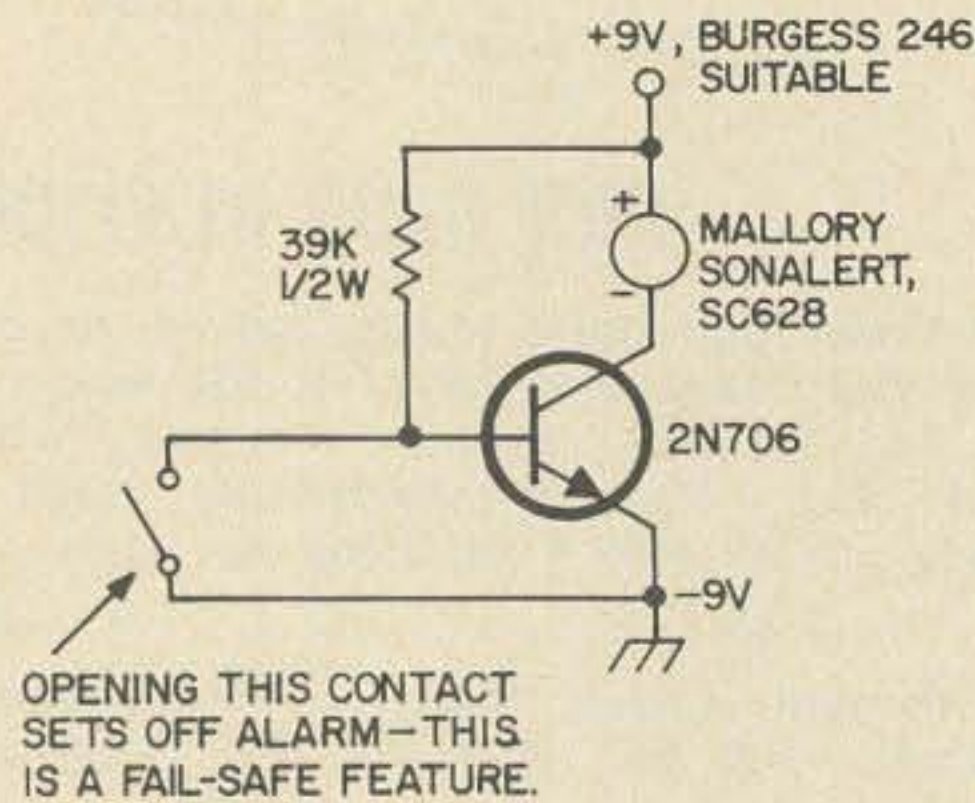

This is a circuit of a loud, low current burglar alarm. Since it operates from a small 9V battery it can be tucked away in a corner and virtually forgotten. Thanks to WB2BDF.

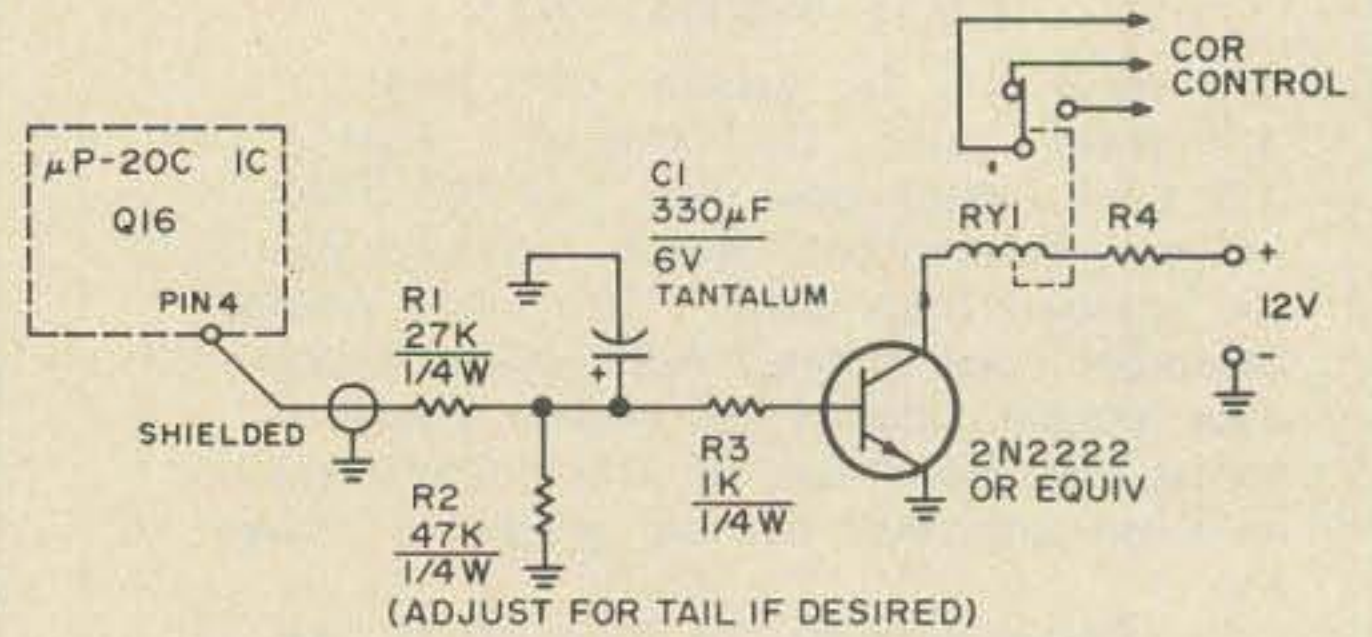

Schematic of a COR circuit for the TR22. R4 must be adjusted to keep the collector current of the transistor less than 750 mA. The value is dependent on the relay resistance. The R2/C1 combination controls tail time. The values shown will not respond to quick button pushers also. Thanks to W1WJR.

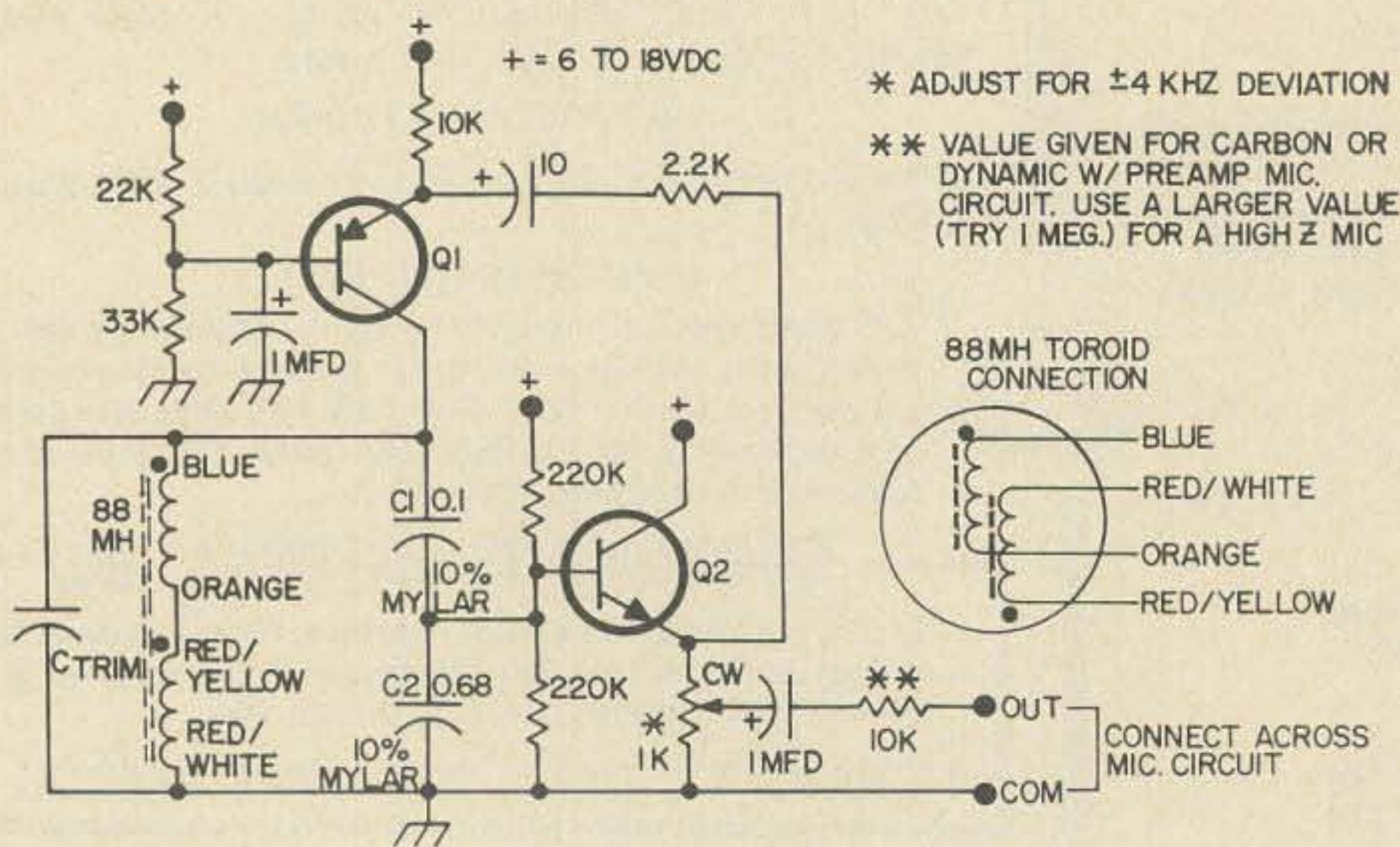

1800 Hz command oscillator for FM. Q1 — any PNP small signal transistor having a  $V_{ce}$  rating of  $1\frac{1}{2}$  or more times the supply voltage. Some suggestions: 2N404, 2N1303 series, 2N2904 series, 2N3638, 2N6516 series, or 2N6533 series. Q2 — Any NPN small signal transistor having a minimum beta of 100 and a  $V_{ce}$  of at least the supply voltage. Some suggestions: 2N1308, 2N2712, 14, 16, 2N2916, 18, 20, 2N3565, 2N3569, 2N6513, 14, 15, 20, or 21. Ctrim — 0.0062  $\mu$ F was used in the first unit. If the mylar capacitors and the toroid are  $\pm$  values,  $f_1 = 1817$  Hz. If C1 is 10% low,  $f_2 = 1897$  Hz. If C1 is 10% high,  $f_1 = 1741$  Hz. To find a value for Ctrim, measure the frequency ( $f_1$ ) without Ctrim. If it is higher than 1800 Hz ( $f_0$ ) calculate Ctrim.  $C_{trim} = 0.1[(f_1/f_0)^2 - 1] = F$ . Thanks to WA0IKY.

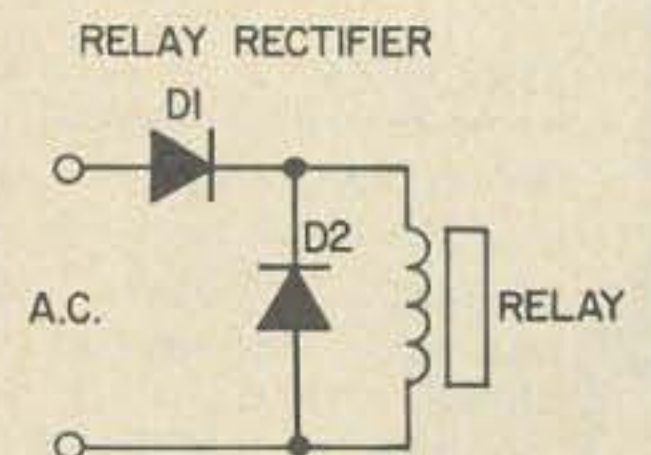

By the use of the circuit shown, it is possible to power a direct current relay from an alternating current source, with NO relay hum or chatter. D1 rectifies the ac in a normal half wave configuration, while D2 will slow down the collapse of the relay coil magnetic field to a point where the relay armature does not start to drop out before the next half wave of current is applied. Thanks to WA6JMM.

# AND EVEN MORE, MORE, MORE, CIRCUITS, CIRCUITS, CIRCUITS...

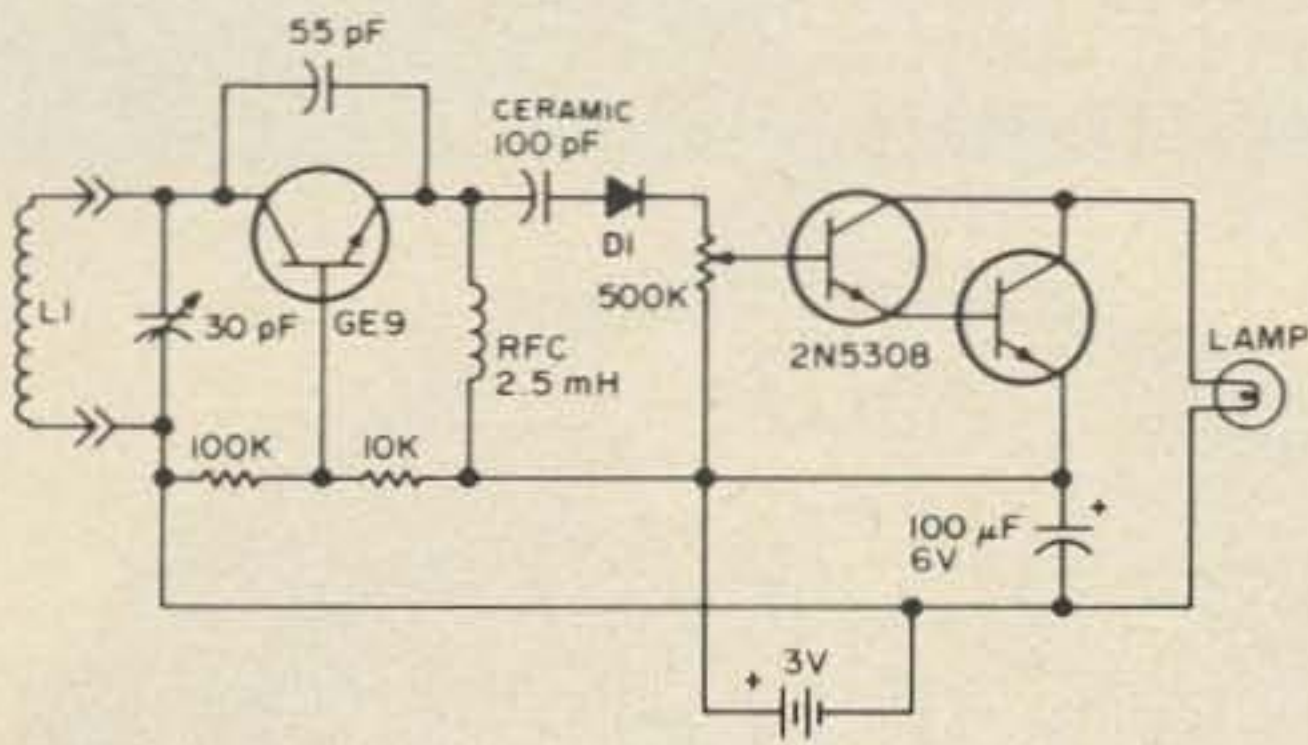

A simple "grid dip" meter that uses a bulb as a resonance indicator. Using the GE9 transistor will enable the unit to oscillate up to 12 MHz. The indicator lamp should be a No. 48 or 49 bulb. L1 should be wound to cover your desired frequency ranges.

VE3ECU

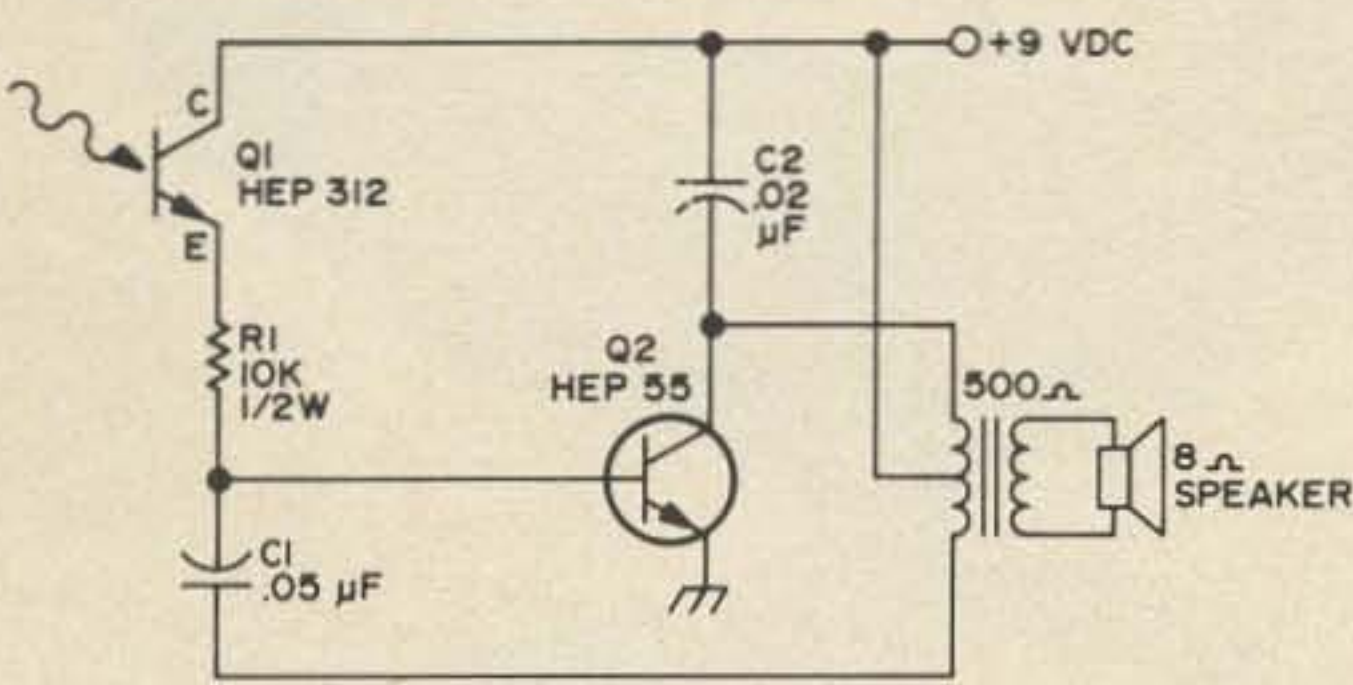

Light triggered tone oscillator that can find numerous applications as a burglar alarm, fire alarm or even to let you know that the sun has come up and it's time to turn off the rig and go to work. Courtesy Motorola Construction Projects HMA 37.

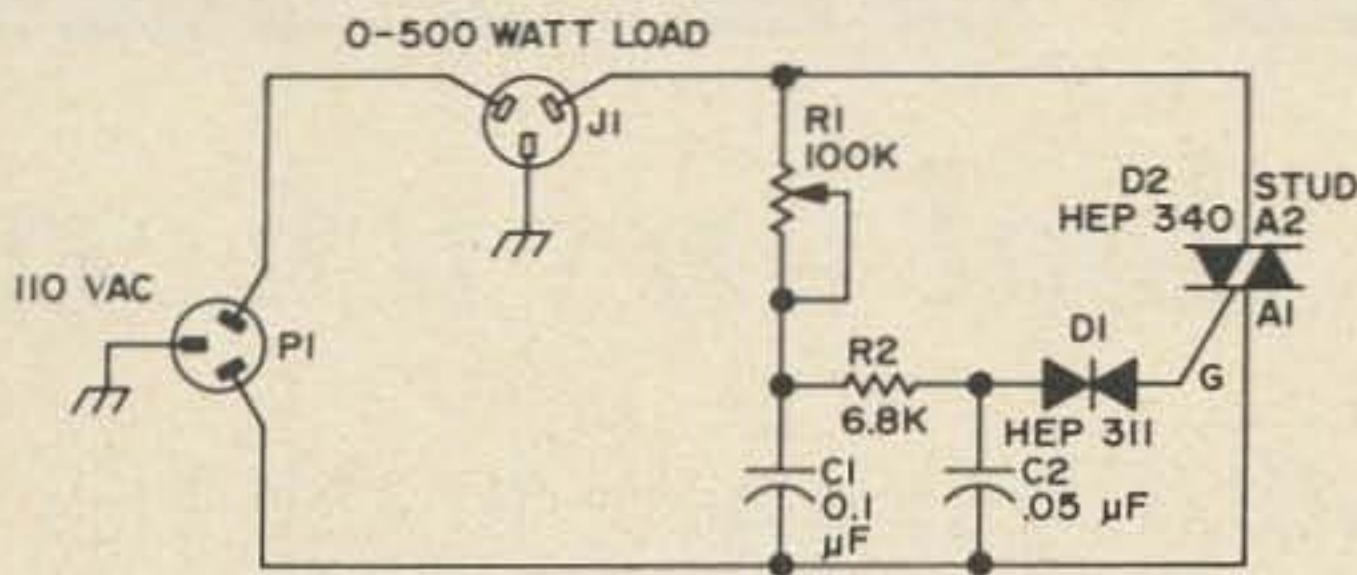

ALL FIXED RESISTORS = 1/2W  
ALL CAPACITORS = 200V PAPER

Light dimmer/motor speed control. This circuit is able to control the voltage on loads up to 500 watts. Courtesy of Motorola Construction Projects HMA 37.

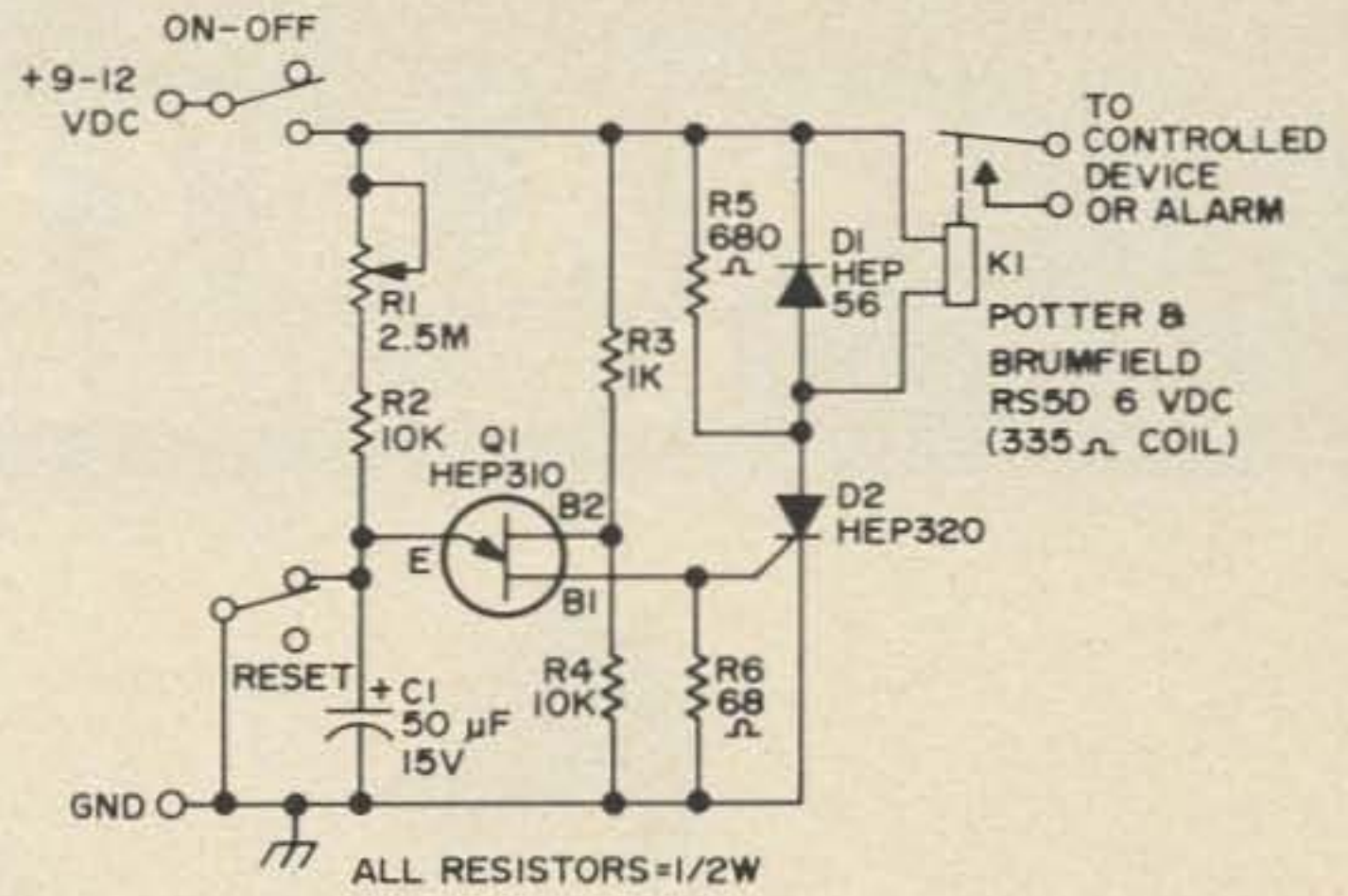

An electronic timer that can be set from 2 seconds to several minutes. This can easily be incorporated into a repeater's control system or even (Heavens!) the XYL's kitchen. Courtesy Motorola Construction Projects HMA 37.

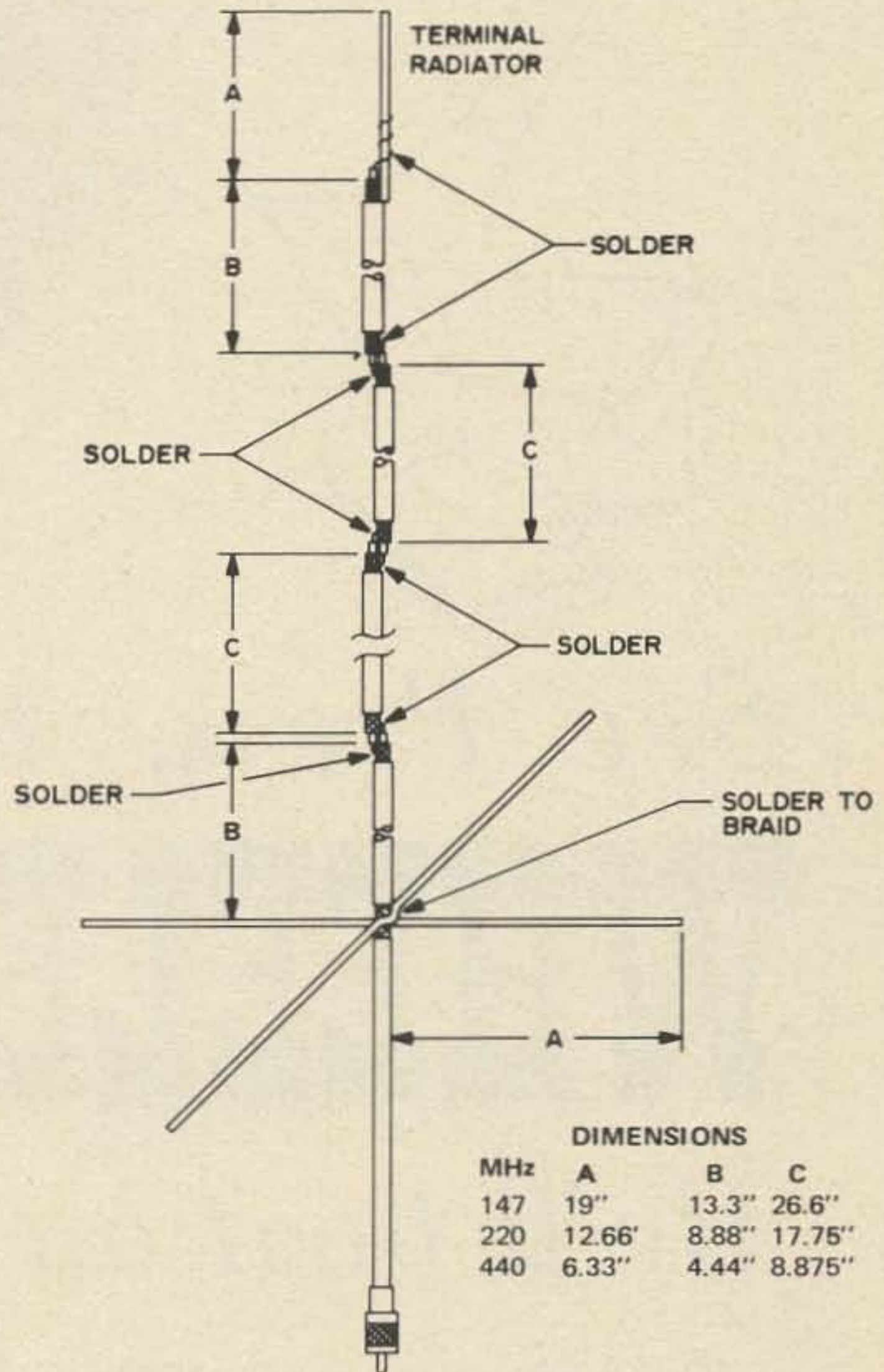

Omnidirectional gain antenna for FM home or repeater use. The sections are constructed of measured lengths of RG-8 coax and are connected at the junction points by soldering the center conductor of one to the braid of the other and vice versa. The terminal radiator and radials can be lengths of stiff brass rod. A total of 9 "C" sections will give about 5.8 dB gain over a dipole.

# "HAMTRONICS" IS

A DIVISION OF TREVOSE ELECTRONICS

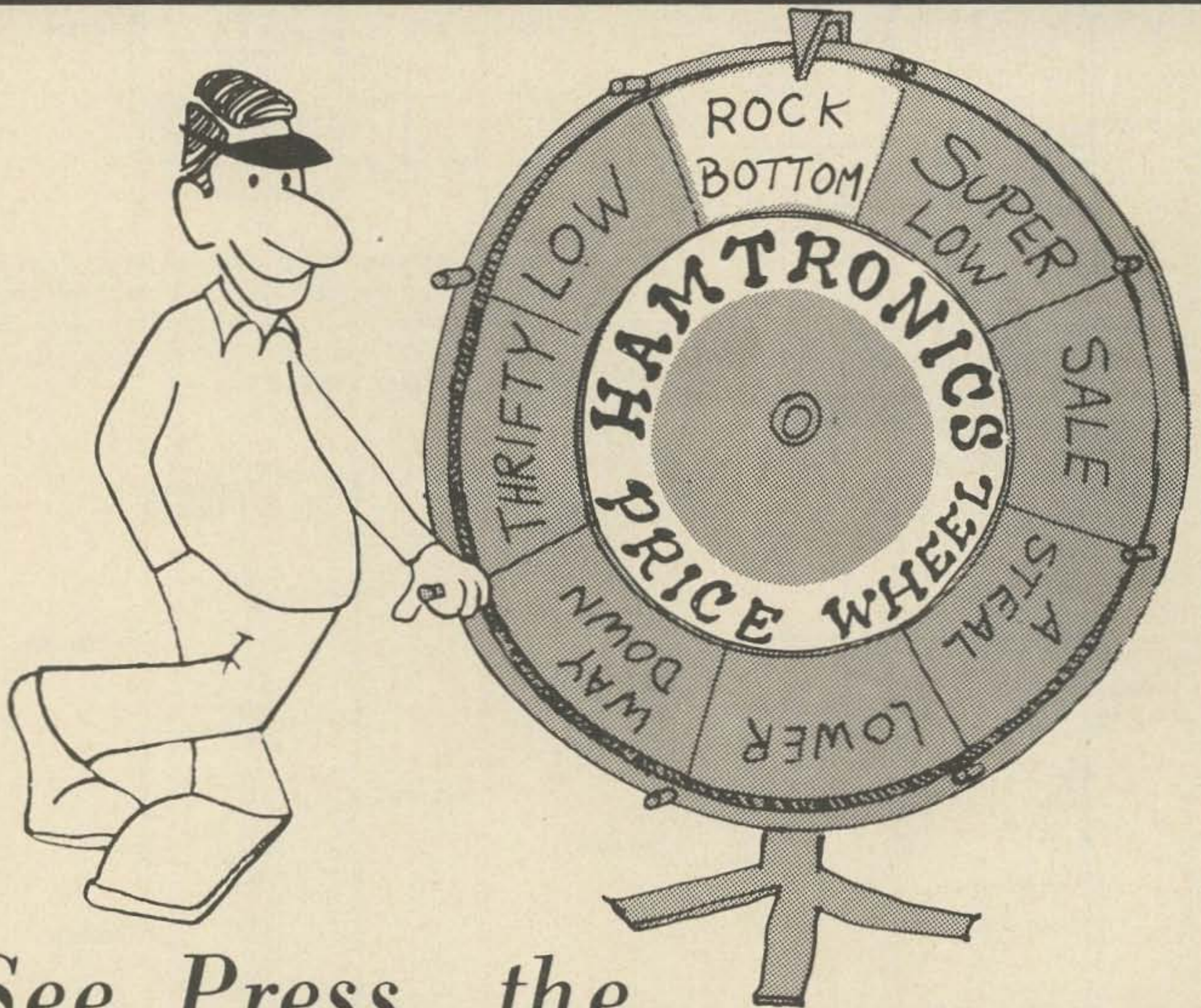

*See Press, the...*

## **WHEELER DEALER**

*He'll beat any deal anywhere!*

Telephone us at NO CHARGE anywhere in the U.S.A.

Send us a copy of your telephone bill and we'll send you a check.

**PLUS**, we ship **FREE** anywhere by U.P.S.

**4033 BROWNSVILLE RD., TREVOSE, PA. 19047**



# FM HEADQUARTERS!

## MAKE A DEPOSIT...

**\$4.95**  
Each,  
all Crystals.

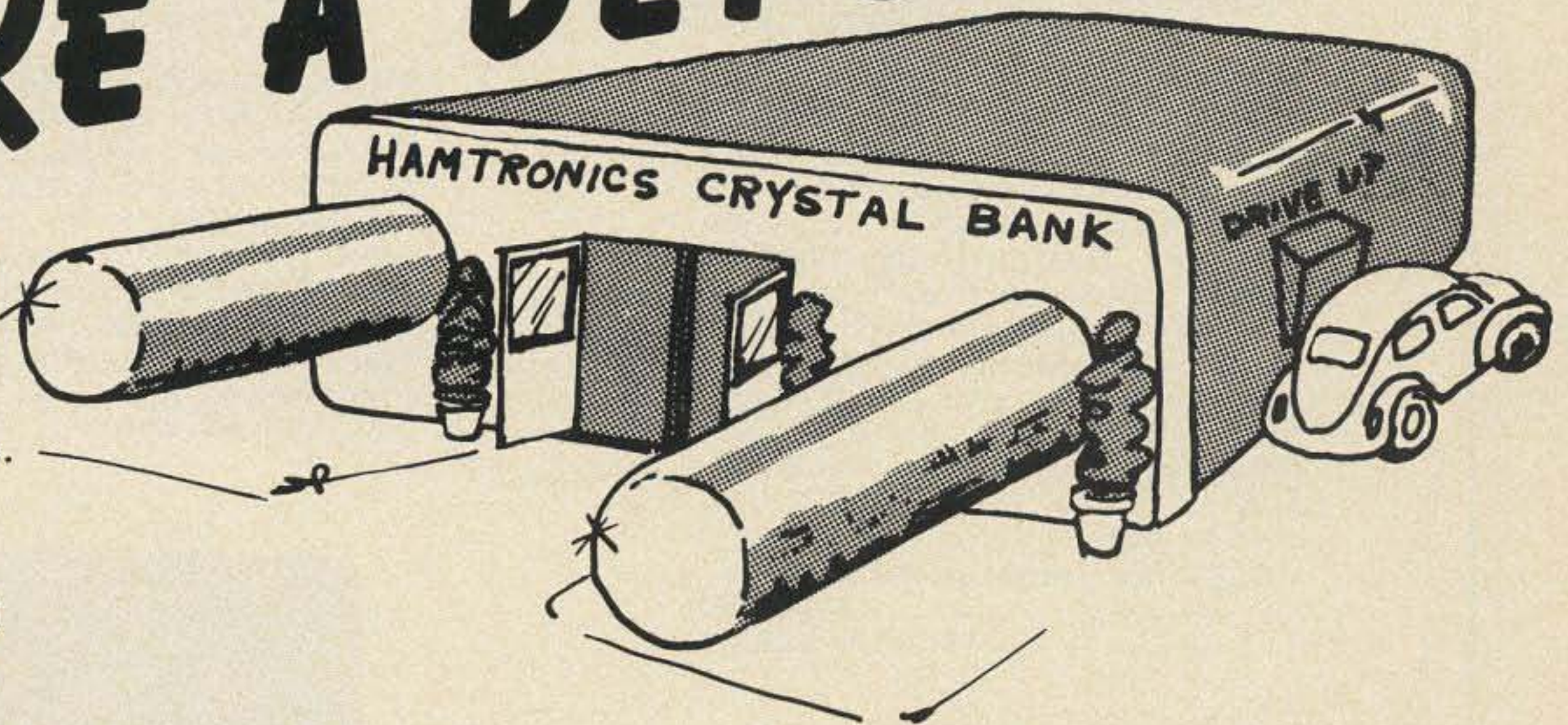

**IN THE**

## **HAMTRONICS CRYSTAL BANK!**

\$30,000 worth of crystals are in the crystal bank. Buy a crystal now. If you need to change frequencies later we'll swap.

Now there is no chance of you ever having outdated crystals. Make a deposit in the Hamtronics Crystal Bank today.

# **\$100.00 Reward**

**WANTED DEAD OR ALIVE!**

\$100.00 will be paid to anyone in the U.S.A.

showing that he can get a **BETTER DEAL**

than he can at Hamtronics.

See Press for the **LOWEST PRICES** anywhere

in the U.S.A.



(215) 357-1400

**PHONES**

(215) 757-5300

when you think CW...

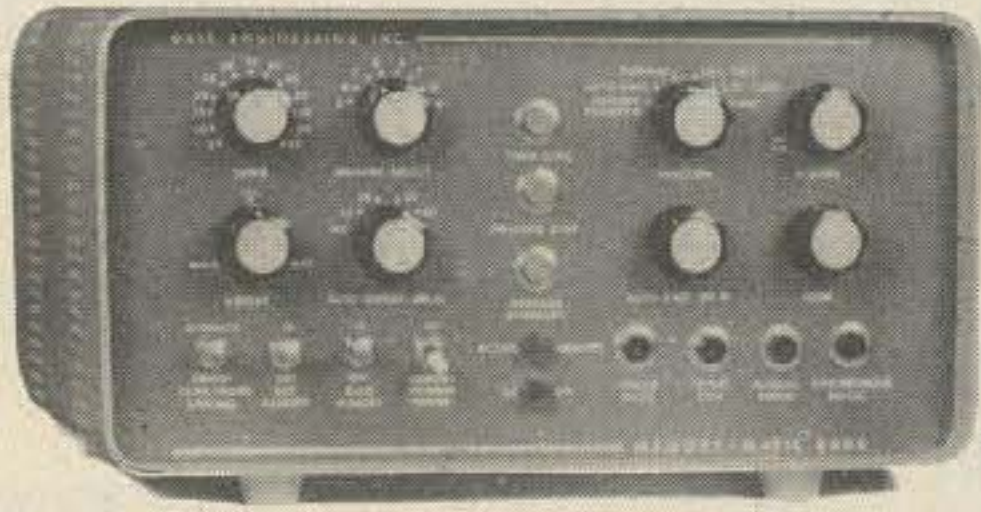

**MEMORY-MATIC 8000 DELUXE**  
Capacity for 8000 bits in 8 Read/Write Pluggable Memories. Each memory can store either a single message or a number of sequential messages. Near-full and Overload alarms. "Message Stop" for char. insertion. "Full Control" weight ratio, message interrupt switch, var. trans. delay, 115/220V ac, 50/60 Hz, incl. SM-21B and MST-60 features. Sh. wt. 8 lbs. (Incl. 3-500 and 1-1000 bit memories.) ..... \$398.50  
Additional Memories, 500 bit for ..... \$21.50  
..... 1000 bit \$37.50



**MEMORY-MATIC 500-B**  
500 or 800 bit R/W memory. Stores either a single message or a number of sequential messages. "Message Stop" for char. insertion. Near-full and Overload alarms, remote control for Stop/Start of message. Incl. SM-21B features. Sh. wt. 4 lbs. (500 bit memory) ..... \$198.50  
(800-bit memory) ..... \$219.50

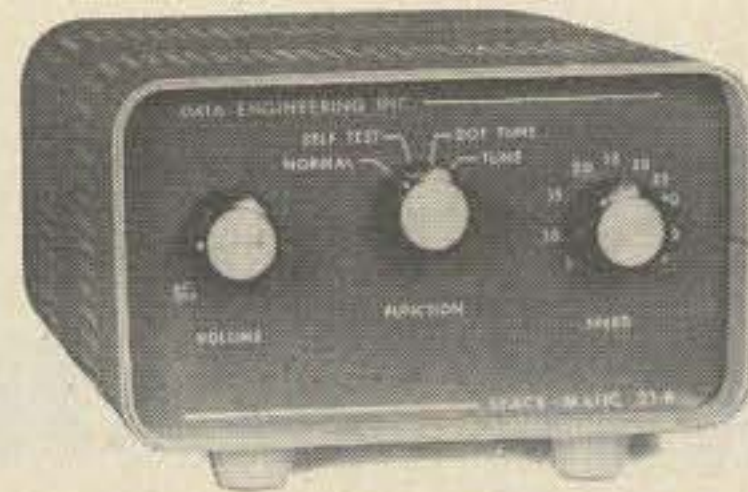

**SPACE-MATIC 21-B**  
This SWITCHABLE keyer gives you "eight-keyers-in-one." Rear switches can delete dot or dash memories or char./word spacing. Instant start, self-completing dots, dashes and char./word spacing. Adj. weighting, sidetone/speaker, dot-dash memories, lambic, 115V ac or 12V dc (SM-21B only.) Sh. wt. 4 lbs ..... \$89.50

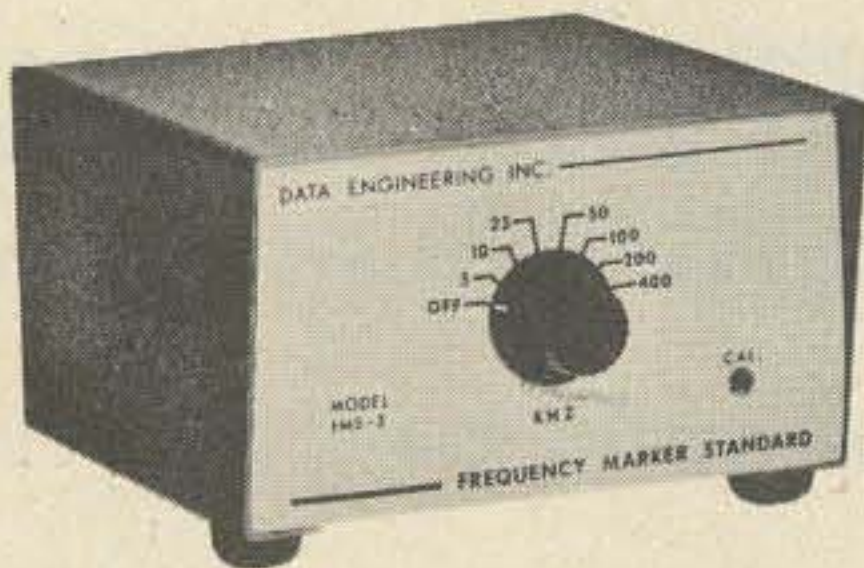

**HF FREQUENCY STANDARD - FMS-3**  
Markers at 5, 10, 25, 50, 100, 200 and 400 kHz. 400 kHz crystal. No unwanted markers. Latest low-power ICs. Osc. and output buffered. Sh. wt. 2 lbs (Less Batteries) ..... \$32.95

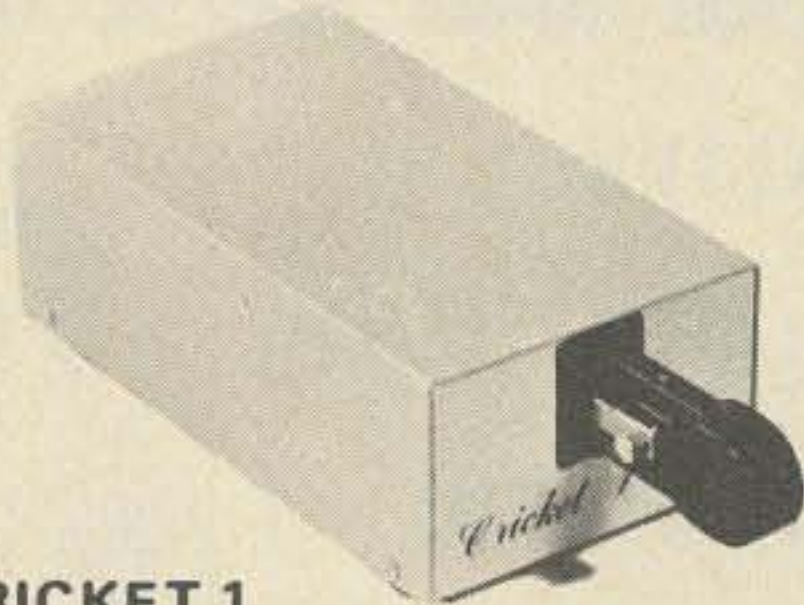

**CRICKET 1**  
The "feature-packed" moderately-priced keyer! Keyed time base, jam-proof spacing, sidetone/speaker. Rear controls for weight, speed, volume, tone, auto-semi-auto., tune. 115V ac or 12V dc. Sh. wt. 3 lbs. .... \$49.95

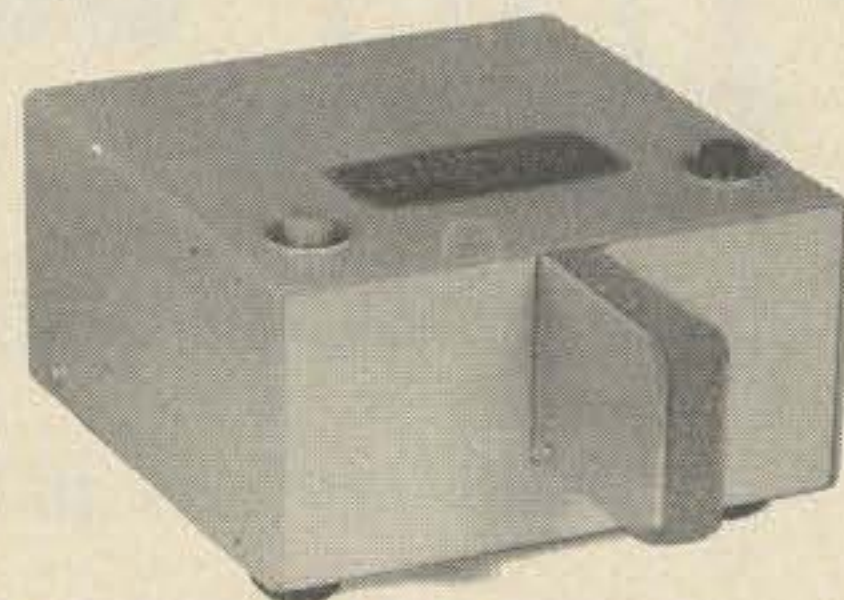

**ELECTRONIC FEATHER TOUCH KEY**  
A completely solid-state key. Detects mere touch of finger. Use as single or twin lever key. Operates with all positive or negative ground digital keyers. Sh. wt. 2 lbs. .... \$22.95  
(Remote S/S Swts. for MM-500B and MM-8000) ..... \$27.95

think Data Engineering

# EXCITING NEW FM PRODUCTS

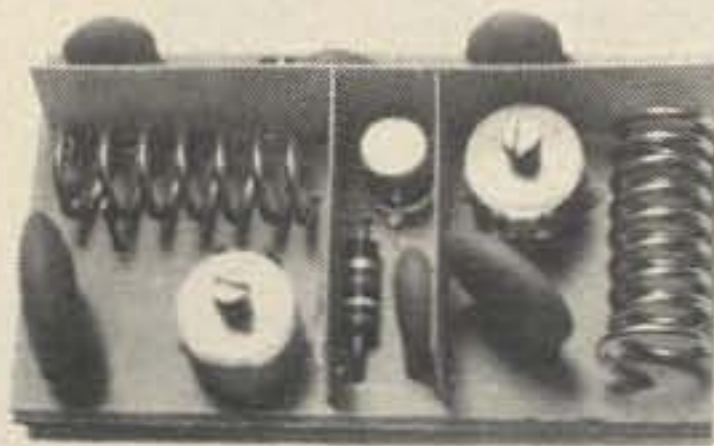

## 2-METER PREAMP

..... \$9.50 Kit  
 ..... \$12.50 Wired  
 20 dB Gain, 2.5 N.F. 12V dc, Size 1" x 1 1/4" x 1/2". Diode protected MOSFET. 90-day guarantee. Sh. wt. 4 oz. Major Components Separately Shielded.



## TONE ENCODER

Eight pre-adjusted tones. Duration and Output adjustable, PLL circuitry for extreme stability. Choice of continuous or tone burst operation. Tone burst operation requires no batteries. Easy to install. Includes three special single or dual tones. TE8-K Complete Kit

..... \$31.95  
 TE-8 Tone Burst Encoder (1800, 1950, 2100, 2250, 2400, plus any 3 single or dual tones above 1200 Hz.)  
 ..... \$39.95



## TOUCH-TONE DIALER

The electronic touch-tone dialer for home and car. It's safer and more accurate to use than a pad. Memory includes Access Code plus five phone numbers. Numbers easily updated. Built-in monitor. Complete PPT operation with transmitter hold.

TTD-4K (Complete Kit) ..... \$49.00  
 TTD-4 (Assembled) \$59.00

## AUTO-PATCH CONSOLE

This mobile or home console includes all the features you need for complete auto-patch operation. A Touch-Tone Pad; an automatic dialer for sending one access code plus five Touch-Tone phone numbers; a single/dual tone burst encoder adjusted to your choice of frequency above 1200 Hz, and a built-in motor. Complete PTT operation with one second transmitter hold.

APC-4K Complete Kit ..... \$84.50  
 APC-4 Assembled . \$98.50

## PAD-PULSER

Now you can also obtain pulsed operation from your Touch Tone Pad. Convert Touch-Tone frequencies to decimal pulses at 2805 Hertz with just a flip of the switch. Option can be added to TTP-2/K, TTD-4/K and APC-4/K.

PP-12K P.C. Board Kit ..... \$22.95  
 PP-12 Assembled . \$29.95

## TOUCH-TONE PAD

In less than 15 minutes you can convert your portable transceiver to Touch-Tone operation.

TTP-1K Complete Kit ..... \$34.50  
 TTP-1 Touch-Tone Pad ..... \$44.50

Assembled in attractive case for home or mobile use. Complete PTT operation with one second transmitter hold. Built-in monitor.

TTP-2K Complete Kit ..... \$34.50  
 TTP-2 (Assembled) \$44.50

## TOUCH-TONE DECODER

A highly reliable twelve digit decoder with input protection, and PLL circuitry for extremely stable operation. Heavy duty output relays, small size, plug-in circuit board. All these major features at an UNBEATABLE price.

TTD-12K P.C. Board Kit ..... \$89.50  
 TTD-12 Touch-Tone Decoder ..... \$129.50



## VHF FREQUENCY STANDARD - FMS-5

Cal. receive and transmit crystals in 10, 6, 2 and 1 1/4 meter FM bands. Markers for all FM channels. Check deviation. Precision 12 MHz crystal. No unwanted markers. Osc. and output buffered. Sh. wt. 2 lbs. (Less Batteries) .. \$44.50



## REPEATER ID

Highly stable oscillator for automatic timing, AC or DC operation. ROM provides for more than 25 characters, more than necessary for DC "any call" RPT. AUX is automatically added to ID if desired when main power is lost. Toneburst operation available.

ID-101K P.C. Board Kit ..... \$49.95  
 ID-101 P.C. Board, wired and tested ..... \$69.95  
 ID-101R Assembled in 1 1/2" rack cabinet \$109.00



## TONE DECODER

Versatile single/dual tone decoder. PLL circuitry for extreme stability. 1 amp output relay can be reset automatically or manually. Monitor position. Adjustable sensitivity. Internal strap selects single or dual tone operation.

TD-2K Complete Kit ..... \$31.95  
 TD-2 Single/Dual Tone Decoder ..... \$39.95  
 (Specify any freq. above 1200 Hz)

5-year guarantees. Send for Catalog



**Data Engineering, Inc.** 5554 Port Royal Road

Ravensworth Industrial Park, Springfield VA 22151

# 2 Meter FM Price Reduced

New lower quantity prices on RF power transistors allows us to offer the same quality transmitter for only . . \$29.95 . .

COMPLETE WITH DRILLED BOARD

NOW ONLY  
\$29.95

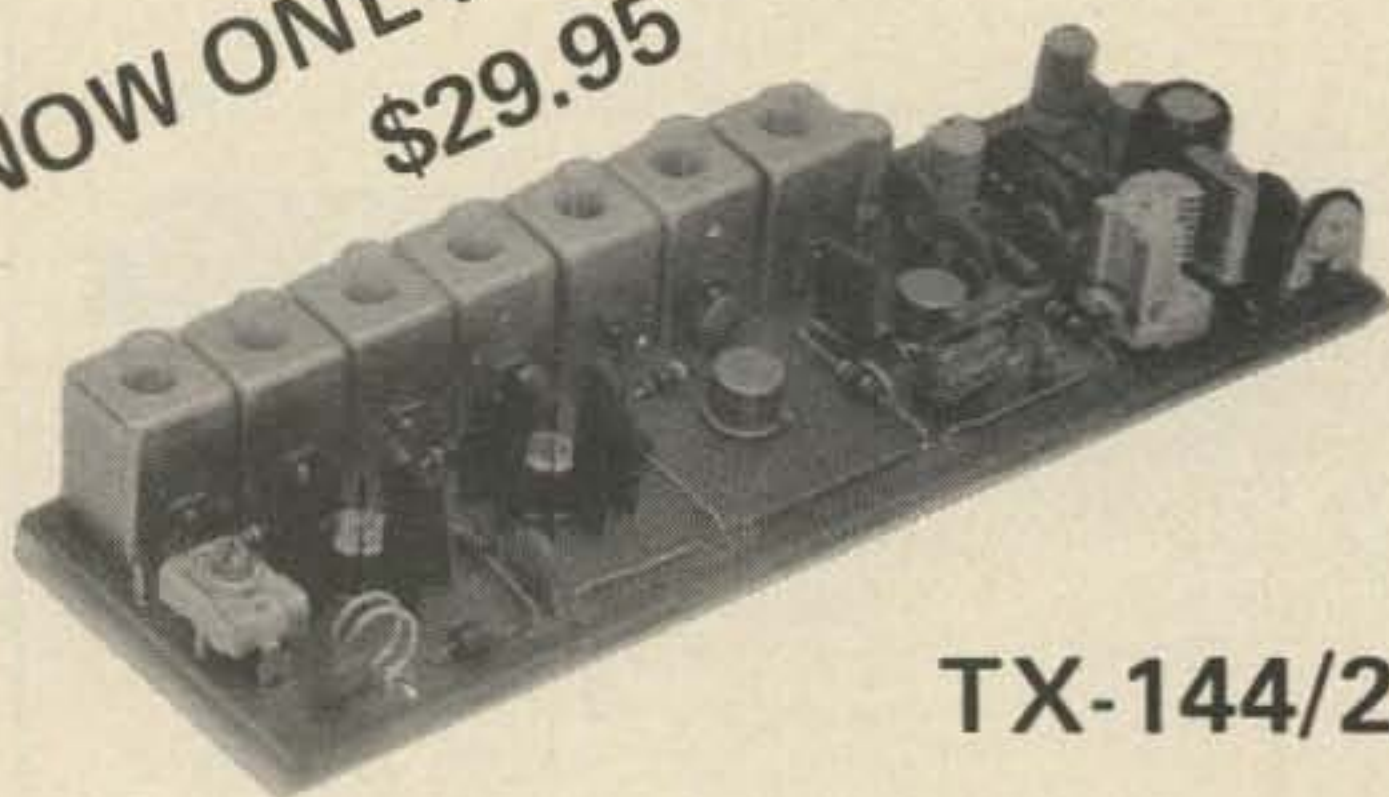

TX-144/220

- TYPICALLY 1 1/2 WATTS OUTPUT AT 12.6 VOLTS (1 WATT ON 220)
- ADJUSTABLE DEVIATIONS TO 10 kHz
- AUDIO CLIPPING AND ACTIVE FILTER
- CRYSTAL NETTING TRIMMER
- DOUBLE TUNED RF STAGES FOR A CLEAN SIGNAL
- STANDARD 12 MHz CRYSTALS (14 MHz FOR 220)
- ZENER REGULATED OSCILLATOR
- PROVISIONS FOR METERING EACH RF STAGE
- PREDRILLED AND TINNED GLASS CIRCUIT BOARDS
- MEASURES ONLY 2" x 6"

A one watt exciter using four RF transistors, two diodes, and one integrated circuit. The RF transistors are operating well below their ratings allowing long keying periods without damage. The exciter may be used alone as a transmitter or with our PA 144 or 220 amplifier for a fifteen watt station.

15 WATT AMP  
\$29.95

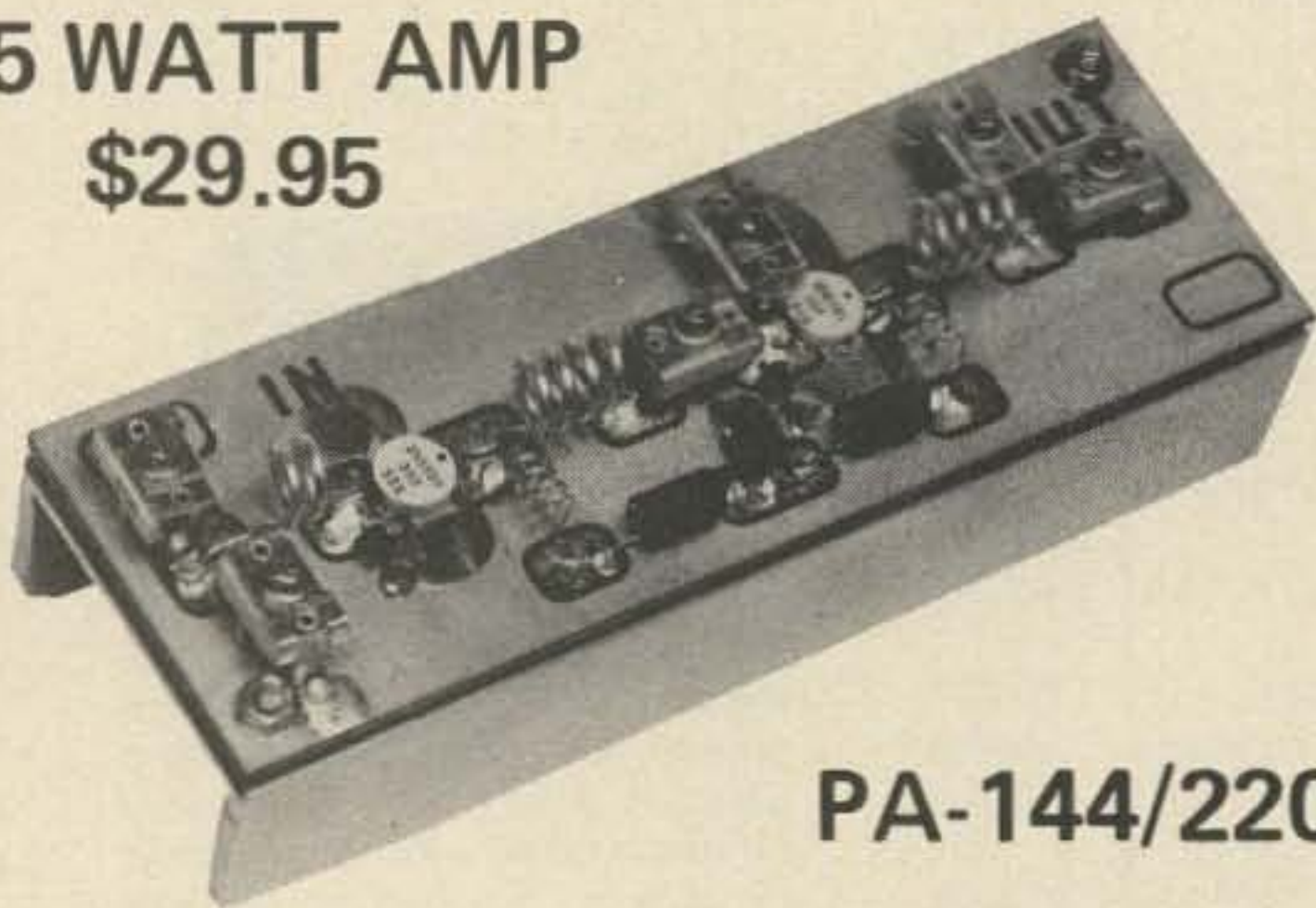

PA-144/220

- 15 TO 20 WATTS OUTPUT WITH 1 1/2 TO 2 WATTS DRIVE. (SLIGHTLY LESS ON 220)
- USES TWO BALANCE EMITTER RF POWER TRANSISTORS ABLE TO WITHSTAND A HIGH SWR.
- TYPICALLY DRAWS 3 AMPS FROM A 12 TO 14 VOLT NEGATIVE GROUND SUPPLY.
- COMPLETE WITH CIRCUIT BOARD AND ALUMINUM HEAT SINK.
- ADD YOUR OWN MINIBOX AND RELAY AND SAVE.

**Note;** We have been swamped with orders. Shipping has fallen back to three to four weeks. We are expanding our facilities and by the time this add appears we hope to cut delivery time to a week to ten days. Please bear with us.

Order TX-144 or TX-220, \$39.95 PA-144 or PA-220, \$29.95. Add 1.00 postage and handling for each kit ordered. New York State residents add sales tax.

BANKAMERICARD



## VHF ENGINEERING

1017 CHENANGO ST. BINGHAMTON NY 13901

"NEW" from

**Antenna  
Engineering  
Company, Inc.**

Box 582 • Wabash, Ind. 46992

# HOTRODS!

## Base & Repeater Mono-skirted Colinears That Beat

### ALL Competition.

FOR VHF & UHF  
COMMUNICATIONS

4.2 DB GAIN  
(6.35 DB Gain  
over Isotropic)

"LITTLE ROD"  
57" Tall  
For 2 Meters.

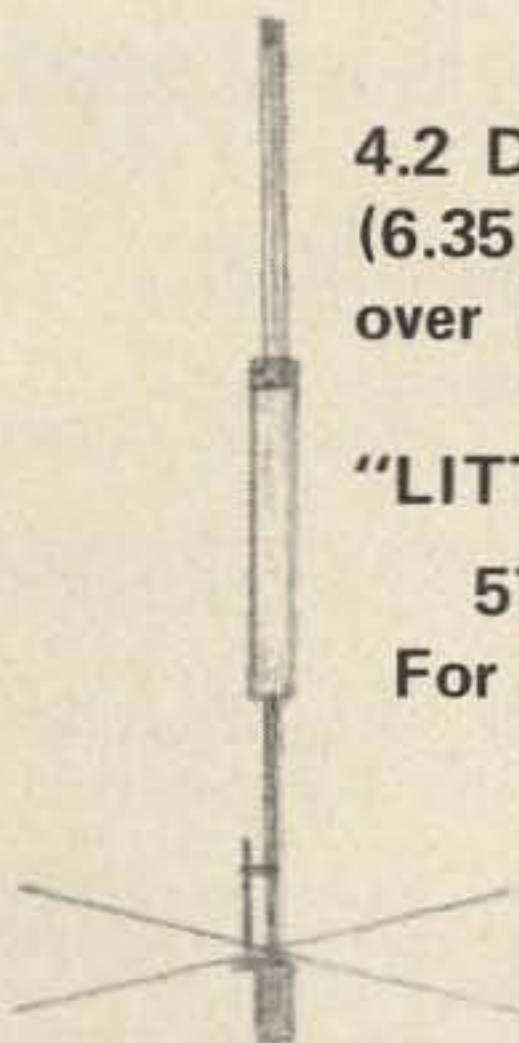

4.8 DB GAIN  
(6.95 DB Gain  
over Isotropic)

"MIDDLE ROD"  
76" Tall  
For 2 Meters.

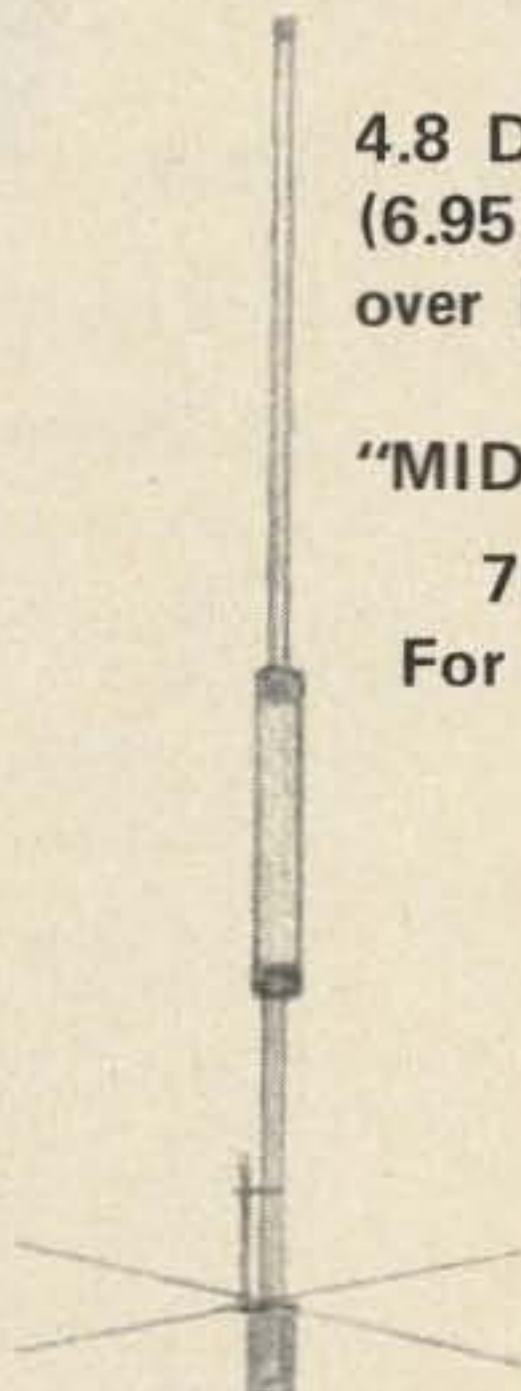

5.3 DB GAIN  
(7.45 DB Gain  
over Isotropic)

"BIG ROD"  
96" Tall  
For 2 Meters.

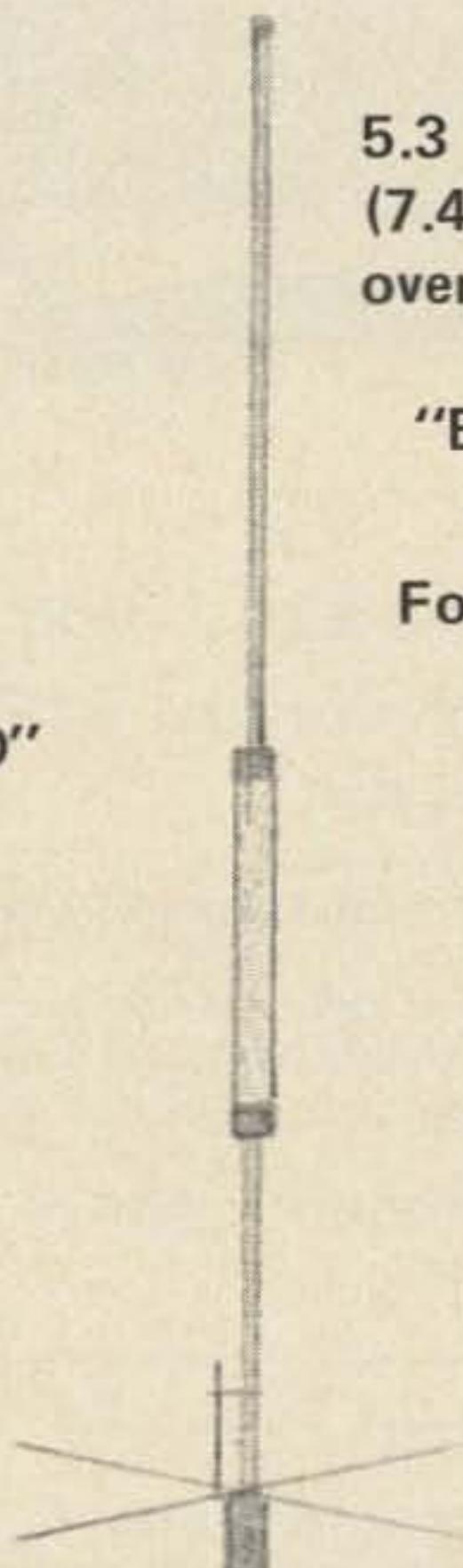

Frequency	Model	Price	Model	Price	Model	Price
140-160 MHZ	150-1	\$12.95	150-2	\$18.95	150-3	\$24.95
220-250 MHZ	220-1	\$12.50	220-2	\$17.95	220-3	\$23.95
430-470 MHZ	450-1	\$11.95	450-2	\$15.95	450-3	\$21.95

### FEATURES:

- 1 1/4" MOUNTING FITS STD. TV MAST • SO239 CONNECTOR
- 6061-T6 HIGH STRENGTH ALUMINUM • SWR TYPICALLY 1.1:1
- .058 WALL THICKNESS • FIELD ADJ. IMPEDANCE, 25 TO 100 OHMS.
- WIND SURVIVAL - 100 MPH • HANDLES 500 WATTS R.F.
- 4 SOLID ROD RADIALS • REACTANCE TUNED TROMBONE GAMMA MATCH • RADIATION PATTERN SUPPLIED WITH EACH ANTENNA • FOR COMMERCIAL & AMATEUR USE.

IMMEDIATE "OFF THE SHELF" DELIVERY ON ALL 150 MODELS!

From \_\_\_\_\_  
 Address \_\_\_\_\_  
 City \_\_\_\_\_  
 State \_\_\_\_\_  
 Zip \_\_\_\_\_ Date \_\_\_\_\_

___ 150-1 @ \$12.95	___ 150-3 @ \$24.95
___ 220-1 @ \$12.50	___ 220-3 @ \$23.95
___ 450-1 @ \$11.95	___ 450-3 @ \$21.95
___ 150-2 @ \$18.95	
___ 220-2 @ \$17.95	
___ 450-2 @ \$15.95	

Add \$1.00 Postage & Handling for Each.

**DEALERS**  
Please Write!

# THE SATISFIERS

INOUE'S 2-METER FM GEAR



IC-22    IC-21  
22 Ch.    24 Ch.  
1/10 W.    1/10 W.



IMAGINE:

On the NEW IC-22 . . . you'll get . . .  
22 Channel Unit for just \$289.00!

- . . . 5 channels supplied
- . . . large built-in speaker
- . . . separate light indicators on squelch break & Xmitt
- . . . quick release mobile mount included
- . . . green back lighting on front panel
- . . . super compact . . . 23/32" X 6" X 8 1/2" 4.5 lbs.
- . . . matching regulated, filtered ac supply available.

On both the 21 and 22 . . . .

Cross channel interference is virtually eliminated with 5 helical resonators in the RF amplifier coupled with 2 i.f. filters to virtually eliminate intermod.

The difference of a truly hot RCVR with INOUE's MOS FET front end providing better than .4µV/20db sensitivity.

With the IC-21 you'll enjoy . . .

24 Channel Base-Mobile Unit for \$389.

- . . . 7 channels supplied
- . . . dual voltage power supplies — 110/220vac power supply and a regulated dc supply.
- . . . p.a. tuning control — allows the power output to be optimized over a wide frequency separation.
- . . . r.i.t. control — offsets the receiver frequency to bring in signals which are not properly calibrated.
- . . . s.w.r. bridge — built right into the front panel is an accurate s.w.r. bridge for 2-meter work. An invaluable aid for vhf antenna experiments.
- . . . discriminator meter — front panel meter allows you to accurately tell if you or other stations in the QSO are on frequency.
- . . . netting switch — this feature allows the IC-21 to listen to itself for calibration purposes.
- . . . modular construction — quicker servicing if needed.
- . . . optional rev. vfo, plug it in and find out what's going on over the rest of the band.

**WARRANTY & SERVICING:** When you buy from the AUTHORIZED INOUE team listed below, you will get the kind of warranty and servicing you can count on, that's backed up by the factory.

See the complete INOUE line at the authorized ICOM dealers listed below.

**ARIZONA**

Ell Dee Enterprises  
1342-A E. Indian School Rd.  
Phoenix, Arizona 85014  
602-942-9715

Sequoia Stereo  
773 8th St.  
Arcata, California 95521  
707-822-0318

**NEW MEXICO**

Robert Foster Sales  
Box 198 Escevosia Star Route  
Tieheras, New Mexico 87059  
505-281-3975

**OKLAHOMA**

Blacks Radio Company  
413 N.E. 38th Terrace  
Oklahoma City, Oklahoma 73105  
405-528-0193

Devlin Electronics  
4817 E. 35th Ct.  
Tulsa, Oklahoma  
918-742-7246

**TEXAS**

Bellaire Electronics Supply  
5204 Bellaire Blvd.  
Bellaire, Texas 77401  
713-667-4294

Electronics Center Inc.  
3939 N. Haskell  
Dallas, Texas  
214-526-2023

Trimble Electronics  
2810 Alexandria  
Tyler, Texas 75701  
214-593-1123

**WASHINGTON**

NHE Communications  
15112 S.E. 44th  
Bellevue, Washington 98006  
206-747-8421

**CALIFORNIA**

ICOM FM Sales  
6234A Fountain Avenue  
Hollywood, California 90028  
213-225-6620

Henry Radio  
11240 W. Olympic Blvd.  
Los Angeles, California 90064

DISTRIBUTED BY:



**ICOM-EAST**

Box 331, Richardson, Texas 75080  
A Division of A.C.S.

**ICOM-WEST**

6232A Fountain Ave., Hollywood CA 90028  
Dealer Inquiries Invited



**Tempo fmh**  
2 watt 6 channel  
S-meter & whip  
**\$189.00**



**Tempo fmp**  
3 watt 6 channel **\$225.00**  
Rechargeable accessory pak  
\$22.00

*See all the Tempo product line, including the fmv 2 & Commercial Line equipment at KASS'*

**\$369.00**



**Standard 826MA**  
12 channels  
10 watt/1 watt output  
16/76 34/94 52/52 94/94

**SBE SB-144**

**\$259.00**



12 channels  
10 watt output  
16/76 34/94 94/94

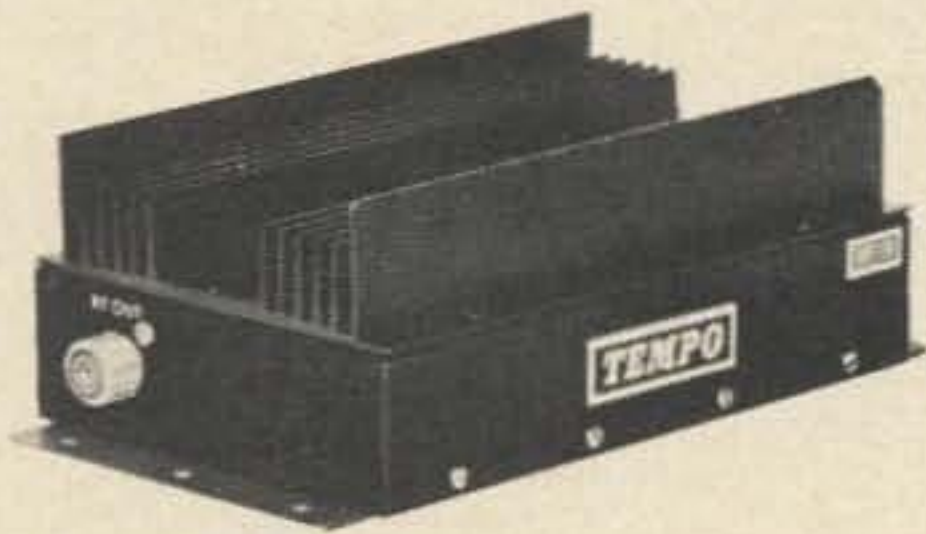

**TEMPO SOLID-STATE AMPS**

MODEL	BAND	IN/OUT	PRICE
1002-3	146	10/125	220
802	146	10/80	180
502	146	10/50	105
502B	146	1/45	130
252A2	146	1/25	85
522	220	10/45	TBA
445-30	450	10/30	215

*SBE / Cush Craft / Hustler / Mosley / Bomar / Drake / Pagel*

*Large stocks of low band too!  
Collins / Drake / Kenwood / Signal One*

**KASS ELECTRONICS**

2502 Township Line Rd.  
Drexel Hill, Pa. 19026  
(215)449-2300 (215)518-6120  
Call and ask for Vince Barr WA3ICS



# The GAM Line

Famous for POWER . . . powerful performance,  
VHF/Antennas ● BASE/MOBILE  
144 to 160 MHz

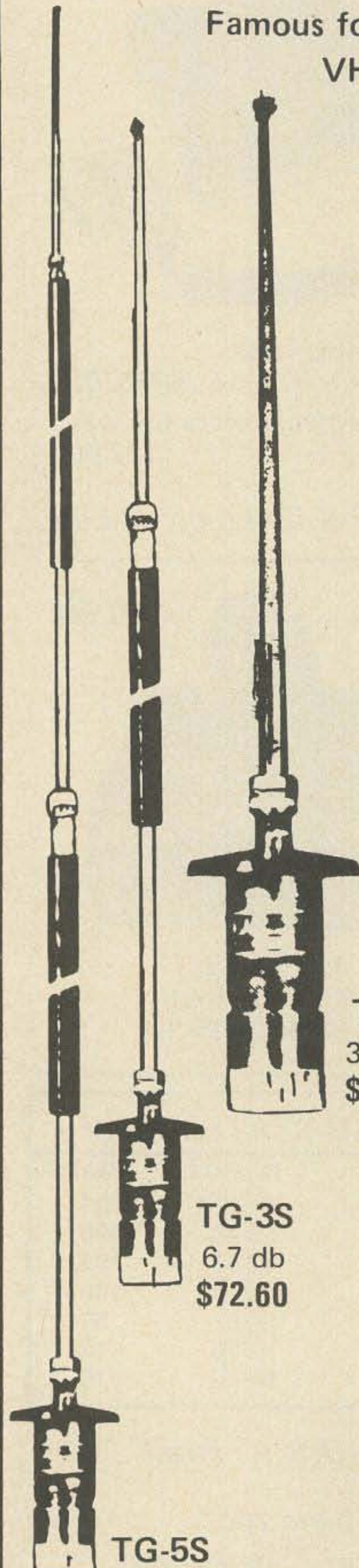

TG-3  
3.7 db  
\$38.75

TG-3S  
6.7 db  
\$72.60

TG-5S  
8.2 db  
\$104.50

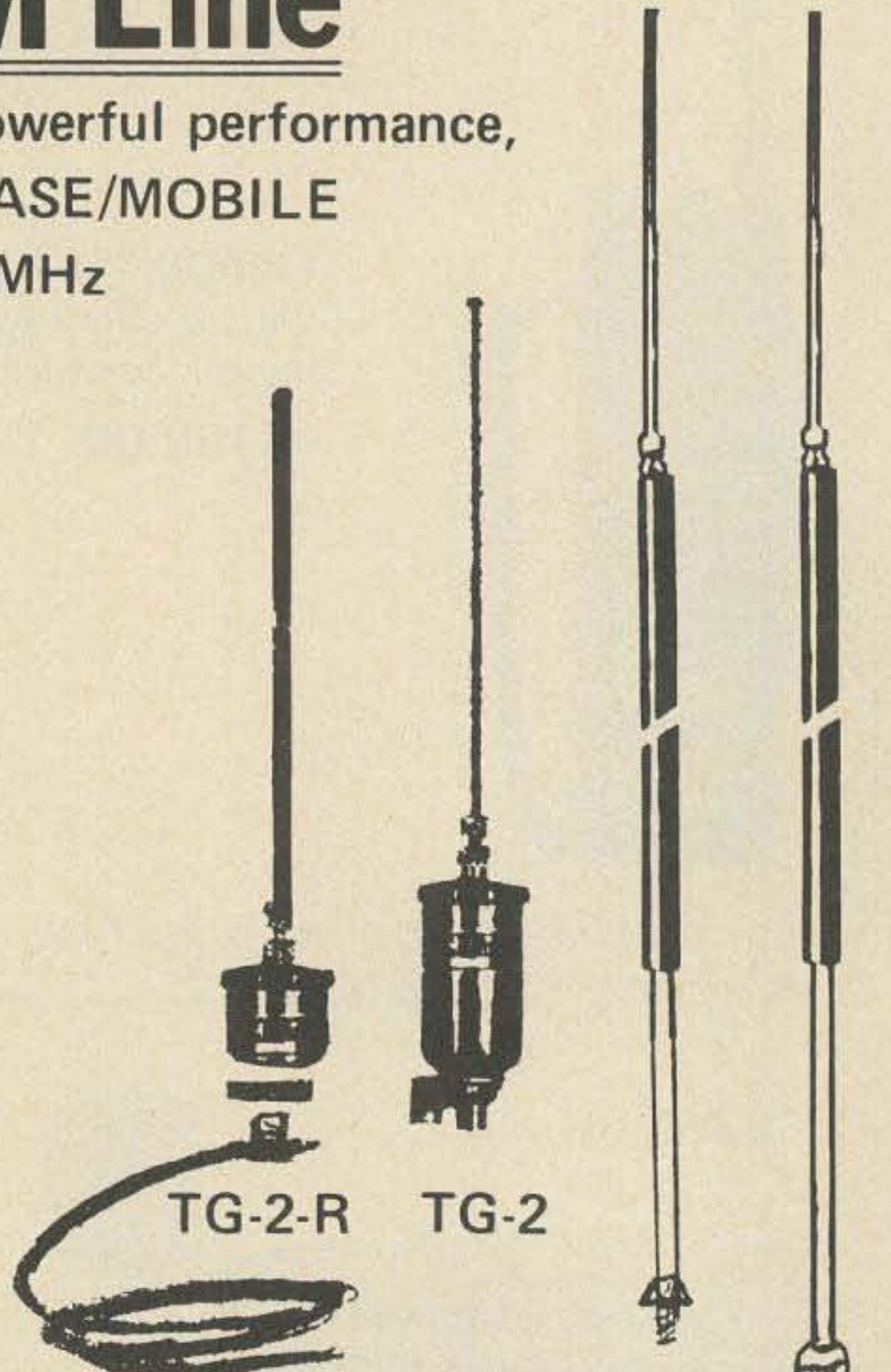

TG-2-R TG-2

MP-34

TG-4-MS

TG-2-R	3.7 db	List	\$33.00
TG-2	3.7 db	List	\$22.05
TG-4-MS	6.7 db	List	\$55.00
MP-34	6.7 db	List	\$34.65

**14.9 db Omni-Directional Gain**

*In System Performance*

(Using the TG-5S and the TG-4-MS)

**GAIN OVER ISOTROPIC RADIATOR**



**Electronics**

191 VARNEY STREET  
MANCHESTER NH 03102  
TEL. (603) 627-1010



# FM 2 Meter UHF 6 Meter USED

GENERAL ELECTRIC . . . RCA . . . MOTOROLA

## General Electric Progress Line 2 Meter Mobile Units

14" case (less accessories & ovens)



**MA/E33**

6/12 volts, 30 watts,  
vibrator power supply

**\$58**



**MT/33**

12 volts, 30 watts,  
transistor power supply

**\$128**

Accessories available for each of above units . . . . . \$30.00

*Just Arrived! General Electric "Message Mates" High Band Receivers with SEL-Call.*

G.E. PROGRESS LINE STRIPS physically complete, but sold on an as-is basis only.

	LOW BAND		VHF		UHF
	MA/E13	MA/E16	MA/E33	MA/E36	MA/E42
Power supply, 30W, less vibrator	\$20	—	\$20	—	\$20
Power supply, 60W, less vibrator	—	\$25	—	\$25	—
TX narrow band, less final tubes Note: MA/E42 wide band	\$18	\$25	\$25	\$30	\$12
RX wide band, less ovens	\$18	\$18	\$18	\$18	\$12

14" Progress Line Case, consisting of front basket and front plate with lock . . . . . \$10.

Low band dual front end, 2 freq. strip . . . . . \$20.

Hi-Band TPL RX with TX exciter strips less speaker, as is, missing parts . . . . . \$25.

15,000 2-way FM mobile units in stock! Send for new '73½ catalog.



**GREGORY ELECTRONICS CORP.**

*The FM Used Equipment People*

243 Route 46, Saddle Brook, N. J. 07662

Phone (201) 489-9000

Dept. 73

# Voyage

**EXPEDITION 'ROUND THE  
WORLD. Remote places:  
Galapagos, Pitcairn, Easter,  
Tahiti, Fiji, etc. 180' Yacht.  
Shipmates wanted. Share  
expenses.**

**Write YANKEE TRADER,  
P. O. Box 120, Dept. RW—,  
Miami Beach, Florida 33139**

#### SHIPMATES SOUGHT FOR 'ROUND THE WORLD EXPEDITION

"YANKEE TRADER" 180 foot, 1100 steel hulled vessel, formerly well known for Coast Guard research, is now being refitted and air-conditioned in Miami by Captain Mike Burke of Windjammer Cruises' fame. The yacht has traveled to the seven seas, and will once again embark on a pleasure seeking adventure around the world beginning on January 15, 1973 for a nine month cruise following the trade winds in southern waters. Shipmates who will share in the adventure and expenses are presently sought for the voyage which will feature the barefooted informality traditional to Windjammer Cruises. She will visit famous, tropical island ports of call such as Galapagos, Easter Island, Tahiti, Bali, Madagascar, Martinique. The group will explore, skin dive, sightsee, take photographs, or just loaf in luxury yachting style known only to a few millionaires — and they'll do it at the unheard of rate of \$18 a day. For details and applications for the 'round the world voyage, as well as the shorter 10 day Caribbean cruises, contact Captain Mike Burke, Windjammer Cruises, P.O. Box 120, Miami Beach, Florida 33139.

# DUPAGE FM

## USED FM GEAR SALE!

### MOBILES

#### SIX METERS 30 to 54 MC.

MOTOROLA T41GGV - 30 watts output, 6/12 volt vibrator power supply, with accessories	\$60.00
GENERAL ELECTRIC MA/E 13 - 30 watts output, 6/12 volt vibrator power supply, with accessories	\$60.00
MOTOROLA D41GGV - 30 watts output, 6/12 volt vibrator power supply, less case	\$35.00

#### TWO METERS

RCA CMCT-30 - 30 watts output, transistor power supply, partially transistorized receiver, fully narrow band, less cover and accessories	\$65.00
RCA CMC-20 - 20 watts output, 6/12 volt vibrator power supply, narrowbanded, less accessories	\$45.00
RCA CMC-25 - 25 watts output, transistor power supply, narrowband, less accessories	\$50.00
GENERAL ELECTRIC MA/E 33 - 30 watts output, 6/12 volt vibrator supply, with accessories	\$75.00
GENERAL ELECTRIC MT-36 - 50 watts output, transistor power supply, with accessories	\$120.00
MOTOROLA T53GAD - 50 watts output, 6/12 volt vibrator-dynamotor power supply, with accessories	\$60.00

#### 450 MC

MOTOROLA U44BBT - 15 watts output, transistor power supply, less accessories	\$50.00
RCA CMU-15 - 15 watts output, 6/12 volt vibrator power supply, less accessories	\$35.00
RCA CMLE-15 - 15 watts output, transistor power supply, narrowbanded, with accessories (less mikes) very clean condition	\$75.00
GENERAL ELECTRIC MT-42 - 15 watts output, transistor power supply, with accessories	\$70.00
GENERAL ELECTRIC MA/E-42 - 15 watts output, 6/12 volt vibrator supply, with head, mike and speaker	\$50.00

### BASE STATIONS

#### TWO METERS

MOTOROLA Y53AAB - ONE OF A KIND - Indoor cabinet contains: 60 watt 2 frequency transmitter, heavy duty blower for cooling of final and driver stages, receiver fully shielded for repeater use, line terminational panel with 2 freq. relay, AC power supply for 60 watt transmitter & receiver, metering panel, single tone decoder, 30 watt transmitter and AC supply. Add crystals and be on the air with your own repeater. The first check or money order will take this for only	\$350.00
MOTOROLA L53GAB - 60 watts output, in an early compastation floor model cabinet	\$200.00

#### 450 MC

GENERAL ELECTRIC FI-42 - 15 watts output, table top base station	\$125.00
GENERAL ELECTRIC FI-42 - 15 watts output, chassis are mounted on a 19 inch panel ready for installation into a rack	\$125.00
RCA CSU-15 - 15 watts output, table top cabinet, clean	\$110.00
RCA FLEETLINE CSLE-15 - 15 watts output, table top cabinet	\$125.00
MOTOROLA L44AAB - 15 watts output, table top cabinet	\$75.00
MOTOROLA J44AAB - 15 watts output, outdoor cabinet with line termination panel	\$100.00

Send check or money order to

**DU PAGE FM INC.**

Telephone 312-627-3540

P.O. Box 1

Lombard, Ill. 60148

We have some more goodies coming in the near future, so watch this space. If you want something special call Bill Lester on the week ends. If you want to make a personal visit on a Saturday or Sunday afternoon call and we will set up a time and give you directions.

Terms of Sale: All items are sold as is. Illinois residents add 5% sales tax. Money back if equipment is returned within five days from shipment date, shipping charges prepaid.

# GOVERNMENT SURPLUS

Digital tuning 500 kc - 32 MHz

32 bands of 1 MHz each except for 1st band which covers ½ MHz to 1MHz

Power requirements 28 volt @ 3 amp.

RECEIVER  
R 392-URR

**\$199.50**

prepaid  
No CODs.

*Jim Nichols*

1074 So. Brawley  
Fresno, California

93706

*California residents add 5% sales tax subject to prior sale.*

# MAN 1 LED

- high brightness--350ft-L @20ma
- single plane, wide angle-viewing---150°
- standard 14 DIP
- long life---solid state
- operates with IC voltage requirements
- displays all digits and 9 distinct letters

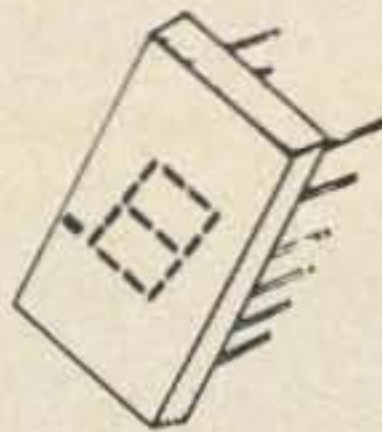

\$4.25 EACH

## 7400 series DIP

7400	.25	74H11	.50	7451	.25	74H74	.85
74L00	.35	7413	1.75	74L51	.35	7475	1.15
74H00	.35	7420	.25	74H51	.35	7476	.55
7401	.25	74L20	.35	74H52	.40	74L78	1.00
74H01	.35	74H20	.35	7453	.25	7480	.50
7402	.25	74H22	.50	74H53	.40	7483	1.15
7403	.25	7430	.25	7454	.30	7486	.65
7404	.25	74L30	.35	74L54	.35	7489	3.00
74L04	.35	7440	.25	74L55	.35	7490	1.00
74H04	.35	74H40	.40	7460	.25	7491	1.15
7405	.25	7441	1.30	74L71	.50	7492	.90
74H05	.35	7442	1.00	7472	.40	7493	.90
7406	1.00	7446	1.50	74L72	.50	7495	1.15
7408	.40	7447	1.50	7473	.55	74L95	2.00
74H08	.50	7448	1.25	74L73	.80	74107	.55
7410	.25	7450	.25	7474	.40	74153	1.75
74L10	.35	74H50	.40	74L74	.80	74192	2.25
						74193	2.00
						74195	1.00

all IC's shipped within 24hrs.

## Schottky TTL \$3.00 EACH

- 82S30 8 input multiplexer
- 82S33 2 input 4 bit multiplexer
- 82S41 quad EX/OR element
- 82S42 4 bit comparator
- 82S62 9 bit parity gen./checker
- 82S67 2 input 4 bit multiplexer

## CD-3 universal counter

Can be programmed to count to any modulus 2-9 for one kit, 2-99 for two kits, etc. Includes board, 7490, 7447, RCA DR2010 Numitron display tube and five programming components. Full instructions included - perfect for displaying second, minutes and hours, etc. **KIT \$8.95**

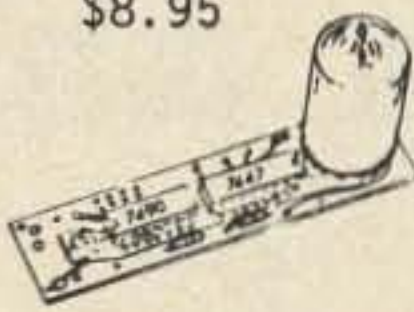

## CD-2 digital counter

Unit includes board, 7490, 7475 quad latch, 7447 seven segment driver, and RCA DR2010 **KIT \$9.95**  
**ASSEMBLED 12.00**



## 8000 series TTL DIP

8200	4 bit comparator	1.60
8210	8 line to 1 line selector	1.40
8220	parity gen/checker	1.00
8223	256 bit programmable ROM	7.50
8230	8 input multiplexer	2.00
8233	2 input 4 bit multiplexer	1.75
8242	4 bit comparator	1.00
8251	BCD to decimal decoder	1.00
8261	fast carry extender	2.00
8266	2 input 4 bit multiplexer	1.50
8270	4 bit PI, SI, PO, SO	2.00
8271	4 bit shift register	2.00
8273	10 bit SI, PO register	3.00
8274	10 bit PI, SO register	3.00
8280	45MC presetable decade counter	1.15
8281	45MC presetable binary counter	1.15
8290	presetable dec. counter 75MC	3.50
8292	presetable dec. counter 10MC	.90
8520	25MC divide by "N" 2 to 15	2.00
8551	tri state quad latch	2.00
8570	8 bit SI, PO	2.50
8590	8 bit PI, SO	1.50
8275	quad bistable latch	.90

748	op amp T05	1.50		
NE555	prec. timer MINI	1.25	CA3065	TV/FM sound system DIP .75

All IC's are new and fully tested - leads are plated with gold or solder. Orders for \$5 or more will be shipped prepaid. Add 35¢ handling and postage for smaller orders. California residents add sales tax. IC orders are shipped within two workdays of receipt of order - kits are shipped within ten days of receipt of order. MONEY BACK GUARANTEE ON ALL GOODS SOLD.....  
.....COD's may be phoned in.....

# BABYLON ELECTRONICS

P.O. BOX J CARMICHAEL, CALIF.  
95608 (961) 966-2111

## linears

LM100	positive DC regulator T0-5	.80
NE526	high speed comparator DIP	1.00
NE560	phase lock loop DIP	3.25
NE561	phase lock loop DIP	3.25
NE565	phase lock loop T0-5 or MINI	3.25
NE566	function generator T0-5 or MINI	3.50
NE567	tone decoder T0-5 or MINI	3.50
709	popular op amp DIP	.35
710	voltage comparator DIP	.50
711	dual comparator DIP	.75
723	precision voltage reg. DIP	1.00
5558	dual 741 op amp MINI	1.00
810	dual op amp DIP	.80
747	dual 741 op amp DIP	1.00
LM302	op amp voltage follower T0-5	1.25
LM308	op amp T0-5	2.00
LM311	comparator T0-5	1.50
LM380	2W audio amp DIP	1.50
LM703	RF-IF amp epoxy T0-5	.80
LM309K	5V-1A power supply module T0-3	2.50
LM309H	5V-200ma power supply T0-5	1.00

## calculator on a chip 40 pin DIP

- Add, subtract, multiply, and divide
- 12 digit display and calculate
- Chain calculations
- True credit balance sign output
- Automatic overflow indication
- Fixed decimal point at 0, 2, 3, or 4
- Leading zero suppression
- Complete data supplied with chip



SILICON  
signal diodes  
100 PIV - 80 ma  
60 for \$2.50

## RCA 2010 NUMITRON

- digital display tube
- incandescent 5V
- 7 segment
- .6" high numeral
- visible at 30 feet
- left hand decimal
- 9 pin base (solderable)



EACH \$ 5.00  
5 FOR 20.00

## 2 METER FM AMPLIFIER WITH BUILT-IN A.C. POWER SUPPLY

- 1 W IN/12 W OUT
- USE AT HOME 110 VAC  
OR CAR 13.6 VDC
- AUTO TR
- SUPPLIES 13.6 VDC FOR YOUR TRANSCEIVER.



**QC-210**

**\$69.95**

**PERFECT FOR RIGS LIKE THE TR-22**

**SEND FOR BROCHURE**

THE QC-210 IS AN ALL SOLID STATE RF POWER AMPLIFIER FOR THE 2 METER BAND WITH A BUILT IN REGULATED AC POWER SUPPLY. THE QC-210 WILL SUPPLY 13.6 VDC FOR YOUR TRANSCEIVER UNDER 110 VAC OPERATION AND WILL RUN DIRECTLY FROM YOUR CAR BATTERY FOR MOBILE OPERATION. THE QC-210 HAS OVER 10 DB POWER GAIN WHEN USED WITH ANY OF THE COMMERCIALY AVAILABLE "1 WATT" TRANSCEIVERS. BUILT IN: AUTOMATIC ANTENNA SWITCHING AND AC/DC ON-OFF SWITCH.

## HIGH CURRENT SOLID STATE REGULATED POWER SUPPLIES PROVIDES REGULATED 13.6 VDC

'A MODEL TO FIT YOUR NEEDS '

**QC-25 2.5 AMP. \$ 24.95**

**QC-50 5.0 AMP. \$ 39.95**

**QC-75 7.5 AMP. \$ 49.95**

**QC-100 10.0 AMP. \$ 59.95**



THESE SUPPLIES ARE PERFECT FOR USE WITH AMATEUR TRANSCEIVERS AND FM BOOSTER AMPLIFIERS WHICH NORMALLY OPERATED FROM AUTOMOBILE VOLTAGE SOURCES. THERE IS A LOW COST QC SUPPLY TO FIT YOUR NEEDS.

**SHIPPED U.P.S. ADD \$ 2.50 FOR SHIPPING**

**QUEZAR COMMUNICATIONS**

**PO BOX 235 TITUSVILLE, NEW JERSEY 08560**

# WORLD'S LARGEST SELECTION OF

NEW & USED TV CAMERAS & ASSOC. EQUIPMENT

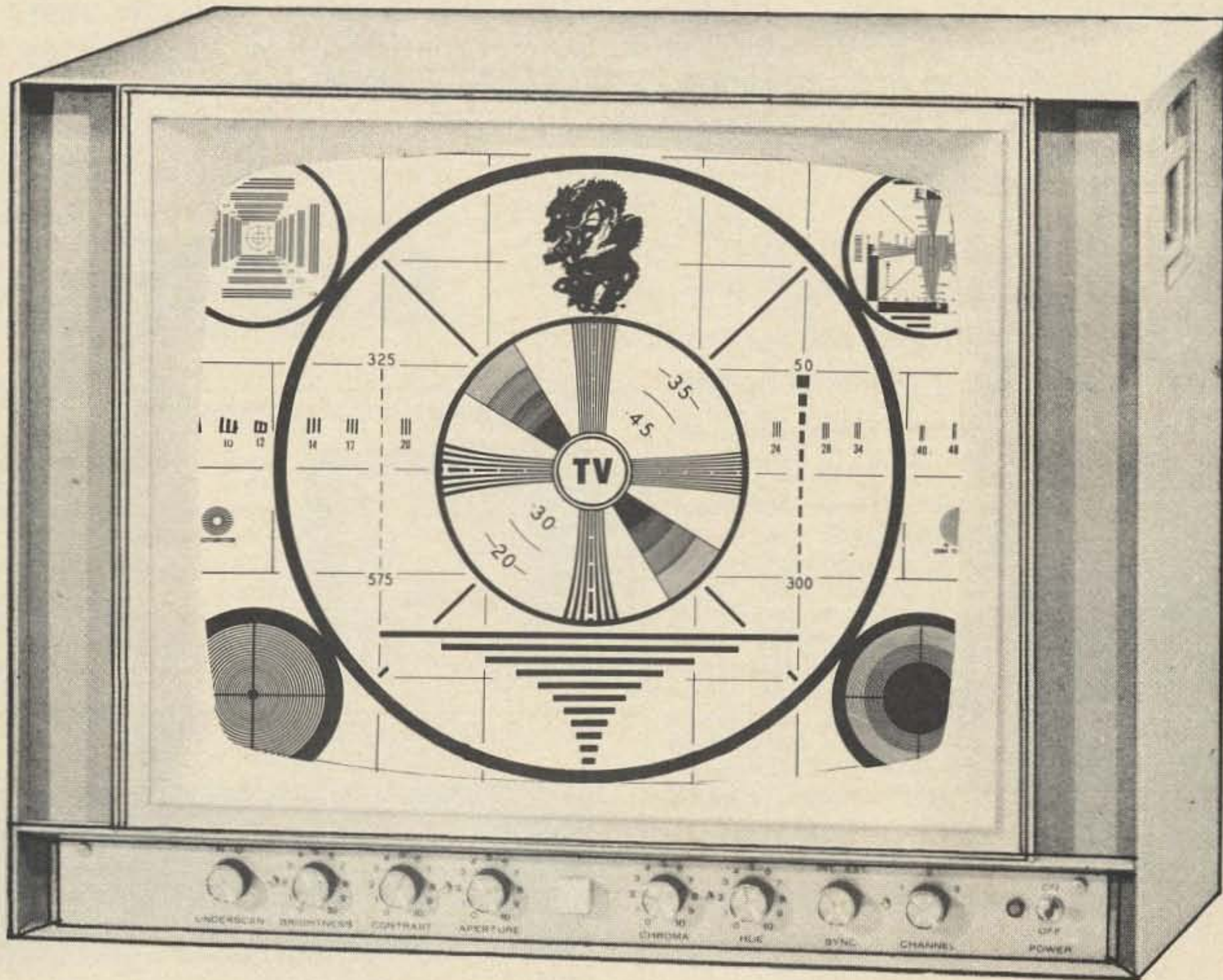

**1973**

INDEX PAGE 142

Broadcast & Closed Circuit TV  
Audio and Video Systems

PRICE  
\$1.00

CATALOG #  
**973A1**

\$1.00 ppd USA—\$2.00 Foreign.  
Free to requests on Company  
Letterhead.

**THE DENSON ELECTRONICS CORP.**

*9AM - 4PM Monday thru Friday; otherwise by appointment.*

OFFICE: Longview St. Tel. Area Code 203/875-5198

MAIL: Post Office Box 85

ROCKVILLE, CONN. 06066 USA

# Save over \$9,000.00 on this AN/WRR-2 SSB Receiver!

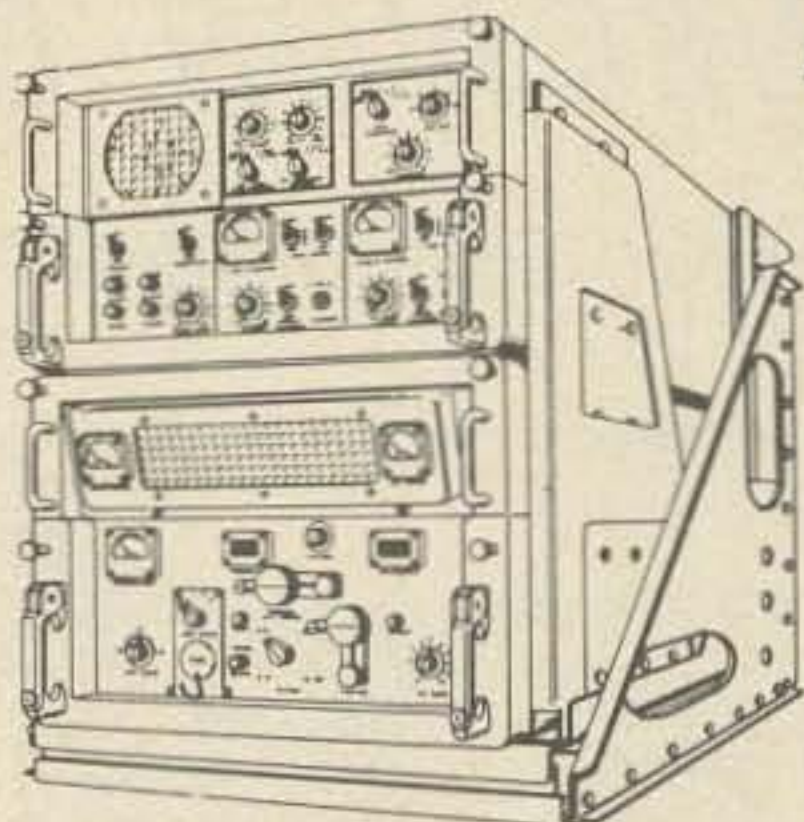

Original government cost: over \$10,000.00! One of Navy's most modern radio receiving sets. Built by National Radio Co. in last decade. A triple conversion super-heterodyne. Frequency range: 2 to 32 MC. continuously, or in 1 kc increments. 4 bands. Featuring full carrier suppression, unit receives AM, CW, MCW, voice, facsimile, Teletype and ISB. RE-

QUIRES NO MODIFICATION! Greatly superior to earlier R390A/URR model. Good cond. Complete, operational. Spec sheet available. Spare parts as needed

## \$495.

Overhauled and certified . . . \$595.00

Xerox copy of Operation Repair Manual: \$35.00. Add \$100.00 for 1/2 kc in lieu of 1 kc increments.

**RADIO RECEIVER R-108/GRC** Late model Army Comm. Recvr! 20-28 Mc. FM. Cont. or preset freq. OK for AM with simple modification. With schematic and hookup info. Like new. Smashing low price! . . . \$19.95  
24 VDC POWER SUPPLY for above . \$4.95



**MODEL 15 TELETYPE PAGE PRINTER** Rebuilt like new by US Navy. In orig. govt. packing! With table, power supply and manual. BARGAIN! 15 KSR WITH KEYBOARD . . . \$200.00  
15 RO. NO KEYBOARD . . . \$175.00

### IP-69/ALA-2 PANADAPTER

This compact unit can be used with most Ham Receivers after conversion. Complete with conversion info and schematic. Good condition . . . \$19.95

### HEWLETT-PACKARD SPECTRUM ANALYZER

The famous Model 8551B with Display H.P. 851B. Excel. cond. CERTIFIED with new TWT. Now reduced to less than half of original price! Special. Only . . . \$5500.00

### NAVY TCS TRANSMITTER



Just arrived! This collector's item is now available in new condition! 1.5 to 23 Mc. CW and AM. 50 watt CW. Ideal for a raft of multi-purpose uses. Designed by Collins Radio. Brand new! A Columbia special . . . \$75.00

### 2 METER AIRCRAFT MONITOR RECEIVER 130-150 MC



R-748/TRC-47 single channel AM crystal controlled 110V 60CPS, pwr supply & speaker built in, squelch, r-f gain, dual conversion modern design. Size 19"W x 5"H x 14"D for rack mtg. Supplied with schematic & hookup info. No conversion required. Exl condition . . . \$29.95

### FM TRANSMITTERS & RECEIVERS



T-14/TRC-1 R-19/TRC-1  
70-100 Mc. Single channel. 50 W. output. 110 V, 60 cycle. New and like new.  
R-19/TRC-1 Receiver . . . \$49.50  
T-14/TRC-1 Transmitter . . . \$49.50

FREE schematics. Convertible to 6 or 2 meters.

190-550KC Q-5er Good Condition Recvr \$14.95  
or like New Receiver . . . \$19.95  
6-9MC 40 Meters Good Condition Recvr . . \$9.95  
2.13MC T 18/ARC-5 New Xmtr . . . \$4.95  
4-5.3MC T-20/ARC-5 Excl. Condition Xmtr \$3.95  
4-5.3MC BC-475 New Xmtr . . . \$5.95  
MD-7/ARC-5 Plate Modulator for Above Xmtrs  
Exl. Condition . . . \$4.95

## Columbia Electronic Sales, Inc.

P.O. Box 9266, 7360 Atoll Ave., North Hollywood CA 91609 Tel (213) 875-2970 & 764-9030



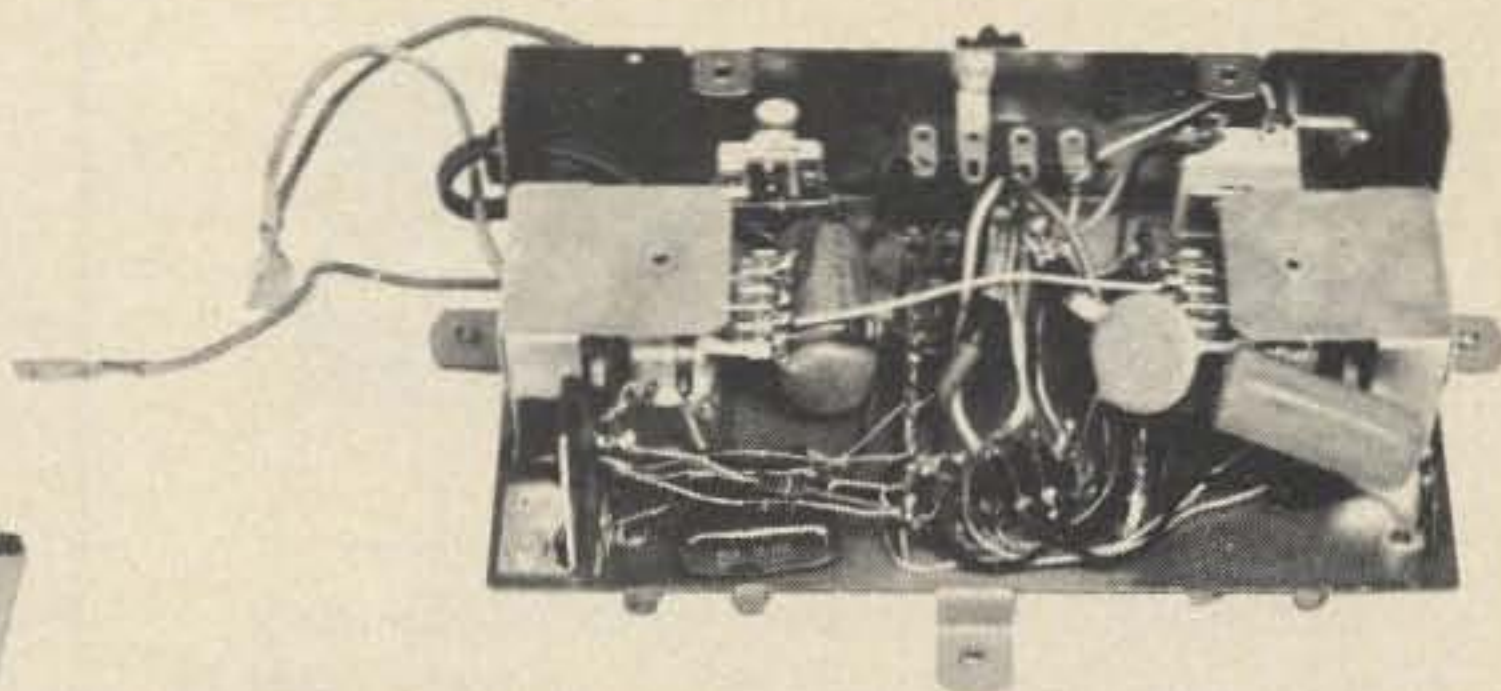
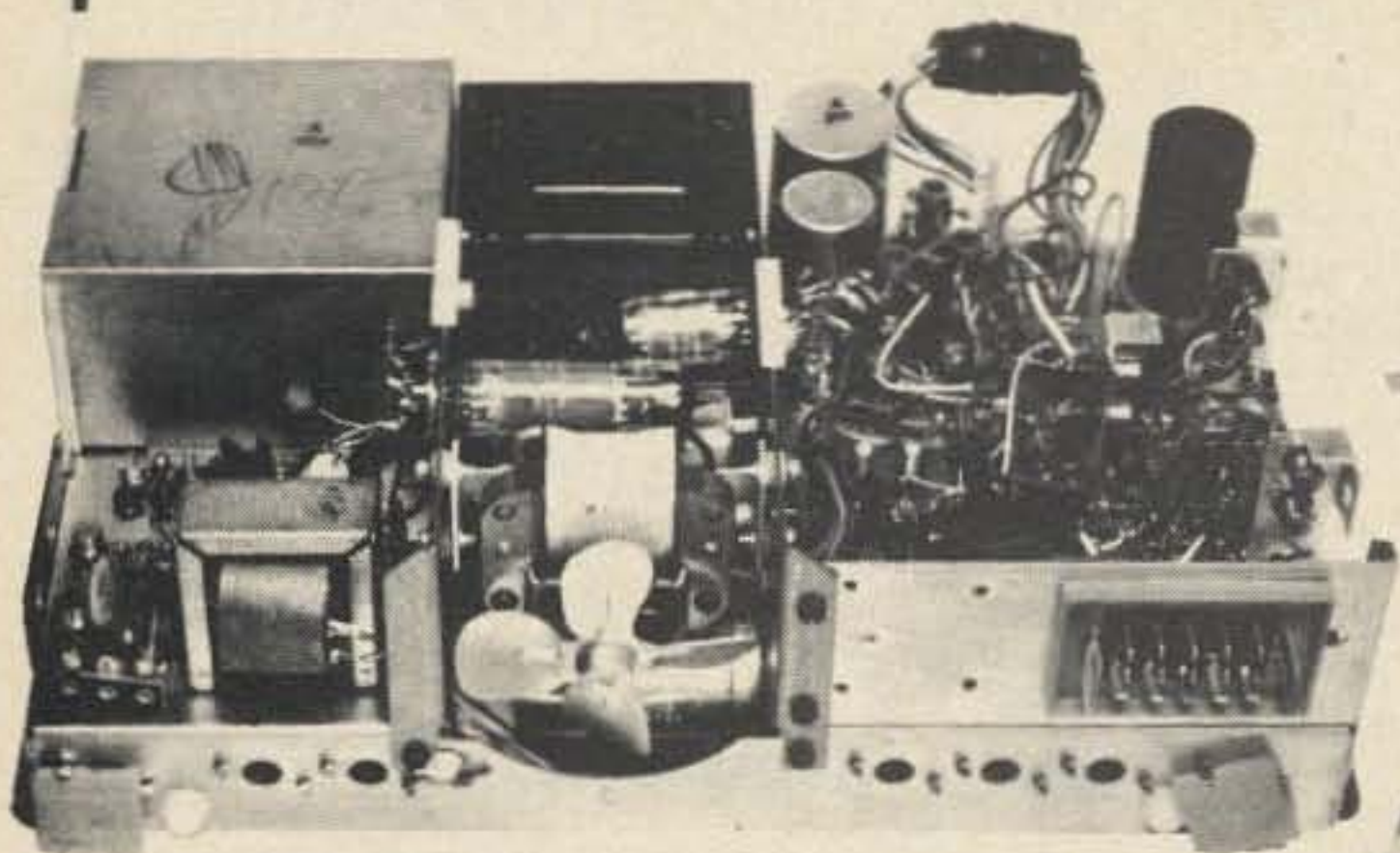

## PAY TV ASSEMBLY \$15.00

A "Super Value" for the gadgeteer. A complete Pay TV installation made for ZENITH and all in original packing (3 cartons — wgt 36 lbs) and all unused. Operates on regular 115 volt 60 cycle power. A wealth of parts, easily removed due to long leads on components, most over one inch long. The 3 units consist of Translator, Adapter, Decoder. Transistors, tubes, solid state bridge power supply, geared clock motor, 35mm geared transport, time recorder, solenoid, relays, hundreds of small parts such as resistors, caps, etc. Our estimate as to cost to Zenith, approx \$1,000 per set. Schematics with each purchase. One set of 3 units \$15.00 wgt of 36 lbs. Special . . . 3 sets \$35 wgt of 106 lbs. All unused, original boxed.

## COOLING FAN BARRAGE \$12.00

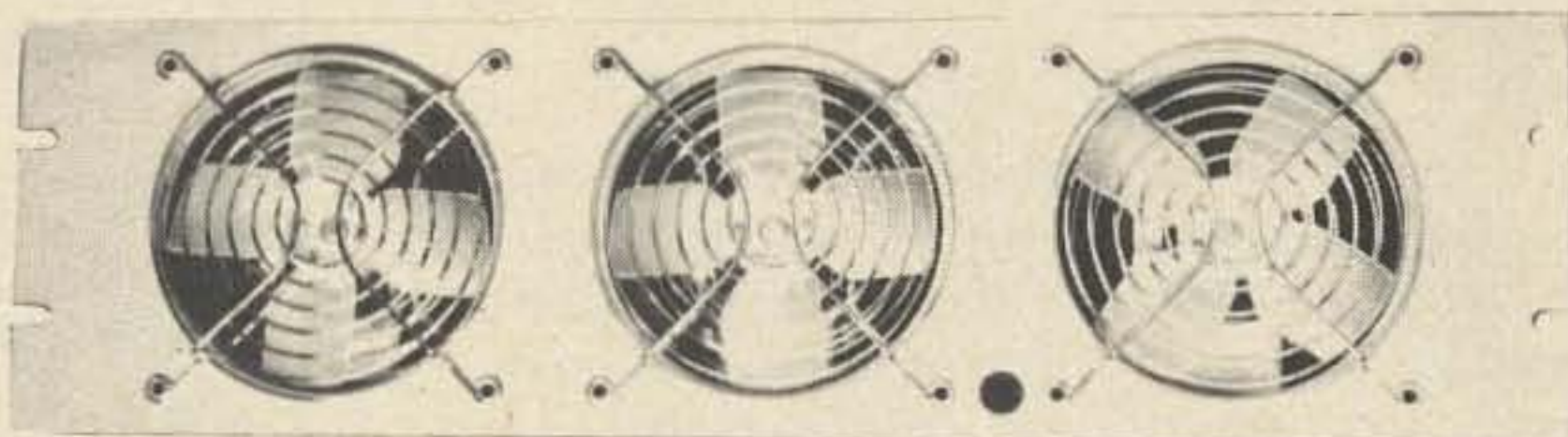

For the photo enthusiast, electronic industry, people cooler, etc. Brand new assembly made by HOWARD Industries, 3 fans per panel, 115 volt 60 cycle. Each fan good for 100 cfm and have blade guards both sides of each fan. To reverse flow of air, mount panel backwards. All brand new, ready to use. Silver gray panel finish. Standard 19 inch panel, 5 1/4 inches high. \$12 per panel of 3 fans or 2 panels of 6 fans for only \$20. Ship wgt 7 lbs per panel.

## AM-FM STEREO RADIO \$25.00

Surplus from DELMONICO RADIO Co. Made for console installation, this fully built chassis requires only plugging into 115 volts AC 60 cycle and the adding of 2 speakers and you are surrounded by beautiful music, AM, FM, or Stereo. Extra outlets for Tape, Mikes or turntable. We furnish fully built chassis, calibrated panel, schematic, all brand new. Has tuner, IF strip, FM tuner, AM tuner, stereo amp. All solid state, all brand new. \$25.00. A pair of heavy ceramic magnet speakers by UTAH, 6x9 inches \$10.00.

*Meshna*

Postage extra on above. MESHNA PO Bx 62 E. Lynn Mass. 01904

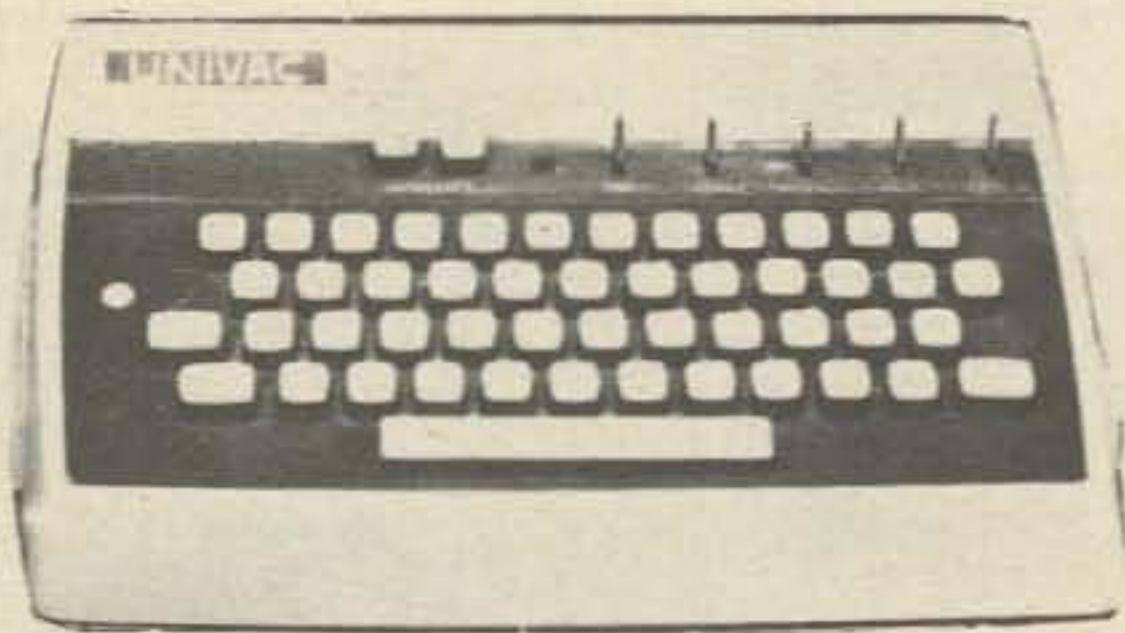

### COMPUTER KEYBOARD W/ENCODER \$35

Another shipment just received. Alpha-numeric keyboard excellent condition. Once again we expect an early sellout. Price of \$35 includes prepaid shipment in the US and shipment made within 24 hours of receipt of order.

### POWER TRANSFORMER

115ac/12V@3 amps . . . \$2.50

### POWER AMP TRANSFORMER

Brand new compact, regular 115 V 60 cycle input. Output of 40 VCT at 4 amps plus another winding 6V at 2.5 amps. Fine business for Power Amps, Logic or Op Amp supply.

\$5.50 each or 5 for \$25.00

### 12VCT 2A XFMR \$1.50

Regular 115 volt 60 cycle input. 12 volt transformers are always in demand, these are brand new.

\$1.50 each or 10 for \$12.00

### 60-SECOND TIMER

A bonanza for the photo lab or any requirement for a precision spring-wound timer. May be set at any interval 0-60 seconds. Contacts rated at 15 amps. Contacts close while running and open at end of time interval. Brand new.

\$1.50 each, 10 for \$12

### 455 KC IF ASSEMBLY

Complete miniature 455kc IF. amp assembly. 1.5 inches long, little over 1/2 inch square. Ready to use w/schem Sim to Miller 8902 . . . . . 2.50

### RF VACUUM SWITCH

Made for the ART-13 good for 100-watts RF, no doubt handles much more due to being underrated for the military . . . #71-17 3/2.00

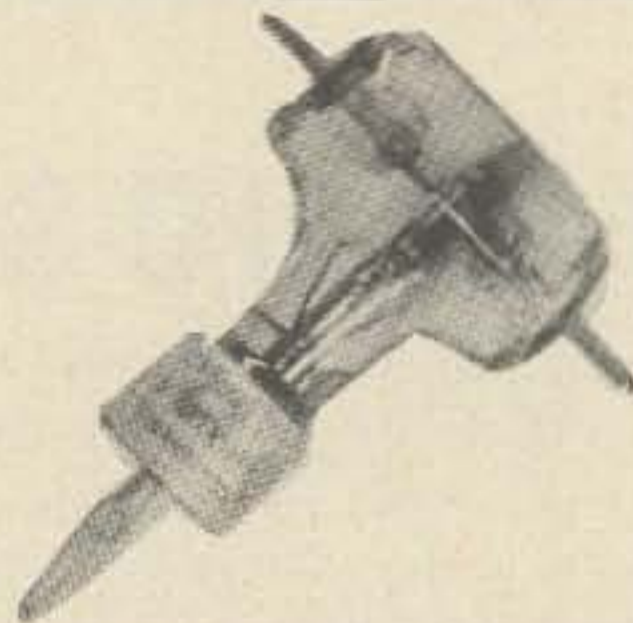

### 7400 SERIES IC GRAB BAG

Mix of 7400 series DIP, unmarked untested. Some schematics provided . . . . . 10 for 1.00  
100 for 8.00  
1000 for 60.00

### IC SPECIAL - ONE MONTH ONLY

Our regular \$15 IC board with approx. 140 DIP ICs on them, with ident sheet. For one month only we are pricing them at \$6.50 per board to reduce our inventory. #IC-S \$6.50 Or 5 for \$25

### COPPER CIRCUIT BOARD

Brand new GE 2-sided glass epoxy G-10, the standard of the industry, bright and shiny new. 6 x 12, \$1.00. 12 x 12, \$1.50. Buy ten pieces and get 2 more free.

### AM-FM RADIO \$5.50

Due to the West Coast ship strike they came in too late for the customer. Now it's your bargain. Use it as is or build it into your own cabinet, desk, wall, etc. All built, ready to use, with AC supply. To make it portable all you do is power it with a couple of "D" cells. Fully assembled solid state chassis with AC power supply, less speakers. Covers full AM as well as FM broadcast. The price. . .an astounding meager \$5.50 postpaid.

### PISTON CAPS 1-8 μF 3 for \$1.00

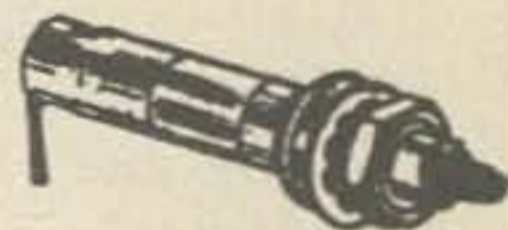

Unused Military surplus. For hi freq. work. List price over \$3.00 each. We have 1 size only, 1-8 μF. No hardware.

#73-18

3 for \$1.00

### BATTERY ELIMINATOR-CHARGER

Plugs into 115 volt 60 cycle and puts out approx. 12 volts DC 100 mils. Sufficient to power most any small transistor radio and also useful for charging small dry cells and small ni-cad cells. Fully built, ready to use.

\$1.00 each, 6 for \$5.00

### RF FERRITE CORE CHOKE

Hi-permeability, ultra midget style, coated for moisture resistance, color coded. Used in xmtrs, receivers, converters, TV-peaking. Brand new, worth 40¢ each. Assortment of 1.8, 27.0, 330 μH. Pack of 30, \$12.00 value.

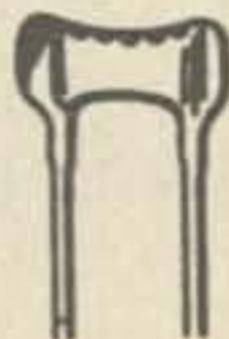

#A-71 30/\$1.00 180/\$5.00

### UHF TRANSMITTER

One of the later designs being released. Superb workmanship by HUGHES. Utilizes 3 pencil triodes worth over \$46.00. Looks like a "natural" for 220 mc transmitter as it's on .264mc now. Simple to lower freq. W/tubes & schematic. Built-in power supply 400 cycle would have to be changed. Measures only 3x4x8 inches. Nice piece of scarce gear, easy to work on & first class condition.

4 lbs. . . . . #TA-40IC 15.00

JOHN MESHNA JR. PO Box 62, E. Lynn Mass. 01904



ZM 1000 NEON  
\$1.75



GE Y 4075 25V Miniature  
\$1.75

GE Y 1938 24V Standard  
\$1.75

RAY CK 1905 Standard  
\$1.75



MAN-3 1.7V Miniature  
\$3.50 ea. 10/\$30

GIANT ALPHA NUMERIC  
B7971 \$1.00

Alpha-numeric keyboards. Excellent to new in condition. Styles may vary slightly from picture. Two models available, one with ASCII encoder in base \$55.00 postpaid in the U.S. Keyboard with no encoder in base \$35.00 postpaid in U.S.

KEY BOARDS  
\$35.00 & \$55.00



OIL CAPS 16 MFD 5000 VOLT

Rare find. \$9.00 each 3/\$25.00

NOISE ACTUATED SWITCH \$1.35

Solid state noise actuated switch fully wired, includes mike pick-up, amplifier, SCR switch. Actuates by noise or whistle. Useful for burglar alarms, lamp lighter, etc. 15 ft range.

LIGHT EMITTING DIODES 3/\$1.00

Ruby red, gold plated leads. With mercury cell for instant testing.

RCA MEMORY STACK 32x32x9

3rd generation, ultra compact. Measures 1x4 1/4x7. Brand new. \$50.00 3 for \$125.00

H.H. SCOTT MULTIPLEX

Solid state brand new multiplex module w/ schematic. Possibility of conversion of various mono sets to stereo. \$3.00 each 10 for \$25.00

URC-11 WALKY TALKY

243 MC 2 way radio, hand held, measures only 3x4 inches. Used for survival in downed aircraft. Can be converted for other freqs. URC-11 \$15 each 3 for \$40.00

CHARACTER GENERATOR SETS \$50

64 bit ASC II Character Generator IC sets. Vertical scan set includes SK0002 kit, two MM502 and one NH0013C. Horizontal scan sets includes SK0001 kit, two MM502, and one NH0013C. Make your own CRT readout or use it for hard copy. Either set only \$50 and includes 10 pages of info on character generators.

15¢

IC BONANZA

Brand new DTL dual inline (DIP) package, factory marked ceramic type. The price is too good to be true. Fully guaranteed and with specs.

930 Dual 4 input NAND gate similar to 7420	
931 Clocked flip flop	74110
932 Dual 4 input Expand Buff	7440
933 Dual 4 input expander	7460
936 Hex Inverter	7405
945 JK Flip Flop	74110
946 Quad 2 input gate	7400
962 Triple 3 input gate	7410

15¢ each. Buy \$100 worth and deduct 10%. 24 hour delivery guaranteed.

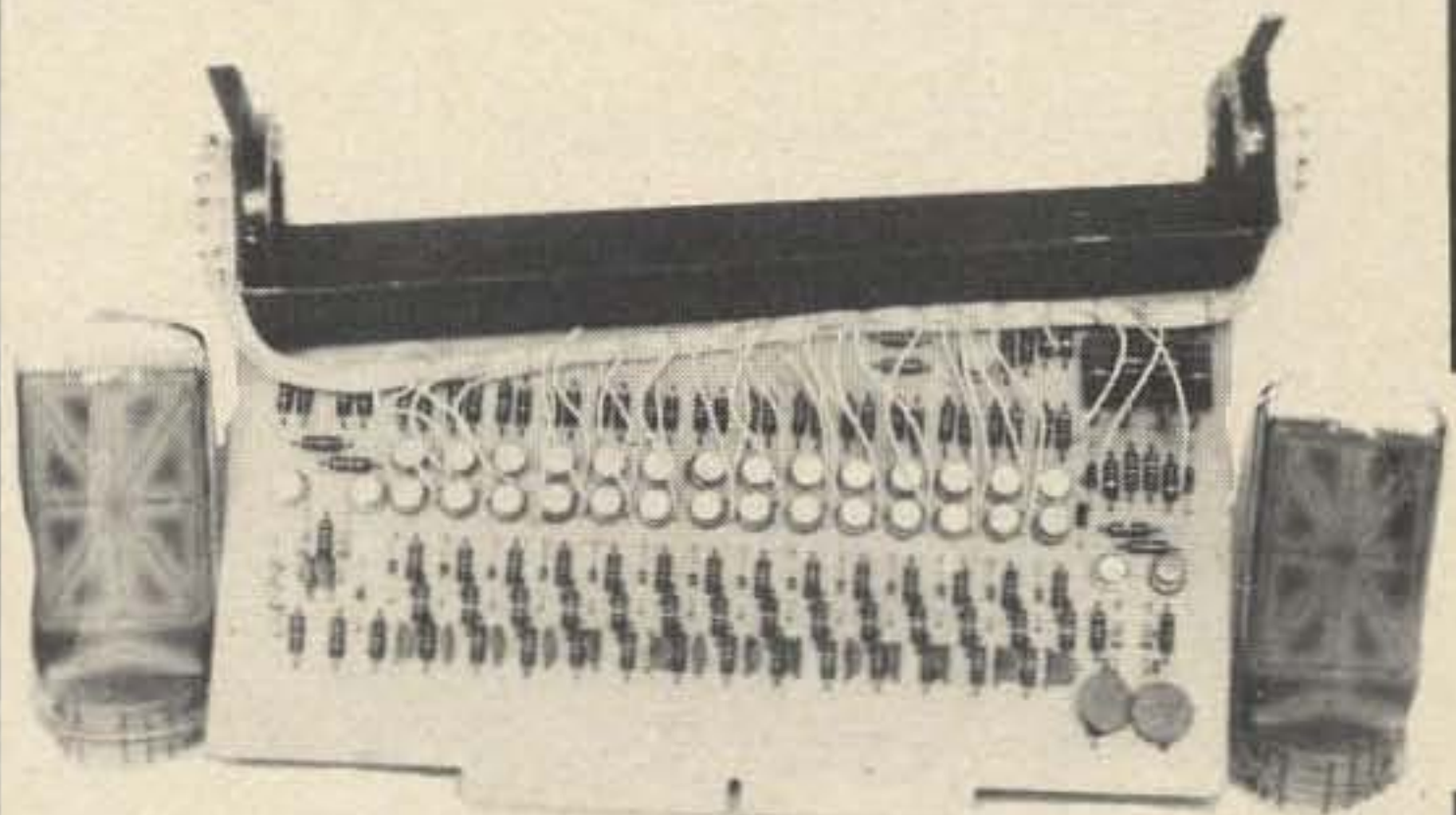

GIANT B-7971 NIXIES (2) with 2 sockets and driver board containing hi voltage transistors. Complete plug-in board as removed from operational equipment. Schematics included. Unbelievable but true... just \$2.50 for the complete package. . . #72S-10 \$2.50

Please add postage for above.

JOHN MESHNA JR. PO Box 62, E. LYNN MASS. 01904

# 100 watts\* on 6 meters!

**6 METERS** is better than ever. With several new 6 meter FM rigs on the air there is plenty of activity.

**6 METERS.** Where else do you find wide coverage repeaters and still have the ability to work real DX?

**6 METERS.** Join the growing number of hams who enjoy activity on one of our most exciting bands.

**6 METERS. NO MATTER WHAT FM RIG YOU ARE NOW USING,** from old Motorola & GE units up to the new Regency HR6, **YOU TOO CAN RUN HIGH POWER.** The JM Communications 6100 will deliver over 100 watts.

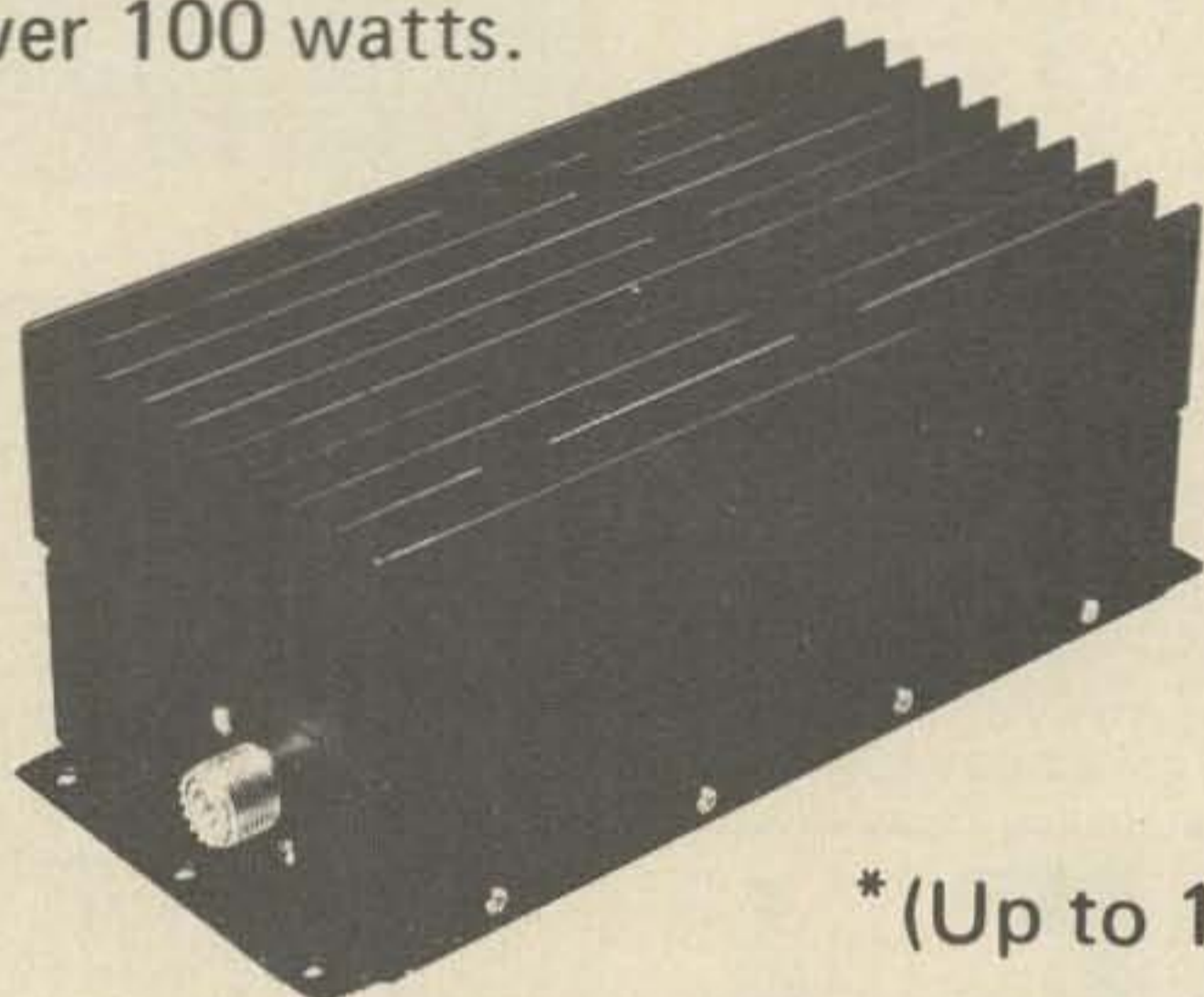

\*(Up to 150 watts)

## 100 WATTS—6 METER FM AMPLIFIER

MODEL 6100 • WIRED/TESTED/READY TO USE

- 52 to 54 MHz
- 15 to 35 Watts Input
- 100 to 135 Watts Output
- Solid State Antenna Switch (no relays)
- Automatic T/R Switching
- Built-in Harmonic Filter
- 13.6 Volts / 10 to 15 Amps
- .5 dB Typical Loss on Receive
- Employs ruggedized transistors for maximum reliability
- Extra large heat sink for operation under severe conditions
- Complete with RF and DC cables

**\$199.95**

California residents add  
5% sales tax.

**JM Communications**  
**101½ Washington St.**  
**Venice, CA 90291**



# Mann

COMMUNICATIONS

## APRIL SPECIALS

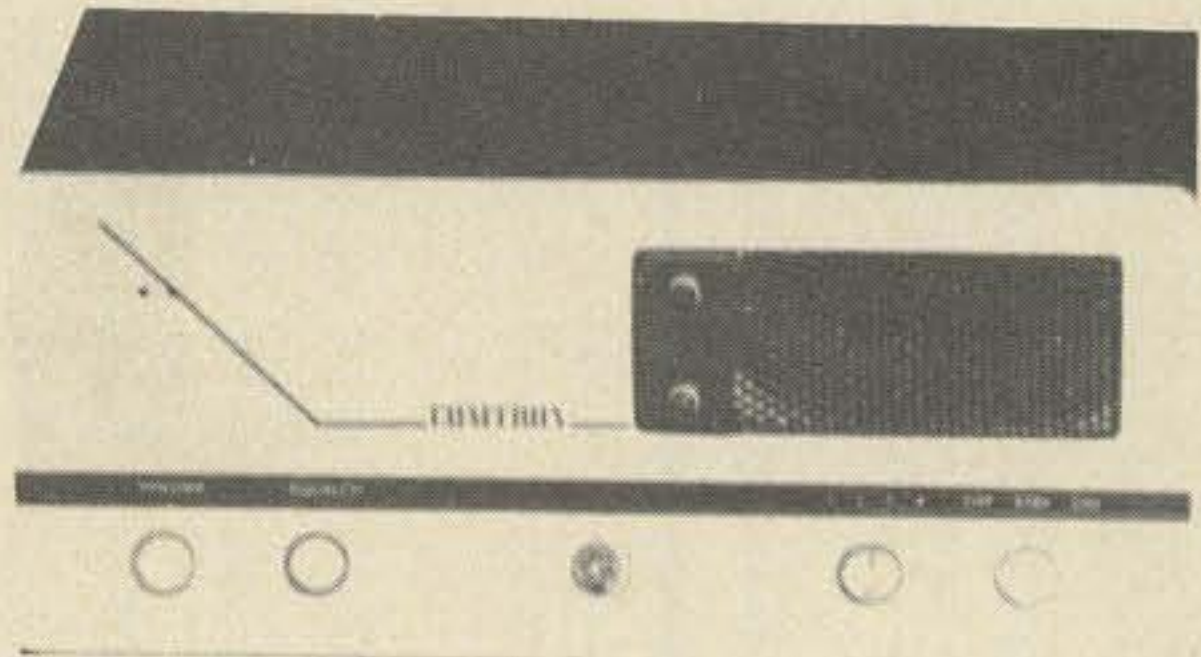

**COMTRON Model 960A DC Mobile Unit New as-is. Complete . . . . . \$129.00**

This unit is all solid state except the driver and final output tubes which are instant heating. Unit is 150MHz Front Mount type 30Watts. Two channel deck included free.

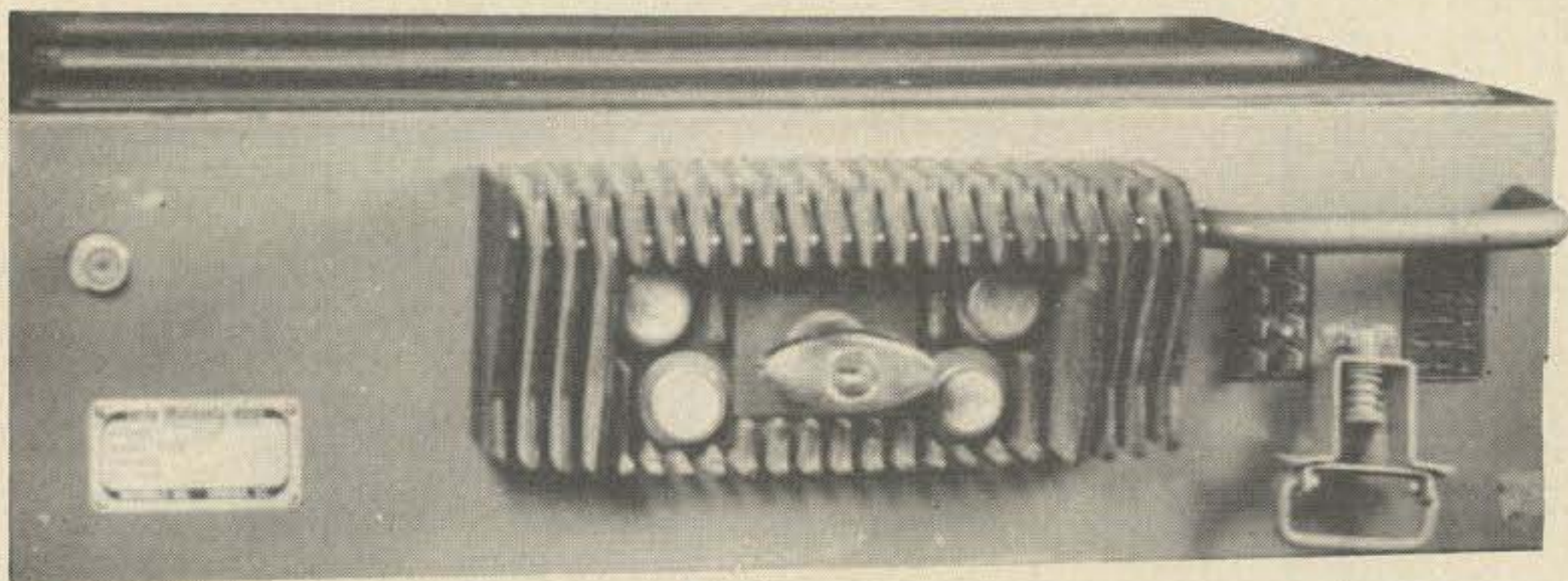

**MOTOROLA Model X53GKT mobile unit with accessories . . . . . \$139.00**

This unit has two 60Watt Hi Band Xmtrs and one Hi Band Receiver for multi-channel operation. Transistor Powered.

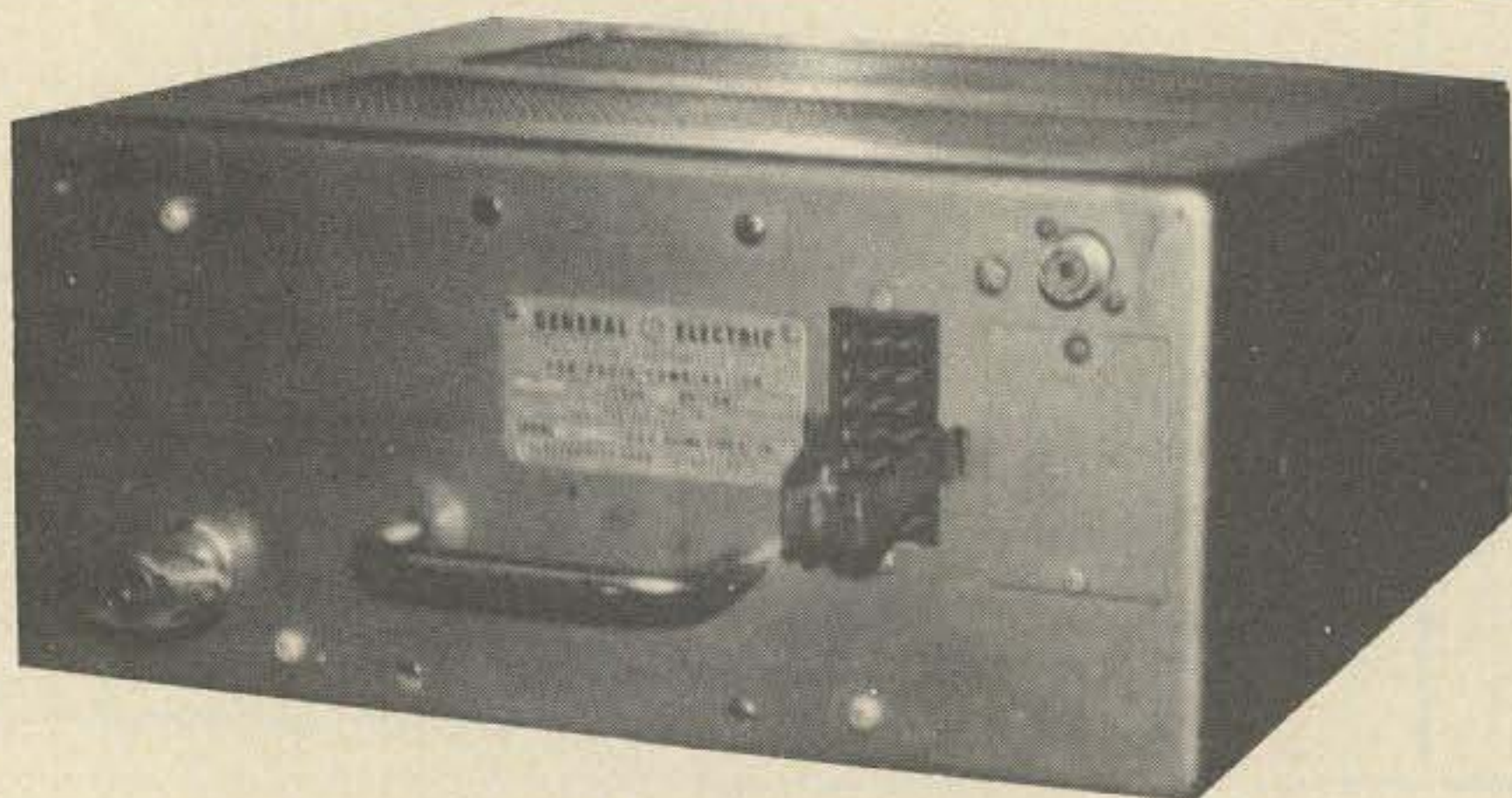

**GENERAL ELECTRIC Model ME33 Mobile Unit with acc . . . . . \$89.00**

This radio is vibrator powered, will operate from 6 or 12VDC on the Two Meter Band with 30 Watts out.

**Mann COMMUNICATIONS & ELECTRONICS, INC.**

28710 Canwood Road  
Drawer M Agoura CA 91301  
(213) 889-6666

2837 North 24th Street  
Phoenix, Ariz 85008  
(602) 955-4570

# Semiconductor Supermart

• MOTOROLA • RCA • FAIRCHILD • NATIONAL • HEP • PLESSEY

## SOMETHING NEW FOR THE HAM!

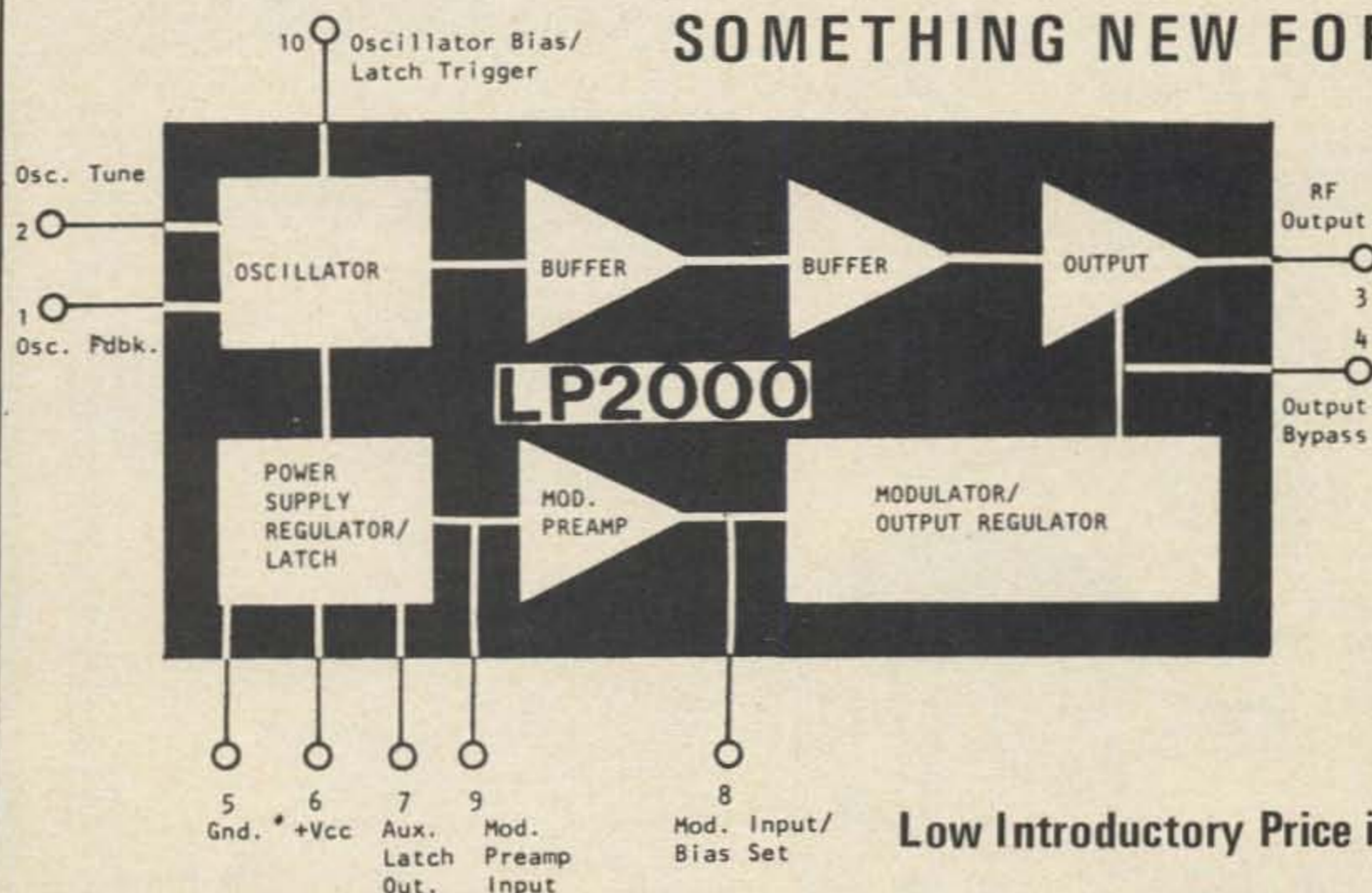

**LITHIC SYSTEMS' MICROTRANSMITTER. A COMPLETE AM TRANSMITTER INTEGRATED CIRCUIT IN A TO-5 CAN.**

With just a few external components you can build a mini-mitter for 10 or 6 meters. Works with fundamental or overtone xtals.

**Low Introductory Price is Only.....\$16.00**

### INTRODUCING **NEW!** DEVICES AT NEW LOW PRICES

LA3018 (Replaces CA3018)	\$1.60
LA3046 (Replaces CA3046)	1.60
LS370 (Replaces LM370)	4.00
LS1496 (Improved MC1496)	2.00
LS3028A (Replaces CA3028)	1.60
LP1000 (A new fun-type device to make LED flashers, audio osc, timer etc.)	1.60

### NEW FAIRCHILD ECL HIGH SPEED DIGITAL IC'S

9258 Dual "D" FF toggles beyond 160 MHz	\$4.65
9582 Multi-function gate & amplifier	\$3.15
95H90 300 MHz decade counter	\$16.00

A 95H90 & 9582 makes an excellent prescaler to extend low frequency counters to VHF — or use two 9528s for a 160 MHz prescaler.

### FETs

MPF102 JFET	\$.60
MPF105/2N5459 JFET	\$.96
MPF107/2N5486 JFET VHF/UHF	\$1.26
MPF121 Low-cost dual gate VHF RF	\$.85
MFE3007 Dual-gate	\$1.98
40673 Dual-gate	\$1.75
3N140 Dual-gate	\$1.95
3N141 Dual-gate	\$1.85

### POPULAR IC's

MC1550	Motorola RF amp	\$1.80
CA3020	RCA 1/2 W audio	\$3.07
CA3020A	RCA 1 audio	\$3.92
CA3028A	RCA RF amp	\$1.77
CA3001	RCA	\$6.66
MC1306P	Motorola 1/2 W audio	\$1.10
MC1350P	High gain RF amp/IF amp	\$1.15
MC1357P	FM IF amp Quadrature det	\$2.25
MC1496	Hard to find Bal. Mod.	\$3.25
MFC9020	Motorola 2-Watt audio	\$2.50
MFC4010	Multi-purpose wide band amp	\$1.25
MFC8040	Low noise preamp	\$1.50
MC1303P	Dual Stereo preamp	\$2.75
MC1304P	FM multiplexer stereo demod	\$4.95

### CORES AND BEADS

T200-2	\$2.00
KW Balun kit only	\$3.50
T68-2 3 cores	\$1.00
T50-2 3 cores	\$1.00
T50-6 3 cores	\$1.00
T50-10 3 cores	\$1.00
T44-10 3 cores	\$1.00

### BEAD SPECIAL

Ferrite Beads 1 doz.	\$1.00
----------------------	--------

Please add 35¢ for shipping

## Circuit Specialists

Box 3047, Scottsdale, AZ 85257

**FACTORY AUTHORIZED DISTRIBUTOR FOR**  
 Motorola HEP — Circuit-Stick — Plessey  
 All devices are first quality and are fully guaranteed.

**EPOXY FULL WAVE SILICON BRIDGE RECTIFIERS**

PIV	2 Amp	6 Amp
50	\$ .69	\$ .88
100	.79	.99
200	.95	1.25
400	1.19	1.50
600	1.35	1.75
800	1.59	1.95
1000	1.79	2.25

Code: 2 amp TO-5 case  
6 Amp 1/2 x 1/2 x 3/16 sq



3 for \$10.  
Only **\$3.95**  
**MAN-4 EQUAL LED 7-SEGMENT READOUTS**

0-9 plus letters, Snaps in 14-pin DIP socket, 3/4" x 1/4" x 3/8", 5V 10ma, with decimal point. Like MAN-1  
 Socket for above, 50c

**6VDC 6AMP/HR MOTORCYCLE BATTERY**

• Worth \$10-\$15 Only **\$5.95**

Use as power pak for mobile rigs & many "Ham" components, other electronic projects. Size: 5 1/2" tall x 4 1/2" wide overall x 2 1/4". Shipped dry, must be filled before use.

- Compact
- Needs only Electrolytic

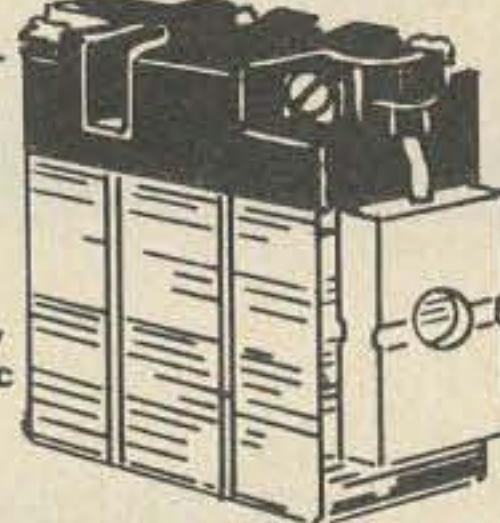

# Spring Clearance Sale

**12-DIGIT "CALCULATOR ON A CHIP"**

Similar to Mostek 5001. Outperforms Texas 8-digit TMS1802. A 40-pin DIP. Adds, multiplies, subtracts, and divides. Use with 7-segment readouts, Nixies, and LED's. We include schematics, instructions to build calculator.

Only **\$12.95**  
3 for \$35



**INTEGRATED CIRCUIT SOCKETS**

Buy Any 3 - Take 10% Discount!

- 14-Pin, dual in line .. \$ .45
- 16-Pin, dual in line .. .50
- TO-5, 8 or 10 pins .. .29

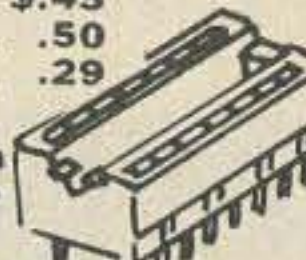

**WIRE-WRAP INTEGRATED CIRCUIT SOCKETS** 3 for \$2.00  
79c ea

**12VDC POWER PAC**

110 VAC to 12 VDC @ 1.6 Amp  
5 x 2 1/2 x 3 3/4"

**\$3.33**



**LINEAR Op Amps**

FACTORY GUARANTEED

FACTORY TESTED

FACTORY MARKED Buy Any 3 PAKS - Take 10% Discount

- 531 Hi slew rate op-amp (TO-5) ..... \$2.50
- 532 Micro power 741 (TO-5) ..... 2.50
- 533 Micro power 709 (TO-5) ..... 2.50
- 536 FET input op amp (TO-5) ..... 3.95
- 537 Precision 741 (TO-5) ..... 2.50
- 540 70W pwr driver amp (TO-5) ..... 2.04
- 550 Precision 723 voltage reg. (DIP) ..... 1.17
- 555 Timer 2 uSeconds to 1-hr (A) ..... 1.00
- 556 5 Times faster than 741C ..... 2.50
- 558 Dual 741 (mini DIP) ..... .88
- 560 Phase lock loops (DIP) ..... 3.25
- 561 Phase lock loops (DIP) ..... 3.25
- 562 Phase lock loops (DIP) ..... 3.25
- 565 Phase lock loops (A) ..... 3.25
- 566 Function generator (A) ..... 3.25
- 567 Tone generator (A) ..... 3.25
- 595 Four quadrant multiplier ..... 3.10
- 702C HI-grain, DC amp (TO-5) ..... .44
- 703C RF-IF, amp, 14 ckts (TO-5) ..... .69
- 709C Operational amp (A) ..... .39
- 709CV Op amp (mini DIP) ..... .49
- 710C Differential amp (A) ..... .39
- 711C Dual diff. comp (A) ..... .39
- 723C Voltage regulator (A) ..... .95
- 741C Frequency compensator 709 (A) ..... .41
- 741CV Freq. comp 709 (Mini DIP) ..... .49
- 747C Dual 741C (A) ..... 1.25
- 748C Freq. adj. 741C (A) ..... .44
- 748CV Freq. adj. 741C (mini DIP) ..... .49
- 709-709 Dual 709C (DIP) ..... 1.00
- 739-739 Dual stereo preamp ..... 1.98
- 741-741 Dual 741C (A) ..... 1.00
- 75450 Dual peripheral driver (DIP) ..... .69

(A) TO-5 or DIP dual in line pak

**'HAM' UHF 400 MC HIGH POWER TRANSISTORS**

Only **\$3.95**  
3 for \$10.

By RCA or equal 2N3632, NPN, 23 watts, 3 amps, TO-60 case, with stud mtg. VCEV max 65.



**PLASTIC RTL'S By Fairchild**

Choose Any **2 for \$1.00**

- 900 Buffer
- 914 Quad 2 Input Gate
- 923 J-K Flip Flop

**Lowest Prices Largest Selection TTL IC's**

Brand New \* "DIP" Packages Order by type number! Spec sheets on request "ONLY"

Type	Sale	Type	Sale	Type	Sale
<input type="checkbox"/> SN7400	\$.25	<input type="checkbox"/> SN7437	.50	<input type="checkbox"/> SN7476	.44
<input type="checkbox"/> SN7401	.25	<input type="checkbox"/> SN7438	.51	<input type="checkbox"/> SN7480	.65
<input type="checkbox"/> SN7402	.25	<input type="checkbox"/> SN7440	.25	<input type="checkbox"/> SN7481	1.10
<input type="checkbox"/> SN7403	.25	<input type="checkbox"/> SN7441	1.30	<input type="checkbox"/> SN7482	.88
<input type="checkbox"/> SN7404	.28	<input type="checkbox"/> SN7442	1.12	<input type="checkbox"/> SN7483	1.25
<input type="checkbox"/> SN7405	.27	<input type="checkbox"/> SN7443	1.21	<input type="checkbox"/> SN7486	.49
<input type="checkbox"/> SN7406	.45	<input type="checkbox"/> SN7444	1.21	<input type="checkbox"/> SN7489	3.50
<input type="checkbox"/> SN7407	.45	<input type="checkbox"/> SN7445	1.50	<input type="checkbox"/> SN7490	1.00
<input type="checkbox"/> SN7408	.29	<input type="checkbox"/> SN7446	1.50	<input type="checkbox"/> SN7491	1.25
<input type="checkbox"/> SN7409	.29	<input type="checkbox"/> SN7447	1.50	<input type="checkbox"/> SN7492	.75
<input type="checkbox"/> SN7410	.25	<input type="checkbox"/> SN7448	1.25	<input type="checkbox"/> SN7493	.75
<input type="checkbox"/> SN7411	.25	<input type="checkbox"/> SN7450	.25	<input type="checkbox"/> SN7494	1.10
<input type="checkbox"/> SN7413	.95	<input type="checkbox"/> SN7451	.25	<input type="checkbox"/> SN7495	.95
<input type="checkbox"/> SN7416	.48	<input type="checkbox"/> SN7453	.25	<input type="checkbox"/> SN7496	1.10
<input type="checkbox"/> SN7417	.48	<input type="checkbox"/> SN7454	.25	<input type="checkbox"/> SN74100	1.41
<input type="checkbox"/> SN7420	.25	<input type="checkbox"/> SN7455	.25	<input type="checkbox"/> SN74107	.49
<input type="checkbox"/> SN7421	.25	<input type="checkbox"/> SN7460	.21	<input type="checkbox"/> SN74121	.49
<input type="checkbox"/> SN7426	.32	<input type="checkbox"/> SN7470	.39	<input type="checkbox"/> SN74122	.65
<input type="checkbox"/> SN7430	.25	<input type="checkbox"/> SN7472	.36	<input type="checkbox"/> SN74123	.99
<input type="checkbox"/> SN7432	.25	<input type="checkbox"/> SN7473	.44	<input type="checkbox"/> SN74141	1.45
		<input type="checkbox"/> SN7474	.39	<input type="checkbox"/> SN74145	1.25
		<input type="checkbox"/> SN7475	1.00	<input type="checkbox"/> SN74150	1.25
				<input type="checkbox"/> SN74151	1.13
				<input type="checkbox"/> SN74153	1.49
				<input type="checkbox"/> SN74154	2.10
				<input type="checkbox"/> SN74155	1.39
				<input type="checkbox"/> SN74156	1.39
				<input type="checkbox"/> SN74157	1.25
				<input type="checkbox"/> SN74158	1.48
				<input type="checkbox"/> SN74160	1.79
				<input type="checkbox"/> SN74161	1.79
				<input type="checkbox"/> SN74162	1.79
				<input type="checkbox"/> SN74163	1.79
				<input type="checkbox"/> SN74165	3.50
				<input type="checkbox"/> SN74180	1.10
				<input type="checkbox"/> SN74181	4.50
				<input type="checkbox"/> SN74182	1.10
				<input type="checkbox"/> SN74184	2.50
				<input type="checkbox"/> SN74185	2.50
				<input type="checkbox"/> SN74192	1.75
				<input type="checkbox"/> SN74193	1.75
				<input type="checkbox"/> SN74195	1.19
				<input type="checkbox"/> SN74198	2.65
				<input type="checkbox"/> SN74199	2.65

Buy 3 or more, 10% discount

**NIXIE**

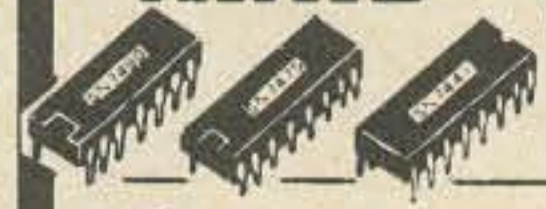

**COUNTING SYSTEM**

Includes SN7490, decade counter, SN7475 latch, SN7441 BCD decoder driver, 0-to-9 Nixie tube, instructions.

**\$4.50**  
3 for \$12.00

**LED READOUTS 4.50**

0-9 plus letters, for SN7446 or SN7447. Snaps in 14-pin DIP socket, 3/4 x 3/8 x 3/8", characters: 1/4 x 3/16", 5V, 20-mils per seg. characters: 1/4 x 3/16". Famous MAN-1 type.  
 Sockets .50 ea.

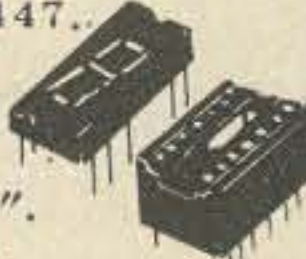

**\$2.95**  
Buy 3 - Take 10%



This display is excellent for small portable electronics, such as DVM's, calculators, etc. Equivalent to Monsanto MAN 3A. Operates from 5V, 20 milliamperes, with 47 ohm dropping resistor.

**HOT MOS FETS**

- 2- MOS FETS, N channel 10k u mos 3N128, TO-18, RCA \$1
- 2- MOS FETS, DUAL GATE, N chan., 3N187-1, TO-18, \$1
- 2- MOS FETS, DUAL GATE, N chan., 3N140-1, TO-18, \$1

**LED—PHOTO—SOLAR 'DOLLAR STRETCHERS'**

- 3 — "LEDS", visible, micro-miniature, axial leads ..... \$1
- 2 — "LEDS", infrared, jumbo, TO-18 ..... \$1
- 2 — "LEDS", visible, jumbo, red, TO-18 ..... \$1
- 1 — "LED", invisible, parabolic reflector, RCA ..... \$1
- 1 — PHOTO TRANSISTOR, with darlington amp filter, lens \$1
- 2 — PHOTO TRANSISTORS, with darlington amp, 2N5777 \$1
- 4 — PHOTO CELLS, Clairex, pancake, 30K-70 ohms ..... \$1
- 2 — SILICON SENSORS, TEXAS, H-38 Matchstix, visible \$1

3 for \$7.50

**NATIONAL VOLTAGE REGULATOR \$2.25**



LM-309K 5 volts, 1 amp TO-3 case. Internally set. Overload and short circuit proof. No external components. With spec sheets. 3 for \$6.00

Terms: add postage, cod's 25%. Rated: net 30  
Phone Orders: Wakefield, Mass. (617) 245-3829  
Retail: 16-18 Del Carmine St., Wakefield, Mass. (off Water Street) C.O.D.'S MAY BE PHONED



**"DIGITAL CLOCK ON A CHIP"**  
Only **\$14.95**



SD-5314 direct substitute to famous U.S. maker. 24-Pin DIP — IMAGINE! ONE CHIP ELIMINATING 15 IC & other parts. Space Saver! Money saver! Latest in clock design. Features 12 or 24-hr. operation. 4 or 6 digits, 40 or 60 Hz operation. Internal digit multiplex oscillator, leading zero blanking, high output current for simple readout interface. Single power supply operation. Digit blanking for reduced current drain, 11 thru 19 volt range. Full MOS LSI. Spec sheets included.

**NEW**  
Buy 3 Take 10%



15c CATALOG on Fiber Optics, 'IC's', Semi's, Parts

**POLY PAKS**

P.O. BOX 942A, LYNNFIELD, MASS. 01940



# MORE CIRCUITS...

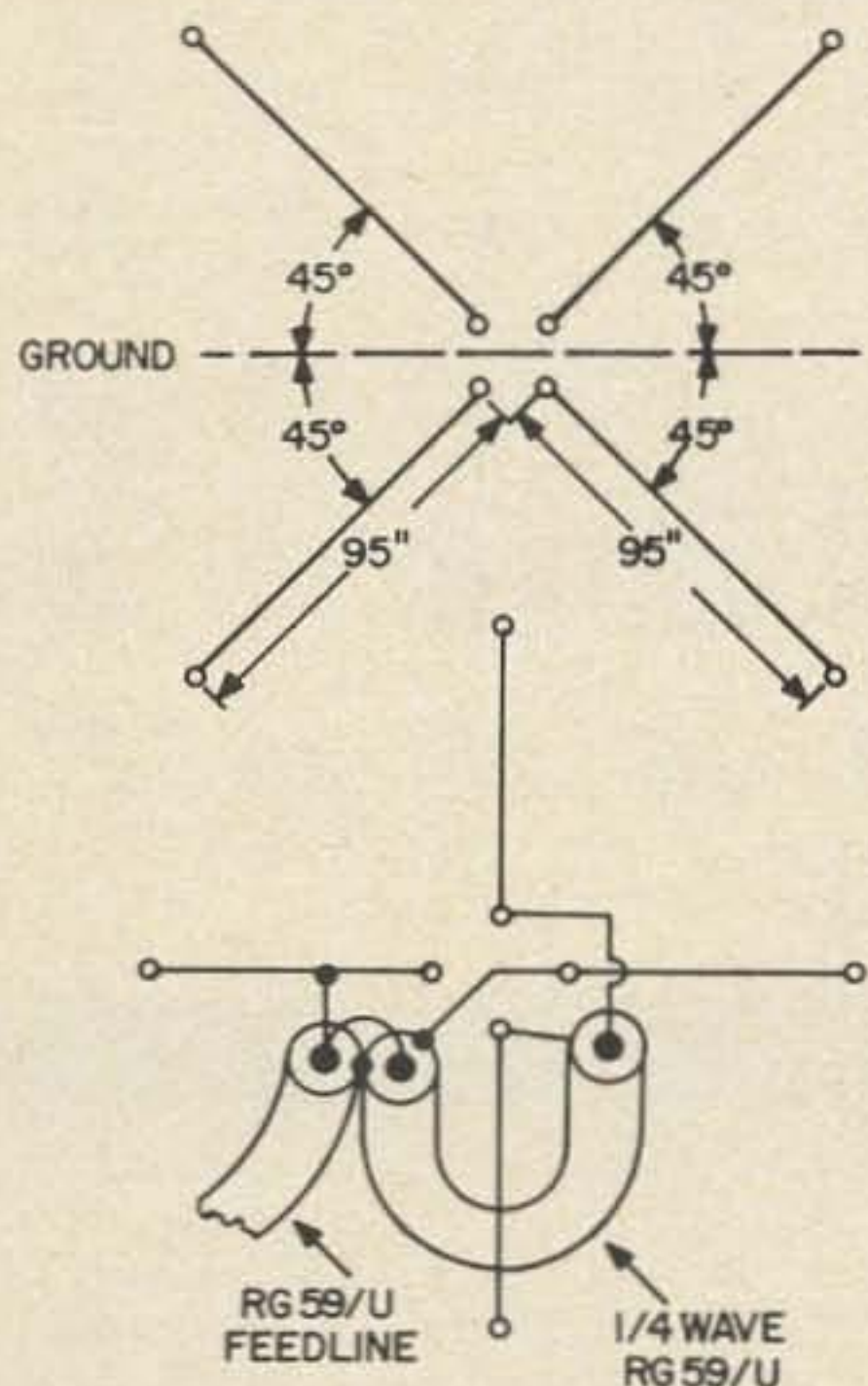

10 meter omnidirectional antenna for OSCAR reception. Mount each dipole antenna at right angles to the other and slant the halves down toward the ground at a 45° angle. Feed one dipole with RG59 coax, the center conductor goes to one half of the dipole and the braid goes to the other half of the dipole. Connect a  $\frac{1}{4}\lambda$  length of RG59/U to the first dipole connections and connect the other end to the 2nd dipole, i.e., braid to one element and the center conductor to the other. Thanks to W2EIF.

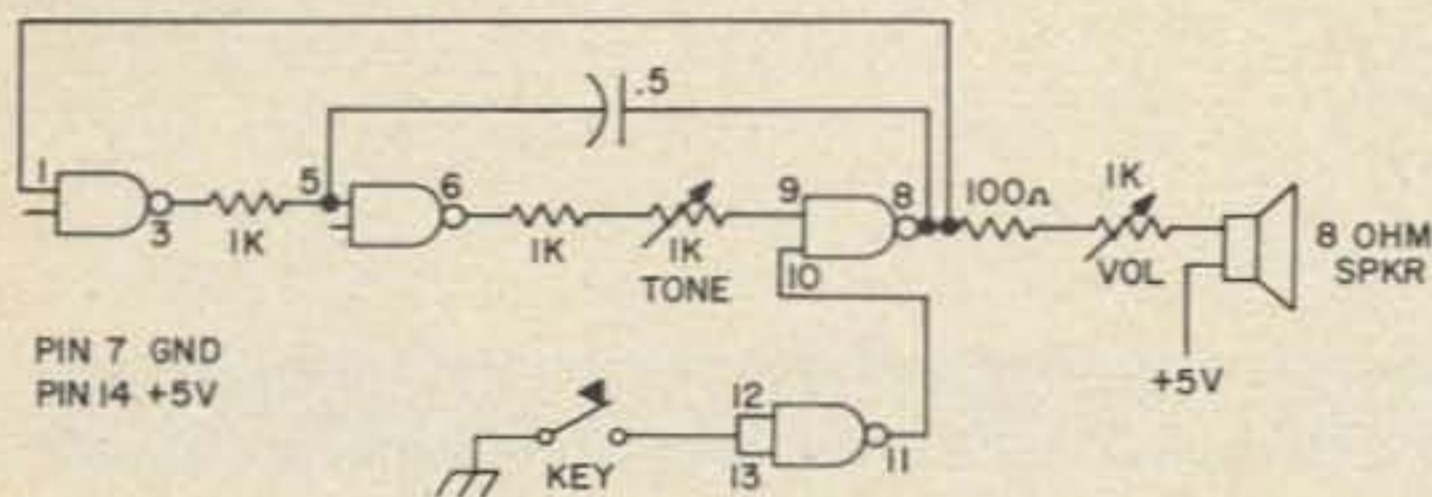

An inexpensive code oscillator circuit which requires one SN7400 quad NAND gate and has tone and volume controls.

If the value of the .5  $\mu$ F capacitor is increased, the frequency range of the oscillator will be lowered. The tone output is not the purest dc note, since a square wave is output directly to the speaker. However, it is quite satisfactory for code copy. The SN7400 requires a 5V dc regulated supply. A suitable supply can be built using a bridge rectifier circuit and a LM309K voltage regulator. Thanks to WA3SKE.

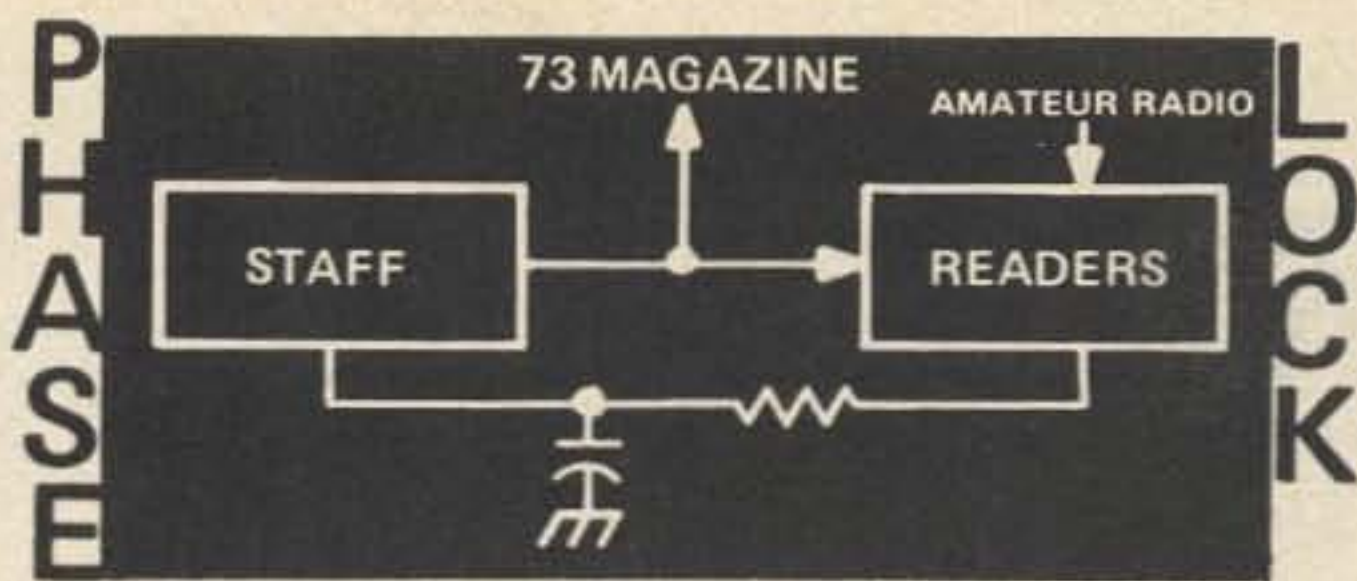

In this issue, do you think there is a need for more

	Yes	No
Simple construction projects	<input type="checkbox"/>	<input type="checkbox"/>
Complex construction projects	<input type="checkbox"/>	<input type="checkbox"/>
General interest articles	<input type="checkbox"/>	<input type="checkbox"/>
Humor articles	<input type="checkbox"/>	<input type="checkbox"/>
Specialized columns	<input type="checkbox"/>	<input type="checkbox"/>
Operating news	<input type="checkbox"/>	<input type="checkbox"/>
Other		

Which do you consider the best articles?

Do you like the idea of specialized issues, as the Mobile, Antenna, FM issues, etc.?

What areas of amateur radio would you like to see emphasized in future issues?

Do you have any comments concerning the layout and style of the magazine?

Do you receive 73 from subscription   
newsstand

Please attach separate sheet for comments on our recent covers . . .

Fill out this form immediately and mail it with the Reader Service coupon on the reverse side.

**SBE** *feature line*

SB-36 • SB-144 • SB-450 • SCANVISION

**NORTHWEST  
ELECTRONICS, INC.**

AVAILABLE  
FROM:

East 730 First Avenue, Terminal Box 3047  
Spokane, Washington 99220

## READER SERVICE

Please either tear out this list of advertisers and send it in to 73 with as many boxes checked off as you would like to see brochures, data sheets or catalogs... or else make a copy and send that in. Include your zip code, please.

### ADVERTISER INDEX APRIL 1973

- |   |   |
|---|---|
| <input type="checkbox"/> Alpha Electronics 64   | <input type="checkbox"/> Hy Gain 110-113        |
| * Amat. Whol. 69, 80                            | <input type="checkbox"/> Jan 99                 |
| <input type="checkbox"/> Antenna Engin. 139     | <input type="checkbox"/> Janel 74               |
| <input type="checkbox"/> Antenna Spec. Cover II | <input type="checkbox"/> Jefftronics 76         |
| * ATV Research 127                              | <input type="checkbox"/> J M Commun. 154        |
| <input type="checkbox"/> Babylon 147            | <input type="checkbox"/> Juge 129               |
| <input type="checkbox"/> B & W 98, 121          | <input type="checkbox"/> Kass Elec. 141         |
| <input type="checkbox"/> Camp Albert Butler 127 | <input type="checkbox"/> Linear Systems-SBE     |
| <input type="checkbox"/> Circuit Spec. 157      | <input type="checkbox"/> 8, 76, 80, 84, 88, 98, |
| <input type="checkbox"/> Clegg 31               | <input type="checkbox"/> 108, 121, 122, 127,    |
| <input type="checkbox"/> Columbia 150           | <input type="checkbox"/> 159                    |
| <input type="checkbox"/> ComCraft 50            | <input type="checkbox"/> Mann 156               |
| <input type="checkbox"/> Command Prod. 127      | <input type="checkbox"/> Meshna 151, 152, 153   |
| <input type="checkbox"/> Control Signal 117     | <input type="checkbox"/> MFJ 121                |
| <input type="checkbox"/> Cornell 80             | <input type="checkbox"/> Midland 45, 130        |
| <input type="checkbox"/> CushCraft 80           | <input type="checkbox"/> Morgain 84             |
| <input type="checkbox"/> Data Engin. 136, 137   | <input type="checkbox"/> NHE 140                |
| <input type="checkbox"/> Densen 149             | <input type="checkbox"/> Nichols 146            |
| <input type="checkbox"/> Drake 32, 37           | <input type="checkbox"/> Novice Mag. 122        |
| * DuPage 145                                    | <input type="checkbox"/> Palomar 60             |
| <input type="checkbox"/> Erickson 54            | <input type="checkbox"/> Pearce Simpson 122     |
| <input type="checkbox"/> Exceltronics 86        | <input type="checkbox"/> Poly Paks 158          |
| <input type="checkbox"/> Fair 121               | <input type="checkbox"/> Quezer 148             |
| <input type="checkbox"/> Gam Elec. 142          | <input type="checkbox"/> Regency 92             |
| <input type="checkbox"/> Gateway 74             | <input type="checkbox"/> Rohn Towers 30         |
| <input type="checkbox"/> Genave 7               | * R P Elec. 115                                 |
| <input type="checkbox"/> G F Elec. 98           | <input type="checkbox"/> Savoy Cover III        |
| <input type="checkbox"/> Gregory 143            | <input type="checkbox"/> Sentry 11              |
| <input type="checkbox"/> Ham Shack 131          | <input type="checkbox"/> Solid State 155        |
| <input type="checkbox"/> Hamtronics 134, 135    | <input type="checkbox"/> SouthWest Tech. 65     |
| <input type="checkbox"/> Hamvention 122         | <input type="checkbox"/> Standard Commns. 26    |
| <input type="checkbox"/> Harrison 133           | <input type="checkbox"/> Telrex 89              |
| <input type="checkbox"/> Heath 14, 15, 62       | <input type="checkbox"/> Vanguard 20            |
| <input type="checkbox"/> Henry Cover IV, 4      | <input type="checkbox"/> VHF Engin. 138         |
| <input type="checkbox"/> Hirsch Sales 99        | <input type="checkbox"/> Vibroplex 121          |
| <input type="checkbox"/> Hobby Industry 29      | <input type="checkbox"/> Waller 61              |
| <input type="checkbox"/> Hoisington 76          | <input type="checkbox"/> Windjammer 144         |
|   | <input type="checkbox"/> World QSL 122          |

73 Stuff  
 Bookshop 102, 103  
 Subscriptions 104  
 Agent 0073 101

\*Reader service inquiries not solicited. Correspond directly to company.

Mail to Readers' Service  
**73 INC., PETERBOROUGH NH 03458**  
 PLEASE PRINT OR TYPE

Name \_\_\_\_\_ Call \_\_\_\_\_

Address \_\_\_\_\_

State \_\_\_\_\_ Zip \_\_\_\_\_

## PROPAGATION CHART

J. H. Nelson

Good (Open), Fair (□), Poor (O)

*April 1973*

SUN	MON	TUES	WED	THUR	FRI	SAT
1	2	3	4	5	6	7
8	9	10	11	12	13	14
15	16	17	18	19	20	21
22	23	24	25	26	27	28
29	30					

### EASTERN UNITED STATES TO:

	GMT:	00	02	04	06	08	10	12	14	16	18	20	22
ALASKA	7A	14	7	7	7	7	7	7	7	7	7	7A	7A
ARGENTINA	14A	14	14	7	7	7	14	21	21	21	21	21	21
AUSTRALIA	14	14	7B	7B	7B	7	7	14	7B	7B	14	14	14
CANAL ZONE	14	14	7	7	7	7	7	7	7	21	21	21	21
ENGLAND	7	7	7	7	7	7B	14	14	14A	14	14	14	7A
HAWAII	14	14	7B	7	7	7	7	7B	14	14	14	14	14
INDIA	7	7B	7B	7B	7B	7B	7A	14	14	14	7A	7B	7B
JAPAN	14	7A	7B	7B	7B	7	7	7	7	7	7B	14	14
MEXICO	14	14	7	7	7	7	7	14	14	14	14A	14A	14A
PHILIPPINES	14	7B	7B	7B	7B	7B	7B	7	7	7	7B	14	14
PUERTO RICO	14	7	7	7	7	7	7	14	14	14	14	14	14
SOUTH AFRICA	14	7	7	7	7B	14	14	14A	21	21	14	14	14
U. S. S. R.	7	7	7	7	7	7B	7B	14	14	14	7B	7B	7B
WEST COAST	14	14	7	7	7	7	7	7A	14	14	14	14	14

### CENTRAL UNITED STATES TO:

ALASKA	14	14	7A	7	7	7	7	7	7	7A	14	14	14
ARGENTINA	14A	14	14	7	7	7	14	14A	21	21	21	21	21
AUSTRALIA	21	21	14	7B	7B	7	7	7A	7B	7B	14	14	14
CANAL ZONE	21	14	7A	7	7	7	14	14	14	21	21	21	21
ENGLAND	7B	7	7	7	7	7	7	7B	14	14	14	14	7A
HAWAII	14A	14	14	7B	7	7	7	14	14	14A	14A	14A	14A
INDIA	14	7A	7B	7B	7B	7B	7B	7B	7	7	7	7	7
JAPAN	14	14	7A	7B	7B	7	7	7	7	7	14	14	14
MEXICO	14	7	7	7	7	7	7	7	14	14	14	14	14
PHILIPPINES	14	14	7B	7B	7B	7B	7	7	7	7	7B	14	14
PUERTO RICO	14	14	7	7	7	7	7A	14	14	14A	14A	14A	14A
SOUTH AFRICA	14	7	7	7	7B	7B	14	14	14	14A	14A	14	14
U. S. S. R.	7	7	7	7	7	7B	7B	7A	14	14	7B	7B	7B

### WESTERN UNITED STATES TO:

ALASKA	7A	14	7A	7	7	7	7	7	7	7	7A	7A	7A
ARGENTINA	14A	14	14	7B	7	7	7B	14	21	21	21	21	21
AUSTRALIA	21	21A	21	14	14	14	7	7	7B	7B	14	21	21
CANAL ZONE	21	14	7A	7	7	7	7	14	14	14	21	21	21
ENGLAND	7B	7	7	7	7	7	7	7B	7B	14	14	14B	14B
HAWAII	21	21	21	14	14	7A	7	7	14	14	21	21	21
INDIA	14	14	14	7B	7B	7B	7B	7B	7	7	7	7	7
JAPAN	14	14	14	7B	7B	7	7	7	7	7	14	14	14
MEXICO	14A	14	7	7	7	7	7	14	14	14	14	14A	14A
PHILIPPINES	14	14	14	7B	7B	7B	7B	7B	7	7	7B	14	14
PUERTO RICO	14A	14	7	7	7	7	7	14	14	14	14A	14A	14A
SOUTH AFRICA	14	7B	7	7	7B	7B	7B	7B	14	14	14	14	14
U. S. S. R.	7	7	7	7	7	7B	7B	7B	7A	7A	7B	7B	7B
EAST COAST	14	14	7	7	7	7	7	7A	14	14	14	14	14

A = Next higher frequency may be useful also.  
 B = Difficult circuit this period.

# Savoy

HIGH EFFICIENCY ANTENNAS  
FOR HF AND VHF

**NEW!**

**NEW!**

Increase your effective radiated power the inexpensive way with the new Bassett Wide Band VHF Collinear Antenna of sparkling white fiberglass and chrome plated brass.

- GETS RADIATOR ABOVE VEHICLE
- QUICK FOLDOVER FOR GARAGING
- COMPLETELY ADJUSTABLE
- 115 MHZ TO 175 MHZ CHOICE
- GAIN WITH LOW VERTICAL ANGLE
- EXTREMELY LIGHT IN WEIGHT
- SPARKLING WHITE FIBERGLASS
- POLISHED CHROME HARDWARE
- EASILY HANDLES 500 WATTS
- STANDARD  $\frac{3}{8}$  - 24 BASE THREAD
- FOR BUMPER OR TRUNK LIP MOUNT

MODEL DGA-2F  
\$39.50  
Postpaid in U.S.A.

- GETS RADIATOR ABOVE VEHICLE
- FIXED — NON ADJUSTABLE
- SUPPLIED FOR DESIRED FREQUENCY
- 115 MHZ TO 175 MHZ CHOICE
- GAIN WITH LOW VERTICAL ANGLE
- EXTREMELY LIGHT IN WEIGHT
- SPARKLING WHITE FIBERGLASS
- POLISHED CHROME HARDWARE
- EASILY HANDLES 500 WATTS
- STANDARD  $\frac{3}{8}$  - 24 BASE THREAD
- FOR BUMPER OR TRUNK LIP MOUNT

MODEL DGA-2M  
\$29.50  
Postpaid in U.S.A.

Antennas of similar appearance and efficiency are now available for Commercial, Public Service, CB, and for use in the Amateur 10-15-20-40 and 75 Meter Bands.

CONTACT YOUR DISTRIBUTOR OR WRITE FOR DATA



**Savoy Electronics, Inc.**

P.O. Box 7127 - Fort Lauderdale, Florida - 33304

Tel: 305-566-8416 or 305-947-1191

# a new standard of comparison

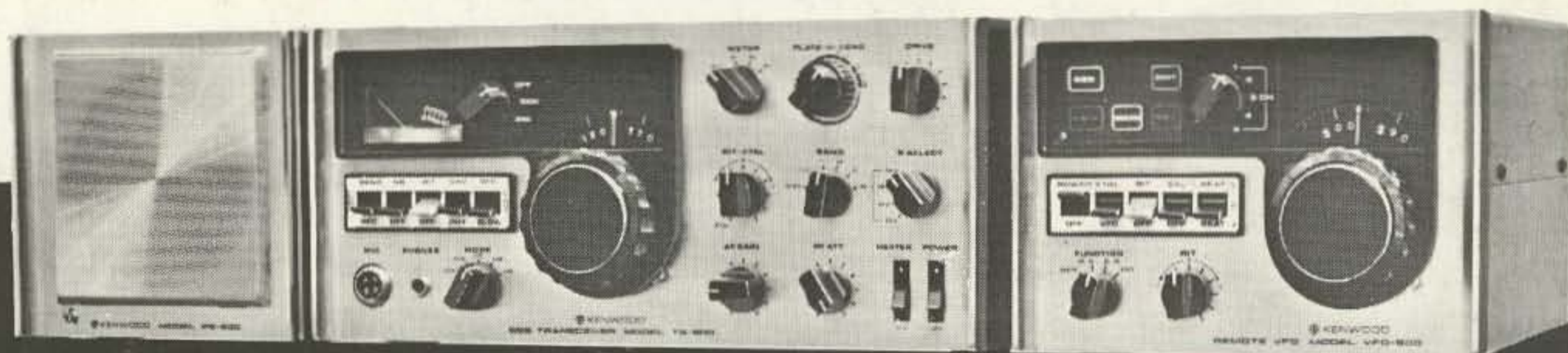

## KENWOOD'S SUPERB NEW SOLID STATE SSB TRANSCEIVER

# TS-900

**FEATURES:** • Break - in CW with sidetone • Built - in 100 KHz and 25 KHz crystal oscillator • Built - in RIT and RIT indicator light • Built - in RTTY frequency shift for FSK • Built - in noise blanker • Built - in VOX • Modular construction — repair in or out of equipment • RF AGC to prevent front end overload to strong signals • Completely solid state except final section • 1 KHz readout

**GENERAL SPECIFICATIONS:** • Frequency Range: 2 - 30 MHz Amateur Bands and WWV • Mode: SSB, CW, or FSK • Power Output: 150 watts PEP nominal into 50 ohms for SSB, 100 watts nominal into 50 ohms for CW, 50 watts nominal into 50 ohms for FSK • Frequency Stability: Within 100 Hz during any 15 minute period after warmup. Within  $\pm 2$  KHz during the first hour after 1 minute of warmup • Receiver Sensitivity: 0.5 microvolts for a 10 db (signal + noise)/noise ratio • Receiver Selectivity: SSB and FSK — 2.2 KHz bandwidth (6 db down), 4.4 KHz bandwidth (60 db down), CW — 0.5 KHz bandwidth (6db down), 1.5 KHz bandwidth (60 db down), (with optional CW filter installed) • Dimensions: 12.6" wide  $\times$  5.5" high  $\times$  12.6" deep • Weight: 26.5 pounds (32.5 pounds shipping weight) • Price: TS - 900 \$745.00, PS - 900 (AC Supply) \$110.00, DS - 900 (DC Supply) \$130.00, VFO - 900 (Remote VFO) \$195.00.

**THE KENWOOD R-599 RECEIVER...** 1.8 to 29.7 MHz (Amateur Bands) • Dial readout to  $\frac{1}{2}$  KHz • Special detectors for SSB, AM, and FM • Transceive operation with T-599 • Built-in 100 KHz and 25 KHz calibrators • Built-in 500 cycle CW filter • Provision for 2 meter and 6 meter coverage with accessory self-contained converters • 120/240 VAC or 12 VDC operation • All solid state • R-599 — \$345.00 Converters — \$31.00 S-599 — \$16.00.

**THE KENWOOD T-599 TRANSMITTER...** Clear, stable, selectable sideband, AM and CW • 4-way VFO flexibility plus RIT when used with the R-599 • Amplified ALC • Built-in VOX • Full metering • Built-in CW sidetone monitor and semi-automatic break-in CW • Built-in power supply for 120/240 VAC operation • Only 3 vacuum tubes • 200 watts PEP input nominal • Full amateur band coverage (3.5 to 30 MHz). T-599 — \$395.00

**THE KENWOOD TS-511S TRANSCEIVER...** a powerful five band transceiver (3.5 to 30 MHz, amateur bands) for operation on SSB and CW • Built-in VOX • Built-in crystal calibrator • Built-in noise blanker • Receiver Incremental Tuning (RIT) • 1 KHz frequency readout • Eight pole filter • Exceptional stability • Provisions for installation of an accessory high selectivity CW filter • 500 watts PEP input for SSB • .5  $\mu$ V sensitivity nominal • Full metering — Cathode current (IP), plate voltage (HV), ALC, and relative power output (RF) as well as an S-meter • Amplified ALC • Heavy duty 120/240 VAC external power supply. TS-511S — \$415.00 PS-511S — \$105.00 VFO-5SS — \$105.00 CW-1 — \$39.00

See the Kenwood line at the following dealers: CALIFORNIA Communications Headquarters, San Diego • Henry Radio, Anaheim • Henry Radio, Los Angeles • Webster Radio, Fresno • COLORADO Radio Communication Co., Arvada • FLORIDA Amateur Radio Center, Miami • Amateur-Wholesale Electronics, Miami • Slep Electronics Co., Ellenton • ILLINOIS Erickson Communications, Chicago • Klaus Radio Peoria • Spectrosonics, Chicago • INDIANA Graham Electronics, Indianapolis • Radio Distributing, South Bend • IOWA Hobby Industry, Council Bluffs • KANSAS Associated Radio Communications, Overland Park • LOUISIANA Electronic Exchange, Metairie • Trionics, New Orleans • MAINE Down East Ham Shack, Lewiston • MARYLAND Professional Electronics, Baltimore • MICHIGAN Electronic Distributors, Muskegon • Radio Supply & Engineering, Detroit • MINNESOTA Electronic Center, Minneapolis • MISSOURI Ham Radio Center, St. Louis • Henry Radio, Butler • MONTANA Conley Radio Supply, Billings • NEW JERSEY Simon Sideband, Oak Ridge • NEW YORK Adirondack Radio Supply, Amsterdam Harrison Radio, Farmingdale and NYC • NORTH CAROLINA Freck Radio & Supply, Asheville • Vickers Electronics, Durham • OHIO Amateur Electronic Supply, Cleveland • Communications World, Cleveland Queen City Electronics, Cincinnati • Srepc Electronics, Dayton • OKLAHOMA Derrick Electronics, Broken Arrow • Radio, Tulsa • OREGON Portland Radio Supply, Portland • PENNSYLVANIA JRS Distributors, York • Kass Electronics, Drexel Hill • SOUTH DAKOTA Burghardt Amateur Center, Watertown • TEXAS Douglas Electronics, Corpus Christi • Industrial Distributors, Dallas • Ed Juge Electronics Fort Worth and Dallas • Madison Electronics, Houston • UTAH Manwill Supply, Salt Lake City • WASHINGTON Amateur Radio Supply, Seattle • WISCONSIN Amateur Electronic Supply, Milwaukee  
(Prices subject to change without notice)

Prices subject to change without notice.