

73

\$1.00
October 1973
26009
A
CE

magazine
for radio amateurs

SLOW SCAN

CONTRAST
NORM
BRIGHTNESS

SLOW SCAN
PROGRAM
CONTEST

See page 6
for details

**IF YOU NEED A
COMMUNICATIONS TOWER
UNDER 100' HIGH,
COMPARE BEFORE
YOU BUY:**

	Free-standing Ascom/Universal Aluminum Tower	Typical Free-standing Commercial Steel Tower
Height	60'	60'
Wind rating	6 Sq. Ft. @ 80 MPH (EIA Standard)	3 Sq. Ft. @ 80 MPH (EIA Standard)
Erection requirement	1 man, 3 hr.	3 men, 8 to 12 hr.
Tower weight	153 lbs.	571 lbs.
Maintenance	none	annual
Mfgr. sugg. list	\$466.20	\$590.00

**Now—can you think of one
good reason to buy a steel tower?**



ascom / UNIVERSAL ALUMINUM TOWERS
ascom electronic products
12435 Euclid Ave., Cleveland, Ohio 44106

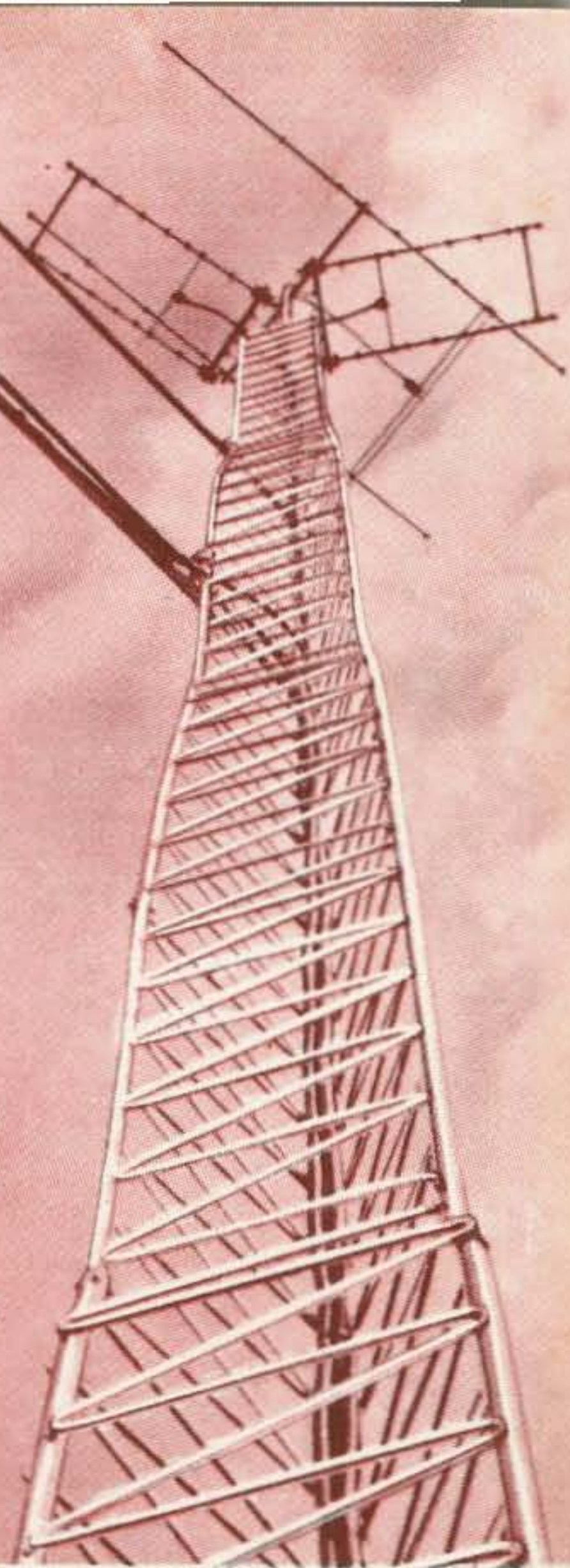

RM640 DURACELL BY MALLORY. 1.4V 500 mA
MERCURY CELL. FRESH! 2/50¢



DUAL 16VCT TRANSFORMER. (2) 16V, 1/2A WINDINGS AT 115 VAC, 60HZ INPUT. PERFECT FOR USE IN YOUR DUAL OP AMP SUPPLY. EACH SECONDARY IS CENTERTAPPED FOR MAXIMUM FLEXIBILITY DESIGN. JACKETED. \$3.25

8K OF 8 BIT BYTE CORE MEMORY PLANES BY RCA ON A PLUG-IN CIRCUIT BOARD. SELECTION DIODES ARE INCLUDED ON THESE BRAND NEW BOARDS.....\$49.50



IC BOARD WITH 3 OR 4 DIGITAL IC'S. LOOKS LIKE EVERY IC PIN COMES TO ONE OF THE CONNECTOR PINS. JUST THE THING FOR EXPERIMENTS. 3/\$1.25

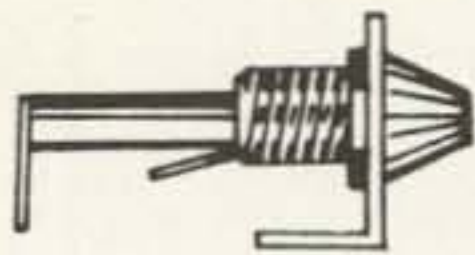

3AG FUSE POST. LITTLEFUSE 342 MOUNTED ON A METAL L BRACKET NEW, UNUSED.....\$.30

DORMEYER #P6102L FAST ACTING SOLENOID. 24VDC. 50¢, 3/\$1.30

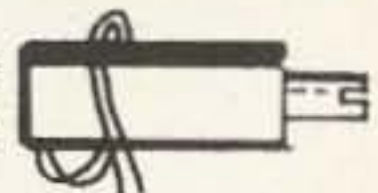

TRANSISTOR HEAT SINK ASSEMBLY. (2) 2N2905 TRANSISTORS MOUNTED ON SMALL HEAT SINK. NEW ASSEMBLIES. PERFECT FOR LOW POWER CONVERTERS OR AMPLIFIERS. \$.60, 2/ \$1.00

STEPPER SWITCH MODULE. AN ALUMINUM RACK WITH A 10 DECK, 25 STEP GOLD CONTACT STEPPER SWITCH PLUS TRANSISTOR DRIVER, FIFTY MINIATURE AMPHENOL STRIPLINE CONNECTORS, (6) 50 CONTACT BLUE RIBBONS, (25) PC BOARDS WITH DIODES, MINIATURE 11 POSITION DECK SWITCH AND THE RACK. USED, IN GOOD CONDITION..... \$12.50

TOROIDAL CORE. SQUARE LOOP FOR USE IN POWER SUPPLY OSCILLATORS, DRIVEN CONVERTERS, CAPACITIVE DISCHARGE IGNITIONS, ETC. 120 WATTS, UP TO 25KHZ. USE IN LINE VOLTAGE DIRECT CONVERSION AVOIDING THE USUAL BULKY TRANSFORMERS AND LARGE FILTER CAPACITORS..... \$1.00



ERIE CERAMIC PC BOARD VARIABLE CAPACITORS. 2-8pf, 5.5-18pf, 9-35pf. YOUR CHOICE.... \$.40



JOHNSON VARIABLE CAP 1.5-5pf \$.65

EH LABS MODEL 1221 PRECISION TIMING UNITS. EXCELLENT 6 CHANNEL PULSE SOURCE. EACH CHANNEL HAS DELAY VARIABLE FROM TRIGGER. LIKE NEW. 2 ONLY. \$450.00

UNIVAC PRINTED CIRCUIT BOARD ASSORTMENT. A GOOD ASSORTMENT OF BOARDS CROWDED WITH TRANSISTORS, DIODES, CAPACITORS, INDUCTORS, POTS, TRANSFORMERS, TEST JACKS AND MORE. ASSORTMENT OF 10.....\$1.00

TRI-TEK HAS A NUMBER OF B.I.T. MODEL 483 MINI-COMPUTERS IN STOCK. MACHINES ARE COMPLETE WITH POWER SUPPLY, MEMORIES, OPERATORS CONSOLE AND TTY BUFFERING. THESE ARE ALL NEW PRODUCTION UNITS USING HIGH SPEED LOGIC IC'S. LESS THAN 1/10th ORIGINAL COST. WRITE FOR DETAILS.



tri-tek, inc.

P.O BOX 14206, DEPT 7
PHOENIX. ARIZONA 85063

NEW AND SURPLUS ELECTRONIC COMPONENTS FOR THE PRO AND SERIOUS AMATEUR. AN ORDER OR 8¢ STAMP PUTS YOU ON OUR MAILING LIST. MINIMUM ORDER \$3.00 U.S., \$15.00 FOREIGN. ALL ORDERS POSTPAID. PLEASE ADD INSURANCE

FEATURES

- | | |
|-----------------------------|-------------------------|
| 1 Table of Contents | 8 Contest Announcements |
| 2 Never Say Die W2NSD/1 | 8 New Products |
| 4 Fantastic Code Tape Offer | 10 QSL Contest |
| 5 SSTV Scene | 11 Caveat Emptor |
| 6 Slow Scan Program Contest | 111 Phase Lock |
| 7 DX Footnotes | 112 Ad Index |
| 7 Social Events | 112 Propagation |
| 8 Repeater Update | |

EDITORIAL STAFF

Wayne Green W2NSD/1
Keith Lamonica W7DXX/1
Ron Subka WA9FPP/1
Yvette Grimes WA8ULU/1

ASSOCIATES

Gus Browning W4BPD
Mike Frye WB8LBP
Bill Hoisington K1CLL
Dave Ingram K4TWJ
Jim Kyle K5JKX
Harry Simpson A4SCF
Bill Turner WA0ABI

PRODUCTION

Ruthmary Davis
Karen Hebert
Biff Mahoney
Peri Mahoney
John Miller
Janet Oxley
Lynn Panciera-Fraser
Philip Price
Bill Suderman
Bill Sundberg

BUSINESS

Knud E.M. Keller KV4GG/1

CIRCULATION

Barbara Block
Jackie Garner
Dorothy Gibson

TRANSPORTATION

Kurt Schmidt
Jinx Townsend

PROPAGATION

John Nelson

DRAFTING

T.M. Graham W8FKW
Bill Morello
Wayne Peeler K4MVW

CONTENTS

- | | | |
|----|--|-----------|
| 13 | Converting the G.E. Pocket Mate | WB4DBB |
| | Transform a pocket transceiver into a pocket transceiver! | |
| 17 | Frequency Measurement at Microwaves | WA9VFG |
| | Be prepared for equipment with tiny knobs. | |
| 21 | 2m Front End Using One IC | K1CLL |
| | A high performance 6 transistor design. | |
| 29 | Instant Replay for your Tape Recorder | W6FPO |
| | A tape recorder is a must for Slow Scan. | |
| 31 | 2KW PEP Building-Block Linear | W2EEY |
| | Module design leaves room for improvement. | |
| 39 | Yet Another Wattmeter | K5CXN |
| | Did you build your first one yet? | |
| 43 | Meter Legerdemain | WB2PAP |
| | Pull a rabbit out of a broken VOM. | |
| 49 | Europe's DX Repeater | W2EEY |
| | Is 2m WTW a future possibility? | |
| 57 | Two Band Balanced Dipole | W2OZH |
| | Another high-wire act for your back yard. | |
| 61 | A Digital "HI" Generator | WA6JMM |
| | Even a Chevrolet can learn CW. | |
| 67 | Oscillating Ring Counter | Weinstein |
| | October foolishness. | |
| 69 | Frequency Multiplication with Transistors | K1CLL |
| | Bill Hoisington turns down his thumb at the standard circuits. | |
| 77 | Amateur Rules and Regulations, Part V | FCC |
| | This month the watertight compartments of the Titanic are explained in detail. | |

73 Magazine is published monthly by 73, Inc., Peterborough, New Hampshire 03458. Subscription rates are \$6 for one year; in North America and U.S. Zip Code areas overseas, \$7 per year elsewhere. Three years, \$14, and \$16 overseas. Second class postage paid at Peterborough NH 03458 and at additional mailing offices. Printed at Menasha, Wisconsin 54942 U.S.A. Entire contents copyright 1973 by 73 Inc., Peterborough NH 03458. Phone: 603-924-3873. Microfilm edition of 73 available from University Microfilms, Ann Arbor, MI 48106. Magnetic tapes available from Science for the Blind, 332 Rock Hill Rd., Bala Cynwyd PA 19904.



NEVER SAY DIE

...de W2NSD/I

EDITORIAL BY WAYNE GREEN

MISQUOTED

The editor of a small DX publication — a sort of newsletter for contest ops — took me to task for the July article on the repeater regulations. Normally I would ignore something like this, but the technique is all too familiar and I would like to point this out in case someone mentions the piece to you over the air.

In this editorial I was accused of holding that it is illegal to experiment with antennas which are to be used for repeaters — that it is illegal to operate a repeater on reduced power when necessary — that it is illegal to use the same station for auxiliary link and remote control and forbidden to have more than six control operators for a repeater. Not one of these things did I say in my article — not *one*!

From there the editor proudly goes on to disprove my statements. Big deal. What I did say is on pages 59-60 of the July issue of 73 and has little resemblance to the statement by the editor. Obviously he was counting on his readers not reading my article — and he is probably right as 73 does not cover contest activity in depth and there probably is little overlap.

Since many readers do not take the time to read through things like this carefully, and thus may be confused about the above points, let me point out that it is not in any way illegal to experiment with antennas — as long as you don't do it on your repeater. Your repeater antenna must be the one that the FCC has okayed for your repeater. If you are going to change it, even for a short while, you should apply to the FCC for permission and include the horizontal and vertical patterns of the new antenna, unless it is an accepted commercial antenna, in which case you merely refer to it by its nomenclature. When you get the official word from the Commission to change, then you change. I realize that this sounds insane, but this is the way Walker wants it and the way HE reads HIS regulations — and this means that this is what we are stuck with for the time being.

It is difficult to keep up with the ever changing interpretations of the rules. Walker was adamant at first that the control operator must have some system for keeping the repeater on the

air with a pulse or something that would indicate that he was in active control. This seems to have been dropped — thank heavens.

Walker has not relaxed much on his position on a maximum of six control operators. This is not in the FCC rules, it is just a Walkerule, but it still has caused quite a few repeater applications to be rejected, nevertheless. Walker does say that if there are serious extenuating circumstances that he *might* accept more than six control points.

As far as operating the repeater with less than the power applied for on the license application, the Walker approach is that *any* changes in the parameters set up in the application must have official FCC sanction before being made. The repeater power obviously is one of these parameters and there is nothing in the rules about being able to operate with lower power with no notification. And Walkerules state that notification **MUST** be before the fact, not after, and that sanction must be received from the Commission before changes are made.

These things are all idiotic and the sooner we are able to get rid of the paperwork garbage the better. In the meanwhile the less squabbling there is in the ranks the better. The editor who backs up the FCC to the hilt like that is no real friend of amateur radio.

JOHNSON BLASTS FCC

FCC Commissioner Johnson, whose term officially ended July first, but who is serving until Nixon finds a successor, lashed out at the Commission recently in an article in the Yale Law Journal. Johnson said the FCC is "manipulated daily by the industries it is supposed to regulate and by its staff." Certainly amateurs have seen that happening in recent months, with the deluge of new Walkerules and the 224 MHz CB band that seems to be wanted by only the Electronics Industry Association — the Washington lobby for the CB industry. Money talks.

"As a result," Johnson continued, "the commissioners often make precedents which return to haunt them." Like the 27 MHz CB band, perhaps.

NASA NIXES HT

With a bonafide ham aboard the next to the last Skylab trip, it seemed a natural to have him pack along a little hand unit for some two meter FM work. The space and weight were no problem — but the politics was.

Owen W5LFL was already in the clean room a few days before departure when K3GKB managed to get a little four channel hand unit through to him via Owen's wife — only to have NASA officials turn thumbs down on the basis that they didn't want to have any possibility of anything being said from Skylab that they couldn't censor before release.

Some amateurs have gotten reprimands from NASA for tuning in the down link and giving the information to news media or letting it go through local radio stations. NASA wants complete control over everything coming from space.

Pity.

Imagine the pileups on 34/94! And 52/52! Plus he had one 147 MHz channel set up for simplex that Clegg users would be able to jump on right away.

Pity.

REPORTS NEEDED

Though radio amateurs are intimately involved in virtually every serious disaster, not one in a hundred are written up and sent in for us to use in the newspapers or in our letters to congress. Please give us the news to use for these valuable services.

Most ops who get involved in emergency work put their all into it and then figure that once the job is done the job is done. There is still a responsibility to help amateur radio by making known what has happened so you can reconstruct the story later and know that you have it straight.

While only 73 and QST are into this type of news, I can assure you that both of these magazines will appreciate knowing what has happened. 73 gives you the extra advantage of knowing that your story has a good chance of being told to congress — and might get into the Congressional Record.

FCC HEARING

Plans are well along for a public hearing before the FCC Commissioners en banc on the matter of the FM repeater rules. The hearing seems to be coming as a response by the FCC to the 73 editorials and pressure to re-examine docket 18803. The en banc hearing was suggested by FCC Chairman Dean Burch in a phone call to 73.

A position paper is in the works which will explain the problems with the new rules, why these rules present

CONSIDERABLY SPECIAL CONSIDERING THE SPECS

2 METER FM TRANSCEIVER

Model SRC-146A



Frequency 143-149 MHz
(2MHz spread)
Number of channels 5
Supplied with 146.94 simplex,
146.34 / .94 (same plug in
crystals as SR-C826M)
R.F. output 2 watt minimum
Sensitivity better than 0.4
uv / 20 DB Q.S.
Audio output 500 mw
Meter monitors battery voltage on
Tx, S Meter on Rx
Current drain 620 ma Tx,
15 ma Rx standby
Size . . . 8³/₈" high x 3" wide x 1⁵/₈" deep
Weight 24 oz., less batteries

Options: *Private channel (CTCSS), external mic, or mic-speaker, stubby flexible antenna, desk top charger, leather case.*

\$289 00

**Suggested
Amateur
Net Price**

NEW 2 METER REPEATER

SCA-RPT-1

All solid state, 2M, 10W, FM REPEATER. Built-in C.O.R., adjustable carrier delay and time out timer.

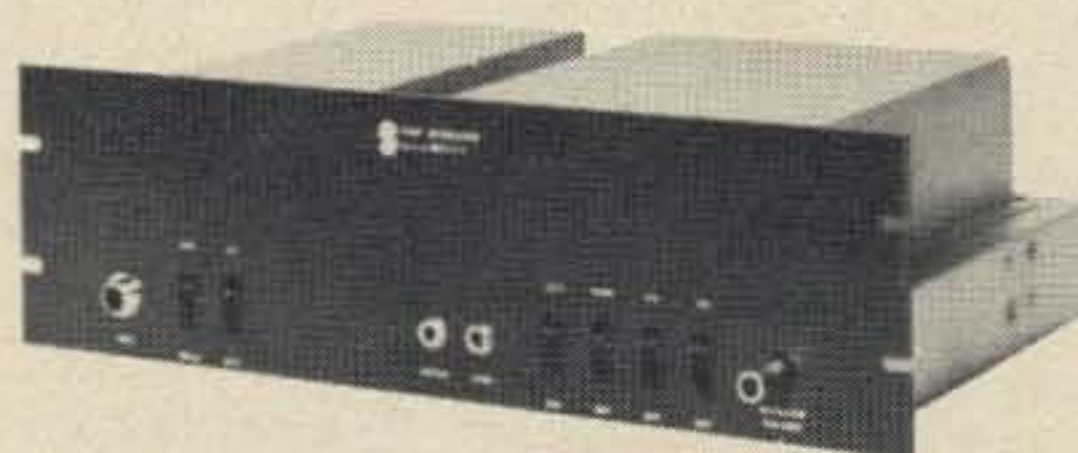

Write for complete specifications and cost.



**Standard
COMMUNICATIONS CORP.**

213 / 775-6284 • 639 North Marine Avenue, Wilmington, California 90744

problems, and what amateurs recommend be done to improve the rules. This paper will be provided to the Commissioners and other interested parties (Walker?) before the hearing.

Representatives of many of the major repeater groups will participate in the hearing. Since time will be very limited, this will probably be kept down to perhaps a dozen at the most. Every effort will be made to have intelligent, well informed and erudite men to answer for all of us at the hearing. The last thing we need is some egomaniac taking the floor to create a bad impression and waste the whole hearing for us...and, as you may realize, amateur radio has more than its share of these critters.

The ARRL was granted a hearing by the Commissioners on July 9th and the reports are that they created a favorable impression with their presentation of the good aspects of amateur radio. Unfortunately they apparently did not get around to explaining why amateurs are so uptight with Walker about the new rules — so this job is still ahead of us.

It is hoped that the result of this hearing will be a re-writing of the repeater regulations. There are many of them that are in bad need of elimination or serious change. Considering the degree of self-regulation of amateur repeaters, it would seem beneficial to have all of the antenna restrictions removed, power limitations removed, crossband restrictions removed, control restrictions removed, map coordinates and height calculations removed, block diagram requirements removed, band limitations removed, power calculations and antenna pattern requirements removed, multiple repeater interconnection restrictions removed — and things like that.

Amateurs, based upon their fantastic record of achievement and service, deserve to be set free to experiment and develop in whatever way they desire.

Once we are able to back Walker down on his Walkerules and Walker-interpretations, perhaps we can get to work on bringing other recent rulings into line — such as the third party traffic restrictions. The FCC handed out a notice of violation to an amateur in a drive-in theater who revealed the price of admission to someone on their way to the drive-in! This insanity has to stop too! The original rules prohibit pecuniary interest and perhaps that is where it should stop. If a chap in Bolivia wants to know where the devil his antenna rotor he ordered from an outfit in New York is, we should be able to call in for him and find out. The fact is that Ma Bell

makes out just fine with most phone patches and darned few ham messages cut into any possible phone revenue. Ma is doing very well anyway, and her major problem is in keeping up with service, not trying to hog it.

We'll try and bring a full report on the FCC hearing — hopefully with some good news on possible rule changes.

Repeater councils that are interested in helping support this hearing should immediately prepare a paper outlining the rules that should be changed — why they should be changed and how they should be changed. Councils who have provided this paper have a right to send a representative to the hearing. Please send the paper to 73 Magazine — and let us know who your representative might be and how to get in touch with him (or her?).

In answer to the editors and amateur radio officials, elected and self-appointed, who took the time and trouble to point out that there was no use in complaining about the repeater regulations — that nothing could be done — that a petition was a waste of time — that we should all just depend upon the League — I would like you to realize that it is indeed possible for someone in our country to speak up and be heard. It is possible for someone to get action. It may even turn out to be possible for rules to get changed!

In this case it was Wayne Green that made the outcry — but it could just as easily have been any individual concerned amateur. Space is available in 73 — and possibly elsewhere for this sort of thing. If you speak up 73 will back you up.

IBM TAPES NEEDED

The tapes for the 73 Magazine MTST IBM composer are wearing out and we need more. Does any reader know where we can get some for a reasonable price? Help!

73 AGENT DOES WELL

One 73 agent made over \$300 at a hamfest in commissions — perhaps you might look into this? That's not a bad pay for a day's work, you know. Drop a note to 73 Magazine and send some references.

DAYTON EXPANDS — AT LAST!

The Hamvention committee has at last decided to expand the Hamvention to a full two and a half days. Thousands of amateurs will certainly cheer this decision — as will an awful lot of manufacturers.

Any amateur with more than one or two interests in the hobby has had a heck of a time getting to the talks of importance. With all of the talks

scheduled in one day, there was incredible overlap. DXers missed important RTTY meetings — delightful SSTV meetings — and so forth. With over two full days for meetings and talks, these things may be able to be spread out a little better.

The size of the flea market has been such that no serious scrounger could possibly do it justice in one short day — there was just far too much.

And the manufacturers exhibits were so packed with hams that only about one in five Hamventioners could break through to ask a question. The odds should be a little better next year. This will be better for the manufacturers too — for they will have a chance to talk personally with more prospective customers — and make more sales — the basic reason for the long trip to Dayton.

The largest hamfest in the country can only get larger with this move.

CASSETTE TAPE CODE COURSE

73 is offering a cassette tape code course that is so simple that the average person can learn the code fast enough to pass the Novice or Tech exam in a few hours. One of the beauties of cassette tapes is that you can take them with you anywhere — at work for lunch break — in the car while you are driving — cassette recorders are simple and inexpensive — and are useful for dozens of ham applications.

This cassette code course will teach the International Morse code at five words per minute — all letters, numbers and punctuation. The tape not only gives all of these characters, but gives them in a very simple order so you can start copying code within one minute of hearing it. This has got to be the easiest way to learn the code ever invented.

The cassette actually has the code being sent at about 6 wpm, allowing a margin for operator panic when the chips are down and the real exam is at hand. It makes the 5 wpm code sound a whole lot slower — and that is a help.

And wait'll you get a look at some of the stuff you'll be copying on this tape — pure Wayne Green, of course. You may lose your place the first time through when some of the stuff hits you. There's no reason why copying code shouldn't be fun — right?

Send now for the 73 Morse Cassette Code Course — only \$3.95 postpaid from 73.

WAYNE

SSTV SCENE

Dave Ingram K4TWJ
Rte. 11, Box 499, Eastwood Vil. 50N
Birmingham AL 35210

SSTV CONTEST ANNOUNCED

This winter promises high Slow Scan activity, and we're kicking it off with a *Slow Scan Program Contest*. It works like this: Make up your prize winning program (6 minutes maximum) on a cassette, and send your entry to 73 Magazine. They will be compiled and reviewed, then forwarded to another "anonymous" judge to be reviewed again. Final results and prize winners will be published. Selected frames from winning tapes will also find a prominent place in these pages.

All entries will be judged on originality, with technical aspects counting in the scoring. This contest begins now and ends December 31, 1973. Be sure to include return postage for your tape.

The purpose of this contest is to get more fellows thinking and acting in terms of good purposeful programs, not just IDs and CQs.

Last month I briefly described some basic scan conversion techniques from the aspect of both solid state and dual gun (lithocon) electron tubes. I also mentioned Don W9NTP, and Art SMØBUO, were developing a converter unit that used the Thompson TME 1238, a single gun storage tube. Since this tube is rather unique, (only one electron gun is used) I have a brief description this month. Figure 1 is a simplified sketch of the tube. First the Slow Scan video is fed in on Grid 1, and stored on the mosaic target. Next, Grid 1 (writing grid) is biased to give a constant electron flow. The electrons now repelled by the "reading" Grid 5, and can be fed to a video amplifier. Since the reading grid does not affect the target (because it doesn't scan it) it is

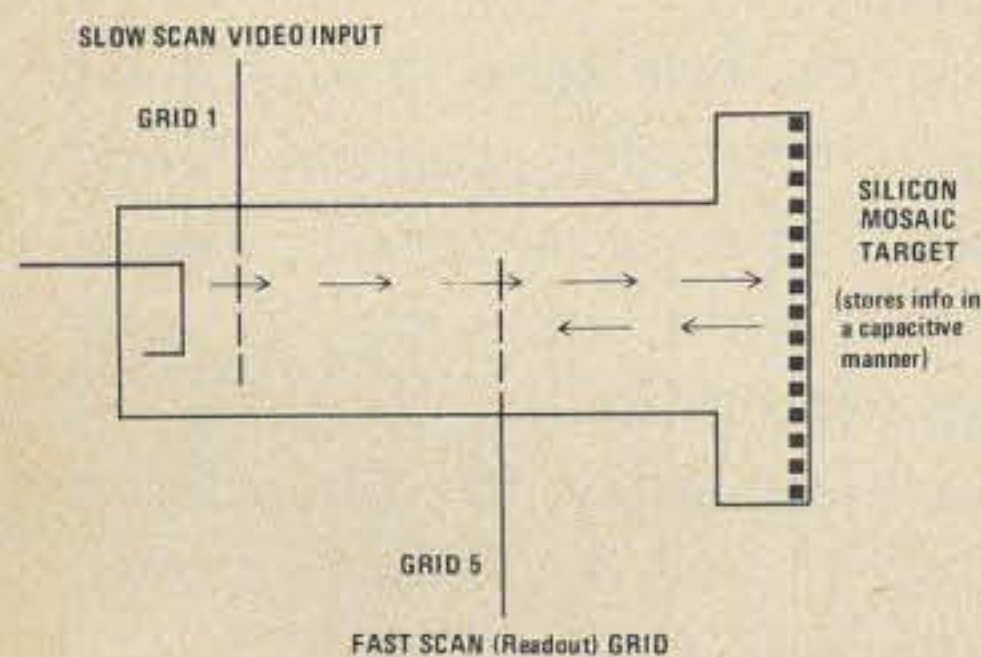

Fig. 1. Simplified sketch of a single-gun storage tube.

considered a nondestructive readout device. In fact, Don turned on his unit two weeks after the Dayton Demonstration, and his last picture was still there! (Of course it wouldn't last this long if it had been constantly "read.")

Our thanks to Dr. Miller for the previous info on the Thompson CSF tube. I understand Don replaced the bad video transistor that caused the noisy pictures at Dayton, and now the unit is working well. Incidentally Don agrees, like many others, digital processing is probably the better way to approach scan conversion from a "standstill." In fact, 3 MOS shift registers, driven by red, green, and blue Slow Scan information could be used to give Slow Scan displayed on a color Fast Scan TV in real time. This is probably 2 or 3 years away yet. A couple of the fellows suggested this MOS shift register method over my "crt/dichroic mirror" color scheme, and I agree this is better. However, for the next few years, the tubes and dichroic mirrors (advertized in the July issue for \$4.95 each) should be less expensive.

Here's some more info on the weather satellite I mentioned last month whose facsimile transmissions might be of interest to Slow Scanners. At this time the four main satellites of interest are ESSA-8 (137.62 MHz), NOAA-2 (137.50 MHz), ATS-1 and ATS-3 (both on 135.60 MHz). ESSA-8 and NOAA-2 are orbital satellites, with an orbital period of 114 minutes, inclination of 101 degrees, and an altitude of 906 miles. (Orbital info is given on W1AW bulletins.) ESSA-8 transmits only while the spacecraft is in daylight areas, and cuts off when it enters a dark area. NOAA-2 is said to be transmitting continuously. ATS-1 and ATS-3 are fixed position (geosynchronous) satellites. ATS-1 is approximately 4,000 miles above Venezuela (70° West/0° latitude). Both of these satellites scan (and can be received by) about 1/3 of the world. You can get a rough idea of this coverage by placing an object 4,000 scale miles above Venezuela on a world globe, for example. Then look at the globe from that point, and you'll see what the satellite sees. If it's "line of sight" (use a piece of string from your QTH to satellite) you should be able to receive it. ATS-1 transmits daily at 0130 to 0215 GMT, and again at 1400 to 1445 GMT. ATS-3 transmits daily at 0730 to 0815 GMT and again at 2045 to 2130 GMT. All of these satellites (except NOAA-2) transmit primarily on facsimile using an amplitude modulated 2400 Hz tone. Maximum amplitude (80 to 100%) corresponds to white, and minimum amplitude (30 db below

this) is black. The horizontal line rate is 4 per second, (240 lines per minute) and a total frame lasts approximately 208 seconds. NOAA-2 differs only in that it has a 48 line per minute rate.

For satellite copy on a surplus deskfax unit, simple video inversion is necessary. (Because maximum amplitude gives the darkest line on current sensitive fax paper.) Then we increase the drum speed from 180 rpm to 240 rpm. There are several methods of accomplishing this like, for example, dividing the 2400 Hz received signal by 30 and using this resultant 80 Hz to run the motor, thus giving 240 rpm. Another method of copying pictures from the satellites is with a converter (for obtaining proper horizontal and vertical timing, a video demod/amplifier, and "front end" limiter) feeding a 'scope or Slow Scan monitor. A camera is then used to photograph the screen (three minute picture...strictly Sloooow Scan!), thus reproducing the picture. Special thanks go to Bob WA7MOV, for his

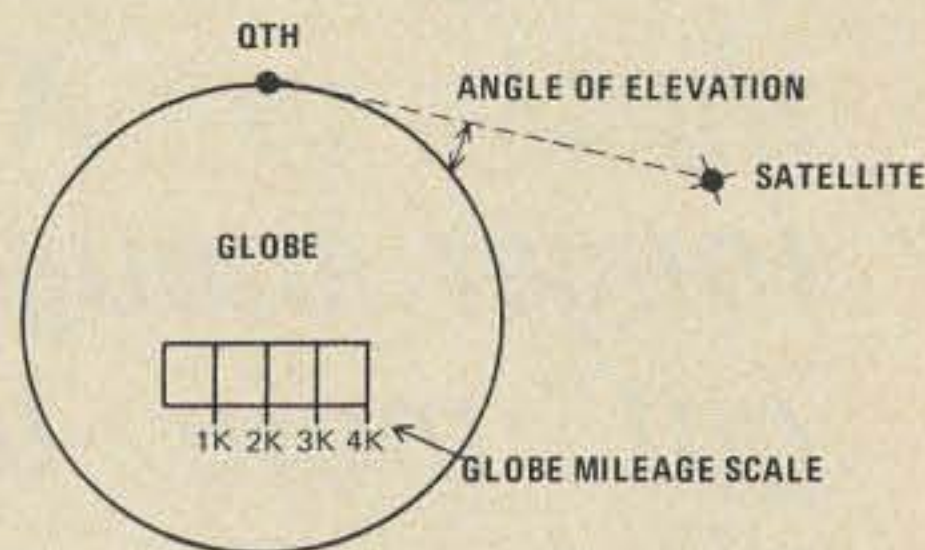

Fig. 2. Setup for measuring satellite antenna positioning.

help in compiling much of the above info. I've also received word from R. L. Drake's Service Manager. Their 2 meter gear should receive okay on 136 MHz, although they have not tried it. Possibly the 2 meter rig's crystal oscillator coil may need slight retuning. (Why shouldn't it work. Many put crystals in 2 meter rigs to pick up Police calls on 150 to 160 MHz.) Mr. Frost of R. L. Drake says crystals are \$7.50 each for the TR-22 and are not returnable. Also the TR-22 bandwidth is 20 kHz...fine for satellite copy. Say — how about a Bearcat "scanner" set up to copy all the satellites.

Barry VK5BS, recently vacationed in the Fiji Islands, carrying quite a bit of SSTV info in hopes of getting some of their hams on slow scan. (Two packs of info I sent him arrived just a couple of days before his departure!) Hopefully, we will soon know the status of SSTV in Fiji.

And finally, the Independent Sideband boys are gathering on Tuesday nights between 14.230 and .240 kHz for ISB SSTV operations. If you're interested, here is the place to be to get in on the action.

...K4TWJ

73

magazine's

1st Annual



a single frame of your shack or XYL is no longer enough — you've got more talent than that . . . now's your chance to prove it?



First Prize

ROBOT Model 61
Fast Scan Viewfinder
Other prizes to be announced.

RULES:

- 6 minute maximum time length
- Subject matter is limited only to your imagination — anything goes.
- Label cassette with your return address and include sufficient return postage. All programs will be returned.
- Decisions of the judges will be final.
- Contest starts now — entries must be mailed before December 31, 1973.

Use only enough time to effectively bring across your idea. An idea that is best expressed in 2 minutes will turn into a horrifying bore if interspersed with 4 minutes of filler.

Don't repeat frames except for a purpose — the closed-circuit quality of tape makes repeating unnecessary.

Please do not send a script or explanation of your program. Since Slow Scan is a visual media, everything you want included in your program should be on your tape.

Send your entry to: Slow Scan Contest, 73 Magazine, Peterborough, NH 03458.

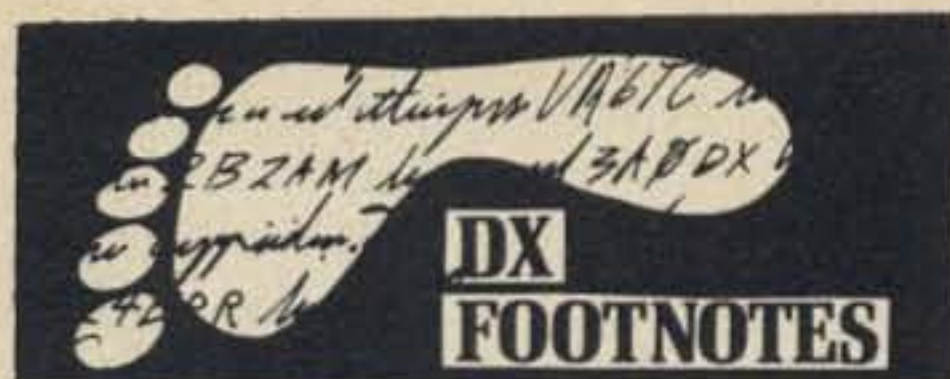

Gus Browning W4BPD
 Drawer "DX"
 Cordova, SC 29039

SOME QSL INFO:

A26AC via	4S7YL
AP2MR via	Callbook address
C29ED via	VK3TL
CT2AZ via	WØ JHY
EL7D via	DK3IA
ELØ Q via	LA9GG
ELØ S via	YU3RCZ
ET3USD via	WA4HVQ
FØ ALN via	K4II
FB8ZB via	F8US
GC5AGA via	K4II
HBØ AVB via	DK3ST
HW3UIT via	F9OE
JW4EJ via	SM5BCS
JW7FD via	LA3UC
JX6VO via	LA1RQ
JX9TM via	LA9TM
SVØ WY via	WAØ VPX
M1C/D via	I4FTU
TJ1BG via	K4WQS
TY7ABM via	DL7JK
WI9ANG via	WA9DZL
WF2OC via	W2HAQ
WS4SKY via	WA3NAN
3D2JA via	W2OVC
5Z4KL via	GM3VLB
7W3ITU via	7X-buro
9X5MV via	DJ2AZ

If you want to see more DX QSL info each month let me know because I can give you a lot more than the above. WTW VERIFICATION POINT:

I wish to announce that we have a FB DX Club that has volunteered to act as our WTW (and 73-73-73, too) verification point for all of W/K1, W/K2, W/K3 land. More or less centrally located too:

The Thomas A. Edison Amateur Radio Assn.

c/o WB2FVO Club QSL Manager

William W. Inkrote, Jr.

52 Elliot Place

Edison, N.J. 08817 - U.S.A.

Be sure to send them all your cards to be checked. Send along the \$ 1.00 to help the expenses for your certificate, and also send along enough extra for the class of postage to return your cards to you. They will give you very fast service I am sure - I will mail you the certificate that you qualify for when they notify me that your cards have been checked and that you have qualified O.K.

We still need more verification checkpoints, how about your club? I am at last getting things fixed up here and will be seeing all of you on or near 14220 sometime between about 2200 to 2400z. 73 till next month - de, *Gus* B P D

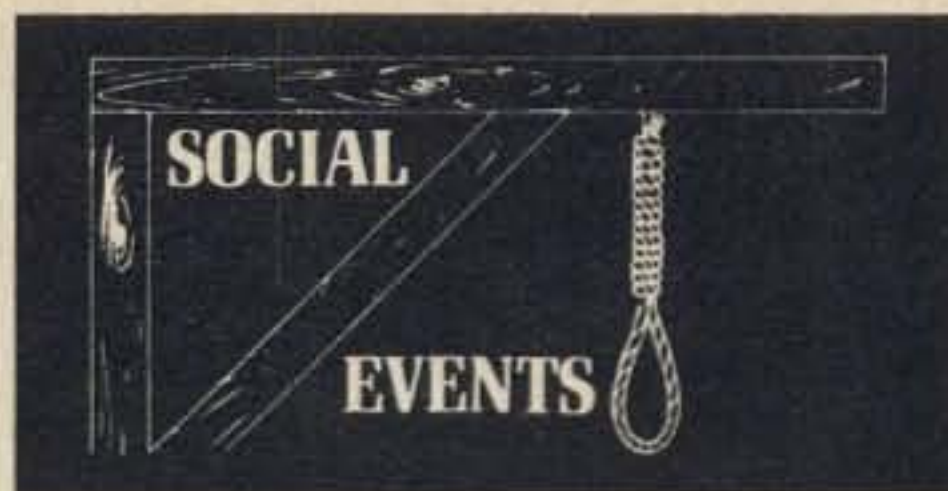

RATARAMA

The Mount Airy VHF Radio Club, Inc., presents the annual Pack Rat Hamarama, Sunday October 7, 1973, at the Warwick Fire Co., Jamison, Pa. The Warwick Fire Co., is located on Rt. 263 North of Philadelphia. Activities include a giant flea market, auction, and an amateur TV demonstration. Festivities begin at 10 AM. Food concession on premises. Registration is \$1.00, flea market tables or tailgate sales, \$2.00. Talk in on 146.52 and 52.525. For further information contact: Dave Zimmerman W3ZD, 520 Centennial Rd., Warminster PA 18974.

MIDWEST CONVENTION

The ARRL Mid-West Convention is being sponsored by the Lincoln Amateur Radio Club this year. It will be held on October 6 and 7, 1973, at the Villager Motel and Convention Center in Lincoln, Nebraska. It promises to be one of the largest in the Mid-West, drawing on radio amateurs in a four state area and more. For information contact: G3UGH/WØ. c/o Lincoln Amateur Radio Club, Inc., P. O. Box 5006, Lincoln, Nebraska, 68505.

MID-SOUTH HAMFEST

The Mid-South ARA is holding its 1973 Hamfest on October 6 and 7, at the State Technical Institute in Memphis TN. There will be a MARS meeting, FM Symposiums and other activities. Contact: Harry Simpson W4SCF, c/o Mid-South ARA, 1830 Macaulay Ave., Memphis TN 38127.

CHAUTAUQUA AUCTION

The Chautauqua County NY FM Association's third annual auction will be held October 13, 1973, at Shore Acres Boat Yard, Bemus Point NY. For further information write to Robert Greenwald WB2YQO, Rte. 2, Box 76, Jamestown NY 14701.

OCTOBER REPEAT

A special meeting of the Illinois Repeater Council will be held on Saturday, October 20, at Southern Illinois University. Hosted by WR9ABU, all Illinois and adjacent repeater representatives are cordially invited. Contact: Kontakt Kim King, Sec. IRC, 1618 Linden, Des Plains IL 60018, 312-824-8419

TAMPA BAY

Seven Tampa Bay Area clubs have joined forces to present, perhaps, the largest ham gathering in the State of Florida. Over \$2500 worth of prizes will be awarded by drawings. First prize will be a complete Galaxy 500 station. Registration is \$2. It will be held on October 6 and 7, 1973, at the Electrical Building, Florida State Fairground on N. Boulevard, 2 blocks north of Kennedy Boulevard, beginning at 8 AM local time. Inquiries may be sent to Mr. George Dixon WA4VQT, 12915 Veronica Ave., Tampa FL 33612. In addition, we are providing an information station on the air Monday, Wednesday and Friday, 7 - 7:30 PM EST and Sunday, 10 - 10:30 AM on 7280 kHz.

ADRIAN HAMFEST

The Adrian Amateur Radio Club Inc, of Adrian Michigan, presents their fall Hamfest, Sunday October 14, 1973, from 8 AM to 3 PM, at the Lenawee County Fairgrounds on Dean St. Talk in on 1812 kHz - 3935 kHz - 52.525 MHz - 146.46 MHz - 146.52 MHz - and 146.94 MHz.

All buyers, sellers and visitors are welcome. Plenty of refreshments and prizes. Cost \$1.00 in Advance, \$1.50 at the gate. Tables \$1.50 per half table. For information on tickets or tables write to the Adrian Amateur Radio Club, P. O. Box 26, Adrian MI 49221.

FAR-OUTING

The Foundation For Amteur Radio will hold its annual Hamfest at the Gaithersburg Fairgrounds, Gaithersburg MD, on Sunday October 21, 1973. Featured is a large flea market, food service, exhibits, ladies events, supervised children's program and many prizes. Main events are all indoors. Picnic grounds and free parking available. Will be held rain or shine. Participation fee \$1.50, sales space \$5.00. Talk-in service provided. Nearby motel rooms available. For info write or call Bill Miller K4MM, 10919 Woodfair Rd., Fairfax Station VA 22039. 703-893-2450.

TERRY SWAP

The Terry County Amateur Radio Club's 19th Annual Brownfield Free Swapfest will be held on October 14, 1973 in the National Guard Armory, Brownfield, Texas. Doors open at 6:30 AM and Swapfest activities last until 3:00 PM. No registration or admission fees! Door prizes. Largest Amateur Radio flea market in Texas! All exhibitors, amateurs, CBers and families welcome. Free parking and trailer camping in Coleman Park adjacent to the Armory.

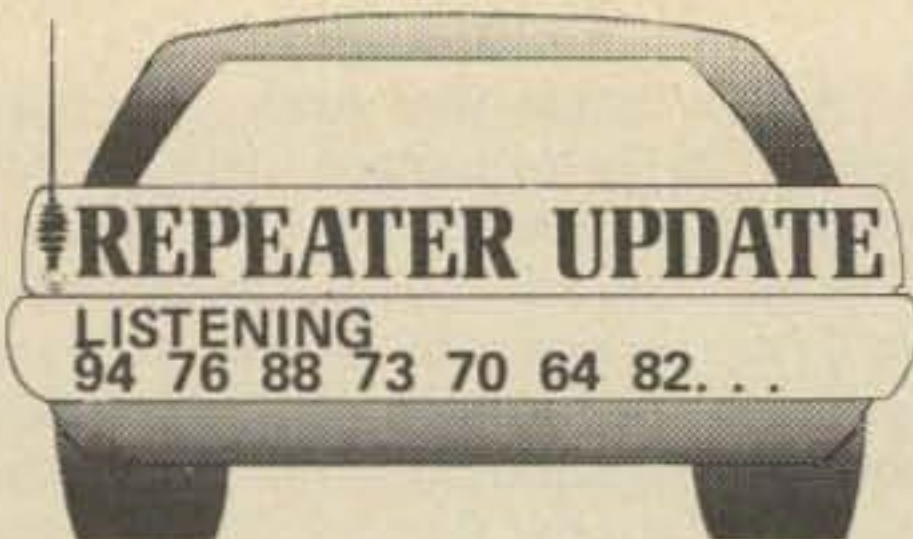

AL	WR4ACK	Decatur	146.40-147.00
AL	WR4ACB	Birmingham	146.16-146.76
			146.13-146.76
CA	WR6ACB	La Habra Hts.	146.10-146.70
CA	WR6ABX	Woodland	146.37-146.97
CT	WR1ABA	Simsbury	146.22-146.82
CT	WR1ABC	Torrington	223.06-224.66
FL	WR4ACV	Boca Raton	146.22-146.82
IA	WR8ABS	Davenport	146.22-146.82
IL	WR9ABX	Rock Island	146.34-146.94
IN	WR9ABP	Indianapolis	146.16-146.76
IN	WR9ABW	Kokomo	146.31-146.91
KS	WR8ABO	Pittsburg	146.13-146.73
KY	WR4ACQ	Ashland	146.34-146.94
MA	WR1ABO	Worcester	146.37-146.97
MA	WR1ABV	Waltham	146.04-146.64
MA	WR1ABK	Foxboro	146.31-146.91
MD	WR3ABO	Harmans	PL 443.95-448.95
MO	WR8ABC	Bonne Terre	146.28-146.88
NY	WR2ABF	Rochester	146.19-146.79
OH	WR8ABA	Mt. Vernon	146.19-146.79
OH	WR8ABC	Cleveland	146.16-146.76
OH	WR8ABF	Dayton	146.34-146.94
OH	WR8ABG	Springfield	146.13-146.73
OH	WR8ABH	Hudson	146.01-146.61
OH	WR8ABJ	Newcomerstown	146.16-146.76
OH	WR8ABO	Chillicothe	146.25-146.85
OH	WR8ABP	Cincinnati	146.28-146.88
OH	WR8ABK	Delaware	146.37-146.97
OR	WR7ABJ	Westport	146.16-146.76
PA	WR3ABF	Valley Forge	Planned
PA	WR3ABG	Valley Forge	Planned
PA	WR3ABH	Valley Forge	222.34-223.94
PA	WR3ABI	Valley Forge	146.34-146.94
TX	WR5ABM	Brownfield	146.22-146.82
VA	WR4ACW	Richmond	146.28-146.88
WI	WR9ABV	Lake Geneva	146.37-146.97
WI	WR9ABS	Milwaukee	146.25-146.85



Tom DiBiase WB8KZD
708 6th Avenue
Steubenville OH 43952

CONTESTS

Sept. 29-Oct. 1	Delta QSO Party
Oct. 6-7	New Mexico QSO Party
Oct. 6-8	California QSO Party
Oct. 13-14	RSGB 21/28 MHz Telephony Contest
Oct. 20-21	RSGB 7 MHz CW Contest
Oct. 20-22	North Carolina QSO Party
Nov. 2-5	CHC/FHC/HTH QSO Party
Nov. 3-4	RSGB 7 MHz Phone Contest
Nov. 5-11	QRPP CW QSO Party

This Month New Mexico QSO Party

From 220 GMT October 6 to 0100 GMT October 7; 0200 GMT to 0600 GMT and 1800 GMT to 2200 GMT October 7, 1973. Frequencies are 65 kHz up from the bottom of each CW band, phone near the edge between

General and Advanced frequencies, Novice near the middle of each Novice band. Only NM stations call CQ Contest near these frequencies. Exchange QSO number, RS/T and QTH (county for NM, state, province or country for others). Stations may be contacted only once on each band, and again if he changes counties. Intrastate NM contacts are valid. Score 1 point per QSO. NM multiplier is total states, provinces, countries and NM counties. Non-NM use total NM counties for multiplier. Appropriate awards. Full log data, including exchanges, should be sent to Bill Wageman, K5MAT, 35 San Juan, Los Alamos NM 87544 by November 1, 1973.

California QSO Party

From 1800 GMT October 6 to 0600 GMT October 7, and 1500 GMT October 7 to 0300 GMT October 8. Same station may be worked once per band/mode. Exchange QSO number, RS/T and QTH (county for California, ARRL section or DX country for others). California stations work anyone. Non-California work California only. Score 1 point per QSO. Multiply total QSO points by total California counties worked or total ARRL sections (including California) and DX countries worked. Frequencies are 3560, 7060, 14060, 21060, 28060, 3880, 3980, 7280, 14280, 21280, 21380, 28580, 3725, 7125, 21125, 28125. Appropriate awards. Logs must show date, time, band, mode, exchanges sent and received. Logs can't be returned. Be sure your call is on each page. A summary sheet is required showing counties, ARRL sections and DX countries worked, breakdown of QSOs per band and scoring. Include your name, call and address in large block letters. Mail logs before November 7, 1973, to John Minke, W6KYA, 6230 Rio Bonito Drive, Carmichael, California 95608. Include a large SAS for results. Comments are encouraged and appreciated.

North Carolina QSO Party

From 1800 GMT October 20 to 0600 GMT October 21 and from 1300 GMT October 21 to 0200 GMT October 22, 1973. Each station may be worked once per band/mode and again if operated portable or mobile, and with each county change. Exchange QSO NR, RS/T and QTH (county for NC; state, province or country for others). NC score 2 points for out of state QSOs, 1 point for QSOs with other NC stations, multiply total points by number of states and provinces worked. Out of states score 2 points per QSO and multiply total by number of NC

counties. Frequencies are 3575, 7090, 14070, 21090, 28090, 3710, 7110, 21110, 28110, 3810/3900, 7290, 14290, 21310, 28510 (all are plus/minus 10 kHz). While on 3575 try not to QRM the Carolina's traffic net which meets at 2300 GMT and 0200 GMT near that frequency. The entire 6 and 2 meter bands can be used, and repeater QSOs count. Appropriate awards. Mail logs before November 25, 1973 to Charlie Wells, K4SKI, Rte 8, Box 414, Greenville NC 27834.

By the shadow on the wall I see that it's time to wrap up another column. Until next time, "CQ Contest, CQ Contest, CQ Contest."

Tom WB8KZD



SBE Scanvision



The W2NSD/1 Scanvision package being tested with special zoom lens.

SBE has come up with a beautiful slow scan system — complete with a built in cassette tape recorder. This system makes it duck soup to put together your own tape programs. . .and let's face it, this is the way slow scan has gone.

With tape reproduction of a slow scan usually identical with "live" camera work, it is only logical that most ops have opted for using tape. It doesn't take long sitting still for eight seconds in front of the camera — and then jumping up to refocus (which isn't all that fast a process unless you have a fast scan monitor too) on a menu board for giving your name, location, signal report, and perhaps a QSL — before you are thinking seriously in terms of tape. Unfortunately, many of the cheaper recorders are not adequate for the job

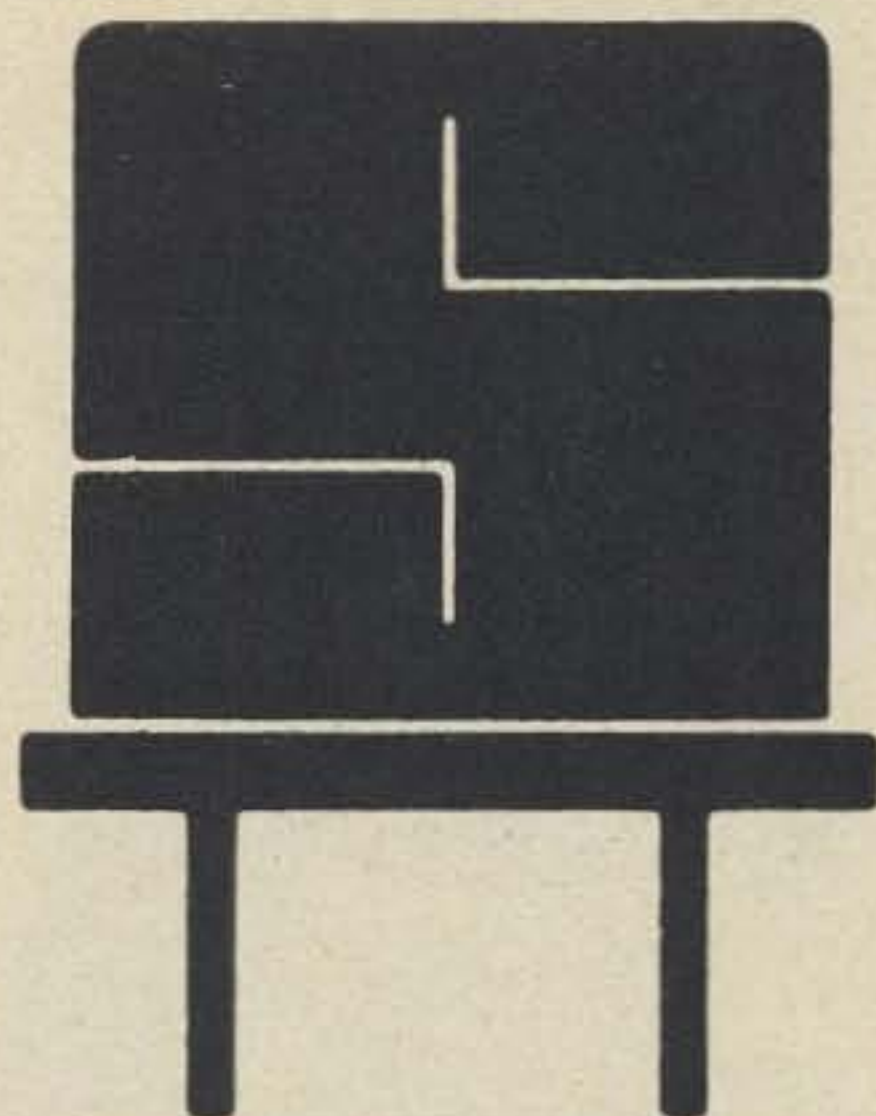

REPEATER OWNERS

Don't Take Chances. SENTRY offers custom made crystals made exactly to your specifications. When it comes to crystals for your repeater, BUY THE BEST - SENTRY.

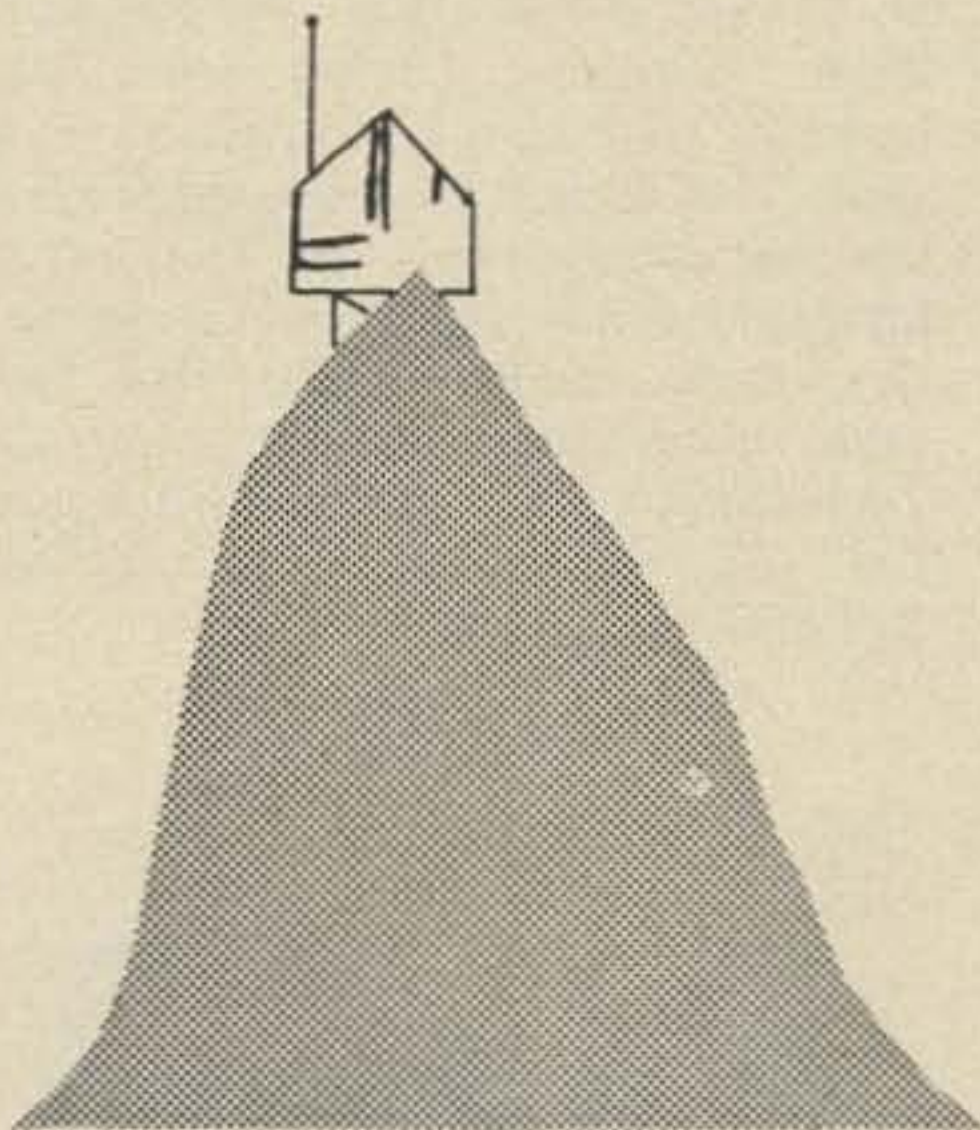

REPEATER USERS

If you want reliable access to the repeaters in your area, you want and need SENTRY CRYSTALS. SENTRY CRYSTALS are custom made for your rig. We don't stock a large quantity of crystals for a certain frequency and hope you can tweak them to frequency in your rig. We do offer FAST service on crystals made especially for you and your rig. If you want reliable, on-frequency operation, INSIST ON SENTRY.

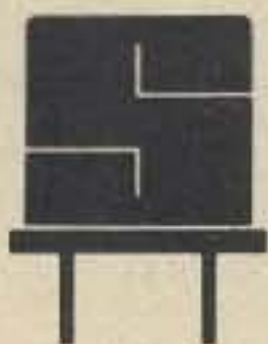

SENTRY MANUFACTURING COMPANY
Crystal Park, Chickasha, Oklahoma 73018

PHONE: (405) 224-6780

TWX-910-830-6425

and there are little squiggles which result from not too steady tape drive mechanism.

Once you are set up with a good recorder you can start putting together short tape programs — a view of your shack — picture of you — your wife — with titles. You can tape the QTH and CQ calls. You can work up a short program showing some of your other interests than amateur radio — which is not only interesting to viewers, but affords plenty to talk about if you match an interest with someone else.

You can put together a program of your QSLs for each country worked, unless you are one of the real slow scan DXers with 73 countries worked, in which case it would take about ten minutes at one card per frame, to show the bunch. Even so, that might be a little better than some of the dumb cartoons that are being shown.

The SBE Scanvision camera has one very handy feature — an automatic contrast control. The less controls you have to diddle with the better. There is a manual over-ride for knob twisters.

After using the Scanvision for several weeks, there are several things that stand out — the ease of hooking it up for use — the beautifully sharp picture — the convenience of the built in tape deck — and (most of all) the fun of actually seeing the fellow you are working.

The Scanvision manufacturer also makes commercial broadcast television cameras and this is obvious when you open the camera and take a look at the construction techniques. . . beautiful! This shows up in the picture too — just take a look at a grey scale on this monitor and see how much more you get than you might expect.

Linear Systems is to be congratulated for making this superb slow scan unit available — slow scan will, it seems certain now, be one of the big growth aspects of amateur radio during the next few years. Once you see it in action you are hooked.

TONE PADS

Interface Technology has introduced a Touch-Tone generator designed to aid repeater and auto-patch users. The unit generates the 12 standard frequency pairs used for Touch-Tone dialing by the telephone companies. It is designed so that the output can be used in several ways. For one, a speaker included in the kit can be mounted internally and the unit simply held up to the microphone. The speaker can also be mounted in a small, remote case (not



supplied) and connected by a cable to the generator. This allows the user to position the generator on a table or desk while the speaker is held up to the microphone. A third approach is to wire the unit directly into the microphone circuit, eliminating the need for the speaker altogether.

There are no switches or controls on the unit other than the key pad, so no current is drawn from the standard 9-volt transistor battery until the operator touches a key to generate a tone. This feature insures long battery life and simplicity of use. The unit is lightweight and packaged in an attractive black molded plastic case. For more information contact: *Interface Technology, Inc., 10500 Kahlmeyer Dr., St. Louis, Missouri, 63132. 314-426-6880*

SBE SCANNERS



Linear Systems has announced the introduction of a complete line of scanners which cover frequencies from 30-470 MHz. The entire line, known as the Sentinel Series, consists of six separate models.

The Sentinel includes 8 channels for scanning, lock-out switches, manual or automatic scan operation and AC/DC capability. An important feature of the Sentinels is the priority channel which assures the reception of the most important channel. All come equipped with cord/plu sets for either 12V dc or 115V ac operation. Also included is a screw-in telescoping an-

tenna for VHF and where applicable a separate VHF plug-in antenna. The receivers have excellent sensitivity of .3 μ V with selectivity rated at -6db @ 9 kHz. Audio output is 4 watts and the receivers are designed to operate over the temperature range of -20°C to +50°C. The specific model numbers and frequency ranges are Sentinel I high-low VHF, Sentinel II high band VHF, Sentinel III low band VHF, Sentinel V UHF, Sentinel VI UHF high band, and Sentinel VII marine VHF.

For further information contact: *David K. Bradley, Vice President, Marketing, Linear Systems, Inc., 220 Airport Boulevard, Watsonville CA. Telephone: 408-722-4177.*

QSL CONTEST



Jane Rice WA6OZS, captured the heart of our contest judge this month with her homebrew silkscreened entry. Win a one year subscription to 73! Send your QSL to: QSL Contest, 73 Magazine, Peterborough NH 03458.

CANADIAN GOVT. SUPPORTS REPEATER GROUP WITH GRANT

\$6,772 AWARDED

State-of-the-art thinking on the part of Canada's Department of National Health and Welfare has prompted a \$6,772 grant to a repeater group in Courtenay, B.C. Realizing the importance of VHF repeaters in providing emergency communications during times of disaster, the grant was endorsed whole-heartedly by civil defense authorities. The planned repeater will provide communications within a 150 mile radius.

Meanwhile, back at the FCC. . .



Price — \$2 per 25 words for non-commercial ads; \$10 per 25 words for business ventures. No display ads or agency discount. Include your check with order.

Deadline for ads is the 1st of the month two months prior to publication. For example: January 1st is the deadline for the March issue which will be mailed on the 10th of February.

Type copy. Phrase and punctuate exactly as you wish it to appear. No all-capital ads.

We will be the judge of suitability of ads. Our responsibility for errors extends only to printing a correct ad in a later issue.

For \$1 extra we can maintain a reply box for you.

We cannot check into each advertiser, so Caveat Emptor . . .

WESTERN UNION DESK-FAX transceiver manual: Complete theory of operation, adjustment, lubrication, preventive maintenance, troubleshooting, parts list. Includes all schematics and mechanical parts drawings. \$3.80 postpaid. Bill Johnston, 1808 Pomona Drive, Las Cruces, New Mexico 88001.

“WANT VIBROPLEX carrying case. Advise condition, age and price. P. O. Box 191, Rye Beach NH 03871.”

2 METER FM Brand new HR-2A 94/94, 22/82, Hustler 5/8 trunk lip, warranty, perfect. WA6LZH, 4130 Carson, Oakland CA 94619, 415-530-7187.

COLLINS MP-1 Power Supply, new never used, trade for 516F2, PM-2, 312B4, HT220, or ST-6. Want to buy 32S1. Fred Slaughter, WB8IJX, 3636 Douglas, Toledo, Ohio, 43613.

“DIGITAL MULTIMETER — 3 ½ digit franklin model 500, — \$60. Chart recorder, — \$20. 6' x 19" rack cabinet — fully enclosed, — \$40. EMC 5 MHz Oscilloscope, — \$90. Sell or swap. Jim Einolf, 1218 W. Ionia, Lansing MI 48915.”

FOR SALE: GE Porta-Mobile 2m, 10 watt portable with nicad, 94/94, 22/82, \$300. HT-220, two watt, two channel with charger, \$275. MOTRAC “A” model transmitter and power supply, \$35. MOTOROLA pocket-receiver with nicad, \$45. MIDLAND CB? — \$25. Gary Eberle, WA6CW, 1655 Via Escondido, San Lorenzo, CA 94580.

WANTED: Facsimile equipment, weather satellite equipment and/or information, RTTY machines 100 wpm. Ken DeBrecht, WB6NOV, P. O. Box 1086, Novato CA 94947.

EQUIPMENT FROM 73

The following list of gear, unless otherwise noted, consists of brand new equipment purchased for testing purposes only.

Cap-Com 40m solid state SSB xcvr	\$150
Heath IB-101 counter with Vanguard Scaler	\$250
Clegg 27B 2m xcvr	\$380
IC-22 2m FM xcvr	\$246
Midland 13500 2m xcvr	\$200
Midland 13509 220 xcvr	\$200
Tempo CL-220 220 xcvr	\$200
Clegg FM-21 220 xcvr	\$255
Regency HR-6 6m xcvr	\$190
HR2MS 8 channel scanning 2m xcvr	\$255
TME-H-LMU 16 channel rcvr	\$255
Digital Logiclocks	\$ 80
Dycom 2m repeater	\$425
Wilson 7 element 10 & 15m beam (pick-up only)	\$250
Waller 60A power supply	\$105
Standard sr-c 120/5 power sup.	\$ 44
Gladding 12V power supply	\$ 60
SBE Scannavision	\$650
Robot Monitor	\$265
Robot Camera	\$265
AX 190 amateur rcvr	\$200
SX 190 SWL rcvr	\$200
Pickering KB-1 keyboard	\$200
TPL 502-B 2m Amp 1w/40w	\$110
TPL 502 2m Amp 10w/45w	\$ 90
Kenwood TS-511S SSB xcvr	\$350
Heath HW-202 w/encoder	\$180
Heath HWA-202-1	\$ 30
Heath HA-2022 amplifier	\$ 70

FACSIMILE PAPER for DeskFax units: \$1.95 per box. 6 boxes for \$10.50; for weathermap recorders; \$4.25 per box, 4 boxes for \$16. Jim Cooper, P. O. Box 73, Paramus NJ 07652.

FOR SALE: Gonset III 6 meters “MINT”, — \$100.00. Gonset III 2 meters AM and FM, excellent, — \$145.00. WANTED: Hallicrafters HA-2. Jim W1VYB, 53 Lothrop St., Beverly MA 01915, 617-922-3850.

OPAQUE/TRANSPARENT PC/IC TAPES. SPECIFY 1X, 2X, 4X. TWO 8 x 10 Assortment sheets plus art worksheet — \$3.50. Eugene Wiener, 523 Morgan No., Minneapolis, Minn 55404.

HOOSIER ELECTRONICS — Your ham headquarters in the heart of the Midwest where only the finest amateur equipment is sold. Individual, personal service by experienced and active hams. Factory-authorized dealers for Clegg, Drake, Genave, Regency, Standard, Hallicrafters, Ten-Tec, Kenwood, Tempo, Midland, Galaxy, Hy-Gain, CushCraft, Mosley, Hustler, Ham-M, Sony, plus many more. Orders for in-stock merchandise shipped the same day. Write or call today for our quote and try our personal, friendly Hoosier service. Hoosier Electronics, R. R. 25, Box 403, Terre Haute, Indiana 47862. 812-894-1297.

“Don and Bob” new guaranteed buys. Discount prices, full warranty. Write for low prices on following: HYGAIN TH6DXX, TH3MK3, 204BA, DB1015A, 402 BA; Mosley CL33, CL36, S402; Triex MW50, MW65, W51 (FOB, Cal); Clegg FM27B; Midland 13500, 13509-W-T; Regency HR2B, HR212; SBE 144 \$199.95; SBE 450 TRC converts 2mFM to 3/4m (\$179.95 list) \$149.00; Standard 826MA, 146A; Ham-M \$99.00; TR44 \$59.95; AR22R \$31.95; Belden 8448 rotor cable 10¢/ft; 8214 RG 8 FOAM 17¢/ft; 8237 RG 8 15¢/ft; Amphenol PL259 49¢; Hallicrafters FPM300 DEMOS, NEED FACTORY WARRANTY REPAIR \$460.00 ea; Used guaranteed; Collins 75A4 \$345.00; Kenwood R599 \$300.00; T599 \$350.00; Hammarlund HQ180 \$250.00; Heath SB300 \$250.00; Write Quote Swan, Eimac, Rohn tower; 3/16" cable clamps 18¢; Motorola HEP 170 epoxy diode 2.5A/1000 PIV 29¢, \$25/100 LOT; Motorola Semiconductor Data Series \$7.50; Calrad KW dualmeter SWR-relative power meter, to 150 MHz \$15.95; MOT MC 1709CG OP AMP (709) TO5 39¢; Write items not listed. Shipping collect. Madison Electronics, 1508 McKinney, Houston, Texas 77002. 713-224-2668 Nite/weekend 713-497-5683

OLD (ANTIQUÉ) Radio Buffs, Repairers for sale, in working order. Complete (16 Vol.) repair manuals — thousands of service data, schematics, etc., almost all makes from the Twenties to the Forties — Gernsback Official Man. Volumes 1 to 7 (1937) plus Riders Volumes 8 thru 14 (1944), plus Volume 5 (1934) and 16 (1945-1946). Atwater Kent Model 35 battery radio (1924). Majestic “B” battery eliminator (1928). Standard Metal Co. 19" upright horn loud speaker (1925). 16" cone Western Electric Model 540AW magnetic speaker (1928). Cathedral type Crosley table model radio (1932). Old books; old tubes; telegrapher's sounder, key; etc. W. C. Motz, 219 Elm St., Pittsburgh PA 15218, 412-371-1580.

MEMPHIS AREA HAMFEST, Sunday, October 7, at State Technical Institute, conveniently located on Interstate 40 at Exit 11. Tennessee Section ARRL Convention in conjunction. ARRL Forum, MARS meetings, prizes, Flea Market, XYL entertainment. Informal group dinners Saturday night. Talk in on 34-94 and 3980. All your friends will be there!

COMPLETE 36 page QSL catalog, 3rd edition. New “SPARKLING” QSLs. Hundreds of cuts, ten report forms, thirteen colored stocks, 25¢. Ten sample QSL cards. Corneilson's Quality QSLs, 321 Warren St., N. Babylon, N. Y. 11704.

CANADIANS — FREE 120 page electronics catalog ETCO-B, 464 McGill, Montreal.

Drake C-Line



Shipments against our orders placed months ago are arriving daily. No long wait for the world's most popular ham gear.

SERVING HAMS for 35 YEARS
ELECTRONIC DISTRIBUTORS, INC.
 1960 Peck Muskegon, MI 49441
 Tel. (616)-726-3196
 HRS. 8:30 - 5:30 SAT. 9 - 4

30 Hz Selectivity!



"... a must for anyone using an inexpensive receiver or a sideband transceiver on our crowded CW bands."

(73 Magazine test report)

Our Q-BOX audio filter features: Bandwidth CONTINUOUSLY VARIABLE from 30 Hz (almost 100x sharper than most xcvrs!) to 2 kHz. Active filter (no coils). No insertion loss. Not a breadboard. Ready to plug into ANY rcvr/xcvr. Drives phones or ext. spkr. amp. Full instructions. In use worldwide. Plug one into your receiver today! ... Only \$17.95 + \$1 shipping in U.S. (Add Sales Tax in Cal.) 10 day moneyback guarantee. SEND FOR FREE LITERATURE AND TEST REPORTS.

AUTEK research
 Box 1494L, Canoga Park, California 91304

KITS

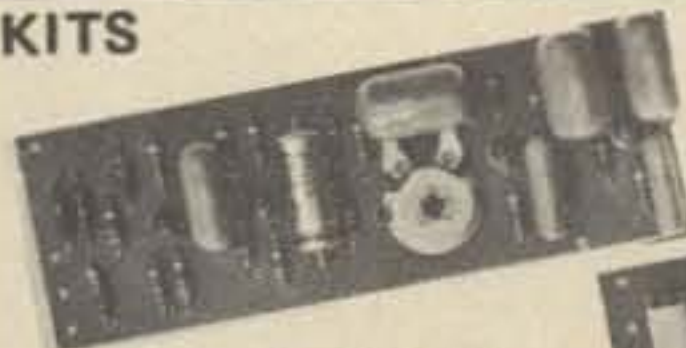

Encoder \$8.95

Sub-Audible tone

Decoder \$9.95



- Compatible with all sub-audible tone systems such as Private Line, Channel Guard, Quiet Channel, etc.
- Glass epoxy PCB's & silicon xstrs throughout.
- Any reeds, except special dual coil types may be used: Motorola, G.E., RCA, S.D.L., Bramco, etc.
- All are powered by 12 vdc.
- Use on any tone frequency 67 Hz to 250 Hz
- Small size 1.5 x 4 x .75"
- All parts included except reed and reed socket
- Postpaid - Calif. residents add 5% sales tax

COMMUNICATIONS SPECIALISTS
 P.O. Box 153 Brea CA 92621

NOW

EXCLUSIVE 66 FOOT

MOR-GAIN

75 THRU 10 METER DIPOLE

NO TRAPS — NO COILS — NO STUBS — NO CAPACITORS

Fully Air Tested — Thousands Already in Use

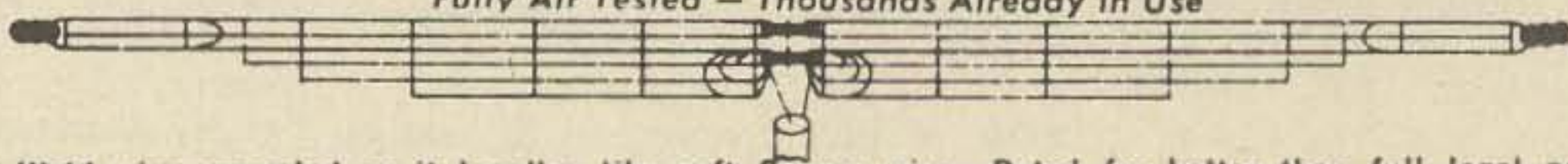

#16 40% Copper Weld wire annealed so it handles like soft Copper wire—Rated for better than full legal power AM/CW or SSB-Coaxial or Balanced 50 to 75 ohm feed line—VSWR under 1.5 to 1 at most heights—Stainless Steel hardware—Drop Proof Insulators—Terrific Performance—No coils or traps to break down or change under weather conditions—Completely Assembled ready to put up—Guaranteed 1 year—ONE DESIGN DOES IT ALL; 75-10HD—ONLY \$12.00 A PAND!

Model 75-10HD	\$60.00	66 Ft	75 Thru 10 Meters	Model 75-40HD	\$40.00	66 Ft	75 Thru 40 Meters
Model 75-20HD	\$50.00	66 Ft	75 Thru 20 Meters	Model 40-20HD	\$33.00	35 Ft	40 Thru 20 Meters
			Model 80-40HD	\$42.00		69 Ft	80-40-15 Meter (CW)

ORDER DIRECT OR WRITE FOR FULL INFORMATION

MOR-GAIN

300 S. Shawnee
 Leavenworth, Kansas 66048

OR THRU YOUR FAVORITE DISTRIBUTOR

IS BACK

More CAVEAT EMPTOR

WANTED: ARC-5/VHF components. Mounting Backs MT-65 and MT-71. Control Unit C-42, Junction Box J-28. Also need connectors. WB8NLM, 146 Schonhardt St., Tiffin OH 44883.

DESK-FAX TRANSCIEVERS as removed from commercial service (working). \$14.95 each, or \$25 pair. Jim Cooper, P. O. Box 73, Paramus NJ 07652.

MOBILE IGNITION SHIELD gives more range, no noise. Everything from economical suppression kits to custom shielding. Literature. Estes Engineering, 543-S West 184th Street, Gardena, Calif., 90248

ROCK CRUSHER — Hallicrafters HT 33A Linear \$200, — HT37 \$150, — SX 101A \$150, — NCX3 TR-Band \$150, — NCXD \$50, — HT40 \$35, — WA8IYL, 419-492-2317.

FOUNDATION for AMATEUR RADIO annual Hamfest Sunday 21 October 1973 at Gaithersburg Maryland Fairgrounds.

COLLINS FOR SALE: Individual prices are indicated. For package deals please write. 32S3 SN 12091 \$650, 75S3 SN 14276 \$600, KWM 2 A SN 11535 \$750, 516F2 P. S. \$75, 312B4 station control \$125, 30L1 linear amp \$350. Jack Aviv, WA2KNC, 106 Glenn Avenue, Lakewood NJ 08701.

WANTED: RD 92/UX fax recorder. Need several mechanical drum sub-assemblies. Don W1GBO, Box 803, North Falmouth MA 02556.

"BRAND NEW": Clegg 66er in original factory carton, \$145. Money order or certified check. J. A. LaTorre, P. O. Box 521, Lawrence MA 01842.

MOTOROLA P33-BAC 5W Handi-Talkie, excellent condition with antenna, mike, Ni-Cads, 34/94 and 94/94 — \$95; Heath HX-20 80-10 meter SSB and CW transmitter, HR-20 80-10 meter SSB, CW, and AM receiver, and HP-20 AC power supply, good condition — \$195. FOB, W5PNY, 2506-A, 35th St., Los Alamos NM 87544.

Recently a number of GE Pocket Mates have become available, and they make ideal walkie-talkies for 2 meter FM. They have several advantages: 1) small size, 2) extremely sensitive receivers ($.3-4 \mu\text{V}$ for 20 dB quieting, 3) good output (1W), and 4) reasonable price.

These units are a good buy provided you make sure of several things first. If all of these requirements are met, then you will be making a good investment:

Make sure the unit is dual channel (if you want it) and check for $\frac{1}{2}$ -1W output. Check for $1 \mu\text{V}$ sensitivity and make sure the speaker is good, because it doubles as the microphone. The unit should squelch at a setting between 2 and 5 on the squelch control. The antenna should telescope properly and no corrosion should be present in the battery compartment. Check the operating frequency with a counter; if it is above 160 MHz or so, some of the brass slugs will have to be replaced with green ferrite ones to lower the frequency (It isn't a bad idea to get several extra green and yellow slugs anyway, since they are easy to break.)

To take the unit apart, first remove the screws holding the speaker and unsolder the wires. Then remove the 4 screws fastening the case to the antenna block. Next remove the small screw just inside the bottom (battery) plate. The chassis should then slide out.

Using a tiny iron, unsolder the crystals and replace them with 2 meter ones (available from KW Industries - they already have correlation data). It isn't a bad idea, either, to write GE and request a manual. This makes it easier to find exactly where everything is.

Now you are ready to tune it up. Tuning the transmitter is simple. Hook the two battery springs to a 14V power supply, with a 0-100 mA meter in series. Hang a $47-52\Omega$ 1W resistor from the antenna jack to ground and tune T5-T10 for maximum current. Remove the resistor, extend the antenna, and peak L10 and L16 for maximum output. Repeat all other coils again, and adjust the drive pots for 180-190 mA (change the meter to a 0-1 amp one). T5 and T6 put crystals Y₁ and Y₂ respectively, on frequency. When properly tuned, you

Herman Cone WB4DBB/4
Route 4, Box 493D
Chapel Hill NC 27514

GETTING ON 2m FM WITH A GE POCKET MATE



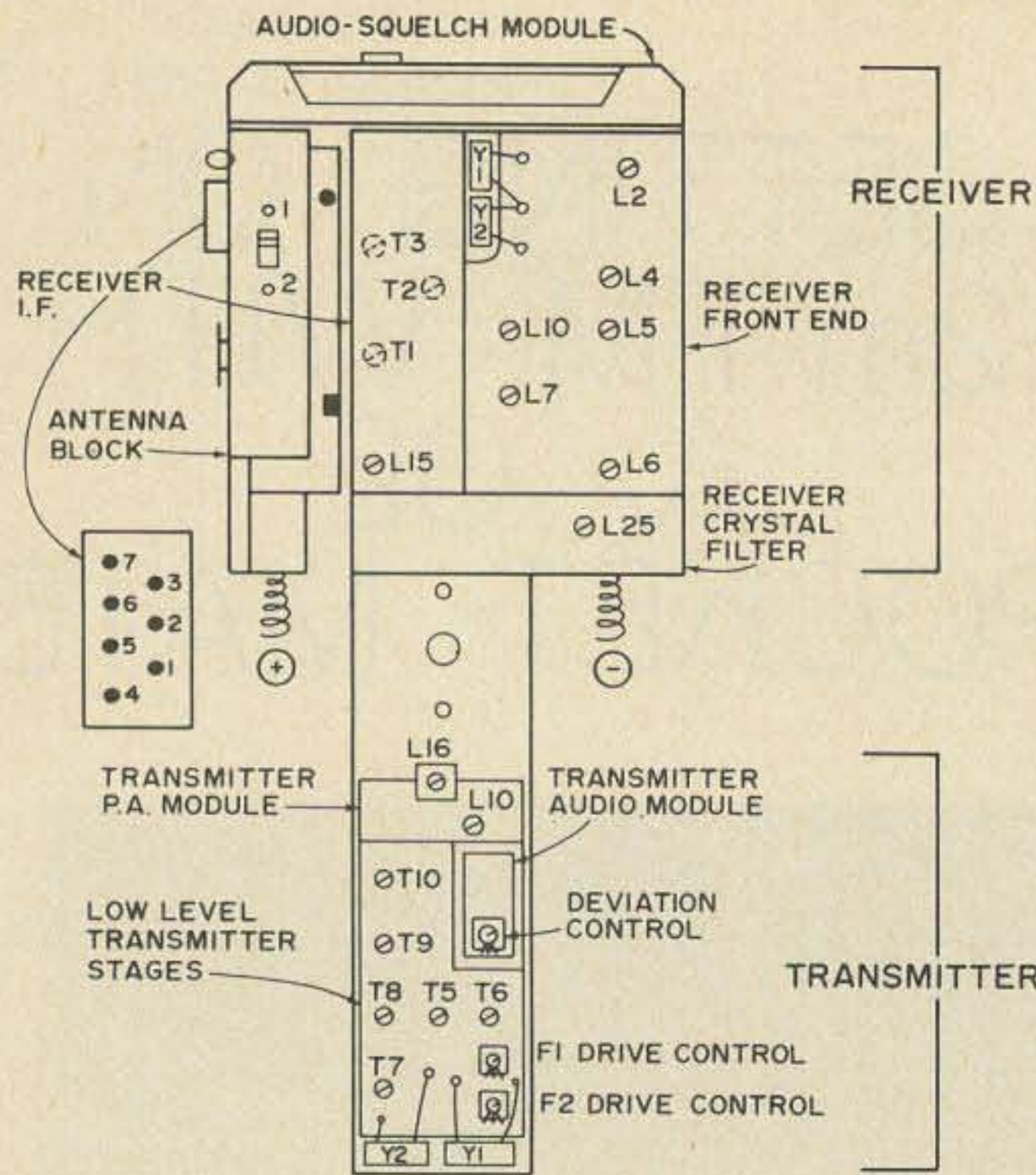

Accessory Jack

(Hole directly above jack is for external antenna.)

Pin 1	ext. mic.	5	ext. squelch
Pin 2	ext. mic.	6	not used
Pin 3	13 to 15V	7	gnd.
Pin 4	ext. PTT		

Receive Crystals (Sc - 18 holder)

$$f_c = \frac{f_0 - 10.7}{2}$$

Transmitter Coils

- T5 – F1 osc. sets crystal(s) on frequency
- T6 – F2 osc. " " " "
- T7, T8, T9 – doublers – tune for max. current
- T10 – driver
- L10 – P.A. tank
- L16 – P.A. output filter
- Tune T10, L10, L16 for max. output into 52Ω load.

Receiver Front End Coils

- L2 – rf amp
- L4, 5 – front end
- L6, L7 – mixer
- L10 – osc. coil (adjust first)

RLVR I-f Coils

- Leave these alone unless you are sure they are off.
- L25 – in filter
- L15 – coupling
- T1, T2 – i-f coils
- T3 – discriminator

Coil Slug Color Codes

Receiver:

- Yellow: L6, L15, L25
- Violet: L10 (Yellow Will Also Work)
- Green: L2, L4, L5, L7

Transmitter:

- Yellow: T5, T6, T7, T8
- Green: T9, T10, L10, L16

Transmit Crystals (Sc - 18 holder)

$$f_c = \frac{f_0}{8}$$

Fig. 1. Internal diagram and coil identification.

should get around a watt out with 180–190 mA drain. Some units have another pot on the transmitter audio board – adjust it for proper deviation. If yours doesn't have this, it is fixed at 5 kHz. To set the deviation on these units, find the wire going from the audio module to the transmitter's phase modulator. It will have a resistor of approximately 1 MΩ in series with it. Decreasing this value will increase deviation. Also, some units have only one drive control, which controls both frequencies. My own is designed this way.

The receiver is a little more difficult to align, but good results can be obtained if you have a good signal to work with. It is best to use a signal generator set exactly on your receiver's frequency. In most cases, the front end board is the only one that should be touched.

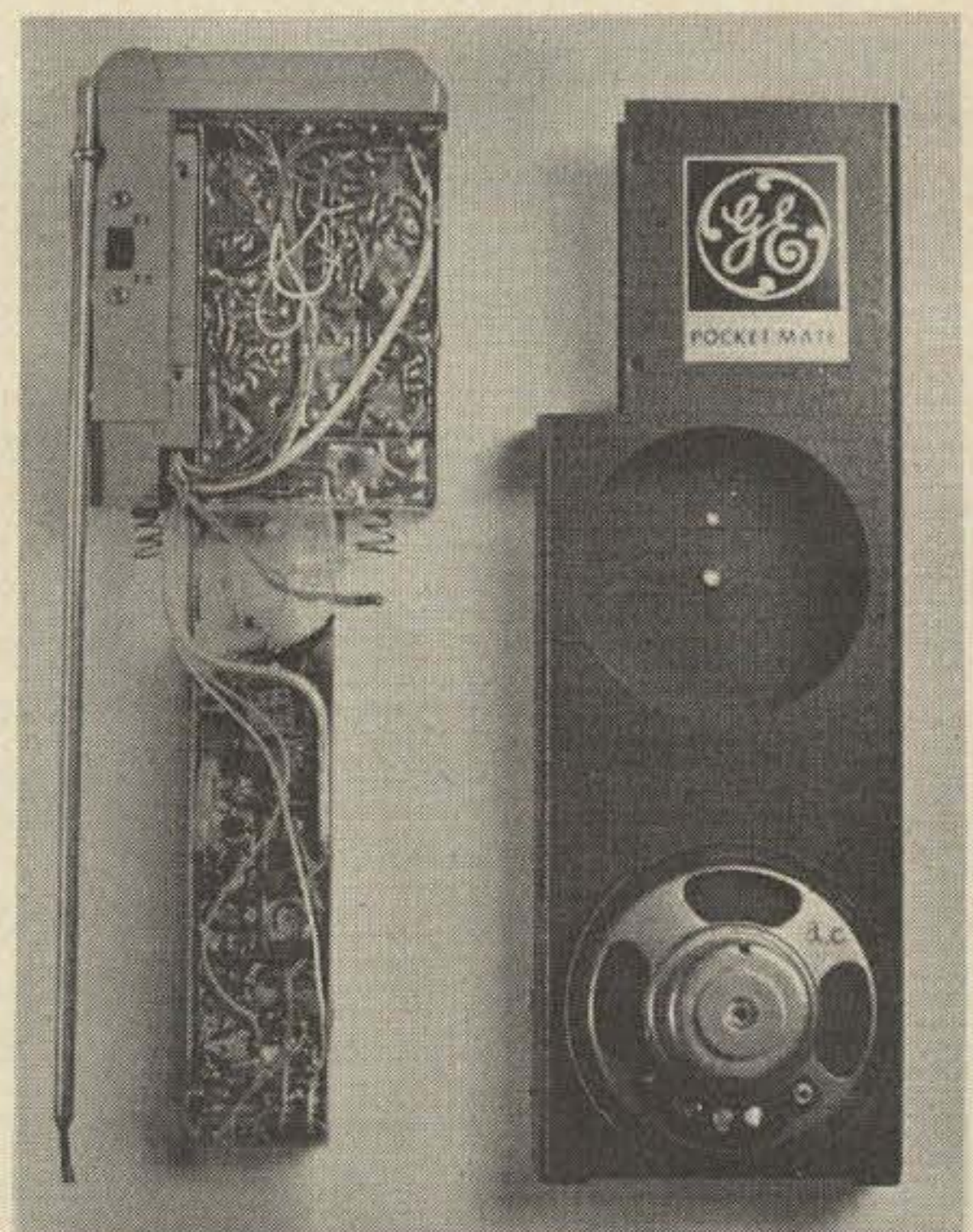

A view of the unit with its case removed.

Antenna KING

Your finest discount antenna supplier.
Beat inflation.

Save time and money with mail order.

• NAME BRANDS •

Gigantic Savings

FREIGHT PREPAID MOST ORDERS

48 HOUR SHIPMENT WITH CASHIERS CHECK OR MONEY ORDER

ROTORS

ANTENNAS

TOWERS

ACCESSORIES

ANTENNA KING

Box A, Lomita, Calif. 90717, Phone (213) 534-"KING"

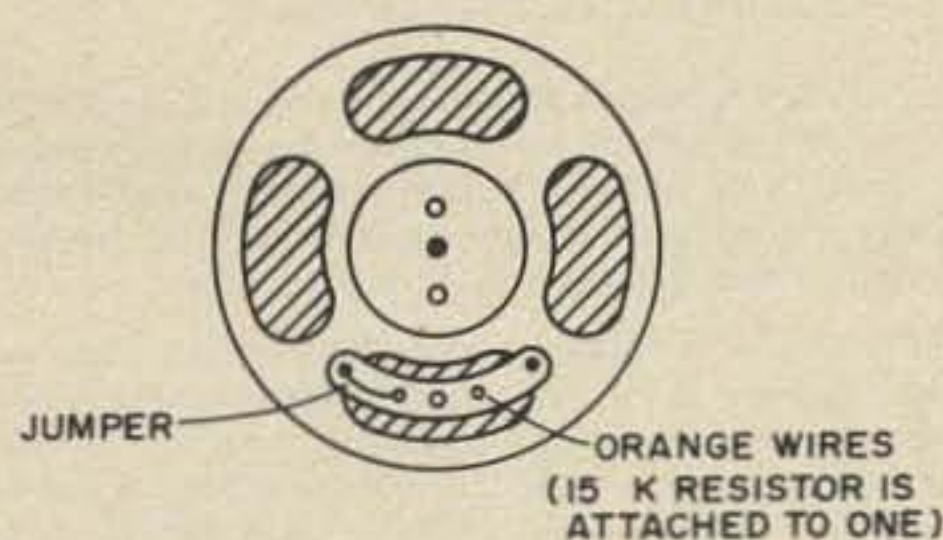

Fig. 2. Rear view of the speaker. Add a wire from the jumper to the chassis to insure a good ground connection. Carefully covering the open areas with tape gives an improved audio response.

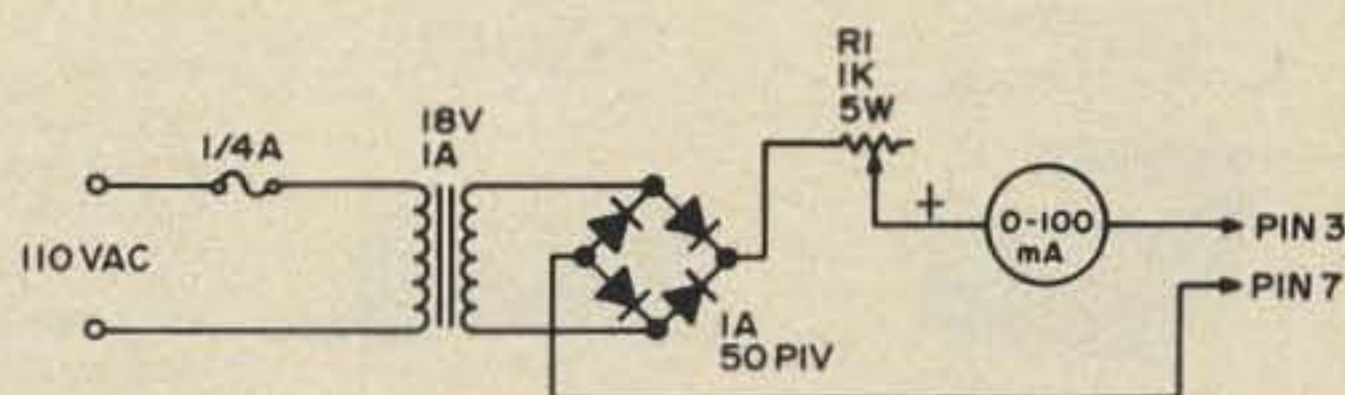

Fig. 3. Schematic of a battery charger suitable for charging the Pocket Mate's Nicads. Starting at maximum resistance on R1, adjust the setting for a meter reading of 15 mA and charge the unit for 10-16 hours.

First, feed a strong signal (30–300 μ V if you have a generator) into the antenna and adjust L10 until the crystal “pops” into oscillation. This is a fairly critical adjustment and a change in noise level will be heard. Then adjust all other coils on this board for maximum quieting, reducing the input signal as you go. It should be fairly easy to get a sensitivity of less than .5 μ V for 20 dB of quieting. The filter and i-f boards are probably in reasonably good alignment already, and shouldn't have to be touched.

When adjusting the various coils, it is advisable to first melt the wax (if there is any) with a warm screwdriver blade, and to

tune them with a flat toothpick, since the slugs are *very* fragile. Check to see that the coils have the appropriate color-coded slugs, since they are made of different material. A vast improvement in audio quality can be had by carefully covering the back of the speaker with masking tape – this is especially noticeable when transmitting. Mallory TR-136 mercury batteries (8.2V) work fine in the Pocket Mate, but for long-term economic feasibility suitable Nicads can be obtained from Alexander Battery Co., Box 1645, Mason City, Iowa 50401.

...WB4DBB



YAESU

YOUR ASSURANCE OF PERFORMANCE & QUALITY

SP101-P \$59.00
SP101 19.00

FV101 \$99.00
160M THROUGH 10M

FT101 \$649.00
TRANSCVR 260W PEP

FL2100 \$339.00
80M THROUGH 10M
1200W PEP

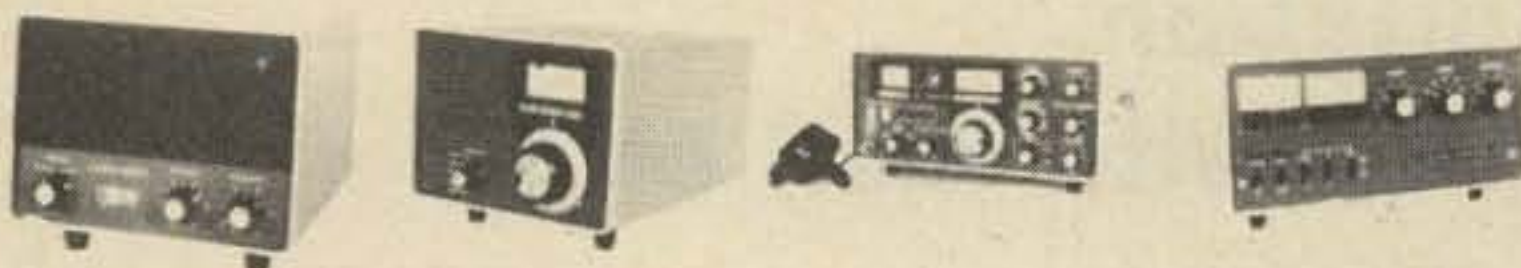

The SP101-P Landliner provides phone patch operation as well as speaker. Front panel: Patch switch, meter, TX and RX gain controls. Rear apron: Receiver 4 ohm output, receiver 600 ohm output, monitor null switch, balance control, line jack, transmitter high Z jack.

The FV-101 permits split frequency operation and control from either the FT-101 or FTDX401.

The FT-101 exciter covers 160, 80, 40, 20, 15, (CB), and 10 meters and comes complete with microphone cable and plug, fused DC power cable and plug. AC cable with plugs and all necessary plugs are furnished. AC and DC supplies are internal.

The FL-2100 linear amplifier needs only 3 wire cable and coax cable. Connectors are furnished.

FTDX401 \$599.00
TRANSCVR 560W PEP

FV401 \$99.00
EXTERNAL VFO
80M THROUGH 10M

FL2000B \$399.00
LINEAR AMP
1200W PEP

FRDX400 \$299.00
RECEIVER
160M THROUGH 10M

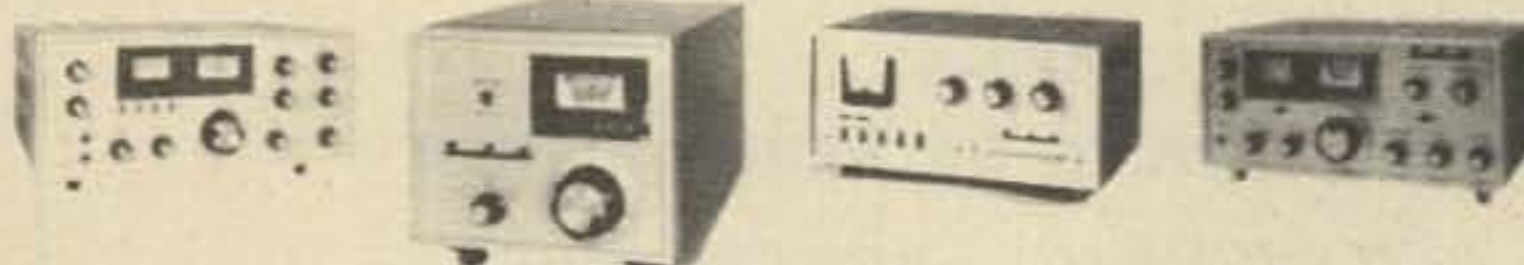

FTdx401 features high power, super sensitivity and sharp selectivity. The FTdx401 includes: AC power supply, noise blanker, 100 KC and 25 KC calibrators. VOX break-in, phone patch terminal, cooling fan. Covers 3.5 through 10 MHz plus WWV. 560 watts PEP. All that is required to get on the air is a microphone and speaker.

The FV-401 permits split frequency operation for the DX chaser or net operator. Covers 80 through 10 meters.

FL 2000 B 1200 watts PEP, 1000 watts CW, 600 watts AM. Drive power required 100 watts. Has two cooling fans and uses two 572 B tubes.

FLDX400 \$399.00
EXCITER
80M THROUGH 10M

FL2000B \$399.00
LINEAR AMP
1200W PEP

SP401-P \$59.00
SP401 19.00
SPEAKER/PATCH

FP-2
AC POWER SUPPLY

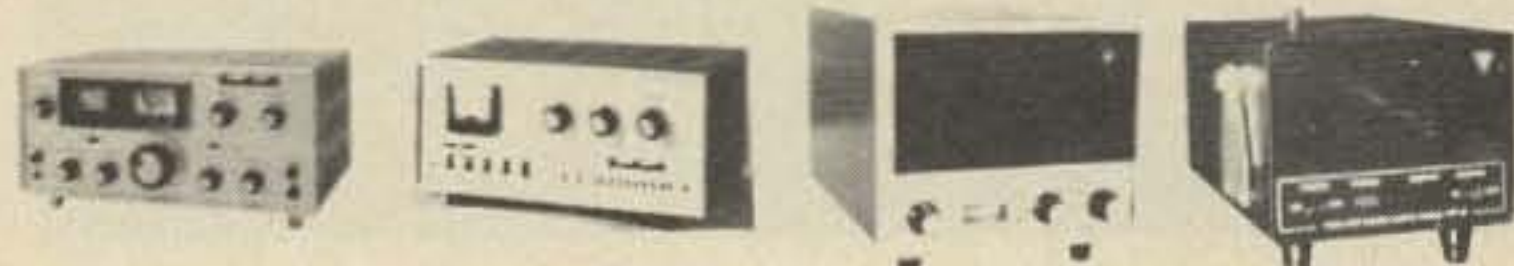

FRdx400 includes 2 mechanical filters plus "T" notch rejection tuning, and clarifier for easy zero set for SSB. Crystal control 1st mixer and tunable 1st I.F. provides stable operation and high spurious rejection. 100 KC and 25 KC calibrators. VFO can be used in transceive operation in conjunction with F series transmitter.

FLdx400 operates SSB, (USB LSB selectable), AM, CW and FSK. Circuitry can be built in for RTTY operation. 240 watts PEP. VOX, PTT, and break-in CW.

FL-2000B grounded grid linear uses a pair of 572 B tubes. Plate meter VSWR monitor, 2 fans, built-in power supply, 80 through 10 meters, 1200 watts PEP with distortion product in excess of 30 DB down.

FT2FB \$239.00
144-148MHz
10W HIGH 1W LOW

FT2-AUTO \$379.00
144-148MHz



FP-2 AC power supply specifications: Output - 13.5 volts, 2 amps. AC input - 100/117/220/234 volts. Speaker - 5" x 3-1/5". Portable or home base operation can be achieved with the addition of the optional FP-2 power pack. This AC power pack provides regulated DC power for the transceiver and charging voltage for optional leak proof rechargeable colloidal type batteries. In addition, a high fidelity elliptical style speaker is built into the pack.

The FT-2FB opens the door to noise free broadcast quality 2 meter operation, and thanks to the repeater stations throughout the country, the 2 meter band is no longer restricted to line of sight. General coverage 144 to 148 MHz, 12 channels (3 supplied). Push to talk. Receiver .3 amps, transmit 1.7 amps, power source 13.5 volts + 10%. Dimensions 6-3/8" w. x 2-1/2" h. x 10" d., weight 4 lbs. Comes with dynamic microphone, connector plug, DC cord, fuse and mobile mount.

The FT-2 auto is a compact base or mobile VHF/FM transceiver, covering 146 to 148 MHz, featuring electronic scanning up to 8 stations between 146-148 MHz with priority channel sampling while locked on another channel. Adjustable tone burst push-button lock on for repeater actuation. The FT-2 auto is self-contained. Two power cables are supplied with the transceiver, including all mounting hardware, cables, connectors, and accessories required for both mobile and base installation, as well as dynamic push to talk microphone. Operates from various AC voltages or 13.5 DC. Dimensions 8-3/4" w. x 4-1/4" h. x 11-5/8" d. Weight 9 lbs.

YC355-D \$289.00
DIGITAL COUNTER BUILT IN PRESCALER



Complete with
A.C. Power Cord 6 Ft.
D.C. Power Cord 6 Ft.
Signal Test Lead with
BNC Connector 3 Ft.

SPECIFICATIONS

	YC-355D	YC-355D	YC-355D
Frequency range	5Hz to 35MHz (50Hz to 200MHz)	MAX Input Voltage	60Vp-p, less than 10 sec (5V p-p)
Accuracy	± time base stability + 1 count	Input Impedance	HIGH 1 M ohm. Low: 56 ohms
Display	5 Digit	Input Capacity	Less than 20pF
Sampling time	1 milli-sec or 1 sec	Time base Frequency	1 MHz Crystal controlled
Display time	0.1 sec 2 sec	Stability	0.0005% at 25°C 0.0025% at 0° - 40°C
Frequency Unit	KHz MHz	Power Requirements	A C 100/110/117/200/220/234V 50/60Hz 18V A
Display	Display tube	D C	12-14.5V 1A
Input Voltage	20mV-20Vp-p (0.15V-5Vp-p)	Weight	220(W)X80(H)X270(D) (8 3/4 W X 3 3/4 H 10 1/2 inches)
		Tube	Display tube 5
		Semiconductors	Silicon diode 12 Silicon transistor 9 FET 1 IC 26

PRICES SUBJECT TO CHANGE WITHOUT NOTICE

FACTORY SERVICE IS AVAILABLE WHERE WARRANTY HAS EXPIRED. MK-160 (160M) KIT \$16.00 WITH XTAL PLUS LABOR. MODERNIZATION KIT MIR-1 FOR OLDER MODEL FT101 \$70.00 FACTORY INSTALLATION ONLY.

HAM RADIO CENTER
8342 OLIVE BLVD., ST. LOUIS MO 63132

ADIRONDACK RADIO SUPPLY
185-191 W. MAIN ST., AMSTERDAM NY 12020

HENRY RADIO STORES.
Los Angeles, Anaheim, CAI.; Butler, Mo.
HAM RADIO OUTLET
Burlingame, Cal.
RACOM ELECTRONICS
Renton, Wash.

FRECK RADIO & SUPPLY/704-254-9551
Asheville, N.C.
HARRISON RADIO/516-293-7990
Farmingdale, L.I. Valley Stream, L.I. New York

HAMTRONICS
4033 BROWNSVILLE RD., TREVISO PA 19047

AMATEUR ELECTRONIC SUPPLY
621 COMMONWEALTH AVE., FL 32803

WEBSTER RADIO
2602 E. ASHLAN., FRESNO CA 93726

GRAHAM ELECTRONICS
133 S. PENNSYLVANIA, INDIANAPOLIS ID 46204

WILSON ELECTRONICS
Pittman, Nev.
ED JUGE ELECTRONICS
Fort Worth, Tex.
AMATEUR ELECTRONICS SUPPLY
Milwaukee, Wis.; Cleveland, Ohio



YAESU MUSEN USA INC.

7625 E. ROSECRANS AVE. UNIT 29 PARAMOUNT, CAL. 90723

TWX 910-346-7624
TEL 213-633-4007

FREQUENCY MEASURING EQUIPMENT AT MICROWAVE FREQUENCIES

This article is not intended to give the theory, but rather a practical solution to the building and use of wavemeters at microwave frequencies.

In microwave work, frequency is one of the most important measurements. It must be understood the wave length in the devices described here is not the exact frequency wave length. A well-constructed wavemeter that has been calibrated can be very precise. They can be within 1.5 MHz at 10 GHz or less than half of a MHz at 1250 MHz. Temperature has some effect on the frequency. Most commercial wavemeters are constructed of Invar, a metal that changes very little with temperature. Some parts are of

bi-metal construction to compensate for temperature. For the average experimenter, brass and copper will have to suffice. Although silver plating is desirable, it isn't an absolute necessity. Frequency at microwave frequencies can be measured by three methods: wavemeters, slotted lines, and frequency comparisons. All of these methods are used commercially. The frequency comparison is usually used in the laboratory to calibrate the wavemeter and the slotted line. As a general rule, any method of frequency measurement used at lower frequencies can also be used at the microwave frequencies, but are not always practical. The resonate cavity as a wavemeter is used in microwave measurements.

There are three types of cavity wavemeters: the transmission type, Fig. 1A and 1B, the reaction type, Fig. 1C, and the absorption or absorption type, Fig. 1D. All are resonate cavities. The way in which the wavemeter is used determines the type.

All wavemeters are adjusted for maximum readings except the absorption type. The absorption is adjusted for a dip in power output. The most popular wavemeter used by the beginner is the open circuited transmission line type, Fig. 2. This type of wavemeter is the equivalent of lecher wires. (Open circuit refers to the standing wave within the cavity, not the physical construction except as it pertains to the frequency wave length.) The practical physical dimen-

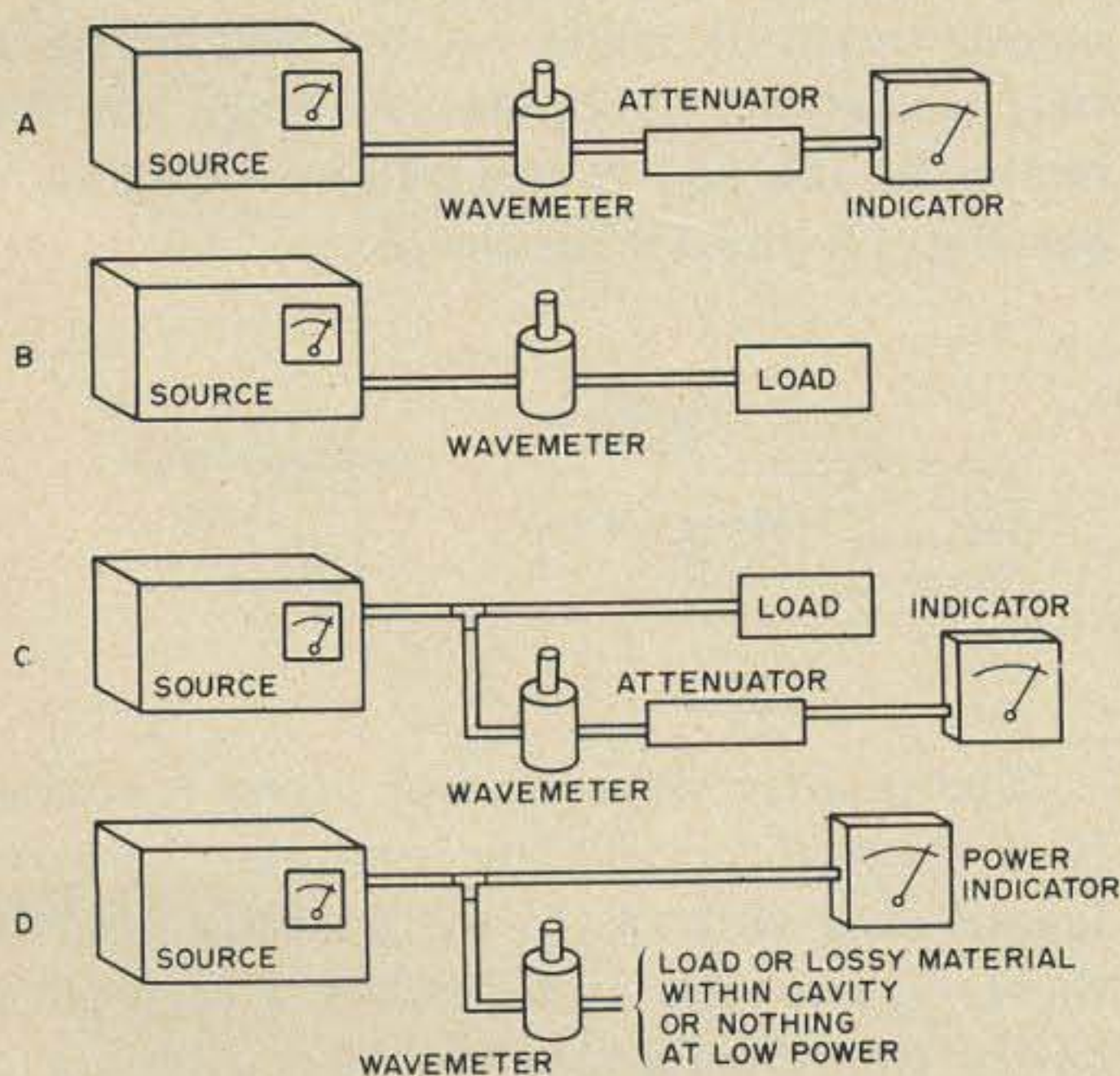

Fig. 1.

**Proved in
Commercial 2-way
Now Available
To Amateurs!**

Larsen Mobile Gain Antenna 144-148 MHz



The result of over 25 years of two-way radio experience. Gives you . . .

- 3 db + gain over 1/4 wave whip
- 6 db + gain for complete system communications
- V.S.W.R. less than 1.3 to 1
- Low, low silhouette for better appearance

The fastest growing antenna in the commercial 2-way field is now available to Amateurs. It's the antenna that lets you **HEAR THE DIFFERENCE**. Easily and quickly adjusted to any frequency. Hi-impact epoxy base construction for rugged long life. Silver plated whip radiates better. Handles full 100 watts continuous. Models to fit any standard mount. Available as antenna only or complete with all hardware and coax.

Get the full facts on this amazing antenna that brings signals up out of the noise . . . provides better fringe area talk power. Write today for fact sheet and prices.

*Sold with a full money back guarantee.
You hear better or it costs nothing!*

also available . . .

5 db Gain Antenna for 420-440 MHz and 440-460 MHz

Phased Collinear with same rugged construction as Larsen 2 meter antennas and 5 db gain over reference 1/4 wave whip. Models to fit all mounts. Comes with instructions. Write today for full fact sheet and price.



Larsen Antennas

11611 N.E. 50th Ave. ■ Vancouver, WA. 98665
Phone 206/695-5383

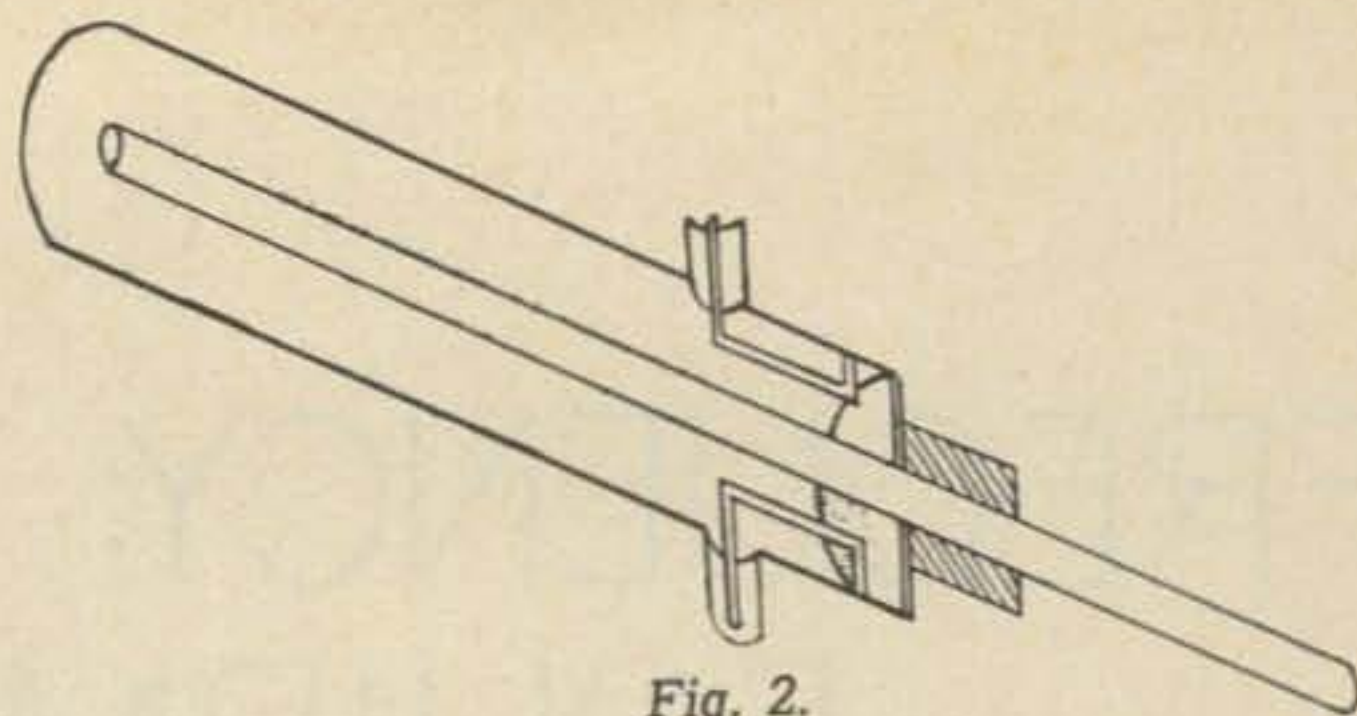

Fig. 2.

sions are not many. The inner circumference of the main tube should be less than one wave length at the highest frequency to be measured. The rod should be small compared to the tube. If inductive coupling is used, the inductive coupling should be close to the shorted end. For probe coupling, the probe should be close to the middle. The open circuited transmission line is generally used in two ways. This type can be used "in line" (Fig. 1B) as it has very little loss when it is resonated. However, it should be removed from the line before transmitting, as it will act as a narrow band filter. The half wave length is the measurement between the two successive points at which the generator will load to maximum, as the rod is inserted or withdrawn.

Another method in the use of the open circuited transmission line calls for the use of an additional circuit, as in Fig. 3. The circuit is a simple crystal diode detector connected to a microammeter. The diode and condenser are usually built into the connector, as the leads should be kept as short as possible. The half wave length measurement is made on the rod between two successive maximum readings on the meter, as the rod is inserted or withdrawn. See Fig. 1A and 1B for the setup.

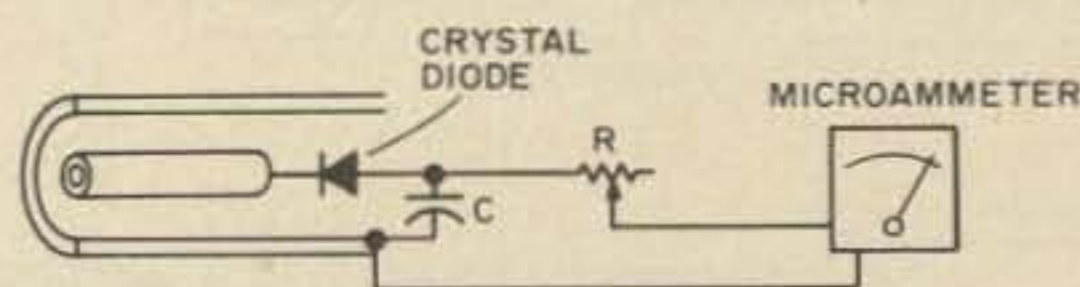

Fig. 3.

The quarter wave coaxial cavity is actually a shorted coaxial line one quarter wave length long (Fig. 4, 5, 6). As illustrated in these figures this type makes a very good cavity to use as a standard. To calibrate, a chart is made of the micrometer settings at different frequency wave lengths from a

calibrated source generator. Don't tell them so, but the Public Relations Department of the Telephone Company may help you here, if they have any microwave technicians close by. The quarter wave coaxial cavity can be either physically open or closed. If closed, the closed end should extend at least a quarter of an inch beyond the center conductor at its lowest frequency. The closing of the end will lower the resonate frequency. Probe (capacitive) coupling as used for coupling in Fig. 5 will shorten the center conductor, and loop (inductive) as used in Fig. 4 will lengthen the conductor. In Fig. 4 we change the length of the center conductor to change its one quarter wave length. In Figs. 5 and 6 the center conductor remains the same, and we change the resonate frequency by capacitance. This method makes it necessary to construct the center conductor very short as compared to the full quarter wave length as in Fig. 4. These devices are not longer, so caution must be used when calibrating. The closed wavemeter as indicated in Fig. 7 is a shorted coax line at each end. The wavemeter uses a shorting plunger which is movable along part of its length. If used as the quarter wave coaxial cavity, the center conductor must be longer than a quarter wave length.

Up to this point we have covered most of the wavemeters that could be used from around 144 MHz up to approximately 3000 MHz. 1000 MHz to 3000 MHz are usually called the lower microwave frequencies. If the inner circumference of the outer tube is kept less than one wavelength, these wavemeters will operate in the desired TM mode.

There are four ways to couple energy into a wavemeter, loop (Fig. 4), probe (Fig. 5), direct (Fig. 6) and slit (Fig. 8). The most commonly used is the loop, as it has very little effect upon the electric field. The usual methods for changing loop coupling is to change the size and orientation of the loop. Loop coupling is usually placed in the high current area of the wavemeter. Capacitive coupling is changed by the size of probe and the distance from the center conductor. Capacitive coupling is usually placed at the high voltage portion of the wavemeter. As in Fig. 5, a small probe — say 1/2 in. piece of No.

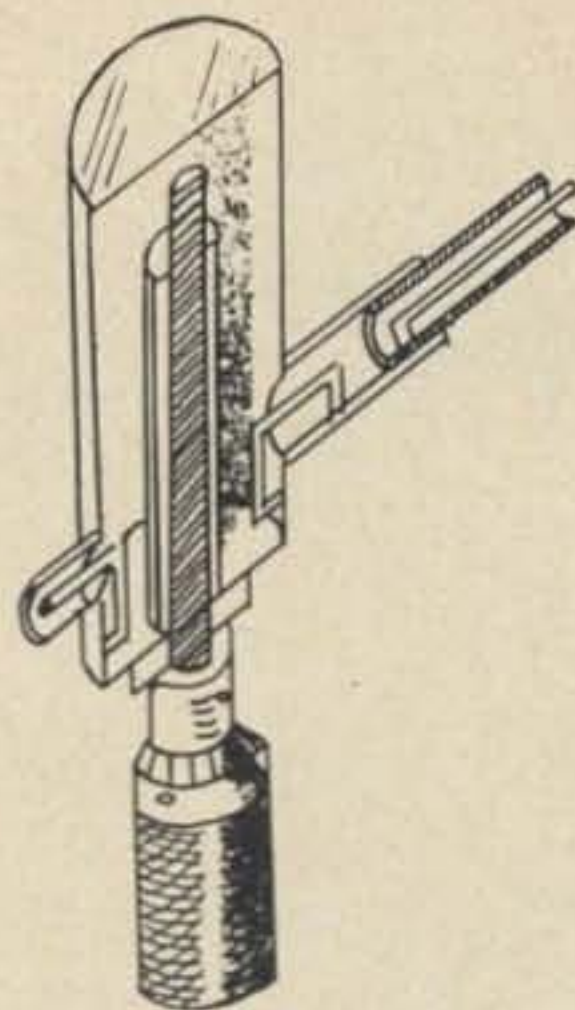

Fig. 4.

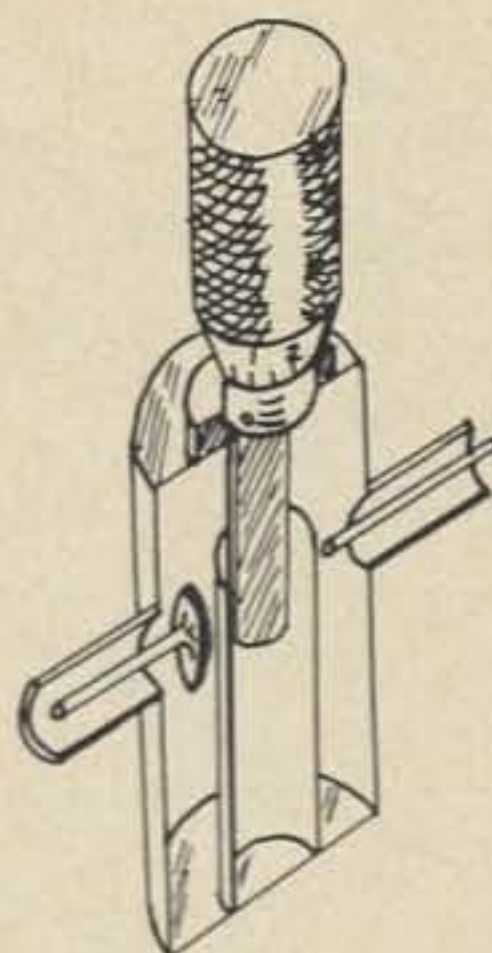

Fig. 5.

22 wire, for example — may require an external voltage amplifier. The smaller the probe, the less effect on the resonate frequency of the wavemeter. In direct coupling as in Fig. 6 the primary concern is impedance. To increase the impedance, move the coupling up the line away from the shorted end. To decrease the impedance, move the coupling down the line toward the shorted end. Slit coupling (Fig. 8) can be a small hole or a series of small holes or a slit. Its purpose is to allow a certain amount of leakage. In all forms of coupling, it is desirable to use loose coupling, as the wavemeter will have less effect on the system, and the Q of the circuit will be higher.

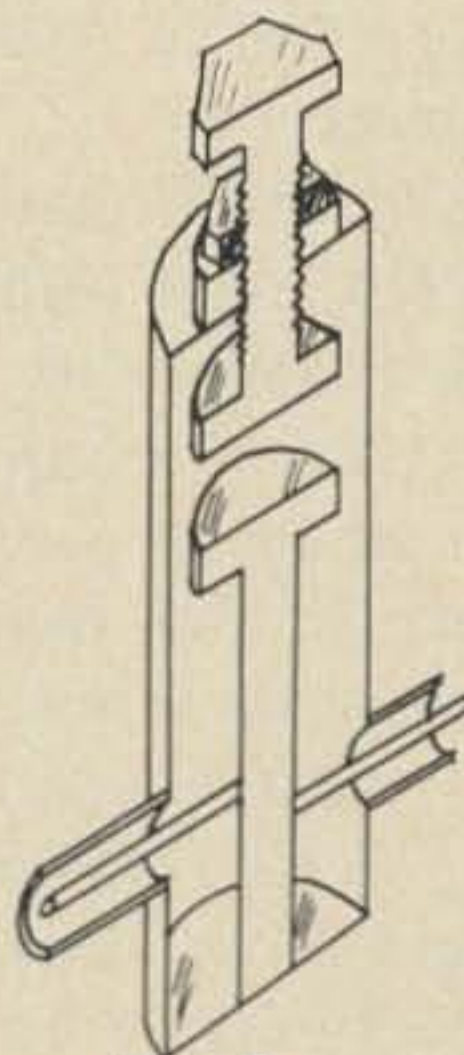

Fig. 6.



Fig. 7.

Above 3000 MHz, usually only the tunable wavemeter is used. The cavity is one quarter wave length long. The cavity can be coupled in three ways: loop, probe and slit. Because of the high frequencies, the slit is usually used, and the meter is most often

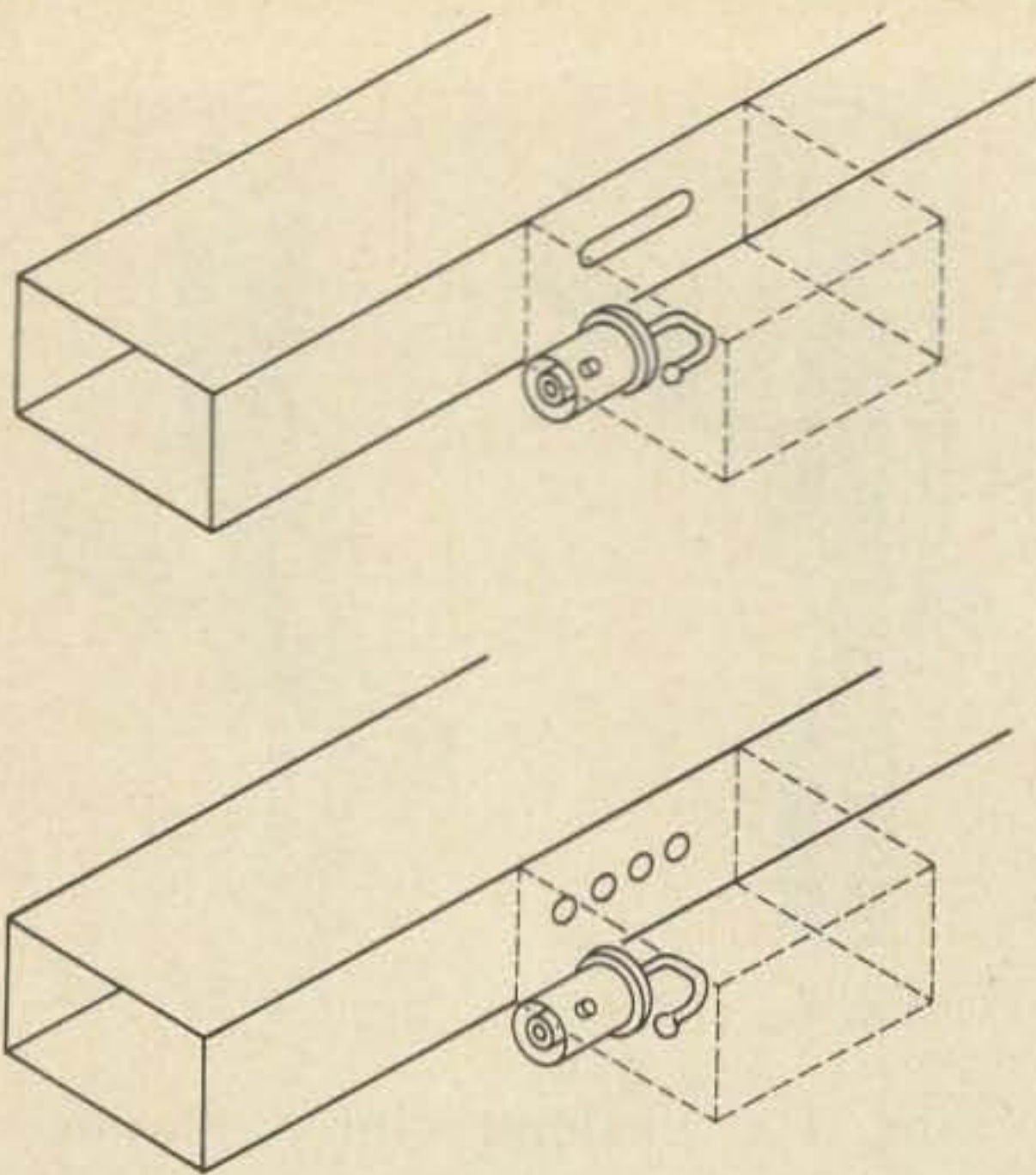

Fig. 8.

kept as an absorption meter. In the absorption method, the wavemeter should be detuned when not in use. Some of the cavity wavemeters have a little lossy material added to absorb some of the energy, as in Fig. 7. Lossy material can be made from graphite impregnated cloth in epoxy.

There is one other type of wavemeter that can be briefly mentioned; it is the reference wavemeter. The reference wavemeter is of any design as described, but would be constructed more like Fig. 6. It can be locked when adjusted to a selected frequency and used as a reference standard. The micrometer assemblies can be made from any micrometer with additional parts welded on. I constructed one using an oversized tube over the main cavity, and dimpled it at various places around its circumference until it fit smoothly over the cavity, and I used a piece of 3/8 threaded brass pipe as the main adjusting screw. I am sure you can come up with a good one without any backlash. This wavemeter spread the 1250 MHz band out to over 100 inches by rough measurements. I haven't calibrated it, so I can't say for sure just how far. There are three nice veeder root counters in the APX 6 which would make excellent wavemeters plus sliding contact material. One could even use the entire cavity.

The last method of microwave measurement that we will look at is the slotted line

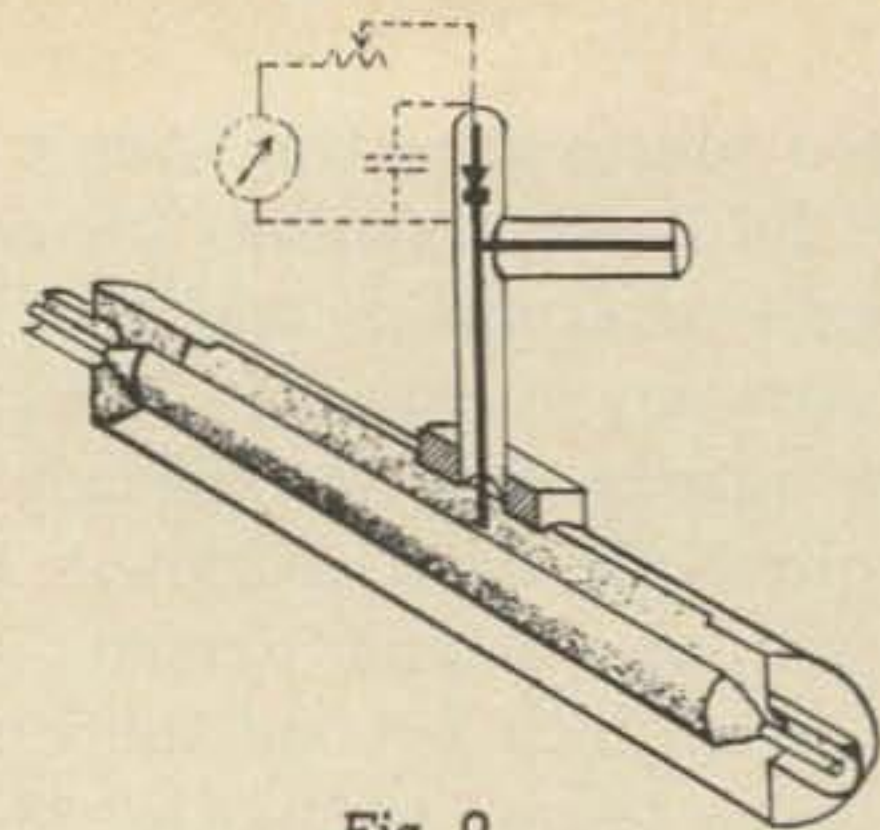

Fig. 9

(Fig. 9). The slotted line is a section of coax line along which is cut a slot. A probe, which is a simple crystal detector with a one quarter wave length shorted stub for a dc return path, is moved along near the center conductor of the slotted section. In this case we are looking for two successive minimum readings along the line. The distance between these readings is one half wave length. A slotted line should also be calibrated. If calibrated at one spot near the intended frequency to be measured, a chart will not have to be made — just a K factor obtained. The distance between two successive readings times the K factor should equal the frequency half wave length. There are a few accessories that can be either built in or used

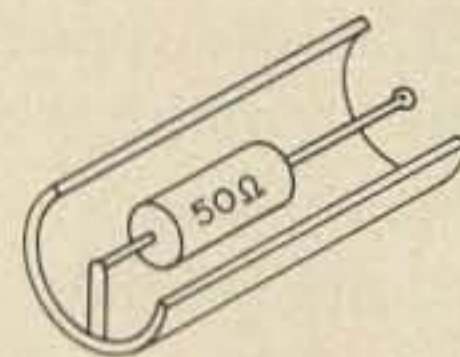

Fig. 10

externally. One is a coax attenuator shown in Fig. 4. It will slide in and out of the other half. It too can be calibrated if one wishes. A 50Ω resistor can be used for an impedance match for 50Ω lines if inductive coupling is used such as in Fig. 10 and when the loop is

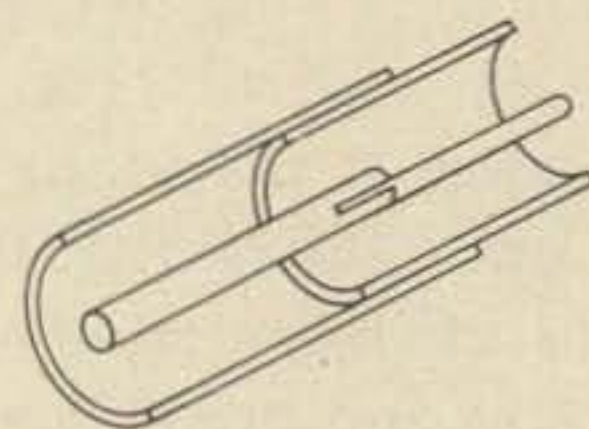

Fig. 11.

small. The line stretcher (Fig. 11) is useful with the slotted line. It merely consists of two coax sections, one sliding into the other.

...WA9VFG

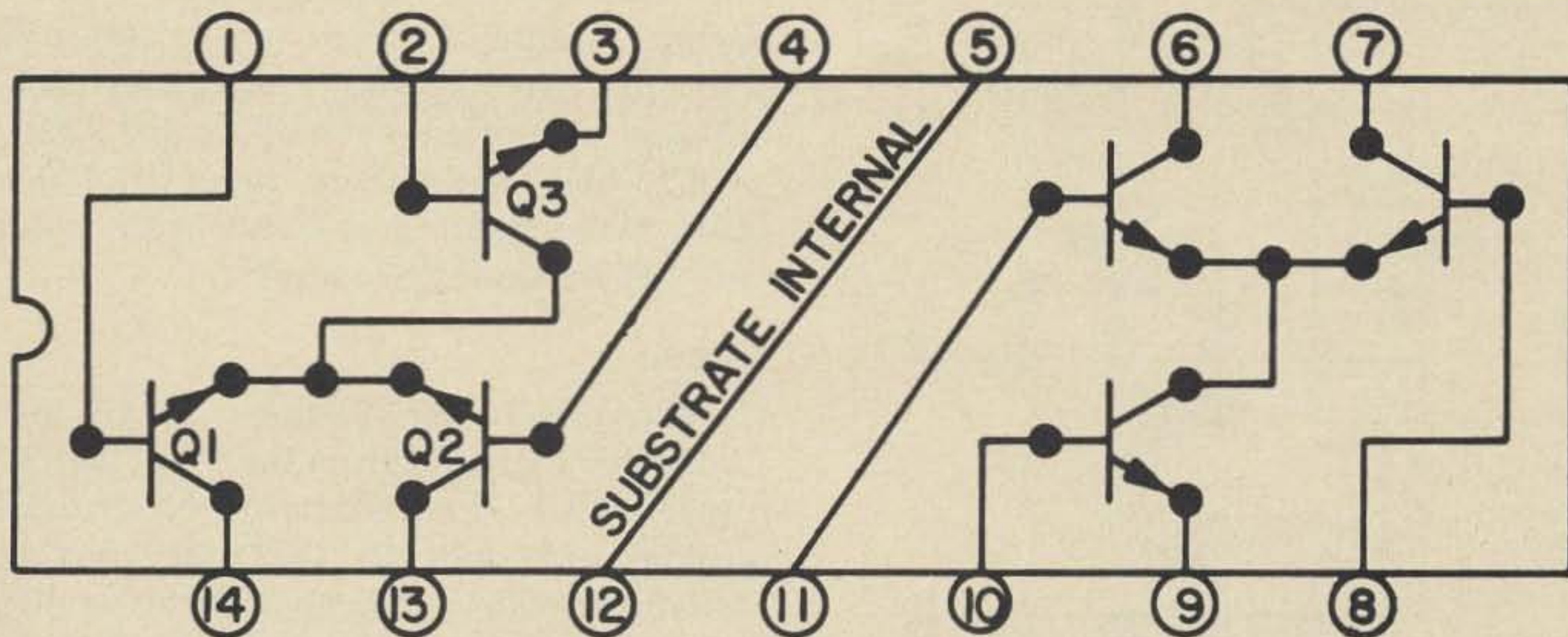

Fig. 1. Build a complete receiver front end with the RCA CA3102E integrated circuit.

Truly it is said, "Nothing succeeds like success," and the RCA lads in Somerville NJ are to be congratulated on this latest achievement of theirs in building an IC which works well as a complete 2 meter front end incorporating rf stage, mixer and oscillator.

This article concerns the RCA IC CA3102E in a 14 pin in-line case which contains six 1000 MHz semiconductors. Bear in mind, please, there is a large difference between integrated circuits for digital work and those for rf work.

This article, like most of mine, is not just a construction article. It deals with the design and philosophy of the components and the circuits shown because I believe amateurs should have the opportunity — if they wish — to learn as much as possible while building. There is a perfectly valid philosophy which concerns "Connect a short red wire between point A and point B." I have done lots of these myself, but always found I had to force myself to forget all I knew about radios and become a true know-nothing while doing it.

The RCA CA3102E

This little gem has two independent differential amplifiers inside, with its schematic shown in Fig. 1. Each of the six transistors has an Ft in excess of 1 GHz, making this IC useful to 500 MHz. Special care has been taken in the internal chip

layout to assure good freedom from reaction between the two independent amplifiers. Inasmuch as I seldom write about anything I have not tried out, I have some running here and they work well.

Since the true home-brewer is always interested in possible applications of what he spends his hard-earned money on, the

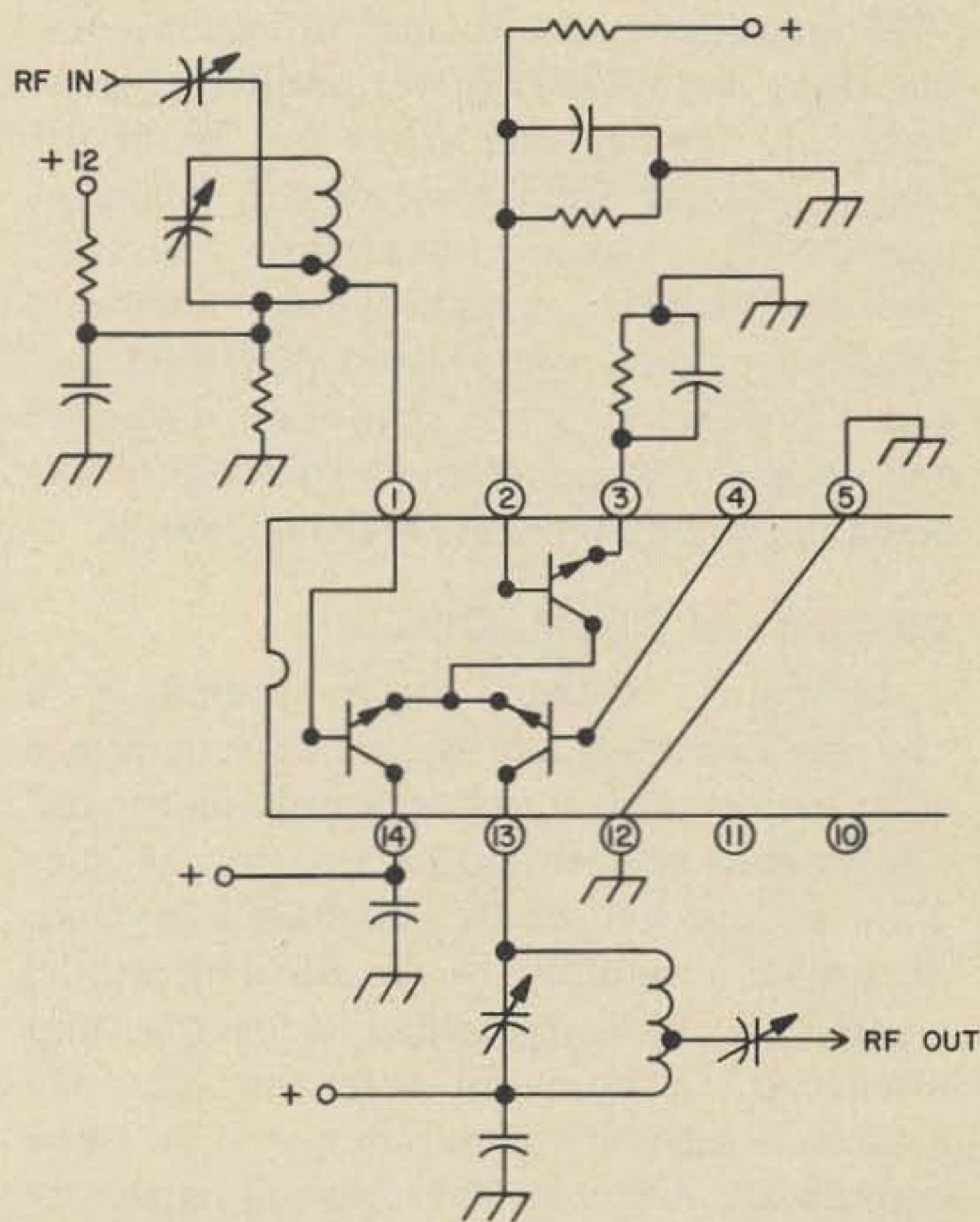

Fig. 2. Differential amplifier connection, RCA CA3102E (pin view). See Figs. 3 & 4 for representative values.

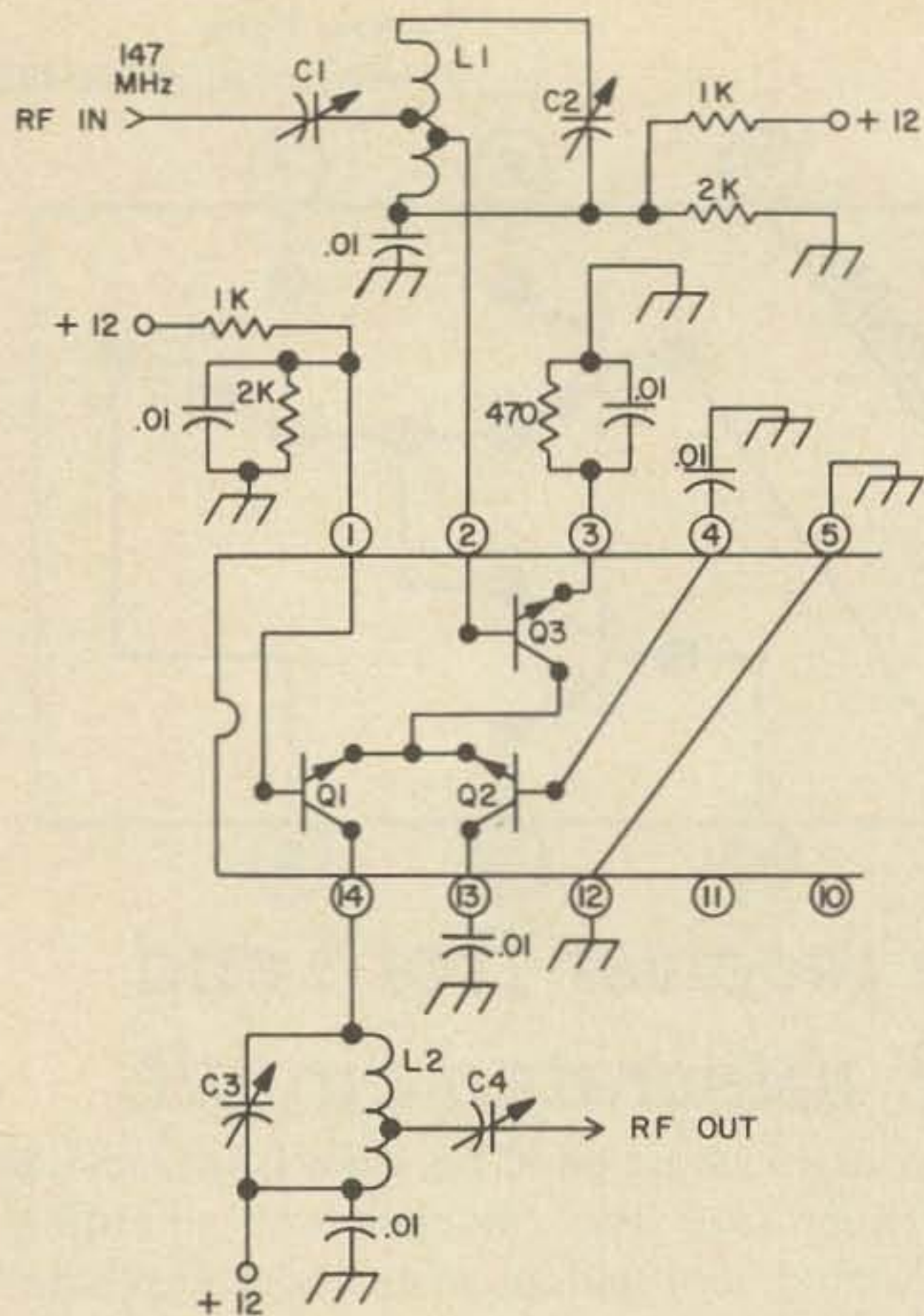

Fig. 3. Cascode connections, CA3102E. For tuned circuit values, see L1 in Fig. 4.

following list of CA3102E uses is included: VHF amplifiers, mixers, multifunction combinations such as rf/mixer/oscillator, converter/i-f, cascode amplifiers for i-f, or dif amps, product detectors, doubly-balanced modulators, balanced quadrature detectors, cascode limiters, synchronous detectors, balanced mixers, synthesizers, balanced cascode amplifiers, sense amplifiers (whew!) and others. The age of the VHF-UHF IC's is being opened up by these 1 GHz beauties.

Dif Amp and Cascode Details

Inasmuch as the L.O. is formed by a cascode amplifier, and the mixer section has an rf amplifier in it, a few words on the use of this chip in both modes is timely. Figure 2 shows one half of this versatile little chip of 1 GHz capability in the dif amp mode, where Q1 is a grounded collector amp driving Q2, a common base amplifier. Q3 acts as a constant-current source. This is the configuration that is best if strong signals are present, as in metropolitan areas, or other areas where amateurs may be in close proximity to each other. This dif amp mode has

slightly less gain than the cascode mode, but this need not be considered unless you are trying to minimize components, often a false concept. Two stages with lower gain, such as dif amps, are often much better and easier as well to build and line up than one of higher gain. Noise figure goes *down* with current, another reason for two stages.

Circuit

Referring to Fig. 2, the rf arrives at the tuned circuit L1-C2 from the input matching capacitor C1. A tap about one turn from the ground end goes to the base of Q1, a common collector amp. Q1 is emitter-coupled to Q2, a grounded base amp whose collector circuit has C3 and L3 for tuning. See rf section for details and component values.

Constant-current Source

The makers of these IC rf circuits use a lot of transistors in these tiny chips for this sort of thing. Making them mainly for commercial users, they put in, for example, Q3, which does not appear to do anything at all. It does however do nice things if you look a little deeper. When the temperature varies it tends to maintain a constant current on the amplifier and therefore lessens any detuning effect that might otherwise occur and other nuisance effects. Just use it as shown. It helps for a better circuit, especially when you can take it out in your car in the winter right out of a heated room or garage. After all, it only costs the maker a fraction of a cent to photograph it in there, so why should *you* worry?

Cascode Connection

Figure 3 shows connections for the cascode configuration, which has the highest gain but cannot handle strong signals like the dif amp. The rf goes through the series matching cap C1 (referring to Fig. 3), then to the tuned circuit L1-C2 and then to the low impedance base of Q3, a grounded emitter stage. This stage is cascode coupled to the emitter of Q1, and the signal goes out on the collector to the tuned output circuit C3-L2 and on out through C4. Q2 is not used in this mode, and simply floats for dc, with external connections 4 and 14 bypassed

to ground for stability purposes. Keep L1 away from L2, and use a shield between them if needed. Put the shield more or less in line with pins 5 and 12, as shown in Fig. 3. More details in the rf section.

Internal Feedback and Stability

The compound (internally connected dif amp or cascode) connections of the dif amp or cascode are both much better for internal feedback (having less) than a single grounded emitter transistor, with the best in this respect being the cascode mode. The ratio of how much better may be as high as 1/140 at low frequencies, to perhaps 1/10 at 100 MHz. In the cascode circuit this may be as high as 1/135 to 1/1200. In any case the internal feedback is low enough so that no consideration of neutralization is needed. This reverse transconductance is sometimes labeled Y_r , in case you should meet it some dark night. Just be sure the *external* feedback does not clobber the nice internal feature. Pay attention to the details and notes in this article and it *won't* (shielding, bypassing, etc.).

AGC

The mixer gain can be easily controlled to a high degree in these versatile chips, up to 60 dB or more, by putting a negative voltage on the base circuit of Q1 in the mixer circuit of Fig. 5. Remove R3 and put the negative going agc voltage on the base at that point. You will more likely use the agc on the rf amp, though. In that case the agc voltage would be applied to the base return of Q3 through L1 in Fig. 3. A good balance of rf amp current (minimize) and gain, as well as mixer gain, should be sought.

Mixer

Figure 4 shows the half of the CA3102E used as an rf amp, mixer, and L.O. buffer-amplifier. Note the grounded line between pins 5 and 12. I am not quite sure how this is physically arrived at inside on that tiny chip, and it will have to wait for my next visit to Somerville NJ (RCA Solid State Hq), but it works fine. You would have to have a good microscope to find it! Q1 is a grounded emitter rf amplifier which takes the rf signal at 147 MHz in on L1 and direct couples it to

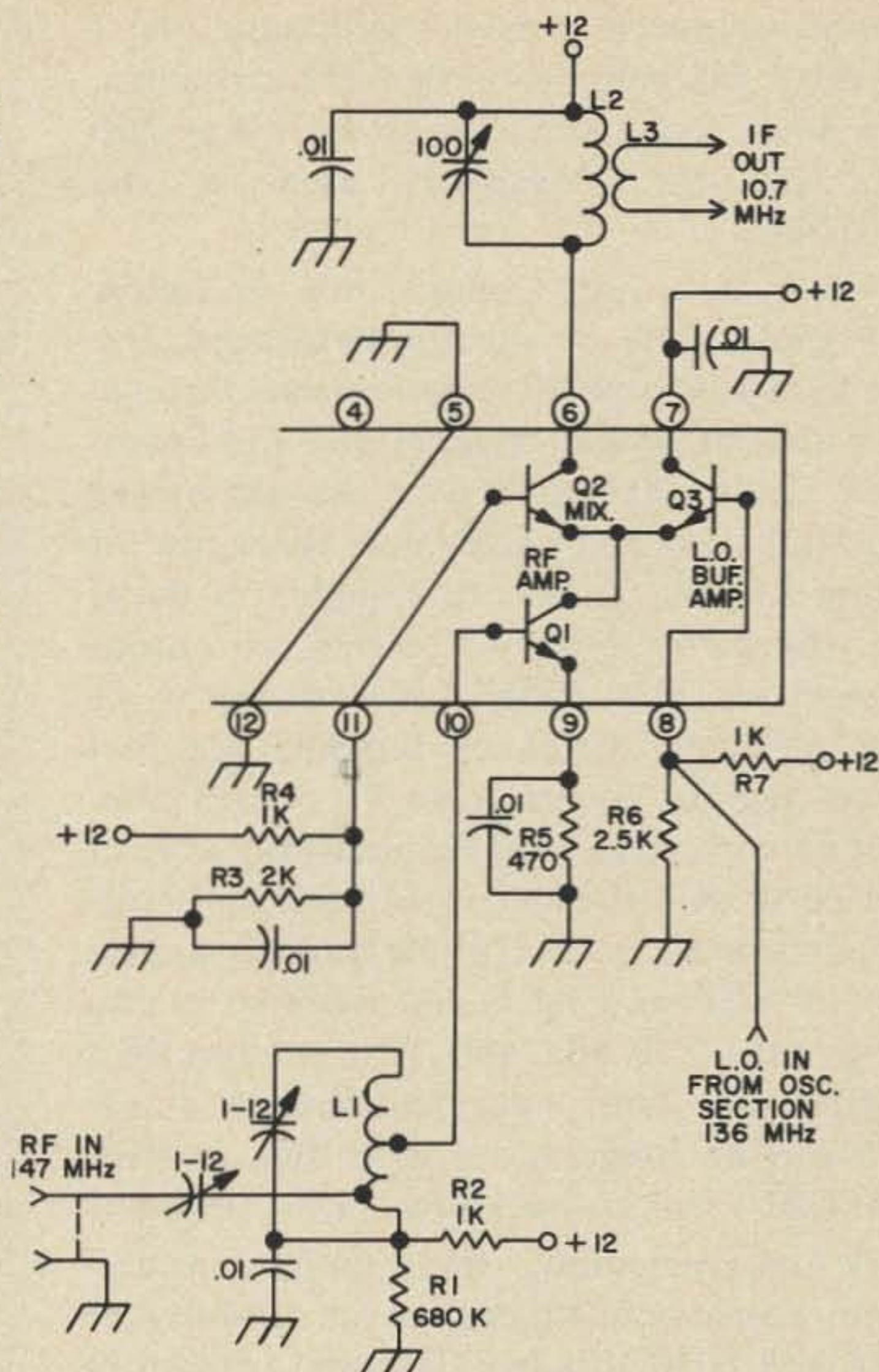

Fig. 4. One-half of CA3102E - use as a complete rf front end. L1, 5 turns No. 20, 12mm long, 8mm diameter. Input tap at 1, output tap at 1½. L2, 15 turns No. 20, closewound 10mm diameter. L3, 2 turns over bottom of L2.

Q2, a grounded base mixer stage. Q2's collector goes out at 10.7 MHz to the if output transformer L2, link coupled by L3, to the output cable. Q3 is used as a buffer amplifier for the L.O. - the 136 MHz injection voltage coming from the other half of the CA3102E used as the crystal oscillator. This section is quite straightforward even though an rf amp and buffer-amp for the L.O. are included, and works well due to the 1 GHz transistors used. I checked it several times against a good 3N200 FET mixer and local oscillator chain, and it has a dB or so better sensitivity, or I should say conversion gain, than the FET job.

Noise Figure

The noise figure of the CA3102E used as an rf amplifier is highly dependent on

current, as indeed in most semiconductors, 2 or even 1 mA being good figures for rf amps. This noise figure runs about 4.6 dB at 200 MHz for the transistors used in the CA3102E.

There is a fairly simple rule to follow with these units, as already mentioned. Use of the lowest possible total current through Q1's emitter will in general give the lowest noise figure. This refers to the use of the CA3102E as rf amps also. Note the setup for tuning L1, the series cap bringing in the rf and the two tie-points serving as output connectors. This method has proven to be very efficient, both for building the first model and for layout of the PC boards later. If done correctly, each tie-point can serve as a place to drill the PC board for a lead hole, or component tie-in. It is particularly important in VHF and more and more so as you go up into 220 and 450 MHz, to furnish a layout man with exact placement detail. You can no longer leave it to him, at VHF and UHF, unless he knows a lot about rf work and particularly the IC under consideration. You should think this out carefully, as VHF and UHF IC's handle quite differently than af, digital, or control circuits.

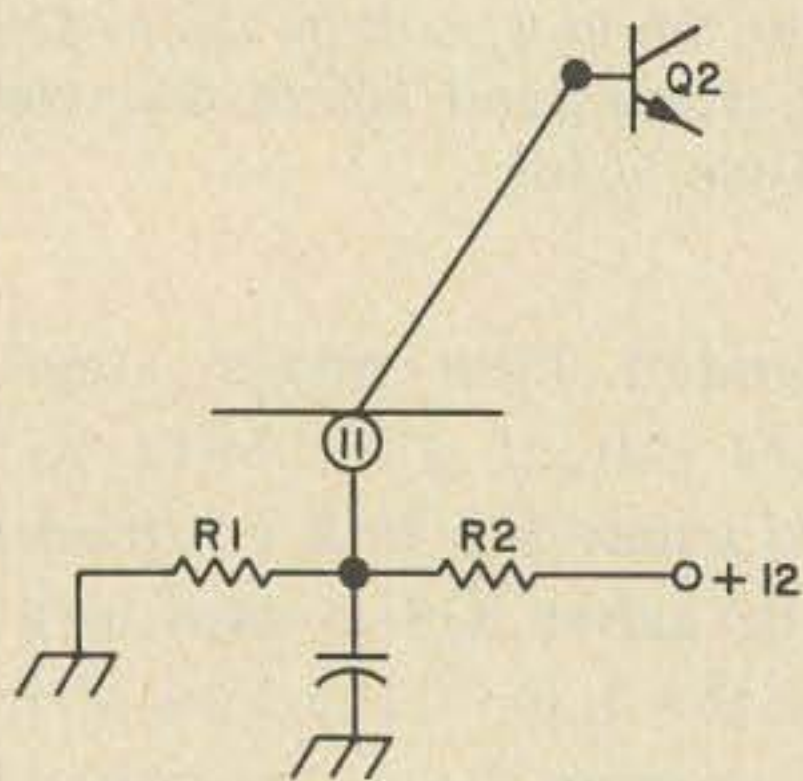

Fig. 5. Example of base bias in the CA3102E.

Base Bias

Due to the direct coupling of the various transistors, placing them in series dc-wise, attention should be paid to the base bias voltages. While in general the resistors may be as in Fig. 5, these should really be adjusted with signals flowing through for checking best noise figure, gain and current. I have already done this for you, but it is a

Hi,

My name is John (WB2AZT), and I'm the Amateur Products Manager for Venus Scientific. By now, you've probably scanned our ad on the opposite page. If you react as most hams do, you're probably thinking, "That's a nice looking package, but who and what is Venus Scientific?"

That's the purpose of this message--to acquaint you with our company, its products, and its reputation. There's nothing like knowing that a manufacturer is able to back up his product claims.

Basically, Venus Scientific is one of the country's leading manufacturers of electronic high voltage control systems for military and industrial applications. Our H.V. Power supplies were used with television cameras on the Apollo flights that sent TV pictures back from the moon. Some time ago, a group of us within the company who are all active hams, began pressuring our boss Fil Galluppi to let us get into the amateur radio market. After considerable urging and coaxing, including actually dragging him to several ham-fests, he too got the bug and gave us a go-ahead.

So here we are with our first of many products we've planned for the amateur market. Our slo-scan monitor is in production, ready for delivery, and frankly, it's something else again. More than just an S.S.T.V. monitor, a flip of the switch converts the unit to the incredible Accu Sync™, an oscilloscope that clearly reads out both incoming and outgoing S.S.T.V. signals. Other features, like our master G10 P.C. Board, make the SS2 flexible and long lasting. The specs on the next page are just a few of the features of the SS2.

Just remember that the ten years we've been in business designing and manufacturing high reliability systems has brought to the ham market the quality product I think we, as hams are entitled to. OK, now you know a little about Venus Scientific. Look for our ads in the months ahead and let us know what you think of our product.

And by the way, in case you're wondering, Yes, we'll announce our companion camera in the next few months.

John M Lotito
John Lotito
WB2AZT

2nd generation slo-scan

Venus Scientific brings ten years of space-age technology development to the production of the latest breakthrough in HAM Equipment... the SS2 Slo-Scan Monitor. The following unique features of the SS2 have been designed to offer the HAM operator the maximum functional performance in SSTV.

These advances include: **ACCU SYNC**,[®] a diagnostic and tuning aid which converts the SS2 Monitor to an oscilloscope by the flip of a switch that monitors incoming and outgoing video; **LED SWEEP INDICATORS**, go-no-go lights for ease of servicing; **CAMERA ADAPTER** provision to accept **Polaroid Color Pack Camera** or **Polaroid Square Shooter**, which enables you to take pictures right off the air; **SIMPLIFIED INDEPENDENT CONTROLS**.

For the full story on how VENUS' SS2 monitor has become the 2nd Generation of Slo-Scan and a list of accessories, write or call today.

Amateur net price \$349 N.Y. State residents add sales tax.

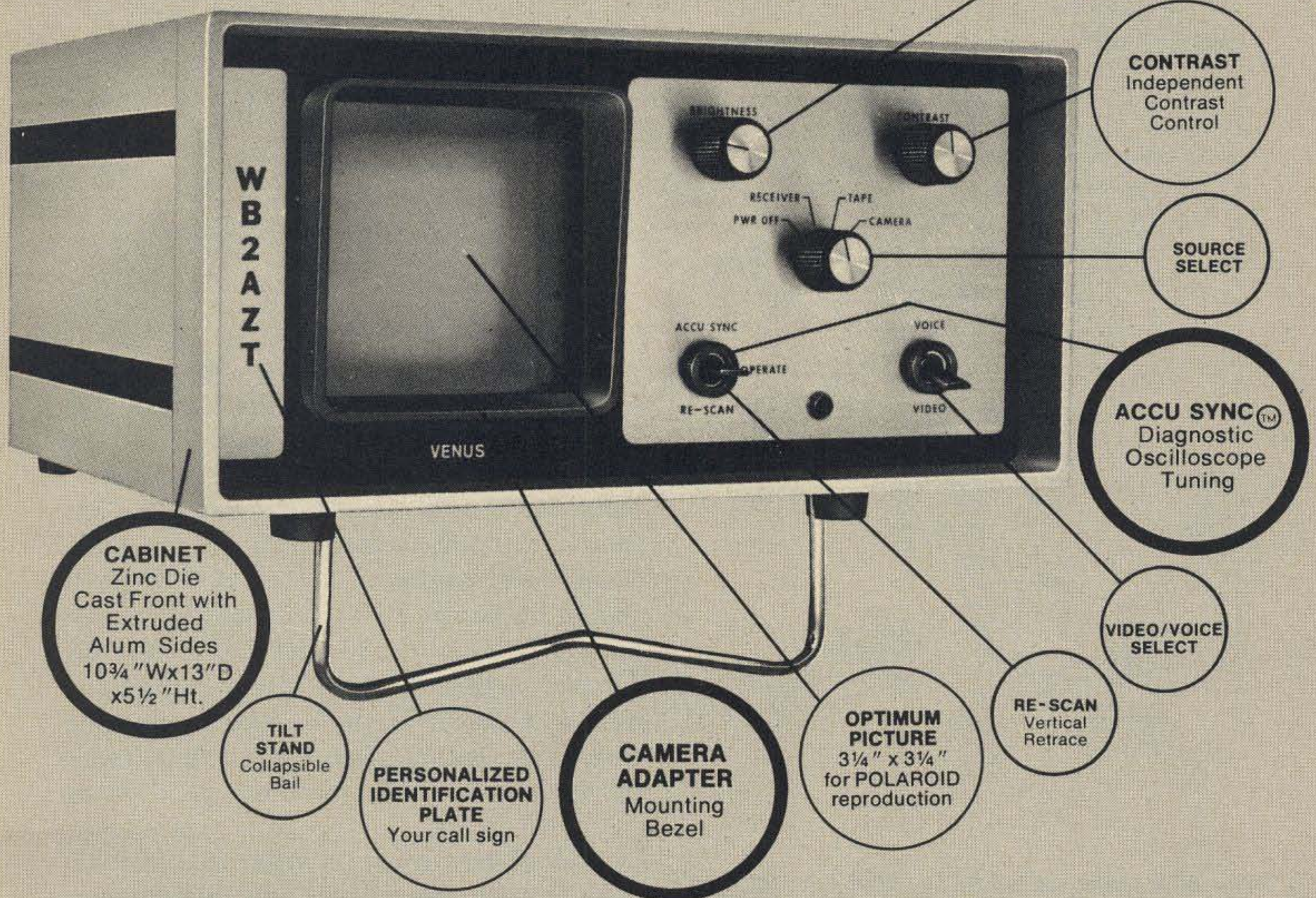

Venus Scientific Inc.

The company that put high voltage on the moon,
now brings you expanding amateur radio technology.

399 Smith Street
Farmingdale, N.Y. 11735
Phone 516-293-4100
TWX 510-224-6492

good thing to learn about. There is also quite naturally a certain amount of interplay between R1, R3, R6 and the current controlling emitter resistor R5. The optimum values are not critical or touchy, but will be seen to be quite responsive to best values. I generally use a 5K pot at the R1, R3 and R6 places to start off with, and a 1K pot as R5. The proper values are soon determined with that arrangement, and you are not left guessing if you have the right values or not. Remember that monolithic photo-built transistors have quite a wide range of parameters at times.

Naturally I ran the mixer when finished, with an outboard oscillator as well as the internal one, to see if there was any reaction between the two halves of the CA3102E when used as rf, mixer and oscillator, but could not find any. It seems to be a "natural."

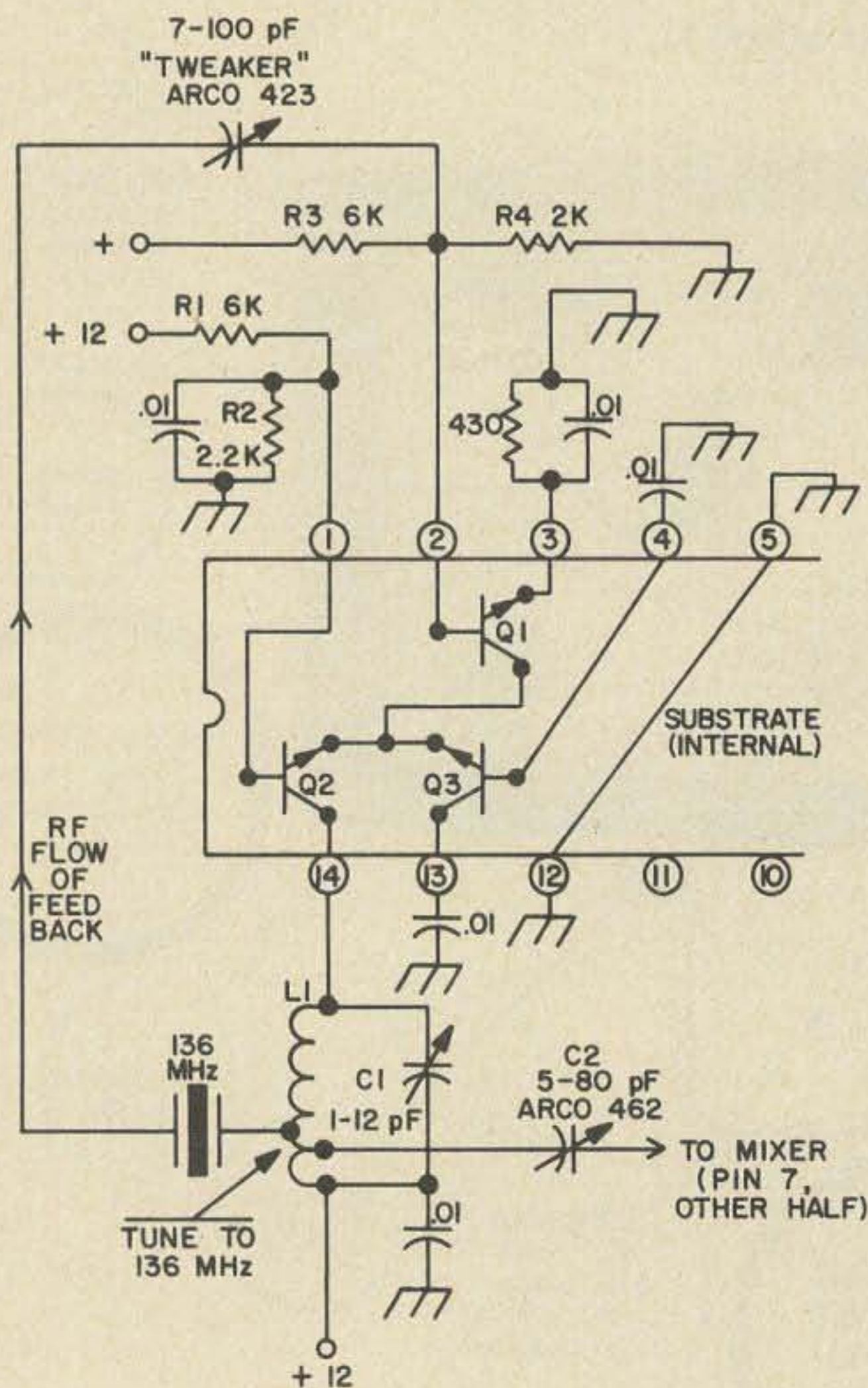

Fig. 6. Internal schematic, 1/2 RCA CA3102E, IC used in the cascode connection as a crystal oscillator. L1, 5 turns No. 20, 12mm long, 8mm diameter. Crystal tap at 1 1/2 turns, output tap at 1 1/2 turns.

I have recently developed an IC tuneable, L.O., which also goes very well with this unit. Disable the internal L.O. by pulling out the crystal, and plug in the external vfo cable to pin 8, the base input of Q3. The unit was described in the July 1973 issue of 73 Magazine.

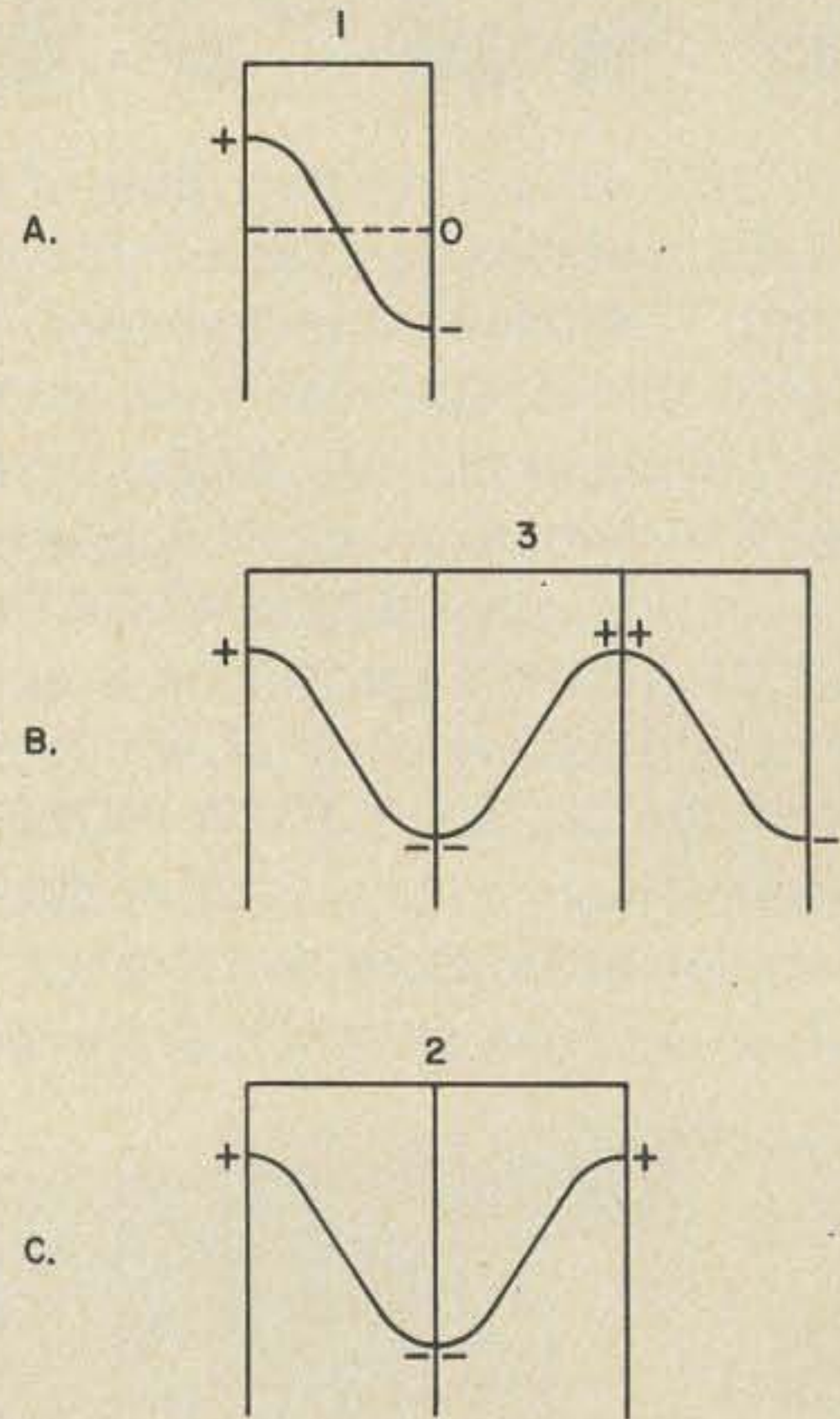

Fig. 7. 136 MHz crystal operation.

Crystal Oscillator on 136 Direct

Referring to Fig. 6, we see the rf signal from the crystal entering Q1 at the base. Q1 is the grounded emitter portion of the cascode amplifier forming the oscillator. Note the crystal used is cut for 136 MHz direct, without multiplication of any kind. Some have expressed surprise at this, but it should be known that today control crystals are available up to 250 MHz direct, not only for two meters. Such crystals are commonly referred to as "overtone," which to my mind smacks of obscurantism, the real functioning of that precious little piece of "glass" being as shown in Fig. 7. This gives you a rough idea of what is going on inside that little tin can. You can also see that only odd numbers can be used. If you try to use the even number combination in Fig. 7C, you will of course get no ac out of it. Never forget that

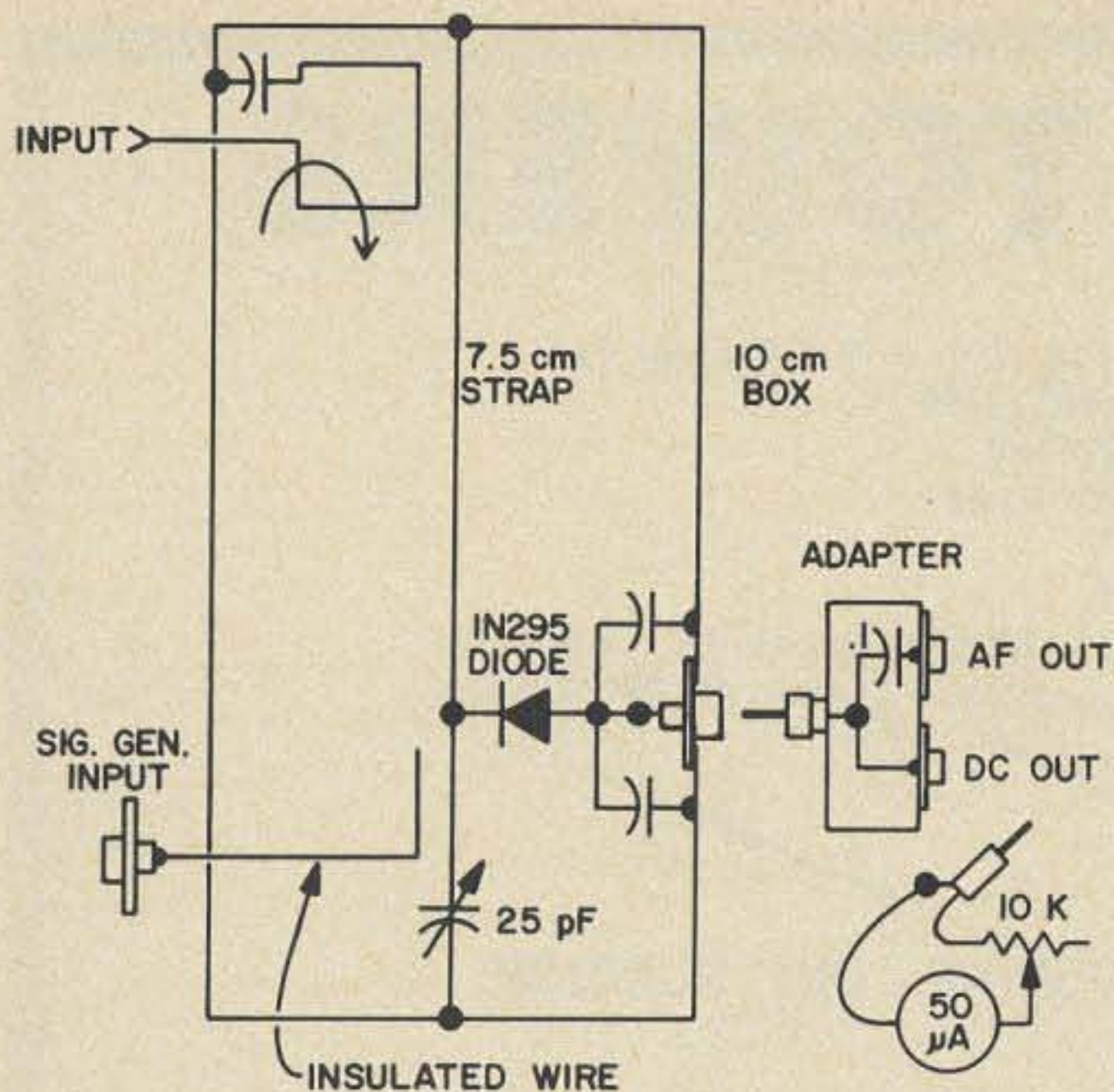

Fig. 8. Oscillator frequency check-out circuit.

a crystal operates on sound waves and that only certain numbers can be used. If this sounds to you like quantum mechanics, good for you, you're getting warm! A piezo-electric chip, if cut right, gives off electricity, positive on one side and negative on the other when compressed, and that is good old dc if you hold it that way! Madame Curie's brother used to demonstrate this nearly one hundred years ago by hitting a piece with a hammer and demonstrating to the entire hall a spark therefrom. What you need first is that the oscillator be running, and if it's a good oscillator, it will be as soon as you throw the switch. It has to run, it's a law of nature. So, as shown in Fig. 5, the oscillator voltage enters the base of Q1 on pin 2, a grounded emitter amplifier. This is internally connected (direct coupled) to the emitter of Q2, a grounded base amplifier, the two-transistor compound forming a cascode amplifier good to 450 MHz. Here it is used at 136 MHz. The output of Q2 goes to a tuned circuit L1-C1, tuned also to 136 MHz. In this circuit, L1 has two taps, one for the output going to C2, and then to the mixer in the other half of the IC. The full gain of the cascode Q1 and Q2 is used and needed. Crystals on 136 MHz are not to be taken lightly. They must be matched as to ac impedance fairly well into and out of the cascode. The input, base of Q1, is sort of a

natural, as the base impedance is quite low and the matching can be helped by adjustment of both the base bias and the emitter bias, which I have done for you.

The output match of Q2 into the crystal is done by tapping down on L1, and is also seen to be low in impedance. It is also possible to couple into the crystal by a two turn link, wound in the same direction as L1, and placed over or inside of L1. I generally tune up such an oscillator with a 5K pot as R2, and another as R4. These are not at all touchy but you can make the oscillator run better that way. To check out and tune up — not only for frequency but also for good starting, absence of squegging; noisy hysteresis jumps either in frequency or power and proper base biases — a tuned diode detector is very handy. A one or two turn link around the cold end of L1 with a cable into a diode trough-line cavity does the trick. You must know if it is really on 136 MHz. Figure 8 shows a helpful setup to do this. Set up the tuned diode detector and check for good, smooth, quiet power out, using both meter to measure and af to listen. Then bring in a wire, as shown, close to or around the diode tuner center conductor as shown in Fig. 8. Tuning the signal generator very slowly over the region 135 to 137 MHz, you should be able to hear the desired heterodyne resulting from the crystal oscillator beating with the signal generator on 136 MHz. If you do not, something of course is wrong. Do *not*, as I have said many times before, use a sensitive receiver for these tests.

Test operation should include good, clean tuning of C1 (Fig. 6) with the oscillator coming on and off with a nice "plunk" in the af speaker indicated in Fig. 8. The meter should also come up and drop off with the proper action. Marginal operation is to be avoided like poison. For example, the oscillator may be *just* working, and the next time it won't come on at all.

So there you are. If you build this IC front end as shown, it will work and in good style. I have done it here and it works fine. The operation is stable and secure — not marginal. You can put any rf stage in front, or use another CA3102E as the rf stage.

...K1CLL



SPIRE TOWERS

- * Self-Supporting With A Tri-Bander (A)
- * 32' - 40' - 48' - 56'
- * 3 Mounting Bases
- * Heavily Galvanized

(A) Limited to JR TriBander, unless guyed, on 56' towers.

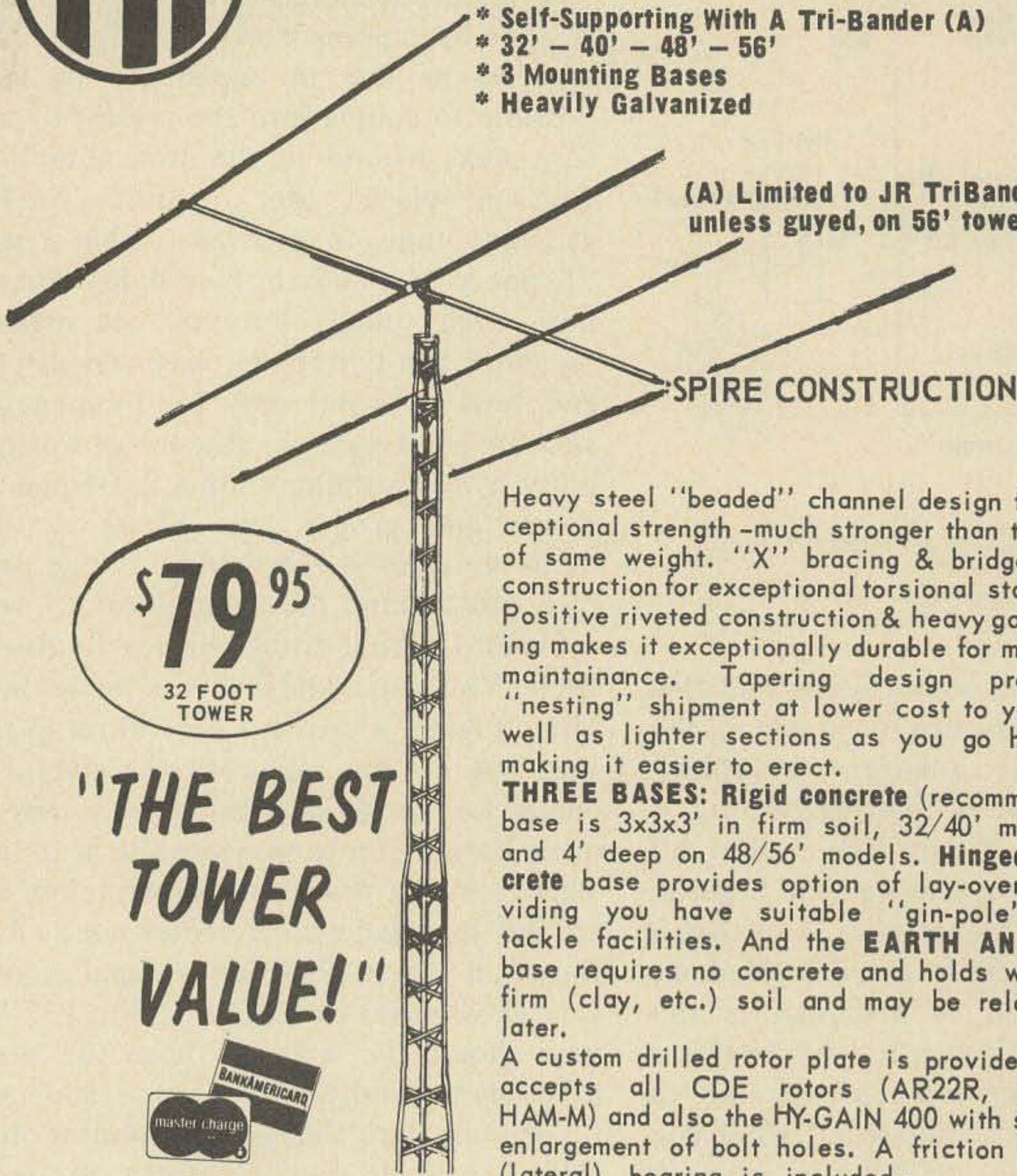

\$79⁹⁵
32 FOOT TOWER

"THE BEST TOWER VALUE!"



Heavy steel "beaded" channel design for exceptional strength - much stronger than tubular of same weight. "X" bracing & bridge type construction for exceptional torsional stability. Positive riveted construction & heavy galvanizing makes it exceptionally durable for minimum maintenance. Tapering design provides "nesting" shipment at lower cost to you, as well as lighter sections as you go higher, making it easier to erect.

THREE BASES: Rigid concrete (recommended base is 3x3x3' in firm soil, 32/40' models, and 4' deep on 48/56' models. Hinged concrete base provides option of lay-over, providing you have suitable "gin-pole" and tackle facilities. And the **EARTH ANCHOR** base requires no concrete and holds well in firm (clay, etc.) soil and may be relocated later.

A custom drilled rotor plate is provided that accepts all CDE rotors (AR22R, TR44, HAM-M) and also the HY-GAIN 400 with slight enlargement of bolt holes. A friction thrust (lateral) bearing is included.

"HI-SPIRE" towers shipped truck collect from Indiana.

TOWERS WITH RIGID CONCRETE BASE

69C091	32'	133 lbs.	\$ 79.95
69C092	40'	175 lbs.	104.95
69C093	48'	243 lbs.	144.95
69C137	56'	308 lbs.	189.95

TOWERS WITH HINGED CONCRETE BASE

69C055	32'	147 lbs.	\$ 89.95
69C056	40'	189 lbs.	114.95
69C057	48'	248 lbs.	154.95
69C138	56'	313 lbs.	199.95

TOWERS WITH EARTH ANCHOR BASE

69C094	32'	191 lbs.	\$119.95
69C095	40'	233 lbs.	144.95
69C096	48'	390 lbs.	239.95
69C139	56'	455 lbs.	284.95

69C100, "T" wrench to drive anchors (8 lbs.) 9.95

Includes anchor base and anchors (anchor bases require no concrete). Earth anchors screw into the ground and hold well in firm soil. May be removed and relocated later.

The Best Ham Tower For 15 Years

When you need "ham" gear & accessories call H. I. !

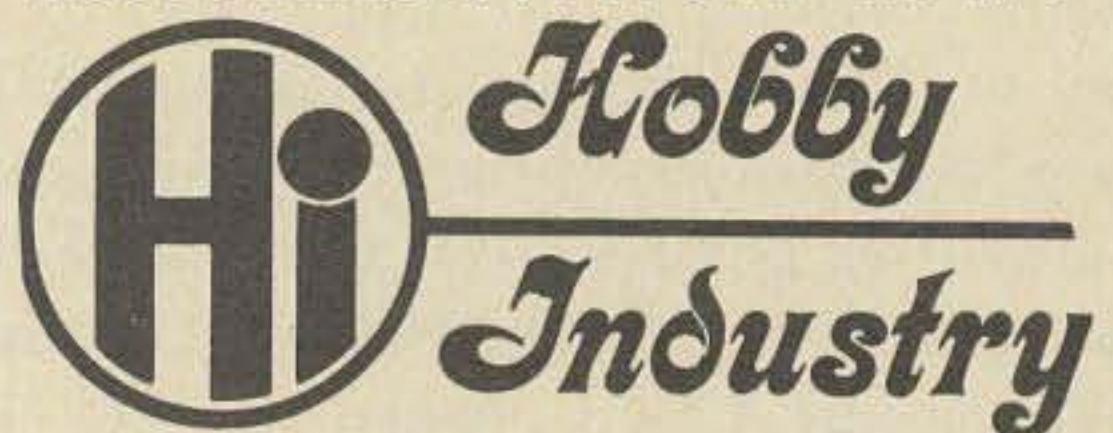

CALL: Tues. / Sat. - Noon / 5PM
Al McMillan WØJJK
(712) 323-0142

WRITE: HOBBY INDUSTRY
Box 864
Council Bluffs, Iowa - 51501

INSTANT REPLAY FOR YOUR TAPE RECORDER

At times a tape recorder can be a useful accessory to any amateur station. One obvious use is relaying information directly to another phone station on the net. Instead of laboriously repeating or paraphrasing the message, why not record it on tape and retransmit it to the other station?

The simple control box described in this article makes this procedure a cinch. It has the following operating features:

1. Off-the-air recording may be monitored on the receiver speaker or earphones at any audio level without affecting the recording level.
2. Recorder output may be monitored either for cuing in or transmitting purposes

without tying up either the transmit or receive function.

3. Recorder output is reduced to the same level as average microphone output during transmit so that it is unnecessary to readjust microphone gain when switching from microphone to recorder.

4. No modification of the tape recorder or other equipment is required other than adding a short audio cable to the audio gain control of the receiver or transceiver.

A block diagram of the setup is shown in

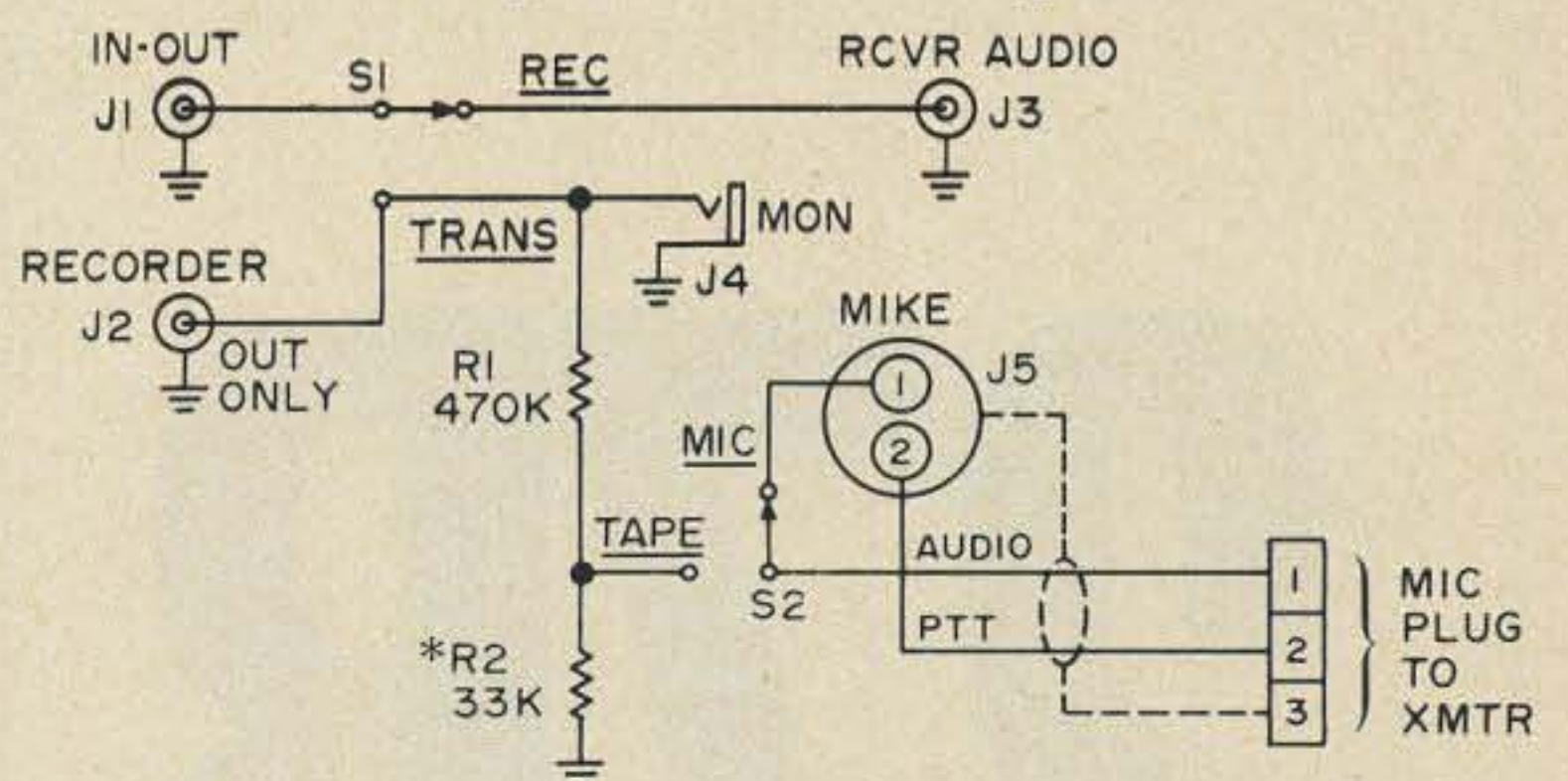
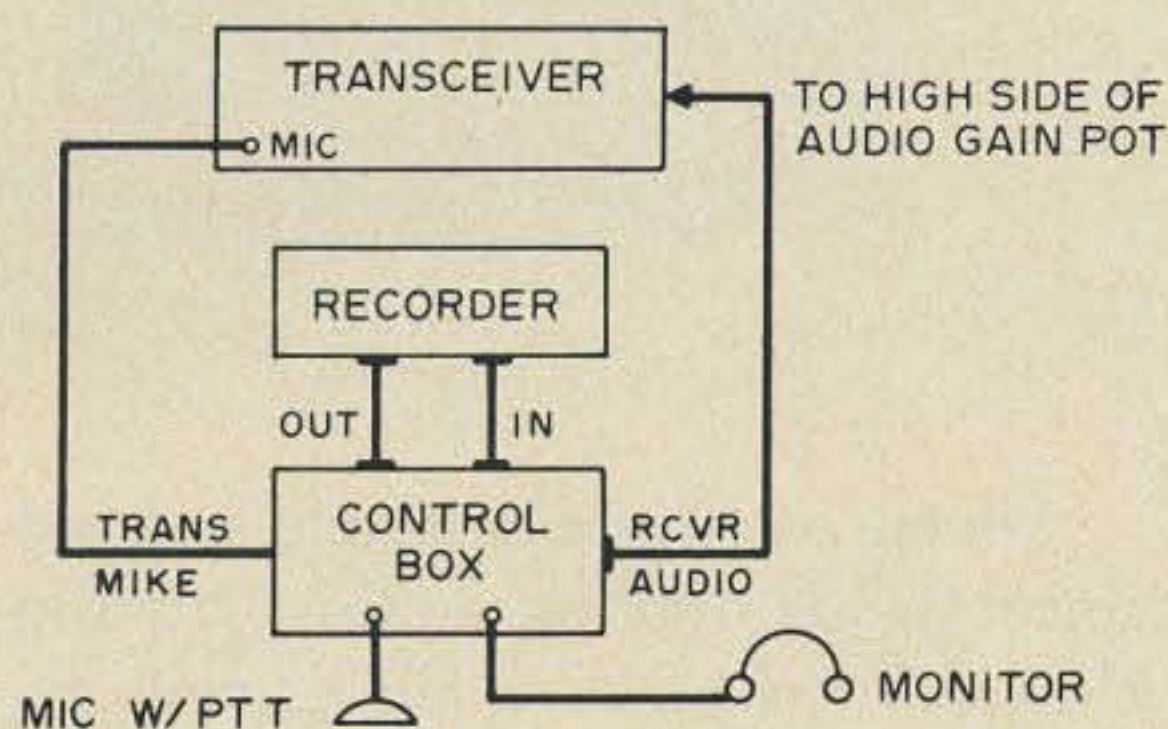

Fig. 2. Control box schematic. Value of R2 should be adjusted so that recorder output is approximately the same as microphone output.

Fig. 1 and the schematic diagram of the control box in Fig. 2. S1 switches the recorder from receiver to transmitter, and S2 switches the transmitter microphone input from microphone to recorder, as required. Resistors R1 and R2 form a voltage divider that drops the recorder output to approximate microphone level. High impedance earphones are directly connected to the high side of the voltage divider for cuing in and monitoring purposes.

Generally speaking, there are two types of tape recorder interconnections available.

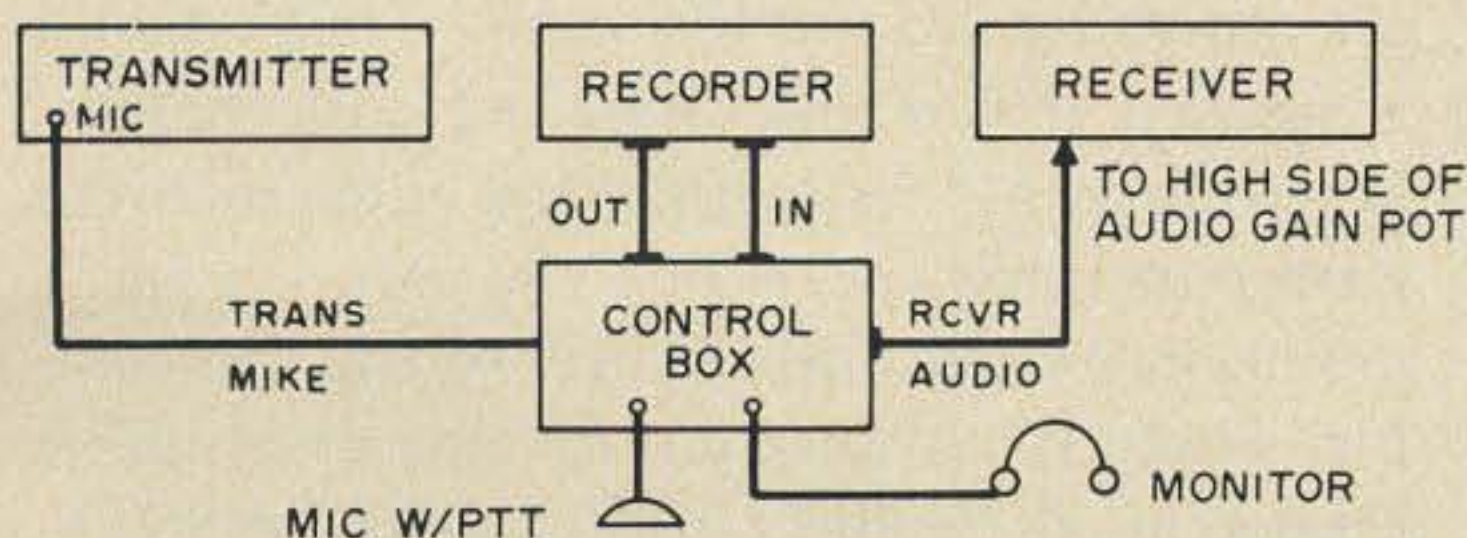

Fig. 1. Tape recorder control box interconnections — all cables are shielded.

Most tape decks have separate inputs and outputs, but many of the older tape decks have only one connection which serves as both input and output, depending upon whether the recorder is in the "record" or "play" mode.

If your recorder has an "in-out" terminus, switch S1 must be operated along with the recorder when changing from "record" to "play". If your recorder has separate inputs and outputs switch S1 should be left in the REC position at all times. The recorder will then always be properly connected when switching to "record" or "play" at the recorder.

Monitoring while recording may be done conveniently by listening to the receiver speaker or earphones. On playback, the recorder is monitored with earphones connected directly to the recorder output.

My unit was housed in an old meter case. This presents a pleasing appearance and also permits mounting the controls at a convenient angle. The meter hole is covered by a small aluminum panel upon which the control switches are mounted. The microphone and monitoring jacks are mounted in the

meter case binding post holes after reaming them out to size. All other remaining cables and connectors are brought out on the rear of the meter case as shown in the photograph.

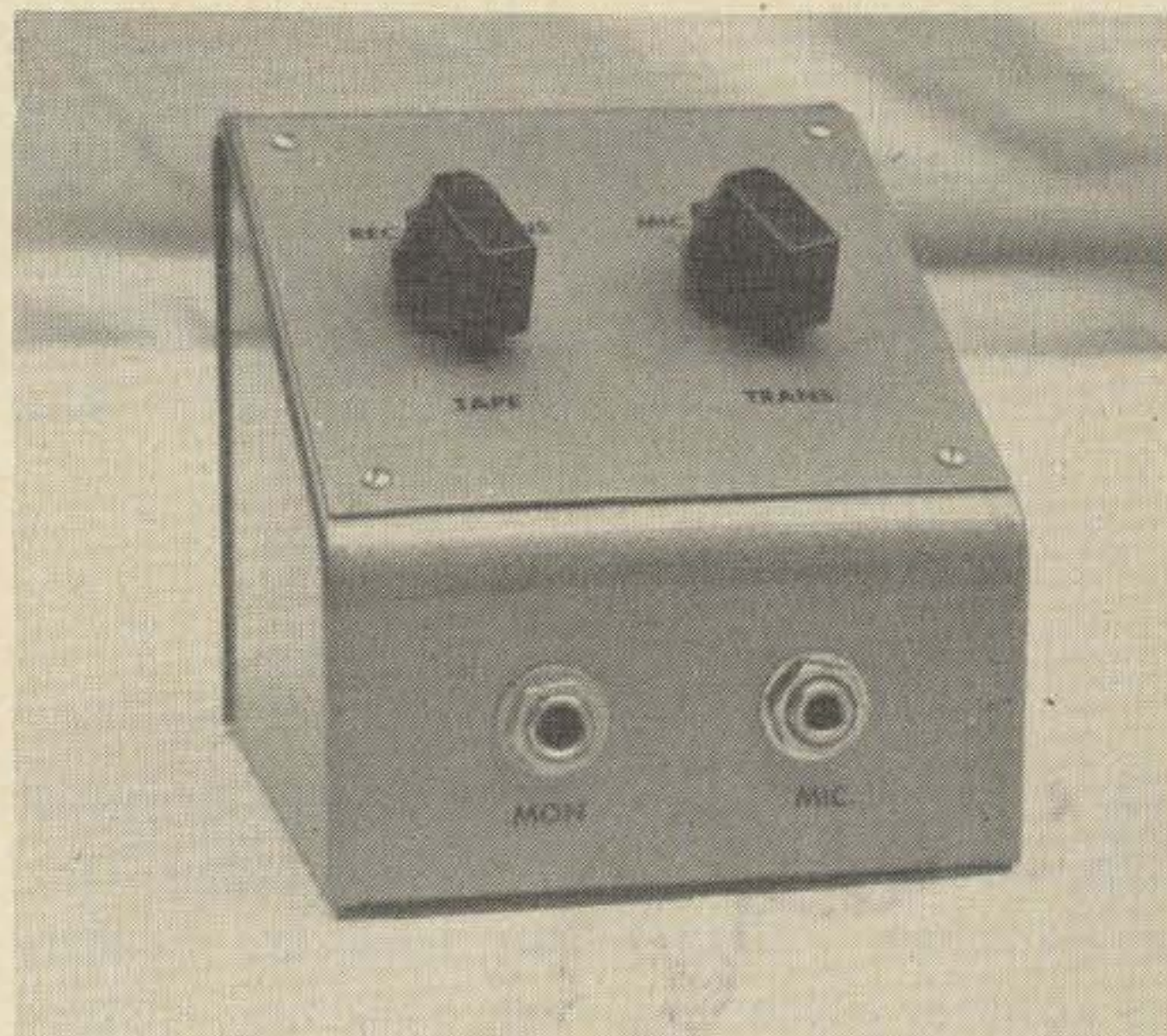

Front and rear views of control box. Photo was taken before the "trans mike" cable and plug was installed through grommet.

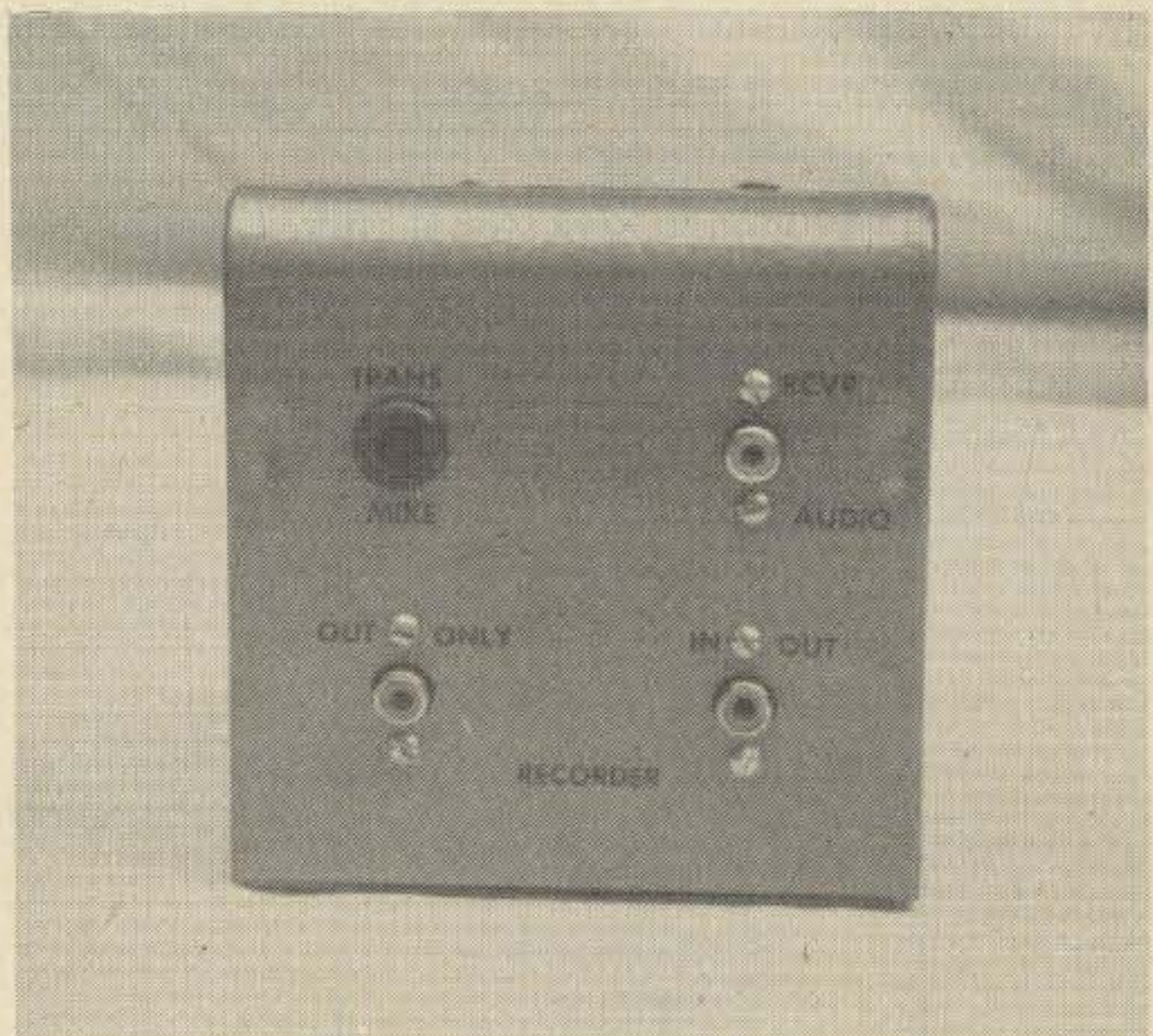

Wiring of course is simple and not critical, since this is only an audio switching device. However, make sure all connectors are properly grounded to avoid hum problems.

A gadget such as this ordinarily does not get much use around the station, but when it is needed it is a real operating convenience. It surely beats haywiring the tape recorder with clip leads and riding the gain, trying to maintain proper output level to the transmitter. There is no reason why this or a similar arrangement couldn't also be used for SSTV, CW, or RTTY.

...W6FPO

27B

2-Meters... Need we say more?

ISC *Clegg* **DIVISION**

3050 Hempland Road
Lancaster, Pennsylvania 17601

2 KW PEP BUILDING BLOCK LINEAR

*A simplified construction approach to homebrew
a high power single or multiband linear.*

Many amateurs have undoubtedly shied away from the construction of a high power linear because they felt the cost or the mechanical work involved in building such a linear would not be justified. After I had built my first few linears, I would have tended to agree with this viewpoint. However, after having built many more linears over the years — and of widely different types — I find that with a small amount of advance planning the construction of almost any power level linear for the HF bands can be attempted by the home brewer using relatively simple hand tools. I should say not only “attempted” by the home brewer, but attempted with a very high probability of success.

The amplifier described in this article is a particular case in point. It illustrates a particularly simple construction technique and illustrates more than just the construction of a specific linear. By selection of the number and types of tubes used, an amplifier of anywhere from the 200 to 2000W PEP level can be constructed. The cost is very low on a watts to dollar ratio and can easily approach 20W of input power per dollar of material cost.

Planning the Linear

If one looks at the overall diagram of any linear, it presents a rather complex picture; that is, perhaps not so much in terms of electrical functions of the various parts but in terms of mechanical construction when one starts to consider in *detail* how the amplifier will be built and how to arrange all the components on a chassis, do the

mechanical work to mount the various components, etc. It is usually at this point that the home brewer starts to falter and forget about the entire project as being too complex and, particularly, too risky. The risk factor comes into play since if one assembles all the necessary parts — tubes, cabinet, chassis, transformer, etc., and then the amplifier project doesn't work out, one will be left with a fair amount of money expended for no real return.

The risk in construction can be almost completely eliminated if one looks at the construction of the amplifier from a different point of view rather than as a complete whole. As shown in Fig. 1, the amplifier can really be considered to be made up of three main “sub-blocks” — a power supply, a pi-network output circuit and a sub-block containing the actual tube circuitry with the antenna switching. The power supply sub-

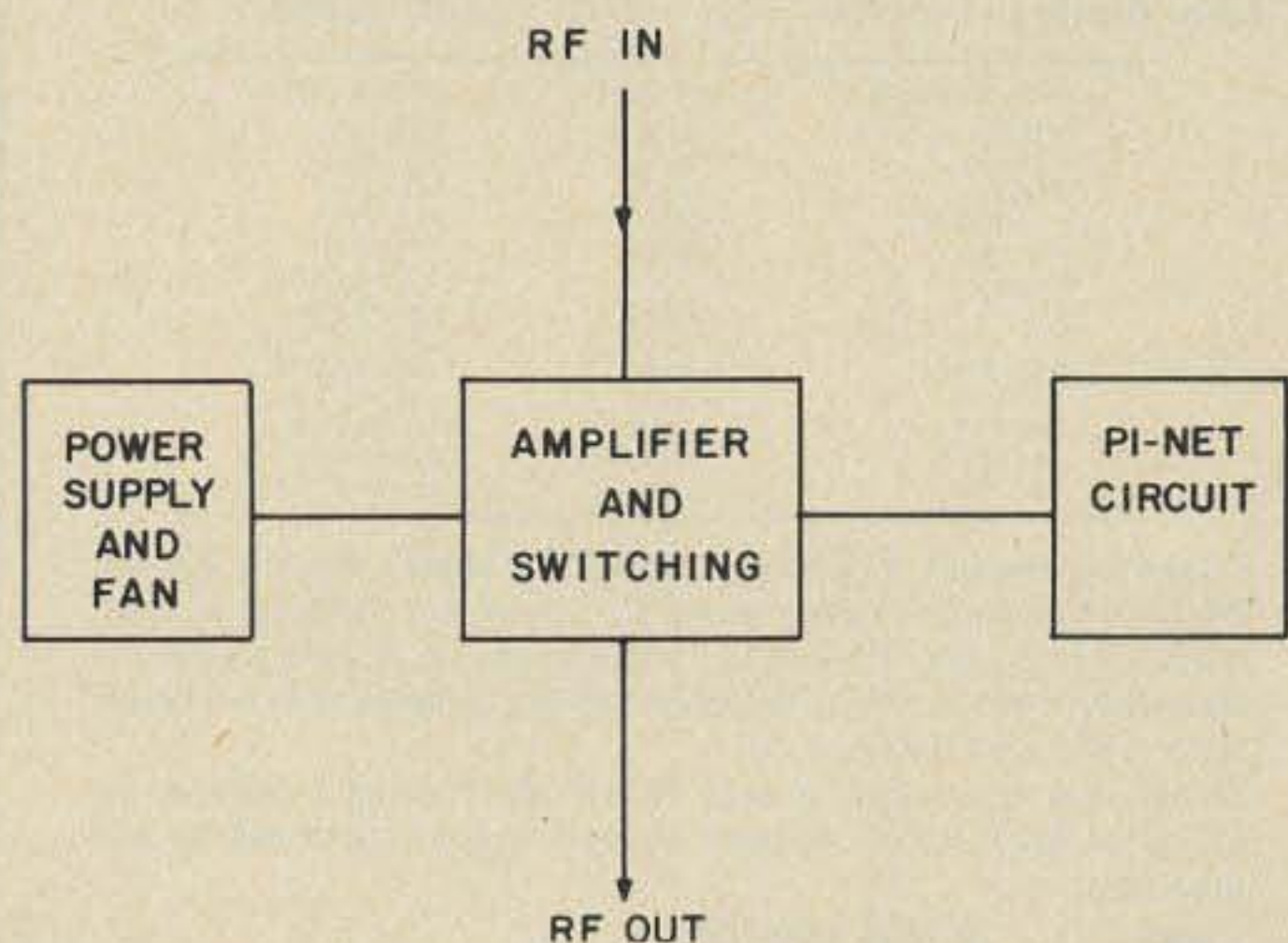
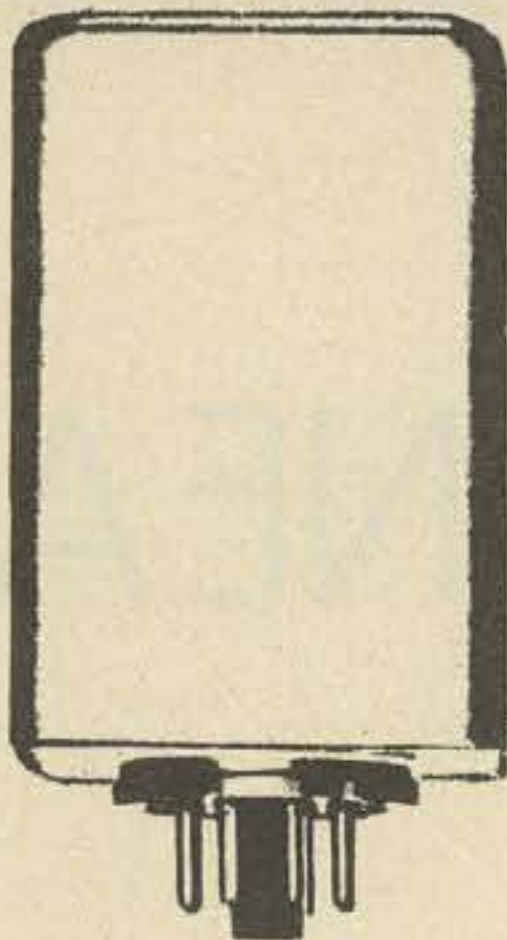

Fig. 1. Most grounded-grid linears can be visualized as consisting of three main constructional blocks.

TOUCH-TONE DECODER



- Dual tone decoder decodes one Touch-Tone digit.
- Available for 1, 2, 3, 4, 5, 6, 7, 8, 9, 0, #, * and other dual tones 700-3000 Hz.
- Latch and reset capability built-in.

- COR control built-in.
- Relay output SPST ½-amp.
- Octal plug-in case.
- Compact 1-¾" square, 3" high.
- Free descriptive brochure on request.

T-2 Touch-Tone Decoder ... \$39.95 PPD.
Specify digit or tone frequencies.
(Include sales tax in Calif.)

PALOMAR ENGINEERS

BOX 455, ESCONDIDO, CA 92025

super sensitive PREAMPS

START
HEARING the
WEAK ONES ...

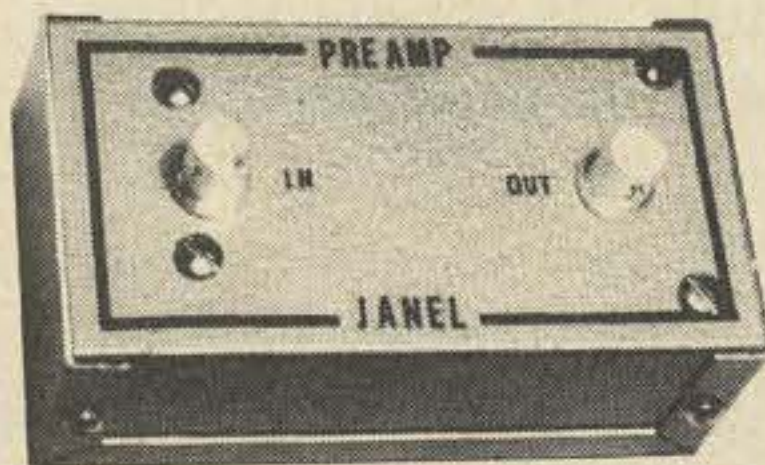

JANEL makes a preamp for improving the performance of almost any receiver. All are resistant to overload and fully diode protected. Top quality construction.

APPLICATION	MODEL	FREQUENCY
OSCAR VI	30PB	29.5 MHz
6 Meters	50PB	50.5 MHz
2 Meters	144PB	144 MHz
2 Meter FM	147PB	147 MHz
220 MHz	220PB	220 MHz
Aircraft	120PB	108-140 MHz
FM	100PB	88-108 MHz
TV	TV-PB	Ch2-13 (Specify)
High Band	160PB	146-174 MHz
432 MHz	432PA	432-438 MHz
440 ATV	432PA-T	435-445 MHz
450 FM	432PA-F	440-450 MHz
UHF FM	432PA-U	450-470 MHz

PB models are only \$19.95 and the 432 PA models are only \$29.95. All are in aluminum cases, have BNC connectors (others available), require 12 vdc, and are postpaid and guaranteed. Specify model and frequency when ordering. Other models are available with AC power supply. Write for details.

JANEL can also supply a wide variety of receiving equipment for industrial applications. A quote to your specifications will be sent promptly.



JANEL laboratories

BOX 112, SUCCASUNNA, NJ 07876

Telephone: 201-584-6521

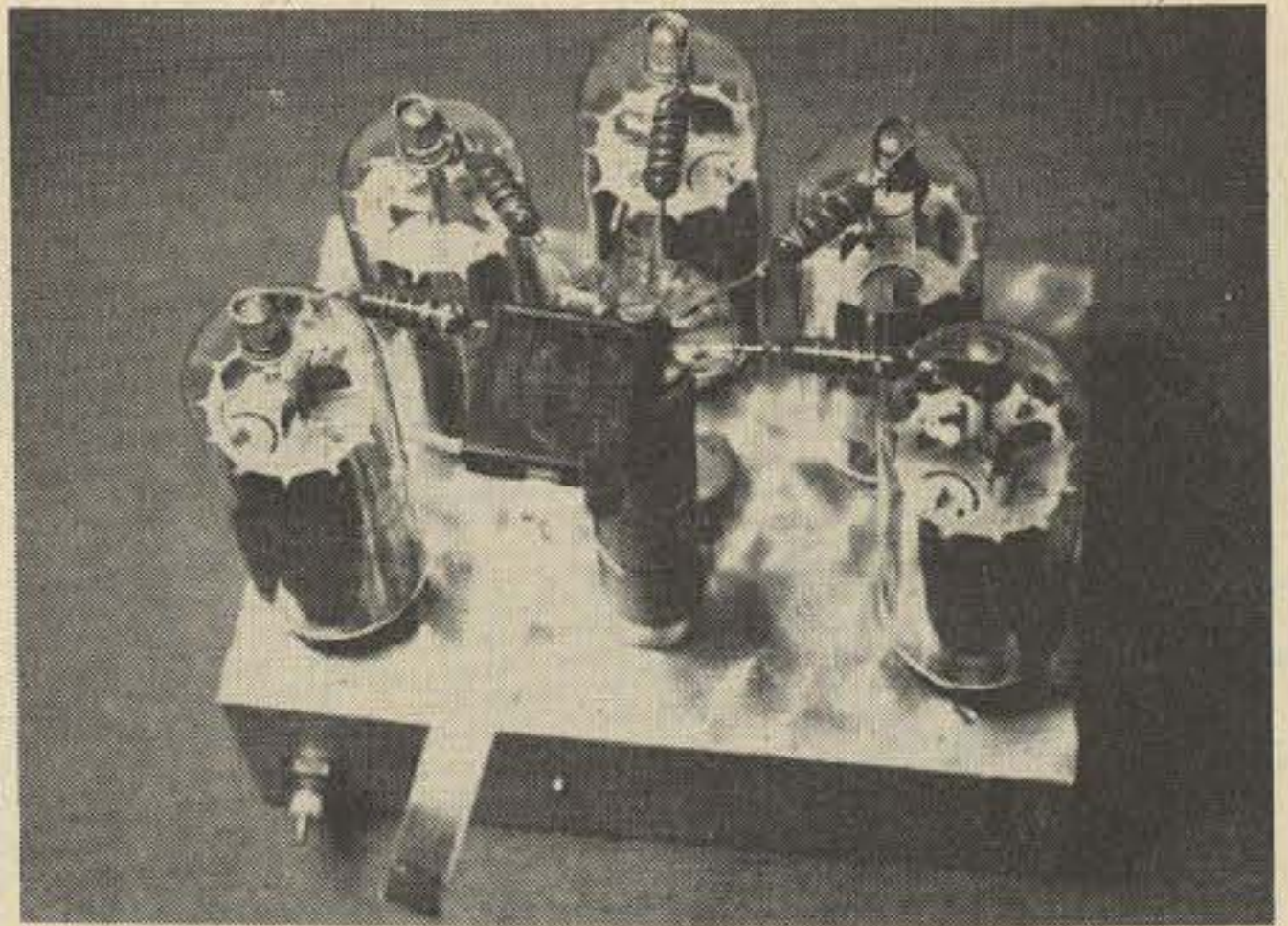

Top view of amplifier sub-chassis shows how tubes are circularly arranged around plate choke.

block should really present no problem. Any number of power supply circuits are available which have been thoroughly proven in operation and one can even purchase relatively inexpensive high power capacity power supplies on the surplus market or used equipment market. Any amateur should be capable of building a simple bridge type rectifier power supply. The pi-network output circuit sub-block should present even less of a problem. Pi-network circuits for single band or multiple band use using conventional components or using toroid coils have been thoroughly described in many handbooks and articles. With a bit of patience, anyone can find the correct tuning conditions and component values to use with a pi-network circuit on any given band.

However, it is the tube circuitry or actual amplifier sub-block that is at the crux of the whole linear construction project both in an electrical and in a mechanical sense. If this sub-block can be electrically complete so that the *only* other electrical wiring that is necessary is the power supply and the pi-network circuitry *and* if this amplifier sub-block can be easy to construct, almost 70 to 90% of the work in building a linear is done! Of course it will still take patience to complete the linear and to tune it, but one can then have confidence that the linear will work. To take a very conservative approach, one need invest initially only in the components necessary to build the amplifier sub-block without risking a total investment in all the linear components that might not be used should one decide to give up the project.

of the overall linear enclosure. This meter plus an ammeter (0-1 or 0-1.5A) connected in series with the plate supply (the ground lead, if possible, for safety) will suffice for metering of the amplifier. A cooling fan is necessary if the amplifier is to be used at its maximum input rating. This can be simply connected across the primary of the power transformer so it is activated at the same time as the power supply is turned on. A 115V fan which is popular is a Barber Coleman D YAF 761-110 with their AYFA-403 fan blades. The larger electronic mail order houses can supply this item. Other suitable surplus type fans can also be used, but there must be a good flow of air (about 100 cfm). The 6KD6 tubes run hot and I have seen several removed from TV sets where under normal operating conditions the glass envelopes have started to distort due to heat problems.

The external connections for the amplifier sub-block consists of the usual rf input and output connectors, a relay connection for switching the linear to transmit via the exciter, and an alc connector for use with the exciter. The latter is an optional feature which can be used if the alc voltages needed by the exciter from the driven linear are known.

The actual circuitry of the amplifier sub-block is extremely straightforward. The 6KD6 tubes operate class AB in a grounded grid configuration. The tubes are not individually current balanced and this is not necessary as long as the tubes used are of the same manufacture. The input circuit to the cathodes of the tubes contains a low-pass filter (L1 and the 100 pF capacitor). This filter helps to prevent further amplification of harmonics from the exciter used and improves the overall distortion rating of the linear. L2 is an rf choke which will pass the cathode current of the tubes while still keeping the cathodes above rf ground. The choke is quite easy to construct and consists simply of close wound turns of #24 wire on a 1.25 cm by 7 cm long ceramic or high temperature plastic form. L3 is the plate rf choke. One has the choice of using one of two simple approaches to construct a suitable rf plate choke. The choke I used is wound on a 9.5 x 2 cm ceramic form with

#24 wire. It consists of five sections, each section separated by about 1 cm. The top section consists of 11 turns and the following sections are 16, 27, 33 and 43 turns. A somewhat simpler rf choke can be made if desired, but then two chokes have to be used in series. The first choke is wound full with #24 wire except for 0.5 cm at the top and bottom. The second choke is an Ohmite Z-50. The .001 μ F plate bypass capacitor is used after the Z-50 choke, not between the two chokes.

Construction

The amplifier sub-block is fully contained on a standard 5 x 7 x 2 in. aluminum chassis. The tube sockets are arranged in a semi-circular fashion with the rf plate choke in the center. The circle is arranged so the center of the end tube sockets are about 2.5 cm away from the side of the chassis on either side. This will permit the tubes to be separated enough to allow good air passage while not allowing the rf leads to become too long. The rf plate choke is about 2.5 cm away from the edge of the chassis also. The tube sockets are oriented so that the number two pin (cathode) on the socket always faces the center of the semi-circle. At the rear of the chassis, the connectors used are a SO-239 for the rf input, phono jacks for the relay control and alc output (if used), and another SO-239 for the rf output. The alc adjustment potentiometer is also located on the rear panel of the chassis. The use of

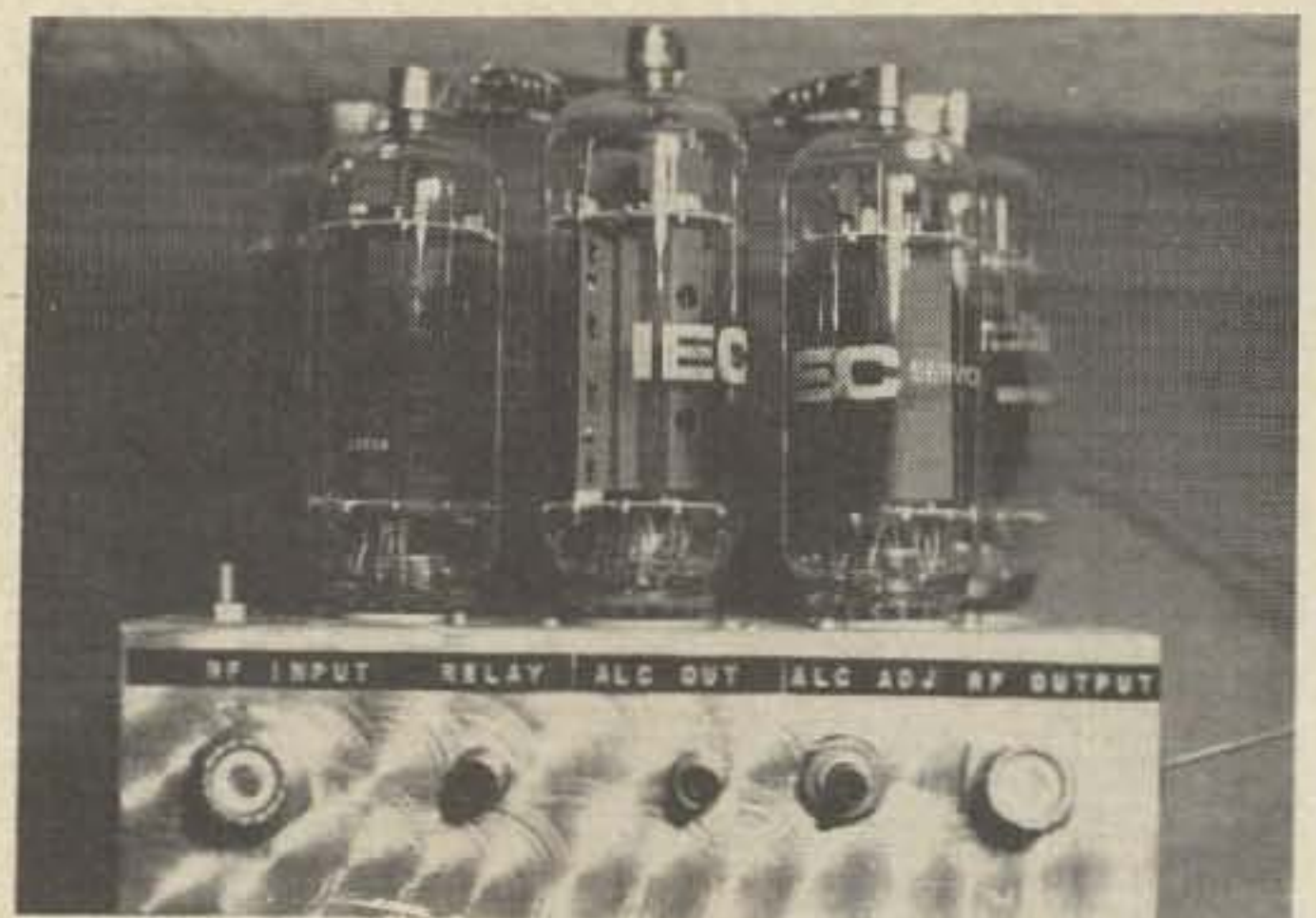

Rear view of amplifier shows arrangement of connectors. Single hole mounting SO-239's are used to facilitate bolting of amplifier sub-chassis into an overall enclosure.

single hole mounting SO-239 connectors and phono connectors greatly simplifies the mechanical work involved.

At the underside of the chassis the antenna transfer relay is mounted on one side wall above a tube socket and close to the front panel. There is no need to mount the relay in any exact position but it should be mounted nearly as pictured so the length of the wire between the rf output connector to the pi-network is as short as possible. This is to minimize coupling between the output line and the rest of the amplifier circuitry. A short piece of coax is used to go from the relay to the input connector. The zener diode for bias regulation may be mounted in any convenient location near the relay. The cathode of the diode is directly bolted to the chassis, as the chassis functions as a heat sink for the diode.

The wiring of the cathode circuitry of the tubes deserves mention. This wiring should be kept as short as possible and an insulated terminal post is mounted for this purpose in the center of the ring of tube sockets. The post can be held in place by the same screw which supports the rf plate choke on the top of the chassis. The cathode choke, L2, is mounted on the side wall of the chassis opposite the relay. The low pass filter coil, L1, is wired between the relay contact and the cathode terminal post in the center. Also the 100 pF capacitor associated with the filter is wired in beneath L1 and utilizes the bottom of the center terminal post for ground. You can also use the ground post of the small terminal strip located in the middle of the inside front panel. This latter terminal strip supports the few components for the relative rf output level circuitry. The 100K resistor in this circuit can be seen going between the relay and the terminal strip. Each cathode pin of the tube sockets is connected with an equal length lead to the center terminal post. 0.5 cm wide copper material is preferred, but large size wire such as #12 or larger can also be used.

simplify the wiring of the chassis is to wire the tube sockets as fully as possible before mounting them, then complete the wiring of the sockets on the chassis, mount the rest of the components on the chassis and then complete the final wiring. The whole process

may sound a bit involved, but actually once the chassis has been drilled and the components assembled the whole wiring can be completed in an afternoon.

All the pins on the tube sockets are wired to ground via the ground lugs on the sockets before mounting the sockets on the chassis except pins 2 (cathodes), 12 (filaments), 5 and 9 (grids) and 7 (internal tube connections). The two .01 bypass capacitors associated with each socket are wired in at the same time. Once mounted on the chassis, the filament pins (12) and grid (9) are wired together from socket to socket. The wiring to the power supply leaves the chassis via a grommet on the side wall opposite the relay.

The mechanical working of the chassis can be done completely with hand tools if desired. The only large holes which require work are the ones for the tube sockets and the SO-239 connectors. These can be made with a punch or with a nibbling tool and round file. There is little sense in investing in a punch if one is not likely to use it again, but a nibbling tool can be used for a variety of chassis work.

Pi-Network Circuits

A number of pi-network circuits have been tried which will work properly with the amplifier. If the linear is to be used on only one or two bands, the pi-network circuitry becomes quite simple and one need only experiment with the component values that produce the highest power output. Extract the single band component values from the

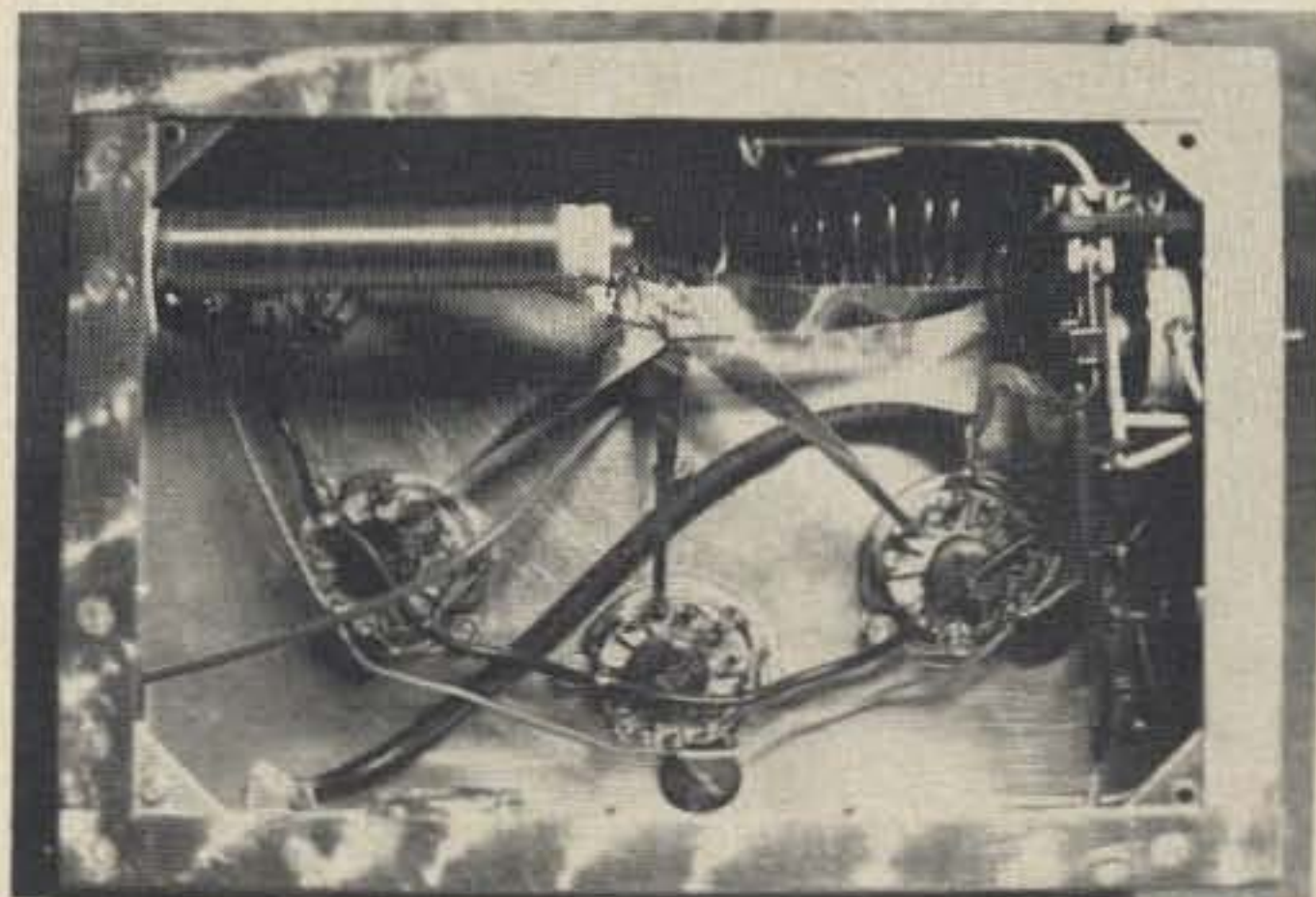

Bottom view of amplifier sub-chassis showing wiring of cathode leads to a central terminal point. Note also placement of 3pdt relay on side of chassis.

it wasn't easy...but Kenwood improved the R-599 & T-599

THOUSANDS HAVE PROVEN THEMSELVES THROUGH DAILY USE. EVERYTHING THAT MADE THEM THE BEST REMAINS, BUT NOW KENWOOD DID THE IMPOSSIBLE BY MAKING THE "TWINS" EVEN BETTER. THE R-599A IS THE MOST COMPLETE RECEIVER EVER OFFERED... MANY FEATURES WHICH ARE "OPTIONAL AT EXTRA COST" IN OTHER RECEIVERS ARE STANDARD

the R-599A

Solid state . . . low power consumption, superbly reliable, small and lightweight • Full amateur band coverage . . . 10 through 160 • CW, LSB, USB, AM, AM.N, FM reception • Selectable AGC . . . slow or fast • Built-in calibrator • Monitor T-599A frequency to calibrate transmitter • Squelch circuit • 1 KHz frequency readout. . . smooth VFO action • Versatile cross channel operation with T-599A • Automatic or manual selectivity selection • Built-in SSB/8 pole, CW/8 pole and AM filters • RIT circuit with RIT tuning separate from RIT switch • Five built-in fixed frequency channel positions • Provisions for installation of 2 and 6 meter converters • Stable, accurate VFO • Built-in power supply for 115/230 VAC operation or 12 VDC operation • Built-in WWV reception • Built-in S-meter • Excellent sensitivity —.5 uv • Easily adaptable to use with Kenwood TS-900 • Modern, beautiful design

New Features:

New easy read dial, same 1 KHz readout . . . same smooth VFO action • Excellent built-in noise blanker • Improved 2 and 6 meter operation with optional accessory converters, easier installation • Continuous RF gain control replaces stepped attenuator • Built-in 11 meter coverage • AGC



The R-599A by Kenwood

turns off if desired • VFO indicator light for cross channel operation •

The R-599A . . . \$439.00 • Converters . . . \$31.00 • S-599 Speaker . . . \$18.00

the T-599A

Mostly solid state . . . only 3 tubes • Built-in power supply • Full metering: ALC, Ip, RF output, high voltage • CW, LSB, USB, AM operation • 1 KHz frequency readout, smooth easy VFO action • Built-in VOX, with delay, sensitivity and anti-VOX adjustments • Built-in semi-automatic CW with sidetone • Built-in calibrator function when used with the R-599A • Full amateur band coverage . . . 10 through 80 • Versatile cross channel operation with the R-599A • Stable, accurate VFO • Modern, beautiful design • ALC feedback • Maximum TVI protection • 200 watts PEP input nominal • Tube saving TUNE position • Built-in cooling fan • Selectable low or high microphone impedance

New Features:

Front panel MIC Gain control • Front panel CAR LEVEL control • Improved, easy read dial, same smooth VFO action • VFO indicator light for cross channel operation • New high reliability final amplifier layout • Improved keying characteristics • New chain drive •

The T-599A . . . \$459.00

Prices subject to change without notice.

Why buy from Henry Radio?

Over 40 years experience. No finance charges if paid with-in 90 days. Low interest contracts - 8%/yr add on (14% annual rate) - as long as 24 months. 10% down or trade-in down payments. Good used equipment. Most makes and models. Used equipment carries a 15 day trial, 90 day warranty and may be traded back within 90 days for full credit towards the purchase of NEW equipment. Write for bulletin. Export inquiries invited.

Henry Radio

11240 W. Olympic Blvd., Los Angeles, Calif. 90064
213/477-6701
931 N. Euclid, Anaheim, Calif. 92801 714/772-9200
Butler, Missouri 64730 816/679-3127

Available at Kenwood Dealers throughout the US

multiband circuits shown in Fig. 3. Under properly loaded conditions and with 800–900V on the plates, the CW plate current will run 200–220 mA per tube used. For the full five tube circuit, the plate current for CW can be loaded up to between 1. and 1.1A. The key-down periods must be kept to 10 seconds or less.

If an 80 to 10 meter multiband pi-network output circuit is desired, Fig. 3 presents two good possibilities. The first circuit has an advantage in that it requires only a conventional 2 pole, 5 position switch for all of the capacitor and coil switching functions. The second circuit avoids the use of auxiliary fixed capacitors for the lower frequency bands but the plate tuning capacitor shaft requires an insulated shaft coupling and mounting above ground. In any case, the final coil tap positions should be experimentally peaked up for maximum power output on each band. The plate tuning capacitor in either circuit should have 1000–1500V spacing while the output loading capacitor need only be a broadcast band type. The fixed capacitors should be mica or ceramic types rated from 1 to 3 kV. Ceramic transmitting type capacitors such as the Centralab 850S are preferred if one can find them surplus at a reasonable price.

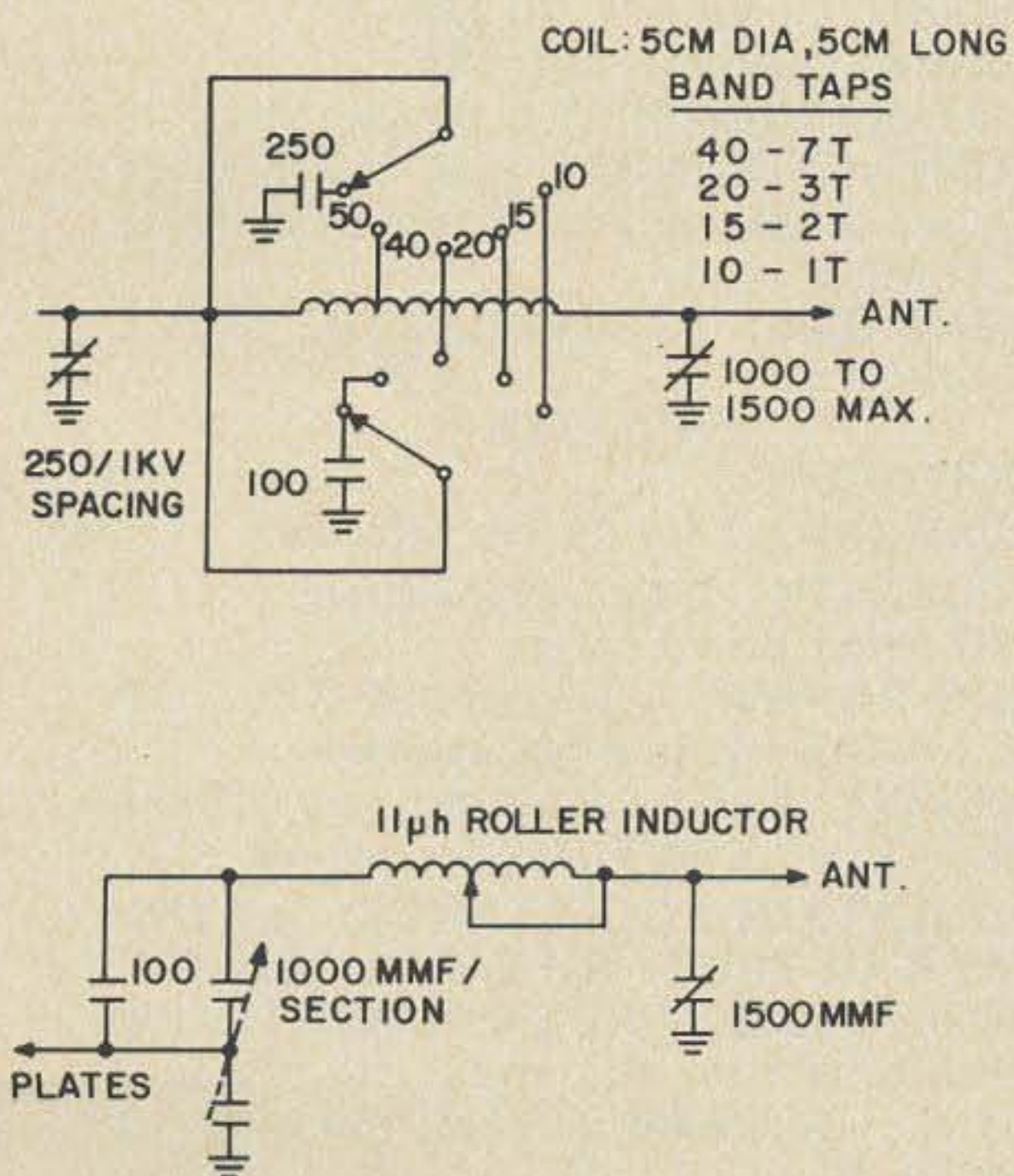

Fig. 3. Two good pi-network circuits which can be used with a 5 tube 6KD6 amplifier for all band operation.

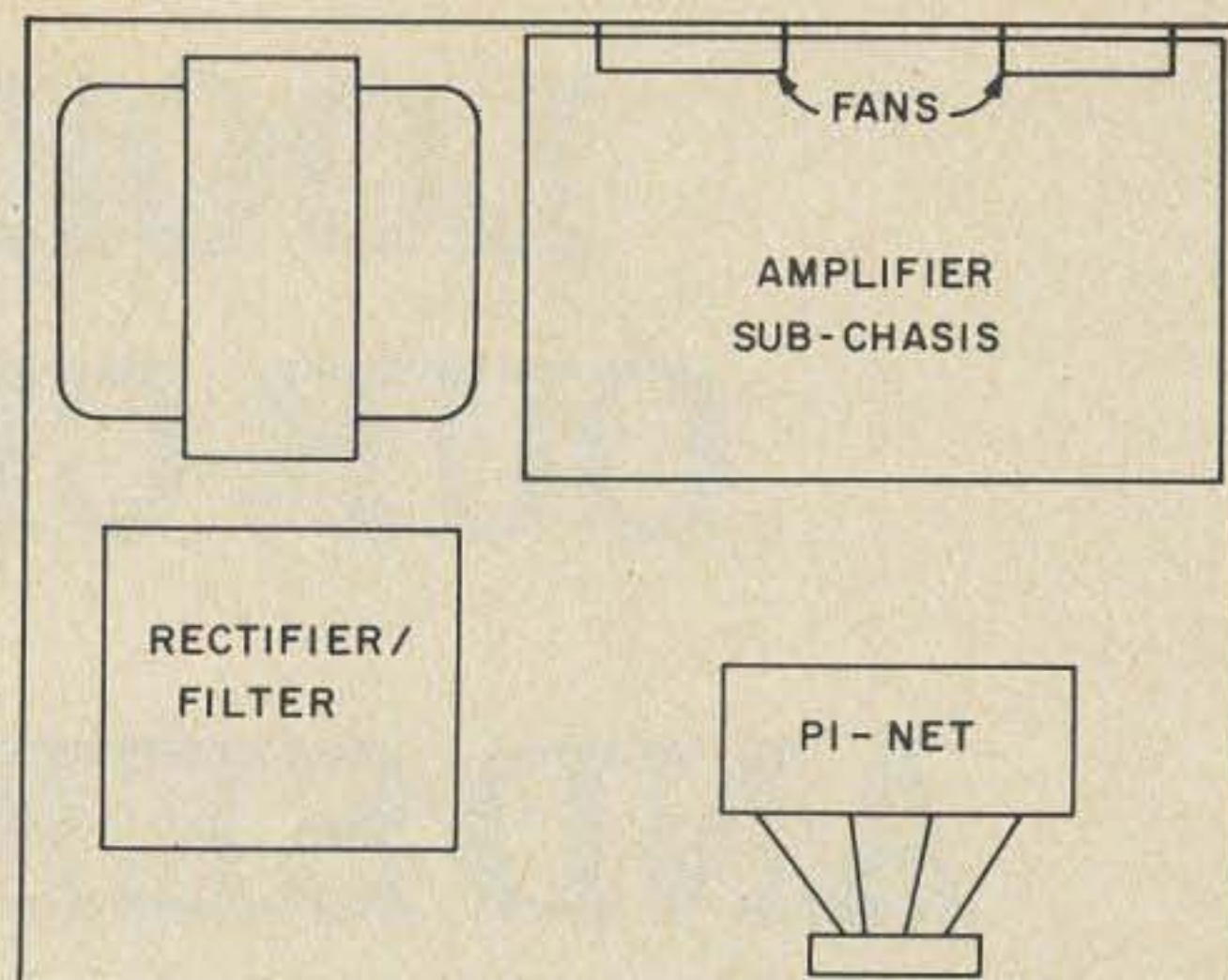

Fig. 4. There are many ways the amplifier sub-chassis can fit into an overall enclosure to fit almost any taste. Build the sub-chassis first and then integrate it into an overall enclosure.

Final Enclosure Assembly

Exactly how one wishes to finish up an amplifier in an enclosure depends to a good degree on how fancy an appearance is wanted, so this part of the project is pretty well left up to the desires of the individual builder. Certainly, if the power supply is ready, the amplifier chassis finished and the parts for the output circuit secured, the grouping of these items in an overall enclosure is not a big problem.

Although not one of the fanciest approaches, but certainly a simple and adequate one which I have used for a number of amplifiers, is the use of standard large size metal utility cabinets (Bud CU or AU series, Par-Metal MC series) as the overall linear enclosure. These enclosures are inexpensive (\$5 to \$6) and come in black wrinkle steel finish or bare aluminum. The black steel cabinets are attractive in that they need no further painting. These enclosures are typically square looking with removable top and bottom covers. The mounting of the amplifier sub-chassis in such an enclosure is particularly simple since the connectors on the back of the amplifier sub-chassis can be used to secure the sub-chassis to the enclosure. Figure 4 shows how the total linear might be assembled in such an enclosure. For ventilation purposes, a series of holes should be drilled in the two side walls of the enclosure which are in the path of the air flow produced by the cooling fan used.

...W2EEY

LOOK INTO OUR CRYSTAL AND SEE BEYOND 2 METERS



The new 220 MHz Clegg FM-21 transceiver has a unique triple-duty crystal feature and offers you a chance to get away from today's 2 meter crowd. The FM-21 uses just 1 crystal in any channel. One crystal gives you a separate transmit and receive frequency plus automatic 1.6 MHz programming in the repeat mode. Our Crystal Saver Frequency Control is just one of the big pluses you get with the FM-21, another all-American made quality rig from Clegg. For the whole story, see your Clegg Dealer or call or write us now for detailed data sheet and escape from the 2 meter crowd.

Amateur Net \$299.95

CHECK THESE SPECIFICATIONS

GENERAL

POWER REQUIREMENTS: 12 to 14.8 VDC

Standby Current: 120 Ma.

Receive Current: 450 Ma.

Transmit Current: 1.5 Amps. Max.

FREQUENCY RANGE: 220 to 225 MHz
Power output down less than 2 db at 220 MHz

DIMENSIONS: 7" wide x 2³/₄" high x 9" deep.

RECEIVER

SENSITIVITY:

25 μ V (Max.) for 12 db SINAD

SELECTIVITY: Adjacent channel (40 KHz) down 50 db

AUDIO POWER: 1.5 watts at 10% THD to internal or external speaker

SQUELCH: Noise actuated, adjustable threshold. .2 to 2 μ V min. range

MODULATION ACCEPTANCE: \pm 7 KHz

POWER OUTPUT: 8-10 watts (min.).

MODULATION: PRE-EMPHASIZED FM with deviation adjustable from 0 to 7 KHz. Adjustable speech clipping up to 10 db.

ISC

Clegg DIVISION

3050 Hempland Road Lancaster, Pa. 17601

Tel: (717) 299-3671

Telex: 84-8438

YET ANOTHER RF WATTMETER

Many VHF operators would like a cheap, accurate instrument to measure rf power. The same desire is frequently expressed by operators of the HF bands. Here is a very simple wattmeter which when used with a 50Ω transmission line or load has all of the following desirable characteristics:

1. Easily calibrated to good accuracy ($\pm 5\%$) with your multimeter and a variable dc source;
2. Perfectly flat from dc to 450 MHz;
3. Insertion VSWR less than 1.05
4. Power readings in the 2 to 50 watt range (higher power can be measured with slight design changes);
5. Cost of approximately \$20.00, assuming the use of a surplus microammeter.

The operating principle of this wattmeter is stark simplicity. A pilot lamp across the rf line senses a small portion of power in the line and glows brighter with increasing power. An appropriately located photovoltaic cell connected to a microammeter measures the light output which is proportional to the power flowing in the line. Of course a good deal of nonlinearity is involved in the various elements — both the lamp's resistance and its spectrum output change with heating; output of the photovoltaic cell varies considerably with both the amount and frequency of the light shining upon it. Some of these factors tend to cancel out however, because the photovoltaic cell produces some current with only infra-red lamp output at low power levels before the lamp even produces a visible glow, and the cell tends to saturate, increasing its output quite slowly at more intense illumination levels.

if the resistance of the lamp filament is very large when compared to the line impedance. In general, a factor of 15 or more times the line impedance is sufficiently large to produce negligible effects. In the case of the suggested 10V, .014 Ampere pilot lamp, the mismatch produced in the line gives a VSWR of 1.05:1 at the power level of 1 watt. This mismatch decreases rapidly with increasing power. It falls to well below 1.01:1 at 50 watts. Another point of interest with regard to this particular choice of lamp is that it is a long-life type with a life expectancy of 10,000 hours. This implies two advantages: (a) The lamp will operate at well over its rated voltage without burnout (50.0V at 50 watts), and (b) the interior of the lamp envelope will resist darkening which would negate the wattmeter calibration. In addition, the filament structure of this type of

Probably the biggest single requirement of any wattmeter is that it must be capable of being inserted into a transmission line without disturbing the operating conditions in the line (low insertion VSWR). It might be argued that hanging a lightbulb across a transmission line will seriously affect the line impedance. Ordinarily, this is true, but the undesirable changes can be minimized and indeed approach an insignificant level

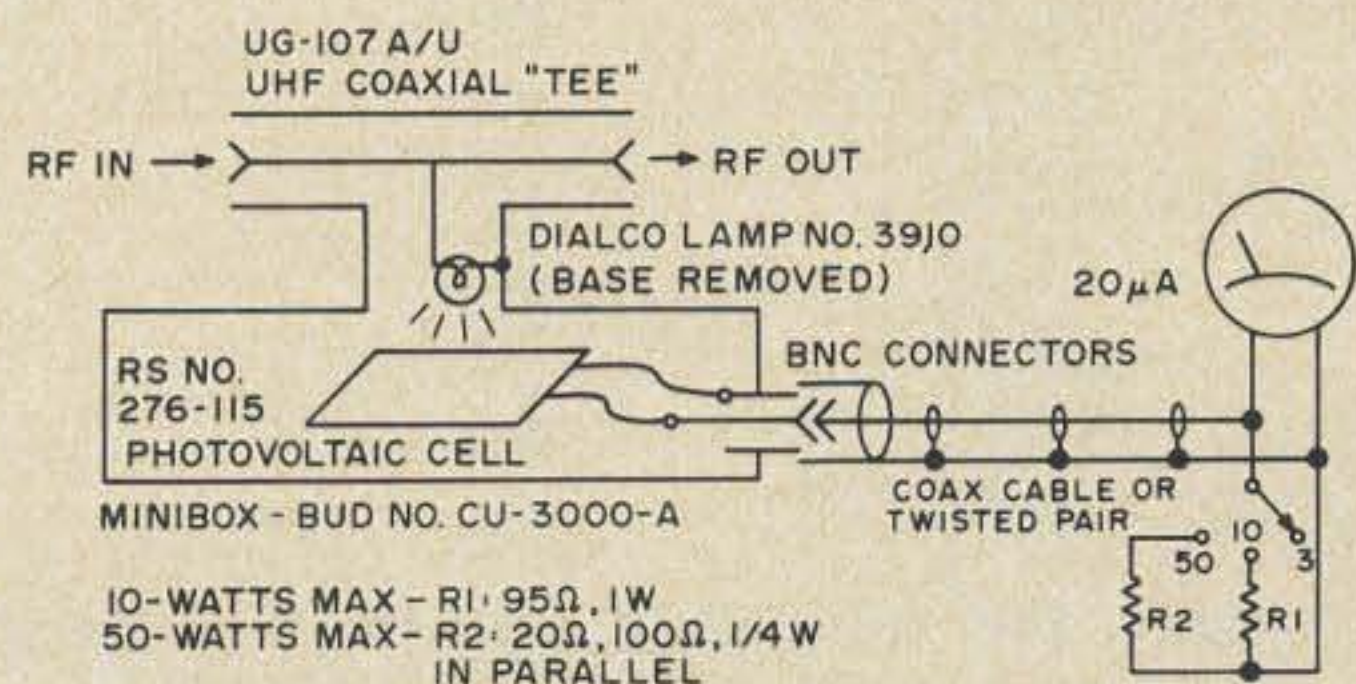

Fig. 1. Schematic diagram.

lamp is a single-strand straight tungsten wire. The coiled type of filament structure introduces undesirable inductance into the circuit which can distort wattmeter readings in the UHF range.

The wattmeter shown is constructed in two boxes for the sake of convenience. The sensor can be located in the transmission line at any point and the meter can be placed beside the transmitter. For test work, the whole unit could easily be put into a single box. Coaxial fittings and cable were used for interconnection, but since dc only flows in this circuit, any type of wiring would be satisfactory.

The photovoltaic cell used in this wattmeter is a unit obtained from the local Allied/Radio Shack store. (Catalog No. 276-115.) Output of the cell is rated .5V at .6 mA in sunlight.

Since the cell generates considerably more than 20 mA under moderate illumination, a switching arrangement is incorporated into the wattmeter to shunt it into progressively higher current ranges with increasing power. Alternatively, a 50 or 100 milliammeter could be used with less switching at a sacrifice of sensitivity in the 1-3 watt range.

Calibration of the wattmeter is a simple process. By solution of the formula $P = V^2/R$ for voltage, the following tabulation is made for a 50Ω line impedance:

VOLTAGE (rms or dc)	POWER (Watts into 50Ω)
7.07	1
10.00	2
12.24	3
14.14	4
15.71	5
17.32	6
18.71	7
20.00	8
21.21	9
22.36	10
31.62	20
38.71	30
44.71	40
50.00	50

Using the tabulation, fasten a metered variable dc supply into the wattmeter according to the following diagram. Now

simply note the reading on your wattmeter for each of the selected voltages in the table and tabulate this reading with the corresponding power in watts in a table of your own. It may even be possible to remove the front of the meter case and mark new calibrations directly on the dial. This was not possible with some hermetically sealed meters. It is best to disconnect the wattmeter from the antenna feedline for this calibration. If the meter is left with a transmission line attached and the antenna happens to be fed through a balun device with near zero resistance, the power supply, and perhaps the balun, will suffer.

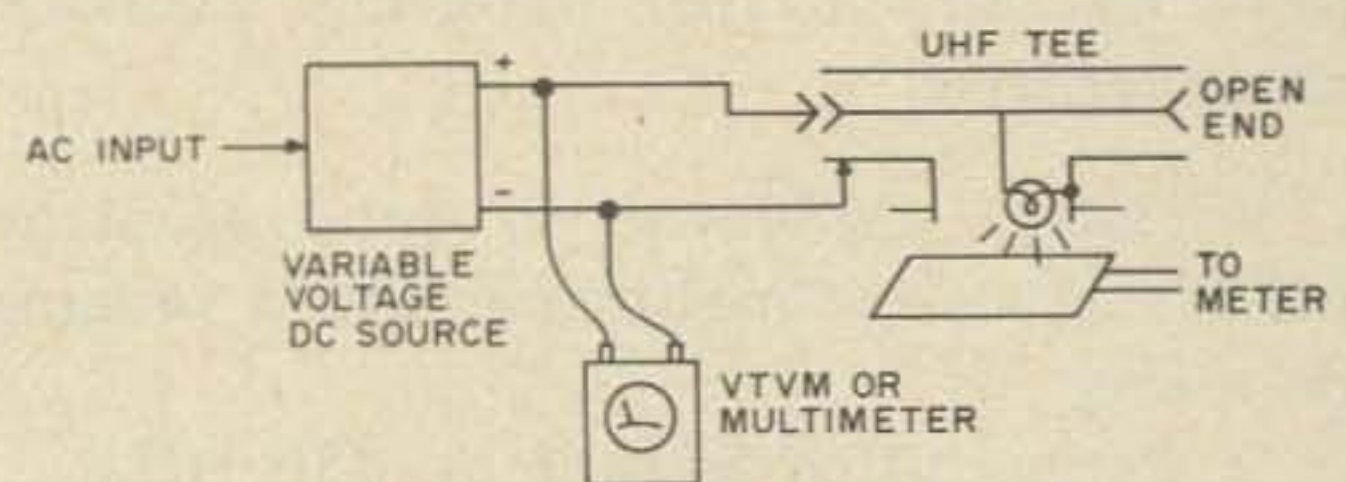

Fig. 2. Calibration diagram.

It must be pointed out again that this power meter is intended for use either with 50Ω coaxial line systems with low VSWR or with 50Ω dummy loads. A coaxial line that is not "flat" (unity VSWR) or a dummy antenna that does not "look like" 50Ω, which is the case with most HF loads used at VHF or UHF, may cause distorted power readings. If you have doubt about your transmitter's power output when using this meter, you should check it while using a known 50Ω load rated at the transmitter's output frequency.

I mentioned before that this power meter was easily adaptable to higher power readings. To upgrade the meter, the only change required is to insert the correct higher voltage pilot lamp having low current, long-life specifications. Suggestions for some of these are the following Dialco Lamps:

Part No.	Max Power Level (Watts)
24CS	100
48CS	200
60PSB	340
120PSB	800

...K5CXN

SBE

SCANVISION
SLOW-SCAN
TV

SCAN- VISION

Now—unexcelled picture performance with exclusive-feature equipment of highest quality in which the most advanced SSTV techniques are expertly applied—**SBE Scanvision**. Here, carefully considered design has simplified operation to the point where the non-engineer radio amateur can have his **SBE Scanvision** monitor connected and start enjoying slow scan in just a matter of minutes.

Most of the many hundreds of SS TV'ers now active on the air agree that the full excitement and enjoyment of SSTV can best be realized only when a tape recorder is part of the system. Incoming pics are taped for future viewing on SS monitor—pre-taped pictures, scenes, I-D—can be transmitted. So—exclusive!—every **SBE Scanvision monitor has a cassette-type tape recorder built-in**—wired—ready to go and selectable with panel switch. Here is the ultimate in convenience.

SBE Scanvision is conservative—reliable, with picture-proved circuitry and is all solid-state except for the scope tube in the monitor and the videocon picture pickup tube, heart of the SB-1CTV camera. Both tubes are standard types with predictable characteristics—not surplus.

High quality is everywhere evident—throughout, the to-be-expected **SBE approach**—fastidious—professional. The **SBE Scanvision, SB-1MTV Monitor**, complete with cassette recorder and SB-1CTV Camera with f/1.9, 25mm lens, connect with patch cable to comprise a **system**. Units are also separately available.

SEE SCANVISION AT YOUR SBE DEALER



Fully meets all accepted SSTV standards. Compatible.

Exclusive!
Built-in,
cassette-type
recorder.
Ready
Instantly

Available—
camera with
high quality
videocon for
“live” or
“still” pics.

Camera is
supplied with
quality f/1.9,
25 mm lens. No
extra charge.

Monitor connects to spkr or phones for receive—to mic input for transmit.

“Live” SSTV pic photographed from monitor. Unretouched.

SBE

**LINEAR
SYSTEMS, INC.**
220 Airport Blvd.
Watsonville,
CA 95076.

If you like 2 METER . . .

YOU'LL LOVE OUR



**15 OR 1 WATT POWER OUT/SWITCH SELECTABLE /
FULL 12 CHANNEL TRANSMIT AND RECEIVE CAPABILITY**

You'll like the crystal clear transmit and receive performance of this compact, 2 meter unit and so will those listening. The 12 transmit channels are provided with individual trimmer capacitors for the optimum in point-to-point and repeater applications. A HI/LO power switch provides 1 watt output or full rated output. The receiver has an audio output of 3 watts at excellent sensitivity. Solid state, American made quality at a low price.

\$229⁰⁰

AMATEUR NET

includes plug-in ceramic mike,
mounting bracket and transmit and
receive crystals for 146.94 MHz.

Regency
the first name in solid state

THE FM LEADER IN 2 METER AND 6 METER... AND NOW 220 MHz

J. K. Bach WB2PAP
Ivy Hill Road
Walden NY 12586

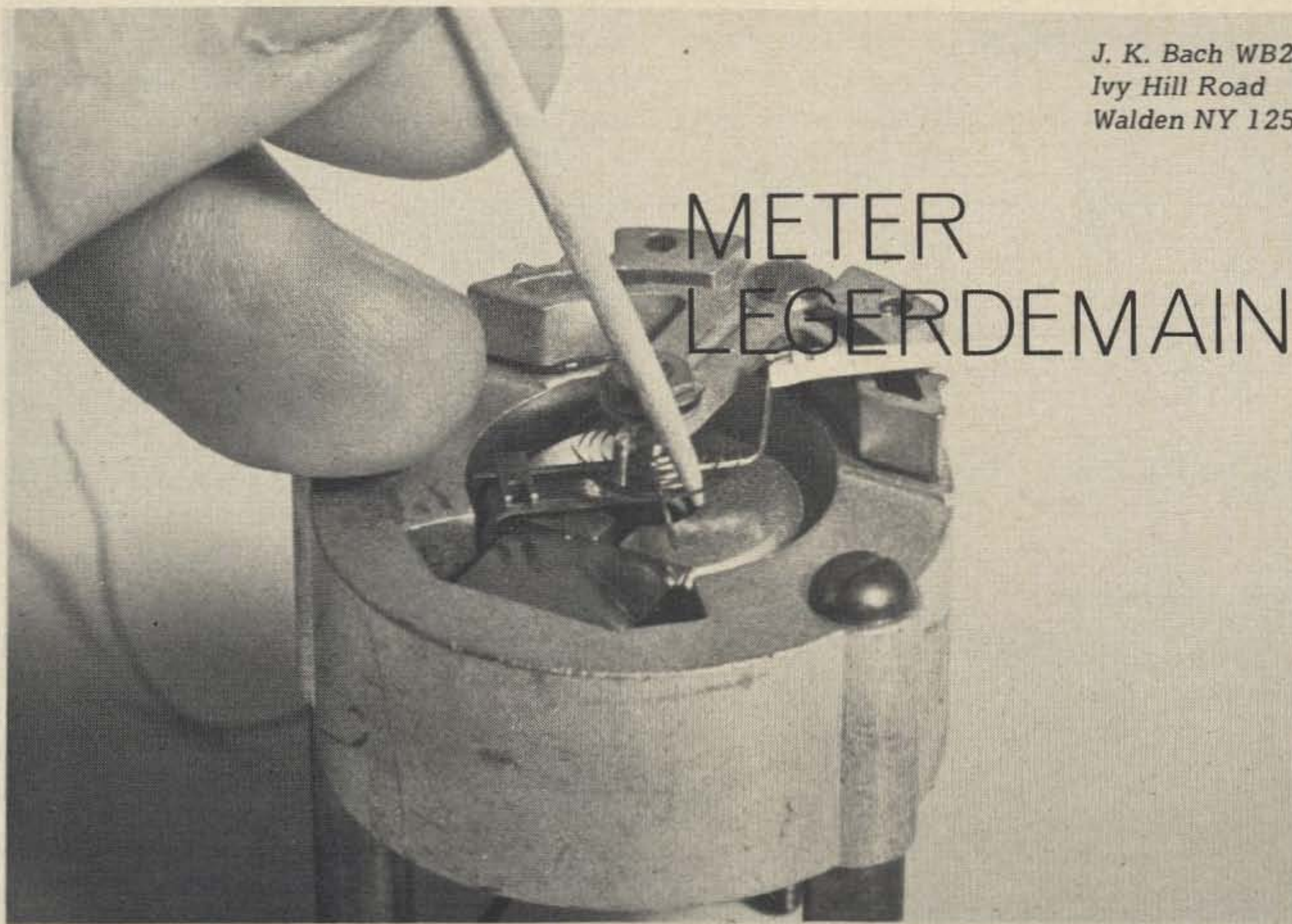

METER LEGERDEMAIN

Nobody in his right mind would fix a meter by choice, any more than he would operate on his wristwatch. But fate, which seems to be a generalization of Murphy's law, determines that sooner or later you will be faced with the necessity. One day you are minding your own business and your boss sidles up to you like an affectionate bison, mumbling something about how easy it would be for you to fix this (heh heh!) meter in your spare time. Or it's your own meter that went ape on a weekend. Whatever the motivation, you decide to take a hack at it.

I had never fixed clocks or watches, but I had reversed a tuning meter or two to read up-scale, so meters held no terrors for me. The first time I was handed one to fix at work, I started out with a show of jolly self-confidence and proceeded to lose my patient — irretrievably — within minutes. The second worked if you tapped it continuously and held your mouth right. The third and fourth I don't remember, but the fifth worked as good as new. By this time I had made most of the more stupid mistakes, learning a bit from each. A meter repairman would laugh himself sick at my methods. Were I in his position, with his facilities and skills, I would laugh too. I'd laugh even

harder watching *him* work on a meter with *my* facilities. He has to work fast to make money and has all the parts he needs. He replaces whole assemblies, as an automobile mechanic does. I have to straighten the kinks out of hairsprings, but I have lots of time. My boss gives me the job because when he sends any meter to any shop he knows how long it takes to get it back. This is true of all shops all over the land. Even buying a new one takes a lot of time, which is why so many of us are volunteered to fix them.

The tools are very simple. A good light, such as a desk lamp, is very useful but not essential if you have young eyes. I haven't. The next thing is to provide a spread newspaper to work on. Meter magnets will attract steel filings and steel wool fuzz from incredible distances. These have to be swabbed out of the air-gap with Scotch tape. One session of this will teach you to spread a clean newspaper.

The second lesson is, no magnetic tools. You naturally try to use your familiar long-nose and screwdriver, but at best you can't control them closely enough near the magnets and they are hazardous besides. What you need is a non-magnetic toothpick. It can be round, like the one in the photograph, or the old square kind. You can

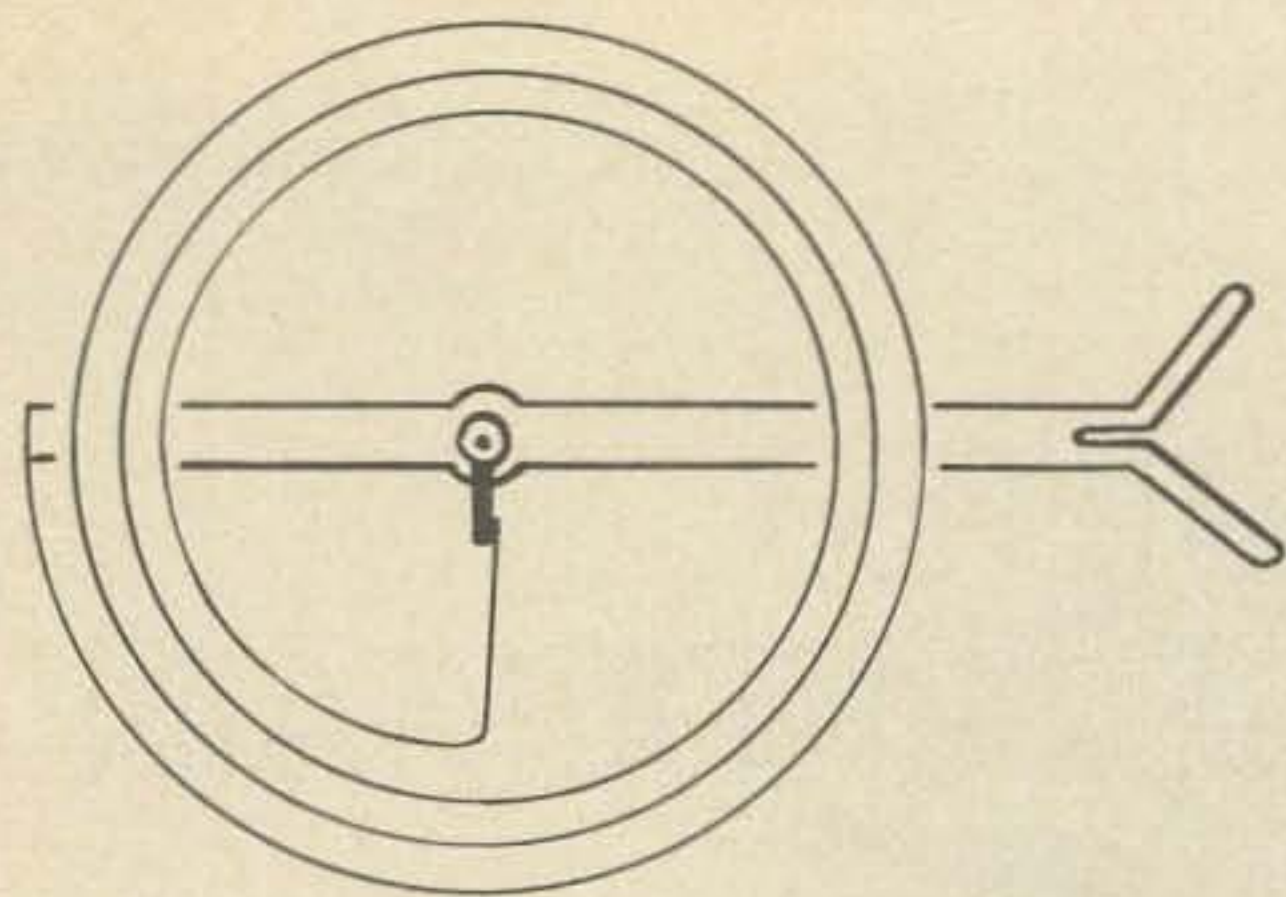

Fig. 1a. Top view of a healthy meter spring.

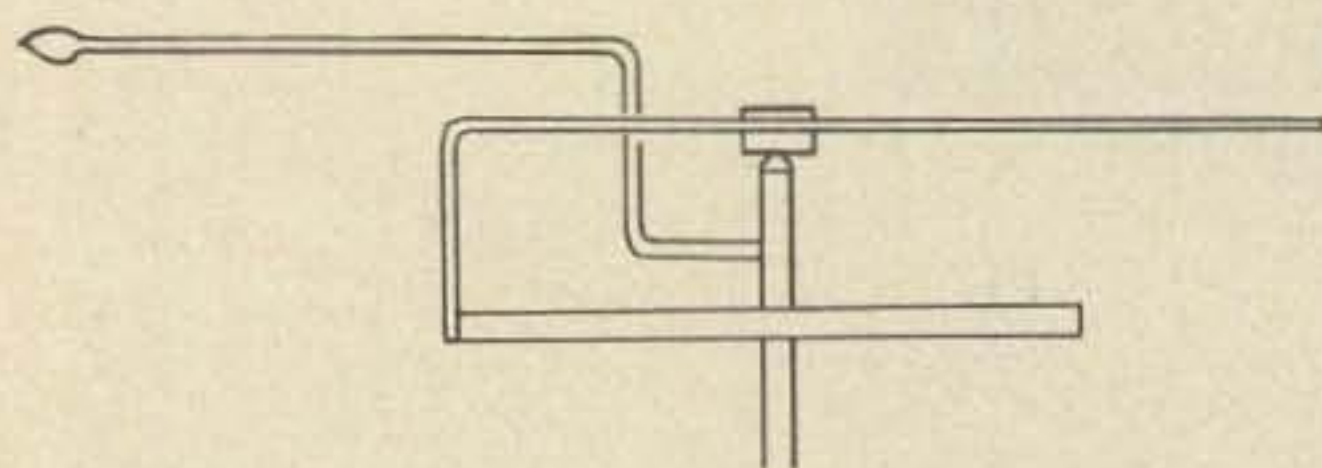

Fig. 1b. Side view with indicating needle added.

cement two together to make a tiny fork for straightening needles and unkinking hair-springs.

By all means get a magnifying glass if you can. Older guys tend to keep them in their toolbox. One of the handiest kinds is the jewelers' loupe with the steel spring head-band on it. The monocle type will cramp all the muscles from your big toe up, with the effort of keeping the silly thing in your eye. Use your own judgment.

Duco or other plastic cement is handy, but do not use it directly. If you have to cement a needle, transfer an invisible dab of cement with the end of a toothpick. Get just one drop of cement in a hairspring and no amount of any solvent will ever get it out. The only cure is to take the meter in your right hand, take a good windup and let fly eastward. This will save you an ulcer in the long run.

All this talk and nothing about the actual work yet? Patience! Watch a good machinist at work — two hours and a half on setup, and two minutes for machining, that's his rule. The beginner reverses these times and strikes out with ruined work. Meter fixing is like this — utter despair can be followed by

delirious delight within a few seconds. Nearly every hairspring trouble is fixed very suddenly or not at all. And all the other troubles taken together are few.

One more warning: the PAP syndrome (WB2PAP). This is not to be confused with the PAP test which is entirely unrelated. The effect is a spasmodic jerk of the hand which, by Murphy's law, invariably stretches the hairspring to its full length and ruins it. This nervous jerk is brought on by fatigue, and I believe it is due to the loss of feedback to the brain, which tries to locate the hand position and reset it, with disastrous results. I don't fully understand the mechanism — who does? — but I know a good way to prevent it. *Never* work free hand. Take a look at the photograph which illustrates this. See that third (fiddle count) or fourth (piano count) finger touching the meter magnet? With it, or any other finger or part of the hand touching, the brain knows right where the hand is, and keeps it there. Also the movements are measured in millimeters, not inches, and finger contact helps with this. It also helps impose gram forces instead of ounce forces. There, I've saved you one meter already.

Another warning — leave the jewels and pivots alone. With a brand new meter, fresh out of the box, you can move the needle along its length a full thirty-second inch, a clearly visible amount. You can even feel the motion of the pivots in the jewels. Everybody has a thing about pivot adjustments, and so did I, once. The natural thing is to take all the slack out — just. But meter pivots should be left sloppy for the least drag.

If you must take meters apart beyond the minimum possible stage, you will need something to put the little screws and nuts and insulators in. I like a baby-food jar. A heavy ash tray is good too; or both. But keep the parts in the jar until you have to put the meter together again, else you may hit the ash tray with your elbow and shower itsy-bitsies all over the place. And tweezers — sound good? Like the idea? Ever "shoot" a little nut or screw clear across the room and into the nap of the rug? Maybe you have the requisite skill to use tweezers, but I want no part of them.

At last — the broken meter. Take the front case off. Is the winding open? Blow the needle to full scale a few times and see how quickly it restores to zero. Now short the terminals and repeat. If the needle restores as fast as before, either the air-gap is very wide or you have a wiring trouble. It figures to be the coil, but several times I have found it in the shunt or multiplier resistances, or other wiring.

Now if the needle is stuck, make sure it really *is* the needle. It can actually stick to one of the stops (rare), scrape on the scale, hook over a scale-screw, or be biased off low mechanically. In any case the needle must be okay before any other source of drag can be located. The air-gap may have filings in it, or the hairspring tangled.

If the air-gap is fouled up, take a short length of Scotch tape and swab it clean. It isn't fun, but it can be done.

If the hairspring is tangled or distorted in any way, the best thing is to just look at it from all angles, in all kinds of light, under the glass (low powered one will do). Try to figure out just how in thunder any normal

very difficult to see unless you have experience. Someone before you has had the meter open and touched the hairspring not quite gently enough. He has put a permanent set at the outer attachment, bending it toward the shaft right where it is soldered, along the horizontal plane of the spring. You can work at this for hours, making it worse and worse. But once you know exactly what the trouble is, you take the non-magnetic toothpick and bend it in the exact opposite direction, removing the "set" and restoring the original set. But don't apply the restoring set all at once, and directly against the arrow in the figure. Rather, engage the sharpened tip of the toothpick between the 3rd and 4th loop of the hairspring and run it back and forth a few millimeters — maybe an eighth of an inch — *along* the spring, but angled very slightly outward. Magic! That spring, under the glass, is one of the most beautiful things you will ever see!

Or take Fig. 2b. By great good fortune, I managed to get something like this in the photograph. I was working left-handed at arm's length with a commercial photographer, tripod, Hasselblad, and speed-flash

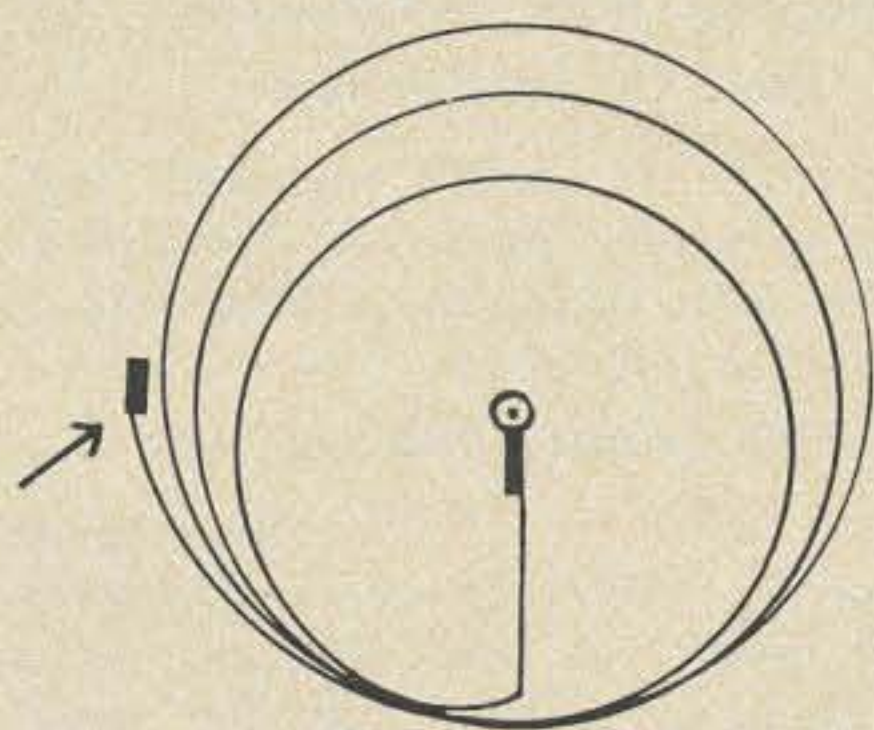

Fig. 2a. Spring is bent at outer attachment.

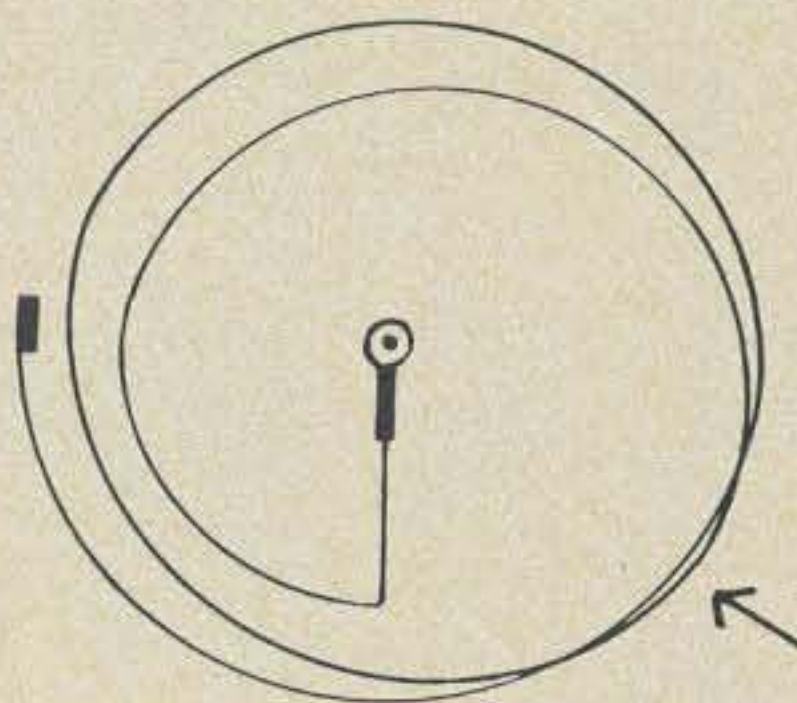

Fig. 2b. The outside loop is hooked over the spiral.

human being could get the hairspring in such shape — but don't touch it yet, just look at it. This will save you a lot of time.

Figure 1a sketches a view of two *moving* parts-hairspring and shaft with side-lug. Also shown is the zero adjusting fork, which also revolves around the same axis as the shaft and pivots. Figure 1b is the same thing from the side, with the indicating needle added. No fixed supports or anything else are shown. All this for comparison.

Now look at Fig. 2a — what causes the bunching at the bottom of the coils? This is

all between me and what I was doing. The only way I could tell that I was contacting the hairspring was that the meter needle quivered a little from time to time. See that little loop up past the outer turn of the hairspring? That's how it looks, except that it stays there by itself and hangs the meter movement up. Same remedy here: move the sharp tip of the toothpick a little further back this time until the spring jumps clear. Imagine you are petting a microbe; this will help you use a minimum of force. This, by the way, is the only trouble that ever clears

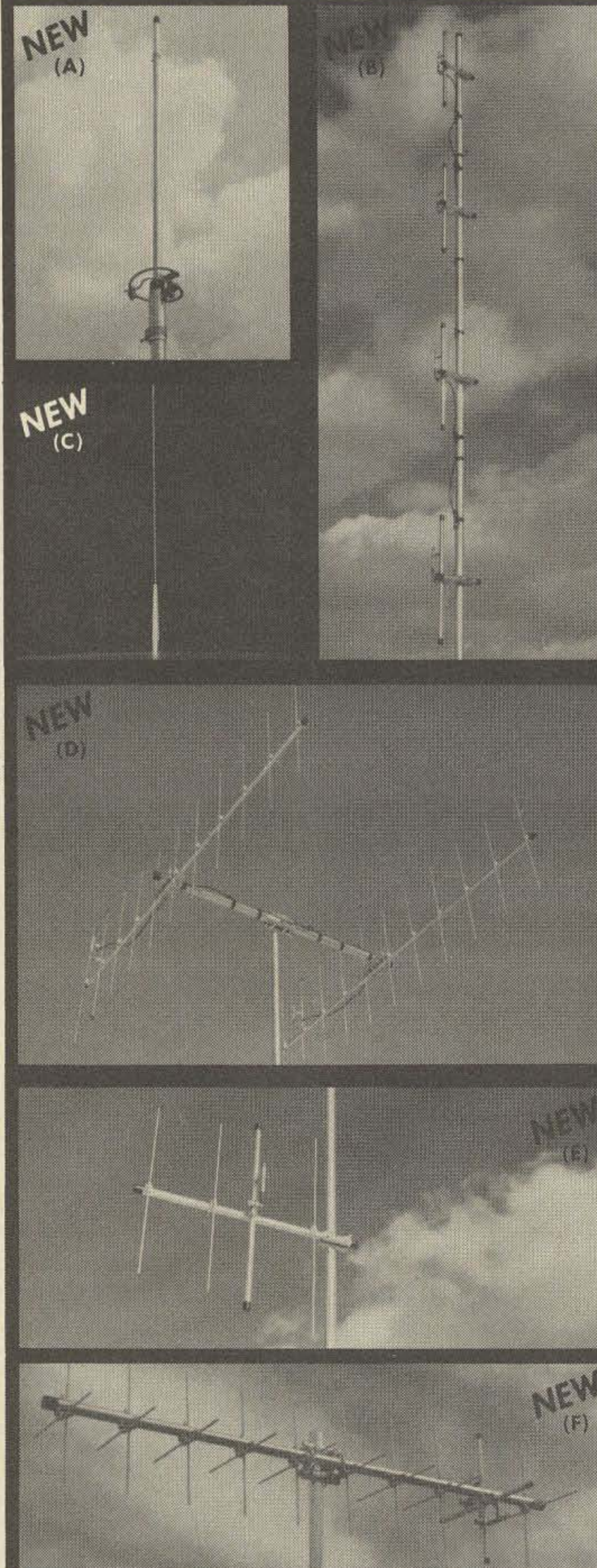

Cush Craft

2 METER FM ANTENNAS

NEW FROM THE WORLD'S LEADING MANUFACTURER OF VHF/UHF COMMUNICATION ANTENNAS

(A) FM GAIN RINGO: The most popular — high performance, half-wave FM antennas. Give peak gain, and efficiency, instant assembly and installation.

AR-2	100 watts	135-175 MHz	\$14.50
AR-25	500 watts	135-175 MHz	18.50
AR-220	100 watts	220-225 MHz	14.50
AR-450	100 watts	420-470 MHz	14.50
AR-6	100 watts	50-54 MHz	19.50

(B) 4 POLE: A four dipole gain array with mounting booms and coax harness 52 ohm feed, 360° or 180° pattern.

AFM-4D	1000 watts	146-148 MHz	\$46.50
AFM-24D	1000 watts	220-225 MHz	44.50
AFM-44D	1000 watts	435-450 MHz	42.50

(C) FM MOBILE: IMPROVED Fiberglass $\frac{5}{8}$ wave mobile antenna with new molded base and quick grip trunk mount. Superior strength, power handling and performance.

AM-147T	146-175 MHz mobile	\$26.95
----------------	--------------------	----------------

(D) POWER PACK: A 22 element, high performance, vertically polarized FM array, complete with all hardware, mounting boom, harness and 2 antennas.

A147-22	1000 watts	146-148 MHz	\$56.50
----------------	------------	-------------	----------------

(E) 4-6-11 ELEMENT YAGIS: The standard of comparison in VHF/UHF communications, now cut for 2 meter FM and vertical polarization. 4 & 6 Element models can be tower side mounted.

A147-4	1000 watts	146-148 MHz	\$11.95
A147-11	1000 watts	146-148 MHz	19.95
A220-11	1000 watts	220-225 MHz	17.95
A449-6	1000 watts	440-450 MHz	11.95
A449-11	1000 watts	440-450 MHz	15.95

(F) FM TWIST: A Cush Craft exclusive — it's two antennas in one. Horizontal elements cut at 144.5 MHz, vertical elements cut at 147 MHz, two feed lines.

A147-20T	1000 watts	145 & 147 MHz	\$39.50
-----------------	------------	---------------	----------------

IN STOCK WITH YOUR LOCAL DISTRIBUTOR

Cush Craft
CORPORATION

621 HAYWARD STREET
MANCHESTER, N.H. 03103

itself, and not very often, either. I think that slamming the needle is what does it. The sharp pulse sets up a standing wave that whips a loop of hairspring outside the spiral, where it catches.

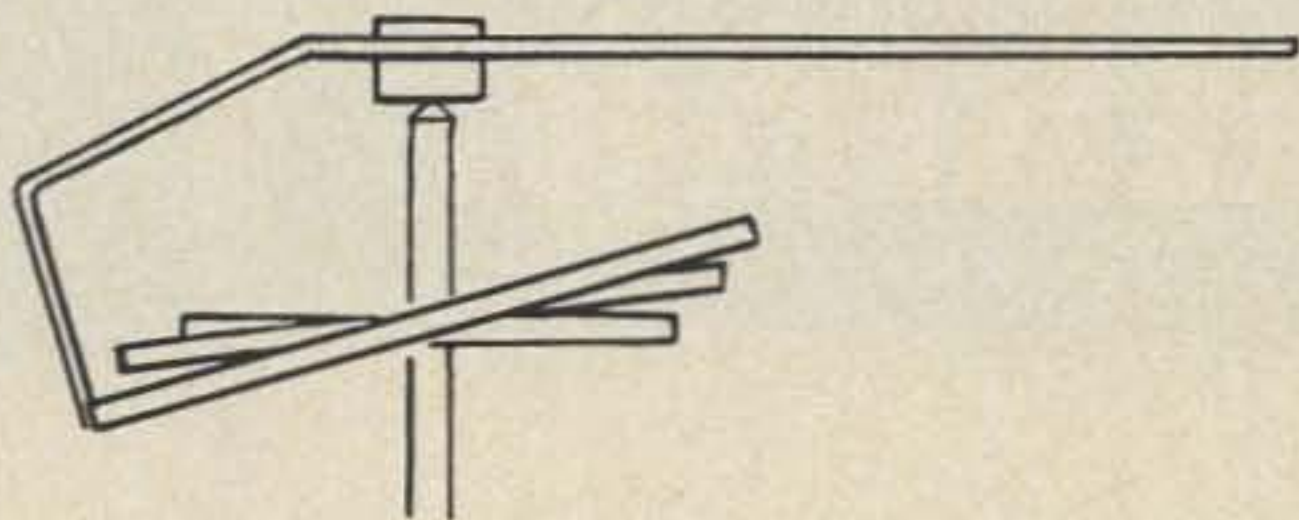

Fig. 3. This anomaly was probably caused by the downward motion of the adjusting fork.

Figure 3 is interesting, too. Obviously, someone has hit the scale end of the adjusting fork, pushing it downward. So take your tool and twist it back up. These "repairs" (adjustments) take five minutes of looking and five seconds of adjusting. Or five hours if you mess it up or "fix" the wrong thing. A good visual imagination is the secret. Of course, the examples illustrated are frequently encountered and basic. But if you get any two of them together at the same time, or even a third mixed in, then the others will be more obvious and can be cleared in their turn. I never said it was easy, but you can do it, nevertheless, if you look before you poke. Most people don't.

Consider: The hairspring is foil thin, it is made of phosphor-bronze, one of the toughest metals, perfect for the purpose. It *wants* to go back like it was. Both ends are soldered fast, which limits the degree of possible entanglement, a sort of antithesis of Murphy's law. The worst thing is kinking and this is also due to big, vulgar, ignorant thumbs getting into the hairspring. Even these can be straightened one at a time, and suddenly the hopeless case is perfectly okay. Some traces may remain, but if the spring is symmetrical, and the eye can't be fooled in this, then by all means *let it alone!* Once you have sufficient clearance, twice as much isn't better, and costs in another dimension.

Generally it is not necessary to remove the scale. Mount the meter level and secure — in a box, or something. If the meter slips and you make a grab for it and stick your highly-skilled thumb through the hair-

spring, it will have exactly the same affect as if the office oaf stuck his in. You won't feel any better, anyhow.

Once I got a meter in a tube tester that was supposed to stick. Impossible! It was a taut-band type, with pole clearances you could throw a cockroach through. I returned it and got it back, with the needle stuck this time. Out of the case, it came unstuck and no possible place to stick could be seen. By considerable mistreatment I managed to hang the needle up on a scale-screw. Bending the needle up a bit fixed things.

A funny one: a meter with no needle at all. I was offered affidavits that the case had never been opened, but still — no needle anywhere. What could I use for one? Broom-straw, inked? Broom? Push-broom!! I plucked a horsehair from it — perfect. However, I ironed it straight on the soldering iron, and dampness finally recurled it. I should have picked the longest and straightest and let it go at that.

How about calibration? You have restored the spring to its original shape, and very probably the calibration is pretty good. You can set the zero adjustment in the middle of the adjuster range by moving the *back* hairspring lever (be very careful of this one, the lever is short and you risk a Fig. 2a). Once you get the zero okay, how about full scale sensitivity? You could adjust the shunt or multiplier, or if you are lucky, there might be a magnetic shunt. This gadget is a thin leaf of magnetic material that can be slid across the poles to leak a little of the flux around the coil. For more sensitivity, slide it back over the magnet away from the pole. This forces more of the flux through the air-gap and coil, increasing sensitivity. Only the very best domestic meters have this feature. Hickok even had one around the *outside of the meter case* in the big Gm meter of one of their tube testers.

It is usually pretty disillusioning to calibrate or compare meters. It really shouldn't be, but even the best meters aren't as accurate as you think. If they were, they would be too fragile and expensive to use. We've been getting along with them very well for years, just as they are.

And if you have to fix one — good luck!

...WB2PAP

Everyone has something.

FIXED STATION TRAP VERTICAL

40 THROUGH 10 METERS

HUSTLER

has everything!

One Setting for TOTAL BAND COVERAGE...

- **Lowest SWR—PLUS!**
- Bandwidth at its **broadest!** SWR 1.6 to 1 or better at band edges.
- Hustler exclusive trap covers "**Spritz**" **extruded** to otherwise unattainable close tolerances assuring accurate and permanent trap resonance.
- Solid one inch **fiberglass trap forms** for optimum electrical and mechanical stability.
- Extra heavy duty aluminum mounting bracket with **low loss—high strength** insulators.
- All sections **1¼" heavy wall**, high strength aluminum. Length 21' 5".
- **Stainless steel clamps** permitting adjustment without damage to the aluminum tubing.
- Guaranteed to be **easiest assembly** of any multi-band vertical.
- Antenna has **3/8"-24 stud** at top to accept RM-75 or RM-75S Hustler resonator for **75 meter operation** when desired.
- Top loading on 75 meters for broader bandwidth and **higher radiation efficiency!**
- Feed with **any length** 50 ohm coax.
- Power capability—**full legal limit** on SSB and CW.

Buy **HUSTLER** ... buy the verified
choice of thousands!

MODEL 4-BTV
\$49.95
AMATEUR NET
Wgt. 15 lbs.

*Available from all distributors
who recognize the best!*

NEW-TRONICS CORP.

15800 COMMERCE PARK DRIVE
BROOK PARK, OHIO 44142

World Wide Export, Roburn Agencies, Inc., 349 W. 14th St., New York, N.Y. 10014, Cable Address: Roburnage - New York



John J. Schultz W2EEY
1829 Cornelia Street
Brooklyn NY 11227

EUROPE'S FIRST AND HIGHEST DX REPEATER

Imagine being able to use a 1W FM transceiver and work stations in West and East Germany, Austria, Czechoslovakia, Yugoslavia, Italy, Switzerland and France! This range of coverage is available through the Zugspitze repeater located in the Alps in southern Germany. The Zugspitze repeater is probably one of the most unique repeaters yet to operate in the 2 meter band. Its story is an interesting one not only because of its location, technical details and the German

amateurs involved but because it may well become the model for a number of DX repeaters located throughout Europe. So, although American amateurs won't be using this repeater, except perhaps when on vacation in Europe, its story should be of value and interest.

Before describing the history of the repeater itself, and unless one is familiar with southern Germany, it would be a good idea to take a look at a map of Europe and locate



A panoramic view from the Zugspitze Mountain.

2 METER FM

SYNTHESIZED !

Inoue's New
IC-230



- 162+ channels, simplex or offset (600 kHz) for repeaters
- All modular construction
- Super hot MOSFET/helical coil .4 μ V receiver
- AVAILABLE NOW ! . . . only \$447.50

Send QSL or check index for detailed brochure

E ERICKSON COMMUNICATIONS
4653 North Ravenswood Avenue
Chicago, IL 60640 (312) 334-3200

the city of Munich in southern Germany. Within a radius of 200 to 250 miles coverage around Munich are located portions of all of the countries mentioned above. These countries cannot be worked directly from Munich because of lack of height, interfering terrain features, etc. However, if one proceeds southward from Munich, the countryside remains relatively flat to gently rolling hills until about 50 miles southward when one rather suddenly encounters the start of the Alps. A number of peaks rise to several thousand feet in height. One of the most famous of these peaks and one of the highest (9,721 feet) is the so-called Zugspitze. It is not the highest peak in the Alps but it is the highest peak in the portion of the Alps which cover Germany and the peak is right on the border between Germany and Austria. A meteorological observatory as well as a hotel are located on the peak and the area is a favorite with skiers. The view of the Alps provided from the peak on a clear day is perhaps one of the most spectacular in Europe. It is reached by means of a rack and pinion railway (not too scenic because of all

the tunnels it travels through) or by an aerial cablecar ride that is guaranteed to fascinate anyone.

When the 2 meter FM repeater idea began to catch hold in Germany it was natural that the amateurs in Munich looked toward the Zugspitze because of its high location and its accessibility. Approaches were made to the Bavarian Weather Service which maintains the weather station on the mountain to be allowed to set up a repeater on top of the weather instrumentation tower. After some rather difficult sessions with the weather service people, the German amateurs involved in the project finally did obtain permission to set up the repeater. Some of the conditions involved were rather hard to take, however. For one thing, the repeater installation could not be located indoors but had to be contained in a metal enclosure outdoors. Only a power line to the repeater, which would be metered and separately charged for, would be provided. Also a liability insurance policy in the amount of some \$250,000 had to be taken out to insure that should the installed equipment, antennas, etc., cause any damage to the weather installation or to a person (there is a tourist observation platform around the weather station) that the weather service would be protected.

It required considerable determination on the part of the amateurs involved to forge ahead under these conditions, especially since at this point the financial support for the project would have to come solely from the amateurs themselves. It might be worthwhile at this point to mention that although only a few amateurs did all the work on the project, all amateurs can use the repeater. Private or "closed" repeaters are simply not allowed on the 2 meter band in Germany. The makeup of the repeater channels in Germany has been described in other articles and so it won't be gone into in great detail here. But either because of the Teutonic characteristic for having everything done by a rule book or because German amateurs saw the mess that was developing about repeater frequencies in the U.S., when repeaters were first authorized in Germany specific channels were set up for their usage. Only these channels could be used and every new

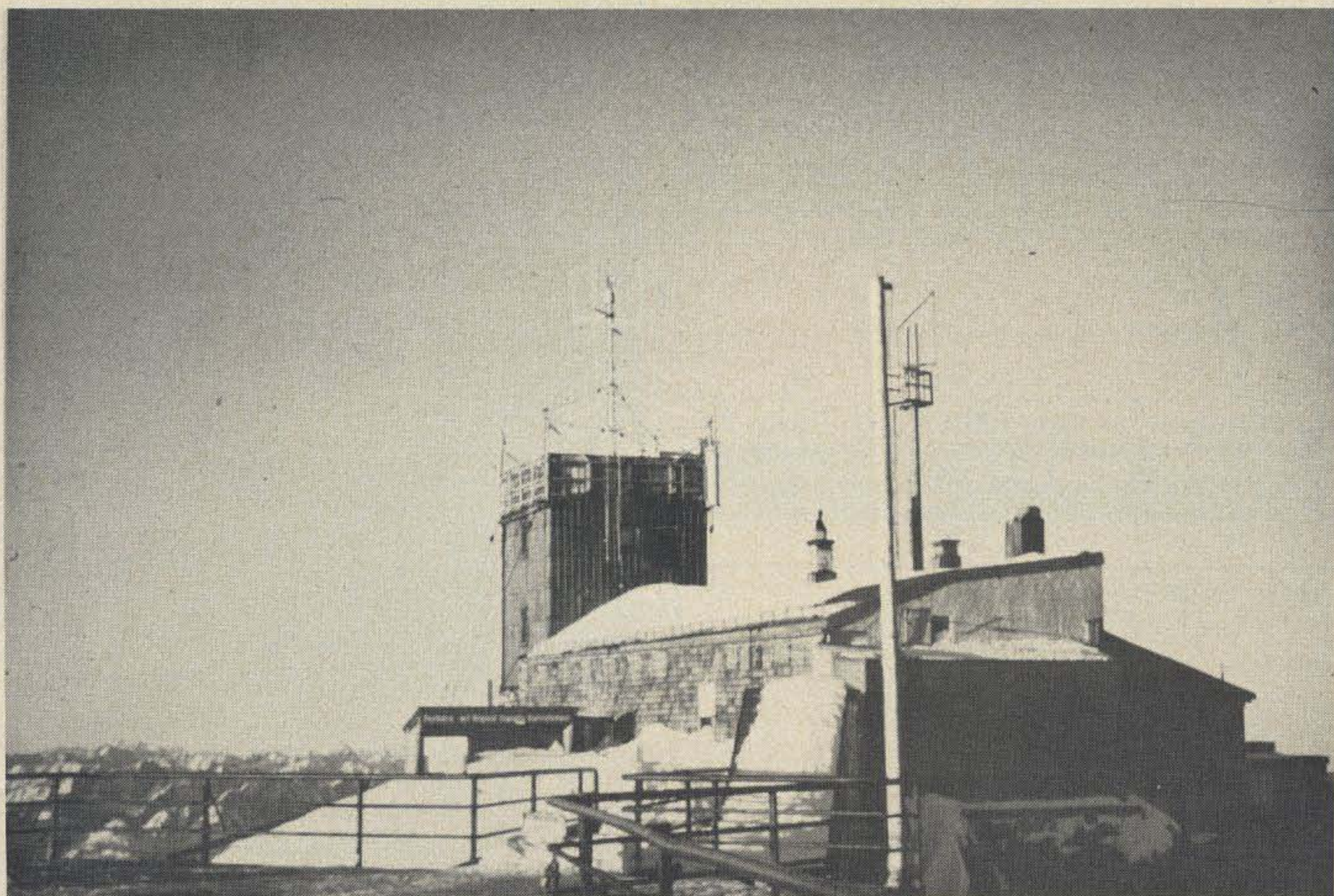

A view of the weather station on the Zugspitze. The transmitting and receiving antennas are directly above and below the tubular structure on the right side of the tower.

repeater that was set up had to use a channel that would be compatible with other nearby repeaters. Originally 3 channels for repeaters were allocated and this now has been expanded to 7 channels. The input channels for repeaters are in the range of 144.15 to 144.30 MHz with 25 kHz spacing and the output range is 145.70 to 145.85 MHz. Repeaters can have a maximum power of 15W and ± 5 kHz deviation. To enter the repeater initially a tone burst of 1750 Hz is required (most will also whistle-on) and then the repeater is carrier keyed as long as no break of more than 3–5 seconds occur. The amateur licensed to operate the repeater also has to be able to remotely disable and enable it. However, a separate link is not required and this control function is done by a multiple tone signal on the input frequency of the repeater.

There were many amateurs in Munich who contributed to the establishment of the Zugspitze repeater, but the leading members of the team were Sepp DJ9HJ, Bernd DL9ZD and Peter DJ3YB. This team was

perhaps an ideal one for such a project because of their complementing interests and talents. DJ9HJ headed the organizational aspects of getting the repeater established while DL9ZD specialized in digital and control circuits and DJ3YB was an experienced engineer on VHF/UHF circuitry.

After receiving the necessary license for the initial Zugspitze repeater in the spring of 1970, the Munich team set about to assemble the necessary equipment to get the repeater into operation as quickly as possible. The emphasis at this point was to get the repeater into operation during the good weather period. Fortunately a commercial VHF transceiver intended for mobile use could be secured, and with the necessary modification for a power supply, frequency changes, a keyer for repeater ident, etc., it formed a repeater "package." Two completely sealed vertical dipole antennas of commercial design and a cavity filter made up the antenna part of the package. After initial testing, the entire package was trans-

FREE Catalog

OF THE WORLD'S FINEST
GOVERNMENT SURPLUS
ELECTRONIC EQUIPMENT



And **BETTER Than Ever!**

Name _____

Address _____

City _____ State _____ Zip _____

Mail Coupon for Your **FREE** Copy, Dept. 73

FAIR RADIO SALES

1016 E. EUREKA • Box 1105 • LIMA, OHIO • 45802

QUAD OWNERS The perfect marriage — your favorite tri-band quad and an "H & H RING TRANSFORMER". Designed specifically for quads, this balun offers the optimum impedance match using a single 50 ohm co-ax feedline.

Now available in three new lightweight weatherproof models:

- 2 element
- boomless
- 3 or 4 element

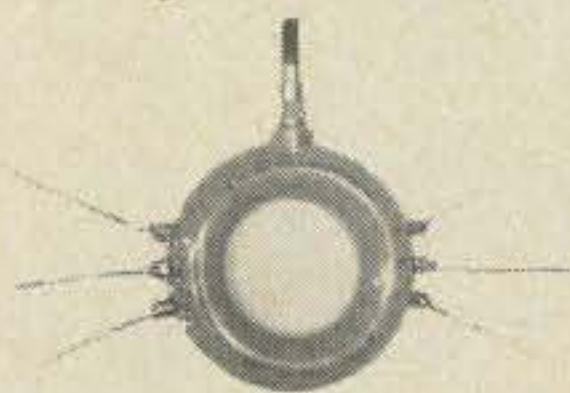

\$24.95 pp

H & H engineering

p.o. box 68
la mirada, ca 90637

also available thru Skylane Products
& Cubex Company

WEST COAST HAMS

Good Deals

Ham Gear

New—Used

M-TRON

DOUG MURRAY — W6HVN

2811 Telegraph Ave., Oakland CA 94609

Synthesize Any FM Rig...With A GLB Channelizer!

- ★ EASILY CHANGED FROM RIG TO RIG
- ★ FASTEST LOCK-UP
- ★ CHOICE OF 10 or 5 KHZ STEPS
- ★ 5 PPM STABILITY
- ★ UNIVERSAL SWITCHING
- ★ DESIGNED FOR MOBILE ENVIRONMENT
- ★ 420-450 MHZ VERSION AVAILABLE

144-147.99 MHZ Model 400B
129.95 Kit
189.95 Wired & Tested
WRITE FOR BROCHURE
Available By Direct Mail Only

GLB ELECTRONICS

404 CAYUGA CREEK ROAD—SOUTH CHEEKTOWAGA, N.Y. 14227

PARTS!

FREE Send For FREE

CORNELL'S
New Color
Catalog

48 Pgs. New Items



33¢ per tube

IN LOTS OF 100

TUBES!

36¢ per tube

ORDER FREE
IF NOT SHIPPED
IN 24 HOURS!

4215 S University Ave. San Diego, Calif. 92105

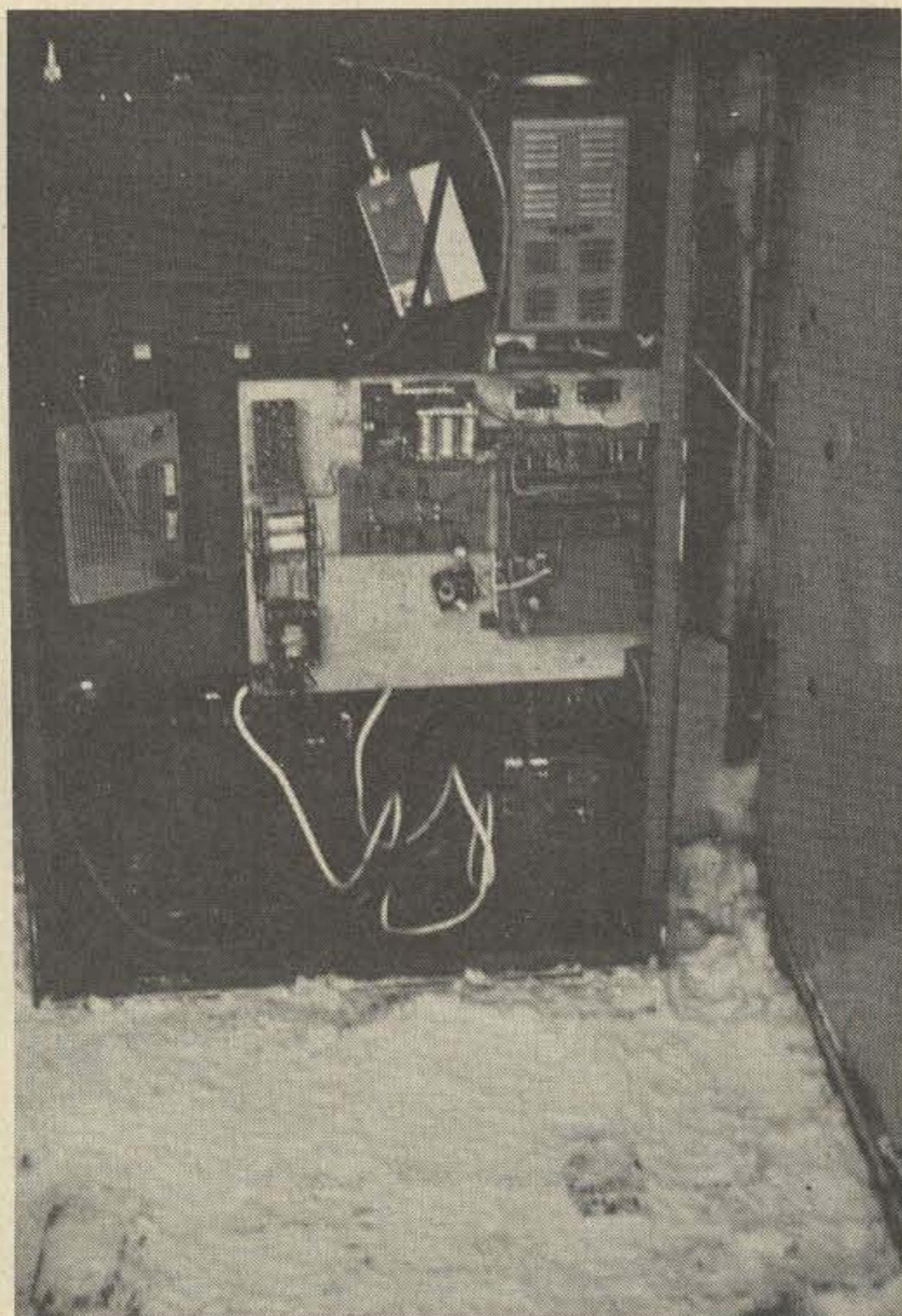

The original Zugspitze repeater housing. The entire repeater is located outdoors.

ported to Garmisch, Germany, in August 1970, where it was loaded on the cable car for transport to the Zugspitze. The station package except for the antenna had been assembled in a metal container intended to remain outdoors. Over a day was required for the initial setup of the repeater and all of the usual Murphy's laws applied, as it was found the metal container was too large for the space it was meant to occupy, etc. None of these problems would normally have caused great concern except that one had to work at 9,000 feet elevation and rides up and down the cable car were costing up to \$15 each because of the equipment that had to be transported. Finally the repeater was set into operation and amateurs in southern Germany began to enjoy a unique repeater operation — but for only eight days. Then the repeater seemed to malfunction as the receiver sensitivity was greatly reduced. The cause was traced to the cavity filter used for antenna isolation. It had been constructed from 1 mm thick copper but apparently this

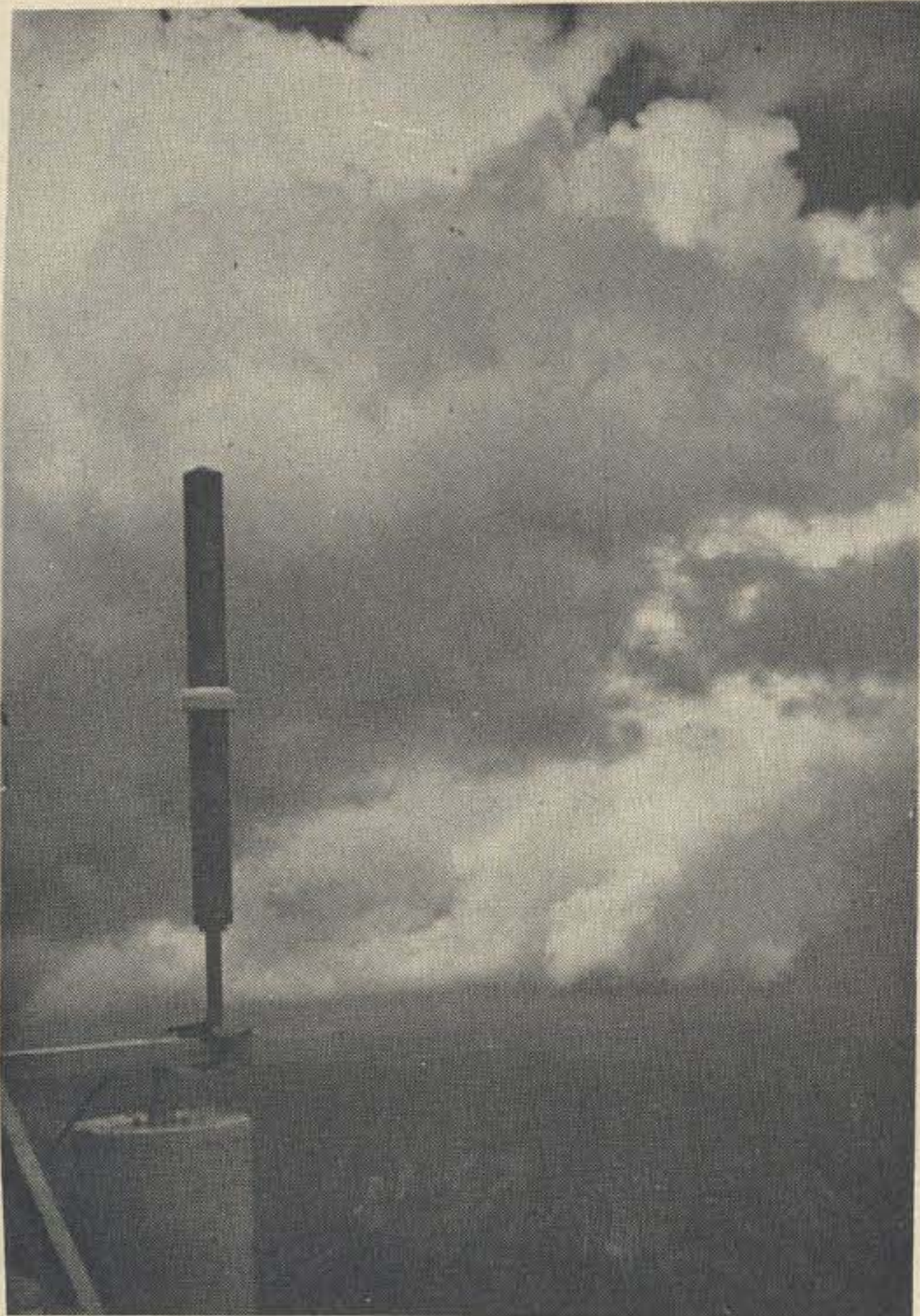

A view of the transmitting antenna in summertime. The antenna is a completely weather-sealed vertical half-wave radiator.

thickness could not remain properly adjusted due to the temperature extremes encountered on the mountain. A look in the statistical records showed that the temperature on the Zugspitze, to which the entire outdoor installation would be exposed, varied from -37 degrees to +70 degrees. The average temperature is about 24 degrees, the same as that for Greenland. The problem with the cavity filter could not be solved, but an anonymous donor came up with a commercial 5 pole filter that did the job.

After solving the filter problem, the repeater basically continued in operation with only minor difficulties. The transmitter used was a tube type and had only 5W output. Nonetheless, German amateurs were pleasantly surprised to find at times Italian, Czeck and other DX stations calling over the repeater. Also, the coverage achieved in Germany was considerable, with stations being worked up to Kassel in northern Germany. The unpleasant side of the picture was that the repeater was starting to inter-

LED READOUTS

Similar to MAN-1. .33" high. 20 mA per segment. With decimal point.

Red - \$2.25 each
Green - \$3.00

LED - molded plastic dome shape with leads.

Red - \$.25 each, 5 for \$1.00
Green - \$.40 each, 5 for \$1.85

KODAK RED Wratten Filters

Perfect for light filter over red LEDs. 4" sq. .005" thick.

\$.35 each, 3 for \$1.00

LM 309 Voltage Regulator IC. 5 volts at 1 Amp. max. current.

\$2.00 each

TTL ICs

7400	\$.35
740235
740439
7441	1.20
7447	1.40
747355
7475	1.20
747665
7490	1.00

MINIMUM MAIL ORDER \$2.00



SEND FOR LATEST FLYER OF SURPLUS AND NEW ELECTRONICS

JEFF-TRONICS

1916 Clark Avenue Cleveland, Ohio 44109

FREE CATALOG

HARD-TO-FIND PRECISION TOOLS

Lists more than 1700 items—pliers, tweezers, wire strippers, vacuum systems, relay tools, optical equipment, tool kits and cases. Also includes four pages of useful "Tool Tips" to aid in tool selection.



JENSEN TOOLS and ALLOYS
4117 N. 44th Street, Phoenix, Arizona 85018

WORLD QSL BUREAU

5200 Panama Ave., Richmond CA USA 94804
THE ONLY QSL BUREAU to handle all of your QSLs to anywhere; next door, the next state, the next county, the whole world. Just bundle them up (please arrange alphabetically) and send them to us with payment of 5¢ each.

ECM-5 FM Modulation Meter

- Operates 30-500 Mhz
- Crystal controlled for fast and easy operation
- Peak reading
- Battery powered with AA pencils
- All solid state
- Built-in antenna
- Quality constructed with G-10 p.c. boards

Only \$75.00 less batteries and crystal



Phone or write "Skip" W9HAK for complete information
Dial 812-476-2121

Available by direct mail only. ORDER INFO: Send check or money order for \$75.00 plus \$1.00 for handling. Indiana residents add 4% sales tax. Crystals for 146.94 Mhz: \$3.95 ea. All other freqs. \$7.10

ECM

ECM Corporation
412 N. Weinbach Ave.
Evansville, Indiana 47711

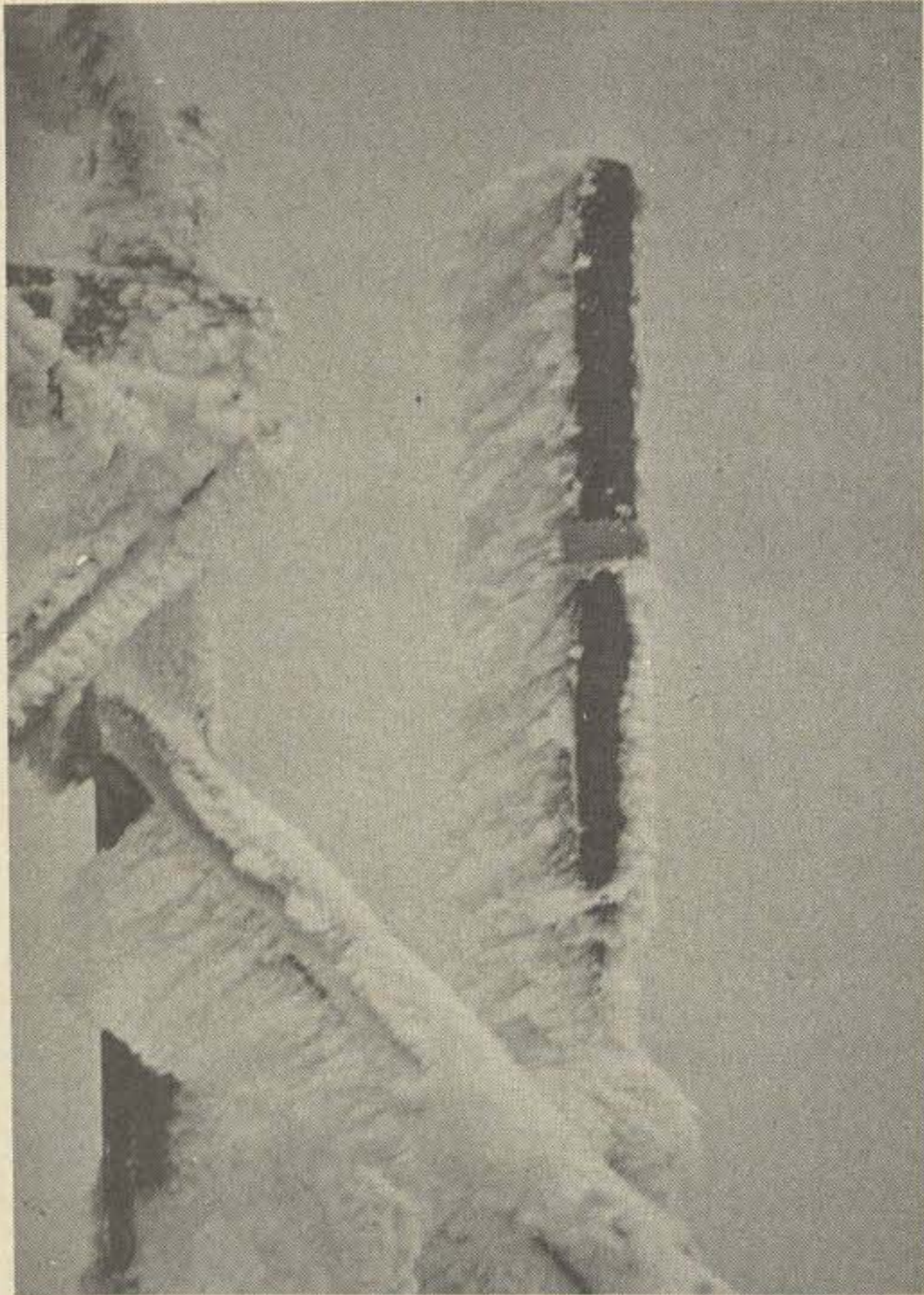

The transmitting antenna after a winter storm. Temperatures easily drop to -37°

ferre with almost every other repeater in Germany operating on the same channel. Since the Zugspitze at this time was set up to be a part of the overall German repeater network and not a special repeater, the interference problem with other repeaters had to be solved. The obvious solution was taken of reducing the transmitter power to a little over $\frac{1}{2}$ W. This power level still provided more than adequate service using the repeater throughout most of southern Germany and the repeater functioned in this manner throughout 1971.

However, the vision had certainly been created in the minds of the Munich amateurs as to what could really be done with the Zugspitze repeater if it was brought up to full power level and allowed to operate on a clear channel. A reorganization of the German repeater network channels in late 1971 made provision for the Zugspitze repeater to be set up on a separate clear channel (enter on 144.275, receive on 145.725) and planning was started on completely re-equipping the repeater.

The team of DJ9HJ, DL9ZD, DJ3YB and other Munich amateurs again got together

and decided that rather than try to refurbish the old repeater equipment to build a completely new installation using high performance equipment and specifically designed for the environment found on the Zugspitze. Although by now there appeared to be some hope of getting the radio clubs in the southern Germany area to help defray the cost of the equipment, the initial expenditures were totally those of the individual amateurs concerned with the project. The equipment designs that evolved for the new Zugspitze DX repeater would deserve several articles in themselves to describe it all completely. The equipment was totally home-brewed, but with a quality I have seldom seen matched in the finest commercial gear.

Basically the total equipment package fits in a container about 2' x 1½' x 2" high and consists of the antenna filter, receiver, transmitter and control and call-sign identifier. Each unit has been tested in an environmental chamber to simulate the extreme conditions encountered on the mountain. The receiver consists of a FET input rf amplifier stage working into a mixer using four HP2800 hot carrier diodes to translate the signal frequency down to 10.7 MHz. At 10.7 MHz several crystal filters are used to achieve a 20 kHz bandwidth and then a phase-locked loop circuit is used as a FM demodulator. The noise figure of the basic receiver is slightly over 2 dB and the noise figure of the entire receiver side of the repeater including the effects of the antenna isolation filter is 3.5 dB. The squelch sensing circuitry operates on a dual frequency sampling basis to guard against accidental trip by stray interference. The transmitter side of the repeater, which is also fully transistorized, produces 15W output. In order to avoid the generation of many spurious signals which is usually the case when one starts with a low frequency crystal and multiplies it up to 144 MHz, a different frequency generation scheme was used. This was considered useful because the transmitter had to operate so closely to a very high performance and sensitive receiver. Figure 1 shows the transmitter frequency control scheme. A Voltage Controlled Oscillator

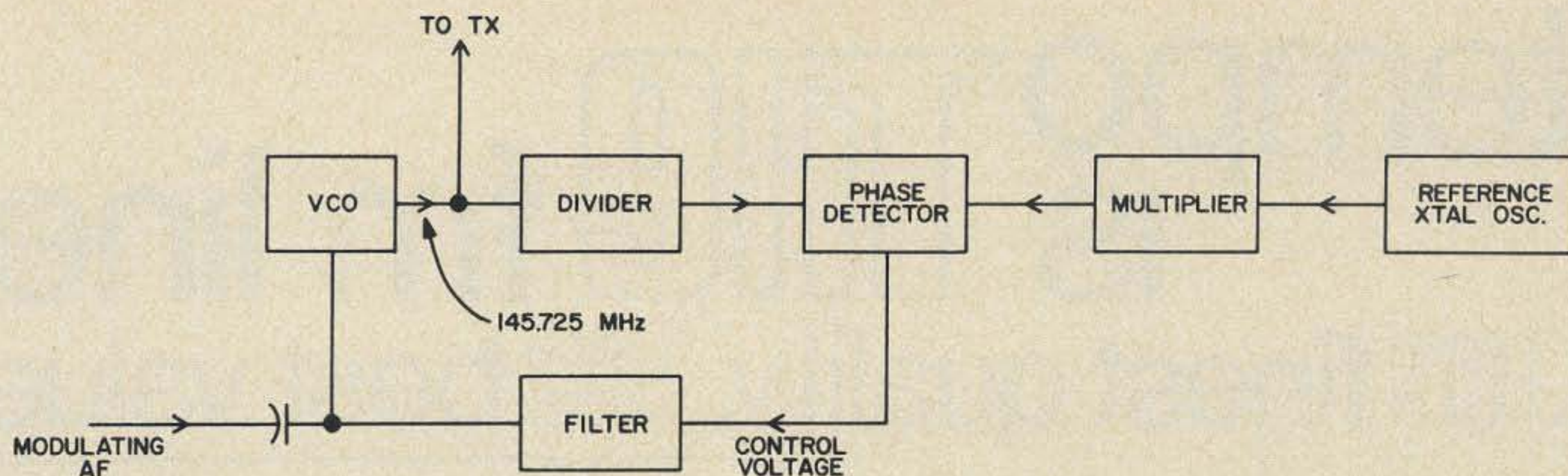

Fig. 1. Principle of operation of transmitter frequency control system.

operating directly at 145.725 MHz is used. The output frequency is divided down and then compared in a phase detector with the frequency of a reference crystal oscillator which has been multiplied up in frequency. The resultant difference control voltage from the phase detector is used to control the frequency of the VCO. The VCO is directly FM modulated by an audio signal, the control voltage from the phase detector being made slow enough not to react on the modulation. The control, alarm and call identifier chores are taken care of by circuitry consisting of some 24 IC's from Texas Instruments. The call repeater works on a shift register principle and is timed to send the call (DBØZU) every 80 seconds. If the transmitter has not been keyed by a user, the transmitter is turned on just for the duration of the ident. Normally, a tone burst of 1750 Hz is necessary to key the repeater. It then remains carrier keyed for 15 seconds after which the tone burst has to be repeated. If someone should open the repeater just as it is about to identify itself via F2, the ident is skipped until the next 80 second period. This is to prevent the call from a weak DX station being obscured by the repeater identifier signal.

The subject of the antenna to be used with the new repeater was often debated. Since the new repeater was intended primarily as a DX repeater, the idea of horizontal polarization became popular since the repeater would be primarily used by home stations. However, this idea was eventually dropped and it was decided to leave the repeater with vertically polarized antennas so mobile stations could also easily use the

repeater. Furthermore, since the antennas already installed performed without failure, it was decided to leave them in operation for the time being. The only fault with the present antenna installation is that as one can see from one of the photos, the receiving antenna is partly shadowed by a portion of the weather tower. The ultimate plan is to use only one antenna for both transmitting and receiving which would be elevated to clear all obstacles. A form of ferrite circulator will be used to isolate the receiver and transmitter rf circuits. Such circulators are economical and provide up to 50 dB isolation but are quite critical as to proper termination. Damage to the antenna, for instance, which causes the swr to rise, would destroy the isolation characteristics. However, that plan belongs to the future as well as the one to have the receiver bandwidth automatically controlled by the strength of the received signal — smaller bandwidths being used for weak stations to increase intelligibility.

The Zugspitze DX repeater was installed in May of 1972 and has been fulfilling a repeater user's dream. Records will still be in the process of being set for some time as to how far away DX can be worked in the various countries the repeater signal covers. The debate also goes on as to whether DX via a repeater is really DX at all. But whatever might be said there is no denying that working various countries via a repeater couldn't be more fun. The Zugspitze repeater will most certainly open up new thoughts and challenges for the usage of repeaters for years to come.

...W2EEY

tempo IS THE fm line

..THE finest quality.. THE best value

Tempo's Commercial Line VHF transceivers offer commercial performance at amateur prices. Compare these transceivers with any other available. Compare their performance, their quality of construction, their ease of maintenance, and then compare prices. Your choice will have to be Tempo.



TEMPO/CL 146

The CL-146 offers operation on the 146 MHz amateur band. The price includes a microphone, power cord, mounting bracket and one pair of crystals. A full line of accessories is also available.

- 12 channel capability • 13 watts or a power saving 3 watts • All solid state, 12 VDC • 144 to 148 MHz (any two MHz without retuning)
- Supplied with one pair of crystals • RF output meter, S-meter, receiver detector meter
- Provisions for external oscillator • Monitor feature • Audio output at front panel • Internal speaker • The Price: \$279.00

TEMPO/CL 220



As new as tomorrow! The superb CL-220 embodies the same general specifications as the CL-146, but operates in the frequency range of 220-225 MHz (any two MHz without retuning). At \$329.00 it is undoubtedly the best value available today.

TEMPO/6N2

The Tempo 6N2 meets the demand for a high power six meter and two meter power amplifier. Using a pair of Eimac 8874 tubes it provides 2000 watts PEP input on SSB and 1000 watts input on CW and FM. Completely self-contained in one small desk mount cabinet with internal solid state power supply, built in blower and RF relative power indicator. \$595.00



TEMPO/fmh

So much for so little! 2 watt VHF/FM hand held. 6 Channel capability, solid state, 12 VDC, 144-148 MHz (any two MHz), includes 1 pair of crystals, built-in charging terminals for ni-cad cells, S-meter, battery level meter, telescoping whip antenna, internal speaker & microphone. \$189.00



TEMPO/fmp

Truly mobile, the Tempo/fmp 2 meter 3 watt portable gives amateurs 3 watts, or a battery saving 1/2 watt, FM talk power anytime. With a leather carrying case included, this little transceiver will operate in the field, in a car, or at home with an accessory AC power supply. The battery pack is included. The price: \$225.00 (Accessory rechargeable battery available: \$22.00)

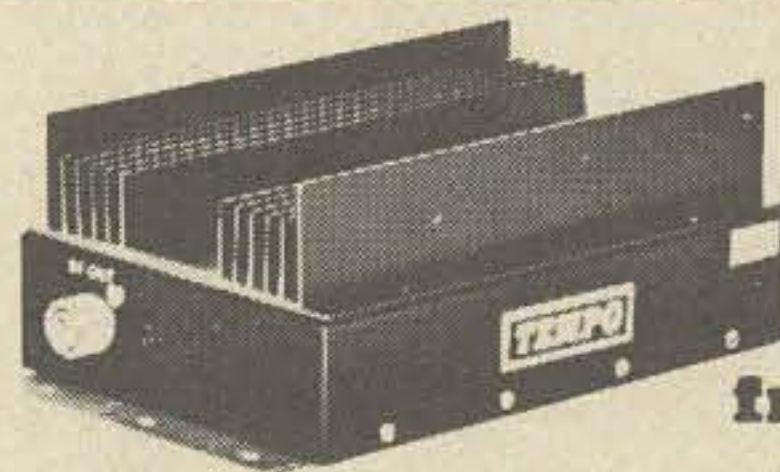

TEMPO/TPL high power fm amplifiers

MODEL NUMBER	POWER INPUT	POWER OUTPUT (min)	BAND	PRICE
TPL1002-3	5 to 25W	100-135W	2M	\$220.00
TPL1002-3B	1-3W	80W	2M	\$235.00
TPL802	5W	80W	2M	\$180.00
TPL802B	1 to 3W	80W	2M	\$195.00
TPL502	5 to 15W	35-55W	2M	\$105.00
TPL502B	1 to 3W	45W	2M	\$130.00
TPL252-A2	1W	25W	2M	\$ 85.00
TPL445-10	1 to 2.5W	12W	440MHz	\$125.00
TPL445-30	4W	30W	440MHz	\$215.00
TPL445-30B	1W	30W	440MHz	\$235.00
TCP 12A Control Head . . .				\$32.00

Prices subject to change without notice.

Henry Radio

11240 W. Olympic Blvd., Los Angeles, Calif. 90064
931 N. Euclid, Anaheim, Calif. 92801
Butler, Missouri 64730

213/477-6701
714/772-9200
816/679-3127

AVAILABLE AT SELECT DEALERS THROUGHOUT THE U.S.

A BALANCED DIPOLE ANTENNA

The antenna described displays the following features: rf balance to ground; lightning protection; low loss ground system; multi-band capability; and simple erection procedure.

Over the years I have erected a large number of 80 meter dipole antennas embodying a great variety of mechanical and electrical arrangements. Out of these multiple experiences have come a fair number of features which might qualify as "good" practice.

It is the purpose of this article to describe a readily erected dipole system which combines excellent performance with unique electrical and mechanical features.

First, I wanted the radiating efficiency to be high. Secondly, since the use of this dipole in a phased array was contemplated, a predictable dipole field pattern was desirable. This required good electrical balance at the feedpoint and a uniform ground system.

Third, since I have had enough good luck for one lifetime regarding lightning damage (none) I wanted the sides of the dipole to be directly connected to ground for dc at all times.

Fourth, since I am addicted to antenna experimentation, I wanted the ends of the dipole to be readily accessible for length adjustment and the entire structure easily taken down for major changes.

In addition, why not add 40 meters?

The principal radiation from such a dipole is in a plane perpendicular to its direction; the polar plot of field strength is essentially a circle tangent to the surface of the ground. Thus, the radiation is concentrated at the high angles, near the vertical.

The desirable low-angle radiation will increase as the height of the antenna is increased. In addition, the losses in the antenna and in the ground are decreased as the height increases.

An effective compromise between operating results and cost of the installation normally calls for a height of about 40 to 60 feet. Greater height is desirable but expensive, whereas at lower heights the efficiency and the pattern shape become unacceptable.

It turns out that the five-section telescoping TV masts, available in the popular TV supply stores for about \$20, are satisfactory for supporting the center of the dipole at a height of 45 feet. This mast can be assembled on the ground and walked up or hoisted to a vertical position. If clamped against a house or other structure at about the 15 foot level the mast need only be guyed at the top, even in the strong winds of the Rochester area.

The two halves of the 80 meter dipole serve as top guys in, say, the north-south directions, and the two halves of the 40 meter dipole (with a common coaxial feed line) double as east-west guys.

For ease of erection the mast is pivoted at its base. This base support is a 5 foot length of 1-1/2" diameter galvanized steel tubing projecting 1 foot above the ground. A 5/16" bolt through the post and mast provides the pivoting shaft. The side of the mast is

SUPER CRYSTAL THE NEW DELUXE DIGITAL SYNTHESIZER!! FROM **R_p**

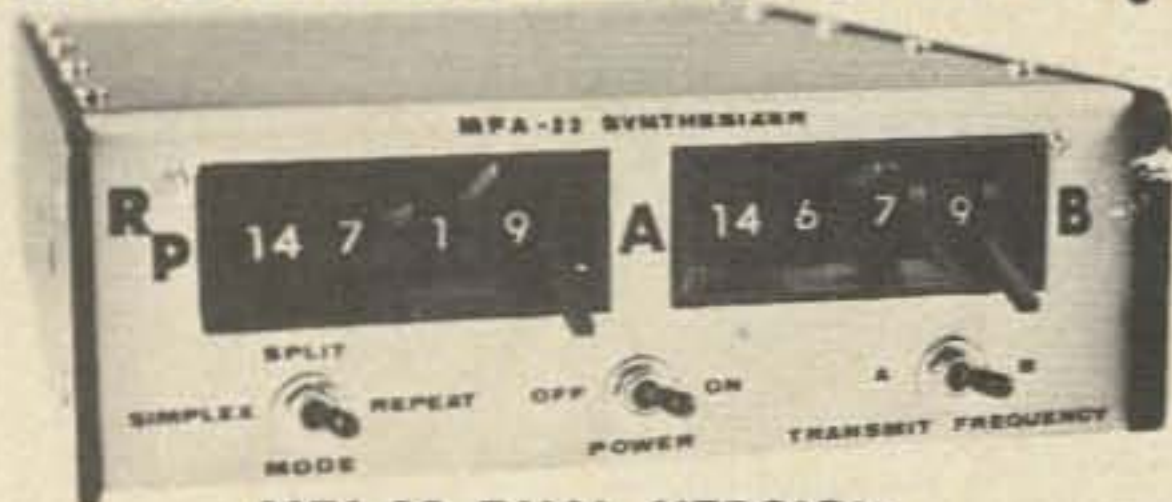

MFA-22 DUAL VERSION

Also Available **MFA-2 SINGLE VERSION**

- **Transmit and Receive Operation:** All units have both Simplex and Repeater Modes
- **Accurate Frequency Control:** .0005% accuracy
- **Stable Low Drift Outputs:** 20 Hz per degree C typical
- **Full 2 Meter Band Coverage:** 144.00 to 147.99 MHz. in 10KC steps
- **Fast Acting Circuit:** 0.15 second typical settling time
- **Low Impedance (50 ohm) Outputs:** Allow long cable runs for mobiles
- **Low Spurious Output Level:** similar to crystal output

• PRICES

MFA-22 \$275.00
MFA-2 \$210.00
Shipping \$3.00

R_p Electronics

Box 1201 B
Champaign, IL 61820

SEND FOR FREE DETAILS

ACTIVE AUDIO FILTERS

IC'S FOR SUPER HIGH PERFORMANCE

CW FILTER (CWF-2) Get razor sharp selectivity; No impedance matching! BW (selectable) 80 Hz, 110 Hz, 180 Hz; Center frequency F=750 Hz; Skirts 60 db down at 1/2F and 2F; 4 op amps; 2"x3" PC board; \$14.95 wired, tested, guaranteed; \$12.95 kit.



CWF-2: \$12.95 KIT, \$14.95 WIRED

CW MINI FILTER (CWF-3) 1 1/2"x2" PC board; Center frequency F=750 Hz; 30 db down at 1/2F and 2F; BW 110 Hz; 2 op amps; \$8.95 wired, tested, guaranteed; \$7.95 kit.

LOW PASS FILTER (LPF-1) Resistors set cutoff 500 Hz to 20 KHz; Factory set to 2.5 KHz; Rolloff 48 db per octave; Input imp 1 M; Gain=1; 5 op amps; 2"x3" PC board; \$16.95 wired, tested, guaranteed; \$14.95 kit.

****please include 55¢ postage on all orders****

WRITE FOR FREE SPEC SHEETS!!!

MFJ ENTERPRISES

P.O. Box 494-C
Miss. State, Ms 39762

SPACE-AGE TV CAMERA KITS & PLANS



BE A PIONEER IN HOME TELECASTING! Build your own TV CAMERA. Model XT-1A, Series D, \$116.95 pp. Solid-State. Step-by-step construction manual. High quality. Connects to any TV without modification. Ideal for hams, experimenters, education, industry, etc.

PHONE or WRITE for CATALOG.
DIAL 402-987-3771

Many other kits, parts and plans available including starter kits, focus/defl. coils, vidicon tubes, const. plans, etc.

130; N. BROADWAY **ATV Research** DAKOTA CITY, NEBR. 68731



DYNAMIC ELECTRONICS INC.
Box 1131 Decatur AL 35601

WHY FIGHT QRM?

Copy code through the QRM with a NEW DE-101 Signal Discriminator. Built in ac Supply, factory tuned, and a one year warranty. \$29.95 plus \$2.00 shipping. Alabama residents add 5% tax.

hacksawed diagonally at the base to clear the supporting post.

The coaxial feed line for the dipoles is inside the mast; this decreases wind problems and also serves to shield the outer sheath of the coax from unwanted rf coupling.

A balun coil arrangement is frequently used to assure balanced currents at the center of a dipole antenna. In the present instance a novel method is used which not only provides the required balance to ground but which also offers a low-resistance dc current path to ground from both sides for lightning protection.

The mast itself forms the outer conductor of a coaxial section having the sheath of the feedline at its inner conductor. The length of this coaxial section inside the mast is approximately one quarter wave length. Therefore, if the shield is shorted to the mast at its base, the impedance viewed from the top will be high so that it can be connected across the center feed point of the dipole without appreciable loading. This unorthodox arrangement is completed by connecting the center conductor of the coaxial feedline directly to the top of the mast! One half of the dipole antenna is connected to this common point, the other half to the shield and, to relieve the suspense, it works fine! The arrangement provides dc current paths to ground for lightning protection of both sides of the dipole and it achieves balance of antenna currents through its balun action.

The rf transmitting currents in either half of each of the dipoles are conveniently indicated by means of four flashlight bulbs, not shown in the figures. Each bulb is shunted across a 3" length of the antenna wire just outside of the top insulator. A 3" length of #18 copper weld wire is used from each side of the bulb so that the latter is soldered in place at a corner of a 3" equilateral triangle. This area of pick up loop gives adequate brilliance for tests without burning out the bulbs. The equal brilliance of the two 80 meter bulbs, for example, provides an excellent indication of the balun action of the unorthodox mast connection used.

In order to insure a stable dipole pattern with symmetrical ground reflection and to

reduce ground losses, a grid of nine parallel ground wires, each approximately 200 feet long, spaced ten feet apart, was buried under the dipole parallel to its plane. A single cross-buss was placed across the middle of the grid and soldered at the cross-over points. The base support of the antenna mast was connected at the center of this ground system.

The clamping hardware supplied with the mast was discarded. The mast was extended horizontally on blocks on the ground and the overlapping sections were secured against vibration by us of #18 self-tapping screws. The mast was painted to discourage rust; the color was chosen to match the shutters of the house in a gesture toward community harmony.

The antenna wires and the coaxial feed line are supported at the top of the mast by a cylindrical plastic insulator. This insulator, which combines high strength with low wind resistance, is made by sawing off the grooved male portion of a "T" fitting for plastic water pipe. There is a size which is a snug push fit over the 1-1/4" o.d. mast. The grooves serve to anchor the wires and they also provide an improved leakage path for rf currents.

The details of the insulator assembly are shown in Figs. 1 and 2. All wires are #12 stranded copperweld. The "D"-shaped wire loops pass through the insulator, one above the other, as shown. There are no screw connections to loosen or corrode and, of course, all connections are twisted and soldered. A radiator hose clamp holds the insulator in place. The RG-8/U coaxial feed

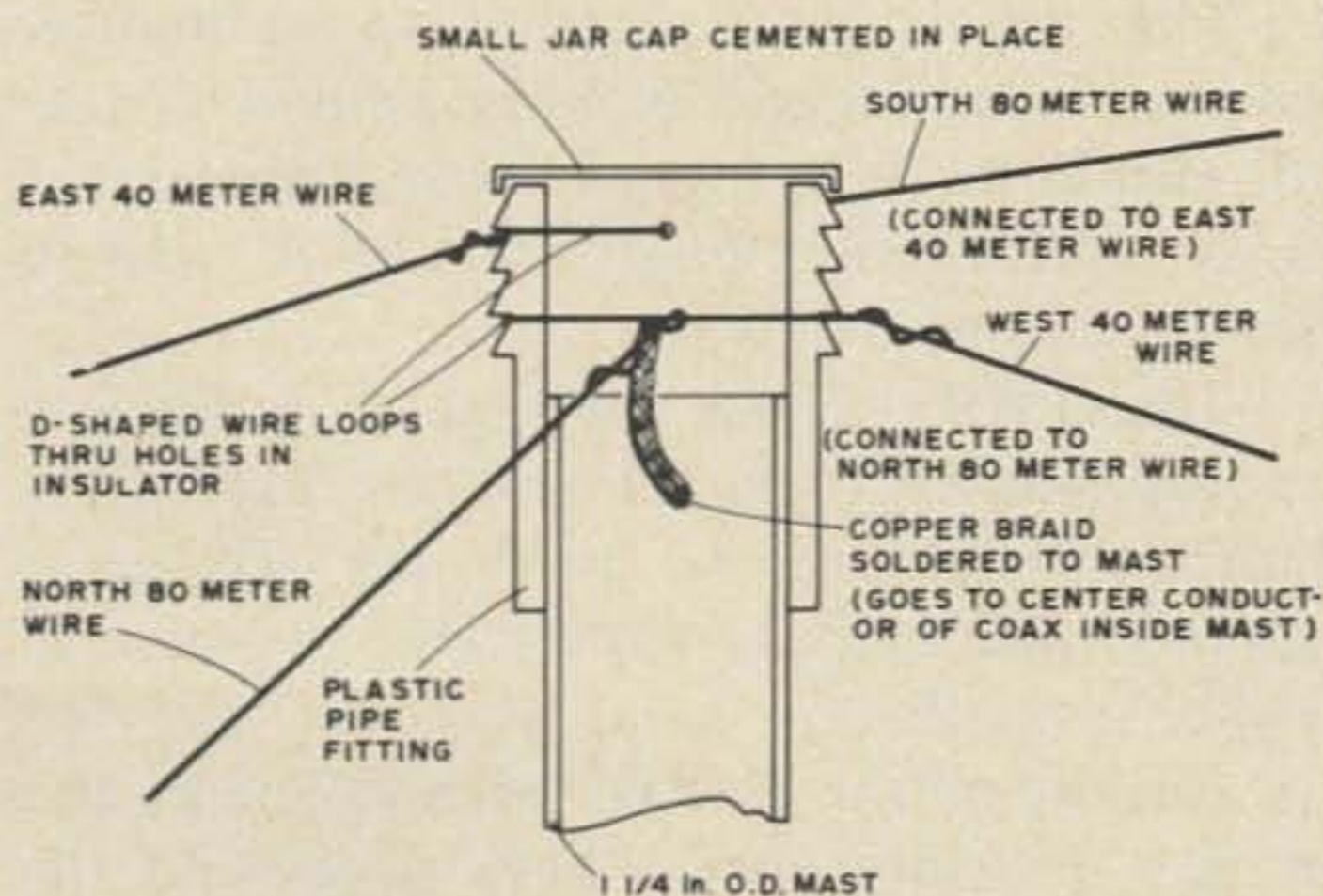

Fig. 1. Top insulator - side view.

CRYSTAL BARGAINS

Depend on . . .

We supply crystals from 16KHz to 100MHz. Over 6 million crystals in stock.

JAN

CRYSTALS

DIVISION OF BOB WHAN & SON ELECTRONICS, INC.

2400 Crystal Dr.
Fort Myers
Florida 33901
(813) 936-2397

SPECIAL

Crystals for most amateur 2-Meter F.M. Transceivers:

\$3.75 Each

Inquire about quantity prices. Order direct. Send check or money order.

For first class mail add 15¢ per crystal...for airmail add 20¢ ea.

Send 10¢ for new catalog with oscillator circuits and lists of thousands of frequencies in stock.

SPECIALS! CRYSTALS FOR:

Frequency Standards	
100 KHz (HC13/U)	\$4.50
1000 KHz (HC6/U)	4.50
Almost All CB Sets, Trans. or Rec. (CB Synthesizer Crystal on request)	2.50
Any Amateur Band in FT-243 (Except 80 meters)	1.50
80 Meter Range in FT-243	4 for 5.00
Color TV 3579.545 KHz (wire leads)	2.50
	1.60
	4 for 5.00

TWO BOOKS EVERY FM'ER MUST HAVE!



How To Use FM. A comprehensive introduction to FM that gets you on the air fast, easily.

Atlas of FM Repeaters. The newest most complete list of repeaters worldwide.

Please send me the book(s) checked above. Enclosed is check or money order for \$

Name _____ Call _____

Address _____

City _____ State _____ ZIP _____

Mail to: 73 Inc., Peterborough NH 03458

NEWEST BOOK for FVlers!

DIGITAL
CONTROL
OF REPEATERS

Thomas R. Yocom
WAØZHT

A 73 PUBLICATION

\$5.00

Here's the book for every ham who wants to design and build a digital repeater control system (or who wants to just think about doing that). Contains sections on repeaters, basic logic functions, logic circuit design, control systems, support circuits, mobile installations, touchtone, plus a special section on a "mini" repeater control system. 224 pages.

Hardcover **\$7.00**

Paperback **\$5.00**

73 Magazine, Peterborough NH 03458

Enclosed is \$ ____ . Please send hardcover (\$7)/ paperback (\$5) copies of "Digital Control of Repeaters" to:

Name _____ Call _____

Address _____

City _____

State _____ ZIP _____

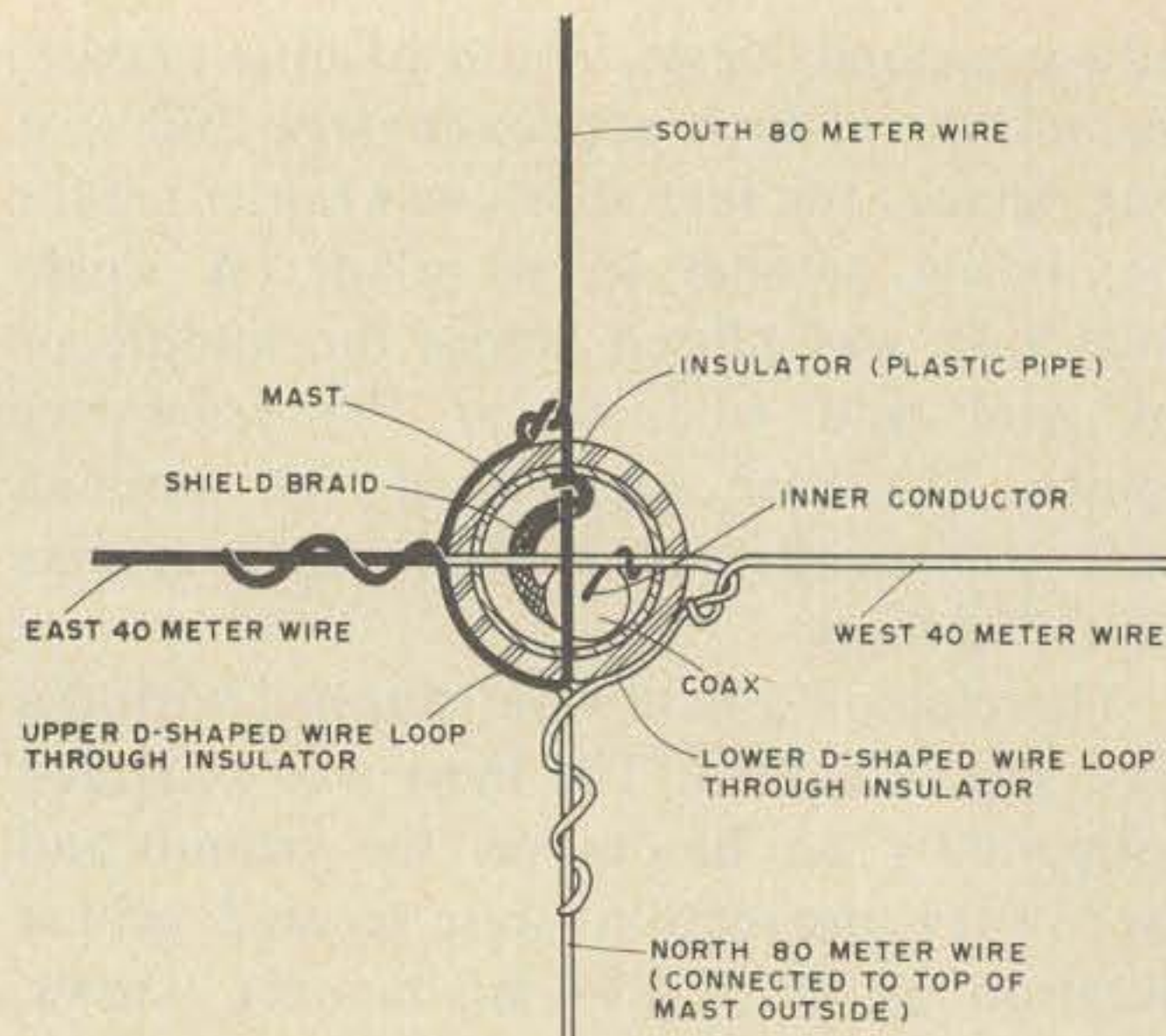

Fig. 2. Top insulator - top view.

line is supported from the "D"-loops, centrally within the mast. (This feed line is cut to be a multiple of a half wavelength - approximately 82' 2" for a 3.955 MHz.) A noise bridge is used for this and all other resonance measurements.

The mast was hoisted to the vertical position using an inexpensive 4-pulley rope hoist attached at the 16' height. After erection the mast was clamped to the house roof at the 15' level using a steel strap and lag screws.

The four halyards at the end of the antenna wires are of 1/8" nylon rope. These are supported by 2-1/2" diameter galvanized posts seven feet high. These posts are each located at a distance of 80 feet from the base of the mast and are connected to the ground system. The ropes are secured by swivel snaps attached to the tops of the posts, for ease of lowering for antenna adjustments.

The dipole was adjusted to resonance, using a noise bridge, by adding equal lengths at either end. Resonance was achieved at 3.955 MHz with a length of 120' 9" and an input resistance of 50Ω.

The SWR of the antenna is quite low (approximately 1.01:1) and its response is sufficiently broad to cover the 80 meter phone band without appreciable decrease in signal strength.

Results on the air have been excellent and it is a pleasure not to have to ground the antenna during lightning storms.

...W2OZH

DIGITAL "HI" GENERATOR

Probably one of the most used greeting or expression in amateur radio be it a car with call letter plates passing another, or the passing of an OSCAR satellite overhead, is the simple world, "HI." I do not know how it all started but I know that if I want to greet another ham on the road, I want to honk "HI." Therein lies the problem. My car is one with the horn incorporated in the steering wheel rim, and it is next to impossible to honk any kind of code, much less the rapid succession of four dots and then two dots. This prompted me to design a circuit which will digitally produce the word "HI." The scope of this article will be to describe the basic digital "HI" generator, which can be used in any application desired by the addition of the appropriate output keying stage.

Figure 3 shows a typical output stage which can be used to key the horn relay of a car. In this application, the driver would be simply required to touch a momentary contact push button type of switch and the "HI" generator will start and self-complete the word "HI." This circuit uses a total of four integrated circuits and eight discrete components, and when built will easily fit in the palm of your hand.

Referring to Figs. 1 and 2, a unijunction transistor oscillator located on plug-in-board

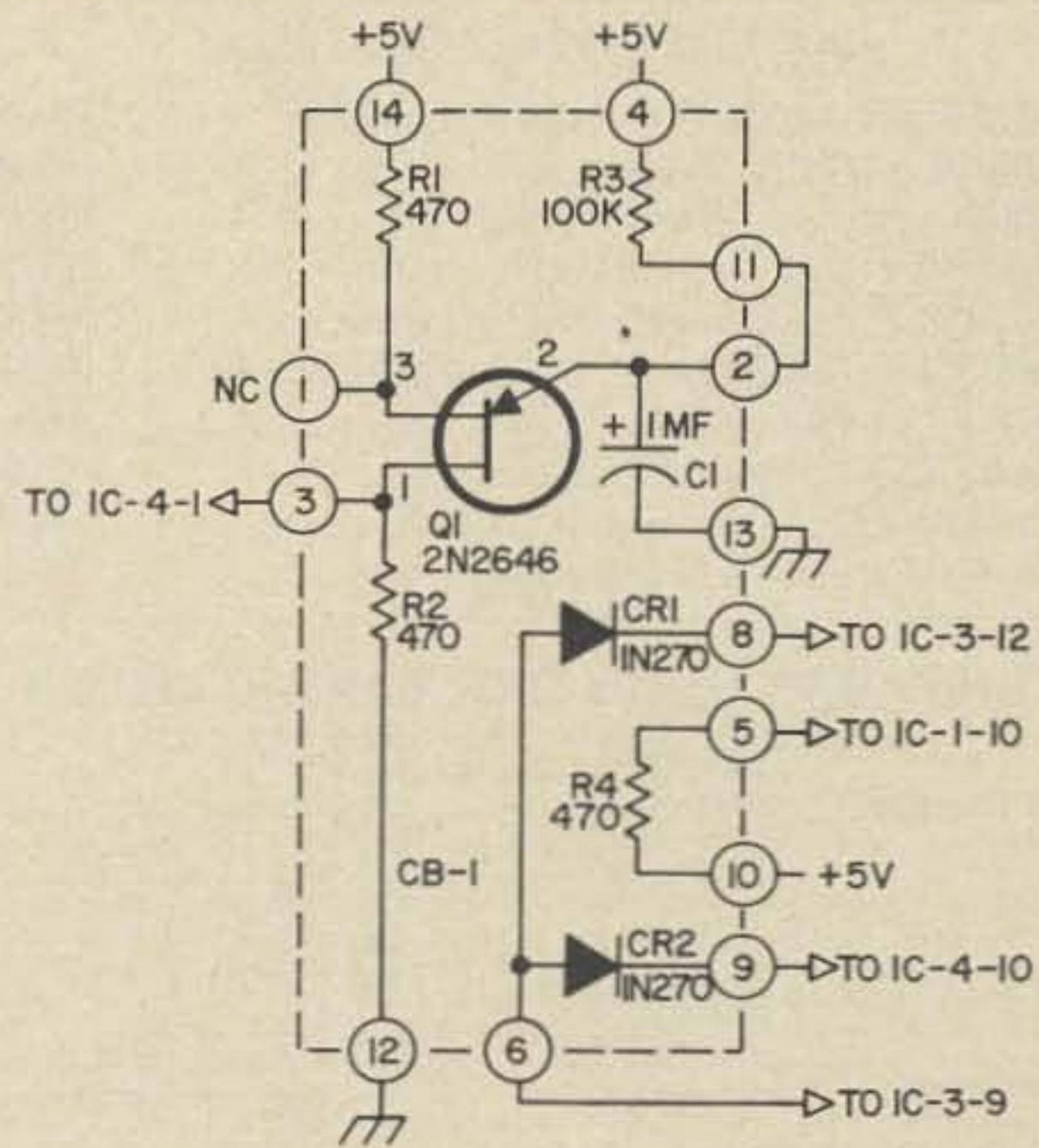

ALL RESISTORS 1/4W

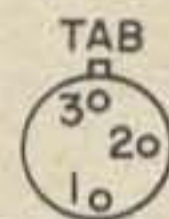

2N2646 BOTTOM VIEW

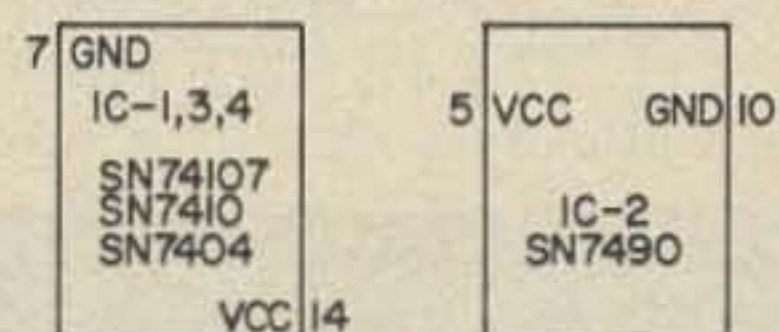

Fig. 1. "HI" generator.

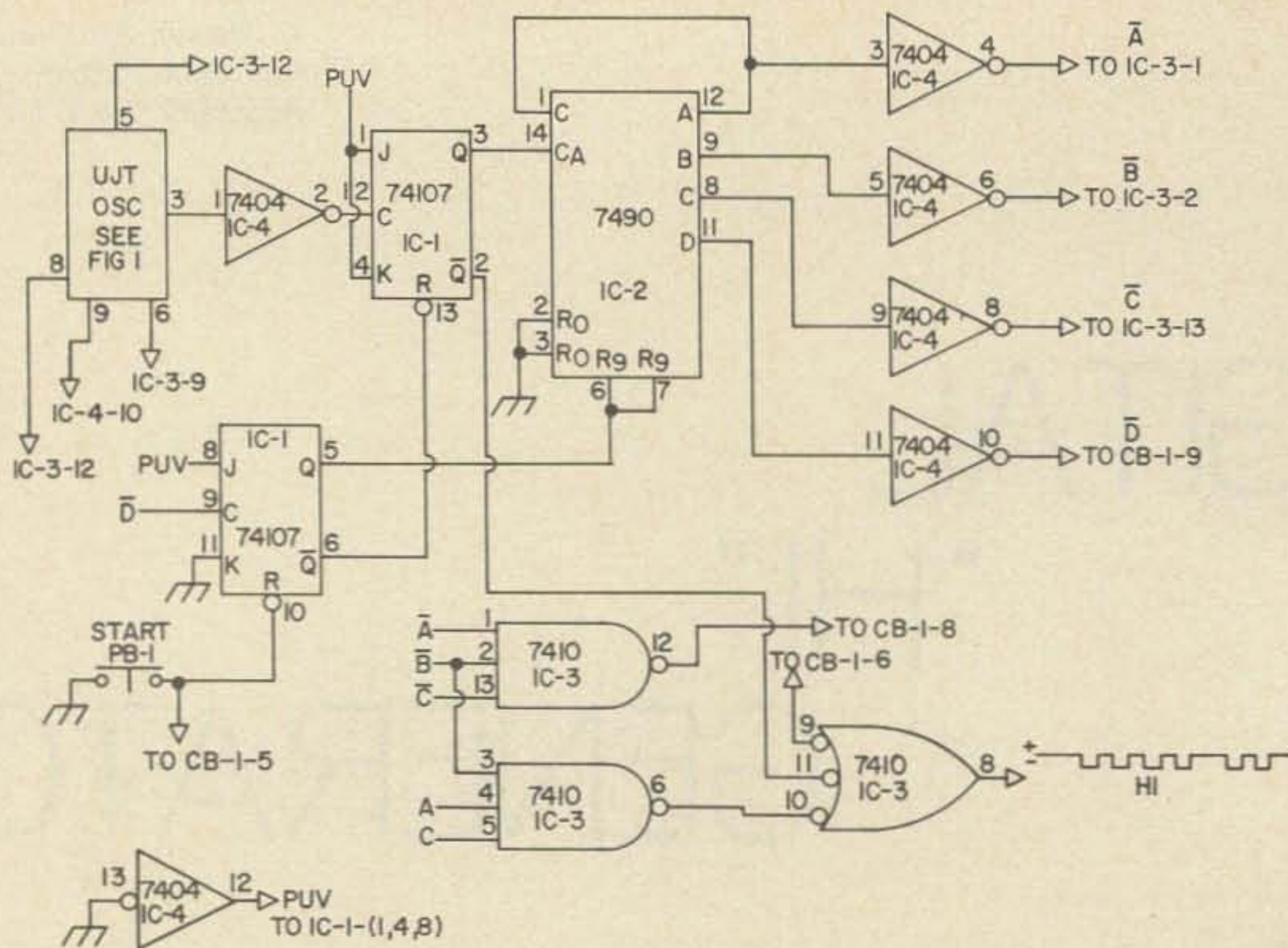

Fig. 2. Basic "HI" generator.

CB-1 generates a timing pulse which is fed into a 7404 inverter (IC-4-1) and is shaped and inverted to form a narrow, negative-

going pulse. This pulse is fed into a JK flip-flop (IC-1) which, when allowed to run by the setting of the "run" flip-flop, acts as a divide-by-two counter whose output is a symmetrical square wave. This square wave, which will be referred to as the clock term, is wired to two locations. The first location is the clock input of the SN7490 decade counter that "counts" the clock pulses, and the second location, the output gate, (IC-3) which uses the oppose phase or $\overline{\text{clock}}$. This term is simply the \overline{Q} side of the clock flip-flop. The purpose of the $\overline{\text{clock}}$ term driving one input of the output gate is to chop anything passing through this gate into a series of dots. Since this gate, as described thus far, will produce an endless string of dots, all we have to do is inhibit the unwanted dots and we will have the word

DIGITALLY-TUNED RECEIVERS:	
R-389/URR: 15-1500 KHz, OK grtd, w/book	375.00
R390: 0.2-32 MHz, OK grtd, w/oper. book	495.00
R390A adds mech. filters, w/oper. book	595.00
AN/WRR-2: 2-32 MHz, OK grtd, w/book	750.00
CV-591A SSB Conv., 455 KHz, OK, w/book	137.50
Nems-Clarke #1670 FM rcvr 55-260 MHz, w/book	195.00
OCT-3 TTY FSK deviat. meter/rcvr, new	49.50
WWVB 60 KHz rcvr/comparator OK, w/book	295.00
Motorola 3 MHz Osc., 5 parts in 10 ¹¹	199.50
AIL 30 MHz rcvr/amplif/atten. calibrator	99.50

HIGH-SENSITIVITY WIDE-BAND RECEIVER	
COMMUNICATIONS • BUG DETECTION	
• SPECTRUM STUDIES	
38-1000 MHz AN/ALR-5: Consists of brand new tuner/converter CV-253/ALR in original factory pack and an exc. used, checked OK & grtd main receiver R-444 modified for 120 v. 50/60 hz. The tuner covers the range in 4 bands; each band has its own Type N Ant. input. Packed with each tuner is the factory inspector's checkout sheet. The one we opened showed SENSITIVITY: 1.1 uv at 38.4 mhz, 0.9 at 133 mhz, 5 at 538 mhz, 4 1/2 at 778 mhz, 7 at 1 ghz. The receiver is actually a 30 mhz IF ampl. with all that follows, including a diode meter for relative signal strengths; an atten. calibrated in 6 db steps to -74 db, followed by an AVC position; Pan., Video & AF outputs; switch select pass of ± 200 khz or ± 2 mhz; and SELECT AM or FM! With Handbook & pwr. input plug, all only	
30 MHz PANADAPTER OK grtd	295.00

Attention!
Buyers, Engineers, advanced Technicians:

We have the best test-equipment & oscilloscope inventory in the country so ask for your needs . . . don't ask for an overall catalog . . . we also buy, so tell us what you have. Price it.

R. E. GOODHEART CO., Inc.
Box 1220 GC, Beverly Hills, Calif. 90213
Phones: Area Code 213, Office 272-5707

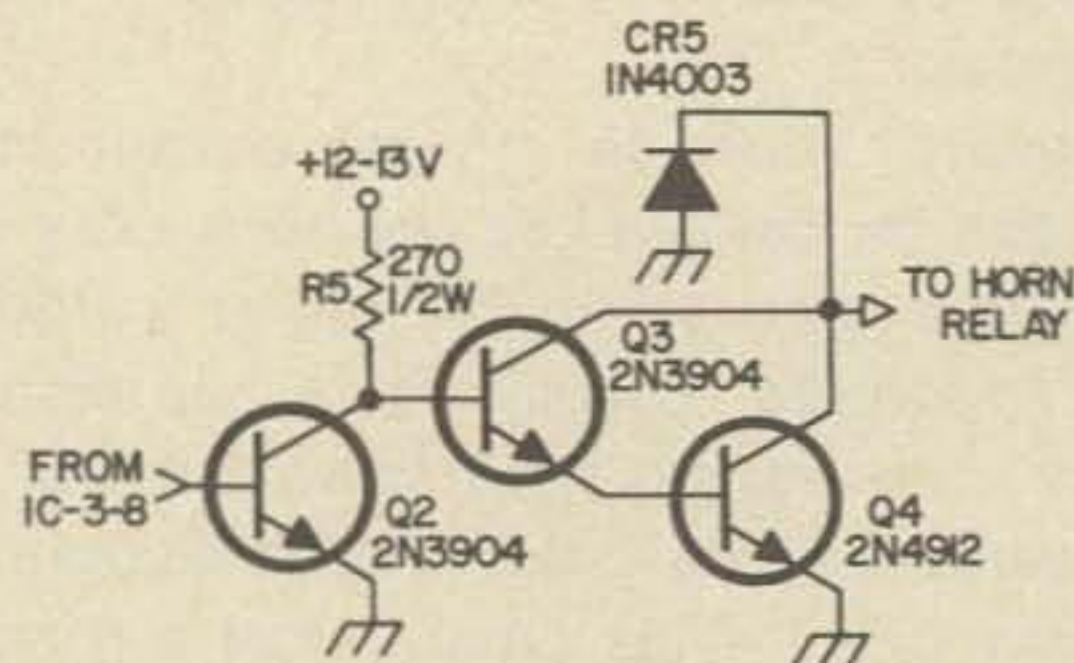
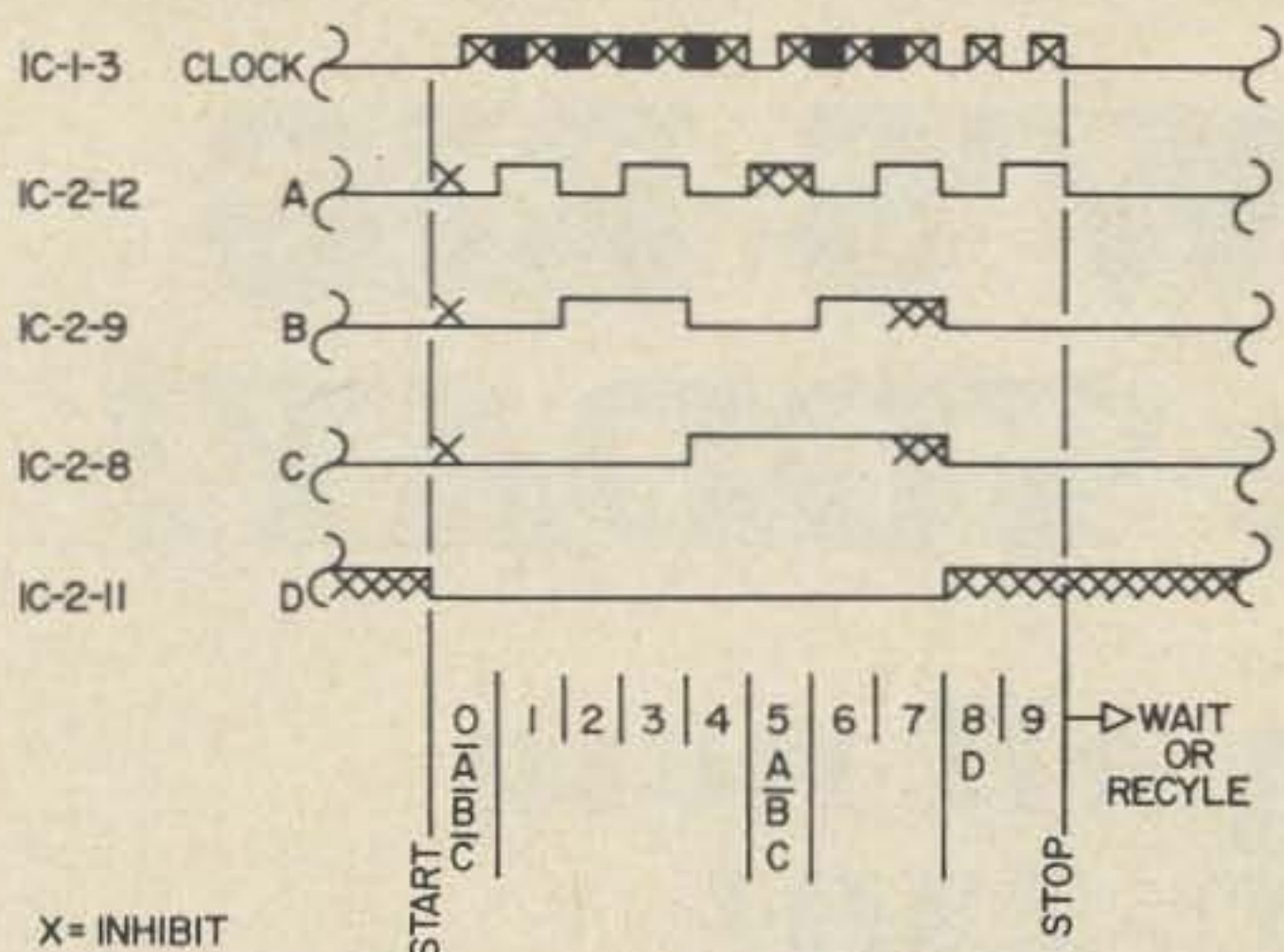

Fig. 3. Typical output stage that will key the horn relay of your automobile.

TIMING DIAGRAM



X = INHIBIT

"BEEP" OUTPUT INHIBIT = $(\overline{ABC}) + (A\overline{B}C) + \text{CLOCK} + D$

OR
OUTPUT = $\overline{\text{CLOCK}} \cdot (\overline{ABC} + \overline{A}B\overline{C} + A\overline{B}C + \overline{A}BC + ABC) \cdot \overline{D}$

Fig. 4. Timing diagram.

"HI" remaining. Referring to the timing diagram (Fig. 4) it will be noted that to form the word "HI" we must get rid of count zero, count five, and counts eight and nine. To do this we do not need to decode all bits; all we need is enough information to electrically describe the period we are interested in. You will see that count zero has a unique condition when terms A, B, and C are all low. These three terms are inverted by IC-4 so as to provide the high level needed for the 7410 to decode an AND condition of $\overline{A} \overline{B} \overline{C}$. In the same manner, the count of five is decoded using the terms A, \overline{B} , and C.

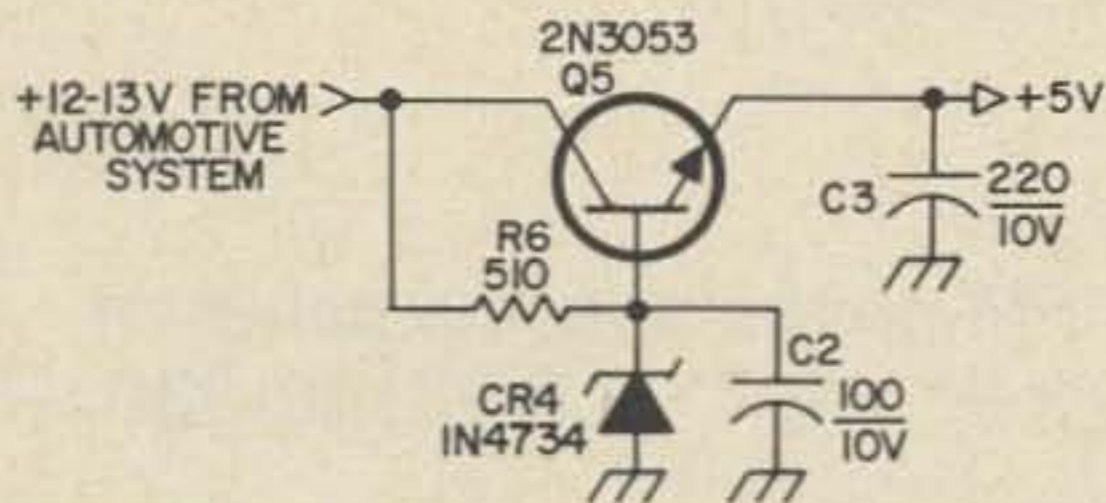

Fig. 5. 5V automotive power supply for the "HI" generator.

Since we do not want counts eight or nine, we use the term "D" which occurs only during these counts, to directly inhibit them. A secondary function of this term is to reset the "run" flip-flop back to the waiting state. So we can now say that we will have an output key unless $\overline{\text{clock}}$ is low or \overline{D} is low or zero decade is present or five decode is present. Add this all together and all that is remaining is "HI."

. . .WA6JMM

YAESU

Newly appointed dealer for the East Coast is now taking orders on Yaesu equipment. Send for literature and free list of used equipment available.

FRECK RADIO & SUPPLY CO.

40 Biltmore Avenue

P.O. Box 7287

Asheville, North Carolina, 28807

Telephone: 704-254-9551, W4WL

FM Schematic Digest

A COLLECTION OF

MOTOROLA SCHEMATICS

Alignment, Crystal, and Technical Notes covering 1947-1960

136 pages 11 1/2" x 17" ppd \$6.50

S. Wolf

Box 535

Lexington, MA 02173

NEW

MX1A

\$47.50

NEW

MX1A

\$47.50

MINI-MIXER

This is a plug in unit to replace the first mixer in Collins 75S-1-2-3. Designed to eliminate all but the strongest (next door) cross modulation in the S line. It uses the latest in FET design. If not satisfied, money refunded.

Designed Built Backed by

ANTENNA MART

BOX 7 RIPPEY, IOWA 50235

Isolated - Pad - Drill - Mill

Precision circuit board construction without etching. Fits hand drill, electric drill. Simple, fast, economical, safe. Sizes: .250, .160 dia.

\$6.95 ea.

Calif. residents add 5%.



A F STAHLER Co

P.O. BOX 354 CUPERTINO, CALIF 95014

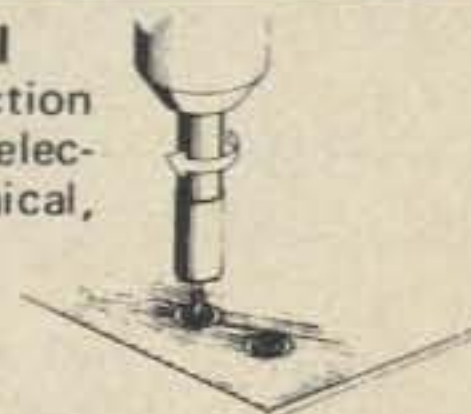

QRPP THE MILLIWATT QRPP

All about under-five watt amateur radio. If you've been wanting to try QRP, then The Milliwatt is a MUST for you!!!

- Construction Projects
- Technical Articles
- Operating News
- WAS & QRPP DXCC Standings

RATES: \$3.40 yearly. Reprints: Vol. I—\$4.00; II & III—\$3.50 each (all three—\$10.00).

Sample 25¢

SUBSCRIPTIONS, to: ADE WEISS KBEEG/8

213 Forest, Vermillion, SD 57069

TOMORROW'S RIG ...available TODAY!

*The exciting all new
INOUE IC-230!*



TAKE A SLICE OUT OF THE FUTURE . . .

. . . and put 67+ CHANNELS* of 2-meter FM pleasure in the palms of your hands . . . with the SUPER COMPACT (2.3" x 6.1" x 9.7") IC-230.

Feature-wise . . . the IC-230 is *fully synthesized* (with the new exclusive "Phase Lock Loop System") . . . *all modular construction* (servicing is a snap—in and out) . . . a receiver that is *very sensitive and selective* as to what it hears (better than 0.4UV / 20db), with unique Inoue helical filters to eliminate intermod . . . plus a super E filter mosfet front end, making copy a pleasure.

* And not a crystal to buy with the exclusive "Phase Lock Loop System".
(That's close to \$650.00 worth of xtals!)

— GRAB HOLD OF THE IC-230 AT YOUR LOCAL DEALER TODAY —

Distributed by:



— Dealerships Available —

ICOM WEST, INC.
1251 - 170th St. N.E.
Bellevue, Wash. 98008
(206) 641-0554

ADIRONDACK
RADIO SUPPLY
185 West Main Street
Amsterdam, N.Y. 12010

ICOM EAST
Div ACS, Inc.
Box 331
Richardson, Tex. 75080
(214) 235-0479

**Get the entire
Inoue ICOM family
at one of the dealers
listed below:**

ALABAMA

Wolfe Electronics
Box 358
Foley, AL 36535

ARKANSAS

Gavin Electronics
516 Ridgeway
Little Rock, AR 72205

ARIZONA

Ell Dee Enterprises
12612 N. 28th Dr.
Suite 3
Phoenix, AZ 85029

CALIFORNIA

Alpha Sound
1405 Dry Creek Road
San Jose, CA 95125

CDS Electronics & Hobbies Unltd.
235 Mitchell Drive
Atwater, CA 95301

Electro Service
240 Main Street
San Mateo, CA 94401

ICOM FM Sales
6234 A. Fountain Blvd.
Hollywood, CA 92028

Henry Radio Company
11240 W. Olympic Blvd.
Los Angeles, CA 90064

Selectronics
1709 Markston Road
Sacramento, CA 95825

Sequoia Stereo
773 - 8th Street
Arcadia, CA 95521

Sichel Equipment Co.
245 E. Harris Avenue
S. San Francisco, CA 94080

COLORADO

LEC Electronics
P. O. Box 7515
Pueblo West, CO 81007

FLORIDA

Amateur Electronic Supply
621 Commonwealth
Orlando, FL

Goldsteins
Box 3561
Pensacola, FL 32506

ILLINOIS

Erickson Communications
4653 N. Ravenswood
Chicago, IL 60640

INDIANA

Story Electric
2039 Fairfield Ave.
Fort Wayne, IN

Story Electric
441 Walnut
Wabash, IN

KENTUCKY

Everhart Electronics
116 Sydney Street
Lexington, KY

MARYLAND

COM Electronics
900 Crain Hwy. S.W.
Glenn Burnie, MD 21061

MEXICO

NOVO Mex
Antonio de Mendoza
Nº320 Lomas
Mexico 10, d.f., Mexico

MONTANA

Conley Radio Supply
405 North 24th
Billings, MT 59101

NEW MEXICO

Robert Foster
Box 198 - Escabosa Star Rt.
Tijeras, NM 87059

NEW YORK

R.E. Nebel Laboratories
31 Whitehall Blvd.
Garden City, NY 11530

Barry Electronics
512 Broadway
New York, NY 10012

NORTH CAROLINA

Vickers Electronic Supply
506 E. Main St.
Durham, NC

OHIO

Amateur Electronic Supply
17929 Euclid
Cleveland, OH

H & C Electronics
6271 Hammell Avenue
Cincinnati, OH 45237

OKLAHOMA

Blacks Radio Company
413 N.E. 38th Terrace
Oklahoma City, OK 73106

Roland Radio Company
5923 E. 31st Street
Tulsa, OK 74114

OREGON

Portland Radio Supply
1234 S.W. Stark
Portland, OR

PENNSYLVANIA

Hamtronics
4033 Brownsville Rd.
Trevose, PA 19047

Kass Electronics
2502 Township
Drexel, PA 19026

SOUTH CAROLINA

Accutek
420 Laurens Rd.
Greenville, SC 29607

Electronic Systems Inc.
1518 Gregg Street
Columbia, SC 29201

TEXAS

Bellaire Electronic Supply
5204 Bellaire Blvd.
Bellaire, TX 77401

Electronic Center, Inc.
2929 N. Haskell
Dallas, TX 75204

Trimble Electronics
1918 Mary Ellen
Pampa, TX 79065

UTAH

Utah FM Sales
1365 E. 5360 So.
Salt Lake City, UT 84117

VIRGINIA

Northern Virginia Communications
729 N. Edison
Arlington, VA 22203

WASHINGTON

ABC Communications
17541 - 15th N.E.
Seattle, WA 98155

ABC Communications
2002 Madison Avenue
Everett, WA 98200

Eichmeyer Electronics
Box 691 - Route 11
Spokane, WA 99208

N.H.E. Communications
15112 S.E. 44th
Bellevue, WA 98006

Progress Electronics
852 Commerce Street
Longview, WA 98632

WISCONSIN

Amateur Electronic Supply
4828 Fond Du Lac Ave.
Milwaukee, WI 53216

**IF YOUR DEALER DOESN'T STOCK
ICOM EQUIPMENT,
LET THE ICOM DISTRIBUTOR
FOR YOUR REGION KNOW.**

GREGORY ELECTRONICS CORP.
The FM Used Equipment People.

243 Route 46, Saddle Brook, N. J.
 Phone (201) 489-9000



SEND FOR NEW
 1973½ CATALOG

**GENERAL ELECTRIC
 VOICE COMMANDER III**

- Full Solid State FM Transmitter-Receiver
- 132-150 and 150-174 MHz/Size: 9.5" x 5.3" x 1.7"
- 1 watt output, .5 micro-volt sensitivity.

High performance, completely self-contained two-way FM radio. Compact, lightweight, easily operated and hand-carried. Housed in high-impact, 2-section case. All external hardware polished stainless steel. Top section has transmitter and receiver modules, built-in mike and speaker, antenna, carrying handle, all switches and controls. Bottom section has battery power supply. Power connections to top section made by plug and jack connection.



\$138.

Includes rechargeable
 nickel cadmium bat-
 tery pack and charger.

Crystals and tuning, add \$50.

Proper chargers available
 separately, each \$15.

Lots of 5 less 10% — \$124.20
 Lots of 10 less 15% — \$117.30

TWO METER MOBILE UNITS

**General Electric
 Progress Line**

14" or 17" case, complete accessories, fully narrow band.

MT/33, 12 volt, 30 watts, transistor
 power supply **\$158.**

with wide band receiver **\$143.**



MT/33

MA/E33, 6/12 volt, 30 watts, vibra-
 tor power supply **\$88.**

with wide band receiver **\$73.**



MA/E33

A THREE-STAGE OSCILLATING RING COUNTER WITH INDICATING SHIFT REGISTER

In past months amateurs have swung to an increasingly large-scale utilization of digital circuitry in the myriad of applications borne by the creative inventiveness inherent to the minds of lazy men. Finding an easier way to get the job done is a cardinal rule among amateurs which often, alas, requires staggering amounts of brainpicking and midnight oil burning.



Being a newcomer to the digital circuitry field, I diligently applied myself to the job of relearning an old hobby. It was in the midst of one of these study sessions that it occurred to me that a venture into an interdisciplinary approach could be profitable.

My friends, if you think this a fiction penned by somebody's relative from "Feenix, Arix," please bear with me. I am going to describe an amazing circuit shortly, but I feel there is much to be learned from the kind of thinking that led to its discovery.

The radio circuits developed in vacuum tube days are mostly analog devices producing unquantized outputs (on a macroscopic scale) proportional to their inputs. One of the greatest tools ever developed for analog circuits was the concept of feedback.

Feedback gave us greater sensitivity in our detectors when we made them oscillate; remember the old super-regenerative rigs? Another form of feedback led us to develop automatic everything control circuits. And do you remember reflex amplifiers?

Negative Amplifiers

Circuit designers applauded the development of the tunnel diode because it exhibited a negative resistance region. Fifteen years ago the easiest place to go for a negative resistance region was a neon lamp. In addition, we could make neon bulbs sensitive to ac, dc, rf, light levels, static, radiation, or body capacity. And an NE-2 is a pretty compact little unit.

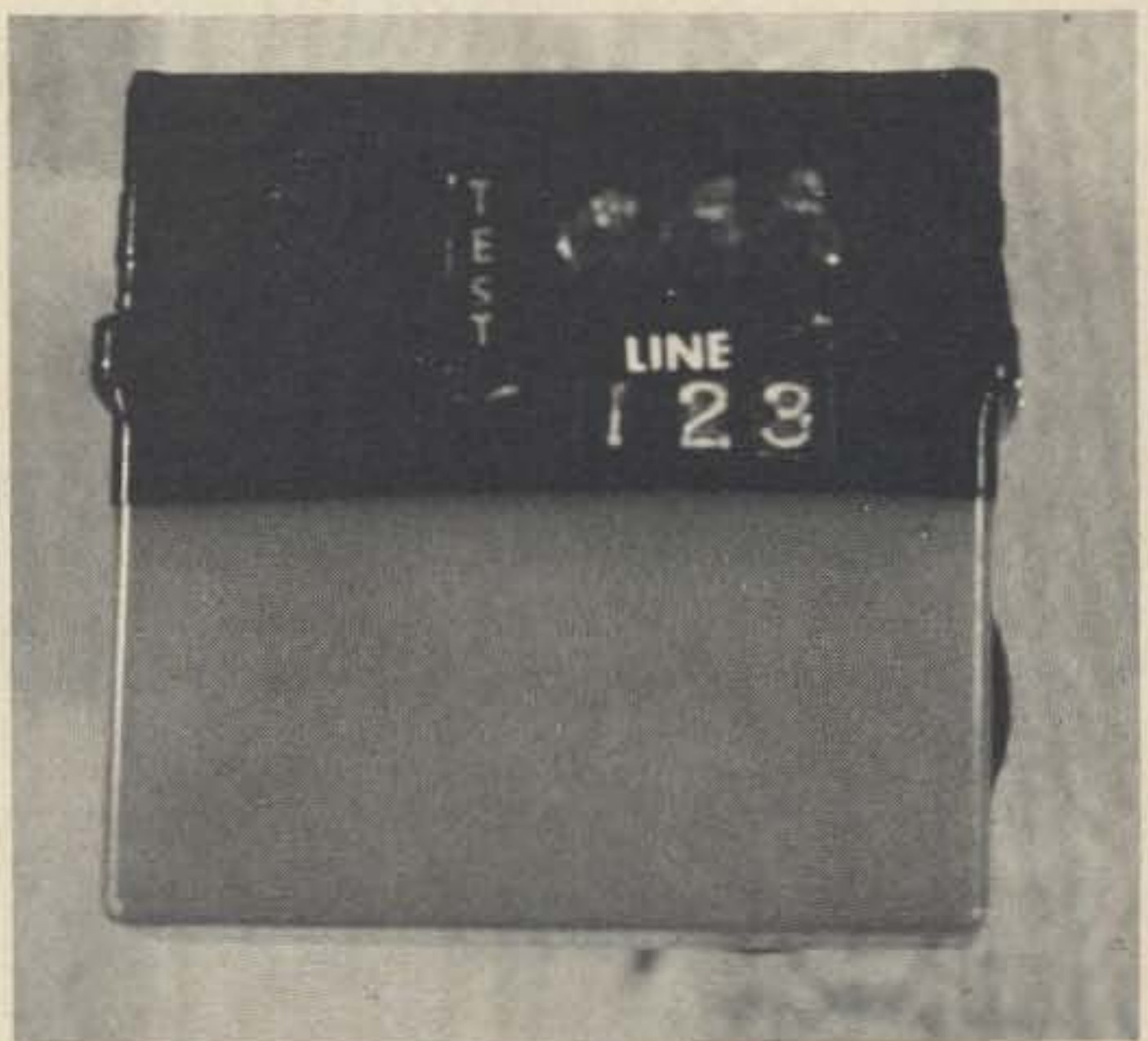

By taking advantage of the negative resistance region of the NE-2 in digital circuitry, we can design into a simple ring counter of a few stages many of the sensitivities of the neon bulb if we correctly choose our operating parameters. We can further sensitize the circuit by many of the tricks we learned in analog days: oscillation, feedback and reflexing. Further, we can sensitize and balance the stages to the point where environmental factors can influence the behavior of the active elements, warping the count. And finally, since the neon bulb is kind enough to glow for us at certain segments of its nonlinear operation, we can utilize it to indicate visually when shifting occurs.

The Circuit

The schematic for the three-stage oscillating ring counter with indicating shift register that resulted from my experimentation is shown around here somewhere. A simple line-operated half wave rectified power supply is included for simplicity and ease of operation. R1 is a current-limiting resistor to prevent damage to the NE-2s and to help make the counter balance less critical.

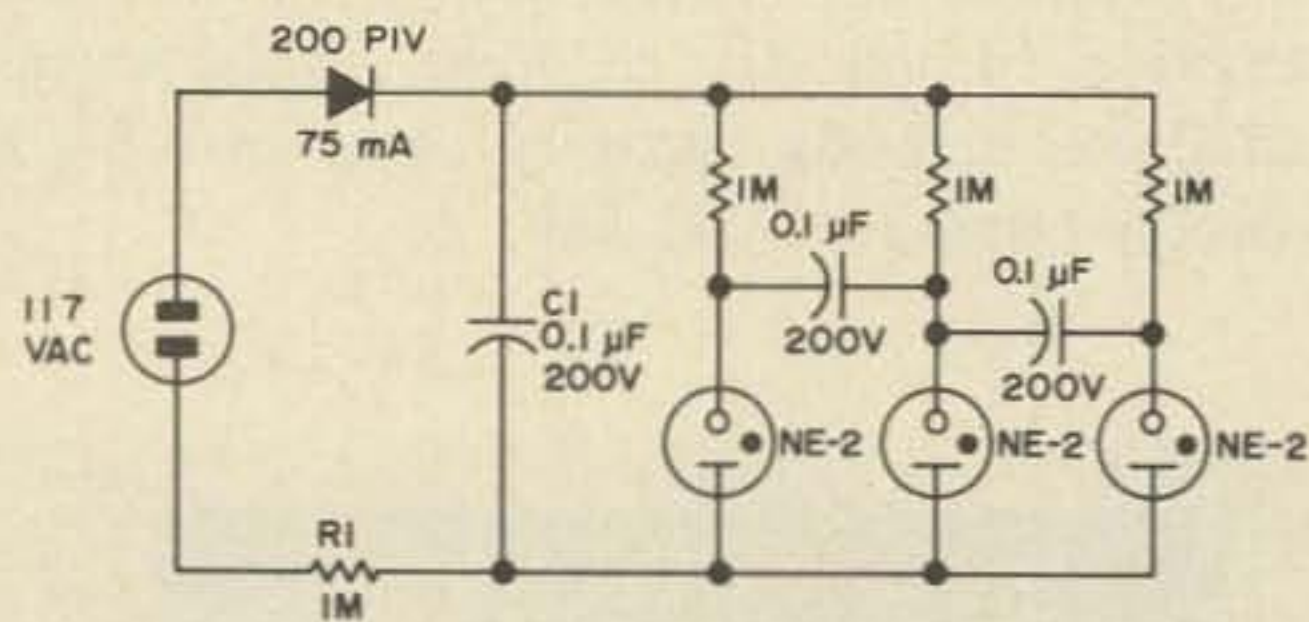

Fig. 1. Schematic diagram of the TSORC/ISR.

C1 is included to slow the circuit shifting to a reasonable rate and to help, or at least to try to help, prevent the circuit from running away as it oscillates in and out of balance.

Match the three remaining 1 meg resistors fairly closely. I got away with using 5% off-the-shelf units. The lamps should be matched and mounted adjacent to one another, with the six electrodes aligned.

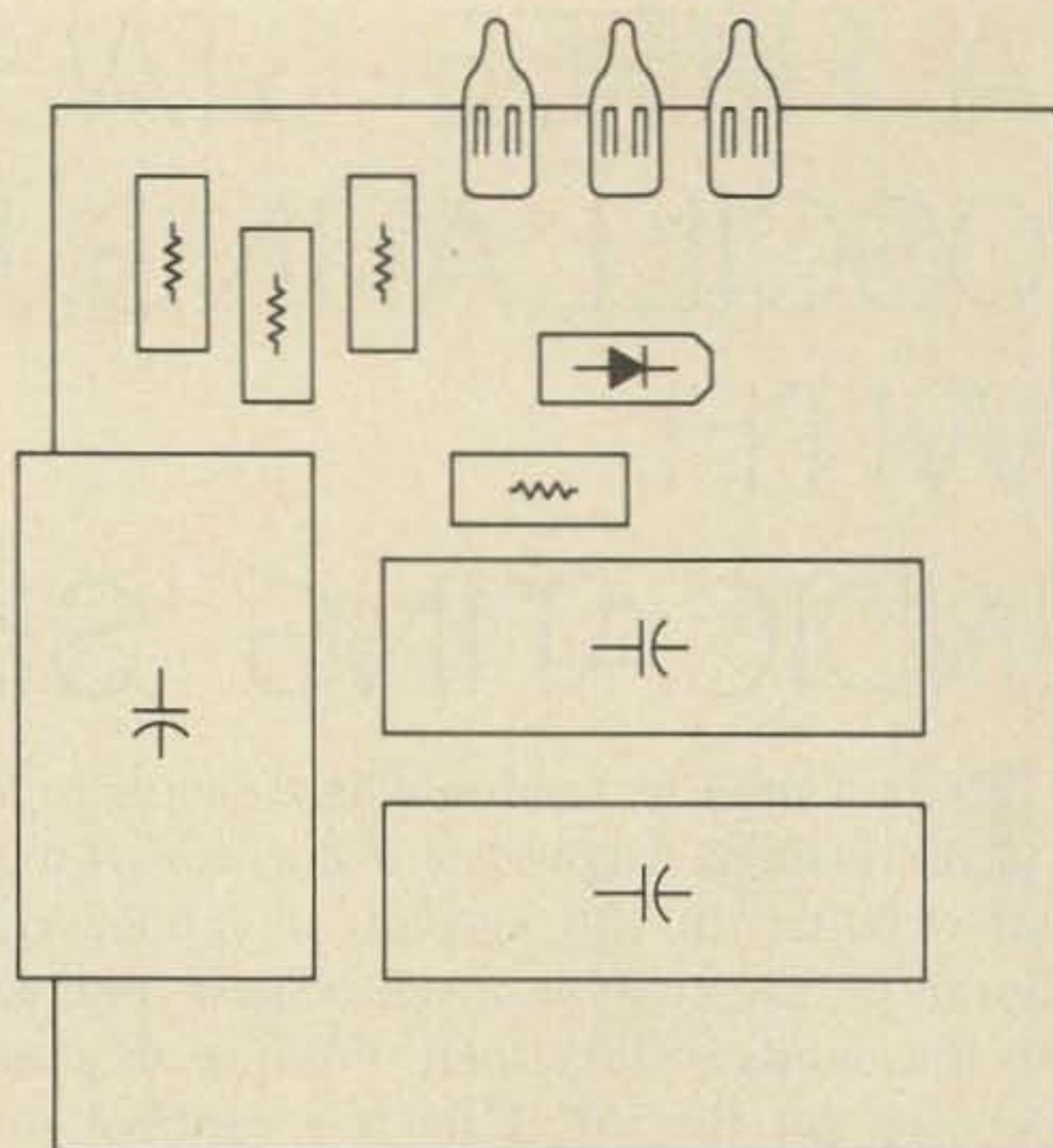

Fig. 2. All components were mounted on one side of a small (1½" x 1¾") piece of perf board. All wiring was done on the bare side of the board, using sleeving where needed.

The simplest test of the circuit is to assemble it and attempt operation at room temperature under normal lighting and radiation conditions. A properly-operating unit will flash in a sequence of 2-1-2-1-2-3-2-1-2-1-2-3.

Once the correct pattern has been established, age the unit by allowing it to operate unattended for about thirty hours. During this time, the kids will get a big kick out of watching the lights blink.

After aging, the unit is ready to function as a eutectic digital-human interface device, not dissimilar to Spock's Tricorder on the fictional program Star Trek. Readout is by means of variation in the basic flash pattern.

The TSORC/ISR, despite its tremendous versatility, has no capability for memory, as do its big second cousins at IBM. Although I have explained its operation rather fully, I have not dealt with the problem of programming the unit. If I receive enough requests, I will include a short article on the programming of the TSORC/ISR in a subsequent issue.

...Weinstein

FREQUENCY MULTIPLICATION THE EASY WAY

Bill Hoisington K1CLL
Farover Farm
Peterborough NH 03458

Multiplying to 2m with transistors is easy if you take the correct precautions.

This article is not only a construction article but also explains some of the things that can happen when you set out to build a frequency multiplier from scratch.

You might say multipliers are easy because you don't have to worry about feedback when the input is on a different frequency than the output. True enough, but that's not all the story. Let me quote from RCA's *Transistor Manual SC-14* the chapter on frequency multiplication: "Various types of instabilities can occur in transistor frequency multiplier circuits, including low-frequency resonances, parametric oscillations, hysteresis and high frequency resonances." Hysteresis refers to discontinuous mode jumps when either the input power, frequency, or both, is increased or decreased. And, "The transistor may behave as a locked oscillator on the fundamental frequency." Further, on VHF or wide-band circuits, "Unless the builder has had considerable experience with these types of circuits, he should not undertake the construction of such items." That's all very well and true to an extent, but it is the same old story; how are you ever going to get that experience if you don't make a start? So

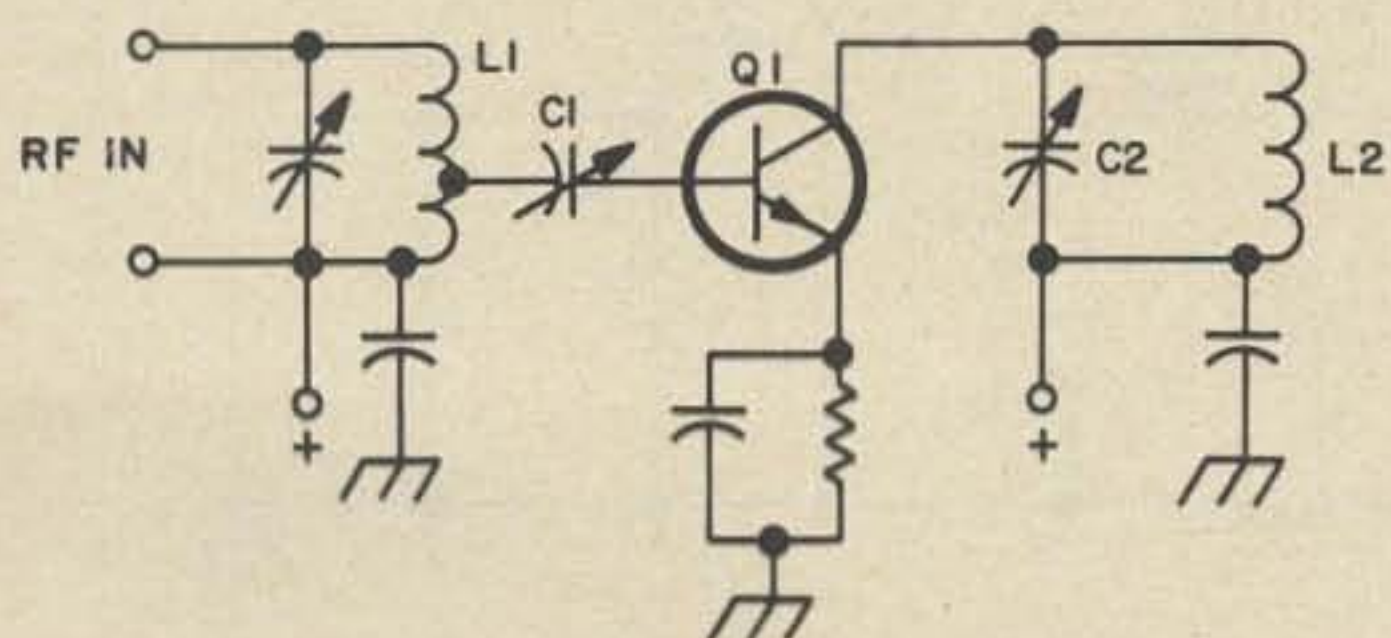

Fig. 1. Schematic of "trouble" circuit. (Do not build.)

here is some help. After half a century in radio I am still learning every day (pretty poor day when you don't) and this is what I've already learned this year about frequency multipliers:

The project calls for high gain because you're out for power while multiplying. It is always pleasant if you can get it. The more power you have in each stage, the less liable you are to have reaction or feedback into that stage from the final output stage. This is very important when you try for power like 25W, and some people are already working on 500W output power on Two!

A two-stage IC FM modulated, low-power source was used to drive the input on 24.5 MHz. This oscillator's output was kept low for stability purposes, which didn't make things any easier to start with, but it is now working very well. The whole project delivers some 1-1.25W output on 147 MHz with good, smooth and easy tuning - no jumps or other troubles.

Figure 1 shows the complete multiplier circuit *first* as a guide, because in the past some readers have built a wrong circuit that was illustrated to show what *not* to do. Figure 1 is one of these. Troubles which occurred during design work are thus shown in Fig. 1. Do not build *this circuit*! The first thing I did was to use the wrong transistor. I have several new, "hot" types, so of course in they went! You need high gain - go ahead! Trouble and plenty of it showed up right away. Now this is a perfectly good circuit and can be found in most manuals. *But*, a fantastic set of unwanted spurious oscillations showed up which clobbered the oscillator drive, and Q1 took off on its own,

even with the drive removed. After fighting it for a day or so, putting in a trimmer for C1 and changing transistors, it was better, but finally I found the cause: The lower half of L1 (in Fig. 1) from the tap to the cold end resonated beautifully and maddeningly with C1 and the base of Q1, producing a base-tuned collector oscillator on 147 MHz. This is not a good circuit even when used intentionally.

The Cure

This also is not a "new" circuit, the idea being to show when to use one or the other in order to do the right thing the first time. At 73 we *try* to help, because in our society today there just isn't all that time available, and this little story can save you some of that precious time. Putting a large capacitor, C3, from ground to base is the solution. Then the base of Q1 does not resonate on 147 MHz, and C3 also acts as a low pass filter unit to stop oscillation at 147 MHz. The incoming 24.5 MHz is resonated by L1 and C2, now referring to Fig. 2, the correct schematic, with the ratio of C2 and C3 dropping the impedance down to match the base of Q1. C3b is added to C3 for this purpose. You will find the tuning with C2 and the matching with C3 to be very smooth. Q1 is a 3866 which is always a good multiplier and does a good job up to 450 MHz. In this case it is used as a tripler to 73.5 MHz. I can assure you that it or the Motorola equivalent (for medium power usage), the HEP 75, will always do a good

job of multiplying for you — all the way to 450 MHz. The collector of Q1 is connected to the top of L1, which is tuned to 73.5 MHz by C4, with C5 matching into the base of Q2 in the same manner as the input to Q1.

An rf choke coil is added to the base of Q2 to keep the gain up. No plus voltage was needed on the base as there is plenty of drive from Q1. Always check this to be sure. No emitter resistor was needed either. Be sure to check this, too! I always have a lot of external pots lying around, 500, 5,000 and 50K, and lots of clip leads for them. Very useful. Q2's collector output is tapped down on L3, as these 3866's have a low collector impedance when being pushed for output, which is what we are doing here. The output, tuned to 147 MHz by C6 and L3, is also tapped down on L3 and matched to the cable by C7. There is about 200 mW of rf here, which lights a No. 48 bulb nicely. You will find the circuit as shown in Fig. 2 is very smooth in tuning and reliable, and will handle 1 or 2 MHz without retuning.

The 1W Amplifier

With 1W you can begin to talk through several repeaters in your area, so we put a little time in on an amplifier for this purpose. Figure 3 shows this unit with a 2N5913 RCA transistor, one of their newer and livelier devices designed for this work. A cable input is shown, but this may be eliminated along with either C7 of Fig. 1 or C1 of Fig. 1, as the two series capacitors are

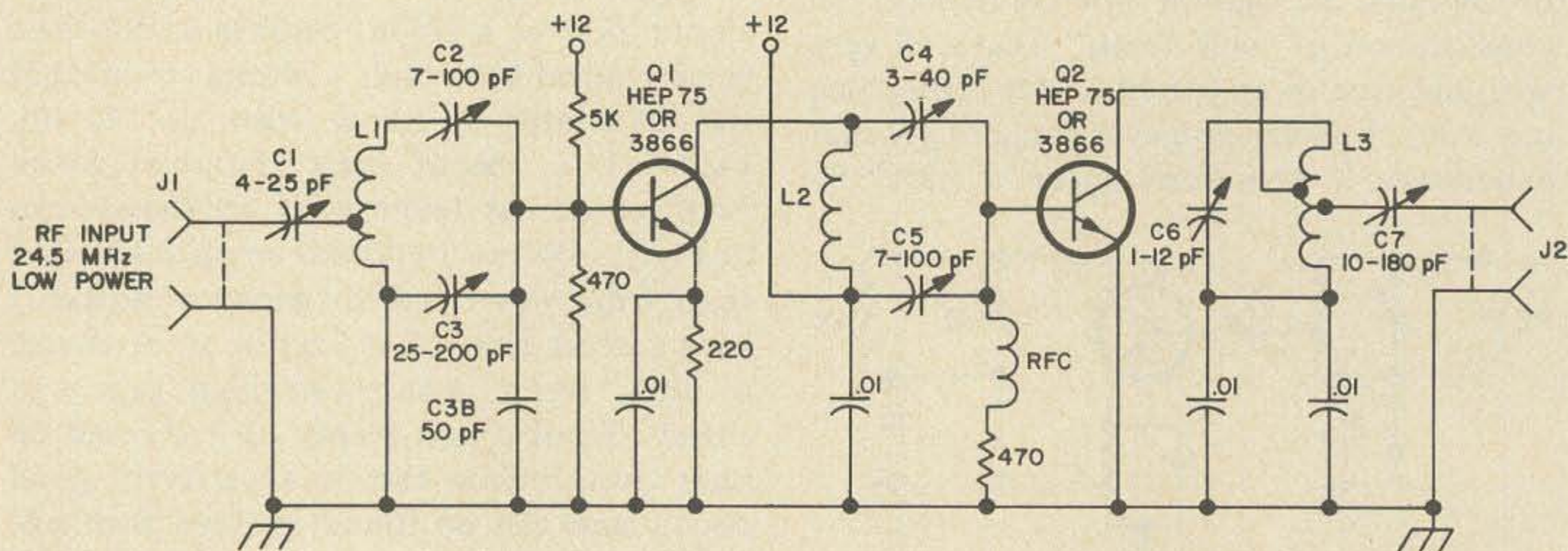
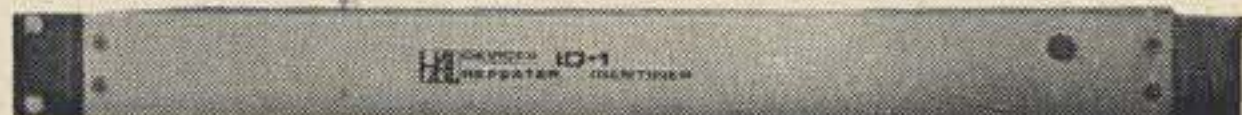

Fig. 2. Schematic of the 25 to 147 MHz multiplier. L1 — 20 turns No. 26 on 0.5 cm diameter form, length 1 cm, tap at center; L2 — 8 turns No. 22 on

form 0.8 cm diameter, winding is 0.8 cm long; RFC — 25 turns on form 0.5 cm diameter, 1.8 cm long.

HAL COMMUNICATIONS HAL ID-1 REPEATER IDENTIFIER



Circuit board wired & tested . . . \$75.00
With rack w/cabinet . . . \$115.00
TTL logic. Power line frequency counter for 3 minute or less timing and control. Easily re-programmable diode ROM uses only 27 diodes (depending on call) to send DE "any call". Low impedance audio with volume and tone control. All circuitry including PS on small G10 glass PC board. Write for full details. HAL COMMUNICATIONS, Box 365L, Urbana IL 61801

HAL COMMUNICATIONS

HOT CARRIER DIODES:	HP2800	\$.90, 12/S10.00	Matched by HAL	4/S4.25
ZENERS:	1N4729(3.6v), 1N4733(5.1v), 1N4735(6.2v), 1N4738(8.2v), 1N4739(9.1v), 1N4742(12v), 1N4742(12v), 1 watt			\$.75
LINEAR ICs:	709N	\$.75	709L, 710N	\$1.25
	MC1429G	\$3.75	MC1496G	\$3.25
			MC1590G	\$5.60
DIGITAL ICs:	F, L923	\$.90	MC767P	\$3.30
			MC723P	\$.95
MRTL:	MC788P	\$1.30	MC880P	\$3.50
	MC724P, MC725P, MC789P, MC792P		MC890P	\$2.00
	MC771P	\$1.75	MC970P	\$3.30
			MC9760P	\$5.45
DIP TTL:	7400, 7401, 7402, 7410, 7420, 7430, 7440			\$.48
	7404, 7405	\$.60	7441, 7495, 7496	\$3.00
	7472	\$.75	7473, 7474	\$1.05
	7486	\$1.15	7490, 7492, 7493	\$2.10
FETS:	40673 MOSFET	\$1.60	MPF102	\$.60
			2N3819	\$.55
TOROIDS:	Indiana General CF102 Q6, CF102 Q1, CF101 Q2			\$.50
	CF102 Q3	\$1.25	FERROXUBE FERRITE BEADS	10/S1.25
CINCH IC SOCKETS:	8-ICS, 14-DIP	\$.60	10-ICS, 16-DIP	\$.70

MANY OTHER DEVICES AND COMPONENTS IN STOCK. WRITE FOR CATALOG.

HAL COMMUNICATIONS

Box 365L, Urbana IL 61801 ● 217-359-7373

from the Center of the Electronic World



VHF PRE-AMP
100 to 160 MHz
25 db gain
2.5 db noise figure
50 ohm input and output impedance
Price \$29.95



VHF CONVERTER
100 to 160 MHz
2.5 db noise figure
50 ohm input impedance
Better than .1 uv sensitivity
30 db gain
Price \$59.50



FREQ. PRESCALER
Up to 250 MHz
Available assembled, or kit form
Price \$96.50 assembled
\$69.50 kit

Q-TRONICS

310-B So. Meadow Lane
Golden Valley, Minn. 55416

WANTED - HAM

With General Class License or better to manage amateur radio department.
Resume to:
C. J. Harrison
Hatry Electronics
500 Ledyard Street
Hartford, Connecticut 06114

Handwritten note: "Needs your used IBM MTST magnetic tapes - contact the typing department. Please for more information." with an arrow pointing to the right.

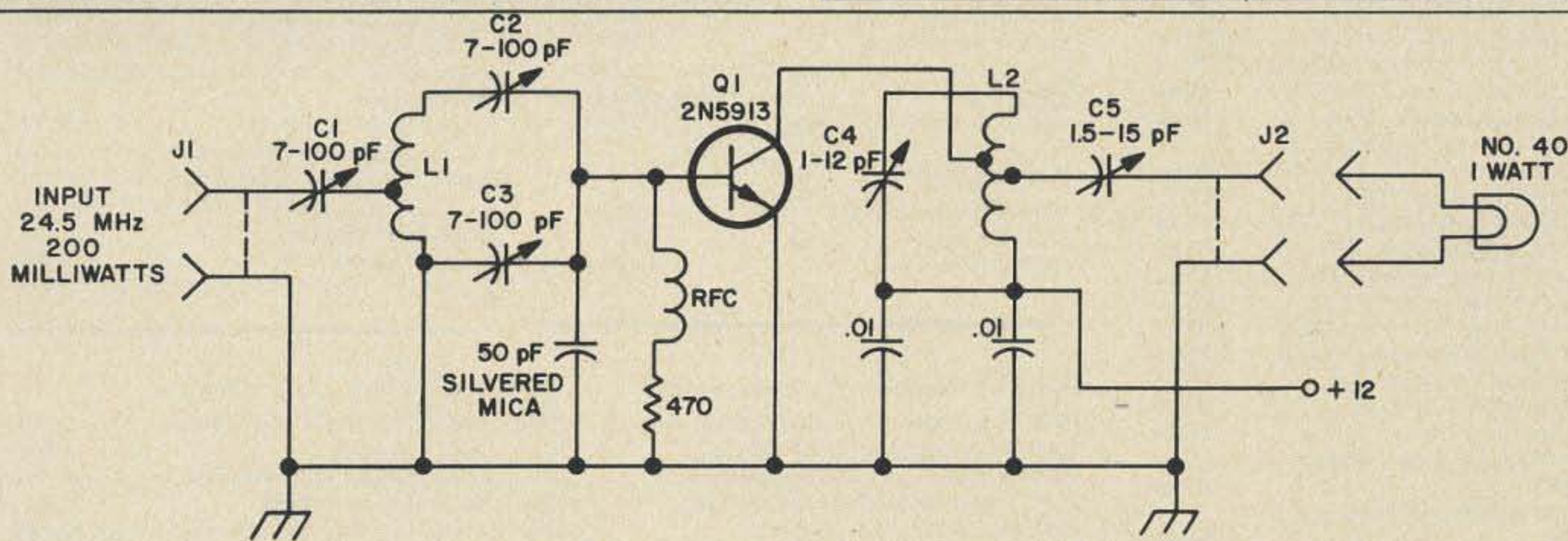

Fig. 3. 2 meter FM amplifier that will deliver 1W output. L1 - 5 turns No. 20, 0.8 cm diameter, 2 cm long. Input tap at 1½ turns from low end; L1 - same as L1 with collector tap at 1½ turns and output tap at 2 turns from the low end; RFC - 25 turns No. 30, on phenolic form, 0.5 cm O.D., 1.8 cm long.

not needed together. The base of Q1 in Fig. 3 is treated in the same way as the multiplier, and responds equally well - C2 and C3 being the impedance matching network. While not critical, the best power output is obtained at the correct tap. I used a No. 40 lamp for a 1W load through C5, and this can be lit to about 1.25W brilliancy with everything working right. Even though the 2N5913 is a pretty hot item, when loaded it

handles well without self-oscillation and does a great job.

Conclusion

So here is a good straightforward project which is very handy to have around. I use it for transmitting exactly 600 kHz lower than the receiver in combination with a 10.1 MHz crystal. But that is another story . . .

...K1CLL

INTERNATIONAL ELECTRONICS UNLIMITED

TTL		7430	.25	7470	.50	74123	1.15	8000 Series	
7400	.25	7432	.30	7473	.55	74145	1.25	8091	.69
7401	.25	7437	.50	7474	.55	74151	1.05	8092	.69
7402	.25	7440	.25	7475	.95	74153	1.45	8093	.69
7403	.25	7441	1.25	7476	.55	74154	1.75	8094	.69
7404	.29	7442	1.15	7483	1.25	74155	1.35	8095	.69
7405	.27	7443	1.25	7485	1.20	74157	1.50	8123	1.75
7406	.55	7444	1.30	7486	.55	74161	1.65	8214	1.95
7408	.29	7445	1.25	7489	3.25	74164	2.95	8280	.95
7409	.29	7446	1.45	7490	1.25	74165	2.95	8520	1.45
7410	.25	7447	1.45	7492	1.05	74175	2.95	8551	1.95
7411	.35	7448	1.50	7493	1.05	74181	4.50	8810	.95
7413	.95	7450	.29	7494	1.10	74192	1.65	8812	1.25
7420	.25	7451	.32	7495	1.05	74193	1.65	8831	1.95
7423	.37	7453	.32	7496	1.05	74194	1.65	8836	1.25
7425	.39	7460	.30	74121	.55	75195	1.15		

FIRST TIME OFFERED

9601 Retriggerable one shot \$1.15 ea

Low Power Devices

74L00	.40	74L72	.60
74L02	.40	74L73	.80
74L04	.40	74L74	.80
74L10	.40	74L78	.80
74L16	.40	74L85	1.25
74L20	.40	74L86	.95
74L30	.40	74L90	1.75
74L42	.80	74L93	1.75
74L51	.40	74L95	1.75
74L71	.60	74L164	2.95

moving sale
10% OFF - ANY ITEM - ANY QUANTITY

Linears

LM300 Pos V reg (super 723 V) TO5	\$.95 ea
LM301 Hi performance ampl TO5	.45 ea
LM302 Voltage follower TO5	.95 ea
LM304 Neg Volt regulator TO5	1.25 ea
LM305 Pos Volt regulator TO5	1.25 ea
LM307 Op Amp (super 741) TO5	.45 ea
LM308 Micro power Op Amp TO5	1.25 ea
LM309K 5V 1A power supply reg TO3	1.95 ea
LM309H 5V regulator TO5	1.25 ea
LM310 Volt follower Op Amp TO5	1.45 ea
LM311 Hi perf volt comp TO5	1.25 ea
LM320 -5.2V Neg regulator TO3	1.95 ea
LM320 -12V Neg regulator TO3	1.95 ea
LM320 -15V Neg regulator TO3	1.95 ea
LM380 2 watt audio amplifier Dip	1.75 ea
LM3900 Quad Amplifier Dip	.50 ea
LM709 Op Amp TO5 or Dip	.29 ea
LM723 Volt reg. Dip	.75 ea
LM741 Comp Op Amp TO5-Dip 10/\$3.95	.45 ea
LM747 Dual 741 Op Amp Dip 4/\$3.50	.95 ea
Phase Locked Loops	
NE565 Phase locked loop dip	\$2.95 ea
NE566 Function Gen TO5-mini dip	2.95 ea
NE567 PLL/Tone Gen TO5-mini dip	2.95 ea
Memories - Are Made Of -	
1101 256 Bit Ram Mos (2501)	2.95 ea
1103 1024 Bit Ram Mos	7.95 ea
7489 64 Bit Ram TTL	3.25 ea
8223 Programmable Rom	
Data Included with Memories	6.95 ea

LED

MV10B Visible red SUPER SPECIAL	.25 ea
MV50 type red emitting	.25 ea or 5/1.00
MV5020 type Large red	.35 ea or 3/1.00
ME4 Infra red TO18	.69 ea
MAN 1 The Original	4.25 ea
MAN 3 type	1.95 ea, 3 or more 1.49 ea
MAN 4 type	2.75 ea, 3 or more 2.50 ea
Data-Lite 707 (MAN 1 repl)	4.25 ea
Opto Isolators	
MCA 2-30 Darlington	.95 ea
MCD 2 Diodes	1.95 ea
MCT 2 Transistor	1.45 ea

MOS Shift Registers - Limited quantities

2506 Dual 100 bit dyn. shift reg. (mini)	.30 ea
2509 Tristate dual 50 bit st. shift reg.	.30 ea
2510 Tristate dual 100 bit st. shift reg.	.30 ea
2511 Tristate dual 200 bit st. shift reg.	.30 ea
2518 Hex 32 bit static shift reg.	.30 ea
2519 Hex 40 bit static shift reg.	.30 ea
2521 Dual 128 bit shift reg. (mini)	.30 ea
2522 Dual 132 bit shift reg. (mini)	.30 ea
2524 512 bit recirc. dyn. shift reg. (mini)	.30 ea
2525 1024 bit recirc. dyn. shift reg. (mini)	.30 ea
2527 Dual 256 bit static shift reg. (mini)	.30 ea
Assortment of any 2500 MOS items	4/1.00

NOTE: 2500 series MOS shift registers are factory seconds & have not been re-screened.

Calculator Chips

5001 LSI (40 pin) Add, subtract, multiply & divide 12 digit	
Data supplied with chip	6.95 ea
Data only-Refundable w/purchase	1.00 ea
5002 LSI Similar to 5001 except designed for battery power	
Data supplied with chip	8.95 ea
Data only-Refundable w/purchase	1.00 ea
5005 LSI (28 pin) Full four function memory. 12 digit display and calc. 7 segment multiplexed output	
Data supplied with chip	10.95 ea
Data only-Refundable w/purchase	1.00 ea

Digital Clock ... on a Chip

MM5311 (28 pin) Any readout. 6 digit BCD, with spec sheet	11.95 ea
MM5312 (24 pin) Any readout. 4 digit 1pps BCD, with spec sheet	8.95 ea
MM5314 (24 pin) LED-Incandescent readout 6 digit with spec sheet	10.95 ea
MM5316 (40 pin) Normal alarm, snooze alarm, sleep timer 12 or 24 hour operation, with spec sheet	15.95 ea

Grab Bag Specials

15 Assorted DTLs (dip)	1.00/bag
15 Assorted TTLs (dips)	1.00/bag

NOTE: Factory seconds, not tested.

Satisfaction guaranteed. All items except as noted are fully tested. Minimum order \$5.00 prepaid in US and Canada. California residents add sales tax. Orders filled within 3 days after receipt. Please add \$.50 per spec sheet for items priced at less than \$1.00 each.

INTERNATIONAL ELECTRONICS UNLIMITED

P.O. BOX 1708 S

MONTEREY, CA 93940

73 LOWERS SUBSCRIPTION



37¢

Would you believe that there are some of us who remember when 73 Magazine was only 37¢ a copy? (How time does fly!)

At the present time our subscriptions are increasing over 1,000 per month and we're beginning to realize that 1973 is *our* year (obviously).

In order to further accelerate this trend, we're rolling back the calendar . . . yes, back to 1960 . . . and 37¢ a copy. We realize that we cannot get rich this way, but who cares when you can make so many subscribers happy!

Now . . . for a limited time only . . . (until we regain our senses) . . . you can subscribe to 73 for only 37¢ a copy on a 3-year subscription. That's only \$13.32 for 3 years.

Subscribe *NOW* and have it end in '76. That's the spirit!

AMATEUR RADIO
is more fun with
73

The regular newsstand cost for 3 years is \$36.00—subscribe Now and save \$22.68.

New Subscription

Renewal or extension

Order Form

10-73

73 Magazine

Peterborough NH 03458 USA

3 yrs, \$13.32

1 yr, \$6

Name _____ Call _____

Address _____

City _____ State _____ ZIP _____

BOOKS



STUFF



Fascinating World of Radio Communications	\$4.00
Novice Class Study Guide	\$4.00
General Class Study Guide	\$6.00
Advanced Class Study Guide	\$4.00
Extra Class Study Guide, reduced price	\$5.00
VHF Projects for Amateur & Experimenter	\$5.00
VHF Antenna Handbook	\$3.00
How to Use FM, an introduction	\$1.50
FM Repeater Atlas, worldwide w/maps	\$1.50
*FM Repeater Circuits Manual	\$5.00
*Digital Control of Repeaters, new	\$5.00
RTTY Handbook, radio teletype A to Z	\$6.00
ATV Anthology, fast scan VHF TV	\$3.00
*SSTV Handbook, new, only slow scan avail.	\$5.00
Diode Circuits Handbook, galore	\$1.00
73 Transistor Circuits, all useful	\$1.00
Transistor Projects, mucho	\$3.00
Solid State Projects	\$4.00
IC Projects	\$4.00
108 Q & A, transmitting, receiving, ant.	\$2.00
TVI Handbook, why suffer	\$1.50
Coax Handbook, cables & connectors	\$3.00
DX Handbook, w/map	\$3.00
World DX Map, wall size, rolled	\$2.00
Custom DX Bearing Charts, beam headings	\$4.00
U.S. Maps, for WAS, etc (4 ea)	\$1.00
Call Sign Badges, for lapel, black or red	\$1.00
Magnetic Call Signs, for autos	\$4.00
73 Magazine Binders, beautiful red	\$5.00

*Hardbound versions available @ \$2.00 more. All items postpaid.

BOOKS ORDER FORM

Name _____ \$ _____ enclosed

Call _____ Books wanted: _____

Address _____

City _____

State _____ Zip _____

73 Magazine, Peterborough NH 03458 USA



GTX-2 30 WATTS OUTPUT

2 meter FM Transceiver

- (1) GTX-2 (built-in DC PS) and 94/94 249.95
 - (2) AC POWER SUPPLY \$49.95
 - (3) 2 Extra crystals your choice (stock list) \$12.00
- REGULAR \$311.90
OUR SPECIAL PACKAGE PRICE! \$249.95



GTX-200 30 WATTS OUTPUT

100 channel combinations; features independent selection of transmit and receive frequencies, and switch for pre-selected pairing.

- (1) GTX-200 (built-in DC PS) & 94/94 \$259.95
 - (2) AC POWER SUPPLY \$49.95
 - (3) 2 Extra xtals your choice (stock list) \$12.00
- REGULAR \$321.90
OUR SPECIAL PACKAGE PRICE! \$259.95

GTX-10

10 watts output

Simple conversion to 30 watts output



100% AMERICAN MADE

- (1) GTX-10 (built-in DC PS) & 94/94 \$199.95
 - (2) AC POWER SUPPLY \$34.95
 - (3) 2 Extra xtals your choice (stock list) \$12.00
- REGULAR \$246.90
OUR SPECIAL PACKAGE PRICE! \$199.95

Please add \$10.00 Substituting HAMPAK for AC on GTX-10 Package. With HAMPAK & AC \$229.00



HAMPAK

Battery pack for GTX-10 portable operation. Uses 10 D cells (not included). (Includes portable antenna, carrying handle & mike clip) \$39.95



CLEGG FM-27Bs

(Reg. \$479.95), with Clegg AC (Reg. \$559) Write for special deal!

Regency, Midland, Gladding 25, SBE, etc., also in stock. Please write for quote

* FLASH * FLASH * FLASH *

Look at what you get for NO REPEAT-NO EXTRA CHARGE. The GTX-2 and GTX-200 now have a super-sensitive Dual-Gate Mos Fet pre-amplifier BUILT IN the receiver front end for superb, less than .25 microvolt sensitivity. THE BEST receiver now even better!

30 WATTS OUTPUT. ALL SOLID STATE (no tubes). TRUE FM (not Phase modulation) for superb audio quality.

10 channels in GTX-2 & GTX-10 with 146.94/146.94 included. Three pole low pass filter on both transmit and receive. 1 watt low power position. Provision for tone encoder. Simple internal strapping provision allows multi-channel use of any crystal in GTX-2 and GTX-10. Microphone and mobile mounting bracket supplied. G-10 GLASS BOARDS. Professional level construction by distinguished Avionics Mfg. — General Aviation Electronics, Inc. The finest amateur FM transceiver available at any price. Size: 9 x 6 1/2 x 2 1/2. Weight 5 lbs. Current Drain: Receive: .09 amps, Transmit: High 5.0 amps, Low: 1.7 amps, Made in U.S.A.

	Reg.	Our Price		Reg.	Our Price		Reg.	Our Price
ALPHA			GONSET			NATIONAL		
Alpha-70 PA-70V vapor cooled linear, brand new cond.	1,275.00	895.00	6m Cumm IV	119.00	69.00	NCX-5 conv. to MK-2 w/NCX-A AC/spk, 100Kc cal.	429.00	325.00
AMECO			HALLICRAFTERS			NC-155 rcvr	119.00	69.00
TX-62 6 & 2 meter xmitter w/621 VFO, Dow Relay	149.00	95.00	SX-111 rcvr latest w/prod. dect.	129.00	99.00	NCX-5 MK II w/NCX-A AC/spk, 100Kc cal.	450.00	379.00
TX-62 6 & 2 meter xmitter	99.00	69.00	SR-150 xcvr w/AC/spk	350.00	249.00	SWAN		
BIRD			SX-146 rcvr, R-50 spk, HA-19 cal, (xceives w/HT-46)	195.00	169.00	SW-240 w/117B AC/ps brand new cond.	229.00	179.00
43 wattmeters (new) limited quantity		95.00	SR-4 2A 2m xcvr, new cond; w/2 xtals	149.00	119.00	250C 6m xcvr w/117XC AC/spk, VOX, NS-1 noise silencer, new cond.	430.00	389.00
COL LINS			SR-46A 6m xcvr new cond. w/4 xtals	109.00	89.00	117X basic AC	65.00	39.00
62S-1 VHF conv.	595.00	495.00	HA-26 6 & 2 VFO	39.00	29.00	TP L/TEMPO		
KWM-1 xcvr w/516F-1 AC and 312 B-3 (same as 312B-4, patch, SWR, etc.) latest, new cond.	495.00	395.00	HEATH			502 5-15/35-55 watt output 2m amp, new	105.00	79.00
CLEGG			HX-10 Marauder, 180 watt SSB-AM xmitter	189.00	119.00	502B 1-3/45-50 watt output 2m amp, new	130.00	99.00
99-er 6m xcvr working, as is	59.00	29.00	HW-16 CW xcvr, 30, 40, 15	99.00	79.00	LW 1500 Dummy load wattmeter, new	119.00	79.00
Thor 6 xcvr w/AC mod	169.00	99.00	HG-10 VFO 80-2 meters	39.00	29.00	TC-102 24 hr. Digital clock, new	89.00	59.00
FM 27A FM xcvr, like new	339.00	289.00	SB-110A 6m SSB xcvr w/SB-500 2m transverter & HP-23A/AC like new, checked by Heath	439.00	329.00	TEST EQUIPMENT		
DRAKE			SB-500 2m transverter	129.00	89.00	Eico 378 Lab audio gen., like new	89.00	39.00
2B rcvr, 2BQ "Q" mult/spk	210.00	179.00	HD-1 "Q" mult w/built in AC ps.	10.00	10.00	Clemmons SB-83B sig. gen. like new	295.00	225.00
2A rcvr, 2AQ "Q" mult/spk and cal.	189.00	149.00	SBA-300-3 6m Conv.	8.00	8.00	RCA WV-98C Senior VTVM, new	99.00	59.00
MN-2000 matching network	159.00	139.00	KNIGHT/ALLIED			Heath 10W-102 solid state scope, new	189.00	129.00
T4X B w/custom AC/spk by Drake, new cond, in carton	489.00	389.00	TR-108 15 watt 2m xcvr w/AC, DC, mic, like new	99.00	79.00	Winslow megohm meter (megger)	150.00	69.00
SW4A gen. cov. rcvr., new cond.	229.00	199.00	AX-190 ham rcvr, 80-10 + WWV, 1 KC. cal, etc.	199.00	149.00	LEADER write for prices		
GALAXY			MAGNUM			B & K write for prices		
FM-210/wAC 210 amp, 6 xtals, mic.	189.00	125.00	Magnum 6 RF speech processor for Kenwood T-599, brand new, warranty	139.95	99.00	MIIDA =6854 4 1/2 digit digital auto-ranging multimeter, new	689.00	529.00
GLADDING						MIIDA =5108 10Hz to 550MHz freq. counter, new	950.00	725.00
Gladding 25 w/xtals 34/76, 94/94, 64/64, 22/82, 28/88, and 16T	199.00	159.00				MIIDA precision calculators	89.00	UP

COMING SOON!!!! Genave Touch-Tone Pad, Genave Repeater and MUCH MORE.

REGENCY, CLEGG, SBE, INOUE, GLADDING, MIIDA, CUSH (CRAFT, DATA ENG., BIRD, OLIVER SWAN (KLM), HY-GAIN, SAVOY, B&K, LEADER, KENWOOD, TEMPO, TEN TEC, DX ENG., MINI PRODUCTS, SWAN, MIDLAND, ETC., IN STOCK—PLEASE WRITE FOR QUOTE.



NO ONE ANYWHERE BEATS OUR DEAL!
AMATEUR-WHOLESALE ELECTRONICS
8817 S. W. 129 Terrace-Miami, FL 33156



Telephone — days (305) 233-3631 — night and weekends — (305) 666-1347

We carefully and professionally service everything we sell. An employee always answers our night and weekend phone—not an answering service.

Standard
SRC-146A
\$289



Regency
HR-2MS **\$319**



Genave
GTX-10 **\$199⁹⁵**

Stop Wasting Time looking for a good deal

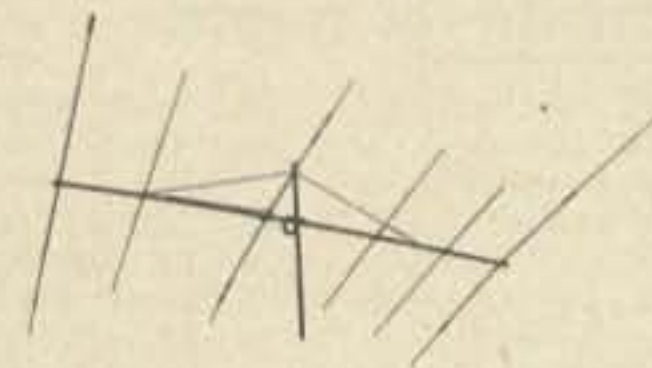

Hy-Gain Thunderbird
\$189



Gladding 25
\$249⁹⁵



Icom 230
\$447⁵⁰

Get a
good deal more at
LOU GOLDSTEIN - K4LAN
P.O. BOX 3561
PENSACOLA, FLA.
32506

Florida's newest and
fastest growing dealer.

*"If I don't have it,
you don't need it."*



Hy-Gain
Galaxy
\$595



A post card brings
results — write me
your needs.

FCC RULES AND REGULATIONS, PART 97 (V)

CONTENTS THIS MONTH

Subpart D—Operating Requirements and Procedures

GENERAL

Sec.	
97.77	Practice to be observed by all licensees.
97.79	Control operator requirements.
97.81	Authorized apparatus.
97.83	Availability of operator license.
97.85	Availability of station license.
97.87	Station identification.
97.89	Points of communications.
97.91	One-way communications.
97.93	Modulation of carrier.

Continuing from last month the complete text of the FCC Rules & Regulations pertaining to the Amateur Radio Service.

SUBPART D—OPERATING REQUIREMENTS AND PROCEDURES

GENERAL

§ 97.77 Practice to be observed by all licensees.

In all respects not specifically covered by these regulations each amateur station shall be operated in accordance with good engineering and good amateur practice.

§ 97.79 Control operator requirements.

(a) The licensee of an amateur station shall be responsible for its proper operation.

(b) Every station when in operation shall have a control operator at an authorized control point. The control operator may be the station licensee or another amateur radio operator designated by the licensee. Each control operator shall also be responsible for the proper operation of the station.

(c) An amateur station may only be operated in the manner and to the extent permitted by the operator privileges authorized for the class of license held by the control operator, but may exceed those of the station licensee provided proper station identification procedures are performed.

(d) The licensee of an amateur radio station may permit any third party to participate in amateur radio communication from his station, provided that a control operator is present and continuously monitors and supervises the radio communication to insure compliance with the rules.

[§ 97.79 headnote and text revised eff. 10-17-72, and (d) further revised eff. 12-1-72; VI(72)-1]

§ 97.81 Authorized apparatus.

An amateur station license authorizes the use under control of the licensee of all transmitting apparatus

at the fixed location specified in the station license which is operated on any frequency, or frequencies allocated to the amateur service, and in addition authorizes the use, under control of the licensee, of portable and mobile transmitting apparatus operated at other locations.

§ 97.83 Availability of operator license.

The original operator license of each operator shall be kept in the personal possession of the operator while operating an amateur station. When operating an amateur station at a fixed location, however, the license may be posted in a conspicuous place in the room occupied by the operator. The license shall be available for inspection by any authorized Government official whenever the operator is operating an amateur station and at other times upon request made by an authorized representative of the Commission, except when such license has been filed with application for modification or renewal thereof, or has been mutilated, lost or destroyed, and request has been made for a duplicate license in accordance with § 97.57. No recognition shall be accorded to any photocopy of an operator license; however, nothing in this section shall be construed to prohibit the photocopying for other purposes of any amateur radio operator license.

§ 97.85 Availability of station license.

The original license of each amateur station or a photocopy thereof shall be posted in a conspicuous place in the room occupied by the licensed operator while the station is being operated at a fixed location or shall be kept in his personal possession. When the station is operated at other than a fixed location, the original station license or a photocopy thereof shall be kept in the personal possession of the station licensee (or a licensed representative) who shall be present at the station while it is being operated as a

GATEWAY ELECTRONICS

8123-25 PAGE BOULEVARD
ST. LOUIS, MISSOURI 63130
(314) 427-6116

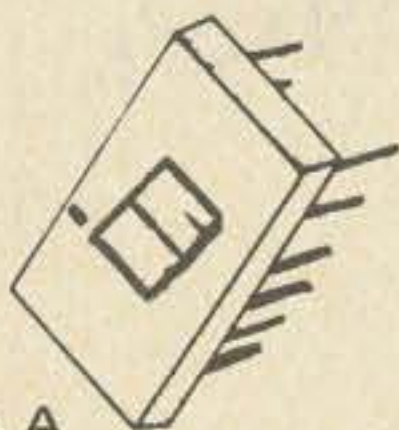

Fig. A

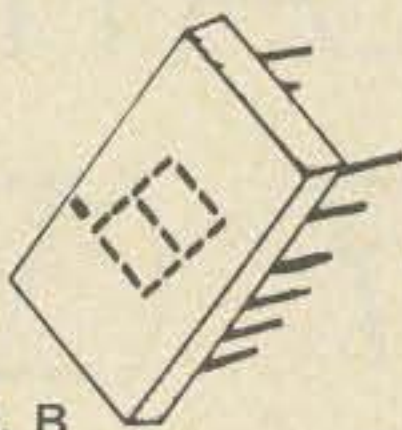

Fig. B

LED READOUTS

- Fig. A MAN-1 Style with diffused segments for improved visibility **\$2.75**
- Fig. B MAN-1 Style **\$2.75**
- Giant 0.6 in. LED similar to Fig. B** **\$3.95**
- Single LED lamp, red or clear, please specify.
\$.35 each, 3 for \$1.00

IC SPECIALS

- Stereo Amp. 2 watt per channel dual in-line package w/data **\$2.00**
- Clock Chip - National 5314 12/24 hr 4 or 6 digit 24 pin pkg w/data **\$12.95**
- 22 Pin PC card socket 0.156 spacing **\$.50**
- WE Touch Tone Pad 12 button new **\$19.50**
- 5 MHz crystal miniature size w/wire leads **\$2.50**

IC SOCKETS

- | | | | |
|------------------|---------------|-----------|--------------|
| 14 pin solder | \$.50 | wire wrap | \$.55 |
| 16 pin solder | \$.55 | wire wrap | \$.60 |
| 24 pin wire wrap | \$1.20 | | |
| 28 pin wire wrap | \$1.30 | | |

BUY 10 & DEDUCT 10%

THUMBWHEEL SWITCHES

STANDARD SIZE - 0.5 x 2.125 x 1.78

- 10 position decimal **\$3.00**
- 10 position BCD & compl. **\$4.00**
- End Plates (per pair) **\$1.45**

MINIATURE SIZE - 0.312 x 1.3 x 1.3

- 10 position decimal **\$2.50**
- 10 position BCD & compl. **\$3.75**
- End Plates (per pair) **\$1.00**
- Divider plates **\$1.25**

\$5 Minimum Order. Visit us when in St. Louis. Please include sufficient postage.

portable or mobile station. The original station license shall be available for inspection by any authorized Government official at all times while the station is being operated and at other times upon request made by an authorized representative of the Commission, except when such license has been filed with application for modification or renewal thereof, or has been mutilated, lost, or destroyed, and request has been made for a duplicate license in accordance with § 97.57.

§ 97.87 Station identification.

(a) An amateur station shall be identified by the transmission of its call sign at the beginning and end of each single transmission or exchange of transmissions and at intervals not to exceed 10 minutes during any single transmission or exchange of transmissions of more than 10 minutes duration. Additionally, at the end of an exchange of telegraphy (other than teleprinter) or telephony transmissions between amateur stations, the call sign (or the generally accepted network identifier) shall be given for the station, or for at least one of the group of stations, with which communication was established.

(b) When an amateur station is operated as a portable or mobile station, the operator shall give the following additional identification at the end of each single transmission or exchange of transmissions:

(1) When identifying by telegraphy, immediately after the call sign, transmit the fraction-bar DN followed by the number of the call sign area in which the station is being operated.

(2) When identifying by telephony, immediately after the call sign, transmit the word "portable" or "mobile", as appropriate, followed by the number of the call sign area in which the station is being operated.

(c) When an amateur station is operated outside of the 10 call sign areas prescribed in § 97.51(b) and outside of the jurisdiction of a foreign government, the operator shall give the following additional identification at the end of each single transmission or exchange of transmissions:

(1) When identifying by telegraphy, immediately after the call sign, transmit the fraction-bar DN followed by the designator R 1, R 2, or R 3, to show the region (as defined by the International Radio Regulations, Geneva, 1959) in which the station is being operated.

(2) When identifying by telephone, immediately after the call sign, transmit the word "mobile" followed by the designator Region 1, Region 2, or Region 3, to show the region (as defined by the International Radio Regulations, Geneva, 1959) in which the station is being operated.

(d) Under conditions when the control operator is other than the station licensee, the station identification shall be the assigned call sign for that station. However, when a station is operated within the privileges of the operator's class of license but which exceeds those of the station licensee, station identification shall be made by following the station call sign with the operator's primary station call sign (i.e. WN4XYZ/W4XX).

(e) A repeater station shall be identified by radio-telephony or by radio telegraphy when in service at intervals not to exceed 5 minutes at a level of modulation sufficient to be intelligible through the repeated transmission.

(f) A control station must be identified by its assigned station call sign unless its emissions contain the call sign identification of the remotely controlled station.

(g) An auxiliary link station must be identified by its assigned station call sign unless its emissions contain the call sign of its associated station.

(h) The identification required by paragraphs (a), (b), (c), (d), (e), (f), and (g) of this section shall be given on each frequency being utilized for transmission and shall be transmitted either by telegraphy using the International Morse code, or by telephony, using the English language. If by an automatic device only used for identification by telegraphy, the code speed shall not exceed 20 words per minute. The use of a national or internationally recognized standard phonetic alphabet as an aid for correct telephone identification is encouraged.

【§97.87(d) amended and redcs. as (h) and new (d), (e), (f), and (g) added eff. 10-17-72; VI(72)-1】

§ 97.89 Points of communications.

(a) Amateur stations may communicate with:

(1) Other amateur stations, excepting those prohibited by Appendix 2.

(2) Stations in other services licensed by the Commission and with U.S. Government stations for civil defense purposes in accordance with Subpart F of this part, in emergencies and, on a temporary basis, for test purposes.

(3) Any station which is authorized by the Commission to communicate with amateur stations.

(b) Amateur stations may be used for transmitting signals, or communications, or energy, to receiving apparatus for the measurement of emissions, temporary observation of transmission phenomena, radio control of remote objects, and similar experimental purposes and for the purposes set forth in § 97.91.

(c) Notwithstanding the provisions of paragraph (a), no more than two repeater stations may operate in tandem, i.e., one repeating the transmissions of the other, excepting emergency operations provided for in § 97.107 or brief periods to conduct emergency preparedness tests.

(d) Control stations and auxiliary link stations may not be used to communicate with any other station than those shown in the system network diagram.

【§ 97.89 amended eff. 10-17-72; VI(72)-1】

§ 97.91 One-way communications.

In addition to the experimental one-way transmission permitted by § 97.89, the following kinds of one-way communications, addressed to amateur stations, are authorized and will not be construed as broadcasting: (a) Emergency communications, including bona-fide emergency drill practice transmissions; (b) Information bulletins consisting solely of subject matter having direct interest to the amateur radio service as such; (c) Round-table discussions or net-type operations where more than two amateur stations are in communication, each station taking a turn at transmitting to other station(s) of the group; and (d) Code practice transmissions intended for persons learning or improving proficiency in the International Morse Code.

§ 97.93 Modulation of carrier.

Except for brief tests or adjustments, an amateur radiotelephone station shall not emit a carrier wave on frequencies below 51 megahertz unless modulated for the purpose of communication. Single audio-frequency tones may be transmitted for test purposes of short duration for the development and perfection of amateur radio telephone equipment.

(Continued next month.)

At Last Repeater Sophistication Is HERE

Now at a realistic price you can have "Touch-Tone" command functions, autopatch, and control. It's the Signal Systems Decoder.

MODEL TTD-1 12/16 BUTTON DECODER

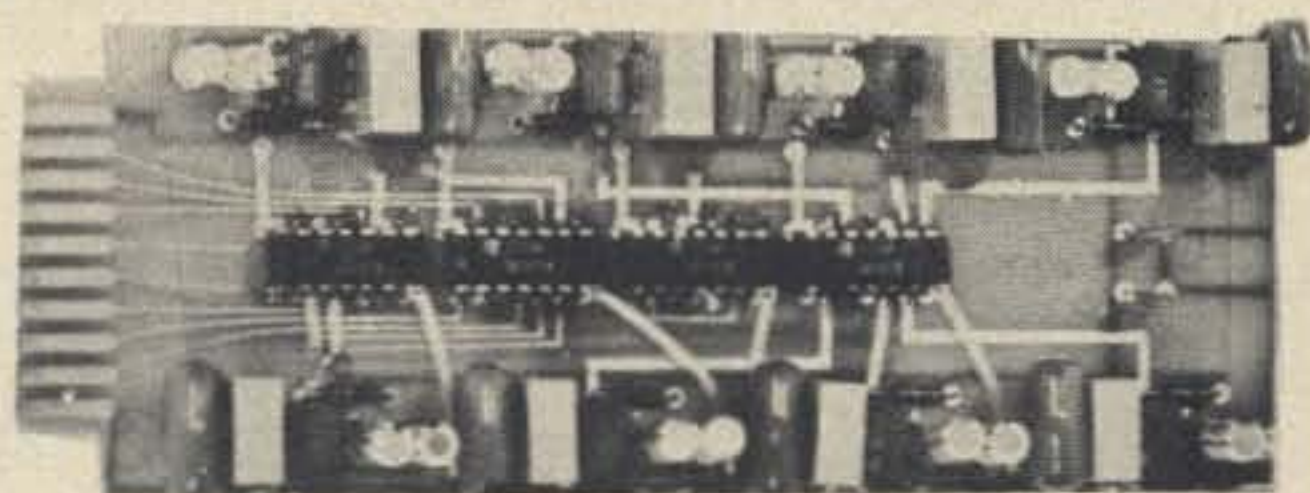

Board	\$10.00
Kit:	12 button \$77.00
	16 button \$88.00
Wired:	12 button \$85.00
	16 Button \$98.00

THE IDENTIFIER TO END ALL IDENTIFIERS ROM-2 Repeater-Identifier (CW-RTTY)

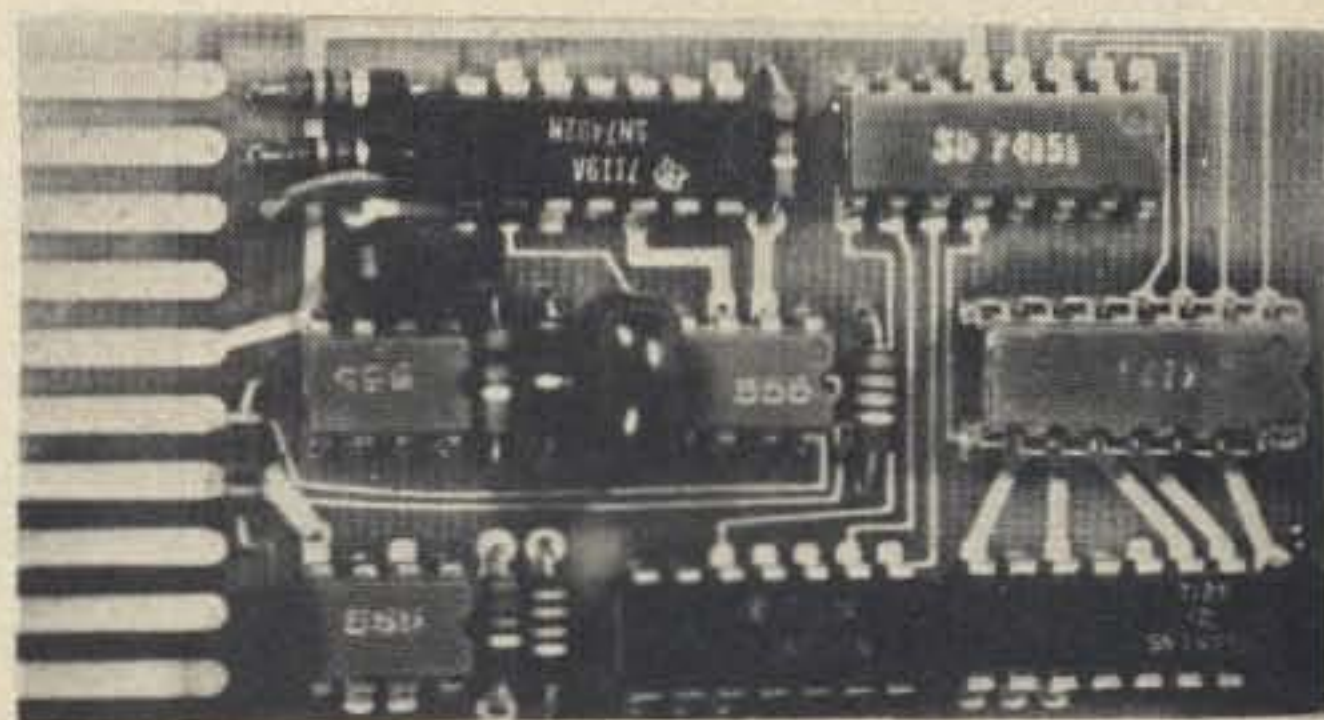

Board	8.00	Option I
Kit	25.00	\$30.00
Wired	29.00	\$35.00

Here is the greatest buy on an identifier you'll ever find.

Look for product review write-ups on these and other exciting new products from . . .

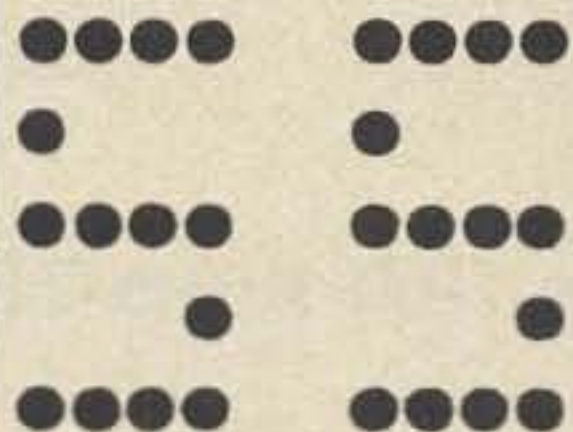

SIGNAL SYSTEMS
2650 Durango Dr.
Colorado Springs,
CO 80910

Phone toll free 800-525-5890

**IF YOU REALLY WANT THE BEST,
YOU'LL JUST HAVE TO ACCEPT THE FACT
THAT IT'S GOING TO COST YOU A LITTLE LESS**

*It's the little things that
make a GTX the value it is:*

- Operation over the entire 2-meter band (including MARS and CAP frequencies) *without* tuning
- No automatic shutdown on SWR bridge. Operate with mismatched antenna *without* damage, due to balanced emitter output transistors
- Lowest AM detection level of any comparable unit (including many commercial rigs)
- Power: the GTX-2 and GTX-200 boast 30 watts nom. output
- Lightweight: manufactured to aviation industry standards
- High-sensitivity receiver pre-amp included as standard (GTX-2 and GTX-200)
- 1/4" phone jack included as standard (GTX-2 and GTX-200)



General Aviation Electronics, Inc., 4141 Kingman Drive, Indianapolis, Indiana 46226 — Area 317 - 546-1111



GTX-200 **\$269.95***

(30 watts output power, nom., up to 100 channel combinations)



GTX-2 **\$259.95***

(30 watts output power, nom., accommodates 10 channels)



GTX-10 **\$209.95***

(10 watts output power, nom., accommodates 10 channels)

* Includes 146.94 MHz.
Add'l. crystals \$6.50 ea.

**Don't Let An Honest Price Scare You Away—
See Your Amateur Dealer Today!**

NEW..... \$49.95

Wired and Tested

- 1-2 WATTS IN
15 WATTS PLUS OUT
- SOLID STATE
SWITCHING
- 12-14 VOLTS
NEGATIVE GROUND
- LESS THAN 1 DB
LOSS ON RECEIVE

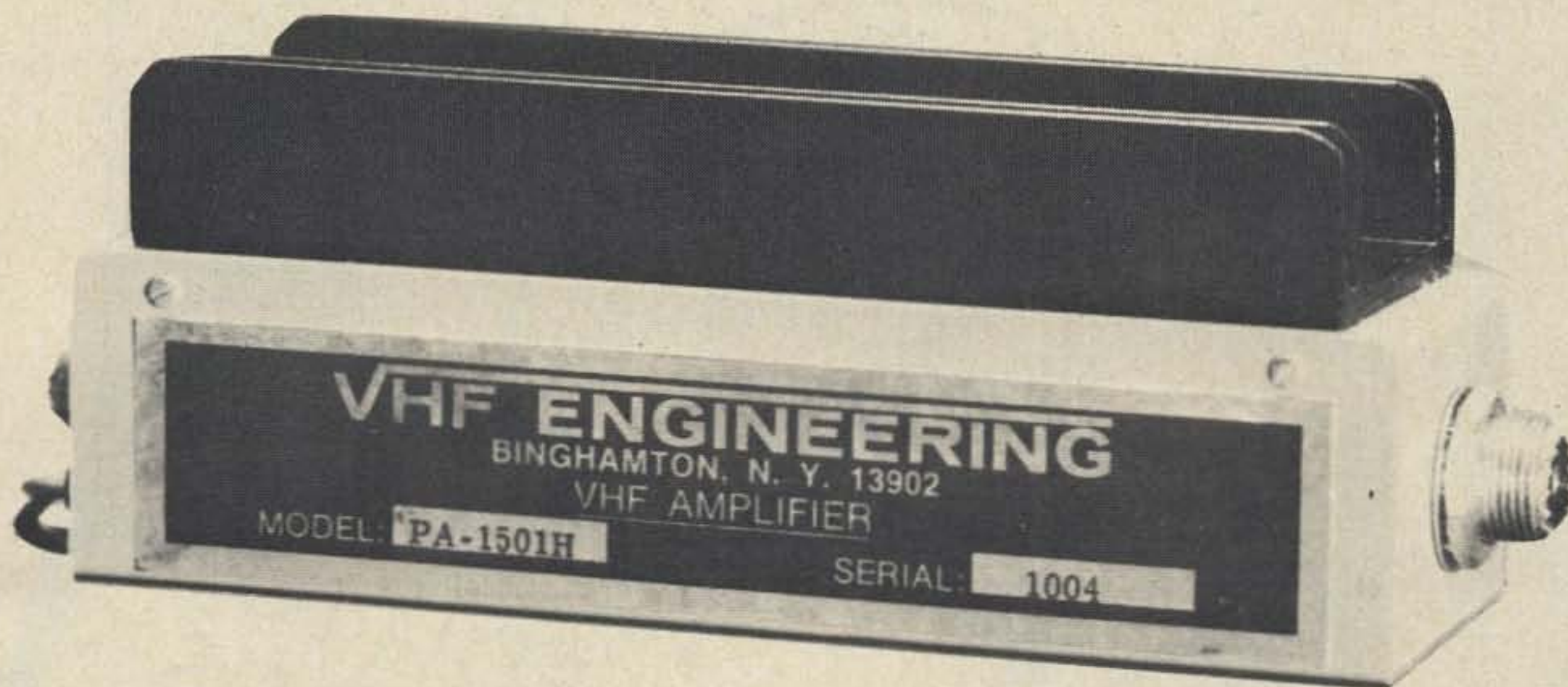

PA-1501 H

Only 2" x 2½" x 6½"

\$39.95 *complete kit*

Also available:

- RX-50C 30-60 MHz receiver kit w/crystal filter \$59.95
- RX-144/220A 2/220 receiver kit 59.95
- RX-144/220F 2/220 receiver kit w/ceramic filter 65.95
- RX-144/220C 2/220 receiver kit w/crystal filter 69.95
- TX-144 1 watt exciter 29.95
- TX-220 1 watt exciter 29.95
- PA-144/220 15 watt amp less cabinet, connectors, and switching . 29.95
- PA-144/220 25 watt amp less cabinet, connectors, and switching . 49.95
- PA-8005H 90 watt amp 5 watts in wired/tested 159.95
- PA-8020H 90 watt amp 25 watts in wired/tested 129.95
- PA-432 10 watt amp less cabinet, connectors, and switching 39.95
- PS-12 12 amp regulated 12-15 volt power supply kit 59.95
- PS-12W Wired/tested 69.95
- PS-24 24 amp same as PS-12 less case 69.95
- COR-1 COR with 3 second and 3 minute timers 19.95

Write for data sheets on any above units. Add postage. NY state residents add sales tax.



VHF ENGINEERING

— DIV. of BROWNIAN ELECT. CORP. —

320 WATER ST. POB 1921 BINGHAMTON, NY 13902 607-723-9574

WORLD'S LARGEST SELECTION OF

NEW & USED TV CAMERAS & ASSOC. EQUIPMENT

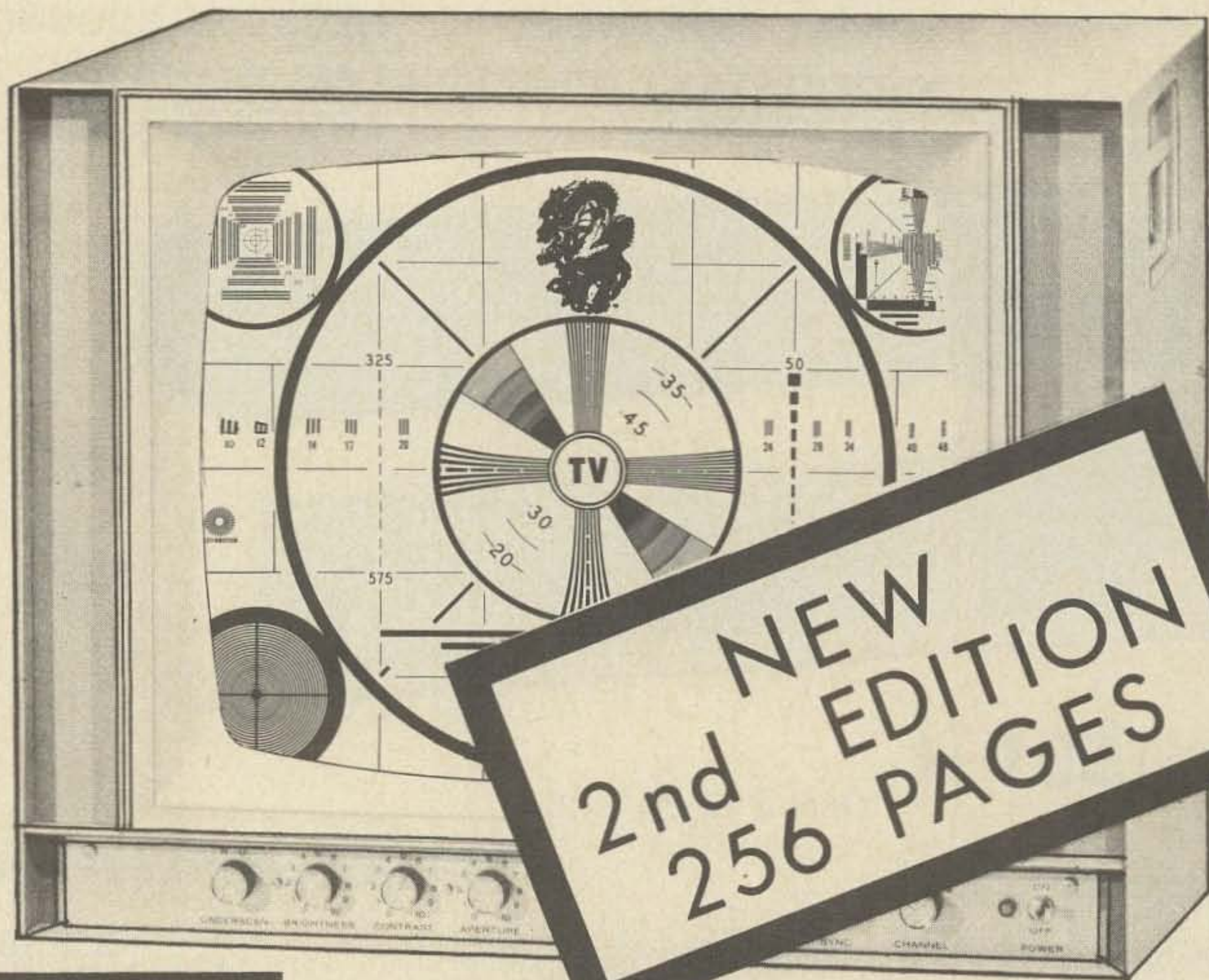

1973
1974

INDEX PAGE 142

Broadcast & Closed Circuit TV
Audio and Video Systems

PRICE
\$1.00

CATALOG #
973 S 1

\$1.00 ppd USA—\$2.00 Foreign.
Free to requests on Company
Letterhead.

THE DENSON ELECTRONICS CORP.

9AM - 4PM Monday thru Friday; otherwise by appointment.

OFFICE: Longview St. Tel. Area Code 203/875-5198

MAIL: Post Office Box 85

ROCKVILLE, CONN. 06066 USA

ANOTHER SELECTRONIC SPECIAL

The R648/ARR41 Receiver

Can be best described as a mini version of the R390A class of receivers, having most of the key features of the R390s. The unit covers from 0 kc to 24,999 Mc in 24 one megacycle bands. It does not include the band covering 1 Mc to 2 Mc. As you might surmise, the rec. includes two Collins mechanical filters. Operation of the receiver is most pleasurable, especially when tuning sideband. Incidentally, the crystal controlled calibrator delivers a tone every 100 kc and is of frequency meter accuracy. The receiver contains a dynamotor designed to operate from 27.5 volts DC at about 4 to 5 amps. Since most of the dynamotors are free of hash, retaining it and operating the set from 24 to 28 v. DC is not really a bad alternative. If you wish to power with A.C. supply requirements are 250 V @100 ma. and 28v for fil. These sets are in like new condition overhauled and checked out. Wt. 34 lbs.

Price: \$175.00 ea.

Solid State 866A Direct Replacement

Price: \$5.95 ea. or 2/\$10.00

R508 VHF Rec. 118-148 MHz

Price: \$14.95 ea.

MODERN ALUMINUM BENCH RACK CABINET

11½" H x 18" D x 19" W. 8" panel openings w/rubber feet and disappearing handle. Lt Blue

Price: \$7.95 ea.

R.F. AMPLIFIERS

TUNES 50 to 100 mhz - COMPACT ALL ALUM. CASE 12" x 15" x 6½" WITH SK 600 EIMAC SOCKET. 1 LARGE AIR VARIABLE CAP. - 2 SMALL AIR VARIABLE TRIMMERS - TEFLON MOUNTED ROTARY INDUCTOR - GOOD FOR LINEAR AMPLIFIER - CAN USE EITHER 4 CX150A or 4 CX250 - LESS TUBE, PRICE: . . . \$14.95 ea. WITH 4 CX150A, PRICE: . . . \$19.95 ea.

ADJUSTABLE PRINTED CARD BOX

For Rack Mount

5" to 7¼" - 16 slides and sockets - includes 30 double contact position edge connector type

Price: \$9.95 ea.

Receiver type VHF-2RM 108-135 MHz crystal control Double Conversion AM with AVC noise limiter and squelch-tunable. 115 volts, 50-60 cycles. Price: \$24.95.

WINTRONIX MODEL 850 INDUCED WAVE FORM ANALYZER.

This unit, in conjunction with your present oscilloscope, permits you to view wave forms in the range from audio thru MHz without any direct connection. The probe is simply placed over the tube in question and the wave form is displayed on the oscilloscope. It may also be used as a high gain amplifier to increase scope sensitivity. Excellent for TV, radio, amplifier, and transmitter repair and maintenance. Brand new, with probe. SHIP WT. 13 lbs.

Price: \$19.95 ea.

MODULE TYPE POWER SUPPLY TRANSISTOR, REGULATED.

115V - 60 cycle in +12 -12 -6V @ 3 amp output. Front Panel adj + or -10%. On-off switch. Fuses. Barrier strip output. 6" x 5" x 7". Excellent Cond. Ship. Wt. 10#

Price: \$14.95 ea.

DIGITAL READOUT SET

Make your own counter, frequency meter, digital voltmeter, readouts, etc.

Kit includes

- 6 nixies with 6 sockets
- 1 transformer
- 1 P/S board w/socket

PRICE: \$12.95, 2/\$20.00

B-7971 LARGE ALPHA NUMERIC READOUT

With sockets & driver board. Can be hardwired to form unusual house address numbers. 2 tubes, 2 sockets, mounted on one driver board. Save \$3.00

Price: 5/\$5.00

COMPUTER TYPE CAPACITORS

- 40,000 @ 20V
- 32,500 @ 25V
- 55,000 @ 15V
- 100,000 @ 8V
- 50¢ each or 5 for \$2.00

- 40,000 @ 10V
- 30,000 @ 10V

PRICE: 3 for \$1.00

Receiver R-36/GR 225-400 MHz. Crystal Control Double conversion FM with squelch and noise limiter. 600 ohms output. 115-230 Volts, 50-60 cps. Price: \$24.95

Just arrived. P-S for R648 fits into receivers. Price: \$24.95

Coaxial relays, single pole - double throw, available in UHF, BNC, Type N. Specify.

Price: \$4.95 each.

LAMBDA POWER SUPPLIES, LT 2095, 0-32 V 2 amp. rack mount. Like New.

Price: \$34.95 each.

Adapters BNC to SO-239.

Price: 2/\$1.00.

VACUUM VARIABLES, UCS 300, 300 mmF, 10,000 V.

Price: \$19.95 each.

SPECIAL ONE OF A KIND

Sorenson Power Supplies:

- MA 28 30, 28 V, 30 A Price: \$125.00
- ERA 0-36 V, 50 A Price: \$150.00
- ERA 0-36 V, 20 A Price: \$100.00

Transmitter, 110 W FM, 406-420 Mc. Rack mount, with power supply.

Price: \$150.00

ALL PRICES ARE F.O.B. OUR WAREHOUSE, PHILADELPHIA, PA. ALL MERCHANDISE DESCRIBED ACCURATELY TO THE BEST OF OUR KNOWLEDGE. YOUR PURCHASE MONEY REFUNDED IF NOT SATISFIED. TERMS ARE CASH. MIN. ORDER \$5.00. ALL MERCHANDISE SUBJECT TO PRIOR SALE. RFE - REMOVED FROM EQUIPMENT.

1206 South Napa Street **SELECTRONICS** Philadelphia, PA 19146
215-468-7891 215-468-4645

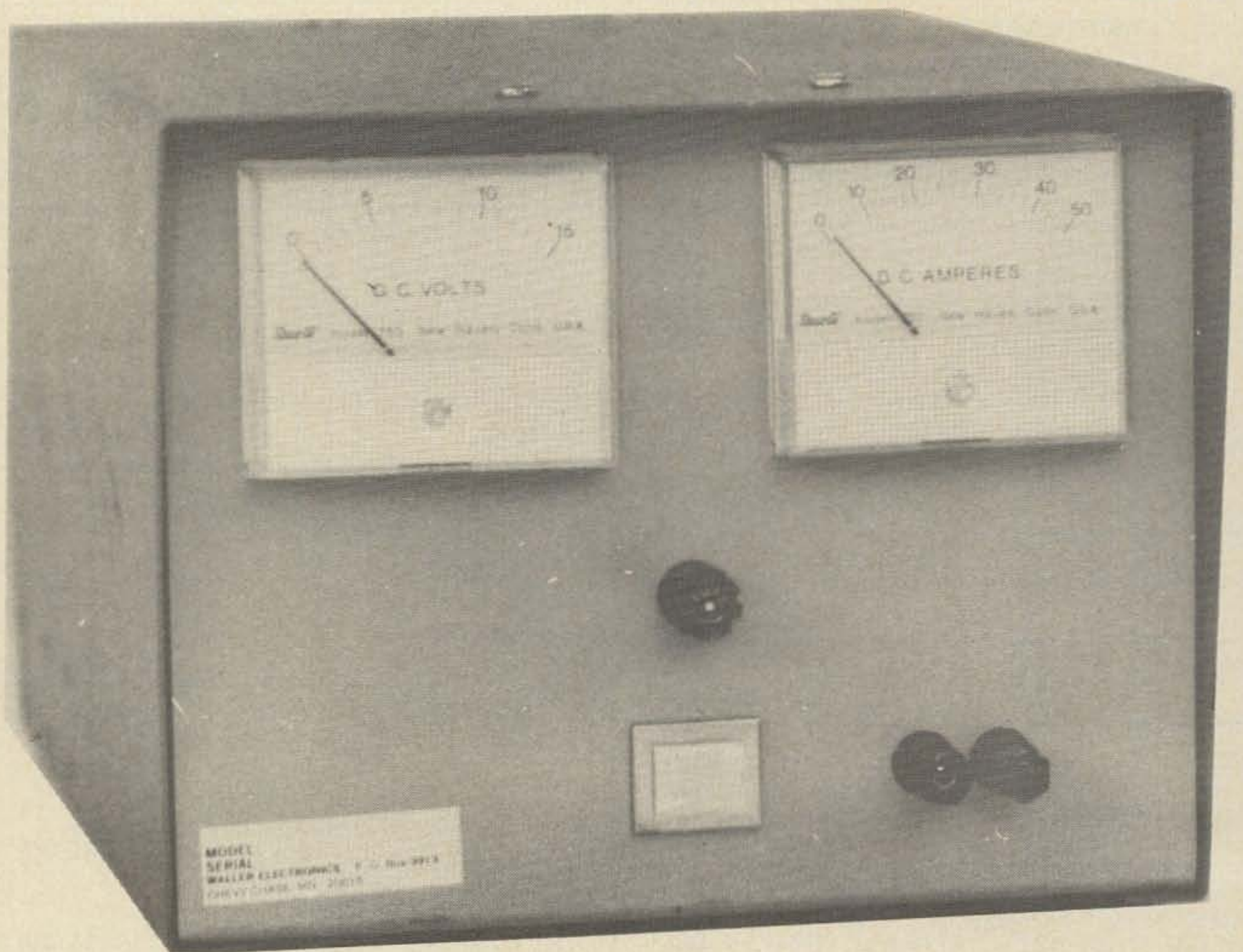

THE ULTIMATE IN 12 V POWER SUPPLIES

- 60 A @ SLIGHTLY LESS THAN 12 Vdc
- NOMINAL OUTPUT: 50 A at 12 Vdc
- BUILT-IN VOLTAGE & CURRENT METERING
- WILL RUN A MOBILE RIG & EVEN AN AMPLIFIER FROM 110 Vac

WALLER ELECTRONICS TEST EQUIPMENT SALES

P.O. Box 9913, Chevy Chase, Md. 20015

Telephone 301-652-0996

SHIPPED FREIGHT COLLECT

EXCITING NEW PRODUCTS



2-METER PREAMP
20 dB Gain, 2.5 N.F., 12V dc, Size 1" x 1 1/4" x 1/2". Diode protected MOSFET. 90-day guarantee. Sh. wt. 4 oz. Major Components Separately Shielded.
Kit \$9.50
Wired \$12.50

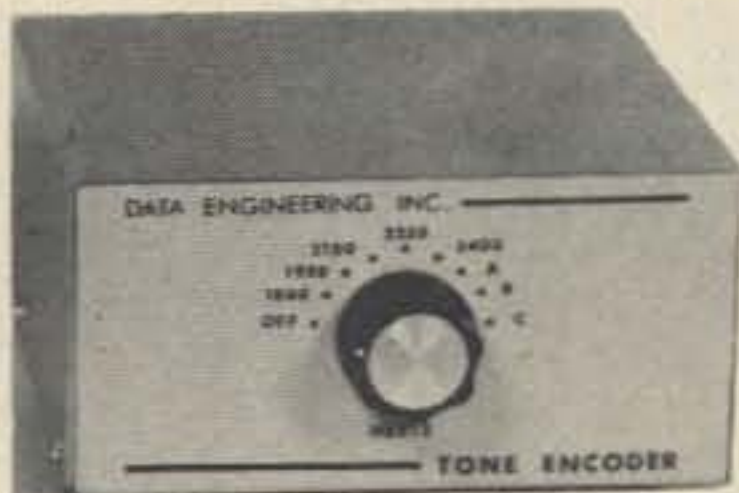

TONE ENCODER
Eight pre-adjusted tones. Duration and Output adjustable, PLL circuitry for extreme stability. Choice of continuous or tone burst operation. Tone burst operation requires no batteries. Easy to install. Includes three special single or dual tones.
TE8-K Kit \$31.95
Wired \$39.95

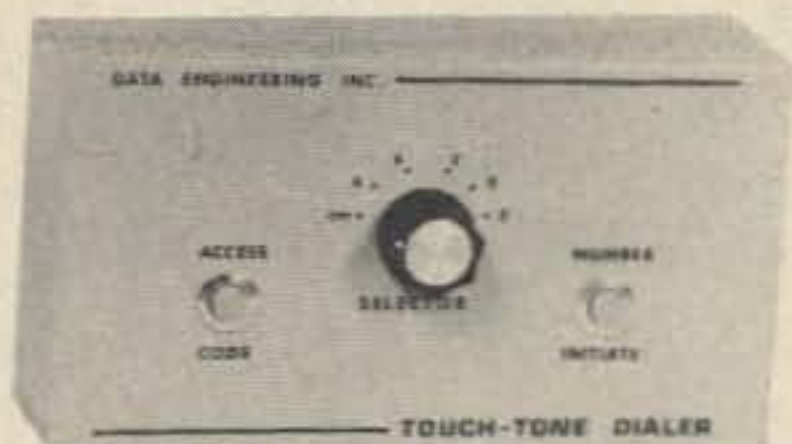

TOUCH-TONE DIALER
The electronic touch-tone dialer for home and car. It's safer and more accurate to use than a pad. Memory includes Access Code plus five phone numbers. Numbers easily updated. Built-in monitor. Complete PTT operation with transmitter hold.
TTD-4K
..... WIRED \$59.00
Kit \$49.00



AUTO-PATCH CONSOLE
This mobile or home console includes all the features you need for complete auto-patch operation. A Touch-Tone Pad; an automatic dialer for sending one access code plus five Touch-Tone phone numbers; a single/dual tone burst encoder adjusted to your choice of frequency above 500 Hz, and a built-in motor. Complete PTT operation with one second transmitter hold.
APC-4K Kit \$84.50
APC-4A Wired \$98.50

TOUCH-TONE DECODER
A highly reliable twelve digit decoder with input protection, and PLL circuitry for extremely stable operation. Heavy duty output relays, small size, plug-in circuit board. All these major features at an UNBEATABLE price.
TTD-12K Kit \$89.50
TTD-12 Wired ... \$129.50



TOUCH-TONE PAD
In less than 15 minutes you can convert your portable transceiver to Touch-Tone operation.
TTP Assembled ... \$44.50
TTP Kit \$34.50

PAD-PULSER
Now you can also obtain pulsed operation from your Touch Tone Pad. Convert Touch-Tone frequencies to decimal pulses at 2805 Hertz with just a flip of the switch. Option can be added to TTP-2/K, TTD-4/K and APC-4/K.
PP-12K Kit \$22.95
PP-12 Wired \$29.95



VHF FREQUENCY STANDARD - FMS-5
Cal. receive and transmit crystals in 10, 6, 2 and 1 1/4 meter FM bands. Markers for all FM channels. Check deviation. Precision 12 MHz crystal. No unwanted markers. Osc. and output buffered. Sh. wt. 2 lbs. (Less Batteries) .. \$44.50
Kit \$37.50



REPEATER ID
Highly stable oscillator for automatic timing. AC or DC operation. ROM provides for more than 25 characters, more than necessary for DC "any call" RPT. AUX is automatically added to ID if desired when main power is lost. Toneburst operation available.
ID-101K Kit \$49.95
ID-101 Wired/Tested
..... \$69.95
ID-101R assembled in 1 1/2" rack cabinet \$109.00



TONE DECODER
Versatile single/dual tone decoder. PLL circuitry for extreme stability. 1 amp output relay can be reset automatically or manually. Monitor position. Adjustable sensitivity. Internal strap selects single or dual tone operation.
TD-2K Kit \$31.95
TD-2 Wired \$39.95

5-year guarantees. Send for Catalog

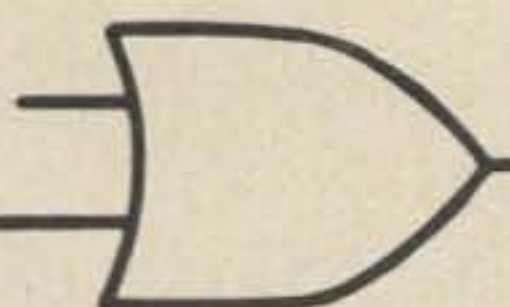

Data Engineering, Inc. 5554 Port Royal Road

Ravensworth Industrial Park, Springfield VA 22151

Phone: 703-321-7171

HAVE A COPY OF OUR NEW CATALOG YET?

IF NOT, WRITE OR CIRCLE READER SERVICE CARD FOR YOUR COPY NOW!

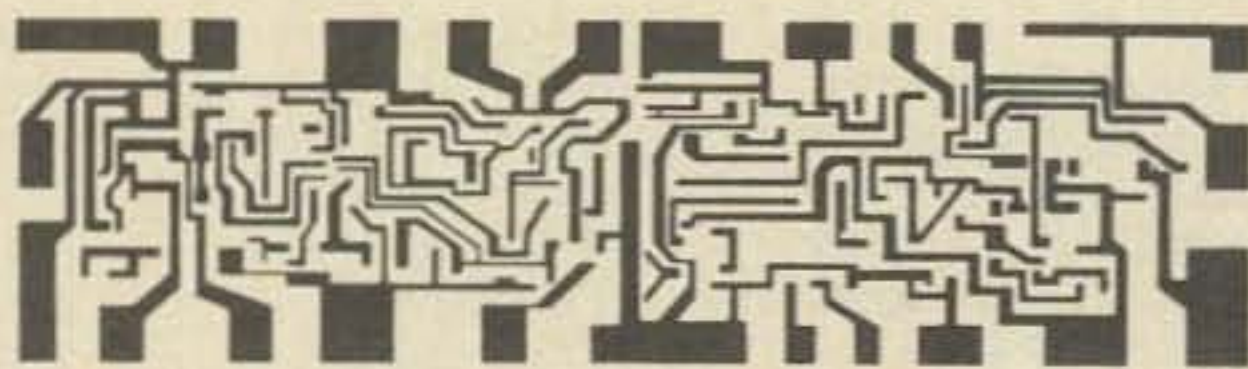

SOLID STATE SYSTEMS, INC.
P.O. BOX 773
COLUMBIA, MISSOURI 65201

(CALL TOLL FREE) 800-325-2981

now there is no excuse for not building your pet project!

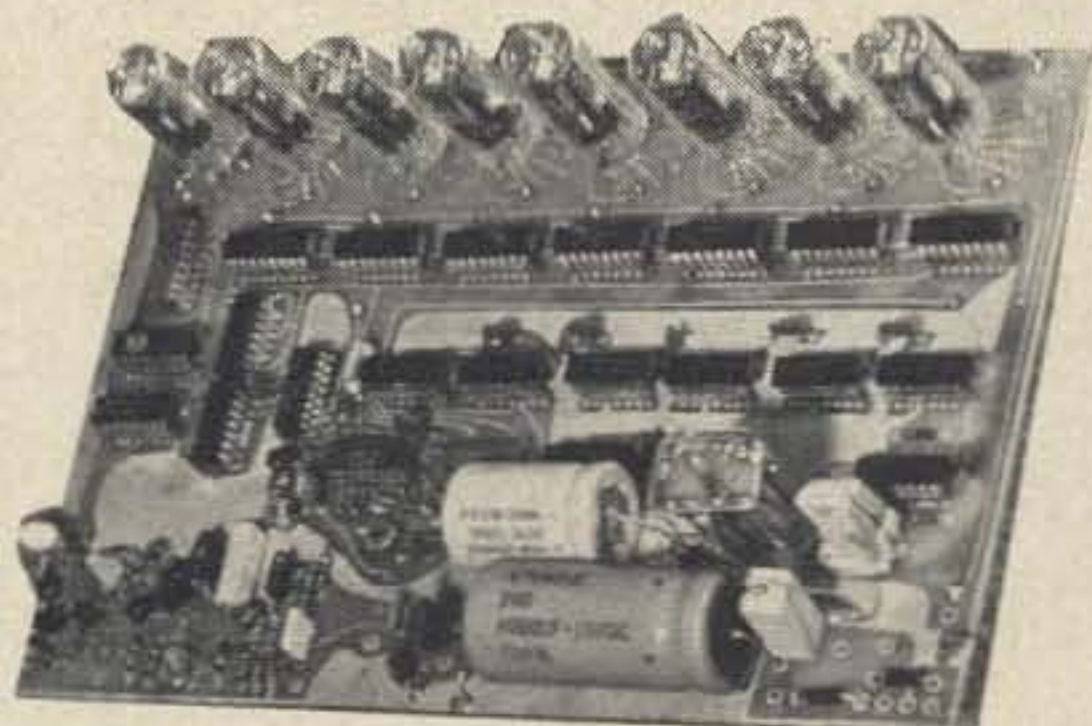
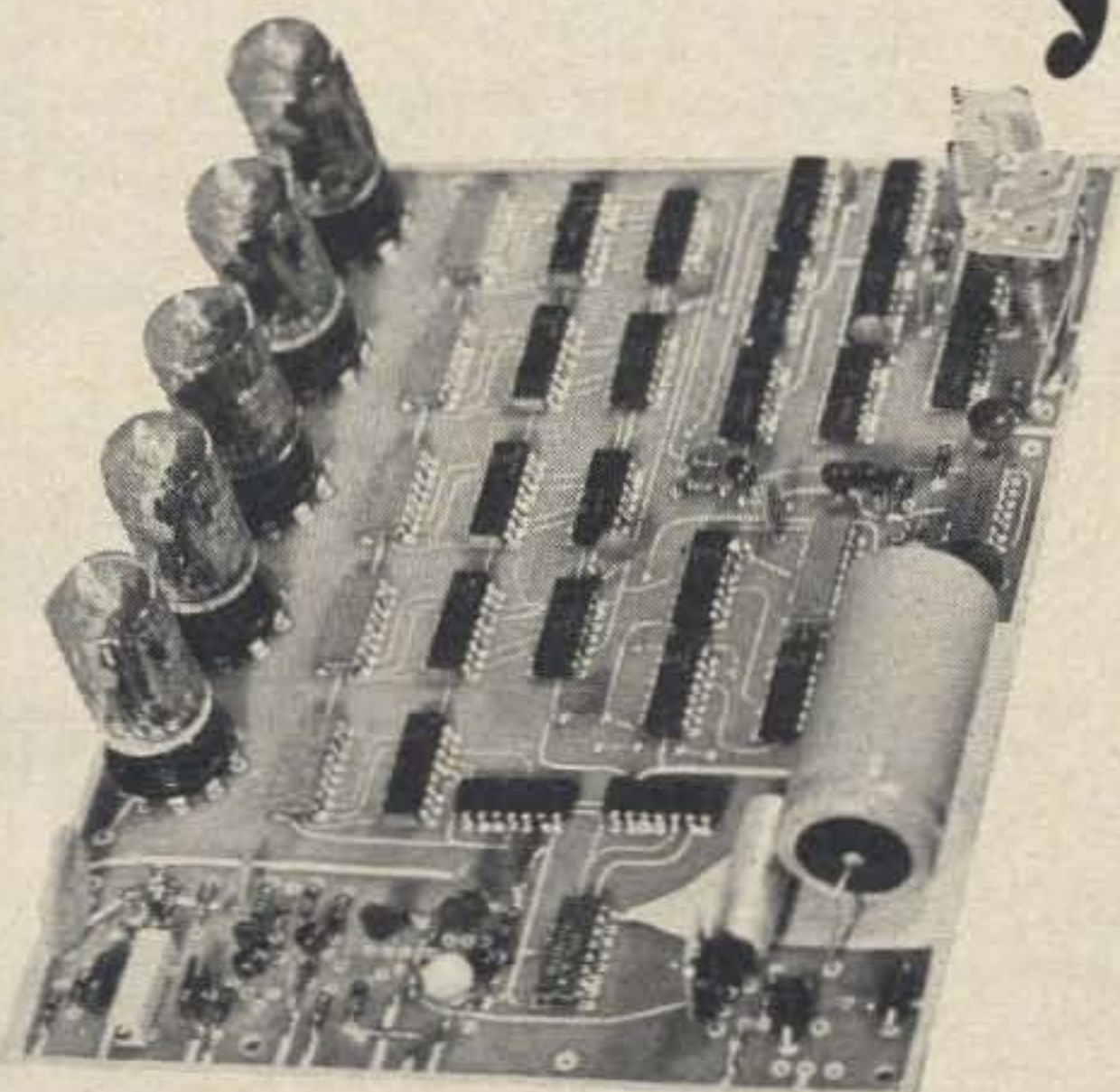

SC 250 8 DIGIT COUNTER SEMI-KIT with built in prescaler, and p.s. good up to approximately 250 MHz. Fully assembled and tested board.

Send for data **\$165**

- ST-5A BOARDS ONLY (same size as those in the ST-6) \$ 5.25
- ST-5A KIT OF ELECTRONIC PARTS \$ 54.00
- ST-6 BOARDS ONLY (these are the 8 original by W6FFC) \$ 18.00
- ST-6 KIT OF ELECTRONIC PARTS \$128.50
- MOD. KIT FOR UPDATING THE ST-5 TO THE ST5A \$ 9.00
- AK-1 BOARD ONLY (same size as those in the ST-6) \$ 3.25
- AK-1 KIT OF ELECTRONIC PARTS (Same size as those in the ST-6). . . . \$ 20.00
- PEMCO MODEL 50A FREQUENCY COUNTER SEMI-KIT \$125.00

This is a fully assembled and tested board with built-in power supply, cabinet, etc.

Write for details.

You must supply the cabinet, A.C. cord, meter, switches, etc. on all kits except where noted otherwise. (All prices are postage paid — we pay shipping.)

If you have been putting off building because of circuit board layout, you have no problems . . . just send a schematic to PEMCO and we will design and build your circuit board to your specs using high quality G10-FR4 2 oz. copper and tin plated for long resistance to oxidation.

PEMCO Inc. **ELECTRONICS MANUFACTURING**

422 18th St., N.E., Salem, Ore. 97301, (503) 585-1641

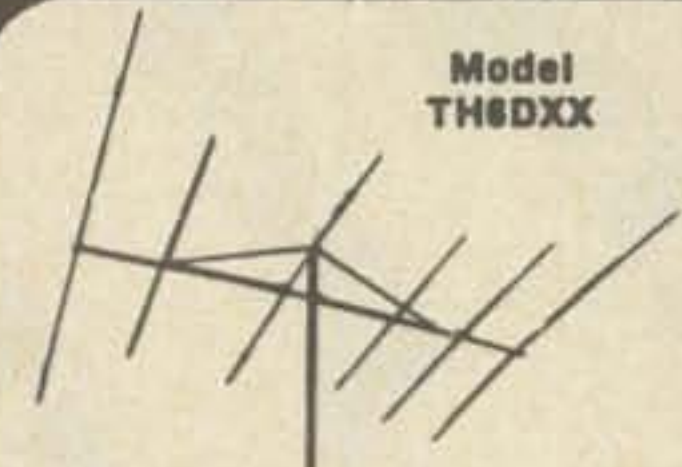

Model TH6DXX
HY-GAIN
A TRULY SUPER BEAM

SUPER THUNDERBIRD TRIBANDER. Ultimate in tribander performance. 6 elements. For 10, 15 and 20 meters. Gain 8.7 dB. F/B ratio, 25 dB. Input, 1 kW AM, 2 kW PEP. Longest element, 31.1'; boom 24'; turning radius 20'. Requires CDR HAM-M rotator. (See p. 12).
Model TH6DXX. 66 lbs. **179.95**

TH3MK3. Improved super 3-element beam. 10-15-20 meters. 36 lbs. **144.95**

TH3JR. 600 watts PEP, 3 el. beam. 10-15-20 meters. Turn radius 14.3', 21 lbs. **99.95**

TH2MK3. Improved 2-element beam. 10-15-20 meters. Turn radius, 14.3', 22 lbs. **99.95**

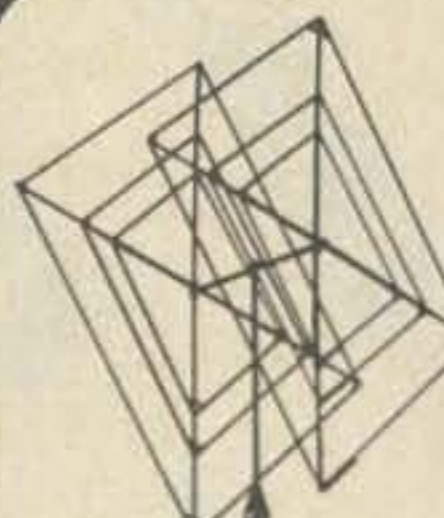

HY-GAIN QUAD and VHF BEAMS

3-BAND, 2-ELEMENT HY-QUAD. Complete, nothing else to buy! Extra strong. For 10, 15, 20 meters. Gain, 8.5 dB. F/B ratio, 25-35 dB. 52 ohms. Spreader length, 25'5", boom dia., 2"; turning radius, 13'6".
Model HY-QUAD. 42 lbs. **139.95**

3-ELEMENT, 6-METER BEAM. Maximum performance, rugged. Gain, 10 dB. F/B ratio, 20-25 dB. Input, 1 kW. 52 ohms. Longest element, 9'10"; boom, 8'; turning radius, 6'.
Model 63B. 7 lbs. **DISCONTINUED**

4-ELEMENT, 6-METER BEAM. Gain, 12.7 dB; F/B ratio, 20-25 dB. Input 1 kW. 52 ohms. Longest el., 9'11"; boom, 12'; turn. radius, 8'.
Model 64B. 10 lbs. **26.50**

3-ELEMENT, 2-METER BEAM. Gain, 9 dB. F/B ratio, 20 dB. Input, 1 kW. 52 ohms. Longest element, 3'6"; boom 3'; turn. radius, 4'.
Model 23. 4 lbs. **9.95**

8-ELEMENT, 2-METER BEAM. Gain, 14.5 dB. F/B ratio, 25-30 dB. Input, 1 kW. 52 ohms. Longest el., 3'6"; boom, 14'; turn. radius, 7'6".
Model 28. 9 lbs. **19.95**

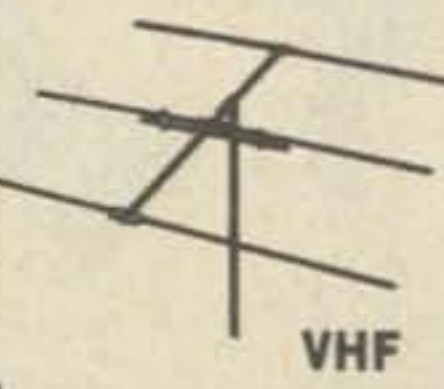

VHF

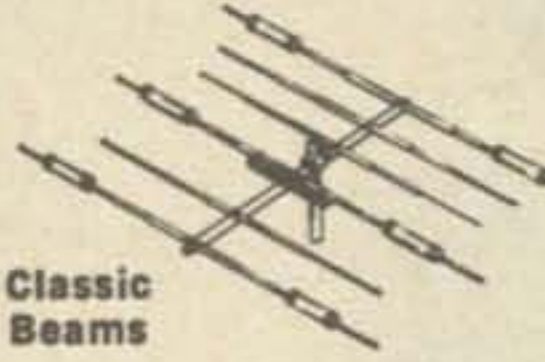

Classic Beams

CLASSIC 6-ELEMENT BEAM. For 10, 15, 20 meters. Extremely rugged and lightweight. Rust and corrosion proof! Maximum gain with increased bandwidth. Rated 1 kW AM/CW, 2 kW PEP on SSB. 52 ohms. Longest element, 29'3"; boom, 24'; turning radius 19'3".
Model CL-36. (Needs HAM-M rotator), 72 lbs. **188.10**
Model CL-33. As above, but 3-elements. Longest element, 27'; boom, 18'; turning radius 16'. 8 dB gain. 47 **153.75**

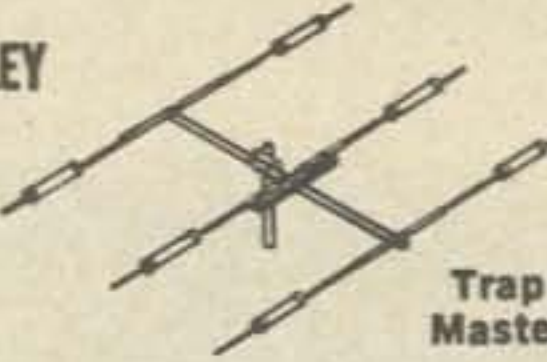

MOSLEY
Trap Master

TRAP-MASTER SERIES. Provides outstanding performance on 10, 15, 20 meters. Exclusive Mosley trap design offers resonant frequency stability under all weather conditions. Traps are weather and dirt-proof.

TA-36. 6-elements, 1 kW AM/CW, 2 kW PEP on SSB. Longest el., 29'; boom, 24'; turning radius, 19'3". 73 lbs. **185.10**
TA-33. 3-elements, 1 kW AM/CW, 2 kW PEP on SSB. Longest el., 28'; boom, 14'; turning radius, 15'6". 41 lbs. **143.40**
TA-33JR. 300 watt version of above. Longest element, 26'8"; boom, 12'; turning radius, 14'9". 28 lbs. **100.00**
TA-32. 2-elements, rated 1 kW. Longest element, 28'; boom, 7'; turning radius, 14'6". 29 lbs. **103.00**
TA-32JR. 300 watt version of above. Longest element, 26'8"; boom, 6'; turning radius, 13'. 20 lbs. **73.15**

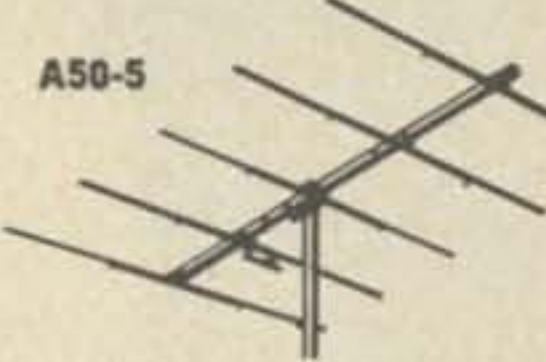

A50-5

6 METER BEAMS. Proven performance, rugged. Engineered for best pattern, high forward gain, good F/B ratio and broad frequency response. Brackets are heavy gauge aluminum. Horizontal or vertical mount. 52 ohms.
Model A50-5. 5-elements, longest element, 117"; boom, 12'; turning radius, 7'6". 12 lbs. **29.50**
Model A50-3. 3-elements, longest element, 117"; boom, 6'; turning radius, 6'. 8 lbs. **18.50**

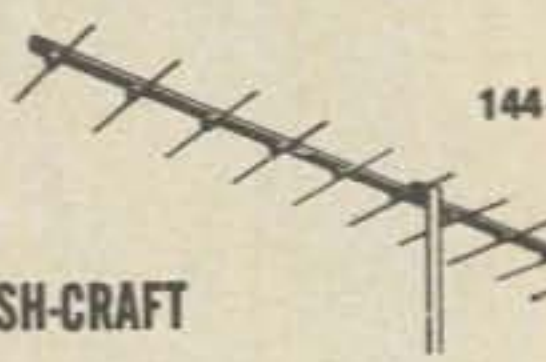

144-11

2 METER BEAMS. High performance VHF beams. Lightweight, rugged and easy to install. Horizontal or vertical mount. Features 1 kW Reddi Match for 52 ohm feed with PL-259 fitting. All elements are spaced at .2 wavelength and tapered for improved bandwidth.
Model A144-7. 7-elements, boom length, 98". Fwd. gain, 11 dB; F/B ratio, 26 dB. 4 lbs. **13.95**
Model A144-11. 11-elements, boom length, 144". Fwd. gain, 13 dB; F/B ratio, 28 dB. 5 lbs. **17.95**

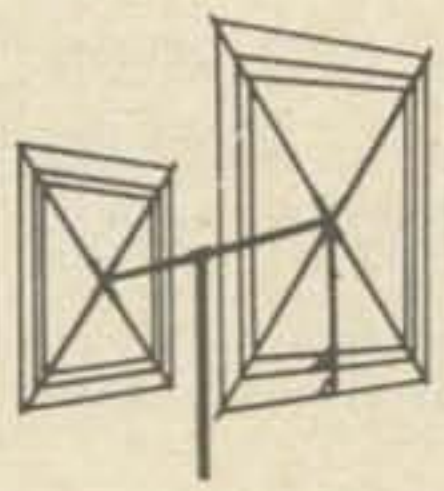

NEW MOSLEY TRI-BAND QUAD

Designed for top DX efficiency. For 10, 15, 20 meters. Aluminum spreaders are well insulated for greater strength. Pre-drilled for easy assembly. Maximum forward gain, F/B ratio, 20 dB. Rated 1 kW on AM. 52 ohms. Spreader length, 12'6"; element length, 17'; boom, 8'; turning radius, 8'.
Model MCQ-3B. 40 lbs. **113.50**

CUSH-CRAFT HALF WAVE SQUALO

Full half-wave, horizontally-polarized, omnidirectional 6-meter antenna. Use it on car top, on mast, or out the window. Direct 52 ohm Reddi Match feed. Only 30" square. Complete with rubber suction cups and mast support.
Model ASQ-6. 5 lbs. **15.95**
Model ASQ-2. For 2 meters. 10" square. 3 lbs. **11.95**

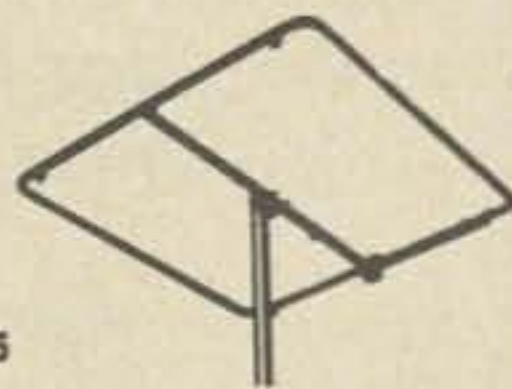



Electronix Sales

23044 CRENSHAW BLVD., TORRANCE, CALIF. 90505
 Phone (213) 534-4456 or 534-4402
 ALSO AMERICAN EXPRESS
 CLOSED SUNDAYS & MONDAYS





CHARGE IT
ON



CHARGE IT
ON



DIAL-A-DEAL HAM RADIO CENTER

TOLL
FREE
NUMBER
(Continental 48 States)

**800
325-3636**

MO CUSTOMERS CALL
314-993-6060
COLLECT

**CALL
FREE**

**CALL
FREE**

**TRADE
ON
NEW**

CALL

**TRADE
ON
USED**

Bill Du Bord, WØKF

(9 A.M.—5 P.M. Central, daily except Sunday)

**FOR
A SQUARE DEAL
ON**

- DRAKE
 - TEMPO/ONE
 - HALLICRAFTERS
 - CLEGG
 - STANDARD
- YAESU
 - SWAN
 - COLLINS
 - KENWOOD
 - REGENCY

*We carry all major brands and a large
stock of used reconditioned equipment*

Write for used list

HAM RADIO CENTER INC.

8342 OLIVE BL.

ST. LOUIS, MO 63132



Numitron 5V 7-Segment
Slimline or Regular \$2.50 ea.



ZM 1000 Neon \$1.75

GE Y 4075 25V Miniature
\$1.75

GE Y 1938 24V Standard
\$1.75

RAY CK 1905 Standard
\$1.75

MAN-3 1.7V Miniature
\$3.50 ea. 10/\$30

GIANT ALPHA NUMERIC

B7971 \$1.00



OIL CAPS 16 MFD 5000 VOLT

Rare find. \$9.00 each

3/\$25.00

NOISE ACTUATED SWITCH \$1.35

Solid state noise actuated switch fully wired, includes mike pick-up, amplifier, SCR switch. Actuates by noise or whistle. Useful for burglar alarms, lamp lighter, etc. 15 ft range.

LIGHT EMITTING DIODES 3/\$1.00

Ruby red, gold plated leads. With mercury cell for instant testing.

H.H. SCOTT MULTIPLEX

Solid state brand new multiplex module w/ schematic. Possibility of conversion of various mono sets to stereo. \$3.00 each 10 for \$25.00

Alpha-numeric keyboards. Excellent to new in condition. Styles may vary slightly from picture. Two models available, one with ASCII encoder in base \$55.00 postpaid in the U.S. Keyboard with no encoder in base \$35.00 postpaid in U.S.

KEY BOARDS
\$35.00 & \$55.00



RCA MEMORY STACK 32x32x9

3rd generation, ultra compact. Measures 1x4 1/4x7. Brand new. \$50.00 3 for \$125.00

CORE STACK

Late model memory stacks, unused,
1Kx9 \$35.00
2Kx9 50.00
8K 4 bit Y-plane 40.00
16K 4 bit Y-plane. 60.00
147K stack 100.00



URC-11 WALKY TALKY

243 MC 2 way radio, hand held, measures 3x4 inches. Used for survival in downed aircraft. May be converted for other frequencies. URC-11 \$15 each or 3 for \$40.00



AM-FM RADIO \$20.00

Fully built chassis by Delmonico with front panel, solid state. Also has stereo tape and stereo turntable inputs, 115 VAC power. Brand new with schematics. \$20.00. Made for console installation. Cost over \$100.00.

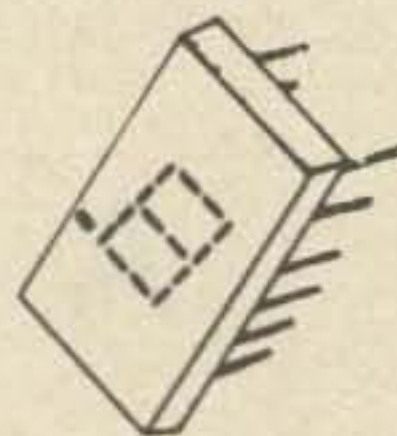

7 SEGMENT LED

Hobby craft due to being factory rejects. Most have a segment or decimal inoperative. Still a great "buy" for the experimenter. What an unusual tie clip you can make with pocket battery . . . demo displays, etc. In many applications you don't need full 7 segments. \$1.00 each or \$10 the dozen. 0.333 inches high character.

12 VDC 3 AMP POWER KIT \$5.00

Just right for powering car tape deck, CB sets, car radio, etc. from regular house current. We furnish parts - transformer, silicon bridge, filtering caps, directions. All new parts, order #KT-3 at \$5.00 ea or 6 for \$25.00.

GIANT 7 SEGMENT

As above only this one is the giant display 13/16 inches hgt of character. First time offered and as far as we know, offered nowhere else. This one is quite an attention getter. Also available in this giant display numeral "one" with "plus" and "minus" sign. Again, these are rejects. Giant display \$1.50 each. 12 for \$15.00

Meshna

Postage extra on above. MESHNA PO Bx 62 E. Lynn Mass. 01904



COMPUTER KEYBOARD W/ENCODER \$35

Another shipment just received. Alpha-numeric keyboard excellent condition. Once again we expect an early sellout. Price of \$35 includes prepaid shipment in the US and shipment made within 24 hours of receipt of order.

POWER TRANSFORMER

115ac/12V@3 amps . . . \$2.50

POWER AMP TRANSFORMER

Brand new compact, regular 115 V 60 cycle input. Output of 40 VCT at 4 amps plus another winding 6V at 2.5 amps. Fine business for Power Amps, Logic or Op Amp supply.

\$5.50 each or 5 for \$25.00

12VCT 2A XFMR \$1.50

Regular 115 volt 60 cycle input. 12 volt transformers are always in demand, these are brand new.

\$1.50 each or 10 for \$12.00

60-SECOND TIMER

A bonanza for the photo lab or any requirement for a precision spring-wound timer. May be set at any interval 0-60 seconds. Contacts rated at 15 amps. Contacts close while running and open at end of time interval. Brand new.

\$1.50 each, 10 for \$12

455 KC IF ASSEMBLY

Complete miniature 455kc IF. amp assembly. 1.5 inches long, little over 1/2 inch square. Ready to use w/schem. Sim to Miller 8902 2.50

RF VACUUM SWITCH

Made for the ART-13 good for 100 watts RF, no doubt handles much more due to being underrated for the military . . . #71-17 3/2.00

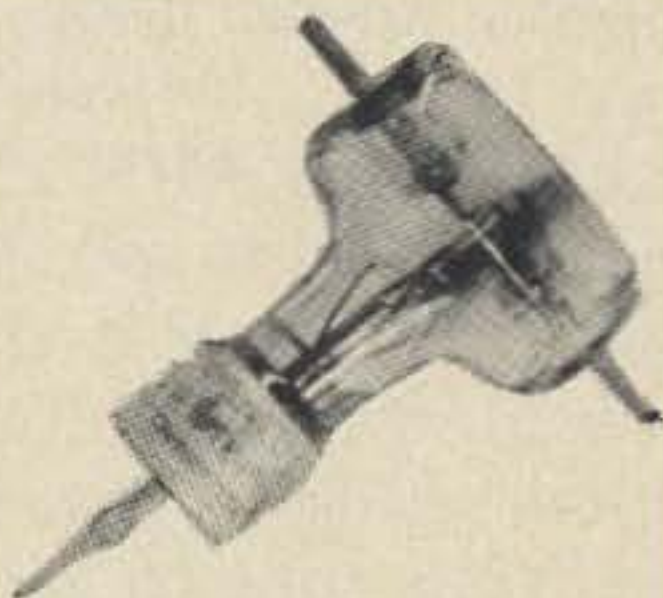

7400 SERIES IC GRAB BAG

Mix of 7400 series DIP, unmarked untested. Some schematics provided 10 for 1.00
100 for 8.00
1000 for 60.00

IC SPECIAL - ONE MONTH ONLY

Our regular \$15 IC board with approx. 140 DIP ICs on them, with ident sheet. For one month only we are pricing them at \$6.50 per board to reduce our inventory. #IC-S \$6.50 Or 5 for \$25

COPPER CIRCUIT BOARD

Brand new GE 2-sided glass epoxy G-10, the standard of the industry, bright and shiny new. 6 x 12, \$1.00. 12 x 12, \$1.50.

AM-FM RADIO \$5.50

Due to the West Coast ship strike they came in too late for the customer. Now it's your bargain. Use it as is or build it into your own cabinet, desk, wall, etc. All built, ready to use, with AC supply. To make it portable all you do is power it with a couple of "D" cells. Fully assembled solid state chassis with AC power supply, less speakers. Covers full AM as well as FM broadcast. The price. . . an astounding meager \$5.50

**PISTON CAPS 1-8 mmF
3 for \$1.00**

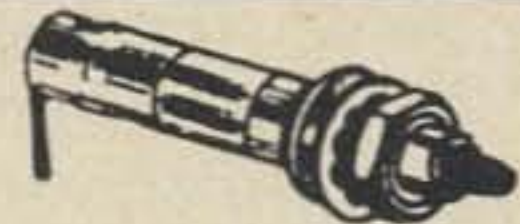

Unused Military surplus. For hi freq. work. List price over \$3.00 each. We have 1 size only, 1-8 μF. No hardware.

#73-18

3 for \$1.00

BATTERY ELIMINATOR-CHARGER

Plugs into 115 volt 60 cycle and puts out approx. 12 volts DC 100 mils. Sufficient to power most any small transistor radio and also useful for charging small dry cells and small ni-cad cells. Fully built, ready to use.

\$1.00 each, 6 for \$5.00

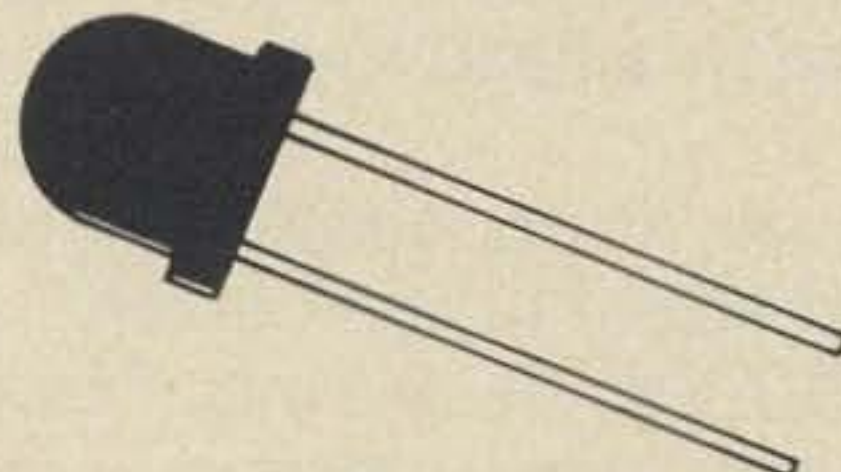

GIANT LED 83¢

Price break at last on these giant LED with 1,000,000 hours of life. Measure full 1/4 by 1/4 inch. First time offered.

RED \$1.00
GREEN 1.25

SUPER BRIGHT collimated RED with parabolic reflector, measures 3/16 diameter. A real hi-intensity red visible over 100 ft.

SUPER RED \$1.25

Meshna

Postage extra on above. MESHNA PO Bx 62 E. Lynn Mass. 01904

COMPUTER KEYBOARDS BRAND NEW

\$50 postpaid



Just arrived, a superb batch of brand new keyboards still in original manufacturers cartons. Beautifully finished in pastel colors with contrasting colored keytops. Made for table operation with fully enclosed metal cabinet. Two encoder boards mounted inside the cabinet with connections terminating on Spectra flat cable with plug. Key operation with bounceless magnet reed switch action. These computer keyboards were dumped as surplus by one of America's largest electronic companies and we were lucky enough to be on the receiving end. The price of \$50 includes prepaid insured shipment in the US and shipment same day as order received. Orders out of the US require an extra \$2.00.

LOGIC POWER SUPPLY \$10

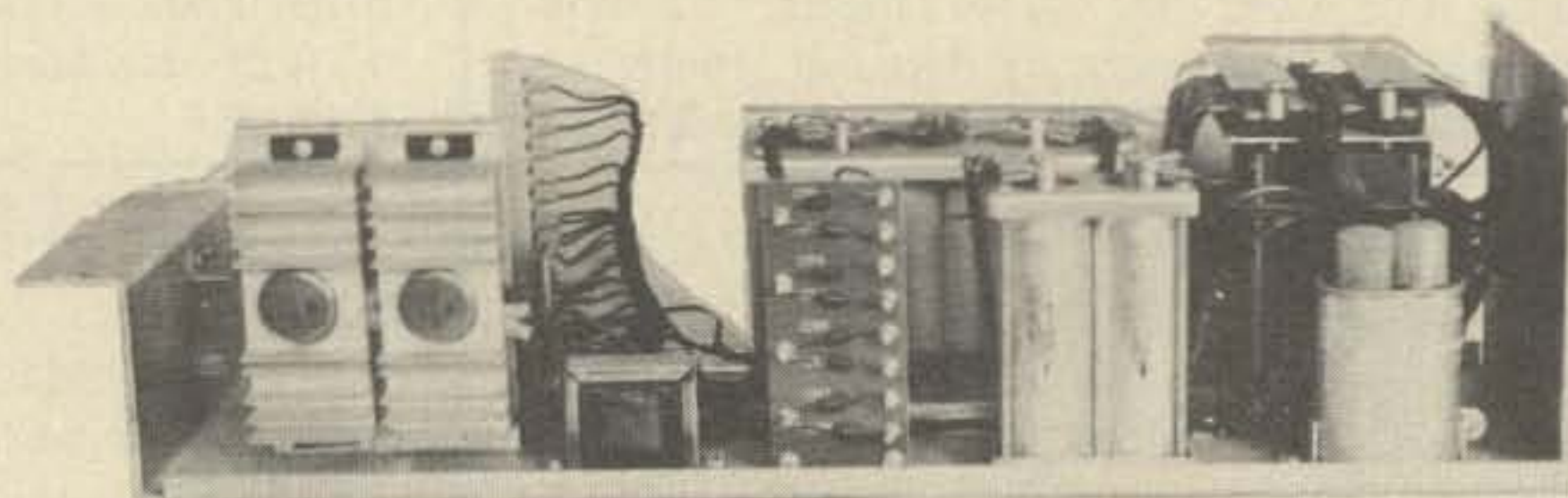

With 400 of these power supplies on hand, we figure we'd better sell them cheap and get them off the floor or all will collapse with a great crashing roar and land in a heap in the cellar.

These are from computer power supplies, used, good condition. Operate from standard house current. 4 output voltages MINUS 30 Vdc at 1 Amp, PLUS 30 Vdc at 1/2 Amp, PLUS 10 Vdc at 1 Amp, MINUS 10 Vdc at 1/2 Amp. Solid state construction with harmonic regulation on the transformer and transistor regulation on the 10 volt outputs. This is one helluva bargain and worth buying just to scrap for parts (if you're crazy enough to tear it apart). You've got 2 transistorized zener regulated plug-in boards with sockets and by changing the zener you can regulate from zero to 25 volts, 2 husky filter caps (18,000 μ f at 35 volts), power transistors on heat sinks, a nice transformer, and misc. other parts.

Ship. wgt. 37 lbs (you pay shipping)

\$10.00 each or 3/\$25.00

Meshna

Postage extra on above. MESHNA PO Bx 62 E. Lynn Mass. 01904

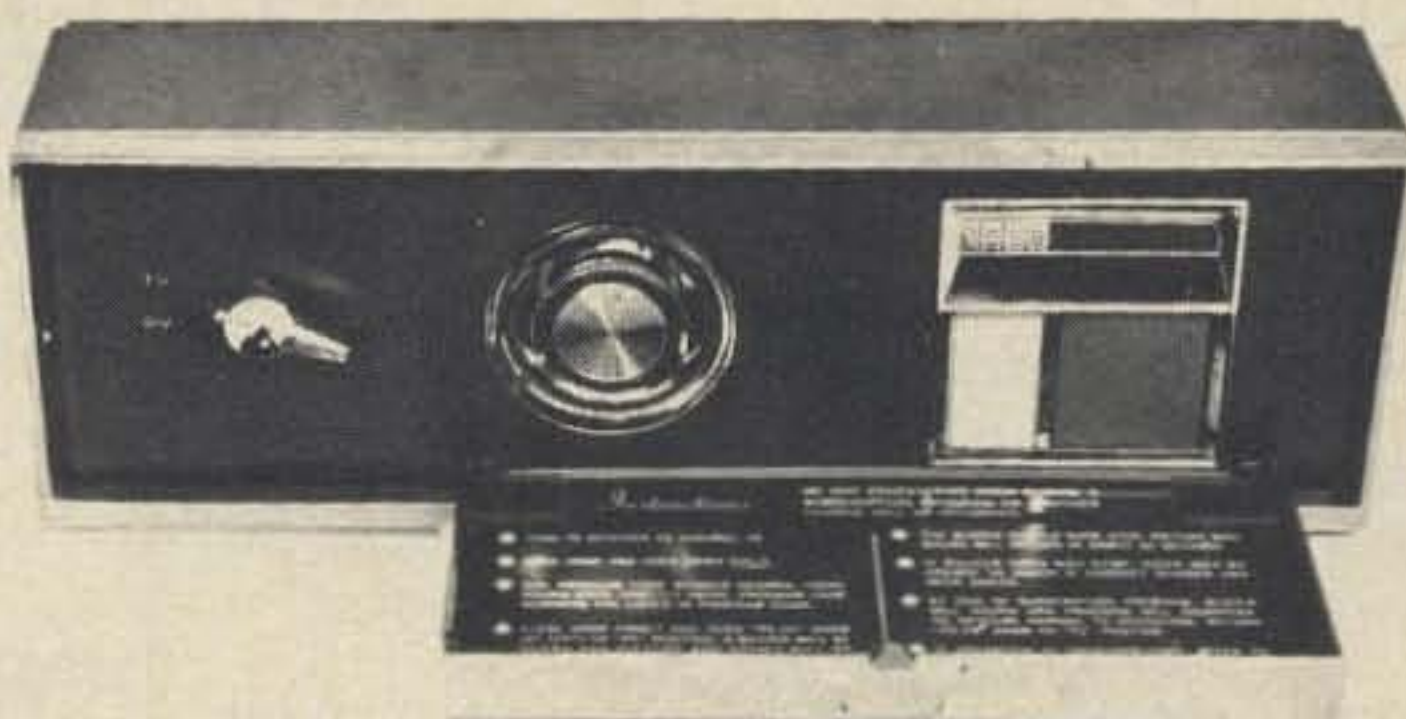
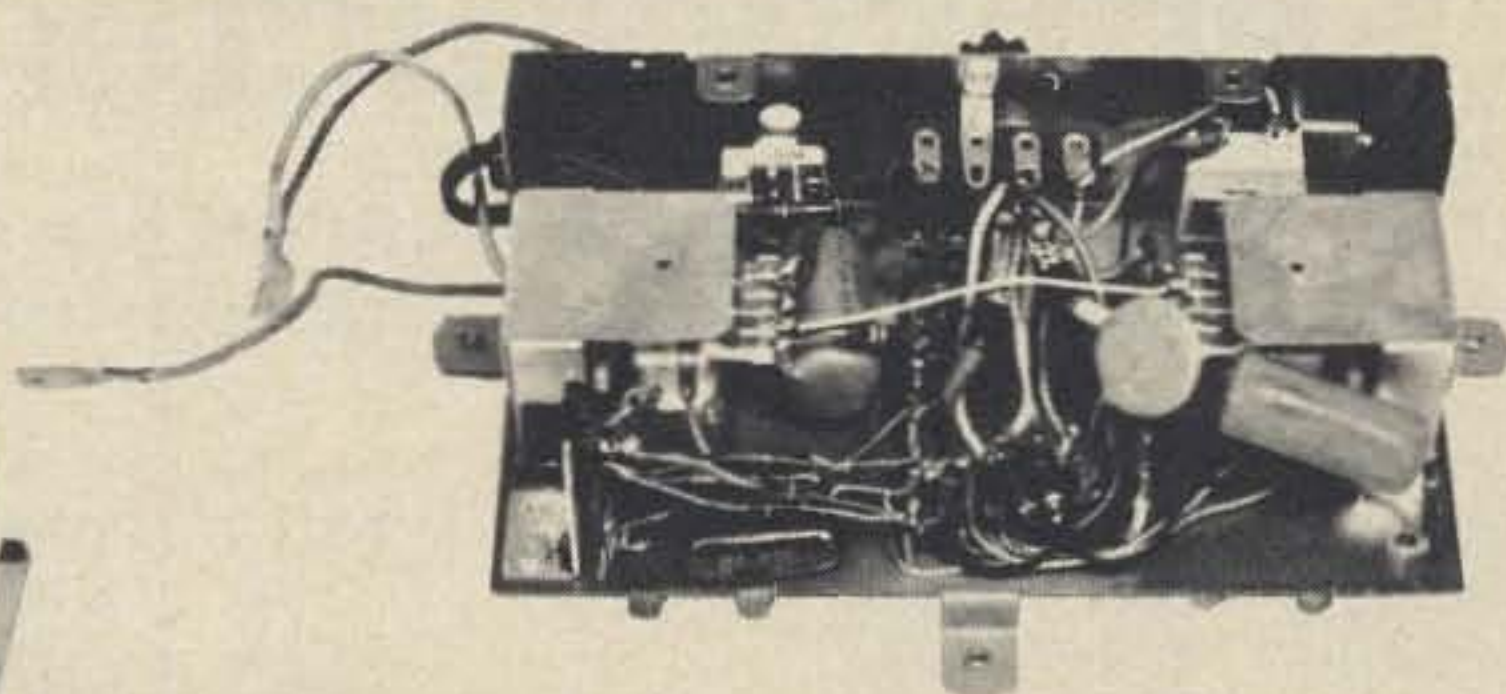
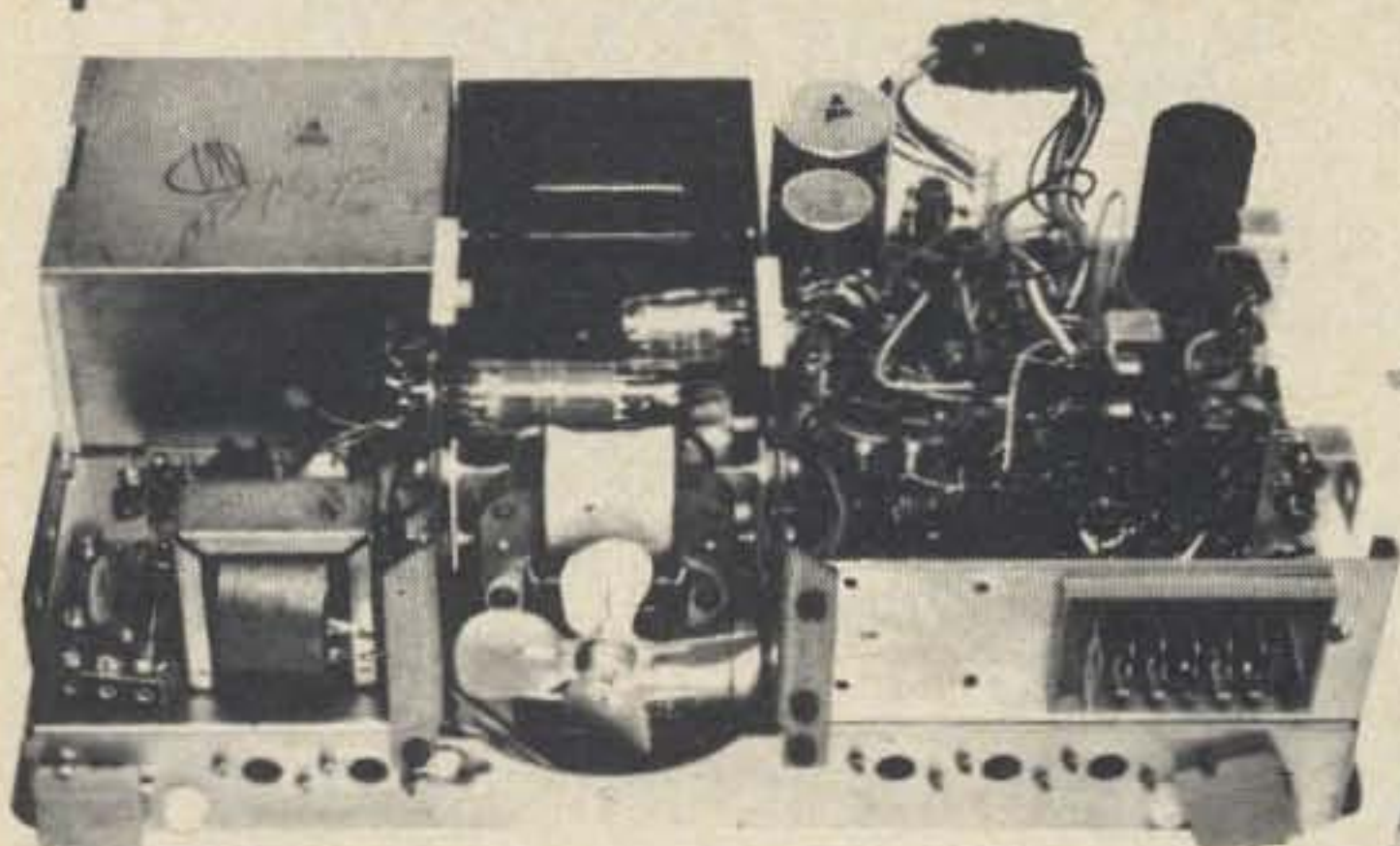

PAY TV ASSEMBLY \$15.00

A "Super Value" for the gadgeteer. A complete Pay TV installation made for ZENITH and all in original packing (3 cartons - wgt 36 lbs) and all unused. Operates on regular 115 volt 60 cycle power. A wealth of parts, easily removed due to long leads on components, most over one inch long. The 3 units consist of Translator, Adapter, Decoder. Transistors, tubes, solid state bridge power supply, geared clock motor, 35mm geared transport, time recorder, solenoid, relays, hundreds of small parts such as resistors, caps, etc. Our estimate as to cost to Zenith, approx \$1,000 per set. Schematics with each purchase. One set of 3 units \$15.00 wgt of 36 lbs. Special . . . 3 sets \$35 wgt of 106 lbs. All unused, original boxed.

COOLING FAN BARRAGE \$12.00

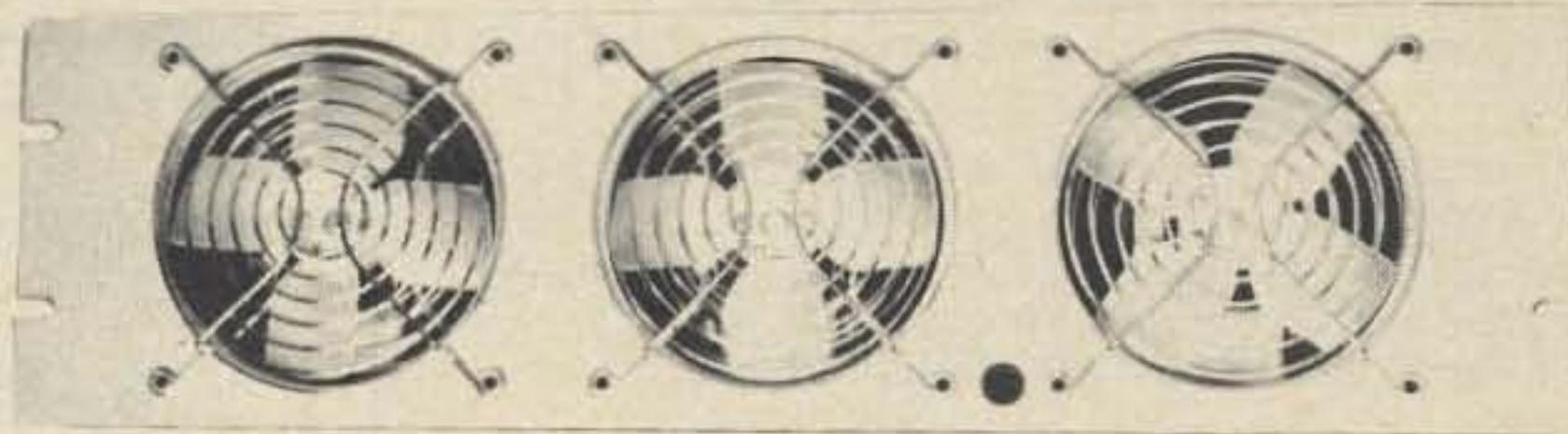

For the photo enthusiast, electronic industry, people cooler, etc. Brand new assembly made by HOWARD Industries, 3 fans per panel, 115 volt 60 cycle. Each fan good for 100 cfm and have blade guards both sides of each fan. To reverse flow of air, mount panel backwards. All brand new, ready to use. Silver gray panel finish. Standard 19 inch panel, 5 1/4 inches high. \$12 per panel of 3 fans or 2 panels of 6 fans for only \$20. Ship wgt 7 lbs per panel.

AM-FM STEREO RADIO \$18.00 AS IS

THESE ARE FACTORY REJECTS TAKEN OFF THE LINE FOR REWORKING BUT THEN THE FACTORY CLOSED. We have UNUSED Solid State AM-FM radios with built in AC supply, extra outlets for tape, mike, or turntable. We furnish the schematic. These units made for console installation. Each with minor defects but we can furnish most any part found defective.

Postage extra on above. MESHNA PO Bx 62 E. Lynn Mass. 01904

Meshna

Semiconductor Supermart

• MOTOROLA • RCA • FAIRCHILD • NATIONAL • HEP • PLESSEY

POPULAR IC's

MC1550	Motorola RF amp	\$1.80
CA3020	RCA 1/2 W audio	\$3.07
CA3020A	RCA 1 audio	\$3.92
CA3028A	RCA RF amp	\$1.77
CA3001	RCA	\$6.66
MC1306P	Motorola 1/2 W audio	\$1.10
MC1350P	High gain RF amp/IF amp	\$1.15
MC1357P	FM IF amp Quadrature det	\$2.25
MC1496	Hard to find Bal. Mod.	\$3.25
MFC9020	Motorola 2-Watt audio	\$2.50
MFC4010	Multi-purpose wide band amp	\$1.25
MFC8040	Low noise preamp	\$1.50
MC1303P	Dual Stereo preamp	\$2.75
MC1304P	FM multiplexer stereo demod	\$4.95

FETs

MPF102	JFET	\$0.60
MPF105/2N5459	JFET	\$0.96
MPF107/2N5486	JFET VHF/UHF	\$1.26
MPF121	Low-cost dual gate VHF RF	\$0.85
MFE3007	Dual-gate	\$1.98
40673	Dual-gate	\$1.75
3N140	Dual-gate	\$1.95
3N141	Dual-gate	\$1.85

NEW FAIRCHILD ECL HIGH SPEED DIGITAL IC'S

9258 Dual "D" FF toggles beyond 160 MHz
\$4.65

9582 Multi-function gate & amplifier ... \$3.15
95H90 300 MHz decade counter ... \$16.00
A 95H90 & 9582 makes an excellent prescaler to extend low frequency counters to VHF - or use two 9528s for a 160 MHz prescaler.

SIGNETICS PHASE LOCK LOOP

NE561B	Phase Lock Loop	\$4.75
NE562B	Phase Lock Loop	\$4.75
N5111A	FM/IF Demodulator	\$1.50
NE566V	Function Generator	\$4.75
NE567V	Tone Decoder	\$4.75

TTL BARGAINS

7400	\$0.28
7401	\$0.30
7404	\$0.30
7410	\$0.30
7420	\$0.30
7446/7447	\$1.50
7475	\$1.00
7490	\$1.00
74192	\$2.00

NATIONAL CLOCK CHIP \$12.50

Set of circuit boards to build a digital clock **\$5.00**

CORES AND BEADS

T200-2	\$2.00
KW Balun kit only	\$3.50
T68-2 3 cores	\$1.00
T50-2 3 cores	\$1.00
T50-6 3 cores	\$1.00
T50-10 3 cores	\$1.00
T44-10 3 cores	\$1.00

BEAD SPECIAL

Ferrite Beads 1 doz. \$1.00

NEW!

INTRODUCING DEVICES AT NEW LOW PRICES

LA3018 (Replaces CA3018)	\$1.60
LA3046 (Replaces CA3046)	1.60
LS370 (Replaces LM370)	4.00
LS1496 (Improved MC1496)	2.00
LS3028A (Replaces CA3028)	1.60
LP1000 (A new fun-type device to make LED flashers, audio osc, timer etc.)	1.60
LP2000 Microtransmitter	16.00

THINKING



DRAKE

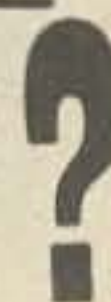

R-4C

TR-4C

T-4XC

TR-22

Check us out

NOW OPEN FOR LOCAL SHOPPING STOP BY AND CHEW THE RAG

1110 N. Scottsdale Road
Hayden Plaza East

Please add 35¢ for shipping

Circuit Specialists

Box 3047, Scottsdale, AZ 85257

FACTORY AUTHORIZED DISTRIBUTOR FOR
Motorola HEP - Circuit-Stick - Plessey
All devices are first quality and are fully guaranteed.

GAM has what your repeater needs

8.2 dB GAIN OVER ISOTROPIC

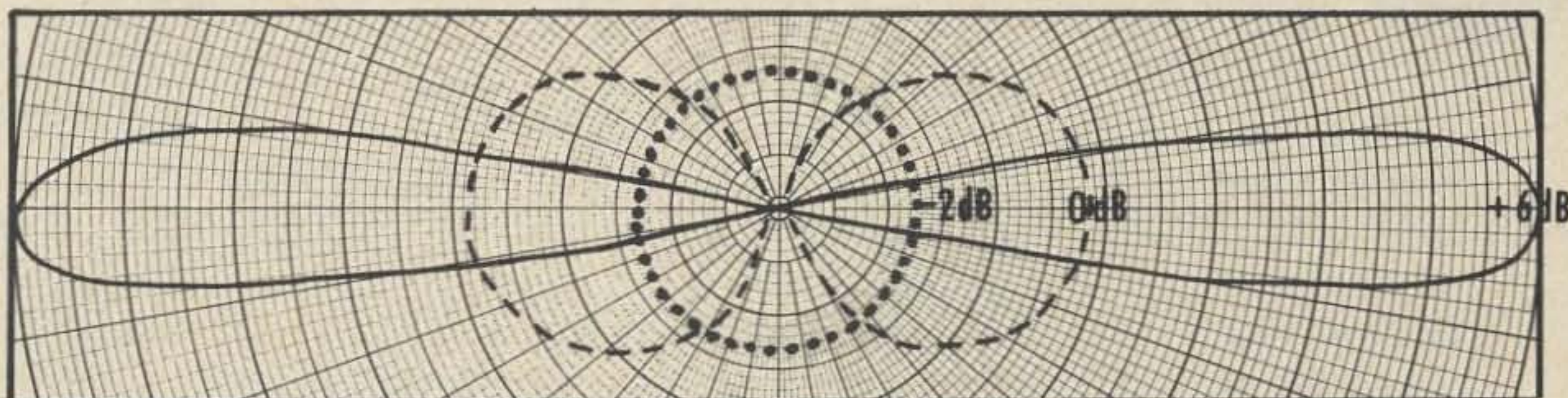

Vertical Radiation Pattern ——— TG5-S
 - - - Dipole
 Isotropic

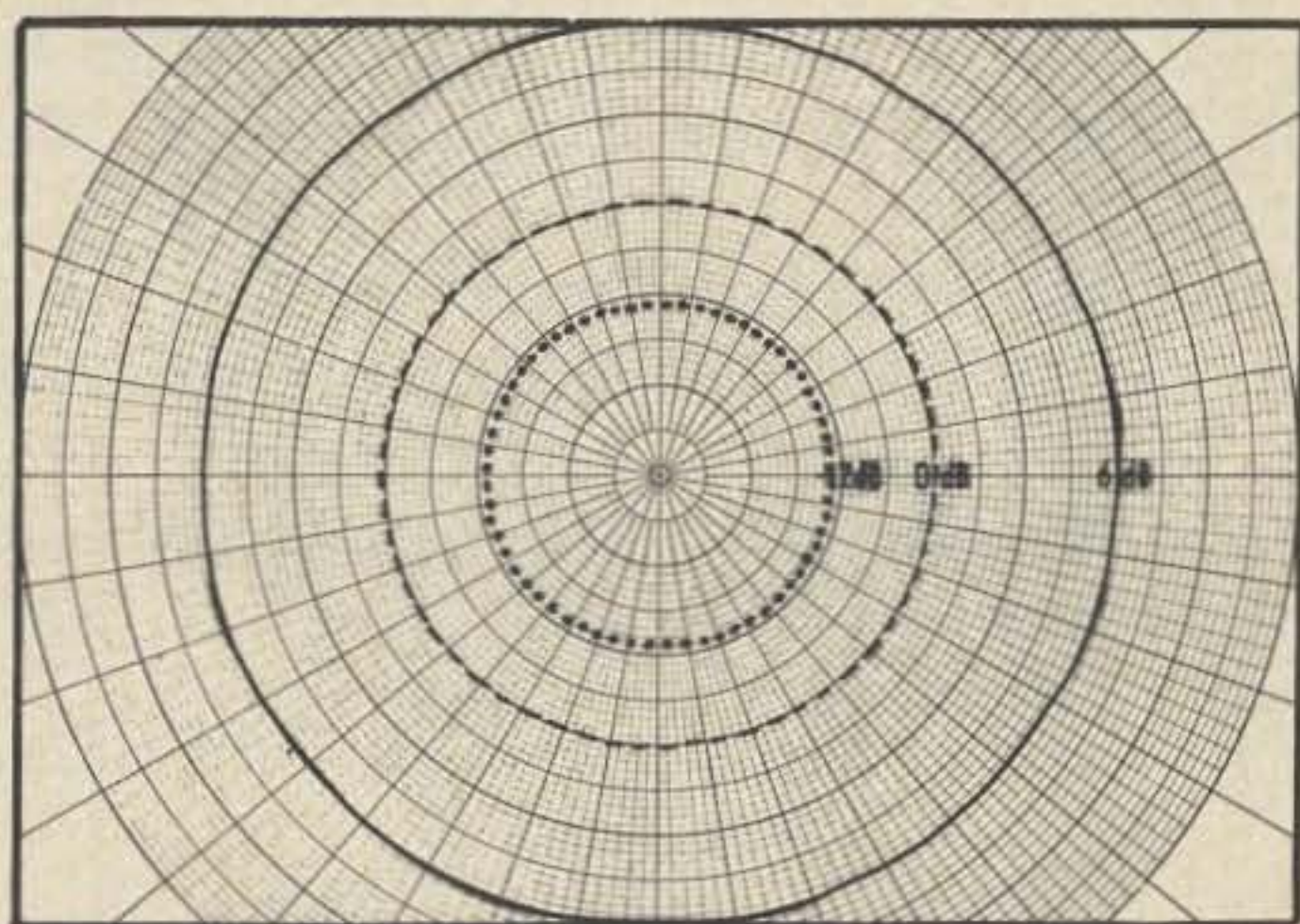

Horizontal Radiation Pattern ——— TG5-S
 - - - Dipole
 Isotropic

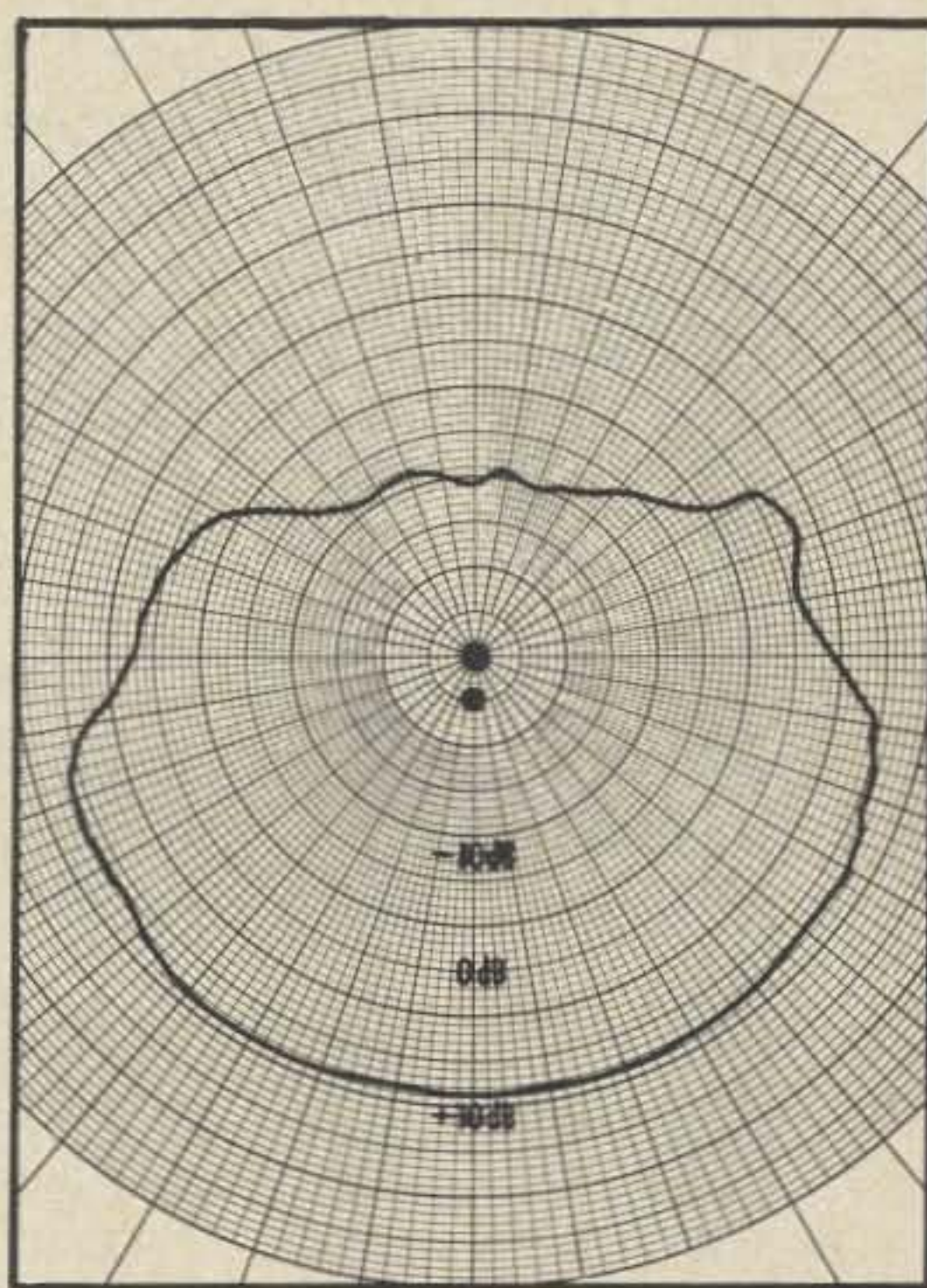

Offset Side Mount Radiation Pattern
 Reference: Dipole

(ON FILE WITH FCC)

MODEL TG5-S
\$104⁵⁰ LIST PRICE

Weight 3½ lbs.



Electronics

191 VARNEY STREET
 MANCHESTER NH 03102
 TEL. (603) 627-1010

GODBOUT

BILL GODBOUT ELECTRONICS

BOX 2673, OAKLAND AIRPORT, CA 94614

- 555 Timers \$1.10 ea
- 566 BCO 2.95 ea
- LED 7 seg. readout, .3 char size sim to MAN I 2.95/10 @2.50
- Power Supply, 5V 2.5 A & 28 V 1 A RO Type 602-28B 19.50
- BRAND NEW Flat Packs in carriers TI 7300/7400. Excellent assortment includes gates, flipflops 14.50 per 100.
- Digital Flat Packs U-Test-M Factory refect 4.95 per 100
- Small Memory Core Planes 3 types for experimental use ... 10.00 for 3
- Small ROTRON SPRITE (muffin) fan 30 CFM 5.95
- Red LEDs, excellent assortment 2.95 for 12
- Zener Diodes U-Test-M assorted 2.95 for 100
- 1000 Assorted Resistors, Capacitors, Diodes including over 100 TTL DTL & Linear ICs on PC boards 10.00
- 5V Digital Logic Supply Parts Kit with schematic easy to hook up! Includes line filter, transformer rectifiers filter & bypass caps 3 terminal regulator 5.50
- 12V 8A REGULATED power supply parts kit. Ideal for powering FM rigs. Everything except the chassis 12.95

ICs, most TTL & LINEAR in stock – Send Stamp for FREE Catalog

CMOS	DIGITAL			LINEAR	
74C00	.70	CD4001	.70	LM 370	1.25
74C02	.70	CD4002	.70	LM 371	1.25 Replaces HEP 590
74C04	.95	CD4009	1.00	LM 372	1.25
74C10	.70	CD4010	1.00	LM 374	2.00
74C20	.70	CD4011	.70	LM 380	1.75
74C73	1.65	CD4012	.70	741T	.45
74C74	1.50	CD4013	1.50	CA 3028	.75
74C76	1.65	CD4016	1.50	CA 3065	.75
74C107	1.65	CD4019	1.40	CA 3086	.45
74C151	3.00	CD4023	.70		
74C160	3.25	CD4025	.70		
74C161	3.25	CD4035	3.00		
74C162	3.25				
74C163	3.25				
74C195	3.50				

Buy 10 IC's – 10% discount
 Buy 100 IC's – 20% discount
 All IC's tested and guaranteed

LINEAR VOLTAGE REGS

- LM 309K 5V 1A REG 2.00
- LM 320K NEG Reg available in 5V 12V & 15V 2.25
- LM 340K POS Reg available in 6V 12V & 15V 2.25
- LM 723 Adjustable precision reg 1.00

TRANSISTOR GRAB BAG mixed NPN PNP 100 for 2.95

ALL ITEMS IN STOCK and will be shipped within 24 hours of receipt of order!

Include 50¢ postage and handling on orders under \$10.00, all others postpaid.

Sorry, NO C.O.D.'s. CALIFORNIA RESIDENTS ADD 6% sales tax.

A&W FM VHF UHF A&W

Clegg

FM27B
\$479.00



FM-21 220 MC \$299.00

We stock Hy-Gain,
Antenna Specialists, Hustler,
CushCraft and Shakespeare.

All 2 meter xtals
in stock . . . Bomar 3.95

We also stock VHF
and UHF amplifiers
TPL, Dy-Comm, Standard

with each Regency rig you purchase. . . you receive 4 FREE CRYSTALS of your choice!

Regency

AR-2
80W 2 meter amp.
\$100.00

HR-6
6 meter 25W
\$239.00

HR-2B NEW
12 ch xmt-rcv
15W min
\$229.00

EC-175
175 MC counter
\$400.00

HR-212
12 ch 20 watt
\$259.00

HR-220 NEW
12 ch 20W 220 MC
\$239.00

SBE

SB-144
12 ch 10 W
\$259.00

SB-450
12 ch 10W
450 MC
\$399.00

Standard Communications

146A
2 meter walkie
\$289.00

SR815TH
25W 12 ch
\$589.00

826MA
12 ch 10 watts
\$398.00

SCARPT-1A
2 meter RPT
\$690.00

SRC14
24 ch 10 watt
base unit
\$598.00

SEND FOR OUR CATALOG WITH SPECIAL PRICES

A&W ELECTRONICS

491 Riverside, Medford, Mass. 02155
(617-396-5550)

TABLE TOP CALCULATOR CASE + KEYBOARD

Attractively designed!!! Excellent craftsmanship. Case and keyboard (designed as one unit). Cabinet is made of high-impact plastic beige color with black bezel and amber window. Keyboard consists of a 3 position slide switch and 25 keys, 5 of which are used for memory function. 20 keys gray, 5 keys orange. All keys mounted on one printed circuit board.....

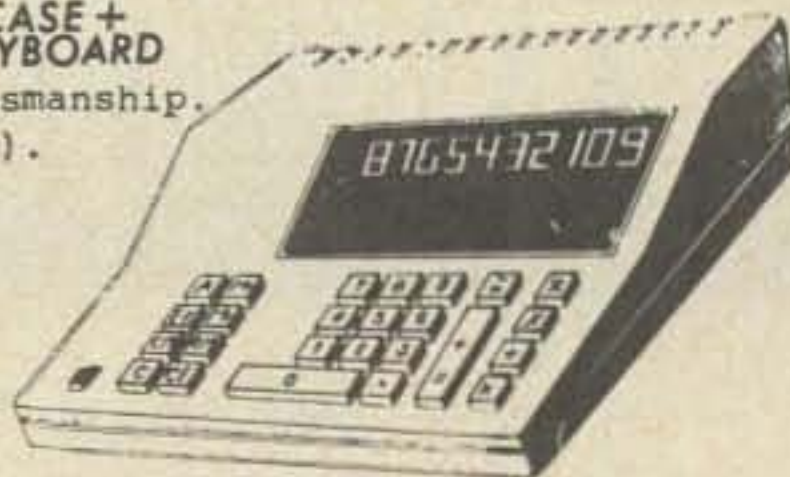

11" wide x 10.5" x 2.9" high

This modular unit is well suited for our calculator chips. Ideal for the CT5005

Case and keyboard complete only \$29.95

3 CHIP CALCULATOR

This calculator set provides all of the electronics for an eight digit, floating point calculator with left hand entry. Keyboard, display, clock generator, and display driver is all that need be added to make a calculator that will add, subtract, multiply, and divide. Overflow and negative signals are also provided. Complete instructions to build a calculator included.....

Chips and data-----\$7.95
Data only-----1.00 (refundable)

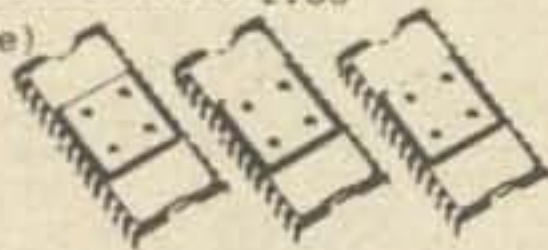

CT5005 CALCULATOR

This calculator chip has a full four function memory, which is controlled by four keys, +M (adds entry into memory), -M (subtract entry from memory), CM (clear memory--without clearing rest of registers), RM (read memory or use as entry).

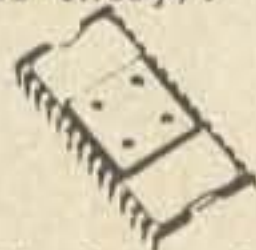

12 digit display and calc. fixed decimal at 0,1,2,3,4, or 5 leading zero suppression seven segment multiplexed output true credit sign display single 28 pin chip

Chip and data-----\$14.95
Data only (refundable)----- 1.00

5001 CALCULATOR

40 pin calculator chip will add, subtract, multiply, and divide. 12 digit display and calculate. Chain calculations. True credit balance sign output. Automatic overflow indication. Fixed decimal point at 0, 2, 3, or 4 Leading zero suppression. Complete data supplied with chip.

Chip and data, only \$9.95
Data only (refundable) \$1.00

All IC's are new and fully tested leads are plated with gold or solder Orders for \$5 or more will be shipped prepaid. Add 35¢ for handling and postage for smaller orders, residents in California add sales tax. IC orders are shipped within two workdays of receipt of order-kits are shipped within ten days of receipt of order. \$10.00 minimum on C.O.D.'s (phone in).

(916) 9662111 Zip--95608
BABYLON ELECTRONICS P.O. Box J Carmichael California

MONEY BACK GUARANTEE ON ALL GOODS...

General Telephone \$5.95

Ten push buttons (0-9) touch-tone, encoding, programming devices. Easy for panel mounting.

Size: 3X2 1/2 X 1"

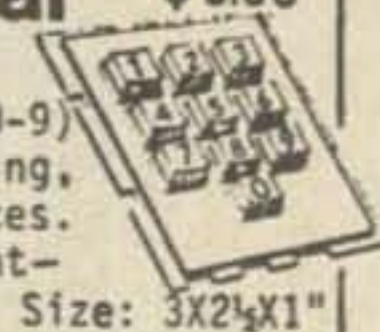

MEMORY SALE!!

256x1 BIT Random Access Memory Fully decoded---TTL Compatible input and output. No clock or refresh required.

INTEL 1101 MOS
16 pin DIP-full data 2.56
1¢ per BIT---- each
10 for \$22.56

7400 series DIP

7400	\$.35	74H53	.50
74H00	.50	7454	.35
7401	.35	74L54	.50
74H01	.50	74L55	.50
7403	.35	7460	.35
7404	.35	74L71	.30
74L04	.50	7472	.50
74H04	.50	74L72	.60
7405	.35	7473	.65
74H05	.50	74L73	.90
74H08	.50	7474	.65
7410	.35	74L74	.90
74L10	.50	74H74	.90
74H11	.60	7476	.70
7413	1.75	74L78	1.00
7420	.35	7480	.65
74L20	.50	7483	1.30
74H20	.50	7486	.80
74H22	.60		
7430	.35		
74L30	.50	7491	1.15
7440	.35	7492	1.15
74H40	.50	7493	1.15
7441	1.60	7495	1.25
7442	1.30	74L95	2.00
7446	1.75	74107	.70
7447	1.75	74121	1.60
7448	1.15	74123	2.00
7450	.35	74154	2.50
74H50	.50		
7451	.35	74192	2.50
74L51	.50	74193	1.50
74H51	.50	74195	1.10
7453	.35		

RECTIFIERS

Varo Bridges

VS447 2A 400V \$.90
VS647 2A 600V 1.10



35A Stud 400V 1.10

MR810 50V 1A .10
1N4997 50V 1A .10
1N4001 1A .10
1N4002 1A .11
1N4003 1A .12
1N4004 1A .13
1N4007 1A .17



SCR's

IR122 100V 8AMP .50
IR122 200V 8AMP .60
IR122 300V 8AMP .80
IR122 400V 8AMP 1.00

LED's

MV-50 red emitting 10-40ma @ 2V 5 for \$.25
1.00
MV5054 red LED 15-100ma @ 2V \$.30
10 for 2.50
MV-10B Visible red 5-70ma @ 2V 10 for 2.50

GIANT "NIXIE"

Comes complete with Socket and DD700 202 Numeric Driver. Readability in high ambient light...200 footlamberts brightness!! All DC operation. Long life with no loss of brightness. Compatible with conventional solid state circuitry.

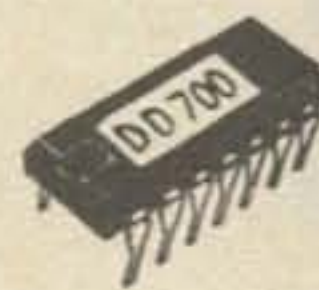

Only \$2.25

These were used in the New York Stock Exchange

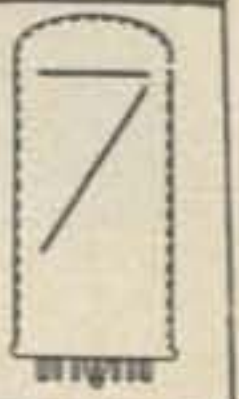

ACA 2010 NUMITRON

Popular digital display tube. This incandescent five volt, seven segment device provides a .6" high numeral which can be seen from a distance of 30 feet. The tube has a standard nine pin base (solderable) and a left hand decimal point....



\$5.00 each

\$4.00 each for 5 or more

MAN1

Seven Segment, 0-9 plus letters. Snaps in 14-pin DIP socket or Molex. Operates with IC voltage requirements. Long operating life

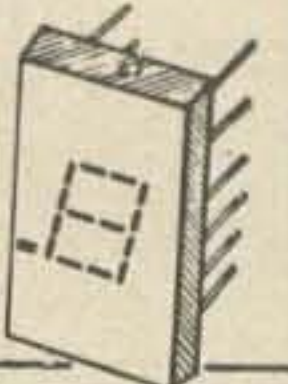

\$4.25 each

MAN4

Seven segment, 0-9 plus letters. Right hand decimal point. Snaps in 14-pin DIP socket or Molex. IC voltage requirements. Ideal for desk or pocket calculators!

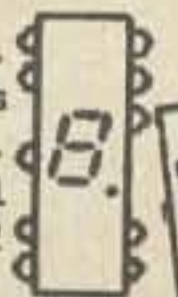

Each.....\$ 3.00

Ten or more..\$25.00

red lens

MAN3

0-9 plus letters. Right hand decimal point. Flat-Pack type case. Long operating life. IC voltage requirements. Ideal for pocket calculators !!!!!



Each.....\$ 2.50

Ten or more..\$20.00

red lens

LINEARS

NE531	op amp TO-5	\$2.00
NE560	phase lock loop DIP	3.25
NE561	phase lock loop DIP	3.25
NE565	phase lock loop TO-5	3.25
NE566	function generator TO-5	4.00
NE567	tone decoder TO-5	4.00
NE5556	op amp DIP	1.00
709	popular op amp DIP	.45
710	voltage comparator DIP	.50
711	dual comparator DIP	.40
723	precision voltage regulator DIP	1.00
747	dual 741 op amp DIP	1.00
748	op amp TO-5	1.00
LM100	positive DC regulator TO-5	1.00
LM302	op amp voltage follower TO-5	1.25
LM1595	4 quadrant multiplier	\$2.00
LM311	comparator TO-5	1.75
LM380	2W audio amp DIP	1.75
LM703	RF-IF amp epoxy TO-5	1.00
LM309H	5V-200ma power supply TO-5	1.00
LM309K	5V-1A power supply module TO-3	2.00

73 SPECIALS

FREQUENCY SYNTHESIZERS

IMMEDIATE
"OFF THE SHELF"
DELIVERY!

YOU'LL NEVER
HAVE TO BUY
CRYSTALS
AGAIN!



MODEL: ST-140
Price: \$129.95 ppd.
Tested, guaranteed and
complete with mobile
mounting bracket, tilt
stand and transmitter
matching kit.

NOTE: NY State residents
add sales tax.

CHECK THE ADVANTAGES OF A VANGUARD SYNTHESIZER OVER OTHER BRANDS...

- No microphonics. Can be used mobile over bumpy roads.
- Reference frequency and spurious output down 70 dB. (excluding harmonics of output frequency which are used in the transmitter anyway.)
- All output frequencies are generated directly from the VCO without the use of multipliers and are therefore free of sub-harmonics.
- Now available with outputs in the 6, 8, 12 and 18 MHz. bands (corresponding to 144 MHz. dial reading) for direct substitution of transmitting crystals. More output frequencies are being made available. Call us if you don't see what you need.
- Entire frequency appears in-line in clear digits. No guesswork or mental additions. Thumbwheel switches provide fast, accurate selection of 1000 channels in 10 KHz. steps from 140.00 to 149.99 MHz.
- 50 ohm output and impedance transformer kit allows use at any distance from transmitter.
- Maintains an accuracy of .0005% (5 parts per million) over the entire range of -10° to +60° C. with a precision temperature compensated crystal that requires no oven. Operates at 5 MHz. for easy checking with WWV and includes a zero trimmer for correcting long term aging drift.
- Fast response time of only 3 milliseconds for a 10 KHz. step change in frequency and a remote control, gated output amplifier for push-to-talk operation.
- No hunting or false locks as with some other synthesizers.
- Operates from 10 to 15 VDC. 3 precision regulators eliminate input voltage fluctuations. Can also be used on 110 volts AC with a small 12 volt 1/2 amp power supply.
- Smallest size of any commercial synthesizer. Only 1-3/8" high, 3-5/8" wide, 8" long.
- All IC's are mounted in high quality insulated sockets and all parts are marked.

Manufactured by VANGUARD LABS renowned for quality since 1952.

NOTE: Our 45 MHz receive synthesizers are now in production. Call us for details.

IMPORTANT: When ordering be sure to state the output frequency you want.

PRE-AMPS

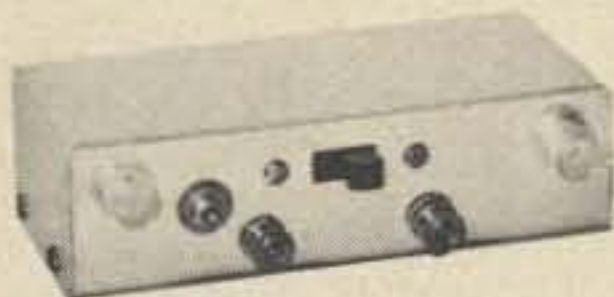

HIGH GAIN • LOW NOISE

35 dB power gain, 2.5-3.0 dB N F. at 150 MHz, 2 stage, R.F. protected, dual-gate MOSFETS. Manual gain control and provision for AGC. 4-3/8" x 1-7/8" x 1-3/8" aluminum case with BNC receptacles and power switch. Available factory tuned to the frequency of your choice from 5 MHz to 350 MHz with approximately 3% bandwidth. Up to 10% B.W. available on special order.

Model 201 price:
5-200 MHz \$24.95
201-350 MHz \$28.95

CONVERTERS



40 dB GAIN 2.5-3.0 N.F. @ 150 MHz

2 RF stages with transient protected dual-gate MOSFETS give this converter the high gain and low noise you need for receiving very weak signals. The mixer stage is also a dual-gate MOSFET as it greatly reduces spurious mixing products - some by as much as 100 dB over that obtained with bipolar mixers. A bipolar oscillator using 3rd or 5th overtone plug-in crystals is followed by a harmonic bandpass filter, and where necessary an additional amplifier is used to assure the correct amount of drive to the mixer. Available in your choice of input frequencies from 5-350 MHz and with any output you choose within this range. The usable bandwidth is approx. 3% of the input frequency with a maximum of 4 MHz. Wider bandwidths are available on special order. Although any frequency combination is possible (including converting up) best results are obtained if you choose an output frequency not more than 1/3 or less than 1/20 of the input frequency. Enclosed in a 4-3/8" x 3" x 1-1/4" aluminum case with BNC receptacles, power and antenna transfer switch. Thousands of our converters are now in use by satisfied customers, many of whom are government agencies and universities.

Model 407 price:
5-200 MHz \$49.95
201-350 MHz \$54.95
Prices include .005% crystal. Additional crystals \$5.95 each.

VHF FM RECEIVER

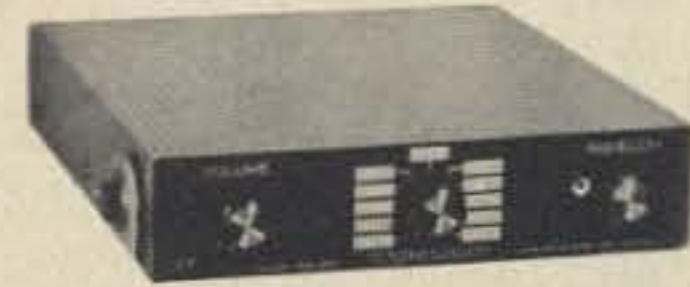

11 CHANNELS • 135-250 MHz

• 11 crystal-controlled channels • Available in your choice of frequencies from 135-250 MHz in any one segment from 1-4 MHz wide • I.F. bandwidth (channel selectivity) available in your choice of ±7.5 kHz or ±15 kHz. • 8-pole quartz filter and a 4-pole ceramic filter gives more than 80 dB rejection at 2X channel bandwidth • Frequency trimmers for each crystal • .2 to .3 μvolt for 20 dB quieting • Dual-gate MOSFETS and integrated circuits • Self-contained speaker and external speaker jack • Mobile mount and tilt stand • Anodized aluminum case, 6" x 7" x 1-3/8".

Model FMR-250-11 price:
135-180 MHz \$119.95
181-250 MHz \$129.95
Price includes one .001% crystal. Additional crystals \$6.95 each.

HOW TO ORDER:

All the items on this page are available only from Vanguard Labs. For receivers and converters, state model input and output frequencies and bandwidth were applicable. Remit in full, including sales tax if you reside in New York State, direct to Vanguard Labs. Prices include postage by regular parcel post. For air mail or special delivery include extra amount; excess will be refunded. Send money order or certified check for faster shipment.

VANGUARD LABS

Call 212 468-2720 for fast C.O.D. shipment.

196-23 JAMAICA AVE. HOLLIS, N.Y. 11423



the **REPEATER** 2 Meter Fixed Station

Designed for the man who demands professional standards in 2 meter equipment. *REPEATER LINE* fixed station antennas are the 2 meter HAM's dream come true. With everything you need for top fixed station performance...toughness, efficiency and the gain to gain access to distant repeaters with ease. Work many stations, fixed or mobile, without access to a repeater.

The right antennas for the new FM transceivers...or any 2 meter fixed station.

REPEATER LINE Fixed Station Antennas

Tough, high efficiency antennas with a long, low radiation. For the top signal and reception you want...and the top performance your transceiver's ready to deliver.

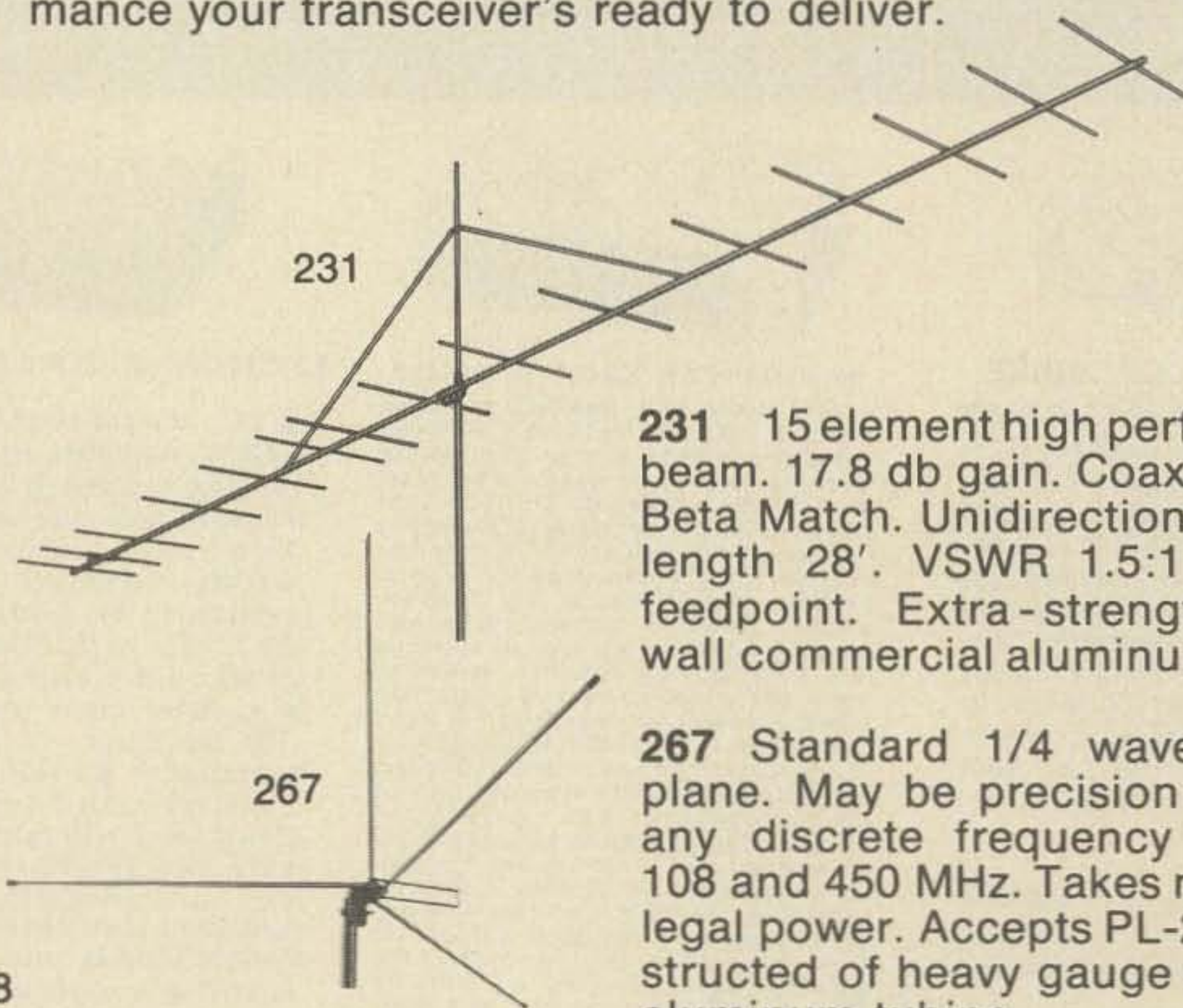

231 15 element high performance beam. 17.8 db gain. Coaxial balun. Beta Match. Unidirectional. Boom length 28'. VSWR 1.5:1 52 ohm feedpoint. Extra-strength heavy wall commercial aluminum tubing.

267 Standard 1/4 wave ground plane. May be precision tuned to any discrete frequency between 108 and 450 MHz. Takes maximum legal power. Accepts PL-259. Constructed of heavy gauge seamless aluminum tubing.

268 For repeater use. Special stacked 4 dipole configuration. 9.5 db offset gain. 6.1 db omnidirectional gain. Heavy wall commercial type construction. 144 thru 174 MHz. 1.5:1 VSWR over 15 MHz bandwidth eliminates field tuning. Extreme bandwidth great for repeater use. Center fed for best low angle radiation. DC ground. Complete with plated steel mounting clamps.

LINE from *hy-gain*

Antennas with real PUNCH!

340 3 element high performance beam. 9 db gain. Coaxial balun. Special VHF Beta Match configuration. Unidirectional pattern. VSWR 1.5:1. 52 ohm impedance. Heavy gauge aluminum tubing and tough aluminum rod construction.

341 8 element high performance beam. 14.5 db gain. Coaxial balun. VHF Beta Match. Unidirectional. Boom length 14'. VSWR 1.5:1. 52 ohm feedpoint. Heavy gauge commercial type aluminum construction.

338 Colinear ground plane. 3.4 db gain omnidirectionally. Vertically polarized. 52 ohm match. Radiator of seamless aluminum tubing; radials of solid aluminum rod. VSWR less than 1.5:1. All steel parts iridite treated. Accepts PL-259.

362 SJ2S4 high performance all-driven stacked array. 4 vertically polarized dipoles. 6.2 omnidirectional gain. 52 ohm. May be mounted on mast or roof saddle. Unique phasing and matching harness for perfect parallel phase relationship. Center fed. Broad band response. DC ground.

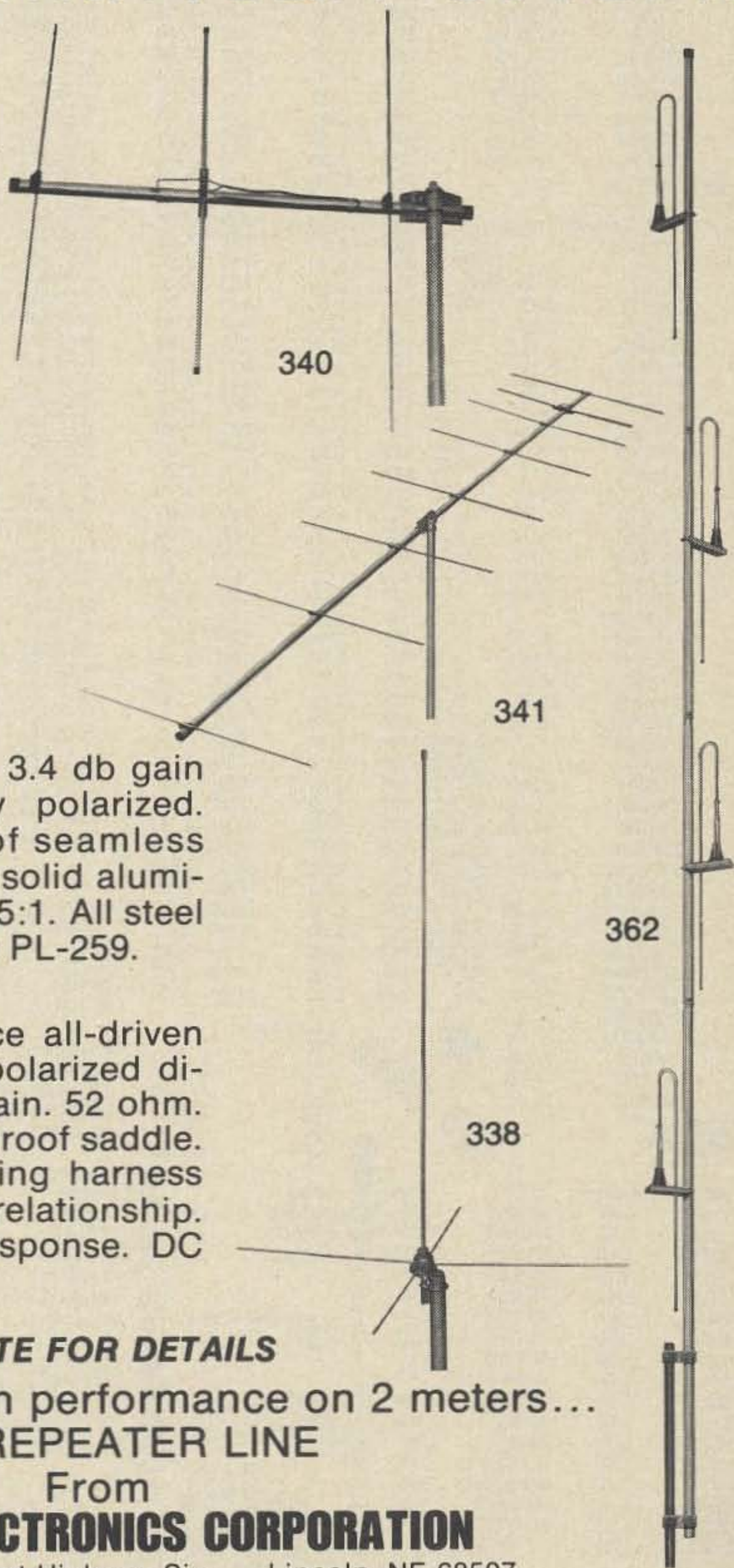

WRITE FOR DETAILS

For top fixed station performance on 2 meters...

THE REPEATER LINE

From

HY-GAIN ELECTRONICS CORPORATION

Dept. CK, 8601 Northeast Highway Six
402/434-9151

Lincoln, NE 68507
Telex 48-6424

S & R Enterprises

1344 E. Indian School Rd.-Phoenix, AZ 85014
(602) 277-2712

This Month's Specials

Motorola RF Transistors Sale (Unmarked)

Qty	Type	Price
2672	2N3866	3/1.50
384	2N5589	3/6.00
128	2N5590	3/9.50
48	2N5591	3/20.00
227	2N6080	3/6.00
280	2N6081	3/9.50
174	2N6082	3/16.00
174	2N6083	3/24.00
260	2N6084	3/40.00
50	2N6166	3/50.00

Please do not mix!

Motorola RF Transistors Sale (Marked)

Qty	Type	Price
3	2N1692	2.00
3	2N1693	3.00
1	2N2857	1.00
2	2N2887	3.00
9	2N2947	8.00
419	2N3925	2.00
13	2N3950	10.00
1963	2N4072	.75
2	2N4073	1.00
1361	2N5109	1.25
1	2N5177	6.00
1754	2N5179	.35
1	2N5583	3.00
33	2N5590	5.00
16	2N5643	10.00
4	2N5849/	15.00
	MM1622	
11	2N5862	20.00
14	2N5942	20.00
42	2N5591	9.00
30	2N6084	18.00
330	MM1688/	15.00
	2N6084	
11	2N6097	15.00
1	2N6135	5.00
40	2N6166	30.00
2	2N6266	40.00
2	MM1500	2.00
950	MM1607/	2.00
	2N5842	
3	MM1620	10.00
1	MM1661	5.00
23	MM1689	10.00
1000	MM8006	1.00
1	MRF207	3.00
4	MRF209	8.00
17	MRF304	10.00
20	2N6081	6.50
24	2N6082	10.00
25	2N6083	15.00



Miniature Variable Capacitors
2-8 pf, 2.5-11 pf, 3-10 pf, 3-15 pf, 5.5-18 pf, 3-15 pf, 8-25 pf, 15-60 pf, 7-25 pf, 9-35 pf, 8-25 pf

★ You save

Power Transistors

Type	Price
MJE 340	1.00
MJE3055	1.00
MJE1093	1.00
MJE1100	2.00
2M4913	1.00
2N4910	.85
2N4912	1.00
2N4399	1.00
2N3771	1.00
2N4901	1.00
2N3714	1.00
2N3055	1.25
2N1545	1.00
2N3238	2.00
2N1358A	2.00
2N4905	1.25
2SB473	1.25

FETs

Type	Price
2N3070	1.00
2N3438	1.70
2N3821	1.31
2N4343	.75
2N4391	2.20
2N4352	1.42
2N4166	1.31
2N5460	.42
2N5465	.63
2N5556	7.00
3N140	.74
3N141	1.00
MFE10000	.82
MFE2001	.92
MPF102	.45
MPF120	.55

Linear ICs

Type	Price
723	1.00
702	1.75
747	2/L.00
703	1.00
709	4/L.00
741	2/L.00

THE SCOTCHMAN'S DREAM

Motorola HEP RF Transistors Sale

Type	List	Sale
HEP75	2.95	2.50
HEP76	4.95	3.50
HEPS001	3.75	3.00
HEPS005	9.55	7.00
HEPS006	19.90	15.00
HEPS007	24.95	17.00

SCRs

Type	Price
2N4443	1.05
2N5061	.50
TI40A2	1.00

Motorola Bridges

Type	Price
MDA962-4	3.80
MDA1591-5	3.75
MDA962-1	2.45
MDA960-3	2.25
MDA920-4	1.40

Diodes

Type	Price
1.5A 1000PIV	10/L.50
1.5A 800PIV	10/L.00
IN914	10/L.00
IN4148	10/L.00
IN1190	10/L.00
IN270	10/L.00
3000 RIV 750MA	1.00

IC Type	Description	Price
ICC-2	GE RF Transistor - PNP-750 MHz-300 MW	1.38
ICC-3	GE RF Transistor - PNP-250 MHz-300 MW	1.68
ICC-50	SI RF Transistor - NPN-250 MHz-400 MW	1.40
ICC-51	SI RF Transistor - PNP-150 MHz-600 MW	1.42
ICC-52	SI RF Transistor - PNP-200 MHz-400 MW	1.35
ICC-53	SI RF Transistor - NPN-200 MHz-60 MW	1.20
ICC-54	SI RF Transistor - NPN-30 MHz-310 MW	1.20
ICC-55	SI RF Transistor - NPN-200 MHz-310 MW	1.20
ICC-56	SI UHF Oscillator - NPN-750 MHz-310 MW	2.40
ICC-57	SI RF Transistor - PNP-200 MHz-310 MW	1.40
ICC-134	GE Diode (IN34A, IN60, IN54I, IN295, IN64) Substitute	.45
ICC-151	SI Power Rectifier-Stud-50 PIV-15 Amps	1.68
ICC-154	SI Rectifier-Axial Lead-50 PIV-1 Amp	.55
ICC-156	SI Rectifier-Axial Lead-200 PIV-1 Amp	.55
ICC-157	SI Rectifier-Axial Lead-400 PIV-1 Amp	.58
ICC-158	SI Rectifier-Axial Lead-600 PIV-1 Amp	.55
ICC-162	SI Rectifier-Axial Lead-200 PIV-3 Amps	1.67
ICC-170	SI Rectifier-Axial Lead-1000 PIV-2.5 Amps	.48
ICC-230	GE Power Transistor-PNP-to-3-5 Amps - 90 Watts	1.20
ICC-231	GE Power Transistor-PNP-to-3-6-15 Amps - 150 Watts	2.55
ICC-232	GE Power Transistor-PNP-to-3-7 Amps - 90 Watts	2.15
ICC-238	GE General Purpose PWR Transistor - PNP-60V-3 A.	4.90
ICC-240	SI Power Transistor - NPN-300V-500 MA - 10 Watts	2.35
ICC-241	SI High Power Transistor - NPN-160 V 5 Amps-40 W.	2.15
ICC-242	SI Med. Power Transistor- PNP-60V-3 Amps-6 Watts	1.75
ICC-243	SI Med. Power Transistor- NPN-60V-3 Amps-6 Watts	2.10
ICC-245	SI Med. Power Transistor- NPN-60V-3 Amps-30 Watts	2.10
ICC-246	SI Med. Power Transistor- PNP-60V-3 Amps-30 Watts	2.55
ICC-250	GE General Purpose Transistor-PNP-Med. Gain-200 MW	1.10
ICC-251	GE General Purpose Transistor-PNP-Med. Gain-200MW	1.28
ICC-253	GE General Purpose Transistor-PNP-Med Gain-225MW	1.65
ICC-254	GE General Purpose Transistor-PNP-Med Gain-225MW	1.85
ICC-310	SI Unijunction Transistor - 300 MW	1.85
ICC-631	GE General Purpose Audio Amplifier - PNP	1.10
ICC-632	GE General Purpose Audio Amplifier - PNP	2.10
ICC-633	GE General Purpose Audio Amplifier - PNP	1.10
ICC-637	GE General Purpose RF-PNP	1.40
ICC-638	GE General Purpose Drift-Field - PNP	1.65
ICC-639	GE General Purpose Drift Field - PNP	1.65
ICC-640	GE General Purpose Drift Field - PNP	1.65
ICC-641	GE General Purpose RF and Audio Amplifier - NPN	1.55
ICC-703	SI General Purpose Audio Power Amplifier - NPN	2.15
ICC-704	SI General Purpose Audio Power Amplifier - NPN	3.90
ICC-706	SI General Purpose Audio Power Amplifier - NPN	4.00
ICC-709	SI UHF Oscillator, Mixer, RF Amplifier - NPN	1.95
ICC-712	SI Low Frequency Oscillator, mixer, RF Amplifier - NPN	4.00
ICC-714	SI Hi Voltage Audio Amplifier - NPN	2.95
ICC-715	SI General Purpose Low Frequency RF and Audio Amp - PNP	1.20
ICC-716	SI General Purpose Med. Current Amplifier and Switch-PNP	1.20
ICC-719	SI VHF/UHF Oscillator, Mixer, RF Amplifier - NPN	2.00
ICC-721	SI General Purpose Audio Amplifier - NPN	1.65
ICC-724	SI General Purpose Audio Amplifier - NPN	1.40
ICC-728	SI General Purpose Audio Amplifier - NPN	1.35
ICC-729	SI General Purpose Audio Amplifier - NPN	1.40
ICC-738	SI General Purpose Audio Amplifier - NPN	1.42
ICC-801	Field Effect Transistor, Audio - N Channel	2.15
ICC-802	Field Effect Transistor - RF-N Channel	1.85
2SA856B/	SI General Purpose Power Amplifier-PNP 90V 7A 90W	5.10

Bargains

Microwave RF Transistors

P/N	Wattage	Frequency	Voltage	Price
DI-28	1	400-1200 MHz	28V	3.75
DI0-28	10	400-1200 MHz	28V	19.00
EI-28	1	1-2 GHz	28V	30.00

Communications Corp.:

P/N	Wattage	Frequency	Voltage	Price
DI-28	1	400-1200 MHz	28V	3.75
DI0-28	10	400-1200 MHz	28V	19.00
EI-28	1	1-2 GHz	28V	30.00

Seven Segment Display

DL-707	Litronix	Price
MOR10A	Motorola	3.00
MAN 1	Mansanto	3.00

Microwave Semiconductors Corp.:

MSC	Wattage	Frequency	Voltage	Price
MSC2001	1	2 GHz	28V	35.00
MSC3001	1	3 GHz	28V	60.00
MSC4001	1	4 GHz	23V	87.50
MSC4003	2.5	4 GHz	28V	125.00

Bird Slugs For 43

Qty.	Price
4	2.5W 105-120MC 20.00 ea
1	25W 50-125MC 20.00 ea
3	25W 200-500MC 23.00 ea
1	2500W 2-30MC 25.00 ea

Microwave Diodes

Varian	Step Recovery	Price
VAS21	Step Recovery	15.00
VAS31	Step Recovery	15.00
VAB800	Standard Bimode	15.00
VAB801	Standard Bimode	15.00
VAB812	Standard Bimode	15.00

Motorola Bridges

Type	Price
MDA962-4	3.80
MDA1591-5	3.75
MDA962-1	2.45
MDA960-3	2.25
MDA920-4	1.40

Motorola

Type	Price
MV1805C	10.00
MV1808	10.00
MV1862D	3.00
MV1863B	3.00
MV1864B	3.00
MV1868D	3.00

Diodes

Type	Price
1.5A 1000PIV	10/L.50
1.5A 800PIV	10/L.00
IN914	10/L.00
IN4148	10/L.00
IN1190	10/L.00
IN270	10/L.00
3000 RIV 750MA	1.00

Linear ICs

Type	Price
MC1303L	1.25
MC1306P	.50
MC1328P	.90
MC1350P	.60
MC1355P	.75
MC1519G	1.00

DuPage FM

WILL NOT BE UNDERSOLD!

Check these bargains and *compare our deal with others...*

DRESS UP YOUR RIG and keep the XYL happy with these modern control heads. These are made by RCA but will work with any rig if you do a little soldering.

Contains a DPST switch, and two 20K pots for volume and squelch, all on concentric shafts, and an Amphenol mike connector.

The multiple frequency version contains the above plus a four position, two pole rotary switch, and lots of room left inside for extra boards for scanners and toneburst generators.



Single frequency control head only.....\$4.00 postpaid

Multiple frequency control head only..... \$5.50 postpaid



ADD MORE TALK POWER with these like new handsets and mikes. Both have a transistor preamp built in and come with coil cord and Amphenol connector.



Handsets in very good condition.....\$6.00 postpaid

Handset hangers with built-in multiple pole switch, only..... \$1.50 postpaid

Mikes only.....\$4.50 postpaid

TERMS: All items sold as is. Illinois residents add 5% sales tax.

Send your check or money order today to **DuPage FM Inc.**

P.O. Box 1

Lombard, Ill, 60148

If you have any questions or are looking for something special give us a call. Just ask for Bill Lester. Our easy to remember (for us) Telephone is 312-627-3540.

SPECIAL NOTE TO CATALOG HUNTERS and those who like having price data handy for future needs: *LOOKING FOR A UNIT?* No matter what your needs are send us a postcard with your name, address, phone number, and a description of the unit you need — We'll do the rest —

VIDEO TAPE RECORDERS



BELL & HOWELL MODEL 2965

This is a portable system and comes with recorder, camera and charger. A TV monitor is built into the recorder. Camera includes built-in Microphone and Zoom lens. Recording time is 20 minutes on 5" tape. Recording is both video and audio.

SPECIFICATIONS

RECORDER:

AGC: Audio & Video
 RESOLUTION: 525 lines, HOR. RESOLUTION: 300 lines
 AUDIO RESPONSE: 80-10,000 Hz.
 POWER REQUIREMENTS: 12V DC, 10 watts
 BATTERIES: 2/3G x 3/U Rechargeable (not warranted)
 CHARGER: Model 105905 Built-in 2:1 EIA Sync generator

CAMERA:

RESOLUTION: 525 lines
 VERT. FREQ: 60 Hz (EIA)
 HOR. FREQ: 15,750 Hz (EIA)
 VIDEO OUTPUT: 1.0 p-p, 75 ohm, unbalanced
 MIN. ILLUMINATION: 30 lux.
 VIEWFINDER: 1 1/2" (1" CRT w/magnifier)
 LENS: 5:1 zoom F2 - 22
 SHIPPING WT: 35 lbs.

LIST: \$1595

OUR PRICE (NEW) \$550.00



BELL & HOWELL Model 2966 - SHIBADEN SU700VC

(Assemble, Edit and Stop Motion)

This video recorder will record directly from a standard TV set or a TV camera. It will play back over your home TV set. Audio may be dubbed onto the tape. A 7" reel (2400') will record 1 hr. No home VTR unit under \$1000 can match the quality and capabilities of this unit.

SPECIFICATIONS

RESOLUTION: 525 lines, Standard TV or CCTV recording
 VIDEO: Input and output: 1.0V p-p, 75 ohms, unbalanced.
 Greater than 3.5 MHz freq. response. 300 lines plus Hor. resolution.
 AUDIO: Mike or line inputs. 60-10,000 Hz freq. range
 POWER REQUIREMENTS: 110V AC, 95 watts
 DIMENSIONS: 18 3/8" W x 10 3/16" H x 15 11/16" D
 AGC or Manual Audio & Video gain
 POWER REQUIREMENTS: 110V AC, 95 watts
 WEIGHT: 65 lbs.

LIST PRICE (1972) \$995.00

OUR PRICE (NEW) \$450.00

(USED) \$250.00

Experimenter's Special \$125.00

MAINTAINANCE
 MANUAL \$5.00

ORDER BLANK

Please rush _____ Bell & Howell model/s 2966 _____ Bell & Howell model/s 2965

_____ Rolls, Video Tape _____ Batteries _____ Color Adapters Price _____

to: Name _____ Shipping _____

Address _____ Total _____

City _____ State _____ ZIP _____

RECHARGEABLE BATTERIES — New, for Porta Pak . **\$36.00** a set.

COLOR ADAPTERS — limited number available, will work in almost any Black and White VTR to convert to color, record-playback **\$275.00** ea. prepaid.

NEW NAME BRAND VIDEO TAPES — 2400 ft. (1 hr.) any quantity available, shipping wt. 2 lbs. **\$25.00** each.

CONDITIONS OF SALE:

NEW EQUIPMENT — sold new, but *as is*. Guaranteed to be new and in good working order. Replaced or repaired by us if found defective upon arrival.

USED EQUIPMENT — sold *as is* in good working order. NO warranty. All units checked prior to shipment.

EXPERIMENTER'S DELIGHT — used *as is* repairable. Physically intact not beat to hell, but requiring some work. Problems and probable causes listed with each machine.

PARTS — available at near giveaway prices, through us.

SERVICE — units can be serviced by any competent video technician, as well as through Bell & Howell AV Service and Shibaden in Melrose Park, Illinois.

QUANTITY DISCOUNT — on orders of more than 10 machines.

DEALER INQUIRIES — are invited for sale of new equipment.

New machines have standard Japan EIA 8P connector to mate with all popular VTR monitors. Used machines have all coax and cannon xl connectors as shown in the ad sheet. Used machines do not have AGC or edit ability but are otherwise identical and interchangeable.

All sales are final. Cash with order. Shipped best way. Add \$20.00 per VTR and \$12.00 per Porta Pak for shipping — excess refunded.

COMMUNICATIONS UNLIMITED

9519 MAIN STREET P.O. BOX 463
WHITMORE LAKE, MICHIGAN 48189

(313) 449-4367

We are also licensed
for
2-way radio repair

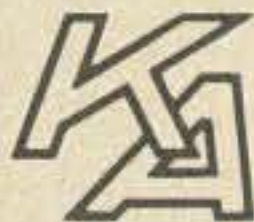

NEW and SURPLUS ELECTRONICS FOR THE HAM and EXPERIMENTER

SIZE:
3.55" X 6.20" X 2.12"

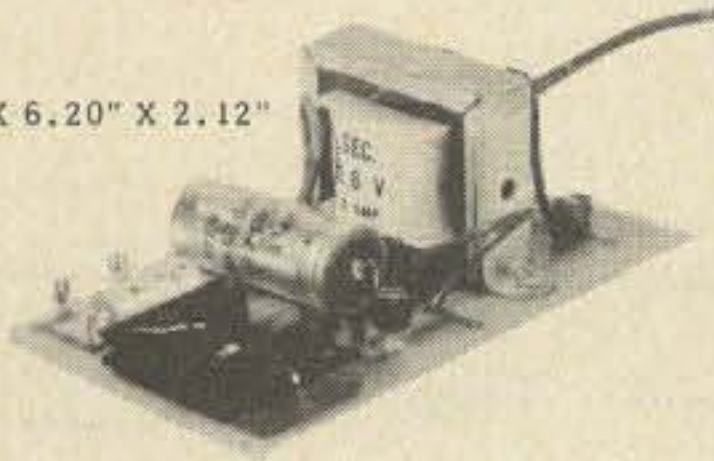

5 VDC
3/4 AMP
POWER
SUPPLY
KIT

12.95

USES THE LATEST STATE-OF-THE-ART THREE TERMINAL REGULATOR CIRCUITRY.

HAS INTERNAL CURRENT LIMIT, THERMAL SHUTDOWN, AND SAFE-AREA COMPENSATION.

Greatest advance
in soldering since
electricity...

\$ 19⁹⁵

WAHL

COMPLETELY PORTABLE
HEATS IN 5 SECONDS
SOLDERS UP TO 150 JOINTS
OR MORE PER CHARGE
RECHARGES AUTOMATICALLY
IN ITS OWN STAND
NO AC LEAKAGE OR INDUCED
CURRENT TO DAMAGE DELICATE
ELECTRONIC COMPONENTS.



COMPLETE WITH RECHARGING STAND, FINE TIP AND INSTRUCTION BOOKLET

ALPHA-NUMERIC
KEYBOARD

\$ 50⁰⁰

MICRO SWITCH



MODEL SW-10639 contains 61 #1SW11 Solid-State switches including key tops, ROM encoded into EBCDIC.

MODEL RW-01135 contains 56 #7A1MS Reed switches including key tops, diode encoded into EBCDIC.

"DIP CLIP" IC TEST CLIP

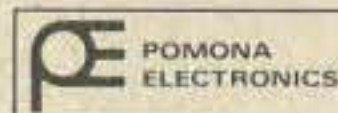

MODEL 3916

4.95

FOR 14 OR 16 DUAL-IN-LINE PACKAGES

The "Dip-Clip" is specially designed to allow the attachment of test probes to 14 or 16 lead DIPS. The unique design greatly reduces the possibility of accidental shorting while testing live circuits. Numerous test probes may be quickly connected for hands-free testing.



MOS DIGITAL
CLOCK CHIP

\$ 14⁹⁵



Four digit electronic clock LSI circuit in 40 pin DIP. Designed for direct output to Liquid Crystal Display. Internal options include: Alarm, Snooze, Seconds Display, Reset, and 24 hour operation.



POWER STRIPS

WITH: FUSE, SWITCH, AND LAMP



\$ 9³⁰

MODEL 11

Other Models Available



\$ 14⁷⁰

MODEL 12

NOBEX DIGIBEZEL

alpha-numeric
display bezels

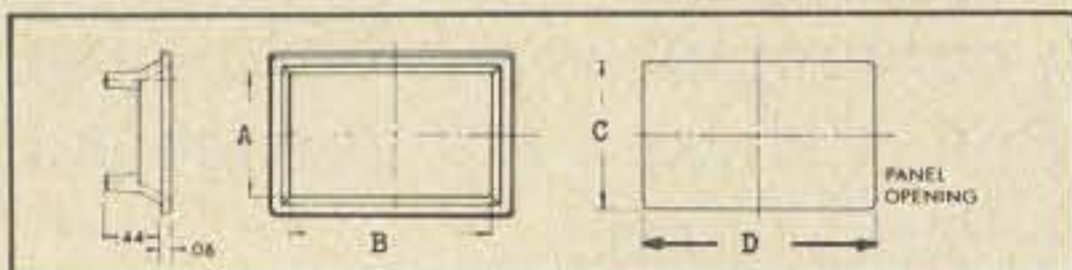

MODEL	DIMENSION				PRICE		
	'A'	'B'	'C'	'D'	1-24	25-99	100-UP
905-XX	.80	1.37	1.172	1.74	\$2.25	2.07	1.91
910-XX	.80	2.00	1.172	2.37	2.30	2.12	1.95
915-XX	.80	3.00	1.172	3.37	2.40	2.21	2.04
920-XX	.80	4.00	1.172	4.37	2.45	2.25	2.08
930-XX	1.38	5.00	1.750	5.37	2.75	2.53	2.33
940-XX	.80	5.58	1.172	5.95	2.65	2.43	2.25
950-XX	1.38	6.50	1.750	6.87	3.15	2.89	2.67

WHEN ORDERING REPLACE XX WITH FILTER COLOR CODE:

NEUTRAL = 15, RED = 60, AMBER = 70, GREEN = 90

example: 930-60 (Model 930 with RED Filter)

DOZY
BOXES

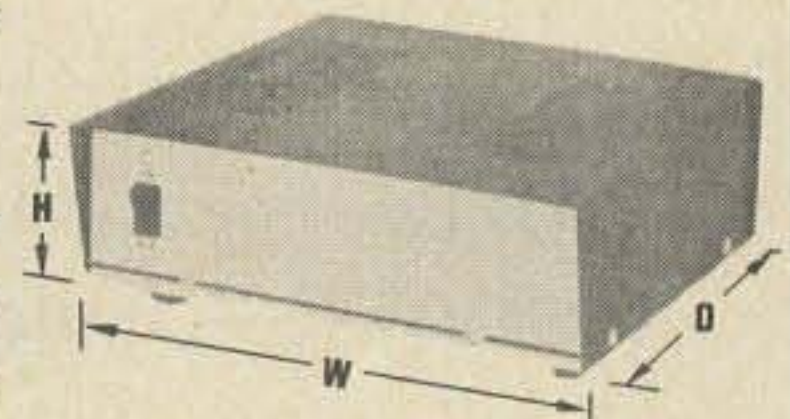

Deluxe Electronic
Equipment Enclosures

MODEL	DIMENSIONS			Screen Vented	RESALE NET
	W.	H.	DEPTH		
"A"	5 1/4"	2 1/2"	3"	no	3.75
"B"	5 1/4"	3 3/4"	3 3/4"	no	4.95
"C"	7 1/4"	3 3/4"	5"	yes	6.85
"D"	8"	2 1/2"	8" (mobile mtg. avail.)	yes	8.75
"E"	6 1/2"	3 3/4"	7 1/4"	yes	8.25
"F"	7 1/2"	4 1/2"	10"	yes	9.95
"G"	10 1/2"	3 3/4"	9"	yes	9.95
"H"	4 3/4"	6 1/2"	4"	no	8.95
"D1"	Mtg. bracket set for "D"				.35
"H1"	"H" Panel with mounted Wide Vue meter, 3 3/4"				19.95
"HA"	0-1 ma DC & 2 Rocker switches				
"HA"	5 1/8"	5 1/2"	4"	(Blank Panel)	8.95
"J"	5"	3 1/2"	5 3/4"	(Sloping Panel)	7.45
"K"	4 3/4"	7 3/8"	11"	W/Handle	13.50
"L"	11 1/8"	6 1/8"	12 3/4"		20.50
"M"	11 1/8"	6 1/8"	16 3/4"		21.80

OTHER DISTRIBUTOR LINES:



TAB BOOKS J.W. MILLER Co.

LUMINETICS Vector Electronic Company

projects WAHL
unlimited



BUD RADIO, INC.

HUNTER TOOLS
A Division of Marshall Industries

STEWART-WARNER MICROCIRCUITS DIVISION
STEWART-WARNER CORPORATION

KA ELECTRONIC SALES
1312 SLOCUM STREET DALLAS, TEXAS 75207

(214) 747-3230
747-1862

WRITE FOR FREE CATALOG.

VISIT OUR STORE SATURDAY FROM
10AM to 4PM. LOCATED OFF STEM-
MONS FREEWAY NEAR OAKLAWN.



Buy Any 3
Take 10%
Discount!



INTEGRATED CIRCUIT SOCKETS

- 14-Pin, DIP .45
- 14-Pin, Wire Wrap .59
- 14-Pin, Side Mount 1.00
- 16-Pin, DIP .50
- 16-Pin, Wire Wrap .59
- TO-5, 8 or 10-Pins .29

'HAM' UHF 400 MC HIGH POWER TRANSISTORS

3 for \$3.95

By RCA or equal 2N3632. NPN, 23 watts, 3 amps, TO-60 case, with stud mtg. VCEV max 65.

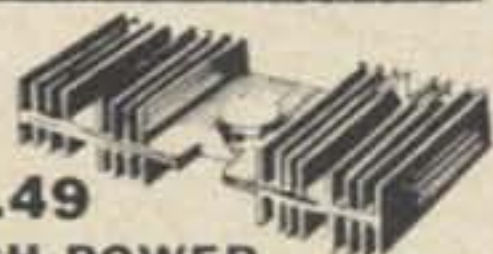

\$1.49
HIGH POWER
TRANSISTOR 3 for \$3
WITH HEAT SINK

Removed from new equipment! Includes popular 2N174 "doorknob" transistor TO-36, germanium, PNP, 150 watts, VCEO 80V, 15 amps, 10 hfe. For ignition, high power transmitters, etc. Mounted on heat sink 5 x 2 1/2 x 1 1/4".

"AEROSPACE" BABCOCK & LEACH CRYSTAL CAN RELAYS

12 for \$3.50

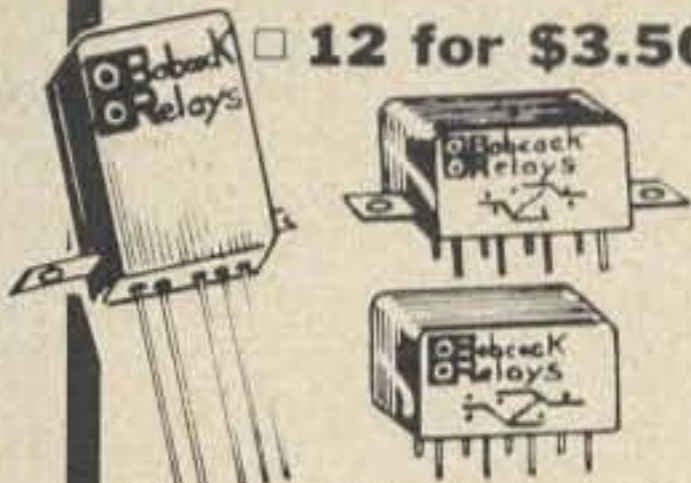

All hermetically sealed. Submini, 1/6, half, and full crystal can types in 6-12-24V in asst contacts up to 4PDT, 1 amp up to 10 amps. Such types as BR40, 41, 10, 44, 16, 24, etc. Sorry, no choosing voltages or types. From factory mixtures . . . to you! Good asst, if you are space-minded, at low prices.

GI "GLASS AMP II" SPACE AGE FEATURE

Meets critical JAN specs. A glass "ball of silicon strength" that meets JAN specs, high reliability, withstands avalanche power surges to 1K watts. ONE amp ratings with 2 amp capabilities. Axial leads.

Type	PIV	Sale
<input type="checkbox"/> 1N4245	200	\$.14
<input type="checkbox"/> 1N4246	400	.22
<input type="checkbox"/> 1N4247	600	.39
<input type="checkbox"/> 1N4248	800	.49
<input type="checkbox"/> 1N4249	1000	.59

SILICON TUBES

<input type="checkbox"/> 5U4	\$1.49
<input type="checkbox"/> 5R4	3.95
<input type="checkbox"/> 866	7.95

Terms: add postage. Rated: net 30
Phone Orders: Wakefield, Mass. (617) 245-3829
Retail: 16-18 Del Carmine St., Wakefield, Mass.
(off Water Street) C.O.D.'S MAY BE PHONED

15¢ CATALOG on Fiber Optics, 'IC's', Semi's, Parts

POLY PAKS

P.O. BOX 942A LYNNFIELD, MASS. 01940

HIGH VOLT 1 AMP

PIV	SALE
<input type="checkbox"/> 2000*	1.00
<input type="checkbox"/> 3000	1.35
<input type="checkbox"/> 4000	1.65
<input type="checkbox"/> 5000	2.25
<input type="checkbox"/> 6000	2.96
<input type="checkbox"/> 8000	3.50
<input type="checkbox"/> 10000	3.95



8-TRACK CAR RADIO STEREO TAPE TRANSPORT \$8.88

Contains complete 8-track stereo recording/playback unit you find in expensive car tape decks. Excellent direct replacement unit if your own does not function properly. Priced to toss away old, and replace with new. Less amplifier. Design your own hi-fi stereo systems around it. Uses standard 8-track cartridge. With hi-fi stereo tape and all its mechanical parts that go with it. Operates off 12VDC. Automatic track locating and changing plus track indicator output. 3 1/2 ips speed, WOW and FLUTTER less than 0.5% MU metal shield motor reduces motor noise to an inaudible one. Uses separate 739 preamp and is ready to go. Size: 5 x 5 x 2".

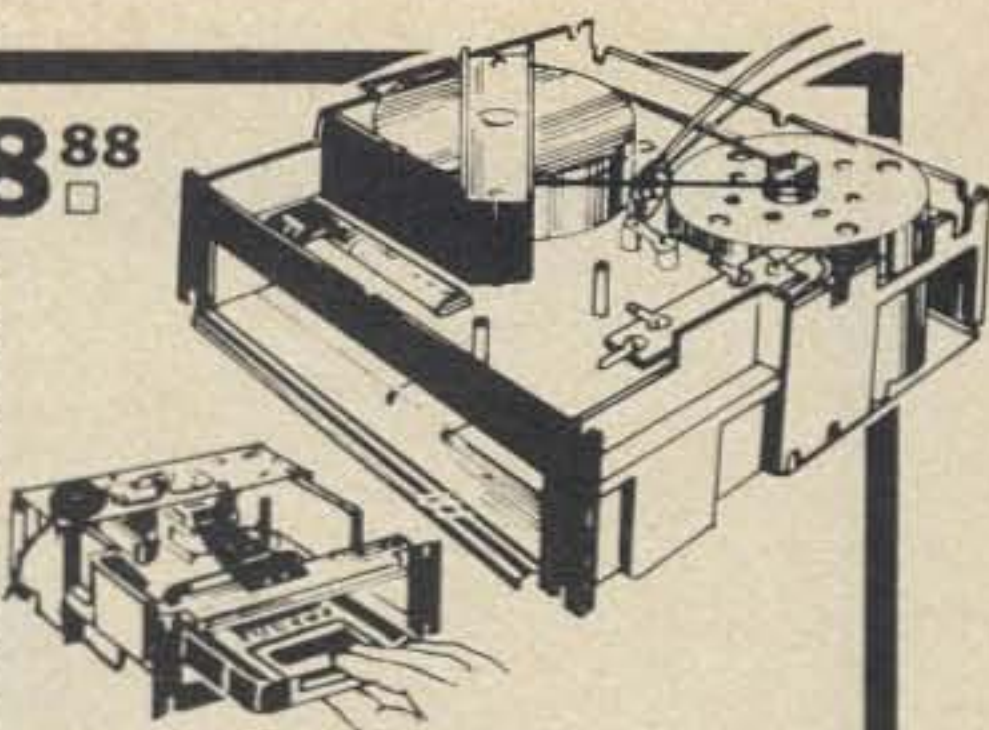

Largest Selection TTL IC's

Lowest Prices

Brand New * "DIP" Packages Order by type number! Spec sheets on request "ONLY"

Type	Sale	Type	Sale	Type	Sale	Type	Sale
<input type="checkbox"/> SN7400	\$0.30	<input type="checkbox"/> SN7430	.30	<input type="checkbox"/> SN7470	.45	<input type="checkbox"/> SN74104	.55
<input type="checkbox"/> SN7401	.30	<input type="checkbox"/> SN7432	.30	<input type="checkbox"/> SN7472	.35	<input type="checkbox"/> SN74105	.55
<input type="checkbox"/> SN7402	.30	<input type="checkbox"/> SN7437	.60	<input type="checkbox"/> SN7473	.52	<input type="checkbox"/> SN74106	1.25
<input type="checkbox"/> SN7403	.30	<input type="checkbox"/> SN7438	.60	<input type="checkbox"/> SN7474	.52	<input type="checkbox"/> SN74107	.60
<input type="checkbox"/> SN7404	.35	<input type="checkbox"/> SN7440	.30	<input type="checkbox"/> SN7475	.95	<input type="checkbox"/> SN74108	1.25
<input type="checkbox"/> SN7405	.32	<input type="checkbox"/> SN7441	1.40	<input type="checkbox"/> SN7476	.55	<input type="checkbox"/> SN74112	1.25
<input type="checkbox"/> SN7406	.55	<input type="checkbox"/> SN7442	1.25	<input type="checkbox"/> SN7477	1.30	<input type="checkbox"/> SN74113	1.25
<input type="checkbox"/> SN7407	.55	<input type="checkbox"/> SN7443	1.35	<input type="checkbox"/> SN7478	.95	<input type="checkbox"/> SN74114	1.25
<input type="checkbox"/> SN7408	.35	<input type="checkbox"/> SN7444	1.35	<input type="checkbox"/> SN7480	.75	<input type="checkbox"/> SN74121	.70
<input type="checkbox"/> SN7409	.35	<input type="checkbox"/> SN7445	1.35	<input type="checkbox"/> SN7481	1.15	<input type="checkbox"/> SN74122	.75
<input type="checkbox"/> SN7410	.30	<input type="checkbox"/> SN7446	1.65	<input type="checkbox"/> SN7482	.95	<input type="checkbox"/> SN74123	1.20
<input type="checkbox"/> SN7411	.35	<input type="checkbox"/> SN7447	1.50	<input type="checkbox"/> SN7483	1.15	<input type="checkbox"/> SN74139	1.50
<input type="checkbox"/> SN7413	.95	<input type="checkbox"/> SN7448	1.50	<input type="checkbox"/> SN7485	1.41	<input type="checkbox"/> SN74140	.50
<input type="checkbox"/> SN7415	.55	<input type="checkbox"/> SN7450	.35	<input type="checkbox"/> SN7486	.55	<input type="checkbox"/> SN74145	1.40
<input type="checkbox"/> SN7416	.55	<input type="checkbox"/> SN7451	.35	<input type="checkbox"/> SN7489	4.25	<input type="checkbox"/> SN74148	4.50
<input type="checkbox"/> SN7417	.55	<input type="checkbox"/> SN7453	.35	<input type="checkbox"/> SN7490	1.30	<input type="checkbox"/> SN74151	1.25
<input type="checkbox"/> SN7420	.30	<input type="checkbox"/> SN7454	.50	<input type="checkbox"/> SN7491	1.50	<input type="checkbox"/> SN74153	1.60
<input type="checkbox"/> SN7421	.35	<input type="checkbox"/> SN7460	.35	<input type="checkbox"/> SN7492	1.10	<input type="checkbox"/> SN74154	1.95
<input type="checkbox"/> SN7422	.35	<input type="checkbox"/> SN7461	.35	<input type="checkbox"/> SN7493	1.10	<input type="checkbox"/> SN74156	1.42
<input type="checkbox"/> SN7425	.30	<input type="checkbox"/> SN7462	.35	<input type="checkbox"/> SN7494	1.10	<input type="checkbox"/> SN74157	1.55
<input type="checkbox"/> SN7426	.37	<input type="checkbox"/> SN7464	.50	<input type="checkbox"/> SN7495	1.10	<input type="checkbox"/> SN74158	1.55
		<input type="checkbox"/> SN7465	.50	<input type="checkbox"/> SN7496	1.10	<input type="checkbox"/> SN74160	1.95
						<input type="checkbox"/> SN74161	1.65
						<input type="checkbox"/> SN74162	1.95
						<input type="checkbox"/> SN74163	1.95
						<input type="checkbox"/> SN74164	3.50
						<input type="checkbox"/> SN74165	3.50
						<input type="checkbox"/> SN74166	2.05
						<input type="checkbox"/> SN74174	2.10
						<input type="checkbox"/> SN74175	2.10
						<input type="checkbox"/> SN74176	2.10
						<input type="checkbox"/> SN74177	2.10
						<input type="checkbox"/> SN74179	2.10
						<input type="checkbox"/> SN74180	1.20
						<input type="checkbox"/> SN74181	4.50
						<input type="checkbox"/> SN74182	1.20
						<input type="checkbox"/> SN74192	1.95
						<input type="checkbox"/> SN74193	1.95
						<input type="checkbox"/> SN74194	1.95
						<input type="checkbox"/> SN74195	1.35
						<input type="checkbox"/> SN74196	1.50
						<input type="checkbox"/> SN74197	2.10
						<input type="checkbox"/> SN74199	2.65

* Factory Marked

* Money Back Guarantee

Buy 100 — Take 20%

Buy 3
or more,
10%
discount

KRONOS \$47.



Any
Type Clock

Buy 3 —
Take 10% **CHRONOMETER**

Cabinet: 6 x 5 1/4 x 6" (included)

All "MAN" readouts by Monsanto

Type	LED	Char.	Sale
<input type="checkbox"/> KR-101	MAN-3	.12	\$47.
<input type="checkbox"/> KR-102	MAN-1	.27	47.
<input type="checkbox"/> KR-103	MAN-4	.19	47.
<input type="checkbox"/> KR-104	Nixie	.45	47.
<input type="checkbox"/> KR-105	707*	.33	47.
<input type="checkbox"/> KR-106	704**	.33	47.
<input type="checkbox"/> KR-107	SLA-1*	.33	47.
<input type="checkbox"/> KR-108	Same as KR-107 except add \$12. for green digits.		

*Litronics or Opcoa equals to MAN-1 char
**Litronics equal to MAN-4 characteristics

COMING SOON: Scientific Devices
low-cost Crystal Standard, watch for it!
TWO CLOCKS IN ONE!

NATIONAL 'OP' AMPS

BUY ANY 3 — TAKE 10%

Type	Description	Sale
<input type="checkbox"/> LM-300	Super 723 V. reg.	\$1.49
<input type="checkbox"/> LM-301	Hi-performance amp	.49
<input type="checkbox"/> LM-302	Voltage follower	1.49
<input type="checkbox"/> LM-304	Neg. V. reg.	1.49
<input type="checkbox"/> LM-305	Pos. V. reg.	1.49
<input type="checkbox"/> LM-307	Super 741	.59
<input type="checkbox"/> LM-308	Hi-Q Fet Type Op Amp	1.50
<input type="checkbox"/> LM-309H	5V 200 mil V. reg.	1.50
<input type="checkbox"/> LM-309K	5V 1-amp V. reg.*	2.25
<input type="checkbox"/> LM-311	Comparator	1.50
<input type="checkbox"/> LM-320	Minus 5V 1-amp V.R.*	1.95
<input type="checkbox"/> LM-320	Minus 12V 1-amp V.R.*	1.95
<input type="checkbox"/> LM-320	Minus 15V 1-amp V.R.*	1.95
<input type="checkbox"/> LM-350	Dual peripheral driver	.59
<input type="checkbox"/> LM-370	AGC squelch op amp	1.49
<input type="checkbox"/> LM-371	R-F, I-F, op amp	.69
<input type="checkbox"/> LM-373	AM-FM, SSB, I.A.D.	3.75
<input type="checkbox"/> LM-374	AM-FM, SSB, IVAD	3.75
<input type="checkbox"/> LM-380	2-watt audio amplifier	1.95
<input type="checkbox"/> LM-3070	Chrome regenerator	1.50
<input type="checkbox"/> LM-3071	TV chroma IF amp	1.50

*TO-3 case, — others TO-5

LINEAR Op Amps

FACTORY GUARANTEED FACTORY TESTED

<input type="checkbox"/> 531	Hi slew rate op-amp (TO-5)	\$2.50
<input type="checkbox"/> 532	Micro power 741 (TO-5)	2.50
<input type="checkbox"/> 533	Micro power 709 (TO-5)	2.50
<input type="checkbox"/> 536	FET input op amp (TO-5)	3.95
<input type="checkbox"/> 537	Precision 741 (TO-5)	2.50
<input type="checkbox"/> 540	70W pwr driver amp (TO-5)	2.50
<input type="checkbox"/> 550	Precision 723 voltage reg. (DIP)	1.17
<input type="checkbox"/> 556	5 Times faster than 741C	2.10
<input type="checkbox"/> 558	Dual 741 (mini DIP)	1.00
<input type="checkbox"/> 560	Phase lock loops (DIP)	3.25
<input type="checkbox"/> 561	Phase lock loops (DIP)	3.25
<input type="checkbox"/> 562	Phase lock loops (DIP)	3.25
<input type="checkbox"/> 565	Phase lock loops (A)	3.25
<input type="checkbox"/> 566	Function generator (A)	3.25
<input type="checkbox"/> 567	Tone generator (A)	3.25
<input type="checkbox"/> 595	Four quadrant multiplier	3.10
<input type="checkbox"/> 702C	Hi-grain, DC amp (TO-5)	.49
<input type="checkbox"/> 703C	RF-IF, amp, 14 ckts (TO-5)	1.00
<input type="checkbox"/> 704	TV sound IF system	1.50
<input type="checkbox"/> 709C	Operational amp (A)	.49
<input type="checkbox"/> 709CV	Op amp (mini DIP)	.49
<input type="checkbox"/> 710C	Differential amp (A)	.49
<input type="checkbox"/> 711C	Dual diff. comp (A)	.49
<input type="checkbox"/> 723C	Voltage regulator (A)	.95
<input type="checkbox"/> 733	Diff. Video Amp	1.75
<input type="checkbox"/> 741C	Frequency compensator 709 (A)	.49
<input type="checkbox"/> 741CV	Freq. comp 709 (Mini DIP)	.49
<input type="checkbox"/> 747C	Dual 741C (A)	1.25
<input type="checkbox"/> 748C	Freq. adj. 741C (A)	.49
<input type="checkbox"/> 748CV	Freq. adj. 741C (mini DIP)	.49
<input type="checkbox"/> 753	Gain Block	1.75
<input type="checkbox"/> 709-709	Dual 709C (DIP)	1.00
<input type="checkbox"/> 739-739	Dual stereo preamp	1.98
<input type="checkbox"/> 741-741	Dual 741C (A)	1.00
<input type="checkbox"/> 75150	Dual peripheral driver	.88
<input type="checkbox"/> 75154	Dual peripheral driver	.88
<input type="checkbox"/> 745512	Dual line driver	.39
<input type="checkbox"/> PA265	5-Watt voltage regulator	1.95
<input type="checkbox"/> ULN2300M	Op amp with SCR	1.50
<input type="checkbox"/> CA3065	Video Audio system	1.50

(A) TO-5 or DIP dual in line pak

HI-FI 1" SQUARE MINI METERS

* Plastic case \$1.49

* Red needle Indicators

- Balancing, stereo, tape, amps.
- VU, side mtg, plus 3 minus 20 db.
- VU, front mtg, plus 3 minus 20 db. 3 for \$3.75





Southern Hospitality

For hundreds of years, the South has been famous for its hospitality and friendliness. Rex Johnson offers you the finest in new and used gear, along with service and follow thru in the true tradition of the South.

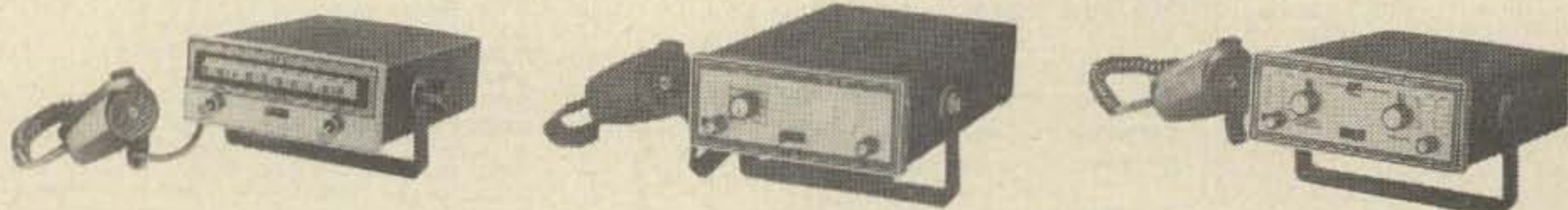

Clegg

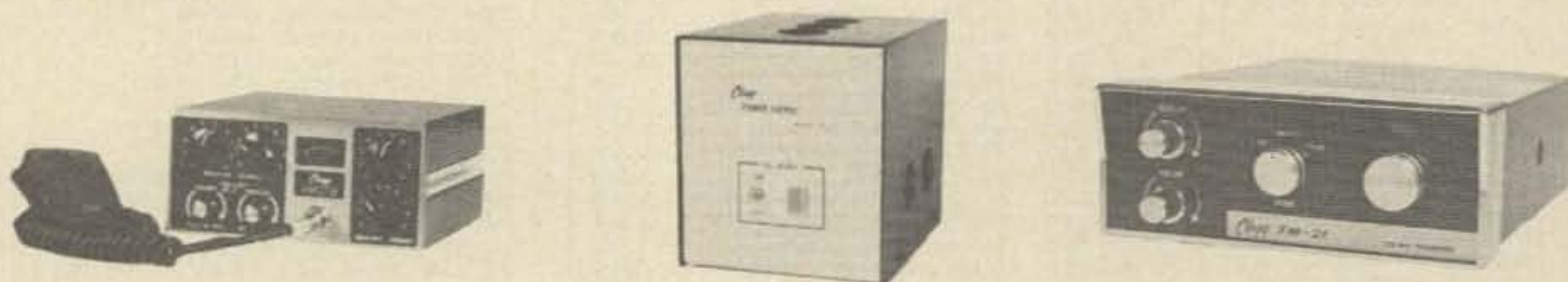

Write us for our Free Used Equipment List and trade-in quote on all Major lines. Remember, the Southern tradition of friendliness and hospitality is alive and well at Johnson Electronic Sales.

P.O. BOX 332 GRIFFIN, GEORGIA 30223
(404) 228-3831

**JOHNSON
ELECTRONIC
SALES**

LITRONICS-MONSANTO-OPCOA LED Readouts

All fit 14-pin IC sockets, 5V 10 to 20 mils, 0-to-9 numerals, plus letters & decimal. With spec sheets.
 * Monsanto Equal, MAN-1
 ** MAN-1 Specs.
 † 35-Diode Array.

MONSANTO "ALL LED" Type	Size	Color Display	Decimal	Driver	Each	Special
<input type="checkbox"/> MONSANTO MAN-1*	.27	Red	Yes	SN7447	4.50	3 for \$12.
<input type="checkbox"/> MONSANTO MAN-2*	.32†	Red	Yes	2513	6.50	3 for \$18.
<input type="checkbox"/> MONSANTO MAN-3*	.115	Red	Yes	SN7448	2.25	3 for \$6.
<input type="checkbox"/> MONSANTO MAN-3*	.115	Red	No	SN7448	1.49	3 for \$3.
<input type="checkbox"/> MONSANTO MAN-4*	.190	Red	Yes	SN7448	2.95	3 for \$8.
<input type="checkbox"/> MONSANTO MAN-4*	.190	Red	No	SN7448	1.79	3 for \$5.
<input type="checkbox"/> MONSANTO MAN-5*	.27	Green	Yes	SN7447	6.50	3 for \$18.
<input type="checkbox"/> MONSANTO MAN-8*	.27	Yellow	Yes	SN7447	6.50	3 for \$18.

"REFLECTIVE LITE BAR" (SEGMENT) LED READOUTS! ** Decimal right or left**

<input type="checkbox"/> LITRONIX 707** (MAN-1)	.33	Red	Yes	SN7447	3.50	3 for \$9.
<input type="checkbox"/> LITRONIX 704*** (MAN-4)	.33	Red	Yes	SN7448	3.50	3 for \$9.
<input type="checkbox"/> OPCOA SLA-1** (MAN-1)	.33	Red	Yes	SN7447	3.50	3 for \$9.
<input type="checkbox"/> OPCOA SLA-1** (MAN-1)	.33	Red	No	SN7447	1.95	3 for \$5.
<input type="checkbox"/> OPCOA SLA-3H Giant Digit	.70	Red	Yes	SN7447	8.60	3 for \$24.
<input type="checkbox"/> OPCOA SLA-2 Plus/Minus/1	.33	Red	No	SN7447	3.50	3 for \$9.
<input type="checkbox"/> OPCOA SLA-11C (MAN-5)	.33	Green	****	SN7447	4.95	3 for \$13.
<input type="checkbox"/> OPCOA SLA-12 Plus/Minus/1	.33	Green	—	SN7447	4.95	3 for \$12.

LED GaAs INDICATORS

- 2-MV1*, Amber, visible jumbo epoxy lens upright. \$1.00
- 1-MV2*, TO-18, Dome, green, visible. 1.00
- 1-MV-2*, green small dome, green diff. lite. 1.00
- 1-MV-2*, clear small plastic dome, green diff. lite. 1.00
- 1-MV-3*, micro-mini 'pin head' dome, TO18, green lite. 1.00
- 3-MV3*, visible, "coax pin pak", red, mini dome lens. 1.00
- 1-MV4*, stud, high power, red, 2-watts. 3.95
- 1-MV4H*, stud, high power, hi-dome, red, 2-watts. 3.95
- 3-MV10B, visible, red, clear, dome lens, TO-18. 1.00
- 3-MV10C visible, red, diffused, dome lens, TO-18. 1.00
- 3-MV50*, axial leads, micro-mini dome, clear, red. 1.00
- 3-MV5012*, visible, red, small dome lens. 1.00
- 3-MV5022*, jumbo red dome, TO-18, visible. 1.00
- 3-MV5020*, jumbo clear dome, TO-18, visible, red. 1.00
- 1-MV5040*, 4-LED red array, with 5-lead pak. 1.49
- 3-MV5054*, visible, red, jumbo dome lens, upright. 1.00
- 2-MV5080*, TO-18, micro-mini, clear dome, red. 1.00
- 4-MV5082, visible, red, clear flat lens, TO-18. 1.00
- 1-MV5222*, green hi plastic dome, diffused green lite. 1.00
- 1-MV5222*, clear hi dome, diff. green lite. 1.00
- 1-MV5222*, jumbo dome, green, panel snap-in. 1.49
- 1-MV5322*, jumbo dome, GaAsp, panel snap-in Yellow. 1.98
- 1-MV9000*, cartridge panel lamp, sealed, red, clear lens. 1.49
- 2-MT-2*, Photo Transistor, light sensor, TO-18. 1.00
- 2-ME-1*, infra-red, parabolic lens, pin type. 1.00
- 3-ME-4*, infra-red, "invisible", TO-18, diff. dome. 1.00
- 3-ME60*, infra-red, "invisible", axial, micro-mini. 1.00

MUX'D DIGITAL CLOCK PC BOARD

Each board properly multiplexed for 6 digits, to hold MAN-1's, MAN-3's, MAN-4's, Litronix 707 (MAN-1) and 704 (MAN-4), and Opcoa's SLA-1 (MAN-1). Board 6 7/8" long with spec sheets. * Elec char. same as Monsanto devices MAN-1 or 4.

Your choice
\$2.50

MAN-1 Litronix 707 (MAN-1*)
 MAN-3 Litronix 704 (MAN-4*)
 MAN-4 Opcoa SLA-1 (MAN-1*)
 6-MAN-3A's for above board, \$9.50.

LED MITY DIGIT DCM

Scientific Devices "Digital Counting Modules" outperform any other DCM on the market today. More features than ever before! Not gaseous, not incandescents, not nixie but the modern LED. Choose from such famous manufacturers as Monsanto's MAN-1, MAN-4, Litronix 707 and 704, Opcoa's SLA-1 (the last 4 having character heights of 0.33 at no extra charge). Each kit includes 3x2" p.c. board with fingers for a FREE edge connector, side-mounting dip socket, LED readout of your choice, resistors, 3 IC's, and Molex connectors (this ELIMINATES SOLDERING YOUR IC's), and booklet. **INCLUDES P.C. EDGE CONNECTOR — FREE!**

* Pin-for-pin MAN-1, ** Pin-for-pin MAN-4 elec. char. same

READOUT	Char. Maker	*Your choice of 5 red LED readouts!
<input type="checkbox"/> MAN-1	.27 h. Monsanto	Buy 3 — Only Take 10% \$9.99
<input type="checkbox"/> MAN-4	.19 h. Monsanto	
<input type="checkbox"/> 707*	.33 h. Litronix	
<input type="checkbox"/> 704**	.33 h. Litronix	
<input type="checkbox"/> SLA-1*	.33 h. Opcoa	

15¢ CATALOG on Fiber Optics, IC's, Semi's, Parts

Terms: add postage Rated: net 30
 Phone Orders: Wakefield, Mass. (617) 245-3829
 Retail: 16-18 Del Carmine St., Wakefield, Mass. (off Water Street) C.O.D.'S MAY BE PHONED

POLY PAKS

P.O. BOX 942A LYNNFIELD, MASS. 01940

SPERRY "ORANGE" TWIN DIGIT ARRAY

Type SP3A2, each digit is individually controlled, operates off 180VDC, 100 ua, 200 mw. Color: ORANGE. 7-digits, glass protection over digits. Character height: 0.33, P.C. mounting. Size: 3/4" x 3/4", 9-pins per digit. Driver: SN7447.

\$5.95
3 for \$15.

OAK FEATHER-TOUCH SWITCHES

*For RTTY
 *Printed Circuits
 *For Unique Panel Switches Sale \$.49

Mfd. by OAK (Ham's note, RTTY, too) data systems, same as used in Keyboard Calculator, SPST, Normally Open, 24V 1 amp contacts. Characters and letters easily changed, 3/8" high. Printed circuit.
 *White top, black numbers.
 †Blue top, white characters.

Kit of 17 above switches for keyboard \$7.50

No. 0*
 1*
 2*
 3*
 4*
 5*
 6*
 7*
 8*
 9*
 CE†
 CL†
 +†
 -†
 X†
 **

3 for \$27
\$9.95

Etched calculator board with holes, as above, less switches \$2.50 Board

CALCULATOR KEYBOARD

Properly etched, drilled, "MULTIPLEXED," with proper diodes. Ready to go! Used with our own CAL TECH's 5001 chip advertised at \$ 9.95 or equal to Cal Tech or Mostek chip. Keyboard uses the new manufactured by OAK, printed-circuit low-profile FEATHER TOUCH switches, 0-to-9 in white with black letters. Decimal white with black dot, CE, CL and the 4 function switches are in blue with white characters. Designed by top maker. Size: 6 1/2 x 4 1/2 x 1/2". All etched connections link to take a 12-pin edge connector.

Cal Tech 5001 12-digit calculator 28-pin DIP for 9.95
 Keyboard, 5001 "chip", and 12 MAN-3's, specs 35.00
 Twelve MAN-3's for above 17.50
 Twelve MAN-4's for above 32.00
 Twelve MAN-1's for above 42.00

12- CALCULATOR ON A CHIP DIGIT

CT5001 Chip **\$9.95**
 Similar to Mostek 5001. Outperforms Texas 8-digit TMS1802. A 40-pin DIP. Adds, multiplies, subtracts, and divides. Use with 7-segment readouts, Nixies, and LED's. We include schematics, instructions to build calculator.
 CT5002-9 Volt version of above — \$9.95
 CT5005-Same as above with MEMORY — \$14.95

NATIONAL EQUAL "DIGITAL CLOCK on a CHIP"

Any "Chip" **\$12.88**

***Money Back Guarantee!**

- 5311 28-pin, ceramic, any readout, 6-digits: A-B-D \$12.88 *With
- 5312 24-pin, ceramic, any readout, 4-digits: C-D \$12.88 Spec
- 5313 28-pin, ceramic, any readout, 6-digits: A-C \$12.88 Sheet!
- 5314 24-pin, plastic, LED and incandescent readouts, 6-digits: A-B \$12.88 Save!

Code: A—Hold Count. C—1 PPS Output. B—Output Strobe. D—BCD

STUD 'TRIACS'

PRV	15 amp	25 amp
50	\$.65	\$.85
100	.85	1.05
200	1.25	1.45
300	1.45	1.65
400	1.85	1.95
500	2.55	2.25
600	—	2.65

POTTER BRUMFIELD MINI CAP RELAYS

Your choice **\$2.49** 3 for \$6
 115 VAC
 24 VDC

Measures only 3/4 x 1 x 1 1/4". Plastic cased. Like KNP type. For pc board or socket, 14 lugs, 1-8/32 stud too! Both 4PDT. All ceramic construction. 3 amps, contacts. For r-f ant. switching. Wt. 1-oz. Wherever space is prime, you need a "mini cap" relay.

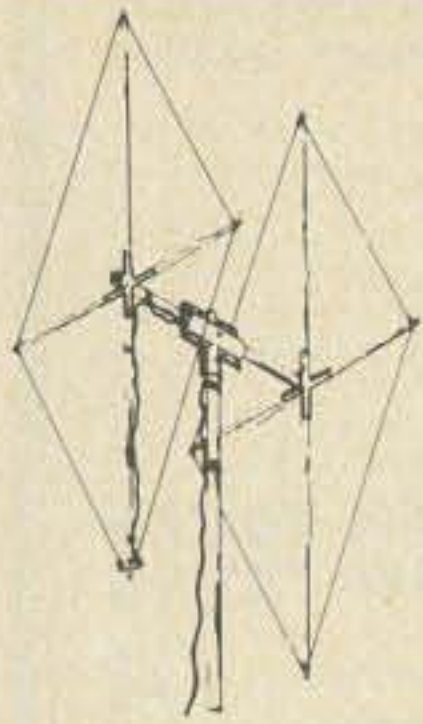

SUPER-QUAD FIBERGLASS ANTENNAS

★
COMPLETE KITS INCLUDE
HARDWARE, WIRE, ALL
MOUNTS, BOOM.

★
STRONGER AND LIGHTER
THAN ALUMINUM.

★
MAXIMUM GAIN.

AVAILABLE IN A COMPLETE RANGE OF KITS

Special Instruction Manual on
Kirk's "Super Quads" - \$2.00

- 2-3-4 ELEMENT TRI BAND
10-15-20 METER AMATEUR NET FROM \$129.95
- 2-3-4 ELEMENT DUAL BAND
10-15 OR 10-6 METER . AMATEUR NET FROM \$77.95
- 2 ELEMENT 40 METER . . . AMATEUR NET \$389.95
- UHF 4 ELEMENT - 2 OR 6 METER
AMATEUR NET FROM \$54.95

ANTENNA MOUNT KITS

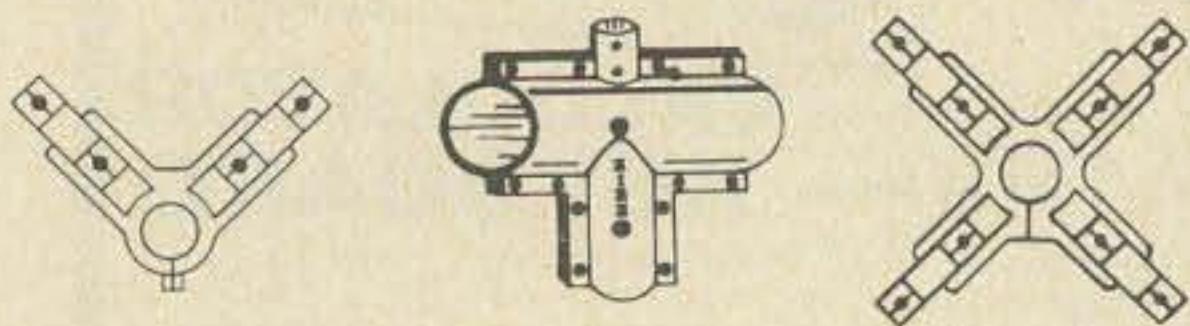

COMPLETE PACKAGED KITS INCLUDING

SPIDERS OR V-SUPPORTS • BOOM TO MAST MOUNT

• ALL NECESSARY ASSEMBLY HARDWARE

• INSTRUCTION MANUAL

HEAVY DUTY CAST ALUMINUM

DELTA LOOP MOUNT KIT

- DL-1 (2) 1 1/2" Hub V-Supports
(1) 1 1/2" Boom to 1 1/2" Mast T-Mount Net \$14.65
- DL-2 (2) 2" Hub V-Supports
(1) 2" Boom to 1 1/2" Mast T-Mount Net \$22.45
- DL-3 (2) 3" Hub V-Supports
(1) 3" Boom to 2" Mast T-Mount Net \$36.95

QUAD MOUNT KIT

- QM-1 (2) 1 1/4" Hub Spiders (Small Spider for VHF)
(1) 1 1/4" Boom to 1 1/4" Mast T-Mount Net \$10.85
- QM-2 (2) 1 1/4" Hub Spiders
(Heavy Spider for 6M & 10M)
(1) 1 1/4" Boom to 1 1/4" Mast T-Mount Net \$13.75
- QM-3 (2) 1 1/2" Hub Spiders
(1) 1 1/2" Boom to 1 1/2" Mast T-Mount Net \$14.65
- QM-4 (2) 2" Hub Spiders
(1) 2" Boom to 1 1/2" Mast T-Mount Net \$22.45
- QM-5 (2) 3" Hub Spiders
(1) 3" Boom to 2" Mast T-Mount Net \$36.95

REVOLUTIONARY BREAK-THRU IN ANTENNA DESIGN

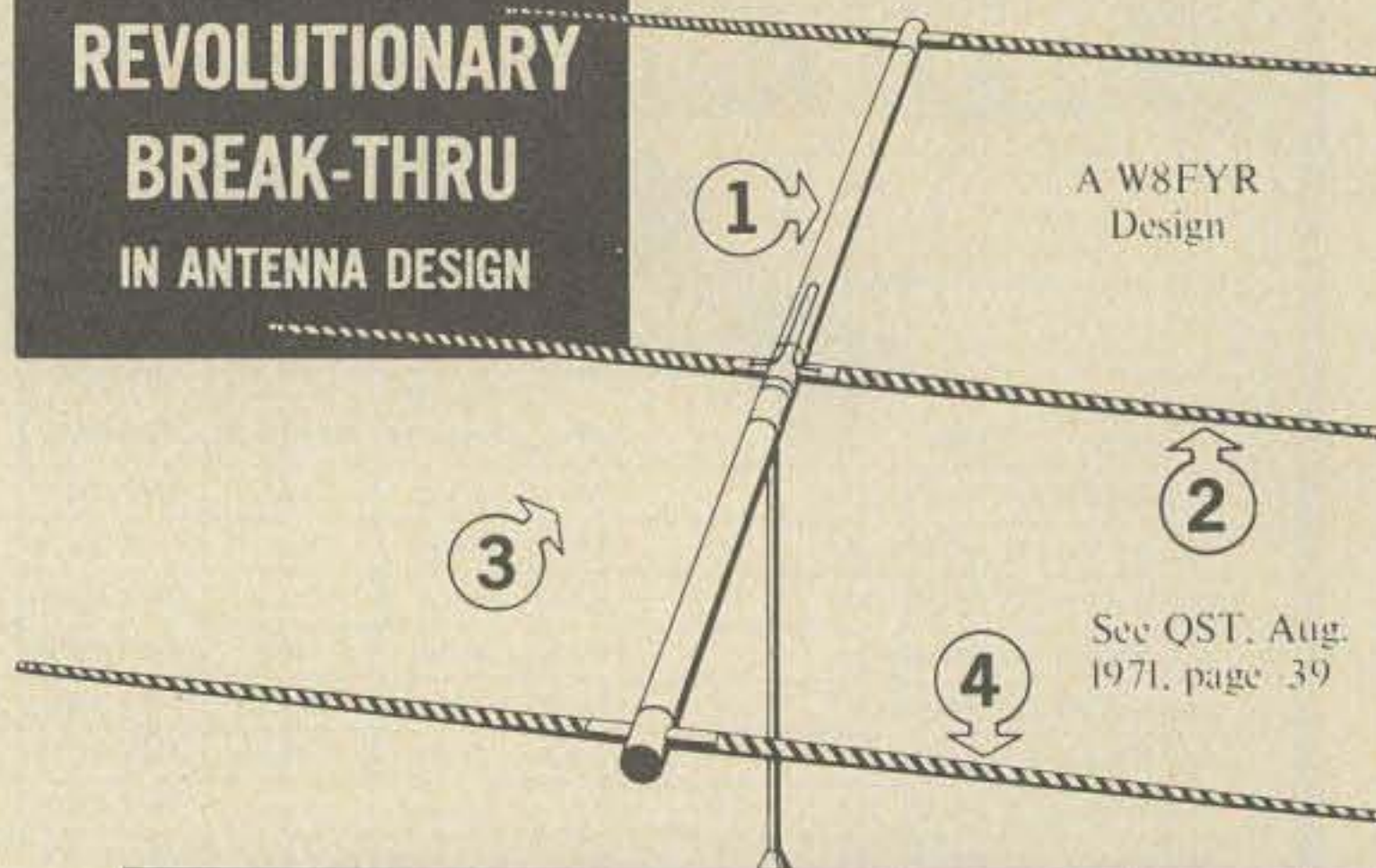

A W8FYR
Design

See QST, Aug.
1971, page 39

KIRK'S BRAND NEW ALL-FIBERGLASS HELICOIDAL BEAMS

AVAILABLE IN: 2 & 3 ELEMENT - 40 METER
2, 3, 4 & 5 ELEMENT - 10-15-20 METER

CHECK THESE OUTSTANDING

- 1 ALL FIBERGLASS
ELEMENTS & BOOM
- 2 ELEMENT LENGTHS 25%
TO 35% SHORTER THAN
METALLIC ARRAYS
- 3 PRECISION CONSTRUCTION,
MINIMUM ASSEMBLY TIME.
NO TUNING
NO ADJUSTING

AND EXCLUSIVE FEATURES:

COPPER TAPE, SPIRALLY
WOUND ELEMENTS
COATED WITH DURATHANE

VSWR LESS THAN 1.5 AT
UPPER & LOWER
BAND LIMITS

GREAT STRENGTH
AND VERY LIGHT

Example:
3 Element 40 M - 46 Lbs. \$525.00
3 Element 20 M - 17 Lbs. \$219.95
3 Element 15 M - 9 Lbs. \$164.95
3 Element 10 M - 8 Lbs. \$119.95

WORLD'S FINEST BROAD BAND BALUNS 1:1 Or 1:4 RATIO



Kirk Broad Band Baluns
are designed for match-
ing an unbalanced
line, such as coaxial
cable, to a balanced
antenna to produce a
symmetrical wave form
of equal intensity from
the current cycle.



MODELS
5075-D
& 5075-LF
For Dipole
Antennas
Net Wt. 7 Oz.

Kirk Baluns provide the greatest breakdown
insurance by use of mylar insulation between
the tough poly thermaleze winding and the
Ferrite Core and a final dip coating of low
dielectric impregnation. Handle peak power of
2000 watts provided ratio error is low.

Unique in design, Kirk Baluns
are produced in two distinc-
tive models: One for Dipoles
and one for Beam Antennas.

NET PRICE
\$12.95

Application Frequency Coverage & Power Rat-
ings For The Various Models Shown Below

MODEL	APPLICATION	F/MC.	POWER
5075-D	Dipole	3.4-52 mcs	2K PEP
5075-B	Beam	3.4-52 mcs	2K PEP
5075-LF	Dipole	1.7-10 mcs	2K PEP



MODEL
5075-B
For Beam
Antennas
Net Wt. 7 Oz.

WRITE FOR FULL INFORMATION. PRICES DO NOT INCLUDE POSTAGE.
PRICES ARE SUBJECT TO CHANGE

KIRK ELECTRONICS DIVISION

ELECTROTEC CORP. Dept. K

73 Ferry Road Chester CT 06412

• Telephone: (203) 873-8643

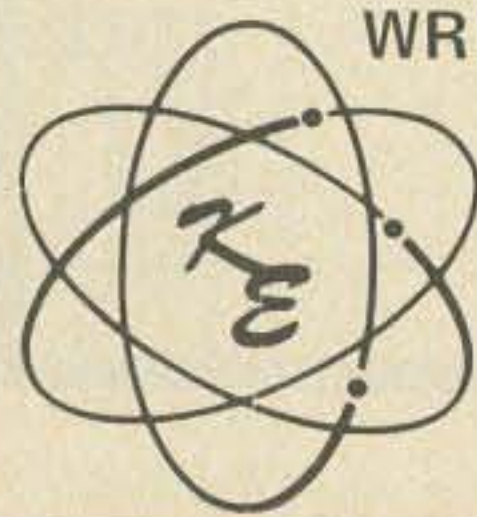

know this sign



To most people this is a symbol from Greek mythology. But to hundreds of thousands of active amateurs, Pegasus is the symbol of the Radio Amateur CALLBOOK the single most useful operating reference for active amateur stations. The U.S. Edition lists over 285,000 Calls, Names and Addresses in the 50 States and U.S. possessions while nearly 200,000 amateur stations in the rest of the World are listed in the DX edition.

Both editions contain much other invaluable data such as World Maps, Great Circle Maps, QSL Managers around the World, ARRL Countries list and Amateur Prefixes around the World, Time information, Postal Information and much, much more. You can't contest efficiently, you can't DX efficiently, you can't even operate efficiently without an up to date CALLBOOK.

To make the CALLBOOK even more valuable, three supplements are issued each year which bring your copy completely up to date every three months. These are available at a modest extra cost. Full details in every CALLBOOK.

Get your copies of the big new 1973 CALLBOOKS today.

US CALLBOOK
(less service editions)
Just \$8.95

DX CALLBOOK
(less service editions)
Just \$6.95

US CALLBOOK
(with service editions)
\$14.95

DX CALLBOOK
(with service editions)
\$11.45

Mail orders add 50¢ per CALLBOOK postage and handling.

See your favorite dealer or send today to:

WRITE FOR
FREE
BROCHURE

RADIO AMATEUR

callbook INC.



Dept. B 925 Sherwood Drive
Lake Bluff, Ill. 60044

MINIATURE METER

0-100 μ A (approx.) - 1/2" dia. \$1.00

MINIATURE POWER SUPPLY

Output 6Vdc - 100 Mils. \$1.00

5 Volt ZENER and Electrolytic for 5 Volt supply furnished for \$1.00 additional.

REED RELAYS

6 Vdc - SPST - 3/4 x 1" \$1.25

12 Vdc - SPST - 1 1/4 x 1/2" \$1.50

FULL WAVE SILICON BRIDGE RECTIFIER

200 PRV (line) 25 Amps - 1"sq. \$2.50

OIL CAPACITORS

4 MFD - 3KVdc G.E. 23F44

4 x 5 x 4 - 7 lbs. ea. 2 for \$10.00

100 MFD - 1500 Vdc - Sprague F1537

Use 2 in series for 50 MFD 3KV

13 x 6 x 5 25 lbs. ea. 2 for \$25.00

POWER SUPPLY

Input 115V/1/60 Output 28 Vdc 50 Amps filtered

Silicon studs - Cased transformer and choke

21 x 12 x 7 - 150 lbs. \$90.00



OMNIBUS *Electronic Industries, Inc.*

383 CANAL ST., NEW YORK, N. Y. 10013 (212) 226-3893

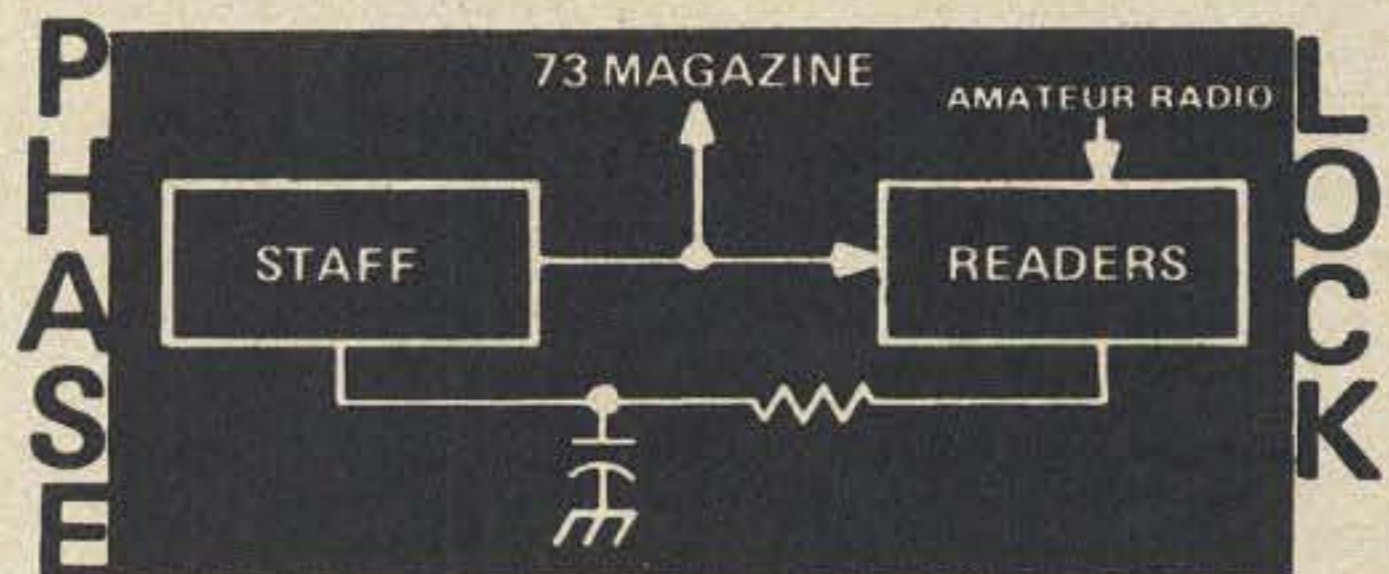

In this issue, do you think there is a need for more

	Yes	No
Simple construction projects	<input type="checkbox"/>	<input type="checkbox"/>
Complex construction projects	<input type="checkbox"/>	<input type="checkbox"/>
General interest articles	<input type="checkbox"/>	<input type="checkbox"/>
Humor articles	<input type="checkbox"/>	<input type="checkbox"/>
Specialized columns	<input type="checkbox"/>	<input type="checkbox"/>
Operating news	<input type="checkbox"/>	<input type="checkbox"/>

Comments

READER SERVICE

Please either tear out this list of advertisers and send it in to 73 with as many boxes checked off as you would like to see brochures, data sheets or catalogs... or else make a copy and send that in. Include your zip code, please. Send money directly to advertisers.

ADVERTISER INDEX

- | | |
|--|--|
| <input type="checkbox"/> Amateur Wholesale 75 | <input type="checkbox"/> International Elec. 72 |
| <input type="checkbox"/> Antenna King 15 | <input type="checkbox"/> Jan 59 |
| <input type="checkbox"/> Antenna Mart 63 | <input type="checkbox"/> Janel 32 |
| <input type="checkbox"/> Ascom Cover II | <input type="checkbox"/> Jeff-tronics 53 |
| ★ <input type="checkbox"/> ATV 58 | <input type="checkbox"/> Jensen 53 |
| <input type="checkbox"/> Autek Research 12 | <input type="checkbox"/> Johnson 108 |
| <input type="checkbox"/> A&W 97 | <input type="checkbox"/> KA Sales 106 |
| <input type="checkbox"/> Babylon 98 | <input type="checkbox"/> Kirk 110 |
| <input type="checkbox"/> Callbook 111 | <input type="checkbox"/> LA Elec. Sales 88 |
| <input type="checkbox"/> Circuit Specialists 94 | <input type="checkbox"/> Larsen 18 |
| <input type="checkbox"/> Clegg 30, 38 | <input type="checkbox"/> Linear Systems 41 |
| <input type="checkbox"/> Com. Unlimited 104, 105 | <input type="checkbox"/> Meshna 90, 91, 92, 93 |
| <input type="checkbox"/> ComSpec 12 | <input type="checkbox"/> MFJ 58 |
| <input type="checkbox"/> Cornell 52 | <input type="checkbox"/> Milliwatt 63 |
| <input type="checkbox"/> CushCraft 46 | <input type="checkbox"/> Morgain 12 |
| <input type="checkbox"/> Data Engineering 85 | <input type="checkbox"/> M-Tron 52 |
| <input type="checkbox"/> Denson 82 | <input type="checkbox"/> Newtronics 48 |
| <input type="checkbox"/> DuPage 103 | <input type="checkbox"/> Omnibus 111 |
| <input type="checkbox"/> Dynamic Elec. 58 | <input type="checkbox"/> Palomar 32 |
| <input type="checkbox"/> ECM 53 | <input type="checkbox"/> Pemco 87 |
| <input type="checkbox"/> Electronic Distr. 12 | <input type="checkbox"/> Polypaks 107, 109 |
| <input type="checkbox"/> Erickson 50 | <input type="checkbox"/> Q-Tronics 71 |
| <input type="checkbox"/> Fair 52 | <input type="checkbox"/> Regency 42 |
| <input type="checkbox"/> Freck 63 | ★ <input type="checkbox"/> RP 58 |
| <input type="checkbox"/> GAM 95 | <input type="checkbox"/> Savoy Cover III |
| <input type="checkbox"/> Gateway 78 | <input type="checkbox"/> Selectronics 83 |
| <input type="checkbox"/> Genave 80 | <input type="checkbox"/> Sentry 9 |
| <input type="checkbox"/> GLB 52 | <input type="checkbox"/> Signal Systems 79 |
| <input type="checkbox"/> Godbout 96 | <input type="checkbox"/> Solid State 86 |
| <input type="checkbox"/> Goldstein 76 | <input type="checkbox"/> S&R 102 |
| <input type="checkbox"/> Goodheart 62 | <input type="checkbox"/> Stahler 63 |
| <input type="checkbox"/> Gregory 66 | <input type="checkbox"/> Standard 3 |
| <input type="checkbox"/> HAL 71 | <input type="checkbox"/> Tri-Tek Cover II |
| <input type="checkbox"/> Ham Radio Center 89 | <input type="checkbox"/> Vanguard 99 |
| <input type="checkbox"/> Hatry 71 | <input type="checkbox"/> Venus Scientific 24, 25 |
| <input type="checkbox"/> Henry 36, 56 | <input type="checkbox"/> VHF Engineering 81 |
| <input type="checkbox"/> H&H Engineering 52 | <input type="checkbox"/> Waller 84 |
| <input type="checkbox"/> Hobby Industries 28 | <input type="checkbox"/> Wolf 63 |
| <input type="checkbox"/> Hy-Gain 100, 101 | <input type="checkbox"/> World QSL 53 |
| <input type="checkbox"/> ICOM 64, 65 | <input type="checkbox"/> Yaesu 16 |

73 Stuff

FM Atlas 59

How to Use FM 59

Subs 73

Books 74

Coupon expires in 60 days

*Reader service inquiries not solicited. Correspond directly to company.

Mail to:

OCTOBER 1973

Reader's Service
73 Inc., Peterborough NH 03458

Please Print or Type

Name _____ Call _____

Address _____

City _____ State _____ Zip _____

PROPAGATION CHART

J.H. Nelson

Good (Open) Fair (□) Poor (O)

October 1973

SUN	MON	TUES	WED	THUR	FRI	SAT
	1	2	3	4	5	6
7	8	9	10	11	12	13
14	15	16	17	18	19	20
21	22	23	24	25	26	27
28	29	30	31			

Possible aurora 24, 25, 26, 27.

EASTERN UNITED STATES TO:

	GMT:	00	02	04	06	08	10	12	14	16	18	20	22
ALASKA	14	7	7	7	3	3	3	7	7	14	14	14	
ARGENTINA	14	7	7	7	7	7	14	21	21	21	21	21	
AUSTRALIA	14	7B	7B	7B	7B	7B	7B	14	14	14	14	14A	
CANAL ZONE	14	7	7	7	7	7	14	14	14A	21	21	14A	
ENGLAND	7	7	7	3A	7	7	14	14A	14A	14	7A	7	
HAWAII	14	7B	7	7	7	7	7	7	7A	14	14A	14A	
INDIA	7	7	7B	7B	7B	7B	14	14	14B	7B	7	7	
JAPAN	14	7B	7B	7B	7	3A	7	7	7	7	7B	14	
MEXICO	14	7	7	7	7	7	7	14	14	14A	14A	14A	
PHILIPPINES	14	7B	7B	7B	7B	7B	7	7	7	7	7B	7A	
PUERTO RICO	7	7	7	7	7	7	7A	14	14	14	14	14	
SOUTH AFRICA	7	7	7	7	7B	14	14A	21	21	14A	14	14	
U. S. S. R.	7	3A	3A	7	7	7B	14	14	14	7A	7B	7	
WEST COAST	14	7	7	7	7	7	7	14	14	14	14A	14A	

CENTRAL UNITED STATES TO:

ALASKA	14	7A	7	7	3	3	3	7	7	14	14	14	
ARGENTINA	14A	7	7	7	7	7	7	14	21	21	21	21	
AUSTRALIA	21	14	7B	7B	7B	7B	7B	7	14	14	14	14A	
CANAL ZONE	14	7	7	7	7	7	7	14	14A	21	21	14A	
ENGLAND	7	7	3A	3A	7	3A	7B	14	14	14	7	7	
HAWAII	14	14	7	7	7	7	7	7	7A	14	14A	14A	
INDIA	7	7B	7B	7B	7B	3B	3B	7	7A	7	7	7	
JAPAN	14	7A	7B	7B	7	7	3A	7	7	7	7B	14	
MEXICO	14	7	7	7	7	7	7	14	14	14	14	14	
PHILIPPINES	14	7A	7B	7B	7B	7B	3A	7	7	7	7B	14	
PUERTO RICO	14	7	7	7	7	7	7A	14	14A	14A	14A	14	
SOUTH AFRICA	14	7	7	7	7B	7B	14	14A	21	14A	14	14	
U. S. S. R.	7	3A	3A	7	7	3A	7B	14	14	7A	7B	7B	

WESTERN UNITED STATES TO:

ALASKA	14	14	7	7	3	3	3	7	7	14	14	14	
ARGENTINA	21	14	7	7	7	7	7B	14	21	21	21	21	
AUSTRALIA	21	21	14	7B	7B	7B	7B	7	7A	14	14	21	
CANAL ZONE	14A	7	7	7	7	7	7	14	14	14A	21	21	
ENGLAND	7	7	3A	3A	3A	3A	3B	7B	14	14	7A	7B	
HAWAII	21	21	14	7	7	7	7	7	7A	14A	21	21	
INDIA	7	14	7B	7B	3B	3B	3B	7	7	7	7	7	
JAPAN	14A	14	7A	7B	7	7	7	7	7	7	14	14	
MEXICO	14	7A	7	7	7	7	7	7A	14	14	14A	14A	
PHILIPPINES	14A	14	7A	7B	7B	7B	7	7	7	7	7B	14	
PUERTO RICO	14	7	7	7	7	7	7	14	14	14A	14A	14A	
SOUTH AFRICA	14	7	7	7	7B	7B	7B	14	14	14A	14	14	
U. S. S. R.	7B	3A	3A	7	3A	3A	3B	7B	7A	7A	7B	7B	
EAST COAST	14	7	7	7	7	7	7	14	14	14	14A	14A	

A = Next higher frequency may be useful also.
B = Difficult circuit this period.

Savoy

BASSETT

High efficiency mobile and portable antennas for all amateur bands, AP, MARS, CB, SECURITY, PUBLIC SERVICE, MARINE, AND GOVERNMENT USE.

2-6-10-15-20-40-75

Identical size, cost, and appearance

FULLY ADJUSTABLE TO FREQUENCY IN FIELD

Low weight, low drag, high strength fiberglass

Polished chrome brass standard 3/8-24 thread

High gain collinear on 2 meters

MODEL DGA-2M

\$29.50 postpaid

in U.S.A.



\$3.75

Postpaid in U.S.A.

TYPE 900 A

TYPE 901

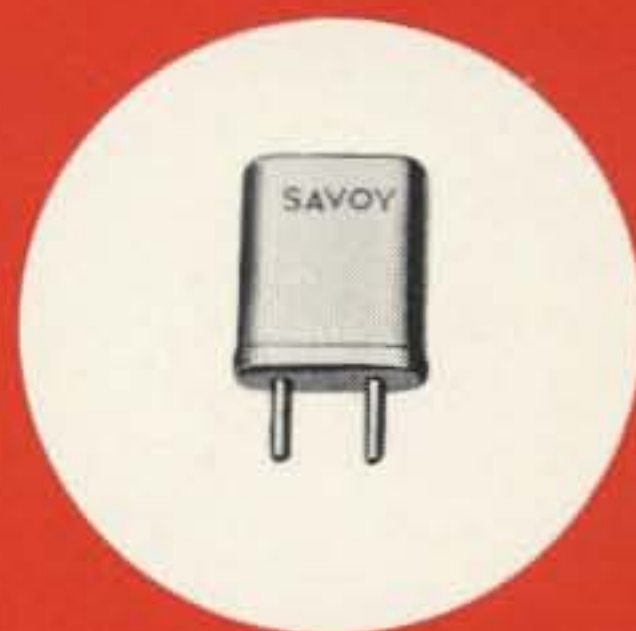

HIGH ACCURACY CRYSTALS FOR OVER 30 YEARS

Either type for amateur VHF in Regency, Swan, Standard, Drake, Vari-tronics, Tempo, Yaesu, Galaxy, Trio, Sonar, Clegg, SBE, Genave.

Quotes on request for amateur or commercial crystals for use in all other equipments.

Specify crystal type, frequency, make of equipment and whether transmit or receive when ordering.



BASSETT VACUUM TRAP ANTENNA SYSTEM
Complete packaged multi-band antenna systems employing the famous Basset Sealed Resonators and Balun from which air has been removed and replaced with pure helium at one atmosphere. Operating bands are indicated by model designation.

MODEL DGA-4075	..	\$59.50
MODEL DGA-204075	..	\$79.50
MODEL DGA-2040	..	\$59.50
MODEL DGA-152040	..	\$79.50

BASSETT VACUUM BALUN



The famous sealed helium filled Balun . . . employed with the DGA Series Antenna Systems. Solderless center insulator and easily handles more than full legal power while reducing unwanted coax radiation. Equipped with a special SO-239 type coax connector and available either 1:1 or 4:1.

MODEL DGA-2000-B . . . \$12.95
Postpaid in U.S.A.

CONTACT YOUR DISTRIBUTOR OR WRITE FOR DATA

Savoy Electronics, Inc.

P.O. Box 5727- Fort Lauderdale, Florida - 33310

Tel: 305-566-8416 or 305-947-1191



73 de

W2NSD/1

73 Pine St.
Peterborough,
NH 03458
USA

(Style 1)
Actual Size

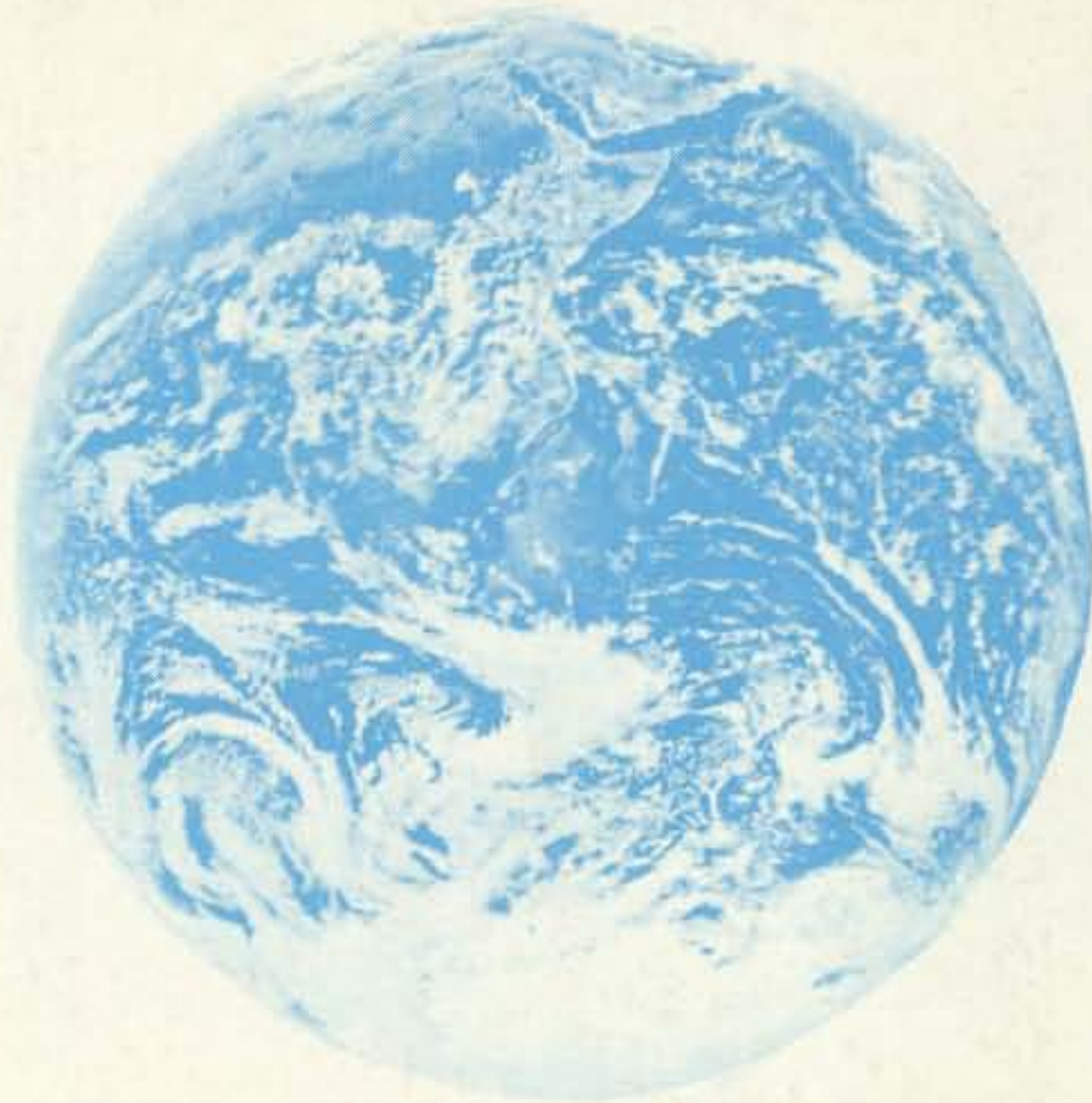

QSLs for 1¢

- two colors
- QSO info back
- LOW PRICES

Just when you're used to being abused by ever skyrocketing prices, 73 comes along with yet another way for Hams to save money! We have figured out a way for you to get *High Quality* QSL cards for as low as a **PENNY-A-PIECE** postpaid!

These cards are printed on *High Quality Glossy Card Stock* and are as good, or better than cards sold elsewhere for two or three times the price. By ganging up QSL printing between other jobs in our own print shop, we are able to offer you this fantastic low price. At this price, do you really have an excuse for not getting in a supply of these nice QSLs? Don't be one to give U.S. amateurs a bad name by not sending a card when requested.

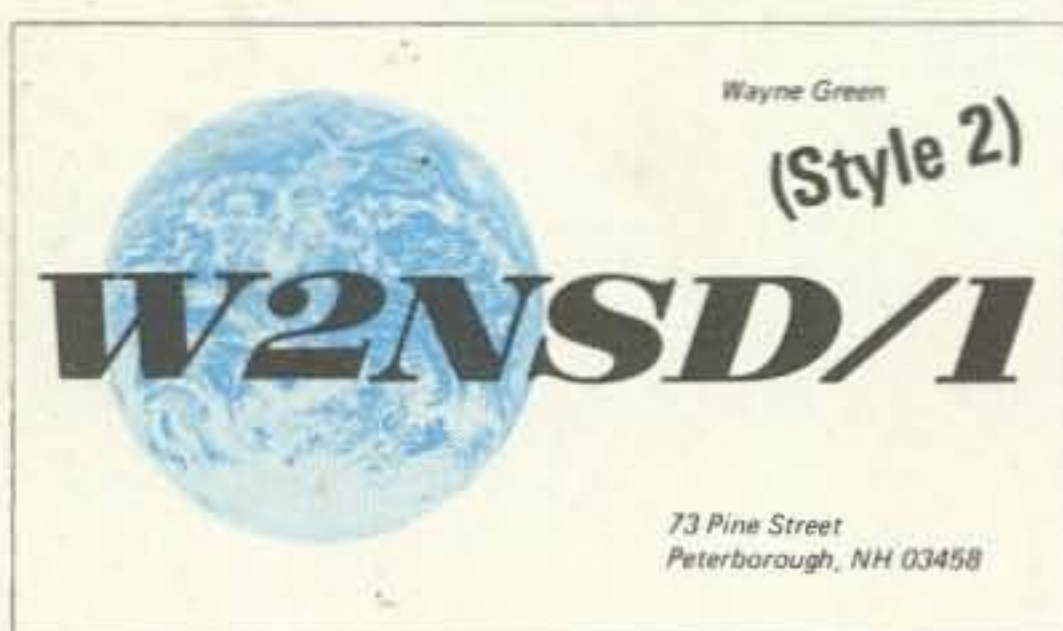

3 STYLES to choose from!

↓ ORDER - AND PAY ↓

250	\$6 (2.5¢ ea)
500	\$10 (2¢ ea)
1000	\$15 (1.5¢ ea)
2000	\$20 (1¢ ea)



ORDER BLANK

Name _____ Call _____
(First and last name is most friendly)

Address _____
(as brief as possible and still get through the mail)

City _____ State _____ ZIP _____ County _____
(a must) (if desired on the card)

Awards to be listed on card _____

250 500 1000 2000 cards Amount enclosed \$ _____

Style	
1	<input type="checkbox"/>
2	<input type="checkbox"/>
3	<input type="checkbox"/>