

JULY 1975
ONE DOLLAR

QST

amateur radio

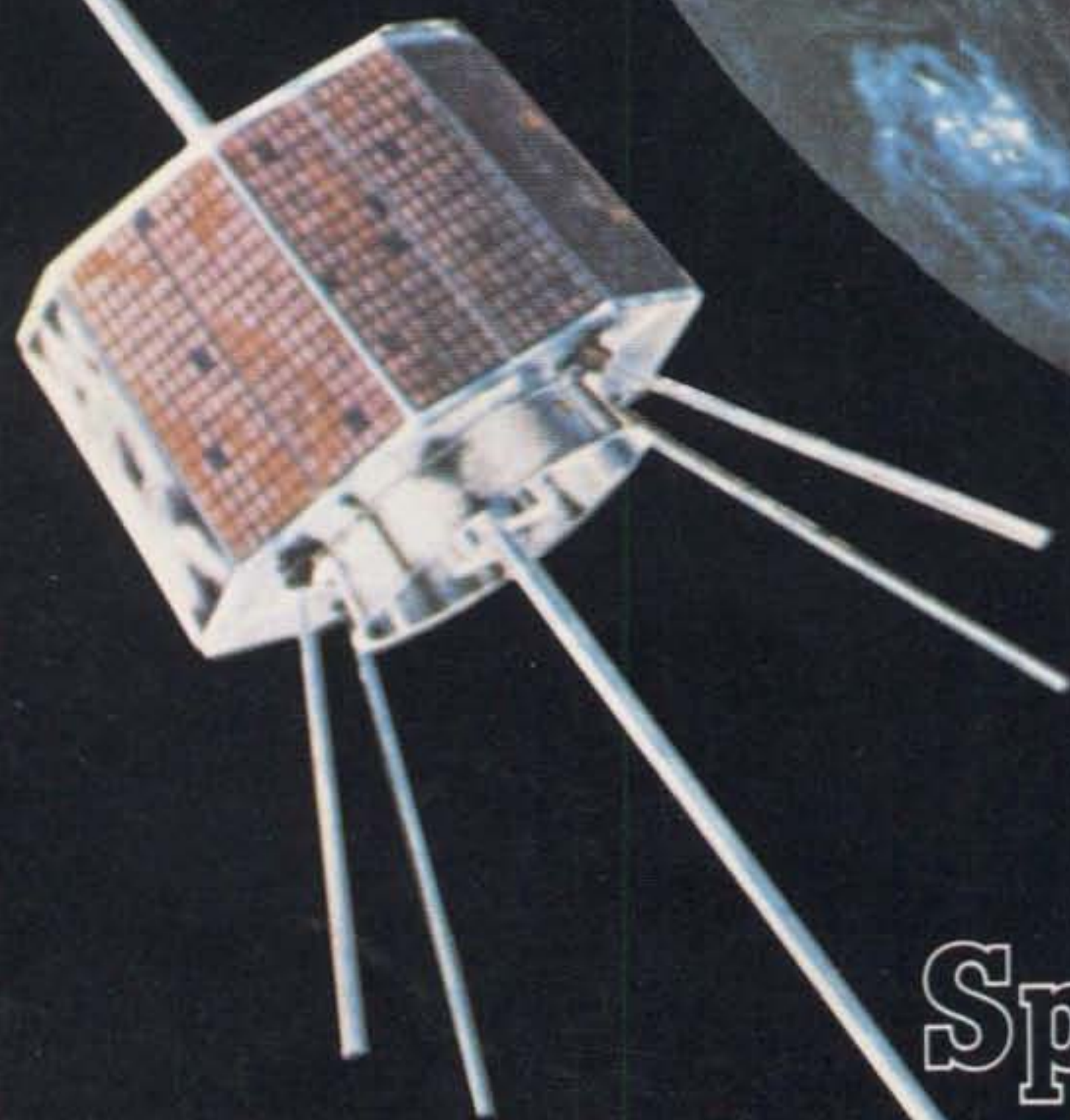

Oscar
Special Issue

new

HUSTLER

the real performer! specifically for repeater

...or any TWO-METER FIXED STATION OPERATION

With **6** db—
db—

- Gain compared to ½ wave dipole
- FCC accepted for repeater application

mechanical

- Vertical element—117" long, 1-1/8" telescopic to 3/8" OD high strength aluminum
- Radials—four, 21" x 3/16" OD aluminum rod
- Connector—SO-239
- Wind load—26 pounds at 100 mph.
- Wind survival—100 mph.
- Completely self-supporting
- Mounting—fits vertical pipe up to 1-3/4" OD

The gain you gain—you gain transmitting and receiving—get both with Hustler!

Available from
all distributors
who recognize the best!

electrical

- 6 db. gain over ½ wave dipole
- Omnidirectional radiation pattern
- Maximum radiation—at horizon
- 50 ohm feed impedance
- Field adjustable—140-150 MHz
- SWR at resonance—1.2:1 measured at antenna
- Bandwidth—6 MHz for 2:1 or better SWR
- Power—one kilowatt FM
- Feed—Shunt with D.C. grounding
- Radiator—5/8 wave lower section, ¼ wave phasing, 5/8 wave upper section

THE HUSTLER MASTER GAINER
MODEL G6-144-A

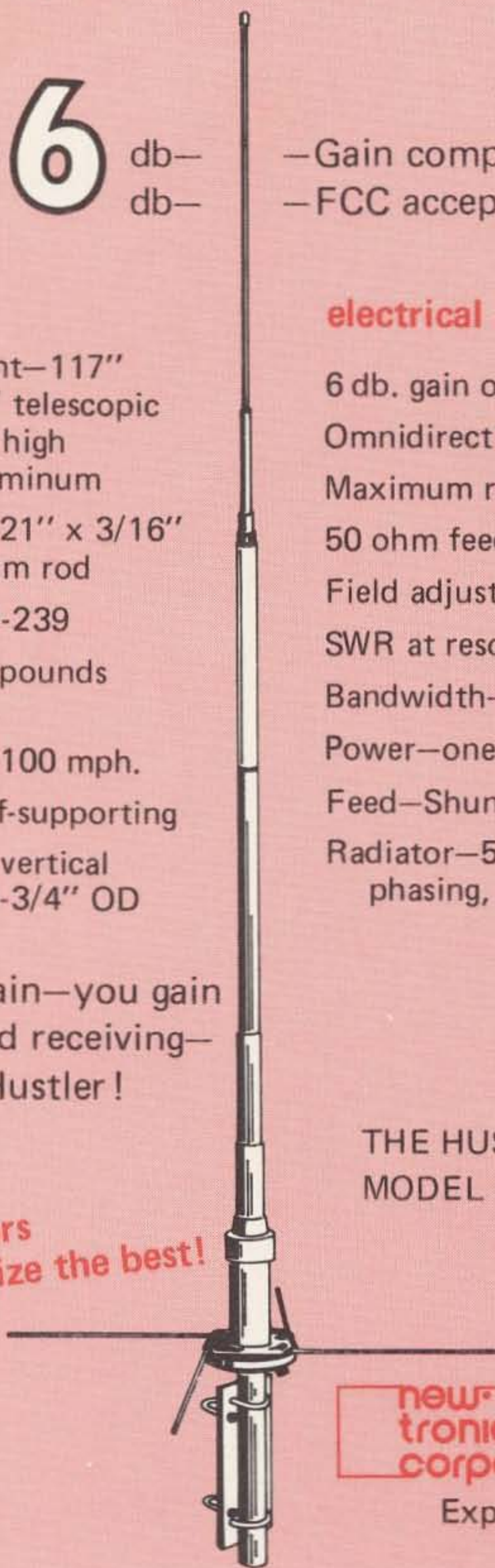

**new
tronics
corporation**

15800 commerce park drive,
brook park, ohio 44142

Exporter: Roburn Agencies, Inc.,
New York, N.Y.

W1FTX	18	Rare DX via Oscar?
W3HUC	25	Antennas for Oscar — What Really Works?
W3TMZ	31	An Oscar Preamp that Works Wonders
K2ZRO	33	Shoot Oscar with a Satellabe
K2QBW	47	Oscar — A Certificate Hunter's Paradise
W3HUC	51	Where's Oscar?
K9PVW, K9HUI	53	Oscar RTTY Converter
W3HUC	57	How You Can Take Oscar's Temperature
WB4VXP	59	Really Zap Oscar with this Helical
WB8DQT	76	Automating Satellite Reception
W1BNN	90	Eskimo Pie
WA3ETD/2	93	FM Alignment Oscillator
WØLMD	96	Master Sync Generator
WØLMD	98	The Audio Synthesizer for RTTY, SSTV and whatever
DOUGLAS	103	Ham Radio in the Arctic — 1925
W3HMU	107	Pack Rat Moonbouncing
W3WLX	111	Gee, What's a Zepp?
WB2NEL	113	How Gates Work — A TTL Primer
WA2CXD	118	Bargain Audio Frequency Source
W8HXR	119	Vertical Antennas for the Novice
MOCKING	123	Do Textbooks PREVENT Learning?
VE3FEZ	129	A Visit to the CB Store
ANDERTON	132	Preventing Regulator Carnage
STAFF	135	The Ultimate in Variable Selectivity
W8HXR	139	Phone Patching — A Public Service
WB4DBB	156	An S-meter for your Swan-250

73 amateur radio

#178 JULY 1975

COVER: Photo provided by Alan Bridges WB4VXP, 2881 S. Main, Kennesaw GA 30144, who has 8x10 copies available for \$3 (or 20 IRCs). Order from Alan, but make checks payable to AMSAT, which gets the proceeds.

2	Never Say Die	16	Caveat Emptor
3	Hotline Headlines	44	Hamburglar
4	Be My Guest	134	Circuits
5	MORE Hotline Headlines	143	Circuits
6	Ancient Aviator	146	New Products
7	AMSAT	150	Social Events
8	Looking West	154	Circuits
9	New Product	166	Grrreen
10	Repeater Update	170	Circuits
12	Letters	192	Advertiser Index
13	Corrections	192	Propagation

73 Magazine is published monthly by 73, Inc., Peterborough, New Hampshire 03458. Subscription rates are \$8 for one year in North American and U.S. Zip Code areas overseas, \$9 per year elsewhere. Three years, \$16 and \$17 overseas. Second class postage paid at Peterborough, New Hampshire 03458 and at additional mailing offices. Phone: 603-924-3873. Microfilm edition of 73 available from University Microfilms, Ann Arbor MI 48106. Magnetic tapes available from Science for the Blind, 332 Rock Hill Rd., Bala Cynwyd PA 19904. Entire contents copyright 1975 by 73 Inc. Peterborough, NH 03458.



73 staff

EDITOR/PUBLISHER
Wayne Green W2NSD/1

BUSINESS MANAGER
Virginia Londner Green

EDITORS

Eric K. Albrecht K8BFH/1
Alex Barvicks WB4RVH
John Burnett

EDITORIAL ASSISTANT

Susan G. Philbrick

PRODUCTION MANAGER

Lynn Panciera-Fraser

ART DEPARTMENT

Bob Drew
Nancy Estle
Neal Kandel
Bob Sawyer

PRINTER

Biff Mahoney

PHOTOGRAPHY

Bill Heydolph

TYPESETTING

Barbara Latti

ADVERTISING

Bill Edwards WB6BED/1

Ernestine Blodgett

COMPROLLER

Knud E.M. Keller KV4GG/1

CIRCULATION

Barbara Block
Dorothy Gibson
Judy Havey
Cheryl Hurd
Marge McCarthy

MARKETING

Cathy Greenwood
Jeff Martin WA5SDV/1

INVENTORY CONTROL

Marshall Raymond

PLANT MAINTENANCE

Bill Barry

ASSOCIATES

Schley Cox WB9LHO
Tom DiBiase WB8KZD
Terry Fox WB4JFI
W. Sanger Green
Dave Ingram K4TWJ
Joe Kasser G3ZCZ
Bill Pasternak WA6ITF
John Schultz W2EY
Waller Scott K8DIZ
Peter A. Stark K2OAW
Gary Tater W3HUC
Bill Turner WA0ABI

DRAFTING

Bill Morello
Lynn Malo
T.M. Graham Jr. W8FKW



NEVER SAY DIE

...de W2NSD/1

EDITORIAL BY WAYNE GREEN

DANGER: OSCAR!

Oscar holds out the same promise... something like a life on drugs.

One of the most virulent mental diseases ever to hit amateur radio has been something very obscure — something called Oscar 7, mode B. It only takes the slightest exposure to this to reduce a normally healthy ham to a wide eyed fanatic, looking frantically for some way to get on 432 MHz.

If you've been around amateur radio for any length of time you've had an opportunity to try to reason with a DX-crazed inhabitator of the pileups — you may have even talked with more than one of these poor people, whose very life structures have been twisted horribly by fate so that their work, their family life and their entire existence is wholly dependent upon being able to work DXpeditions. Oscar holds out the same promise... something like a life on drugs.

You say you can listen in and not get hooked? Ignore, if you will, the testimony of thousands of lives, reduced to shambles, now being spent waiting for each next orbit of Oscar... or Oscars... there are two up there now.

Let's see if you have any guts. Let's see if you have the strength of character to listen in to Oscar. That's right... all you have to do is listen. Nothing serious can happen from that, right? So you'll listen and maybe you'll hear some stuff. Big deal. You can hear a lot better on 20 meters, right?

Both Oscar 6 and 7 are relaying signals from 2m to 10m, so you have plenty of opportunity to tune them in. It doesn't take much of an antenna either, though you can always use a little better antenna or a lower noise receiver to get a little better reception. If you have a 2m receiver which can pick up CW or SSB you are even better off, for the 2m signals from

Oscar 7 in mode B are almost unbelievable at times.

You have to know two things, obviously... when to tune in and where to tune. The where is the easiest — with Oscar 6 (let's call it O6) you tune around 29.5 MHz. The signals should come in from 29.45 to 29.55 MHz, and you may hear a telemetry beacon on 29.45. The signals coming out on these frequencies are going in from 145.90 to 146.00 MHz. Many of the fellows are using low powered FM rigs, keying them with the PTT for CW, to get into the satellite. O7 comes out from 29.4 to 29.5 MHz and goes in from 145.85 to 145.95.

The when to tune is a bit more complicated, but not seriously. The orbital data is printed in 73 and in Hotline, with one orbit per day listed for each satellite. From there you can figure out the rest in a couple of minutes. It's easier if you use a hand calculator, but you don't really need one.

The orbiting data tells you the time and place Oscar crosses the equator in an ascending orbit for the first time each day. Next you'll want to project the time and place for each successive ascending orbit crossing. Oscar is going in a circle around the globe, crossing near the poles... about 12° tilted from the axis of the earth. The earth turns beneath it. It takes Oscar about 115 minutes for a complete loop. Take a sheet of paper, and put down the orbit number for the first daily orbit and those for the next twelve orbits under that in a list. Put the time for the first orbit and then work out the times for the next twelve equator crossings (ascending, of course). It will be two hours later for each one, less five minutes. You can make a third column for your local time, if you think better that way, since the orbit time is in GMT.

The chart gives the longitude of the first crossing... put that down. Add 28.7° (29° is close enough) to that for each succeeding crossing, and put that on the list. You can check an atlas to see where you live in longi-

tude... 75° runs through Philadelphia, 90° through Chicago, 105° through Denver and 120° through L.A. You'll be able to hear the satellite when it is within about 45° of you. If you have a world globe you are really set, for you can draw a circle 4000 km in radius around your shack and see just when the satellites will be in range. Lacking a globe, you can make a rough estimate of how long after it passes the equator it will be before you will be able to hear it. Figure that if it passes right overhead you will be able to hear it about 24 minutes total. A line across the country from San Francisco through Oklahoma City and Norfolk is about 12 minutes away from the equator so you'll hear it as it comes over the equator if you live along that line and it is going to pass overhead. If it is about 15° from you, figure it'll take about a minute extra. At 30° add three minutes. At 45° it'll take about 10 minutes and you'll only hear it for a short while... but this gives you the best distance, so it's worth it. Add about a minute for each 200 miles you live north of the Norfolk-S.F. line.

Okay, now you have your times for ascending passes. When Oscar is ascending on the other side of the world it will go on up and over near the pole and come down over you on a descending pass. You can get a good idea of the times for these by making a further column on your list for descending longitudes... subtract 166° from the ascending longitude. Add 29 minutes to the ascending equator time and you'll know when it has passed the pole. This is a good time to start listening.

There is much to be said for getting a world globe for working out exact satellite passes... or else a map made

for this purpose. The chances are that you'll be able to hear at least some of about ten of the thirteen passes it makes each day, providing you don't have to be away from the shack for more than an hour and a half or so at a time.

The present schedule calls for Oscar 6 to be turned on Sunday morning and evening (local time) as well as Wednesday and Friday evenings. Oscar 7 will be on the 10m output every other day (listed as mode A on the orbital lists), but it is not used on Wednesdays. On the even numbered days of the year (starting from Jan. first), O7 is in mode B, listening from 432.125 to 432.175 MHz and relaying this from 145.925 to 145.975 MHz. Mode B is working the best, with signals often reaching S-7 or better even with relatively poor receivers. Other than the Wednesday rest period, O7 is on all the time.

Once you've heard the signals you'll want to give the system a try. The mode B, while it is easier to hear, requires more sophisticated equipment, so you'll probably start out with the mode A relay first. Many amateurs have managed contacts using FM rigs, keying the mike button... even the TR-22 has made it many times with its one Watt output. Sideband is more complicated unless you have an Echo or Multi-2000 transceiver. CW on 432 is not difficult with converted commercial FM gear, but again, sideband requires a lot more effort.

Let's take Saturday, July 5th, and work out a schedule for O7 in mode B from the published orbital info. You can cheat and get this all worked out for the whole year for both satellites from Skip Reymann W6PAJ, Box 374, San Dimas CA 91773, for \$3.

Continued on page 158

Orbit	GMT	EDT	Equator longitude	Descending longitude	Time over pole	Estimated acquisition
2898B	0011	(July 4) 2011	52.7		2040	2016-2037
2899	0206	2206	81.5		2235	2209-2230
2900	0401	(July 5) 0001	110.2		0030	0015??
2901	0556	0156	139.0		0225	
2902	0751	0351	167.7	1.7	0420	
2903	0946	0546	198.4	30.4	0615	0627??
2904	1141	0741	225.2	59.2	0810	0815-0835
2905	1336	0936	253.9	87.9	1005	1007-1030
2906	1531	1131	282.6	116.6	1200	1201-1220
2907	1726	1326	311.4	145.4	1355	1353-1402
2908	1921	1521	340.1	174.1	1550	1547-1553
2909	2116	1716	8.8		1745	1738-1747
2910	2311	1911	37.6		1940	1919-1940

HOTLINE HEADLINES

CB Mags continue to advertise illegal linear amplifiers "not for CB." FCC is not amused and repercussions could be serious to amateurs as a result of FCC attempts to stem 11m amplifiers.

W8HRV is the winner of the Chronex digital LED readout watch in the 73 Magazine bumper sticker contest at Dayton Hamvention.

Dayton pulls nearly 12,000 this year — event is beyond description — flea market boggles 173 minds, Dayton hospitals reported filling up with amateurs raving over the incredible bargains — exhibitors reported leaving wide trails of excess cash as they struggle homeward after the convention with boxes of money, bags of money, and pockets bulging — so where's the depression?

Reaction to 20282 changing — more and more resistance to Communicator license despite heavy ARRL pressure in favor.

Fred Laun W9SZR/3 awarded Foreign Service Award for Valor by Kissinger.

Oscar 8 plans progressing — equipment to be made almost 100% in other countries. Need for an Oscar 7-1/2 is becoming obvious as 2/10m translator will be important to continue after Oscar 7 fades away and before Oscar 8 is lofted — plans being made.

K4LSP continues repeater war in Tennessee via WR4ADO despite attempts by repeater council and coordinators to cool the battle — Eddie Palmer on the way toward winning citation as disgrace of the year.

New phone rates for one minute excellent for ham scheds — Ma Bell is not all bad.

Silver Box — new phone gadget which permits you to listen in on any line — Bell hoist on own petard as gadget allows people to use Bell system for monitoring company business office calls — Congress investigating invasion of privacy.

WA4SAM theft — the SAM car is rigged to blow the horn, sound a siren, and flash the headlights when broken into — plus a goodly signal on two meters. When the car was stolen the other day the thief made the cleanest get away in ham mobile history... according to WA4LCL.



BE MY GUEST

Visiting views from around the globe.

QPR: Quality Public Relations

In the last few years hams have had several problems to cope with. Among these are A. Prose Walker, the EIA and the 220 MHz bit, TVI complaints which turn out to be CBers, etc. But the most drastic problem to face U.S. amateurs in recent years is the dwindling number of hams joining the ranks.

After reading Wayne's March editorial, I really hate to make this next statement, but it is the truth. The real blame for the lack of interest in our hobby by the public lies with the hams themselves. The public has many people itching to get into some kind of radio, and most turn to CB. Why? Well, it is fairly evident. The public knows more about CB than amateur radio. The fault for this lies within the already established amateur ranks. PR is the name of the game and some of us have yet to learn how to play it!

This game is rather simple to play and has only one really important rule. **BE WHERE THE PEOPLE ARE!** This means most anywhere. Where people congregate in numbers, amateur radio should be there, too! You don't make the public come to you —

you go to the public. Shopping malls make a fantastic place. In the neighboring city, the area malls host everything from ballets to horseshoe throwing contests. By merely being there, these events cause the people to stop and watch.

The greatest numbers of potential amateurs are at the local high schools. If they don't have a radio club, start one. You'll find help from the resident electronics teachers, math teachers, etc, I'm sure. The administration might not like the idea of putting up antennas, of course, but if you work it right you can turn their relentlessness into interest.

Get the local amateur club into the act. Set up a booth at the numerous county fairs. Appear where least expected — at CB coffeebreaks. If CBers knew more about ham radio we could turn them into a decent breed of hams. Set up some kind of public function and invite the newspapers, radio and television stations. Invite them to your hamfest, etc. Let everyone know that **HAM RADIO IS AROUND.**

Include in your demonstration as many different facets of the hobby as

you can get your hands on. This not only draws interest but also serves as an incentive to those who already have their Novice licenses. SSTV, RTTY, FAX, FM, ATV, CW, SSB, HF, VHF, UHF, antennas, building — they all should be there. Have recent ham publications around for people to browse through. Catalogues of different types of equipment should be on hand. There's nothing as impressive as an S-line. Get young and old hams there. Get the people involved and don't stop there.

After you have gotten to the public, let it be known where classes are being held. Of course someone in your town is holding Novice classes, aren't they? If not, start them.

Remember, don't lecture the public — that doesn't help at all. Just make it super interesting and you'll have more bites than you can handle.

We hams have to get to the public to help our dwindling numbers or the FCC will try, and we've seen what that has done in the past. Give your club a purpose, if you don't have one, and work on it!

Mark D. Poss WB8URH
Fostoria OH

! Thirteen Billion

Lou Breetz W3LB gave a talk at the club meeting on April 3 about the U.S. Satellite Detection System's main transmitter and antenna array, operating in Texas. Lou was head of the Transmitting Section of the Space Surveillance Branch in the Applications Research Division of the NRL while this project was being developed and gotten into operation. Operating at 216 MHz with a continuous rf power output of 10 megawatts and an antenna gain of 41.3 dB from a 2 mile long array of 2550 inverted V dipoles, this system develops the ERP referred

to above. The antenna pattern is fan-shaped, with the broad dimension along an East-West line, and the angular thickness of the fan pattern is about 1½ degrees from North to South. This huge array has a near field pattern up to 2000 miles above the earth, before the far field pattern starts to form.

Since the system's purpose is to detect any potentially hostile nuclear weapon satellite, high reliability of the design was required. Two separate commercial power sources are available, and four master frequency

sources are installed, backed up by storage batteries to insure continuity of frequency stability. Any of the 18 bays of antennas, each bay fed by a 60 kW transmitter, can drop out without any major effect, and the drive to that section is automatically switched to a dummy load.

Each transmitter uses five type 6166A tubes with 12 kW plate dissipation each, and operating at about 50% efficiency. Styroflex coaxial cables, to the extent of 15 and 20 miles' worth, run from the antenna bays to feed

my view

There I was, cheerfully working away at my overdue income tax returns, and in walks an old friend. Price, you ole son-of-a-gun, I said. How's things — is the Federal Candy Company keeping you busy? After a thoughtful pause, Price begins his woeful story. Well Bill, to tell you the truth I haven't slept in days. Say Price old man, now that you mention it, you do look in bad shape. Pull up a chair and let's hear about it.

Well, you know about this restructuring proposal we've had going for awhile. Oh yeah, that's the 20282 I've heard so much about lately. Right, that's it — well anyway, you know we've been trying to find a new home for the citizens banders for a long time and this is it... Wait just a minute there friend. I think you're talking about the wrong one. Don't you mean the Class E proposal for 220? No, no — see that's just it. I mean 20282, but let me fill you in a little bit first.

For years now the citizens band has just completely gotten out of hand. Most of the legitimate users moved out long ago and the ones still there give me nightmares, but that's not the problem. The problem is that the CBers don't want to move. Now we tried the Class E proposal, but not only did the CBers complain, with their Washington lobby and all, but

the hams put up such a ruckus that between them they just about killed Class E. Now normally that's that, but not in this case. Some real big guns over at the Electronic Toy Association want the CBers to move as badly as I do, but for a different reason. They figure that once we find another place for the CBers, they'll be able to sell a lot more toys. Maybe three to six hundred bucks or so per CBer times about 800,000 of them makes for some big bucks. Well anyway, with a carrot that big, they don't want to see it disappear just because people don't like Class E.

OK, I follow you so far, but what does this have to do with amateur restructuring? A lot my boy, matter-of-fact it has everything to do with amateur restructuring. See, it doesn't really matter if we call the new CB class citizens band or amateur radio, as long as they move. The point is that if we give them an "incentive" to become Communicators, like officially closing down 27 MHz CB and moving some military transmitter in there, we'll have the same thing as if we had a Class E service. Not only that, but there'll be a whole lot less opposition than there was to the Class E thing.

But you already said the hams are helping kill Class E... Why wouldn't

Continued on page 7

Watts ERP?

information to motor driven phasing equipment. This phasing system tends to go wild when a cloud passes low over an end of the 2 mile array. The phasing cables are run underground in controlled temperature water jackets.

Receivers for the system are located at considerable distances from the transmitting site, and common lines between all sites provide signals accurate to 1 Hz in frequency.

Several of the people on the transmitter and antenna project were amateurs, and a man from ARRL came

down to look at the system and its antennas. The dipoles are phase-sensitive to ice accumulation on their ends, so special cones were installed to keep ice formations spaced away from the tips. The system went into operation in 1966 and is in active use. The electric bill before the price rises was \$18,000 per month!

Ed Westbrook K3CS

Reprinted from *Auto-Call*, May, 1975, p.19.

MORE HOTLINE HEADLINES

HB9PJ saves another life. Fernand made the papers again by getting medicine to a man in Romania. Just a few years ago he did the same for a Polish child and got ham radio excellent PR.

CB cleanup program instituted by amateurs in New York is remarkable success with over 100 CBers being cited by FCC plus arrest of four illegal aliens, four persons in possession of stolen radios, twelve on gambling charges, 19 on narcotics charges, etc.

QSL returned by Post Office — addressee moved — only hitch was that card was sent 27 years ago by Borcher of Omaha and just returned! Post Office reached new levels.

F3 magazine folds after two issues — insufficient support of readers and advertisers cited — residual reaction to... rpt alleged.

FCC cites amateur 30 cycles into Extra Class band! Too busy with this nit picking to bother the CBers?

Canadian crossband repeater authorized — DOC not trying to stifle amateur pioneering. Walker, take note.

Tufts Radio growing to be biggest New England ham dealer — reports Multi-2000 sales are booming — other dealers concur. Yaesu readying FM/SBB rig to meet this new market demand.

More CBers blunder onto ham repeaters with stolen rigs — fast thinking hams con them into revealing themselves and arrests follow — happened with WR1ABQ in Derry NH and WR1AEA on Mt. Mansfield VT.

Ham market holding very well — magazine ads up substantially with 73 leading, up 20% over 1974, QST up 16%, HR down 2% and CQ down 24%.

FCC steps in to sit on W6 hogging Oscar with overpower. Shades of CB! **FCC okays six callsign blocks** — expect companion docket to 20282 designating callsigns for each class of license soon. Amateur call formats can be: W1A, W1AA, W1AAA, WA1A, WA1AA, WA1AAA... with K, N and AA-AL prefixes also available.

Autobiography of an Ancient Aviator

W. Sanger Green
1379 E. 15 Street
Brooklyn NY 11230

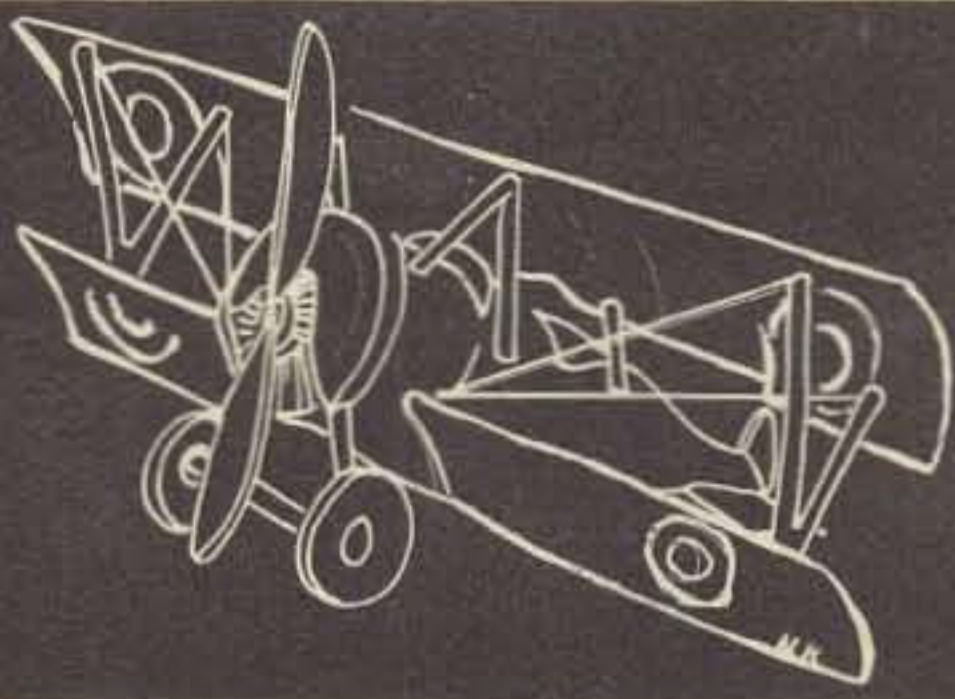

KELLY FIELD

and the

Happening of September 3rd

The 1922 Advanced Flying School at Kelly Field was composed of ground school and three flying schools: pursuit, bombardment and observation. The five best suited cadets got fighter training, seven were assigned to bombardment training and all the rest, including myself, were assigned to observation training. Ground school was in the morning and flying in the afternoon.

We all had schooling in the operation, repair and maintenance of liberty engines and training in DH4b rigging. Other subjects covered were aerial photography, radio and Morse code, anti-aircraft and searchlights, maps, reconnaissance missions, artillery regulage, aerial gunnery, infantry contact and a lot of army related subjects such as staff duties, rules of land warfare, combat orders, tactics of other arms, military law, army reg., field service reg., service of supply, etc. They kept us busy.

At Kelly Field army discipline was slightly relaxed. We had to stand reveille but no other formations, except to stand in front of our planes for instruction when we were scheduled to fly. Of course we had to stand at attention beside our bunks for the Saturday morning barracks inspection by the Detachment Commander. This took him about two minutes and then we had the rest of the weekend off.

In the flying department the observation and bombardment cadets had DH4bs with liberty engines for equipment. We were paired into teams for

our flying. My teammate was Homer Munson. One of the field regulations was "no stunting in DHs" so when pushing DHs around got a little tiresome I'd go over to the pursuit hangar and borrow an SE5 to "wring out" for half an hour or so. In September the SE5s were condemned and withdrawn from service as a result of an accident that Cadet Harris had in one. He dove at a mark on the field and when he pulled out the wings folded and, since we did not wear parachutes in those days, he had to ride it in. None of those who witnessed the crash thought that Harris could possibly come out of it alive. However, due to the fast and expert work of the meat wagon crew that removed him from the wreck, he came out of it with only numerous cuts and bruises, a broken leg, a broken arm and several broken ribs. He was back on flying status again in four weeks.

Last month I told you that Cleo (my wife) was expecting early in September and had joined her parents in New Hampshire to await the event. I felt that this was to be one of the most important happenings in our lives so I requested a ten day furlough to be with Cleo when the baby was born. I had to make some arrangement with Lt. Chauncy who was in charge of ground school with regard to making up the subjects I would miss while on furlough. He knew that I was a reserve infantry officer so he offered to give me a passing 70 with no examination in five purely military subjects that he would schedule during my absence. He also offered to

give me whatever coaching was necessary to pass examinations in any other subjects I might miss.

My furlough was from 9/4 to 9/15. I was fortunate to get a lift to Dallas on September 3rd, thereby saving me half a day on my train trip to Littleton, N.H. I thought I would be in plenty of time for the big event since the doctor's prognostication was for September 7th to 14th. But Cleo fooled us all. Her birthday was on September 2nd and her folks and some friends gave her a party to celebrate. Whether the party had anything to do with it or not, Cleo had to be rushed to the Littleton hospital in the early hours of the 3rd where Doctor Giles smartly thumped the new baby's rump at 06:00 and started him on his career. I first learned that my son had preceded me when I arrived in Littleton the afternoon of September 6th. Naturally the hospital was my first stop.

One omission in our planning was brought to my attention immediately. Cleo and I hadn't reached an agreement on a name for the new arrival. Birth certificate and letting relatives and friends know of our good luck, you know. So I assembled a council of a few friends for the purpose of recommending a choice of a name. I won't go into details of our evening long discussion. After much deliberation we chose the original name of Wayne Sanger Green II. That is how and where your publisher was born and named.

The ten day furlough only allowed less than four days in Littleton so I sent a telegram requesting a ten day extension. This was granted at once. I was glad to have this additional time to be with Cleo and Wayne and to do a little local trout fishing. I reported back for duty at Kelly Field on September 25th.

When I checked in with Lt. Chauncy I found that I had only missed three written exam subjects: Staff Duties, Tactics of Other Arms and Combat Orders. These I already knew so I brushed up a bit and had no trouble with the exams. The flying part of the school was different. I had missed several missions. However, when ground school was finished on 9 October I could fly mornings and afternoons. So, with Homer Munson's help, I got through everything OK.

Next month I'll tell you about the flying missions and cross country trips that we made. Also about a couple of situations that might easily have been a bit "hairy".

they be as upset over the Communicator proposal? For a number of reasons. First off, the only people concerned are amateurs, and they don't have a Washington lobby like the CBers. Next, there's just not that many hams compared to CBers and anyway, most hams figure that if a guy gets an amateur ticket he's paid his dues and that's it. The catch is that we have to make the dues a lot less so the CBers can move. Back in 1971 we made a study and found that most CBers didn't become hams because of the code test, so that's the first thing to go. Next we have to make the test pretty simple and have mail exams so everyone can get his test out of the way in a hurry.

That's a laugh. I've heard that Gettysburg takes about three or four months to get a license out... Well, yeah, but that's just ham tickets. We have the CB tickets out in a couple of weeks - so we just gear that operation up for the Communicator Class and

have everyone licensed in about a year.

Well, that's OK for you but what about those hams that do object? Actually that one's a cinch. According to International Law we don't have to give a code test if we don't want to, but privileges must be limited to 144 MHz and above. That's the greatest part, since we wanted 220 in the first place anyway. So you see, even if someone does object, we can still put it through just like we did with citizens band in the beginning. Really though, most hams should be so upset about the other trivia in 20282 they won't even bother objecting to a Communicator Class. Their attention is going to be on the loss of privileges, so while they're busy justifying their own piece of the action they'll forget about the Communicators. And that power proposal, that's a beauty - that one should keep 'em going right up to the deadline and then some. What most of them don't realize is that with a few thousand comments on the docket most of them will conflict.

Then we do the same thing we did with the original 35 petitions - discard them.

You might run into some trouble if the American Rotary Rhombic League ever gets the amateurs organized... Well, yes, but if they ever find out how, I wish they'd let me know. Since the League has taken on the air of a big business they've lost a lot of support. They'd really have to get a fire going to rally support now with the deadline so near... special newsletter editions... straight talk... and a lot of other people-to-people things that haven't happened in a long long time. You know, Bill, that's it, that's the trouble. Every night just as I begin to fall asleep, I think of 20282 and bust out laughing. If maybe I thought about the League organizing amateurs again and putting some real pressure on me, maybe... just maybe I could worry myself to sleep.

William J. Howard K1LNJ/3
Fort Meade MD



amsat

Oscar 6 Orbital Information

Orbit	Date (July)	Time (GMT)	Longitude of Eq. Crossing °W
12376	1	0002.4	51.1
12389	2	0057.4	64.8
12402	3	0152.4	78.6
12414	4	0052.3	63.6
12427	5	0147.3	77.3
12439	6	0047.2	62.3
12452	7	0142.2	76.0
12464	8	0042.1	61.0
12477	9	0137.1	74.7
12489	10	0037.1	59.7
12502	11	0132.0	73.5
12514	12	0031.6	58.5
12527	13	0126.5	72.2
12539	14	0026.5	57.2
12552	15	0121.5	70.9
12564	16	0021.4	55.9
12577	17	0116.4	69.6
12589	18	0016.3	54.6
12602	19	0111.3	68.4
12614	20	0011.3	53.4
12627	21	0106.2	67.1
12639	22	0006.2	52.1
12652	23	0101.1	65.8
12664	24	0001.1	50.8
12677	25	0056.1	64.5
12690	26	0151.0	78.3
12702	27	0050.6	63.3
12715	28	0145.5	77.0
12727	29	0045.5	62.0
12740	30	0140.4	75.7
12752	31	0040.4	60.7

Oscar 7 Orbital Information

Orbit	Date (July)	Time (GMT)	Longitude of Eq. Crossing °W	Mode
2848	1	0024.2	55.9	B
2861	2	0118.4	69.5	AX
2873	3	0017.6	54.3	B
2886	4	0112.2	67.9	A
2898	5	0011.4	52.7	B
2911	6	0105.5	66.3	A
2923	7	0005.1	51.2	B
2936	8	0059.3	64.7	A
2949	9	0153.5	78.3	BX
2961	10	0053.1	63.1	A
2974	11	0147.3	76.7	B
2986	12	0046.5	61.5	A
2999	13	0141.0	75.1	B
3011	14	0040.2	59.9	A
3024	15	0134.4	73.5	B
3036	16	0034.0	58.3	AX
3049	17	0128.2	71.9	B
3061	18	0027.4	56.8	A
3074	19	0121.6	70.3	B
3086	20	0021.2	55.2	A
3099	21	0115.3	68.7	B
3111	22	0014.5	53.6	A
3124	23	0109.1	67.1	BX
3136	24	0008.3	52.0	A
3149	25	0102.5	65.5	B
3161	26	0002.1	50.4	A
3174	27	0056.3	63.9	B
3187	28	0150.4	77.5	A
3199	29	0050.0	62.4	B
3212	30	0144.2	75.9	AX
3224	31	0043.4	60.8	B



W3GEY (l) and DJ4ZC (r) discussing Oscar 8 at the March 22, 1975 AMSAT Experimenters meeting. DJ4ZC designed and built the 432 to 145 transponder on Oscar 7, and W3GEY did the final integration. (Photo by WB4IWF)



Bill Pasternak WA6ITF
14725 Titus St. #4
Panorama City CA 91402

HAWAII IS GETTING THE WORD OUT! Such is the information furnished to me by Bill KH6IAF/6. The word I talk about is that of letting the general public know what we are, who we are and what we have to offer to them.

Sitting directly below a reprint of my Hotline blurb titled, "CBers Advertise on TV" in the March issue of the Honolulu Amateur Radio Newsletter (and Hotline expresses its thanks for the credit line), was the following article: "We're doing something about it... Hawaii Ham Forum... a monthly public affairs broadcast by HARC." It continues: "Accepted for public affairs airing on the following stations. Times will be announced at the March general meeting, and will be published in subsequent issues of the Bulletin. Stations carrying this program are KLEI, 1130 kHz, 10,000 Watts, Kailua, Hawaii (at press time KLEI informs us it will be on Wednesday nights, thus available to the far flung parts of the Pacific on skip) and KTUH, 90.3 MHz FM, located at the University of Hawaii, Manoa (also translator station K209AA, 89.7 MHz, Kahala to Hawaii).

Guests on the first edition of "Hawaii Ham Forum" were Richard Kimitsula KH6DVT, Dave Dengler of the Bulletin staff, and Russell Roberts, a non-ham of the Leeward Community College faculty, to question Richard about ham radio from the public's point of view. This program is intended to inform the public and improve the image in the local community. It is not meant for hams only. Therefore, many questions will seem redundant to seasoned radio amateurs. Remember... it's for the "general public." As one of those interested in promoting such public information programs, I wish to compliment the members of HARC for showing the rest of us that such ideas are not beyond the reach of us all. All

it takes is a little time, effort and a tape recorder to begin the basic effort. There is no reason why your club cannot follow the lead now set in Hawaii and achieve similar results. For those interested, HARC can be reached at: Honolulu Amateur Radio Club, c/o Jim Morris KH6HGQ, 197 19 Street, Hickam AFB, Hawaii 96553. A letter of compliment goes a long way in keeping such a worthwhile venture going. Now, how about the rest of you?

Sometimes, people become heroes when (and in ways that) they least expect. Such was the case for three of the users of the WR6ABE repeater system the evening of March 29. As related to me by Arnie Gamson K6PXA, here is what transpired. In the midst of an early evening "roundtable" on ABE, Lazlo WA6SWG broke the QSO to request aid for his boat that was stranded in the channel between Catalina Island and San Pedro Harbor. The weather had turned very bad, seas were choppy, and for some reason he could not reach the Coast Guard on his Marine Radio gear. His plea for assistance was answered immediately by Lou K6QWO, Ben W6WPT and Hap WA6WPP. Concurrently, Burt K6OQK, owner of ABE, requested a secure channel until the emergency had passed. Though communications were rough at times, Lazlo was able to describe his position and problem and in short order this information was passed on to Coast Guard Air Rescue. I am glad to report that thanks to the quick action on the part of QWO, WPT and WPP, this story has a happy ending. The Coast Guard located Lazlo and the necessary aid quickly arrived.

According to Bill KH6IAF/6, who also joined us in this late night QSO, and unlike yours truly, does have considerable experience aboard boats, the quick action taken by Hap, Lou and Ben most probably saved the lives of those aboard the stricken craft. With this thought in mind, I ask you this: "What better public service can we amateurs render than to be there when we are needed and be willing to help?" To me, that's what our hobby is all about, and Lou, Ben and Hap are prime examples. In my eyes, they deserve the tag "hero."

A call from Stu WB6HEE last night reported that he and Ed WA6YVX have completed final work on their San Diego based autopatch system, and are presently testing same on an inverted split-split channel of 147.285

in, and 147.885 out. Stu projects a 30 day test period after which the system will go into full time operation. With 250 members in the sponsoring organization, this will probably be the largest free-access open autopatch system in the country. Hopefully, we will have some pictures in a forthcoming issue... hint-hint Stu.

Pete WA6UEE is into an interesting project, WR6AIW by name. Unlike other systems, though, Pete's project will not be found on the air on a regular basis. WR6AIW is a portable repeater designed specifically to provide communication for another hobby, that of "Off Road Racing." Pete's black box was successfully smoke tested the weekend of January 31 from Black Peak, Arizona, providing communication for the Score-sponsored Parker 400 race. The system sat at 1700' HAAT, and provided coverage for about 60 miles over low mountains on .16 - .76. Operation was from noon on January 31 to 8 am on February 2, and proved that portable systems of this type are not only an aid, but can also be a major safety factor in coordinating events of this nature. Next big test for AIW will come with the well known Baja 1000 later this year. Pete, you done a good job.

A couple of notes on new or proposed systems in this area. There is now an open autopatch system currently testing here in the SF Valley area. At present WR6AJP is operating on a rather odd channel pair of 147.525 - 146.505 without SCRA sanction, but talk on the air hints that they may soon move to another channel pair in the near future. At this time, this is the only information I have other than the fact that AJP has one "wicked signal" here in the Valley.

I have also heard that there may be a 450 MHz open or semi-open (published PL frequencies). The callsign will be WR6AJO and talk is that it will be located atop Mt. Wilson. I have no information as to whether the above is accurate and if so, when this system will begin operation or on which channel pair it will be. As information becomes available, I will pass same along.

If the EIA plans to continue pushing for Class E CB on 220 MHz, they're going to have one hard time implementing it out here. 220 is really beginning to boom out here with new systems coming on the air every week. Bill WA6DVG hopes to have his 223.34 - 224.94 system operational

from atop Mt. Wilson in the near future on a regular basis, and PARC is in the process of getting its 220 version of WR6ABB into operation now that the new two meter Micor is up and working. WR6AER, LA's second 220 system, is still the busiest of them all, and now has begun to revive an old VHF tradition: the weekly T-Hunt. Saturday mornings, those interested in locating the elusive hidden transmitter get together at the AER site, Bill WA6NTW's house on "AER Mountain", at about 11 am. AER's output channel of 223.94 is used for the hunt and there are prizes awarded. Information concerning these T-Hunts can be had locally on WR6AER, 222.34 - 223.94, or on the Thursday evening Mt. Wilson Repeater Association News Program at 9 pm.

Amateur Radio Service-CARS, the experimental LAPD-Amateur Radio Cooperative program, wants to expand. To do so will require more LA amateurs interested in serving their community. Complete information on this program can be found in the March 21st issue of Hotline, and the program's directors have asked me to thank those from other parts of the country who have shown interest. Your letters will be answered. Those wishing to volunteer or those wishing information should write to Amateur Radio Service-CARS, PO Box 7302, Burbank CA 91504.

For almost a year now, I have been trying to find space to publish the following corrected information on the Stockton, California, .28 - .88 repeater, as furnished by Wally Wallin (its trustee), but with all that has transpired these past months, it was impossible to find the space - though I tried. However, I made myself a promise to do so this month regardless of what else came to pass, so here is the information. The correct callsign is WR6ACV and the repeater is located on the northeast slope of Mt. Oso in Stanislaus County, or, for those of you with maps, about 12 miles west of Patterson, California. From its 3,000 foot perch, it covers 39 counties in California and 3 in Nevada. The system is carrier access, open to all licensed amateurs, and boasts all Motorola equipment. The system is owned by the Central Valley VHF-FM Club, Inc., and is "affectionately called MOM (Mt. Oso Machine)". And Wally, this time we learned how to spell Stockton... hi...!

I find it impossible to close this

month without a word or two addressed to some friends back East. The March 21st issue of Hotline heralded a story about the WR2ABK repeater being used to provide emergency police communication following a fire that wiped out telephone service in lower Manhattan last Feb. 27th. Prime motivating force behind this fantastic project was a New York City Patrolman, Andy Merendini WB2EIR. Andy and I go back many years - many, many years. In fact, I knew Andy way before he joined the NYC Police Department, and distinctly remember one evening when many of us waited breathlessly for Andy to emerge from the hospital, get on his mobile, and let us know if his first child was a boy or girl. It was a girl, Lisa by name, and you couldn't find two prouder parents than Andy and Mary. Andy and Mary were part of our unofficial group known as the Flying Amateur Radio Team back in the late sixties, and were always there to run the contests, go to the dinners or hold a party.

After reading the story in Hotline, I phoned Andy and taped a 15 minute interview that was used on the Mt. Wilson Repeater Association News Program that evening and has been the talk in public service ham circles out here since the Hotline article hit. Also mentioned in that article were two other close friends, Stu Seit WA2JNF and Jim Passione WA2ECP. I know these two guys quite well also, since they were two of the tech crew that made WA2ZWP (now WR2ACV) a reality. Therefore, along with everyone else, I want to add my congratulations to these three and to Mike WB2EIL and Bill WA2RXQ for doing what was needed at the moment it was needed. When the need was there, the people of WR2ABK were there, and their performance is a shining star in the world of Amateur Radio, our world!

... WA6ITF

BIG REWARD

The big companies in amateur radio today were, for the most part, started by one or two amateurs... and many grew very rapidly as a result of the low ad rates in 73 and the wide circulation among active (buying) hams. We'll give you 10% of the first ad run by a new company if you let us know about them and they advertise first in 73. Do yourself and the new firm a big favor - drop a note to 73 Advertising, Peterborough NH 03458.

NEW PRODUCTS



DENTRON TESTED

Old timers still spin yarns about the finest ham band we ever had. It's one you won't find on your transceiver, in all probability, though it's still there, providing a lot of enjoyment for the fellows who know about it.

This is what is known in England as Top Band... 160 meters... and it has several sterling advantages. First of all, 160 comes into its own during the low sunspot years... where we are right now. Secondly, since it isn't on all those transceivers, you don't have all that QRM you run into on 75 meters and the higher bands.

How do you get on 160... easily? Lucky you asked... it seems that Dentron has figured this all out for you and has made available their model 160 XV transverter. This gadget takes the 80m output of your sideband transceiver and converts it down to 160m. It converts the received signal back up to 80m. The XV is self powered (120/220 V, 50/60 Hz). It's designed to match a 50 Ohm antenna. If you want to hook on something else you'll want to look into the Dentron antenna tuner.

The XV runs 100 Watts input with 5 Watts of drive - it is protected against over drive - so you have a substantial signal.

Give 160m a try - it's a great local band during the daytime and at night you can work out quite a ways. W1BB has been plugging away at getting DX stations down to 160 for a long time, and he's brought a lot of great DX to the band. The 160 XV sells for \$199.95 postpaid from Dentron, 2100 Enterprise Parkway, Twinsburg OH 44087. It's built like a battleship - first rate construction. And be sure to listen for the 73 gang when you get on there... okay?



REPEATER UPDATE

ALABAMA				D- WR1ABZ Holliston 146.385 146.985				†WR3AEZ Pittsburgh 146.28 146.88			
*WR4AMM Selma 146.13 146.73				D-DL2AA/1 Medway 147.81 147.21				†WR3ADN Pittsburgh 146.37 146.97			
*WR4AMM Selma 444.50 449.50				†WR1AEY Mt. Greylock 146.31 146.91				†WR3AFQ Pittsburgh 146.07 146.67			
ARIZONA				†WR1AEY Mt. Greylock 52.78 52.525				D-WA3BJS Pittsburgh 146.16 146.76			
*WR7ABR Flagstaff 146.22 146.82				D-WR1ACX Somerville 146.145 146.745				†WR3ADG Washington 146.19 146.79			
†WR7AEL Kingman 146.16 146.76				*WR1AFG Worcester 146.34 146.94				RHODE ISLAND			
†WR7AEL Kingman 146.34 146.94				MICHIGAN				*WR1AFA E. Providence 146.235 146.835			
*WR7ABS Phoenix 146.04 146.64				D-WR8AEC Detroit 147.96 147.36				TEXAS			
D-WR7ABS Phoenix 449.30 445.30				*WR8 Ionia 146.01 146.61				*WR5AHA El Paso 146.19 146.79			
*WR7ABQ Phoenix 449.30 445.30				MINNESOTA				*WR5ACR Fort Worth 147.81 147.21			
D-WR7ABR Phoenix 146.04 146.64				†WR0AGG Waseca 146.94 146.46				†WR5ABR San Antonio 146.13 146.73			
†WR7ACC Phoenix 52.76 53.76				MISSISSIPPI				VIRGINIA			
*WR7AFC Phoenix 147.60 147.00				*WR5AIG Oxford CLOSED				*WR4AII Woodbridge 147.84 147.24			
D-WR7ABL Phoenix 147.60 147.00				MISSOURI				WASHINGTON			
*WR7 Tucson 147.69 147.09				†WR0AJA Warrensburg 146.28 146.88				*WR7AEP Spokane T1950 146.13 146.73			
*WR7ABH Tucson 146.34 146.94				NEVADA				CANADA			
†WR7ABM Tucson 146.22 146.82				*WR7ACW Reno 146.34 146.94				ALBERTA			
*WR7 Tucson 147.69 147.09				NEW HAMPSHIRE				*VE6WQ Edmonton 146.46 147.06			
†WR7ABH Tucson 146.34 146.94				†WR1AEQ Manchester CLOSED				D-VE6WQ Edmonton 146.46 147.00			
CALIFORNIA				NEW JERSEY				*VE6HM Edmonton 146.46 147.06			
*WR6AJB Santa Cruz 146.19 146.79				†WR2ABJ Cedar Grove 147.78 147.18				ONTARIO			
COLORADO				*WR2AGV Elizabeth 147.885 147.285				*VE3TAR Cobalt 146.34 146.94			
*WR0AES Colorado Springs 146.37 146.97				†WR2ADV Paramus 146.19 146.79				D-VE3TAR New Liskeard 146.34/146.46 146.46			
CONNECTICUT				*WR2AGZ West Orange 147.415 146.415				*VE3NFM North Bay 146.34 146.94			
*WR1ACY Glastonbury 147.69 147.09				NEW YORK				QUEBEC			
†WR1AEX New London 146.34 146.94				*WR2AGI Armonk 147.615 147.015				*VE2MRC Montreal 147.72 147.12			
FLORIDA				D-WR2AGH Owego 146.16 146.76				OVERSEAS			
*WR4ABN Palm Beach 146.28 146.88				*WR2AJH Rockland County 147.765 147.165				AUSTRALIA			
ILLINOIS				*WR2AGH Tiroga County 146.16 146.76				*VK4WIG/R1 Gold Coast 146.10 146.70			
D-WR9ADJ Bloomington 146.04 146.64				NORTH DAKOTA				*VK2RAN/R2 Newcastle 146.30 146.90			
*WR9AET Chicago 222.02 223.62				*WR0AEL Minot 146.16 146.76				*VK2RAB Tamworth 146.25 146.85			
*WR9 Libertyville 146.01 146.61				OHIO				*VK2RAO Central West 146.10 146.70			
*WR9AES Rockford 146.01 146.61				*WRBAGN Cincinnati CLOSED				*VK2RAS Sydney, No. 146.40 147.00			
INDIANA				†WR8AEG Cincinnati 147.69 147.09				*VK2 Sydney, So. 146.20 146.80			
*WR9ADJ Bloomington 146.04 146.64				†WR8AEX Cincinnati 147.75 147.15				*VK2AMW Wollongong 146.25 146.85			
*WR9ABJ Hammond 147.60 147.00				*WR8ACC Cincinnati 146.16 146.76				*VK Canberra 146.30 146.90			
*WR9ABJ Hammond 223.22 224.82				†WR8ADW Cincinnati 147.99 147.39				*VK3RAM Bendigo 146.20 146.80			
*WR9AEU South Bend 146.13 146.73				D-WB8CQS Cincinnati 146.16 146.76				*VK3WI/R1 Melbourne 146.10 146.70			
IOWA				*WR8AFG Cincinnati 147.66 147.06				*VK3RAG Geelong 146.40 147.00			
*WR0AGC Denison 146.28 146.88				D-WR8ABP Cincinnati 147.78 147.18				*VK3RAB Latrobe Valley 146.20 146.80			
†WR0AHO Mason City 146.16 146.76				D-W8AIC Columbus 146.34 146.76				*VK3RMW Western Victoria 146.10 146.70			
†WR0AHH Waterloo 146.22 146.82				D-W8WTB Columbus 147.66 147.06				*VK7RAA N. E. Tasmania 146.40 147.00			
KANSAS				*WR8AES Columbus 147.66 147.06				*VK5RAD Adelaide 146.40 147.00			
*WR0 Topeka 146.07 146.67				D WR8ABR Columbus 146.31 146.91				*VK6RAA Albany 146.20 146.80			
KENTUCKY				*WR8AEJ Columbus 146.31 146.91				*VK6RAP Perth 146.10 146.70			
*WR4AHV Louisville 146.01 146.61				D-WB8NWE Delaware 146.37 146.97				GUAM			
MAINE				*WR8AGI Louisville 147.72 147.12				*WR6AJH Agana 146.34 146.94			
†WR1ACI Bangor/Holden 146.34 146.94				D-WR8AGO Nelsonville 147.72 147.12							
*WR1 Dedham 146.31 146.91				*WR8AGO Nelsonville 147.72 147.12							
*WR1AFC Rockland 146.39 146.99				*WR8AGC Warren CLOSED							
*W1PMR Sugarloaf Mtn. 146.16 146.76				OREGON							
MARYLAND				*WR7AFA Eugene 146.28 146.88							
†WR3ADZ Jessup 146.16 146.76				D-WR7ADD Mary's Peak 146.22 146.82							
MASSACHUSETTS				*WR7 Sutherland 146.16 146.76							
*WR1AEW Attleboro 147.93 147.33				PENNSYLVANIA							
*WR1AFO Belmont 146.34 146.94				*WR3ADU Acme 146.04 146.64							
*WR1AEZ Chestnut Hill 145.55 147.55				*WR3AEM Exton 146.10 146.70							
*WR1AER Fair Haven 146.055 146.655				*WR3AET Greensburg 146.07 146.67							
				*WR3ADF Hazleton 146.01 146.61							
				†WR3ADK Pittsburgh 146.01 146.61							

† = Change
D = Delete
* = New

Temtron Electronics

"We carry the largest stock of all types of ELECTRON TUBES, SEMICONDUCTORS, ICs. Special prices on 4CX1000As, 3-400Zs, 829Bs, 811As - and many other industrial and receiving types. Prices and catalog on request.

138-69 FRANCIS LEWIS BLVD. ROSEDALE NY 11422 (212)978-5896

WANNA WORK MORE DX ?

Subscribe to THE WORLDS ONLY weekly DX Magazine. Strictly DX news in depth. I give you upcoming events, dates, times, freqs, DX QSL info, contest info, DX articles, etc. SUBSCRIBE NOW and WORK EM ALL ! DX NEWS GALORE ! \$ 6.00 for 6 mo. or \$ 12. per yr to W/K, VE, XE, First Class mail. THE DXERS MAGAZINE, (W4BPD), Drawer "DX", CORDOVA, S.C. 29039. DXING IS GREAT USING OUR INFO !

Reliability.



That's what you get from Sentry.
The most reliable crystals you'll find anywhere.
Because Sentry crystals are made of the finest quartz to the latest state-of-the-art specifications. And our manufacturing methods are the most precise available.
Since Sentry has the largest semi-processed crystal bank in the world, we can custom-make crystals for any rig. Any frequency. Faster than anyone else in the business.

And talk about frequency stability. You've got it with Sentry.

So place your next order with us. It's easy. Our processing is quick, accurate, efficient. Our guarantees are solid. And we'll send you our complete 1975 Catalog. Absolutely free.

Sentry. You can depend on us.
Sentry Manufacturing Company.
Crystal Park, Chickasha, Oklahoma 73018.
Phone: (405) 224-6780,
TWX-910-830-6425.

Sentry

Manufacturing Company

Tuned-In to Quality.



73:7

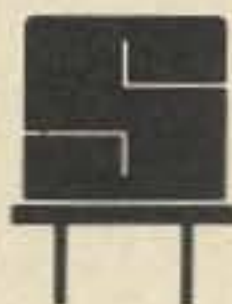

Sentry Manufacturing Co.
Crystal Park
Chickasha, Okla. 73018

**Please send me your Free 1975 Sentry Catalog.
RIGHT AWAY!**

Name _____

Street _____

City _____ State _____ Zip _____

**Send for
Sentry's
FREE 1975
Catalog!**

ou goons don't ever proofr
 lousy man scripps from bab
 bunch of rocks preening on
 you ignored my comments in
 I insist that you print ev

SEALS OF MERIT?

The editorial by Wayne Green, in the April issue, prompts me to renew my subscription to your magazine.

I agree with what he said about the ham exams. If an automobile license entailed an examination comparable to the ones for the amateur General and higher classes, only mechanics would have cars — and no repair business. Come to think of it, Grandma wouldn't have been able to drive the old "oat-burner" either.

I don't believe that the code requirement should be abolished because code IS ham radio. I do believe, however, that the code speed for the General ticket should be reduced to ten words per minute with, perhaps, an opportunity to earn "seals of merit" for increased speed (over 10 wpm) to attach to one's General license.

A renewable Novice license would seem to be in order. Not all who pass the Novice exam are able to get on the air immediately to take full advantage of the two year period. To remove a Novice from the air for one year if he hasn't obtained a General license is just what he *doesn't* need. Much of what he has gained may be lost during this time, including his interest. His pocketbook may also be leaner as a result of his having taken up a "hobby" which, by definition, isn't.

S. B. Groenier
 Madison WI

IC-230 CONT.

I have read with great interest the article in your May 1975 issue by Paul Bunnell dealing with changing the IC-230 for 15 kHz spacing. The article came out just in time for me as I was about ready to order a crystal for my IC-230 to be able to use a new autopatch repeater in my neighborhood.

To my dismay I was unable to use WA6VJR's table, as he followed the

ARRL adopted Modified Texas Plan and here in Southern California we are using the MWRA Inverted Split-Split plan supported by the SCRA.

With the help of my SR 10 calculator it took but a few minutes to jot down the LO and CO crystals necessary to get complete 15 kHz coverage for 146.025 to 146.655 and from 147.345 to 147.975. See attached list.

Owners of early IC-230's were able only with great difficulty to read from the schematic just what the output was from the accessory socket. So maybe now would be the time to show the configuration.

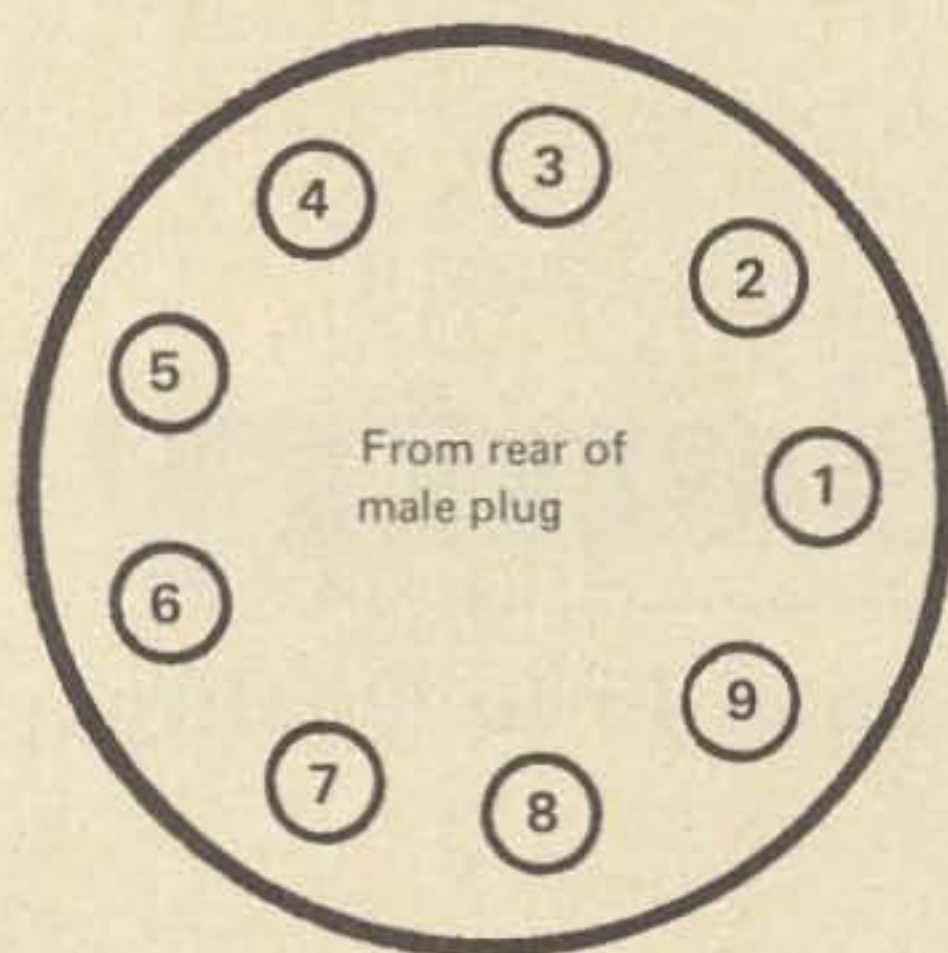

- PIN 1 Discriminator
- 2 + 9 V
- 3 + 13.8 V
- 4 PTT
- 5 Detector Output
- 6 MIC
- 7 VFO
- 8 Ground
- 9 C.O. — Out

146 MHz

SELECTOR		100 kHz	10 kHz	
A	1	146.025		
	4	.055		
	7	.085		
	0	.115		
	3	.145		L0 Crystal
	6	.175		13.7844 MHz
	9	.205		Position 8
	2	.235		
	5	.265		
	8	.295		
	C	.325		
B	1	146.355		
	4	.385		
	7	.415		
	0	.445		L0 Crystal
	3	.475		13.8211 MHz
	6	.505		Position 9
	9	.535		
	2	.565		
	5	.595		
	8	.625		
	C	.655		

147 MHz

SELECTOR		100 kHz	10 kHz	
A	1	147.345		
	4	.375		
	7	.405		
	0	.435		
	3	.465		L0 Crystal
	6	.495		13.9311 MHz
	9	.525		Position 10
	2	.555		
	5	.585		
	8	.615		
	C	.645		
B	1	147.675		
	4	.705		
	7	.735		
	0	.765		L0 Crystal
	3	.795		13.9678 MHz
	6	.825		Position 11
	9	.855		
	2	.885		
	5	.915		
	8	.945		
	C	.975		

CO Crystal 11.565 MHz

Late model IC-230's, I understand, have this information included in their manuals.

Mike Maurer WA6BMK
 N. Hollywood CA

FREEBIE

As a magazine collector, I would like to put my ever-growing collection to better use than taking up space. I'll be glad to provide any reader photocopies of any article in any magazine available; there is no cost and return postage is not necessary. All issues of 73 Magazine, Popular Electronics and Electronics Illustrated, CQ from 1947, QST from 1921, and some issues of Ham Radio and others are available.

Donald Erickson SWL WPE6DIQ
 6059 Essex Street
 Riverside CA 92504

HALF RATIONS

The rise in cost of living, taxes, etc. (not to mention gasoline) seemed to indicate that a change in my manner of living was mandatory and that some of the luxuries would have to go — "73" was among the first to get chopped.

Somehow, it seemed, you didn't get the word as you continued to send the above-mentioned publication to my QTH and, as if that wasn't enough, you fired the shot that sunk me — your May cover. That did it — the

custom-built car, the handy talkie, the exquisite fur and the pretty dress with the beautiful stuffing in it, made me reach for my checkbook. But Wayne, before you become intoxicated with your success, let me say that *you* didn't make me change my mind — Miss Kelly did.

Yours for a bigger and better amateur radio,

Aloha Nui Loa, from the Bamboo American.

Walt Deiter KH6ANM
Kailua HI

P.S. You may be interested in knowing that, because of this, the XYL has put me on half rations for a week.

We have received many favorable comments on our lovely cover girl and wish to thank VHF Engineering for providing the photo — Wayne.

PROFESSIONAL AMATEURS?

At the top of my FCC license, it says (among other things) Amateur Radio License. My Merriam-Webster Dictionary defines "Amateur" as follows:

"AMATEUR — One who cultivates a particular pursuit, study, or science, from taste, without pursuing it professionally — One practicing an art without mastery of its essentials. One with a taste or liking for something rather than an expert knowledge of it."

Now I ask you, what in the h - - - is the FCC trying to do to us? Make everyone a Professional Amateur, or an Amateur Professional?

The defense rests - - -

Bob Wiles W0DLL
1476 Prospect Drive
Loveland CO 80537

TURNING OUT TESTERS

Thanks for 73 — and especially such articles as "The Violet Tester" and the "What Have I Done" box.

I thought "The Violet Tester" would be an appropriate Mother's Day gift — expanded to my mother and mother-in-law. Then my neighbor (also a ham) joined in and so did several others at the office.

As of this date I have built 7 Violet Testers and supplied 11 additional "kits"!

The "What Have I Done" box is different — it didn't work. I changed the .01 to a .1 uF to get freq. down to

additions and corrections

• I have recently received a letter from C. Warren Andreasen WA6JMM, PO Box 8306, Van Nuys, California, concerning one of my articles in the May issue, "AC Power for the HW-202" (p. 79).

He presented a very legitimate correction concerning this article. With two 2N3055 pass transistors in parallel, one of the transistors would "hog" all of the current. My particular supply shows both of the transistors in parallel although, due to the current capability of the 2N3055s, one can easily handle the current demand of the HW-202.

By placing a 10 Ohm resistor in both base leads or by placing a .25 Ohm resistor in both emitter leads of the 2N3055s, the current demand would be balanced between the 2N3055s.

I wish to thank Mr. Andreasen for his well taken correction.

Warren L. MacDowell W2A00
East Amherst, New York

Look for WA6JMM's Touchtone Sequence Decoder in an upcoming issue of 73. — Ed.

• "Fat Nixies for Chronometer Nuts", W2A00, May, 1975, p. 23.

K3JJO, among others, noted that the 1 meg resistors which one of our draftsmen inadvertently shorted out (Fig. 2, p. 24) may lead to a bit of a smoke problem. Not as much as was seen after Wayne hit the Art Department, Waldo!

• "Me Friend", W7IDF, June, 1975, p. 17.

Ken Cole, in his assiduous endeavors to locate DL1CU, publisher of the unique "Ham's Interpreter", has tracked his prey as far as the DARC — with no luck. The Ole King now prays for assistance from *lieber* OM's around the world, who might send him a note if they run into DL1CU on the air and can get his current address. *Gute Jagd!*

• "The Minirepeater", WB4DBB, June, 1975, p. 55.

Page 56, col. 1, line 4 — "two channel unit." Page 57, Fig. 2 — The audio test point should be labeled "4". Page 60, col. 2, line 10 — "B3" should read "B+". Page 64, Fig. 7 — The asterisk refers to the caption's "Make this larger, etc."

audible, and after wondering for a day or so why the SCR wouldn't latch, I added a 1k Ω resistor across the osc. ckt. (It shuts off ea. cycle it seems, allowing the SCR to reset.) With those changes it works fine.

Will Rassbach WA7GRN
Seattle WA

A+ FOR THERESA

I thought you might like to see a photo of my 9 year old daughter,

Theresa, and her social studies project for the fourth grade. The project earned her an A+ and gained some good exposure for amateur radio.

As you can see, the project consisted of a map, DX QSL cards and some newspaper articles about good things in amateur radio. Maybe other kids could do similar projects to promote goodwill for amateurs. Young hams could turn this type of idea into a science project with the use of LED devices and magnetic switches.

Wade Van Fair W4GIW
Doraville GA



MEET THE STATE OF THE ART ON 2 METERS... THE ITC MULTI-2000 CW/SSB/FM TRANSCEIVER

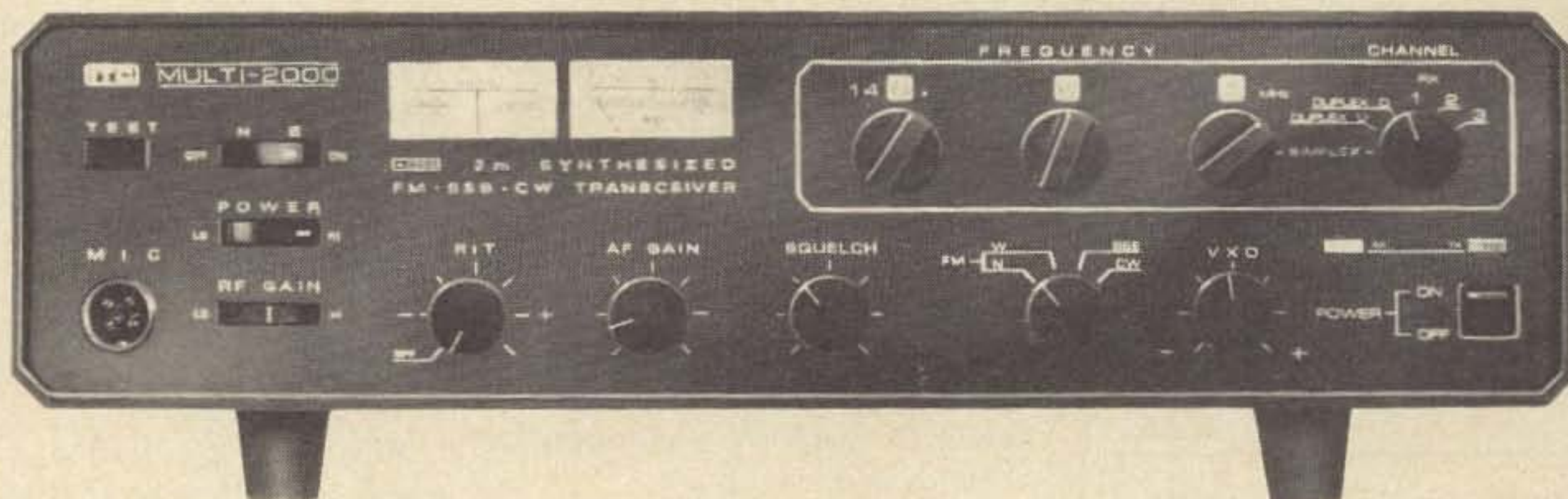

Whether your interest is simplex, repeater, DX or OSCAR the new ITC MULTI-2000 lets you get into all the action on all of the

band. Fully solid-state and employing modular construction, the MULTI-2000 enjoys features found in no other 2m transceiver.

FEATURES

- PLL synthesizer covers 144-148 MHz in 10 kHz steps
- Separate VXO and RIT for full between-channel tuning
- Simplex or ± 600 kHz offset for repeater operation
- Three selectable priority channels
- Multi-mode operation (CW/SSB/NBFM/WBFM)
- Built-in AC and DC power supplies, noise-blanker squelch and rf gain control
- Selectable 1W or 10W output
- Separate S-/power and frequency deviation meters
- Built-in test (call) tone and touch-tone provision.
- Excellent sensitivity ($.3 \mu\text{V}$ for 12 dB SINAD)
- Superior immunity to crossmodulation and intermodulation
- Introductory price: \$695.

THE ITC MULTI-2000 TRANSCEIVER...
PERFORMANCE THAT CHALLENGES YOUR IMAGINATION
INTERNATIONAL TELECOMMUNICATIONS CORP.
P.O. BOX 4235, TORRANCE, CALIF. 90510 • (213) 375-9879

MULTI-2000

SPECIFICATIONS

RECEIVER SECTION:

- Sensitivity:
 - FM: 0.3uV for 12 dB SINAD
1.0uV for 20 dB Quieting
 - SSB: 0.25uV for 10 dB SN + N
Noise Figure less than 3 dB
- Intermodulation:
 - Third-order intermodulation products reduced more than 70 dB below one of two RF test signals within the RF passband.
- Crossmodulation:
 - Better than 80 dB
- Selectivity:
 - FM: 15 kHz at -6 dB, Shape Factor 2.5:1 (6/60 dB)
Ultimate rejection greater than 90 dB
 - SSB: 2.4 kHz at -6 dB, Shape Factor 2:1 (6/60 dB)
Ultimate rejection greater than 95 dB
- Spurious Signals:
 - Reduced more than 70 dB.
- IF Rejection:
 - Greater than 60 dB.

TRANSMITTER SECTION:

- Power Output:
 - FM: Low power 1.5 Watts (Adjustable 0W – 10 W)
High power 10 Watts (Typically 15 W)
 - SSB: 15 Watts PEP Output
- Carrier Suppression:
 - Greater than 50 dB
- Unwanted Sideband Suppression:
 - Greater than 50 dB at 1 kHz.

GENERAL:

Continuous tuning in 10 kHz bands... Stability better than 50 Hz after 5 minute warmup... Separate VXO and RIT for independent transmitter and receiver tuning... Built-in AC/DC Power Supply, Noise Blanker, IDC... Built-in Test Tone, provision for PL or Touch-Tone.

INTERNATIONAL TELECOMMUNICATIONS CORP.

P.O. BOX 4235, TORRANCE, CALIF. 90510 • (213) 375-9879

Caveat Emptor?

PRICE — \$2 per 25 words for non-commercial ads; \$10 per 25 words for business ventures. No display ads or agency discount. Include your check with order. Deadline for ads is the 1st of the month two months prior to publication. For example: January 1st is the deadline for the March issue which will be mailed on the 10th of February.

We will be the judge of suitability of ads. Our responsibility for errors extends only to printing a correct ad in a later issue. For \$1 extra we can maintain a reply box for you.

AN OFFER you can't refuse — **BUYERS & SELLERS** P. 54.

TWO PLASTIC HOLDERS FRAME and display 40 QSL's for \$1.00 or 7 holders enhance 140 cards for \$3.00 — from your Dealer, or prepaid direct: TEPABCO, Box 198M, Gallatin, Tennessee 37066.

FM RECEIVER, preamp, scanner, UHF converter kits. Hamtronics, Inc., 182 Belmont, Rochester NY 14612.

FOUNDATION FOR AMATEUR RADIO annual Hamfest Sunday, 19 October 1975 at Gaithersburg Maryland Fairgrounds.

POLICE AND FIRE Scanner Special — Regency ACT — R — 10 H/L/U 10 channel 3 bands, combined ac/dc 10 free crystals included \$169.00 prepaid, dealer inquiries invited, Four Wheeler Communications 10-F New Scotland Avenue, Albany NY 12208.

JIG SAW PUZZLES wanted. If you have any old wooden jig saw puzzles in your attic — or run across them at an auction (they go for 25¢ usually), please keep in mind that Wayne Green collects them and might even pay a buck apiece for them. c/o 73 Magazine, Peterborough NH 03458. Wood, not cardboard — and complete.

VERY INTERESTING! Next 5 issues \$1. "The Ham Trader," Sycamore IL 60178. (Ask about our "HAM EQUIPMENT BUYERS GUIDE" covering receivers, transmitters, transceivers, amplifiers 1945-75. Indispensable!)

HALL OF FAME HAMFEST and auction rain or shine, Aug 3, 1975, Canton, Ohio. Come to Canton for football's greatest weekend. Saturday's activities — parade, enshrinement, NFL game Cincinnati vs Washington. Sunday — hamfest and auction at Stark County Fairgrounds. Main prizes — ICOM 230 — Hallicrafters FPM 300 — Standard 2 mtr hand held. Motel and camping space available. Call WF8HOF 146.19/79 or 146.52/52. Further information write WA8SHP, 73 Nimishillan St., Sandville, Ohio 44671 or call W8SWB (216) 455-4449.

WILL TRADE: My \$170 for your unwanted working HF XCVR, W/PS if possible. Bill Seibt, Box 33, FPO Seattle 98790.

RADIO SOCIETY of Ontario 1975 convention hosted by the Ottawa Amateur Club at the Skyline Hotel, Ottawa, Canada, October 3rd, 4th and 5th. For information contact P.O. Box 8873, Ottawa, Canada K1G 3J2.

SELL GONSET GSB-2 SSB transceiver matching ac supply speaker 144-148 MHz: \$190 or best offer. New 5 element FM Yagi portable: \$8. Cesco S.W. reflectometer model CM-52: \$7. Good coax RG58U 100 ft: \$5. All shipping postpaid. George Konnick, Apt. P-2, 1750 West Main Street, Riverhead, New York 11901.

HT-200 HANDITALKIE Gud shape on 94 and 147.99-39, 2 battery, home-bru-charger, rubber ant. \$200.00. Bob Sumption K9VYE, 142 E. Murray St., South Bend, Indiana, 272-4832.

REGENCY floor models and demos at big savings! Full factory warranty. HR2B \$229 now \$199.99, HR2MS \$319 now \$289.99, HRT2/nicad \$229 now \$199.99, HR212 \$259 now \$229.99. Add \$3.50 per unit for shipping and handling. VEGAS RADIO, 1108 So. 3rd, Las Vegas NV 89101.

FREE: 8 EXTRA CRYSTALS of your choice with the purchase of a new ICOM IC-22A at \$249. With the 10 crystals which come factory installed in the IC-22A, this gives you a total of 18 crystals! For equally good deals on Kenwood, Drake, Ten-Tec, Collins, Swan, Atlas, Midland, Standard, Regency, Tempo, Alpha, Genave, Hy-Gain, CushCraft, Antenna Specialists, Hustler, Mosley, and others, write or call HOOSIER ELECTRONICS, your ham headquarters in the heart of the Midwest, and become one of our many happy and satisfied customers. Hoosier Electronics, PO Box 2001, Terre Haute, Indiana 47802. (812) 894-2397.

FOR SALE — HEATHKIT SB104 with N/Blanker and HP1144 power supply mint condition — \$925.00 — FPM 300 transceiver with blower & mobile mount — \$325.00. WB8GGM — 419-468-1438.

LENSES — Fit Robot and other SSTV or FSTV cameras, "C" mount, 1 inch, f2.5 regular; ½", F1.5 wide angle; 3 inch, f3.5 telephoto; all wollensak, all three for \$150. Asa F. Tift, 3200 Trowbridge Road, Albany GA 31707.

FOR SALE. 4-400 tetrode tubes. Guaranteed. \$20 each. K4KKW, 228 S E 43rd Ter., Cape Coral, Fla. 33904.

LOW & MEDIUM FREQUENCY RADIO SCRAPBOOK. Unique new handbook dedicated to the experimenter. Receivers, converters, coil winding, antennas, loops, the non-licensed communication bands and the FCC rules. Over 100 pages chock-full of diagrams and data. Nostalgia for the old-timers and an introduction to radio communications for the newcomer. \$4.75, Cornell, 225 Baltimore Avenue, Point Pleasant Beach NJ 08742.

TECH MANUALS — \$6.50 each: R-220/URR, SP-600JX, USM-159, GRR-5, URM-25D. Thousands more available. Send 50¢ (coin) for large list. W3IHD, 7218 Roanne Drive, Washington DC 20021.

MONTREAL HAMFEST 75, Aug 3, MacDonald College Farm, Ste. Anne de Bellevue, prizes, giant fleamarket, technical sessions, family fun \$2.50/adult. Info contact VE2RM, Box 201, PointeClaire-Dorval, Quebec H9R 4N9.

Continued on page 112

73's

EMPHASIS AMSAT™

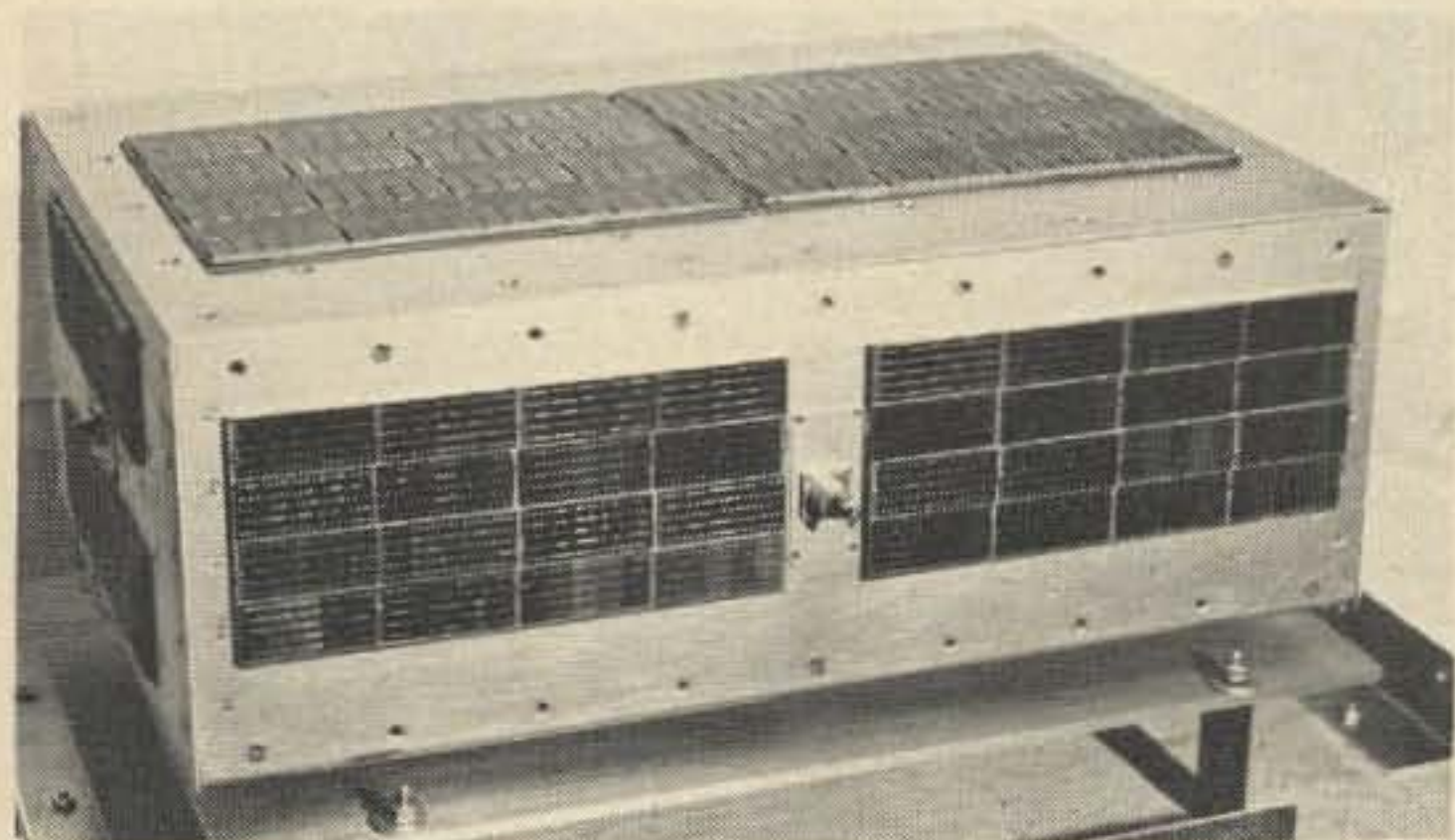

OSCAR 6

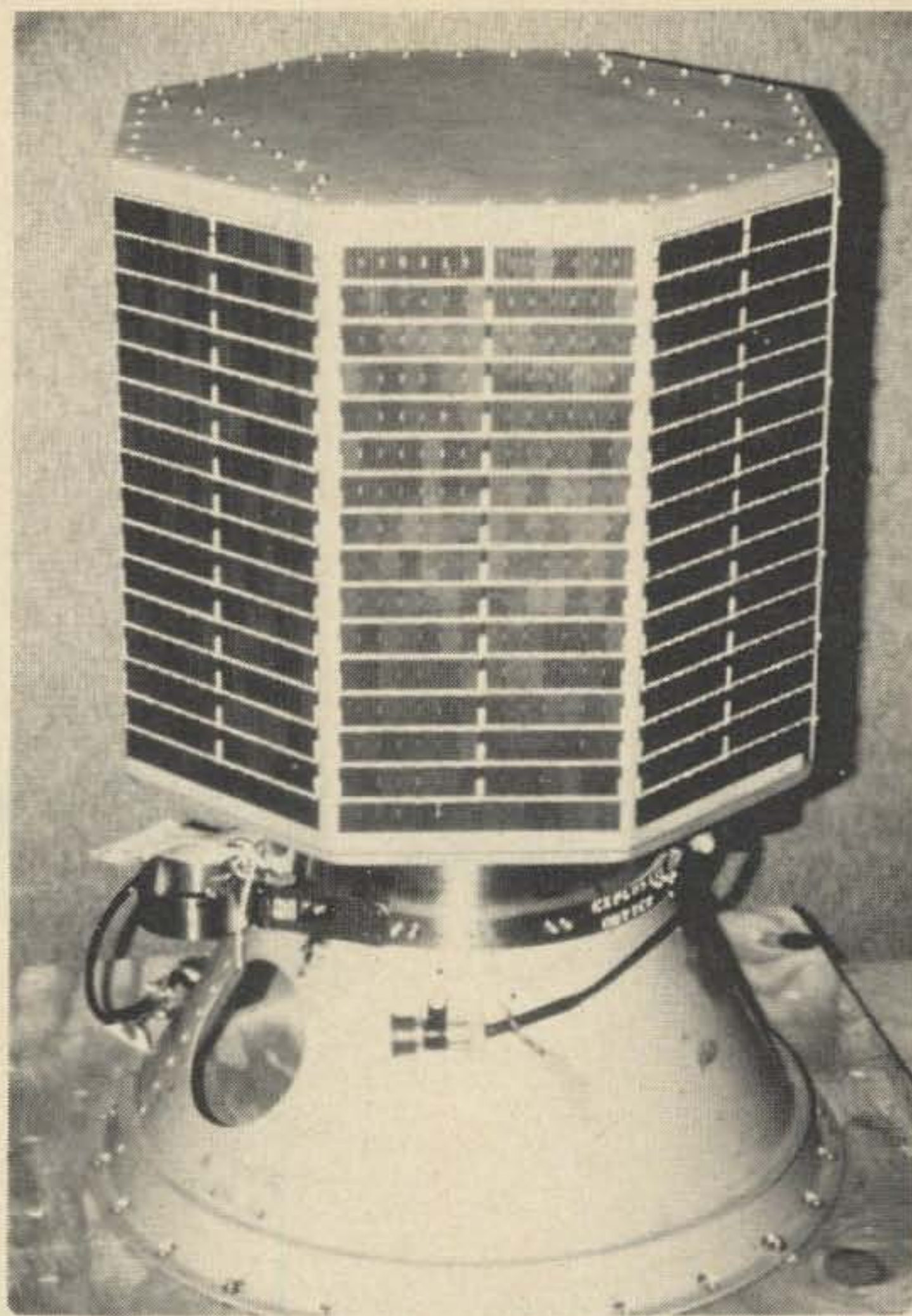

OSCAR 7

With two amateur satellites functioning in orbit, amateur satellite communications have come of age. Bulletin stations, emergency communications, traffic handling, scheduled contacts with friends, and DXing are all techniques commonplace on the HF spectrum that are now also possible using satellites.

This special issue of 73 spotlights the OSCAR satellites and AMSAT, the organization behind this adventure. Perhaps after reading these articles in this special 73 and several basic articles on getting started referenced in the articles, you too will join the thousands of amateurs who find satellite communications an exciting new dimension in their amateur activities.

73



AMSAT™ Membership Application

I hereby apply for membership in AMSAT. Attached is \$ _____ for _____ years' dues and \$ _____ donation. (Memberships run from the beginning of the current calendar year, for which you will receive back issues of the quarterly *AMSAT Newsletter*. Approximately half the dues are for subscription to the *AMSAT Newsletter*.)

Dues are \$10 per year (\$5 for students until the age of 18), and you are invited to prepay dues for any number of years. Life Membership is available for a donation over \$100.

Signed

Address

Date

RADIO AMATEUR SATELLITE CORP., P.O. Box 27, Washington DC 20044

Rare DX via Oscar?

Having completed OSCAR-style DXpeditions to PJ9, PJ7, VP2A and VP2L with a reasonable amount of success during the past two summers, I learned a few things that may be worth passing along to others who are contemplating similar travels to "rare and exotic" places.

When and Where?

One big difference between OSCAR DXpeditions and others is the fact that your operating schedule must be tailored to the availability of usable orbits of the satellite from wherever you plan to travel. At this writing, a very favorable situation exists, because both OSCAR 6 and OSCAR 7 are operational, so there are plenty of orbits available. However, if you are pressed for time, you may want to conduct a little research on how much operating time will actually be available based on the latest satellite operating schedule. You'll probably drive your travel agent completely wild trying to arrive at an itinerary that will produce the greatest amount of on-the-air time for the dollars you'll spend getting there! At present, Wednesday (GMT) is an OFF day for both satellites, and therefore a good day to travel! Midweek airfares are also

usually cheaper than weekends. So the really serious minded DXpeditioner will plan his trip accordingly. When we only had OSCAR 6 available, and a battery-saving operating schedule was in effect, this took considerably more planning than I'd care to admit.

Another major factor in satellite DXing is selection of a favorable spot for the trip. In contrast to a low band DXpedition where worldwide propagation is a relatively safe bet, when you are thinking of OSCAR activity, bear in mind that (1) your maximum range will be about 5000 miles (with our present satellites), and (2) most of the OSCAR activity is concentrated in the USA, Canada, Europe and Australia/New Zealand, with growing activity in South America, Africa, Hawaii and Alaska. Therefore, consult the globe before you decide where to go. For US amateurs, the logical choice is the Caribbean area, because it is within range of the USA, western Europe, North Africa, and about two thirds of South America. The choice of one island *versus* another introduces a few other variable considerations such as ease of licensing, availability of local hams who are interested enough to want to help you, and the terrain of the island.



WIFTX operating at PJ7VL, St. Maarten, 1973.

In my limited experience, I've found that if you are planning to go to the Dutch islands, you should apply for your license *at least* four months ahead of time. My PJ9FTX license arrived nearly a month after I returned to the States, and it was only because I was traveling with WIBIH, who already held PJ9JT, that operation from Curacao was made possible. By contrast, licensing in St. Lucia is very rapid, and application can be made on the day of your arrival. All that is needed is your stateside license, a description of the equipment you plan to use and a fee of about \$2.50 (\$5.00 ECI). Licensing procedures vary widely from island to island in the Caribbean, however, and you would be wise to check with the ARRL for the latest licensing information, as soon as you decide on which island you want to visit.

The terrain of the island is also of greater importance for an OSCAR venture than for others. Many of the islands are very mountainous, with peaks rising to 2500-3000 feet right out of the ocean. Obviously, if such a peak should be in the path of your desired transmission to OSCAR, you'd have a very limited "window" and fewer QSOs would result. In general, if you are going to the Caribbean, try to find an operating site on the northern tip of the island, or, if not there, at a point sufficiently distant from the peaks that a reasonably low "horizon" exists. The National Geographic Society maps of the various islands will be of help

here, because they usually show where the peaks are.

Another factor is the hotel accommodations available and whether they object to having operation from their premises. I have found that most of the hotels do not raise objections and are usually very cooperative, even to the extent of providing maintenance personnel to help in erecting antennas. It is advisable to check this out first by mail, however, before you start. I've found that a few words describing the specialized nature of your satellite experimentation goes a long way toward opening the door, both in the hotel and in licensing problems. Most of the local officialdom will not have heard much about OSCAR, but it is a fascinating story, and they will be quick to show an interest when you point out that your efforts may be a "first" from their island. If you can enlist the help of one of the local hams beforehand, as I did with PJ7VL and VP2LAW, this will also help in cracking any "ice" that officials may exhibit. The fact that one of their own hams is to participate makes it more palatable.

If you can't make advance arrangements with a resident ham, the local officials will sometimes introduce you to an active local ham who might be a likely candidate to help out. This was how I met Mickey VP2AR and

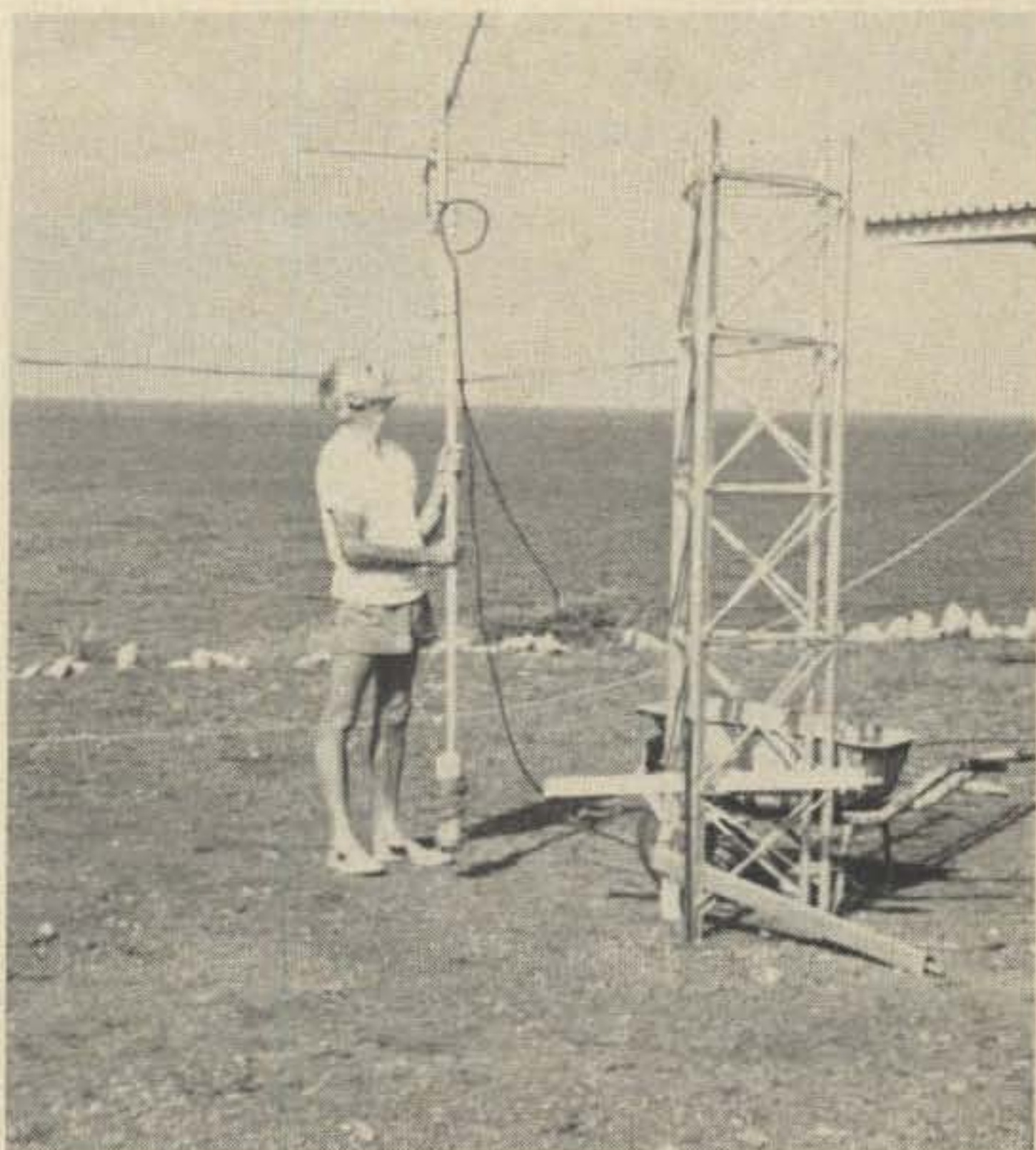

WIBIH aiming OSCAR antenna, at PJ9JT, Curacao, 1973.

his XYL Hya VP2AYL, who were most hospitable during my brief visit to Antigua in 1973.

Another consideration is what kind of commercial power is available. Some islands have 120 volt 50 cycle, others 220 volts. Fortunately, most of the hotels have an electric shaver outlet at 115 V ac available, but you should check this out in advance.

What Equipment?

The selection of equipment to take with you will be governed by your own tastes, but in some instances cooperative arrangements to use equipment already on the islands can be made in advance with one of the local hams. If you plan to operate from his station, this will lighten your load, but you may still need a license to operate, so check this too, in advance.

Usually, the local hams will not have any 2 meter or 432 MHz gear, so you'll have to carry it with you. Obviously, the lighter the better! I found an old typewriter case that could be used, after some slight modification, to carry my Ameco TX-62 transmitter (weight about 24 lbs.). The 20 Watts output of this rig was entirely adequate for OSCAR 6 use, but is marginal for OSCAR 7, Mode A, unless at least a 7 element yagi is used.

A 7 element 2 meter yagi was carried, knocked down, in a device resembling a golf bag made from a 4 inch diameter cardboard mailing tube. The tube was fitted with a carrying handle made out of scraps of twin



W1BIH and W1FTX operating OSCAR 6 from PJ9JT, Curacao, 1973.

lead. A metal coffee can was glued inside the tube to close one end of the tube and another one was used as a removable top. Carrying the antenna in the original carton (in which it came from the manufacturer) is not recommended, because the customs officials in some countries may think that you are trying to avoid duty charges on new equipment for sale to someone on the island. If the equipment is obviously not new, their fears are usually not a problem. I've had no experience with the 432 MHz to 2 meter translator in OSCAR 7, but from present reports, 10 to 20 Watts output coupled with modest antenna gain should be sufficient. The 7 element 2 meter yagi seems to be a good compromise between size and gain for use on the 2 to 10 meter translators in OSCARs 6 and 7. Good results have also been obtained by PJ9JT using a homemade 4 element 2 meter yagi. His signals were sometimes S8 to 9 in Connecticut. I would not recommend simpler antennas, unless the rig to be used is in the higher power range with output in the 100 Watt class.

The coaxial cable for the antenna will probably weigh more than the antenna itself. I found that a 50 foot length is probably the minimum you can get along with, and more is desirable if you can cope with the weight. (Don't count on coaxial cable being available on the island.) I chose the heavier RG8/u instead of RG58/u, because the lower loss factor of RG8/u at 145 MHz made it seem wise, in view of the fact that I was using a QRP rig. For a receiving antenna, a folded dipole cut for 29.5 MHz and fed with 75 Ohm RG59/u worked very well for me wherever I went. You will probably miss hearing some of the weaker stations with this antenna, but unless you are planning a fairly long visit, you won't have time to work everyone anyway. Obviously, if a 10 meter beam is available at the site, use it.

You can make up for some of the deficiencies of the folded dipole (*versus* the beam) by taking with you a transistorized 29 MHz preamplifier powered by a small 9 volt battery. The preamplifier is a must, unless you are going to be using a 10 meter receiver known to have excellent sensitivity at the 29.5 MHz downlink frequency. Most of the older receivers (even some of the high priced



WIFTX with VP2LAW holding OSCAR antenna, St. Lucia, 1974.

ones) are noticeably lacking in sensitivity at the high end of the 28 MHz range.

In the category of miscellaneous things to take with you, I'd suggest a ball of nylon twine for use in supporting the receiving antenna, various coaxial connectors and short lengths of coax, some lightweight tools, including a soldering iron, a dependable timepiece, a magnetic compass and of course, orbital data. If you know the latitude and longitude of the island, you can usually find someone on the AMSAT net* who can furnish rather exact orbital data including both azimuth and elevation figures from one of several existing computer programs. Another very valuable addition is a pair of headphones equipped with a long enough cable to permit the person who is aiming the antenna to hear what is coming in on the receiver.

Operating

Once you have armed yourself with a good set of orbital data and have worked out a reasonable installation, the fun begins. You

*Wednesday — 3850 kHz at 0100 GMT for eastern USA, 0300 for West Coast; Sunday — 14280 kHz at 1800 GMT, 21280 at 1900 GMT.

will probably have given prior notice to other OSCAR users to be on the lookout for you. It is advisable to announce in advance what downlink frequency, or frequencies, you plan to use. A quick CQ will then usually bring an immediate pile up. The best way, in my opinion, to work the pileup, is to announce in advance (before you leave home) that you will not work anyone who calls on your own frequency, but that you will listen ± 5 kHz. This will stymie a few of the less experienced guys, but if they are smart they'll soon catch on and you will have a relatively clear frequency. A brief RST exchange is suggested, identifying the station you are working a couple of times at the beginning and end to compensate for fading and possible QRM. Exchanging names, QTH and weather data is not for OSCAR DXing!

After the first few days, the pileup will have subsided somewhat, and you will want to move around a bit on the band looking for some of the stations who have fixed operating frequencies. They will appreciate your efforts to move to their rockbound downlink signal.

There will always be a few guys who are

not satisfied to work you only once. You can be accommodating and work them again, or not, as the mood strikes you. I tried merely acknowledging duplicate calls with a quick W - - - -, B4, meaning "you're in my log already, see you later," but sometimes they didn't understand. I can't fault them for wanting to be sure that they are in the log. Sometimes, in the heat of a pileup, there is enough QRM to make it less than certain that a two-way exchange has taken place, and you have to give the other guy the benefit of the doubt.

On north to south passes of the satellite, it will pay dividends to tune around a bit after the W/K stations have faded out. I worked PY2CSS and ZP5AY this way from VP2LBP. When I vfo'ed onto their frequencies, I think they got a mild shock when they heard me calling them. There is also activity in Argentina, Colombia, Venezuela and Peru; interest is also being shown in Chile, Ecuador and Bolivia. By the time this is in print, there may be even more activity in South America, so tune around.

Tracking the satellite, once you are armed with orbital data, is rather simple, but here's where assistance from another operator on the scene comes in. Most of my Caribbean DXing was done with the assistance of another person to do the antenna aiming. At PJ9JT, W1BIH was the other member of the

team. At PJ7VL it was my XYL, at VP2LBP it was either John VP2LAW or John Purdy, an SWL. We would map out each orbit beforehand, placing markers (rocks) on the ground describing the arc of horizontal rotation required by the particular pass. One marker for each 3 or 4 minutes of the orbit was usually enough. We would also rehearse briefly the elevation required at each of the markers (the horizon at the start and finish, increased to a maximum of about "X" degrees above the horizon in the middle). This can be written down on a card which the antenna aimer can refer to, calibrated in minutes after the "go" signal. An added refinement, if the aimer can copy CW, is to equip him/her with a pair of headphones which are connected to the receiver. This gives the aimer exactly the information needed to keep the antenna tracking at the optimum. He can hear the returning signal from your rig, and knows that when the returning signal starts to get weak, some adjustment in the antenna aiming is needed. Actually, the pattern you get from a 7 or 4 element 2 meter yagi is broad enough in both the horizontal and vertical planes so that aiming is not at all critical. Another gimmick that might be useful is to change the polarization of the transmitting antenna from horizontal to vertical to see which is best. In general, vertical polarization seems

VP2LBP

CHOC BAY, ST. LUCIA, W.I.

Confirms QSO with **W3HUC**
 Date **15 Aug. 1974**
 Time **00:26 GMT** *VIA*
 Band **145/29 MHz,**
 Ur Sigs **579**
 Mode **A1**

Richard M. Smith, W1FTX
 RFD 2, West Hill
 Winsted, Conn.
 U.S.A.

73! Deck

OSCAR 6 ORBIT  **8369**
 OSCAR 6

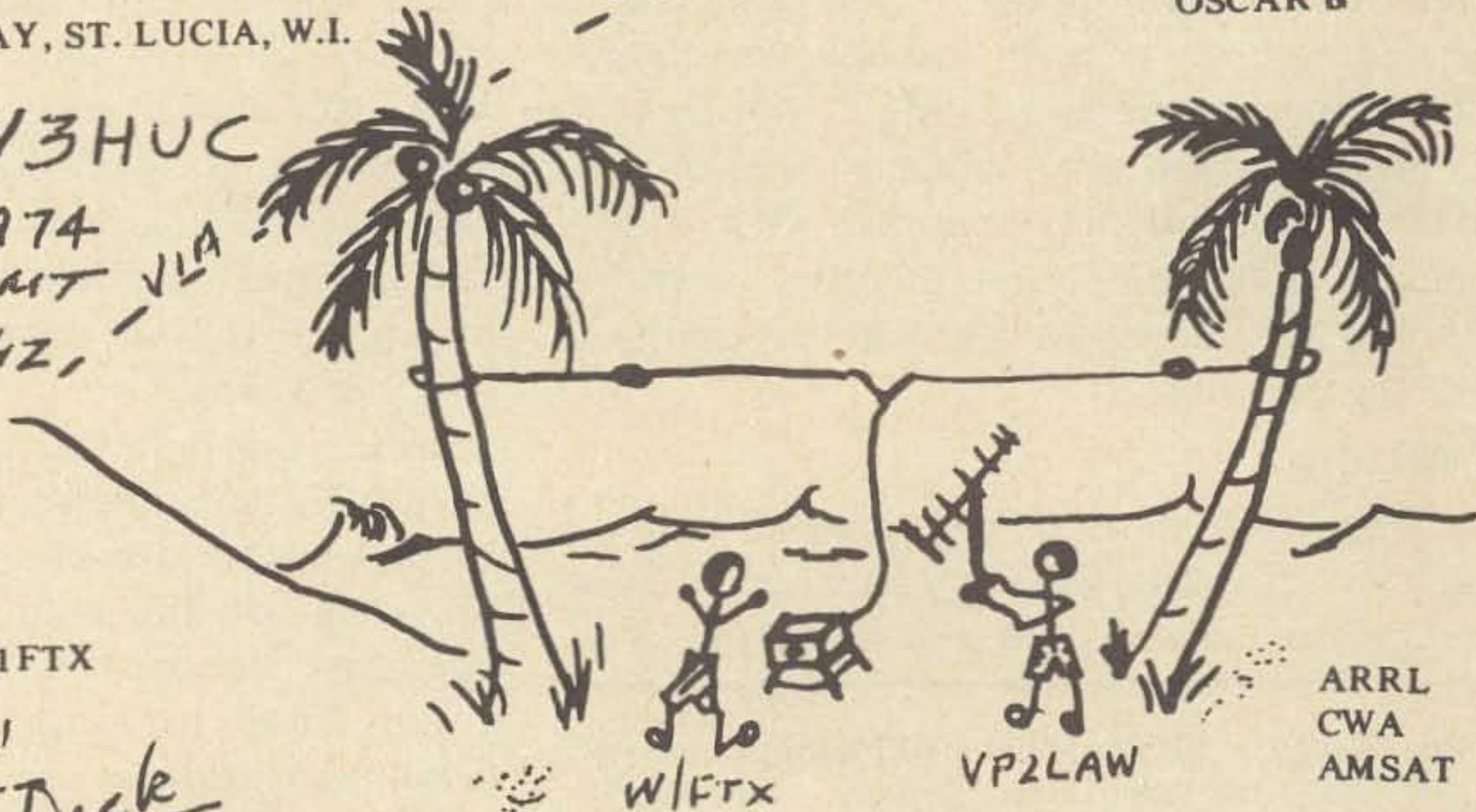

Specializing in VHF-UHF FM & SSB Equipment

The ITC MULTI-2000 CW/SSB/FM transceiver



Whether your interest is simplex, repeater, DX or OSCAR the new ITC MULTI-2000 lets you get into all the action on all of the band. Fully solid-state and employing modular construction, the MULTI-2000 enjoys features found in no other 2m transceiver.

Full one year written warranty — Introductory price \$695

KLM Accessories in stock (partial list)

KLM 144-150-12C Circularly polarized (for OSCAR)	\$54.95
KLM 144-148-12 12 element DX antenna	43.95
KLM 144-148-16 16 element DX antenna	54.95
KLM Balun (recommended, optional)	13.95
KLM Two Antenna Coupler	19.95
KLM PA-10-140BL 2m 140 W linear (FM-CW-SSB)	199.95
(add \$3.00 shipping per antenna or amplifier.)	

We Ship!

Our large inventory of VHF equipment assures shipment within 24 hours ARO. WESTCOM prepays delivery and insurance on transceivers when full payment accompanies order (M.O. or cashiers check). COD available with \$25 deposit. California residents add 6% sales tax.

Westcom

BOX 1020 • ESCONDIDO • CAL • 92025 • (714) 744-1395

**some people
talk power-
we
deliver it.**



**VHF Class C
Power Amplifiers**

- *Superb Craftsmanship*
- *State of the Art Performance*
- *Full One Year Warranty*

MODEL P15A1 — 1-3 W input 12-25 W output.
13.6 V at 2 Amps \$55 ppd.

MODEL P50A1 — 1-3W input 40-60W output.
13.6V at 8 Amps \$139.

MODEL P50A10 — 1.5-15 W input 12-65 W
output. 13.6 V at 6 Amps \$98 ppd.

MODEL P100A5 — 2-5 W input 60-100+ W
output. 13.6 V at 14 Amps \$198 ppd.

MODEL P100A10 — 3-10 W input 60-100+ W
output. 13.6 V at 14 Amps \$198 ppd.

MODEL P100A20 — 15-30 W input 75-100+ W
output. 13.6 V at 14 Amps \$155 ppd.

M-Tech Engineering, Inc.

Box C, Springfield VA 22151 (703) 354-0573

M-TECH . . . The Quality Company

best at the start and end of a pass, when the satellite is near the horizon, and horizontal at other times. We even found that when working through OSCAR 6, it sometimes helps to cock the antenna 10 or 15 degrees away from horizontal or vertical. Not enough experience exists at this time to know whether the simple aiming technique we used for OSCAR 6 work will be equally effective for OSCAR 7. If you can't use the headphone "feedback loop," you can sometimes do the same thing by merely turning up the audio gain on the speaker to the point where the person aiming the antenna can hear what is going on. We used this to good advantage at PJ9JT, where the operating position was on a patio less than 40 feet from where the antenna aimer was standing.

One more slightly humorous note: While my XYL was doing her aiming chores during one daytime orbit at PJ7VL, one of the other guests at the hotel asked "Is your husband inside watching TV?" (The nearest TV station was on Antigua!)

... W1FTX



*For detailed technical information
and pricing—write to:*

APTRON

Dept. AMTV
P.O. Box 113, R.R. 2
Bloomington, IN 47401

FAST SCAN Amateur TELEVISION

**NOW YOU CAN ENJOY FSTV
AT REASONABLE COST.**

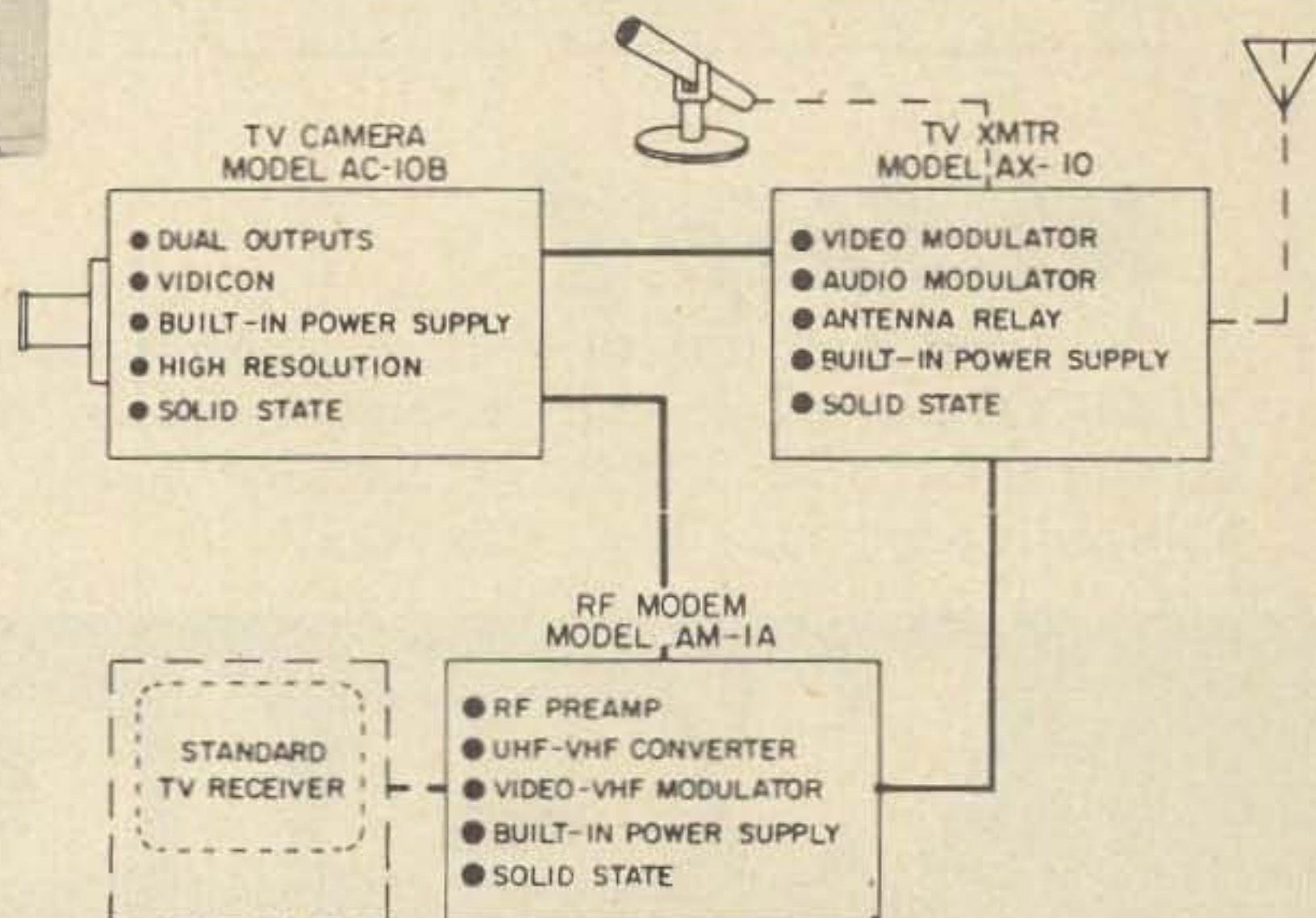

Gary L. Tater W3HUC
7925 Nottingham Way
Ellicott City MD 21043

Antennas for Oscar - What really works?

Although mobile in motion contacts through AMSAT-OSCAR 6 have been accomplished with a simple two meter verticle whip, if you plan to make some contacts via satellite you should consider using some of the antennas mentioned in this article. You'll find that a good antenna

system is the key to being a successful satellite operator.

If you are just getting started in satellite communications, you will want to concentrate on antennas for ten and two meters and later on add something for 70 centimeters. AMSAT-OSCAR 6 uses two meters



The author with his four element CushCraft two meter beams at 30 and 60. A fourteen element KLM beam for 432 MHz is used for AMSAT-OSCAR 7.

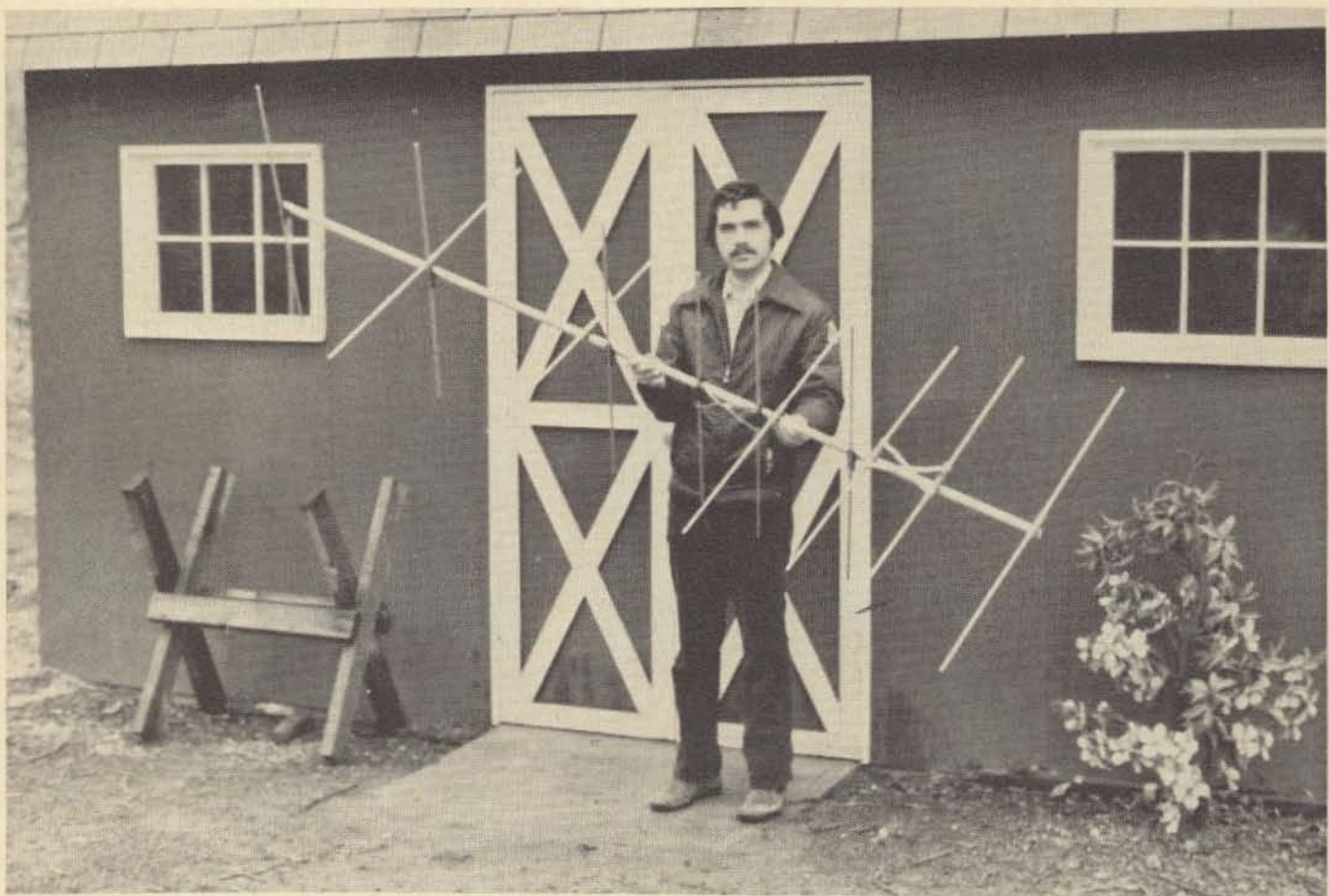

The KLM six element cross-polarized OSCAR two meter antenna.

as an uplink and ten meters as a downlink. One transponder on AMSAT-OSCAR 7 uses this same combination while the second transponder uses 70 centimeters as the uplink and two meters as the downlink. These three bands are ideal with regard to antennas since antennas for these frequencies are (1) straightforward to construct, (2) easy to erect, and (3) economical to purchase.

Your antenna choice will depend on several variables, such as cost, available space and transmitter power. But even lack of space shouldn't discourage you, as many fine stations operate through the satellites from apartments. This article describes several antennas that should help you decide which one you will want for your OSCAR station.

Standard Antennas

The two meter uplink for both AMSAT-OSCAR 6 and 7 requires approximately 100 Watts effective radiated power (ERP), made up of your transmitter power and the gain of your antenna less the feedline loss. Usually this calculation will indicate that an antenna with about 10 dB gain is needed. Because antennas with 10 dB of gain have a wide angle of radiated power, they are easy to keep aimed at the satellite. Thus, you will find that many active satellite users have two meter beams with from four to eleven elements.

One such antenna is the four element yagi by CushCraft, cut for FM use. It needs no modification and is very economical. Because the half power points are at 66° , you need only move the antenna every three or four minutes during a satellite pass. The

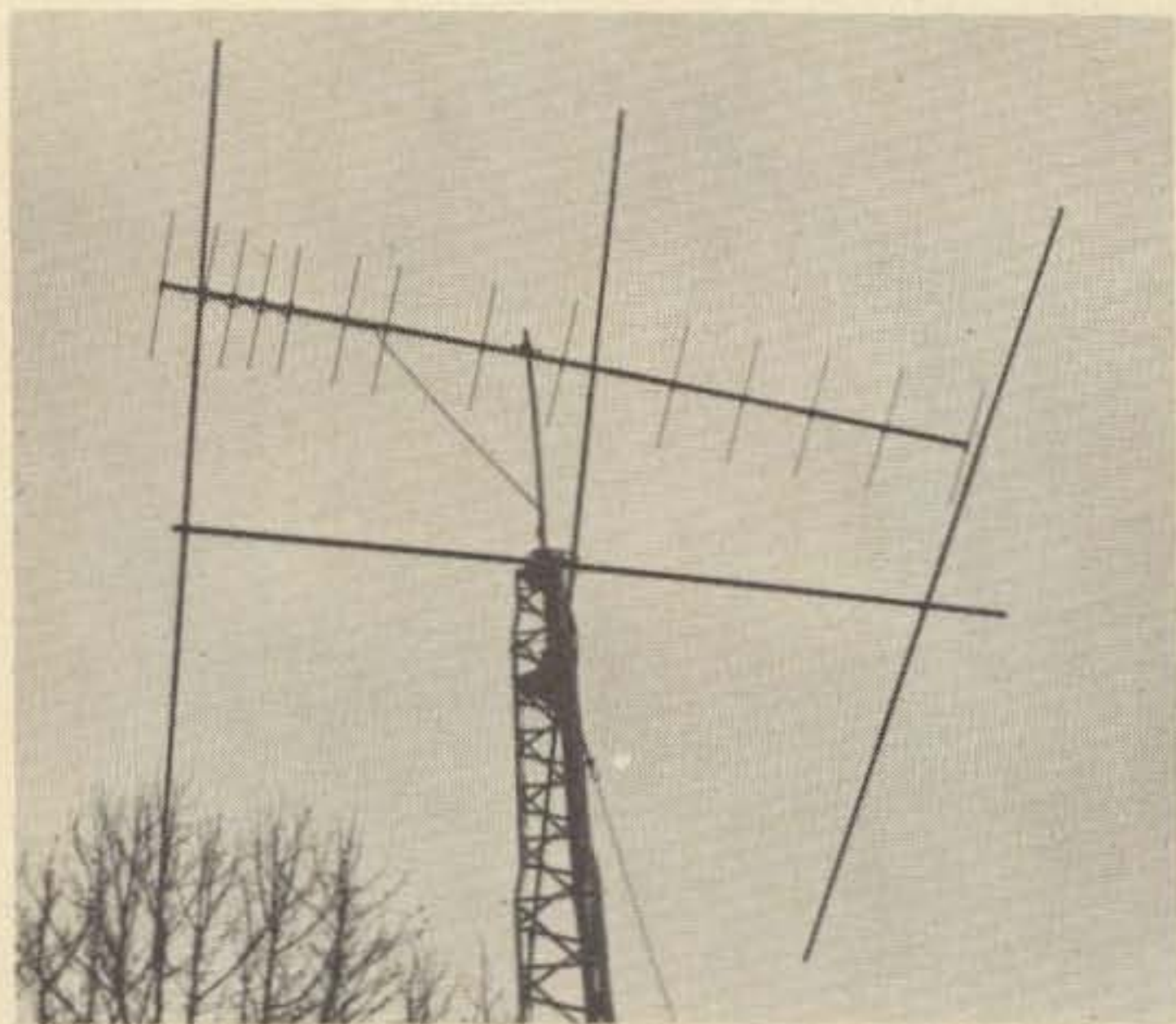

A three element beam for ten meters and a fourteen element KLM for two meters.

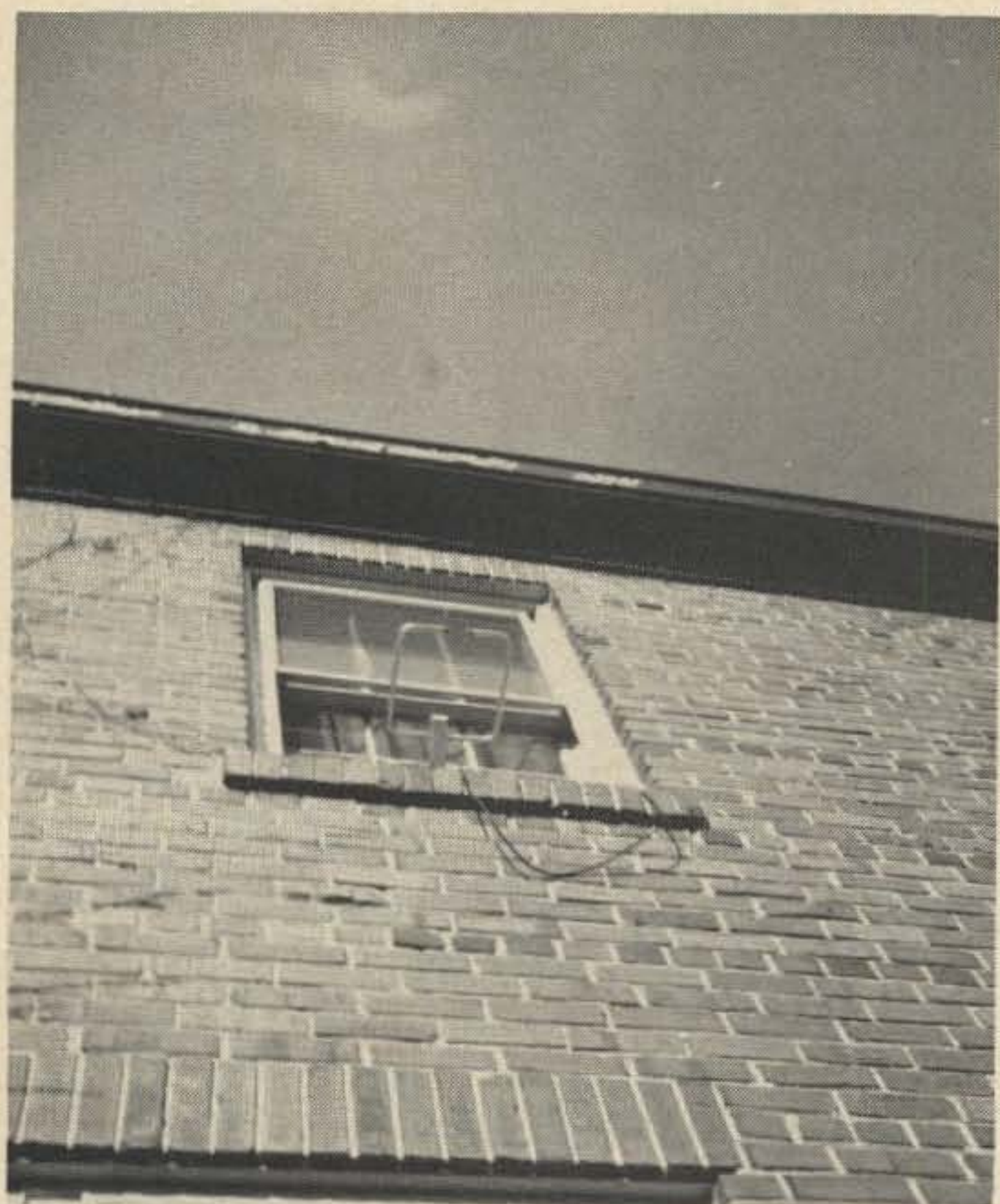

Squalo for two meter uplink at K2QBW/3.

photo shows two of these antennas in use, along with a fourteen element KLM yagi for 432 MHz. The four element beam at 60° elevation is used for overhead passes, while the second four element beam at 30° eleva-

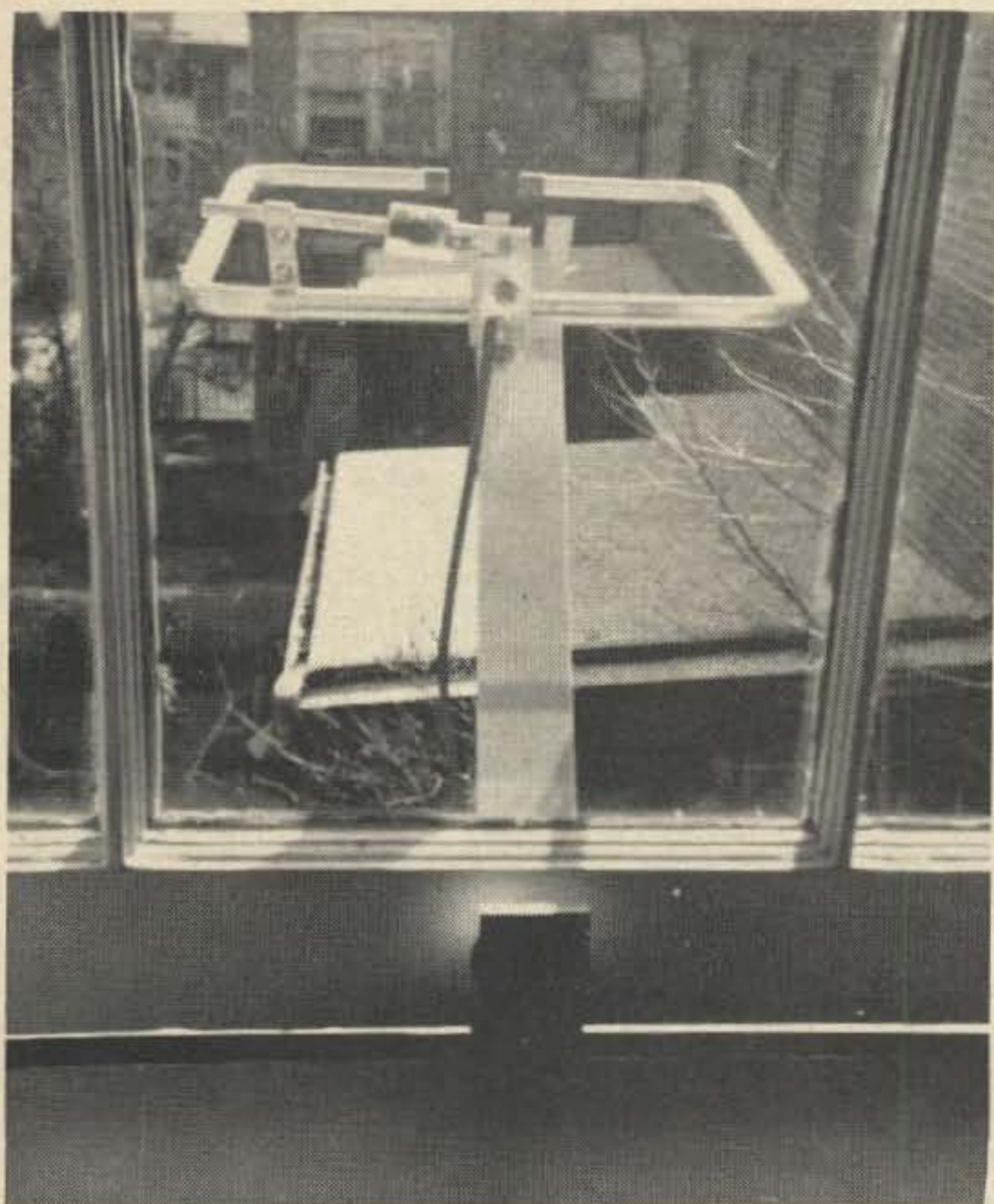

The apartment dweller's special — a two meter Squalo that disappears during the day.



W2GN/1 ten and two meter cross-polarized array.

tion is used when the satellite is lower in the sky. I find this combination of antennas more convenient than az-el control and very economical. When the satellite is on the horizon, I switch to the fourteen element KLM beam.

For the ten meter downlink a simple dipole can be quite effective, especially on overhead passes. You can, however, increase the time period you can hear the spacecraft by several minutes by using a ten meter beam. The ten meter beam is very inexpensive and easily tuned to 29.5 MHz. Horizontal polarization is used, but vertical could also be used.

Of course, there are many other choices for you. I've also had excellent luck with a 16 element two meter collinear on AMSAT-OSCAR 6. A cross-polarized antenna specifically designed for satellite operation by KLM is also shown. If you already possess a tribander you're in luck — they are fine antennas for the ten meter downlink.

Small Antennas

Many amateurs who live in apartments find that they can't be successful on the high frequency bands because they can't put up large beams or dipoles. Fortunately, the

OSCAR transponders use VHF and UHF where antenna sizes are relatively small. Since it is effective radiated power (ERP) from your station that limits your ability to access the spacecraft, by increasing the transmitter power you can maintain the typical 100 Watts ERP required and still get by with a small antenna.

There are many two meter antennas designed for FM use that are well suited to satellite use. The four element two meter yagi by CushCraft is my favorite and should fit on an apartment dweller's outside balcony. Perhaps you could find a Squalo at a hamfest and mount it from a window. By mounting it under the window when you need it, your neighbors will never know you exist.

Small satellite antennas make fine construction projects because they can be completed in several evenings of work. An array built by W2GN is a three element cross-polarized two meter beam and a crossed dipole for ten meters. It was recently used at the Bennington, Vt. airport on one of the

many expeditions W2GN has undertaken to put inactive states on the satellites.

Also shown is the W3TMZ homemade beam, which has been used in several demonstrations given by AMSAT members in the Washington, D.C. area. This five element cross-polarized two meter beam was built on a wooden boom using dimensions from the third edition of the ARRL VHF Handbook. By using 1/4 inch aluminum clothesline wire for the directors and the reflectors, you should be able to keep costs below four dollars for the project. As simple as this antenna is, it allowed a group of AMSAT members to make eleven contacts on one pass during a recent demonstration.

Large Arrays

Many amateurs who have been active on the VHF bands, with large arrays for moon-bounce, meteor scatter, etc., have become active on both AMSAT-OSCAR 6 and A-0 7 with excellent success. Of course, with large antennas it is very easy to overload the satellite's automatic gain control in the

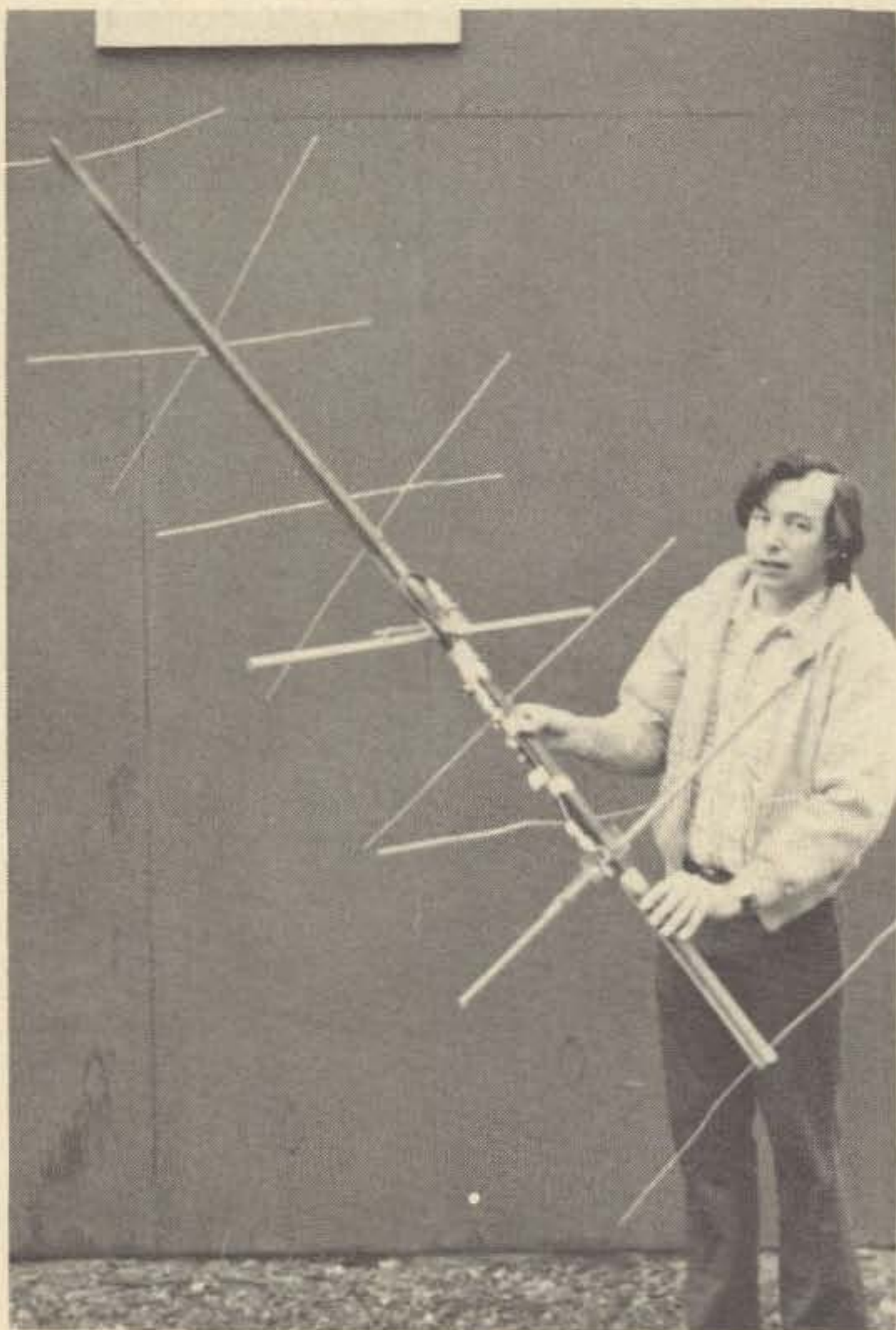

W3TMZ with his inexpensive cross-polarized two meter yagi on a wooden mast.



W3TMZ inspecting his AMSAT-OSCAR 7 antennas — two fourteen element KLM beams and a fourteen element 432 MHz K2RIW yagi.



ICOM

THE LEADER



IC21A

- 24 CHANNEL CAPABILITY
- 7 CHANNELS SUPPLIED
- MOSFET FRONT END
- 0.4 UV SENSITIVITY
- 5 HELICAL FILTERS
- BUILT IN AC & DC POWER SUPPLIES

DV-21

- FULLY SYNTHESIZED VFO
- OPERATES IN 5 OR 10KH STEPS
- COVERS ENTIRE 2 METER BAND
- SCANNING CAPABILITY
- 2 PROGRAMMABLE MEMORIES
- TOUCH KEYS TO SET XMIT & RECEIVE FREQUENCY



IC 230

- PLL SYNTHESIZER
- 67 CHANNELS - 30 KH SEPARATION
- HELICAL FILTERS
- AUTOMATIC PROTECTION CIRCUITRY
- MODULAR CONSTRUCTION

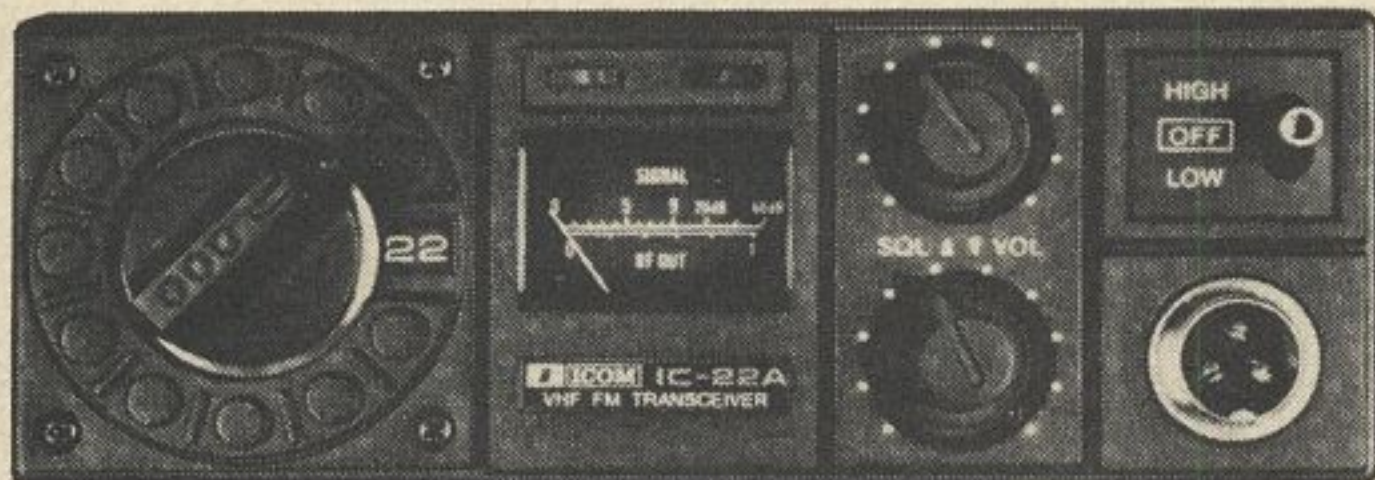

IC22A

- 22 CHANNEL
- 5 CHANNELS SUPPLIED
- SOLID STATE TR SWITCHING
- 10W-1W POWER SAVER OPTION
- TRIMMER CAPS ON EACH CHANNEL



ICOM 30A

- 10 WATT OUTPUT
- ALL SOLID STATE
- 0.6 UV FOR 20dB QUIETING
- 22 CHANNEL - 5 INSTALLED
- MODULAR CONSTRUCTION

TUFTS

"New England's Friendliest Ham Store"

INVITES YOU TO SEE THE ABOVE LINE

TUFTS

Radio Electronics

386 Main St., Medford, Mass. 02155



Aha, the SECRET of PC Board success finally revealed. A perfectly balanced lighting tool combining magnification with cool fluorescence. Excellent for fine detail, component assembly, etc. Lens is precision ground and polished.

Regularly \$65.00. Now, over 30% discount (only \$46.00) to all licensed Hams, verified in Call-Book. Uses 22 watt fluorescent tube 8 inch diameter circle (not supplied).

Include \$3.00 U.S. postage, or \$4.00 in Canada, \$5.00 elsewhere. California residents include 6% sales tax. Or send stamped envelope for free brochure of other incandescent or fluorescent lamps suitable for all engineers, architects, students, etc.

\$46.00 price assured until Jan. 1, 1976

D-D ENTERPRISES

Dept. B-2, P.O. Box 7776
San Francisco CA 94119

2 METER FREQUENCY STANDARD



- * Accurately calibrates 2 meter gear
- * Uses WWV as Standard
- * Voltage regulated
- * Standard 30 kHz spacing

FM-146 Introductory price — \$59.95

Highest quality components — cast aluminum housing — military grade board — reverse polarity protection — also available in 450 MHz version. . . send for complete details

CA residents add 6% sales tax

MAGTECH ENGINEERING

P.O. 21979 San Jose, CA 95151

DIPOLE ANTENNA CONNECTOR

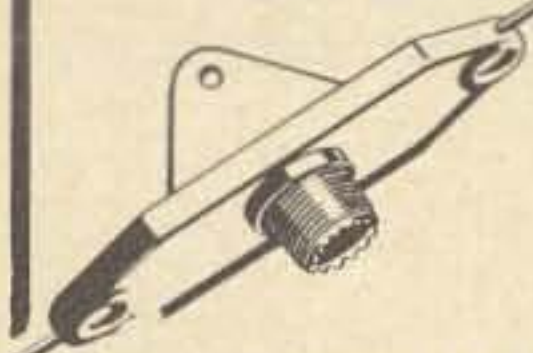

HYE-QUE (HQ-1) dipole connector has coax SO-239 socket molded into glass filled plastic body to accept coax PL-259 plug on feedline. Drip-cap keeps coax fittings dry. Instructions included. Guaranteed. At your dealers or \$3.95 postpaid. Companion insulators 2/\$.99.

BUDWIG MFG. Co. P.O. Box 97B, Ramona CA 92065

PRINTED CIRCUIT

EPOXY GLASS CIRCUIT BOARD STOCK;
CARBIDE DRILL BITS; TAPE RESIST;
ARTWORK; BUBBLE ETCHERS
SEND S.A.S.E. FOR FLYER

TRUMBULL

833 BALRA DR., EL CERRITO, CA. 94530



"Armstrong Baby," the best satellite antenna and rotor available.

receiver — so constant monitoring of the downlink signal is necessary.

Still, when you set out to work DX a second class station will just not do. One such multipurpose antenna system consists of two fourteen element KLM yagis for two meters and a K2RIW fourteen element yagi for 432 MHz. The elevation rotor is an Alliance U-100 with a HAM-M for azimuth control. With an array such as this and normal propagation conditions, you should be able to hear your return signal on ten meters with only a few Watts on overhead passes. However, it's when the satellite is on the horizon and you are looking for DX that you'll appreciate this antenna.

Conclusion

As you can see, there are many antennas that you can use to be successful on the two satellites now available for your use. My final recommendation, however, is the W4CKB special. On order, "Armstrong Baby" will point the antenna any direction requested. How many years have you wasted with just a HAM-M?

Reference

ARRL VHF Handbook, Third Edition, Two Meter Yagi, Figs. 9-27, page 190.

... W3HUC

An Oscar Preamp that Works Wonders

Probably the greatest problem most amateurs have with obtaining satisfactory two-way communications via satellites is in hearing the ten meter downlink. If you are not able to copy the 29.45 MHz beacon on AMSAT-OSCAR 6 on an overhead pass or even passes that are somewhat removed from overhead, then your receiving system is not as good as it can and should be for satellite communications. Generally, most receivers' sensitivity is reduced considerably at 29.5 MHz for numerous reasons (poor noise figure, inadequate gain, and poor impedance match). A good antenna will help, but a low noise preamplifier will do more to improve the receiving system than an elaborate antenna system. Generally, most receivers have noise figures ranging from 8 to 20 dB at 29.5 MHz (a good guess). With a properly operating and designed preamp the noise figure can be reduced to 2.5 dB and 15 to 20 dB of gain can be realized. Such a preamp will improve the receiving system sensitivity greatly.

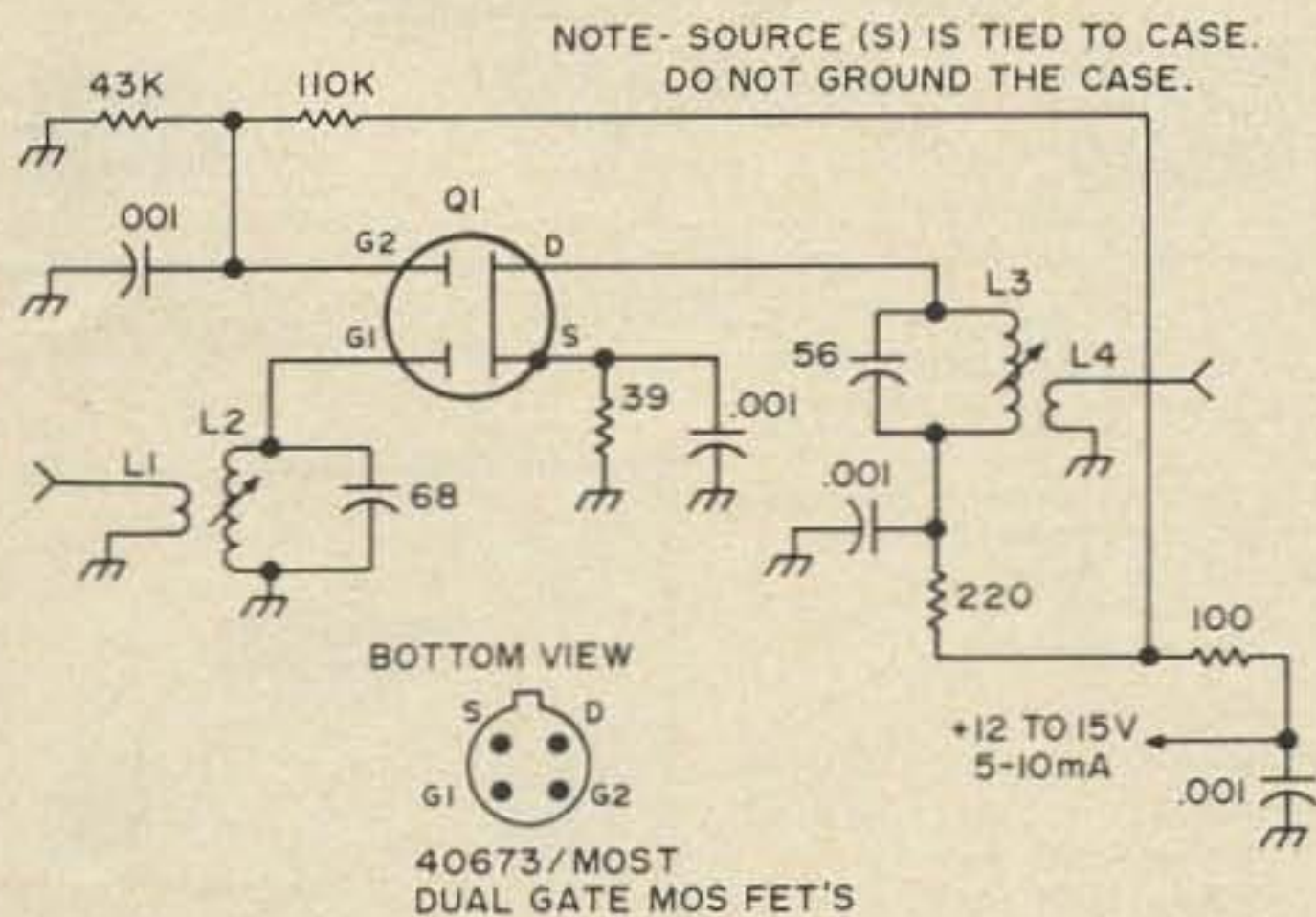

Fig. 1. Schematic. L1 - 2T No. 24E closewound over cold end of L2; L2 - 10T No. 24E spaced wire diameter, 1/4" dia. slug tuned (RED); L3 - 10T No. 24E closewound, 1/4" dia. slug tuned (RED); L4 - same as L1; Q1 - RCA 40673.

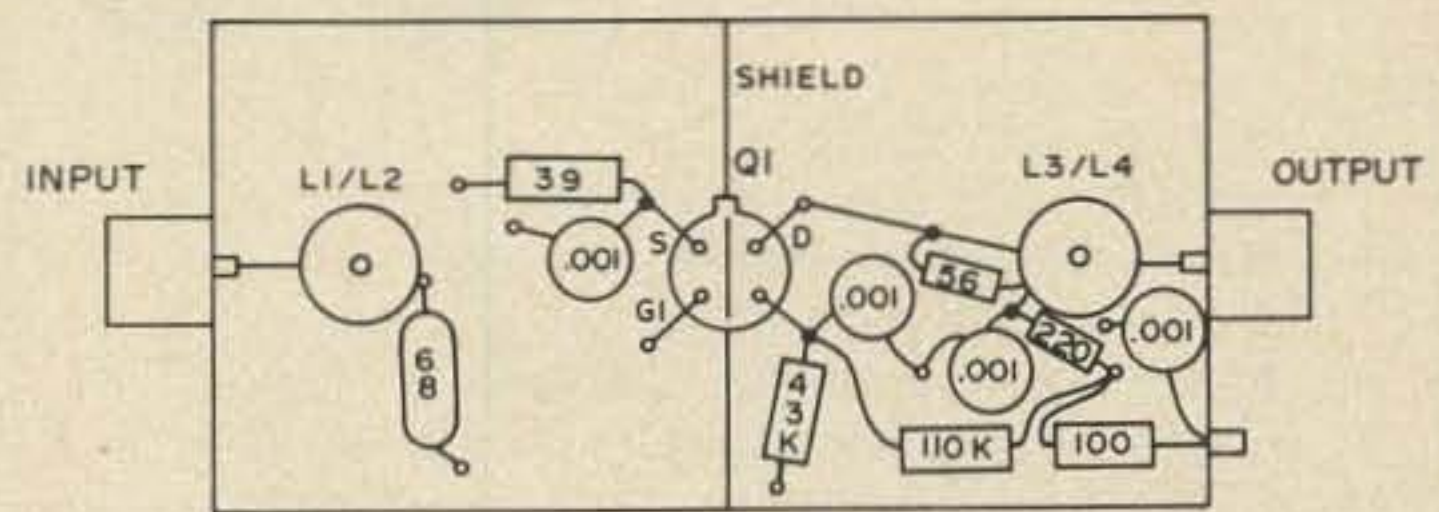

Fig. 2. Simplified component layout.

One important factor that must be dealt with now that the receiving system has been made super-sensitive is the susceptibility to overload, cross-modulation, etc. Unfortunately, this is almost always a problem with very sensitive receiving systems. This situation is even more profound with regard to OSCAR communications, i.e., simultaneous receiving and transmitting. Depending on the transmitters' operating characteristics (unwanted products) and proximity of the receiving/transmitting antennas, this problem will vary with each installation.

A number of preamps of the following design have been built. These have had measured noise figures ranging from 2.5 to 4.5 dB and power gains ranging from 15 to 22 dB. An absolute best design has not been attempted, but what has been built performs quite well.*

The layout of the components is not critical, but a shield partition across the device (dual-gate MOSFET) is desirable. Almost any dual gate MOSFET will work in this circuit. The devices that have protective diodes will have slightly poorer noise figures but they do offer good transient protection and are easy to use (3N187, 3N200, 40819, 40820, etc). The 40673 is normally priced at

*This preamp design has proven over several years to be almost totally immune to overload/cross modulation.

FM YOUR GONSET

(or your Clegg 22'er, Poly Comm 2, PC 62, Johnson 6N2, Aerotron 500, Ameco TX 62 or VHF 1)

- New! Plug-in modulator puts the Communicator transmitter on FM.
- No modification or rewiring on your Communicator. Just plug into mike jack and crystal socket.
- Compact self-contained modulator measures 4" x 3" x 1 1/2".



- Works with Communicator I, II, III, IV and GC 105, and other rigs listed.
- FM at a tenth the cost of a new rig.
- Frequency adjust for netting built in.
- \$37.50 postpaid USA & Canada. Specify transmitter model. Calif. residents add sales tax. (HC-6/U crystal and 9 volt transistor battery not supplied.)
- Send for free descriptive brochure.

PALOMAR ENGINEERS

BOX 455, ESCONDIDO, CA 92025

ALUMA TOWERS

LOW PRICED

Made In Aluminum

- ★ TELESCOPING
- ★ WALL MOUNTED
- ★ GUYED

FOR:

**TV — CB — HAM
MARINE — MOBILE
RADIO TELEPHONE
COMMERCIAL**

Towers to 100 feet. Specials designed & made. See dealer or call.

ALUMA DIVISION

FRED FRANKE, INC.

Box 2806Q
Vero Beach, Florida 32960 U.S.A.
Phone (305)-567-3415
Cable: FREDFRANKE VEROBEACH FL.
Some Territories Available

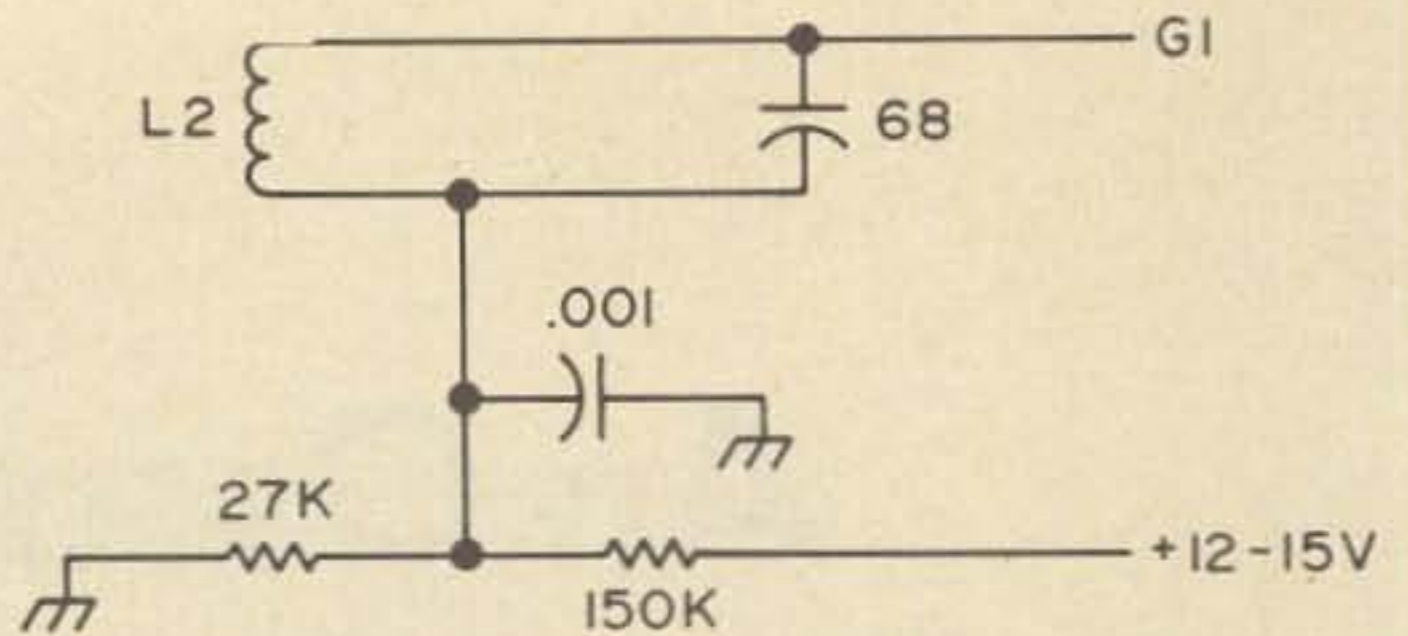

Fig. 3. Biased gate no. 1.

\$1.01.

Using the coil/capacitor combinations shown in the schematic will produce a very low noise figure and excellent gain. In some cases it is necessary to reduce the gain of the preamp because the noise from it and the antenna will overload the receiver. Two simple methods of achieving this gain reduction are to add a pad (attenuator) on the output of the preamp or make a slight modification to the preamp by biasing gate no. 1 as shown in Fig. 3. The gain will decrease as G1 is biased positively (6 V maximum).

REFERENCE

AMSAT Newsletter, March, 1973.

... W3TMZ

— WE GOT 'EM —

CLEGG, COLLINS, DRAKE, SWAN, YAESU, TEN-TEC, and many more in stock. Large selection of used equipment. See us for quick courteous service. Established 1928.

FRECK RADIO & SUPPLY CO. Inc.

P.O. Box 7287

W4WL

Asheville NC 28802

704-254-9551



YOU ASKED FOR IT! ECM-5B

FM Modulation Meter
ONLY \$132 less batteries and crystals

- 0-7.5 kHz deviation peak reading Meets commercial requirements
- Operates 30-500 MHz
- Crystal Controlled for easy operation
- Telescopic antenna

NEW OPTIONS

- NICAD power pak \$20.46
- Charger \$29.95
- Audio/scope output with earphone \$12.95

Write or call for complete info.



Send check or money order for \$132.00 plus \$1.50 for shipping. Indiana residents add 4% sales tax. Crystals for 146.94 MHz \$3.95. All other freq. \$7.10.

ECM

ECM Corporation
412 North Weinbach Ave.
Evansville, Indiana 47711
812-476-2121

Shoot Oscar with a Satellabe

Communication via Oscar satellites is, in principle, similar to conventional amateur operating procedure. In both cases, one calls or answers CQ, exchanges signal reports and other "vital" information, wraps up the QSO with a 73, and then tries to work somebody else. For communicating over long distances on VHF and UHF bands, large gain antennas are routinely employed. Because such antennas are characterized by a narrow beam-width, they must be accurately aimed toward the station sought.

While in ground-to-ground communications, directing the antenna towards the desired direction is not a particularly difficult task. In satellite work this matter becomes more complicated.

Let's review some of the problems encountered in satellite communications.

1) The large distance (912 to 3000 miles) between the spacecraft and ground station, and the QRP power of the translator, make high gain beams a necessity for Oscar communications, if consistent results are desired.

2) A satellite represents a "moving target" traveling with the velocity of 4 miles per second (14,000 mph), some 912 miles above the surface of the earth.

3) The satellite rises above the horizon several times a day for periods lasting from a few seconds to a maximum of 22 minutes, during which time it becomes available for communications. (Oscar is not accessible beyond the line-of-sight.)

4) The times the satellite rises and sets are different for each geographical location on the earth.

5) The elevation (vertical angle) of the spacecraft, in respect to the tracking station, may, during certain passes, change from 0° to 90° within a period of only 12 minutes. During the same time the azimuth (horizontal angle) may sweep an arc 180° wide.

The above points clearly imply that an Oscar user must follow the satellite with his high gain antennas to secure optimum performance. Consequently, he must know the position of the satellite in respect to his QTH at any time around the clock. This objective can only be achieved by employing some form of satellite tracking method.

The reference point for satellite tracking purposes is the time and longitude at the very instant the satellite crosses the equator from south to north. (The orbital constants of the spacecraft, period and inclination, must also be known.) Listings of Oscar 6 and Oscar 7 equatorial crossings, hereafter referred to as EQX, are published by Amsat, 73 and many other sources months in advance, and are, in general, easily available. Some listings include all daily EQX's, others provide that data for reference orbits only. A reference orbit is the first daily satellite pass which crosses the equator after 0000 GMT.

Once the EQX data becomes available to the Oscar user, it is left to his discretion how to employ it for tracking purposes.

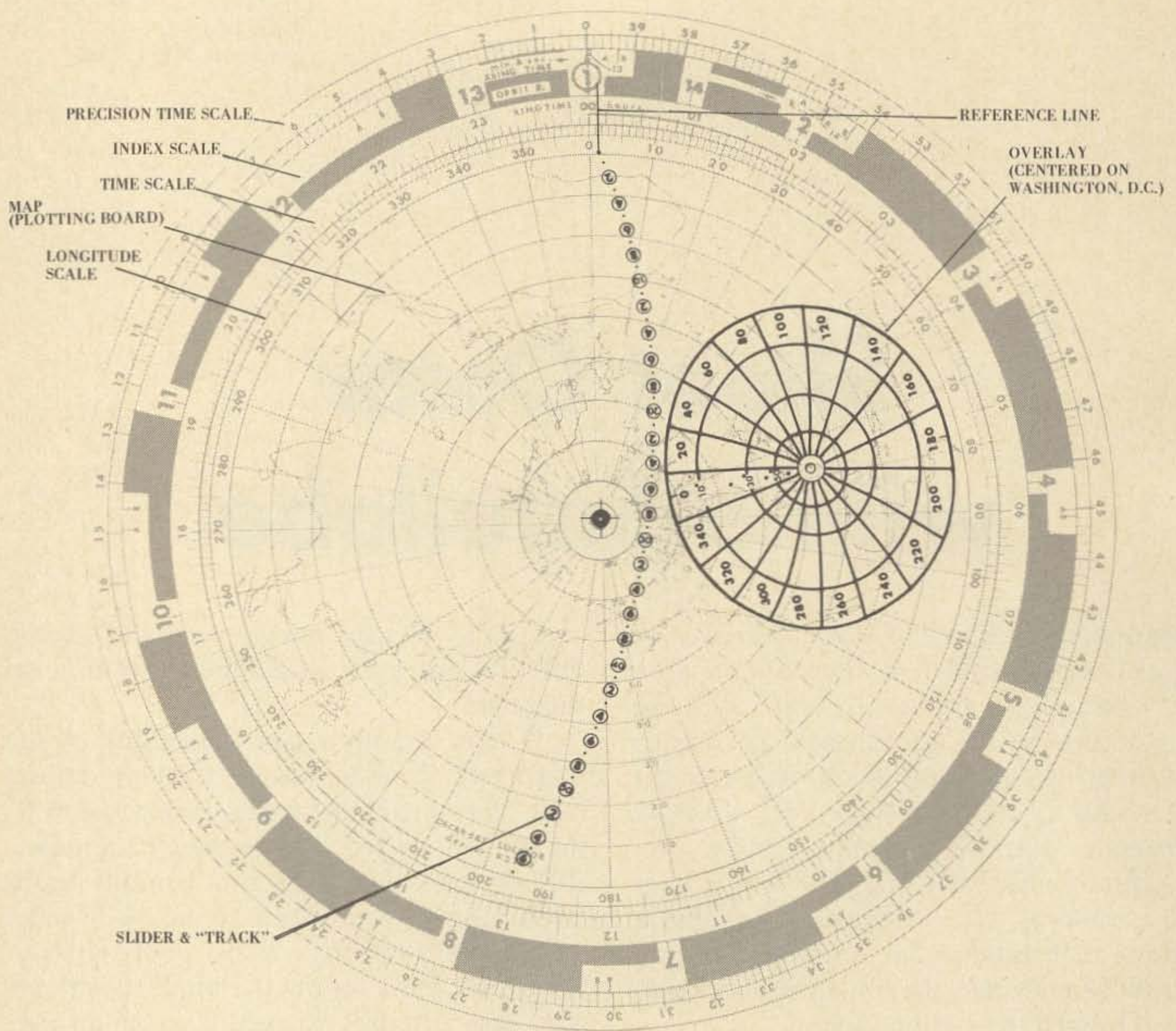

Fig. 1. Total view of Satellabe, showing four concentric scales (Map Plotting Board, Time Scale, Index Scale, and Precision Time Scale), with their relation to each other. The Range Overlay is centered on the QTH of the tracking station. Rotary transparent Slider shows the path and instantaneous location of Oscar in terms of minutes after equatorial crossing. The Slider pivots in the center of the device.

A number of amateurs, lacking adequate tracking facilities, resort to "dead reckoning" — namely, trying to guess the approximate direction and periods of accessibility of Oscar satellites. On the other end of the scale, there are individuals who by employing sophisticated mathematical formulas, processed by modern computers, come up with tracking data which equal those used by NASA.

In the middle, there is a group of Oscar users which has developed all kinds of "private" tracking methods, using globes, maps of different projection, and other ingenious schemes or devices perfectly suitable for their intended purpose. Unfortunately, the remainder of amateurs who own suitable equipment for space communications become so overwhelmed by the

apparent complexity of satellite tracking that, in all probability, they never even attempt to try this new and exciting form of amateur communications.

The device described in this article allows tracking of Oscar satellites with an accuracy exceeding the needs of even the discriminating amateur. It requires no knowledge of the mathematics or astrophysics on the part of the user.

It resembles a circular slide rule 11 inches in diameter with a map of the northern hemisphere in the middle. It operates on the principle of an "astrolabe," an instrument used by astronomers in the ancient times for predicting the apparent movement of celestial bodies as viewed from a particular location on the earth. I feel that this

“instrument” can be called a Satellabe for lack of a better name.

The Satellabe must be pre-set only once a day using EQX data of the reference orbit of the day for which it will be employed. Once pre-set, the following become immediately available in easy and illustrative form:

- EQX time and longitudes of all consecutive orbits of that day with an accuracy of ± 5 sec time and $\pm .5^\circ$ longitude.
- Location of sub-satellite point in respect to the northern hemisphere at any time during the next 24 hours with an error no larger than 100 miles.
- Periods of time, $\pm .5$ minute, during which the satellite remains within theoretical range of accessibility of the tracking station.

– Instantaneous beam headings, both azimuth and elevation, during each in-range pass of the satellite. The accuracy is about $\pm 5^\circ$ for distant passes, but it is somewhat worse for close approaches where the elevation changes very rapidly with time.

– EQX data of the reference orbit of the next day, accurate to within ± 2 sec time and $\pm .5^\circ$ longitude.

The Satellabe is an analog device and, like a slide rule, its accuracy depends on the precision with which it is made. Conceivably, this device can be made much more accurate if techniques employed in developing good quality circular slide rules are used.

The Satellabe (Fig. 1) resembles a circular

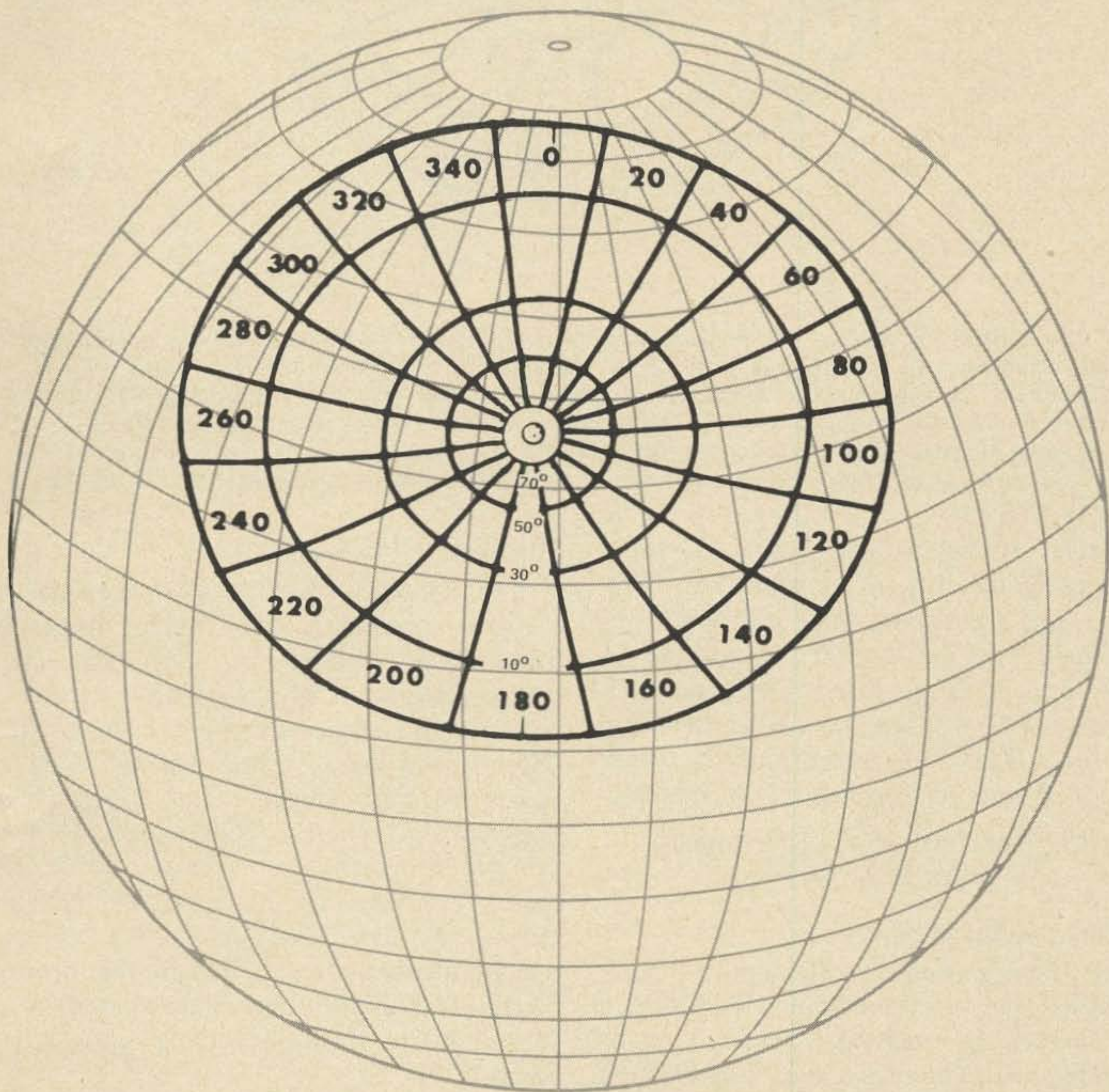

Fig. 2. Range Overlay placed on a globe. The circle represents the area of accessibility of Oscar (2450 miles) from the point in the center of the Overlay. Azimuth lines shown are 20° apart. Concentric circles show the locations where the satellite will be positioned 10° , 30° , 50° and 70° above the horizon of the tracking station; interpolation is used for in-between angles.

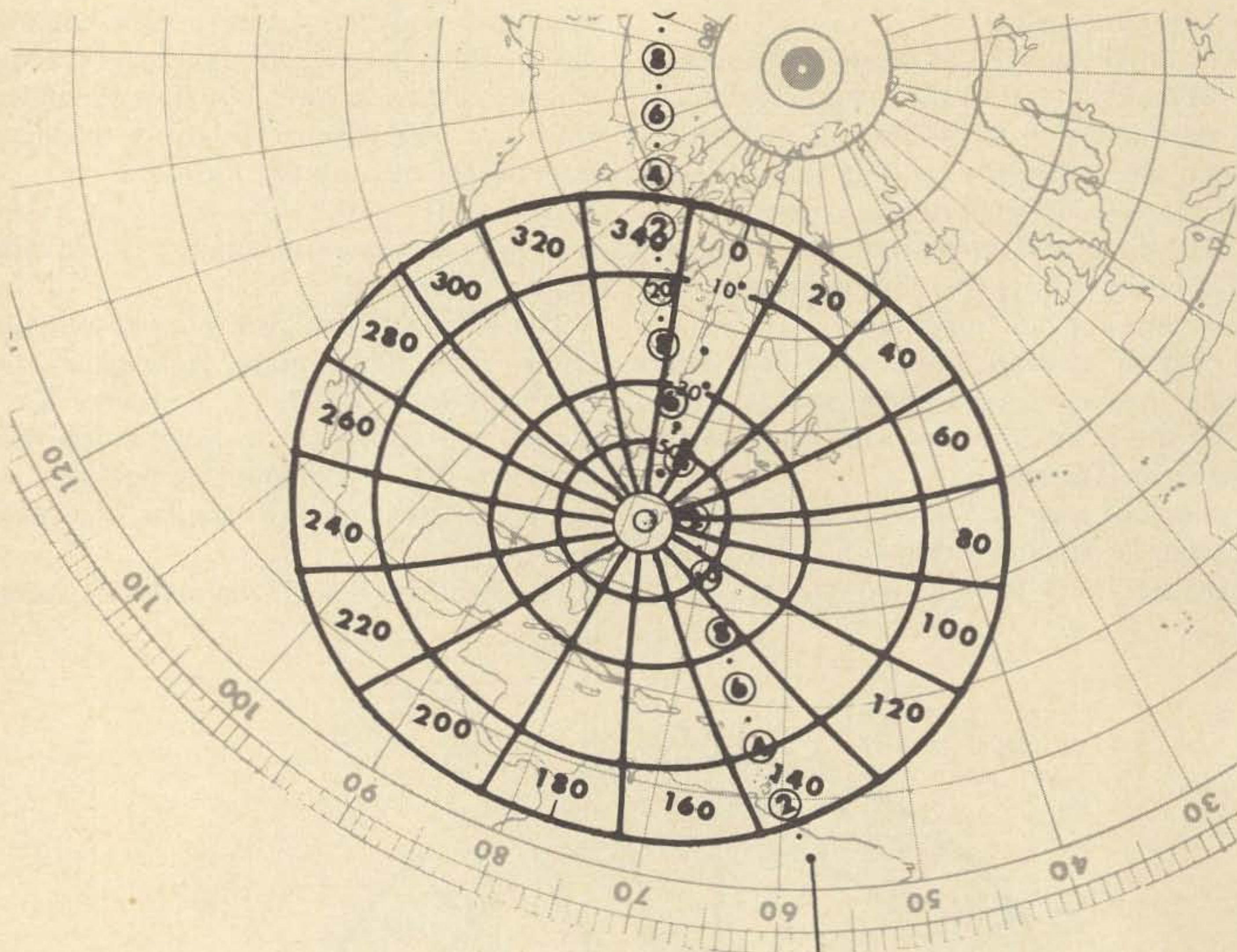

Fig. 3 (Section of Fig. 4). The Range Overlay transposed on a flat map looks like an ellipse; straight azimuth lines become curved. The position of the satellite in respect to the tracking station is determined by its instantaneous location, in terms of minutes after crossing the equator, and by relating it to markings on the Overlay. It can be seen, in this example, that during this pass Oscar will enter the area of accessibility 2.5 minutes after EQX and descend beyond the horizon 24 minutes after EQX. 12 minutes after EQX, for instance, the azimuth will be 100° and elevation 50° in relation to the tracking station.

slide rule. It has 4 scales, one of them representing the map of the northern hemisphere,, and a rotating slider that simulates the "track" of the satellite. In addition, a Range Overlay is provided. This overlay is affixed on the map and must be centered on the user's QTH. All scales and the slider pivot on the center (north pole) of the map.

DESCRIPTION AND FUNCTIONS OF SCALES

The Plotting Board (Map)

The first (innermost) scale depicts a polar projection map of the northern hemisphere with degrees of longitude indicated on its circumference. The map serves as a Plotting Board where the position of the satellite is being determined. A polar graph can be used instead of the map; the map, however, is more illustrative.

The Slider and "Track"

The Slider, made of thin transparent material, represents the "track" (locus of sub-satellite points) of any spacecraft orbiting the earth with a period close to 115 minutes and inclined approximately 102° ; Oscar 6 and 7 and several weather satellites belong to this category. The "track" is so designed that when its Reference Line is set on the longitude of a chosen EQX, the "track" follows the path of the satellite during this particular pass. The numbers printed along the track indicate the location of the satellite after that many minutes from the moment the space craft crossed the equator.

Using the map with the described slider and knowing all daily EQX data is sufficient to plot the location of the satellite at any time during that day. Those informations,

EBC 144JR



HEY! This is like two transceivers in one! Fully synthesized covering 143.5 to 148.5 MHz in 5 kHz increments. Operate Simplex or Repeat on either Channel A or B at the flip of a switch! Split mode allows total independent receive and transmit frequencies. PLUS, standard or reverse 600 kHz offsets up or down automatically and a priority channel that switches you over as soon as a signal is detected.

\$599.00

- Sensitivity — .35uV for 12 dB sinad, .30uV for 20 dB quieting
- 20 Watts output
- Intermodulation, spurious and image 60 dB minimum
- 10 pole xtal filter
- Frequency stability .001%
- Built in S-meter and speaker
- 12 volt operation

**write for your closest
stocking dealer**

**emergency
beacon corp.**

15-B10 River Street
New Rochelle NY 10801

GATEWAY ELECTRONICS

8123 Page Blvd.
St. Louis MO 63130
(314)427-6116

2839 W. 44th Ave.
Denver CO 80211
(303)458-5444

THUMBWHEEL SWITCHES

STANDARD SIZE - 0.5 x 2.125 x 1.78

10 position decimal **\$3.00**

10 position BCD & comp. **\$4.00**

End Plates (per pair) **\$1.45**

MINIATURE SIZE - 0.312 x 1.3 x 1.3

10 position decimal **\$2.50**

10 pos. BCD & comp. **\$4.00**

10 pos. BCD only **\$2.50**

End Plates (per pair) **\$.50**

Divider Plates **\$.40**

Blank Body **\$.40**

Half Body **\$.40**

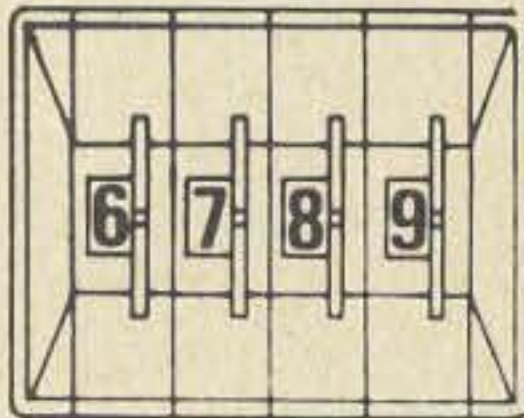

All switches are black with white figures and snap-in front mounting.

RF TRANSISTOR - Motorola 9477 -
2.3 Watt - 175 MHz - used in PT and
HT Series handy-talkie - **\$2.00**

SCR - 200 Volt - 110 Amp SCR with
heat sink - ship wt 5 lb. **\$8.50**

SCR - 50 Volt - 8 Amp SCR - 2N4441
- **.75**

SCR - 100 Volt - 4 Amp SCR -
C106-A1 - **.75**

SCR - 300 Volt - 4 Amp SCR -
C106-C1 - **\$1.00**

SCR - 100 Volt - 800 mA SCR -
2N4147 - **.75**

SOLDER 63/37 Alpha Vacculoy - 2 lb.
bar solder - ship wt 2 lb. **\$6.00**

TV CHEATER CORD - 18 ga. 8 foot
length - ship wt 1 lb. **.40**

AC LINE CORD - 18 ga. 8 foot length -
ship wt 1 lb. **.35**

CO-AXIAL ANTENNA RELAY - 6 Volt
dc coil - BNC conn. - ship wt 1/2 lb.
\$5.00

PC GLASS BOARD - Single sided - 8"
x 5 1/2" - ship wt 1/2 lb. **.90** 12" x 4 1/2" -
ship wt. 1/2 lb. **\$1.00**

JULY SPECIAL CALCULATOR CHIP

TI Type TMS 0103NC - 8 digit -
4 function - floating or pre-set
decimal point - constant - fits 28
pin dip socket - with data
sheets. **\$2.95**

*\$5.00 minimum order -
Please include sufficient postage.*

VISIT US WHEN IN ST. LOUIS OR DENVER

however, are not adequate to determine the exact position of the satellite with respect to the geographical location of the tracking station. At this stage, we can only roughly estimate the approximate direction, elevation, and periods of accessibility by "dead reckoning" and educated guesses.

The Overlay

In order to obtain more accurate information regarding azimuth, elevation, and the time when the satellite passes over the horizon, as viewed from the QTH of the tracking station, a range overlay has been developed.

If such an overlay was designed for a globe (rather than a flat map) it would take the form of a circle with a radius equivalent to 2450 miles, or 35.6 great circle degrees. The overlay must be centered on the geographical location of the tracking station (see Fig. 2). This circle represents the area of accessibility of a satellite orbiting at an altitude of 912 miles. In other words, when the satellite passes through the area of the overlay its position lies above the horizon of the tracking station (not considering local topography) and communication becomes possible. A circle on the globe can easily be divided into azimuth sectors; then, circles of equal elevation angles can be calculated and drawn as shown on Fig. 2.

Due to projection distortion, what is a circle on a globe resembles an ellipse when transferred to a polar projection map; also, straight azimuth lines become curved. With the aid of the overlay, centered on our QTH, we now can easily track the satellite in reference to our geographical location. While following the satellite minute by minute after it has crossed the equator, we may now determine its azimuth and elevation by relating its instantaneous location to the elevation and azimuth marking of the overlay.

The time of accessibility is simply established by noting the time at which the satellite track enters and exits the overlay (see Fig. 3).

HINT: It is very convenient to use an auxiliary clock. If this clock is set to indicate 00 minutes at the exact time the satellite crosses the equator, the numbers on the

slider will directly correspond to the time shown by the clock.

The Time Scale

The second disc is the equatorial crossing Time Scale. Its function will be described further in the text. This scale is divided into 24 major segments of 15° , representing GMT hours. These are further sub-divided into 10 and 5 minute intervals of 2.5° and 1.25° respectively. You may note, for future reference, that 1 minute on this scale equals $.25^\circ$.

The Index Scale

The third disc is the Index Scale. It works in conjunction with the first, second and (not yet described) fourth scale. This scale contains 14 index marks spaced 28.74° apart. They represent the averaged and rounded intervals between successive EQX longitudes of Oscar 6 and 7. (The exact precesses are 28.748637° for Oscar 6 and 28.73625° for Oscar 7.)

If the EQX longitude of the reference orbit of the day is lined up with the #1 index position, the remaining index marks will indicate positions on the equator of all successive EQX of that day. The longitudes of these crossings can be read on the circumference of the map.

The index marks superimposed on the Time Scale (second disc) divide the time into intervals corresponding to the period of a satellite that has a precess that equals the separation, in degrees, of the index marks. Again, if the EQX time of the reference orbit of the day (as read on the Time Scale) is lined up with #1 index position, the remaining index marks will indicate the time of successive EQX's.

The precess and the period of a satellite are directly related to each other. The fact that the earth revolves 360° in 24 hours, or in 1440 minutes, means that any point on the surface of the earth travels with an angular velocity of $.25^\circ$ per minute. Consequently, during one period of the satellite (P) the earth rotates $P/4$ degrees. Therefore, the quantity $P/4$ becomes equal to the precess of the satellite.

The above relation allows using the index marks spaced $P/4^\circ$ apart for indexing both

HERE IS A FIST FULL of 2 METER POWER



NEW

American Made
Quality at Import Price

Model HRT-2 5 Channel, Narrow Band 2.2 watt FM Transceiver

This light weight, "take anywhere" transceiver has the "Regency-type" interior componentery to give you what others are looking for in portable communications. You get a heavyweight 2.2 watt signal . . . or if you want, flip the HI/LO switch to 1 watt and the receiver gives you 0.7 uv sensitivity and 0.5 watts audio. Both transmitter and receiver employ band-pass circuitry so that power and sensitivity are maintained across the entire band. Get one to go . . . only

\$179⁰⁰

Amateur Net

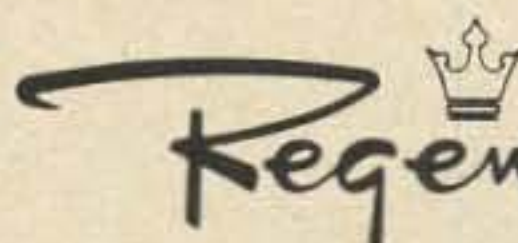
 **Regency ELECTRONICS, INC.**

7707 Records Street
Indianapolis, Indiana 46226

An FM Model For Every Purpose . . .
Every Purse



HR-2MS
8 Channel Transcan
2 Meter FM Transceiver



HR-212
12 Channel-20 Watt
2 Meter FM Transceiver



AR-2
2 Meter FM
Power Amplifier

time and longitude of consecutive EQX's. The index marks of the Satellabe, spaced 28.74° apart, assume the averaged period of Oscar 6 and 7 to be 114.97 minutes or 114 min. 58.2 sec. Since the period of Oscar 6 is 114 min. 59.673 sec. and that of Oscar 7 is 114 min. 56.7 sec, the error amounts to approximately 1.5 seconds per orbit. Such an error is too small to be resolved on the Time Scale. Actually, considering the relatively small size of the Satellabe, the equatorial crossing time, read on the Time Scale, can be determined to an accuracy not much better than ± 1 minute, even on the most accurately drawn and centered devices.

Summarizing: It has been shown that setting the EQX time and longitude of a reference orbit under position #1 of the index scale results in immediate availability of EQX data of all successive orbits of the day. Furthermore, placing the reference line of the slider against any of the index marks allows display of the path of the satellite during that particular pass over the northern hemisphere.

This feature is very convenient for the purpose of "pre-viewing" the entire day's operation. Rotating the slider from one index mark to the next, it now becomes very easy to see which passes will be in-range,

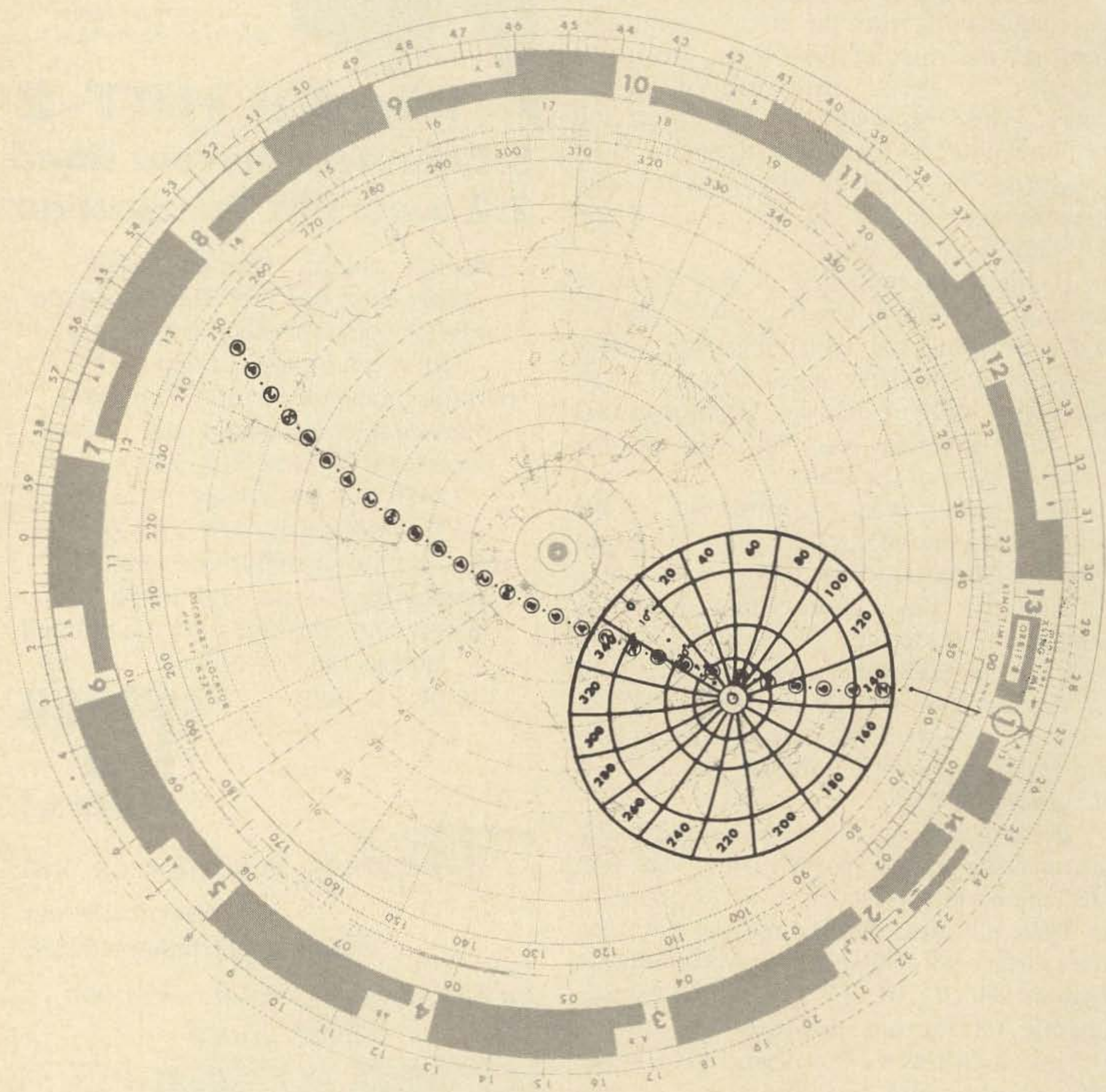

Fig. 4. Setting of the Satellabe for operation on February 24, 1975. The EQX time and longitude of the Reference Orbit are 00:26:54 GMT and 56.6° . The "track" shows the position of the satellite every minute after the spacecraft has crossed the equator.

marginal, or "out of sight." The times of operation will also be easy to pre-plan because the time when the satellite's path enters the overlay can now be clearly estimated. This is particularly convenient for daytime passes, when the satellite appears within range about one half hour after EQX time.

The Precision Time Scale

Estimating the time of successive EQX's with an accuracy of a couple minutes may be quite satisfactory to most Oscar users. Some amateurs, however, would like to have this data available with much better precision. For those who use very high gain antennas, characterized by very narrow beamwidths, an error of two minutes is significant, especially when the satellite passes nearly overhead and its elevation changes rapidly with time. The EQX time inaccuracy of the Satellabe can easily be corrected if orbital predictions of all daily passes are available. Those who have access only to reference orbit data must resort to the pencil-and-paper method.

In order to improve the accuracy of prediction of successive EQX time, the Precision Time Scale has been developed. This scale, the fourth, is divided into 60 sections of 6° each, representing minutes, and is further sub-divided into 10 second segments at 1° intervals.

An additional set of index marks, designated "A" for Oscar 6 and "B" for Oscar 7, has been placed on the outer rim of the index scale and "framed" together with the corresponding original index marks described previously. "A" and "B" index marks will be used to predict EQX time with an error of only a few seconds. This accuracy can be tolerated by even the demanding Oscar users.

In order to predict the time of subsequent EQX's, the rule of thumb in Oscar work is to add 115 minutes, or more conveniently add 2 hours and subtract 5 minutes, to each successive EQX time. Because the exact period of Oscar 6 is 114 minutes 59.673 sec. and of Oscar 7, 114 minutes 56.7 seconds, the "rule of thumb" results in an error of about .3 sec. and 3.3 sec. per orbit for Oscar 6 and 7 respectively.

This error may appear trivial; nevertheless, it amounts to more than 40 seconds per day for Oscar 7.

Index marks "A" and "B" are so arranged around the Index Scale as to subtract 5 minutes .3 seconds and 5 minutes 3.3 seconds from the successive EQX time of Oscar 6 and 7. It should also be mentioned that additional marks can be placed for other satellites having different orbital periods.

To use the Precision Time Scale, the minutes and seconds of EQX time of the reference orbit are set against the #1 position of the index scale. Then, the minutes and seconds of all daily equatorial crossings are read *above* marks "A" for Oscar 6 and *above* "B" for Oscar 7 on the Precision Time Scale. The "A" and "B" marks are "framed" together with corresponding precess index marks for easier identification. The hours of EQX time are read on the Time Scale as described previously.

How To Use The Satellabe

Let us try an example:

The tracking point is Washington, D.C., located at latitude 39° N. and longitude 77° W. The overlay is centered on the above coordinates.

The orbital data for February 24, 1975 indicates EQX of the Reference Orbit of Oscar 7 to be 00:26:54 GMT and longitude 56.6°.

The Satellabe is set as shown on Fig. 4.

Lined up under the Reference Line of the Slider are:

EQX longitude 56.6° at the equator of the map;

EQX time 00:27 GMT — Time Scale;

#1 position of Index Scale;

26 min. 54 sec., on the Precision Time Scale (fourth disc).

Analyzing the first pass we see that:

1) Acquisition of Signal (AOS) will occur 2.5 minutes after EQX, beam heading 145°.

2) Beam headings during the pass will be:

MINUTES AFTER EQX	AZIMUTH	ELEVATION
5	142°	10°
7	140	20
9	135	30
10	130	40

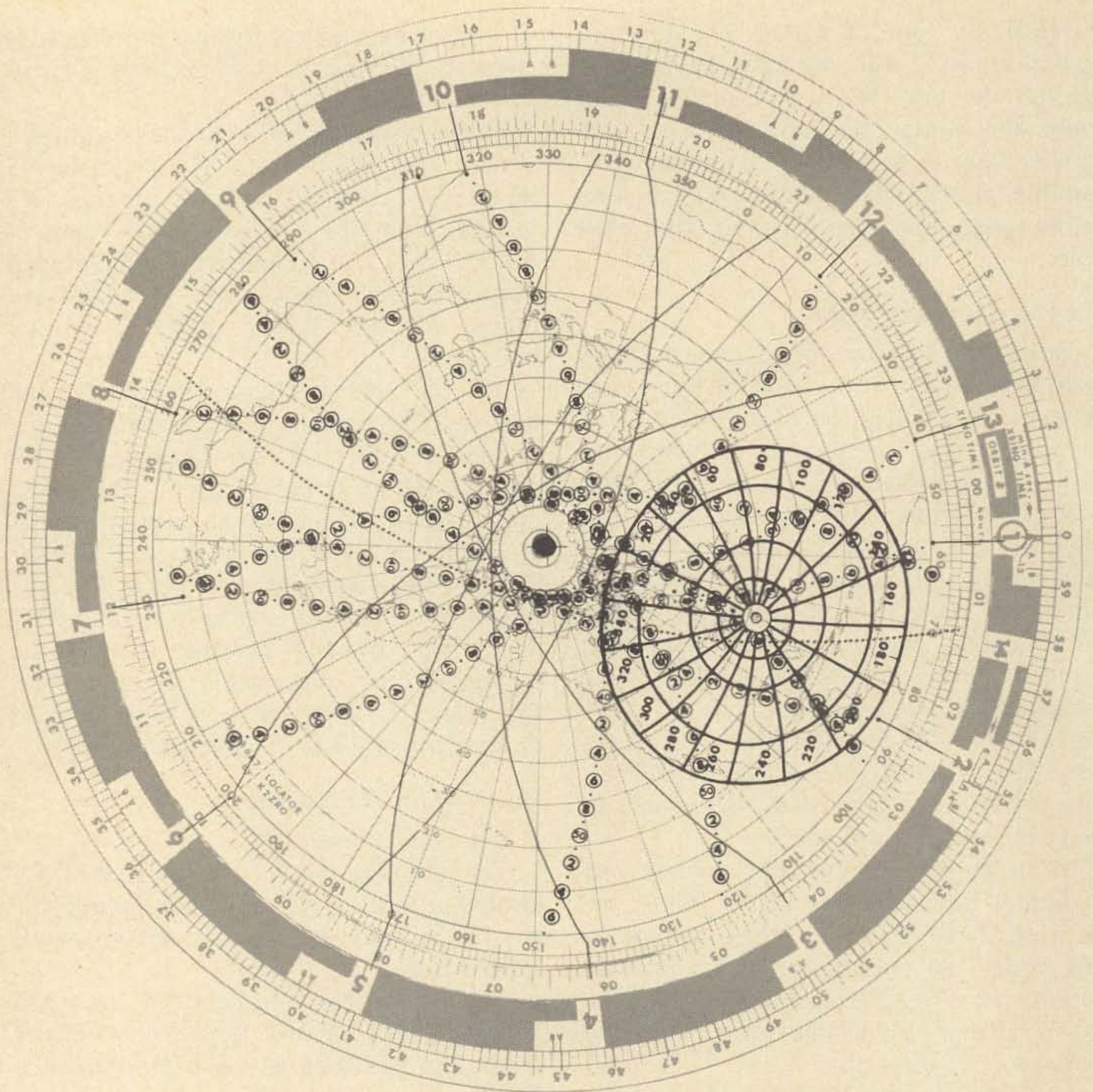

Fig. 5. This drawing may look rather "messy"; nevertheless, it shows all passes of a satellite over the northern hemisphere during one GMT day. Orbits not in-range of the tracking station are shown as solid lines. Moving the Slider through consecutive Index Marks allows recognition of in-range passes and time of AOS and LOS for each orbit. Overhead and marginal passes can easily be recognized. EQX longitude of each pass is read under the corresponding Index Mark; the approximate EQX time is read on the Time Scale opposite Index Marks; the exact time (minutes and seconds) is read on the Precision Time Scale above marks "A" or "B" for Oscar 6 and 7 respectively. The Reference Orbit of the next day is Orbit 14 in this example, because it is the first pass that occurred after 0000 GMT. Setting the values of EQX time and the longitude of the 14th orbit under the Index Mark #1 makes the Satellite available for the next day's operation. On alternate days pass #13 will be the next day's Reference Orbit.

12	105	50
13	70	60
14	40	60
15	20	50
16	10	40
18	355	30
19	355	20
21.5	350	10
24	350	0

minutes after EQX at azimuth of 350° .

Now we will preview the whole day's operation.

Without disturbing the original setting of all scales (locking them with a paperclip works fine) we place the Reference Line of the Slider against each consecutive index mark and draw the following conclusions (see Fig. 5):

3) Loss of Signal (LOS) will occur 24

Orbit 2

EQX: 02:21:51 GMT; use marks "B" for Oscar 7; longitude 85.5°;

Pass within range; AOS-2 min., LOS-22 min. after EQX;

Beam heading 200°-320°;

Closest approach 11 min. after EQX, elevation 30°.

Orbits 3, 4, 5 and 6

Out of range.

Orbit 7

Pass in range; EQX: 11:56:38 GMT; 229°;

Looks like a good pass to work Europe;

AOS-37 min., LOS-55 min. after EQX;

Beam heading 40°-145°; closest approach elev. 20°, 46 min. after EQX.

Orbit 8

Pass within range, almost overhead, close to 90° elevation 45 min. after EQX;

EQX: 13:51:34 GMT; 258°;

AOS-34 min., LOS-56 min. after EQX.

Orbit 9

Pass in range; EQX: 15:14:30 GMT; 287°;

AOS-33 min., LOS-50 min. after EQX;

Closest approach 42 min. after EQX, elevation 20°.

Orbit 10

Marginal pass; EQX: 17:41:28 GMT, 316°;

Probable AOS-34 min., LOS-46 min. after EQX, provided the horizon is virtually at 0° elevation.

Orbit 11

Out of range.

Orbit 12

Pass in range but just about over the horizon;

Good for working Eastern Europe;

EQX: 21:31:20 GMT, 13°;

AOS-16 min., LOS-24 min. after EQX;

Beam heading — horizontal throughout the entire pass, azimuth 60°-10°.

Orbit 13

Pass in range; EQX: 23:26:17 GMT; 41.5° (Note that "A" and "B" marks for Orbit 13 are located to the left of index mark #1 and are labeled "13".);

AOS-55 min., LOS-25 min. after EQX.

Zulu 10... precise GMT plus 10-minute identification alarm.



From Corvus, a unique 100% solid-state digital clock packed with features any ham radio operator will appreciate.

Built around a single MOS integrated circuit, Zulu 10 provides 24-hour GMT with to-the-second accuracy. The special alarm alerts you every 10 minutes with a soft, pleasant signal to help you meet station identification requirements. And it's reset with a single "flick of the wrist" motion of the clock.

Feature-packed, trouble-free operation.

- Bright LED display for hours and minutes. Seconds are indicated by a pulsing lamp
- Automatic display dimming for easy viewing
- Attractive, compact silver case
- Pushbutton controls neatly tucked in base
- 60 HZ AC operation
- Full year written warranty

Designed and engineered for the ham radio operator by Corvus Corporation, Dallas-based subsidiary of Mostek Corporation, an industry leader in MOS integrated circuit technology.

Order yours today.

corvus

13030 Branch View Lane, Dallas, Texas 75234

Please send me ___ Zulu 10(s) at \$39.95 each, plus \$2.65 for postage and handling (add local and state tax where applicable). I've enclosed check money order.

Name _____

Address _____

City _____ State _____ Zip _____

Money back guarantee. If you are not totally satisfied with your Zulu 10, send it back to us within 10 days and your money will be refunded.

73

SWIPED: Kenwood TS520 transceiver s/n 040600, Drake T4XB transmitter s/n 16869, Drake R4C receiver s/n 18897, Standard SRC826M transceiver s/n 203066, RP MFA22 synthesizer s/n 000133, Heath SB610 monitor scope. \$50 reward for information leading to the arrest and conviction of the guilty party(s). Contact Gerald P. Swetsky WB9EBO, 219 E. Division, Villa Park IL 60181 - 833-8122.

LIFTED: Regency HR212 s/n 24-01453 filled with crystals. CFAR - A.F. Mars Repeater 154.34 RX. Contact Clark Fulton W9GYN.

STOLEN: at Dayton Hamfest. Ultracom 25 2 meters FM s/n 090511. Contact Montgomery County Sheriff's office, 333 W. Second St., Dayton, Ohio. John Dykstra VE3BOY.

RUSTLED: 2 meter Gladding 25 from my car March 5. s/n 97050370. Stan Hart WA4GQA.

ROBBED: IC-22A s/n 3401424. Contact Stan Staten K4JOB, 729 No. Edison St., Arlington, Virginia 22203, 703 527-5628 or Officer Dennis of U.S. Park Police - case no. 11527.

RIPPED OFF: HW-202 s/n 04350; HW-100 s/n 006-4255. Contact Donald L. Upp WB8STQ, 52 East Sherry Drive, Trotwood OH 45426.

TAKEN: Standard 826M w/9 channels installed s/n 106049. Contact Ron WB8NWK9, 1005B W. North Avenue, Villa Park IL 60181.

HIJACKED: Standard SRC-146 ht s/n 3708560 with rubber ducky, external mic, case, 94/94, 34/94, 07/67, 84/24, ABE. Contact Phil WA0QLA, K3TNV or WA6HMC on WR6ABE.

ABDUCTED: Drake TR-22 all channels filled, 131.5 PL circuit 34/94, 94/94, 16/76, 37/97, 52/52, 97/37 s/n 720050 also same number is engraved on chassis near speaker. Contact Allen R. Short WA9FPU, 205 Boardman Drive, La Porte IN 46350.

PILLAGED: Drake TR-22C 2M FM transceiver s/n 810,989. Contained 8 sets of crystals on various repeater frequencies. Also a Johnson C.B., 5 channel set, Model 110. Contact Gerald E. Jelley W8PGC.



**The Hamburglar
STRIKES AGAIN!**

PLUNDERED: Yaesu FT 401B, serial #316104, Yaesu FV 401, #679927, Collins 75A4, #5564, Johnson Valiant, #29166, Johnson matchbox, Heathkit SB200, electronic keyer, vibroplex key, Yaesu mike, speaker and headphones. Contact Vermont State Police or Peter Kragh, 170 Summit Avenue, Ramsey NJ 07446. W1BRG.

SNATCHED: Varitronics HT-2, serial #640256. Contact Sam Pliscof K3ZPH.

Orbit 14

Pass in range; EQX: 01:21:11 GMT; 70.5°. (Note that "A" and "B" marks for Orbit 14 are located near index mark #2 and are labeled "14".)

Because the EQX of Orbit 14 occurred after 0000 GMT it becomes the Reference Orbit of the next day, namely, February 25, 1975.

Using the data of EQX of this orbit, we set those values (01:21:11 GMT and 70.5° longitude) under index #1 and the calculator is ready for the next day's operation.

The next day's Reference Orbit is either Orbit 13 or 14 of the present day, whichever occurs first after 0000 GMT.

The above example illustrated the simplicity of operation and ease with which the Satellabe can be used for tracking Oscar satellites. All tracking information is presented in a readily understood pictorial form, which makes this device a good teaching tool. The analog operation of the Satellabe, and particularly the ability of pre-viewing the entire day's operation is, I dare say, easier to apply and interpret than

computer generated rows of numbers containing essentially identical information.

Familiarity with the Satellabe may yield more information than is presented in the text. Here are a few examples:

1) Using additional overlays centered on different locations of the world would allow one to recognize if that area is workable via Oscar (overlays overlap).

2) All accessible locations can be worked only if the satellite's track passes through the overlapping sector of both overlays. The EQX longitudes and the time of accessibility can be easily predicted ahead of time.

3) The maximum communication range from any location on the northern hemisphere can be established.

4) Using a "movable" overlay, one may track the satellites while mobile and traveling large distances in a short span of time (such as aeronautical and maritime mobile).

5) The satellabe is easily adaptable for tracking satellites other than Oscars which circle the earth in similar orbits.

... K2ZRO

Suddenly...the answer IS KENWOOD

Today when you ask "How can I modernize my SSB operation?", the answer certainly is KENWOOD. The deluxe TS-900 transceiver, the superb, go-anyplace TS-520 transceiver and the versatile R-599A receiver and T-599A transmitter offer today's amateur advanced design, reliable solid-state performance, contemporary styling. . . and the cost is modest. Now more than ever the answer is KENWOOD.

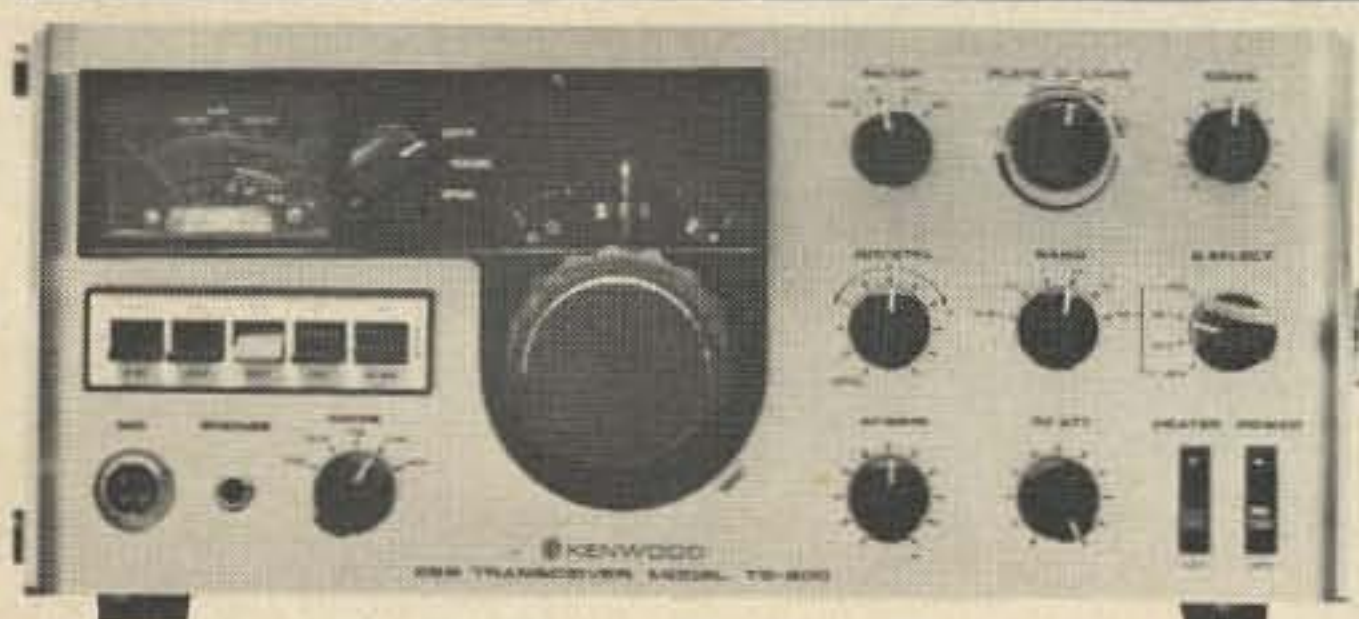

TS-900 Kenwood's superb state-of-the-art SSB transceiver

. . . the ultimate transceiver. The promise of the transistor has been fulfilled. Here is the transceiver you will want to own . . . whatever you have now, get ready to trade up. Its important features are far too numerous to list. Its specifications are superb. The TS-900 is unquestionably the best transceiver of its kind ever offered.



TS-520 Kenwood's go every place . . . do everything transceiver

The new TS-520 is the transceiver you have wanted, but could not buy until now. It is a non-compromise, do everything, go everywhere 5 band transceiver for SSB or CW that performs equally well at home, in an automobile, airplane, boat or trailer. The TS-520 features built-in AC power supply, built-in 12 volt DC power supply, built-in VOX with adjustable gain delay and anti-VOX.

The "Twins" by Kenwood



R-599A Receiver

The R-599A is the most complete receiver ever offered. It is solid state, superbly reliable, small and lightweight, covers the full amateur band . . . 10 thru 160 meters, CW, LSB, USB, AM, AM.N and FM.

The T-599A is mostly solid state . . . only 3 tubes, has built-in power supply, full metering (ALC, Ip, RF output & high voltage), CW-LSB-USB-AM operation.



T-599A Transmitter

WRITE FOR QUOTE ON TRADES

TUFTs

"New England's Friendliest Ham Store"

INVITES YOU TO SEE THE ABOVE LINE

TUFTS

Radio Electronics

386 Main St., Medford, Mass. 02155

PUT MORE REACH IN YOUR FM WITH A TEMPO RF POWER AMPLIFIER FROM HENRY RADIO

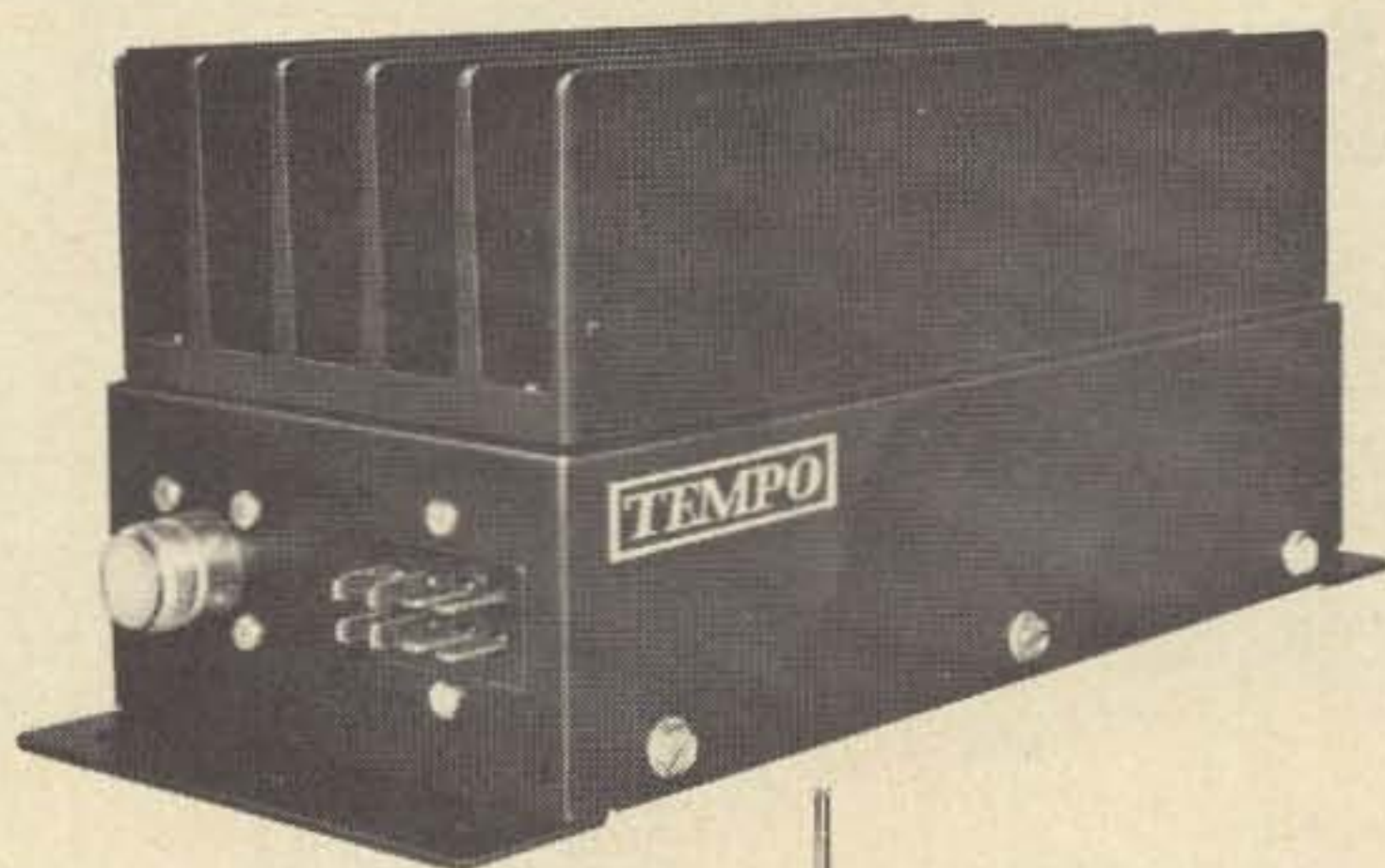

With the simple installation of a Tempo VHF or UHF power amplifier you can extend the range of your mobile FM transmissions far more than you dreamed possible.

They operate in the VHF frequency range of 135 to 175 MHz and the UHF range of 400 to 512 MHz, offering a wide choice of power outputs. They effectively increase the range and clarity of two way communications under all operating conditions, can be used with hand held units, low or medium power mobile transceivers or in repeaters.

Altho moderately priced, Tempo amplifiers offer meaningful savings in new equipment costs and greater efficiency in either new or existing communications systems. Are compact, reliable, fool-proof to operate and are available for immediate delivery.

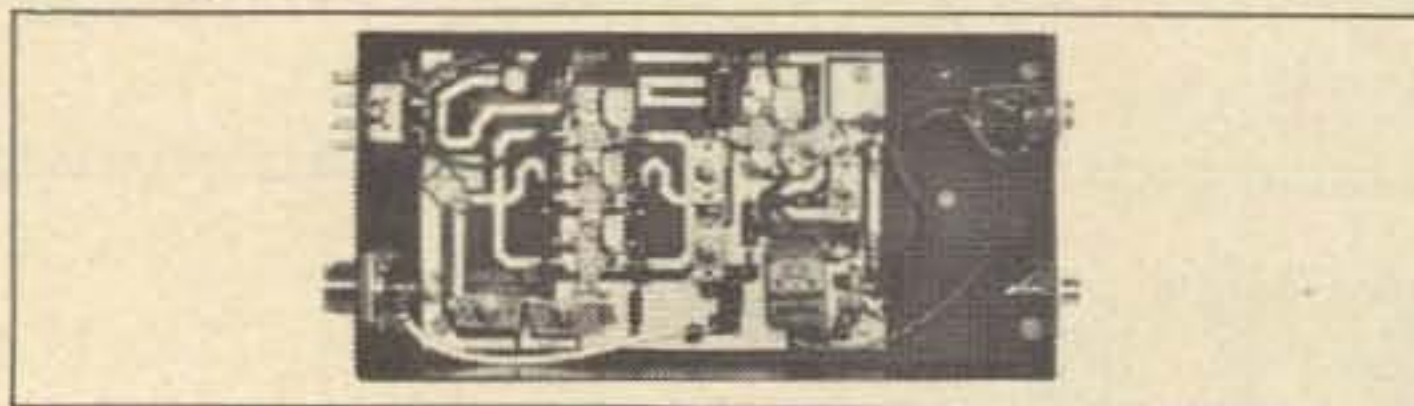

Modern solid state technology is used throughout, along with conservatively rated components to assure the highest possible reliability. Microstrip design on glass epoxy circuit boards give added resistance to damage from shock or prolonged vibration.

FCC type accepted models also available.

Available at select Tempo dealers throughout the U.S.

*High performance at low cost...
the Tempo FMH*

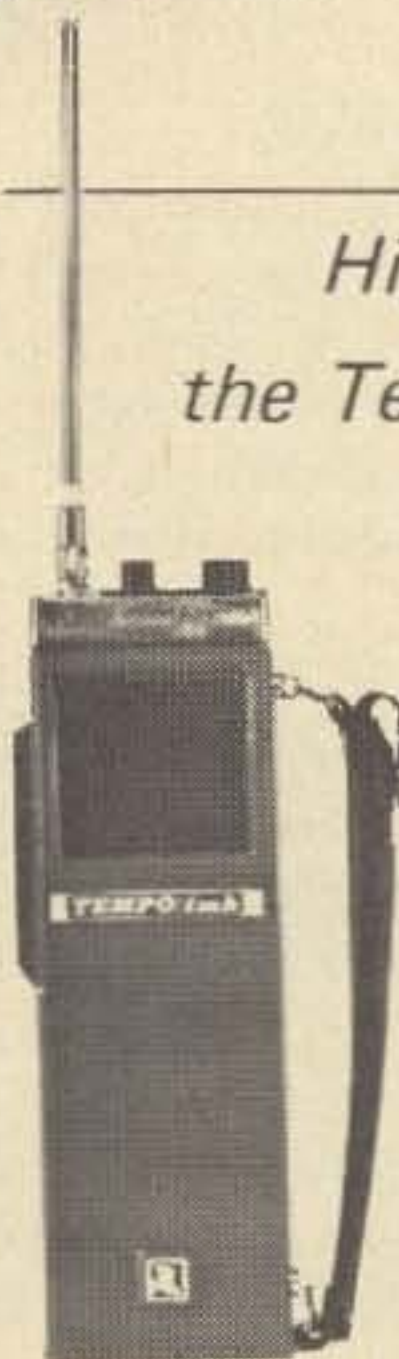

Excellent performance at low cost. The Tempo FMH is a compact two watt VHF/FM transceiver offering high quality performance and features usually found on more expensive units. Six channel capability, completely solid state, lightweight and reliable. A perfect companion for the Tempo RF power amplifiers. Plugged into the amplifier, the hand held FMH becomes a mobile with much greater power. \$199.00

FMH-MC for marine & commercial service also available.

The Tempo 6N2

Meets the demand for a high power six meter and two meter power amplifier. Using a pair of Eimac 8874 tubes it provides 2000 watts PEP input on SSB and 1000 watts input on CW and FM. Completely self-contained in one small desk mount cabinet with internal solid state power supply, built in blower and RF relative power indicator

\$795.00	
2 meter only	\$695.00

For prices and specifications please write

Henry Radio

11240 W. Olympic Blvd., Los Angeles, Calif. 90064

931 N. Euclid, Anaheim, Calif. 92801
Butler, Missouri 64730

213/477-6701
714/772-9200
816/679-3127

Prices subject to change without notice.

Raphael Soifer K2QBW
c/o AMSAT
P.O. Box 27
Washington DC 20044

Oscar -

A Certificate Hunter's Paradise

Since the first edition of this article appeared in the AMSAT *Newsletter* of June, 1973, operation via amateur satellite has increased approximately threefold. More than 3,000 stations are now active, and the addition of AMSAT-OSCAR 7 with its two translators has introduced a whole new dimension. Several new operating awards have been offered, and the rules for many of the older awards have been changed. The present article has been revised and additional material has been included to bring the awards situation up to date as of February, 1975. As with the previous edition, this article will focus primarily on awards available to amateurs in the United States and Canada, as well as awards of international scope. No attempt has been made to include local or regional-type awards where the areas involved are not within satellite range of North America.

Satellite Communicator's Club

Sponsored by AMSAT, this attractive certificate is offered to any licensed amateur station, anywhere in the world, making a two-way contact through AMSAT-OSCAR 6 or AMSAT-OSCAR 7. To receive yours, send a QSO report, requesting the Satellite Communicator's Club certificate, to AMSAT, P.O. Box 27, Washington DC 20044, USA. Please include the call of the station worked, the satellite, downlink frequency (e.g., 29 or 145 MHz) and modes (e.g., CW or SSB) used, and whether or not you have received a QSL card. A QSL is not required for this award, but sending in a report is. If possible, please use the official AMSAT "Summary Sheet for Two-Way Satellite Contacts," copies of which are available on request. In addition to your certificate, you may request with your report an AMSAT-OSCAR 7 QSL card, telemetry and/or QSO reporting

forms, and a printout of the next month's equatorial crossings for both satellites. All free for the asking, but an SASE is appreciated. Only one Satellite Communicator's Club certificate per station, regardless of satellite or band used. Further QSO reports, of course, are welcome, and will be acknowledged by sending you a month of orbits on request.

Satellite DX Achievement Award ("1000")

Sponsored by the ARRL, the "1000" recognizes two-way communication via AMSAT-OSCAR 6 or AMSAT-OSCAR 7. More than 300 of these beautiful certificates have been awarded. To qualify, a station must accumulate 1000 points as follows: Each contact with a new station counts 10 points, each new country counts 50 points, each new continent counts 250 points. Standard DXCC and WAC definitions apply. For example, the first European contact for a WVE would normally count 310 points — 250 for the new continent, 50 for the new country, and 10 for the new station. A station having worked (and confirmed) 15 different stations (150 points), 3 countries (150 points) and two continents (500 points) would have a total of 800 points and would still need 200 more to qualify. QSL cards are required; they must confirm two-way communication via amateur satellite on or after December 15, 1972, plus usual QSL information. Photocopies of the QSL cards are not acceptable. Contacts via AMSAT-OSCAR 6 and AMSAT-OSCAR 7 are equally acceptable and may be intermixed; again, only one award per station regardless of satellite. When you're about ready to apply for the award, request the appropriate application form from ARRL Headquarters, 225 Main Street, Newington CT 06111, USA. Enclose your required QSL cards with the

completed application. Postage of \$1.00 is required if you wish cards to be returned via registered mail. Incidentally, the first "1000" award went to club station LA1K and the second to K2LGJ. K2QBW, W6OAL, W1BIH and several others each have received two awards, recognizing work at more than one station location.

OSCAR Worked All States

When the first edition went to press, this award had yet to be won. That honor initially went to W3TMZ, followed by seventeen others, all of whom received special trophies from AMSAT recognizing their pioneering achievement in working 50 states via AMSAT-OSCAR 6. With the launch of AMSAT-OSCAR 7, this award has been taken over by the League, and made a regular (if highly prestigious and exclusive) part of the amateur awards structure. A specially endorsed Worked All States certificate will now be awarded instead of the former trophy. Regular ARRL rules for Worked All States apply, except that Rule 3, prohibiting contacts made through repeater devices, is replaced by a requirement that all 50 states be contacted through an amateur satellite. Each QSL card must confirm two-way contact via AMSAT-OSCAR 6 or AMSAT-OSCAR 7; contacts made via either satellite are equally acceptable and separate endorsements for each satellite are not available. To apply, secure a copy of the WAS application form (Operating Aide No. 8) from ARRL HQ.

Ten American Districts Award

The Lockheed Amateur Radio Club will issue specially endorsed versions of its Ten American Districts Award to show operation via amateur satellite. To qualify for the special endorsement, all QSL cards submitted must confirm two-way QSO via satellite. The award is available to all licensed amateurs and club stations. All contacts must have been made from the same callsign area, but not necessarily from the same location. QSL cards must be submitted as proof of two-way contact with each of the ten USA amateur radio call districts. KH6 counts as the sixth district, KL7 as the seventh. Each QSL must show a

postmark or QSL bureau marking, or must be accompanied by the original envelope in which it was mailed. There is no minimum report, but a signal report is required on the card. Send cards and \$1 or appropriate IRCs to award manager Bill Welsh W6DDB, Lockheed Amateur Radio Club, 2814 Empire Avenue, Burbank CA 91504, USA.

WVE Satellite Award

Sponsored by the Northern Alberta Radio Club, this award (Worked Canadian VE Call Areas Via Amateur Satellite) is designed primarily to develop a greater interest in amateur satellite communication. WVE stations must contact any four Canadian call areas (V01, V02, VE0, 1, 2, 3, 4, 5, 6, 7, 8) via amateur satellite. DX stations, including KH6 and KL7, must contact any two. Only contacts after January 1, 1973, will count. An application will consist of the required QSL cards accompanied by a fee of 25 cents for WVE or one IRC for DX stations. Include sufficient Canadian postage or IRCs if cards are to be returned via registered mail. Send cards and fees to the Chairman, Ray J. Nadeau VE6SF, P.O. Box 52, Barrhead, Alberta, Canada.

Washington Satellite Communicators Award

This award has been established by WA7FVT to encourage QSOs with Washington amateurs via satellite. US and Canadian amateurs must work five stations in the State of Washington, DX stations must work three. Only contacts after March 1, 1974, will count. Separate certificates for AMSAT-OSCAR 6 and AMSAT-OSCAR 7 are available. The required QSL cards should be submitted to WA7FVT together with a fee of \$1, which covers registered mail return of the cards and certificate. Please note WA7FVT's new address: Tim Blair, P.O. Box 2262, Tacoma WA 98401.

Hawaiian Satellite Communications Award

Sponsored by KH6IHP (ex-W7EOT), this award promotes two-way communication with Hawaiian amateurs via satellite. The required KH6 contacts vary with your location, as follows: Stations located in WAZ Zone 5, plus W8, VE3, ZL and VK must

have one confirmed QSO; those in Zone 4 (minus W8) or Zones 6, 7 or 25 must have two confirmed contacts; all others must have three. QSOs must be dated January 10, 1974, or later. QSL cards showing two-way satellite contact are required, and should be submitted to KH6IHP with a fee of \$1, which covers registered mail return of the cards and award. The address is Stephen M. Carson, 1624 Kaweleka St., Pearl City HA 96782, USA.

CQ DX Award Satellite Endorsement

Sponsored by CQ Magazine, this endorsement is offered to holders of CQ CW and SSB DX Awards for working 50 countries via amateur satellite. All QSL cards must show two-way satellite QSO using the same mode as the original certificate; e.g., if you hold the CQ CW DX Award, all satellite QSOs must be via two-way CW. All contacts must be on or after November 15, 1945, but be advised that any cards submitted showing dates before OSCAR 3's launch (March 9, 1965) are most carefully scrutinized! Rules are, in all other respects, the same as those for the basic CQ DX Awards. Contacts made via any amateur satellite are equally acceptable. Complete rules and applications are available by sending a business size SASE to the CW DX Editor, WA6GLD, P.O. Box 1271, Covina CA 91722, USA. Although several amateurs, including VE2BYG, K1HTV, W2BXA, G3IOR and OH2RK, have worked more than 50 countries via satellite, this award has yet to be won because of the single-mode requirement and also because of the need for the prospective winner to qualify for the basic (HF) award itself. It can be done, but it's tough!

More satellite operating awards will undoubtedly be originated as the need for them develops. For example, no amateur has yet worked all six continents via satellite, although many in certain parts of North America have worked five. The first DXpedition to the right part of eastern Siberia will certainly receive a much-needed warm welcome when they return home. As for me, I am waiting for someone to sponsor an award for confirming 49 states — either that, or move Hawaii closer to New Jersey!

... K2QBW

WEIRNU P.O. Box 1307
Colton, California 92324

Inflation-Fighting
DISCOUNTS \$10+ orders take 5%; \$30+ orders take 10%;
\$60+ orders take 15%; \$100+ orders take 20%

7400 SERIES			MM Series		
7400	.20	7496 .90	74L00	.30	
7401	.20	74100 1.50	74L02	.30	
7402	.20	74107 .45	74L03	.35	
7403	.20	74122 .50	74L04	.35	
7406	.45	74123 1.00	74L10	.30	
7410	.20	74126 .75	74L20	.35	
7413	.75	74132 2.85	74L30	.30	
7416	.45	74141 1.10	74L42	1.50	
7417	.45	74145 1.10	74L51	.30	
7420	.20	74151 1.25	74L54	.30	
7425	.35	74153 1.45	74L55	.40	
7426	.30	74155 1.25	74L86	.55	
7430	.30	74157 1.40	74L93	1.50	
7432	.25	74161 1.60	74L95	1.50	
7437	.45	74162 1.45	74L98	2.00	
7438	.45	74163 2.40	74L193	2.00	
7439	.45	74164 2.40	76L13	4.00	
7440	.20	74170 2.90	76L93	9.00	
7441	1.00	74173 1.70	81L22	1.00	
7442	.95	74174 1.85			
7443	1.00	74175 1.85	74S00	.50	
7445	.95	74177 .85	74S05	.50	
7446	1.15	74180 .95	74S10	.60	
7448	1.15	74185 2.25	74S15	.50	
7450	.25	74189 3.00	74S40	.75	
7454	.35	74190 1.50	74S64	.75	
7460	.25	74191 1.50	74S86	1.75	
7472	.40	74192 1.25	74S112	1.95	
7473	.40	74193 1.25	74S157	1.95	
7474	.45	74195 1.00	74S200	7.95	
7475	.75	74196 1.25			
7476	.40	74198 2.20	MH		
7483	1.10	74200 7.00	0025CN	2.00	
7492	.90		0026H	2.75	
7493	.90	NSH90A 2.50	0026CG	4.00	
				AH	
				0014D	9.00
				0014CD	4.00
				0151CD	4.50
				0126CD	4.50
				DM7160J	5.00
				DM7200J	6.50

Check back in last month's Ad — Those parts and prices are also still available.

1. Add 50¢ for postage & handling on orders under \$10.
2. All items guaranteed.
3. Spec Sheets 25¢ each.
4. SEND YOUR ORDER ALONG WITH CHECK OR MONEY ORDER TO:
WEIRNU, P.O. Box 1307, Colton, CA 92324
(Calif. residents include 6% tax)

NEW **NEW** **NEW**

MX1A **MX1A**

\$47.50 **\$47.50**

MINI-MIXER

This is a plug in unit to replace the first mixer in Collins 75S-1-2-3. Designed to eliminate all but the strongest (next door) cross modulation in the S line. It uses the latest in FET design. **If not satisfied, money refunded.**

Designed *Built* *Backed*

by

ANTENNA MART

BOX 7 RIPPEY, IOWA 50235

WORLD QSL BUREAU

5200 Panama Ave., Richmond CA USA 94804

THE ONLY QSL BUREAU to handle all of your QSLs to anywhere; next door, the next state, the next county, the whole world. Just bundle them up (please arrange alphabetically) and send them to us with payment of 6¢ each.

Touch pads and enclosures —
Novice gear and used equipment . . .

TEN-TEC SALES

Communications Specialties

97 Amsterdam Ave., Warwick RI 02889
Phone: 401-738-3287

WE'VE GIVEN IT A NEW LOOK!

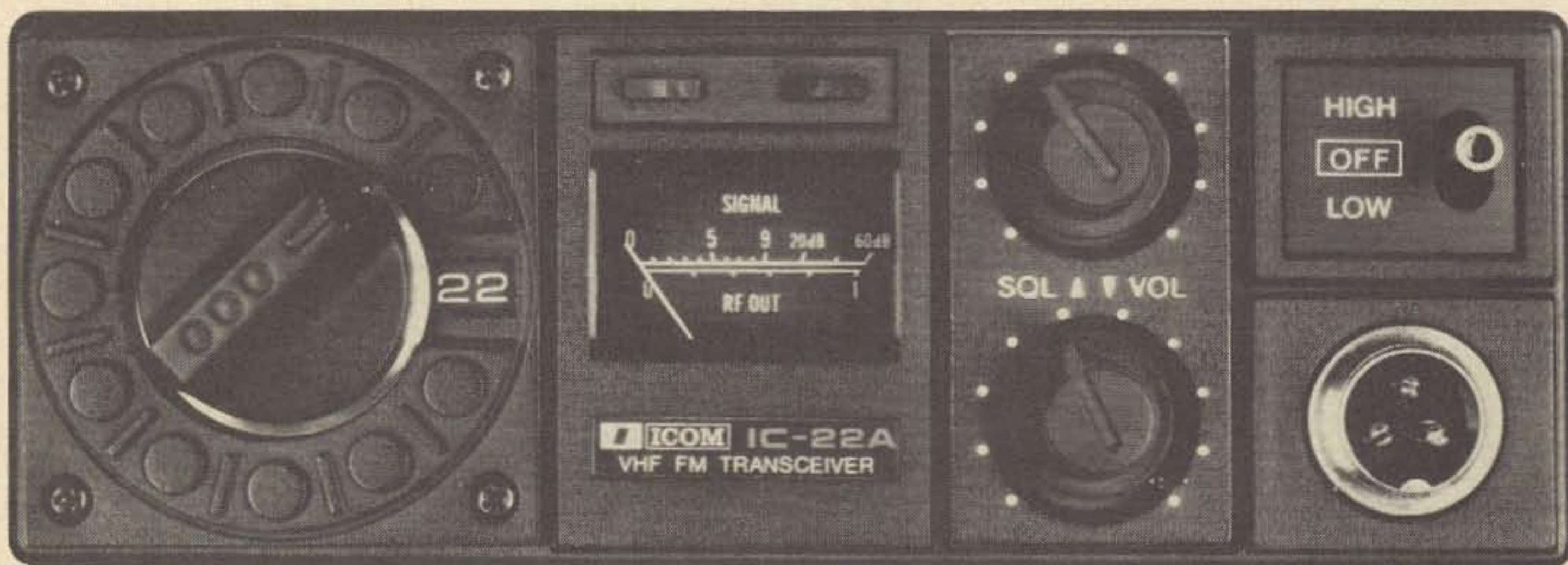

IC-22A

The front panel and control locations have been changed to make the IC-22A even better looking and easier to operate. The new design allows the use of larger channel numbers which may be

viewed from the left side or right side by reversing the window position and installing a new dial. (optional at nominal cost)

Inside is the same high quality radio construction and engineering that has made the IC-22 the most reliable, most popular two meter crystal controlled set on the market.

When you join 22 channels of capacity (five supplied) with the unexcelled performance of helical RF filtering in the receiver front end then add solid state T-R switching you get one great radio for your money. All the great features that made the IC-22 so desired are still there. Including, 1 watt/10 watt switch option, trimmer capacitors on both receiver and transmitter crystals plus a 9 pin accessory jack with the discriminator already wired for frequency calibration.

Bob Smith Electronics

1226 9th Ave. N., Fort Dodge, Iowa 50501

Where's Oscar?

Knowing when AMSAT-OSCAR 7 is within range of your station is perhaps the hardest part of communicating via satellite, but it isn't really that hard once you have done it a few times. This article makes it even simpler by allowing you to see at a glance when the satellite will be available to you.

It is relatively simple to keep track of the evening orbits. An article that appeared in the February, 1975, issue of 73 Magazine, page 54, discusses how in detail. Briefly, if you live in North America, all that you need to do is to check the "AMSAT News" column in 73 Magazine, or obtain orbital information from AMSAT at Box 27, Washington DC, 20044, for the time that the satellite will cross the equator heading northbound that evening. Remember, these orbits listed are the first orbit of the Greenwich day (reference orbits), which means you must use the next day's date. Depending on how far north you live and how far east or west of you the satellite crosses the equator, you should begin to hear signals from four to ten minutes after the crossing.

You'll notice that only one orbit per day is listed. Thus, it is up to you to determine the remaining orbits by adding 115 minutes

and 28.75° west for each orbit. If you perform this addition six times, you'll see that the satellite crosses the equator on the other side of the earth and will be in range of your station as it comes down from the North Pole.

For example, if the first orbit of the Greenwich day occurred at 0005Z, it would cross the equator at 51 degrees west longitude. The equator crossings for this day would be as follows:

Orbit #	Time	Degrees West
1	0005Z	51
2	0200	80
3	0355	108
4	0550	137
5	0745	166
6	0940	195
7	1135	223
8	1330	252
9	1525	280

Stations in eastern North America would find orbits one, two and perhaps three, which are ascending node (northbound) passes, useful for satellite communications. Later in the day, three more orbits would be useful to these same stations — orbits 7, 8 and 9. Since the satellite crosses the equator heading northbound at the equator, the satellite becomes available for North Amer-

K. O. Learner II K9PVW
 RR 5 Box 307
 Kokomo IN 46901

and

W. A. Kotras K9HUI
 2809 Westbrook Ct.
 Kokomo IN 46901

Oscar RTTY Converter

There are many fine RTTY terminal units, such as the ST-6, that can be used to copy the RTTY teletype telemetry from AMSAT-OSCAR 7. However, if you do not plan to work RTTY but are interested in receiving RTTY from the satellite, then the simple terminal unit presented here may be what you need.

Space-Only Keying

To conserve power on AMSAT-OSCAR 7, the RTTY is transmitted as space-only

keying. Although the space-only transmission technique of the system may seem unusual, it has the advantage of reduced power consumption compared to the 100% power duty cycle of conventional RTTY. Fixed station applications of RTTY can tolerate high power consumption, but in a space satellite the power available from the solar arrays is at a premium. In addition, the space-only keying allows a much simpler terminal unit to be used to convert the audio signal into the pulses required by the printer.

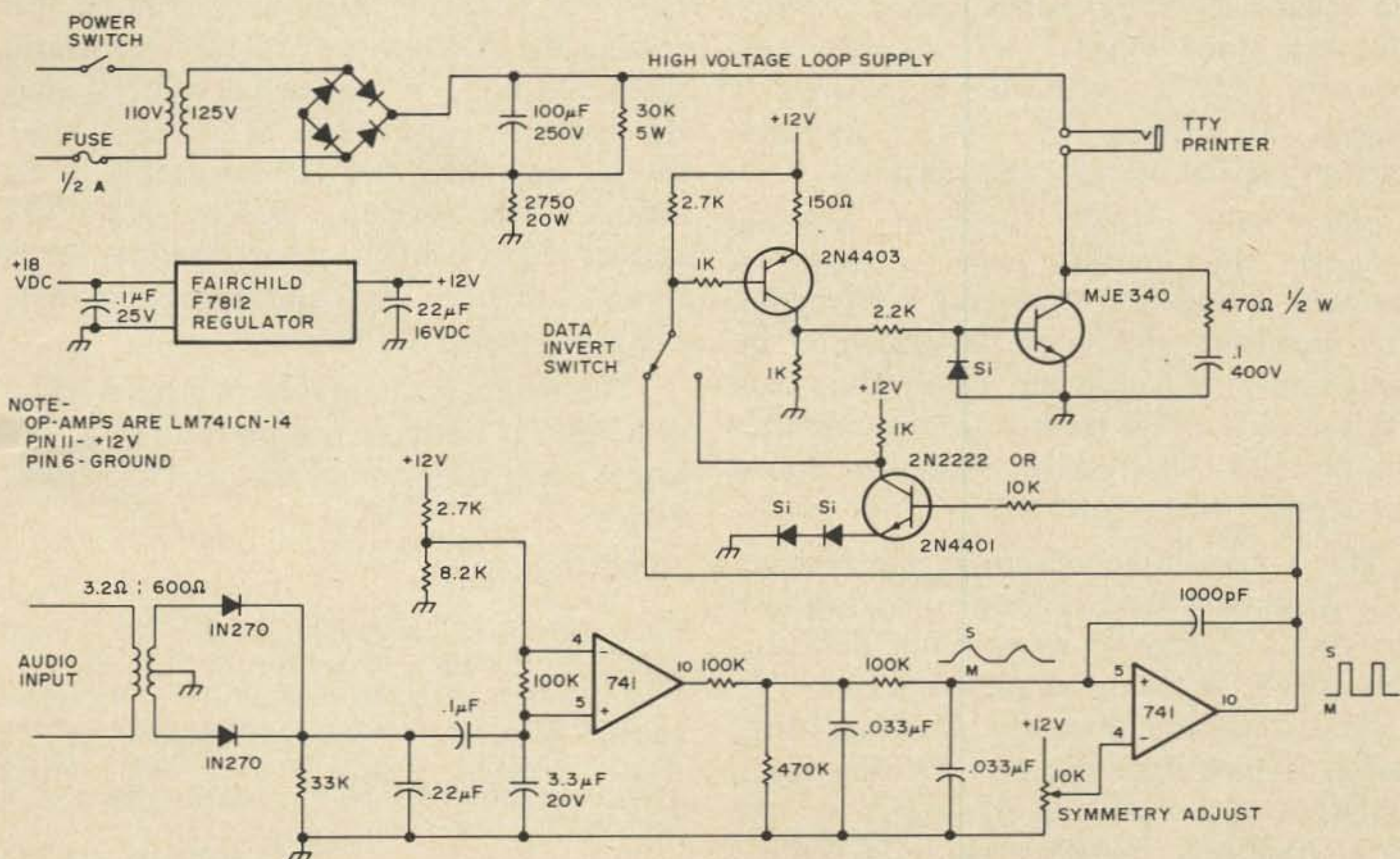

Fig. 1.

A
NEW
DIRECTION
in the
BUYING & SELLING
of
AMATEUR RADIO GEAR.
BUYERS & SELLERS
ham radio brokerage

- ↑ IMMEDIATE REFERRALS
(without the delays of
classified advertising)
- ↑ REFERRALS IN CLOSE
GEOGRAPHICAL VICINITY
- ↑ NO CHARGE TO BUYER
WHATEVER
- ↑ 10% SELLERS FEE PAID
ONLY IF A SALE IS
ACTUALLY MADE

call

617-536-8777
WFSun 12pm-6pm EST
TTHSat 6pm-12am EST

or write

BUYERS & SELLERS
Post Office Box 73
Boston, Mass. 02215

The Circuit

The usual TU consists of circuitry to discriminate between the mark (2125 Hz) and space (2975 Hz) tones received. Since only one tone (space) is received, it is necessary only to determine if the tone is present or absent. A simple envelope detector may be used for this purpose.

Since only a single frequency is being received, the station receiver may be operated in the CW or narrow filter mode, thus increasing the signal-to-noise ratio by significantly reducing the bandwidth. Any receiver with a 400 Hz bandwidth CW filter can be used. The receiver should be tuned for an audio output of 1 kHz.

The 1 kHz audio output of the receiver with good S/N ratio is then converted to a varying dc voltage by an envelope detector. This signal is then amplified by a 741 op-amp stage and drives an additional filter having a high level output for the space condition and a low level output for the mark condition. The slow rise and fall times of the varying voltage are converted to the on/off keying signals by means of a 741

op-amp used as a comparator. This stage then drives a two stage driver and a high voltage loop keying circuit of conventional design.

Only one adjustment is necessary for proper operation. This is the "symmetry pot", which establishes the switching point of the comparator. The ideal alignment method is to adjust this pot for a symmetrical mark and space element time of 22 ms. A space-only signal source can be obtained by tape recording the AMSAT-OSCAR 7 RTTY transmissions. In lieu of a calibrated scope, the "symmetry pot" may be adjusted for best printing.

Results

AMSAT-OSCAR 7 is currently being operated in the Teletype telemetry mode when the spacecraft is in Mode B. This means that the RTTY space-only 145.972 MHz beacon is available to amateurs on alternate (even) UTC* days of the year. This configuration is ground commandable and may vary with other developments of spacecraft hardware.

Results with this simplified TU have been quite good. Many AMSAT-OSCAR 7 passes have been printed, and punched paper tape has been prepared for computer processing for AMSAT by W3HCF. Of course, receiver tuning is somewhat critical, since the approximately 6 kHz of Doppler shift is several times the 400 Hz bandwidth of the receiver. The envelope detector is less frequency dependent than the CW filter of the receiver. If the receiver audio tone is audible, the print quality will be good.

The telemetry data returned by AMSAT-OSCAR 7 is both interesting and educational and is easily obtained using this TU configuration.

REFERENCES

- Hoff, W6FFC, "The Mainline ST-5 RTTY Demodulator", Ham Radio, September, 1970, p. 11.
- Hoff, W6FFC, "The Mainline ST-6 RTTY Demodulator", Ham Radio, January, 1971, p. 6.
- Webb, W4FQM, "Phase-Locked Loop RTTY Terminal Unit", Ham Radio, January, 1972, p. 8.

... K9PVW, K9HUI

*UTC - Coordinated Universal Time.

The Modularized SPEC COMM 512/560

— 2 METER FM —

- **LARGE SCALE USE OF ICs** for superior performance at lower cost!
- The **HOT CARRIER DIODE MIXER** virtually eliminates inter-mods & rcvr. overload!
- **5 TIMES THE POWER** of the usual 1 Wt. portables!



NEW!
AMERICAN MADE
QUALITY



SPEC COMM 512 \$199⁹⁵
5W 12 channels

SPEC COMM 560 \$179⁹⁵
5W 6 channels

EXTREMELY VERSATILE —
OVER THE SHOULDER, MOBILE, or
FIXED with Plug-In/Clip-On Accessory
Modules. No messy wires or cables to
connect!

BUY FACTORY DIRECT AND SAVE!

100 DAY FULL WARRANTY — 100% Moneyback Guarantee —
10 Days — You can't lose!

Accessory Modules:

- Clip-on battery pack — Nicad — complete with charger, whip antenna and carrying strap — heavy duty Nicads (not those penlight size cells). Clip-on and automatically connect! \$79.95 (BP-1)
- Clip-on ac supply — automatically interconnects when you clip on — uses newest type high efficiency transformer and IC regulator. \$44.95 (AC-1)
- Clip-on 25 Watt amplifier — automatically connects to power and rf. Fully protected from shorted or open antenna. \$84.95 (BA-1)
Xtals $\pm 0.001\%$ (any frequency). No chg. for factory installation. \$4.95.

Features

- Uses inexpensive TR-22 xtals
- Reverse polarity protection
- Final transistor fully protected
- Large 3" speaker for good sound
- Front and rear antenna jacks
- 146.52 crystals supplied
- Clip-on accessory modules
- Lightweight — 2 lbs
- Size 2 $\frac{1}{4}$ x6x8"
- Electronic T/R — no clicking relay
- Battery voltage indicator
- Ceramic mic — non stealable
- Fantastic squelch circuit — fast
- Extremely sensitive MOSFET front end, 0.3uV for 20dB Qt.
- Trimmers on all crystals
- Very easy to service
- Incredibly sharp i-f, at least -80dB @ ± 30 kHz
- Single Conversion Rcvr. — superior to dual conv. designs for spurious resp. rejection!



PENNSYLVANIA Residents add 6% sales tax. Include \$3.50 shipping.

SCR — 100 Repeater Receiver Board —

Greatly reduce or eliminate "desense" or intermod problems! W/1uV received sig., desense just begins @ about 60K uV, and is only slightly noticeable @ 100K uV (± 600 kHz)! 0.3uV/20dB Qt. — 80dB (min.) @ ± 30 kHz. **\$89.95.**

See Review Article in April 73 Mag. — Send Card for Data Sheet.

SPECTRUM COMMUNICATIONS

BOX 140, WORCESTER PA 19490 (215) 584-6469

ME-3 microminiature tone encoder

Compatible with all sub-audible tone systems such as: Private Line, Channel Guard, Quiet Channel, etc.

- Powered by 6-16vdc, unregulated
- Microminiature in size to fit inside all mobile units and most portable units
- Field replaceable, plug-in, frequency determining elements
- Excellent frequency accuracy and temperature stability
- Output level adjustment potentiometer
- Low distortion sinewave output
- Available in all EIA tone frequencies, 67.0 Hz-203.5 Hz
- Complete immunity to RF
- Reverse polarity protection built-in

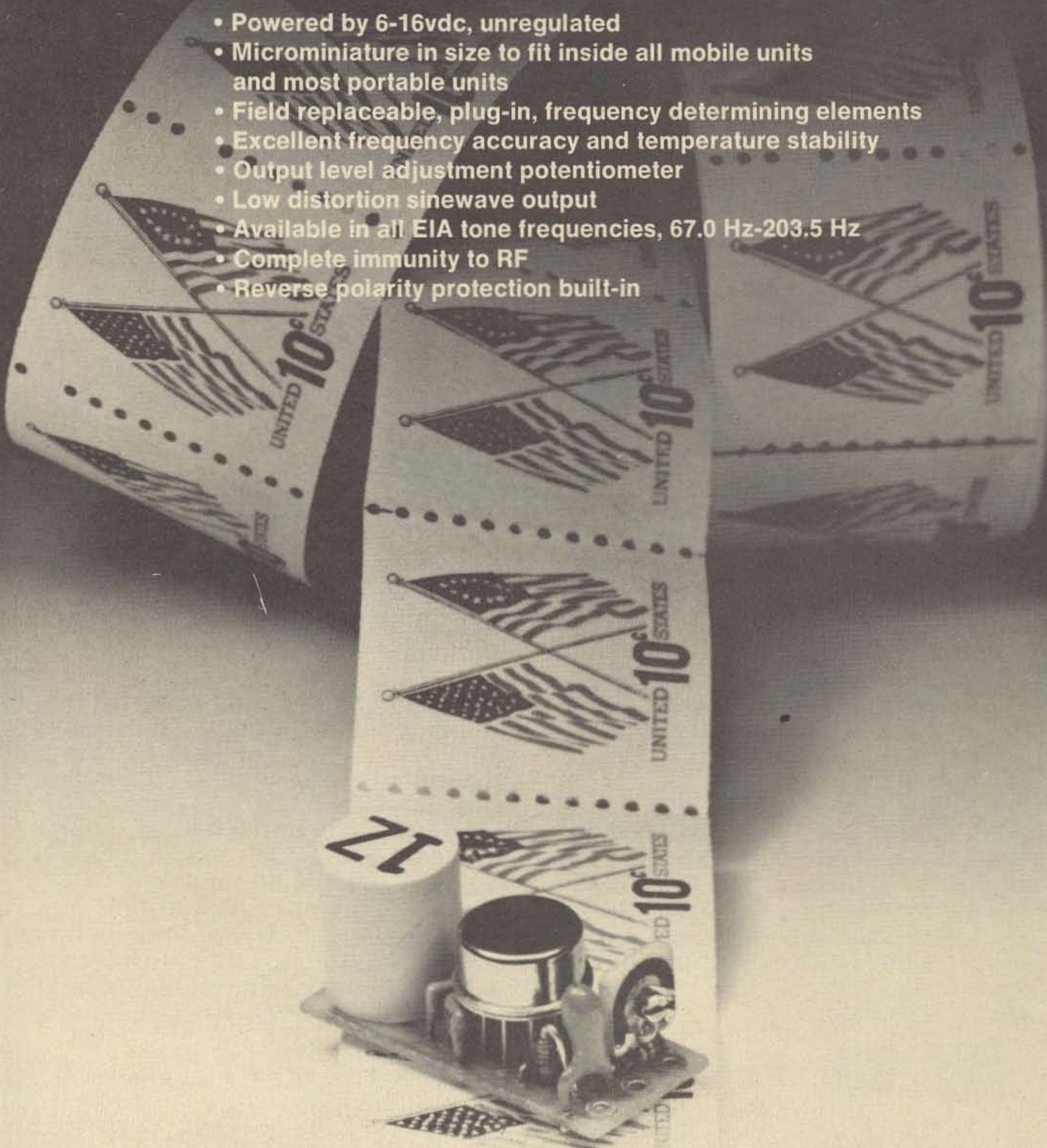

\$29.95 each

Wired and tested, complete with K-1 element

communications specialists

P. O. BOX 153
BREA, CALIFORNIA 92621
(714) 998-3021

K-1 FIELD REPLACEABLE,
PLUG-IN, FREQUENCY
DETERMINING ELEMENTS

\$3.00 each

How You Can Take Oscar's Temperature

Have you ever wondered what the temperature inside AMSAT-OSCAR 7 is? As the satellite has been in orbit since November 15, 1974, perhaps you want to know how the batteries are holding up. The answers to these and many other facts about the status of OSCAR 7 are readily available to you from the CW signals transmitted by the beacon transmitters on the satellite. Best of all is the fact that all you need to get started is a ten meter receiver and the ability to copy numbers in CW!

What Is Available

There are twenty-four parameters transmitted by the Morse code telemetry system

on board OSCAR 7. Table 1 lists these channels and the parameter each channel is measuring. As you can see, the first five channels indicate the current in milliamperes from the solar cells that generate the power for all of the systems on OSCAR 7. Channel 2B monitors the power output of the transmitter for the 70 centimeter to 2 meter transponder. The next channel, 2C, increases by one count every 14.4 minutes and is used to show that the spacecraft twenty-four hour clock will switch the satellite between the two transponders at 0000Z. Channels 2D through 3C can tell you the status of the batteries. Temperatures at strategic places in OSCAR 7 are monitored by channels 3D through 5A and 5D. The remaining channels

CHANNEL	PARAMETER	EQUATION
1A	Total Solar Array cur (mA)	$I_T = 29.5N$
1B	+X Quadrant cur (mA)	$I_{+X} = 1970-20N$
1C	-X Quadrant cur (mA)	$I_{-X} = 1970-20N$
1D	+Y Quadrant cur (mA)	$I_{+Y} = 1970-20N$
2A	-Y Quadrant cur (mA)	$I_{-Y} = 1970-20N$
2B	70/2 Pwr Out (W)	$P_{70/2} = 8(1-.01N)^2$
2C	24 Hr Clock Time (hrs)	$t = .253N$
2D	Bat. Charge-Discharge cur (mA)	$I_B = 40(N-50)$
3A	Bat. Voltage (volts)	$V_{BAT} = .1N+6.4$
3B	½ Bat. Voltage (volts)	$V_{1/2B} = .1N$
3C	Bat. Charge Reg #1 (volts)	$V_{CRI} = .15N$
3D	Bat. Temp (°C)	$T_{BAT} = 95.8-1.48N$
4A	Base Plate Temp (°C)	$T_{BP} = 95.8-1.48N$
4B	PA Temp 2/10 Transponder (°C)	$T_{10M} = 95.8-1.48N$
4C	+X Facet Temp (°C)	$T_{+X} = 95.8-1.48N$
4D	+Z Facet Temp (°C)	$T_{+Z} = 95.8-1.48N$
5A	PA Temp 70/2 Transponder (°C)	$T_{2M} = 95.8-1.48N$
5B	PA Emitter Cur 2/10 (mA)	$I_{10M} = 11.67N$
5C	70/2 Transponder Modulator Temp (°C)	$T_{MOD} = 95.8-1.48N$
5D	Instrument Switching Regulator Cur (mA)	$I_{ISR} = 11+.82N$
6A	Rf Pwr Out 2/10 Transponder (mW)	$P_{2/10} = N^2/1.56$
6B	Rf Pwr Out 435 Beacon (mW)	$P_{435} = .1N^2+35$
6C	Rf Pwr Out 2304 Beacon (mW)	$P_{2304} = .041N^2$
6D	Midrange TLM Calibration (volts)	$V_{CAL} = .01N$

Table 1. Morse code telemetry channels.

measure emitter currents of power amplifier stages and power outputs of several of the transmitters on board. An analysis of each of these channels is available in an article listed in the references.

Frequency

The Morse code telemetry system is available to you on 29.500 MHz. The ten meter downlink for OSCAR 7 covers the frequencies from 29.40 to 29.50 MHz with SSB activity below 29.445 MHz and CW activity above 29.455 MHz. Amateurs in the CW segment usually leave a five kilohertz guardband below the beacon, so you should have no trouble finding it.

The 29.50 MHz beacon is always on when the two to ten transponder is on (Mode A). This occurs on odd days (GMT) of the year. On the even days of the year the seventy centimeter to two meter transponder (Mode B) is on and the 29.50 MHz beacon is off.

How It Is Done

The first thing you need to do is to determine when the satellite will be within range of your station. The references list several articles that explain when to listen. When you begin to hear stations in the ten meter downlink, tune your receiver to 29.50 MHz and look for a carrier that transmits only numbers.

After copying the numbers for a few minutes, you will see the following pattern emerging:

1xx 1xx 1xx 1xx 2xx 2xx 2xx 2xx 3xx
3xx 3xx 3xx etc.

Table 2 lists the six lines of Morse code telemetry in a convenient format in case you miss some digits due to fading or QRM. The first digit and its placement indicates the channel number (1A, 1B, 1C, etc.) and the two remaining digits provide the information we are looking for.

Data Conversion

Hopefully, by the time the satellite is out of range you will have copied data on each channel several times. Take the last two digits of each channel and substitute this value for N in the equations in Table 1. For example, let's assume channel 3D read 51.

	A	B	C	D
1	1xx	1xx	1xx	1xx
2	2xx	2xx	2xx	2xx
3	3xx	3xx	3xx	3xx
4	4xx	4xx	4xx	4xx
5	5xx	5xx	5xx	5xx
6	6xx	6xx	6xx	6xx

Table 2. The six lines of OSCAR 7 CW telemetry.

The equation for 3D battery temperature is:

$$T_{\text{bat}} = 95.8 - 1.48 N (^{\circ}\text{C})$$

$$T_{\text{bat}} = 95.8 - 1.48 (51)$$

$$T_{\text{bat}} = 95.8 - 75.48$$

$$T_{\text{bat}} = 20.32^{\circ}\text{C}$$

As you can see, for this example the temperature of the battery is essentially room temperature, which is quite often the case. If you copy this telemetry for several passes, you will see that some channels remain relatively constant while others vary considerably.

Helpful Hints

Should fading occur while you are copying the beacon, there are several landmarks that you can use to identify what channel is coming up next. After channel 6D, the telemetry system sends "HI HI" and starts the entire cycle again. If you copy a channel that reads 200 and the satellite is in mode A, then it's most likely you have just received channel 2B, as this is the value transmitted when the 70/2 meter transponder is not in use.

Because telemetry reports are used by AMSAT to chart trends in the satellite's life, you should submit the data you collect along with such pertinent information as orbit number, date, time, signal strength and your receiving equipment to AMSAT, Box 27, Washington DC 20044. If you enclose an SASE you will receive two months of orbital data.

References

- Kasser and King, "OSCAR 7 and its Capabilities", QST, February, 1974, p. 56.
- King, "AMSAT-OSCAR 7 Final Telemetry Parameters and Equations", AMSAT Newsletter, December, 1974, p. 4.
- Tater, "CQ OSCAR 7," 73, February, 1975, p. 54.

... W3HUC

Really Zap Oscar with this Helical

Part One

The helical antenna has been around since the 1940's or earlier — it was invented by Dr. John D. Kraus, who has written many papers on helical antennas and their properties [1]. The helical beam antenna or the axial mode helix has several unusual characteristics which make it desirable for use in amateur satellite and space communications. This antenna operates as an end-fire or beam antenna and generates circularly polarized radiation. This type of radiation persists over a 2-to-1 range in frequency, while the gain is nearly maximum over this range. The gain and the beam width, as well as other characteristics of the axial mode helix, depend upon the number of turns; the more turns, the higher the gain and consequently the narrower the beam width. The axial mode helix can be used in designing a versatile, high performance antenna system since one can achieve right circular, left circular, and linear polarizations with helices. With satellite communications becoming an important facet of amateur radio (especially with OSCAR 7), an array of helices for both 2 meters and 70 centimeters with moderate gain was built during the spring and summer of 1974. The antenna array, which is shown in the photos, consists of four antennas in total, with a pair of

helical beam antennas, of opposite sense, for both 2 meters and 70 centimeters, so that right circular, left circular, and linear polarizations can be selected.

If beam antennas are used with amateur radio communications satellites, such as the OSCARs, then one must be able to "track" or follow the satellite by using azimuth-elevation rotators. A narrow beamwidth or high gain antenna makes the tracking more difficult, as a narrower beamwidth requires greater pointing and tracking accuracy; when designing moderate to high gain narrow beamwidth antennas, this point must be kept in mind. It was my belief that the number of turns for a helical beam antenna for use with the OSCAR 6 & 7 satellites should be between 6 and 8 turns. Thus a desirable gain and half-power beamwidth are of the order of 10 to 15 dBi and 45 to 50 degrees, respectively. With the assistance of Cliff Burdette WA8GRE, I have made antenna pattern measurements that indicated a half-power beamwidth of 39 degrees and a gain of 16 dB over a half wave dipole for an 8 turn helix designed for 70 cm and tested at 445 MHz. A helix of more than 8 turns represents a gain too high to be used for amateur satellite communications (i.e., the beamwidth would be too narrow), unless

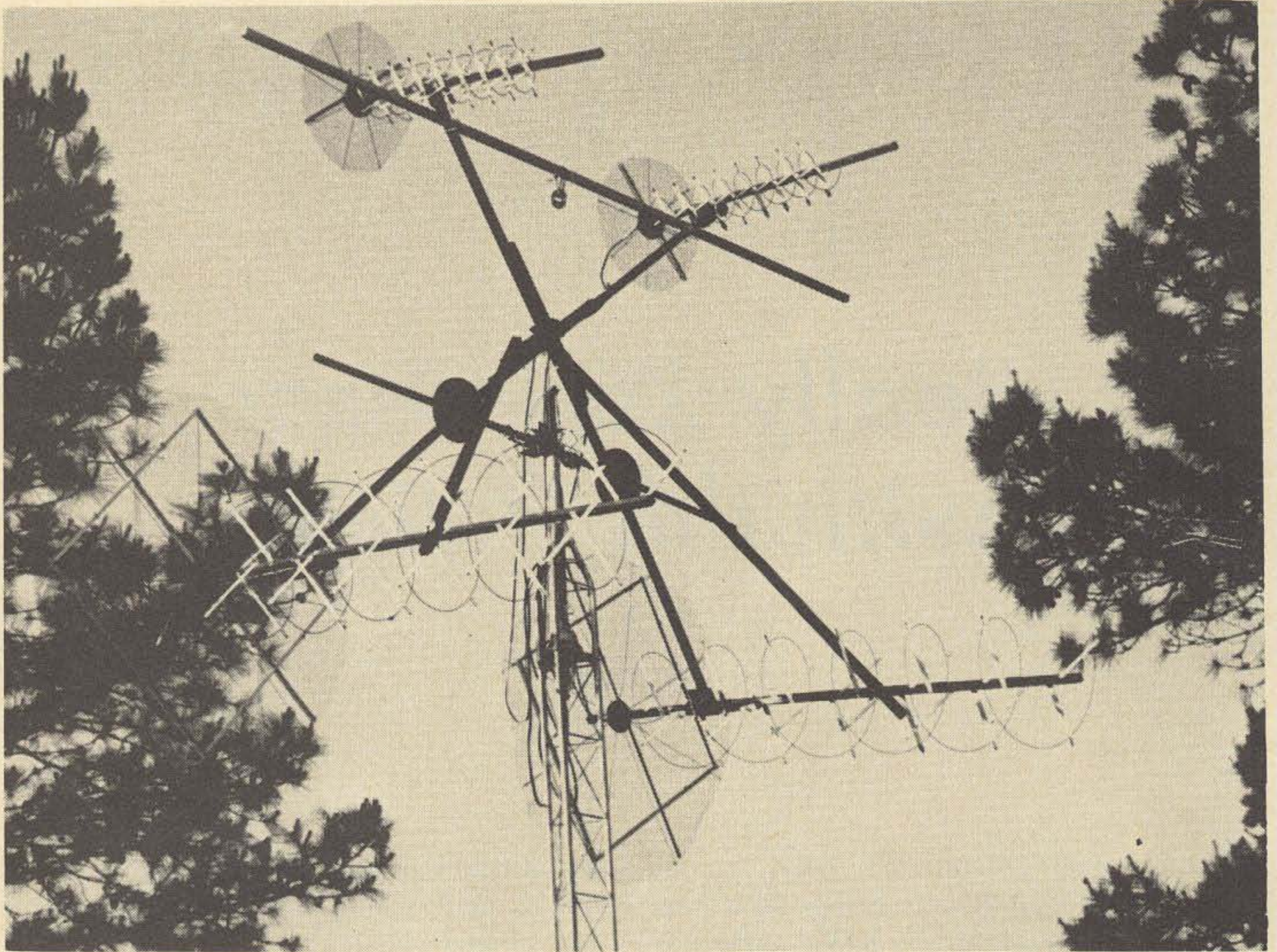

The antenna array completed and installed on the tower. The 70 cm helices are at the top, with the 2 m helices at the bottom. Each pair of helices are of opposite sense. The conduit or horizontal boom on which the elevation rotor is mounted is 10 feet long, making the size of the array about 11x11 feet.

very precise, automatic tracking is available.

There are, of course, certain tradeoffs that have to be made in using high gain antennas for OSCAR 6 and 7, as using an omnidirectional, low gain antenna with an effective radiated power of 80 to 100 Watts is recommended and, in fact, does not present the problems associated with successful tracking of satellite passes. But building and experimenting with helical beam antennas has been most enjoyable. This article describes the helical beam antenna, its design parameters and characteristics, the basic design, construction and installation of the helices that I have built, and antenna range measurements and results.

Circular Polarization

A brief discussion of circular polarization and the nomenclature used in describing the polarization and sense of the helices is necessary. Circular polarization is desired for space and satellite communications since

periodic fading, due to the Faraday Effect as well as tumbling of the satellite, is encountered in trans-ionospheric propagation. Linear polarization is not desirable because of a periodic rotation of the polarization of the radio wave (known as Faraday rotation) as it passes through the ionosphere. For instance, a horizontally polarized antenna would receive very little energy from a wave that was initially horizontally polarized but that had become vertically polarized after traveling through the ionosphere.

With linear antennas the electric vector of the electromagnetic wave radiated from the antenna is parallel to itself, i.e. on a fixed line at all times, whereas in the case of circular polarization the electric field vector rotates continuously around an axis in the direction of propagation, that is, describes a circle. Fig. 1(a) shows how linear polarization maps out a line on a plane normal to the direction of propagation, while Fig. 1(b)

IT'S TIME TO SWITCH TO ALPHA



IF YOU'RE STILL SETTLING, WORRYING, FIDDLING, OR PUTTING UP

SETTLING FOR LESS THAN MAXIMUM LEGAL POWER — even when you really need it to bore through a pileup or hang onto a ragchew frequency? *Every ALPHA linear, from the least expensive ALPHA 74K to "THE ULTIMATE" ALPHA 77D, easily handles a solid kilowatt of continuous average dc input . . . in any mode including slow scan and teletype. (Most competitive tabletop amplifiers have power supplies capable of no more than 400 to 500 watts continuous average power. CHECK THE SPECS!)*

WORRYING THAT YOUR OLD LINEAR WON'T HANG TOGETHER through a long, tough contest weekend . . . or thirty minutes of "Key-down" time on SSTV? *Every ALPHA is specifically designed for that kind of heavy service. That's why they have rugged Hipersil®/solid state power supplies, Eimac ceramic tubes, ducted-air circulatory cooling, and top quality throughout.*

FIDDLING WITH TUNING AND LOADING KNOBS every time you change bands? *With the exclusive "No-tune-up" ALPHA 374 you simply flip the bandswitch and start talking. Pretuned bandpass output filters do the tuneup for you . . . instantly! And precision controls in the ALPHA 77D can easily be returned to any previous setting in a few seconds.*

PUTTING UP WITH AN OLD-STYLE CONSOLE THAT'S TOO BIG and heavy to put where you really want it? *Every ALPHA model is self-contained in a handsome, designer-styled desk-top cabinet that sits right at your fingertips without monopolizing operating space . . . and can be handled by one man.*

ALPHA linear amplifiers by ETO — an investment in performance, pleasure, and convenience. See your dealer or contact ETO direct for full details, top trades, and prompt delivery. ALPHA 74K, \$695; ALPHA 274, \$995; ALPHA 374, \$1295; *THE ULTIMATE*, ALPHA 77D, \$2695.



EHRHORN TECHNOLOGICAL OPERATIONS, INC.
BROOKSVILLE, FLORIDA 33512
(904) 596-3711

shows how circular polarization maps out a circle. Detailed discussions of circular polarization can be found in References 2, 4, 5 and 6. Circular polarization can be generated by various methods, the most common being crossed linear antennas and helical antennas. The helical antenna is preferred since it has a wide bandwidth, non-critical dimensions, and high unidirectional gain, whereas crossed yagis, for instance, have narrow bandwidths, critical dimensions and impedance-matching problems. Here we are talking about either right circular polarization (r.c.p.) or left circular polarization (l.c.p.)*; alternately we speak of clockwise or anticlockwise polarization which refers to the direction of rotation of the approaching wave.

The axial mode helix can be "wound" for either r.c.p. or l.c.p., and linear polarization is obtained by feeding a left-hand and a right-hand helix in phase. Thus a versatile system can be built around the basic helical beam antenna.

Axial Mode Helix And Its Characteristics

The helix is a basic geometrical form, and can be described in terms of a conductor wound on an imaginary cylinder. The diameter of the helix and the spacing between each turn determine the performance and the radiation mode of the helix. When the circumference of the helix is of

the order of 1 wavelength ($0.75 \lambda < C\lambda < 1.33 \lambda$, where $C\lambda$ is the circumference in wave lengths), the helix radiates in the axial or beam mode. This particular mode produces radiation that is maximum along the axis of the helix and that is circularly polarized. A broadside or omnidirectional pattern can be obtained with other dimensions, but since we are mainly interested in the beam mode we will not discuss the other modes [1,2]. The pattern shape, circular polarization, and terminal impedance are relatively stable over a wide frequency range. Basically, the axial mode is generated by using a ground plane or screen reflector mounted behind the helix conductor or driven element and fed by a coaxial line as seen in Fig. 2(a). The dimensions associated with the helix as seen in Figs. 2(a) and 2(b) are:

- D = Diameter of the helix
- S = Spacing between turns
- $a = \text{Pitch angle} = \text{Arctan} \left(\frac{S}{\pi D} \right)$
- L = Length of 1 turn
- n = Number of turns
- A = Axial length = nS
- d = Diameter of conductor
- g = Distance of ground plane to first turn
- G = Ground plane diameter

If one turn of the helix were unrolled on a flat plane the circumference (πD), the spacing (S), the turn length (L), and the pitch angle a are related by the triangle shown in Fig. 2(b). Since the turn length L equals:

$$\sqrt{(\pi D)^2 + S^2}$$

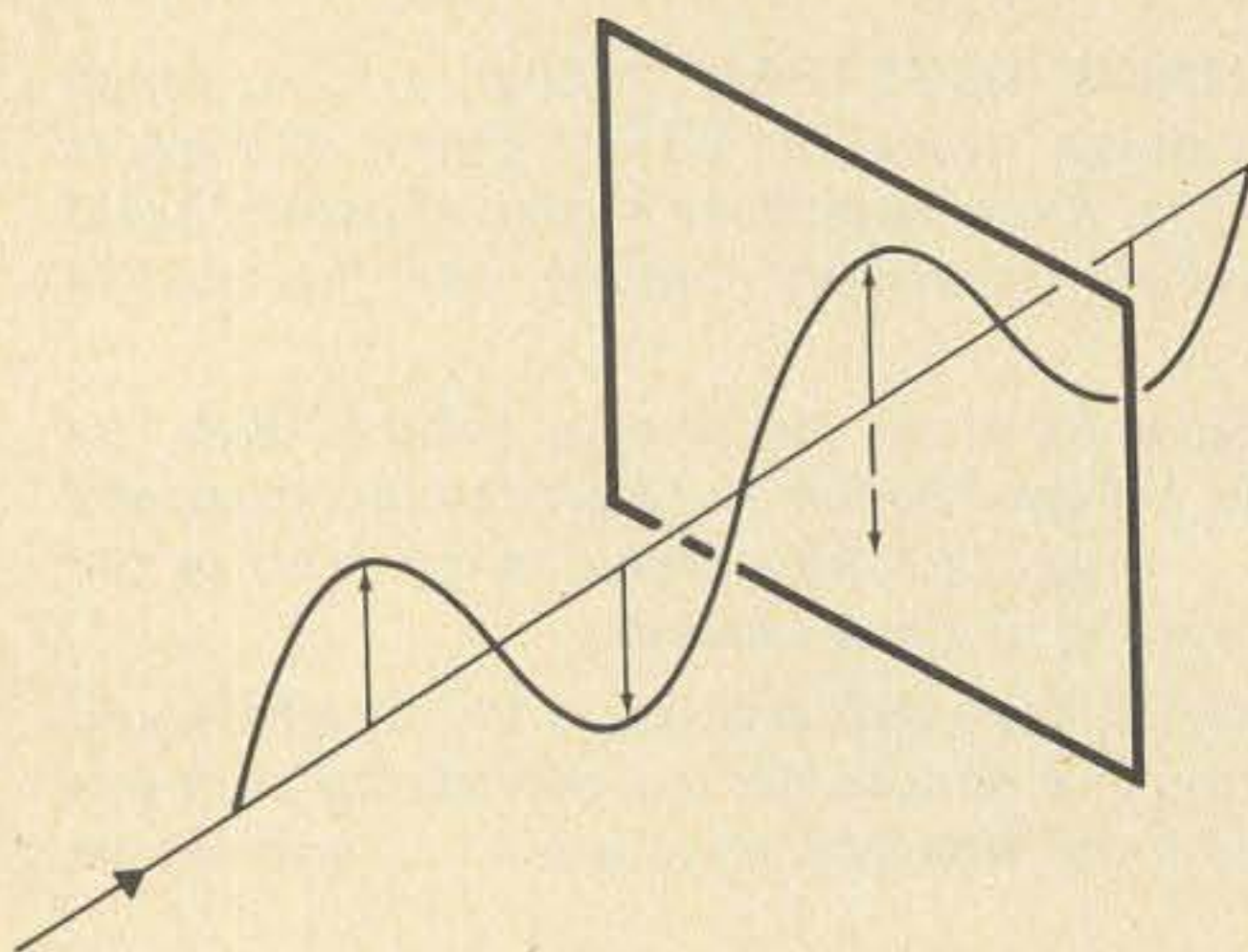

Fig. 1(a). Illustration of waves of linear polarization.

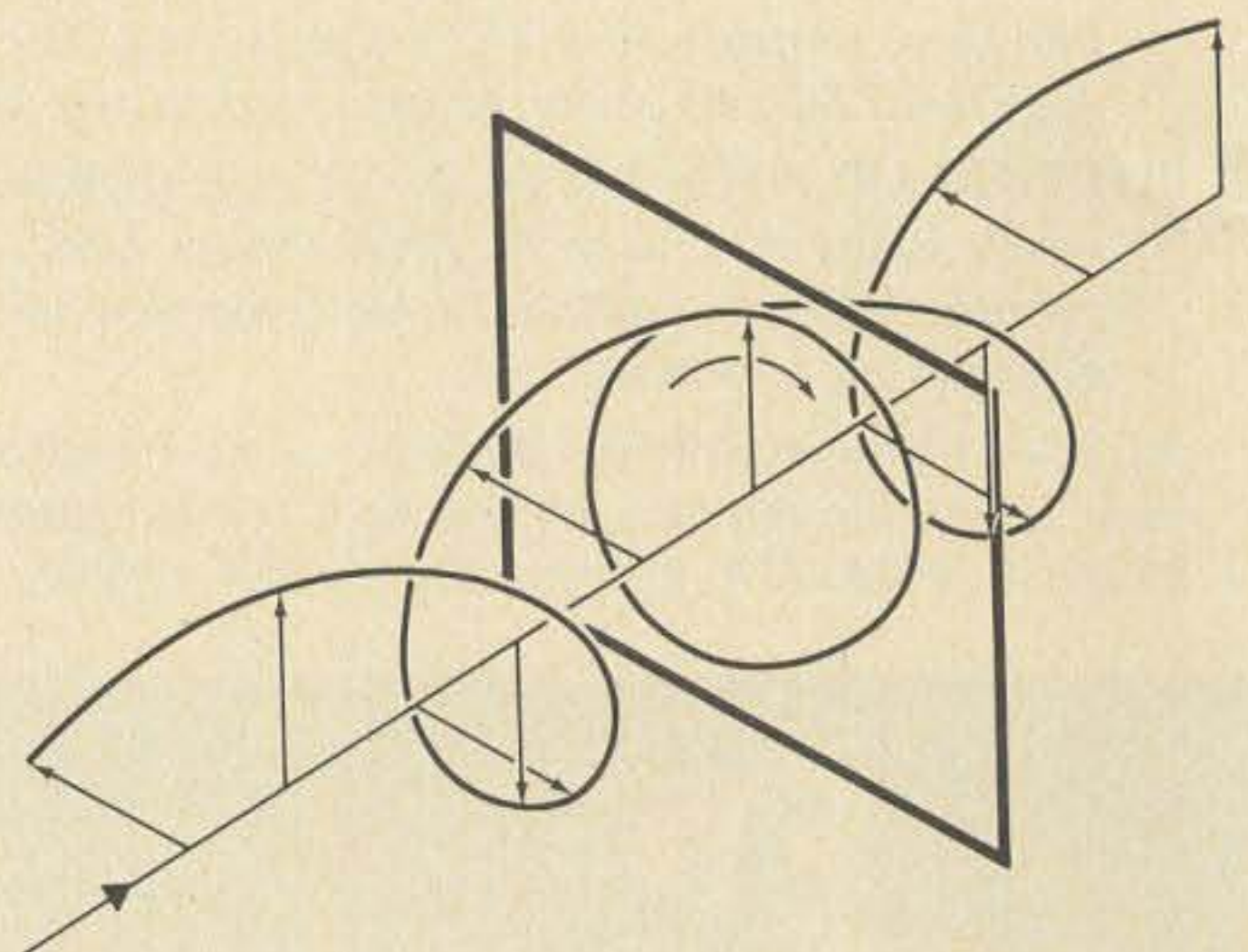

Fig. 1(b). Illustration of waves of circular polarization.

*Recommended polarizations for working OSCAR 7:

MODE	POLARIZATION SENSE	
	Transmitting	Receiving
2m to 10m (A)	l.c.p.	--
70cm to 2m (B)	r.c.p.	r.c.p.
435.1 MHz beacon	--	r.c.p.

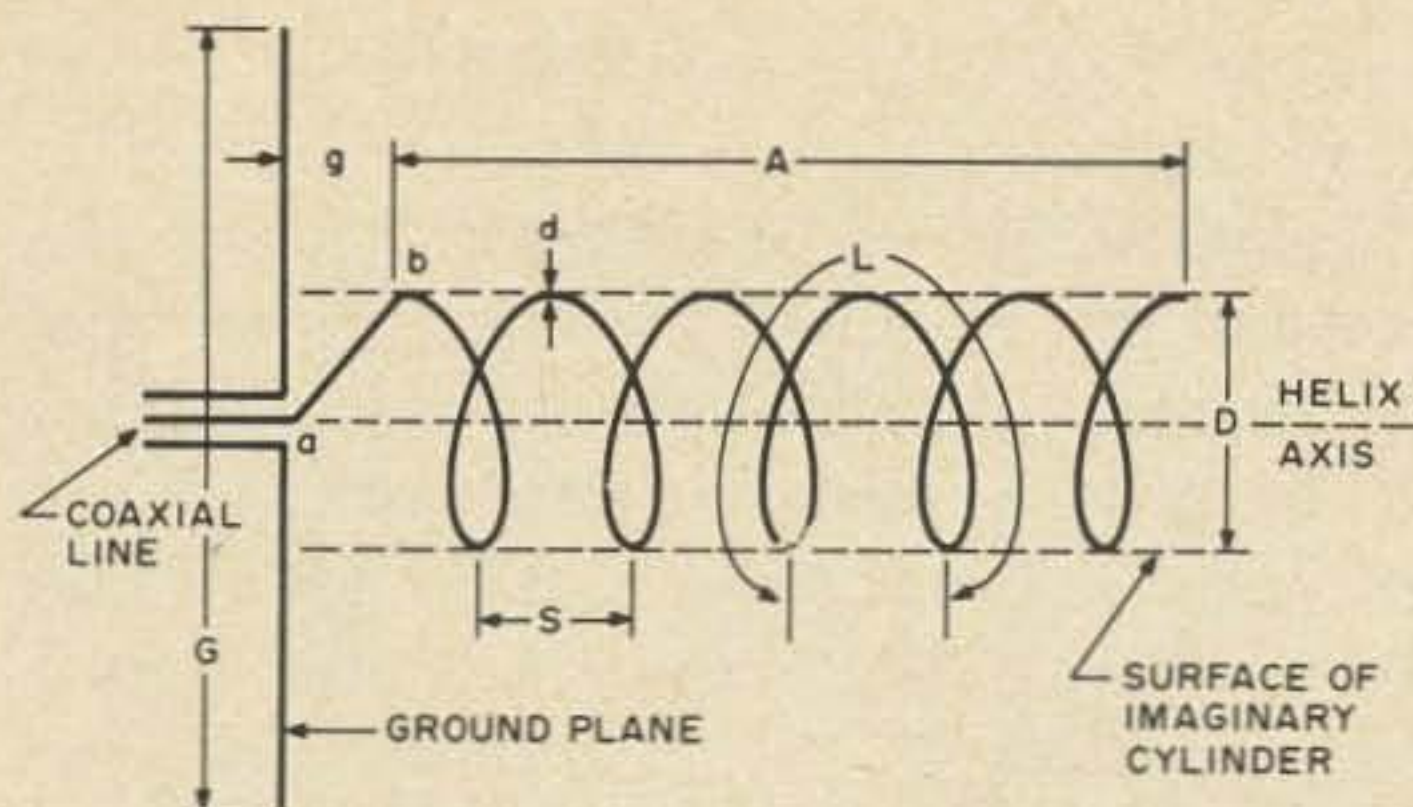

Fig. 2(a). Helix and associated dimensions.

the optimum dimensions for a helix with a turn length of the order of 1.00λ can be found. The dimensions used in general design of a helical beam antenna, in terms of free-space wavelengths at the design frequency are as follows:

$$D = 0.32$$

$$S = 0.22$$

$$G \geq 0.80$$

$$g = \frac{S}{2} = 0.12 \lambda$$

Other dimensions can be used, but in general the dimensions for the optimum helix are those listed above. These dimensions can be found from the spacing-circumference chart found in Reference 1 and also from the spacing-diameter chart found in Reference 2. The conductor diameter can be from .006 to .05 wave lengths, as the conductor diameter does not seem to critically affect the properties and performance of the axial mode helix when operating in the frequency range of this mode. Various materials can be used for the helix conductor or driven element; here I used a conductor of 3 strands of 12 gauge copperweld wire.

The characteristics of the axial mode helix, such as the gain, half-power beamwidth, axial ratio, and terminal impedance, depend upon the dimensions of the helix and also on the number of turns. In designing a helix the gain and the beamwidth are important parameters, and it is necessary to consider how long the antenna should be, i.e. the number of turns, and what the optimum dimensions should be in order to achieve the desired gain and beamwidth.

When the radiated pattern of a unidirectional antenna is concentrated into a single major lobe, the angular width of the lobe is

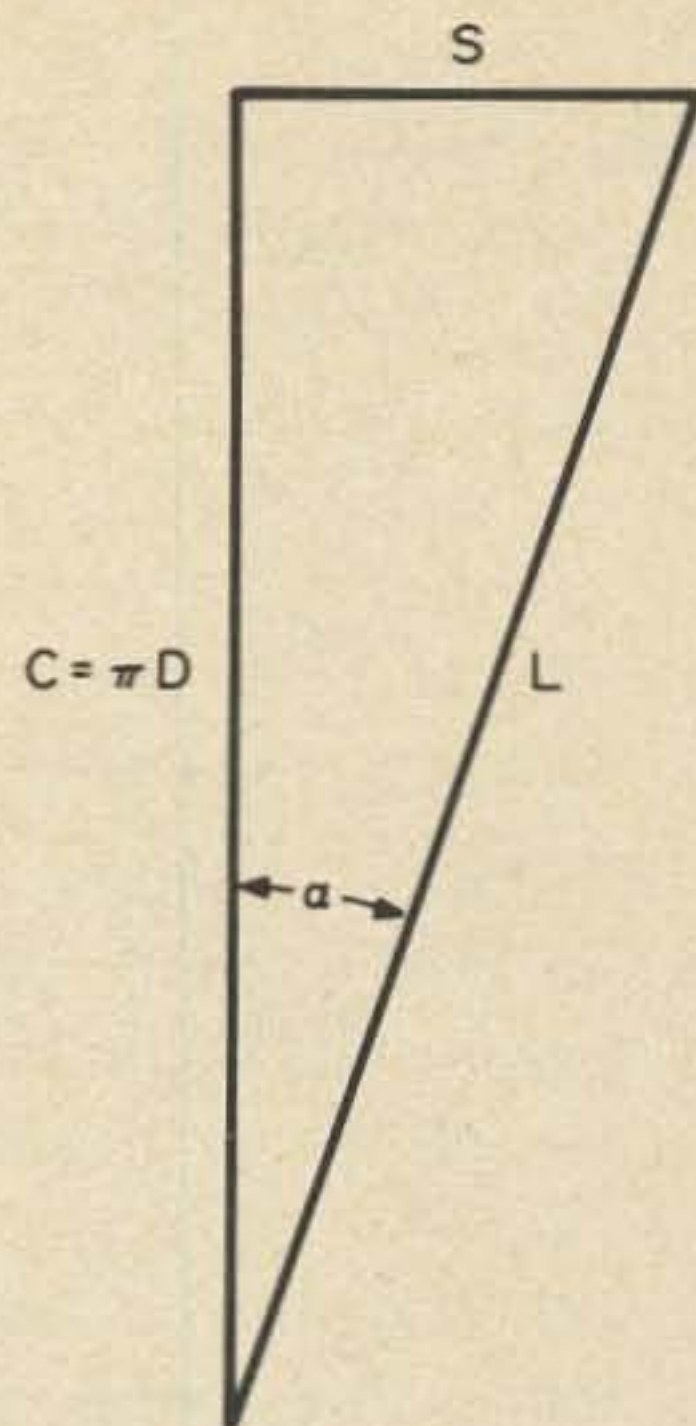

Fig. 2(b). Relation between circumference, spacing, turn length, and pitch angle of a helix.

the beamwidth. The beamwidth is adopted by measuring the beamwidth between the points on the pattern at which the power density is half its maximum value (i.e. 3 dB down). For the helix the beamwidth β between the half-power points is given by:

$$\beta = \frac{52}{C_\lambda \sqrt{nS_\lambda}} \text{ degrees,}$$

where C_λ is the circumference (expressed in terms of free-space wavelengths) and S_λ is

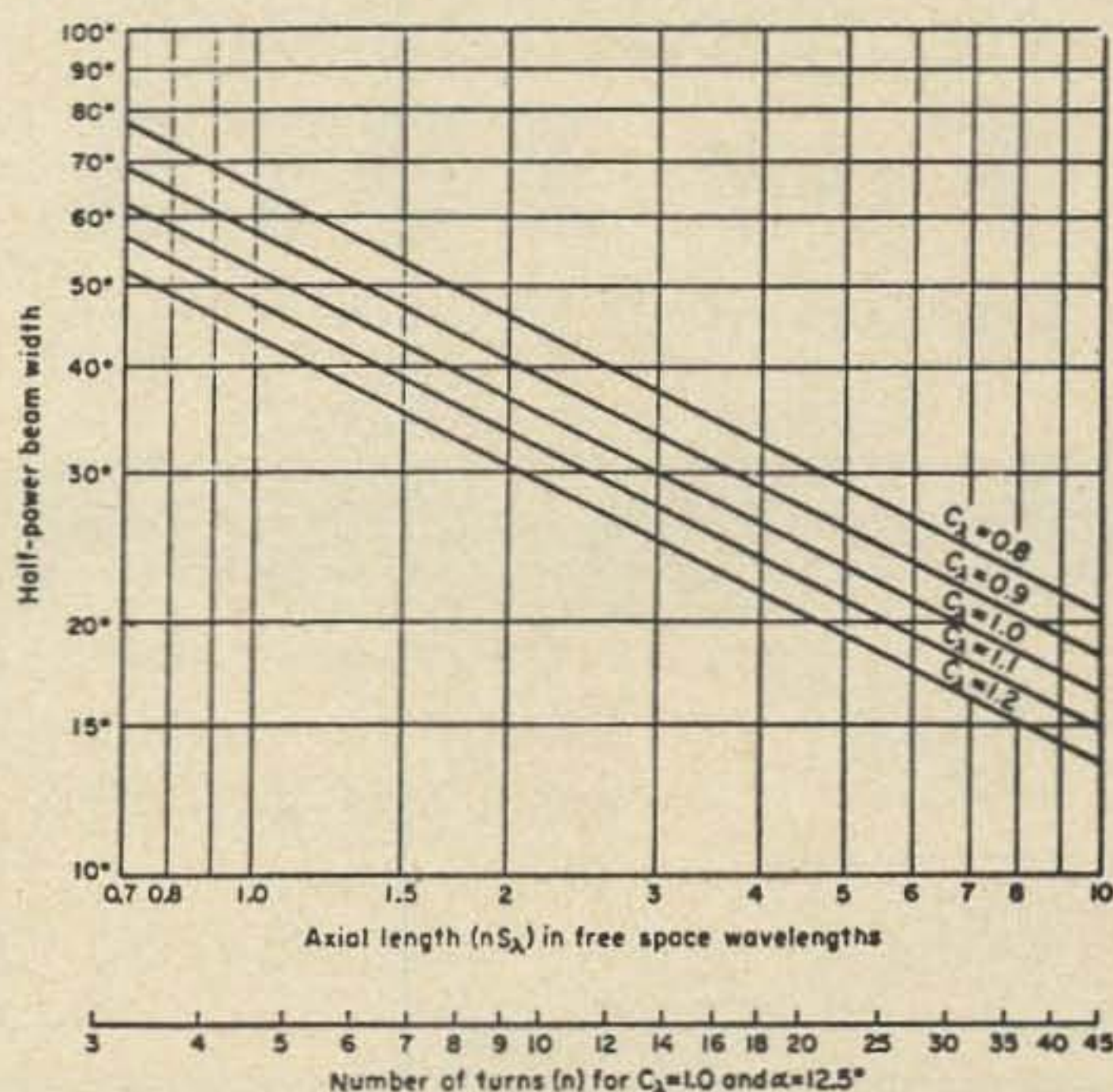

Fig. 3. Half-power beamwidth of axial mode helical antenna as a function of the axial length and circumference in free-space wavelengths and also as a function of the number of turns for $C_\lambda = 1.0$ and $\alpha = 12.5^\circ$. From Antennas, by John D. Kraus. Copyright 1952. Used with permission of McGraw-Hill Book Company.

N	Gain for $C\lambda = 1.00$	Gain for $C\lambda = 1.05$	Gain for $C\lambda = 1.10$
3	9.99	10.42	10.82
4	11.25	11.67	12.07
5	12.214	12.64	13.04
6	13.0	13.43	13.83
7	13.675	14.10	14.5
8	14.25	14.68	15.08

Table 1. Gain of Helix as a Function of $C\lambda$ and N.

the spacing. This formula applies to helices of turns $n > 3$, $0.75\lambda < C\lambda < 1.33\lambda$, and $12^\circ < \alpha < 15^\circ$. The half-power beamwidth of the helical beam antenna as a function of the axial length or number of turns is shown graphically in both References 1 and 2. For 6 and 8 turn helices the half-power beamwidth calculated from this formula, with $C\lambda = 1.00\lambda$, is approximately 45° and 39.8° respectively.

The power gain of the helical beam antenna, with respect to an isotropic circularly polarized source, is obtained by dividing the square of the beamwidth into the number of square degrees in a sphere, and is given by

Gain $\approx 15 C^2 \lambda n S \lambda$, a power ratio; or, in terms of a decibel ratio:

Gain $\approx 11.8 + 10 \text{Log}_{10}(C^2 \lambda n S \lambda)$ dBi. A graph of the power gain as a function of the number of turns and the circumference of the helix is found in Reference 2. For 6 and 8 turn helices ($C\lambda = 1.00\lambda$) the gain for $C\lambda = 1.00\lambda$ is 13.00 and 14.25 dBi, respectively, and for $C\lambda = 1.05\lambda$ the gain is 13.43 and 14.68 dBi respectively. These formulas do not take into account the effect of minor lobes. Also, the gains quoted in Table 1 and above are with respect to a circularly polarized isotropic source.

The axial ratio is essentially the polarization in the direction of the helix axis and is given by:

$$AR = \frac{2n + 1}{2n}$$

When the axial ratio approaches unity the polarization is nearly circular; for $n > 3$, circular polarization should be obtained.

The terminal impedance is nearly a pure resistance for the helical beam antenna, and for a helix of 3 turns or more with $0.75\lambda < C\lambda < 1.33\lambda$, the terminal resistance is given by (within $\pm 20\%$):

$$R = 140 C\lambda \text{ Ohms}$$

For a circumference of 1.00 wavelength the terminal resistance is approximately 140 Ohms. This requires impedance matching if one uses 50 Ohm coaxial cable as feedline.

References

- [1] John D. Kraus, "Antennas," McGraw-Hill, 1952.
- [2] Edward F. Harris, "Helical Antennas," *Antenna Engineering Handbook*, editor Henry Jasik, McGraw-Hill, 1961, Chapter 7.
- [3] Doug De Maw W1CER, "The Basic Helical Beam Antenna," *QST*, November, 1965, p. 20+.
- [4] T. Bittan G3JVQ/DJ0BQ, "Circular Polarization on 2 Meters," *VHF Communications*, Vol. 5, Edition 2, May 1973, p. 104-109.
- [5] Dr. Ing. A. Hock DC0MT, "Theory, Advantages, and Types of Antennas for Circular Polarization at UHF," *VHF Communications*, Vol. 5, Edition 2, May 1973, p. 110-115.
- [6] T. Bittan G3JVQ/DJ0BQ, "Antenna Notebook," *VHF Communications*, Vol. 5, Edition 4, November 1973, p. 220.

Next month: Design, construction and installation.

... WB4VXP

CATALOG

GOVERNMENT SURPLUS ELECTRONIC EQUIPMENT

For 1975

FREE UPON REQUEST! Write for
Copy of Catalog WS-75 Now!
Address: Attention Dept. 73

FAIR RADIO SALES

1016 E. EUREKA • Box 1105 • LIMA, OHIO • 45802

want
some?

quality - value
integrity - variety
fast ppd delivery

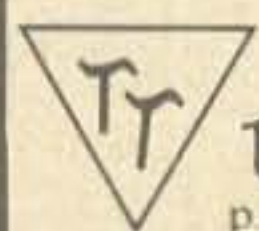

try

TRI-tek, inc.

P. O. Box 14206 • PHOENIX, ARIZONA 85063

10¢ Stamp for Latest Flyers Full of New
and Surplus Elec-
tronics Bargains

PARTS! CORNELL TUBES!

FREE Send For FREE
CORNELL'S
New Color
Catalog

48 Pgs. New Items

33¢ per
tube

IN LOTS OF 100

36¢ per
tube

ORDER FREE
IF NOT SHIPPED
IN 24 HOURS!

4215 S University Ave. San Diego, Calif. 92105

**THE ATLAS 210 AND 215
SOLID STATE SSB TRANSCEIVERS**



Plug-In-and-Go-Power!

This may sound like just another catchy headline, but this is the best, and quickest way we can think of to describe the Atlas transceiver.

Plug-In

For mobile operation all you have to do is make a one time installation of the Plug-in Mobile Mount, and thereafter, when you want to operate mobile, just slide your Atlas transceiver into the mount. All connections are made automatically, as shown below. It takes only seconds, and you are ready to operate. Fixed station operation is achieved in the same easy manner, since the Atlas AC Console has the same plug-in system as the mobile mount.

soever. This permits instant QSY or band-switching. Simply tune in to your frequency and GO!

No other rig on the market will provide you with so much operating pleasure.

When you combine the simplicity of operation with unparalleled selectivity, immunity to cross modulation or overload, solid state reliability, 200 watts P.E.P. input power and 5 band coverage...the Atlas 210/215 has everything you could want in a transceiver.

Model 210 covers 80 through 10 meters.
Model 215 covers 160 through 15 meters.

Go-Power!

No Transmitter Tuning!

This is another outstanding feature of the Atlas transceiver. There is no transmitter tuning what-

Plug-in and GO!

\$599

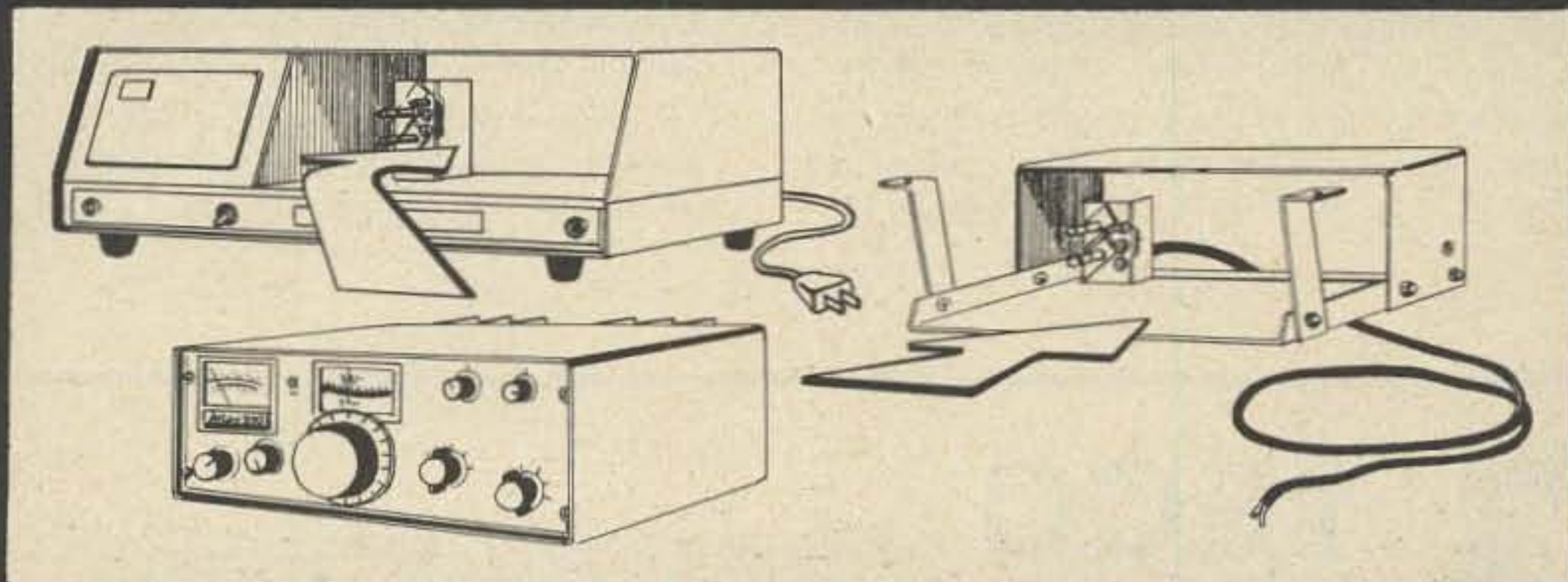

AMERICAN MADE AND GUARANTEED BY:



**ATLAS
RADIO INC.**

417 Via Del Monte Oceanside, CA 92054
Phone (714) 433-1983

*Available NOW at your Atlas dealers. See him for complete details, or drop us a card and we'll mail you a brochure and dealer list.



TECO

A SUBSIDIARY OF TUCKER ELECTRONICS CO.

SUMMER
1975

SPECIAL SALES FOR THE HOBBYIST, AMATEUR AND BARGAIN HUNTER.

INVENTORY REDUCTION SALE!!

Quantities are very limited on many items.
When calling, ask for Test Equipment Sales

The instruments listed are surplus unless otherwise stated. Each unit is sold as is and every attempt is made to assure completeness. While most instruments are operational, no warranty is implied or stated. There is a 10 day trial period for each instrument which allows you to inspect and assure yourself that you are satisfied. You may return the instrument for full credit during this 10 day period-paying only freight charges. Since it is impossible to list the individual condition of each instrument-call and discuss your choice. Should you desire the same instrument completely reconditioned and guaranteed, we can put you in touch with our parent company for price and availability information.

CREDIT - TECO'S terms are cash or COD with the following exceptions. TECO accepts BankAmericard, Master Charge and American Express. TECO will sell on net 10 days to D&B or credit established customers. Our aim is to keep our overheads as low as possible so we can continue to offer instruments at the very lowest prices. Please help us to meet our goals and send your check with your order.

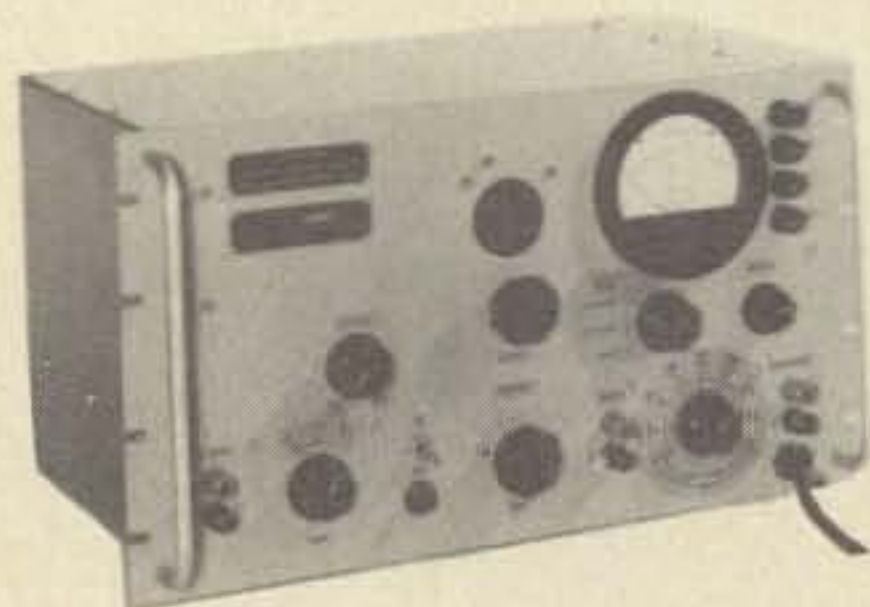

MILITARY TS-723B/U (HP 330B) DISTORTION ANALYZER

This marvelous noise and distortion analyzer gives accurate direct readings from 20 Hz to 20 KHz. Perfect for measuring audio distortion, voltage level, power output, gain, distortion of AM RF carrier, measuring hum and noise level and audio signal frequency. Blanketing the audio spectrum the TS-723 measures noise levels as small as $100\mu\text{V}$ and distortion as low as 0.1%. A wide-band 20dB gain amplifier is built in as well as a VTVM with nine full scale ranges from 0.03 to 300 volts and nine dB ranges spaced exactly 10dB per range from -12dB to +2dB. Residual frequencies are measured to within $\pm 3\%$ of full scale value. TECO'S special sale price is only\$125.00



LEEDS & NORTHRUP 5430 A (MILITARY ZM-4B/U) RESISTANCE BRIDGE.

This advertised special is a portable, general purpose wheatstone bridge designed primarily to measure resistances when locating faults which occur in conductors used for communications systems and those used for power transmission. It can also measure the value of any fixed resistor. In addition to the self-contained galvanometer it has provision for external null indicator and batteries. Measures resistance values from 0.001 to 1,011,000 ohms, internal battery power supply. Ratio dial multiplying values for resistance measurements and Varley loop tests are 1/1000, 1/100, 1/10, 1/9, 1/4, 1, 10 and 100. Ratio for Murray loop tests are M1000, M100 and M10. Accuracy is $\pm 0.1\%$ of indicated resistance\$75.00



TECO

a subsidiary of Tucker Electronics Co.

P.O. BOX 1050 1717 S. Jupiter Rd. GARLAND, TX. 75040

800-527-4642 toll free

In Texas Call 214-348-8800

HICKOK 1890M TRANSISTOR TESTER: Measures in-circuit Beta and Rin of transistors and leakage of out-of-circuit transistors, $\pm 5\%$ Beta measurement accuracy **\$75.00**

MILITARY UPM-6B Radar Test Set: For deck testing of Mark VIFF equipment **\$65.00**

MILITARY UPM-12 SWR INDICATOR TEST SET: Used to make impedance measurements in X-band waveguide equipment **\$150.00**

MILITARY UPM-17 SPECTRUM ANALYZER: Military version of Lavoie LA-18M, general purpose spectrum analyzer covers 10MHz to 16 GHz. TECO Price **\$595.00**

POLARAD R100 KLYSTRON TUBE TESTER: **\$100.00**

POLARAD PJ-1 PULSE JITTER TESTER: **\$125.00**

POLARAD TSA SPECTRUM ANALYZER MAIN-FRAME: Resolution 2-80 KHz, dispersion 400 KHz to 25 MHz, sensitivity -50 to -95 dbm, variable attenuator, built-in marker. Other plug-ins available to 44 GHz **From \$150.00**

SINGER SSB-3B SINGLE SIDEBAND SPECTRUM ANALYZER: A comprehensive communications system analyzer with five preset and one continuously variable sweep widths, $2\mu\text{v}$ sensitivity switch selectable 50 or 600 ohm input impedance and resolution variable from 10 Hz to 3 KHz Internal markers and many features **\$1295.00**

SINGER (TELESIGNAL) TA216B TEST SET: Includes interconnecting cable **\$155.00**

SPRAGUE TCA-1 CAPACITOR ANALYZER: **\$50.00**

STELMA TDA-2 RTTY DISTORTION TEST SET: TECO Price **\$20.00**

VIDAR 720 FLUTTER ANALYZER: Seven operating frequencies from 3.125 KHz to 200 KHz, flutter bandwidth from 312 Hz to 10 KHz. Built-in scope, solid state unit **\$350.00**

FREQUENCY MEASURING EQUIPMENT

BECKMAN 7570 CONVERTER MAINFRAME: Accepts 7570 series converter plug-ins to expand basic range of counters using heterodyne technique **\$35.00**

BECKMAN 7571 PLUG-IN CONVERTER: 10 MHz to 110 MHz **\$25.00**

GERTSCH FM-3 FREQUENCY METER: Measures 20-1000 MHz with 0.001% accuracy, generates over same frequency **\$195.00**

GERTSCH FM-4 FREQUENCY MULTIPLIER: Measures and generates signals from 500 MHz to 12.5 GHz, requires 400-1000 MHz driving source **\$295.00**

GERTSCH FM-7/DM-3 FREQUENCY METER: Includes deviation meter, measures and generates signals from 20-1000 MHz with 0.001% accuracy **\$795.00**

HP 524B COUNTER: DC to 10 MHz, 6 digit neon, 2 meters **\$95.00**

HP 524D COUNTER: DC to 10 MHz, 8 digit neon **\$145.00**

HP 525B CONVERTER PLUG-IN: 110 MHz to 220 MHz **\$75.00**

SIGNAL GENERATOR

ALFRED 620 SWEEP OSCILLATOR: 0.5 to 1.0 GHz, N output at 10mWatts **\$395.00**

ALFRED 622BK SWEEP GENERATOR: Complete unit covers 2-4 GHz range **\$395.00**

ALFRED 623B SWEEP GENERATOR: Complete sweeper covers 4-8 GHz range **\$395.00**

ALFRED 624B SWEEP GENERATOR: Complete sweeper for 8-12.4 GHz range **\$395.00**

ALFRED 625B SWEEP GENERATOR: Complete unit covers 12.4 to 18.0 GHz **\$395.00**

ALFRED 642K SWEEP GENERATOR: Complete 2-4 GHz unit **\$795.00**

DUMONT 404 PULSE GENERATOR: 1-100 KHz rep rate, 0.02 to 100 μsec pulsewidth, 3V into 600 ohms, 0-50dB attenuator **\$65.00**

EH 120D PULSE GENERATOR: 100Hz to 20MHz, 20V into 50 Ω , 1.3ns rise at 20V, variable pw, dual pulse **\$295.00**

EH 121 PULSE GENERATOR: 10Hz to 10MHz, 4ns rise $\pm 50\text{V}$ into 50 Ω . Variable width with fixed 120ns delay **\$295.00**

FXR S771B TEST OSCILLATOR: 1.9-4.0 GHz **\$175.00**

FRX C772A SIGNAL GENERATOR: 3.95 to 8.2 GHz, 10-100mW output, internal square wave modulation, external pulse and FM **\$195.00**

GENERAL MICROWAVE 301 POWER SUPPLY: Powers GMC noise generators in 501 series **\$20.00**

GR 605B STANDARD SIGNAL GENERATOR: 9.5 KHz to 30 MHz **\$100.00**

GR 1208B UNIT OSCILLATOR: 65 to 500 MHz, requires unit power supply **\$80.00**

GR 1218A UNIT OSCILLATOR: 900 MHz to 2 GHz, requires unit power supply **\$125.00**

GR 1390A RANDOM NOISE GENERATOR: 30Hz-5MHz, 1V output **\$95.00**

HP 205AG AUDIO OSCILLATOR: 20 Hz to 20 KHz **\$250.00**

HP 205AH HIGH POWER OSCILLATOR: 20 Hz to 20 KHz 5 watts output into 50, 200, 600, or 5000 Ω . Built-in attenuators, input and output meters. **\$275.00**

HP (BOONTON) 207E UNIVERTER: Extends range of 202 series generator **\$125.00**

HP 616A SIGNAL GENERATOR: Direct reading and direct control from 1.8 to 4.2 GHz. The HP 616A features $\pm 1.5\text{dB}$ calibrated output accuracy from -7dBm to -127dBm. The output is directly calibrated in microvolts and dBm with continuous monitoring.



TECO

a subsidiary of Tucker Electronics Co.

P.O. BOX 1050 1717 S. Jupiter Rd. GARLAND, TX. 75040

800-527-4642 toll free

In Texas Call 214-348-8800

METERS OF ALL TYPES Continued

- ORION V-100M VTVM:** Similar to HP 400H, like new\$60.00
- NARDA MODEL 440 SOLID STATE MICROWAVE POWER METER:** Rechargeable batteries\$95.00
- PRD 277B STANDING WAVE INDICATOR:** \$75.00
- PRD 650 POWER METER:**\$40.00
- SRI AEW EDGESCALE METER:** 0 to 50/100/200 VDC ranges, 7" scale, 0.5%\$25.00
- SRI AEW EDGESCALE METER:** 0-250 VDC range, 7" scale, 0.5%\$20.00
- SRI CEW-7 EDGESCALE METER:** 0 to 200 VDC, 7" scale, 0.5%\$20.00
- SRI JW-4A EDGESCALE METER:** 0 to 1.5/6 mVDC ranges, 4" scale, 0.5%\$30.00
- SRI JW-4A EDGESCALE METER:** 0 to 150 mVDC range, 4" scale, 0.5%\$20.00
- SRI JW-4A EDGESCALE METER:** 0 to 150 mADC range, 1/2" scale, 0.5%\$20.00
- WILTRON 321 PHASE & AMPLITUDE INDICATOR:** Includes local oscillators from 2.5-1000 MHz TECO Price\$1395.00
- AIL 130 PRECISION TEST RECEIVER:** 30 MHz IF, 0-80dB precision attenuator\$250.00
- HAMMARLUND SP600 RECEIVER:** 560 KHz to 54 MHz\$225.00
- MILITARY URTM-7 RFI MEASURING SET:** Measures broadband and CW interference. Frequency range is 20-400 MHz in two bands. Voltage range is 6 μ V to 5V/MHz. Contains an impulse generator for noise reference standard. \pm 10% voltage accuracy\$995.00
- NEMS-CLARKE 1401 TELEMETRY RECEIVER:** 215 to 260 MHz range\$95.00
- NEMS-CLARKE 1412 RECEIVER:** 215-260 MHz, crystal controlled with deviation meter, 100/500 IF bandwidth\$75.00
- NEMS-CLARKE 1432 TELEMETRY RECEIVER:** 215 to 260 MHz range, identical to 1412 except uses phase lock detector\$75.00
- NEMS-CLARKE 1455 RECEIVER:** 215-260 MHz, crystal controlled or internal VFO, 150/300 IF bandwidth\$125.00

RECEIVERS

- POLARAD R RECEIVER BASIC UNIT:** Nine plug-ins cover 400-84,200 MHz range. AM, CW, FM, MCW or pulse reception. IF bandwidth 3 MHz, video bandwidth 2 MHz, sensitivity - 50 to - 90 dBm. Requires plug-in to operate\$350.00
- POLARAD R SERIES RECEIVER PLUG-IN:** Nine plug-ins cover 400-84,200 MHz. Specify correct band\$300.00

STODDART NM-50A RFI RECEIVER: 375-1000 MHz receiver, excellent units\$595.00



BALLANTINE 300 VTVM: The model 300 is a sensitive, wide bank VTVM with a 100,000 to 1 voltage range and accuracy of better than 2% anywhere on the scale and at any frequency from 10 Hz to 150 KHz. Specific ranges allow measurement from 1mV to 100V with an input impedance of 0.5M Ω shunted by 30pF. The voltage ranges are logarithmic and there is a matching 0 to 20 dB linear decibel scale. Special while they last\$29.50

HP 434A CALORIMETRIC POWER METER: Just connect to the Type "N" input and read the power from 10mW to 10 watts anywhere in the frequency range from DC to 12.4 GHz. No external terminations or detectors - readings directly in watts or dBW. 50 ohms input with internal calibrator circuit and \pm 5% accuracy. (Accuracy at low end of frequency range is as good as 0.5%). New price exceeds \$2000.00 TECO PRICE\$695.00

MILITARY TS-537/TSM CRYSTAL IMPEDANCE METER.

With a frequency range from 75 to 1100 KHz in 6 ranges and measurement scales from 0 to 99,000 Ω and 12 to 110 nanofarads this portable, general purpose, test instrument is designed to measure equivalent electrical parameters of quartz crystals of the type used for communications purposes. Provision is made to measure directly the effective series-resonant and anti-resonant resistances of a piezo-electric quartz crystal in its holder. The load capacitance is obtained by applying dial markings to a calibration chart. With the static capacity measured by an external capacity measuring device and with the series-resonant and anti-resonant frequency measured by an external frequency measuring device, the series capacitance and inductance can be calculated. A microammeter indicates the magnitude of oscillation of the oscillator tube by measuring its grid current. Frequency is selected by a switch and a fine tuning control. Equipment can be bench or rack-mounted\$55.00



TECO

a subsidiary of Tucker Electronics Co.

P.O. BOX 1050 1717 S. Jupiter Rd. GARLAND, TX. 75040

800-527-4642 toll free

In Texas Call 214-348-8800



GENERAL ELECTRIC PORTABLE METERS include snap-on self contained cover, carrying handle and 0.5% DC accuracy. These excellent instruments are priced to move quickly so get your order in today.

SINGLE RANGE UNITS \$15.00 each
 MULTIPLE RANGE UNITS \$20.00 each

AC Ranges in Stock:

0 to 0.75/1.5 KW; 0 to 1.5/3 KW; 0 to 30/60A;
 0 to 10/20V; 0 to 15/30V; 0 to 25/150V;
 0 to 150V; 0 to 150/300V.

DC Ranges in Stock:

0 to 500 μ A; 0 to 1 mA; 0 to 300 mA; 0 to 3A; 0 to 30A;
 0 to 3V; 0 to 7.5/30/75V; 0 to 150V; 0 to 150/300V;
 0 to 150/300/750V; 0 to 300V; 0 to 600V; 0 to 750V.

METERS OF ALL TYPES

ASSOCIATED RESEARCH 259 VIBROGROUND:
 Similar to Model 293 \$65.00

ASSOCIATED RESEARCH 293 VIBROGROUND:
 Lightweight instrument for measurement of soil-resistance and ground resistance, 0-1/10/100/1000 ohms. \$80.00

BALLANTINE 300 VTVM: 1mV to 100V, 10 Hz to 150 KHz \$25.00

BALLANTINE 305 PEAK READING VTVM:
 Measures P-P, positive or negative peak values, 5 Hz to 500 KHz response 1mV to 1000V with mirror back scale \$95.00

BALLANTINE 310A VTVM: 100 μ v to 100V. Measurements from 10 Hz to 2 MHz, 3% accuracy to 1 MHz \$75.00

BALLANTINE 314 VTVM: 1 mV to 1KV, 15 Hz to 6 MHz, less probe \$75.00

BALLANTINE 316 VTVM: Peak to peak, 0.05 Hz to 30 KHz \$35.00

BIRD 61S4 WATTMETER: Direct reading 20 or 5 watts (choice), 50 Ω , N(F) connector, includes meter \$65.00

BIRD 694 WATTMETER: 0 to 1000W direct reading, 2 to 36 MHz, 50 Ω , N(F) connector \$195.00

BOONTON 91CR RF VTVM: 1 mV to 3V, 20 KHz to 1.2 GHz, rackmount \$225.00

BORG WARNER (SINGER) M401 SWR INDICATOR: \$95.00

CARY MODEL 31 VIBRATING REED ELECTROMETER: 1mV to 30V in 10 ranges \$50.00

E-H RESEARCH 140A SWITCHING TIME METER:
 TECO Price \$50.00

FLUKE 910A TRUE RMS VOLTMETER: 10 Hz to 7 MHz 100 μ V to 300V fs. \pm 1% accuracy \$225.00

FXR B810A SWR METER: \$35.00

GENERAL MICROWAVE 451 POWER METER:
 TECO Price \$35.00

GR 1932A DISTORTION METER: 50 Hz - 18 KHz, TECO Price \$125.00

HP H18-340B NOISE FIGURE METER: Automatic display and measurement of IF or RF amplifier noise at 30 and 60 MHz. Operates with external noise sources for other bands \$400.00

HP 400DR VTVM: 10 Hz to 4 MHz, 1 mV to 300V, 2% accuracy \$65.00

HP 400HR VTVM: 10 Hz to 4 MHz, 1 mV to 300V, 1% accuracy \$95.00

HP 412A RDC VTVM: 1 mV to 1KV, 1 microamp to 1A, can be used as DC amplifier, 2% accuracy \$195.00

HP 415A VSWR INDICATOR: \$25.00

HP 416A RATIONOMETER: Displays ratio of forward and reverse signals automatically \$125.00

HP 416B RATIONOMETER: Later version of 416A \$395.00

HP 500C TACHOMETRY: 180 RPM to 6,000,000 RPM \$85.00

ITE (PHAZOR) 100A PHASE SENSITIVE NULL METER: 30 Hz to 10 KHz, 8 volts to 120V reference. Separates in-phase and quadrature null voltages. 40 dB selectivity \$95.00

KINTEL 202BR DC MICROVOLTMETER: Full scale ranges from 300 μ V - 1000V \pm 3%, can be used as 70dB amplifier \$35.00

CAUTION: THESE INSTRUMENTS ARE SOLD AS-IS. WHILE EVERY ATTEMPT IS MADE TO ASSURE COMPLETENESS AND TO DELIVER AN OPERATIONAL INSTRUMENT, THERE IS NO WARRANTY IMPLIED OR STATED EXCEPT: "YOU MAY EXAMINE THE UNIT FOR TEN DAYS AND, IF YOU ARE NOT SATISFIED, YOU MAY RETURN FOR FULL CREDIT PAYING ONLY THE FREIGHT CHARGES". EVERY TECO INSTRUMENT IS CONSIDERED TO BE A GENUINE BARGAIN, BUT THE BUYER SHOULD HAVE ACCESS TO COMPETENT TECHNICAL TALENTS TO MAKE THE PURCHASE PRACTICAL.

SEND FOR THE LATEST "BARGAIN HUNTER" BROCHURE - IT'S FREE!

MILITARY UPM-4A TRANSPONDER TEST SET:

Three piece unit in single cabinet includes power supply, simulator unit and oscilloscope display unit. The UPM-4A performs many measurements on radar equipment operating in the 925 to 1225MHz range including checks on decoding, receiver bandwidth and frequency, receiver sensitivity, pulse counting, pulse analysis and IFF target generators. This unit sold new for nearly \$5000 but at TECO its cost is a low\$175.00

MILITARY AN/UPM-15 200 VOLT PULSE GENERATOR.

A Portable, general purpose pulse generator set used for testing pulse amplifiers and networks, and for modulating oscillators in field and depot maintenance. It generates single or double pulses of variable repetition rate, width, amplitude, separation, delay and rise decay time. The pulses may also be synchronized with oscillators or other instruments. Output rep rate is externally or internally variable from 50Hz to 10KHz, pulsewidth variable from 0.5 to 100 μ seconds, amplitude 0.002 to 200 volts and calibrated delay from 2 to 225 μ sec. An extraordinary value\$50.00

TEKTRONIX 1121 AMPLIFIER: 5Hz to 17MHz, gain of 100\$175.00

WEINSCHEL CF-1 AF SUBSTITUTION ATTENUATOR: For use with square low detector\$150.00

WEINSCHEL IN-1 AUDIO LEVEL INDICATOR: For use with square low detector\$50.00

MILITARY TEST EQUIPMENT is the biggest value for your money. Each military unit is ruggedized and constructed of the highest quality parts. The U.S. government has put severe MIL-SPECS into each of their purchases assuring YOU an instrument now that bears the U.S.A. mark of quality and yet is usually less expensive. Examine the Military units carefully for **BEST BUYS** — call TECO for your requirements that cannot be filled by this brochure. TECO has thousands of instruments that, due to space limitations, are not shown in this brochure.

OSCILLOSCOPES AND RELATED INSTRUMENTS

HP 185 SAMPLING OSCILLOSCOPE: DC to 1GHz\$195.00
HP 1100A DELAY LINE: 120nsec\$75.00

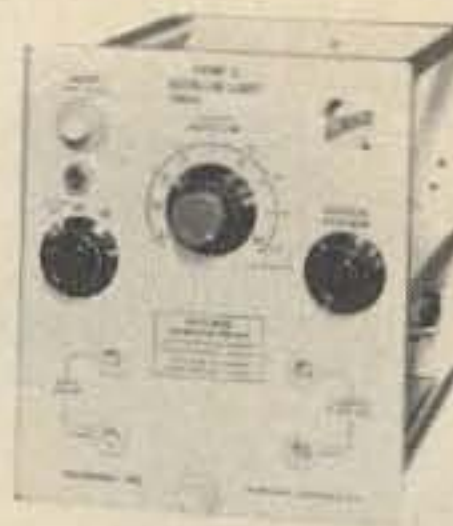

TEKTRONIX OSCILLOSCOPE PLUG-INS: Can be used with the 530, 540 or 550 series oscilloscopes with equal performance.

Model 53/54C dual trace 20 MHz unit\$95.00

TEKTRONIX CA PLUG-IN: DC - 24 MHz dual trace\$150.00

TEKTRONIX E PLUG-IN: DC - 60 KHz differential\$75.00

TEKTRONIX DIFFERENTIAL PLUG-IN: 50mV to 20V/cm sensitivity, DC to 20 MHz bw, 18ns risetime\$65.00

TEKTRONIX H SINGLE TRACE PLUG-IN: 50mV to 20V/cm sensitivity, DC to 15 MHz bw, 23ns risetime\$75.00

TEKTRONIX K SINGLE TRACE PLUG-IN: 50mV to 20V/cm sensitivity, DC to 30 MHz bw, 12ns risetime\$50.00

TEKTRONIX R PLUG-IN: Transistor risetime\$65.00

TEKTRONIX 262 PROGRAMMER: Remotely program the 6R1A digital unit\$250.00

TEKTRONIX 535 OSCILLOSCOPE: DC to 11 MHz less plug-in\$425.00

TEKTRONIX 536 OSCILLOSCOPE: DC to 15 MHz less plug-in\$350.00

RECORDERS AND PRINTERS

BRUSH RE3610-60 100 CHANNEL EVENT RECORDER: "as-is"\$150.00

EAIBAR CHART RECORDER: 40 channels recording time 9, 18, 27 hours\$150.00

FAIRCHILD 321-A OSCILLOSCOPE RECORD CAMERA: Continuous motion 35mm camera with magazine and variable speeds\$75.00

HP 560A DIGITAL PRINTER: Up to 11 columns capacity with plug-in boards, 5 line/second print speed\$250.00



TECO

a subsidiary of Tucker Electronics Co.

P.O. BOX 1050 1717 S. Jupiter Rd. GARLAND, TX. 75040

800-527-4642 toll free

In Texas Call 214-348-8800

Simple operation, frequency dial accuracy is $\pm 1\%$ and stability exceeds $0.005\%/^{\circ}\text{C}$ change in ambient temperature. Calibrated attenuator is within $\pm 1.5\text{dB}$ over entire output band. 50 ohm impedance unit has internal pulse modulation with rep rate variable from 40 Hz to 4 KHz, variable pulsewidth (1 to $10\mu\text{sec}$) and variable pulse delay (3 to $300\mu\text{sec}$). External modulating inputs increase versatility. New price exceeds \$2000.00. TECO PRICE

HP (BOONTON) 207G UNIVERTER: Extends range of 202 series generators\$175.00

HP 212AR PULSE GENERATOR: 60 Hz to 5 KHz\$65.00

HP 218A/219B DIGITAL DELAY GENERATOR WITH DUAL PULSE PLUG-IN: Superb units have many features\$375.00

HP 233A CARRIER TEST OSCILLATOR: 50 Hz to 500 KHz, 3 watts into 600 ohms, tests loops over 200 miles long\$75.00

HP (BOONTON) 240A SWEEP SIGNAL GENERATOR: Designed for alignment of broadband amplifiers, 4.5 to 120 MHz range. Output $1\mu\text{V}$ to 0.3V\$395.00

HP 616A SIGNAL GENERATOR: 1.8 GHz to 4.2 GHz\$395.00

HP 684C SWEEP GENERATOR: 4 to 8.1 GHz range, sweep rates 16 MHz to 160 MHz/sec in 9 steps. 10mw output Bad BWO\$195.00

HP 686A SWEEP OSCILLATOR: Electronic sweep with sweep rate from 32MHz to 320Hz/sec in 9 steps. 8.2 to 12.4 GHz range\$195.00

HP 686C SWEEP GENERATOR: Same as 684C except 8.2 MHz to 12.4 GHz unit\$195.00

HP 938A MICROWAVE DOUBLER: 9 to 13 in, 18 to 26 GHz output at 10mW\$995.00

HP (DYMEC) DY5731 HIGH POWER SIGNAL GENERATOR: X-Band, +24 to -76dBm\$495.00

HOLT AO-1 AUDIO OSCILLATOR: 20 to 20 KHz, less than 0.1% distortion\$125.00

JERROLD CM-6 PORTABLE CRYSTAL MARKER GENERATOR: Six crystal markers between two and 100 MHz, up to 20th harmonic\$150.00

JERROLD 601 SWEEP FREQUENCY GENERATOR: 12-225 MHz, 50 Ω output, small portable\$150.00

JERROLD 900A SWEEP GENERATOR: 500 KHz to 1200 MHz, many features\$395.00

KAY MEGA-NODE SR VARIABLE NOISE GENERATOR: 1-3000 MHz, 50 Ω output, 0-20dB noise figure measurement, $\pm 0.25\text{dB}$ accuracy \$75.00

MAXON 1141A POWER OSCILLATOR: 200 to 2500 MHz, 5 to 40 Watts output\$495.00

MEASUREMENTS 80 SIGNAL GENERATOR: Covers UHF from 2 to 400 MHz and 0 to $10,000\mu\text{V}$ calibrated output\$295.00

MEASUREMENTS 82 SIGNAL GENERATOR: 20 Hz to 50 MHz, 0 to 50V output, 0-50% internal modulation\$250.00

MEASUREMENTS 84 TV SIGNAL GENERAL: 30 MHz to 1000 MHz, 75 ohm, $0.1\mu\text{V}$ to 1V output\$175.00

MEASUREMENTS 88 FM SIGNAL GENERATOR: 88 to 108 MHz, 0.1 to $100,000\mu\text{V}$ output\$150.00

MEASUREMENTS 188 FM SIGNAL GENERATOR: 88 to 108 MHz, 0.1 to $100,000\mu\text{V}$ Output\$350.00

MEASUREMENTS 210A SIGNAL GENERATOR: 86 to 108 MHz. FM generator with 0.5% dial accuracy. 50 Ω 0.1 to $100,000\mu\text{V}$ output\$125.00

MILITARY TS-382 AUDIO GENERATOR: 20 Hz to 200 KHz\$65.00

POLARAD HU-2A BASIC SIGNAL GENERATOR: Requires "G" series plug-in to operate\$350.00

POLARAD G SERIES TUNING UNIT FOR HU-2A: 7 units cover band from 18.0 to 39.7 GHz, 10mW average power output, 0.1% frequency accuracy, attenuator and wavemeter\$300.00 each

PRD 903 SIGNAL GENERATOR: 7-11 GHz, CW, FM pulse\$195.00

PRD 904 VHF-UHF NOISE GENERATOR: 30-1000 MHz\$250.00

RUTHERFORD B-2A PULSE GENERATOR: 10Hz to 100 KHz, variable parameters\$45.00

RUTHERFORD B-7 PULSE GENERATOR: 20Hz to 2MHz, all variable parameters\$125.00

RUTHERFORD B-7B PULSE GENERATOR: 20Hz to 2MHz, late model of B-7\$225.00

RUTHERFORD B-14 PULSE GENERATOR: 20Hz to 2MHz, solid state units\$125.00

SIERRA 215B-470 POWER OSCILLATOR: 150 to 450 MHz. 50 watts output\$795.00

TMC TTG-2 TWO-TONE TEST GENERATOR: 25 Hz to 1 MHz\$75.00

TEKTRONIX 105 SQUARE WAVE GENERATOR: 25 Hz to 1 MHz\$75.00

TEKTRONIX 180A TIME MARK GENERATOR: Excellent units\$195.00

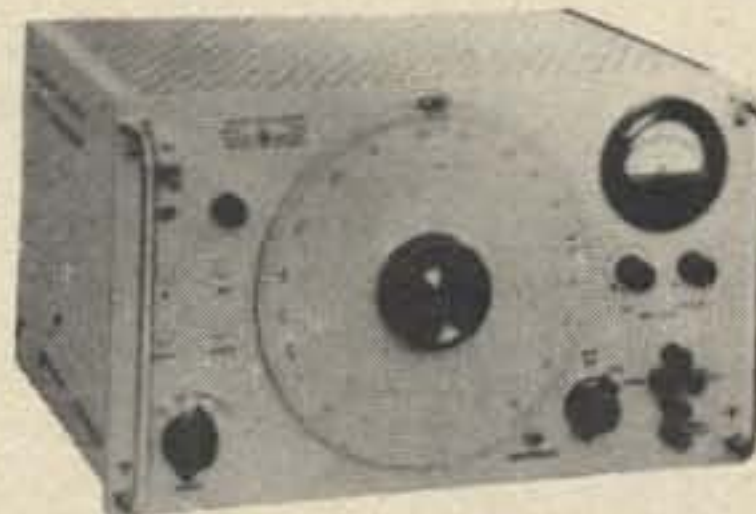

HP 233A (MILITARY SG-71B) CARRIER TEST OSCILLATOR: A bargain hunter's delight. The 233A checks carrier current systems and much more. This fine oscillator generates 3 watts output into 600 ohms over the frequency band from 50 Hz to 500 KHz making possible a variety of tests including 100 to 200 mile loop tests. A second 6V at 600 Ω output can be used simultaneously for other tests. New price exceeds \$700.00
TECO price for this special\$75.00

CAUTION: THESE INSTRUMENTS ARE SOLD AS-IS. WHILE EVERY ATTEMPT IS MADE TO ASSURE COMPLETENESS AND TO DELIVER AN OPERATIONAL INSTRUMENT, THERE IS NO WARRANTY IMPLIED OR STATED EXCEPT: "YOU MAY EXAMINE THE UNIT FOR TEN DAYS AND, IF YOU ARE NOT SATISFIED, YOU MAY RETURN FOR FULL CREDIT PAYING ONLY THE FREIGHT CHARGES". EVERY TECO INSTRUMENT IS CONSIDERED TO BE A GENUINE BARGAIN, BUT THE BUYER SHOULD HAVE ACCESS TO COMPETENT TECHNICAL TALENTS TO MAKE THE PURCHASE PRACTICAL.

SEND FOR THE LATEST "BARGAIN HUNTER" BROCHURE - IT'S FREE!

HP 561B DIGITAL PRINTER: Up to 8 columns, 5 line/second speed\$225.00
RUSTRAK +20B DUAL CHANNEL RECORDER: 100 to 140 VAC, 0 to 5 amps\$60.00
RUSTRAK 133 TEMPERATURE RECORDER: 15C to 55°C\$65.00
SANBORN 150 SERIES: All types amplifiers, recorders, plug-ins. Write for details .P.U.R.

SEND FOR YOUR NEW LEADER CATALOG



CALL OR WRITE FOR CATALOG



MISCELLANEOUS

ALFORD 1128-PS AUTOMATIC IMPEDANCE PLOTTER:\$175.00
ALFORD 3775 TRANSFEROMETER: 1.0 to 3.2 GHz band, for use with AMCI plotters\$395.00
BENDIX 636NC TERMINATION: 600 watts continuous, 50Ω, 0 to 36Hz range, N(F) connector ...\$95.00
BIRD 883 TERMINATION: 1000 watts continuous, 50Ω, LC connector\$95.00
BIRD 888 TERMINATION: 1200 watts continuous, 50Ω, N(F) connector\$105.00
BIRD 8221 TERMINATION: 500 watts continuous, 50Ω, LC connector DC to 2GHz bandwidth ...\$75.00
BIRD 8841 COAX TERMINATION: 1000 watts continuous, 50Ω, LC connector\$95.00
DYMEC 2307A SERVO PROGRAMMER: ...\$295.00
DYMEC 2420A MEASUREMENT CONTROL UNIT: TECO PRICE\$295.00
DYMEC 2530A BINARY/DECIMAL REGISTER: Includes 2532A digital comparator\$295.00
DYMEC 2550A DUAL REGISTER:\$200.00

DYMEC 2551A DUAL REGISTER:\$200.00
DYMEC 5207-1 V-F CONVERTER:\$200.00
GR 1206B UNIT AMPLIFIER: 20Hz-50KHz, 3 watts output, requires unit power supply\$45.00
GR 1219A PULSE AMPLIFIER:\$70.00
GR 1231B AMPLIFIER AND NULL DETECTOR: 50Hz - 100 KHz\$50.00
HUGHES IGC-101 IONIZATION GAUGE CONTROL:\$95.00
HUGHES VTW-30C STORED ENERGY WELDING POWER SUPPLY:\$95.00
JERROLD TC-3 ELECTRONIC SWITCH:\$45.00
KROHN-HITE 310AB ELECTRONIC FILTER: 20Hz to 200KHz bp filter with adjustable bw and ct. \$90.00
L&N 9835B DC INDICATING AMPLIFIER: Can be used as null detector, direct reading indicator or recording preamplifier ± 25μV to ± 1V\$95.00
RAYTHEON 50C WELDER:\$100.00
HP 340B NOISE FIGURE METER: Automatically measures and displays IF or RF amplifier noise figure at 30 to 60 MHz. Bandwidth 1 MHz with input from -60 to -10dBm. Powers HP 340 series noise generators\$395.00
AMI 500 FM MONITOR DEVIATION CALIBRATOR:\$395.00
BIDDLE 601235 STANDARD RESISTOR: NBS Type 0.01 ohm, new\$50.00
GR 107 SERIES VARIABLE INDUCTOR: Specify inductance range\$30.00
GR 544B MEGOHM BRIDGE: 0.1 - 1,000,000 megohm range\$150.00
GR 602 SERIES RESISTOR BOX:\$20.00
GR 716C CAPACITANCE BRIDGE: 100pf to 1.1mf, 0.1% accuracy\$195.00
GR 722ME PRECISION VARIABLE CAPACITOR: 10.5 to 105pF\$50.00
GR 740B CAPACITANCE BRIDGE: 5pF - 100μF, 60Hz\$95.00
GR 1409 SERIES STANDARD CAPACITORS: Specify capacitance\$25.00 to 50.00
GR 1432N 5 RESISTANCE DECADES: 0.1 ohm steps to 11,111 ohms\$65.00
GR 1454A DECADE VOLTAGE DIVIDER: 10 Kohms ratios 0.001 to 1\$75.00
GR 1481 SERIES TWO TERMINAL STANDARD INDUCTOR: Specify inductance\$10.00
GERTSCH CRB-2B COMPLEX RATIO BRIDGE: Self-contained unit measures complex voltage ratios of transformer, synchors, resolver, networks, etc\$395.00
GERTSCH CRT-12AF COAXIAL RATIO TRANSFORMER: 5 digit\$35.00
HP 803A VHF BRIDGE: 50-500 MHz, measures impedance 2 to 2000 ohms magnitude\$150.00
HONEYWELL RUBICON 1163 STANDARD CURRENT SHUNT: 0.1 ohms, 15A\$20.00
L&N 4360 CURRENT SHUNT: 0.1 ohm, 15A\$20.00
L&N 4390 SHUNT BOX: 0.075 to 7.5 amps in 7 ranges\$65.00

CAUTION: THESE INSTRUMENTS ARE SOLD AS-IS. WHILE EVERY ATTEMPT IS MADE TO ASSURE COMPLETENESS AND TO DELIVER AN OPERATIONAL INSTRUMENT, THERE IS NO WARRANTY IMPLIED OR STATED EXCEPT: "YOU MAY EXAMINE THE UNIT FOR TEN DAYS AND, IF YOU ARE NOT SATISFIED, YOU MAY RETURN FOR FULL CREDIT PAYING ONLY THE FREIGHT CHARGES". EVERY TECO INSTRUMENT IS CONSIDERED TO BE A GENUINE BARGAIN, BUT THE BUYER SHOULD HAVE ACCESS TO COMPETENT TECHNICAL TALENTS TO MAKE THE PURCHASE PRACTICAL.

SEND FOR THE LATEST "BARGAIN HUNTER" BROCHURE - IT'S FREE!



MEASUREMENTS MODEL 95 (MILITARY VERSION SG-3) STANDARD FM SIGNAL GENERATOR.

A super buy. Perfect for the Ham using the 220 MHz, 2 or 6 meter bands. Frequency range is 50 to 400 MHz in three bands and a $\pm 0.5\%$ direct reading dial. Output voltage is continuously variable from 0.1 to 100,000 μ V into 50 Ω . The many features in these excellent condition instruments make this the TECO buy of the quarter\$375.00

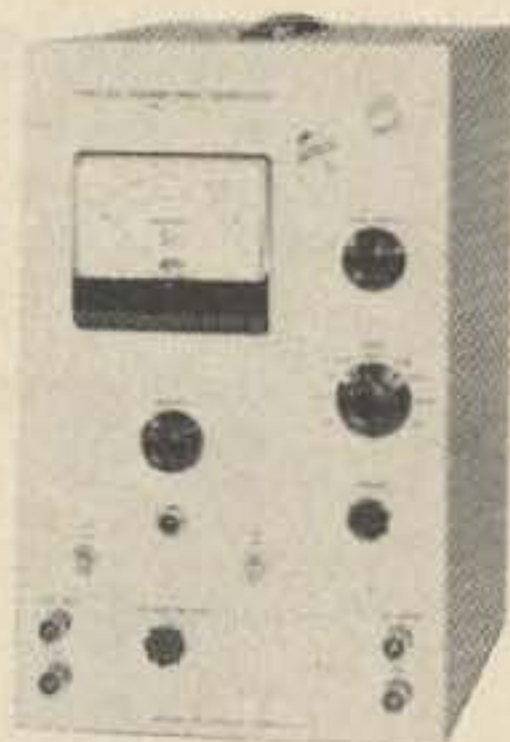

TEXTRONIX 105 SQUARE-WAVE GENERATOR:

From 25 Hz to 1 MHz and with a risetime of less than 20nsec into a terminated 93 ohm cable - the 105 will generate up to 15V and more than 15mA peak-to-peak. Precision square waves over the complete range make the 105 a perfect instrument for testing amplifiers and other test instruments. The TECO price makes it even better\$75.00

ANALYZER'S AND TEST SETS

AD-YU 405 PRECISION PHASE METER: 1 Hz to 500 KHz, direct indication of phase angle in degrees, ± 1 degree accuracy\$125.00

BUDENBERG 280H DEADWEIGHT TESTER Hydraulic with range of 10 to 8000 PSID. Pistons are 1/8 and 1/80 square inch in area. Automatic changeover from low to high range. Accuracy to $\pm 0.025\%$ \$395.00

BUDENBERG 283 DEADWEIGHT TESTER: Hydraulic with range of 2000 to 50,000 PSID. Motorized unit incorporating an overhang piston head on a 0.005 square inch piston unit. Accuracy $\pm 0.05\%$, some weights\$795.00

DAVEN 10B TRANSMISSION MEASURING SET: TECO Price\$295.00

DAVEN 12B TRANSMISSION SET:\$495.00

D&R FL-4 FLUTTER METER: Percent deviation and percent flutter meter. Scope readout. Flutter bandwidth in four ranges from 0.5 to 30Hz, 30 to 300 Hz, 300 to 5000 Hz and DC to 5 KHz\$250.00

DONNER 2102 WAVE ANALYZER: 0-50 KHz unit\$395.00

HP (BOONTON) 275A TRANSISTOR TEST SET: Precise measurements of basic transistor parameters plus characteristics of diodes and other semi-conductors\$295.00

HP 623B TEST SET WITH MILITARY KLYSTRON: 7175 to 7725 MHz range\$395.00

HP 739AR FREQUENCY RESPONSE TEST SET: Provides measurement from 300 KHz to 10 MHz\$250.00

HICKOK 123A AUTOMATIC TUBE TESTER: Roll chart unit performs over 1500 tube tests\$125.00

HICKOK 870 TRANSISTOR ANALYZER: In-circuit tester has six circuit configurations, tests NPN OR PNP\$75.00

DID YOU EVER need a scope, meter or power supply, but really didn't need it all calibrated and checked out? Well, TECO understands and saves you more money than you could believe at the same time. TECO is just the place to pick up that extra counter or generator ... or for that matter anything from a vacuum pump to a TV monitor. AND THERE'S ONLY ONE PRICE AT TECO - CHEAP.

CAUTION: THESE INSTRUMENTS ARE SOLD AS-IS. WHILE EVERY ATTEMPT IS MADE TO ASSURE COMPLETENESS AND TO DELIVER AN OPERATIONAL INSTRUMENT, THERE IS NO WARRANTY IMPLIED OR STATED EXCEPT: "YOU MAY EXAMINE THE UNIT FOR TEN DAYS AND, IF YOU ARE NOT SATISFIED, YOU MAY RETURN FOR FULL CREDIT PAYING ONLY THE FREIGHT CHARGES". EVERY TECO INSTRUMENT IS CONSIDERED TO BE A GENUINE BARGAIN, BUT THE BUYER SHOULD HAVE ACCESS TO COMPETENT TECHNICAL TALENTS TO MAKE THE PURCHASE PRACTICAL.

SEND FOR THE LATEST "BARGAIN HUNTER" BROCHURE - IT'S FREE!

NEW

FROM

TECO

TRI Model 5165 1000 MHz Frequency Counter \$895

TRI Model 5163 250 MHz Frequency Counter \$295

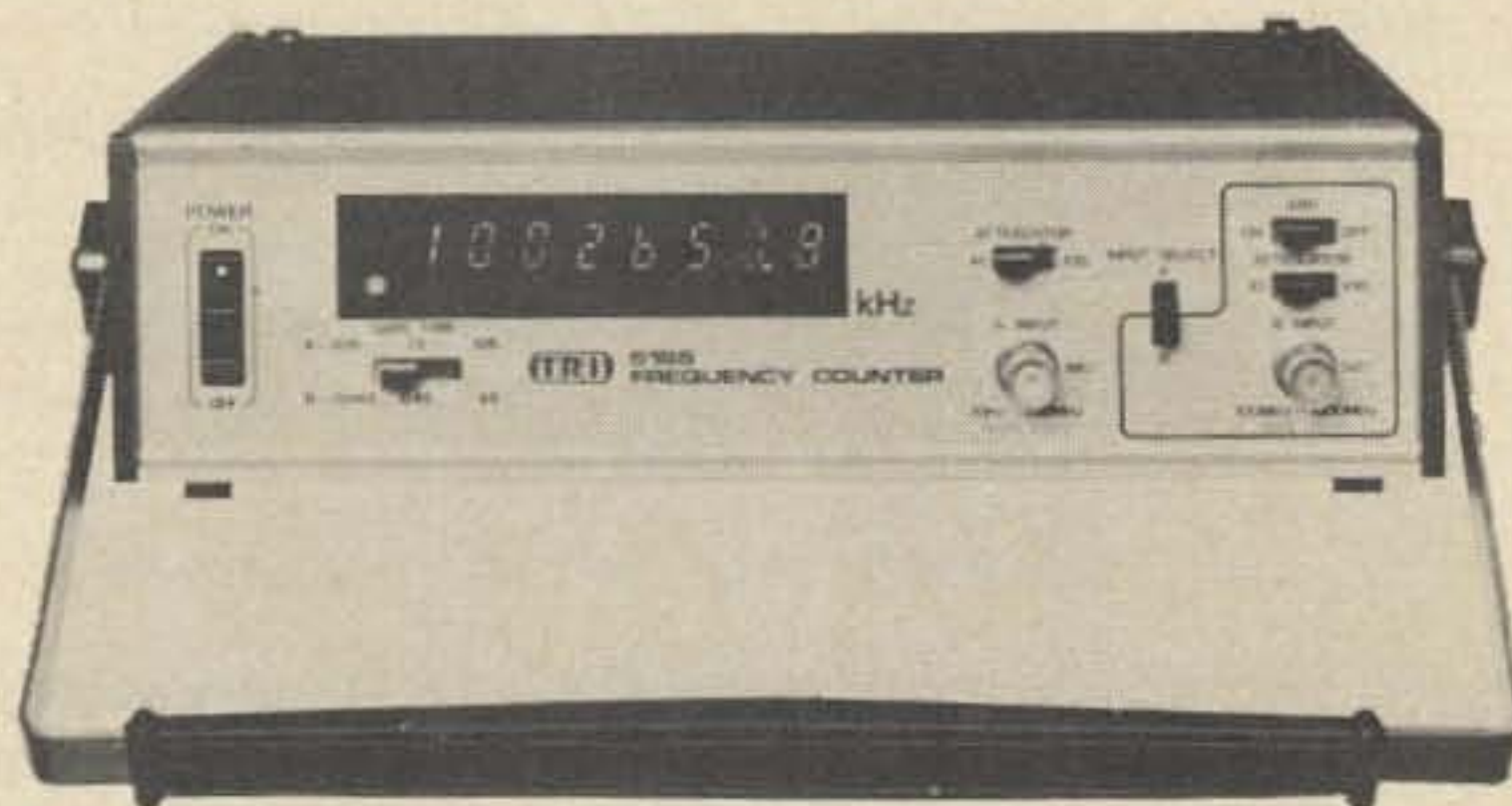

MODEL 5165

★ 1000 MHz

Automatic noise suppression
10mV sensitivity
8 digits/LED

NEW!
\$895



MODEL 5163

★ 250 MHz

25mV sensitivity
8 digits/LED

NEW!
\$295

NOW AVAILABLE FROM TECO!
CALL OR WRITE FOR COMPLETE SPECIFICATIONS



P. O. Box 1050 • Garland, Texas 75040

TOLL-FREE CALL
800-527-4642

(In Texas call collect 214-348-8800)

**A GREAT SCOPE-
AT A GREAT PRICE**

!

\$1295 (Reconditioned)

WHILE THE SUPPLY LASTS

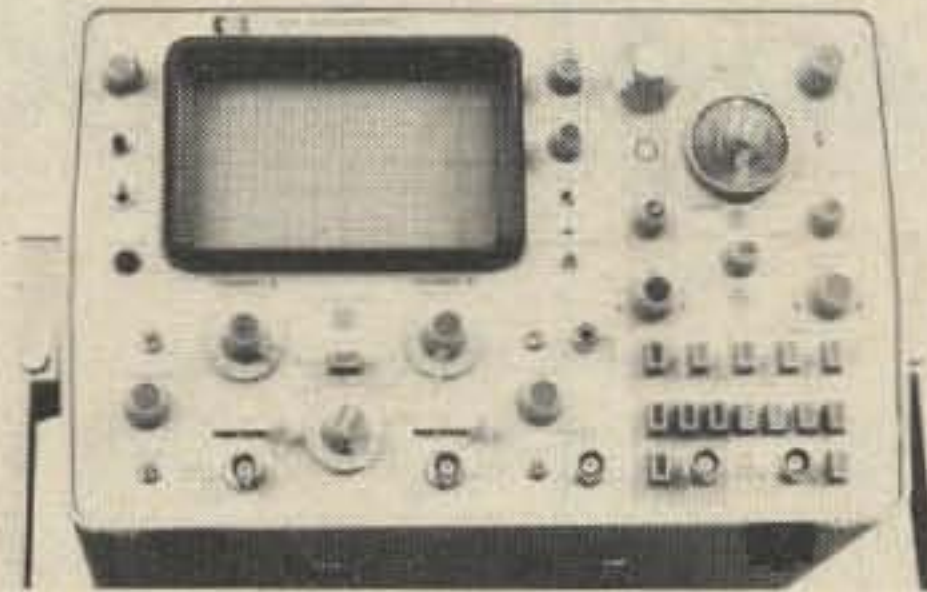

HEWLETT PACKARD 1707B

DUAL CHANNEL, 75 MHz BANDWIDTH, 10 mV/DIV SENSITIVITY, SWEEP SPEEDS FROM 0.1 μ SEC/DIV TO 2 SEC/DIV. DELAYED TIME BASE FROM 0.1 μ SEC TO 2 SEC DELAY. EXTERNAL HORIZ INPUT - DC TO 1 MHz. CHANNEL A OUTPUT - 100 mV PER DIV.

MANUFACTURED BY HEWLETT PACKARD - SOLD BY TUCKER
TUCKER ELECTRONICS has a limited quantity of reconditioned HEWLETT PACKARD 1707B OSCILLOSCOPES in like new condition. These units are complete with all standard accessories and instruction manual. The current list price on these scopes is \$1995 - by buying now from TUCKER ELECTRONICS you save \$700 (that's 35%) and get immediate delivery. The HP 1707B is covered by our famous 30 day, unconditional, money-back guarantee and our 90 day parts and labor warranty.

SOME INFORMATION ABOUT TUCKER ELECTRONICS -

Chances are you won't have any warranty problems, but it's reassuring to know that TUCKER ELECTRONICS is the nation's largest supplier of quality reconditioned test equipment. We also distribute 12 lines of new test equipment and also operate the Southwest's largest independent repair and calibration laboratory.

**HOW TO ORDER THE HEWLETT PACKARD
1707B OSCILLOSCOPE -**

It's easy. Just call our toll-free WATS line (800-527-4642) and ask for test equipment sales. Your area salesman will assist you in completing your purchase. He's a good man to know whenever you have test equipment requirements.

TOLL-FREE CALL 800-527-4642



TUCKER

ELECTRONICS • COMPANY

P. O. Box 1050 • Garland, Texas 75040

Automating Satellite Reception

One of the many inconvenient aspects of having to work for a living is the action you miss while you're away earning the money to pay for the stuff in the basement. While I'm sure DXers have their own unique perspective on this sad fact of life, satellite enthusiasts also miss out on a lot of fun. Daylight passes of weather satellites, usually in the middle of the morning, represent the only opportunity to acquire visible light cloud cover pictures. Stations interested in acquiring OSCAR telemetry data also miss useful daylight data which are particularly critical in evaluating spacecraft thermoregulation and battery charging status. Having spent a great deal of time and money in building up a weather satellite receiving station, I was rather reluctant to limit myself to acquiring pictures only on the weekends. The automatic station control equipment to be described here was an outgrowth of this frustration.

The heart of the automatic system is the satellite orbital timer previously described in 73 Magazine (February, 1975). Using this timer as a source of time and position data for any satellite you are interested in, it is possible to automatically handle station functions such as turning the receiver and recorder on and off at the proper times, as well as auxiliary functions such as antenna position control. The on-off function is absolutely indispensable; whether or not antenna control is required will depend on the type of antenna available. Since the satellite timer is absolutely required for the operation of the system to be described, the description of the interfacing circuits will take for granted that you are familiar with the function of the basic timer. Actual construction of the automatic circuitry is

simple compared to that of the timer, so if you have successfully completed that unit the conversion to automatic station operation will cause little difficulty.

The first step in the evolution of the automatic station control system was the setting of realistic and attainable goals. Given that the project had to be a modest financial undertaking it soon became obvious that some compromises had to be made. The major compromise was to settle for a single satellite pass on any given day. The single pass to be acquired should be the "best" of the day — the one that would yield the greatest amount of data — which in my case meant the most picture coverage. The best daylight pass is an overhead track. The nature of the orbits of both weather and OSCAR satellite orbits is such that if a given satellite normally passes overhead at 9 am local time, the best pass of the day will occur somewhere between 8 and 10 am, with the best opportunity represented by a 9 am pass. This will be obvious if you are already into the satellite game far enough to be thinking about automatic station control. If you are not, I would suggest the satellite tracking article in 73 (January, 1975) as must reading on the subject. If we take our example of an 8-10 am "window" (the actual figures will vary slightly depending upon the satellite, your location, and the season of the year), all that remains is to provide some means of turning the station equipment on and off at the proper time during a satellite orbit. Whether or not antenna controls will also be required will depend on the antenna system used, so we will digress slightly and discuss antenna considerations for the automatic receiving station.

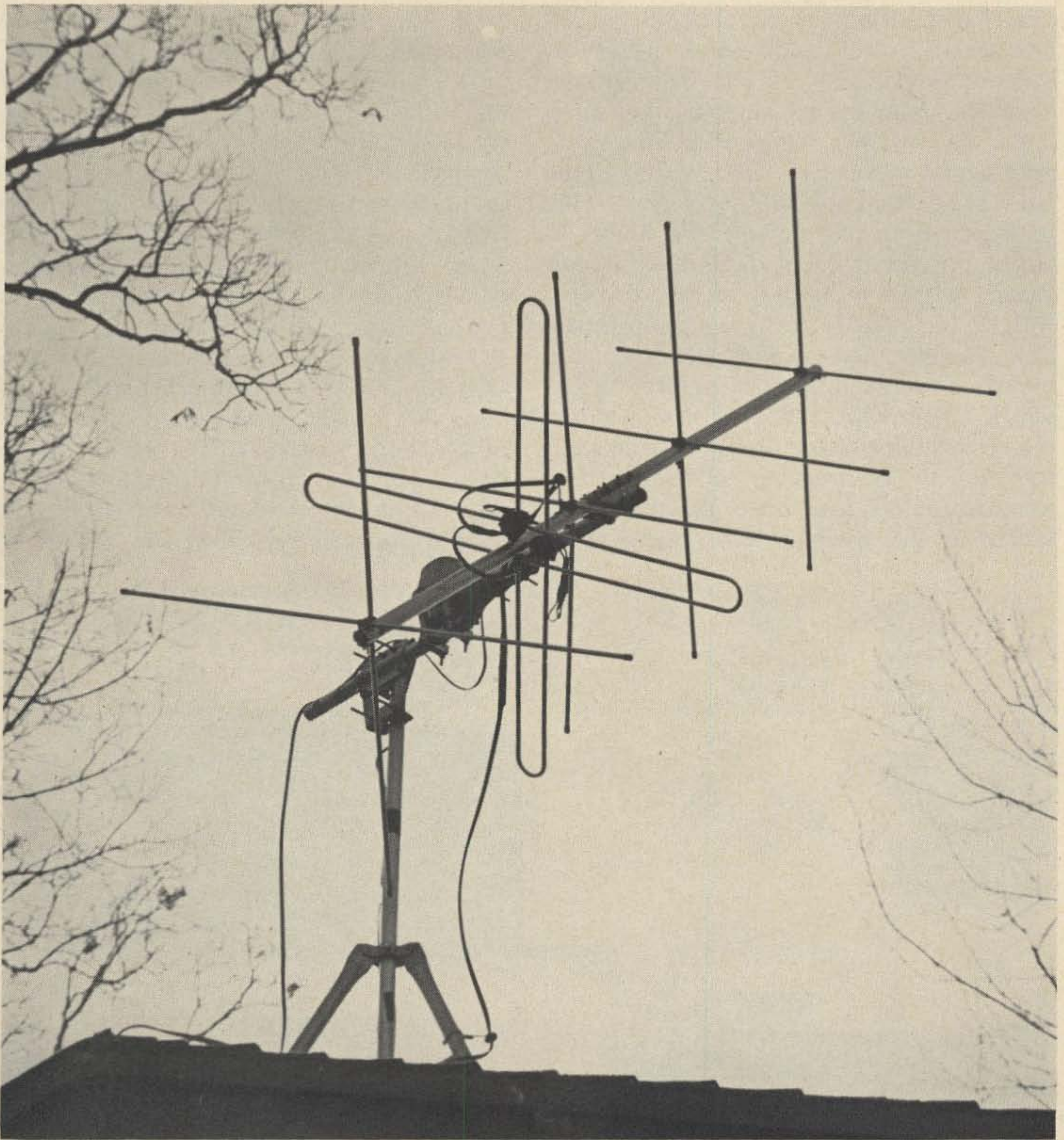

The author's satellite antenna, used with the automatic receiving system. The antenna is a 5 element crossed yagi array with fixed azimuth and variable elevation. The antenna and rotor assembly are mounted on a small tripod. (See Fig. 4.)

Satellite Antennas

The ideal antenna for our system would be an omnidirectional circularly polarized array that would provide solid signals on overhead and near overhead (\pm one hour) passes. With such an antenna it would only be necessary to turn the receiver and recorder on and off at the proper times and we would be in business. I have yet to develop such an ideal antenna system but experiments by many OSCAR operators

may provide a possible solution. A simple dipole, oriented with its ends facing east and west, would seem to be ideal since the satellite would always be in the pattern as it passed overhead. Unfortunately such an antenna always exhibits deep fades even during overhead passes. The problem here is polarization. If the satellite is not fully stabilized it will change polarization in reference to the receiving antenna. Even with a complete stabilization system, the

changing position of the satellite in its orbital track will result in a change in received polarization. If you have had no experience with space communications, it is rather easy to underestimate the effect of a polarization mismatch. The result can be fades of as much as 20 dB, sufficient to take the signal from full quieting one minute to out of the picture the next. Since we are not dealing with a great deal of gain to begin with, it is necessary to bypass the polarization dilemma. One possible solution is the use of a crossed dipole array over a reflecting screen (QST, Sept., 1974). I have not had the opportunity to try such an antenna, but the idea shows promise, particularly if a weatherproofed low noise preamp is installed at the antenna. Experiments along

these lines might be justified by stations wishing to keep complexity to a minimum.

It is possible to go to a high gain crossed yagi or helix, but such antennas tend to have narrow beamwidths and hence require rather complex tracking inputs. The solution I adopted was a compromise — a five element crossed yagi (see photo) which has a very broad frontal lobe and hence requires minimal tracking movement to maintain a full-quieting signal. Such an antenna, cut for 137 MHz for weather satellite use or 146 MHz for OSCAR, can be readily constructed using information in the space communications chapter of the ARRL Antenna Book. At my location, an overhead satellite track originates to the NNE and terminates in the SSW. I discovered one morning that if the

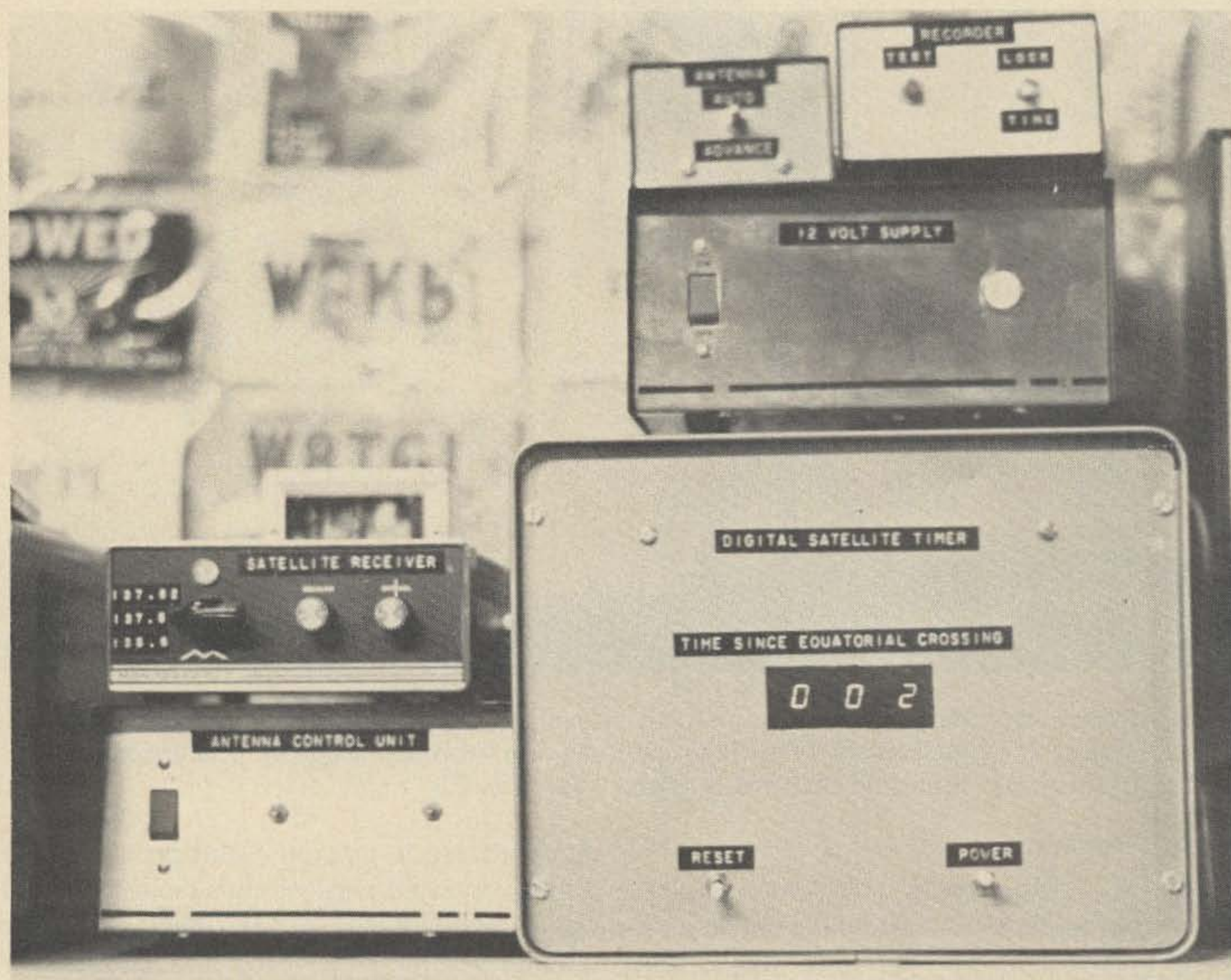

Components of the author's automatic satellite receiving station. The digital satellite timer is in the lower right with the antenna control unit to the left and the satellite receiver (Regency TMR-1H converted to multichannel wideband operation) on top of that. The 12 V supply for the station is on top of the satellite timer with the station control and antenna photocell relays stacked on the supply. The antenna relay unit is a separate module simply because of the way I developed my own station, and is most easily enclosed in the antenna control unit.

The best amateur SSTV equipment was the Robot Model 70B Monitor and 80A Camera

Now it's the Robot Model 300 SSTV Scan Converter

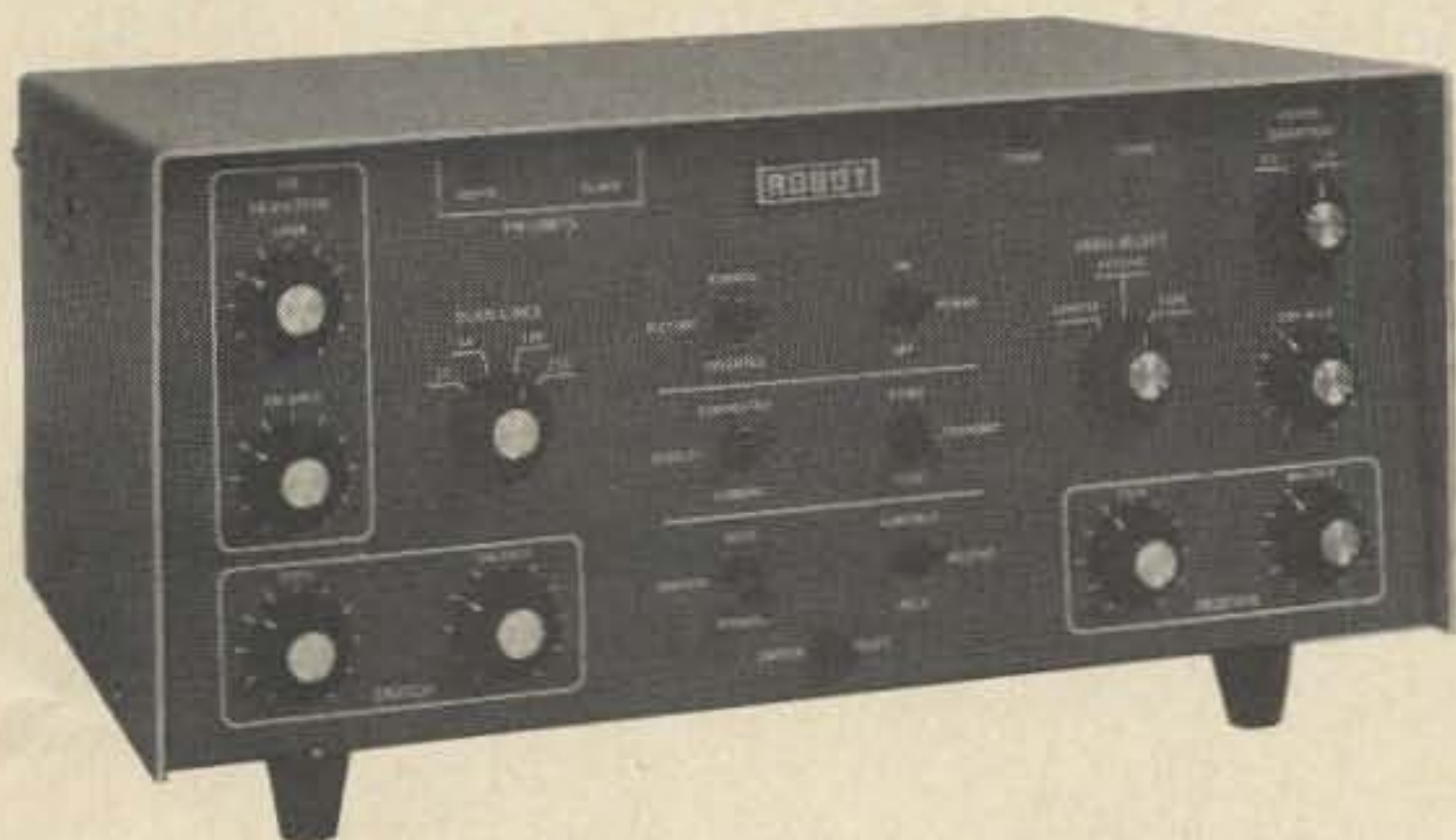

Our new Model 300 Scan Converter offers a complete new dimension to amateur SSTV: commercial TV picture quality on amateur SSTV operation.



The Model 300 offers both fast-to-slow and slow-to-fast scan conversion capabilities, and is able to generate and to accept either 128-line or 256-line SSTV pictures. The Model 300 accepts standard TV video signals from a TV camera or other video source and converts them to amateur-standard SSTV audio tones in the accepted range of 1200 to 2300 Hertz.

It also accepts amateur-standard SSTV audio tones in the same range and converts them to TV standard video signals capable of being reproduced on any closed circuit monitor or home set.

Subject matter no longer needs to be stationary either, since the 300 "grabs" and stores one TV field (1/60 second) thus freezing moving scenes.

Model 300 Scan Converter.....	\$1,295
RCA Closed Circuit Camera	\$ 260
Setchell-Carlson Monitor	\$ 225

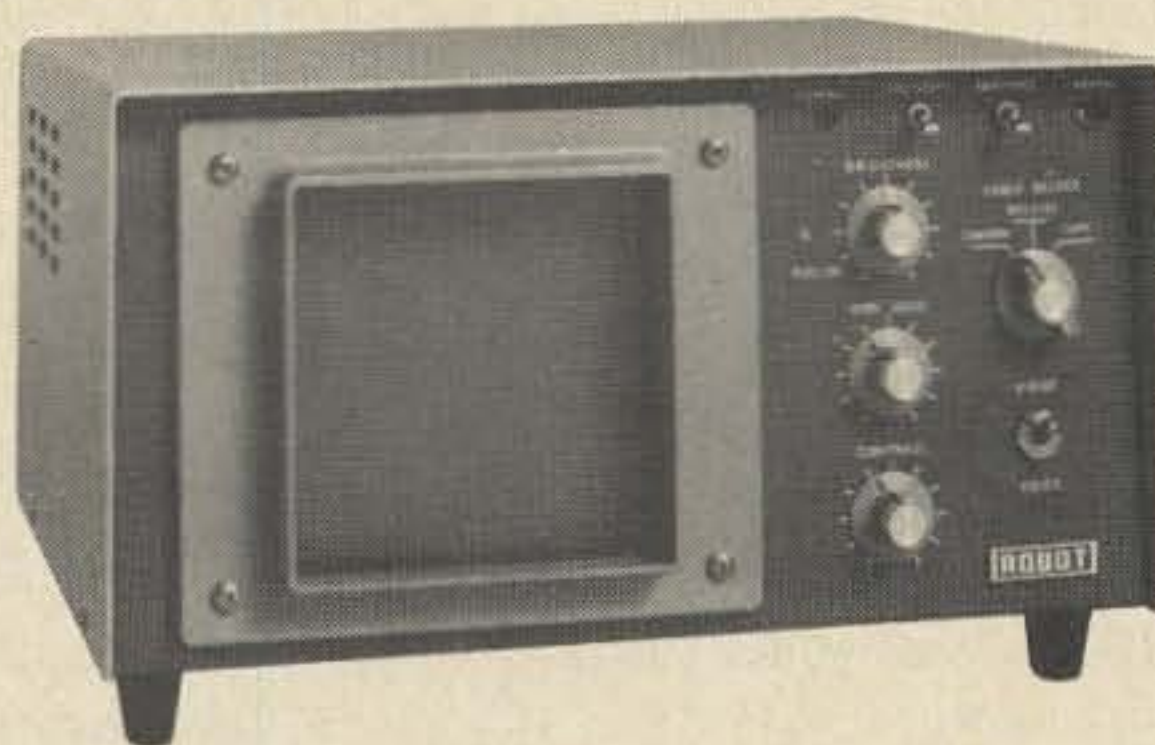

Our popular Model 80A Camera and 70A or 70B Monitor will continue to be available.

Because of the many thousands of Robot SSTV units now on the air, and their reasonable price, we feel many amateurs will continue to choose this economical way to get in on the fast growing amateur SSTV activity.

Model 70A Monitor.....	\$345
Model 70B, 3-in-1 SSTV Monitor with built-in fast scan viewfinder and oscilloscope	\$445
Model 80A Camera	\$345

Please send me the following:

Complete descriptive literature on the

- Model 300 Converter Model 70B SSTV Monitor
 Model 80A SSTV Camera Model 300 Converter

Name _____ Call _____

Address _____

City _____

State _____ Zip _____

ORDER FACTORY DIRECT TODAY

ROBOT

ROBOT RESEARCH INC.

7591 Convoy Court
San Diego, CA 92111
Ph. (714) 279-9430

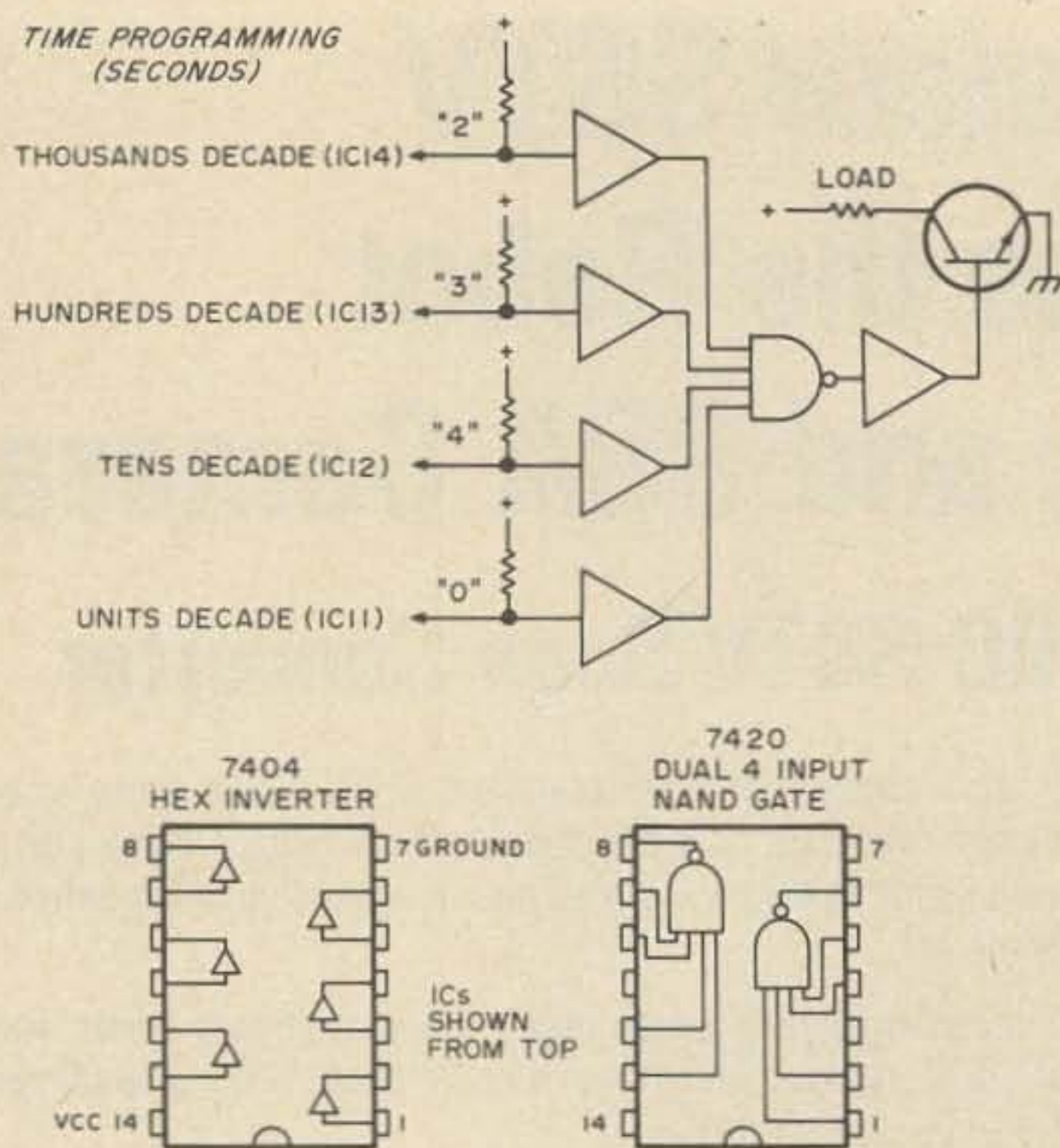

Fig. 1. Logic diagram of the basic timer module and base diagrams for the ICs used. One of these modules is required for each control function desired (on, off and the optional antenna control).

antenna were pointed to the NNE at an elevation of 45° it would maintain a full-quieting signal until the satellite was past its overhead position. This suggested that a single movement of the antenna (when the satellite was overhead), from 45° elevation to the NNE to 45° facing SSW, might be sufficient to maintain a reliable signal for the duration of a pass. This in fact proved to be the case with the additional bonus that this single movement "tracking" was sufficient for any pass falling within the "best pass window" previously described. The antenna is thus fixed in azimuth (NNE-SSW) and a single signal from the control circuits actuates an elevation rotor to accomplish the position change. Mercury limit switches, mounted on the antenna, cause the antenna to stop at the proper position. The antenna control unit, to be described, also provides for automatic reset of the antenna to its initial starting position at the beginning of a pass. In summary, after this lengthy introduction, we have a system, to automatically control the various station functions, that permits completely unattended satellite reception. It is thus possible to acquire satellite data on a daily basis for several weeks if need be with no manual intervention. In fact, the biggest problem I have in

returning from a vacation is to find the time to read out all the pictures that have accumulated.

The Timer Module

I will use my own situation to outline some of the timing guidelines that need to be determined in achieving automatic control functions. Since the desired reception window is relatively narrow (\pm one hour from nominal overhead), the time factors can be determined on the basis of an overhead pass. First one has to decide how much of a pass is to be recorded. Since my time is limited and I am not likely to have time to read out more than a single picture each evening, I decided that 10-12 minutes of recording time per day would be ade-

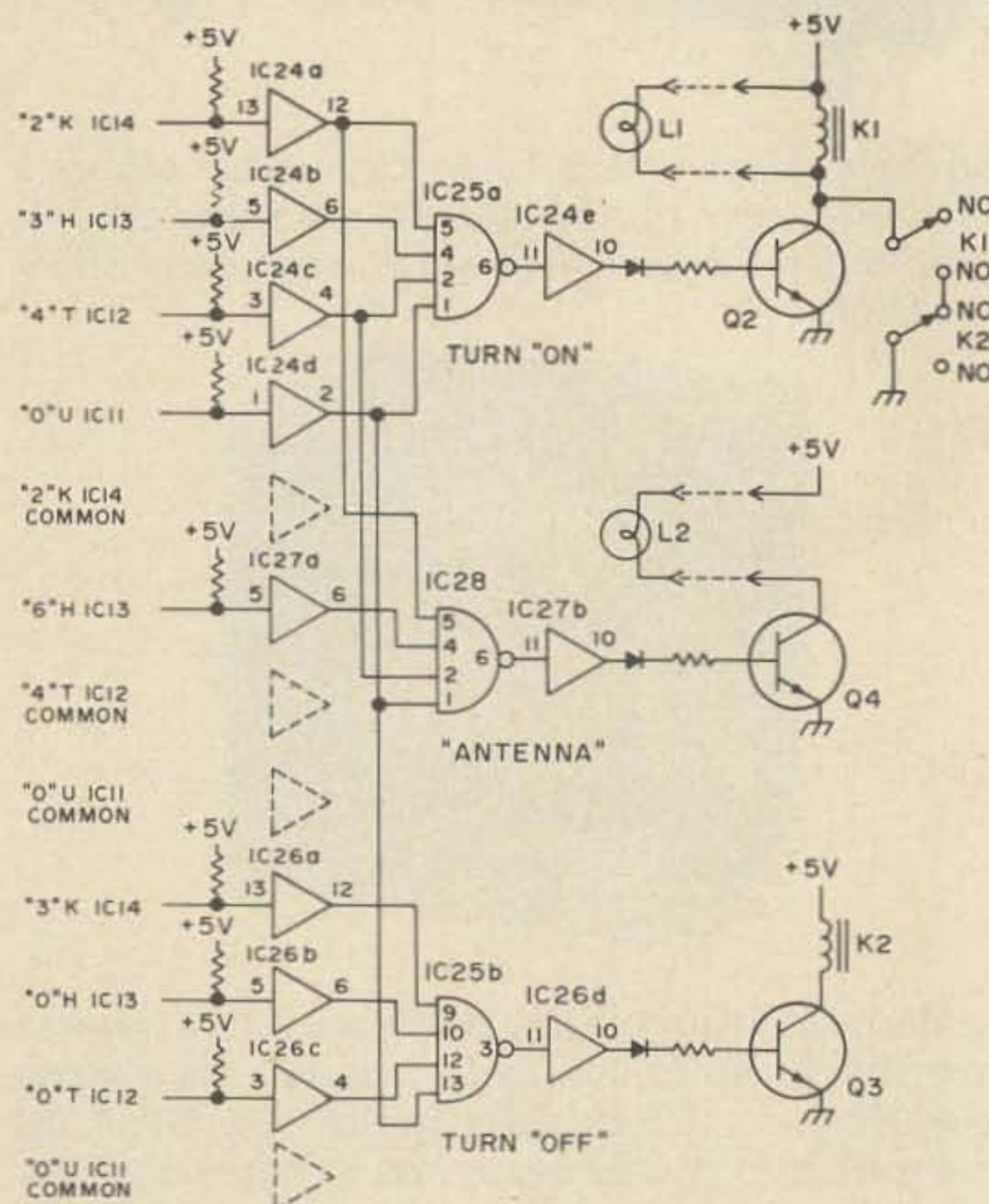

Fig. 2. The author's version of the timer module. Numbers in quotation marks refer to decimal outputs of the orbital timer board ICs indicated. Inverter sections indicated in dotted lines show sections that were eliminated because of common program values in that decade (see text). All resistors are 1000 Ohm, 1/2 Watt. IC24, 26 and 27 are 7404s, IC25 and 28 are 7420s. Q2-4 are HEP 53 or any g.p. NPN. Diodes are general purpose silicon switching (1N457, 1N914, etc.). K1 and 2 are 4.5 V dc SPDT subminiature relays (Calectro or equiv.). L1 and L2 are #47 pilot lamps remotely located at their respective photocell relay units. Component numbering is consistent with that of the satellite orbital timer.

MEET THE STATE OF THE ART ON 2 METERS... THE ITC MULTI-2000 CW/SSB/FM TRANSCEIVER



Whether your interest is simplex, repeater, DX or OSCAR the new ITC MULTI-2000 lets you get into all the action on all of the

band. Fully solid-state and employing modular construction, the MULTI-2000 enjoys features found in no other 2m transceiver.

FEATURES

- PLL synthesizer covers 144-148 MHz in 10 kHz steps
- Separate VXO and RIT for full between-channel tuning
- Simplex or ± 600 kHz offset for repeater operation
- Three selectable priority channels
- Multi-mode operation (CW/SSB/NBFM/WBFM)
- Built-in AC and DC power supplies, noise-blanker squelch and rf gain control
- Selectable 1W or 10W output
- Separate S-/power and frequency deviation meters
- Built-in test (call) tone and touch-tone provision
- Excellent sensitivity ($.3 \mu\text{V}$ for 12 dB SINAD)
- Superior immunity to crossmodulation and intermodulation
- Introductory price: \$695.

KLAUS RADIO Inc.

8400 N. Pioneer Parkway, Peoria IL 61614, Phone 309-691-4840
Cliff Morris W9GAO — Jim Plack WB9BGS

quate. With the antenna system described it would be possible to acquire 15 minutes or more, but this would decrease the number of consecutive days that could be handled due to limitations in the amount of tape that could be loaded on the machine. If you will always read out the tape every day this is not a problem, but it does affect your ability to acquire pictures over an extended vacation trip. Ten to twelve minutes per day will permit a weekend of passes to be logged on a large reel at 7½ ips, while permitting several weeks of picture accumulation on a large reel at 1-7/8 ips. At my location, I can expect good signals 37-38 minutes after an equatorial crossing (AEC). I thus chose 39 minutes as the desired "turn on" time. The satellite will be overhead at roughly 44 minutes, and 50 minutes was chosen as the "turn off" time, giving a total of 11 minutes of recording. The orbital timer board of the satellite timer counts out the orbital period in thousands, hundreds, tens and unit seconds so the desired timing operations were converted to seconds:

Function	Minutes AEC	=	Seconds AEC
Station on	39		2340
Antenna change	44		2640
Station off	50		3000

It is then only necessary to develop a circuit to sense the desired time accumulation in the BCD to decimal decoders of the orbital timer board (ICII-14) of the satellite timer in order to achieve the desired control functions. In the simplest terms, when the desired time has accumulated in the orbital timers we want to trigger relays that will handle the appropriate control functions. Although the sensing circuits are simple enough, it turns out to be quite difficult to trigger control relays directly with the timer circuit, because switching loads on and off has an annoying tendency to scramble the count in the decade counters of the satellite timer, thereby throwing off the orbital clock. The circuit which I finally settled on triggers pilot lamps which are optically coupled to photocell relays, thus eliminating switching transients in the satellite timer.

Fig. 1 shows the logic diagram for the basic time sensing circuit. One of these

circuit arrays or its equivalent is required for each function we wish to control. The circuit is designed to apply power to a load, either a lamp or a relay, whenever the desired count has accumulated in the four decades (thousands, hundreds, tens and unit seconds) of BCD to decimal decoders of the orbital timer board. The four input lines which establish the time programming are each routed through inverters whose inputs are initially held high by resistors connected to the +5 V line. As the programmed count is reached in each decade, the appropriate output of the decoder will go to ground, bringing its inverter input low, causing the output of the inverter to go high. The output of each inverter is connected to one input of a 4 input NAND gate. When the programmed time interval has accumulated, the output of the four inverters will be high, a condition that causes the output of the NAND gate to go from a high to a low. The output of the gate is routed through another inverter with the result that when the programmed time is reached the inverter output goes high, turning on a transistor and applying power to the load. In the example shown, the load would be activated when a count of 2340 seconds had accumulated in the decoders (ICII-14) of the orbital timer board.

Although one of these circuit arrays is required for each of the three functions we desire to control (on, off and the optional antenna control), the actual circuit can be simplified somewhat depending upon the program times chosen. If two or more functions share common digits in any decade, it is possible to eliminate some of the input lines and inverter sections as shown in the schematic of my control circuit diagramed in Fig. 2. The program times I happened to choose were:

"On" = 2340 seconds;
 "Antenna" = 2640 seconds;
 "Off" = 3000 seconds.

All these functions share a common requirement for a "0" input in the units decade while the "on" and "antenna" functions also share a requirement for a "4" input from the tens decade and a "2" input from the thousands decade. Rather than run separate

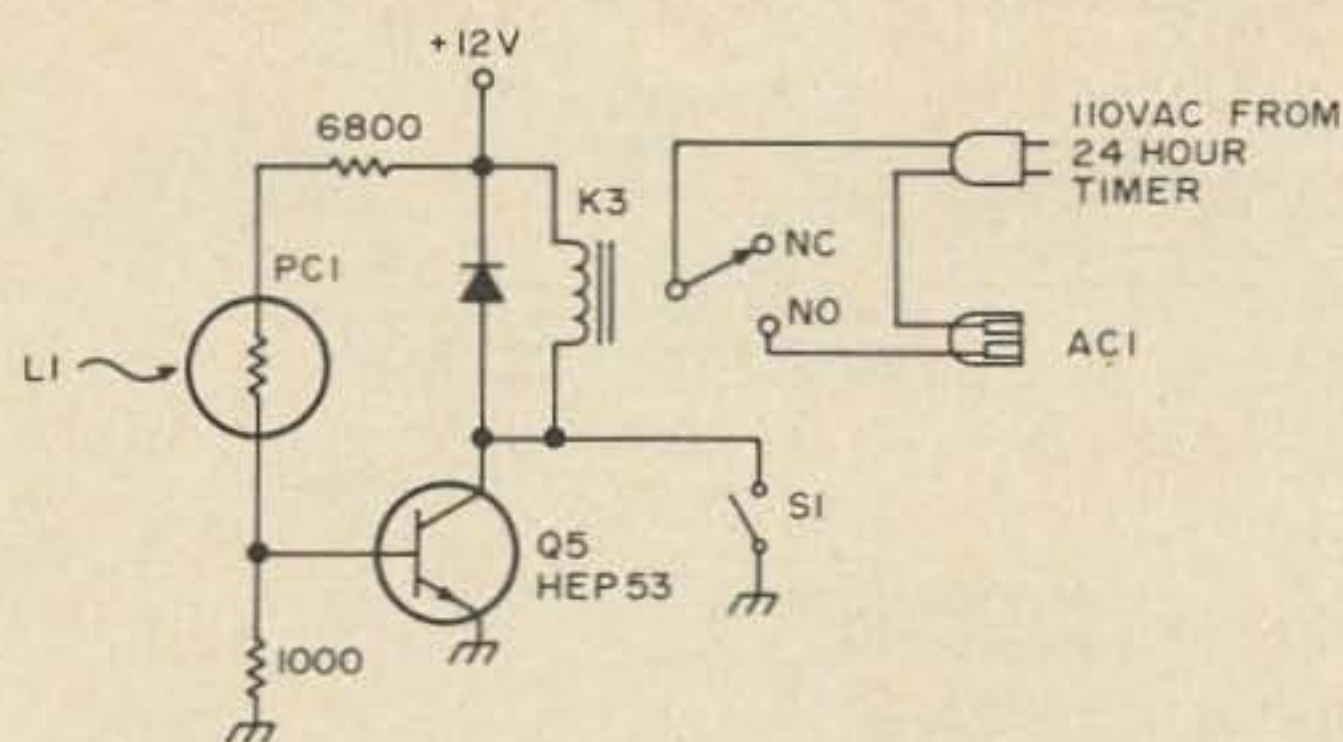

Fig. 3. Control module for the "on-off" station functions. L1 of the timer portion of the circuit is placed so that when it goes on it will shine on PC1, a cadmium sulfide photocell (Clairex type CL703 or equiv.). K3 is any 12 V dc SPDT relay. S1 is a SPST toggle switch, which serves as a manual control to activate equipment connected to AC1. AC1 provides power for all equipment which must be turned on and off, including the receiver, tape recorder, and the antenna control unit (if used). The 12 V dc must be available from a supply which is on at all times.

input lines and inverters for these common inputs, a single input line and inverter can be used with the output of the inverter driving the required gate inputs.

The "on" function operates as follows: When the programmed count of 2340 seconds accumulates in the decoders of the orbital timer transistor, Q2 will go on for one second, the time between the first register of a count of 2340 seconds and the point where the count goes to 2341 seconds. During this one second interval pilot lamp L1, which will actually control station operation, goes "on" and relay K1 pulls in. Once K1 has closed, the relay will stay on and the lamp will remain lighted even though Q2 goes off. This is achieved by connecting the collector of Q2 through the NO contacts of K1 and the NC contacts of K2 to ground. The "antenna" function operates in a similar fashion and will turn L2 on for one second when a time of 2640 seconds has accumulated. The turn "off" circuit comes into play at 3000 seconds when Q4 goes on for one second momentarily pulling in K2. This breaks the ground connection for the collector of Q2, causing K1 to open and L1 to go out. Neither will be re-energized when Q4 goes off, because Q2 has been off since 2341 seconds.

Thus L1 will be lighted for the desired station "on" interval and L2 will light momentarily when we want to move the

antenna. As mentioned previously, these lamps are used to energize photo-relays to prevent aberrant counting in the satellite timer (caused by switching transients). The photo-relay circuit for the basic station control is diagramed in Fig. 3 and is about as simple as can be. L1 is remotely located in the photo-relay enclosure and is positioned so that it shines on a cadmium sulfide photocell when lighted. This lowers the resistance of the CdS cell, raising the base voltage on Q5 and energizing the station control relay, K3. It is this relay which controls the ac line to the station equipment we wish to control (receiver, tape recorder, etc.). Since L1 will come on for the programmed time during every orbit, we would waste a lot of tape during orbits where the satellite was not above the local horizon. This is circumvented by getting the ac to run the station equipment from a 24 hour timer set to go on at the start of the best pass window and off at the end of the window. This window is from 9-11 am local time in my own case. The window can be determined by setting the timer to come on one hour prior to the time of a nominal overhead pass and off one hour later. The many inexpensive 24 hour timers are inadequate for precision satellite timing but function well in this application, where all they are required to do is define the general period where reception is desired.

Construction of the timer module is easily accomplished using a small piece of perf board with 0.1" hole spacing to accommodate the IC sockets. One photo shows my own module mounted in the satellite timer. The relays specified for K1 and 2 are subminiature units and will mount on the board with the other components. Relays with higher current requirements should not be used, as the inductive "kick" when they are activated can cause erratic timer operation. Leads for L1 (and L2 if used) are run from the timer to the photo-relay enclosure.

The only requirement for the photo-relay circuit is that it be enclosed to protect PC1 from direct room light. L1 should be positioned so that it shines on the face of PC1; otherwise, layout is completely non-critical. A small barrier strip on the back of the enclosure can serve as a connection point for

the control cable for L1 and the 12 volts required by the relay.

The Antenna System

The name of the game in terms of the antenna installation is to install the yagi with a fixed azimuth bearing that parallels the overhead satellite track and use an antenna rotor to rotate the antenna between the two 45° elevation points. A CDE AR-20 rotor is used for this purpose. Complete rotors with conventional control units are widely available at very modest prices but it is often possible to obtain rebuilt rotor assemblies, at even less cost, from local distributors or TV service shops. A heavy metal plate and four heavy duty U-bolts are used to fabricate a right angle mounting plate for the support

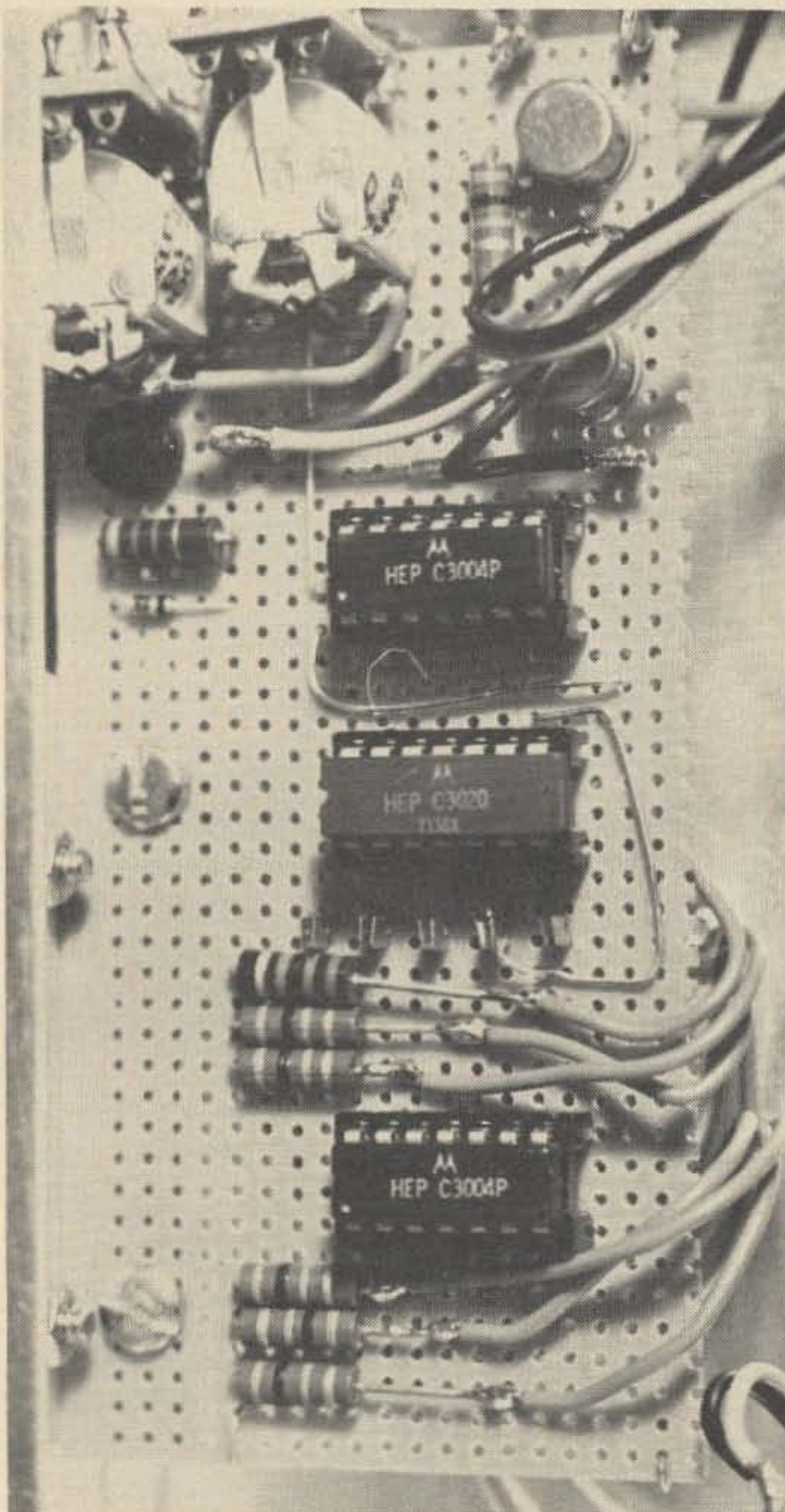

The author's timer module mounted under the chassis of the satellite orbital timer.

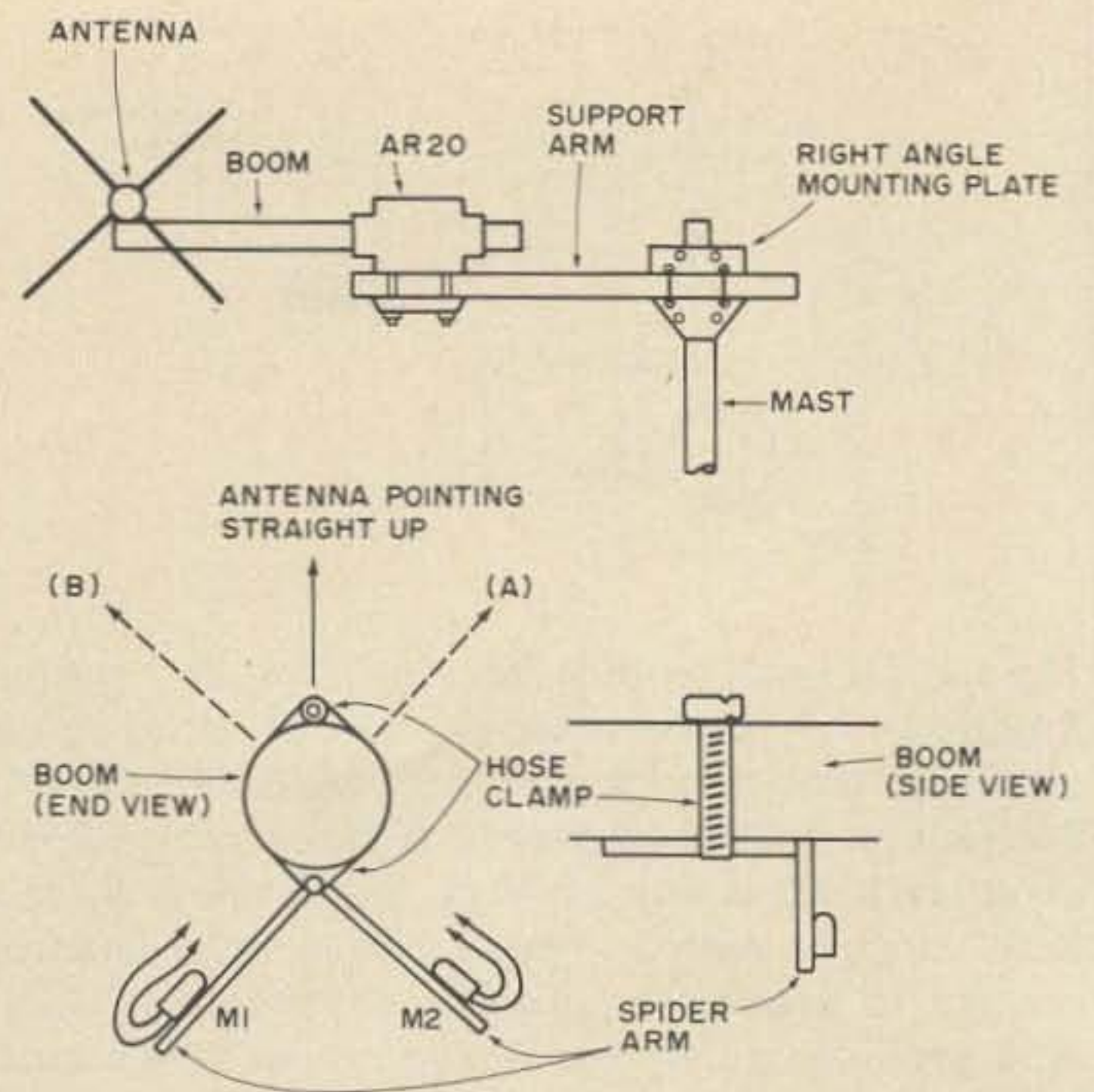

Fig. 4. Details of the antenna mounting assembly. The spider arm assembly holds the two mercury switches (M1 and 2) which serve as limit sensors. Styles of switches vary, but in all cases the contact end of the switch should face the bottom of the spider arm assembly as shown. The spider should be mounted as shown, with the antenna facing straight up. When the antenna is in the reset position (A), M1 should be open. When the antenna is in the advance position (B), M2 should be open. Antenna bearing is fixed by the adjustment of the mounting plate to the mast and should be tightened up so the long axis of the antenna parallels the direction of an overhead pass. The reset position points toward the origin of the pass, while the advance position points the antenna in the direction where the satellite signal is lost. Each spider arm should be 6-12" in length, with the switches mounted as close to the end as possible. Switch leads are dressed up to the rotor cable.

arm for the rotor. The rotor should be mounted on the support arm as close to the mast as possible to minimize stress on the mast. The photograph and drawing show the rotor mounted above the support arm. While it might seem mechanically superior to mount the rotor below the arm, this would give rainwater the opportunity to run down the rotor mounting bolts and pool in the housing. Mounted above the arm as shown, my own unit has been in service for over a year with no moisture problems. Before mounting the rotor it should be run to somewhere near the center of travel. The boom assembly, on which the rotor acts, carries the antenna, which initially should be tightened up so that it faces directly upward. As in the case of the support arm, the boom should be no longer than necessary, to assure

Special Sale - Limited Quantities



Attention Hams, Two-Way Radio Service Shops, and Others

THE GE PE SERIES PORTABLE IS ONE OF THE MOST VERSATILE ON THE MARKET TODAY. FOR THE FIRST TIME EVER WE ARE OFFERING STARTER KITS FOR THESE RADIOS. OWN A SERVICE SHOP? SERVICE PE'S? THEN THIS IS THE DEAL OF THE YEAR FOR YOU.

THESE PE CASES HAVE HAD THE RADIOS REMOVED, THEY ARE NEW AND COMPLETE WITH THE FOLLOWING: VOLUME, SQUELCH, ON/OFF CONTROLS WITH KNOBS (THE EIGHT FREQUENCY CASES ALSO HAVE THE FREQUENCY SELECT SWITCHES AND

KNOBS), REMOTE SPEAKER/MICROPHONE JACK, ANTENNA CONNECTOR, BATTERY CONNECTOR, AND PC ANTENNA STRIP.

PRICES: 2 Frequency cases: **\$30.00 each**
 8 Frequency cases: **\$40.00 each**

*Prices FOB L.A. Cash or check with order or COD
Quantity Discounts available; Call or write for information.*

OTHER SPECIALS

GE PE Channel Guard Boards complete with 94.8 Hz tone filters. List Price: \$136.40 plus selective amp at \$47.80. Total List Price: \$184.20

Special Price: **\$75.00 each**

GE PE type 99 Decoders (two tone) complete with versatone modules. (misc.) List Price \$152.00

Special Price: **\$55.00 each**

Write for our list of other equipment including Repco Modules, Test equipment, etc.



BIOCOM INC.

advanced concepts in bio/instrumentation

9522 w. jefferson blvd. (213) 836-7263

culver city, california 90230

To order or for additional information contact: Andrew M. Seybold W8GEC/6

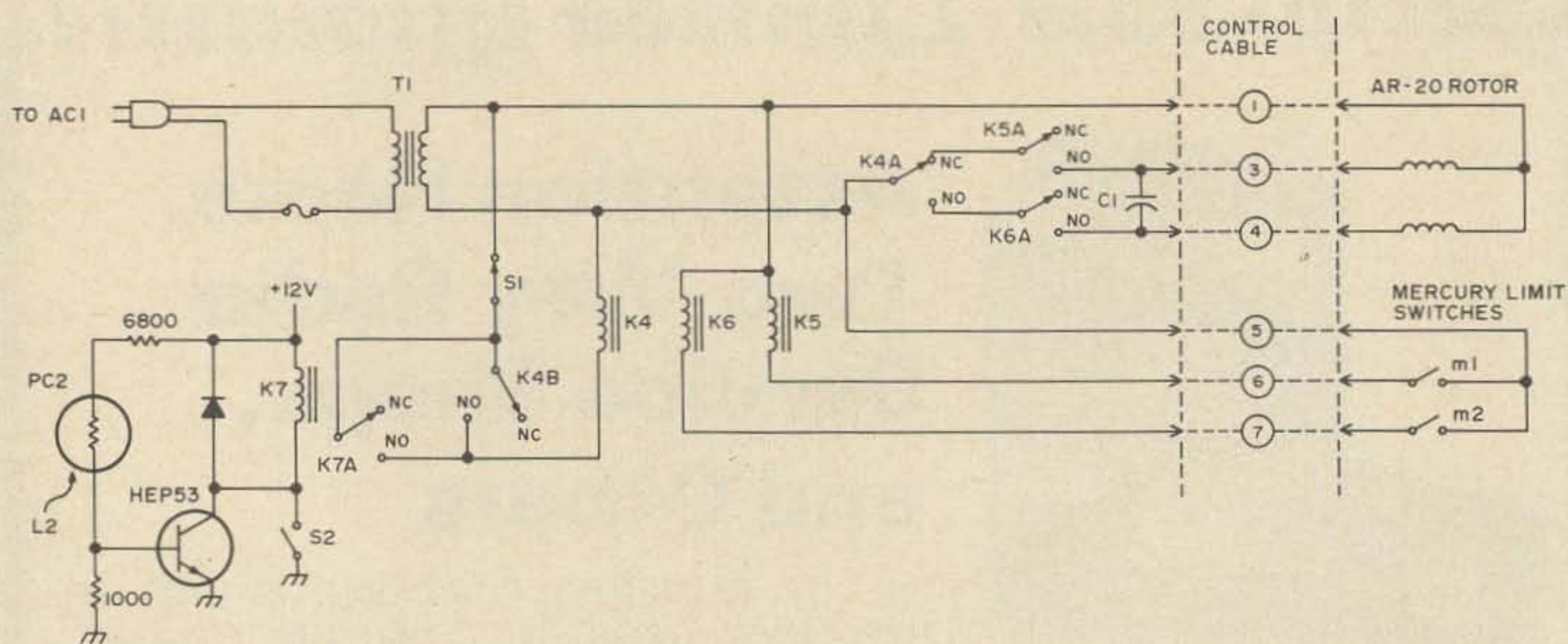

Fig. 5. Schematic of the antenna control unit. S1 — normally closed push-button switch (manual reset); S2 — normally open push-button switch (manual advance); T1 — 24 V ac 3 A filament transformer; K4 — DPDT 24 V ac; K5-6 — SPDT 24 V ac; K7 — SPDT 12 V dc; PC2 — Clairex CL703 (similar types available from Calectro or Radio Shack); C1 — 40 mF non-polarized (unit from AR20 rotor control may be used or a replacement 50040-10 may be ordered from CDE or a distributor). M1 and 2 are general purpose mercury switches. A wide variety of types are available from jobbers and appliance shops, and the glass types present no weatherproofing problems. The rotor cable connections to the AR-20 correspond to normal connections so the numbering of the rotor terminal strip can be followed.

that the antenna elements clear the mounting as the antenna rotates. Although the mechanical assembly looks rather ungainly, it has withstood without difficulty ice storms and winds in excess of 60 mph since installation. Sensing of the proper antenna position is achieved using two mercury switches (M1 and M2) mounted on a spider arm assembly constructed of aluminum rod. These arms are at right angles to each other and, if clamped to the boom as shown (Fig. 4) with the antenna in a vertical position, they serve as sensors that the antenna has reached the desired angle. Angle A, where the antenna is in the reset position, as it would be at the start of a pass, will result in switch M1 being horizontal and thus off, while M2 is vertical and on. With the antenna at angle B, the advance position at the end of a pass, M2 is now horizontal and off while M1 is vertical and on. Leads from M1 and M2 are dressed up along the spider arms and back along the boom to the rotor cable. As shown in Fig. 5, one lead from each switch is tied to a single conductor (#5) of the cable while another lead from each switch is run to a separate conductor.

Antenna Control Unit

The antenna control circuit (Fig. 5) looks

complex, but it is actually a fairly simple-minded switching arrangement. The direction of movement of the AR-20 rotor is determined by which of the two motor windings is directly actuated by ac from the power transformer. Let's assume for the moment that the antenna is up on the roof pointing straight up the way we left it. If we supply ac power to T1, simulating a station activation, T1 will provide 24 V ac to energize both K5 and K6 through M1 and 2 respectively, since both mercury switches are closed with the antenna in a vertical position. K4 remains open when power is first applied. T1 also supplies ac to the common rotor lead and ac to conductor 3 of the rotor cable, through the normally closed contacts of K4 and the normally open contacts of K5. This causes the rotor to move in a counterclockwise direction, rotating the antenna away from the vertical to the NNE. When it reaches 45° elevation, M1 on the spider arm assembly up at the antenna will open, dropping out K5 and removing power to the rotor. The antenna thus stops at 45° elevation — in the reset position. All of this only takes a few seconds after power is applied. If the antenna is in the advanced position or any intermediate point, it will always move to the reset

position when power is first applied at the start of a pass. If the antenna is already in the reset position at the start of a pass, K5 will be open and the antenna will remain in that position. In the case of my own programming, all of this occurs at 39 minutes after an equatorial crossing that falls within the reception window. Five minutes later, at 44 minutes after the crossing, L2 will be momentarily activated by the control module. This will momentarily pull in K7 in the antenna photocell relay circuit, which in turn energizes K4. When K4 pulls in, two things happen simultaneously. One set of contacts (K4B) locks up K4 so it stays pulled in, even though K7 drops out, and the remaining set of contacts (K4A) now route

power to the other rotor winding (conductor #4 of the rotor cable). K6 is still closed, since M2 is closed in the reset antenna position, so the rotor will begin to move in a clockwise direction until the antenna reaches 45° elevation to the SSW — the advanced position. At this point M2 opens up, dropping out K6 and stopping the rotor. Since K4 is still locked up, the antenna will remain in this position until the end of the pass when power drops out at AC1. The power dropout causes K4 to open. Since M1 is closed in the advanced position, as soon as power is applied at the start of the next pass, usually the next day, K5 will close and the antenna will reset to its starting position. S2, which is used to manually advance the



NOAA-4 photo of eastern Canada and the northeastern US in the grip of winter. The southern tip of Hudson's Bay (James Bay) is visible in the upper left, while the Gulf of St. Lawrence, the Gaspé, New Brunswick, Nova Scotia, and Maine are visible in the upper right half of the picture. Snow cover outlines the northern east coast of the US, highlighting Cape Cod and Long Island. Inland portions of the Great Lakes can be seen under low cloud cover.

1/2 KW WIND ELECTRIC GENERATOR



NEW KIT INCLUDES:
BLADES
SPECIAL ALTERNATOR
CONTROL UNIT
FABRICATION INSTRUCTIONS
BASIC KIT AS LOW AS:
\$ 147⁰⁰

STANDARD RESEARCH INCORPORATED
P. O. BOX 1291
EAST LANSING, MICH. 48823

SUMMER SPECIAL

STANDARD SRC-146A

Two Watt handheld transceiver with leather case, GE ni-cads, and rubber duckie antenna.

LIST

339.95

COMCRAFT CST-50

VHF two band transceiver for 2 and 1 1/4 meters with digital frequency synthesis.

LIST

869.95

Complete line of

Standard, Cushcraft, Comcraft, Hy-Gain and Aluma Tower Products.

EXPERT SERVICING ON ALL TWO
METER AMATEUR GEAR

Call or write for further details.

**SYNCHRO-SOUND
Enterprises**

146-29 Laburnum Ave.
Flushing, N.Y. 11355

(212) 359-1489 (9AM-5PM)

antenna, merely functions to cycle K7. Momentarily pushing S1 will reset the antenna if it is in the advanced position.

Despite its apparent complexity, the antenna control unit goes together very quickly, particularly since plug-in relays are used with screw terminal sockets. Before attempting to put the unit in service, you should set up the control unit, rotor, boom and limit switches in the shop, to verify the proper movement of the rotor and the function of the limit switches. The connections shown for the AR-20 assume that the rotor support arm will come off to the left of the mast (facing in the direction of the origin of a pass). This arrangement requires that the rotor move clockwise (viewed from the top) when advancing and counterclockwise when resetting. If it does not move in this way, or you require the opposite direction of movement for your mounting arrangement, simply reverse the connections to conductors 3 and 4. I use a barrier strip on the rear of the control unit to handle connections to the multiconductor rotor cable.

With the rotor mounted horizontally (as it will be on the roof) and the boom arm in place, the mercury limit spider arm assembly should be mounted so that each of the arms is below the boom and at an angle of 45° to the vertical. The rotor itself should be somewhere near its center of travel for this test. A small wooden pointer can be mounted at the end of the boom (facing straight up) to simulate the antenna. Plug the 110 V ac plug into an outlet and the pointer should swing to the reset position and stop. Momentarily press S2 and the pointer should swing around to the advance position. Pressing S1 should reset the pointer. Momentarily applying 5 V to L2 should cause the antenna (pointer) to advance. Pulling the ac plug and re-inserting it should cause the pointer to reset. If all these tests are satisfactory you are ready to lug the whole assembly to the top of the roof and replace the silly wooden pointer with a real antenna. This ground check is highly desirable since if you miswire a relay you can cause a real tangle of coax and cable up on the roof.

... WB8DQT

90db isolation at 450MHz

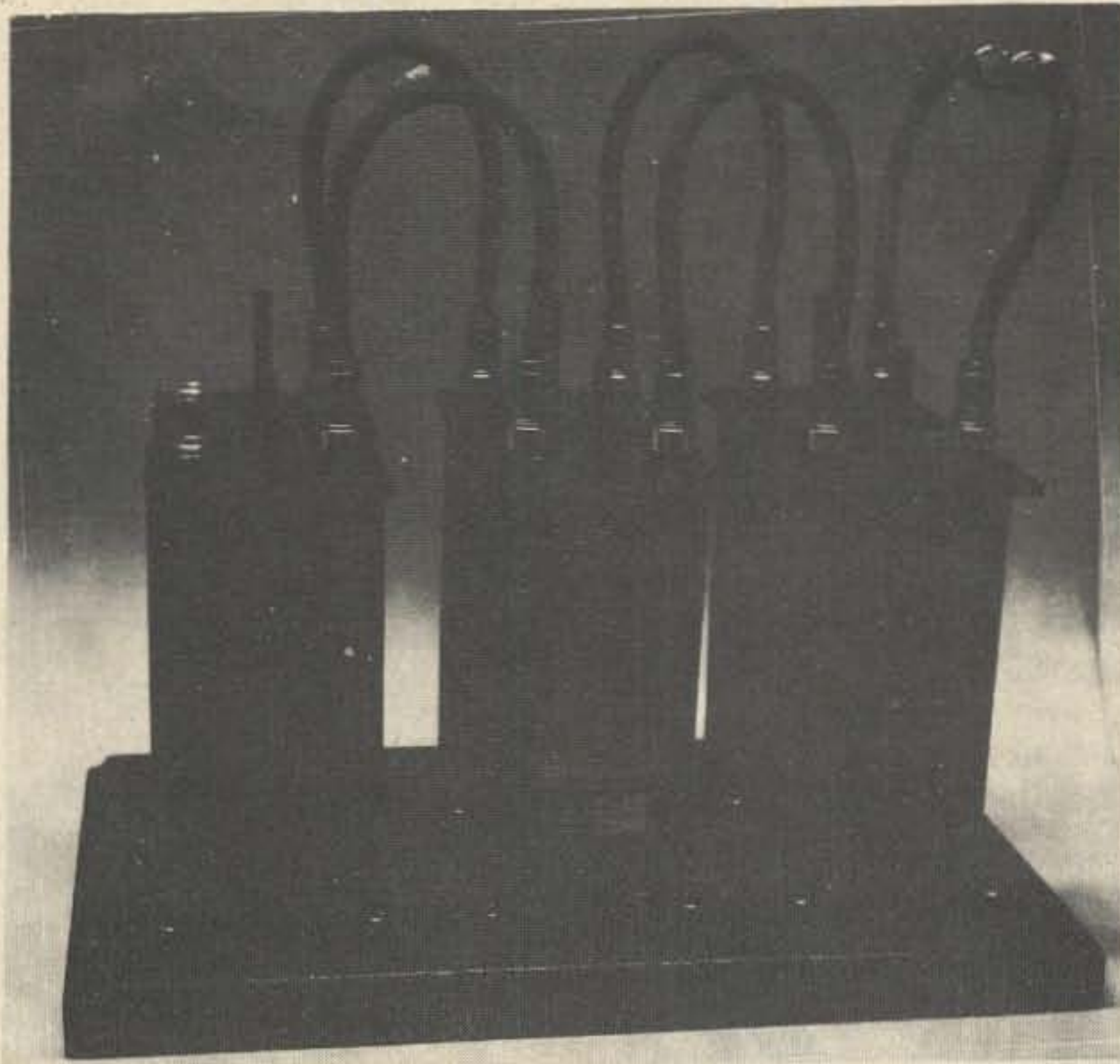

THAT'S RIGHT — 90dB isolation at 450MHz with less than 1.5dB insertion loss with our .7M6A 6 cavity duplexer. Complete for only \$350.00.

SEE IT AND OUR OTHER FINE CAVITY DUPLEXERS AND FILTERS FOR 2 METERS, 1.5 METERS AND 70 CENTIMETERS AT YOUR LOCAL HAM DEALER'S. OR CALL OR WRITE FOR OUR FREE CATALOG.



544 LASSEN ST. • LOS ALTOS, CALIFORNIA • 94022 • (415)941-2118

John M. Murray W1BNN
4 Kenwood Circle
Bloomfield CT 06002

Eskimo Pie

Fan letters from SWLs used to be a mixed blessing. Sure, it took time and postage to answer them. But occasionally one would drift in that was amusing and, at times, unforgettable.

Somehow, sideband has squashed most of these guys out of the picture. When we were on AM on the DX bands, ears all over the world hung on our words. No more.

Until the SWLs get and/or learn how to



Apparently fed up with people, the Queen was not in much demand as a baby sitter.

use SSB receivers, the great silence may continue — and we'll save considerable postage. But I predict the floodgates will open one day again. Human nature, events and history have a way of repeating . . .

Take, for example, a wild letter I received with photographs many years ago from a Catholic missionary, a German by the way, whose beat was way out yonder in the Canadian Arctic. He was associated with "the flying priest," Father Schulte — and decided after listening to my multi-language QSOs with hams in Europe that I was the guy to develop his hot story for the world to learn. Believe me, it was a shocker!

It seems that this tasty item related to His Majesty IKTUKSHAKDGUK, Eskimo King of Igloolik, and his charming wife, the Queen — permanent igloo address not revealed. Anyhow, judging by the photos, you will note from the King's nonchalance and the Queen's obvious *savoir-faire* that they were indeed unusual people.

My missionary SWL outlined in his fine German script — translation of which was not too easy — that I should "feed" the story to Life magazine, or some other great American publication. For various reasons, I never got around to it. So now 73, which is not a bad publication at all, may do the honors.

If you have a queasy stomach or don't like to bite off more than you can chew, perhaps you'd better look away and not read on. Otherwise, "press on regardless . . ."

"It seems that our Queen ate her first husband and two babies some winters ago," my holy friend divulged. "She allowed that



Eskimo King IKTUKSHAKDGUK had "just one eye more for his sweetie pie."

he was a tough husband. He did not provide enough food for the family . . ." It was that simple.

The letter continued, "The King seems happy, however, he has only one eye more. He calls her sweetie pie."

My wife (XYL to some of you guys) observed, "The Queen obviously looks ahead — but with those two sharp teeth and two wedding rings on the wrong hand she is undoubtedly dreaming up a savory new recipe for Eskimo pie. I wouldn't trust her. The safety pin on his shirt, backed up by those solid looking buttons, only stresses her desire to meet, I mean meet, Eskimo standards of good taste — in dress of course. At least, he doesn't appear to be in any big stew about it — at the moment."

Let's hope that the old gal has reformed, if she is still navigating. She could even be the head of her local PTA. However, disclosure of her former diet could annoy the lady if she has continued to forage around, as above. She might even come down here and give us a hard time. Oh, yes. As the French say, "Bon appetit." . . .W1BNN

Which would you rather be, jack-of-all-bands or master of one?

We make our SkyClaw™ vertical antennas for the ham who doesn't want to be a jack-of-all bands. Because no antenna can be all things to all people. You tune our SkyClaw™ to your choice of 160 (50kHz bandwidth), 80 (200kHz bandwidth), or 40 (the whole band). We don't fudge the tuning for multi-band performance. We put the materials into it that let you pump the legal limit through it. We build it to withstand more wind than you'll find in a QSO on 75.

And we deliver the whole thing for \$79.50, postpaid in the USA. Radial and phasing harness kits are available, too.

It's self-supporting. Weatherproof. You put it up yourself with just 4 tools. It stands

24'7". And you connect to an SO-239 in its base.

Now, then. Have you decided which kind of operator you want to be?

Yes, Master.



Dentron

Radio Co., Inc.

2100 Enterprise Parkway
Twinsburg, Ohio 44087
(216) 425-8073

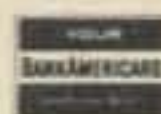

New Heath Ham Accessories



New solid state Heathkit Electronic Keyer...49.95

Sending code's easy with the HD-1410 whether you're operating base or portable. The dot and dash paddles' travel and tension are easily adjustable. When the two paddles are treated as one, the HD-1410 operates like a single-paddle keyer with dot and dash memories. Iambic operation forms most characters with reduced wrist movement. Dots and dashes are self-completing and always in proper proportion. During construction, you select the speed range you want up to 35 words per minute or up to 60 words per minute. Operates on 120 VAC or 12 VDC. Adjustable sidetone frequency, built-in speaker, headphone jack, weighted base. Styled to match our famous "SB" line.

Kit HD-1410, 5 lbs., mailable49.95*

HD-1410 SPECIFICATIONS — **Keying Speed:** Variable from under 10 to over 35 or from under 10 to over 60 wpm. **Keying Output, Positive Line to Ground:** max. voltage open circuit or spikes — 300 volts. Max. current — 200 mA. **Keying Output, Negative Line to Ground:** max. voltage open circuit or spikes — 200 volts. Max. current — 10 mA. **Audio:** internal speaker or jack for optional hi-Z (at least 500 ohms) headphones. **Sidetone:** adjustable from 500 to 1000 Hz. **Internal Controls:** sidetone frequency, paddle tension, paddle travel. **Rear Panel Connections:** AC power cord, 12-volt power input, keyer out, headphones, receiver audio in, ext. key. **Temperature Range:** 0°C to +40°C (typ. -10°C to +40°C) or approx. 50°F to 105°F. **Power Requirement:** 120/240 VAC (±10%), 60/50 Hz, 3.5 watts or 10-14.5 VDC, negative ground, 150 mA. **Dimensions:** approx. 3" H x 5" W x 7½" D. **Net Weight:** 3 lbs.

HEATHKIT ELECTRONIC CENTERS —
Units of Schlumberger Products Corporation
Retail prices slightly higher.

ARIZ.: Phoenix; CALIF.: Anaheim, El Cerrito, Los Angeles, Pomona, Redwood City, San Diego (La Mesa), Woodland Hills; COLO.: Denver; CONN.: Hartford (Avon); FLA.: Miami (Hialeah), Tampa; GA.: Atlanta; ILL.: Chicago, Downers Grove; IND.: Indianapolis; KANSAS: Kansas City (Mission); KY.: Louisville; LA.: New Orleans (Kenner); MD.: Baltimore, Rockville; MASS.: Boston (Wellesley); MICH.: Detroit; MINN.: Minneapolis (Hopkins); MO.: St. Louis (Bridgeton) NEB.: Omaha; N.J.: Fair Lawn; N.Y.: Buffalo (Amherst), New York City, Jericho (L.I.), Rochester, White Plains; OHIO: Cincinnati (Woodlawn), Cleveland, Columbus, Toledo; PA.: Philadelphia, Pittsburgh; R.I.: Providence (Warwick); TEXAS: Dallas, Houston; VA.: Norfolk (Va. Beach); WASH.: Seattle; WIS.: Milwaukee.



New solid state Heathkit Dip Meter...59.95

A better dip meter at lower cost. The Colpitts oscillator covers 1.6 to 250 MHz in fundamentals with MOS-FET paraphase amplifier and hot-carrier diodes for more sensitivity and better dip. Q-multiplier for greater detector sensitivity and responsive 150 μ A meter movement for positive resonance indications. Phone jack for modulation monitoring. Solid-state design and 9-volt battery operation. Custom molded gray carrying case protects the meter and the 7 color-coded, pre-adjusted, plug-in coils in transit, and makes a handy storage place. Build it in one evening. Nearly everything mounts on two circuit boards. And when you finish, you'll have the best dip meter around — for a lot less money.

Kit HD-1250, less battery, 4 lbs., mailable. .59.95*

Send for FREE Catalog

HEATH	Heath Company, Dept. 11-07 Benton Harbor, Michigan 49022	
Schlumberger		
<input type="checkbox"/> Please send my free 1975 Heathkit Catalog. <input type="checkbox"/> Enclosed is \$ _____, plus shipping. please send model(s) _____		
NAME _____		
ADDRESS _____		
CITY _____ STATE _____ ZIP _____		
PRICES & SPECIFICATIONS SUBJECT TO CHANGE WITHOUT NOTICE. *MAIL ORDER PRICES; F.O.B. FACTORY.		
		AM-314

FM Alignment Oscillator

Surplus commercial transceivers still provide the most economical means of getting started on the amateur FM bands. Often, however, these rigs require considerable "tweaking" to bring them into our bands. An rf signal source to align the i-f and rf sections of the receiver is almost always required to accomplish tune-up.

This article describes a simple test oscillator built around the ever popular International Crystal "OX" oscillator board. Two oscillators provide a 10.7 or 21 MHz signal for i-f tune-up and a low level signal for rf section alignment. The crystal selected

for rf alignment is in the range of 6 to 10 MHz — a harmonic provides output on the operating frequency. I chose the 24th harmonic for two meter work, and have successfully tuned several 430 MHz rigs utilizing the 50th harmonic of a 9 MHz EX crystal. This allows an "OX-LOW" oscillator to be used in both sections of the test unit.

Construction

The unit consists of a 5x2½x2½" minibox with a S0-239 coax jack and a SPDT switch mounted in opposite ends. The

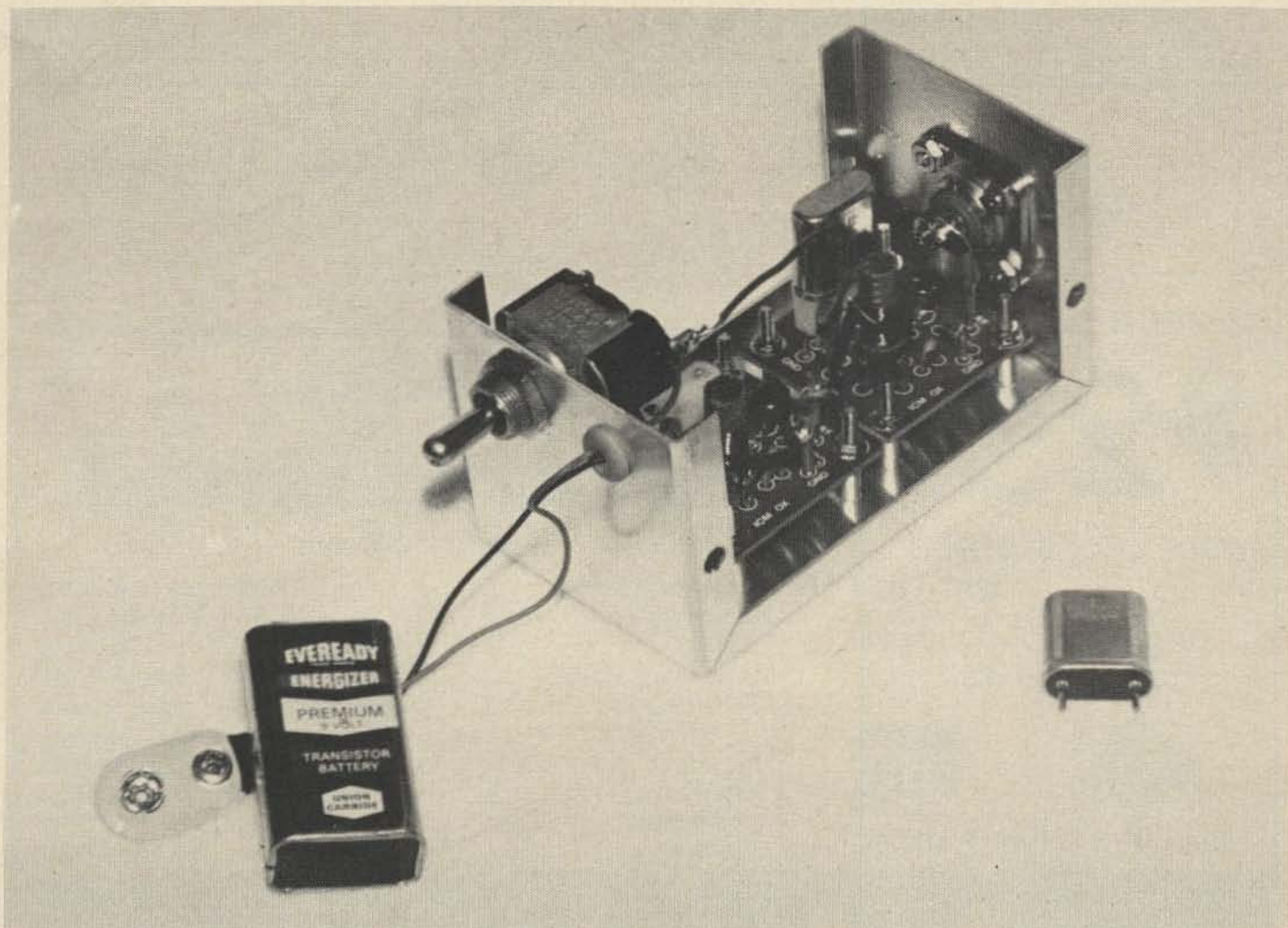

The complete test oscillator. Note link from OSC1 to OSC2. I-f crystal should be used in OSC1, closest to switch.

What's All the Shouting About ?



It's the All New *Clegg* FM-DX

Amateur Net \$589.95 — Factory Direct Only

**Owners are shouting their praise
for all sorts of reasons**

The ones we hear most often are ,

- The operating simplicity, accuracy and stability of the Synthesizer and LED Frequency Readout.
- The unmatched receiver performance with super sensitivity and freedom from spurious responses.
- Those beautiful, clean 35 Watts of Transmitter Output.
- The rugged Modular construction.
- The 143.5 — 148.5 MHz coverage — opens a whole new world of SIMPLEX operation.

**UNTIL YOU TRY ONE YOU WON'T KNOW WHICH
FEATURE YOU WILL SHOUT ABOUT - PROBABLY
ALL THE ABOVE - AND MORE! CALL CLEGG'S TOLL
FREE NUMBER TODAY FOR DETAILS ON THE FM-DX.**

Clegg

208 Centerville Rd. Lancaster, Pa.
Toll free sales & services phone (800) 233-0250
In Pa. call (717) 299-7221 (collect)

Master Sync Generator

This master sync generator is designed to produce interlaced sync for a black and white camera at minimum complexity and cost. The heart of this circuit is an IC made by Texas Instruments for the '74 series of Sylvania color TVs.

This IC, Sylvania part number 15-37701-1, is a $\div 2$, a $\div 525$, and a single-shot all-in-one 14 pin dip IC. The list price is \$5.40, and the net price is proportionately lower. This IC was designed so that the TV set generates its own sync signals if off the

air sync is temporarily lost.

By putting in a 31.5 kHz signal, and adding a singleshot to the horizontal output lead, interlaced sync results. My method of getting 31.5 kHz is shown. I had a surplus 6300 kHz xtal in the junkbox, so I followed it with a $\div 200$ set of flip flops. Many other combinations of xtal and dividers would work fine, such as 3150 kHz and $\div 100$, 504 kHz and $\div 16$, etc., or you can pay the long dollar for a 31.5 kHz xtal.

... W0LMD

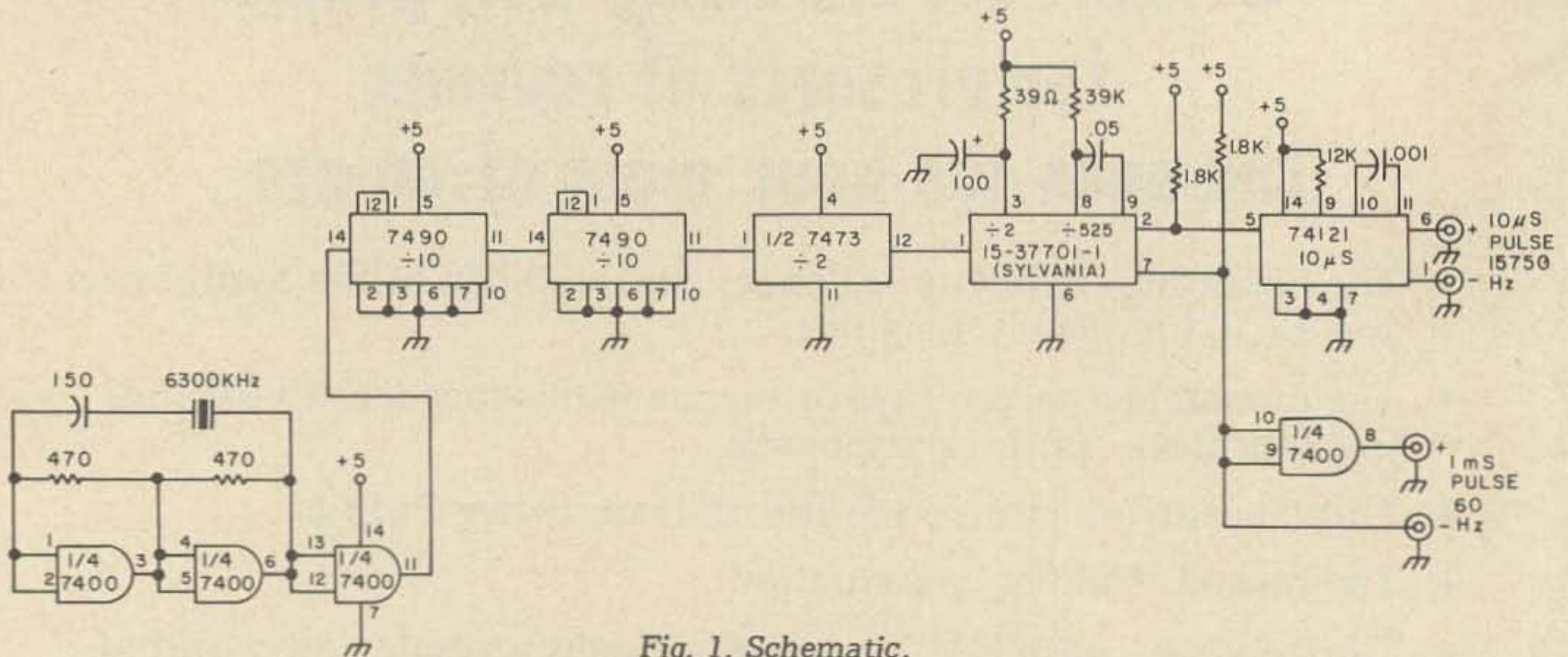

Fig. 1. Schematic.

18" FACSIMILE RECORDERS FOR SALE

The leading manufacturer of 18" facsimile weather chart recorders is now updating an existing network to solid state equipment. This updating is making available a number of 18" weather map recorders ideally suited for anyone interested in experimenting with facsimile.

These recorders, with suitable receiver and FSK converter, can be used to monitor radio weather chart broadcasts as well as press wire photo transmissions. With some modifications, data from weather satellites can also be received.

These recorders are reasonably priced and available on a first come, first served basis.

Call or write Mr. Armand D. Bouchard:

ALDEN ELECTRONICS & IMPULSE
 RECORDING EQUIPMENT CO., INC.
 Washington Street, Westboro MA 01581
 617/366-8851

CMOS KEYS

ASSEMBLED PCB
 \$24.95 ppd

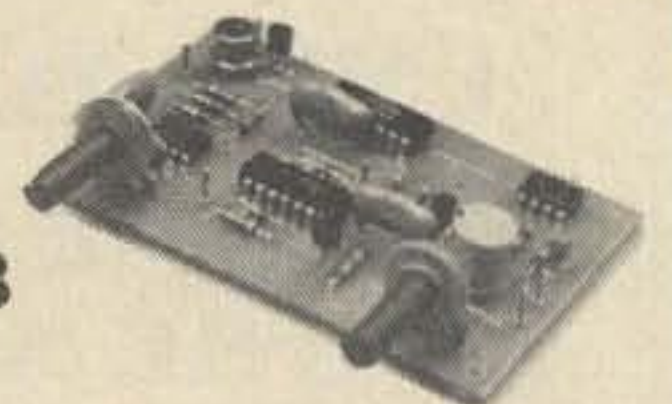

- *SELF-COMPLETING DOTS AND DASHES
- *INSTANT START WITH JAM PROOF SPACING
- *BUILT-IN SIDETONE
- *5-50 WPM
- *OPERATES ON 5-12 Vdc
- *FOR GRID-BLOCK AND CATHODE KEYING
- *SIZE: 2.3 x 3.5 INCHES

(WI residents add 4% sales tax)

DGM ELECTRONICS
 787 Briar Lane, Beloit, WI. 53511



SUPER-STRIPS

UNIVERSAL BREADBOARDING ELEMENTS WITH SOLDERLESS PLUG-IN TIE POINTS

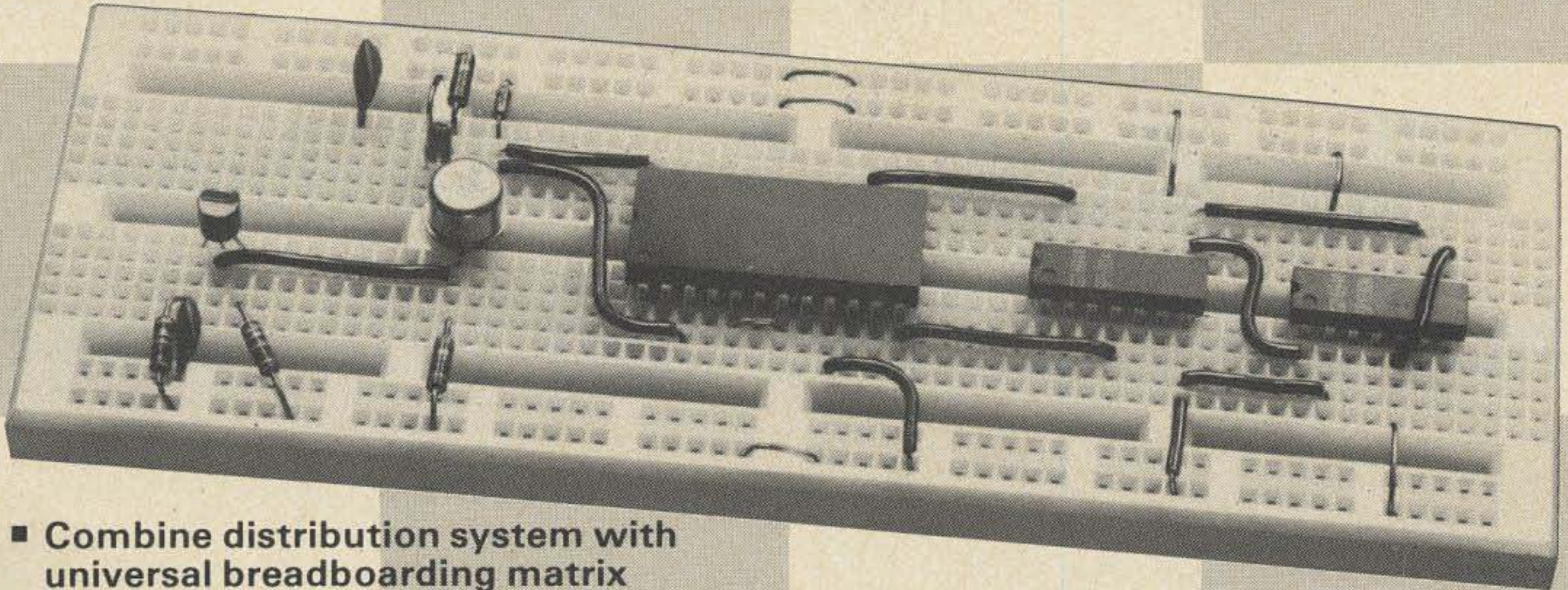

- Combine distribution system with universal breadboarding matrix
- 840 solderless, plug-in tie-points
- Accommodate all DIP's and discretes with lead diameters to .032"
- Require no special patch cords

The A P Super-Strips combine a power/signal distribution system with a matrix of 128 terminals, each with 5 tie points. The distribution system consists of eight buses, each individual bus consisting of a line of 25 tie points. All tie points are the solderless, plug-in type, used on A P Terminal and Distribution Strips.

The Super Strip will accept all DIP's, TO-5's and discrete components with leads up to .032" dia. As many as eight 14-pin DIP's can be accommodated. Use any solid wire up to No. 20 AWG for interconnections. Super-Strip can be panel-mounted with the No. 4 screws provided. A vinyl-insulated backing prevents short circuiting. Included are four self-adhesive polyurethane feet for protection during bench work. Body is acetal copolymer.

Super-Strip 1: 923748 (Gold-plated terminals) \$18.90 ea.
Super-Strip 2: 923252 (Nickel/silver terminals) \$17.00 ea.

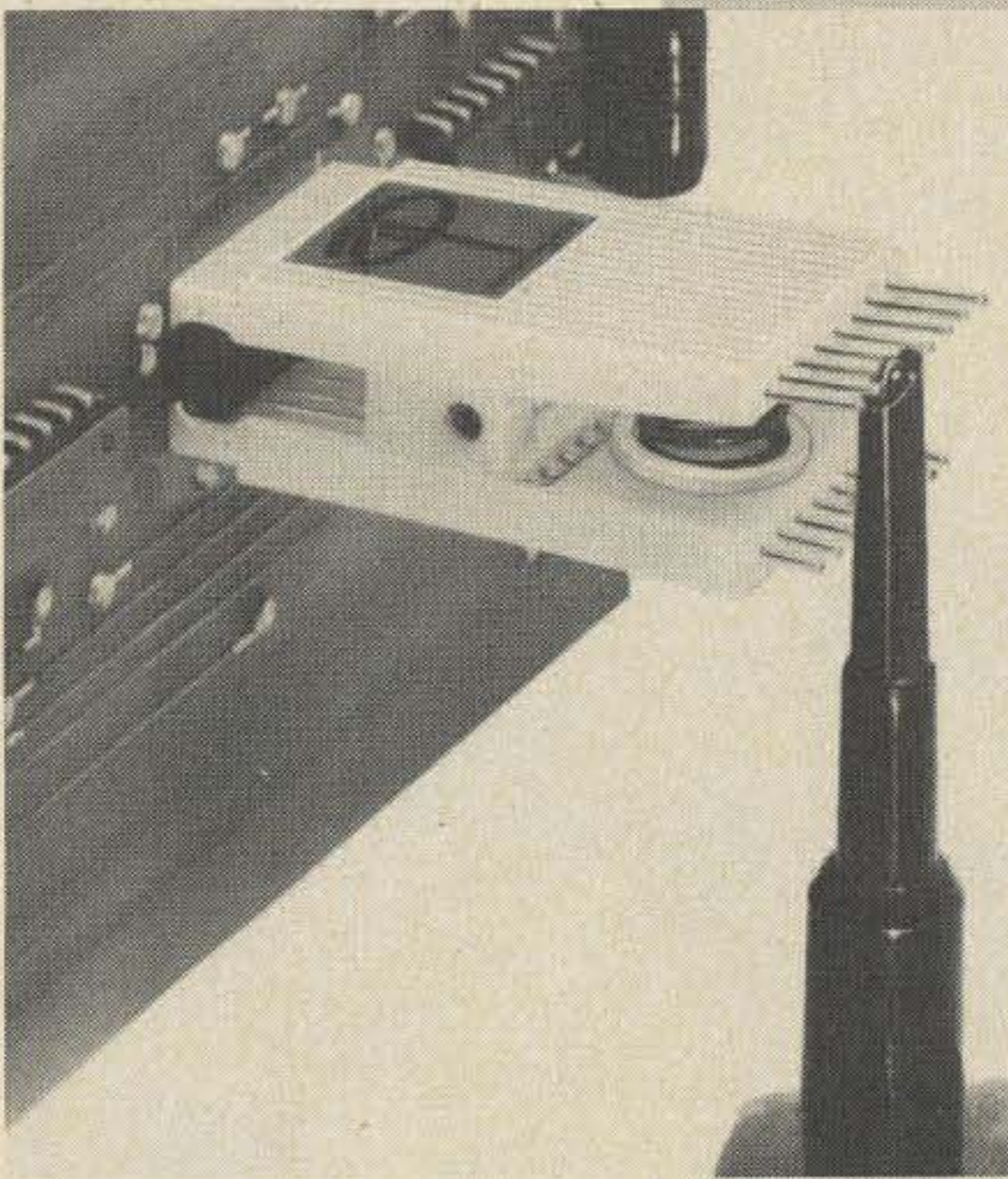

IC TEST CLIPS

FOR DUAL-IN-LINE PACKAGES

- Provide full access to integrated circuit DIP leads
- Solve probe attachment problems
- Simplify prototype and production testing, field service work, and quality control
- Remove DIP's damage free
- Available in sizes to accommodate all DIP's;

The unique design of the A P Test Clip assures positive, non-shorting electrical connection and positive mechanical clamping to dual-in-line packages.

Gold-plated phosphor bronze spring contacts are designed for wiping action. The "contact comb" separating the spring contacts provides positive positioning to prevent accidental shorting of adjacent leads.

Oscilloscope probes can hang free on the longer terminal wires in the top row of the Test Clip and not interfere with the terminals in the bottom row.

All products are guaranteed to meet or exceed published specifications

A P PRODUCTS INCORPORATED
 Box 110-Z • Painesville, OH 44077

TC-14	TC-16	TC-24
923689.....\$ 5.25 ea.	923700.....\$ 5.75 ea.	923714.....\$13.85 ea.

The Audio Synthesizer for RTTY, SSTV, and whatever

Have you ever had a need of an audio generator for precisely tuning your SSTV or RTTY equipment? This audio frequency synthesizer generates highly accurate tones useful for tuning both SSTV and RTTY station equipment. The output frequencies are within .4 Hz of the exact desired frequency of 11 tones critical, or very helpful in the tuning of an SSTV or RTTY station. A single crystal is subdivided to derive the desired tones, and the complete unit can be built for less than \$20.

The frequencies considered critical to SSTV tuneup were 1200, 1500 and 2300 Hz, representing Sync, Black and White respectively. In addition, 1700, 1900 and

2100 were considered useful for grey scale adjustments of SSTV, so these were added, resulting in six synthesized frequency requirements for SSTV.

RTTY has five frequencies which can be considered critical to tuneup. These are 1275, 1445, 2125, 2295 and 2975 Hz. These are the five tones which may be utilized on either wide or narrow frequency shift keying, using the low or high tone set.

Theory of Operation

The af synthesizer starts off with a simple crystal oscillator feeding three synchronous binary counter ICs. Since each IC has four stages, a possible frequency division of 2^{12}

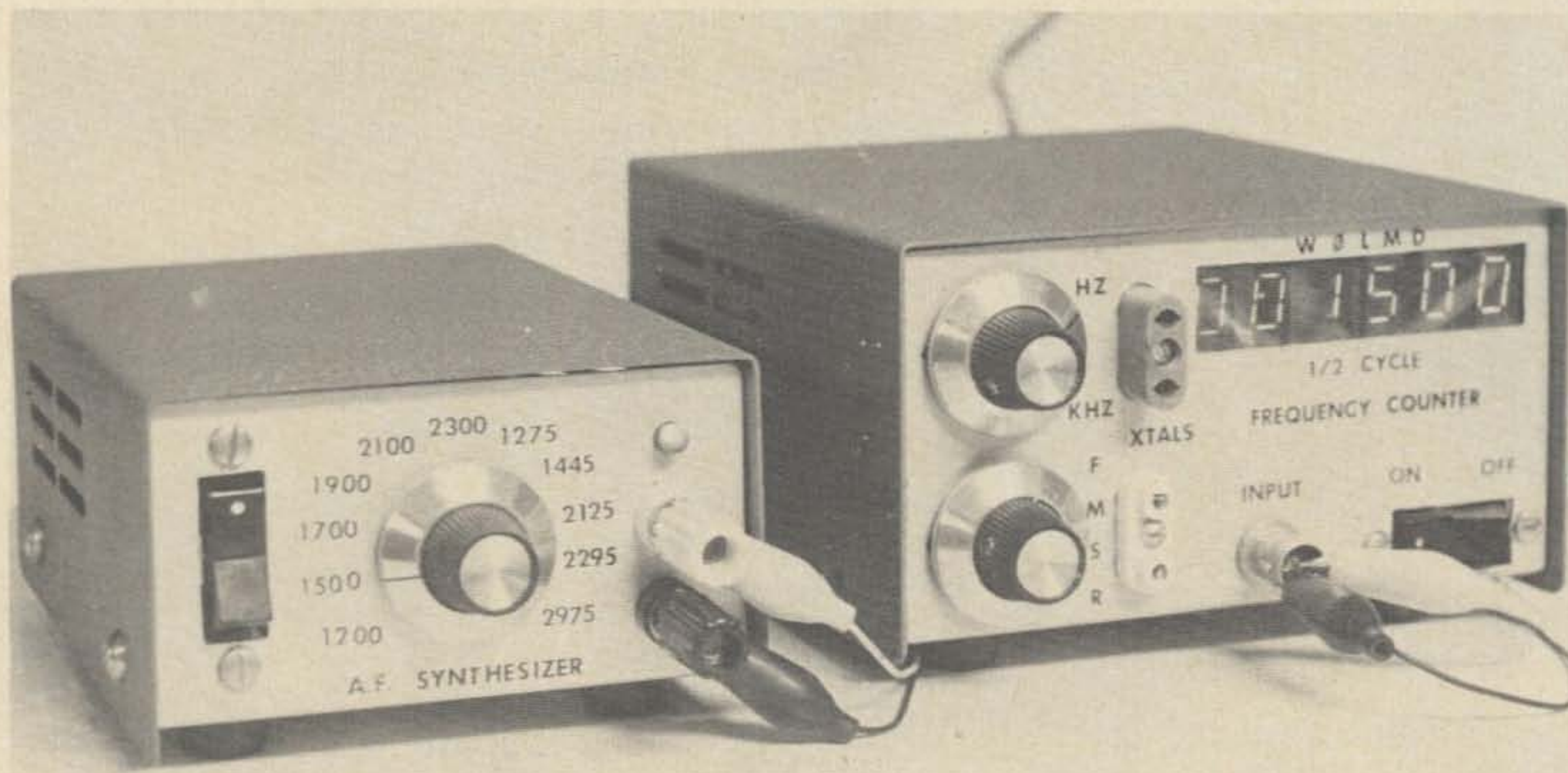

Af synthesizer on left, with frequency counter on right showing resultant output.

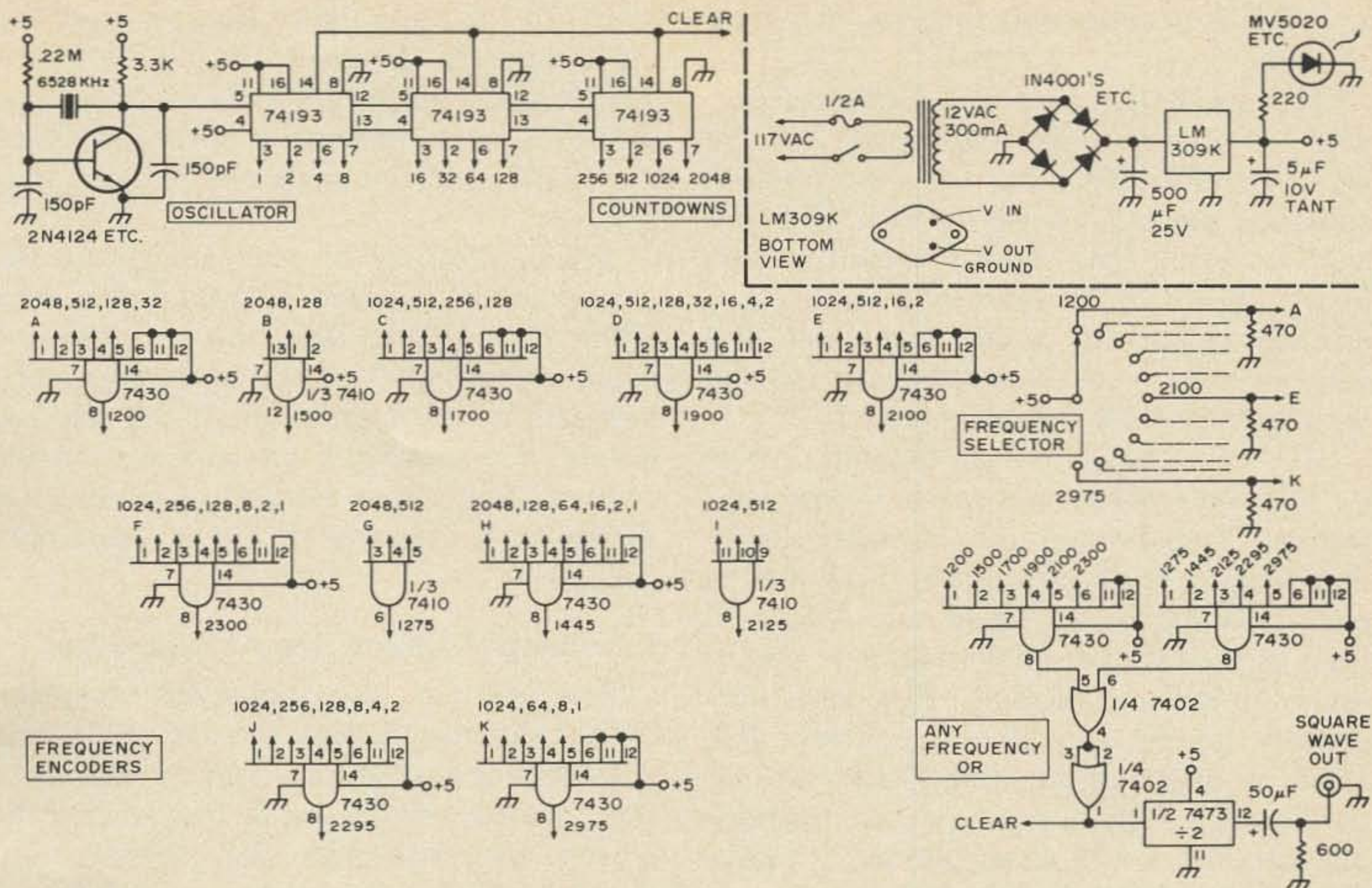

Fig. 1. SSTV and RTTY frequency synthesizer.

or 4096 exists before the counters carry to 0. However, if the proper outputs are gated together, the counters can be reset prior to 4096, thus establishing control of the exact frequency division. As shown on the schematic, by sequentially labeling the outputs of the counters in powers of 2, the desired frequency division can be easily assembled. The problem then becomes one of getting the simplest gating combination for the desired accuracy.

A rather complex computer program was written to analyze the problem stochastically, and the relevant portion of the print-out is shown in Table 1.

The computer did in a few minutes what would take years of manual calculation and comparison. Eleven NAND gate decoders are wired to detect a 1 bit at every input to produce a 0 bit at the output of one of the decoders, the decoder of the selected frequency to be synthesized. This 0 bit at the output of any decoder then produces a 1 bit at the output of the OR section, resetting the divider section, and also toggling the output flip flop.

The various NAND division decoders are selected by a switch which puts a + enabling voltage on one input of the desired fre-

quency's decoder. If remote manual, or electronic selection, is desired, such as a grey scale pattern for SSTV, or AFSK for RTTY transmission, the builder merely has to supply a + voltage to the desired decoder selector input in the sequence and/or for the time required.

Since the calculated frequency has been doubled, then halved in the output flip flop, the output waveshape is a symmetrical square wave, excellent for tuneup and calibration, but poor for transmission. If you wish to transmit this signal, build a low pass or bandpass filter to convert the output to a sine wave. Those not needing either SSTV or RTTY synthesis can omit the unneeded decoder NANDs, the 7430 OR gate associated with the undesired block of decoders, and the 7402. The remaining 7430 in the OR section is then directly connected to the 7473 and the Clear line.

Construction

I built the af synthesizer as a self-contained unit having its own power supply. The cabinet is a Radio Shack #270-252 measuring 4" wide by 2-3/8" high by 6" deep. The power transformer is any 12 volt

ac 300 mA or more unit that you may have around.

The actual IC board is a perfboard unit with .1" center holes measuring 2½" by 4½". The ICs and other parts are inserted and then the tedious wiring with #30 wire and a small, fine tipped soldering iron begins. Since it is very easy to make a mistake, be sure to develop some kind of a wiring system, such as labeling the ICs and wiring similar sections sequentially.

It is easier to build if an ordered process is followed which will allow progressive testing. Complete and test the power supply first. Next wire up power pins of all the ICs and build the crystal oscillator. After you have verified proper oscillation, wire up the three frequency dividing ICs, and temporarily ground pin 14 of these three ICs. Look at pin 7 of the last 74193 with an oscilloscope. If everything is working correctly so far, you should see a square wave, 1593.75 Hz in frequency.

Start wiring the decoders by wiring the 7430 labeled "1200." Reading the abbreviated schematic, you will find that the 1200 Hz decoder requires a 2048, 512, 128 and 32 bit input to pins 2, 3, 4 and 5 respectively. The 2048 and 512 bits come from pins 7 and 2 of the third 74193, and bits 128 and 32 come from pins 7 and 2 of the second 74193. Pin 1 of the 1200 Hz decoder is connected to "A" (the 1200 Hz position of the switch). The output of the 1200 Hz decoder (pin 8) is connected to the 7430 OR gate NAND associated with the SSTV frequencies, the 1200 Hz decoder input, pin 1.

Then wire the other connections to the OR section, except do not connect the OR

inputs to the unwired decoders yet. Remove the temporary ground from pin 14 of the 74193s and connect the OR section output as shown on the schematic to the pin 14s of the 74193s and the input pin of the output ½ 7473.

Select 1200 Hz on the switch, and the output of the synthesizer should now read 1200 Hz, ± one digit, on a frequency counter. Now wire the rest of the frequency decoders and test each one. If any selected output does not read out correctly on the counter, you either have an error in your wiring, or a defective IC. Or maybe a bum counter!

Extending/Modifying The Af Synthesizer

The unit can also synthesize other frequencies between 800 Hz and 3264 kHz with varying degrees of accuracy. The lower the desired synthesized frequency, the greater the probability that the resultant output will be very close. A number of extra, currently unused, input gates in the OR section are shown on the schematic. These can be connected to additional decoders, and additional switch positions will allow selection of up to 16 synthesized frequencies.

Suppose you wish to add 1000 Hz output. First use the following formula to derive the frequency division needed:

Division required =

$$\frac{3264000}{\text{Synthesized Frequency Desired}}$$

Entering our desired frequency of 1000 Hz we get:

3264000	SSTV	2720.00	2176.00	1920.00	1717.89	1554.29	1419.13	
	RTTY	2560.00	2258.82	1536.00	1422.22	1097.14		
2720	1200.0000	2048	512	128	32	0	0	0
2176	1500.0000	2048	128	0	0	0	0	0
1920	1700.0000	1024	512	256	128	0	0	0
1718	1899.8836	1024	512	128	32	16	4	2
1554	2100.3861	1024	512	16	2	0	0	0
1419	2300.2114	1024	256	128	8	2	1	0
2560	1275.0000	2048	512	0	0	0	0	0
2259	1444.8871	2048	128	64	16	2	1	0
1536	2125.0000	1024	512	0	0	0	0	0
1422	2295.3586	1024	256	128	8	4	2	0
1097	2975.3874	1024	64	8	1	0	0	0

Table 1. Computer printout of frequency synthesis combinations.

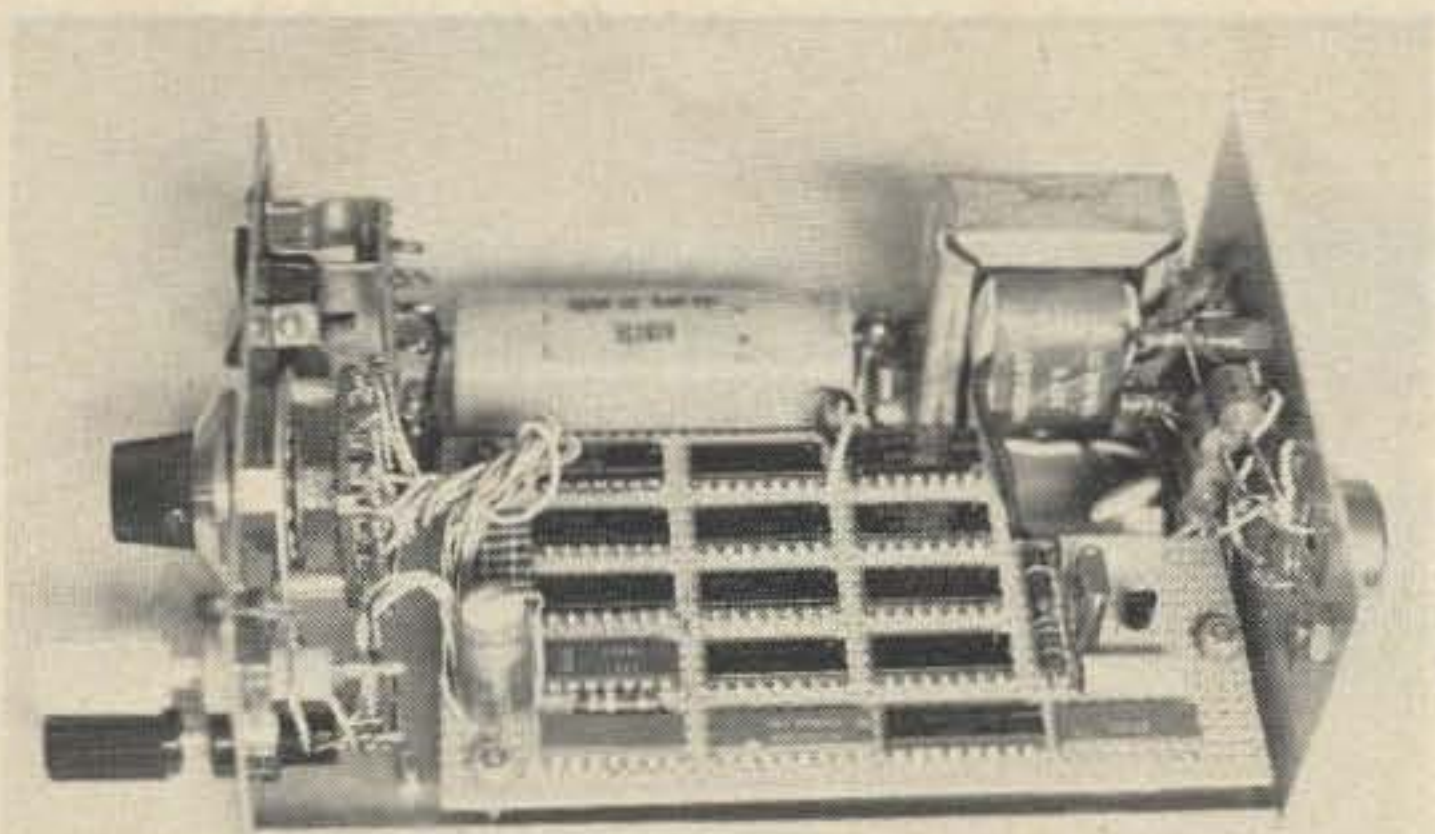

Inside view.

$$3264 = \frac{3264000}{1000}$$

Next, we determine the binary divisions required. Sequentially subtract the highest binary number listed on the 74193 outputs, in descending order:

$$3264 - 2048 = 1216 - 1024 = 192 - 128 = 64 - 64 = 0.$$

This indicates that a decoder connected to the 2048, 1024, 128 and 64 outputs of the 74193s will give a 1000 Hz synthesized output from the af synthesizer when selected.

A problem comes in when the division required is not a whole number. In this case, the division required is rounded off to the nearest whole number, but some resultant inaccuracy will have to be tolerated, or a new computer analysis can be run, using this new desired frequency as another simulation constraint.

Table 1 shows several examples of how the computer listed the resultant error for me. The first number on the top line was the stochastically selected master frequency. The SSTV and RTTY frequencies required the 11 division ratios shown to the right of the master frequency. 2100 Hz actually required a division of 1554.29. The computer rounded off to 1554 beneath, and then calculated the resultant frequency and the required binary divisions. Notice that the 1554 division results in a frequency .3861 Hz too high, but this is close enough for my application so the design was accepted.

Another consideration is that a 7430 has only 8 input legs. Since one input goes to the switch, each decoder must use a maximum of 7 input legs to the counters. This

was another variable entered into the computer as a design constraint. Note on the printout of Table 1 that only one decoder (1900) required all 8 inputs. Synthesized frequencies requiring only two counter inputs can use a 1/3 7410 as shown, and those requiring only three can use a 1/2 7420, in the interest of lowering the total IC count.

Conclusion

This project has presented an af synthesizer for SSTV and RTTY frequencies which is accurate to within .4 Hz, in the worst case. A computer was utilized to obtain the needed data for building a unit which gives the required accuracy, as well as minimizing the complexity of the unit. The output is a symmetrical square wave.

Subsequent computer simulations have been run for af synthesizers which synthesize a sine wave output of the desired frequencies of SSTV, RTTY and SSTV and RTTY. These designs will be written up at some later date.

... WØLMD

YOUR HAM TUBE HEADQUARTERS!

TUBES BOUGHT, SOLD AND TRADED
SAVE \$\$\$ - HIGH \$\$\$ FOR YOUR TUBES

MONTHLY SPECIALS

2K25	\$ 28.00	6146B	\$ 4.25
3-500Z	42.00	6360	3.75
3-1000Z	120.00	6883B	4.50
4-125A	42.00	6939	9.00
4-400A	45.00	811A	5.00
4CX250B	24.00	813	18.00
4X150A	19.00	7735A	38.00
572B	18.00	8236	22.00

BRAND NEW****FACTORY GUARANTEED

TOP BRAND Popular Receiving Tube Types.
BRAND NEW 75%+ Off List*Factory Boxed.
FREE LIST Available - Minimum Order \$25.



COMMUNICATIONS, Inc.
2115 Avenue X
Brooklyn, NY 11235
Phone (212) 646-6300

SERVING THE INDUSTRY SINCE 1922

CRYSTALS are OLD FASHIONED

*Now in stock
The latest synthesized rigs available.*



ICOM 230 146-148
FM



ITC Multi-2000 144-148
FM-CW-SSB



Brimstone 144 142-149
FM



EBC 144 Jr. 143.5-148.5
FM



ICOM 21-A 146-148
ICOM DV-21

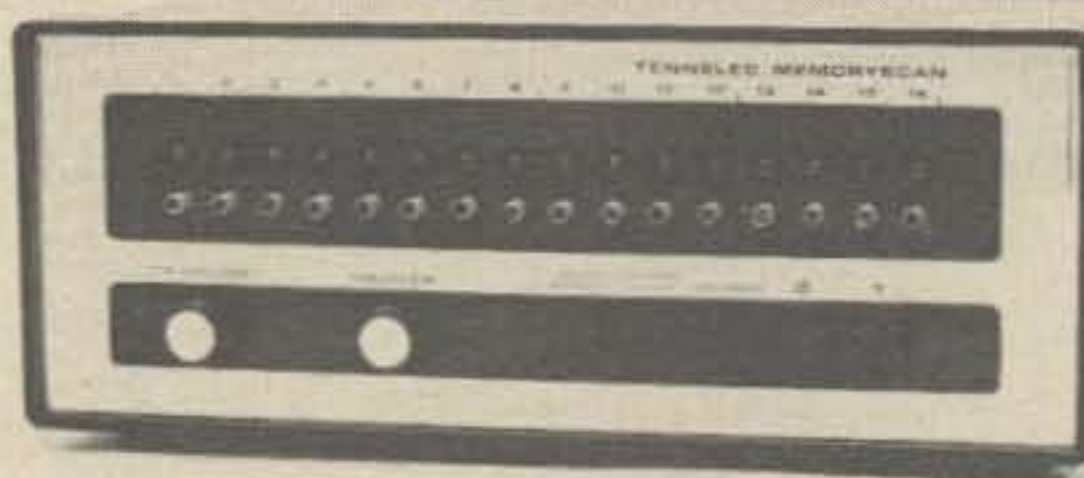

Tennelec Memory Scanner 30-50 146-170
450-510 MHz

AUDIO LAND is now offering high trade-in prices for your used equipment. Write for trade-in prices and price quotes. Now in stock — CUSHCRAFT — REGENCY — SBE — HAL COMMUNICATIONS — NEWTRONICS — HY GAIN — AMPHENOL — TURNER — E.V. — SURE — STANDARD — TEMPO. 3000 xtals for most rigs. Rotors and cables. Stereo and quad equipment — and much more. Specials on N.P.C. regulated power supplies. All major charge cards accepted. Several finance plans available.

Audioland

36633 S. Gratiot
Mt. Clemens Michigan 48043
313-791-1400

Alan S. Douglas
Box 225
Pocasset MA 02559

Ham Radio in the Arctic - 1925

Just fifty years ago, in the summer of 1925, Commander Donald B. MacMillan led an expedition to the Arctic, to search for land masses near the Pole. His previous expedition in 1923-24 had been smaller, but he had set a precedent by equipping his schooner *Bowdoin* with amateur radio gear with the call WNP (Wireless North Pole), and enlisting Don Mix as operator. Although only one Canadian amateur was able to work them with any regularity, WNP was the most talked-about event of the year. From that time, no geographic expedition was complete without radio to keep in touch with the outside world.

MacMillan's 1925 plans were more ambitious. He was sponsored by the National Geographic Society and he had two ships, his favorite *Bowdoin* and the converted French trawler *Peary*. The *Peary* carried a group of three Navy amphibian aircraft commanded by Richard E. Byrd. The radio gear, as in the first expedition, was custom-built by Zenith; in fact, E. F. MacDonald, Zenith's president, was MacMillan's second in command.

What made this expedition so important to amateur radio? Short waves! The equipment was made to operate all the way to 20 meters, a relatively uncharted area in the days when most activity was around 200. A few amateurs had conducted experiments at 40 and 20, notably John Reinartz 1XAM/1QP, and had noted that these bands were especially suited to daytime work. The expedition would be in continuous daylight

during the Arctic summer, and the 200 meter band would be nearly useless, as the first expedition and WNP had shown.

On the basis of these short wave experiments, 20 meters was chosen as the primary traffic frequency, and QST expressed the hope that as many amateurs as possible would build suitable rigs to work MacMillan. Reinartz himself, one of the few men familiar with the construction and operation of short wave apparatus, was engaged by



John Reinartz 1XAM/1QP, at the base camp in Etah, Greenland. (Photo copyrighted by the National Geographic Society.)

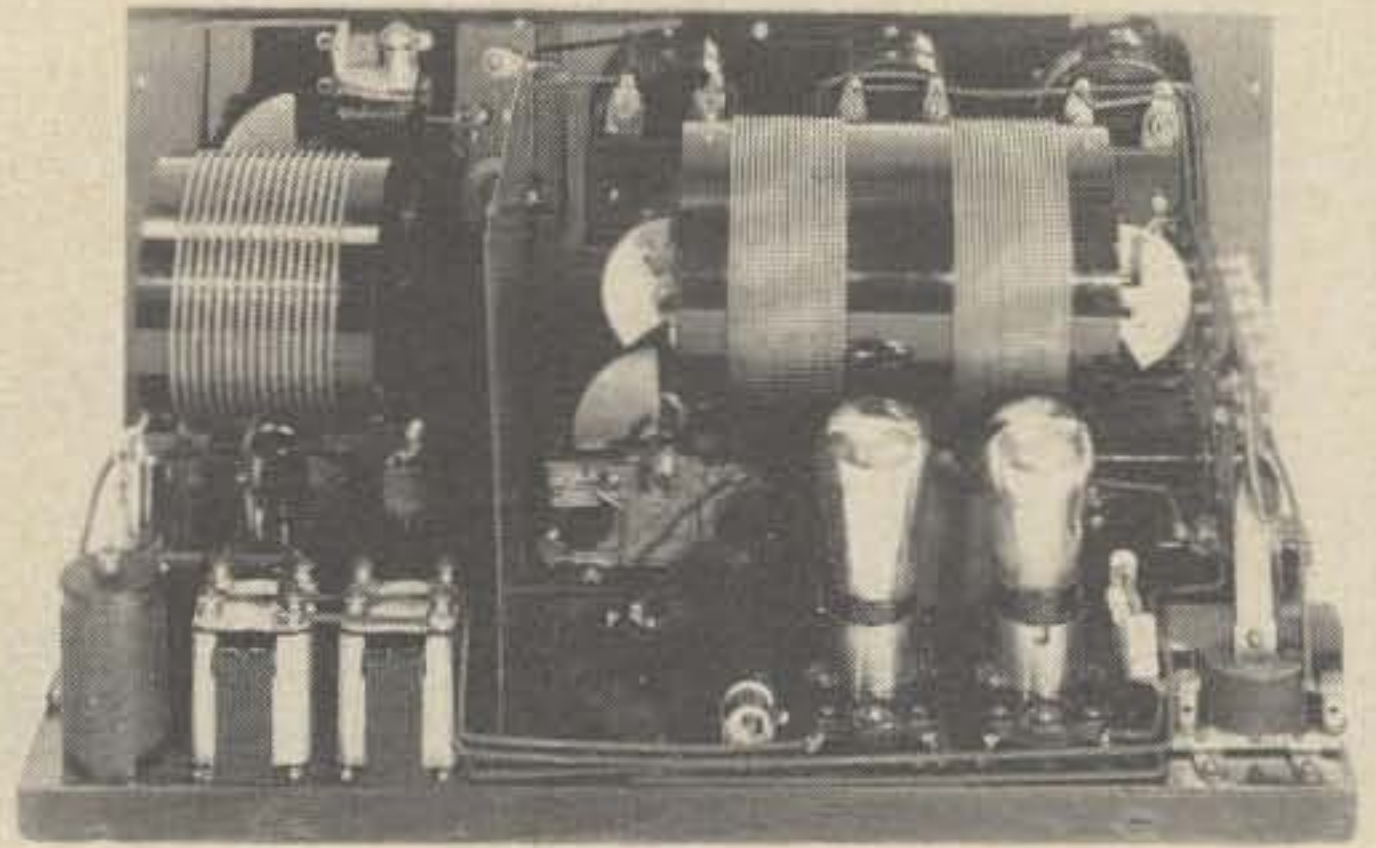

The author's 40m Reinartz-Zenith transmitter-receiver. (Photos by Robert H. Macdonald.)

Zenith to design the necessary radio gear, and to accompany MacMillan as chief operator. He was already famous for his "Reinartz circuit," a peculiar form of regenerative tuner that was immensely popular in the 1920s.

Though I have no first-hand information (I was born almost twenty years later), I'm probably not sticking my neck out too far if I speculate that the chance to hear and work MacMillan directly was enough to convince

many hams to get out of their 200 meter ruts and make the jump to short waves. Did someone mention "incentive"?

My own interest in MacMillan's work began when I had the good fortune to buy one of the few existing pieces of gear that he used, from the man who had owned it ever since the expedition returned. This 40 meter transmitter-receiver was installed on one of the aircraft, for emergency use in case of forced landing. The receiver is a Reinartz



These snapshots were taken by Donald Whittier, a Maine amateur, when the first expedition returned in September, 1924. They hung among his QSL cards for many years.

detector and two-stage audio amplifier using type 99 tubes. The transmitter runs 3 to 5 Watts to an 01-A tube and can be Heising-modulated by another 01-A for phone. The receiver covers 6-11 MHz and works quite well, even on today's crowded band, helped by the filter action of my Baldwin phones that resonate at 1000 Hz. The transmitter has a fearsome chirp at anything above 500 mW input, but I'm told this was normal in those days.

Geographically speaking, the expedition was a flop. The summer was unusually short, and the areas of open water, where the aircraft could be landed, never developed. This made flights far to the north and west of Greenland out of the question, as a landing on the rugged ice would have meant a crash. Furthermore, the short summer left only 15 days for flying, most of which were poor. Still, the planes logged 6000 miles and did explore a large part of Greenland's interior. For detailed accounts of both expeditions, refer to *National Geographic*, June and November, 1925.

... DOUGLAS



Glade Valley School Radio Session

16th Year — July 26 thru August 8, 1975

UPGRADE YOUR HAM TICKET

BE READY FOR ANY FCC RESTRUCTURING

The Glade Valley Radio School is the only place in the country where you can get two solid weeks of concentrated radio theory and code — all taught by instructors with Extra Class licenses and years of experience in teaching.

You meet fine people of all ages and backgrounds. All with a sincere interest in ham radio. During the 15 years of this school's operation, over 900 have attended, and many long lasting friendships have developed.

Instruction is given at the General, Advanced and Extra Class levels, with small groups for personal attention.

Excellent rooms and meals are provided, and the schedule is planned for a healthy mixture of learning and recreation, all in the beautiful mountains of cool North Carolina. Facilities are available for single people as well as for married couples.

C.L. Peters K4DNJ, DIRECTOR
Box 458, Glade Valley NC 28627

Please send me the booklet and application blank for the Glade Valley School Radio Session.

Name _____ Call _____

Address _____

City/State/Zip _____

It's faster than a speeding bullet!
More powerful than the legal limit!
And able to match long wires with a single bound!

SuperTuner™



Did we mention smaller than a breadbox?

This amazing visitor from far-off Ohio has powers and abilities far beyond ordinary mortal antenna tuners. Single-handedly, it matches coax feed, random wire, balanced or unbalanced line on any band, 160 through 10, up to the full legal limit. And Dentron's new Super SuperTuner handles a full 3 KW PEP—in case you-know-who passes you-know-what. SuperTuner and Super SuperTuner. Who, in black wrinkled finish, fight a never-ending battle for truth, justice, and juicier signals. Up, up and away. Just \$119.50 ppd. in the USA.

Dentron

Radio Co., Inc.
2100 Enterprise Parkway
Twinsburg, Ohio 44087
(216) 425-8073



GET TO THE FAST TOP!

NOW YOU CAN CHANGE, ADJUST OR JUST PLAIN WORK ON YOUR ANTENNA AND NEVER LEAVE THE GROUND!

ROHN manufactures towers that are designed and engineered to do specific jobs and that is why we have the FOLD-OVER TOWER . . . designed for the amateur. When you need to "get at" your antenna just turn the handle and there it is. Like other ROHN big communication towers, they're hot dip galvanized **after** fabrication to provide a maintenance free, long lived and attractive installation. ROHN towers are known and used throughout the world . . . for almost a quarter century . . . in most every type of operation. You'll be in good company. Why not check with your distributor today?

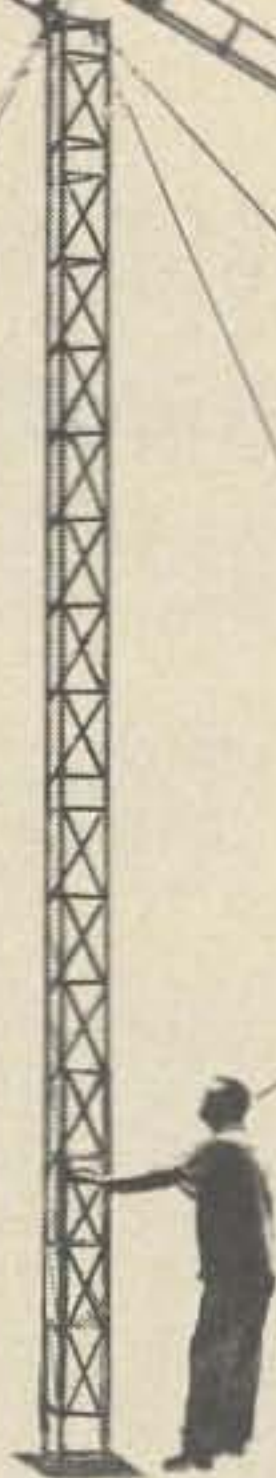

ROHN **MANUFACTURING**

® DIVISION OF **UNARCO**
INDUSTRIES, Inc.

P.O. Box 2000 / Peoria, Ill. 61601

Pack Rat Moonbouncing

A long standing desire of the Pack Rats was fulfilled Friday night, February 21, 1975, when the Pack Rat Moonbounce station became operational. It has been a long time since the first organizational meeting at the home of Chuck Benavides WA3LNH (now WA1KIR) in the winter of 1973, when the 432 MHz band was agreed upon as the best band for the project. Much work was required, since almost no equipment was available of moonbounce quality or capability. The donation of a twenty foot stressed dish by Allen K2UYH provided a shot in the arm, but still the high power transmitter and low noise preamps required were only dreams.

Little by little progress was made. Two high powered amplifiers were built and tested by W3HMU and K3BPP. A few low noise preamps were built and tested — most worked only fair and gave problems of oscillation or cross-modulation. Modern filter designs and preamp circuits were tried with eventual success. Although the bits and pieces were taking shape, the pressure of contests and other club activities took priority due to the urgency of their schedules.

An injection of fresh enthusiasm in the person of Bill W3HQT got things rolling. Bill decided this past fall that the time had come to start assembly of the dish and that his backyard could be the location for the

W3CCX moonbounce station. After some time off for the January Contest, word came from California of the plans for moonbounce tests using the Stanford Research 150 foot dish. This gave us the final push. It was decided to be ready to operate during the tests scheduled for the weekend of February 22 and 23. The twenty foot dish was re-assembled and covered with new chicken wire during the coldest part of the winter. Several times the dish crew worked in the rain, because rainy weather meant mild temperatures. The chicken wire covering was completed Saturday, February 15, by head chicken wire plucker W3HQT, assisted by W3HMU and K3BPP. Notable contributions to the dish construction were made by WA3NGK and WA3JUF.

February 16 was dish mounting day. The mount had been positioned in the ground behind the barn in early January before the ground froze. A brute force technique reminiscent of past June contest operations was used to place the dish on its mount. The dish was lifted into position by "dish chief" W3HQT and K3BPP, with WA3NGK, WA3AXV, WA3JUF, W3HMU and K3ZSG providing additional muscle. During this operation, K3ZSG found that his Vietnam boots were no match for the combination of snow and sheep droppings in the barnyard. The dish sure looked impressive when we stepped back to see the results of our labor!

The week of the 17th of February saw completion of the details of the major station equipment, some of which were presented at Pack Rat Home Brew Night,

Reprinted from *Cheese Bits*, Mt. Airy VHF Radio Club, Inc., Philadelphia PA, March, 1975.



K3BPP with the feed.

Thursday, February 20. Friday night the station was assembled into the new room W3HQT had built into one corner of his barn. Although an attempt was made to calibrate the receiving set up on sun noise before sunset on Friday, the attempt was foiled by cantankerous BNC connectors which caused problems that were not resolved until after sunset. The weather was good, although the temperature dropped quickly after sunset with a clear sky and the moon in full view. The moonbounce station was on the air by 11 pm and testing was begun to see if we could hear our own echoes off the moon.

After only a few test transmissions Al K2UYH called to tell us he was hearing our echoes quite well and to look about 1 kHz below our frequency for the echoes — which were shifted due to Doppler effect. With this information we then heard our own echoes — quite weak but definitely there! To have heard our echoes on the first night was more success than we had dreamed possible. We then copied a portion of a moonbounce QSO between K2UYH and W0OQI. WA6LET was copied Q5 at about 2 am calling CQ, but not responding to calls.

About 3 am Saturday morning the crew ran out of steam and shut down operations. Saturday afternoon was perfect for antenna and receiver tests and adjustments. Initially 4 dB of sun noise were measured, indicating something wrong. The problem turned out to be a mis-tuned input filter. Seven dB of sun noise were measured after adjusting the filter. Antenna patterns were studied using a signal source and some improvements made

to the mount alignment and antenna supports. Two bore sights were mounted and adjusted so that when the antenna was peaked on the sun, the sun was centered in the sights. Setting circles (basically protractors used in measuring antenna orientation) were mounted on the antenna frame and calibrated on the rising moon by bore-sighting the moon and adjusting the setting circles to the values of azimuth and elevation in the moon table sent to us by K2UYH. Using these setting circles, it is possible to point the antenna at the moon when the moon is not visible.

Moonbounce operations were begun around 6 pm on Saturday evening with good echoes being received. WA6LET was heard calling CQ around 7:15 and was worked with 559 signal exchanges both ways. The crew then broke for a victory cup of Red Zinger. Further echo tests and a CQ brought a phone call from W0YZS and K0TLM of Kansas City MO, who were hearing us off the moon and wanted a schedule. Both stations were worked on schedule around 10:30 pm. After listening around for awhile the station was secured at midnight.

Sunday evening was extremely foggy with occasional light rain. Not very good weather to be outdoors. W3HQT and K3BPP, who were working on the moonbounce shack, decided to try for echoes using the elevation

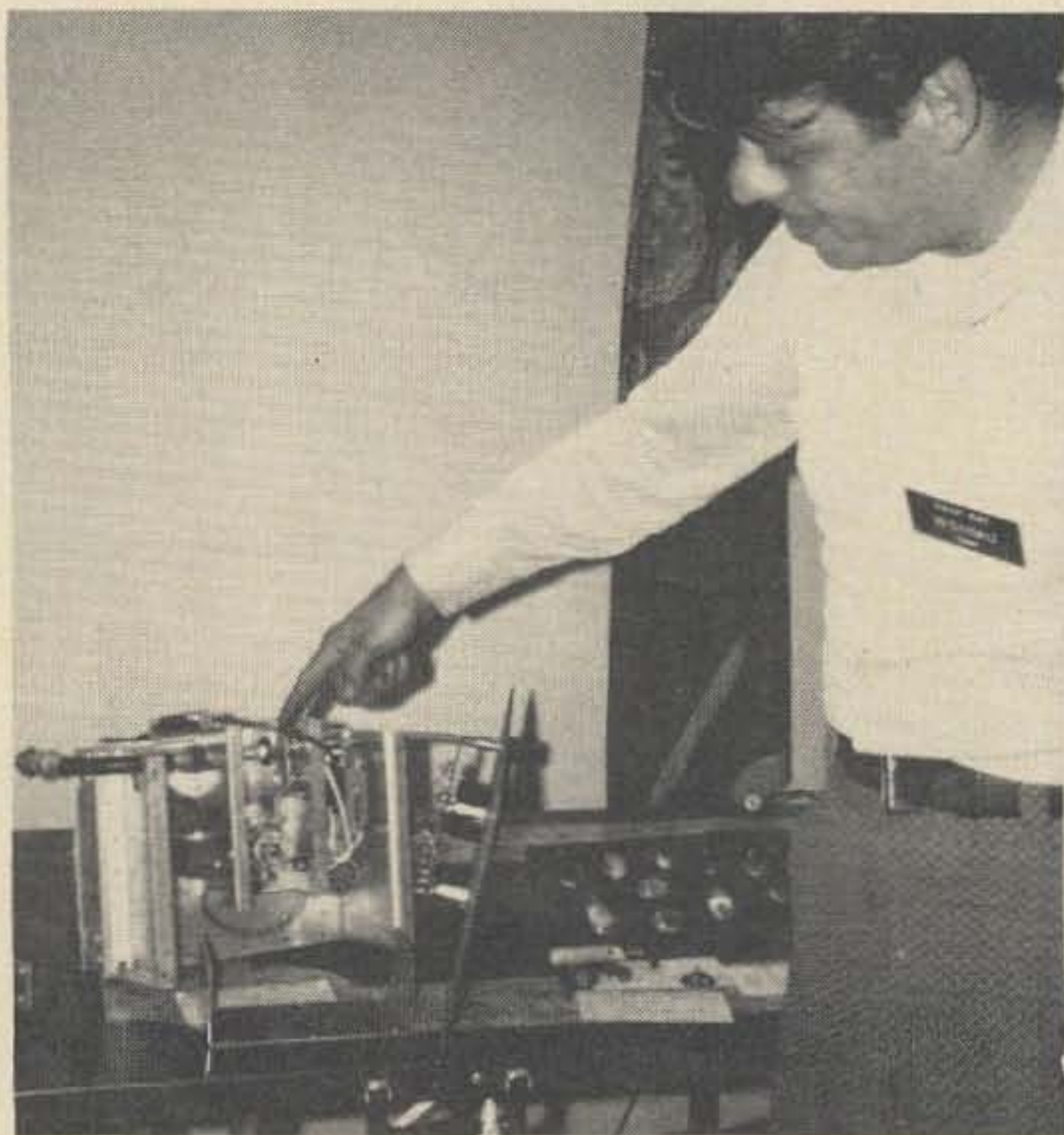

W3HMU with the amplifier.

2 METER CRYSTALS IN STOCK

We can ship C.O.D. either by parcel post or U.P.S. Orders can be paid by: check, money order, Master Charge, or BankAmericard. Orders prepaid are shipped postage paid. Phone orders accepted. Crystals are guaranteed for life. Crystals are all \$5.00 each (Mass. residents add 15¢ tax per crystal).

We are authorized distributors for: Icom and Standard Communications Equipment. (2 meter)

We stock A/S and Mosley two-meter antennas

We have thousands of crystals for monitor radios (Bearcat, Regency, etc.) along with many C.B. crystals

Note: If you do not know type of radio, or if your radio is not listed, give either fundamental frequency or formula and loading capacitance.

LIST OF TWO METER CRYSTALS CURRENTLY STOCKED FOR RADIOS LISTED BELOW:

- | | |
|----------------|--|
| 1. Drake TR-22 | 5. Ken/Wilson |
| 2. Drake TR-72 | 6. Regency HR-2A/HR212/Heathkit HW-202 |
| 3. Genave | 7. Regency HR-2B |
| 4. Icom | 8. S.B.E. |
| | 9. Standard |

The first two numbers of the frequency are deleted for the sake of being non-repetative. Example: 146.67 receive would be listed as - 6.67R

- | | | | | | | | |
|----------|------------|------------|-----------|-----------|-----------|-----------|-----------|
| 1. 6.01T | 8. 6.70R | 15. 6.175T | 22. 6.85R | 29. 6.37T | 36. 7.60T | 44. 7.72T | 52. 7.84T |
| 2. 6.61R | 9. 6.13T | 16. 6.775R | 23. 6.28T | 30. 6.97R | 37. 7.00R | 45. 7.12R | 53. 7.24R |
| 3. 6.04T | 10. 6.73R | 17. 6.19T | 24. 6.88R | 31. 6.39T | 38. 7.63T | 46. 7.75T | 54. 7.90T |
| 4. 6.64R | 11. 6.145T | 18. 6.79R | 25. 6.31T | 32. 6.99R | 39. 7.03R | 47. 7.15R | 55. 7.30R |
| 5. 6.07T | 12. 6.745R | 19. 6.22T | 26. 6.91R | 33. 6.52T | 40. 7.66T | 48. 7.78T | 56. 7.93T |
| 6. 6.67R | 13. 6.16T | 20. 6.82R | 27. 6.34T | 34. 6.52R | 41. 7.06R | 49. 7.18R | 57. 7.33R |
| 7. 6.10T | 14. 6.76R | 21. 6.25T | 28. 6.94R | 35. 6.94T | 42. 7.69T | 50. 7.81T | 58. 7.96T |
| | | | | | 43. 7.09R | 51. 7.21R | 59. 7.36T |

SPECIAL • BUY THE STANDARD 146A W/T AND RECEIVE A \$60.00 MERCHANDISE CREDIT GOOD FOR THE FOLLOWING ACCESSORIES:

SR-CSA DESK TOP CHARGER \$43.00

SR-C-AT19 RUBBER DUCKY ANTENNA \$6.00

NI-CAD BATTERIES (10 REQUIRED) \$2.00 ea.

CRYSTALS (UNIT COMES WITH 34/94 AND 94 DIRECT) \$5.00 ea.

SR-C-PT3644 LEATHER CASE \$8.50

SPECIFICATIONS

Microphone:	Internal dynamic type	Frequency range:	143 to 149 MHz
Dimensions:	9" h x 3" w x 1-5/8" d	Number of channels:	5
Weight:	32 oz. max. (including batteries)	Channel spread:	2 MHz max.
Supplied with 2 channels:	146.94Tx/Rx (national calling channel)	Input voltage (negative ground):	12.5V dc ±20%
	146.34Tx/146.94 Rx (repeater channel)	Circuitry:	All solid state
	Internal 2" dynamic	Current drain:	15ma squelched max., 100ma receive max. 0.62A transmit max.

CASH, CHECK OR M.O. ONLY TO QUALIFY FOR W/T SPECIAL

STORE HOURS: MON-FRI: NOON-9 P.M. SAT: 10 A.M.-6 P.M.



Kensco 46 PEARL STREET PHONE (617) 471-6427
QUINCY MA. 02169
Communications INC.

Gee, What's a Zepp?

Practically every time I describe my antenna system during a QSO I get replies like "Gee what's that?" or "Haven't heard of one of those in 20 years." I admit that the center fed Zepp (or multiband antenna) isn't used much these days; however, I think it is ideal for the amateur with limited space and budget.

For the past fifteen years my station has been located in a row house. Those readers familiar with row homes can appreciate my position when I tried to get some kind of radiator into the air. No beams or verticals

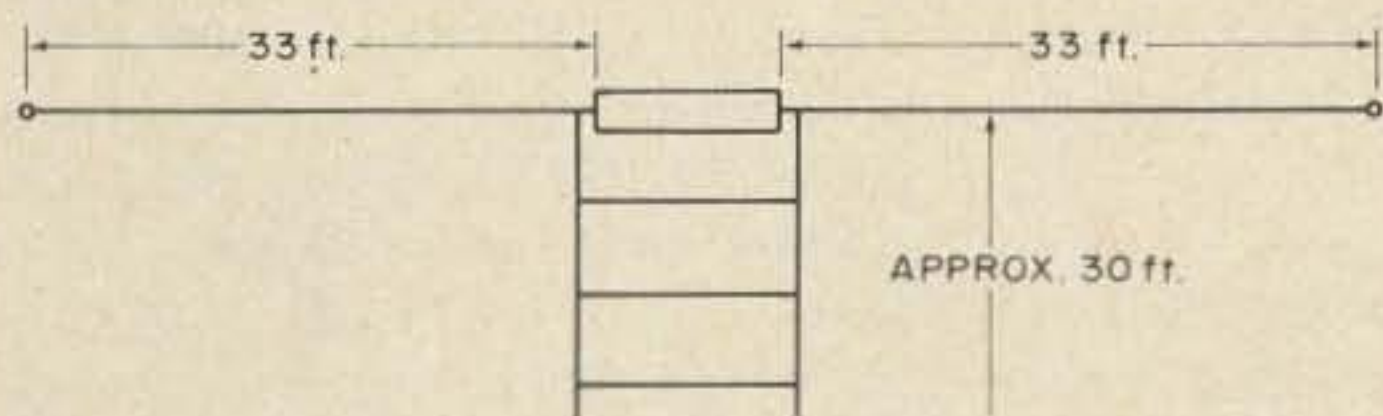

Fig. 1. Basic antenna.

are allowed; thus, I had only a few alternatives. At first, when I was very young and naive, I tried long wires stretched all over the tiny backyard. One of these gems contained four 90° bends, but I managed to use up 135 feet of wire. This system worked fine on 80 and 40 when connected to my homebrew 75 watt parallel 807 rig. (I considered any contact beyond PA to be DX.) Ten years later I faced a new problem after obtaining some Drake equipment. Being able to work all bands using one antenna and achieving a low vswr had become a real challenge.

After glancing through the Amateur's Handbook and several magazines, I decided to tear down the old corroded wire and install a Zepp. Following this decision, I carefully handspanned the backyard and the front to back distance of the house. The

dimensions seemed appropriate, so I began construction. Two 33 foot lengths of #14 wire and one 30 foot section of inexpensive 450Ω open wire line were cut and soldered together in the usual fashion. One end of the aerial is connected to a clothesline pole extension, and the other end is connected to the edge of the roof towards the front of the house. An off center support is required to prevent chimney contact as shown in Fig. 2. The support is simply an 8 foot piece of 2" x 2" lumber lashed to the chimney. The lead in wire hangs alongside the house and enters the basement via a window. *Voila*, an all band row home antenna is born.

As you may have guessed, this antenna does require an antenna tuner to match the 50Ω unbalanced output of the transmitter to a high impedance "balanced" line. The term balanced is questionable here since the two legs of the antenna definitely are not balanced to ground. But, recall our motto, "never say die." To eliminate some or most of the unbalance problem, a slight change has been made in the conventional coupler circuit which can be any one of the types described in the various handbooks. (A typical circuit is shown in Fig. 3.) C2 is usually a ganged dual section capacitor of 100 to 300 pF per section. I simply used

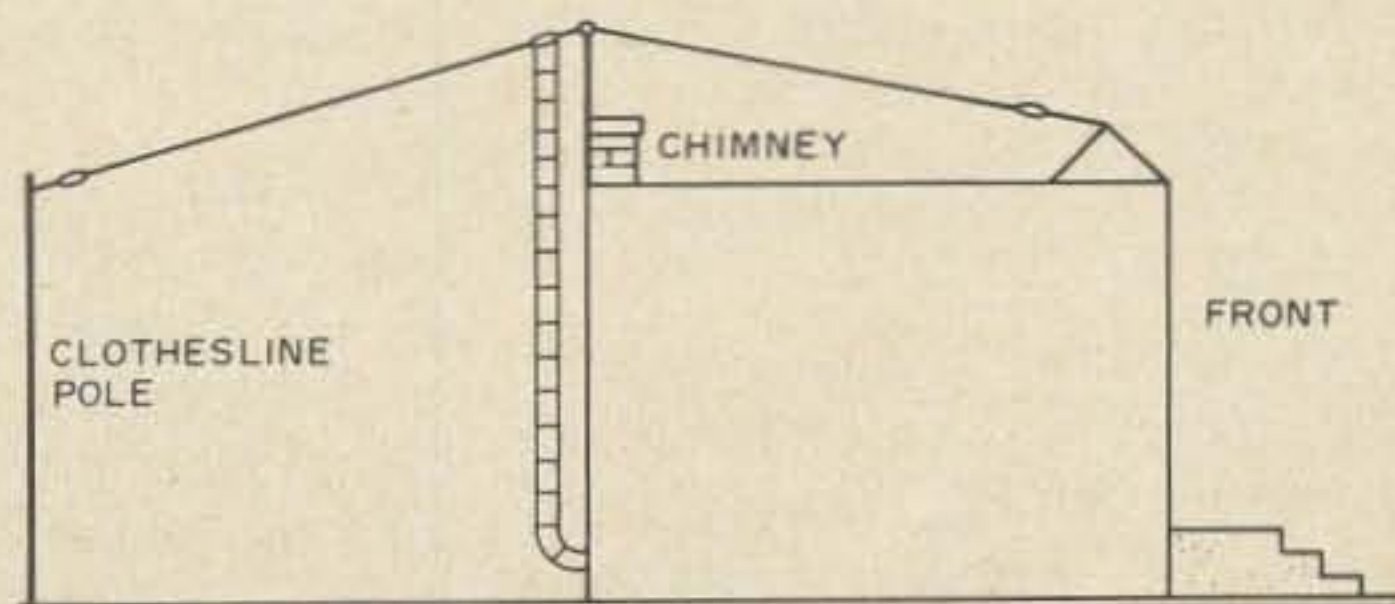

Fig. 2. Side view of row house antenna.

**MINIATURE
SUB-AUDIBLE
TONE
ENCODER**



- Compatible with all sub-audible tone systems such as Private Line, Channel Guard, Quiet Channel, etc.
- Glass Epoxy PCB, silicon transistors, and tantalum electrolytics used throughout
- Any miniature dual coil contactless reed may be used (Motorola TLN6824A, TLN6709B - Bramco RF-20)
- Powered by 12vdc @3ma
- Use on any tone frequency 67Hz to 250Hz
- Miniature in size 2.5x.75x1.5" high
- Wired and tested \$14.95
- Complete less reed (Available in 33 freqs. for \$17.50 ea)
- Output 3v RMS sinewave, low distortion
- Postpaid - Calif. residents add 5% sales tax

**COMMUNICATIONS
SPECIALISTS**

P.O. Box 153, Brea CA 92621

500 MHZ PRESCALER

Extend the range of your present frequency counter to measure through 500 MHZ (typically 525 MHZ). Works into any standard counter rated for 5 MHZ or higher. A must for work on 2 meters, 432 MHZ and commercial high bands.

- 150 mv sensitivity
- Input overload protected
- 50 ohm input Z
- Small size
2 3/4 x 2 1/8 x 1 5/8"
- BNC connectors
- Divide by 100 or 10
- Light blue case
- Model Ps 2A \$99.95



Prescaler is shipped assembled, tested and ready to operate. Complete with line cord power supply.

DAVIS ELECTRONICS

636 Sheridan Dr., Tonawanda, N.Y. 14150 716/874-5848-9

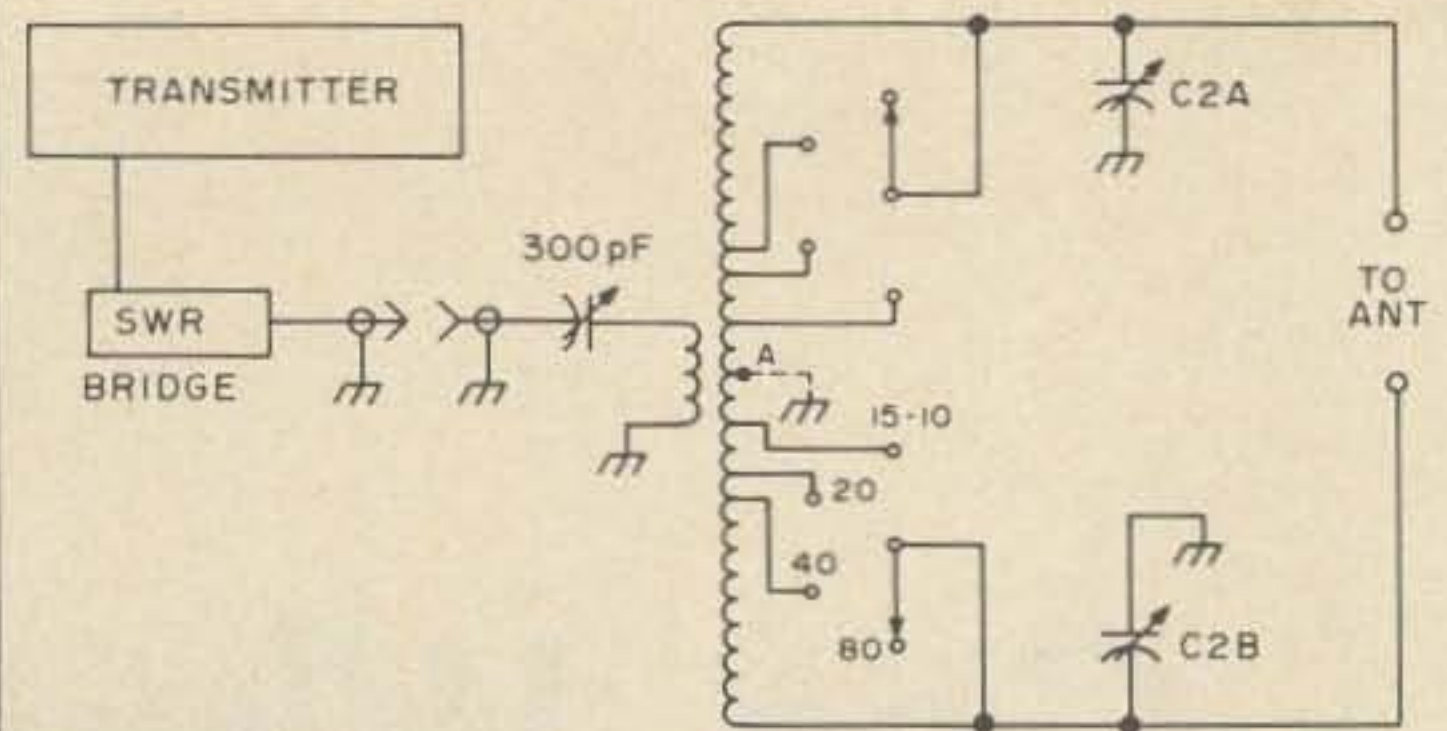

Fig. 3. Typical antenna coupler. A is optional center tap ground which is helpful on some bands. C2 section should be connected in series with antenna for 80 meter operation.

two separate capacitors and tune them individually for minimum vswr and maximum forward power. When properly adjusted, the antenna coupler acts as a very effective low pass filter; consequently, any existing TVI can be reduced considerably.

My antenna loads up well on all bands and radiates a respectable signal with less than 1.5 to 1 vswr. Although the Amateur's Handbook doesn't give this system a real great DX capability rating, I have worked my share on 15 meters.

...W3WLX



from page 16

MANUFACTURERS, Distributors! The Memphis Hamfest will be bigger than ever. The dates are Saturday and Sunday October 4 and 5. Best location possible - State Technical Institute, Interstate 40 at Macon Road, Security. Contact Chairman, Harry Simpson W4SCF, Box 27015, Memphis TN 38127, phone (901) 358-5705.

CALL LETTER LICENSE PLATES - still being collected by 73 Magazine for possible cover use. Please send in an old call letter plate - most treasured are out-of-district plates such as W2NSD/NH, etc. Got any real oldies? 73 Magazine, Peterborough NH 03458.

RADIO ARCHIVES, amateur ANECDOTES (then & now) solicited for proposed (SASE subscription) monthly PR newsletter. Electronic Avocations, 3207 fourth St. N., Mpls., Mn. 55412.

WANTED - Make, Model and Serial

number of stolen ham gear for big list. W7UD, 3637 West Grandview, Tacoma WA 98466.

SWAN, CushCraft at prices I dare not publish. Call or write W0NGS, Bob Smith Electronics, 1226 9th Avenue North, Fort Dodge IA 50501. (515) 576-3886.

ARIZONA FORT TUTHILL HAMFEST July 25, 26, and 27th. Grand Prize: FT-101B. Flea Market, Contests, south of Flagstaff on Highway I-17 across from airport.

WARREN HAMFEST! Sunday, August 17, Yankee Lake, Ohio. On Rt. 7, five miles north of I80. Dealers' displays. Swimming and picnicing. Giant flea market (Vendor's fee: \$1.00 plus registration). A \$3.00 registration includes: Door prize, Main prize, and XYL tickets. More info: Hamfest, PO Box 809, Warren OH 44482.

THE 28th ANNUAL Turkey Run Hamfest and VHF Picnic sponsored by the Wabash Valley ARA, Inc., will be held Sunday, July 27, at Turkey Run State Park near Rockville, Indiana. Don't miss the midwest's finest flea market. XYL Bingo, refreshments, camping facilities and park recreation for the kids. Also this year, banquet July 26, 7:30 pm

featuring guest speaker W9NTP, in park dining hall. Banquet by reservation only, \$6.50/person; reservation deadline July 1. Activities begin 9 am Sunday, talk-in 146.94 W9UUU/9. For details, tickets and banquet reservations SASE WVARA Hamfest, Box 81, Terre Haute IN 47808.

HAMFESTERS 41st Hamfest and Picnic, Sunday August 10, 1975, Santa Fe Park, 91st and Wolf Road, Willow Springs, Illinois, Southwest of Chicago. Exhibits for OMs and XYLs, famous Swappers Row. Information contact John Raiger K9DRS, 8919 West Golfview Drive, Orland Park, Illinois 60462. Tickets write Joseph Poradyla WA9IWU, 5701 South California, Chicago, Illinois 60629.

MEMPHIS is beautiful in October! The Memphis Hamfest, bigger and better than ever, will be held at State Technical Institute, Interstate 40 at Macon Road, on Saturday and Sunday October 4 and 5. Demonstrations, displays, MARS meetings, flea market, XYL entertainment, prizes. Informal dinners Saturday night. Dealers and distributors welcome. Talk-in on 3980, .34.94 and MARS. Contact Harry Simpson W4SCF, Box 27015, Memphis TN 38127 or telephone (901) 358-5707.

How Gates Work

A TTL PRIMER

The writing technology of integrated circuits has not kept pace with the design and application technology, as evidenced by the hunger of 73 readers for very basic articles.

It is relatively easy to find circuit designs using ICs and easier still to mimic the projects to a fruitful end although the basic understanding is still lacking.

When writing a book on tube electronics it is simple to know where to begin. It has been standard practice to start with the concept of atomic structure and electron flow off a hot filament. With transistor texts, we begin with atomic structure of semiconductor material and explain the movement of "holes". Digital IC theory does not require us to go microscopic, but it does call on us to think in new ways about electricity, new and unique ways. It is the purpose of this article to start the amateur on this new way of thinking; logically!

Integrated circuits are a complex interconnection of circuit elements within one continuous structure. An IC "chip" may contain the equivalent of fifty transistors and resistors in one package. The TTL ICs discussed in this article are of a digital nature (to be defined later) and so called because each chip can have its function imitated by a myriad of transistor circuitry. In other words, we can do everything a TTL IC can do with transistor-transistor logic circuits, but they will be bulkier, costlier and less efficient.

For the purposes of this discussion let's think of electricity as existing on different

levels of value instead of different voltages. For example: We can assign a voltage of 5 volts the value 0, and a voltage of 10, the value of 1. It is customary to give the higher voltage the value of 1 and the lower, 0. If we have a square wave function we can say that the wave fluctuates from a level of 0 to 1 and back. Since the change is almost instantaneous in a wave of this form, the voltage can be thought of as having only two states, 0 and 1. The idea of discrete steps or states is known as digital. The states can be used for yes-no, on-off, or any meaning you may need.

LOGIC GATES: EASY STUFF

The AND Gate

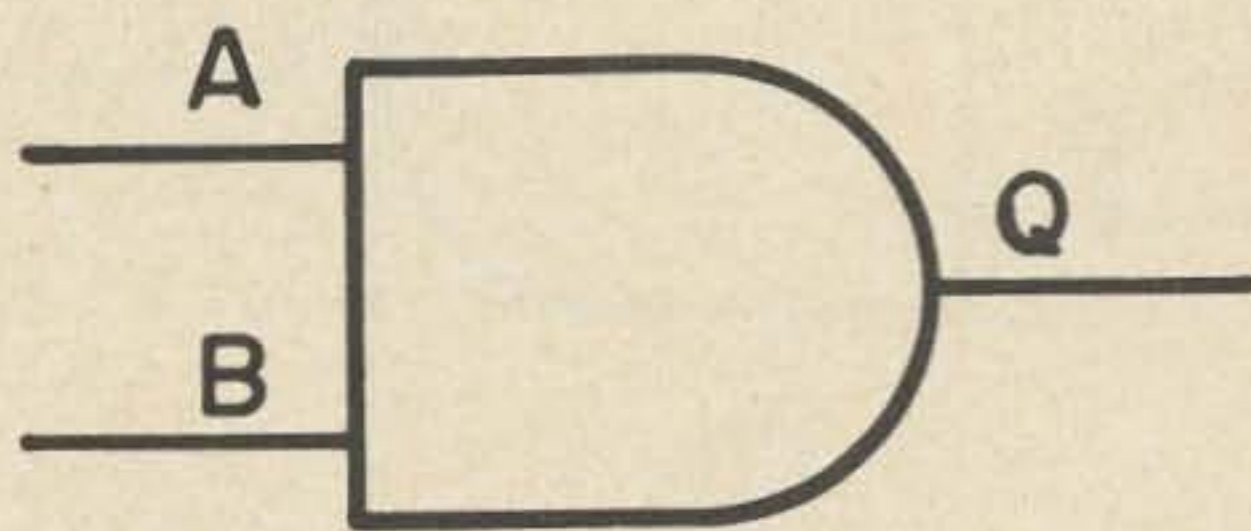

Fig. 1.

Fig. 1 is the symbol for the AND gate. There are two inputs, A and B, and one output, Q. There can be more than two inputs. The concept of AND can be put into everyday terms.

Suppose I said, "I can drive my car only if I have my KEYS *and* GAS." I cannot drive my car if I have only my KEYS or only GAS. I must have both simultaneously. Table 1 is a "Truth Table".

Keys?	Gas?	Drive the Car?
NO	NO	NO
NO	YES	NO
YES	NO	NO
YES	YES	YES

Table 1.

If we let the symbol 0 mean NO and 1 mean YES, we have the following truth table for the AND gate:

A	B	Q
0	0	0
0	1	0
1	0	0
1	1	1

Table 2. AND gate truth table.

This can be expanded to three inputs by saying that to drive my car I must have KEYS and GAS and EYEGLASSES. To have two out of three is not sufficient; we must have all three together to obtain an output (drive car).

The NAND Gate

The NAND gate is drawn as shown in Fig. 2.

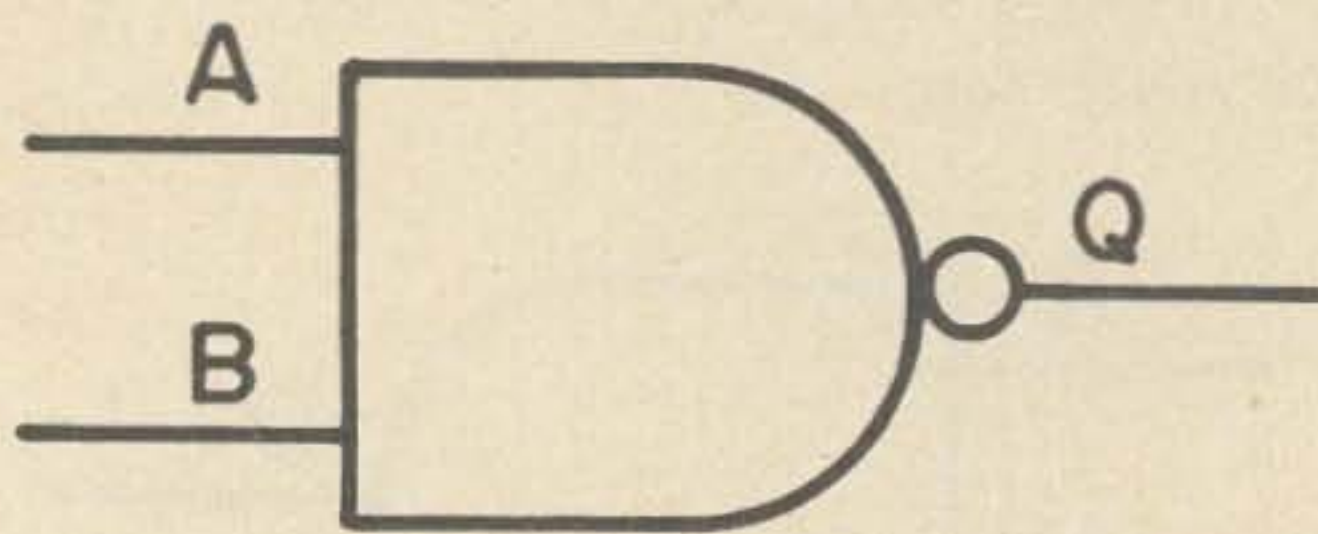

Fig. 2.

The little pimple on the end of the AND gate means "negation". It says, take the AND gate and make a truth table. But, take every answer and negate it. If it comes out 1, make it 0; if it comes out 0, make it 1. That's all.

A	B	Q
0	0	1
0	1	1
1	0	1
1	1	0

Table 3. NAND gate truth table.

The OR Gate

The OR gate is not used as much as the AND and NAND, but it is important nonetheless. Here is how it looks:

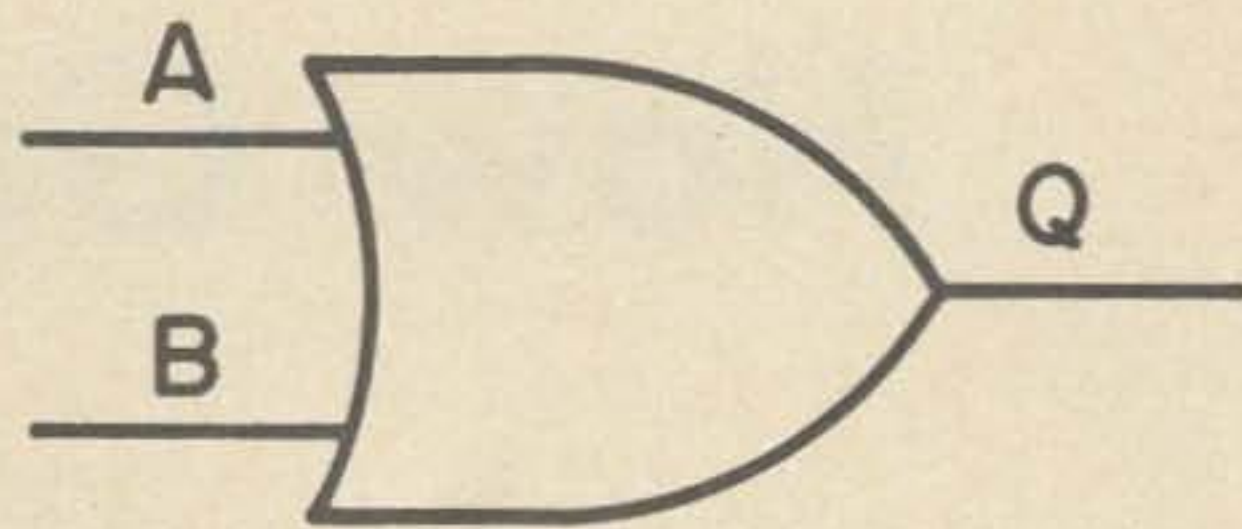

Fig. 3.

An example of its function is to say, "I will have a pleasant day if I GET ON THE AIR or GO MOTORCYCLE RIDING."

Get on Air?	Motorcycle Riding?	Pleasant Day?
NO	NO	NO
NO	YES	YES
YES	NO	YES
YES	YES	YES

Table 4.

As you can see it is not necessary to do both, but at least one. Of course if I do both, I will have a pleasant day, but either is sufficient. The truth table is shown in Table 5.

A	B	Q
0	0	0
0	1	1
1	0	1
1	1	1

Table 5. OR gate truth table.

The NOR Gate

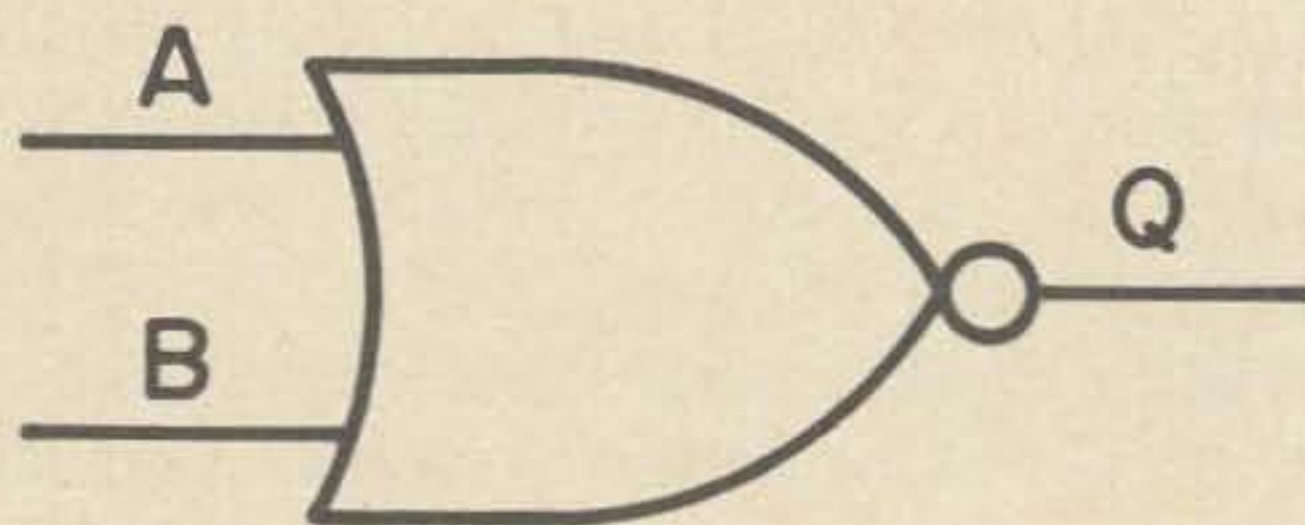

Fig. 4.

As the NAND negates the AND, the NOR is the negation of the OR. Whatever the output of the OR gate, negate it. Table 6 shows a NOR truth table.

A	B	Q
0	0	1
0	1	0
1	0	0
1	1	0

Table 6. NOR gate truth table.

The last simple gate is the NOT gate. Also known as the INVERTER. Its symbol is:

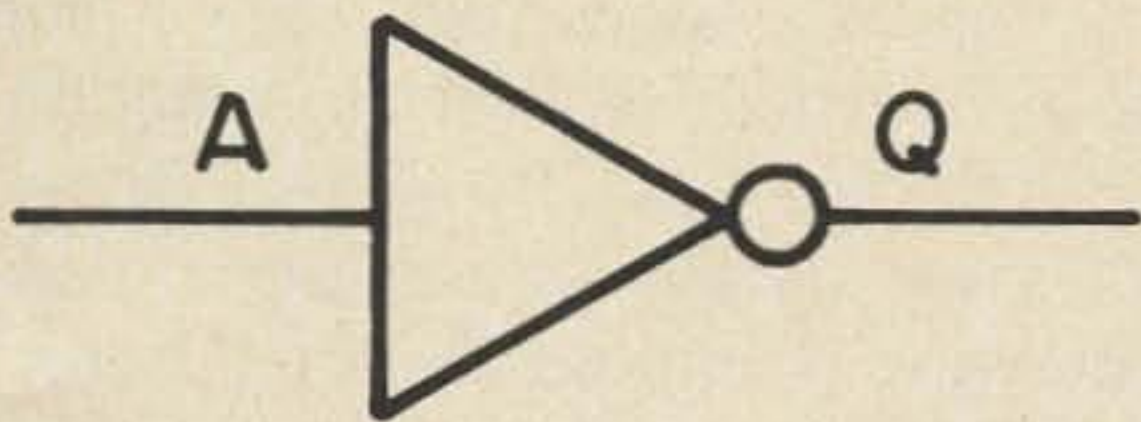

Fig. 5.

Its function is the simplest one of all. It inverts or negates the input. It can have only one input and only one output.

A	Q
0	1
1	0

Table 7. NOT gate truth table.

There are two more gates worth mentioning but they are not considered simple gates like the ones above.

They are the EXCLUSIVE OR gate and the AND OR INVERT gate. The EXCLUSIVE OR gate has a truth table similar to the OR, except that it has no A=1, B=1, Q=1 state. It is exclusive of this logic sequence.

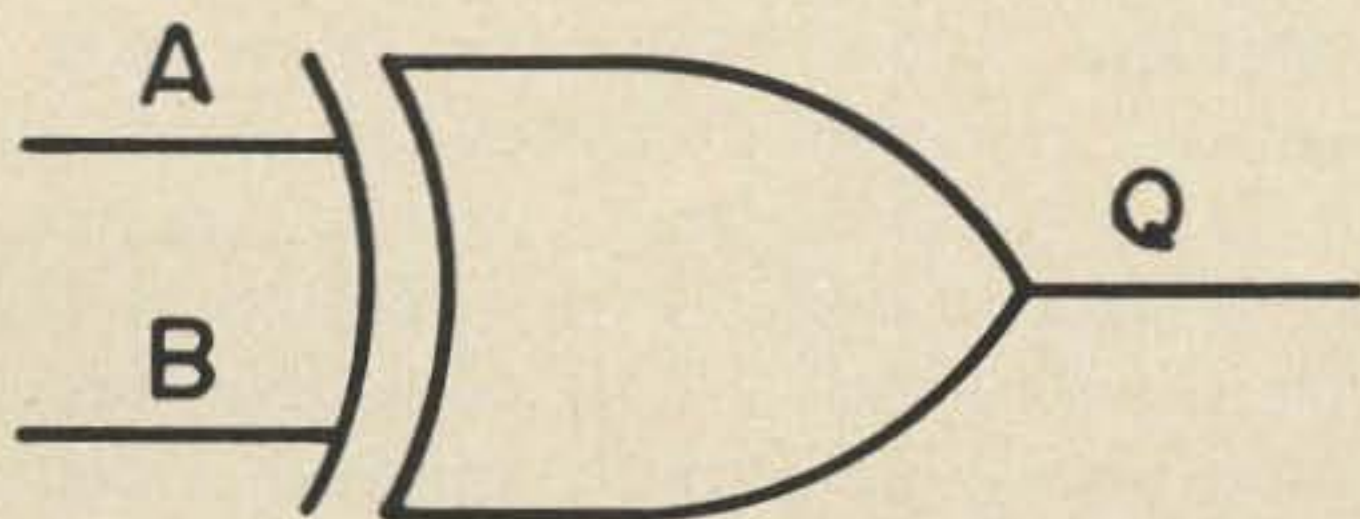

Fig. 6. EXCLUSIVE OR gate.

A	B	Q
0	0	0
0	1	1
1	0	1
1	1	0

Table 8. EXCLUSIVE OR gate truth table.

The AND OR INVERT gate is a combination of AND and NOR gates and looks like this:

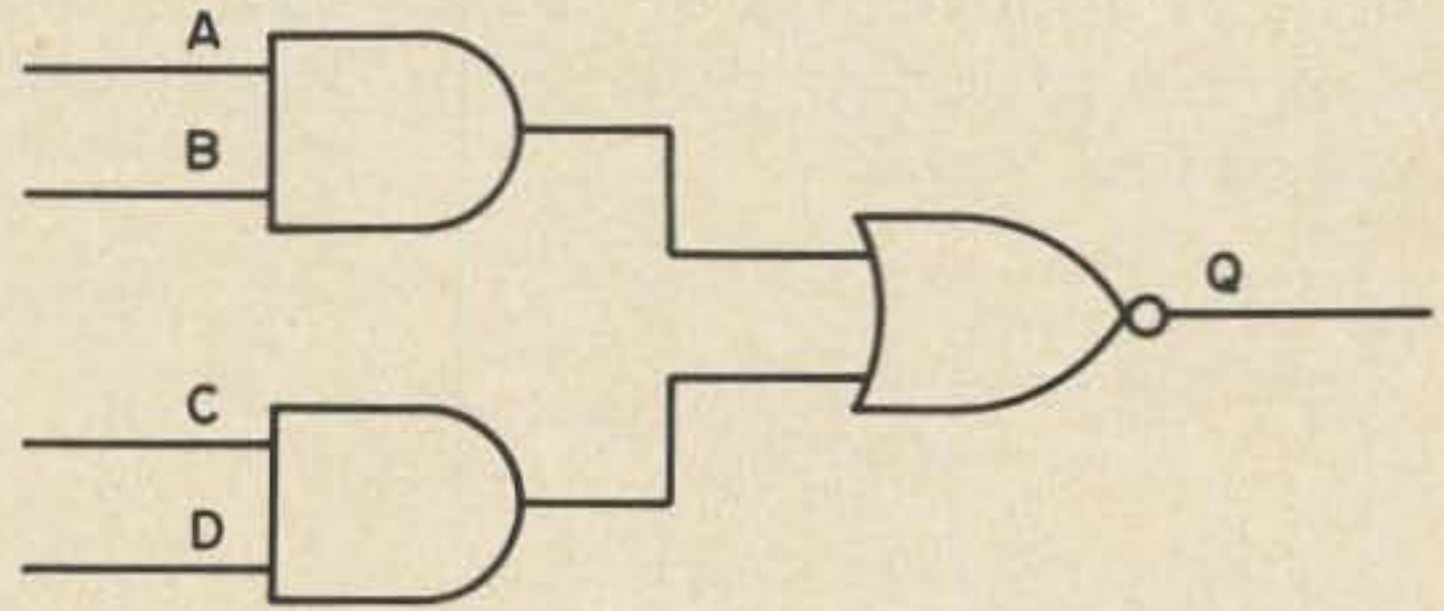

Fig. 7.

To construct a truth table, take each gate individually and follow through to the output. It may be helpful to call the inputs of the NOR gate E and F, and give them each a column until you can do it in your head.

A	B	C	D	Q
0	0	0	0	1
0	0	0	1	1
0	0	1	0	1
0	0	1	1	1
•	•	•	•	•
•	•	•	•	•
•	•	•	•	•

Table 9. Partial truth table for AND OR INVERT gate.

CLOCK INPUTS: A LITTLE TOUGHER

The square wave previously discussed is very often seen in digital circuitry. It is used in clocks and all types of counters.

If we take an AND gate and impose the square wave (also called a clock input) on input A, we can think of it as going from logic state 0 to 1 to 0 to 1 etc... If we then keep input B fixed at logic state 0, the output at Q will be 0. Again look at Table 2. But if we make B=1, then Q will be 0 when A is 0, and 1 when A is 1. We have an unchanged input from Q.

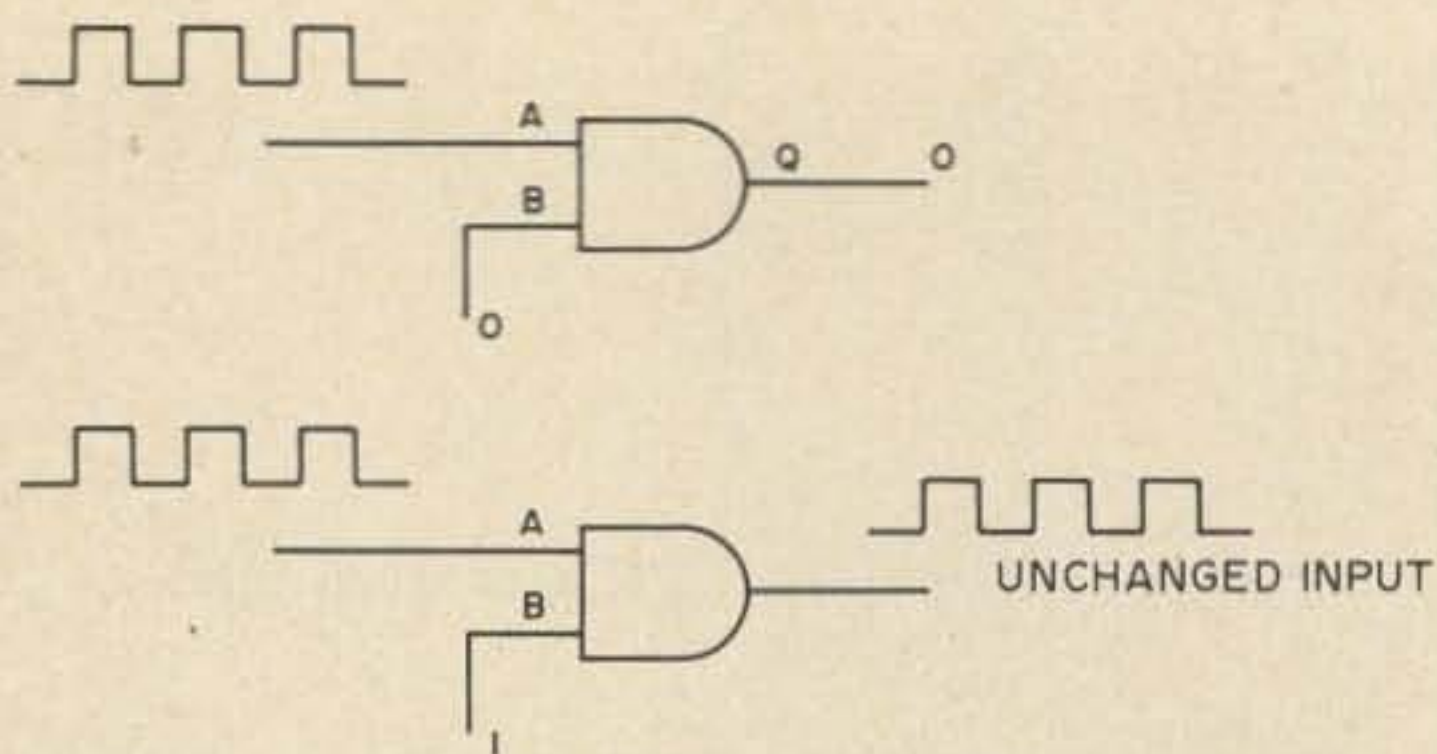

Fig. 8.

The "trick" to doing these is to think of the input as a movement of discrete points and to do the logic for these points. Here is the NAND gate again:

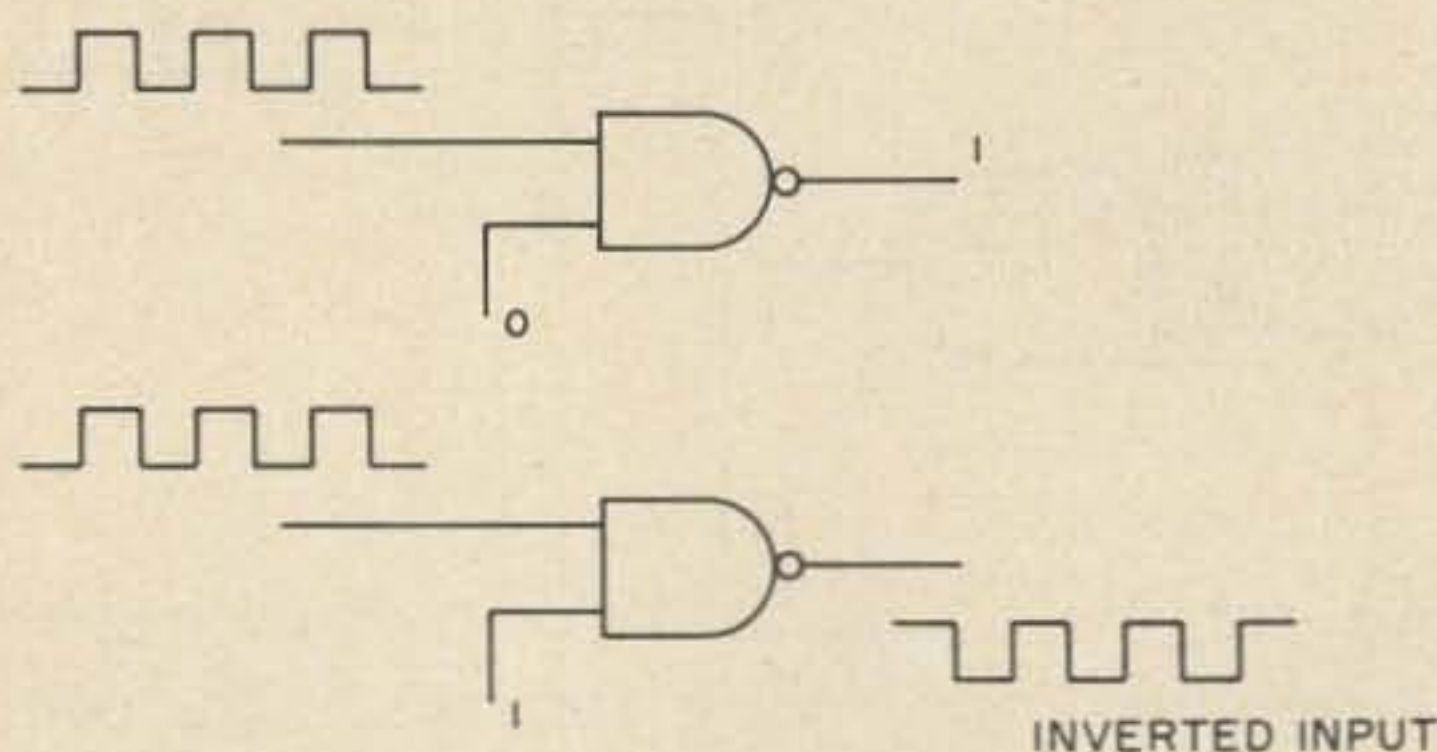

Fig. 9.

The OR and NOR gates follow in like manner:

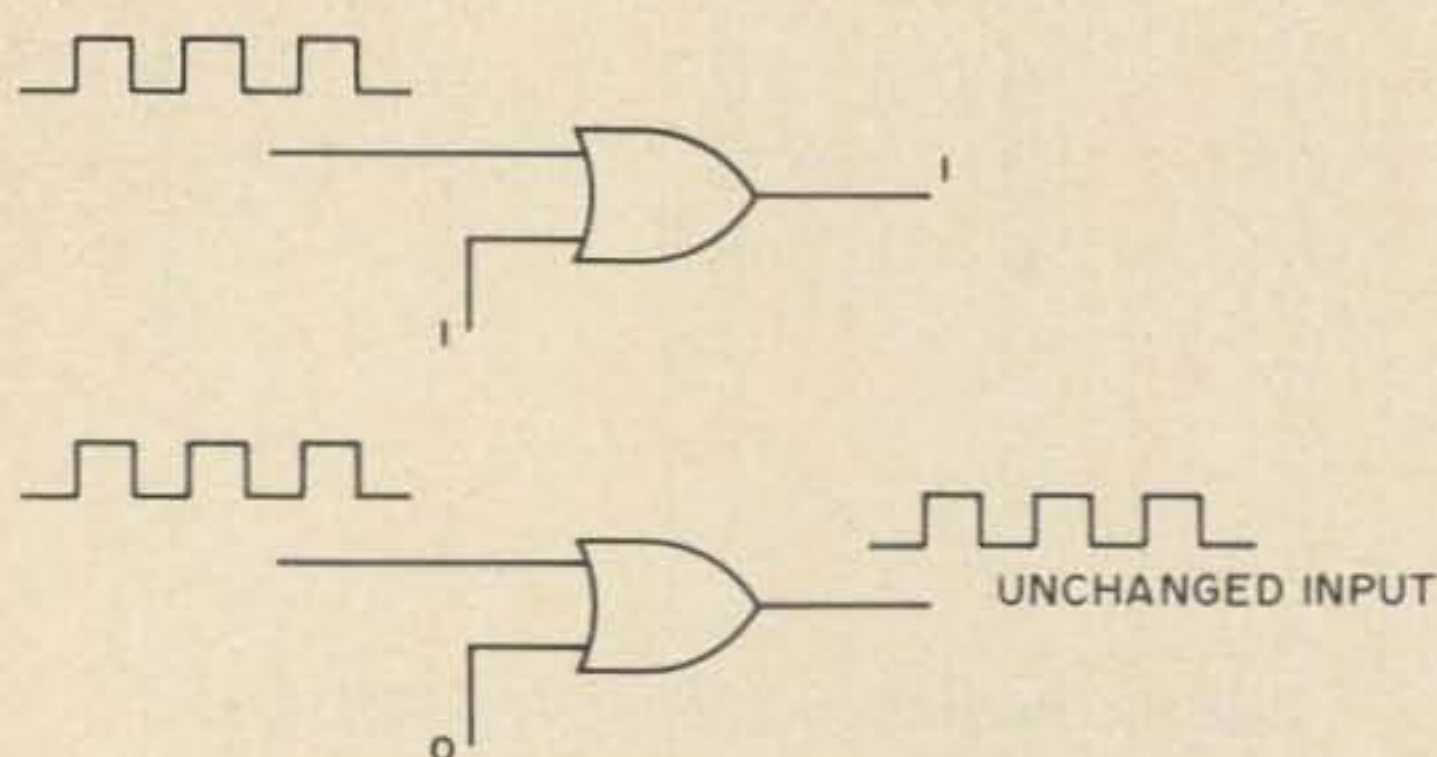

Fig. 10. OR gate.

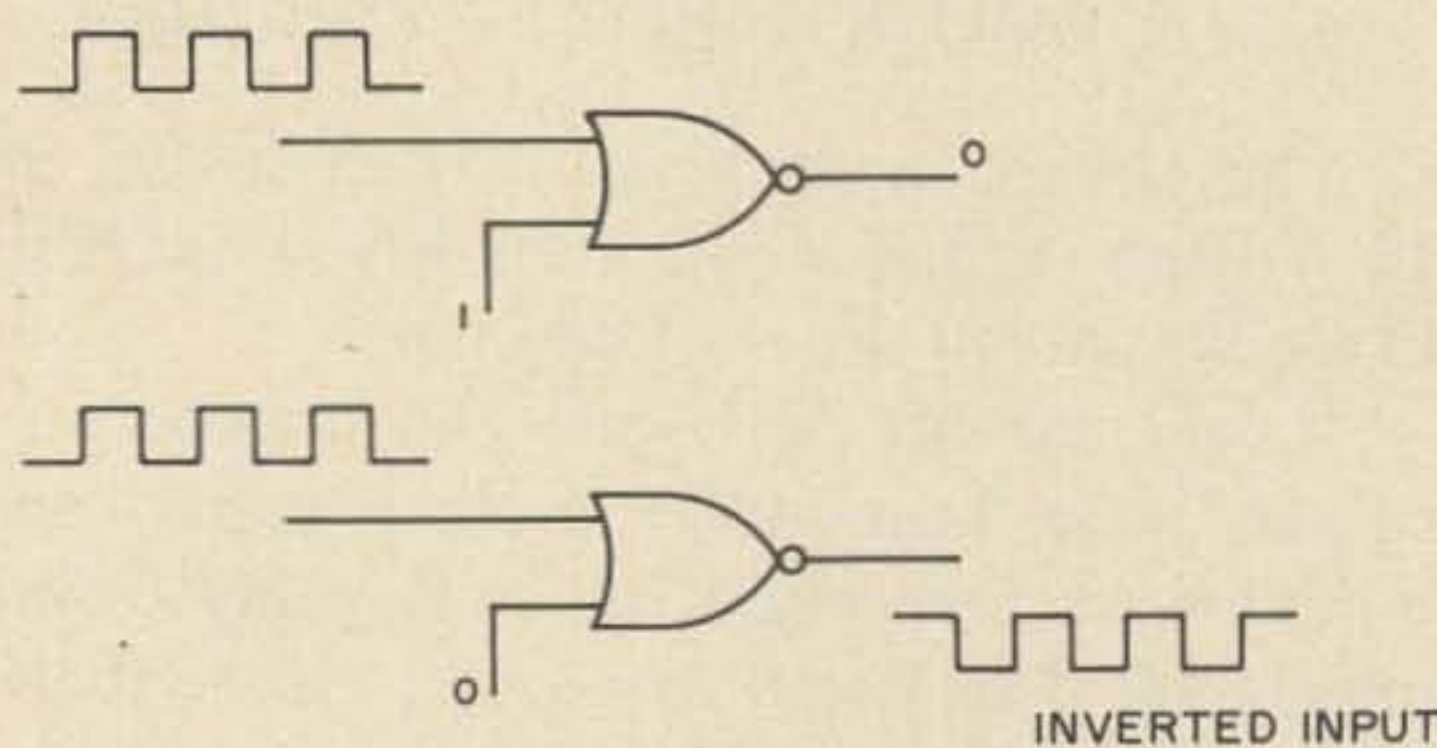

Fig. 11. NOR gate.

GATE TO IC: THE MISSING LINK

If we could look inside the 7400 chip, we would see this:

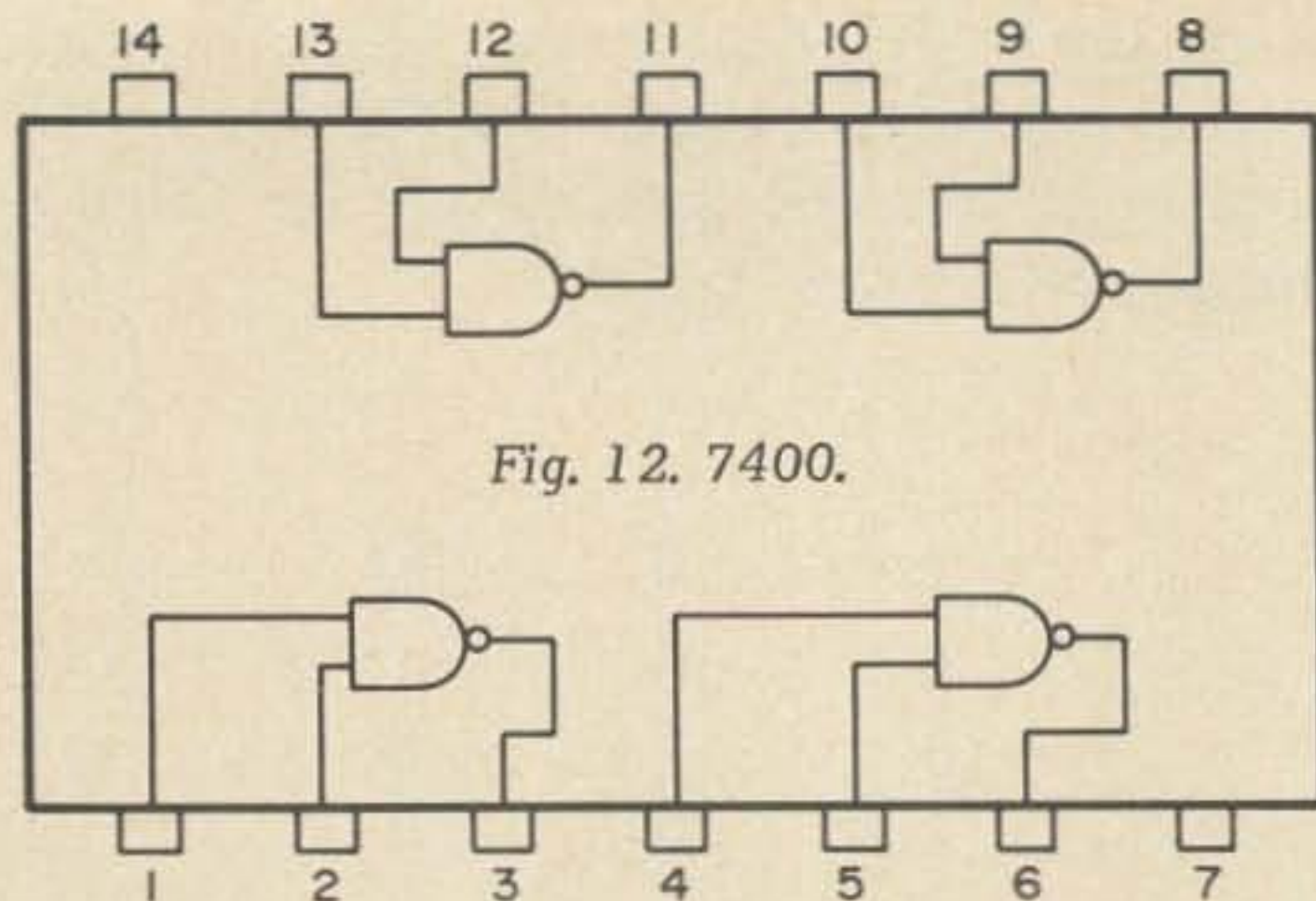
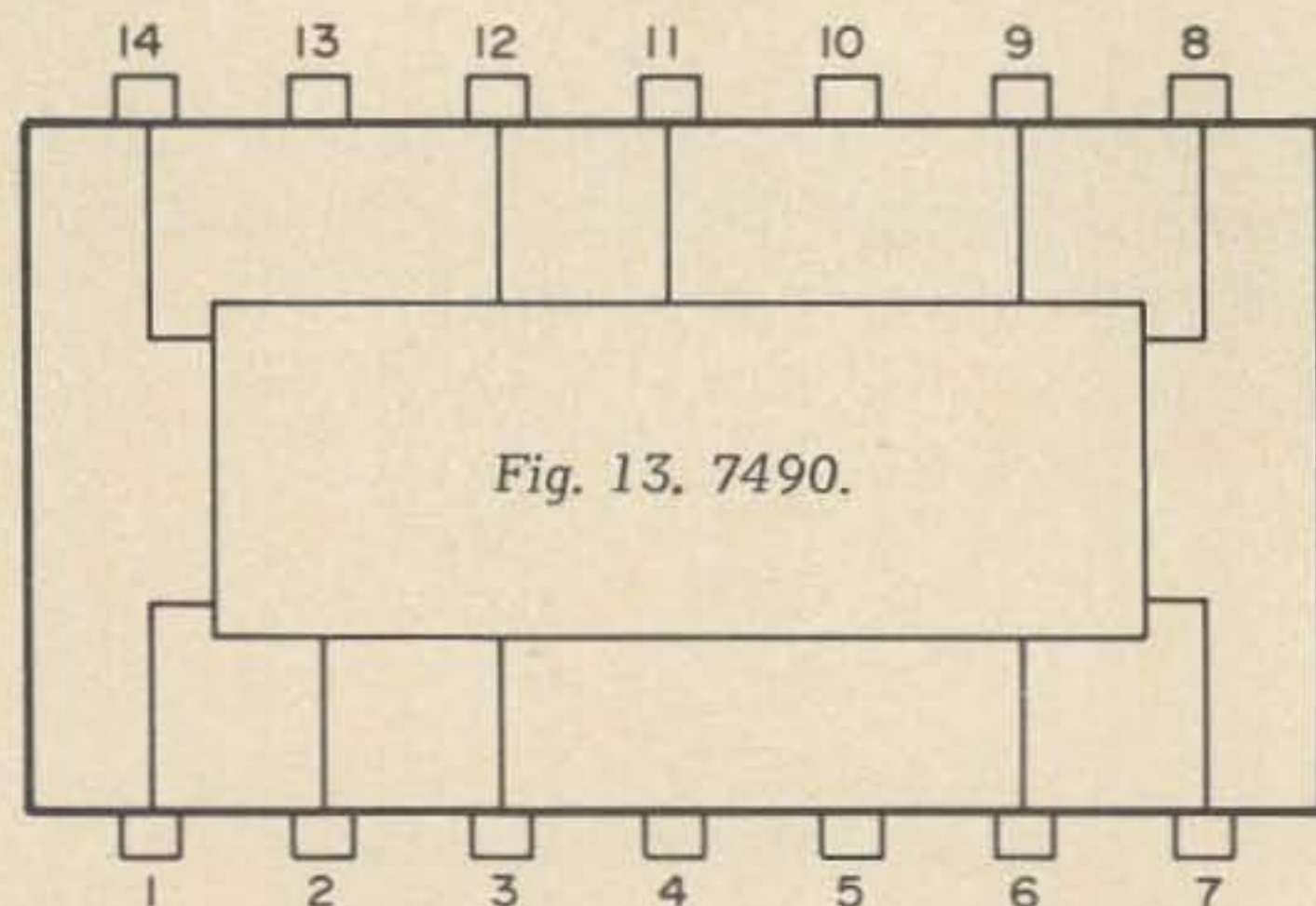

Fig. 12. 7400.

According to the manufacturer it is a Quad, 2 input NAND gate. It has four (quad) gates of which each has 2 inputs, and, they are NAND gates. Pin 7 is ground and 14 is the voltage supply. We can use all or any of the gates. Gates can be connected together if needed for a certain function.

Not all chips can be shown in an "X-rayed" view because some are so complex that drawing is impossible. Such is the case in the 7490 chip which is shown like this:



In some schematic IC projects you may also see the chip divided into gates separated from each other. It is easier to break it up than draw the chip in the schematic in one piece. It is also easier to trace the logic with it broken down to gate functions.

Well, believe it or not, that is all there is to digital TTL ICs. That is, the 7400 series. And there are quite a lot of them.

But this isn't all there is to know on ICs. There are non-digital devices, op amps and hybrid or mixture (dig. and lin.) devices, too. If reader response is favorable to this type of a very basic primer on IC technology (not stressing application), the author could be cajoled to do another.

...WB2NEL

ATLAS 210

for 10, 15, 20, 40 and 80 METERS AND THE COMPANION
MODEL 215 FOR 15 through 160 METERS.



ATLAS
RADIO INC.



Measuring only 0.18 cu. ft. and weighing less than 7 pounds, the Atlas 210/215 Solid State Single Sideband Transceiver is a real GIANT KILLER. It packs a hefty 200 watts P.E.P., offers 5 band coverage, and unprecedented selectivity (only 9200 cycles at 120 db down).

Priced at just \$599, it's the best transceiver value on the market today.

HUSTLER[®]

PERFECT CHOICE FOR
THE ATLAS WHEN
MOBILE

STANDARD HUSTLER RESONATORS—

Model RM-10	10 meter resonator
Model RM-15	15 meter resonator
Model RM-20	20 meter resonator
Model RM-40	40 meter resonator
Model RM-75	75 meter resonator
Model RM-80	80 meter resonator

SUPER HUSTLER RESONATORS— Legal Power Limit —Normal SSB Duty Cycle

Model RM-10S	10 meter resonator
Model RM-15S	15 meter resonator
Model RM-20S	20 meter resonator
Model RM-40S	40 meter resonator
Model RM-75S	75 meter resonator
Model RM-80S	80 meter resonator

TUFTS Radio Electronics

386 Main St., Medford, Mass. 02155

Paul Perlman WA2CXD
 3 Joslen Pl.
 Hudson NY 12534

Bargain Audio Frequency Source

About a month ago I had occasion to check the frequency response of an audio filter I had built for CW work. Unfortunately, my modest test bench lacked an audio oscillator, and all attempts to beg, borrow, or otherwise finagle one failed. It was at this point I realized I had been unable to complete several projects because I didn't have such an oscillator. Buying one was out of the question; being a college student, my financial status is slightly above that of a medieval serf. I shelved the audio filter and moved on to projects that required simpler equipment, like gas pliers and scissors.

A few weeks ago I walked into the local Radio Shack to pick up my free "battery-of-the-month" (you thought I was kidding about being broke, huh?). On the way out I walked by the record rack and looked over the selections. All of a sudden there it was — a solution to the audio oscillator problem. In the corner of the rack sat Stereo Test Record number 50-1971, which, in addition to many nifty stereo system tests, contained twenty different test tones. It was only \$1.49, so I took one home.

Inside of an hour, I had checked out the record on a friend's oscilloscope, which showed that the tones were pretty much sinusoidal. A little work with pen and paper showed that, if played at different speeds,

the record could produce seventy-one unique tones. Granted, the record is hardly a replacement for a good oscillator, but it's certainly great in a pinch. In particular, I've used it for checking the approximate bandwidth of phase-locked loops, and it's been a lifesaver.

The following chart lists the frequencies, to the nearest cycle, which can be generated when the record is played on a four-speed turntable:

	SPEED (rpm)			
	33 1/3	16 2/3	45	78*
FREQUENCY (Hz)	30	15	41	70
	70	35	95	164
	100	50	135	235
	200	100	270	470
	300	150	405	704
	400	200	540	939
	440	220	594	1033
	500	250	675	1174
	800	400	1080	1878
	1000	500	1350	2348
	2000	1000	2700	4696
	3000	1500	4050	7043
	4000	2000	5400	9391
	5000	2500	6750	11739
	6000	3000	8100	14087
	7000	3500	9450	16435**
	8000	4000	10800	18782**
	9000	4500	12150	21130**
	10000	5000	13500	23478**
	15000	7500	20250**	35217**

*Actual turntable speed is 78.26 rpm.

**Beyond the capabilities of most phonographs.

... WA2CXD

Vertical Antennas for the Novice

The vertical antenna takes up very little space. It is hard to imagine a situation where a vertical could not be installed. It

requires no rotator. It can be made of cheap material — just wire and insulators, or metal tubing. It is easy to tune, has no icing problem, and is great for working mobiles. I have repeatedly tested it on 40 against an inverted V, and find I can work mobiles all the way in from Columbus, Ohio, about 40 miles away, but on the inverted V the best I can do is ten miles. This is, of course, the result of cross polarization. The antennas on mobiles are verticals, also.

In the past ten years at this address, I have tested at least thirty antennas, from 40 meter beams to 2 meter ground planes, but there is one pair of antennas that I always keep up, and that is the one shown in Fig. 1. There is nothing quite as handy for antenna experimenting as a pair of good pulleys on the top of a TV tower. You can let the rope down, 1/4" nylon, and tune or change your antenna in a few minutes. I have another TV antenna at the other end of the house, also with a pair of pulleys. Before I got the pulleys put up I used a hobby type bow and arrow to shoot my rope through my tower to pull up the antennas.

The two antennas in Fig. 1 are ground

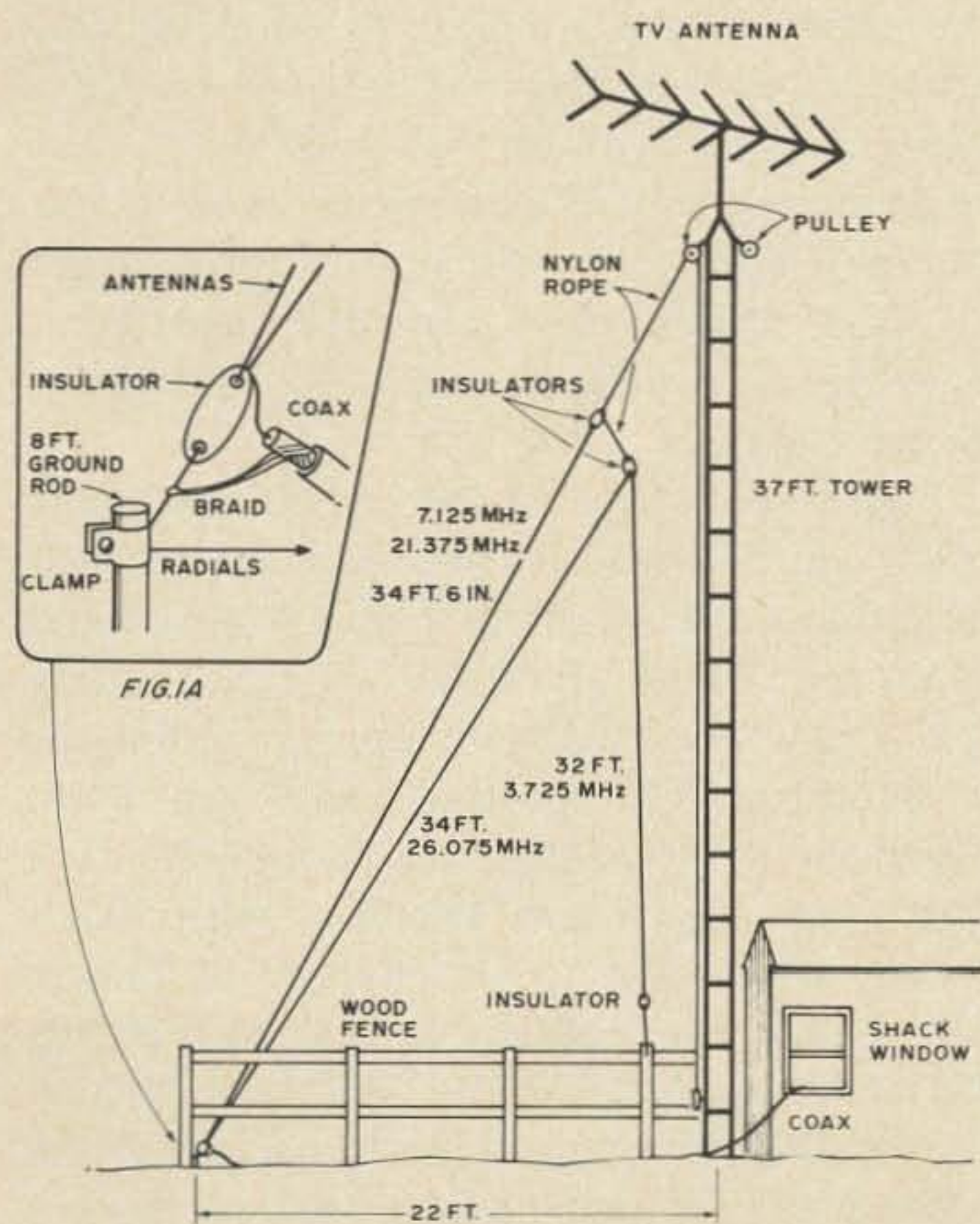

Fig. 1.

mounted "almost" verticals. By placing them 22' from the tower, I could get a longer radiator, and have the base at the wooden fence, where I could run a couple of tuned radials along the fence.

The 7 MHz antenna can be used on 21 MHz band, and the 3.7 MHz antenna can be used on 28 MHz. A 68 ft. radial runs in each direction at the base. The radials are not buried. They are insulated except where they connect to the ground rod. The ends are well taped because on 3.7 MHz the ends are hot. The coax runs from the bottom end of the two antennas on or in the ground into the shack and is 45'5" long. This is a full wave at 7.125 MHz times .66 velocity factor for the coax. It is about a foot too long for 1/4 wave on 3.7 MHz.

The reason I show this antenna is to give you an idea how far you can go in designing antennas away from the general idea of verticals, and yet have a cheap, effective, easily erected 4 band antenna.

The base of the usual vertical antenna is about 36 Ohms impedance, and the coax is 50 Ohms. This gives an swr of about 1.4. If you are using an swr bridge, don't make the mistake of cutting the antenna to 1.1. Leave it at 1.4.

If you use an swr bridge, it must be either at the antenna, or at a multiple of a half wave away from the antenna. I once worked a ship in the harbor at Valparaiso, Chile, where the radio man had just spent two days with a hack saw taking an inch at a time off a 26" vertical pipe antenna, and got it down to 1:1 swr on 40 meters when the pipe was about 8' long. He wondered why. I found out that he had put the bridge at the transmitter and had no idea how long the coax was. He asked what to do. Of course I told him to get another pipe and start over, and put the bridge at the antenna. I told him to start with 32'.

If you cannot afford an swr bridge, Fig. 4 shows a way to get along without one, for

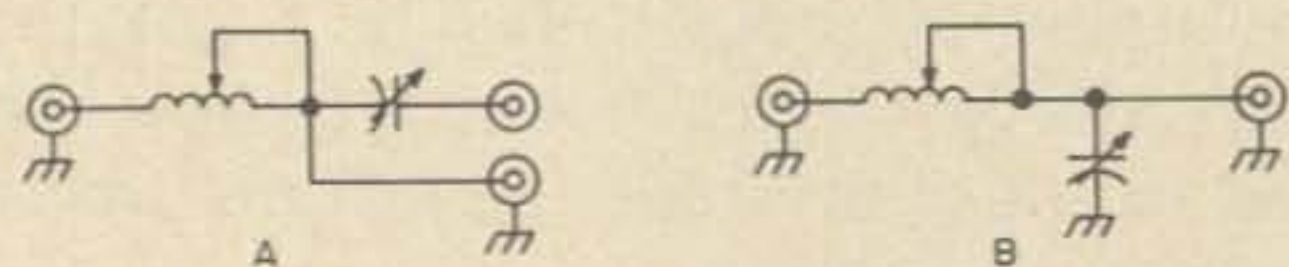

Fig. 2.

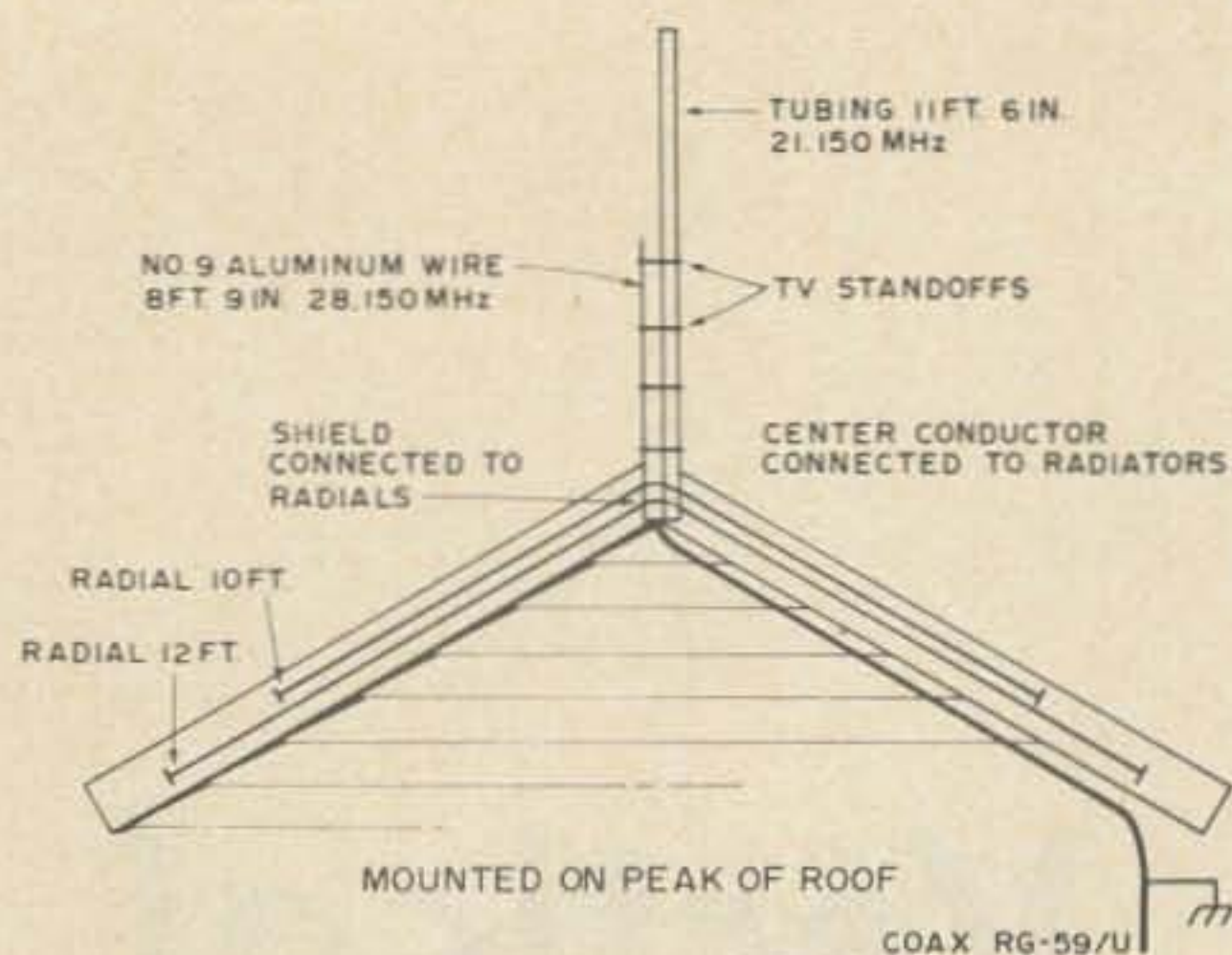

Fig. 3.

many purposes. For a 72 Ohm antenna, such as a dipole, you connect the transmitter to A, and tune the transmitter to the proper loading on the plate meter. Then throw the switch to B, and tune until you get the same output on the plate meter. If you have a 52 Ohm antenna, then use a 52 Ohm resistor. You should use non-inductive resistors, and most hams use parallel 2 Watt carbon resistors; for example you can use 20 1000 Ohm 2 Watt resistors in parallel, and get 50 Ohms at 40 Watts, which is enough for a fast tune up of a Novice transmitter. You can use 1500 Ohm resistors for approximately 72 Ohms.

Fig. 2(a) shows how to make a random wire tuner, using a length of Air Dux coil and a well spaced 100 pF capacitor, or a line flattener as in 2(b) for use with most coax fed antennas. It will work best one way, and you may have to turn it end for end to get the best results. The capacitor can be a receiving type variable capacitor, of about 365 pF capacity.

Fig. 5 shows one of the favorite verticals, which can be made as follows: Hammer into the ground a 4' length of 1 1/4 inch galvanized water pipe until about 12" is left sticking out. Then take two telescoping 10' lengths of anodized TV masting, and slip them together. Drill two small holes opposite each other and hold them together with metal screws. Then slip a 12" length of plastic tubing over the bottom of the 1 1/4 masting, and fasten with 2 U-bolts. The U-bolts may slip in a high wind, so you can use either the method of 5(a), which is a split section of 1 1/4" water pipe, with the halves welded together back to back, or guy the antenna

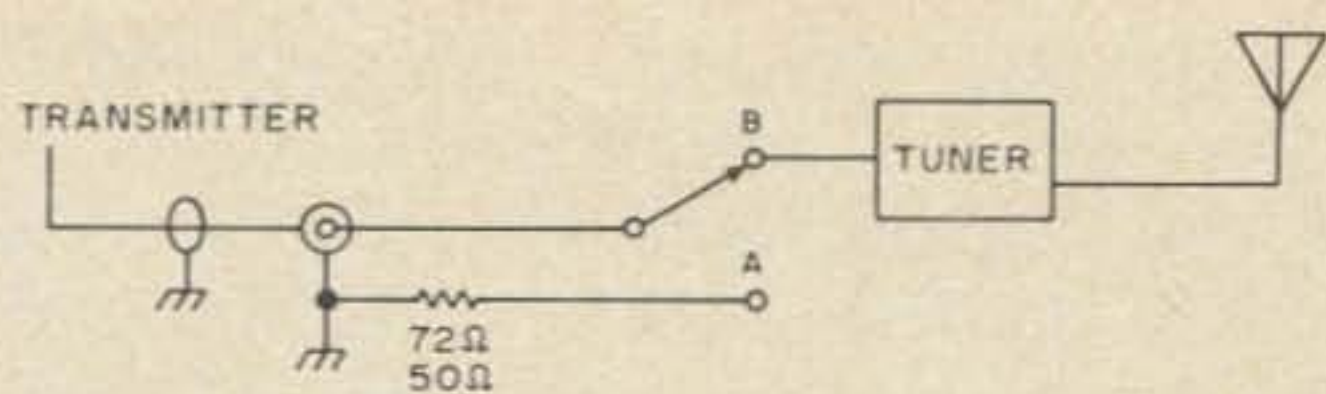

Fig. 4.

with a guy ring as in 5(b). For this you use a TV guy ring with three screw eyes, and 1/8" nylon or plastic line.

If you only want to work 15 meters, the masting can be 11'6" high, and for ten meters 8'9" high. The coax shield is attached to the support rod, and should have an eight foot ground rod. No coil will be needed for either of the last two, 15 or 10 meters.

For 15 meters and 10 meters there is a better way, which is shown in Fig. 3. Use a house peak mount, with a tubing 11'6" long, and then with TV standoff insulators run a piece of #9 clothes line aluminum wire up 8'9", with the lower end attached to the base of the tubing. Then from this same base run two radials stapled to the facing on the house with one being about 12' long and the other about 10' long with the ends taped or with a piece of plastic tubing slipped over the ends. Ground the shield of the coax in as direct line as possible to an earth ground or water pipe. This little antenna will work the world when the propagation is right.

I am purposely not telling you about \$50 commercial antennas, or anything that costs a lot of money. When you are a Novice you want to get on the air as easily as possible and work stations so you can get your speed up and go to a higher license.

If I were to want a real simple antenna of high quality which my wife would never object to, I would make one change in Fig. 5. I actually have the tubing, but have not yet put it up. It is a ten foot length of 1 1/2" thick walled (1/8") aluminum, with a ten foot length of 1 1/4" aluminum tubing slipped inside it. The bottom is slipped inside a foot of 1 1/2" plastic tube, and the plastic set in a 2'x2'x3' block of concrete, with the bottom of the plastic sealed shut to insulate the pipe from ground. Then I would take two TV standoff insulators with the rods unscrewed, and strap them to the 1 1/2" tubing, and using the screw holes, would bolt a plastic box to the two standoffs. Then

put a length of Air Dux coil in the box, and a 100 pF wide spaced capacitor in the box as per 5(d). Run one or two insulated wires 34 feet long as radials with the ends taped, either through shrubbery, or along the house, or along a fence, in random directions. Then I would put a wooden ball with a 1 1/4" hole in it on top of the tubing. I would paint the ball or spray it dark green so it would not show against the trees and grass. Then I would have an antenna which would work 40, 15 or 10 meters with excellent results, and I could even put a pulley in the ball, and a nylon loop so a flag could be raised on it. No guying would be necessary and a small shrub at the base could hide the tuner. The voltage at the base is very low, and shrubbery or long grass or even deep snow has little or no effect. A stepladder will be enough to raise you so you can take down the top section and put it back. Put a collar on the top section so it won't slip down inside, and seal the joints with tape or spray so that no water can run down inside and freeze. Or you can run the top inside the bottom section about 6" and drill a hole and bolt the two sections together, and then tape over the bolts.

By using an swr bridge you can get someone to help you dip it, or take the bridge out with you and dip it at the antenna. Short out turns until the capacity dips at about mid-scale.

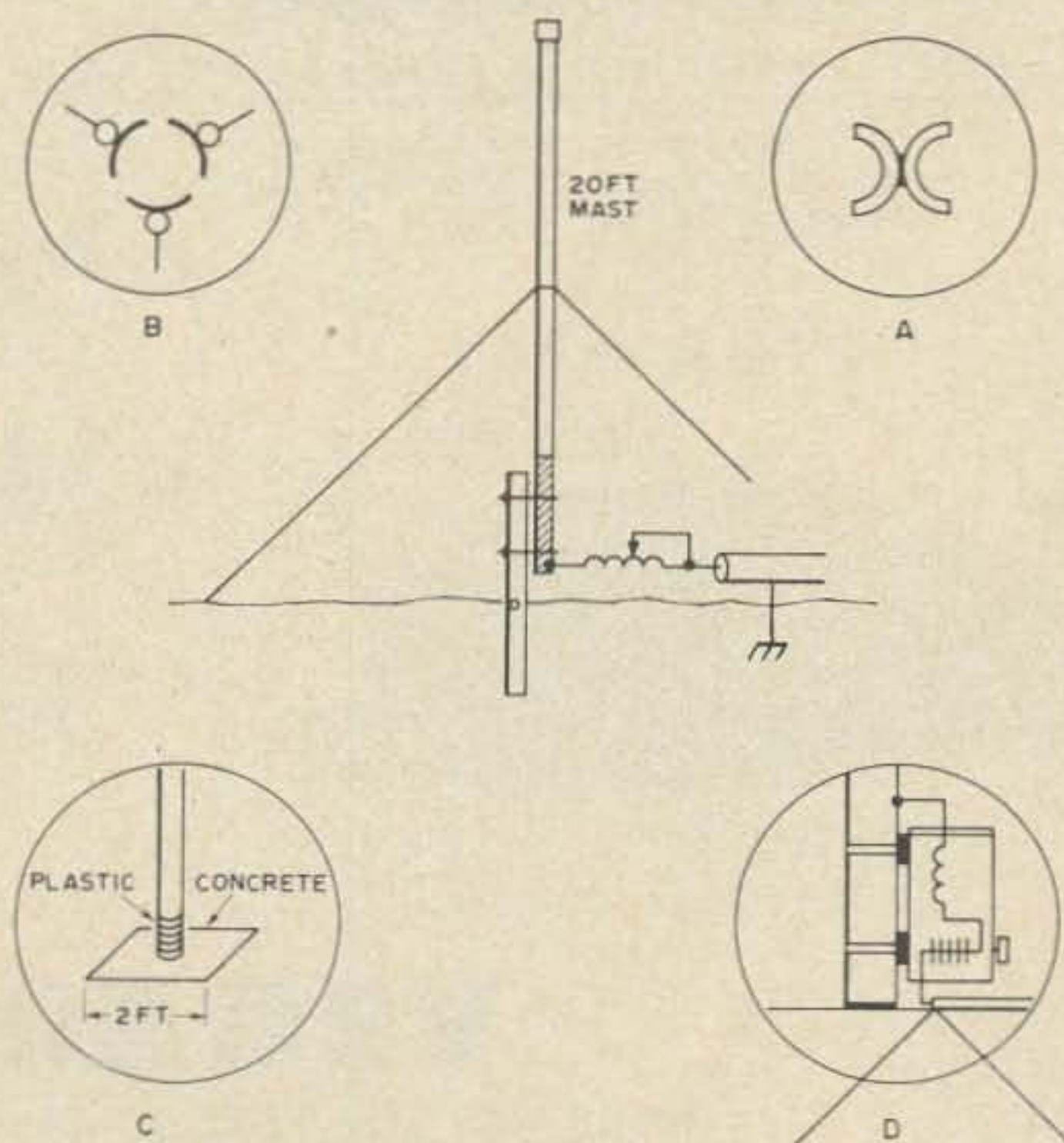
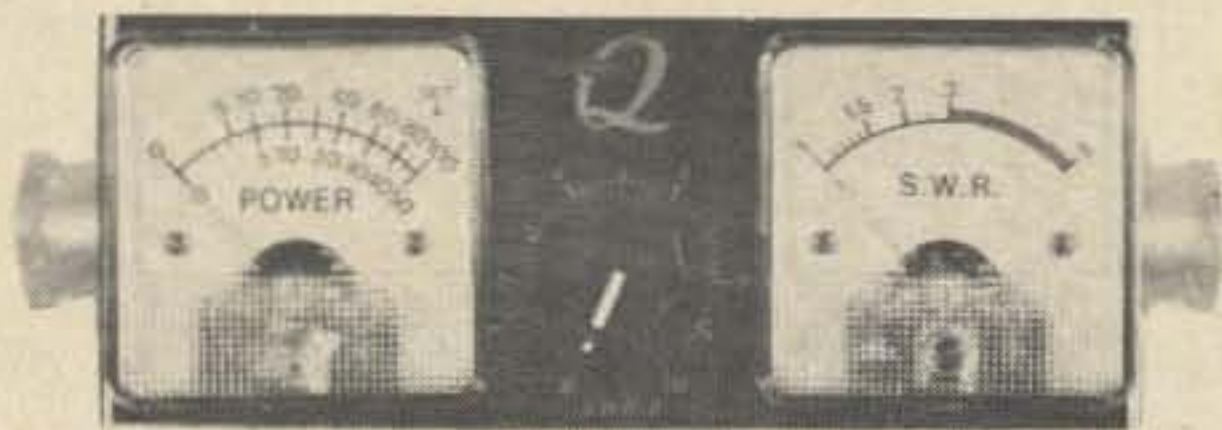

Fig. 5.



SWB-2 \$22.95 *

SWR BRIDGE READS FORWARD & REFLECTED POWER
SIMULTANEOUSLY 'EASY READ' METERS

DUAL 100-MICROAMP METER MOVEMENTS

LOW INSERTION LOSS SIZE 5X2X2

MAY BE LEFT IN LINE UP TO 2,000 WATTS'
3 TO 150 MHZ

ADD \$1.50 FOR POSTAGE

* prices subject to change without notice . . .

OUR BEST "HAM" BUY



**QUEMENT ELECTRONICS
1000 SO. BASCOM AVE.
SAN JOSE, CA. 95128**

If you will only work 15 meters and 10 meters, with this antenna you can forget the coil and capacitor and connect the coax center to the base of the antenna. Then slide the top section down until the overall length is 11' which will put it on 15 meters, 21.150 MHz, and then use the tuner in 2(b) to tune it for 10 meters. When you get your General license you can run it back up to 16' and use it on 20 meters.

That way nothing is wasted, and with an inverted V antenna for 80 meters you may never want another antenna. There are people who will tell you that a vertical needs a hundred radials, just as there are people who will tell you that you need a linear. I worked phased verticals for phone patch traffic for ten years with Antarctica with a single eight foot ground rod at the base of each antenna, and a single tuned radial running along my fence from the base of each antenna. I put one of the most consistent S9 plus signals into all the Antarctic stations for ten years on 40 meters during the winter down there. The beams beat me out on 20 meters but not on 40. . . W8HXR

ICOM IC 230 \$489.00

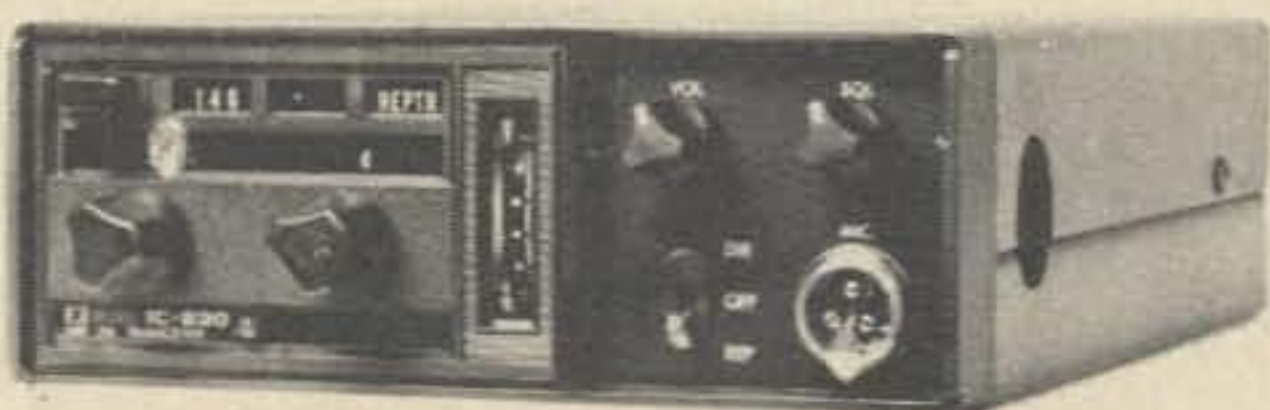

FREE • HYGAIN 6 db MOBILE ANTENNA

6. Fully Synthesized Channels
Quick Disconnect Mobile Mount
Modular Construction

LITTLE VEGA I

AMPLIFIER For
Hand
Held
Units



1-2 Watts Drive = 25 Watts Out
144-148 mc Carrier Operated Relay
12 → 14 v.d.c. Operation

Regulated
Power Supply
4 AMP

\$49.95

Wired
& Tested \$69.95
Kit \$49.95

\$838.95 ICOM 21A & DV21
COMBINATION



**FREE • AR22 ROTATOR
8 ELEMENT HYGAIN BEAM**

Variable Output .5 to 10 Watts
Built-in SWR Bridge
Receive Offset Tuning
Digital Programmable VFO

VEGA BEEP BOX

~~\$39.95~~
\$29.95

July, 1975 Only

12 Button Tel Touch
Self Contained Battery
Audible Coupled -
No Wiring



VEGAS RADIO

1108 SO. 3rd STREET • LAS VEGAS, NEVADA 89101

Call or Write: Norm, W7IUC 702-382-4305

Add \$2.50 for Shipping & Handling

Nevada Residents Add Sales Tax

Do Textbooks PREVENT Learning?

Tom Swift and his electric science fair project

Tom walked down the street humming a happy tune to himself. He had built an electromagnet with his own hands and was going to test it out as soon as he got home. The test was simply to determine how many paper clips it could pick up.

At home, he gathered a handful of paper clips, a D cell from his flashlight, and his homemade electromagnet (Fig. 1). Holding the leads from the electromagnet to the top and bottom of the flashlight cell, he picked up a bunch of paper clips. He released one lead and all the clips dropped to the table. "Seven clips," he counted. This was less than he had hoped for, but better than nothing. The hour was getting late so Tom put away his materials in a cardboard shoebox, and went to bed.

The next evening Tom visited his Uncle Boll to discuss how to lift more paper clips with his electromagnet.

"We decided that it should lift at least 12 paper clips, but it won't lift more than 7," Tom told his uncle.

"How would you increase the pull?" asked Boll.

"Well, how about 2 cells?" said Tom.

Boll said "Go ahead and try it." So Tom did, and sure enough, he did pick up a nice size clump of paper clips. At the same time, the wire began to get warm — always a warning signal.

"That's the brute force method," said Boll. "It works, but there are better ways. Let's add a heelpiece."

"What the heck is that?" asked Tom.

"Here is an example," said Boll as he handed Tom an angle bracket. "Put it on like this." He connected the bracket so the end was flush with the screw head, as in Fig. 2.

"Now how many paper clips can you pick up?"

Tom tried it again and came up with a good bunch of clips sticking to the head of the bolt and the end of the bracket. He released the wires and they all fell to the table.

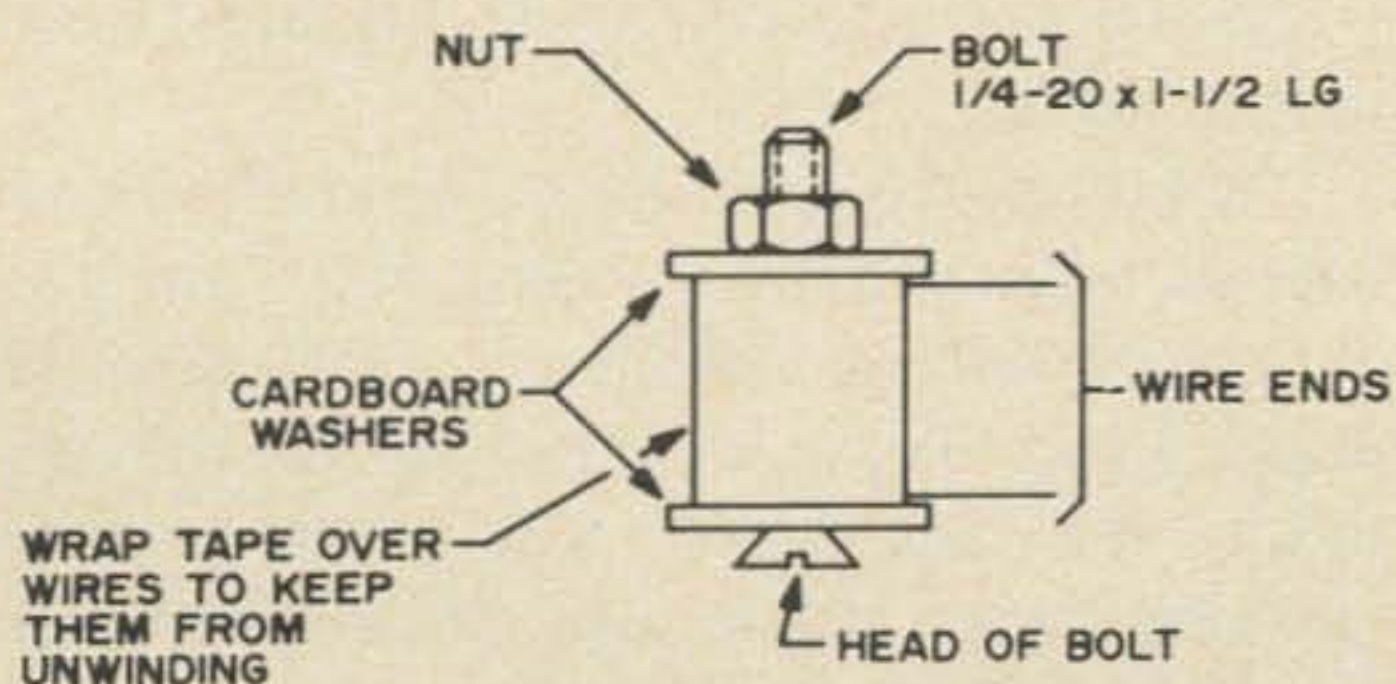

Fig. 1. Tom's electromagnet.

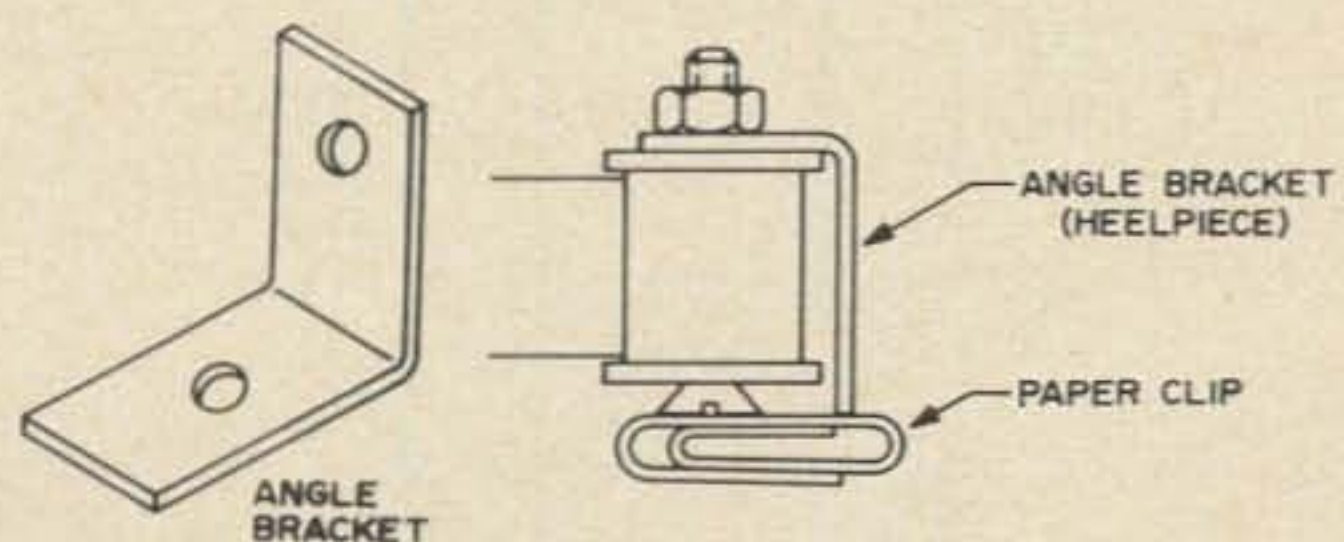

Fig. 2. Angle bracket added to electromagnet for more "pull."

"Seventeen! Hey, that's a real improvement. How come it works that way, Uncle Boll?"

"Well, the theory is a little complicated but I'll give you a simplified explanation. When you had the bolt without the angle bracket, the magnetic field was like this. (Fig. 3) Current in the coil makes the bolt act as a magnet, but most of the magnetic path is through the air, and air is an insulator for magnetism."

"So the result is a weak magnetic effect?" asked Tom.

"Exactly. But watch what happens with the heelpiece added.

"Most of the magnetic path is through the iron bolt and bracket and only a short path is through the air. And when there are paper clips in the air gap, they have the effect of providing a better magnetic path."

"Wait a minute!" Tom said. "You told me once you can't get something for nothing, but this sure looks like it. Where does the extra pull come from?"

"Good question, Tom. If your coil was wound on a solid ring of iron, you would have zero air gap and a very strong magnetic field. It would be hard to measure with simple equipment. Someday we'll look into it. But suppose we cut a tiny slot in the ring. When we cause current to flow in the coil, what will happen?" (Fig. 5.)

"Would it pick up a lot of paper clips?" asked Tom.

"No, hardly any at all," replied Boll. "Guess again. Too bad we don't actually have one to try, but here's what will happen.

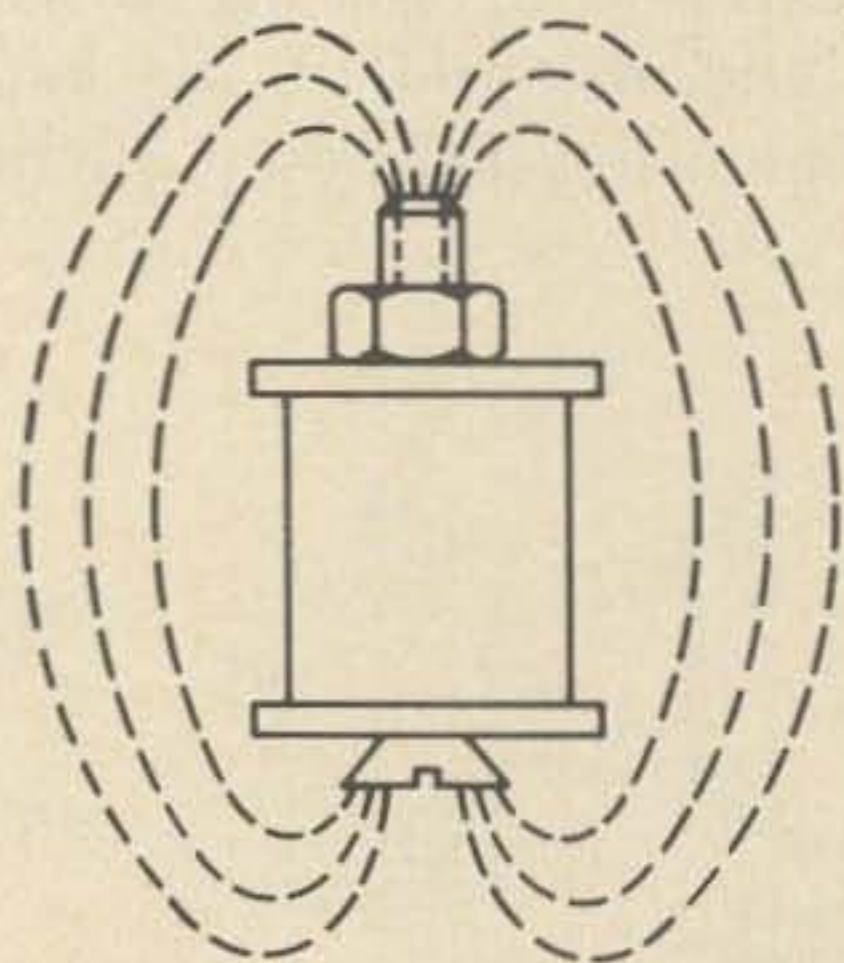

Fig. 3. Lines showing magnetic path through the air.

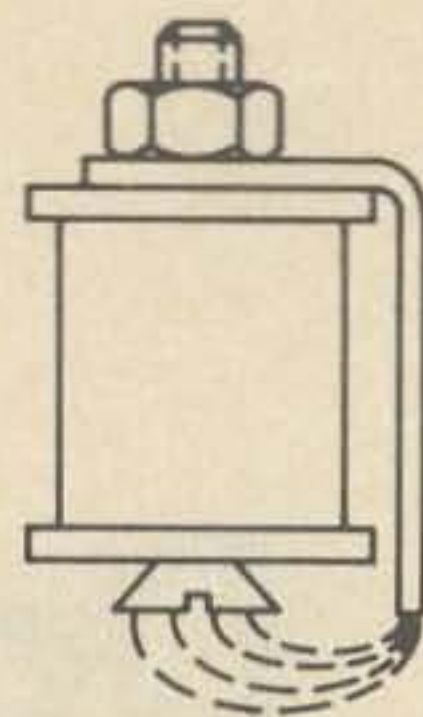

Fig. 4. Lines after heelpiece is added.

When current flows through the coil, the gap in the ring will close up."

"Gee, it seems like the magnetic force must be very strong to do that."

"Sure," answered Boll. "Anyway, the crude electromagnets we are building are far less efficient than the ring and we are getting far less out of the design than we might. We are just making a small improvement but you see we are not getting something for nothing."

"What about that sketch in my science book," said Tom, "where there is a spike and some turns of wire and a dry cell? That's pretty inefficient."

"Well, Tom, that's a good example of a brute force approach that is totally impractical."

"But why is it in the textbook then?" asked Tom.

"Look at the title page of your book. Notice that the authors are all educators. Not one of them is an engineer or knows anything practical about building devices that must work. That's why that sketch is there. Since most of these sketches were copied from earlier books, most of your science books have the same unworkable projects in them.

"But that's enough for tonight, Tom. Tomorrow is another day."

So Tom went home, with his latest model in his pocket.

At school the next day, Tom talked to his friends who were also using electromagnets in their science projects. One boy was duplicating the electromagnet in the textbook; the other boy was using a similar electromagnet but he had obtained a power supply to eliminate need for the dry cells. Unfortunately, his wire coil got very hot and

he could not keep it turned on continuously.

"The brute force approach again," Tom said to himself.

A week went by before Tom spoke to his uncle again. They discussed the other boys' projects and Boll said, "Why don't you help them improve their projects?"

"Are you kidding?" said Tom. "That would be helping *them* to win, but *I* want to win!"

"Why is that?" asked Boll.

"Well, the rules say that there will be only one winner picked in the electromagnetism category."

"But if you helped those boys improve their projects, wouldn't they learn more as a result?" asked Boll.

"Sure, but what has that got to do with it?" Tom asked.

"Aren't science fairs supposed to be educational?" prodded Boll.

"Yeah," said Tom, puzzled. "I don't get you, Uncle Boll. What do you mean?"

"Simply this," his uncle answered. "As you can see, the rules are set up to *prevent* learning, not encourage it. But those are *their* rules. If you believe in the value of learning, and helping others, follow your own rules. The penalty to you is to reduce your chance of winning. There are other ways to operate, such that everybody wins and nobody loses. But that is not the science fair as we know it."

This was a startling idea to Tom and he said nothing while he was thinking about it. His uncle interrupted his thoughts.

"Let's work on your project. What can we do with the electromagnet?"

"We can demonstrate how a relay operates. But we'll need a moving part," said Tom.

"Armature is the proper word," his uncle corrected.

"A hinge would make a good armature, but we need a way to hold it in the right position."

Boll handed Tom a box of angle brackets and other parts. "Try these," he suggested. After some experimenting Tom ended up with the apparatus sketched here as Fig. 6.

When Tom connected the dry cell to the coil, the armature banged in with a satisfying

clank. When he interrupted the current, the spring pulled the armature back against the backstop.

Tom also noticed that if the backstop was too far back, the electromagnet could not attract the armature. The bolt that held the spring was put in after experimenting to determine the best position.

Tom took this "thing" home. It needed a name and he decided to call it a tester. The reason he picked this name was that he could try out different electromagnets and see which ones worked best. He showed his mother and dad the tester and they were very pleased.

"So that's what you've been doing at Bolivar's house all this time," his dad said.

"I hope you haven't neglected your homework," was his mother's comment. His folks didn't see too much value to this tester but at least it was constructive activity for their son.

When Tom got home from school the next afternoon, there was a note for him.

"Call your uncle tonite after 6:00." His uncle hated to be interrupted with phone calls during the dinner hour.

At 6:01 sharp, Tom called. "What's up, Uncle Boll?"

"We have to get started on production," his uncle said. "When can you come over?"

Tom had loads of homework that night and his understanding with his parents and uncle was that homework had priority over other activities.

"How about Saturday?" Tom asked.

"Saturday it is," his uncle replied. "Ten o'clock." And he marked it on his calendar, next to the telephone.

Saturday morning Tom was at his uncle's house with his electromagnet and his tester.

"What are we going to do today, Uncle Bolivar?"

With a chuckle his uncle replied, "We are

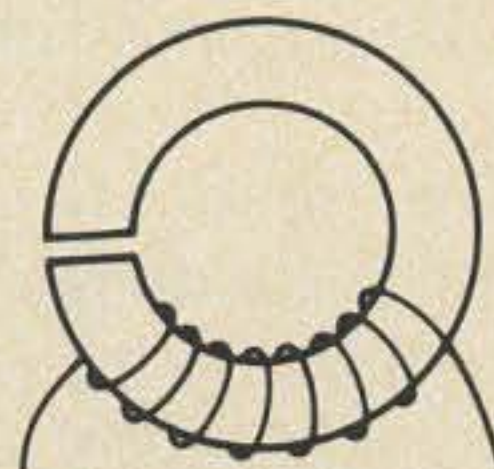

Fig. 5. Coil wound around a slotted ring.

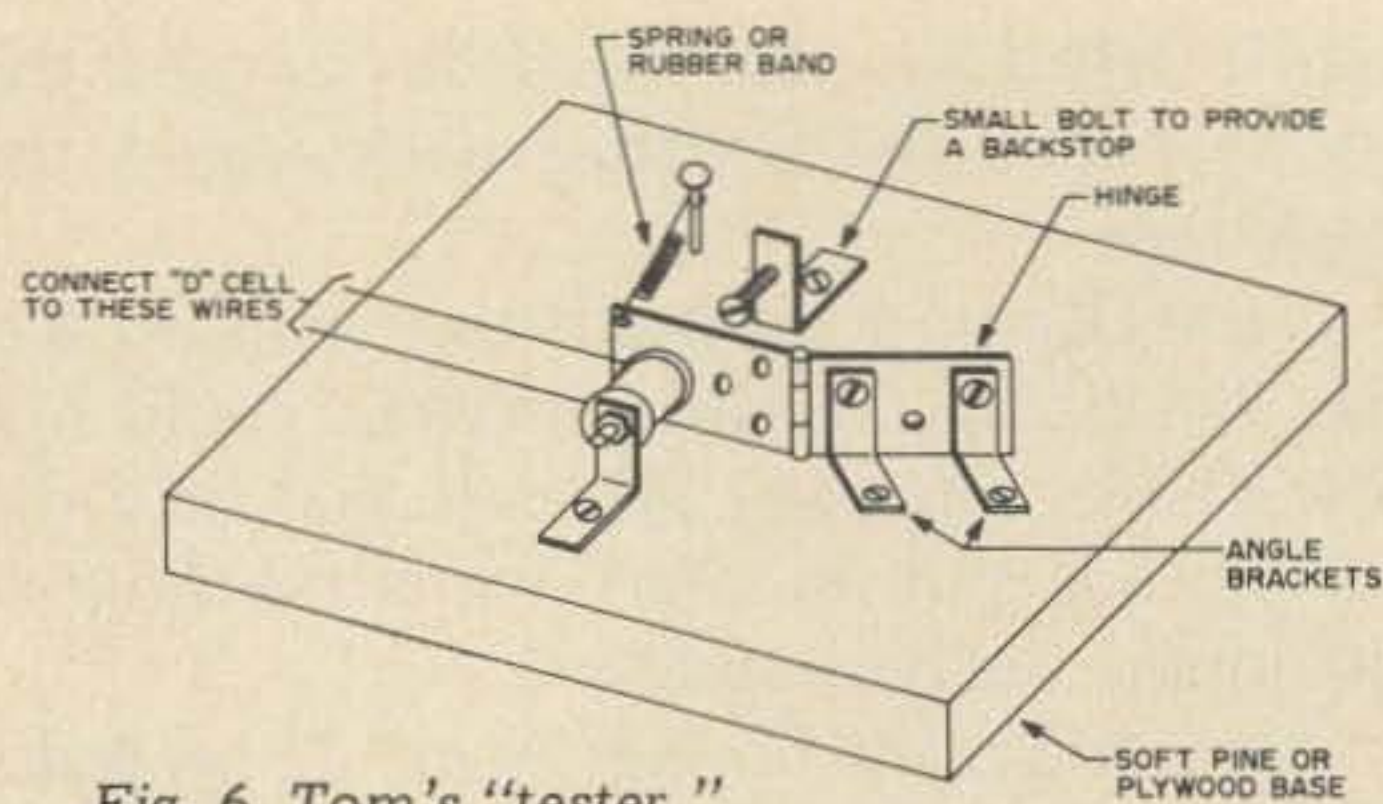

Fig. 6. Tom's "tester."

making a gift for your science teacher."

"Like what?" Tom asked.

"Like 60 electromagnet kits for her next semester classes to use when they study electricity," he replied. "Here are the materials we need."

There on the table was a box of bolts, another box of angle brackets, a large spool of wire, a bundle of small paper bags, and some other materials.

"We will start with winding the wire on something. We'll use about 80 to 100 feet of wire," said Boll.

"Why don't we wind it on the bolt?" said Tom.

"Nope, you miss the whole point," replied Boll. "This kit is designed to be educational. If we wanted to make it *easy* we could build the entire electromagnet, but then it would have less value for learning. Let the students wind the wire on the bolt themselves. We will use these little cardboard tubes to wind the wire on."

Under his uncle's direction, Tom set up a small electric drill, holding it in the bench vise. He plugged the cord of the speed control into an adjustable timer.

By experimenting with the timer and speed setting of the drill, Tom was able to wind about 90 feet of wire on a cardboard tube in about 30 seconds. He guided the wire back and forth as it wound up so that it was fairly even. The arrangement looked like the sketch of Fig. 7. The timer shut off automatically in 30 seconds, making Tom's task very simple.

"Say, this is fun," said Tom, as the small pile of wire-wound cardboard tubes was increasing. But by the time he got to the last of the 60, he was saying, "I'm sure glad I don't have to do this every day."

"Is this how they wind coils for relays

and stuff in factories?" Tom asked his uncle.

"Well, the idea is the same, but the actual equipment is different and runs much faster. Also, they will count the actual number of turns of wire, where we just want a rough figure on the amount of wire. But if you understand this, you would have no trouble in understanding a modern coil-winding machine."

"Gee that's simple," said Tom. "I always thought machines in factories were complicated and mysterious."

"If that was true," his uncle said, "how would ordinary people be able to use them — or invent them?"

The next step was making the cardboard washers that held the ends of the coil on the bolt. Tom used a paper punch to make the holes, and a small cardboard fixture to hold each cardboard disc in the same position so that the holes were always in the center. His hands were sore from squeezing the punch by the time he had made 120 washers, and he was glad when lunchtime came.

After lunch, parts were placed into the bags so that they had 60 complete kits. Tom made up five extra kits for his own use later on. The box of electromagnet kits was too heavy to carry home so Tom left them at his uncle's house.

Tom had decided to help the other boys who were entering electromagnets in the science fair. He showed them his tester and explained some of the things his uncle had showed him. The boys were both pleased that Tom had taken the trouble to help them, but also puzzled that he would reduce his own chances of winning.

Tom showed the students in Mrs. Smith's science class how his tester worked. Most of them found it very interesting. Mrs. Smith asked Tom if she could take it home over the weekend. Tom readily agreed.

When she brought it back on Monday, she was bubbling with enthusiasm over how it

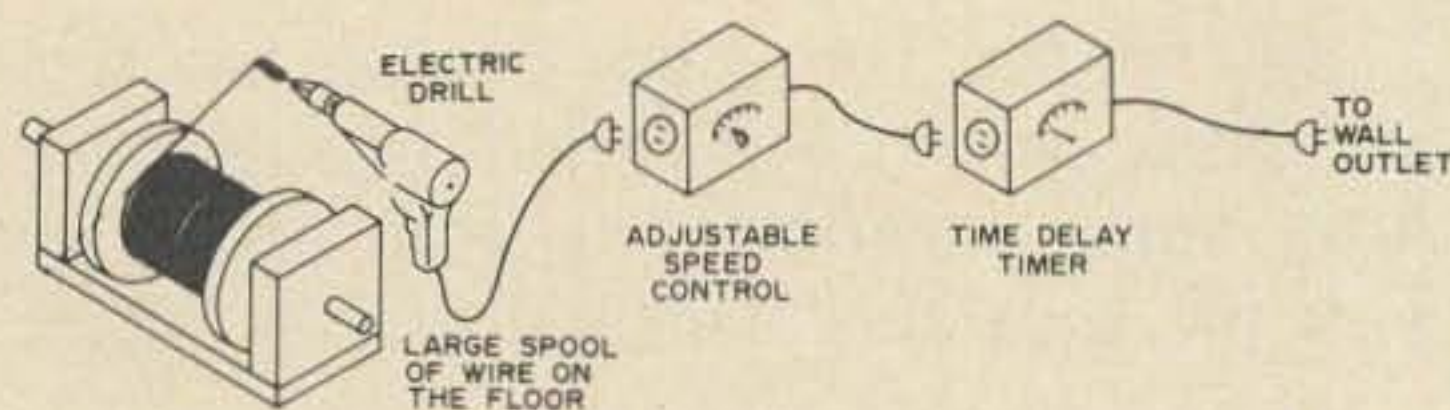

Fig. 7. Uncle Bolivar's coil winding equipment.

was a great teaching aid. She even wished aloud that she had enough for the whole class to use. Tom had not mentioned the 60 kits and he kept quiet now. But he thought to himself how his school had had science fairs for the last ten years, with hundreds of students working on hundreds of projects and not one of them ever resulting in any equipment that the teachers or students could use in class. He intended to change that pattern at this year's school science fair. In discussions with his uncle he had decided on a title for his project:

DESIGN OF AN ELECTROMAGNET FOR CLASSROOM USE

His poster showed the simple calculations he had made in calculating wire length, how the value of current was selected, etc. An assembled kit was fastened to the poster, and another kit, with parts spread out and labeled, was also included. The tester and some graphs were also part of the exhibit. These were graphs Tom had made from measurements of pull as it was affected by the air gap spacing between the armature and the core (bolt head). Another was a graph of pull as affected by the amount of current in the coil. Tom made all the measurements himself, but he borrowed instruments from his uncle as he needed them.

On the day of the science fair, Tom was up early in the morning. He carefully loaded all his materials into the family car. At ten o'clock he had his dad drive him to school so he could set up his project. There were many students there already, with lots of milling around, noise and last minute crises. As Tom was setting up his equipment, Mrs. Smith walked by.

"Who do you think will win in your category?" she asked Tom.

"You will," Tom replied, and quickly walked away before she could ask any questions.

Later that morning, two judges came by and interviewed Tom. They were quite impressed with his exhibit and with his knowledge of what he built and how it functioned. In fact, they were agreed to give him a rating of outstanding in his category when one of the judges asked Tom why he decided to work out the design of the

electromagnet, and why did he say, "FOR CLASSROOM USE." So Tom explained about the 60 kits he had built which he was going to give to Mrs. Smith.

At this the judges were first very surprised and then very intrigued. There was a hurried conference that Tom couldn't hear, and then the judges came back. They asked Tom if they could assist in presenting the kits. Tom readily agreed because he was not too sure how he was going to handle it anyway. The judges left, smiling and talking excitedly to each other.

About an hour later, the school principal was reading off the names of all the winners. As you might have guessed, Tom did win in his category. But then a gentleman in a brown suit stepped to the microphone. Tom recognized him as the older of the two men who had judged his exhibit.

"I would like to announce a very special award to Mrs. Mary Smith who teaches science here." And he was holding a large, heavy box, wrapped in tissue, and tied with a shiny white ribbon. Mrs. Smith was completely surprised and flustered as she walked up to the microphone, and Tom chuckled to himself as he recognized that inside the gift wrapping was his box of kits.

Mary was puzzled as she opened the box, and took out a bag, and opened it. When she peeked inside, all of a sudden she smiled, looked around and caught Tom's eye and winked. Tom thought he saw a tear in that wink. Then the man at the microphone was saying, "... and this young man, who saw a need and took it upon himself to constructively meet that need, is truly a credit to your school and your community."

When Tom found himself up front shaking hands with the judges and the principal and Mrs. Smith, there was a tear in his eye, too. Way back at the edge of the crowd he caught sight of his mother, dad and Uncle Bolivar beaming at him.

Later, as they went home, his uncle said to him, "Well, Tommy, we beat their system. We beat 'em at their own game and we did it without tearing anything down. How about that!"

And Tom thought that was really great.

... MOCKING

The Ultimate in SSTV Equipment



SEEC HCV-3KB SSTV KEYBOARD

Another first from the company and the designer of the world famous HCV-1B SSTV Camera and the HCV-2A SSTV Monitor, now the HCV-3KB Slow Scan TV Keyboard. This is the first commercially made SSTV Keyboard and it is built with the same quality as all SEEC/THOMAS equipment. We will not attempt to list all the features of the HCV-3KB here and we suggest that you write for full specifications. For those that are not familiar with SSTV Keyboards, the HCV-3KB

eliminates the need for a menu board or other number/letter set-up arrangements which are very time consuming to set-up a meaningful text by arranging letters one at a time, by hand on a board or other surface. It also "frees up" the SSTV camera for other uses, such as live shots of the operator or other subject matter. Simply type out the message you wish to send.
#DD-033469 on file in U.S. Patent Office. All American made

— BASIC SPECIFICATIONS —

- 30 characters per SSTV frame — 6 characters horizontally and 5 vertically. Special 35 characters per frame available.
- Meets all standard accepted SSTV specifications
- Positive-negative color (video) reversal
- ¼ and ½ frame rates
- 4 shade gray scale generator
- Dual fast and slow scan rf and video outputs (special-optional)
- Plug-in printed circuit board — gold flashed edge connector
- ICs, op amps, transistors in plug-in sockets
- Built-in 115V 50/60 Hz power supply
- Special 16½" x 8½" x 3¼" aluminum cabinet, black and white or optional 2-tone gray — specify. B&W standard

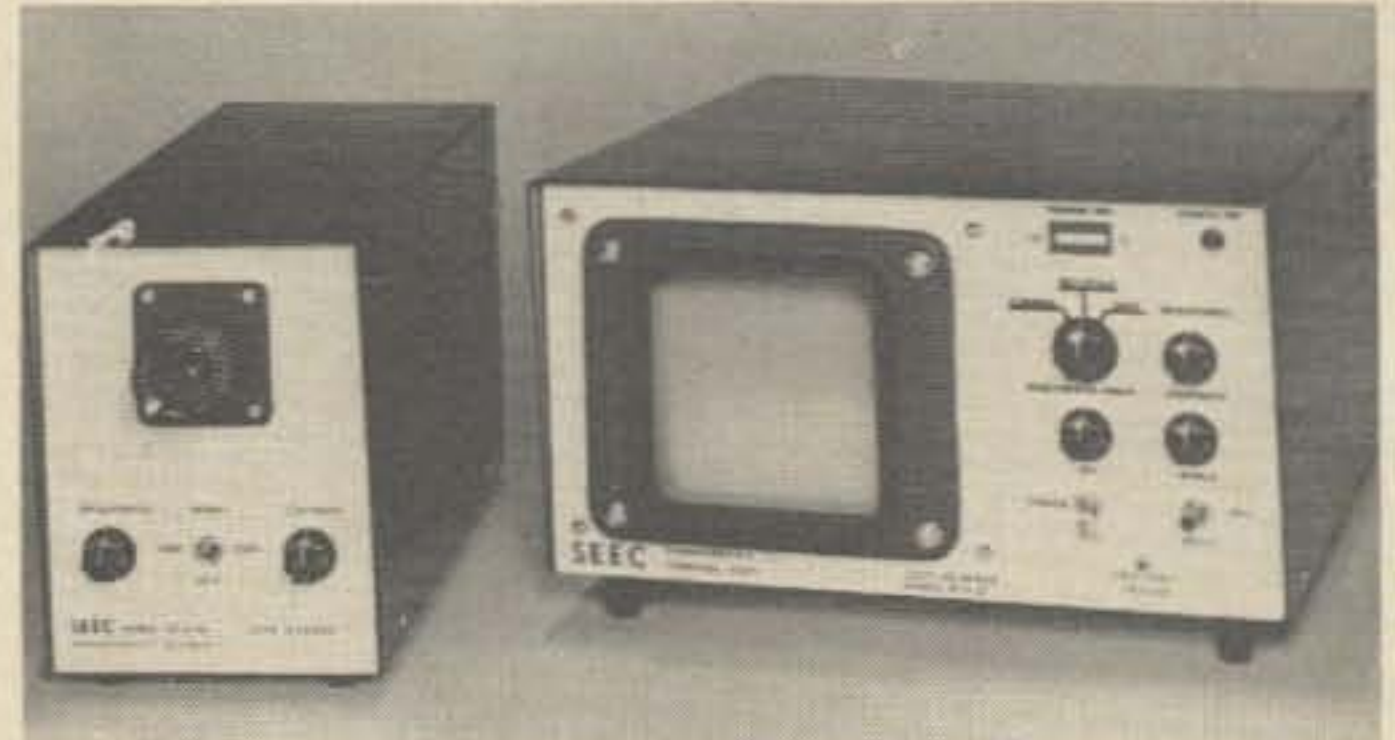

JULY

SPECIAL — cash w/order price — \$420
(reg. \$450)

HCV-1B SSTV Camera, w/lens & power supply	\$425.00 (Reg. \$450.00)
HCV-1B SSTV Camera with ALC, w/lens & power supply	\$450.00 (Reg. \$480.00)
HCV-2A SSTV Monitor w/2 CRT filters	\$360.00 (Reg. \$380.00)
HCV-2B SSTV Monitor w/ built-in Fast Scan viewfinder	\$455.00 (Reg. \$480.00)
HCV-70FSVFK Fast Scan viewfinder modification kit for 70 & 70A, monitors.....	\$69.95
(Factory installation \$37.50 additional)	
Sony TC110A Cassette Recorder	\$134.95
Heavy Duty Camera tripod	\$34.95

A complete line of camera and monitor accessories are available — please write for current prices and delivery, complete specifications on any of our equipment or to be put on our mailing list. We have a 24-hour telephone answering service to better serve you, plus on the air technical assistance from the designer, WB4HCV (Jim). Two locations to better serve you — our main plant at 138-B Nauta-Line Drive and our lab at 218 Tyne Bay Drive, Hendersonville. Complete 80-2 meter operation from either location. Drop in to see us if you are ever near Nashville, Tennessee!

All export dealer inquiries and orders should be sent to:

SINGER PRODUCTS CO. INC.
ATTN: John Hayes
One World Trade Center Suite 2365
New York NY 10045



Five ways to purchase:
Cash with order — C.O.D. (20% deposit) — Mastercharge — BankAmericard
— SEEC Financing (up to 36 months). Note: all credit cards pay regular price shown. All prices F.O.B. Hendersonville TN.



Summer Electronics & Eng. Co. inc.

P.O. BOX 572
HENDERSONVILLE, TENNESSEE 37075
TELEPHONE: 615-824-3235

Pete Walton VE3FEZ
421 Lodor Street
Ancaster, Ontario
CANADA

A Visit to the CB Store

I normally don't like to knock the other services but I just couldn't resist writing about my recent visit to a CB store. I was just walking past the place and thought I would go in and see what's new on the other side of the fence. I stopped at the door and looked up and down the street to make sure nobody would see me entering this type of establishment. I didn't recognize anyone on the street so in I went.

The fellow at the counter was very busy demonstrating a new piece of gear. It was an AM/FM broadcast receiver, automatic alarm clock with digital readout, a 23-channel CB transceiver and several other things but I forget what these were. The best part of this rig, however, was its price tag, only \$499 for a full 5W. I just kept listening to the man behind the counter trying to sell this fantastic electronic device. He was now pointing out a real handy feature. Inside the covers on this little rig was a small adjusting screw which you could turn to get anywhere from zero to better than 100% modulation. At this point I did a very ignorant thing. I asked him how you could obtain better than 100% modulation. Would that not be overmodulation? The man was very kind and patient, he explained that you can run with better than 100% modulation as long as you don't have any distortion. It seems it's the distortion that gets you in trouble not the overmodulation. "Hmmm," says I, "is that how it works?"

Still keeping an eye on the window to make sure nobody would recognize me, I spotted a device that looked like one of the gadgets that hams use. It was called an antenna matching unit. It consisted of two variable capacitors and one coil mounted in a mini box about 4cm (1½") square. The

price was \$15.95, and there was just nothing that it couldn't match. No wonder these fellows don't build their own antenna tuners when there are fantastic bargains like this available. Another thing I noticed was a counter full of wattmeters that read from 0-200W. Now I wonder what a CB operator would use one of these for since the scale was graduated in 5W divisions. A lot of the beams and quads were rated at 1 kW. This seems to be an unnecessary expense for people who never run over 5W. Oh well, I guess they want to have a good safety factor.

This store really had everything: Ham M rotators, antennas of every size and shape and hundreds of microphones and speech compressors. I was told that a speech compressor is the living end. If you had a speech compressor, well, there would be no limit to what you could work because these devices double your output to 10W. Some of the new rigs even have them built in. I asked about SSB. He said SSB has two big advantages. It gives you 46 channels instead of 23. You can work more DX with it because it increases your power output. It does, however, have several disadvantages. It is very expensive, only hams can afford it. It sounds funny, and if something ever goes wrong you are really in trouble. It seems there are not too many people around who can fix SSB, especially if it is solid state. The only way to get them fixed is to have them replaced by the importer. Maybe some of us hams should start up a CB repair business. The CBers generally seemed to agree that SSB is the only way to go. Some of them even feel that AM should be outlawed (sound familiar?).

In another corner of the store they had VHF receivers. You wouldn't believe how many different types. If you have one of these in your car, you can get to the scene of an accident or crime before the police. You can get to the scene really fast because they also sell flashing red lights to put on the top of your car. These make you look like a police car. If you want to go all the way you can purchase a big sign to go on your trunk that says, "This is an Emergency Vehicle." Oh, well, I better get out and do the rest of my shopping... 10-4.

...VE3FEZ

THE FIRST AND STILL THE LEADER! the exciting super compact IC230



PUT OVER 67 CHANNELS IN THE PALMS OF YOUR HANDS

SPECIAL FEATURES:

- **No More Crystals** . . . Over 67 . . . fully synthesized channels available.
- **All Channel Capability** . . . Travel with confidence that you'll be able to work all repeaters along the way.
- **Super Compact** . . . 2.28" high x 6.14" wide x 9.72" deep at a weight of only 5.5 lbs.
- **Quick Dismount Mobile Mount** . . . Allows quick car installation.
- **Easy Operation** . . . Punch up frequency, select repeater or simplex mode, and you're on the air. (A crystal may be added for a unique repeater frequency.)
- **Modular Construction** . . . In case of a problem, modules can easily be removed and sent for repair. A replacement module will be air mailed to minimize down time.
- **Super Hot Receiver** . . . Better than .4uv / 20db. sensitivity, helical filters to eliminate intermod . . . plus a super E filter and a mosfet front end.

IF THERE IS A SIGNAL, YOU'LL HEAR IT ON THE IC-230!

LATCH ON TO THE IC-230 AT YOUR AUTHORIZED ICOM DEALER

Distributed by:



— Dealerships Available —

ICOM WEST, INC.
Suite 3
13256 Northrup Way
Bellevue WA 98005

ICOM EAST, INC.
Suite 307
3331 Towerwood Drive
Dallas TX 75234

IF YOU HAVE
ALREADY GONE 450 ♦ ♦ ♦ ♦



GO ICOM 30A ♦ ♦ ♦ ♦
before you go bananas!

If you have been trying to resurrect something from the pre-transistor past that more closely resembles the mechanism used to keep large ships in place, or if the sound of bumble bees is keeping you awake at night--REJOICE!!! The ICOM 30A is here and working!

Consider these reasons for owning an IC-30A:

- (1) Despite the fact that the radio is completely solid state, it has output of ten watts
- (2) Receiver sensitivity is better than 0.6UV for 20 db of quieting and that means easy on the ears listening.
- (3) The IC-30A comes with five channels of the 22 channel capacity installed
- (4) Shielding is excellent because the unit is modularly constructed.
- (5) Your car tires will last long because the IC-30A weighs less than ten pounds.
- (6) Like its predecessors, the unit is equipped with a 9 pin plug in the side of the radio to provide you easy access to the discriminator and room for adding the necessary wiring for external accessories -- with all this and more, for only \$399.00.

SEE ONE !! BUY ONE !! AT YOUR ICOM DEALER TODAY

Distributed by:



ICOM

ICOM WEST, INC.
Suite 3
13256 Northrup Way
Bellevue WA 98005

ICOM EAST, INC.
Suite 307
3331 Towerwood Drive
Dallas TX 75234

Preventing Regulator Carnage

Monolithic IC regulators such as the LM309 et al are here to stay, as are the newer, more sophisticated dual tracking voltage regulators like Raytheon's 4194. They include a number of fail-safe features — most notably, short-proof circuitry and thermal overload shutdown; but in many cases, that's not enough protection. Presented here are some other possible failure modes, and how to avoid them.

Reverse Bias Across the Regulator

This accounts for a number of otherwise unexplainable regulator failures. To see why this problem occurs, examine the typical 3 terminal regulator supply in Fig. 1(a). If the input capacitor should go rapidly to ground (through a short, for example) the output becomes more positive than the input, setting up a reverse bias across the regulator's series pass transistor which can destroy it. Adding a diode in series with the dc input, as

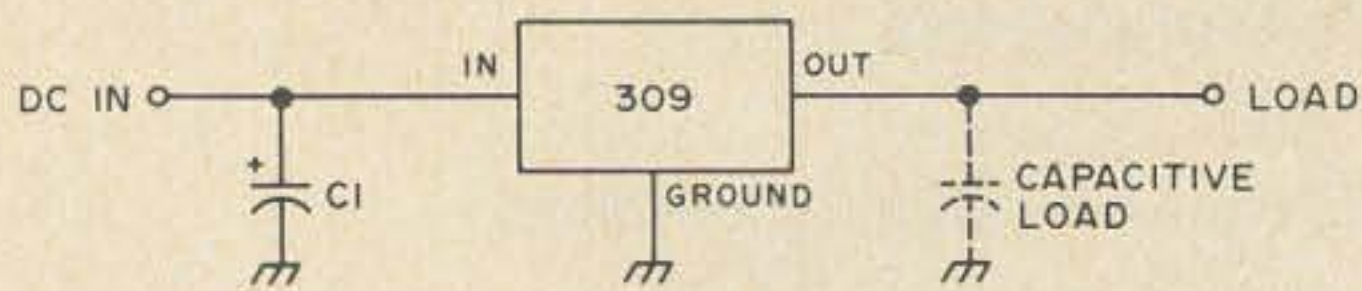

Fig. 1(a).

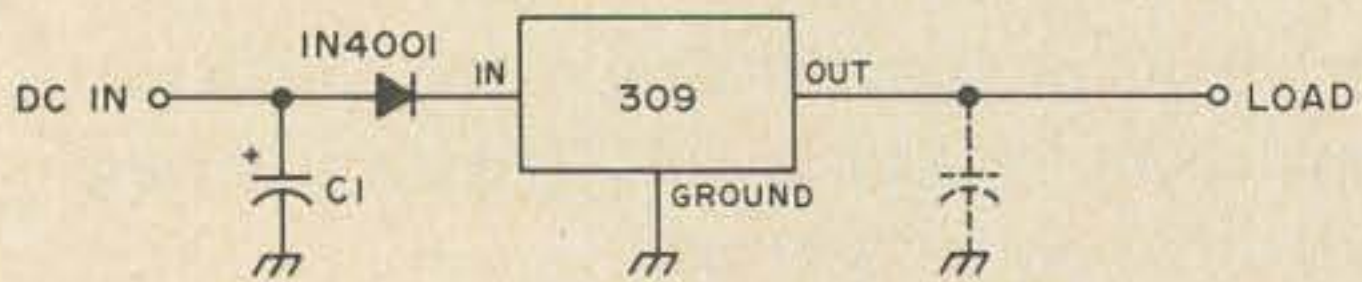

Fig. 1(b).

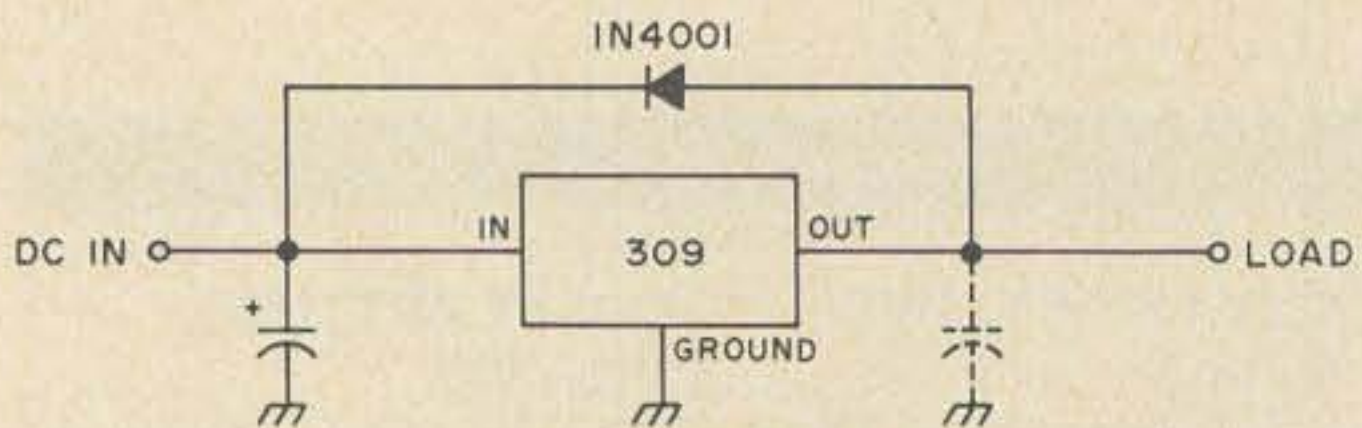

Fig. 1(c).

shown in Fig. 1(b), can eliminate the problem; but the diode does add a series resistance and consequent voltage drop. Fig. 1(c) shows a better way. The 1N4001 is normally biased off because V_{in} is greater than V_{out} ; but should V_{out} become more positive, the diode conducts, dumping the current back to the input without going through the regulator itself.

Improper Polarity Transients at the Output

If a large negative transient hits the output of a positive regulator, or if a positive transient hits the output of a negative regulator, all kinds of troubles can occur. Unfortunately, transients riding the power supply line can be a fairly common occurrence; once again, a diode solves the problem.

Fig. 2 shows a simplified diagram of a typical dual tracking regulator. By connecting two diodes as shown, opposite polarity transients can do no damage. Any positive transients on the negative line shunt to ground through diode D1; D2 performs a similar function for negative transients.

Excessive Input Voltage to the Regulator

The popular LM309 and several similar regulators are rated at a maximum 35 volt input, and that's for real. Anything over 35 volts can easily zap the regulator. Even if you're running around, say, 33 volts, a good

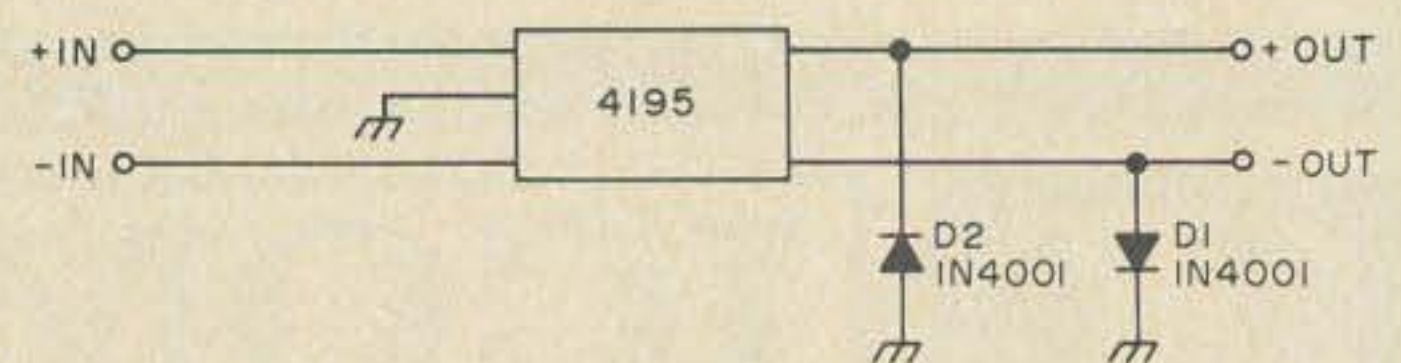

Fig. 2.

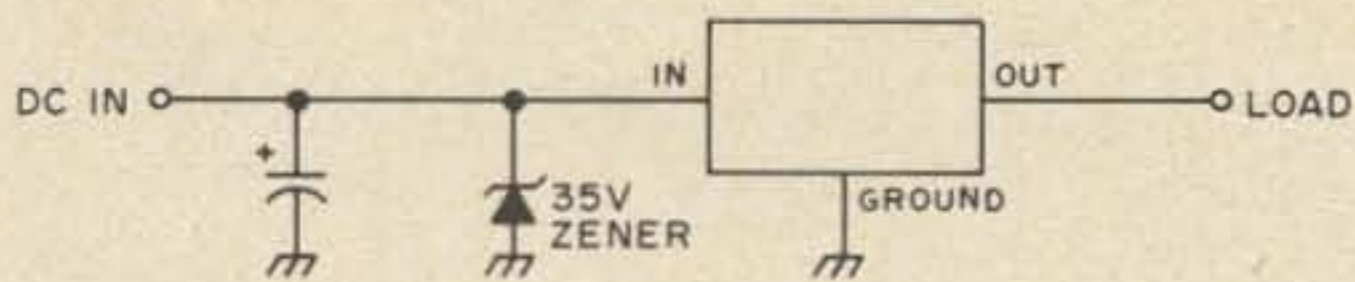

Fig. 3.

voltage spike or upward change in the line voltage can cause the 35 volt figure to be exceeded. The best way to deal with this is to use a 35 volt zener across the input of the regulator, catching any possible overvoltage problems (see Fig. 3).

Excessive Voltage at the Regulator Output

This can happen in a couple of ways. The first is human error: Test probes slip, a loose lead will brush up against an output terminal. Additionally, in some regulator systems external output transistors are used in conjunction with a low power regulator (like the 723) to give higher output currents. When these external devices fail (and they sometimes do, unless you're using one of National's LM395 blow-out proof transistors), the chances are excellent that they will fail as a short, rather than open, circuit. So what happens? Look at Fig. 4(a). The *full* voltage at the input of the regulator is now present at the output... not a healthy set of circumstances. The simplest way to deal with this problem is a zener diode across the output of the regulator, as in Fig. 4(b). Any excess voltage will shunt to ground.

A somewhat more thorough method of resolving this problem is with an SCR-resistor-zener diode "crowbar" circuit, applied to a simplified 15 volt supply in Fig. 4(c). As long as the output voltage remains at 15 volts, the SCR does not have sufficient gate current to trigger, and represents an "off" or high resistance state. But if the voltage on the output of the supply goes higher than 15 volts, the voltage differential between the gate and anode of the SCR — hence the current injected into the gate terminal — suffices to turn the SCR on, causing a virtual dead short to ground and shunting any high voltage safely away from the circuitry. Choose an appropriate zener for different power supplies; it should be the same as the desired output voltage.

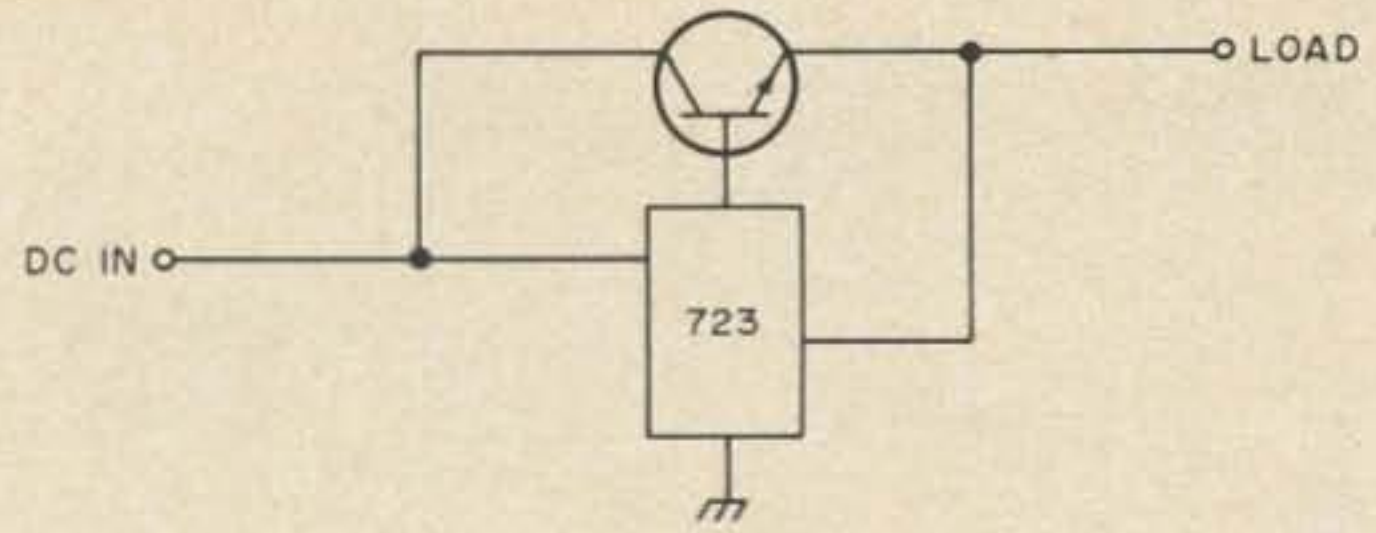

Fig. 4(a).

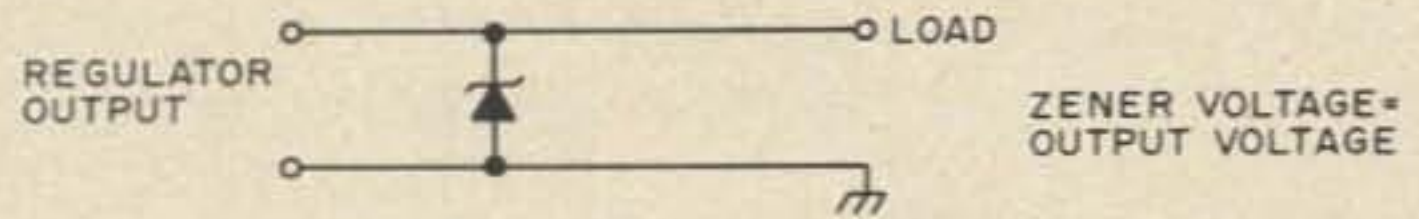

Fig. 4(b).

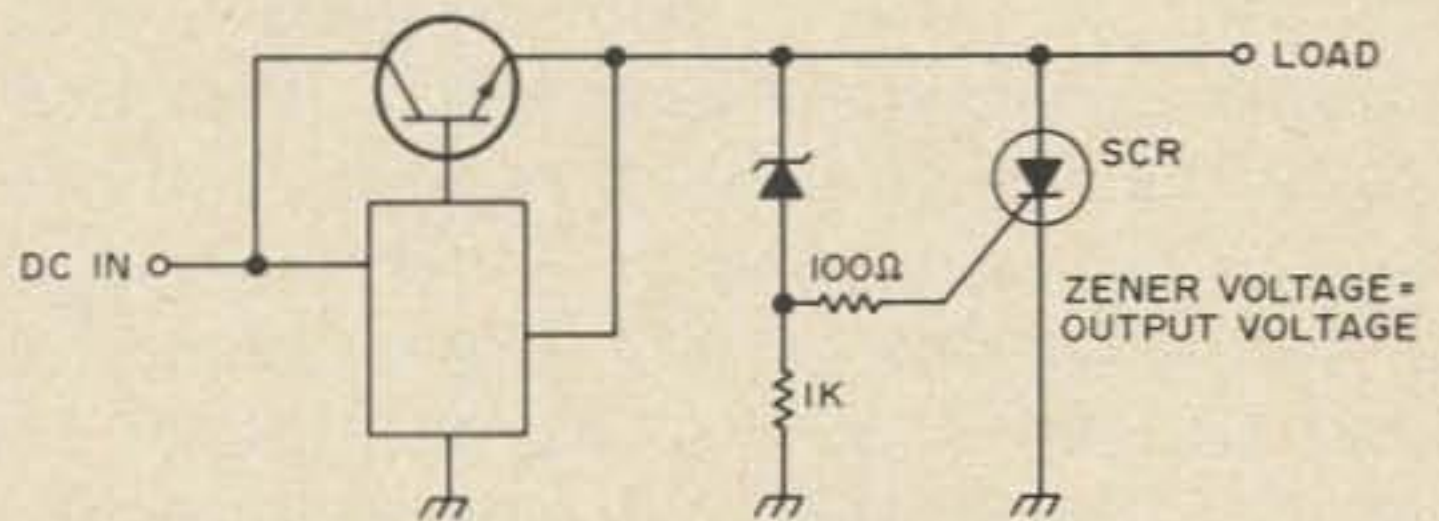

Fig. 4(c).

Protecting Circuits from Power Supply Reversal

Although not a modification made to the power supply, this still falls under the heading of protection. As you may have already found out on the bench, reversing the voltage going to an IC can instantly destroy it. Simply placing two diodes in series with the op amp supply leads shown in Fig. 5(a) guarantees that even if you reverse the supply lines, the op amp will be safe from harm.

If you have a lot of ICs on a board, however, adding two diodes for each one can

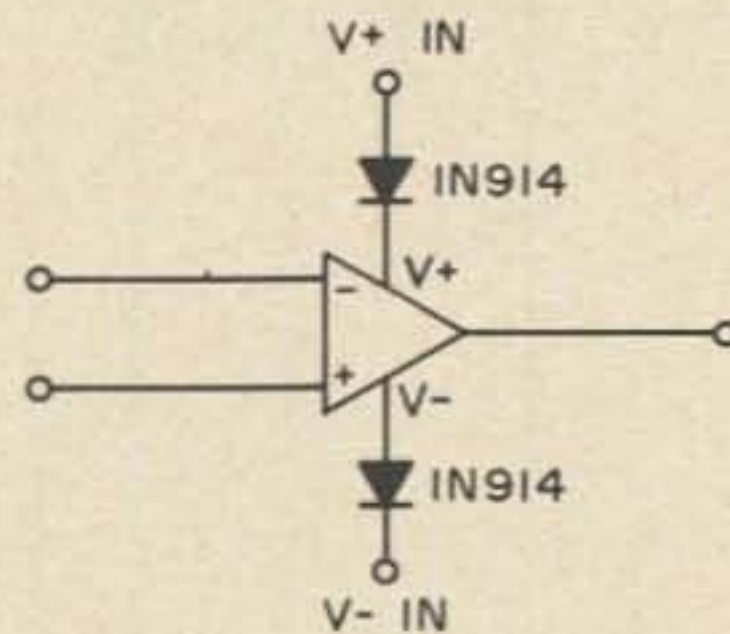

Fig. 5(a).

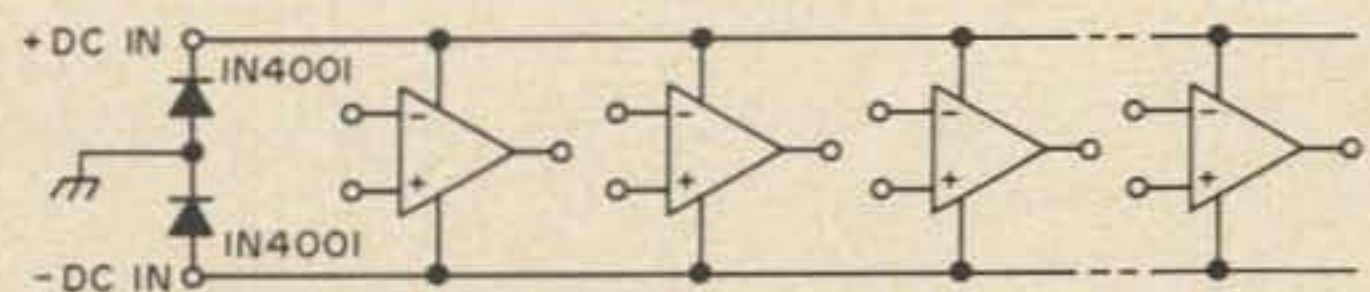

Fig. 5(b).

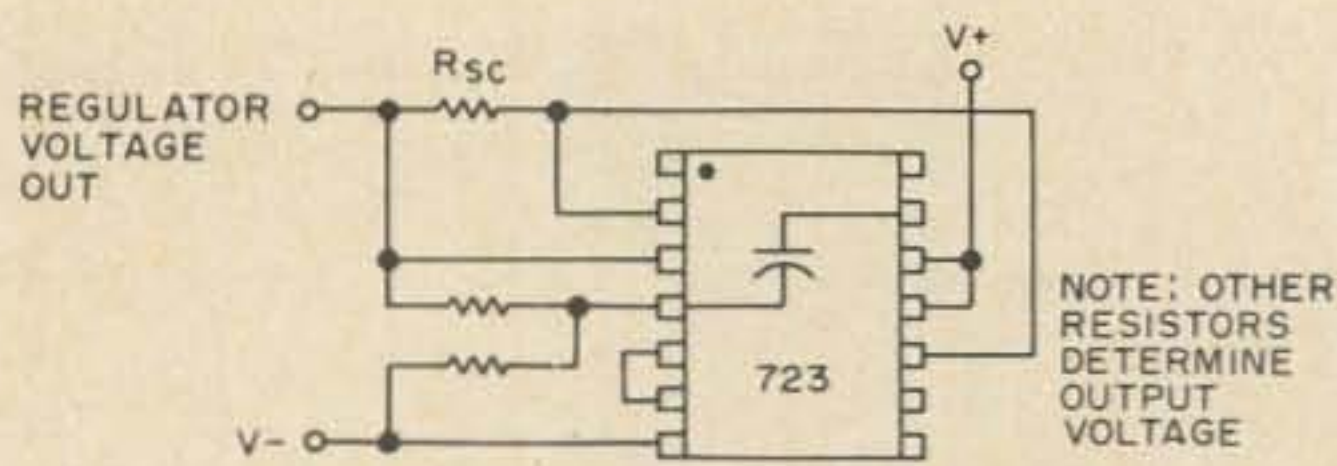

Fig. 6.

be a bit of a chore. In this case, try two diodes as in Fig. 5(b). Should the power supply lines to the board reverse, the diodes shunt improper polarity voltages to ground.

Protecting the 723 from Excess Current

The 723, one of the most common regulator ICs, has a built-in current limit feature. Looking at Fig. 6, you'll notice that R_{sc} is the current limiting resistor. You can derive its value from the formula $R_{sc} \cong .7/\text{max allowable current}$ (for example, to limit current to 50 mA, $R_{sc} = .7/.05$ or 14 Ohms). This feature not only protects the regulator, but the circuit under power.

Protecting Circuits from Excess Current

It is possible to limit current with a power transistor-zener diode arrangement

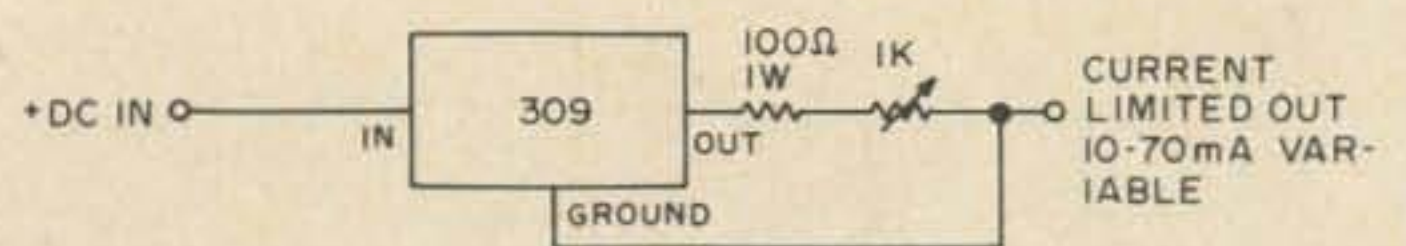

Fig. 7.

for power supplies that don't have current limiting; an approach that involves a smaller parts count uses the current limiting properties of the LM309. When hooked up as in Fig. 7, resistor R sets the current limit point. A good 309 will limit down to about 10 mA. Remember, though, that you are dissipating a certain amount of power through R, particularly at high current values ($P = I^2 R$), so choose an appropriate wattage. The circuit shown limits from 10 to about 70 mA, a good range for experimental breadboarding.

There you have it, seven ways to help protect your circuits and power supplies. If you use these various protective techniques, you'll find that the number of "mysterious" failures will go down, and that you will feel more secure about using the equipment you've made.

...ANDERTON

CIRCUITS, CIRCUITS, CIRCUITS...

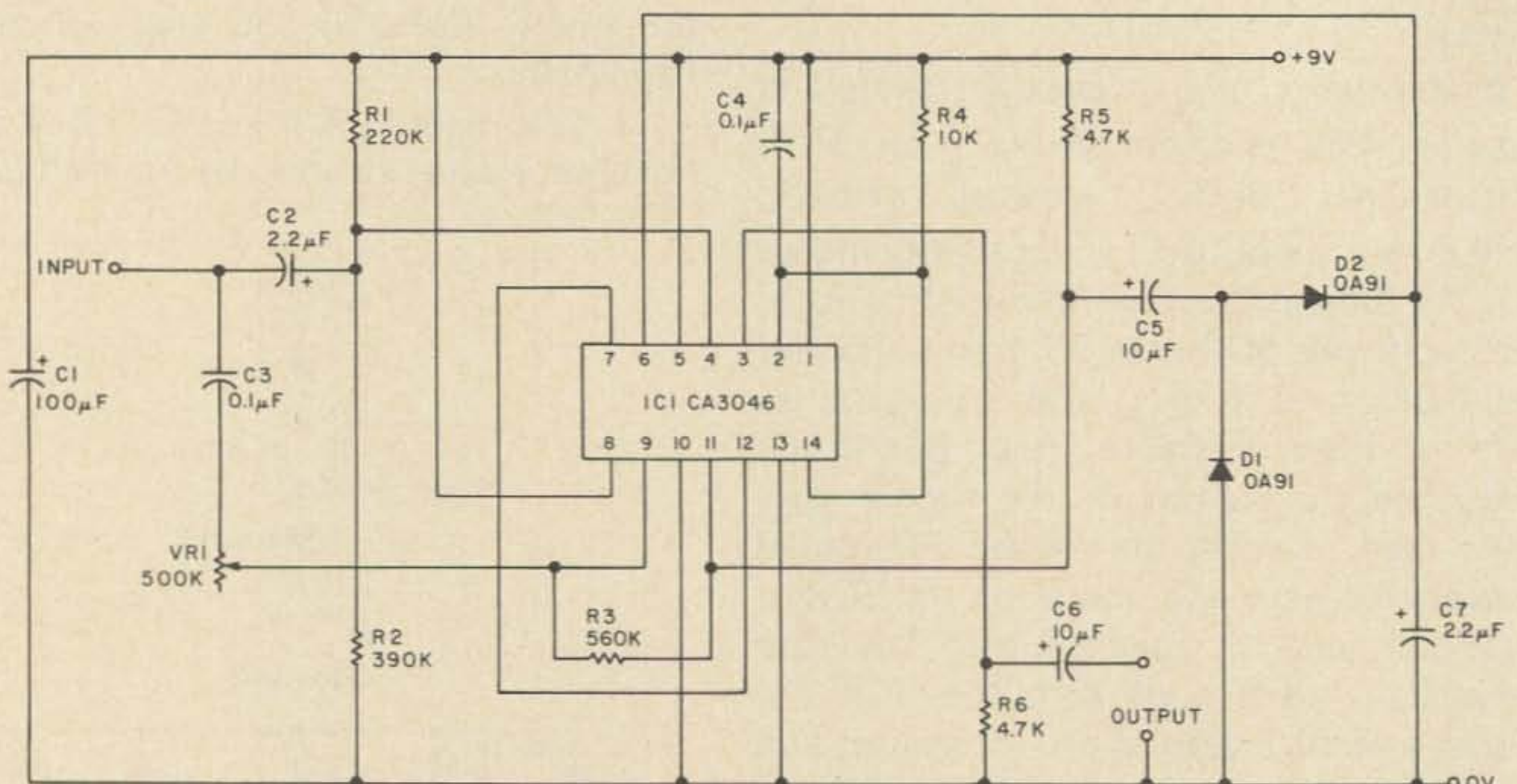

Audio squelch unit. Complete project is in Sept. 74 issue of Radio & Electronics Constructor, 57 Maiden Vale, London W91SN, England. Subs \$7 per year.

The Ultimate in Variable Selectivity?

Many amateurs would undoubtedly love to have available on their receivers or transceivers a *continuously* variable i-f selectivity control that allowed the selection of i-f bandwidths suitable for CW reception under extreme QRM conditions to the selection of i-f bandwidths suitable for normal SSB reception. Such continuously variable i-f bandwidth and bandpass tuning controls have been present on various commercial grade receivers in the \$1,000+ category for several years and usually involved the use of a tailored multiple-gang air variable capacitor (up to six sections) of special design and very critical inductor elements. The direct adaptation of such designs to amateur equipment is certainly not practicable. However, the introduction and wide availability of capacitance variable varactor diodes at low prices (less than \$1.00 each for the Motorola MV series) provides radio amateurs with the possibility of a low-cost approach to an unusual degree of convenience and flexibility in i-f bandwidth selection for any HF to VHF receiver.

This article explores some ways in which these diodes can be used to build up continuously variable i-f filters of different ranges of selectivity. Such circuits can be applied to HF receivers with bandwidths ranging down to a narrow CW bandpass or to VHF FM where it may be desired to use additional selectivity to reduce splatter from adjacent channel repeaters.

Normally, i-f bandwidths are selected in fixed steps by switching in mechanical,

crystal or multiple section LC filters of different bandwidth characteristics. As was mentioned before, some expensive receivers do use a continuously variable LC filter such as illustrated in Fig. 1. Special components are required for the multiple tuning arrangement and the bandpass tunable filter is usually supplemented by other filters which define the overall bandwidth within which the bandpass tuning feature functions.

The tunable bandpass filter in Fig. 1 is made up of a number of series connected parallel LC sections with a fixed amount of capacitive coupling between the LC sections. If another approach were taken, namely to have each LC section fixed tuned at the i-f center frequency but vary instead the degree of coupling between the LC sections, one would have a fixed center frequency filter of variable bandwidth. Such a filter could consist of two or more LC sections with variable coupling. A two to three section will usually suffice when it is supplemented by a fixed filter which established the overall maximum i-f bandwidth. The building of a fixed-frequency variable bandwidth i-f filter by means of varying the capacitive coupling between LC sections is possible, but

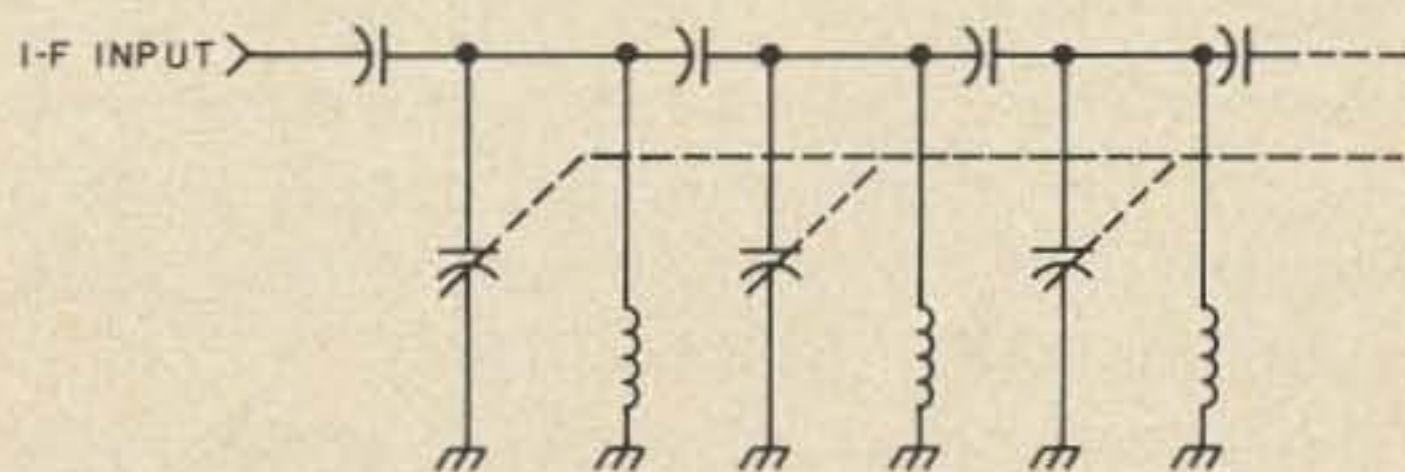

Fig. 1. Development of a tunable bandpass filter.

becomes extremely complicated using normal air variable capacitors because of the requirement to isolate each section of the capacitor. However, it is here that varactors come into their own. Many types are available today which have a capacitance range of 5:1 or 10:1. This range might cover 10 to 400 pF but it comes close enough to build practical circuits.

Fig. 2(a) shows a two section variable bandwidth filter built around a single varactor diode. The circuit values given are those applicable to a 455 kHz i-f but the circuit can be adapted to any other i-f frequency by proper selection of LC elements which resonate at the desired i-f. The selectivity depends upon the Q of the tuned circuits involved and the number of circuits used. These values can be calculated by the standard handbook formulas for any desired response. By varying the bias on the varactor

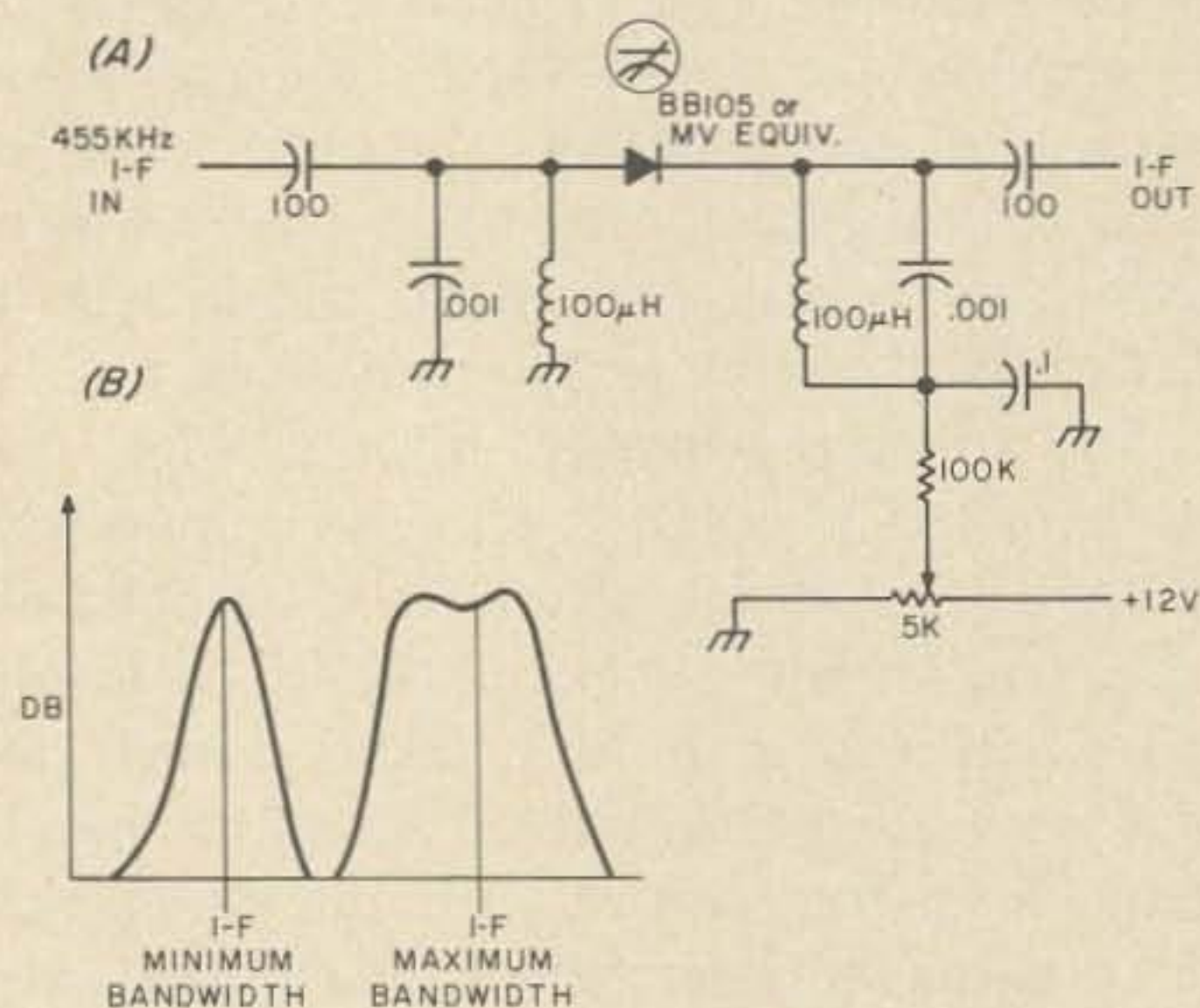

Fig. 2. Basic variable selectivity circuit.

diode, the selectivity response of the circuit can be varied over the extremes shown in Fig. 2(b). Because there is only a dc bias on the varactor diode, the dc lead after the 68k resistor can be any desired length. As can be seen from Fig. 2(b), the simple circuit has one disadvantage. The selectivity circuit is not completely symmetrical about the center i-f frequency. The shift in the selectivity bandpass around the center frequency may not be serious although it may require touch-up of the receiver's main tuning while varying the i-f bandwidth circuit.

For some types of receivers, particularly crystal-controlled ones, it would be desirable to keep the bandpass shape of the selectivity

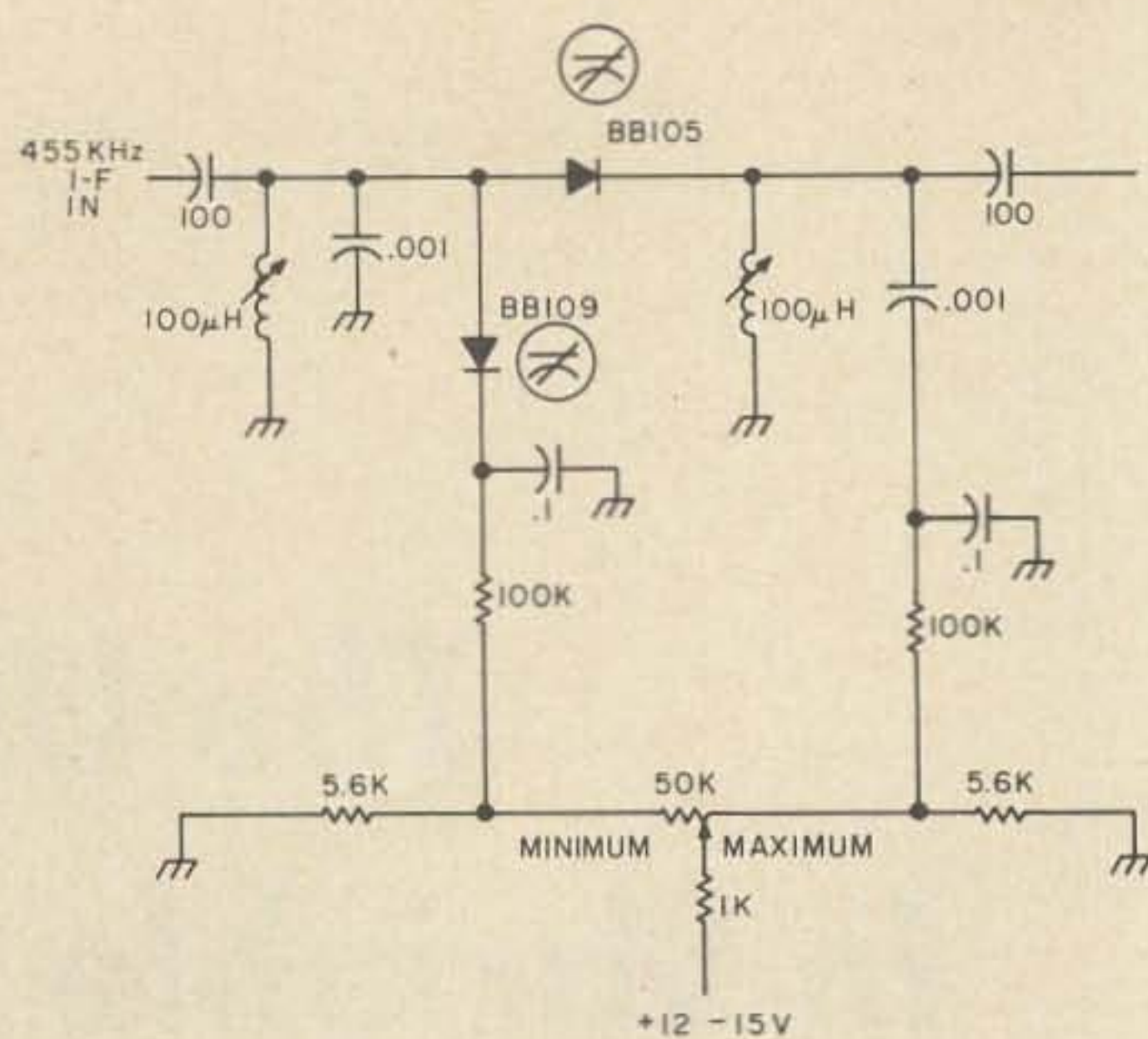
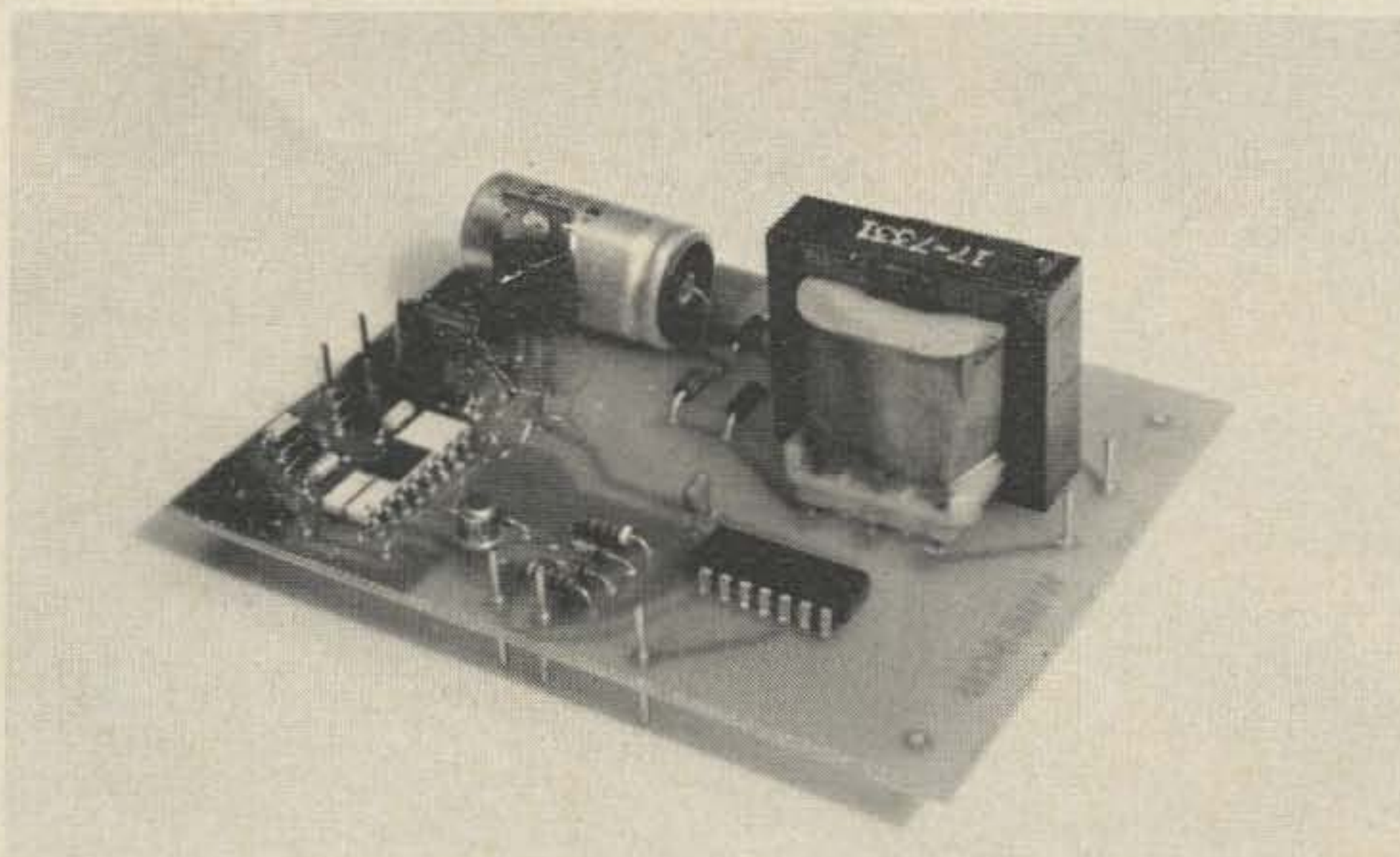

Fig. 3. Variable selectivity circuit with compensation.

curve symmetrical. A circuit for doing this is shown in Fig. 3. The lack of symmetry occurs in the circuit of Fig. 2 because as the varactor diode capacitance changes, it changes the resonant frequency of the tuned circuits. By using two diodes on the circuit of Fig. 3, a compensating arrangement is provided. In Fig. 3 the two tuned circuits are no longer peaked at the same frequency. Each is peaked at a different frequency at the extremes of the desired bandwidth with the circuit pot set to the widest bandwidth position. Diode D1 in Fig. 3 controls the selectivity by varying the degree of coupling between the tuned circuits, the same as in the circuit of Fig. 2. However, as the coupling is varied the tendency of the bandpass curve to shift lower in frequency is compensated for by tuning the first LC circuit to a higher frequency via the capacitance change of diode D2. The bandpass shape remains the same as in Fig. 2(b) except that it doesn't change in relation to the center i-f frequency. The circuit also has advantage of being able to provide a somewhat greater selectivity range. The circuit of Fig. 2 can operate over about a 4:1 range. That of Fig. 3 can operate over a 5:1 or greater range, depending on the component values chosen. So, it would be possible with the latter circuit to achieve a selectivity range which goes from 500 Hz for CW reception to about 2500 Hz for SSB reception.

...STAFF

500 MHZ PRESCALER



3" x 4" x 1½"

EXTEND YOUR COUNTER to 500 MHz!!!
Can be used with Any counter capable of 5 MHz.

- FMAX greater than 500 MHz.
- HIGH INPUT SENSITIVITY: less than 150 mV needed at 500 MHz — overload protected
- HIGH INPUT IMPEDANCE: 500 Ohms
- OUTPUTS: ÷10 and ÷100 TTL compatible
- INCLUDES POWER SUPPLY

PS-K kit \$ 89.00

PS-A wired and tested \$109.00

BRAND NEW!
500 MHz COUNTER
WRITE FOR DETAILS

plus \$.85 postage
Calif. residents add 6% sales tax

LEVY ASSOCIATES

P.O. Box 961 S
Temple City, Calif. 91780

Altair The Computer. Something you need to be very much aware of.

The Altair Computer is a true, 16-bit (parallel 8-bit processor) minicomputer with 78 mnemonic instructions. Standard interface cards and a sophisticated bus structure allow direct addressing of up to 256 I/O devices, and the memory complement can be expanded to 65K on the 2 usec machine.

Altair options include 3 serial and 1 parallel I/O cards, 1K and 4K memory cards, computer terminals, line printers, teletypewriters, disk controller and disk drives, real-time clock, vectored interrupt, PROM programmer and more.

Software includes a 4K, 8K and EXTENDED BASIC that can control input/output channels for machine control without assembly language. Other software includes an assembler, text editor, and system monitor. A debugging package and DOS will soon be available.

The Altair Computer comes both in kit and assembled form (as do most Altair options). The kit price is \$439 and the assembled price \$621 in single quantities. OEM discounts available.

MIT S

"Creative Electronics"

SEND FOR FREE 24 PAGE CATALOG

6328 LINN NE, ALBUQUERQUE NM 87108 (505) 265-7553

Jerrold A. Swank W8HXR
657 Willabar Drive
Washington Court House
Ohio 43160

Phone Patching - a Public Service

In 1964, after 45 years of CW and no AM operating, I decided to go sideband. I had only been on about a month when I was broken one night by KC4USB, Byrd Station, Antarctica. I was using a pair of phased verticals at the time and just signing with a Houston, Texas station. I turned the pattern south, and asked who it was and what I could do.

He said, "You are one of four stations who come into the Antarctic well every night, and we wonder if you could run some phone patches for us." I didn't have a phone patch, but I soon acquired one. In the meantime I offered to run some one-way messages, and KC4USK broke in with a request for a one-way message to Michigan.

The first message was copied through heavy static, with many repeats, and was a request from Ross Smith, who designed most of the antenna installations for the Ice. He wanted a recipe for his mother's sugar cookies. His mother gave me the recipe on the phone, and Ross said that Bob Smart, the cook, and one of the operators at KC4USK, Eights Station, had promised to bake the cookies if Ross got the recipe.

Well, that started my ten year stint of 40 meter phone patching for a total of twenty stations in Antarctica, including a bunch of ice breakers and supply ships. I would run anywhere from two to twenty patches each night and after ten years I learned a great many things. I will tell some of the common errors which one hears.

Probably the most annoying is the habit hams have of joining in the conversation. He seems to feel that he is an entertaining wit, and when the wife says something to her husband and he laughs, this ham feels that he must assert his rights as a wit, and they have to listen while he demonstrates what a

real live wire he is. One of the best known phone patchers has this affliction, and I remember one night a Navy man at Byrd Station remarked, "It costs me more for Charlie to talk to my wife than for me to talk to her."

The people whom you are patching are trapped. You are doing them a favor, they feel, and they can't tell you to "SHUT UP," which they would like to do, so they take it as well as they can.

There is another type who wants to make an impression, so he keeps the patch on the line while he explains to the operator that he is a radio amateur running overseas patches for service men in Antarctica, or wherever, then he keeps the operator on the line while the phone rings, and the party answers. First, to broadcast an operator or anyone without their PRIOR permission is a violation of the secrecy of communications act. Second, the person who answers the phone may be a wrong number, which at 3:00 am may get you a broadcast cussing out. Third, you may cause a divorce, as one operator running traffic for the Antarctic did several years ago. He left the line open, and a baby sitter answered the phone. When asked if Mrs. Smith was there, she said, "No, she's out with her boy friend." This was totally uncalled for and there are many more things that may happen when you connect a phone to a worldwide broadcast without notifying and getting permission to put someone on the air.

The other reason why it is very selfish to hold the line open is that the operator on the ship or other service location cannot talk to anyone else while you are gabbing. The old pros who run most of the traffic to service men keep the line absolutely silent until the party answers, and then say,

ANTARCTICA

SP 900

TASK
43
FORCE

THE WORLD'S LAST FRONTIER

"Break, your party is on the line." During this silent time the ship can line up another patch with another station, or can accept breakers, or talk with someone else. The neophytes are usually so impressed with themselves that they do not think that any other station is of any importance whatever.

Another bad habit that some stations have is chatting among themselves when they cannot hear the patch which they know is going on. This is especially true with Antarctic patches. The real problem is receiving the ice stations, and often they are reading you Q5, but you can't hear them because of local summer static. I have many times asked for repeats because other well-meaning stations on the West Coast, while waiting for the propagation to favor them, sit and talk back and forth on frequency, full power. Just thoughtlessness, of course, but the result is very annoying.

I can patch an Antarctic station most of the time if he is S-3 or better, and he can patch me at S-0 if he has no snow static, yet strong stations will talk on frequency.

I had a long argument, and finally had to move because a ham would not believe I was running a patch because he could not read the station at the other end. He claimed I was running a monologue to get him to move!

You would be surprised how many stations resent phone patches, and will move as close as possible to you to give you trouble, and then sit there and discuss how they feel about "tying up the band with

phone patches." This is public service for people who have no other way of communicating. As a matter of fact, that is my criterion. I will not run a patch for anyone who has any other means at his disposal, unless he is in the service or Peace Corps.

So much for the problems, now for some of the methods. I never explain anything to an operator. It is none of her business, and trying to explain to those who seldom get patches just ends up in a conversation with the supervisor.

I have run thousands of patches, and I have a very simple formula. When the operator answers, I say, "Station to station collect 614-335-4478, and tell them Joe is calling." She will dial the number and ask my number. I say, "1160." When the party answers she says, "I have a collect call for anyone from Joe, will you accept the charges?" Of course there is an enthusiastic, "I sure will!" I then say, "This is Jerry in Ohio, and I have Joe on the line, he will talk first, and when he says 'OVER', it is your turn to talk." If this is not a first time patch, you don't need the last part. Usually the calling party will tell you if it is a first time patch. If not, ask him, I say only "Ohio" because they remember that easily, and if I were to say Washington Court House, Ohio I would start a long explanation. But I want her to know when she gets her phone bill why the call is there. I have NEVER had a call questioned in ten years.

If the band becomes unusable, I cut the patch and tell her he will call her another

time when conditions are better, and they usually accept that. I never tell her to expect another call in a few minutes or an hour. She might be up all night for nothing. Often they will ask my name and be in the mood for talking, and if so I talk, but not on the air. I tell them about the place where her husband is, and the weather, etc., and finally she says goodnight. Sometimes they ask for my address, and send me nice letters, or even some beef "jerky" and canned Columbia River Trout (once).

One couple phoned me when their son came back from overseas and I met them in Dayton. They took me to dinner and we spent the evening together. They even brought me some nice souvenirs, photos and New Zealand money. I have received over 2,000 color slides of places around the world.

Whenever they ask if there is anything they can do for me, I say, "Yes, send me a color slide of the station and yourself, if you have any." Usually they shoot a roll and send it to me unprocessed, and I process it, keep a few, and send the rest to their home address.

There is one thing which makes the Antarctic different than anywhere else. The call letters are issued to the Admiral under whose direction Antarctica operates. He may let anyone, with no license, operate the equipment providing they are checked out on it by a Navy operator. Thus very few of the men who run the traffic are amateurs. They are doctors, scientists, bull dozer operators, dentists and others. So I smile when I hear a ham describing his equipment to the poor guy, who doesn't even know what the ham is talking about, but they listen politely, and then say, "We are running all Collins equipment."

Another thing is that the men who are running patches are doing it because it is a pleasant diversion, but mostly they just want to talk. They look down on what they call the "big score guys", who just want to see how many patches they can run. Some will limit the patches to five minutes just to get more run. I will never make any limit. If the station of origin wants the time limited because they have a heavy load, I let them

do it, and let them stop the man on the patch.

Some of the most hated hams are the ones who run big scores, and move off the minute they are through, without waiting to learn anything about the man they have been talking to. They feel you are "using" them for your own "score." We used to have a "coffee klatch" on 7210 in the old days when I was patching for seven Antarctic stations, and when all the traffic was run, sometimes at 5:00 am my time, all the stations and many of the hams would join and "yak" and have coffee till daylight took the band out. One morning I patched South Pole station direct to the Pentagon at noon for orders, after running all night on 40 meters.

Whenever an operator lets it ring a few times and there is no answer I always ask her to re-dial it. You would be amazed at how many times the operator has misdialed. One night I knew this woman was going to the hospital for a checkup, and I had arranged to call her the night before so her husband could talk to her. The phone rang and rang. I asked the operator, a new one, to re-dial the number and she said, "Sir, I dialed the number you gave me." I said, "Would you rather I called your supervisor to re-dial it?" She dialed again and it was answered on the first ring. The operator apologized.

If the phone is busy, I ask the operator to make it an urgent call. I ask her to break in and tell the party that her husband is calling. This almost immediately gets a reply, "I can ring, now." I thank her. Only once did an operator turn me over to her supervisor. She



asked the nature of the emergency. I said, "Are you married?" She said she was. I said, "Your husband has just left Seoul, Korea, on a Naval Repair ship. You have not heard from him for nearly a year. He has stood in line for hours waiting for his turn. If he loses his place he may not be able to call again for a week, radio communications being what they are. Is that an emergency?" She replied, "That IS an emergency," and promptly cut in on the line and put me through. For the purists, please remember that the man who is calling is the man who is paying for the home phone, and he wants to use it!

One of the troubles you will have is letting a 2600 Hertz heterodyne come in. That is the switching frequency and you may lose your circuit. I lost one four times one night to Washington State. I asked the operator what the trouble was and she told me that a high pitched note was cutting my circuit. Now I carefully squeeze it out of the pass band or zero beat it if I have trouble.

Of course you NEVER use Vox for a patch unless you are running one between two S9 hams. The sound of the Vox

operating, and letting bursts of static and other noises through will thoroughly demoralize most people on a patch.

My most unusual patch happened on November 14, 1965. Eights Station had just closed, and all the men had taken a plane to McMurdo Sound. I wanted to see if they had made it, so I called McMurdo station, and found that they were all there, and the station at Eights was permanently closed. I had worked them every night except three for a whole year. Suddenly I got a "Break". I said, "Go ahead breaker."

"This is KC4USC. Are we patch quality?"

I told him that he was, and he wanted to run a patch to California, which I did. When he was through I asked him where he was. "We are on Pensacola Mountain in two helicopters. When we heard you we landed and ran a wire between the two copters and gave you a call." Pensacola Mountain is near the South Pole and is 12,000 feet high, and this was in pitch darkness in the Antarctic Winter.

...W8HXR

New!

COMPLETELY NEW!

VHF Antenna Handbook

The theory, design and construction of dozens and dozens of different VHF and UHF antennas . . . antennas for FM, for DXing, for repeaters, for mobiles, for emergencies, for contests, quickies, mammoth arrays . . . everything.

This is a practical book written for the average amateur, not full of formulas for the design engineer — this is a book for the amateur who takes joy in building — perhaps it is a brookstick and some coat hangers fashioned into an effective beam for some instant mountain top DX into far off repeaters during a vacation . . . perhaps it is a folding beam you can take with you on business trips, packed away in your suitcase . . . this book is packed full of fabulous antenna projects that you can build.

This book, which would normally sell for \$5 or \$6 is being offered for a short while at a pre-publication price of \$2.00 postpaid. Send cash, check, money order . . . or give your Master Charge or Bank Americard number

GREEN PUBLISHING, INC.

Peterborough NH 03458

Name	State	Zip
Address		
City		
BankAmericard or Master Charge No.		
Signature		Exp. date

CIRCUITS, CIRCUITS, CIRCUITS...

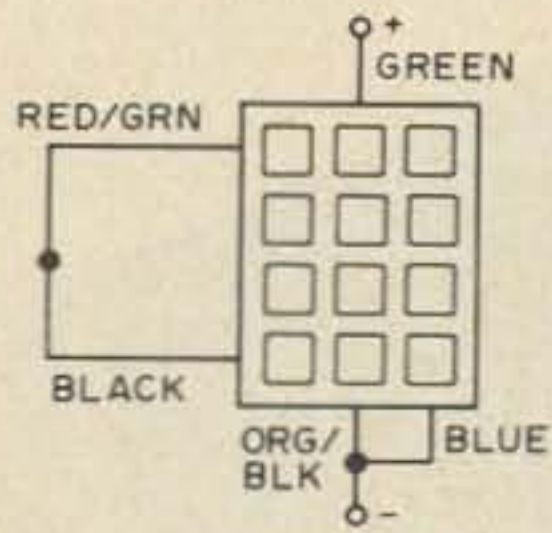

(A) LARGE W.E.

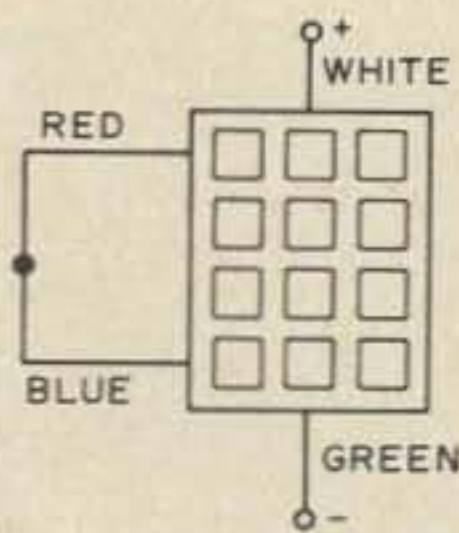

(B) LARGE A.E.

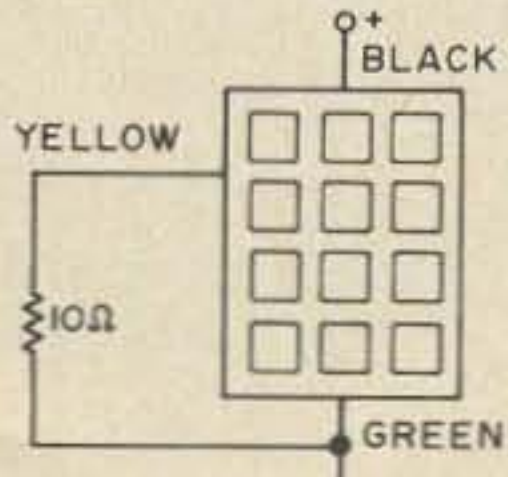

(C) SMALL A.E.

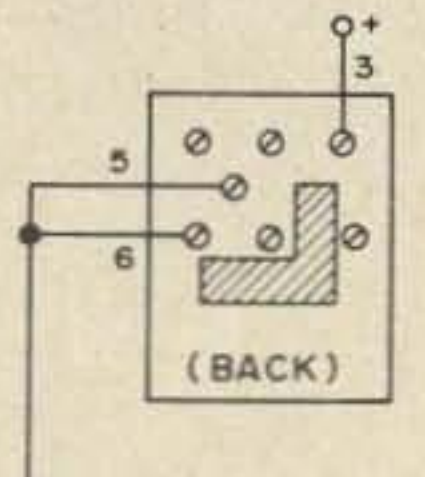

(D) SMALL W.E.

Here are the four most popular TT pads and how to hook them up. Tape all unused leads so they don't short out. Be careful of polarity of the pad and power supply. All pad circuits here from WR9ABN newsletter, Box 342, Ft. Wayne, IN 46801.

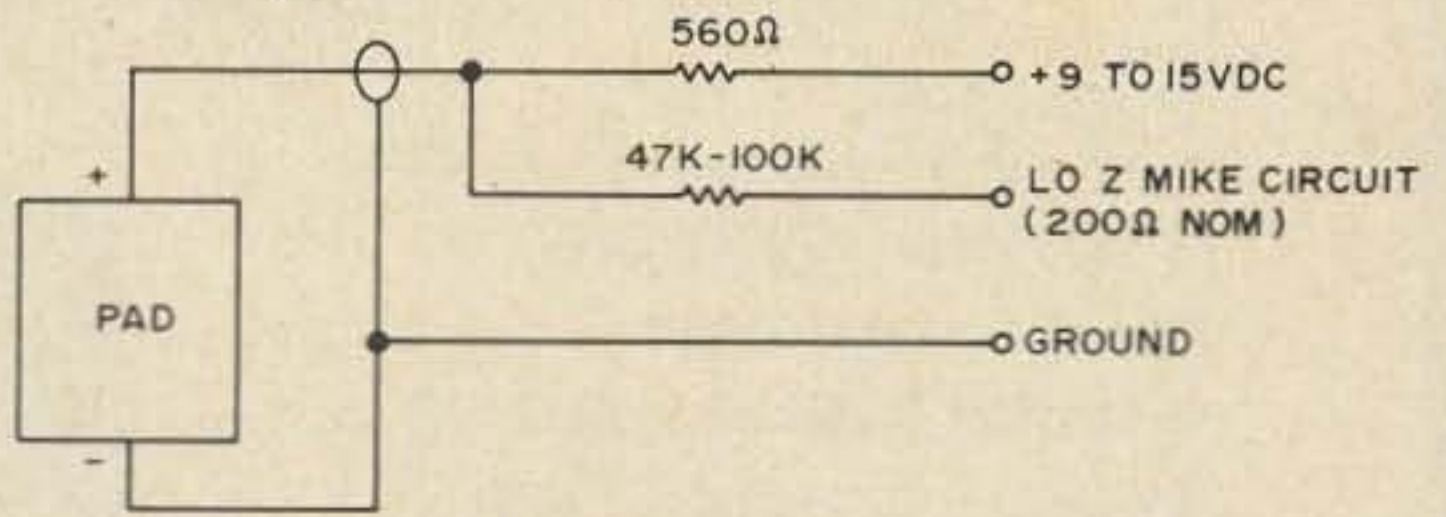

Another low impedance dynamic mike input circuit match for the pad — uses only two resistors and may be wired into the accessory plug — only two leads to the pad. Works with Drake-Trio TR-72 and may work with a few other rigs.

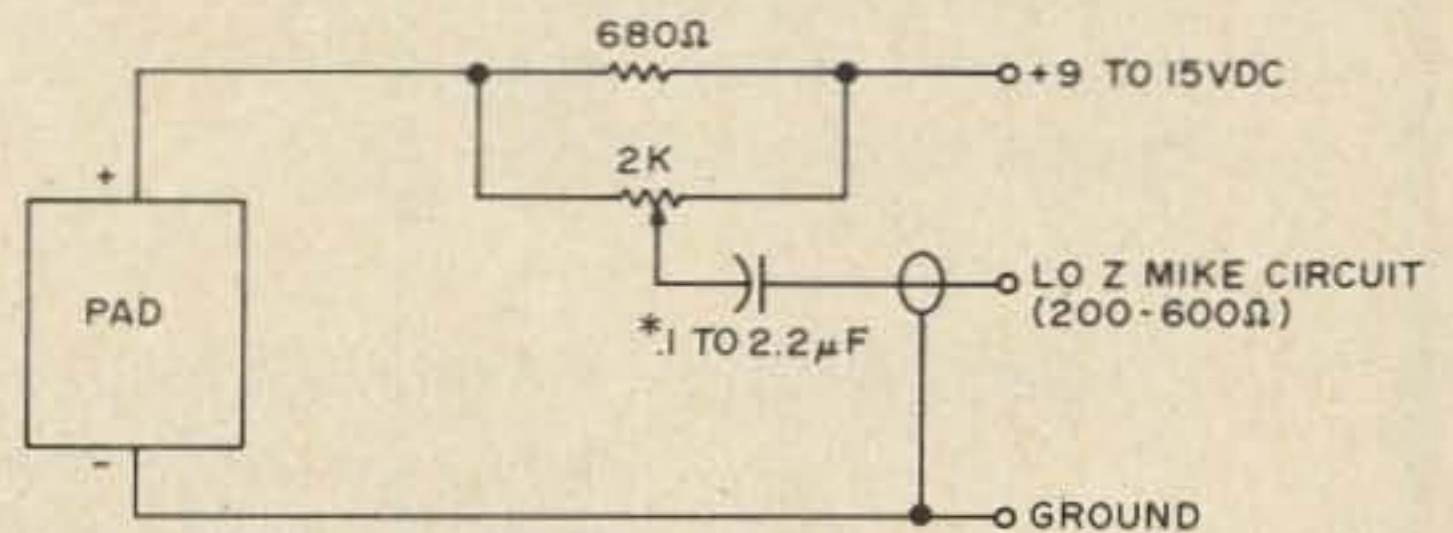

Hooking a pad to a low impedance carbon mike circuit; tube type Motorola, G.E., RCA, Dumont, Aerotron, etc.

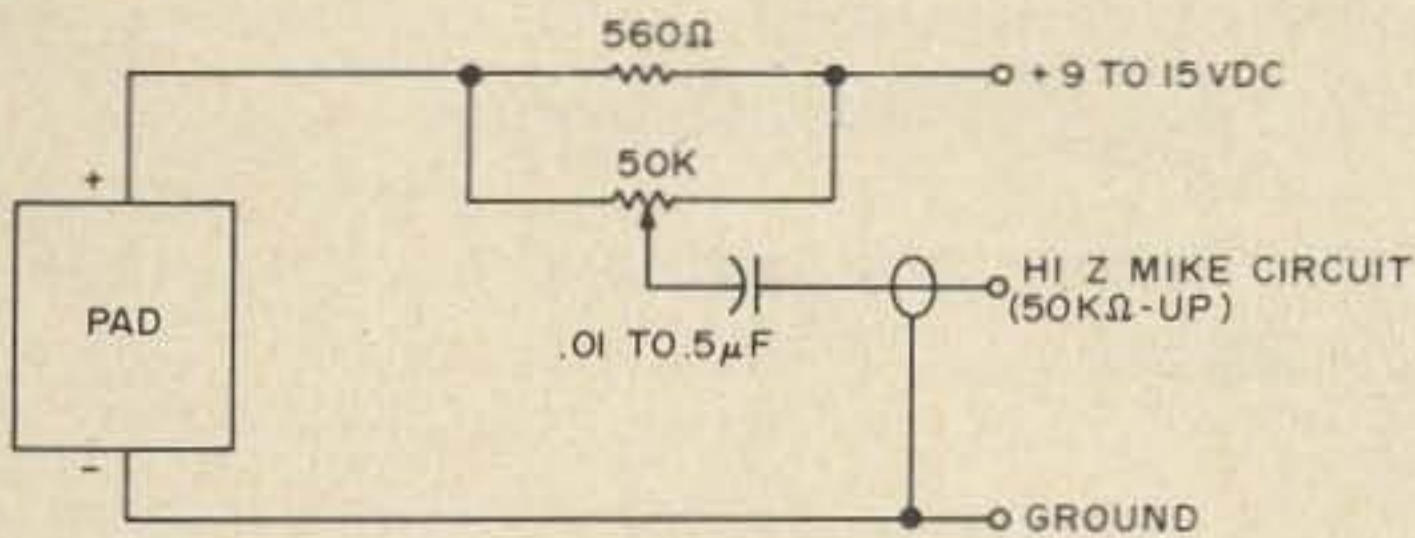

Hooking a pad to a low impedance dynamic mike input circuit such as in the Standard, Icom, Drake-Trio, Clegg, etc.

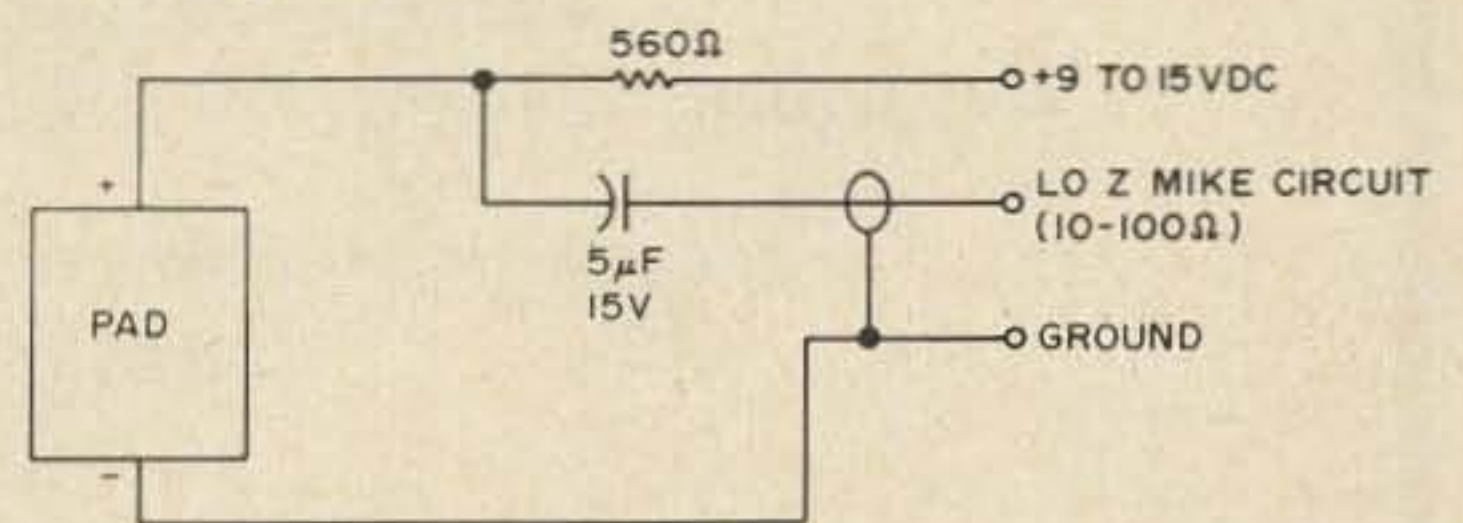

Hooking a pad to a high impedance ceramic mike input circuit — Regency, Genave, etc.

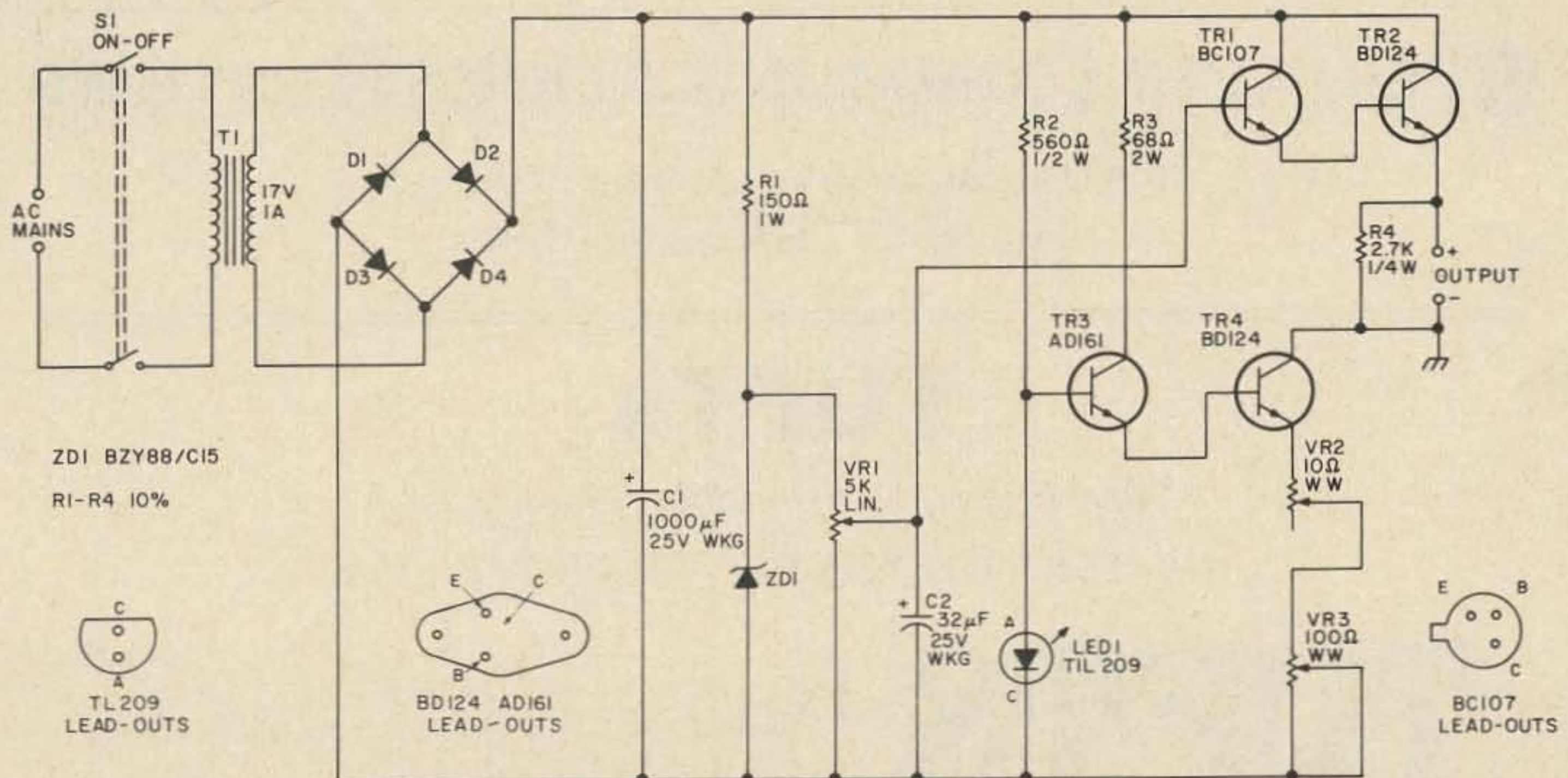

Current limiting power supply. Output voltage is controlled by VR1 and limiting current level by VR3. D1-D4: 2 A silicon rectifiers in metal encapsulation; they may have a piv rating of 100 V or more. (From Radio and Electronics Constructor, February, 1975)

Mobile Amplifiers With Versatility

220 MHz

- 10 W in - 60 W out
- 9 dB linear gain
- Under 1 dB Rx (0.7 dB typ.)

Model #1.3M10 - 60L

144 MHz

- 10 W in - 70 W out
- 10 dB linear gain
- Under 1 dB Rx (0.6 dB typ.)

Model #2M 10-70L



- Both Amps:
- Fully VSWR & reverse voltage protected
 - No tuning required across band
 - Switchable Class C or AB operation
 - Built-in TR switching, w/increased delay for SSB
 - Fully compatible with all 1-15W FM/SSB/AM/CW rigs
 - All solid-state and microstrip construction

Also available: 1-10W, 10-40W and 420-450 MHz linearized amps

*See your local dealer, or write for further information
Dealer inquiries desired*

Dealers

Vegas Radio
1108 S. 3rd
Las Vegas NV 89101

Discount Electronic Supply
Dept M-1, 99 Asylum Ave.
Hartford CT 06105

Gary Radio Inc.
8199 Clairmont Mesa
San Diego CA 92105

SPECIALTY COMMUNICATIONS SYSTEMS

4519 Narragansett Ave., San Diego CA 92107
Louis N. Anciaux WB6NMT, Owner

TUFTS

"New England's Friendliest Ham Store"

INVITES YOU TO SEE THE ABOVE LINE

TUFTS

Radio Electronics

386 Main St., Medford, Mass. 02155

WE'VE GIVEN IT A NEW LOOK!



IC-22A

The front panel and control locations have been changed to make the IC-22A even better looking and easier to operate. The new design allows the use of larger channel numbers which may be

viewed from the left side or right side by reversing the window position and installing a new dial. (optional at nominal cost)

Inside is the same high quality radio construction and engineering that has made the IC-22 the most reliable, most popular two meter crystal controlled set on the market.

When you join 22 channels of capacity (five supplied) with the unexcelled performance of helical RF filtering in the receiver front end then add solid state T-R switching you get one great radio for your money. All the great features that made the IC-22 so desired are still there. Including, 1 watt/10 watt switch option, trimmer capacitors on both receiver and transmitter crystals plus a 9 pin accessory jack with the discriminator already wired for frequency calibration.

New and Used Equipment

RADIO STORE

59th & South Penn, Oklahoma City, Oklahoma

*See us at Oklahoma Ham Holiday and State ARRL Convention Aug. 2-3
South Gate Inn I-35 at S.E. 51st*

NEW PRODUCTS

HEATHKIT HD-1250 SOLID STATE DIP METER

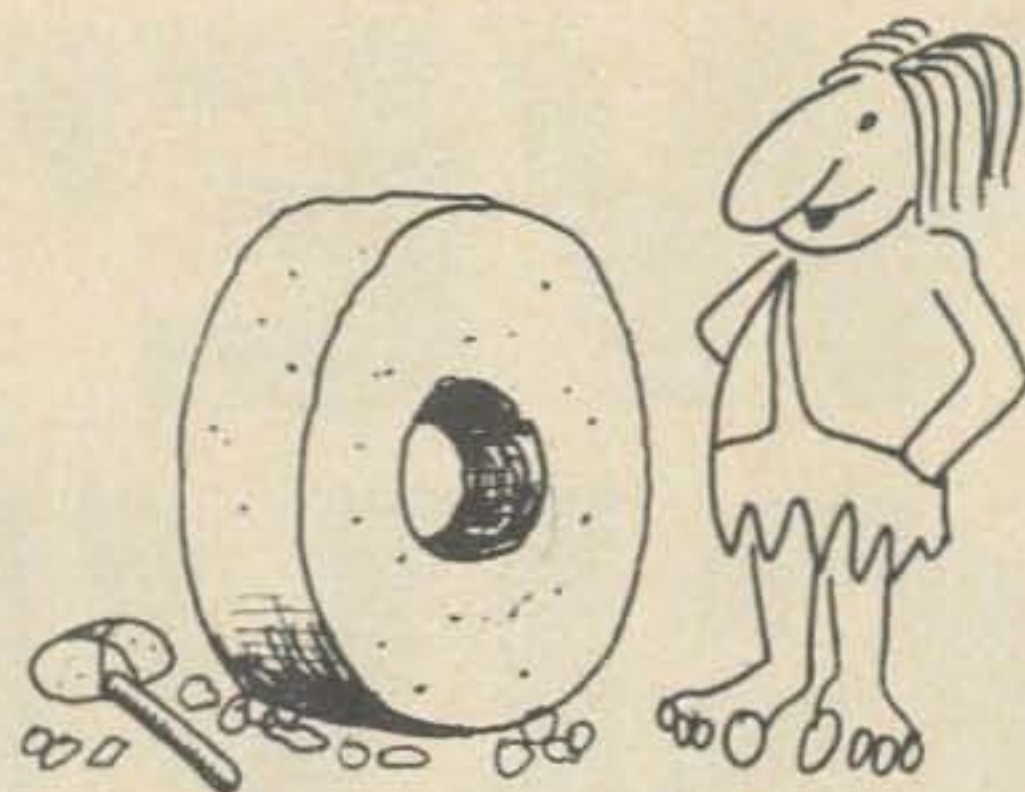

Almost every ham at one time or another finds himself in need of a grid-dipper. For many applications, no other instrument can be used in its place. Even the so-called "appliance operator", who never builds any gear himself, will sooner or later need a dipper to check a tuned circuit or prune his antenna.

Strictly speaking, the old fashioned grid-dipper has gone the way of spark gaps and galena detectors. Modern circuits are solid state and there is no longer a "grid" to "dip". Until lately however, the few dip meters that have been available were either bulky, inconvenient to use due to power requirements, or too expensive.

The new Heathkit HD-1250 Solid State Dip Meter is a winner on all counts, and should prove to be one of the most popular ham-type kits ever produced. Added to the Heath line of products in January of this year, this is an updated and vastly improved version of their old familiar grid-dipper which was discontinued more than ten years ago.

The HD-1250 circuits are comprised of an NPN transistor functioning as a balanced Colpitts rf oscillator, coupled to a broadband amplifier/detector using a dual-gate MOSFET and two hot-carrier diodes. Components are mounted on two small printed circuit boards.

In the injection mode the oscillator generates a signal which is coupled into the circuit under test, and the detector section amplifies and rectifies the voltage impressed across the plug-in tank coil. The average dc value of this voltage is indicated on a 150 microamp meter.

In the absorption mode the oscillator section acts as a Q-multiplier and the MOSFET amplifier boosts weak rf signals to a usable level to provide an indication of relative signal strength. In this application the dipper can be used to neutralize amplifier

stages, check for parasitic oscillations, or measure field strength.

Frequency coverage is 1.6 to 250 MHz in seven ranges. The prewound plug-in coils and precision tuning dial ensure simple calibration of the unit without the necessity of using auxiliary lab equipment. All you need is a receiver to check signal output at several points across the tuning range. Accuracy of the dial calibration at the extreme ends of each band is quite impressive.

Mechanically this new kit is a dream. A compact handful measuring approximately 2" x 2" x 6", the various cabinet panels, chassis and dials fit together in a neat, close-fitting fashion to make up a package which rivals or surpasses the precision finished appearance of many commercial instruments. And the self-contained 9 volt battery allows the dipper to be used for antenna work just as conveniently as on the bench. An added feature is the attractive shock-padded molded carrying case with individual storage slots for each plug-in coil.

The superb assembly manuals

written by the people in Benton Harbor are legendary, and the book furnished with this kit is one of their finest efforts. The detailed step-by-step instructions ensure that even first-time kit builders may put one of these together with full confidence that the unit will operate properly when completed.

Assembly and wiring of the kit took me less than three hours, but I was anxious to get it working so I could tune up an inverted vee that wouldn't load properly on 40 meters. Even at a leisurely pace you can figure on no more than 5 to 6 hours at the outside, including calibration.

The manual also contains 16 full pages of operational information listing many applications for the instrument, with illustrated instructions about various test procedures.

After you get your hands on one, I think you'll agree that the Heathkit HD-1250 Solid State Dip Meter is a real bargain at its modest price of \$59.95. It's sure to become one of the pieces of test gear most used in your Hamshack.

... W6QJM



VHF Engineering

12 and 24 Amp Power Supplies

High current power supplies are an absolute requirement in commercial two-way radio shops and are now on the verge of becoming a requirement in the ham shack. Most of the new equipment being released for the amateur market for the LF/VHF/UHF bands is of solid state design and thus designed for 12 V operation either mobile or from a fixed station 12 V supply. The 12 V fixed station supply has in the past been a problem, since high current, well regulated supplies tend to be complex and expensive to build while commercially available supplies are even more expensive and are frequently in short supply. VHF Engineering, of Binghamton, New York, has recently announced two inexpensive solid state 12 V power supply kits which are simple to construct and can be used in either

commercial or amateur applications to power LF/VHF/UHF equipment in the repair shop or in the base station. The power supplies may be used with FM, SSB or other equipment requiring pure 12 V dc at currents up to 24 A.

The circuit for both power supplies consists of a full wave dc current source feeding a capacitive filter network and an integrated circuit regulator (Signetics NE550). The IC regulator controls a set of pass transistors and keeps the output voltage consistent to within 2% over a load range of from 0 to 20 Amps (0 to 10 Amps on PS12). Both power supplies have large heat sinks mounted on the back of the cases to dissipate the heat produced by the pass transistors. The 12 Amp supply is rated at 10 Amps continuous or 12 Amps for 50% intermittent duty. The 24 Amp supply is

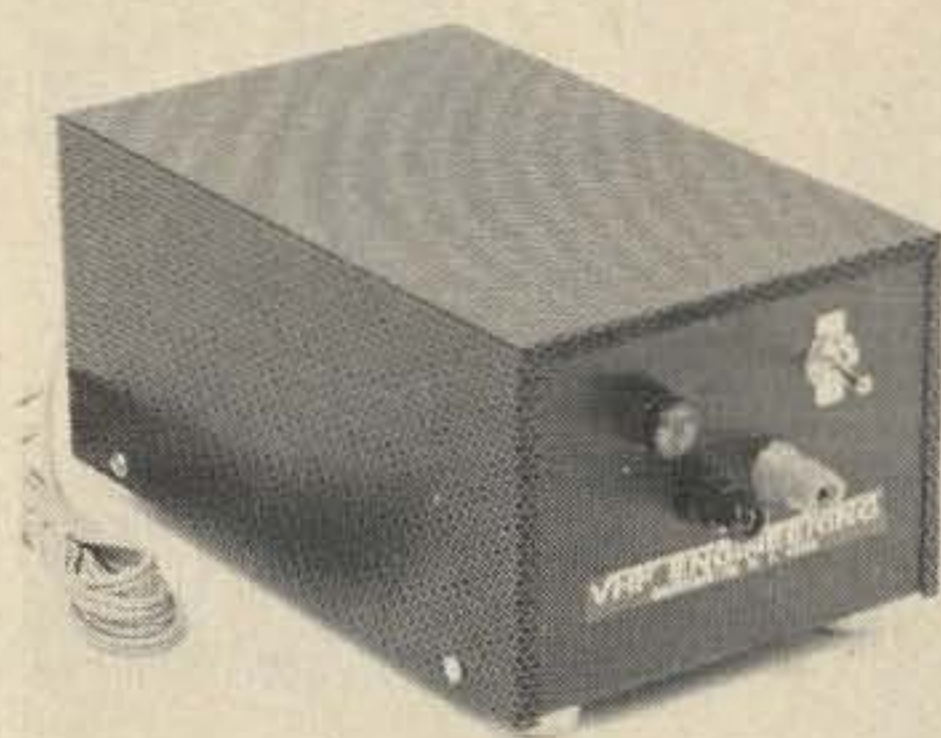

PS-12.

rated at 20 Amps continuous or 24 Amps for 50% intermittent duty. Current limiting is provided to prevent damage to the supply in the case of an accidental short circuit. In the event of a short circuit across the power supply terminals, the output voltage drops to a low value and the output current is limited to a maximum of either 12 or 24 Amps (depending on supply) until the short is removed. When the short is removed, the output voltage rises to the nominal 12 volt value.

The output voltage of the supplies may be adjusted over a nominal range from 12-15 V. Both supplies may be utilized as general purpose, variable voltage supplies by replacing the voltage controlling resistor by a 10k Ohm pot.

The VHF Engineering power supply kits are supplied in kit form complete with all parts, computer grade capacitor, epoxy glass circuit boards, styled case, and complete instructions. Average construction time is an evening or less.

The uses of these quality power supplies are endless. A large number of commercial two-way radio firms are using the VHF supplies both as bench supplies and as supplies for commercial repeaters. Amateurs are using the supplies for powering solid state SSB at the home shack, and one of the biggest uses is for the FM operator. The FM operator can operate the mobile transceiver and the mobile power amplifier from the base by using one of the VHF Engineering supplies. These supplies are also being used in a large number of amateur repeaters.

The VHF Engineering power supplies are available from VHF Engineering, 320 Water Street, Binghamton NY. They cost \$69.95 and \$99.95 for the PS12C and PS24C kits, respectively. They are available wired and tested for \$85.95 and \$114.95, respectively.

... W1HCl

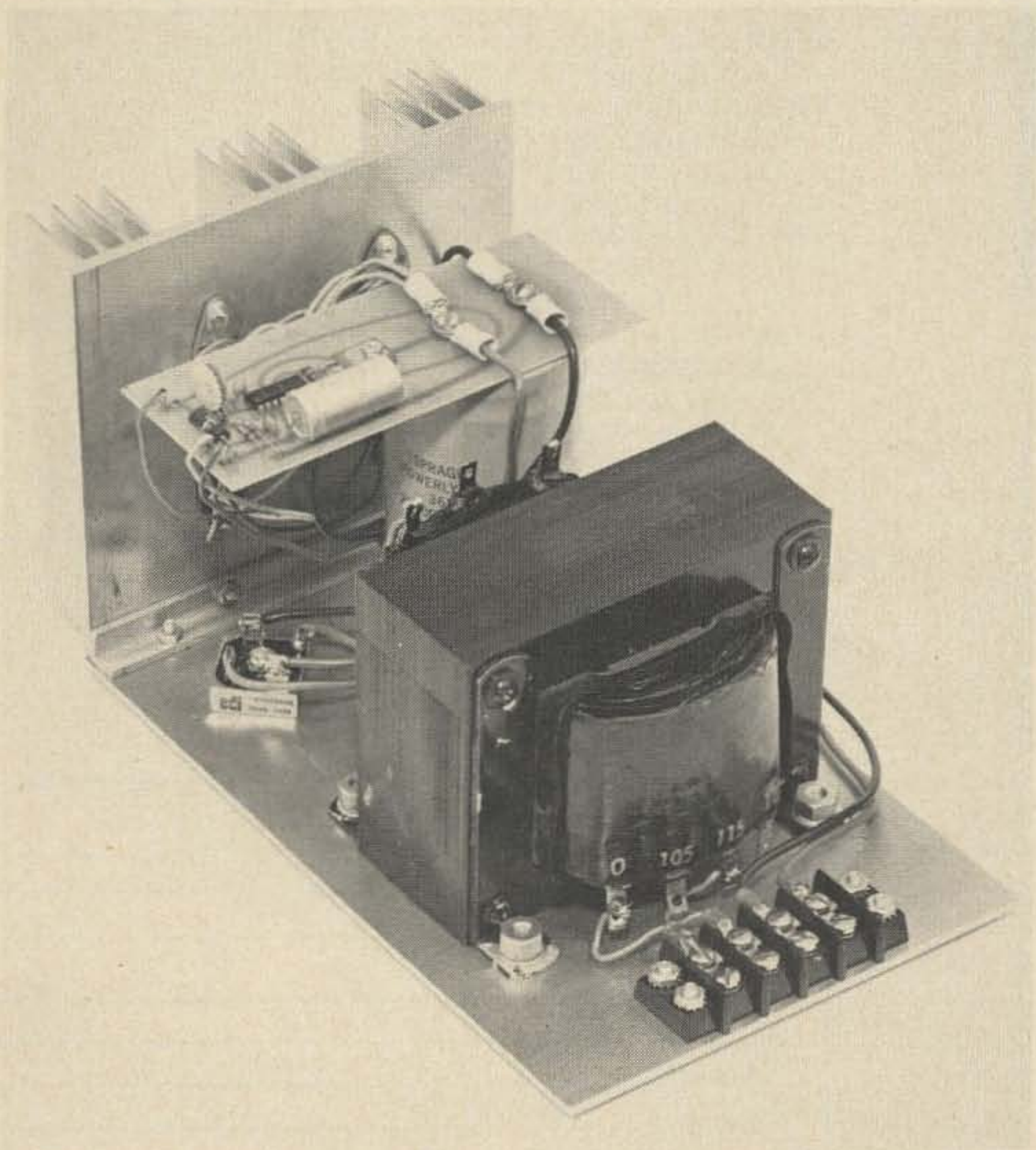

PS-24.

Wilson Electronics

FACTORY DIRECT

Special JULY SALE !!!

WILSON 1402SM HAND HELD 2.5 WATT FM TRANSCEIVER

- * Rubber Flex Antenna
- * Complete Set NiCad Batteries
- * Leather Case
- * Three Sets of Crystals, 52-52,

Plus Your Choice Of 2 Pair of Common Frequencies
Extra Crystals, \$4.50 ea., Common Frequencies Only

\$ 320 VALUE ALL FOR JUST **\$ 199⁹⁵**

- 6 Channel Operation, Individual Trimmers On All TX and RX Xtals. All Xtals Plug In.
- S Meter Battery Indicator.
- 10.7 IF and 455 KC IF. 12 KHz Ceramic Filter.
- .3 Microvolt Sensitivity For 20dB QT.
- 2.5 Watts. Nominal Output 12 VDC.
- Microswitch Mike Button.
- Size 8-7/8 x 1-7/8 x 2-7/8 Inches.
- Weight 1 lb. 4 ounces. Less Battery.
- Current Drain RX 14MA TX 380 MA.

ACCESSORIES:

- SMI Speaker Mike \$24.00
- BCI Battery Charger \$29.95
- 1410A Amplifier Mobile Mount \$99.00
- 10.7 MHz monolithic IF filter (installed) \$10.00

To: Wilson Electronics
P.O. Box 794
Henderson, Nevada 89015
(702) 451-5791

Ship me 1402 July Package
Plus SM1 1410A BC1

Enclosed is \$ _____ Check Money Order
 Master Charge Bank Americard
Expiration Date _____ M/C Interbank # _____
Card # _____

Xtals _____

Name _____

Address _____

City and State _____ Zip _____

Signature _____

All orders will be shipped Parcel Post within 48 hours after receipt of order (excluding weekends). Enclose additional \$4.00 for prepaid shipping & handling. Nevada residents add sales tax.

Sale ends July 31st.



90 DAY WARRANTY
10 DAY MONEY BACK GUARANTEE
CAN BE MODIFIED FOR ARMY MARS

Wilson Electronics



WILSON 204 MONOBANDER

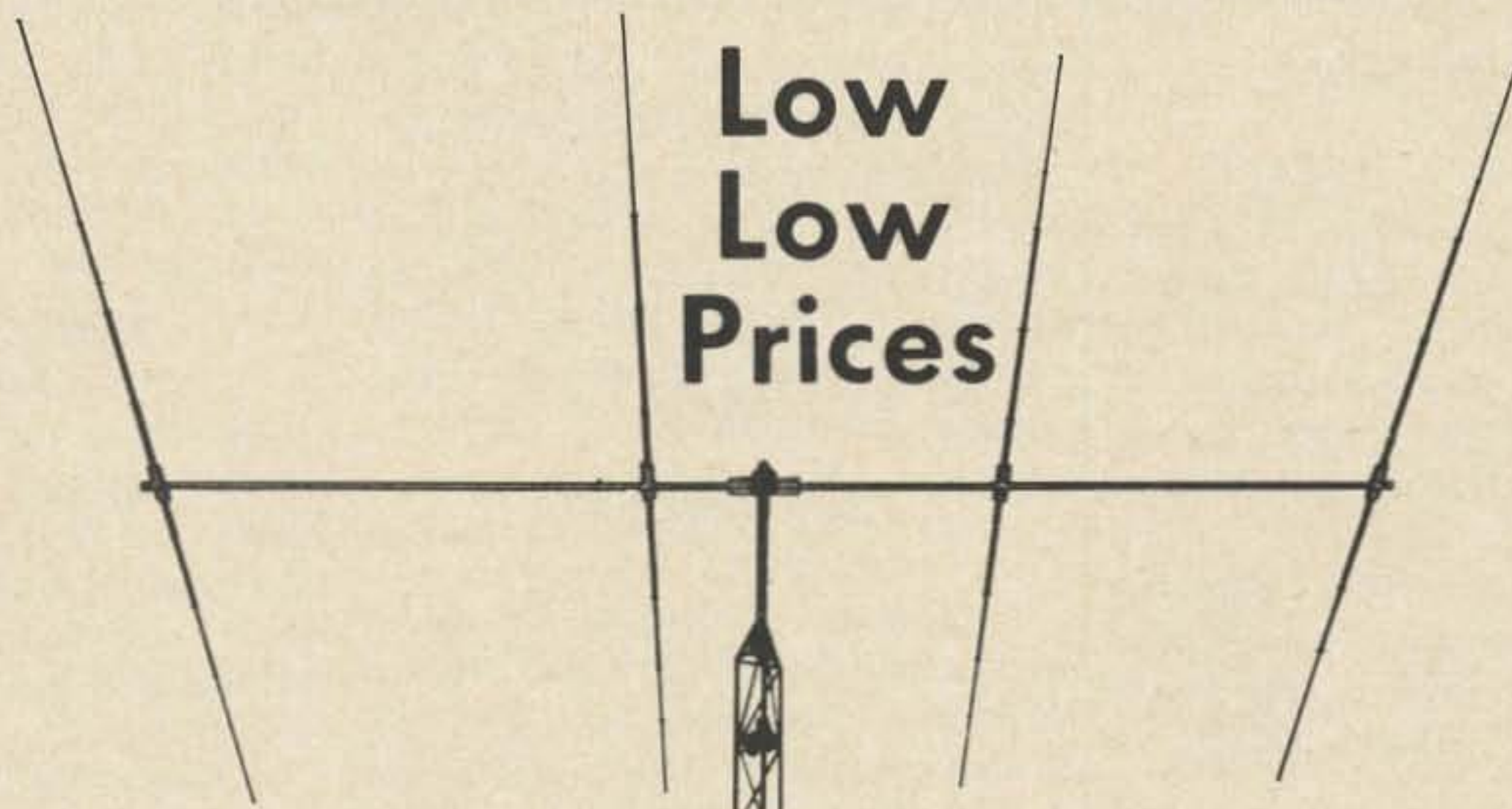

The Wilson 204 is the best and most economical antenna of its type on the market. Four elements on a 26' boom with Gamma Match (No balun required) make for high performance on CW & phone across the entire 20 meter band.

The 204 Monobander is built rugged at the high stress points yet using taper swaged slotted tubing permits larger diameter tubing where it counts, for maximum strength with minimum wind loading. Wind load 99.8 lbs. at 80 MPH. Surface area 3.9 sq. ft., Weight 50 lbs., Boom 2" OD.

All Wilson Monoband and Duoband beams have the following common features:

- Taper Swaged Tubing
- Full Compression Clamps
- No Holes Drilled in Elements
- 2" or 3" Aluminum Booms
- Adjustable Gamma Match 52Ω
- Quality Aluminum
- Handle 4kw
- Heavy Extruded Element to Boom Mounts

- **M204** 4 ele. 20, 26', 2" OD
- **M203** 3 ele. 20, 20', 2" OD
- **M155** 5 ele. 15, 26', 2" OD
- **M154** 4 ele. 15, 20', 2" OD
- **M105** 5 ele. 10, 20', 2" OD
- **M106** 6 ele. 10, 26', 2" OD
- **M104** 4 ele. 10, 17', 2" OD

- **M340** 3 ele. 40, 40', 3" OD
- **M240** 2 ele. 40, 16', 3" OD
- **M520** 5 ele. 20, 40', 3" OD
- **M715** 7 ele. 15, 40', 3" OD
- **DB45** 4 ele. 15, 5 ele. 10, 26', 2" OD
- **DB43** 4 ele. 15, 3 ele. 10, 20', 2" OD
- **DB54** 5 ele. 20, 4 ele. 15, 40', 3" OD

All Wilson Antennas are FACTORY DIRECT ONLY! The new low prices are possible by eliminating the dealer's discount. All antennas in stock. If you order your antenna during January you may purchase a CDR Ham II for \$109.00 or a CDR CD44 for \$69.00. Order by Phone, COD. All 2" Boom antennas shipped UPS or PP. 3" by truck.

Wilson Electronics Corporation

P. O. BOX 794 HENDERSON, NEVADA 89015

702-451-5791

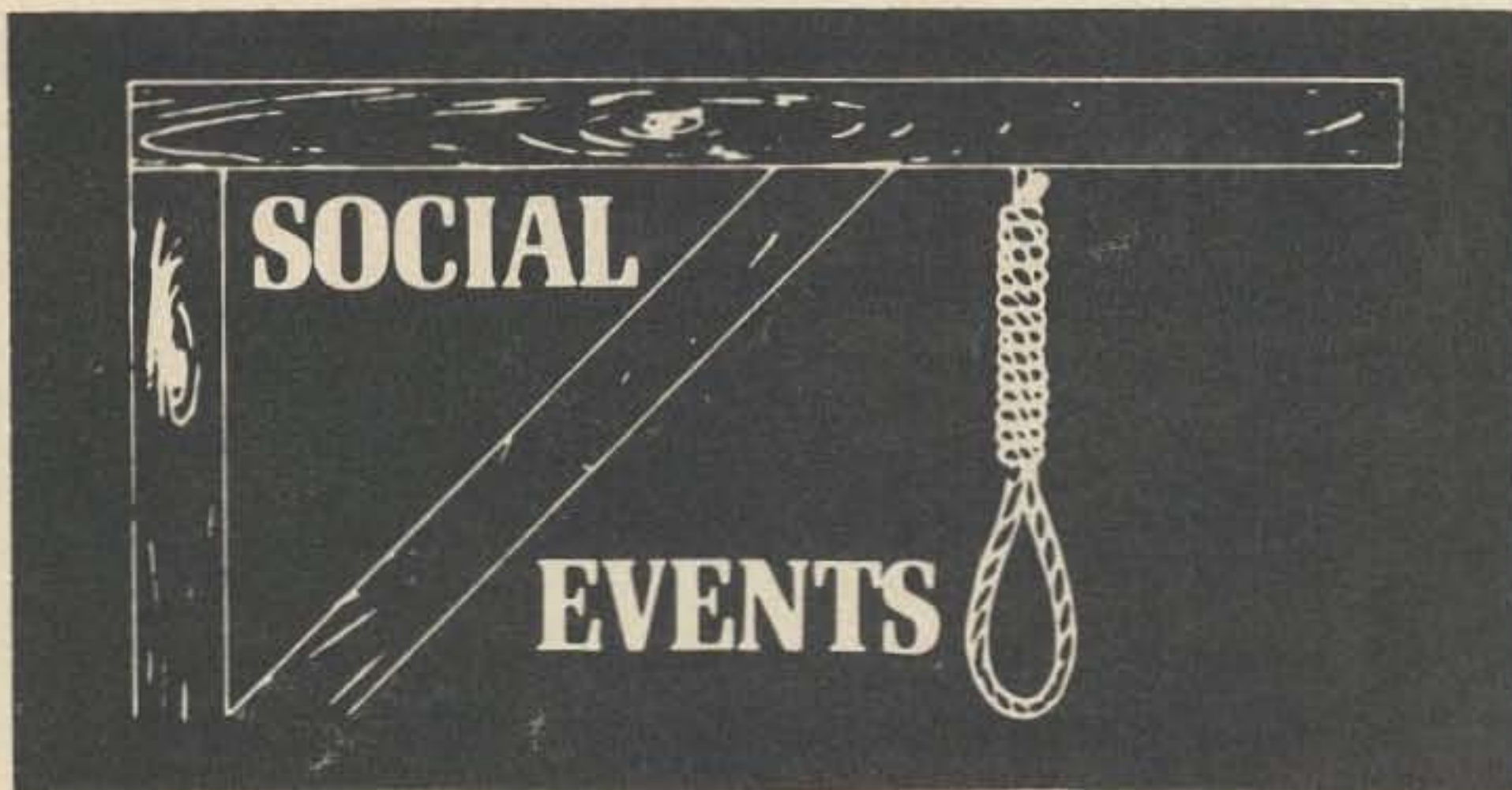

HEAR PROSE SPEAK

(or)

"HERE, PROSE . . . SPEAK!"

Spend the Fabulous Fourth of July weekend at the 47th annual Atlanta Ham Radio Festival and ARRL Georgia State Convention. Center of activity will be the Royal Coach Motor Inn, I-75 North, July 5th and 6th.

Highlight of the Festival will be the Saturday night banquet with Keynote Speaker, FCC's A. Prose Walker whose topic will be, "Docket 20282 — Restructuring."

Activities cover all phases of amateur radio including ARRL Forum, FCC examinations, biggest flea market and manufacturer's display in the south, special events for XYLs and Junior OPs, Sunday afternoon grand prize drawing, MARS meetings, technical programs, something of interest to every ham and his family.

Pre-registration — \$2 per person or \$4 per family (\$3 or \$5 at hamfest). Special hamfest motel rates \$16 single and \$21 double (children under 13 free).

For more info write: Atlanta Ham Radio Festival, P.O. Box 76553, Atlanta, Georgia 30328.

VANCOUVER BC

JULY 11-13

Maple Ridge Hamfest is being held on July 11, 12 and 13 at the Maple Ridge Fairgrounds approximately 30 miles east of the city of Vancouver on the north side of the Fraser River. The hamfest includes: Technical seminars and displays; contests for the women and children, as well as the OMs; a hidden transmitter hunt; mobile judging; technical IQ quiz; home brew equipment contest; commercial displays; two meter home brew antenna contest; Saturday evening meal. Registration: At the door, \$3.00 no meal, \$7.00 with Saturday meal. Pre-

registration available for \$6.00, cutoff date June 30. Overnight parking for trailers and campers plus spaces for tents available for \$2.00, but no hook-ups. VE7MRC will be monitoring 146.94, 146.76, 146.79, 147.33 and 3970, 3755 for talk-in purposes from 1600 July 11 on.

OAK CREEK MI

JULY 12

The South Milwaukee Amateur Radio Club 5th annual Southeastern Wisconsin Swap-Fest will be held Saturday, July 12, 1975 at Shepard Park (American Legion Post 434), 9327 South Shepard Avenue, Oak Creek MI. Activities begin at 7 am to 5 pm or later. Admission \$1.00, includes a "happy hour" with free beverages. Prizes will be awarded. Talk-in on 146.94 MHz FM. For more details write South Milwaukee Amateur Radio Club, S. F. Schreiter W9AKF, Sec., 104 Brookdale Drive, South Milwaukee WI 53172.

CHARLESTON SC

JULY 12-13

The Charles Town Hamfest will be held on July 12-13, 1975 in Charleston, South Carolina. For more information write: P.O. Box 12502, Charleston SC 29412.

INTERNATIONAL PEACE

GARDEN

JULY 12-13

The 12th Annual International Hamfest is scheduled for July 12 and 13, 1975 at the International Peace Garden between Dunseith, North Dakota and Boissevain, Manitoba. For further information contact: John McCann WB0FUO, 1234 Valley View Dr., Minot ND 58701.

CARY NC

JULY 19

The Cary ARC will hold the third annual Mid-summer Swapfest, Satur-

day, July 19, 9 am — 3 pm. A la carte cookout, 11:30 am. Auction, 12:30 pm. Doorprize drawing, 2 pm. No commissions charged. Talk-in 146.04/64, 146.22/82, 146.28/88, and 222.34/223.94. At Lions Club Shelter, Cary, NC (near Raleigh). For info, SASE to K4FBG, 1022 Medlin Drive, Cary NC 27511.

CROSSVILLE TN

JULY 19-20

The Oak Ridge Amateur Radio Club, Inc. Annual Crossville Hamfest is July 19-20 at Crossville TN. July 19 highlights are technical forums and a banquet; July 20 features a picnic, flea market and a raffle of many prizes. Events will be held at the local Holiday Inn and at nearby Cumberland State Park.

McKEESPORT PA

JULY 20

The Two Rivers Amateur Radio Club of McKeesport, Pa., will hold their 11th Annual Hamfest on July 20, 1975 at the Green Valley Volunteer Fire Station Grounds off the East Pittsburgh-McKeesport Blvd. Talk-in on 146.52, .22/.82 and 29.00 MHz. For further info, contact Donald J. Myslewski K3CHD, 359 McMahan Road, North Huntingdon PA 15642.

PHILADELPHIA PA

JULY 23-25

The ARRL Atlantic Division Convention will be held on July 23-25, 1976 in Philadelphia at the huge Benjamin Franklin Hotel. This is expected to be a very large gathering. Firms wishing to exhibit should contact Ken Miller W2KF, 309 Cherry Hill Blvd., Cherry Hill NJ 08034.

FLAGSTAFF AZ

JULY 25-27

Ft. Tuthill Summer Hamfest, Coconino County Fairground. Flea market, contests, social activities, pot luck, etc. Grand prize: FT-101B. Location: South of Flagstaff on I-17 across from airport. Talk-in on 146.94 and 3992.

OKANAGAN VALLEY

CANADA

JULY 26-27

The 25th Anniversary Okanagan International Hamfest will be held July 26th and 27th, 1975 at Gallagher Lake KOA Campsite — 8 miles North of Oliver, B.C. Canada. Grand prize raffle draw: IC-22A. Prizes, entertainment for hams, XYLs, YLs and harmonics and visitors. Call-in frequencies: 3800 on 75 M, 34/94 OKN Rpter, 76/76 Simplex on 2M. Regis-

tration: 9 am PDT, Saturday July 26th. Activities: 1 pm PDT, Saturday — 2 pm PDT, Sunday. For more information contact: Kirk Carter VE7DV, 450 Vista Rd, Kelowna, B.C.

**TRAVERSE CITY MI
JULY 27**

The Cherryland Amateur Radio Club annual family picnic and trunk swap and shop welcomes all Northern Michigan hams to their picnic July 27 at Whitewater Township Park in Williamsburg (just outside of Traverse City). Bring your wife and kids, your food and drinks, and be prepared for a good old fashioned picnic with boating, fishing, swimming, swings and play for children, lots of picnics tables and grills, a pavilion and a place for pop to park his trailer overnight. It's a freebee — no charges — for details write to W8GI, Box 176, Kingsley, Michigan 49649.

**ROCKVILLE IN
JULY 26-27**

The 28th annual Turkey Run Hamfest and VHF Picnic sponsored by the Wabash Valley ARA, Inc., will be held Sunday, July 27, at Turkey Run State Park near Rockville, Indiana. Don't miss the midwest's finest flea market. XYL Bingo, refreshments, camping facilities and park recreation for the kids. Also this year, banquet July 26, 7:30 pm featuring guest speaker W9NTP, in park dining hall. Banquet by reservation only, \$6.50/person. Activities begin 9 am Sunday, talk-in 146.94 W9UUU/9. For more info SASE WVARA Hamfest, Box 81, Terre Haute IN 47808.

**TEMPLE TX
AUG 1-3**

The Texas VHF-FM Society will hold its Summer Convention 1975 Aug 1, 2 and 3 at The Ponderosa Inn in Temple, Texas. This year's convention will be the best ever with the featured speaker Mr. A. Prose Walker, Chief of the Amateur and Citizens Division of the FCC. There will also be equipment displays, technical sessions, a swap-fest, ladies activities and many, many prizes. For more information contact the Temple VHF Repeater Association, PO Box 23, Temple, Texas 76501.

**OKLAHOMA CITY OK
AUG 2-3**

The Oklahoma Ham Holiday and State ARRL Convention will be held Saturday and Sunday, August 2 and 3 in Oklahoma City OK. In addition to the largest flea market in the Southwest, the program will include special

programs, technical seminars, equipment displays. MARS meetings and unique activities for the XYL. For information and advance registration write Oklahoma Ham Holiday, P.O. Box 20567, Oklahoma City OK 73120.

**MONTREAL
AUG 3**

Montreal Hamfest 75 will be held on August 3, 1975, at MacDonald College Farm, Ste. Anne de Bellevue. Prizes, giant fleamarket, technical sessions, family fun. Adults \$2.50. For information contact: VE2RM, Box 201, Pointe Claire-Dorval, Quebec H9R 4N9.

**LEVELLAND TX
AUG 3**

The Tenth Annual Northwest Texas Emergency Net Swapfest and Picnic will be held in the City Park at Levelland, Texas on Sunday, August 3, 1975. Bring your own picnic basket. Free registration begins at 0900. Lunch at 1300. Swapping all day. This event is for the entire family. Mobile talk-in is the net frequency of 3950 kHz and via the Levelland Repeater (WR5AFX), on 28-88.

**CANTON OH
AUG 3**

Hall of Fame Hamfest and Auction rain or shine, Aug 3, 1975, Canton, Ohio. Come to Canton for football's greatest weekend. Saturday's activities — parade, enshrinement, NFL game Cincinnati vs Washington. Sunday — hamfest and auction at Stark County Fairgrounds. Main prizes — ICOM 230 — Hallicrafters FPM 300 — Standard 2 mtr hand held. For more info write WA8SHP, 73 Nimishillan St., Sandyville OH 44671 or call W8SWB at (216) 455-4449.

**UPPER ST CLAIR PA
AUG 3**

The 38th Annual Hamfest of the South Hills Brass Pounders and Modulators will be held on August 3rd, from noon till dusk, at St. Clair Beach, Upper St. Clair Township, 5 miles south of Mt. Lebanon on route 19. Swap and shop, picnic space and swimming for the family. Mobile check in on 29.0, 52 simplex and popular 2 meter frequencies. Information and pre-registration at \$1.50 per ticket (\$2 at door) from Fred Schreiber, 181 County Line Road, Bridgeville PA 15017.

**WASHINGTON MO
AUG 3**

The Zero-Beaters ARC will hold their annual hamfest on Sunday,

August 3rd, at the Washington, Missouri city park. Free parking, auction, and bingo for the XYLs. No admission fee or fee for parking in the traders row. Many prizes including IC-22A, station accessories, books and a handmade quilt. For info or tickets contact Kevin Weiskopf WBØMNP, or Zero-Beaters ARC, WAØFYA, Box 24, Dutzow MO 63342.

**FLOURTOWN PA
AUG 10**

The Mt. Airy VHF Radio Club (The Pack Rats) will hold their 19th Annual Family Day & Picnic on Sunday, August 10, 1975 (rain date August 17th) at the Fort Washington State Park, Flourtown PA. The Delaware Valley chapter of QCWA will again join us in the festivities. All hams and their families are cordially invited. Games and entertainment, free prizes to the kiddies, free soda. Talk-in on 52.525 MHz FM — 146.52 MHz FM — 222.98/224.58 MHz FM repeater. Registration \$2 per family.

**WILLOW SPRINGS IL
AUG 10**

The 41st Hamfest and Picnic will be held Sunday, August 10, 1975, Santa Fe Park, 91st and Wolf Road, Willow Springs, Illinois, Southwest of Chicago. Exhibits for OMs and XYLs, famous swappers row. Information contact John Raiger K9DRS, 8919 West Golfview Drive, Orland Park, Illinois 60462. Tickets write Joseph Poradyla WA9IWU, 5701 South California, Chicago IL 60629.

**YANKEE LAKE OH
AUG 17**

The Warren Hamfest will be held Sunday, August 17, Yankee Lake, Ohio, on Rt. 7 five miles north of I80. Dealers' displays. Swimming and picnicing. Giant flea market (Vendor's fee: \$1 plus reg.) A \$3 reg includes: Door prize, main prize and XYL tickets. More info: Hamfest, PO Box 809, Warren OH 44482.

**DECATUR AL
AUG 17**

The Decatur Amateur Radio Club will host the North Alabama Hamfest in Decatur, Alabama on Sunday, August 17, 1975. Location is the campus of Calhoun Junior College at the Decatur-Athens Municipal Airport. Doors will open at 8 am. Tickets \$1.00 each will be available at door or in advance from Ken Hixon WB4NLN, P.O. Box 9, Decatur AL 35601. Talk-in on 34-94 and 3.965 MHz.

Specializing in VHF-UHF FM & SSB Equipment



IC-22A \$249.00 ppd.

Supplied with
Seven channels
94/94 39/94
22/82 28/88
52/52

Plus TWO channels
of your choice.
Additional channels
\$9.95 installed

THE PREMIUM 2 METER FM TRANSCEIVER

IC-230 \$489.00 ppd.

SAVE \$50.00!

Purchase an ICOM for \$489 with no-trade, and you may apply \$50 credit towards the purchase of accessories below.



IC-230

For the Mobile —

KLM PA10-70B 70W 2M Ampl	\$129.95
KLM PA10-140B 140W 2M Ampl	\$189.95
Hustler CGT-144 5.2dB Colinear, trunk lip mount	\$39.95
Hustler CG-144 5.2dB Colinear, 3/8 thread	26.75
Larsen LM-150K 3dB 5/8 wave	\$28.35
Larsen LM-150 on Magnetic Mount	\$35.00

For the Ham Shack —

KLM 144-148-12 12el DX Beam	\$49.95
KLM 144-148-16 16el DX Beam	\$54.95
KLM Baluns (optional, recommended)	\$13.95
KLM 2 Antenna Combiner	\$19.95
Cushcraft ARX-2 Ringo Ranger	\$26.50
Cushcraft A147-11 11el Beam	\$23.95
Cushcraft A147-22 Stacked 11's	\$68.50

We Ship!

Allow \$3.00 shipping per antenna or amplifier.

Our in-depth stock assures filling orders the same day received. We ship UPS or best way. For fast shipment we suggest 1. Cashier's check or MO., 2. C.O.D. (\$15 deposit), 3. BankAmericard, 4. Master Charge. California residents add 6% sales tax.

Westcom

BOX 1020 • ESCONDIDO • CAL • 92025 • (714) 744-1395



A head start on the future

Midland's 220 MHz mobile transceiver puts you into this fast developing band for less than you might think. 10-watt output power, 12-channel capability with crystals for 223.5 simplex, plus these professional performance features...

A dual conversion receiver with complete multiple FET front end coupled with high-Q helicalized cavity resonators • Zener regulated, crystal controlled first and second oscillators • 10-watt output power transmitter (switchable to 1 watt) with zener regulated crystal oscillator • High-Q and shielded stages for minimal interstage reaction • Encased low-pass filter • VSWR bridge and four DC amplifiers to monitor output and give instant automatic protection • Accessory jack for tone burst and discriminator filter • Swing-up circuit board for easy access to all sections... all modules easily removable • Operation on 13.8 volts DC, negative ground • Compact steel case 2 1/4" h. x 6 3/8" wide x 8 7/8" d. Complete with mike, mounting bracket and hardware.

Midland's exclusive
added ingredient

R.S.V.P.

Positive, practical support
for *your* repeater service
when you buy any Midland
amateur mobile transceiver.

Write for free Midland Amateur
Radio Catalog... see why
"COMMUNICATIONS IS OUR
MIDDLE NAME"

MIDLAND[®]
INTERNATIONAL
Communications Division

P.O. Box 19032
Kansas City, Missouri 64141

MODEL 13-509



CIRCUITS, CIRCUITS, CIRCUITS...

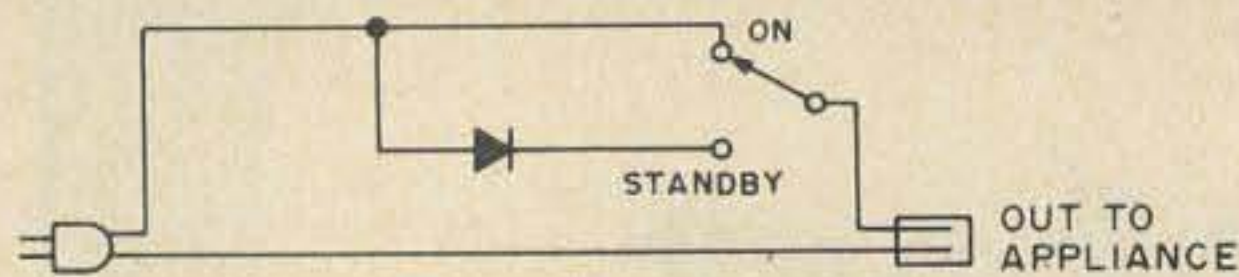

Instant on for ac/dc radios and tv's. On standby about 60 Volts goes through, keeping the filaments slightly warm so they will heat up immediately when full ac is applied. Do NOT use this circuit on equipment with a power transformer. Note: tube life is extended when the filaments are not permitted to cool off. Added note: watch that polarity. —WA3SWS

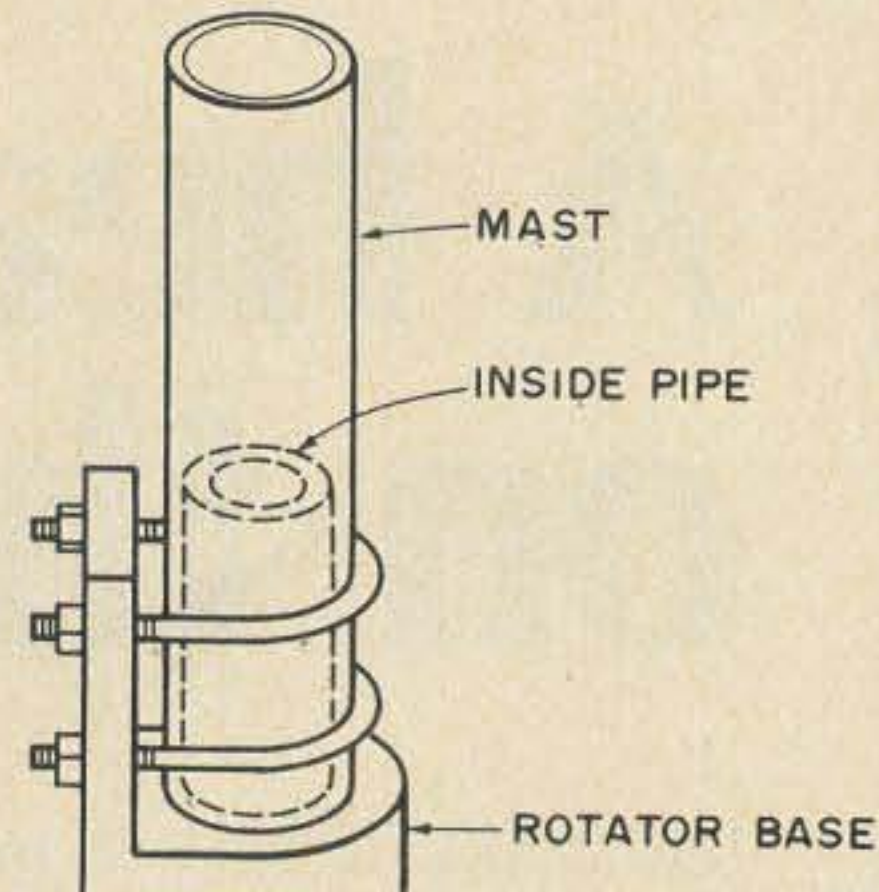

TV type masts are inexpensive and made of thin metal. Rotor clamps tend to crush the mast. Prevent this by inserting iron gas pipe of next smaller dimensions where clamps make contact. Coat with rust preventative. Tnx WAØKKC.

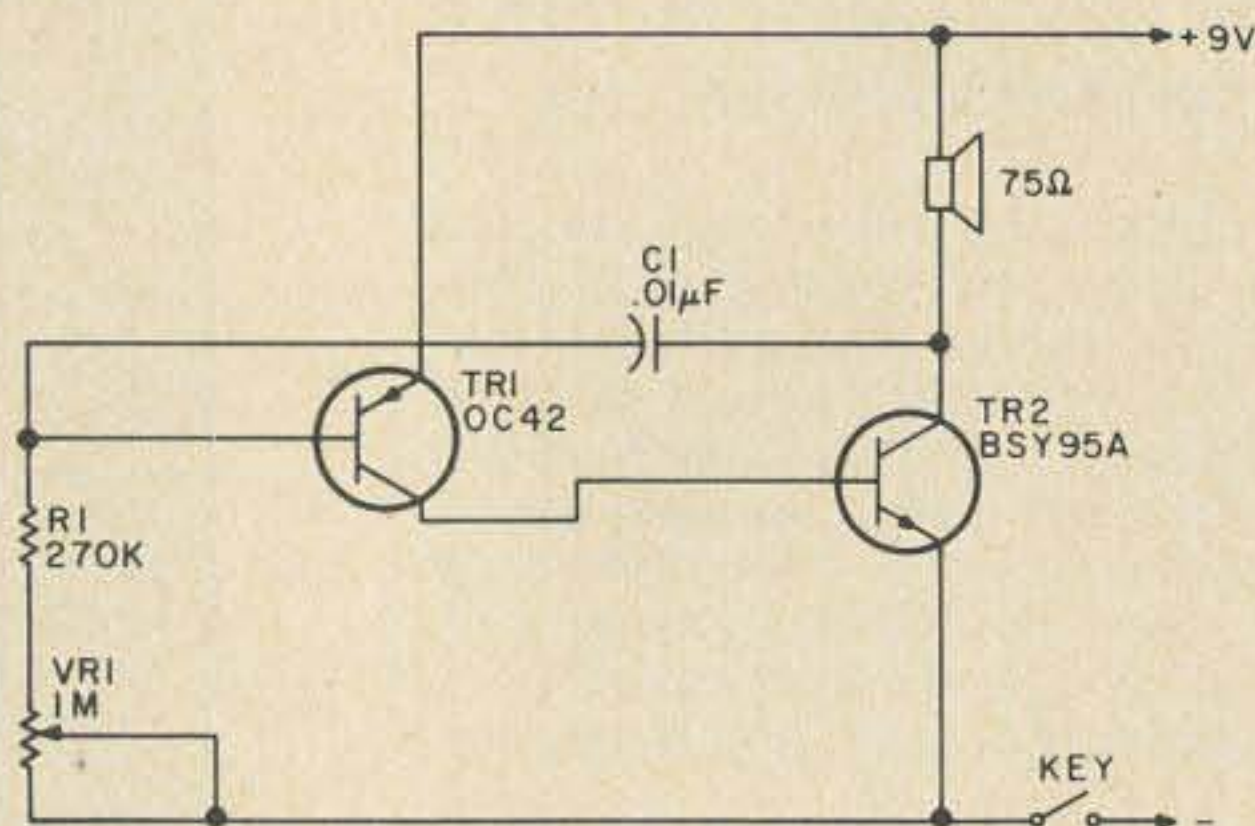

Morse Code Oscillator. R1 — ¼ W. (From Practical Wireless, March, 1975)

73's Test Lab Clearance Sale

Quartz electronic watch — liquid crystal readout (does not take two hands to read) — sells for \$55 — brand new unit provided to 73 to prove watch is first rate — in original box never used . . . only \$49.

Multi-2000 2m FM/SSB transceiver — tested for a few days by 73 staff and found to be fantastic — in original box and still brand new — \$700 value — just one on hand so first come at \$625.

Atlas model 210 transceiver 80-10m — sells for \$600 — tried out for a few days in the W2NSD/1 shack and worked like a charm — incredible rig — still completely new with original box — only \$540 for first check received.

Emergency Beacon EBC-144 Jr 2m FM rig — \$600 price tag — priority channel system — synthesized for all channels, even the splinters — tested out on 73 Mountain, one of the roughest rf spots in New Hampshire and performed beautifully — still absolutely new in original carton — first cashier's check for \$550 takes this gem.

Magtech FM Frequency Standard — needs only +12 V to swing — gives standard signal for tuning in all FM repeater channels (30 kHz)

— tested in 73 lab — perfect! — sells for \$60 — one only, first check for \$50.

Venus Scientific SSTV Monitor — used by W2NSD/1 for a couple weeks — works great — still new — cost \$349 — first check for \$299 takes it — here's a chance to get active on SSTV at a real bargain.

Venus Scientific SSTV Camera — these are very hard to get — almost impossible — and the reason is that they are fantastic — sell for \$469 if you could get them (which you can't) — one unit, used by a little old lady at 73 Magazine for a few minutes one Saturday — she was so astounded at the perfection of the camera that she said we should sell it so she wouldn't get addicted. First check for \$425 will get us off this problem.

Toshiba Cassette Deck PT-490 with Automatic Reverse, Dolby, record or play for a full two hours straight with a C-120 cassette. One of the very finest Dolby decks out — Cost \$350 — used a few days for evaluations and a review — first check for \$259 takes this beauty.

MITS 908M calculators — cost \$130 — brand new — one of the most useful of the hand calculators — programmable decimal point — X^2 — $1/X$ — \sqrt{X} — with charger — memory key — only \$69.

Corvus calculators — nationally advertised at \$70 — brand new, with nicads, charger, has memory — \$49.

Herman Cone WB4DBB
Rt. 5 Box 341
Chapel Hill NC 27514

An S-meter for your Swan-250

The Swan-250 can be easily modified so that the existing meter can also serve as a signal strength meter. Only three parts are needed: a 100 Ohm $\frac{1}{2}$ W resistor, a 1k linear pot, and a small signal diode, such as the 1N914. To make this modification, proceed as follows:

Remove ground wire on common side of meter. Remove wire going from (+) meter

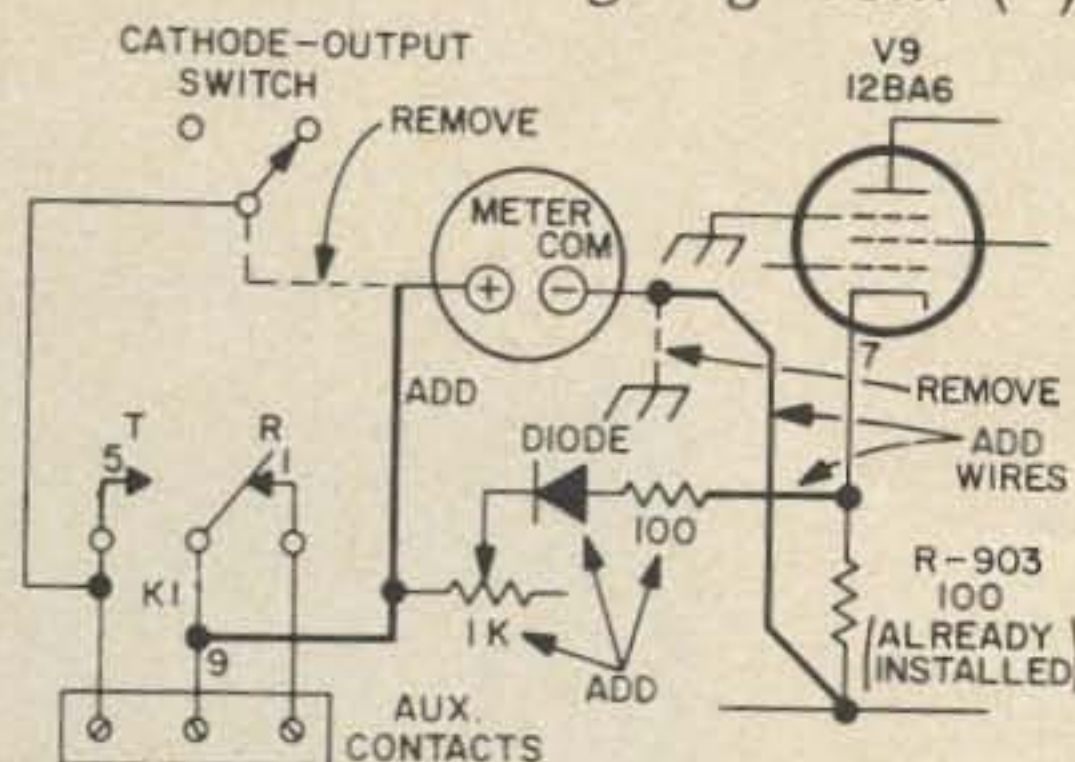

Fig. 1. Schematic for adding an S-meter to the Swan-250.

terminal to cathode-output switch. Connect wire from pin 5 of K1 to cathode-output switch (connect it to the same terminal that was just disconnected). Connect wire from pin 9 of K1 to (+) meter terminal. Connect wire from (+) meter terminal to one side of the 1k pot. (The pot can be mounted underneath the chassis on the rear panel near the 6146s.) Connect cathode (banded end) of diode to middle terminal of the 1k pot. Connect the 100 Ohm resistor from free end of diode to pin 7 of V-9.

Then, find the *already existing* 100 Ohm resistor connected to pin 7 of V-9. Connect a wire from this resistor (R-903) to the common meter terminal. The wire connects to the end of the resistor that is *away* from pin 7 of V-9.

Finally, turn the radio on and wait for it to warm up. Set the 1k pot so the meter rests at exactly full scale (400 mA) with no signal. The S-meter is now complete and you can calibrate it. You will readily notice that it reads backwards, similar to the Swan-350 S-meter.

... WB4DBB



ICOM

IC-

phase locked
synthesized
t



- * 67 + channels
- * Simplex - Duplex
- * Modular construction
- * Super hot receiver

This is the radio everyone has been talking about. The ICOM IC-230 is the first phase locked Loop transceiver to be introduced. It is the best unit available for your car. The IC-230 has 67 channels installed and operating in the 15 kHz spaced channels. It features a phase locked synthesizer that puts out one of the cleanest signals. It uses helicalized resonators in the rf section which are impervious to intermodulation. Because of this, the IC-230 system used in the 230, 15 kHz spaced channels is easy to plug in four inexpensive crystals. The IC-230 is easy to repair simpler and faster when and if the need arises.

See your ICOM AUTHORIZED DEALER

BELLAIRE ELECTRONICS

CLIP OUT AND ORDER NOW

THIS PAGE IS YOUR ORDER BLANK!

ORDER NOW AND SAVE!

Specials at Unbeatable Prices



GENAVE, 4141 Kingman Dr., Indianapolis, IN 46226

HEY, GENAVE! Thanks for the nice prices! Please send me:

- | | | | | |
|--------------------------|---|--|----------------------------|---------------------------|
| <input type="checkbox"/> |  | GTX-200-T
2-meter FM, 100 channels. 30 watts
(incl. 146.94 MHz) | Special Introductory Price | \$249⁹⁵ |
| <input type="checkbox"/> |  | GTX-200
2-meter FM, 100 channels. 30 watts
was \$299.95 (Incl. 146.94 MHz) | NOW | \$199⁹⁵ |
| <input type="checkbox"/> |  | GTX-100
1 1/4-meter FM, 100 channels, 12 watts
was \$309.95 (Incl. 223.5 MHz) | NOW | \$219⁹⁵ |
| <input type="checkbox"/> |  | GTX-10
2-meter FM, 10 channels, 10 watts
was \$239.95 (Incl. 146.94 MHz) | NOW | \$169⁹⁵ |
| <input type="checkbox"/> |  | GTX-2
2-meter FM, 10 channels. 30 watts
was \$299.95 (Incl. 146.94 MHz) | NOW | \$189⁹⁵ |
| <input type="checkbox"/> |  | GTX-600
6-meter FM, 100 channels, 35 watts
was \$309.95 (Incl. 52.525 MHz) | NOW | \$219⁹⁵ |

- | | | | |
|--------------------------|---|---|------------------|
| <input type="checkbox"/> | ARX-2 2-M Base Antenna | @ | \$ _____ |
| <input type="checkbox"/> | Lambda/30 2-M Base Antenna | @ | \$29.95 \$ _____ |
| <input type="checkbox"/> | Lambda/4 2-M Trunk Antenna | @ | \$39.95 \$ _____ |
| <input type="checkbox"/> | TE-I Tone Encoder Pad | @ | \$29.95 \$ _____ |
| <input type="checkbox"/> | TE-II Tone Encoder Pad | @ | \$59.95 \$ _____ |
| <input type="checkbox"/> | PSI-9 Port. Power Package (less batteries) | @ | \$44.50 \$ _____ |
| <input type="checkbox"/> | PS-1 AC Power Supply | @ | \$29.95 \$ _____ |
| | | @ | \$59.95 \$ _____ |

and the following **standard** crystals @ \$4.25 each: _____ \$ _____

Non-standard crystals @ \$5.75 each: _____ \$ _____

(allow 8 weeks delivery.)

For factory crystal installation add \$8.50 per transceiver.

IN residents add 4% sales tax:

CA residents add 6% sales tax:

All orders shipped post-paid within continental U.S.

Sub-Total: \$ _____

TOTAL: \$ _____

(minimum order \$12.00)

NAME _____ AMATEUR CALL _____

ADDRESS _____ CITY _____ STATE & ZIP _____

Payment by: Certified Check/Money Order Personal Check C.O.D. Include 20% Down.

Note: Orders accompanied by personal checks will require about two weeks to process.

20% Down Payment Enclosed. Charge Balance To:

BankAmericard # _____ Expires _____

Master Charge # _____ Expires _____ Interbank # _____

Prices and specifications subject to change without notice.

Then the FCC came personally to visit! That's hard to ignore.

At 0000 GMT the satellite will change over to mode A again.

Once you start listening to the satellites you will get interested in improving your setup. You'll start reading to find out which antennas work best, whether a preamplifier will pep up your receiver, what kind of antennas are best for transmitting, etc. That's the nice thing about working Oscar, you can get started simply and go as far as you like, complete with tiltable antennas, circular polarization, etc. Don't plan on too much transmitting power, for this bogs down the satellite receiver and ruins things for everyone. A California "QRPer" did the usual stunt and zapped just about everyone out of the passband. Oscar users complained and he ignored them. The Amsat officials requested he lower power and he ignored that. Next came a note from the FCC, and that too was ignored. Then the FCC came personally to visit! That's hard to ignore. Hopefully there are not any other amateurs so intent on spoiling the fun for everyone else.

And *fun* is the name of the Oscar game.

After a few days you'll be an Oscar expert, zeroing in on the chap you want to contact and getting him the first call. If you arrange your station right you'll be able to hear your signals coming back — this helps you know when the satellite has been acquired and gets you on the frequency you want. The time delays involved keep you from getting feedback when you tune yourself in on sideband, by the way.

Ready? Set? GO!

REPEATER FREQUENCY ANGUISH

The jamming up of repeater channels has brought on some mighty unpleasant developments — repeaters going on the air ignoring coordination efforts. It won't take much of this before we'll be right back to the Prose Walker plan for having the FCC allocate repeater channels... and this means the slow grinding frustration of one to four year waits for decisions, interminable showings and correspondence, the need for engineers with FM broadcast experience to put together the topographic exhibits, etc. Re-

peater clubs and councils had better face this situation right now and not let things go any further.

I might remind repeater councils that when I offered to put out a council newsletter a year ago they ignored it with the result that there is virtually no communication between councils. Together we progress, separately we sink, to coin a thought. Perhaps the situation now is serious enough so repeater councils will have the courage to take positive steps and stop sitting around waiting for the ARRL to do something.

One suggestion that has been made is that councils send reports from their frequency coordinators to the publishers of repeater lists indicating which repeaters are pirates... or do you prefer to call them uncoordinated? Or outlaw? It would seem time that amateurs be made aware of these outlaw repeaters and that some stigma be attached to flaunting coordination.

Should we put the black hand print on each pirate repeater? Maybe a skull and crossbones?

The other side of the coin is obvious... coordinators have a serious responsibility to provide an honest and even-handed service. They should deal out the few frequency channels available in the best way possible, not favoring friends, not holding channels for imaginary repeaters, giving major channels to larger groups and splinters to the smaller groups.

Repeater councils are hereby requested to contact me and let me know what you think of the idea of trying to get amateurs to put pressure on repeaters which ignore coordination. Should we put the black hand print on each pirate repeater? Maybe a skull and crossbones?

Right here in the fringe area of Boston we have a great flurry... a small group is totally ignoring coordinating efforts... they have a 19-79 repeater on in Malden now which is pirate... and they've just put a 34/94 machine on the air which is jamming another nearby repeater on that channel... and seem impervious to reason. The justification is that it is a "bicentennial repeater". They are having the same problem in New York... and across the country... even in Kansas! Let's get this rotten mess straight... and fast.

MICROPROCESSORS

I sure feel like a dummy trying to decipher articles and ads in the computer magazines. These fellows have a language all of their own and they keep the dictionary in their pocket. Well, Never Say Die, right? I'll be damned if they are going to stop me just by being difficult. Between a whole bunch of applications for a computer for 73 business and a nice list of ham applications, I decided that one way or another I would take the rocky path and overcome.

The articles in Poptronics and Radio Electronics on the MITS Altair 8800 microprocessor and video terminals were duly read and mulled. I grabbed anyone with computer knowledge at ham club meetings and did my best to pump them... a few were snagged via repeaters and brain-picked... Bill Godbout has run up a terrible phone bill trying to defeat my ignorance.

Next we bought one of those Altair 8800 jobs and I sat down, large instruction book in hand, 8800 facing me. After a couple of hours, with a few hints on some computer language translations, and after following rigidly the instructions for programming the unit, I was successful... I got it to add two numbers together and come up with the sum. I plunged on recklessly and made up my own program to get it to add three numbers... success again!

Thus reinforced by confidence I turned to the next chapter in the instruction book... multiplying. Disaster. After four hours of sweat and dither I was nowhere... except to the typewriter to write MITS for help. I haven't heard anything from them yet... they probably have a problem of their own... something over 4000 of the microprocessors out and a ton of mail asking questions. I don't think I'm the only one to bog down.

Southwest Technical has come out with a gadget which may help — a unit which will take a surplus keyboard and provide me with a video readout on a television set. Once this is working I expect I'll be able to hook the unit into the 8800 and speed up the input action.

I'll let you know if I have any success.

Continued on page 160

Vanguard now has the World's Largest Selection of Frequency Synthesizers from \$129.95

- Smallest size of any commercially available synthesizer — only 1-3/8" x 3-3/4" x 7".
- Excellent spectral purity since no mixers are used.
- .0005% (5 parts per million) accuracy over the temperature range of -10 to +60 C.
- Immune from supply line voltage fluctuations when operated from 11 to 16 volts dc.
- Up to 8000 channels available from one unit. Frequency selected with thumbwheel switches.
- Available from 5 MHz to 169.995 MHz with up to 40 MHz tuning range and a choice of 1, 5 or 10 kHz increments (subject to certain restrictions depending on the frequency band selected).
- Top quality components used throughout and all ICs mounted in sockets for easy servicing.
- All synthesizers are supplied with connecting hardware and impedance converters or buffers that plug into your crystal socket.



Vanguard frequency synthesizers are custom programmed to your requirements in 1 day from stock units starting as low as \$129.95 for transmit synthesizers and \$139.95 for receive synthesizers. Add \$20.00 for any synthesizer

for 5 kHz steps instead of 10 kHz steps and add \$10.00 for any tuning range over 10 MHz. Maximum tuning range available is 40 MHz but cannot be programmed over 159.995 MHz on transmit or 169.995 MHz on receive (except on special orders) unless the i-f is greater than 10.7 MHz and uses low side injection. Tuning range in all cases must be

in decades starting with 0 (i.e. - 140.000 - 149.995 etc.). The output frequency can be matched to any crystal formula. Just give us the crystal formula (available from your instruction manual) and we'll do the rest. We may require a deposit for odd-ball formulas. On pick-up orders please call first so we can have your unit ready. Call 212-468-2720 between 9 am and 4 pm Monday through Friday.

*You'll never
have to buy crystals
again!*

SEND NO MONEY.
WE SHIP C.O.D.
ORDER BY PHONE
AND SAVE TIME.

Available for aircraft, fire, police and amateur frequencies.

*We ship open account only to U.S. and Canadian government agencies,
universities and selected AAA rated corporations.*

VANGUARD LABS

196-23 Jamaica Ave., Hollis, New York 11423

NEWSPAPER CLIPPINGS

Since there is no way for me to get every newspaper, I'd sure appreciate it if you would keep your eyes peeled for me for items of interest... clip them out... and send them along the next time you get a chance. I sure don't want to miss anything having to do with amateur radio, particularly good PR... also of interest are CB misery items, IRS (sob's), UFOs, Oscar, stuff like that. Quite a few readers seem to be doing this already and I want to thank them for remembering me.

PREDICTION

Somewhere in the neighborhood of a thousand ham club newsletters are received by 73 each month and I look through every one of them to try and keep up with what is happening. One thing is beginning to stand out... more and more clubs are running classes to get newcomers licensed. There has been a major change in this in just the last few months. I predict that this will result in a substantial change in the FCC licensing figures and that we will begin to see a noticeable upturn in the number of hams.

I wish I had the time to write individually to every club that has set up classes to teach theory and code... I'm very proud of them... they are doing something of great value for all of us. Not a few have written to say that they are using the 73 Morse code cassettes for teaching the code. I spent a lot of time and agony making those cassettes, so I really like to hear when they are helping people. Several people at Dayton mentioned that they were using my Novice theory cassettes for their classes since I had organized the material so well... and they wanted to know if I had some in the works for General Class. I've been putting that off... it is an unbelievable amount of work to make the theory cassettes and, like you, I tend to do easier things first. If there really is a need, I'll (sigh) get to work.

If your club hasn't yet got license classes going, put a burr under the blanket. Get things organized and then beat the hell out of the bushes, particularly around high schools.

2001?

No, let's make that 1984, that ever popular year for futurists, and look into the Green crystal ball (made of

reconstituted quartz and fed by eight of the new Intel 8888 micro-mini super-processor chips). It's beginning to clear a bit as the uart settles down with the fifo and my HDT (holographic display terminal) comes into focus on a full page ad in the latest video magazine for the HCM-2001 Nightmare Machine, only \$5500, complete with a ham ticket.

The Ham Communicator Multi-2001 does it all — the full legal 250 Watts on all HC bands — automatically zeros in on any repeater and quickly solves the most devilish of access tone code requirements — reads out the ID in LEDs from CW, RTTY, or ASCII codes — scans — holds up to 24 different basic QSO messages to relieve you of that drudgery — fills out QSL and posts it — records contact in log — keeps track of all pertinent information on everyone you've worked and displays it on any HDT for you — will automatically search all repeaters for any specific station you want and call it — etc.

For an extra charge the HCM-2001 comes with four original scripts for entertaining introductory transmissions — just send your name, a list of the ball teams you like, what kind of beer you drink, and your make and model car so the scripts can be personalized.

Once we've turned ham licensing over to the dealers via docket 20282, we should have no further problems with too little growth. Each rig will come with a 610 form ready for a signature.

ARTICLES WANTED

Having recently spent about half a kilobuck to attend a symposium on modern typesetting techniques, only to see the whole thing centered around punched paper tape, which even I know to be antique... I got to thinking that there have been all too few articles in 73 on using audio cassettes for RTTY applications instead of paper tape.

Hell's bells, we were using paper tape for RTTY back when I first got involved, way back in prehistory (1948) and it was old then, dating back to the twenties or before. I think some of the tape gear I used was well over twenty years old at the time. So here we are in 1975 and they are still using punched paper tape! Lordy. If you've ever handled that stuff, you'll know why I'm asking (pleading) for some audio cassette articles on replacing punched tape.

I've been reading all I can on computers, as I've mentioned before, and one of the gadgets mentioned as being particularly useful for computer input/output is the Teletype ASR-33, a machine that has a paper tape system built in. The KSR-33 is also mentioned (no paper tape), and that sounds more reasonable to me. Say, where do I get a KSR-33? Anyone have any info on that? Oh, sure, from Teletype for a kilobuck — no, I don't want to hear about that.

One of the many terms I've had to come to terms with while trying to defuzz my brain to enter the world of computers is modem. Any RTTYer knows immediately about this, since it's a gadget to take a TT signal and turn it into audio tones which can be sent over a pair of wires... and also reverse the process. We call them AFSK terminal units or even more simply, converters. We've been building them for years. As a matter of fact, all of the early RTTY work was done with audio frequency shift keying (AFSK) up on two meters, since frequency shift keying was not permitted on the low bands. That took several years of fighting the ARRL to accomplish... ask W6NRM, one of the fighting pioneers, about that battle.

So how about it you computer folk and RTTYers... let's have some of your audio cassette circuits so we can put our paper tape gear into glass display cases and admire it.

While there isn't much trouble when dealing with the old slow speed Teletype systems... 60 words per minute... when you get into the faster machines and into ASCII (eight bit instead of five) (pronounced as-tea), you can get lousy results when faced with run of the mill tape recorder speed differences. Oddly enough, the fact is that a great many cassette recorders vary quite a bit in speed. We noticed this when we got into making Morse code tapes and found that some would be as much as a word or two faster per minute when played back on some recorders... and the same amount slower on others. Well, that is more than you can get away with in RTTY, so some solutions to the problem are in order.

One possible way to handle the trouble would be to use the two stereo channels on the tape, one for the message and the other for the clock. Just thought I'd mention it.

... W2NSD/1

the best slo-scan deal in town

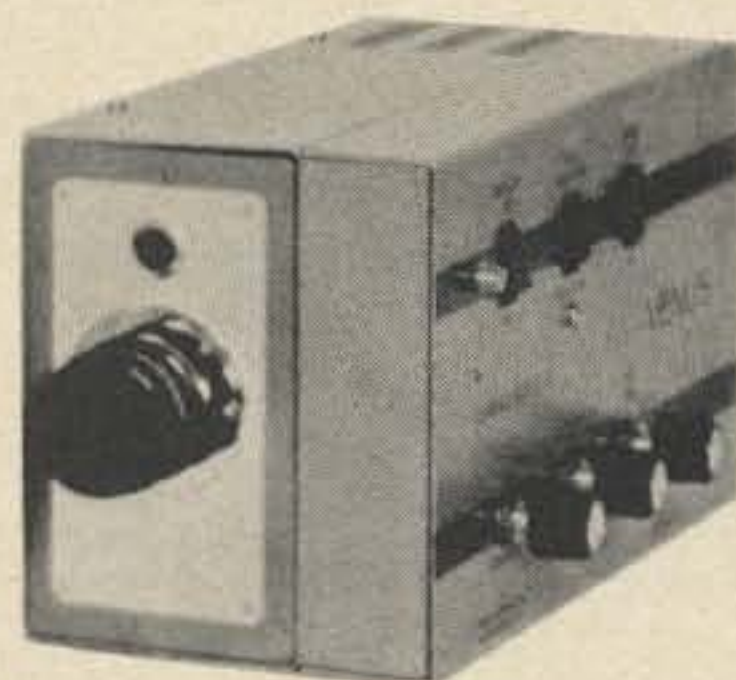
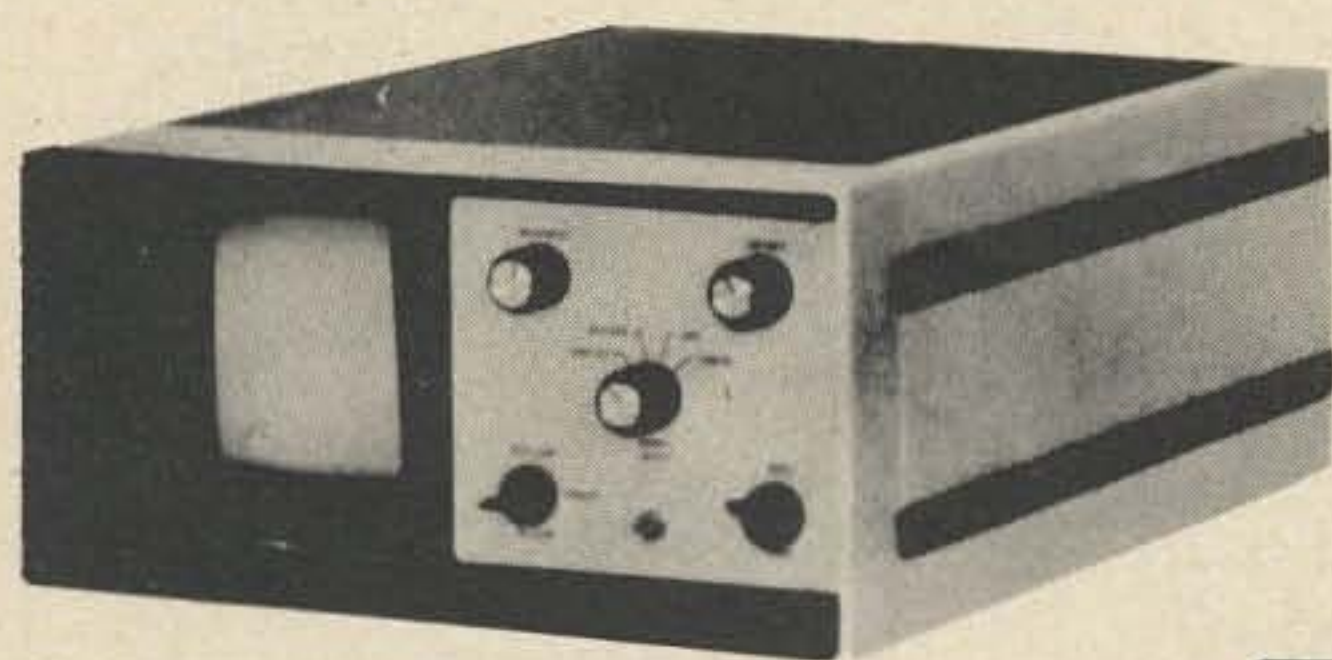

WIN
WITH



*** PRICE:**

SS2 MONITOR STILL ONLY \$349

*** KIT:**

THE VENUS SS2 IN KIT FORM FOR ONLY \$269

- 25 PAGE MANUAL
- TEST AND ALIGNMENT TAPE

*** PERFORMANCE:**

ACCUSYNC[™] OSCILLOSCOPE DISPLAY OF SSTV SIGNAL
FAST SCAN/SLO SCAN CAMERA

- USE CAMERA WITH YOUR HOME TV SET
- FOCUS ON POSTAGE STAMP

*** COMPLETE LINE:**

- SS2 MONITOR \$349
- SS2K MONITOR KIT \$269
- C1 FAST/SLO SCAN CAMERA \$469
- P1 POLAROID[™] CAMERA ADAPTER \$34.50
- V1 VIEWING HOOD \$14.50
- T1 TRIPOD \$24.95

*** LOCAL DISTRIBUTORS:**

VENUS SSTV AVAILABLE FACTORY DIRECT OR FROM
ONE OF THE FOLLOWING AUTHORIZED DISTRIBUTORS:

Amateur Electronics Supply
Milwaukee, Wisc.
Cleveland, Ohio
Orlando, Fla.

Argon Electronics
Miami Springs, Fla.

Barry Electronics
New York, N. Y.

CFP Enterprises
Lansing, N. Y.

A-G Co., Inc. A and W Electronics
Imperial, Pa. Medford, Mass.

Electronic Distributors
Muskegon, Michigan

Goldstein's
Pensacola, Fla.

Harrison Electronics
Farmingdale, N. Y.

Henry Radio
Los Angeles, Cal.

Hobby Industry
Council Bluffs, Iowa

Venus Scientific Inc.

The company that put high voltage on the moon, now brings you expanding amateur radio technology.

399 Smith Street
Farmingdale, N.Y. 11735
Phone 516-293-4100
TWX 510-224-6492

73 PRODUCTS

BRAND NEW QSL'S



X Style X — Black type, blue satellite

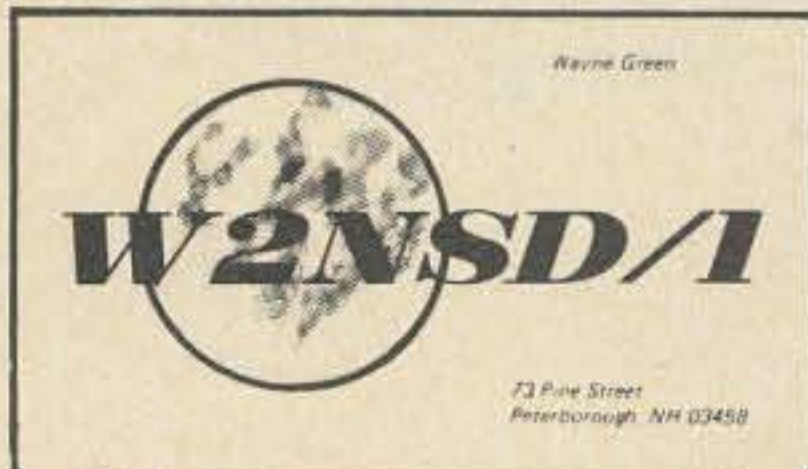

W Style W — Black type, blue world
"back by popular demand!"

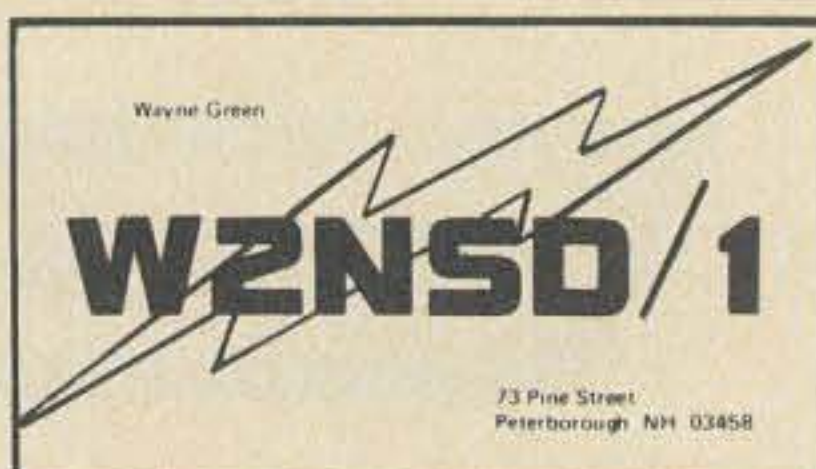

Y Style Y — Black type, red lightning bolt

- three styles
- QSO info back
- two colors
- LOW PRICES

These QSLs are printed on Fine Quality Coated Card Stock and are as good or better than cards sold elsewhere for several times the price. We can offer this fantastic low price, because we "gang print" orders between other jobs in our own print shop which keeps the costs way down and we pass the savings on to you. If you haven't been QSLing as much as you'd like to because of the cost of cards, do you really have an excuse anymore? Get some cards and help improve the image of U.S. Amateurs. Please allow 6-8 weeks for delivery.

SPREAD the WORD!
RADIO AMATEURS! TALK TO THE WORLD!!
...ask me about it!

ONLY .50¢

Ham radio is too great a hobby for us to keep it to ourselves. Let's tell the whole world about it! And what better way than by sporting this attractive lime-green bumper sticker on your car! It's only 50¢ — and it's phosphorescent so you can see it even at night. Go ahead... SPREAD THE WORD! Order yours TODAY!



4 STUDY GUIDES
NOVICE — \$4 GENERAL — \$6
ADVANCED — \$4 EXTRA — \$5

FCC exams got you scared? Frustrated by theory fundamentals? There's no need to worry. 73's four License Study Guides will help you breeze through any of the four tough exams! They are the ONLY guides which cover ALL the material you will have to know. Many amateurs find that one quick reading through our guides is enough to get them through with no sweat.

SOLID STATE PROJECTS

\$4
More than 60 projects of interest to anyone in electronics. The devices range from a simple transistor tester to a ham TV receiver. This collection will help you become more intimately acquainted with zeners, ICs and varactors, etc.



VHF PROJECTS FOR AMATEUR AND EXPERIMENTER

\$4
A must for the VHF op. Opening chapters on operating practices and getting started in VHF, both AM and FM, followed by 58 chapters on building useful test equipment, modifying existing and surplus gear.

2M FM HANDBOOK

hardbound \$7
softbound \$5

Contains almost every conceivable circuit that might be needed for use with a repeater. All circuits explained in detail. All aspects covered, from the operator to the antenna.



DIGITAL CONTROL OF REPEATERS

softbound \$5 hardbound \$7
Here's a book for the FMer who wants to design and build a digital repeater control system. Contains sections on repeaters, basic logic functions, logic circuit design, control systems, support circuits, mobile installations, touch-tone, plus a special section on a "mini" repeater control system.

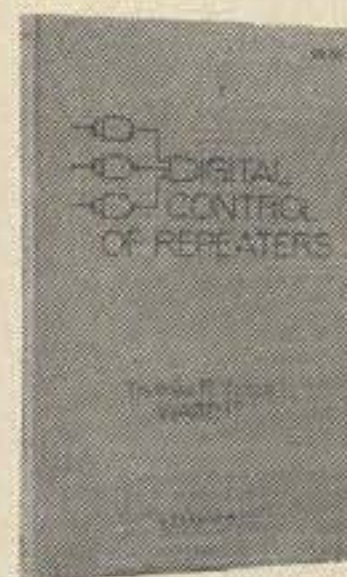

LATEST RELEASES from 73 publications

RF and DIGITAL TEST EQUIPMENT YOU CAN BUILD

RF burst, function, square wave generators, variable length pulse generators — 100 kHz marker, i-f and rf sweep generators, audio osc, af/rf signal injector, 146 MHz synthesizer, digital readouts for counters, several counters, prescaler, micro-wavemeter, etc. 252 pages. \$5.95



PRACTICAL TEST INSTRUMENTS YOU CAN BUILD

37 simple test instruments you can make — covers VOMs, VTVMs, semiconductor testing units, dip meters, watt meters, and just about anything else you might need around the test lab and ham shack. \$4.95



COAX HANDBOOK

\$3
All about coaxial cables, connectors and applications. It's all here — pictures, part numbers and specifications for all types. Includes lengths for different types for quarter, half and full wave feed-lines.



73 BINDERS

\$5
These binders are a gorgeous red and come with the nicest set of year stickers you've ever seen. The perfect thing for storing your issues of 73 so that they won't get lost or spilt on, or into the hands of the Jr. Op. Dress up your shack with these binders.

Startling Learning Breakthrough



NOVICE THEORY TAPES
Set of 4 Tapes only \$13.95

You'll be astounded at how really simple the theory is when you hear it explained on these tapes. Three tapes of theory and one of questions and answers from the latest Novice exams give you the edge you need to breeze through your exam.

73 is interested in helping get more amateurs, so we're giving you the complete set of four tapes for the incredibly low price of ONLY \$13.95.

Scientists have proven that you learn faster by listening than by reading because you can play a cassette tape over and over in your spare time — even while you're driving! You get more and more info each time you hear it.

You can't progress without solid fundamentals. These four hour-long tapes give you all the basics you'll need to pass the Novice exam easily. You'll have an understanding of the basics which will be invaluable to you for the rest of your life! Can you afford to take your Novice exam without first listening to your tapes?

1975 fm repeater atlas



LISTINGS BY STATE ORDER TODAY!

STILL ONLY \$1.50

73's all new REPEATER ATLAS is a must for every ham on 2 meters. There are 2,500 repeaters around the world (2,000 of them in the U.S.), and this atlas lists them all! Just off the presses, the 1975 edition is the most up-to-date listing you can buy. And monthly repeater updates in the 73 newpages makes sure that it stays that way! You can still purchase this invaluable tool for JUST \$1.50. Isn't it nice to know that there are a few places left where your dollar is still worth something?

GET IT while it's HOT!



Latest FCC News
(from inside the FCC)
Latest Docket Releases
usually in entirety
Late DXpedition News
Hot Propagation Report
Job Openings
Contest News
Conventions — Hamfests
Brand New Products
Inside Industry News

The fact is, if you are an astute shopper, you can pay 50% more for Brand X than the subscription price of Hotline (a mere \$8 per year by First Class Mail) and end up with a newsletter which is about half as big (half as much news).

Hotline overcomes the two month news delay of 73 Magazine (and all other ham magazines) by bringing you the latest hot news while it is still news. This puts you in the know on the air — over the repeater — and at your ham club.

Now you can learn the code in a fraction of the time it used to take!

four speeds available

*\$4.95 for one hour.
All four \$14.95.*

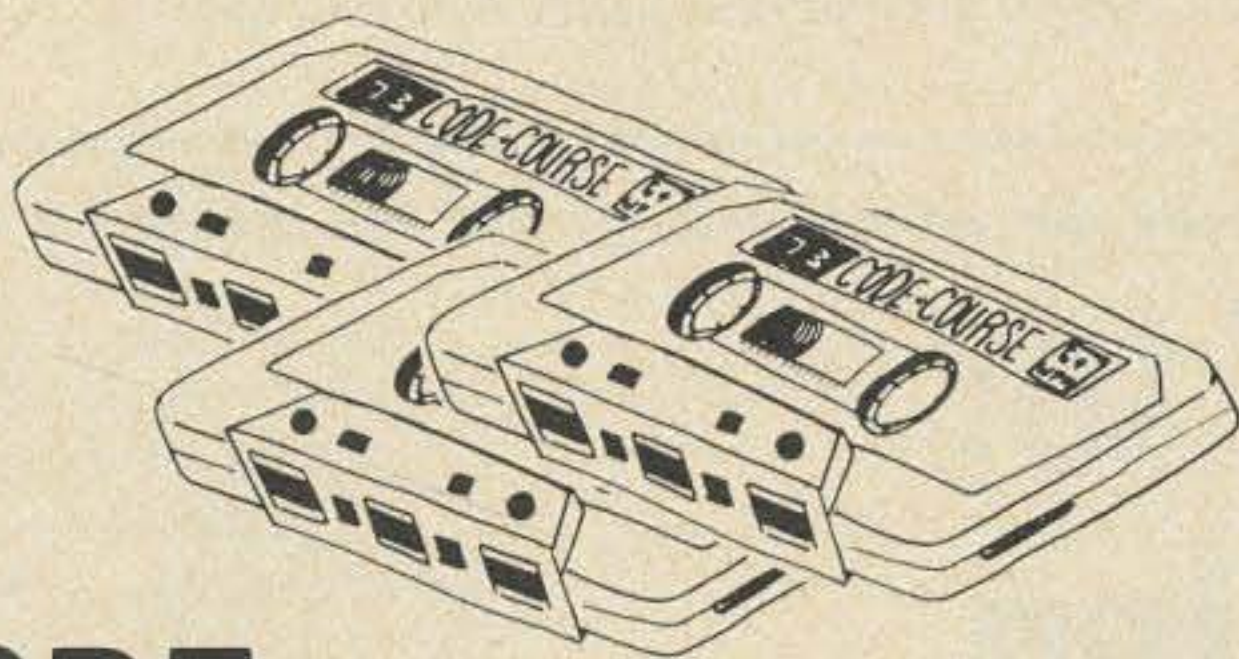

NEW CODE SYSTEM

Plays on any cassette player so you can practice anywhere anytime!

□ **6 WPM** This is the practice tape for the Novice and Technician licenses. It is made up of one solid hour of code, sent at the official FCC standard (no other tape we've heard uses these standards, so many people flunk the code when they are suddenly — under pressure — faced with characters sent at 13 wpm and spaced for 5 wpm). This tape is not memorizable, unlike the zany 5 wpm tape, since the code groups are entirely random characters sent in groups of five. Practice this one during lunch, while in the car, anywhere and you'll be more than prepared for the easy FCC exam.

□ **21 WPM** Code is what gets you when you go for the Extra Class license. It is so embarrassing to panic out just because you didn't prepare yourself with this tape. Though this is only one word faster, the code groups are so difficult that you'll almost fall asleep copying the FCC stuff by comparison. Users report that they can't believe how easy 20 per really is with this fantastic one hour tape. No one who can copy these tapes can possibly fail the FCC test. Remove all fear of the code forever with these tapes.

□ **5 WPM** This is the beginning tape for people who do not know the code at all. It takes them through the 26 letters, 10 numbers and necessary punctuation, complete with practice every step of the way using the newest blitz teaching techniques. It is almost miraculous! In one hour many people — including kids of ten — are able to master the code. The ease of learning gives confidence to beginners who might otherwise drop out.

□ **14 WPM** Code groups again, at a brisk 14 per so you will be at ease when you sit down in front of the steely eyed government inspector and he starts sending you plain language at only 13 per. You need this extra margin to overcome the panic which is universal in the test situations. When you've spent your money and time to take the test you'll thank heavens you had this back breaking tape.

SPECIAL BACK ISSUE



OFFERING

NOW YOU CAN BUILD UP YOUR HAM LIBRARY FOR NEXT TO NOTHING!

25 different issues (of our choice) for ONLY \$5.00. That's just 20¢ an issue — it costs us more than that to print them! Choose from three different categories:

Vintage: 1962-1965

Recent: 1966-1969

Very Recent: 1970-1973

Add \$1.50 postage per package

FREE?

ONE YEAR SUBSCRIPTION

Well - Ahem - almost - look at it this way -

1 YEAR = \$8.00
3 YEARS = \$16.00

So how much does the second year cost? - Nothing, really!

12 REASONS FOR SUBSCRIBING TO 73 MAGAZINE... RIGHT NOW.

- You get every issue — makes a first rate electronics reference library
- No more missing issues sold out at the newsstand
- Many more articles every month than other ham magazines
- The most and the best of the ham advertising — see new products first in 73
- The editorials — like 'em or hate 'em — they do make you think
- Complete FCC releases in detail so you won't miss anything important
- The newest state of the art construction projects by top authors
- Plus five other reasons which are too obvious to mention here

mail TODAY to:



magazine

Peterborough, New Hampshire 03458

Name _____ Call _____

Address _____

City _____ State _____ Zip _____

 
 Check

Signature _____

Card No. _____

Expiration Date _____ Total enclosed _____

- Novice Theory Tapes \$13.95
- 5 WPM Beginners Cassette 4.95
- 6 WPM Back Breaker Cassette 4.95
- 10 WPM Canadian Code Tape 4.95
- 13 WPM General Practice Tape 4.95
- 20 WPM Extra-Back Breaker Tape 4.95
- 5-6-13-20 Tape Package 14.95
- Vintage Back Issues 5.00
- Recent Back Issues 5.00
- Very Recent Back Issues 5.00
- Hotline — 1 year 8.00
- 1975 Repeater Atlas 1.50
- 250 QSL — Style W X Y 6.00
- 500 QSL — Style W X Y 10.00
- 1000 QSL — Style W X Y 15.00
- 2000 QSL — Style W X Y 20.00
- Bumper Stickers @ 50c each
- Novice Study Guide 4.00
- General/Tech Guide 6.00
- Advanced Guide 4.00
- Extra Guide 5.00
- Solid State Proj 4.00
- VHF Projects 5.00
- 2m FM Handbook Hard \$7 Soft 5.00
- SSTV Handbook Hard \$7 Soft 5.00
- Digital Control Hard \$7 Soft 5.00

Horizon "2"_{mtr.}

12 channels/25 watts from

Standard

NEW



ASTROPOINTS

- ✓ 144-148 Mhz for Ham, CAP, & MARS
- ✓ 12 channels, 3 included
- ✓ Glass Epoxy Circuit Board
- ✓ TX and RX Trimmers
- ✓ PL option
- ✓ Tone burst option
- ✓ FCC Type accepted family for Business/Industrial & Marine
- ✓ 25 watts output (nom.)
- ✓ .4 μ V sensitivity
- ✓ 70 db selectivity
- ✓ 3 watts Audio
- ✓ Built in speaker
- ✓ Small size, 6" x 2" x 9"

All this Horizon "2"_{mtr.}, under "3"

Get all the specs and complete Amateur Brochure,
write today:

 **Standard
Communications**

P.O. Box 92151 Los Angeles, California 90009 Telephone 213/532-5300

GRR GRRREEN

I've made an absolute itch of myself down through the years fighting rules which prevent us from exploring and inventing new techniques and modes of communications.

It is about time for a basic change in FCC attitude toward amateur radio. The whole attitude seems to be one of repression and restriction... of making rules to keep amateurs from causing trouble... of stopping them from experimentation and development.

The purpose of the amateur rules is most explicit as I wrote in April... it says (97.1c) that the purpose of the rules is the "encouragement and improvement of the amateur radio service through rules which provide for advancing skills in both the communication and technical phases of the art."

By any stretch of the imagination are rules which prohibit experimentation and pioneering consistent with that mandate? I've made an absolute itch of myself down through the years fighting rules which prevent us from exploring and inventing new techniques and modes of communications. I started out with a big battle back in 1950 to get permission to use frequency shift keying on the amateur bands below two meters. The ARRL put up one hell of a fight to try and stop this, and the FCC dragged its heels for many years. Eventually we made it, and the result has been an orgy of development of circuits which have been taken over by the commercial companies.

One of the major obstacles in the path of development of narrow band FM on the high frequencies was the FCC resistance to permitting it to be used in all of the phone bands. If the FCC had permitted free development of this mode it might have been a different story, with NBFM detectors built into commercial receivers. As it is, this mode won out on the VHF bands and has replaced AM there. NBFM was a ham invention, by the way.

Why is it that amateur rules are so prohibitive? Why is it necessary to get some sort of special permission from Washington before a new idea can be tried out? How many good inventions have been stifled as a result of this restrictive policy?

When you look at the record of what amateur radio has accomplished, even with these rules, the rationale for the rules is even more difficult to understand.

W2BFD put up one of the very first ham repeaters along in 1949... we all wept in frustration when the FCC put it off the air.

There is good reason to believe that VHF repeaters might have been developed by amateurs at least twenty five years earlier if the FCC hadn't been so repressive and shut down early experimental repeaters. W2BFD put up one of the very first ham repeaters along in 1949 on the top of the Municipal Building in Manhattan and it provided RTTY communications over all of Greater New York for many months before the FCC forced it to shut down. I helped John put it up and was one of the active users... we all wept in frustration when the FCC put it off the air.

Now there is a request for rule making to permit ASCII code to be used on the air and the FCC is dragging its heels again. What possible justification is there for the FCC to clog the wheels of progress so consistently?

PARKINSON LIVES

The Parkinson concept of more and more government administrators working hard to keep up with the proliferation of regulations they issue is certainly embodied in the FCC Amateur Division.

One of the big moves in this field was the growth from three classes of ham ticket in 1950 (really only two, Class A and B, with Class C the same as B) to six. This called for a lot more administration of the department —

more staff — and a whole lot more work. There is little indication that any benefit ever accrued to the governed — certainly the substantial change in the growth pattern which this was supposed to promote never really materialized.

Docket 20282 seems to represent another step forward in unneeded and restrictive control which will result inevitably in more people in Washington to manage the amateurs and help slow down pioneering and invention.

The next biggie was the repeater regulations. This was a beaut and involved the Amateur Division in a fantastic flurry of bureaucratic endeavor — all to no observable benefit to amateurs. Repeaters were on the air and doing fine with little problem — now, two years later, repeater growth and operation is again growing and everything is about the same except for several tons of paperwork and an almost infinite amount of frustration and resentment with the FCC Amateur Division — and God knows how many tens of thousands of dollars in totally unnecessary phone calls.

Docket 20282 seems to represent another step forward in unneeded and restrictive control which will result inevitably in more people in Washington to manage the amateurs and help slow down pioneering and invention. Callsigns which indicate every one of the proposed sixteen different classes of ham license should delight the FCC at all levels — the added people needed to issue and process the many different types of licenses — the people involved in monitoring and keeping the sixteen classes separated from each other on the bands — this might well double the department!

Hail Parkinson. Readers not familiar with the only slightly tongue in cheek books by Parkinson are encouraged to plan some browsing time in their local paperback emporium and bone up on some basic mechanisms for governmental (and industry) growth.

USE IT OR LOSE IT — BALONEY!

That's right... horseradish on that old saw. And that is despite the fact that I admit to having been a willing sucker in promoting the concept.

One worry we hear a lot from ARRL is over the possible loss of our bands through lack of use. I hear this

from the FCC too, which only proves to me that they are no more reliable than the League as far as putting amateur radio into any realistic perspective. I guess that leaves just you and me... and I'm not too sure about *you*.

I'll lay it right on the line... I think that amateur radio has every right to the permanent use of all of the UHF bands allotted, whether we use them or not at any one particular time.

None of us is so encrusted with conservatism that we think for one minute that amateurs are not going to come up with some new ideas... new types of communication... new techniques... new inventions. Amateurs always have done this, despite the bitter reaction against it by old timers within our ranks who have been dragged screaming and kicking along from spark to CW, from AM to sideband, and even into NBFM. We know that new ideas will be along, though we may be determined to fight them.

Just because hams aren't using a band fully at any particular time doesn't mean that the long range good for everyone doesn't lie in preserving the band for future developments.

So there we were in the late 60's with a few thousand Techs trapped up on two meters, making do the best they could with Goonie Boxes and Heathkit Lunchboxes. A bunch more

were living it up on six meters, waiting out the damp nights for the occasional band openings. Above 146 MHz there was this virtually unused land with a couple of wide band FM guys doing something... we couldn't make copy with our AM receivers. CB manufacturers were beginning to nudge the FCC, asking how come all that two megs of blank space which could just as easily be filled with jolly chatting CBers? Think of the megabucks!

It turned out that those chaps on FM were onto something... they were inventing the ham two meter FM repeater. The vacuum above 146 MHz sucked just about everyone out of the low end of two and all of six meters, leaving some embarrassing empty bands. And, while hams weren't first with repeaters, it didn't take long before they were leading the commercial boys in sophisticated designs and in showing the world what repeaters could do.

The basic moral is this... just because hams aren't using a band fully at any particular time doesn't mean that the long range good for everyone doesn't lie in preserving the band for future developments. It is awfully difficult for manufacturers to put off financial gratification — they want to make money right now and if this means getting a ham band away from politically naive hams, well, that's business.

But the fact is that hams, despite their incredible record of inventing and pioneering most of the communications systems we have today, have only scratched the surface. We see hints of some things that could come... the growing number of low cost microprocessor chips is opening many areas for development. We'll be able to get voice channels down in several ways with computer processing, permitting phone contacts on bandwidths not much wider than CW requires... and watch for multiplexing — a lot more development in narrow band television — slow scan applications, etc.

All these things and more will be along, if we have the bands to accommodate them. We and the FCC (and the ARRL) should remember that once we have lost a band there is no hope of ever getting it back. Our loss of virtually all satellite UHF bands was without a doubt the worst disaster in the history of the hobby, even if it is not yet recognized by many amateurs. This loss was all the worse because it was avoidable and happened only because we made

I notice that despite the value of the land and the need for building space, that Central Park is still around. Well, let's keep the developers out of our ham bands.

almost no effort to prevent the loss. We stood by helplessly, doing absolutely nothing, and got shafted.

The "use it or lose it" concept is destructive. It aids our enemies — the manufacturers who want to sell equipment and nothing more — in that it gives them a good excuse to ask for presently unused ham bands. Why is it that we are able to conserve our forests and park areas in good conscience without demanding full use to keep exploiters from building housing developments, and yet we don't have this concept for our amateur bands? I notice that despite the value of the land and the need for building space, that Central Park is still around. Well, let's keep the developers out of our ham bands.

PERSONAL FULFILLMENT

Do you ever feel that sort of nagging need to leave the world a little further ahead than it was when you arrived? This is the need that rag chewing, watching television, and keeping up with baseball won't placate.

It is elusive... it has something to do with leaving a mark on the world other than a headstone. Not everyone can produce Nobel Prize research, or invent narrow band FM, but that is no reason to just give up and settle for being a cypher in the statistic books. The fact is that there is a lot of research and inventing that you could do if you could get yourself off dead center. It doesn't take a master's degree to plow new and exciting ground. It doesn't even take massive intellect. The prime ingredients are interest and persistence... they will win out over just about anything.

Outside of the radio field there are an unlimited number of areas for investigation that beg for answers. A new book out in paperback (Bantam Y8368) *Supernature* by Lyall Watson (\$1.95) should be quite inspirational. This should fill you so full of ideas and questions that you will have a difficult time deciding where to get started.

In amateur radio there are many areas for progress. One relatively simple one which is about ready for development is multiplexing for ama-



teurs. This might be a gigantic step forward for us since it could do two things at once... firstly it would permit us to use each shortwave frequency for several contacts without interference. And perhaps even more important, it would allow us to get started with duplex contacts where, like the telephone, either party can talk at any time and be heard. This could have a profound effect as the strictly one-way talking limitation is a much heavier burden on amateur radio than is generally recognized.

While I don't know much about it, it appears to me that by use of some outside standard such as the color burst frequency or, better, the UHF location signals, we could set up multiplexing on any band... say 20 meters... and have a six way duplex contact all on one frequency. What a way for a round table! We haven't had that type of communication in amateur radio since the old days on 160 meters before a few chaps got over zealous with playing phonograph records and "broadcasting" was prohibited. Later, they got to looking at the rule they had passed and discovered that it also prohibited duplex... well, that's the way it goes when you mess with the FCC, you lose ten times what you expect. I wonder if any of the fellows are still alive that insisted that the FCC outlaw broadcasting back in 1938... probably not. Their heritage is with us... hopefully not too many present day amateurs will push the FCC for changes which will leave such a heritage for future hams.

The few remnants of the old days will tell you, wistfully, how great 160 meters and those fantastic duplex round tables used to be. You can actually talk with people that way instead of lecturing them and then falling asleep while they ramble on... and on.

Multiplexing could solve the repeater problem too... at least for a while. If we could get six or eight simultaneous contacts through repeaters we could not only work duplex, but we'd be able to talk at length again and not worry about timing out... providing we could ever get the FCC rules forcing repeaters to have timers changed. Outmoded rules have a way of living on.

There are many other areas for amateur invention and pioneering... just keep your eyes and mind open.

IT TAKES MONEY

No, it doesn't. The fact is that you can generally find a way to get the things done that interest you... including getting money for them. Most research can be done very inexpensively and money for it shouldn't be much of a problem.

There are so many ways open for making money that it seems ridiculous for anyone to be seriously in need of it. I mentioned a couple of years ago that hams have a natural in with such electronic developments as security and burglar alarm systems. Several amateurs took the cue from that and started in the business in their spare time, building up from nothing to where they were working full time and had several employees.

There are ideas everywhere. A few days ago I visited Tufts Radio, probably the biggest ham dealer in New England today... Chuck Martin WA1KPS, the owner, went out with Virginia and me to dinner and then decided to get an ice cream cone... Chuck mentioned a place nearby with famous ice cream... sure enough, we had to wait over a half hour in line for it... and this was during the week! We had fun while on line with HTs and the time quickly passed, but it did not escape me that here was a business that anyone could get started and which would be very successful. They make ice cream the old fashioned way... with cream, real flavors, and a big motor cranked freezer right out in plain sight. They didn't have many flavors, but they made their own hot fudge from butter and chocolate, and their own whipped cream from real cream and real vanilla flavor.

Another one which I haven't seen anywhere in this country... Syrian ice cream! Syrian bread is all over the place now, so how about their ice cream? It's easy to make and totally different... and should sell like crazy. If you start up and franchise it how about a ten percent fee for my idea? I've never seen it anywhere else in the world, not even in the neighboring countries.

There is still plenty of room in the ham business for new companies. Most of the present companies started in cellars and grew out of spare time gambles. It takes a lot of time, but it sure is nice to have your own company... beats working for a living... if you don't figure hamming as work.

COMING COMPUTER REVOLUTION

The development of the microprocessor IC such as the Intel 8008 and 8080, the Motorola 6800, and such ilk has created a wave of change which may eventually destroy the present balance of power in the computer field. Oddly enough, amateurs are in a very good position to benefit from this revolution.

As you no doubt know, IBM got in there early and by virtue of their designing and marketing expertise have been able to control the major part of the market. A few other firms are in there pitching, but IBM is the biggy. Digital Equipment Corporation is large by any other standards except comparison to IBM... and then comes a lot of other much smaller companies.

IBM stayed on top by being smart enough to call the turn of the cards on equipment developments. They got started with tube computers and were one of the first to go transistor... and again first with ICs. Put together with their very effective sales force and service, with very little serious competition, IBM did fine.

Normally I don't buy the Scientific American magazine... mostly as a way to save my own time. I used to subscribe and found that I was reading the darned thing from cover to cover, fascinated by the articles... but then a few weeks later the details would start to slip from my memory unless I looked over the articles again or discussed them with someone... something like being familiar with a foreign language... you gradually forget more and more unless you keep it fresh. I decided it was better to just skip the whole thing and not read the articles in the first place.

Anyway, the May issue has an IC on the cover so I broke loose with the \$1.25 and bought it. The thrust of the article is that things are moving faster and faster in computer IC design. A computer that took three big circuit boards covered with ICs last year is now on one small board this year, or even a 2" chip!

Since we're looking around for an in-house computer for 73, I think of these developments in terms of the cost of computer systems to a businessman. And since I'm also getting more and more into playing with these things as a hobby, I think in terms of hobby applications and home or family uses.

A computer system consists of three major parts — the input/output unit such as a Teletype machine, a video terminal with a keyboard, or perhaps a line printer — a central processing unit (CPU) — and some sort of memory. Memories can be on discs, floppy discs, cassettes, ICs, or on reel to reel tape.

Now, while there are advancements in all phases of computer hardware, the CPUs seem to be progressing fastest. The new ICs have to drop the CPU cost substantially . . . as witness the MITS Altair 8800 unit at \$621 assembled and working. I immediately got in line for one of these and am busy trying to figure out how it works and what I can hook up to it. Motorola was making a big deal out of their 6800 Chip at Dayton, so we can expect some microprocessors using that soon, also in the low price range. All this has got to have an impact on IBM, Digital Equipment (DEC) and the other big computer firms.

What I see ahead, and not too far off, is these large companies scrambling to keep up with designing and manufacturing hardware and the sales of computer systems going to smaller local companies who can plan, install, program and service systems tailored to local businesses. They will use one make of CPU, another VDT (video display terminal), another brand of printer, and perhaps someone else's memory units. This might evolve something along the line of two-way radio sales and service shops.

There will be plenty of room for new and small companies to design and make hardware. MITS is very small, yet look at the impact they have had in the business already! Southwest Technical is another small outfit, yet their new terminal kit, which will mate with many of the surplus (\$20-\$40) ASCII output keyboards and any TV set to make your own VDT, is a smash success. This can simply be connected to the Altair 8800 and you are beginning to have something in the way of a real toy to play with. A little extra memory (maybe the Godbout chips which give you 1024 bytes for \$39.50) is needed . . . or perhaps someone will get hot with a discount priced floppy disc drive system.

Applications? Just with stuff available now you can set up a good sized mailing list and print out labels . . . keep track of every LP record in your collection . . . or even

every selection . . . every book in your library . . . articles in back issues of magazines . . . movie reviews . . . your checkbook . . . who you've worked and whether they've QSLed . . . all the repeaters . . . your junkbox inventory . . . etc. You can store this stuff on cassettes for long term memory using the serial output interfaces (uart) (\$40 from SWT — or build it from an article in 73).

Much of the older computer hardware is turning up in surplus houses or junk shops and a saddening thing is that many of the proprietors have no idea what they are hacking up and selling for junk metal . . . such as perfectly good keyboards, disc memory units (make great cocktail tables), page printers (nice motor in there, mac), keyboard to video display IC boards (lotta ICs on there, but we don't get none of them resistors on the boards like we used to).

The big companies had things their own way while they were selling high cost systems to bit companies, but now that computers are getting down to thousands of dollars instead of tens or hundreds of thousands, I think things will change and I expect the entrepreneur to be the one to benefit . . . and this could well be you, since you know enough about electronics to get into this new field. Oh, you'll have to start reading the articles carefully, do some building and playing around, and maybe crack some books. You'll have to get together with the computer types on the local repeater (and there are plenty of them in many areas) and get to be able to decipher the odd language computer folk have devised to keep their conversations and publications relatively private.

One dividend of the air of secrecy computer folk have generated is that very few of the people in the field have competency in more than a very narrow segment of computers. Some are real hot on programming (software, they call it) — some are zingers at hardware (nothing to it, they say) — some have an understanding of the applications of the equipment — darned few are into all three. And, since most of the computer people have been tied to one company, there is nowhere near as much general knowledge of what is available as there should be. IBM people tend to really believe that there really is nothing else much worthwhile to even consider, certainly not worth spending time understanding. DEC people have heard of the IBM gear, but don't seem

too sure about that dark age stuff. Thus there is another opportunity for the amateur to step in and get to know the field . . . and become the expert . . . the consultant.

We're still trying to sort out all the info we can get as far as automating 73 is concerned. We need a few VDTs for data entry and output to make subscription changes, bill advertisers, credit them, bill for subscriptions, and things like that. It should also keep the repeater atlas and print it out for each new edition. It should handle reader's service requests. We need a 132 line page printer (rather fast so it can print out the mailing list in at most one day) . . . probably from Centronics over in Hudson NH. The most difficult matter is a memory unit capable of having the entire mailing list available . . . that would take about 8 million bytes, so we may have to break that up into smaller bites (those are eight bit bytes) and work on part of the list at one time. Anyone with good ideas on how to do that — cheap?

FIENDISH IDEAS

The June Esquire arrived . . . dreary magazine . . . but it did have a couple of moments for me such as one about cutting your own hair . . . I've been doing that for almost ten years . . . ever since hair cut prices went to over \$1.50 and it got cheaper to buy scissors. Sears has a pair that does the job . . . one for cutting and the other for thinning. Every few weeks I clip off the hair which is creeping down toward my collar and trim around the ears. Then I thin away fiercely and it comes out fine. The whole operation takes maybe about ten minutes every few weeks . . . a far cry from those long waits at the barber shop of my youth . . . and the worn old issues of magazines.

Esquire also had an article on celebrity shaving . . . none of 'em know what they're doing. I lucked on the ideal shaving system over thirty years ago . . . in the shower using an injector razor . . . I like the twin blades now and rarely come out bleeding. The hot water softens the skin beautifully and makes an absolutely painless shave . . . all the while the stream of the shower is generating ions by splashing off your back, helping your brain to think more clearly (many of my most fiendish ideas come to me in the shower) and making you feel better in general.

. . . WAYNE

CIRCUITS, CIRCUITS, CIRCUITS.

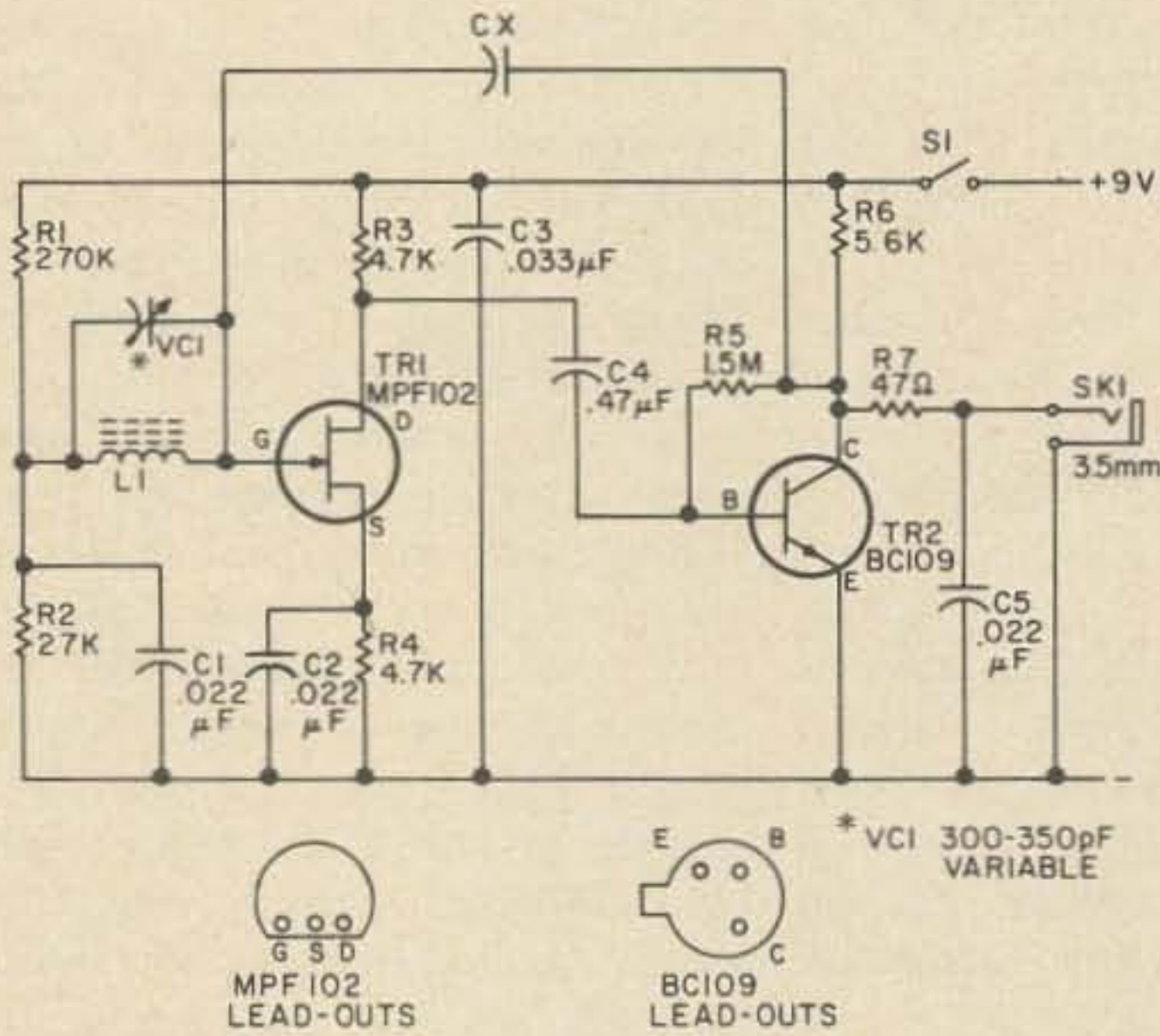

Two transistor receiver. All resistors $\frac{1}{4}$ Watt 10%. L1 — aerial tuned winding on $3\frac{1}{2}$ " x $\frac{5}{16}$ " diameter ferrite rod. S1 — slide switch. Also needed: 9 V battery, type PP3 (Ever Ready); battery connector; crystal earphone with 3.5mm jack plug; knob; case; materials for printed circuit board. (From Radio and Electronics Constructor, February, 1975)

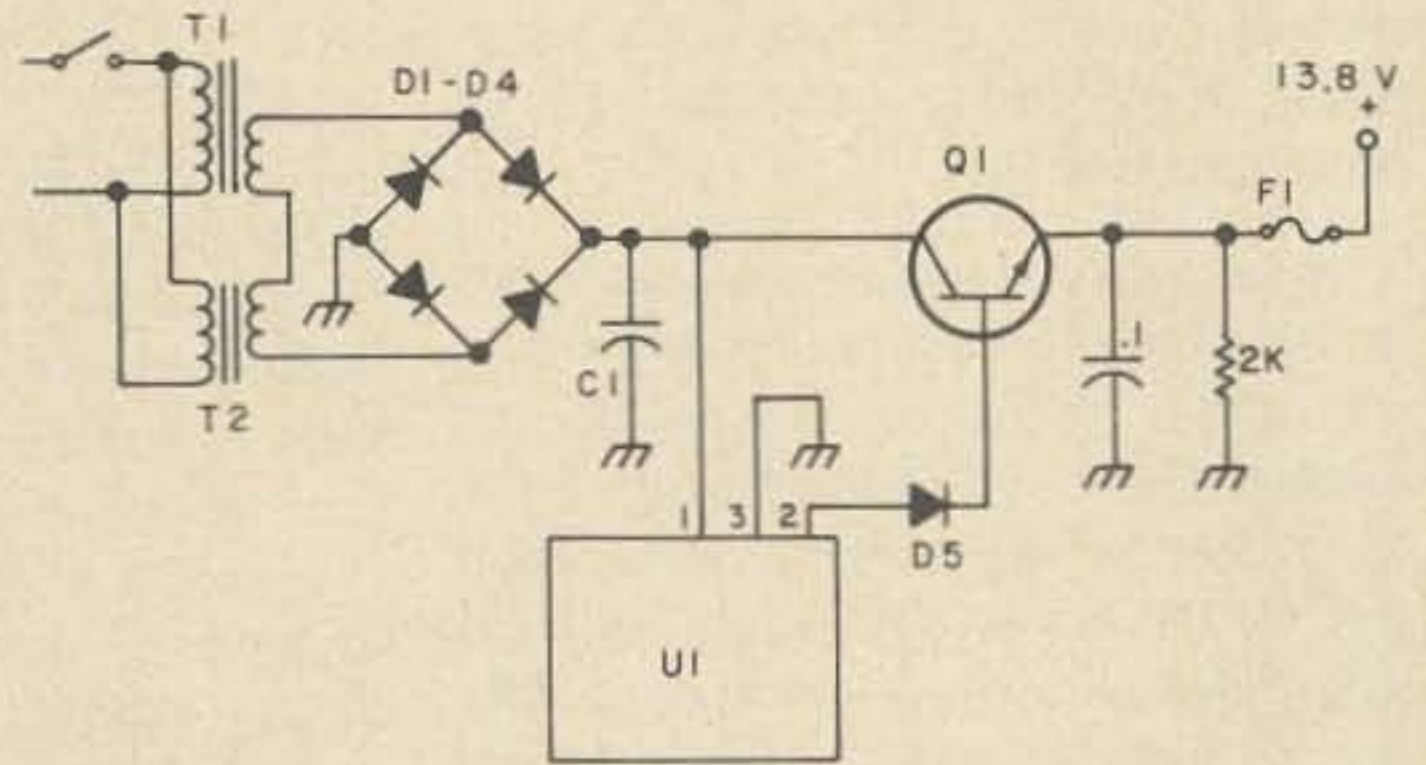

Simple power supply for 2m FM rigs (thanks W3HUC).

T1	12.6V 3A
T2	6.3V 3A
D1 - D4	3A 50 PIV
C1	2000 μ F 35V
U1	μ A 7815 *
D5	1A 50PIV
Q1	2N3055*
F1	4 amp fuse

*Semi-conductors available from Circuit Specialists Co., P.O. Box 3047, Scottsdale AZ 85257.

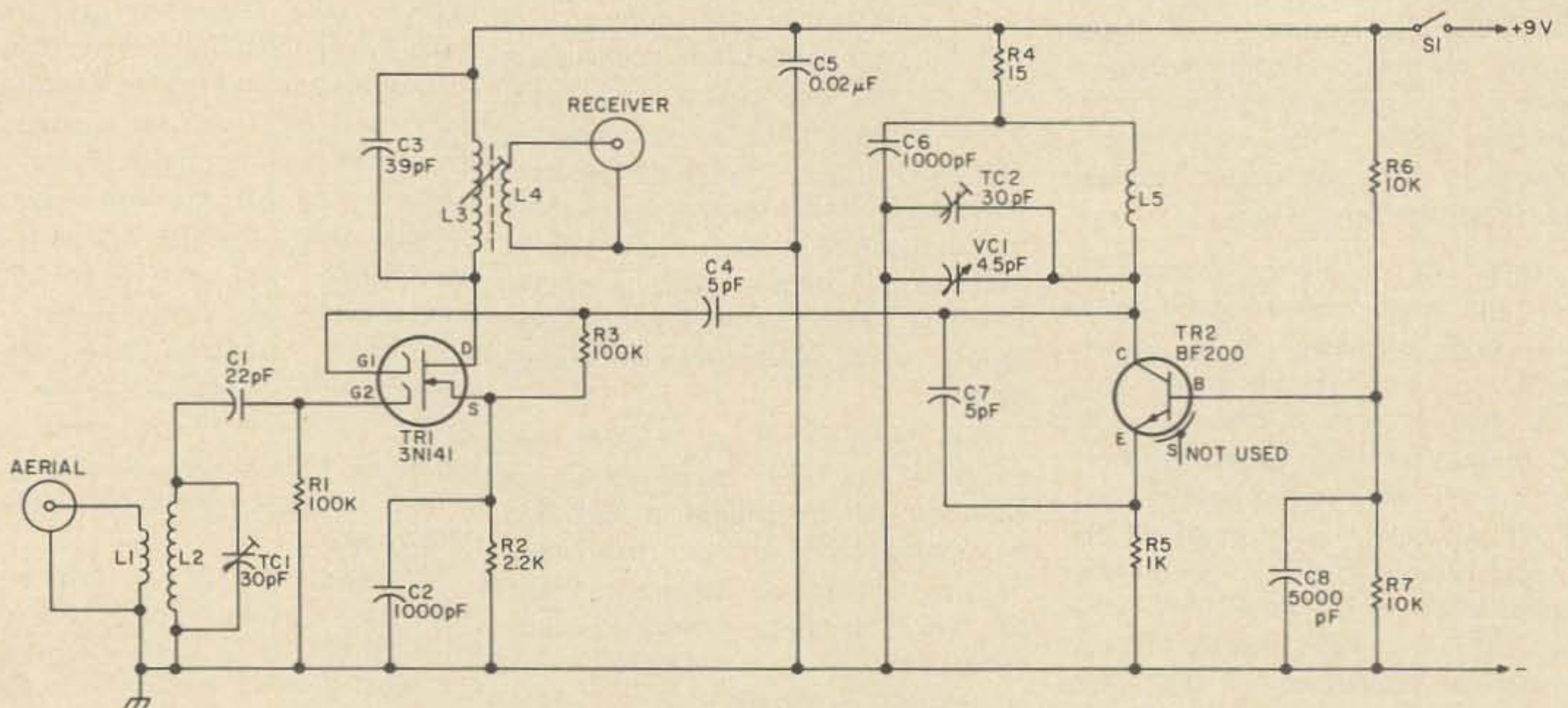

Two transistors are the basis for this tunable converter. L1 — 2T #22 swg wire, wound at $\frac{1}{4}$ " diameter; L2 — 5T, same as L1; L3 — 21T #24 swg enameled closewound; L4 — 4T insulated connecting wire wound on L3; L5 — $1\frac{1}{4}$ T. (From Practical Wireless, March, 1975)

IT PAYS TO ADVERTISE IN 73

MORE MEMORIES THAN AN

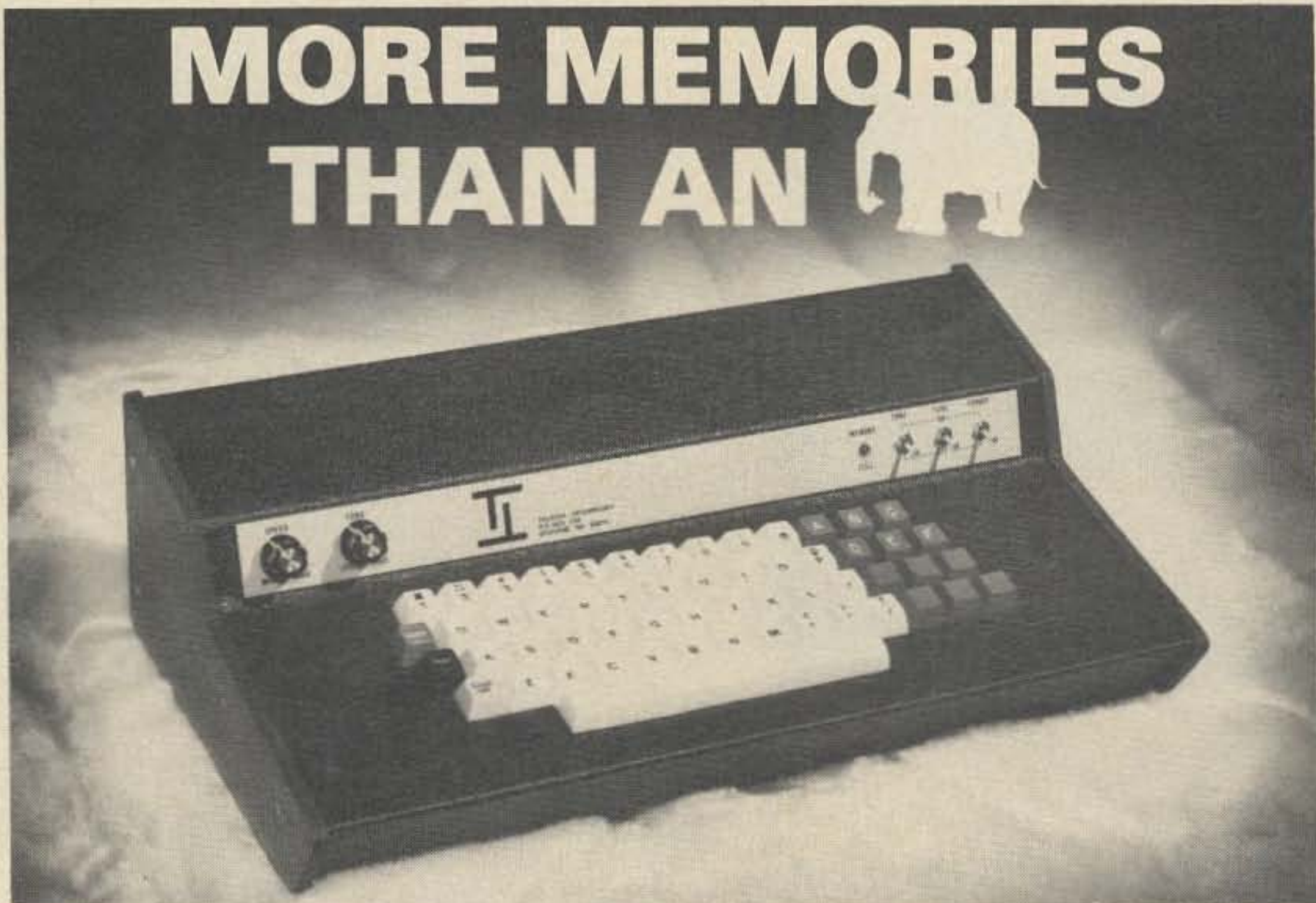

DOES ANY OTHER MORSE CODE KEYBOARD
HAVE ALL THESE FEATURES?

- II Programmable Memory right on the Keyboard
- II Running Memory lets you Type up to 72 Characters Ahead
- II Variable Speed from 6 to 35 WPM
- II Memory Overload Indicator (LED)
- II 48 Hour Burn-In Prior to Shipment
- II Space Bar is used for Word Spacing
- II Computer Grade Switches and Keytops
- II Cooling Fan to Assure Long Component Life
- II 110 VAC Operated with Built-In Audio Monitor
- II Double Sided-Plated Thru- G10 Glass Printed Circuit Board
- II Black Naugahyde Finish on Metal Case with Walnut End Plates

ORDERING INFORMATION		
MODEL	PROGRAMMABLE MEMORY INCLUDED	PRICE
TS-172	One	\$369.95
TS-272	Two	\$389.95
TS-372	Three	\$409.95
TS-472	Four	\$429.95
TS-572	Five	\$449.95
TS-672	Six	\$469.95



TELSTAR ENTERPRISES
P. O. Box 235
Spokane, Washington 99215

Enclosed is \$ _____

Charge Master Charge # _____

Charge BankAmericard # _____

Send Free Brochure

Call Letters _____

Name _____

Address _____

City/State/Zip

THINKIN' ABOUT OSCAR?

KLM HAS THE ANSWERS....



2 METER SSB/CW

- Echo II 2 meter SSB/CW transceiver
- 10 Watts PEP output
- Complete with microphone, two power cords & mobile mounting bracket

\$389.00

- Options now available for ECHO II
- USB/LSB mod kit for reception of OSCAR 7 mode B 2 mtr downlink
 - LOW NOISE (2.5db nf typ.) preamp

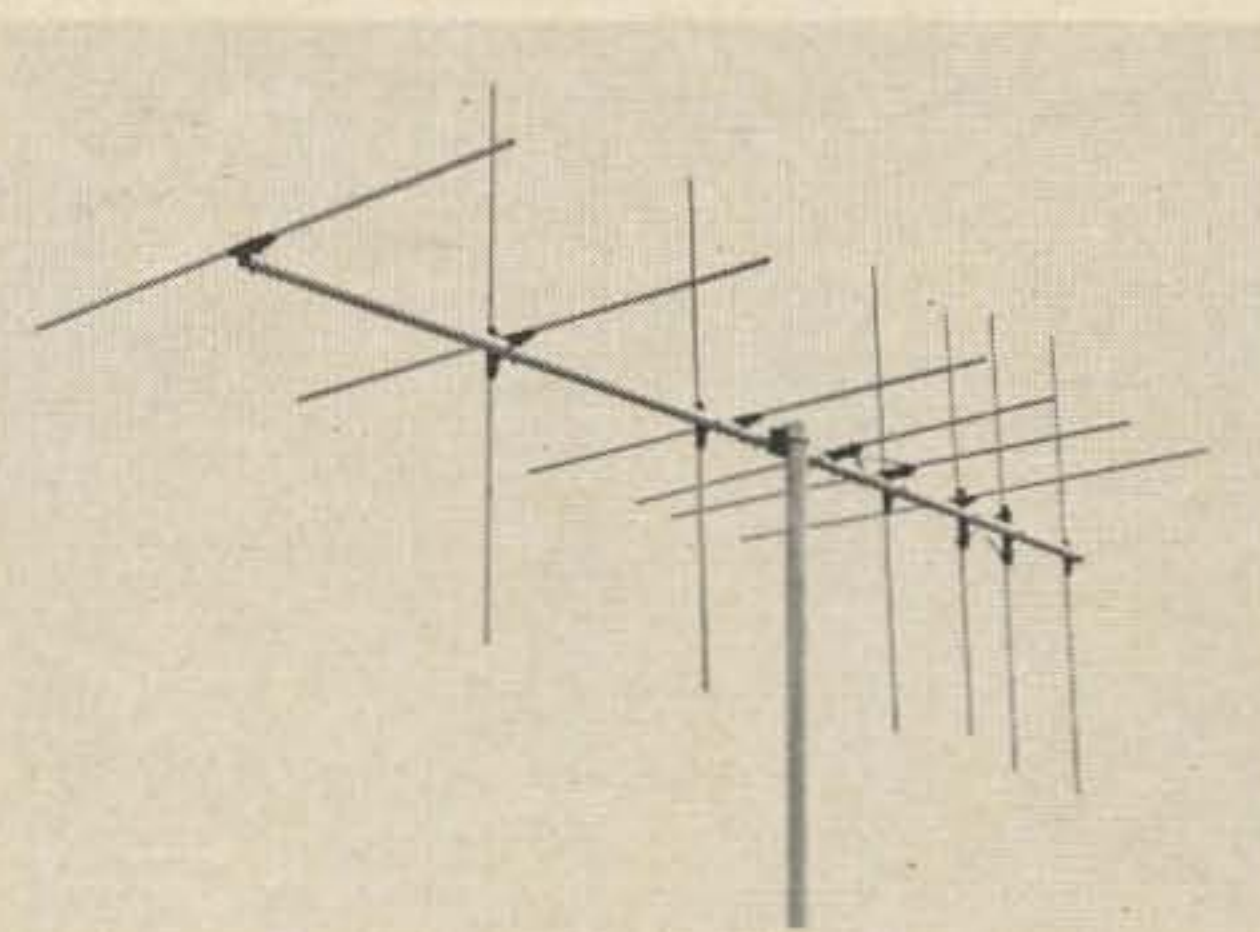

2 METER CIRCULAR POLARITY

- Great for OSCAR, FM, AM and SSB
- Gain 9.5 dbd
- Complete with harness and balun... ready for 50 Ohm feedline

\$54.95

- WINNER 1975 UHF WEST COAST ANTENNA CONTEST
NEW... KLM 432-16 LB 15 dbd 16 ele. yagi for 430-434 MHz complete with balun

\$45.95

Write for complete catalog or contact your local KLM DEALER (see June 73 Magazine for COMPLETE LIST)

KLM ELECTRONICS

1600 Decker Avenue, San Martin CA 95046 408-683-4240

RGS ELECTRONICS

008A MICROCOMPUTER KIT

8008 CPU, 1024 x 8 memory; memory is expandable. Kit includes manual with schematic, programming instructions and suggestions; all ICs and parts supplied except cabinet, fuses & hardware. Includes p.c. boards. \$375.00

MANUAL ONLY, \$25.00
(no discount on manual)

008A-K ASCII keyboard input kit. \$135.00

008A-C Audio cassette adapter kit. \$100.00

Details on computer, peripheral kits in our flyer.

TTL

7400	\$.20	7485	\$1.40
7401	.20	7486	.50
7402	.20	7489	2.90
7403	.20	7490	.80
7404	.25	7492	.80
7405	.25	7493	.80
7406	.45	7495	.90
7407	.45	7496	.85
7408	.25	74107	.50
7409	.25	74121	.60
7410	.20	74122	.60
7411	.30	74123	1.10
7413	.85	74125	.65
7416	.45	74126	.65
7417	.45	74141	1.25
7420	.20	74150	1.70
7430	.20	74151	1.00
7432	.30	74153	1.40
7437	.50	74154	1.70
7438	.50	74157	1.40
7440	.20	74161	1.50
7442	1.10	74163	1.70
7446	1.45	74164	2.00
7447	1.45	74165	2.00
7448	1.45	74166	1.75
7450	.20	74174	2.20
7451	.20	74175	2.20
7453	.20	74176	1.60
7454	.20	74177	1.35
7473	.45	74181	3.90
7474	.45	74192	1.50
7475	.80	74193	1.45
7476	.50	74195	1.00
7483	1.10		

"THE CUBE" Fully assembled subaudible tone generator for small handheld or portable FM radios. 9-16 volts; no moving parts, set anywhere between 98 & 240 Hz with a trim resistor.

.5" x .6" x .8" \$19.95
Set on frequency by the factory, \$5.00 extra

POWER SUPPLIES

PS 5-1 5v 1a regulated power supply kit with p.c. board & instructions. Board measures 2" x 5", completed kit is 2" high. Transformer has internal r.f. shield. \$8.00

PS 25-1 0 to 25v 1a lab type power supply with adjustable current limiting; remote sensing & remote programming for voltage & current. Instructions included. All parts except chassis, meter(s), p.c. board. Kit of parts with schematics \$14.95
P.C. boards available, No. 007 \$3.00 ea.

SOME NEW TRANSISTORS . . .

			1-99	100+
N1	T0-92	NPN Darlington	\$.35	.30
N2	T0-92	NPN lo-noise, lo-level	.15	.10
N3	T0-92	NPN medium purpose	.20	.15
N4	T0-92	NPN 2N3904 type	.15	.10
N5	T0-92	NPN UHF	.20	.15
N6	T0-92	NPN RF-IF	.15	.10
P2	T0-92	PNP lo-level	.15	.10
P3	T0-92	PNP medium power	.20	.15
P4	T0-92	PNP 2N3906 type	.15	.10
P7	T0-92	PNP high-voltage	.25	.20
P8	T0-92	PNP higher-voltage	.30	.25

AND SOME OLD TRANSISTORS . . .

		1-99	100+
2N2222	T0-18 NPN	\$.25	.20
2N2907	T0-18 PNP	.25	.20
NPN	T0-92 general purpose	.08	.0595
PNP	T0-92 general purpose	.08	.0595

Data on all transistors and jFETS is now in our flyer.

BRAND NEW ALUM. ELECTROLYTIC CAPS, RADIAL LEAD

	10ww	35ww	50ww
1mfd	\$.10	\$.12	\$.15
2mfd	.10	.12	
5mfd	.10	.12	
10mfd	.11	.13	.16
30mfd	.12	.20	.28
50mfd	.13		
100mfd	.15	.30	.45
200mfd	.20		.70
500mfd	.28	.75	
1000mfd	.50		

RGS ELECTRONICS

3650 Charles St., Suite K ■ Santa Clara, CA 95050 ■ (408) 247-0158

We sell many ICs and components not listed in this ad. Send a stamp for our free flyer. TERMS OF SALE: All orders prepaid; we pay postage. \$1.00 handling charge on orders under \$10.00. California residents please include sales tax. Please include name, address and zip code on all orders and flyer requests. Prices subject to change without notice.

DISCOUNTS: 10% OFF ORDERS OVER \$25.00; 20% OFF ORDERS OVER \$250.00

UPDATE

to

DIGITAL READOUT TUNING

42.95

Kit: includes;
Power Supply,
Display card,
Timing card,
Misc. parts, less
case.



WORKS WITH ANY 160-20 METER TRANSMITTER OR
TRANSCEIVER WITH JUST A PICKUP LOOP

- All IC
- Build it into your rig
- Converts to 15 and 10
- Even works with QRP rigs
- Mobile too
- MHz/KHz coarse/fine readout
- Frequency to 100 Hz
- Easy to build
- Power supply included
- Crystal controlled time base

BRING YOUR RIG TO THE STATE OF THE ART

HURRY, I don't want to lay out several hundred bucks for a new rig,
but I gotta have digital readout (doesn't everyone?)

Here's a check for _____ for _____ unit(s). You pay shipping.

Name _____ Call _____

Address _____

City _____ State _____ Zip _____

TWS LABS

P.O. Box 357, Provo, Utah 84601

CHARGE IT
ON



CHARGE IT
ON



**CALL
FREE**

TOLL
FREE
NUMBER
(Continental 48 States)

**CALL
FREE**

**800
325-3636**

MO CUSTOMERS CALL
314-993-6060
COLLECT

**TRADE
ON
NEW**

CALL

**TRADE
ON
USED**

HAM RADIO CENTER

(9 A.M.—5 P.M. Central, Closed Sun. & Mon.)

**FOR
A SQUARE DEAL
ON**

- **DRAKE**
- **TEMPO/ONE**
- **TEN-TEC**
- **ATLAS**
- **STANDARD**

- **YAESU**
- **SWAN**
- **COLLINS**
- **KENWOOD**
- **REGENCY**

*We carry all major brands and a large
stock of used reconditioned equipment*

HAM RADIO CENTER INC.

8342 OLIVE BL. PO Box 28271 ST. LOUIS, MO 63132



Our Call Letters are. . .

IDAHO

When you hear them think about good food; think about the world's greatest potato.



Idaho Potato Commission

Boise, Idaho



S. D. SALES CO.

P. O. BOX 28810 DALLAS, TEXAS 75228

6 Digit Digital Clock Kit

Our Engineer said it would be "impossible" to sell a Six Digit kit for this price. But because of several special super buys we made on chips and displays we can offer this unbelievable bargain on our Clock Kit. Sure, this price is too good to be true, but rest assured, all parts in this kit are prime, first run units. Also, all kits are sold with an unconditional money back guarantee.

Here's What The Kit Includes:

- 1 — MM5314 National Clock Chip with socket
- 6 — Common Cathode Led Readouts (.25 in. char.)
- 13 — NPN and PNP Driver Transistors
- 2 — Push Button Switches for time set
- 1 — Rocker Switch for time hold
- 1 — 1000 MFD 25V Filter Cap
- 4 — IN4001 Rectifiers
- 1 — IN914 Diode
- 2 — .01 Disc. Caps
- 9 — Carbon Resistors

\$9⁹⁵
(KIT)
WITH SPECS.
POSTPAID

P.C. BOARD FOR ABOVE — \$3.00 each

All you need to add is a 12VAC Transformer, perfboard, and your choice of case. The above parts, if ordered separately from our competitors, could cost you as much as \$20. Buy from S.D. and you'll be happy with our quality parts and ultra fast shipment.

<p>IC SOCKETS 14 PIN-5 For \$1 16 PIN-4 For \$1</p>	<p>SWITCHES FOR DIGITAL CLOCKS, ETC. Rocker style. SPDT. miniature size. 4 for \$1. Push Button. SPST N.O. Enclosed, mini. 4 for \$1</p>
<p>NATIONAL 2K ERASEABLE PROM 2048 Bit, static units. U.V. light erasable. MM5203. Factory prime new units. Special — \$14.95.</p>	<p>SUBMINIATURE TRIMMER CAPS Ultra stable. Range: 3.5 to 18 PF. 2 for \$1</p>
<p>DIGITAL CLOCK CHIPS BY NATIONAL FACTORY NEW UNITS! MM5314 — 4 or 6 digits. 24 pin DIP. Use with LED Readouts. With Specs. — \$3.95 MM5316 — Alarm chip. 40 pin DIP. \$4.44</p>	<p>FILTER CAPS Dual section, 2000 MFD and 1500 MFD at 30 WVDC. Twist Lock. 79c ea. 3 For \$2</p>
<p>TEXAS INSTRUMENTS 8 DIGIT CALCULATOR CHIP TMS0 103NC. Four function. Same style as used in TI pocket calculators. Factory new units, with specs. \$1.99 each.</p>	<p>NATIONAL VOLTAGE REGULATOR Like 7805. 5VDC — 1 AMP output. Has TO-220 plastic power tab — 99c</p>
<p>1AMP 1000 PIV SILICON RECTIFIERS IN4007. Factory prime devices. 10 for \$1.00.</p>	<p>IN4148 COMPUTER DIODES Same as IN914. Factory prime. 20 for \$1.</p>
<p>741C OP AMPS Prime, factory tested and marked. Full spec on all parameters. Not re-tested, functional only, units as sold by others. 741CH — TO-5 8 Lead Metal Can 3/\$1 741CV — 8 Lead Mini Dip 4/\$1</p>	<p>FULL WAVE BRIDGE By G.I. 1.5 AMP 800PIV — 75c</p>
<p>12VDC RELAY DPDT. Heavy gold plated 5 amp contacts. 300 OHM coil. Limited Qty. 99c</p>	<p>2N706A 400MHZ. TRANSISTORS Silicon NPN. 1 WATT. TO-18 Case. 5 For \$1</p>
	<p>723CH PRECISION VOLTAGE REGULATOR Build a circuit regulating the voltage from 2 to 37 volts. Complete specs included. One of the easiest to use regulators now on the market. S.D. Special Introductory Price 2 For \$1.00</p>

S. D. SALES CO.

P. O. BOX 28810 DALLAS, TEXAS 75228

FAST SERVICE — QUALITY MERCHANDISE
BARGAINS GALORE — NO BACK ORDERS

We are **SMALL** enough to give personalized service, but
LARGE enough to handle every order swiftly and efficiently!

<p>INTEL 1K 2102 RAM Factory prime, tested units. Factory selected for much faster speed than units sold by others. 650 NS. These are <i>static</i> memories that are TTL compatible and operate off + 5 VDC. The real workhorse of solid state memories because they are so easy to use. Perfect for TV typewriters, mini-computers, etc. With specs. \$4.95 ea. or 8 for \$30</p>	<p>FAIRCHILD LED READOUTS — 69c FND-70. Common cathode. Right hand decimal point. .25 inch character. Prime new units. Perfect for clocks, frequency counters, etc. 69c 10 For \$6 Best Readout Buy In USA!</p>																																																																								
<p>SIGNETICS 1K P-ROM 82S129. 256 x 4. Bipolar, much faster than MOS devices. 50NS. Tri-state outputs. TTL compatible. Field programmable, and features on chip address decoding. Perfect for microprogramming applications. 16 pin DIP. With specs. \$2.95 ea.</p>	<p>10 PIN SOCKETS FOR FND-70 An S.D. exclusive. For use with our Fairchild LED readouts. 29c ea. 10 For \$2.50</p>																																																																								
<p>LM324 — QUAD 741 OP AMP — \$1.50</p>	<p>DO YOU NEED A LARGE, COMMON ANODE READOUT AT A FANTASTIC PRICE? S.D. presents the MAN-64 by Monsanto - .40 inch character. All LED construction - not reflective bar type, fits 14 pin DIP. Brand new and factory prime. Left D.P. \$1.59 ea. 6 For \$7.50</p>																																																																								
<p>NE555 — Timers — 69c or 10 For \$6</p>	<p>DL747 JUMBO LED READOUTS By Litronix. .65 inch character. Common anode. Outperforms SLA-3. Perfect for giant digital clocks. Only 20 MA. per segment. Special — \$2.50 ea.</p>																																																																								
<p>709CH — OP AMPS — 4 For \$1</p>	<p>LARGE SIZE LED LAMPS Similar to MV5024. Prime factory tested units. We include plastic mounting clips which are very hard to come by. Special 4 For \$1</p>																																																																								
<p>GE SCR C106B1 4 AMP 200PIV. Sensitive Gate. 59c</p>	<p>PC BOARD MATERIAL FR-4 blank epoxy boards. 2 oz. copper, 5 x 10 in. Single Sided. Limited Qty. — \$1.49</p>																																																																								
<p>MOTOROLA POWER DARLINGTON — \$1.99 MJ3001 - .NPN - 80 Volts - 10 Amps - HFE 6000 typ. To-3 Case. Ideal for power supplies, etc. We include a free 723 regulator w/schematic for power supply with purchase of the MJ3001. You get the two key parts for a DC supply for only \$1.99. Regular catalog price for the MJ3001 is \$3.82</p>	<p>MOTOROLA VOLTAGE REGULATOR MC1469R. TO-66 9 Lead package. For 3 TO 30V Outputs. Provides 600 MA direct output or more by using an external power transistor. Reg. catalog \$4 ea. With specs. \$1.95 ea.</p>																																																																								
<p>TRANSISTORS</p> <table border="1"> <thead> <tr> <th>Type</th> <th>Mat.</th> <th>Pol.</th> <th>Vceo</th> <th>Ic</th> <th>Hfe</th> <th>Case</th> <th>Price</th> </tr> </thead> <tbody> <tr> <td>2N3904</td> <td>S</td> <td>N</td> <td>40</td> <td>100MA</td> <td>200</td> <td>TO-92</td> <td>6/1.00</td> </tr> <tr> <td>2N3906</td> <td>S</td> <td>P</td> <td>40</td> <td>100MA</td> <td>200</td> <td>TO-92</td> <td>6/1.00</td> </tr> <tr> <td>2N4401</td> <td>S</td> <td>N</td> <td>40</td> <td>250MA</td> <td>200</td> <td>TO-92</td> <td>6/1.00</td> </tr> <tr> <td>2N4403</td> <td>S</td> <td>P</td> <td>40</td> <td>250MA</td> <td>200</td> <td>TO-92</td> <td>6/1.00</td> </tr> <tr> <td>2N3638</td> <td>S</td> <td>P</td> <td>25</td> <td>150MA</td> <td>60</td> <td>TO-105</td> <td>6/1.00</td> </tr> <tr> <td>EN930</td> <td>S</td> <td>N</td> <td>45</td> <td>50MA</td> <td>300</td> <td>TO-106</td> <td>6/1.00</td> </tr> <tr> <td>2N2905</td> <td>S</td> <td>P</td> <td>40</td> <td>350MA</td> <td>200</td> <td>TO-5</td> <td>4/1.00</td> </tr> <tr> <td>2N4249</td> <td>S</td> <td>P</td> <td>60</td> <td></td> <td></td> <td></td> <td>6/1.00</td> </tr> </tbody> </table>	Type	Mat.	Pol.	Vceo	Ic	Hfe	Case	Price	2N3904	S	N	40	100MA	200	TO-92	6/1.00	2N3906	S	P	40	100MA	200	TO-92	6/1.00	2N4401	S	N	40	250MA	200	TO-92	6/1.00	2N4403	S	P	40	250MA	200	TO-92	6/1.00	2N3638	S	P	25	150MA	60	TO-105	6/1.00	EN930	S	N	45	50MA	300	TO-106	6/1.00	2N2905	S	P	40	350MA	200	TO-5	4/1.00	2N4249	S	P	60				6/1.00	<p>MOTOROLA NEGATIVE VOLTAGE REG MC1463R — Like our 1469R above, except for negative voltage. Reg. catalog \$5. Our price \$1.95.</p>
Type	Mat.	Pol.	Vceo	Ic	Hfe	Case	Price																																																																		
2N3904	S	N	40	100MA	200	TO-92	6/1.00																																																																		
2N3906	S	P	40	100MA	200	TO-92	6/1.00																																																																		
2N4401	S	N	40	250MA	200	TO-92	6/1.00																																																																		
2N4403	S	P	40	250MA	200	TO-92	6/1.00																																																																		
2N3638	S	P	25	150MA	60	TO-105	6/1.00																																																																		
EN930	S	N	45	50MA	300	TO-106	6/1.00																																																																		
2N2905	S	P	40	350MA	200	TO-5	4/1.00																																																																		
2N4249	S	P	60				6/1.00																																																																		
<p>RCA HIGH VOLTAGE POWER TRANSISTOR 100 Watts. 5 Amps. 300 VCEO. TO-3 case. Silicon NPN. Mfg. house numbered 2N5240. Regular catalog is \$6. Perfect for H.V. supplies or vertical and horizontal circuits. SPECIAL — 99c</p>	<p>POWER TRANSISTOR PC BOARD Mfg. by Memorex Computer Corp. Board has 20 Power Transistors. 10-RCA 2N3585 TO-66 SILICON NPN. VCEO-300 IC-2AMPS. 10-MOTOROLA MJE-340. NPN Silicon. VCEO-300. Plastic power tab case. Also has 10-2N2222A TO-18 NPN transistors and 10-1N5059 1 AMP 200 PIV rectifiers, plus 32 resistors. LIMITED QTY. Board #103. \$3.99 ea.</p>																																																																								
<p>HEAVY DUTY TRANSFORMER 36 VAC, 3.5 AMPS. 115VAC 60HZ. PRI. For power supplies or audio power amps. Best quality, fully enclosed. \$4.95</p>	<p>48 HOUR SERVICE You deserve, and will get prompt shipment. On orders not shipped in 48 HRS., a 20% cash refund will be sent. We do not sell junk. Money back guarantee on every item. WE PAY POSTAGE. Orders under \$10 add 75c handling. No C.O.D. Texas Res. add 5% tax.</p>																																																																								
<p>HEWLETT-PACKARD LED READOUT .30 inch character. Common cathode. One of the brightest readouts around. Factory prime units, not retested seconds as sold by others. #5082-7740 99c ea.</p>	<p>S. D. SALES CO. P.O. BOX 28810 DALLAS, TEXAS 75228</p>																																																																								
<p>ORDERS OVER \$15 CHOOSE \$1 FREE MERCH.</p>	<p>FREE BONUS All clock or calculator chips are shipped with <i>free socket</i>.</p>																																																																								

JAMES Summer Specials*

TTL IC'S		
7400	Quad. NAND Gate	6/\$1.00
7447	BCD - Seven Seg. Dec.	.89
7490	Decade Counter	.59
74100	4 Bit Bistable Lath	1.25
74150	16-Line 1 Mult.	1.00
74154	4-16 Line Decoder	1.00

LINEAR IC'S		
LM301AN	OP AMP	4/\$1.00
LM307H	Super Op Amp	4/\$1.00
LM311 H	Hi perf. V comp.	.75
LM311 H	Hi perf. V comp.	.75
LM555V	Timer	.69
NE565T	Phase lock loop	1.25
NE567T	Tone Decoder	1.25
NE567V	Tone Decoder	1.75
LM723H	Volt. Reg.	2/\$1.00
LM723N	Volt. Reg.	2/\$1.00
8038	Function Generator	3.95

DIODES - TRANSISTORS					
IN751A	5.1	400M	7/\$1.00		
IN965B	15	400M	6/\$1.00		
IN4002	100Piv	1 AMP	15/\$1.00		
IN4003	200Piv	1 AMP	15/\$1.00		
IN4004	400Piv	1 AMP	15/\$1.00		
IN4148 (IN914)			20/\$1.00		
IN4735A	6.2	1 W	5/\$1.00		
2N3055	NPN		.79		

NEW KITS
TTL Logic Probe Kit \$9.95 per kit
 Detects TTL levels, pulses, with man 3 readout

DIGITAL VOLTMETER KIT
 0-10 Volt, 3% digits (Man 7) DVM
 MOS - LSI Design
 Size: 3" x 3" x 1 1/4" **\$39.95**

IC'S EXAR KITS FUNCTION GENERATOR KIT

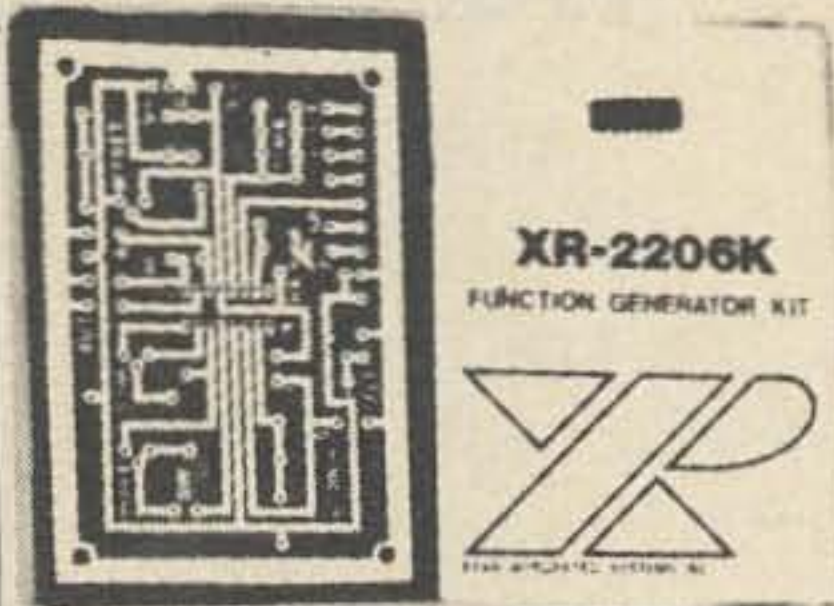

features sine, triangle and square wave; THD 0.5% typ.; AM/FM capability

XR-2206KA **\$19.95**
 Includes monolithic function generator IC, PC board, and assembly instruction manual.

XR-2206KB **\$29.95**
 Same as XR-2206KA above and includes external components for PC board.

TIMERS		
XR-555CP	Monolithic Timer	\$ 1.10
XR-320P	Precision Timer	1.55
XR-556CP	Dual-555 Timer	1.85
XR-2556CP	Dual Timing Circuit	3.20
XR-2240CP	Programmable Counter/Timer	4.80

PHASE LOCKED LOOPS		
XR-210	FSK Demodulator	5.20
XR-215	High Frequency PLL	6.60
XR-567CP	Tone Decoder (mini DIP)	1.95
XR-567CT	Tone Decoder (TO-5)	1.70

STEREO DECODERS		
XR-1310P	PLL Stereo Decoder	3.20
XR-1310EP	PLL Stereo Decoder	3.20
XR-1800P	PLL Stereo Decoder	3.20

WAVEFORM GENERATORS		
XR-205	Waveform Generator	8.40
XR-2206CP	Monolithic Function Generator	5.50
XR-2207CP	Voltage-Controlled Oscillator	3.85

OTHER EXAR IC'S		
XR-1468CN	Dual + 15V Tracking Regulator	3.85
XR-1488N	Quad Line Driver	5.80
XR-1489AN	Quad Line Receiver	4.80
XR-2208CP	Operational Multiplier	5.20
XR-2211 CP	FSK Demodulator/Tone Decoder	6.70
XR-2261	Monolithic Proportional Servo IC System w/4 ea. Driver Transistor	3.79

4' POWER SUPPLY CORDS

Black **.59¢ ea.**

8' POWER SUPPLY CORDS
 Black or Gray **\$1.45 ea.**

WALL or T.V. DIGITAL CLOCK

25' VIEWING DISTANCE
 Walnut Case-6" x 3" x 1"
 Hr. & Min.-6" High
 Seconds-3" High
 KIT - All Comp. & Case **\$39.95**
 Wired & Assembled 115 Vac **\$44.95**

MULTIPURPOSE KEYBOARDS

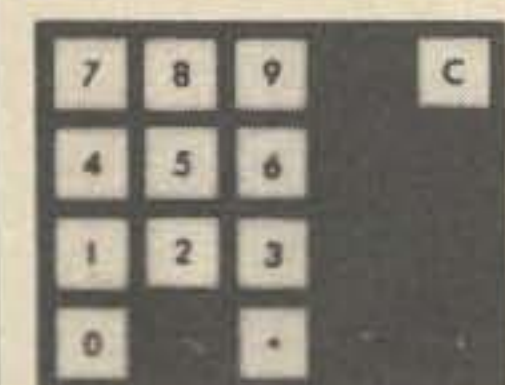

20 Keys - Touch Tone
 No schematic needed, (pop-off) key tops.
 This unit may be cut apart for smaller units.

1-4 **\$3.25 ea.**
 5 **\$2.95 ea.**

SWITCHES



SLIDE SWITCHES
 DP-DT Locking 0.5A-DC
 PART NO. 1-9 10-29 30 up
 223-462061 B .39 .30 .27

SUB-MINATURE TOGGLE



SPDT			DPDT		
ON	NONE	ON	JMT	2.05	1.65
123			2.95	2.15	
223					

PB PUSH-BUTTON SERIES - (SPDT)

5 AMP RATINGS
 Momentary Action Switch
 Normally Open or Normally Closed. (For N C circuit use terminals 2 & 1; for N O, 2 & 3; for N C and N O, 1,2&3 PB-126 \$2.35 \$1.95

For the economy-minded student or experimenter . . .

NEW PROTO BOARD-100

Here's a low cost, big 10 IC capacity breadboard kit with all the quality of QT Sockets and the best of the Proto-Board series . . . complete down to the last nut, bolt and screw. Includes 2 QT-35S Sockets; 1 QT-35B Bus Strip; 2 5-way binding posts; 4 rubber feet; screws, nuts, bolts; and easy assembly instructions.



COMPLETE KIT . . . **\$19.95**

IC SOLDERTAIL - LOW PROFILE (TIN) SOCKETS

1-24			25-49			50-100		
8 pin	\$.22	.20	14 pin	.26	.23	24 pin	.68	.62
14 pin	.26	.23	28 pin	.89	.81	36 pin	1.10	.99
16 pin	.29	.26	40 pin	1.25	1.13			.93
18 pin	.46	.41						
22 pin	.65	.59						

SOLDERTAIL STANDARD (TIN)

14 pin	\$.30	.28	28 pin	.99	.90	36 pin	1.39	1.26
16 pin	.33	.31	40 pin	1.59	1.45			1.30
18 pin	.42	.39						
24 pin	.59	.54						

SOLDERTAIL STANDARD (GOLD)

8 pin	\$.30	.27	24 pin	.70	.63			.57
14 pin	.35	.32	28 pin	1.10	1.00			.90
16 pin	.38	.35	36 pin	1.55	1.40			1.26
18 pin	.52	.47	40 pin	1.75	1.59			1.45

WIRE WRAP SOCKETS (GOLD) LEVEL #3

10 pin	\$.45	.41	24 pin	\$1.05	.95			.85
14 pin	.46	.42	28 pin	1.40	1.25			1.10
16 pin	.55	.50	36 pin	1.59	1.45			1.30
18 pin	.75	.68	40 pin	1.75	1.55			1.40

DISPLAY LEDS

CA	Common Anode	CC	Common Cathode
MAN 1	Com. Ano.	.270	\$1.95
MAN 3	Com. Cath.	.125	.95
MAN 4	Com. Cath.	.187	1.95
MAN 7	Com. Ano.	.30	1.50
DL 33	Com. Cath.	.125	1.95
DL 747	Com. Ano.	.625	2.50

DISCRETE LEDS

MV 10	Red	5/\$1.00
MV 50	Red	6/\$1.00
MV 5024	Red	5/\$1.00
MV 5024	Green	4/\$1.00
MV 5024	Yellow	4/\$1.00
MV 5024	Orange	4/\$1.00



CAPACITOR CORNER

50 VOLT CERAMIC DISC CAPACITORS

	1-9	10-49	50-100	1-9	10-49	50-100
10pf	.05	.04	.03	.001	.05	.04
22 pf	.05	.04	.03	.0047	.05	.04
47 pf	.05	.04	.03	.01	.05	.04
100 pf	.05	.04	.03	.022	.06	.05
220 pf	.05	.04	.03	.047	.06	.05
470 pf	.05	.04	.035	.1	.12	.09

100 VOLT MYLAR FILM CAPACITORS

.001mf	.12	.10	.07	.022mf	.13	.11	.08
.0022	.12	.10	.07	.047mf	.21	.17	.13
.0047mf	.12	.10	.07	.1mf	.27	.23	.17
.01mf	.12	.10	.07	.22mf	.33	.27	.22

+ 20% DIPPED TANTALUMS (SOLID) CAPACITORS

.1 35V	.28	.23	.17	1.5 35V	.30	.26	.21
.15 35V	.28	.23	.17	2.2 25V	.31	.27	.22
.22 35V	.28	.23	.17	3.3 25V	.31	.27	.22
.33 35V	.28	.23	.17	4.7 25V	.32	.28	.23
.47 35V	.28	.23	.17	6.8 25V	.36	.31	.25
.68 35V	.28	.23	.17	10 25V	.40	.35	.29
1.0 35V	.28	.23	.17	15 25V	.63	.50	.40

MINIATURE ALUMINUM ELECTROLYTIC CAPACITORS

Axial Lead				Radial Lead			
.47 50	.15	.13	.10	.47 25	.15	.13	.10
1 50	.16	.14	.11	.47 50	.16	.14	.11
3.3 50	.15	.13	.10	1 16	.15	.13	.10
4.7 25	.16	.14	.12	1 25	.16	.14	.11
10 25	.15	.13	.10	1 50	.16	.14	.11
10 50	.16	.14	.12	4.7 16	.15	.13	.10
22 25	.17	.15	.12	4.7 25	.15	.13	.10
22 50	.24	.20	.18	4.7 50	.16	.14	.11
47 25	.19	.17	.15	10 16	.14	.12	.09
47 50	.25	.21	.19	10 25	.15	.13	.10
100 25	.24	.20	.18	10 50	.16	.14	.12
100 50	.35	.30	.28	47 50	.24	.21	.19
220 25	.32	.28	.25	100 16	.19	.15	.14
220 50	.45	.41	.38	100 25	.24	.20	.18
470 25	.33	.29	.27	100 50	.35	.30	.28
1000 16	.55	.50	.45	220 16	.23	.17	.16
2200 16	.70	.62	.55	470 25	.31	.28	.26



7400N TTL



SN7400N .18	SN7451N .27	SN74151N 1.25
SN7401N .21	SN7453N .27	SN74153N 1.35
SN7402N .21	SN7454N .41	SN74154N 1.25
SN7403N .21	SN7459A .25	SN74155N 1.21
SN7404N .21	SN7460N .22	SN74156N 1.30
SN7405N .24	SN7470N .45	SN74157N 1.30
SN7406N .45	SN7472N .39	SN74160N 1.75
SN7407N .45	SN7473N .45	SN74161N 1.45
SN7408N .25	SN7474N .45	SN74163N 1.65
SN7409N .25	SN7475N .80	SN74164N 1.65
SN7410N .20	SN7476N .47	SN74165N 1.65
SN7411N .30	SN7480N .50	SN74166N 1.70
SN7412N .42	SN7482N 1.75	SN74167N 5.50
SN7413N .85	SN7483N 1.15	SN74170N 3.00
SN7414N .70	SN7485N 1.12	SN74172N 18.00
SN7416N .43	SN7486N .45	SN74173N 1.70
SN7417N .43	SN7488N 3.50	SN74174N 1.95
SN7418N .25	SN7489N 3.00	SN74175N 1.95
SN7420N .21	SN7490N .69	SN74176N .90
SN7421N .39	SN7491N 1.20	SN74177N .90
SN7423N .37	SN7492N .82	SN74180N 1.05
SN7425N .43	SN7493N .82	SN74181N 3.55
SN7426N .31	SN7494N .91	SN74182N .95
SN7427N .37	SN7495N .91	SN74184N 2.30
SN7429N .42	SN7496N .91	SN74185N 2.20
SN7430N .26	SN74100N 1.50	SN74187N 6.00
SN7432N .31	SN74107N .49	SN74190N 1.50
SN7437N .47	SN74121N .55	SN74191N 1.50
SN7438N .40	SN74122N .49	SN74192N 1.50
SN7439A .25	SN74123N 1.05	SN74193N 1.40
SN7440N .21	SN74125N .60	SN74194N 1.45
SN7441N 1.10	SN74126N .81	SN74195N 1.00
SN7442N 1.08	SN74132N 3.00	SN74196N 1.25
SN7443N 1.05	SN74141N 1.15	SN74197N 1.00
SN7444N 1.10	SN74142N 6.50	SN74198N 2.25
SN7445N 1.10	SN74143N 7.00	SN74199N 2.25
SN7446N 1.15	SN74144N 7.00	SN74200N 7.00
SN7447N .89	SN74145N 1.15	SN74251N 2.50
SN7448N .99	SN74148N 2.50	SN74284N 6.00
SN7450N .26	SN74150N 1.10	SN74285N 6.00

20% Discount for 100 Combined 7400's

HIGH SPEED	LOW POWER	SCHOTTKY
SN74H00N .33	SN74L00N .33	SN74S00N .60
SN74H01N .33	SN74L02N .33	SN74S03N .60
SN74H04N .33	SN74L03N .33	SN74S04N .65
SN74H05N .35	SN74L04N .33	SN74S05N .65
SN74H08N .33	SN74L10N .33	SN74S10N .60
SN74H10N .33	SN74L20N .33	SN74S11N .65
SN74H11N .33	SN74L30N .33	SN74S15N .60
SN74H20N .33	SN74L42N 1.50	SN74S20N .60
SN74H21N .33	SN74L73N .69	SN74S22N .60
SN74H22N .33	SN74L74N .69	SN74S40N .60
SN74H30N .33	SN74L75N .79	SN74S64N .60
SN74H40N .33	SN74L85N 1.15	SN74S65N .60
SN74H50N .33	SN74L86N .69	SN74S112N 1.25
SN74H51N .35	SN74L90N 1.60	SN74S153N 2.50

CD4000	CMOS	74C10N
CD4001 .39	CD4030 1.00	74C20N .65
CD4002 .39	CD4035 2.65	74C30N .65
CD4006 3.75	CD4040 3.95	74C42N 2.15
CD4007 .55	CD4042 2.75	74C73N 1.50
CD4009 .89	CD4044 2.75	74C74 1.15
CD4010 .69	CD4046 2.75	74C90N 3.00
CD4011 .39	CD4047 2.75	74C95N 2.00
CD4012 .39	CD4049 1.00	74C107N 1.25
CD4013 1.00	CD4050 1.00	74C151 2.90
CD4016 1.00	CD4051 3.95	74C154 3.00
CD4017 2.65	CD4053 3.45	74C157 2.15
CD4019 1.15	CD4060 4.85	74C160 3.25
CD4020 1.50	CD4066 2.25	74C161 3.25
CD4022 1.50	CD4069 .75	74C163 3.00
CD4023 .39	CD4071 .41	74C164 3.25
CD4024 1.95	CD4081 .41	74C173 2.60
CD4025 .39	74C00N .39	74C193 2.75
CD4027 1.15	74C02N .55	74C195 2.75
CD4028 2.65	74C04N .75	80C97 1.50
CD4029 3.95		

LM100H 15.00	LINEAR	LM1310N 2.95
LM106H 2.50	LM373N 3.25	LM1351N 1.65
LM171H 3.75	LM377N 4.00	LM1414N 1.75
LM212H 7.00	LM380N 1.39	LM1458C .65
LM300H .80	LM380CN 1.05	LM1496N .95
LM301H 3/1.00	LM381N 1.79	LM1556V 1.85
LM301CN 3/1.00	LM382N 1.79	LM2111N 1.95
LM302H .75	NE501K 8.00	LM2901N 2.95
LM304H 1.00	NE510A 6.00	LM3065N .69
LM305H .95	NE531H 3.00	LM3900N .55
LM307CN .35	NE536T 6.00	LM3905N .60
LM308H 1.00	NE540L 6.00	LM5556N 1.85
LM308CN 1.00	NE550N .79	MC5558V 1.00
LM309H 1.10	NE553 2.50	LM7525N .90
LM309K 1.25	NE555V .75	LM7528N 2.20
LM310CN 1.15	NE565H 1.25	LM7534N 2.20
LM311H .90	NE565N 1.95	LM7535N 1.25
LM311N .90	NE566CN 1.95	8038B 4.95
LM318CN 1.50	NE567H 1.25	LM75450 .49
LM319N 1.30	NE567V 1.95	75451CN .39
LM319D 9.00	LM703CN .45	75452CN .39
LM320K-5 1.35	LM709H .29	75453CN .39
LM320K-5.2 1.35	LM709N .29	75454CN .39
LM320K-12 1.35	LM710N .79	75491CN .79
LM320K-15 1.35	LM711N .39	75492CN .89
LM323K-5 14.00	LM723N .55	75494CN .89
LM324N 1.80	LM723H .55	RCA LINEAR
LM339N 1.70	LM733N 1.00	CA3013 1.70
LM340K-5 1.95	LM739N 1.29	CA3023 2.15
LM340K-12 1.95	LM741CH 3/1.00	CA3035 2.25
LM340K-15 1.95	LM741CN 3/1.00	CA3039 1.35
LM340K-24 1.95	LM741-14N .39	CA3046 1.15
LM340T-5 1.75	LM747H .79	CA3059 2.46
LM340T-6 1.75	LM747N .79	CA3060 2.80
LM340T-12 1.75	LM748H .39	CA3080 .85
LM340T-15 1.75	LM748N .39	CA3083 1.60
LM340T-24 1.75	LM1303N .90	CA3086 .59
LM350N 1.00	LM1304N 1.19	CA3089 3.25
LM351CN .65	LM1305N 1.40	CA3091 8.25
LM370N 1.15	LM1307N .85	CA3123 1.85
LM370H 1.15		CA3600 1.75

8091 .59	8092 .59	8095 1.39	8121 .89	8123 1.59	8130 2.19	8200 2.59	8210 3.49	8214 1.69	8220 1.69	8223 * 3.00	8230 2.59	8263 7.00	8267 4.00	8280 .75	8281 .85	8288 1.15	8520 1.29	8551 1.65	8552 2.49	8554 2.49	8810 .79	8820 2.00	8826 3.00	8830 2.59	8831 2.59	8836 .49	8864 2.00	8880 1.35
----------	----------	-----------	----------	-----------	-----------	-----------	-----------	-----------	-----------	-------------	-----------	-----------	-----------	----------	----------	-----------	-----------	-----------	-----------	-----------	----------	-----------	-----------	-----------	-----------	----------	-----------	-----------

DIODES (Zener)			DIODES (Rectifier)				
TYPE	VOLTS	W	PRICE	TYPE	VOLTS	W	PRICE
IN746	3.3	400m	4/1.00	IN4003	200 PIV	1 AMP	.10
IN751A	5.1	400m	4/1.00	IN4004	400 PIV	1 AMP	.10
IN752	5.6	400m	4/1.00	IN3600	50	200m	6/1.00
IN753	6.2	400m	4/1.00	IN4148	75	10m	15/1.00
IN754	6.8	400m	4/1.00	IN4154	35	10m	12/1.00
IN965B	15	400m	4/1.00	IN4734	5.6	1w	.28
IN5232	5.6	500m	.28	IN4735	6.2	1w	.28
IN5234	6.2	500m	.28	IN4736	6.8	1w	.28
IN5235	6.8	500m	.28	IN4738	8.2	1w	.28
IN5236	7.5	500m	.28	IN4742	12	1w	.28
IN456	25	40m	6/1.00	IN4744	15	1w	.28
IN458	150	7m	6/1.00	IN1183	50 PIV	35 AMP	1.60
IN485A	180	10m	5/1.00	IN1184	100 PIV	35 AMP	1.70
IN4001	50 PIV	1 AMP	.09	IN1186	200 PIV	35 AMP	1.80
IN4002	100 PIV	1 AMP	.10	IN1188	400 PIV	35 AMP	3.00

50 PCS. RESISTOR ASSORTMENTS \$1.75 PER ASST.

ASST. 1	5 ea:	10 OHM- 12 OHM- 15 OHM- 18 OHM- 22 OHM- 27 OHM- 33 OHM- 39 OHM- 47 OHM- 56 OHM	1/4 WATT 5% = 50 PCS.
ASST. 2	5 ea:	68 OHM- 82 OHM- 100 OHM- 120 OHM- 150 OHM- 180 OHM- 220 OHM- 270 OHM- 330 OHM- 390 OHM	1/4 WATT 5% = 50 PCS.
ASST. 3	5 ea:	470 OHM- 560 OHM- 680 OHM- 820 OHM- 1K	1/4 WATT 5% = 50 PCS.
ASST. 4	5 ea:	1.2K 1.5K 1.8K 2.2K 2.7K 3.3K 3.9K 4.7K 5.6K 6.8K 8.2K 10K 12K 15K 18K	1/4 WATT 5% = 50 PCS.
ASST. 5	5 ea:	22K 27K 33K 39K 47K 56K 68K 82K 100K 120K	1/4 WATT 5% = 50 PCS.
ASST. 6	5 ea:	150K 180K 220K 270K 330K 390K 470K 560K 680K 820K	1/4 WATT 5% = 50 PCS.
ASST. 7	5 ea:	1M 1.2M 1.5M 1.8M 2.2M 2.7M 3.3M 3.9M 4.7M 5.6M	1/4 WATT 5% = 50 PCS.

JAMES Electronics

P. O. Box 822 - Belmont, Ca. 94002

PHONE ORDERS WELCOME
(415) 592-8097

Special Requested Items

8008 Processor	\$29.95	8267	\$ 4.00	4024P*	\$2.25
1101 256 x 1 RAM	2.25	2513*	11.00	N8T97	3.00
2102 1024 RAM	5.50	2518	7.00	MC1741	4.00
AY5-1013 UART	9.95	2519	4.00	MC4044	4.50
RC4194 TK	5.95	2524*	3.50	40409	1.65
8101	18.00	2525	7.00	40410	1.75
8263	7.00	2529*	4.00	40673	1.75

Satisfaction Guaranteed. \$5.00 Min. Order. U.S. Funds.
California Residents - Add 6% Sales Tax
Write for FREE 1975 Catalog - Data Sheets .25¢ each

HAMTRONICS

JULY

SALE ANNOUNCEMENT

FEATURING ICOM



IC21A — REG. \$449. NOW

- 24 CHANNEL CAPABILITY
- 7 CHANNELS SUPPLIED
- MOSFET FRONT END
- 0.4 UV SENSITIVITY
- 5 HELICAL FILTERS
- BUILT IN AC & DC POWER SUPPLIES



DV-21 — REG. \$389. NOW

- FULLY SYNTHESIZED VFO
- OPERATES IN 5 OR 10KH STEPS
- COVERS ENTIRE 2 METER BAND
- SCANNING CAPABILITY
- 2 PROGRAMMABLE MEMORIES
- TOUCH KEYS TO SET XMIT & RECEIVE FREQUENCY



ICOM 30A — REG. \$399. NOW

- 10 WATT OUTPUT
- ALL SOLID STATE
- 0.6 UV FOR 20dB QUIETING
- 22 CHANNEL — 5 INSTALLED
- MODULAR CONSTRUCTION



IC22A — REG. \$249. NOW

- 22 CHANNEL
- 5 CHANNELS SUPPLIED
- SOLID STATE TR SWITCHING
- 10W-1W POWER SAVER OPTION
- TRIMMER CAPS ON EACH CHANNEL



IC 230 — REG. \$489. NOW

- PLL SYNTHESIZER
- 67 CHANNELS — 30 KH SEPARATION
- HELICAL FILTERS
- AUTOMATIC PROTECTION CIRCUITRY
- MODULAR CONSTRUCTION



PRICES ARE SO EXPLOSIVE YOU MUST CALL OR WRITE FOR QUOTES.
SPECIAL GIVEAWAY FOR JULY ONLY!



HAMTRONICS



A DIVISION OF TREVOSE ELECTRONICS

4033 BROWNSVILLE ROAD, TREVOSE, PA. 19047

215-357-1400 or 1475

JULY SPECIALS

**10% OFF
ANY ITEM • ANY QUANTITY**

DIGITAL

7404	Hex inverter	\$.19
7406	30V hex inverter	.29
7410	Triple 3 input NAND	.17
7437	Quad 2 input NAND buffer	.29
7442	BCD to decimal DCDR	.79
7490	Decade counter	.59
74107	Dual J-K flip flop	.39
74123	Retrig monostbl mult	.89
74175	Quad D flip flop	1.69
8263	3 input 4 bit mult	5.99
8267	2 input 4 bit mult	2.79
74C00	Quad 2 input NAND gate	.19

MEMORY

1103	Fully decoded — 1024 bit static RAM MOS — 18 pin	\$1.99
5260	Fully decoded — 1024 bit dynamic RAM MOS — 16 pin	.99

**SPECIAL PURCHASE
LED DISPLAY MAN 3M**
\$.25 ea. 5/\$1.00 8/\$1.50

16 BIT MICROPROCESSOR CHIPS

MM5750	Arithmetic and logic unit	\$30.00ea.
MM5751	Control and read only memory (Imp-16 standard set or extended set)	\$40.00 ea.
Set of 4 MM5750 and 1 MM5751		\$129.00

CT5005 CALCULATOR CHIP

12 digit — 4 function with memory — chain operation	\$4.95 ea.
---	-------------------

8008 CENTRAL PROCESSING UNIT

8 bit microcomputer capability — 16 pin DIP	\$44.95 ea.
---	--------------------

POCKET CALCULATOR KIT



5 function plus constant — addressable memory with individual recall — 8 digit display plus overflow — battery saver — uses standard or rechargeable batteries — all necessary parts in ready to assemble form — instructions included. 3" x 5 1/4"

**\$19.95
ASSEMBLED \$24.95**

LINEAR

301	Hi perf amp	mDIP	\$.19
311	Volt comp.	mDIP	.79
555	Timer	mDIP	.89
567	Tone decoder	mDIP	2.75
3900	Quad amp	DIP	.33
75453	Dual per. drv	mDIP	.30

TTL

7400	\$.19	7485	\$ 1.39
7401	.19	7486	.44
7402	.19	7489	2.75
7403	.19	7490	.76
7404	.22	7491	1.29
7405	.22	7492	.79
7406	.39	7493	.79
7407	.39	7494	.89
7408	.25	7495	.89
7409	.25	7496	.89
7410	.19	74105	.49
7411	.29	74107	.49
7413	.79	74121	.57
7415	.39	74122	.53
7416	.39	74123	.99
7417	.39	74125	.69
7420	.19	74126	.79
7422	.29	74141	1.23
7423	.35	74145	1.15
7425	.39	74150	1.09
7426	.29	74151	.89
7427	.35	74153	1.29
7430	.22	74154	1.59
7432	.29	74155	1.19
7437	.45	74156	1.29
7438	.39	74157	1.29
7440	.19	74161	1.39
7441	1.09	74163	1.59
7442	.99	74164	1.89
7443	.99	74165	1.89
7444	1.10	74166	1.65
7445	1.10	74173	1.65
7446	1.15	74175	1.89
7447	1.15	74176	1.65
7448	1.15	74177	.99
7450	.24	74180	1.09
7453	.27	74181	3.65
7454	.39	74182	.89
7460	.19	74190	1.59
7464	.39	74192	1.49
7465	.39	74193	1.39
7472	.36	74194	1.39
7473	.43	74195	.99
7474	.43	74196	1.85
7475	.75	74197	1.15
7476	.47	74198	2.19
7483	1.11	74199	2.19

Data sheets supplied on request
Add \$.50 for items less than \$1.00

**10% Off on orders over \$25.00
15% Off on orders over \$100.00
20% Off on orders over \$250.00**

LINEAR CIRCUITS

301	Hi perf. op amp	mDIP	\$.32
307	Op amp	mDIP	.29
308	Micro-pwr op amp	mDIP	.99
309K	5V reg 1A	TO-3	1.50
310	V follr. Op Amp	mDIP	1.19
311	Hi perf. V comp	mDIP	1.05
319	Hi-speed dual comp	DIP	1.29
320	Neg. regulator (5V, 5.2V, 12V, 15V)	TO3	1.25
324	Quad op amp	DIP	1.89
339	Quad comp	DIP	1.69
340T	Pos V reg (5V, 6V, 8V, 12V, 15V, 18V, 24V)	TO-220	1.75
372	AG-IF strip det	DIP	.79
376	Pos V reg	mDIP	.59
377	2 w stereo amp	DIP	2.69
380	2w audio amp	DIP	1.29
380-8	.6w audio amp	mDIP	.89
381	Lo noise dual preamp	DIP	1.69
550	Prec. V reg	DIP	.79
555	Timer	mDIP	.99
560	Phase locked loop	DIP	2.75
562	Phase locked loop	DIP	2.65
565	Phase locked loop	DIP	2.65
566	Function gen	mDIP	2.50
567	Tone Decoder	mDIP	2.95
709	Op amp	DIP	.29
710	Hi speed V comp	DIP	.39
723	Volt reg.	DIP	.69
739	Dual hi perf amp	DIP	1.19
741	Comp. op amp	mDIP	.35
747	Dual 741	DIP	.79
748	Freq adj 741	mDIP	.39
1304	FM mux st demod	DIP	1.19
1307	FM mux st demod	DIP	.82
1458	Dual Comp op amp	mDIP	.69
1800	Stereo Multiplexer	DIP	2.75
3900	Quad amp	DIP	.39
7524	Core mem sense amp	DIP	.79
7525	Core mem sense amp	DIP	.95
75451	Dual prl. driver	mDIP	.39
75452	Dual prl. driver	mDIP	.39
75453	Dual prl. driver	mDIP	.39
75491	Quad seq driver	DIP	.79
75492	Hex dig. driver	DIP	.89

Data sheets supplied on request
Add \$.50 for items less than \$1.00

MEMORIES

1101	256 bit RAM MOS	\$1.75
1103	1024 bit RAM MOS	3.95
2101	1024 bit static RAM	6.95
5203	2048 bit UV eras PROM	19.95
5260	1024 bit RAM	2.95
5261	1024 bit RAM	2.95
5262	2048 bit RAM	7.95
7489	64 bit ROM TTL	2.75
8223	Programmable ROM	3.95
74200	256 bit RAM tri-state	7.95

CALCULATOR & CLOCK CHIPS

5001	12 DIG 4 funct fix dec	3.95
5002	Same as 5001 exc btry pwr	4.95
5005	12 DIG 4 funct w/mem	5.95
MM5725	8 DIG 4 funct chain & dec	2.25
MM5736	18 pin 6 DIG 4 funct	4.95
MM5738	8 DIG 5 funct K & Mem	5.95
MM5739	9 DIG 4 funct (btry sur)	5.95
MM5311	28 pin BCD 6 dig mux	4.95
MM5312	24 pin 1 pps BCD 4 dig mux	4.45
MM5313	28 pin 1 pps BCD 6 dig mux	4.95
MM5314	24 pin 6 dig mux	4.95
MM5316	40 pin alarm 4 dig	5.95

LED'S AND OPTO ISOLATORS

MV10B	Red TO 18	\$.25 ea.
MV50	Axial leads	.20
MV5020	Jumbo visible red	.25
ME4	Infra red diff. dome	.60
MAN1	Red 7 seg. .270"	2.50
MAN2	Red alpha num .32"	4.95
MAN4	Red 7 seg. .190"	2.15
MAN5	Green 7 seg. .270"	2.95
MAN7	Red 7 seg. .270"	1.35
MAN8	Yellow 7 seg. .270"	3.95
MAN66	60" high dir. view	4.65
DL707	Red 7 seg. .3"	2.15
MCT2	Opto-iso transistor	.69

CMOS

4000 AE	\$.40	4019 AE	\$2.10	4066 AE	\$1.05
4001 AE	.40	4020 AE	2.20	4068 AE	.40
4002 AE	.40	4021 AE	2.05	4069 AE	.40
4006 AE	1.75	4023 AE	.40	4071 AE	.40
4007 AE	.40	4024 AE	1.45	4072 AE	.40
4008 AE	2.45	4025 AE	.40	4073 AE	.40
4009 AE	.80	4027 AE	1.20	4075 AE	.40
4010 AE	.80	4028 AE	1.75	4078 AE	.40
4011 AE	.40	4030 AE	.85	4081 AE	.40
4013 AE	.80	4042 AE	1.90	4082 AE	.40



Satisfaction is guaranteed. Shipment will be made via first class mail — postage paid — in U.S., Canada and Mexico within three days from receipt of order. Minimum order — \$5.00. California residents add sales tax.

INTERNATIONAL ELECTRONICS UNLIMITED

(408) 659-3171

P.O. BOX 1708

MONTEREY, CALIF. 93940 USA

DuPage FM

WILL NOT BE UNDERSOLD!



MODEL CMUA6

- 450 mc
- Solid State
- 60 Watts Output
- Solid State Receiver and Exciter
- 2 Frequency Transmit and Receive
- Tone Encoded Squelch at No Extra Cost

**RCA
Supercarphones**

only \$250⁰⁰

**Accessories
included!!**

(LESS ACCESSORIES - \$225)

TERMS: All items sold as is. Accessories do not include antennas or crystals. If equipment is not as represented, return for exchange within five days of receipt, shipping charges prepaid. Illinois residents add 5% sales tax. All items shipped freight charges collect.

**DuPage FM, Inc.
P.O. Box 1
Lombard, Ill. 60148
(312) 627-3540**

1ST PRIZE: 16 BIT MICROCOMPUTER CHIP!

CONTEST!

GODBOUT

BILL GODBOUT ELECTRONICS
BOX 2355, OAKLAND AIRPORT, CA 94614

2nd prize: 8080 CPU

3rd prize: 8008 CPU

We were 1st to offer the 8008 to hobbyists over 16 months ago; now we're setting the pace again with a powerful new 16 bit microcomputer IC in a 40 pin DIP, made by:

the **SECRET MICROCOMPUTER Co!**

YOU MAY WIN ONE OF THESE CHIPS --- SIMPLY:

- 1) Reveal the Secret Microcomputer Co.'s true identity
- 2) Tell us in 25 words or less why you should receive a free chip

If you can convince our jaded judges, in a form suitable for use in this family (?) magazine, you win.

★ **GOOD LUCK!**



FINE PRINT: ALL ENTRIES MUST BE POSTMARKED BY JULY 31 AND BE IN OUR HANDS BY AUG 7, 1975; ENTRIES BECOME PROPERTY OF BILL GODBOUT ELECTRONICS. ALL CONTESTANTS RECEIVE A DATA SHEET ABOUT OUR FIRST PRIZE FOR THEIR TROUBLE. WINNER WILL BE NOTIFIED BY SEPT 1, 1975. IF YOU DON'T WIN ANYTHING THIS TIME AROUND DON'T FEEL TOO BAD; ENTER OUR COMING CONTEST FOR A COMPLETE 16 BIT MICROCOMPUTER KIT. THESE CONTESTS SPOTLIGHT PRODUCTS TO BE INTRODUCED BY US IN THE FALL OF '75. SEND ENTRIES TO "BGE CONTEST", BOX 2355, OAKLAND AIRPORT, CA 94614.

NOW...YOU CAN CALL (415) 357-7007 FOR MASTERCHARGE OR BANKAMERICARD ORDERS WITH OUR 24 HOUR TELEPHONE ANSWERING SERVICE. BEST OF ALL, YOU'LL TALK TO A REAL LIVE HUMAN BEING, NOT AN ANSWERING MACHINE!

GODBOUT

BILL GODBOUT ELECTRONICS
BOX 2355, OAKLAND AIRPORT, CA 94614

THE ANIMAL ON THE FACING PAGE IS A 4K X 8 MEMORY BOARD, COMPATIBLE WITH THE MK-8 AND OTHER 8008-BASED MICROCOMPUTERS... HERE ARE THE FEATURES: **ON BOARD REGULATION (OR DIRECT 5 V OPERATION) **BUFFERED DATA OUTPUTS CAN DRIVE 20 TTL LOADS-- IDEAL FOR DRIVING BUSES IN NOISY ENVIRONMENTS **STANDARD 100 PIN EDGE CONNECTOR SUPPLIED WITH KIT **GLASS EPOXY PC BOARD W/ ALL HOLES BRIGHT PLATED - THROUGH FOR EXCELLENT SOLDERABILITY **TOP QUALITY CLOSED ENTRY SOCKETS PROVIDED FOR ALL ICS **ALL INPUTS & OUTPUTS AVAILABLE ON EDGE CONNECTOR; CHOICE OF D OR \bar{D} OUT **PLENTY OF V_{CC} BYPASSING IN ALL THE RIGHT PLACES USING BOTH TANTALUM AND DISC CAPACITORS **FLEXIBLE ADDRESSING

**4K x 8
memory
board**
\$163.84

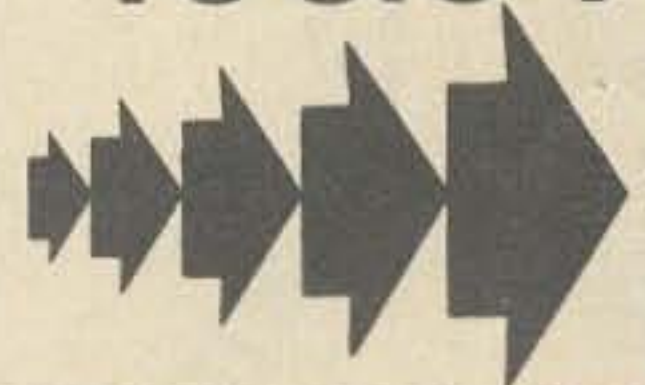

ALL THIS FITS ON A 6.5 BY 9.5 INCH PC BOARD, AND COSTS HALF-CENT PER BIT. CONVINCED?

**4 Quad NOR
C
M
O
S
S**
while they last

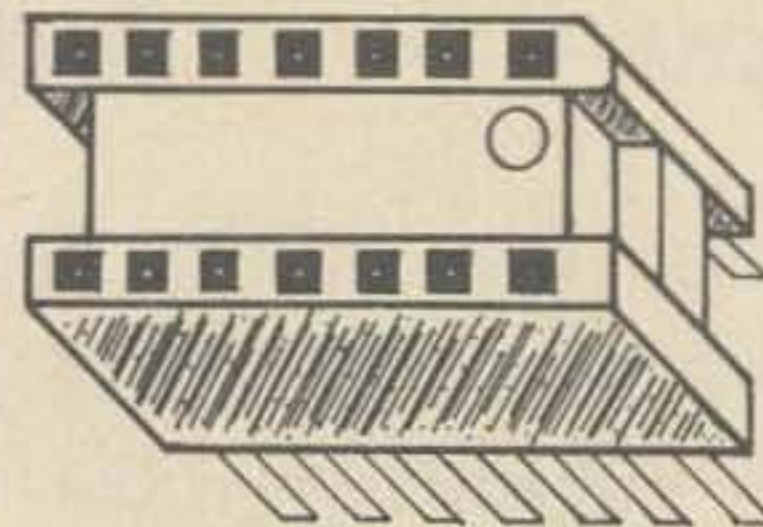
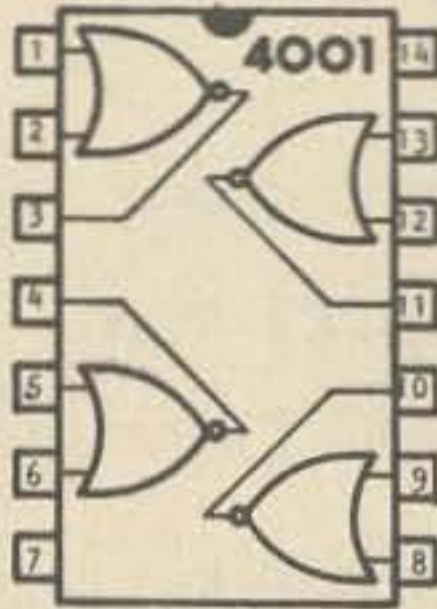

SOCKETS

**CAN WE
PROGRAM
EROMs?**



"YUP"

like
**5203s,
1702s,
etc.**

**15¢
each**

SOCKET TO YOU! WE MADE A SPECIAL PURCHASE OF PC MOUNT SOLDER TAIL SOCKETS, INCLUDING DISCONTINUED TYPES AND A LOT OF 14 PIN SOCKETS THAT REQUIRE HIGHER THAN SPEC INSERTION FORCE. BRAND NEW FROM A LEADING MFR OF TOP QUALITY IC SOCKETS.

**Plantronics
Headset \$59.95**

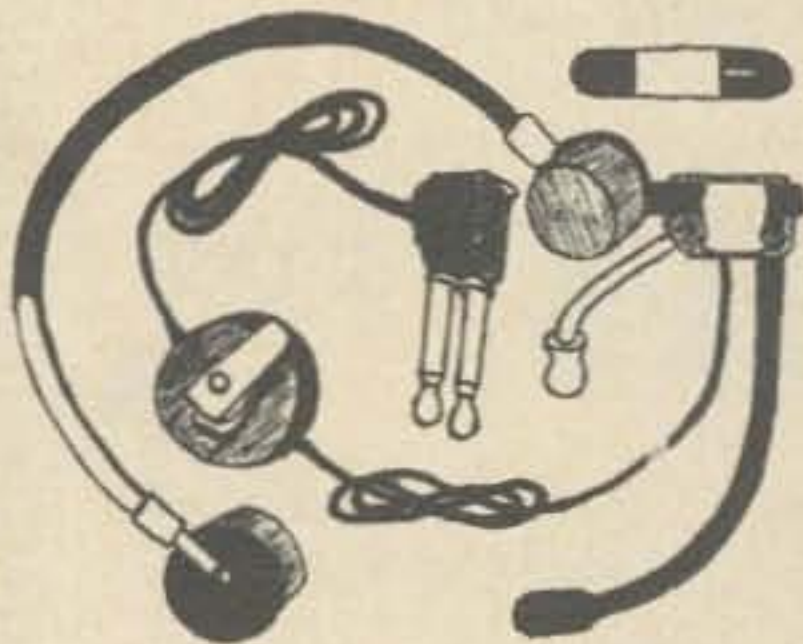

FOR SWITCHBOARDS, AIRCRAFT, HAM, CB, TELEPHONE SYSTEMS. LIGHT, DURABLE, ADJUSTABLE. HAS BUILT-IN MIC AMPLIFIER. COMPLETE AND READY TO GO--- UNCONDITIONALLY GUARANTEED. LIMITED QUANTITY!

(G) = GOLD PLATED CONTACTS (T) = BRIGHT TIN PLATE

T 14 PIN	11/\$1.95	T 40 PIN	5/\$2.95
G 14 PIN	10/\$1.95	LOW PROFILE SOCKETS:	
T 24 PIN	5/\$1.95	G 16 PIN	10/\$1.95
T 28 PIN	5/\$1.95	G 40 PIN	5/\$2.95

Flyer

If you like what you see in this ad, remember it's only the tip of the iceberg. Send name + address + stamp to find out about all the other good stuff we sell at ridiculously low prices.

Louisville Book

Residents of Louisville, KY or vicinity can obtain any of the items in this ad from Steve Roberts at Cybertronic Systems. Say you saw it in 73

We'll be carrying Craig Anderton's book on electronic projects starting Nov. 1; watch for it.

TERMS AND OTHER FINE PRINT: ADD 50¢ TO ORDERS UNDER \$10. CALIFORNIA RESIDENTS ADD TAX. SORRY, WE CAN'T PROCESS ANY COD ORDERS. CUSTOMERS OUTSIDE THE U.S.: WE SPEAK YOUR LANGUAGE (IF IT'S FRENCH OR GERMAN).

\$17.95

postpaid!

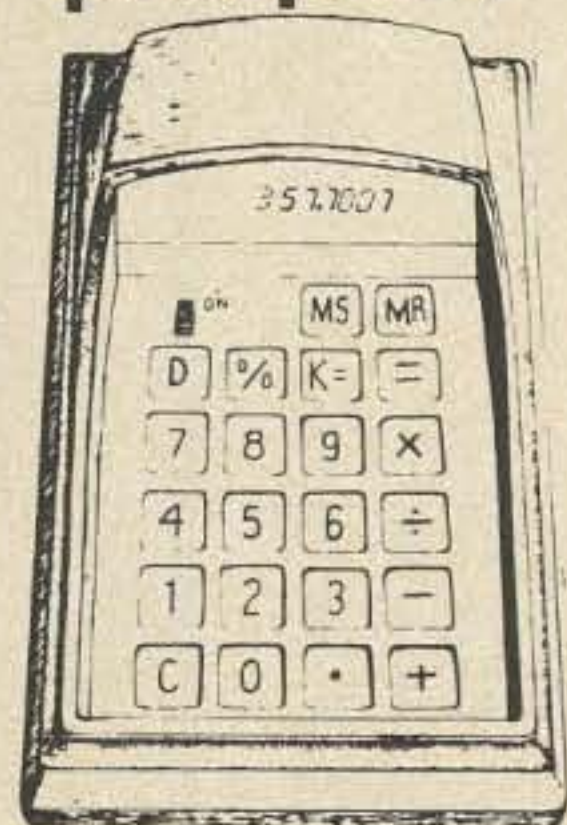

CALCULATOR 8 DIGIT-FIVE FUNCTION (+ - X ÷ %) PLUS MEMORY, CONSTANT, FLOATING PT, LOW BATTERY INDICATOR, TIMED DISPLAY TURNOFF (PRESS "D" TO RECALL).

TK-01-RT KIT INCLUDES PARTS, INSTRUCTIONS, CASE AND ALKALINE BATTERIES. POSTPAID.

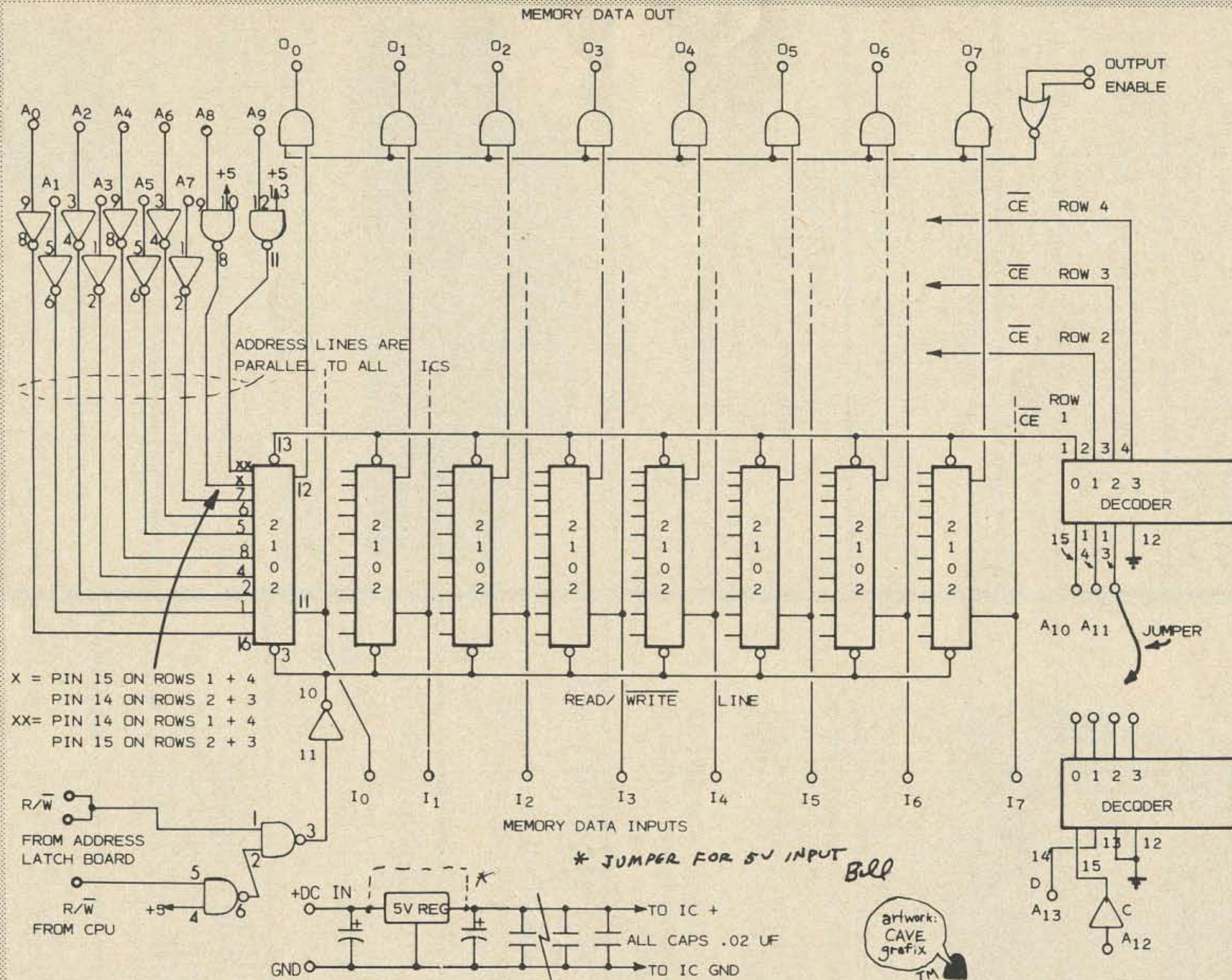

GODBOUT

BOX 2355, OAKLAND AIRPORT, CALIFORNIA 94614



Desk top calculator by well known mfr. These are rejects, 8 digit, 4 function, liquid crystal display. Fully assembled, some factory reject, some customer returns. Most are repaired in a few minutes. Sold "as is." Ship wt 3 lbs.

AC model \$10 each 3 for \$26.50
 Battery portable model \$11 each 3 for \$30.00

SINGLE CHIP ASCII ENCODER

A hot item today. We furnish full data booklet with each order. \$10 each 3 for \$25.00

8 CHAN MULTIPLEX SWITCH

Solid state 16 pin IC MOS. 8 channel w/output enable control & one-of-eight decoder in chip. With data. Fairchild 3705. . \$5.00

RC OSCILLATORS

16 pin IC chip contains 4 RC osc. Ideal for touch tone encoder. TCA 430. . \$5.00

PHOTO-STROBE

Made for Instamatic but useful on any camera with instructions provided. Info also on trick uses, automotive strobe, slave strobe, automotive strobe, Psychadelic repetitive strobe, etc. Complete with charger & Nickel Cadmium batteries.

\$9.00, 3 for \$25.00

COLUMBIA 4 CHANNEL SQ

Solid state SQ 4 channel adapter, 2 amps built in. Decodes 4 channel or synthesizes 4 channel. \$20.00

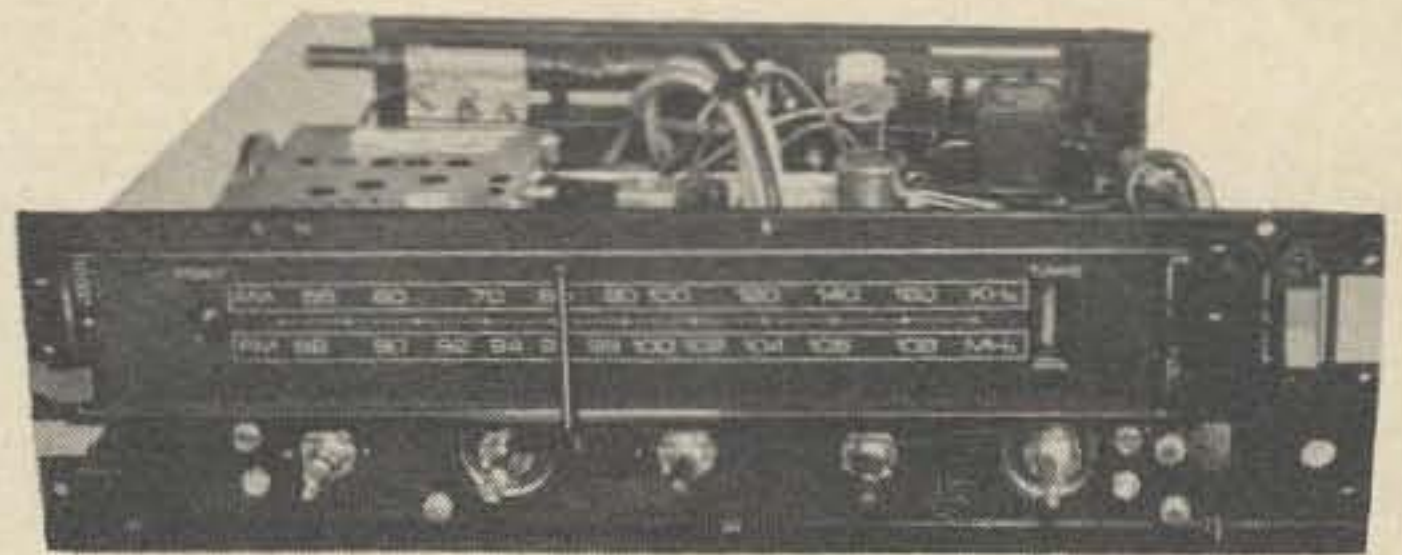

Beautiful AM-FM Stereo Multiplex radios made to sell in the over \$100 range. Picture shows typical unit. Solid state. AC powered, made for famous US manufacturer. Ship wt 10 lbs. \$35.00

LED READOUTS 5/\$1.00!

The price is not a mistake. We have some hobby variety with some segments out. Ukinbuyem for as low as 5 for \$1.00

DUAL 16 BIT MEMORY

Dual 16 bit memory, serial MOS by Philco TO-5 case, brand new with 2 page specs. #PLR 532 \$1.00 each \$10/12

AM-FM RADIO

For console installation, w/face plate, no knobs. Stereo amplifiers for tape or turnable playback. \$15.00
 Pair of matching speakers w/xfmrs for above \$5.00

CALCULATOR CHASSIS

Fully assembled pocket calculator chassis with calculator chip. Uses LED readouts not included. \$5.00

BELLTONE PAGER

Genuine "Ma Bell" belt clip radio receiver beeper. Picks up specific radio signals in 35 MHz area, encoded by internal reed encoder. Seems to be a "natural" for construction jobs, in-plant calling. An interesting experimental gadget. Self contained antenna, adjustable coding by shifting wires on coding module.

#SP-125 \$5.00 each, 6/\$25.00



Please add shipping cost on above.

Meshna

P.O. Box 62
 E. Lynn MA 01904

FREE CATALOG

KEYBOARD \$35.00

One of the nicest keyboards we've found. Mounted in modern design wood grained enclosure for desk-top use. Magnetic reed relay bounceless keyswitches, Encoder board mounted within. Fine Biz. for Morse Code Generators – TV Typewriter – computer terminals, etc.



7 lb #SP-153L \$35.00

GENERAL PURPOSE POWER SUPPLY

Well designed transistorized, regulated power supply with many uses. Each voltage adjustable by pot. Each voltage fused. 115 volts ac input. Output (minus) 12 volts at 1/3 Amp, 12 volts (plus) at 3 Amps, 6 volts at 1 Amp. Three output voltages. Many uses . . . as battery charger, op amp (plus & minus 12 volts), 5 volt logic (adjust 6 volts to 5 volts), operate your car radio, tape player, CB set in the house, etc. A commercially built supply for less than the price of kit.

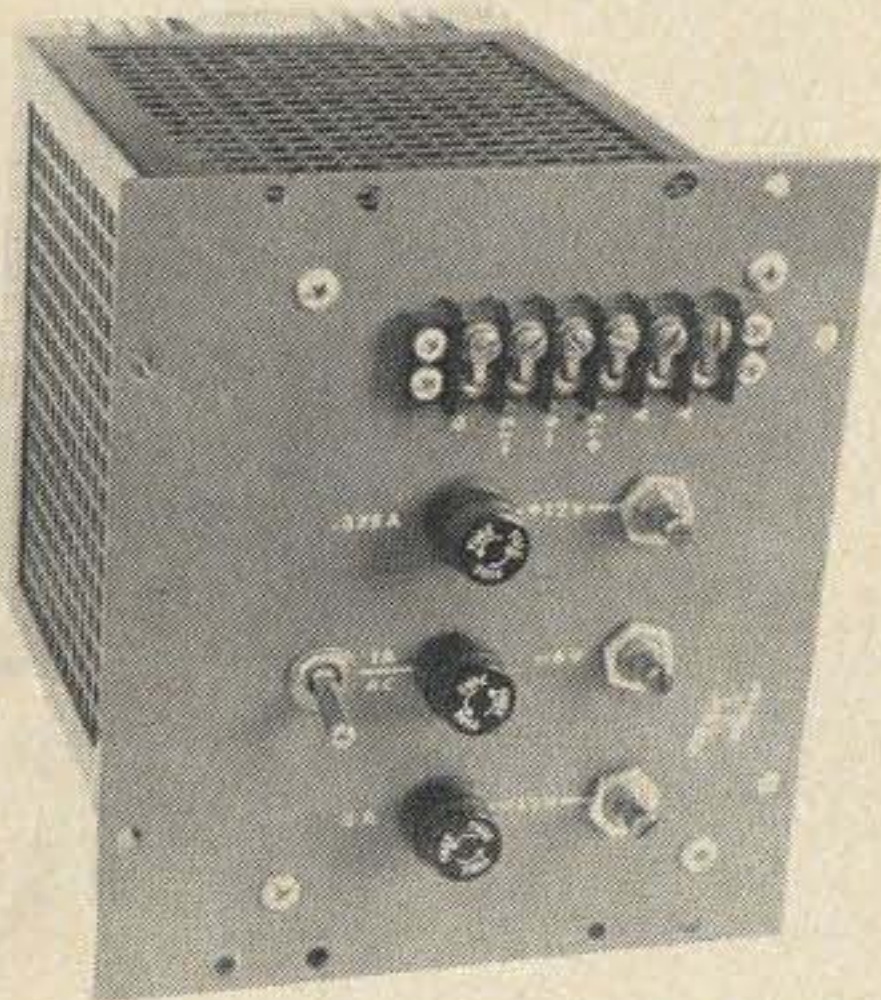

10 lb #SP-152L \$12.50 5/\$50

AIR COMPRESSOR \$22.00

Diaphragm compressor brand new surplus from the computer industry. Built-in 115 volt ac motor ball bearing for long life. Puts out 17 PSI with volume 0.7 SCFM. For general paint spraying, air cleaning, bubble bath for PC etching tank, etc. Many uses in lab or home.

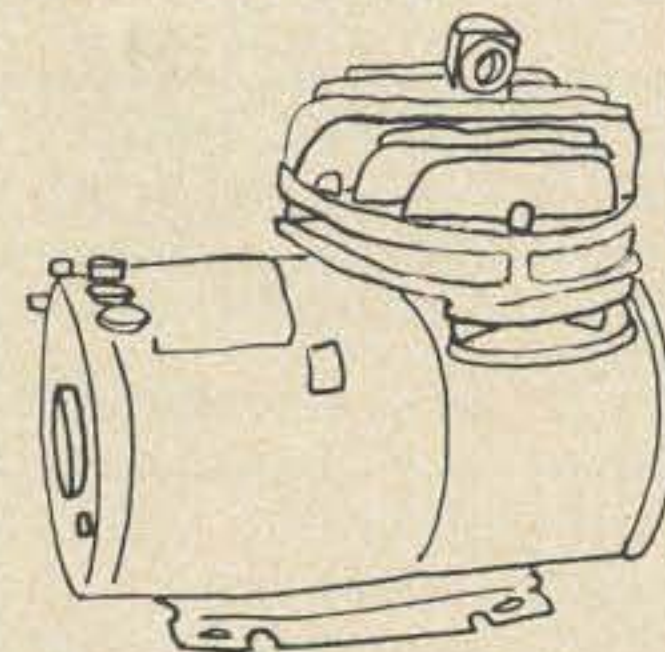

14 lb #SP-148L \$22.00

ANTIQUE SOUNDER

Takes you back to the Pony Express days. A genuine antique relic dating back to the old days. A real beauty, polished brass, wood base, bright and shiny new despite its age. In original packing as issued to the US Navy Dept. Already worth more than our asking price. Makes an unusual gift or desk top conversation piece for the man who has almost everything.

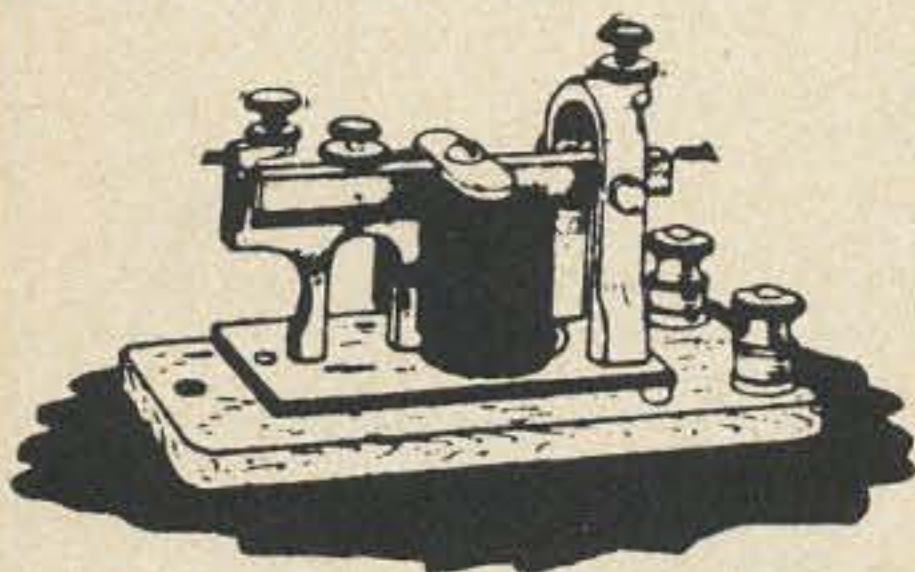

#SP-115 \$15.00 2/\$25.00

SPERRY 9 DIGIT DISPLAY \$2.50

180 volt 9 digit, 0.25 inch height character. Brand new and we include free with each, the \$1.50 mating socket. The price an astounding new low . . . \$2.50



#SP-145 \$2.50 5/\$10.00

Please add shipping cost on above.

FREE CATALOG

Meshna

P.O. Box 62
E. Lynn, Massachusetts 01904



7-Segment Readout 12-PIN DIP

Three digits with right-hand decimal
Plugs into DIP sockets
Similar to (LITRONIX) DL337
Magnified digit approximately .1"
Cathode for each digit
Segments are parallel for multiple
operation
5-10 MA per segment
EACH \$1.75 4 (12 DIGITS) \$6.00

RCA Numitron

EACH.....\$ 5.00

SPECIAL: 5 FOR \$20.00

DR2010



1024 Bit Memory

1024 Bit Fully Decoded Static MOS
Random Access Memory

- fast access 650ns
- fully TTL compatible
- n channel silicon gate
- single 5 volt supply
- tri-state output
- 1024 by 1 bit
- chip enable input
- no clocks or refreshing required

Brand New Factory Parts
16 PIN DIP Each \$5.00
8 for \$34.95

Power Supply SPECIAL!

723 DIP variable regulator chip 1-40V,
+ or - output @ 150 MA 10A with external
pass transistor--with diagrams for
many applications.
EACH \$1.00 10 FOR \$8.95

5001 Calculator

40-Pin calculator chip will add, sub-
tract, multiply, and divide. 12-digit
display and calculate. Chain calcula-
tions. True credit balance sign out-
put. Automatic over-flow indication.
Fixed decimal point at 1, 2, 3, or 4.
Leading zero suppression. Complete
data supplied with chip.

CHIP AND DATA.....ONLY \$2.49
DATA ONLY (Refundable)... \$1.00
5002 LOW POWER CHIP AND DATA \$12.95

High Quality PCB Mounting IC Sockets

8-PIN, 14-Pin, 16-Pin and 24-Pin PCB
mounting ONLY--no wire wrap sockets.

- 8-Pin.....\$.22
- 14-Pin.....\$.26
- 16-Pin.....\$.30
- 24-Pin.....\$.75
- 40-Pin.....\$1.25



All IC's are new and fully tested. Leads
are plated with gold or solder. Orders
for \$5.00 or more will be shipped prepaid
Add \$.55 for handling and postage for
smaller orders; residents of California
add sales tax. IC orders are shipped
within 2 workdays--kits are shipped with-
in 10 days of receipt of order. \$10.00
minimum on C.O.D.'s.

Mail Orders to: Phone
P.O. Box 41727
Sacramento, CA (916) 334-2161
95841

BABYLON ELECTRONICS

Money back guarantee
on all goods!



Dale Trimmer

-12 turn trimpots which plug
into a DIP socket
-5K and 200K
-1/2" x 1/4" x 1/4"
-4 leads spaced .3" x .2"
Each \$1.00 10 for \$8.95

1000 MHz Counter

11C05 Fairchild 1GHz Divide By Four
-DC to 1000 MHz operation
-AC or DC coupled
-Voltage compensated
-TTL or ECL power supply
-50 ohm drive output
-Lead compatible with Plessey SP613
-True and complement ECL outputs
-14 pin DIP
-Data and application notes
Each \$49.95

LED's

- MV50 Red Emitting \$.20
10-4 MA @ 2V 10 FOR \$1.25
- MV5024 Red TO-18 \$.35
High Dome 10 FOR \$2.95
- MV10B Visible Red \$.30
5-7 MA @ 2V 10 FOR \$2.50

CMOS

- | | |
|---------------|---------------|
| CD4001 \$.45 | CD4023 \$.45 |
| CD4002 .45 | 74C20 .65 |
| CD4011 .45 | 74C160 3.25 |
| CD4012 .45 | |

3-Amp Power Silicon Rectifiers

MARKED EPOXY AXIAL PACKAGE

- | PRV | PRICE | PRV | PRICE |
|----------|-------|-----------|-------|
| 100..... | \$.10 | 800..... | \$.30 |
| 200..... | .15 | 1000..... | .40 |
| 400..... | .18 | 1200..... | .50 |
| 600..... | .23 | 1500..... | .65 |

DIODE ARRAY 10-1N914 silicon
signal diodes in one package. 20
leads spaced .1"; no common connec-
tions.
EACH.....\$.29
10 FOR \$2.50



- | | |
|-----------|------------|
| 7400 .20 | 74H51 .25 |
| 74H00 .30 | 7453 .20 |
| 7401 .20 | 7454 .20 |
| 74H01 .25 | 74L54 .25 |
| 7402 .25 | 74L55 .25 |
| 7403 .25 | 7460 .16 |
| 7404 .25 | 74L71 .25 |
| 74H04 .30 | 7472 .40 |
| 7405 .30 | 74L72 .60 |
| 7406 .40 | 7473 .35 |
| 7408 .30 | 74L73 .75 |
| 74H08 .30 | 7474 .45 |
| 7410 .20 | 74H74 .75 |
| 7413 .75 | 7475 .80 |
| 7417 .40 | 7476 .55 |
| 7420 .20 | 74L78 .70 |
| 74L20 .30 | 7480 .50 |
| 74H20 .30 | 7483 .70 |
| 74H22 .30 | 7489 3.00 |
| 7430 .20 | 7490 1.00 |
| 74H30 .30 | 7492 .65 |
| 74L30 .30 | 7493 1.00 |
| 7440 .20 | 7495 .65 |
| 74H40 .30 | 74L95 1.00 |
| 7442 1.00 | 74107 .35 |
| 7447 1.50 | 74145 1.25 |
| 7450 .20 | 74180 1.00 |
| 74H50 .30 | 74193 1.50 |
| 7451 .20 | 74195 .65 |

7400 Series DIP

25K Trimmer

PRINTED CIRCUIT BOARD TYPE
EACH \$2.20 10 FOR \$1.50

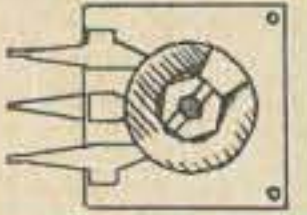

Rectifiers



- VARO FULL-WAVE BRIDGES
- | | | |
|----------|------|--------|
| VS447 2A | 400V | \$.90 |
| VS647 2A | 600V | \$1.10 |
- MR810 Rectifier 50V 1A \$.10

Special 811: Hex Inverter

TTL DIP Hex Inverter; pin interchangeable with SN
7404. Parts are brand new and branded Signetics
and marked "811."

- | | |
|-------------------|--------|
| EACH | \$.16 |
| DATA 10 FOR | 1.50 |
| SHEET 100 FOR | 14.00 |
| SUPPLIED 1000 FOR | 110.00 |

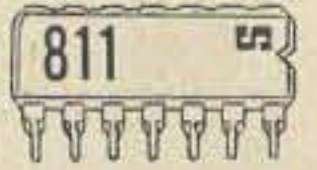

1 AMP RECTIFIER

- 1N4007 1KV PRV EACH \$.15
SALE 10 for \$1.00



MAN 4 7-Segment, 0-9 plus letters.
Right-hand decimal point. Snaps in 14-
pin DIP socket or Molex. IC voltage re-
quirements. Ideal for desk or pocket
calculators!



EACH \$1.20 10 OR MORE \$1.00 EACH

CD-2 Counter Kit

This kit provides a highly sophisticated display
section module for clocks, counters, or other nu-
merical display needs. The unit is .8" wide and
4 3/8" long. A single 5-volt power source powers
both the ICs and the display tube. It can attain
typical count rates of up to 30 MHz and also has
a lamp test, causing all 7 segments to light. Kit
includes a 2-sided (with plated thru holes) fiber-
glass printed circuit board, a 7490, a 7475, a
7447, a DR2010 RCA Numitron display tube, complete
instructions, and enough MOLEX pins for the ICs...
NOTE: boards can be supplied in a single panel of
up to 10 digits (with all interconnects); there-
fore, when ordering, please specify whether you
want them in single panels or in one multiple
digit board. Not specifying will result in ship-
ping delay.

COMPLETE KIT ONLY \$10.95
FULLY-ASSEMBLED
UNIT \$15.00

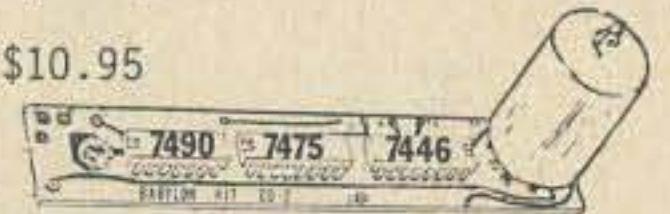

Boards supplied separately @ \$2.50 per digit.

LINEARS

- | | | |
|---------|---|------|
| NE555 | Precision timer..... | .90 |
| NE560 | Phase lock loop DIP..... | 2.95 |
| NE561 | Phase lock loop DIP..... | 3.00 |
| NE565 | Phase lock loop | 2.95 |
| NE566 | Function generator TO-5..... | 3.50 |
| NE567 | Tone decoder TO-5..... | 3.50 |
| 709 | Popular Op Amp DIP..... | .40 |
| 710 | Voltage comparator DIP..... | .60 |
| 711 | Dual comparator DIP..... | .45 |
| 723 | Precision voltage regulator DIP..... | 1.00 |
| 741 | Op amp TO-5/MINI DIP..... | .45 |
| 748 | Op Amp TO-5..... | .80 |
| CA3018 | 2 Isolated transistors and a Darling-
ton-connected transistor pair..... | 1.00 |
| CA3045 | 5 NPN transistor array..... | 1.00 |
| LM100 | Positive DC regulator TO-5..... | 1.00 |
| LM105 | Voltage regulator..... | 1.25 |
| LM302 | Op Amp voltage follower TO-5..... | 1.25 |
| LM308 | Op Amp TO-5..... | 2.00 |
| LM309H | 5V 200 MA power supply TO-5..... | 1.00 |
| LM309K | 5V 1A power supply module TO-3..... | 1.00 |
| LM311 | Comparator Mini..... | 1.75 |
| LM370 | AGC amplifier..... | 1.75 |
| LM380 | 2-Watt Audio Amp..... | 1.75 |
| LM1595 | 4-Quadrant multiplier..... | 1.70 |
| MC1536T | Op Amp..... | 1.35 |

SALE PRICES GOOD TILL SEPT. 15, 1975

LOWEST PRICES IN POLY PAKS SMASHES U.S.A.!

'CALCULATOR' PRICES

9-FUNCTION, 8-DIGIT MEMORY CALCULATOR KIT

It's the easiest multi-function kit today!

- DOUBLE MEMORY
- Percent, Constant, Display Restore

\$16.95



4-Function Arithmetic
• 22 KEYS!

EASY TO PUT TOGETHER! You bet it is... imagine no resistors, capacitors, but it **ONLY REQUIRES 2 CHIPS** and a **READOUT!** How's that for simplicity? The 2 Memory keys are MS Memory Storage and MR Memory Recall (requires very little soldering). The display restore key is to conserve battery life. Your display on panel shuts off 25 seconds after the last operation. By depressing "D" key, the display is restored! Uses 6 N cell batteries. Red decimal appears on left to show when batteries need replacement or charging. Has Decimal, Clear, Constant, Percent, and arithmetic key red, white and blue colors. Lightweight, pocket size 5 1/4 x 3 x (2" at back side) x 1 1/4" front side of angular display panel black case. Nifty unit for business, school, home, and for the youngsters. Slips into any pocket, briefcase with ease. Easy-to-understand pictorial instruction booklet and how-to-use-book.

AC/DC tool!
KIT INCLUDES: case, 22-key keyboard kit, ON-OFF switch (part of keyboard) PC board, driver and memory calculator chips, 9-digit "bubble" magnifier LED array, array cable, AC adapter jack & wires, battery case, 6 battery card display, instruction and pictorial step-by-step construction booklet.



MICROPROCESSORS! ROMS! RAMS! MEMORIES!

- 8008 Microprocessor \$44.00
- 8080 Super 8008 250.00
- 2102 1024 Static RAM 3.95
- 1101 256 bit RAM 1.50
- 1103 1024 bit RAM 2.95
- MM5260 1024 RAM 2.95
- MM5262 2048 bit RAM ... 6.50
- 2513 Character generator .. 12.50
- MM5203Q Erasable PROM .. 19.95
- MM5202Q Erasable PROM .. 19.95
- 1702A Erasable PROM ... 19.95
- 8223 Programmable ROM ... 2.95

- 555 Timer
- OR
- 558 Dual 741
- 2 for \$1**
- Sale good till Sep. 15, 1975

POSTAGE STAMP MOBILE MIKE SPKR

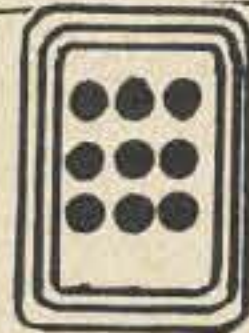

This unit is not advertised anywhere! Made for Motorola Communications at the original cost of \$4.50 each (for insertion in their Walkie Talkie Program). It's a 60-ohm imp MIKE. It's an excellent speaker too, covering broad range in sound. Extremely well-made.

\$1.98

LED MITY DIGIT "DCM'S"

"Digital Counting Modules" outperform any other DCM on the market today. More features than ever before! Not gaseous, not incandescents, not nixie but the modern LED. Choose from such famous manufacturers as Monsanto's MAN-1, MAN-4, Litronics 707 and 704, Opcoa's SLA-1 (the last 4 having character heights of 0.33 at no extra charge). Each kit includes 3x2" p.c board with fingers for a FREE edge connector, side-mounting dip socket, LED readout of your choice, resistors, 3 IC's, and Molex connectors (this **ELIMINATES SOLDERING YOUR IC'S**) and booklet. **INCLUDES P.C. EDGE CONNECTOR — FREE!**

* Pin-for-pin MAN-1, ** Pin-for-pin MAN-4, elec. char.

Buy 3 — Take 10%
Only **\$8.88**

- READOUT Char. Maker
- MAN-1 .27 h. Monsanto
- MAN-4 .19 h. Monsanto
- 707* .33 h. Litronics
- 704** .33 h. Litronics
- SLA-1* .33 h. Opcoa
- MAN6 .4 h. Monsanto

SCRS! TRIACS! QUADRACS!

10-Amp Power Tab Plastic Units

PRV	Sale
<input type="checkbox"/> 50	\$.75
<input type="checkbox"/> 100	.95
<input type="checkbox"/> 200	1.25
<input type="checkbox"/> 300	1.50
<input type="checkbox"/> 400	1.98
<input type="checkbox"/> 500	2.25
<input type="checkbox"/> 600	2.50



INDUSTRIAL SPEED CONTROL \$4.95

A \$30 item from G.E. Model 533A (made for Xerox) that controls home, shop and industrial lighting too! A very elaborate circuit for controlling many electrical and electronic devices. Easily controls speeds of electric drills, brush type motors, etc. 115vac, rated at 1100 watts. With variable speed or dimming control in heavy-duty aluminum case. 3 x 2 3/4 x 2. With diagram and hookups.

Touch Tone KEYBOARD KIT \$4.95

Kit includes 4 x 2 1/2" G-10 glass etched pc board, with 10 OAK "smooth touch" white keys with black numerals, plus diagram on "touch tone encoder". Makes many "keyboard systems" readily available. 0-to-9



Wow! INCREDIBLE PRICES

BUY ANY 10 TAKE 15%

BUY 100 TAKE 25%



FULL WAVE EPOXY SILICON BRIDGE RECTIFIERS

PIV	2 Amp	6 Amp	10 AMP
50	<input type="checkbox"/> \$.69	<input type="checkbox"/> \$.88	<input type="checkbox"/> \$1.49
100	<input type="checkbox"/> .79	<input type="checkbox"/> .99	<input type="checkbox"/> 1.69
200	<input type="checkbox"/> .95	<input type="checkbox"/> 1.25	<input type="checkbox"/> 1.89
400	<input type="checkbox"/> 1.19	<input type="checkbox"/> 1.50	<input type="checkbox"/> 2.09
600	<input type="checkbox"/> 1.35	<input type="checkbox"/> 1.75	
800	<input type="checkbox"/> 1.59	<input type="checkbox"/> 1.95	Code: 2 amp TO-5 case
1000	<input type="checkbox"/> 1.79	<input type="checkbox"/> 2.25	

6 Amp 1/2 x 1/2 x 3/16 sq.

CLOCK CHIPS ON A "DIP"

WITH DATA SHEETS

- MM5311 6-digit 28-Pin \$5.50
- MM5312 4-digit 24-Pin 5.50
- MM5313 6-digit 28-Pin 5.50
- MM5314 6-digit 24-Pin 5.50
- MM5316 4-digit 40-Pin, alarm 5.50
- MM5316-A no alarm 3.95



Money-Back GUARANTEE on all items

NATIONAL LM-340T VR's

• TO-220 Case • 1 Amp • POSITIVE VOLTAGE

\$1.75 Each

Buy 3 — Take 10%

- Type Volts
- LM-340-05T 5v
- LM-340-06T 6v
- LM-340-08T 8v
- LM-340-12T 12v
- LM-340-15T 15v
- LM-340-18T 18v
- LM-340-24T 24v



"BLASTAWAY" ON 1N4000 RECTIFIER PRICES

Type	PIV	Sale
<input type="checkbox"/> 1N4001	50	10 for 45c
<input type="checkbox"/> 1N4002	100	10 for 55c
<input type="checkbox"/> 1N4003	200	10 for 65c
<input type="checkbox"/> 1N4004	400	10 for 75c
<input type="checkbox"/> 1N4005	600	10 for 85c
<input type="checkbox"/> 1N4006	800	10 for 99c
<input type="checkbox"/> 1N4007	1000	10 for 1.29

XENON FLASH STROBE TUBE

\$1.95



Terms: add postage Rated: net 30
Phone Orders: Wakefield, Mass. (617) 245-3829
Retail: 16-18 Del Carmine St., Wakefield, Mass. (off Water Street) C.O.D.'S MAY BE PHONED

20c CATALOG Fiber Optics, 'IC's', Semi's, Parts
MINIMUM ORDER — \$4.00

POLY PAKS

P.O. BOX 942A LYNNFIELD, MASS. 01940



- SN7400 \$.16
- SN7401 .16
- SN7402 .16
- SN7403 .16
- SN7404 .19
- SN7405 .19
- SN7406 .35
- SN7407 .35
- SN7408 .19
- SN7409 .19
- SN7410 .16
- SN7411 .25
- SN7413 .59
- SN7414 1.65
- SN7416 .34
- SN7417 .34
- SN7420 .16
- SN7412 .45
- SN7423 .29
- SN7425 .29
- SN7426 .25
- SN7427 .29
- SN7430 .16
- SN7432 .25
- SN7433 .49
- SN7437 .34
- SN7438 .34
- SN7440 .16
- SN7441 1.00
- SN7442 .70
- SN7444 1.25
- SN7445 .89
- SN7446 1.15
- SN7447 .99
- SN7448 .99
- SN7450 .16
- SN7451 .17
- SN7452 .17
- SN7453 .17
- SN7454 .17
- SN7455 .22
- SN7460 .17
- SN7462 \$.22
- SN7470 .29
- SN7471 .49
- SN7472 .29
- SN7473 .36
- SN7474 .36
- SN7475 .59
- SN7476 .39
- SN7478 .79
- SN7480 .52
- SN7481 .99
- SN7482 .89
- SN7483 1.25
- SN7485 1.25
- SN7486 .37
- SN7488 3.95
- SN7489 2.45
- SN7490 .59
- SN7491 1.10
- SN7492 .59
- SN7493 .59
- SN7494 .95
- SN7495 .79
- SN7496 .79
- SN74100 1.40
- SN74104 .44
- SN74105 .44
- SN74106 .52
- SN74107 .44
- SN74108 .89
- SN74112 .89
- SN74113 .89
- SN74114 .89
- SN74121 .49
- SN74122 .48
- SN74123 .85
- SN74125 .59
- SN74126 .59
- SN74132 1.75
- SN74140 2.10
- SN74145 1.05
- SN74148 2.25
- SN74150 .98
- SN74151 .75
- SN74153 .90
- SN74154 1.35
- SN74155 .95
- SN74156 .95
- SN74157 .95
- SN74158 .95
- SN74160 1.35
- SN74161 1.25
- SN74163 1.35
- SN74164 1.50
- SN74165 1.50
- SN74166 1.50
- SN74173 1.45
- SN74174 1.39
- SN74175 1.30
- SN74176 1.20
- SN74177 1.20
- SN74180 .95
- SN74181 2.98
- SN74182 .74
- SN74184 1.98
- SN74185 1.98
- SN74190 1.40
- SN74191 1.40
- SN74192 1.25
- SN74193 1.25
- SN74194 1.20
- SN74195 .85
- SN74196 1.80
- SN74197 .90
- SN74199 1.75
- SN74200 4.95
- CD4000AE \$.29
- CD4001AE .29
- CD4002AE .29
- CD4006AE 2.50
- CD4007AE .29
- CD4008AE 1.98
- CD4009AE .59
- CD4010AE .59
- CD4011AE .29
- CD4012AE .29
- CD4013AE .69
- CD4014AE 1.98
- CD4015AE 1.98
- CD4016AE .69
- CD4017AE 1.75
- CD4018AE 1.98
- CD4019AE .69
- CD4020AE 1.98
- CD4021AE 1.98
- CD4022AE 1.70
- CD4023AE .29
- CD4024AE 1.50
- CD4025AE .34
- CD4026AE 3.95
- CD4027AE .85
- CD4028AE 1.65
- CD4029AE 2.90
- CD4030AE .65
- CD4033AE 3.95
- CD4035AE 1.85
- CD4040AE 2.45
- CD4041AE 1.90
- CD4042AE 1.90
- CD4043AE 1.50
- CD4044AE 1.50
- CD4049AE .79
- CD4050AE .79
- CD4051AE 2.98
- CD4052AE 2.98
- CD5053AE 2.98
- CD4055AE 2.75
- CD4056AE 2.50
- CD4060AE 3.25
- CD4066AE 1.75
- CD4069AE .45
- CD4071AE .45
- CD4081AE .45
- CD4518AE 3.10
- CD4520AE 3.10

\$4.95 6-VOLT NICAD POWER PAK

Includes 4 "A" cell nicad batteries hooked up to give you 6-volts for all types of energy uses. The best batteries made. Rechargeable.

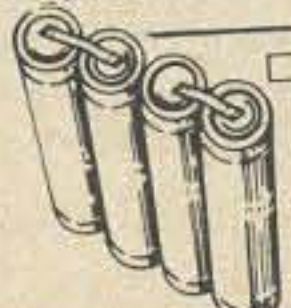

73 reader service

Check appropriate boxes for desired company brochures, data sheets or catalogs and mail in to 73. Include your zip code, please. Send money directly to advertisers. **LIMIT: 25 requests.**

ADVERTISER INDEX

- | | |
|--|---|
| <input type="checkbox"/> Alden Elec. 96 | <input type="checkbox"/> Jones, Marlin P. 171 |
| <input type="checkbox"/> A. P. Products 97 | <input type="checkbox"/> Kensco 109 |
| <input type="checkbox"/> Apron 24 | <input type="checkbox"/> K-Enterprises 94 |
| <input type="checkbox"/> Antenna Mart 49 | <input type="checkbox"/> Kenwood 45 |
| <input type="checkbox"/> Atlas 65, 117 | <input type="checkbox"/> Klaus 81 |
| <input type="checkbox"/> Audioland 102 | <input type="checkbox"/> KLM 173 |
| <input type="checkbox"/> Babylon 190 | <input type="checkbox"/> Levy 137 |
| <input type="checkbox"/> Bellaire 155 | <input type="checkbox"/> Magtech 30 |
| <input type="checkbox"/> BIOCUM 85 | <input type="checkbox"/> Meshna 188, 189 |
| <input type="checkbox"/> Budwig 30 | <input type="checkbox"/> Midland 153 |
| <input type="checkbox"/> Buyers & Sellers 54 | <input type="checkbox"/> MITS 138 |
| <input type="checkbox"/> Byte 156 | <input type="checkbox"/> M-Tech 24 |
| <input type="checkbox"/> CeCo 101 | <input type="checkbox"/> Newtronics CII, 117 |
| <input type="checkbox"/> CFP 110 | <input type="checkbox"/> Palomar 32 |
| <input type="checkbox"/> Clegg 95 | <input type="checkbox"/> Poly Paks 191 |
| <input type="checkbox"/> Coakit 110 | <input type="checkbox"/> Quement 122 |
| <input type="checkbox"/> Comm. Specialists 56, 112 | <input type="checkbox"/> Radio Store 145 |
| <input type="checkbox"/> Comm. Specialties 49 | <input type="checkbox"/> Regency 39 |
| <input type="checkbox"/> Cornell 64 | <input type="checkbox"/> RGS 174 |
| <input type="checkbox"/> Corvus 43 | <input type="checkbox"/> Robot 79 |
| <input type="checkbox"/> Davis 112 | <input type="checkbox"/> Rohn 106 |
| <input type="checkbox"/> D-D Enterprises 30 | <input type="checkbox"/> S. D. Sales 178, 179 |
| <input type="checkbox"/> Dentron 91, 105 | <input type="checkbox"/> Sentry 11 |
| <input type="checkbox"/> DGM 96 | <input type="checkbox"/> Smith, Bob 50 |
| <input type="checkbox"/> DuPage 184 | <input type="checkbox"/> Space 110 |
| <input type="checkbox"/> DXers Mag. 10 | <input type="checkbox"/> Specialty Comm. 144 |
| <input type="checkbox"/> ECM 32 | <input type="checkbox"/> Spectrum Comm. 55 |
| <input type="checkbox"/> Ehrhorn 61 | <input type="checkbox"/> Standard Comm. 165 |
| <input type="checkbox"/> Emergency Beacon 37 | <input type="checkbox"/> Standard Research 88 |
| <input type="checkbox"/> Fair 64 | <input type="checkbox"/> Sumner 128 |
| <input type="checkbox"/> Franke 32 | <input type="checkbox"/> Swivetek 89 |
| <input type="checkbox"/> Freck 32 | <input type="checkbox"/> Synchronoud 88 |
| <input type="checkbox"/> Gateway 38 | <input type="checkbox"/> Telstar 172 |
| <input type="checkbox"/> GENAVE 157 | <input type="checkbox"/> Temtron 10 |
| <input type="checkbox"/> Glade Valley 105 | <input type="checkbox"/> Tri Tek 64 |
| <input type="checkbox"/> Godbout 185, 186, 187 | <input type="checkbox"/> Trumbull 30 |
| <input type="checkbox"/> Green Pub. 142 | <input type="checkbox"/> Tucker 66-75 |
| <input type="checkbox"/> Ham Radio Center 176 | <input type="checkbox"/> Tufts 29, 45, 117 |
| <input type="checkbox"/> Hamtronics 182 | <input type="checkbox"/> TWS Labs 175 |
| <input type="checkbox"/> Heath 92 | <input type="checkbox"/> Vanguard 159 |
| <input type="checkbox"/> Henry 46 | <input type="checkbox"/> Vegas Radio 122 |
| <input type="checkbox"/> ICOM 29, 50, 130, 131
145, 155 | <input type="checkbox"/> Venus Scientific 161 |
| <input type="checkbox"/> Idaho 177 | <input type="checkbox"/> VHF Eng. CIV |
| <input type="checkbox"/> Int. Elec. Unltd. 183 | <input type="checkbox"/> Weirnu 49 |
| <input type="checkbox"/> Int. Telecomm. 14, 15 | <input type="checkbox"/> Westcom 23, 152 |
| <input type="checkbox"/> James 180, 181 | <input type="checkbox"/> Wilson 148, 149 |
| <input type="checkbox"/> Jan 52 | <input type="checkbox"/> World QSL 49 |
| <input type="checkbox"/> 73 Stuff
162, 163, 164 | <input type="checkbox"/> Yaesu CIII |

Test lab sale 154

This 73 was acquired through:

- NEWSSTAND SUBSCRIPTION

Reader's Service JULY 1975
73 Inc., Peterborough NH 03458
 Please print or type.

Name _____ Call _____
 Address _____
 City _____
 State _____ Zip _____

Coupon expires in 60 days . . .

PROPAGATION CHART

J.H. Nelson

Good (open) Poor (0)

Fair (□) VHF/DX (■)

July - 1975

Sun	Mon	Tue	Wed	Thu	Fri	Sat
		I	2	3	4	5
6	7	8	9	10	11	12
13	14	15	16	17	18	19
20	21	22	23	24	25	26
27	28	29	30	31		

EASTERN UNITED STATES TO:

GMT: 00 02 04 06 08 10 12 14 16 18 20 22

	7	14	7	7	7	7	7	7	7	7	7	7
ALASKA	7	14	7	7	7	7	7	7	7	7	7	7
ARGENTINA	14	14	7A	7	7	7	7A	14	14	14	14	14
AUSTRALIA	14	14	14B	7B	7	7	7	7	7	7	14	14
CANAL ZONE	14	14	7	7	7	7	7	14	14	14	14	14
ENGLAND	7	7	7	7	7	7	7A	14	14	14	14	14
HAWAII	14	14	7	7	7	7	7	7	7A	14	14	14
INDIA	7	7	7B	7B	7B	7B	7	7	7	14	14	14
JAPAN	14	14	7	7	7	7	7	7	7	7	7	14
MEXICO	14	14	7	7	7	7	7	7	7	14	14	14
PHILIPPINES	14	14	7	7B	7B	7B	7B	7	7	7	7	7A
PUERTO RICO	14	7	7	7	7	7	7	7	7A	14	14	14
SOUTH AFRICA	7	7	3A	7	7	14	14	14	14	14	7	7
U. S. S. R.	7	7	7	7	7	7	14	14	14	14	14	14
WEST COAST	14	14	7A	7	7	7	7	14	14	14	14	14

CENTRAL UNITED STATES TO:

	7A	7A	7A	7	7	7	7	7	7	7	7	7
ALASKA	7A	7A	7A	7	7	7	7	7	7	7	7	7
ARGENTINA	14	14	7A	7	7	7	7A	14	14	14	14	14
AUSTRALIA	14	14	14	14B	7	7	7	7	7	7	14	14
CANAL ZONE	14	14	7A	7	7	7	7	14	14	14	14	14
ENGLAND	7	7	7	7	7	7	7	7	7	7A	14	14
HAWAII	14	14	7A	7	7	7	7	7	7A	14	14	14
INDIA	14	7	7B	7B	7B	7B	7	7	7	7	7	7A
JAPAN	14	14	14	7	7	7	7	7	7	7	7	14
MEXICO	14	7	7	7	7	7	7	7	7	7	14	14
PHILIPPINES	14	14	14	7B	7B	7B	7	7	7	7	7	7A
PUERTO RICO	14	14	7	7	7	7	7	14	14	14	14	14
SOUTH AFRICA	7	7	3A	7	7B	7B	14	14	14	14	7	7
U. S. S. R.	7	7	7	7	7	7	7	7	7	7A	14	14

WESTERN UNITED STATES TO:

	7A	7A	7A	7	7	7	7	7	7	7	7	7
ALASKA	7A	7A	7A	7	7	7	7	7	7	7	7	7
ARGENTINA	14	14	7A	7	7	7	7	7A	14	14	14	14
AUSTRALIA	14	14	14A	14	7A	7	7	7	7	7	14	14
CANAL ZONE	14	14	7A	7	7	7	7	14	14	14	14	14
ENGLAND	7A	7	7	7	7	7	7	7	7	7A	7A	14
HAWAII	14	14	14	14	7A	7	7	7	7	14	14	14
INDIA	14	14	14	7B	7B	7B	7	7	7	7	7	7A
JAPAN	14	14	14	7A	7	7	7	7	7	7	14	14
MEXICO	14	14	7A	7	7	7	7	7	14	14	14	14
PHILIPPINES	14	14	14	7A	7	7	7	7	7	14B	14B	14
PUERTO RICO	14	14	7A	7	7	7	7	14	14	14	14	14
SOUTH AFRICA	7	7	3A	7	7B	7B	7B	7A	14	14	7	7
U. S. S. R.	7	7	7	7	7	7	7	7	7	7A	7A	7
EAST COAST	14	14	7A	7	7	7	7	14	14	14	14	14

A = Next higher frequency may be useful also.
 B = Difficult circuit this period.



YAESU FT-101E TRANSCEIVER

Now, more radio from the radio company.

Are Yaesu's FT-101's the finest all-around transceivers in the world? Yes — and now the best is even better. The new FT-101E includes a potent R. F. speech processor. Plus improved, easy-to-use lever switches. A more refined clarifier control for push-button, independent clarifier operation. There's also a 160 meter crystal included without extra charge.

And all the other features that have made the FT-101 series of transceivers among the world's most popular are still here: 260 watts SSB

PEP. Globe-circling power on CW and AM. 160 to 10 meters range. 0.3uV receiving sensitivity. And one very important feature you never want to forget is the famous Yaesu warranty, strong dealer network and convenient serviceability.

If you're a serious amateur, you're always looking for more radio. And the FT-101E is just that. \$749* buys you a million bucks worth of enjoyment. See your Yaesu dealer or write for our catalog. Yaesu Musen USA, Inc. 7625 E. Rosecrans, No. 29, Paramount, Calif. 90723.

YAESU
The radio.

*FT-101EE (less processor): \$659.

The world's most complete line of VHF - FM kits and equipment



- TX144B Kit . . . exciter - 1 watt - 2 meters . . . 29.95
- TX144B W/T . . . factory wired 49.95
- TX220B Kit . . . exciter - 1 watt - 220 MHz . . . 29.95
- TX432B Kit . . . exciter - NEW - 432 MHz . . . 39.95

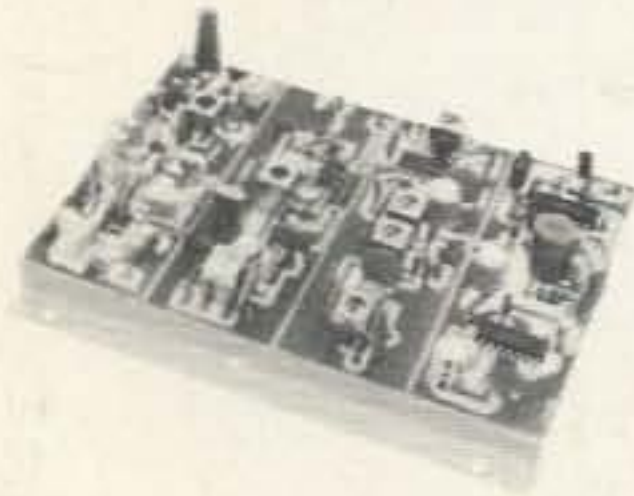

- RX50C Kit . . . 30-60 MHz rcvr w/2 pole 10.7 xtal filter 59.95
- RX144C Kit . . . 140-170 MHz rcvr w/2 pole 10.7 xtal filter 69.95
- RX144C W/T . . . factory wired / mounted 114.95
- RX220C 210-240 MHz rcvr w/2 pole xtal 10.7 filter 69.95
- RX432C Kit . . . NEW - 432 MHz receiver 79.95
- RXFL 70DB filter option for all RX-Recv (w/exch.) 9.50



- HT144B Kit . . . 2 meter - 2w - 4 channel - hand held xcvr 129.95



- PA2501H Kit . . . similar to above - 25w 59.95
- PA2501H W/T . . . factory wired 74.95
- PA4010H Kit . . . 10w in - 40w out - relay switching 59.95
- PA4010H W/T . . . factory wired 74.95
- PA144/15 Kit . . . similar to PA1501H less case, connectors & switching 39.95
- PA144/25 Kit . . . similar to above - 25w 49.95
- PA220/15 Kit . . . similar to PA144/15 for 220 MHz 39.95
- PA432/10 Kit . . . NEW - similar to PA144/15 except 10w and 432 MHz 39.95
- PA140/10 NEW - 10w in - 140w out 2 meter amp - factory wired . . . 179.95
- PA140/30 NEW - 30w in - 140w out 2 meter amp - factory wired . . . 159.95

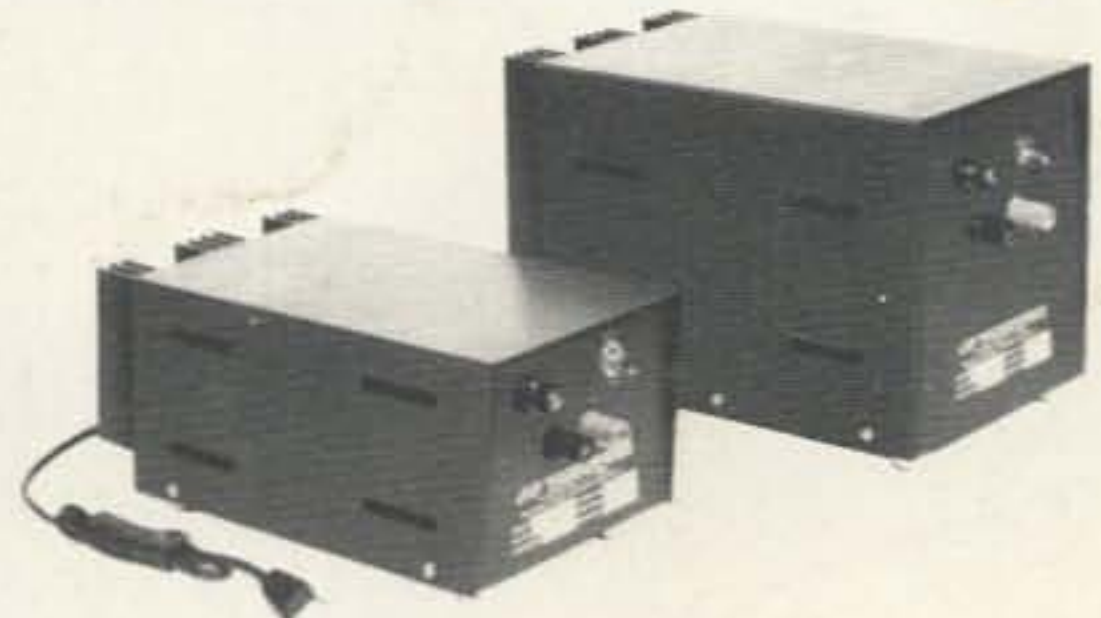

- PS3 Kit power supply regulator card . . . 8.95
- PS12C Kit . . . 12 amp - 12 volt regulated power supply w/case 69.95
- PS12C W/T . . . factory wired 85.95
- PS24C Kit . . . 24 amp - 12 volt regulated power supply w/case 99.95
- PS24C W/T . . . factory wired 114.95



- RPT144 Kit . . . 2 meter - 15w - complete 364.95
- RPT220 Kit . . . 220 MHz - 15w - complete . . . 364.95
- RPT432 Kit . . . NEW - 10 watt - 432 MHz repeater 399.95
- RPT144 NEW - 15 watt 2 meter repeater - factory wired 595.95
- RPT220 NEW - 15 watt - 220 MHz repeater - factory wired 595.95
- RPT432 NEW - 10 watt - 432 MHz repeater - factory wired 649.95

OTHER PRODUCTS BY VHF ENGINEERING

- CD1 Kit 10 channel receive xtal deck w/diode switching \$ 6.95
- CD2 Kit 10 channel xmit deck w/switch and trimmers 14.95
- COR2 Kit complete COR with 3 second and 3 minute timers 19.95
- CWID-1 Kit . . . NEW - code identifier - 160 bits, field programmable diode matrix . . . 39.95
- SC2 Kit 10 channel auto-scan adapter for RX 19.95
- Crystals we stock most repeater & simplex pairs for 146.0-147.0 5.00
- *DPLX-144 . . . 2 meter, 6 cavity, close spaced duplexer - tuned to frequency . . . 399.95
- *DPLX-220 . . . 220 MHz, 6 cavity duplexer tuned to frequency 399.95

SHIPPING INFORMATION: All shipments are F.O.B. Binghamton, N.Y. 13902. Shipments will be made by the most convenient method. Please include sufficient funds to cover shipping and handling. Figure shipping charges on a minimum weight of 2 pounds per unit with the exception of the following: PS 12C - 13 lbs., PS 24C - 25 lbs., Repeaters - 25 lbs.



320 WATER ST. • PO BOX 1921 • BINGHAMTON, NY 13902 • 607-723-9574
DIVISION OF BROWNIAN ELECTRONICS CORP.