

AUGUST 1975
ONE DOLLAR

73

amateur radio

Helical Antennas

OPTIONAL THIRD GENERATION FLEXIBILITY

SWR Computer

BALANCED RECIPROCAL CAPABILITY

TTL Logic

INTEGRATED TRANSITIONAL OPTIONS

Wx Satellite Monitor

FUNCTIONAL INCREMENTAL CONCEPT

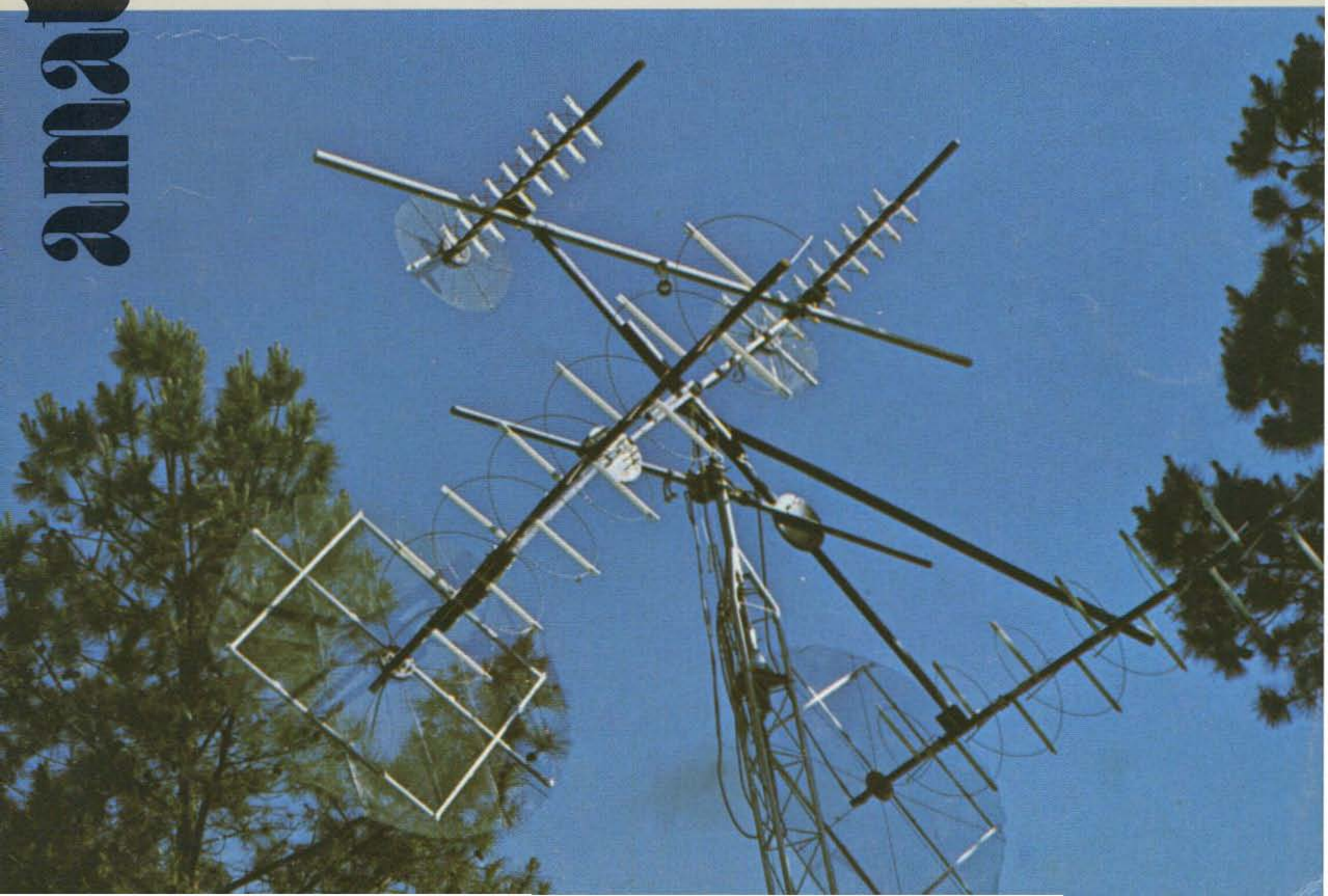

new

HUSTLER[®]

the real performer! specifically for repeater

...or any TWO-METER FIXED STATION OPERATION

With **6** db—
db—

- Gain compared to ½ wave dipole
- FCC accepted for repeater application

mechanical

- Vertical element—117" long, 1-1/8" telescopic to 3/8" OD high strength aluminum
- Radials—four, 21" x 3/16" OD aluminum rod
- Connector—SO-239
- Wind load—26 pounds at 100 mph.
- Wind survival—100 mph.
- Completely self-supporting
- Mounting—fits vertical pipe up to 1-3/4" OD

electrical

- 6 db. gain over ½ wave dipole
- Omnidirectional radiation pattern
- Maximum radiation—at horizon
- 50 ohm feed impedance
- Field adjustable—140-150 MHz
- SWR at resonance—1.2:1 measured at antenna
- Bandwidth—6 MHz for 2:1 or better SWR
- Power—one kilowatt FM
- Feed—Shunt with D.C. grounding
- Radiator—5/8 wave lower section, ¼ wave phasing, 5/8 wave upper section

The gain you gain—you gain transmitting and receiving—get both with Hustler!

Available from
all distributors
who recognize the best!

THE HUSTLER MASTER GAINER
MODEL G6-144-A

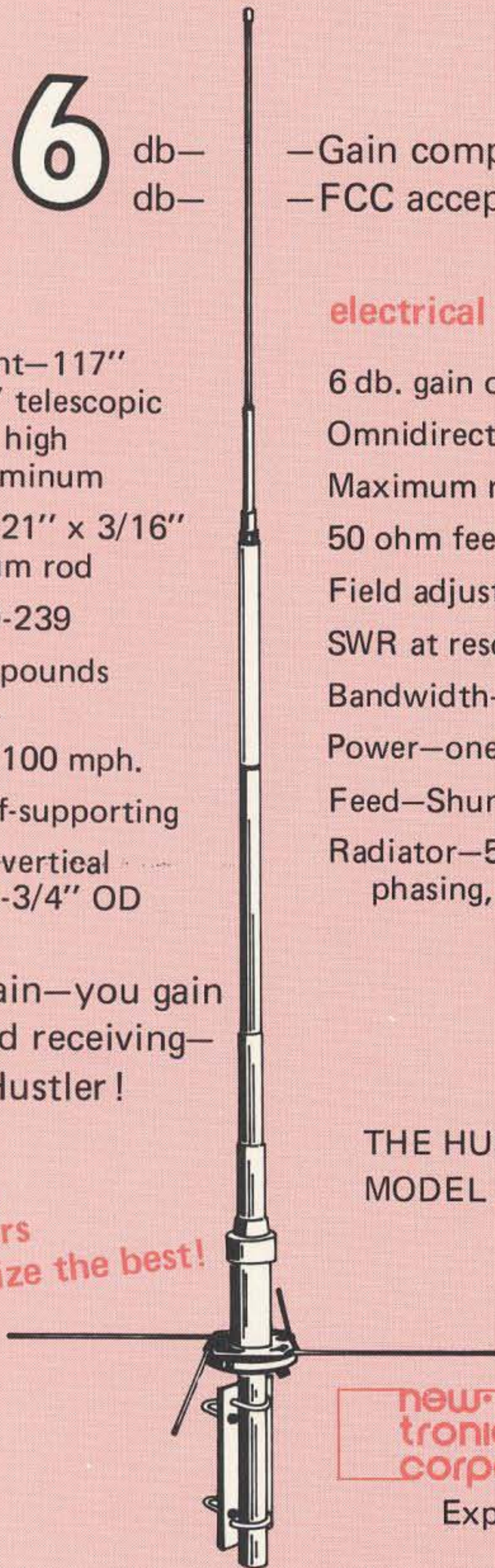

**new
tronics
corporation**

15800 commerce park drive,
brook park, ohio 44142

Exporter: Roburn Agencies, Inc.,
New York, N.Y.

WB4VXP	12	The Oscar Zapper
K2PMA	22	Identalert C
K2OAW	25	Digital SWR Computer
K1CLL	36	RF Feedback, The Experimenter's Curse
W9KXJ	42	Surveying the DVM Scene
WB8DQT	45	How About a Weather Satellite Monitor?
WA5KPG	58	The QRP Accu-Keyer
W1BNN	62	Catenary Suspense
W7SHY/6	69	Copper Rip-Off
K4TWJ	70	Better Results from those Sweep Tubes
WB5IRY	73	The Best Logic Yet
VE3GSP	80	How to Compact Multiband Dipoles
MICHIGAN RADIO DOCTOR	92	Don't Feed the Bears!
W2A00	95	The Wonderful Mini-Chronometer
STAFF	103	An Accessory VFO — The Easy Way
K8BFH/1	111	Modern Non-Morse Codes
W6GXN	121	Build This Amazing Function Generator
VK3OM	141	Charge that KP202
K7PVZ	147	So You Want Front-to-Back Ratio?

73 amateur radio

#179 AUGUST 1975

COVER: The notorious Oscar Zapper, by Alan Bridges WB4VXP. Article begins on page 12.

2	Never Say Die	137	AMSAT
3	Hotline Headlines	138	New Products
6	Be My Guest	140	Super Circuits
8	Repeater Update	140	Correction
10	Letters	144	Hamburglar
127	FCC	144	Ham Help
128	Contests	150	Caveat Emptor
133	Ancient Aviator	155	Social Events
134	Looking West	192	Advertiser Index
137	Grrreen	192	Propagation

73 Magazine is published monthly by 73, Inc., Peterborough, New Hampshire 03458. Subscription rates are \$8 for one year in North American and U.S. Zip Code areas overseas, \$9 per year elsewhere. Three years, \$16 and \$17 overseas. Second class postage paid at Peterborough, New Hampshire 03458 and at additional mailing offices. Phone: 603-924-3873. Microfilm edition of 73 available from University Microfilms, Ann Arbor MI 48106. Magnetic tapes available from Science for the Blind, 332 Rock Hill Rd., Bala Cynwyd PA 19904. Entire contents copyright 1975 by 73 Inc. Peterborough NH 03458.

73 staff

EDITOR/PUBLISHER

Wayne Green W2NSD/1

BUSINESS MANAGER

Virginia Londner Green

EDITORS

Eric K. Albrecht K8BFH/1

Alex Barvicks WB4RVH

John Burnett

EDITORIAL ASSISTANT

Susan G. Philbrick

PRODUCTION MANAGER

Lynn Panciera-Fraser

ART DEPARTMENT

Bob Drew

Nancy Estle

Neal Kandel

Peri Mahoney

Bob Sawyer

PRINTER

Biff Mahoney

PHOTOGRAPHY

Bill Heydolph

TYPESETTING

Barbara Latti

ADVERTISING

Bill Edwards WB6BED/1

Nancy Cluff

COMPTROLLER

Knud E. M. Keller KV4GG/1

MARKETING

David H. Lodge

CIRCULATION

Barbara Block

Susan Chandler

Dorothy Gibson

Judy Havey

Cheryl Hurd

Pearl Lahey

Marge McCarthy

INVENTORY CONTROL

Marshall Raymond

PLANT MAINTENANCE

Bill Barry

Elaine Mercier

ASSOCIATES

Robert Baker WA1SCX

Schley Cox WB9LHO

Tom DiBiase WB8KZD

Terry Fox WB4JFI

W. Sanger Green

Dave Ingram K4TWJ

Joe Kasser G3ZCZ

Bill Pasternak WA6ITF

John Schultz W2EY

Waller Scott K8DIZ

Peter A. Stark K2OAW

Bill Turner WA0ABI

DRAFTING

Bill Morello

Lynn Malo

T. M. Graham Jr. W8FKW



NEVER SAY DIE

...de W2NSD/1

EDITORIAL BY WAYNE GREEN

BYTE MAGAZINE

The response to computer-type articles in 73 has been so enthusiastic that we here in Peterborough got carried away. I found myself enormously interested in the rapidly evolving microcomputer field and started subscribing to many of the small newsletters in the field. The more I read the more enthusiastic I got... and on May 25th we made a deal with the publisher of a small (400 circulation) computer hobby magazine to take over as editor of a new publication which would start in August... BYTE.

We figured we could print the first issues on our own small offset presses as the magazine gathered steam. We might run 5000 copies of a 24 page magazine for starters. Within a couple of days, with the telephone ringing constantly, we knew we had underestimated the thing... it would take a 10,000 run of 48 pages to meet the interest. A week later we were up to 96 pages and a 35,000 press run, far beyond our small print shop facilities.

How come all the enthusiasm? Well, it appears that just about everyone who is in any way involved with computers has a very deep need to have one for himself. You can get a nice little computer working for under \$500 and use it for a wide range of applications. You can hook in cassette recorders, television typewriters, and teletypewriters. All kinds of goodies are available surplus. The applications are myriad... some are using their systems to aim antennas for Oscar or

BIG REWARD

The big companies in amateur radio today were, for the most part, started by one or two amateurs... and many grew very rapidly as a result of the low ad rates in 73 and the wide circulation among active (buying) hams. We'll give you 10% of the first ad run by a new company if you let us know about them and they advertise first in 73. Do yourself and the new firm a big favor — drop a note to 73 Advertising, Peterborough NH 03458.

moonbounce, some for keeping track of their music or book libraries, some to index ham articles, some to automatically print weather satellite pictures, some to automate RTTY stations, some to run their home security systems, and almost all to play a wide range of games.

Calls come in daily with more uses... one chap has a program to look for key words in any text and set your printer going when matter comes up of interest. Suppose you tune in the RTTY broadcasts of the Congressional Record every day and scan it for the words "amateur radio." Others are working out ways to make use of the one minute phone rates for a maximum exchange of information, computer to computer. Remember that there is no charge if your computer is called and tells the calling computer that it has nothing for it... or if the exchange is under a second or two. Many of the commercial computer systems use this aspect of the phone system... polling dozens or even hundreds of computers through the night and only interconnecting (with a phone charge) where there is traffic to be passed.

Most of the top writers in the field have leaped to help get BYTE going in good style and articles are pouring in... lots of information on the presently available microcomputers such as the Altair 8800, the Scelbi 8B, RGS 008A, etc. BYTE will cover interconnecting to these units, peripherals, interfaces, the circuits and construction plans for building your own CPUs, news of all user clubs, news of programs available and how to get them, news of all specialized publications, explanations of all computer terms and how the various computer programming systems work.

In no time at all you'll be throwing around computer buzz words such as loader, compiler, assembler, basic, Dibal, Cobol, machine language, byte, bit, word, flag, and so forth.

Computers will be adding a whole new dimension to amateur radio... you wait and see. Right now you have the choice of getting in at the

beginning of a fantastic new hobby or waiting and trying to catch up later on. First issues of BYTE will be as rare as early issues of 73... you'll see.

BYTE will be \$1.50 per copy, subscription \$12 per year, and a Charter Subscription is only \$10. BYTE, Peterborough NH 03458.

MORE BAD NEWS FOR OTs

The "W" clan are in for another massive trauma which may regress them even further into the old spark days. After a good solid ten years of having to read about transistors and five years of rapid strides in IC technology, many old timers are still shaking their heads and waiting for the return of the tube. Fellows, you might as well start cracking the books because you can't even pass a ham exam anymore without solid state savvy.

And what is coming up... rapidly... is a whole new technology that we are all going to have to accommodate, whether we like it or not. It's them ICs what done it to us. When I was a youngster I used to wonder why they didn't make micro-circuits... now I see why... the whole thing has gotten completely out of hand and is taking over... they never should have started. Massive monolithic integration... micro-putianism gone berserk.

You've undoubtedly seen the RGS ads for the 8008 microcomputer kit... the MITS Altair 8800 micro-computer kit... the Southwest Technical keyboard visual display kit... so you probably sense on some level that computers are beginning to creep into your world. What you may not realize is that you are going to have to adjust to them and learn to talk the language... and think it.

If you are shifting around uncomfortably, thinking that well, shucks, sure... you can bone up on digital stuff and get it straight about those damned nand and eitheror gates, you are in for a ghastly awakening. They are building thousands of transistors into those ICs these days and what has developed is a whole new approach to dealing with the situation. It's called programming... or software, if you prefer the computerese buzzword. This is the system by which you can get these incredibly complex little black boxes with those funny centipede legs to do something useful for us.

Software. This can be the throwing of a bunch of switches to feed the

instructions to the circuits... or it can be typing on a Teletype keyboard... or data from a tape cassette... or punched tape... etc. There are a raft of "languages" used to put the instructions into computers... basic, machine, fortrons, cobalt, diabolic, assembly, and others... many others. You are going to be learning some of these languages. The chances are that you will eventually get familiar enough with them to actually understand what you are talking about.

Is it worth all the work? No question about it... if you are one of those who is the first in his block to get new things you'll be eating up the articles on software systems as they come out... if you are the guy who never gets the word you'll be missing out on more fun than you can imagine. The new microprocessor chips are opening up a fantastic (and complicated) world for us.

The prices on this stuff will be much like those of hand calculators and digital watches... relatively high at first and then dropping rapidly as more and more people find out where the action is and volume picks up. I remember all the resistance I ran into in 1948 when I wanted to buy a television set... they were very expensive... about \$750 for a 10" black and white set by today's dollarette standards... turned out to be one of the best investments I could have made... years of entertainment... and I got to see all those fantastic early programs you missed. I bought one of the first transistor radios too... a Regency... expensive... and I never regretted it. You can miss a lot of fun waiting for that price to drop.

We'll try to do the best we can on getting articles for you... if you have an article of value lurking in the back of your mind, get busy and write it up.

WANTED

We're getting up to here in old files and would like to start microfilming the stuff. On the odd chance that some reader has a microfilm or microfiche camera, film processor and reader system available... hopefully at a bargain... this notice is given.

We're needing some cassette duplicators too, if there are any of those flying around that are not badly needed.

Another need: IBM Selectric II typewriters... used. Also we could use a couple of Teletypes with forms feeders.

... W2NSD/1

HOTLINE HEADLINES

Pacific Telephone brings national spotlight to 73 Magazine with suit over circuits in June issue. Other ham publishers furious over PR coup. Citing the circuits in the Inside Ma Bell series in 73, PTT brought suit for \$100,000. Dealer's immediately ran out of counter copies of this issue and subscriptions were up substantially.

Emergency Beacon Canceled. All further advertising in 73 Magazine has been canceled by the publisher until some problems with meeting specs and customer relations have been resolved.

QST board votes unanimously to increase size of the magazine to about that of Radio Electronics — members not consulted in this major decision — no benefits to members likely. Increased size will make for many problems, few economies. Other ham magazines will certainly be forced to follow QST in size change. This appears to be change for the sake of change.

RFI bill introduced in congress — HR7052 will regulate susceptibility of home entertainment devices to radio interference. Get your congressmen to push this one.

Saroc Hawaii convention disappointing. Commercial "convention" for profit run by defrocked ham attracts few despite allure of Hawaii and strong backing of one ham magazine.

Rochester hamfest a winner this year. Attendance estimated at 3500 — money was a bit tight according to exhibitors — possibly due to cash drainage at Dayton a few weeks earlier.

California fights Bell — prohibits steep rates for insignificant bits of hardware such as answering machine and phone patch couplers.

ARRL breaks \$2 million in 1974. Despite reported loss for the year (a small one), cash and stocks are now totalling nearly a million dollars, building up steadily. When is a loss not a loss, IRS?

Wichita Amateur Radio Club has the most outstanding comment filed on docket 20282 — reprinted in entirety in Hotline #31. Goes right to the heart of the matter and lays it on the line.

SSTV contest winner: WB4ECE. Runners up — WA1NXR, W9NTP, WB9LVI and G3IAD.

MEET THE STATE OF THE ART ON 2 METERS... THE ITC MULTI-2000 CW/SSB/FM TRANSCEIVER



Whether your interest is simplex, repeater, DX or OSCAR the new ITC MULTI-2000 lets you get into all the action on all of the

band. Fully solid-state and employing modular construction, the MULTI-2000 enjoys features found in no other 2m transceiver.

FEATURES

- PLL synthesizer covers 144-148 MHz in 10 kHz steps
- Separate VXO and RIT for full between-channel tuning
- Simplex or ± 600 kHz offset for repeater operation
- Three selectable priority channels
- Multi-mode operation (CW/SSB/NBFM/WBFM)
- Built-in AC and DC power supplies, noise-blanker squelch and rf gain control
- Selectable 1W or 10W output
- Separate S-/power and frequency deviation meters
- Built-in test (call) tone and touch-tone provision
- Excellent sensitivity ($.3 \mu\text{V}$ for 12 dB SINAD)
- Superior immunity to crossmodulation and intermodulation
- Introductory price: \$695.

THE ITC MULTI-2000 TRANSCEIVER...
PERFORMANCE THAT CHALLENGES YOUR IMAGINATION
INTERNATIONAL TELECOMMUNICATIONS CORP.
P.O. BOX 4235, TORRANCE, CALIF. 90510 • (213) 375-9879

MULTI-2000

SPECIFICATIONS

RECEIVER SECTION:

- Sensitivity:
 - FM: 0.3uV for 12 dB SINAD
1.0uV for 20 dB Quieting
 - SSB: 0.25uV for 10 dB SN + N
Noise Figure less than 3 dB
- Intermodulation:
 - Third-order intermodulation products reduced more than 70 dB below one of two RF test signals within the RF passband.
- Crossmodulation:
 - Better than 80 dB
- Selectivity:
 - FM: 15 kHz at -6 dB, Shape Factor 2.5:1 (6/60 dB)
Ultimate rejection greater than 90 dB
 - SSB: 2.4 kHz at -6 dB, Shape Factor 2:1 (6/60 dB)
Ultimate rejection greater than 95 dB
- Spurious Signals:
 - Reduced more than 70 dB.
- IF Rejection:
 - Greater than 60 dB.

TRANSMITTER SECTION:

- Power Output:
 - FM: Low power 1.5 Watts (Adjustable 0W — 10 W)
High power 10 Watts (Typically 15 W)
 - SSB: 15 Watts PEP Output
- Carrier Suppression:
 - Greater than 50 dB
- Unwanted Sideband Suppression:
 - Greater than 50 dB at 1 kHz.

GENERAL:

Continuous tuning in 10 kHz bands... Stability better than 50 Hz after 5 minute warmup... Separate VXO and RIT for independent transmitter and receiver tuning... Built-in AC/DC Power Supply, Noise Blanker, IDC... Built-in Test Tone, provision for PL or Touch-Tone.

INTERNATIONAL TELECOMMUNICATIONS CORP.
P.O. BOX 4235, TORRANCE, CALIF. 90510 • (213) 375-9879



BE MY GUEST

Visiting views from around the globe.

HOW TO GENERATE YOUR OWN INTERFERENCE

In the past year, WR2ABU has been plagued with incidents of malicious interference, illegal stations with obscene "traffic" and other harassments. Dick's phone has been ringing off the wall with members demanding that "The Club" do something about it. Well, the Club did. An unnamed Committee was established with the purpose of tracking down the offenders. It was unnamed because we were well advised to keep the Committee's activities, methods and identities a secret.

The Committee's investigations produced results in an amazingly short time. In several instances surveillance cars monitored illegal transmissions from right next door to the offending source. Names and addresses were obtained. Every new call on the air was investigated via FCC files.

It is not the purpose of this article to talk about the Committee, however.

Most of the offenders turned out to be part of a "hate ham radio group" consisting of a group of Citizen's band operators. Although the evidence was overwhelming, I couldn't help but wonder why they would hate us. What do they have against amateurs? Since their interests so closely parallel ours does it not follow that every CB operator is an aspiring amateur operator.

For me the answer was not long in coming. All I had to do was listen to the repeater for a couple of days. Whenever something bad comes up the speaker blames it on "those CBers". When something derogatory about an operator is called for (?) he is called a CBer. CBers are ridiculed, scorned, taunted and verbally abused

in every conversation they are discussed.

In short, gentlemen, WE ASKED FOR IT! I'm not sympathetic in any way with those who would for any reason deliberately and maliciously cause interference to communications, but I believe it is time for us to administer a cure.

First, our attitude towards CB must change. Sure, the 11 meter operations leave a lot to be desired. Yes, there are many poorly qualified CB operators and much of the worst we think about CBers is true of *some* of them. But how do you feel when someone makes a derisive remark about ham radio, citing the actions of a ham that you don't like any better than he does? What we are doing is blaming ALL CBers for their ills. Aren't they people, each with an individual personality? Is it fair to generalize and say that anyone who holds a CB license is all bad? If so, we better start weeding out those in our own ranks because many hams also hold CB licenses.

And why not? CB has a legitimate intent, just as amateur radio does. If all radio services were to be discontinued due to abuse all you would hear on a radio is static.

Stop for a moment and consider the relationship between ham radio and CB. Before the Citizen's Band service was established, a person with an interest in radio had two choices: listen only, becoming an SWL; or study and work toward an amateur license. SWLs were never the object of ridicule or slander by hams. They were considered potential hams and were treated with friendliness and encouragement. Classes were held by ham clubs to help them obtain licenses. This process continues today, but haven't you noticed that there are fewer SWLs lately? Has it escaped your notice that the average age of members of ham clubs is increasing?

Acting Professional

Some of the largest problems the SCRA elected officers and appointed officials have had to contend with over the past three years have come from within the ranks of our own membership. The systems whose idea of support is to agree with you only as long as you agree with them; those systems who wave their flag of SCRA membership as though it gave them divine right to do as they please; those systems who bend and twist every word in an effort to subvert the very job the SCRA was created to do; those systems who scream *interference* if, by pointing their yagis at *exactly* 127°37', a new co-channel user breaks their squelch; those systems who cry *foul* if the SCRA dares to propose an adjacent-channel system within 800 miles of them; those systems who hang up on you

when you call to tell them their "local" machine is devastating 25,000 square miles. Until you've actually been there, you wouldn't believe it! If you ask them about it, they tell you to go pick on somebody else, after all, as members of the SCRA, we should be helping and supporting *them*, not harassing them, etc., etc. Maybe it is time the SCRA reassessed its values since some of its members appear to have lost theirs. To be supported, you must support; to be helped, you must help; to be an Amateur, you must act professional. Should this trend continue, it, like a cancer, will doom the SCRA to a slow and painful death. If it does, I, for one, will grieve.

Charles R. Flanagan W6OLD
Chairman, Southern
California Repeater
Association

Look around at your favorite ham club the next meeting you attend. COUNT! How many young fellows are there?

What is happening is that there is a third choice available to the young SWL today. The path to a CB license is easy and tempting. Granted, many of the people that take it might not make good hams, but what of those who would? I'll bet most of the people who would have otherwise become good amateur operators are now going into CB. We can't expect to turn the tide from CB because the easier path will always be followed, but there are things we should be doing and most importantly there are things we SHOULD'N'T BE doing!

What we should do is to consider CB as the source of new amateur operators. The first stage of filtering from the general public has already taken place — all we have to do is to provide encouragement, incentive and cooperation. Those having sufficient interest to make it will then become amateurs and both will be gainers. We should contact legitimate CB groups and establish understanding with them. We should do what we can to make amateur radio an attainable goal for those willing to work for it. Finally, we should help make them WANT to become qualified amateurs.

What we should NOT do is to use our licenses (and repeaters) as the means for public denunciation of CBers. If they weren't interested in amateur radio, why would they be listening in on the repeater? They should certainly not hear themselves insulted — that only alienates them and causes them to hate amateurs.

Unless we start to face reality soon things will get a lot worse before they get better. Even the best of Committees (such as ours) won't be able to do much good.

Don't make nasty or unfair remarks about CBers on the air. Don't let others doing it stand unchallenged. The only way listening CBers can defend themselves is by kerchunking or transmitting interference. If you say it for them they won't have to. If the subject compels you to make negative statements, change it!

Don't say CBers when you mean LID. If you like to make enemies, the repeater is the place to do it wholesale.

Gilbert Boelke W2EUP

Reprinted from The Link, Bulletin of the Buffalo Amateur Radio Repeater Assn, Inc., May 1975.

reading everything

The local QRPer, who was worrying about the DXCC fees a week back, came up the hill again last week.

"You know something," this QRPer said, "I understand that the ARRL has been losing money and that they are going to have to dig it out of somewhere . . . like the DXCC for instance. Did you know that?" We had read this over the years, so we nodded our head, thus preserving our erudite facade. The QRPer smiled at our reply and we should then have been a bit suspicious . . . just a bit.

"You know something," he continued, "I checked back to 1964 and would you believe that every year since 1964 the ARRL has shown an operating loss . . . eleven straight years of deficits?" We nodded again to this, but the QRPer rattled on without waiting for our reply. "And that the total of these eleven years of deficits runs to about \$470,000?" And again we nodded, for these are parlous times and many must bear a heavy burden. But the QRPer was smiling again and for sure by then we should have been wary.

"Do you know," the QRPer asked, "that last year they reported an operating loss of \$137,547 but they showed an asset increase of

\$216,546?" Son of a Gun — we were on our feet at this for something was not adding up. "How do you figure that?" we roared, for we were feeling trapped again. "How do you figure they had the assets go up so much when they lost over a hundred thousand?"

The QRPer shrugged. "Don't ask me," he said. "All I know is what I read in the Annual Reports. And since 1964, when the operating loss was over \$470,000, the assets increased over a half million. That's all I know." He was saying this, but that beady-eyed smile was just a bit brighter.

We thought this over for a bit. "I hear what you're saying," we said, "but what does all of this mean?"

The QRPer was quick to reply. "It means that we DXers are fortunate to have someone to watch out for our interests," he said, and away he went down the hill.

And vexed and bewildered, we dug out our own Annual ARRL reports. All we can say is that QRPer sure does read everything.

Reprinted from West Coast DX Bulletin, June 2, 1975.

If amateur radio operators throughout the nation would follow the example of those in little Union City, Tenn. (population 13,500), they probably would be petitioning the FCC for new frequencies, rather than fearing the loss of some they now have.

During the past few months, mainly through the efforts of Willie Pope K4VDQ, radio classes have been organized and 11 new Novices licensed, while others have upgraded to Advanced.

The story actually began last winter when Mr. Pope returned to the local radio station in Union City after having worked for some years in Orlando, Fla.

While there were a number of hams in Union City, most were going their own merry way and little was being done to teach the art to the younger set. Something had to be done to revive the interest among the youth in amateur radio and Willie proved to be the catalyst.

He rounded up Glen Leggett K4GMQ and Bill Porter WA4PRA, and plans were hastily worked out to conduct a Novice instruction class and to organize the Reelfoot Amateur Radio Club.

Stories were run in the Union City newspaper and aired on the radio station, and between 17 and 18

Continued on page 143

Taking Action

DIGITAL PERFORMANCE YOU CAN RELY ON.



The Hickok Model 334 DMM is a rugged, non-temperamental, hardworking tool that's easy to use and easy on your eyes. Hickok has established a unique reputation in digital electronics during the past 10 years. The Model 334 is another example of our engineering expertise — an economical lab quality instrument with exceptional durability and accuracy.

- Easy reading, green fluorescent display
- 3½ digit — auto polarity
- 26 ranges including 200 mV AC & DC ranges
- Fast response — 2.5 readings/sec

Basic Accuracies (% of reading)
 DC Volts; ±0.2% (±0.5% on 200V, 1200V ranges)
 AC Volts; ±0.5% (±2.0% on 200 mV, 2V ranges)
 OHMS; ±0.5%
 DC Current; ±1.5%
 AC Current; ±2.0%

Ask to see the Model 334 at your Hickok distributor. It's a no compromise DMM at a price you can afford.

\$229⁰⁰

HICKOK

the value innovator

INSTRUMENTATION & CONTROLS DIVISION
 THE HICKOK ELECTRICAL INSTRUMENT CO.
 10514 Dupont Avenue • Cleveland, Ohio 44108
 (216) 541-8060 • TWX: 810-421-8286

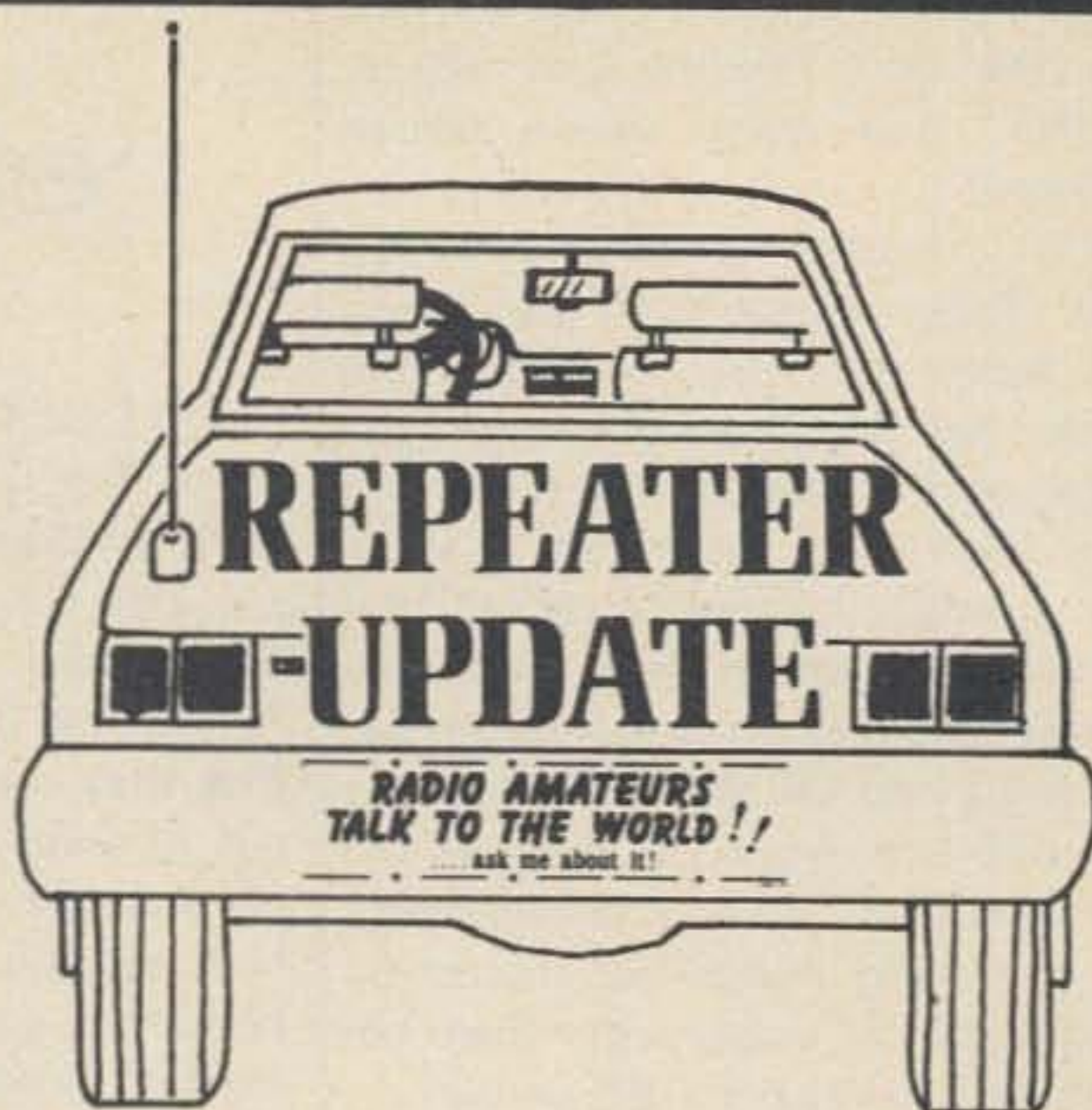

ALABAMA		PENNSYLVANIA			
*WR4ACB	Birmingham	146.76	*WR3ACT Allentown	146.745	
†WR4ALR	Evergreen	146.76	*WR3ACM Altoona	146.82	
*WR4AFP	Jasper	146.64	*WR3ADJ Berwyn	147.36	
†WR4AEJ	Montgomery	146.64	*WR3AFF Clinton	147.21	
D-WR4AJH	Montgomery	146.94	*WR3AEJ Corry	147.09	
			*WR3ADD Hatfield	147.33	
CONNECTICUT			*WR3ACE Lancaster	146.82	
D-WR1AAF	Oxford	146.49	†WR3ADB Muncy	146.82	
			*WR3ADU New Kensington	146.64	
INDIANA			*WR3ADC Pottstown	147.21	
†WR9AFL	Indianapolis	443.75	*WR3AEP Rydal	147.30	
*WR9AFN	Logansport	147.18	*WR3ACW Sunbury	147.30	
			*WR3AES Susquehanna	147.24	
IOWA			RHODE ISLAND		
*WR0AGJ	Cedar Rapids		*WR1AFA	E. Providence	146.835
	RTTY	146.70			
†WR0AIM	Cedar Rapids	147.27	SOUTH DAKOTA		
*WR0	Clinton	146.67	D-WR0	Aberdeen	146.94
*WR0	Davenport	223.94	†WR0ABL	Rapid City	146.94
†WR0	Knoxville	146.64	D-WR0ABX	Sioux Falls	146.94
*WR0AEO	Lamoni	146.73	*WR0AHM	Green Mt.	
*WR0	Ossian	146.85		(N. Black Hills)	146.76
†WR0ADC	Ottumwa	146.97	*WR0AEE	Watertown	146.85
MAINE			VERMONT		
*WR1AEU	Litchfield	146.70	*WR1AFL	Winooski	146.61
MASSACHUSETTS			VIRGINIA		
D-WR1AEZ	Chestnut Hill	147.55	*WR4ALR	Hampton	146.73
*WR1AEZ	Newton	146.715	*WR4	Portsmouth	146.85
D-WR1AER	Fair Haven	146.655	*WR4AMQ	Roanoke	146.73
*WR1AFK	Falmouth	146.85			
*WR1AFI	Hyannis	146.94	WEST VIRGINIA		
*WR1ACU	Reading	147.075	*WR8ACO	Beckley	146.94
*WR1AED	Springfield	146.76	D-WR8	Huntington	146.94
*WR1ABG	Webster	147.345	*WR8AGH	Huntington	146.76
†DL2AA/WR1	Medway	147.21	*WR8AFE	Huntington	146.85
	(previously deleted in error)		*WR8AAB	Hinton	146.88
			*WR8ADD	Logan	146.97
MISSISSIPPI			FOREIGN		
*WR5AJC	Ackerman	146.73	HONG KONG		
			*VS6	Hong Kong (144.48)	145.64
MONTANA			ISRAEL		
†WR7AFW	Great Falls	146.88	*4X4	Jerusalem	145.775
†WR7AFE	Helena	146.76			
*WR7	Judith Gap		MEXICO		
	(Lewistown)	146.76	*XE2IO	Baja Calif	147.33
†WR7AFU	Missoula	146.94	*XE2RMX	Mexicali	146.91
NEW HAMPSHIRE			PUERTO RICO		
*WR1ADB	Gorham	146.76	*WR4AEC	Adjuntas	146.76
NEW YORK					
*WR2AHB	Jamestown	146.79			
*WR2AHS	Hornell	146.91			
NORTH CAROLINA					
*WR4ALC	Asheville	146.64			
*WR4ALC	Asheville (52.01)	53.99			
†WR4AJX	Fairview (147.24)	147.90			
†WR4AHA	Forest City	146.67			
†WR4AMB	Greenville	147.09			

† = CHANGE
 D = DELETE
 * = ADD

It
 pays
 to
 advertise
 in

73

New Heath Ham Accessories



New solid state Heathkit Electronic Keyer...49.95

Sending code's easy with the HD-1410 whether you're operating base or portable. The dot and dash paddles' travel and tension are easily adjustable. When the two paddles are treated as one, the HD-1410 operates like a single-paddle keyer with dot and dash memories. Iambic operation forms most characters with reduced wrist movement. Dots and dashes are self-completing and always in proper proportion. During construction, you select the speed range you want up to 35 words per minute or up to 60 words per minute. Operates on 120 VAC or 12 VDC. Adjustable sidetone frequency, built-in speaker, headphone jack, weighted base. Styled to match our famous "SB" line.

Kit HD-1410, 5 lbs., mailable49.95*

HD-1410 SPECIFICATIONS — **Keying Speed:** Variable from under 10 to over 35 or from under 10 to over 60 wpm. **Keying Output, Positive Line to Ground:** max. voltage open circuit or spikes — 300 volts. Max. current — 200 mA. **Keying Output, Negative Line to Ground:** max. voltage open circuit or spikes — 200 volts. Max. current — 10 mA. **Audio:** internal speaker or jack for optional hi-Z (at least 500 ohms) headphones. **Sidetone:** adjustable from 500 to 1000 Hz. **Internal Controls:** sidetone frequency, paddle tension, paddle travel. **Rear Panel Connections:** AC power cord, 12-volt power input, keyer out, headphones, receiver audio in, ext. key. **Temperature Range:** 0°C to +40°C (typ. -10°C to +40°C) or approx. 50°F to 105°F. **Power Requirement:** 120/240 VAC (±10%), 60/50 Hz, 3.5 watts or 10-14.5 VDC, negative ground, 150 mA. **Dimensions:** approx. 3" H x 5" W x 7½" D. **Net Weight:** 3 lbs.

HEATHKIT ELECTRONIC CENTERS —
Units of Schlumberger Products Corporation
Retail prices slightly higher.

ARIZ.: Phoenix; CALIF.: Anaheim, El Cerrito, Los Angeles, Pomona, Redwood City, San Diego (La Mesa), Woodland Hills; COLO.: Denver; CONN.: Hartford (Avon); FLA.: Miami (Hialeah), Tampa; GA.: Atlanta; ILL.: Chicago, Downers Grove; IND.: Indianapolis; KANSAS: Kansas City (Mission); KY.: Louisville; LA.: New Orleans (Kenner); MD.: Baltimore, Rockville; MASS.: Boston (Wellesley); MICH.: Detroit; MINN.: Minneapolis (Hopkins); MO.: St. Louis (Bridgeton) NEB.: Omaha; N.J.: Fair Lawn; N.Y.: Buffalo (Amherst), New York City, Jericho (L.I.), Rochester, White Plains; OHIO: Cincinnati (Woodlawn), Cleveland, Columbus, Toledo; PA.: Philadelphia, Pittsburgh; R.I.: Providence (Warwick); TEXAS: Dallas, Houston; VA.: Norfolk (Va. Beach); WASH.: Seattle; WIS.: Milwaukee.

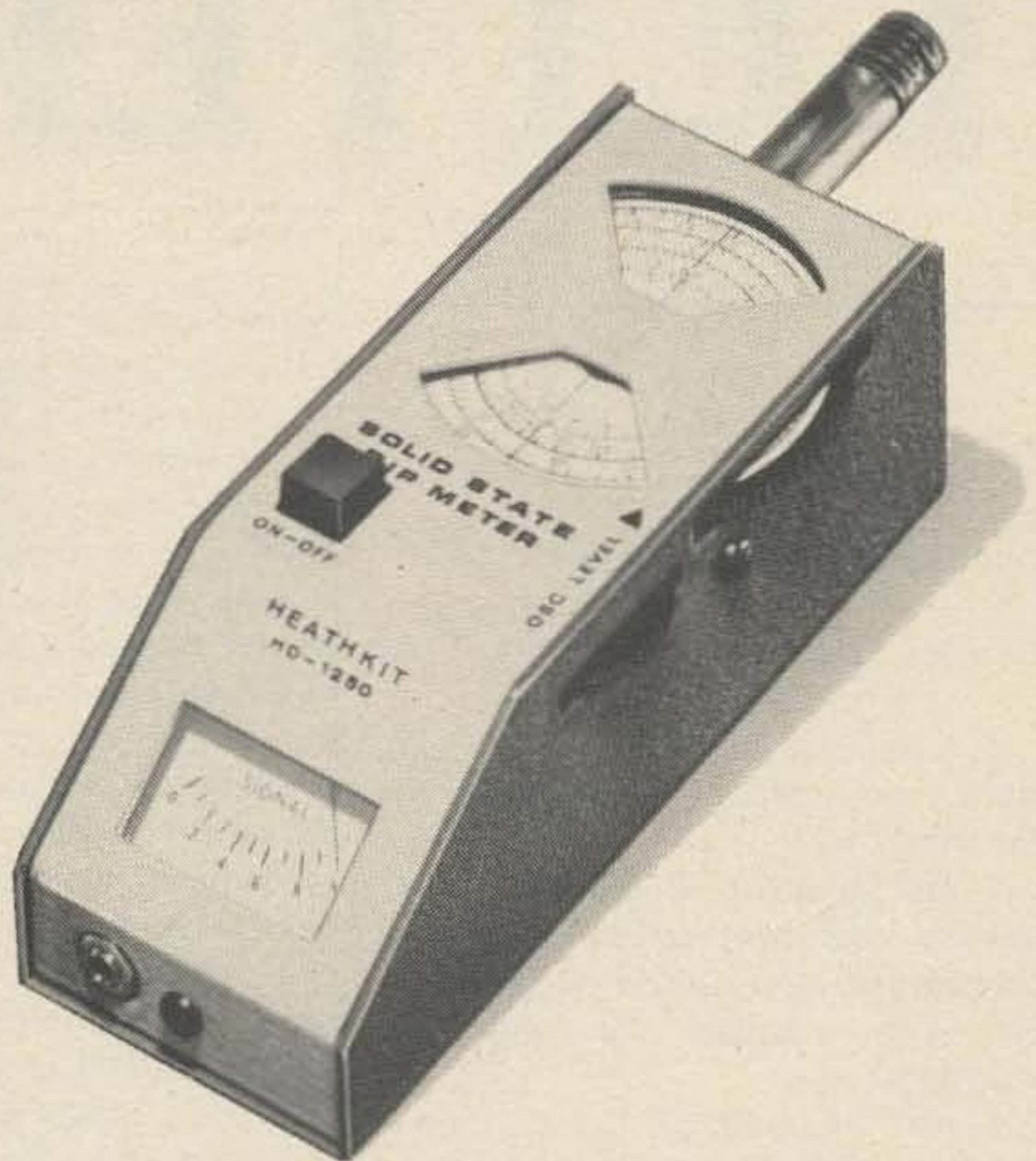

New solid state Heathkit Dip Meter...59.95

A better dip meter at lower cost. The Colpitts oscillator covers 1.6 to 250 MHz in fundamentals with MOS-FET paraphase amplifier and hot-carrier diodes for more sensitivity and better dip. Q-multiplier for greater detector sensitivity and responsive 150 μ A meter movement for positive resonance indications. Phone jack for modulation monitoring. Solid-state design and 9-volt battery operation. Custom molded gray carrying case protects the meter and the 7 color-coded, pre-adjusted, plug-in coils in transit, and makes a handy storage place. Build it in one evening. Nearly everything mounts on two circuit boards. And when you finish, you'll have the best dip meter around — for a lot less money.

Kit HD-1250, less battery, 4 lbs., mailable. .59.95*

Send for FREE Catalog

HEATH	Heath Company, Dept. 11-08 Benton Harbor, Michigan 49022	
Schlumberger		
<input type="checkbox"/> Please send my free 1975 Heathkit Catalog. <input type="checkbox"/> Enclosed is \$ _____, plus shipping. please send model(s) _____		
NAME _____		
ADDRESS _____		
CITY _____ STATE _____ ZIP _____		
<small>PRICES & SPECIFICATIONS SUBJECT TO CHANGE WITHOUT NOTICE. *MAIL ORDER PRICES; F.O.B. FACTORY.</small>		
		AM-314

ou goons don't ever proofr
loasy man scripts from bab
bunch of rocks preening on
you ignored my comments in
I insist that you print ev

SWEATING IT OUT

Mr. Spenser Whipple, Jr.
c/o 73 Magazine
Peterborough NH 03458

Dear Mr. Whipple,

I have just unglued my eyeballs from your June article on couplers for the third time!

I am sweating it out until you publish your next article where you promised to take up the discussion of telephone couplers for answering machines.

I just inquired of the California Public Utilities Commission about their Interim Order Number 138. This opens up the field of customer designed telephone couplers, if they are approved by a Registered Professional Engineer (EE).

Only two, one fellow out in Chatsworth, California, and myself, sent in an ordinary inquiry letter, and Bang! They put both of us on their approved engineer list! Yeah, just for opening our big mouths and asking for information.

So, I am scrambling around trying to re-build my telephone engineering reference library. I disposed of it nine years ago when I tried to retire, hi! So, all circuits and descriptions of approved types of telephone couplers for telephone answered machines are most welcome.

Again, I am looking forward to your next article.

E. Kenneth Taylor W6WT
Communications Consultant
8528 West Hargis St.
Los Angeles CA 90034

THE GOOD . . .

With all the bad deals consumers seem to get hit with these days, there's still hope for us.

I saw an ad in 73 by S. D. Sales, Dallas, Texas: Digital Clock Kit, \$9.95 ppd. All parts less transformer and case. Almost too good to be true. I've

wanted one of these things for years, but sixty bucks always seemed such a waste for a clock. This offer was more in line with my price range.

I sent the \$9.95 and three days later a small box from S. D. Sales arrived. Talk about fast service. But when I opened the little box, alas, the chip and socket were missing. I immediately fired off a letter expressing my displeasure and asking for a free circuit board, if they had one, to dampen my ire. Once again, three days later, another little box. Inside: clock chip, socket, double size circuit board layout, 1/2 dozen free MV-50 LEDs — and an apology.

In two days time, I laid out a board, reduced it 50%, and printed, etched, and drilled it. By 8:00 pm that night I had it going, and played with it for several minutes trying to get it on the second with CHV.

Now let me tell you I'm impressed to no end. The only problem is that the XYL doesn't understand GMT, and now I guess I'll have to order another one for EDT.

Anyway, all I need now is a box to put it in, and it will make tracking the Oscars and working satellites a lot easier.

I've got to hand it to this company — a real bargain, and once again 73 scores with me.

Bill Richarz WA4VAF
Charlotte NC

That digital clock kit, \$9.95, from S. D. Sales, Dallas, is great. Several already in operation here at State Tech plus one on my operating desk at home.

LeRoy Dean Clough W5GQV
Waco TX

As you know, some "bargains" are not anything of the kind, but the Digital Clock Kit advertised in the June issue by S. D. Sales Co. is a genuine jewel. The soldering requires a magnifying glass, but the results are worth the trouble. A lot of thought went into the kit. I've ordered more.

You may or may not be interested to know that my "Me Friend" piece in the June issue brought some un-

expected mail — W6DEF, K6AJG, K3CHP and a half dozen or so others which were inadvertently filed in the IRS basket and lost before I could answer them. Sorry about that — I'm scrupulous about answering nice letters. Anyway, it surprised me.

Ken Cole W7IDF
Vashon WA

A longtime contributor to 73, W7IDF swears up and down that "Me Friend" was his only connection with our June issue. Our sources in the Northwest, though, report that Ken has been sighted at several watering spots in the company of none other than "Dear Gabby" (June, page 172). — Ed.

THE BAD . . .

I am also a victim of Trigger Electronics, 7361 North Ave., River Forest IL 60305. I mailed an order on Jan. 4, 1975, and the check was cashed Jan. 13. Both sides of the check show the stamp, "Trigger Electronics — Trigger W9IVJ". According to the Callbook, W9IVJ is "Israel Treger", whose address is the same as that of Trigger Electronics.

I've mailed him a copy of the check, and I'm waiting a few weeks for the results before I give another copy to the "postal inspectors". If enough folks can put "postal inspector on the ball", perhaps it could then start rolling in the right direction. To me, this appears like using the "mail to defraud" — and it's time we went after him.

Scotty Bottom
Worcester MA

AND THE UGLY

This is my first letter to a ham magazine. I am writing in to protest the way I was treated while working for my Novice license. I do, however, want to say that I have met a few amateurs who did help me. But for the most part I was treated as if I did not exist. I did join an amateur radio club, only to find the club was of little or no help. When I would ask one of them to help me with code they would say they had no time. When I would ask one of them to help me with theory the answer was there was nothing they could do to help me. Well, the fact remains that I am one of those people who, finding a wall in front of him, will fight to overcome it, and I did — I have my Novice license.

And the thing that kept me going was the thought of being able to walk in and tell them that even without their help I got my license. Most people are not like that — if they hit a wall like that they give up. Proof of that is shown by the fact that I brought 3 friends who are very interested in radio to the club and only one of them stayed. I think these hams who think themselves so great had better wake up to the fact that they are going to lose to CB operation many would-be hams because of their way of treating newcomers.

Wayne S. Gateman WN1UXS
Newton Centre MA

WRISTFUL OF DOLLARS

After a little bit of experience with the quartz digital watch I won in your bumper sticker contest at the Dayton Hamvention, it is hard to recall how I got along without it. Resetting my previous watch several times a week had become a way of life for me. Now a weekly hack with CHU or WWV keeps me within a second anytime. Needless to say, I am quite happy with my new CHRONEX.

Funny thing, Wayne, many people have remarked about how lucky I was and how they never win anything. I always ask if they were aware of the contest — those who subscribe to HOTLINE invariably were. Then I ask if they got a bumper sticker and put it on their car. So far, not one has answered yes. How can they win if they don't try? For me it meant a 50¢ LED watch and a free bumper sticker.

Thanks very much for the contest. I hope you have more. There are lots of other things I could use . . .

Dixon Switzer W8KRV
Bellbrook OH

FAT ALBERT AND THE MOB

Have read your magazine ever since I saw a copy in the PX when I was in Germany in 1962. Outstanding!!! Especially the editorials about the Infernal Revenue Service. Have been in ham radio since 1956 and started out in Albuquerque. Am now in a town that is in the fringe area of 5 repeaters (60-140 miles away) and has only 3 active VHFers! Your readers' comments on overcrowded channel conditions on 2m are hard to relate to when the only active channel is 94!

I would like to suggest a new ally (if we'll appeal to them) in the hams'

fight to keep CB off 220: namely, the military and NASA. Out west of us here in New Mexico is White Sands Missile Range, and Holloman Air Force Base, both top secret installations. They are so important they have an FCC frequency coordinator, out in the boondocks! Any ham who calls out on 220 will be told to move immediately! No ifs, ands or buts. Those frequencies are used extensively in this area — "get off, period.", etc. Now, I ask you, will the unruly mob now squatting on 27 MHz cooperate, or even attempt to cooperate with this lawful order (shared with government radiopositioning service, which has priority)? Lord NO, they won't!!! Therefore, my suggestion is: write to the Army, which runs White Sands and other similar installations, and write to NASA. Tell them of the devastating consequences to their vital efforts if CB is allowed on 220, and ask their help. Remind them that when they ask hams to QRT it is done. Tell them that the frequencies they occasionally need so much will be complete and utter chaos if Fat Albert and the mob come up on 220. Our fight may be ended much quicker this way.

Bob Isselhard K5INW
2100 North Cielo
Hobbs NM 88240

STLRRMH

We thought that you would be interested to know that we have developed what could set a precedent in two meter communications contesting. We call it "Spontaneous, Time Limited, Rapid Relay, Message Handling". It is, in essence, a message issued suddenly, without any previous announcement, on a local repeater. Included in the message is the starting time, ending time, and encouragement to send the message via two meter repeaters as quickly and accurately as possible. At the end of the message is the address of the originating station (or club) requesting a copy of the message, and the location of the last repeater that it went through.

Following is a copy of a message that we sent last April 26, and the response that we received.

Original

Message No. 1: Originated by STARRS, WR2ABL. Date: 4/26/75. Time: 9:45 am. Text: Please relay this message through available two meter FM repeaters as rapidly and accurately as possible until 12:45 pm today. At

that time, it is requested that the last station receiving this message please send a copy to STARRS, P.O. Box 301, Corning, New York 14830. Thanks.

Response

No. 1A: From WR2ADL/Check 45 / Daytime Group 0953/ 4/26/75/// Text: Please relay this message through all available FM repeaters as rapidly and accurately as possible up hill 12:45. It is requested at this time the last station receiving the message be sent to S.T.A.R.S., P.O. Box 301, Corning, New York 14830. Thanks.

This response was sent in by Guy R. Williams at Corry, Pennsylvania. The message traversed several repeaters located at Elmira, Owego, Binghamton, Ithaca, Auburn, Rome, and — we theorize — Syracuse, Rochester, Buffalo, New York and Corry, Pennsylvania.

We believe that this type of two meter message handling has not really been tried before (at least we have not heard of such) and hope that it might catch on as a method of contesting, and also as a technique of exercising the potentially great capabilities of two meter repeaters.

Bryant Hozempa WB2LVW
Editor — Kerchunk
Director — S.T.A.R.S.
Corning NY

THE FLIPPER SHOW

That slide synchronizer in the June issue, page 155, is a good start for a slide show. However, depending on the money and time you want to put into your system, you can do some incredible things with slides synchronized with sound.

If you have two projectors of roughly similar make, that have control of the lamp circuits and change circuits, you can keep the screen from going dark with a gadget called a Flipper. Simply, it switches back and forth the lamps, immediately after the "flip" command is given from a push-button control or tape synchronizer — and then, the projector that is "dark" changes slides. This allows you to switch images on the screen almost instantly, and in time with music, and can create some spectacular effects. Those of you with digital knowledge can see how some TTL and a couple of relays can do the job for less than twenty bucks. You will gulp when you hear that the cost of a commercial Flipper is \$120.

Continued on page 130

Alan L. Bridges WB4VXP
2754 Pine Hill Dr. NW
Kennesaw GA 30144

The Oscar Zapper

Part Two

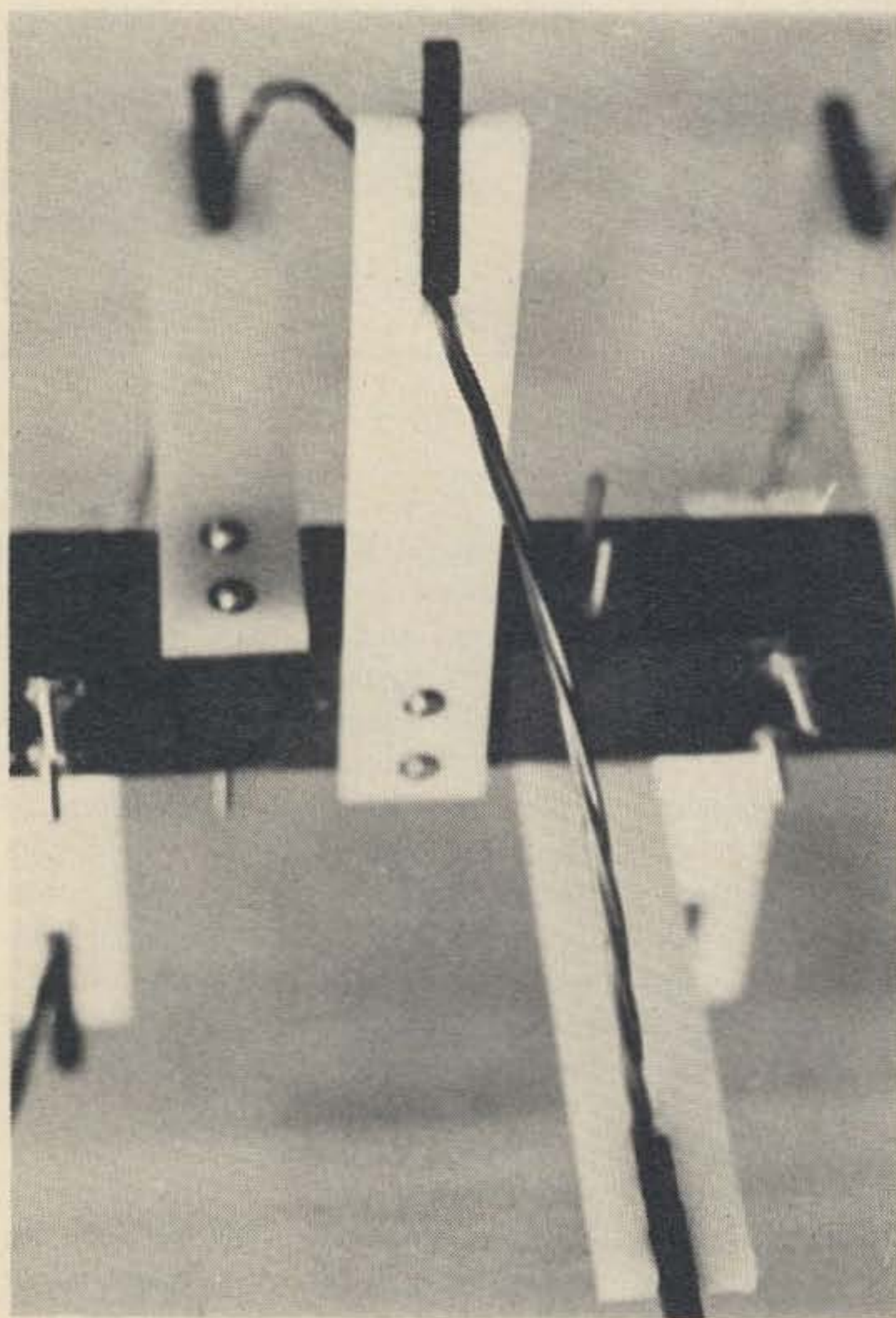

The plexiglass supports of the 70 cm helix with the helix conductor mounted on the supports and with the plexiglass rods permanently bonded to the strips. Note how close the supports are, and the spacing of the supports every 90° along the turns of the helix.

Last month, I discussed the basic characteristics and the general design parameters that one must be familiar with in talking about helices. This part of the article is devoted to the actual construction of the antennas and the installation of the array at my QTH. Basically, the antenna array is four helices mounted on a thirty foot tower with an azimuth-elevation drive. The original installation was completed last summer, but this spring I have taken the array down to modify the az-el drive; this will be discussed later on in the article.

Design, Construction And Installation

The helices that make up the array consist of a pair of antennas, of opposite sense, for both 2 meters and 70 centimeters. The basic design parameters were followed fairly closely. A circumference of 1.00λ was chosen, although after having constructed the antennas the measured or actual circumference was nearly 1.05λ , an acceptable value. The design or center frequency for the helices was 146 MHz and 432 MHz respectively for the 2 m and 70 cm bands. The dimensions corresponding to these frequencies were calculated according to the optimum design parameters, and for $C_\lambda = 1.00\lambda$ the spacing S_λ and the diameter D_λ are summarized below.

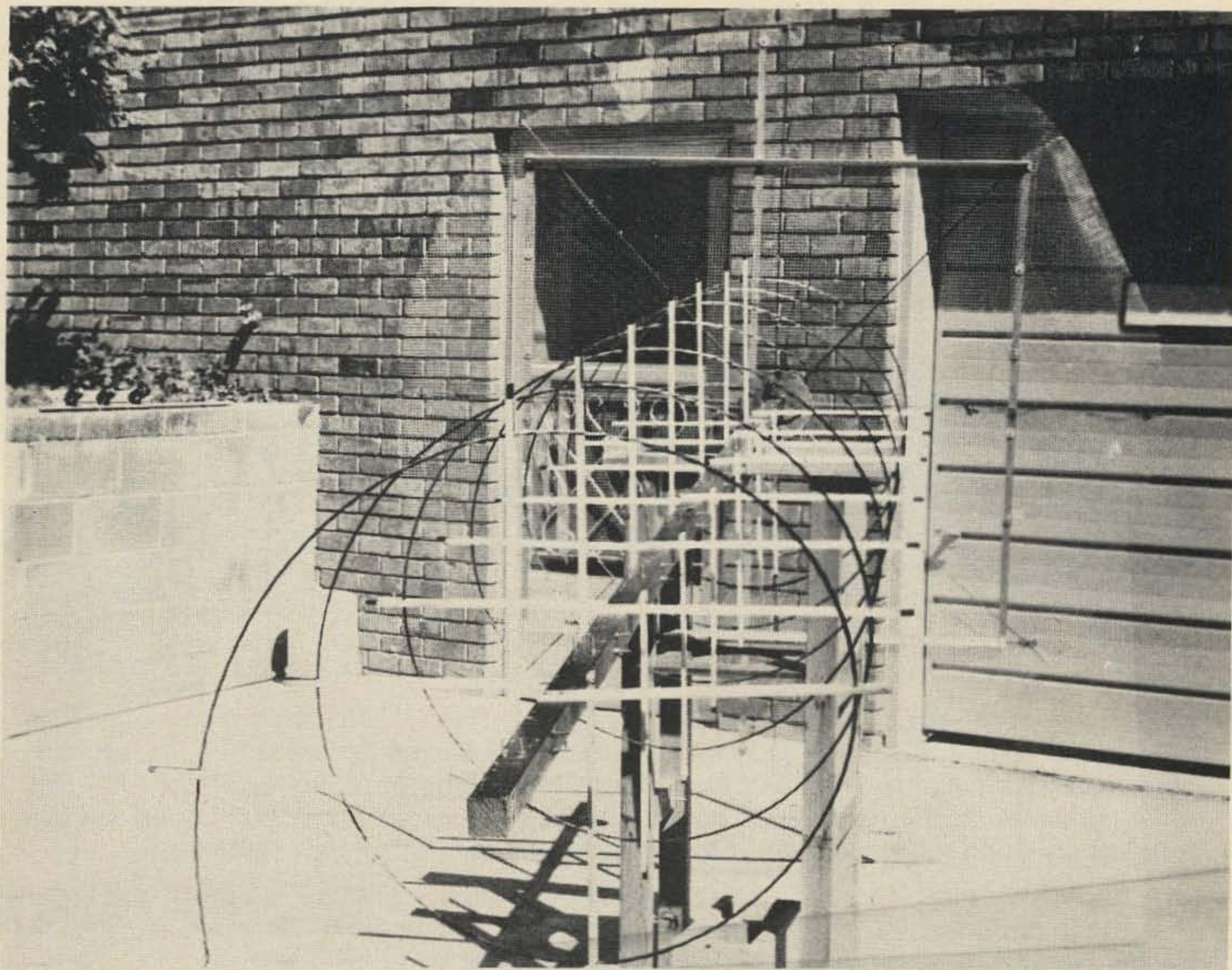

The 2 meter helix under construction. The ground plane is 6 feet in diameter and here the helix has 8 turns instead of the 6 turns that we end up with.

For the 2 meter helices:

$$\lambda = 80.9 \text{ in} = 2.05 \text{ m}$$

$$C\lambda = 1.00\lambda \text{ (Actual value } \sim 1.05\lambda)$$

$$S\lambda = 0.22\lambda = 17.8 \text{ in (Value of } \sim 18 \text{ is used)}$$

$$D\lambda = 0.32\lambda = 25.9 \text{ in}$$

For the 70 cm helices:

$$\lambda = 27.3 \text{ in} = 69.4 \text{ cm}$$

$$C\lambda = 1.00\lambda \text{ (Actual value } \sim 1.05\lambda)$$

$$S\lambda = 0.22\lambda = 6.0 \text{ in}$$

$$D\lambda = 0.32\lambda = 8.8 \text{ in}$$

For the 2 meter helices the spacing and diameter are roughly 18 and 26 inches, whereas on the 70 cm helices the spacing and diameter are roughly 6 and 9 inches, respectively. The axial length, $nS\lambda$, plus the distance from the ground plane to the first turn of the helix, is the total length of the helix, and for the 2 m and 70 m helices this is approximately 9.75 feet and 52 inches, respectively.

After designing the antenna on paper one

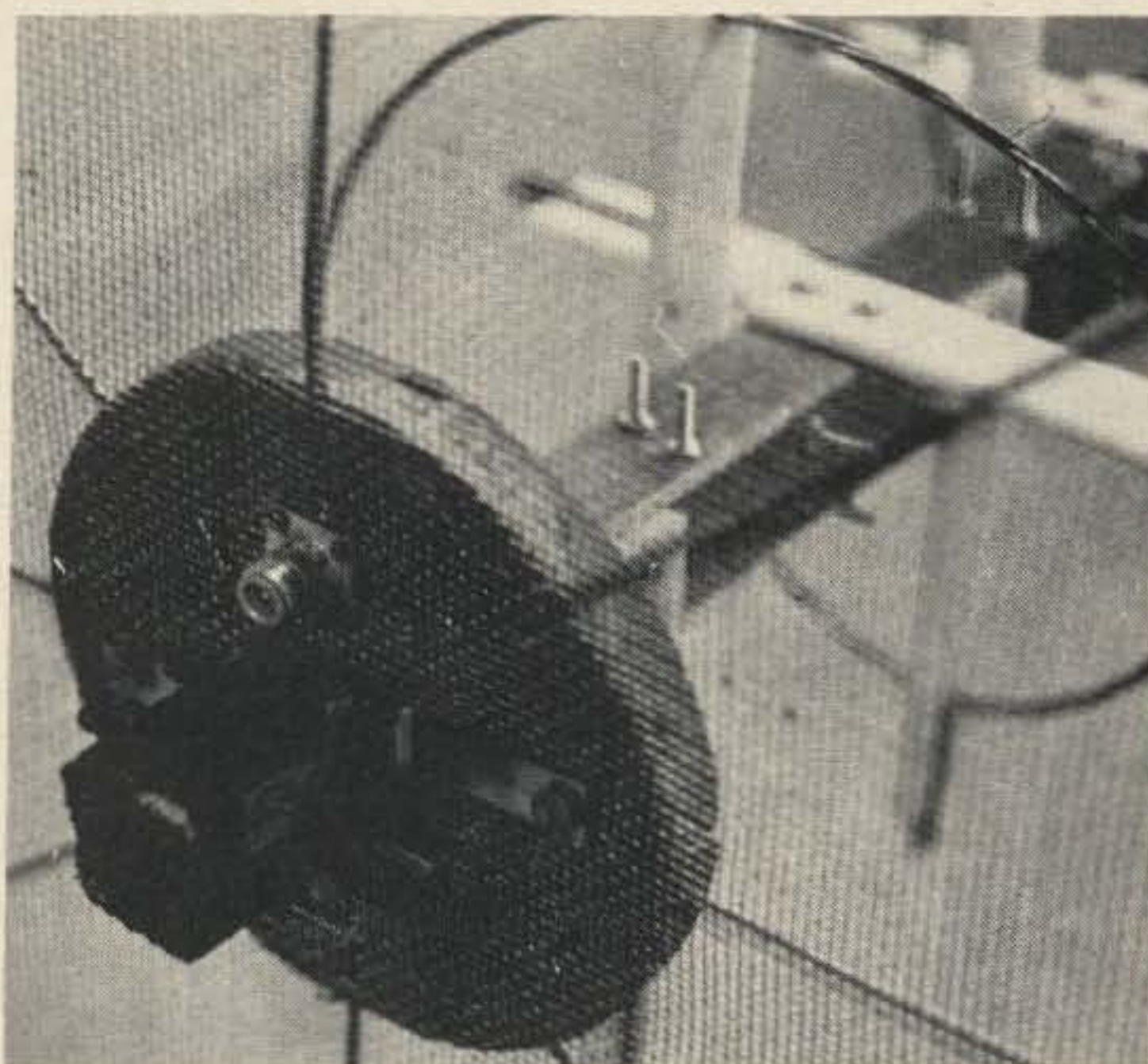

The ground plane and the angle brackets used to mount it to the mast. The wooden disk fits onto the mast of the helix (70 cm helix shown here). The chassis mount type N connector is mounted about 2 inches off the axial center of the helix. Brass welding rods are used to support the hardware cloth.

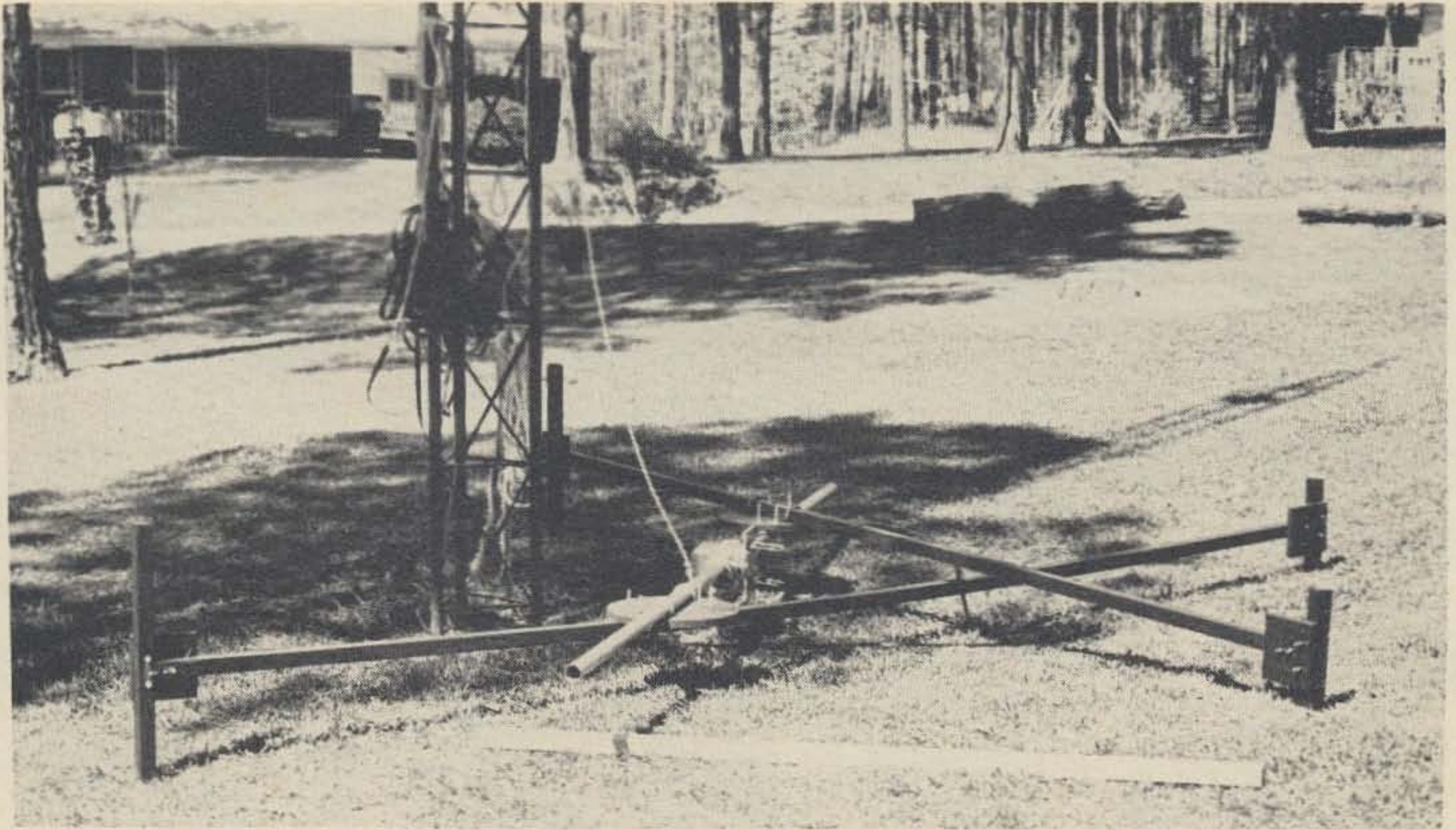

The array support structure before its completion. The "X" structure is incomplete in this picture. Here the rotator (elevation) is mounted on the horizontal boom, which is subsequently attached to the "X". Note the "T" structure on the ends of the "X". The "X" is mounted so that each leg is on the opposite side of the horizontal boom, and this requires that wood spacing be put in between the two legs at the crossover point.

must find the most practical way to assemble it and also utilize available materials. I first thought of using copper tubing for the helix conductor, but after calculating the length that was needed and figuring the cost I was easily dissuaded from this route (for 2 meters about 6.8λ of wire are used). I used three strands of 12 gauge copperweld wire. The next step in the process is to support the conductor and to engineer a support structure for the driven element that would be light, durable and structurally sound. The most important factor here is to preserve the symmetry of the helix, that is, to prevent the conductor from becoming egg-shaped. Also it is important that each turn is 1.00λ long — here there is some room for error since small errors in measurements, mounting of the supports, etc., can throw off the circumference by as much as 0.10λ (an accuracy of about $\pm 0.05\lambda$ in the circumference is acceptable). Also, in designing a support structure for the driven element one must consider the ease or difficulty of winding or placing the conductor on the supports and securing the conductor firmly while adjustments are made. I decided on using a wooden antenna

mast with insulating supports (plexiglass) extending out from the mast at every 90° along the turns of the helix. The pictures reveal the basic ideas and construction techniques. I used high quality 2 x 2 for the masts, treated with linseed oil and painted with outdoor enamel after measurements and drilling were completed. The insulating supports are quarter inch thick, white plexiglass; each support is about 1 inch wide and of an appropriate length for the antenna. This requires a total of $(4n + 1)$ strips of plexiglass for n turns; I bought a large sheet of plexiglass and then cut it into small strips that were needed. Each strip was machined so that the conductor could be wound on these strips after they were mounted on the mast. Each strip has two holes drilled on the end that is to be mounted to the mast and a slot that will hold the conductor on the other end. The dimensions that yield the correct diameter and spacing after the strips are mounted and after the wire is placed on them is calculated from the geometry of this type of structure. It was necessary to make accurate measurements here as any errors would result in an egg shaped conductor, i.e. non-symmetric shape. The basic idea is to

place the wire or conductor of the helix in the slot and to just wind it through so that the shape is very nearly perfect. If my measurements were accurate, then the shape of the helix would be perfect, and I think that this success can be seen in the photos.

After the wire is placed on the plexiglass supports and adjusted, a small piece of plexiglass is placed in the slot and permanently bonded to the white plexiglass support. This small piece of plexiglass is $\frac{1}{4} \times \frac{1}{4} \times 2\frac{1}{4}$ inches long colored plexiglass rod. An alternate and better way to support the wire is to drill a $\frac{1}{4}$ inch diameter hole and then wind the wire through. This has been tried on prototypes (both before and after this array was completed). Once the plexiglass rods are in place and bonded, the helix conductor can still be adjusted, and is epoxied to the plexiglass supports.

Since the helices for each band are of opposite sense, it was necessary to mount the plexiglass supports so that the sense

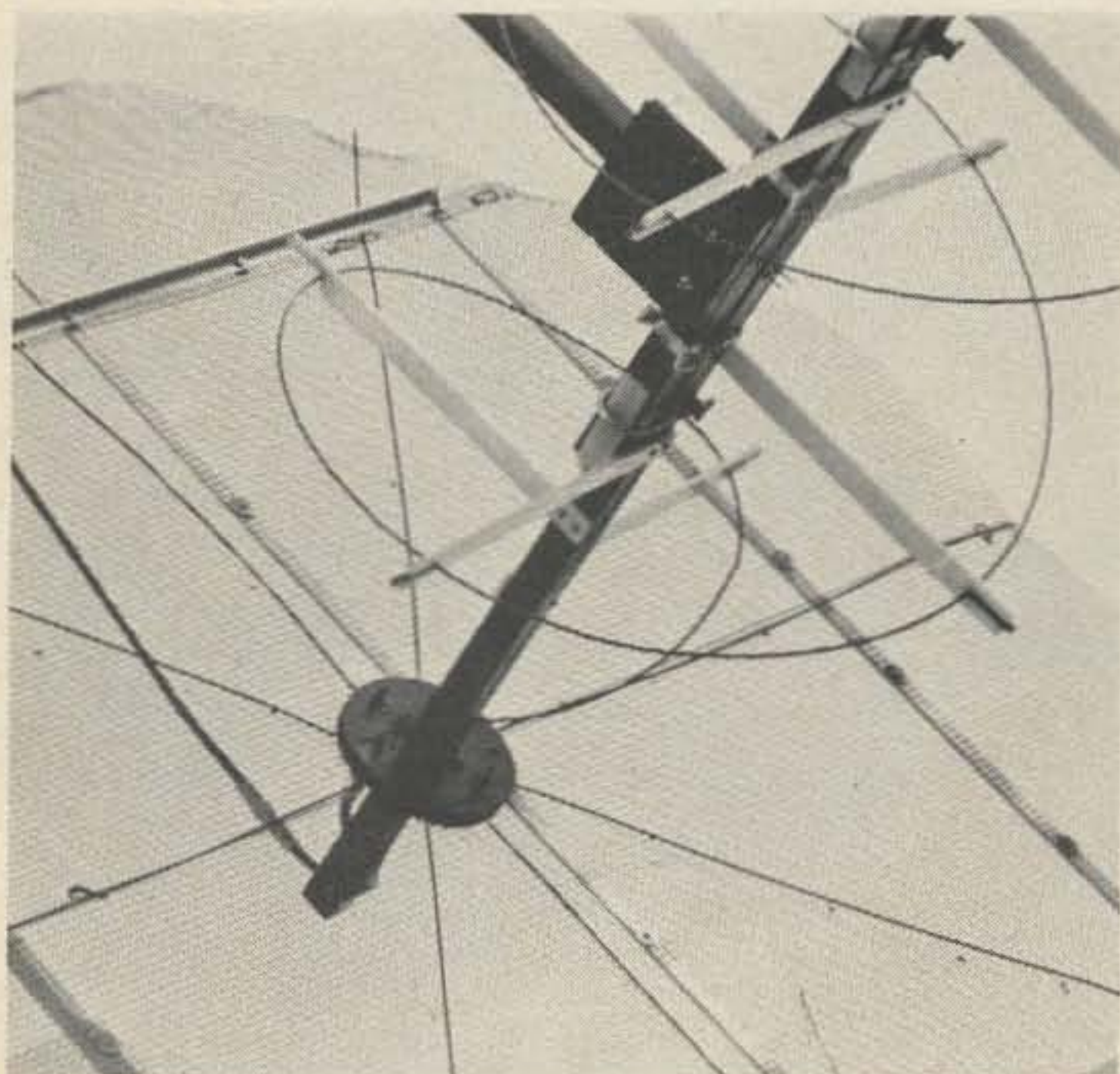

The 2 meter helix, showing the plexiglass supports and the rest of the mounting structure. Note the wooden disk, the hardware cloth, and the aluminum angle stock used to construct the ground plane. The angle stock is mounted on the disk, after which the hardware cloth is attached to both the disk and the supporting structure. The feedline is seen behind the ground plane. The "T" of the leg of the array support structure is attached to the mast of the 2 meter helix with 4 U-bolts.

would be correct. Also, it was noted that the wire used was wound in a right-hand sense, and when the left-hand helix was built it was necessary to uncoil it and rewind it in the opposite direction as it was placed on the structure. With the stiff wire, this turned out to be quite a difficult task.

The ground plane essentially consists of hardware cloth that is mounted on a wooden disk before installation on the mast. The larger ground plane is supported by aluminum angle stock. The ground plane diameter is 6 feet and 32 inches, respectively, for the 2 m and 70 cm helices. Two angle brackets are used to secure the ground plane to the mast.

The feedpoint is slightly off center, but this does not critically affect the performance of the antenna (although it does appear in the antenna pattern). A better ground plane would consist of a metal plate with the connector mounted on the disk; this aluminum or brass disk could be square, with radials extending out to obtain the desired dimensions of the ground plane. Before the antenna array was installed on the tower, all metal parts were coated with a rust preventive (Val Oil). The antennas were completed separately and then installed on the array support structure, but before the array was installed, Cliff Burdette WA8GRE, of the Engineering Experiment Station, Georgia Tech, and I made far-field antenna pattern measurements which will be discussed later. The array support structure is shown in the photos. In order to put up the four helices this structure must be capable of supporting them and also rotating them. Basically the azimuth rotator is a TR-44 and is mounted on a mounting plate inside the top section of the Rohn tower. The elevation rotator is an RCA 10W707 rotator. This rotator is mounted horizontally in an azimuth-elevation system similar to that used in Reference 9. A better elevation system, like the system used by K6HCP (Reference 8), is desired, even though this system seems to work well. The horizontally mounted rotator is mounted via a small steel plate to a tower mast pipe that extends up from the azimuth rotator through the top section of the tower. This pipe is quarter inch wall 2-1/8 inch diameter steel, about 4

feet long, that was found in a local junk yard. Through the elevation rotator is placed a 1-1/2 inch diameter heavy duty, 10 foot length of conduit. The basic array support structure is built about this horizontal boom. This structure is basically an "X", with a helix mounted on each leg of the "X" structure. The center or crossover point of the "X" is off center, and the horizontal boom about which the array is rotated in elevation is about 2.5 feet below this point. The points where each of the legs cross are permanently secured to each other. Each leg is about 12 feet long, and this makes the array about 11 x 11 feet. The legs are secured to the horizontal boom with a wooden disk and with U-bolts and lock-washers. The ends of the legs, where the helices are mounted, consist of a "T" made of a small piece of 2 x 2, metal mending plates, and a 6 x 6 inch piece of very hard

wood. The larger helices are mounted to the "T" with four U-bolts and appropriate hardware. The smaller helices are permanently mounted to the "T"'s. A wooden brace is attached to the 2 m helices as seen in the photos. Also, a counterbalance, consisting of another 2 x 2 about 13 feet long, is attached to the upper part of the array where the smaller helices are mounted. Weights can be attached to this. The total array weighs about 80-100 pounds. Once the antennas were mounted on the structure, which itself was supported by a rope attached to a gin pole mounted at the top of the tower, it was necessary to get some help in order to haul it up. The feedline also had to be mounted and the swr checked out before the antennas were pulled all the way up and installed. The swr was checked by raising and lowering the array to a height of about 20 feet (more on this later). The tower on which the



The support structure of the helix conductor or driven element. The plexiglass strips are spaced every 90° along the turns of the helix. Also shown is the "T" used to attach the helix to the array support structure. The ground plane is to the left. Note the symmetry of the helix and also the small plexiglass rods on the ends of the plexiglass strips where the conductor is mounted and epoxied to the supports.

←
SAME ARRANGEMENT THIS SIDE
EXCEPT HELICES ARE OF
OPPOSITE SENSE

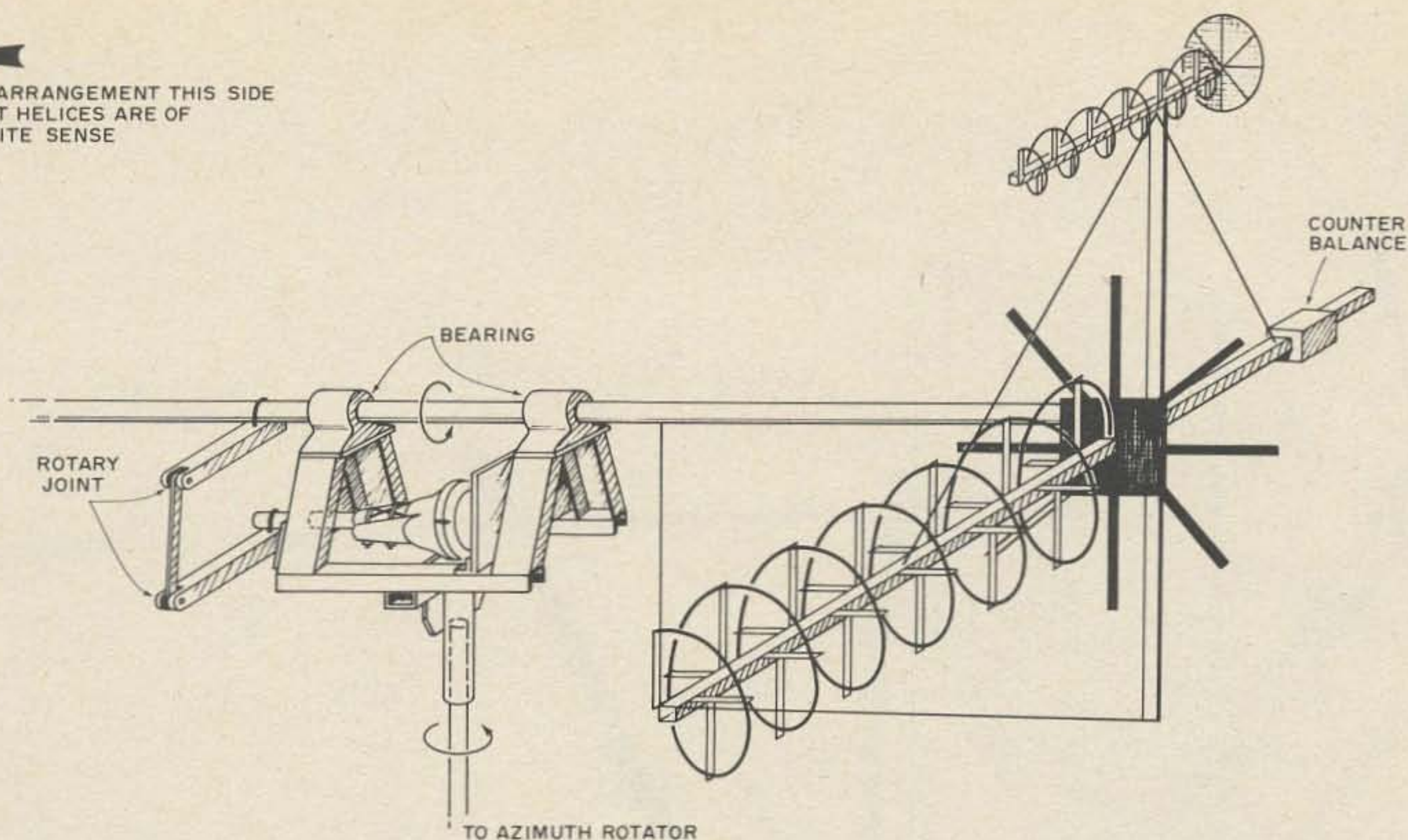

Fig. 4. Half-view of the updated version of the array, showing how the helices are mounted on the main boom and illustrating the az-el system and the antenna frame. The rotor is a Ham II mounted horizontally, covered to prevent the entrance of moisture. The main antenna boom is mounted at the top of the frame (or fork) through two bearings. This boom is rotated by the lever assembly. The rotary joints are tie rod ends (a surplus C141 assembly). At the bottom of the frame is the assembly that attaches to the azimuth rotor. Here a two inch inside diameter aluminum tube slips over a two inch outside diameter pipe, which in turn is attached to the other Ham II inside of the tower. This arrangement eliminates major stresses and windmilling of any kind.

antenna array is mounted is a Rohn 25, with a section mounted in three feet of concrete. It is about 27 feet high and is non-guyed. To install the array I used a regular gin pole plus a commercial gin pole designed specifically to be used with Rohn towers. The antenna array was hauled up by using a block and tackle hoist as well as the two gin poles. The last two feet were the most difficult, and eventually after much sweat and some very exasperating work hurrying to get the bolts secured, while the people on the ground held the array suspended in the air, the array was installed. Both the antennas and the array have been successfully subjected to hail storms and high winds — and even two tornadoes which passed through the area.

Since the original construction and installation were completed last summer, there have been some additions and changes in the array. First of all, during February 1975 there were two severely damaging tornadoes in the Atlanta area. One struck the McCollum Airport, which is less than $\frac{1}{2}$ mile from my QTH, and the other one destroyed

a great part of northwest Atlanta. With the one that struck here in Kennesaw, my antenna array felt the high winds and hence suffered some damage. As I now travel most of the time as a sales representative, I came home to find that the tornado and the high winds left the array windmilling, i.e. rotating freely in the wind and just barely attached by a safety (aircraft) cable that I had installed just in case this might happen. I immediately lowered the array as I did not want it to fall if another tornado came through. I had been planning to lower it anyway to revise the az-el system and redo the basic mounting of the antennas.

During May and June I redid the array. In my original installation the problems were mainly mechanical, i.e. mounting of the antennas and rotating them in elevation was not as strong as I had hoped. Basically the new az-el drive and antenna frame, which can be seen in Fig. 4, was designed so that a large moonbounce antenna array could be rotated easily. A drive system like this has been used by DJ9JT (see Ref. 16). The basic arrangement consists of a frame, very similar

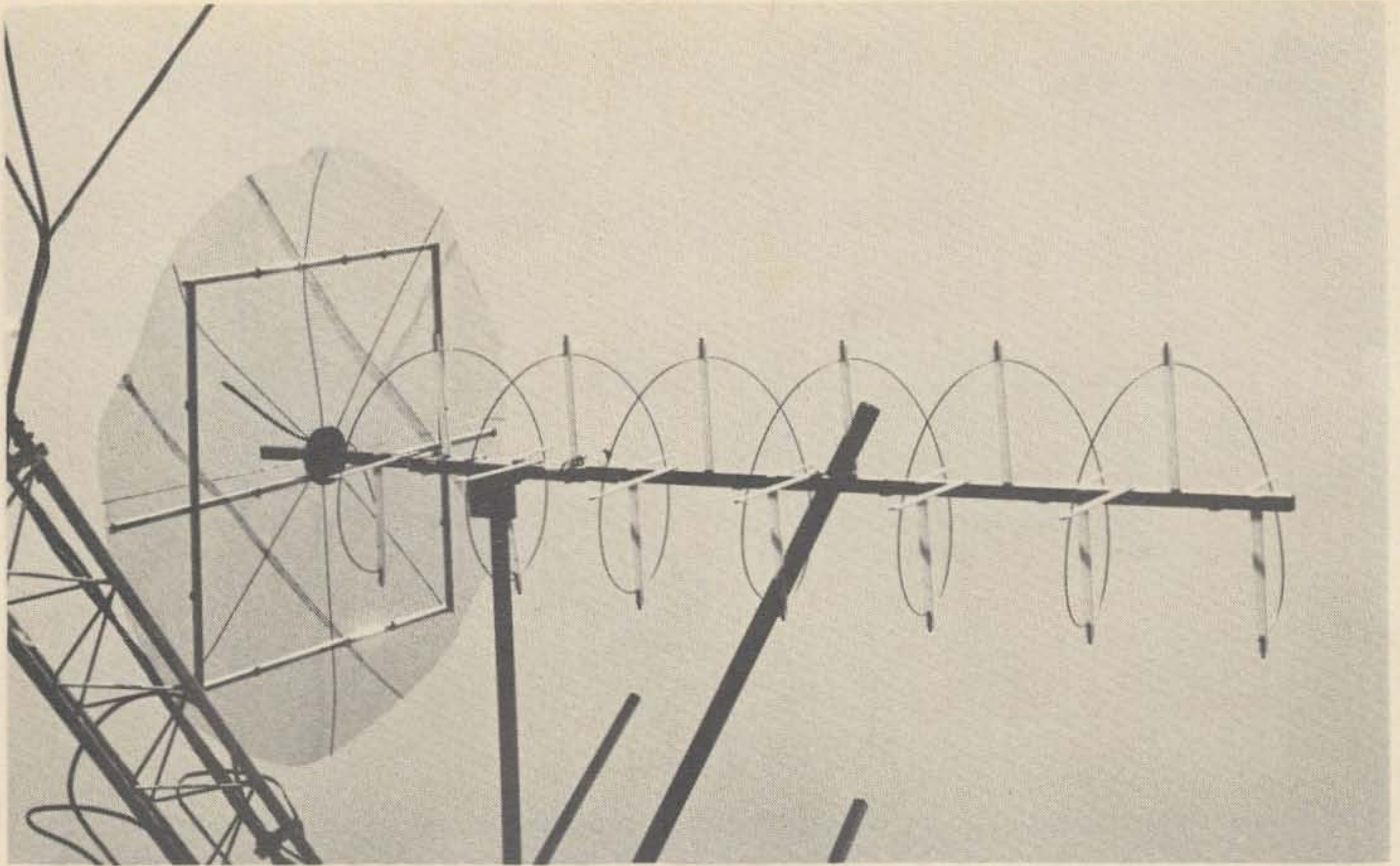

The 2 meter helix as viewed from ground level with a telephoto lens.

to a telescope fork, through which the main antenna boom is mounted. This boom is supported by bearings. The elevation drive is mounted in the lower part of the fork assembly. Here a Ham II mounted horizontally is to be used. A short section of tubing connects the drive motor to the mechanical arrangement used to drive the main mast. This is a basic lever, with the rotary joints being surplus tie rod ends. When the drive motor is engaged, the upper boom will rotate as does the lower boom, due to the lever-action. A chain drive could have been used instead of this particular arrangement. The main boom is 6061-T6 aluminum tubing, with an o.d. of 2.5 inches. This boom is 21 feet long and all of the antennas are mounted about this boom. The fork was made up of surplus materials, mostly aluminum, and was HeliArc welded. At the center of the fork on the bottom side, a piece of 2 inch i.d. 6061-T6 aluminum tubing is HeliArc welded. A 2 inch o.d. pipe can be inserted and then secured; the other end is then attached to the azimuth rotor (Ham II). This fork assembly has eliminated major stresses that caused most of the problems in my original mount. Also, I have replaced the

TR-44 with a new Ham II. The major problem is wind resistance, and since the Ham II has a 7.5 square foot rating as compared to the 2.5 square foot rating of the TR-44, this replacement has eliminated tendencies of the array to whip around in the wind (mainly the clamps slipped). I am also using the Ham II in elevation. This has also been successfully done at Philco in Vandenburg, California, as well as by Jacques Cousteau on his research ship. The major cost factor here was the rotors, as everything else used surplus or otherwise cheaply available materials.

I have also modified the mounting of the helices. This time I did not use this "X" mounting as before, but used more of an "H" type mounting as seen in Fig. 4. I have also tried to make the array as lightweight as possible by redoing the mounting, adding counterbalancing, and by reducing the weight of the groundplane on the 2 meter helices. On the 2 meter groundplane: Here I have replaced the whole groundplane with a 3/16 inch thick aluminum plate, about 15 in. by 15 in., that has 8 radials of aluminum mounted on it. I also have a lighter mesh that is 4 feet by 4 feet, and this is attached to the radials which extend out as in the

drawing. This reduced the weight considerably, as I used really heavy hardware cloth on the original version. Also, I have remounted the helix so that the 2 meter helix can be mounted on the main boom. By having a 6 to 8 foot extension of 2 x 2 beyond the balance point, I can counterbalance the antenna by adjusting a weight along this mast. I have tried to mechanically beef up the array in this process, and have also added a gin pole with a winch to lower and raise it.

Impedance Matching

The helix has a terminal impedance of 140 Ohms and is pure resistance. Since 50 Ohm cable was used to feed the antennas, it was necessary to match the 50 Ohm impedance of the RG-8 polyfoam coax to the 140 Ohm terminal resistance of the helix. A quarter-wave coaxial matching transformer is used as in Reference 4. The formula used to determine the correct impedance value is:

$$Z_0 = \sqrt{Z_s Z_a} \text{ Ohms,}$$

where Z_0 is the desired impedance, Z_s is the transmission line impedance, and Z_a is the antenna impedance. This is 83.7 Ohms in this case, and a value of 75 Ohms is very close. Here RG-11/U was used for the matching section and RG-8/U polyfoam coax was used for the feedline. The matching section was made according to the formula:

$$\text{Length (feet)} = \frac{246 V}{f}$$

where V is the velocity factor for the RG-11/U (approximately .66) and f is the frequency in MHz. Two alternate and even better matching systems are described by Doug De Maw W1CER, in Reference 4. Swr measurements were made with the antenna about 20 feet off the ground, and trimming the driven element was done by lowering the antennas within the reach of a step ladder. An initial swr of 1.7 to 1.8 was obtained on the 2 meter helices, while a similar one was obtained on the 70 cm helices. By trimming

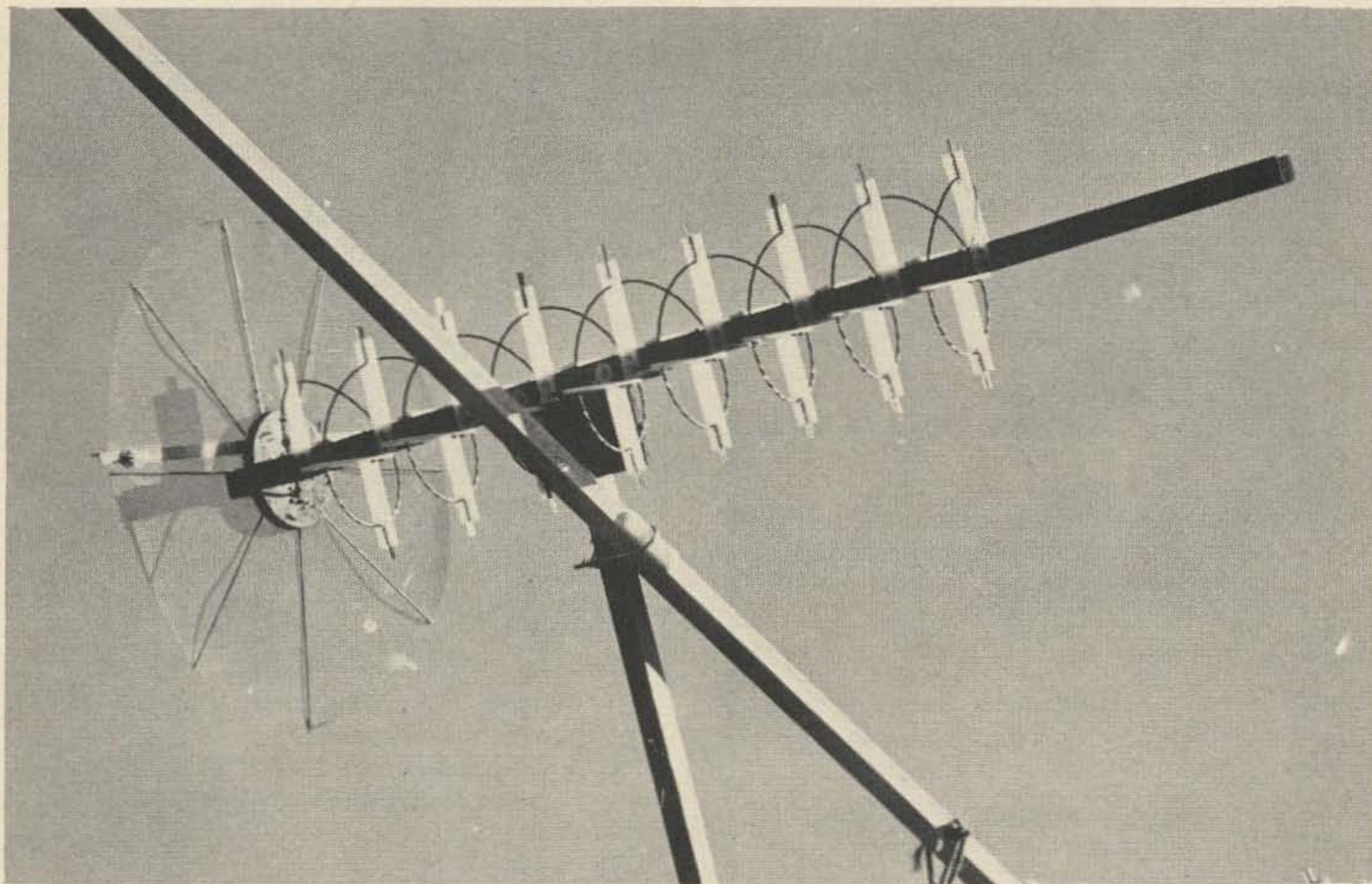

The 70 cm helix mounted on one of the legs of the antenna array support structure. The ground plane is 32 inches in diameter, and has brass welding rods as well as one piece of angle bracket for support. The "T" structure is permanently attached to the mast. The 13 foot long counterbalance is attached with a U-bolt to the leg of the "X". Besides acting as a counterbalance, the 2x2 keeps the two 70 cm helices from whipping around during wind or rotation.

THE LM-3 VOLKSMETER

World's lowest priced precision digital multimeter
-- more accurate and rugged than the old pointer
meter -- ideal for field service.



With rechargeable
batteries and charger unit **\$125**

Now a multimeter with truly outstanding features.

- Super Rugged: Ideal for field service use - you don't have to recalibrate or replace if dropped.
- High Input Impedance: 10 megohms on all ranges; no more circuit loading.
- Automatic Polarity: No more test lead reversing or switching.
- Automatic Zero: No more adjustment of the zero when you change range, function or position; no more full scale ohms adjust.
- Full three digits without parallax or required interpolation; a 0.33" high LED display. A true one percent meter.
- 13 ranges: 4 vdc, 4 vac and 5 ohms.
- Measurements: Up to 700 vdc or 500 vac and up to 10 megohms.
- Small Size: 1.9" H x 2.7" W x 3.9" D.
- Versatile: Operates from standard 115V outlets or on self-contained rechargeable batteries.
- Fully Protected: No damage from overload on volts and ohms measurements.

Optional Features:

- Leather Case.
- High Voltage Probe: For measuring up to 30KV.
- Current Shunts: One percent accuracy from 1 μ A to 1A.

LM-3 basic meter also available in four digits with 0.02% accuracy. Ask for LM-4.

See your local distributor!

Distributor inquiries invited.



Non-Linear Systems, Inc.

Originator of the digital voltmeter.

Box N, Del Mar, California 92014

Telephone (714) 755-1134 TWX 910-322-1132

the driven elements, an swr of about 1.5 to 1 was obtained. A better swr could be obtained if a matching section with an impedance of about 83 to 84 Ohms were used.

To obtain a better match and hence a lower swr, I have talked with Mike Staal K6MYC, at KLM Electronics, about building a sleeve balun to match the 140 Ohm terminal impedance of the helix to 50 Ohm coax. By this time I will have either built one myself or else have had them made by Mike. The big problem in popularity of the helix has probably been the impedance matching, and since it is very easy to build the helices and get them working, it would be worth the cost of getting a sleeve balun made by someone who makes them professionally.

References

- [7] R. McClain K9PVW, and K. O. Learner W9MDW, "Helix Antenna Guidelines," *AMSAT Newsletter*, Vol. 4, No. 3, September 1973.
- [8] Kenneth Holladay K6HCP, "A Practical Moonbounce Array," *Ham Radio*, Vol. 3, No. 5, May 1970, p. 52.
- [9] Wilfred Scherer W2AEF, "An Az-El Antenna Mount," *CQ*, Vol. 26, No. 11, December 1970, p. 42.
- [10] G. R. Jessop, "VHF-UHF Manual," RSGB, p. 9.8-9.9.
- [11] William Hale, L. DeSize, W. Offutt, "Methods of Obtaining Circular Polarization," Chapter 17, *Antenna Engineering Handbook*.
- [12] T. Bittan G3JVQ/DJ0BQ, "Antenna Notebook," *VHF Communications*, Vol. 6, Spring Edition, 1/1974, p. 38-41.
- [13] Perry I. Klein and Jan A. King, "Results of the AMSAT-OSCAR 6 Communications Satellite Experiment," presented at the IEEE International Convention, New York City, March 28, 1974.
- [14] Raphael Soiffer K2QBW, "Getting Started in Satellite Communications: How and When to Work Through OSCAR 6 and OSCAR 7," *AMSAT Newsletter*, Vol. VI, No. 2, June 1974, p. 25-35.
- [15] K. P. Timmann DJ9ZR, "A 5 Watt Transistorized SSB Transmitter for 145 MHz," *VHF Communications*, Vol. 1, Edition 2, May 1969, p. 73-82. See also "An 8 Watt SSB Transmitter Suitable for OSCAR 6 and OSCAR 7," *VHF Communications*, Vol. 5, Edition 4, November 1973, p. 228-233.
- [16] E. Reitz DJ9JT, "A Tilttable Antenna with Selectible Polarity," *VHF Communications*, Vol. 2, Edition 1, February, 1970, pages 12-20.

Next month: Measurements and conclusions.

... WB4VXP

2 METER CRYSTALS IN STOCK

We can ship C.O.D. either by parcel post or U.P.S. Orders can be paid by: check, money order, Master Charge, or BankAmericard. Orders prepaid are shipped postage paid. Phone orders accepted. Crystals are guaranteed for life. Crystals are all \$5.00 each (Mass. residents add 15¢ tax per crystal).

We are authorized distributors for: Icom and Standard Communications Equipment. (2 meter)

We stock A/S and Mosley two-meter antennas

We have thousands of crystals for monitor radios (Bearcat, Regency, etc.) along with many C.B. crystals

Note: If you do not know type of radio, or if your radio is not listed, give either fundamental frequency or formula and loading capacitance.

LIST OF TWO METER CRYSTALS CURRENTLY STOCKED FOR RADIOS LISTED BELOW:

- | | |
|----------------|--|
| 1. Drake TR-22 | 5. Ken/Wilson |
| 2. Drake TR-72 | 6. Regency HR-2A/HR212/Heathkit HW-202 |
| 3. Genave | 7. Regency HR-2B |
| 4. Icom | 8. S.B.E. |
| | 9. Standard |

The first two numbers of the frequency are deleted for the sake of being non-repetative. Example: 146.67 receive would be listed as - 6.67R

- | | | | | | | | |
|----------|------------|------------|-----------|-----------|-----------|-----------|-----------|
| 1. 6.01T | 8. 6.70R | 15. 6.175T | 22. 6.85R | 29. 6.37T | 36. 7.60T | 44. 7.72T | 52. 7.84T |
| 2. 6.61R | 9. 6.13T | 16. 6.775R | 23. 6.28T | 30. 6.97R | 37. 7.00R | 45. 7.12R | 53. 7.24R |
| 3. 6.04T | 10. 6.73R | 17. 6.19T | 24. 6.88R | 31. 6.39T | 38. 7.63T | 46. 7.75T | 54. 7.90T |
| 4. 6.64R | 11. 6.145T | 18. 6.79R | 25. 6.31T | 32. 6.99R | 39. 7.03R | 47. 7.15R | 55. 7.30R |
| 5. 6.07T | 12. 6.745R | 19. 6.22T | 26. 6.91R | 33. 6.52T | 40. 7.66T | 48. 7.78T | 56. 7.93T |
| 6. 6.67R | 13. 6.16T | 20. 6.82R | 27. 6.34T | 34. 6.52R | 41. 7.06R | 49. 7.18R | 57. 7.33R |
| 7. 6.10T | 14. 6.76R | 21. 6.25T | 28. 6.94R | 35. 6.94T | 42. 7.69T | 50. 7.81T | 58. 7.96T |
| | | | | | 43. 7.09R | 51. 7.21R | 59. 7.36T |

* * * * *

SPECIAL

Buy the STANDARD 146/A W/T for ONLY \$298 and receive a \$60 MERCHANDISE CREDIT good for the following accessories:

- SR-CSA DESK TOP CHARGER \$43.00
- SR-C-AT19 RUBBER DUCKY ANTENNA \$6.00
- NI-CAD BATTERIES (10 REQUIRED) \$2.00 ea.
- CRYSTALS (UNIT COMES WITH 34/94 AND 94 DIRECT) \$5.00 ea.
- SR-C-PT3644 LEATHER CASE \$8.50

SPECIFICATIONS

Microphone:	Internal dynamic type	Frequency range:	143 to 149 MHz
Dimensions:	9" h x 3" w x 1-5/8" d	Number of channels:	5
Weight:	32 oz. max. (including batteries)	Channel spread:	2 MHz max.
Supplied with 2 channels:	146.94Tx/Rx (national calling channel) 146.34Tx/146.94 Rx (repeater channel)	Input voltage (negative ground):	12.5V dc ±20%
	Internal 2" dynamic	Circuitry:	All solid state
		Current drain:	15ma squelched max., 100ma receive max. 0.62A transmit max.

CASH, CHECK OR M.O. ONLY TO QUALIFY FOR W/T SPECIAL

STORE HOURS: MON-FRI: NOON-9 P.M. SAT: 10 A.M.-6 P.M.



Kensco 46 PEARL STREET PHONE (617) 471-6427
QUINCY MA. 02169
Communications INC.

Identalert C

for Clock Watchers

To further increase the utility of the Identalert*, a digital, solid state read-out has been added. With a minimum of effort you can now watch the time tick by. With a little more effort it is possible to vary the identification cycle for use with repeaters, for example.

Adding a solid state display is accomplished by wiring in six more ICs and changing the power supply to accommodate the increased power requirements of the displays. The Identalert counts seconds derived from the power line whereas the display shows minutes and seconds. One pulse per second is taken from the Identalert as is the reset pulse. Q21, Q22 and Q23 count these pulses and drive BCD-to-seven segment decoders, Q18, Q19 and Q20, which, in turn, drive the GaP displays.

Each segment of each display must have a current limiting resistor between it and its driver output. Rather than use twenty-one discrete resistors, the new resistor networks were used. These are thick film resistors fired on to a ceramic base. They have the configuration of an integrated circuit. In Identalert C, ICR1, ICR2 and ICR3 have seven resistors per package. R20 is used to light the decimal point. If available to you, a resistor network with 8 resistors (CTS 761-3-R150) can be used for ICR2.

My display was built in a separate 5" x 2¼" x 2¼" minibox with a short interconnecting cable (4-cond) running to the Identalert. Be sure to use no less than #18 wire for Vcc and ground wires. We are dealing

with a fair amount of current, and voltage drops in the wiring can disrupt the operation of the display.

Because the power supply is required to supply approximately ¾ of an Ampere instead of the 250 mA for the Identalert alone, it is necessary to make some extensive changes to the original supply. Just about all the parts used in the original supply are used and the parts designation numbers reflect this. Where an original part changes value it is noted in the accompanying parts list, i.e., R5 is 10 Ohm 10 W instead of 25 Ohm 10 W. In order to use the original pass transistor, Q15, it is essential that this device be attached to the chassis — which acts as its large heat sink. The original heat sink won't come close to keeping Q15 within its thermal rating. In addition, be sure that the box containing the power supply and the one containing the display have plenty of ventilation — a lot of heat is generated!

After the supply has been built, connect about 6 Ohms (5 W) across the output and adjust R16 and R17 for 5 volts. If there is a length of cable involved, connect the calibration resistor at the display end of the cable. The parts list indicates two different types of trimmer. Whereas both will work, it is advisable to use cermet trimmers for their better temperature characteristics.

I usually avoid using IC sockets, but did so in this case to mount the LED displays. The resistor networks and the sockets for the displays were mounted on a piece of punchboard and this assembly was epoxied, at right angles, to another piece of punchboard on which were mounted the six ICs. The wiring from the networks to the display

*See "The Identalert", K2PMA, 73, April, 1975, p. 89.

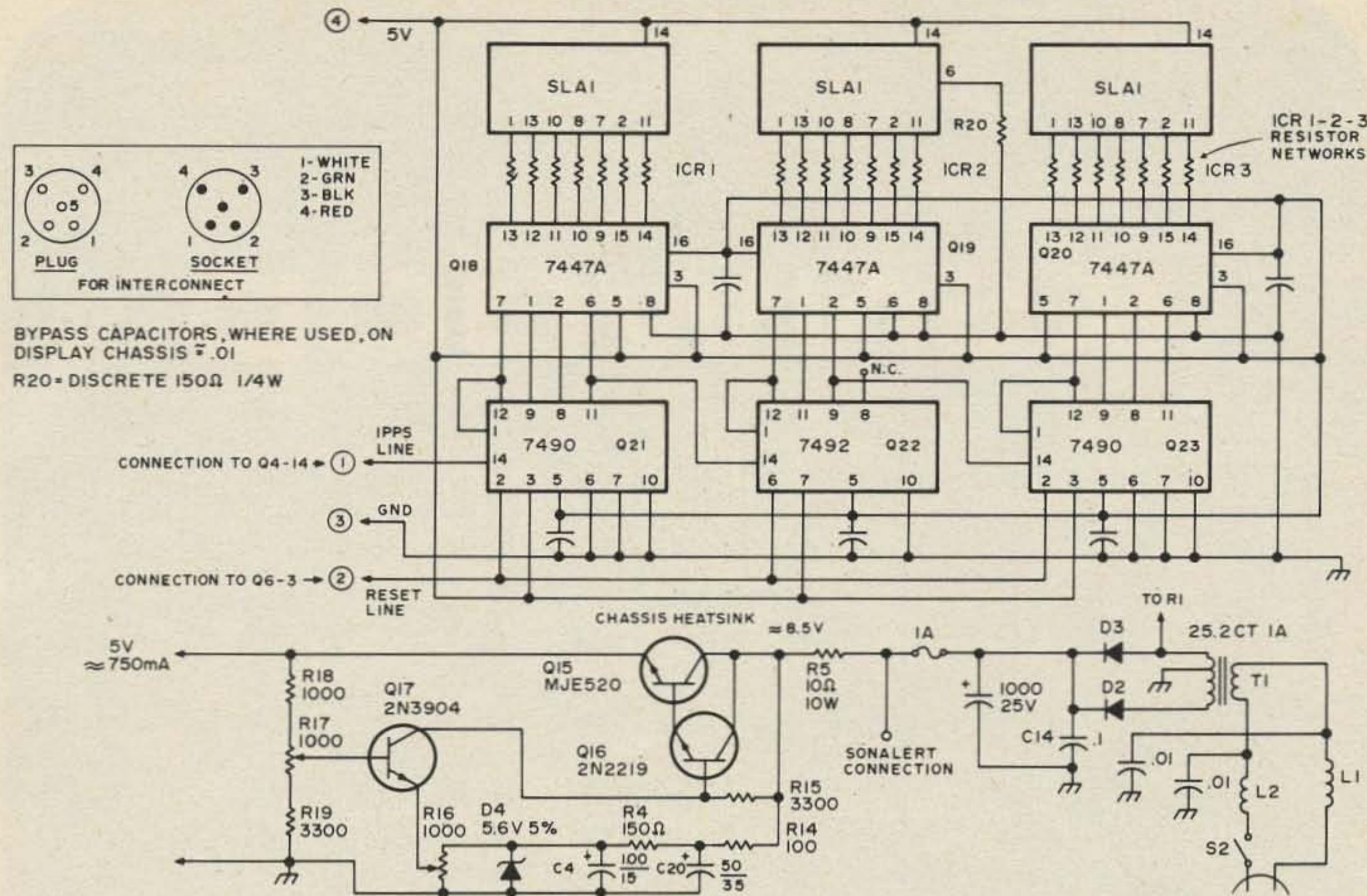

Fig. 1. Schematic.

sockets was accomplished via #22 insulated wire; the same type of wiring was used from the networks to the drivers on the main board. There are a lot of wires in a small space, so some discretion is called for here to avoid shorts. Use a Discap to bypass Vcc for each two ICs.

If you desire to vary the time cycle, wire in a single pole, 10 position, non-shorting rotary switch to Q7 and Q8 as shown in Fig. 2. Remember, the Identalert counts seconds. For example, if your repeater times out at 2 minutes 45 seconds, set the Q7 switch at 1 and the Q8 switch at 5. The Identalert will sound off at 158 seconds — 2 minutes 38

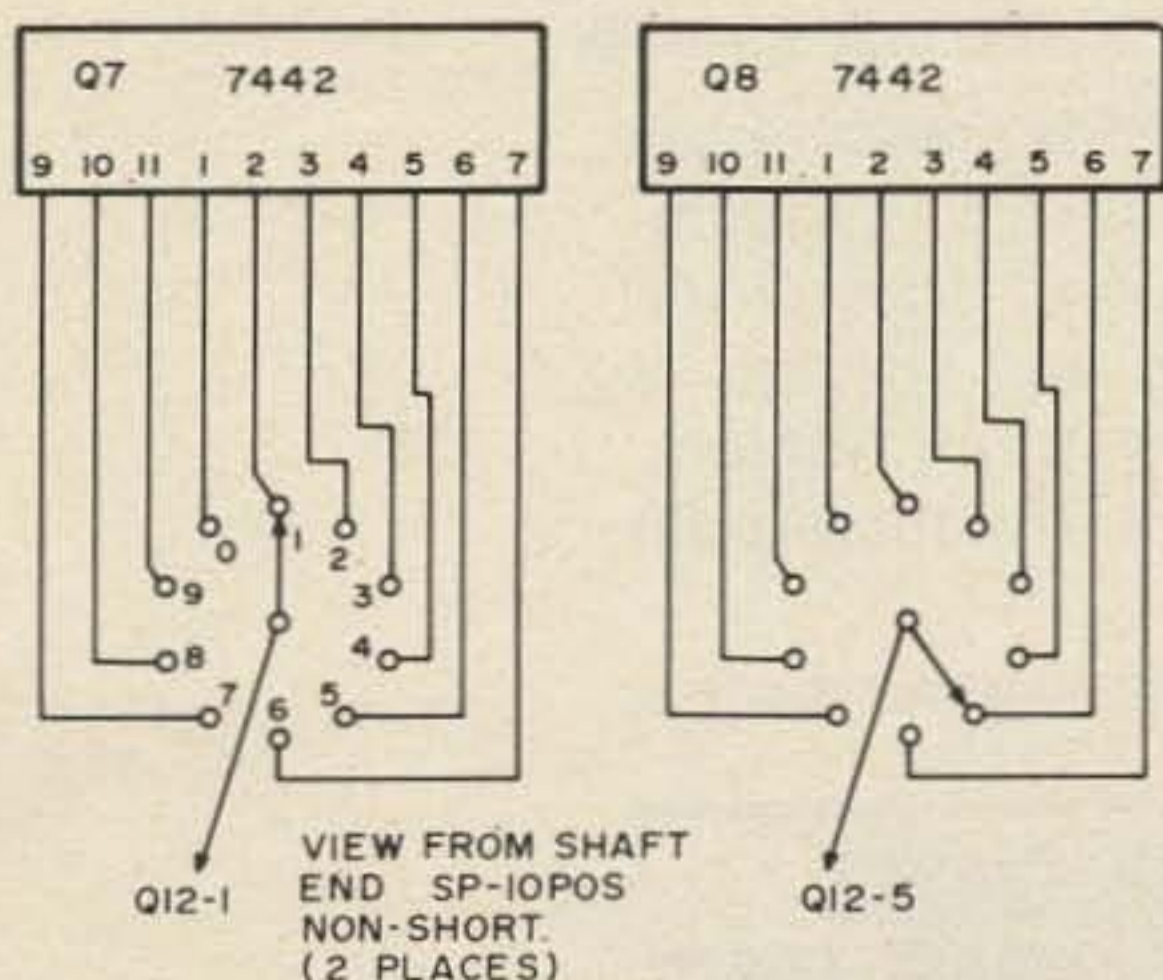

Fig. 2. Switch decode.

seconds on the display. With this device in your shack, you'll never time out! If you add the switches, it is now possible to time events (within 0.1%) up to sixteen and a half minutes. The display will show only minutes and seconds (not tens of minutes), but the "one" can be added mentally.

The Identalert operates just as before, but now you can C how long you've got before an ID or timeout.

Parts List

- | | |
|------------------|--|
| Displays | OPCOA SLA 1 |
| ICR1, ICR2, ICR3 | 14 pin DIP resistor network (CTS 760-3-R150) |
| R4, R20 | 150 Ohm 1/4 W 10% |
| R15, R19 | 3.3k 1/4 W 10% |
| R18 | 1000 Ohm 1/4 W 10% |
| R16, R17 | 1000 Ohm trimmer (CTS X201R102B or 360S102B) |
| R5 | 10 Ohm 10 W |
| R12 | 39k |
| C20 | 50/35 V lytic |
| Q16 | 2N2219 (hfe 80 or better) |
| Q17 | 2N3904 |
| Q18, Q19, Q20 | 7447A IC |
| Q21, Q23 | 7490 IC |
| Q22 | 7492 IC |
| F1 | 1 A |

KENWOOD

*...Why settle
for less!*

There are several good transceivers on the market today. But if you compare them carefully . . . study the specifications, note the important features, and finally talk to some Kenwood owners, you will have to come to the same conclusion that thousands of others have come to . . . you can't buy a better rig for the money than a Kenwood. Every unit is built with pride and designed to give top performance year after year. Join the switch to Kenwood.



The TS-520 shown
with the VFO-520 and SP-520

The TS-520 is the final word in SSB transceivers . . . the "hottest little rig on the air." It is a compact, mostly solid state, all-in-one transceiver with built-in AC/DC power supply and speaker. It operates SSB and CW on 80 thru 10 meters. Features include 2-position ALC and double split frequency controlled operation.

Available at select Kenwood dealers throughout the U.S.

Distributed by



**TRIO-KENWOOD
COMMUNICATIONS INC.**

116 East Alondra / Gardena, California 90248

Peter A. Stark K2OAW
196 Forest Drive
Mt. Kisco NY 10549

Digital SWR Computer

Part One

Ask two different designers to design some particular device, and quite likely they will come up with two circuits as different as night and day. It can sometimes be very interesting to compare these circuits to see just how they approach the same problem.

In the November and December 1974 issues of 73 Magazine, Terry Mayhugh W6OTG described his design for a digital swr computer. Shooting for the best possible accuracy practically available, his circuit used 27 ICs, not including those in the power supply. This included some rather exotic op amps, an analog multiplier IC, and a digital-to-analog converter, as well as a variety of precision metal film resistors. K2OAW, on the other hand, says that he was primarily concerned with making his digital swr computer simple and easy to build, even if it might provide slightly less accuracy. His circuit uses 11 ICs (plus one in the power supply), all of them standard, easy-to-get. In addition, his article provides the layout for a printed circuit board about 4 x 6", which mounts all components except for the transformer and directional coupler.

Measurement of swr requires a directional coupler in the transmission line, which provides two voltages, called V_F and V_R , proportional to

Swr measurements are a common part of an amateur's life. Most active hams have an swr bridge of one kind or another, and often use it to adjust antennas, feedlines, matching networks, or other parts of their

the voltages traveling in the forward and reverse directions, respectively. The swr is then computed from the equation:

$$\text{Swr} = \frac{V_F + V_R}{V_F - V_R}$$

W6OTG uses precision operational amplifiers to sum the two voltages to provide the top term in this equation, and to subtract the two voltages to provide the bottom term. An analog divider circuit then does the actual division, and a simple digital voltmeter converts the resulting voltage into the displayed digital swr reading.

K2OAW starts off with a similar approach, also using op amps to provide the sum and difference terms in the equation. But then, instead of doing an analog division, he converts the two voltages into digital signals and does the division digitally. This eliminates several hard-to-get components, and also simplifies the digital readout circuitry.

To sum up, W6OTG's circuit, if properly built and aligned, can be somewhat more accurate, while K2OAW's circuit is simpler and easier to build. Even if you don't decide to build either, we feel that you can pick up many useful hints by comparing the two designs. — Ed.

antenna systems. Even when everything is finally done, an swr measurement is a useful check to make sure everything is still working properly.

Unfortunately, swr measurements are

simple but awkward. The more affluent hams may have an in-line wattmeter which can measure something called "forward power" and "reflected power." Once these values are read, they have to consult a table or do a short calculation to find their actual swr. On the other hand, most of us have a simpler "swr bridge," which is normally operated by placing a switch in the "forward" position, adjusting a pot for a full-scale meter reading, and then flipping the switch to the "reflected" position to get a reading.

Both of these methods are awkward and time consuming. Though they are simple, some time is required for each reading — and it is hard to make adjustments and take readings at the same time. There is no such thing as slowly adjusting some component while looking for a null in swr — you have to alternately adjust, take a reading, adjust, etc.

Thus there is a need for some sort of swr indicator which can give you a continuous reading without the need to flip switches or adjust pots. Though such a device exists commercially — it is a dual-pointer meter where one pointer reads the forward power while the other pointer reads the reverse

power at the same time — it is expensive and still difficult to read accurately and fast. This article describes another approach to the problem of fast and accurate readings — a digital swr computer which automatically computes the swr and displays it on a digital readout automatically every time you transmit. The swr computer is specially valuable when making any kind of antenna or transmission line adjustments, but it can be left in the line permanently to give you a day-to-day check on the performance of your antenna system with just a glance at the digital readout.

The swr computer uses a directional coupler inserted into your transmission line in the same way as any swr bridge. In fact, you may use your present swr bridge just by making three connections to it: bringing out a ground, the forward voltage (V_F) and the reverse voltage (V_R). The computer then calculates the swr from the formula:

$$V_{swr} = \frac{V_F + V_R}{V_F - V_R}$$

and displays it as a three-digit number between 01.0 and 99.9 on a light emitting diode (LED) readout.

All the parts mount on one 4x6" printed circuit board, except for the directional

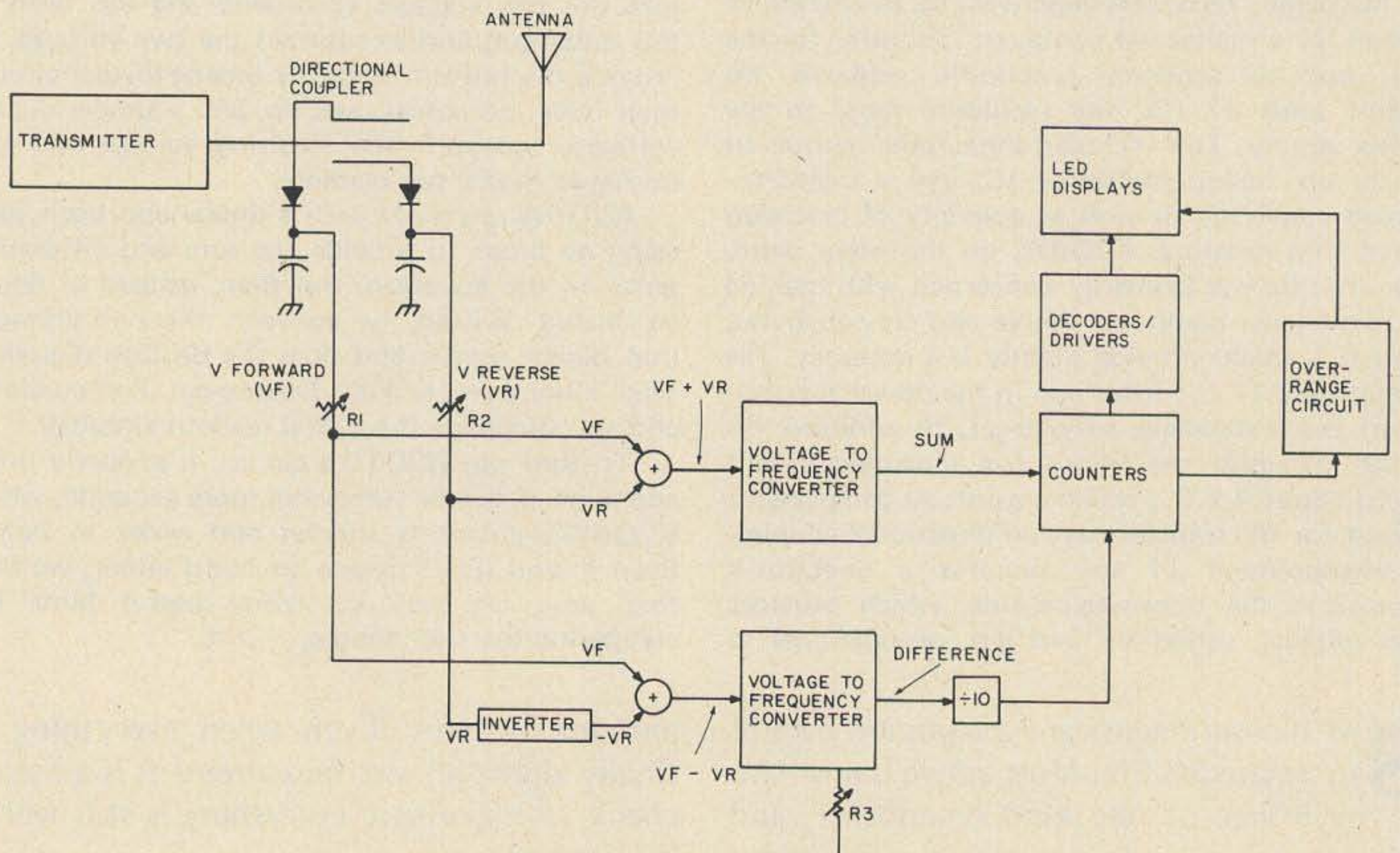

Fig. 1. Block diagram.

SPEC COMM 512/560 The New 5W 2M FM Portables With "Snap Pack" Modules

- 5 TIMES THE POWER of the usual 1 Wt portables! (But draws *only* 2x the current!)
- EXCLUSIVE HOT CARRIER DIODE MIXER virtually eliminates intermods & receiver overload.
- LARGE SCALE USE OF ICs IN RCVR. and XMTR. for superior, more reliable performance at lower cost!
- Engineered and built in U.S. — Top Quality throughout.
- FACTORY DIRECT SALES & SERVICE. You deal direct with the experts.

FEATURES

*Uses inexpensive TR22 xtals * 146.52 xtals supplied * Trimmers on *all* xtals * Reverse polarity protection * Final transistor fully protected * Large 3" spkr. for *unusually good sound* * Ext. spkr. jack * Front and rear antenna jacks * *Rugged but light* — 2 lbs. * Size 2¼X6X8" * Electronic T/R-no relay problems * LED Btry. voltage indicator * Super eff. xmtr — draws *only* 900 mA @ 5W. out * High quality Ceramic mic * Fantastic Squelch — fast & sensitive * Extremely sens. MOSFET front end, 0.3uV/20dB Qt.* Incredibly sharp IF, at least -80dB @ ±30 kHz * Single Conv. Rcvr. — *superior* to dual conv. designs for spurious resp. rejection! * Very easy to service.

See Review Article in April 73 Mag.
Send Card for Data Sheet.



SC512 W/BA-1 "Snap Pack"

A limited number of units are In Stock for Immediate Shipment.
(Allow 2 wks for personal checks to clear.)

- USE IT PORTABLE — OVER THE SHOULDER — with the BP-1 Nicad Battery "SNAP PACK"
- USE IT MOBILE with the BA-1 25 Wt. Amp "SNAP PACK"
- USE IT FIXED with the AC-1 AC Supply "SNAP PACK"
- UNIQUE "SNAP PACK" MODULES merely Snap-On and automatically interconnect — No messy wires or cables to hook-up. It only takes a few seconds!

SPEC COMM 512 \$199⁹⁵
5W 12 channels

SPEC COMM 560 \$179⁹⁵
5W 6 channels



SC512 W/BP-1 "Snap Pack"

Inquire about our:

- Package Deals
- SCR-100 Repeater Receiver Board
- SCT-100 Transmitter Board.



100% Moneyback Guarantee

100 Day Warranty

Please ship the following:

- SC512 @ \$199.95
- SC560 @ \$179.95
- MB-1 Mobile Mount @ \$7.95
- BP-1 pkg. (Btry pack, chgr., ant., carrying stp) @ \$79.95
- BA-1 Amp @ \$84.95
- AC-1 Sply. @ \$44.95

- SCR100 @ \$89.95
- Precision Xtals ±0.001% @ \$4.95
(List on separate sheet)

Name _____

Address _____

City _____

Amt. Encl. \$ _____

M.O.
 CK.

M/C BAC Exp. Date _____

Card No. _____

M/C Interbank No. _____

Add \$3.50 Shipping/Handling
PA residents add 6% tax.

State _____

Zip _____

SPECTRUM COMMUNICATIONS

BOX 140, WORCESTER PA 19490 (215) 584-6469

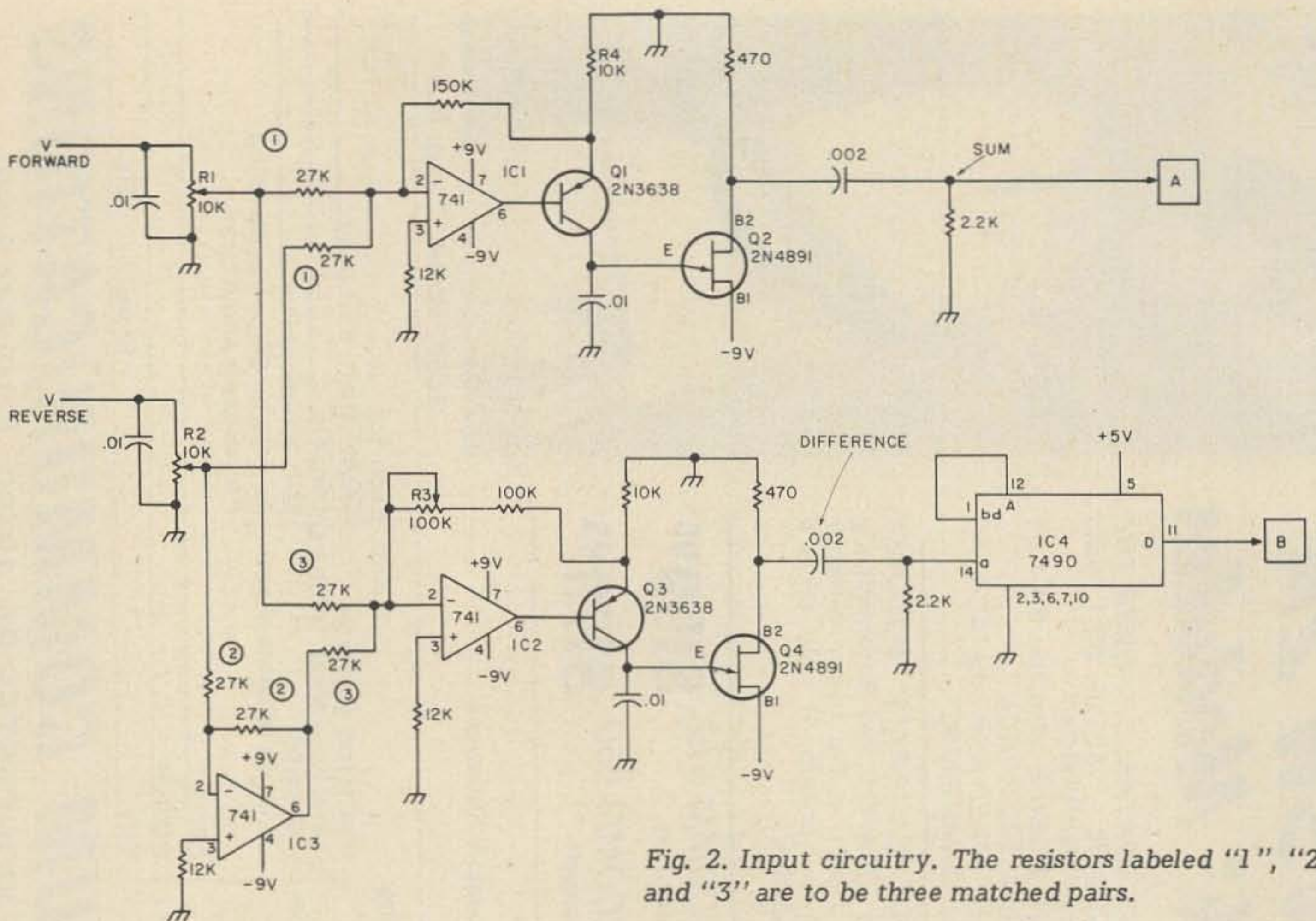

Fig. 2. Input circuitry. The resistors labeled "1", "2", and "3" are to be three matched pairs.

coupler, a 6.3 volt power transformer, fuse, on-off switch, and line cord. The computer is therefore very easy to build and troubleshoot, since the printed circuit board eliminates 99% of your problems. Calibration consists of adjusting only three potentiometers.

The estimated price of the parts listed at the end of the article is about \$40, assuming that you shop carefully. (By limiting the swr computer to a two-digit readout instead of a three-digit readout — a maximum swr of 9.9 rather than 99.9 — you can save about \$5. A much greater savings can be made if you already have, or intend to build, the K20AW frequency counter — you can save about \$30 by using the counter as the readout device.)

How It Works

Fig. 1 shows the block diagram. We start with a directional coupler, shown in the upper left corner. You may build your own following the ARRL Handbook or any of a number of other designs, or you may use a commercially available swr bridge, such as the \$12 Lafayette bridge.

The coupler, using a combination of inductive and capacitive coupling, provides two output voltages called V_F and V_R ,

which represent the forward and reflected voltages. These are tapped off the coupler circuitry at the output of the signal diodes, as shown in Fig. 1. (Note: Make sure the diodes are oriented as shown to provide a positive output voltage to the computer.) For calibration purposes, the V_F and V_R voltages go through R1 and R2, two adjustment pots. An IC inverter changes V_R into a negative voltage $-V_R$ and two IC analog adders then provide the sum voltage $V_F + V_R$ and the difference voltage $V_F - V_R$.

These two voltages are then fed into two voltage-to-frequency converters, which provide a pulse signal whose frequency is proportional to the applied voltage. R3 allows adjustment so that the two converters track each other. The difference frequency is then divided by 10 in a digital divider and both signals are applied to the counters.

The counters are three stages of 7490 decade counters, which count the input pulses arriving from the sum circuit. These counters can count from 000 to 999, and a decimal point is inserted on the LED display so that the count is displayed as 00.0 through 99.9. The resulting count is fed to the LED display through IC decoder/drivers. If the count ever exceeds 799, the overrange

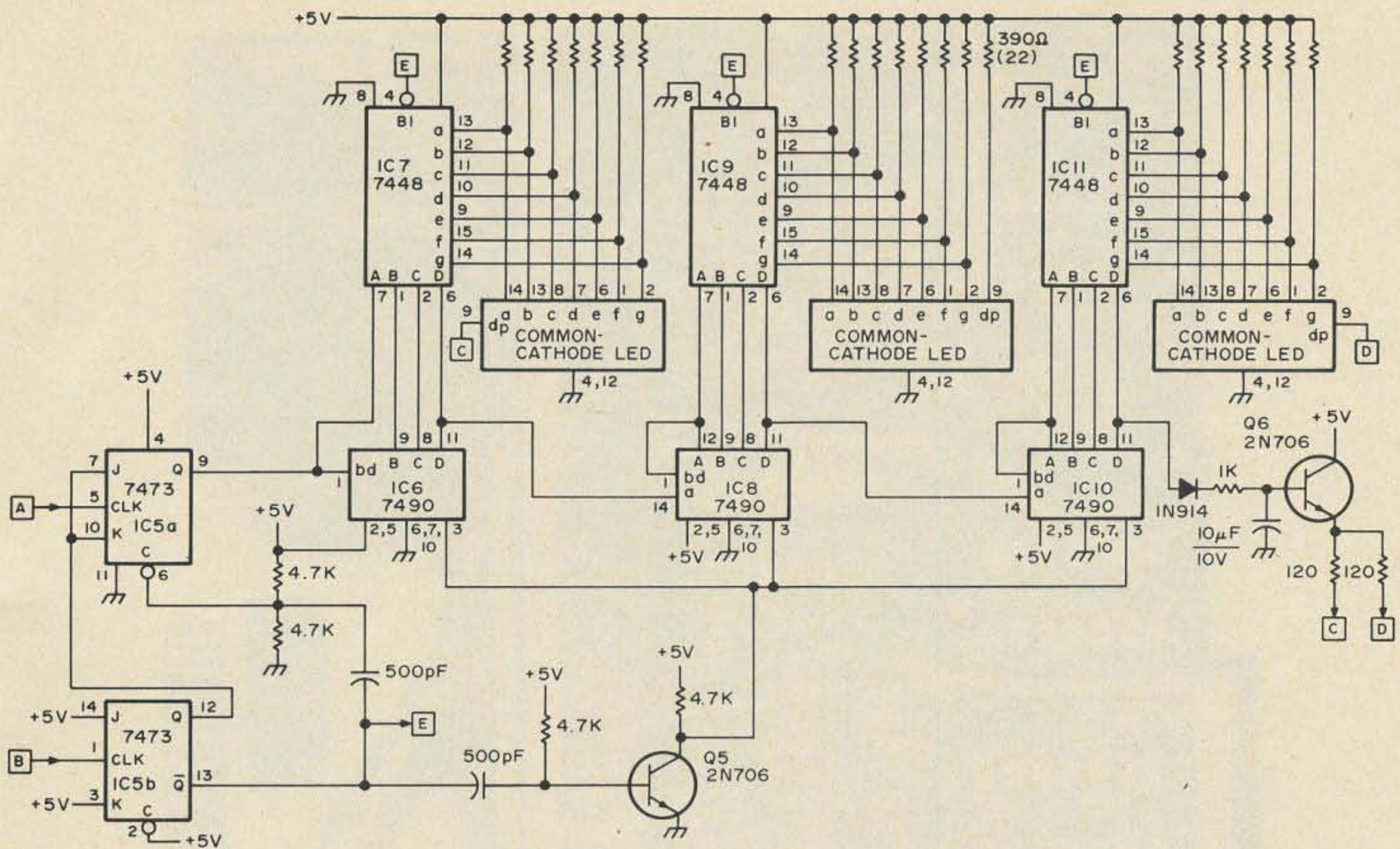

Fig. 3. Display circuits.

circuit lights up all the decimal points to indicate that the swr is very high.

The actual division in the formula:

$$V_{swr} = \frac{V_F + V_R}{V_F - V_R}$$

is done in the decade counters digitally, by allowing the difference frequency to reset the counters back to zero. To see how this is done, let's work through a simple example.

Suppose that the forward voltage V_F is 3 volts, and the reverse voltage V_R is 1 volt. This condition represents an swr of 2. Depending on how the adjustment pots are set, let us suppose that the sum signal, $V_F + V_R$, will be 4 volts, while the difference signal, $V_F - V_R$, will be 2 volts. Then, since the voltage-to-frequency converters are

reasonably linear, the sum frequency may be 1000 Hz, while the difference frequency would be half that, or 500 Hz.

Hence the counters get the 1000 Hz signal to count, but are reset back to zero at a 50 Hz rate (since the 500 Hz signal is divided by 10 before reaching the counters). Thus the counters will only reach a count of 020 (which will be displayed as 02.0) before being reset back to zero. In this way, the display shows the true swr. As with any counter, any reading is correct to within one digit, while the voltage-to-frequency conversion process is linear to within about 1 or 2 percent — so the overall accuracy of the computer is easily within a few percent.

Fig. 2 shows the input stages of the computer. Except for IC3, which inverts V_R

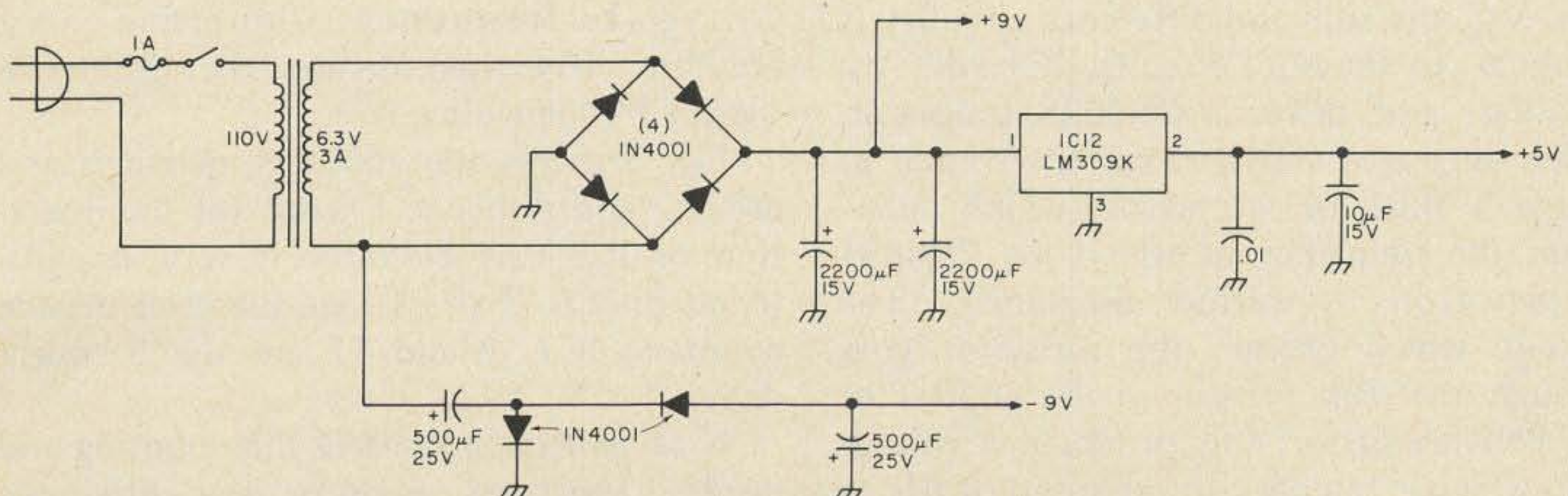

Fig. 4. Power supply.

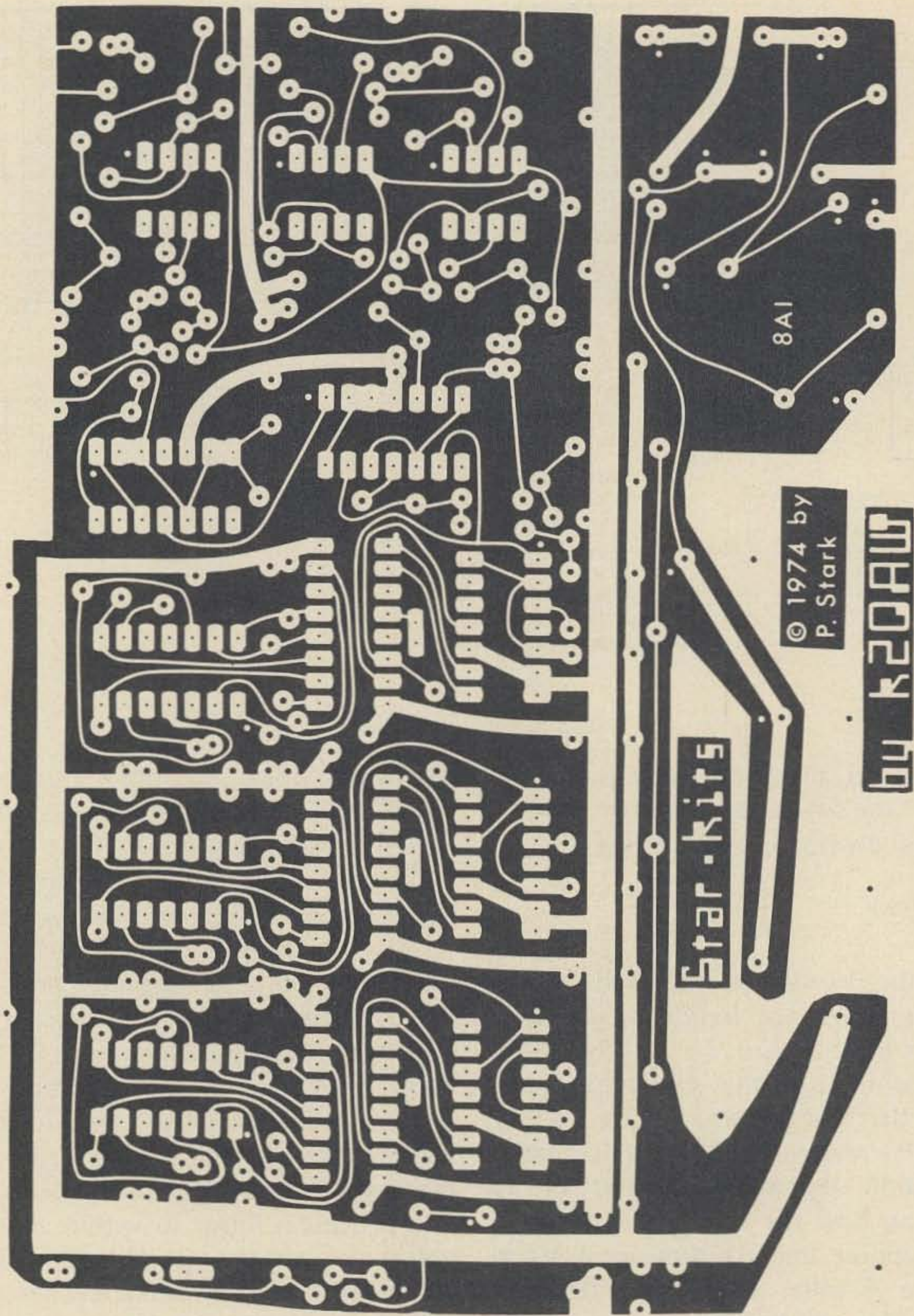

Fig. 5(a). Pc board (full size).

into $-V_R$, the sum and difference circuitry is identical. In the sum circuits, IC1 adds V_F and V_R , and drives a 2N3638 transistor, which acts as a constant current source to charge a 0.01 μF capacitor (which determines the frequency at which the 2N4891 unijunction transistor oscillates). The current which charges the capacitor goes through the 10k resistor in the emitter of the PNP transistor; this produces a voltage drop which is fed back to the input of IC1 as negative feedback, making the overall

voltage-to-frequency conversion very accurate. IC4 then divides the difference signal's frequency by 10.

Fig. 3 shows the counters, decoders and drivers, and displays. Except for the operation of IC5, the circuitry is very straightforward: IC6, 8 and 10 are the three decade counters, IC7, 9 and 11 are the decoder/drivers.

IC5a and IC5b control the counting and display functions. Suppose the difference frequency coming in at the B input is 50 Hz,



ICOM

THE LEADER



IC21A

- 24 CHANNEL CAPABILITY
- 7 CHANNELS SUPPLIED
- MOSFET FRONT END
- 0.4 UV SENSITIVITY
- 5 HELICAL FILTERS
- BUILT IN AC & DC POWER SUPPLIES

DV-21

- FULLY SYNTHESIZED VFO
- OPERATES IN 5 OR 10KH STEPS
- COVERS ENTIRE 2 METER BAND
- SCANNING CAPABILITY
- 2 PROGRAMMABLE MEMORIES
- TOUCH KEYS TO SET XMIT & RECEIVE FREQUENCY



IC 230

- PLL SYNTHESIZER
- 67 CHANNELS - 30 KH SEPARATION
- HELICAL FILTERS
- AUTOMATIC PROTECTION CIRCUITRY
- MODULAR CONSTRUCTION



IC22A

- 22 CHANNEL
- 5 CHANNELS SUPPLIED
- SOLID STATE TR SWITCHING
- 10W-1W POWER SAVER OPTION
- TRIMMER CAPS ON EACH CHANNEL



ICOM 30A

- 10 WATT OUTPUT
- ALL SOLID STATE
- 0.6 UV FOR 20dB QUIETING
- 22 CHANNEL - 5 INSTALLED
- MODULAR CONSTRUCTION

TUFTS

"New England's Friendliest Ham Store"

INVITES YOU TO SEE THE ABOVE LINE

TUFTS Radio Electronics

386 Main St., Medford, Mass. 02155

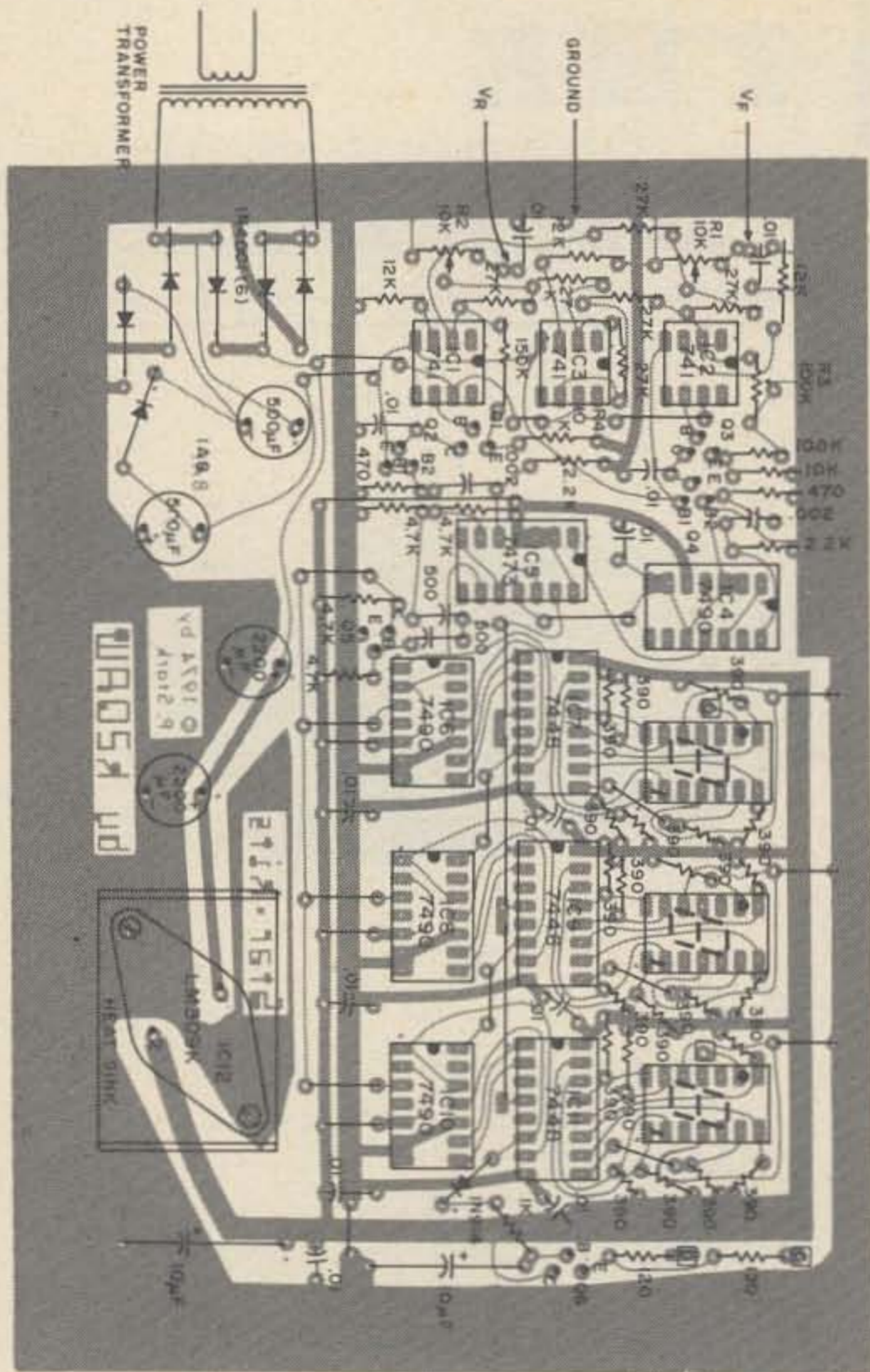

Fig. 5(b). Parts layout.

that is, a pulse arrives every 1/50th of a second (every 20 milliseconds). IC5b is connected so that it flips at every input pulse, so it will be *on* for 20 milliseconds, and *off* for 20 milliseconds.

While IC5b is *on*, its output on pin 12 is positive, which is sent to IC5a; this allows IC5a to accept the sum pulses. IC5a acts with IC6 to count the input pulses, so during this 20 milliseconds the counter is working. If, as in our above example, the sum frequency is 1000 Hz (the sum pulses arrive 1 millisecond apart), then 20 pulses will arrive during this time, and the counter will count to 20. But pin 13 of IC5b connects to IC7, 9 and 11 in such a way that the displays are turned off (a zero voltage is applied to point E, which feeds the BI — Blanking Input — on these ICs). Hence the displays don't indicate anything at this time. When the 20 milliseconds are up, IC5b flips to *off*.

With IC5b *off*, IC5a is prevented from counting as it gets zero volts at its JK inputs, so for the next 20 milliseconds the counters stay at the value they reached at the end of

the counting interval. At the same time the BI inputs to the decoders go positive, so the LED display shows this count. At the end of this time interval, when IC5b again goes *on*, short pulses are sent through the two 500 pF capacitors which force IC5a, IC6, IC8 and IC10 back to a count of 000, so that the next count starts again with 000.

The only unexplained circuit is transistor Q6 connected to IC10. As soon as the counters reach a count of 800, pin 11 of IC10 goes positive, which charges up the 10 uF capacitor connected to the transistor's base; this in turn connects a positive voltage to the decimal points on the first and third LED digits to indicate a very high swr. Actually, the swr is too high much before it gets anywhere near 80, and the purpose of this circuit is not to tell you which swr's are OK and which are not. Rather, the purpose is to warn you in case the swr might be computed as something like 101 or 102. Since the maximum swr which can be displayed in the three digits is only 99.9, an swr of 101 would be shown only as 01.0, with the first 1 missing. The extra decimal points are there to warn you of this condition.

Fig. 4 shows the power supply, which consists of a standard bridge and IC voltage regulator to generate +9 and +5 volts, and a modified voltage doubler to generate -9 volts. See the Parts List for comments regarding the power transformer and the heat sink for the regulator. A perfectly adequate heat sink, if the IC is mounted on the board, is a 1 x 4" piece of aluminum, bent into the shape of a squarish U, and mounted under the IC so that the ends of the U stick up off the board. Alternatively, the IC can be mounted on the cabinet.

Construction

With the exception of the power transformer and the ac line components, all the components shown in Figs. 2 through 4 mount on the printed circuit board as shown in Fig. 5. Note the following points before starting to mount the parts:

1) The 500 uF and 2200 uF capacitors in the power supply mount upright; axial lead capacitors will work, though radial lead capacitors fit better.

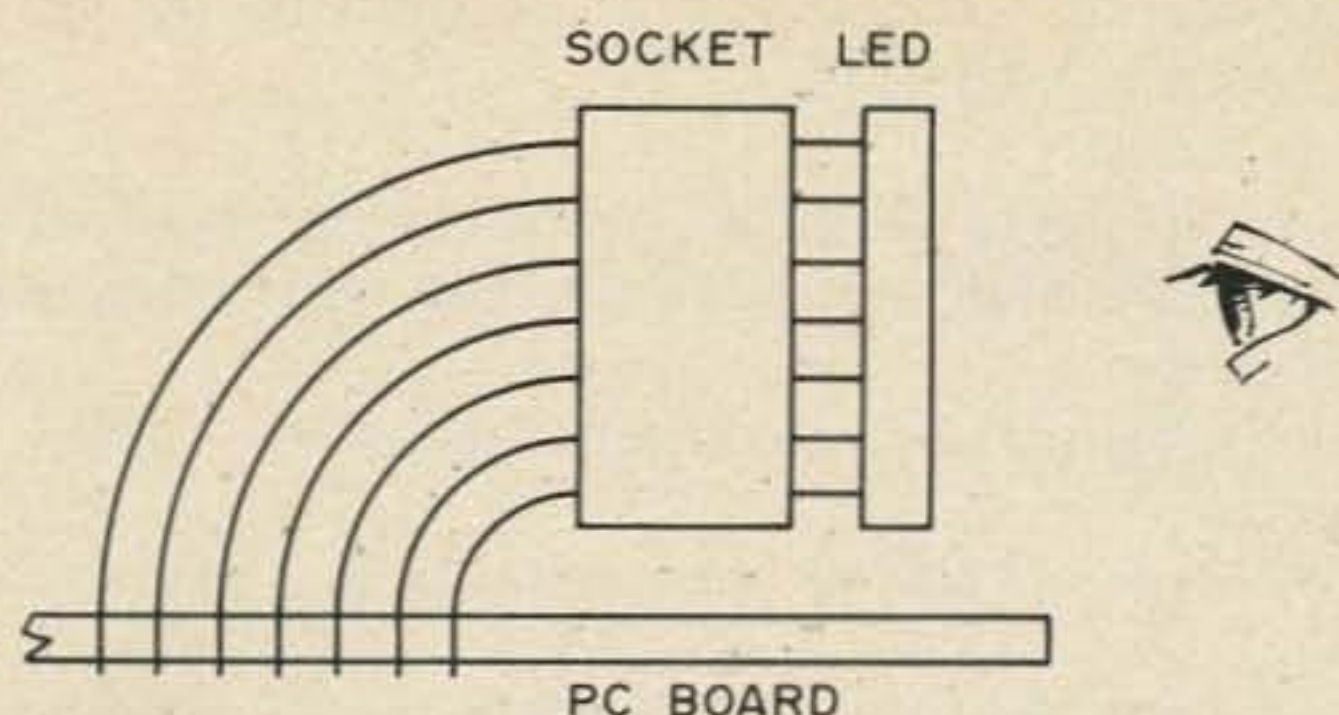

Fig. 6. Alternate LED mounting.

2) IC sockets or Molex Soldercon pins should be used under all ICs and LEDs. Our own preference is Molex pins, as 8-pin sockets for the 741 ICs are difficult to obtain. Moreover, many LEDs have round rather than flat pins, and do not fit into most sockets.

3) The twenty-two 390 Ohm resistors near the LEDs are quite crowded, and some can lie flat against the board while others have to be mounted standing up. Be especially careful while mounting these resistors to leave room for those resistors still to come.

4) The LEDs are shown as being mounted flat against the board, like ICs. This would be an appropriate way of mounting them if you intend to look at the LEDs from the top of the board. Observe especially how the LEDs mount — with pin 1 of each LED towards Q6. The proper way to hold the board for correct rightside-up display is with the LEDs in the lower left corner. In order to be able to mount the board closer to the face of the cabinet, you may wish to place the standup electrolytic capacitors on the wiring side of the board. Either sockets or Molex pins may be used for the LEDs, but make sure that the sockets you use will accommodate the LED pins.

On the other hand, the LEDs can be mounted vertically as shown in Fig. 6, by using short wire jumpers either with a socket or soldered directly to the LED pins. Though somewhat more laborious, the latter mounting method is more convenient if you intend to mount the board horizontally in a cabinet and look at it from the front edge.

5) Most of the jumpers on the board are straight point-to-point wire jumpers, but there are two which have to span several inches; these connect the two points labeled C and D near the LEDs to the two 120 Ohm

resistors near the edge of the board. You may place these two either on top or under the board, but make sure they are insulated.

6) The LM309K IC mounts on a U-shaped heat sink made out of a 1 x 4" piece of aluminum (or a Wakefield sink can be used — see Parts List). It can also be mounted on the cabinet, in which case no heat sink is needed if the cabinet is metal. The case of the IC is grounded, so no insulators are needed.

7) To reduce the possibility of errors, a small dot on the printed circuit board identifies pin 1 of ICs, the positive terminal of electrolytic capacitors, and the cathode terminal of diodes.

8) In accordance with good design practice, a number of 0.01 uF capacitors are scattered throughout the board, connected between the +5 — volt line and ground; these are generally not shown on the diagrams. Small 10 or 25 volt units are quite adequate, and are recommended because of their small size. In this application their exact value is not important, and anything from 0.005 to 0.1 uF should work.

9) The 0.01 uF capacitors connected in the timing circuit (the emitters of the unijunction transistors) are important in determining the long term accuracy of this unit. Though their capacity is greatly dependent on temperature, disc ceramics will work here quite well (as long as they are the same brand and type) since the two capacitors should track each other and thus compensate, to a large extent, for each other. Nevertheless, if you are really concerned about accuracy, you might want to consider a more stable capacitor type for this application, such as a polystyrene or mylar capacitor.

10) The six 27k resistors determine op amp gain, and must therefore be carefully chosen. They need not be exactly 27k, but must be selected as *matched pairs*. Each pair is connected to one of the 741 op amps, and the resistors to be matched are shown in Fig. 2. The best way of matching the resistors is with a digital VOM or an accurate bridge, but even a fairly good VOM should be adequate.

11) Under certain circumstances, the digital circuitry may be susceptible to rf

interference from your transmitter. When mounting the board in an enclosure, keep in mind the future possibility that bypass capacitors may have to be added to all inputs — signal and power.

PARTS LIST

Integrated Circuits

3-741, 1-7473, 4-7490, 1-LM309K, 3-7448.

Resistors

10% ¼ Watt: 2-120, 22-390, 2-470, 1-1k, 2-2.2k, 4-4.7k, 2-10k, 3-12k, 1-150k, 1-100k;

1% ¼ Watt: 6-27k. These resistors need not actually be 1% tolerance, but for best accuracy should be matched pairs. They can be 10%, as their actual resistance is not too important as long as they are in matched pairs.

Potentiometers

2-10k and 1-100k, upright printed-circuit type, such as CTS type (avail. at Radio Shack.).

LED Readouts

Three common-cathode DL-704, MAN-4 or equivalent LEDs; other common-cathode LEDs can be used, though board layout may not fit other pin connections. Common-anode LEDs can be used if 7448 ICs are changed to 7447, 390 Ohm resistors are replaced by 220 Ohms, and a different set of connections is used between 7447 and LEDs.

Capacitors (those marked * are upright mount)

Disc: 2-500 pF, 2-0.002, 12-0.01;

Electrolytic: 2-10uF 10 V, 2-500* uF @ 16 V, 2-2200* uF 16 V.

Transistors

2-2N706 NPN switching transistors or equivalent; 2-2N3638 PNP or equivalent, but must have fairly good beta;

2-2N4891 unijunction (Radio Shack RS-2029).

Diodes

1-1N914 or 1N4148 silicon signal diode or equivalent;

6-1N4001 rectifier, 1 Amp 50 piv or equivalent.

Transformer

6.3 volts at 3 Amps. Actually, only about ½ ampere is required, but 6.3 volts is a little marginal. If you can get a 7 or 8 volt transformer, then a ½ Amp transformer will do. Otherwise, a 6.3 volt 3 Amp transformer under this very light load will provide about 7½ volts, which is OK.

Assorted

Line cord, fuse, on-off switch, wire, solder, cabinet, display bezel. Wakefield NC-631-3 or equivalent heat sink, if LM309K is mounted on board; no heat sink required if it is mounted on the cabinet. Also needed is any type of home brew or commercial directional coupler or "swr bridge." IC and LED sockets or Molex Soldercon pins are helpful. Printed circuit boards may be made from Fig. 5; etched and drilled boards are also available from Star-Kits, G.P.O. Box 545, Staten Island NY 10314.

Next month: Operation and calibration.

... K2OAW

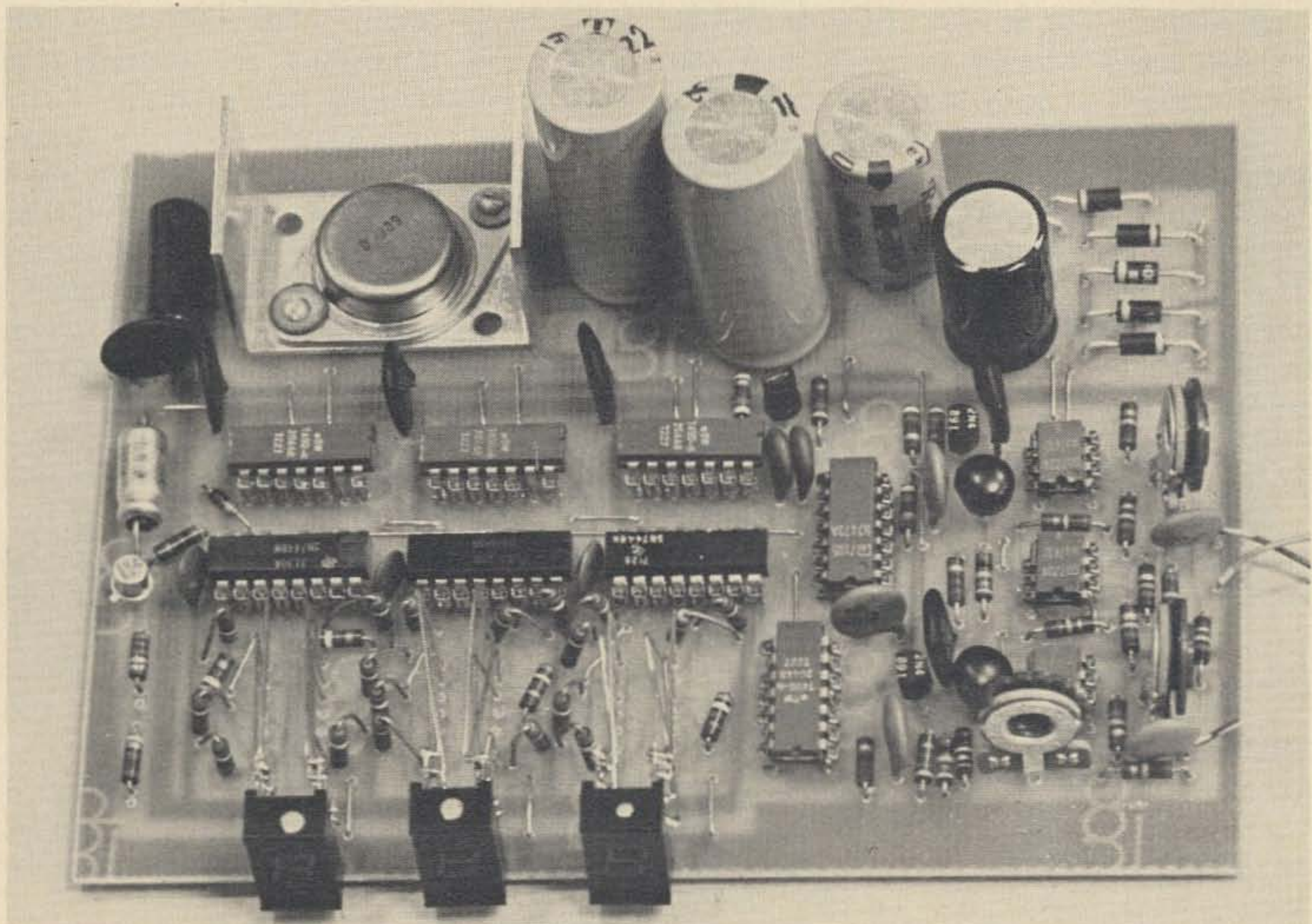

Pc board with components.

Specializing in VHF-UHF FM & SSB Equipment



IC-22A \$249.00 ppd.

Supplied with
Seven channels
94/94 34/94
22/82 28/88
52/52

Plus TWO channels
of your choice.
Additional channels
\$9.95 installed

THE PREMIUM 2 METER FM TRANSCEIVER

IC-230 \$489.00 ppd.



IC-230

SAVE \$50.00!

Purchase an ICOM for \$489 with no-trade, and you may apply \$50 credit towards the purchase of accessories below.

For the Mobile —

KLM PA10-70B 70W 2M Ampl	\$129.95
KLM PA10-140B 140W 2M Ampl	\$189.95
Hustler CGT-144 5.2dB Colinear, trunk lip mount	\$39.95
Hustler CG-144 5.2dB Colinear, 3/8 thread	26.75
Larsen LM-150K 3dB 5/8 wave	\$28.35
Larsen LM-150 on Magnetic Mount	\$35.00

For the Ham Shack —

KLM 144-148-12 12el DX Beam	\$49.95
KLM 144-148-16 16el DX Beam	\$54.95
KLM Baluns (optional, recommended)	\$13.95
KLM 2 Antenna Combiner	\$19.95
Cushcraft ARX-2 Ringo Ranger	\$26.50
Cushcraft A147-11 11el Beam	\$23.95
Cushcraft A147-22 Stacked 11's	\$68.50

Allow \$3.00 shipping per antenna or amplifier.

We Ship!

Our in-depth stock assures filling orders the same day received. We ship UPS or best way. For fast shipment we suggest 1. Cashier's check or MO., 2. C.O.D. (\$15 deposit), 3. BankAmericard, 4. Master Charge. California residents add 6% sales tax.

Westcom

831 GRAND AVE. • SAN MARCOS • CAL • 92069 • (714) 744-0700

RF Feedback, The Experimenter's Curse

There is a particularly nasty form of trouble which can afflict solid state transmitters, and multi-rf stage receivers too, much more than the old-fashioned tube jobs, and considerable attention must be paid in order to avoid it. This is interstage coupling through the low impedance power lead connections and wires, which ordinarily with tubes would not allow sufficient rf voltage to be sent from stage to stage to cause much trouble.

Even with tubes, precautions against this type of trouble had to be taken at times, especially as one went higher and higher in frequency up into UHF. One of the bad features about it is that it can happen easily enough between a first stage and a last stage, transforming one millivolt into one volt and causing violent reaction.

Very complicated power lead filters have been devised for this deal, as for example eight and sixteen section filters for an eight tube radar i-f strip.

Ceramic feedthrough bypass capacitors were designed for use where power leads went through partitions, which cut down the nuisance rf voltage to a certain extent, enough for the tube type sources, exciters, and finals, if sufficient care and shielding was used in the overall design. Some of these ceramic feedthroughs work at 432 and some do not, as you will see.

Now we are faced with devices (transistors) which exaggerate this kind of trouble due to very low rf impedances.

Some transistor collector circuits operate with impedances of less than ten Ohms, and for high power it may go under an Ohm. This means that a bypass, that was good at 432 MHz with tubes, may let through rf voltage at low impedance, driven by those high current solid state devices to couple back from the final right past a "bypass" capacitor and into the exciter and knock it right out, subject to the phase involved. Or worse, throw the stages into self-oscillation, because the input of these devices is also low and so operates on very small voltages of just the kind we're talking about. This is further aggravated if low cost devices are used in the first stages because then the low level operation is more subject to feedback.

Say you've got a gain of 10 or 12 in each of two rf stages, the last one putting out one or two hundred milliwatts, and you couple back just one percent along the battery leads to a tripler stage with an output of only one or two milliwatts. You see what can happen? And it does, too! Not only that, but if it just happens to be in phase, you get output even when you pull the crystal out, and that is about the worst thing that can happen to any transmitter.

So it will pay to examine this question in detail, because as amateurs we have an obligation as well as the need to develop our skills in the art, and this subject is a basic one for all types of transmission and reception by solid state devices.

With this in mind, I started in on the power lead filter deal with the goal being a small low-cost unit easy to make, with at least 40 dB of attenuation in voltage, if possible. It turned out that it was.

These tests and the final low cost filters are good for receivers also. A contemporary author in another magazine I happened to be reading recently mentioned, "You'll have an easier time with one rf stage than with two." No argument there at all. Just that these tests and filters should help reduce the effort needed to "tame" two rf receiver stages, as well as multi-stage transmitters.

How to Get "Cold" Connections

Most of our work on UHF calls for hot wires, that is, wires carrying plenty of rf, and losing the least amount possible through insulation losses, radiation, wire resistance, or by any other nuisance method. For power leads we want just the opposite, to carry dc and lose all the rf immediately. Or at least so much that you can neither detect it, nor find any nuisance effects, which amounts to the same thing. An oscillator and rf amplifier will do for the source and a tuned diode detector will do the job of measuring. After all, we're not doing a research job for a capacitor company, we're just interested in learning how to put a solid state transmitter on the air with a good stable signal without touchy feedback, connectors that jump rf-wise, and other transmitting plagues. The same holds for the multi-stage receiver also.

Fig. 1 shows a test set-up that can tell us what's what in this matter. After all, if I do it and tell you about it, that gives you more time to build things and get them on the air.

At "A" we have a good 20 milliwatts at 432 MHz coming onto the test plank. At "B" we have another cable going to the tuned diode detector, and with the units shown the meter reads four volts dc when "A" is connected to "B."

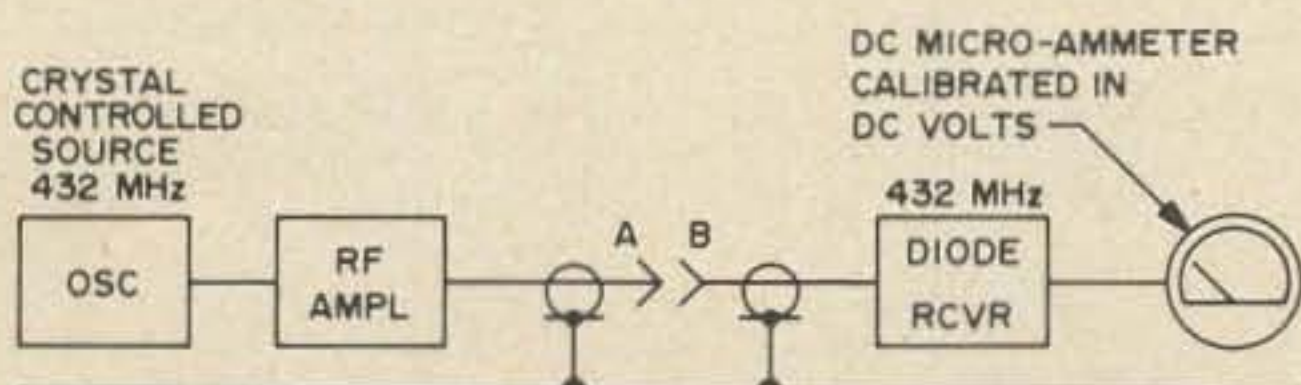

Fig. 1. Test setup, power lead filters.

The trick is to connect "something" between A and B that will carry heavy current 12 volts dc with only a small drop or none at all. This may mean a thin wire choke, or a resistor for a low power first stage drawing only 10 or 20 mils, and it may mean later a heavy wire choke for 12 volts at one quarter of an Amp for a three Watt final.

Tests

Referring to Fig. 1, all results are given in dc volts at the output of the diode detector:

Coaxial cable A to B, 4 volts; piece of wire on the ground, 3.5; piece of wire with 1000 pF to ground at B, .3; 1000 pF at A, .29; 1000 pF at A and B, .04 (40 milliwatts); 100 Ohm resistor between A and B, .042; with 1000 pF at A and B, plus 100 Ohms between A and B, zero volts. This could be used with a low current stage like a receiver where even down to six volts is all right for low noise rf, but let's keep going. You certainly couldn't modulate a solid state final through a 100 Ohm resistor.

Choke coil between A and B, no. 40 wire, 1/4" diameter, length 1/2", no capacitors, .2; with 1000 pF at A, .01 volts; with 1000 at A and B, 1/2 mV. Beginning to look good.

10 turns no. 34 wire, 20 mV, showing that the choke question is subject to variations in filter power, in this version.

Yellow surplus choke, 1 mV, good but not quite the ideal yet. Ten turns on the choke and 1000 dipped mica at A and B, 10 mV. Same, with small 3/16th Lafayette ceramics, 3 mV.

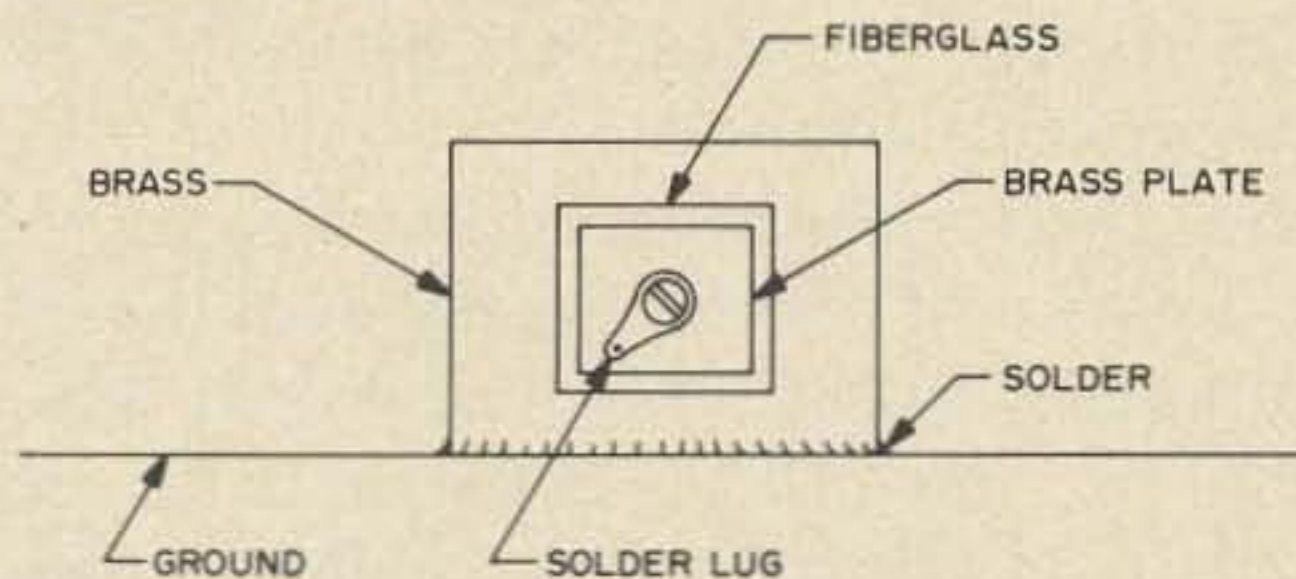

Fig. 2. Simulated, flat coaxial filter.

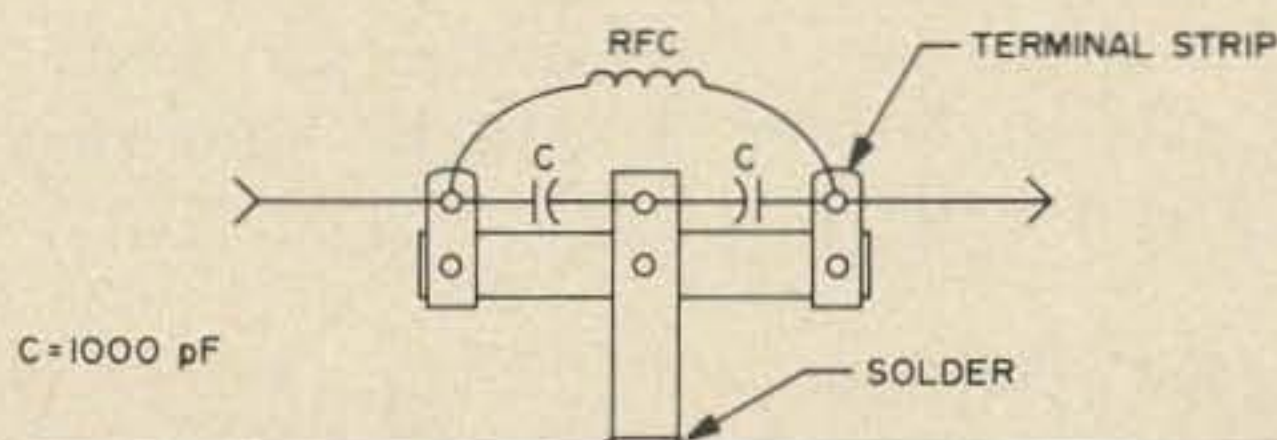

Fig. 3. Filter module.

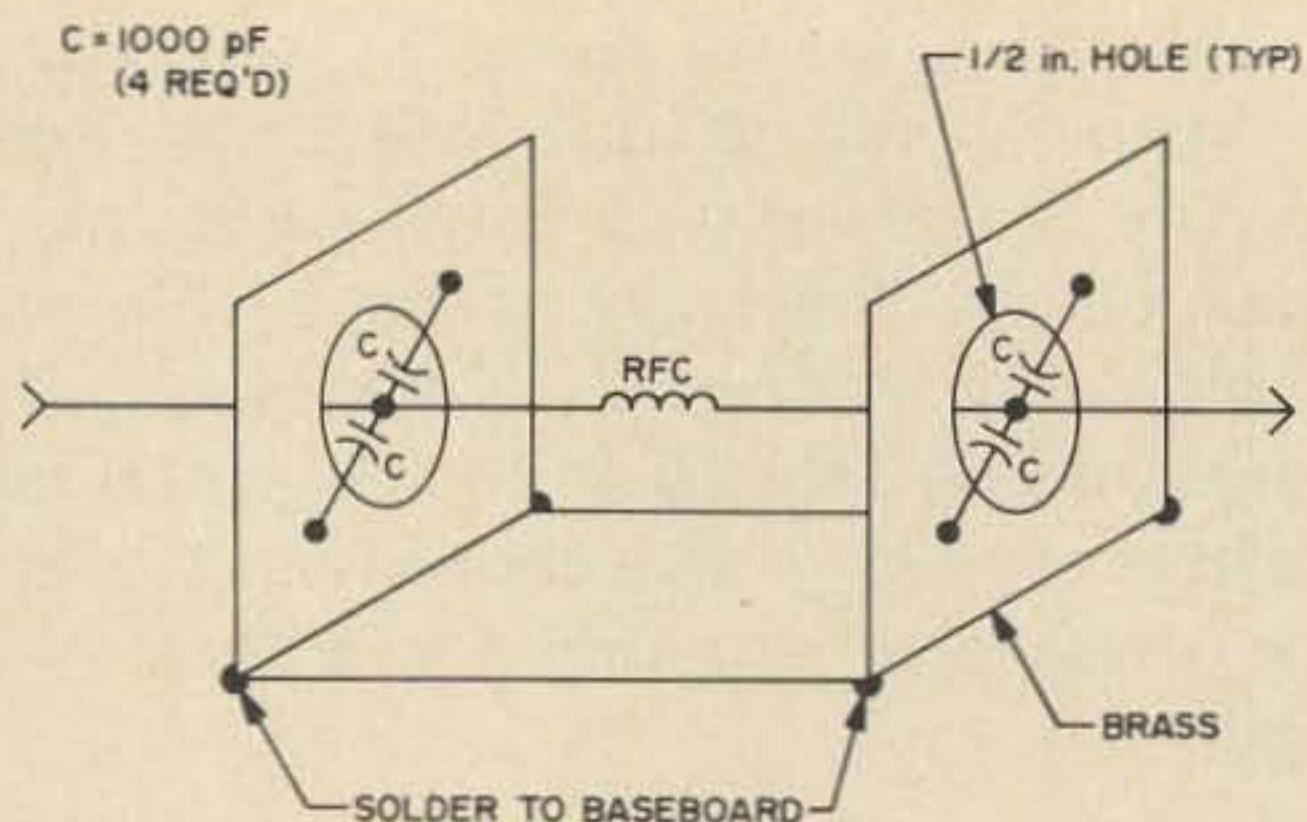

Fig. 4. Brass frame module.

Home-brewed flat coax, as in Fig. 2, 10 mV; two 1000 pF at A and B, plus 20 turn choke, 1 mV. At this point I thought about a small module as in Fig. 3. The meter hit the pin. Bringing the two capacitors to *one* connector, which had some inductance to ground, was absolutely N.G.

I then cut out a small brass frame as in Fig. 4. Hurray! The first time to hit a real zero volts. It makes you haul out the ohmmeter and check for a short or an open! Same, but without choke, also zero.

I noticed that every time I checked with another 1000 pF on a little coffee stick from A or B to ground, in effect paralleling the one already there, the meter plunged to near zero. At 432 MHz this is the same thing you may have read about more than once in my articles. More than one capacitor at the same place. It parallels the inductance and drops it.

Now we're getting close to the ideal; in fact, to cut it short, Fig. 5 shows the ideal. No brass plate is needed, and you can use it either on the baseboard or with the choke-resistor installed in a hole in a box wall, or what have you.

The two-section filter, using 4 capacitors plus a choke in between, really does the job. You imagine the meter moves, maybe. There might be somewhere between 1/10 and 1/100 of a millivolt of rf leaking through, and some or all of this may be "jumping" through the air.

So now you can make up units in advance, as in Fig. 5, and be sure they'll work at 432 MHz.

30 pF Capacitors

Just for fun, another two-section filter was assembled, as in Fig. 5, but with the low

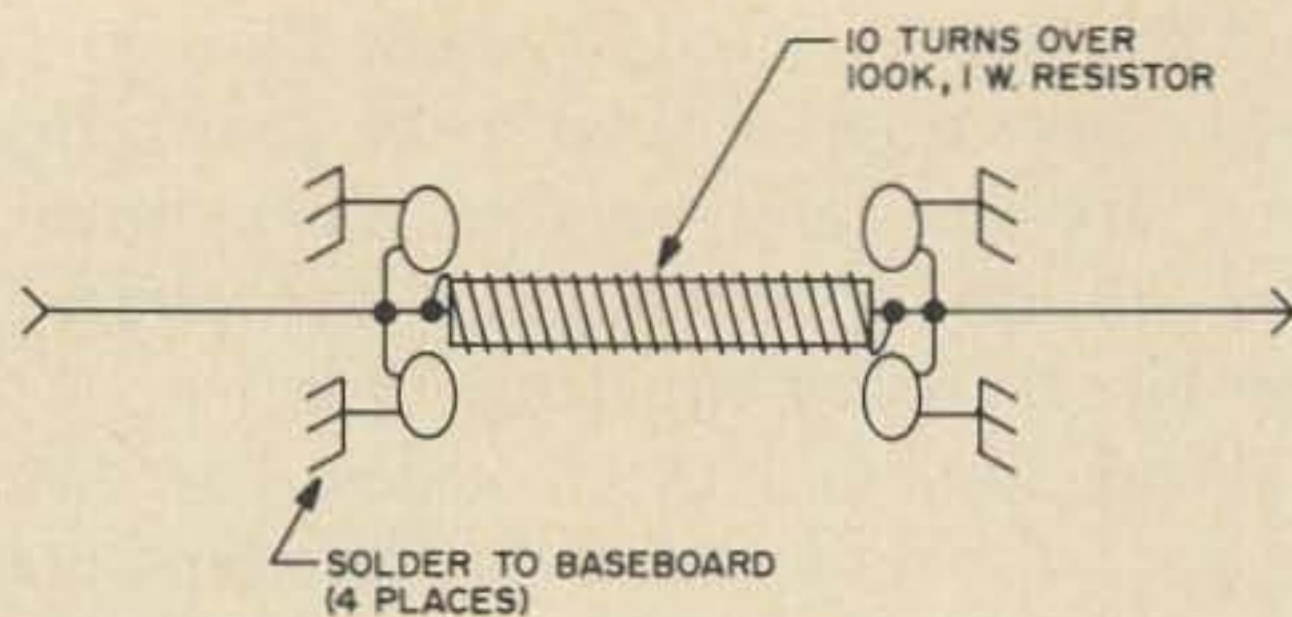

Fig. 5A. Ideal low-cost power lead filter, top view.

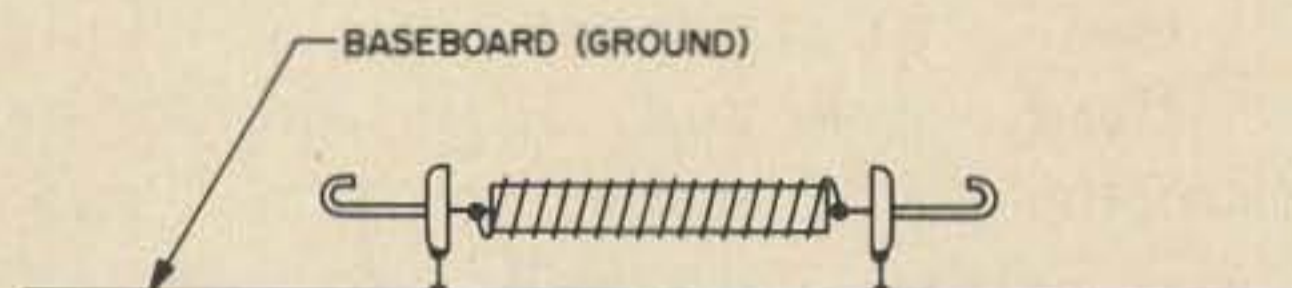

Fig. 5B. Side view of power lead filter.

value of 30 pF for each of the four capacitors. Of course at 432 MHz the rf impedance of 30 pF looks almost like a dead short, and it was. I could not tell the difference between the 150 pF filter and the 30 pF one. This makes it easy if you have large quantities of surplus dipped mica capacitors of odd values.

The reduction in rf voltage is something like 50 dB, dropping from four volts down to about 1/100,000 of a volt. This is plenty for power and lead filters. The cost in parts is that of four capacitors at around 10 cents each, and a resistor for a coil form.

"Boughten" Feedthrough Capacitors

The first ones tried were disappointing. The type "FT," shown in Fig. 6, allowed 20 mV to leak through.

I did dig up a couple of good ones out of a 1946 surplus UHF Navy unit. I suspect that the price will be quite high on such units, if they can be found. These

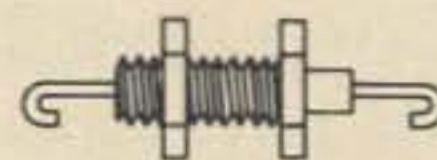

Fig. 6. Type "FT" feedthrough capacitor.

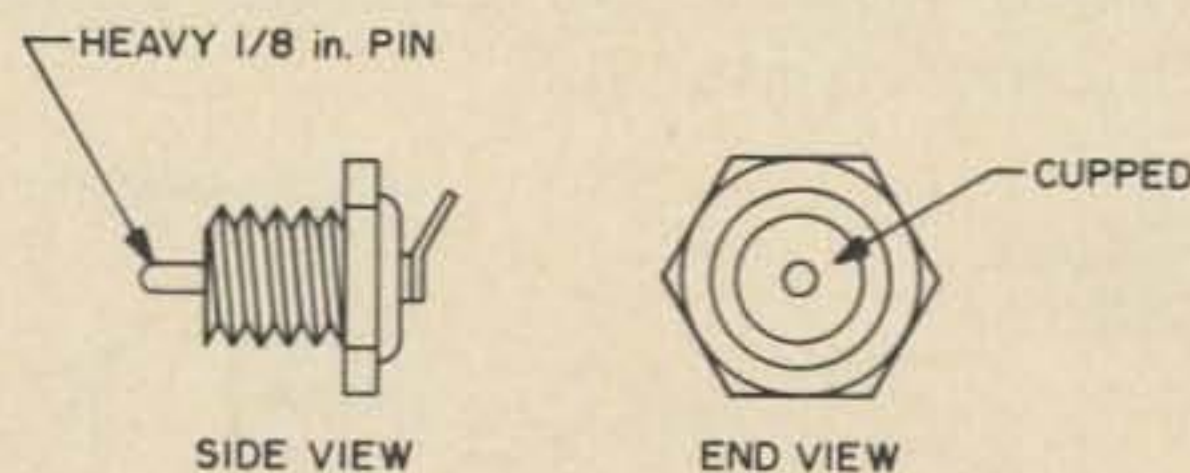

Fig. 7. Feedthrough capacitor.

What's All the Shouting About ?



It's the All New *Clegg* FM-DX

Amateur Net \$589.95 — Factory Direct Only

**Owners are shouting their praise
for all sorts of reasons**

The ones we hear most often are ,

- The operating simplicity, accuracy and stability of the Synthesizer and LED Frequency Readout.
- The unmatched receiver performance with super sensitivity and freedom from spurious responses.
- Those beautiful, clean 35 Watts of Transmitter Output.
- The rugged Modular construction.
- The 143.5 — 148.5 MHz coverage — opens a whole new world of SIMPLEX operation.

**UNTIL YOU TRY ONE YOU WON'T KNOW WHICH
FEATURE YOU WILL SHOUT ABOUT - PROBABLY
ALL THE ABOVE - AND MORE! CALL CLEGG'S TOLL
FREE NUMBER TODAY FOR DETAILS ON THE FM-DX.**

Clegg

208 Centerville Rd. Lancaster, Pa.
Toll free sales & services phone (800) 233-0250
In Pa. call (717) 299-7221 (collect)

look like Fig. 7, and perhaps some reader from the sales department of Sprague or Centralab or Erie can tell me what they are, and for how much they go to amateurs interested in good UHF feedthrough bypasses. They do seem to work as well as the final form shown in Fig. 5, so if you can find them, pay the price, and have a wall to put them in, such as in an enclosed rf stage, you can use them.

Subminiature Filters

The test setup of Fig. 1 being in operation, a smaller version was tried, to be ready for the size reduction being looked forward to with all kinds of new and exciting very small components becoming available on the market.

As long as 30 pF capacitors worked well, anything over that would naturally be all right, so with a 1/10 Watt resistor for the choke coil form, away we went.

While this is not as small as can be made today, when you get into chips and hybrids, prices go in an inverse ratio. Little 1/8 inch by 1/8 inch by 1/16 inch square Lafayette ceramics cost around 13 cents, so we still can call this one low cost.

The assembly is just the same as in Fig. 5, with the total space occupied being 1/2 inch long by 5/8 inch wide by 1/4 inch high, and, as mentioned, it could be cut down even more if you tried.

It worked just the same as the larger one in Fig. 5. Need I say more?

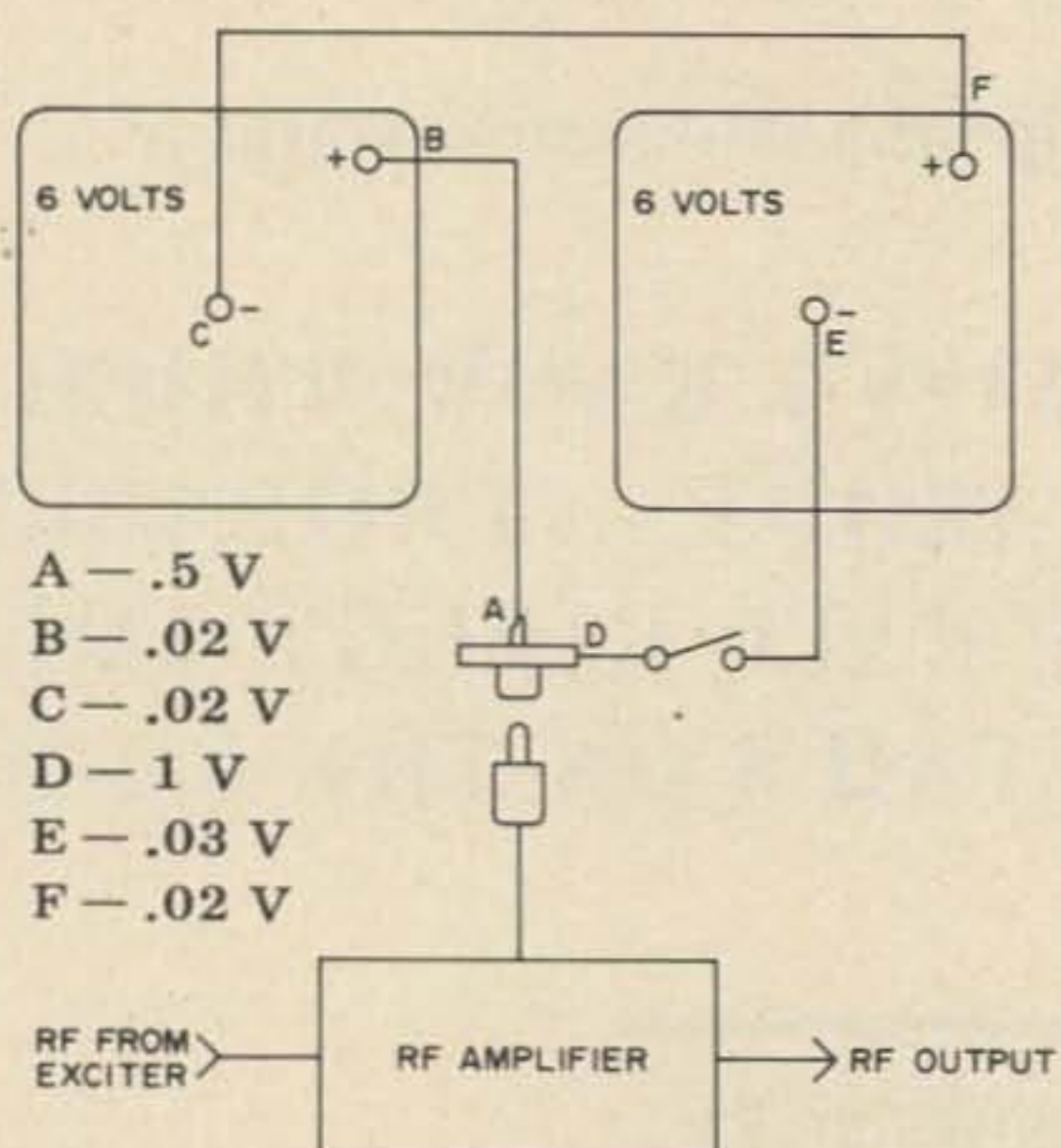

Fig. 8. Test results, rf on batteries and leads.

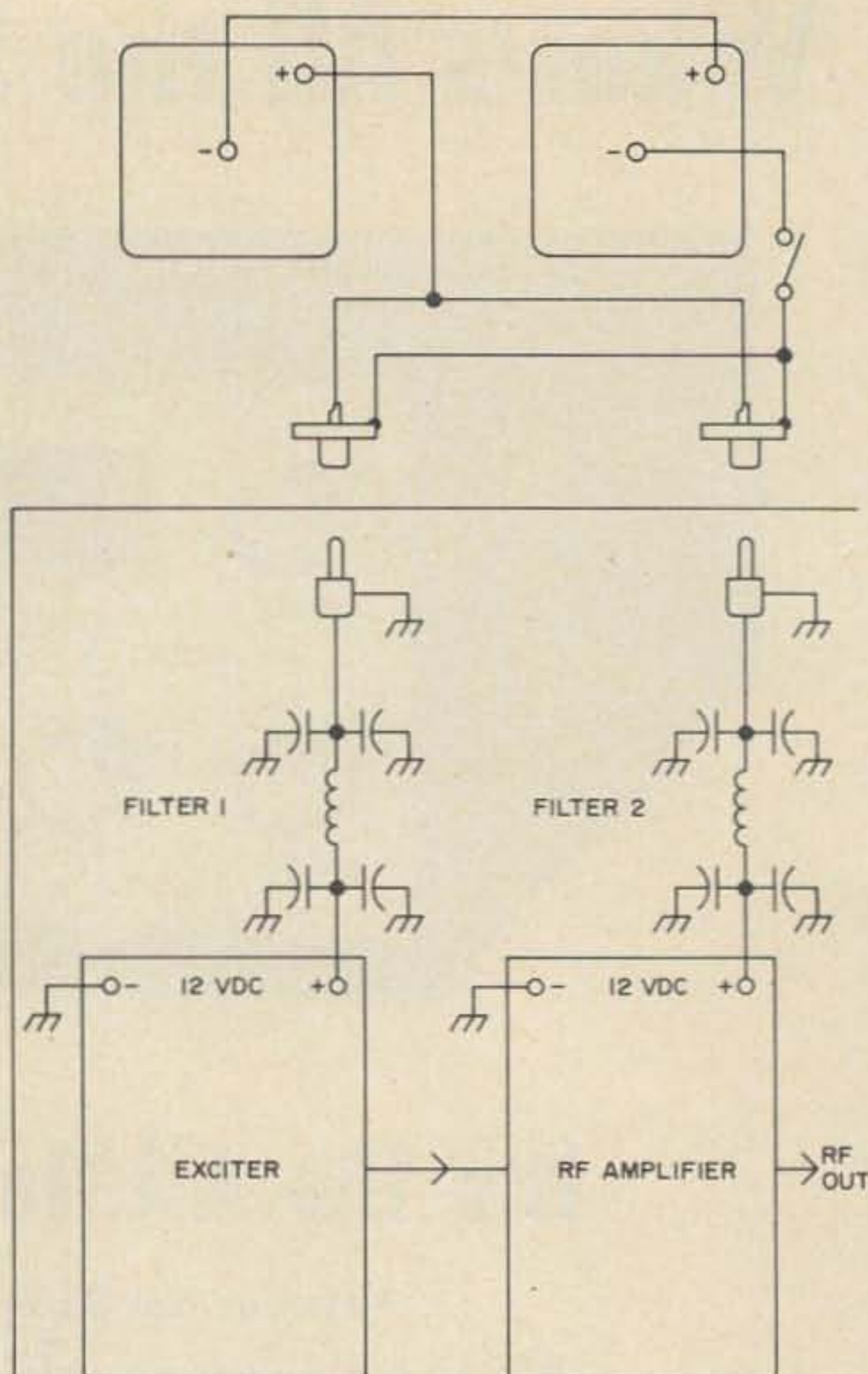

Fig. 9. Battery lead filters.

Checking Out the Filter

Fig. 8 shows the results of tests conducted on a crystal-controlled exciter and rf final destined for use in the 432er Solid State assembly. Note the one volt of rf at test point D *without* the filter. At the same point, also without the filter, about a tenth of a volt was found with only the exciter fired up. See Fig. 9. You can see what that kind of rf path will do for feedback from a quarter Watt or a 1/2 Watt final.

So a piece of copper-clad was put down under the two units as shown in Fig. 9 and the two filters installed. Perfect! No rf could be detected at all at any place on the batteries. Note that *two* filters are now present across any feedback path through the batteries and their leads.

There still exist possible voltage field and magnetic field feedback paths between the rf final and the exciter, but that's another story. The battery lead feedback path is now eliminated. And at least one thing shows up in favor for the solid state devices. There is only *one* wire in which to put a filter!

... K1CLL

Mobile Amplifiers With Versatility

- 2M10-70L \$139.95
10 W in – 70 W out 144-148 MHz amp
- 2M30-140L \$179.95
30 W in – 140 W out 144-148 MHz amp
- 2M10-140L \$199.95
10 W in – 140 W out 144-148 MHz amp
- 1.3M10-60L \$159.95
10 W in – 60 W out 220-225 MHz amp
- 1.3M30-120L \$199.95
30 W in – 120 W out 220-225 MHz amp
- 1.3M10-120L \$219.95
10 W in – 120 W out 220-225 MHz amp

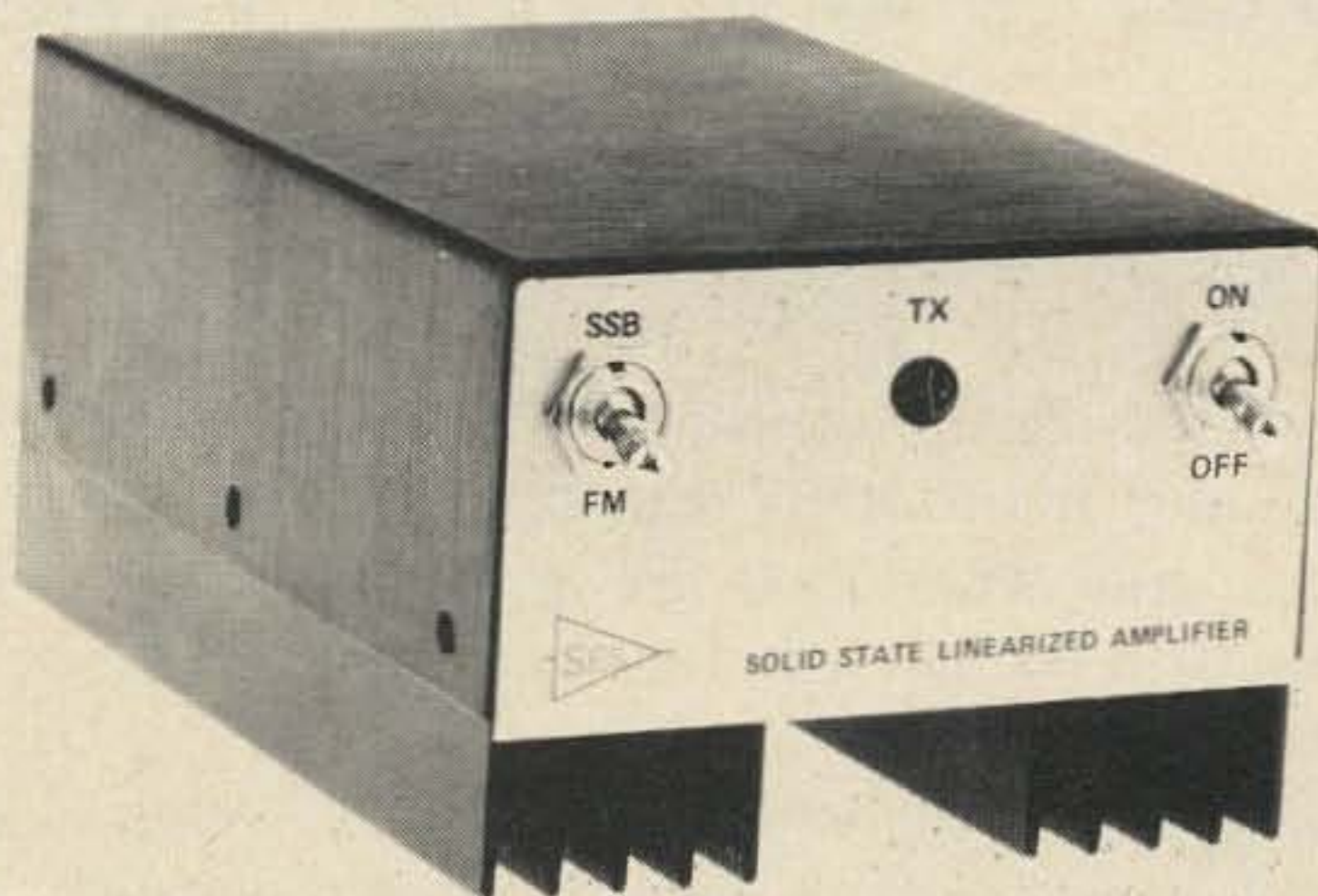

\$2.50 shipping USA, CA residents add 6% tax.

- All Amps:
- Fully VSWR & reverse voltage protected
 - No tuning required across band
 - Switchable Class C or AB operation
 - Built-in TR switching, w/increased delay for SSB
 - Fully compatible with all 1-15W FM/SSB/AM/CW rigs
 - All solid-state and microstrip construction

Also available: 1-10W, 10-40W and 420-450 MHz linearized amps

*See your local dealer, or write for further information
Dealer inquiries desired*

... some of our dealers ...

Vegas Radio
1108 S. 3rd
Las Vegas NV 89101

James M. Homan W4DPH
PO Box 719
Clearwater FL 33517

Gary Radio Inc.
8199 Clairmont Mesa
San Diego CA 92105

SPECIALTY COMMUNICATIONS SYSTEMS

4519 Narragansett Ave., San Diego CA 92107

Louis N. Anciaux WB6NMT,

TUFTS

"New England's Friendliest Ham Store"

INVITES YOU TO SEE THE ABOVE LINE

TUFTS Radio Electronics
386 Main St., Medford MA 02155
Phone: 714-222-8381

Surveying the DVM Scene

Do you remember when a single CK-722 cost five dollars, or for that matter when one decade counter cost about ten? If you, like most of us, can remember those prices and what they are today, you can appreciate the growth and acceptance of the digital vom, or DMM.

Digital multimeters as opposed to conventional analog-metered devices offered several distinct advantages and until recently, one disadvantage. On the "plus" side of the ledger: accuracy, simplicity and lack of parallax. On the "minus" side, cost frequently in the range of about four hundred dollars.

Why should a digital meter cost so much more than a conventional meter, or more accurately, why did it cost so much more? Until recently, costs of digital display devices priced the DMM out of the reach of hams and confined it to the R&D laboratory bench. However, with the pocket calculator boom, the cost per digit of display dropped dramatically from around ten-dollars per digit to around a dollar a digit.

If we were to attribute one singular advantage to the DMM over the analog meter it would be simplicity. Due to different viewing angles it is possible to get several values from a given analog meter reading (that is, assuming the meter hasn't been dropped or driven off-scale and pegged). This duplicity is known as parallax. However, with the digital display, we deal with absolutes. For example, "125", regardless of what angle we view these three digits, will read "125".

Terms

Digital meters use a set or two of terms unique to themselves, and it behooves the smart shopper to understand them and that to which they refer (usually some magnitude of \$\$ over the competition).

Accuracy, as: $\pm 2\% \pm 1$ Digit — The reading (basic) will be accurate to within $\pm 2\% \pm$ the least significant digit, e.g. E in = 100 V $\pm 2\%$ — displayed as 98 or 102, ± 1 digit = Readout 103- -101 Or 99-97.

Display, as: $3\frac{1}{2}$ Digit — For reasons of economy, the most significant digit will display either \emptyset or 1, so:

$2\frac{1}{2}$ Digit displays — 199 Max
 $3\frac{1}{2}$ Digit displays — 1999 Max
 $4\frac{1}{2}$ Digit displays — 19999 Max

BUT

4 Digit displays - 9999 Max

Auto-polarity: Voltage and current will be displayed with the proper polarity prefix automatically, without the need to reverse leads or flip switches.

Auto-ranging: Automatic display of voltage and current within the capabilities of the device with no need to utilize a range switch.

Selecting A DMM

Buying your first DMM is alot like buying a car, stereo or for that matter, taking a mistress. Obviously you get what you pay for. Are you going to use this unit only on your bench, or will you be climbing towers with it? If you can be satisfied to be bench-bound you can get a model with ac only operation. If you choose to "fly" select one with capability for dc as well as ac operation. How many digits are enough? How accurate do you want to be, keeping in mind that most voltage and resistance measurements on schematics were taken by a trusty, oft-dropped 20k Ω /volt VOM. Do you want to read current to the pico-Amperes?

Many people feel that it's cheaper to build than to buy; with today's market place

that remains to be seen. The lowest priced DMM fully assembled, calibrated, etc., is \$170.00 as opposed to the least expensive kit DMM at \$79.00, but for that extra few bucks you lose an extra ¼ digit and get full calibration and the ability to meter current. The choice is yours, but remember, your meter will only be as accurate as your calibration sources.

Survey

The following survey/buyer's guide represents major and minor manufacturers of DMM devices. Prices listed are current, but the reader should beware of Murphy's Law Sub-Section XIVa, which states, "...if a price can go up, *it will most assuredly* and following closely the publication of a buyer's guide...".

Manufacturer	Model	Price	Wired/Kit	Power Source	Digits Displayed
Ballantine	3/24	195.00	W	DC/AC*	3
B-K Precision	281	170.00	W	AC	2 ¼
B-K Precision	282	200.00	W	AC	3½
DanaMeter	2000	195.00	W	DC	3½
Data Precision	134	189.00	W	AC	3½
	245	295.00	W	AC/DC	4½
Data Technol.	21	269.00	W	DC/AC*	3½
Digi Tec	2110	219.00	W	AC/DC	3½
	2120	275.00	W	AC/DC	3½
Fluke	8000A	299.00	W	AC	3½
Heath	IM-1202	79.95	K	AC	2½
	IM-102	239.95	K	AC	3½
Hewlett-Packard	970A	275.00	W	DC/AC	3½
Hickok	334	229.00	W	AC	3½
Keithly	168	299.00	W	AC	3½
	168	359.00	W	AC/DC	3½
Non-Linear Sys	LM-4	187.00	W	AC	4
Simpson	360	295.00	W	AC/DC	3½ + Analog Mtr
Tekelec	357	179.00	W	AC	3½
Weston	4448	under 300.00	W	AC	3½
	4449	"	W	AC	3½
	4440	"	W	DC	3½
	4442	"	W	DC	3½
	4443	"	W	DC	3½

Legend:

(*) Optional (Additional Cost Item)

DC - Battery operation

DVM Manufacturers & Addresses

Ballantine Laboratories, P.O. Box 97, Boonton NJ 07005

B-K, Div Dynascan, 1801 Bell Plaine, Chicago IL 60613

Dana Laboratories, 2401 Campus Dr., Irvine CA 92664

Data Precision Corp., Audubon Rd., Wakefield MA 01880

Data Technology, 2700 Fairview, Santa Ana CA 92704

DigiTec, 918 Woodley Rd., Dayton OH 45403

John Fluke Co., P.O. Box 7428, Seattle WA 98113

Heath Co., Benton Harbor MI 49022

Hewlett-Packard Co., 1501 Page Mill Rd., Palo Alto CA 94304

Hickok Elec. Instr. Co., 10514 Dupont Ave., Cleveland OH 44108

Keithly Instrument Co., 28775 Aurora Rd., Cleveland OH 44139

Non-Linear Sys., P.O. Box N, Del Mar CA 92014

Simpson Electric Co., 853 Dundee, Elgin IL 60120

Tekelec Inc., 31829 La Tienda Dr., Westlake Village CA 91361

Weston Instruments, 614 Frelinghuysen, Newark NJ 07114

... W9KXJ

Atlas has something new for you



... the 5 band Atlas-210 solid state SSB transceiver for 10, 15, 20, 40 and 80 meters
... and the Atlas-215 for 15, 20, 40, 80 and 160 meters

The same outstanding performance, reliability, and compact size as the Atlas-180 . . . Only 3½ in. high, 9½ in. wide, 9½ in. overall depth, and only 7 lbs. total weight . . . Operates directly from 12-14 volts D.C. All solid state, modular construction . . . No transmitter tuning (special Braille dial available for blind operators at no extra cost).

FREQUENCY RANGES, Atlas-210: 3700-4050, 7000-7350, 14,000-14,350, 21,100-21,450, and 28,400-29,100 KHz, Model 215 deletes 28,400-29,100 band, and instead covers 1800-2000 KHz.

POWER RATING: 200 watts P.E.P. input and CW input. *On 10 meters the power rating is 120 watts. PLUG-IN DESIGN, for quick removal from mobile mounting, and insertion into AC Console as illustrated.

PRICE: Model 210 or 215...\$599 • AC console, 117V 50-60 cycles...\$129

• AC console, 117-230V...\$139 • Mobile plug-in kit...\$44



...and the best place
to buy Atlas
...Henry Radio,
naturally

Why buy from Henry Radio?

Over 40 years experience. No finance charges if paid within 90 days. Low interest contracts - 8%/yr add on (14% annual rate) - as long as 24 months. 10% down or trade-in down payments. Good used equipment. Most makes and models. Used equipment carries a 15-day trial, 90-day warranty and may be traded back within 90 days for full credit towards the purchase of NEW equipment. Write for literature. Export inquiries invited.

Henry Radio

11240 W. Olympic Blvd., Los Angeles, Calif. 90064
213/477-6701
931 N. Euclid, Anaheim, Calif. 92801
Butler, Missouri 64730

714/772-9200
816/679-3127

Henry Radio is
Exclusive Export
Agent For
Atlas Radio Inc.

How About a Weather Satellite Monitor?

In a series of previous articles in 73 (Sept. 74, Dec. 74, and June 75), I outlined a number of circuits and techniques that could be used to display weather satellite pictures on conventional SSTV monitors. My correspondence in regard to these articles indicates that there is a widespread interest in copying weather satellite pictures and, as one might expect, the interest is not confined to

individuals who are active in SSTV. The volume of mail clearly indicated the desirability of a simple monitor circuit designed specifically for weather satellite service, and this article will describe such a project.

The circuit is simple, yet incorporates some of the latest circuit ideas which I have developed in experimenting with this interesting mode. In addition, printed circuit

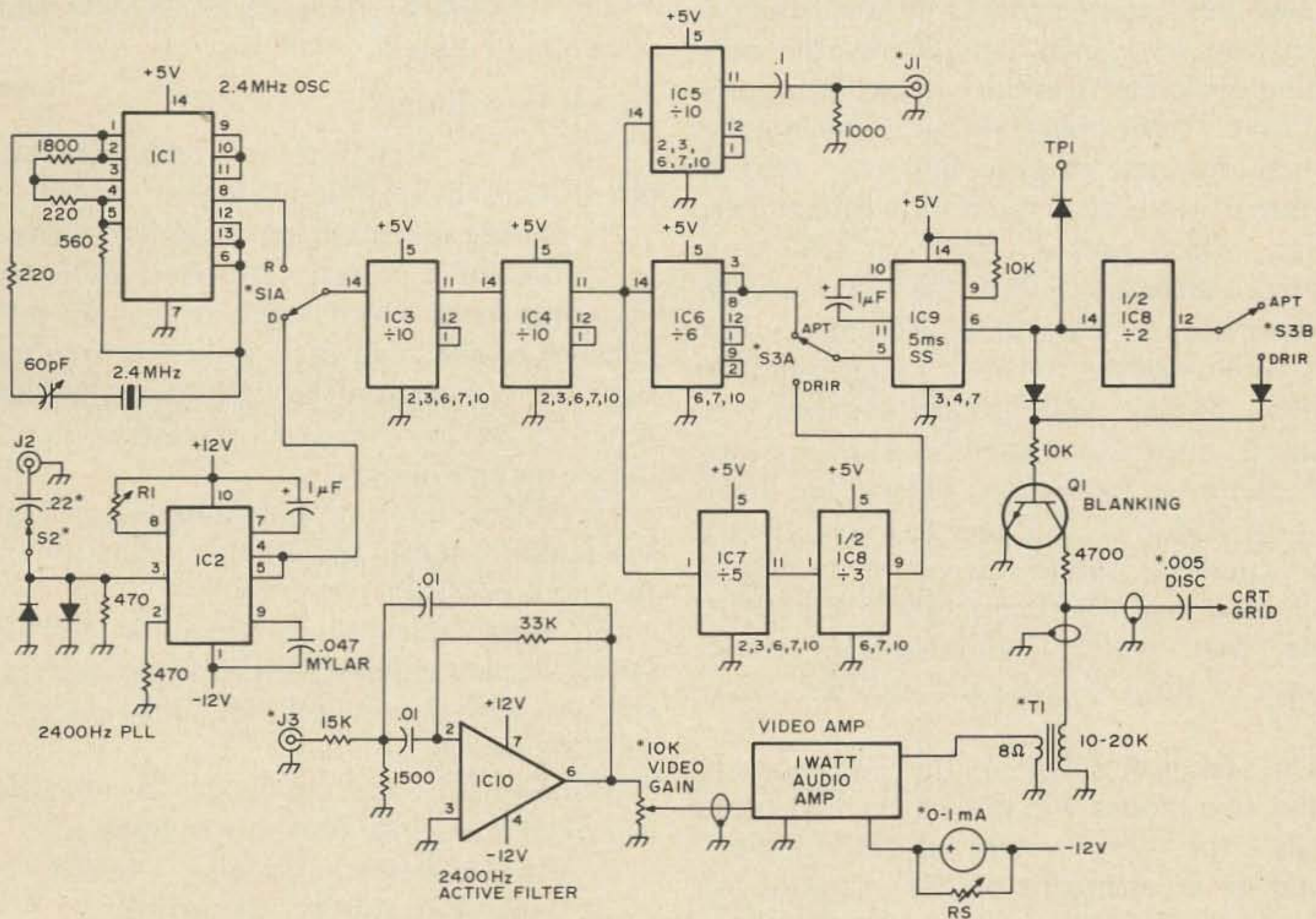

Fig. 1. Unless noted, all resistors are 1/4 or 1/2 Watt, 10%. Capacitors are mylar, disc, or electrolytic (polarity marked) as noted. Unmarked diodes are general purpose computer or switching types (1N457, 1N914, etc.). R1 - 5k pc pot, VCO frequency control. S1 - DPDT toggle, receive (R) or display (D). S2 - normally closed push-button, phasing. S3 - 4 pole 2 pos. rotary, APT/DRIR mode selection. Components marked with an asterisk (*) mount on the chassis, all others are on board #1. IC1 - 7400, IC2 - NE565 PLL, IC3, 4, 5, 6, 7 - 7490, IC8 - 7492, IC9 - 741 op amp. T1 - output transformer, 10-20k to 8 Ohms. Rs - 50 Ohm pot, adjustable meter shunt (see text). J - RCA phono jack; J1 - 2400 Hz to left channel input of tape deck, J2 - to left channel output of tape deck, J3 - satellite video from right channel output of tape deck. Q1 - HEP712.

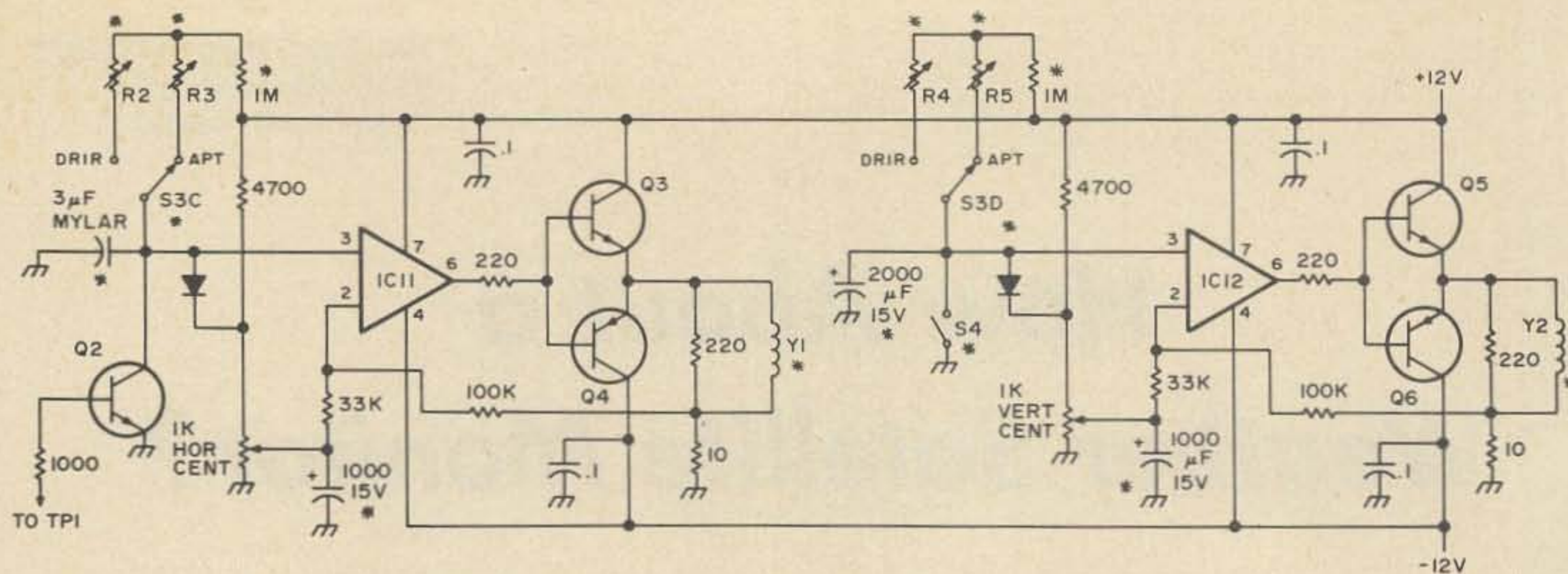

Fig. 2. Deflection circuit (board #2). General component notes as in Fig. 1. Q2 — HEP55. Q3, 5 — HEP 245. Q4, 6 — HEP 247. IC11, 12 — 741 op amp. Y1 — horizontal deflection coils, Y2 — vertical deflection coils; both coils incorporated in standard TV deflection yoke (Stancor DY-2A or equiv.). S3 — see Fig. 1. R2 — 1m DRIR hor. size. R3 — 1m APT hor. size. R4 — 1m DRIR vertical size. R5 — 1m APT vertical size. S4 — SPST toggle, close to reset vertical sweep, open to run. Components with an asterisk (*) mount off the board, all others mount on board #2.

board layouts were developed for the active circuits and are included here to make the project even easier to tackle. Virtually all of the circuit components, with the exception of switches, controls, and power supply, mount on two small circuit boards, permitting complete flexibility in packaging the final unit. In the course of development, the original circuits were modularized into a number of units that interface with my own station, which uses a variety of CRT and facsimile techniques, but the same boards can be incorporated into an extremely compact CRT monitor for multi-mode weather satellite display. Multi-mode capability is required, since some satellites use the older APT picture transmission system (the polar orbiting ESSA 8 and the geosynchronous ATS satellites) while the current NOAA satellites utilize the time multiplexed DRIR mode that permits simultaneous transmission of both visible light and IR picture data.

The technical details of the video format of the two modes will not be covered here. Ideally, the sync system of the monitor should be independent of the condition of the satellite signal for maximum reliability. This is achieved by generating a 2400 Hz sync reference tone that is recorded simultaneously with the satellite picture, requiring the use of a stereo tape deck. Any tape format (reel-to-reel, cassette, or 8 track cartridge) may be used with the system. In addition to the recorder, a VHF receiving

system will be required to complete the satellite receiving station. A low noise FM receiver with a 15 kHz i-f and crystals for 135.6 (ATS), 137.5 (primary NOAA), and 137.62 (ESSA 8 and backup NOAA) will put you in business.

Circuit Description

The basic functions provided by the monitor circuit are listed below:

- 1) During reception of a satellite signal, generation of a crystal controlled 2400 Hz reference signal which is recorded on the left channel of the tape deck while the satellite signal is recorded on the right channel. This tone serves as the sync reference signal during picture display.
- 2) Video filtering and amplification of the satellite signal, and Z axis modulation of the monitor CRT.
- 3) Switch selection of either the APT or DRIR display modes with appropriate sync count-downs and pre-set size and centering for both modes.

Conceptually and physically the monitor is broken down into four sub-assemblies:

- 1) Video and sync processing — board #1.
- 2) Deflection circuits — board #2.
- 3) The CRT and associated controls.
- 4) The power supply.

Video and Sync Processing (Fig. 1)

These circuit elements are included on board #1 and control the generation of the 2400 Hz reference tone, appropriate division circuits to generate either 4 Hz (APT) or 1.6

Hz (DRIR) trigger pulses for horizontal triggering, and satellite video filtering with additional amplification provided by a small transistorized amplifier module. In order to limit circuit complexity, several of the devices on board #1 are used for both receive and display functions. S1 is used to set either of these two conditions. In the receive mode only board #1 is operational, to reduce power consumption. With S1 in the receive position, IC1 functions as a 2.4 MHz oscillator whose output is divided by 1000 (IC3, 4 and 5) to provide the 2400 Hz reference tone at J1. This tone is recorded on the left channel of the station recorder as the satellite signal is recorded on the right channel.

With S1 in the display position all of the monitor circuits are functional. The reference tone recorded on the left channel is routed to J2 where it locks up IC2, which functions as a 2400 Hz phase locked loop, tracking any small variations in the reference signal due to recorder speed variations. S2 in the input circuit to IC2 functions to unlock the PLL for picture phasing. The 2400 Hz output of the PLL is routed through S1 to a series of digital frequency dividers. The



Modular units used to develop the satellite monitor. The large chassis contains the CRT, deflection yoke, and the HV module. The cabinet with the meter contains the two circuit boards and the power supplies. If the unit were constructed in a single cabinet it would be possible to package it in a cabinet about the same size as that for the electronics package. Such an integrated unit should have the power supply located remotely to eliminate 60 Hz trace distortion in the CRT.

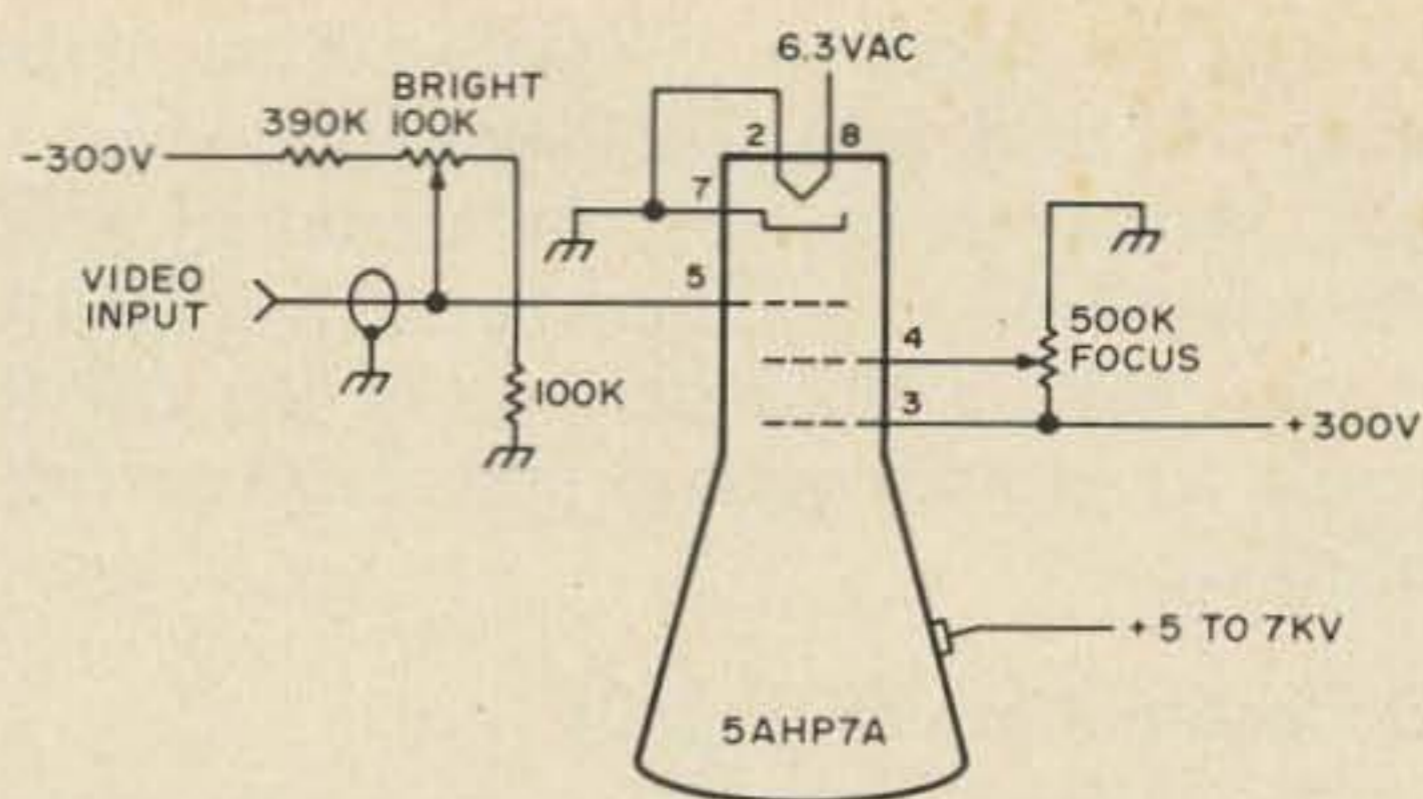

Fig. 3. CRT and associated control circuits. Fixed resistors are 1/2 Watt, brightness and focus pots are 2 Watt composition pots.

division sequence is controlled by two sets of contacts of the mode switch (S3). In the APT mode the 2400 Hz signal is divided by 600 (IC3, 4 and 6) to produce a 4 Hz square wave. In the DRIR mode the 2400 Hz is divided by 1500 (IC3, 4, 7 and 1/2 of IC8) to produce a 1.6 Hz square wave. The appropriate square wave output of the division sequence is routed to a 5 ms single shot (IC 9) which provides a short TTL pulse to trigger the horizontal deflection. This trigger pulse is routed to TP1 and also to the base of Q1, where it provides for retrace blanking of the video signal. Since the DRIR video format consists of alternate lines of visible and IR picture data, it is necessary to blank alternate lines of video in the DRIR mode to assure display of either visible light or infrared (IR) pictures. This is accomplished by routing the trigger pulse to 1/2 of IC8, which functions as a flip-flop, turning on the blanking transistor (Q1) on every other video line.

Video processing is straightforward yet effective. The satellite video from the right channel of the tape deck is routed to J3 and through a 2400 Hz active bandpass filter. This filter has a bandwidth of 1000 Hz and unity gain. A sharper filter would reduce noise in the IR channel (video bandwidth of 450 Hz) but would degrade resolution in the visible channel (bandwidth of 900 Hz). Further video amplification is provided by a small transistorized amplifier available from Radio Shack. Any small 1 Watt amplifier would do equally well. A meter with an adjustable shunt, in the power lead to this amplifier, serves as a video level indicator. The output of the amplifier drives T1, which

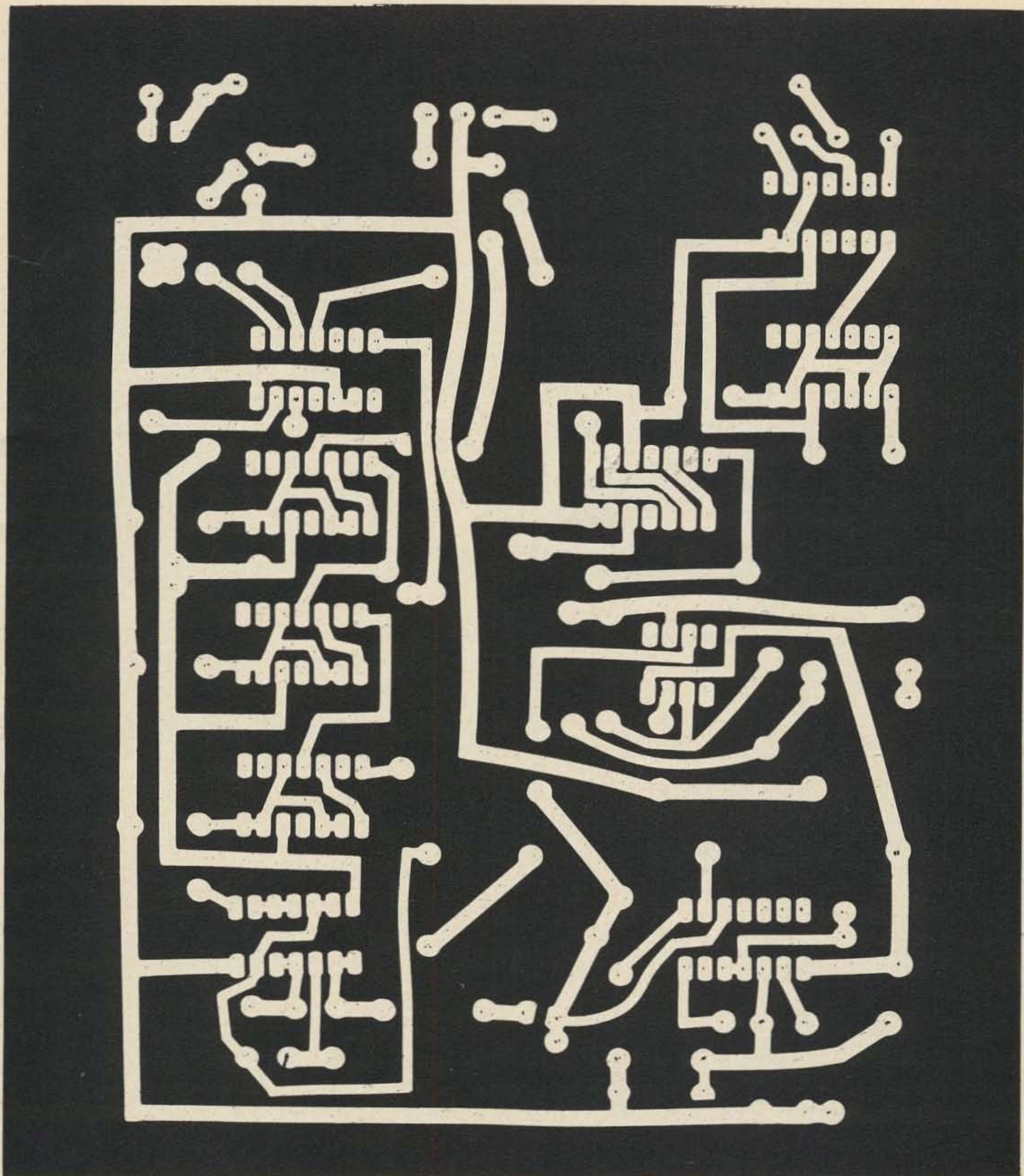

Fig. 5(a). PC board #1 (full size).

visibility threshold in the absence of video. The component values in the brightness circuit are chosen so that the video output from T1 is not loaded excessively by the grid circuit. The 5AHP7A is electrostatically focused, as indicated in the schematic. The 5FP7, which is commonly available on the surplus market, may be used with two modifications. The focus pot may be eliminated but either a permanent magnet or electromagnetic focus coil must be used. The

long persistence of the P7 phosphor enables many details of cloud cover to be evaluated as the image is being photographed. With some modification of circuit values and pin connections a number of the small P4 tubes used in solid state TV circuits could also be used, but they would not have the long persistence feature. Since detailed evaluation of cloud and terrain features is best accomplished with photographs of the CRT image, this is not a great drawback — and a great

Full size negatives for Fig. 5(a) are available for \$2.00 each from PC NEGS, 73, Peterborough NH 03458.

Order #WB8DQT-1.



RIGHT NOW

is the time to order your

75 callbook

Don't wait until 1975 is half over. Get your new **Callbooks** now and have a full year of the most up-to-date QSL information available anywhere.

The new **1975 U. S. Callbook** will have over 300,000 W & K listings. It will have calls, license classes, names and addresses plus the many valuable back-up charts and references you have come to expect from the **Callbook**.

Specialize in DX? Then you're looking for the new, larger than ever **1975 Foreign Callbook** with over 225,000 calls, names and addresses of amateurs outside of the USA.



United States Callbook
All W & K Listings
\$12.95

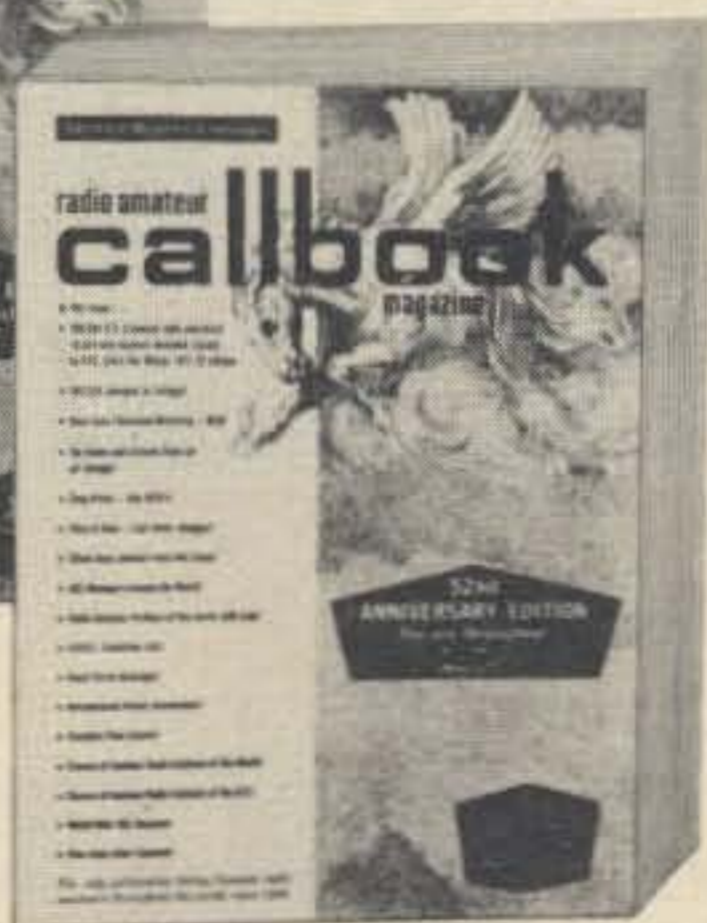

Foreign Radio Amateur Callbook
DX Listings
\$11.95

Order from your favorite electronics dealer or direct from the publisher. All direct orders add 75¢ shipping and handling per Callbook.

WRITE FOR FREE BROCHURE RADIO AMATEUR **callbook** INC.
Dept. B 925 Sherwood Drive
Lake Bluff, Ill. 60044

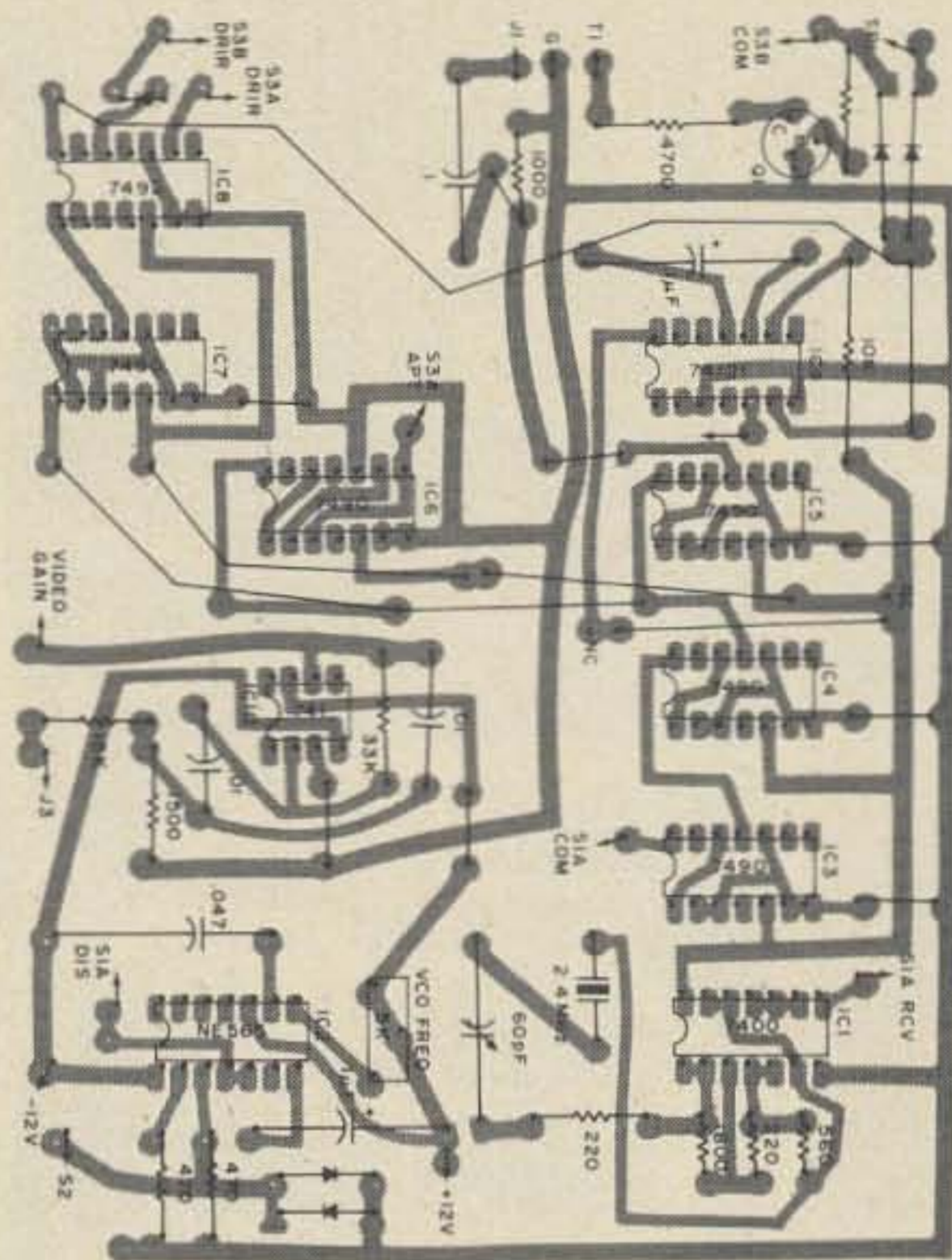

Fig. 5(b). Parts layout for board #1.

many of the small TV tubes are quite reasonably priced.

Power Supply (Fig. 4)

The power supply is strictly conventional and any variations that would provide the proper voltages and regulation would work well. The HV module for the CRT is a simple transistor oscillator working into an unmodified TV flyback transformer. The basic supply should be remoted from the monitor to prevent 60 Hz distortion of the trace, but the HV module should be mounted close to the CRT so the HV connector from the flyback (which includes the HV rectifier assembly) can reach the appropriate connection to the shell of the tube.

Construction

Fig. 5 shows the printed circuit foil pattern and component layout for board #1 while Fig. 6 provides similar data for board #2. If the component placement figures are followed carefully no problems should be encountered. Packaging of the completed boards with the CRT can be accomplished in virtually any enclosure that will hold them. The following controls and indicators are

TUFTS Radio Electronics

386 Main St., Medford, Mass. 02155

"FEATURING VHF ENGINEERING"

THE WORLD'S MOST COMPLETE LINE OF VHF—FM KITS AND EQUIPMENT

CD1 Kit	10 channel receive xtal deck w/diode switching	\$ 6.95
CD2 Kit	10 channel xmit xtal deck w/switch and trimmers	\$14.95
COR2 Kit	complete COR with 3 second and 3 minute timers	\$19.95
SC2 Kit	10 channel auto-scan adapter for RX	\$19.95
TX144 Kit	exciter—1 watt—2 meters	\$29.95
TX220 Kit	exciter—1 watt—220 MHz	\$29.95
TX432 Kit	exciter— NEW —432 MHz	coming soon
RX144/220 F Kit	140-170 or 210-240 MHz rcvr w/8 pole cer 455 filter	\$65.95
RX144/220 C Kit	140-170 or 210-240 MHz rcvr w/2 pole 10.7 xtal filter	\$69.95
RX432 C Kit	NEW —432 MHz receiver	coming soon
HT144 B Kit	2 meter—2w—4 channel—hand held xcvr	\$129.95
PA1501H Kit	2 meter pwr amp—15w—compl. kit w/SS switching	\$49.95
PA2501H Kit	similar to above—24w	\$59.95
PA144/15 Kit	similar to PA1501H less case, connectors and switching	\$39.95
PA144/25 Kit	similar to above—25w	\$49.95
PA220/15 Kit	similar to PA144/15 for 220 MHz	\$39.95
PA432/10	NEW —similar to PA144/15 except 10w and 432 MHz	coming soon
PA4010H Kit	10w in—40w out—relay switching	\$59.95
PA110/10	10w in—110w out 2 meter amp	factory wired \$179.95
PA110/30	30w in—110w out 2 meter amp	factory wired \$149.95
PS3 Kit	power supply regulator card	\$ 8.95
PS12C Kit	12 amp—12 volt regulated power supply w/case	\$69.95
PS24C Kit	24 amp—12 volt regulated power supply w/case	\$99.95
RPT144	NEW —15 watt—2 meter repeater	factory wired \$595.95
RPT220	NEW —15 watt—220 MHz repeater	factory wired \$595.95
RPT432	NEW —10 watt—432 MHz repeater	coming soon

Repeaters are available in kit form—write for prices

ITEM	PART #	DESCRIPTION	PRICE	EXTENSION

NAME _____ TOTAL _____
 ADDRESS _____ SHIPPING _____
 CITY _____
 STATE _____ ZIP _____ TOTAL ENCLOSED _____

operational controls and should be mounted where they are accessible: S1 (receive/display), S2 (phasing), S3 (APT/DRIR mode selector), S4 (vertical sweep), brightness, the video gain control, and M1 (video level). The focus control and deflection size controls are "set and forget" features and can be located anywhere. Although not required, the use of IC sockets for the circuit boards is highly recommended as removal of a bad IC can be a chore if it is soldered directly to the circuit board. J1-3 can be mounted on the rear apron of the completed unit. The photo shows the modular packaging used for my own circuit evaluation. Except for the large meter used for the video level control, the whole unit could have been packaged in the cabinet used for the electronics package, had that been the initial goal while the circuits were being designed.

Initial Setup

Prior to connecting the power supply to the completed unit you should verify the presence of the proper voltages and polarity — a mistake here will send you back to the parts store for additional ICs and transistors!

Place S1 in the receive position and apply power. Attach a frequency counter to the common lug of S1A and adjust the 60 pF trimmer on board #1 for a frequency reading of exactly 2.4 MHz. This frequency should be set to the maximum resolution of the counter. Move the counter to pin 11 of IC5 — it should read exactly 2400 Hz. Move the counter to pin 3 or 8 of IC6 — a reading of 4000 Hz should be obtained. Set the counter on pin 9 of IC8 and you should get a reading of 1600 Hz. If you've gotten this far you can rest assured that the oscillator and all frequency dividers are operating properly.

Set the counter on pin 4 or 5 of IC2. With no input at J2, adjust R1 for a frequency of 2350 Hz. Temporarily connect a test lead from J1 to J2. The counter should read 2400 Hz, dropping to 2350 Hz when S2 is depressed and rising back to 2400 when S2 is released. Remove the test jumper and turn off the monitor supply.

At this point it is desirable to have a satellite tape for further tests. The satellite video should be recorded on the right

Which would you rather be, jack-of-all-bands or master of one?

We make our SkyClaw™ vertical antennas for the ham who doesn't want to be a jack-of-all bands. Because no antenna can be all things to all people. You tune our SkyClaw™ to your choice of 160 (50kHz bandwidth), 80 (200kHz bandwidth), or 40 (the whole band). We don't fudge the tuning for multi-band performance. We put the materials into it that let you pump the legal limit through it. We build it to withstand more wind than you'll find in a QSO on 75.

And we deliver the whole thing for \$79.50, postpaid in the USA. Radial and phasing harness kits are available, too.

It's self-supporting. Weatherproof. You put it up yourself with just 4 tools. It stands

24'7". And you connect to an SO-239 in its base.

Now, then. Have you decided which kind of operator you want to be?

Yes, Master.

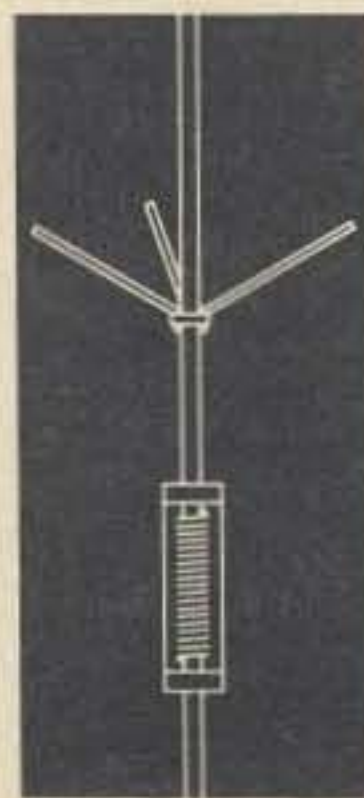

Dentron

Radio Co., Inc.
2100 Enterprise Parkway
Twinsburg, Ohio 44087
(216) 425-8073





SUPER-STRIPS

UNIVERSAL BREADBOARDING ELEMENTS
WITH SOLDERLESS PLUG-IN TIE POINTS

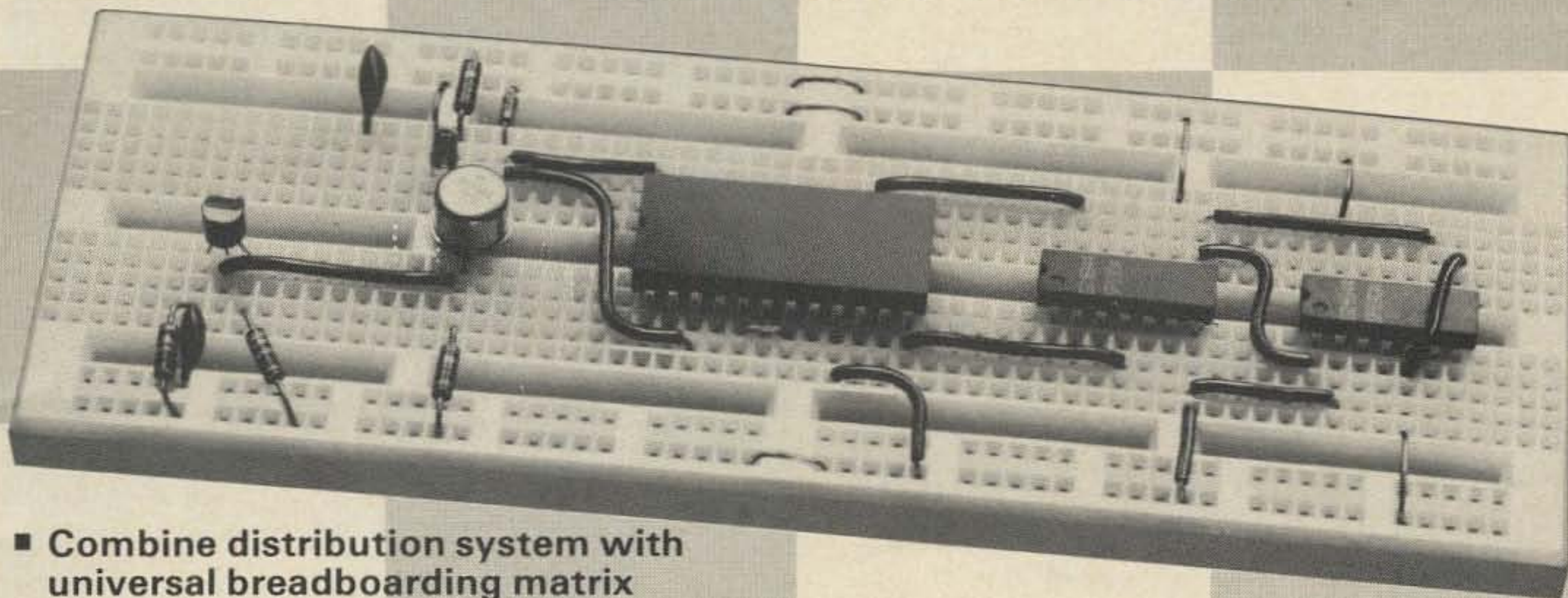

- Combine distribution system with universal breadboarding matrix
- 840 solderless, plug-in tie-points
- Accommodate all DIP's and discretes with lead diameters to .032"
- Require no special patch cords

The A P Super-Strips combine a power/signal distribution system with a matrix of 128 terminals, each with 5 tie points. The distribution system consists of eight buses, each individual bus consisting of a line of 25 tie points. All tie points are the solderless, plug-in type, used on A P Terminal and Distribution Strips.

The Super Strip will accept all DIP's, TO-5's and discrete components with leads up to .032" dia. As many as eight 14-pin DIP's can be accommodated. Use any solid wire up to No. 20 AWG for interconnections. Super-Strip can be panel-mounted with the No. 4 screws provided. A vinyl-insulated backing prevents short circuiting. Included are four self-adhesive polyurethane feet for protection during bench work. Body is acetal copolymer.

Super-Strip 1: 923748 (Gold-plated terminals) \$18.90 ea.
Super-Strip 2: 923252 (Nickel/silver terminals) \$17.00 ea.

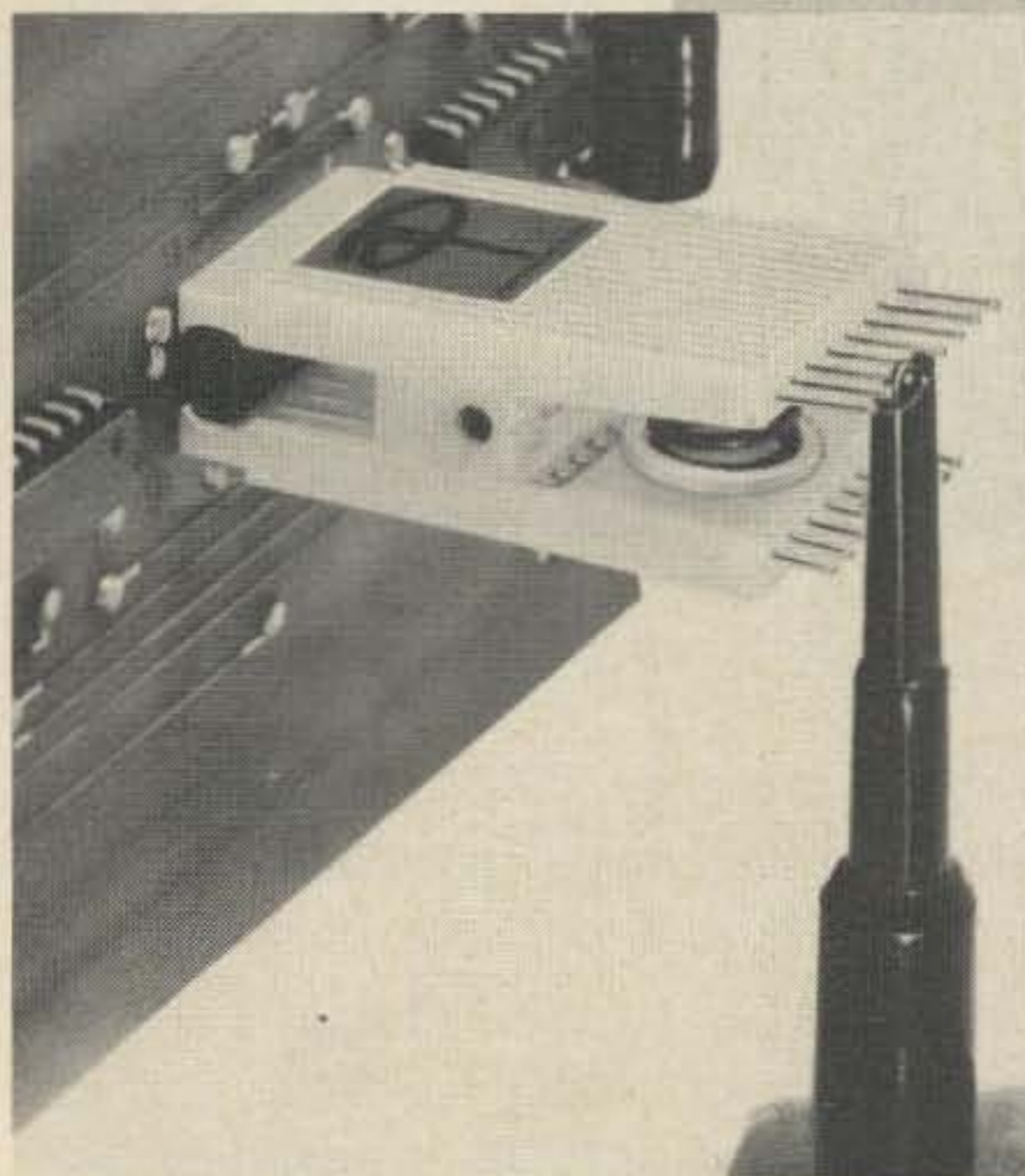

IC TEST CLIPS

FOR DUAL-IN-LINE PACKAGES

- Provide full access to integrated circuit DIP leads
- Solve probe attachment problems
- Simplify prototype and production testing, field service work, and quality control
- Remove DIP's damage free
- Available in sizes to accommodate all DIP's;

The unique design of the A P Test Clip assures positive, non-shorting electrical connection and positive mechanical clamping to dual-in-line packages.

Gold-plated phosphor bronze spring contacts are designed for wiping action. The "contact comb" separating the spring contacts provides positive positioning to prevent accidental shorting of adjacent leads.

Oscilloscope probes can hang free on the longer terminal wires in the top row of the Test Clip and not interfere with the terminals in the bottom row.

All products are guaranteed to meet or exceed published specifications

A P PRODUCTS INCORPORATED
Box 110-Z • Painesville, OH 44077

TC-14	TC-16	TC-24
923689.....\$ 5.25 ea.	923700.....\$ 5.75 ea.	923714.....\$13.85 ea.

channel. Set the VU or recording level meter for the maximum permissible recording level on receiver noise with no signal present so you will not overload the recorder with the actual satellite signal. J1 should be connected to the left channel input of the recorder. When a satellite signal is heard, verify that S1 is still in the receive position and apply power to the unit. Set the left channel recorder level for 1/3 to 1/2 of the permissible recording level on the 2400 Hz tone, and record the pass.

During playback of the picture the right channel output of the recorder should go to J3 while the left channel output goes to J2. Set the output level of the tape deck to near maximum on both channels. If you are using a recorder rather than a deck, insert pads to keep the levels to J2 and 3 at about 1 volt. Prior to applying power to the monitor preset all controls as follows: S1 — display, S2 — normally closed, S3 — APT, S4 — closed, video gain — minimum, M1 shunt — zero resistance, all centering and size controls — midrange, brightness — minimum (maximum negative voltage on CRT grid), focus — midrange. Apply power to the monitor. After a few minutes for warmup, carefully advance the brightness control until the trace is just visible on the CRT — it should be a horizontal line. If no line is visible, adjust both horizontal and vertical centering to bring it into view. Mask off the largest possible square viewing area on the CRT. Adjust the horizontal centering and APT horizontal size so the line just fills the viewing area from side to side. Momentarily short the collector of Q2 to ground — the trace should form a spot off on the left hand side of the screen. If the trace jumps to the right, turn the unit off and reverse the horizontal deflection leads and repeat the size and centering adjustments after reapplying power. Open S4 and observe the direction of movement of the horizontal line. If the line moves downward close S4 and move ahead in the adjustment sequence. If the trace moves upward, power down, reverse the vertical deflection leads, and reapply power. Set the vertical centering so the trace is just at the top of the viewing area with S4 closed. Open S4 and set the vertical APT size control for a 200 second top to bottom

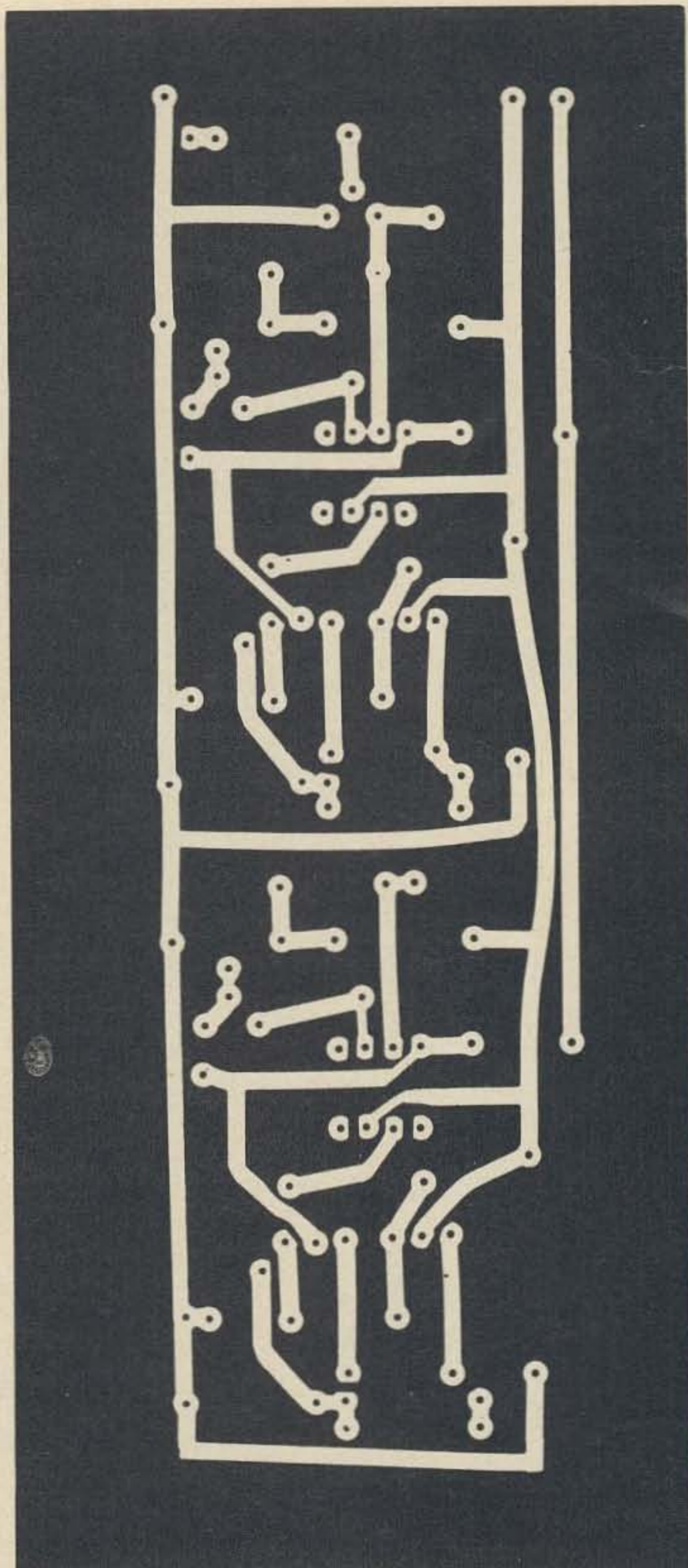

Fig. 6(a) PC board #2 (full size).

sweep. Switch S3 to the DRIR position and adjust the DRIR horizontal size control for a sweep that extends just beyond the margins of the viewing area. Cycle S4 and set the DRIR vertical size pot for a 7 minute top to bottom sweep. This should be done carefully so the pictures will have the proper aspect ratio.

If all has gone well to this point you are ready to watch pictures. Back down the brightness control until the trace just disappears in a dark room. Play the previously

Full size negatives for Fig. 6(a) are available for \$2.00 each from PC NEGS, 73, Peterborough NH 03458.

Order #WB8DQT-2.

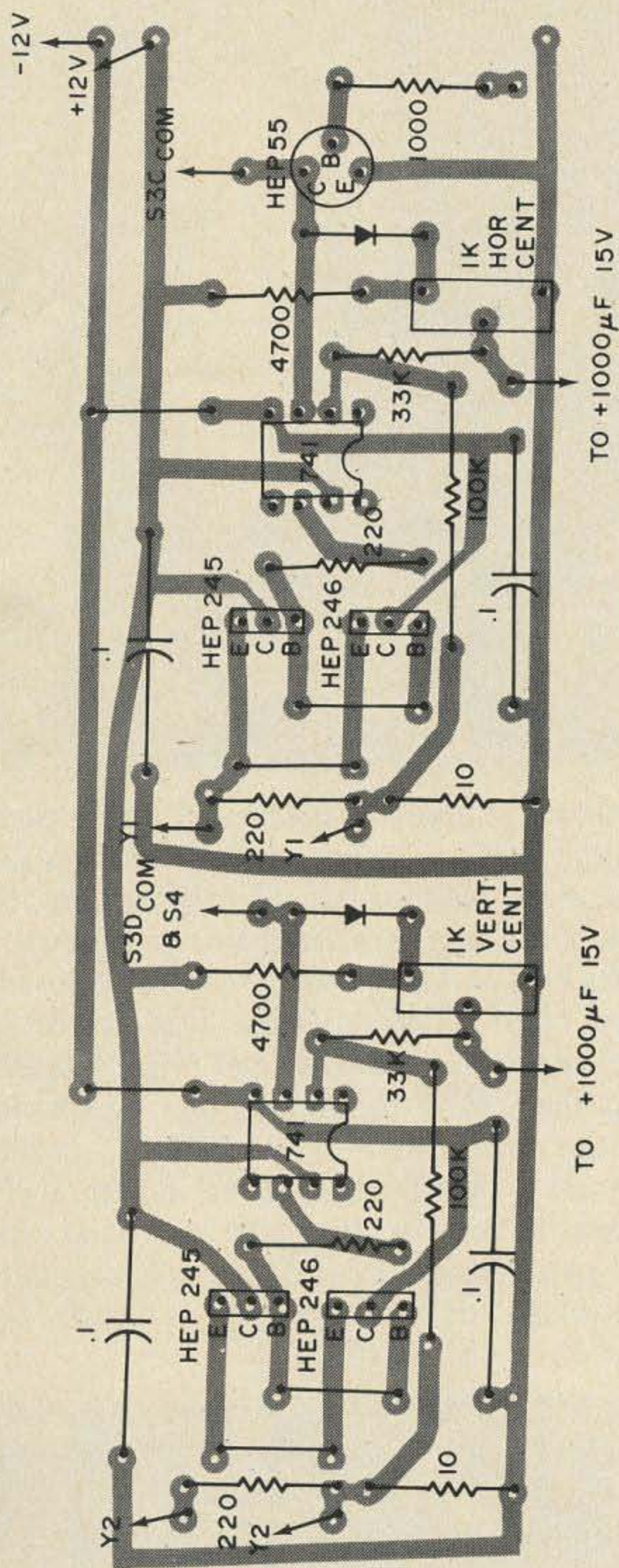

Fig. 6(b). Parts layout for board #2.

recorded satellite tape into the monitor. If your recording is from ESSA 8 or one of the ATS satellites, set S3 to APT. If a NOAA satellite was copied, set S3 to DRIR. Slowly advance the video gain control until satellite video is visible on the CRT. A proper gain setting represents a point showing good whites while still retaining black areas in the picture. It is unlikely that the picture is properly phased at this point. In the case of an APT picture, improper phasing is indicated by the presence of a vertical white bar

in the picture area (actually the satellite sync pulse). Press S2 until the bar moves to the left edge of the picture, and release. The APT picture is now properly phased. In normal operation S4 is kept closed during the inter-picture interval (steady 2400 Hz satellite subcarrier) and opened at the start of the picture. Phasing need only be accomplished once during a single pass or picture sequence, as long as the recorder is not turned off. DRIR phasing is used to determine which of the pictures, either visible light or IR, you wish to view. The sync pulse of the DRIR format is a vertical white bar that is actually composed of seven discrete pulses which should be visible if you look closely. Phasing is accomplished by pushing S2 until the bar lines up just off the left margin of the viewing area. In the IR format, the space just after the sync bar will be white while the visible channel view will have a black area immediately following the sync bar. If the picture, as phased, is the wrong channel (the one you don't want at the moment) simply keep S2 depressed and a second sync bar will drift in from the right and move to the left margin. When this one lines up with the left side of the viewing area, release S2 and you are in business with the proper video channel. Both the visible and IR channel of the DRIR format will have usable video during daylight passes while the visible channel will be completely black at night with only the IR view producing usable pictures. As noted in the previous references, the NOAA DRIR format produces a continuous vertical strip of video rather than discrete frames. The geometry of the CRT means that only about seven minutes of this strip can be seen at one time.

Once you are getting reasonable video display you can gradually increase the resistance of the 50 Ohm meter shunt pot. The shunt should be set at a point that gives near maximum meter deflection on video peaks. The meter can now be used for video levels.

Photography of the weather satellite pictures can be done with virtually any camera that can be focused on the CRT. See the 73 SSTV Handbook for photographic techniques. All photographs should be made in a dark room because of the long time

2 METER FREQUENCY STANDARD



- * Accurately calibrates 2 meter gear
- * Uses WWV as Standard
- * Voltage regulated
- * Standard 30 kHz spacing

FM-146 Introductory price — \$59.95

Highest quality components — cast aluminum housing — military grade board — reverse polarity protection — also available in 450 MHz version. . . send for complete details

CA residents add 6% sales tax

MAGTECH ENGINEERING

P.O. 21979 San Jose, CA 95151

DIPOLE ANTENNA CONNECTOR

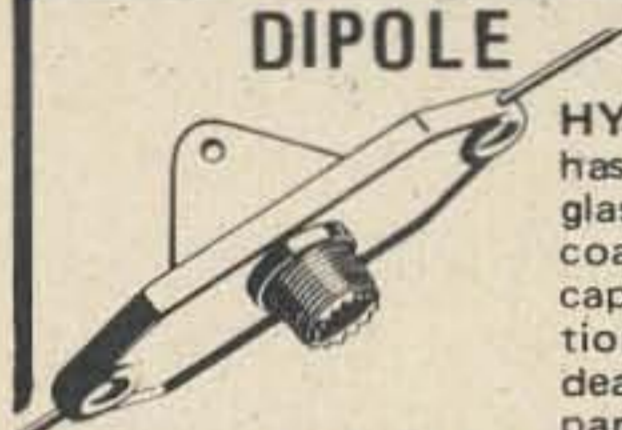

HYE-QUE (HQ-1) dipole connector has coax SO-239 socket molded into glass filled plastic body to accept coax PL-259 plug on feedline. Drip-cap keeps coax fittings dry. Instructions included. Guaranteed. At your dealers or \$3.95 postpaid. Companion insulators 2/\$.99.

BUDWIG MFG. Co. PO Box 97B, Ramona CA 92065

PRINTED CIRCUIT

EPOXY GLASS CIRCUIT BOARD STOCK;
CARBIDE DRILL BITS; TAPE RESIST;
ARTWORK; BUBBLE ETCHERS
SEND S.A.S.E. FOR FLYER

TRUMBULL

833 BALRA DR., EL CERRITO, CA 94530

exposures required. Polaroid type 107 film will give you "instant" weather satellite pictures but gets expensive if you plan to take pictures every day. 35mm black and white film is convenient for taking large numbers of pictures but you are forced to wait until you fill up the roll unless you load your own film in short segments. The advantage of roll film over Polaroid (aside from cost) is that the final pictures can be printed at any size desired. Despite the small size of the CRT, satellite pictures enlarged to 8x10 inches look quite good. Most satellite buffs choose their film and camera on the basis of how many pictures they routinely acquire and the state of their wallets. I use 35mm for day to day operation, keeping Polaroid in reserve for demonstrations. You will probably shoot a lot of Polaroid in the beginning and then phase into other film types as you get into the routine.

I will be happy to correspond on the subject of the satellite monitor but please include an SASE so I have change enough to buy more film!

. . . WB8DQT



Hurricane Carmen battering the coast of Yucatan in September, 1974. The coast and interior of Mexico are faintly visible to the left while Cuba, outlined in sunglint off the waters of the Caribbean, may be seen in the upper right. This picture was transmitted from one of the operational NOAA satellites using the DRIR mode and can be displayed on the monitor. The NOAA satellites transmit a continuous video signal and this segment represents just part of a long picture strip extending from southern Greenland in the north to Panama and western South America to the south.

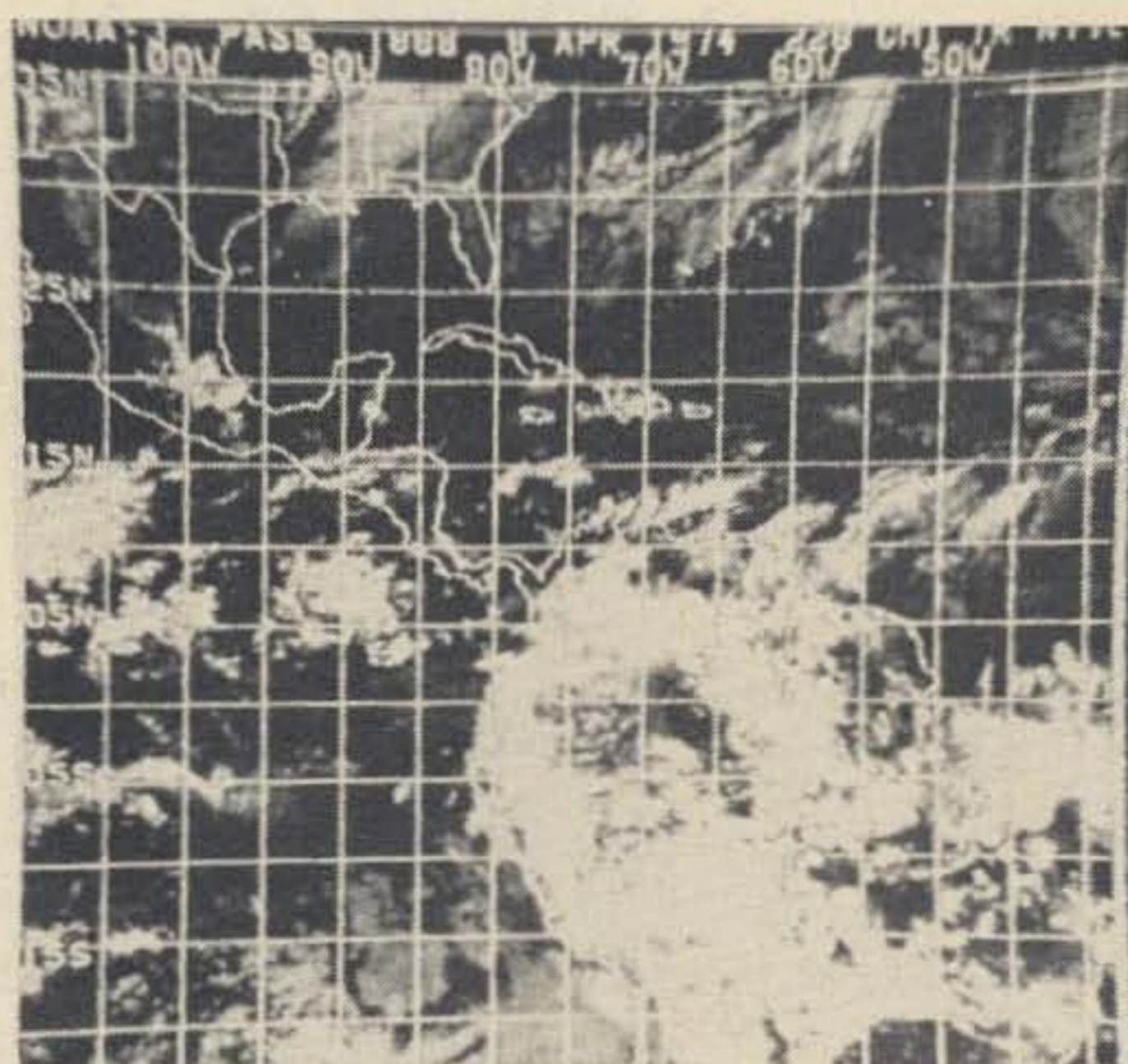

Gridded NOAA data relayed by the ATS-3 geostationary satellite on 135.6 MHz. Such data, from either ATS-1 or ATS-3, as well as the pictures from the polar orbiting ESSA-8, are transmitted in the APT mode and can be displayed on the satellite monitor.

IT'S TIME TO SWITCH TO ALPHA



IF YOU'RE STILL SETTling, WORRYING, FIDDLING, OR PUTTING UP

SETTLING FOR LESS THAN MAXIMUM LEGAL POWER — even when you really need it to bore through a pileup or hang onto a ragchew frequency? *Every ALPHA linear, from the least expensive ALPHA 74K to "THE ULTIMATE" ALPHA 77D, easily handles a solid kilowatt of continuous average dc input . . . in any mode including slow scan and teletype.* (Most competitive tabletop amplifiers have power supplies capable of no more than 400 to 500 watts continuous average power. CHECK THE SPECS!)

WORRYING THAT YOUR OLD LINEAR WON'T HANG TOGETHER through a long, tough contest weekend . . . or thirty minutes of "Key-down" time on SSTV? *Every ALPHA is specifically designed for that kind of heavy service. That's why they have rugged Hipersil®/solid state power supplies, Eimac ceramic tubes, ducted-air circulatory cooling, and top quality throughout.*

FIDDLING WITH TUNING AND LOADING KNOBS every time you change bands? *With the exclusive "No-tune-up" ALPHA 374 you simply flip the bandswitch and start talking. Pretuned bandpass output filters do the tuneup for you . . . instantly! And precision controls in the ALPHA 77D can easily be returned to any previous setting in a few seconds.*

PUTTING UP WITH AN OLD-STYLE CONSOLE THAT'S TOO BIG and heavy to put where you really want it? *Every ALPHA model is self-contained in a handsome, designer-styled desk-top cabinet that sits right at your fingertips without monopolizing operating space . . . and can be handled by one man.*

ALPHA linear amplifiers by ETO — an investment in performance, pleasure, and convenience. See your dealer or contact ETO direct for full details, top trades, and prompt delivery. ALPHA 74K, \$695; ALPHA 274, \$995; ALPHA 374, \$1295; *THE ULTIMATE*, ALPHA 77D, \$2695.



EHRHORN TECHNOLOGICAL OPERATIONS, INC.

BROOKSVILLE, FLORIDA 33512

(904) 596-3711

The QRP Accu-Keyer

The Accu-Keyer is a low-cost TTL integrated circuit keyer having many features comparable to those of many high-cost commercial keyers. These features include: self-completing dots and dashes, dot and dash memories, iambic operation, dot and dash insertion, and automatic character spacing.¹ The Accu-Keyer was first described in the August, 1973 issue of *QST*. However, that keyer used TTL circuits which are not compatible with QRP operations. The QRP Accu-Keyer is a much needed alternative to the original design.

The QRP Accu-Keyer uses an integrated circuit family known as CMOS. CMOS (also known as COS/MOS by RCA) was first introduced during the middle 60's as an extremely low power digital circuit using complementary-symmetry metal oxide semiconductors. The basic CMOS circuit uses complementary, insulated gate FETs, to achieve extremely low standby power — 10 nW per package for gates. This power feature and moderate cost makes CMOS an attractive logic family to consider for QRP operations, where power is at a premium. This is the philosophy behind the QRP Accu-Keyer.

Design Concepts

Several modifications must be made to the original Accu-Keyer logic in order to incorporate the CMOS family. The basic flip flop design in CMOS differs from that of TTL. The notable exceptions are the set and clear functions. The set and clear functions on a TTL flip flop are inverse logic compared to CMOS functions. CMOS circuits use a logic "one" as a set or reset signal and a logic "zero" as a normal state. This is directly opposite to TTL where a normal

state is high and a set/clear command is low. Therefore, it is clear that to convert a TTL logic diagram to a CMOS diagram, all sets and clears must be inverted.

Another difference between the two families is that of supply voltage. TTL requires a rather critical supply source near 5 volts in order to function properly. CMOS, on the other hand, will work properly with any supply voltage between 3 and 15 volts, and the supply regulation is non-critical. This means that the keyer will operate directly from the batteries which power the QRP rig, without any regulation needed. This is an excellent feature of CMOS over TTL.

QRP Accu-Keyer Circuit

Fig. 1 shows the schematic of the QRP Accu-Keyer. There are several differences between the QRP version and the original design. A CMOS astable clock was designed so that discrete components could be held to a minimum. IC8 is connected as a typical astable, producing a square wave output. The output period is equivalent to one time unit in Morse code. Secondly, since the keyer is used with a QRP rig, HW-7 in this instance, the output driver needs to be only a low level transistor switch. This greatly simplifies the output stage of the keyer. Driving a higher power rig would only require the inclusion of a suitable output transistor after Q1. Thirdly, as previously mentioned, all set/clear lines on the type "D" flip flops must be inverted when using CMOS in the original circuit.

Construction

Only eight CMOS circuits are needed for this design. The ICs were mounted in sockets for ease of construction. The sockets were

¹Garrett, "The WB4VVF Accu-Keyer", *QST*, August, 1973, p. 19.

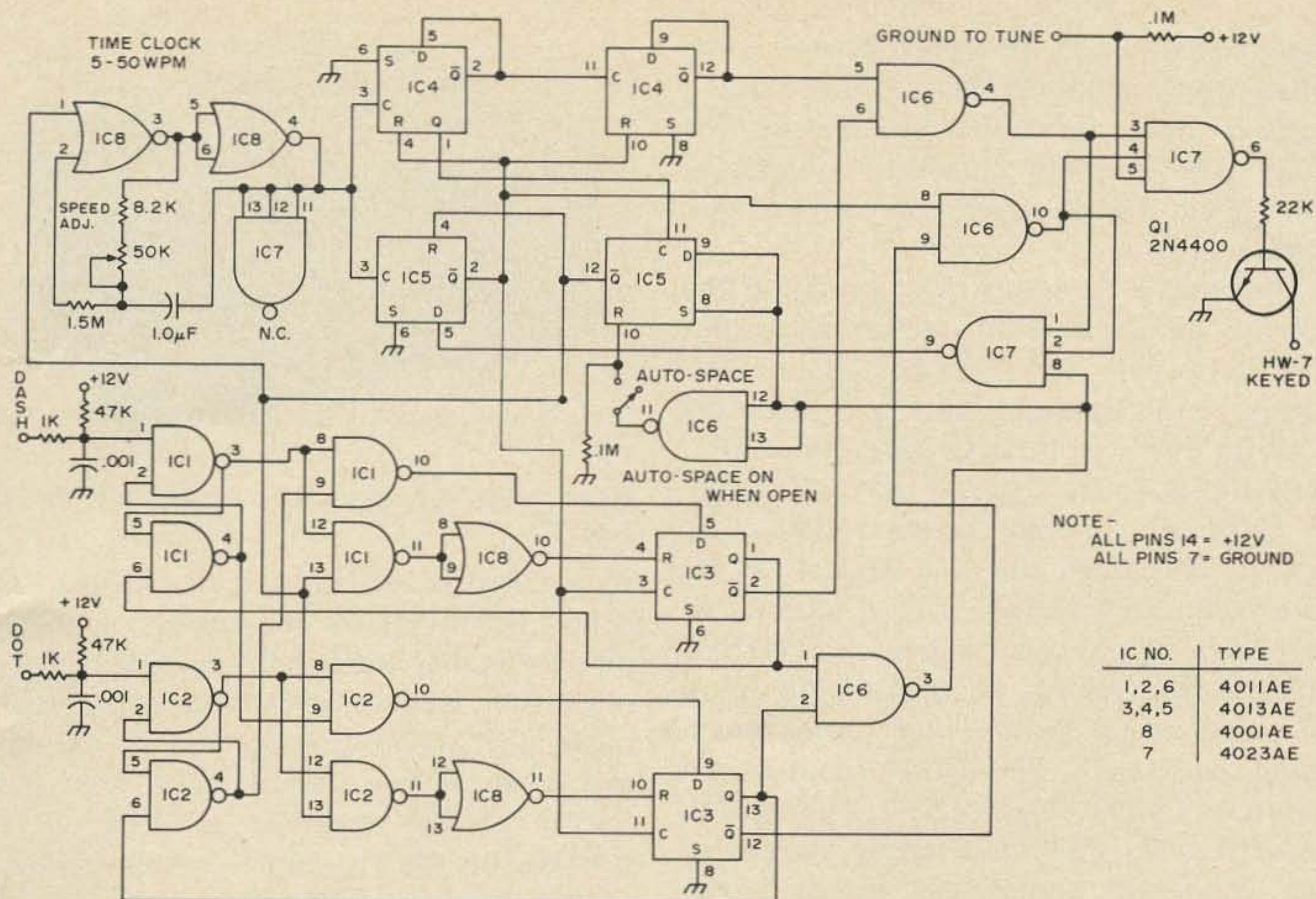
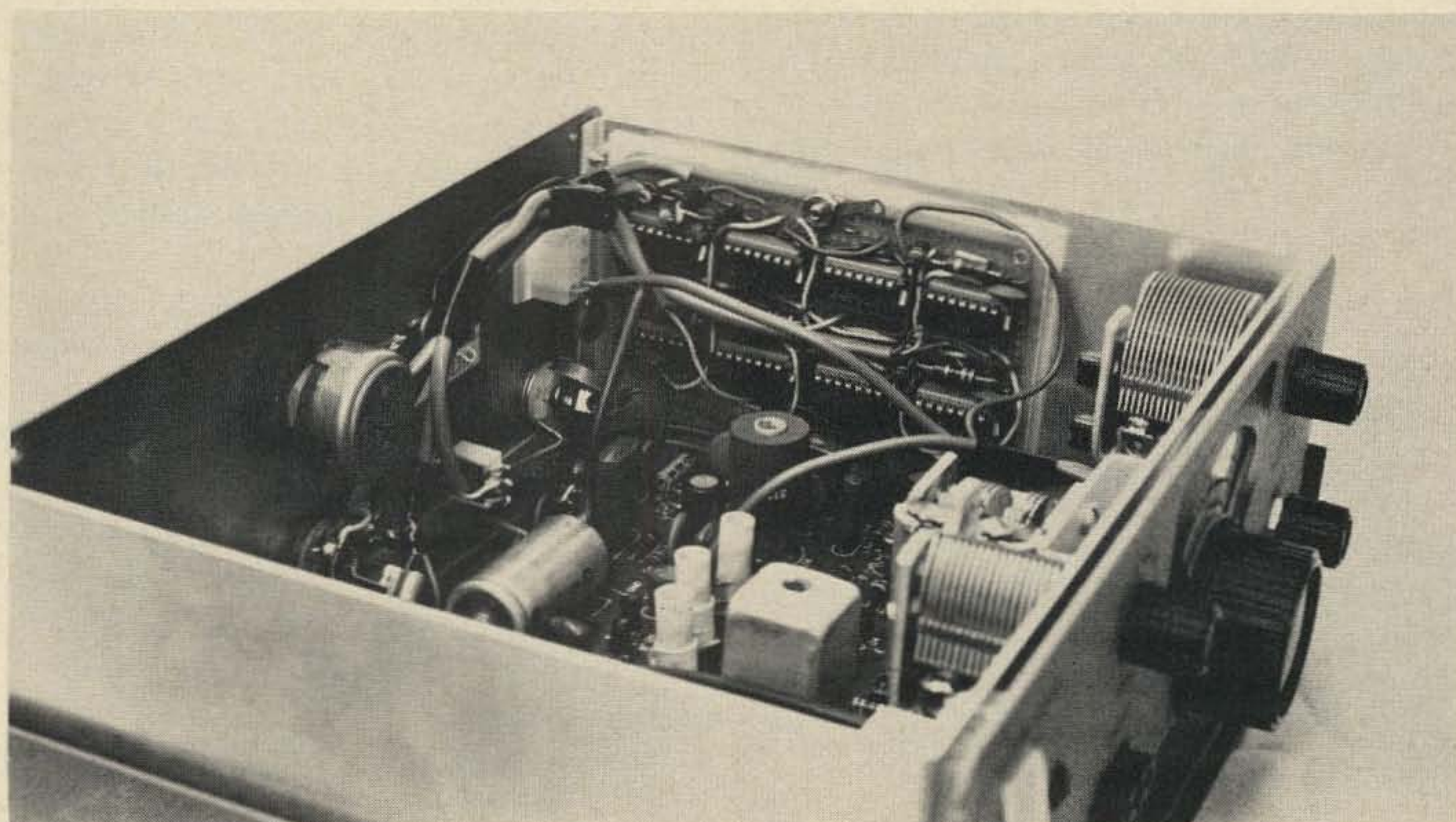

Fig. 1. Schematic diagram of the QRP Accu-Keyer using CMOS integrated circuits. Output transistor is sufficient to drive a HW-7 QRP transceiver. Standby power is less than a microwatt.

first mounted on a perforated board and then hard-wired together with small solid hook-up wire. No special precautions are needed when working with CMOS. However,

it is recommended that CMOS not be in the circuit when using a soldering iron with an ungrounded tip. CMOS are now presently being made with diode protected inputs, and



Inside photograph of HW-7 with keyer board in place. Placement of the keyer board is non-critical inside of the HW-7. The associated controls are mounted on the rear panels, as well as a tune button. Three conductor phone jack replaces the usual two conductor jack for the twin paddle key. (Photos courtesy of Robert Baker WA5KVB.)

can usually withstand a limited amount of abuse, but why take a chance? Bypassing the CMOS supply is not necessary because of the excellent noise immunity inherent in the family. The excellent flexibility and ease of design make CMOS a very attractive family to work with.

There may be some question as to the suppliers of CMOS. There are several surplus advertisers who list CMOS. Allied Electronics and Burstein-Applebee also list CMOS in their current catalogues. Generally, the D flip flops are from \$1 to \$1.50, while the gates are all well below a dollar per package. Although the ICs appear to be more expensive than their TTL counterparts, the power supply requirements and ease of applications should be considered also. There are several nomenclature items which should be stated. The RCA's commercial version of CMOS (4000 series) is listed with the suffix AE, signifying supply voltage of 3-15 volts and commercial specs respectively. The AD suffix signifies 3-15 volts with military specs. The AE version is significantly less expensive than the AD version, and is usually more plentiful on the surplus markets. The 4000 series is the most readily available type of CMOS now produced.

Since this keyer was designed to go with a QRP rig, a HW-7 was a likely candidate. The photo shows the installation of the keyer to the Heathkit. The keyer is mounted on a

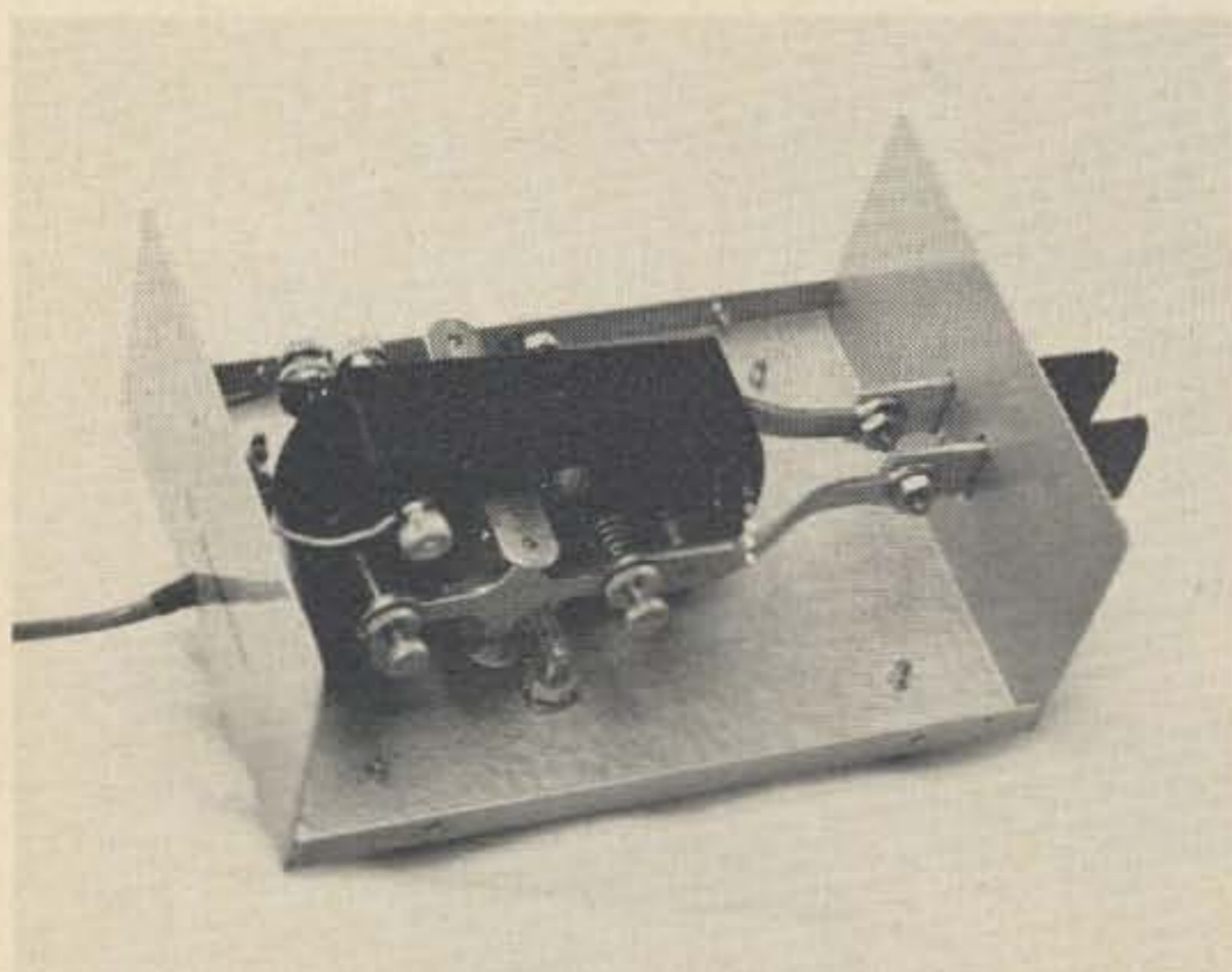

Inside view of the "Siamese" twin paddle key. Two inexpensive straight keys are used, although higher quality keys could be substituted. Box measures 4" x 2" 3/8" x 6" inches.



Rear view of the control layout on the HW-7.

vector board and located in the rear side corner of the HW-7. The keyer is connected directly across the supply terminal since no regulation is necessary. The speed adjustment pot and auto-space switch are both mounted on the rear plate. A tune push-button is also included to facilitate the tune-up of the rig. Since a twin paddle is now needed instead of a straight key, a 3 conductor earphone jack is installed where the previous jack was located.

The twin paddle built makes use of two straight keys in a Siamese paddle configuration.² Two inexpensive straight keys were bolted together and mounted perpendicular to the bottom of a small utility box. Two small paddles, made from a fiberglass PC board, were then connected to the two straight keys. If a better "feel" is needed, two higher grades of straight keys can be used. However, the original design is quite adequate.

The QRP Accu-Keyer is definitely the answer to the power crisis when working QRP from a battery source. Extremely low standby power can be obtained by using the CMOS integrated circuits. This keyer can be used with any rig if the appropriate driver transistor is installed. I hope these suggestions will be helpful to those who work CW-QRP from a finite power source.

Additional Reference

COS/MOS Digital Integrated Circuits SSD-203A, RCA.

... WA5KPG

² Hexter, "The Siamese Paddle", *Hints and Kinks*, Volume Six, p. 66.

Suddenly...the answer is KENWOOD

Today when you ask "How can I modernize my SSB operation?", the answer certainly is KENWOOD. The deluxe TS-900 transceiver, the superb, go-anyplace TS-520 transceiver and the versatile R-599A receiver and T-599A transmitter offer today's amateur advanced design, reliable solid-state performance, contemporary styling. . . and the cost is modest. Now more than ever the answer is KENWOOD.

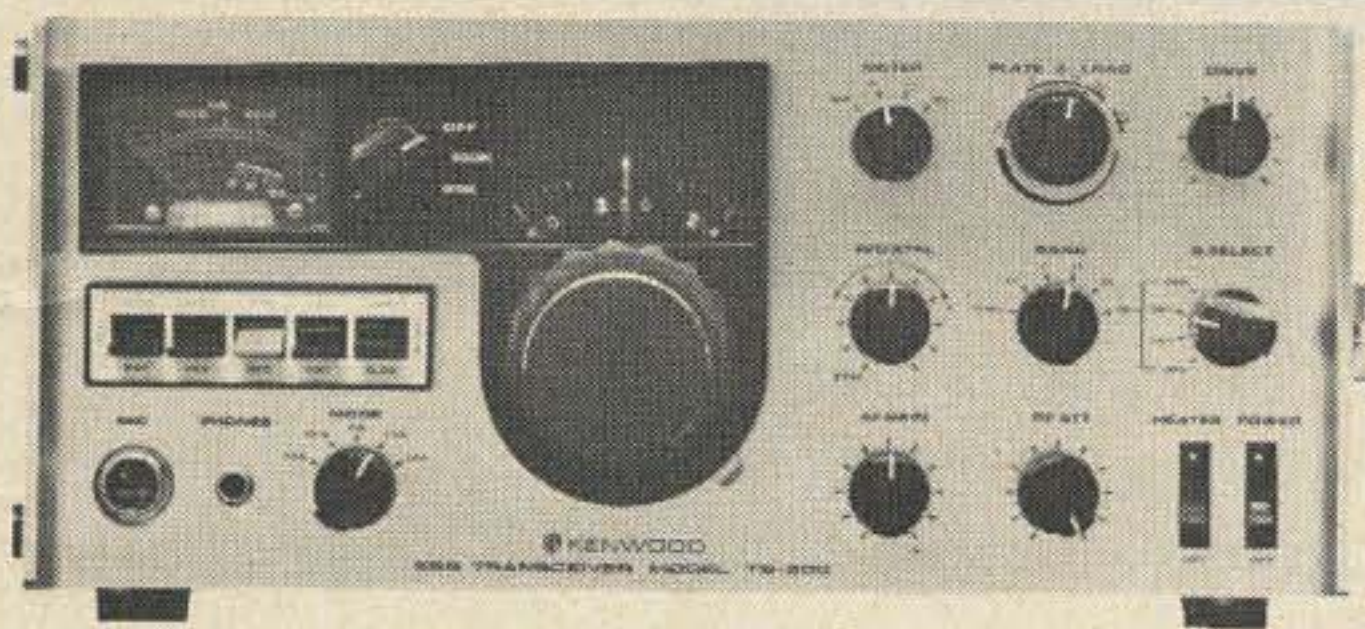

TS-900 Kenwood's superb state-of-the-art SSB transceiver

. . . the ultimate transceiver. The promise of the transistor has been fulfilled. Here is the transceiver you will want to own . . . whatever you have now, get ready to trade up. Its important features are far too numerous to list. Its specifications are superb. The TS-900 is unquestionably the best transceiver of its kind ever offered.



TS-520 Kenwood's go every place . . . do everything transceiver

The new TS-520 is the transceiver you have wanted, but could not buy until now. It is a non-compromise, do everything, go everywhere 5 band transceiver for SSB or CW that performs equally well at home, in an automobile, airplane, boat or trailer. The TS-520 features built-in AC power supply, built-in 12 volt DC power supply, built-in VOX with adjustable gain delay and anti-VOX.

The "Twins" by Kenwood



R-599A Receiver

The R-599A is the most complete receiver ever offered. It is solid state, superbly reliable, small and lightweight, covers the full amateur band . . . 10 thru 160 meters, CW, LSB, USB, AM, AM.N and FM.

The T-599A is mostly solid state . . . only 3 tubes, has built-in power supply, full metering (ALC, Ip, RF output & high voltage), CW-LSB-USB-AM operation.



T-599A Transmitter

WRITE FOR QUOTE ON TRADES

TUFTs

"New England's Friendliest Ham Store"

INVITES YOU TO SEE THE ABOVE LINE

TUFTS

Radio Electronics

386 Main St., Medford, Mass. 02155

Catenary Suspense

Take my advice: Don't use a hockey stick on your cat! Strange things are liable to happen. Aunt Henna was quite well adjusted for a cat until I began to use the stick. You see, she disagreed with me about the need for her to go out at night — and with glaring yellow eyes hid as far back as she could under any handy bed. Hooked with the hockey stick, however, there'd be a loud yowl, a scramble of flailing claws — as I chased her to the open door, where she would leap into the snow, yelling her outraged head off.

For a short period the system seemed to be working quite well. I even tried to believe the message was getting across. Soon, I thought, she would go to the door by herself and meow plaintively, like a well-trained puppy.

Aunt Henna had other ideas. For one thing, I noticed she suddenly had taken an avid interest in television. For hours she would stare at the boob tube, her eyes wide and unblinking. At the same time, while watching, she was soon making strange sounds in her throat. Preference of programs? She looked at 'em all — and even, we were astounded to note, learned how to turn the set on and off, but mostly on.

And so things continued most of last winter, hockey stick routine included. She definitely didn't want to go out — and adroitly evaded me a good part of the time, dashing back to her beloved TV.

One evening in May my hockey stick

must have clipped her a bit, instead of scooping.

"You bastards," she spat.

"Look here, Aunt Henna," I said, "no use including the family. This is all my idea. Make that single."

"Hurry down to Railroad Salvage and save, save, save, brother," she hissed.

Then it dawned on me that Aunt Henna had cussed me out. Perhaps I was cracking up. My XYL, Amie, was standing in the doorway, a twisty smile on her map. "I heard you talking to someone in here. What's going on?" she demanded.

"Aunt Henna called me a bastards. I was merely trying to correct her grammar."

Amie turned on her heel. "I'm going to lock up the liquor. You ought to be ashamed."

Just then Aunt Henna stalked out from under the bed, tail high, padded feet taking her gracefully toward the babbling TV. "Sucker," she muttered.

"I tell you," I yelled to Amie, "This damn cat talked to me. Go on, kitty, say something else!" All I got was a feline smile — or something in that cat-e-gory.

The booze was promptly locked up.

Later in the evening I sensed that Amie was sort of looking at me sideways. "Don't you think it would be wise to see Dr. Bingleflick? You haven't had a checkup in a long time. Besides, Katy Bingleflick tells me he just got his Extra Class ham ticket. Your Advanced deal somehow is not a word I would normally associate with you."

"Yes, dear." The rest of my reply, silently recorded, was to get me a private supply of vodka, which could be stashed away in the garage. I was going to need it for sure.

In ensuing weeks Aunt Henna gradually became more friendly, even sitting contentedly by me when I was on the air. She never would speak in Amie's presence — but on other occasions was pleased to tell some of the boys she was a six year old cat and got a bang out of ham radio. "No kitten," she was wont to add. That generally put them in the aisles — but obviously they suspected me of some sort of hoax.

Out of deference to her growing erudi-

tion, it seemed only fair to lay off the hockey stick business. She was soon busily learning to read, almost ignoring the TV. Evidencing a great interest in electronics, she was becoming expert on the subject, particularly anything to do with antennae.

Then came an unexpected catastrophe. She lapsed back into form and ate our canary. It was a lovely spring afternoon. I was getting ready to string a new 40-meter dipole over the back lawn. The gilded cage had a neat little hasp on its door — but somehow she got it open. Only a few yellow feathers lay under the cage by the patio rubber plant. She'd practically inhaled the bird. It was that fast.



Wilson Electronics Corp.

FACTORY DIRECT

SPECIAL AUGUST SALE!!!

WILSON 1402SM HAND HELD
2.5 WATT FM TRANSCEIVER

* Rubber Flex Antenna

* Complete Set NiCad Batteries

* Leather Case

* Three Sets of Crystals, 52-52,

Plus Your Choice of 2 Pair of Common Frequencies
Extra Crystals, \$4.50 ea., Common Frequencies Only

\$320 VALUE ALL **\$199⁹⁵**
FOR JUST

- 6 Channel Operation, Individual Trimmers On All TX and RX Xtals. All Xtals Plug In.
- S Meter Battery Indicator.
- 10.7 IF and 455 KC IF. 12 KHz Ceramic Filter.
- .3 Microvolt Sensitivity For 20dB QT.
- 2.5 Watts. Nominal Output 12 VDC.
- Microswitch Mike Button.
- Size 8-7/8 x 1-7/8 x 2-7/8 Inches.
- Weight 1 lb. 4 ounces. Less Battery.
- Current Drain RX 14MA TX 450 MA.

ACCESSORIES:

SMI Speaker Mike \$24.00

BCI Battery Charger \$29.95

1410A Amplifier Mobile Mount \$99.00

XF-1 10.7 MHz monolithic IF filter (installed) \$10.00

TE-1 Continuous sub-audible tone encoder (installed) \$39.95

COMING
SOON !!!
220 & 420 MHz
HAND HELD
TRANSCEIVERS



90 DAY
WARRANTY

10 DAY MONEY BACK GUARANTEE
CAN BE MODIFIED
FOR ARMY MARS OR CAP

To: Wilson Electronics Corp.
P.O. Box 794
Henderson, Nevada 89015
(702) 451-5791

Ship _____ 1402 August Packages

Plus SM1 1410A BC1 XF-1 TE-1

Enclosed is \$ _____ Check Money Order

Master Charge Bank Americard

Expiration Date _____ M/C Interbank # _____

Card # _____

Xtals _____

Name _____

Address _____

City and State _____ Zip _____

Signature _____

All orders will be shipped Parcel Post within 48 hours after receipt of order (excluding weekends). Enclose additional \$4.00 for prepaid shipping & handling. Nevada residents add sales tax. Sale ends August 31, 1975.

Wilson Electronics Corp.

ANNOUNCES ITS

NEWEST EDITION

WILSON 1405SM HAND HELD 5 WATT FM TRANSCEIVER

- * NEW SLIMLINE UNBREAKABLE LEXAN® CASE
- * SWITCHABLE 1 or 5 WATT OUTPUT
- * EXTERNAL EARPHONE MIC JACK
- * EXTERNAL POWER JACK

* FACTORY DIRECT AUGUST SALE INCLUDES:

Rubber Flex Antenna, NiCad Batteries, Leather Case, 52/52 Crystals, Plus Your Choice of 2 Extra Pairs of Common Frequency Crystals. Extra Common Pairs, \$9.00 pr.

\$390 VALUE ALL **\$ 269⁹⁵**
FOR JUST

- 6 Channel Operation, Individual Trimmers on all TX and RX Xtals. All Xtals Plug In.
- 5 Meter Battery Indicator.
- 10.7 IF and 455 KC IF. 12 KHz Ceramic Filter.
- .3 Microvolt Sensitivity For 20dB QT.
- 5 Watts Nominal Output 12 VDC.
- Microswitch Mike Button.
- Size 8-7/8 x 1-3/4 x 2-7/8 Inches.
- Weight 1 lb. 4 ounces, Less Battery.
- Current Drain RX 14MA TX 800 MA.

ACCESSORIES:

- SM2 Speaker Mike \$24.00
- BC2 Battery Charger \$29.95
- XF-1 10.7 MHz monolithic IF filter (installed) \$10.00
- TE-1 Continuous Sub-Audible Tone Encoder (installed) \$39.95

90 DAY WARRANTY
10 DAY MONEY BACK
GUARANTEE

CAN BE MODIFIED FOR
ARMY MARS OR CAP

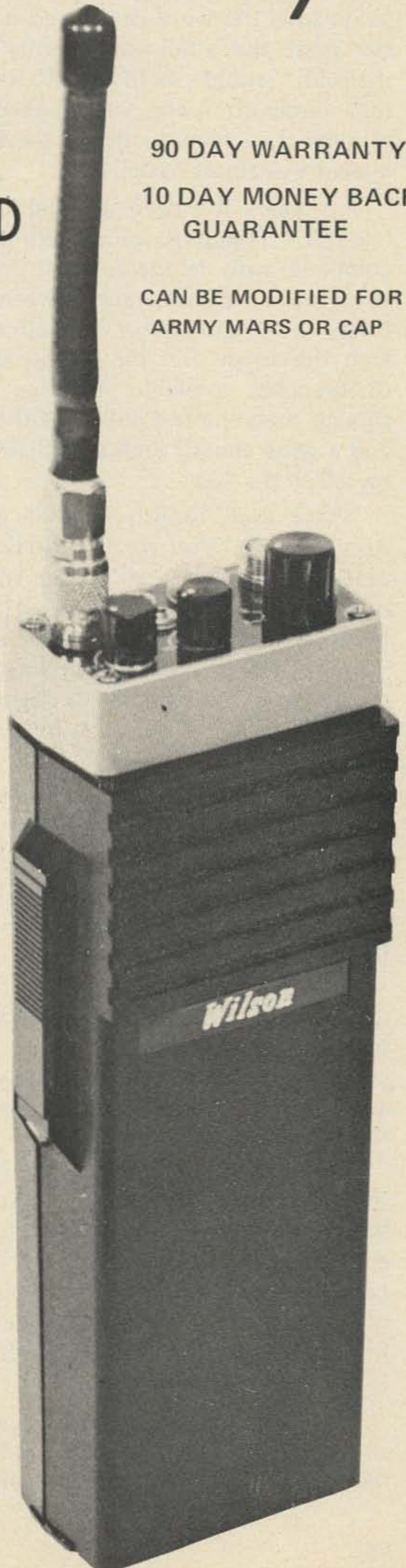

To: Wilson Electronics Corp.
P.O. Box 794
Henderson, Nevada 89015
(702) 451-5791

Ship _____ 1405 August Packages

Plus SM2 BC2 XF-1 TE-1

Enclosed is \$ _____ Check Money Order

Master Charge Bank Americard

Expiration Date _____ M/C Interbank # _____

Card # _____

Xtals _____

Name _____

Address _____

City and State _____ Zip _____

Signature _____

All orders will be shipped Parcel Post within 48 hours after receipt of order (excluding weekends). Enclose additional \$4.00 for prepaid shipping & handling. Nevada residents add sales tax.

Sale ends August 31, 1975.

I shook an admonishing finger at her, a bit at a loss for words. She was daintily wiping her whiskers with a paw, studying a Sears Roebuck catalogue. Anything that had to do with the word cat stirred her interest. Her great, fluffy tail waved gently. "Mister," she said, "would you like me to help you get that dipole up?" This was an abrupt change of subject, a feint to divert the lecture she knew I was about to deliver.

For years it's been a ritual to don my "Robin Hood"-Bavarian climber's hat, complete with feathers, when preparing to string up a new antenna between trees. My trusty bow and arrow can almost always arch the arrow over the highest sturdy fork of branches available, bringing with it a thread, then line and pulley. Without the hat and a good shot of vodka I'm liable to shoot myself in the foot.

"You look foolish in that gear," said Aunt Henna. "You want me to help you get that wire up in the air?" Her voice trailed off, then returned suddenly, "Hurry down to Railroad Salvage and save, save, save, brother! 430 people were drowned when the ferryboat turned turtle. A raging fire has now become a holocaust in the stricken city . . ."

"Hold it, Aunt Henna," I cried. Her boob tube categories were merging in general confusion. "Just how do you propose to assist?" I asked, trying to get her back in the groove. "Perhaps this is a bit over your head."

"Since my mean altitude is only about ten inches, it better be, Mister, if you expect to get out anyplace."

"Not anyplace — anywhere," I admonished. "Your English is simply dreadful."

Well, in short order Aunt Henna had started up the 80-foot pussy willow tree, the thread, with a small weight attached to its end, in her mouth. Up, up she went, occasionally jumping to an adjoining trunk of the huge tree. At about 65 feet I shouted for her to drop the weight over a crotch. Down it came beautifully.

With the mission accomplished, she then stretched out on a branch, her great tail flicking this way and that, which it always

did when she was thinking deep thoughts. "You know, Mister," her voice drifted down, "it was a mistake eating that bird."

"Yes, I know. It was very naughty."

"Oh, I don't mean that. It's given me a wicked stomach ache. It's been a lousy day, with awful TV programs. That yellow bird — canary you call it? — was the catalyst that's brought on one of my dizzy spells."

This was alarming. "Just hold on tight," I called, "until it passes. You'll be all right. Take a cat nap or something."

"My middle, with that miserable canary in it, is supported between my front and hind legs in catenary suspension." Her voice was growing weaker. "You get it, Mister?"

In the instant I was mulling that one over, there came a screech from on high — and down came Aunt Henna tumbling through the spring foliage. She hit with an enormous thump and lay still. I rushed over and bent down.

She opened one eye and murmured, "This is the end, a cataclysm!"

"Oh, no, Aunt Henna. I'll get you down to Dr. Bingleflick — he'll fix you up."

"He's for humans — not a cat doctor."

"Veterinarian, please," I corrected. "But since you are almost human . . ."

"Thanks a lot," she said, now back on three of her feet, tail twitching violently — and a ground dragging droop in her middle.

We stopped off in the garage so I could brace myself slightly. Two or three good slugs of vodka seemed in order. Noting her gleaming eyes, both of them now back on duty, I held out the bottle. "Like some?" I asked.

"Just a touch," she replied. "I found where your Amie hid the key to your main grog supply."

"And that was?"

"In the ashes of her cremated Uncle Jake's urn, which she keeps on the top shelf with her hats in your closet."

From her rambling comments, it developed that Aunt Henna had been nipping on the main supply for some time. The afternoon's exploits, including demolition of the canary and plunge from the willow tree, related to an over abundance of cat nips. She was now wabbling and weaving

around some paint cans. "Are we going to Dr. Flickbingle's?" she asked. Her eyes were slightly crossed, or perhaps I was looking in my workbench mirror at the moment.

It suddenly occurred to me that Amie had the car. Here we were in the garage and it definitely was not around. "If you don't mind," I apologized, "we'll take Amie's bicycle — OK?"

Aunt Henna jumped into the basket. "You better open the door as a precaution for a dignified exit. Your Amie won't like it if you bang up her bike."

It was easy to ignore such flippant remarks, considering their source. I couldn't help admiring the old cat, as she stood proudly in the front basket, her feet slipping through this way and that as she lurched around for a footing.

"Let us be off," she ordered.

Dr. Bingleflick's office was on the other side of the town, close to the airport, which we would pass on our way. For some odd reason, the road had become very unsteady, like a rippling, waving ribbon, hardly suitable for bicycling.

Anyhow, as we came abreast of the airport, Aunt Henna let out another great screech, pointing with her bad foot at a huge four-engined jet that was parked close by.

Slamming on the brake, I nearly went over the handlebars. "What in the world is the trouble?"

"That's the fantastic plane they were telling us about on TV! It can take off straight up."

"So-o what?"

"So — this I've got to see closer. Please, can we go in?"

Aunt Henna had a most persuasive way about her. After all, why not humor her? It was a lovely spring afternoon. We were in no hurry, at least I wasn't.

Jumping from her basket, she was up on top of the Cyclone fence in a flash, her tail swishing around like a kid's pinwheel. "Hey,

look at that guy," she yelled. "What's he doing? I smell birds!"

A sort of grid-platform stepladder was in place at the front of the outboard jet engine on our side. A mechanic with a big mesh screen in his hands was descending the ladder. In the screen were what seemed to be a mess of ducks, starlings, geese, or what have you — mostly mushy looking stuff.

"Looks like those birds weren't so smart tangling with that big job," I offered.

"Yeah," said Aunt Henna. "This I must see." With that she jumped down and in a graceful arc of motion was up on the platform stepladder.

By this time, the mechanic was trundling his screen full of crunched birds toward the

hangar. He paused for an instant, looking up at an engineer gazing from the pilot's window. "OK — Jack, blow her and you'll clear the rest of the trash."

Here's to a cat

Who ate a fat bird

In a similar vein

Which one was

Named Aunt Henna

For her denner

She was et by a plane

The wickeder sinner?

An accelerating whirl of enormous noise screamed into being as the engine started up. Aunt Henna was on top of the ladder, clutching with all three feet and part of the other one. For a second or two she managed to hang on — but there was nothing to get her claws in. Then she departed into the engine with tremendous velocity, a blurred flash of fur. She had simply vanished in the gigantic suction.

The speed of it all was shocking. It took me some moments to get hold of things. Then, pedalling slowly homeward, it all seemed rather just retribution. Cat eats bird — airplane eats cat. . .

Certainly there was no need to tell Dr. Bingleflick any of this. There was no proof. Nothing. He would surely have good reason to have me put under observation. As for Amie, she wouldn't believe anything anyhow. There was only one answer! Tell Wayne Green . . . He wouldn't dare print it in 73 . . . The boys would be sure *he* was nuts . . . 'By, now.

. . .W1BNN

CRYSTALS are OLD FASHIONED

*Now in stock
The latest synthesized rigs available.*



ICOM 230 146-148
FM

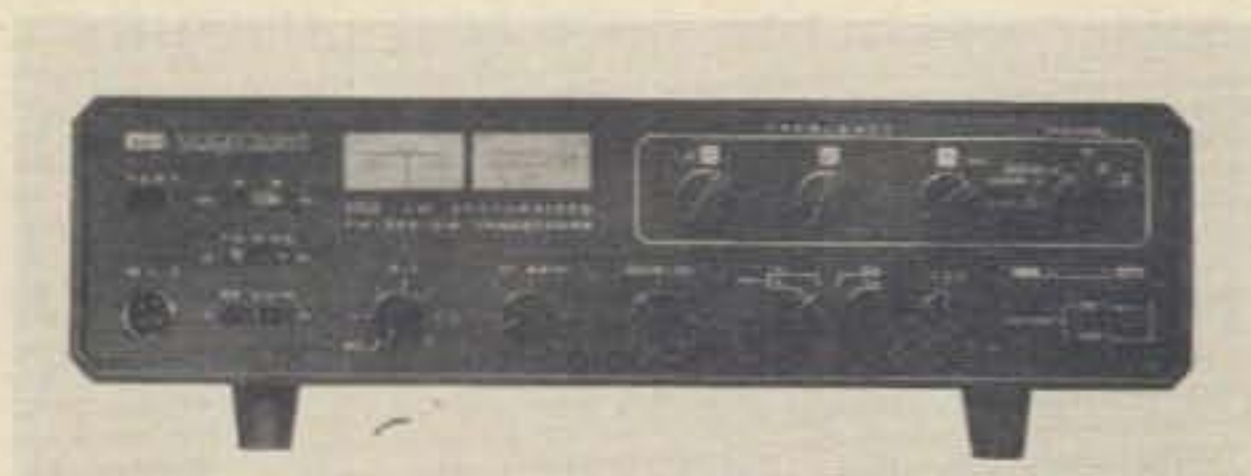

ITC Multi-2000 144-148
FM-CW-SSB

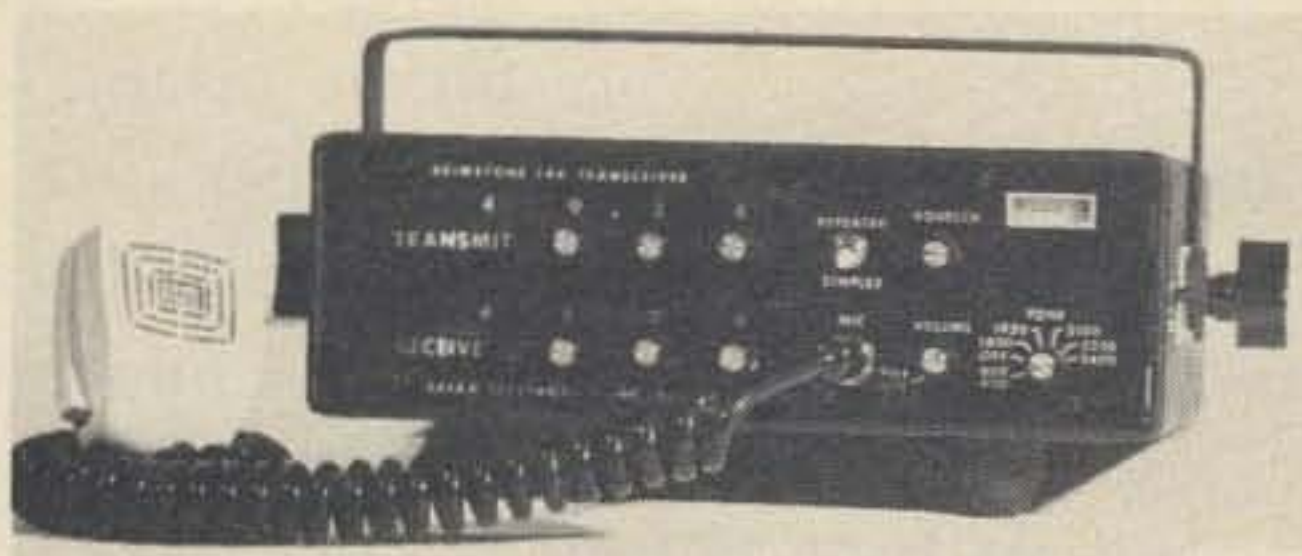

Brimstone 144 142-149
FM



EBC 144 Jr. 143.5-148.5
FM with priority



ICOM 21-A 146-148
ICOM DV-21

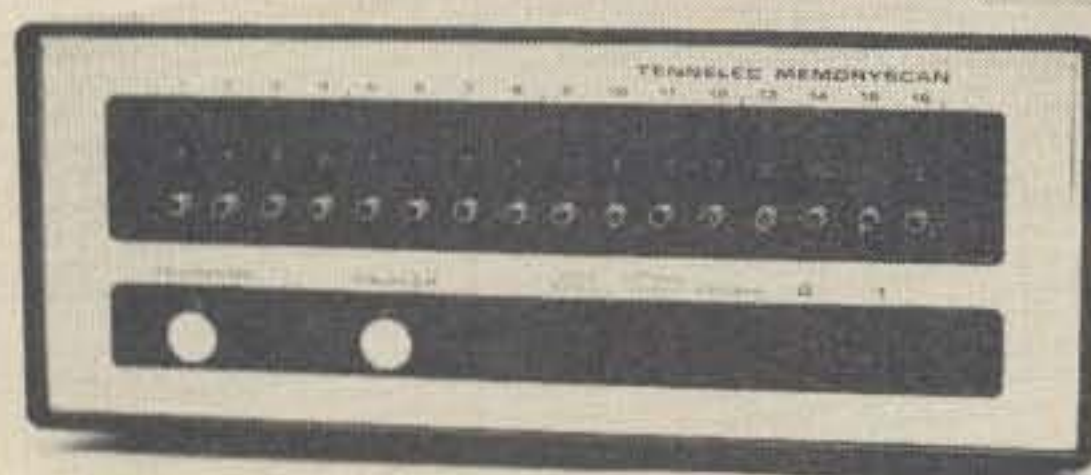

Tennelec Memory Scanner 30-50 146-170
450-510 MHz

AUDIO LAND is now offering high trade-in prices for your used equipment. Write for trade-in prices and price quotes. Now in stock – CUSHCRAFT – REGENCY – SBE – HAL COMMUNICATIONS – NEWTRONICS – HY GAIN – AMPHENOL – TURNER – E.V. – SHURE – STANDARD – TEMPO. 3000 xtals for most rigs. Rotors and cables. Stereo and Quad equipment – and much more. N.P.C. regulated power supplies. All major charge cards accepted. Several finance plans available. Write for our latest trade-in listing.

OUR HAMS SERVE YOU!

Sales: Earl K8BHP – Chris WB8OHK – Dave WB8TOB

Service: Jerry WB8OHJ – Jerry K8IDE

Audioland

36633 S. Gratiot
Mt. Clemens, Michigan 48043
(313) 791-1400

Copper Rip - Off

After a recent move, as often happens, an urgent construction project came up before some of my tons of boxed junk had been unpacked. A PC board was needed. My plastic bottle of ferric chloride was nowhere to be found.

I needed to whomp up a mixer board and did not want to use a perforated breadboard. As is true with most mixers, I needed all the shielding I could get. About ten years ago I saw a board for an emitter follower that someone at the Navy Research Lab had made by cutting the foil rather than etching it. My rat's nest memory said, "Try it."

An ideal method is to use a hand-held

high speed rotary drill with a burr bit. Not having one, I used an ole faithful 1/4" drill, with a small rotary saw blade. The results, as pictured, are in the "worst possible case" category, but the technique worked. The mixer was built and was successful.

Also pictured is a more civilized, carefully made, professional looking example of mechanical removal of copper clad.

The point is, however, that you can prepare a PC board mechanically, whether by sawing, reaming, burring or using an Exacto knife, rather than by chemical etching, if it becomes necessary to do so.

... W7SHY/6

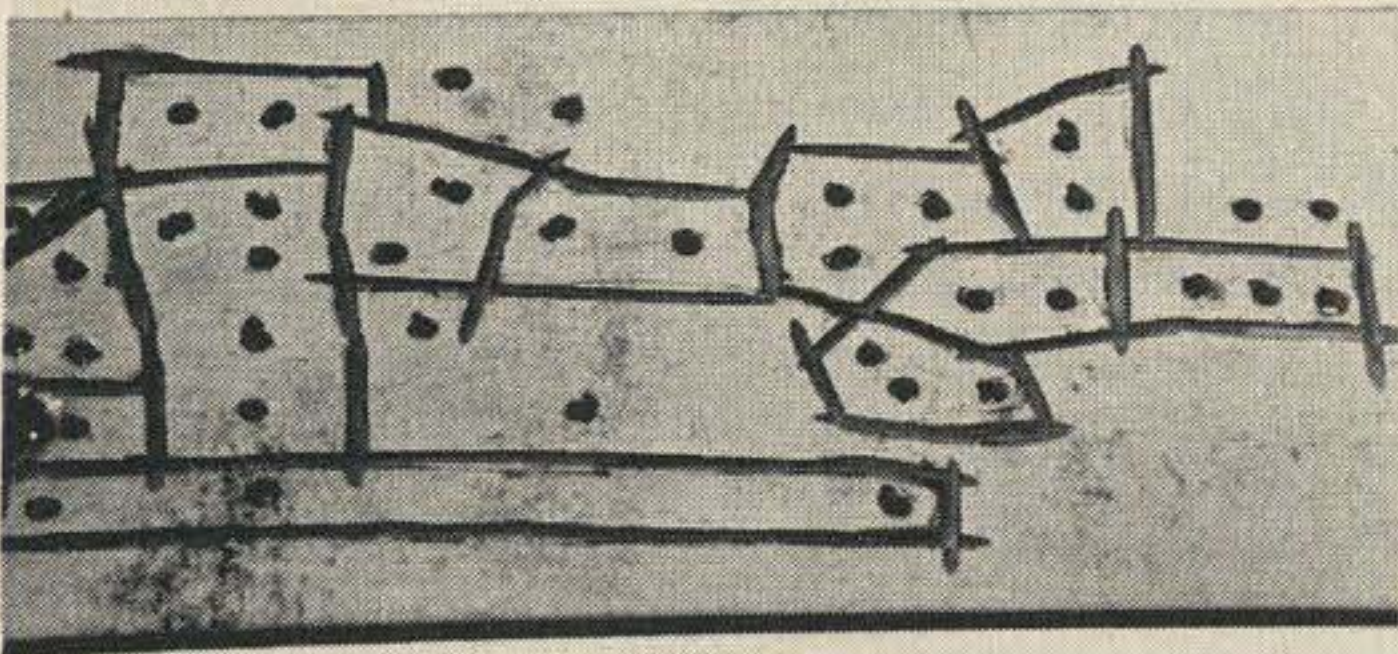

The "worst possible case" category, done with a rotary saw blade.

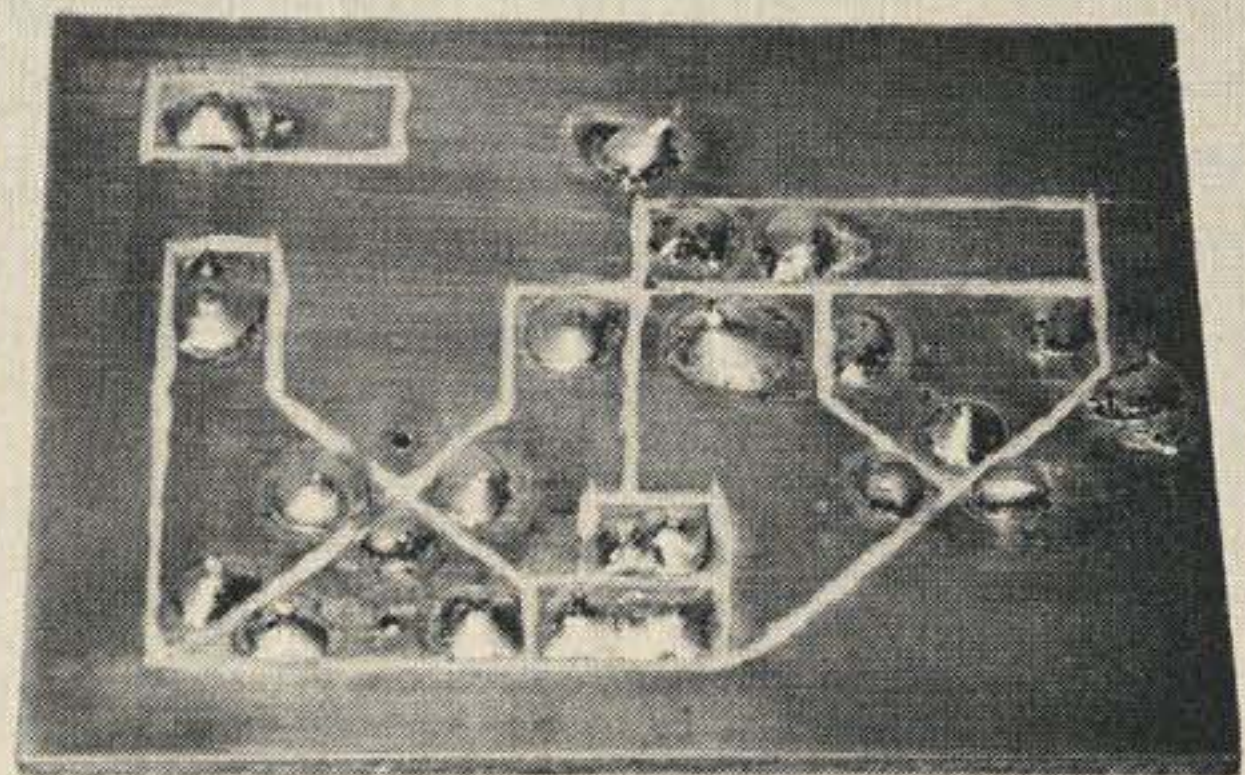

A more professional looking example of mechanical removal.

Dave Ingram K4TWJ
Rte. 11, Box 499
Eastwood Vil. #604 N.
Birmingham AL 35210

Better Results from those Sweep Tubes

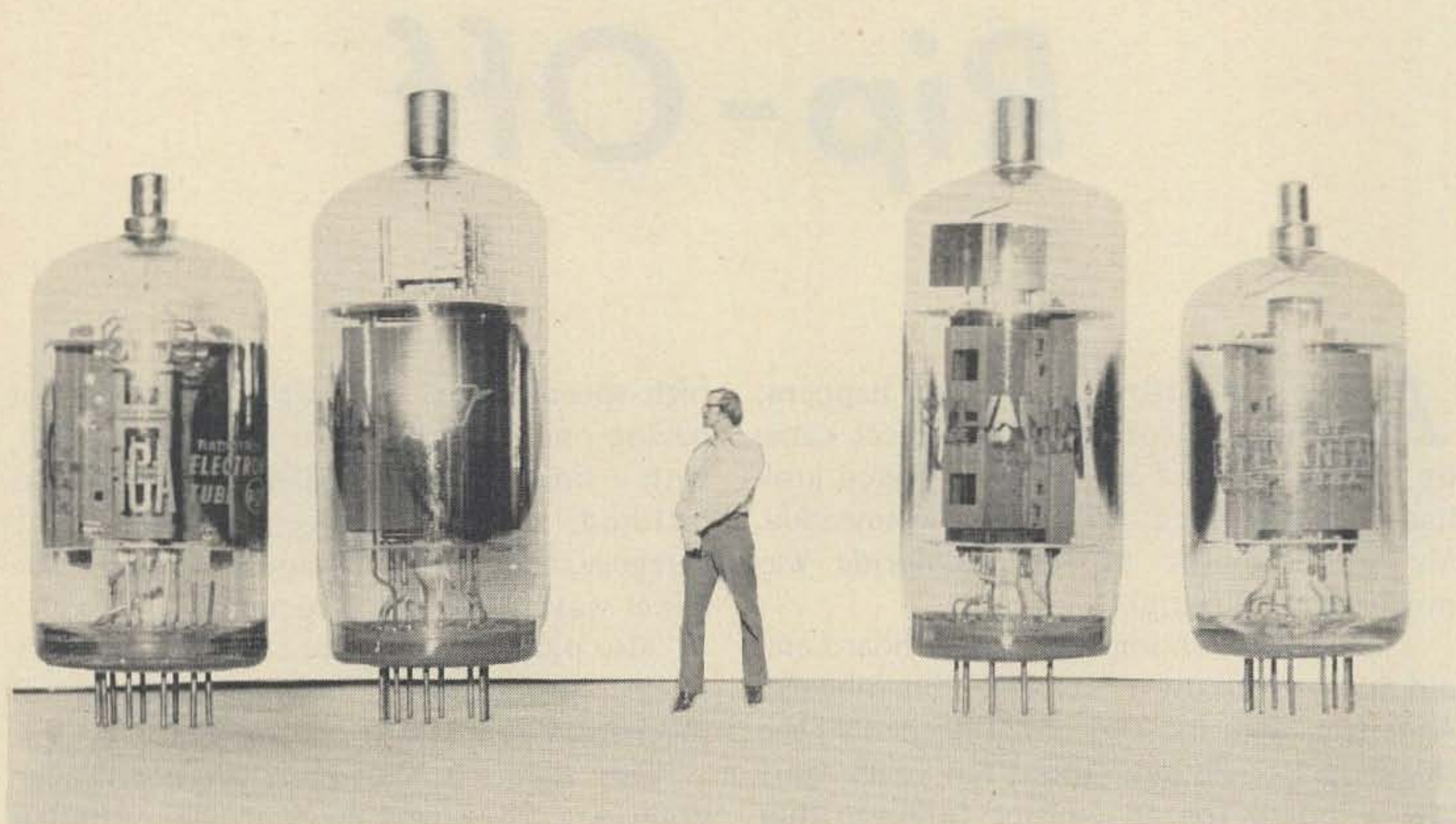

Sweep tubes have come of age, and are appearing in more and more ham transmitting gear. The first group of sweep tubes to appear in transceivers, 6GE5s, 6GJ5s, 6JB6's, etc., were of the 200-300 W class. Soon their "big brothers," like the 6JE6s, 6LQ6s, etc., became more prevalent, running a solid half gallon. Now, these tubes are finding their way into many linears, both commercial and home brewed. Sweep tubes are very popular because they are quite efficient and relatively inexpensive.

Listed herein are some tips which I have found that will help assure longer life and improved efficiency from these "little bottles."

A fan is the most worthwhile investment you can make, since most rigs restrict the air

flow around the final amplifier to a marked degree. Heat is the main killer of not just sweep tubes, but all tubes. A small fan blowing across the final is better than no fan, and it can be mounted to the side of the final or even placed on the desk beside the rig. However, a fan above the final pulling the air up is preferred.

It's best to mount the fan directly over the final amplifier compartment. Vibration can be reduced by the use of felt pads under the mounting bracket(s). I have found this to extend tube life and efficiency to a marked degree. Needless to say, this is practically a necessity with the 500 W transceivers, or high power linears.

A choice fan for this application is the fan manufactured by Rotron and Delwin, like the whisper, muffin and skeleton fan; they are quiet and they move plenty of air.

Photo by Don Langston WB4JVY.

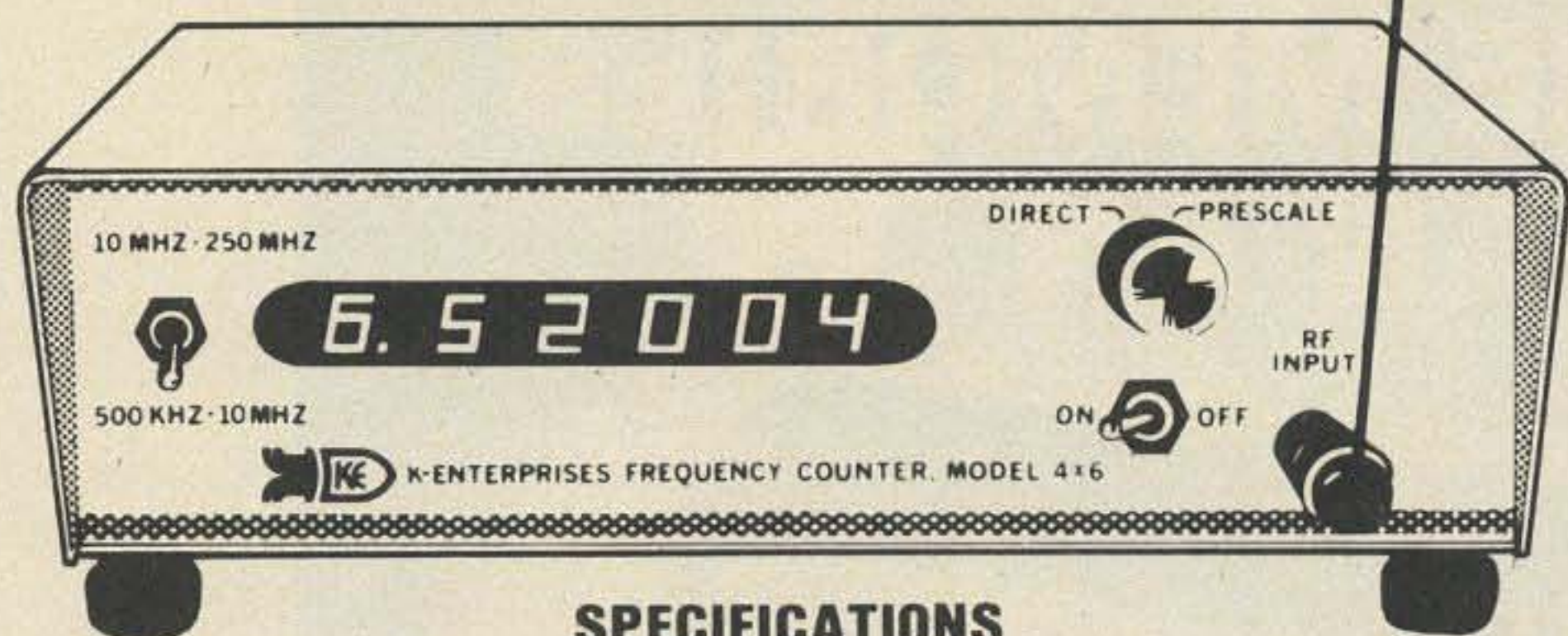

SPECIFICATIONS

Frequency Range	500 KHz—250 Mhz
Sensitivity	Less than 80 mV at 150 Mhz
Input Z...(500 KHz to 10 Mhz)	1 Meg.
Input Z...(10 Mhz to 250 Mhz)	50 ohms
Max. Input Voltage	15 V rms, 50 V dc
Time Base	Crystal Clock plus-minus 10 ppm 0°C to 40°C ambient
Readout	6 Digit 7 Segment LED
Power	120 V ac
Dimensions	2 1/4" H, 10" L, 7" D
Cabinet	Light Blue



Model 4x6 250 Mhz FREQUENCY COUNTER

250 Mhz for \$1.00 per Mhz
Wired and Tested

\$250

Price FOB Shawnee, Okla.

Include \$2.50 for Postage
& Insurance

Model 4x6-C Wired &
Tested with Temperature
Compensated Oscillator &
Temperature Certification
furnished with coun-
ter....\$270.00.



K-ENTERPRISES 1401 E. Highland • Shawnee, Okla. 74801

When adding the fan, try one on the power supply also. Most transceiver supplies run pretty hot, especially the 500 W units. A fan will at least keep the transformers and diodes cool enough so you can touch them without second degree burns.

If you use a sweep tube linear, either commercial or home brew, try to use as low idling current (high bias) as practical — this extends life appreciably. One easy way to do this is to increase the bias until the output just starts to drop off using an swr bridge or watt meter for indication. (I assume the rig is already tuned and drive is applied as usual for full CW carrier). This bias setting is usually close to optimum and linearity is usually excellent.

Another method, when an output indicator is not on hand, is to increase the bias (from a very low value) while the tubes are idling with no drive until the plates cool from cherry red to a no-color condition. Usually the plates will show color (blood red) after a no-drive idling state for about 30 seconds when the idling current is too high (bias too low).

On CW use minimum drive; in fact, it's best to cut power (by inserting less carrier, not by loading rig lighter) to about one-half the sideband rating unless your keying is around 15-20 wpm and then only two-thirds the sideband rating would be the most practical value.

The swr is especially critical on CW and an swr of even 1.5:1 may cause these tubes to blush even more under key-down condition. It is also a good idea to note the exact dial settings of the loading and plate tuning on all bands to prevent an off resonance condition when tuning up. With a simple chart of all settings the plate need never come off resonance by more than 30 milliamperes. Tune-up time can be reduced further by the use of a scope or modulation indicator. A meter takes time to "settle," whereas a scope is accurate immediately.

So, there you have it. Try some of the ideas presented above and see if you're not happier with your sweep tube rig. I'm sure you will be pleasantly surprised.

... K4TWJ

MORE MEMORIES THAN AN



DOES ANY OTHER MORSE CODE KEYBOARD
HAVE ALL THESE FEATURES?

- ▣ Programmable Memory right on the Keyboard
- ▣ Running Memory lets you Type up to 72 Characters Ahead
- ▣ Variable Speed from 6 to 35 WPM
- ▣ Memory Overload Indicator (LED)
- ▣ 48 Hour Burn-In Prior to Shipment
- ▣ Space Bar is used for Word Spacing
- ▣ Computer Grade Switches and Keytops
- ▣ Cooling Fan to Assure Long Component Life
- ▣ 110 VAC Operated with Built-In Audio Monitor
- ▣ Double Sided-Plated Thru- G10 Glass Printed Circuit Board
- ▣ Black Naugahyde Finish on Metal Case with Walnut End Plates

ORDERING INFORMATION		
MODEL	PROGRAMMABLE MEMORY INCLUDED	PRICE
TS-172	One	\$369.95
TS-272	Two	\$389.95
TS-372	Three	\$409.95
TS-472	Four	\$429.95
TS-572	Five	\$449.95
TS-672	Six	\$469.95



TELSTAR ENTERPRISES
P. O. Box 235
Spokane, Washington 99215

Enclosed is \$ _____

Charge Master Charge # _____

Charge BankAmericard # _____

Send Free Brochure

Call Letters _____

Name _____

Address _____

City/State/Zip _____

The Best Logic Yet

When I first got into amateur radio just about three years ago, I had a little understanding of the way tubes worked. I decided that if I built anything for the shack it would be with tubes — and that I would just buy anything that had to use that mysterious solid state.

This decision did not last for long, however. I just don't like having to buy everything, since I'm really a builder at heart. So all that was left for me to do was start learning about solid state. I started building some projects from the pages of "73" and some other magazines — some worked and some didn't. When they didn't, I was usually lost as to why.

Then I found that the projects that used what was called TTL logic usually worked the first time and that when they didn't I could usually find out why. Over a period of a few months I had formulated a list of fundamentals that almost assured that the projects would work.

Presented here are some of those fundamentals from my notes. If you use them as a guide line I know you can do as well or probably better at TTL projects than I have.

FIRST: The power supply for TTL is one critical spot. The absolute maximum voltage for most of the TTL ICs is 7 volts, with 5 volts being normal. *Stay within 4.5 and 5.5 volts.*

SECOND: Find the output pins, and *do not connect two outputs together.*

THIRD: If you use the 5 volts from the power supply for an input signal on an input pin or for any reason put the 5 volts from the power supply to an output pin without a load, *connect a resistor in series* (any size from 100 Ohms to 10k Ohms will work in most cases).

If you follow these first three design rules you will find that it is almost impossible to damage the ICs and you can now experiment with them all that you want to.

Now that we are not going to send the IC up in smoke, let's see what we will find inside some of them and how we can put them to work for us.

The first one to look at, which is the simplest of all, is the buffer. With the buffer the output is the same as the input. It is used to isolate the input circuit from the output and also to drive more circuits than your input signal may be able to. The logic symbol for a buffer is shown in Fig. 1.

With the buffer, if we put "0" volts or ground on the input, the output will be "0" volts. If we put 5 volts (often referred to as logic 1) on the input, the output will be 5 volts (logic 1). See Fig. 2.

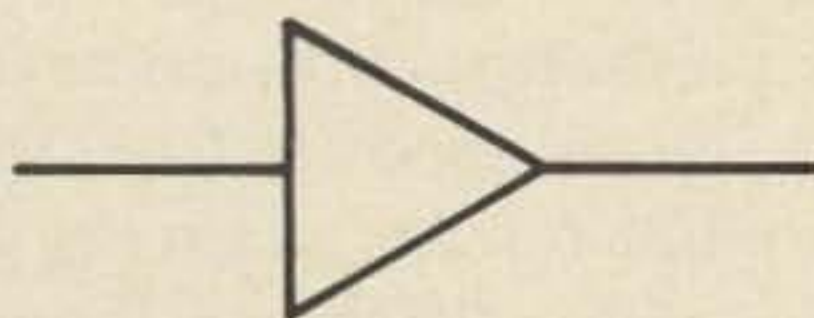

Fig. 1.

You will notice that the input is a square type wave; this is the type of input that digital circuits need to work properly. There are input circuits that will let us use sine wave inputs and some special ICs which are designed for a sine wave input, but for now we will stay with the square type input.

One digital IC which uses the buffer is the 7407 hex buffers/drivers. This chip has six buffers on the one IC. Each buffer can be used separately. (The layout of the chip is shown in Fig. 3.)

Note that +5 volts goes to pin 14 and that ground is on pin 7. This supplies power for operation of all six buffers. With an input on pin 1 you get an output on pin 2, while an input on pin 3 will give you an output on pin 4, input on 5 for output on 6, input 9 for output on 8, etc.

One thing that works out nice for testing

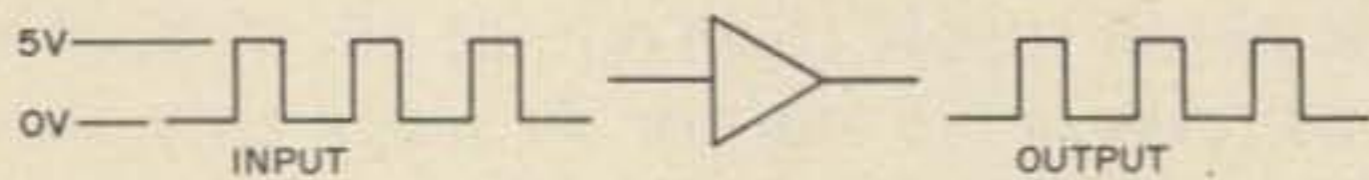

Fig. 2.

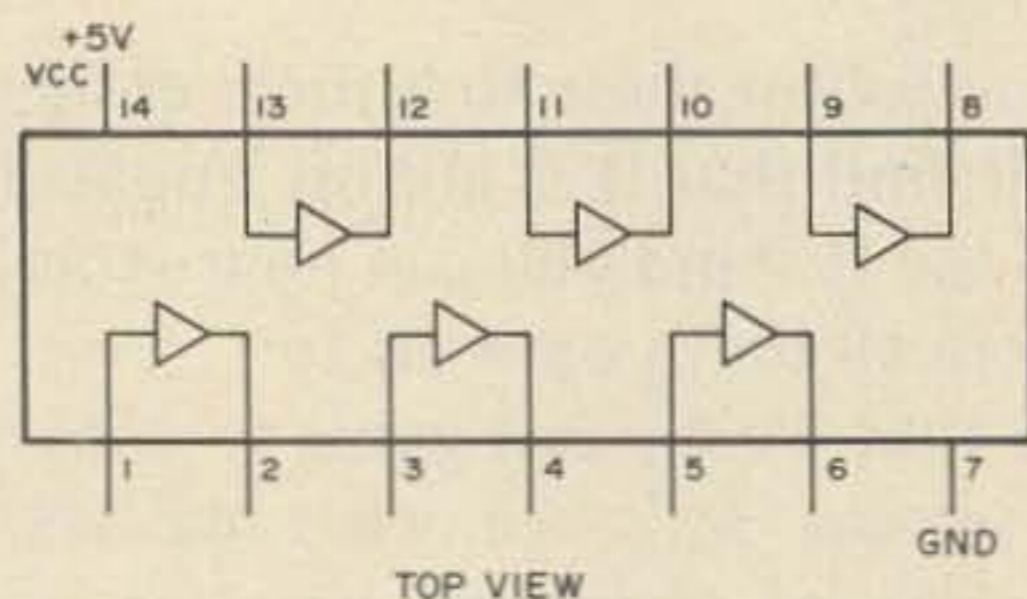

Fig. 3.

is that if an input is not connected to anything (is floating), the IC sees it as logic 1 (5 volts) and the output goes to 5 volts. If the input is grounded (logic 0) the output goes to 0 volts. You can test a chip by watching the output on a voltmeter as you ground and unground an input.

FOURTH: Consider a "Floating" input as logic 1.

If an input is to be at 0 volts make sure that it is connected to ground.

The next "gate" to look at and experiment with a little is the inverter. It is almost the same as the buffer, with one exception: its output is always opposite from the input. The logic symbol for an inverter is shown in Fig. 4. (The only difference between the symbol of an inverter and the symbol for a buffer is the small circle at the output.)

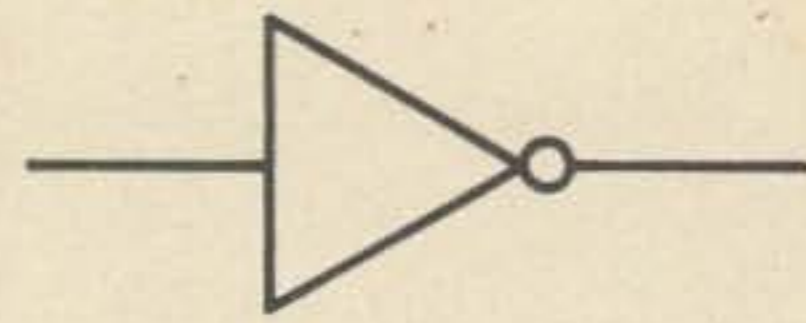

Fig. 4.

With the inverter, 0 volts or ground on the input will give you 5 volts (logic 1) on the output, and 5 volts on the input (or a floating input) will give you 0 volts on the output. See Fig. 5.

One digital IC which uses the inverter is the 7404 hex inverter. This chip has six inverters on the one IC. Each inverter can be used separately. The layout of the chip is shown in Fig. 6.

Note that on the 7404, +5 volts is on pin 14 and that ground goes to pin 7. This supplies the power for operation of all inverters. With an input on pin 1 you get your output on pin 2, while an input on pin 3 will give you an output on pin 4, etc.

It is possible to use an inverter as a buffer by putting two gates in series. As an example using the 7404, you could connect pins 2 and 3 together, place your input on pin 1 and take the output from pin 4. The output now will be the same as the input just like with the buffer. See Fig. 7.

One other thing that you may want to keep in mind about the inverter is its other name: the "NOT" gate. This comes from the fact that its output is NOT the same as its input. But whether you call it an inverter or you call it a "NOT" gate, it is the same thing with the same symbol.

Another gate that you will find in the logic family is the "AND" gate. It is similar to the buffer, the only difference being that it has more than one input. The logic symbol for an "AND" gate is shown in Fig. 8.

With the "AND" gate, both inputs must be at logic 1 (5 volts) before the output will be logic 1. This is where the gate gets its name: input 1 AND input 2 must both be 1 (5 volts) to get a 1 for an output. See Fig. 9.

The "AND" gate can also be used as a buffer and there are two ways to do it. One

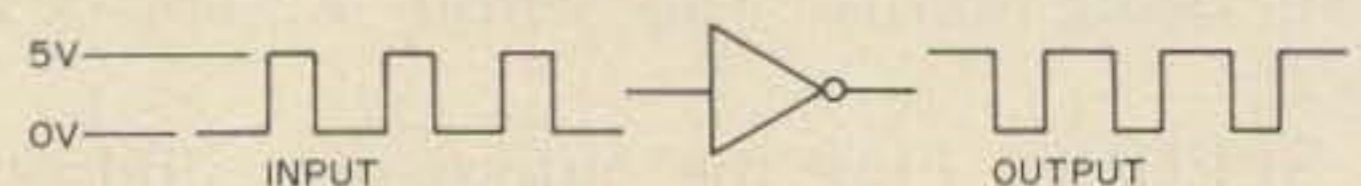

Fig. 5.

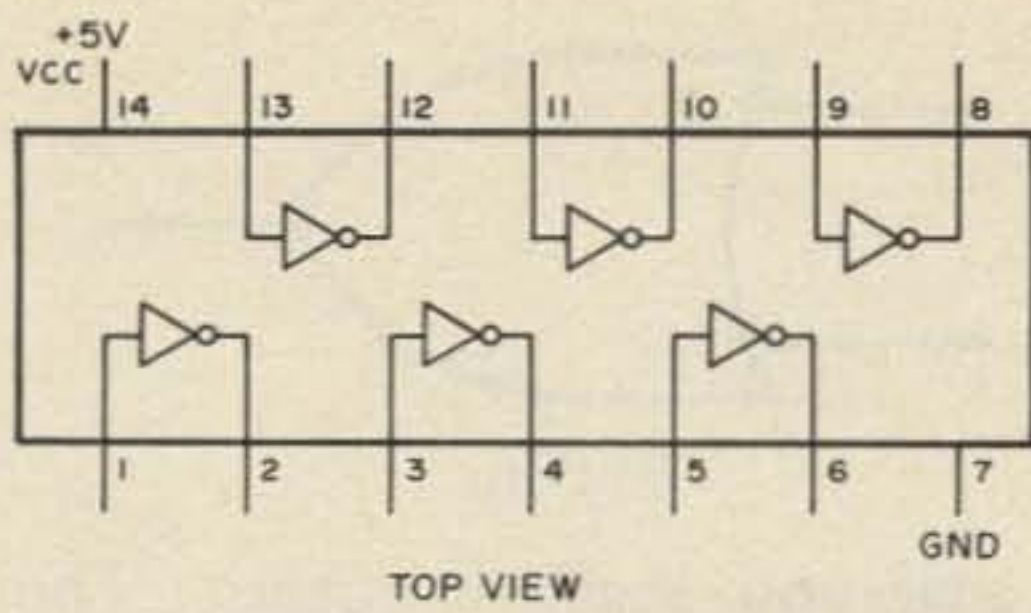

Fig. 6.

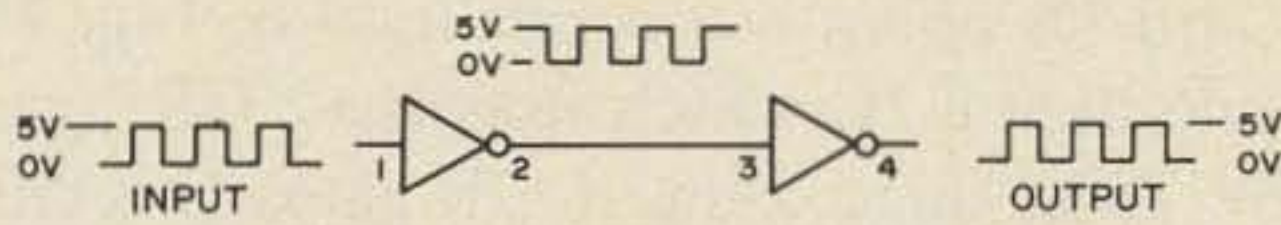

Fig. 7.

way is to put a constant 5 volts on one of the inputs and put your input signal on the other. (If you use this method use a resistor in series with the 5 volt power supply.) The other way is to connect the two inputs together and put your input signal into both at the same time. See Fig. 10.

One digital IC which uses the "AND" gate is the 7408 quad 2-input AND gate. This chip has 4 "AND" gates on one IC. Each gate can be used separately; the layout of the chip is shown in Fig. 11.

As with the other chips, the +5 volts is put on pin 14 and the ground is put to pin 7. Input 1 and input 2 go to output 3. Input 4 and input 5 go to output 6, etc.

In some circuits it is desirable to have the two inputs with the AND function, plus the signal inversion of the NOT gate (inverter). This is now easy to do by using the two gates together. See Fig. 12.

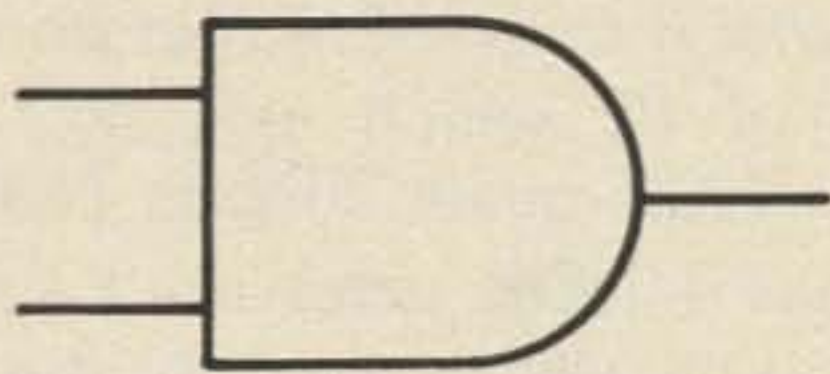

Fig. 8.

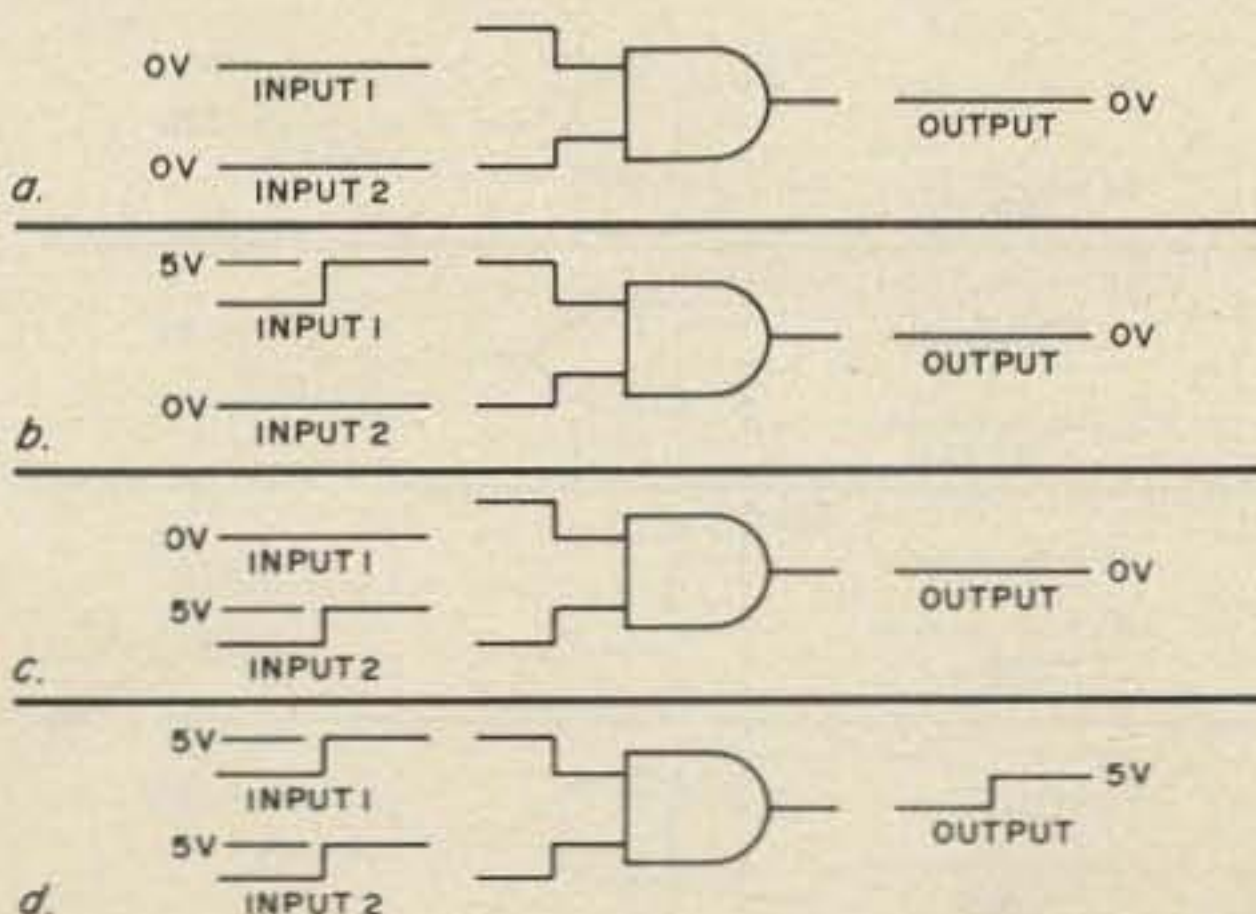

Fig. 9.

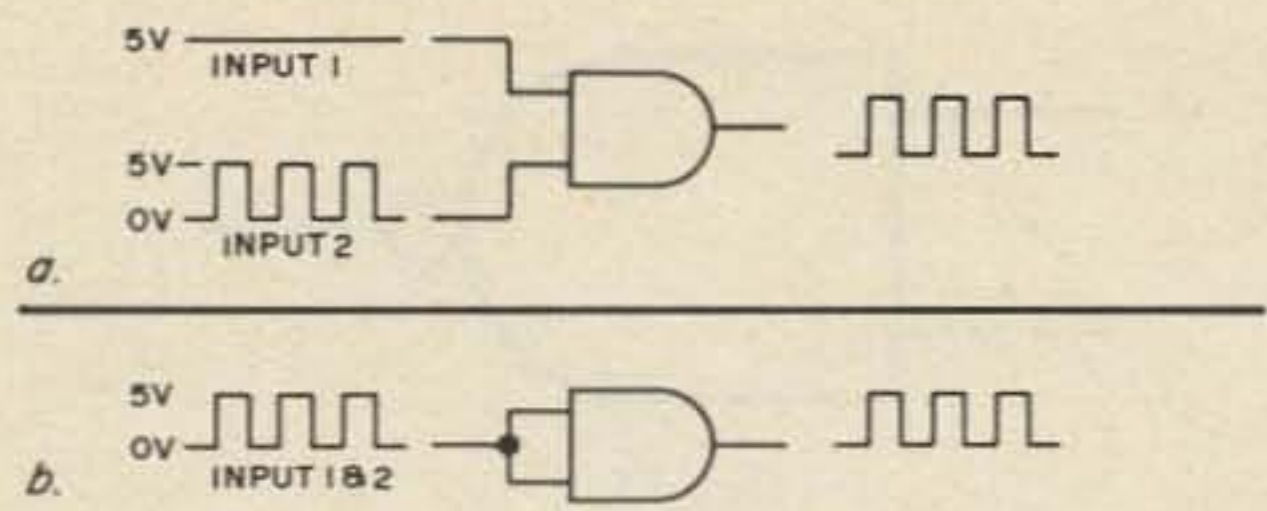

Fig. 10.

The use of the "NOT" and the "AND" gate together is a very common combination, so common in fact that it is considered as another gate called a "NOT-AND" gate or even more frequently a "NAND" gate. So remember, when you see "NAND", that it is just an "AND" gate followed by a "NOT" gate. These two gates are often combined on one chip as one gate and the symbol for the combination, the "NAND" gate, is shown in Fig. 13.

You will notice that the only difference in the symbol of the "NAND" and the symbol of the "AND" is the "o" at the output of the gate. In the use of logic symbols the "o" will indicate that the signal is inverted.

One digital IC which uses the "NAND" gate is the 7400 quad 2-input NAND gate. This chip has 4 "NAND" gates on the one IC. Each gate can be used separately; the layout of the chip is shown in Fig. 14.

As can be seen, +5 volts goes to pin 14 and ground goes to pin 7. Inputs 1 & 2 go to output 3, inputs 4 & 5 go to output 6, etc. The 7400 is one of the most widely used ICs of the TTL logic family, since it can be used as a buffer, as an inverter or "NOT" gate, as an "AND" gate, and as a "NAND" gate. Whatever the operation you have in mind, the 7400 can be made to work. Not bad for

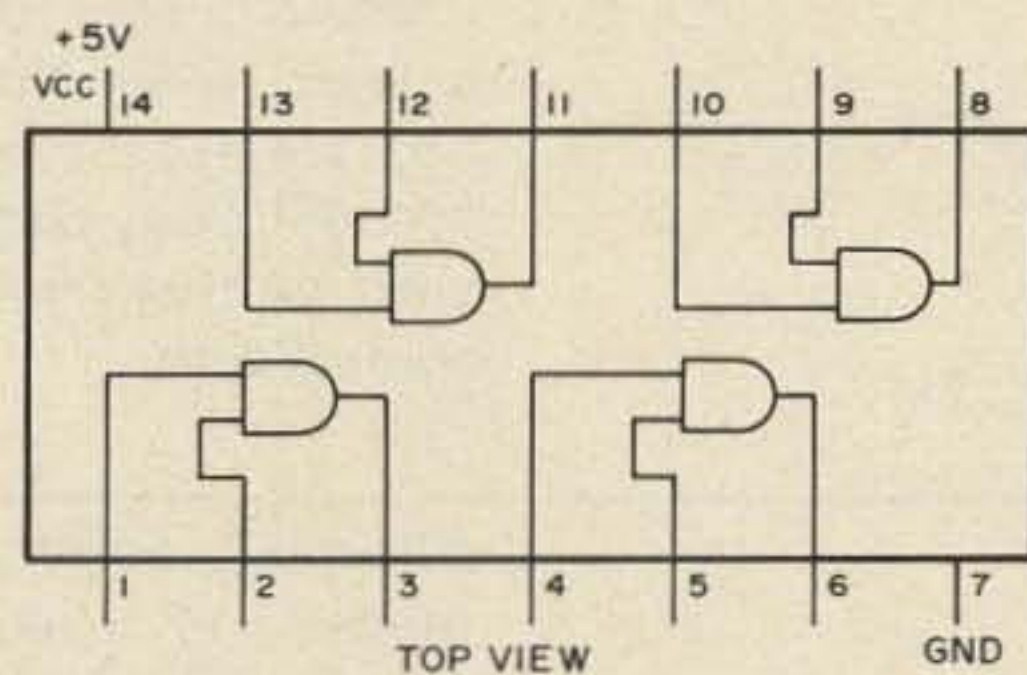

Fig. 11.

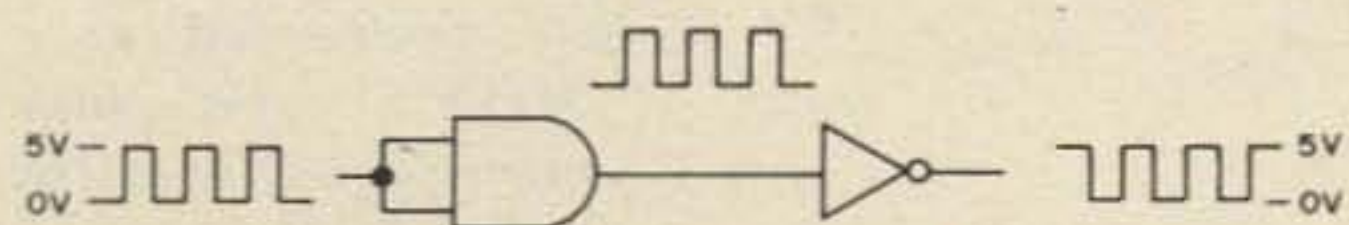

Fig. 12.

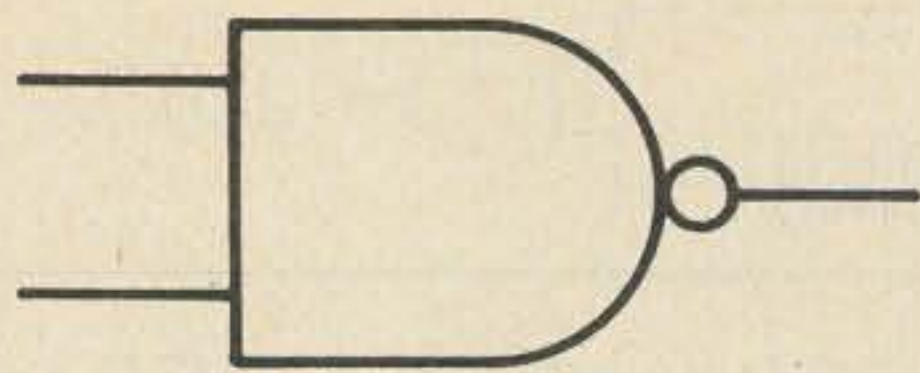

Fig. 13.

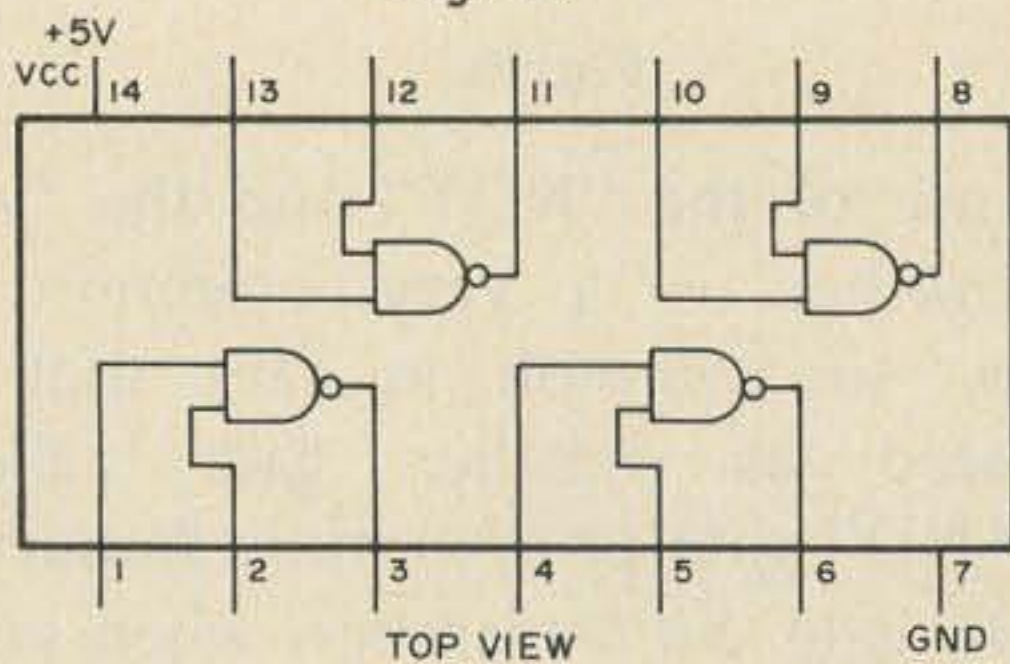
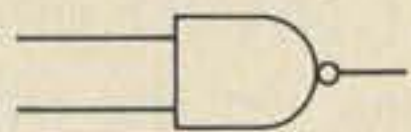

Fig. 14.

an IC that can be picked up for under a dollar. Fig. 15 shows how to connect it to work as the different gates.

Another type of gate that you may come across is what is known as an "OR" gate. It is similar to the "AND" gate with one exception: With the "AND" gate you had to have 5 volts (logic 1) on both inputs 1 and 2 to get logic 1 (5 volts) for an output. With the "OR" gate, a 5 volt input on input 1 or



"NAND" — Use each gate as is.

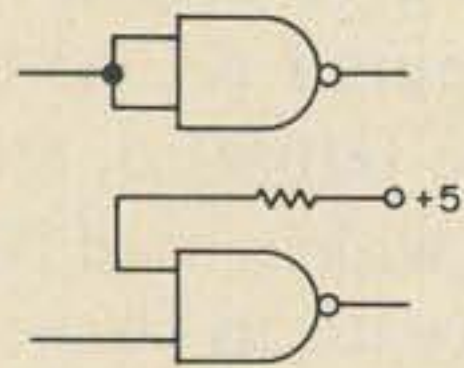

"Inverter" or "NOT" — Connect the two inputs together, or connect one input to +5 volts and use the other input for your signal.

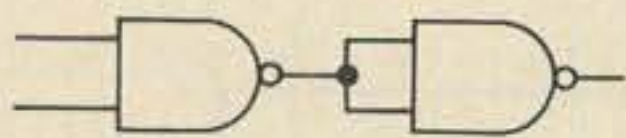

"AND" — Feed the output of one "NAND" gate into a second gate that is connected as a "NOT" gate, and take your output from the second gate.

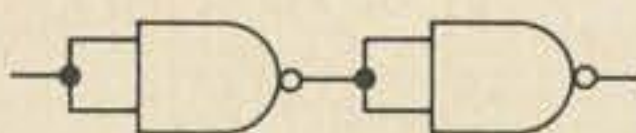

"Buffer" — Feed the output of one gate connected as a "NOT" into a second gate connected as a "NOT", and take your output from the second gate.

Fig. 15.

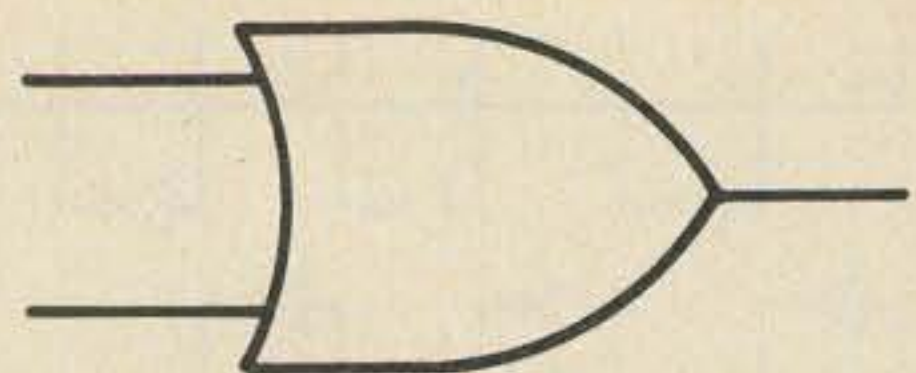

Fig. 16.

2 will give you logic 1 output. The logic symbol for an "OR" gate is shown in Fig. 16, and its operation is outlined in Fig. 17.

One digital IC which uses the "OR" gate is the 7432 quad 2-input OR gate. This chip has 4 "OR" gates on one IC. Each gate can be used separately; the layout of the chip is shown in Fig. 18.

As with the other ICs that we have looked at, the +5 is to pin 14 and ground is to pin 7. Inputs 1 and 2 go to output 3, inputs 4 and 5 go to output 6, etc.

In some circuits it is desirable to have the two inputs with the OR function, plus the signal inversion of the NOT gate (inverter). It is easy to use the two gates together as shown in Fig. 19.

The use of the NOT and the OR gate together is also a very common combination. The combination is usually considered as one gate called a NOT-OR gate or, more commonly, a "NOR" gate. The logic symbol of a "NOR" gate is shown in Fig. 20.

Note that the only difference in the symbol of a "NOR" gate and the symbol of an "OR" gate is that the "NOR" gate has a "o" at the output.

FIFTH: Consider a "o" at any chip to show the signal is inverted at that point.

One digital IC which uses the "NOR" gate is the 7402 quad 2-input NOR gate. This chip has 4 NOR gates on a single IC. Each gate can be used separately; the symbol for the chip is shown in Fig. 21. The +5 goes

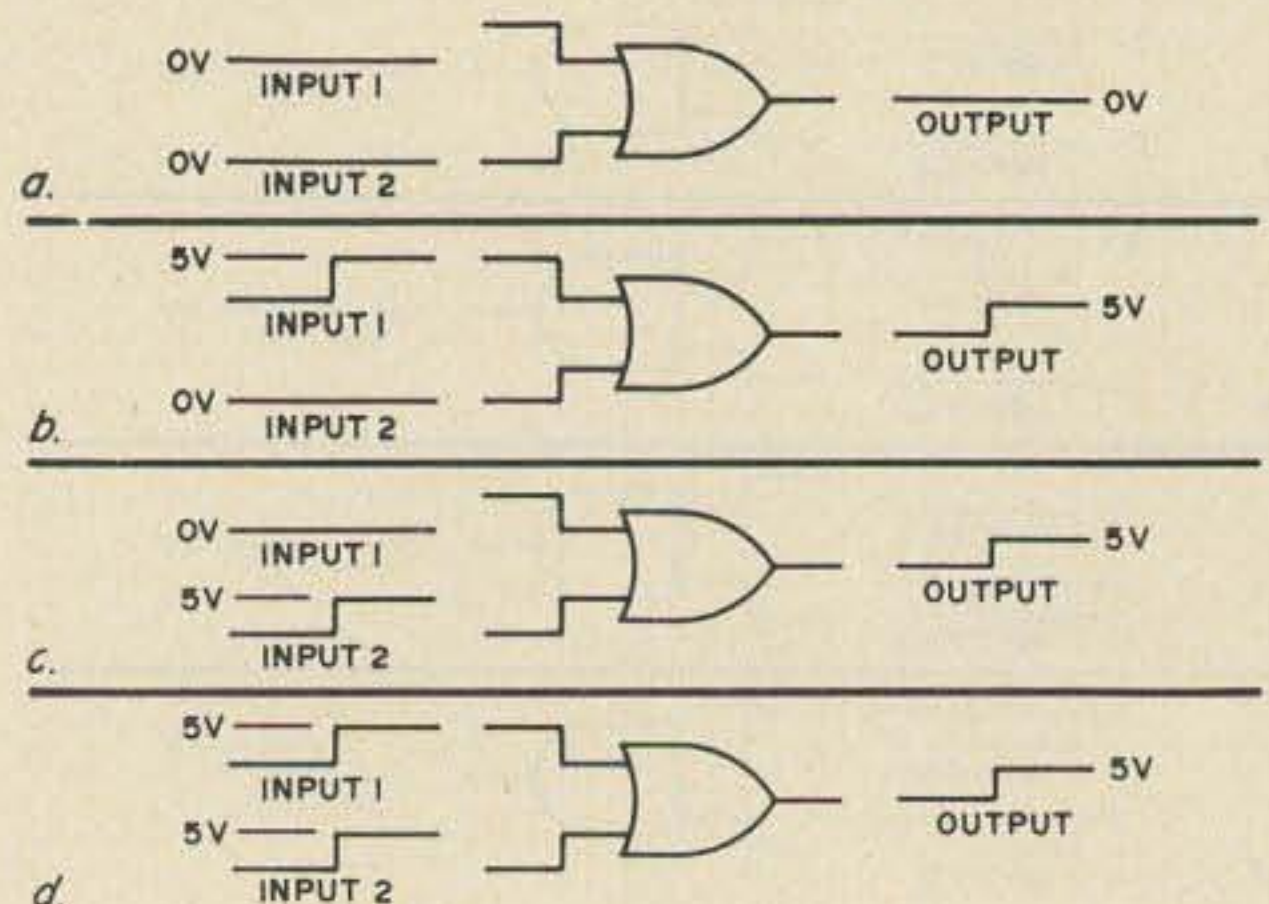

Fig. 17.

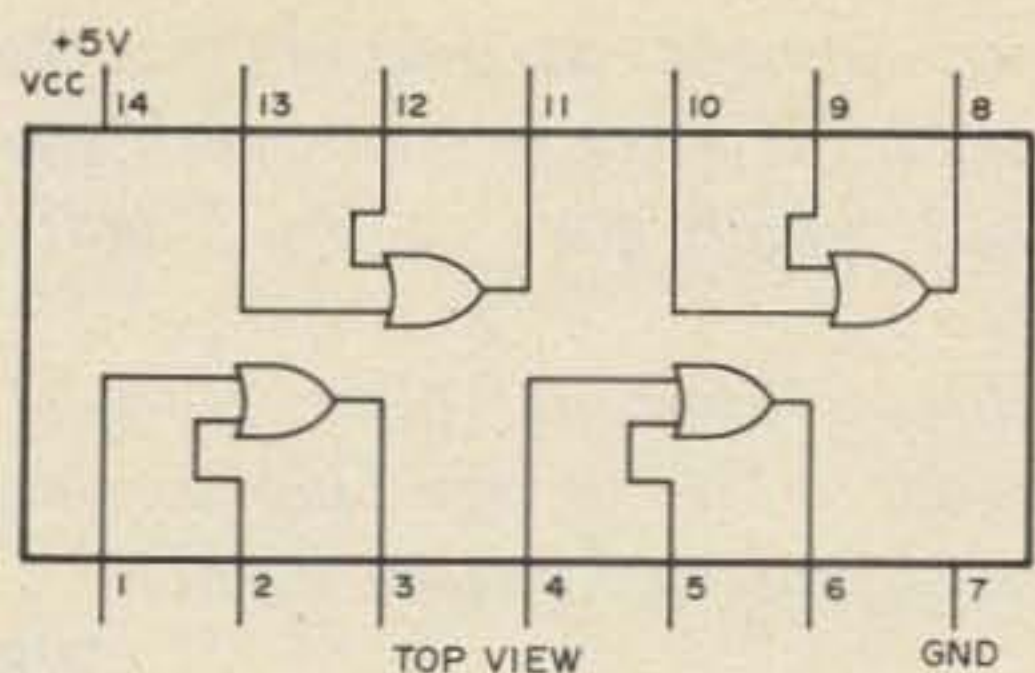

Fig. 18.

to pin 14, ground to pin 7, inputs 2 and 3 to output 1, inputs 5 and 6 to output 4, etc.

With this chip you can have the operation of a "NOR" gate, the operation of a "NOT" gate (inverter), the operation of an "OR" gate, and the operation of a "buffer". Fig. 22 shows the connections for the different gates.

Two other IC gates that you may run across are:

1) The 4-input "NAND". There is not much difference between a 4-input gate and the 2-input gate that we looked at before. With the 4-input "NAND" gate, all 4 inputs must be at 5 volts (logic 1) to get 0 volts at the output. If any input is ground (logic 0), the output will stay at 5 volts. See Fig. 23 for the logic symbol of the 4 input "NAND".

2) The 8-input "NAND". With this gate we find that all 8 inputs must be at logic 1 for the output to be at logic 0 (ground). If any of the inputs is at ground, the output will stay at logic 1 (5 volts). See Fig. 24 for the logic symbol of the 8-input "NAND".

I have not tried to show all of the ways that TTL logic can be used or all of the different types of gates that you may see from time to time. I have not included anything on flip flops, decade counters, or any of the more complex ICs, most of which would take an article the size of this one to discuss fully.

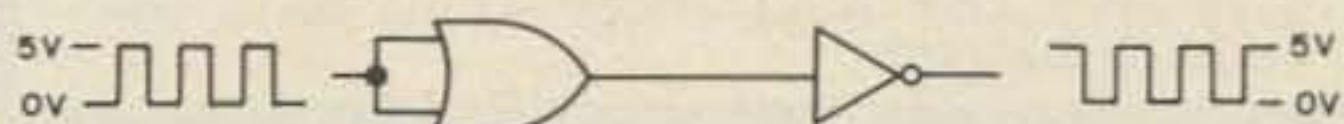

Fig. 19.

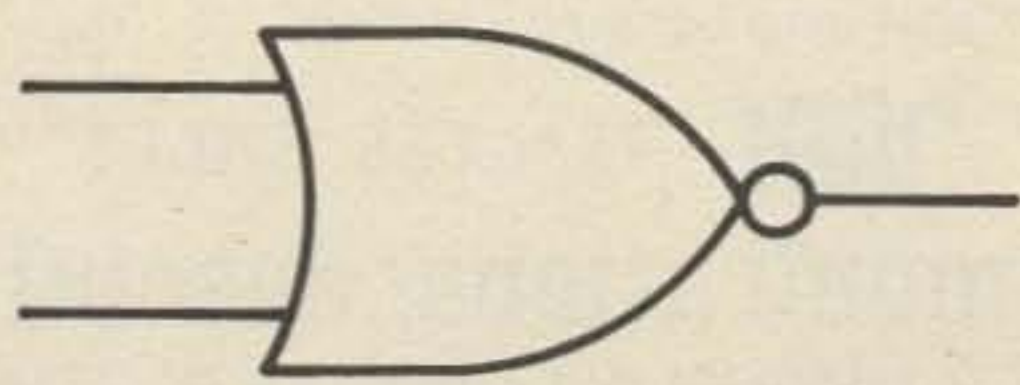

Fig. 20.

What I have tried to do is show some of the fundamental logic gates that make up most of the TTL logic circuits. If you have an understanding of the operation of the "buffer", the "inverter" (NOT) gate, the "AND" gate, the "NOT-AND" (NAND) gate, the "OR" gate and the "NOT-OR" (NOR) gate, you are ready to start building with TTL.

My suggestion now is to get a 5 volt power supply, and 2 or 3 7400s, and see just what they will do. Then pick a project from the pages of "73" Magazine, and try it. Don't be too surprised if it works the first

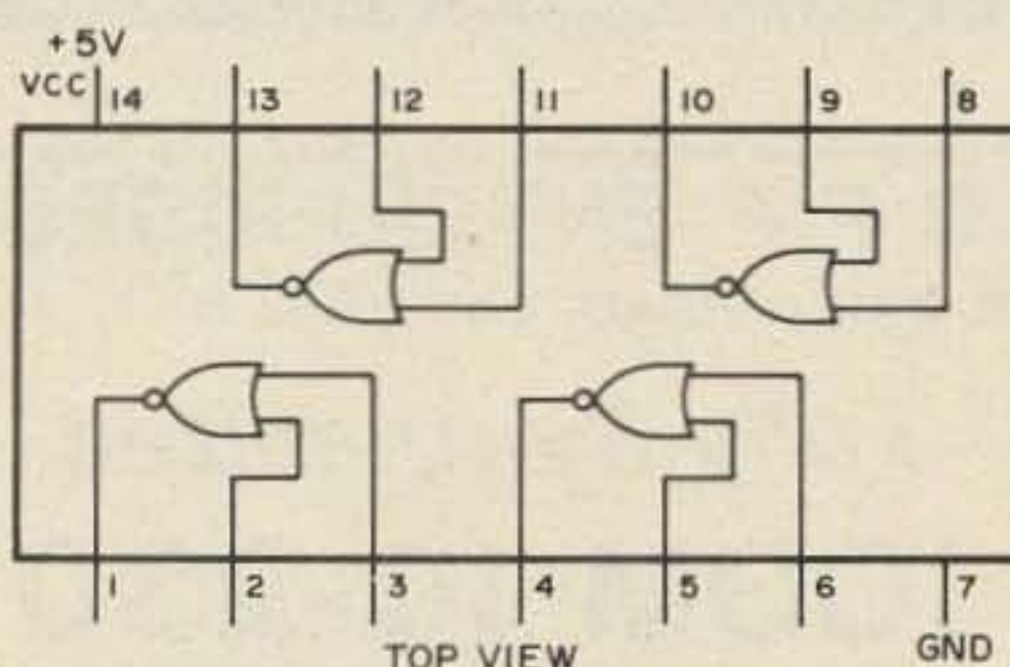
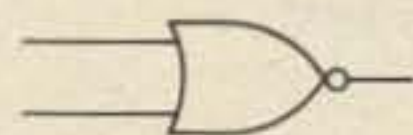

Fig. 21.



"NOR" — Use each gate as is.



"NOT" — Connect the two inputs together, or you can put one input to ground and use the other input.

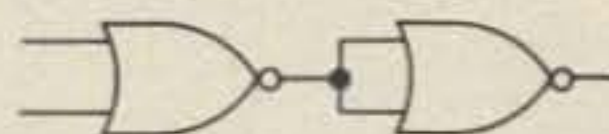
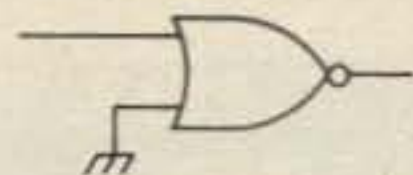

"OR" — Feed the output of one gate into a second gate that is connected as a "NOT" gate.

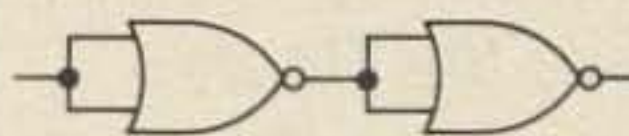

"Buffer" — Feed the output of one gate connected as a "NOT" into a second gate connected as a "NOT".

Fig. 22.

time the power is turned on. If it doesn't, look back over the fundamental gate operation and I'll bet you find out why in a very few minutes.

Above all, remember "Browning's Rules of Order":

1. Stay within 4.5 and 5.5 volts.

PL-259
SO-239
COAKIT

Either Plugs OR Sockets
5 for \$3.50
POST-PAID
N.J. residents add 18c Sales Tax
Send SASE for other Connectors.
P.O. Box 101-A, Dumont, N. J. 07628

CASHAROOONIE

Money! You can get top dollars now for U.S. surplus electronics, particularly Collins. Write or call now for your bigger than ever quote. Space Electronics Corp., 76 Brookside Ave., Upper Saddle River, N.J. 07458 (201) 327-7640.

C F P ENTERPRISES
866 RIDGE ROAD, LANSING, N. Y. 14882

Fully Synthesized
ICOM IC-230

The most wanted FM transceiver

- 67+ Channels (Direct or \pm 600 kHz)
- Full 146-148 MHz Coverage
- Digital Readout

\$489.00

You'll never have to buy another crystal
Write today for complete details & our best price

PARTS! CORNELL TUBES!

FREE Send For FREE
CORNELL'S
New Color
Catalog
48 Pgs. New Items

33¢ per tube
IN LOTS OF 100

36¢ per tube
ORDER FREE
IF NOT SHIPPED
IN 24 HOURS!

4215 S University Ave. San Diego, Calif. 92105

Rush \$1 for exciting Surplus and Factory Closeouts Catalog. Save Big Money.

ETCO Electronics

Dept 73 Box 741
Montreal, Quebec H3C 2V2 Canada

WANNA WORK MORE DX ?

Subscribe to THE WORLDS ONLY weekly DX Magazine. Strictly DX news in depth. I give you upcoming events, dates, times, freqs, DX QSL info, contest info, DX articles, etc. SUBSCRIBE NOW and WORK EM ALL ! DX NEWS GALORE ! \$ 6.00 for 6 mo. or \$ 12. per yr to W/K, VE, XE, First Class mail. THE DXERS MAGAZINE, (W4BPD), Drawer "DX", CORDOVA, S.C. 29039. DXING IS GREAT USING OUR INFO !

2. Do not connect two outputs together.
3. Connect a resistor in series with any input or output which goes to the 5 volt power supply.
4. Consider a "floating" input as logic 1.
5. Consider a "o" at any chip to show that the signal is inverted at that point.

... WBSIRY

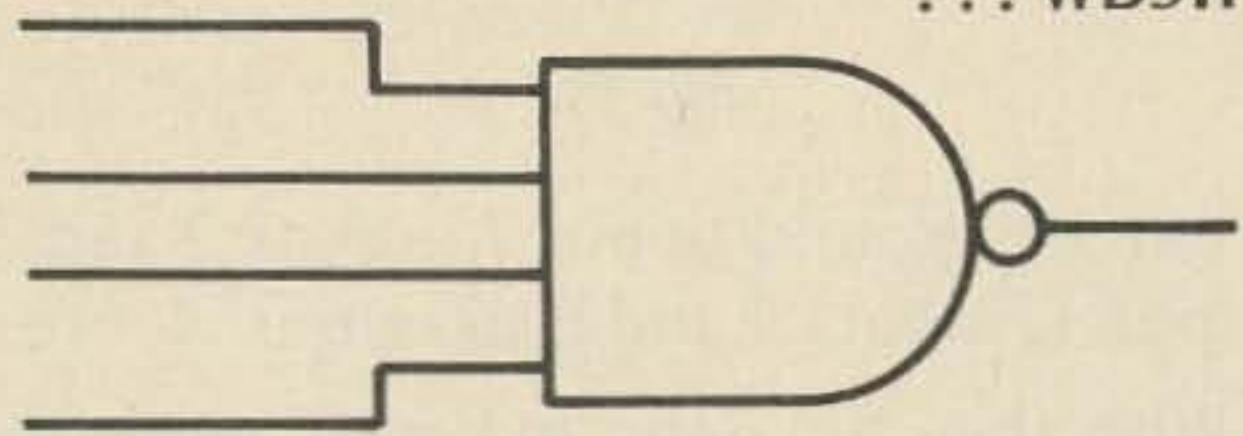

Fig. 23.

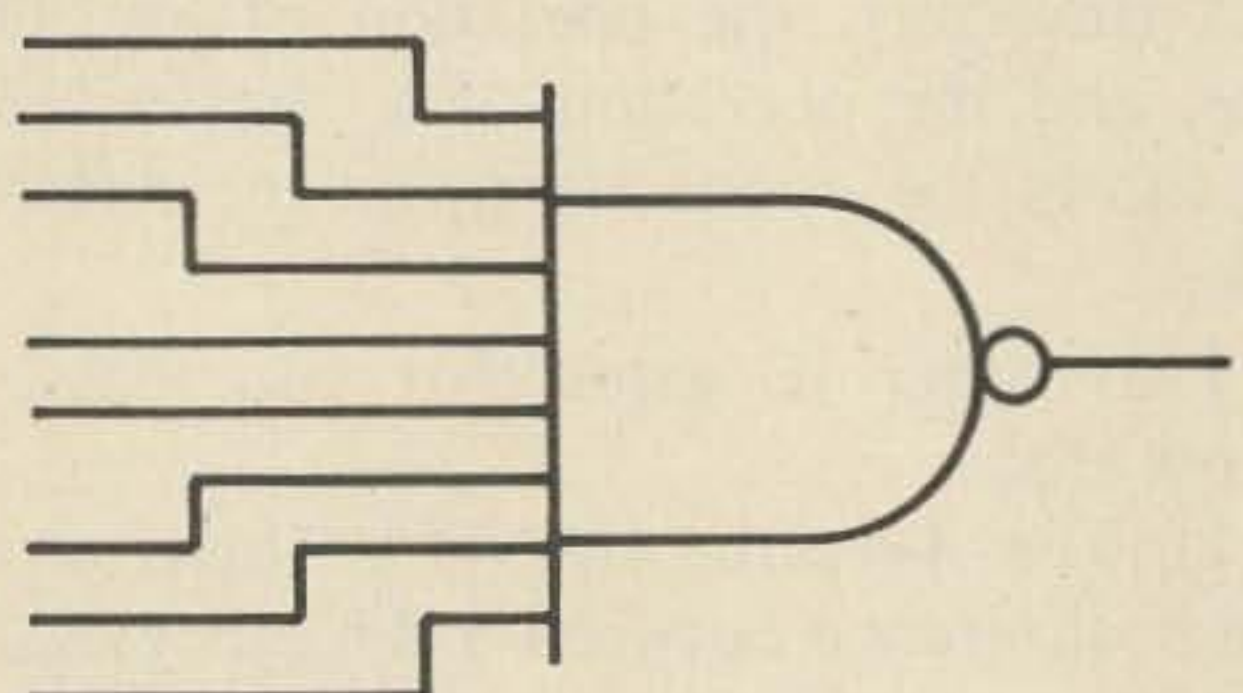

Fig. 24.

NEW MX1A NEW MX1A NEW

\$47.50 MINI-MIXER \$47.50

This is a plug in unit to replace the first mixer in Collins 75S-1-2-3. Designed to eliminate all but the strongest (next door) cross modulation in the S line. It uses the latest in FET design. If not satisfied, money refunded.

Designed Built Backed
by

ANTENNA MART
BOX 7 RIPPEY, IOWA 50235

WORLD QSL BUREAU

5200 Panama Ave., Richmond CA USA 94804

THE ONLY QSL BUREAU to handle all of your QSLs to anywhere; next door, the next state, the next county, the whole world. Just bundle them up (please arrange alphabetically) and send them to us with payment of 6¢ each.

*Touch pads and enclosures -
Novice gear and used equipment . . .*

TEN-TEC SALES

Communications Specialties

97 Amsterdam Ave., Warwick RI 02889
Phone: 401-738-3287

Horizon "2" mtr.,

12 channels/25 watts from

Standard

NEW



ASTROPOINTS

- ✓ 144-148 Mhz for Ham, CAP, & MARS
- ✓ 12 channels, 3 included
- ✓ Glass Epoxy Circuit Board
- ✓ TX and RX Trimmers
- ✓ PL option
- ✓ Tone burst option
- ✓ FCC Type accepted family for Business/Industrial & Marine
- ✓ 25 watts output (nom.)
- ✓ .4 μ V sensitivity
- ✓ 70 db selectivity
- ✓ 3 watts Audio
- ✓ Built in speaker
- ✓ Small size, 6" x 2" x 9"

All this Horizon "2" mtr., under "3"

Get all the specs and complete Amateur Brochure,
write today:

 **Standard
Communications**

P.O. Box 92151 Los Angeles, California 90009 Telephone 213/532-5300

How to

COMPACT MULTIBAND DIPOLES

Peter Fischer VE3GSP
1379 Forest Glade Road
Oakville, Ontario Canada

Often the need arises for a temporary or permanent low cost antenna. Usually, a dipole or inverted vee antenna is the logical choice. They are easy to install and certainly cheap to build. One of the disadvantages of such an antenna is that they are only usable on a single band, unless they are fed with an open feeder line (300–600 Ω) in combination with an antenna tuner. This article describes two types of dipoles for operation on A) 80, 40 and 15 meters; and B) for 80 and 20 meters.

These dipoles are fed with a random length of 50 Ω coax, and they can be strung as straight dipoles or inverted vees. The latter configuration makes it easier to adjust the antenna for resonance and requires only one high support. Each antenna leg has one loading coil to obtain the desired resonance points on the described amateur bands.

Theory

Generally, centerfed dipoles can be fed with 50–75 Ω coax if the current maximum of an operating frequency occurs at the antenna feedpoint. Therefore, a dipole with the leg dimensions of 67, 35, 18 or 11.5 feet will show a feedpoint impedance of 50–75 Ω for 80, 40, 20 or 15 meters accordingly. If a portion of each 67 foot leg (80 meter halfwave dipole) is substituted with a loading coil, and that loading coil is placed at the correct position, the dipole can be made to have current maxima at the feedpoint at 40 and 15, or at 20 meters.

For example: If a loading coil is placed about 35 feet from the feedpoint, a current maximum will occur at the feedpoint for 40 meters. With the correct coil dimensions and

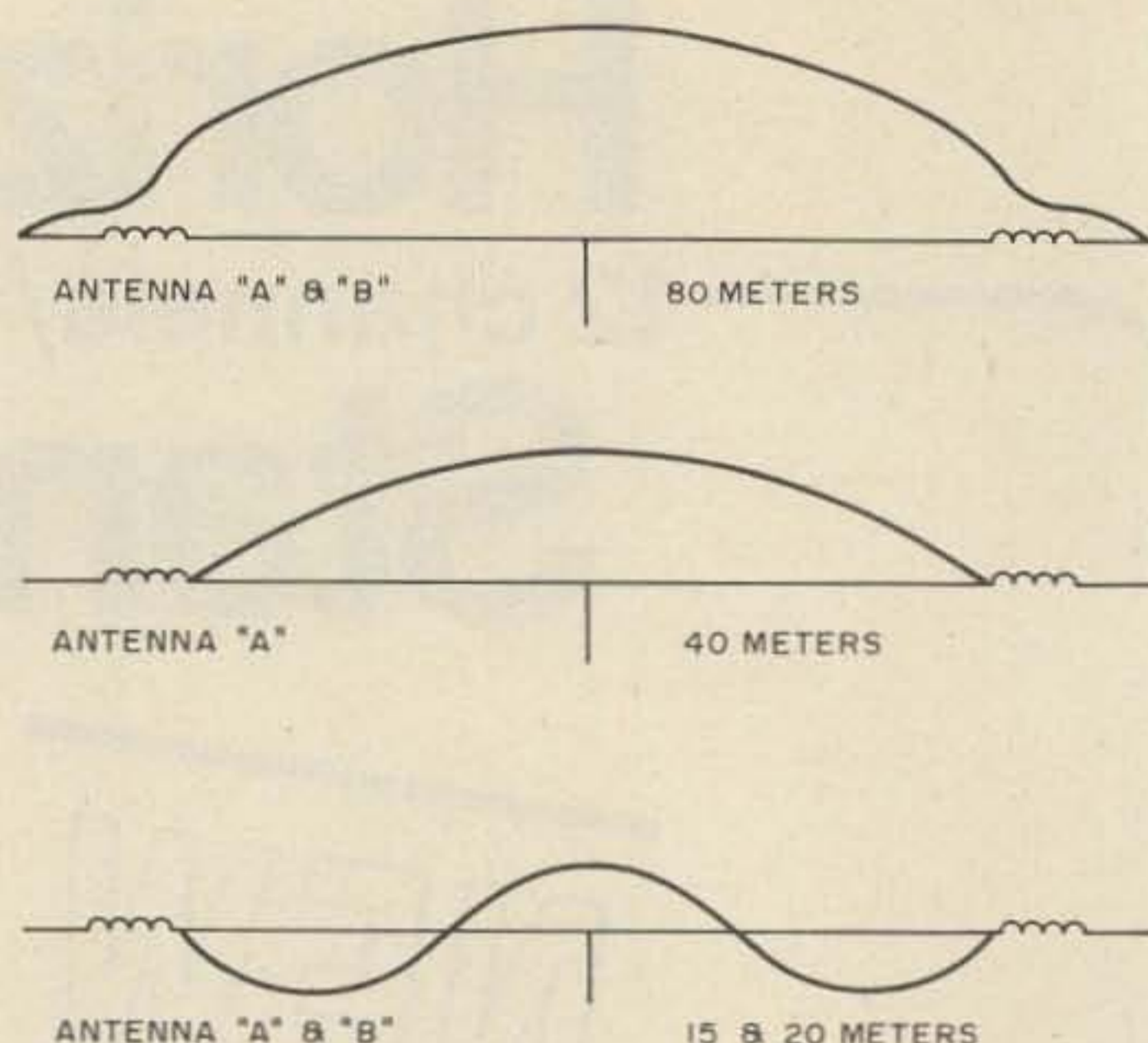

Graph 1. Antenna current distribution.

top-wire length, the dipole can also show current maximum at the feedpoint for 80 meters. In both cases, the dipole functions electrically as a halfwave dipole.

Coincidentally, since the 35 foot wire portion from the feedpoint to the loading coil corresponds to 3 x 1/4 wavelength on 15 meters, there will also be a current maximum at the feedpoint for 15 meters. Thus, the antenna will work on 80, 40 and 15 meters when fed with a 50–75 Ω coax.

The 50 Ω coax (RG8U, RG58U) is favored as the loading coils decrease the feedpoint impedance from a theoretical 75 Ω (classical halfwave dipole) to about 50 Ω .

If the leg- and coil-dimensions are altered, the antenna can be made to work on 80 and 20 meters. Here, the antenna functions as a halfwave dipole on 80 and as a 1½ wave dipole on 20 meters.

Ten meter operation is possible with both antennas, but the swr is in the order of 3:1 or worse.

Antenna Dimensions

Dipole A – 80, 40 and 15 meters

Overall length: 2 x 41.5 feet
Leg dimensions: 61 feet of wire, coil, 5 feet of wire

Dipole B – 80 and 20 meters

Overall length: 2 x 61 feet
Leg dimensions: 53 feet of wire, coil, 5 feet of wire
See Graph 1.

Antenna Assembly and Coil Data

Prepare the loading coils for the desired dipole, model A or B. For coils (antenna A) densely wind 70 turns of #20 copper enamelled wire on to a 1¼ inch O.D. plastic body. Use 24 turns for coil antenna B. Plastic sewer pipe is suitable and readily available everywhere. You need about 2 x 5 inches for A and 2 x 3.5 inches for B for convenient assembly. The coil windings are secured and weatherproofed with varnish or better with epoxy glue. The wire ends are soldered on to bolted solder lugs, which also serve to connect the antenna wire to the coils. (See Fig. 1.)

The antenna wire should be #14 or #16 copperweld for adequate strength. The dipole center is a porcelain strain insulator; it secures the wires at the dipole center and permits you to solder an SO-239 coax receptacle to the wires for easy coax connection. The far ends of the dipole are terminated on porcelain eggs. I recommend nylon or other nonmetallic line for fastening the porcelain eggs to a support. If wire is used, corona flashovers occur across the eggs at higher power levels.

Calculating Wire Length

Both dipoles should be cut specifically for your primary operating frequencies. Precise wire length can be calculated from the formulas given below, provided you stick with the recommended coil dimensions. Note that the wire lengths for 80 meters (A and B) include the wire portion from the center to the coil plus the coil to the porcelain insulator at the antenna ends.

Antenna A

80 meters: Ft. per leg = 153000/kHz
40 meters: Ft. per leg = 250000/kHz
15 meters: Ft. per leg = 750000/kHz

Obviously, if you optimize your 40 meter resonance for 7200 kHz you cannot reach

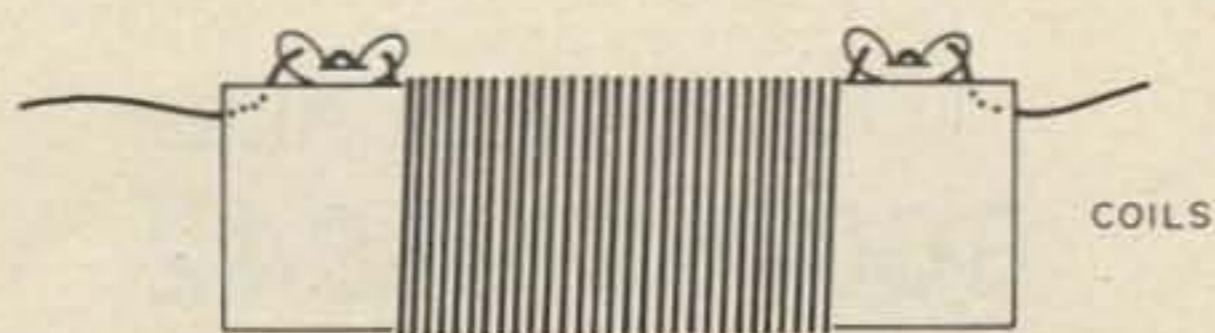

Fig. 1. Coil layout.

optimum conditions on e.g., 21.100 kHz, since the 15 meter resonance occurs automatically on 3 times the frequency than that of 40 meters. You therefore have to compromise slightly. 7,100 kHz seems like a good compromise, keeping in mind that the swr on 15 meters is fairly low over the entire band.

Antenna B

80 meters: Ft. per leg = 227000/kHz
20 meters: Ft. per leg = 750000/kHz

Tuning Procedure

First the antenna is adjusted for resonance (minimum swr) on the high frequency bands, 40 and 15 or 20 meters. This is done by lengthening or shortening the wire portion from the feedpoint to the loading coils. To increase the resonance frequency shorten this wire portion, and to decrease the resonance frequency lengthen the wire portion in each antenna leg symmetrically. A change in wire dimension will affect the resonance frequency for the 80 meter band. Therefore, the 80 meter tuning is done next by shortening or lengthening the 5 foot wire portion between loading coils and porcelain eggs. This last adjustment is critical; about one inch of wire results in 20 kHz resonance change on the 80 meter band. The second tuning step will not affect the first one. Do not forget to adjust both antenna legs symmetrically.

Comments

I tried both antenna versions as inverted vees, mainly because it simplified the tuning procedure very much. The swr at resonance for antenna A was 1.1:1 at resonance on 80, 40 and 15 meters.

Antenna B showed an swr of 1.5:1 on 80 and 1.1:1 on 20 meters at the resonance frequencies. I assume that the poorer 80 meters swr results from a relatively low Q and L of the loading coil of antenna B. The signal reports on 80 and 40 meters were excellent, and 20 and 15 meters showed a difference of about 3 S-units in receive mode as compared to my 2 element quad antenna. The antenna can also be tuned with a grid-dip meter.

... VE3GSP

NEW

FROM

TECO

TRI Model 5165 1000 MHz Frequency Counter \$895

TRI Model 5163 250 MHz Frequency Counter \$295

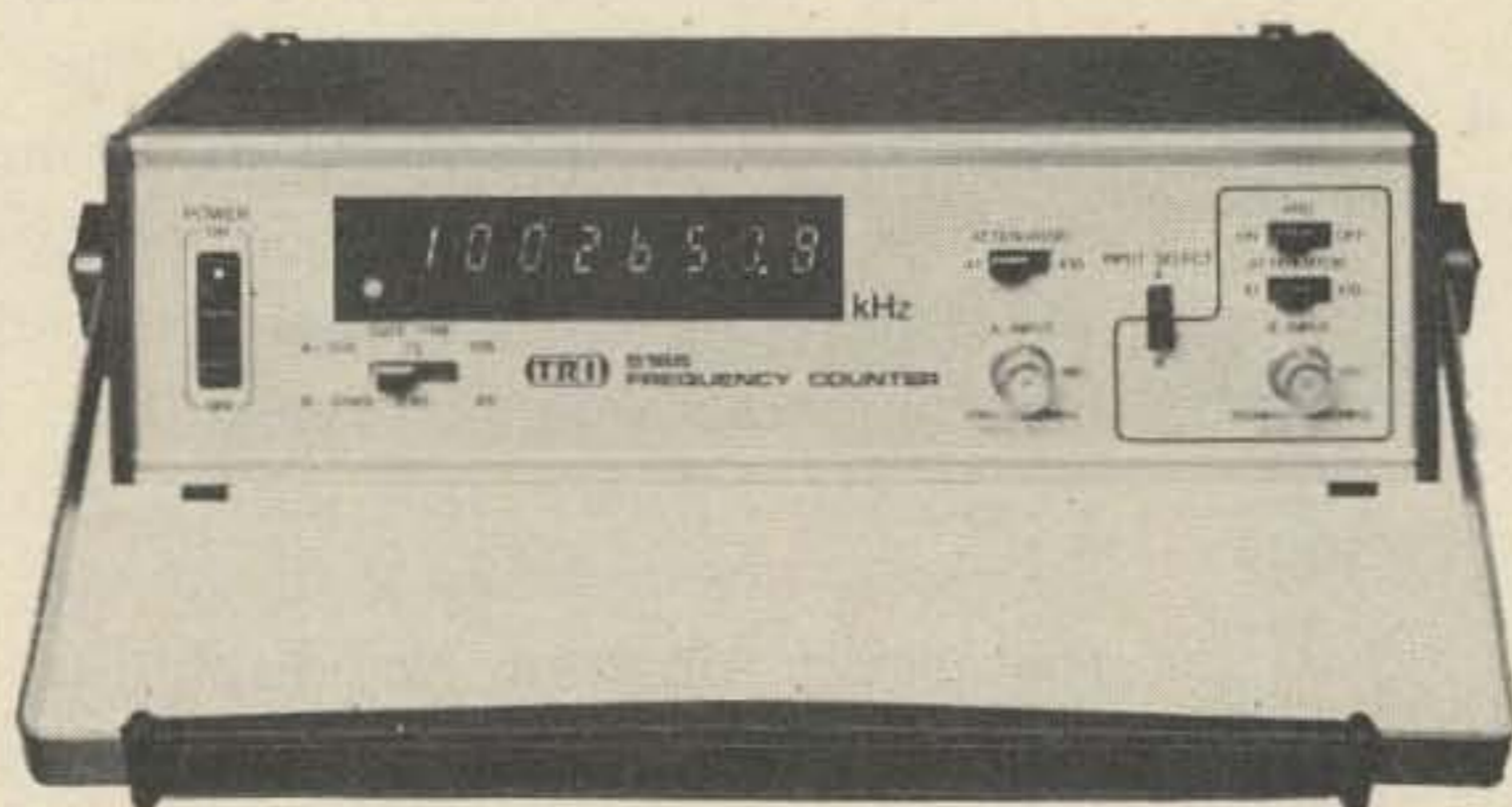

MODEL 5165

★ 1000 MHz

Automatic noise suppression
10mV sensitivity
8 digits/LED

NEW!
\$895



MODEL 5163

★ 250 MHz

25mV sensitivity
8 digits/LED

NEW!
\$295

NOW AVAILABLE FROM TECO!
CALL OR WRITE FOR COMPLETE SPECIFICATIONS



P. O. Box 1050 • Garland, Texas 75040

TOLL-FREE CALL
800-527-4642

(In Texas call collect 214-348-8800)

**A GREAT SCOPE-
AT A GREAT PRICE**

!

\$1295 (Reconditioned)

WHILE THE SUPPLY LASTS

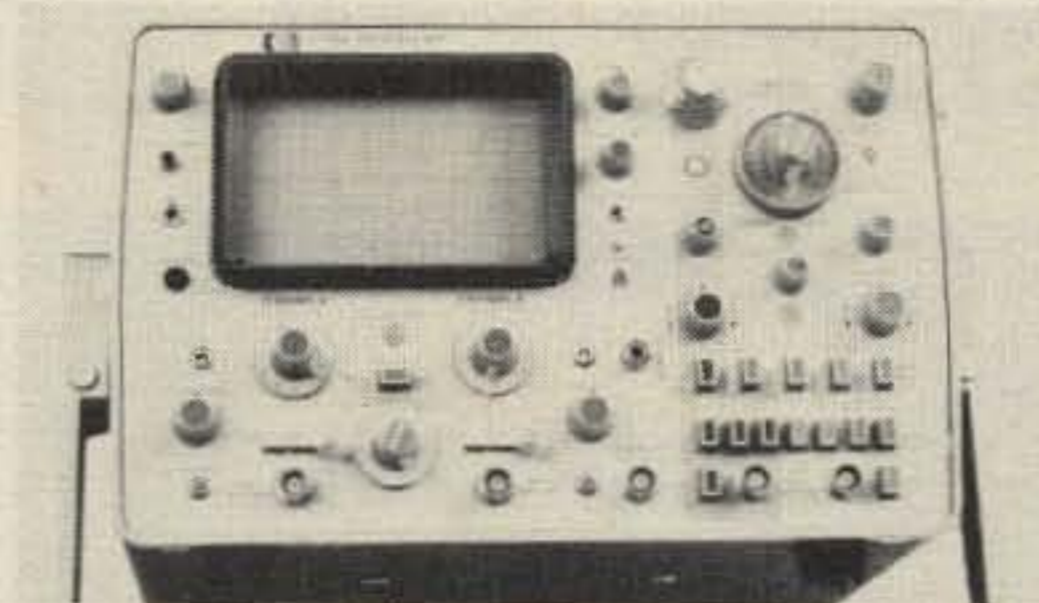

HEWLETT PACKARD 1707B

DUAL CHANNEL, 75 MHz BANDWIDTH, 10 mV/DIV SENSITIVITY, SWEEP SPEEDS FROM 0.1 μ SEC/DIV TO 2 SEC/DIV. DELAYED TIME BASE FROM 0.1 μ SEC TO 2 SEC DELAY. EXTERNAL HORIZ INPUT - DC TO 1 MHz. CHANNEL A OUTPUT - 100 mV PER DIV.

MANUFACTURED BY HEWLETT PACKARD - SOLD BY TUCKER
TUCKER ELECTRONICS has a limited quantity of reconditioned HEWLETT PACKARD 1707B OSCILLOSCOPES in like new condition. These units are complete with all standard accessories and instruction manual. The current list price on these scopes is \$1995 - by buying now from TUCKER ELECTRONICS you save \$700 (that's 35%) and get immediate delivery. The HP 1707B is covered by our famous 30 day, unconditional, money-back guarantee and our 90 day parts and labor warranty.

SOME INFORMATION ABOUT TUCKER ELECTRONICS -

Chances are you won't have any warranty problems, but it's reassuring to know that TUCKER ELECTRONICS is the nation's largest supplier of quality reconditioned test equipment. We also distribute 12 lines of new test equipment and also operate the Southwest's largest independent repair and calibration laboratory.

**HOW TO ORDER THE HEWLETT PACKARD
1707B OSCILLOSCOPE -**

It's easy. Just call our toll-free WATS line (800-527-4642) and ask for test equipment sales. Your area salesman will assist you in completing your purchase. He's a good man to know whenever you have test equipment requirements.

TOLL-FREE CALL 800-527-4642



TUCKER

ELECTRONICS • COMPANY

P. O. Box 1050 • Garland, Texas 75040

MEET THE STATE OF THE ART ON 2 METERS... THE ITC MULTI-2000 CW/SSB/FM TRANSCEIVER



Whether your interest is simplex, repeater, DX or OSCAR the new ITC MULTI-2000 lets you get into all the action on all of the

band. Fully solid-state and employing modular construction, the MULTI-2000 enjoys features found in no other 2m transceiver.

FEATURES

- PLL synthesizer covers 144-148 MHz in 10 kHz steps
- Separate VXO and RIT for full between-channel tuning
- Simplex or ± 600 kHz offset for repeater operation
- Three selectable priority channels
- Multi-mode operation (CW/SSB/NBFM/WBFM)
- Built-in AC and DC power supplies, noise-blanker squelch and rf gain control
- Selectable 1W or 10W output
- Separate S-/power and frequency deviation meters
- Built-in test (call) tone and touch-tone provision
- Excellent sensitivity ($.3 \mu\text{V}$ for 12 dB SINAD)
- Superior immunity to crossmodulation and intermodulation
- Introductory price: \$695.



TECO

a subsidiary of Tucker Electronics Co.

P.O. BOX 1050 1717 S. Jupiter Rd. GARLAND, TX. 75040

214-348-1560

TECO has the newest from *Dentron*

The Brand New 160-V Vertical Antenna

Another eye opener from Dentron, this new vertical antenna will solve your 160, 80 and 40 meter problems. 

- Efficient Vertical Design
- Self Supporting
- Weatherproof
- Quick & easy one man installation
- Covers 160, 80 or 40 meter band with only one adjustment.

160-40V Antenna \$79.50 ppd. USA



 Here is another Dentron first, a six band antenna tuner designed to solve virtually any matching problem you may have.

- Covers all bands 160 through 10 meters
- Handles maximum legal power
- Matches coax feed, random wire and balanced line
- Includes heavy duty balun for balanced line
- Black wrinkle finish cabinet

160-10 Super Tuner \$119.50 ppd. USA

Be ready for restructuring — Special Supertuner handles 3 KW PEP amplifiers —

\$229.50 ppd. USA

This is the low cost way to match almost any random length wire on the five most used HF bands.

- Covers 80 through 10 meters
- Handles maximum legal power
- Matches random length long wire antennas
- Features Dentron quality and value

Model 80-10 Antenna Tuner \$49.50 ppd. USA

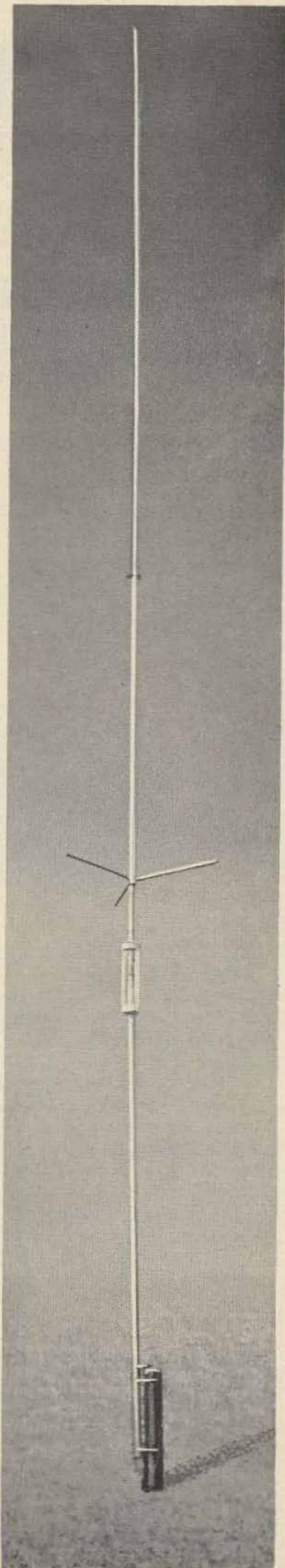

TECO

P.O. BOX 1050

a subsidiary of Tucker Electronics Co.

1717 S. Jupiter Rd. GARLAND, TX. 75040

800-527-4642 toll free

In Texas Call 214-348-8800



TECO

A SUBSIDIARY OF TUCKER ELECTRONICS CO.

SUMMER
1975

SPECIAL SALES FOR THE HOBBYIST, AMATEUR AND BARGAIN HUNTER.

INVENTORY REDUCTION SALE!!

Quantities are very limited on many items.
When calling, ask for Test Equipment Sales

The instruments listed are surplus unless otherwise stated. Each unit is sold as is and every attempt is made to assure completeness. While most instruments are operational, no warrantee is implied or stated. There is a 10 day trial period for each instrument which allows you to inspect and assure yourself that you are satisfied. You may return the instrument for full credit during this 10 day period-paying only freight charges. Since it is impossible to list the individual condition of each instrument-call and discuss your choice. Should you desire the same instrument completely reconditioned and guaranteed, we can put you in touch with our parent company for price and availability information.

CREDIT - TECO'S terms are cash or COD with the following exceptions. TECO accepts BankAmericard, Master Charge and American Express. TECO will sell on net 10 days to D&B or credit established customers. Our aim is to keep our overheads as low as possible so we can continue to offer instruments at the very lowest prices. Please help us to meet our goals and send your check with your order.

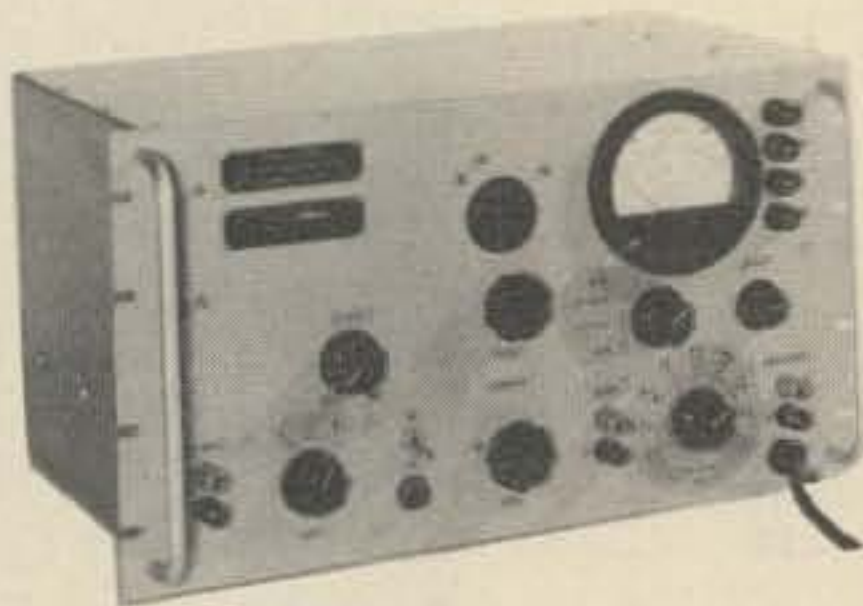

MILITARY TS-723B/U (HP 330B) DISTORTION ANALYZER

This marvelous noise and distortion analyzer gives accurate direct readings from 20 Hz to 20 KHz. Perfect for measuring audio distortion, voltage level, power output, gain, distortion of AM RF carrier, measuring hum and noise level and audio signal frequency. Blanketing the audio spectrum the TS-723 measures noise levels as small as 100 μ V and distortion as low as 0.1%. A wide-band 20dB gain amplifier is built in as well as a VTVM with nine full scale ranges from 0.03 to 300 volts and nine dB ranges spaced exactly 10dB per range from -12dB to +2dB. Residual frequencies are measured to within $\pm 3\%$ of full scale value. TECO'S special sale price is only\$125.00



LEEDS & NORTHRUP 5430 A (MILITARY ZM-4B/U) RESISTANCE BRIDGE.

This advertised special is a portable, general purpose wheatstone bridge designed primarily to measure resistances when locating faults which occur in conductors used for communications systems and those used for power transmission. It can also measure the value of any fixed resistor. In addition to the self-contained galvanometer it has provision for external null indicator and batteries. Measures resistance values from 0.001 to 1,011,000 ohms, internal battery power supply. Ratio dial multiplying values for resistance measurements and Varley loop tests are 1/1000, 1/100, 1/10, 1/9, 1/4, 1, 10 and 100. Ratio for Murray loop tests are M1000, M100 and M10. Accuracy is $\pm 0.1\%$ of indicated resistance\$75.00



TECO

a subsidiary of Tucker Electronics Co.

P.O. BOX 1050 1717 S. Jupiter Rd. GARLAND, TX. 75040

800-527-4642 toll free

In Texas Call 214-348-8800

HICKOK 1890M TRANSISTOR TESTER: Measures in-circuit Beta and Rin of transistors and leakage of out-of-circuit transistors, $\pm 5\%$ Beta measurement accuracy **\$75.00**

MILITARY UPM-6B Radar Test Set: For deck testing of Mark VIFF equipment **\$65.00**

MILITARY UPM-12 SWR INDICATOR TEST SET: Used to make impedance measurements in X-band waveguide equipment **\$150.00**

MILITARY UPM-17 SPECTRUM ANALYZER: Military version of Lavoie LA-18M, general purpose spectrum analyzer covers 10MHz to 16 GHz. TECO Price **\$595.00**

POLARAD R100 KLYSTRON TUBE TESTER: **\$100.00**

POLARAD PJ-1 PULSE JITTER TESTER: **\$125.00**

POLARAD TSA SPECTRUM ANALYZER MAIN-FRAME: Resolution 2-80 KHz, dispersion 400 KHz to 25 MHz, sensitivity -50 to -95 dbm, variable attenuator, built-in marker. Other plug-ins available to 44 GHz **From \$150.00**

SINGER SSB-3B SINGLE SIDEBAND SPECTRUM ANALYZER: A comprehensive communications system analyzer with five preset and one continuously variable sweep widths, $2\mu\text{v}$ sensitivity switch selectable 50 or 600 ohm input impedance and resolution variable from 10 Hz to 3 KHz Internal markers and many features **\$1295.00**

SINGER (TELESIGNAL) TA216B TEST SET: Includes interconnecting cable **\$155.00**

SPRAGUE TCA-1 CAPACITOR ANALYZER: **\$50.00**

STELMA TDA-2 RTTY DISTORTION TEST SET: TECO Price **\$20.00**

VIDAR 720 FLUTTER ANALYZER: Seven operating frequencies from 3.125 KHz to 200 KHz, flutter bandwidth from 312 Hz to 10 KHz. Built-in scope, solid state unit **\$350.00**

HP 524B COUNTER: DC to 10 MHz, 6 digit neon, 2 meters **\$95.00**

HP 524D COUNTER: DC to 10 MHz, 8 digit neon **\$145.00**

HP 525B CONVERTER PLUG-IN: 110 MHz to 220 MHz **\$75.00**

SIGNAL GENERATOR

ALFRED 620 SWEEP OSCILLATOR: 0.5 to 1.0 GHz, N output at 10mWatts **\$395.00**

ALFRED 622BK SWEEP GENERATOR: Complete unit covers 2-4 GHz range **\$395.00**

ALFRED 623B SWEEP GENERATOR: Complete sweeper covers 4-8 GHz range **\$395.00**

ALFRED 624B SWEEP GENERATOR: Complete sweeper for 8-12.4 GHz range **\$395.00**

ALFRED 625B SWEEP GENERATOR: Complete unit covers 12.4 to 18.0 GHz **\$395.00**

ALFRED 642K SWEEP GENERATOR: Complete 2-4 GHz unit **\$795.00**

DUMONT 404 PULSE GENERATOR: 1-100 KHz rep rate, 0.02 to 100 μsec pulsewidth, 3V into 600 ohms, 0-50dB attenuator **\$65.00**

EH 120D PULSE GENERATOR: 100Hz to 20MHz, 20V into 50 Ω , 1.3ns rise at 20V, variable pw, dual pulse **\$295.00**

EH 121 PULSE GENERATOR: 10Hz to 10MHz, 4ns rise $\pm 50\text{V}$ into 50 Ω . Variable width with fixed 120ns delay **\$295.00**

FXR S771B TEST OSCILLATOR: 1.9-4.0 GHz. **\$175.00**

FRX C772A SIGNAL GENERATOR: 3.95 to 8.2 GHz, 10-100mW output, internal square wave modulation, external pulse and FM **\$195.00**

GENERAL MICROWAVE 301 POWER SUPPLY: Powers GMC noise generators in 501 series. **\$20.00**

GR 605B STANDARD SIGNAL GENERATOR: 9.5 KHz to 30 MHz **\$100.00**

GR 1208B UNIT OSCILLATOR: 65 to 500 MHz, requires unit power supply **\$80.00**

GR 1218A UNIT OSCILLATOR: 900 MHz to 2 GHz, requires unit power supply **\$125.00**

GR 1390A RANDOM NOISE GENERATOR: 30Hz-5MHz, 1V output **\$95.00**

HP 205AG AUDIO OSCILLATOR: 20 Hz to 20 KHz **\$250.00**

HP 205AH HIGH POWER OSCILLATOR: 20 Hz to 20 KHz 5 watts output into 50, 200, 600, or 5000 Ω . Built-in attenuators, input and output meters. **\$275.00**

HP (BOONTON) 207E UNIVERTER: Extends range of 202 series generator **\$125.00**

HP 616A SIGNAL GENERATOR: Direct reading and direct control from 1.8 to 4.2 GHz. The HP 616A features $\pm 1.5\text{dB}$ calibrated output accuracy from -7dBm to -127dBm. The output is directly calibrated in microvolts and dBm with continuous monitoring.

FREQUENCY MEASURING EQUIPMENT

BECKMAN 7570 CONVERTER MAINFRAME: Accepts 7570 series converter plug-ins to expand basic range of counters using heterodyne technique **\$35.00**

BECKMAN 7571 PLUG-IN CONVERTER: 10 MHz to 110 MHz **\$25.00**

GERTSCH FM-3 FREQUENCY METER: Measures 20-1000 MHz with 0.001% accuracy, generates over same frequency **\$195.00**

GERTSCH FM-4 FREQUENCY MULTIPLIER: Measures and generates signals from 500 MHz to 12.5 GHz, requires 400-1000 MHz driving source **\$295.00**

GERTSCH FM-7/DM-3 FREQUENCY METER: Includes deviation meter, measures and generates signals from 20-1000 MHz with 0.001% accuracy **\$795.00**



TECO

a subsidiary of Tucker Electronics Co.

P.O. BOX 1050 1717 S. Jupiter Rd. GARLAND, TX. 75040

800-527-4642 toll free

In Texas Call 214-348-8800



GENERAL ELECTRIC PORTABLE METERS include snap-on self contained cover, carrying handle and 0.5% DC accuracy. These excellent instruments are priced to move quickly so get your order in today.

SINGLE RANGE UNITS\$15.00 each
 MULTIPLE RANGE UNITS\$20.00 each

AC Ranges in Stock:

0 to 0.75/1.5 KW; 0 to 1.5/3 KW; 0 to 30/60A;
 0 to 10/20V; 0 to 15/30V; 0 to 25/150V;
 0 to 150V; 0 to 150/300V.

DC Ranges in Stock:

0 to 500 μ A; 0 to 1 mA; 0 to 300 mA; 0 to 3A; 0 to 30A;
 0 to 3V; 0 to 7.5/30/75V; 0 to 150V; 0 to 150/300V;
 0 to 150/300/750V; 0 to 300V; 0 to 600V; 0 to 750V.

METERS OF ALL TYPES

- ASSOCIATED RESEARCH 259 VIBROGROUND:**
Similar to Model 293\$65.00
- ASSOCIATED RESEARCH 293 VIBROGROUND:**
Lightweight instrument for measurement of soil-resistance and ground resistance, 0-1/10/100/1000 ohms.\$80.00
- BALLANTINE 300 VTVM:** 1mV to 100V, 10 Hz to 150 KHz\$25.00
- BALLANTINE 305 PEAK READING VTVM:**
Measures P-P, positive or negative peak values, 5 Hz to 500 KHz response 1mV to 1000V with mirror back scale\$95.00
- BALLANTINE 310A VTVM:** 100 μ V to 100V. Measurements from 10 Hz to 2 MHz, 3% accuracy to 1 MHz\$75.00
- BALLANTINE 314 VTVM:** 1 mV to 1KV, 15 Hz to 6 MHz, less probe\$75.00
- BALLANTINE 316 VTVM:** Peak to peak, 0.05 Hz to 30 KHz\$35.00
- BIRD 61S4 WATTMETER:** Direct reading 20 or 5 watts (choice), 50 Ω , N(F) connector, includes meter\$65.00
- BIRD 694 WATTMETER:** 0 to 1000W direct reading, 2 to 36 MHz, 50 Ω , N(F) connector\$195.00
- BOONTON 91CR RF VTVM:** 1 mV to 3V, 20 KHz to 1.2 GHz, rackmount\$225.00
- BORG WARNER (SINGER) M401 SWR INDICATOR:**\$95.00

- CARY MODEL 31 VIBRATING REED ELECTROMETER:** 1mV to 30V in 10 ranges\$50.00
- E-H RESEARCH 140A SWITCHING TIME METER:**
TECO Price\$50.00
- FLUKE 910A TRUE RMS VOLTMETER:** 10 Hz to 7 MHz 100 μ V to 300V fs. \pm 1% accuracy\$225.00
- FXR B810A SWR METER:**\$35.00
- GENERAL MICROWAVE 451 POWER METER:**
TECO Price\$35.00
- GR 1932A DISTORTION METER:** 50 Hz - 18 KHz, TECO Price\$125.00
- HP H18-340B NOISE FIGURE METER:** Automatic display and measurement of IF or RF amplifier noise at 30 and 60 MHz. Operates with external noise sources for other bands\$400.00
- HP 400DR VTVM:** 10 Hz to 4 MHz, 1 mV to 300V, 2% accuracy\$65.00
- HP 400HR VTVM:** 10 Hz to 4 MHz, 1 mV to 300V, 1% accuracy\$95.00
- HP 412A RDC VTVM:** 1 mV to 1KV, 1 microamp to 1A, can be used as DC amplifier, 2% accuracy\$195.00
- HP 415A VSWR INDICATOR:**\$25.00
- HP 416A RATIO METER:** Displays ratio of forward and reverse signals automatically\$125.00
- HP 416B RATIO METER:** Later version of 416A\$395.00
- HP 500C TACHOMETRY:** 180 RPM to 6,000,000 RPM\$85.00
- ITE (PHAZOR) 100A PHASE SENSITIVE NULL METER:** 30 Hz to 10 KHz, 8 volts to 120V reference. Separates in-phase and quadrature null voltages. 40 dB selectivity\$95.00
- KINTEL 202BR DC MICROVOLTMETER:** Full scale ranges from 300 μ V - 1000V \pm 3%, can be used as 70dB amplifier\$35.00

CAUTION: THESE INSTRUMENTS ARE SOLD AS-IS. WHILE EVERY ATTEMPT IS MADE TO ASSURE COMPLETENESS AND TO DELIVER AN OPERATIONAL INSTRUMENT, THERE IS NO WARRANTY IMPLIED OR STATED EXCEPT: "YOU MAY EXAMINE THE UNIT FOR TEN DAYS AND, IF YOU ARE NOT SATISFIED, YOU MAY RETURN FOR FULL CREDIT PAYING ONLY THE FREIGHT CHARGES". EVERY TECO INSTRUMENT IS CONSIDERED TO BE A GENUINE BARGAIN, BUT THE BUYER SHOULD HAVE ACCESS TO COMPETENT TECHNICAL TALENTS TO MAKE THE PURCHASE PRACTICAL.

SEND FOR THE LATEST "BARGAIN HUNTER" BROCHURE - IT'S FREE!

METERS OF ALL TYPES Continued

- ORION V-100M VTVM:** Similar to HP 400H, like new\$60.00
- NARDA MODEL 440 SOLID STATE MICROWAVE POWER METER:** Rechargeable batteries ...\$95.00
- PRD 277B STANDING WAVE INDICATOR:** \$75.00
- PRD 650 POWER METER:**\$40.00
- SRI AEW EDGESCALE METER:** 0 to 50/100/200 VDC ranges, 7" scale, 0.5%\$25.00
- SRI AEW EDGESCALE METER:** 0-250 VDC range, 7" scale, 0.5%\$20.00
- SRI CEW-7 EDGESCALE METER:** 0 to 200 VDC, 7" scale, 0.5%\$20.00
- SRI JW-4A EDGESCALE METER:** 0 to 1.5/6 mVDC ranges, 4" scale, 0.5%\$30.00
- SRI JW-4A EDGESCALE METER:** 0 to 150 mVDC range, 4" scale, 0.5%\$20.00
- SRI JW-4A EDGESCALE METER:** 0 to 150 mADC range, 1/2" scale, 0.5%\$20.00
- WILTRON 321 PHASE & AMPLITUDE INDICATOR:** Includes local oscillators from 2.5-1000 MHz
TECO Price\$1395.00
- AIL 130 PRECISION TEST RECEIVER:** 30 MHz IF, 0-80dB precision attenuator\$250.00
- HAMMARLUND SP600 RECEIVER:** 560 KHz to 54 MHz\$225.00
- MILITARY URTM-7 RFI MEASURING SET:** Measures broadband and CW interference. Frequency range is 20-400 MHz in two bands. Voltage range is 6 μ V to 5V/MHz. Contains an impulse generator for noise reference standard. \pm 10% voltage accuracy\$995.00
- NEMS-CLARKE 1401 TELEMETRY RECEIVER:** 215 to 260 MHz range\$95.00
- NEMS-CLARKE 1412 RECEIVER:** 215-260 MHz, crystal controlled with deviation meter. 100/500 IF bandwidth\$75.00
- NEMS-CLARKE 1432 TELEMETRY RECEIVER:** 215 to 260 MHz range, identical to 1412 except uses phase lock detector\$75.00
- NEMS-CLARKE 1455 RECEIVER:** 215-260 MHz, crystal controlled or internal VFO, 150/300 IF bandwidth\$125.00

RECEIVERS

- POLARAD R RECEIVER BASIC UNIT:** Nine plug-ins cover 400-84,200 MHz range. AM, CW, FM, MCW or pulse reception. IF bandwidth 3 MHz, video bandwidth 2 MHz, sensitivity -50 to -90 dBm. Requires plug-in to operate\$350.00
- POLARAD R SERIES RECEIVER PLUG-IN:** Nine plug-ins cover 400-84,200 MHz. Specify correct band\$300.00

STODDART NM-50A RFI RECEIVER: 375-1000 MHz receiver, excellent units\$595.00



BALLANTINE 300 VTVM: The model 300 is a sensitive, wide bank VTVM with a 100,000 to 1 voltage range and accuracy of better than 2% anywhere on the scale and at any frequency from 10 Hz to 150 KHz. Specific ranges allow measurement from 1mV to 100V with an input impedance of 0.5M Ω shunted by 30pF. The voltage ranges are logarithmic and there is a matching 0 to 20 dB linear decibel scale.
Special while they last\$29.50

HP 434A CALORIMETRIC POWER METER: Just connect to the Type "N" input and read the power from 10mW to 10 watts anywhere in the frequency range from DC to 12.4 GHz. No external terminations or detectors - readings directly in watts or dBW. 50 ohms input with internal calibrator circuit and \pm 5% accuracy. (Accuracy at low end of frequency range is as good as 0.5%). New price exceeds \$2000.00
TECO PRICE\$695.00

MILITARY TS-537/TSM CRYSTAL IMPEDANCE METER.

With a frequency range from 75 to 1100 KHz in 6 ranges and measurement scales from 0 to 99,000 Ω and 12 to 110 nanofarads this portable, general purpose, test instrument is designed to measure equivalent electrical parameters of quartz crystals of the type used for communications purposes. Provision is made to measure directly the effective series-resonant and anti-resonant resistances of a piezo-electric quartz crystal in its holder. The load capacitance is obtained by applying dial markings to a calibration chart. With the static capacity measured by an external capacity measuring device and with the series-resonant and anti-resonant frequency measured by an external frequency measuring device, the series capacitance and inductance can be calculated. A microammeter indicates the magnitude of oscillation of the oscillator tube by measuring its grid current. Frequency is selected by a switch and a fine tuning control. Equipment can be bench or rack-mounted\$55.00



TECO

a subsidiary of Tucker Electronics Co.

P.O. BOX 1050 1717 S. Jupiter Rd. GARLAND, TX. 75040

800-527-4642 toll free

In Texas Call 214-348-8800

MILITARY UPM-4A TRANSPONDER TEST SET:

Three piece unit in single cabinet includes power supply, simulator unit and oscilloscope display unit. The UPM-4A performs many measurements on radar equipment operating in the 925 to 1225MHz range including checks on decoding, receiver bandwidth and frequency, receiver sensitivity, pulse counting, pulse analysis and IFF target generators. This unit sold new for nearly \$5000 but at TECO its cost is a low\$175.00

MILITARY AN/UPM-15 200 VOLT PULSE GENERATOR.

A Portable, general purpose pulse generator set used for testing pulse amplifiers and networks, and for modulating oscillators in field and depot maintenance. It generates single or double pulses of variable repetition rate, width, amplitude, separation, delay and rise decay time. The pulses may also be synchronized with oscillators or other instruments. Output rep rate is externally or internally variable from 50Hz to 10KHz, pulsewidth variable from 0.5 to 100 μ seconds, amplitude 0.002 to 200 volts and calibrated delay from 2 to 225 μ sec. An extraordinary value\$50.00

TEKTRONIX 1121 AMPLIFIER: 5Hz to 17MHz, gain of 100\$175.00

WEINSCHEL CF-1 AF SUBSTITUTION ATTENUATOR: For use with square low detector\$150.00

WEINSCHEL IN-1 AUDIO LEVEL INDICATOR: For use with square low detector\$50.00

MILITARY TEST EQUIPMENT is the biggest value for your money. Each military unit is ruggedized and constructed of the highest quality parts. The U.S. government has put severe MIL-SPECS into each of their purchases assuring YOU an instrument now that bears the U.S.A. mark of quality and yet is usually less expensive. Examine the Military units carefully for **BEST BUYS** — call TECO for your requirements that cannot be filled by this brochure. TECO has thousands of instruments that, due to space limitations, are not shown in this brochure.

OSCILLOSCOPES AND RELATED INSTRUMENTS

HP 185 SAMPLING OSCILLOSCOPE: DC to 1GHz\$195.00
HP 1100A DELAY LINE: 120nsec\$75.00

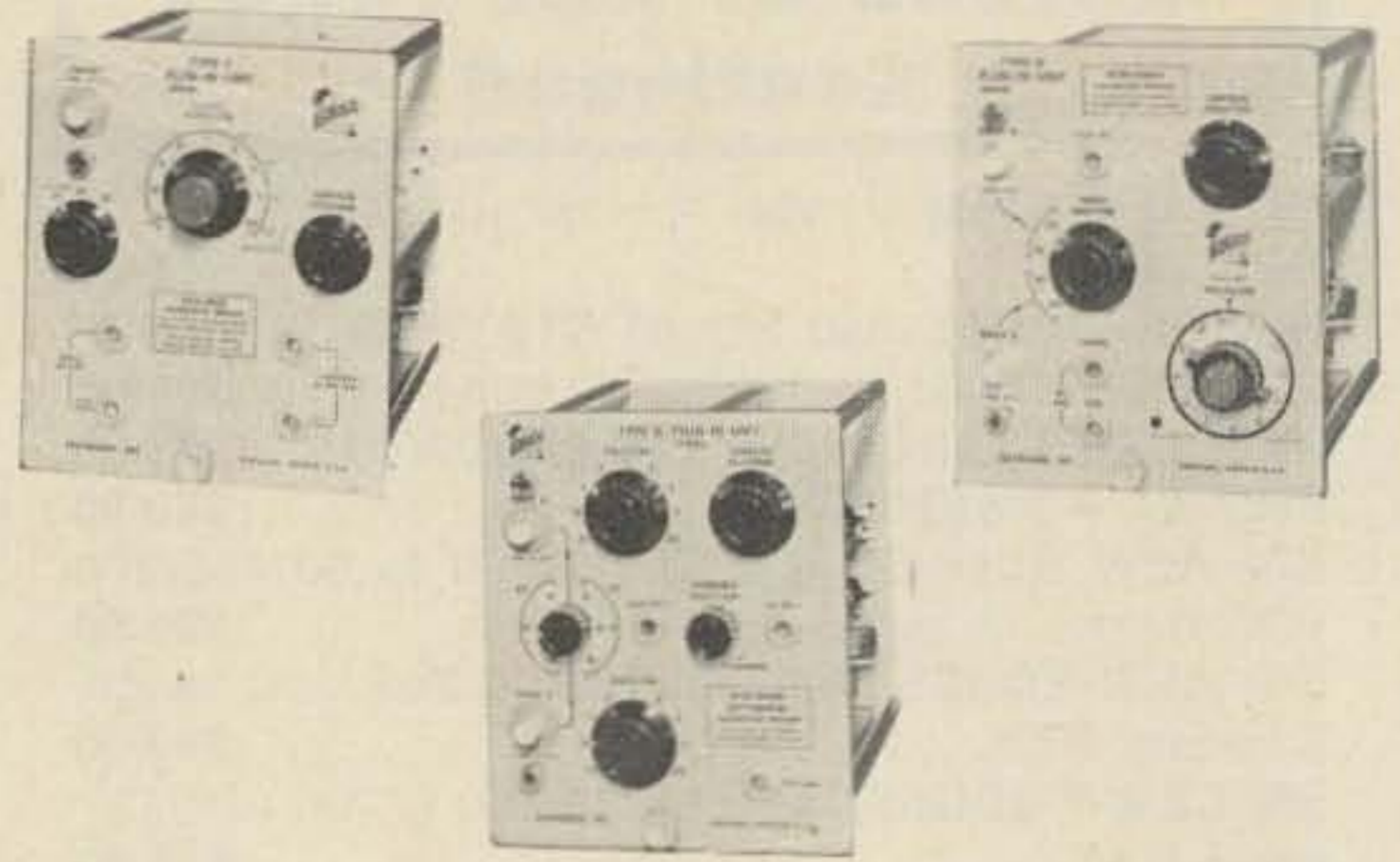

TEKTRONIX OSCILLOSCOPE PLUG-INS: Can be used with the 530, 540 or 550 series oscilloscopes with equal performance.

Model 53/54C dual trace 20 MHz unit\$95.00

TEKTRONIX CA PLUG-IN: DC - 24 MHz dual trace\$150.00

TEKTRONIX E PLUG-IN: DC - 60 KHz differential\$75.00

TEKTRONIX DIFFERENTIAL PLUG-IN: 50mV to 20V/cm sensitivity, DC to 20 MHz bw, 18ns risetime\$65.00

TEKTRONIX H SINGLE TRACE PLUG-IN: 50mV to 20V/cm sensitivity, DC to 15 MHz bw, 23ns risetime\$75.00

TEKTRONIX K SINGLE TRACE PLUG-IN: 50mV to 20V/cm sensitivity, DC to 30 MHz bw, 12ns risetime\$50.00

TEKTRONIX R PLUG-IN: Transistor risetime\$65.00

TEKTRONIX 262 PROGRAMMER: Remotely program the 6R1A digital unit\$250.00

TEKTRONIX 535 OSCILLOSCOPE: DC to 11 MHz less plug-in\$425.00

TEKTRONIX 536 OSCILLOSCOPE: DC to 15 MHz less plug-in\$350.00

RECORDERS AND PRINTERS

BRUSH RE3610-60 100 CHANNEL EVENT RECORDER: "as-is"\$150.00

EAI BAR CHART RECORDER: 40 channels recording time 9, 18, 27 hours\$150.00

FAIRCHILD 321-A OSCILLOSCOPE RECORD CAMERA: Continuous motion 35mm camera with magazine and variable speeds\$75.00

HP 560A DIGITAL PRINTER: Up to 11 columns capacity with plug-in boards, 5 line/second print speed\$250.00



TECO

a subsidiary of Tucker Electronics Co.

P.O. BOX 1050 1717 S. Jupiter Rd. GARLAND, TX. 75040

800-527-4642 toll free

In Texas Call 214-348-8800

Simple operation, frequency dial accuracy is $\pm 1\%$ and stability exceeds $0.005\%/^{\circ}\text{C}$ change in ambient temperature. Calibrated attenuator is within $\pm 1.5\text{dB}$ over entire output band. 50 ohm impedance unit has internal pulse modulation with rep rate variable from 40 Hz to 4 KHz, variable pulsewidth (1 to $10\mu\text{sec}$) and variable pulse delay (3 to $300\mu\text{sec}$). External modulating inputs increase versatility. New price exceeds \$2000.00. TECO PRICE\$395.00

HP (BOONTON) 207G UNIVERTER: Extends range of 202 series generators\$175.00

HP 212AR PULSE GENERATOR: 60 Hz to 5 KHz\$65.00

HP 218A/219B DIGITAL DELAY GENERATOR WITH DUAL PULSE PLUG-IN: Superb units have many features\$375.00

HP 233A CARRIER TEST OSCILLATOR: 50 Hz to 500 KHz, 3 watts into 600 ohms, tests loops over 200 miles long\$75.00

HP (BOONTON) 240A SWEEP SIGNAL GENERATOR: Designed for alignment of broadband amplifiers, 4.5 to 120 MHz range. Output $1\mu\text{V}$ to 0.3V\$395.00

HP 616A SIGNAL GENERATOR: 1.8 GHz to 4.2 GHz\$395.00

HP 684C SWEEP GENERATOR: 4 to 8.1 GHz range, sweep rates 16 MHz to 160 MHz/sec in 9 steps. 10mw output Bad BWO\$195.00

HP 686A SWEEP OSCILLATOR: Electronic sweep with sweep rate from 32MHz to 320Hz/sec in 9 steps. 8.2 to 12.4 GHz range\$195.00

HP 686C SWEEP GENERATOR: Same as 684C except 8.2 MHz to 12.4 GHz unit\$195.00

HP 938A MICROWAVE DOUBLER: 9 to 13 in, 18 to 26 GHz output at 10mW\$995.00

HP (DYMEC) DY5731 HIGH POWER SIGNAL GENERATOR: X-Band, +24 to -76dBm\$495.00

HOLT AO-1 AUDIO OSCILLATOR: 20 to 20 KHz, less than 0.1% distortion\$125.00

JERROLD CM-6 PORTABLE CRYSTAL MARKER GENERATOR: Six crystal markers between two and 100 MHz, up to 20th harmonic\$150.00

JERROLD 601 SWEEP FREQUENCY GENERATOR: 12-225 MHz, 50 Ω output, small portable\$150.00

JERROLD 900A SWEEP GENERATOR: 500 KHz to 1200 MHz, many features\$395.00

KAY MEGA-NODE SR VARIABLE NOISE GENERATOR: 1-3000 MHz, 50 Ω output, 0-20dB noise figure measurement, $\pm 0.25\text{dB}$ accuracy \$75.00

MAXON 1141A POWER OSCILLATOR: 200 to 2500 MHz, 5 to 40 Watts output\$495.00

MEASUREMENTS 80 SIGNAL GENERATOR: Covers UHF from 2 to 400 MHz and 0 to $10,000\mu\text{V}$ calibrated output\$295.00

MEASUREMENTS 82 SIGNAL GENERATOR: 20 Hz to 50 MHz, 0 to 50V output, 0-50% internal modulation\$250.00

MEASUREMENTS 84 TV SIGNAL GENERAL: 30 MHz to 1000 MHz, 75 ohm, $0.1\mu\text{V}$ to 1V output\$175.00

MEASUREMENTS 88 FM SIGNAL GENERATOR: 88 to 108 MHz, 0.1 to $100,000\mu\text{V}$ output\$150.00

MEASUREMENTS 188 FM SIGNAL GENERATOR: 88 to 108 MHz, 0.1 to $100,000\mu\text{V}$ Output ...\$350.00

MEASUREMENTS 210A SIGNAL GENERATOR: 86 to 108 MHz. FM generator with 0.5% dial accuracy. 50 Ω 0.1 to $100,000\mu\text{V}$ output\$125.00

MILITARY TS-382 AUDIO GENERATOR: 20 Hz to 200 KHz\$65.00

POLARAD HU-2A BASIC SIGNAL GENERATOR: Requires "G" series plug-in to operate\$350.00

POLARAD G SERIES TUNING UNIT FOR HU-2A: 7 units cover band from 18.0 to 39.7 GHz, 10mW average power output, 0.1% frequency accuracy, attenuator and wavemeter\$300.00 each

PRD 903 SIGNAL GENERATOR: 7-11 GHz, CW, FM pulse\$195.00

PRD 904 VHF-UHF NOISE GENERATOR: 30-1000 MHz\$250.00

RUTHERFORD B-2A PULSE GENERATOR: 10Hz to 100 KHz, variable parameters\$45.00

RUTHERFORD B-7 PULSE GENERATOR: 20Hz to 2MHz, all variable parameters\$125.00

RUTHERFORD B-7B PULSE GENERATOR: 20Hz to 2MHz, late model of B-7\$225.00

RUTHERFORD B-14 PULSE GENERATOR: 20Hz to 2MHz, solid state units\$125.00

SIERRA 215B-470 POWER OSCILLATOR: 150 to 450 MHz. 50 watts output\$795.00

TMC TTG-2 TWO-TONE TEST GENERATOR: 25 Hz to 1 MHz\$75.00

TEKTRONIX 105 SQUARE WAVE GENERATOR: 25 Hz to 1 MHz\$75.00

TEKTRONIX 180A TIME MARK GENERATOR: Excellent units\$195.00

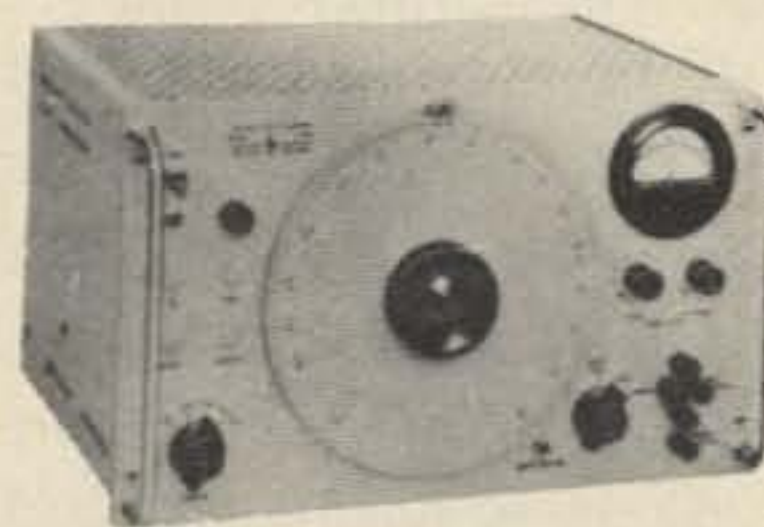

HP 233A (MILITARY SG-71B) CARRIER TEST OSCILLATOR: A bargain hunter's delight. The 233A checks carrier current systems and much more. This fine oscillator generates 3 watts output into 600 ohms over the frequency band from 50 Hz to 500 KHz making possible a variety of tests including 100 to 200 mile loop tests. A second 6V at 600 Ω output can be used simultaneously for other tests. New price exceeds \$700.00

TECO price for this special\$75.00

CAUTION: THESE INSTRUMENTS ARE SOLD AS-IS. WHILE EVERY ATTEMPT IS MADE TO ASSURE COMPLETENESS AND TO DELIVER AN OPERATIONAL INSTRUMENT, THERE IS NO WARRANTY IMPLIED OR STATED EXCEPT: "YOU MAY EXAMINE THE UNIT FOR TEN DAYS AND, IF YOU ARE NOT SATISFIED, YOU MAY RETURN FOR FULL CREDIT PAYING ONLY THE FREIGHT CHARGES". EVERY TECO INSTRUMENT IS CONSIDERED TO BE A GENUINE BARGAIN, BUT THE BUYER SHOULD HAVE ACCESS TO COMPETENT TECHNICAL TALENTS TO MAKE THE PURCHASE PRACTICAL.

SEND FOR THE LATEST "BARGAIN HUNTER" BROCHURE - IT'S FREE!

Don't Feed the Bears!

It seems that as the weeks go by, you read more and more about CB antics in the papers. As more drivers rebel against the government imposed 55 mph speed limit, the citizens radio service, better known as CB, is being used to avoid wallet thinning (and insurance cancelling) tickets. Approximately 40% of all the big trucks on the road have CB radios in them to watch for "Smokey." If you tune in channel 10 (27.075 MHz) and live near a major highway, you will probably hear the strange lingo. Some of it is easily recognized, and some of it is not. Even though CB has a rather short useful range, due to frequency congestion and the illegal use of high power amplifiers, it is still useful for about 10 miles mobile to mobile, 15 miles mobile to base, and 25 miles base to base. This is more than enough to watch for "Smokey" or to report accidents or other highway emergencies. Many state and local police monitor channel 10 and/or channel 9 for just that reason. On many expressways between metropolitan areas, it can be 15 miles or more to the nearest phone or exit where help can be called.

Unfortunately, there have been some areas of abuse by both the users and the law. Many police resent the truckers' use of CB

to avoid tickets and speed traps, and in turn, use it to find out if they are known to the speeders. In some areas the police will issue a ticket for only one or two mph over the limit if they hear the offender on CB warning other truckers of where the "Bears" are. It has also been known that they will write a ticket on an out-of-state vehicle for 70 in a 55 zone, even if they don't actually see the driver going 70. If they heard the driver say, "We got the hammer down to that 70", they apparently figure that you're from out of state and won't stay to fight the ticket. And after all, they heard you publicly admit to doing more than the limit.

On the brighter side of the road, there are many great "Smokies" out there and many of them spend a lot of time talking to the truckers and telling them where the traffic tie-ups are and how to avoid them. I have even had the Illinois and Indiana Smokies tell me to "put the hammer down, the way is clear for 40 miles," and mean it.

Oh, well! Let's face it! No one wants a ticket or \$25 fine, no matter why or how much he exceeds the limit, so here is a collection of words and phrases frequently used to describe what is happening on our highways. You too can decipher channel 10, but be careful: Don't feed the bears!

<i>Advertising</i>	<i>Police car with lights on.</i>
<i>Back Door</i>	<i>Friend following behind you guarding the rear approach (the friend can be the truck you just passed two minutes ago).</i>
<i>Bear</i>	<i>Any Police Officer.</i>
<i>Bear Cave</i>	<i>Police station or Highway Patrol post.</i>
<i>Beat the Bushes</i>	<i>Lead mobile driving just fast enough to cause a police car to come out of hiding to investigate, but not fast enough to get a ticket; a sacrificial lamb, looking real hard for Smokey.</i>
<i>Beaver</i>	<i>As in, "Feed the Beaver" — give your money to Mama, not to Smokey.</i>
<i>Break One-Oh</i>	<i>Break on Channel 10. (I want to talk.)</i>
<i>Break Ten</i>	<i>Break on Channel 10.</i>
<i>Bushels</i>	<i>As: "I got 70 bushels" — 1 bushel = 1000 lbs.</i>
<i>Camera</i>	<i>Radar unit used to check speed of vehicles.</i>
<i>Channel 10</i>	<i>CB channel 10 — 27.075 MHz, truckers' paradise.</i>
<i>Chicken coop</i>	<i>Truck weighing station.</i>
<i>Clean</i>	<i>No police seen.</i>
<i>Comic Books</i>	<i>Truckers' logs.</i>
<i>Cotton Picker</i>	<i>Usually used in place of swear words, such as, "That cotton pickin' Smokey gave me a cotton pickin' ticket."</i>
<i>County Mouny</i>	<i>County Police or Sheriff.</i>
<i>Ears</i>	<i>Radio, also used to indicate antennas.</i>
<i>Eatum-up</i>	<i>Restaurant or truck stop.</i>
<i>Eighteen Wheeler</i>	<i>Semi-tractor-trailer truck (may have more or fewer than 18 wheels).</i>
<i>Fat load</i>	<i>Overweight load. Each state has its own load limits.</i>
<i>Feed the Bears</i>	<i>Get a ticket.</i>
<i>Five-five</i>	<i>55 as in 55 mph.</i>
<i>Four</i>	<i>Right.</i>
<i>Four ten</i>	<i>Ten-four in spades.</i>
<i>Four wheeler</i>	<i>Automobile.</i>
<i>Front Door</i>	<i>Lead vehicle watching for Smokies in front of group.</i>
<i>Grass</i>	<i>Median or off on side of road.</i>
<i>Green Stamps</i>	<i>Money, 1 green stamp - 1 dollar.</i>
<i>Green Stamp Road</i>	<i>Toll road.</i>
<i>Hammer</i>	<i>Accelerator pedal.</i>
<i>Hammer Down</i>	<i>Driving fast, as in: "Put the hammer down."</i>
<i>In the Grass</i>	<i>In the median.</i>
<i>Mercy</i>	<i>Oh My! Goodness sakes! Imagine that! Wow!</i>
<i>On the Move</i>	<i>Traveling.</i>
<i>On the side</i>	<i>Pulled over onto the shoulder, (Smokey has a four wheeler) just listening, (I'm . . .).</i>
<i>Other Half</i>	<i>Husband or wife, whoever is not speaking.</i>

<i>Plain Wrapper</i>	<i>Unmarked police car or state public service car.</i>
<i>Picture Taker</i>	<i>Police radar unit.</i>
<i>Pickum-up</i>	<i>Pick-up truck.</i>
<i>Pregnant Roller Skate</i>	<i>VW.</i>
<i>Put the Good Numbers on you</i>	<i>73, 88, etc.</i>
<i>Rake the leaves</i>	<i>Last vehicle in a group, bringing up the rear, back door.</i>
<i>Ratchet Jaw</i>	<i>Talk for a long time – usually at the wrong time.</i>
<i>Rest-um up</i>	<i>Rest area.</i>
<i>Rig</i>	<i>Tractor.</i>
<i>RIG</i>	<i>Radio (ears).</i>
<i>Rocking Chair</i>	<i>Truck (or car) between the front door and the back door. A good place to be.</i>
<i>Roger Rollerskate</i>	<i>Driver of a car who is more than 20 mph over the limit; also known as Roger Ramjet, a cartoon character.</i>
<i>Roller Skate</i>	<i>Small car, compact, import, motorcycle (rare).</i>
<i>Seatcovers</i>	<i>Passengers, especially good looking passengers.</i>
<i>Six Wheeler</i>	<i>Car with trailer.</i>
<i>Smokey</i>	<i>Any police officer.</i>
<i>Smokey the Bear</i>	<i>State Police.</i>
<i>Smokey with Ears</i>	<i>Police with CB radio or CB monitor.</i>
<i>Ten-four</i>	<i>Whatever the other guy said was absolutely right.</i>
<i>*Thirty Three</i>	
<i>10-33</i>	<i>Accident or emergency message.</i>
<i>Threes on you</i>	<i>Best regards (73).</i>
<i>Threes & Eights</i>	<i>73 & 88 – Best regards, love and kisses (also known as stack them eights).</i>
<i>Tijuana Taxi</i>	<i>Police car with lights and insignia.</i>
<i>Train Station</i>	<i>Court with high guilty rate . . . kangaroo court.</i>
<i>Two Wheeler</i>	<i>Motorcycle.</i>
<i>Two Way Radar</i>	<i>Radar which can be used to monitor traffic while in a moving vehicle. Some Smokies are said to have two way ears, no radar but a monitor.</i>
<i>Wall to Wall Bears</i>	<i>Any area with heavy police patrol, such as I-240 in Memphis, Tenn., I-94 Berrian County, Mich., the whole State of Ohio, and other areas where the Police enforce the letter of the law to extremes or conduct known traps.</i>
<i>We Gone!!</i>	<i>Stopping transmitting and just listening.</i>

. . . Michigan Radio Doctor
Michigan Mother Trucker

**EMERGENCY MESSAGES HAVE PRIORITY OVER ALL OTHERS.*

The Wonderful Mini-Chronometer

The state of the art in electronics miniaturization for digital clocks has evolved to the point where digital crystal controlled wrist watches are now commonplace. For the average cheapskate such as myself, a \$200.00 digital wrist watch is out of the question. What I am about to describe however, is a miniature digital alarm clock that will fit in a 3 inch square cube — power supply, readout, speaker and all.

This compact clock could possibly be constructed in a Zippo lighter case if printed circuit techniques were *not* employed. The

power supply and alarm speaker would then have to be remote and you might well be wearing 1" thick bifocals after completing this project.

Anyway, my particular mini alarm chronometer was constructed in the discarded case of a defunct Radio Shack Weather Radio. The entire cube shaped case has the internal dimensions of about 3 square inches. When completed, this little beauty contained power supply, 10 digit LED readout (6 used), an alarm speaker and all necessary switching.

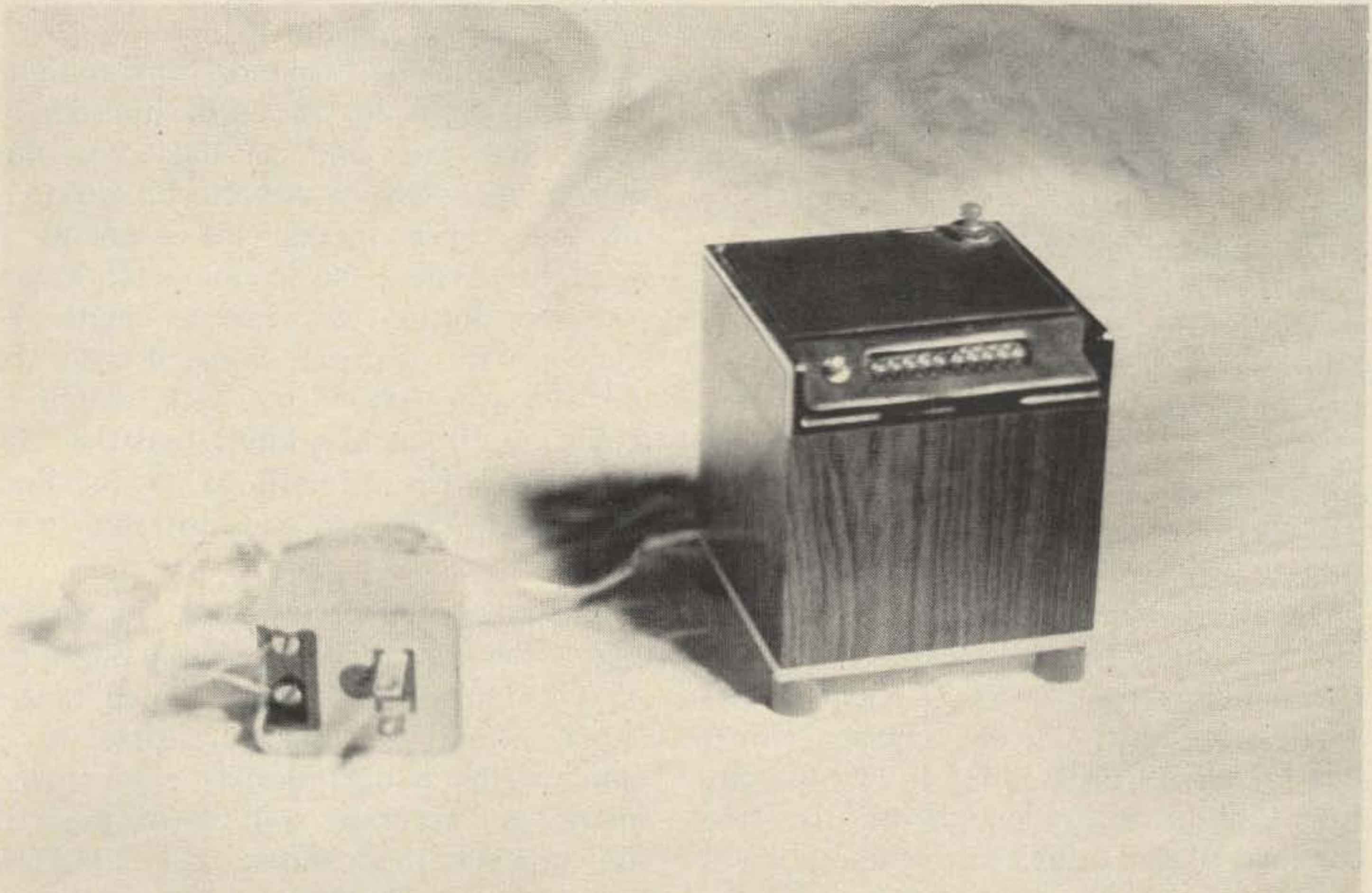

Complete clock, power cord and "power plug" transformer. The case is that of a discarded Radio Shack Weather Radio.

The only external component was the power transformer which serves also as a power line plug. This particular transformer is a telephone company encapsulated 6-8 V ac unit, with wall plug built in. If I am not mistaken, these are used to provide dial light power for "Princess" telephones. Our particular transformer just happened to fall out of a passing telephone company truck and they never returned to claim it. This encapsulated transformer is self current limiting (short proof) and, therefore, does not require a line fuse for the completed clock. If you don't have many phone company trucks passing your home, a conventional miniature 6.3 V ac, 500 mA filament transformer (imported type) can be fitted into the 3" cube with all necessary space to spare. Then, the only component external to the clock will be the line cord and "conventional" wall plug.

The current drain of the entire clock is very low and well within the requirements of this small transformer. The greatest "current hogs" in digital clocks tend to be the LED readouts. A garden variety large single LED can draw as much as 20-30 milliamperes per segment, of which there are seven. This gives you a grand total of 210 milliamperes (worst case) when all segments are illuminated.

Once again, the state of the art in LED readout manufacture has created very small encapsulated bubble (magnified) type devices containing 5 complete seven segment readouts. This entire 5 digit readout plugs directly into a common 14 pin DIP integrated circuit socket. Our particular readouts were obtained from Radio Shack for about \$2.98 per device (2 required). For those with Radio Shack stores nearby it is part #276-059 (7 Segment Monolithic 5 Digit Numeric Display).

The average current per segment in these displays is about 5 milliamperes. That results in 35 milliamperes total per 7 segment digit (worst case) and 210 milliamperes (worst case) for all six digits when totally illuminated. Built-in magnification of the self-contained plastic bubbles provides excellent readability and the total life span of the device is comparable to any other LED device.

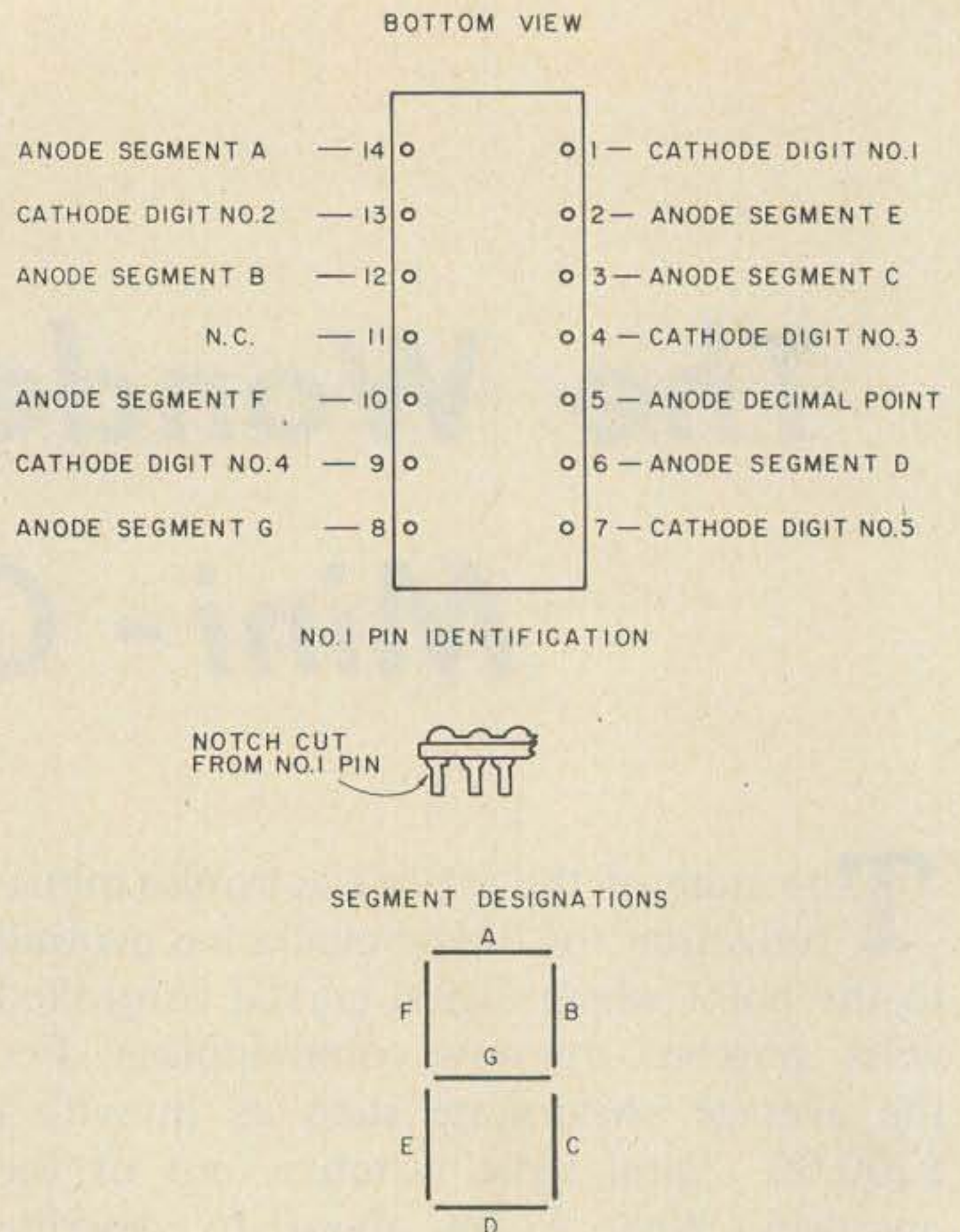

Fig. 1. 5082 readout pin connections.

These readouts are internally designed for strobed or multiplex operation. This means that the individual digits have separate pins or connections and the segments are all connected in parallel with a common pin connection.

In multiplex or "scanning" operation, the individual digits are turned on (pulsed) at a very rapid rate and at the same time, appropriate segments are also turned on. In this way, even though the segments are wired in parallel, the scanning action gives you the illusion of separate digits. The scanning rate of course is much faster than the eye can follow but well within the repetition (frequency limit) that the LEDs can follow. Pin connections for the Radio Shack part #276-059 are illustrated in Fig. 1.

The integrated circuit clock chip that we used is the Mostek 50250 (Radio Shack part #276-1715). This IC can be used to drive either a four or six digit display. In our opinion, the 6 digit display is much more impressive, accurate and useful, especially for amateur applications. The 50250 has both 12 and 24 hour timekeeping capabilities. The 12 hour timekeeping format requires a 60 cycle input as a clock fre-

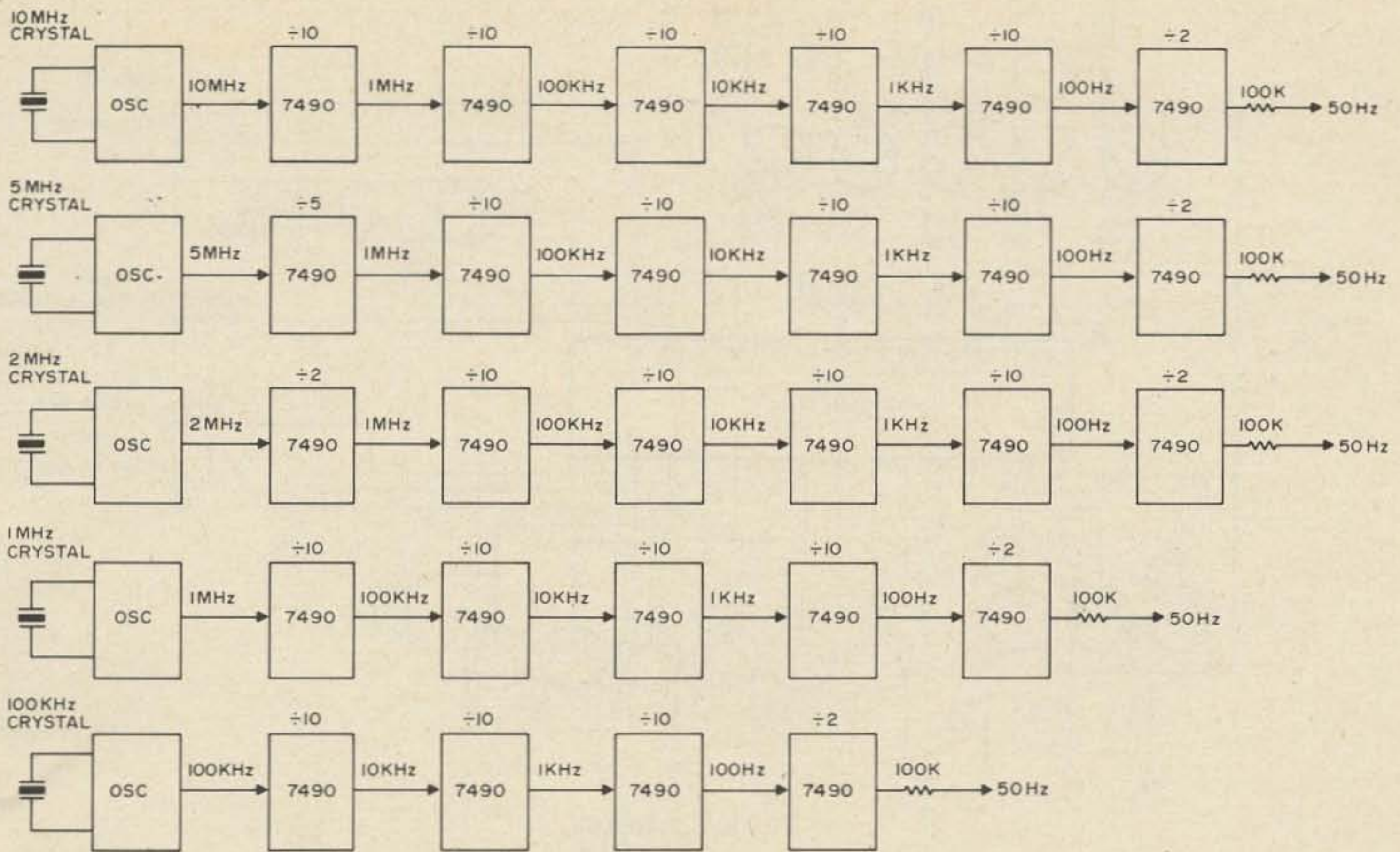

Fig. 2. 50 Hertz crystal time base ideas.

quency source. In other words, for normal timekeeping the 60 cycle line frequency must be sampled by the IC. The clock accuracy is thereby directly affected by the 60 cycle power line frequency. When the power fails, the clock loses its frequency source and timekeeping also fails.

For the 24 hour timekeeping function, the 60 cycle power line reference cannot be used. The 24 hour format requires a 50 cycle frequency source. The 50 cycle frequency source lends itself well to a crystal time base for the clock and excellent accuracy. By using a few other inexpensive TTL (transistor-transistor-logic) integrated circuits, a 10 MHz, 1 MHz, 100 kHz or other crystal oscillator may be divided down to provide the necessary 50 Hz reference. See Fig. 2.

The most common and available crystals are those of 100 kHz and 1 MHz. the majority of amateur receivers have a built-in

calibrator crystal at 100 kHz. Removing this crystal for use as a clock frequency source will not destroy its function as a calibrator. In fact, by constructing the clock source, you now have frequency references at 100 kHz, 10 kHz, 1 kHz, etc. The clock, while running in normal operation, will radiate calibration signals. While operating, this can become an annoyance. Therefore, shielding of the clock may become necessary if placed near your station receiver. Crystal sources may be divided down to provide 60 Hz but oddball crystals are generally required. It is much easier to use the 60 Hz power line source for the 12 hour format.

The 50250 is really designed for operation as an "alarm clock" chip. With proper interface to a speaker, it will generate a *loud* 1 kHz beep at one second intervals until the

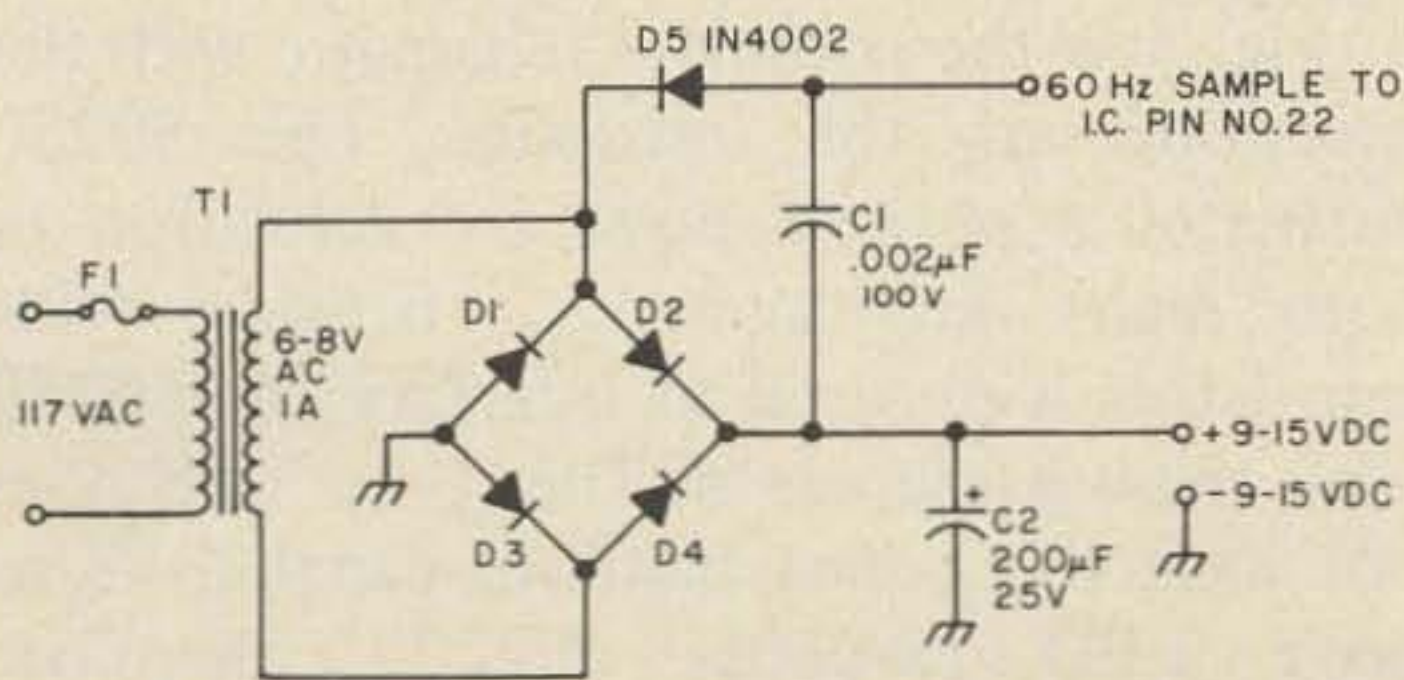

Fig. 3. Power supply.

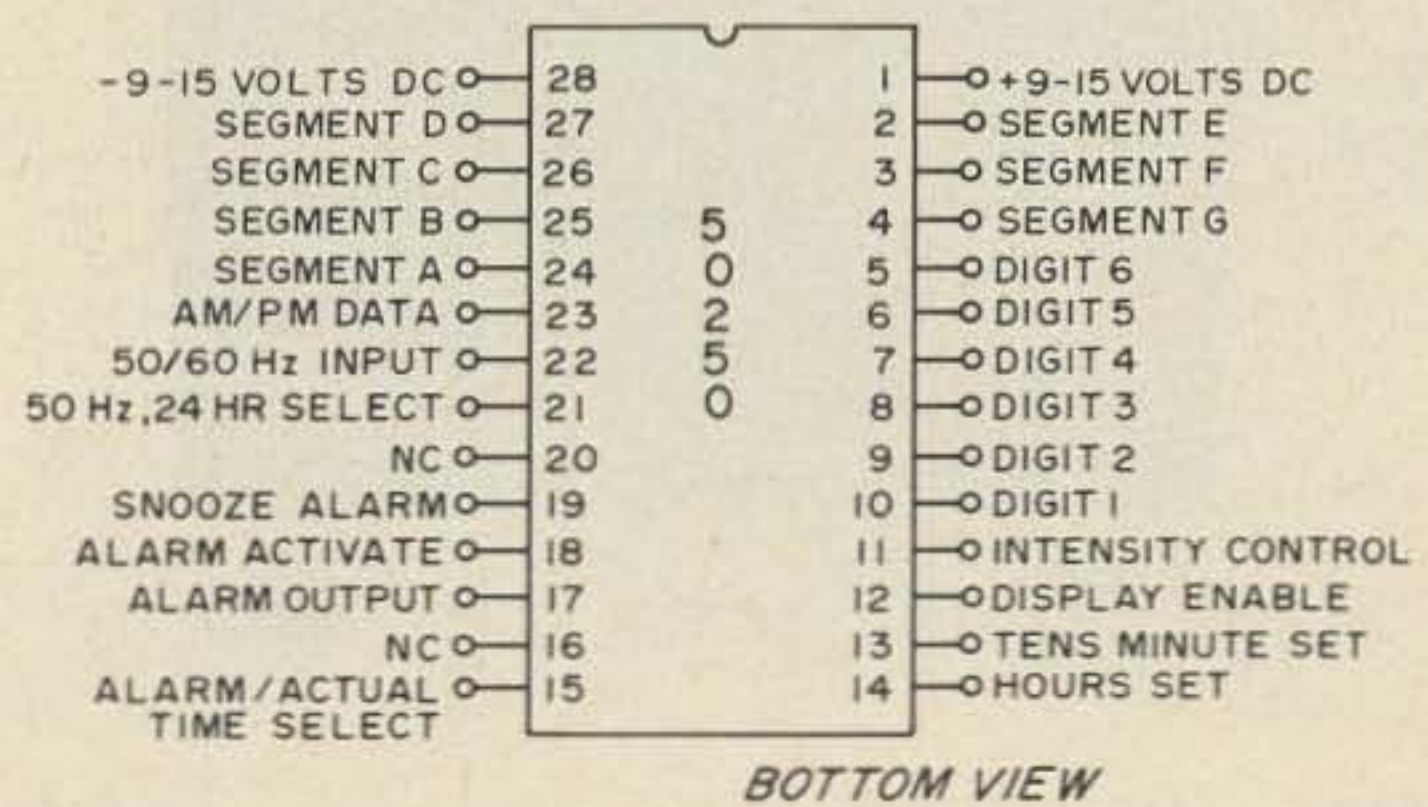

Fig. 4. 50250 pin connections.

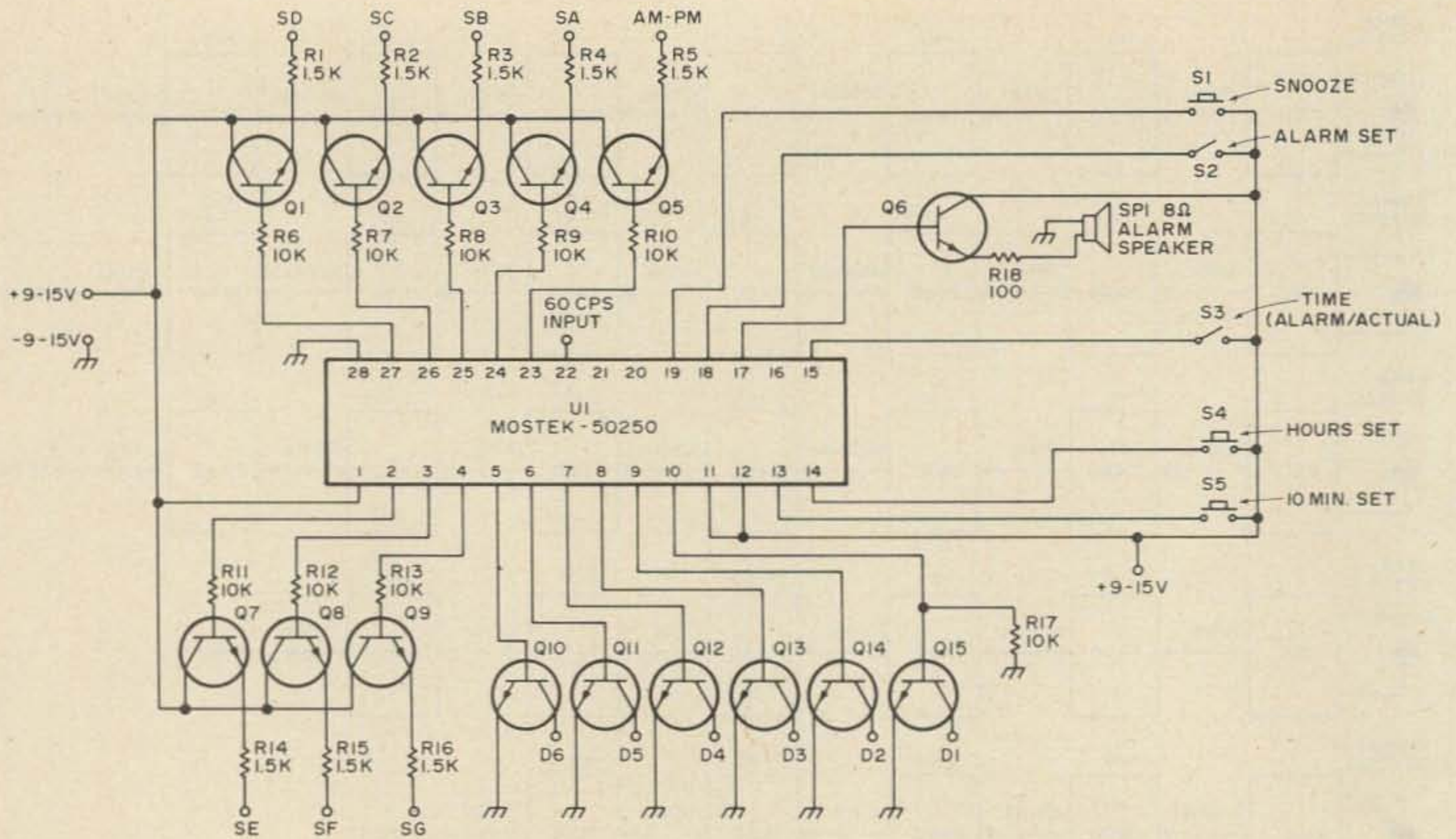
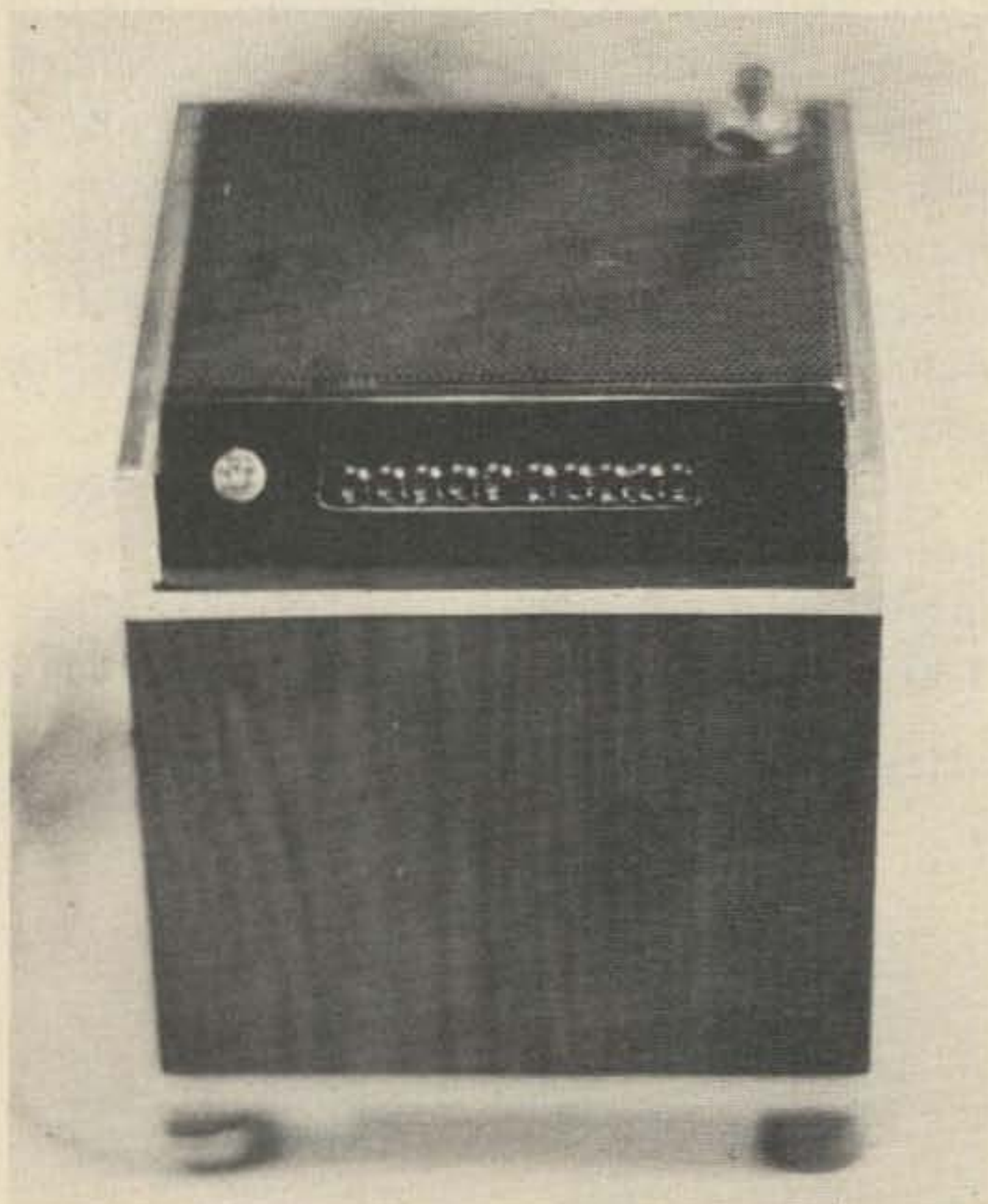

Fig. 5. Schematic.

alarm circuitry has been reset. The alarm operates in a 24 hour mode which allows you to disable and immediately re-enable the alarm to activate 24 hours later. Also built in is a snooze alarm for a period of 10 minutes upon which the alarm again sounds. The snooze alarm may be reset repeatedly at 10 minute intervals.



Mini chronometer readouts mounted in black plastic sheet.

Fig. 3 illustrates the power supply required to run the clock. T₁ is either a telephone transformer or a miniature 6.3 ac, 500 mA filament transformer. Of course, the phone transformer is more convenient as it doubles as a wall plug. D₁-D₅ are 1N4002 silicon rectifiers. Here, any 50 volt or more, 1 Ampere silicon rectifier will suffice. An encapsulated bridge rectifier rated at the same is also convenient to replace D₁-D₄. D₅, which acts as a half wave rectifier, provides the 60 cycle sample (clock) source for the IC. C₂ may be 200 uF at 25 volts or more; 200 uF is just about the low limit for proper filtering. A 1000 uF or higher value may also be used. Depending on the transformer used, (6 or 8 V ac) the dc output voltage should range anywhere from 7.5 to 15 volts dc.

Fig. 4 shows the pin connections of the 50250. This is a bottom view with pins upward.

Fig. 5 is the complete schematic with the exception of the readouts. The 50250 emanates a positive pulse for activation of both digits and segments. Therefore NPN transistors were used to interface the 50250 with the outside world. The IC by itself does not have the power handling capabilities to drive LED readouts directly, therefore higher power transistors must do the actual

ATLAS 210

for 10, 15, 20, 40 and 80 METERS AND THE COMPANION
MODEL 215 FOR 15 through 160 METERS.



ATLAS
RADIO INC.



Measuring only 0.18 cu. ft. and weighing less than 7 pounds, the Atlas 210/215 Solid State Single Sideband Transceiver is a real GIANT KILLER. It packs a hefty 200 watts P.E.P., offers 5 band coverage, and unprecedented selectivity (only 9200 cycles at 120 db down).

Priced at just \$599, it's the best transceiver value on the market today.

HUSTLER[®]

PERFECT CHOICE FOR
THE ATLAS WHEN
MOBILE

STANDARD HUSTLER RESONATORS—

Model RM-10	10 meter resonator
Model RM-15	15 meter resonator
Model RM-20	20 meter resonator
Model RM-40	40 meter resonator
Model RM-75	75 meter resonator
Model RM-80	80 meter resonator

SUPER HUSTLER RESONATORS— Legal Power Limit —Normal SSB Duty Cycle

Model RM-10S	10 meter resonator
Model RM-15S	15 meter resonator
Model RM-20S	20 meter resonator
Model RM-40S	40 meter resonator
Model RM-75S	75 meter resonator
Model RM-80S	80 meter resonator

TUFTS Radio Electronics

386 Main St., Medford, Mass. 02155

switching. All of the NPN switching transistors used were those obtained from the Radio Shack Quad Pack (Part #276-530) and were NPN medium power general purpose. The snooze, hours set and 10 minute set switches are of the normally open type of push-button.

The actual size printed circuit board shown in the figures can be photographically reproduced and made up; however, for a single clock, this process seems hardly necessary. We generally take a template such as this and cut a piece of PC board stock the same size. Scotch tape is then used to hold the template on the PC board. A sharp punch is used to indent the copper at all points where a hole is to be drilled or component inserted. When the pattern is removed, the punch marks will be in exact position. Ordinary finger nail polish and a fine brush are then used to "paint between the dots" and duplicate the original pattern. The nail polish dries very fast and is an excellent resist. The board is then placed in a heated ferric chloride solution which rapidly removes the excess copper. The nail polish resist is then removed with nail polish

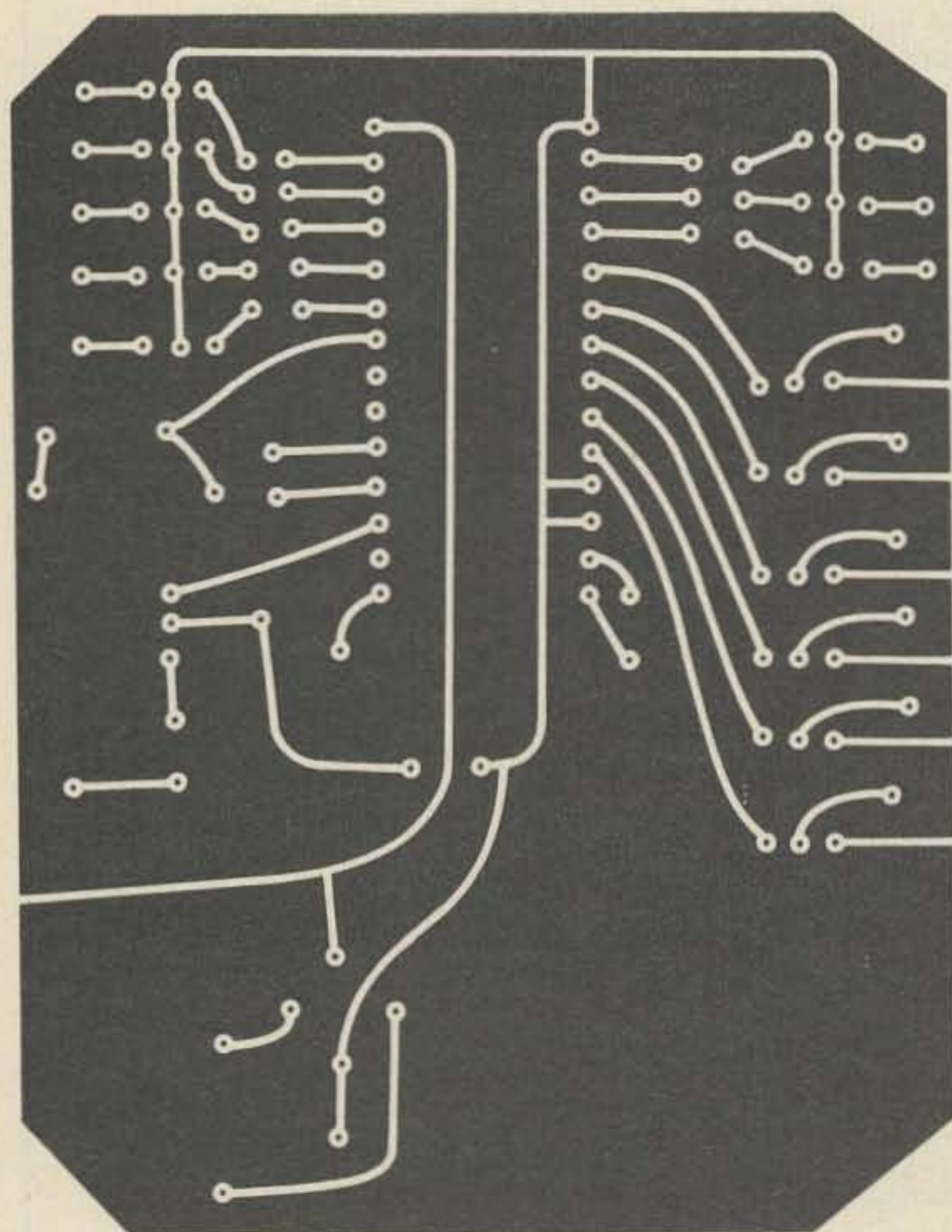

Fig. 6. PC board (full size).

Full size negatives for Fig. 6 are available for \$2.00 each from PC NEGS, 73, Peterborough NH 03458.

Order #W2A00-1.

remover or "Stripeze" (paint remover). The initial punch marks now serve as center-punch guide holes when you drill all the holes (#56#60 drill). All necessary components with the exception of the power transformer and readouts are placed on this board.

Fig. 7 shows where transistors and diodes are inserted on the PC board. Make sure you use the 50250 socket. It would be very difficult to remove a defective 28 pin IC should it be defective. The NPN Radio Shack transistors used do not have the conventional lead connections as do normal garden variety transistors; therefore, we have illustrated where the "flat" side of the transistor is placed to correctly orient the leads. All parts are inserted from the non-foil side of the board. As you insert the components, solder them in place with a 25 Watt fine tip iron and trim off the excess leads close to the PC board.

Fig. 8 illustrates the placement of the encapsulated rectifier bridge, as well as the resistors and capacitors. Individual 1N4002 silicon diodes may be used, although the encapsulated bridge is a much more convenient device. The bridge we used was a 50 piv, 1 Ampere unit which is also a Radio Shack device. The .005 capacitor is a small ceramic disc type rated at 50-100 volts. The 200 uF 35 volt filter capacitor is small enough to be placed flat on the PC board, and polarity must be observed. Only one jumper is

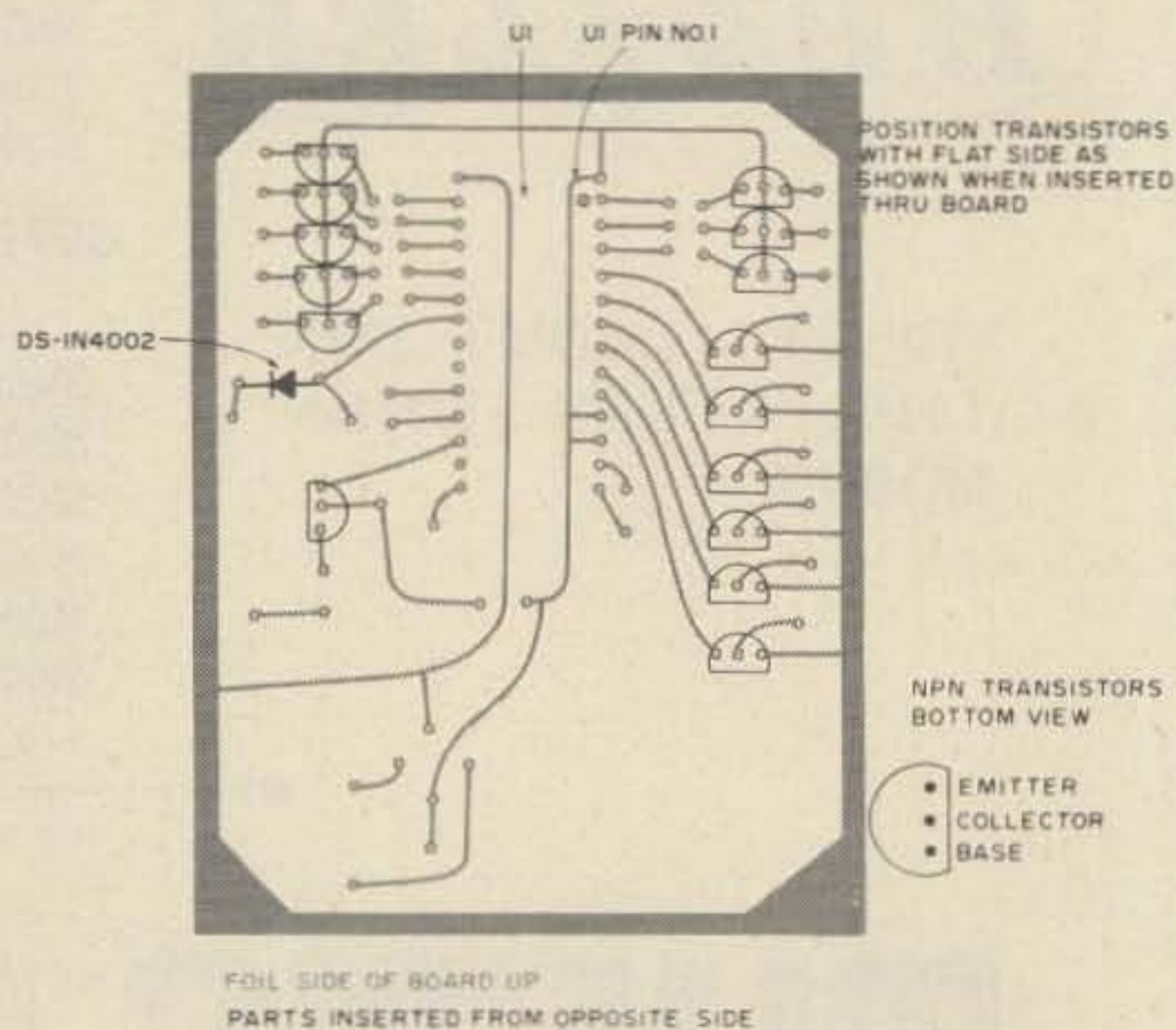

Fig. 7. Transistor and diode placement. Transistors are NPN, medium power from \$1.98 Radio Shack Quad Pack #276-530.

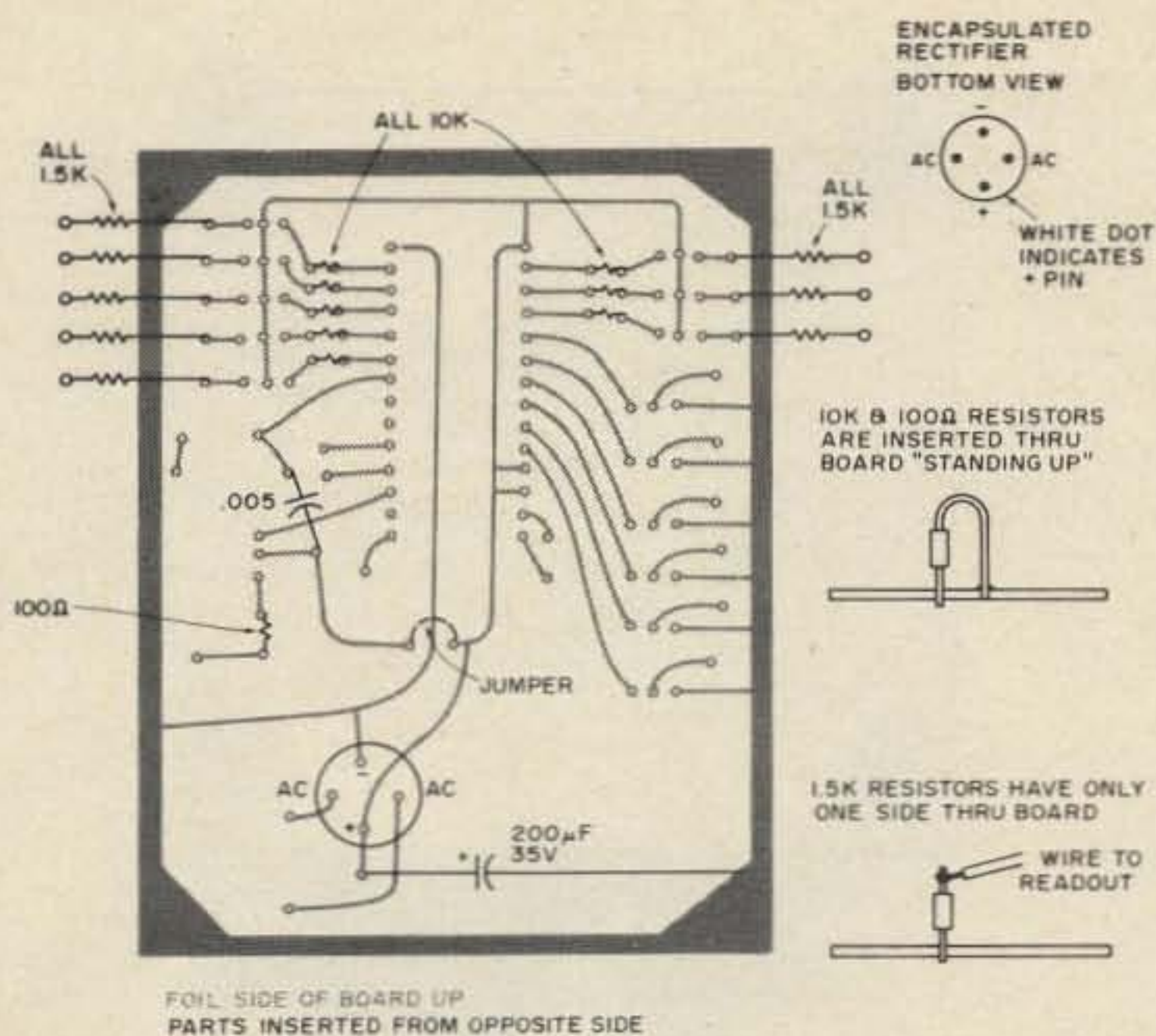

Fig. 8. Rectifier and resistor placement.

necessary on the board and may be any small piece of copper wire. The 10k resistors and the 100 Ohm resistors are inserted "standing up" so as to conserve space. The 1/8 Watt resistors stand up about 1/2" high. The 1.5k resistors also are inserted in the board "standing up" and soldered. The opposite end is trimmed off leaving about 1/8" of lead on the resistor. A wire going to the proper readout must be soldered to this standing resistor lead. This was used to conserve PC board space. To really conserve on space, the PC board may be cut off so that the encapsulated bridge and 200 uF capacitor are separate (with appropriate jumpers made up). This is necessary to squeeze the board into the 3" square cube, if these are your plans.

Fig. 9 shows the external and time function control switch connections. The digit wires are soldered directly to the board. All of the segment wires are attached to the top lead of the 1.5k resistors previously soldered in place. The 60 cps connection can either go to an external 60 cps frequency source such as a crystal frequency divider or to either of the ac points on the PC board for a 60 cps sample (jumper). The speaker terminal goes directly to an 8 Ohm miniature speaker and the other speaker connection returns to ground or the edge foil of the PC board. Holes may be drilled in the corner section of the PC board for mounting it on standoffs.

The opposite side of the time function control switches is attached to the +9 -15

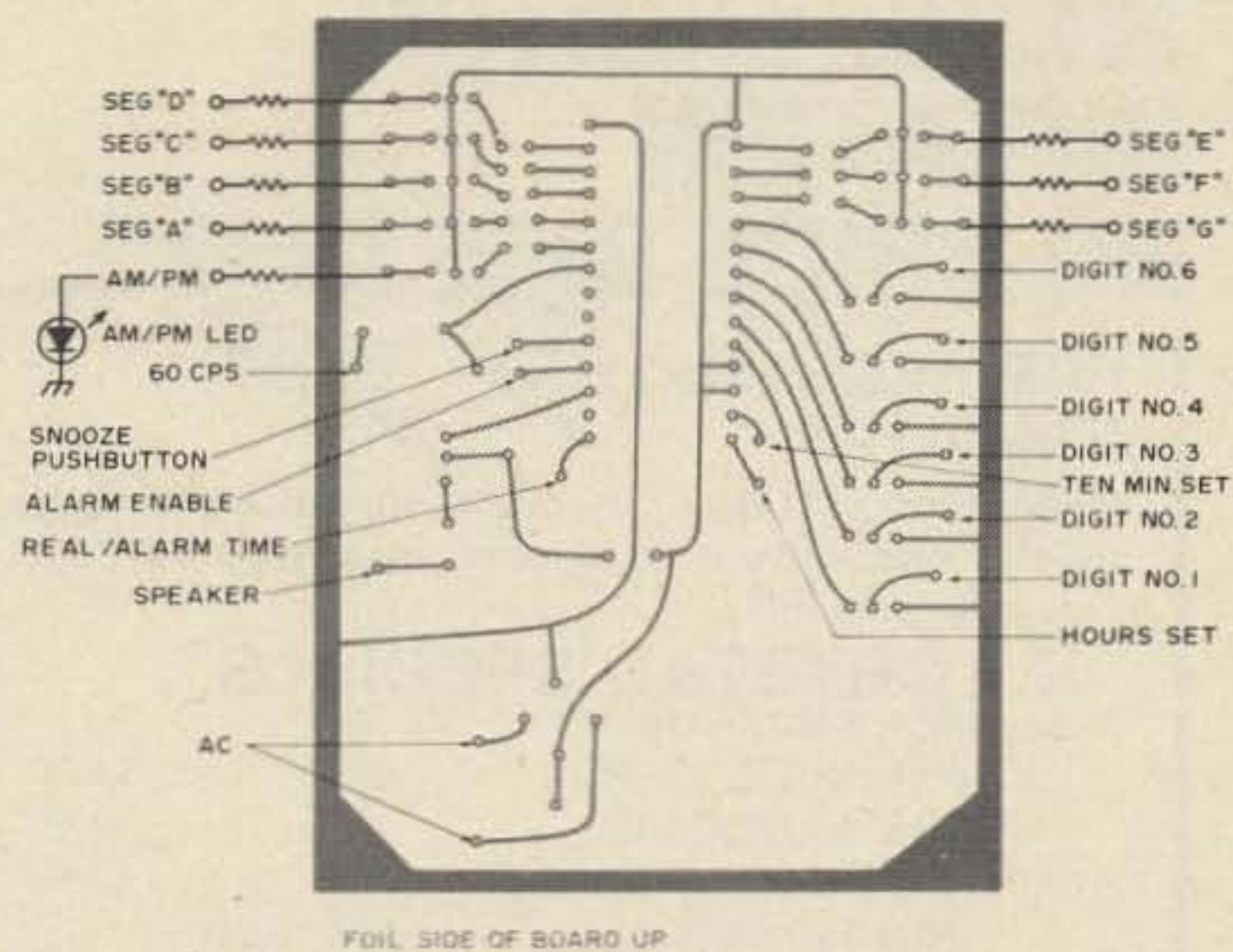

Fig. 9. External and time function/control switch connections.

volt lead. Refer to the main schematic (Fig. 5) for the type of switch and connections.

After you have wired and completed all the previous goodies no doubt you have had your bifocal prescription modified as well.

Once power is applied, there are two possible things that will happen. The clock will either smoke and immediately burn up, or the numbers 12:00:00 will appear when the switch for real/alarm time is in either position. Luck is with you and the phases of the moon are correct if you obtain the 12:00:00 reading. Don't let it frighten you if the seconds are not counting when first obtaining a display. Both the hours and ten minute push-button switches must be depressed simultaneously to begin the time-keeping function with the real time/alarm switch in the real time position. If there is leak over between digits, it means you have a transistor that has excessive leakage in your driver stages. It is quite common to find a "lemon" in the transistor drivers.

Anyway, it takes a bit of practice to get used to setting the clock with the hours and ten minute switches. Once you have become proficient at this, it is time to experiment with alarm. We should have mentioned previously that an am-pm LED should have been attached as shown in Fig. 9. This may be any small LED connected to the am-pm transistor driver. When the clock is in the am mode, this LED will illuminate. The main purpose of this LED is to allow you to set the alarm function properly. If you place the alarm/real time switch in the alarm position,

WE'RE FIGHTING INFLATION NO PRICE RISE IN '75

FOR FREQUENCY STABILITY



Depend on JAN Crystals. Our large stock of quartz crystal materials and components assures Fast Delivery from us!

CRYSTAL SPECIALS

Frequency Standards

100 KHz (HC 13/U).....	\$4.50
1000 KHz (HC 6/U).....	4.50
Almost all CB sets, TR or Rec	\$2.50
(CB Synthesizer Crystal on request)	
Amateur Band in FT-243	ea. \$1.50
	4/\$5.00
80-Meter.....	\$3.00 (160-meter not avail.)

Crystals for 2-Meter, Marine, Scanners, etc. Send for Catalog.

For 1st class mail, add 20¢ per crystal. For Airmail, add 25¢. Send check or money order. No dealers, please.



Div. of Bob Whan & Son Electronics, Inc.
2400 Crystal Dr., Ft. Myers, Fla. 33901
All Phones: (813) 936-2397

Send 10¢ for new catalog with 12 oscillator circuits and lists of frequencies in stock.

the LED will come on if you desire an alarm settings. The same switches used to set the alarm time are used to set the real time. When the alarm enable switch is in the enable position, the alarm will sound with a loud one second beep when the real time has reached the alarm set time. The snooze alarm switch, if depressed when the alarm goes off, will allow 10 minutes of silence before the alarm sounds again. This may be repeated indefinitely until the alarm enable switch is shut off. If you wish, this feature may be incorporated as a 10 minute timer for station identification.

With the alarm system, there are two characteristics that should be avoided. The alarm should not be exactly set at 12:00 am or 12:00 pm or 8:00 am or 8:00 pm. Setting the alarm a few minutes before or after these times will allow reliable operation.

Should the local line power drop below a usable level, the am/pm LED will blink at a 1 cycle rate. This tells you the clock has lost time or needs to be reset correctly.

This clock should be an interesting project to construct and will serve you well. At

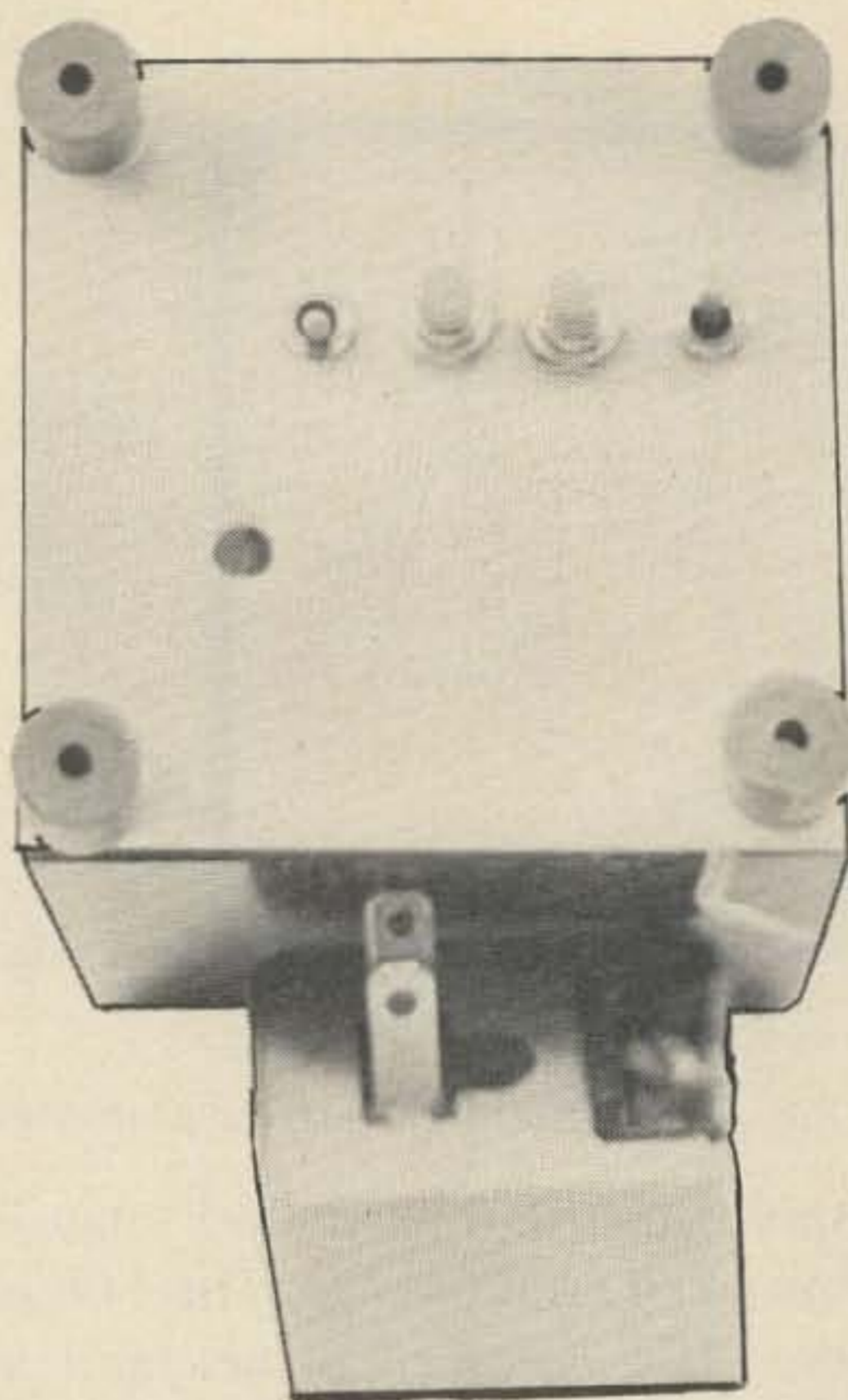

Bottom view of mini chronometer, showing time set push-buttons and alarm/real time switches.

the very least, it will give you considerable insight into the functions of large scale integrated circuits and their capabilities. The state of the art in electronics is no further away than the tip of your soldering iron (25 Watt fine tip).

Parts List

Fig. 3.

- C1 — .002 μ F 100 V capacitor
- C2 — 200 μ F (or higher)
- D1-D5 — 1N4002 silicon diodes. A single encapsulated bridge (50 V @ 1 A) works well also.
- F1 — 1 A 125 V slow blow fuse
- T1 — Plug in Princess telephone transformer, 6-8 V ac, 1.75 VA secondary, 117 ac primary (or 6.3 ac 500 mA filament transformer)

Fig. 5.

- Q1-Q15 — Radio Shack (Archer) #276-530 transistor quad pack (\$1.98). Use the NPN medium power general purpose transistors (6 per pack). There are 24 transistors (assorted) in each pack, the remainder of which make good spares, etc.
- R1-R5, R14-R16 — 1/8 Watt, 1500 Ohm carbon resistors
- R6-R10 — 1/8 Watt, 10,000 Ohm carbon resistors
- R18 — 1/2 Watt, 100 Ohm carbon resistor
- S1, S4, S5 — Normally open miniature push-button switches
- S2, S3 — Single pole miniature toggle switches
- SP1 — 8 Ohm 2 in. speaker
- U1 — Radio Shack #276-1751 MOS-LSI Digital Alarm Clock IC

...W2A00

An Accessory VFO

- The Easy Way

Most amateurs who use an HF transceiver at times desire having an accessory VFO for separate VFO control of the transmitting and receiving frequencies. If the transceiver does not have receiver incremental tuning, the addition of an accessory VFO becomes an even more desirable item. Accessory VFO's can be purchased for most transceivers, of course, but their cost can be a considerable fraction of the original cost of the transceiver since the accessory VFO usually duplicates the stability, housing and frequency scale readout of the transceiver's VFO.

The accessory VFO circuits described in this article can be developed into full-scale accessory VFO's but there is another possible use for them with a transceiver which requires far less work and yet provides most of the advantages of a regular accessory VFO. As was just mentioned, most regular accessory VFO's duplicate the transceiver

VFO and one can use the transceiver or accessory VFO interchangeably since they both have the same frequency calibration scales. Another approach to the use of an accessory VFO would be to tune the transceiver (using the transceiver VFO) to a desired transmitting frequency, switch on an accessory VFO which can be zero-beated to the transceiver's VFO frequency and then switch VFO control of the transceiver in the *transmit* mode to the accessory VFO. In the receive mode the frequency control of the transceiver would remain with the transceiver VFO and could, of course, be tuned as desired. This scheme requires only the use of a stable, external VFO *without* elaborate frequency readout, which can be zero-beat with the transceiver VFO and which can be switched in the transceiver to assume frequency control of the transceiver during transmit periods. The circuitry to do the latter is already provided in any transceiver which has provisions for the use of an accessory VFO. To zero-beat the external VFO with the transceiver VFO, the external VFO signal is introduced to the transceiver in the receive mode as though it were a regular received signal, and the external VFO tuned for zero-beat. With most transceivers the level of an external VFO is usually great enough so it can be introduced at the antenna terminals of the transceiver and not be severely affected by the selectivity of the

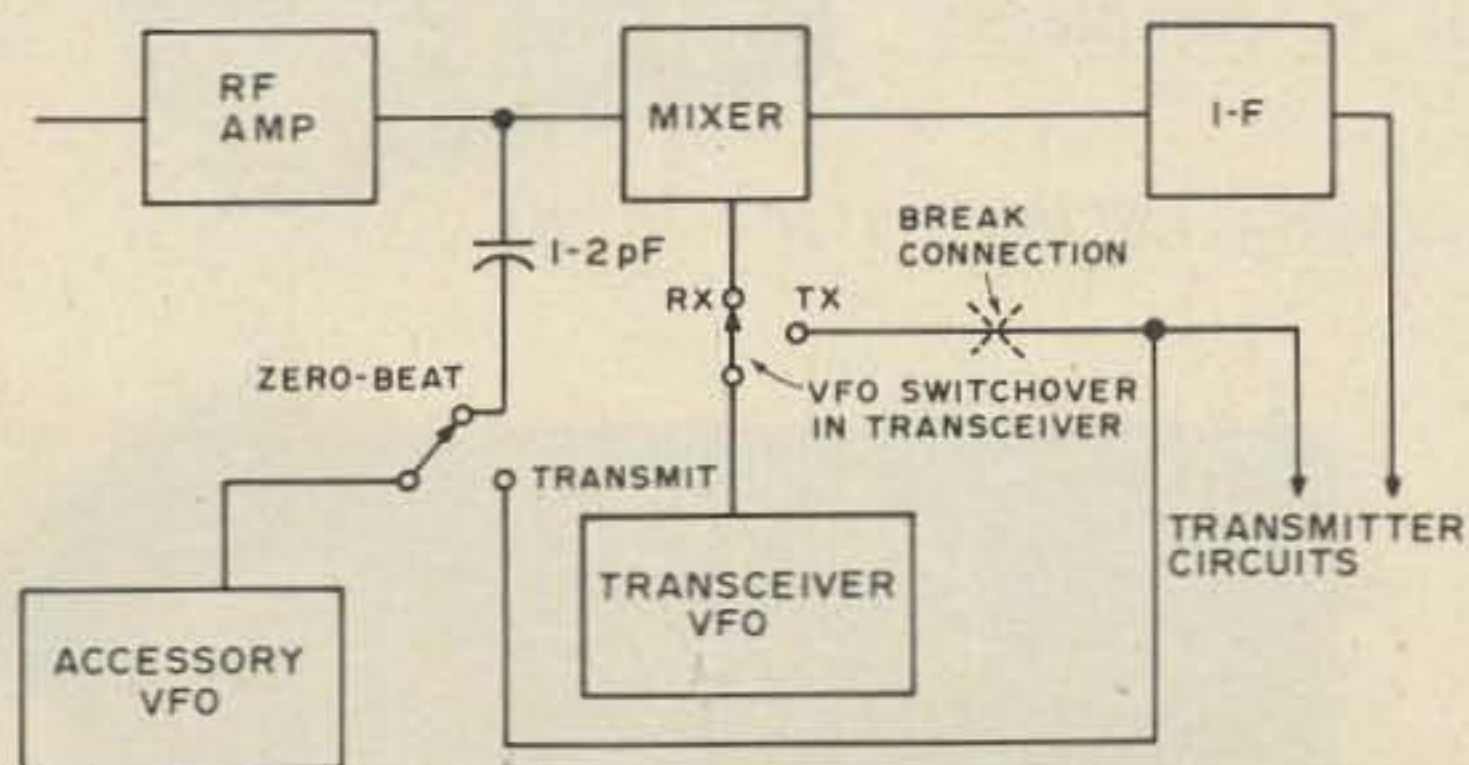

Fig. 1. Basic use of accessory VFO.

NEW!



Operate Auto-Patch

use antenna and power . . . The GTX-200-T does all the rest!

The 12-digit tone encoder is an integral part of the 2-meter VHF-FM transceiver (WOW!) Separate controls allow independent transmit and receiver frequency selection.

The GTX-200-T is all solid state, transmits at 30 watts (nom.), also features super-sensitive dual-gate MOS FET preamp receiver. Same old GTX-200—but what an addition!

Your Low Price

\$249⁹⁵

Use coupon to order direct from factory

IMMEDIATE DELIVERY FROM STOCK

TE-II Tel Encoder . . .

so small and compact it can be mounted on the faceplate of most any transceiver, including smaller-sized walkie-talkies. Completely self-contained: connect to B+ ground and signal output, and it's ready to operate.

The TE-II produces all standard double frequency tones used in telephone signalling circuits. It is completely shielded.

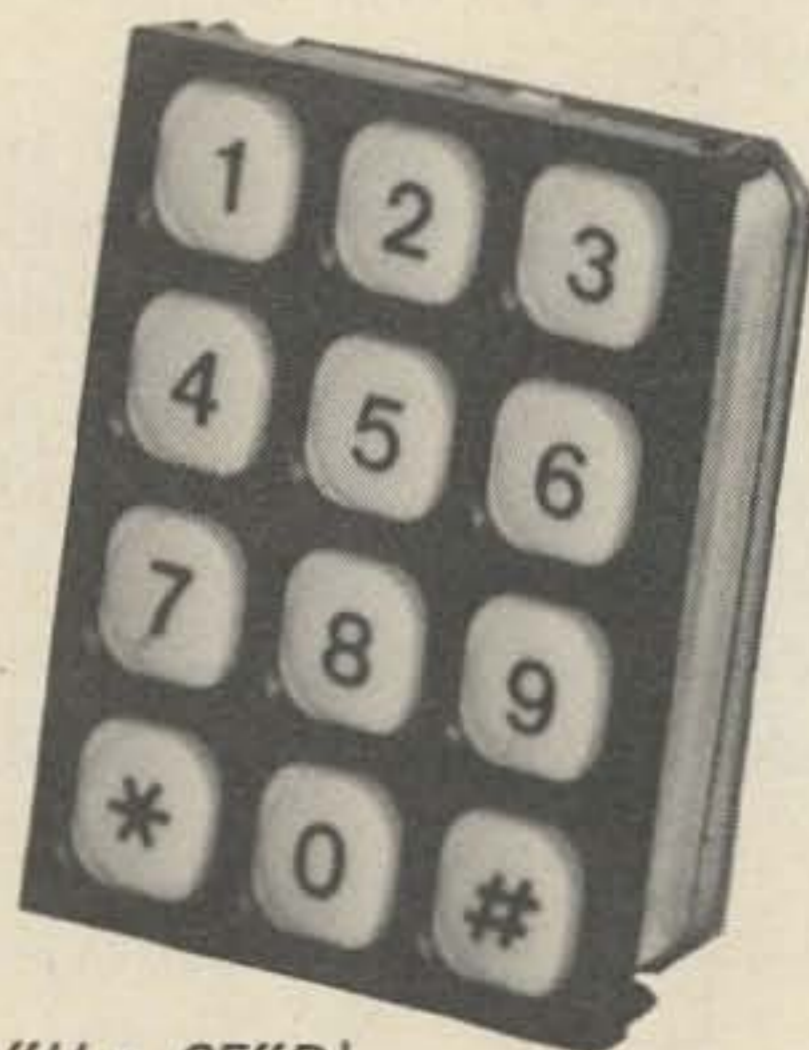

(Size — 1.6"W x 2.1"H x .65"D)

Your Low Price

\$44⁵⁰

Use coupon to order direct from factory

Use This Handy Order Form

CLIP OUT AND ORDER NOW

THIS PAGE IS YOUR ORDER BLANK! ORDER NOW AND SAVE!

Specials at Unbeatable Prices



GENAVE, 4141 Kingman Dr., Indianapolis, IN 46226 (317+546-1111)

HEY, GENAVE! Thanks for the nice prices! Please send me:

-   **GTX-200-T Operate Auto-Patch**
 2-meter FM, 100 channels. 30 watts (incl. 146.94 MHz) **Special Price** **\$259⁹⁵**
-  **GTX-200**
 2-meter FM, 100 channels. 30 watts **was \$299.95** (Incl. 146.94 MHz) **NOW \$199⁹⁵**
-  **GTX-100**
 1 1/4-meter FM, 100 channels. 12 watts **was \$309.95** (Incl. 223.5 MHz) **VERY SPECIAL \$199⁹⁵**
-  **GTX-10** 2-meter FM, 10 channels, 10 watts **WOW! ~~\$169⁹⁵~~ \$139⁹⁵**
-  **GTX-2**
 2-meter FM, 10 channels. 30 watts **was \$299.95** (Incl. 146.94 MHz) **NOW \$189⁹⁵**
-  **GTX-600**
 6-meter FM, 100 channels. 35 watts **was \$309.95** (Incl. 52.525 MHz) **SPECIAL NOW \$199⁹⁵**

- PSI-11 Battery Pack (with charger)** @ \$109.95 \$ _____
- ARX-2 2-M Base Antenna** @ \$29.95 \$ _____
- Lambda/4 2-M Trunk Antenna** @ \$29.95 \$ _____
- TE-I Tone Encoder Pad** @ \$59.95 \$ _____
- TE-II Tone Encoder Pad** @ \$49.95 \$ _____
- PSI-9 Port. Power Package (less batteries)** @ \$29.95 \$ _____
- PS-1 AC Power Supply** @ \$69.95 \$ _____

and the following **standard** crystals @ \$4.50 each: _____ \$ _____

Non-standard crystals @ \$6.50 each: _____ \$ _____

(allow 8 weeks delivery.)
For factory crystal installation add \$8.50 per transceiver.

IN residents add 4% sales tax:

CA residents add 6% sales tax:

All orders shipped post-paid within continental U.S.

Sub-Total: \$ _____

TOTAL: \$ _____
(minimum order \$12.00)

NAME _____ PHONE _____

ADDRESS _____ CITY _____ STATE & ZIP _____

Payment by: Certified Check/Money Order Personal Check C.O.D. Include 20% Down.

Note: Orders accompanied by personal checks will require about two weeks to process.

20% Down Payment Enclosed. Charge Balance To:

BankAmericard # _____ Expires _____

Master Charge # _____ Expires _____ Interbank # _____

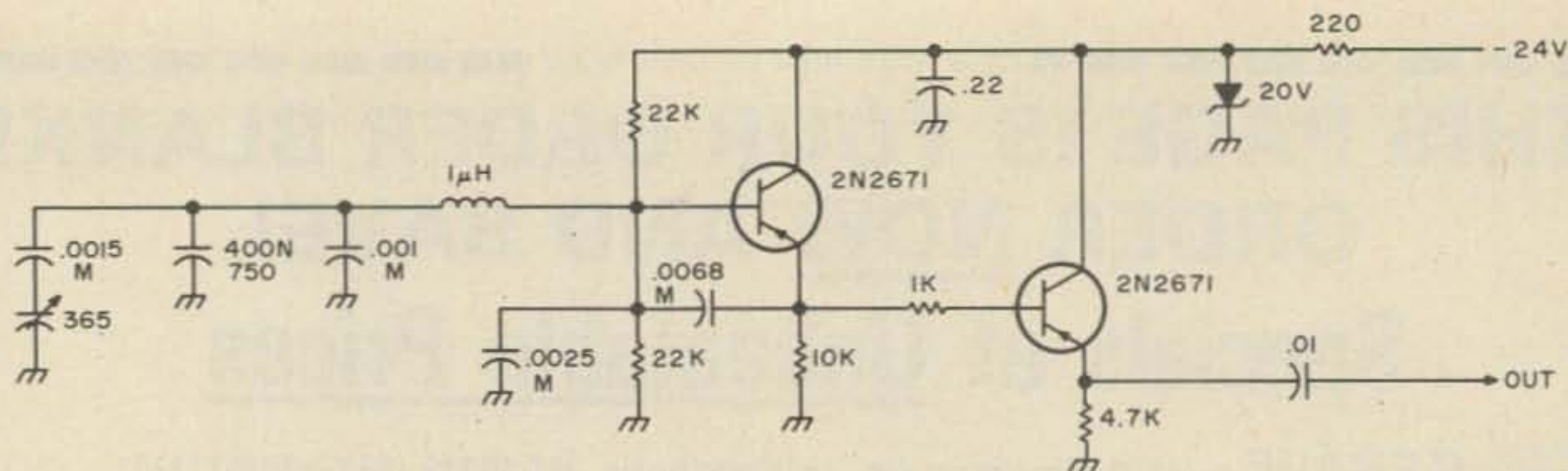

Fig. 2. An old fashioned (PNP transistors) but extremely stable VFO. Basic oscillator frequency is 5 MHz with about a 250 kHz tuning range. Capacitors marked "M" must be silver mica type.

circuits in the rf amplifier stage. So, it can be used to zero-beat with the transceiver VFO.

If, however, an effective zero-beat cannot be obtained, the external VFO signal can be introduced directly to the input of the mixer stage which the transceiver VFO also feeds. The amount of the coupling required is usually very light and can be effected via a simple 5 to 10 pF capacitor coupling from the external VFO. This method will work with any transceiver where single conversion is used, such as the usual 9 MHz i-f transceiver. Unfortunately, it is not possible to present the VFO switching circuits available in every transceiver but if the general switching idea outlined is followed and experimented with, there should be no difficulty in making a satisfactory connection to one of the VFO circuits to be described.

Fig. 1 illustrates the transceiver switching idea involved. The rest of this article describes several circuits suitable for external VFO usage. Each is quite stable and can be adapted to work over any of the ranges suited to an HF transceiver — namely, a 250 to 600 kHz range within any selected portion from about 4 MHz to 12 MHz. The various circuits have their own advantages and disadvantages depending both upon what components one already has available and on the tuning method desired.

Fig. 2 illustrates a rather old fashioned VFO, in a sense, since PNP transistors are used. But, it is an extremely simple and stable circuit. The tuning range is about 250 kHz in any segment of the 5 to 9 MHz range depending upon how the oscillator coil is set. It is a high -C type circuit and so the oscillator coil is relatively small in value. The coil, however, should be wound on a ceramic coil form or be an air-wound coil. The capacitors noted in the circuit *must* be mica

types to ensure stability. The tuning capacitor is a very easy to obtain 365 pF AM radio tuning variable. The 400/N750 temperature compensating capacitor shown is not absolutely necessary and may be a difficult component to obtain although it is not expensive. It can be replaced by a regular 400 pF mica capacitor. The only instance in which this capacitor is necessary is if the VFO is to be used in a mobile application. In that case, it should be placed near the VFO coil to achieve maximum temperature stability of the oscillator. A positive supply voltage could be used by grounding of the collector circuit and feeding the positive supply voltage via the emitter resistors of each transistor. Because of the high capacitance loading on the oscillator tank circuit, the 365 pF tuning capacitor need not be located directly adjacent to the VFO. It can be coupled to the VFO via a short length of shielded cable (RG174) if this is more convenient in a given transceiver.

The circuit of Fig. 3 is a bit more conventional in that it operates from a positive 12 volt dc source. The VFO coil is air-wound and consists of 17 turns of #18 wire, 5/8" in diameter, or the B&W coil stock

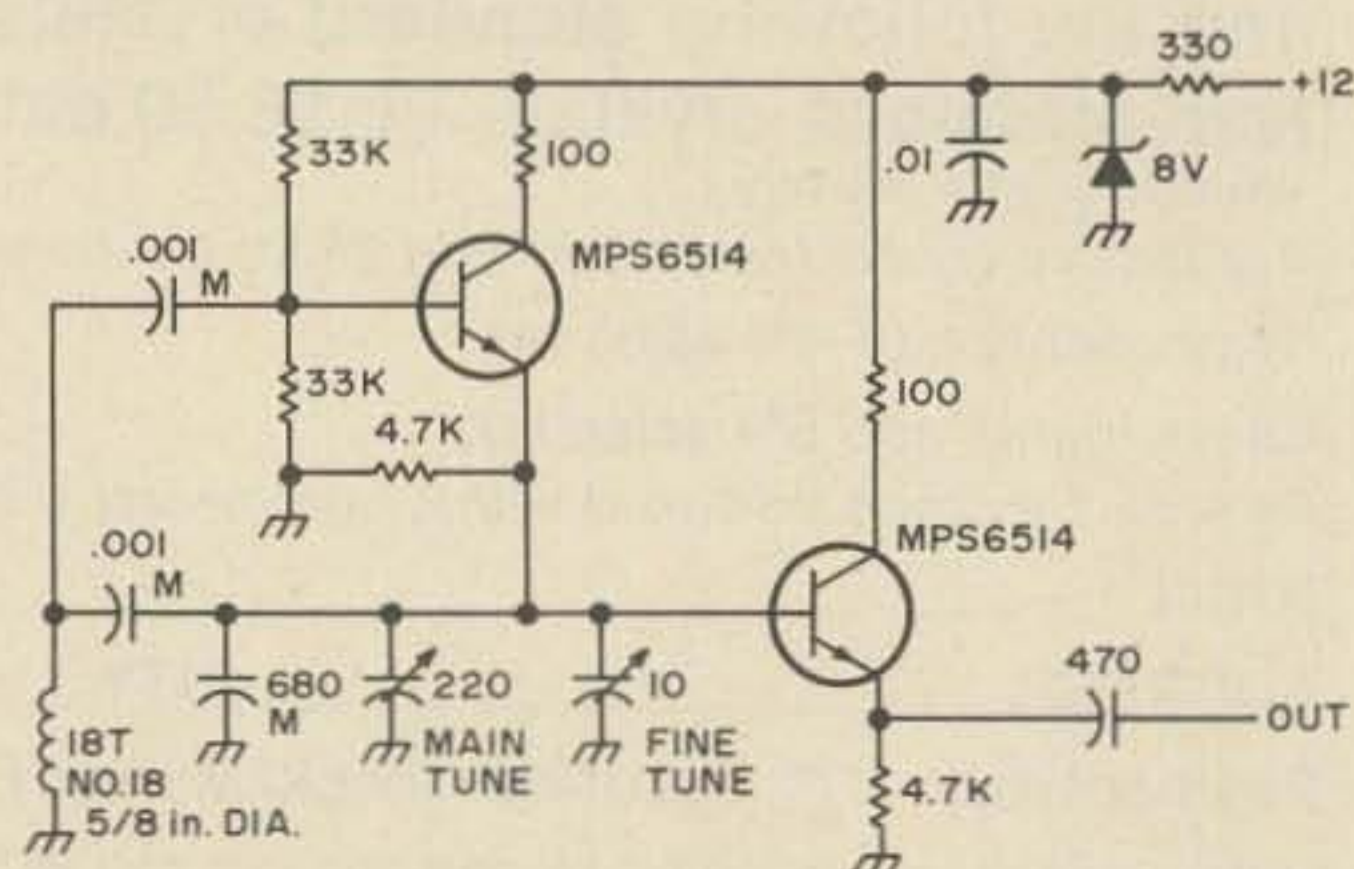

Fig. 3. This oscillator tunes about 500 kHz starting at 5 MHz. Only three silver mica capacitors are required.

equivalent. The oscillator operates at about 5 MHz with the main tuning control covering a 500 kHz range and the fine tuning control covering a ± 20 kHz range. The oscillator can be made to operate over almost *any* position of the HF range by proper selection of the coil. Note that mica capacitors *must* be used for the two .001 μ F and one 680 pF capacitors associated with the oscillator coil. The output at the emitter coupling capacitor of the buffer stage is a relatively high 4 volts peak-to-peak.

The circuit of Fig. 4 is extremely interesting in that it requires no tuning capacitors (and no varactor diodes) and provides tuning over a small tuning range (about 50 kHz centered on 7 MHz). It would be very suitable for someone interested in operation over a particular portion (CW or phone) of one band. Although there are no varactor diodes in the circuit, as such, the collector to base junctions of the two 2N3053 transistors perform the same function. The circuit requires a minimum of critical components. Only the three capacitors marked as being "M" must be of the silver mica type. If one wanted to considerably expand the frequency bandspread of the oscillator (to about ± 250 kHz about the center frequency), the 130 pF "M" capacitor could be replaced by an air variable and the potentiometer tuning still be retained for fine tuning. This modification would not change the very good basic frequency stability of the oscillator and only two silver mica capacitors (50 and 380 pF) would be required for the whole oscillator circuit.

Fig. 5 is another oscillator circuit that has been widely used, especially in QST articles. It is the same type of oscillator as the preceding one but includes an emitter follower buffer stage for isolation. The emitter follower stage contains a low pass

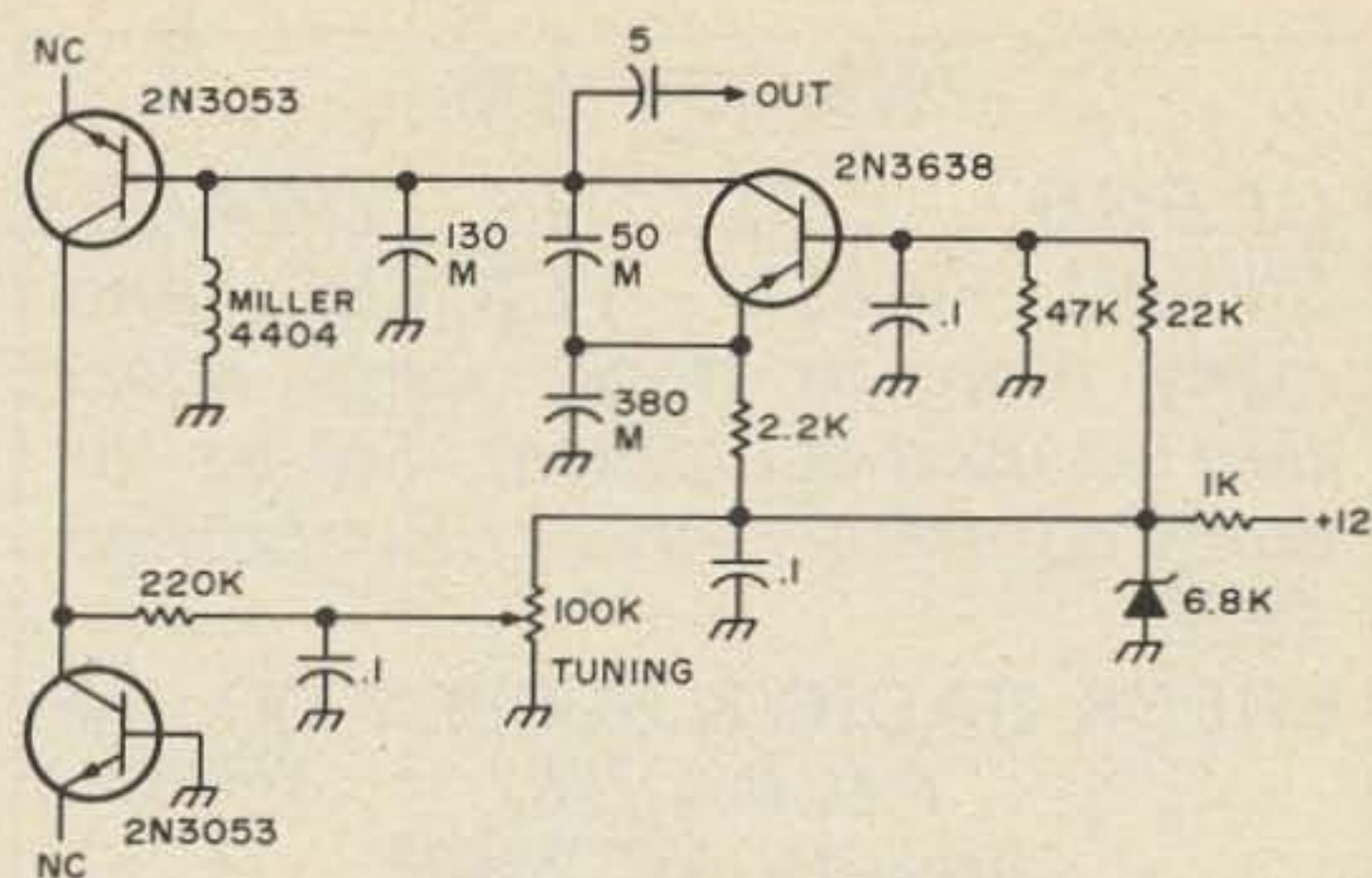

Fig. 4. This interesting VFO tunes only about 50 kHz starting from 7 MHz. It can be modified for greater range.

filter to reduce harmonic output and produce a better sine wave output waveform. It is not really necessary if the VFO is to be used for transmitting control only. The oscillator coil should be enclosed in a shield at least twice as wide as the oscillator coil diameter. Such a shield can be assembled by soldering together pieces of copper clad circuit board. With the components shown, this oscillator tunes from about 4000 to 4600 kHz. It can, of course, be modified to cover other frequency ranges. If one wanted to try the oscillator without the buffer stage, the 33 pF mica should be connected instead to the junction of the two 1,000 pF mica capacitors and the output taken from this point.

This article presents a variety of oscillator circuits to be used as a transmitting control VFO in the manner described. Each of the circuits has been tried and proven. The main precautions to be used in the construction of any oscillator is to use a good quality, rigid oscillator coil (cemented air core or wound on a ceramic form) and to use silver mica capacitors at the locations specified. Styroflex capacitors may be used as substitutes but never disc ceramic types. If the VFO is used to zero-beat with the transceiver VFO,

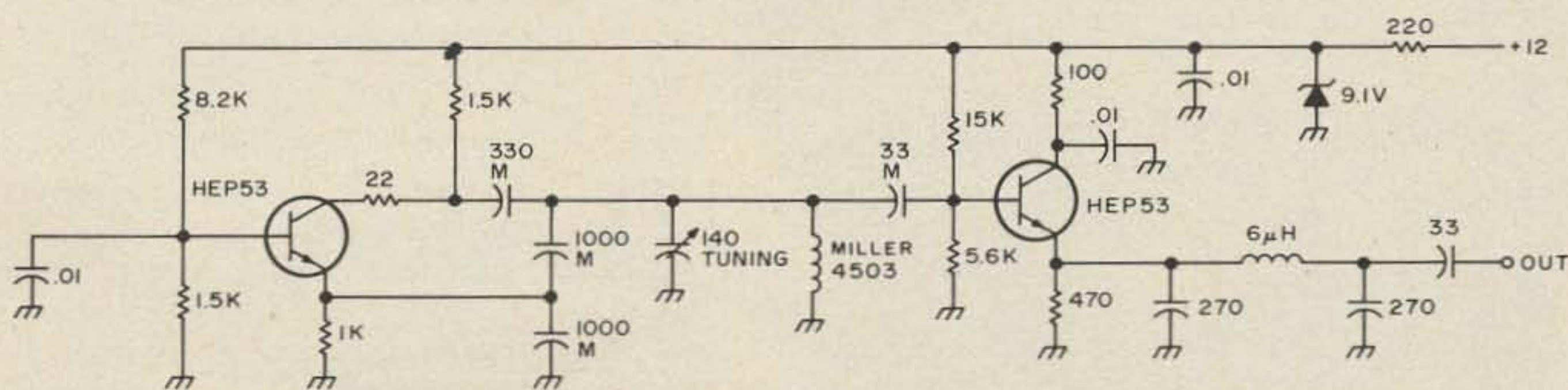

Fig. 5. This oscillator tunes over about a 500 kHz range. Both transistors are HEP 53.

— WE GOT 'EM —

CLEGG, COLLINS, DRAKE, SWAN, YAESU, TEN-TEC, and many more in stock. Large selection of used equipment. See us for quick courteous service. Established 1928.

FRECK RADIO & SUPPLY CO. Inc.

P.O. Box 7287 W4WL

Asheville NC 28802

704-254-9551



YOU ASKED FOR IT! ECM-5B

FM Modulation Meter

ONLY \$132 less batteries and crystals

- 0-7.5 kHz deviation peak reading
Meets commercial requirements
- Operates 30-500 MHz
- Crystal Controlled for easy operation
- Telescopic antenna

NEW OPTIONS

- NICAD power pak \$20.46
- Charger \$29.95
- Audio/scope output with earphone \$12.95

Write or call for complete info.



Send check or money order for \$132.00 plus \$1.50 for shipping. Indiana residents add 4% sales tax. Crystals for 146.94 MHz \$3.95. All other freq. \$7.10.

ECM

ECM Corporation
412 North Weinbach Ave.
Evansville, Indiana 47711
812-476-2121

a frequency readout scale on the accessory VFO is *not* really required once one is sure of its frequency range. Construction can, therefore, be extremely compact in any form of shielded enclosure.

The last point to check is that the accessory VFO has sufficient output level. One should, of course, check the VFO output level necessary with a transceiver before building the accessory VFO. Most of the oscillator circuits shown will provide several volts peak-to-peak output and should suffice for almost any requirement. If the oscillator is to be used only for transmitting control as described, the criterion for proper oscillator output is quite simple. The transmitter output level and signal quality should be the same as when the transceiver VFO is used for frequency control in the transmit mode. These qualities are fortunately quite simple to check using the transceiver's meters and on-the-air checks. The situation in checking such a VFO for receiving control is far more difficult to evaluate and usually demands a good array of test equipment.

... STAFF

It's faster than a speeding bullet!
More powerful than the legal limit!
And able to match long wires with a single bound!

SuperTuner™



Did we mention smaller than a breadbox?

This amazing visitor from far-off Ohio has powers and abilities far beyond ordinary mortal antenna tuners. Single-handedly, it matches coax feed, random wire, balanced or unbalanced line on any band, 160 through 10, up to the full legal limit. And Dentron's new Super SuperTuner handles a full 3 KW PEP—in case you-know-who passes you-know-what. SuperTuner and Super SuperTuner. Who, in black wrinkled finish, fight a never-ending battle for truth, justice, and juicier signals. Up, up and away. Just \$419.50 ppd. in the USA.

Dentron

Radio Co., Inc.
2100 Enterprise Parkway
Twinsburg, Ohio 44087
(216) 425-8073



ME-3 microminiature tone encoder

Compatible with all sub-audible tone systems such as: Private Line, Channel Guard, Quiet Channel, etc.

- Powered by 6-16vdc, unregulated
- Microminiature in size to fit inside all mobile units and most portable units
- Field replaceable, plug-in, frequency determining elements
- Excellent frequency accuracy and temperature stability
- Output level adjustment potentiometer
- Low distortion sinewave output
- Available in all EIA tone frequencies, 67.0 Hz-203.5 Hz
- Complete immunity to RF
- Reverse polarity protection built-in

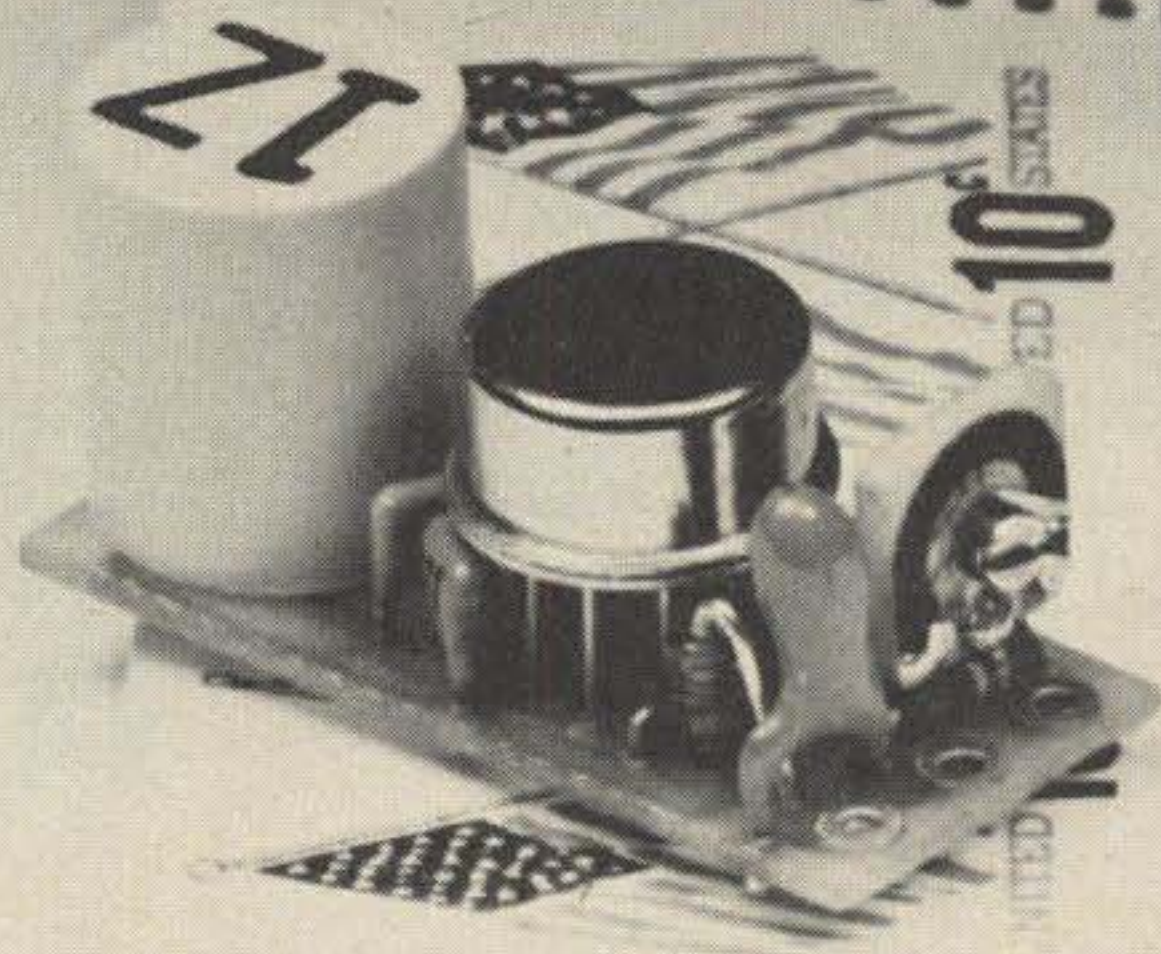

\$29.95 each

Wired and tested, complete with K-1 element

communications specialists

P. O. BOX 153
BREA, CALIFORNIA 92621
(714) 998-3021

K-1 FIELD REPLACEABLE,
PLUG-IN, FREQUENCY
DETERMINING ELEMENTS

\$3.00 each

THINKIN' ABOUT OSCAR?

KLM HAS THE ANSWERS....



2 METER SSB/CW

- Echo II 2 meter SSB/CW transceiver
- 10 Watts PEP output
- Complete with microphone, two power cords & mobile mounting bracket

\$389.00

- Options now available for ECHO II
- USB/LSB mod kit for reception of OSCAR 7 mode B 2 mtr downlink
 - LOW NOISE (2.5db nf typ.) preamp

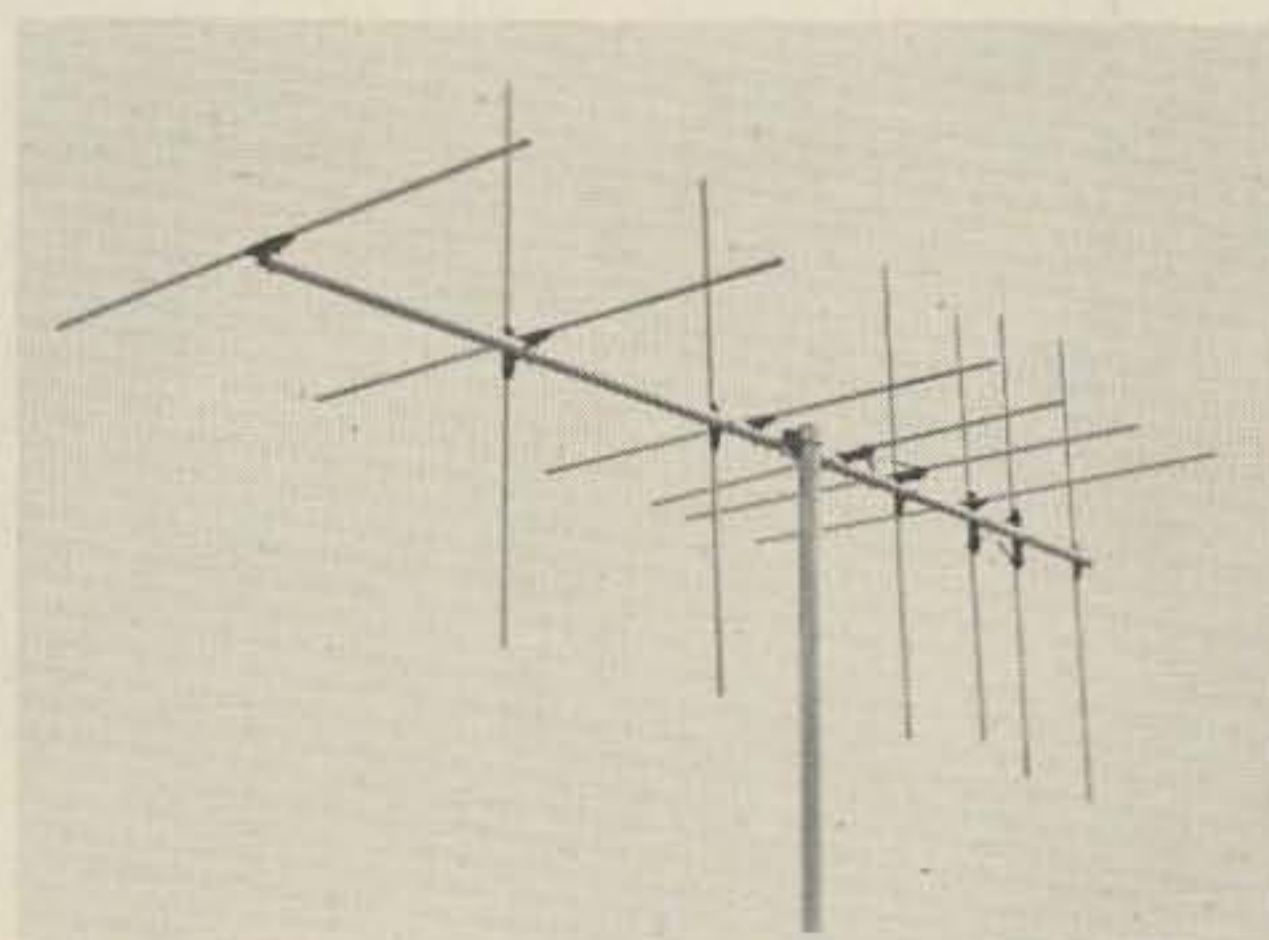

2 METER CIRCULAR POLARITY

- Great for OSCAR, FM, AM and SSB
- Gain 9.5 dbd
- Complete with harness and balun... ready for 50 Ohm feedline

\$54.95



- WINNER 1975 UHF WEST COAST ANTENNA CONTEST
NEW... KLM 432-16 LB 15 dbd 16 ele. yagi for 430-434 MHz complete with balun

\$45.95

Write for complete catalog or contact your local KLM DEALER (see June 73 Magazine for COMPLETE LIST)

KLM ELECTRONICS

1600 Decker Avenue, San Martin CA 95046 (408) 683-4240/226-1780

Modern Non - Morse Codes

Like ASCII and such

Digital information may be in the form of individual on-off signals, or it may be encoded. And if encoded, it may be serial or parallel. The serial format consists of various bits of information in one place at different times, and parallel has the various bits in several places at the same time. For example, a RTTY signal is serial, a series of pulses in order. Within the machine, the information is converted from electrical to mechanical information, in a parallel format. Punched tape is a parallel format as well (bit-wise anyway; complete characters are arranged in a series).

There are a number of encoding schemes of interest to amateurs, the first of which is Morse. This is generally found in serial form only, but these days not always. Others are Baudot, the old five-unit-plus-context teleprinter code, and the American Standard Code for Information Interchange (ASCII), eight-unit, or seven-plus-parity actually, also used for TTY and computers as well. This pretty well takes care of the Major Leagues. There are other codes used for computers, notably EBCDIC (Extended Binary Coded Decimal Intercommunication Code), IBM's favorite; Univac's entry, Fieldata; Hollerith (used on punch cards but almost nowhere else — the punch card was invented by Mr. Hollerith in the late 19th Century and exists today basically unchanged except for the addition of numerous characters, including my favorite, the lozenge); TTS (teletypeset),

a six-bit version of Baudot used, as its name implies, in typesetting, with or without computers; and the Friden Flexowriter code. These also belong in the Majors, but are not generally of interest to hams.

The Minors include BCD, Gray, XS3, XS3 Gray, Touch-Tone, MFKP (Multi-Frequency Key Pulse, the operator's Touch-Tone), 2-4-2-1, biquinary, straight binary and its alter egos octal and hexadecimal. These are all simple systems which basically represent only numbers. In the case of MFKP there are two extra combinations representing the start of a sequence, called KP, and the end, called Start. And TT has asterisk (*) and hash mark (#) and four nameless combinations.

Then there are the bush leagues — an endless variety of possibilities, tailored to the applications. Any time you have more information than wires, and sometimes even when you don't, you have a code. Without encoding, for example, 10 wires can embody 20 functions in pairs, such as on-off, up-down, etc. This has the advantage that all of them are completely independent — or sometimes the disadvantage. But encoding gives those same 10 wires a maximum capacity of 1024 functions, or 2^{10} instead of 2×10 . This does not mean that you have to lose any sleep over some of those possibilities going to waste, and often unused combinations provide elbow room, making it

easier to work with a code scheme. Of course, now that we have implemented a code, the whole system can represent only one function at a time. If this is a problem, the information can be partially encoded, with various subgroups of bits assigned to various functions or groups of functions, while the whole 10 (or whatever) bits can be used for others. You can even make the subgroups (called bytes) talk to each other — such as carry or borrow signals when performing arithmetic functions in a calculator circuit, or override signals for shutting down the carnotron when the klaveman goes south.

Definitions

Before going any further, I ought to define some terms I have already used.

Context: In the Baudot code, two of the 32 possible combinations of five bits are assigned to shift between two sets of meanings for most of the rest of the code. When a Shift or Unshift character is received, it is stored, either mechanically or electrically, and must be considered when deciding what the subsequent code combinations mean. A particular combination means either the letter Y or the numeral 6, and you can look at it all night and not know, unless you know the context in which it was sent. Of course you can take a whole line without shifts (and sometimes you have to), try it both ways and see which way it makes sense, but that is just a more complex way of arriving at the same information. You still have in any given character five bits of text and one of context; almost like six for the price of five, but it helps to at least say so each time you change from one context to the other. TTS, meanwhile, sends all six and uses shifts to expand the code, to handle lower case letters and functions peculiar to typesetting.

Parity: In ASCII and several other codes, an extra bit is included to check for errors, and sometimes several bits are added (more about that later). It is much more likely that a noise burst will clobber one bit than two, so all the information bits are added up, and a parity bit is added so that the total number of "on" or "1" bits will be even, or odd, depending on the system — but once estab-

lished, it does not change. If the system is Even Parity and a character whose info bits are 1101100 is to be sent, a zero bit is tacked onto the end, giving 11011000. If the next one is 1001111, that's odd, so we add a 1 and get 10011111, which is even. This is a simple error-checking system, and it is possible for multiple errors to sneak through, as long as they alter an even number of bits. But a noisy circuit will show its hand pretty quickly anyway.

Binary: There are actually two slightly different meanings floating around. Generally it refers to a number system or representational system, each element of which can be in one of two states. The states can be called mark and space, one and zero, high and low, true and false, A and \bar{A} (not -A), or even Mark and Fred. Whatever you call them, as long as there are two of them, it is binary. A code can be binary while having little or nothing to do with numbers — ASCII is a binary code, even though only 10 of the 128 combinations represent numbers. The other shade of meaning is specifically the base 2 number system, where the digits are 1 or 0, where a 1 has a numerical value of some power of 2. Whenever there is a possibility for confusion, you can add a word, and say straight binary or something like that to indicate the second meaning.

Octal: This is binary in disguise, and consists of using the base 8 system, with the digits 0-7, as a shorthand to indicate three-bit groups of binary, 000 through 111. Programming languages such as Fortran allow for using octal representation anywhere desired, when indicated by sticking a leading zero on the number. Thus $0427 = 427_8 = 100\ 010\ 111_2$. (Subscripts are not available on a TTY.) Similarly, I often use a pair (or more) of leading zeros to indicate base 2. So $010 = 10_8 = 810$; $0010 = 10_2 = 2$; but $10 = ?$ When the scratch pad gets full, it helps to have some indication.

Hexadecimal ("Hex"): This is another disguise like octal, but bits are grouped in fours, giving sixteen combinations. The digits 0-9 are used, and the letters A-F; e.g. $A_{16} = 10_{10} = 1010_2$. Neither octal nor hex has any effect on the binary code itself.

BCD: This stands for binary coded de-

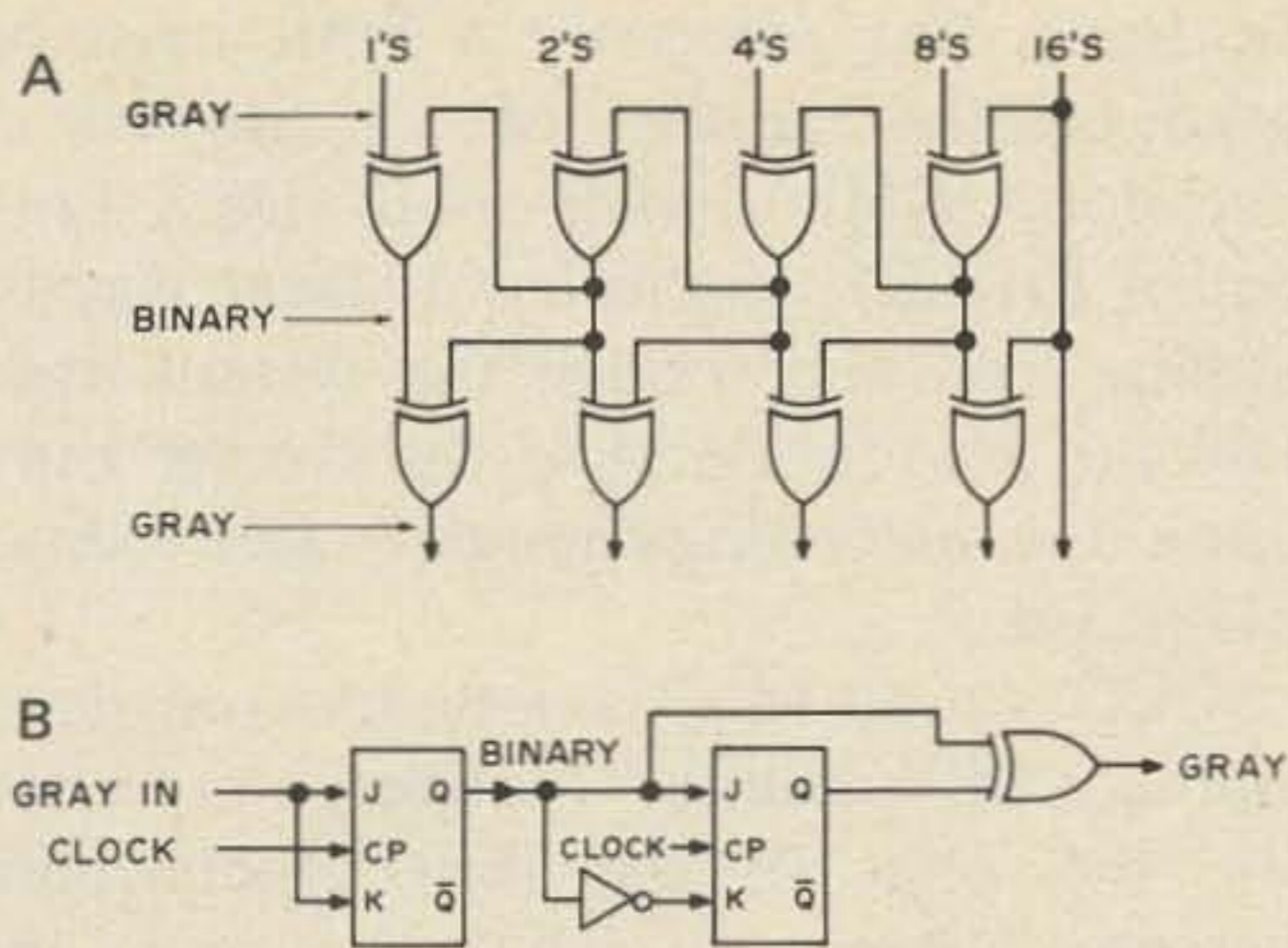

Fig. 1. A) Parallel: Gray to binary to Gray (for XS3 — XS3 Gray, delete one gate); B) Serial (most significant bit first).

cimal. Any number can be expressed in any format, and they all have their advantages. Straight binary is most suited to the internal workings of computers, but it's harder for humans to use than decimal. BCD groups the bits in fours, and the first group on the right represents the same value in hex, namely 8-4-2-1, but the largest number represented is 9, with the six remaining combinations defined as meaningless. Thus 0101 = 5, but 1101 = error. The tens digit of a decimal number is represented by another group of four bits with the values 80-40-20-10, and so on. So 0101 0000 then means 50, and 73 comes out as 0111 0011.

Some other decimal/binary crossbreeds are 2-4-2-1 and biquinary (5-4-2-1). The

latter gives a symmetrical cycle in the most significant bit, and some decimal counters, such as the 7490, can be connected for this code output or for BCD, as desired.

Gray code: This is a modified binary code having only one bit changing at a time when going from one number value to the next higher or lower. If you wish to encode the position of a shaft, for instance, BCD and binary have serious drawbacks. In either base, for instance, changing from 7 to 8, 0111 to 1000, has four bits changing at once. The changes will never be truly simultaneous, making errors just about inevitable. If only one bit changes at a time, the only possible outputs are the two codes on either side of the transitions.

XS3 (Excess-3): This is BCD code except that the literal value of the code is offset +3 counts. This is useful in decimal arithmetic, since the inversion (trading 1's for 0's) of any number produces the nines complement of that number (9-n), greatly simplifying subtraction.

XS3 Gray: Decimal position encoding with regular Gray code would have a three-bit transition between 0 and 9, but XS3 Gray has only a one-bit jump there. Conversion to BCD involves two steps: first to XS3 with a string of exclusive-or gates (if parallel format) or a JK flip flop (serial); then from XS3 to BCD by subtracting 3

Decimal	Binary	Octal	Hex	BCD	XS3	XS3 Gray	Gray
0	0000	0	0	0000	0011	0010	0000
1	0001	1	1	0001	0100	0110	0001
2	0010	2	2	0010	0101	0111	0011
3	0011	3	3	0011	0110	0101	0010
4	0100	4	4	0100	0111	0100	0110
5	0101	5	5	0101	1000	1100	0111
6	0110	6	6	0110	1001	1101	0101
7	0111	7	7	0111	1010	1111	0100
8	1000	10	8	1000	1011	1110	1100
9	1001	11	9	1001	1100	1010	1101
10	1010	12	A	-----	-----	-----	1111
11	1011	etc.	B	-----	-----	-----	1110
12	1100		C	-----	etc.	-----	1010
13	1101		D				1011
14	1110		E				1001
15	1111		F				1000
16	10000		10				11000
17	10001		11				11001
18	10010		12				11011
etc.	etc.		etc.				etc.

Table 1.

(another whole subject). Gray to binary conversion is the same as the first step here. Binary to Gray or XS3 to XS3 Gray uses the same parts with different connections.

BCD is a *weighted* code, meaning that a 1 in any given position always has the same numerical value, or weight. Gray is a non-weighted code; an individual bit does not have a value by itself, but the whole group of bits does.

In addition to the codes themselves, there are transmission schemes (though they are sometimes also called codes) with a lot of strange terms. Starting with the standard RTTY signal for illustration, this could be described as an alphanumeric code (letters and numbers), serial asynchronous (also called start-stop; a zero bit is sent for a start signal and a 1 bit for stop; timing is suspended between the stop and the next start), NRZ, or Non-Return-to-Zero, which means that if a pulse is a 1, or mark, it stays there until the next pulse (which will keep it there if it's a mark too). The opposite of asynchronous is synchronous, where start and stop signals are not used. Instead the timing is continuous, and at the receiving end the timing information is recovered from the individual transitions. The idling condition, instead of a steady mark, must have some code character present to preserve the synchronization, and in ASCII a character called SYN, synchronous idle, is provided.

In RZ (Return-to-Zero), encoding timing is again extracted from the individual bits, and each bit contains both space-mark and mark-space transitions. The transition to mark occurs at the beginning of the bit, and for a 1 it stays marking for most of the bit-time, but for a 0 it goes quickly back to space and stays there for the rest of the interval. RZ has the disadvantage of requiring increased bandwidth as each info bit is accompanied by an explicit timing bit; that's one for the price of two.

NRZI (I for Inverted) does not assign a mark as 1 and a space as 0, but instead defines a change (inversion), either mark-space or space-mark, as 0, and a steady state as 1. "No data" can be represented as steady null characters (all zeroes) without loss of timing since a string of 0's is a string of

transitions. But obviously a limit must be placed on the number of 1's allowed in succession. IBM's Synchronous Data Link Control (SDLC) system has a clever way of handling this, and though the system itself might not be too useful to the average ham, I think it is interesting enough to give a short description.

SDLC is used when a network consists of a number of "satellite" (not to be confused with the ones in the sky) synchronous machines, terminals, whatever, and one master device which is in charge of the network. The master can talk to any of the satellites, and the satellites can talk only to the master, even though they are all on a party line. If station A has a message for station B, the master can tell B to listen in, or can retransmit to B. It doesn't matter, though; this is up to the designer of the individual system and not of interest to SDLC.

SDLC uses NRZI encoding, and allows a maximum of five 1's in a row, except for one special character called a flag, which has six. Any time the information you wish to transmit has five 1's in a row, a zero is inserted and then removed at the other end. If you have 111110, you send 1111100, and the other end knows that this means 111110. The flag consists of 01111110 and is the only exception to this rule. Any transmission starts with a flag and ends with a flag. The idling condition between transmissions is a series of flags. Bit timing is recovered, as mentioned before, from the 0's, and character timing is started from the flags and maintained from the bit timing.

The first non-flag characters sent are address and control fields of fixed lengths. The control field is a code entirely independent of whatever codes are used in the text of the message. The address field designates the satellite involved: If the master is sending, it tells who is supposed to be paying attention; if the satellite is sending, it tells which one. Assuming that the master knows whether it is talking or listening, and given the constraint that satellites do not talk to each other, this is sufficient.

After these fixed-length fields, we have the information field, or the text. This may be in any code you like, and any length,

the best slo-scan deal in town

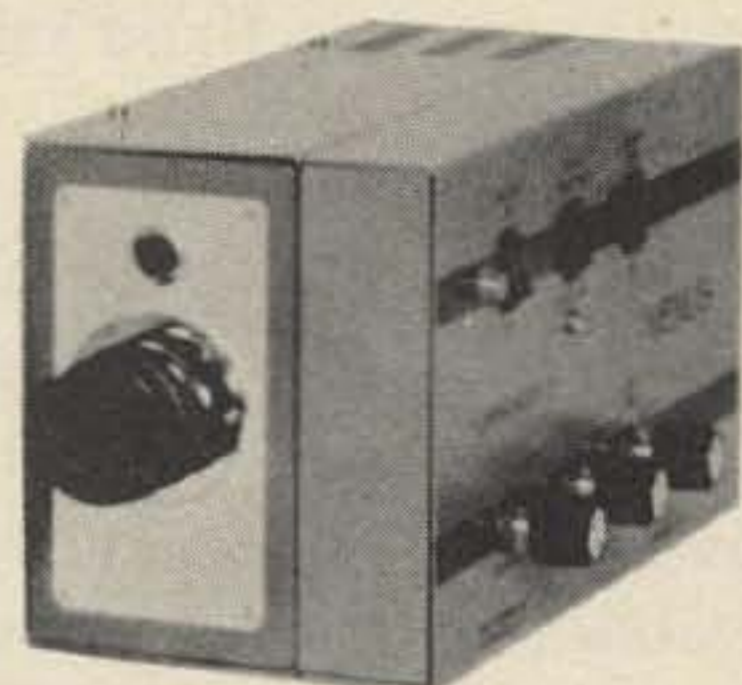
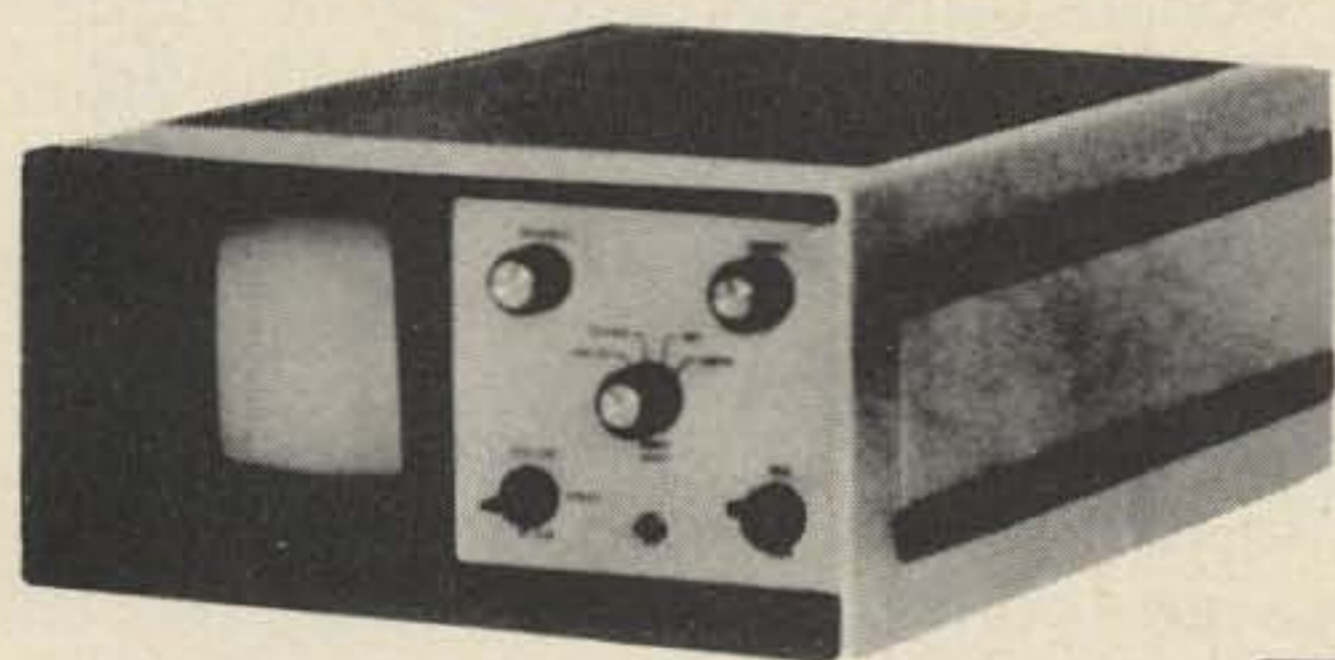

WIN
WITH



*** PRICE:**

SS2 MONITOR STILL ONLY \$349

*** KIT:**

THE VENUS SS2 IN KIT FORM FOR ONLY \$269

— 25 PAGE MANUAL

— TEST AND ALIGNMENT TAPE

*** PERFORMANCE:**

ACCUSYNCTM OSCILLOSCOPE DISPLAY OF SSTV SIGNAL
FAST SCAN/SLO SCAN CAMERA

— USE CAMERA WITH YOUR HOME TV SET

— FOCUS ON POSTAGE STAMP

*** COMPLETE LINE:**

● SS2 MONITOR \$349

● SS2K MONITOR KIT \$269

● C1 FAST/SLO SCAN CAMERA \$469

● P1 POLAROIDTM CAMERA ADAPTER \$34.50

● V1 VIEWING HOOD \$14.50

● T1 TRIPOD \$24.95

*** LOCAL DISTRIBUTORS:**

VENUS SSTV AVAILABLE FACTORY DIRECT OR FROM
ONE OF THE FOLLOWING AUTHORIZED DISTRIBUTORS:

Amateur Electronics Supply
Milwaukee, Wisc.
Cleveland, Ohio
Orlando, Fla.

Argon Electronics
Miami Springs, Fla.

Barry Electronics
New York, N. Y.

CFP Enterprises
Lansing, N. Y.

A-G Co., Inc.
Imperial, Pa.

A and W Electronics
Medford, Mass.

Electronic Distributors
Muskegon, Michigan

Goldstein's
Pensacola, Fla.

Harrison Electronics
Farmingdale, N. Y.

Henry Radio
Los Angeles, Cal.

Hobby Industry
Council Bluffs, Iowa

Venus Scientific Inc.

The company that put high voltage on the moon, now brings you expanding amateur radio technology.

399 Smith Street
Farmingdale, N.Y. 11735
Phone 516-293-4100
TWX 510-224-6492

even empty. The only restriction is the five 1's rule, which is not really a restriction at all since it has no effect on the data conveyed. Next comes a parity (error-checking) field: fixed length, except it too is subject to the Rule. Last comes the flag, at which time the location of the parity field and the end of the info field are revealed by counting back a fixed number of bits from the flag.

Error-Detecting and Error-Correcting Codes

Parity bits as provided in ASCII and blocks of parity information as in SDLC provide a means for detecting errors, but it is possible to add more redundant information and not only detect errors, but correct most of them as well. No system can be totally foolproof, though, and there are diminishing returns from trying to make it so, as the efficiency of a system drops when you add the redundant bits needed to detect or correct errors. For amateur use, a message can just be repeated if received in damaged condition, but some systems have to get it right the first time. For them, insurance is available in the form of additional redundancy. While a single parity bit can always catch a single error, it does not contain enough information to reliably detect multiple errors, and it cannot *correct* errors at all. But error-correcting codes, called Hamming codes(!) are fairly easy to implement (though at least at present not legal for hamming). Such a code will always detect a double error, and will always correct a single error. It is available in the following standard-sized packages:

Data bits	Hamming bits	Overall parity	Total bits
4	3	1	8
11	4	1	16
26	5	1	32
	etc.		

A Hamming code with overall parity contains 2^n bits; n is the number of Hamming bits, and there are $2^n - n - 1$ data bits. The longer the code, the more efficient it is (in data bits as % of total), though at the same time it is more susceptible to error.

With three Hamming bits there are a total of eight combinations. One of them is

assigned to mean "no error", and the other seven correspond to a detected error in one of the seven bits (4 info + 3 Hamming bits). The code is arranged so that the numeric value of the combination is the actual location of the error — even if the error is in one of the Hamming bits itself. If a double error were received, however, this system by itself would correct the wrong error. Addition of the overall parity takes care of this; double errors still cannot be corrected, but at least they can reliably be detected. If overall parity comes out wrong and the error address is zero, then either there is a single error in the overall parity itself, or a double error, not correctable. The character is rejected. If overall parity is right and error address is not zero, a double error occurred. But if overall parity is wrong *and* the error address is not zero, there was a single error which can be corrected. Further discussion of error correcting codes is available elsewhere.^{1,2}

Code Conversion

With all these codes flying around there is often a need to convert from one to another. One way which will work with any codes is to use a Read-Only Memory (ROM) which simply consists of a cross-reference table. If the ROM is large enough, several codes can be accommodated in it, and it is possible to make one device which will handle, for instance, ASCII, Baudot, Morse, Touch-Tone, and turning on the coffee pot on your way home.

Any binary code, whether weighted or not, can be easily converted to 1-of- n notation with chips like the 7442, a 1-of-10 decoder. This one takes a BCD input and produces a "low" on one of ten output lines, corresponding to the value of the input code. All other output lines remain high. If the input code has a value greater than 9 (defined as bogus in BCD), all output lines are high. Similar 1-of-10 chips are available for XS3 (7443) and XS3 Gray (7444). There are also 1-of-16 decoders, 1-of-8, and dual 1-of-4. The latter has two independent de-

¹ *Error Correcting Codes*, Peterson and Weldon, MIT Press, Cambridge, 1972.

² Applications Manuals from various IC manufacturers. My favorite is Fairchild.

coder circuits in one chip. All of these will work with any code; 1-of-10 requires special chips for special codes since, for instance, some of the combinations in XS3 Gray are wrong numbers in BCD, and vice versa. One of the main limitations in chip design is the number of output leads available, but a limitation in amateur design is the parts available. You can use a 7442 as a 1-of-8, or two of them as 1-of-16, and so on. Different codes are handled by redefining the outputs.

In the same way, by arranging the inputs and outputs, a chip like the Fairchild 9318 Priority Encoder can be used to *encode* 1-of-8 or multiples thereof into any code. Only one input can be encoded at a time, and this chip produces output code corresponding to the highest-numbered active input if there are more than one. For some applications this is quite handy, while for others it is necessary to bypass this feature by ensuring that there is actually only one active input at a time. There must be thousands of ways to use this chip.

A code converter can be made from decoder and encoder chips very easily. This is most suited to the situation where either the input or the output code, or both, is oddball, which includes alphanumeric codes. ASCII/Baudot/Morse can be handled this way. Each input code requires a set of decoders (and only one may be active at a time) and each output code takes a set of encoders. All output codes are available simultaneously without switching. If there are several input codes, open-collector decoders should be used, such as the 7445 in place of the 7442, an otherwise identical chip.

Display Codes

What good is it if you can't read it, right? Fortunately there are a lot of ways to do that. For strictly numeric readout, there are the old faithful Nixies, which use a 1-of-10 decoder, and seven-bar, which takes a special chip. Seven-bar LEDs are making it big these days, and they can be driven directly from an IC, as can Numitrons (which I don't like, as they lose segments too easily) and others. Many chips have provisions for leading- and trailing-zero blanking, and some have latches built in for multiplexing, where one set of BCD (or hex) lines is connected to all

decoders, and another input tells the individual chip when the data is intended for it. Data is "frozen" in each chip and periodically updated, and all digits of the display are on continuously. Chips without latches can be multiplexed too, but only one is on at a time. Scanning is rapid and continuous, and all the digits appear to be lit simultaneously. With a large number of digits, since brightness is proportional to average current, and each digit is lit only a small portion of the time, peak current may be rather high.

Another display system, variously called matrix, scoreboard, etc., has the characters formed by lighting a pattern of dots, and this is suited to just about any character, not just numerals. If only upper case letters are to be displayed, 5 x 7 is a popular choice, but with upper and lower case, legibility suffers and a denser matrix is used, 7 x 9, 9 x 12, etc. This system can be used both with LED matrices and TV screens. Instead of a relatively simple decoder chip, a ROM is used, and called a character generator. Inputs for the TV version (usable with LED also) are the code for the character and the address (location within the matrix in binary code) of the dot which is to be on or off. There is only one output line; it is the on/off signal going direct to the CRT gun. Other circuits such as random-access memories (RAM) or shift registers, keep track of what characters are in what places and provide the proper ASCII (e.g.) code to the generator at the proper time. The column and row inputs to the ROM and the RAM are provided by counters which run from a master clock (oscillator).

LED single line readouts are usually scanned a column at a time, and the character generator will have 7 outputs for a 5 x 7 display. Inputs are just the code and the column. This allows for a seven-fold increase in brightness, as the dots in a column do not have to share the time among themselves. In the TV system, brightness is not a problem, and only one dot can be scanned at a time anyway.

It is possible to get more well-defined characters in a TV system; 64 x 64 would only take six more bits (three for the column and three for the row) for the inputs

TOUCH-TONE DECODER

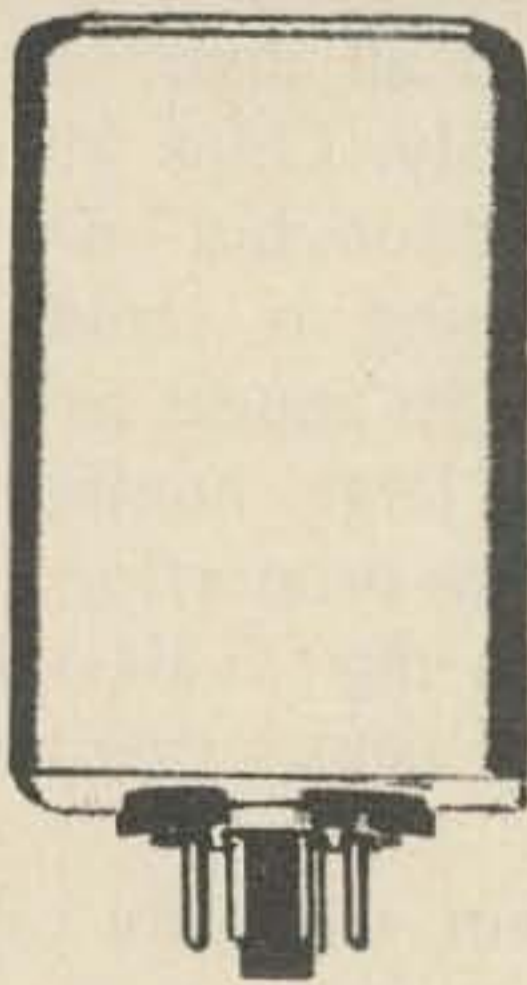

- Dual tone decoder decodes one Touch-Tone digit.
- Available for 1, 2, 3, 4, 5, 6, 7, 8, 9, 0, #, * and other dual tones 700-3000 Hz.
- Latch and reset capability built-in.

- COR control built-in.
- Relay output SPST 1/2-amp.
- Octal plug-in case.
- Compact 1-3/4" square, 3" high.
- Free descriptive brochure on request.

T-2 Touch-Tone Decoder ... \$39.95 PPD.
Specify digit or tone frequencies.
(Include sales tax in Calif.)

PALOMAR ENGINEERS

BOX 455, ESCONDIDO, CA 92025

to the ROM, and no more outputs. If you wish to display Chinese this would probably do it well. You would probably run out of room in the ROM, but you can split it right down the middle and use two or four ROMs. Each split turns one input bit into a chip select function.

There are other ways to generate characters on a TV screen, such as making the beam follow the curvature of the letter. This is needed for such things as typesetting, but is unnecessarily complex for most applications, and I will not go into it here.

Other Aspects of Codes

I have purposely left out BCD to binary and back again, since this is a big enough subject for another separate article. Some basic arithmetic can be covered along with it. I can't think of anything else to write about codes, but I think I'll take all these ideas and some others I have and whip up a complete amateur station completely run with a keyboard and a TV set. It may take a while, but there will certainly be a lot to write about when it's done.

... K8BFH/1

New!

COMPLETELY NEW!

VHF Antenna Handbook

The theory, design and construction of dozens and dozens of different VHF and UHF antennas ... antennas for FM, for DXing, for repeaters, for mobiles, for emergencies, for contests, quickies, mammoth arrays ... everything.

This is a practical book written for the average amateur, not full of formulas for the design engineer — this is a book for the amateur who takes joy in building — perhaps it is a brookstick and some coat hangers fashioned into an effective beam for some instant mountain top DX into far off repeaters during a vacation ... perhaps it is a folding beam you can take with you on business trips, packed away in your suitcase ... this book is packed full of fabulous antenna projects that you can build.

This book, which would normally sell for \$5 or \$6 is being offered for a short while at a pre-publication price of \$2.00 postpaid. Send cash, check, money order ... or give your Master Charge or Bank Americard number

GREEN PUBLISHING, INC.

Peterborough NH 03458

Name

Address

City

State

Zip

BankAmericard or Master Charge No.

Signature

Exp. date

IF YOU HAVE ALREADY GONE 450 ♦ ♦ ♦ ♦



GO ICOM 30A ♦ ♦ ♦ ♦ before you go bananas!

If you have been trying to resurrect something from the pre-transistor past that more closely resembles the mechanism used to keep large ships in place, or if the sound of bumble bees is keeping you awake at night--REJOICE!!! The ICOM 30A is here and working!

Consider these reasons for owning an IC-30A:

- (1) Despite the fact that the radio is completely solid state, it has output of ten watts
- (2) Receiver sensitivity is better than 0.6UV for 20 db of quieting and that means easy on the ears listening.
- (3) The IC-30A comes with five channels of the 22 channel capacity installed
- (4) Shielding is excellent because the unit is modularly constructed.
- (5) Your car tires will last long because the IC-30A weighs less than ten pounds.
- (6) Like its predecessors, the unit is equipped with a 9 pin plug in the side of the radio to provide you easy access to the discriminator and room for adding the necessary wiring for external accessories -- with all this and more, for only \$399.00.

SEE ONE !! BUY ONE !! AT YOUR ICOM DEALER TODAY

Distributed by:



ICOM

ICOM WEST, INC.
Suite 3
13256 Northrup Way
Bellevue WA 98005

ICOM EAST, INC.
Suite 307
3331 Towerwood Drive
Dallas TX 75234

DUPLEXER KITS

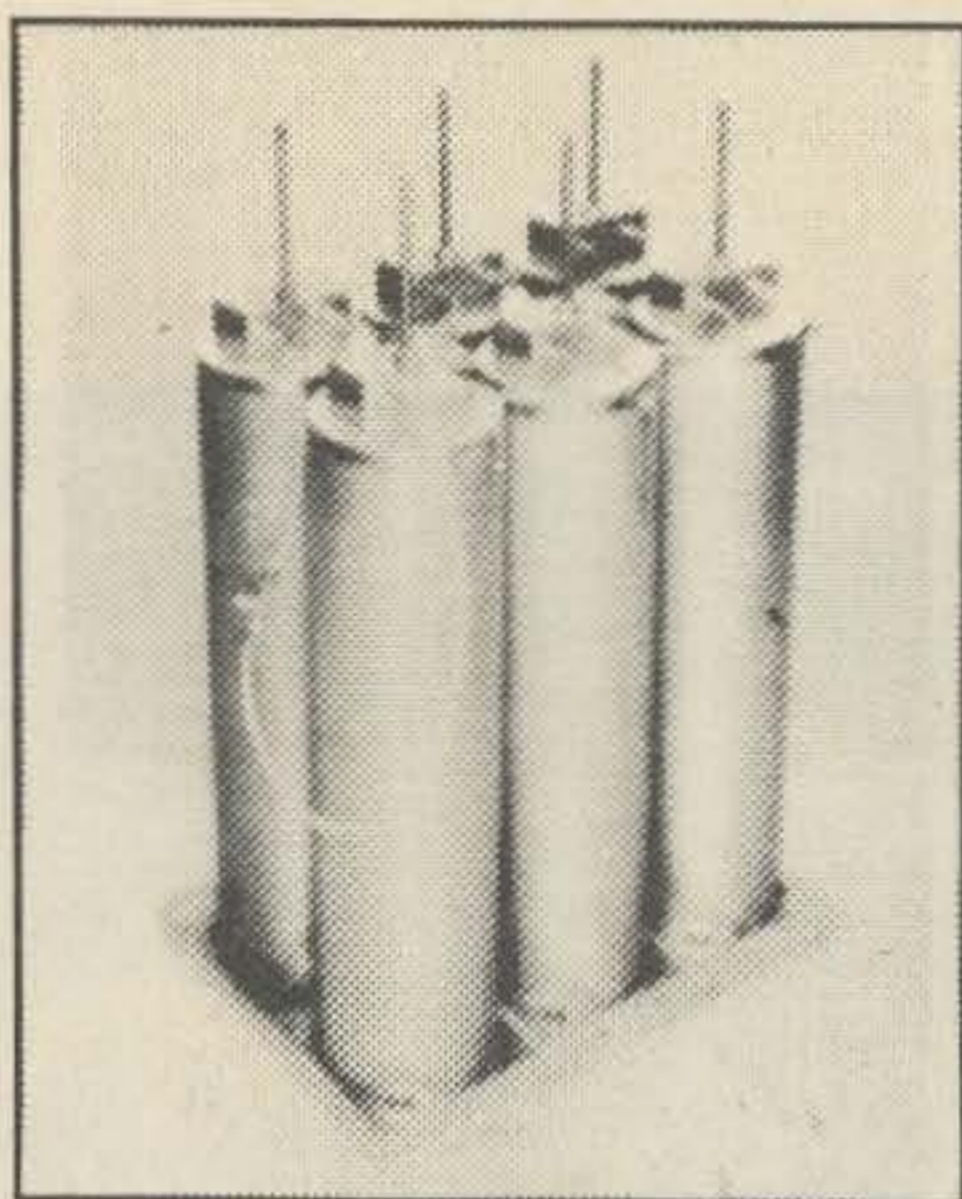

PROVEN DESIGN
OVER 150 SOLD IN U.S.,
CANADA AND EUROPE.
CONSTRUCTION —
WELDED ALUMINUM IRIDITE
AND SILVER PLATED.
ALL PARTS PROFESSIONAL QUALITY
EVERYTHING SUPPLIED.

CAN BE ASSEMBLED & TUNED IN ONE EVENING. NO SPECIAL TOOLS. RECEIVER & TRANSMITTER CAN BE USED FOR TUNE UP.

MOD. 62-1 6 CAVITY 135-165 MHz POWER 250W ISOLATION GREATER THAN 100dB 600 kHz. INSERTION LOSS .9 dB MIN. TEMP STABLE OVER WIDE RANGE

PRICE \$349.00

MOD. 42-1 4 CAVITY SAME AS 6 CAVITY EXCEPT ISOLATION GREATER THAN 80 dB 600 kHz INSERTION LOSS .6 dB MAX

PRICE \$249.00

OTHER KITS SOON TO BE AVAILABLE

146 to 148 MHz band pass filter. 1296 & 2304 Interdigital Mixers
144 to 450 MHz 250w tube amp. 130 to 170 MHz notch filter kit

NORTH SHORE RF TECHNOLOGY

TUFTS

Radio Electronics

386 Main St., Medford, Mass. 02155
617-395-8280

NEW ENGLAND'S EXCLUSIVE DEALER

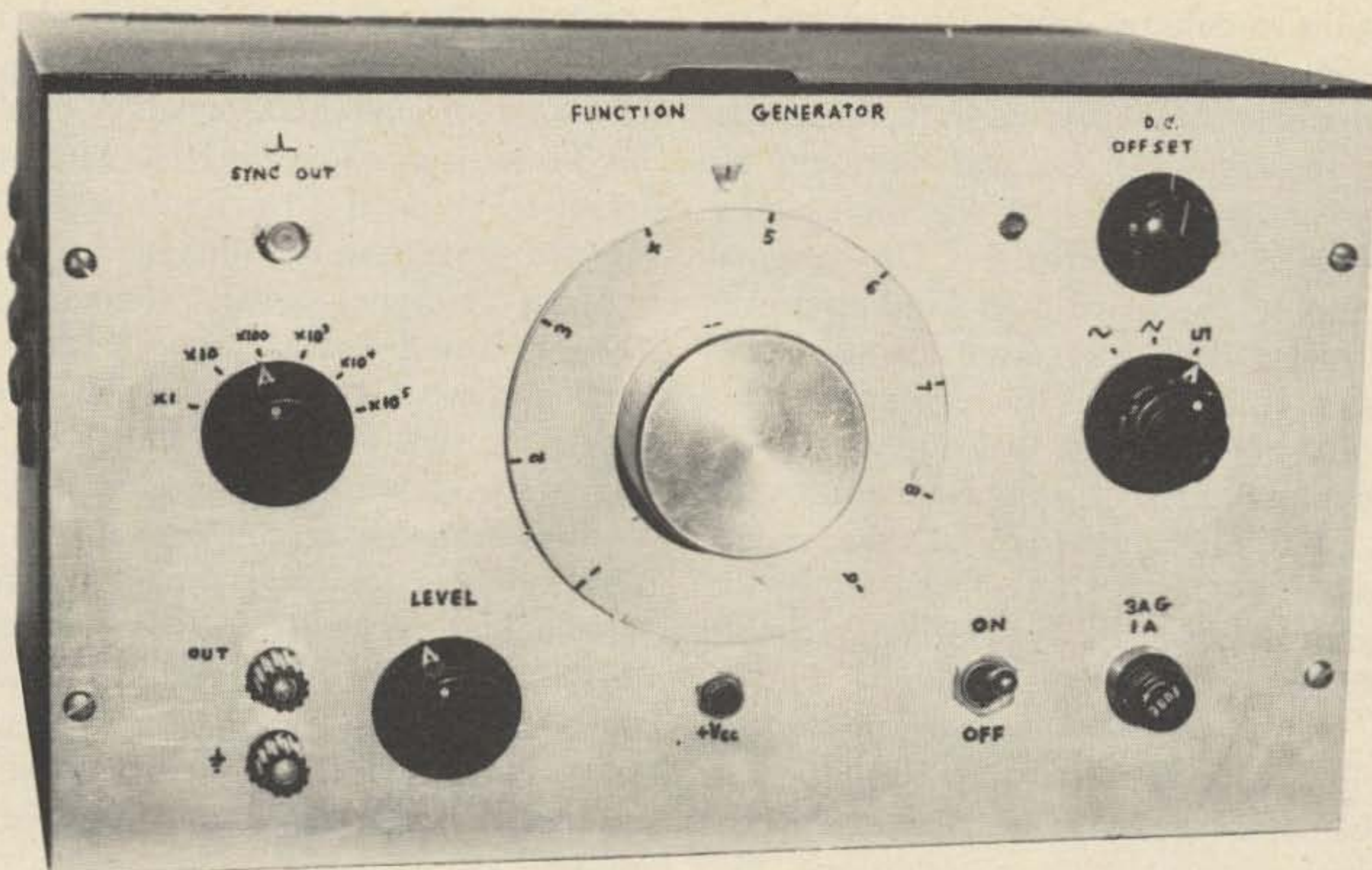

Hank Olson W6GXN
 P.O. Box 339
 Menlo Park CA 94025

Build this Amazing Function Generator

The increasing popularity of a relatively new piece of test equipment (the function generator) has spurred at least two IC manufacturers to design special monolithic chips for this purpose. The Intersil 8038 and the Exar XR2206 are examples of such specially committed ICs, and several technical articles using these ICs as function generators have appeared in the recent literature.^{1,2} These new ICs offer great simplicity in function generator construction, but offer the user very little "feel" for what is actually going on in the process of waveform generation. Since I find that the

building of a piece of test gear is also a learning process, circuit flexibility and stage-by-stage analysis are important. For this reason, an older design for a function generator from a Motorola application note (AN510A) was the starting point.³

The Motorola application note AN510A by Bob Botos is actually the second edition of this publication, in which several printing errors in the earlier AN510 were corrected. So we can assume that the designs therein are at least five years old — pretty ancient in the fast-moving technology of the semiconductor era. However, Mr. Botos' design techniques are really timeless, and can be

¹Megirian, R., "Integrated Circuit Function Generator", Ham Radio, Jan. 74, p. 22.

²Grebene, A., "Generate Waveforms with a Single IC", Electronic Design, Sept. 13, 1974, p. 132.

³Botos, R., "A Low Cost, Solid State Function Generator", Motorola Application Note AN510A, 1971.

brought up to date by substitution of newer, better components as they become available. The original AN510A output amplifier section, for instance, is a real "klooge" by today's standards, and so it was replaced by a simpler all-IC substitute. The original power supply used two dual-winding power transformers, four integrated bridge rectifiers, and four power IC regulators. This rather elaborate supply was replaced with one inexpensive transformer, one integrated bridge rectifier, and two of the newer Raytheon \pm regulator ICs. A feature in the new function generator is dc offset, a simple addition that is really worthwhile.

The circuit of the function generator is shown in Fig. 1; note that four ICs as well as a number of discrete devices are used in the waveform forming circuitry. In addition, two more power ICs are used in the power supply, shown in Fig. 2. A block diagram of the waveform forming circuitry is shown in Fig. 3.

The integrator is composed of U1 and Q1, an op amp and an emitter-follower to lower the op amp output impedance.

The comparator is composed of U2, Q2, Q3, Q4, Q5, Q6, Q7, D8 and D9. U2 is an Emitter-Coupled Logic IC capable of extremely fast switching. Associated with, but not actually part of, the comparator are D10, D11 and D12 which serve as voltage

regulators to provide U2 with +1.4 volts and -3.9 volts. It is worth noting that Q4, Q5 and Q6 were originally designated as Motorola MPS-L08 types in AN510A, but since this transistor type is now obsolete, appropriate substitutions have been made.

The "reference-switch" is made up of D1, D2, D3 and D4. Note that D3 and D4 are dual diodes. Also note that RB in Fig. 3 is either R8 plus R10 or R9 plus R11, depending on the state of the reference switch.

The "sync-amplifier" is a simple differentiator, rectifier and emitter-follower. The square wave from the comparator is differentiated by C13 and R30. D7 allows only the positive-going spike to be passed to the base of Q8. This positive spike is then available at the emitter of Q8 for a sync pulse.

The "sine wave shaper" consists of D5, D6, Q9 and Q10. D5 and D6 act as "soft" clippers on the triangle wave, and produce a near approximation to a sine wave. Q9 and Q10 simply act as emitter-followers after shaping — one NPN and one PNP, so that their emitter-base voltage drops cancel each other.

Since it was necessary to attenuate the triangle wave (with the voltage divider R33-R34) to make it compatible with the shaping diodes D5 and D6, the resulting sine

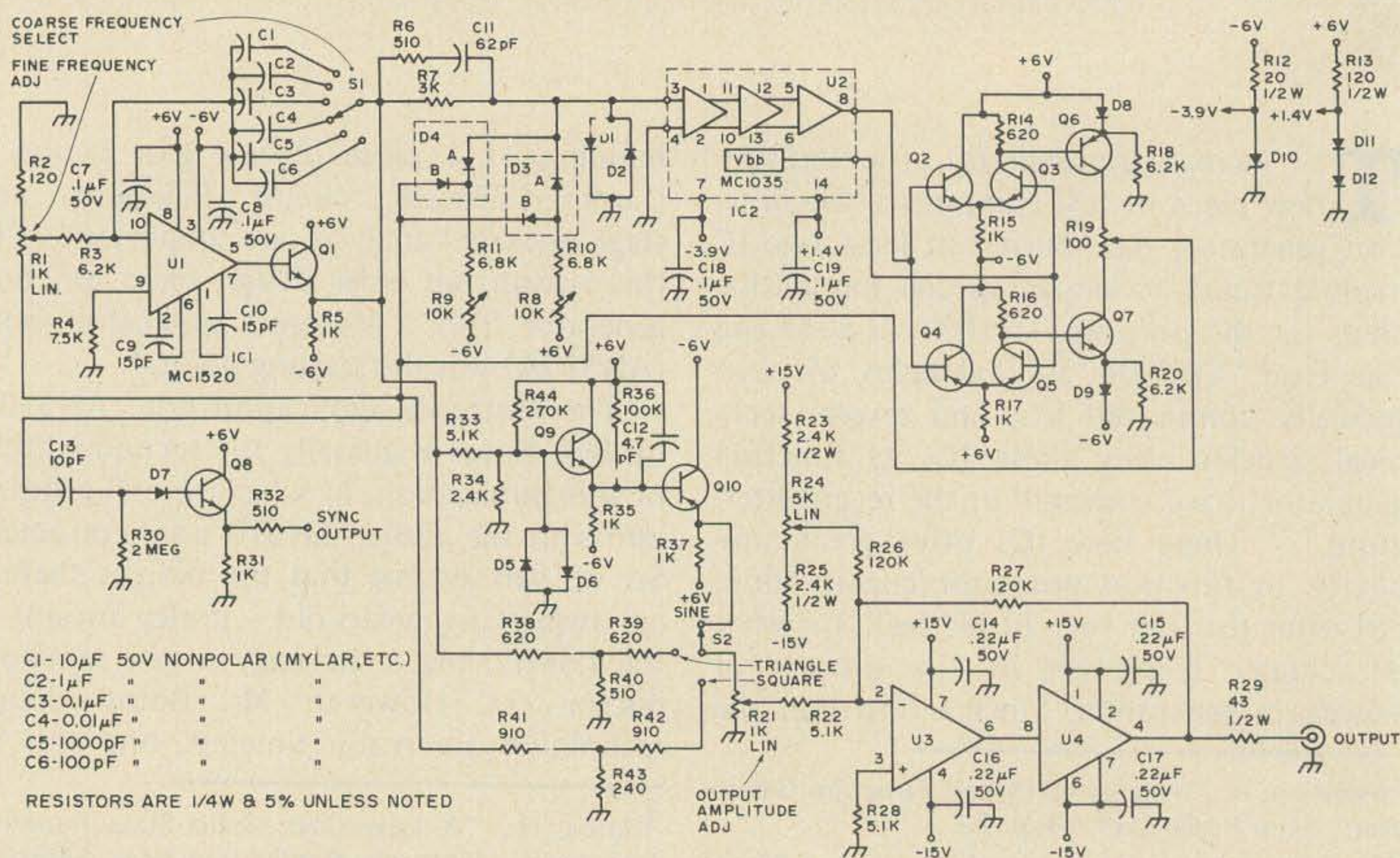

Fig. 1. Function generator, waveform circuits.

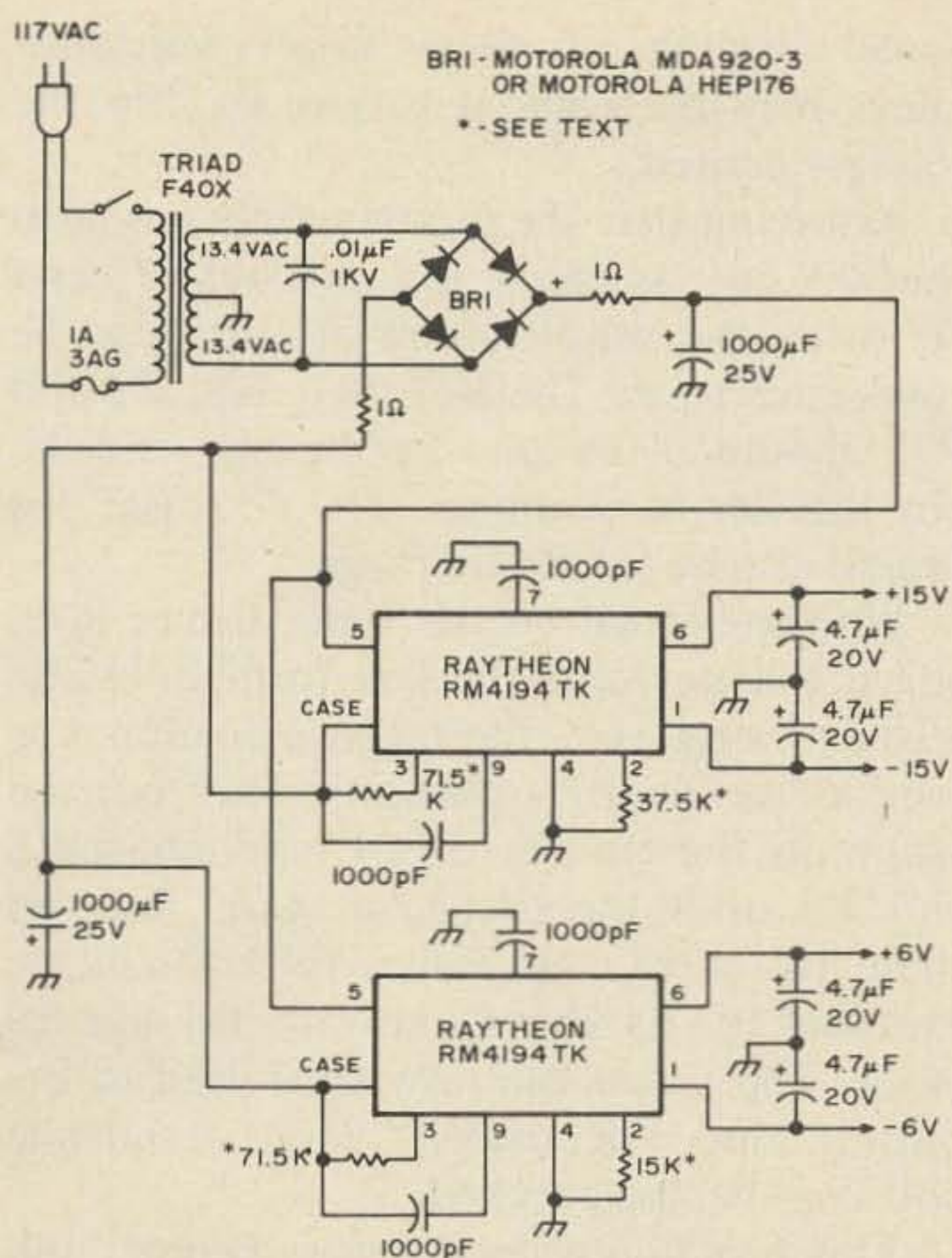

Fig. 2. Regulated power supply for function generator.

wave is smaller in amplitude than the triangular wave or square wave. To equalize the output levels of the three waveforms, simple "T" attenuators are placed in the triangle and square wave lines. These consist of R38, R39, R40 and R41, R42, R43 respectively.

Finally, the "output amplifier" consists of U3 and U4, a high slew-rate op amp and buffer amplifier. Note that the buffer is inside the closed loop of the amplifier. By

adding in variable dc at the inverting input of U3 via a 120k resistor, a "dc offset" adjustment is easily obtained. This "dc offset" enables one to offset the three types of waveforms for testing of circuits which will accept only unipolar signals — such as logic circuits.

The power supply utilizes a Triad F40X (26.8 Vct 1A) transformer which combines low price, small relative size and high current capability. An integrated bridge and two Raytheon RC4194TK integrated circuits in the circuit of Fig. 2 provide ± 15 volts and ± 6 volts for the waveforming circuitry. The RC4194TKs are heat-sink mounted to the chassis with T066 mica wafers for heat transfer and electrical insulation. The F40X transformer is mounted *under* the chassis to keep it electrostatically shielded from the top-mounted waveforming circuits. The two 1000 uF filter capacitors are also mounted under the chassis because of the relatively large ac line ripple on them.

The function generator is built into an old 7" x 8" x 10" steel equipment cabinet, to which an aluminum panel has been fitted. The aluminum panel was originally an old black-crackle finished relay rack panel which was stripped of paint and cut down to size. The left over portion of this same panel was made into the frequency dial, by rough sawing and turning down the outer diameter on a lathe. The large aluminum "spinner" knob for the center of the frequency dial was also turned from a scrap of bar stock on the lathe. The basic planetary drive for this

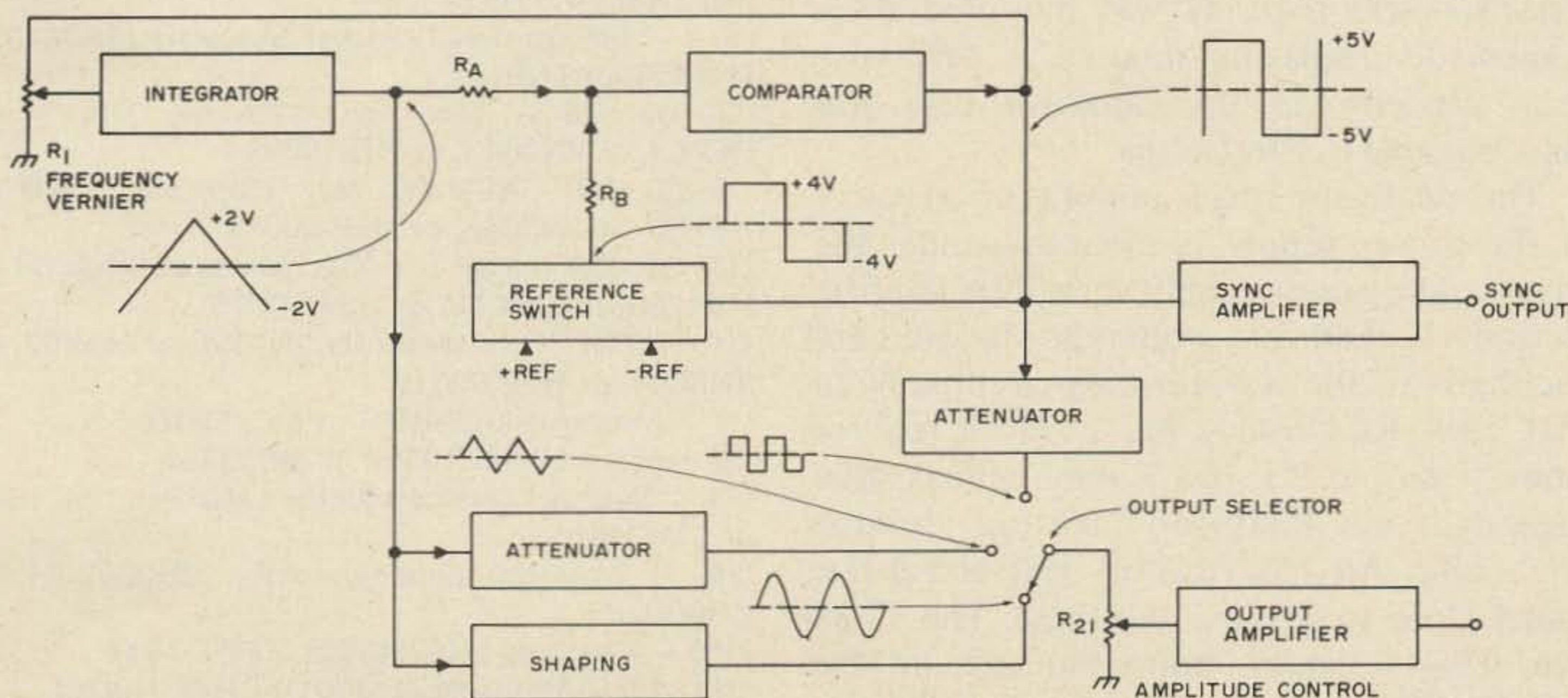
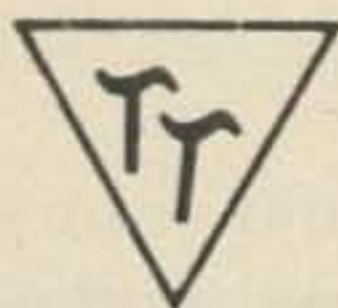

Fig. 3. Block diagram of function generator.

AY5-1013A UART	\$10.90, 2/\$19.95
8038 VCO	\$4.95
MK5002 4 Decade counter	\$13.95
9374 7 Segment Decode, Quad Latch, LED Driver	\$2.99
MM5740AAEN ASCII Keyboard Encoder	\$17.99
XR205 Function Generator	\$8.40
XR210 FSK Demod	\$5.25
XR320 Precision Timer	\$1.55
XR2206CP Monolithic Function Gen	\$5.50
XR2207CP VCO	\$3.85
XR2240CP Programmable counter timer	\$4.85
100V/3A Epoxy Diodes SPECIAL 10/	\$1.00
500 μ f/50V Electrolytics SPECIAL 10/	\$2.50
MC1306P 1/2W Audio Amp	\$0.70, 10/\$6.00

All orders postpaid — please add insurance
 minimum order — \$5 U.S./\$15 foreign
 latest lists — 10¢ stamp



TRI-TEK, INC.

P.O. BOX 14206, DEPT 7
 PHOENIX, ARIZONA 85063

control was a National Velvet Vernier salvaged from a surplus BC375 or BC191 tuning unit. Those with fancier dial systems available or without access to a lathe and the above surplus drive units can use other methods — even a plain large knob. One will note that one of the timing capacitors in the circuit of Fig. 1 is a 10 μ F non-polar type. Because the author had the room in the cabinet, an old 10 μ F 600 V transmitting capacitor was used. It was mounted on a homemade insulating mount, as otherwise stray capacity to the capacitor case was objectionable in this circuit.

The relatively small amount of circuitry of the power supply is mounted under the chassis. The power supply should be the first section checked out, preferably before connecting it to the waveforming circuits. Note that each RC4194TK has a 71.5k resistor from "case" to #3; this is the nominal value suggested by Raytheon. Sorting through one's 68k and 75k resistors will give a few values close to 71.5k — use these. The 37.5k and 15k resistors from pin #2 of the RC4194TKs will then be target values to give ± 15 volts and ± 6 volts respectively.

Some juggling of these target resistance values may be required to give exactly the voltages desired.

Assuming that the power supply has been checked out, as above, and puts out ± 15 and ± 6 volts, the waveforming circuitry can be connected to it. The pots R1, R8, R9 and R19 should all be set at mid range, and the pot R21 set at minimum. The dc offset pot should also be set at mid range.

With the scope on the wiper arm of R19, adjust this pot until the waveform looks like a square wave (i.e., the positive portion is as long as the negative portion). Then put the scope on the emitter of Q1, and adjust R8 and R9 until the triangular wave observed there has a ± 2 volt value. R19 should be "retweaked" as above and then R8 and R9 again. The scope can now be shifted to the output, and "dc offset," level, frequency and sine-shaping checked.

This function generator has been a "silk purse from sow's ear" project for me, a useful piece of test equipment built up from odds and ends. While the semiconductor costs can be as high as \$35.00, appropriate substitutions can trim this figure somewhat. To this end most of the diode (D) and transistor (Q) designations have several acceptable numbers given in the parts list.

Parts List

- D1, 2 — Silicon signal diodes: Motorola MSD6102, 1N4454, or 1N914
- D3 — Dual Si. signal diode: Motorola MSD6150, or two 1N4454, 1N914
- D4 — Dual Si. signal diode: Motorola MSD6100, or two 1N4454, 1N914
- D5-9 — Silicon signal diodes: Motorola MSD6102, 1N4454, or 1N914
- Q1, Q8, Q9 — NPN Xstr: Motorola 2N4124 or HEP53, or 2N3643, or HEP-S0014
- Q2, Q3, Q7 — NPN Sw. Xstr: Motorola 2N709 or HEP50, or 2N3646, or HEP-S0J11
- Q4, Q5, Q6 — PNP Sw. Xstr: Motorola 2N4260 or HEP720, or 2N3640, or HEP-S0019
- Q10 — PNP Xstr: Motorola 2N4126 or HEP57, or 2N3644, or HEP-S0019
- U1 — Motorola MC1420G or MC1520G
- U2 — Motorola MC1035P or MC1235L
- U3 — National Semiconductor LM318H, LM218H, or LM118H
- U4 — National Semiconductor LH0002CH or LH0002H
- D10 — Motorola 1N4730A or HEP-Z0403
- D11, 12 — Motorola 1N4001 or HEP-R0050

... W6GXN

THE FIRST AND STILL THE LEADER! the exciting super compact IC230



PUT OVER 67 CHANNELS IN THE PALMS OF YOUR HANDS

SPECIAL FEATURES:

- **No More Crystals** . . . Over 67 . . . fully synthesized channels available.
- **All Channel Capability** . . . Travel with confidence that you'll be able to work all repeaters along the way.
- **Super Compact** . . . 2.28" high x 6.14" wide x 9.72" deep at a weight of only 5.5 lbs.
- **Quick Dismount Mobile Mount** . . . Allows quick car installation.
- **Easy Operation** . . . Punch up frequency, select repeater or simplex mode, and you're on the air. (A crystal may be added for a unique repeater frequency.)
- **Modular Construction** . . . In case of a problem, modules can easily be removed and sent for repair. A replacement module will be air mailed to minimize down time.
- **Super Hot Receiver** . . . Better than .4uv / 20db. sensitivity, helical filters to eliminate intermod . . . plus a super E filter and a mosfet front end.

IF THERE IS A SIGNAL, YOU'LL HEAR IT ON THE IC-230!

LATCH ON TO THE IC-230 AT YOUR AUTHORIZED ICOM DEALER

Distributed by:



— Dealerships Available —

ICOM WEST, INC.
Suite 3
13256 Northrup Way
Bellevue WA 98005

ICOM EAST, INC.
Suite 307
3331 Towerwood Drive
Dallas TX 75234



Build Your Own Computer

ALTAIR
COMPUTER
SYSTEM

DOCUMENTATION

ALTAIR 8800 COMPUTER

\$439

For complete information package including 24 page catalog, technical data, price list and sample Altair Users Group newspaper send \$2.00 to: Altair Package, MITS, 6328 Linn NE, Albuquerque,



FCC NEWS

Before the
Federal Communications
Commission
Washington, D.C. 20554

In the Matter of

Amendment of Part 97 of
the Commission's Rules
to permit linking of
amateur repeater stations

Docket No. 20073
RM-2349

Report and Order
(Proceeding Terminated)

Adopted: May 28, 1975

Released: June 5, 1975

By the Commission: Commissioners
Hooks and Washburn absent.

1. On June 5, 1974, the Commission adopted a Notice of Proposed Rule Making in the above-entitled matter which was published in the Federal Register on June 13, 1974 (39 FR 20704). Proposals in this proceeding contemplated amendment of Part 97 of the Commission's Rules to delete the proscription against interconnecting more than two repeater stations in the Amateur Radio Service, i.e., the tandem operation of more than two repeaters. Comments as to these proposals were submitted by the parties listed in Appendix A. Each of these comments has been carefully considered as indicated in the following discussion.

2. By way of background, in 1972, the Commission formalized specific rule provisions for the operation and technical development of amateur radio stations which can receive and automatically retransmit the signals of other amateur stations. (See the Report and Order in Docket No. 18803, 37 FCC 2nd 225, 1972.) Prior to these rule changes, repeater stations had been authorized in the Amateur Radio Service under limited general rules that related primarily to any remotely controlled station. In that

proceeding the Commission expressed the opinion that terrestrial repeater stations should be utilized only for intra-community radio-communication. This and a desire to conserve spectrum led the Commission to adopt rules which would accommodate the majority of situations. In March, 1974, the American Radio Relay League, Incorporated, submitted a Petition for Rule Making, RM-2349, to delete the portion of the rules which prohibits the interconnection of more than two repeater stations.

3. All comments supported the proposal as being timely and in general conformance with today's practical requirements for amateur repeater operations. Some respondents, however, confused the proposal to permit unrestricted tandem operation of repeater stations with a proposal to eliminate the prohibition of crossband operation of such interconnected stations. The subject of crossband operation of amateur repeaters is being considered in a separate proceeding, FCC Docket No. 20113. This proceeding deals only with the tandem operation of repeater stations which are being operated in the same frequency band.

4. In line with our proposal, we are deleting the prohibition of tandem operation of more than two repeater stations. Certain requirements will, however, have to be observed by the licensees/trustees of all such stations which are interconnected. Since at least two different stations are involved in a system of interconnected repeaters, a system network diagram, showing all related stations in the system, must be submitted in accordance with Section 97.47(e) of the Commission's Rules by the licensee(s) of each participating station. This diagram should include any auxiliary link stations which may be used to effect the interconnection. It is re-

quired even though the interconnection may occur only occasionally or on a part-time basis and is brought about by the Commission's need to be aware of which stations are involved in such a system.

5. Licensees/trustees and control operators of all tandem operated repeater and associated stations should remain aware that the interconnection of their station with any other station does not relieve them of the responsibility for proper operation of their station. If any of the participating stations are licensed to be operated by remote control, the submission of a revised system network diagram does not, in itself, alter the list of authorized control points for each remotely controlled station. Where the authorized control points of one station in a system of interconnected stations are also intended to serve as primary control points for other stations in the system, the station licenses of those other stations must be appropriately modified.

6. The revised rules will afford amateurs considerably increased flexibility in the operation of repeater systems. Implementation of tandem operation of repeater stations will require no special applications. However, as previously discussed, revised system network diagrams must be submitted to the Commission for each participating station. These diagrams should be sent directly to the Federal Communications Commission, Gettysburg, Pa., 17325, and should be clearly marked as to the name(s) of the licensee(s) and the callsigns of the participating stations.

7. In consideration of the foregoing, the Commission finds that amendment of the rules to permit unrestricted interconnection of amateur repeater stations is in the public interest, convenience, and necessity.

8. Accordingly, pursuant to authority contained in sections 4(i) and 303(r) of the Communications Act of 1934, as amended, IT IS ORDERED That, effective July 11, 1975, Part 97 of the Commission's Rules IS AMENDED as set forth below:

§97.89 [Amended]

In §97.89, paragraph (c) is deleted and designated "[Reserved]".

9. IT IS FURTHER ORDERED That this proceeding IS TERMINATED.

Federal Communications Commission
Vincent J. Mullins
Secretary

CONTESTS

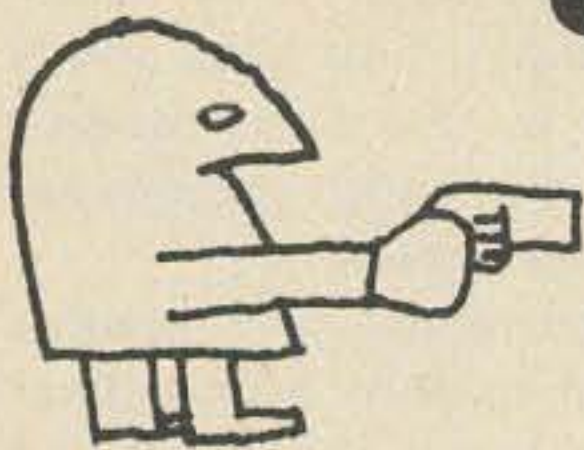

Editor:
Robert Baker WA1SCX
34 White Pine Drive
Littleton MA 01460

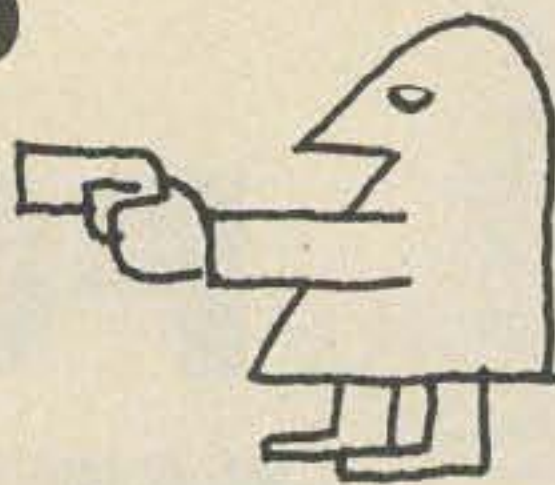

CALGARY CENTENNIAL CALGARY-to-MOBILE CONTEST

Starts: 1700 GMT July 26

Ends: 1700 GMT August 7

The contest is to promote hospitality and interest in the Calgary Centennial Convention. All contacts must be between CY stations (fixed or mobile) and convention guests who are not Calgary residents and who are operating mobile on their way to the convention.

EXCHANGE:

Report, name, location of mobile. One contact per band per mode per day.

SCORING:

Score 1 point between CY and mobile who is within city limits of Calgary, 2 points between CY and mobile outside city but within Alberta, 3 points between CY and Sask, B.C., or Mont., 4 points between CY and any other QTH.

FREQUENCIES:

Mobiles look for CY stations afternoons and evenings \pm 20 kHz of 3770. When in range, check 34-94, 28-88, and 146.46-147.00.

LOGS:

Logs must be deposited at the Calgary Centennial Convention registration desk no later than 2359 GMT August 2. Show date and time in GMT, mode, band, reports, first names, and location of mobile.

ILLINOIS QSO PARTY

Starts: 1800 GMT Saturday, August 2

Ends: 2300 GMT Sunday, August 3

Rest period from 0500 to 1200 GMT Sunday, August 3. The 13th Annual Illinois QSO Party is sponsored by the Radio Amateur Megacycle Society, Inc. (RAMS). Same station may be worked with each mode (CW and phone) on each band. No repeater contacts allowed. Contacts with K9CJU/9 aboard U.S.S. Silversides submarine will count as 5 regular contacts for scoring. The word SUBMARINE will be added to the exchange sent by K9CJU/9. Send an SASE for special QSLs that will be available.

EXCHANGE:

Illinois stations give RS(T) and

county. Others, give RS(T) and state, province, or country.

SCORING:

Illinois stations add the number of Illinois counties, states, Canadian provinces, and ARRL countries. Multiply total by the number of QSOs for score. Illinois mobiles, add 200 points to score for each county operated from (except home county) with 10 or more contacts made. Other stations, multiply total number of contacts by county multiplier. For Non-IL only, each group of eight contacts with the same county gives one bonus multiplier. Sum of counties worked plus bonus multipliers equals county multiplier.

FREQUENCIES:

60 kHz from low end of CW bands. 25 kHz from high end of phone bands, and 21375 & 28675. 25 kHz from low end of Novice bands on the half hour.

AWARDS:

For Illinois stations, certificates to top three scorers in Single-op, Multi-op, Portable (non-home county), Mobile, and Novice categories. Others, awards go to scorers in Fixed, Mobile or Novice groups in each state, Canadian province or county from which 2 entries are received. Top scorer in any club mentioned in 3 entries also rates an award. Decisions of contest committee are final.

LOGS:

Legible logs must be submitted. A separate summary sheet must show name, address, call and category of operation. Summary should also show number of contacts, list of multipliers, and claimed score. Entries should be postmarked no later than Sept. 15, 1975. Include a business size SASE and mail to: RAMS — K9CJU, 3620 N. Oleander Avenue, Chicago IL 60634.

NEW JERSEY QSO PARTY

Two Periods (GMT)

2000 Saturday, August 16 to 0700 Sunday, August 17

1300 Sunday, August 17 to 0200 Monday, August 18

The 16th Annual N.J. QSO Party is sponsored by The Englewood Amateur Radio Assoc., Inc. Phone and CW

are considered the same contest. A station may be contacted once on each band; phone and CW are considered separate bands. N.J. stations are requested to identify themselves by signing "DE NJ" or "NJ CALLING" and N.J. stations may work other N.J. stations.

EXCHANGE:

QSO Nr., RST and QTH — County for N.J., ARRL Section or country for others.

SCORING:

N.J. Stations — W, K, VE, VO QSOs count 1 point while DX QSOs count 3 points. Final score is sum of QSO points times number of ARRL Sections (including NNJ & SNJ). KP4, KH6, KL7, KZ5, etc., count as both 3 point DX QSOs and as section multipliers. Others — Multiply number of completed N.J. QSOs by number of N.J. counties worked (maximum of 21).

FREQUENCIES:

1810, 3535, 3735, 3905, 7035, 7135, 7235, 14035, 14280, 21100, 21355, 28100, 28600, 50-50.5, 144-146. Suggest phone activity on even hours, 15 meters on odd hours between 1500 & 2100 GMT, and 160 meters at 0500 GMT.

AWARDS:

Certificates will be awarded to first place stations in each N.J. county, ARRL Section, and country. Second place certificates will be awarded when 4 or more logs are received. Novice and Technician certificates will also be awarded.

LOGS:

Logs must show GMT date and time, band and emission in addition to the required exchange information. First contact for each claimed multiplier must be indicated and numbered. A check list of QSOs and multipliers should be included. Multi-operator stations should be noted and calls of all active operators listed. Logs and comments should be received not later than Sept. 13, 1975 and should be sent to: Englewood Amateur Radio Assoc., Inc., 303 Tenafly Road, Englewood, NJ 07631. Include a size #10 SASE for results.

ALL ASIAN DX CONTEST — CW

Starts: 1000 GMT Saturday,

August 23

Ends: 1600 GMT Sunday, August 24

Non-Asian stations work Asian stations, KA contacts do not count.

CLASSES:

Single operator, single and all band. Multi-operator, single transmitter, all

band only. Club stations are considered Multi-operator stations.

EXCHANGE:

RST plus age of operator, YLs send "00" for age. Each operator of Multi-operator stations will give his age while operating.

SCORING:

One point per QSO. Asians, use number of non-Asian countries worked as multiplier. Non-Asian stations, use number of prefixes of Asian stations worked as multiplier.

FINAL SCORE:

The total QSO points from each band times the sum of the multiplier on each band equals the final score.

AWARDS:

Certificates awarded to top single operator, all band and each single band, in each country and USA call area; up to the fifth rank where returns justify. In addition to the certificates, medals will be awarded to the continental all band leaders and multi-operator continental leaders.

LOGS:

Use a separate log for each band, show all times in GMT, fill in country or prefix column first time worked. A summary sheet is required, showing scoring and other information. Include a signed declaration that all rules and regulations have been observed. Logs must be received no later than Nov 30, 1975. Logs should be sent to: J.A.R.L. Contest Committee, P.O. Box 377, Tokyo Central, JAPAN. Include an IRC and SAE for results.

FOUR LAND QSO PARTY

**Starts: 1800 GMT Saturday,
September 6
Ends: 0200 GMT Monday,
September 8**

The Sixth Annual Four Land QSO Party is sponsored by the Fourth Call District Amateur Radio Association of the I.A.R.S. The same station may be worked again on each band and/or mode fixed, and repeated again if operated portable or mobile, and from each different county.

EXCHANGE:

RS(T), county and state for 4th call district; state, province or country for others.

SCORING:

Fourth call district stations score 1 point for W/VE QSOs, 3 points for DX contacts (include KH6 and KL7); final score is total points times states and provinces (states and provinces counted only once). All others score 2 points per QSO and multiply by the number of fourth district states and

counties. Count each state and county only once.

FREQUENCIES:

CW: 3575, 7060, 14070, 21090, 28090 plus or minus 10 kHz. Phone: 3940, 7260, 14340, 21360, 28600. Novices: 3710, 7110, 21110, 28110 plus or minus 10 kHz.

AWARDS:

Certificates to top scorers in each state, VE province, and country. Second and third place awards when scores warrant. HHTA (High Honor Trophy Award) certificate to high scorer in four-land, high W/K, out of four-land, VE and DX country. Also, county awards to fourth call district states and special awards to Novices, SWLers, and B/H (blind/handicapped).

LOGS:

Contestants must mail logs with score within thirty (30) days of the end of party to 4th District A.R.A., Att: Bob Knapp W4OMW, 105 Dupont Circle, Greenville NC 27834. Include an SASE for contest results.

WASHINGTON STATE QSO PARTY

**Starts: 2000 GMT Saturday,
September 13
Ends: 0200 GMT Monday,
September 15**

The Tenth annual Washington State QSO Party is sponsored by the Boeing Employees' Amateur Radio Society (BEARS), and all amateurs are invited to participate. All bands and modes may be used. Stations may be worked once each band and each mode for contact points and more than once each band/mode if they are additional multipliers.

EXCHANGE:

Washington stations send QSO number, RS(T), and county. All others send QSO number, RS(T), and state, province or country.

FREQUENCIES:

CW: 3560, 7060, 14060, 21060, 28160. Phone: 3835, 7260, 14280, 21350, 28660. Novice: 3735, 7125, 21150, 28160.

SCORING:

Washington stations score one point for each contact (including contacts with other Washington stations). All others score two points for each contact with a Washington station. Washington stations multiply total contact points by the total of different states, Canadian provinces and other foreign countries worked. All others multiply total contact points by the total of different Washington counties worked (39 maximum). There will be an extra multiplier of one for each group of eight contacts with the same Washington county.

AWARDS:

Certificates will be awarded to the highest scoring stations (both single and multi-operator) in each state, Canadian province, foreign country and Washington county. Additional certificates may be issued at the direction of the Contest Committee. Worked Five BEARS Awards are also available to anyone working five club members before, during or after the QSO Party (unless previously issued). All QSO Party entries will be screened by the Contest Committee for possible Worked Five BEARS Awards. Worked Three BEAR Cubs Award is available for working three Novice members.

LOGS:

Logs must show dates and times in GMT, stations worked, exchanges sent and received, bands and modes used and scores claimed. Include check sheet for entries with more than 100 QSOs. Each entry must include a signed statement that the decision of the Contest Committee will be accepted as final. No logs can be returned. Results of the QSO Party will be mailed to all entrants. SASE is NOT required! Log sheets and scores must be postmarked no later than October 13, 1975 and sent to: Boeing Employees' Amateur Radio Society, c/o Contest Committee, Willis D. Propst K7RSB, 18415 38th Avenue S., Seattle WA 98188.

CONTEST CALENDAR

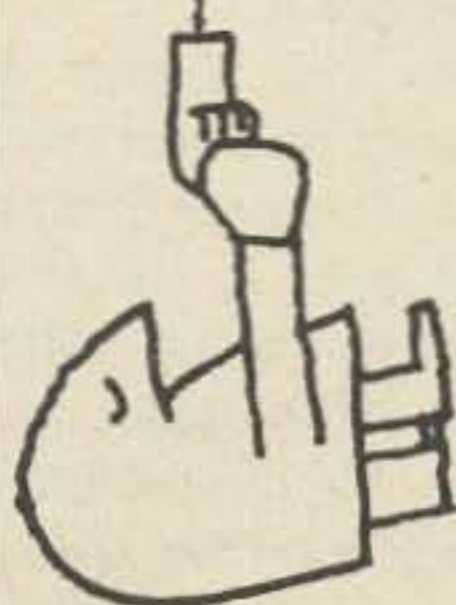

July 26 - Aug 7
Aug 2 - 3
Aug 2 - 3
Aug 2 - 3
Aug 9 - 10
Aug 16 - 18
Aug 23 - 24
Sept 6 - 7
Sept 6 - 8
Sept 13 - 14
Sept 13 - 15
Sept 27 - 29

Calgary Centennial, Calgary-to-Mobile
WAE DX Contest - CW
YO Contest
Illinois QSO Party
European DX Contest - CW
New Jersey QSO Party
All Asian Contest - CW
ARRL VHF QSO Party
Four Land QSO Party
European DX Contest - Phone
Washington State QSO Party
Delta QSO Party

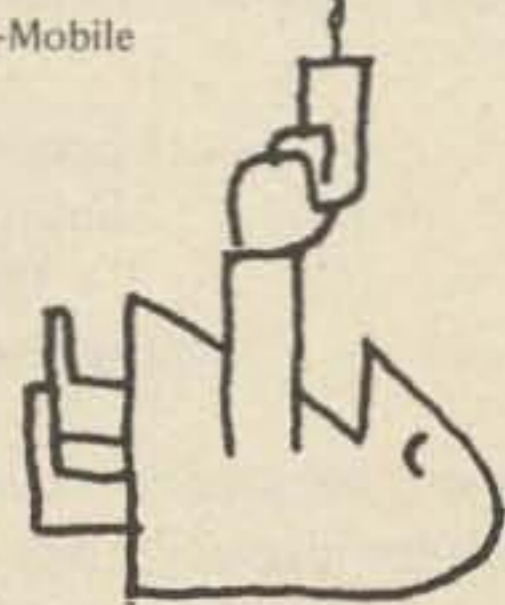

ou goons don't ever read
lousy maga...
LETTERS
bunch of rocks...
you ignored my comments in
I insist that you print ev

from page 11

After you experiment with a Flipper and tape system, you may want to try some of those "multi-screen" effects that you see in movies. You can add more Flippers and pairs of projectors (if you don't feel like buying them, some college communications departments are buying whole systems), but you run into the problem of how to put that many tones on tape. Touchtone signalling, like you do for autopatch, might work. However, a commercial synchronizer that costs (gasp) \$1200 uses a different system. It develops a pulse train very rapidly, and frequency-shifts an audio tone to put the commands on tape. The big improvement over touch-tone is the fact that this system controls nine channels, and can operate them all *simultaneously*.

If any of you gents or ladies have had experience building anything complicated like that, would you write me? If nothing else, this might develop an interesting method of repeater control.

I want to thank you for three months of interesting reading. I have no ham license, but I do have a commercial First Phone, and I am fascinated by the great variety of articles you print. The series exposing Ma Bell is manna from heaven, and your other articles are more candid than anything I have read since before I was born. (I was an early learner.)

A relative of mine is a rabid CBer, and has stuck one of those cursed linears on his set. I have been trying to talk him into becoming a ham, but he claims that Morse code and electronics are too hard, and besides, he says all hams are conceited cottonpickers. Can you tell me what a cottonpicker is? I hear this word from CBers, on and off the air, and it appears to have a mystic significance, like "Om mane padme om" and "Hare Krishna". Can anybody translate, please?

Thomas E. Reed
Chief Engineer, KBIL Radio
Saint Louis University
1220 Midland Blvd.
University City MO 63130

The Michigan Radio Doctor and friend supply one cotton pickin' definition on page 93. — Ed.

BEST

I just received my June issue of 73 and after going over it cover to cover and back again, I have one comment to make: It's the best damn ham mag I've ever read! I've subscribed to the other mags (CQ and QST) and I must admit that they are not even a close 2nd to 73.

I think I got the best enjoyment out of your editorials and letters from your readers. I would like to see more articles for the Novice and beginning ham like QST once had a long time ago.

Not being an engineer, just a ham that likes QRP and home brewing all of my gear, I like to see articles that the ordinary ham who doesn't have an EE or a complete machine shop at his disposal can duplicate. I run anywhere from 500 mW to 35 Watts in power on all of the Novice bands, and have much enjoyment in talking to these hams because they usually don't have the hello-goodbye QSO that is mostly the rule on the bands today.

Keep up the good work, Wayne, and you can bet that when my one year subscription to 73 is up, I'll renew for many years.

Tom Cullen Jr. K1WXK/W1NXZ
2 Westview Dr
Wallingford CT 06492

STOP THIS CHEATING

I read ur "In Pursuit of the Perfect SSTV Picture" on p. 73 of May 75 "73 Magazine" with great interest. I started SSTV in Dec. 1972 with a gift cassette recorder "Standard SR-T115" which my daughter had bought me as a present at KV4AA's shop on St. Thomas V.I. when she was a nurse on the next Island of St. John — she has recently moved to Hugo, Okl. I soon found that the absence of a "turns counter" made finding a spot again on a cassette in a hurry an impossibility. Therefore in Jan. 1973 I bought the SONY TC 129 stereo deck, the later model of the one recommended by ROBOT, and it is excellent.

When you review the lengths of cassettes u do not start on a real short length; I use 3 and 6 minute Endless Cassettes, the EC-3 & EC-6 (there is also a one minute one) made by TDK Electronics Co. Ltd. of/in Japan, and find them excellent for pre-recorded information e.g. 3m for 2xCQs, 6 min. for Name, QTH, station equipment,

etc., etc., another 3 minute for QRZ de G3WW, ok from G3WW, hw copy? pse K., etc., etc.

Ur SSTV column and articles are of great interest to the SSTV gang in Great Britain & are regularly discussed each Sunday morning about 0730 gmt on the 80m SSTV Net on 3735 kHz; "SSTV Video Analysis" by WB8DQT in Jan. 75 issue has been applied to two home built monitors (SSTV) with the results forecast, while it saved me (?) \$99.0 in nt having to buy the ROBOT mod. kit to up-date my 70 Monitor, already modded to 70A, to 70B. I already have the Fast Scan Montr Model 61, so by adding his (WB8DQT's) Video analyzer with single sided discriminator to my Robot Monitor I achieved a better-than-70B result as with the 61 I cld set up camera 80A on the F/S Mon while receiving SSTV on the 70A. BUT IT IS NECESSARY TO FULLY FLOAT THE EXTRA SINGLE-SIDED DISCRIMINATOR WITH A three pole (nt double pole) double throw switch when nt in use, as *if the input is left connected to the Robot Limiter Output the circuit will "ring" and distort the video — try it and see.*

G3GGJ has made up for me both the W0LMD Keybrd (CQ-Sept 74) with PC Board by W8OZA, to give me the very first one in Europe in Apl. 75, and the SSB/SSTV Bandpass filter by DJ6HP (CQ-DL-Aug. 1974); there are now two SEEC Keyboards in HB9 land and one in OD5.

I used ur Navassa battery tape recording method for /M SSTV reception (see last Fall's ROBOT Newsletter) but with an outboard tuning indicator between FT.101 & recorder; did u know that if an SSTV signal is recorded "off tune" it can be restored to full intelligibility by transmitting the tape thru a dummy load & receiving that transmission on a sep. rx which in turn can be tuned to give an intelligible "picture" of what is on the tape?? Finally, this year's Worldwide SSTV was AGAIN a FARCE; the rules should be the SAME FOR EVERYONE; nt the Ws praying in aide the FCC reqmnt for voice station identification at start & end of each qso while the rest of the world must nt utter a word, *and then expanding this to "This is WB4... calling CQ SSTV contest" — "Hallo, W2... did u get ur report ok?" "Yes WB4... I got my report ok at 5.7 but did you give me 010 or 020 in video?" "No, I gave u 020 & thanks for my 5.9" — ALL THIS SORT OF EXCHANGE BY*

Continued on page 132

500 MHZ PRESCALER

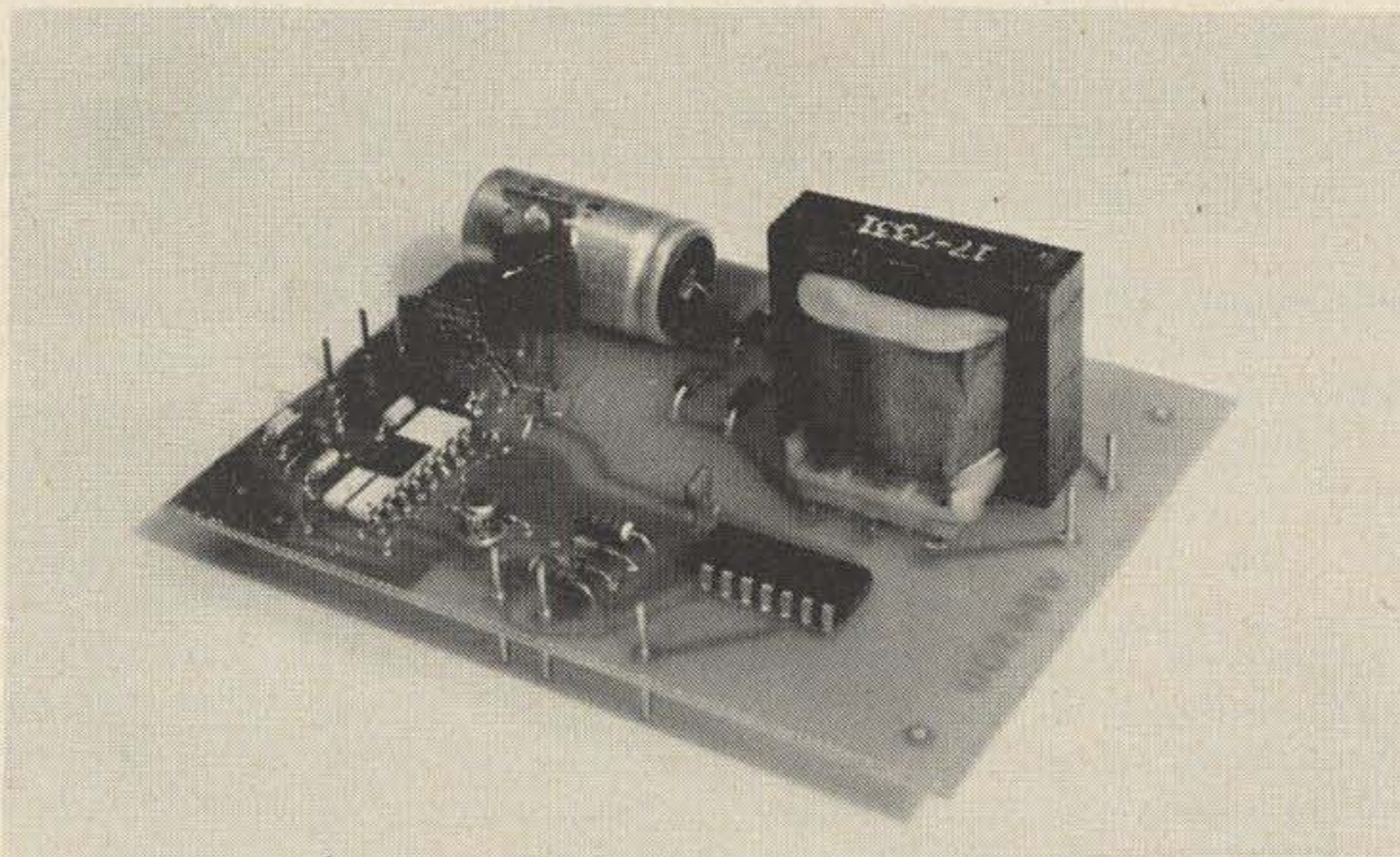

3" x 4" x 1½"

EXTEND YOUR COUNTER to 500 MHz!!!
Can be used with Any counter capable of 5 MHz.

- FMAX greater than 500 MHz.
- HIGH INPUT SENSITIVITY: less than 150 mV needed at 500 MHz — overload protected
- HIGH INPUT IMPEDANCE: 500 Ohms
- OUTPUTS: ÷ 10 and ÷ 100 TTL compatible
- INCLUDES POWER SUPPLY

PS-K kit \$ 89.00

PS-A wired and tested \$109.00

BRAND NEW!
500 MHz COUNTER
WRITE FOR DETAILS

plus \$.85 postage
Calif. residents add 6% sales tax

LEVY ASSOCIATES

P.O. Box 961 S
Temple City, Calif. 91780

ou goons don't ever
LETTERS
I insist that you print ev

from page 130

VOICE. Let evryone use voice for station identification worldwide AND FOR NO OTHER PURPOSE and stop this cheating. Is it not now marvelous to think how ur review of Voice Operated Switch (for a Mobile transmitter) in CQ, August 1958 (when I telephoned u about it in NY from Princeton NJ) has become the world-wide VOX system?

Richard Thurlow G3WW
2 Church Str.
Wimblington, March
Cambs, England

STAY THE SAME

I'm enclosing a credit memo you issued to me, apparently when I paid for a subscription twice. Please apply the amount toward extending the subscription, advising me of the date the extended subscription will run out. (There aren't many magazines that I would consider subscribing to for such a length of time. Stay the same.)

Don Sawyer
Roswell NM

VOICE WITH CHARACTER

I would like to order several of your cassette tapes for learning the code and theory for friends of mine. However, before sending the Basic Code and 6 wpm tape, I would like to know if the letter characters are sent at a speed of approximately 14 to 15 words per minute with spacing between the characters to make the speed only 6 words per minute. I understand this is the new method (as I was taught that way), wherein you do not have time to count the dits and dahs yet you learn the characters at a fast sending speed so that when you increase your speed you merely close the gap between letters, etc. Also this does away with hearing slowly sent characters and when you increase the speed the dahs won't sound like dits.

I'm sure you know what I mean since you are in this business. I've heard various tapes and records by AMECO and Radio Shack and they are terrible. A friend of mine bought a Radio Shack tape for code - it is so

noisy and bad (and the characters are also sent at slow speed) that when you hear these same characters sent at a high speed it doesn't sound the same. Please do not send these two tapes if they are not what I want. This is also why I have not sent money with this order, as I don't know if it is what I want for my friend. Otherwise I will make up my own tapes for him, but I'd rather save time and let him buy yours, if they are what he should have.

Also, on the basic tape, do you give the character in voice as you first learn the character or is it written on a sheet of paper? I think voice with the character as in a class is best.

Thank you kindly.

Mervin Behlen WA6SMG
Fresno CA

Yes, I have my voice on the basic tape telling about each character. And the letters are all sent at 13 wpm with spacing for 6 wpm so you only have to learn the code one time... by the sound. This is by far the fastest system of learning the code and, as far as I know, only my tapes use this fantastic system - Wayne.

TRAGIC

Having recently subscribed to Hotline, I am very pleased with it. This is really worth the price. If the price was twice as much it still would be a bargain!

Re your editorials: I agree that the new FCC proposals would definitely hurt amateur radio. I think the code test should be lowered to 5 wpm and left there for all classes. And I also agree that only two classes of licenses should be issued.

But as usual, the FCC will probably ram the new rules down our throats to the detriment of amateur radio. If this happens our numbers will decrease, not increase!

Which gets me down to the point that now interests me, because I sell CB and some ham equipment in a store which I recently put in business. When I first opened I thought that there would be some interest in amateur radio but so far I have experienced very little. Most CBers don't care a bit about getting their tickets. This to me is tragic. CB now is a bunch of lawbreakers who don't use call letters, swear on the air, run over power, give location of police cars to break the law, throw carriers, and just are plain ignorant! When I was on CB in the early and mid 1960's, call

letters were used and people operated properly most of the time. To buy a CB rig and try to use it is an exercise in futility, as you will get blown off the air by people who just don't care. Too many people are on the few channels that there are.

A complaint I hear quite often and have noticed myself a bit is the lack of interest many amateurs take in getting new people interested in our hobby. There are too many people who don't want new members in our ranks. This is why some good people have gone bad with CB radio.

I sure hope things change for the better, because they have been getting worse since the ARRL incentive plan ten years ago.

I am really glad you understand the issues - the other magazines sure don't. I let my subscription to CQ lapse. It has gotten very poor, with few pages.

Well, I'd better go now. Thanks for taking the time to read my letter. Keep up the really good work, and fight for what you believe in.

Pete K. Hons
Portage PA

VISCIOUS CODERY

You may enter my name and call on your list of satisfied code tape users who, after mastering that mean, vicious piece of "Morse codery" put out by 73 Magazine under the guise of 14 wpm, passed his 13 wpm code test with ease. I might add that I failed it 5 times prior to using your tape for practice. I think anyone who wants to spend the time mastering this extremely tough tape should have no problem passing the test before an FCC examiner - even with the jitters that accompany the test. By the way, I now have my Advanced Class test passed and am waiting for my ticket.

Jim France WA8HHO
Massillon OH

ASTONISHED CLUB

Acting on the advice of some smart ham, I ordered your Advanced Study Guide (after about nine months of struggle with several other books). Two months later I passed it (much to the astonishment of the rest of my ham club!). Many thanks.

Phil Litchfield WA10FP
New Canaan CT

Continued on page 136

Autobiography of an Ancient Aviator

W. Sanger Green
1379 E. 15 Street
Brooklyn NY 11230

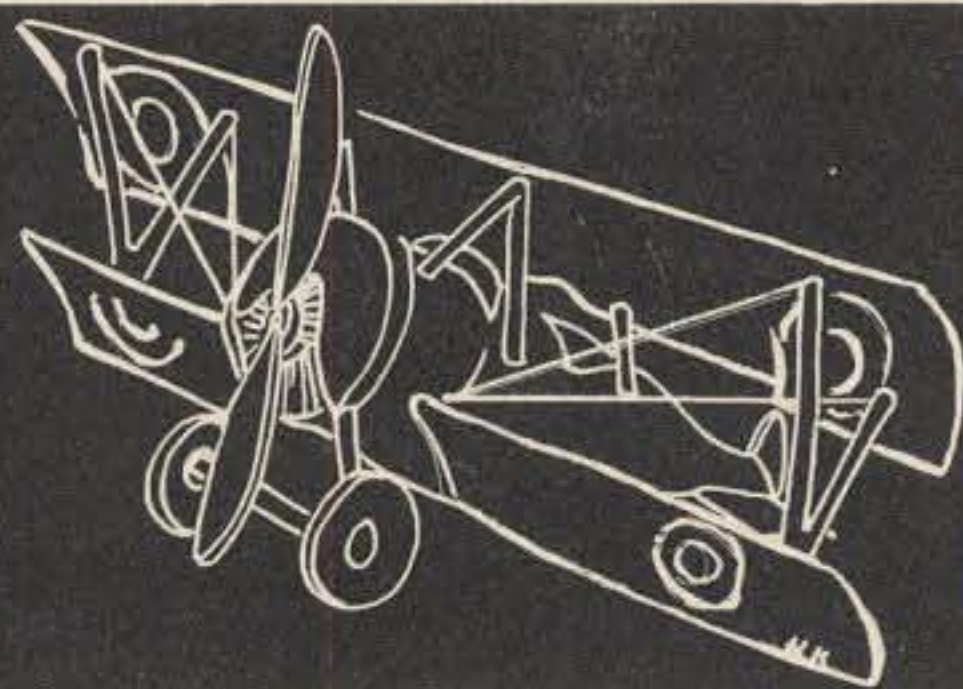

KELLY FIELD FLYING

The Kelly Field flight training was very interesting. We didn't just fly around aimlessly. Each day some aspect of our ground training was put to use in the air.

Visual reconnaissance missions (There were several of these to different towns): We were instructed to fly over a certain town or district, usually within a 50 mile radius, and make a sketch of the area indicating any features of military interest such as factories, railroads, highways, water towers, flying fields, etc.

Aerial Photography (Several to various locations): Same procedure as Visual Recon Missions except that we photographed strategic places. I even took a good shot of Art Caperton riding on the turtle back of another ship.

Puff target range: We dropped simulated bombs on the smoke bomb range and were marked according to our accuracy.

Artillery Regulate: This was more fun. It was done in cooperation with a Field Artillery unit at Camp Stanley (about 30 miles away). Our job was to fly over a target at a low altitude and direct the artillery fire (live ammo) to right, left, forward or backward of the target center. The radio equipment we had for communication with the artillery consisted of a transmitter with key and an antenna that trailed below the plane with a fish (weight) to hold it down and a reel in the rear cockpit to raise and lower it. One time I tried to climb too fast with the antenna out and the DH fell off into a turn of a spin. This wound the antenna around the tail of the ship. The rudder didn't work too well but the elevators were OK, so I got back to the field and landed with no trouble. I didn't get a

Everyone enjoyed a wild orgy of flying calculated to draw flowers.

very good mark on that mission.

Aerial Gunnery: For this work we spent several days at Ellington Field (near Galveston). Small ponds, shadows, panels and birds were our targets. Live ammunition was used in the two Lewis machine guns which were mounted on a scarfmount over the rear cockpit. While we were at Ellington the rigid flying rules of Kelly Field were dispensed with. Everyone enjoyed a wild orgy of flying calculated to draw flowers. However, all eventually returned to Kelly more or less safely. Although the return weather was CAVU (clear and visibility unlimited) some got lost on the way and didn't straggle in to Kelly until the next day.

Cross Country Trips: The trip to Ellington and return was our first, about 235 miles each way. Our longest trip was to Post Field, Oklahoma, via Dallas, with return via Waco. An overnigher of about 720 miles if you flew in a straight line. There were several other shorter cross countries of up to 300 miles.

Formation Flying: Only about ten hours of this flying was done by our observation group. Five ships to a Vee formation. A lot of this practice was in formation take-offs, lands and turns. The object was to keep away from the other fellow and not let him put his wing in your lap.

As we approached Love Field, Dallas, on our way to Post Field, I was driving the ship. As I came in to land I saw giraffes, zebras, camels, elephants and other animals grazing on the field.

I decided to circle the field again while I reviewed what I had eaten in the last 24 hours and asked Munson in the rear cockpit if what I was seeing was really there. Affirmative. Then I managed to land without hitting any of the beasts. When I climbed out of the ship an over-friendly black bear came up to be petted. This one exuded that rare combination of B.O. and halitosis. I have a snapshot of this delightful experience.

When Munson and I were coming in to land at Kelly from our cross-country trip to Post Field, we had a slight mishap that could easily have been much worse. It was almost dark and what we didn't know was that, during the two days we were away, they had put up some goal posts for a football field, one of which was right on the hangar line. Munson was piloting and made his landing approach in the usual manner. He landed and taxied up to our hangar. Then we found out that on our approach we had hit one of the goal posts with our wing and broken the post off. The fortunate part of the mishap was that contact with the goal post was at the root of the right wing (next to the fuselage). If it had been farther out on the wing we would most probably have been in serious trouble.

This masterpiece of engineering, built with a heavy Army hand, looked pretty ferocious sitting on the ground — but only Jimmy Doolittle managed to get it around the field.

I can't leave Kelly Field without telling you about the G.A.X. (ground attack experimental). This was a masterpiece of aeronautical engineering with a heavy Army hand laid on. I understand that only two of them were ever built, and if they had tried to fly #1 first they would have quit work on #2. The one I refer to was housed in a large hangar on the far side of the field. It was a large biplane powered by four liberty engines, gunner's cockpits forward and aft and half inch armor all around the two pilot cockpit. It looked pretty ferocious sitting on the ground but the main trouble with it was that it had a ceiling of about 200 to 300 feet on a cool day. The only time I saw it fly was when we put on an aerial revue for General Patrick, Chief of the Air Service. Jimmy Doolittle managed to get it around the field twice at full throttle with very, very shallow turns.

Next month I'll tell you about my return to civilian life and of some of my first "gypsy" flying experiences.



Bill Pasternak WA6ITF
14725 Titus St. #4
Panorama City CA 91402

PANORAMA POLLYANA?

"PACIFIC TELEPHONE FILES SUIT AGAINST 73 MAGAZINE" . . . and now that we have your attention we shall move on to other matters. Not that I don't have my own opinions on this historic event — I just do not feel that Looking West is the proper place to express them. There is just too much other news to report and events to cover to justify steering this column in that direction. Therefore, Looking West will still be the same old column you have come to know these past few years and thanks to this magazine's editorial policy, I will be able to cover the aforementioned legal action elsewhere in print. I assure you that I will be far from silent on this issue, since it affects the future of each of us — both as individuals and collectively.

I have a rather strange policy in writing this column. I have no interest whatever in printing items that tend to bring down amateur radio or, through innuendo and gossip, to in any way bring harm to any individual or group within the amateur community. It is my feeling that there are enough individuals devoted to doing just the opposite, and someone has to point out the good and dwell upon it. Apparently most of you seem to agree with this policy. As a direct result of it, we have been able to bring you the type of news items that you seem to enjoy. On the other hand, some have accused me of being a "Pollyanna" — what they say is dig deep and give us the dirt. To those I say please look elsewhere since I have no intention of changing my policy; you will find the good news here and the "dirt" will have to come from someone else.

With the aforementioned in mind, I am happy to report that it looks as if the California Amateur Relay Council, a state-wide VHF/UHF frequency co-

ordinating body, has survived its internal political unrest and will re-organize its structure along the lines of the report submitted by the "Blue Ribbon Panel" organized for that specific purpose. In its final report given June 7 at Santa Barbara, it was recommended that regional management be adopted with given individuals or groups being appointed to oversee the needs of these areas in relation to spectrum management as well as other forms of peripheral support to all special interest groups involved in FM communications. There would be Northern, Southern 144/220 and Southern 50/450 and up coordinators assigned initially with invitation left open for other interests to join as well.

Executive and administrative affairs of the Council at large will be administered by a body comprised of the Chairman, Secretary and local area managers, whose duties will be to direct Council-wide activities. What has actually been done by the "Blue Ribbon Committee" is to apply common modern business management technique to an amateur organization, thereby permitting local needs to be cared for on a local level while at the same time stressing the need for total unity on a statewide basis. It took the committee four months to prepare this report — four months of gathering information from all available inputs, looking carefully and evaluating the needs of different geographic locations and finally preparing all this data in a form that would make a truly workable new



Art WA6TKO of Henry Radio displays the prototype Kenwood TS-700 2 meter All Mode Transceiver at the LERC Burbank Hamfest.

constitution acceptable to all involved. In October, they will meet again, this time to discuss the proposal and decide whether it is the route they wish to guide the future of CARC along. To my eyes, it seems a good foundation upon which to build a viable statewide organization, and I must commend those who gave of themselves for a job well done. If CARC can be reborn on a basis acceptable to all, then we are really going to have something out here.

Where, then, does this leave the Southern California Repeater Association? In a resolution introduced for consideration on a basis parallel to that of the revised CARC constitution, the work of SCRA was noted and it was moved that SCRA be recognized as the Southern Regional Coordinator for 144/220 MHz (and that its elected chairman be considered as fulfilling the duties of liaison coordinator with the CARC Executive Committee). This too will be voted upon in October and the outcome of this vote will actually determine whether a working statewide organization, responsible to the needs of all FM users, is possible. I sincerely hope that such an organization does come to pass. There is a lot more that I wish I had time to cover: the interesting discussion aimed at developing an official CARC response to docket 20282; the direction they voted to take in obtaining official FCC recognition for remote-base operation; and a rather funny discussion as to where to hold their February '76 meeting. Can you believe that Tahoe lost to Los Angeles! I will try to cover more of this in greater depth next month, but at present wish to close by thanking Martin WA6TIC, who provided transportation, and Don WB6HJW, who recorded the meeting for me with my Panasonic RQ-309 cassette tape recorder. Since Saturday is a work day for me, this report would not have been possible without their kind assistance.

I really had not planned on attending this year's LERC Burbank Hamfest but as the event progressed, word kept filtering to me via two meters that Henry Radio was showing a new piece of two meter gear that would possibly revolutionize two meter operation. That I had to see, so I made the 15 minute drive to "Beautiful Downtown Burbank" and

Continued on page 143

The Ultimate in SSTV Equipment



SEEC HCV-3KB SSTV KEYBOARD

Another first from the company and the designer of the world famous HCV-1B SSTV Camera and the HCV-2A SSTV Monitor, now the HCV-3KB Slow Scan TV Keyboard. This is the first commercially made SSTV Keyboard and it is built with the same quality as all SEEC/THOMAS equipment. We will not attempt to list all the features of the HCV-3KB here and we suggest that you write for full specifications. For those that are not familiar with SSTV Keyboards, the HCV-3KB

eliminates the need for a menu board or other number/letter set-up arrangements which are very time consuming to set-up a meaningful text by arranging letters one at a time, by hand on a board or other surface. It also "frees up" the SSTV camera for other uses, such as live shots of the operator or other subject matter. Simply type out the message you wish to send.
#DD-033469 on file in U.S. Patent Office. All American made

— BASIC SPECIFICATIONS —

- 30 characters per SSTV frame — 6 characters horizontally and 5 vertically. Special 35 characters per frame available.
- Meets all standard accepted SSTV specifications
- Positive-negative color (video) reversal
- ¼ and ½ frame rates
- 4 shade gray scale generator
- Dual fast and slow scan rf and video outputs (special-optional)
- Plug-in printed circuit board — gold flashed edge connector
- ICs, op amps, transistors in plug-in sockets
- Built-in 115V 50/60 Hz power supply
- Special 16½" x 8½" x 3¼" aluminum cabinet, black and white

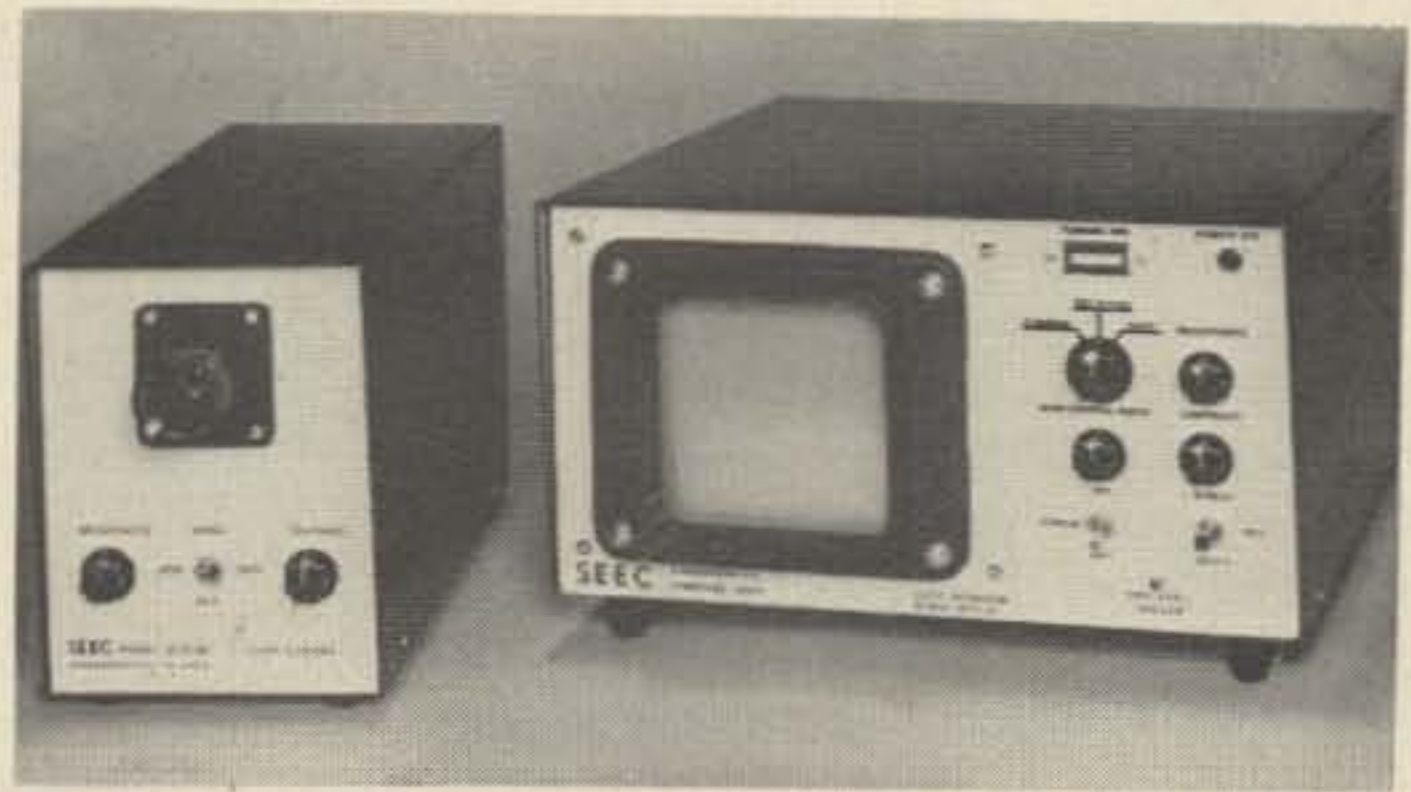

AUGUST
SPECIAL — cash w/order price — \$420
(reg. \$450)

HCV-1B SSTV Camera, w/lens & power supply	\$425.00 (Reg. \$450.00)
HCV-1B SSTV Camera with ALC, w/lens & power supply	\$450.00 (Reg. \$480.00)
HCV-2A SSTV Monitor w/2 CRT filters	\$360.00 (Reg. \$380.00)
HCV-2B SSTV Monitor w/ built-in Fast Scan viewfinder	\$455.00 (Reg. \$480.00)
HCV-70FSVFK Fast Scan viewfinder modification kit for 70 & 70A, monitors	\$69.95
(Factory installation \$37.50 additional)	
Sony TC110A Cassette Recorder	\$134.95
Heavy Duty Camera tripod	\$34.95

A complete line of camera and monitor accessories are available — please write for current prices and delivery, complete specifications on any of our equipment or to be put on our mailing list. We have a 24-hour telephone answering service to better serve you, plus on the air technical assistance from the designer, WB4HCV (Jim). Two locations to better serve you — our main plant at 138-B Nauta-Line Drive and our lab at 218 Tyne Bay Drive, Hendersonville. Complete 80-2 meter operation from either location. Drop in to see us if you are ever near Nashville, Tennessee!

Bulletin— Write for specifications on our new slow scan to fast scan/fast to slow scan monitor. The HCV-2CS will have built-in 9" fast scan display, all necessary station interconnects in one unit, and much more. No assortment of black boxes needed. Price range \$850 — \$925. Available September 1975.

Five ways to purchase:
Cash with order — C.O.D. (20% deposit) — Mastercharge — BankAmericard — SEEC Financing (up to 36 months). Note: all credit cards pay regular price shown. All prices F.O.B. Hendersonville TN.



Sumner Electronics & Eng. Co. inc.

P.O. BOX 572
HENDERSONVILLE, TENNESSEE 37075
TELEPHONE: 615-824-3235

ou goons don't ever proair
lasy...
LETTERS
you ignored my comments in
I inslst that you print ev

from page 132

ETHER THE UNIFIED FIELD?

In the correspondence I have had on the subject of Ether, the biggest question seemed to center on the efficiency of wave travel.

That light and radio waves can survive billions of years of travel from distant galaxies is a direct indication of the near perfect, if not perfect, basic efficiency of their linear travel in space, the decrease of intensity being primarily a function of spheroidal dispersion.

It appears that subatomic "particles" are actually somewhat similar energy-Ether motions trapped in circulatory resonances, the frequencies, number of wave lengths, direction of rotation and number of interlocking resonances setting the characteristics, such as mass, charge, polarity, life, etc. The more stable of these "particles" continue in what amounts to perpetual motion, if billions of years qualifies them for that.

The importance of Ether is its being a perfect base for energy. Is the zero condition of the equation, $E = Mc^2$, fundamentally important and Ether? Is Ether the unified field? How test?

D. H. Gieskieng W6NLB/7
Box 386
Clarkdale AZ 86324

Dave Gieskieng is the author of "Does Ether Cause Gravity?" in our May issue, and is now working on "A Strip Chart Recorder for Everyone".
— Ed.

SOONER REPORT

I would like to report on 2 meter sideband activity here in southwestern Oklahoma. First of all, we are on using the KLM ECHO II, which checks out as a very nice rig. When I say we, I mean my wife Rosa WA4KBA as well as me. We are using 2 KLM 9-element beams up about 14 meters and hear Oklahoma City every-time they are on. We normally operate on 145.110 and are listening all the time (squelch). We have ordered a lower sideband crystal from International and should be getting it shortly. KLM now has 144.0 MHz crystals in stock and we have ordered

one of them as well. We are getting another ECHO II for the car and hope that we will have good luck with it.

The conversion to both upper and lower sideband is very easy and you are able to bring the switch out to the front panel by using the test switch which is no longer needed with a CW plug in the back. KLM could probably give you a good report on the conversion, or as soon as I get the crystal and other parts I can.

Rosa and I would like to see a lot more activity on 2 meter sideband and hope that the ECHO II and the ITC 2000 will help.

Bob Willsey W4NUL/5
Altus OK

FASCINATING SAGA

Just a quick note to say that I think the April issue is one of the best 73s in the past year or so. It had a nice mix of articles, and I especially liked the article on the phone system. As a pilot for the Air Force, I found W. S. Green's continuing saga fascinating. Some of the events I experienced at pilot training 50 years later sound very familiar.

I would like to see an article on these small decoders that you usually see in your friendly neighborhood CB store for use with a police band receiver. They are simple enough for a CBer to install, and appear to be about \$8 worth of parts usually sold for around \$40. However, they do unscramble broadcasts.

Alan P. Biddle WA4SCA/5
Jacksonville AR

CULPRIT CAUGHT

The attached for your perusal. Just cut it out of the ad section of one of our local papers. Use it as you wish, as I didn't know of a better person to send it to than you, as you have always carried the fight against CBers breaking the law as if there was no law. I was blamed for a lot of interference to TV and hi-fi in the neighborhood, until I got all fired tired of it and started an investigation. To make a long story short, I found the culprit, a CBer a short distance from me who was opening an electronic garage door, wiping out TV pictures, including my own, and coming in "loud and clear" on the hi-fi's. Needless to say he is out of business per the FCC and he was running a 1000 Watt amplifier. 5 Watts????? He was taken to court but

CB RADIO

AM-SSB Midland Base with digital clock, slider SSB kick desk mike; Kris (big boomer) Linear Amp. Both AM-SSB and receive pre amp, 300 watts AM-1500 watt SSB; mobile side bander II, AM-SSB plus 50-150 watt mobile linear. Palomar 500 watt SWR (in line) monitor; antenna (1,000 watt) mast and coax; Solid State desk VHF receiver Hi-Lo bands FM, Police, Fire, Weather; antenna and coax included. Other goodies thrown in too. Talk to the world! \$900 takes all. 241-3413.

don't know the outcome. However, we are no longer bothered with that bird and I am no longer being blamed for any kind of interference.

The mag is swell and look forward to receiving it each month. Keep up the good fight, Wayne. It's a good thing that somebody has the "guts" to fight "city hall". It is just too bad that you don't get more support from the other publishers.

Andy Anderson W6QV
Sunland CA

BUYER GUIDED

Your article, "Which 2m Rig For You?", in the May 1975 issue of 73, was very good.

I have been in the market for a new 2m rig for quite some time and did not know exactly what to buy.

After reading through your article several times, I decided a synthesized rig was just what I needed. Then it was just a matter of how much the pocket could afford. I liked the Clegg FM-27B, because of the independent receiver-transmitter frequency selectors.

After scanning through my 73 magazine, I found one of your ads with the FM-27B on sale.

Thanks to your article, I got the features I wanted in the 2m rig and a price to match.

Now, to get maxium use from the 2m rig, you will find a check for \$1.50 to cover the cost of your 1975 Repeater Guide. I don't want to cut up my 73 Magazine for the order blank.

Terry Smock WA1RXF
Springfield MA

Continued on page 144

GRR GRRREEN

QST CHANGES SIZE

Honestly, I don't want to be forever carping at ARRL, but dammit, they've gone and done it again! Before you chalk another one up to my constant criticism of the League (which I think is utter hogwash, but I realize that my having the gall to even mention the League in print is an affront to some of the more seriously disturbed ARRL followers), take a look at the facts.

Fact 1: The board of directors decided, without consulting the members, to change the size of QST. This was not a modest change, but one of magnitude, bringing it from the size it has been for over 50 years up to Radio-Electronics magazine size (approximately). Economy move, they said.

Fact 2: The publishers of the other ham magazines have been trying for

years to get the League to shave 3/16" off QST so it would match the other magazines and made ad preparation less expensive for manufacturers. This would also, as has been pointed out many times, allow QST to fit modern web offset presses and allow commonly available paper rolls to be used without excessive waste... permitting an estimated saving of \$30,000 a year just on paper.

Fact 3: Once a magazine fits web paper rolls and presses, the actual size of the magazine is irrelevant and it costs about the same per pound of magazine to print it. This means that pricewise there is nothing much to be gained from going to the 8-1/2" x 11" format over the present size of 73 Magazine other than a loss of face in "going the 73 route."

Fact 4: No mention was made of any decrease in QST subscription rates, so apparently there will be no savings to readers. On the contrary, there undoubtedly will be some extra money coming out of ham pockets as a result of this change. With the size of each page almost doubled, there is no question that the advertising rates will have to be raised substantially... and this will inevitably force the prices of ham gear to increase.

Fact 5: The bigger magazine won't match the libraries of ham magazines built up over the years. It will be thinner and floppier and won't stand up on a shelf. Stopping your subscription to QST won't solve the problem because the other ham magazines will be forced to change too, whether they like it or not, and all magazines will come in the unhandy giant size.

So what are the benefits to ARRL members of this move by the board... a move made without consulting the members in any way? I have tried and tried to think of one single advantage to the reader of the larger magazine and I can't come up with one.

So, before you put me down as carping, I challenge you to give me a good valid reason for the change.

BYTE magazine will be published in the larger size, primarily because this will give more room for the large schematics required for many of the computer circuits these days. No firm decision has yet been made on a change for 73, though I suppose we will have to go along in order to accommodate the new ad sizes.

... WAYNE

amsat

Oscar 6 Orbital Information

Oscar 7 Orbital Information

Orbit	Date (Aug)	Time (GMT)	Longitude of Eq. Crossing °W	Mode	Orbit	Date (Aug)	Time (GMT)	Longitude of Eq. Crossing °W
12765	1	0135.6	74.5	A	3237	1	0137.9	74.3
12777	2	0035.5	59.4	B	3249	2	0037.3	59.2
12790	3	0130.5	73.2	A	3262	3	0131.6	72.7
12802	4	0030.4	58.2	B	3274	4	0030.9	57.6
12815	5	0125.3	71.9	A	3287	5	0125.2	71.1
12827	6	0025.3	56.9	BX	3299	6	0024.6	56.0
12840	7	0120.2	70.6	A	3312	7	0118.8	69.5
12852	8	0020.1	55.6	B	3324	8	0018.2	54.4
12865	9	0115.1	69.4	A	3337	9	0112.5	68.0
12877	10	0015.0	54.3	B	3349	10	0011.8	52.8
12890	11	0109.9	68.1	A	3362	11	0106.1	66.4
12902	12	0009.9	53.1	B	3374	12	0005.4	51.2
12915	13	0104.8	66.8	AX	3387	13	0059.7	64.8
12927	14	0004.7	51.8	B	3400	14	0154.0	78.3
12940	15	0059.7	65.5	A	3412	15	0053.3	63.2
12953	16	0154.6	79.3	B	3425	16	0147.6	76.7
12965	17	0054.5	64.3	A	3437	17	0046.9	61.6
12978	18	0149.5	78.0	B	3450	18	0141.3	75.1
12990	19	0049.4	63.0	A	3462	19	0040.6	60.0
13003	20	0144.3	76.7	BX	3475	20	0134.9	73.6
13015	21	0044.3	61.7	A	3487	21	0034.2	58.4
13028	22	0139.2	75.4	B	3500	22	0128.5	72.0
13040	23	0039.1	60.4	A	3512	23	0027.8	56.8
13053	24	0134.0	74.2	B	3525	24	0122.1	70.4
13065	25	0033.9	59.2	A	3537	25	0021.5	55.2
13078	26	0128.9	72.9	B	3550	26	0115.8	68.8
13090	27	0028.8	57.9	AX	3562	27	0015.1	53.6
13103	28	0123.8	71.6	B	3575	28	0109.4	67.2
13115	29	0023.7	56.6	A	3587	29	0008.7	52.0
13128	30	0118.6	70.3	B	3600	30	0103.0	65.6
13140	31	0018.6	55.3	A	3612	31	0002.3	50.4

NEW PRODUCTS

NSC's PACE Microprocessor

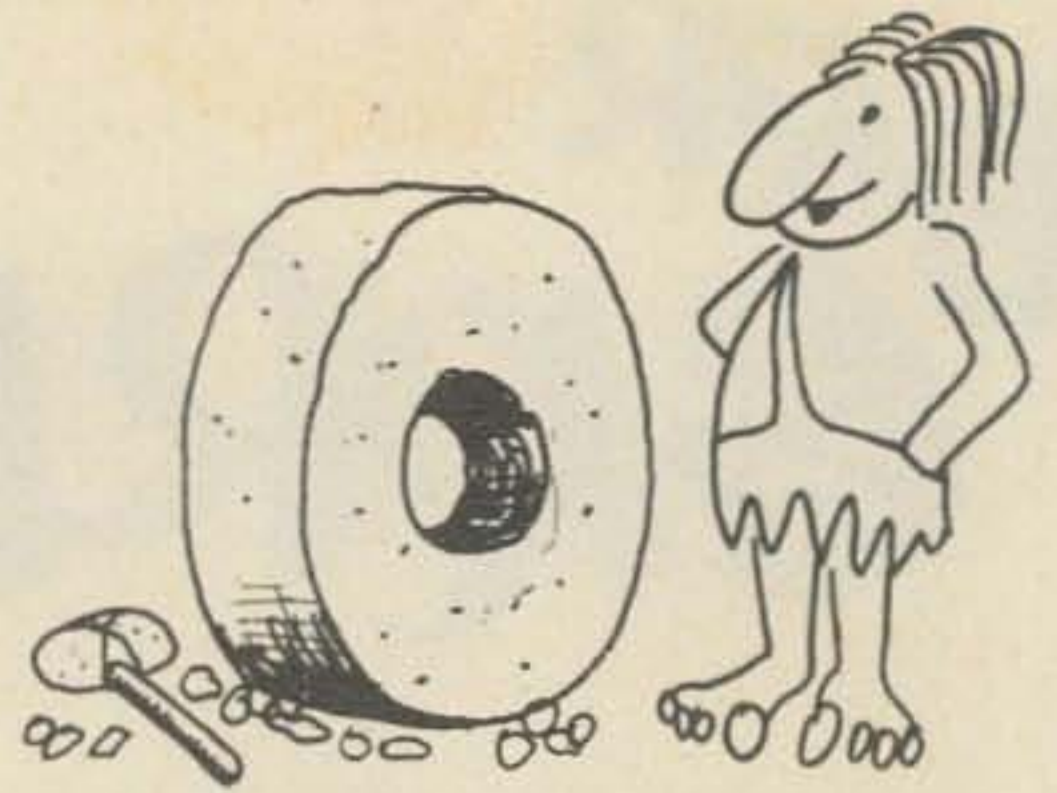

One of the most powerful microprocessor chips yet released has been announced by National — The PACE (processing and control element). This is the first of the 16-bit uP (is that a good abbreviation for microprocessor?) and it opens up a bigger and better world to the computer folk.

The PACE chip opens up a new wave of panic for the computer establishment in that it is the next big step in making computers drop substantially in cost... a move which

threatens the whole distribution system set up to merchandise computers. While computers cost \$100,000 or more, sales could efficiently be handled by a factory sales force... with trained salesman making the sales... factory techs installing the system, and software firms aligned with that factory programming the installation.

Part of this mystique resulted from the dominance of IBM (about 80% of the market) and their enormous profit margins. Other major manufacturers

found that they had to offer at least as much sales fantasy as the meticulously trained IBM sales teams. Ditto for service, programming, etc. It was a hard act to beat, even with that gold mine of a markup in prices.

Then came the large scale integrated computer chips such as the Intel 8008 and the 8080... the Motorola M6800... and now the National PACE. Suddenly it was possible to make a central processing unit (CPU) which would do everything a small business could ask... not for \$50,000, but for \$5000 or perhaps even down to \$500 if the user didn't mind getting it in kit form.

Computers are more than a CPU... you need something to communicate with the CPU and some memory for the CPU to delve into... these are still costly, but they too are coming down rapidly... to the utter dismay of the computer industry. So far the result has been a nervousness, and myopia. Much of the computer industry has tried hard to ignore these new chips... the reaction seems to be that perhaps if they refuse to even read about them they won't exist and threaten the future.

But peripherals are going down in price too, though not as fast as CPUs. How long will it be before some chip company comes out with a single IC for a visual display terminal? There are about 60 ICs in the Southwest Technical visual display generator... how long until this is one big chip? Memories are getting smaller and going onto chips too... and it only takes about eight of the new memory chips to give a computer all the memory it needs to work.

The CPU has to take the input from a keyboard and sort the material out for suitable filing in the main memory bank... which these days is usually a disk of some sort... floppy disk for a small amount of memory and a hard disk pack for bigger memories. A floppy disk will, for instance, hold

Continued on page 144

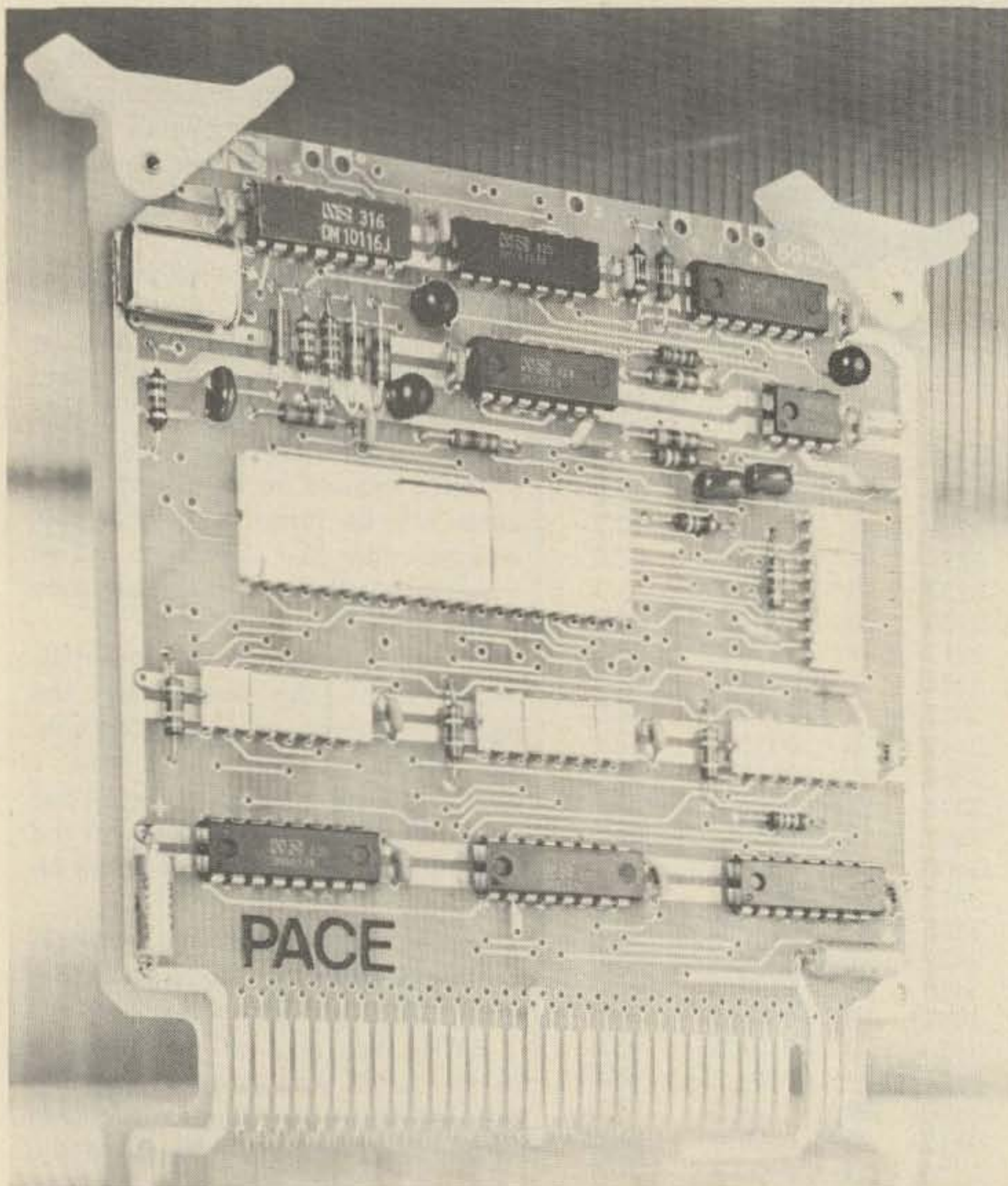

This single 4½ inch by 4½ inch printed circuit card contains a complete data processing controller. At the heart of the system is PACE, a single-chip 16-bit microprocessor developed by National Semiconductor Corporation. Other circuits on the board include four DS3608 hex MOS sense amplifiers and three DM8097 hex buffers below PACE, and the crystal oscillator and clock drivers above PACE.

better CHECK these

SSTV Handbook (Second Printing)

A brand new edition of the Slow Scan Television Handbook has just come off the 73 presses. This 250 page book covers slow scan like a blanket, starting from the basics and covering the latest developments. There are construction projects for building everything you'll need for good slow scan work. While many of the new books coming out are priced almost beyond belief (one recent small "cook-book" was \$15!), 73 has held down the price of the SSTV Handbook to just \$5.00. Order this book today from 73 (\$5 postpaid) or look for it at your local ham supplier. The Handbook was put together by two of the top pioneers in the field - Ralph Taggart WB8DQT and Don Miller W9NTP.

Danger: Back Issues

It has been brought to our attention that a large number of amateurs have been fired from their jobs and been divorced by their hitherto resigned wives - the trouble turns out to be in many cases tied to the receipt of a large bundle of back issues of 73 Magazine! Apparently this has caused the recipients to become so engrossed that they have essentially lost contact with the world. Several cases of near starvation due to aggravated engrossment have been reported. Authorities have been asked to prohibit the further distribution of back issue bundles of 73 on humanitarian grounds. Until these slow-witted authorities act, 73 has agreed to continue to ship these dangerous bundles - and at no increase in price... 25 back issues (our choice) \$5.00 plus \$1.50 for postage and handling.

SSTV HANDBOOK \$5.00 ppd Name _____
 73 BACK ISSUES MIND BLOWER Address _____
 Vintage Years \$5.00 (shpg. \$1.50) City _____ State _____ Zip _____
 Mid-years _____ Cash _____ Check _____ Money Order
 Recent Years MasterCharge # _____
BankAmericard # _____
Expiration Date _____
Total Enclosed \$ _____ Signature _____

Send to: 73 Magazine Peterborough NH 03458

12/24 HOUR 6 DIGIT CLOCK KIT GIANT DIGITAL READOUT

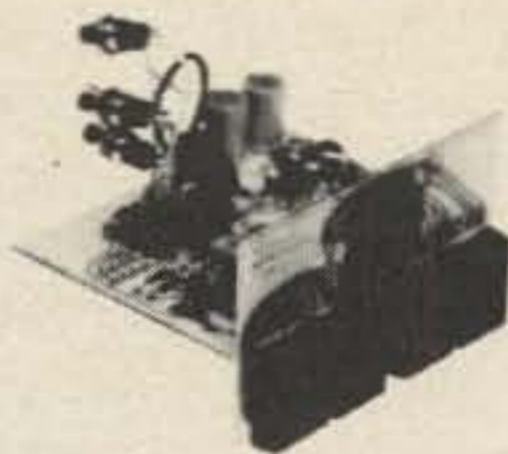

KIT INCLUDES:

- Full, illustrated P.C. Boards
- (4) Giant .6 inch LED Readouts (DL-747)
- (2) .3 inch Monsanto Man-7
- National MM S314 Clock Chip
- (3) Pushbutton Switches
- Transistors, Diodes, Resistors, Capacitors, LEDES
- Easy to Follow Step by Step Instructions
- (12V AC Transformer Not Included)

\$29.95

8008	Microprocessor	\$24.95
2102	RAM	4.95
NE-555	Timer	.49
NE-556	Dual Timer	1.59
NE-553	Quad Timer	3.95
NE-566	PLL	1.95
NE-567	Tone Decoder	2.95
741	Mini Dip	.39
309K	Voltage Reg.	.99
LM-380	Audio Amp	.99
LM-377/ 2277	Stereo Amp	2.29
PA-239/ 2126	Stereo Pre-Amp	1.79
TT 1W	1 Watt Audio Amp To-5	.69
8038	VCO (Intersil)	3.79
2N2222	Unbranded NPN	10/1.00
2N2907	Unbranded PNP	10/1.00
Jumbo LEDS	Red	10/1.39
Jumbo LEDS	Yellow or Green	10/1.79

MINIMUM ORDER: \$10.00
Add \$1.00 to cover postage and handling
SEND CHECK OR MONEY ORDER (NO C.O.D.) TO:

I. C. KITS INC.

• **P.O. BOX 921**

• **METUCHEN, N. J.
08840**

N. J. Residents Add 5% Sales Tax

GATEWAY ELECTRONICS

8123 Page Blvd.
St. Louis MO 63130
(314)427-6116

2839 W. 44th Ave.
Denver CO 80211
(303)458-5444



IC SOCKETS

	8	14	16	18	24	28	36	40	
Commercial CS	.24	.28	.30	.36	.53	.67	.84	.89	Gold
	.21	.25	.27	.35	.52	.64	.82	.86	Tin
Low Profile LS	.26	.34	.36	.40	.59	.70	.88	.94	Gold
	.23	.33	.35	.39	.58	.67	.86	.91	Tin
Standard CA	—	.36	.38	.42	.62	.74	.93	.99	Gold
	—	—	—	—	—	—	—	—	Tin
Standard Wire Wrap	—	.39	.41	.45	.79	.95	1.08	1.14	Gold
	—	—	—	—	—	—	—	—	Tin

IC sockets may be assorted for quantity discounts. 1 to 9 pcs. NET, 10 to 24 pcs. LESS 5%, 25 to 99 LESS 10%, 100 to 499 LESS 20%. WRITE FOR LARGE QUANTITY QUOTATIONS, D.I.P. plugs and covers also available.

MINIATURE THUMBWHEEL SWITCHES

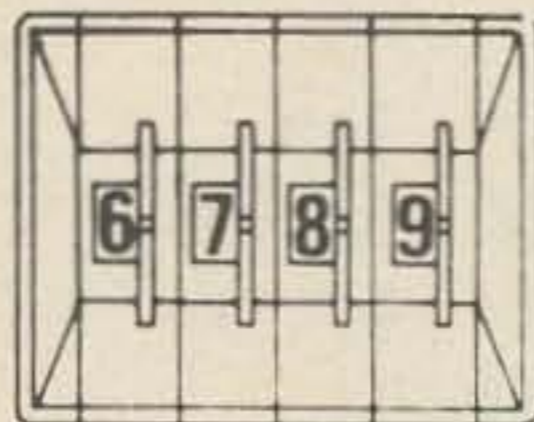

BCD ONLY	\$2.50
COMPLIMENT ONLY	2.75
BCD & COMPLIMENT	4.00
DECIMAL	2.50
END PLATES (PAIR)50
HALF BLANK BODY40
FULL BLANK BODY40
DIVIDER PLATE40

MINIATURE SIZE 0.315 X 1.3 X 1.78

All switches are black with white figures and snap-in front mounting.

\$5.00 minimum order —
Please include sufficient postage.

VISIT US WHEN IN ST. LOUIS OR DENVER

TWO NEW

SUPER CIRCUITS

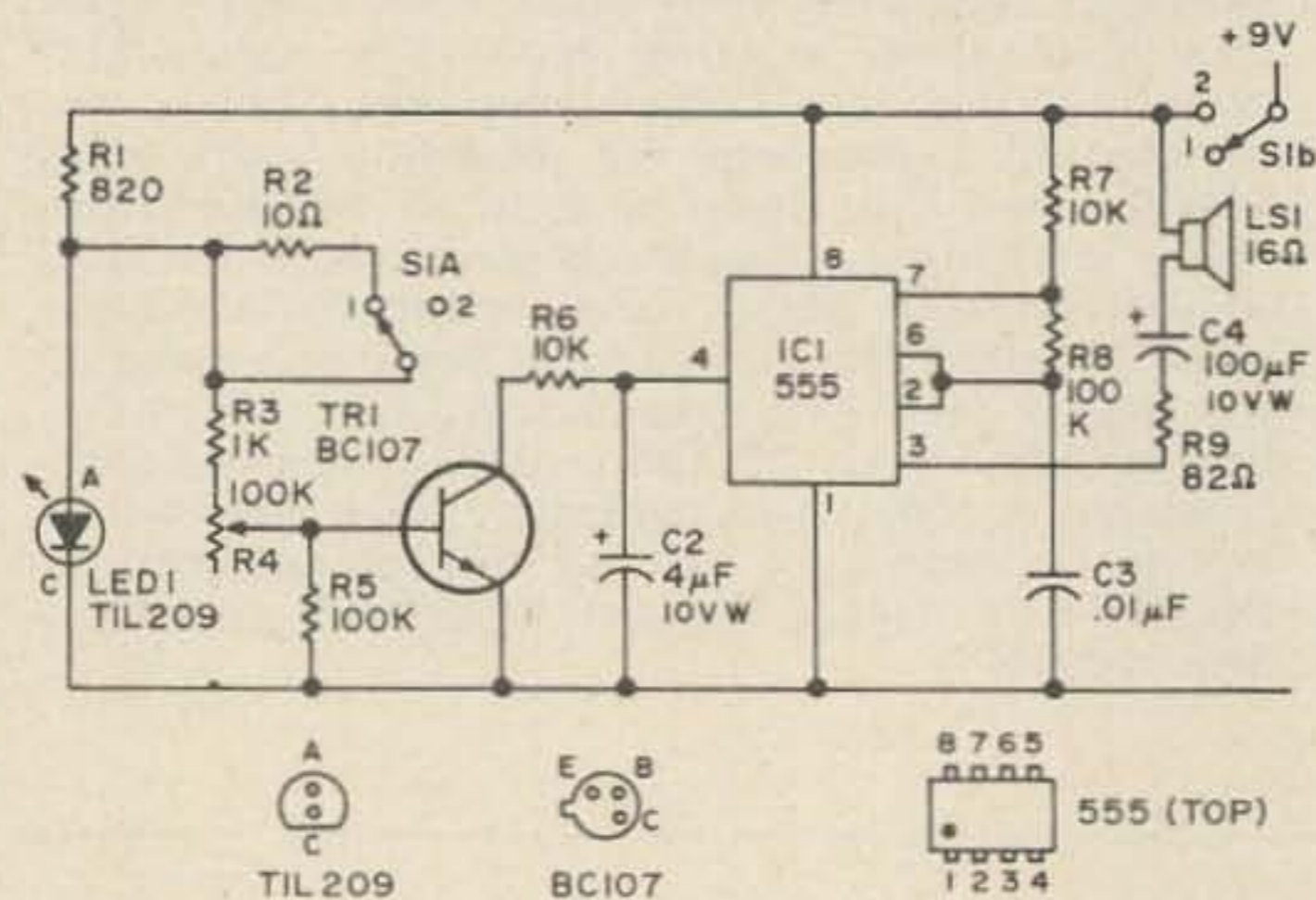

Electronic egg timer. The IC functions as an af multivibrator which is controlled by the external transistor. S1a/b is the on-off toggle switch. (From Radio and Electronics Constructor, May, 1975)

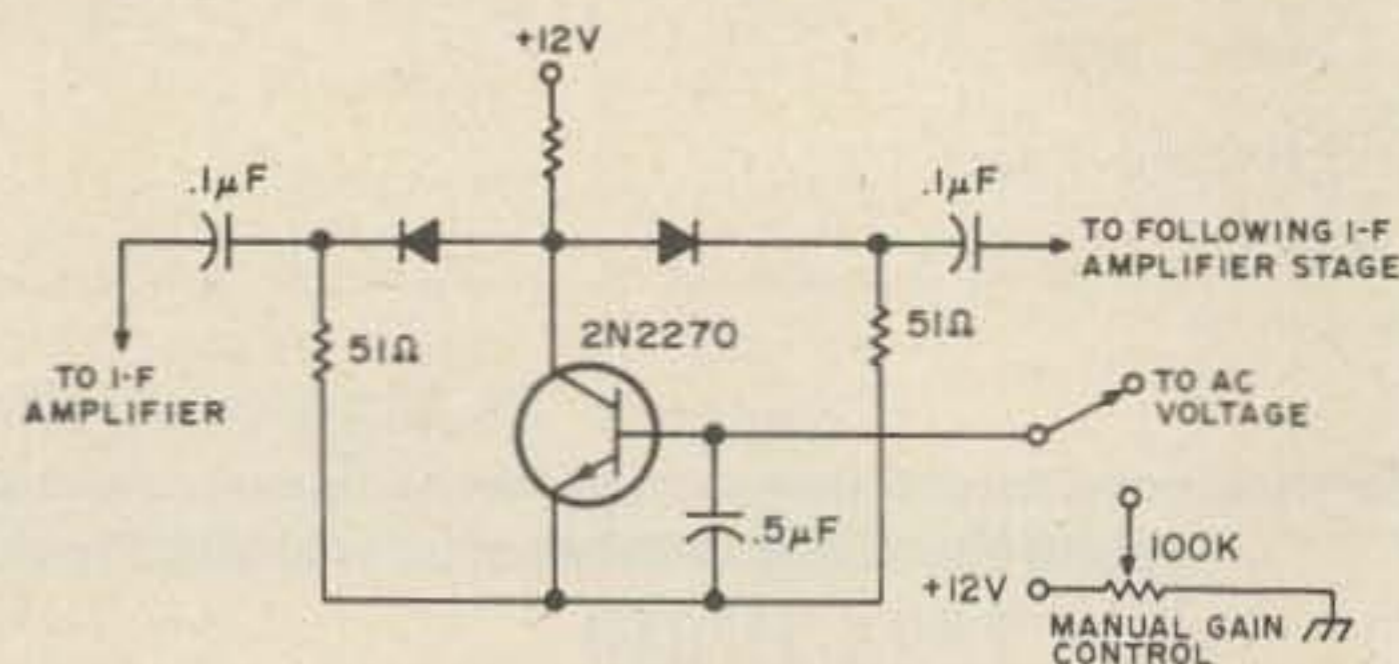

"T" Type Attenuator. This circuit, when inserted in between the stages of an i-f amplifier, acts as a three section attenuator with a dynamic range beyond 60 dB. It can be controlled by a positive voltage from the AVC system or manually by use of a potentiometer. If AVC voltage is negative, substitute the NPN with a PNP transistor and transpose the collector and emitter connections. Don't forget to use a minus supply on the pot. Diode and transistor types are not critical. Pin diodes are the best. Original design used in present home brew receiver. (From W6YUY)

Further Revisions for "Scanning with a Synthesizer" (April, 1975, pages 23-36)

Page 26 — Fig. 3. Unlabeled pin on IC39 is pin 1. Add connection (where they cross) between wires IC20D, pin 9/IC29A, pin 13 and IC26B, pin 5/IC19D, pin 10. Note: Where schematic shows "--- o" termination (e.g. IC36, pin 3), connect to Vcc.

Page 36 — Parts List. Control board: Push button for "Proceed" switch on Fig. 3 (C12) is 500 pF.

John Gearhart WA0AQO
1408 Dawn Drive
Columbia MO 65201

Ron Fisher VK3OM
3 Fairview Avenue
Glen Waverley, 3150
Australia

Charge that KP202

Bob Goulet VK3BU, 7 Drew St., East Keilor, 3042, has designed and constructed a charging adaptor which most of us would find quite handy. This little unit is ideal if you already have a dc supply capable of delivering 15 to 18 volts at about 100 milliamps. It would also be suitable to use with a twelve volt car system under charging conditions. Another source of voltage often found around the home is junior's model train or slot car power supply. Make sure that the polarity is right and perhaps a series diode might be good insurance. Also, a 1000 mF electrolytic across the output of the power supply would be worthwhile.

The series globe in the adaptor serves two purposes. It acts as a charging indicator and also as a current limiter. In operation the rheostat should be adjusted so that the globe lights to about half brilliance with the batteries in a discharged condition.

The mechanical construction of the adaptor should be fairly clear from the illustration. It was bent up from light gauge aluminum, and the contact studs are simply two 1/8 inch round head screws mounted on a piece of bakelite or similar insulating material.

Another charger, designed by Don Paice VK3ADP, 21 Allister St., MT Waverly, 3149, is completely self-contained with a built-in power supply. The mechanical basis of this is a medium size die-cast box with the KEN

holding bracket bent from a piece of perspex after careful heating with either boiling water or a blow torch. After attachment to the diecast box, the whole assembly was sprayed with silver enamel.

Don's unit features quite a few deluxe items. Firstly, a micro switch in the ac line, actuated when the KEN is placed in the cradle. A small meter salvaged from an old Japanese tape recorder serves to indicate charging current. The zener diode across the

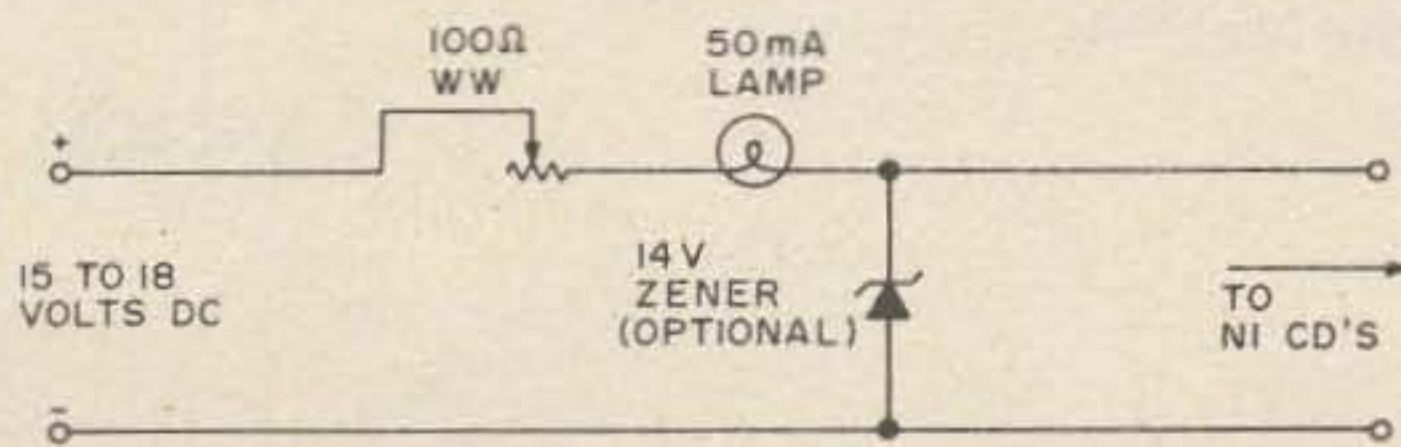
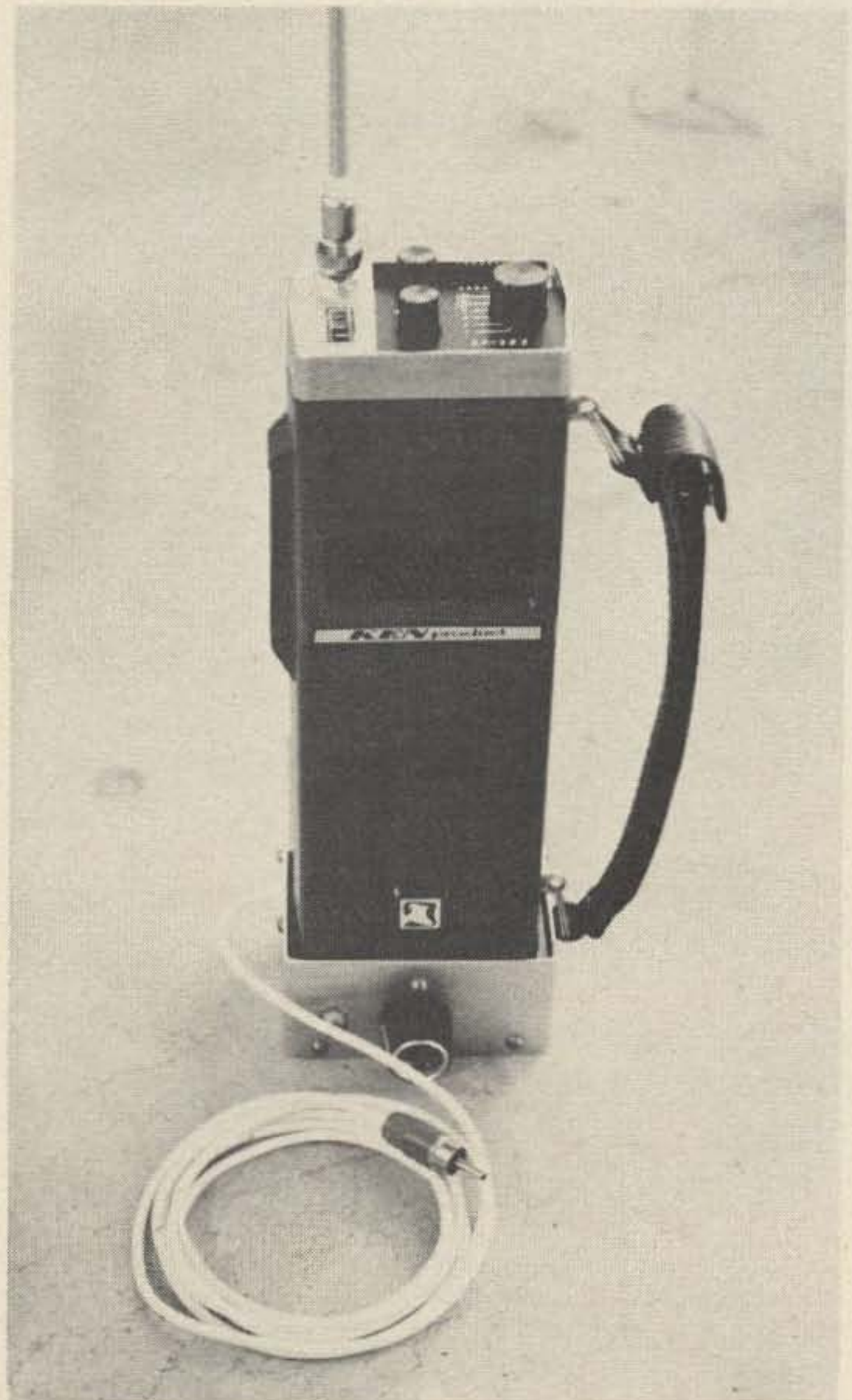
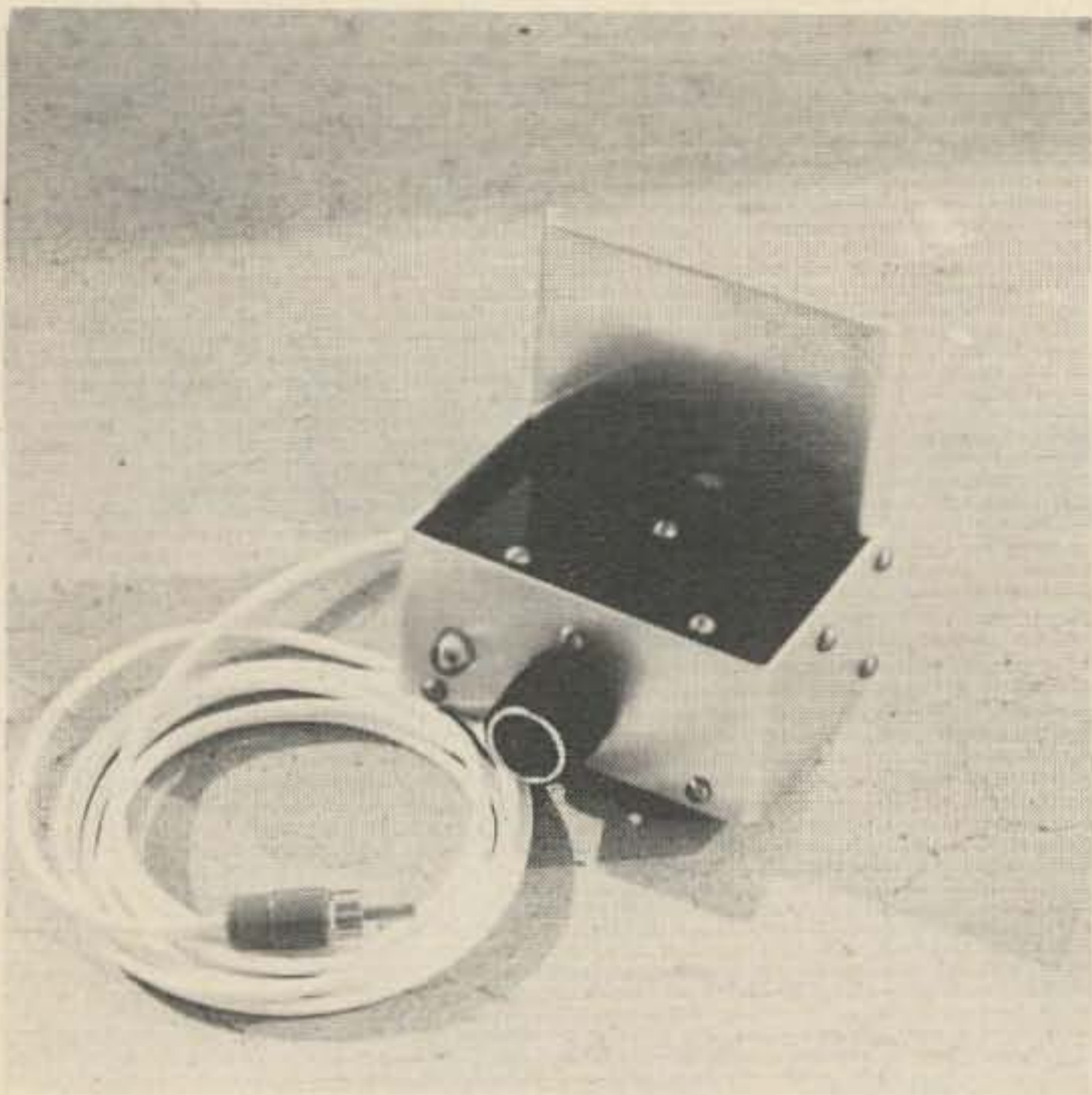

Fig. 1. NICAD Charging Adaptor.



The KP202 sitting in the VK3BU charging adaptor.

Reprinted from *Amateur Radio*, Journal of the Wireless Institute of Australia, August, 1974.



A close-up of the VK3BU charging adaptor.

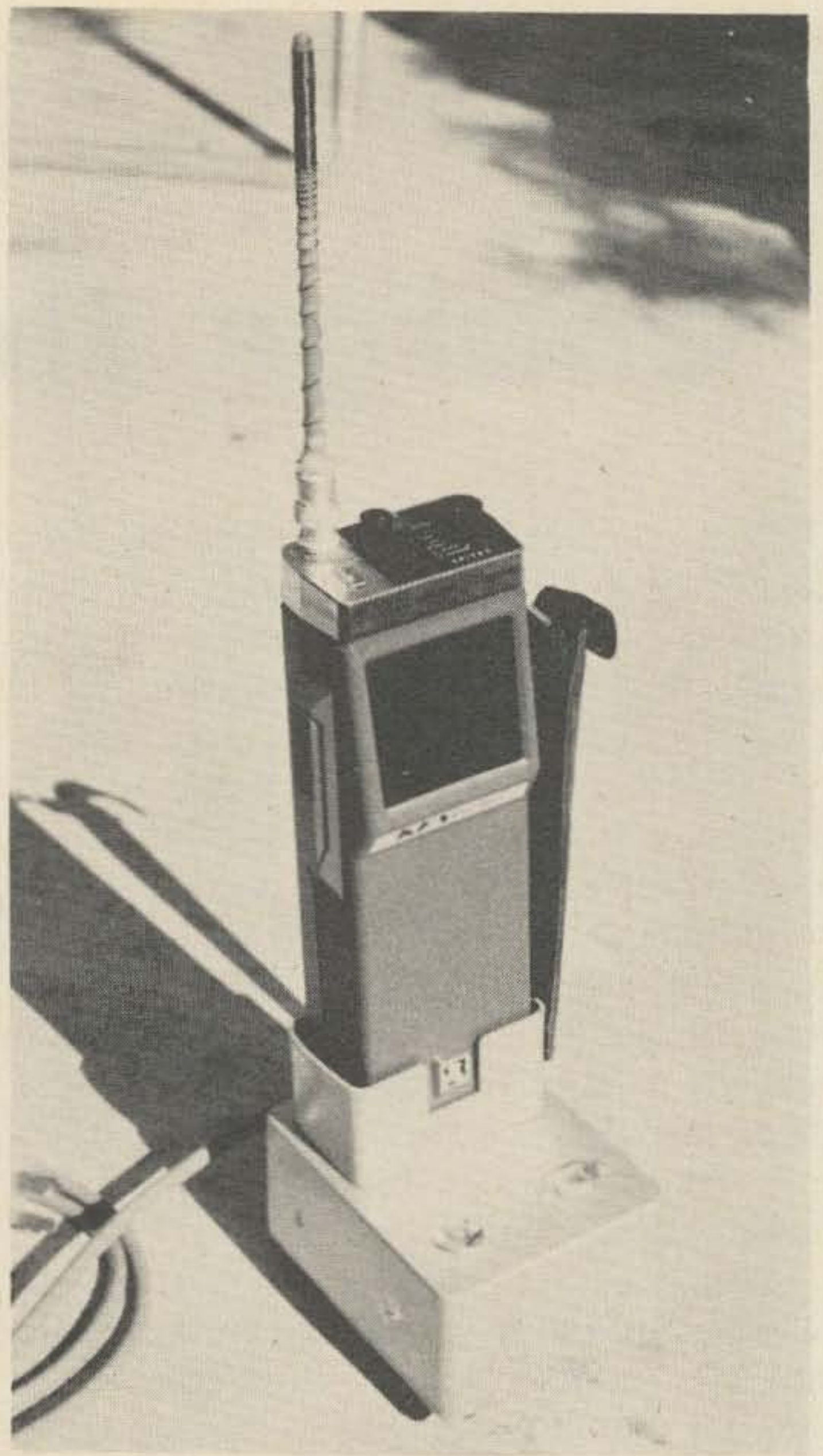

The KP202 in the VK3ADP charger.

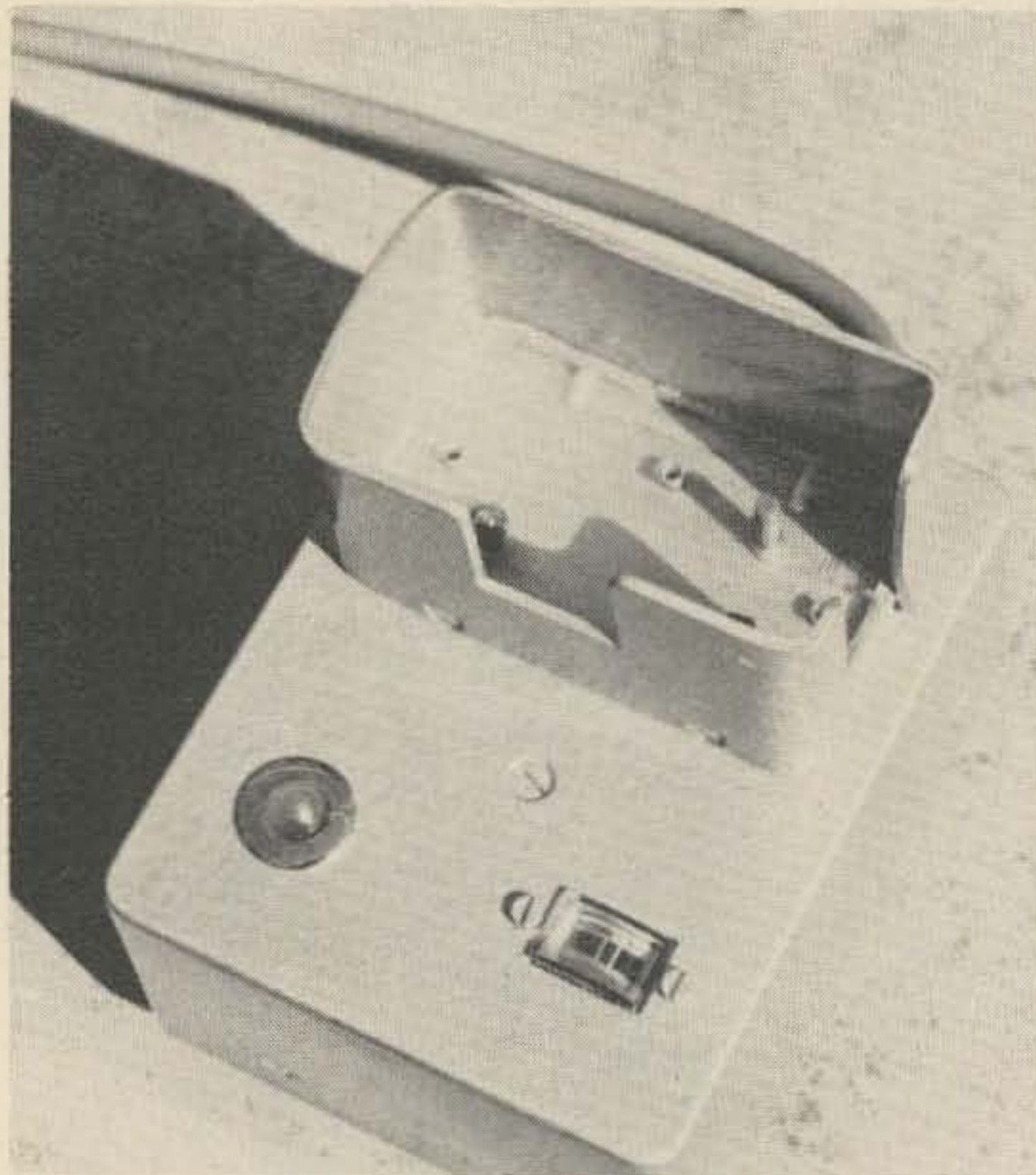

A close-up of the VK3ADP charger, showing the ac micro switch actuator.

output conducts when the battery voltage reaches 14 volts, and thus prevents overcharging.

In conclusion, a few words about charging

ing nicads:

When on charge, battery temperature should never exceed 38 deg. C. (100 deg. F). Check on published data for your particular batteries for maximum allowable charging current.

The required charging time can be calculated by dividing the amp-hour rating by the charging current, then multiplying this figure by 1.25.

Batteries in series should not be charged unless they are of the same type and in the same state of discharge.

...VK30M

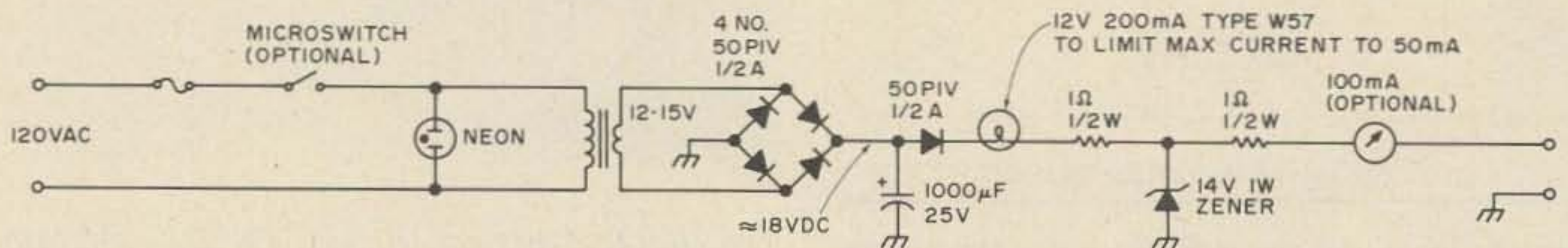

Fig. 2. NICAD PS for KEN KP202.



Ottis Barron (K5BSE), Assistant Professor of Engineering at the University of Tennessee at Martin, is teaching General and Advanced theory to the 11 new Novices of the Reelfoot Amateur Radio Club and to other members interested in upgrading their licenses. The newly formed club is one of the few throughout the nation with a college professor as an instructor.

BE MY GUEST from page 7 persons indicated an interest.

The classes in code and theory were conducted twice a week for the next nine weeks and, when it was completed, there were 11 new Novices.

Once the Novices had their tickets, the three instructors felt additional help was needed in order to continue into the General and Advanced fields and a nearby amateur, Ottis Barron K5BSE, assistant professor of electrical engineering at the University of Tennessee at Martin, consented to teach the classes without charge.



Radio activities in Union City, Tenn. (pop. 13,500), lay dormant for years until early this year when Willie Pope (standing center) returned to the city and enlisted the aid of fellow ham Glen Leggett (standing left) and Bill Porter to help initiate Novice Radio Class instruction. Eleven persons have already passed their Novice tests and new classes will begin this fall with the goal of tripling the number of hams here within one year's time. The new Novices are, from left: David Critchlow, Jr., Herman Wisniewski, Morris Mahan, Tim Fox, Mrs. Willie Pope, John Row, Jeff Row, Steve Harpole, Lance Hurd, and not shown, Jody Harpole and Jerry Bennett.

Within two months, Willie, who had held a Conditional for more than 15 years, upgraded his class to Advanced — and three Generals also moved up one more rung on the amateur ladder.

Now, within a few weeks, some of the Novices hope to try for their Generals and the newly-formed Reelfoot Amateur Radio Club is not only preparing to begin a new class in Novice, but has plans for booths at

two fairs, a hamfest, a picnic and two campouts.

If the club meets its goal of 25 new hams in its area this year, the amateur population will have more than tripled in size, in the period of 12 short months.

Talk's cheap — it's the action that counts.

David G. Critchlow WB4CYX
Managing Editor
Union City Daily Messenger
Union City TN

Looking West

from page 134

along with many other attendees of this event got a glimpse of the new Kenwood TS-700 multi-mode two meter transceiver.

The first thing that I noticed was that it did not look like the conventional two meter radio, but much more like a piece of HF gear. When it becomes available in the not too distant future, you will have one radio that will permit you to operate FM (simplex or via your favorite repeater), chat with those still on AM, or at the flip of a switch give you the ability to go hunting DX and the Oscar satellite on CW or SSB. You have a choice of either upper or lower

sideband with built-in receiver incremental tuning as an added feature. If it sounds like the ultimate in a radio for two meters, be prepared to spend in the \$700 to \$900 bracket for this beauty. The TS-700 is dubbed the "All Mode 2 Meter Transceiver" and the quick glance I got of it leads me to believe that it will be well worth the bread. More on this as information is available; in the meantime I hope that the photos will suffice.

Next month we will continue with more on CARC, coverage of the June 21 SCRA meeting at J.P.L. in Pasadena, and a story on the first repeater to go full time microwave control — all with photos I hope. Till then goodbye from those of us who write for the 3:00 am shift in Los Angeles.

... WA6ITF

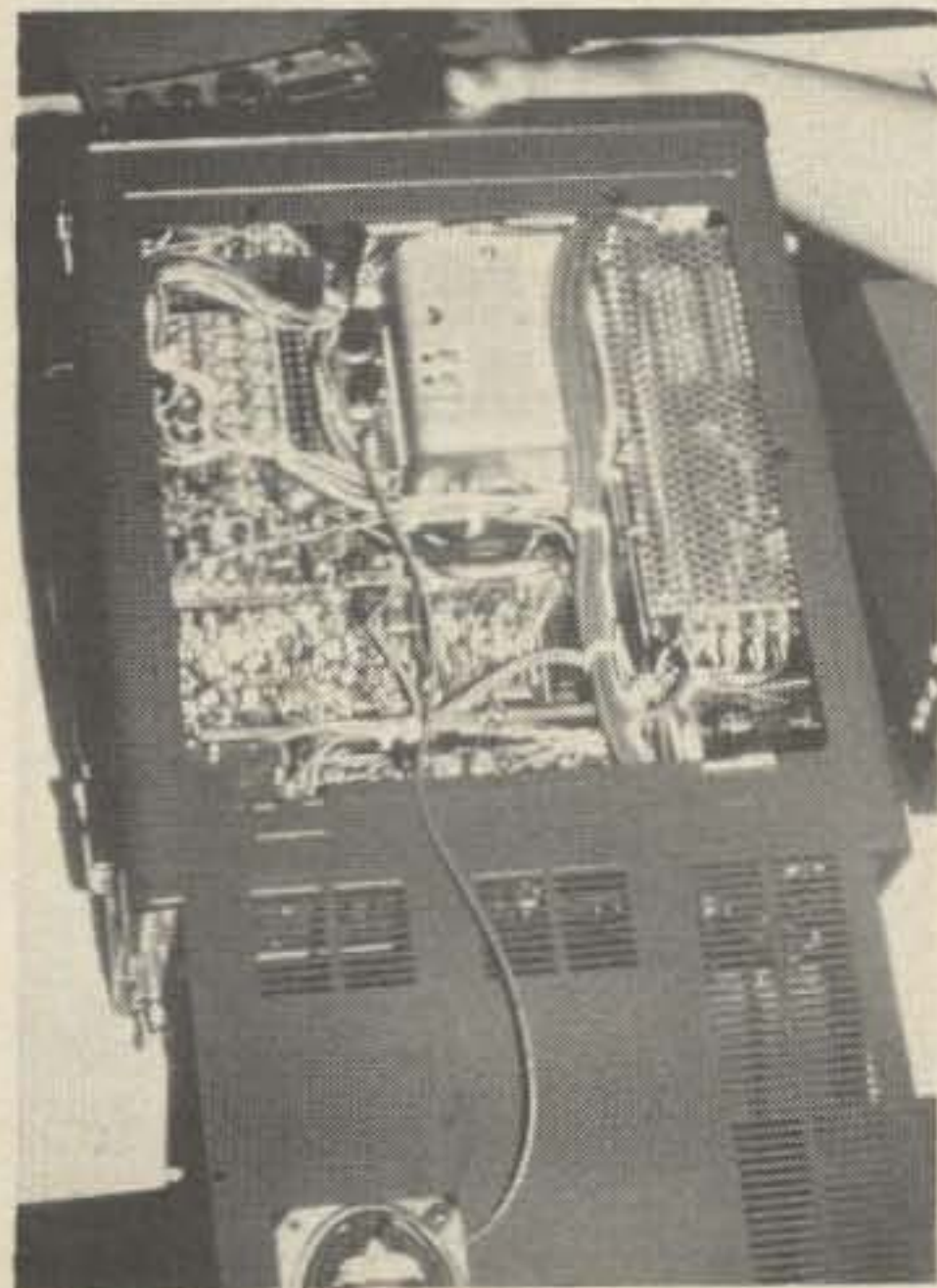

How do they pack so much radio into so little space?

ou goons don't ever prooff
lasy...
bluch of rocks are...
you ignored my comments in
I inslst that you print ev

from page 136

HAVING A BALL

Considering I've received *no* response from any of the other publications I've addressed similar correspondence to, your reply was both timely and appreciated.

Therefore and henceforth, etc., please find one(1) each check in the amount of \$4 for the back issues of Sept, Oct and Nov 1972 and any possible postage, etc. If you would please pass this request for back issues to inventory control (some fine

STOLEN: 2 meter FM transceiver consisting of VHF Engineering transmitter strip and 10 channel deck in black box mounted on top of Heathkit GR-110 scanning receiver, with touchtone pad on transmitter. Contact WA1UZE, 7 Gertrude Ave, Runford RI 02916.

TAKEN: FM transceiver, Regency HR2A with Topeka FM Eng. additional 6 channel transmit conversion. S/N 04-07415. Contact W. H. Faulkner, Jr., W4DO, 6475 Chapman Field Drive, Miami FL 33156. 305 666-9614.

RIPPED OFF: Clegg FM-27B, S/N 27053-1854, May 15, 1975. Contact W4PJG or Ft. Myers, Florida Police Department. Dr. Louis Persons W4PJG, Box 1647, Fort Myers FL 33902.

people, I'm sure) I would be appreciative.

I must say to you that in addition to having a fine magazine (although a bit short on HF) it was 73's fine technical publications that enabled me to get my first ticket while stationed on Okinawa (Conditional) and my upgrade to Advanced in March of this year. By the way, I got that first ticket in June of 74 and although electronics is my avocation I would never have made it to Advanced without 73's help. Thanks. I'm having a ball.

Richard E. Snider WA7YYA/4
SSG, USA
Warrenton VA

Sergeant Snider refers to a technical query he addressed to our editorial staff - Ed.



The Hamburglar STRIKES AGAIN!

SWIPED: ICOM IC30A, S/N 3803043. Contact Richard F. Helvey, 2207 Central Ave No. 209, Billings MT 59102.

HAM HELP

Gerald J. Hughey
107 New Street Apt. 303
East Orange NJ 07017
(201) 672-9276

According to long-standing policy, 73 Magazine makes a continual effort to match those in need of technical help or instruction with those who feel they can offer it. If you find yourself in one of these two categories, please do yourself and amateur radio a favor by contacting Ham Help, 73, Peterborough NH 03458.

Please add my name to your list of Ham Helpers. I have had CW, RTTY, AM, SSB, building, antenna and mobile experience, and would be especially interested in helping CBers get off 27 MHz and into legitimate radio. And I say that without malice towards any CBER who wants a ham ticket.

Bob Isselhard K5INW
2100 North Cielo
Hobbs NM 88240

I would like to offer my help to anyone needing help with home brew equipment, tube or solid state, and antennas and antenna tuners.

Tom Cullen Jr. K1WXK/W1NXZ
2 Westview Dr
Wallingford CT 06492

ARRL ERROR?

We think that the ARRL is making an error in holding its National Convention in Reston, Va.

Reston, Va., has very restrictive antenna regulations and it does not allow outdoor antennas on its town houses (cluster housing).

We feel that the League should not hold its convention in a community that is so hostile to amateur radio.

Kay Alston WN3ZCE
Nick Leggett WA3YFU
Washington DC

REALLY GOOD

You might like to know that the Lake Amateur Radio Association, "K4FC", has just started another Novice class, using Wayne's tapes - they're really good.

Ken Aitken W4FIQ
Tavares FL



from page 138

about 3000 names and addresses for a mailing list. A hard disk can manage 60,000 names! The CPU has to be able to print these out on a CRT or on a line printer... or a Teletype machine. The magic is in getting the names into and out of the memory quickly in whatever order you want them.

If you are using the system for bookkeeping, then you want the CPU to be able to add and subtract for you. The programmer has to put instructions into the system which will tell it how to respond to the input... usually a keyboard. The process is not simple.

Unless you are into computers, the great benefits of the PACE chip over the other microprocessors will be lost on you. It does have some sterling benefits... okay?

OUR APOLOGIES...

To George Allen W1HCI and VHF Engineering, for including incorrect pictures of the PS12C and PS24C power supply kits with George's recent New Product Review (July, 1975, p. 147). Look for photos of the impressive real McCoys in an upcoming issue of 73...



complete stock
of the following **lines:**

- ITC MULTI-2000
- ATLAS
- VHF ENGINEERING
- STANDARD
- REGENCY
- BOMAR CRYSTALS FOR 2MTR FM
- 73 MAGAZINE PUBLICATIONS
- QST PUBLICATIONS
- EMERGENCY BEACON
- NEWTRONICS
- TEN-TEC

Largest inventory of used equipment in the Boston area.

NEW ENGLAND'S FRIENDLIEST HAM DEALER

TUFTS Radio Electronics
386 Main St., Medford MA 02155

YOUR HAM TUBE HEADQUARTERS!

TUBES BOUGHT, SOLD AND TRADED
SAVE \$\$\$ - HIGH \$\$\$ FOR YOUR TUBES

MONTHLY SPECIALS

2K25	\$ 28.00	6146B	\$ 4.25
3-500Z	42.00	6360	3.75
3-1000Z	120.00	6883B	4.50
4-125A	42.00	6939	9.00
4-400A	45.00	811A	5.00
4CX250B	24.00	813	18.00
4X150A	19.00	7735A	38.00
572B	18.00	8236	22.00

BRAND NEW****FACTORY GUARANTEED

TOP BRAND Popular Receiving Tube Types.
BRAND NEW 75%+ Off List*Factory Boxed.
FREE LIST Available - Minimum Order \$25.



COMMUNICATIONS, Inc.

2115 Avenue X
Brooklyn, NY 11235
Phone (212) 646-6300

SERVING THE INDUSTRY SINCE 1922

73 in the works

The Calculating Counter
NOAA FAX System
0-60 MHz Synthesizer
Remote Controlled RF Amp

Plus MORE of

The Oscar Zapper
and
K20AW's Digital
SWR Computer

APOLLO PRODUCTS by "Village Twig"



1500X-2

Rotary Antenna Switch

Single pole, 3 position Antenna Switch. Low SWR. Use up to 30 MHz. 500 Watt handling capacity. Sloping Front Console Cab.

\$12.95



450X-S Antenna Switch

3-Position Slide Switch
Low Loss - Walnut-grain Finish Chassis - Gold Cover

\$5.95

700X-2 KW Wattmeter

Dummy Load Wattmeter for 52 Ohm Input. Measures RF in 4 ranges to 1000 watts. Measures modulation percentage on calibrated scale. Portable.

\$124.50

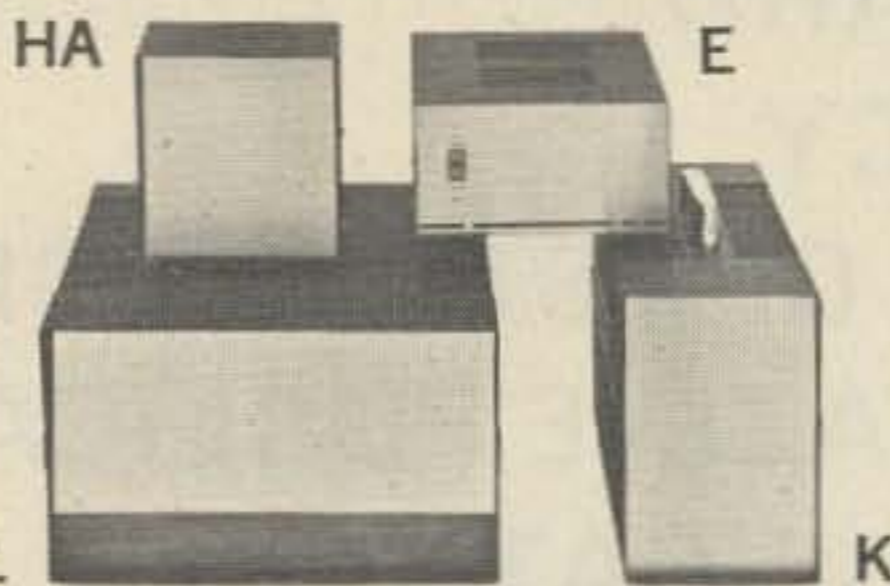

Model	Dimensions	Resale Net
"E"	6 1/2 x 3 15/32 x 7 1/16	8.25
"HA"	5 1/8 x 5 1/2 x 4 (Blank Panel)	8.95
"K"	4 3/4 x 7 3/8 x 11 W/Handle	13.50
"L"	11 1/8 x 6 1/8 x 12 3/4	20.50



Meter 0-1 MA
to fit "L" box
ppd. 5.00

APOLLO PRODUCTS



2100X-2
SWR
Bridge
Large
Meter -

Sloping Panel Cabinet - Rubber Feet - Keep in Antenna Line up to 1 Kilowatt

\$29.95



900X-2

Wattmeter

Measures RF in 2 ranges 25 and 250 watts. 52 Ohm input.

\$29.95

1700X-2 Vertical/Horizontal Antenna Switch

Allows operator to select any one of 3 antennas or dummy load. Two Antennas can be switched in simultaneously. New Sloping Front Console Cab.

12.95

"L" package enclosure "Shadow Box" machined with: 2-SO239, 1 - Pilot Light, 3 - Rocker Switches, and 2 - Knobs
pkg. 29.95

WRITE FOR COMPLETE INFORMATION ON ANY OF THE ABOVE

BOX 245 - VAUGHNSVILLE, OHIO 45893 - Phone (419) 646-3495 - Evening Phone (419) 646-3495

So You Want Front - to - Back Ratio?

It all started on the drawing board with a 5-element, widespaced beam – from there to six; then the idea struck me to add two more elements – why not two reflectors. This started to get me in the ballpark. After trying a number of different spacings, and receiving reports from near and far on the changes, I arrived at the present design.

I ran several constant checks with K7UWZ, Renton WA, W7WDZ, Bainbridge Island WA, and W7BVV, Salem OR. All reports revealed a front-to-back ratio of 48 dB with little or no signal off the sides. Subsequent worldwide reports have been outstanding. I knew this was what I was looking for.

The elements are 7/8 and 3/4 inch aluminum tubing. The boom is three 10 foot sections of 2 1/4" diameter aluminum. Each end is threaded so they can easily be joined together with a coupling sleeve.

The driven element was cut and tuned for 29 MHz using a grid dip meter at the element with the gamma disconnected. This is one thing that most hams don't do, and this is the most important part of the antenna – to get that driven element on the resonating frequency. After the connection of the gamma to the beam and subsequent adjustments, the swr at this frequency was 1.1:1. The rest of the elements were figured from the antenna handbook for 29 MHz.

All three reflectors are the same length; the spacing of the reflectors was very critical as far as front-to-back ratio was concerned until I arrived at the spacings as shown in the illustration.

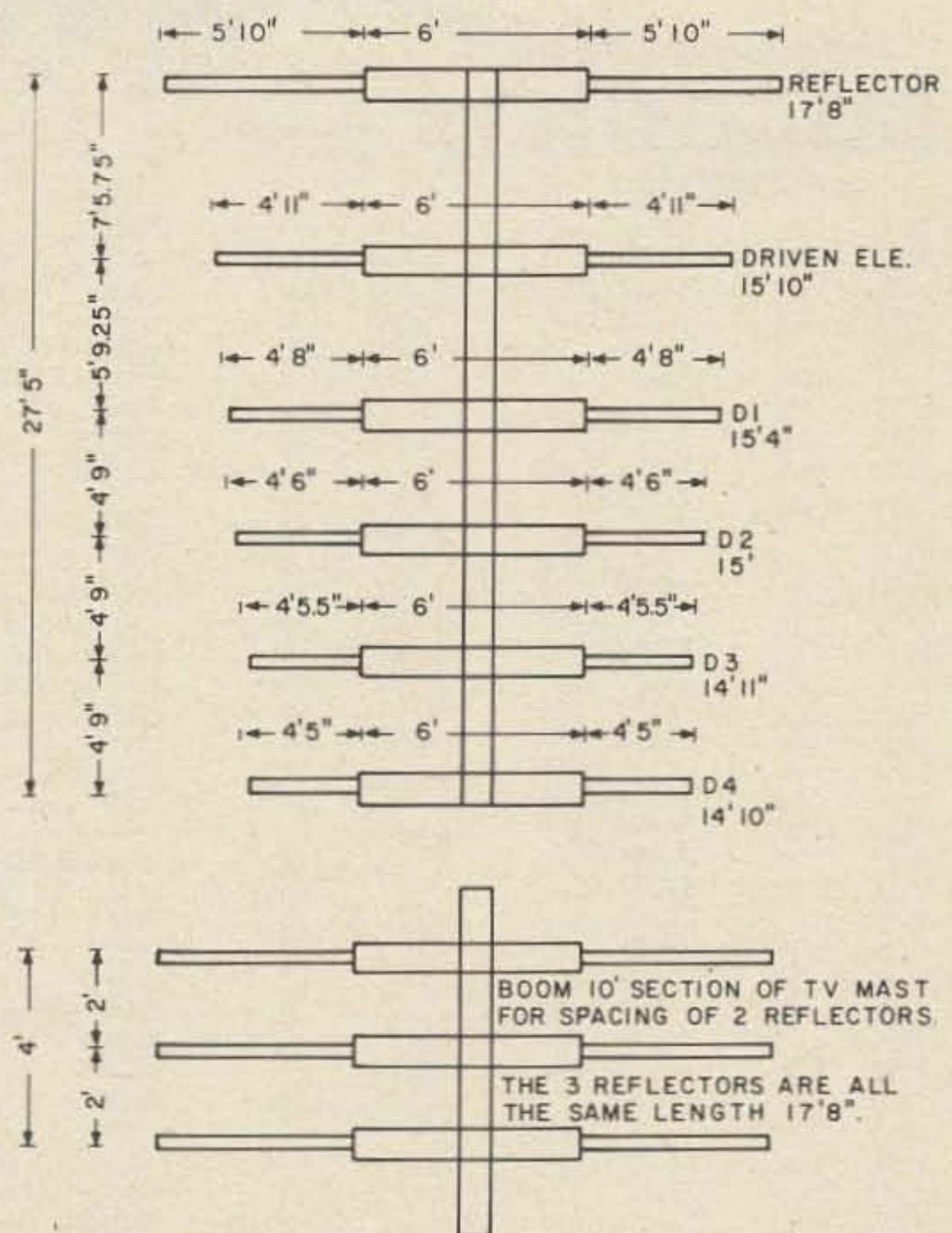

Fig. 1. End view of 3 reflectors. Note: The above spacing resulted in very, very good front-to-side and front-to-back ratios.

Now Two Great Ideas Got Their Start In Boston

BUYERS & SELLERS ham radio brokerage

to sell: Call or write with a list of what you have to sell and how much you want for each item. Include serial no.s, age, condition, etc.

to buy: Call us. We'll put you in touch with someone selling what you're looking for in your vicinity.

There is never a charge to the buyer for our service.

The seller pays 10% of the asking price upon the sale of the equipment. If no sale is made, the seller pays nothing.

call
617-536-8777
W F Sun 12pm-6pm EST
T Th Sat 6pm-12am EST

or write
BUYERS & SELLERS
Post Office Box 73
Boston, Mass. 02215

The mast for the two reflectors is a 10 foot section of TV mast mounted to the boom in the same manner as the boom is mounted to the mast.

The spacing between the reflectors and the driven element is .22 wavelength, and spacing between the driven element and director 1 is .17 wavelength; the remaining directors are evenly spaced 4'9" on the boom.

The boom length is 27'5" and each end is supported with nylon cord to a center mast to keep the ends from drooping.

The antenna is 57' above the ground, and mounted on a crank-down, tilt-over tower.

The gamma is out of the antenna handbook.

One other experiment I ran was to extend the boom another five feet to add a ninth element (director). By doing this the results were about the same as with the eight elements - practically no improvement.

With a little extra effort, you can be on the air with a high power signal running QRP power.

...K7PVZ

Inflation-Fighting

DISCOUNTS

P.O. BOX 1307 COLTON, CALIFORNIA 92324

\$10+ orders take 5%; \$30+ orders take 10%; \$60+ orders take 15%; \$100+ orders take 20%

7400 SERIES		LINEAR		MM Series		DM 8000		CMOS							
7400	.20	74126	.75	74L86	.55	301H/N	.30	711N	.30	1101N	2.00	8090N	.60	CD4001	.50
7401	.20	74132	2.85	74L93	1.50	304H	.80	723N/H	.55	1402N	5.40	8092N	.50	CD4010	.60
7402	.20	74141	1.10	74L95	1.50	305H	.90	741N/H	.30	2102N	7.75	8095N	.50	CD4013	1.45
7403	.20	74145	1.10	74L98	2.00	306H	4.00	1304N	1.00	2501N	4.50	8097N	.50	CD4016	1.35
7406	.45	74151	1.25	74L193	2.00	307H/CN	.35	1307N	.75	252PN	8.50	8123N	1.55	CD4017	2.75
7410	.20	74153	1.45	76L13	4.00	308H/N	1.00	1310N	3.50	2602N	8.00	8130N	2.10	CD4020	1.50
7413	.75	74155	1.25	76L93	9.00	309K	1.50	1489N	2.00	5007H	3.00	8210N	3.10	CD4022	2.45
7416	.45	74157	1.40	81L22	1.00	310H/N	1.10	1800H	2.50	5010AH	3.40	8211N	1.95	CD4049	1.25
7417	.45	74161	1.60			311H/N	.95	1845N	1.00	5013N	3.50	8212N	2.50	CD4050	1.25
7420	.20	74162	1.45	74H00	.30	312H	1.50	1899N	2.50	5017N	2.95	8214N	1.75	74C157	2.10
7425	.35	74163	2.40	74H04	.30	318H/N	1.65	2111N	.90	5058N	5.50	8220N	1.50	74C162	3.00
7426	.30	74164	2.40	74H11	.30	319H	1.25	3067N	2.00	5081N	14.00	8223N	3.00	74C163	3.15
7430	.30	74170	2.90	74H30	.30	320K	1.50	3071N	1.35	5203N	20.00	8225N	2.50	74C164	3.50
7432	.25	74173	1.70	74H40	.30	(5.2v, 12v, 15v)		3301N	.75	5213N	11.00	8230N	2.50	74C192	5.00
7437	.45	74174	1.85	74H60	.40	322N	2.25	3401N	.75	5230N	4.50	8288N	1.10	74C193	5.00
7438	.45	74175	1.85	74H62	.50	324N	1.80	4250H	2.25	5260N	3.85	8470N	.50	74C195	3.00
7439	.45	74177	.85	74H72	.50	340K	1.90	5741N	.30	5261N	6.00	8520N	1.20		
7440	.20	74180	.95	74H74	.55	(6v, 8v, 12v, 15v, 18v, 24v)		7521N	1.00	5262N	5.50	8598N	4.90	AH	
7441	1.00	74185	2.25	N8H90A	2.50	340T	1.75	7523N	1.00	5314N	5.95	8599N	3.00	0014D	9.00
7442	.95	74189	3.00			7524N	1.80	7528N	2.00	5316N	6.95	8612N	2.00	0014CD	4.00
7443	1.00	74190	1.50	74S00	.50	(5v, 6v, 8v, 12v, 15v, 18v, 24v)		75451N	.40	5320N	12.50	8613N	.75	0151CD	4.50
7445	.95	74191	1.50	74S05	.50	351N	.50	75452N	.40	5554N	1.10	8640N	.50	0126CD	4.50
7446	1.15	74192	1.25	74S10	.60	371H	1.75	75491N	.80	5725N	3.95	8796N	2.00		
7448	1.15	74193	1.25	74S15	.50	373N	2.25	75492N	.90	5736N	4.95	EP10N	.50	9003N	.25
7450	.25	74195	1.00	74S40	.75	376N	.50	75494N	.90	5738N	4.25	8811N	.85	9004N	.25
7454	.35	74196	1.25	74S64	.75	377N	2.75	LMB800H	5.00	DM7160J	5.00	8812N	.50	9005N	.25
7460	.25	74198	2.20	74S86	1.75	380N	1.25			DM7200J	6.50	8822N	2.60	9009N	.25
7472	.40	74200	7.00	74S112	1.95	380-8N	1.00	949	.17	9093	.27	8830N	.30	9009N	.25
7473	.40			74S157	1.95	381N	1.75	950	.22	9094	.32	8831N	2.55	9016N	.25
7474	.45	74L00	.30	74S200	7.95	555N/H	.80	951	.22	9097	.32	8832N	2.55	9024N	.30
7475	.75	74L02	.30			565N	2.10	955	.22	9099	.32	8833N	1.15	9300N	.90
7476	.40	74L03	.35	MH		566N	2.05	960	.22	1800PC	.37	8835N	1.00	9324N	1.30
7483	1.10	74L04	.35	0025CN	2.00	703N/H	.40	961	.17	1808-2P	.37	8836N	.50	9503N	1.00
7492	.90	74L10	.30	0026H	2.75	709H	.30	962	.17	1812-2P	.70	8837N	1.45	9504N	1.00
7493	.90	74L20	.35	0026CG	4.00			963	.20			8853N	.95	9507N	1.50
7496	.90	74L30	.30									8864N	1.95	9528N	2.90
74100	1.50	74L42	1.50									8880N	1.35	9538N	4.50
74107	.45	74L51	.30									8895N	1.00	9581N	4.25
74122	.50	74L54	.30											9582N	1.50
74123	1.00	74L55	.40											9601N	.45
														9602N	.65

1. Add 50¢ for postage & handling on orders under \$10.
2. All items guaranteed. 3. Spec Sheets 25¢ each.
3. SEND YOUR ORDER ALONG WITH CHECK OR MONEY ORDER TO: WEIRNU, P.O. Box 1307, Colton, CA 92324 (Calif. residents include 6% tax)

**THE ATLAS 210 AND 215
SOLID STATE SSB TRANSCEIVERS**



Plug-In-and-Go-Power!

This may sound like just another catchy headline, but this is the best, and quickest way we can think of to describe the Atlas transceiver.

Plug-In

For mobile operation all you have to do is make a one time installation of the Plug-in Mobile Mount, and thereafter, when you want to operate mobile, just slide your Atlas transceiver into the mount. All connections are made automatically, as shown below. It takes only seconds, and you are ready to operate. Fixed station operation is achieved in the same easy manner, since the Atlas AC Console has the same plug-in system as the mobile mount.

Go-Power!

No Transmitter Tuning!

This is another outstanding feature of the Atlas transceiver. There is no transmitter tuning what-

soever. This permits instant QSY or band-switching. Simply tune in to your frequency and GO!

No other rig on the market will provide you with so much operating pleasure.

When you combine the simplicity of operation with unparalleled selectivity, immunity to cross modulation or overload, solid state reliability, 200 watts P.E.P. input power and 5 band coverage...the Atlas 210/215 has everything you could want in a transceiver.

Model 210 covers 80 through 10 meters.
Model 215 covers 160 through 15 meters.

Plug-in and GO!

\$599

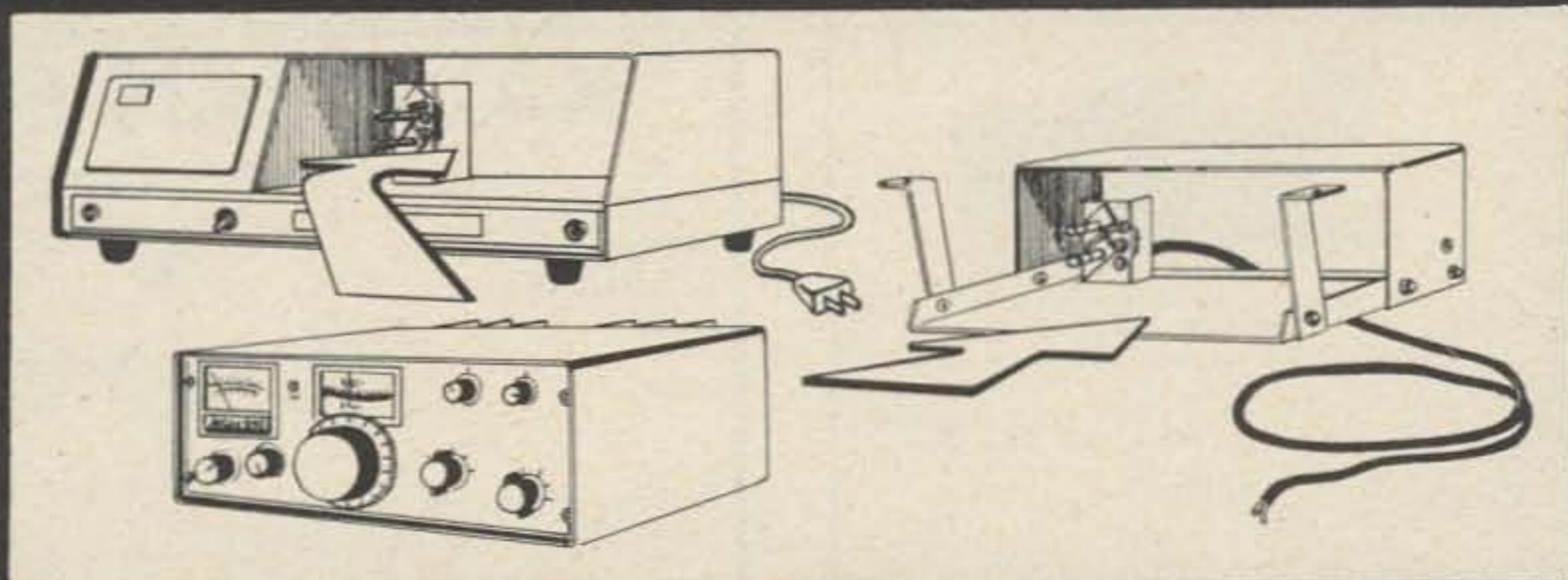

AMERICAN MADE AND GUARANTEED BY:



**ATLAS
RADIO INC.**

417 Via Del Monte Oceanside, CA 92054

Available NOW at your Atlas dealers. See him for complete details, or drop us a card and we'll mail you a brochure and dealer list.

Caveat Emptor?

PRICE — \$2 per 25 words for non-commercial ads; \$10 per 25 words for business ventures. No display ads or agency discount. Include your check with order. Deadline for ads is the 1st of the month two months prior to publication. For example: January 1st is the deadline for the March issue which will be mailed on the 10th of February.

We will be the judge of suitability of ads. Our responsibility for errors extends only to printing a correct ad in a later issue. For \$1 extra we can maintain a reply box for you.

MANUFACTURERS, Distributors!
The Memphis Hamfest will be bigger than ever. The dates are Saturday and Sunday October 4 and 5. Best location possible — State Technical Institute, Interstate 40 at Macon Road. Security. Contact Chairman, Harry Simpson W4SCF, Box 27015, Memphis TN 38127, phone (901) 358-5705.

TWO PLASTIC HOLDERS FRAME and display 40 QSL's for \$1.00 or 7 holders enhance 140 cards for \$3.00 — from your Dealer, or prepaid direct: TEPABCO, Box 198M, Gallatin, Tennessee 37066.

R-390A/URR — like new, recent overhaul with manuals and connectors. \$500. WA1TEJ 603 880-2788 days.

AN/FGC-20 — RTTY TT-100/FG Kleinschmidt printer, like new, with table, 60, 66, 75, 100 gears and manual. \$150. WA1TEJ 603 880-2788 days.

STANDARD 830L-3 Hi-band 3 channel 2 Watt HT less accessories. \$100. WA1TEJ 603 880-2788 days.

SNOOPERSCOPE M-3-20KV infrared see-in-the-dark telescope in excellent working condition with power supply. \$150. WA1TEJ 603 880-2788 days.

HALL OF FAME HAMFEST and auction rain or shine, Aug 3, 1975, Canton, Ohio. Come to Canton for football's greatest weekend. Saturday's activities — parade, enshrinement, NFL game Cincinnati vs Washington. Sunday — hamfest and auction at Stark County Fairgrounds. Main prizes — ICOM 230 — Hallicrafters FPM 300 — Standard 2 mtr hand held. Motel and camping space available. Call WF8HOF 146.19/79 or 146.52/52. Further information write WA8SHP, 73 Nimishillan St., Sandysville, Ohio 44671 or call W8SWB (216) 455-4449.

WANTED — Make, Model and Serial number of stolen ham gear for big list. W7UD, 3637 West Grandview, Tacoma WA 98466.

AN/URA-8A — complete RTTY diversity group: 2 CV-89A/URA-8B converters, CM-22A/URA-8B comparator, MT-719/URA-8B cabinet, connectors and manuals all like new. \$250. WA1TEJ 603-880-2788 days.

SWAN, CushCraft at prices I dare not publish. Call or write W0NGS, Bob Smith Electronics, 1226 9th Avenue North, Fort Dodge IA 50501. (515) 576-3886.

Continued on page 152

CMOS KEYER

ASSEMBLED PCB
\$24.95 ppd

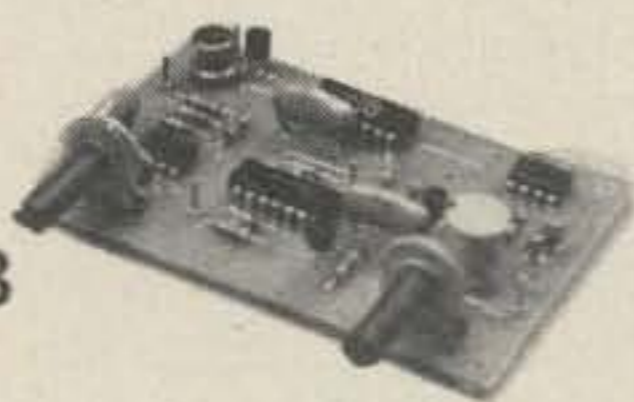

- *SELF-COMPLETING DOTS AND DASHES
- *INSTANT START WITH JAM PROOF SPACING
- *BUILT-IN SIDETONE
- *5-50 WPM
- *OPERATES ON 5-12 Vdc
- *FOR GRID-BLOCK AND CATHODE KEYING
- *SIZE: 2.3 x 3.5 INCHES

(WI residents add 4% sales tax)

DGM ELECTRONICS
787 Briar Lane, Beloit, WI. 53511



CURTIS KEYER CHIP as low as \$7.95

- 8043; IC only, 50-up group rate \$ 7.95
- 8043-1; IC, PCB, Manual \$ 24.95
- 8043-2; Semi-kit \$ 49.95

Add for air postage and handling ... \$ 1.50

(See Feb 75 CQ and Apr 75 HR articles)

- KB4200 Keyboard Keyer (Oct 74 QST) ... \$549.95
- EK420/KM420 Keyer/Memory (Oct 73 QST) \$439.90
- EK430 CMOS Keyer (uses 8043 chip) \$124.95
- IK440 Instructokeyer (Jun 75 "73") \$224.95

CURTIS ELECTRO DEVICES, Inc.

(415) 964-3136

Box 4090, Mountain View, Cal. 94040



MINIATURE SUB-AUDIBLE TONE ENCODER



- Compatible with all sub-audible tone systems such as Private Line, Channel Guard, Quiet Channel, etc.
- Glass Epoxy PCB, silicon transistors, and tantalum electrolytics used throughout
- Any miniature dual coil contactless reed may be used (Motorola TLN6824A, TLN6709B — Bramco RF-20)
- Powered by 12vdc @3ma
- Use on any tone frequency 67Hz to 250Hz
- Miniature in size 2.5x.75x1.5" high
- Wired and tested \$14.95
- Complete less reed (Available in 33 freqs. for \$17.50 ea)
- Output 3v RMS sinewave, low distortion
- Postpaid — Calif. residents add 5% sales tax

**COMMUNICATIONS
SPECIALISTS**

P.O. Box 153, Brea CA 92621

KAUFMAN BALUN

new and improved
molded plastic

KAUFMAN
water tight
BALUN



with or
without
BALUN
1:1 impedance
match

Patent No. For dipoles,
D219106 beams, inverted "V", and quads

- KAUFMAN Center Insulator with BALUN \$12.50 postpaid USA
- KAUFMAN Center Insulator without BALUN 7.50 postpaid USA
- Dragon Fly antenna construction sheet and drawing \$2.50 postpaid USA

3 Kw PEP
4 Ounces
Q1 Ferrite

KAUFMAN INDUSTRIES
BOX 817
REEDS FERRY, NH 03054



The TEN-TEC Argonaut and LINEAR AMPLIFIER

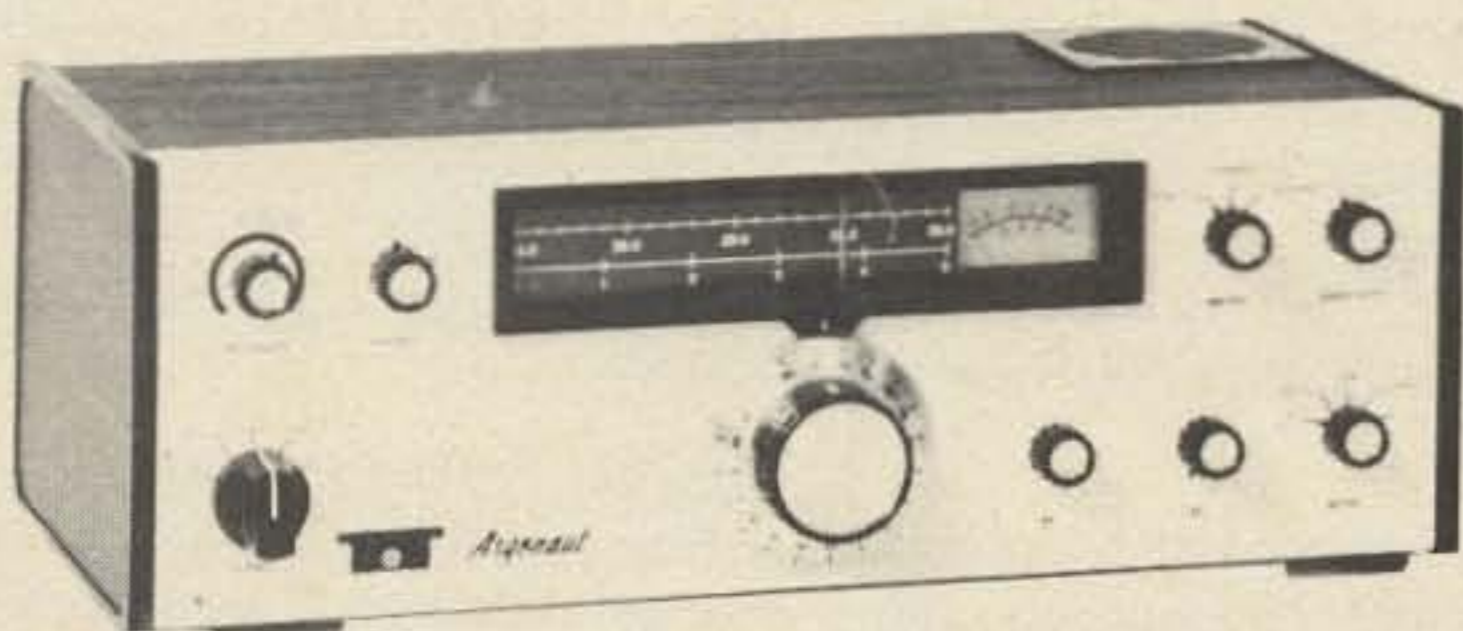

Argonaut

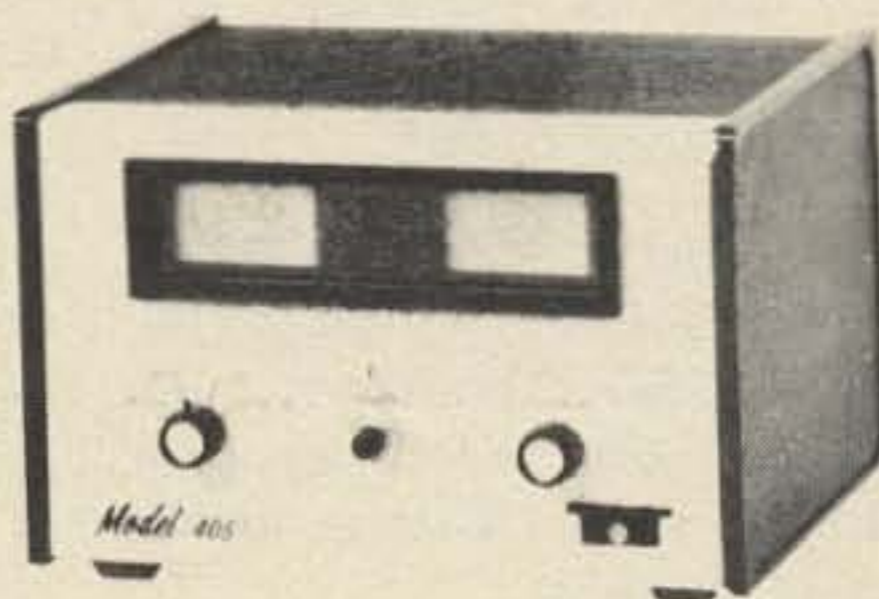

Model 405 Linear

SPECIFICATIONS

ARGONAUT, MODEL 505

GENERAL: Covers all Amateur bands 10-80 meters. 9 MHz crystal filter. 2.5 kHz bandwidth. 1.7 shape factor @ 6/50 dB points. Automatic sideband selection, reversible. Solid state design. Permeability tuned circuits. Seven plug-in circuit boards. Direct frequency readout. Vernier tuning. Dial accuracy ± 5 kHz (slightly more at 10 meters). Drift less than 100 Hz. Power required 12-15 VDC @ 150 mA receive, 800 mA transmit at rated output. Construction: aluminum chassis, top and front panel, molded plastic end panels. Cream front panel, walnut vinyl top and end trim. Size: HWD 4½" x 13" x 7". Weight 6 lbs.

RECEIVER: Sensitivity less than ½ uV for 10 dB S+N/N. "S" meter. AGC. Offset tuning. Tuned MOSFET RF amplifier and mixer. Audio distortion less than 2%. Internal speaker. Headphone/external speaker jack.

TRANSMITTER: 5 watts input power. Broad band final amplifier eliminates tuning. 50-75 ohms output impedance. Press-to-talk. Instant CW break-in. SWR bridge. Integral TVI filter. CW sidetone. Integrated circuit balanced modulator. Automatic CW offset of approximately 700 Hz. Shaped keying.

LINEAR AMPLIFIER, MODEL 405

Covers all Amateur bands 10-80 meters. 50 watts output power, continuous sine wave. Broad band design eliminates tuning. Less than 2 watts of drive required. RF wattmeter. SWR meter. Exciter actuated antenna changeover. Front panel T/R time delay control. Individual band-switched low pass filters. TVI filter. Two plug-in circuit boards. Computer estimated life of output transistors 25.7 years. Power required 12-15 VDC @ 8 A, max. Construction: aluminum chassis, top and front panel, molded plastic side panels. Cream front panel, walnut vinyl top and end trim. Size: HWD 4½" x 7" x 8". Weight 2½ lbs.

TUFTS

Radio Electronics

386 Main St., Medford, Mass. 02155

617-395-8280

NEW ENGLAND'S EXCLUSIVE DEALER

Caveat Emptor?

from page 150

FB CONDITION SBE-34 ACDC transceiver \$195. HRT-2 Regency HT W-4 rocks, cost \$200 plus. (Sell 4 \$145.) Kenny, 455-41st Ave., SF 415-386-6313. Hot Water 17A with FM-adaptor 2m transceiver. Visit Singapore... the best Country in the WORLD.

SSTV MONITOR, W6MXV, PC boards factory checked, with extra 7" CRT and 2 cassettes — \$85.00 — you pay shipping. WA4TST, 507 Pinecone Street, Waycross GA 31501.

TECH MANUALS — \$6.50 each: R-220/URR, SP-600 JX, USM-159, GRR-5, URM-25D. Thousands more available. Send 50¢ (coin) for large list. W3IHD, 7218 Roanne Drive, Washington DC 20021.

FOREIGN LANGUAGE cassettes. 2 — 60 minute quality tapes per set. French, German, Italian, Spanish. \$6 a set, 4 sets \$20. Royal, Box 2174, Sandusky, Ohio 44870.

CINCINNATI HAMFEST: 38th annual — Sunday, September 21, 1975 at the New Stricker's Grove on State Route 128, one mile west of Ross (Venice), Ohio. Flea market, contests, model aircraft flying, food and beverages all day. Advanced tickets \$7, covers everything; \$8 at gate. For tickets or further information: Carl J. Dettmar W8NCV, 8630 Cavalier Drive, Cincinnati OH 45231.

FM RECEIVER, preamp, scanner, UHF converter kits. Hamtronics, Inc., 182 Belmont, Rochester NY 14612.

WARREN HAMFEST! Sunday, August 17, Yankee Lake, Ohio. On Rt. 7, five miles north of I80. Dealers' displays. Swimming and picnicing. Giant flea market (Vendor's fee: \$1.00 plus registration). A \$3.00 registration includes: Door prize, Main prize, and XYL tickets. More info: Hamfest, PO Box 809, Warren OH 44482.

WANTED used Bruel and Kjaer audio test equipment measuring amp, spectrometer, pistonphone, hearing aid test box, chart recorder. Contact Bob Sumption, Berrien County Day Program for Hearing Impaired Children, Sylvester Boulevard, Berrien Springs, Michigan 49103.

STANDARD 840ZA carrier squelch pocket paging receiver, like new, now on 154.19, with charger and spare nicad. \$125. WA1TEJ 603 880-2788 days.

VERY INTERESTING! Next 5 issues \$1. "The Ham Trader," Sycamore IL 60178. (Ask about our "HAM EQUIPMENT BUYERS GUIDE" covering receivers, transmitters, transceivers, amplifiers 1945-75. Indispensable!)

FOUNDATION FOR AMATEUR RADIO annual Hamfest Sunday, 19 October 1975 at Gaithersburg Maryland Fairgrounds.

GE — PREPROGRESS 450 MHz base station transmitter with oven and power supply, 12 Watts out, 4ET19A1. \$25. K. Bassett, 1124 Woodrow Ave., Waynesboro VA 22980.

POLICE AND FIRE Scanner Special — Regency ACT — R — 10 H/L/U 10 channel 3 bands, combined ac/dc 10 free crystals included \$169.00 pre-paid, dealer inquiries invited, Four Wheeler Communications 10-F New Scotland Avenue, Albany NY 12208.

Continued on page 154

**some people
talk power -
we
deliver it.**



**VHF Class C
Power Amplifiers**

- Superb Craftsmanship
- State of the Art Performance
- Full One Year Warranty

MODEL P15A1 — 1-3 W input 12-25 W output. 13.6 V at 2 Amps \$55 ppd.

MODEL P50A1 — 1-3W input 40-60W output. 13.6V at 8 Amps \$139.

MODEL P50A10 — 1.5-15 W input 12-65 W output. 13.6 V at 6 Amps \$98 ppd.

MODEL P100A5 — 2-5 W input 60-100+ W output. 13.6 V at 14 Amps \$198 ppd.

MODEL P100A10 — 3-10 W input 60-100+ W output. 13.6 V at 14 Amps \$198 ppd.

MODEL P100A20 — 15-30 W input 75-100+ W output. 13.6 V at 14 Amps \$155 ppd.

M-Tech Engineering, Inc.

Box C, Springfield VA 22151 (703) 354-0573

M-TECH . . . The Quality Company

**NOW THE AMATEUR
CAN BUY COMMERCIAL QUALITY
SSB EQUIPMENT**

*(Present users include foreign
government agencies)*



Solid State 2-30 MHz Linear Power Amplifiers

1. CR250AA: 250 to 400 Watts P.E.P. input power with as little as 2 to 5 Watts drive. 12VDC. \$299.00
2. CR500AA: 500 to 700 watts P.E.P. input power with as little as 4 to 10 watts drive. 115/230 VAC \$599.00

Also 20 watt P.E.P. Walkie Talkie, 400 to 600 watt monobanders, receivers and multi-band transceivers, VHF-FM Mobile base and repeaters. We accept Master Charge, BankAmericard or certified check on mail orders. Please include charge cards account number and expiration date.

CR electronics
1169 Chess Drive, Unit G
Foster City, Ca. 94404

WE'VE GIVEN IT A NEW LOOK!



IC-22A

The front panel and control locations have been changed to make the IC-22A even better looking and easier to operate. The new design allows the use of larger channel numbers which may be

viewed from the left side or right side by reversing the window position and installing a new dial. (optional at nominal cost)

Inside is the same high quality radio construction and engineering that has made the IC-22 the most reliable, most popular two meter crystal controlled set on the market.

When you join 22 channels of capacity (five supplied) with the unexcelled performance of helical RF filtering in the receiver front end then add solid state T-R switching you get one great radio for your money. All the great features that made the IC-22 so desired are still there. Including, 1 watt/10 watt switch option, trimmer capacitors on both receiver and transmitter crystals plus a 9 pin accessory jack with the discriminator already wired for frequency calibration.

New and Used Equipment

RADIO STORE

59th & South Penn, Oklahoma City, Oklahoma

*See us at Oklahoma Ham Holiday and State ARRL Convention Aug. 2-3
South Gate Inn I-35 at S.E. 51st*

Caveat Emptor?

from page 152

MEMPHIS is beautiful in October! The Memphis Hamfest, bigger and better than ever, will be held at State Technical Institute, Interstate 40 at Macon Road, on Saturday and Sunday October 4 and 5. Demonstrations, displays, MARS meetings, flea market, XYL entertainment, prizes. Informal dinners Saturday night. Dealers and distributors welcome. Talk-in on 3980, .34-.94 and MARS. Contact Harry Simpson W4SCF, Box 27015, Memphis TN 38127 or telephone (901) 358-5707.

FOR SALE: Clegg 66er BRAND NEW 6 meter 117V ac & 12 V dc. Built-in P.S. and Manual. \$120 + UPS. Heathkit SB301 w/filters, SB600. SB401 w/xtal Pack & Manuals Mint \$460.00 + shipping. Henry 2K-4 linear amp console mint \$585.00 + shipping. J.A. La Torre, P.O. Box 521 G, Lawrence MA 01842.

F.R.R.L. HAMFEST — August 17th. U.S. Rt. #30 East of Aurora, Ill. Phillips Park — Picnic — Zoo — Family Fun. Advance Donation \$1.00, \$1.50 at Park. S.A.S.E. to P.O. Box 443, Aurora, 60507. Two Grand Prizes and many others.

NO DX QSLs? Try ham sentences in 54 languages on your card! "K3CHP's DX QSL GUIDE," \$3.95. Joe Mikuckis, 6913 Furman Pkwy., Riverdale MD 20840.

WANTED: Full correspondence course of computer digitals and ICs from someone who has moved up in the field. State price. Cyril Lievesley, 142 Brightman St., Fall River MA 02720.

FREE: 8 EXTRA CRYSTALS of your choice with the purchase of a new ICOM IC-22A at \$249. With the 10 crystals which come factory-installed in the IC-22A, this gives you a total of 18 crystals! For equally good deals on Kenwood, Drake, Collins, Ten-Tec, Swan, Atlas, Midland, Standard, Regency, Tempo, Alpha, Genave, Hy-Gain, CushCraft, Antenna Specialists, Hustler, Mosley and others, write or call HOOSIER ELECTRONICS, your ham headquarters in the heart of the Midwest, and become one of our many happy and satisfied customers. Hoosier Electronics, P.O. Box 2001, Terre Haute, Indiana 47802. (812) 894-2397.

THE ORIGINAL FM Hamfest Aug. 3, 1975, near Angola, Ind. Free flea market, picnic grounds, swimming, boating available. Talk-in on 146.16-76, 146.94. For information contact Fort Wayne Repeater Association, Box 6022, Fort Wayne, IN 46806.

WANTED: Mobile telephone equipment such as Delco, GE, etc. Also heads, decoders, duplexers. Greg Hyman, WA2OTG, 19 Sicard Ave., New Rochelle, New York 10804, (914) 636-2494.

GPL — TELEVISION SYSTEM, PD150 camera with lens and book, 18 inch Conrac monitor. \$140. K. Bassett, 1124 Woodrow Ave., Waynesboro VA 22980.

WANTED to buy — TRIBAND ANTENNA. FOR SALE — TR106 & VFO \$75.00; Clegg FM27B & AC \$250.00; Clegg Mark II \$150.00. Ameco TX62 \$40.00. Swan 350/AC and upper lower sideband adaptor, VOX, and factory installed VFO. All guaranteed perfect condition. Duane Kilbourn, 17100 14 Mile Rd, Battle Creek MI 49017.

AN OFFER you can't refuse — BUYERS & SELLERS P. 148.

RADIO ARCHIVES, amateur ANECDOTES (then & now) solicited for proposed (SASE subscription) monthly PR newsletter. Electronic Avocations, 3207 fourth St. N., Mpls., Mn. 55412.

THE 28th ANNUAL Turkey Run Hamfest and VHF Picnic sponsored by the Wabash Valley ARA, Inc., will be held Sunday, July 27, at Turkey Run State Park near Rockville, Indiana. Don't miss the midwest's finest flea market. XYL Bingo, refreshments, camping facilities and park recreation for the kids. Also this year, banquet July 26, 7:30 pm featuring guest speaker W9NTP, in park dining hall. Banquet by reservation only, \$6.50/person; reservation deadline July 1. Activities begin 9 am Sunday, talk-in 146.94 W9UUU/9. For details, tickets and banquet reservations SASE WVARA Hamfest, Box 81, Terre Haute IN 47808.

HAMFESTERS 41st Hamfest and Picnic, Sunday August 10, 1975, Santa Fe Park, 91st and Wolf Road, Willow Springs, Illinois, Southwest of Chicago. Exhibits for OMs and XYLs, famous Swappers Row. Information contact John Raiger K9DRS, 8919 West Golfview Drive, Orland Park, Illinois 60462. Tickets write Joseph Poradyla WA9IWU, 5701 South California, Chicago, Illinois 60629.

HP-65 USERS exchange ideas, programs, methods. Monthly newsletter. Request information and sample newsletter. Richard Nelson, 2541 W. Camden Pl, Santa Ana CA 92704.

MOTOROLA HANDIE-TALKIE WANTED. Also want accessories. Sidney Helperin, 5046 Veloz Ave., Tarzana CA 91356. (213) 345-6760.

500 MHZ PRESCALER

Extend the range of your present frequency counter to measure through 500 MHZ (typically 525 MHZ). Works into any standard counter rated for 5 MHZ or higher. A must for work on 2 meters, 432 MHZ and commercial high bands.

- 150 mv sensitivity
- Input overload protected
- 50 ohm Input Z
- Small size
2 3/4 x 2 1/8 x 1 5/8"
- BNC connectors
- Divide by 100 or 10
- Light blue case
- Model Ps 2A \$99.95



Prescaler is shipped assembled, tested and ready to operate. Complete with line cord power supply.

DAVIS ELECTRONICS

636 Sheridan Dr., Tonawanda, N.Y. 14150 716/874 5848-9

TELETYPE

UT-4 — ASCII to BAUDOT CONV. — AUTO CW IDER — AK-2 AFSK — XK-2 XTAL AFSK — and LOTS MORE.

CALL OR WRITE FOR DETAILS AND PRICES

edi

Electronic Development, Inc., P.O. Box 951, Salem, Oregon 97308 (503) 399-9660.

BUILD YOUR OWN TV CAMERA

Ideal for home & business



THE ECONOMICAL APPROACH TO AMATEUR TELECASTING, BUSINESS & INDUSTRIAL SURVEILLANCE, ITV, GENERAL HOME MONITORING OF NURSERIES, ETC. MODEL XT-1A, SERIES D - KIT FORM 5185; FACTORY ASSEMBLED \$275. SOLID-STATE. CONNECTS TO ANY TV SET WITHOUT MODIFICATION. OPTIONAL SOUND KIT \$28.95. PHONE OR WRITE FOR ILLUSTRATED CATALOG...DIAL 402-987-3771 TODAY.

1301 N. BROADWAY **ATV Research** DAKOTA CITY, NEBR. 68731

SOCIAL EVENTS

CALGARY ALBERTA AUG 1-3

Century Calgary Amateur Radio Convention — CARF National and ARRL Canadian Division Convention. Speakers include astronaut Dr. Owen Garriot K5LFL (Skylab 3, 24.4 megamiles in 59 1/2 days orbiting Earth), Martin Laine OH2BH — DX, Larry Kayser VE3QB — AMSAT, Lew McCoy W1ICP — ARRL — quads and humor, Dr. F. Green VE3IO — D.O.C. — on interference, Dr. J. S. Belrose VE2CV — D.O.C. — antennas, Dr. E. Hara — D.O.C. — fiber optics. Bill Porter W3AAC-K1YPE/VE3, US Ambassador to Canada, has also been invited.

Pre-registration \$5 til end of June; registration at door \$7.50 starts at noon August 1. Various special interest breakfasts, luncheons and tech sessions Saturday, August 2. Banquet \$14.50 with K5LFL talk. Tech sessions Sunday also. The convention will be held in the Calgary Inn; rooms available at 1973 rates (\$20-25 compared to \$30-38). Camping available north and west of town. Info write Convention '75, Box 592, Calgary, Alberta T2P 2J2.

TEMPLE TX AUG 1-3

The Texas VHF-FM Society will hold its Summer Convention 1975

Aug 1, 2 and 3 at The Ponderosa Inn in Temple, Texas. This year's convention will be the best ever with the featured speaker Mr. A. Prose Walker, Chief of the Amateur and Citizens Division of the FCC. There will also be equipment displays, technical sessions, a swap-fest, ladies activities and many, many prizes. For more information contact the Temple VHF Repeater Association, PO Box 23, Temple, Texas 76501.

WINCHESTER VA AUG 2-3

The Shenandoah Valley Amateur Radio Club will present its 25th Annual Hamfest in Winchester, Virginia, on August 2nd and 3rd, 1975. The festivities start Saturday night at the Lee Jackson Motor Inn with the Social Hour beginning at 6 pm. Buffet-dinner will be served at 7 pm, after the dinner there will be guest speakers and musical entertainment. Dinner — \$6. Fleamarket starts Sunday 10 am till 4 pm. Registration tickets are \$2 or \$5 for 3 tickets or \$10 for 10 tickets. For more information contact the Shenandoah Valley ARC, Box 139, Winchester VA 22601.

Continued on page 156

1/2 KW WIND ELECTRIC GENERATOR



NEW KIT INCLUDES:

BLADES

SPECIAL ALTERNATOR

CONTROL UNIT

FABRICATION INSTRUCTIONS

BASIC KIT AS LOW AS:

\$ 147⁰⁰

STANDARD RESEARCH INCORPORATED

P. O. BOX 1291

EAST LANSING,

MICH. 48823



SWB-2 \$22.95*

SWR BRIDGE READS FORWARD &
REFLECTED POWER SIMULTANEOUSLY

'EASY READ' METERS

DUAL 100-MICROAMP METER MOVEMENTS

LOW INSERTION LOSS

SIZE 5X2X2

MAY BE LEFT IN LINE UP TO 2,000 WATTS

3 TO 150 MHZ

ADD \$1.50 FOR POSTAGE

** prices subject to change without notice . . .*

OUR BEST "HAM" BUY



**QUEMENT ELECTRONICS
1000 SO. BASCOM AVE.
SAN JOSE, CA. 95128**

MORE



OKLAHOMA CITY OK AUG 2-3

The Oklahoma Ham Holiday and State ARRL Convention will be held Saturday and Sunday, August 2 and 3 in Oklahoma City OK. In addition to the largest flea market in the Southwest, the program will include special programs, technical seminars, equipment displays. MARS meetings and unique activities for the XYL. For information and advance registration write Oklahoma Ham Holiday, P.O. Box 20567, Oklahoma City OK 73120.

UPPER ST CLAIR PA AUG 3

The 38th Annual Hamfest of the South Hills Brass Pounders and Modulators will be held on August 3rd, from noon till dusk, at St. Clair Beach, Upper St. Clair Township, 5 miles south of Mt. Lebanon on route 19. Swap and shop, picnic space and swimming for the family. Mobile check in on 29.0, 52 simplex and popular 2 meter frequencies. Information and pre-registration at \$1.50 per ticket (\$2 at door) from Fred Schreiber, 181 County Line Road, Bridgeville PA 15017.

ANGOLA IN AUG 3

The original FM Hamfest will be August 3, 1975, near Angola, Indiana. Free flea market, picnic grounds, swimming, boating available. Talk-in on 146.16-76, 146.94. For information contact Fort Wayne Repeater Association, Box 6022, Fort Wayne IN 46806.

CANTON OH AUG 3

Hall of Fame Hamfest and Auction rain or shine, Aug 3, 1975, Canton, Ohio. Come to Canton for football's greatest weekend. Saturday's activities — parade, enshrinement, NFL game Cincinnati vs Washington. Sunday — hamfest and auction at Stark County Fairgrounds. Main prizes — ICOM 230 — Hallicrafters FPM 300 — Standard 2

mtr hand held. For more info write WA8SHP, 73 Nimishillan St., Sandyville OH 44671 or call W8SWB at (216) 455-4449.

LEVELLAND TX AUG 3

The Tenth Annual Northwest Texas Emergency Net Swapfest and Picnic will be held in the City Park at Levelland, Texas on Sunday, August 3, 1975. Bring your own picnic basket. Free registration begins at 0900. Lunch at 1300. Swapping all day. This event is for the entire family. Mobile talk-in is the net frequency of 3950 kHz and via the Levelland Repeater (WR5AFX), on 28-88.

MONTREAL AUG 3

The Montreal Hamfest will be held Saturday, August 3, 1975, 9 am to 5 pm, MacDonald College Farm, Ste. Anne de Bellevue, PQ, on the west end of Montreal Island, Exit 26 off the Trans-Canada Highway. Admission \$2.50 includes prizes, fleamarket, tech sessions, exhibits, mobile clinic (2 m) and an International Tug-o-War. Activities for XYL and kids. Talk-in VE2RM (146.40) 147.00, VE2PY 146.88 (English), VE2XW 146.70, VE2DN 146.76 (French), VE2BG 147.06, 146.52 simplex (both). For more info write Montreal Hamfest c/o VE2RM Inc., P.O. Box 201, Pointe Claire-Dorval, PQ.

WASHINGTON MO AUG 3

The Zero-Beaters ARC will hold their annual hamfest on Sunday, August 3rd, at the Washington, Missouri city park. Free parking, auction, and bingo for the XYLs. No admission fee or fee for parking in the traders row. Many prizes including IC-22A, station accessories, books and a handmade quilt. For info or tickets contact Kevin Weiskopf WB0MNP, or Zero-Beaters ARC, WA0FYA, Box 24, Dutzow MO 63342.

RENO NV AUG 9

Nevada Amateur Radio Association will host the annual "Sierra" Hamfest, August 9th, at the California Building, Idlewild Park, Reno, Nevada. Pre-registration, \$10. For information, contact NARA, P.O. Box 2534, Reno, Nevada.

FLOURTOWN PA AUG 10

The Mt. Airy VHF Radio Club (The Pack Rats) will hold their 19th

Annual Family Day & Picnic on Sunday, August 10, 1975 (rain date August 17th) at the Fort Washington State Park, Flourtown PA. The Delaware Valley chapter of QCWA will again join us in the festivities. All hams and their families are cordially invited. Games and entertainment, free prizes to the kiddies, free soda. Talk-in on 52.525 MHz FM — 146.52 MHz FM — 222.98/224.58 MHz FM repeater. Registration \$2 per family.

WILLOW SPRINGS IL AUG 10

The 41st Hamfest and Picnic will be held Sunday, August 10, 1975, Santa Fe Park, 91st and Wolf Road, Willow Springs, Illinois, Southwest of Chicago. Exhibits for OMs and XYLs, famous swappers row. Information contact John Raiger K9DRS, 8919 West Golfview Drive, Orland Park, Illinois 60462. Tickets write Joseph Poradyla WA9IWU, 5701 South California, Chicago IL 60629.

HILLIARD OH AUG 10

The Central Ohio Radio Club, Inc., will sponsor a Flea Market Hamfest Auction to be held Sunday, August 10, 1975 from 8 am to 6 pm rain or shine at the Franklin County Fairgrounds, Hilliard, Ohio (just west of Columbus). Flea market, free auction, main prizes: Midland 30 Watt 2 mtr FM Mobile unit, Model 13-505, 12 ch., Regency 2 Watt 2 mtr FM hand held unit. Door prizes, XYL prizes, refreshments. Entrance and registration — one (1) ticket @ \$2/person (including all prize drawings). For more info write CORC, Inc., P.O. Box 23, Delaware OH 43015.

NEWBURGH NY AUG 16

Mt. Beacon A.R.C. 3rd Annual Hamfest, Saturday, August 16, 1975, 8 am to 6 pm at Stewart Airport, Newburgh, New York. Inside Hangar E. Flea market and auction, door prizes, free parking. Rain or shine. Talk-in on WR2ABB 37/97, 94 and 52. Admission: \$1.00, tailgating \$1, under 12 admitted free. For advance tickets write: Marty Irons WB2TBI, 46 Magic Circle Drive, Goshen, New York 10924.

MIDDLEFIELD MA AUG 16-17

Many activities are planned for both days of the NOBARC Hamfest, August 16-17, at the Middlefield Fair-

grounds, Middlefield MA. Talk-in on 31/91, 43/03, 52 simplex, 34/94, 52.525 and 223.50. Admission \$3.00/adult or \$5/family. Flea market parking \$1/car. For further info, contact Don Huntington WA1IQJ, 11 Sullivan Dr., Granby CT 06035.

**DECATUR AL
AUG 17**

The Decatur Amateur Radio Club will host the North Alabama Hamfest in Decatur, Alabama on Sunday, August 17, 1975. Location is the campus of Calhoun Junior College at the Decatur-Athens Municipal Airport. Doors will open at 8 am. Tickets \$1.00 each will be available at door or in advance from Ken Hixon WB4NLN, P.O. Box 9, Decatur AL 35601. Talk-in on 34-94 and 3.965 MHz.

**SAUK RAPIDS MN
AUG 17**

The St. Cloud Area Hamfest will be held on August 17, 1975, at the Sauk Rapids Municipal Park from 1000, with registration and eyeball QSO, Swapfest \$1.00 per call, refreshments and door prizes. For info contact WA0OTO.

**AURORA IL
AUG 17**

The F.R.R.L. Hamfest will be held August 17th at Phillips Park, U.S. Rt. No. 30, East of Aurora, Illinois. Picnic, zoo and family fun. Advance donation \$1, \$1.50 at park. SASE to P.O. Box 443, Aurora IL 60507. Two grand prizes and many others.

**YANKEE LAKE OH
AUG 17**

The Warren Hamfest will be held Sunday, August 17, Yankee Lake, Ohio, on Rt. 7 five miles north of I80. Dealers' displays. Swimming and picnicing. Giant flea market (Vendor's fee: \$1 plus reg.) A \$3 reg includes: Door prize, main prize and XYL tickets. More info: Hamfest, PO Box 809, Warren OH 44482.

**BRANCHVILLE NJ
AUG 23-24**

The 550 Club - Oakland Repeater Association will hold its Family Piknik on August 23 and 24 at the Harmony Ridge Campgrounds, Mattison Road, Branchville, New Jersey. Flea market, Door prize TR22C, bring your own food, beer and soda provided. Hidden transmitter hunts (bring your handy talkie), hiking, contests. Talk-in 147.49-146.49 repeat 10-70 & 52. Camping fee \$4 per day, \$5 per day w/water and electric hook-ups. Entrance fee \$2 per adult - \$.50 per child under 12. Checks payable to 550 Club - mail to: Rick Anderson WB2QOQ, 53 Garside Avenue, Wayne, New Jersey 07470.

**BELVIDERE IL
AUG 24**

The Bel Rock Hamfest will be held August 24th in Belvidere, Illinois. Advance registration is \$1.50. For more information contact: Bel Rock Hamfest, P.O. Box 1744, Rockford IL 61110.

**MARSHALLTOWN IA
AUG 24**

The Iowa 75 Meter picnic will be held August 24 at Riverview Park in Marshalltown, Iowa. Bring your own table service and a dish for the pot-luck meal; coffee and soft drinks are furnished. No registration fee. For more info contact Iowa 75 Meter Net, Mary Keener WA0DAG, R.R. 2, Cascade IA 52033.

**SPRINGFIELD MO
AUG 24**

The Southwest Missouri Amateur Radio Club will hold its annual Hamfest, swap meet, and family picnic on August 24, 1975, at Lake Springfield Park. Our highly successful meeting draws over two hundred radio amateurs and their families each year. Please send any merchandise for prizes

or enquiries to me at the following address: Joe Hargis WB0CIW, Secretary, Southwest Missouri Amateur Radio Club, 3228 N. Wildan, Springfield MO 65803.

**LAPORTE IN
AUG 24**

The LaPorte County Amateur Hamfest will be held 24 August, 1975, at the County Fairgrounds in LaPorte, Indiana, 60 miles East of Chicago. Paved Midway for sellers, inside tables available. On-site camping with hook-ups. Advance tickets are \$1 each, \$1.50 at gate. Cold drinks and food available. Contact Dave Nicolaus WB9AOU, RR7, Box 275, Valparaiso IN 46383.

**SAN FRANCISCO CA
AUG 29-SEPT 1**

The Quarterly NORCAL DXers (Northern California DXers) gabfest will be held Labor Day weekend at the El Rancho Inn, 1100 El Camino Real, Millbrae CA 94030. \$1 reg. at door. Emphasis on SWL DXing. Technical sessions, displays, quiz, auction and free refreshments. Door prizes. For more info write NORCAL, Rick Heald, 17412 Rolando Avenue, Castro Valley CA 94546.

**MONCTON NEW BRUNSWICK
AUG 29-SEPT 1**

The Moncton Area Amateur Radio Club will sponsor the Atlantic Canada ARRL Amateur Radio Convention, August 29 - September 1, 1975 at the Hotel Beausejour, Moncton, New Brunswick. Exhibits, technical forums conducted by ARRL Headquarters personnel, VHF forum, swap shop, buffet Saturday night followed by dance, dinner and entertainment Sunday night, hidden transmitter hunt, etc. Talk-in on 146.28 - 88 and 146.52 simplex. For full information, write: Moncton Area Amateur Radio Club, P.O. Box 115, Moncton, N.B.

DIGITAL FREQUENCY COUNTER

50 Hz to over 250 MHz - 8 digit LED display less than 90 mV to 45 MHz - less than 250 mV to 250 MHz - packaged 10 MHz clock - ± 1 PPM stability - AC or DC operation - wired and tested. **CALL OR WRITE FOR DETAILS AND PRICES**

edi

Electronic Development, Inc., P.O. Box 951, Salem, Oregon 97308 (503) 399-9660.

**18" FACSIMILE RECORDERS
FOR SALE**

The leading manufacturer of 18" facsimile weather chart recorders is now updating an existing network to solid state equipment. This updating is making available a number of 18" weather map recorders ideally suited for anyone interested in experimenting with facsimile.

These recorders, with suitable receiver and FSK converter, can be used to monitor radio weather chart broadcasts as well as press wire photo transmissions. With some modifications, data from weather satellites can also be received.

These recorders are reasonably priced and available on a first come, first served basis.

Call or write Mr. Armand D. Bouchard:

**ALDEN ELECTRONICS & IMPULSE
RECORDING EQUIPMENT CO., INC.**
Washington Street, Westboro MA 01581
617/366-8851

73 Got Us Covered?
is always looking for photos or artwork suitable for cover use - and the pay is good.

BRAND NEW QSL'S



X Style X – Black type, blue satellite

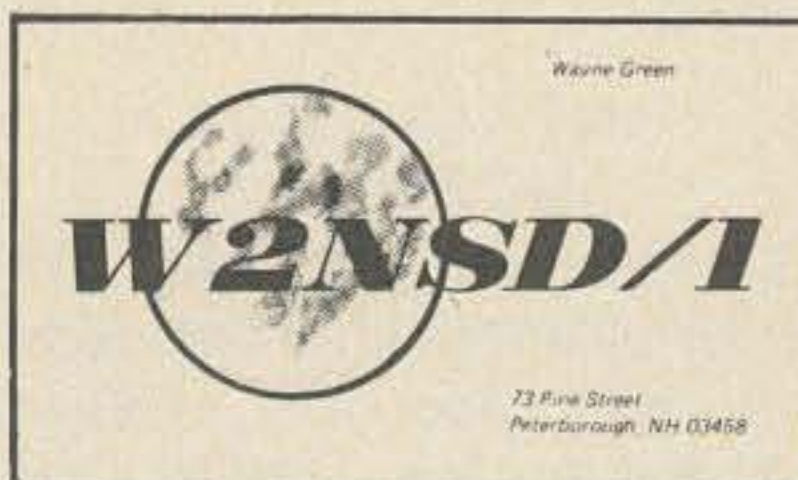

W Style W – Black type, blue world
"back by popular demand!"



Y Style Y – Black type, red lightning bolt

- three styles
- QSO info back
- two colors
- LOW PRICES

These QSLs are printed on Fine Quality Coated Card Stock and are as good or better than cards sold elsewhere for several times the price. We can offer this fantastic low price, because we "gang print" orders between other jobs in our own print shop which keeps the costs way down and we pass the savings on to you. If you haven't been QSLing as much as you'd like to because of the cost of cards, do you really have an excuse anymore? Get some cards and help improve the image of U.S. Amateurs. Please allow 6-8 weeks for delivery.

SPREAD the WORD!
RADIO AMATEUR'S TALK TO THE WORLD!!
...ask me about it!
ONLY .50¢

Ham radio is too great a hobby for us to keep it to ourselves. Let's tell the whole world about it! And what better way than by sporting this attractive lime-green bumper sticker on your car! It's only 50¢ – and it's phosphorescent so you can see it even at night. Go ahead... **SPREAD THE WORD!** Order yours **TODAY!**



4 STUDY GUIDES
NOVICE – \$4 GENERAL – \$6
ADVANCED – \$4 EXTRA – \$5

FCC exams got you scared? Frustrated by theory fundamentals? There's no need to worry. 73's four License Study Guides will help you breeze through any of the four tough exams! They are the **ONLY** guides which cover **ALL** the material you will have to know. Many amateurs find that one quick reading through our guides is enough to get them through with no sweat.

SOLID STATE PROJECTS

More than 60 projects of interest to anyone in electronics. The devices range from a simple transistor tester to a ham TV receiver. This collection will help you become more intimately acquainted with zeners, ICs and varactors, etc.

\$4



VHF PROJECTS FOR AMATEUR AND EXPERIMENTER

A must for the VHF op. Opening chapters on operating practices and getting started in VHF, both AM and FM, followed by 58 chapters on building useful test equipment, modifying existing and surplus gear.

\$4

2M FM HANDBOOK

hardbound \$7
softbound \$5

Contains almost every conceivable circuit that might be needed for use with a repeater. All circuits explained in detail. All aspects covered, from the operator to the antenna.



DIGITAL CONTROL OF REPEATERS

softbound \$5 hardbound \$7

Here's a book for the FMer who wants to design and build a digital repeater control system. Contains sections on repeaters, basic logic functions, logic circuit design, control systems, support circuits, mobile installations, touch-tone, plus a special section on a "mini" repeater control system.



LATEST RELEASES from 73 publications

RF and DIGITAL TEST EQUIPMENT YOU CAN BUILD

RF burst, function, square wave generators, variable length pulse generators – 100 kHz marker, i-f and rf sweep generators, audio osc, af/rf signal injector, 146 MHz synthesizer, digital readouts for counters, several counters, prescaler, micro-wavemeter, etc. 252 pages. \$5.95



PRACTICAL TEST INSTRUMENTS YOU CAN BUILD

37 simple test instruments you can make – covers VOMs, VTVMs, semiconductor testing units, dip meters, watt meters, and just about anything else you might need around the test lab and ham shack. \$4.95



COAX HANDBOOK

\$3

All about coaxial cables, connectors and applications. It's all here – pictures, part numbers and specifications for all types. Includes lengths for different types for quarter, half and full wave feed-lines.



73 BINDERS

\$5

These binders are a gorgeous red and come with the nicest set of year stickers you've ever seen. The perfect thing for storing your issues of 73 so that they won't get lost or spilt on, or into the hands of the Jr. Op. Dress up your shack with these binders.

Startling Learning Breakthrough



NOVICE THEORY TAPES
Set of 4 Tapes only \$13.95

You'll be astounded at how really simple the theory is when you hear it explained on these tapes. Three tapes of theory and one of questions and answers from the latest Novice exams give you the edge you need to breeze through your exam.

73 is interested in helping get more amateurs, so we're giving you the complete set of four tapes for the incredibly low price of ONLY \$13.95.

Scientists have proven that you learn faster by listening than by reading because you can play a cassette tape over and over in your spare time — even while you're driving! You get more and more info each time you hear it.

You can't progress without solid fundamentals. These four hour-long tapes give you all the basics you'll need to pass the Novice exam easily. You'll have an understanding of the basics which will be invaluable to you for the rest of your life! Can you afford to take your Novice exam without first listening to your tapes?

1975 fm repeater atlas



LISTINGS BY STATE
ORDER TODAY!

STILL ONLY \$1.50

73's all new REPEATER ATLAS is a must for every ham on 2 meters. There are 2,500 repeaters around the world (2,000 of them in the U.S.), and this atlas lists them all! Just off the presses, the 1975 edition is the most up-to-date listing you can buy. And monthly repeater updates in the 73 newspaper makes sure that it stays that way! You can still purchase this invaluable tool for JUST \$1.50. Isn't it nice to know that there are a few places left where your dollar is still worth something?

GET IT while it's HOT!



Latest FCC News
(from inside the FCC)
Latest Docket Releases usually in entirety
Late DXpedition News
Hot Propagation Report
Job Openings
Contest News
Conventions — Hamfests
Brand New Products
Inside Industry News

The fact is, if you are an astute shopper, you can pay 50% more for Brand X than the subscription price of Hotline (a mere \$8 per year by First Class Mail) and end up with a newsletter which is about half as big (half as much news).

Hotline overcomes the two month news delay of 73 Magazine (and all other ham magazines) by bringing you the latest hot news while it is still news. This puts you in the know on the air — over the repeater — and at your ham club.

Now you can learn the code in a fraction of the time it used to take!

four speeds available
\$4.95 for one hour.
All four \$14.95.

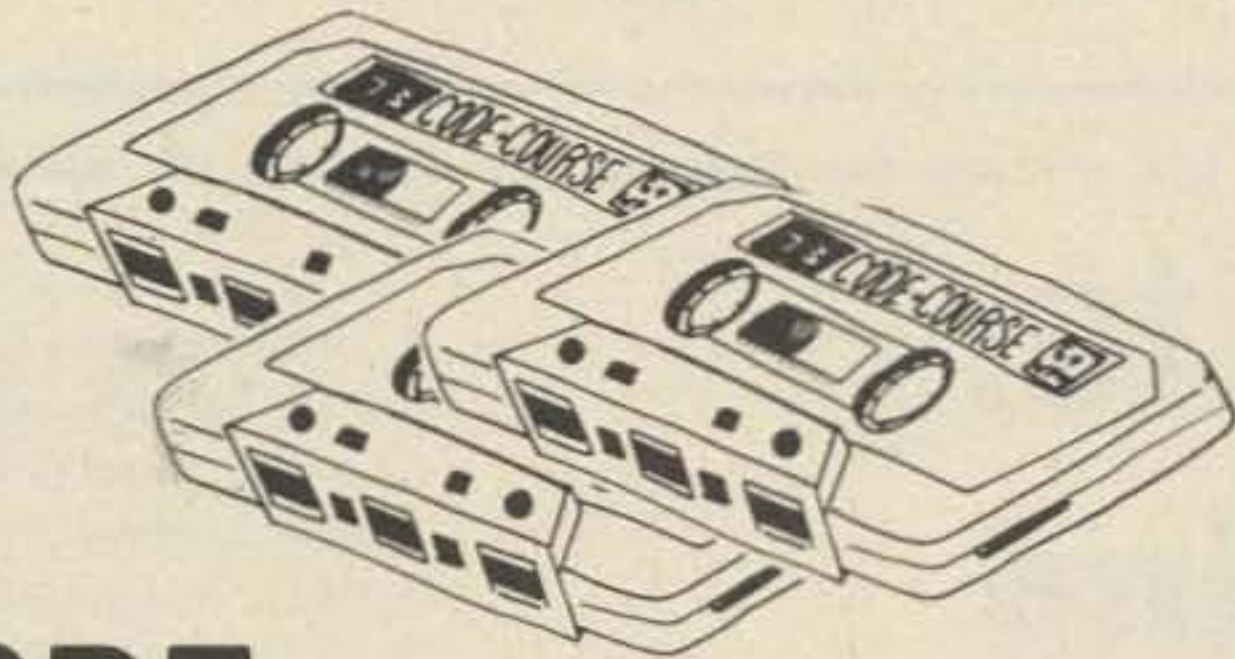

NEW CODE SYSTEM

Plays on any cassette player so you can practice anywhere anytime!

□ **5 WPM** This is the beginning tape for people who do not know the code at all. It takes them through the 26 letters, 10 numbers and necessary punctuation, complete with practice every step of the way using the newest blitz teaching techniques. It is almost miraculous! In one hour many people — including kids of ten — are able to master the code. The ease of learning gives confidence to beginners who might otherwise drop out.

□ **14 WPM** Code groups again, at a brisk 14 per so you will be at ease when you sit down in front of the steely eyed government inspector and he starts sending you plain language at only 13 per. You need this extra margin to overcome the panic which is universal in the test situations. When you've spent your money and time to take the test you'll thank heavens you had this back breaking tape.

□ **6 WPM** This is the practice tape for the Novice and Technician licenses. It is made up of one solid hour of code, sent at the official FCC standard (no other tape we've heard uses these standards, so many people flunk the code when they are suddenly — under pressure — faced with characters sent at 13 wpm and spaced for 5 wpm). This tape is not memorizable, unlike the zany 5 wpm tape, since the code groups are entirely random characters sent in groups of five. Practice this one during lunch, while in the car, anywhere and you'll be more than prepared for the easy FCC exam.

□ **21 WPM** Code is what gets you when you go for the Extra Class license. It is so embarrassing to panic out just because you didn't prepare yourself with this tape. Though this is only one word faster, the code groups are so difficult that you'll almost fall asleep copying the FCC stuff by comparison. Users report that they can't believe how easy 20 per really is with this fantastic one hour tape. No one who can copy these tapes can possibly fail the FCC test. Remove all fear of the code forever with these tapes.



FREE?

ONE YEAR SUBSCRIPTION

Well - Ahem - almost - look at it this way -

1 YEAR = \$8.00
3 YEARS = \$16.00

So how much does the second year cost? - Nothing, really!

12 REASONS FOR SUBSCRIBING TO 73 MAGAZINE... RIGHT NOW.

- You get every issue — makes a first rate electronics reference library
- No more missing issues sold out at the newsstand
- Many more articles every month than other ham magazines
- The most and the best of the ham advertising — see new products first in 73
- The editorials — like 'em or hate 'em — they do make you think
- Complete FCC releases in detail so you won't miss anything important
- The newest state of the art construction projects by top authors
- Plus five other reasons which are too obvious to mention here

mail TODAY to:



magazine

Peterborough, New Hampshire 03458

Name _____ Call _____

Address _____

City _____ State _____ Zip _____

 
 Check

Signature _____

Card No. _____

Expiration Date _____ Total enclosed _____

- Novice Theory Tapes \$13.95
- 5 WPM Beginners Cassette 4.95
- 6 WPM Back Breaker Cassette 4.95
- 10 WPM Canadian Code Tape 4.95
- 13 WPM General Practice Tape 4.95
- 20 WPM Extra-Back Breaker Tape 4.95
- 5-6-13-20 Tape Package 14.95
- Vintage Back Issues 5.00
- Recent Back Issues 5.00
- Very Recent Back Issues 5.00
- Hotline — 1 year 8.00
- 1975 Repeater Atlas 1.50
- 250 QSL — Style W X Y 6.00
- 500 QSL — Style W X Y 10.00
- 1000 QSL — Style W X Y 15.00
- 2000 QSL — Style W X Y 20.00
- Bumper Stickers @ 50c each
- Novice Study Guide 4.00
- General/Tech Guide 6.00
- Advanced Guide 4.00
- Extra Guide 5.00
- Solid State Proj 4.00
- VHF Projects 5.00
- 2m FM Handbook Hard \$7 Soft 5.00
- SSTV Handbook Hard \$7 Soft 5.00
- Digital Control Hard \$7 Soft 5.00

GET TO THE FAST TOP!

NOW YOU CAN CHANGE, ADJUST OR JUST PLAIN WORK ON YOUR ANTENNA AND NEVER LEAVE THE GROUND!

ROHN manufactures towers that are designed and engineered to do specific jobs and that is why we have the FOLD-OVER TOWER . . . designed for the amateur. When you need to "get at" your antenna just turn the handle and there it is. Like other ROHN big communication towers, they're hot dip galvanized **after** fabrication to provide a maintenance free, long lived and attractive installation. ROHN towers are known and used throughout the world . . . for almost a quarter century . . . in most every type of operation. You'll be in good company. Why not check with your distributor today?



ROHN **MANUFACTURING**

®

DIVISION OF



P.O. Box 2000 / Peoria, Ill. 61601



ICOM

IC-230

phase locked loop
synthesized
transceiver*



- * 67 + channels
- * Simplex — Duplex
- * Modular construction
- * Super hot receiver
- * ± 5 kHz freq. deviation
- * MOSFET front end
- * 5 helical filters
- * 10 Watts output

This is the radio everyone has been talking about. The IC-230 was the first Phase Locked Loop transceiver to be introduced to the U.S. amateurs and it is still the best unit available for your car. The IC-230 comes with all the standard 30 kHz channels installed and operating in the unique double mixed phase locked loop synthesizer that puts out one of the cleanest signals available anywhere. FIVE helicalized resonators in the rf section and three i-f filters help make it almost impervious to intermodulation. Because of the amazing versatility of the PLL system used in the 230, 15 kHz spacing channels may be added by simply plugging in four inexpensive crystals. The IC-230 modular construction makes repairs simpler and faster when and if they are needed.

See your ICOM AUTHORIZED DEALER TODAY!

BELLAIRE ELECTRONIC **supply**

5200 BELLAIRE BLVD.
BELLAIRE, TEXAS 77401
Phone: 713-667-4294

42.95

Kit: includes;
Power Supply,
Display card,
Timing card,
Misc. parts, less
case.



UPDATE

to

**DIGITAL
READOUT
TUNING**

**WORKS WITH ANY 160-20 METER TRANSMITTER OR
TRANSCEIVER WITH JUST A PICKUP LOOP**

- All IC
- Build it into your rig
- Converts to 15 and 10
- Even works with QRP rigs
- Mobile too
- MHz/KHz coarse/fine readout
- Frequency to 100 Hz
- Easy to build
- Power supply included
- Crystal controlled time base

BRING YOUR RIG TO THE STATE OF THE ART

HURRY, I don't want to lay out several hundred bucks for a new rig,
but I gotta have digital readout (doesn't everyone?)

Here's a check for _____ for _____ unit(s). You pay shipping.

Name _____ Call _____

Address _____

City _____ State _____ Zip _____

TWS LABS

P.O. Box 357, Provo, Utah 84601

digital clock



- 1/2" LED Digital Display
- AM PM Indicator
- Power Failure Indicator
- Power-Lock feature allows clock to hold correct time in case of brief power failures
- Size H 3 1/8 x D 3 3/8 x W 3 3/4 inches
- Color - White only
- 110 volt 60 Hz

• THIS IS NOT A KIT!
\$29.95 in Continental USA

liquid crystal display watch

... You never thought it could happen but it did, and you saw it first in 73. The digital timepiece for your wrist is finally available at the price of an ordinary wind-up watch. Yet this **QUARTZ LIQUID CRYSTAL** watch is the equal of those you've seen at two and three times our **LOW PRICE**.



- Pulsating dots show elapse of seconds
- Continuous Display
- Mfd. by American Micro Systems International (AMI)
- Guaranteed for one year by manufacturer
- Specify stainless or gold color
- Color coordinated leather watch band
- Crystals will not fade in sun like other liquid crystals
- PP in continental USA

• THIS IS NOT A KIT! \$55.00

491 Quad segment driver for LED displays 492 hex digit driver for LED displays 1 for \$1.00 10 for \$7.50	7446 IC BCD to seven segment for common anode displays 1 for \$1.00 10 for \$7.50																														
14 pin Chip Clip used for troubleshooting IC 1 for \$3.75 10 for \$35.00	GE elapsed time meter 2 5/8" x 2 5/8" sq by 3" long 120 v 60 Hz GE cat. no. 50-236402AAAA 2 jap \$7.50																														
<table border="0"> <tr> <td></td> <td></td> <td></td> <td></td> <td><i>1 ea.</i></td> <td><i>10</i></td> </tr> <tr> <td>P2102</td> <td>1024 x 1</td> <td>RAM</td> <td>\$5.75</td> <td>\$55.00</td> <td></td> </tr> <tr> <td>1101</td> <td>256 x 1</td> <td>RAM</td> <td>1.50</td> <td>12.50</td> <td></td> </tr> <tr> <td>MC1550</td> <td>rf op amp</td> <td></td> <td>1.75</td> <td>10.00</td> <td></td> </tr> <tr> <td>TC430</td> <td>quad rc tone gen</td> <td></td> <td>3.75</td> <td>30.00</td> <td></td> </tr> </table>					<i>1 ea.</i>	<i>10</i>	P2102	1024 x 1	RAM	\$5.75	\$55.00		1101	256 x 1	RAM	1.50	12.50		MC1550	rf op amp		1.75	10.00		TC430	quad rc tone gen		3.75	30.00		Computer logic diodes IN4148, same as IN914 tested prime units on tape min 25 for \$1.00 100 for \$3.00
				<i>1 ea.</i>	<i>10</i>																										
P2102	1024 x 1	RAM	\$5.75	\$55.00																											
1101	256 x 1	RAM	1.50	12.50																											
MC1550	rf op amp		1.75	10.00																											
TC430	quad rc tone gen		3.75	30.00																											
<p>resistor and cap array all resistors are 50Ω caps are .01</p> <p>1 for \$1.00 10 for \$6.50</p>	100,000 uF cap. at 10v 1 for \$2.75 10 for \$20.00																														
	Push button switch spst normal open 4 for \$1.00 25 for \$5.00																														

We are a surplus house. All items are new unless otherwise stated and all are 100% guaranteed. If you have surplus send list or sample. All samples are accounted for.

*Florida residents remit 4% state sales tax.
 All items PP in continental USA.*

Marlin P. Jones & Associates

P.O. Box 9023 • Riviera Beach • Florida 33404

THE FIRST AND STILL THE LEADER! the exciting super compact **ICOM** 230



PUT OVER 67 CHANNELS IN THE PALMS OF YOUR HANDS

SPECIAL FEATURES:

- **No More Crystals** . . . Over 67 . . . fully synthesized channels available.
- **All Channel Capability** . . . Travel with confidence that you'll be able to work all repeaters along the way.
- **Super Compact** . . . 2.28" high x 6.14" wide x 9.72" deep at a weight of only 5.5 lbs.
- **Quick Dismount Mobile Mount** . . . Allows quick car installation.
- **Easy Operation** . . . Punch up frequency, select repeater or simplex mode, and you're on the air. (A crystal may be added for a unique repeater frequency.)
- **Modular Construction** . . . In case of a problem, modules can easily be removed and sent for repair. A replacement module will be air mailed to minimize down time.
- **Super Hot Receiver** . . . Better than .4uv / 20db. sensitivity, helical filters to eliminate intermod . . . plus a super E filter and a mosfet front end.

IF THERE IS A SIGNAL, YOU'LL HEAR IT ON THE IC-230!

C F P enterprises

866 RIDGE ROAD, LANSING, N.Y. 14882

Vanguard now has the World's Largest Selection of Frequency Synthesizers from \$129.95

- Smallest size of any commercially available synthesizer — only 1-3/8" x 3-3/4" x 7".
- Excellent spectral purity since no mixers are used.
- .0005% (5 parts per million) accuracy over the temperature range of -10 to +60 C.
- Immune from supply line voltage fluctuations when operated from 11 to 16 volts dc.
- Up to 8000 channels available from one unit. Frequency selected with thumbwheel switches.
- Available from 5 MHz to 169.995 MHz with up to 40 MHz tuning range and a choice of 1, 5 or 10 kHz increments (subject to certain restrictions depending on the frequency band selected).
- Top quality components used throughout and all ICs mounted in sockets for easy servicing.
- All synthesizers are supplied with connecting hardware and impedance converters or buffers that plug into your crystal socket.



Vanguard frequency synthesizers are custom programmed to your requirements in 1 day from stock units starting as low as \$129.95 for transmit synthesizers and \$139.95 for receive synthesizers. Add \$20.00 for any synthesizer

for 5 kHz steps instead of 10 kHz steps and add \$10.00 for any tuning range over 10 MHz. Maximum tuning range available is 40 MHz but cannot be programmed over 159.995 MHz on transmit or 169.995 MHz on receive (except on special orders) unless the i-f is greater than 10.7 MHz and uses low side injection. Tuning range in all cases must be

in decades starting with 0 (i.e. — 140.000 — 149.995 etc.). The output frequency can be matched to any crystal formula. Just give us the crystal formula (available from your instruction manual) and we'll do the rest. We may require a deposit for odd-ball formulas. On pick-up orders please call first so we can have your unit ready. Call 212-468-2720 between 9 am and 4 pm Monday through Friday.

*You'll never
have to buy Crystals
again!*

**SEND NO MONEY.
WE SHIP C.O.D.
ORDER BY PHONE
AND SAVE TIME.**

Available for aircraft, fire, police and amateur frequencies.
*We ship open account only to U.S. and Canadian government agencies,
universities and selected AAA rated corporations.*

VANGUARD LABS

196-23 Jamaica Ave., Hollis, New York 11423

MEET THE STATE OF THE ART ON 2 METERS... THE ITC MULTI-2000 CW/SSB/FM TRANSCEIVER



Whether your interest is simplex, repeater, DX or OSCAR the new ITC MULTI-2000 lets you get into all the action on all of the

band. Fully solid-state and employing modular construction, the MULTI-2000 enjoys features found in no other 2m transceiver.

FEATURES

- PLL synthesizer covers 144-148 MHz in 10 kHz steps
- Separate VXO and RIT for full between-channel tuning
- Simplex or ± 600 kHz offset for repeater operation
- Three selectable priority channels
- Multi-mode operation (CW/SSB/NBFM/WBFM)
- Built-in AC and DC power supplies, noise-blanker squelch and rf gain control
- Selectable 1W or 10W output
- Separate S-/power and frequency deviation meters
- Built-in test (call) tone and touch-tone provision
- Excellent sensitivity ($.3 \mu\text{V}$ for 12 dB SINAD)
- Superior immunity to crossmodulation and intermodulation
- Introductory price: \$695.

KLAUS RADIO Inc.

8400 N. Pioneer Parkway, Peoria IL 61614, Phone 309-691-4840
Cliff Morris W9GAO — Jim Plack WB9BGS

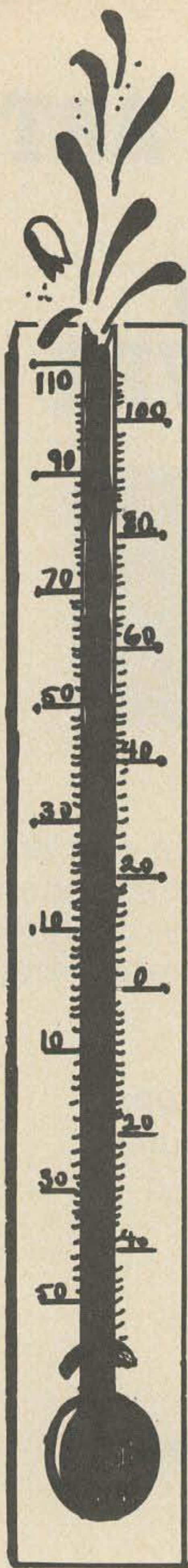

WRITE FOR
PRICE QUOTES



IC 230

- PLL SYNTHESIZER
- 67 CHANNELS - 30 KH SEPARATION
- HELICAL FILTERS
- AUTOMATIC PROTECTION CIRCUITRY
- MODULAR CONSTRUCTION

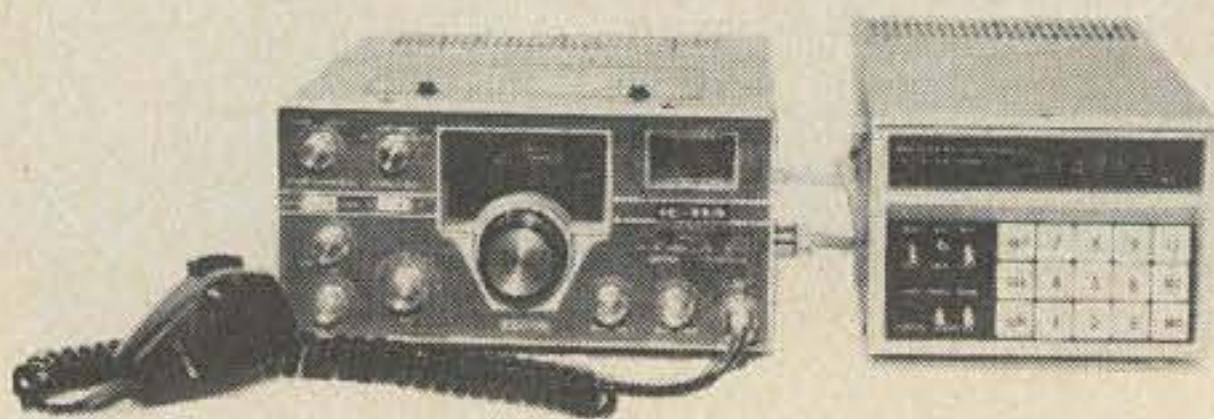

IC21A

- 24 CHANNEL CAPABILITY
- 7 CHANNELS SUPPLIED
- MOSFET FRONT END
- 0.4 UV SENSITIVITY
- 5 HELICAL FILTERS
- BUILT IN AC & DC POWER SUPPLIES

DV-21

- FULLY SYNTHESIZED VFO
- OPERATES IN 5 OR 10KH STEPS
- COVERS ENTIRE 2 METER BAND
- SCANNING CAPABILITY
- 2 PROGRAMMABLE MEMORIES
- TOUCH KEYS TO SET XMIT & RECEIVE FREQUENCY

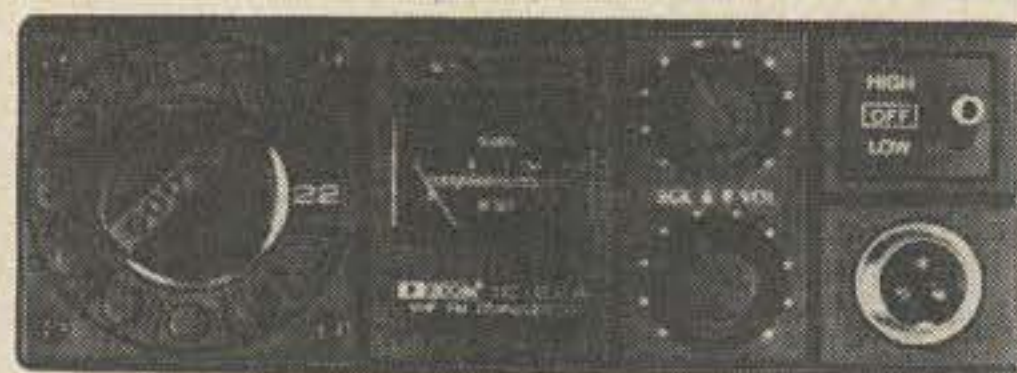

IC22A

- 22 CHANNEL
- 5 CHANNELS SUPPLIED
- SOLID STATE TR SWITCHING
- 10W-1W POWER SAVER OPTION
- TRIMMER CAPS ON EACH CHANNEL

HAMTRONICS FEATURING ICOM

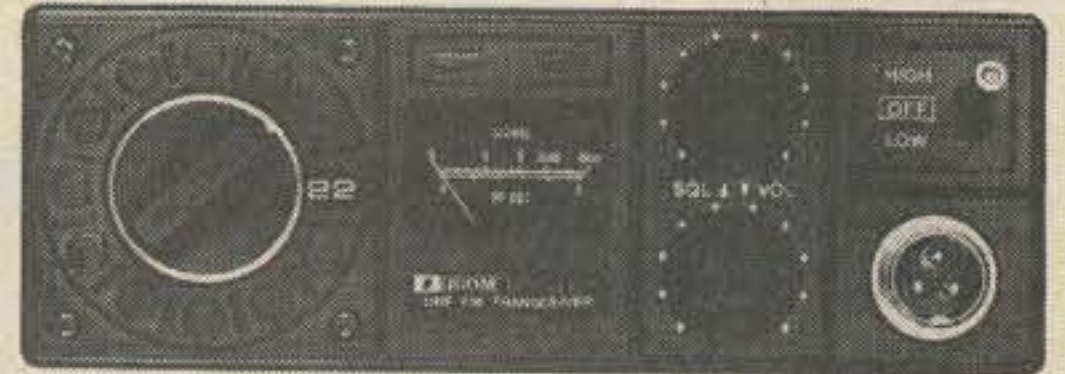

ICOM 30A

- 10 WATT OUTPUT
- ALL SOLID STATE
- 0.6 UV FOR 20dB QUIETING
- 22 CHANNEL - 5 INSTALLED
- MODULAR CONSTRUCTION



HAMTRONICS



A DIVISION OF TREVOSE ELECTRONICS

4033 BROWNSVILLE ROAD, TREVOSE, PA. 19047

215-357-1400 or 1475

ICOM

IC-21A



Program any frequency you want... any frequency split you desire. Scan... active or inactive frequencies... adjustable scan rate. LED Digital readout on transmit and receive. The ICOM IC-21A and the DV-21... a truly advanced and unique package well ahead of its time.

\$838.95

ICOM

IC-230



VHF FM PHASE LOCKED LOOP SYNTHESIZED TRANSCEIVER
PUT OVER 67 CHANNELS IN THE PALMS OF YOUR HANDS FOR JUST **\$489.00**

\$100.00 FREE MERCHANDISE
with purchases over \$800.00

\$50.00 FREE MERCHANDISE
with purchases over \$400.00

\$25.00 FREE MERCHANDISE
with purchases over \$200.00

ICOM IC-22A



22 CHANNEL
2-METER FM
10 WATTS
ONLY \$249.00

READY TO GO ON:
1 94/94
2 34/94
3 22/82
4 28/88
5 52/52

REGULATED POWER SUPPLY

4 AMP
6 AMP MAXIMUM

\$49⁹⁵

SPECIAL LIMITED QUANTITY VARITRONIC'S AS-2HG

5/8 2 METER
GROUND PLANE
3.5 db GAIN

\$22⁹⁵

10W in - 70W out

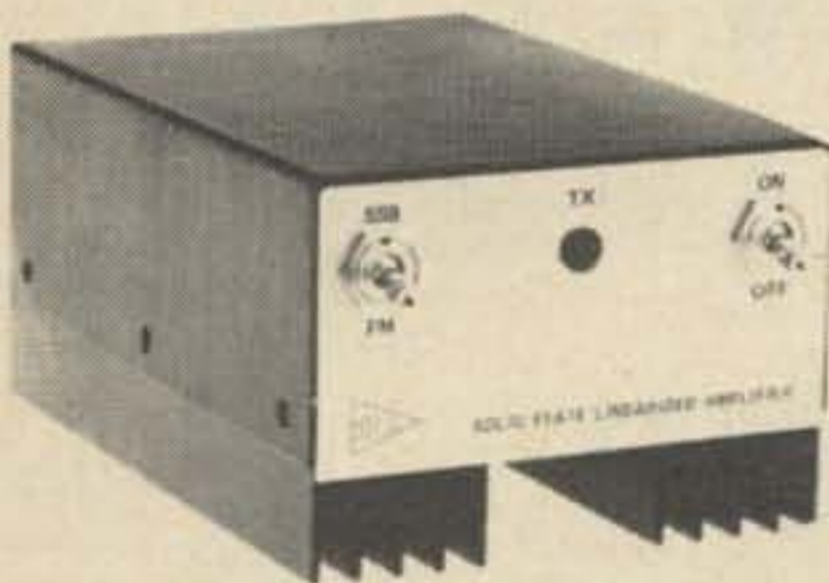

\$139.95
2 M10 - 70 L

THE GROWING LINE OF SCS AMPLIFIERS INCLUDE THESE NO COMPROMISE FEATURES:

Completely Solid State Broadband Design Requires No Retuning Across Band Selectable Biasing For:
Class C-High Power FM at Peak Efficiency
Class AB-Linear for SSB or Low Power FM
Increased T-R Delay for SSB/CW Operation. Fully VSWR and Reverse Voltage Protected. One Year Warranty on Entire Amplifier. Under One DB Insertion Loss in Receive.

2 METER AMPLIFIERS

1 WATT = 25 WATTS OUTPUT



TOUCH TONE PAD
SALE **\$29.95**
VEGA BEEP BOX

Sale Extends Thru August... 12 Button Tel Touch Self-Contained Battery. Audible Coupled. No Wiring.



\$49.95 Kit
\$69.95 Assembled

AN AMPLIFIER FOR YOUR HAND-HELD

Carrier Operated Relay Can Be Driven From 180 mw. No Tuning. Output Short Circuit Protected. Easy to Install & Operate.



Bearcats
SCANNING MONITORS
\$139.95
Powerful, Crisp, Clear Speaker Performance!
Bearcat Scans 25-Channels-Per-Second... fewer missed signals! Built-in 12-Volt DC/117-Volt AC Power Capability! Made in Cumberland, Indiana, U.S.A.

VEGAS RADIO

1108 SO. 3rd STREET • LAS VEGAS, NEVADA 89101
Call or Write: Norm, W7IUC 702-382-4305

ORDER UNDER \$100 ADD \$2.50 FOR SHIPPING & HANDLING... NEVADA RESIDENTS ADD SALES TAX

**WE DON'T HAVE
YOUR NUMBER
BUT YOU HAVE OURS**

Toll Free
(Cont. 48 States)

800-325-3636

(MO. cust call 314-993-6060 coll.)

**CALL
HAM RADIO CENTER
ST. LOUIS
FOR NEW AND USED
AMATEUR RADIO EQUIPMENT**

*We Trade on New or Used
Charge it on Master-Charge or BankAmericard*

HAM RADIO CENTER INC.

8342 Olive BL.
P.O. Box 28271
St. Louis, MO 63132

A head start on the future

Midland's 220 MHz mobile transceiver puts you into this fast developing band for less than you might think. 10-watt output power, 12-channel capability with crystals for 223.5 simplex, plus these professional performance features...

A dual conversion receiver with complete multiple FET front end coupled with high-Q helicalized cavity resonators • Zener regulated, crystal controlled first and second oscillators • 10-watt output power transmitter (switchable to 1 watt) with zener regulated crystal oscillator • High-Q and shielded stages for minimal interstage reaction • Encased low-pass filter • VSWR bridge and four DC amplifiers to monitor output and give instant automatic protection • Accessory jack for tone burst and discriminator filter • Swing-up circuit board for easy access to all sections... all modules easily removable • Operation on 13.8 volts DC, negative ground • Compact steel case 2¼" h. x 6¾" wide x 8⅞" d. Complete with mike, mounting bracket and hardware.

Midland's exclusive
added ingredient

R.S.V.P.

Positive, practical support
for your repeater service
when you buy any Midland
amateur mobile transceiver.

Write for free Midland Amateur
Radio Catalog... see why
"COMMUNICATIONS IS OUR
MIDDLE NAME"

MIDLAND
INTERNATIONAL®
Communications Division

P.O. Box 19032
Kansas City, Missouri 64141

MODEL 13-509



WE'VE GIVEN IT A NEW LOOK!



IC-22A

The front panel and control locations have been changed to make the IC-22A even better looking and easier to operate. The new design allows the use of larger channel numbers which may be

viewed from the left side or right side by reversing the window position and installing a new dial. (optional at nominal cost)

Inside is the same high quality radio construction and engineering that has made the IC-22 the most reliable, most popular two meter crystal controlled set on the market.

When you join 22 channels of capacity (five supplied) with the unexcelled performance of helical RF filtering in the receiver front end then add solid state T-R switching you get one great radio for your money. All the great features that made the IC-22 so desired are still there. Including, 1 watt/10 watt switch option, trimmer capacitors on both receiver and transmitter crystals plus a 9 pin accessory jack with the discriminator already wired for frequency calibration.

Bob Smith Electronics

1226 9th Ave. N., Fort Dodge, Iowa 50501

RGS ELECTRONICS

008A MICROCOMPUTER KIT

8008 CPU, 1024 x 8 memory; memory is expandable. Kit includes manual with schematic, programming instructions and suggestions; all ICs and parts supplied except cabinet, fuses & hardware. Includes p.c. board.

\$375.00

MANUAL ONLY, \$25.00
(no discount on manual)

008A-K ASCII keyboard input kit. \$135.00

008A-C Audio cassette adapter kit. \$100.00

Details on computer, peripheral kits in our flyer.

\$12.00 VALUE FREE

With each order of \$50.00 or more, a FREE subscription to *BYTE*, the new computer hobbyists' magazine. ASK FOR IT when you order; we won't include it unless you ask. (Offer open to residents of continental U.S. only.)

"THE CUBE" Fully assembled subaudible tone generator for small handheld or portable FM radios. 9-16 volts; no moving parts, set anywhere between 98 & 240 Hz with a trim resistor.

.5" x .6" x .8" \$19.95

Set on frequency by the factory, \$5.00 extra

PS 25-1 0 to 25v 1a lab type power supply with adjustable current limiting; remote sensing & remote programming for voltage & current. Instructions included. All parts except chassis, meter(s), p.c. board. Kit of parts with schematics \$14.95
P.C. boards available, No. 007 \$3.00 ea.

TTL

7400	\$.20	7485	\$1.40
7401	.20	7486	.50
7402	.20	7489	2.90
7403	.20	7490	.80
7404	.25	7492	.80
7405	.25	7493	.80
7406	.45	7495	.90
7407	.45	7496	.85
7408	.25	74107	.50
7409	.25	74121	.60
7410	.20	74122	.60
7411	.30	74123	1.10
7413	.85	74125	.65
7416	.45	74126	.65
7417	.45	74141	1.25
7420	.20	74150	1.70
7430	.20	74151	1.00
7432	.30	74153	1.40
7437	.50	74154	1.70
7438	.50	74157	1.40
7440	.20	75161	1.50
7442	1.10	74161	1.70
7446	1.45	74164	2.00
7447	1.45	74165	2.00
7448	1.45	74166	1.75
7450	.20	74174	2.20
7451	.20	74175	2.20
7453	.20	74176	1.60
7454	.20	74177	1.35
7473	.45	74181	3.90
7474	.45	74192	1.50
7475	.80	74193	1.45
7476	.50	74195	1.00
7483	1.10		

SOME NEW TRANSISTORS . . .

			1-99	100+
N1	T0-92	NPN Darlington	\$.35	.30
N2	T0-92	NPN lo-noise, lo-level	.15	.10
N3	T0-92	NPN medium purpose	.20	.15
N4	T0-92	NPN 2N3904 type	.15	.10
N5	T0-92	NPN UHF	.20	.15
N6	T0-92	NPN RF-IF	.15	.10
P2	T0-92	PNP lo-level	.15	.10
P3	T0-92	PNP medium power	.20	.15
P4	T0-92	PNP 2N3906 type	.15	.10
P7	T0-92	PNP high-voltage	.25	.20
P8	T0-92	PNP higher-voltage	.30	.25

AND SOME OLD TRANSISTORS . . .

		1-99	100+
2N2222	T0-18 NPN	\$.25	.20
2N2907	T0-18 PNP	.25	.20
NPN	T0-92 general purpose	.08	.0595
PNP	T0-92 general purpose	.08	.0595

Data on all transistors and JFETS is now in our flyer.

BRAND NEW ALUM. ELECTROLYTIC CAPS, RADIAL LEAD

	10wv	35wv	50wv
1mfd	\$.10	\$.12	\$.15
2mfd	.10	.12	
5mfd	.10	.12	
10mfd	.11	.13	.16
30mfd	.12	.20	.28
50mfd	.13		
100mfd	.15	.30	.45
200mfd	.20		.70
500mfd	.28	.75	
1000mfd	.50		

RGS ELECTRONICS

3650 Charles St., Suite K ■ Santa Clara, CA 95050 ■ (408) 247-0158

We sell many ICs and components not listed in this ad. Send a stamp for our free flyer. **TERMS OF SALE:** All orders prepaid; we pay postage. \$1.00 handling charge on orders under \$10.00. California residents please include sales tax. Please include name, address and zip code on all orders and flyer requests. Prices subject to change without notice.

DISCOUNTS: 10% OFF ORDERS OVER \$25.00; 20% OFF ORDERS OVER \$250.00

S. D. SALES CO.

P. O. BOX 28810 DALLAS, TEXAS 75228

6 Digit Digital Clock Kit

Our Engineer said it would be "impossible" to sell a Six Digit kit for this price. But because of several special super buys we made on chips and displays we can offer this unbelievable bargain on our Clock Kit. Sure, this price is too good to be true, but rest assured, all parts in this kit are prime, first run units. Also, all kits are sold with an unconditional money back guarantee.

Here's What The Kit Includes:

- 1 — MM5314 National Clock Chip with socket
- 6 — Common Cathode Led Readouts (.25 in. char.)
- 13 — NPN and PNP Driver Transistors
- 2 — Push Button Switches for time set
- 1 — Rocker Switch for time hold
- 1 — Filter Cap
- 4 — IN4001 Rectifiers
- 1 — IN914 Diode
- 2 — .01 Disc. Caps
- 9 — Carbon Resistors

Transformer for this kit — \$1.50.

\$9⁹⁵ (KIT)
WITH SPECS.
POSTPAID

P.C. BOARD FOR ABOVE — \$3.00 each

All you need to add is a 12VAC Transformer, perfboard, and your choice of case. The above parts, if ordered separately from our competitors, could cost you as much as \$20. Buy from S.D. and you'll be happy with our quality parts and ultra fast shipment.

<p>IC SOCKETS 14 PIN-5 For \$1 16 PIN-4 For \$1</p>	<p>SWITCHES FOR DIGITAL CLOCKS, ETC. Rocker style. SPDT. miniature size. 4 for \$1. Push Button. SPST N.O. Enclosed, mini. 4 for \$1</p>
<p>NATIONAL 2K ERASEABLE PROM 2048 Bit, static units. U.V. light erasable. MM5203. Factory prime new units. Special — \$14.95.</p>	<p>SUBMINIATURE TRIMMER CAPS Ultra stable. Range: 3.5 to 18 PF. 2 for \$1</p>
<p>DIGITAL CLOCK CHIPS BY NATIONAL FACTORY NEW UNITS! MM5314 — 4 or 6 digits. 24 pin DIP. Use with LED Readouts. With Specs. — \$3.95 MM5316 — Alarm chip. 40 pin DIP. \$4.44</p>	<p>FILTER CAPS Dual section, 2000 MFD and 1500 MFD at 30 WVDC. Twist Lock. 79c ea. 3 For \$2</p>
<p>TEXAS INSTRUMENTS 8 DIGIT CALCULATOR CHIP TMS0 103NC. Four function. Same style as used in TI pocket calculators. Factory new units, with specs. \$1.99 each.</p>	<p>NATIONAL VOLTAGE REGULATOR Like 7805. 5VDC — 1 AMP output. Has TO-220 plastic power tab — 99c</p>
<p>1AMP 1000 PIV SILICON RECTIFIERS IN4007. Factory prime devices. 10 for \$1.00.</p>	<p>IN4148 COMPUTER DIODES Same as IN914. Factory prime. 20 for \$1.</p>
<p>741C OP AMPS Prime, factory tested and marked. Full spec on all parameters. Not re-tested, functional only, units as sold by others. 741CH — TO-5 8 Lead Metal Can 3/\$1 741CV — 8 Lead Mini Dip 4/\$1</p>	<p>FULL WAVE BRIDGE By G.I. 1.5 AMP 800PIV — 75c</p>
<p>12VDC RELAY DPDT. Heavy gold plated 5 amp contacts. 300 OHM coil. Limited Qty. 99c</p>	<p>2N706A 400MHZ. TRANSISTORS Silicon NPN. 1 WATT. TO-18 Case. 5 For \$1</p>
	<p>723CH PRECISION VOLTAGE REGULATOR Build a circuit regulating the voltage from 2 to 37 volts. Complete specs included. One of the easiest to use regulators now on the market. S.D. Special Introductory Price 2 For \$1.00</p>

S. D. SALES CO.

P. O. BOX 28810 DALLAS, TEXAS 75228

FAST SERVICE — QUALITY MERCHANDISE
BARGAINS GALORE — NO BACK ORDERS

We are **SMALL** enough to give personalized service, but
LARGE enough to handle every order swiftly and efficiently!

INTEL 1K 2102 RAM

Factory prime, tested units. Factory selected for much faster speed than units sold by others. 650 NS. These are *static* memories that are TTL compatible and operate off + 5 VDC. The real workhorse of solid state memories because they are so easy to use. Perfect for TV typewriters, mini-computers, etc. With specs.

\$3.95 ea. or 8 for \$30

SIGNETICS 1K P-ROM

82S129. 256 x 4. Bipolar, much faster than MOS devices. 50NS. Tri-state outputs. TTL compatible. Field programmable, and features on chip address decoding. Perfect for microprogramming applications. 16 pin DIP. With specs. \$2.95 ea.

LM324 — QUAD 741 OP AMP — \$1.50

NE555 — Timers — 69c or 10 For \$6

709CH — OP AMPS — 4 For \$1

GE SCR C106B1

4 AMP 200PIV. Sensitive Gate. 59c

MOTOROLA POWER DARLINGTON — \$1.99

MJ3001 - .NPN - 80 Volts - 10 Amps - HFE 6000 typ. To-3 Case. Ideal for power supplies, etc. We include a free 723 regulator w/schematic for power supply with purchase of the MJ3001. You get the two key parts for a DC supply for only \$1.99. Regular catalog price for the MJ3001 is \$3.82

TRANSISTORS

Type	Mat.	Pol.	Vceo	Ic	Hfe	Case	Price
2N3904	S	N	40	100MA	200	TO-92	6/1.00
2N3906	S	P	40	100MA	200	TO-92	6/1.00
2N4401	S	N	40	250MA	200	TO-92	6/1.00
2N4403	S	P	40	250MA	200	TO-92	6/1.00
2N3638	S	P	25	150MA	60	TO-105	6/1.00
EN930	S	N	45	50MA	300	TO-106	6/1.00
2N2905	S	P	40	350MA	200	TO-5	4/1.00
2N4249	S	P	60				6/1.00

RCA HIGH VOLTAGE POWER TRANSISTOR

100 Watts. 5 Amps. 300 VCEO. TO-3 case. Silicon NPN. Mfg. house numbered 2N5240. Regular catalog is \$6. Perfect for H.V. supplies or vertical and horizontal circuits.

SPECIAL — 99c

HEAVY DUTY TRANSFORMER

36 VAC, 3.5 AMPS. 115VAC 60HZ. PRI. For power supplies or audio power amps. Best quality, fully enclosed. \$4.95

Our 6 DIGIT CLOCK is not a CHEAP CLOCK KIT, only inexpensive. That's why we have sold several thousand in the last three months, without a single kit being returned for refund.

ORDERS OVER \$15

CHOOSE \$1

FREE MERCH.

FREE BONUS

All clock or calculator chips are shipped with *free socket*.

FAIRCHILD LED READOUTS — 69c

FND-70. Common cathode. Right hand decimal point. .25 inch character. Prime new units. Perfect for clocks, frequency counters, etc. 69c 10 For \$6
Best Readout Buy In USA!

10 PIN SOCKETS FOR FND-70

An S.D. exclusive. For use with our Fairchild LED readouts.

29c ea. 10 For \$2.50

DO YOU NEED A LARGE, COMMON ANODE READOUT AT A FANTASTIC PRICE?

S.D. presents the MAN-64 by Monsanto - .40 inch character. All LED construction - not reflective bar type, fits 14 pin DIP. Brand new and factory prime. Left D.P.

\$1.59 ea. 6 For \$7.50

DL747 JUMBO LED READOUTS

By Litronix. .65 inch character. Common anode. Outperforms SLA-3. Perfect for giant digital clocks. Only 20 MA. per segment. Special — \$2.50 ea.

LARGE SIZE LED LAMPS

Similar to MV5024. Prime factory tested units. We include plastic mounting clips which are very hard to come by.

Special 4 For \$1

PC BOARD MATERIAL

FR-4 blank epoxy boards. 2 oz. copper, 5 x 10 in. Single Sided.

Limited Qty. — \$1.49

MOTOROLA VOLTAGE REGULATOR

MC1469R. TO-66 9 Lead package. For 3 TO 30V Outputs. Provides 600 MA direct output or more by using an external power transistor. Reg. catalog \$4 ea. With specs. \$1.95 ea.

MOTOROLA NEGATIVE VOLTAGE REG

MC1463R — Like our 1469R above, except for negative voltage. Reg. catalog \$5. Our price \$1.95.

POWER TRANSISTOR PC BOARD

Mfg. by Memorex Computer Corp. Board has 20 Power Transistors. 10-RCA 2N3585 TO-66 SILICON NPN. VCEO-300 IC-2AMPS. 10-MOTOROLA MJE-340. NPN Silicon. VCEO-300. Plastic power tab case. Also has 10-2N2222A TO-18 NPN transistors and 10-1N5059 1 AMP 200 PIV rectifiers, plus 32 resistors. LIMITED QTY. Board #103. \$3.99 ea.

48 HOUR SERVICE

You deserve, and will get prompt shipment. On orders not shipped in 48 HRS., a 20% cash refund will be sent. We do not sell junk. Money back guarantee on every item. WE PAY POSTAGE. Orders under \$10 add 75c handling. No C.O.D. Texas Res. add 5% tax.

S. D. SALES CO.

P.O. BOX 28810
DALLAS, TEXAS 75228

Expedition 'round the world

Meet adventure head on. Shipmates wanted who yearn to achieve for themselves rather than be pampered aboard plush, pretentious cruise ships. Share this adventure with a small congenial group in a highly informal atmosphere without regimentation or timetable. In this age of luxury and self-indulgence our expedition offers a unique, exciting opportunity.

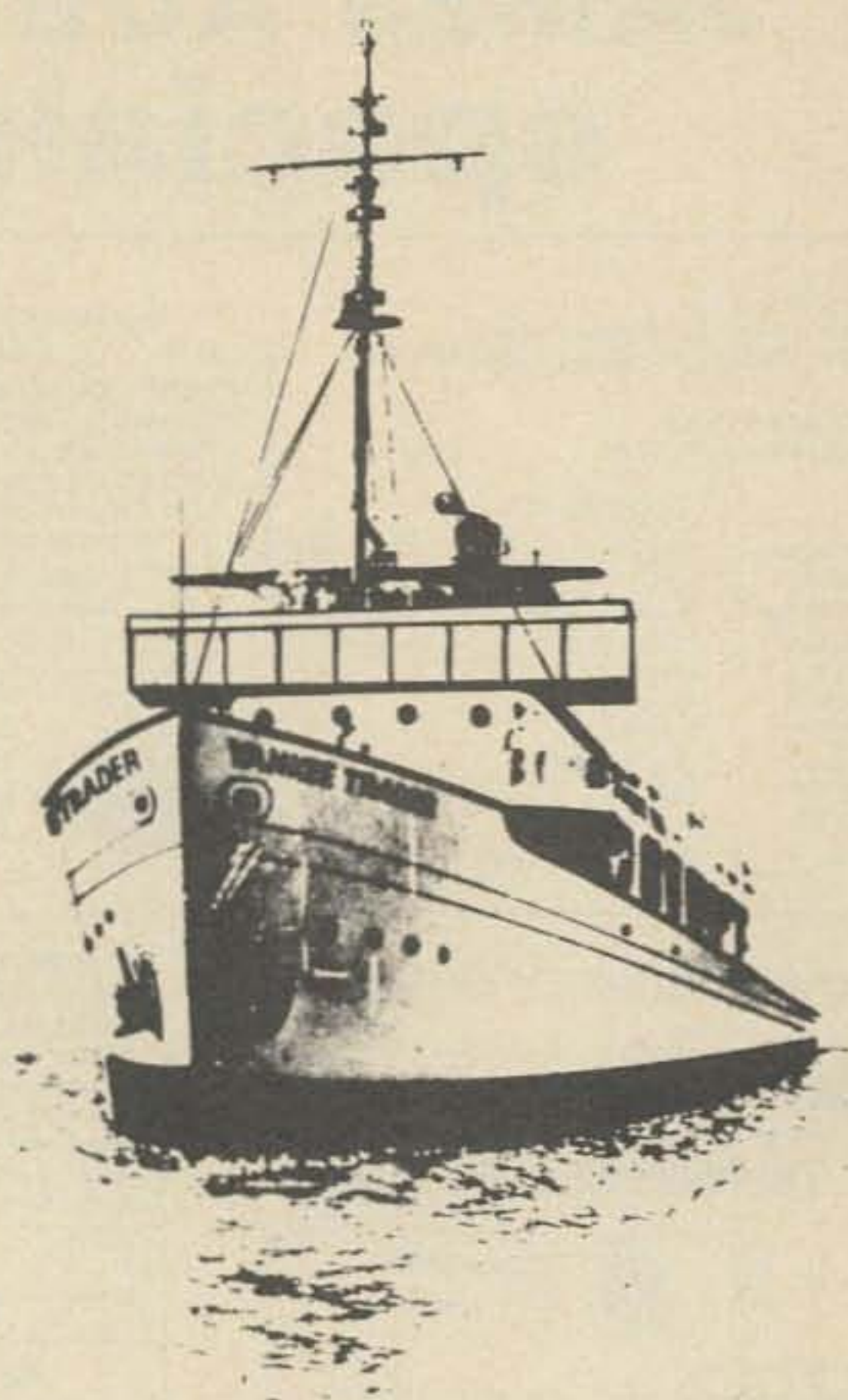

YANKEE TRADER
(Famous oceanographic vessel)
Length 180. Beam 31.5, 1106 tons
9 MONTHS — SHARE EXPENSES

Special Ham Discount!

Ports of call

**Cape Haitien.
San Salvador.
Panama.
Pitcairn Island.
Easter Island.
Rapa. Tahiti.
Ahe. Moorea.
Galapagos.
Samoa. Tutuila.
Danger Island.
Guadacanal.
Tulagi. Bali.
New Guinea. Java.
Madagascar.
Zanzibar. Beira.
Capetown.
St. Helena.
Ascension Island.
Rio. Devil's Island.
Paramariba.
Martinique.
Antigua. Exuma.
Nassau.**

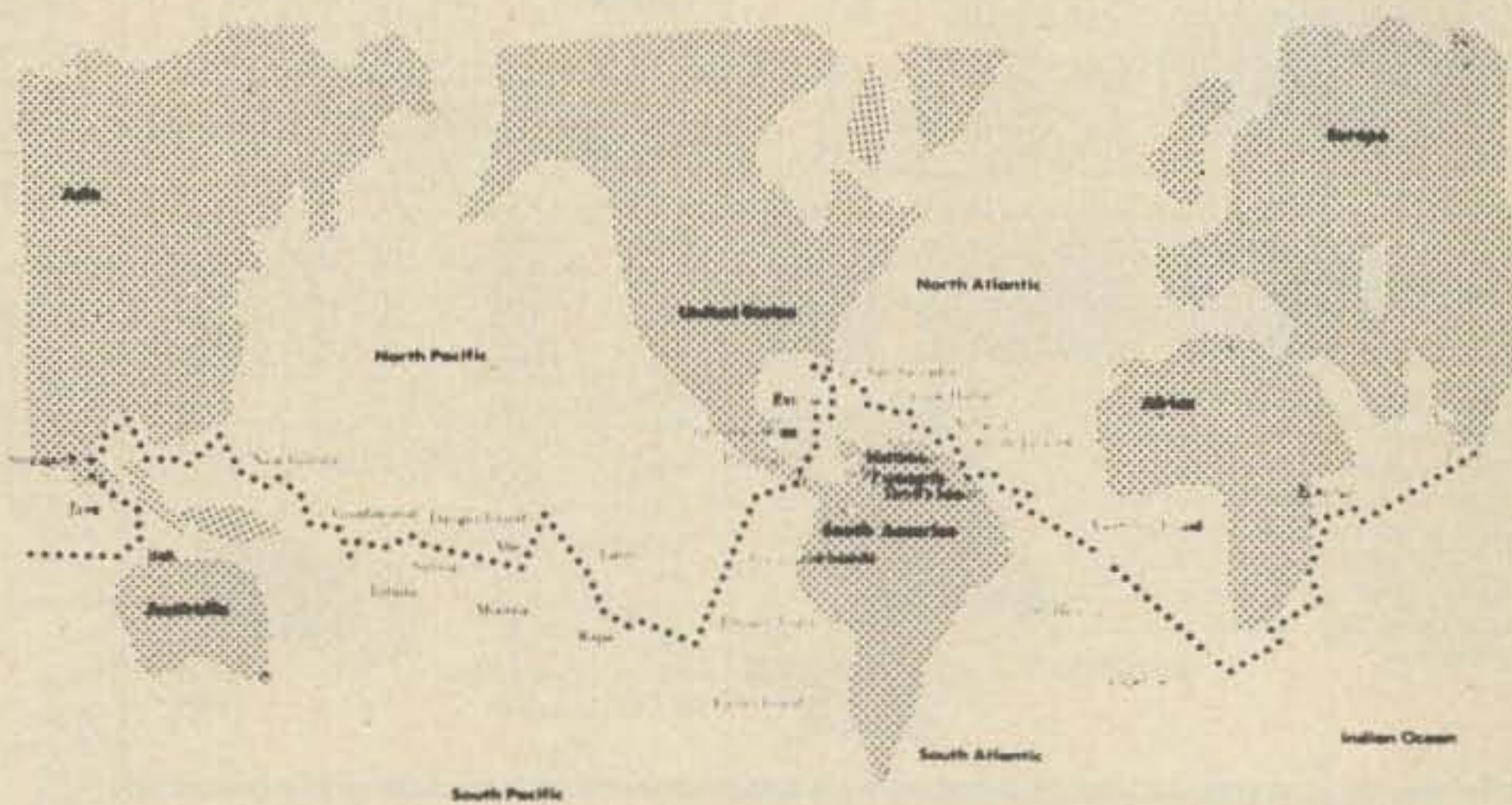

Please send me your free 'round the world expedition booklet



Windjammer Cruises.
A WINDJAMMER INTERNATIONAL SUBSIDIARY - OTC

Name _____
Address _____
City _____ State _____ Zip _____
Phone _____

P.O. Box 120, Dept. 121. Miami Beach, Florida 33139

Take off your shoes.



Hit the deck in shorts and a tee shirt. Or your bikini if you want.

You're on a leisurely cruise to remote islands. With names like Martinique, Grenada, Guadeloupe. Those are the ones you've heard of.

A big, beautiful sailing vessel glides from one breathtaking Caribbean jewel to another. And you're aboard, having the time of your life with an intimate group of lively, fun-loving people. Singles and couples, too. There's good food, "grog," and a few pleasant comforts...but there's little resemblance to a stay at a fancy hotel, and you'll be happy about that.

Spend ten days exploring paradise and getting to know congenial people. There's no other vacation like it.

Your share from \$245. A new cruise is forming now. Write Cap'n Mike for your free adventure booklet in full color.



SPECIAL HAM DISCOUNT



Windjammer Cruises.
A WINDJAMMER INTERNATIONAL SUBSIDIARY • OTC

Name _____

Address _____

City _____

State _____

Zip _____

Phone _____

P.O. Box 120, Dept. 121

Miami Beach, Florida 33139



SUNTRONIX COMPANY

6 KING RICHARD DRIVE, LONDONDERRY, N. H. 03053

603-434-4644

ITEM D: CRT HIGH VOLTAGE POWER SUPPLY —

This is a real super CRT High Voltage Power supply, providing all voltages needed for any CRT. Outputs 10-14KV DC, plus 490 Vdc, minus 150 Vdc. Needs inputs of plus 5.0 VDC, plus 16.0 VDC and a drive signal of approx 8.4 kHz @ 1.0 vrms or more. All inputs/outputs via plug/jack cables and even has a socket/cable assy for the CRT. A very fine buy at only — \$14.95 (incl. data) **FOB**

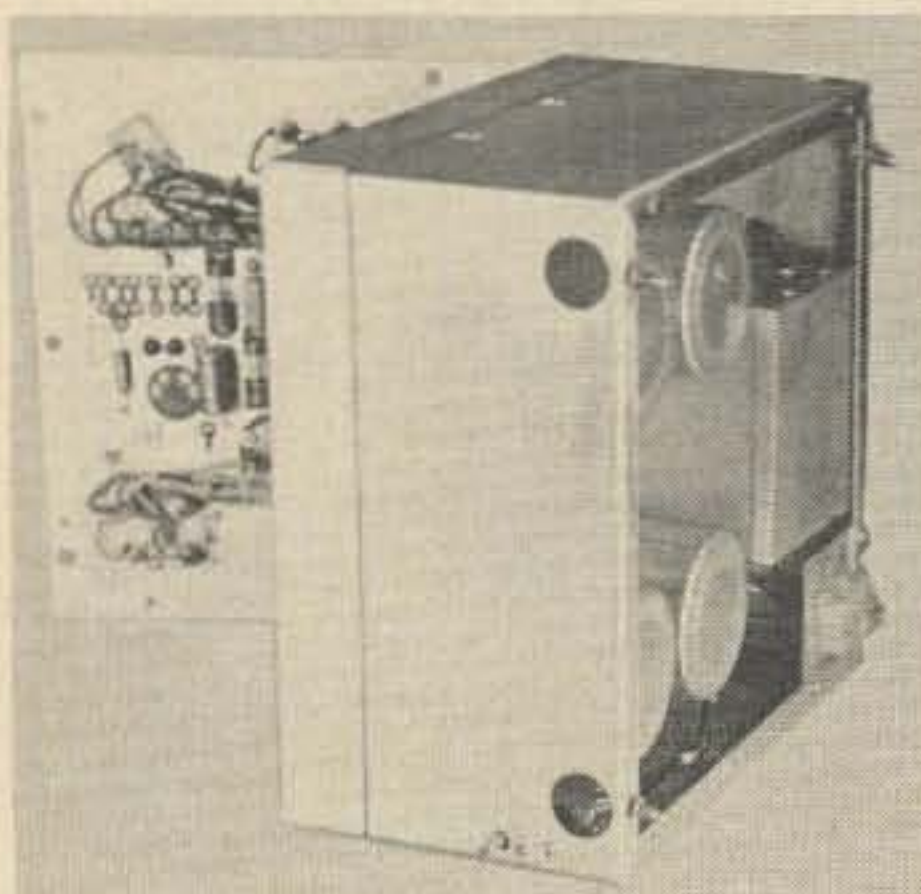

ITEM E: LOW VOLTAGE POWER SUPPLY —

A real brute used to supply all low voltages needed by the original 720 CRT Terminal. Input, 117VAC, outputs: plus 16.0 VDC @ 10.0 A; minus 16.0 VDC @ 10.0A; plus 5.0VDC @ more than 2.0A, all regulated. Mounts on the rear of the Basic Chassis (Item B) Weighs approx 45 lbs and will be shipped with interconnection data for only — \$19.95 **FOB**.

ITEM F: ENCLOSURE AND BEZEL FOR 12" CRT —

This is the frosting on the cake. All components A thru E fit perfectly inside this enclosure. It is hinged and can be lifted for easy access to the electronics. It will really dress up any project. Measures approx. 22"L x 18"W x 20"H and weighs approx. 10 lbs. Made of steel with a handsome blue crackle finish. Get 'em while they last, for — \$11.95 (incl. bezel) **FOB**.

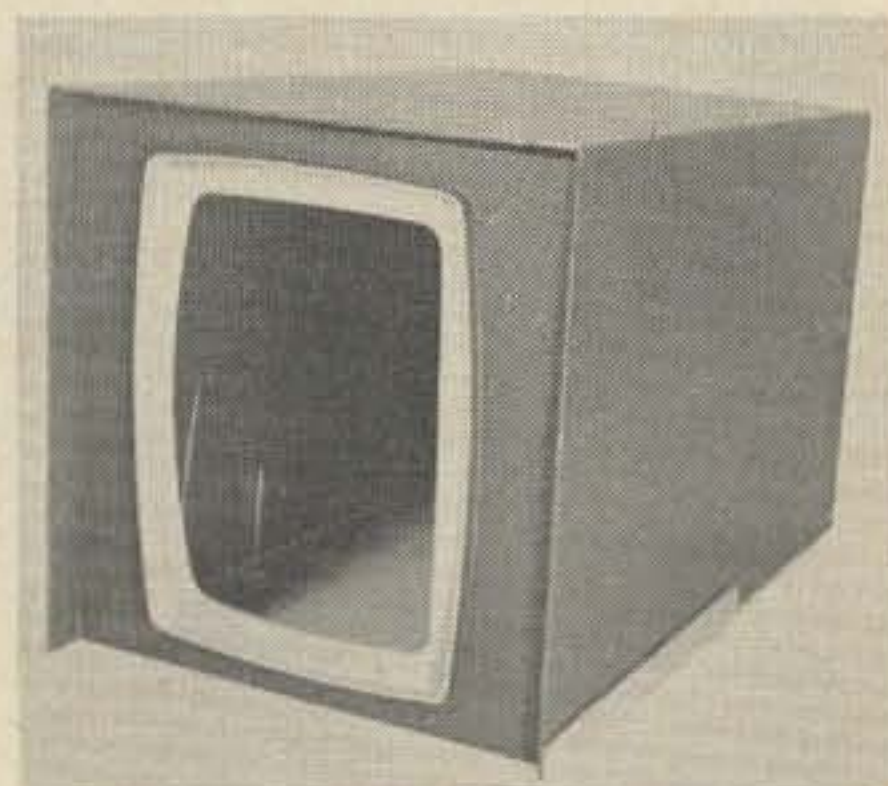

ITEM G: ASCII KEYBOARD —

This is the ASCII encoded keyboard used with the SANDER'S ASSOCIATES 720 System Terminal. Plugs into the front of the chassis mounting base. Makes a very professional Video Readout Terminal combination. These keyboards are in like new condition, have interconnection data etched on the IC-Diode matrix PC board. They can be readily used for any ASCII encoded requirement. Similar keyboards, when available, sell for almost two times the very low SUNTRONIX price of — \$49.95. **PPD**

PACKAGE DEAL — For the really serious experimenter we'll make a very special offer — you can buy all of the sub-assemblies listed above plus a good 12" CRT, a muffin fan for cooling. We'll supply instructions for interconnection for all subassemblies so that you can, within minutes after receiving this once-in-a lifetime deal, put an X-Y display on the CRT. We'll also include a list of possible applications for those with short imaginations! Don't miss out on this real money-saving buy; the individual prices for the sub-assemblies add up to \$127.70. You can buy the entire package for a very low package price of — \$79.95 **FOB**.

We've got a bunch of these fantastic video display terminals . . . and we've got a little problem. We promised Sanders Associates that we would sell them as scrap. A couple of wires disconnected makes them scrap, right? These VDTs should be great for SSTV, for a CW/RTTY keyer terminal, an oscilloscope, weather satellite monitor, or even a computer terminal (which they were). We've tested some of these and they seem to be near-perfect. You aren't likely to find a VDT system like this for less than ten times the price . . . so order several right away while we've got 'em.

ITEM A: VERTICAL AND HORIZONTAL AMPLIFIER Subassemblies — Good for a conservative 150W complementary DC coupled output. Freq. resp. beyond 2.0 MHz. Parts alone worth many times the low, low price of — \$6.95 ea., or both for \$10.95 PPD

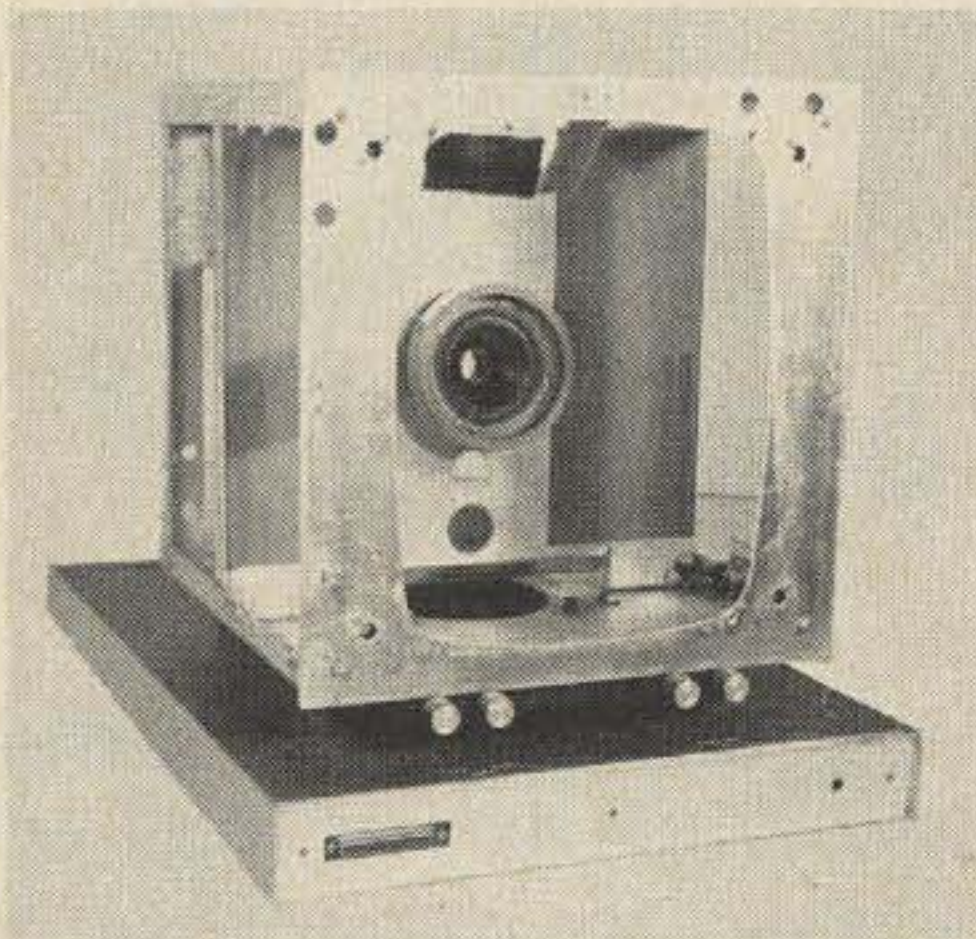
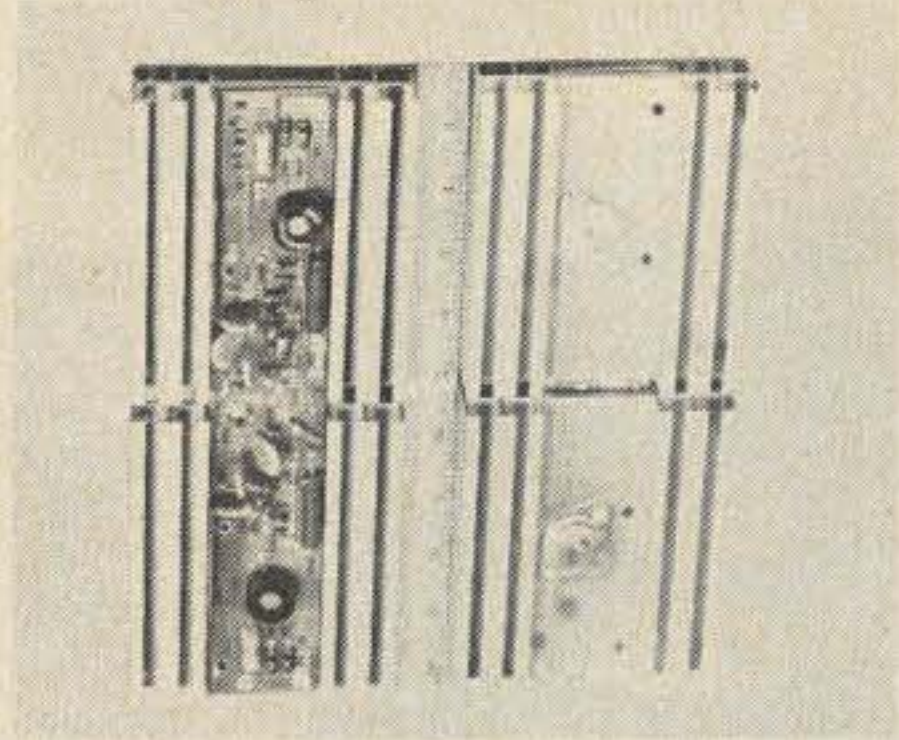

ITEM B: BASIC CHASSIS AND MOUNTING BASE for 12" big-screen CRT. Tube can be mounted either vertically or horizontally by rotating front plate 90 degrees. Comes with base, on-off sw. and intensity control, four controls for vert. and horiz. Has plenty of room for most any electronics needed for your pet project. All subassemblies offered will perfectly fit in spaces provided. Why try to cut the metal yourself? This chassis will let you concentrate on the electronics instead of the metal-work!! Order now for only — \$14.95 FOB, less CRT.

ITEM C: FOUR PC BOARDS CHOCK-FULL OF GOODIES — Two D/A converters, one IC-loaded logic board, and one multipurpose board. We have no schematic data for these boards at present. We will supply any data we obtain to purchasers as we get it. Of course when we finally figure out what these boards are good for, the price will change accordingly. Take the gamble now and we'll provide any data we get free of charge. Buy all four boards or just one — \$1.50 ea. (our choice) or all four for \$5.00. PPD

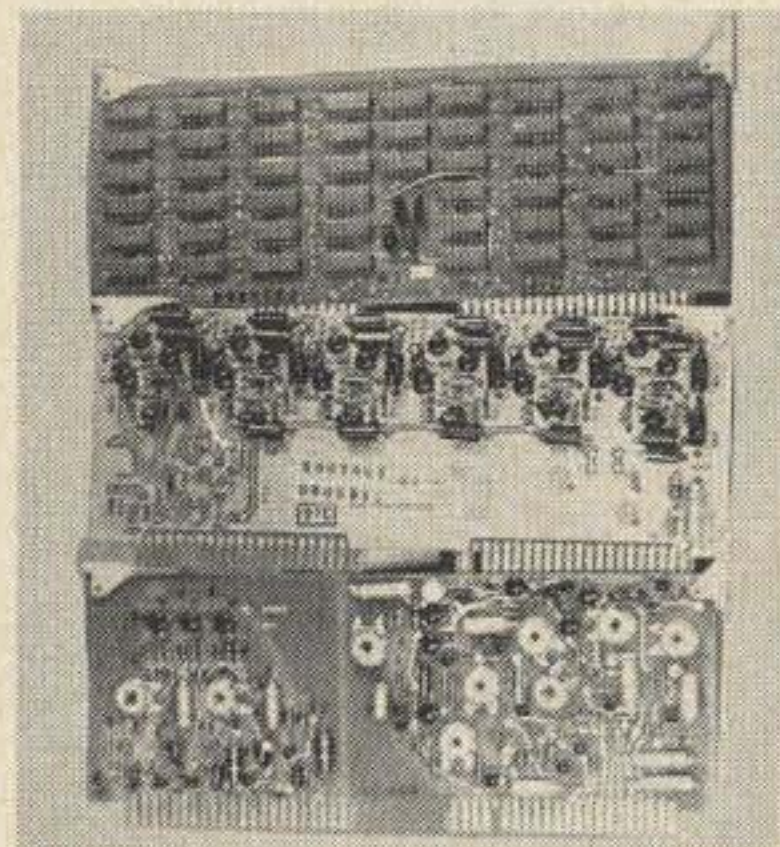

On all postpaid orders, please ADD \$1.50 to cover handling costs. Orders shipped same day in most cases.

F.O.B. warehouse. Send SASE for literature.



SUNTRONIX COMPANY

6 KING RICHARD DRIVE, LONDONDERRY, N. H. 03053

603-434-4644

TERMS AND ALL THAT STUFF: ADD 50¢ TO ORDERS UNDER \$10; ITEMS POSTPAID EXCEPT WHERE INDICATED. CALIFORNIA RESIDENTS ADD TAX. NO COD.

NOW...CALL (415) 357-7007 24 HOURS A DAY TO PLACE MASTERCARD OR BANKAMERICARD ORDERS.

GODBOUT

BILL GODBOUT ELECTRONICS
BOX 2355, OAKLAND AIRPORT, CA 94614

KEYBOARDS!

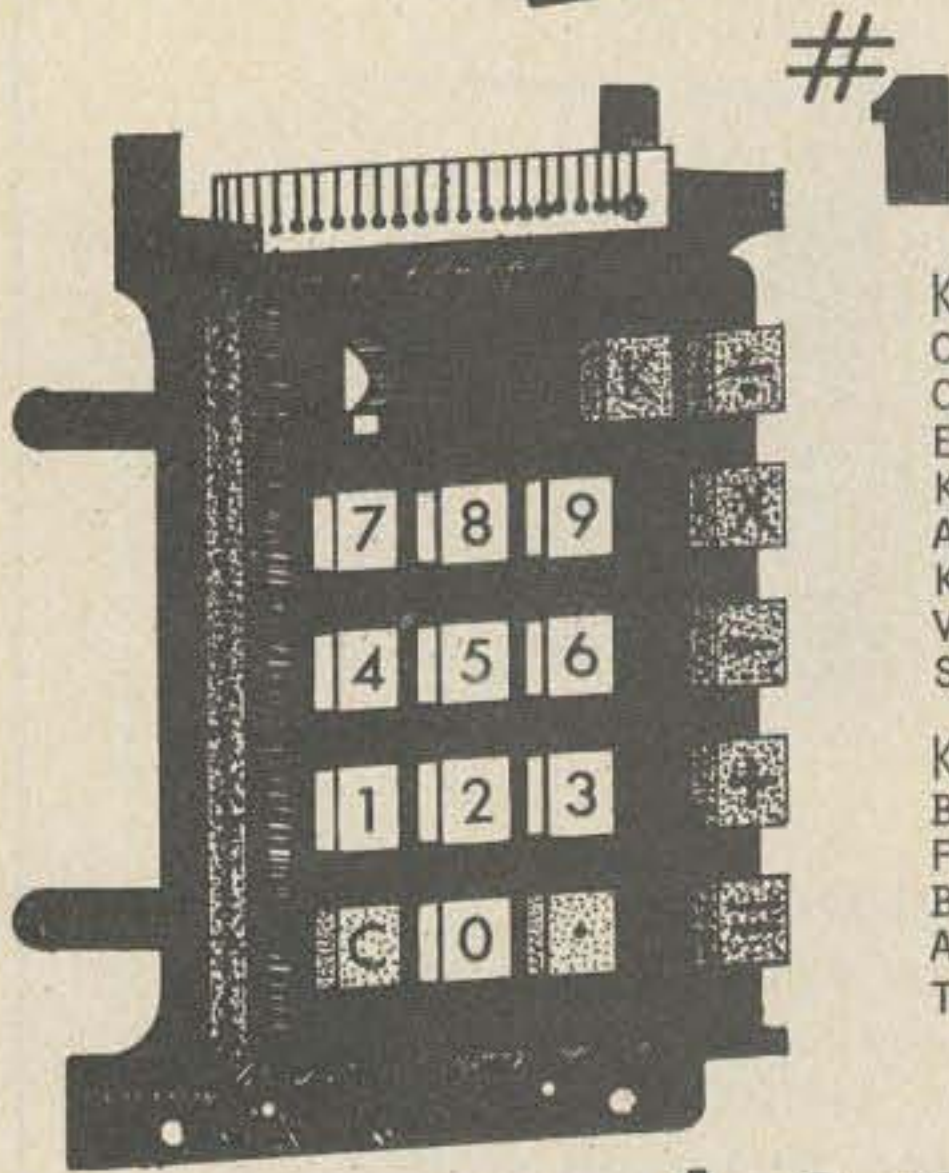

#1
\$2.95

KEYBOARD #1 IS A NON-MULTIPLEXED TYPE; IT CAN BE USED FOR APPLICATIONS OTHER THAN CALCULATORS (TOUCH TONE, LOGIC CIRCUITS, ELECTRONIC MUSIC). ONE TERMINAL OF EACH KEYSWITCH IS COMMON BUSSED, BUT AN X-ACTO KNIFE CAN MAKE BOTH TERMINALS OF ALL KEYS ISOLATED FROM ALL OTHER KEYS. A VERY VERSATILE KEYBOARD, COMPARABLE TO OTHERS SELLING NATIONALLY FOR FIVE BUCKS AND UP.

KEYBOARD #2 IS A MULTIPLEXED TYPE, SUITABLE FOR CALCULATOR + OTHER APPLICATIONS. FOR LESS THAN TWO BUCKS YOU GET ONE KEYBOARD WITH CHARACTERS PRINTED ON THE KEYS AS SHOWN, ALONG WITH AN IDENTICAL MODEL THAT HAS NO PRINTING ON THE KEYS.

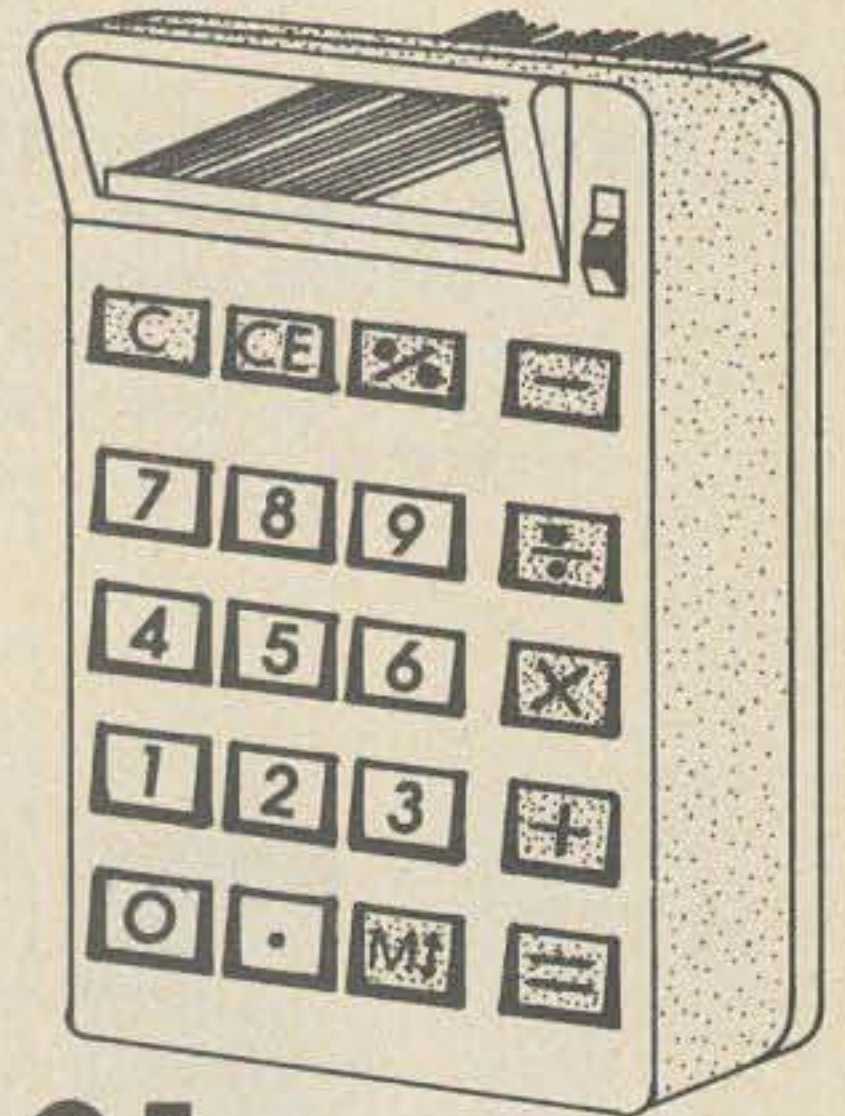

#2
2/\$1.95

DIP SWITCH
\$1.50

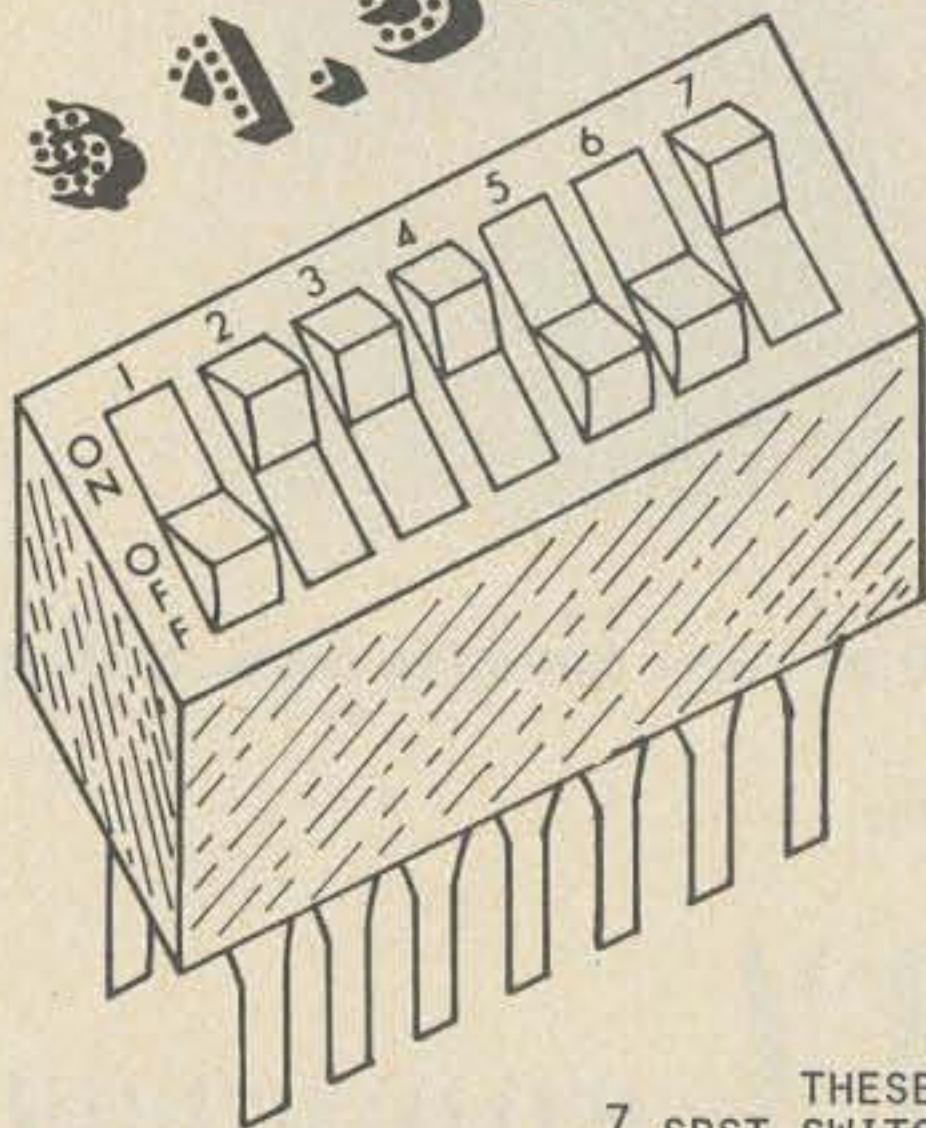

THESE ARE 7 SPST SWITCHES, PACKED INTO A DIP PACKAGE. GREAT FOR SET AND FORGET SWITCHING APPLICATIONS, PATCHING, SIGNAL ROUTING + DOZENS OF OTHER USES. THIS ITEM IS TO SWITCHES AS TRIMPOTS ARE TO RESISTORS; BEST OF ALL, THE PRICE IS RIGHT.

HOBBYWRAP TOOL---WHY SOLDER YOUR PROTOTYPES? WIRE WRAPPED CONNECTIONS PROTECT COMPONENTS FROM HEAT, ARE EASILY MODIFIED FOR CORRECTIONS OR CHANGES, MAKE CONNECTIONS THAT ARE BETTER THAN SOLDER, AND CAN SPEED UP THE TIME REQUIRED FOR ASSEMBLY OF COMPLEX DIGITAL PROJECTS. IF THE HIGH COST OF WRAPPING PUTS YOU OFF, LOOK AT OURS..YOU GET THE TOOL (RECHARGEABLE SO YOU DONT HAVE TO DEAL WITH TRAILING CORDS IN TIGHT PLACES), BIT, CHARGER, NICADS, AND INSTRUCTIONS.

HOBBYWRAP TOOL



\$41.95

CHEAP CLOCK = \$12.95

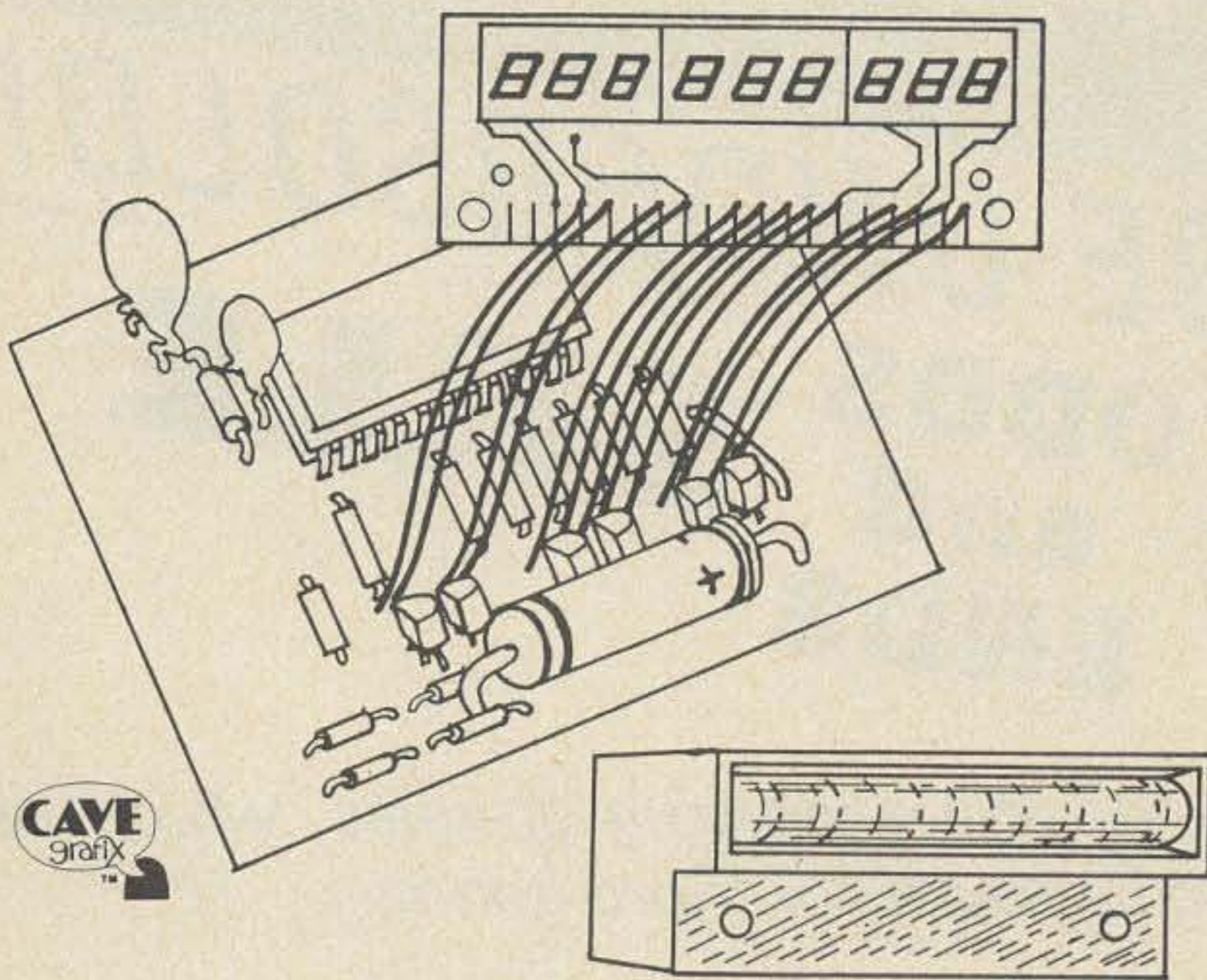

THIS KIT HAS GONE OVER VERY WELL. COMES LESS CASE AND TRANSFORMER, BUT INCLUDES EVERYTHING ELSE. PARTS MOUNT ON MOTHERBOARD; READOUT + LENS MOUNT ON DAUGHTERBOARD, AND THE READOUT MAY BE REMOVED. THE READOUT-BOARD-LENS COMBINATION ALONE HAS SOLD FOR \$14.95 NATIONALLY.

TIME BASE KIT \$13.95

IF YOU WANT TO USE OUR CHEAP CLOCK---OR OTHER DIGITAL TYPES---IN THE FIELD, TRY OUR MICROPOWER 60 HZ TIME BASE KIT. IT DELIVERS A STABLE, CRYSTAL - CONTROLLED SOURCE OF 60 HZ TIMING PULSES. USES CMOS LOGIC: WORKS FINE WITH A 9 VOLT BATTERY.

COMPUTER STUFF*****

ROM PROGRAMMING*****

WE CAN PROGRAM YOUR 5203s, 1702s, AND OTHER ROMs. COST IS \$7.50 FOR ONE, OR 10 FOR \$35.00. CALL OUR 24 HOUR PHONE LINE TO REQUEST HEXADECIMAL CODING FORMS.

8008 MICROPROCESSOR*****

THIS EXTREMELY POPULAR PROCESSOR CHIP FORMS THE BASIS FOR 8 BIT MICROCOMPUTERS, GAMES, SMART TERMINALS, AND OTHER COMPUTER ORIENTED APPLICATIONS. WE'VE GOT THEM, AND FOR ONLY \$27.95.

RESISTOR ASSORTMENT

OUR POPULAR RESISTOR ASSORTMENT IS BACK IN STOCK AFTER A SHORT VACATION. STILL CONTAINS 500 OR MORE QUARTER-WATT RESISTORS, WITH A WIDE RANGE OF POPULAR VALUES. LEADS ARE CUT AND FORMED FOR PC MOUNTING. IF YOU PREFER HALF-WATT RESISTORS, WE CAN STILL MAKE A DEAL. 300 OR MORE HALF-WATTERS PER ASSORTMENT.

ASSORTMENTS: ¼ WATT \$3.95; ½ WATT \$1.95

DIODE SPECIAL

LEADS CUT FOR PC INSERTION; HOWEVER, THE CUTTING + BENDING JOB ISN'T THE GREATEST IN THE WORLD. IN FACT, MIKE QUINN SAYS THEY'RE KIND OF SCHMOOGILY. STILL, THEY'RE ELECTRICALLY PERFECT, BRAND NEW 1N4003 TYPE DIODES, PERFECT FOR HOBBYISTS AND COMPUTER FREAKS.



DIODE SPECIAL: 100/ \$2.49

PC BOARD STOCK

THESE ARE SINGLE SIDE COPPER CLAD PC BOARD STOCK, .050 INCHES THICK, AND 9 x 14.5 INCHES TOTAL SIZE. MAY HAVE NOTCH IN CORNERS, OTHERWISE NEW CONDITION.

PC BOARD \$1.50/SHEET, 2/ \$2.95. ADD SHIPPING, 1 LB. PER BOARD.

GODBOUT

BILL GODBOUT ELECTRONICS
BOX 2355, OAKLAND AIRPORT, CA 94614

POWER SUPPLY NEWS: OUR 12 VOLT--8 AMP POWER SUPPLY, FEATURED IN THE MAY ISSUE OF 73 MAGAZINE, IS ONE OF OUR ALL-TIME BEST SELLING KITS. WE RECENTLY IMPROVED THE UNIT BY ADDING A PRECISION 723 REGULATOR, AND IT TESTED OUT SUPERBLY ON THE BENCH. HOWEVER, A FEW PEOPLE WROTE US SAYING THAT WHEN OPERATED IN THE PRESENCE OF A STRONG RF FIELD, THE POWER SUPPLY SEEMED TO MYSTERIOUSLY SHUT DOWN, AS IF IT HAD BEEN OVERLOADED. K3IUY, IRV SANDERS, WROTE IN TO SAY THAT HE FIGURED THE PROBLEM WAS DUE TO RF GETTING INTO THE CURRENT LIMITING NETWORK OF THE 723. WE WOULD SUGGEST THAT OWNERS OF OUR HEFTY 12 VOLT SUPPLY ADD TWO .001 CAPACITORS FROM PINS 2 AND 3 OF THE 723 TO GROUND, AND A .01 DISC CERAMIC ACROSS THE OUTPUT OF THE POWER SUPPLY. THIS KEEPS RF AWAY FROM THE CHIP, SOLVING THE PROBLEM. IF BY ANY CHANCE YOU DON'T HAVE ONE OF THESE HANDY BENCH/LAB/EQUIPMENT SUPPLIES, THEY'RE STILL AVAILABLE FOR \$20.95 + SHIPPING FOR 8 POUNDS. GIVE US YOUR STREET ADDRESS SO WE CAN SHIP IT UPS.

OTHER NEWS: REMEMBER THE "WE-NEED-A-NEW-TYPEWRITER" SPECIAL OF A FEW MONTHS BACK? WELL, WE GOT THE NEW TYPEWRITER. THANK YOU VERY MUCH!

DUPAGE FM

WILL NOT BE UNDERSOLD!

Motorola

**ODDS
and
ENDS**

SALE

We have limited quantities of the following goodies, which we offer at a cut rate price to make room for more goodies.

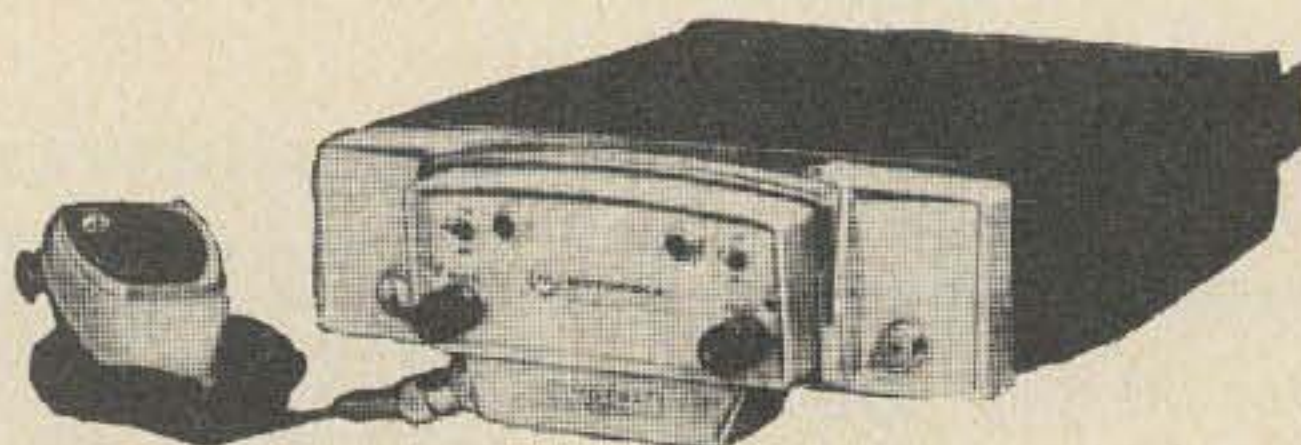

MOTRACS U43HHT-1100 152 to 162 MHz, thirty Watts output. Transistorized receiver and power supply. Trunk mount, with cables and control head. Regularly \$240.00 only \$200.00.

T-POWER U43GGT-3100 152 to 162 MHz, thirty Watts output. Transistor power supply. With private line squelch. Trunk mount with cables and control head. Regularly \$145.00 now only \$125.00.

MOTORCYCLE RADIOS D33BAT 152 to 162 MHz. 10 Watts output. Transistorized receiver and power supply. Front mount, less mike & power cable. Only \$50.00.

Quantities are limited, please specify your second choice.

SEND A CHECK OR MONEY ORDER TODAY TO:

**DU PAGE FM INC. P.O. Box 1 Lombard, Ill. 60148
(312) 627-3540**

TERMS: All items sold as is. If not as represented return for exchange or refund (our option) shipping charges prepaid within 5 days of receipt. Illinois residents must add 5% sales tax. Personal checks must clear before shipment. All items sent shipping charges collect unless otherwise agreed. Accessories do not include crystals, relay or antennas.



7-Segment Readout 12-PIN DIP

Three digits with right-hand decimal
Plugs into DIP sockets
Similar to (LITRONIX) DL337
Magnified digit approximately .1"
Cathode for each digit
Segments are parallel for multiple
operation
5-10 MA per segment
EACH \$1.75 4 (12 DIGITS) \$6.00

RCA Numitron

EACH.....\$ 5.00

SPECIAL: 5 FOR \$20.00

DR2010



1024 Bit Memory

1024 Bit Fully Decoded Static MOS
Random Access Memory

- fast access 650ns
- fully TTL compatible
- n channel silicon gate
- single 5 volt supply
- tri-state output
- 1024 by 1 bit
- chip enable input
- no clocks or refreshing required

Brand New Factory Parts
16 PIN DIP Each \$5.00
8 for \$34.95

Power Supply SPECIAL!

723 DIP variable regulator chip 1-40V,
+ or - output @ 150 MA 10A with external
pass transistor--with diagrams for
many applications.
EACH \$1.00 10 FOR \$8.95

5001 Calculator

40-Pin calculator chip will add, subtract,
multiply, and divide. 12-digit
display and calculate. Chain calculations.
True credit balance sign output.
Automatic over-flow indication.
Fixed decimal point at 1, 2, 3, or 4.
Leading zero suppression. Complete
data supplied with chip.

CHIP AND DATA.....ONLY \$2.49
DATA ONLY (Refundable)... \$1.00
5002 LOW POWER CHIP AND DATA \$12.95

High Quality PCB Mounting IC Sockets

8-PIN, 14-Pin, 16-Pin and 24-Pin PCB
mounting ONLY--no wire wrap sockets.

- 8-Pin.....\$.22
- 14-Pin.....\$.26
- 16-Pin.....\$.30
- 24-Pin.....\$.75
- 40-Pin.....\$1.25



All IC's are new and fully tested. Leads
are plated with gold or solder. Orders
for \$5.00 or more will be shipped prepaid
Add \$.55 for handling and postage for
smaller orders; residents of California
add sales tax. IC orders are shipped
within 2 workdays--kits are shipped with-
in 10 days of receipt of order. \$10.00
minimum on C.O.D.'s.

Mail Orders to: Phone
P.O. Box 41727
Sacramento, CA (916) 334-2161
95841

BABYLON ELECTRONICS

Money back guarantee
on all goods!



Dale Trimmer

-12 turn trimpots which plug
into a DIP socket
-5K and 200K
-1/2" x 1/2" x 1/4"
-4 leads spaced .3" x .2"
Each \$1.00 10 for \$8.95

1000 MHz Counter

11C05 Fairchild 1GHz Divide By Four

- DC to 1000 MHz operation
 - AC or DC coupled
 - Voltage compensated
 - TTL or ECL power supply
 - 50 ohm drive output
 - Lead compatible with Plessey SP613
 - True and complement ECL outputs
 - 14 pin DIP
 - Data and application notes
- Each \$49.95

LED's

- MV50 Red Emitting \$.20
10-4 MA @ 2V 10 FOR \$1.25
- MV5024 Red TO-18 \$.35
High Dome 10 FOR \$2.95
- MV10B Visible Red \$.30
5-7 MA @ 2V 10 FOR \$2.50

CMOS

- | | |
|---------------|---------------|
| CD4001 \$.45 | CD4023 \$.45 |
| CD4002 .45 | 74C20 .65 |
| CD4011 .45 | 74C160 3.25 |
| CD4012 .45 | |

3-Amp Power Silicon Rectifiers

MARKED EPOXY AXIAL PACKAGE

- | PRV | PRICE | PRV | PRICE |
|----------|-------|-----------|-------|
| 100..... | \$.10 | 800..... | \$.30 |
| 200..... | .15 | 1000..... | .40 |
| 400..... | .18 | 1200..... | .50 |
| 600..... | .23 | 1500..... | .65 |

DIODE ARRAY 10-1N914 silicon
signal diodes in one package. 20
leads spaced .1"; no common connec-
tions.

EACH.....\$.29
10 FOR \$2.50

- | | |
|-----------|------------|
| 7400 .20 | 74H51 .25 |
| 74H00 .30 | 7453 .20 |
| 7401 .20 | 7454 .20 |
| 74H01 .25 | 74L54 .25 |
| 7402 .25 | 74L55 .25 |
| 7403 .25 | 7460 .16 |
| 7404 .25 | 74L71 .25 |
| 74H04 .30 | 7472 .40 |
| 7405 .30 | 74L72 .60 |
| 7406 .40 | 7473 .35 |
| 7408 .30 | 74L73 .75 |
| 74H08 .30 | 7474 .45 |
| 7410 .20 | 74H74 .75 |
| 7413 .75 | 7475 .80 |
| 7417 .40 | 7476 .55 |
| 7420 .20 | 74L78 .70 |
| 74L20 .30 | 7480 .50 |
| 74H20 .30 | 7483 .70 |
| 74H22 .30 | 7489 3.00 |
| 7430 .20 | 7490 1.00 |
| 74H30 .30 | 7492 .65 |
| 74L30 .30 | 7493 1.00 |
| 7440 .20 | 7495 .65 |
| 74H40 .30 | 74L95 1.00 |
| 7442 1.00 | 74107 .35 |
| 7447 1.50 | 74145 1.25 |
| 7450 .20 | 74180 1.00 |
| 74H50 .30 | 74193 1.50 |
| 7451 .20 | 74195 .65 |

7400 Series DIP

25K Trimmer

PRINTED CIRCUIT BOARD TYPE
EACH \$.20 10 FOR \$1.50

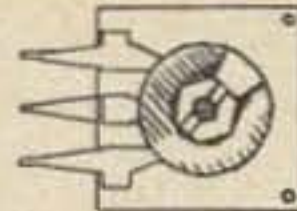

Rectifiers

- | | | | |
|------------------------|----|------|--------|
| VARO FULL-WAVE BRIDGES | | | |
| VS447 | 2A | 400V | \$.90 |
| VS647 | 2A | 600V | \$1.10 |
| MR810 Rectifier 50V 1A | | | \$.10 |

Special 811: Hex Inverter

TTL DIP Hex Inverter; pin interchangeable with SN
7404. Parts are brand new and branded Signetics
and marked "811."

- | | | |
|----------|----------|--------|
| | EACH | \$.16 |
| DATA | 10 FOR | 1.50 |
| SHEET | 100 FOR | 14.00 |
| SUPPLIED | 1000 FOR | 110.00 |



1 AMP RECTIFIER

- EACH \$.15
1N4007 1KV PRV
SALE 10 for \$1.00

MAN 4 7-Segment, 0-9 plus letters.
Right-hand decimal point. Snaps in 14-
pin DIP socket or Molex. IC voltage re-
quirements. Ideal for desk or pocket
calculators!



EACH \$1.20 10 OR MORE \$1.00 EACH

CD-2 Counter Kit

This kit provides a highly sophisticated display
section module for clocks, counters, or other nu-
merical display needs. The unit is .8" wide and
4 3/8" long. A single 5-volt power source powers
both the ICs and the display tube. It can attain
typical count rates of up to 30 MHz and also has
a lamp test, causing all 7 segments to light. Kit
includes a 2-sided (with plated thru holes) fiber-
glass printed circuit board, a 7490, a 7475, a
7447, a DR2010 RCA Numitron display tube, complete
instructions, and enough MOLEX pins for the ICs...
NOTE: boards can be supplied in a single panel of
up to 10 digits (with all interconnects); there-
fore, when ordering, please specify whether you
want them in single panels or in one multiple
digit board. Not specifying will result in ship-
ping delay.

COMPLETE KIT ONLY \$10.95

FULLY-ASSEMBLED
UNIT \$15.00

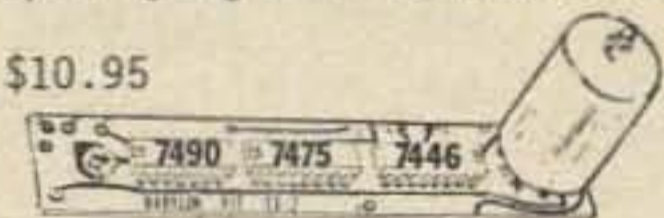

Boards supplied separately @ \$2.50 per digit.

LINEARS

- | | | |
|---------|---|------|
| NE555 | Precision timer..... | .90 |
| NE560 | Phase lock loop DIP..... | 2.95 |
| NE561 | Phase lock loop DIP..... | 3.00 |
| NE565 | Phase lock loop..... | 2.95 |
| NE566 | Function generator TO-5..... | 3.50 |
| NE567 | Tone decoder TO-5..... | 3.50 |
| 709 | Popular Op Amp DIP..... | .40 |
| 710 | Voltage comparator DIP..... | .60 |
| 711 | Dual comparator DIP..... | .45 |
| 723 | Precision voltage regulator DIP..... | 1.00 |
| 741 | Op amp TO-5/MINI DIP..... | .45 |
| 748 | Op Amp TO-5..... | .80 |
| CA3018 | 2 Isolated transistors and a Darling-
ton-connected transistor pair..... | 1.00 |
| CA3045 | 5 NPN transistor array..... | 1.00 |
| LM100 | Positive DC regulator TO-5..... | 1.00 |
| LM105 | Voltage regulator..... | 1.25 |
| LM302 | Op Amp voltage follower TO-5..... | 1.25 |
| LM308 | Op Amp TO-5..... | 2.00 |
| LM309H | 5V 200 MA power supply TO-5..... | 1.00 |
| LM309K | 5V 1A power supply module TO-3..... | 1.00 |
| LM311 | Comparator Mini..... | 1.75 |
| LM370 | AGC amplifier..... | 1.75 |
| LM380 | 2-Watt Audio Amp..... | 1.75 |
| LM1595 | 4-Quadrant multiplier..... | 1.70 |
| MC1536T | Op Amp..... | 1.35 |

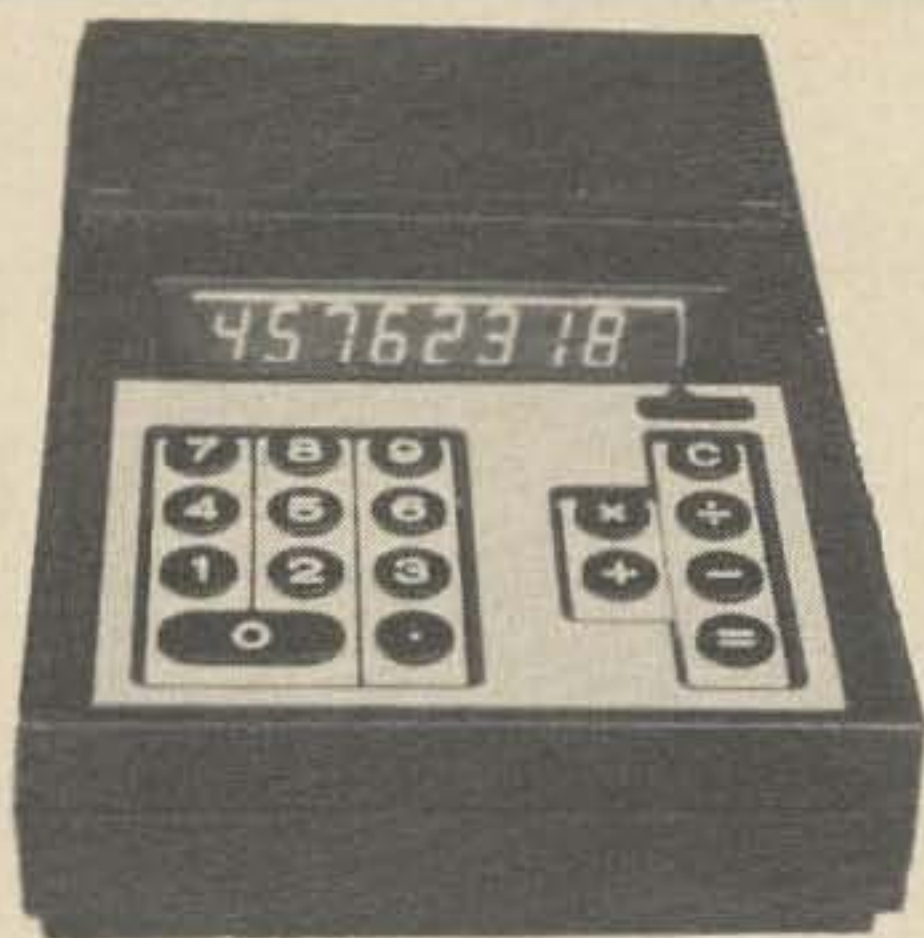

Desk top calculator by well known mfr. These are rejects, 8 digit, 4 function, liquid crystal display. Fully assembled, some factory reject, some customer returns. Most are repaired in a few minutes. Sold "as is." Ship wt 3 lbs.

AC model \$10 each 3 for \$26.50
 Battery portable model \$11 each 3 for \$30.00

SINGLE CHIP ASCII ENCODER

A hot item today. We furnish full data booklet with each order. \$10 each 3 for \$25.00

8 CHAN MULTIPLEX SWITCH

Solid state 16 pin IC MOS. 8 channel w/output enable control & one-of-eight decoder in chip. With data. Fairchild 3705. . \$5.00

RC OSCILLATORS

16 pin IC chip contains 4 RC osc. Ideal for touch tone encoder. TCA 430. . \$5.00

PHOTO-STROBE

Made for Instamatic but useful on any camera with instructions provided. Info also on trick uses, automotive strobe, slave strobe, automotive strobe, Psychadelic repetitive strobe, etc. Complete with charger & Nickel Cadmium batteries.

\$9.00, 3 for \$25.00

COLUMBIA 4 CHANNEL SQ

Solid state SQ 4 channel adapter, 2 amps built in. Decodes 4 channel or synthesizes 4 channel. \$20.00

LED READOUTS 5/\$1.00!

The price is not a mistake. We have some hobby variety with some segments out. Ukinbuyem for as low as 5 for \$1.00

DUAL 16 BIT MEMORY

Dual 16 bit memory, serial MOS by Philco TO-5 case, brand new with 2 page specs.
 #PLR 532 \$1.00 each \$10/12

AM-FM RADIO

For console installation, w/face plate, no knobs. Stereo amplifiers for tape or turnable playback. \$15.00
 Pair of matching speakers w/xfmrs for above \$5.00

CALCULATOR CHASSIS

Fully assembled pocket calculator chassis with calculator chip. Uses LED readouts not included. \$5.00



Beautiful AM-FM Stereo Multiplex radios made to sell in the over \$100 range. Picture shows typical unit. Solid state. AC powered, made for famous US manufacturer. Ship wt 10 lbs. \$35.00

BELLTONE PAGER

Genuine "Ma Bell" belt clip radio receiver beeper. Picks up specific radio signals in 35 MHz area, encoded by internal reed encoder. Seems to be a "natural" for construction jobs, in-plant calling. An interesting experimental gadget. Self contained antenna, adjustable coding by shifting wires on coding module.

#SP-125 \$5.00 each, 6/\$25.00



Please add shipping cost on above.

Meshna

P.O. Box 62
 E. Lynn MA 01904

KEYBOARD \$35.00

One of the nicest keyboards we've found. Mounted in modern design wood grained enclosure for desk-top use. Magnetic reed relay bounceless keyswitches, Encoder board mounted within. Fine Biz. for Morse Code Generators — TV Typewriter — computer terminals, etc.

7 lb #SP-153L \$35.00



GENERAL PURPOSE POWER SUPPLY

Well designed transistorized, regulated power supply with many uses. Each voltage adjustable by pot. Each voltage fused. 115 volts ac input. Output (minus) 12 volts at 1/3 Amp, 12 volts (plus) at 3 Amps, 6 volts at 1 Amp. Three output voltages. Many uses . . . as battery charger, op amp (plus & minus 12 volts), 5 volt logic (adjust 6 volts to 5 volts), operate your car radio, tape player, CB set in the house, etc. A commercially built supply for less than the price of kit.

10 lb #SP-152L \$12.50 5/\$50

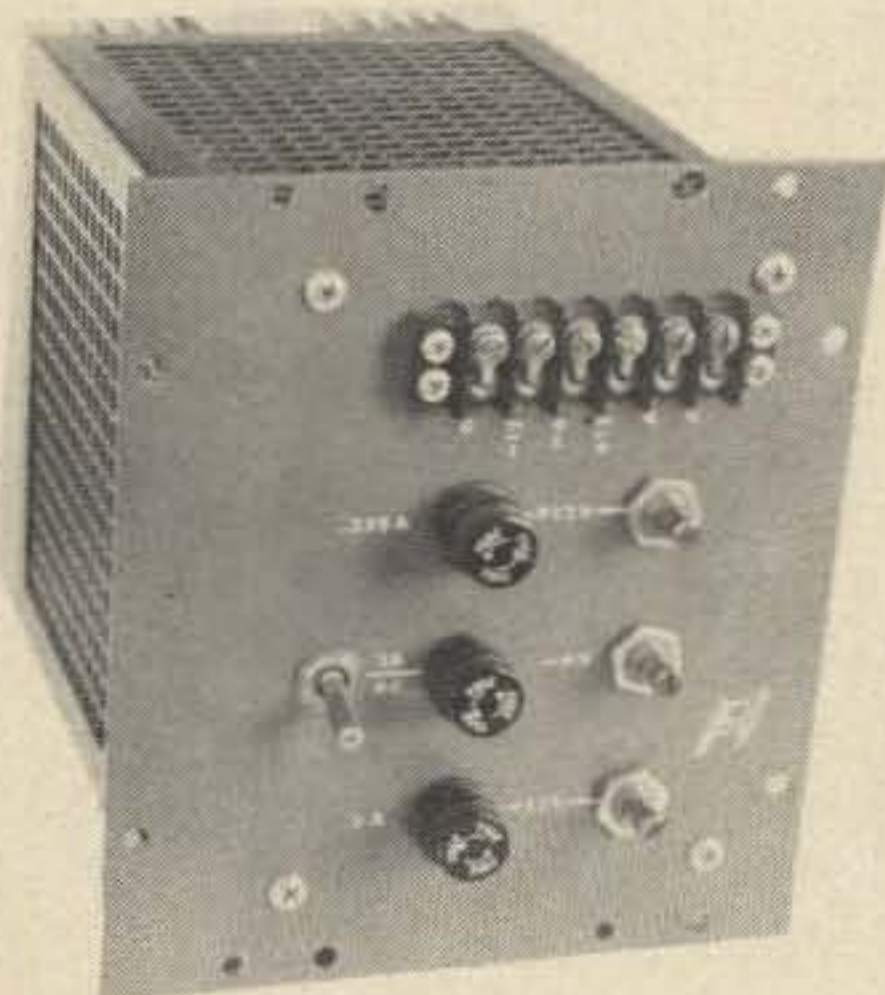

AIR COMPRESSOR \$22.00

Diaphragm compressor brand new surplus from the computer industry. Built-in 115 volt ac motor ball bearing for long life. Puts out 17 PSI with volume 0.7 SCFM. For general paint spraying, air cleaning, bubble bath for PC etching tank, etc. Many uses in lab or home.

14 lb #SP-148L \$22.00

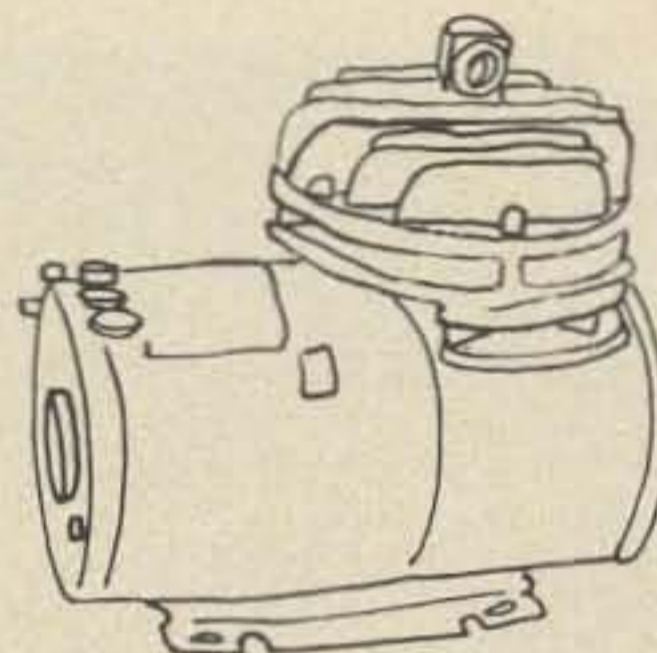

ANTIQUE SOUNDER

Takes you back to the Pony Express days. A genuine antique relic dating back to the old days. A real beauty, polished brass, wood base, bright and shiny new despite its age. In original packing as issued to the US Navy Dept. Already worth more than our asking price. Makes an unusual gift or desk top conversation piece for the man who has almost everything.

#SP-115 \$15.00 2/\$25.00

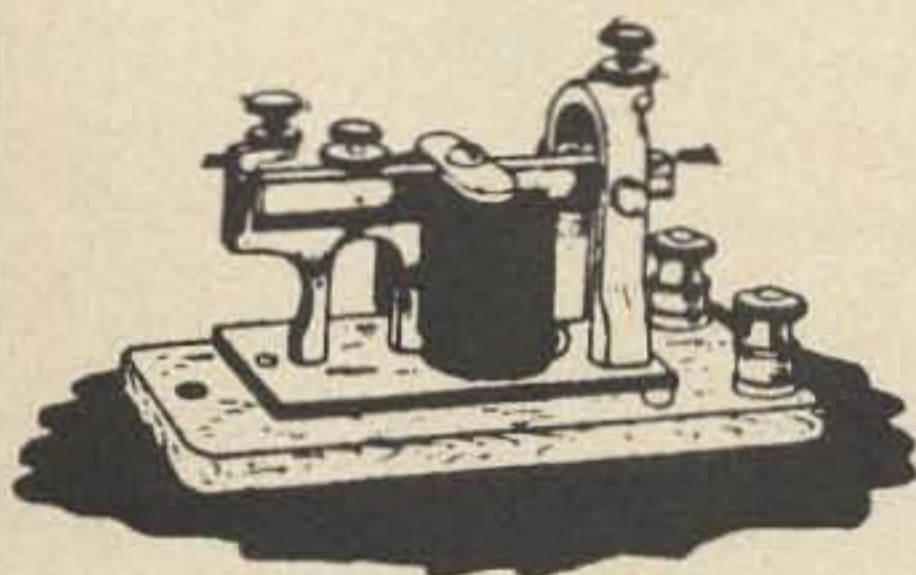

SPERRY 9 DIGIT DISPLAY \$2.50

180 volt 9 digit, 0.25 inch height character. Brand new and we include free with each, the \$1.50 mating socket. The price an astounding new low . . . \$2.50

#SP-145 \$2.50 5/\$10.00



Please add shipping cost on above.

P.O. Box 62
E. Lynn, Massachusetts 01904

FREE CATALOG

Meshna



MULTI-2000

IF YOU'RE GETTING
SOMETHING GOOD
GET A LOT OF IT!
THE MULTI-2000
IS A LOT OF RADIO!



FEATURES

- PLL synthesizer covers 144-148 MHz in 10 kHz steps
- Separate VXO and RIT for full between-channel tuning
- Simplex or ± 600 kHz offset for repeater operation
- Three selectable priority channels
- Multi-mode operation (CW/SSB/NBFM/WBFM)
- Built-in AC and DC power supplies, noise-blanker squelch and rf gain control
- Selectable 1W or 10W output
- Separate S-/power and frequency deviation meters
- Built-in test (call) tone and touch-tone provision
- Excellent sensitivity (.3 μ V for 12 dB SINAD)
- Superior immunity to crossmodulation and intermodulation
- Introductory price: \$695.

TUFTS

Radio Electronics

386 Main St., Medford, Mass. 02155

73 reader service

Check appropriate boxes for desired company brochures, data sheets or catalogs and mail in to 73. Include your zip code, please. Send money directly to advertisers. **LIMIT: 25 requests.**

ADVERTISER INDEX

- | | |
|---|---|
| <input type="checkbox"/> Alden Elec. 157 | <input type="checkbox"/> Kaufman Ind. 150 |
| <input type="checkbox"/> Apollo 146 | <input type="checkbox"/> Kensco 21 |
| <input type="checkbox"/> A. P. Products 53 | <input type="checkbox"/> K-Enterprises 71 |
| <input type="checkbox"/> Antenna Mart 78 | <input type="checkbox"/> Kenwood 24 |
| <input type="checkbox"/> Atlas 149 | <input type="checkbox"/> Klaus 169 |
| <input type="checkbox"/> *ATV 154 | <input type="checkbox"/> KLM 110 |
| <input type="checkbox"/> Audioland 68 | <input type="checkbox"/> Levy 131 |
| <input type="checkbox"/> Babylon 187 | <input type="checkbox"/> Magtech 56 |
| <input type="checkbox"/> Bellaire 162 | <input type="checkbox"/> Meshna 188-189 |
| <input type="checkbox"/> Budwig 56 | <input type="checkbox"/> Midland 173 |
| <input type="checkbox"/> Buyers & Sellers 148 | <input type="checkbox"/> *MITS 126 |
| <input type="checkbox"/> BYTE 166 | <input type="checkbox"/> M-Tech 152 |
| <input type="checkbox"/> CeCo 146 | <input type="checkbox"/> Newtronics CII |
| <input type="checkbox"/> CFP 78, 167 | <input type="checkbox"/> Non-Linear Systems 20 |
| <input type="checkbox"/> Clegg 39 | <input type="checkbox"/> Palomar 118 |
| <input type="checkbox"/> Coakit 78 | <input type="checkbox"/> Poly Paks 191 |
| <input type="checkbox"/> Comm. Specialists 109, 150 | <input type="checkbox"/> Quement 155 |
| <input type="checkbox"/> Comm. Specialties 78 | <input type="checkbox"/> Radio Am. Callbook 50 |
| <input type="checkbox"/> Cornell 78 | <input type="checkbox"/> Radio Store 153 |
| <input type="checkbox"/> CR Electronics 152 | <input type="checkbox"/> RGS 175 |
| <input type="checkbox"/> Curtis 150 | <input type="checkbox"/> Rohn 161 |
| <input type="checkbox"/> Davis 154 | <input type="checkbox"/> S. D. Sales 176, 177 |
| <input type="checkbox"/> Dentron 52, 108 | <input type="checkbox"/> Smith 174 |
| <input type="checkbox"/> DGM 150 | <input type="checkbox"/> Space 78 |
| <input type="checkbox"/> DuPage 186 | <input type="checkbox"/> Specialty Comm. 41 |
| <input type="checkbox"/> DXers Mag. 78 | <input type="checkbox"/> Spectrum Comm. 27 |
| <input type="checkbox"/> ECM 108 | <input type="checkbox"/> Standard Comm. 79 |
| <input type="checkbox"/> Ehrhorn 57 | <input type="checkbox"/> Standard Research 155 |
| <input type="checkbox"/> Electronic Develop. 154, 157 | <input type="checkbox"/> Sumner 135 |
| <input type="checkbox"/> Electronic Distrib. 165 | <input type="checkbox"/> Suntronix 182-183 |
| <input type="checkbox"/> ETCO 78 | <input type="checkbox"/> Telstar 72 |
| <input type="checkbox"/> Freck 108 | <input type="checkbox"/> Tri-Tek 124 |
| <input type="checkbox"/> Gateway 140 | <input type="checkbox"/> Trumbull 56 |
| <input type="checkbox"/> GENAVE 104, 105 | <input type="checkbox"/> Tucker 82-91 |
| <input type="checkbox"/> Godbout 184, 185 | <input type="checkbox"/> Tufts 31, 51, 61, 99, 120, 145, 151, 190 |
| <input type="checkbox"/> Green Pub. 118 | <input type="checkbox"/> TWS Labs 163 |
| <input type="checkbox"/> Ham Radio Center 172 | <input type="checkbox"/> Vanguard 168 |
| <input type="checkbox"/> Hamtronics 170 | <input type="checkbox"/> Vegas Radio 171 |
| <input type="checkbox"/> Heath 9 | <input type="checkbox"/> Venus Scientific 115 |
| <input type="checkbox"/> Henry 44 | <input type="checkbox"/> VHF Eng. CIV |
| <input type="checkbox"/> Hickok 8 | <input type="checkbox"/> Weirnu 148 |
| <input type="checkbox"/> IC Kits 139 | <input type="checkbox"/> Westcom 35 |
| <input type="checkbox"/> ICOM 119, 125 | <input type="checkbox"/> Wilson 64, 65 |
| <input type="checkbox"/> Int. Telecomm 4, 5 | <input type="checkbox"/> Windjammer 180, 181 |
| <input type="checkbox"/> James 178, 179 | <input type="checkbox"/> World QSL 78 |
| <input type="checkbox"/> Jan 102 | <input type="checkbox"/> Yaesu CIII |
| <input type="checkbox"/> Jones, Marlin P. 164 | |

- 73 Stuff
139, 158-160

This 73 was acquired through:

- NEWSSTAND SUBSCRIPTION

*Reader service inquiries not solicited. Correspond directly to company.

Reader's Service AUGUST 1975
73 Inc., Peterborough NH 03458

Please print or type.

Name _____ Call _____

Address _____

City _____

State _____ Zip _____

Coupon expires in 60 days . . .

PROPAGATION CHART

J.H. Nelson

Good (open) Poor (0)

Fair (□)

August - 1975

Sun	Mon	Tue	Wed	Thu	Fri	Sat
					1	2
3	4	5	6	7	8	9
10	11	12	13	14	15	16
17	18	19	20	21	22	23
24 31	25	26	27	28	29	30

EASTERN UNITED STATES TO:

	GMT: 00	02	04	06	08	10	12	14	16	18	20	22
ALASKA	7A	7A	7	7	7	7	7	7	7	7	7A	7A
ARGENTINA	14	14	7	7	7	7	7A	14	14	14	14A	14A
AUSTRALIA	14	14	7B	7B	7	7	7	7	7	7	14	14
CANAL ZONE	14	7A	7	7	7	7	7A	14	14	14	14	14
ENGLAND	7	7	7	7	7	7	7A	14	14	14	14	14
HAWAII	14	14	7B	7	7	7	7	7A	14	14	14	14
INDIA	7	7	7	7	7B	7	7	7	7A	14	7A	7
JAPAN	14	7A	7	7	7	7	7	7	7	7	7	14
MEXICO	14	7A	7	7	7	7	7	7A	14	14	14	14
PHILIPPINES	14	7A	7B	7B	7B	7B	7	7	7	7	7A	14
PUERTO RICO	7A	7	7	7	7	7	7	7	7A	14	14	14
SOUTH AFRICA	7	7	3A	7	7B	14	14	14	14	14	14	7
U. S. S. R.	7	7	7	7	7	7	14	14	14	14	14	7
WEST COAST	14	14	7	7	7	7	7	7A	14	14	14	14

CENTRAL UNITED STATES TO:

ALASKA	14	14	7	7	7	7	7	7	7	7	7	7
ARGENTINA	14	14	7A	7	7	7	7	14	14	14	14	14A
AUSTRALIA	14	14	7A	7B	7	7	7	7	7	7	14	14
CANAL ZONE	14	14	7	7	7	7	7	14	14	14	14	14
ENGLAND	7	7	7	7	7	7	7	7	7A	7A	14	14
HAWAII	14	14	14	7	7	7	7	7	14	14	14	14
INDIA	7A	7A	7	7	7	7	7	7	7A	7A	7	7
JAPAN	14	14	7A	7	7	7	7	7	7	7	7	14
MEXICO	14	7	7	7	3A	3A	7	7	7	7	14	14
PHILIPPINES	14	14	7B	7B	7B	7B	7	7	7	7	7A	14
PUERTO RICO	14	7A	7	7	7	7	7	14	14	14	14	14
SOUTH AFRICA	7	7	3A	7	7B	7B	14	14	14	14	14	7
U. S. S. R.	7	7	7	7	7	7	7	7	7A	14	14	7

WESTERN UNITED STATES TO:

ALASKA	7A	7A	7A	7	7	7	7	7	7	7	7	7
ARGENTINA	14	14	7A	7	7	7	7	14	14	14	14	14A
AUSTRALIA	14	14A	14	14	7	7	7	7	7	7	14	14
CANAL ZONE	14	14	7	7	7	7	7	7A	14	14	14	14
ENGLAND	7	7	7	7	7	7	7	7	7	7	14	14
HAWAII	14	14A	14	14	7	7	7	7	14	14	14	14
INDIA	7	14	14	7	7B	7	7	7	7A	7A	7	7
JAPAN	14	14	14	7A	7	7	7	7	7	7	14	14
MEXICO	14	14	7	7	7	7	7	7A	14	14	14	14
PHILIPPINES	14	14	14	7B	7B	7B	7	7	7	7	7A	14
PUERTO RICO	14	14	7	7	7	7	7	14	14	14	14	14
SOUTH AFRICA	7	7	3A	7	7B	7B	7B	7B	14	14	14	7
U. S. S. R.	7	7	7	7	7	7	7	7	14	14	7	7
EAST COAST	14	14	7	7	7	7	7	7A	14	14	14	14

A = Next higher frequency may be useful also.
B = Difficult circuit this period.



YAESU FT-101E TRANSCEIVER

Now, more radio from the radio company.

Are Yaesu's FT-101's the finest all-around transceivers in the world? Yes — and now the best is even better. The new FT-101E includes a potent R. F. speech processor. Plus improved, easy-to-use lever switches. A more refined clarifier control for push-button, independent clarifier operation. There's also a 160 meter crystal included without extra charge.

And all the other features that have made the FT-101 series of transceivers among the world's most popular are still here: 260 watts SSB

PEP. Globe-circling power on CW and AM. 160 to 10 meters range. 0.3uV receiving sensitivity. And one very important feature you never want to forget is the famous Yaesu warranty, strong dealer network and convenient serviceability.

If you're a serious amateur, you're always looking for more radio. And the FT-101E is just that. \$749* buys you a million bucks worth of enjoyment. See your Yaesu dealer or write for our catalog. Yaesu Musen USA, Inc. 7625 E. Rosecrans, No. 29, Paramount, Calif. 90723.

YAESU
The radio.

*FT-101EE (less processor): \$659.

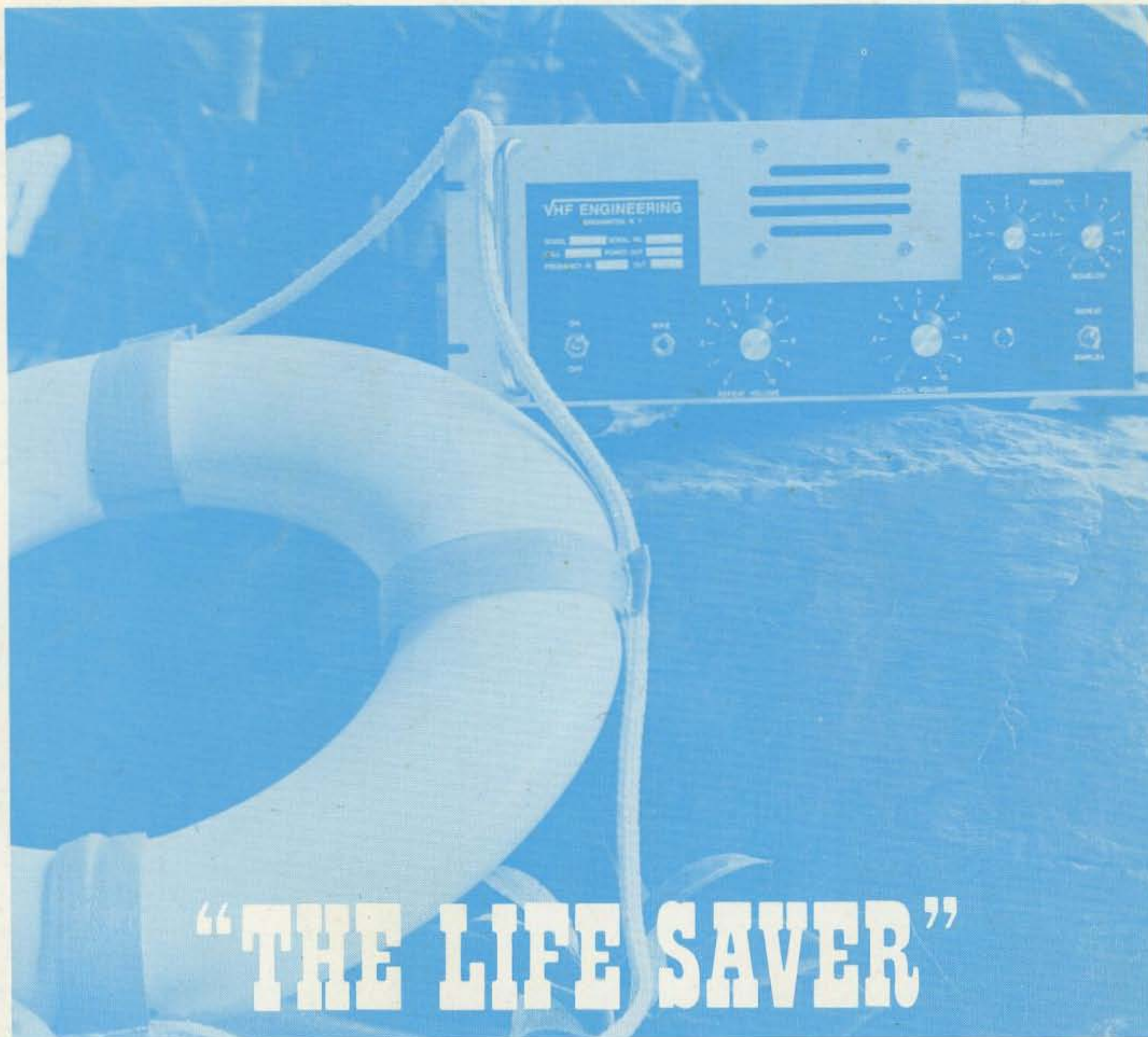

“THE LIFE SAVER”

Problem Your local club has decided to put up a repeater, but funds are limited and you know that an old commercial tube rig converted will work but never will be first rate.

Solution “The Life Saver” — A state of the art completely solid state repeater. Complete including CW-ID, control circuitry, power supply (12V 12Amp) and all hardware. Packaged to take up to 25,000 microvolts before desensing.

PRICES

Kit	\$364.95	Factory wired and tested	\$595.00
-----	----------	--------------------------	----------

Need Cavaties? With kit or wired and tested repeater, add \$399.95 for commercial grade 6 cavity system.



320 WATER ST. • PO BOX 1921 • BINGHAMTON, NY 13902 • 607-723-9574
 DIVISION OF BROWNIAN ELECTRONICS CORP.