

OCTOBER 1977
\$2.00

73

AMATEUR
RADIO

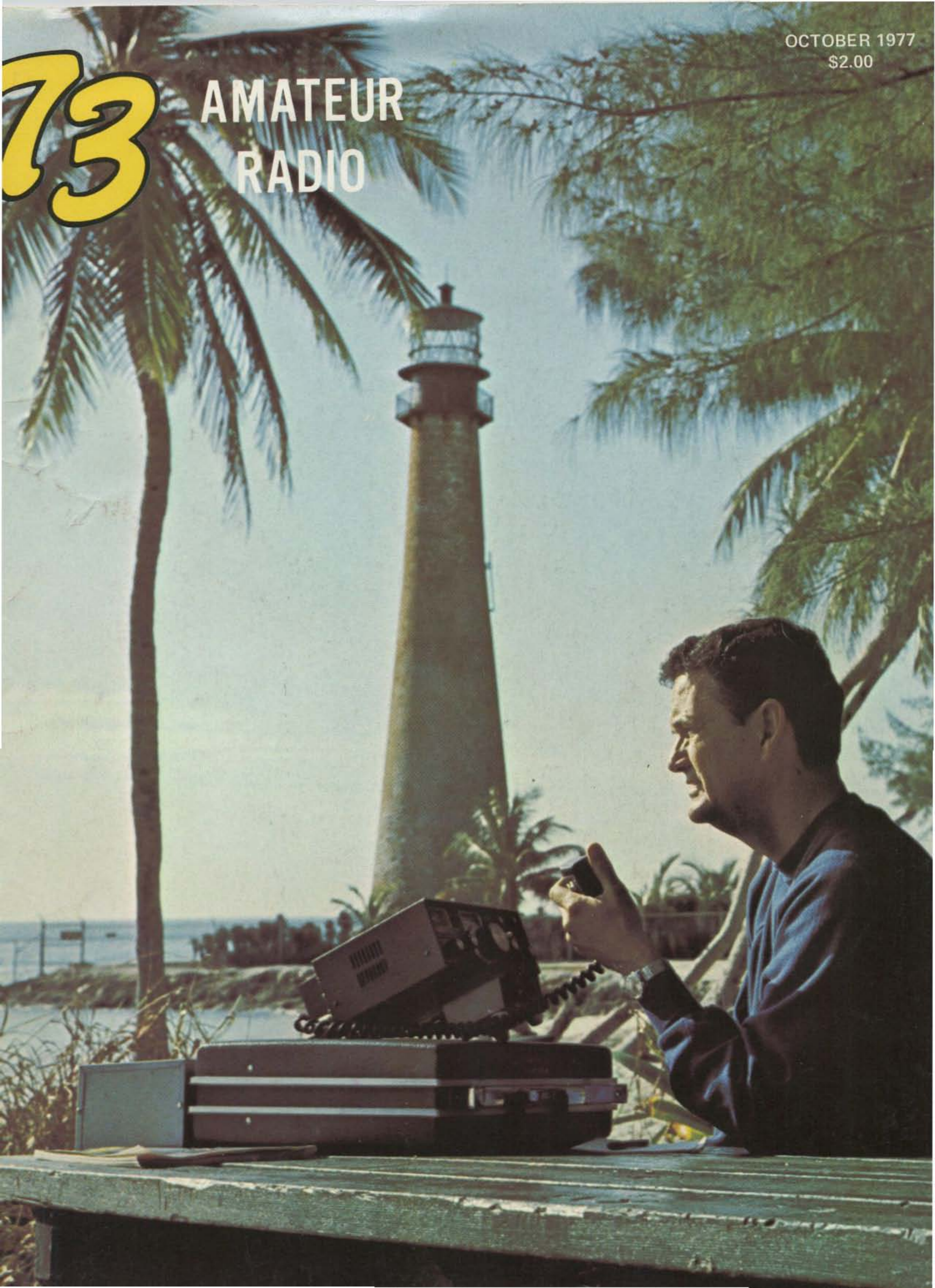



Always outstanding . . . now even better!

KLM

RF AMPLIFIERS

for 50, 220, 144, 432 MHz amateur bands

- All models meet F.C.C. 20777 specs.
- All models have built-in low pass filters.
- Coverage is unimpaired. All models still cover an entire amateur band without tuning.
- Now available. Entirely new amplifiers (shown above) in a 30% more efficient heat sink housing featuring **full length radiating fins, top and both sides.** Cooler operation at all inputs . . . improved safety factor.
- New amplifiers also have thermal overheat protection with LED warning indicator on panel.
- New amplifiers have reverse polarity protection.
- New amplifiers feature automatic RF sensing or hard keying from the driver, can also be remotely controlled.
- Power outputs to 160 watts.
- Amplifiers are simply installed on an "add-on" basis.

At your favorite dealer. Write for information.

KLM electronics, inc.

17025 Laurel Road, Morgan Hill, CA 95037 (408) 779-7363

FREQ. MHZ	MODEL NUMBER	PWR. INP. (watts)	NOM PWR. OUTPUT (watts)	NOM. CUR. (amps.)	NOM. VOLTS	SIZE	FREQ. MHZ	MODEL NUMBER	PWR. INP. (watts)	NOM PWR. OUTPUT (watts)	NOM. CUR. (amps.)	NOM. VOLTS	SIZE
50-54	PA4-70AL ◊	2-8	80	10	13.5	C	"	PA10-140BL ◊	5-15	140	18	"	D
50-54	PA10-160AL ◊	5-15	160	10	28	C	"	PA10-160BL ◊	5-15	160	22	"	D
144-148	PA2-25B	1-4	25	3	13.5	A	"	PA30-140B	15-45	140	15	"	D
"	PA2-70B	1-4	70	10	"	C	"	PA30-140BL ◊	15-45	140	15	"	D
"	PA2-70BL ◊	1-4	70	10	"	C	219-226	PA2-70BC	1-4	70	10	"	C
"	PA2-140B	1-4	140	20	"	D	"	PA10-60BC	5-15	60	8	"	C
"	PA10-40B	5-15	40	5	"	B	"	PA30-120BC	15-45	120	15	13.5	D
"	PA10-40BL ◊	5-15	40	5	"	B	400-470	PA2-40C	1-4	40	7	"	C
144-148	PA10-70B	5-15	70	8	"	C	"	PA10-35C	5-15	35	6	"	B
"	PA10-70BL ◊	5-15	70	8	"	C	"	PA10-35CL ◊	5-15	35	6	"	B
"	PA10-80BL ◊	5-15	80	10	"	C	"	PA10-100C	5-15	100	15	"	D
"	PA10-140B	5-15	140	18	13.5	D	"	PA10-110CL ◊	5-15	110	20	"	D

SIZES: Inches: "A", 6.5×2×2. "B", 6.5×5×2. "C", 6.5×7×2. "D", 6.5×10×2
 MM 165×50.8×50.8 165×127×50.8 165×178×50.8 165×254×50.8
 ◊ LINEAR AMPLIFIER

NOTE: NEW STYLE DIMENSIONS WILL BE: 7.0×2.375 inches (178×60.3mm) instead of 6.5×2.0 inches (165×50.8mm).

ME-3 microminiature tone encoder

Compatible with all sub-audible tone systems such as: Private Line, Channel Guard, Quiet Channel, etc.

- Powered by 6-16vdc, unregulated
- Microminiature in size to fit inside all mobile units and most portable units
- Field replaceable, plug-in, frequency determining elements
- Excellent frequency accuracy and temperature stability
- Output level adjustment potentiometer
- Low distortion sinewave output
- Available in all EIA tone frequencies, 67.0 Hz-203.5 Hz
- Complete immunity to RF
- Reverse polarity protection built-in

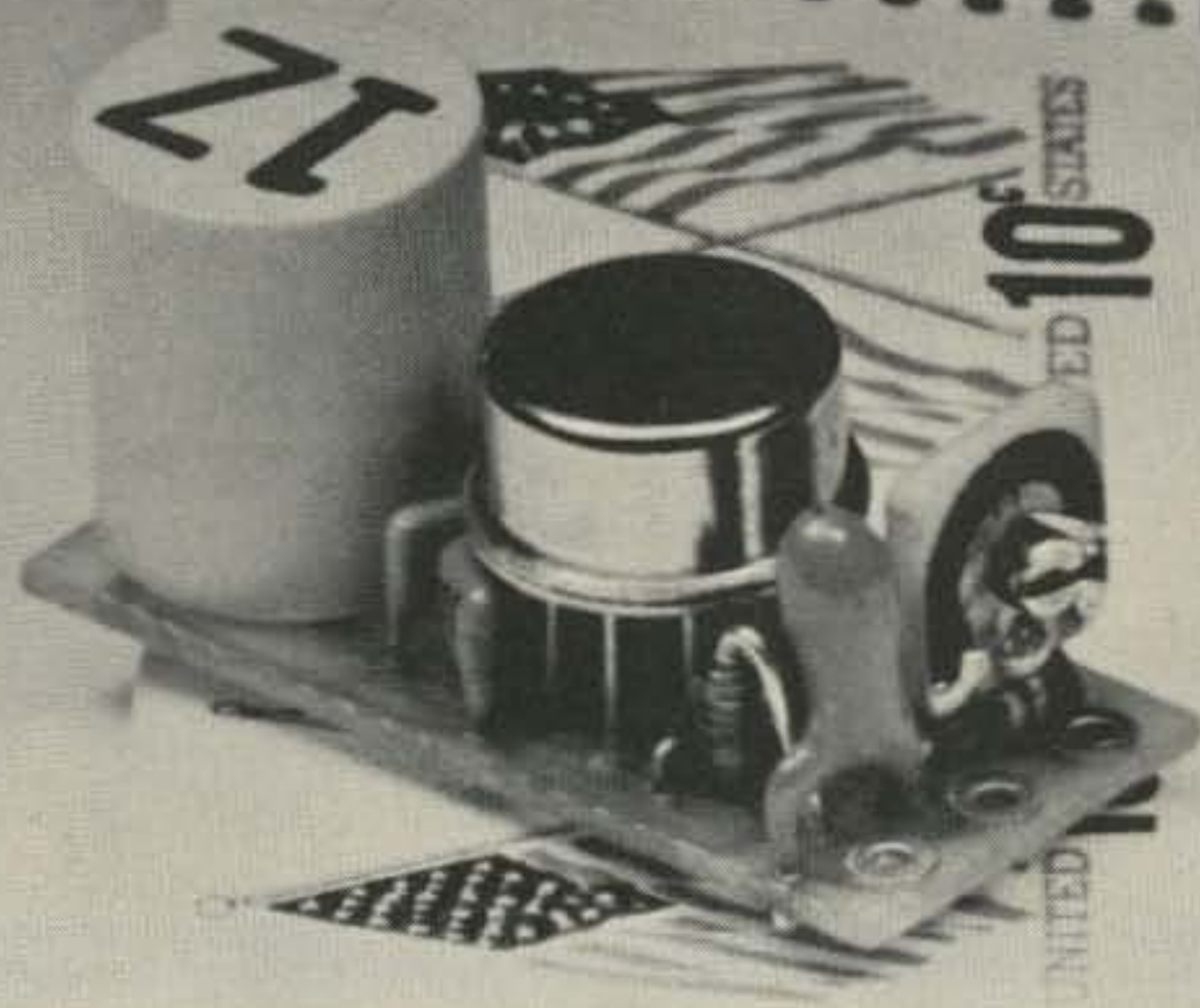

\$29.95 each

Wired and tested, complete with K-1 element



communications specialists

P. O. BOX 153
BREA, CALIFORNIA 92621

(714) 998-3021

K-1 FIELD REPLACEABLE,
PLUG-IN, FREQUENCY
DETERMINING ELEMENTS

\$3.00 each



That's all, Folks!

All you need for All Mode Mobile, that is.

All Mode Mobile is now yours in a superior ICOM radio that is a generation ahead of all others. The new, fully synthesized **IC-245/SSB** puts you into FM, SSB and CW operation with a very compact dash-mounted transceiver like none you've ever seen.

- **Variable offset:** Any offset from 10 KHz through 4 MHz in multiples of 10 KHz can be programmed with the LSI Synthesizer.
- **Remote programming:** The **IC-245/SSB** LSI chip provides for the input of programming digits from a remote key pad which can be combined with Touch Tone* circuitry to provide simultaneous remote program and tone. Computer control from a PIA interface is also possible.

* a registered trademark of AT&T.

- **FM stability on SSB and CW:** The **IC-245/SSB** synthesis of 100 Hz steps make mobile SSB as stable as FM. This extended range of operation is attracting many FM'ers who have been operating on the direct channels and have discovered SSB.

The **IC-245/SSB** is the very best and most versatile mobile radio made: that's all. For more information and your own hands-on demonstration see your ICOM dealer. When you mount your **IC-245/SSB** you'll have all you need for All Mode Mobile.

SPECIFICATIONS

FREQUENCY COVERAGE
MUGES: 144.00 to 148.00 MHz
FM (F3)
SSB (A3), CW (A1)
DC 13.8V ± 15%
90W ± 15W ± 2.5dB
2.7

TRANSMITTER
TX OUTPUT: 73 10W
*ASL 12W (PER) A1 10W

CARRIER SUPPRESSION: 40 dB OR BETTER

SPURIOUS RADIATION
MAXIMUM FREQUENCY
DEVIATION: ±5KHz
MICROPHONE IMPEDANCE: 600 OHMS

RECEIVER
SENSITIVITY:

-60 dB BELOW CARRIER

±5KHz

600 OHMS

*ASL 21.05 MICROVOLT
INPUT GIVES 10 dB S+N
FOR 20 dB OVER TONE
S+N = 20 dB AT 1 MICROVOLT
INPUT 30 dB

SCISSOR THRESHOLD
SPURIOUS RESPONSE:

SYNTHESIZER
FREQUENCY RANGE
STEP SIZE:

STABILITY:

-8 dB OR LESS (F3)

60 dB OR BETTER

144 MHz to 148 MHz

5 KHz for FM

100 Hz or 3 KHz for SSB

PER C. IN THE RANGE OF -10

TO +80C ±0.000145%

*CALC. WITH SSB UNIT ONLY

VHF/UHF AMATEUR AND MARINE COMMUNICATION EQUIPMENT

Distributed by:



ICOM



ICOM WEST, INC.
Suite 3
13256 Northrup Way
Bellevue, Wash. 98005
(206) 747-9020

ICOM EAST, INC.
Suite 307
3331 Towerwood Drive
Dallas, Texas 75234
(214) 620-2780

ICOM CANADA
7087 Victoria Drive
Vancouver B.C. V5P 3Y9
Canada
(604) 321-1833

73

#205 OCT 1977

- 26 Communicate On 10.25 GHz — with a simple transceiver
WA3ETD
- 30 Home Brew Tilt-Over — the water pipe special
W4MEA
- 32 Minimize Feedline Loss — UHF buffs, front and center!
W2STM
- 34 How About 6 FM? — it's easy with a modified HE-50
W3KBM
- 38 W.A.S. — Easily! — catching the last few
W7FGD
- 42 Fool the Wire Wizard — a computer would have helped
Simmons
- 44 Ultra Simple Diode Checker — for grab bag specials
K4GOK
- 48 Beat the PC Shortage — build (glue) your own!
Stanfield
- 51 Identify That Transformer — tips for using boat anchors
Tenny
- 52 Subaudible Tone Encoder — access those closed machines
W4NFR
- 60 Build A ComCoder — versatility for the IC-22S
K5UBM, WB5WSG
- 66 Attache' Case Portable — Bond would like it!
N4AL/WB4SCN
- 68 Build A Beeper Alarm — if staying in touch is important
WA4SAM
-  88 Try Your KIM-1 On RTTY — CUL on your computer
WA5DXP
-  94 S. D. Sales Z-80 Review — quality at a good price
WA2INM
-  96 Title Your Pix With A Micro — a useful SSTV accessory
K6AEP
- 104 Mastering Network Operations — everything you need to know!
WB4EZM
- 107 Try A Trapped Dipole — save copper and coax!
K4IFH
- 108 Liberate Your Wilson HT — who needs nicads?
K2HUF
- 110 Novice Antenna Specials — tips for that first antenna
W2FEZ
- 114 Sound Operated Relay — for the ultimate security system
WB8DQT
- 118 Traffic Handling Explained — a lost art?
WB2YKG
- 120 The Third Hand — how many times?
Miller
- 122 Vehicle Security Systems — protect your rig
WB5DEP
- 150 One Cent Channels for the IC-22S — inflation fighter!
WB2CBC, WA2HGQ
- 151 The Missing Length — phantom IC-22S channel
KL7IEP/1
- 152 Design A Circuit Designer! — with special plug-in boards
Staff
- 153 Sensitive Meters Saved
W6GXN
- 154 Big Bust In Amarillo — bootlegger nabbed!
Staff
- 156 Right Way, Wrong Way, Navy Way — or the 73 way
K6DZY
- 158 Living With the Family Ham — planning births, etc.
WA4WZL
- 160 Add Jazz To Your Tempo — with a few simple mods
WB8ZBJ
- 164 Interested In Television? — how to get started
WB8DQT
- 176 Simple Electronic Siren — it's loud!
K4DHC
- 178 Digital To Audio Decoder — for the blind operator
Pacholok
- 182 Synthesize Yourself! — practical experiments
W1HCI

- 4 Never Say Die
14 Letters
18 Looking West
20 AMSAT
22 Contests
24 New Products
36 Ham Help
41 Hamburglar
43 Oscar Orbits
190 Social Events
224 Propagation

COVER: Photo by Delia Coya.
Article begins on page 66.

73 Magazine is published monthly by 73, Inc., Peterborough NH 03458. Subscription rates in the U.S. and Canada are \$15 for one year, \$26 for two years, and \$36 for three years. Outside the U.S. and Canada, write for rates. Second class postage paid at Peterborough NH 03458 and at additional mailing offices. Publication No. 700420. Phone: 603-924-3873. Entire contents copyright 1977 by 73, Inc. INCLUDE OLD ADDRESS AND ZIP CODE WITH ADDRESS CHANGE NOTIFICATION.

Microfilm edition — University Microfilms, Ann Arbor MI 48106.

73 STAFF

EDITOR/PUBLISHER
Wayne Green W2NSD/1

EXECUTIVE VICE PRESIDENT
Sherry Smythe

ADMINISTRATIVE ASSISTANT
Dotty Gibben

EXECUTIVE EDITOR
John Molnar WA3ETD

MANAGING EDITOR
John C. Burnett

ASSISTANT MANAGING EDITOR
Susan G. Philbrick

EDITORIAL ASSISTANT
Beth Turin

I/O EDITOR
John Craig

PUBLICATIONS EDITOR
Larry Kahner WB2NEL

PRODUCTION MANAGER
Lynn Panciera-Fraser

ART DEPARTMENT
Craig Brown
Gayle Cabana
Bob Drew
Michael Murphy
Weston Parker
Bob Sawyer
Noel R. Self WB1ARP
Robin M. Sloan

PRINT SHOP MANAGER
Michael Foster

PRINTING
William Caring
Dwight Perry

PHOTOGRAPHY
Bill Heydolph
Teddi Cluff

TYPESETTING
Barbara J. Latti
Pauline Halvorkik
Marie Walz

COMPTROLLER
Krud E. M. Keller KV4GG/1
Marge Nielsen

CIRCULATION
Barbara Block
Fran Dillon
Janet Ames
Florence Goldman

DATA ENTRY
Judy Waterman
Judy Brumaghim

MARKETING
Sherry Smythe
Lisa Josephs

SHIPPING
Theresa Toussaint
Nancy Chantler
Alice Hope
Ethan Perry
Maureen Toussaint

PLANT MAINTENANCE
Bill Barry
Lorraine Pickering
Ken Cox

RECEPTIONIST
Dani Jarvis

ASSOCIATES
Robert Baker WB2GFE
E. H. Barnett WB2IX
Schley Cox WB2LHD
Tom Dillman WB2KZD
Terry Fox WB4JF1
W. Sanger Green
Dave Ingram K4TWJ
Joe Kassar G3ZCZ
Bill Patterson W4G1TF
John Schultz W4FA
Walter Scott K3D1Z
Peter Stark K2DAW
Bill Turner W4B4B1

COMPUTER SYSTEMS MANAGER
Bob Leach W4MCC/1

COMPUTER PROGRAMMING
Richard J. Dykema

DRAFTING
Bill Morello
Lynn Malo

ADVERTISING
Bill Edwards W6BED/1
Nancy Cluff WA1WSU
Gary Dozier
Tobee Phipps



NEVER SAY DIE

...de W2NSD/1

EDITORIAL BY WAYNE GREEN

CAN THE QCWA SAVE AMATEUR RADIO?

The Quarter Century Wireless Association (QCWA) has been around for a long time, but has had little impact on events. As an editor of a ham magazine, I've been getting a little newsletter from the QCWA for years. It dwelt mostly on the departed and the departing, so I had an impression of the club as one of retired old-timers who were doing little more than waiting to die.

When my 25th anniversary as a ham arrived, I gave little consideration to joining the QCWA, not yet being ready to consider myself an old man. Eventually a good friend of mine, Harry Gartsman W6ATC, got rather involved with the club, so along about my 35th hamming year, I joined. Nothing came of it.

For some obscure reason, the QCWA invited me to give the talk at their yearly banquet — held in Seattle, during the ARRL convention. The League was pretty upset about this, but since it was not their banquet, they couldn't stop it. Mary Lewis, one of the organizers of the convention, asked me to speak to a couple of the convention groups — one on micro-computers and the other on hamming, for which blasphemy the ARRL appears to be making every possible effort to block her appointment as SCM. Petty politics, but routine.

Just judging from the QCWA newsletters, I'd gotten the impression that most members were old ARRL stalwarts, now living on social security and still afraid of trying anything new or experimental. I'd tried speaking to several ham clubs which were controlled by this type of old-timer, only to find that the minds were so tightly closed that there was no way for a new thought to penetrate. These are the musty ham clubs where you find virtually no new hams — no youngsters — and heaven help the CBER that wanders in for a meeting!

Not being willing to give up without a fight, when it came my time to speak at the banquet, I decided to find out who and what the QCWA was really made up of. I asked for a showing of hands of those present who had pioneered FM back before WW II (el biggo). Much to my surprise and pleasure, about fifteen hands went up. Hmmm.

Next I asked how many had helped pioneer narrow band FM in the late 40s, and again a bunch of hands went up. I was more impressed.

My critical question — how many were active on RTTY before 1950 —

these had to be hard core pioneers. About 30 hands went up around the room. Very impressive for a group of about 500.

Well, okay for the long past, but what have they done for us recently? I asked about sideband pioneering and almost a third of the people in the room had been active on SSB before 1957. How about SSTV? Again, up went the hands! About 20 of them had been involved with moonbounce work and at least 50 were active on OSCAR. These were not just ordinary old men; these were the men whose pioneering has made amateur radio what it is today.

AMATEUR RADIO NEEDS LEADERSHIP

Readers keep getting exasperated with me for talking down the ARRL. I wish that these people would try for a moment to suspend blind belief in what they read in *QST* and talk with some of the old-timers who pioneered the hobby we have today and find out the true place the ARRL holds in history. It is not a nice one.

For instance, right now I doubt if you would be able to find one amateur anywhere in the world with any real grasp of the WARC situation who would take a bet that we will come out with even one ham band below 50 MHz. Yet you see little of this in *QST* and you hear nothing about it during the ARRL forums at conventions.

This is a complicated story, but it is one of which you should be aware, for this will have a profound effect on your hamming in a few years.

The QCWA members, far from being a bunch of withering old men, turned out to be representative of the very heart and spirit of amateur radio. These are the people who made amateur radio what it is today — the ones who pioneered and invented the circuits which we and all of the commercials are using. And they did all this with little help from either the FCC or the ARRL. Perhaps this group could do the job which the ARRL is not doing and help us to save our ham bands.

Before I explain the situation in detail, I should give some of my own background.

MY CREDENTIALS

Old-timers know me pretty well. Newcomers to amateur radio may not, so I'll take this opportunity to introduce myself. I should do this at least once every ten years anyway, and it is now about ten years overdue.

I first got attracted to amateur

radio in the mid-30s, building my own shortwave radios along in 1936 and getting seriously into hamming by 1937. I started subscribing to *QST* in 1938, and have been a member of the ARRL ever since. That'll be 40 years next year. In 1941, I was quite active, mostly on 160m, and I even managed to win the ARRL Sweepstakes contest for my section that year, working entirely on 160m.

When the war came along, I enlisted in the Navy and went to radio and radar school, an experience which had a profound effect on me. The Navy school was splendid and made my later college work insignificant by comparison. I served on a submarine (*USS Drum SS228*) and went on five war patrols. For those of the readers who are particularly interested in submarines, I've been publishing a *Drum* newsletter which records the reminiscences of the crew, complete with a lot of 30-year-old pictures. I took a lot of pictures at the time and still have them all. We were one of the top scoring subs, by the way.

After the war and after college, I went into radio broadcasting as an engineer-announcer, then into television, first as an engineer and then as a director and producer. The TV work didn't turn out to be as creative as I'd hoped, so I left it and got into hi-fi, putting a speaker cabinet on the market in 1952, back in the early days of high fidelity. That business did very well, but when the chance came along to edit *CQ*, I picked that... wouldn't you?

Along in 1946, I got involved with the first narrow band FM experiments. I built several transmitters using NFM and had a lot of fun with it during those years. NFM would be with us today on the low bands if receiver manufacturers had built FM discriminators into their ham receivers. Using the slope of the i-f for NFM detection worked fairly well, but AM signals wiped out the FM, so NFM never really made it on HF. It was just the ticket for VHF though, and here FM detectors were being used — about 95% of the VHF and UHF communications today is by NFM.

About this same time, I got involved with RTTY. In 1948, I was working with WPIX (TV) in New York and had my 2m ham station set up on top of the News Building next to the WPIX transmitter. I was using a 522 (I had the first of them) and worked out all over the place from

Continued on page 15



KENWOOD ANNOUNCES THE TR-8300. NOW YOU CAN TAKE ADVANTAGE OF THE LUXURIES OFFERED ON UHF. THE 70 CM (440 MHz) BAND OFFERS YOU NOISE-FREE, UNCROWDED OPERATION ON FM. THE TR-8300 PUTS YOU ON THE AIR WITH 10 WATTS RF OUTPUT POWER ON 23 CRYSTAL CONTROLLED CHANNELS (3 SUPPLIED) AT A LOW COST WHICH WILL SURPRISE YOU. THE TR-8300 HAS BEEN CAREFULLY DESIGNED BY KENWOOD ENGINEERS TO GIVE YOU EXCELLENT PERFORMANCE OVER A BROAD FREQUENCY RANGE. THE TR-8300 IS FACTORY ADJUSTED AS FOLLOWS: TRANSMITTER (445.0-450.0 MHz), RECEIVER (442.0-447.0 MHz). HOWEVER, THE TR-8300'S RECEIVER AND TRANSMITTER SECTIONS CAN BE INDEPENDENTLY ADJUSTED TO COVER ANY 5 MHz SEGMENT BETWEEN 440.0 and 450.0 MHz.

Excellent Performance Characteristics

A host of new innovations developed as a result of intensive testing have been incorporated. These include a 5 section helical resonator and a two-pole crystal filter in the IF section of the receiver for improved intermodulation characteristics. In addition, receiver sensitivity, spurious response, and temperature characteristics have all been improved drastically.

Safety Protection Circuit

Special protection circuitry designed to protect the final stage transistors from the effects of severe SWR fluctuations that mobile equipment is subject to is provided. In addition, a power supply stabilization circuit is provided for the final stage to prevent any damage to the power transistors because of excessively high power supply voltages.

Protection Circuit for Reversed Polarity Connections

A protection circuit is provided to prevent any damage to the unit even if the polarity of the power supply connections is inadvertently reversed.

Call Channel Switch

The TR-8300 incorporates an additional feature called CALL CH. It allows control of a user desired function (CTCS, etc.) by using a single button on the front panel.

Broad Band Operation

The TR-8300 is designed for flexible coverage of the 70 CM band. The transmitter and receiver can be independently adjusted to cover any 5 MHz segment between 440.0 and 450.0 MHz.

2 Output Settings

Maximum transmitting power is a husky 10 watts from meticulously designed and assembled final stage. It may be set to provide either this 10 watt "Hi" output or a "Low" 1 watt output simply by means of a pushbutton switch.

Special Monitor Circuit

The TR-8300 includes a special monitor circuit which enables the user to listen to his own modulation and make frequency adjustments.

**Coaxial Relay Employed for Antenna Switching
Motorola Power Transistor for Excellent Reliability**

TRIO-KENWOOD COMMUNICATIONS INC.
1111 WEST WALNUT/COMPTON, CA 90220

KENWOOD
...pacesetter in amateur radio

KENWOOD

...pacesetter in amateur radio

TS-520S

AND DG-5 DIGITAL FREQUENCY DISPLAY



FULL COVERAGE TRANSCEIVER

The TS-520S provides full coverage on all amateur bands from 1.8 to 29.7 MHz. Kenwood gives you 160 meter capability, WWV on 15.000 MHz., and an auxiliary band position for maximum flexibility. And with the addition of the TV-506 transverter, your TS-520S can cover 160 meters to 6 meters on SSB and CW.

DIGITAL DISPLAY DG-5 (option)

The Kenwood DG-5 provides easy, accurate readout of your operating frequency while transmitting and receiving.

OUTSTANDING RECEIVER SENSITIVITY AND MINIMUM CROSS MODULATION

The TS-520S incorporates a 3SK35 dual gate MOSFET for outstanding cross modulation and spurious response characteristics. The 3SK35 has a low noise figure (3.5 dB typ.) and high gain (18 dB typ.) for excellent sensitivity.

NEW IMPROVED SPEECH PROCESSOR

An audio compression amplifier gives you extra punch in the pile

ups and when the going gets rough.

VERNIER TUNING FOR FINAL PLATE CONTROL

A vernier tuning mechanism allows easy and accurate adjustment of the plate control during tune-up.

FINAL AMPLIFIER

The TS-520S is completely solid state except for the driver (12BY7A) and the final tubes. Rather than substitute TV sweep tubes as final amplifier tubes in a state of the art amateur transceiver,

Kenwood has employed two husky S-2001A (equivalent to 6146B) tubes. These rugged, time-proven tubes are known for their long life and superb linearity.

HIGHLY EFFECTIVE NOISE BLANKER

An effective noise blanking circuit developed by Kenwood that virtually eliminates ignition noise is built into the TS-520S.

RF ATTENUATOR

The TS-520S has a built-in 20 dB attenuator that can be activated by a push button switch conveniently located on the front panel.

PROVISION FOR EXTERNAL RECEIVER

A special jack on the rear panel of the TS-520S provides receiver signals to an external receiver for increased station versatility. A switch on the rear panel determines the signal path... the receiver in the TS-820 or any external receiver.

VFO-520 — NEW REMOTE VFO

The VFO-520 remote VFO matches the styling of the TS-520S and provides maximum operating flexibility on the band selected on your TS-520S.

AC POWER SUPPLY

The TS-520S is completely self-contained with a rugged AC power supply built-in. The addition of the DS-1A DC-DC converter (optional) allows for mobile operation of the TS-520S.

EASY PHONE PATCH CONNECTION

The TS-520S has 2 convenient RCA phono jacks on the rear panel for PHONE PATCH IN and PHONE PATCH OUT.

CW-520 — CW FILTER (OPTION)

The CW-520-500 Hz filter can be easily installed and will provide improved operation on CW.

AMPLIFIED TYPE AGC CIRCUIT

The AGC circuit has 3 positions (OFF, FAST, SLOW) to enable the TS-520S to be operated in the optimum condition at all times whether operating CW or SSB.

The TS-520S retains all of the features of the original TS-520 that made it tops in its class: RIT control • 8-pole crystal filter • Built-in 25 KHz calibrator • Front panel carrier level control • Semi-break-in CW with sidetone • VOX/PTT/MOX • TUNE position for low power tune up • Built-in speaker • Built-in Cooling Fan • Provisions for 4 fixed frequency channels • Heater switch.

TS-520 Specifications

Amateur Bands: 160-10 meters plus WWV (receive only)
 Modes: USB, LSB, CW
 Antenna Impedance: 50-75 Ohms
 Frequency Stability: Within ± 1 kHz during one hour after one minute of warm-up, and within 100 Hz during any 30 minute period thereafter

Tubes & Semiconductors:
 Tubes 3 (S2001A x 2, 12BY7A)
 Transistors 52
 FETs 19
 Diodes 101

Power Requirements: 120/220 V AC, 50/60 Hz, 13.8 V DC (with optional DS-1A)

Power Consumption: Transmit: 280 Watts Receive: 26 Watts (with heater off)

Dimension: 333(13 1/4) W x 153 (6-0) H x 335(13- (13-3/16) D mm(inch)

Weight: 16.0 kg(35.2 lbs)

TRANSMITTER

RF Input Power: SSB: 200 Watts PEP CW: 160 Watts DC

Carrier Suppression: Better than -40 dB

Sideband Suppression: Better than -50 dB

Spurious Radiation: Better than -40 dB

Microphone Impedance: 50k Ohms

AF Response: 400 to 2,600 Hz

RECEIVER

Sensitivity: 0.25 μ V for 10 dB (S+N)/N

Selectivity: SSB: 2.4 kHz/-6 dB, 4.4 kHz/-60 dB

Selectivity: CW: 0.5 kHz/-6 dB, 1.5 kHz/-60 dB (with optional CW-520 filter)

Image Ratio: Better than 50 dB

IF Rejection: Better than 50 dB

AF Output Power: 1.0 Watt (8 Ohm load, with less than 10% distortion)

AF Output Impedance: 4 to 16 Ohms

DG-5

SPECIFICATIONS

Measuring Range: 100 Hz to 40 MHz

Input Impedance: 5 k Ohms

Gate Time: 0.1 Sec.

Input Sensitivity: 100 Hz to 40 MHz... 200 mV rms or over, 10 kHz to 10 MHz... 50 mV or over

Measuring Accuracy: Internal time base accuracy ± 0.1 count

Time Base: 10 MHz

Operating Temperature: -10° to 50° C/14° to 122° F

Power Requirement: Supplied from TS-520S or 12 to 16 VDC (nominal 13.8 VDC)

Dimensions: 167(6-9/16) W x 43(1-11/16) H x 268(10-9/16) D mm(inch)

Weight: 1.3 kg(2.9 lbs)



DG-5

The luxury of digital readout is available on the TS-520S by connecting the DG-5 readout (option). More than just the average readout circuit, this counter mixes the carrier, VFO, and heterodyne frequencies to give you your exact frequency. This handsomely-styled accessory can be set almost anywhere in your shack for easy to read operation... or set it on the dashboard during mobile operation for safety and convenience. Six bold digits display your operating frequency while you transmit and receive. Complete with DH (display hold) switch for frequency memory and 2 position intensity selector. The DG-5 can also be used as a normal frequency counter up to 40 MHz at the touch of a switch. (Input cable provided.)

NOTE: TS-520 owners can use the DG-5 with a DK-520 adapter kit.

KENWOOD

...pacesetter in amateur radio



TS-820S

WITH DIGITAL FREQUENCY DISPLAY

We told you that the TS-820 would be best. In little more than a year our promise has become a fact. Now, in response to hundreds of requests from amateurs, Kenwood offers the TS-820S*... the same superb transceiver, but with the digital readout factory installed. As an owner of this beautiful rig, you will have at your fingertips the combination of controls and features that even under the toughest operating conditions make the TS-820S the Pacesetter that it is.

Following are a few of the TS-820S' many exciting features.

PLL • The TS-820S employs the latest phase lock loop circuitry. The single conversion receiver section performance offers superb protection against unwanted cross-modulation. And now PLL allows the frequency to remain the same when switching sidebands (USB, LSB, CW) and eliminates having to recalibrate each time.

DIGITAL READOUT • The digital counter display is employed as an integral part of the VFO readout system. Counter mixes the carrier VFO, and first heterodyne frequencies to give exact frequency. Figures the frequency down to 10 Hz and digital display

reads out to 100 Hz. Both receive and transmit frequencies are displayed in easy to read, Kenwood Blue digits.

SPEECH PROCESSOR • An RF circuit provides quick time constant compression using a true RF compressor as opposed to an AF clipper. Amount of compression is adjustable to the desired level by a convenient front panel control.

IF SHIFT • The IF SHIFT control varies the IF passband without changing the receive frequency. Enables the operator to eliminate unwanted signals by moving them out of the passband of the receiver. This feature alone makes the TS-820S a pacesetter.

*The TS-820 and DG-1 are still available separately.

TS-600



Experience the excitement of 6 meters. The TS-600 all mode transceiver lets you experience the fun of 6 meter band openings. This 10 watt, solid state rig covers 50.0-54.0 MHz. The VFO tunes the band in 1 MHz segments. It also

has provisions for fixed frequency operation on NETS or to listen for beacons. State of the art features such as an effective noise blanker and the RIT (Receiver Incremental Tuning) circuit make the TS-600 another Kenwood "Pacesetter".



TV-506

An easy way to get on the 6 meter band with your TS-520/520S, TS-820/820S and most other transceivers. Simply plug it in and you're on... full band coverage with 10 watts output on SSB and CW.



TR-8300

Experience the luxury of 450 MHz at an economical price. The TR-8300 offers high quality and superb performance as a result of many years of improving VHF/UHF design techniques. The trans-

ceiver is capable of F₃ emission on 23 crystal-controlled channels (3 supplied). The transmitter output is 10 watts. The TR-8300 incorporates a 5 section helical resonator and a

two-pole crystal filter in the IF section of the receiver for improved intermodulation characteristics. Receiver sensitivity, spurious response, and temperature characteristics are excellent.

KENWOOD

...pacesetter in amateur radio

TS-700S

WITH DIGITAL FREQUENCY DISPLAY



Check out the new "built-ins":
digital readout, receiver pre-amp,
VOX, semi-break in, and CW sidetone!
Of course, it's still all mode, 144-148
MHz and VFO controlled.

Features: Digital readout with "Kenwood Blue" digits • High gain receiver pre-amp • 1 watt lower power switch • Built in VOX • Semi-break in on CW • CW sidetone • Operates all modes: SSB (upper & lower), FM, AM and CW • Completely solid state circuitry provides stable, long lasting, trouble-free operation • AC and DC capability (operate from your car, boat, or as a base station through its built-in power supply) • 4 MHz band coverage (144 to 148 MHz) • Automatically switches transmit frequency 600 KHz for repeater operation. Simply dial in your receive frequency and the radio does the rest... simplex, repeater, reverse • Or accomplish the same by plugging a single crystal into one of the 11 crystal positions for your favorite channel • Transmit/Receive capability on 44 channels with 11 crystals.



VFO-700S

Handsomely styled and a perfect companion to the TS-700S. This unit provides you with the extra versatility and the luxury of having a second VFO in your shack. Great for split frequency operation and for tuning off frequency to check the band. The function switch

on the VFO-700S selects the VFO in use and the appropriate frequency is displayed on the digital readout in the TS-700S. In addition a momentary contact "frequency check" switch allows you to spot check the frequency of the VFO not in use.

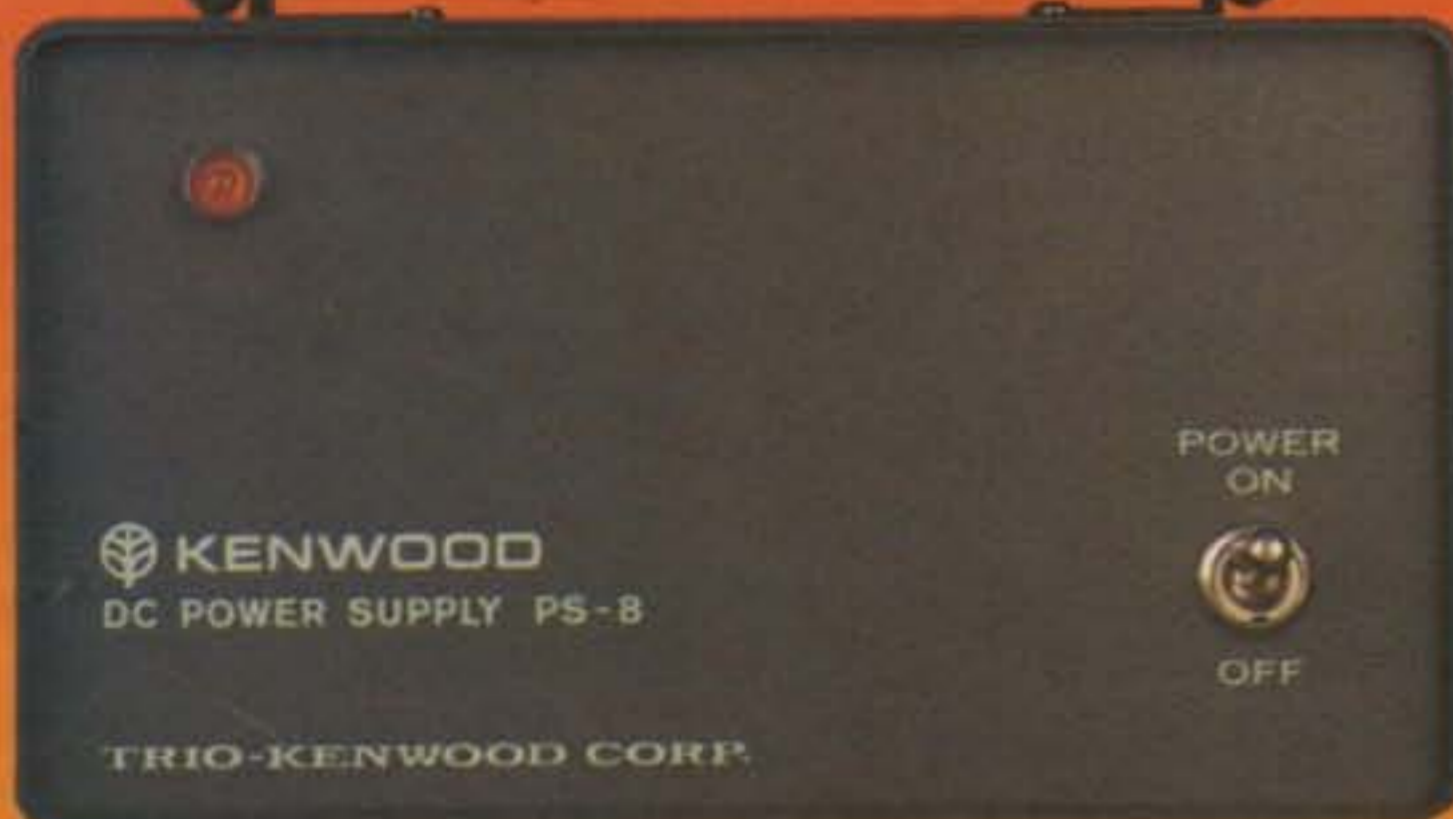

TR-7400A

Features Kenwood's unique Continuous Tone Coded Squelch system, 4 MHz band coverage, 25 watt output and fully synthesized 800 channel operation. This compact package gives you the kind of performance specifications you've always wanted in a 2-meter amateur rig.

Outstanding sensitivity, large-sized helical resonators with High Q to minimize undesirable out-of-band interference, and give a 2-pole 10.7 MHz monolithic crystal filter combine to give your TR-7400A outstanding receiver performance. Intermodulation characteristics (Better than 66dB), spurious (Better than -60dB), image rejection (Better than -70dB), and a versatile squelch system make the TR-7400A tops in its class.

Shown with the PS-8 power supply

(Active filters and Tone Burst Modules optional)



TR-7500

This 100 channel PLL synthesized 146-148 MHz transceiver comes with 88 pre-programmed channels for use on all standard repeater frequencies (as per ARRL Band Plan) and most simplex channels. For added flexibility, there are 6 diode-programmable switch positions. The 15 KHz shift function makes these 6 positions into 12 channels. 10 watt output, ± 600 KHz offset and LED digital frequency display are just a few of the many fine features of the TR-7500. The PS-6 is the handsomely styled, matching power supply for the TR-7500. Its 3.5 amp current capacity and built-in speaker make it the perfect companion for home use of the TR-7500.



TR-2200A

The high performance portable 2-meter FM transceiver. 146-148 MHz, 12 channels (6 supplied), 2 watts or 400 mW RF output. Everything you need is included: Ni-Cad battery pack, charger, carrying case and microphone.

KENWOOD

...pacesetter in amateur radio

Kenwood developed the T-599D transmitter and R-599D receiver for the most discriminating amateur.

The R-599D is the most complete receiver ever offered. It is entirely solid-state, superbly reliable and compact. It covers the full amateur band, 10 through 160 meters, CW, LSB, USB, AM and FM.

The T-599D is solid-state with the exception of only three tubes, has built-in power supply and full metering. It operates CW, LSB, USB and AM and, of course, is a perfect match to the R-599D receiver.

If you have never considered the advantages of operating a receiver/transmitter combination... maybe you should. Because of the larger number of controls and dual VFOs the combination offers flexibility impossible to duplicate with a transceiver.

Compare the specs of the R-599D and the T-599D with any other brand. Remember, the R-599D is all solid state (and includes four filters). Your choice will obviously be the Kenwood.



R-599D

T-599D

R-300

Dependable operation, superior specifications and excellent features make the R-300 an unexcelled value for the shortwave listener. It offers full band coverage with a frequency range of 170 KHz to 30.0 MHz • Receives AM, SSB and CW • Features large, easy to read drum dials with fast smooth dial action • Band spread is calibrated for the 10 foreign broadcast bands, easily tuned with the use of a built-in 500 KHz calibrator • Automatic noise limiter • 3-way power supply system (AC/Batteries/External DC) ... take it anyplace • Automatically switches to battery power in the event of AC power failure.





Fine equipment that belongs in every well equipped station

HF LINES

820 Series

- TS-820S... TS-820 with Digital Installed
- TS-820... 10-160 M Deluxe Transceiver
- DG-1... Digital Frequency Display for TS-820
- VFO-820... Deluxe Remote VFO for TS-820/820S
- CW-820... 500 Hz CW Filter for TS-820/820S
- DS-1A... DC-DC Converter for 520/820 Series

520 Series

- TS-520S... 160-10 M Transceiver
- DG-5... Digital Frequency Display for TS-520 Series
- VFO-520... Remote VFO for TS-520 and TS-520S
- SP-520... External Speaker for 520/820 Series
- CW-520... 500 Hz CW Filter for TS-520/520S
- DK-520... Digital Adaptor Kit for TS-520

599D Series

- R-599D... 160-10 M Solid State Receiver
- T-599D... 80-10 M Matching Transmitter
- S-599... External Speaker for 599D Series

- CC-29A... 2 Meter Converter for R-599D
- CC-69... 6 Meter Converter for R-599D
- FM-599A... FM Filter for R-599D

SHORT WAVE LISTENING

- R-300 General Coverage SWL Receiver

VHF LINES

- TS-600... 6 M All Mode Transceiver
- TS-700S... 2 M All Mode Digital Transceiver
- VFO-700S... Remote VFO for TS-700S
- SP-70... Matching Speaker for TS-600/700 Series
- TR-2200A... 2 M Portable FM Transceiver
- TR-7400A... 2 M Synthesized Deluxe FM Transceiver

- TR-7500... 100 Channel Synthesized 2 M FM Transceiver
- TR-8300... 70 CM FM Transceiver (450 MHz)
- TV-506... 6 M Transverter for 520/820/599 Series

POPULAR STATION ACCESSORIES

- HS-4... Headphone Set
- MB-1A... Mounting Bracket for TR-2200A
- MC-50... Desk Microphone
- PS-5... Power Supply for TR-8300
- PS-6... Power Supply for TR-7500
- PS-8... Power Supply for TR-7400A
- VOX-3... VOX for TS-600/700A

Trio-Kenwood stocks a complete line of replacement parts, accessories, and manuals for all Kenwood models.

MORE ACCESSORIES:

Description	Model #	For use with
Rubber Helical Antenna	RA-1	TR-2200A
Telescoping Whip Antenna	T90-0082-05	TR-2200A
Ni-Cad Battery Pack (set)	PB-15	TR-2200A
4 Pin Mic. Connector	E07-0403-05	All Models
Active Filter Elements	See Service Manual	TR-7400A
Tone Burst Modules	See Service Manual	TS-700A; TR-7400A
AC Cables	Specify Model	All Models
DC Cables	Specify Model	All Models



The Kenwood HS-4 headphone set adds versatility to any Kenwood station. For extended periods of wear, the HS-4 is comfortably padded and is completely adjustable. The frequency response of the HS-4 is tailored specifically for amateur communication use. (300 to 3000 Hz, 8 ohms).



The MC-50 dynamic microphone has been designed expressly for amateur radio operation as a splendid addition to any Kenwood shack. Complete with PTT and LOCK switches, and a microphone plug for instant hook-up to any Kenwood rig. Easily converted to high or low impedance. (600 or 50k ohm).

TRIO-KENWOOD COMMUNICATIONS INC.
1111 WEST WALNUT/COMPTON, CA 90220



ou goons don't ever proof
lousy manuscripts from bab
LETTERS
I insist that you print ev
tell Ma Bell that she shou

HOOKED!

Way back in Oct., 1960, I subscribed to a new magazine which I found I enjoyed immensely. I didn't always agree with you, but I always enjoyed you. However, after about seven or eight years, I found that my interest in ham radio in general had waned and I let my subscription lapse. I have done just enough operating to keep my license current, but that's all.

Then, a couple of months ago, there arrived in the mail an announcement about a new magazine (where did you ever get my name?). It sounded interesting, especially with the name Green on the masthead, so I subscribed. Wow, hooked! This whole business of microprocessors sounded fantastic. So, I went out and bought an Intel evaluation board as one way to get started in this thing. In the process, the proprietor of the Byte Shop where I bought the board threw in a few recent issues of 73. You know, it's even better than I remembered. So, enclosed is my check for another subscription. You have re-whetted my appetite for ham radio. I am looking forward to amalgamating these interests. Don't let anyone talk you out of continuing the I/O articles in 73 — it's obviously the future of the hobby, just like SSB was back in the 50s and repeaters have been recently.

Dr. Jerrold Goldman WB6MOE
Milbrae CA

STANDARDS

I just got done reading your last issue of 73 and I must say I enjoyed it very much, as usual. But there are a couple of things I would like to get off my chest.

First, I must say that I was a CBer, but after much frustration, I decided that there had to be something better in life, so I went to work on my ham ticket, code and all. And sure enough, it paid off when I worked WB6TVX — no great amount of DX, but I was a ham and very proud of it. I hope we will fight to keep our standards high enough to be proud of our licenses. They weren't just given to us — we had to earn them, and for some of us, it took a lot of work. Needless to say, it's something I value very much.

Hopefully, any CBer who wants to upgrade will take on the responsibility that comes with a ham ticket — that means code and all.

Also, as far as the I/O section and the computer articles, I don't understand much of it now, but I didn't

even understand a simple amplifier circuit when I started. I am excited about the possibilities of computers in ham radio; it's a very high goal and a big challenge for me, but it's not impossible.

So, keep up the good work; it's a worthy cause.

Eugene Morgan WB7RLX
Ogden UT

COSMAC

To all 1802 users: *The 1802 Exchange*.

Very little software for the RCA CDP1802 is currently in the public domain. To remedy this situation, I am going to publish a ten-page booklet listing available software. If you desire to sell or even give away your software, please send me a listing for my review. My booklet will provide a complete description and cost information with a reference number corresponding to a number on an ordering coupon.

I plan to charge \$1 for the booklet. This amount will also cover the costs associated with processing the coupons. The use of the coupon will reduce the costs to the person ordering from more than one source.

The publication date is set for early December. Advance orders may be made at \$1 per copy. Here is your chance to buy a good selection of software as well as sell some. Send all orders, software listings, and other correspondence to:

Ross Wirth
1636 S. 108 E. Ave.
Tulsa OK 74128

TSETSE NIT

Pardon me while I pick a nit.

I enjoyed Sam Kelly's article on Soviet test gear (Aug. 77), but spotted one miniscule error. I'm sure that this important bit of information will be of great importance to all of your readers.

The VOM discussed and pictured is not a U-4341. The designation is Ts-4341. Although that letter may look like our "U," it is not the same. Note that it is somewhat square and has a tail. Transliterated, the letter is called "tse." (For what it's worth, the Cyrillic "U" sound looks like our "Y" — but that's another story.)

Now, aren't you glad that I spotted that grievous error?

William F. Blinn
Worthington OH

Got it! Thanks, Bill. — J.M.

MORE 220

This is in response to the letter "220 — No Loss" from M.P. Lewton WA6PHR, appearing in the August issue of 73. I am sure that Mr. Lewton has not taken the time to examine the problems involved with an adjacent (or shared) amateur/CB 220 MHz allocation. We now realize that the allocation of 11 meters to the Citizens Service was a mistake, if only because of the proximity of the desirable amateur frequencies and the availability of equipment which is obviously illegal for use by the CB licensee. I, for one, do not want any of the three 220 MHz repeaters in Columbus to be infested by the uncontrollable illegal use that would occur if a CBer merely had to buy a crystal to cross the line. Perhaps Mr. Lewton would propose a CB band at 148.0 MHz?

M.P. suggests that we could still use the frequencies with our CB licenses, so there would be no loss to us. If I wanted to operate as a CBer, I would be a CBer and not bother with the FCC examinations in the amateur service. I am an amateur, I have not found any reason that requires me to get a CB license, and I don't foresee any reason that would make a CB license necessary or desirable for me in the future. 220 MHz is ours now, and we are getting along quite well without undisciplined intrusion.

Concerning the suggested reduction in prices on 220 rigs due to the CB mass production — where have you been, M.P.? Look in *QST* for May, 1977, page 169. The Midland 13-509, one of the best available 220 rigs, sells for \$149 from AES, and similar prices from other suppliers all over the country. The Clegg FM-76 is similarly priced. The prices, when compared to two meter rigs of similar quality, are so reasonable now that it is unreasonable to assume that the EIA manufacturers will make any effort to reduce the price of 220 CB rigs.

The matter of whether CB really needs (or more importantly, *deserves*) more frequency allocations is really irrelevant — 220 is currently used extensively in some areas by a disciplined, licensed service. 220 MHz activity is growing strongly in many areas of the country as 2 meters becomes more and more congested, and the promise is for increased development as a practical, logical alternative.

Add to this the objections of Canada and Mexico, the widely-held view of a 220 MHz CB band as a governmental reward to CBers for their excellent success in creating a bastion of garbage and illegal activities on 11 meters, and the reluctance of the FCC to place a CB service in a frequency range that would allow the use of available amateur amplifiers, and you find the finger pointing to 900 MHz as the only reasonable spot to stick any expanded CB service.

So, Mr. Lewton, I suggest you get in touch with some 220 group in your area and learn some of the facts concerning the current amateur 220

MHz band. Maybe we'll see you there soon — as an amateur, *not* as a CBer.

Jeff Maass WB8JXS/WR8AOV
Central Ohio Area
Repeater Group
Columbus OH

DOES NOT COMPUTE

Please relieve me of the duty of removing that big thick book from my tiny apartment size mailbox, and the obvious advertising it gives the neighbors when placed in the adjacent junk mail collection box.

The last straw was the "article" in Aug., '77, "When the Lights Go Out — prepare yourself." Please, prepare first, like a good scout. Also, jelly for sandwiches for five days? Jelly spoils when opened in hot humid climates. Why leave out good old peanut butter? It keeps without cooling, is very nourishing, and is politically expedient.

Amateur radio as it used to be is still my favorite hobby. I can still remember listening to Pitcairn Island on 20 meter AM on a single tube superregenerative receiver. And the thrill of the very first xtal clear CW on a homemade two tube receiver. And listening to Tennessee and Kentucky on 5 meters, back in Wisconsin, on a June day in '39.

Try *that* on your doggone new-fangled computers.

Roy A. McCarthy K6EAW
Anaheim CA

WELL DONE

Our congratulations to Stew Perry, "King of 160," on his thirty years in amateur radio. I was impressed with his station as pictured on the cover of your June issue, but he really should do something about the accuracy of his clocks!

Chuck LaPointe WD9DXF
Orland Park IL

THANKS

This letter is to express my sincere appreciation to you for publishing my letter in the August issue of 73, in which I asked assistance in getting information on ham radio for the deaf.

The response was immediate and dramatic. Only this morning, Gene DeGroot from Randolph WI called me. He has accomplished some remarkable work in this field. His advice has saved me many hours of ground work. Moreover, he has put me in touch with some ham operators who are deaf . . . and some both deaf and blind.

I do not mean this as a criticism of *QST* or ARRL, but as a high compliment to you.

Over a period of 4 months, I wrote Mr. Baldwin *twice* requesting this

Continued on page 46



NEVER SAY DIE

...de W2NSD/I

EDITORIAL BY WAYNE GREEN

from page 4

that beautiful location. My 16 element beam didn't hurt either. It was one built by UHF Resonator, Bill Hoisington, who many years later would write a long series of articles for 73 and would move to Peterborough to be near the magazine.

By late '48 I was deeply into RTTY and helped John Williams W2BFD set up the first ham repeater in the country in the Municipal Building in New York in 1949. It lasted a few months and then the FCC closed it down. The FCC worked for years to do all it could to prevent amateurs from pioneering and inventing... and they are still at it, though things are getting better.

In 1951, I started a RTTY newsletter; this ran until 1955 when I became editor of CQ. It was during this period that I became aware of the heavy hand the ARRL had on amateur radio and the way they worked with the FCC to discourage amateur pioneering. A group of us worked for years to get RTTY permitted on the low bands, with the ARRL fighting us every inch of the way.

When I became editor of CQ in January, 1955, I began to really get the inside dope on what was going on in amateur radio, and the more I heard, the more disgusted I got with the ARRL. Having known Harry Dannals W2TUK for several years, I figured almost anyone would be better as a Hudson Division Director, so I backed another chap - who won. This chap in short order put the League into good financial shape, got rid of the old general manager, and had things running better than they had been in years.

73 STARTED

After leaving CQ in January, 1960, I tried my hand at working for an ad agency, and then decided it was time

to see if I could get a new ham magazine started. The projected expense for starting a new magazine was about \$500,000, so I didn't have a lot of luck getting investors - I couldn't find one. Oh, well - I decided to go ahead without money and do it anyway.

Before I got into editing and publishing 73, I was doing reasonably well... I had two Porsches, a nice Chris Craft Express Cruiser, a plane, yearly trips to Europe, and my own Arabian horse. Starting a magazine is akin to taking vows of poverty when joining a religious order... except that you can get out of the religion. No more Porsches, yachts, planes, or horses... and darned few European trips. After 17 years, I've become accustomed to working 100 or so hours a week, and since I have virtually no private life whatever, I am sort of amused at even the concept of a "personal expense."

Mind you, I'm not beefing. I signed up for this when I started 73... and I aggravated it when I started Byte and Kilobaud magazines. There is a degree of self-destructiveness involved, too. Obviously this will catch up with me one of these days and bam, silent keys. My long-range goals are to try to make the world a little better place. Through the magazines, I provide entertainment, education, and help people have a lot more fun. Since I have little interest in money other than as a necessity for getting things done, I'm an enigma to many people.

Enough of all that - the main subject at present is the future of amateur radio. I've participated in many of the developments of the past: working personally with NFM, RTTY, SSB, SSTV, moonbounce, repeaters, OSCAR, DXing, DXpeditioning, and so forth. There isn't much that's gone on in the last 40 years of amateur radio that I haven't

Continued on page 95

EXPORT INFORMATION

SEALS

Canadian and European community customers use our EXPORT DELIVERY SERVICE. Guaranteed delivery to your address. We take care of charges for customs clearance, duties, federal taxes, air freight and insurance. Add exactly 35% to the prices shown. (45% in Canadian dollars). Allow 5 extra days for delivery. MINIMUM EXPORT ORDER \$100.00

DEALER INQUIRIES WELCOME

THE SEAL OF PERFORMANCE

SEALS

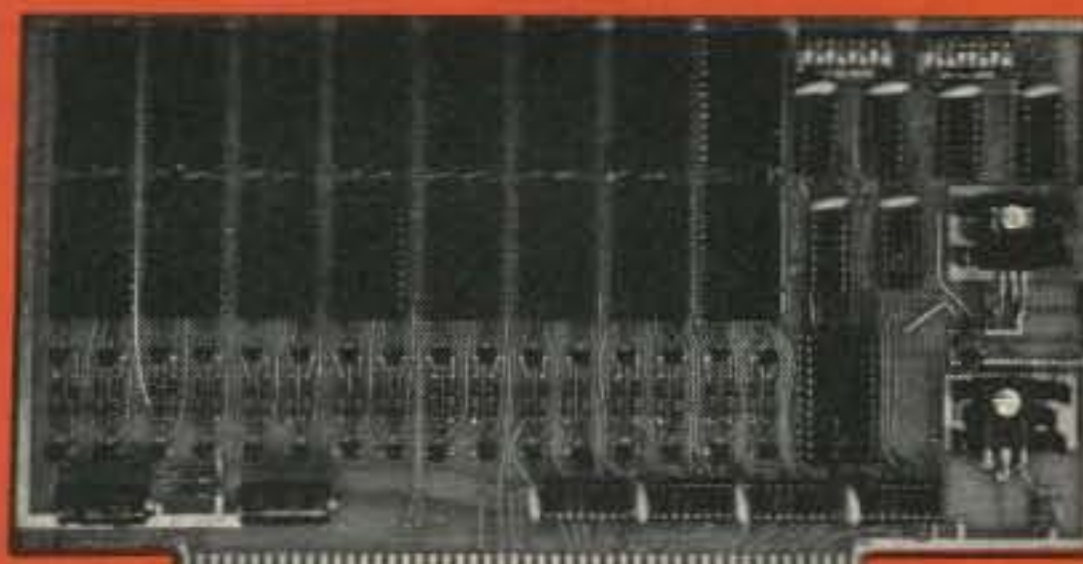

4K ROM

READ ONLY MEMORY

- Will accept up to 16 ea. 1702A or 5203 EProm Providing up to 4096 Words of non-volatile memory for Boot Loads to Complete Programs.
- Programming Available at Factory for \$3.00 per EProm when accompanied by binary formatted tape.
- Each 1702-A has its own V_{gg} clocked for Low Power Consumption. Will work with the weakest power supply based S-100 buss computer.
- Switched Selected Address in 4K Blocks.
- Switch selected wait states so that even the slowest 1702-A can work in your system.
- Solder masked on both sides of PC Board.
- Component Screened on Component Side of PC Board.

Kit Price
\$109.00

Assembled Price
\$119.00



8K SC-Z

STATIC MEMORY CARD

- ALTAIR[®], IMSAI[®] and S-100 buss compatible.
- Access Time: 250 nsec max.
- Zilog Speed Compatible up to 4 mhz.
- Memory Chip: 2102LHPC or 2102-2.
- Battery Standby >1.5 to 4 volts.<
- Address Select: 8 ea. Spst. Dip Switch.
- Wait States: None.
- Current Reg.: Less than 200 ma per 1K.
- All Address, Control, and Data Out lines fully buffered.
- All IC's supplied with IC Sockets.
- Solder Masked on both front and back of P.C. board.

Kit Price
\$285.00

Assembled Price
\$295.00

SEALS
ELECTRONICS, INC.
BOX 11651, KNOXVILLE, TN. 37919

TELEX NO. 55-7444

TELEPHONE NO. 615/693-8655

S-10-77

**MICROSWITCH
TELEPHONE FORMAT
KEY BOARD "BRAND NEW"
NW SERIES**

16 NW7-25 Numeric Keyboard
16 NW7-21 Alphanumeric Keyboard

SPECIAL PRICE \$9.50 each

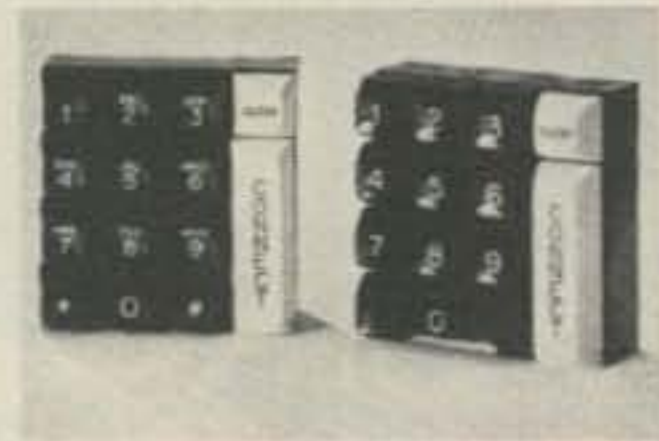

Quality Guaranteed. PA residents include 6% sales tax. Add \$.75 for Shipping and Handling. Quantity Discounts Available.

STANDARD ELECTRONICS
1 BROWN STREET
PHILADELPHIA PA 19123
215/925-5711

S35

CS_{dc} Silicon Rectifier Modules



FEATURING:

- Voltage ratings up to 20,000 volts
- Current ratings up to 6.0 amps
- Fully glassivated diode building blocks by —
GENERAL ELECTRIC
- Wide variety of standard assemblies available in configurations such as half wave, center-tap, doublers, and bridges (1 & 3 phase)
- Avalanche types
- Both standard power line frequency and fast switching types
- Capable of replacing many other manufacturers' types which are no longer available such as silicon retro-fits for tube types 866, 872, 8020, etc.
- Custom designs and engineering services
- Applicable to higher reliability applications such as industrial control systems, communication equipment, ham radio gear, smoke stack precipitators, etc.

FOR MORE INFORMATION CONTACT:

CONDITIONING SEMICONDUCTOR DEVICES CORP.
Post Office Box No. 816 Wayne, N. J. 07470
Telephone: 201-227-2539

C11

**77/78 AMATEUR RADIO
EQUIPMENT DIRECTORY**



A one stop buying and reference guide to all your amateur needs. The new 77/78 supplement (32 pages) updates the 1977 Edition and brings the total number of pages to 168 (2 volumes). Almost 100 manufacturers/distributors are included.

\$3.50 plus 25c postage and handling — U.S. only
Canadian orders \$4.00. Foreign orders \$5.00 (air)

KENGORE CORP — Dept. C K11
9 James Ave. Kendall Park, NJ 08824

**How You
Can Convert
Your Rohn
25G Tower to a
FOLD-OVER**

**CHANGE, ADJUST OR JUST
PLAIN WORK ON YOUR
ANTENNA AND NEVER LEAVE
THE GROUND.**

If you have a Rohn 25G Tower, you can convert it to a Fold-over by simply using a conversion kit. Or, buy an inexpensive standard Rohn 25G tower now and convert to a Fold-over later.

Rohn Fold-overs allow you to work completely on the ground when installing or servicing antennas or rotors. This eliminates the fear of climbing and working at heights. Use the tower that reduces the need to climb. When you need to "get at" your antenna . . . just turn the handle and there it is. Rohn Fold-overs offer unbeatable utility.

Yes! You can convert to a Fold-over. Check with your distributor for a kit now and keep your feet on the ground.

AT ROHN YOU GET THE BEST

**Do not attempt to raise antenna or
antenna support near power lines—
You can be KILLED.**

Unarco-Rohn
Division of Unarco Industries, Inc.
P.O. Box 2000, Peoria, Illinois 61601

U2

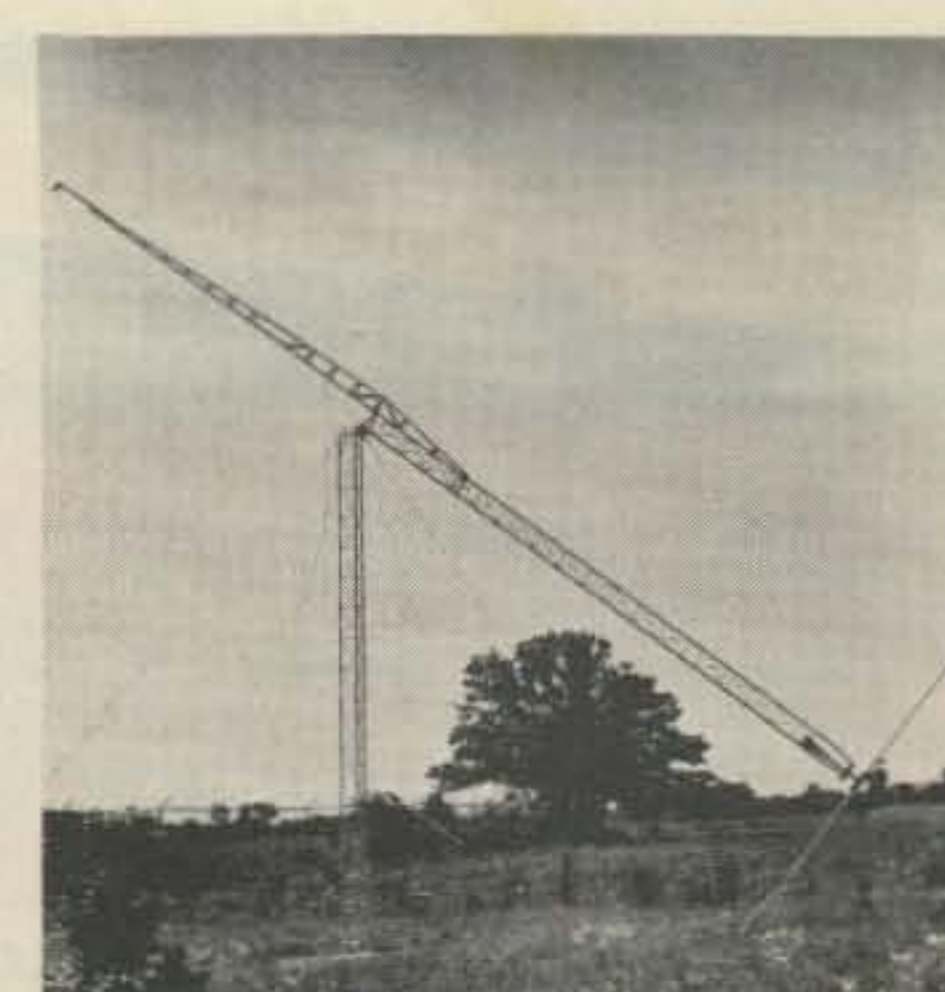
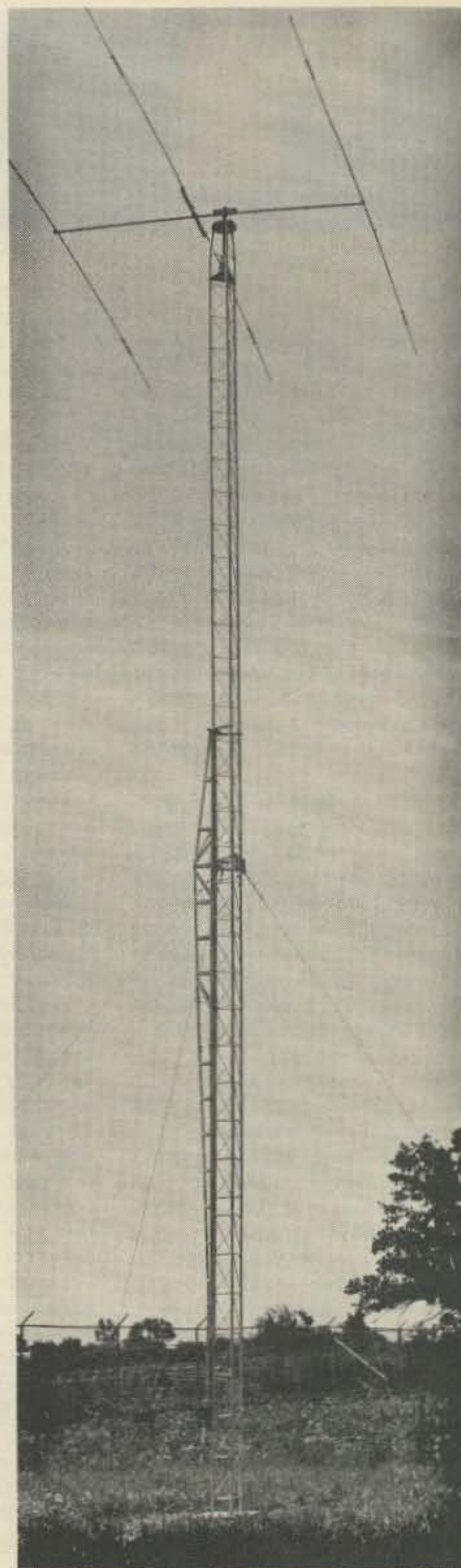

YOU... AND AMSAT PHASE III

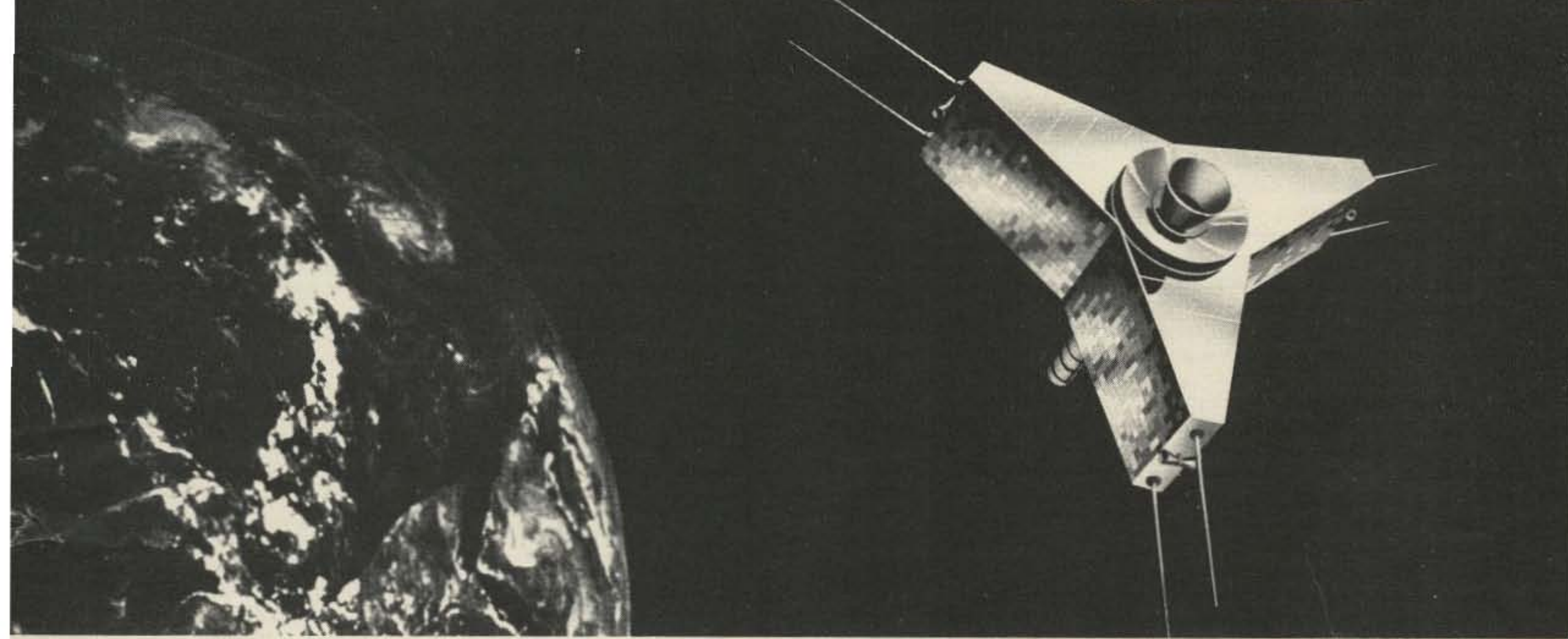

An exciting new era in amateur radio is about to begin... the era of AMSAT PHASE III OSCAR satellites.

Many of you are familiar with the benefits of the AMSAT OSCAR satellites, notably OSCAR 6 and 7. These satellites, with a combined total of over 8 years in orbit, have provided communications between amateurs throughout the world. They have also provided a capability for an educational program in space sciences and many interesting experiments.

AMSAT, with members and contributing groups worldwide, and headquarters in Washington, D.C., has been responsible for our current satellite program. Many people feel that perhaps the greatest value of the amateur satellite program is the dramatic demonstration of amateur resourcefulness and technical capability to radio spectrum policy makers around the world.

The value of this aspect of amateur radio as we prepare for the 1979 World Administrative Radio Conference (WARC) is enormous.

The AMSAT PHASE III satellite program promises a continuing demonstration that amateur radio is at the forefront of modern technology. PHASE III satellites will routinely provide reliable communications over paths of up to 11,000 miles (17,600 km) for 17 hours each day. You can think of them as a resource equivalent to a new band.

The cost of these PHASE III satellites is a projected \$250,000. Commercial satellites of similar performance would cost nearly \$10,000,000.

Your help is needed to put these PHASE III OSCAR satellites in orbit.

Your valued, tax-deductible contribution can be as small as one of the 5000+ solar cells needed. A handsome certificate will acknowledge the numbered cells you sponsor for \$10 each. Larger components of the satellites may also be sponsored with contribution acknowledgements ranging to a plaque carrying your name aboard the satellites. Call or write us for the opportunities available.

Your membership in AMSAT is important to the satellite program, and will give AMSAT a stronger voice in regulatory matters concerned with satellites. At \$10 per year or \$100 for life, you will be making a most significant contribution to the satellite program and the future of amateur radio. You will also receive the quarterly AMSAT newsletter.

Clip the AMSAT PHASE III coupon below and send your support today, or call 202-488-8649 and charge your contribution to your BankAmericard (VISA) or Master Charge card.



AMSAT PHASE III
Radio Amateur Satellite Corporation
Box 27, Washington, D.C. 20044
202-488-8649

A34

YES, I want to support AMSAT PHASE III OSCAR satellites. Enclosed is:

- \$_____ in sponsorship of _____ solar cells (@ \$10 each)
 \$10 Annual membership \$100 Life membership
 Send information on sponsoring larger satellite components.

Name _____ Call _____ AMSAT Member? _____

Street _____

City _____ State _____ Zip _____

Looking West

Bill Pasternak WA6ITF
24854-C Newhall Ave.
Newhall CA 91321

FOUR DIFFERENT KINDS?

When I am invited to talk to an amateur group, I often begin by asking a rather simple but loaded question: "How many different kinds of repeaters are there?" Usually, I get as a first response exactly what I expect. An amateur raises his hand and says, "Two: open and closed." Then someone in the back of the room will shout out: "You forgot autopatch!" Most of the time it stops there, and the discussion starts.

Southern California relay communication is steeped in areawide traditions, and out of this has come acceptance of four different categories of relay operation: open, closed, private, and the individually owned and operated, remotely-controlled amateur base station radio, more commonly known as a remote base. To complicate matters even further, these four categories of relay systems operate under one of two operational formats: basic and advanced. Let's cover the latter of these two designers first.

Until about a year and a half ago, very few people gave much consideration to operational format. A repeater was a repeater, and remote bases were those "things" that popped up on .94 once in a while and were usually heard on .46. However, as technology progressed, so did a need on the part of some to show their own individuality. Out of this grew the terminology, "advanced format" and "basic format."

How, though, does an "advanced format" system differ from one of "basic format"? Really, it's in the peripherals and the use a system is put to. In many ways, the microprocessor had a lot to do with it, I guess. Many "advanced format" systems utilize microprocessors for overall system control and security. Then there is the concept of interlinking on a wide scale basis. Some of these groups have intentions of building national interlinked networks, by which they will be able to "function up" any city they wish at the touch of a finger on a tone pad. Some are well on their way to achieving this goal. From the foregoing, you might imagine that most "advanced format" systems are also private systems. Your assumption would be correct. In fact, "super private" would be far better terminology. This type of advanced state-of-the-art communications requires a totally controlled environment, and it is for this reason that no such system is found on two meters. Those involved in "advanced format" amateur relay communications tend to go to spectrum where they can achieve their objectives without taking away valuable spectrum from the average ham. They "do their thing," bother no one, and (most important) help advance

communications technology. If there is one point of consternation, it is that such systems are not available for use by the average "Joe Ham"; their basic structure precludes this. Sometimes a system such as this is "down" for months of redesign, and very few "users" are willing to put up with this. By and large, they are made up of small groups of a dozen or fewer dedicated experimenters, who seem to live for a "mission" of finding a better way to "do it," to talk farther. In actuality, the terms "advanced" and "basic" have come from those involved in the former, as a way of letting the world know that their particular operation is indeed different from the norm. Anything that does not meet the criteria of an "advanced format" system is then considered "basic format." Having an autopatch does not count.

Now, let's discuss categories of repeaters. We are talking "types" and not access coding. Open repeaters? Yes, we have our share of them. In fact, this state boasts more open repeaters than anywhere else in the nation. Want to involve yourself in emergency communications? Want to rag chew? No matter what you are looking for, there is a repeater somewhere to meet your needs, an open repeater, there for your use. Most licensees and/or sponsoring organizations only ask that you use and support such systems and not abuse them. Some have very lenient system regulations, while others might well constitute a structured mini-society. Whatever your preference, you will find it.

How, then, do "closed" and "private" systems differ from open systems and from each other, and, under the structure of FCC regulation, how can they exist? The latter answer is indeed simple. Justification for such systems comes from official recognition of their existence. Such was the case during the early days of deregulation, when, in its report and order on remote control, the FCC specifically recognized the concept of the closed system and granted such systems the ability to operate under the doctrine of "fully automatic remote control" (while at the same time granting only "semi-automatic remote control" to open systems). There are also the statements made by FCC personnel when questioned on this topic, such as that of Dick Everett at SAROC's FCC Forum last January, when he stated that no amateur is obligated to provide any service to any other amateur. Then, too, there is the question of the constitutional right of an individual to use his amateur station (his own personal property) in any way he sees fit, as long as its use does not bring harm to others.

Suffice it to say that the FCC and the overall amateur community have come to recognize the existence and operation of relay systems whose access is available only to a limited

segment of the amateur community. I realize that to some the existence of such systems is a sore spot; however, the fact is that the concept of the "limited access system" is growing out here, and I suspect that we are indicative of what's happening nationally. You in your area know far better than I. By present count, southern California holds (on 2 meters) twenty such classified systems, up three from last year. 220, a band most thought would be a haven for open systems, is about 30% limited access. However, here such systems are forced to share channels with other such systems. So while there may be twenty SCRA-coordinated closed and private systems on 2, only part of that number of channel pairs is in use by them.

"Closed" systems differ from "private" systems in the following way. A "closed" repeater is one in which membership within the sponsoring organization is required in order to use said system; however, such membership is available to all interested members of the amateur community. Systems dedicated to emergency services, such as RACES and ARES, wherein all communication content must be of either an operational or "drill" nature, would probably be fair examples. On the other hand, a "private" repeater also requires group membership. However, membership and thereby system access is at the total discretion of the system licensee and/or his sponsoring organization. Therein lies the difference.

I'd like to dispel the long-standing myth among amateurs that a repeater is automatically to be considered "closed" or "private" if it requires that users equip themselves with tone coding devices to activate the system.

I call this a myth because that is exactly what it is. However, even such an austere organization as the ARRL seems to live under this total misapprehension, as was made evident in their July, 1977, issue of *QST* ("Washington Mailbox" column, p. 74), in which the writer states something to the effect that any repeater that requires a tone to activate it is a closed repeater. While placing a tone-activated device on a system's input can have the effect of limiting usership, such is not the proper use of such devices. Tone coding in its many forms, including burst, digital burst, CTCSS, and digital CTCSS, was developed for use in the commercial land mobile radio sector as a means of increasing spectrum loading — not to keep people off repeaters.

Here is how such a system works. Most commonly used in the land mobile service is CTCSS, which stands for Continuous Tone Coded Squelched System. You might be more familiar with it under one of its trade names, such as Motorola Private Line (PL) or General Electric Channel Guard. These are registered trademarks of these manufacturers. They enable more than one person to operate on a given channel (or channel pair, in the case of relay devices) on a minimal interfering basis. Such an entity might be a "community re-

peater," as we shall now describe.

Most of us consider a repeater to be a device with which one group of people communicates via a given channel pair. In commercial service, one repeater may be set up to serve the needs of two, three, or even a dozen individuals or business groups. This is accomplished by assigning individual tone code assignments to each person on the system. In our example, let's say that we have three businesses sharing a commercial repeater. Let's call them Smith's Delivery Service, Tom the Plumber, and City Bus Service. Each has a specific communications need, and CB radio will not suffice. They all wind up on a given "community repeater." Each is assigned a specific EIA standardized tone code of the CTCSS variety. Smith is assigned 1A, Tom gets 3B, and CBS gets 4B. However, all operate through the same repeater and transmit and receive on the same channel pair.

Contained within the electronics of both the repeater and each user's radio are tone encoders and decoders. The repeater itself has the ability to decode and regenerate all three of the CTCSS tones installed, while the users' radios only respond to their preassigned codes. Let's suppose that Mrs. Jones, the dispatcher for the bus company, wants to tell Tim, the driver, to go over to the Little Red Schoolhouse. She removes the microphone from its cradle. When she does this, a switch built into the cradle automatically closes and defeats the internal decoder, allowing her to hear any channel activity that's not being directed toward her. Hearing nothing, Mrs. Jones calls her mobile and passes her message. Had she heard another conversation in progress, she would have been obliged to wait for its conclusion. In the meantime, when no traffic is being directed at her, her radio is silent, even though the channel may be under heavy use. The same holds true for each of the channel users. They only hear traffic directed at them — unless they want to listen in for entertainment purposes. I suspect some do.

The ability to share, to increase channel loading, and thereby to use spectrum more efficiently, is the true purpose of tone coding. To use it to restrict those "unwanted" by you or your group is defeating its intent — tone coding was never meant to be a means for security, and besides, with tone codes EIA-standardized, how much and how effective a security method can it really be?

This being the case, what really makes a repeater "closed" or "private"? It's attitude, the attitude of those people placing such systems into operation and the attitude of those invited onto such systems. In our part of the country, we have a number of totally "open" systems which, due to either co-channel assignments or nearby adjacent channel assignments, have utilized tone coding as a method to minimize interference to their operation. Still, these systems are in every sense of the word "open"; they are available to any amateur who wants to use them. By the same

token, we have a few "private" repeaters that require no tone access whatsoever. Yet these systems are truly "private" in every sense of the word. In each case, it is the attitude of those involved with a given system that decides its category — tone coding enters not.

How can amateurs make better use of methods such as CTCSS? On an individual basis, it's been happening for years on WR6ABB and a few other LA area repeaters. Following the lead of the commercial sector, a number of individual sub-user groups have taken to installing CTCSS encoder/decoder packages in their radios, with automatic mike cradle switches as earlier described. In this way, they can still hear the messages directed toward them, even though they are not forced to listen to all the channel chatter. One might call this "private" groups functioning through "open" repeaters.

Another method is that of channel sharing in crowded urban areas, where coordinators have run out of available spectrum and are faced with an ever-mounting deluge of channel assignment requests. What I am about to describe may not now be popular, but wait four or five years and then read it again.

Suppose that an area is totally out of spectrum upon which to coordinate another repeater without causing massive interference to existing area activity. On the coordinator's desk sit 100 or more demands for repeater pairs. If he does not act soon, he may have a hundred or more pirate systems challenging existing activity. A hundred repeater wars. Then an idea hits him . . . CTCSS! "Why not?" he says to himself. "Why not assign all existing activity of open repeaters a given areawide CTCSS tone, and then assign a second tone and the necessity for a lockout receiver to all the next generation of repeaters — and then coordinate them atop one another?" In essence, all existing systems would become primary channel activity, and any new system could only operate when existing activity of the initially coordinated system ceased. Now, it might not work for every channel pair, but it would be fine for those of low activity. In fact, you could possibly put six or seven per channel, with each assigned a different tone and each required to lock out when it heard any other tone of any system of an earlier coordination date.

Okay, there are obvious pitfalls to such a system. The largest is getting any group of hams to agree totally to anything. With ever-mounting pressure on urban area coordinators and councils, however, do not be too surprised to see something along these lines in the not-too-distant future. Note that many of the new radios coming to the marketplace have tone coding built in — or at least a provision for it. Do the manufacturers know something that the rest of us don't?

Let's finish this by putting this myth to rest forever. It is not tone coding that makes a repeater "closed" or "private," but rather the attitude of the people who own and use it. If tone coding has one asset, it is that of

a "sign" or "symbol" that states to the rest of the world that it is for use by and for members only.

What about the fourth category, the aforementioned "individually owned and operated, remotely-controlled amateur base station radio"? How does it differ from a repeater, and why is there a rather phenomenal growth lately in the number of these systems? Statement of fact: A remote base is not a repeater. The only similarity lies in the hardware, and that is where the similarity ends. The root structure is "simplex ability using relay technique." Suppose you lived in a bad spot for direct station-to-station communications, but for some reason did not want to use a repeater to communicate. In fact, you wanted the total flexibility of your base station radio, with the added ability of long distance communication. You could relocate atop a mountain, but is it not better to just move your radio atop a mountain and then operate through it by remote control? In its purest form, that is exactly what a remote base is.

However, today's modern remote base is far and away a lot more than that. First, if you can put a two meter downlink radio on the hill, why not six, 220, or 10? Why not 160 through 10 on CW and/or SSB, as well? Why not an autopatch function? How about the ability to "swing" a tri-band beam or remotely tune in single kHz steps all of the low bands? Remember, unlike a repeater, whose licensee has a specific responsibility to a given usership, a remote base is technically individually owned. Therefore, the licensee can do things with it that might bring chaos to the average open repeater. With a remote rather than a repeater, the owner is totally free to experiment and operate to his heart's content — and never once worry about the responsibilities that an amateur running a repeater for a given usership has. I suspect that it is this overall total freedom that is responsible for the dramatic growth in such systems.

While by law an individual by himself must own a remote (in the eyes of the Commission), this does not mean that there's always one remote per ham. While a good number of single owner/user systems abound, at least an equal number are organized as closed membership amateur communications organizations. These organizations, usually numbering no more than ten individual amateurs, are very closely knit, and in virtually every case are made up of individuals of exceptional skill in the art of two-way VHF/UHF communications.

I said earlier that a remote is a "simplex" device using relay technique. Taking this further, most remotes come into being because an individual or group is interested in expanding their ability to talk without the aid of a repeater. They do not want the restrictions of "3-minute timers" and of having their QSOs interrupted every two minutes by breakers. They want the same ability from their mountain as they have from their home ham shack. By utilizing the concept of the remote

base, they achieve their individual objective. At present, there are an estimated 300 or more such systems in this area alone; hardly a day goes by without running into someone who tells you that he is building one also. I might be wrong, but I would be willing to venture a guess and say that the modern remote base is possibly the fastest growing of all forms of amateur relay communications currently to be found out here.

THE GOOD GUY

While back east a while ago, one of my scheduled stops was at Clegg Communications in Lancaster, Pennsylvania, both to see Ed again and to do a "Manufacturer Profile" story for this magazine. It was about 90 miles to Lancaster from Valley Stream, Long Island, where I was staying, so early that particular morning I made a beeline into Brooklyn to pick up Larry Levy WA2INM, who was to act as my photographer. The two of us then headed toward Lancaster in my father-in-law's '73 T-Bird.

By five that afternoon, we were ready to head back to New York. We bid good-bye to Ed and his staff, and jumped back into the car. It started fine, but when we placed it into "drive," we found that it had decided that it liked Lancaster a lot and wanted to remain. The transmission had died — or so we thought. Not knowing exactly what to do, Larry and I ran back into Ed's office just as he was about to depart. We explained our plight, and in short order Ed had literally solved every problem for us.

First, he found us an auto mechanic who later turned out to be one of the most righteous individuals I have ever run into. Then, though he had a rather important dinner and meeting to make, he personally took the time to take us around and help us find transportation back to NYC, finally dropping us at the airport in Lancaster. We had hoped to make a commuter flight to Philadelphia and then grab either TWA or American back to JFK. As luck would have it, the commuter flight (which was the last one) was a sellout, but National Car Rental came through with an Olds Cutlass that got us back to the "Big Apple" in fine fashion by midnight.

If "LW" could give a "good samaritan" award, my first nomination would be Ed Clegg W3LOY. He did not have to go out of his way for us. Even though he had important appointments to keep, an act of human kindness to a friend he deemed more important. Both Larry and I probably will never find the proper words with which to say thanks. We both hope that this is a proper beginning. This being my first trip to the Lancaster area, I was quite at a loss when the situation arose; having someone extend a warm hand of friendship at that moment was very welcome indeed.

THE BIG LINK

What do repeater stations WR5AFS in Houston, Texas, and WR6AWQ in Los Angeles have in common? What



event did repeater stations WR6AWS and WR6AAE also share in part? Answer: probably the record for the longest duration repeater interlink between two cities separated by over 1,000 miles. Would you believe three hours and forty-two minutes? Not that this record is important. More so is what happens after the initial shock of a two thousand mile link wears off.

I have been involved, in one way or another, in linking efforts before. In fact, one of the very first, between Waltham, Mass., and Los Angeles (about five years ago), was a direct result of an offer by one of our local repeater owners to try such an experiment that was printed in one of the earliest "LW" columns. Not long ago, we reported on Sam Davis WA1GQY/6 and his "Linking America," which at last report is still going fairly strong. However, most of the latter consisted of people at both ends exchanging callsigns, salutations, and requests for QSL cards.

WR6AWQ and WR5AFS are quite different from one another. WR5AFS is an open repeater located in Houston, with about 70 to 100 regular users. It is a two meter system, sponsored by an organization known as the Houston ECHO Society. WR6AWQ, on the other hand, is a private 220 MHz system that is itself part of an organization called Westlink, the objective of which is to organize a network of autonomous interlinked repeaters to provide statewide communication. As I mentioned earlier in this column, a good number of such organizations exist. With the differences in operational category and format between the two, what would you imagine the outcome to be?

It was, for all participating, one of the most fascinating and educational evenings ever spent. After "initial shock," which lasted for about a half hour, one began to realize that QSO after QSO was taking place — meaningful QSOs, in which everything from system operation to things of a far more human nature were being discussed. It was a Sunday evening, and the Houston group had been involved in their weekly net as the link started. For part of the linkup, the Los Angeles AWQ group took part in a net in a city a couple of kilometers away!

What happens, then, when you link two repeaters? People talk, and out of this gain a far better understanding of

their fellow man than they could when isolated by the coverage restrictions of an average repeater. Both systems are eager to do it again. If your system is interested in linking with either or both, drop me a note, and I'll act as a clearinghouse and pass it on to the proper party. WR5AFS and WR6AWQ may hold the current record for the longest repeater interlink, but I suspect that they also might account for the greatest number of new friendships evolving from amateur radio in one evening.

220 IS ALIVE, WELL, AND GROWING IN HOUSTON

According to Kent Marshall W5TXV, six months ago there were about ten intrepid souls in the Houston, Texas, area who were playing around on 220. What a difference a few months can make. At present, there are over fifty amateurs now on 220, and an experimental repeater is operating on the high .34/.94 pair, under the callsign WR5ATG. Kent credits this growth to two factors: the Clegg FM-76, and a gentleman named Doug Burns W5FUH, who is spearheading 220 growth. In Texas, as here in California and elsewhere, amateurs have come to like 220 because it is still uncrowded. Even via a repeater, one can hold a true conversation — a feat which is fast becoming impossible on two in many places. How long this will hold true is anyone's guess, since 220 seems to really be taking off. Here in southern California, the last of the available 220 pairs was recently coordinated, and now Tom Rutherford W6NUI and his SCRA 220 Technical Committee are involved in multiple co-channel coordinations. Nineteen such coordinations have already been made, with many more expected to follow.

In Texas, 220 is growing, and if what I hear about Texans is true, I suspect that 220 will get the "Big Texas Treatment" that has helped two to grow and prosper. Amateurs have headed the call of "220 — Use It Or Lose It!", and while we must never be complacent, I have a sneaky feeling that Class E CB would find it quite hard to manifest itself up there in quite a few places, contrary to what certain EIA-oriented information might say. Good work, Texas!

SOUTH CENTRAL U.S. MAY ADOPT CALIFORNIA TERTIARY PLAN

While no official announcement has been made as of this writing, according to informed sources the Texas VHF-FM Society, along with coordinating groups from Tennessee, Mississippi, Louisiana, Oklahoma, and New Mexico, will shortly announce formal adoption of the Modified SCRA Inverted Tertiary Plan for split-split repeaters. This would signify two things. First, that interest in VHF relay communications among amateurs continues to grow, and thus a need to expand the number of available channels has reached these areas of the nation. Second, it signifies that endorsement of this plan by the

ARRL in a recent QST article on the subject (October, 1976, pp. 47, 48) has had a profound effect on its acceptance by the amateur community.

It is my sincerest hope that these areas have as much success with this plan as we have in southern California. The ARRL has stated that the best chance of technical success seems to come through this method, and I think our overall success during the past three years has shown this to be true. The SCRA still has available a technical paper written by Bob Thornberg WB6JPI on this subject, and an 8½ x 11 SASE with a bit of patience on your part will bring a copy. Send your request to SCRA, PO Box 2606, Culver City CA 90230. Though written three years ago, the concepts contained therein are as practical today as they were then. They are the basis for a good part of this area's successful coordination effort.

TSARC CARES

As you are already aware, in May I was back east. I happened to show up at just the right time. Well, to be truthful, I had been made aware beforehand by Dave Minot WA2EXP, TSARC chairman, that the Tri-State Amateur Repeater Council would be holding an open general membership meeting. Dave extended a personal invitation for me to attend and meet the group.

What intrigued me was a discussion underway when I arrived. It dealt with a matter very close to my heart: willful and malicious interference to amateur relay communications by the "sickies" of this world. Now, nothing new came of this discussion. What in my mind may be precedent-setting, though, is the fact that a repeater council had felt it was in the interest of all amateurs to involve themselves in some way in trying to solve this problem. Maybe for the first time ever, such a body was saying "we've had enough" and was beginning to turn their heads toward finding a way to take action. I personally wish them all the success in the world, and pledge to do anything in my power to aid them or anyone else so inclined.

Their structure is a bit different from that of the SCRA, and perhaps a bit of comparison is warranted. As you may be aware, the SCRA's chairman appoints two Technical Committee heads, one for two meters and one for 220, who in turn form technical committees whose makeup is representative of each geographic area administered by the parent organization. The committees discuss all coordination requests, evaluate them for technical merit and compatibility with existing activity, and assign or deny coordination by majority vote.

The TSARC, however, has an individual coordinator. He makes such decisions, based on the same criteria, and works with the organization proper on sort of an "advise and consent" basis. As I understand it, the overall responsibility for the implementation of his rulings rests with the council itself. The council also retains the prerogative to override the co-

ordinator's decisions, request reevaluation, and/or implement a decision of its own.

Which system works better? It's hard to say. Each fits the overall needs of an area, and each has proven to be successful. Each has its own form of controls and restraints built in, and each affords representation to any and all systems that request and require such. As Dave said to me, "Duke Harrison has been doing such an overwhelmingly successful job that there is no reason to change things."

Everyone I met seemed satisfied with the structure of the TSARC and with the dedication that they have shown to that area's relay communications needs. They also care a lot about what's happening and where we are heading. If they were to adopt a motto, I guess it would be "Technical Competence With An Eye Toward Tomorrow."

10 METER NON-RELAY BAND PLANNING COUNCIL FORMED

According to Norm Lefcourt W6IRT, the large and continually growing number of amateurs in southern California who are converting CB radios to channelized 10 meter activity, after evaluating all of the band plans offered, have concluded that what they originated late last year is best. They have now begun to form a council for the purpose of implementing this on a wider scale.

It was felt by 10 meter interests in this area that with all the band plans that have been proposed, and with everyone taking off in different directions as was the case before the days of repeater councils for relay communications, some organization has to be formed for voluntary coordination of 10 meter non-relay channelized operation. I spoke with Norm the other morning via WR6ABN and on .52 simplex, and he told me that a pilot organization has been formed and that they would soon be holding an open meeting to adopt a title, construct a constitution and

bylaws, and formalize the organization.

As I have been led to understand, this organization intends to adopt the southern California 10 meter band plan which was presented earlier in this magazine, and possibly coordinate specific forms of activity or utility to each channel. It's too early to even surmise the kind of impact that this will have on the future of non-relay operation on 10 meters — and on non-FM operation as well. One thing is sure, though: 10 meters AM is possibly the biggest thing to hit the southland since the two meter repeater. It was only a matter of time until some form of organization to direct its growth took root out here.

WHEN ALL ELSE FAILS, TRY MY ANSWERING MACHINE

Take this number down. If you have something that you feel the rest of your peers may be interested in but don't have the time to write a letter, you can place a call anytime, 24 hours a day, to my unofficial "LW" hotline at (805) 259-8243. One catch, though: My machine will only take a fifteen second message. If you plan to call in, I suggest that you write down what you intend to say and then edit it to the most necessary information. Start with your name and callsign when you hear the first "beep," and stop when you hear the second "beep." I will try to send you a postcard within a few days to confirm the receipt of the information.

One such piece of information that came to me via "Elmo" (the pet name for our answering machine) is this, passed on from Oliver W7WEW to K6UQJ via Westcars and then via phone to me. It concerns a brand new repeater system serving the area around Prescott, Arizona, from a point 7800 feet up atop Mingus Mountain. Its callsign is WR7AFC, its channel pair is 147.60 in/147.00 out, and it's open for all to use.

AMSAT

AMSAT has received Circular No. 1273 dated July 12, 1977, of the International Telecommunication Union's International Frequency Registration Board giving advance publication information on a planned amateur satellite network of the USSR. The published information is summarized below.

General Information: "The USSR Administration wishes to inform countries, members of the ITU, that the USSR is working on the establishment of an amateur-satellite service system. This system 'RS' will be based on 3-4 satellites on a circular near-polar orbit. The amateur satellite stations are designed for multiple access with re-transmission and frequency translation without demodulation on a real time scale."

Date of bringing into use: 1977-1978.

Number of satellites: 3-4.

Orbital information: Inclination, 82°; Altitude of apogee & perigee, 950 km (circular orbit); period, 102 minutes.

Uplink characteristics: 145.8-145.9 MHz (100 kHz bandwidth); quarter-wave receiving antenna, circularly polarized; user uplink power, 10-15 Watts to 10-12 dB antenna; transponder receiver noise temperature, 3000° K.

Downlink characteristics: 29.3-29.4 MHz (100 kHz bandwidth); half wave transmitting antenna, circularly polarized; transponder power, 1.5 Watts peak to 0 dB gain antenna.

Maximum communications distance: 6,000 km (3,700 st. mi.).

From the advance publication orbital information, it seems likely that the "RS-OSCARs" will be launched piggyback with the Meteor meteorological satellites from the Plesetsk launch site.

the TEMPO 2020



...an accepted and proven performer

- Phase lock-loop (PLL) oscillator circuit minimizes unwanted spurious responses.
- Hybrid Digital Frequency Presentation.
- Advanced Solid-state design...only 3 tubes.
- Built-in AC and 12 VDC power supplies.
- CW filter standard equipment...not an accessory.
- Rugged 6146-B final amplifier tubes.
- Cooling fan standard equipment...not an accessory.
- High performance noise-blanker is standard equipment...not an accessory.
- Built-in VOX and semi-break in CW keying.
- Crystal Calibrator and WWV receiving capability.
- Microphone provided.
- Dual RIT control allows both broad and narrow tuning.
- All band 80 through 10 meter coverage.
- Multi-mode USB, LSB, CW and AM operation.
- Extraordinary receiver sensitivity (.3u S/N 10 db) and oscillator stability (100 Hz 30 min. after warm-up)
- Fixed channel crystal control on two available positions.
- RF Attenuator.
- Adjustable ALC action.
- Phone patch in and out jacks.
- Separate PTT jack for foot switch.
- Built-in speaker.
- The TEMPO 2020...\$759.00.
- Model 8120 external speaker...\$29.95. Model 8010 remote VFO...\$139.00.

Send for descriptive information on this fine new transceiver, or on the time proven Tempo ONE transceiver which continues to offer reliable, low cost performance.

AVAILABLE AT SELECT DEALERS THROUGHOUT THE U.S.

Henry Radio

11240 W. Olympic Blvd., Los Angeles, Calif. 90064 213/477-6701
 931 N. Euclid, Anaheim, Calif. 92801 714/772-9200
 Butler, Missouri 64730 816/679-3127

Prices subject to change without notice.

Editor:
Robert Baker WB2GFE
15 Windsor Dr.
Atco NJ 08004

CONTESTS

VK/ZL/OCEANIA CONTEST

Phone
Starts: 1000 GMT
Saturday, October 1
Ends: 1000 GMT
Sunday, October 2
CW
Starts: 1000 GMT
Saturday, October 8
Ends: 1000 GMT
Sunday, October 9

Sponsored by the Wireless Institute of Australia. Entry classifications: single transmitter-single op, multi-op (outside VK/ZL only).

EXCHANGE:

RS(T) plus serial number starting at 001.

SCORING:

Oceania stations score 2 points per QSO with VK/ZL, 1 point for QSO with Oceania other than VK/ZL. All other stations score 2 points per VK/ZL QSO, 1 point per Oceania (other than VK/ZL) QSO. Final score is derived by multiplying total QSO points by the sum of VK/ZL call areas worked on all bands. The same VK/ZL call area worked on different bands counts as a separate multiplier.

ENTRIES AND AWARDS:

Logs must show, in this order: date/time in GMT, callsign of station contacted, band, serial number sent/received. Underline each new VK/ZL call area contacted and make separate logs for each band. Summary sheet must show callsign, name, address (please use block letters), details of equipment used, and for each band —

QSO points for that band and total of VK/ZL call areas worked on that band. All band score will be total QSO points multiplied by sum of VK/ZL call areas on all bands while single band scores will be that band's QSO points multiplied by VK/ZL call areas worked on that band only. Attractive colored certificates will be awarded top scorers. You may obtain contest results and next year's rules by enclosing one IRC or mint stamps of your country to value of one IRC. Certificate winners will receive results and next year's rules regardless. Send entries to: WIA-VK/ZL Contest Manager, GPO Box 1002, Perth, 6001, Western Australia, or WIA-VK/ZL Contest Manager, N. Penfold VK6NE, 388 Huntriss Road, Woodlands, 6018, Western Australia — posted to reach Australia before Jan. 31.

OCTOBER QRP QSO PARTY

Starts: 2000 GMT
Saturday, October 8
Ends: 0200 GMT
Monday, October 10

Sponsored by the QRP Amateur Radio Club International Inc., this contest is open to all amateurs and all are eligible for awards. Stations can be worked once per band; general call is CQ QRP DE . . .

FREQUENCIES:

CW — 3540, 7040, 14065, 21040, 28040. SSB — 3855, 7260, 14260, 21300, 28600. Novice — 3720, 7120, 21120, 28040. All frequencies \pm 5

kHz to avoid QRM, as license permits.

EXCHANGE:

Members send RS(T), state, province, or country, and QRP number. All others send RS(T), state, province, or country, and power input.

SCORING:

Each member QSO counts 3 points, non-members count 2 points per QSO, stations other than W/VE count as 4 points. Multipliers based on input power of transmitter: greater than 100 Watts — x1; 25 to 100 Watts — x1.5; 5 to 25 Watts — x2; 1 to 5 Watts — x3; less than 1 Watt — x5. Total score is QSO points times total number of states or provinces or countries per band times power multiplier.

ENTRIES AND AWARDS:

Certificates to highest scoring station in each state, province, or country, other places depending on activity. One certificate for the station showing three "skip" contacts using the lowest power. Send full log data, including full name, address, and bands used, plus equipment, antennas, and power used. Entrants desiring results please enclose a #10 SASE. Logs must be received by Nov. 30 to qualify. Send all entries to: QRP ARC Contest Chairman, E. V. Sandy Blaize W5TVW, 417 Ridgewood Drive, Metairie LA 70001.

MANITOBA QSO PARTY

Starts: 2200 GMT
Saturday, October 15
Ends: 0200 GMT
Monday, October 17

Sponsored by the Amateur Radio Clubs of Manitoba and dedicated to ARLM (Amateur Radio League of Manitoba) to commemorate their 25th anniversary in 1977. Stations may be worked once per band and mode. VE4 mobiles can be worked each time they change municipalities. ARLM members will be bonus stations for out of province contacts. VE4 to VE4 and 2 meter simplex QSOs will be permitted.

EXCHANGE:

RS(T), name, QTH (municipality for VE4).

SCORING:

VE4s multiply number of QSOs times number of US states, VE provinces, and DX countries. All others multiply number of QSOs times number of Manitoba municipalities, local government districts, provincial parks, and forest reserves (134 max.) times the number of ARLM members worked.

FREQUENCIES:

SSB — 3770, 3905, 7195, 7230, 14190, 14285, 21245, 21355, 28600. CW — 3705, 7105, 14065, 21205, 28205.

ENTRIES AND AWARDS:

Certificates to high score in each province, state, and country. Plaques for high VE4 and high out of province station. Additional plaques if war-

ranted. Send log data and signed declaration no later than Nov. 14 to: Doug Bowles VE4QZ, 1104 First Street, Brandon, Manitoba, Canada R7A 2Y4.

CQ WE CONTEST October 22 and 23

See schedule for times and frequencies!

Sponsored by the Murray Hill ARC, the contest is open to all licensed amateurs employed by or retired from Western Electric, Bell Labs, and Teletype Corp. Also, participation of employees and retirees of AT&T and AT&T Long Lines is permitted. The contest is divided into four sessions with a total allowed operating time of 20 hours. A separate QSO may be made with a station on each of three modes — phone, CW, and RTTY. No form of cross mode, cross band, or repeater operation will be permitted. There is nothing in the rules to prohibit operation outside of the suggested schedule, but it is hoped that by using the schedule as a guide, many more QSOs will be made by knowing when and where to listen. If conditions do not favor a particular band called for in the schedule, participants are free to move elsewhere, preferably to the next band scheduled. However, please observe the contest time periods. Each station must be operated by a single operator with a single transmitter. Club stations operated under the club station call-sign may compete to submit a score for that location's total. These contacts may not, however, be counted toward an individual's personal score. Successive contacts with the same station may not be made by changing mode! Violation of any rules of this contest, or any of the current FCC rules and regulations governing amateur radio service, can result in disqualification of the station involved.

EXCHANGE:

RS(T), name, location code. A location shall be counted once for each band for which that location is worked in each of the three contest sections.

SCORING:

Contacts with a Novice or Technician on an HF or CW Novice band will count 10 points; contacts with a retiree will count 5 points; all other contacts count 1 point.

ENTRIES:

All logs must be in GMT and should be forwarded to your local "Works Coordinator" as soon as possible after the contest. They should be to your coordinator no later than Nov. 15. All local coordinators should forward their location summary and log sheets to reach Murray Hill by Dec. 15. In order to create an incentive to get your logs in, you may add 10 points to your score if you sign a statement that your entry was forwarded to

CALENDAR

Oct 1	Open CD Party — CW
Oct 1-2*	California QSO Party
Oct 1-2	VK/ZL/Oceania — Phone
Oct 8-9	VK/ZL/Oceania — CW
Oct 8-9	RSGB 21/28 MHz Phone Contest
Oct 8-10	October QRP QSO Party
Oct 12-13	YLRL Anniversary CW Party
Oct 15-16	Open CD Party — Phone
Oct 15-16	RSGB 7 MHz Phone Contest
Oct 15-17	Manitoba QSO Party
Oct 22-23	CQ WE Contest
Oct 22-23	CARTG RTTY Sweepstakes
Oct 29-30	CQ WW DX Phone Contest
Nov 3-4	YLRL Anniversary Phone Party
Nov 5-6	ARRL Sweepstakes — CW
Nov 5-6	RSGB 7 MHz CW Contest
Nov 12-13	IPA Contest
Nov 12-13	European DX Contest — RTTY
Nov 12-13	Missouri QSO Party
Nov 13	OK DX Contest
Nov 19-20	ARRL Sweepstakes — Phone
Nov 19-20	WWDXA International CW Contest
Nov 19-20	All Austria Contest
Nov 26-27	CQ WW DX CW Contest
Dec 3-4	ARRL 160 Meter Contest
Dec 10-11	ARRL 10 Meter Contest

*Described in last issue.

TIME AND FREQUENCY SCHEDULE FOR CQ WE CONTEST

Session One: HF/VHF Phone — 1700 to 2200 UTC Oct. 22, 1977

Suggested operation:

1700-1800	VHF/160 meters
1800-1900	10 meters
1900-2000	15 meters
2000-2100	20 meters
2100-2200	40 meters

Session Two: HF/VHF CW and RTTY — 2300 UTC Oct. 22 to 0400 UTC Oct. 23, 1977

Suggested operation: CW on the hour, RTTY on the half hour.

2300-0000	20 meters
0000-0100	40 meters
0100-0200	VHF/160 meters
0200-0300	80 meters
0300-0400	80 meters

Session Three: HF/UHF CW and RTTY — 1700 to 2200 UTC Oct. 23, 1977

Suggested operation: CW on the hour, RTTY on the half hour.

1700-1800	VHF/160 meters
1800-1900	10 meters
1900-2000	15 meters
2000-2100	20 meters
2100-2200	40 meters

Session Four: HF/VHF Phone — 2300 UTC Oct. 23 to 0400 UTC Oct. 24, 1977

Suggested operation:

2300-0000	20 meters
0000-0100	40 meters
0100-0200	VHF/160 meters
0200-0300	80 meters
0300-0400	80 meters

Suggested Frequencies:

Band	CW	RTTY	Phone
160	Use segment permitted locally		
80	3540-3570, 3730	3605	3900-3950
40	7040-7080, 7130	7055	7260-7300
20	14040-14050	14080	14280-14330
15	21040-21080, 21140	21095	21380-21420
10	28150	28150	28675
6	50.1-50.13	50.1-50.13	50.1-50.13
2	145.05-145.1	145.05-145.1	145.05-145.11, 146.52

your local works coordinator before Tuesday, Nov. 1.

CARTG RTTY SWEEPSTAKES

Starts: 0200 GMT

Saturday, October 22

Ends: 0200 GMT

Monday, October 24

Sponsored by the Canadian Amateur Radio Teletype Group, VE3RTT. Not more than 30 hours of operation is permitted, with non-operating periods taken at any time during the contest. Summary of times on and off must be submitted with score. Use all amateur bands authorized for F1 emission (RTTY). Country status as per ARRL country list; KL7, KH6, and VO to be considered as separate countries. Classes of entry include: single op, single transmitter; multi-op, single transmitter; and SWL printer. Individual operators of multi-operated stations may submit their logs singly instead of a group log.

EXCHANGE:

Messages will consist of message number, time in GMT, and zone.

SCORING:

All 2-way RTTY QSOs with own zone will earn 2 points; all others as per CARTG zone chart (send SASE if needed). Stations may not be contacted more than once on any one band. Multiplier is number of different countries contacted including one's own on each band. Each US and

VE district also counts as a separate country. Total score is total number of exchange points times number of countries worked times number of continents (6 max.). Canadian bonus points to be added last — 100 bonus points for each VE/VO contact on all bands.

ENTRIES AND AWARDS:

Use separate log sheet for each band. Log sheets and zone charts available from CARTG for SASE or IRCs. Logs must be received before December 31 to qualify. Engraved plaques to top 10 scorers plus 6 special categories. Certificates to top scorers in each US and VE/VO district and each country. Send logs, summary, and scores to: CARTG — VE3RTT, 85 Fifeshire Rd., Willowdale, Ontario, Canada M2L 2G9.

CQ WORLDWIDE DX CONTEST

Starts: 0000 GMT

Saturday, October 29

Ends: 2400 GMT

Sunday, October 30

Sponsored by *CQ Magazine*, the contest is open to all amateurs worldwide. Use all amateur bands, 160 through 10 meters. Entry classifications include: single op, single and all band; multi-op (all band), single or multi-transmitter.

EXCHANGE:

RS(T) and zone.

SCORING:

Contacts between stations on different continents count 3 points; stations on same continent but different countries 1 point, except for North American stations only! — contacts between stations within North American boundaries count 2 points. Contacts between stations in the same country are permitted for zone or country multiplier credit, but have zero point value. Multipliers are number of different zones on each band and different countries on each band. Final score is result of total QSO points multiplied by sum of zone and country multiplier.

ENTRIES AND AWARDS:

Many various awards in different classes and categories. Plaque to highest club score. Logs should include all times in GMT; indicate zone and country multipliers only first time worked on each band. Logs must be checked for duplicate contacts; use separate sheets for each band. Each entry must be accompanied by a summary sheet showing all scoring information, category of competition, name and address in block letters, and a signed declaration that all contest rules and regulations have been observed. Official logs and summary sheets and zone maps are available from *CQ*; include a large SASE. All entries must be postmarked no later than Dec. 1 for phone and Jan. 15 for CW. Send logs to: CQ WW Contest

Committee, 14 Vanderventer Avenue, Port Washington, LI, NY USA 11050.

Check *CQ Magazine* for any last minute rule changes!

ISLANDS OF THE WORLD AMATEUR RADIO ACHIEVEMENT AWARD

Sponsored by amateurs residing on Whidbey Island, the award is available to all licensed amateurs in the world. All contacts must be made after October 1, 1977! The award will be issued for: 50 islands, including contact with Whidbey Island; 100 islands, including contact with Whidbey Island; 150 islands, including contact with Whidbey Island; maximum possible, including contact with Whidbey Island.

Islands are taken from the "prefix by countries list" as they appear in the *Radio Amateur Callbook*, with the exception of Whidbey Island. Each island must also be recognized as such by the National Geographic Society. To obtain the award, proof of contact must be submitted on a self-prepared list showing the island's name, callsign of amateur contacted, date of contest. This list should be arranged in alphabetical order by island. *Do not send QSL cards!* This list must be verified by at least two amateurs, General class or above, or by a local radio club secretary. Send your verified list of contacts, which must include Whidbey Island, \$1.00, and a self-addressed stamped envelope, to: Bill Gosney WB7BFBK, 4471 40th N.E., Whidbey Island, Oak Harbor WA 98277 USA. Foreign amateurs may exclude the fee and stamps on their return envelopes.

The rules that govern this award will be reviewed annually on October 1!

CARTG MERIT AWARD

A plaque has been offered for this award complete with engraving, and the CARTG is requesting names of suggested qualifiers. The award was created in 1967 to be presented annually to the radio amateur chosen for his outstanding contribution to the art of amateur radio teletype communications. It need not necessarily be confined to technical contributions but recognition of any outstanding achievement worldwide: experimental work, articles, traffic handling, net operation, DX, or any other outstanding RTTY achievement. Send complete information to: CARTG — VE3RTT, 85 Fifeshire Rd., Willowdale, Ontario, Canada M2L 2G9.

ALL VE/VO ON RTTY

The CARTG is also offering a certificate to anyone working all VE/VO on RTTY. There is no charge for the award, but QSLs must be included with the request and will be returned. An official of a RTTY group or society may inspect and send a *signed* list of such QSLs in place of sending the actual cards. Send all requests to CARTG — VE3RTT, 85 Fifeshire Rd., Willowdale, Ontario, Canada M2L 2G9.

New Products

JMR MOBILE-EAR CLEAR-1 MICROPHONE

A common problem faced by FM and SSB operators is inadequate microphone gain and directivity. A poor mic can make a TS-820 or Hy-Gain 3750 sound like an early phasing rig. Most modern FM transceivers employ audio limiting circuits which are designed to provide consistent modulation under differing audio conditions. Unfortunately, most "stock" microphones do not have sufficient output and the directional capability required to enhance the transceiver with which they are used.

This month I reviewed the Clear-1 microphone by JMR Systems Corp. The Model 40 mic is advertised as a high output device, capable of driving any audio circuit to its fullest extent. The mic is also highly directional, allowing it to be used in noisy mobile environments.

All it takes is one look at the Model 40 Clear-1 to realize that something is different. The microphone is shaped like a small Derringer pistol, with a push-to-talk button on one end. The microphone element is a capacitor device, mounted behind a tiny brass screen on the top of the transducer. The Model 40 contains a built-in FET preamp requiring an internal battery, and a variable gain control is provided. A five conductor cable is used to interface the user-supplied mic connector. Normally open and normally closed PTT contacts are available, allowing the Clear-1 to be used with any transceiver. Mic output is a high -42 dB, and audio response is 200-600 Hz ... most definitely communications quality! The high upper-end frequency response is responsible for the quality "sound" of the Model 40.

I tested the JMR mic with the Hy-Gain 3750 transceiver on 20 and 75. Good reports were received — with the compressor in the 3750 disabled. The output control on the

mic can be left about one-eighth open under normal "close-talk" conditions. I found that it was possible to clip the Hy-Gain by using excessive mic output — a good audio reserve is present! By carefully adjusting the JMR's level control, I was able to hold the mic at arm's length and talk in a normal tone ... undetected by the listening station.

I have a popular 2m SSB transceiver in my shack — when I use it with those who know me, I am accused of having a cold or some other disgusting nasal malady. The standard mic supplied with this rig does not cut it, a classic case of anemic audio. This rig was the perfect test situation for the Model 40 on VHF. I changed microphone connectors and fired up. Amazing — no more Donald Duck with the flu! The transceiver sounded like its designers had intended. It was not possible to overdrive the 2m rig, probably because the audio limiter has good range.

The only shortcoming I noted is the lack of VOX capability with the Model 40. Since the internal preamp is battery powered, it would have to be continuously activated for VOX operation. This limitation is understandable when it is considered that the Clear-1 was indeed designed for mobile operation. I normally use PTT on HF, so it didn't make any difference.

In my opinion, the Mobile-Ear mic performed exactly as specified. Its performance on VHF was most impressive. The mic is light enough to survive even the longest "white-knuckle" sessions. It should also be indicated that the JMR Clear-1 microphone is compatible with most CB transceivers! The microphone is priced at \$44.95. *JMR Systems Corp., 168 Lawrence Rd., Salem NH 03079.*

John Molnar WA3ETD
Executive Editor

RADIO SHACK TRS-80 MICROCOMPUTER SYSTEM

Computers are about to become a part of everyday life in American businesses, schools, and homes, according to Radio Shack, the nationwide electronics store chain.

The company has just introduced their new Radio Shack TRS-80 Microcomputer System. Not a kit, the TRS-80 comes completely wired and tested, ready to plug in and use.

The TRS-80 system consists of a 53-key professional-type keyboard and microcomputer plus regulated power supply, a data cassette recorder which is computer-controlled through an interface, and a 12" video display monitor.

A comprehensive owner's manual will be supplied with the TRS-80 that will explain everything necessary for its operation, from plugging it in through programming.

Radio Shack will also supply pre-recorded cassette programs for such applications as a small business payroll, general ledger accounting, accounts receivable, and inventory control.

For educational purposes, the microcomputer can be used to teach mathematics, music theory, and virtually any subject through programmed teaching methods.

Just for fun, a variety of game programs will be available, including blackjack and backgammon. Other uses around the home would be personal finance management, storage of recipes, menu planning, and use as a message center.

Provisions have been made in the TRS-80 for later addition of accessory, or "peripheral," items such as an additional tape recorder, "disk" programming, and a printer which would create a permanent, typed record of the computer output.

At the heart of the Radio Shack TRS-80 Microcomputer System is a Z-80 microprocessor chip that serves as the central processing unit, or "brain," of the microcomputer. This remarkable device, about the size of a watermelon seed, is one of the most advanced microprocessor chips available today.

The Radio Shack TRS-80 Microcomputer System is priced at \$599.95, complete with video display monitor and data cassette recorder. The microcomputer alone will sell for \$399.95.

Leading the way in electronics since 1921, Radio Shack is a division of Tandy Corporation (NYSE), headquartered in Fort Worth, Texas, which is also where the TRS-80 is manufactured. Radio Shack presently has more than 6,000 stores and dealers in all 50 states and Canada, as well as nearly 500 stores overseas operating under the name Tandy International Electronics. *Radio Shack, 2617 West Seventh Street, Fort Worth TX 76107.*

FLESHER PS-170 RTTY PRESELECTOR

Last month I described the new RTTY terminal unit from Flesher Corp., the DM-170. This device has considerable built-in filtering which allows good isolation of the mark and space tones. However, in conditions of extreme QRM and noise, additional selectivity is required to reliably copy RTTY signals. Flesher has responded to this need by providing an active filter preselector that can be used with the DM-170 TU, or any other demodulator.

The PS-170 filter is connected between the receiver's audio output and the input of a terminal unit. This allows narrow shift (170 Hz) tones to pass, and not much else. The PS-170 has two outputs. The normal output couples the filter directly to the TU, while the limiter output provides an additional stage of hard limiting, which removes amplitude variations from the received signal.

The PS-170 is tiny. It consists of a 2" x 2" PC board, which can be mounted in any existing enclosure. Requiring ±15 V dc at 12 mA, the PS-170 can steal power from the terminal unit, or may be powered from a simple, zener regulated supply. I found that the preselector operated fine on voltages between 12 and 15. The 3 dB bandwidth of my PS-170 is 400 Hz, between the frequency range of 2000-2400 Hz. This differed



JMR Clear-1 microphone.



The new Radio Shack TRS-80 Microcomputer System features a built-in 53-key professional-type keyboard and one of the most advanced microprocessor chips available today, the Z-80.

slightly from the published frequency range of 2025-2400 Hz. I measured frequency response with an audio oscillator and VTVM, using the non-limited output.

Careful tuning is required when using the PS-170. The bandpass is such that even slight mistuning causes the tones to be excessively attenuated. However, the reception quality under heavy QRM and noise is fantastic! I used the DM-170 and ST-5 for comparison tests. The PS-170 was switched between the two terminal units, and under conditions of extreme interference was the difference between copying and missing weak RTTY signals. The DM-170 already has bandpass filters incorporated; the ST-5 does not. Thus, the ST-5 benefitted most when the PS-170 was used. I have since incorporated the PS-170 into the same cabinet with the Flesher TU. An SPDT switch selects either the normal or limiting output.

The PS-170 is available in kit or factory-built form. The kit takes about one half hour to build and align. The components are all resistors, capacitors, and ICs. Tune-up is accomplished in the same manner as was used in aligning the DM-170. Resistors are substituted into the circuit until the proper response is obtained — the op amps require only resistance changes to modify the response curve — no 88 mH toroids to prune! The Flesher PS-170 is priced at \$11.95 in kit form and \$18.95 factory assembled and aligned. *Flesher Corporation, Box 902, Topeka KS 66601.*

John Molnar WA3ETD
Executive Editor

NEW PERSONAL COMPUTER FROM OHIO SCIENTIFIC

Challenger IIP from Ohio Scientific is an exciting new personal computer complete with BASIC in ROM and RAM (4K) for programs in BASIC. All you have to do is turn it on and go!

Challenger IIP is a fully self-contained personal computer with a full size keyboard and a 32 x 64 character video display interface.

Complete with an audio cassette interface, the Challenger IIP simply connects to a video monitor or home TV set via an rf converter (not supplied). A cassette recorder can be used for program storage.

Challenger IIP comes complete with

a 4 slot backplane and case for \$598.00 fully assembled, and is expandable via compatibility with all Ohio Scientific computer accessories. *Ohio Scientific, Hiram OH 44234.*

GARY MODEL 101 DIGITAL VOLTMETER KIT

A complete DVM kit for \$29.95? You've got to be kidding! That's what I thought when I received the Gary McClellan Model 101 Digital Voltmeter kit to review. Why not? The end result of the kit is a four digit DVM, complete with sign, auto zero, and overvoltage blanking!

The DVM market is similar to the calculator industry. Several years ago, the DVM was an exotic test instrument found only in electronic labs. Capable of extreme accuracy, the DVM is based on an LSI A/D (analog to digital) converter. The output of the converter is multiplexed and displayed on seven-segment displays, exactly as in some digital clocks. The price of DVM chips has plunged, aided by the mass production of calculator and microprocessor chips. The Gary DVM is based upon the Motorola MC14433 A/D converter, and has a basic range of 0-±1.999 volts.

The Gary DVM took exactly two hours to build and calibrate. The display mounts on a small PC board, which is fastened to the larger DVM board. All components appear to be quality devices, and the CMOS chips are first run units! Molex pins are used to mount the DVM chip and two other CMOS packages. The four digit display is multiplexed to reduce power consumption. The associated transistors and resistors for the display require a bit of close wiring, but Gary's eleven page manual contains detailed instructions and several photos of the completed unit. No special problems were encountered while wiring the kit.

The most enjoyable part of kit building (for me) is applying the juice for the first time. It sure is nice when things perk right from the opening gun, but I was doomed to disappointment this time. The Model 101 requires a single five volt supply, which should be regulated. I happened to have a little supply based on an LM-309K which was used in microprocessor experiments. I connected the supply, turned it on, and nothing! Then I thought I had better read

Gary's instructions. There is a single screwdriver resistor that is used to calibrate the DVM. My control was all the way to one end; that's why the display was dark. Shorting the probe leads, I adjusted the control, and sure enough, the display illuminated. I adjusted for a reading of -000 volts, which is the normal condition with no signal input. The minus sign blinks to indicate that the DVM is functioning.

I should have read further, because the next thing I did was connect a handy 9 V transistor to the DVM. The display blanked out! Again consulting the manual, it turns out that the 101 DVM has a basic range of 0-1.999 volts. Any overvoltage blanks the display — a nice touch! Calibration is accomplished by adjusting the control until the reading corresponds to a known source. I used the Gary Model 120 DVM calibrator, which I will review next month. A good reference source is a single mercury cell, which has a no load voltage of 1.35 volts, or very nearly that. After calibrating the 101, I checked my year-old standard mercury cell. Not bad, 1.352 volts. Amazing!

The 101 DVM has a sign function, which means the probes do not have to be reversed when measuring minus voltages. It looks like I will have to retire my old trusty Knight VTVM — boy, I sure hate the constant reversing of the polarity switch!

The only problem, if you can call it a problem, is the low range of the 101 basic DVM. An attenuator is required to measure voltages of greater magnitude than 1.999 volts. Gary provides an attenuator for his DVM, the Model 101-1 four range kit. It includes a .05% resistor network and switch. The accuracy of the basic kit is .05%, so make sure to use quality resistors if you build your own attenuator.

All in all, I am very impressed with the 101 DVM. Its features are found on much more expensive devices, and the quality, accuracy, and flexibility are hard to beat in a \$29.95 kit! It is small enough to custom mount, and can be used as the basis for a complete multimeter or digital tuning display. The input impedance is 1000 megs, and it only draws 80 mA maximum at 5 volts. Gary also provides a full line of accessories for the 101 DVM.

Gary McClellan Company, 1001 W. Imperial Hwy., La Habra CA 90631.

John Molnar WA3ETD
Executive Editor

NEW SERIES OF FREQUENCY SYNTHESIZED TWO METER AMATEUR TRANSCEIVERS, AMPLIFIERS, AND ANTENNAS FROM HALLICRAFTERS

Darrell Fletcher, Chairman of the Board of the Hallicrafters Company, and Cliff Mathews, Vice President of this leading manufacturer of paramilitary and government FM and SSB portable and manpack communications systems for the international market, have announced the introduction of a new series of two meter transceivers, amplifiers, and antennas for the domestic USA amateur market and international markets.

The new series of amateur transceivers features a military-type frequency synthesizer for up to 800 channel operation in 5 kHz steps in the FM mode and digital frequency readout for operating on both simplex and repeater modes. The all solid state rf power amplifiers provide up to 1/4 kilowatt power output on FM and up to 300 Watts peak envelope power on SSB for either base or mobile operation. Completing the new equipment series is Hallicrafters' new line of two meter base and mobile antennas having high rf power handling qualities and featuring a magnetic mount mobile antenna for easy installation and removal.

"Hallicrafters' new line of two meter amateur equipment is a natural expansion of Hallicrafters' traditional line of VHF and UHF-FM and HF-SSB communications products sold in international markets," says Darrell Fletcher. "The frequency coverage plan features and 5 kHz channel spacing enables the equipment to be used in any market in the world," claims Mathews, who says the equipment will be marketed directly in the USA and Canada by selected amateur equipment dealers and internationally by Hallicrafters International, Inc.

Continued on page 67



Ohio Scientific's new personal computer, Challenger IIP.



Communicate On 10.25 GHz

-- with a simple transceiver

Many hams feel that the world of amateur radio ends at two meters, or even twenty in some cases! As the frequency increases, the amount of commercially available gear diminishes. Above 450 MHz, the operator must build his equipment — little prebuilt equipment is around. Thus, the bands

above 450 are underpopulated, and misunderstood by the majority of hams. Possibly you have eyed those "microwave" frequencies starting at 1220 MHz... and wondered how to operate or experiment there. Well, let's see... 1296 might not be too bad — you can triple an old Motorola transmitter

strip, and come up with a converter for your 2m rig. Definitely a project for two hams, as it is nice to have someone to talk with after the construction is done! However, if you desire to experiment with waveguide, horns, and point-to-point communications, the 10.5 GHz band is the place to go.

Why 10.5 GHz? The possibilities for experimentation are endless. If you need a true point-to-point link for your repeater, microwaves are the answer. A low power link can provide reliable control for remote bases, with a lower long-term cost than phone lines! Everyone is familiar with police radar, which is, incidentally, located just above the ham band. Experiments with Doppler radar are possible on 10 GHz.

The road to 10 GHz has not been easy. Little military gear is available, and a machine shop is often required to build microwave gear. The problem of equipment has stifled most amateur ventures into the world of microwaves. However, this problem no longer exists!

Enter the Gunnplexer

A progressive company in Massachusetts has introduced a line of microwave gear specifically designed for

amateurs operating on 10.5 GHz. Microwave Associates, Inc., provides a microwave transmitter and receiver front end in a single package. Dubbed the Gunnplexer, this device produces 20 mW of microwave energy. A portion of that energy is coupled to a receiving diode, which, in the presence of another microwave signal, produces a low frequency i-f signal. The Gunnplexer is easily incorporated into a complete communications system. All that is needed is a Gunnplexer, i-f receiver, and power supply. This article describes just such a system. This transceiver can be used for two-way communications on 10.5 GHz, as a control link, or for Doppler effect radar. Before starting, let's look at the Gunnplexer and discuss its operation.

A Gunn Diode Is the Key

The Gunnplexer consists of five main parts. The heart of the rf head is a Gunn diode. This diode produces a microwave energy directly from dc when it is properly mounted in a resonant cavity. Similar to the familiar tunnel diode, the Gunn diode exhibits a negative resistance region under certain bias conditions. Microwave oscillations occur in this region. The diode employed in the Gunnplexer produces about 20 mW at 10 volts. Current drain is about 225 mA. Referring to Fig. 1, the Gunn diode is contained in the left barrel on the rear of the rf head.

The second component of the device is a varactor diode, housed in the right barrel, next to the Gunn diode. The varactor is used to control the frequency of the microwave radiation. If af modulation is applied to the varactor, FM will occur. The varactor can shift the frequency of the Gunnplexer 60 MHz. A crystal or other high output microphone may be coupled directly to the diode — no preamp is required on a simple system.

The receive components

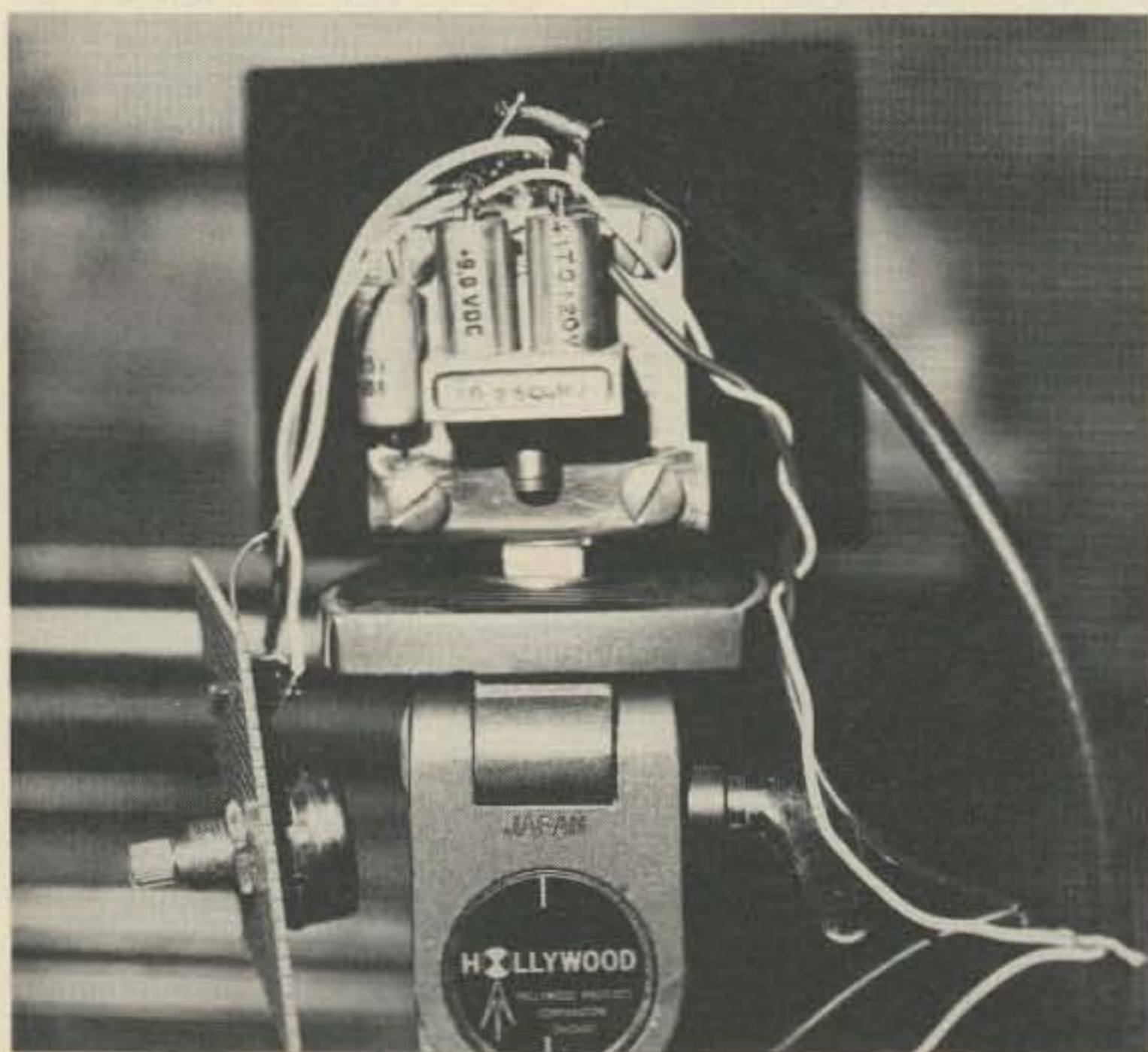

Fig. 1. A rear view of the Microwave Associates MA-87108 Gunnplexer. The Gunn diode is in the cavity under the left barrel. The tuning varactor diode is under the right barrel. Electrical tuning control is mounted on the perfboard, and the i-f connection is visible at the top of the rf head. The homemade bracket for tripod mounting is attached to the lower two bolts. A 1/4 inch nut is sweat soldered to the bottom of the copper flashing. Refer to the text for details.

comprise the third and fourth areas of the Gunnplexer. A tiny portion (about .5 mW) of the transmitted energy from the Gunn diode is coupled to a microwave mixer diode. An i-f signal is produced when a received signal is heterodyned in the mixer. Mixer injection is accomplished by a ferrite "circulator," located next to the mixer diode (Fig. 3). Injection is also controlled by a screw protruding into the body of the Gunnplexer. The standard i-f frequency used by amateurs is 30 MHz. However, different i-fs can be produced by mechanical and electrical tuning of the Gunnplexer. Remember, the transmitted signal also provides mixer injection! A standard FM broadcast receiver can be used as the i-f receiver in a simple transceiver. More on this later!

The normal Gunnplexer frequencies are 10.250 and 10.280 GHz. Thus, it can be

seen that the difference frequency is 30 MHz, even though the local oscillator injection is different at each end of the communications link.

The last major part of the Gunnplexer is, as expected, an antenna. The body of the Gunnplexer is actually a section of UG-39/U waveguide. This guide can be bolted to transmission waveguide, or a gain horn antenna may be attached. Microwave Associates provides a 17 dB gain horn for the Gunnplexer (Fig. 4).

Using the Gunnplexer as a Transceiver

A microphone, i-f receiver, and power supply is required to turn a Gunnplexer into a complete transceiver for 10.25 GHz. A well-regulated 10 volt supply is required for the Gunn diode. About 4.5 volts of bias is needed for the varactor to maintain frequency. The Gunn diode

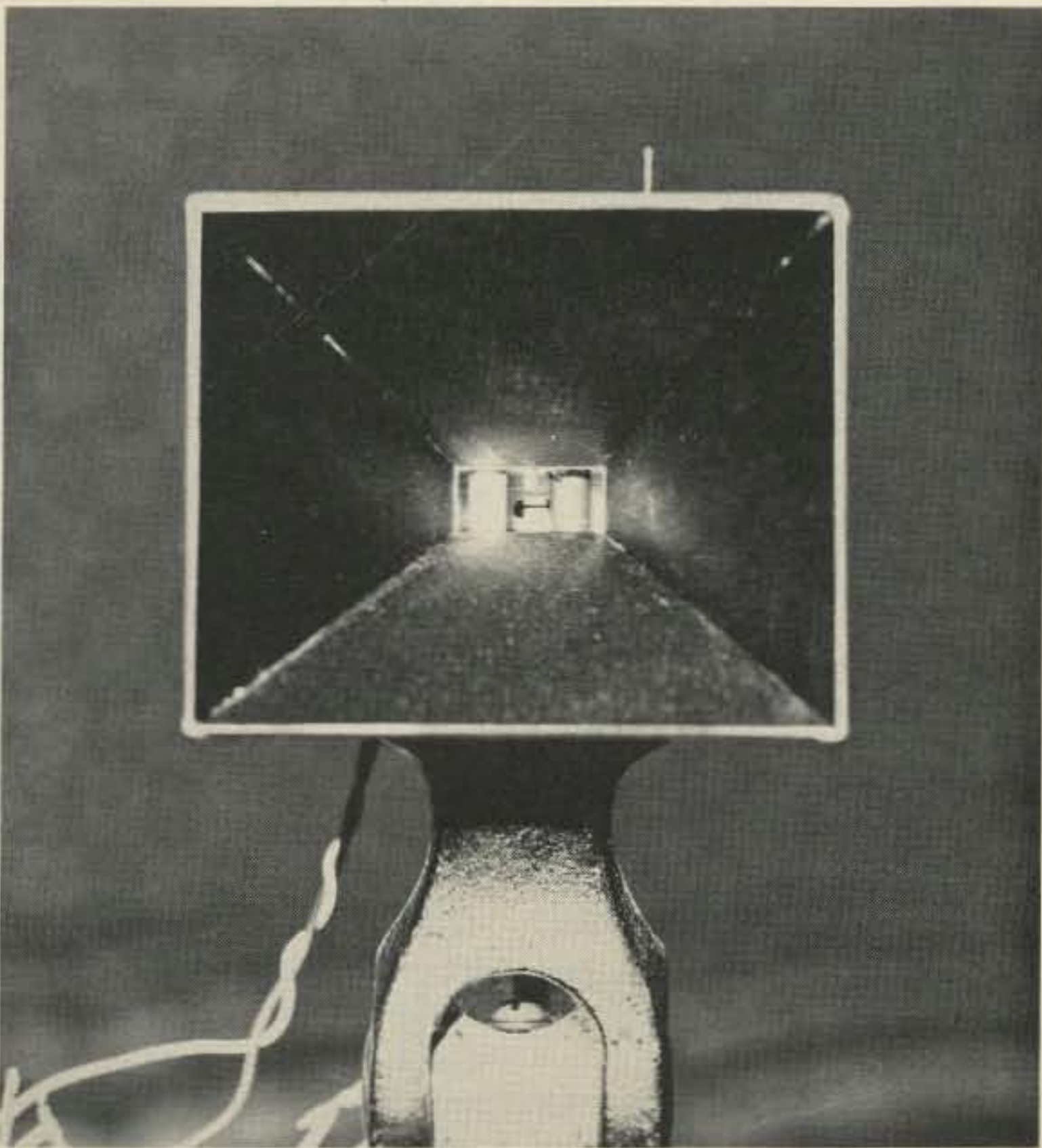

Fig. 3. Big Brother is watching you! This shot shows the mixer diode (left) and the ferrite mixer circulator in the waveguide. The tuning screw can be seen between the diode and circulator. Microwave energy is generated in the cavity behind the oval "iris," which is visible directly behind the tuning screw. The wire extending from the top of the horn is not a scratch in the photo, but rather a ground bus mounted on the rf head.

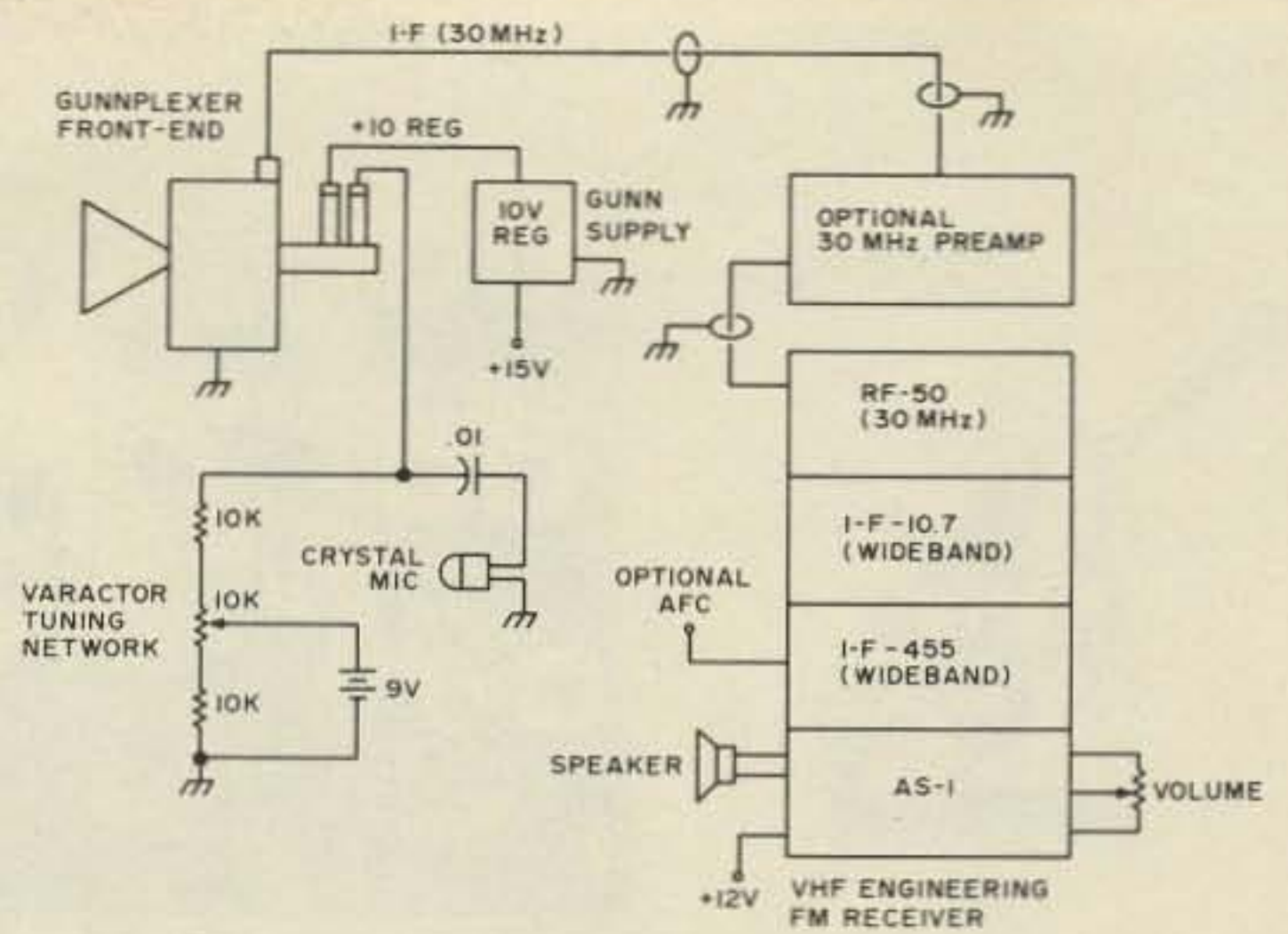

Fig. 2. Block diagram of the simple Gunnplexer transceiver. Details of the bias supply are shown, as well as all interconnections. This circuit uses VHF Engineering receiver strips for the receiver i-f and FM detector. A National Semiconductor LM-317 regulator chip is employed to provide the 10 volts required by the Gunn oscillator.

output drifts as temperature changes, at a rate of -350 kHz per degree Centigrade. Quite a drift factor!

Thus, a change in temperature of only a degree will move the Gunnplexer frequency 350 kHz — right out of your i-f passband! In some cases, afc is required to maintain communications, especially when a narrow i-f passband is employed. A simple transceiver can use a voltage divider with the varactor supply to "tune" the Gunn transceiver. This scheme is adequate, especially in a system with wideband i-f

capability. Refer to Fig. 2 for details of the bias voltage divider.

The most important element (next to the Gunnplexer) in the transceiver is the i-f receiver. A low noise figure is required. The i-f channel must also match the 200 Ohm impedance of the mixer diode for optimum results. Of course, the receiver must have an FM detector! An additional consideration is the i-f bandpass characteristic. If a narrow (10 kHz) i-f is used, Gunnplexer range increases — up to 100 miles under good conditions!

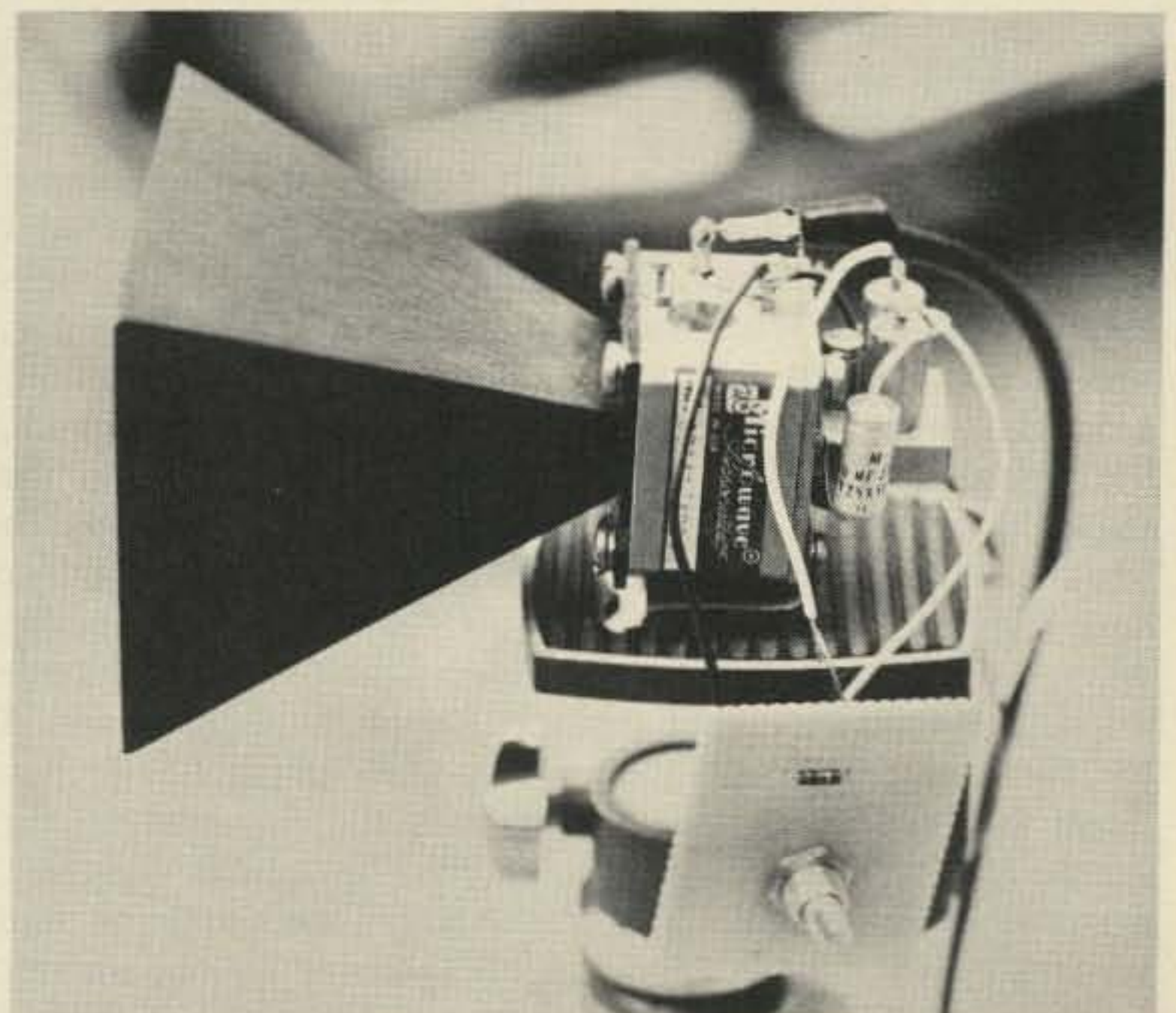

Fig. 4. Side view of the Gunnplexer. The 17 dB horn is clearly visible, as well as the tuning control, cavity, and mounting bracket.

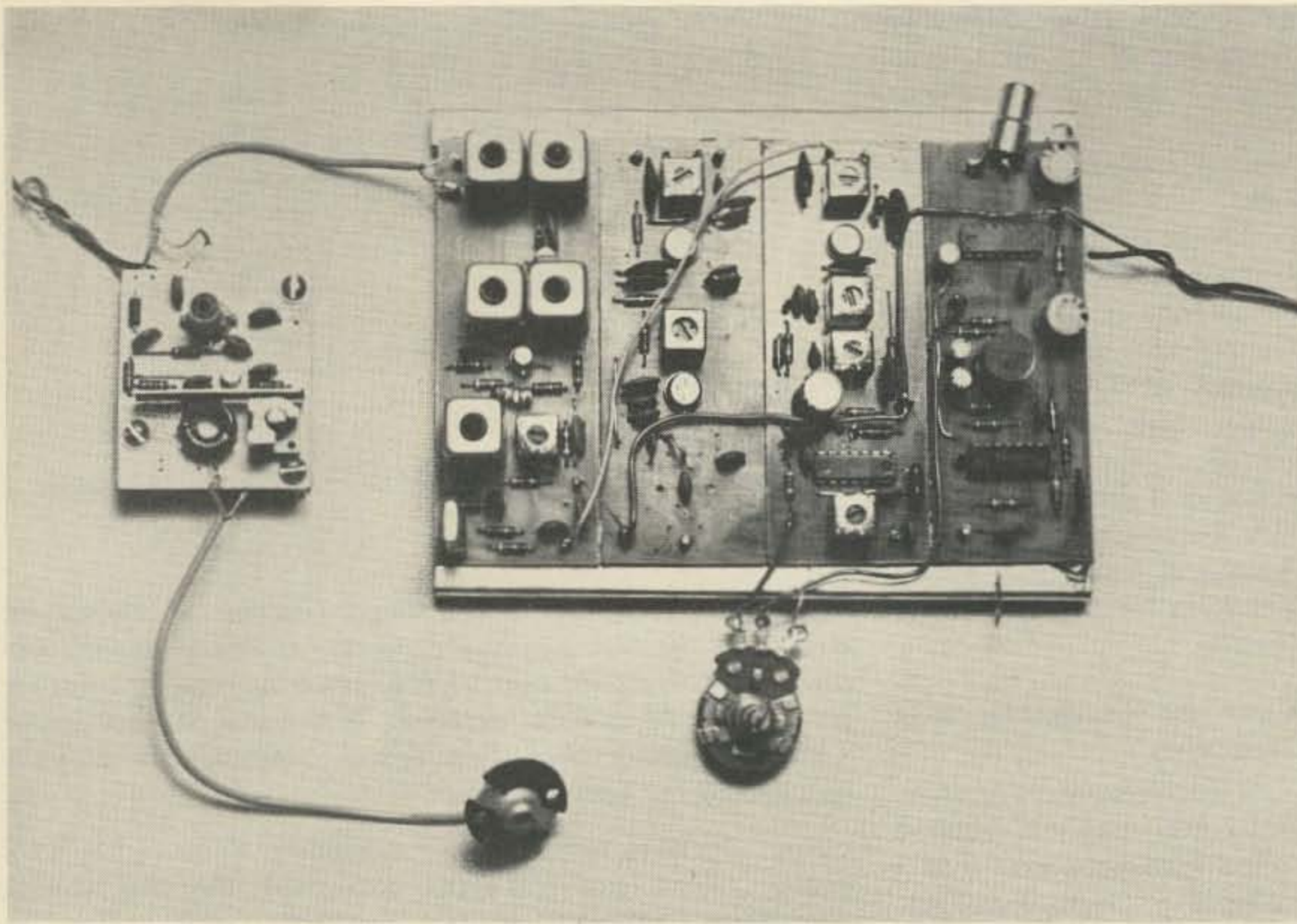

Fig. 5. The i-f receiver and preamplifier. The wideband VHF Engineering receiver consists of the rf module (second from left), two 100 kHz 10.7 MHz i-f amplifiers, and an audio amplifier. The pot is the volume control. No squelch is used on my system. A converted OSCAR 30 MHz preamp is also illustrated. The rewind toroid matches the 200 Ohm Gunnplexer mixer diode.

However, as mentioned earlier, afc is required on a narrowband system. Afc can be produced by comparing the i-f to a standard, and using the error voltage to tune the varactor. Additional details are provided in the Microwave Associates bulletin, number 7624A.

A wide i-f passband decreases effective range. However, the drift problem is eliminated. Range with an i-f passband of 100 kHz is about 50 miles. As indicated earlier, a commercial FM broadcast receiver can be used in experimental systems. The bandwidth of commercial FM broadcasting is 150 kHz; thus the commercial receiver is a viable i-f system. If used, the broadcast receiver should have a good front end. Provision should be made to match the receiver's input to the Gunnplexer mixer diode.

My goal was to construct a simple i-f receiver that would perform in an experimental system. I also wanted to use available parts around the shack. Let's see ... an FM receiver, battery operated, simple? My first thought was

an unused VHF Engineering receiver once used for 2m experiments. The only real problems were that the i-f was 10.7 MHz, and narrowband at that! I needed a 30 MHz i-f with a bandpass of 100 kHz. The first problem was solved by building a converter from International Crystal modules. This scheme used an International OF-1 oscillator with an inexpensive OX crystal oscillator, and an MXX-1 mixer module. The EX crystal provides injection at 19.3 MHz, thus matching a 10.7 i-f when 30 MHz is present. The only item purchased was the EX crystal.

If you try this technique, increase the link coil on the MXX-1 several turns to match the Gunnplexer. The mixer must be mounted as close as possible to the mixer diode on top of the Gunnplexer. A short run of RG-174 coax couples the converter to the VHF Engineering receiver. The mixer and oscillator were powered by a 9 volt transistor battery. This system worked fairly well. However, the mixer is noisy, and is not sensitive enough to comple-

ment the Gunnplexer.

I decided to use a better converter in my system. VHF Engineering makes a 30 MHz receiver strip, called the RF-50. This receiver has an FET preamp, and can be tuned over a range of 30-50 MHz. Remember to wind the coils for the 30 MHz option! This rf module is then used with the VHF receiver, consisting of the IF-10.7, IF-455, and AS-1 audio module. If you order these strips from VHF Engineering, specify the "wideband" option. The wideband kit consists of 10.7 MHz transformers that replace the 455 kHz units normally used. The wideband option converts the double-conversion receiver to a wideband (100 kHz) single-conversion job, suitable for Gunnplexer use.

It is best to wideband your modules immediately. I had to convert mine, which was a messy, time-consuming job. All the old 455 i-f transformers had to be removed from the PC board — ugh! Fig. 5 details the completed i-f receiver, mounted on standard VHF Engineering

rails.

Preamp Option

An additional problem exists when using the VHF receiver. The input impedance of the RF-50 is 50 Ohms, and the Gunnplexer diode impedance is 200 Ohms. A simple balun could be used to effect a match, or the input coil on the receiver could be rewound. In the interest of performance, I chose another tack. I just happened to have a small, low noise OSCAR 10 meter preamp available. This preamp has a broadband toroid as an input circuit. It was a simple matter to rewind the toroid to produce a 200 Ohm input impedance. This preamp is visible in Fig. 5. A preamp is *not* necessary. I used one because it was available. I think the best method of matching the mixer in a simple system is to modify the input coil on the RF-50. The system will work if a 200-50 Ohm mismatch is present — you won't even notice it in close range tests!

Putting It All Together

Since my system is experimental at this point, I did not mount all the components in a single enclosure. I coupled the mixer to the OSCAR preamp (Mode X?), and ran a piece of RG-58 from the preamp to the RF-50. A nine volt battery powers the preamp, while a 12 volt nicad is used for the VHF receiver. The Gunn oscillator requires regulated power at 10 volts. I derived this voltage by using a National LM317 three terminal regulator (Fig. 6). This regulator requires an input voltage at least 2 volts higher than the regulated output. I built a battery producing about 16 volts from old AA nicad cells. Remember that the Gunn diode draws considerable current, and carbon cells probably won't last during experiments. Fig. 2 is a block diagram of the system. The voltage divider is constructed from a 10k pot and two 10k

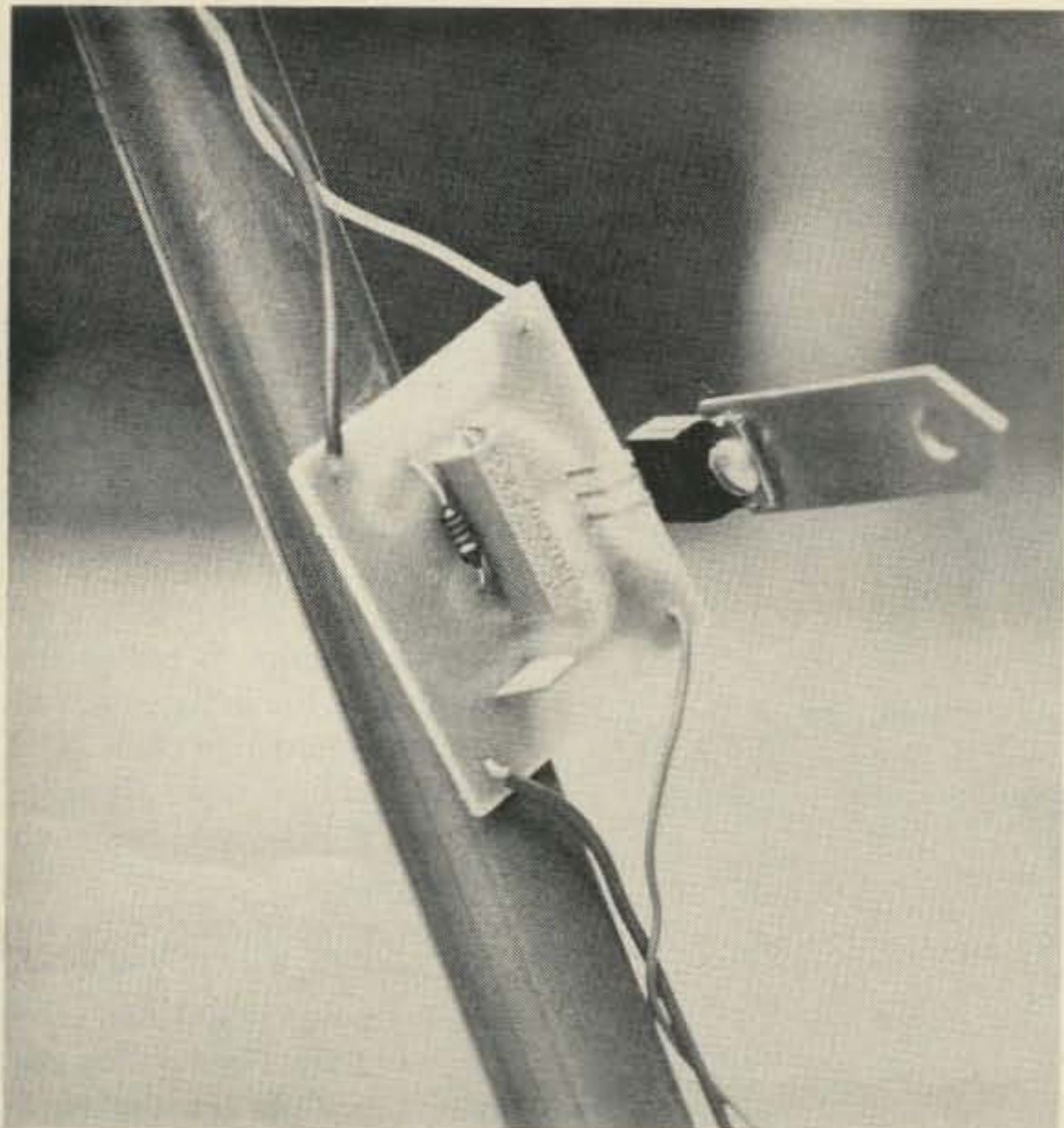

Fig. 6. The Gunn oscillator voltage regulator. A National LM-317 variable regulator, set for 10 volts, is used. The PC board and resistor are part of an evaluation device from National Semiconductor. The regulator is mounted on a leg of the tripod in my experimental system.

resistors in series with a 9 volt battery. The varactor bias is developed at the slider. The negative side of both the Gunn supply and bias supply should be connected to the body of the Gunnplexer. I mounted the Gunnplexers to standard photo tripods by making a simple mount out of copper flashing. Drill two 1/4" holes in a 2" piece of flashing to line up with the bottom screws holding the Gunn baseplate to the Gunnplexer body. Bend the flashing around the bottom of the Gunnplexer, and sweat-solder a 1/4" nut to the flashing. The nut will mate with the bolt built into most tripods.

Tuning Up

My system consists of two Gunn transceivers. When initially checking your system, position the two transceivers about 50 feet apart, facing each other. Adjust the bias supply so that about 4.5 volts is present at the varactor diode on each transceiver. Apply Gunn voltage. If a 0-500 mA meter is available, check current

draw. The Gunn diodes should draw about 225 mA at 10 volts. This is not standard; different diodes draw slightly different currents. Adjust the varactor voltage divider on *one* transceiver. Tune very carefully until the receiver quiets — there, you're on 10.25 GHz! This system is full duplex — you will hear yourself in your receiver when talking. Occasional tweaking of the bias will be required to keep the transceivers locked ... however, once they are temperature stabilized, remarkable stability will be noted with a 100 kHz i-f.

At this point, you will probably begin experimenting with the transceivers. Try reflecting the signal around a 90 degree corner with aluminum foil. I won't even attempt to suggest experiments and applications — if you've followed me this far and built a system, you don't need my prodding! However, I will be continuing this series with practical experiments and applications involving radar. Don't keep us in the

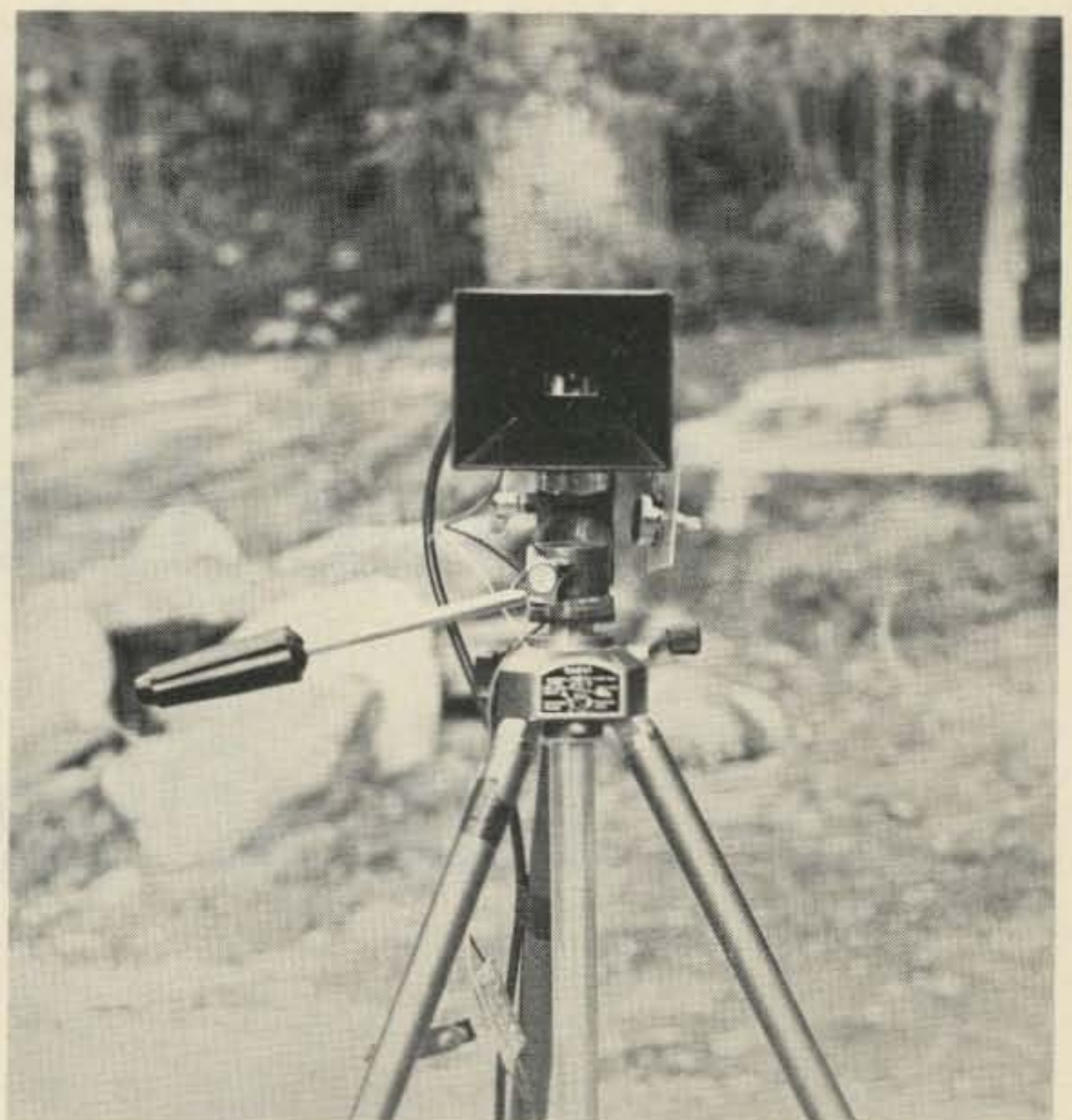

Fig. 7. Not a Martian, but a Gunnplexer transceiver rf head. The i-f amplifier and power supply is at the base of the tripod. Two transceivers should be separated by 25-50 feet for initial test. Ultimate range is 50 miles with this system.

dark, however. I would appreciate hearing from anyone experimenting with Gunnplexers and will welcome articles featuring the device. Write me, in care of 73.

A Word of Caution

If you have been following my editorial in 73, what follows will be repetitive. Microwaves are potentially dangerous. Do not needlessly expose yourself to the microwaves generated by the Gunnplexers. Although the level is very low, why take a chance? Opinion concerning microwaves varies, but one fact is certain: Microwave radiation can damage the tissues of the eye. The effects are cumulative, so treat the Gunnplexer with the same respect afforded a high voltage plate supply. *Never* look into the horn of an operating microwave transmitter. Avoid looking at the mixer diode in a Gunnplexer while it is operating; if you see it you're being exposed. I personally do not stand in front of a Gunnplexer at distances under 25 feet. When operating indoors, I use a cheap

police radar detector to monitor the Gunnplexer — it's too easy to leave the Gunn supply connected ... no noise is generated by a Gunn diode! Happy experimenting!

Interesting effects are liable to occur if you operate your Gunn transceiver mobile in a police radar zone. Their radar is broadband by nature, and will respond to your legal microwave transmission, exactly as my detector responds to "out of band" signals from the Gunnplexer. Have a copy of your amateur ticket available — I would hate to learn that your transceiver was impounded. New-fangled devices, what's the world coming to?

I would like to thank Dana Atchley, Jr. of Microwave Associates and Bob Brown of VHF Engineering for their advice and suggestions. ■

References

Gunnplexers are available from: Microwave Associates, Inc., Burlington MA 01803. VHF Engineering products from: VHF Engineering Corp., 320 Water St., Binghamton NY 13901.

Home Brew Tilt-Over

-- the water pipe special

*Max Holland W4MEA
Hiwassee College
Madisonville TN 37354*

A primary disadvantage of antenna work is the need to constantly climb up and down the tower. A tilt-over tower is very desirable; however, the expense is often prohibitive. If a person has access to a fairly heavy-duty welder and is interested in building his own tower, this design seems to be a fairly good compromise between

height and convenience. The very tall towers have such extreme weight when tilted over that they require some heavy-duty cable and construction.

This tilt-over tower was constructed using galvanized water pipe and reinforcing bars (called "rebars") purchased at the local junk yard.

The total cost, not counting labor and the welding expenses, was approximately \$100. The dimensions given in the accompanying diagram will be of great help in getting started.

Basically, the construction consists of determining the dimensions of the base section and making up two plywood forms with the holes drilled in the shape of a triangle. One and one quarter inch water pipe is put in the holes, and the rebars are cut and tack-welded in place. The final welding is done after the necessary alignment has been checked.

The base section calls for one cubic yard of concrete. The hole was dug 3 feet by 3 feet by 3 feet. Gravel was put in the bottom of the hole, and the legs of the lower section were put down into the gravel to allow for the drainage of any accumulated water. Wires were attached to the legs of the tower, and additional rebars were placed in the sides of the holes at this time.

After the concrete has set, the top or tilt-over section of the tower is hoisted into position, using the cable and winch attached to the tower. After the top is placed in position, a 5/8 inch diameter bar is required. Then the cable and the winch can be moved to the end of the tilt-over section of the tower, and the tower can be pulled up into a vertical position. A

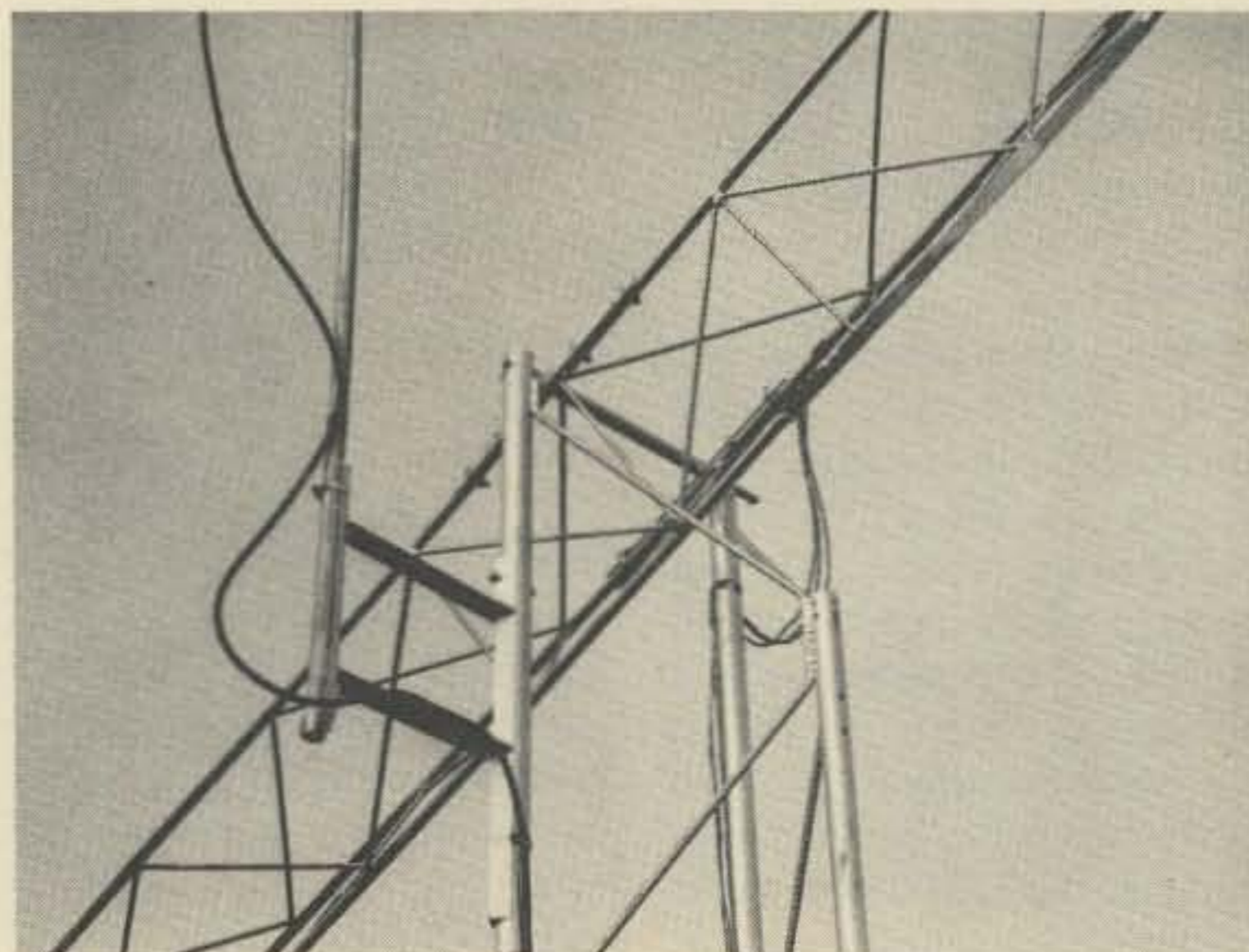
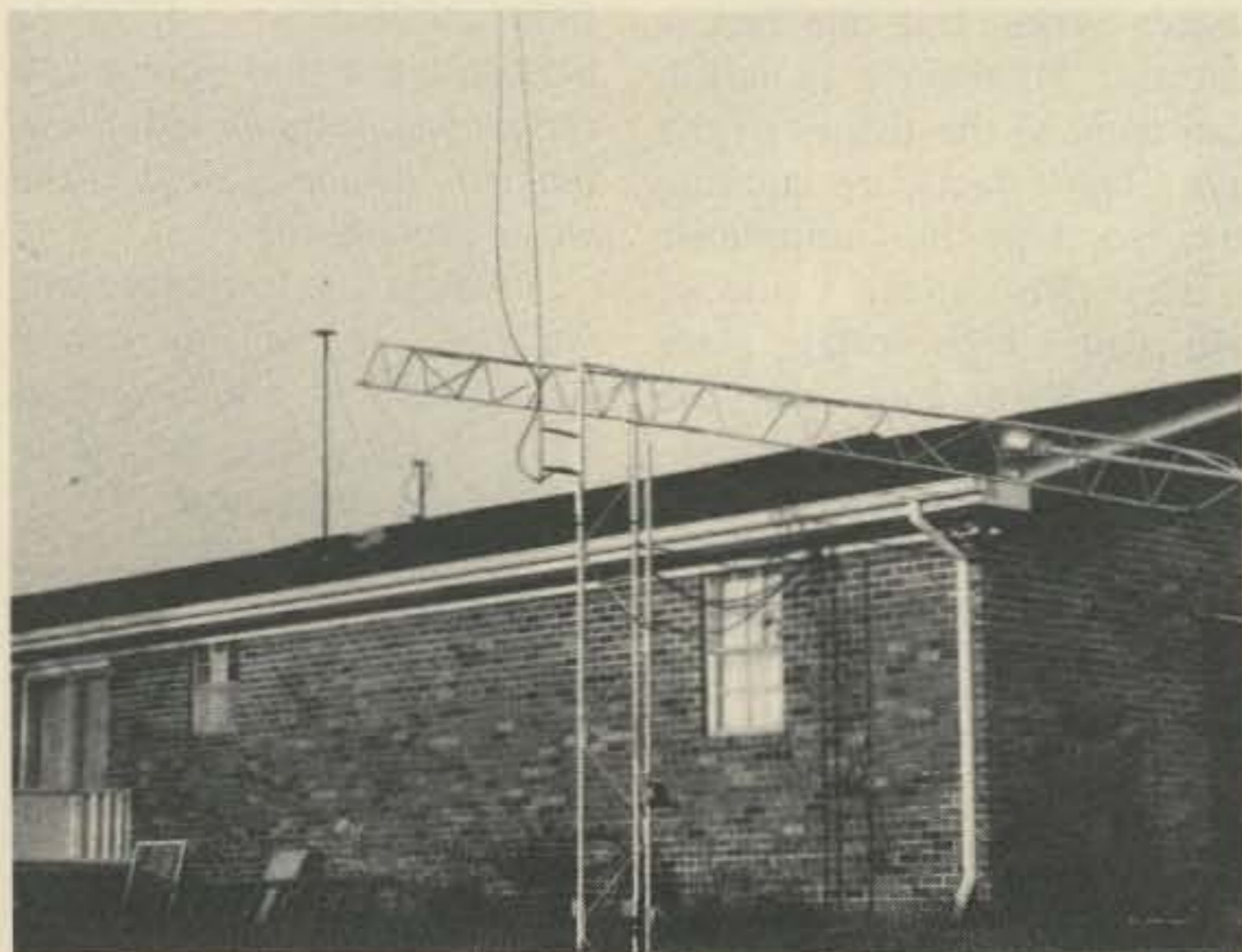

yoke, in which the tilt-over section of the tower lies, is then made, secured by at least 6 stainless steel clamps (the kind used on automobile water hoses). A more suitable method of attachment may be used; however, this method provided good side clearance between the tilt-over section and the base section. After two years of use, it seems to be more than adequate for the weight involved.

The total height of the tower is around 35 feet. The top section was made out of conduit tubing, for the additional benefit of light weight. Three quarter inch conduit fits over the one half inch galvanized pipe used for the tilt-over section. Once again, rebars were put into the tower section in triangular shapes for additional strength where the tower bends. Additional rebars and reinforcement were used to keep the tower from collapsing at that point.

A metal plate was attached inside the tower and a CDR Model AR 22 rotator was mounted. A Model 44 or Ham-M rotator could be mounted in the space, but the holes for the mounting plate would have to be changed accordingly. The pipe upon which the antenna mounts is 1-1/4 inch aluminum with the topmost part being 1-1/8 inch aluminum tubing.

The tower was given a coat of aluminum paint, and seems

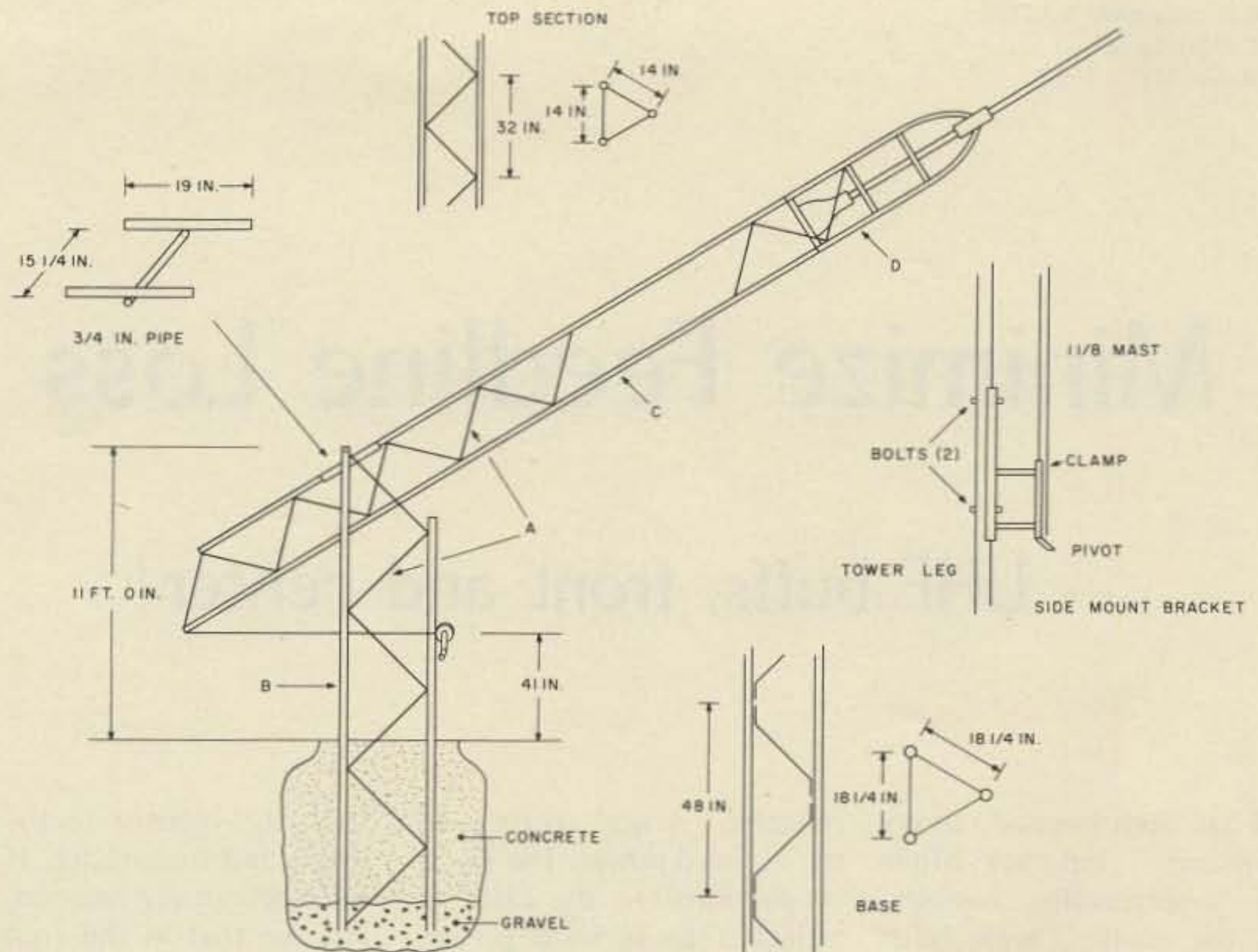

Fig. 1. A = 3/8" rebar. B = 1 1/4" galvanized pipe. C = 1/2" galvanized pipe. D = 3/4" conduit tubing.

to be holding up fairly well after 2 years. The aluminum paint will probably last 3 or 4 years. The total time to paint the tower (considering all the small and minute parts) amounted to about 6 hours. Spray painting could be used if desired.

The winch is sold by Sears, Roebuck and Co. The cable is rated at about 1500 pounds.

As an additional safety precaution, when the antenna is in the vertical position, a heavy-duty chain and lock is wrapped around the legs of both sections. The triangular shape of the leg braces for the

base of the tower discourages the climbing of the tower.

The feedline for the antenna can travel along the legs of the tower. There is enough clearance between the two sections to tape the coax

cable directly to the tower. The bracket mounted on the side of the tower (see photo) is used to support a 10 foot long pole, which is used as a center support for an 80 meter wire dipole. ■

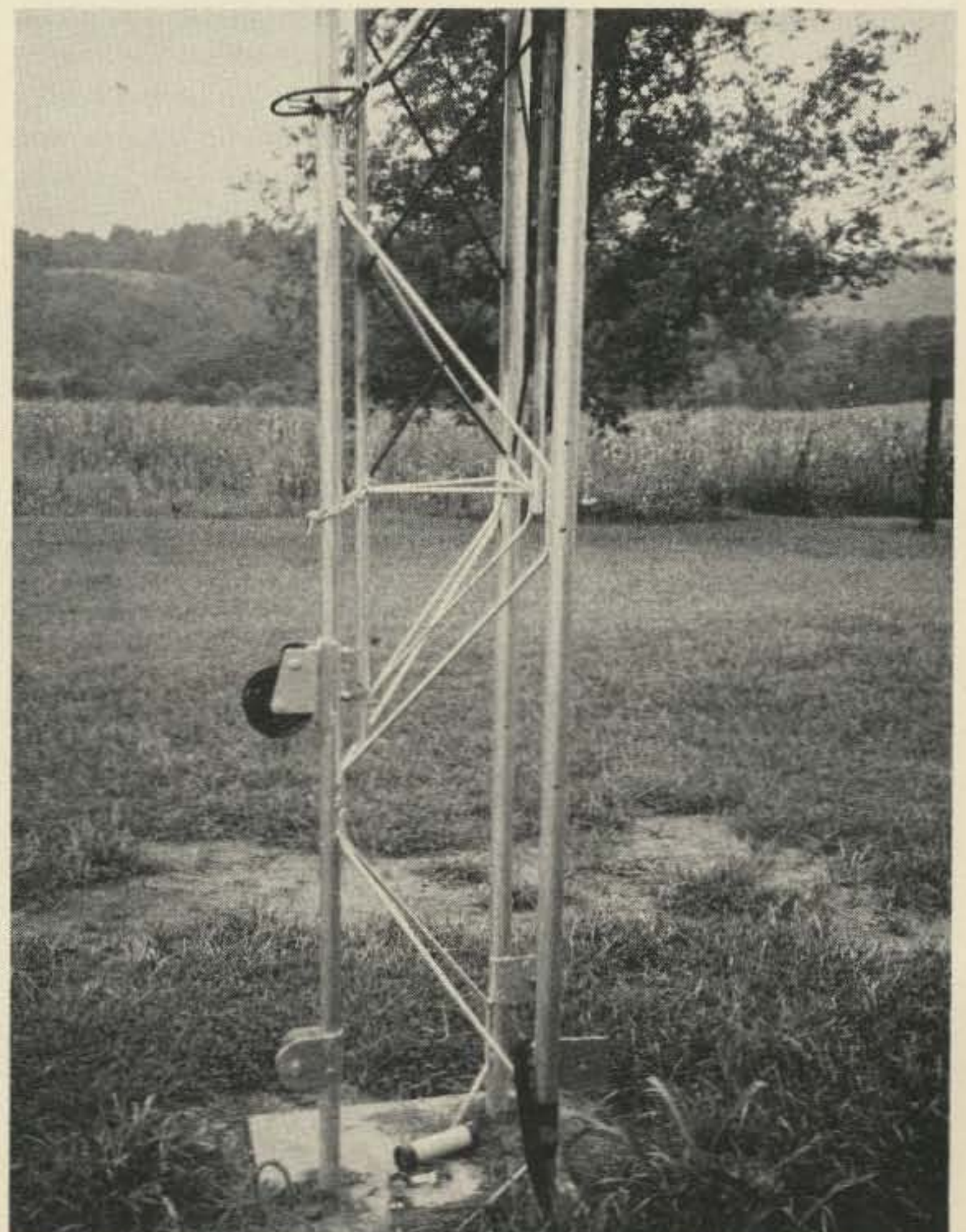
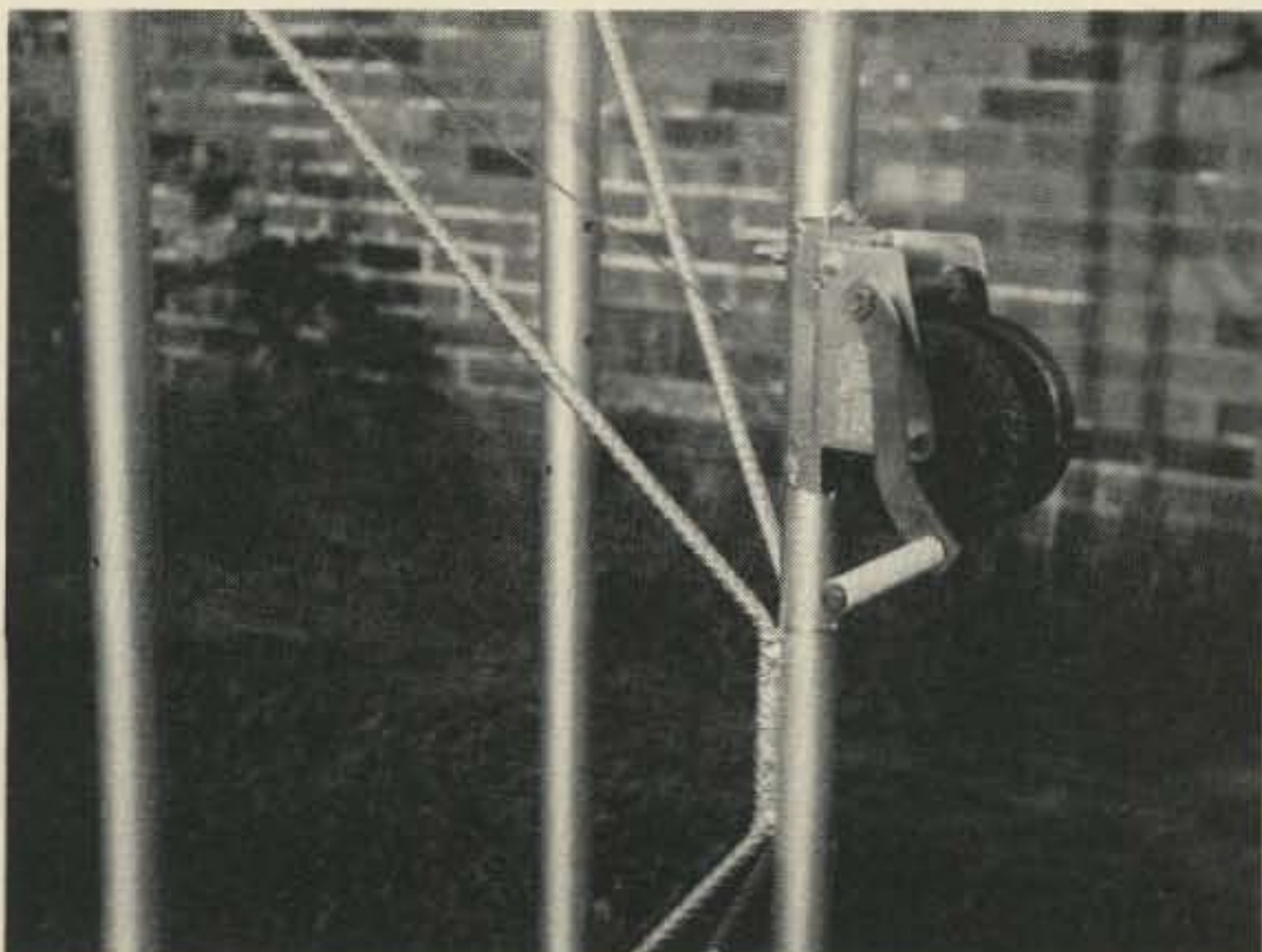

Minimize Feedline Loss

-- UHF buffs, front and center!

It has been pointed out on occasion, but not often nor emphatically enough, that the standing wave ratio (swr) as measured down in your cozy ham shack is not the same as the actual swr up at your antenna. The swr at the antenna will always be higher than what you measure it to be at the transmitter end. The reason that the swr is lower at the transmitter end is because of losses in the transmission line between transmitter and antenna. So, while it is undeniably nice to have a low swr at the transmitter, line losses are not exactly the most efficient way to go about it.

How do line losses lower the swr at the transmitter end and fool you into thinking that your antenna is a better match than it really is? Glad you asked. Here's the answer. That little swr meter atop your transmitter measures the

reflected power relative to the forward power. The swr is proportional to the ratio of reflected to forward power, or more precisely:

$$swr = \frac{1 + \sqrt{\frac{\text{reflected power}}{\text{forward power}}}}{1 - \sqrt{\frac{\text{reflected power}}{\text{forward power}}}}$$

Unfortunately, the ratio of reflected to forward power which the swr meter sees down in the shack is not the same as that which the antenna sees. Because of the losses in the line, the forward power at the antenna is less than that leaving the transmitter, which is what the swr meter sees. What's more, the reflected power which the swr meter measures is less than the reflected power at the antenna, again, by the amount of loss in the line. This is because the reflected power travels backwards through the same lossy line

from the antenna to the swr meter and transmitter. If you are algebraically inclined, you can see that in the equation for swr, the reflected power in the numerator of the square root terms is made lower by the line loss, while the forward power in the denominator of these same terms is made higher. Both effects cause the square root terms to be less, which results in the value of swr being lower. Thanks, or no thanks, to line loss, the swr at the transmitter end is lower than the actual swr of the antenna.

"So what," you say. Well, for those skeptics who may be sitting back reading this article after calling CQ for fifteen minutes straight with no replies, let me present an example of just how significant an effect this can be.

Consider a ham who operates on ten meters using 150 feet of RG58/U coax to feed his antenna. One night his antenna blows down, leaving the feedline dangling in thin air on his roof. The next morning, unaware of the disaster which befell his antenna, he sits down for a few hours of operation. Tuning up, he checks his swr meter. It reads about 2.1:1, a little worse, perhaps, than usual, but not too bad. It will do for now, or so he thinks. After an hour of fruitless CQing, he throws in the towel and goes out for a walk,

tripping over his antenna on the front lawn. An extreme example, you think? Not at all. It has happened to me and I'll bet to many others.

The startling fact is that the swr at the antenna end of the feedline (where the antenna *used* to be) is infinite; all the power is reflected because there's nowhere else for it to go but back. Yet the swr meter in the shack reads 2.1:1. This clearly demonstrates the kind of difference line loss can cause between actual and apparent swr.

And that's not all the bad news. Remember that power reflected from the antenna (let's assume again that there *is* an antenna) is reduced by the effect of line losses as it travels back from the antenna towards the transmitter. This is lost power, just the same as power is lost in going forwards from the transmitter to the antenna. But this reflected power loss is a function of how much power is reflected in the first place. Or, put another way, the additional power loss (in the reflected wave) is a function of the antenna swr. The higher the antenna swr, and the higher the rated attenuation of the feedline, the more the additional loss will be.

So now that you are a believer, you will want to know what your antenna swr *really* is, and how much additional power loss that swr is causing in your line. Thanks to a friendly computer, the answer is easily found. Just look it up in Table 2. To use Table 2, all you need to know is the *rated* attenuation for the type and length of feedline you are using, as well as the reading of your swr meter at the transmitter. The rated attenuation of feedlines is available in manufacturers' literature and in the various radio handbooks. Don't be surprised if you find the values from different sources differing by up to a dB or so. But so you don't have to go searching, I've summarized the rated attenuation per

Band	Type of Cable			
	RG58A/U	RG59B/U	RG8A/U	RG11A/U
80/75m	0.9	0.63	0.3	0.38
40m	1.3	0.91	0.44	0.54
20m	1.9	1.3	0.66	0.77
15m	2.45	1.65	0.84	0.95
10m	2.9	1.95	1.0	1.1
6m	4.1	2.7	1.4	1.5
2m	7.6	4.8	2.7	2.7
1 1/4m	9.7	6.1	3.4	3.4
3/4m	14.5	9.0	5.2	4.9

Table 1. Attenuation in dB per hundred feet for common coaxial cables. Source: Alpha Wire Corporation, Catalog W-8.

hundred feet of line for some of the more popular coaxial cables in Table 1.

An example will serve to illustrate the proper use of these tables.

Let's say that you have one of the popular 100 Watt output SSB transceivers feeding a trap tribander through about 150 feet of RG58A/U coax. You tuned the antenna for the CW end of the bands because that's where you spend most of your operating time. At your favorite frequency of 14.026 MHz, the swr meter sitting atop the rig reads about 1.2. On occasion, you QSY up the band to 14.335 MHz to keep a weekend sked there and add to the QRM. Up here in the high end of the phone band, your swr meter reads about 2.0. Darn good, you think. But let's see if it is.

From Table 1, the loss per hundred feet of RG58A/U is 1.9 dB in the 20 meter band. Now, since your line is 150 feet long, its rated attenuation will be (150 feet/100 feet) x 1.9 dB = 2.85 dB. Going to Table 2, we find that line which has a third column entry ("Rated Line Loss in dB") closest to 2.85 dB (it will be 3.0 dB), and a first column entry ("Measured swr at Transmitter") closest to the 2.0 your meter reads (it will be 2.0). Finding this line, the actual swr at the antenna is given in the second column ("Actual Antenna swr") and we note that it is 4.97, almost 5 to 1! A lot higher than you thought, isn't it? The value in the fourth column ("Actual Overall Loss in dB") gives you just what it says, the real losses in your line in dB, including the effects of the actual swr and losses in reflected power.

This is 5.03 dB. *Surprise!* And now for the final shocker. The last or fifth column, labelled "Overall Efficiency of Line," reads 31.4%. This just about says it all in a single figure, and possibly explains why you have such a tough time com-

Measured swr at Transmitter	Actual Antenna swr	Rated Line Loss in dB	Actual Overall Loss in dB	Overall Efficiency of Line
1.0	1.0	0.5	0.5	89.1%
1.5	1.58	0.5	0.55	88.2%
2.0	2.19	0.5	0.64	86.2%
3.0	3.56	0.5	0.89	81.4%
4.0	5.12	0.5	1.18	76.1%
5.0	6.94	0.5	1.51	70.7%
1.0	1.0	1.0	1.0	79.4%
1.5	1.67	1.0	1.11	77.5%
2.0	2.45	1.0	1.33	73.6%
3.0	4.40	1.0	1.94	63.9%
4.0	7.18	1.0	2.73	55.4%
5.0	11.45	1.0	3.74	42.3%
1.0	1.0	2.0	2.0	63.1%
1.5	1.93	2.0	2.28	59.1%
2.0	3.24	2.0	2.91	51.2%
3.0	8.64	2.0	5.05	31.3%
4.0	39.83	2.0	10.26	9.4%
1.0	1.0	3.0	3.0	50.1%
1.5	2.33	3.0	3.58	43.9%
2.0	4.97	3.0	5.03	31.4%
3.0	890.01	3.0	25.23	0.3%
1.0	1.0	4.0	4.0	35.5%
1.5	3.59	4.0	5.98	25.2%
2.0	11.30	4.0	8.74	13.4%
1.0	1.0	5.0	5.0	31.6%
1.5	4.44	5.0	7.04	19.8%
1.0	1.0	6.0	6.0	25.1%
1.5	8.82	6.0	10.19	9.6%

Table 2. Note that for rated line loss above 2 dB, the measured swr at the transmitter end will never go very high, even with very large swr at the antenna.

pleting that sked. Of the 100 Watts your transmitter is putting into the lines, only 31.4 Watts is actually delivered to the antenna for radiation. You've been working QRP and you didn't even know it.

Now you should be prepared to check out the real facts of life in your own antenna system. I hope it won't turn out too badly for you, but I'll lay odds that it will be worse than you thought it was. Well, back to the drawing board.

Just what can you do to improve things? A full answer is far beyond the scope of this article. But a few things you can do would have to start with getting *low loss* feedline. Every tenth of a dB of loss hurts you two ways — forward power loss and reflected power loss. No single factor will improve your overall efficiency as much as using the lowest loss feedline feasible. That's one reason

why open-wire line sometimes works so well. It is *extremely* low loss. After you have gotten your line losses down as low as your finances will permit (lower loss, bigger bucks), then work on reducing the swr at the antenna feedpoint, by tuning, matching, trimming, or whatever is appropriate to your particular antenna. After that, there's always a matchbox or antenna tuner as a new addition at the transmitter end. Now understand this very clearly: A matchbox at the transmitter end will not in any way reduce the kind of transmission line losses discussed in this article, except over that short portion of line connecting the matchbox to the transmitter. A matchbox will, however, provide a very low swr to the transmitter which will enable it to put out all the power it was designed to, even though we know some will be lost in the line. Without a matchbox,

it is quite possible that the transmitter will be unable to put out its full rated power in the first place. Incidentally, it is probably worth mentioning that the "Measured swr at Transmitter" in Table 2 and in the discussion implies that it is measured on the antenna side of any matchbox, if one is used. This should be obvious, but probably won't be to everyone. The swr at the transmitter side of a matchbox is normally 1.0 if the matchbox is tuned correctly, but something quite higher at the antenna side. So if you already have a matchbox and are going to make these measurements, be sure to move the swr meter to the antenna side, after first tuning the matchbox for minimum swr going into the transmitter.

There is no one big secret to a stand-out signal, just a lot of small ones. Now some of them aren't secret any more. ■

How About 6 FM?

- - it's easy

with a modified HE-50

Allan S. Joffe W3KBM
1005 Twining Road
Dresher PA 19025

WR3ABE is a fine, well-managed six meter FM repeater in our area. I have had access to it on a mobile basis for some time, but never had gotten around to installing a base station at the QTH. The search for such a facility had

Photos by WA3PTC

been an off again, on again type of romance until fate intervened. W3GHH announced that his Lafayette HE-50, a little old-time ten meter transceiver, was available if anyone had a use for it. Examination of the contents of the box and its schematic showed great promise for a good six meter conversion. The receiver is single conversion with an rf amplifier, two stages of 1650 kHz i-f, a good noise limiter, plus capability of operating

on either the 110 volt line or on 12 volts dc.

The transmitter consisted of two tubes, a 6EA8, and a 2E26 in the final. The triode section of the 6EA8 worked as an oscillator/doubler. The pentode section of the 6EA8 worked as a second doubler, and the 2E26 worked straight through on ten meters.

The transmitter conversion consisted of getting six meter output on the repeater frequency using 8 MHz crystals. Then the AM modulation had

to be removed from the final and an FM modulator installed. The first doubler coil was pruned so the stage would now be a tripler. Thus its output was in the 24 MHz area. The pentode doubler was left a doubler, but its tank circuit was altered so it would tune to six meters. The same operation was performed on the final tank coil. Thanks to a grid dip meter, this operation took about 3/4 of an hour, and the transmitter was putting about five Watts out on six meters. The normal dc input to the final is about 12 Watts. The rf conversion included clipping and discarding a built-in TVI harmonic trap which had been connected from output of the pi network to ground. With some five Watts of rf available, it was time to attend to the change in modulation.

Fig. 1 shows the final form of the FM modulator. The AM modulation was divorced from the final by the simple expedient of changing the B+ feed to the final so that it got no audio. The 5k 5W resistor was added as a load across the modulator output to replace the class C rf load that had



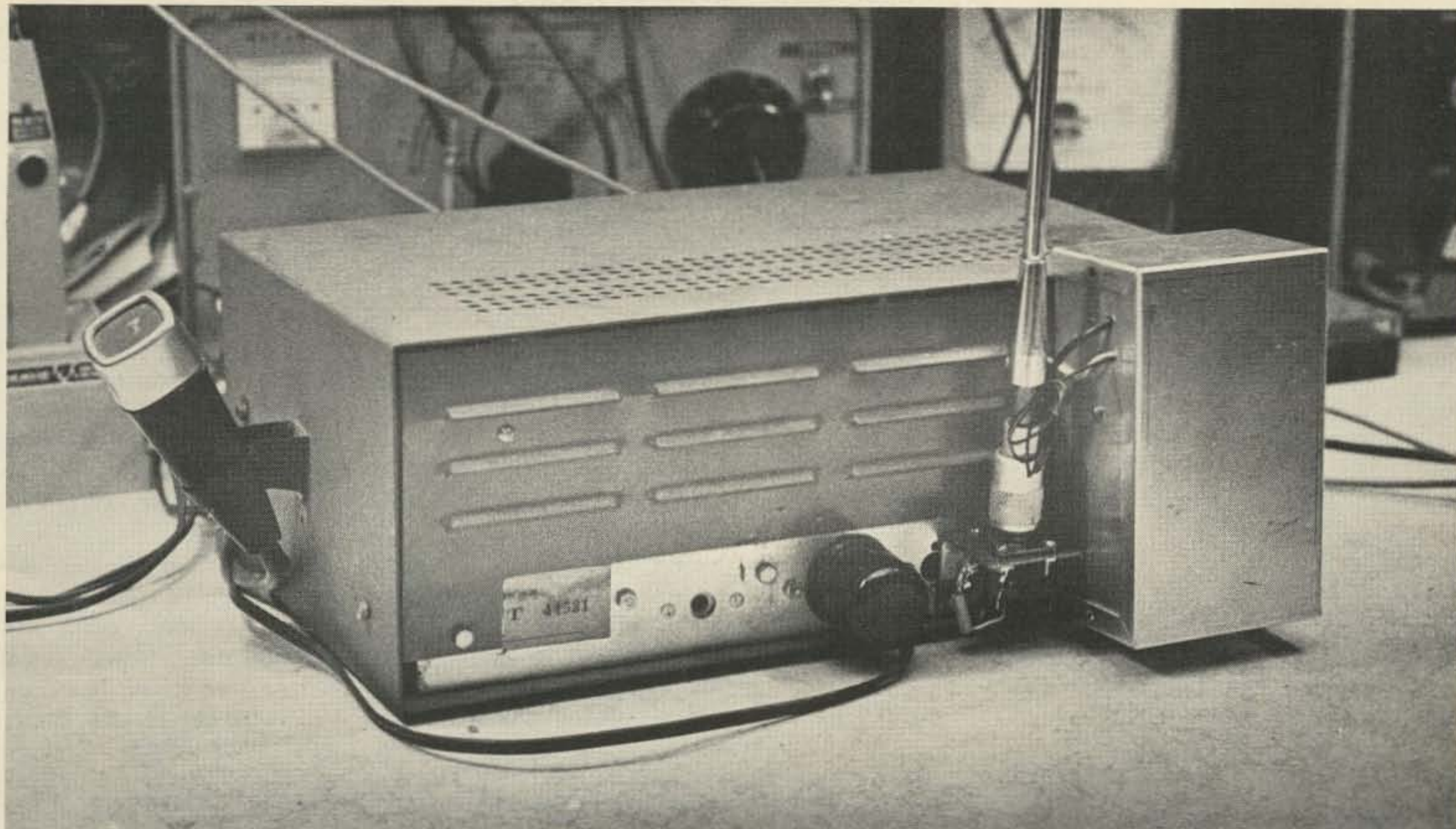

been removed. A small audio transformer with a 20,000 Ohm primary and a 600 Ohm secondary was fed from the old modulator through a 0.01 uF capacitor to isolate the B+ from the primary. The varicap network was wired across the 600 Ohm secondary and coupled across the crystal. A 45 pF trimmer was put in series with the crystal to put me on the nose with the repeater input frequency. There are those who will shudder at the lack of frills in the modulator, e.g., no dc bias on the varicap, etc., but the proof of the audio is in the hearing and reports have been uniformly favorable.

With the transmitter so nicely under control, attention was paid to the receiver. The lineup consisted of an rf stage, a converter, two i-f stages, and the usual functions after this point. The initial thought was to convert from six to ten meters using an external converter. Then, second thoughts came to bear as the front end was examined more closely. Fig. 2 shows the first several stages of the receiver. The thought that came through was to examine the possibility of making the rf amplifier a converter, add a crystal-controlled local oscillator for injection, and leave the rest

of the receiver untouched.

A six meter tuned circuit was put in the grid circuit and dipped to frequency. The bench signal generator was used as an injection oscillator, with very satisfying results. An order went out for a 23.64 MHz crystal, which produced the hardest part of any building or conversion ... waiting for the mail! Naturally, being human and subject to impatience, I put the thing on the air for an initial contact through the repeater. With the assistance of WA3RMA, I overcame such obstacles as a varicap that decided to head west, an intermittent mike cable, and other standard assorted griefs.

If the signal generator that I was using as the converter injection oscillator could have been condensed, I might have been tempted to call it a day and button up the case. As usual, though, reason did prevail and the wait for the crystal began.

The received audio from the repeater is so good by merely using slope detection that all thoughts of installing a conventional FM detector vanished. This may, in part, be due to the excellent rf signal that the repeater puts into my QTH. In any event, armchair copy exists here without any detector changes.

As the crystal-controlled

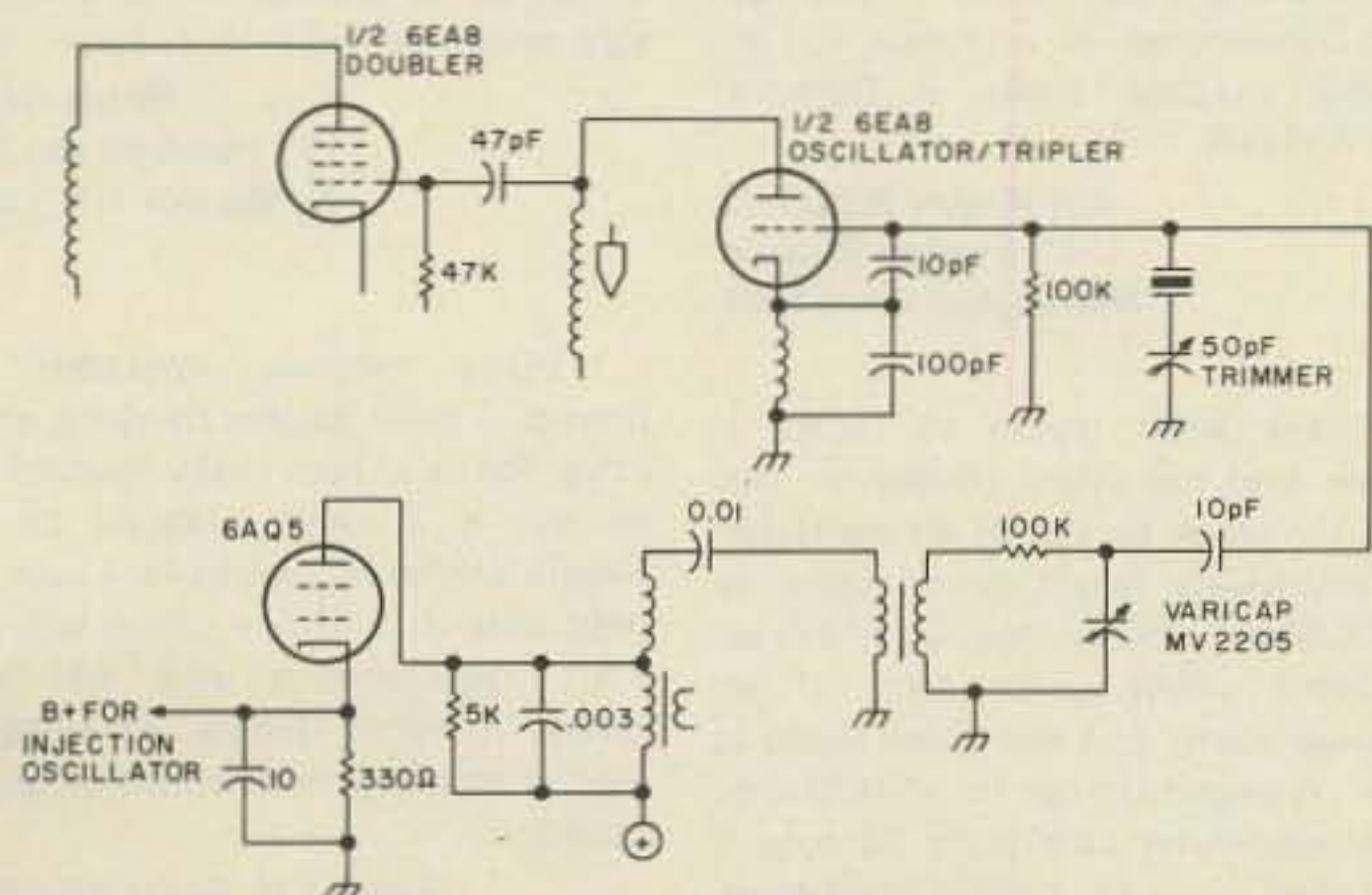

Fig. 1.

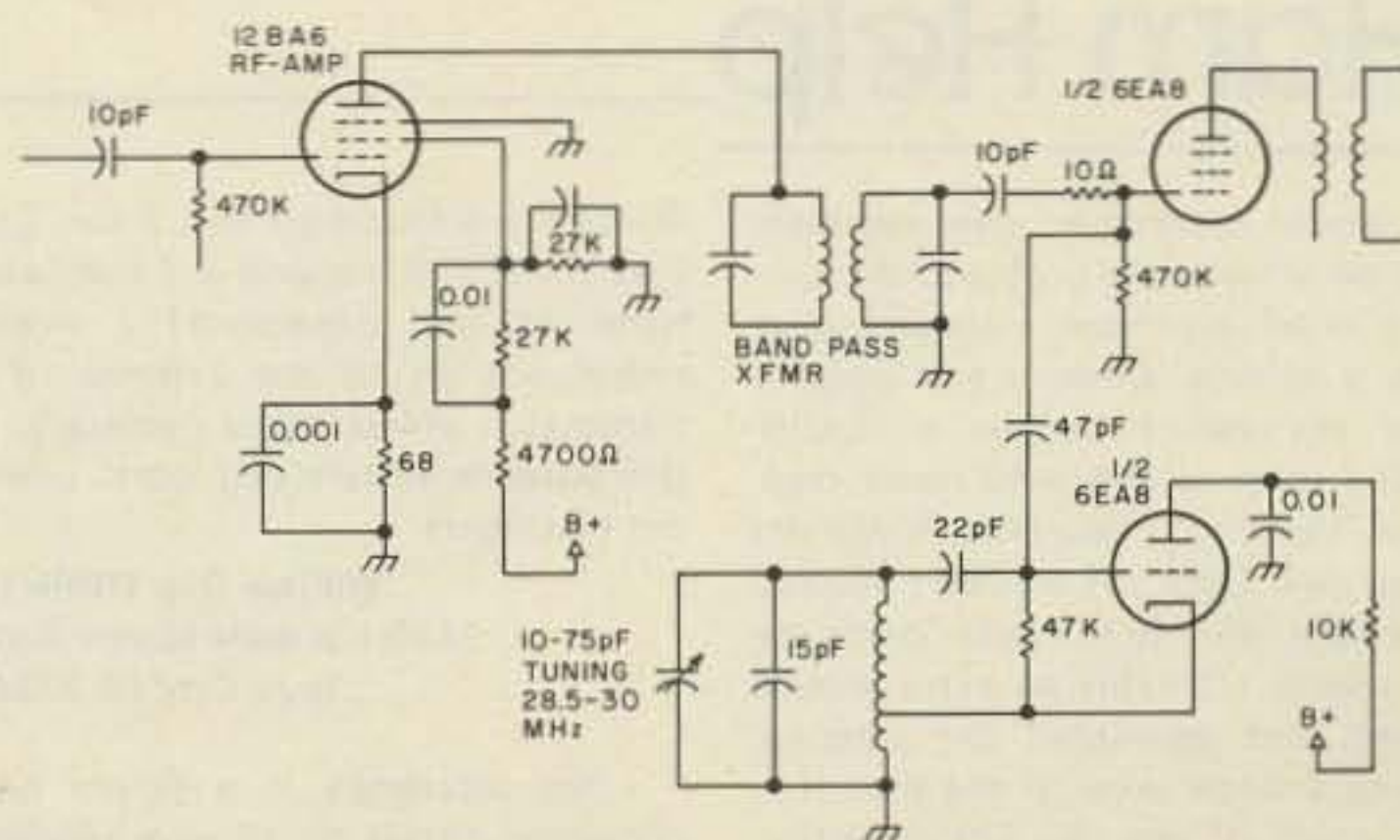

Fig. 2.

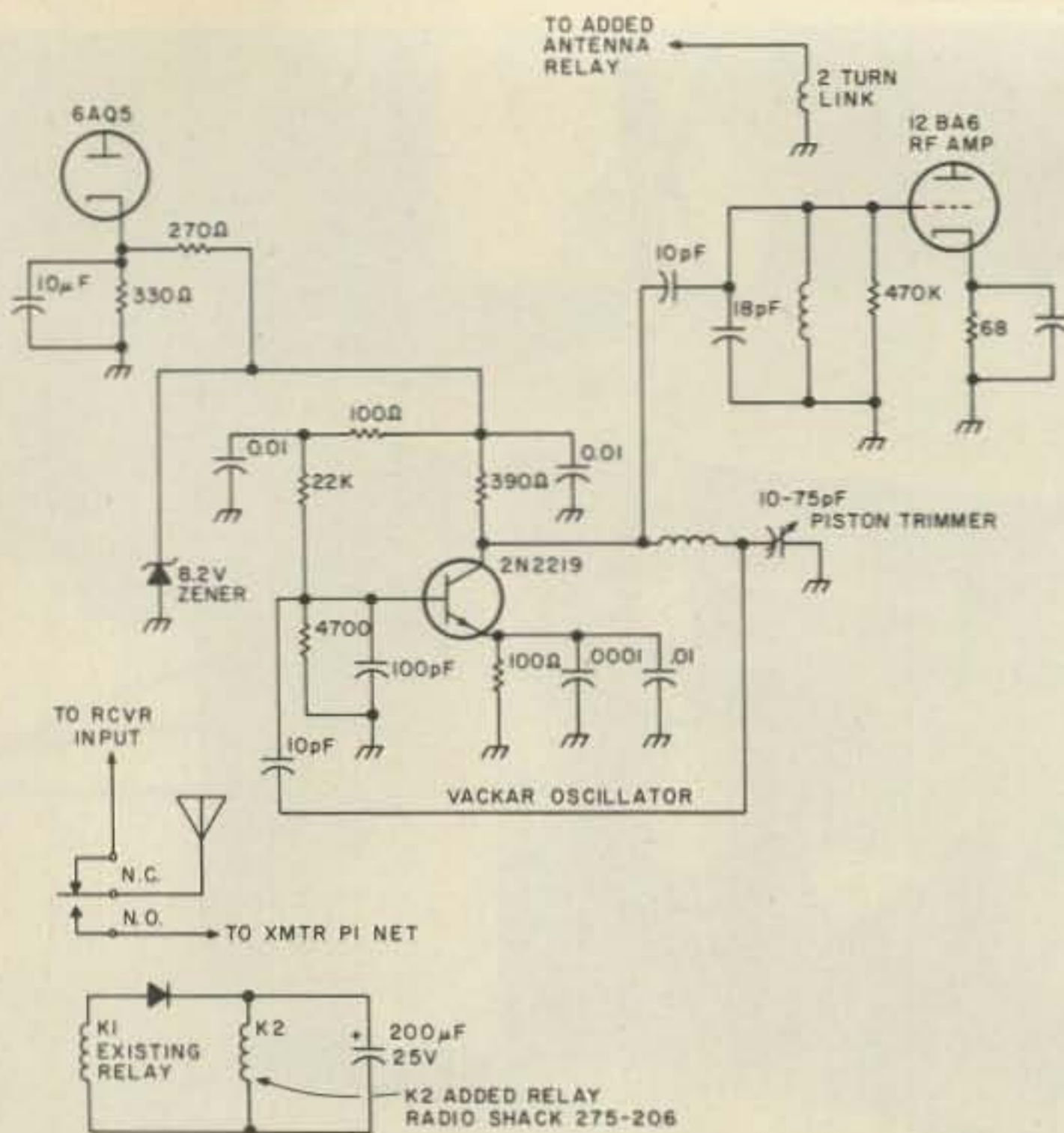

Fig. 3.

injection oscillator was going to be solid state, a source of low voltage was needed. The cathode bias resistor of the 6AQ5 proved to be a handy source of plus 10 volts, solving this problem.

Nothing could spoil this fine forward progress except the mailman, or more precisely, the mail person, as he is really a she. The postcard was from the Great American Pool Table and Quartz Crystal Company. It said: "Dear Cur: Your crystal will be along in about eight weeks."

Not only were they making me wait two months for the crystal I wanted yesterday, but they also had

included a finely drawn character analysis in the message.

Fortunately, I had heard of Mr. Vackar and his driftless, easy-to-roll VFO. This little item (Fig. 3) worked extremely well, and was installed in a minibox on the rear of the transceiver. The design information was abstracted from a fine article in the February, 1968, issue of *Electronic Engineer*, written by Gary Blake Jordan. A rough check of stability showed a drift of about 100 Hz over a period of about three hours after turn-on. There is plenty of room inside the transceiver for this unit, but there is a hostile tube-induced heat

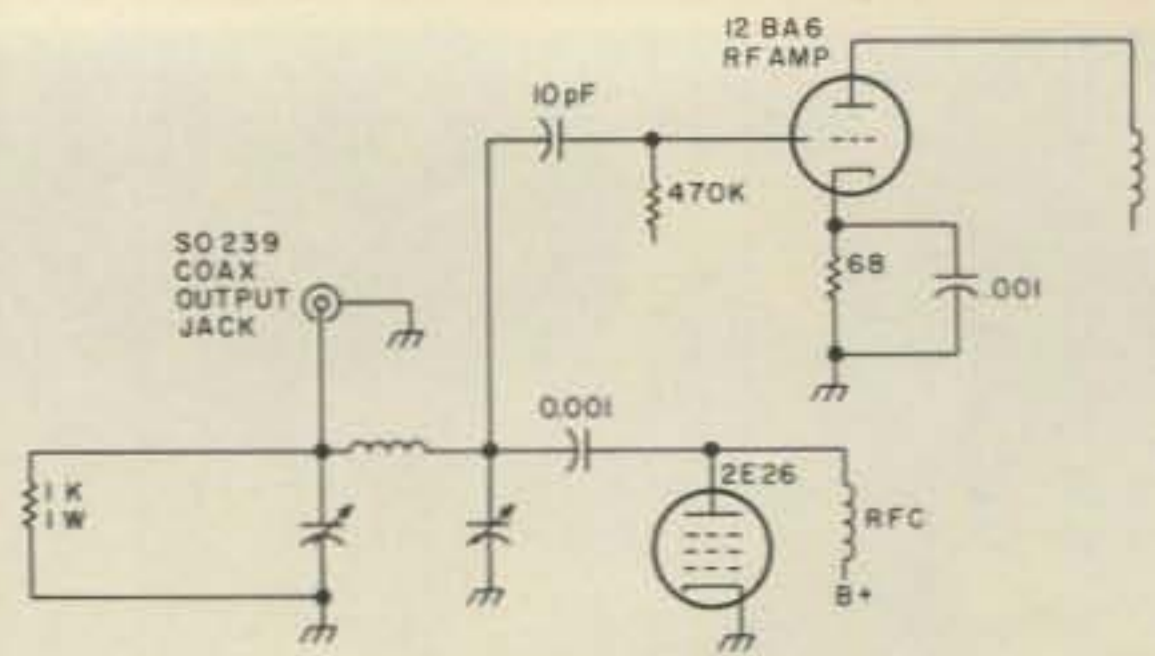

Fig. 4.

problem that I wished to avoid — hence the external mounting site.

The only other item of business was to install an antenna transfer relay. You might well ask, if it is already a transceiver, why do you have to install one of these? The answer is simple. The original design had the transmitter output and the receiver input tied together as shown in Fig. 4. It worked fine on 10 meters, but I could not get it to behave on 6 meters — hence the added relay.

Afterthoughts

The nice part about a globe like the 12BA6, in contrast to a transistor, is that it has three possible ports of entry for the injection oscillator. I tried all three, cathode, control grid and suppressor grid. The control grid injection seemed to give the greatest gain, and thus was used in the finished conversion.

The original press-to-talk relay is actually an ac relay which has a resistor thrown in series with it when the unit is

used on 12 volts dc for portable use. This explains why the diode and the filter cap appear along with the added relay as shown in Fig. 3.

The FM modulator deserves a special note. Perhaps due to personal preference and how the gods smile at the time, I have always had good luck with the varicap modulator when it gets its audio from a relatively low impedance winding of a transformer. For some delightful reason, the diode does not seem to care which end is up, and there is no polarity problem. It also seems to be perfectly happy without any obvious dc bias, so why fight fortune?

The vertical antenna shown mounted on the rear of the unit is OK for short hauls, but there is nothing that can take the place of a good skyhook as high up as reason will allow.

There are many similar units that have fallen into disuse as the times change, just waiting to be rescued and put to good use. Try it — you'll like it. ■

Ham Help

I would appreciate your technical help on an antenna problem. Because I live in an apartment, I decided to go with a mobile antenna and operate from my car. I bought a Hustler mobile antenna and a 40 meter resonator. Much to my surprise, it worked quite well. Later, of course, I wanted to at least listen to the radio inside my apartment. I bought an extra mobile mount and assembled the antenna, adding a single wire to the mount — the length of the car. The reception was still very good. Now the problem. I tuned up the transceiver (a Kenwood

TS-520) and found a 1 to 1.3 swr. Can I go ahead and transmit and not cause harm to my transceiver? I would rather not go to the expense of a transmatch unless really necessary. If this antenna system will work, where did I go right?

William Day WB0VTB
3420 Lakeside Manor Apts.
Iowa City IA 52240

I am interested in a simple tube converter circuit to observe received signals on my general purpose scope, which has a horizontal sweep range of

250 kHz and a transceiver i-f of 3180 kHz. Transceiver is a Yaesu 101-B. General purpose scope is Dumont type 304-AR.

Bill Massey WB6SSQ
1505 Lynton Avenue
Wilmington CA 90744

I have been trying to locate a source that has Gunn diodes for the 10 GHz range to use in an oscillator for microwave bench experiments, as in 73, March, 1974, page 33. I have an oscillator cavity, once part of an intruder alarm, but the Gunn diode is gone. It seems similar to what Microwave Associates calls style 30 case. I have had no luck calling companies for a possible replacement. Might any of your readers be able to supply an

exotic device such as this at a reasonable price for 1-2 units? Thank you.

Merek Geiger
111 Hendrickson Ave.
N. Merrick NY 11566

Having recently upgraded my license, I have begun thinking about other forms of ham radio. I would like to put a 2 meter antenna on my Cessna Skyhawk, but so far I have not been able to find one which will pass FAA requirements and not cost several hundred dollars. Any help in solving this problem would be appreciated.

Richard H. Seslar WD8BTW
173 Fairview Drive
Marysville OH 43040

- Booming 25 watts output power @ 14v DC input
- Separate controls for independent transmit and receive frequency selection
- Switch for lock-in of pre-selected frequency pairs allows one-knob operation
- Supersensitive dual-gate MOS FET in receiver head end
- Backlighted for night operation
- Factory-installed, front panel mount 12 digit, alpha-numeric tone encoder



GTX-200T
(incl. 146.94 MHz)
\$249⁹⁵

Features Like These Make Genave The FM Transceiver For You!

The GTX-200T is only one of the superior 2-meter transceivers in Genave's complete line of American-made amateur radios.

All Genave gear is carefully handcrafted under the strictest quality control conditions in a facility inspected and approved by an agency of the federal government for the production of precision aircraft navigation and communication equipment.

And, all Genave amateur FM transceivers are an unprecedented value because you order factory direct eliminating middlemen profits!

Each Genave unit has 10.7 MHz first IF and 455 KHz second IF filters for high selectivity, with RF output stages VSWR protected. In addition, Genave units are unusually lightweight, with fully transistorized integrated circuitry.

Standard features include netting trimmers for each transmit crystal and single circuit board designs which permit easy modifications.

So, take a good look at the GTX-200T and other Genave amateur gear. Then fill out the coupon below—better yet, call collect: 317+546-7959, today!



GTX-2

2 meter FM, 10 channels, 25 watts with pushbutton frequency selector (incl. 146.94 MHz)

\$189⁹⁵



GTX-200

2 meter FM, 100 channel combinations, 25 watts (incl. 146.94 MHz)

\$199⁹⁵



GTX-200T

2 meter FM, 100 channel combinations, factory-installed front panel mount 12 digit alpha-numeric tone encoder.

\$249⁹⁵



GTX-10S

2 meter FM, 10 channels, 10 watts (Xtals not included)

\$149⁹⁵



GTX-1

\$249⁹⁵

GTX-1T

\$299⁹⁵

Hand-held, 2 meter FM, 6 channel, 3.0 watts, GTX-1T with factory installed tone encoder.

Add \$4 per radio for Shipping, Handling & Crystal Netting



4141 Kingman Drive
Indianapolis, IN 46226
Phone-in orders accepted
317/546-1111

Name _____

Address _____ City _____

State & Zip _____ Amateur Call _____

Payment by:

- Certified Check/Money Order Personal Check
 C.O.D. Include 20% down

Note: Orders accompanied by personal checks will require about two weeks to process. 20% down payment enclosed. Charge balance to:

- BankAmericard # _____ Expires _____
 Master Charge # _____ Expires _____
 Interbank # _____ Expires _____

IN residents add 4% sales tax: \$ _____

All orders shipped post-paid within continental U.S.

73-10

ACCESSORIES

- Ringo Ranger ARX-2 6 db 2-M Base Antenna \$29.95
 Lambda/4 2-M and 6-M Trunk Antenna \$29.95
 TE-I Tone Encoder Pad \$59.95
 TE-II Tone Encoder Pad \$29.95
 PS-1 Regulated AC Power Supply for use with all makes of transceivers 14 VDC-7 amp \$69.95

and the following **standard crystals**

@ \$4.50 each \$ _____

Non-standard crystals

@ \$6.50 each: \$ _____

ACCESSORIES FOR GTX-1 and GTX-1T

- PSI-18 Optional Nicad battery pack \$29.95
 PS-2 Charger for GTX-1(T) battery pack \$39.95
 GLC-1 Leather carrying case \$12.95
 TE-III Tone Encoder (for use with GTX-1) \$49.95

W.A.S. - - Easily!

- - catching the last few

Dave Waterman W7FGD
1810 E. Terrace Way
Kelso WA 98626

Regardless of whether you have had your ticket for quite a while now or you are just getting on the air for the first time, I would like to present you with a challenge. The purpose of this article is to give you some hints and techniques to enable you to work a ham in every state of the United States and to get a QSL card back from him.

The ARRL has awarded over 25,000 Worked All States certificates to hams all over the world, and you can get one, too! It requires a little patience, a lot of listening on the bands, and a bit of work. Oh, come on now! You're not afraid of a little work!

A WAS award is a lovely certificate to frame and hang

on the wall of your shack, a fine conversation piece to show friends and family, and working for it will sharpen your operating skills. The ARRL offers one as do several other organizations and magazines.

But how do I work all 50 states? How can it possibly be done on the crowded Novice bands? How do I get that elusive Delaware contact? Or Wyoming? Or South Dakota?

Hopefully, we will answer these questions for you and get you started down the road to a WAS award.

Starting Off

First you must get yourself organized for the task. Take a sheet of lined paper and list all 50 of the states on it in two vertical columns, one down the left margin, and one down the center. Most lined paper has 25 lines on it, so you can get half the states in each

column. This is to be a check-off sheet for you to mark your progress. Each time you get a QSL from a new state, put a check beside that state on your list. As time goes by, this list may become dog-eared, so I would suggest a clear plastic cover for it to protect it. Keep this list at your operating desk where it can be seen at a glance. This list serves several purposes. It not only shows the states you've worked, but shows you the states you still need. If you hear a station give his QTH, a quick look at the list will tell you if you need him. Don't rely on your memory — use the list. Another thing this list does is help keep you on your toes and very aware of the states that you need.

Antennas

OK! You've got your check-off list prepared. Now what? In your studies to get

an amateur license and in almost all literature that you've come across concerning operating, you've been told time and time again that your antenna is the most important part of your station. I'm sorry to do this to you, but we're going to talk about this subject again for the million and first time, because it is so very, very important. You absolutely *must* get the best antenna you can for the bands which you choose to operate. If you have an oversized lot, lots of trees for wire arrays, neighbors who will let a few wires spill over onto their property, pat yourself on the back and light up a cigar; you're a lucky fellow. (I fall into this select category and realize how very fortunate I am.) Most hams are not so fortunate, and we're going to assume that you're one of them.

For the purpose of this article, we will assume that you run 100 Watts and use a dipole or an inverted vee antenna, which is capable of operation on 80, 40, and 15 meters. Ten meters is so sporadic these days we will disregard it. I may be doing a disservice to this band, but you can't rely on it right now.

Now our next step is to trot outside and take a close look at that antenna of yours. Is there any possible way to put up a full wave loop or Delta loop for 40 or 80? If so, do so! If not, can you raise that dipole any higher? How about adding a sloping dipole off one or both ends of its supports? Slopers are very effective antennas, and also hear very well. Info on these antennas can be found in the many antenna books available either by mail or from your local ham store. (You do have a local ham store?)

You say you can't do a thing different, huh! OK, make sure your antenna is radiating in the direction of a maximum number of states.

A north-south radiating antenna in Southern California isn't going to do too well in the Eastern seaboard. Of course, power lines and TV antennas slue radiation some, but check to see which way your signal is going. If you have any questions about this, refer to the antenna books. What you want is as low an angle of radiation as you can get, in the desired direction.

Now, how about the coax (or whatever feedline)? Check your connection to the antenna. Is it corroded? Just one hard rain can seriously lower signal levels if you haven't weatherproofed your feedline connection to your antenna. A W2AU balun*, or one similar, is ideal for this weatherproofing and eliminating feedline radiation with coax. Assuming your antenna is satisfactory, now look at your ground system. Ground system, not a ground wire! You need a ground wire going out of your shack to a buried cold water pipe (if at all possible). In addition to this, you need a separate counterpoise for each band you operate on. Check the antenna books again for info on these. They're simply lengths of wire cut to various lengths for each band — simple to install and effective in boosting your transmitted signal.

Having maximized antenna and ground systems, we now turn to take a look at your shack. Do you use an antenna tuner and swr meter in your feedline? You say you don't! Oh, come on, I'm trying to help you, not start a fight, but really now!

An antenna tuner and swr meter are essential for minimizing losses, especially if you're trying to utilize that dipole of yours on 15 meters. There are many plans for building tuners in past ham magazines (73 has had several). You can build one for next to nothing, with a large coil and a wide spaced

tuning capacitor from an old AM radio. Please get a tuner if you don't have one already. Some day you'll thank me.

If you operate a transceiver with VOX, you need not worry about a transmit-receive switch. If you run separate receiver and transmitter, you will. (Don't try and hide that knife switch you use. I can see the guilty look on your face.) If you have been using a separate switch to go from transmit to receive, carefully disconnect it, hold it firmly in your right hand, and throw it as far as you can. Now build, buy, beg, trade, or steal some sort of a T-R switch to use. It's hard enough to get that elusive Rhode Island contact when his signal is 339, the QRM is 599, and the QRN is 40 over. You don't need to be flipping switches while that is going on. It will be plenty hard enough as it is. This is the electronic age and you're a member of the brotherhood of ham radio operators. Use your electrical knowledge and get rid of that old knife switch.

As for the swr meter, they're available at every CB store, ham emporium, and from every gypsy on the street in every city of the US (and by mail order).

We have upgraded all the hardware now, except for one

item. There is still one link in your communications system we need to look at. That's you!

As long as there are different people in the world, there are going to be different operating techniques. What this is really boiling down to is the psychology of what makes you — you. But before we get into this very deeply, let's look at the different ways there are to work all states. You mean there's more than one? Yes! Actually there are three ways, all separate and distinct, in which a ham can achieve WAS. The first is to be a contestor. That is, operate in the large number of contests that occur each year. Successful contestors usually have years of experience and large numbers of them work all states every contest they enter. They have a high degree of competitiveness and a great pride in their gear, antennas, and especially their skill. They are after contacts and multipliers; they want all the stations they can work, the more, the better. They seldom rag chew. They are above our level of operation and they're not reading this article anyway, so we'll forget them.

The second way to work all states is to get on the air for an hour a night, every

now and then, and possibly two or three on the weekends. Chat for hours at a time, long and lengthy, about the height of the tides and the phase of the moon with every station that answers your CQ. Sooner or later, this operator will obtain a WAS certificate by chance. It is entirely possible, however, that the Sphinx will have turned to dust, the Rockies will be a desert, and everyone will have moved to Andromeda by then.

The third way, and the one that you need to take, is to sit down with some sort of an organized plan, listen to the stations that are on the air, find the ones you need, and slowly check off the blank spaces on your check-off list as you move closer and closer to your goal. Here is where the psychology angle comes in. You need to ask yourself, what kind of person am I? Do I like to talk? Do I talk, maybe too much? If so, it could be that while you're chatting away for 45 minutes to Ralph in the next county, that Maine station 3 kHz down from you that you didn't even know was on the band, has worked twenty stations and went QRT for the night. Now please don't get me wrong. I'm not against rag chewing. As a matter of fact, I'm very much for it. I

W7FGD

**1810 E. TERRACE WAY
KELSO, WASHINGTON
98626 - U.S.A.
COWLITZ COUNTY**

THIS CERTIFIES THAT _____ IS AN OPERATOR OF UNPARALLELED SKILL AND PATIENCE. IN SPITE OF THE QRM AND QRN, HERE AT THIS STATION FROM FOUR LITTLE GIRLS, ONE WIFE, AND AN INCESSANTLY RINGING LANDLINE, HE HAS MIRACULOUSLY BEEN ABLE TO CONTACT AND MAINTAIN A _____ QSO OF _____ 19____ AT _____ . FREQ _____ . RST _____ . RIG _____ . ANT _____ . THIS STELLAR ACCOMPLISHMENT CAN ONLY BE LAUDED WITH THE HIGHEST OF PRAISE, THE BEST OF 73'S AND A FOND WISH FOR GREAT DX.

MARAC - R653
ISSB - 9393

David Waterman

*Brand name.

dislike formalized QSOs and have made many, many great QSOs with interesting people. But a serious fisherman, when he goes fishing, is after fish. If the fish aren't biting and are not to be found, then they sit back and watch the sun set. You can very easily spend far too much time in a QSO during prime band hours if you like to chat. You need to look at yourself and the way you operate and ask yourself what you get out of ham radio. Are you operating correctly? Are you achieving what you want? If you love to chat and enjoy people, that's great. If you find it hard to open up to strangers, shorter QSOs will be your norm and you will log more stations in a given time than one who is more long-winded. Maybe you're not going after stations with enough aggression. If you're really serious about this WAS award, go after it with gusto. Keep your QSOs short and be alert for the next fellow down the line, at least during prime band hours.

Enough Talk — Let's Get At It

OK, we're starting off. Let's quickly look at our bands. 15 meters is usually a daytime band, with some seasonal variations to different parts of the country. Check it out. It can be your most valuable band when it's open. Your dipole and 100 Watts won't make you a powerhouse, but many stations that you work will be using beams and that will help. 15 meters is a fun band and you have a little elbow room to move in. Favor it as much as possible. It can get those states on the opposite seaboard that you need. It can also get most everything in between.

40 meters begins to come in strong during late afternoon (out here in Washington, anyway!) and will drop out in middle evening. 40 also has seasonal variations. Winter is best. Summer brings static, but hang in there if

you can. There is still a lot of action if your eardrums can take it. 40 will get you the midwest and the south easily.

80 meters is best in early to late evening. Summer brings much static, too. Keep in mind that we are being very general about all this and that sunspots and cold fronts and other factors can change things greatly. 80 will get you the adjacent states and midwest and south, too.

In your early quest for WAS, a lot of CQing can be beneficial. You need to work most every state. The states will come quickly and it will be great fun to watch the cards come in and check off the states on your list. But, as time goes by, and your check-off sheet gains marks, new states will get harder and harder to come by. Here is where the real work will begin. (Remember, I never said it would be easy!)

Now you're going to have to change your operating habits a bit. You're going to have to listen more and be more selective in the stations you work. After your twenty-fifth 6-land QSL, you really won't have to work very many more for a while now, will you? In this respect, the guys in California have it rough, but there's nothing to be done about it. Just grit your teeth, California, and carry on.

Call areas will begin to slowly fill in. When you work all the zero-land states, forget them and move on to the others.

In order to get those remaining states, you're going to have to *listen*. Also, I would recommend a couple of techniques that have helped me. Buy a brand new *Callbook*. (Gulp — I know what they cost, but you're going to need it.) Practice using that book on calls that you hear on the air. Practice to the point that you can find a given call in about ten seconds. (Easy, huh? Just try it!) Now you have a valuable tool. In your tuning across

the band, any station that you think you may need can be quickly looked up to find where he is, and not only him, but the guy he's talking to. I can hear you complaining about this from here. But look, you have doubled your chances to find those missing states you need. You need not now wait for him to give his QTH — look him up quickly. As you progress toward your goal, you will come to appreciate this technique.

Moving Right Along

OK. We have progressed along. You're spending more and more time now listening to the bands. You're learning how to fight the QRM and pick out the weak signals. You are looking for weak signals, aren't you? You don't expect that KH6 to come in 599 in New York, do you? He's probably going to be a 339, if that. You're going to have to listen for the weak ones and be very alert. Here you're going to suffer from the QRM problems on the Novice bands. There's a lot of you guys out there and you're all trying to work each other. It's only natural that the first time you hear that KL7 you need so badly, half the world is going to want him, too.

Audio filters, crystal filters, or just anything that will increase your selectivity is going to be a real asset to you.

If you find that the station you need is being called by a zillion other guys, there are two things you can do (three, if you consider quitting, but I'm assuming you've got gusto!). The first is to join the pack and have at him. For this you will need patience and perseverance. Be of stout heart and don't give up if you need him, even after the tenth time you called him and he went back to someone else. Or the twentieth. If he just won't come back to you, try tuning off his frequency just a little. Maybe there are so many people calling him

that he can't make your signal out. Timing is important here. You'll just have to face a few of these and you'll learn fast. But there is another course of action left to you in a pileup. Be cagey! If the band is open to KL7-land and everyone is after one guy, maybe there's another KL7 down band a ways. Or maybe something just as juicy. If you hear a big pileup, check down band. When all the cats are out chasing a rat, the mice are left to play.

With everyone else after the same station, QRM drops down band and weak signals come through. In actual practice, on our crowded Novice bands, this situation would probably never happen. I can't really imagine every station in the band all on one frequency after one station. On twenty meters, yes, that happens; on the Novice bands, probably not. But I wanted to get the point across to you. You're going to have to be alert and think.

Now, let's say we've progressed further. Time has gone by and by spending more and more time on the air, and patiently listening, looking up calls in your book, and working the ones that you needed, you've got down to the point where you need just a handful. Let's say you need six more. You've spent weeks and weeks, now turning into months and months, and you haven't heard any station in those states. You spend your evenings on 40 and 80. Your Saturdays and Sundays are spent on 15. You spend so much time on your radio that the forest service is proclaiming your lawn a national park. Your dog bites you when you come home from work. Your two year old daughter cries when she looks at you out of fear of a stranger. All this and still nothing. OK, here are some things you can do.

First, watch for the state QSO parties in the states that you need. Most states have QSO parties once a year.

Some combine several states into one party, but it's all the same thing. At these times, operators in these states are more active than usual and are looking for contacts. Another thing you can do is spread the word to your friends that you are desperate for these states and if they hear them on the air to give you a call. Four, six, or eight sets of ears are better than one. Here's another idea — get copies of *QST* and look up the listings each state SCM sends in each month. Find out what's going on in those states you need. Sometimes you can get a valuable clue as to when and where a club or special events station will be on the air. Also try your hand in operating in a contest. The best one for you is the Novice Roundup. Your chances of having an operator on in a needed state are improved. However, the increased QRM caused by the contest makes it harder to get through. Still, it's something to try.

Suppose none of this works. You're going around muttering. "What the hell's happened to Delaware anyway. Why don't they send a DXpedition there?" Your job is suffering. Your wife is threatening divorce. And still nothing.

Get on your ham friends again. Keep on them. Check with any DXers in the area, any you might faintly know, any you may have heard of. DXers, county hunters, and

regional net men have friends all over the country. Maybe one of them can fix up a schedule and give you a hand with the contact.

If all is for nought, and you still need some states, here's what you do. First put an ad in the ham magazines requesting a sked with the states you need. If that's fruitless, as a last resort, look up in the ham magazines, contest winners in the states you need. If a man is a contest winner, he probably has a better than average rig and antenna setup, and probably is more skilled than most. Sit down and write him a letter explaining your plight and beg him for a schedule at his convenience. That should work if nothing else will. I would do it for you, and I think most other hams would also. This should be considered as a last, last, last resort only. It is an imposition on people's time and themselves, and should not be requested lightly.

With the techniques I've outlined, plus a lot of time on the air, you should be able to contact a ham in all 50 states. But we're not done yet. Contacting them and getting a QSL are two different matters.

A QSL card should be a representation of yourself. It's all the other guy will have to remember you by. It should be different from the run-of-the-mill cards, and, if at all possible, unique. I would recommend to you

that you have some special cards printed up. I have included one of my own cards to show you what I mean. It's not that my card is so great, but it is different, and reflects my own personality. I am constantly getting comments about it — just get something different that reflects you. Don't you dare copy mine; just get something out of the ordinary that people will remember, a photo card if you want.

Now, when you have that special card of yours, you're going to have to do one more thing. Do you know what an SASE is? It stands for self-addressed stamped envelope. Use them. At today's postage prices, please don't expect someone in a far-off state to spend his own money to send you one of his cards. Many will, but many won't also.

If you use a distinctive QSL card, filled out properly, with a polite thank you and a line or two about yourself on the back, together with an SASE, I'll guarantee you a 95% return rate (excluding calamities at the Post Office).

Have I made it sound easy? Well, it's not! It's hard work and at times very frustrating. QRM will be your biggest problem. Remember, all you have to get is the RST reports both ways to have a valid QSO.

Summary

Let's summarize what we've covered:

1. To earn your WAS, you're going to have to make it your goal. That means work for it.
2. Make your check-off list.
3. Maximize your antenna and ground systems.
4. Use an antenna tuner and swr meter.
5. Get a T-R switch if you don't have one already.
6. Spend time on the air and listen for the states you need.
7. Get a *Callbook* and be able to use it quickly.
8. Plan your operating time to take greatest advantage of open bands (prime time).
9. Take advantage of special operating events or state QSO parties.
10. Be alert and keep thinking.
11. Listen for the weak ones.

Lastly, you're going to have to look at yourself and evaluate yourself a little. If you're having trouble getting those states, maybe it's something you're doing wrong. Change your operating habits. Get on the air at different times than you did before. Listen longer. Listen harder.

Well, I've done all I can do. Those 50 states are out there waiting for you. It's a great challenge and a fine reward to work all states. Good luck to you. ■

Tracking the Hamburglar

RIPPED OFF: Hallicrafters FPM300 MKII, s/n K530010, taken during break-in at home weekend of July 22, 1977. Bronx 52nd Police Precinct complaint no. 4565. Marty Greenbaum K2HTO, 3070 Hull Avenue, Bronx NY. Tel. (212) 231-3635.

SHANGHAIED: Heath Model 2021 handie-talkie with Model 201 touch-tone pad built-in. Channel switch wired wrong in that channels 3, 4, and

5 go to crystal sockets 3, 2, and 1. Crystalled for 146.52 (ch. 3), 146.655 (ch. 4), and 146.94 (ch. 5). Stolen July 23, 1977 in Westport, Connecticut. S. W. Daskam K1POK, 38 Settlers Trail, Stamford CT 06903, (203) 329-0187.

LOOTED: Clegg FM27B, s/n 4647 was taken from my truck on August 11, 1977. Contact: K1ZUW, PO Box 102, Hudson NH 03051.

STOLEN: Clegg Mark III, 2 meter transceiver, serial 750,187 with .52-.52 from Dick Haskin W6KEC, 149 Mauna Loa Dr., Monrovia CA 91016.

STOLEN: Drake TR-4 SSB transceiver #16491, AC-3 power supply #18572, L-4B linear amplifier #1102, L-4PS power supply #1124, Hallicrafters SX-100 receiver #151257. These items were stolen in a break-in on April 27, 1977, at a local radio store in Louisville KY, where they were held on consignment for Ev Ballard WA4ACJ. Any information would be appreciated. Contact him collect at 502-451-8923 or 812-294-4819, or write 2438 Longest Ave., Louisville KY. (Also: Jefferson County Police Department, 502-588-2111.)

PURLOINED: Standard SRC 826M 2 meter FM transceiver, SN: 104207. Stolen on June 27, 1977 from Bill Myers WB0MCS, 942 E. Mississippi, Denver CO 80210, 303-777-3353. Has the following frequencies installed: 146.94-94, 52-52, 16-76, 34-94, 28-88, 88-88, 31-91, 148.01-01, 37-97, 19-79, 25-85, and 91-31. Has KØKGA scribed on receiver board. Receiver crystal board has been rebuilt. Channel 12 — 91-31 transmit is 450 cps. high in frequency; transmit trimmer for this channel is different from others.

RIPPED OFF: Icom IC-22A, s/n 9900 with 12 sets of crystals. Call and SS no. etched on back. Pete Jordan WA1AXK, 832 Temple Street, Whitman MA 02382.

Fool the Wire Wizard

-- a computer would have helped

Once upon a time, far, far away, there lived a wire wizard. The time was during World War II, and the place was on a US Navy warship. The wizard was an old Navy warrant officer with a nimble brain that was like a bear trap for facts of every description. One of his many skills was the ability to quickly give

almost any information about soft drawn copper wire. For example: What is the resistance of 533 yards of 13 gauge wire? What is the cross section area of 33 gauge wire?

Mr. Steele, for that was his name, had a habit that just about drove me to distraction. He liked to bet on various matters. He always

bet exactly \$5.00, and he *never* lost a bet. When I would bet with him, he would tell me I was foolish because I knew he never lost. But, what the hell, I knew I was right *this* time (the *this* was for *every* time). But I wasn't, and he won again. One time he asked me who invented the audio amplifier. I replied, "Dr. Lee De Forest, who invented the audion (triode vacuum tube)."

"Nope," he said, "someone invented an audio amplifier before him."

"Who?" said I.

"Thomas Edison, that's who."

Aha! I had him. Old Tommy invented a passel of things, but not an audio amplifier. But I lost again because Edison invented a carbon microphone, and this was easily shown to be an audio amplifier. When the earpiece was placed over the mouthpiece of an old-fashioned country telephone, the thing would whistle on its own.

All of us pestered Mr. Steele to tell us how he could produce wire table facts so

quickly, but he would never say. One day I asked him if he always bet when he knew he would win. "Absolutely," was his reply, "that is a cardinal principle with me." I then bet him \$5.00 he could not teach me his wire table methods. Now he was boxed in. He thought about it a little, and then he told me he wouldn't bet because I might be too stupid to understand even though the method was simple. However, he offered to teach me on the sole condition that I would never tell it to anyone else on the ship. That particular ship has rusted on the bottom of the Pacific Ocean for more than 30 years now, so it seems fairly safe that I can now speak freely on the matter.

He told me to take a lined tablet and, on one of the lines about a third of the way down the page, to write the numbers 1, 10, 100, 1000, and 10000. He said that among these numbers was a fairly typical wire gauge which I was to select. It could only be ten gauge. One gauge is possible, but not common, while the other numbers are ridiculous as a wire size.

Mr. Steele then asked how the resistance of copper wire is given. The answer to this is in Ohms per 1000 feet, which takes care of the 1000 on the line of numbers. One can compute the cross section of a wire in circular mils by squaring the diameter in mils (a mil is 1/1000 of an inch). $1 \cdot 1 = 1$ is no help because it uses one value for two different data. We can't use $10 \cdot 10 = 100$ because 10 is already spoken for as the gauge number. The only other possibility is $100 \cdot 100 = 10000$ to give us a diameter of 100 mils and a cross section of 10000 circular mils. The 1 that remains is the resistance of one Ohm per 1000 feet.

There you have it for 10 gauge, soft drawn copper wire. One Ohm per 1000 feet, 100 mils diameter and 10000 circular mils cross section.

"Now," he said, "number

Resistance (Ohms)	Gauge	Diameter (mils)	Cross Section Area (C.M.)
.125	1	283	80000
.156	2	253	64000
.185	3	226	51200
.25	4	200	40000
.313	5	179	32000
.39	6	160	25600
.5	7	141	20000
.625	8	126	16000
.781	9	113	12800
1	10	100	10000
1.25	11	89.4	8000
1.56	12	80	6400
2	13	70.7	5000
2.5	14	63.2	4000
3.13	15	56.6	3200
4	16	50	2500
5	17	44.7	2000
6.25	18	40	1600
8	19	35.4	1250
10	20	31.6	1000
12.5	21	28.3	800
16	22	25	625
20	23	22.4	500
25	24	20	400

Table 1. The characteristics of soft drawn copper wire as developed by the wire wizard.

upward and downward from the 10 for the wire size." So above the 10 in a column I placed 1 through 9, and below the 10 I wrote 11, 12, etc., until I got to the bottom of the page. In the resistance column, he told me to skip two lines and double, skip two more and double again, etc., to give 2 Ohms for 13 gauge, 4 Ohms for 16 gauge, 8 Ohms for 19 gauge, etc. As the resistance goes up, the cross section goes down in the same proportion; thus the

cross section for 13 gauge wire is 5000 circular mils, 16 gauge is 2500, and so forth. After doing all of these and taking square roots of the area to get the diameters, I still had many gaps in the table. The next step was to go ten places on the size and increase the resistance by ten times to give us 10 Ohms per 1000 feet for 20 gauge wire. Now we can go up from 20 gauge to fill in for gauges 17, 14, 11, 8, etc. From 11 gauge we can go down 10 for 21

gauge, and so forth. In a very short time we get the complete table as shown in Table 1. It is a pity this table is not quite exact, but it is close enough for any practical purpose. Mr. Steele also showed me how all of these numbers can be read from an ordinary slide rule. I will not go into this because slide rules are now ancient history. Now I can't rightly say how this discussion of soft drawn copper wire will

improve your life unless you join up with a few nuts like we were with entirely too much free time on our hands during the big blowout. An interesting coincidence to me is the fact that a wire three gauge numbers smaller than another can handle only half the power (it is half the size), and cutting the power in half is a change of 3 dB (decibels). In like manner, a change of six gauge numbers changes the power capacity by 6 dB, and so forth. ■

De WA3ETD

Oscar Orbits

John Molnar WA3ETD
Executive Editor

WIN MONEY!

A new contest is starting in 73 this month that should interest authors and readers alike. Get ready for this one!

The author of the best article published each month will receive a check for \$100 — in addition to our regular payment for the article. I can hear the questions now! How will the winning author be selected? Not by the staff, that's for sure . . . otherwise I would insure that my editorial would win each month!

The readership of 73 will select the winning article each month by voting on the reader service card in the back of the magazine. It's simple to cast your vote. On the bottom of the reader service card there will be a small box with the word "Winner" close by. Place the page number of the article's title page in the box. This eliminates all possibility of confusion, as some issues contain multiple articles by the same author. After voting, make sure to fill in the rest of the reader service card — advertisers appreciate the attention, and hopefully will continue to manufacture ham gear! Each month Dynamic Doreen (5'7", blond, blue eyes) will present me with the totals indicating the winner. In order to avoid confusion and late votes, each month's ballots will be accepted until the next issue of 73 is mailed. Start writing, authors! An extra C-note will go a long way toward a major piece of new gear.

An additional Christmas present will be presented to the best article of the year, voted upon in the December issue. The yearly top prize is a check for \$500! Dream about that for awhile!

We have not forgotten those readers who vote each month. A periodic drawing will be held from all reader service cards containing a vote. If you

need a nice piece of new gear for your shack, this might be the way to get it. Drawing dates will be announced well in advance.

10 GHz

Well, as promised, I finally completed an article on the Gunnplexer transceiver. If you have been following this column, you know that the Gunnplexer is a microwave front end that can be used in communications systems and Doppler radar devices. Working with microwaves is fun, and I think you will enjoy experimenting with Gunnplexers if you are into UHF tinkering. My article concerning the transceiver is in this issue, and it can be built for under \$200 — depending on the state of your junk box. Cost is much lower if you use a broadcast FM radio as an i-f receiver.

Microwave Associates, the outfit that makes the Gunnplexer, has an interesting information package concerning experiments with amateur microwave equipment. Most of the serious experiments have taken place in Europe and England. Hopefully it won't be long before American hams get going on 10 GHz.

Don't fail to keep me posted of your experiments with the Gunnplexers. I will respond to any and all related correspondence. I'll see if I can talk Wayne into a prize for the best microwave article of the year — check here next month.

COMING EVENTS

Our OSCAR special issue is next month (November issue). You won't want to miss this one, as it is full of info about the new satellite. There are also plenty of new antenna projects — especially related to portable operation. I just built a 432 MHz circular polarized groundplane from one of the articles, and it works great. Details about the new Russian satellites will also be provided. Make sure your subscription is up to date!

Oscar 6 Orbital Information				Oscar 7 Orbital Information			
Orbit	Date (Oct)	Time (GMT)	Longitude of Eq. Crossing °W	Orbit	Date (Oct)	Time (GMT)	Longitude of Eq. Crossing °W
N 22682	1	0014:57	67.3	13159 B	1	0141:56	80.0
NA 22695 BTN	2	0109:52	81.1	13171 A	2	0041:16	64.9
N 22707	3	0009:48	66.1	13184 BQ	3	0135:33	78.4
NA 22720 BTN	4	0104:44	79.8	13196 A	4	0034:54	63.3
NA 22732 BTN	5	0004:40	64.9	13209 BX	5	0129:11	76.9
N 22745	6	0059:36	78.6	13221 A	6	0028:32	61.7
NA 22758 BTN	7	0154:31	92.4	13234 B	7	0122:49	75.3
N 22770	8	0054:27	77.4	13246 A	8	0022:09	60.1
NA 22783 BTN	9	0149:23	91.1	13259 B	9	0116:27	78.7
N 22795	10	0049:19	76.1	13271 A	10	0015:47	58.6
NA 22808 BTN	11	0144:14	89.9	13284 B	11	0110:04	72.2
NA 22820 BTN	12	0044:10	74.9	13296 AX	12	0009:25	57.0
N 22833	13	0139:06	88.6	13309 B	13	0103:42	70.6
NA 22845 BTN	14	0039:02	73.6	13321 A	14	0003:03	55.4
N 22858	15	0133:58	87.4	13334 B	15	0057:20	69.0
NA 22870 BTN	16	0033:54	72.4	13347 A	16	0151:37	82.6
N 22883	17	0128:49	86.1	13359 BQ	17	0050:58	67.5
NA 22895 BTN	18	0028:45	71.1	13372 A	18	0145:15	81.0
NA 22908 BTN	19	0123:41	84.9	13384 BX	19	0044:35	65.9
N 22920	20	0023:37	69.9	13397 A	20	0138:53	79.5
NA 22933 BTN	21	0118:32	83.6	13409 B	21	0038:13	64.3
N 22945	22	0018:28	68.7	13422 A	22	0132:30	77.9
NA 22958 BTN	23	0113:24	82.4	13434 B	23	0031:51	62.7
N 22970	24	0013:20	67.4	13447 A	24	0126:08	76.3
NA 22983 BTN	25	0108:16	81.2	13459 B	25	0025:29	61.2
NA 22995 BTN	26	0008:12	66.2	13472 AX	26	0119:46	74.8
N 23008	27	0103:07	79.9	13484 B	27	0019:06	59.6
NA 23020 BTN	28	0003:03	64.9	13497 A	28	0113:24	73.2
N 23033	29	0057:59	78.7	13509 B	29	0012:44	58.0
NA 23046 BTN	30	0152:54	92.4	13522 A	30	0107:01	71.6
N 23058	31	0052:50	77.4	13534 BQ	31	0006:22	56.5

The listed data tells you the time and place OSCAR crosses the equator in an ascending orbit for the first time each day. To calculate successive orbits, make a list of the first orbit number and the next twelve orbits for that day. List the time of the first orbit. Each successive orbit is 115 minutes later (two hours less five minutes). The chart gives the longitude of the first crossing. Add 29° for each succeeding orbit. When OSCAR is ascending on the other side of the world, it will descend over you. To find the equatorial descending longitude, subtract 166 degrees from the ascending longitude. To find the time it passes the north pole, add 29 minutes to the time it passes the equator. You should be able to hear OSCAR when it is within 45 degrees of you. The easiest way to do this is to take a globe and draw a circle with a radius of 2480 miles (4000 kilometers) from the home QTH. If it passes right overhead, you should be able to hear it for about 24 minutes total. OSCAR will pass an imaginary line drawn from San Francisco to Norfolk about 12 minutes after passing the equator. Add about a minute for each 200 miles that you live north of this line. If OSCAR passes 15 degrees from you, add another minute; at 30 degrees, three minutes; at 45 degrees, ten minutes.

OSCAR 6: Input 145.85-145.95 MHz; Output 145.90-146.00 MHz; Output 29.45-29.55 MHz; Telemetry beacon at 29.45 MHz.
 OSCAR 7 Mode A: Input 145.925-145.975 MHz; Output 29.40-29.50 MHz. Mode B: Input 432.125-432.175 MHz; Output 145.925-145.975 MHz.

Orbits designated "X" are closed to general use. "ED" are for educational use. "BTN" orbits contain news bulletins. "Q" orbits have a ten Watt ERP limit. "L" indicates link orbit. "N" or "S" indicates that Oscar 6 is available only on northbound or southbound passes. Satellites are not available to users on "NA" days.

Ultra Simple Diode Checker

-- for grab bag specials

Marion D. Kitchens K4GOK
7100 Mercury Ave.
Haymarket VA 22069

This simple diode checker is an up-to-date version of an idea that has been around for a number of years. It can be built in one or two evenings from the parts in most experimenters' junk boxes. The parts required are one resistor, two LEDs, and any 117 V ac transformer that will provide from 3 to 25 V ac. Discarded audio inter-stage transformers from old tube-type radios and TVs can be used. If all new parts are

bought, the cost will be about \$5.00, including the small aluminum box. The small cost can be recovered many times over by buying unmarked, untested, manufacturers' closeouts, diodes by the pound, etc., available from most discount mail-order houses (like Poly Paks). Bad diodes can cause disastrous results in some circuits and can be difficult to detect and locate in other circuits. It is a wise precaution to check them all before installation. This simple diode checker was conceived and built for just such purposes.

The Circuit

The simple schematic is shown in Fig. 1. The transformer provides a low ac voltage, through the current limiting resistor, to two LEDs connected back-to-back. The diode to be tested is connected in series with this combination and the return side of the transformer. The

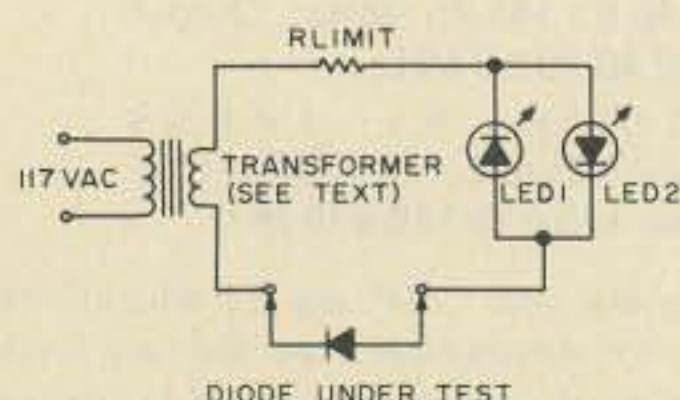

Fig. 1. Schematic.

LEDs will respond to the four possible conditions of the diode under test. If the diode is open, no current flows and neither LED will light. If the diode is shorted, one half cycle of the ac voltage will light LED1 and the other half cycle will light LED2. Since each LED is lit 60 times per second, a shorted diode will cause both LEDs to appear lit continuously. If the diode is good, LED1 will light when the diode's anode is toward the return side of the transformer and LED2 will light when the diode's cathode is toward the transformer return side. By proper physical arrangement of the LEDs and diode, the LED near the diode's cathode will always light.

The resistor should be sized to limit the current through the LEDs to about 10 mA. Most LEDs will have a voltage drop of about 1.5 volts across them, and most signal-type diodes will have from 0.1 (germanium) to 0.5 (silicon) volts drop across them. The resistor value can then be found by subtracting

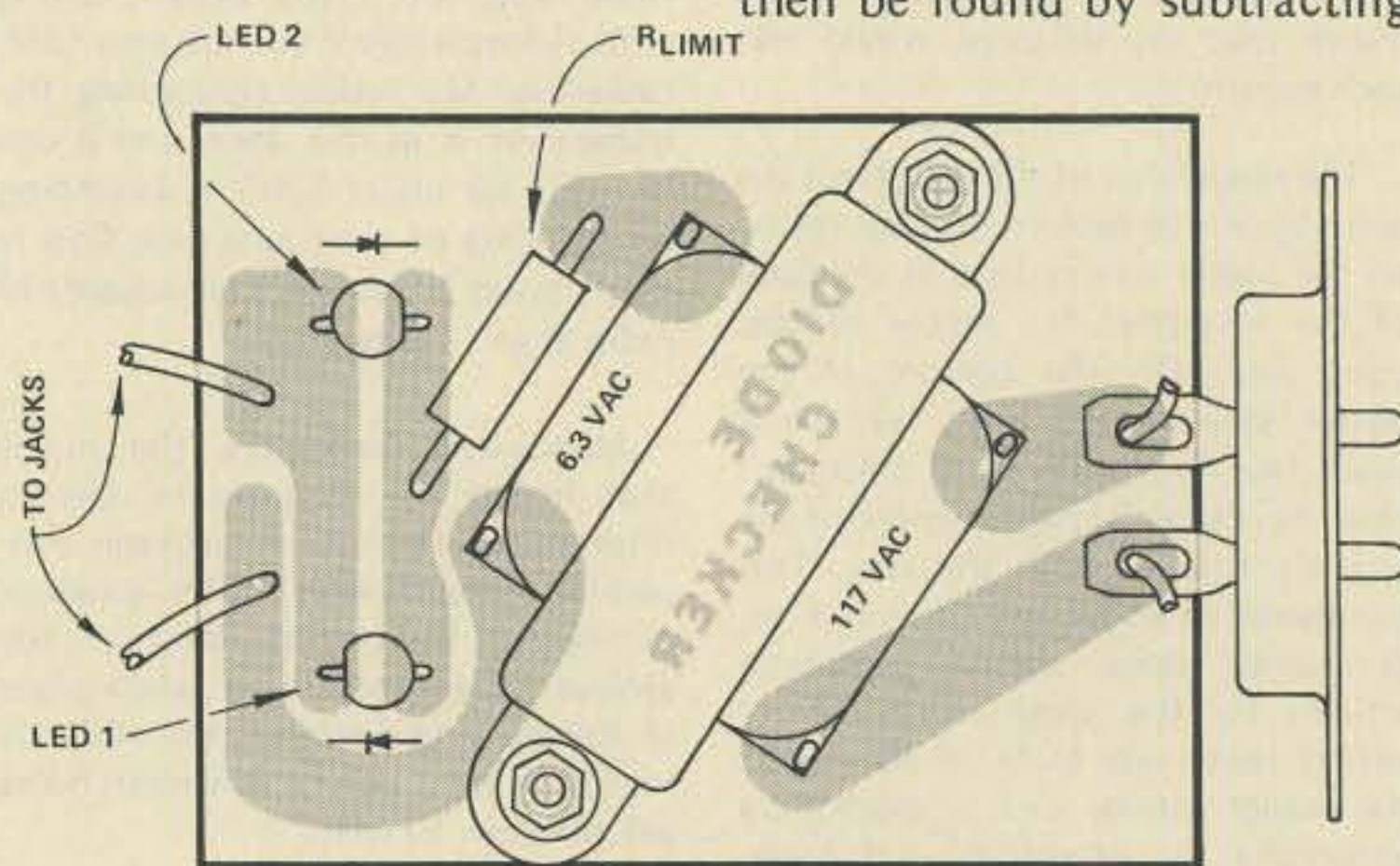

Fig. 2. Parts placement drawing.

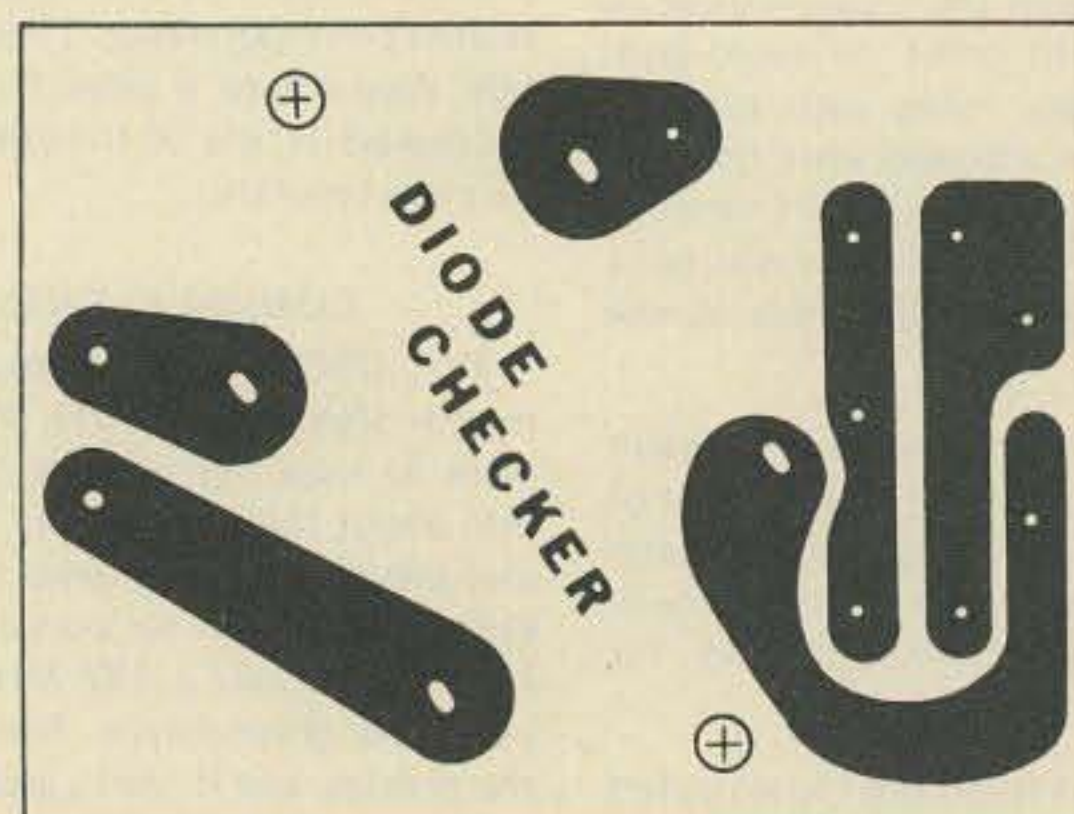
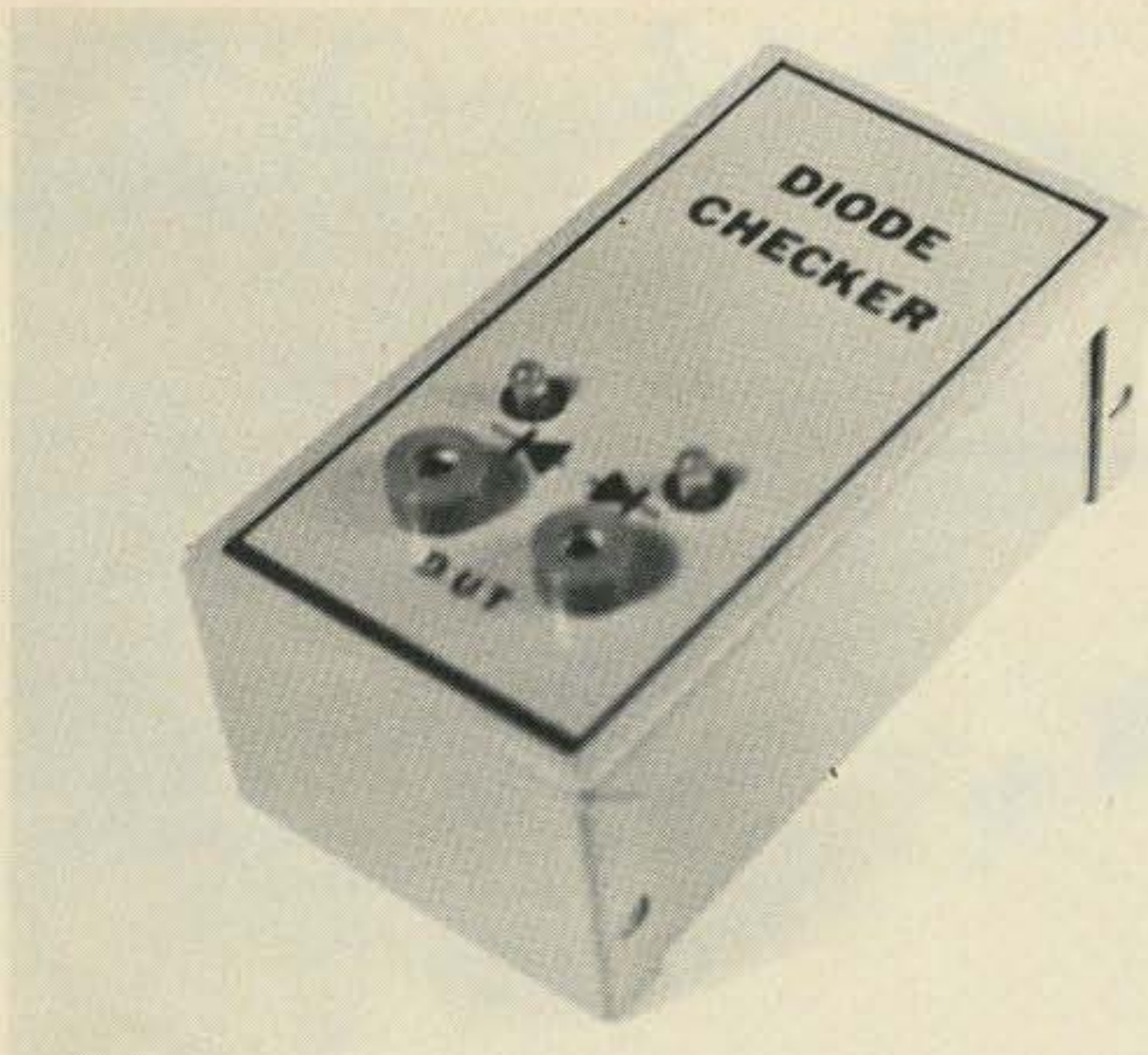

Fig. 3. PC board layout.



Finished, labeled checker.

these two voltages (say 1.5 and 0.5) from the transformer voltage and dividing by 10 mA:

$$R = \frac{V_{XFMR} - 1.5 - 0.5}{.010}$$

For a 6.3 V ac transformer, the resistor value is 430 Ohms. A 330 or 470 Ohm resistor will do. Its value is not critical.

Construction

The simple circuit lends itself well to point-to-point wiring, which is probably the quickest way to build the checker. If the builder prefers a neater appearance, the printed circuit board layout shown in Fig. 3 can be used. It is easy to duplicate with an etch-resist pen, or, if a profes-

sional look is desired, by photographic means. Fig. 2 shows the parts placement for the circuit board, and Fig. 4 shows the matching hole locations for mounting it in a 4 x 2-1/8 x 1-5/8 box. A Radio Shack 6.3 volt transformer, stock number 273-1384, was used for the circuit board layout and hole patterns. No on/off switch is used; the unit is simply plugged in for use. A TV cheater cord plug and socket are used so that the diode checker is easy to store without dangling ac cords everywhere.

Pin jacks, banana jacks, or five-way binding posts can be used for connecting to the diode to be tested. The binding posts allow for a variety of connections to diodes that cannot be

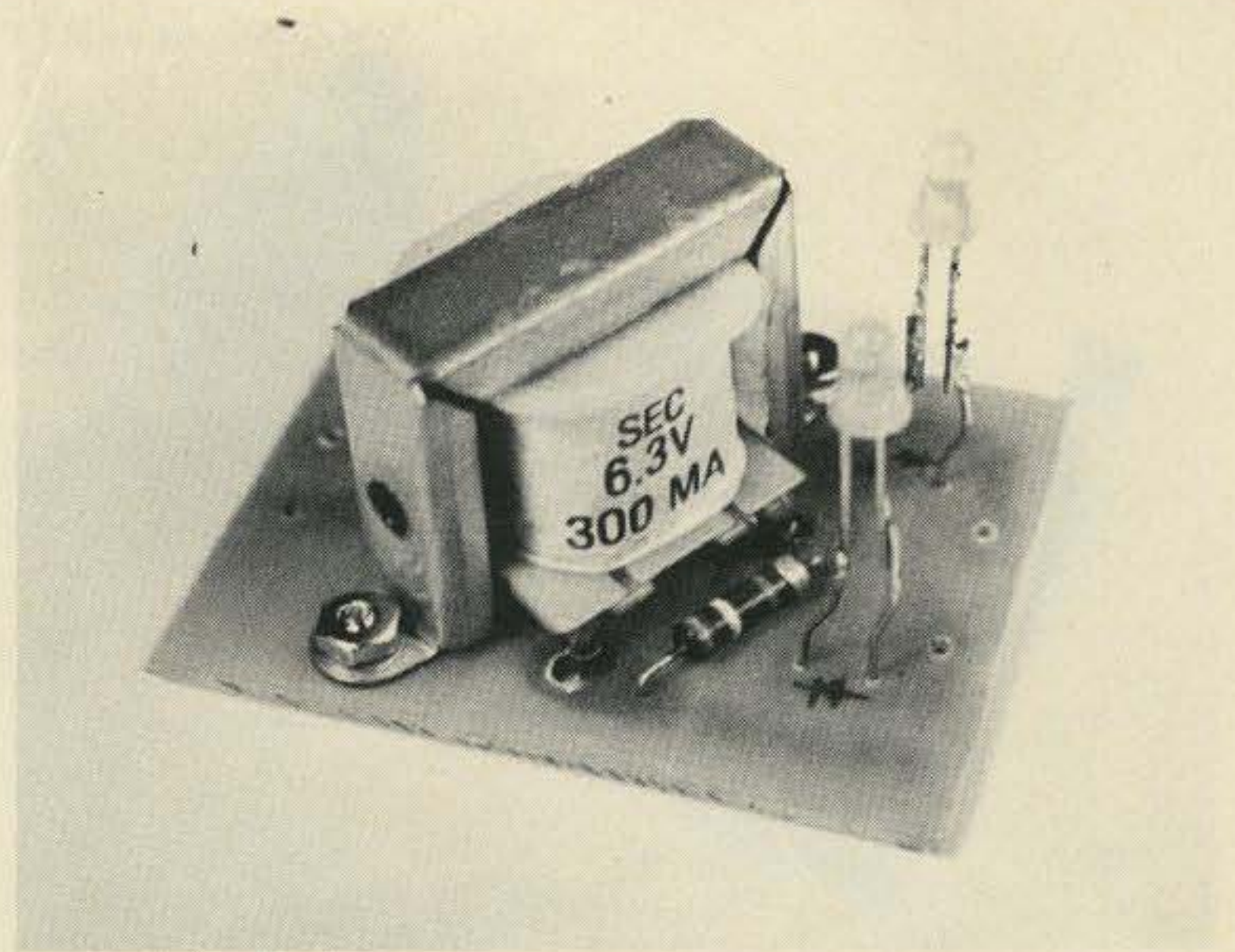

Assembled circuit board.

brought directly to the checker. Adapters with a V-notch are used so that loose diodes can easily be dropped into place for testing. Fig. 5 shows two easy methods of making such adapters.

The holes should be cut in the box, and it should be painted and labeled to suit the builder's taste. The

photographs show how I did it. The current limiting resistor and transformer should be mounted to the circuit board next. The ac plug and pin or banana jacks should then be mounted in the box, with short lengths of wire soldered to them as shown in the photographs. Next, insert the LEDs and bend their leads so that they will not fall

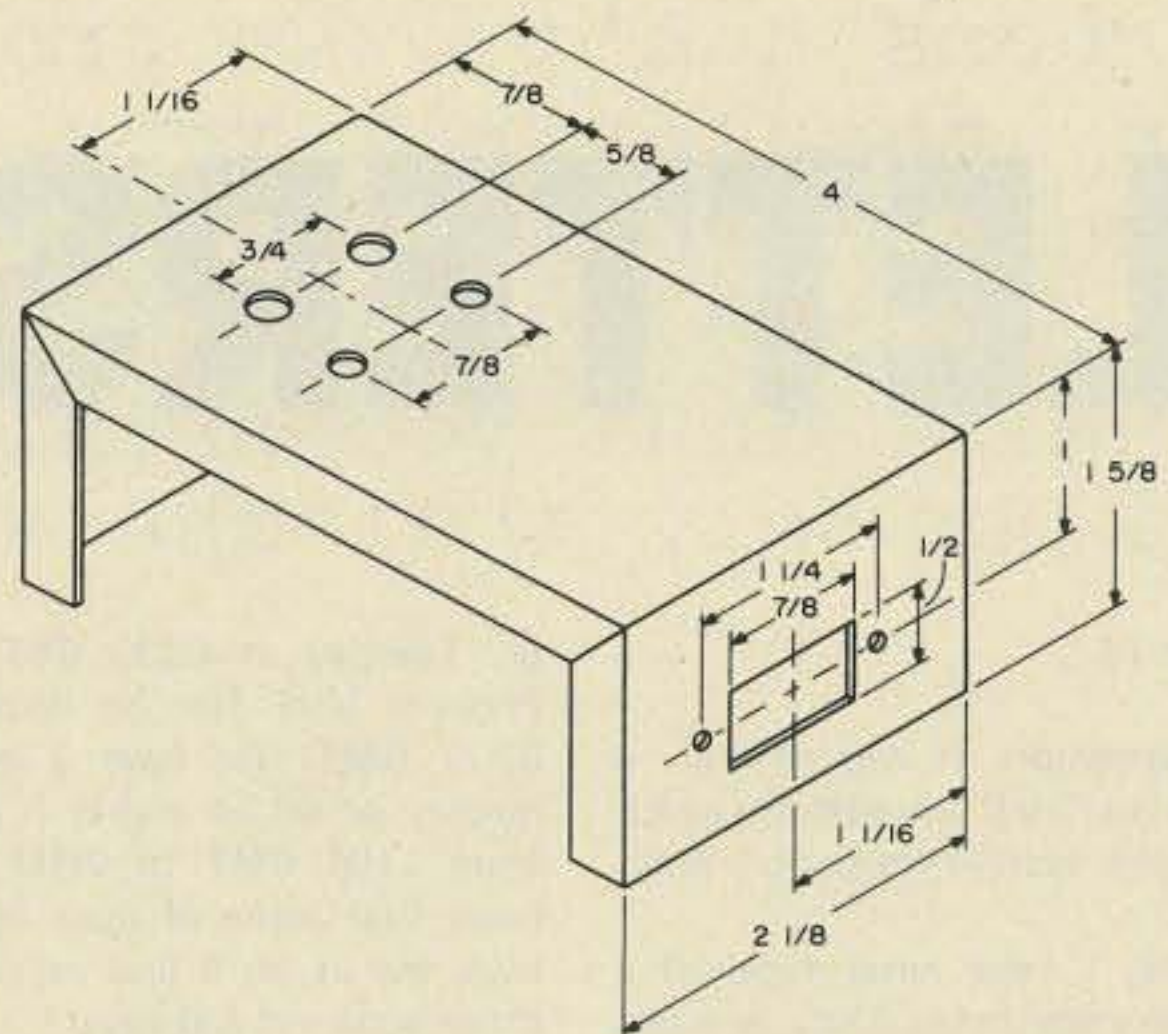
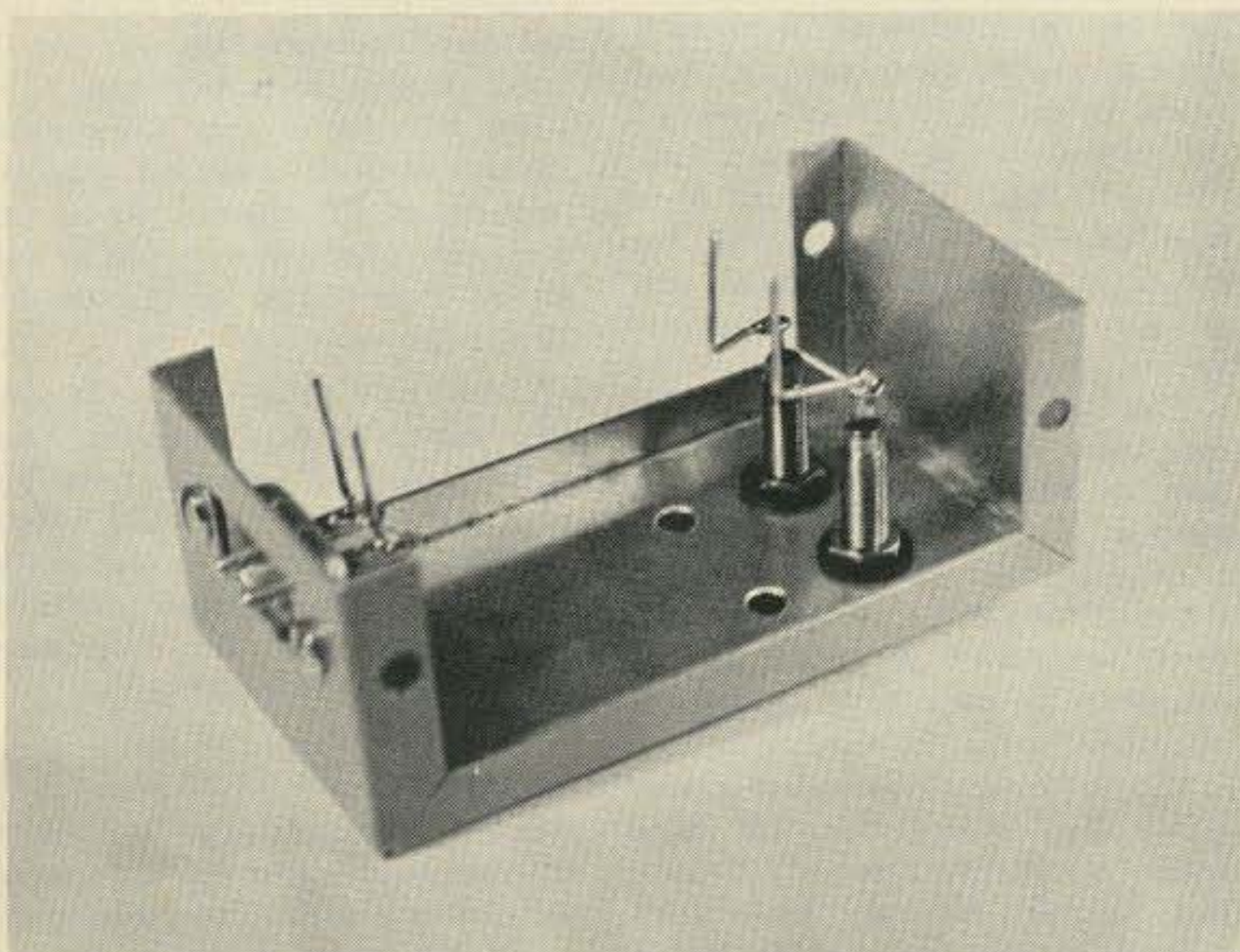

Fig. 4. Hole pattern for a 4 x 2-1/8 x 1-5/8 inch box. Cut holes to fit parts on hand. Holes are centered on centerline of box.



Box with jacks and ac plug ready for circuit board installation.

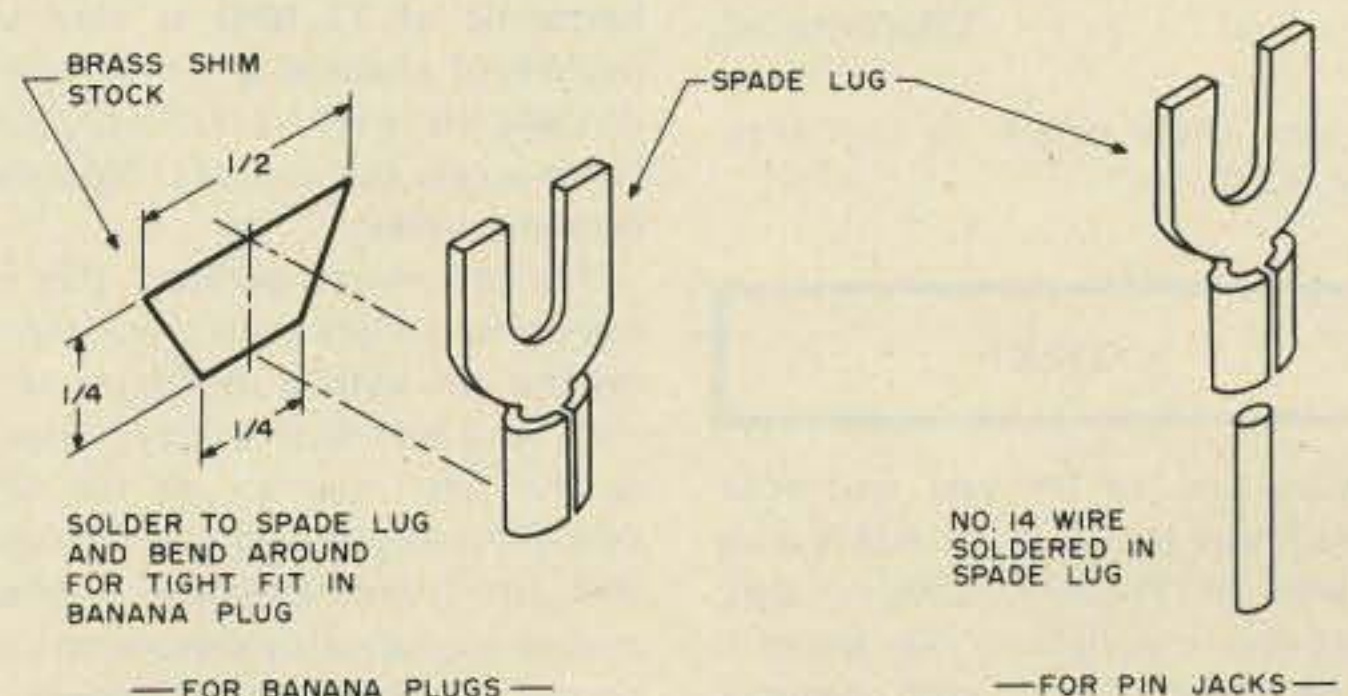
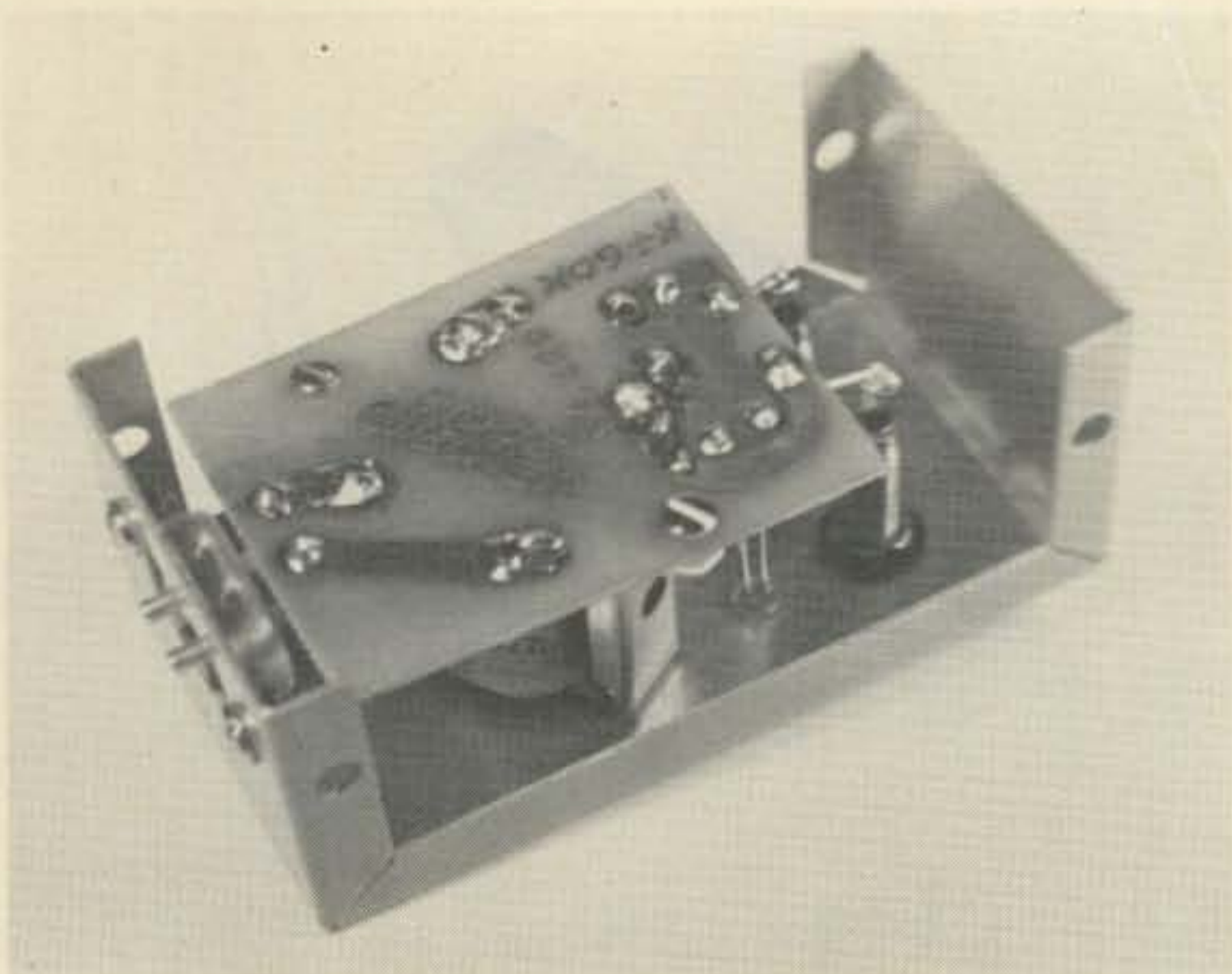
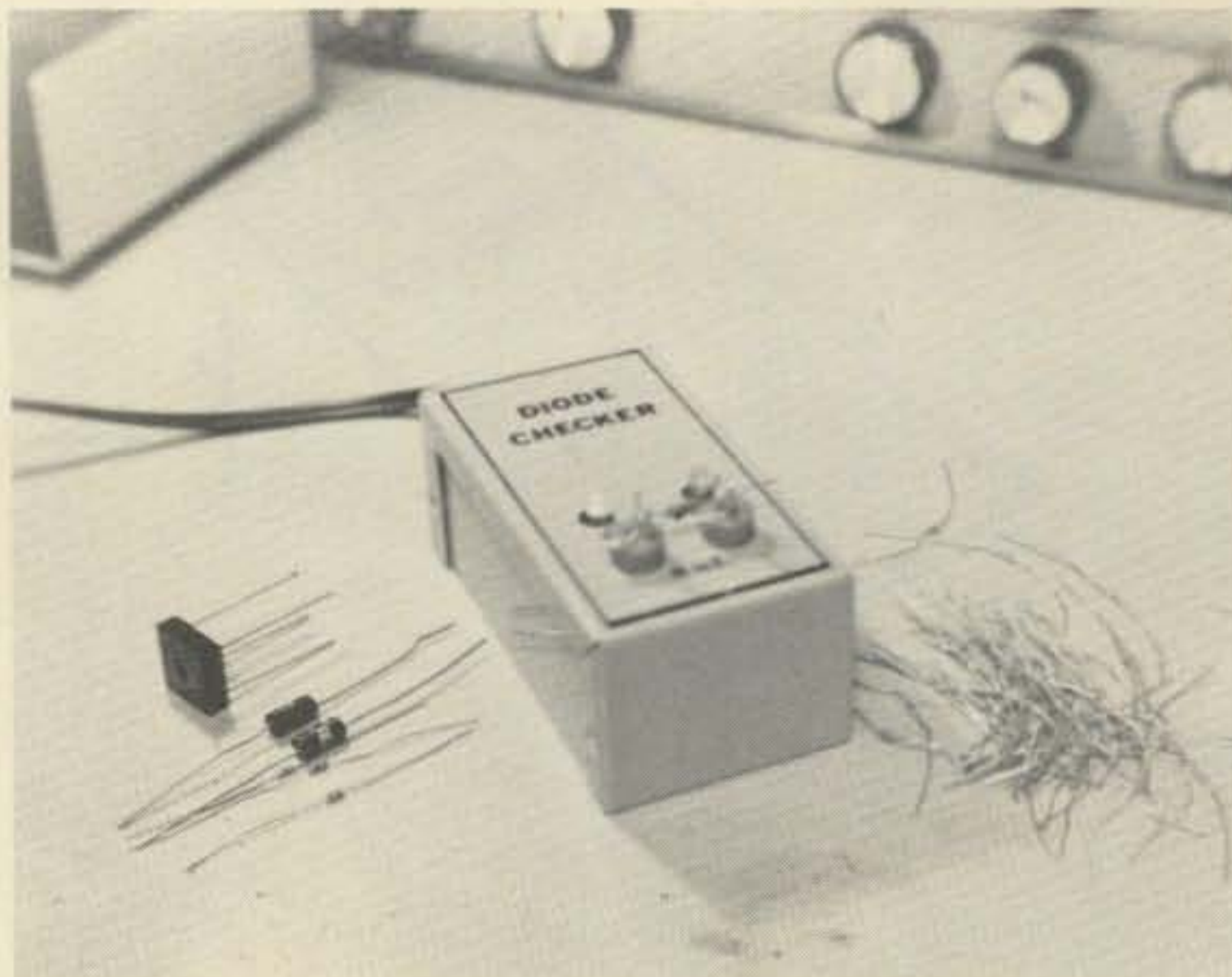

Fig. 5. Adapters.



Box with PC board installed.



Finished diode checker in use.

out. Do not solder them yet. The LED leads must be long enough for the LEDs to protrude through the box, so the builder may have to add short lengths of wire. Now feed the four wires from the ac plug and the jacks through the proper holes in the circuit board, check for proper fit and clearance, and solder the four wires. Position the LEDs

and solder them to the circuit board. Put insulation on the inside of the box bottom to prevent any possibility of shorts to the circuit board. Don't forget that it has 117 V ac on it! Make adapters to fit your jacks and you are ready to check out the unit.

Test the checker by applying power to the 117 V ac plug. Neither LED should

light. Now put a short circuit across the jack terminals and both LEDs should light. A diode that is known to be good should now be connected across the jack terminals. The LED closest to the diode's cathode should light. Try it both ways to make sure the LEDs are oriented properly.

After building and using

this simple diode checker, the owner will find a desire to also know if the diode under test is silicon or germanium. Since a germanium diode will develop about 0.1 volts across itself and a silicon diode about 0.5 volts, it seems that some very simple circuit might be devised that would light an LED if the diode under test were silicon. ■

ou goons don't ever proof
lousy manuscripts from tab
bunch of trok on
you could y
I insist that you print ev
tell Ma Bell that she shou

LETTERS

from page 14

same information. It was natural to turn first to OUR association which should have such information available.

To date, I have never received a reply or any assistance. Only as a last resort did I write 73... and pronto! You reacted with immediate and successful results.

Thank you again, many times.

Ervin Jackson Jr.
Charlotte NC

Now you know where to turn first,
Ervin! — J.M.

CQ SIX

Just a line to let you and your readers know that 6 meter AM is alive and well in Phoenix. Despite ugly rumors and speculation, our group is growing steadily and, with summer skip, widely. We operate two nets on 50.34 MHz — the Arizona Cactus Net

on Tuesday at 0200 GMT and the Phoenix VHF Net on Wednesday at 0300 GMT. We have a calling frequency of 50.34 and it is monitored from 1400 GMT to 0500 GMT. We hope that some of your readers will look for us on 6 and relive some of those good old AM days.

Before you mention TVI, I'll say that I have had and continue to have some on 15 meters and on 80 meters too. While TVI is more likely to be a problem on 6 with channel 2, the 3rd harmonic of 21 MHz is right in the middle of channel 3. These problems can and are worked out every day by hams across the country. Nothing can surpass resolve.

For the new operator, this is the only way to get your own phone rig on the air, with a minimum of time, cost, and technical ability. While SSB is the best way to go for reliable communication, it is also the costliest and the more complex. Further, it makes appliance operators out of us, taking away our inventiveness, skill, and that thirst for knowledge. Just try to build as your first rig a home brew

SSB rig. Unless you're an engineer, you might just as well pack it away. Six is cheap, it's dirty, and what is more to the point, if we don't use it, we are going to lose it.

This didn't start out to be a sermon, but I've said it and I'll stick by it.

Lawrence Day WB7EAX
Phoenix AZ

BAND PLAN

"Amplitude modulation and sideband can live together on 10 meters if there is sensible band planning," said Norm Lefcourt W6IRT, chairman of the recently created Southern California 10 Meter AM/SSB Band Planning Council. Lefcourt, noting the recent proliferation of conversion plans for CB rigs to 10 meters and the various proposals for channelization of the popular HF band, said unless everybody settles on a single band plan, no one will be able to talk to anyone. "Using crystal controlled transceivers," he continued, "makes the need for a single, widely accepted band mandatory — we have to be able to work each other on common frequencies."

"Some people want frequencies above 29.0 MHz, others are advocating AM frequencies in what has been sideband territory, some want monitoring frequencies at 28.8, and others have suggested using other monitoring frequencies 5 to 500 kHz

away," he said. "It is very confusing."

Council members tentatively approved a "comprehensive band plan" for 10 meters which begins in the sideband portion and ends in that part of the band which is now used by most of the AM operators. "That's very important," said Lefcourt, "because we don't want to exclude anyone." Most commercial CB rigs which have single sideband capability are also able to transmit and receive AM phone signals.

The Council's plan places channel 1 at 28.560, 1.595 MHz above the existing channel 1 on CB radios. The ratio remains constant on each new 10 meter channel, so that channel 23 is 1.595 MHz higher than CB channel 23; new channel 40 also is 1.595 MHz higher than CB channel 40, so the conversion plan will work just as well for 40-channel rigs as it does for 23-channel sets.

"This band plan puts our new channel 4 at 28.6, a commonly used SSB monitoring frequency, and our new channel 20 will fall at 28.8 MHz, the frequency generally used as an AM monitoring channel," said Lefcourt. "Incidentally, with this band plan, channel 40 falls at 29.0 MHz."

The council voted to make public its "tentative list" of 10 meter channels and indicated that a "final recommended list" would be forthcoming after other amateurs from around the country have had a chance to com-

Continued on page 50

TOM, I'VE ABOUT DECIDED TO ORDER A NEW ROBOT SSTV CONVERTER, EXCEPT I'M NOT SURE I CAN INSTALL IT PROPERLY. IS INSTALLATION DIFFICULT?

SHOULDN'T TAKE YOU OVER TEN MINUTES OR SO JIM. THERE'S NOT MUCH INVOLVED. ALL THE CONNECTING CABLES ARE SUPPLIED, SO ALL YOU HAVE TO DO IS PLUG THEM IN.

I DON'T HAVE TO MODIFY ANY OF MY EQUIPMENT?

NO. JUST PLUG THE CABLE FROM THE ROBOT CONVERTER INTO THE MIC JACK OF YOUR TRANS-CEIVER, AND CONNECT THE OTHER LEAD FROM YOUR ROBOT CONVERTER TO YOUR SPEAKER TERMINAL IN PARALLEL WITH THE LOUDSPEAKER. THAT'S ALL THERE IS TO IT.

TOM, DO I TUNE MY TRANSCEIVER FOR SSTV THE SAME WAY AS FOR AN AUDIO TRANSMISSION?

EXACTLY! JUST ZERO BEAT TO THE STATION YOU'RE COPYING, AND FROM THERE ON THE ROBOT CONVERTER'S CIRCUITRY TAKES OVER CONVERTING THE VIDEO IMAGE BEING SENT OR RECEIVED INTO A TV IMAGE ON YOUR MONITOR.

YEAH, BUT HOW CAN I TELL IF THE SIGNAL I'M HEARING IS AN SSTV SIGNAL?

THE SSTV SIGNAL HAS A VERY DISTINCTIVE SOUND, JIM — COMPLETELY DIFFERENT FROM ANY OTHER SIGNAL YOU'LL HEAR. AND IF YOU LISTEN FOR A WHILE, YOU'LL HEAR THE SSTV STATION'S VERBAL ID THAT'S REQUIRED BY THE FCC.

THEN ALL I DO WHEN I GET MY CONVERTER IS TO MAKE TWO CABLE CONNECTIONS, TUNE TO THE STATION I'M WORKING, AND START EXCHANGING PICTURES.

THAT'S IT. AND ONCE YOU'VE STARTED, YOU'LL AGREE THE \$695 FOR THE ROBOT CONVERTER IS THE BEST INVESTMENT YOU EVER MADE.

WRITE TODAY FOR YOUR SSTV FACT PACK FROM ROBOT. IT'S FREE AND TELLS YOU ALL ABOUT SSTV.

ROBOT

ROBOT RESEARCH INC.

7591 CONVOY CT. SAN DIEGO, CA 92111

R9

Beat the PC Shortage

-- build (glue) your own!

Between Radio Shack, Lafayette, and Heathkit, there were 37 retail electronics stores in the area, and I couldn't get my hands on a blank PC board larger than 2 by 3 inches. As I required a board at least 6 by 8 inches, my choices in this preposterous situation weren't too attractive. I could abandon the project, wait for the local stores to restock, or try to get some by mail. None of these options appealed to me. I had already spent quite a number

of hours laying out the artwork and wanted to get this project wrapped up.

As so often happens, I didn't have a blinding flash of inspiration and suddenly solve this problem. Instead, I waited until a local store finally got some in and then completed my project. But in the back of my mind, I felt a vague sense of frustration. Perhaps it was a sign of advancing paranoia, but I kept wondering when there would be another shortage.

One evening a few months later, I was half following something on television and thumbing through a copy of *The Radio Amateur's Handbook* when I spotted an item that looked interesting. In the section covering construction techniques, they suggested using epoxy to glue strips of copper to an unclad board. The idea was to glue the strips where you wanted conductors. By doing so you could get around having to

etch a board.

Things clicked into place, and I immediately figured out the solution to any future shortages of circuit board. After all, if you could epoxy strips of copper to a board, it shouldn't be hard to epoxy an entire sheet of copper and make a real circuit board.

A couple of days later, I had the epoxy, some sheet copper, and a piece of phenolic perfboard. Following instructions, I cleaned the copper and phenolic board, mixed equal amounts of epoxy resin and hardener, and glued the copper to the piece of phenolic. I then placed them under a stack of books and left them overnight. Next morning I took a look at my circuit board and almost went into shock. When I gave the copper a little tug it peeled completely away from the board.

Feeling that I must have done something wrong, I tried again. First, I made sure that room temperature was in the range they recommended. Next, I used more weight to apply more pressure to the pieces while the epoxy was setting. Finally, I doubled the time for the epoxy to set from 12 to 24 hours. When that time had passed, I examined the board. As before, the copper just pulled completely away from the phenolic.



Fig. 1. Tools and materials needed are a pair of scissors, a steel wool soap pad, small pieces of cardboard cut from a filing card, contact cement, a sheet of copper and a phenolic board. The photographic roller is optional.



Fig. 2. Use the soap pad to thoroughly clean the surfaces of both the copper and the phenolic.



Fig. 3. Apply thin, even coats of contact cement to the copper and phenolic using small pieces of cardboard cut from a filing card.

I must admit that I felt foolish. Years of advertising had convinced me that one drop of epoxy will hold anything to any other thing. If there was an outside chance of some combination of materials being beyond the power of epoxy, I seemed to have found it. While many discoveries make you rich and famous, I felt that this wasn't one of them.

At this point I used a little logic and deduced that commercially prepared circuit boards don't grow out of the ground, so there had to be some glue that would work. If I tested every glue I could find, it was probable that one of them would do the job. Dim memories of the thousands of experiments Thomas Edison performed when he was searching for a filament that would work in the electric light gave me inspiration. The saga of San Juan Hill lent me courage, and my local hardware store made a fortune selling me a lot of glue.

I don't intend to bore you with the details of every

experiment I tried, but let me tell you about one that almost worked. In their advertisements, they refer to it as "Amazing," "Incredible," "Stronger Than Steel," and "A Space-Age Miracle." Well, it was. And fast. If I applied a drop of it to a piece of copper about an inch square and stuck the copper to a phenolic board, within a couple of seconds it was bonded tight. And once they had bonded, there was no way short of an atomic blast to separate them.

The problem was that when I tried to spread that stuff over a piece of copper larger than one square inch, it started hardening before I could finish spreading it. Once that happened, it wouldn't stick to anything. So if you feel like making some tiny circuit boards, give it a try.

The Solution

Persistence on my part was finally rewarded. When I tried contact cement, everything worked so well that I almost forgot my earlier disap-

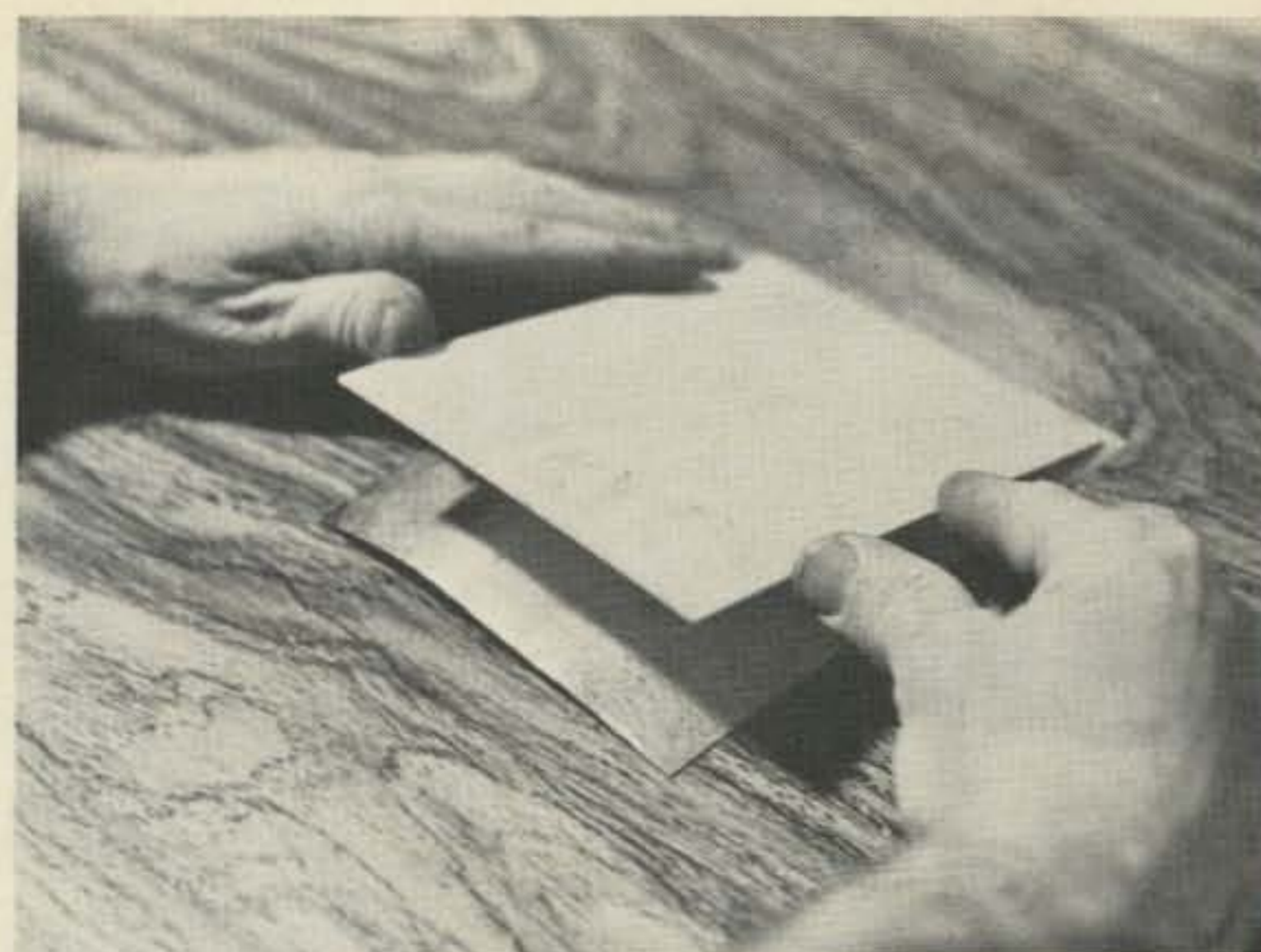

Fig. 4. After allowing the contact cement about ten minutes to dry, carefully align the coated surfaces and press them together.

pointments. Not only did it do a fine job of bonding copper to the board, but it also withstood prolonged soldering operations from a 140 Watt gun after I had etched out a circuit. And since so many people use contact cement, it's made by several companies, is priced fairly low, and comes in containers ranging from small tubes to five gallon buckets.

If you are interested in rolling your own PC boards, let me quickly run through the procedure I use. I think you'll agree it's so simple that you won't have any hesitation about trying it.

The first step is to gather up all of the materials required. These include contact

cement, phenolic board, and a sheet of copper. Once you've made these purchases, you will want to round up the simple tools required. These tools are a pair of sharp scissors, a steel wool soap pad, some pieces of thin cardboard cut from a filing card and, if you have one, a photographic roller.

The copper sheets can be found in hobby shops. They are available in several thicknesses, and I strongly recommend that you get the thinnest you can find in order to keep down the time required for etching. You should be able to find contact cement at any hardware store or in the hardware section of most discount stores. Phenolic



Fig. 5. I used a photographic roller to apply even, heavy pressure to the joined pieces, but you can use the palms of your hands.

boards are available at Radio Shack or similar stores. If you

want to give it a try, sheets of formica should work very

well in place of phenolic. Formica is available in many colors and patterns which could go a long way toward dressing up the average project. And, based on costs per square inch, formica is much cheaper than phenolic.

Once you have these materials and tools, begin by using the steel wool soap pad to thoroughly clean both the copper and phenolic on the sides you are going to apply the glue. The copper sheets I bought were coated with a transparent film to keep air from contacting the copper. Since I felt this film might interfere with the bonding process, I removed it with the soap pad. If your copper lacks this coating it will probably be heavily oxidized, which means a good scrubbing will be beneficial.

The copper takes on a highly polished appearance when it is properly cleaned. Once the entire sheet takes on a good shine, rinse it thoroughly and allow it to

dry. Giving the phenolic a scrubbing helps to roughen its surface slightly and gets rid of any dirt or oil that might be present. Again, rinse carefully and allow to dry.

After the copper and phenolic are clean and dry, place them on some newspaper and apply the contact cement. Using small pieces of cardboard cut from a filing card, spread the contact cement evenly over the entire surfaces of both the phenolic and the copper. Strive for thin coats and work fairly rapidly.

When both surfaces are properly coated, set them aside and allow them to dry for about ten minutes. Then carefully align the two coated surfaces and join them together. Using either your hands or a roller, apply fairly heavy pressure to the pieces for a few seconds in order to insure good contact between them. Finally, trim away any excess copper with a pair of scissors. ■



Fig. 6. As your final step, trim away any excess copper with a pair of scissors.

ou goons don't ever proof
lousy manuscripts from bat
bunch of rock on
you lighted in
I insist that you print ev
tell Ma Bell that she shou

LETTERS

from page 46

ment.

Tentative Frequency List	
Channel Designation	Frequency
1	28.560
2	28.570
3	28.580
4	28.600
5	28.610
6	28.620
7	28.630
8	28.650
9	28.660
10	28.670
11	28.680
12	28.700
13	28.710
14	28.720
15	28.730
16	28.750
17	28.760
18	28.770
19	28.780
20	28.800
21	28.810
22	28.820
23	28.850

"We want to hear from other hams," said Phil Kogel W6MRQ, "because if they keep sending their thoughts to magazines as letters to the editor, there'll be hundreds of band plans but no real band planning." Kogel asked anyone with comments to send them to him, W6MRQ, 1245 North Laurel Ave., Number 9, West Hollywood CA 90046. "Please send a self-addressed, stamped envelope if you want a reply," he said. "We don't have the funds to mail copies of our final frequency chart to everyone."

John McAulay WA6QPL, a QRP sideband operator, said the council will not advocate exclusive use of any frequency by either AM or SSB. "Normally, SSB is in the low end, AM a couple of hundred kHz higher," he said. "But there is no reason why one operator on SSB shouldn't enter a QSO with another on AM. As long as they can understand each other — that's all that counts."

John English WB6QKF, council vice-chairman, also pointed out that the council is giving some thought to planning a portion of the CW band for

Novices. "Right now," he said, "we're thinking about 8 CW channels (28.105, 28.115, 28.125, 28.145, 28.155, 28.165, 28.175, and 28.195) which would put low cost HF gear in the hands of Novice operators who can't afford to spend a lot of money on equipment."

This letter reflects the opinion of the Southern California 10 Meter AM/SSB QRP Band Planning Council. What a title! — J.M.

In your June, 1977, issue, a band plan for CB/10m conversion suggests the use of the OSCAR downlink frequencies. Please! Please! — Don't.

Since you need 230 kHz bandspace, I suggest you add 2.0 MHz to get 28.965-29.255. This band plan will be easy to relate to CB channels using 10 meter spectrum that is less used than others.

Don't forget the 10m Novice (28.1-28.2), the 10m DXer (28.5-28.8), and most of all, OSCAR (29.4-29.55), when preparing a potentially heavily used band plan on 10 meters.

Even so — I would strongly recommend SSB or FM in lieu of AM. If this plan becomes successful, AM will lose in the end anyway.

My conversion of a CB set would consist of:

1. Move frequencies to slot of interest
 - a. AM (28.965-29.255) (why hassle the SSB and OSCAR

- boys?)
- b. FM (28.965-29.255)
- c. SSB (28.665-28.955) (think of the mobile DX work when the band is open)
- d. CW (28.465-29.755)
2. Disable AM modulator
3. Install varactor FM modulator
4. Install FM discriminator (careful use of AM detector will work)

Yes — convert those rigs, but plan the new use around existing use to add to the hobby.

Bob Winchester W8LSS
Midland MI

CB to 10 meters is great. Past three issues bring this interesting phase of ham radio to the front.

Keep pounding on this, Wayne; this could be the start of something big ... big as 2m FM repeaters. We hams need to do something with the 10 meter band or it will be given to the CBers.

I have my set all ready for its new crystals and am now putting up a modified CB beam to get active on 10m AM.

Wilbur T. Golson W5CD/4
Panama City Beach FL

Now is the time to get a firm channelized band plan for 10 meters. We have seen two or three frequency plans, and if people use different sets

Continued on page 53

Identify That Transformer

-- tips for using boat anchors

The experimenter often relies on junk box parts and surplus electronic parts. Many power transformers are marked clearly, but even unmarked transformers are perfectly usable after they have been tested and rated.

Even the completely unmarked transformer will usually offer clues to its design. For example, the ac input leads (primary winding) are usually color-coded black. Other windings probably will be yellow or green. If the transformer has a large number of secondary windings, it may have a high voltage winding color-coded red, and other leads will be yellow, green and brown. If

any winding has a center tap, this wire usually is striped in the same color as the winding. For example, a yellow coded winding might have a yellow center tap with a blue stripe.

Fig. 1 shows a transformer as a "Black Box" — a unit with unknown characteristics which must be deduced. Begin by verifying that leads of the same color connect to the same winding and not to another winding. Then, measure the dc resistance of each winding.

At this point, the black box of Fig. 1 has been identified to the point shown in Fig. 2. The next step is to apply line voltage to the black winding through a

1/8 Ampere slow blow fuse and measure the voltage on the other winding. In this particular example, the ac scale on a VOM showed a no-load output from the secondary winding equal to 12.5 volts. This was measured with 122 volts ac in (line voltage is high in Texas).

The next step is to load the transformer enough to determine a safe power rating. Since the transformer will be used for a dc supply, make a rectifier-filter network as shown in Fig. 3. The capacitor value is not critical so long as the dc ripple under load is no more than 5% (a typical value might be 2000 uF). Remember that the voltage rating for the capacitor must be greater than 1.4 times the no-load transformer output voltage. For the trans-

former under discussion: 1.4 x 12.6 V dc is the minimum allowable voltage rating.

Determine the current rating of the transformer by applying a dc load to the rectifier-filter network until the ac voltage of the output winding drops by 10%. This dc current rating then can be multiplied by the dc voltage to get a power rating. For the transformer illustrated, a 250 milliamp dc load reduced the 12.5 volt ac (open circuit) to 11.3 volts. With that load, the dc out was .25 A x 11.6 volts = 2.9 Watts. As a final check, weigh the transformer; allow about 1 ounce per Watt of power.

The dc load for the transformer can be power resistors, but the circuit of Fig. 4 is easy to build and is easily variable over a wide range. (Q3 is a power transistor and must be mounted on a heat sink.) Choose R1 with the formula $R1 = .6/I$ minimum; for 50 mA minimum load, $R1 = .6/.05 = 12$ Ohms. The upper current limit will be set by the value of R1 and the output voltage of the supply. For a 12 volt supply, the maximum current would be about 1 Ampere.

The final check for any transformer is to operate it with rated load for several hours. If there is any problem with the transformer (shorted turns, etc.) or if the load is too high, the transformer will get hot. In general, transformers run a little warm, but the transformer should not be too hot to touch comfortably. ■

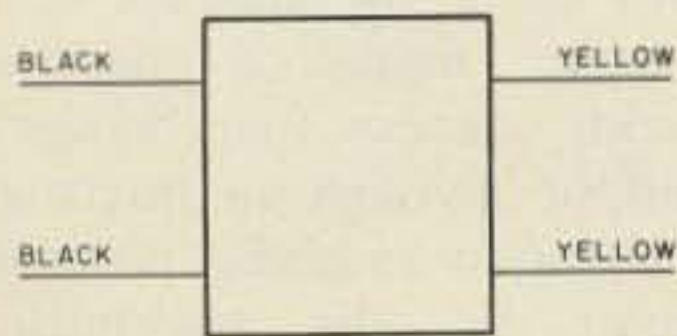

Fig. 1.

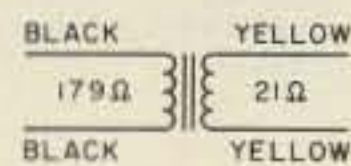

Fig. 2.

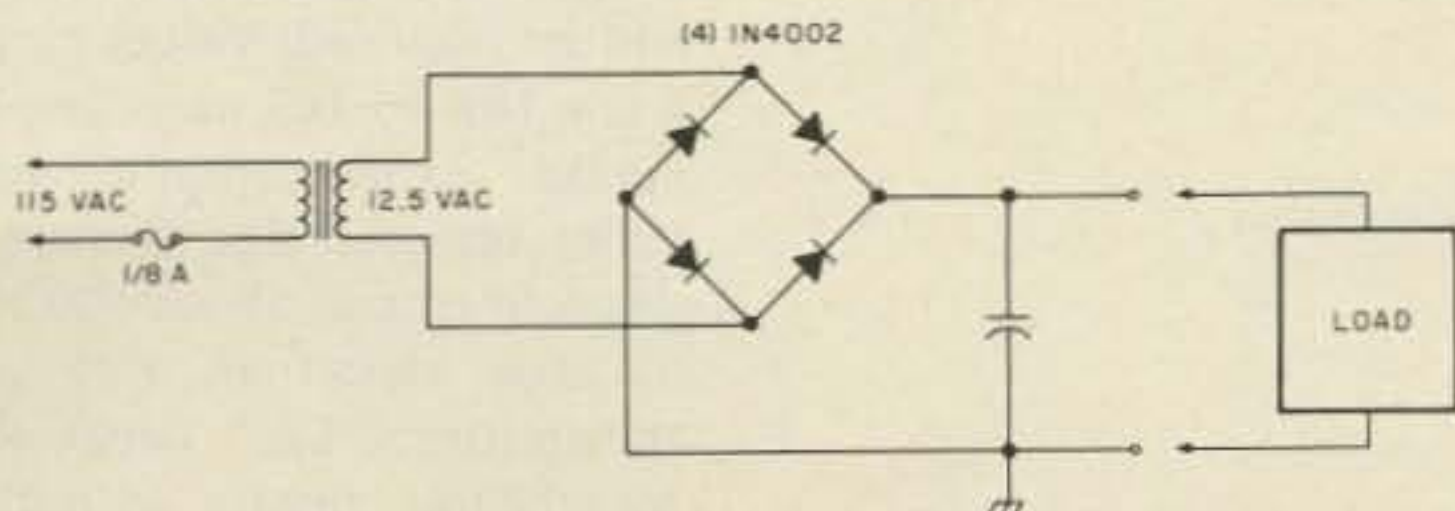

Fig. 3.

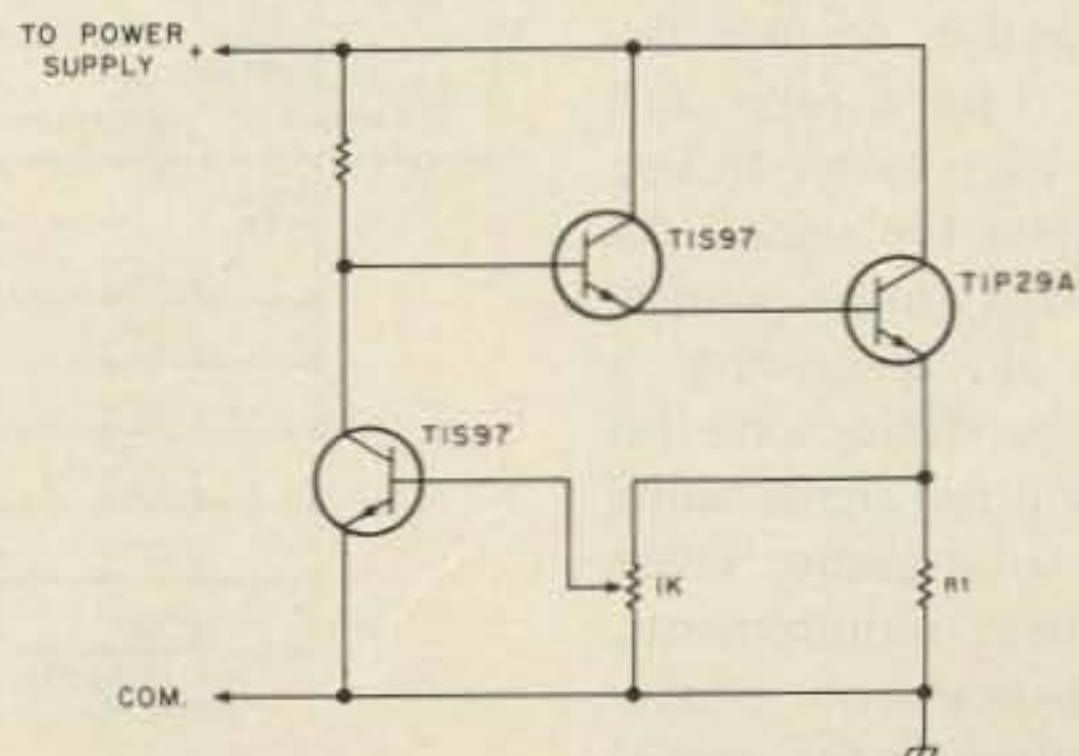

Fig. 4.

Subaudible Tone Encoder

-- access
 those closed machines

With the ever increasing two meter activity, many repeater owners have chosen to incorporate PL, CG, or QC as a means of accessing their machines. A subaudible tone is required to access and maintain your signal through the repeater. At the repeater site, a subaudible tone decoder is interfaced with the receiver. When a transmitted signal opens up the receiver, a subaudible tone must be present on the incoming audio, so the decoder will close a relay and permit the transmitter to key up and repeat the signal. All individual users must provide a means of generating a specific subaudible tone on their transmitted signal along with their voice audio. There are two main requirements, tone frequency and proper tone deviation of the carrier frequency. Tone frequency is

determined by the particular repeater decoder frequency and the deviation level is usually around 350 to 500 Hz.

In areas where many different repeaters are available, it is necessary to have more than just one tone encoder. This article describes a six

channel subaudible encoder that works very well. The circuit is laid out on a 1" x 3" PC board. Parts are fairly common to obtain and construction takes about an hour.

The basic circuit is a twin T oscillator designed to operate in the subaudible tone range (93 to 170 Hz) for amateur use. It is versatile because the tones are adjustable with 20 turn trimpots. The theory of operation can best be described by saying R4 and R5 and C6 form a low pass type network. C7 and C8 and R6 and R7 form a high pass. As the phase shifts are opposite, there is only one frequency at which the total phase shift from the collector to base is 180 degrees, and oscillation will occur at this frequency. Optimum operation results when C6 is approximately twice the capacitance of C7 and C8, and R6 and R7 have a resistance about 0.1 that of R4 or R5. (R4 = R5) and (C7 = C8). Output is taken off from the collector of Q1 via R2 and C3.

By decreasing R6 and R7, the output tone will go higher. If R6 and R7 are increased, the output frequency will lower. This allows adjustment of oscillator to a precise output frequency, anywhere in the subaudible range.

Frequency is set by feeding the output into a counter. This will get you into the ball park. Adjustment of R7 will bring the encoder to a precise frequency desired. Next, connect the encoder's output through an insertion resistor to an audio injection point on the transmitter audio board. The output of this encoder is quite high (1 volt). An insertion resistor will be required. Values range from 10k to 0.5 megs and is found experimentally and varies between rigs. Choose a value to obtain about 500 Hz of tone deviation. Key up transmitter; "fine" tweak R7 for reliable results with the repeater. Set up each trimpot

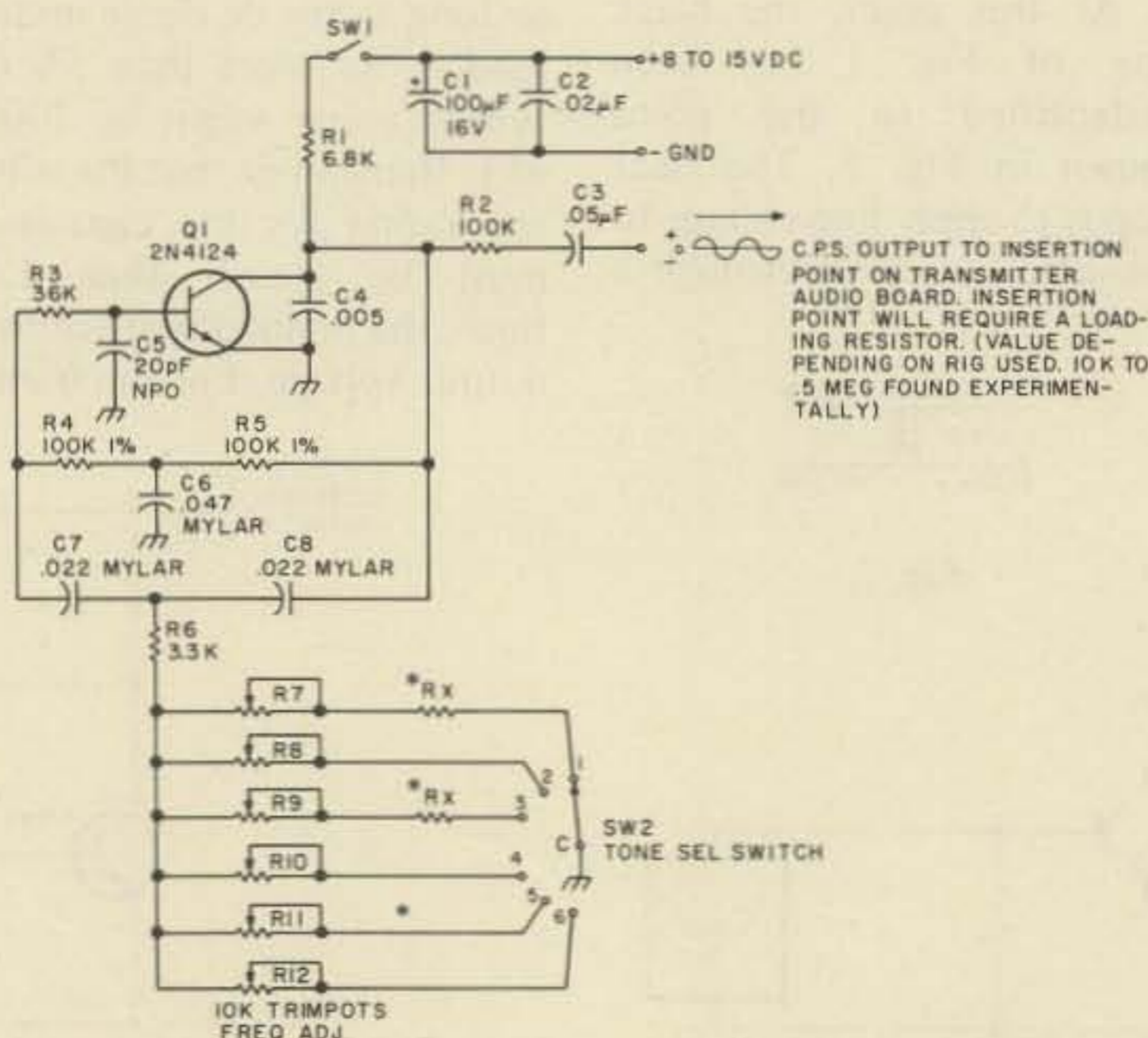

Fig. 1. Subaudible tone encoder.

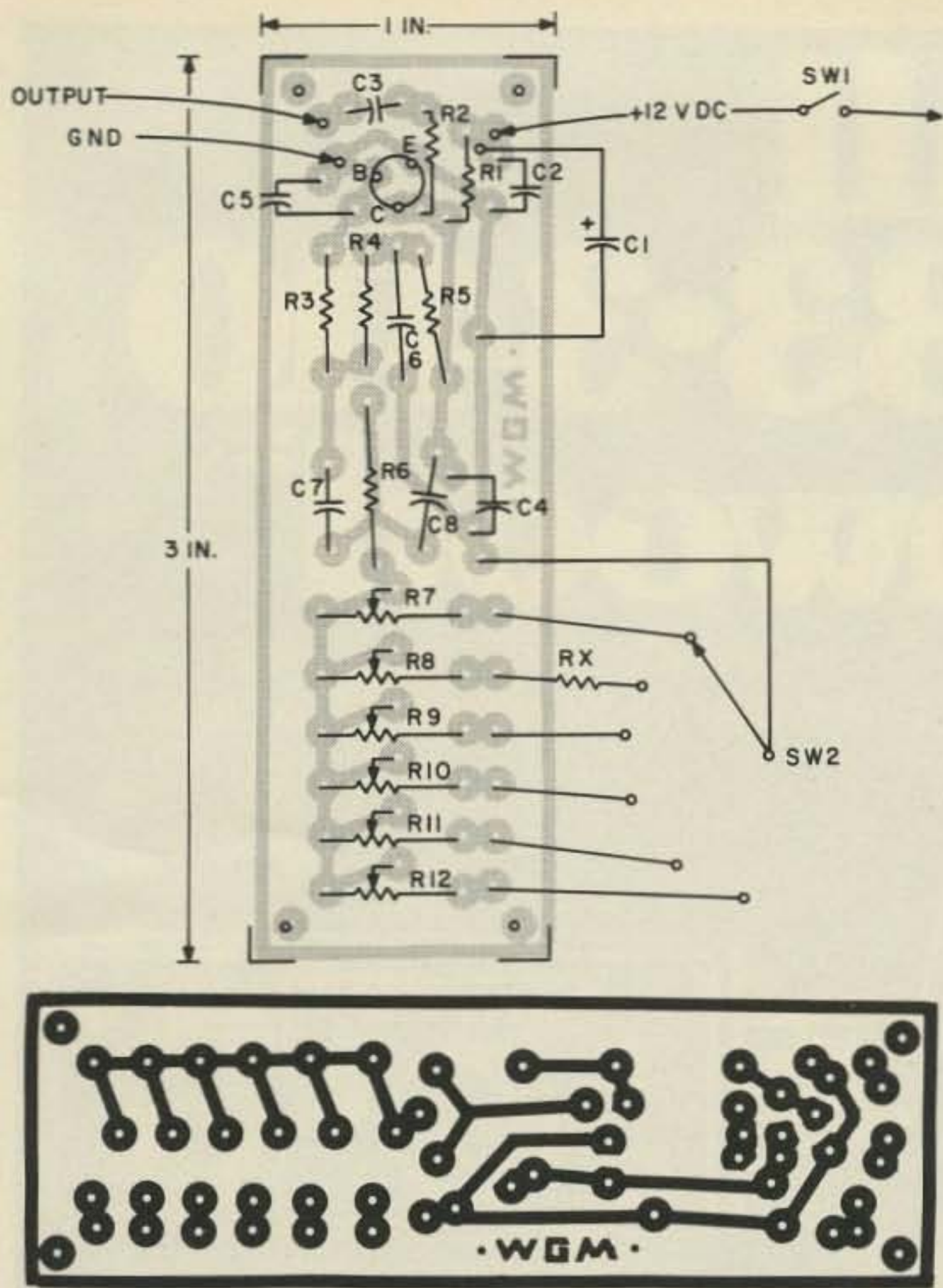

Fig. 2. PC board and component layout.

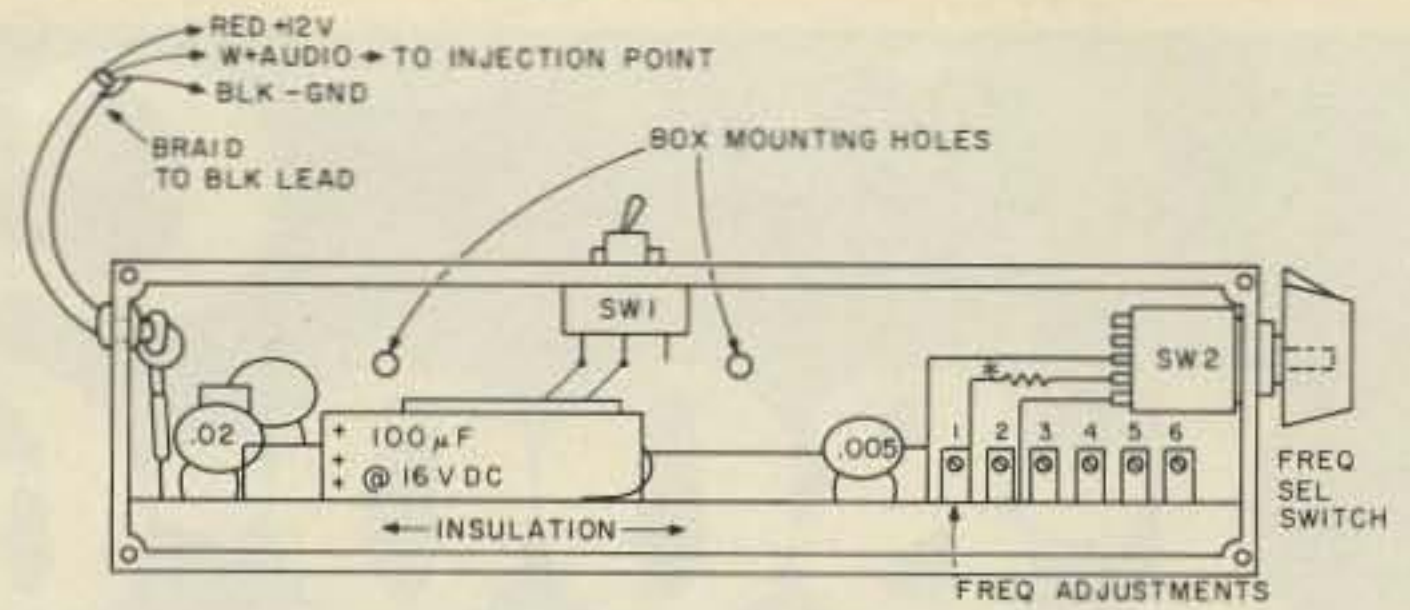

Fig. 3. Suggested layout of board in enclosure.

for a different required tone. The ability to have six individual tones will probably be a great asset in the near future of repeater users. More and more repeaters are going the subaudible route, because of the FCC monitoring requirement, and the many problems with co-repeater interference. This unit is easy and reasonable to build for around \$18. It has been in

Tone freq. range	*Rx
93 to 107 Hz	= 12k
98 to 116 Hz	= 8.2k
114 to 170 Hz	= jumper

Table 1.

use for a couple of years with excellent reliability. ■

Parts List

- Q1 = Motorola NPN 2N4124
- R1 = 6.8k ± 5% ¼ W
- R2 = 100k ± 5% ¼ W
- R3 = 36k ± 5% ¼ W
- R4, R5 = 100k ± 1% ¼ W
- R6 = 3.3k ± 1% ¼ W
- R7-R12 = Bourns 20 turn "trim-pot" Model 3005P 10k
- C1 = 100 uF @ 16V
- C2 = .02 uF disc
- C3 = .05 uF disc
- C4 = .005 uF disc
- C5 = 20 uF NPO disc
- C6 = .047 uF Mylar
- C7, C8 = .022 Mylar
- SW1 = Miniature SPDT switch
- SW2 = ALCO switch MRA-1-10 1P 10T rotary with knob
- Enclosure = Bud Diecast Box (CU-123 1½ x 3-5/8 x 1-7/32)

ou goons don't ever profit
lousy manuscripts from bab
bunch of trok...
you...
I insist that you print ev
tell Ma Bell that she shou

LETTERS

from page 50

of frequencies, we will have chaos. Rigs will have to be modified to travel from one area to another.

We personally approve of the plan by WA4MFT. We are ready to buy rigs and modify them as soon as a firm set of frequencies can be established.

Ed Johanson K7TEO
Sandy UT
John Dorociak WB7PQI
Layton UT

I am writing about your articles on CB conversions to 10 meters. The Mokane chapter of 10-X International has sponsored our group to increase activity on 10. The whole project was started just before your first article on the subject, and after we had converted several rigs, we found out that you had proposed a different frequency scheme than we had (Murphy's law). We favor a standard scheme that everyone can follow so that when the band opens, we do not cause interference to everyone on the

air.

We favor the use of 28.800 MHz because this is the nationwide AM calling frequency and there are several nets, including the 10-X net, on this frequency. We also favor keeping the channels low in frequency. The lower channels can in effect be DX channels, and the upper ones can be for rag chewing. There is also the possibility that many people will use phase locked loop rigs which can be modified to create 70 or more channels. The frequency scheme we propose would allow a PLL rig to have 60 channels and still not interfere with OSCAR satellite operations. Well, here it is — another frequency scheme:

Channel	Freq.
1	28.690
2	28.7
3	28.71
4	28.73
5	28.74
6	28.75
7	28.76
8	28.78

9	28.79
10*	28.8
11	28.81
12	28.83
13	28.84
14	28.85
15	28.86
16	28.88
17	28.89
18	28.9
19	28.91
20	28.93
21	28.94
22	28.95
23	28.98
40	29.13

* Universal calling frequency

Jay Sprenkle WB0OUG
Kansas City MO

What's the matter with you people at 73? I decided to convert a junk CB I picked up into a 10 meter rig; however, after looking at all the 10 meter conversion articles, I was ready to give up. What good is a 10 meter AM rig if I am the only one with that set of frequencies? In all the letters and articles, I think there were nine different band plans, most claiming to be the best.

I would like all the people who have converted CBs and who use 10 meter AM often to drop me a note giving their band plan and most used frequencies. With this data, I will determine the most used plan covering the most popular frequencies and re-

port it to 73.

Darryl Holman WB9TCY
729 Ziegler Rd.
Madison WI 53714

Well, the CB to 10 plot thickens! The above letters are but a few of the pile received at 73 this month. We need a band plan. I would like to take Darryl up on his suggestion, and gather information from interested converts. If you like, send your comments to me and I'll combine them with information on hand — let's get this thing going. Of course, OSCAR frequencies must be considered in any plan, as several letters indicate. I can see that I'm going to have to fire up my old DX-60 on 10 AM and see what is going on... maybe I won't sell the goodie as previously planned! — J.M.

73

...tell us you love us

see page 223

Call 1-800-633-3410 for Kenwood*

*YAESU, DRAKE, ICOM, CDE, HYGAIN, CUSHCRAFT, NPC, TPL, TRISTAO, NEWTRONICS, DENTRON, REGENCY, ROHN, WILSON, TEN-TEC, MCM & MFJ

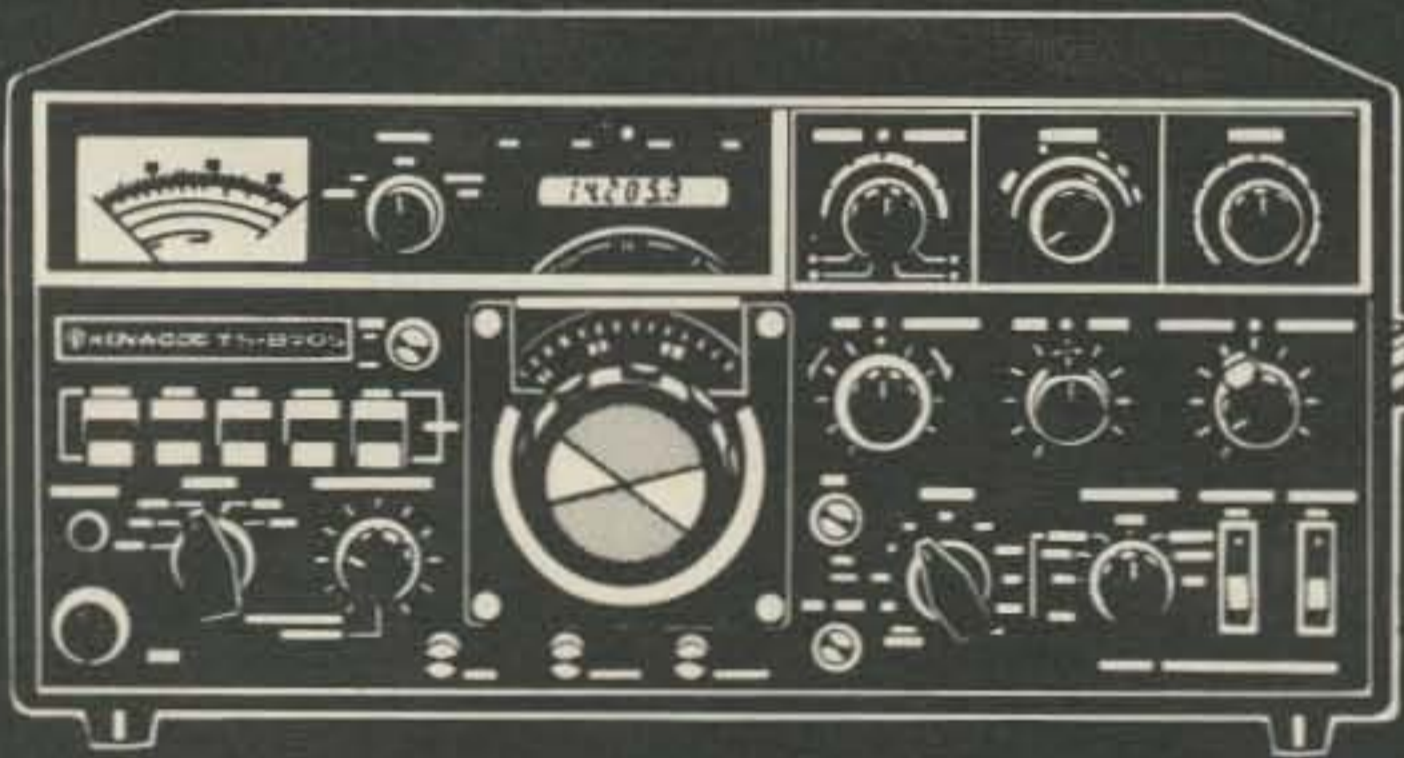

KENWOOD TS-820S transceiver

The NEW Kenwood TS-820S features a factory installed digital frequency readout. • 160 thru 10 meter coverage • Integral IF shift • RF speech processor • VOX • Noise blanker • PLL • Built-in 25 KHz calibrator • CW side tone & semi-break-in • IF OUT, RTTY, & XVTR • Phone patch IN and OUT terminals.

1048.00 is list price. Call Toll-Free for quote.

KENWOOD TR-7500 2m FM transceiver

The NEW TR-7500 has the features you need! Check these: • PLL synthesized • 100 channels (88 pre-programmed, 12 extra diode programmable) • Single knob channel selection • 2-DIGIT LED frequency display • Powered tone pad connection • Helical resonators • 10 watts HI output, 1 watt LOW output. Available very soon! Call us for quote.

299.00 list price. Call for quote.



KENWOOD TS-600 6m transceiver

Full 4 MHz coverage • Modes: SSB, FM, CW, AM • Repeater activation • 11 fixed channels (crystals optional) • Built-in AC/DC operation • Noise blanker • Amplified-type AGC circuit • Fully equipped RF w/dual-gate MOS FET.

649.00 list price. Call for quote.

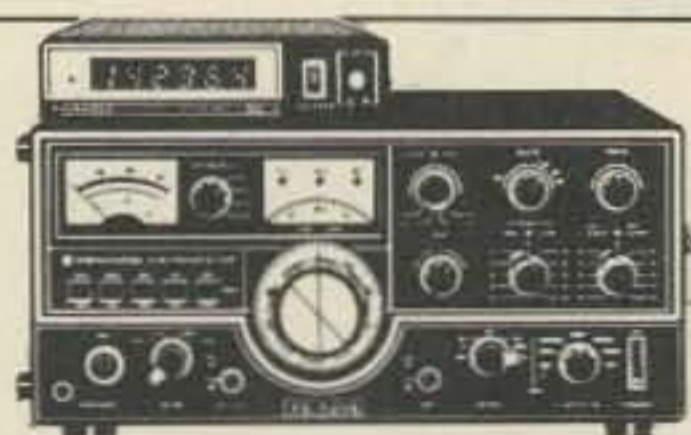

KENWOOD TS-520S transceiver

• 160 - 10 meter coverage • Optional DG-1 digital frequency display • New speech processor w/audio compression amplifier • AC power supply (DC optional) • RF attenuator, front-panel activated • Provisions for sep. receive antenna & phone patch.

649.00 list price. Call for quote.



KENWOOD TR-2200A 2m FM transceiver

Features: • Solid-state construction • 2 watts HI, 0.4 watts LOW output • 12 fixed channels (6 supplied) • ¼ wave telescoping antenna • Rechargeable Ni Cad batteries • Lighted channel indicators • Hand-held microphone.

229.95 list price. Call for quote.

Remember, you can call TOLL-FREE: 1-800-633-3410 in U.S.A. or call 1-800-292-8668 in Alabama for our low price quote. Hours: 8:30 a.m. to 5:30 p.m., Monday thru Friday.



Long's Electronics



L9

MAIL ORDERS: P.O. BOX 11347 BIRMINGHAM, AL 35202 • STREET ADDRESS: 3521 10TH AVENUE NORTH BIRMINGHAM, ALABAMA 35234

Call 1-800-633-3410 for Yaesu*

*KENWOOD, DRAKE, ICOM, CDE, HYGAIN, CUSHCRAFT, NPC, TPL, TRISTAO, NEWTRONICS, REGENCY, ROHN, WILSON, TEN-TEC, B&W, DENTRON, & MFJ.

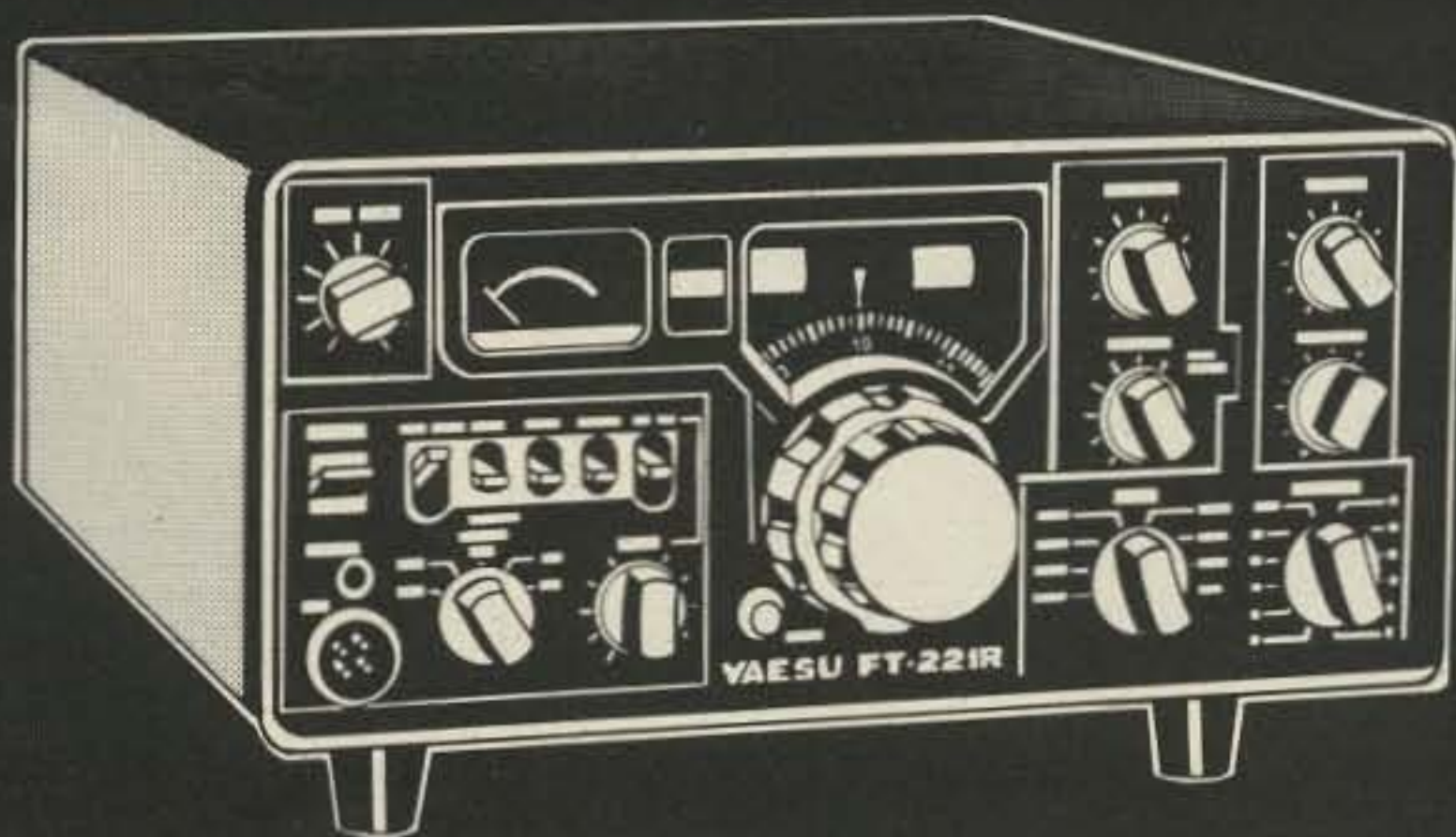

YC-221 digital display

Features: • All cables and connectors for connection • 7-digit display (LED) • Calibration control on front • Sits easily on top of transceiver.

119.00 list price. Call for quote.

YAESU FT-221R 2 meter transceiver with YC-221 digital display...

714.00 is list price for FT-221R & YC-221
Call for quote.

The FT-221R features: • Complete 144 to 148 MHz coverage in 8 band segments • Built-in AC/DC power supplies • Modes: SSB, CW, FM, AM • Selectable ± 600 KHz repeater offset • Built-in VOX and break-in CW • External tone input connector • Noise blanker • 11 crystal channels per band segment (88 total channels) • SSB output 12 watts PEP, FM/CW output 14 watts, AM output 2.5 watts • PLL circuitry.

The YC-221 digital frequency display is designed for use with the FT-221 or FT-221R. It displays the operating frequency in MHz, KHz and 100 Hz ranges in 7 digits (LED).



YAESU FT-301D HF transceiver

• All solid-state • LED read-out • 160 - 10 meter coverage • Receive only: WWV/JJY & CB • 200 W PEP: SSB, CW, and 50 W on AM, FSK • Noise blanker • RF speech processor • VOX • Auto break-in on CW w/side tone • AGC

935.00 list price. Call for quote.



YAESU FT-101E transceiver

• Solid-state • 160 - 10 meter coverage • Built-in AC/DC power supplies • Built-in RF speech processor • 260 W PEP on SSB, 180 W on CW, 80 W on AM • FVO • VOX • Auto break-in on CW w/side tone WWV/JJY reception

729.00 list price. Call for quote.



YAESU YC-500J frequency counter

• 8-digit readout covers up to 500 MHz • Dual range system • Frequency range: Input 1: 10 to 50 MHz, Input 2: 50 to 500 MHz • Accuracy: 10 PPM • Display: 6-digit LED • Display time: 0.1 or 2 seconds.

249.00 list price. Call for quote.

Remember, you can call TOLL-FREE: 1-800-633-3410 in U.S.A. or call 1-800-292-8668 in Alabama for our low price quote. Hours: 8:30 a.m. to 5:30 p.m., Monday thru Friday.



Long's Electronics



MAIL ORDERS: P.O. BOX 11347 BIRMINGHAM, AL 35202 • STREET ADDRESS: 3521 10TH AVENUE NORTH BIRMINGHAM, ALABAMA 35234

Call 1-800-633-3410 for ICOM*

*KENWOOD, YAESU, DENTRON, CDE, HYGAIN, CUSHCRAFT, NPC, TPL, TRISTAO, NEWTRONICS, REGENCY, ROHN, WILSON, TEN-TEC, B&W, DRAKE, & MFJ.



ICOM IC-211 2m transceiver

- 144 to 148 MHz coverage • Modes: SSB, CW, FM • LSI synthesizer PLL • 4-digit LED readout • Pulse-type noise blanker • VOX w/adjustable gain • SWR bridge • CW monitor • Automatic power control • AC/DC power supplies • Antenna impedance: 50 ohms unbalanced • TX output: 10W PEP.

749.00 is list price. Call Toll-Free for quote.

ICOM IC-245 2m transceiver

- LSI synthesizer PLL • 4-digit LED readout • Transmit & receive frequencies are independently programable on any separation • Receiver front-end is a balance of low noise, high-gain MOS FET & 5 section filter • TX output: 10 W PEP • Frequency step size: 5 KHz for FM, 100 Hz (with adapter) or 5 KHz for SSB.

499.00 is list price. Call Toll-Free for quote.



ICOM IC-215 2m FM transceiver

- 2 meter FM • 3 W PEP • 15 channels, 12 by selector, 3 by function switch • Dual power level, 3 W HI for long distance, 0.5 W LOW for local • Dial illumination for night use • Power pilot lamp • Frequency range: 146 to 148 MHz.

229.00 list price. Call for quote.



ICOM IC-22S FM transceiver

- Frequency range: 146 to 148 MHz • Preset any 15 KHz channel in the frequency synthesizer by diode matrix board • Output: 10 W HI, 1 W LOW • Excellent spurious attenuation • 22 channels.

289.00 list price. Call for quote.



ICOM IC-30A FM transceiver

- 22 channels, 450 MHz • Modulation F3 • Power output: 10 W HI, 1 W LOW • TX band width: 15 KHz w 5 KHz deviation • Low intermodulation comes from a low noise MOS-FET RF amp. coupled with a 5-section filter.

399.00 list price. Call for quote.

Remember, you can call TOLL-FREE: 1-800-633-3410 in U.S.A. or call 1-800-292-8668 in Alabama for our low price quote. Hours: 9:00 AM til 5:30 PM, Monday thru Friday.



Long's Electronics



L9

MAIL ORDERS: P.O. BOX 11347 BIRMINGHAM, AL 35202 • STREET ADDRESS: 3521 10TH AVENUE NORTH BIRMINGHAM, ALABAMA 35234

Call 1-800-633-3410 for Drake*

*KENWOOD, YAESU, ICOM, CDE, HYGAIN, CUSHCRAFT, NPC, TPL, TRISTAO, NEWTRONICS, REGENCY, ROHN, WILSON, TEN-TEC, B&W, DENTRON, & MFJ.



DRAKE TR-4CW transceiver

- 80 thru 10 meters • 300 W PEP on SSB; 260 W on CW, AM • 500 Hz CW filter included • RIT • Wide range receiving AGC • Solid-state VFO • Shifted-carrier CW • VOX or PTT • Output impedance is adjustable • CW semi-break-in • Audio output: 3 watts • Transceive or separate PTO.

699.00 is list price. Call Toll-Free for quote.

DRAKE L-4B linear amplifier

- Plate input: 2000 watts PEP on SSB, 1000 watts DC input power on CW, AM, RTTY • High-efficiency class B grounded grid circuit • Transmitting AGC • Broad-band tuned input • RF negative feedback • Directional watt meter • Solid-state power supply • Two taut-band suspension meters.

895.00 is list price. Call Toll-Free for quote.



DRAKE W-4 directional RF watt meter

- Covers 2 thru 30 MHz • 2000 watts continuous duty power capability • Line impedance: 50 OHM resistive • VSWR insertion: no more than 1.05:1 • Accuracy: $\pm 5\%$ of reading • 4-position switch on front selects desired scale, forward or reflected power.

72.00 list price. Call for quote.



DRAKE 1525 EM microphone

- Auto-patch encoder and mike are a single unit, fully wired and ready to use • High accuracy IC tone generator, no frequency adjustments • Digitran® keyboard • Low output impedance, use with most transceivers.

49.95 Call for shipping.



DRAKE TR-33C 2m transceiver

- 12 channel provision (2 supplied) • All FET front-end crystal filter for superb intermod. rejection • Ni-Cad cells supplied • Built-in charger • Low power drain circuit on squelched receive • Lighted dial when using external power.

229.00 list price. Call for quote.

Remember, you can call TOLL-FREE: 1-800-633-3410 in U.S.A. or call 1-800-292-8668 in Alabama for our low price quote. Hours: 9:00 AM til 5:30 PM, Monday thru Friday.



Long's Electronics



MAIL ORDERS: P.O. BOX 11347 BIRMINGHAM, AL 35202 • STREET ADDRESS: 3521 10TH AVENUE NORTH BIRMINGHAM, ALABAMA 35234

Call 1-800-633-3410 for Dentron*

*KENWOOD, YAESU, ICOM, CDE, HYGAIN, CUSHCRAFT, NPC, TPL, TRISTAO, NEWTRONICS, REGENCY, ROHN, WILSON, TEN-TEC, B&W, DRAKE, & MFJ.



DENTRON MLA-2500 linear amplifier

- Continuous duty power supply • 160 thru 10 meter coverage • 2000 + watts PEP input on SSB • 1000 watts DC input on CW, RTTY, SSTV • Two external-anode ceramic/metal triodes operating in grounded grid • Covers MARS w/o modifications • 50 ohm input/output impedance • Built-in RF watt meter.

799.50 is list price. Call Toll-Free for quote.

DENTRON MT-3000A antenna tuner

- 160 thru 10 meter coverage • Handles a full 3KW PEP • Continuous tuning 1.8 - 30 mc • Built-in dual watt meters • Built-in 50 ohm dummy load for proper exciter adjustment • Antenna selector switch enables you to by-pass the tuner direct or select the dummy load or 5 other antenna systems.

349.50 is list price. Call Toll-Free for quote.



DENTRON 160-10AT super tuner

Balanced line, coax cable, random, or long wire antennas, the 160-10AT will match it—160 thru 10 meters • Continuous tuning, 1.8-30 mc • 3 inputs • Handles 500 watts DC, 1000 watts PEP • Heavy duty, 2-core Balun (3½" dia. x 3" H) • Tapped inductor #12 ga. wire.

129.50 list price. Call for quote.

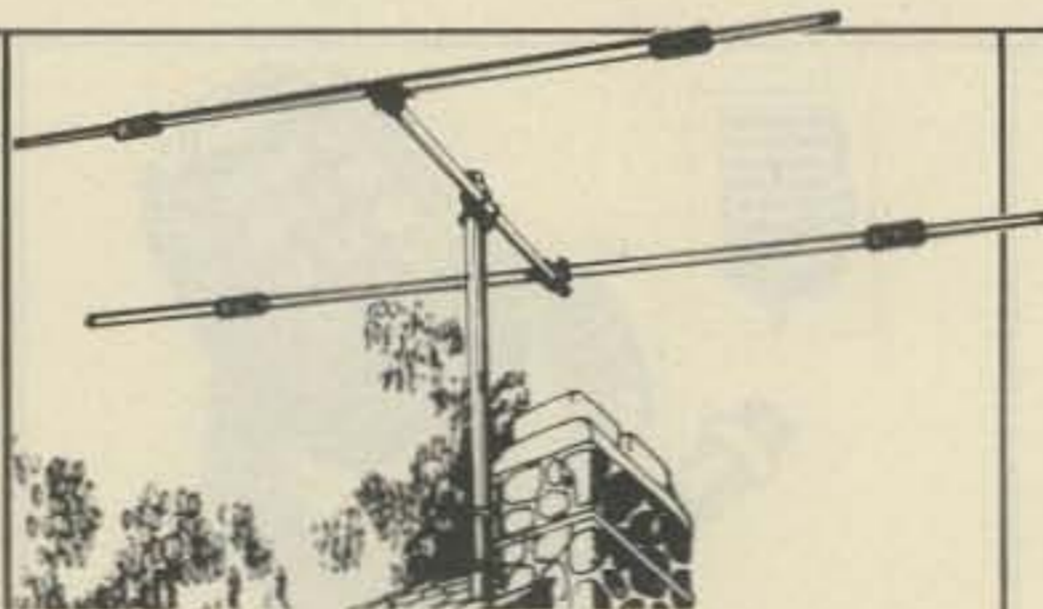

DENTRON Trim Tenna 20 meter beam

For the amateur who wants fantastic performance with good looks! • Front element: 16' driver with H-Q coils fed directly with 52 ohm coax • Reflector element: 17' with 15 dB F/B ratio • 8½' turning radius • 4 dB forward gain over dipole • Elements 7 feet apart • Weight: 14 lbs.

129.50 list price. Call for quote.

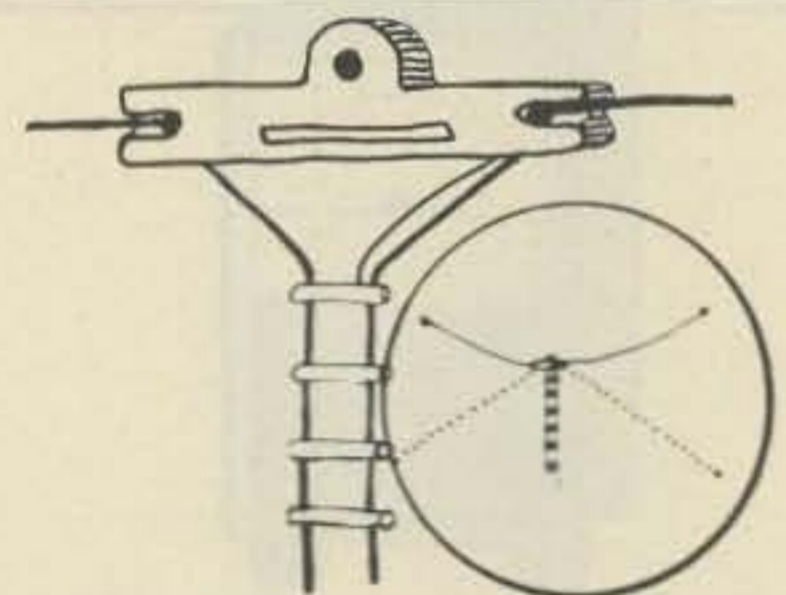

DENTRON all band doublet antenna

This all band doublet or inverted antenna covers 160 thru 10 meters. Has total length of 130 ft. of 14 ga. stranded copper wire. The doublet is tuned & center fed thru 100 ft. of 470 ohm PVC covered transmission line. Assembly is complete.

24.50 is Long's low price.

Remember, you can call TOLL-FREE: 1-800-633-3410 in U.S.A. or call 1-800-292-8668 in Alabama for our low price quote. Hours: 9:00 AM til 5:30 PM, Monday thru Friday.



Long's Electronics



L9

MAIL ORDERS: P.O. BOX 11347 BIRMINGHAM, AL 35202 • STREET ADDRESS: 3521 10TH AVENUE NORTH BIRMINGHAM, ALABAMA 35234

Call 1-800-633-3410 for Ten-Tec*

*KENWOOD, YAESU, ICOM, CDE, HYGAIN, CUSHCRAFT, NPC, TPL, TRISTAO, NEWTRONICS, REGENCY, ROHN, WILSON, DENTRON, B&W, DRAKE, & MFJ.



TEN-TEC Triton IV digital transceiver

- Solid-state • Instant bank change • Covers 3.5 to 30 MHz • 200 watts input on all bands • Receiver sensitivity: 0.3 micro V • 8-pole crystal IF filter • Large LED readout • Offset receiver tuning • WWV at 10 & 15 MHz • Separate receiving capability • Full CW break-in • S-meter and SWR bridge.

869.00 is list price. Call Toll-Free for quote.



TEN-TEC Century 21 CW transceiver

- Full break-in • 70 watts input • Solid-state • Built-in speaker • Receive CW or SSB • Instant band change • Overload protection • Offset receiver tuning • Sidetone w/adjustable level • Regulated power supply • Full band coverage: 80 thru 20 meters with crystals supplied. Other crystals available.

289.00 is list price. Call Toll-Free for quote.



TEN-TEC KR-50 electronic keyer

- Speed range: 6-50 wpm • Weighting ratio range: 50 to 150% of classical dit length • Output: reed relay, contact rating 15 VA, 400 V max. • Sidetone: 500 Hz tone • Dit& dah memories with defeat switches.

110.00 list price. Call for quote.



TEN-TEC KR-20A electronic keyer

- Keyed output: reed relay: 15 volt-amp. contacts, 400 volts max • Speed range: 6 to 50 wpm • Time base: keyed to start with paddle actuation • Self-completing characters • Side-tone oscillator with adjustable level.

67.50 list price. Call for quote.

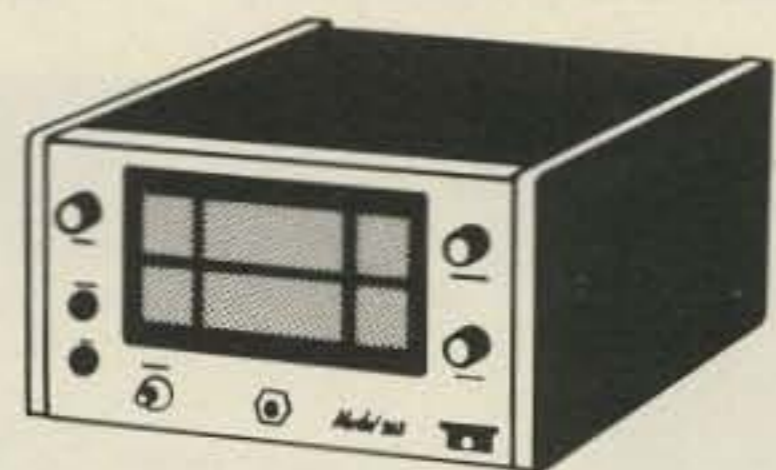

TEN-TEC 262G power supply

- Input voltage: 117 VAC, 50-60 Hz • Output voltage 13.0 VDC • Regulation: Better than 1%, NL to FL @ 117 VAC • Output current: 0 to 18 amps • Sation speaker • VOX circuits • Over current protection.

129.00 list price. Call for quote.

Remember, you can call TOLL-FREE: **1-800-633-3410** in U.S.A. or call **1-800-292-8668** in Alabama for our low price quote. Hours: 9:00 AM til 5:30 PM, Monday thru Friday.



Long's Electronics



MAIL ORDERS: P.O. BOX 11347 BIRMINGHAM, AL 35202 • STREET ADDRESS: 3521 10TH AVENUE NORTH BIRMINGHAM, ALABAMA 35234

Bob Walker K5UBM
1608 E. Tucker Blvd.
Arlington TX 76010

Philip Todd WB5WSG
11456 Dumbarton Dr.
Dallas TX 75228

Build A ComCoder

-- versatility for the IC-22S

One of the most versatile two meter rigs on the market is the Icom 22S PLL synthesized transceiver. With the addition of a device we call the ComCoder, all of the channels that can be programmed into a 22S are available at the flick of three direct reading BCD thumb-wheel switches.

Even though several commercial and homemade devices have been developed to increase the programming

capacity of the 22S, we feel that the ComCoder is one of the most practical because it is relatively inexpensive, is easy to construct using off-the-shelf components, and is small in size. Moreover, the original 22 positions can still be used, duplex and simplex functions are performed automatically, and the unit can provide a means of remote operation. Perhaps the most significant feature is that any frequency in 15 kHz steps

can be dialed in and read out directly on the switch numerals. No codes, charts, or mental calculations are needed. The frequency range covered by the ComCoder on our radios is from 145.340 to 148.215 MHz, in 15 kHz steps. The range below 146.00 MHz may vary from unit to unit. It should be noted that the range above 148.00 MHz is out of the band and should not be used.

Most owners of a 22S who

have programmed the matrix board have probably noticed that the board has 23 positions, not just 22! The foresight of Icom in providing the 23rd position along with position 23 on the rotary channel selector switch (first dot past numeral 22) makes addition of the ComCoder or other systems a fairly simple task.

Inside the radio, only one very minor modification is required. Add two diodes, one resistor, a 24-pin accessory socket, and a few wires, and your 22S is ready to accept the ComCoder.

The following steps represent the minimum operations required to make the 22S ready to accept the ComCoder. (We say "minimum" because optional connections such as audio in and output required to remote the entire rig will vary according to the individual's desires.)

1. Remove the standard 9-pin accessory socket and replace it with a 24-pin accessory socket. Icom sells a 24-pin socket complete with bracket that will fit with no modifications to the rig. However, we used a molex #03-06-1241 female and #03-06-1241 male connector. The original bracket with a round hole for the 9-pin socket was carefully filed out into a rectangular shape to accept the 24-pin socket.

2. Disconnect the blue discriminator meter wire from the 9-pin socket, and reconnect it to pin 3 of the 24-pin socket. (See step 4.)

3. Disconnect the ground wire from the 9-pin socket and the board. Reconnect a new ground wire of approximately 20 AWG from the board to pin 4 of the 24-pin

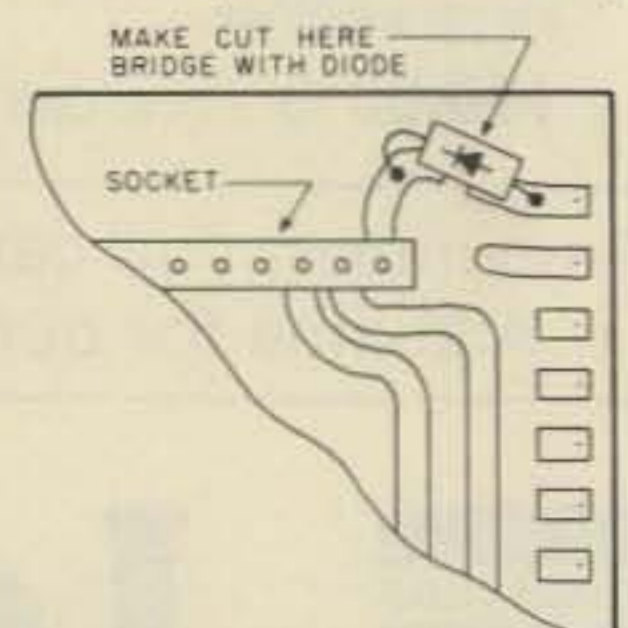
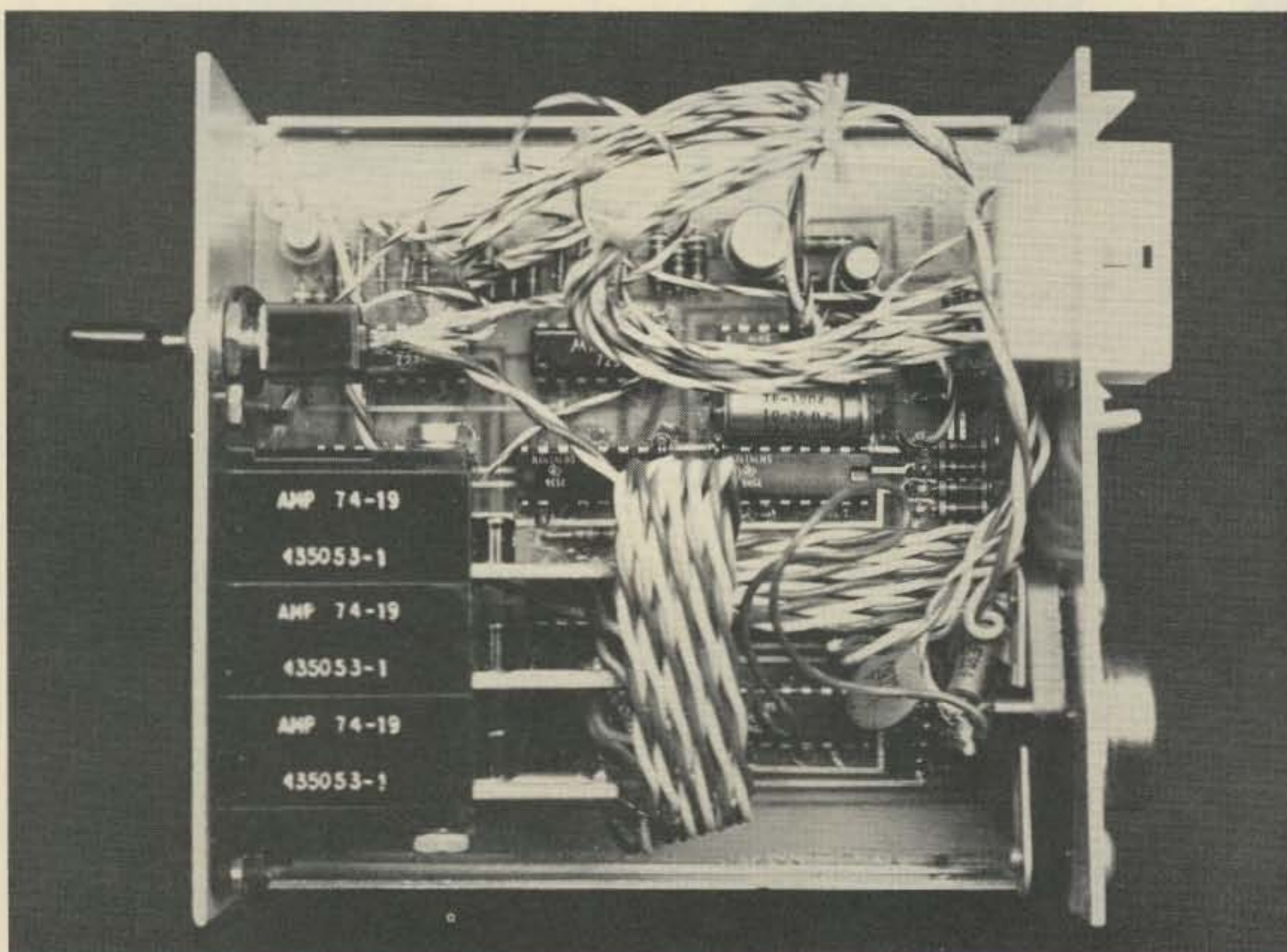

Fig. 1. Bottom of matrix board.



socket. (See step 4.)

4. Disconnect the .01 uF capacitor from the 9-pin socket and reconnect it between pin 3 and pin 4 of the 24-pin socket. This should be done at the same time as steps 2 and 3. We actually used a new capacitor, because it was easier than removing the one from the 9-pin socket.

5. On the bottom side of the matrix board, one strip of copper foil must be separated as shown in Fig. 1, and bridged with a diode. The cathode is placed toward the pin socket. A small triangularly shaped file works well for separating the copper. A diode of the same type used for programming the 22S (1N914) should be used. Cutting the copper at this point is the only real modification required.

6. On the top side of the matrix board, connect a diode to the second pin of the matrix board socket as shown in Fig. 2. This diode should be placed parallel with

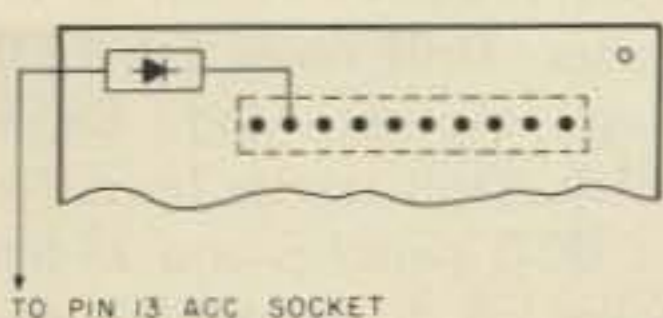

Fig. 2. Top of matrix board.

the end of the board, with the cathode connected to the pin. The other end should be passed through an existing hole in the corner of the board and connected to a wire. This method of installation stabilizes the diode and minimizes the possibility of the leads being broken during other operations. The wire from this diode is the DP line, and connects to pin 13 of the accessory socket. Use the same type of diode as was used in step 5.

7. Connect a 330 Ohm 1/4 Watt resistor between the matrix board position 23 common bar, as shown in Fig. 3, and pin 16 of the accessory socket. The end of the resistor should be inserted through an existing hole in the corner of the PC board for stability. The wire from this resistor goes to pin 16 (+9 V) of the accessory socket.

8. Connect a wire from the

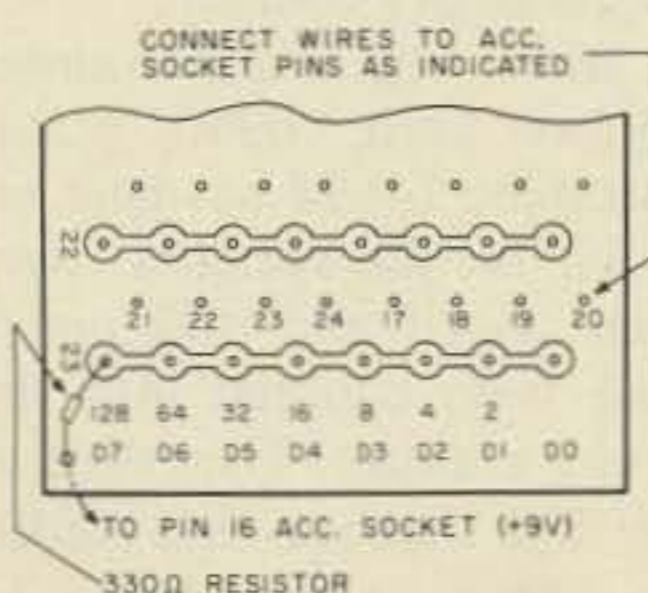

Fig. 3. Top of matrix board.

position 23 pad on the bottom of the matrix board, as shown in Fig. 4, to position 23 of the rotary channel selector switch.

9. Install 8 wires from the matrix board channel 23 position locations D7, D6, D5, D4, D3, D2, D1, and D0, as shown in Fig. 3. The wires should connect to the 24-pin accessory socket, as shown in the accessory socket pin assignment (Fig. 5).

10. Connect an 18-20 AWG wire from the top connector (one closest to the squelch control) of the high-off-low switch to pin 2 of the 24-pin accessory socket. This is the 12 volt power wire.

11. Connect a wire from the push-to-talk wire to pin 5 of the accessory socket, as shown in Fig. 6. Connection is recommended at this point, to avoid disassembly of the front of the radio to get to the wire.

The wires connected to

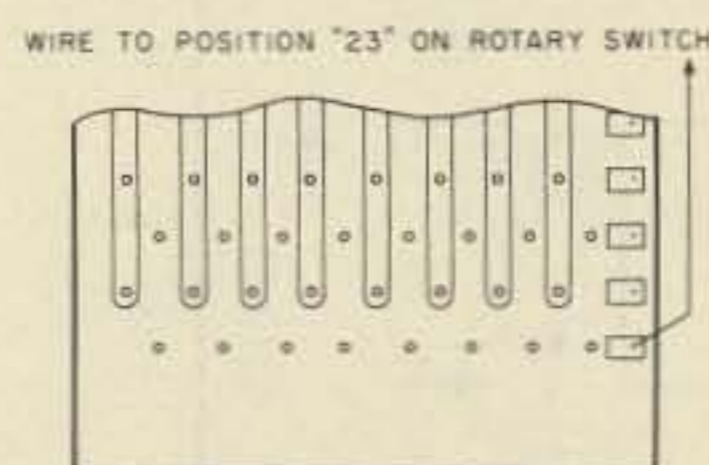
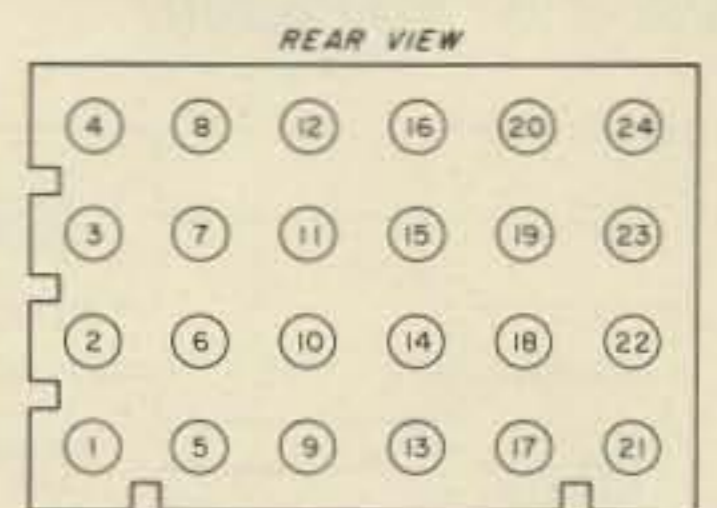

Fig. 4. Bottom of matrix board.



Pin No.	Assignment
* 1	"S"-meter
2	+12 volts (switch)
3	Discriminator
4	Ground
5	Push-to-talk
* 6	Audio input (MIC)
* 7	Ground
8	
* 9	12 V Unswitch
*10	Audio output
11	
12	
13	DP line
*14	Lock lamp
*15	Signal lamp
16	+9 V Pos. 23
17	D3 (Pos. 23)
18	D2 (Pos. 23)
19	D1 (Pos. 23)
20	D0 (Pos. 23)
21	D7 (Pos. 23)
22	D6 (Pos. 23)
23	D5 (Pos. 23)
24	D4 (Pos. 23)

Fig. 5. Accessory socket pin assignments and connections. Note: Any pin configurations are acceptable, but it is recommended that the above pins be standardized. *Optional connections required only if you desire remote operation.

the matrix board should be of sufficient length to allow manipulation of the board. After completing the above steps, the radio is ready to accept the ComCoder.

Before you start construction of the ComCoder, you probably will want to know how it works. Fig. 7 shows a block diagram of operation of the system.

In order to understand how the ComCoder works, the programming requirements of the 22S need to be

identified. The 22S uses an eight bit binary code to control the phase locked loop (PLL). Normally this code is provided by the diodes in the transceiver and selected by the 23 position switch. A ten position binary coded decimal (BCD) thumbwheel switch produces a code that looks exactly like a binary until the number ten is to be encoded. A binary ten is 1010. A BCD ten is 0001,0000. Therefore, it would take two BCD switches

to produce a ten and three to produce a three digit number such as 694.

The range of frequencies that the 22S can be coded for is from 00000000 (which corresponds to a frequency of 144.390 MHz) to 11111111 (which is a frequency of 148.215 MHz). Even though the 22S could be coded for 144.390 MHz, inherent characteristics of the 22S PLL will not let the unit lock up on frequencies in the upper 144 and lower 145 MHz range. Note that only three thumbwheel switches are required. The first two digits (1 and 4) and the 5 showing a 15 kHz are automatic. The 1 and 4 numerals could be painted beside the thumbwheel numerals if desired. The red LED lights to show a 15 kHz split frequency. For instance, when (14) 743 is dialed in, the red LED will light, thus indicating a frequency of 147.435 MHz.

The formula to convert a number such as (14) 6940 to the appropriate binary code is $(6940-4390) \div 15 = 170$. The 170 corresponds to the binary code as shown in the IC-22S owner's manual programming chart. This arithmetic formula required to convert a direct reading number (on the thumbwheels) is solved by the ComCoder. Detailed operation of the ComCoder is as follows:

1. The numbers on the three BCD switches are loaded into the three BCD counters. At the same time, a constant equal to -292(14390/15) is loaded into the binary counters.

2. The oscillator counts down the BCD counter toward zero, while every 15th pulse of the oscillator counts up the binary counter.

3. When the BCD counter reaches zero, 6940 pulses (assuming 14694 has been selected on the switches) have been issued and 462 pulses have been counted into the binary counter. The result of the -292 that was first loaded in and the 462 is $462 - 292 = 170$. A pulse is

issued to load the latch with this value.

4. The divide by 15 is reset and the process is restarted.

The components not mounted on the circuit board are as follows: capacitors C7 and C6, 5 volt regulator LM309, light emitting diode (15 kHz offset indicator), BCD thumbwheel switches, DPST center off duplex line switch, 1N2069 diode CR13, and the 24-pin plug. The 24-pin plug could be optional. The wiring could be made directly to the components and the circuit board. This is not desirable unless the unit is to operate in a permanent location. Any problems that show up after the unit is operational would probably be the result of a broken wire. Repair would be simplified by having the connecting cable capable of being plugged into the radio and the ComCoder. Also, the use of cables of different lengths for operations such as remote setup in your car and fixed in the house is more practical.

After you have scrounged or bought all of the parts, assembly is as follows:

1. Mount the components on the circuit board. Note that wiring is not critical and that alternate methods other than a printed circuit board could be used. However, in order to make the unit as small and neat as possible (as well as easy to assemble), a printed circuit board is recommended (as shown in the photograph of the inside of the ComCoder).

2. Prepare the housing box to receive the BCD switches, 5 volt regulator, LED, DPST switch, and 24-pin socket. Layout is not critical, but should generally follow that as shown in the photographs. Drill holes for the regulator pins and mounting screws. The pin holes should be approximately 1/4 inch in diameter. Drill holes for LED snap mount and DPST switch. Drill starter holes for the BCD switches and 24-pin socket. A hand nibbler was used to complete the rectan-

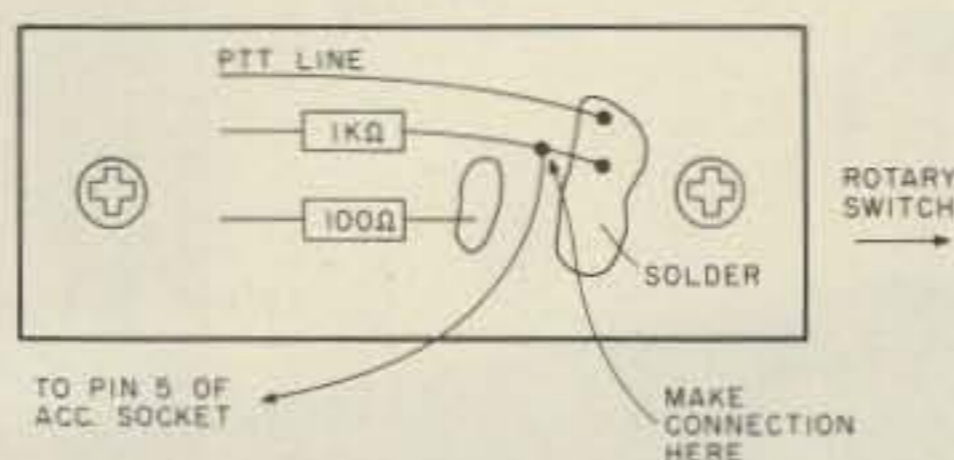

Fig. 6. PTT line connection procedure (located on the back side of the front panel).

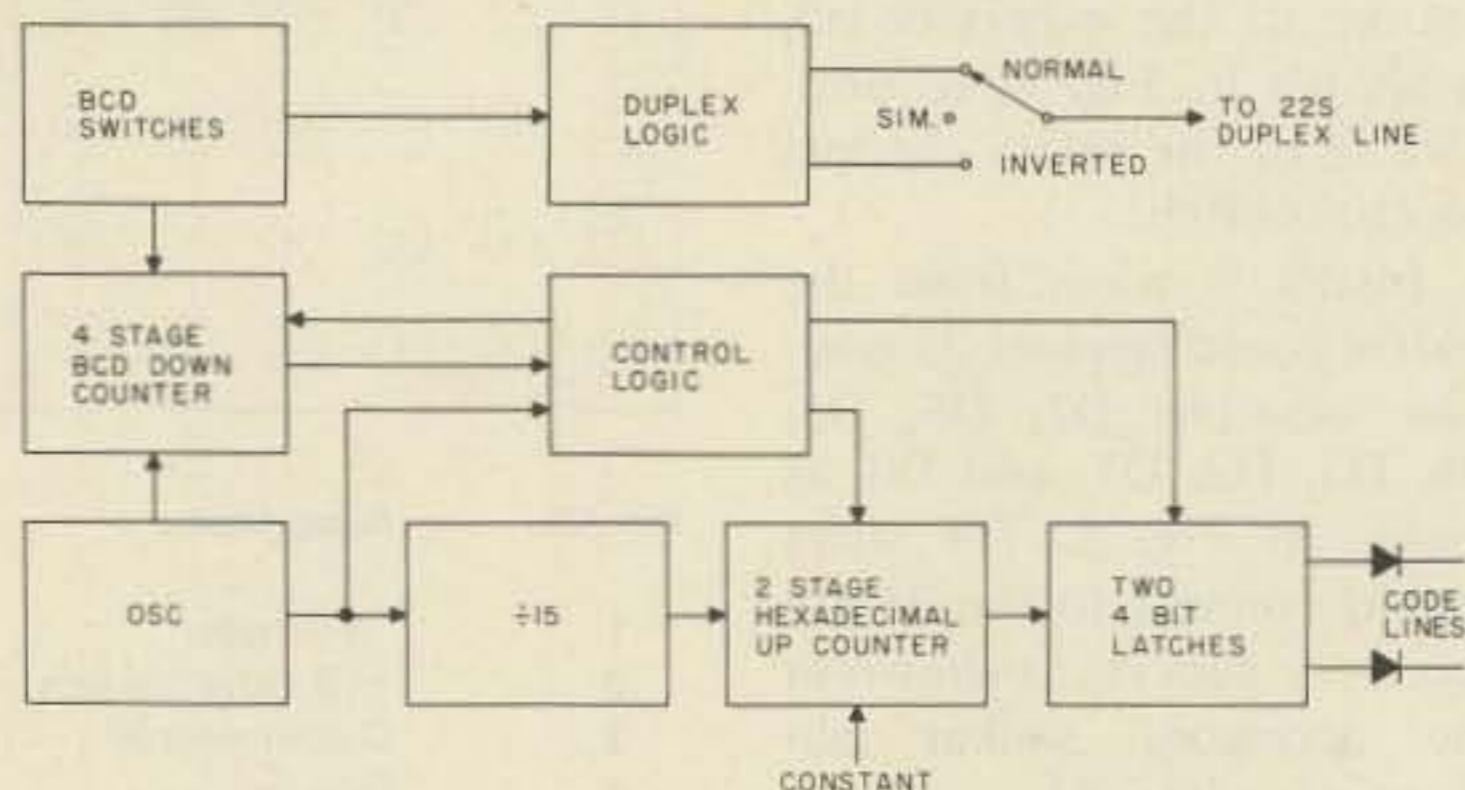

Fig. 7. Block diagram.

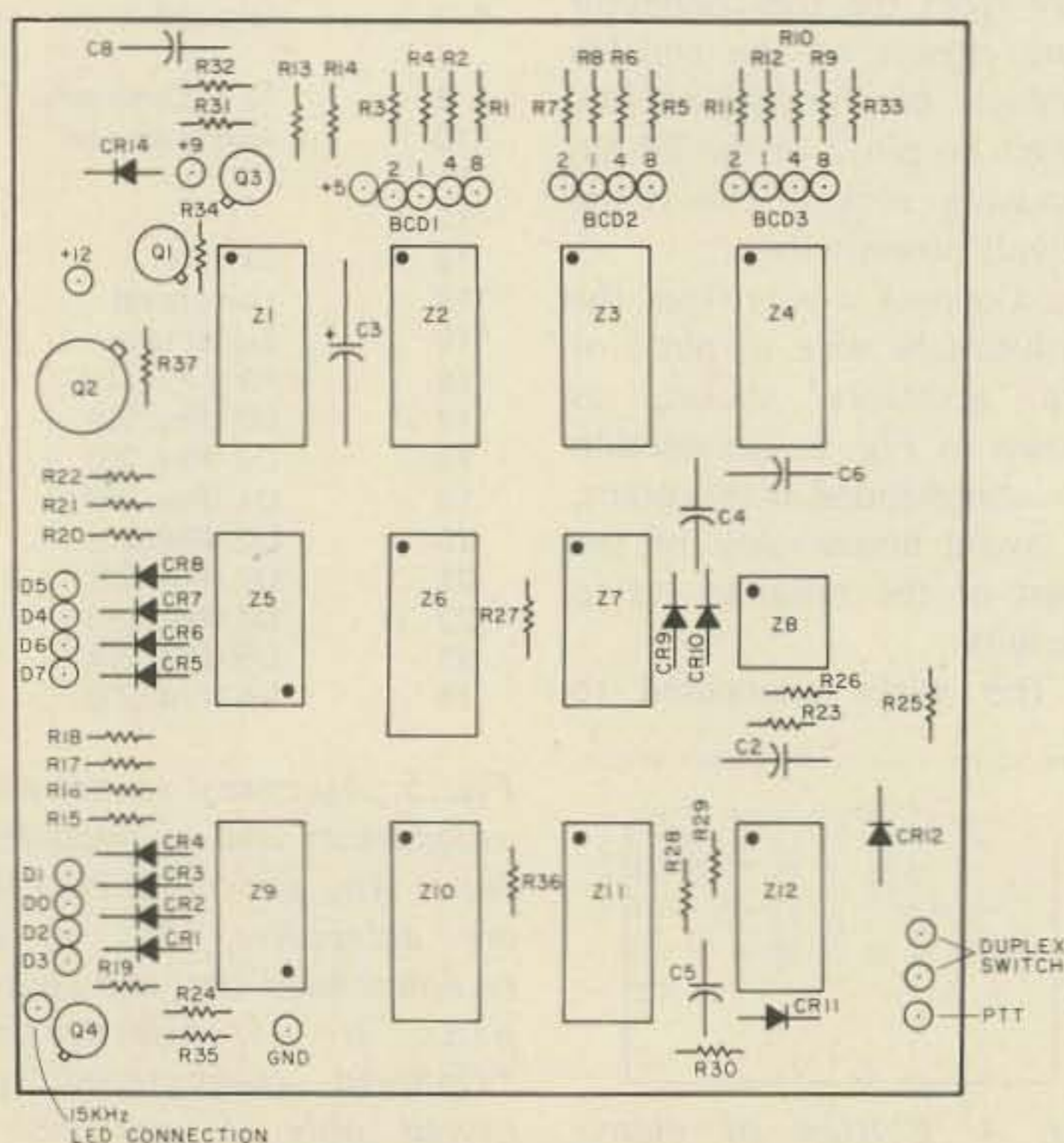

Fig. 8. Suggested parts layout.

gular holes for the BCD switches and 24-pin socket. If a nibbler is not available, the holes could be filled. Note that as shown in the photographs, the switches and LED are over to one side. This will allow the addition of a mike jack for remote operation.

3. Mount components listed in step 2 in their appropriate location. Do not install permanently at this time, because some of the wiring connections are simplified with components not mounted. We used a power transistor socket to mount the 5 volt regulator. This made the task of connecting C1, C7, and the wiring easier. Silicone grease should be used in mounting the regulator, to insure good heat conductivity. Also, if your box is painted, you should scrape the paint beneath the regulator.

4. Install wiring from the BCD switches to the circuit board. We mounted diode CR13 directly to the BCD switch connection points. The connection points are shown on the parts layout drawing (Fig. 8).

5. Install wiring from the PC board, regulator, and DPST switch to the 24-pin socket.

6. Connect the LED to the PC board. We used a snap mount type LED, but almost any type can be used.

7. Mount the PC board inside the housing. Make sure it is well insulated and makes no contact with the box or any other components (see test procedures).

8. Mount all other components permanently (see test procedures).

After completing the above steps, the unit should be ready to operate. How-

ever, before you connect the ComCoder to your radio, the following tests are recommended:

1. Measure the resistance from ground to +12 V dc and from ground to +5 V dc, to insure there is not a short.
2. Connect +12 V dc and ground to the unit. Measure +5 V dc. Connect PCB to 5 V dc. The 5 V dc should draw a current of approximately 500 mA.
3. If you have an oscilloscope, insure that the clock is running (555, pin 3).
4. Measure the collector of Q2. The voltage should be less than one volt.
5. Connect 5 V dc to R34, +9 V input to PCB. The collector of Q2 line should go to +12 V dc.
6. Select a 15 kHz frequency. The LED should come on.

7. Select 144.39 and measure each of the code lines. They should all be less than one volt.
8. Select 144.37. The code lines should all measure 12 volts.
9. Connect a 10k Ohm resistor from your meter probe to ground and measure each of the code lines. They should be less than 9.5 volts and greater than 7.5 volts.
10. Set duplex switch on normal. Select 146.34. Center of duplex switch should measure approximately 5 V dc.
11. Ground PTT line voltage should go to less than one volt.
12. Switch to invert. Voltage should go to 9 V dc. Un-ground PTT line voltage should be less than 1 volt.
13. Select a frequency of 146.52. The duplex line

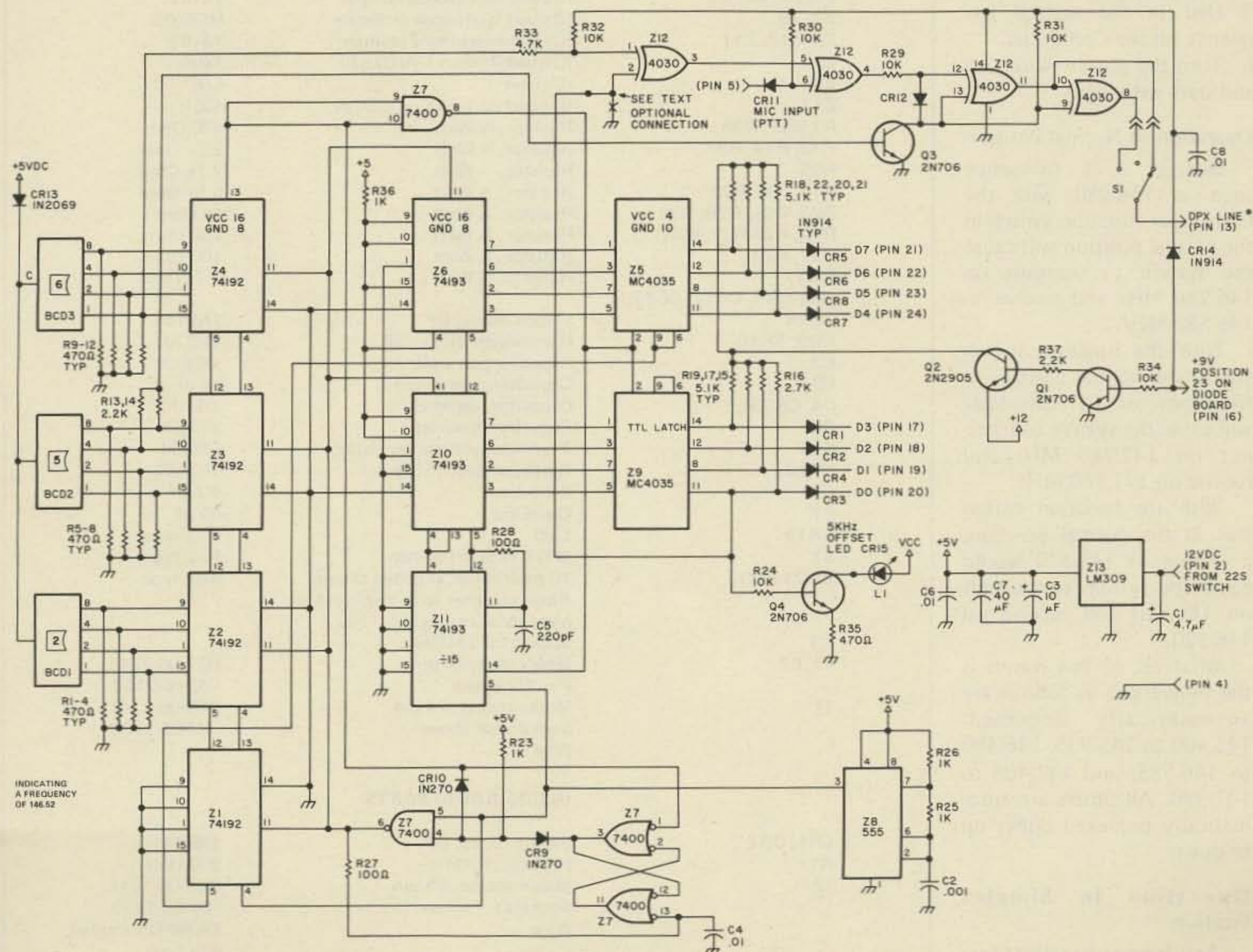

Fig. 9. Logic diagram. All resistors 1/4 W. *Note: Diodes must be put in DUP line.

HEATH COMPANY

BENTON HARBOR MI 49022

**PUT STAMP
HERE**
The Post Office
will not deliver
mail without postage

Get your very own copy of the latest
HEATHKIT
MAIL-ORDER KIT CATALOG

FREE!

Kits for almost everything in electronics: auto and marine accessories, TV, stereo hi-fi, home products and much more. All are easy to build with crystal-clear, step-by-step Heathkit assembly manuals.



SEND FOR IT TODAY!

Send for your copy of the world's largest catalog of quality kit-form electronic products.



Take your pick of nearly 400 fun-to-build and practical money-saving kits — all backed by Heath — world leader in better electronic kits since 1947.

FREE! mail card now ▶

FREE!

FILL IN THIS CARD AND MAIL TODAY

Yes! Please rush me my personal copy of the **NEW Heathkit Catalog.**

I am not on your mailing list.

Name _____

Address _____

City _____

State _____

Zip _____

Dept. 11-34
"73" Magazine

PC-1

TECHNICALLY SPEAKING, HEATH HAS THE BEST 2-METER AROUND.



\$269⁹⁵

With Standard Microphone

Shown with optional MICODER™ installed

Take our HW-2036 Frequency-Synthesized 2-Meter Transceiver for example

Our circuit designs prove it

The HW-2036 offers true digital frequency synthesis for real operating versatility. No extra crystals are needed and there are no channel limitations. Advanced digital circuitry uses a voltage-controlled oscillator (VCO) that is phase-locked to a highly stable 10 MHz crystal-controlled reference. Double-tuned stages following the VCO in the receiver and transmitter provide clean injection signals. The result is a signal that has spurious output more than 70 dB below the carrier (see spectrum analyzer photos below). Additionally, the "add 5 kHz" function is accomplished digitally in the HW-2036 so that no frequency error is introduced.

True FM

Careful attention to the transmitter audio circuitry and the use of true FM gives exceptional audio quality. A Schmitt-trigger squelch circuit with a threshold 0.3 μ V or less provides positive,

clearly-defined squelch action. Other design advantages include diode-protected dual-gate MOS FET's in the front end, IC IF and dual-conversion receiver.

Outstanding Specifications

The HW-2036 puts out a minimum 10 watts and operates into an infinite VSWR without failure. Receiver sensitivity is an excellent 0.5 μ V for 12 dB Sinad making the HW-2036 ideal for use in crowded signal areas. We think you'd be hard-pressed to find a comparably-priced 2-meter transceiver that gives you the features and performance of the HW-2036.

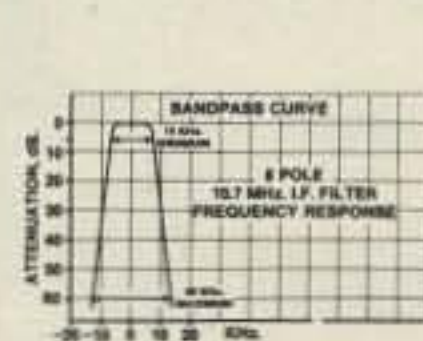

An 8-pole IF crystal filter greatly reduces adjacent channel interference.

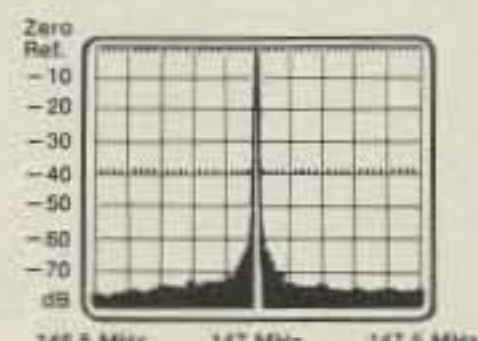

Actual spectrum analyzer photos of the HW-2036 transmitter output operating at 147 MHz. Spurs within 20 MHz of carrier are down a full 70 dB!

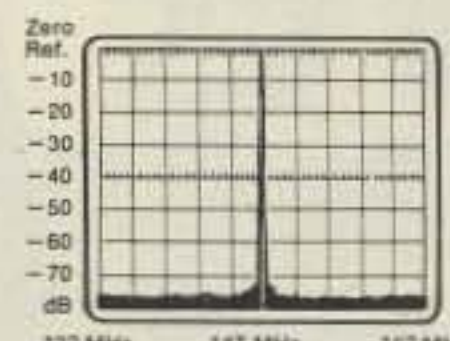

There's more for the Ham at Heath

FREE HEATHKIT CATALOG

Read about other fine Ham equipment and our wide variety of outstanding electronic kits — everything from lamp dimmers to color television is in our big FREE catalog.

Send for yours today!

Heath Company, Dept. 011-340, Benton Harbor, Michigan 49022

HEATH
Schlumberger

Heath Company, Dept. 011-340
Benton Harbor, Michigan 49022

Please send me my FREE Heathkit Catalog.
I am not on your mailing list.

Name _____

Address _____

City _____ State _____

AM-343 _____ Zip _____

Attaché Case Portable

-- Bond would like it!

Albert H. Coya N4AL/WB4SCN
1710 SW 83rd Ct.
Miami FL 33155

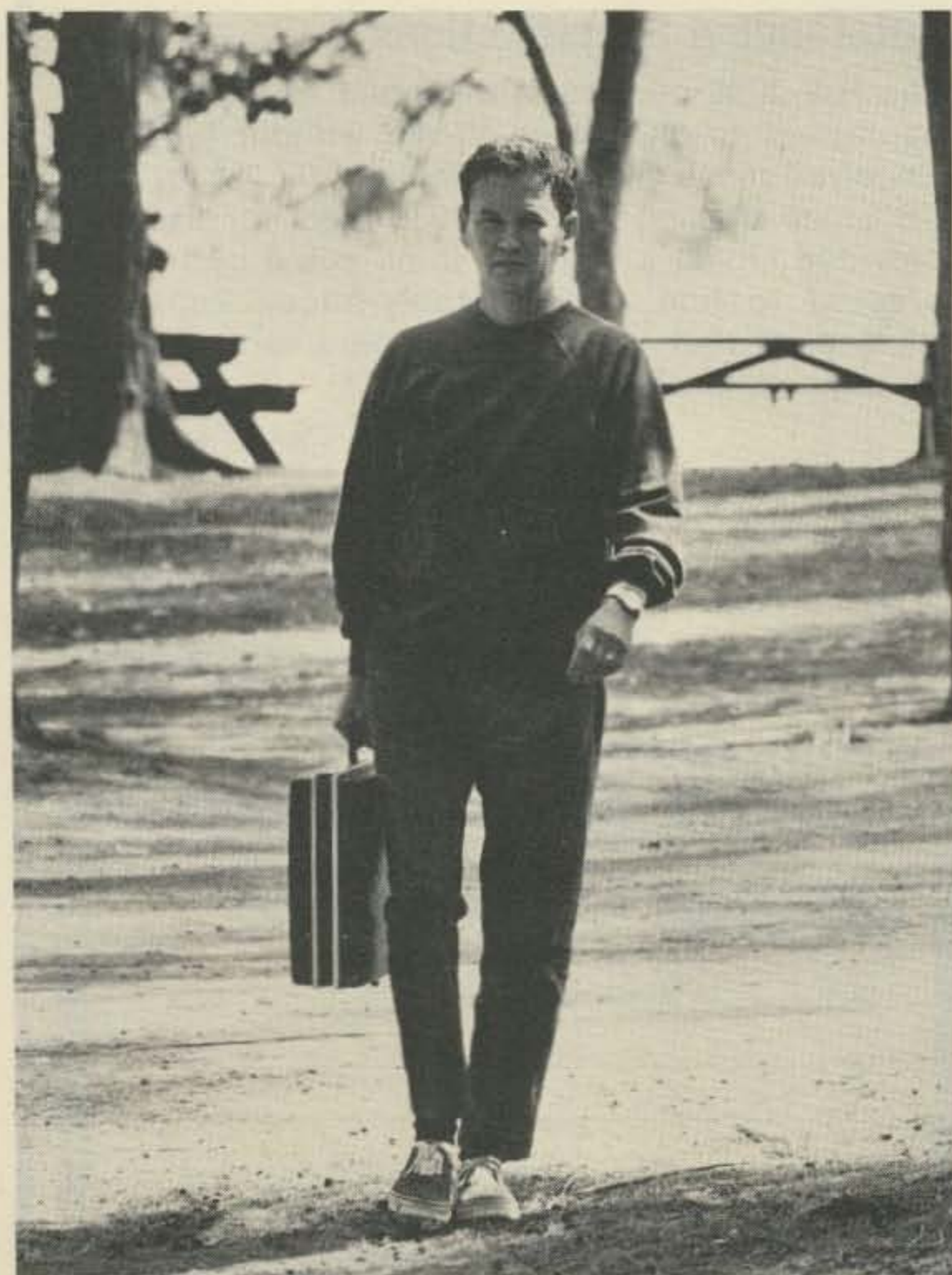

James Bond and his counterspy gadgetry made the attaché case notorious a decade or so ago. The black vinyl rectangle became a symbol of the super-secret agent. Bond was able to produce weapons and communications devices from his case with the ease of a magician pulling rabbits from his velvet hat.

Usually, the attaché case contained a rapid fire 7 mm machine gun, smoke grenades, plastic explosives, a telescopic blowgun with a provision for darts impregnated in curare, a bottle of champagne and two glasses, and, of course, a two-way radio. With this radio (frequency unknown) and an invisible antenna, he always kept in touch with headquarters in London, even while traveling aboard a dromedary in the Gobi Desert.

Unfortunately, or fortunately, I don't have a license to kill, and my attaché case must be as legal as possible. So I will leave out the explosives, poisoned darts, etc., and will stick to the communications business. My

attaché case portable may lack all those lethal weapons, but it contains an efficient and down-to-earth communications system.

As a staff photographer with the *Miami Herald*, I travel throughout the United States and abroad. On short trips I drive, but most of the time I fly. The long hours in a motel waiting for a news-break can be shortened if I do some hamming. But I needed to have a compact and portable operation.

I contemplated the need for two possible modes of communication — from a hotel or motel room and from a rented car. To attach the rig to the car, I built a telescopic center-loaded antenna with a gutter clip. To feed the 12 volts from the car battery, I used a long, stranded wire, twelve gauge, coded for polarity, and with heavy-duty battery clips on the end.

The motel operation is a lot simpler. Just be sure to get a room on the top floor. Open one of the back windows, and drop a long, covered wire down to ten to twelve feet above the ground level. Attach the end of the wire to the transmatch, tune the wire to the band of your choice, and you will be talking to the boys back home in no time at all.

In case you can't get a room at the top or it is difficult to drop a wire, the gutter antenna can be clipped to a pipe, the windowsill, etc., and, with the proper band tank coil, you'll go airborne.

For the attaché case operation I chose the Atlas 210X, because of its small size and light weight. I also have an ac power supply and a long wire tuner, compact enough to fit in my case, and coax, wire, pliers, screwdrivers, etc.

Lately I added to this a gel battery, capable of seven Ampere-hours at 12 volts. I use this battery on camping trips and picnics. I have my own private field days and talk to a lot of guys while the

steaks char in the barbecue pit.

On these trips I toss a long, covered wire over the trees and connect the end to the transmatch. On forty meters, stations from all over Florida start popping up. Everybody is interested in my portable operation. The fun starts when they pile up.

The seven Ampere-hour gel battery is compact enough to fit into the attaché case and strong enough for a full morning of rewarding QSOs.

One weekend I took the XYL and my attaché case to Cape Florida State Park, on the south tip of Key Biscayne across the bay from Miami. After biking and swimming, we took our things to a picnic table. While the XYL was preparing the food, I tossed a long wire over the pine trees and connected it to the transmatch. It is a very simple one that was advertised in 73 and sells for less than thirty dollars. Inside the little green box, you will find a toroid coil attached to a ten-position switch and a variable capacitor. Be careful when tuning this toy, because the rf jump can bite your fingers! A neon bulb tells you when the maximum output is obtained.

After installing the gel battery and mike, I started tuning the twenty meter band. It was buzzing like a beehive. At 12:20 pm Miami time, I got my first contact — Hank W3DX in Rockville, Maryland. Hank gave a good report, but he had a sked and had to QSY.

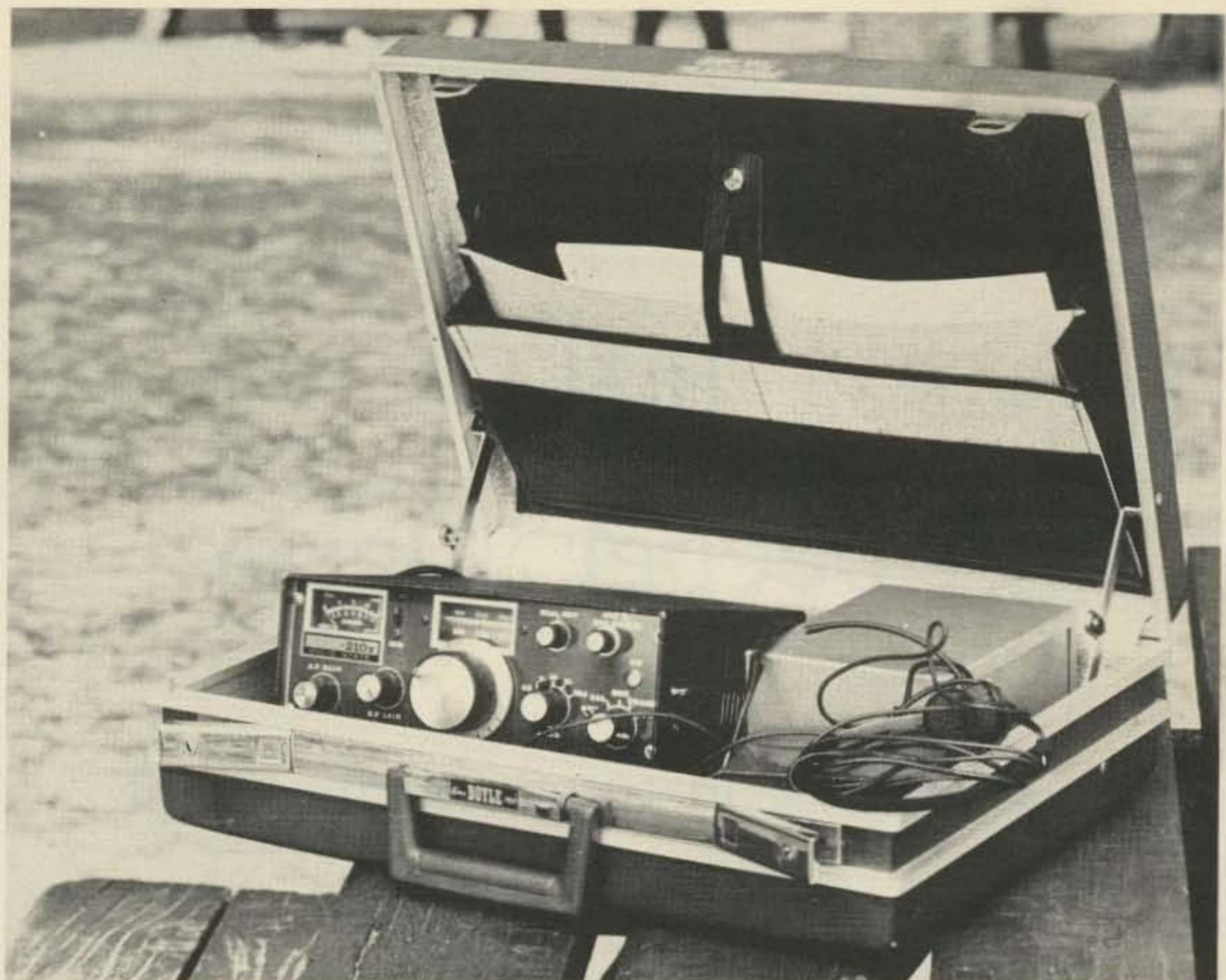

My next contact was a maritime mobile in the Pacific Ocean near Central America. He was calling a W7 station, so our QSO was short.

At 12:50 pm, TG9TG, a Guatemalan station manned by Glen, gave me a 5 by 6 report. Then I tried the forty meter band. Wayne W4JMU was near Jacksonville, Florida. The report was very good. In the low section of the forty meter band, a group of Cuban stations were talking to each other. I called CO2RS in Camaguey, and Ricardo answered my call. We

got a nice report from the group, which included one ham working with an AM rig.

Then I switched to the 15 meter band. WA6SKI was on 21.350 MHz in Riverside near Los Angeles. I explained to him that I was having a private field day in Cape Florida. His signal was a solid S9, and he gave me a nice report.

Then the excitement started, when I asked Ray to phone patch my daughter, Susan, who lives in LA with her husband and my only granddaughter, Jenny. It was like a direct pipeline with the

West Coast. My XYL had a great time talking with Susan. My daughter couldn't believe that we were sitting there on a picnic table facing the Gulf Stream. In the past, we had spent many hours together in the same spot, when she was in high school.

It was a tremendously satisfying and exciting experience, thanks to the kindness of Ray WA6SKI. I forgot to ask for his QTH to send him my QSL, but, Ray, if you are reading this story, I hope you have a smile and remember this interesting afternoon. ■

New Products

from page 25

For inquiries concerning domestic USA sales of the new series of amateur equipment from Hallicrafters, contact *The Hallicrafters Company, 2501 Arkansas Lane, Grand Prairie TX 75051*, telephone 214-647-9090, telex number 73-2310. Inquiries from other countries will be handled by Hallicrafters International, Inc., at the same Texas address.

FILTER DESIGN MADE EASY

Active Network Design by Claude

S. Lindquist is a new 749-page book which describes filter design and applications. It is an invaluable reference for engineers, technicians, and hobbyists who must understand signal processing and filtering, and who must specify, design, or adapt filters for their own uses. A.B. Williams of Coherent Communications Systems says, "It is the most impressive textbook on filters I have ever come across."

The book features standard design curves and tables, practical design examples, numerous problems with

selected problem solutions, extensive references, original and unpublished research results, and complete cross-referenced index including applications.

The price is \$21.95 prepaid (\$23.27 for California orders) or add \$1.50 postage and handling for 30 day billing. *Steward & Sons, P.O. Box 15282, Long Beach CA 90815.*

Corrections

In reference to "More Channels for the IC-22S," June, 73, I would like to point out that the address of Bryant Electronics was in error on my part. Bryant Electronics is alive and well. To all those people who wrote for the boards, and the response was overwhelming, please write to me if you

wish the board. To those who received theirs late due to having to have another batch made, accept my apologies. You should have them by now.

Bill Richarz WA4VAF
4124 Colebrook Rd.
Charlotte NC 28215

Build A Beeper Alarm

-- if staying in touch is important

Since the advent of my article, "The Ultimate Alarm II" (73 Magazine, June, 1973), there has been much interest in the feature which transmits a tone to a handie-talkie worn on the belt. This lets me know if the alarm is sounding while I am in a location where I can't hear the automobile horns. Moreover, people are impressed that I caught a thief in the act of tampering with my car

even though he thought he wasn't setting anything off by climbing through a window. The vehicle described in the above article was broken into a total of 24 times by genuine thieves and, no doubt due to the article, "tested" numerous other times by enterprising individuals at hamfests. One such person jumped violently up and down on the bumper at an ARRL convention, thus

destroying .94 talk-in facilities and making me immediately unpopular with several groups.

Another problem manifesting itself, and somewhat harder to rectify, was the fact that whenever I was in a theater, during the quietest and most suspenseful part of the picture, my handie-talkie invariably picked up other hams who would choose this

time to vent their feelings on the traffic, the world situation, or other nonsense, at full volume and probably directly in front of said theater. This invariably did not sit well with my nearest neighbors or the management, and once, at a posh symphony concert, with the conductor himself. Usually I ended up by turning the receiver off, thus voiding the whole point of the thing.

The HT-220 handie-talkie was bulky, heavy, stretched my pockets on my jacket, and made me look like a plainclothes detective. Something had to be changed.

I then noted that at things like concerts or public meetings, no one got particularly upset when a bona fide physician's beeper went off. Here was an Important Person, clearly not a Xerox repairman, and armed with his beeper and a deprecating smile, he usually made his way to an exit with people nodding their approval and falling over one another to give him room.

It became obvious that there seemed to be a difference between physicians and hams.

Recently, feeling somewhat affluent, I purchased a new car and a Motorola Pageboy II (used) with no real idea of what I was going to do with either one. I was,

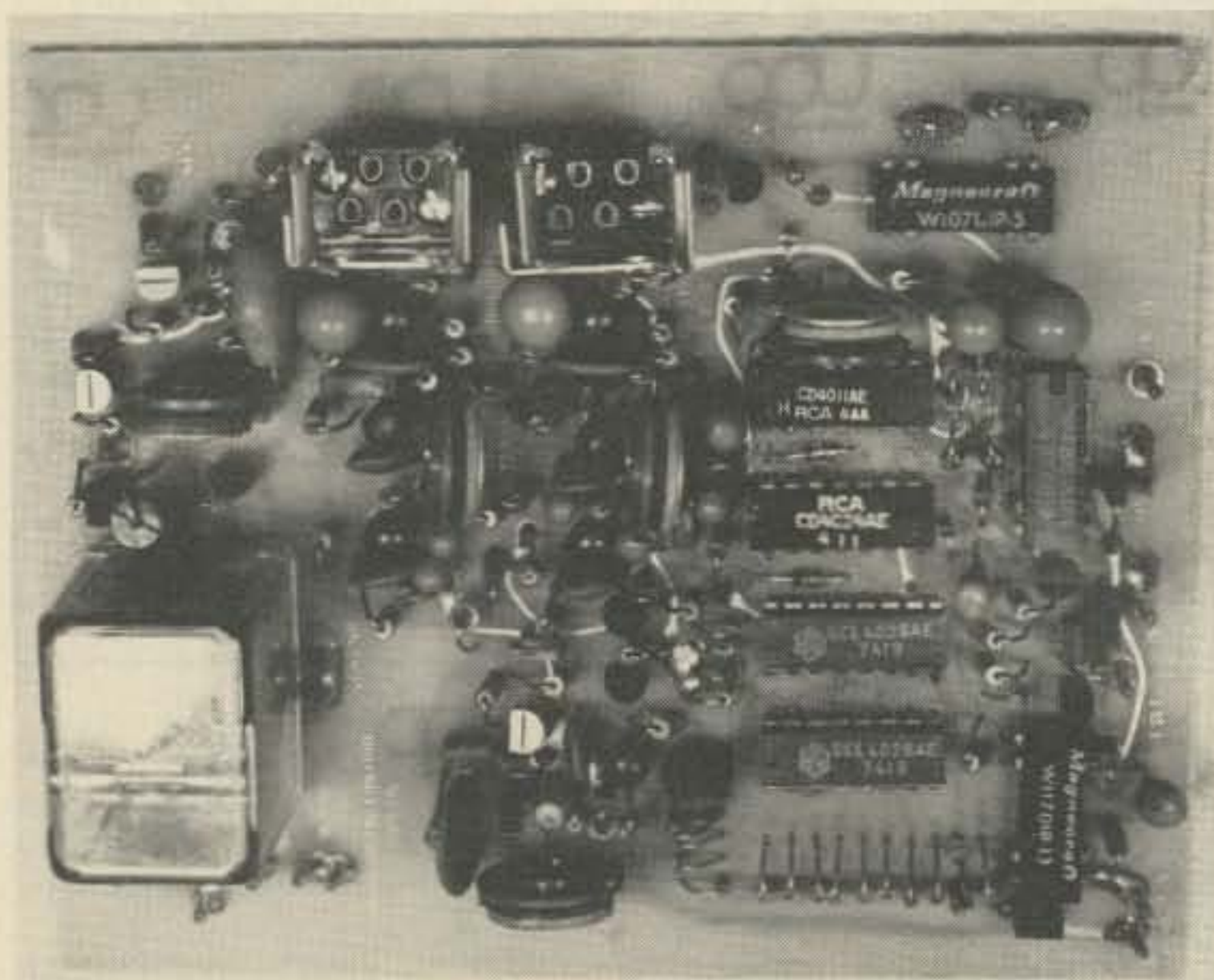

The completed PC board.

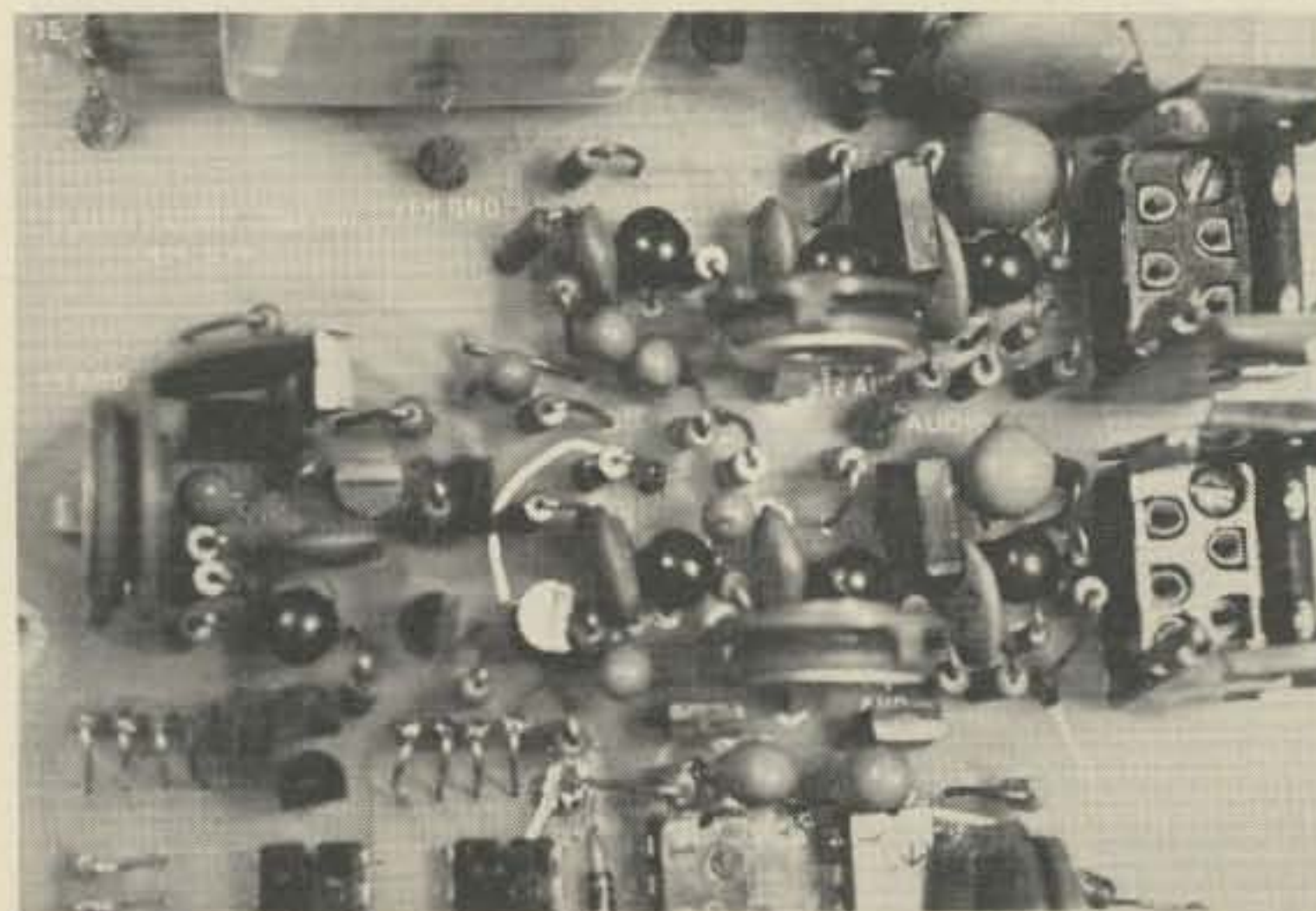

Another view of PC board. The two sockets are for the reeds. The two reed oscillators and the alert (ID) tone oscillator are the portion shown. Above these is the switching and sensor circuitry for the main alarm. Below are the ICs for the logic section.

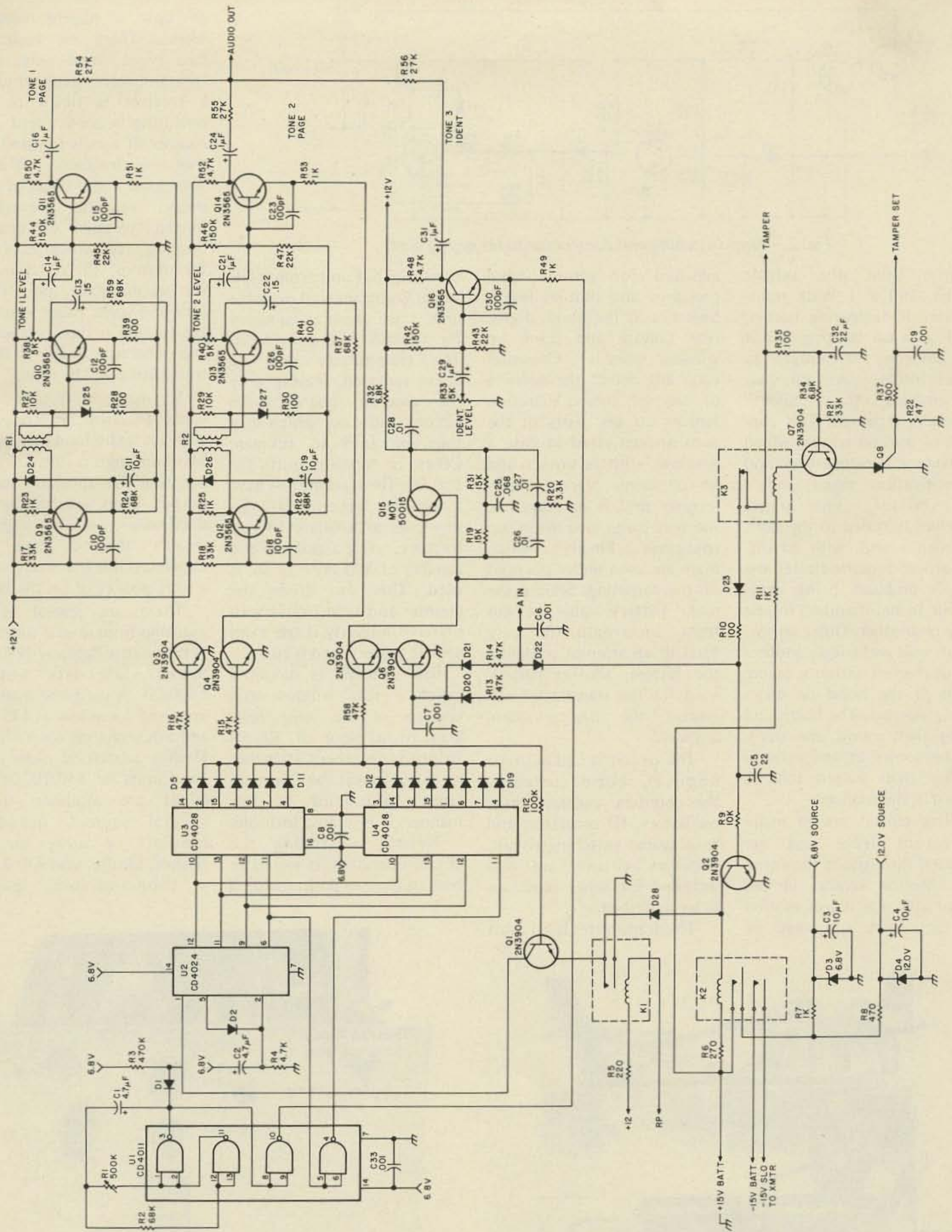

Fig. 1. Radio paging alarm circuit board schematic.

however, determined that anybody who scratched my new car while trying to break in would be dealt with severely. My old car had wear marks all around the various

openings from all the attempts made on it. When I sold it, it was depreciated accordingly (should have been cleaned and burned). I, therefore, completely re-

designed the alarm system from the collection of several dirty miniboxes full of electromechanical relays to a new integrated unit replete with transmitter, control board,

test switches, and all the conceivable input/output combinations I would need.

The new unit provides the appropriate control to energize a 100 Watt elec-

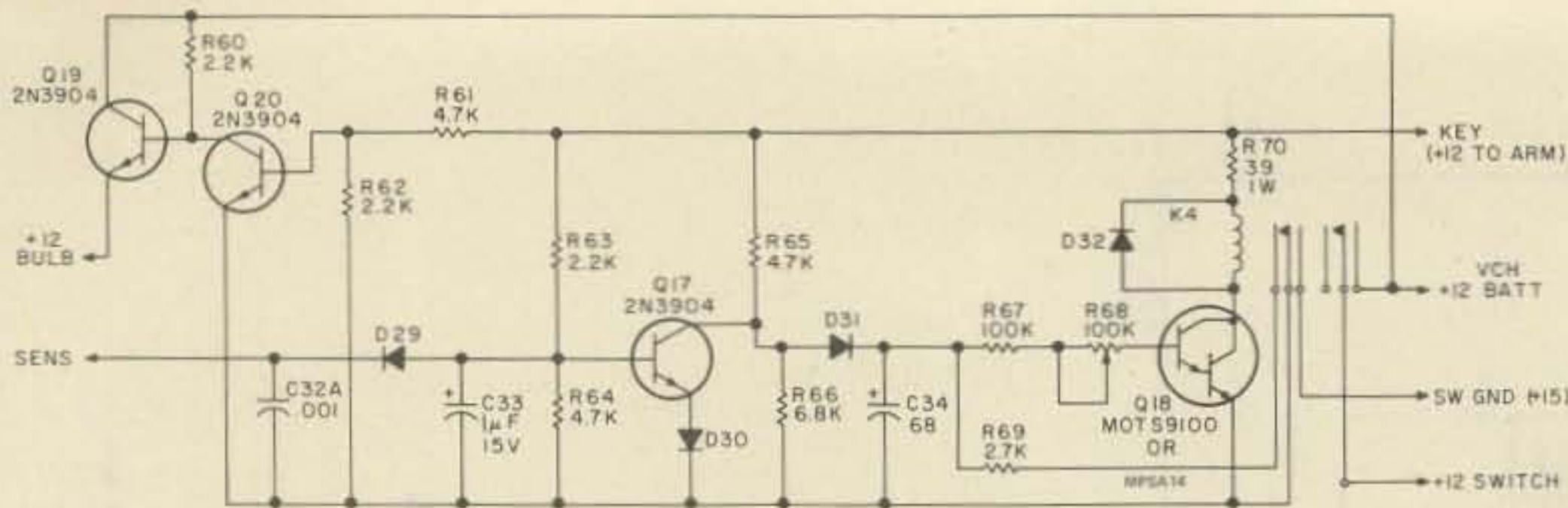

Fig. 2. Alarm switching and control for radio paging alarm.

tronic siren, the vehicle horns, and a 1 Watt transmitter. If tampering occurs, such as a car backing into it or someone attempting to climb inside, jack it up, steal an antenna, etc., a "silent" alarm is activated. This consists of motion sensors which activate a two-tone page and identification signal and a transmitter. The pager receiver is tuned to the same frequency and, with an off-on-off-on tone, indicates the car is probably being, or is about to be, modified in one way or another. Other sensors lie in wait and trigger another input if overt action is taken, such as the hood or doors being opened. The horns and siren then sound, the transmitter comes on, and a steady rather than pulsed tone is heard in the receiver.

The sensors are of many different types and are located throughout the entire car. Motion sensors in the front and rear detect motion of any sort and may be

adjusted for various wind pressures and motion levels. Switches in the hood, doors, rear tailgate and crank up window (this is a Chevrolet carry-all) detect the opening of any of these. Vibration sensors on key parts of the auto are activated in case a window is hit or broken and an ultrasonic alarm sender-receiver unit is employed in the rear cargo area in certain instances. Finally, switch mats are used under portions of the carpeting. Should the main battery cable be cut from underneath (no easy feat) in an attempt to defeat the system, another battery used for the transmitter will sound the paging alarm anyway.

The circuit is laid out on a single PC board containing the counters, two-tone page oscillators, ID oscillator, and basic alarm switching circuit. Auxiliary circuits are also included for other functions to be described.

The transmitter is a 1 Watt

transistorized unit from a GE Voice Commander II portable unit. I see these at hamfests for about \$15.00 quite a bit. The transmitters may be easily removed, leaving only the receiver board audio circuits and case, which may then be sold to firemen, CBers, or monitor buffs for \$30.00. The transmitters have a positive ground arrangement, so an auxiliary 15 volt battery, rechargeable and capable of 500 mAh or so, is used. This also drives the counter and tone circuitry to preserve integrity if the main vehicle battery lead is cut.

The antenna is mounted inside a rear window and consists of the solid inner lead of a piece of RG-59 stripped back about 19 inches or so for lowest swr (more on this). Mounted in this manner, it is almost invisible.

Before describing the circuit operation, it would be best to have an understanding

of how a paging receiver works. There are basically two types: tone only, and tone-and-voice. In either case, a receiver is tuned to an operating frequency and will receive all signals transmitted over this frequency. If two sequential audio tones of the proper frequency are transmitted, the pager will emit a beeping tone which stays on for most of the duration of the second page tone. If a tone-and-voice pager is used, the speaker is then turned on and whatever audio is then transmitted will be heard.

My pager is a tone-and-voice Motorola Pageboy II with an "extra loud housing." The housing is a tuned cavity boosting the apparent audio output. Even with the larger dimensions, it is slightly smaller than a pack of cigarettes and fits nicely into a shirt pocket or on the belt.

There are several types available from several sources. A brand new Pageboy II from Motorola costs about \$400.00. A used one may be procured for as low as \$75.00 and a new charger for \$20.00. Meshna advertised older low band units for \$30.00. Other types are available from several sources, including hamfests or other surplus dealers. Ideally, you will want a tone-and-voice pager

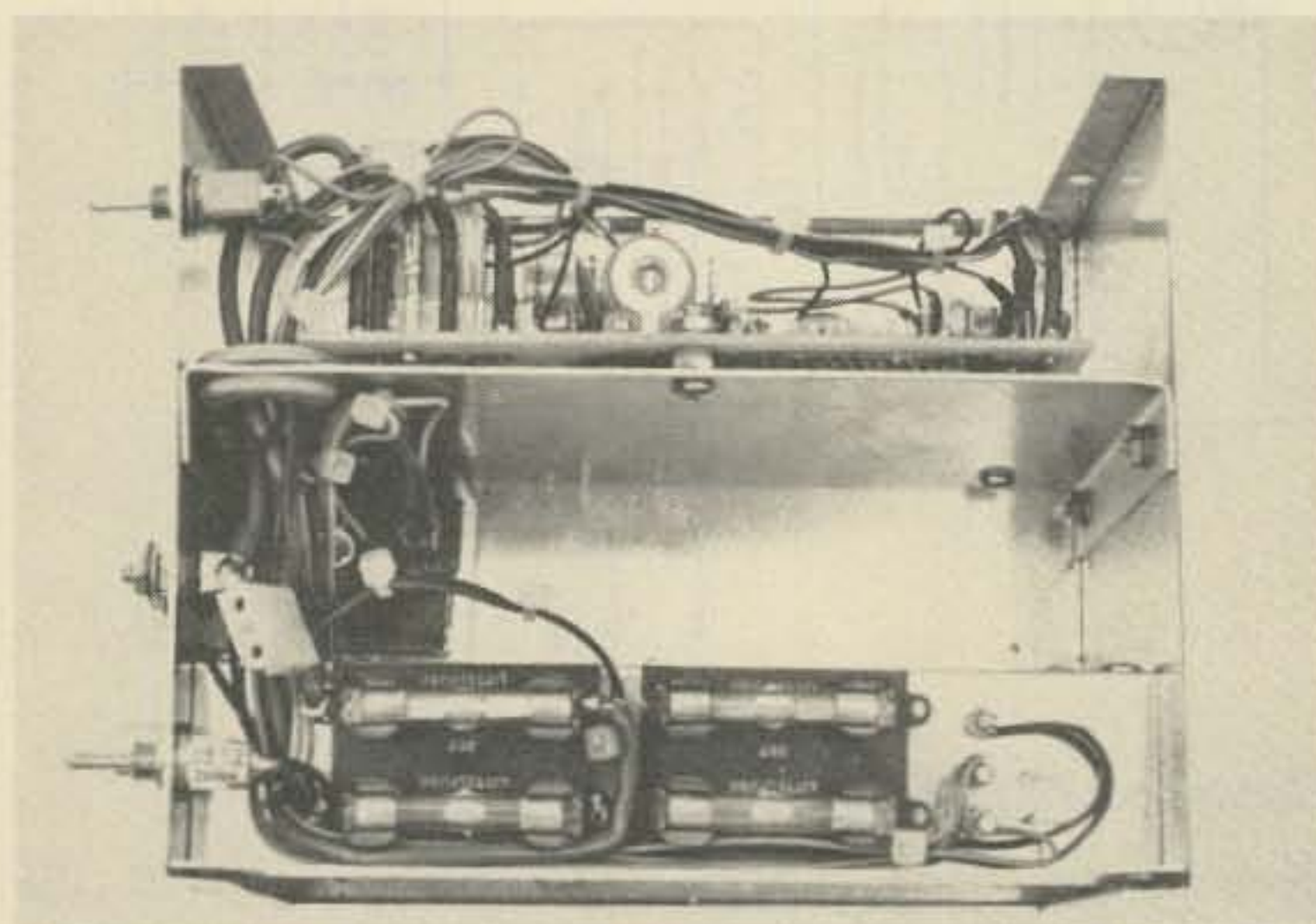

Top view of alarm box showing parts placement. Top — logic board. Middle — battery compartment with VW relay installed. Bottom — fuses over transmitter compartment. Note sub-chassis bent to fit in box.

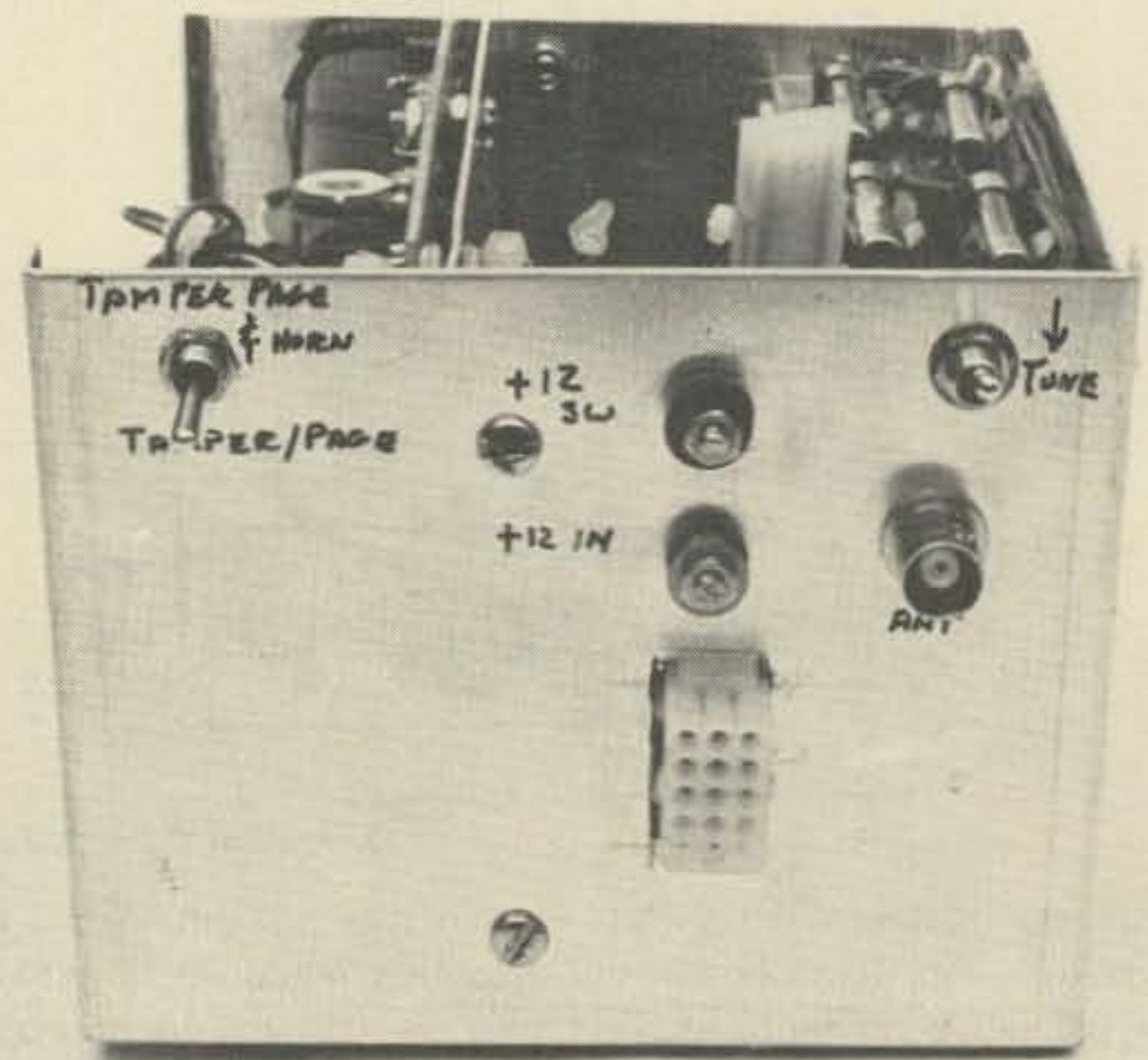

Alarm box without battery showing front panel controls and plugs.

utilizing a standard two-tone paging signal. Tone only units will suffice, but with my circuit, you won't be able to use the identification feature for break-in or tamper.

The alarm circuit is shown in Figs. 1 and 2. If the car is rocked or the motion sensors are otherwise put into motion, the tamper input relays a pulsed ground (remember we are using a positive 15 volt vehicle ground) to the base of Q2 through K3. C5 smooths this voltage and, with R9, provides a short delay to keep Q2 turned on. Relay K2 is energized and provides power to the transmitter and logic circuits. With regulated 6.8 volts and 12 volts now available, the CMOS clock provides a square wave to U2 at a rate determined by pot R1 and C1, the rate being adjustable by the pot.

At the same time, R4 and C2 provide an initial reset on U2 so that it starts counting from zero to insure the page tones get sent first, with the identification tone following.

U2 counts each clock pulse, providing a binary count to 16 to the decimal decoders U3 and U4, wired to provide 16 sequential logic ones at their outputs. These are used to turn on Q3, Q4, and Q5 in turn through diode coding. Q5 is clocked by Q4, which turns on and off with clock U1 if the tamper input is enabled. When Q3, Q4, and Q5 turn on, their collectors

go low, thus enabling the tone oscillator outputs in turn. Q3 is on for one count and Q4 for 3 counts. These are the paging tone drivers, and, if the clock is made to run at an approximate 1 second rate, the required "on" time of the two tones will be automatically observed because of the diode coding. A pager requires the 1st tone be one second long and the 2nd tone three seconds. Q5 may be pulsed or steadily on, depending on whether the tamper or alarm inputs are enabled. The former is obtained by gating Q5 and Q6 with the clock so that a half second tone is generated. In the latter case, Q6 is turned on independent-

ly by the "alarm" input, providing a continuous path for the emitter of Q5. In this way, a continuous identification tone is generated after the fourth count.

The tone encoder circuitry incorporates two reed oscillators and amplifiers for the page tones and one twin T oscillator for the identification tone. The output amplitude of each is fully adjustable for proper insertion to the transmitter. For reasons of frequency stability, reed encoders were used. These are able to withstand the wide temperature

extremes found in automobiles without drifting off frequency. The basic design was from one encoder board, socket, and reed purchased from Communications Specialists, Box 153, Brea, California, and adapted for this use.

Since most pagers may come with reeds installed, it will be cheaper to match these reed frequencies to your encoder rather than buy new sets. From name plate information on the pager or the reeds themselves, you can determine the frequencies and order the proper reeds

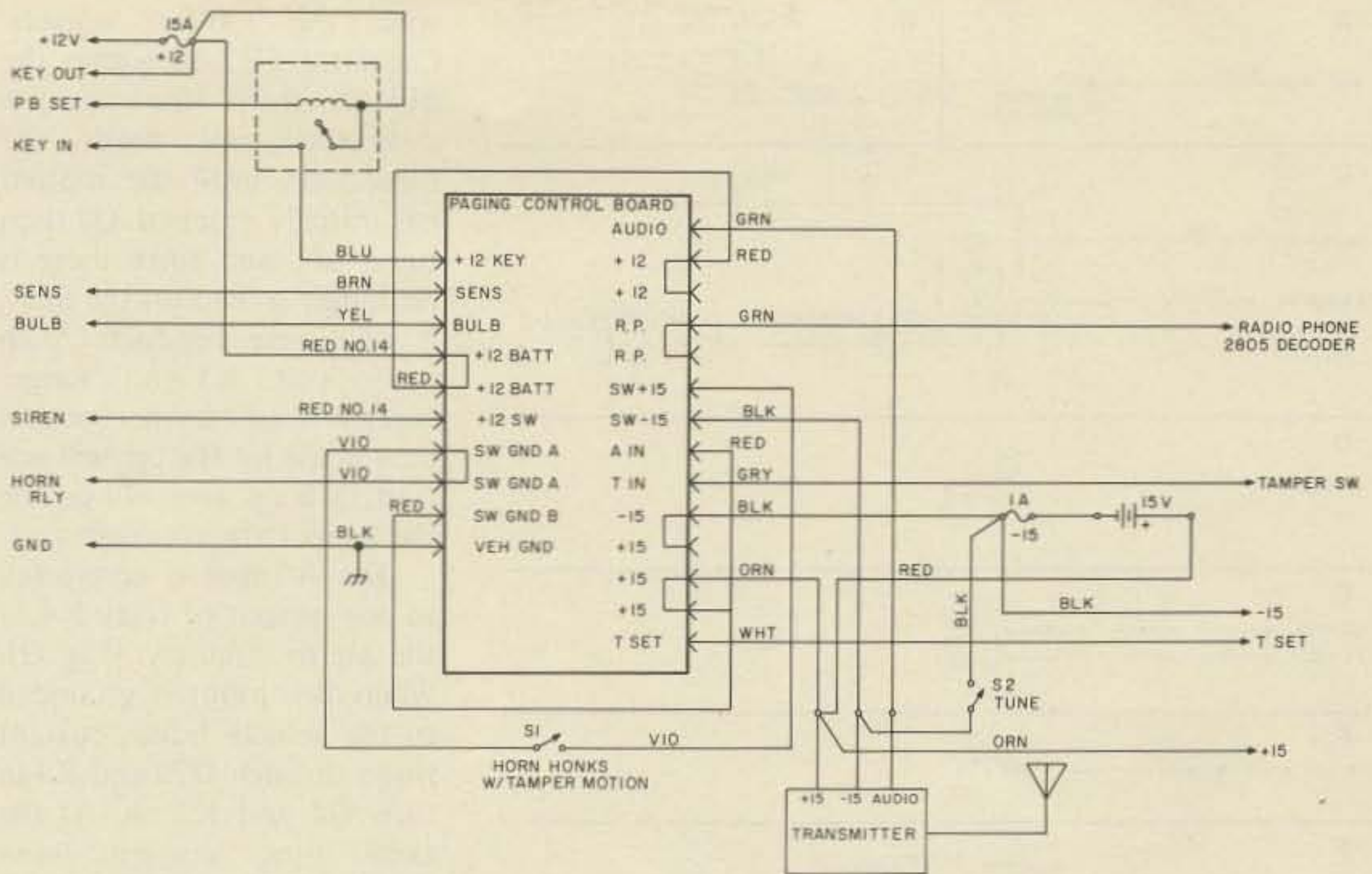
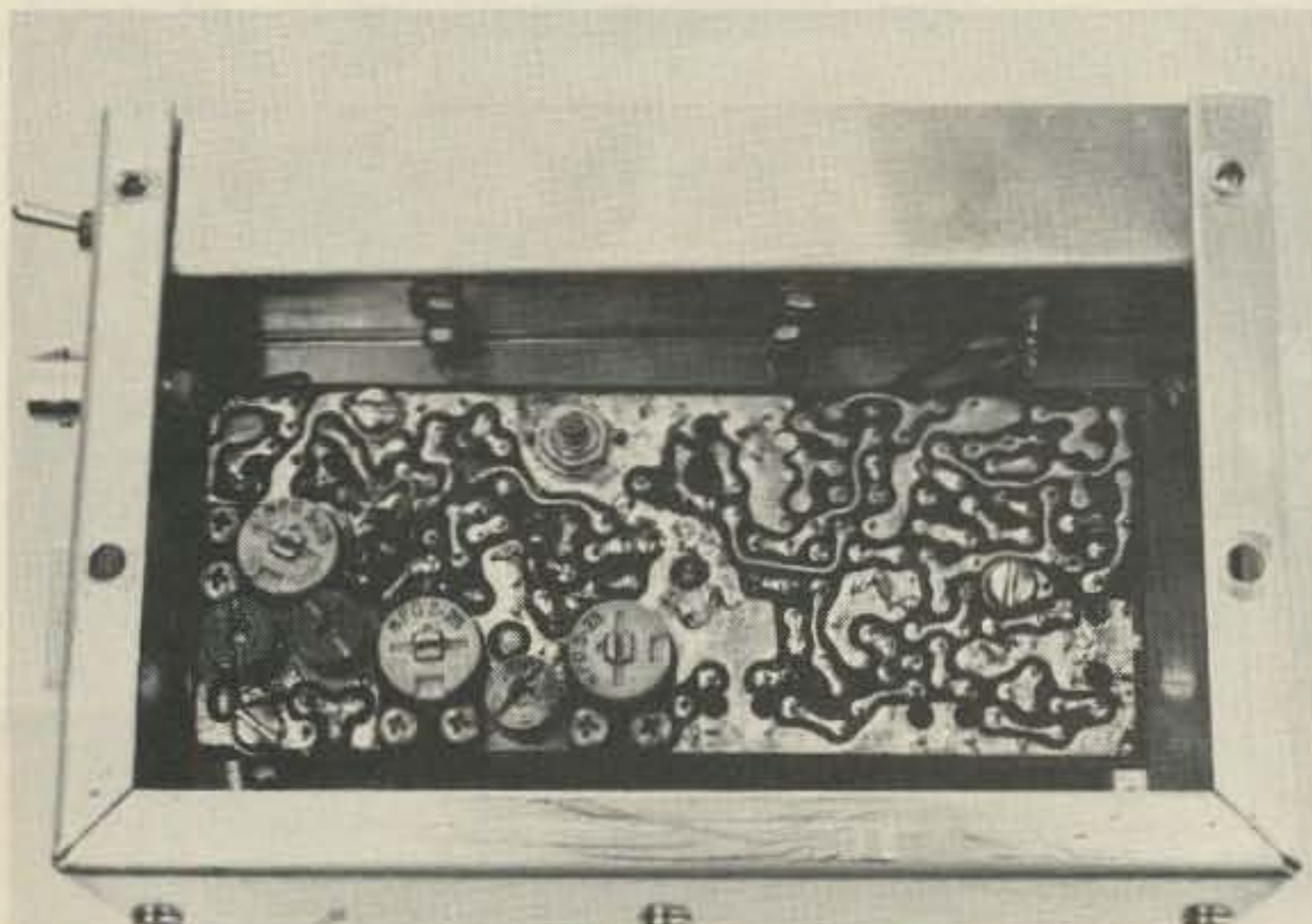
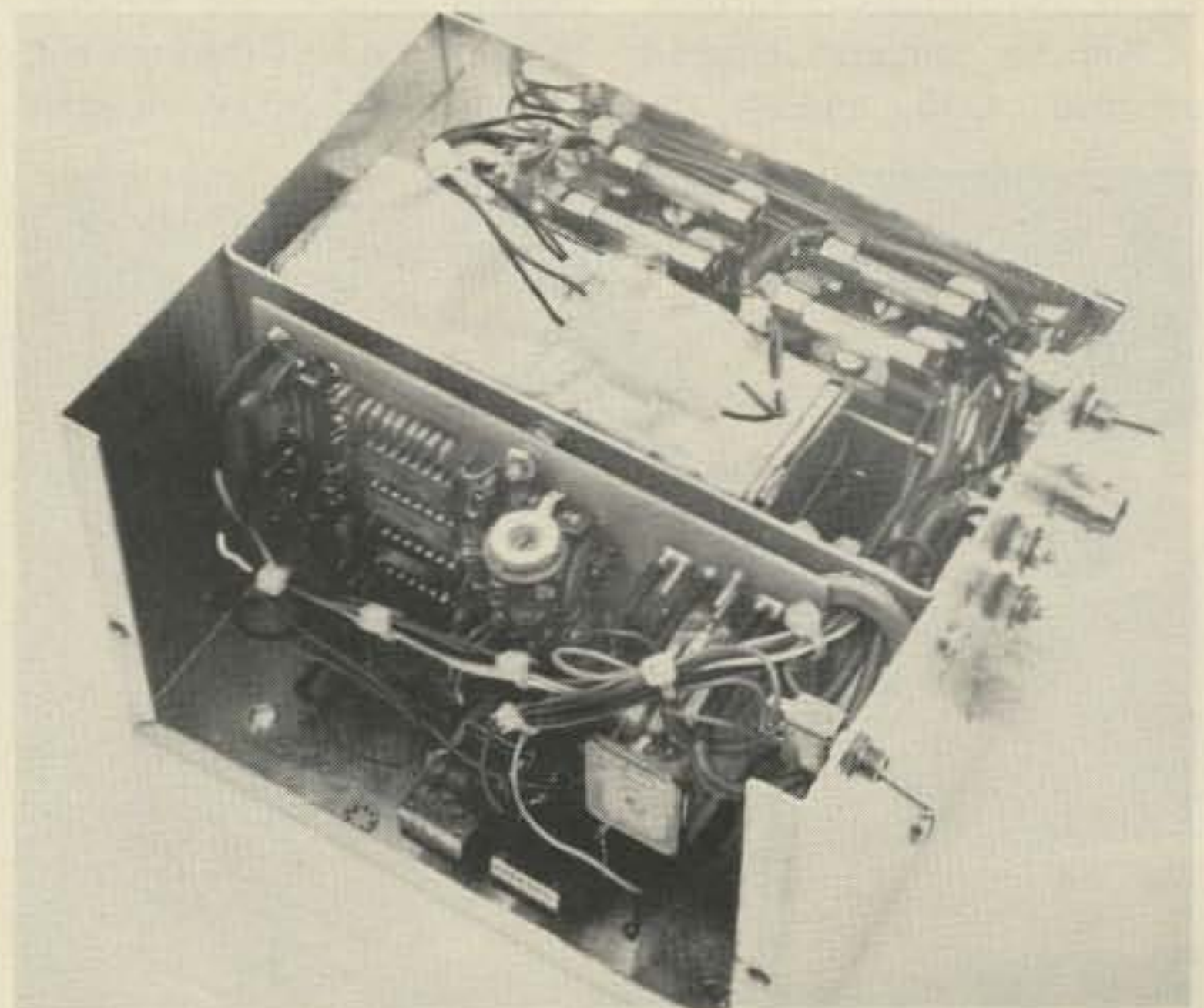

Fig. 3. Main wiring.



Side views of alarm showing transmitter board installed.



The completed alarm with battery installed. Note battery plug and method of mounting control board.

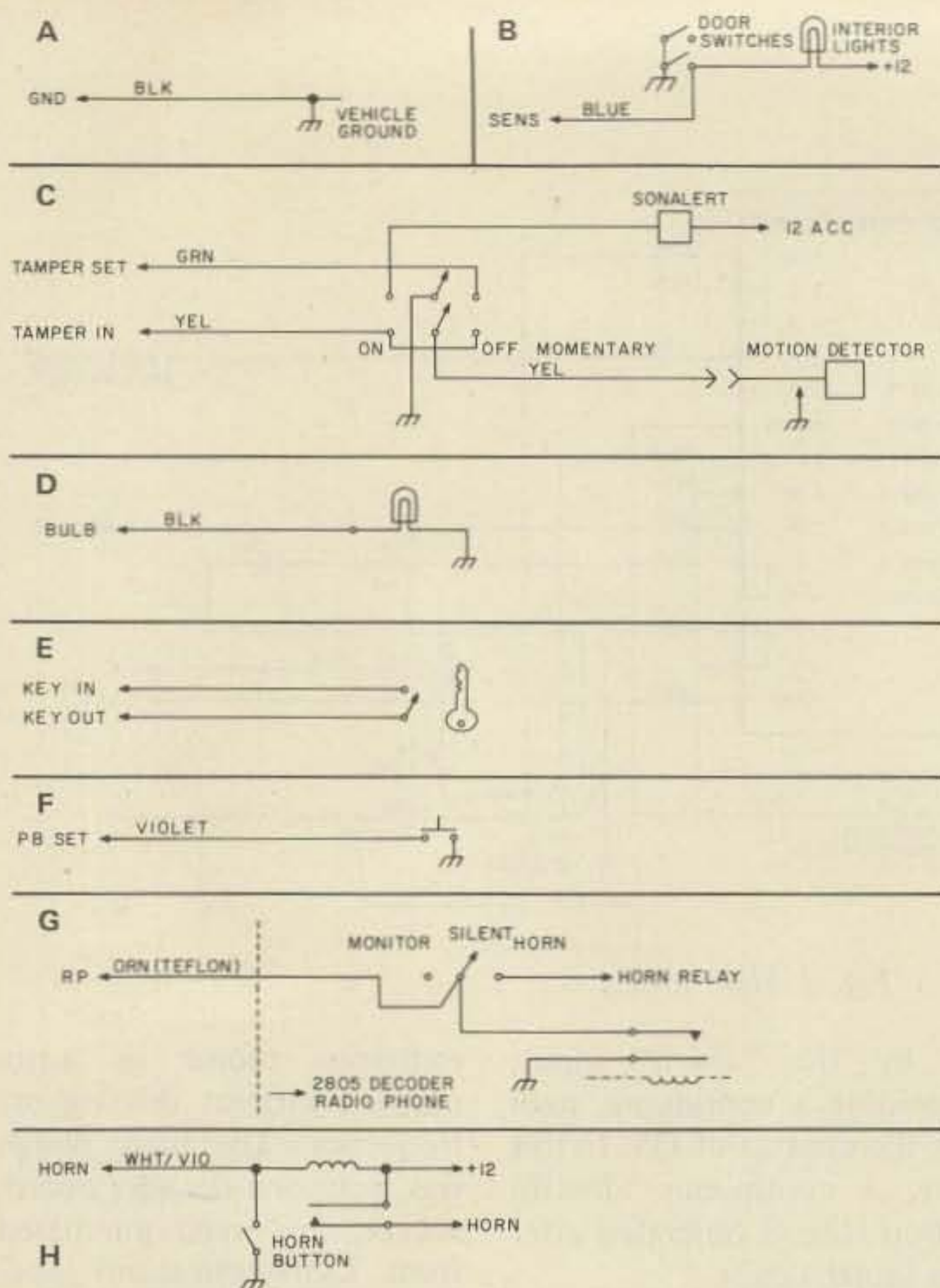

Fig. 4. Interface wiring, alarm to automobile. (c) Tamper set wiring. (d) Status lamp wiring. (e) Keyswitch wiring (operational). (f) Push switch set/reset wiring. (g) Radio page feature.

and sockets. Communications Specialists can supply either reeds, sockets, or complete encoders. If you don't have the reeds installed in the pager, choose any two tones you want or specify you want popular reeds, so that you can get new ones in the future at hamfests or surplus.

Another circuit centered around Q16 allows the

tamper sensors to settle down after the car has been driven. Essentially, this circuit disconnects the motion sensors until they have stopped moving to prevent your pager from going wild every time you park your car. If Q8, the SCR, is turned on while the motion sensors are moving, Q7 will conduct through K3, an NC SPST relay in series

with the motion sensors. Capacitor C32 smooths the pulses from the motion detectors and keeps Q7 turned on until the motion has initially stopped. Q7 then turns off, and since there is no longer a load on the SCR, it no longer conducts. With relay coil K3 no longer energized, any further motion now made by the car will not turn Q16 on and will enable the tamper alarm circuitry.

The A input is connected to the output of relay K4 of the alarm circuitry (Fig. 2). When this input is grounded to the vehicle frame, current flows through D22 and R9 to turn Q2 and K2 on. At the same time, current flows through R14 and D21 to Q6, keeping it on so that the identification tone will be steady rather than pulsing.

The vehicle alarm circuit is triggered only when sensors described above are triggered (door switches, mats, vibration sensors, etc.). This circuit is shown in Fig. 2. When the input marked "key" is at +12 volts, Q17 is biased on and grounds the R65-D31 combination which is essentially the base of Q19. If Q17 is turned off by grounding the sensor input momentarily, the collector goes high. Q18 turns on and C34 is charged through R65 and D31. With Q17's collector low again, current flows from C34 into the base of Q19, keeping it on for the

length of time determined by R67 and R68. D31 prevents C34 from discharging back to ground through the now "on" Q17.

As C34 becomes discharged, Q18 turns off and K4 opens. Since C34 holds a residual charge and will therefore exhibit different time periods if a sensor is again triggered, R69 keeps C34 discharged through K4 while the alarm is off, thereby providing instant reset to whatever time delay has been set (2-3 min.).

K4 provides +12 volt and vehicle ground switching. This is a 4PDT relay rated at 10 Amps. Two sets of contacts are brought out to connectors to provide +12 volts directly to a Federal electronic siren, and two discrete switched grounds are available for the horn relay and the A input to the paging alarm.

Since it was desirable to have easy set/reset capability, a mechanical latching relay is used to arm the system. A push-button sets or resets the alarm and, with no physical switch position to tell if it is set or not, an indicator light is included. When the "key" input is connected through the latching relay to +12 volts, R61 turns on Q20. Initially Q19 is biased on by R60 and passes current to a bulb, keeping it lit. With Q20 on, however, Q19 is turned off and the light goes out,

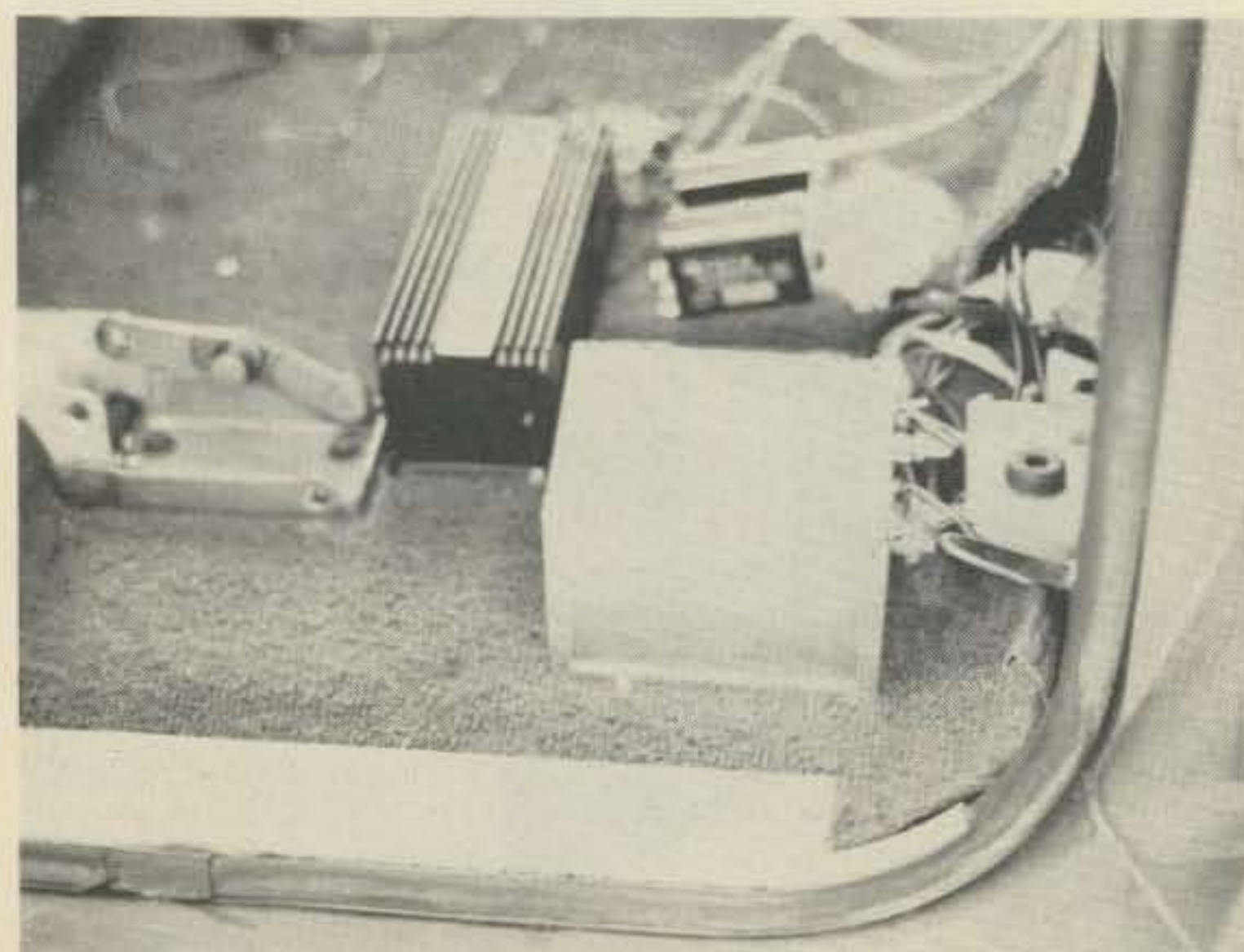

The completed system installed under rear pull-up seat in car.

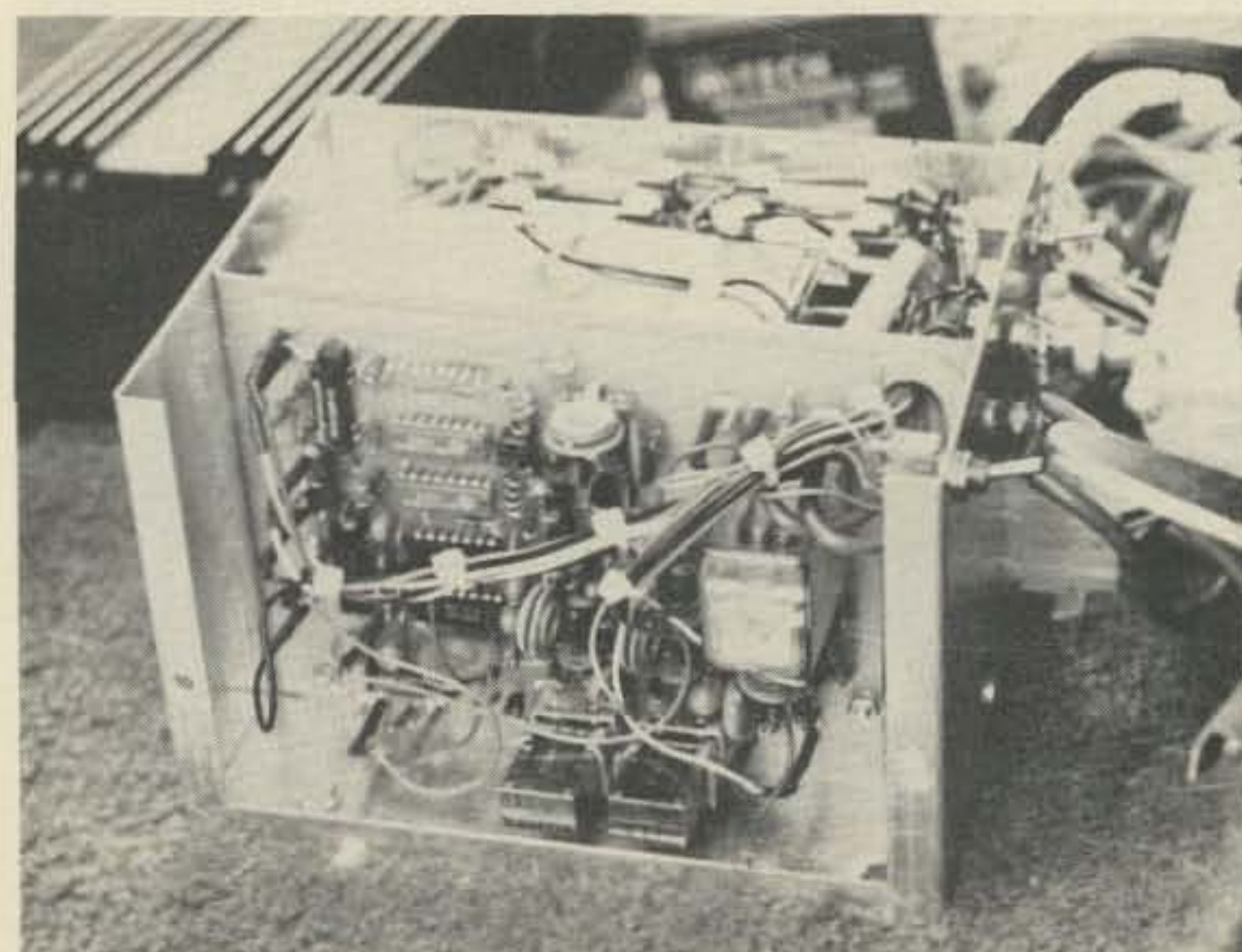

Alarm system installed in car, with cover off.

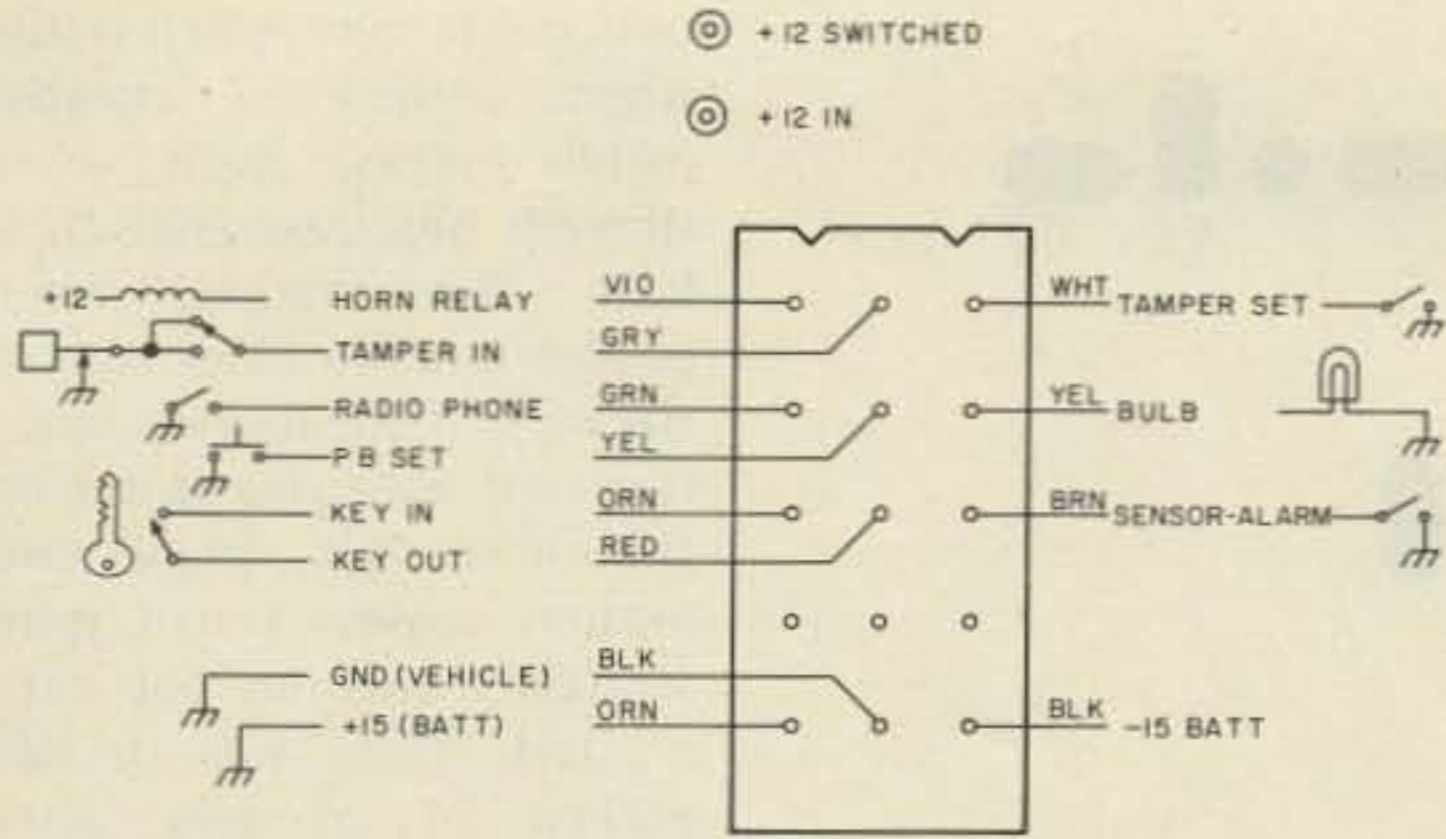

Fig. 5. Connector wiring. Connector as viewed from outside chassis; colors shown in interior wiring. Vehicle wiring color code: green — tamper set; yellow — tamper sensor; blue — sensor; violet — push-button set; white/violet — horn relay; white — headlight relay; black — indicator bulb; orange (teflon) — RCC phone.

indicating the alarm is set.

One other circuit is on the board and is a specialized circuit for my own use. With an RCC phone in the car, it has become desirable to have some form of paging occur if someone calls. Since the equipment was present, it seemed easy enough to add a simple circuit to have the alarm call the paging receiver.

When an RCC operator decodes me, a decoder in the RCC radio provides a relay closure to ground. The output of this is tied to isolating relay K1, an SPST relay. This grounds K2, turning on the system and the regular page tones are sent. As explained before, the second page tone sets off the pager receiver's alert tone, which stays on as long as the

second tone is transmitted. However, with Q1's emitter grounded by K1, when the base goes high, the collector inhibits the clock input to U2 so that the second page tone will stay on as long as the operator pages me, thereby triggering a continuous alert tone in the pager.

This portion of the circuit is useful if you have RCC or ham decoders, such as touch-tone or PL, which are activated when someone calls you.

We thus have three modes of operation for the paging alarm, identifiable by means of the types of tones out of the pager:

1. A pulsed tone after the alert — Someone is either tampering with the car or an object has hit it, possibly a

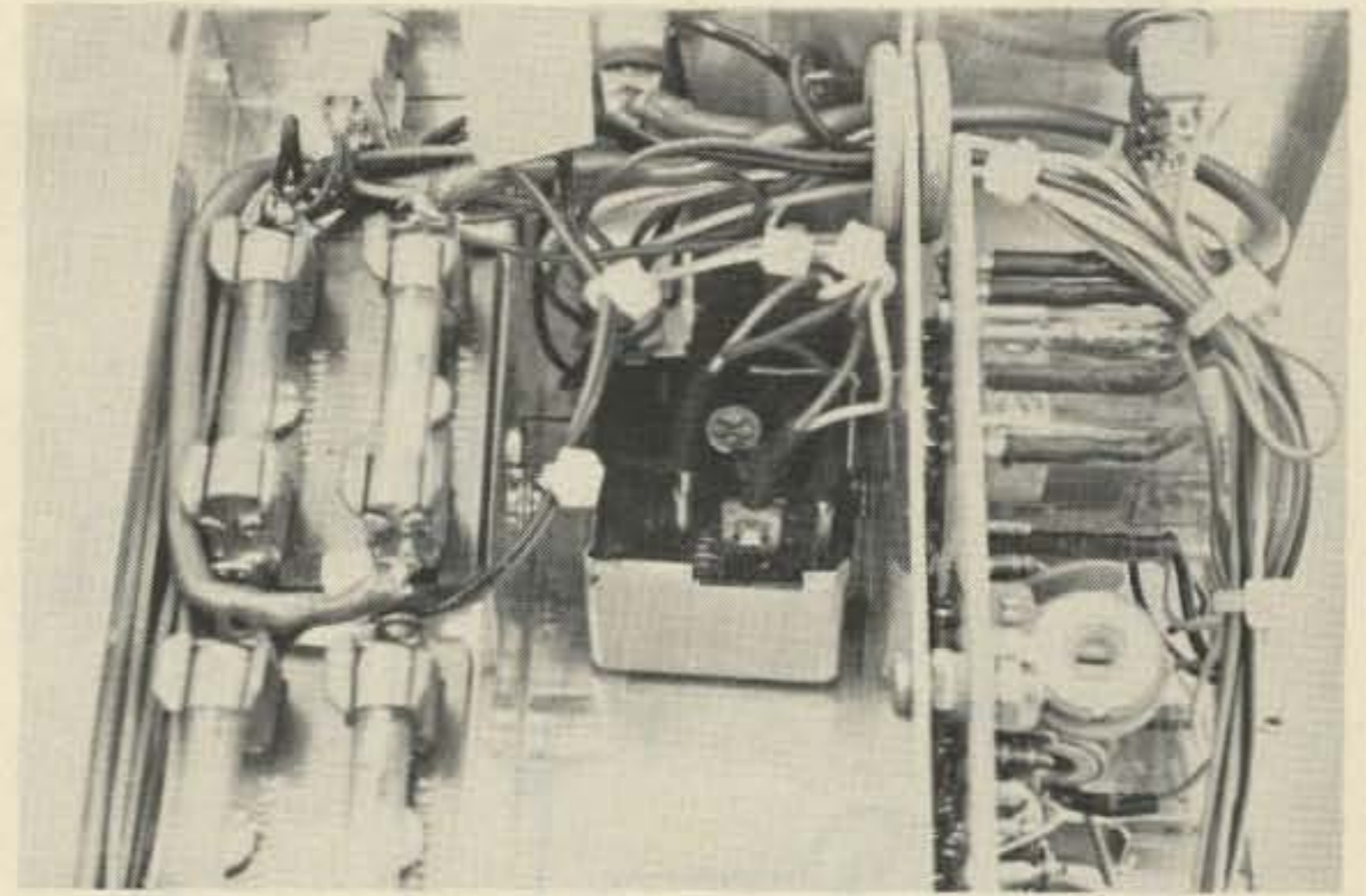

Close-up of battery compartment. Note VW relay, 15 conductor plug through to outside, fuses, and logic board mounting.

truck.

2. A steady tone after the alert — Overt action has been taken and entry has been gained, or the above truck totaled your car.

3. A repeating alert signal only — You have just been called on one of the car radios.

Construction was in an LMB 6" x 5" x 4" minibox (#AMC 1007). Two sub-chassis were bent to fit within the box and used to hold the transmitter and circuit boards (see photos). The battery pack is in between the two. Use was made of Waldom PC card terminals for easy servicing. At each labeled input/output pad, Waldom pins (#R-62-3) were used. The connecting wires had crimp-on sockets (#0206 1103) and

were routed to a Waldom plastic 15 circuit connector shell on the outside of the housing, mounted through into the battery compartment. Also located in the battery compartment is the VW headlight dimmer relay (P/N 803941589). This relay is a mechanical latching type so that a single momentary pulse to the coil will turn it on or off. One contact goes to the +12 fuse (Fig. 3) and the other goes to the "key in" on the PC board. A hidden push-button switch may then be used to turn the alarm on or off from anywhere outside the car, in addition to having a more cumbersome (and secure) key switch.

Also mounted through into the battery compartment

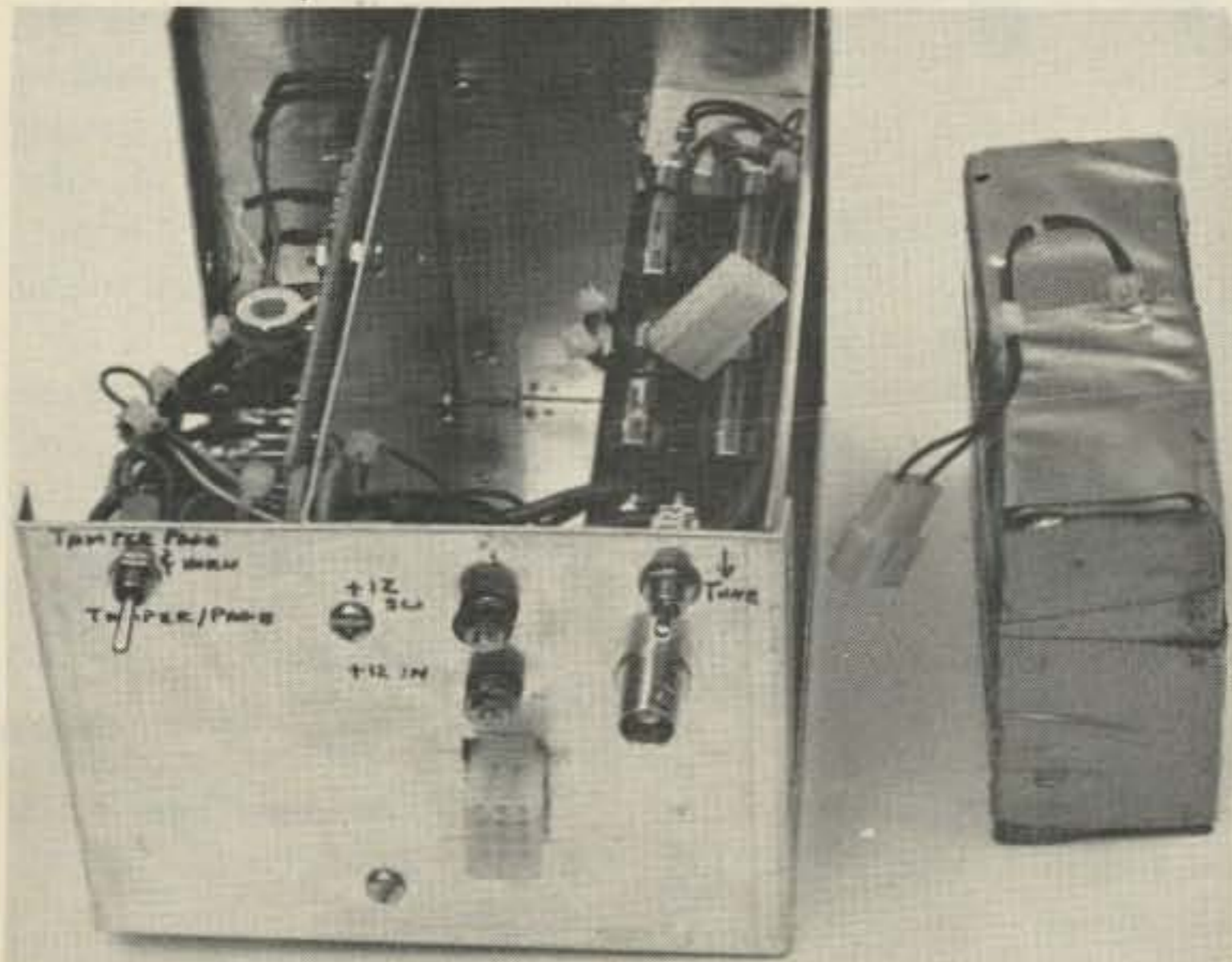

View of completed unit. Note battery pack and connectors.



The automobile installation. The light is "on" when the alarm is not set. Of the two switches, the left, when pushed down, sets the tamper delay. When in the up position, the tamper alarm is on. The switch on the right controls another circuit in the car.

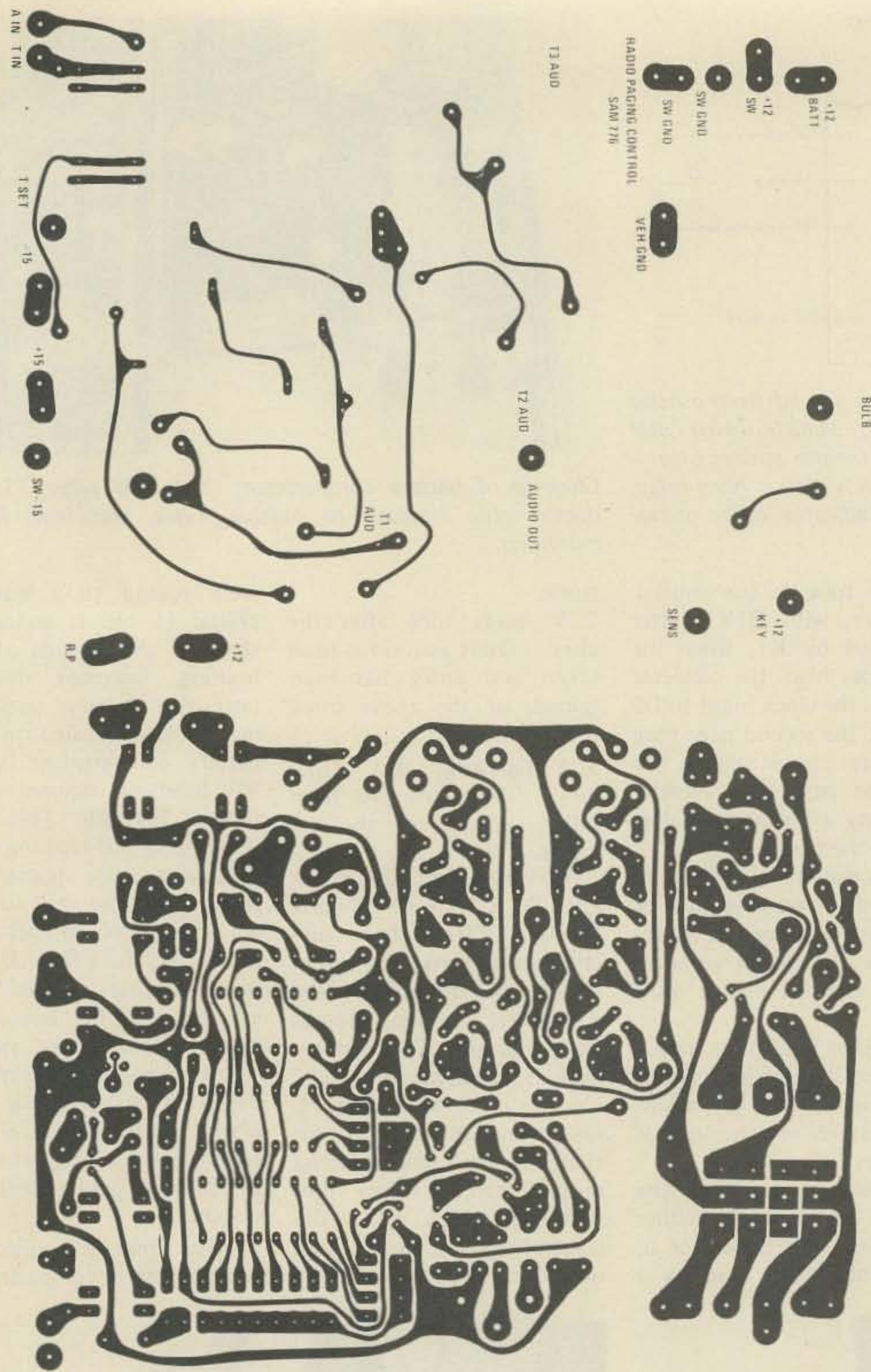

Fig. 6(a). PC board.

above the Waldom connector shell are two #8 screws with fiber washers to insulate them from the chassis. A solder terminal is under each one. #14 wires are then soldered to these and go to the +12 input fuse and relay K4. These two terminals then pass the heavy current required by the siren.

The battery pack is a 15 volt, 1 Ah array made from 12 commercial 1 Ah 1.25 volt nicad cells. Since these were already available, I wired

them together in series and potted them in casting plastic, using an aluminum foil pie pan bent into a mold. These had solder tabs, but the flashlight "C" size will work every well with the plastic battery holders, which may be easily obtained, although they will take up more space.

Other sources of 15 volt batteries are Motorola HT-220 (omni) or HT-200 batteries, usually available for \$5.00 from hamfests. A contact arrangement will have

to be made up for these. For those of you with Motorola HTs, this is the very thing to use because you can use your HT chargers to keep the batteries up.

The battery ratings should be at least 500 mAh and 1 Ah is best. The larger the battery rating, the more time you can go between charging.

Two switches are mounted on the box. One is S2 (Fig. 3), which allows me to tune the transmitter by turning on the carrier alone. It is an

optional feature which is used when parked in crowded public areas, such as a summer bluegrass festival, or ham flea market, where people tend to sit or lean on the cars. If the motion sensor is set off with this switch on, the horn will blow until motion ceases. I had many scratch marks on one car I owned that was usually parked in an area where people used to wait for buses. They wore exposed key rings and would lean back or sit on the car, leaving many deep scratches. It's very hard to sit on the hood of a car when the horn is blowing.

The double-sided PC board has been laid out for small components. Tantalum capacitors were used wherever there was a potential temperature problem (such as in the timing circuits) and also because of their size. CK05 capacitors were used in other locations for bypass and noise padding. Other types can be used, but judiciously, to prevent variation in clock speed, deviation, etc., with temperature. Ceramic disc bypass capacitors can be used if they are the 25 volt size to fit the layout.

After the board has been completed, you will need an audio amplifier and a 10 to 15 volt source to check it out. Begin by setting all controls to their midrange. Attach the hot lead of the amplifier to the point marked "Audio," +15 volts to the "+15" input, and -15 volts to the "-15" input. Also, attach the ground lead of the amplifier to the "-15" input, and connect a clip lead to the +15 volt battery lead.

Using a VOM connected between -15 and the junction of R7 and D3, connect the free end of the clip lead to the "A" input. The VOM should indicate 6 to 7 volts, although higher readings are permissible. Next, move the probe to the junction of R8 and D4 and check for 12 volts here.

At the same time, as you connect the clip lead to the A

input, you should hear a faint clicking noise from the audio amplifier and, after a short delay, you will hear the page tones followed by a steady alert tone. If this does not happen, the clock may be running too slow. Adjust pot R1, the clock adjustment, to a point at which something starts to happen with the tones.

Move the clip lead from the "A" input to the "T in" input and pulse it at a 2 or 4 pps rate by tapping the clip against the post. The voltage at R7 and D3 should be constant and the paging sequence should start as before. The only difference will be the alert tone, which will be pulsing rather than steady.

Now attach the clip lead to the "T in" post and adjust R1 for a one second 1st page tone or a 1/2 second on, 1/2 second off alert tone. Momentarily ground (-15) the "T set" input and insure that the voltage at R7 and D3 goes to zero until you *momentarily* release the clip lead from the "T-in" post. This indicates the tamper delay is working.

After the clock is adjusted and the circuit is performing correctly, check the radio call feature. Connect a clip lead between the "-15" input and "RP" input. Then connect another clip lead between the point marked "+12" (next to the "RP" input) and "+15". You should hear the two page

tones; however, the second tone will stay on for as long as you have the clip leads attached.

Assembly is simple and straightforward. The minibox bottom is divided into three equal parts by two subchassis bent to fit into the interior. Between the outside of the box and fastened to one subchassis is the control board. A hole punched into this subchassis allows the wires from the various pin connectors to be routed to their various destinations, mostly the 15 pin Waldom connector in the battery compartment.

The other subchassis holds

the transmitter board between it and the other side of the minibox. Power and audio is fed to it through two feedthrough capacitors. You will note in the photographs that this subchassis is bent to provide a ledge holding the feedthrough caps and the fuse holders. One set of fuses are spares.

The antenna connector is mounted through to the transmitter compartment and a short piece (about 1/2 inch) of #18 stranded wire attaches to the antenna output of the transmitter board.

The battery compartment in the center holds the VW

latching relay as well as the batteries. Depending on the size of the batteries you use, this may be otherwise empty with the batteries external to the box. If 12 "D" or "C" cells are used, the box will have to be larger. Another alternative is to use a large dry 15 volt "electronic equipment" battery, external to the box, making connections through the 15 pin connector.

After completion of the wiring and mechanical assembly, plug in the batteries with the 1 Amp fuse removed. Check with a milliammeter to insure that

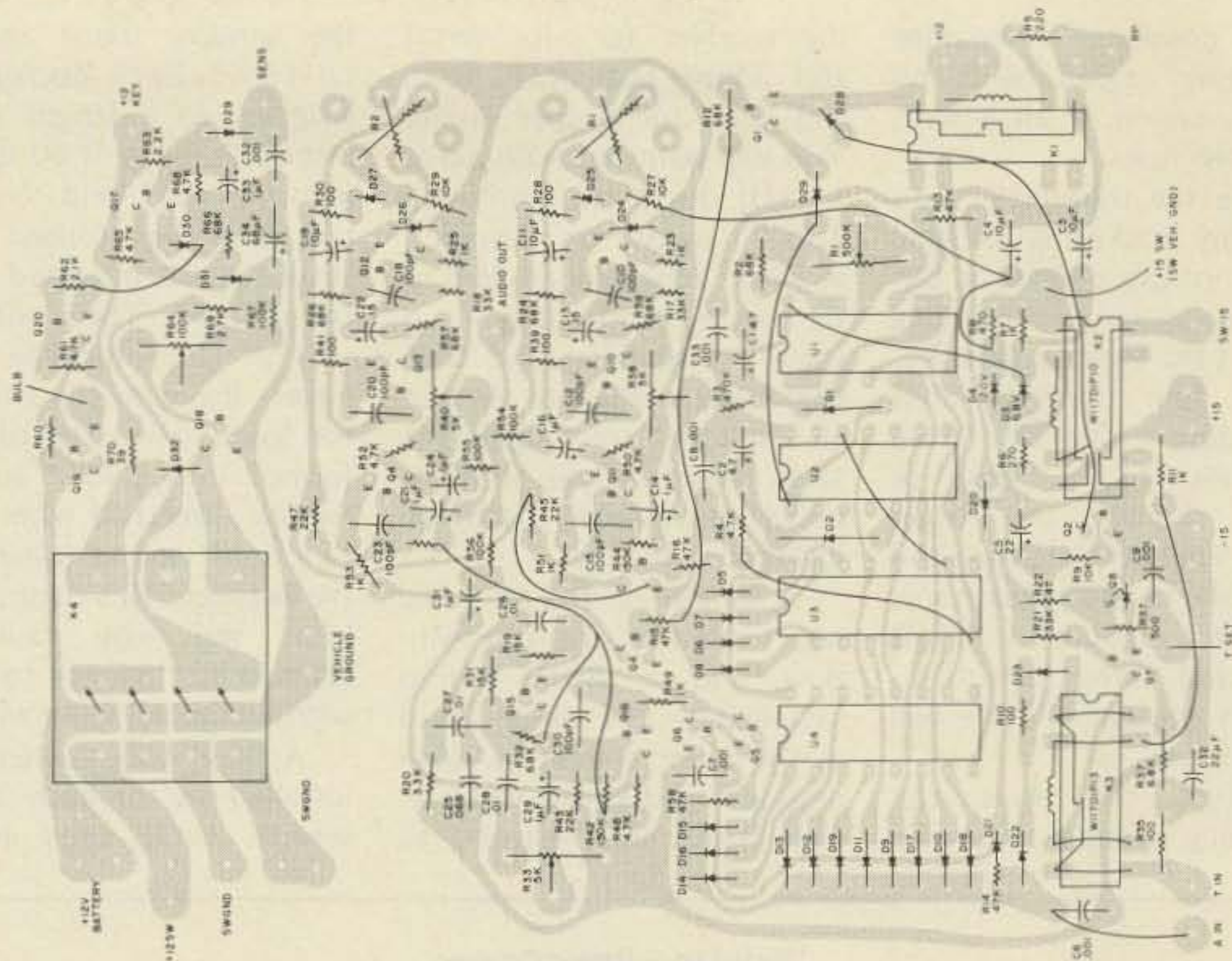
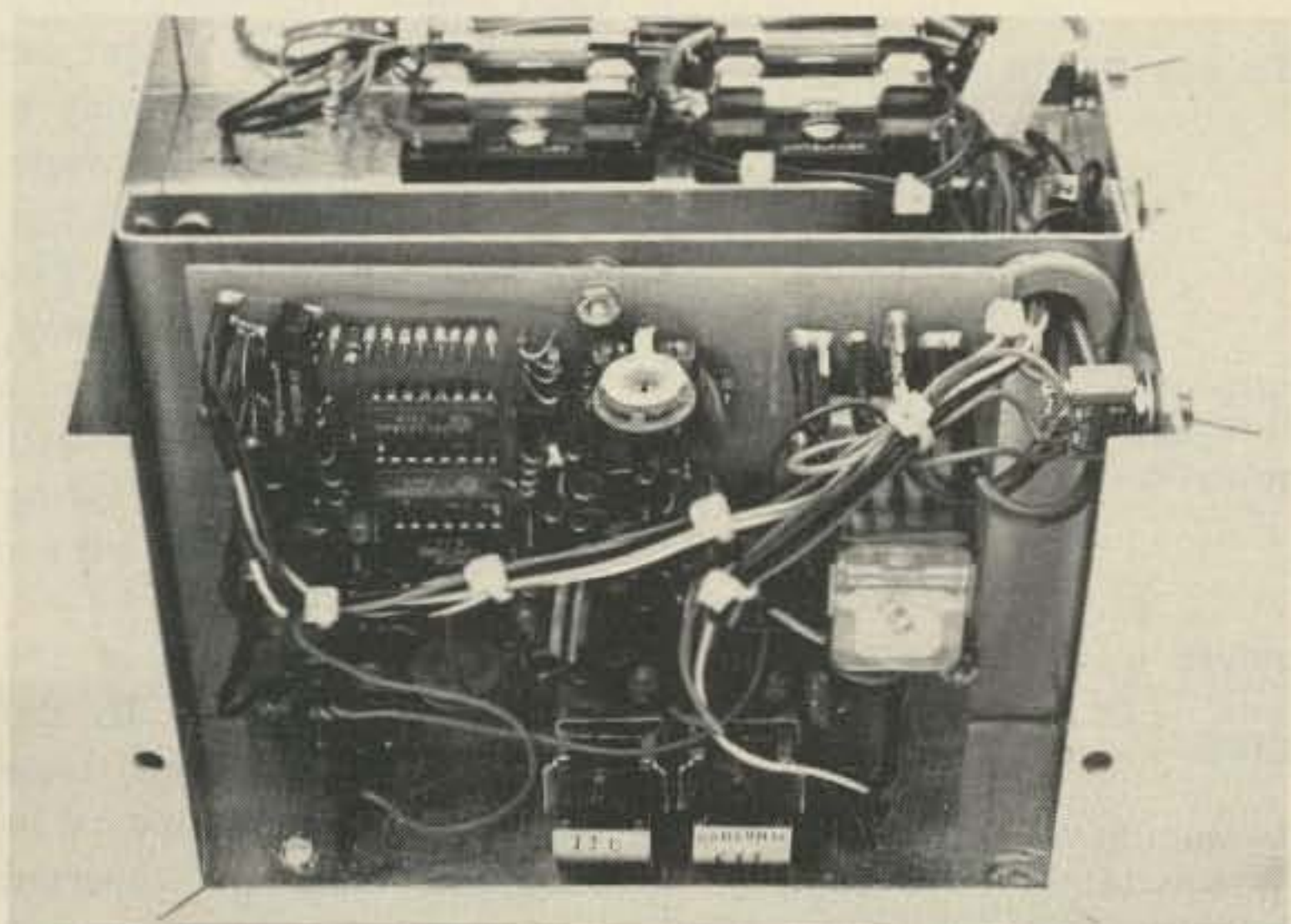
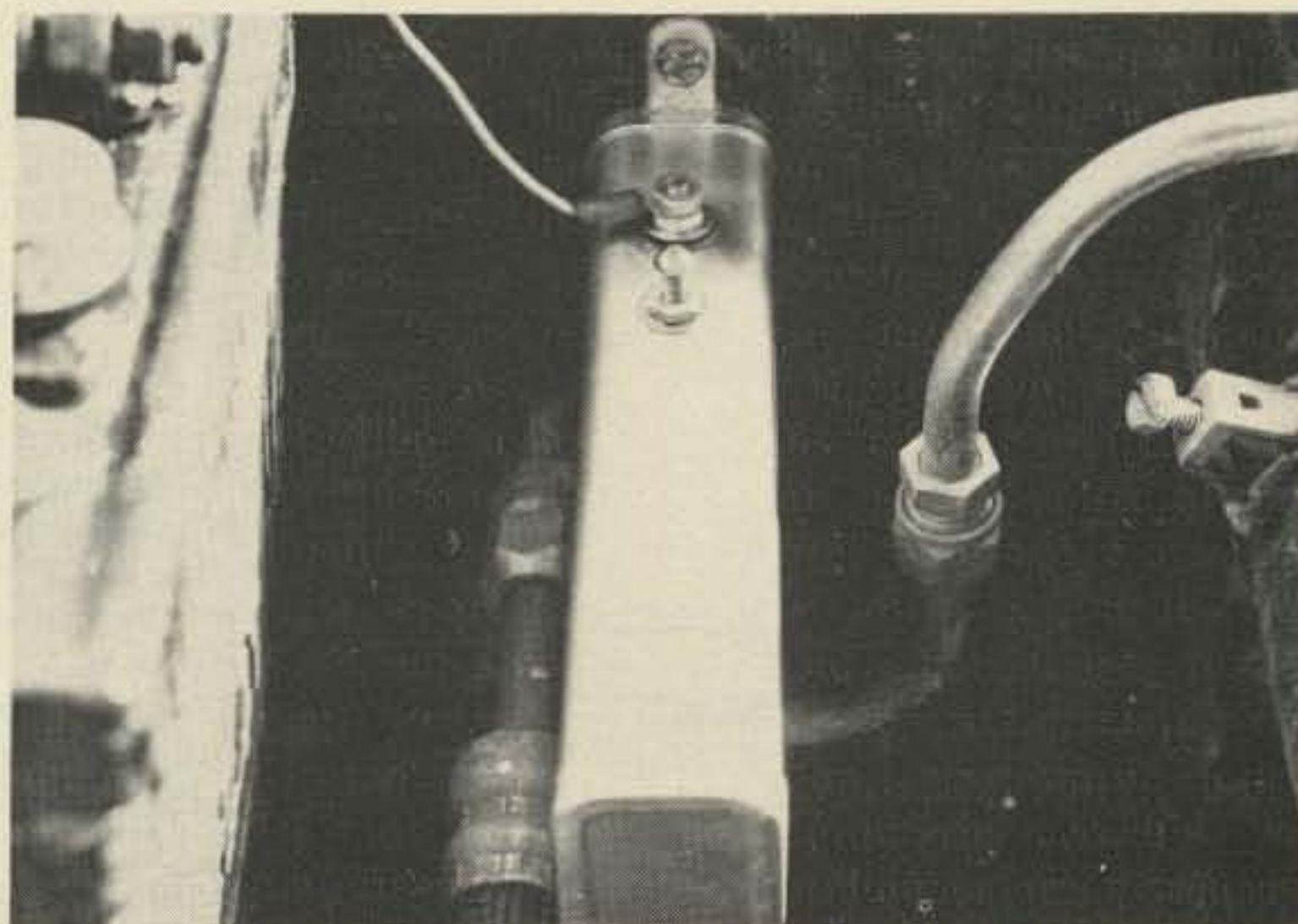

Fig. 6(b). Component layout.



View showing subchassis mounting.



One of the tamper sensors mounted in place in the engine compartment.

only a couple of microamps are being drawn with no inputs enabled. If all is well, install the fuses.

Tune the transmitter into a dummy load using the tune switch. At this point, you can check operation of the paging alarm if the pager is close by. About four seconds after connecting a clip lead from the chassis to the "A in" or "T in" inputs, the pager should emit its alert tone and sound the identification tone. If the circuit is left connected, after about 15 seconds the entire cycle will repeat itself.

Adjust the transmitter frequency trimmer to zero on

the receiver (or vice versa) and adjust pots R38, R40, and R33 for proper audio. You will want to ideally be at ± 5 kHz deviation, but if you don't have a deviation monitor, adjust for as close to the same audio level as a voice transmission and then check with a scope to see that all the tones are roughly the same. After making sure the unit is operational, it may be installed in the car.

A length of RG-58 cable was routed to the rear window and a metal clamp attached to the outer shield at the point where the cable emerged next to the window. The clamp was fastened to

the window frame and the solid inner conductor stripped to a length of 20 inches. A piece of 50 lb. test nylon fishline held this wire taut and was routed to a small bracket mounted above the window. Then, with the aid of a through-line wattmeter, the wire was trimmed for lowest swr. The top was formed into a loop and the fishline stretched from there to a small spring fastened to the bracket. This method has kept the wire taut yet allowed for parcels to hit it without breaking the wire.

A key lock switch was installed on the body of the vehicle and is used in high

risk areas, where the hidden push-button may not be as secure. The wires to this switch are routed to the 15 pin connector on the alarm chassis. See Fig. 4(e).

A momentary-on push-button switch was mounted in an easy-to-get-to yet unostentatious place on the outside of the car. In low risk areas, this switch is used exclusively as it allows quick and easy setting/unsetting of the alarm without the usual fumbling for the keys. The status bulb is located within the car on the dash. As mentioned before, when it is "on", the alarm is not set, and when it is out, the alarm is set. This prevents an occasional uninterested glance inside by passersby to change to an interested glance when they notice a green light glowing.

The switch for the tamper alarm set/reset function is also on the dashboard. This is a center off DPDT switch with a spring return in one position, and "on" in the other position. Depressing the switch momentarily, then quickly switching to the "on" position sets the tamper delay and readies the circuit so that when all preliminary motion has ceased, any further motion will sound the alarm.

The tamper sensors are made by Empire. Mine were obtained at a discount auto parts store. The term "discount" does not apply here because they cost \$10.00 each and consist merely of a flat spring with a weight on one end. The whole thing is mounted in a small enclosure with the spring supported at one end. When the surface to which it is attached is moved, the weight causes a pendulum-like effect and brings the grounded spring into contact with an adjustable screw contact.

One characteristic of the motion is that due to the force against the screw contact, a small secondary or harmonic motion is imparted to the spring. As the car is driven to a halt and the alarm

Parts List — Paging Counter

U1	CD4011
U2	CD4024
U3, U4	CD4028
Q1, Q2, Q3, Q4, Q5, Q6, Q7	NPN 2N3904, HEP S0025, etc.
Q8	SCR 2N5061, HEP R1001, etc.
Q9, Q10, Q11, Q12, Q13, Q14, Q16	NPN 2N3565, HEP S0015, etc.
Q15	NPN S0015 HEP
D1, D2, D5-D28	1N914, 1N4148, etc.
D3	Zener, 6.8 volt, ¼ Watt
D4	Zener, 12.0 volt, ¼ Watt
R1	500k Potentiometer CTS X201R504B or equiv.
R2, R24, R26, R57, R59	68k ¼ Watt 10%
R3	470k ¼ Watt 10%
R4, R48, R50, R52	4.7k ¼ Watt 10%
R5	220 ¼ Watt 10%
R6	270 ¼ Watt 10%
R7, R11, R23, R25, R49, R51, R53	1k ¼ Watt 10%
R8	470 ¼ Watt 10%
R9, R27, R29	10k ¼ Watt 10%
R10, R28, R30, R35, R39, R41	100 ¼ Watt 10%
R12	100k ¼ Watt 10%
R13, R14, R15, R16, R58	47k ¼ Watt 10%
R17, R18, R21	33k ¼ Watt 10%
R19, R31	15k ¼ Watt 10%
R20	3.3k ¼ Watt 10%
R22	47 ¼ Watt 10%
R32, R34	6.8k ¼ Watt 10%
R33, R38, R40	5k Potentiometer, CTS X201R502B
R37	300 ¼ Watt 10%
R42, R44, R46	150k ¼ Watt 10%
R43, R45, R47	22k ¼ Watt 10%
R54, R55, R56, R57	27k ¼ Watt 10%
R36	deleted
C1, C2	4.7 uF Tantalum electrolytic
C3, C4, C11, C19	10 uF Tantalum electrolytic
C5, C32	22 uF Tantalum electrolytic
C6, C7, C8, C9, C33	.001 Disc or CK05
C10, C12, C15, C18, C20, C23, C30	100 pF Ceramic disc
C13, C22	.1 Ceramic disc
C14, C16, C21, C24, C29, C31	1 uF Tantalum electrolytic
C25	.068 Ceramic disc
C26, C27, C28	.01 Ceramic disc or CK05
K1	SPST-NO DIP relay Magnecraft W107 DIP 5
K2	DPST-NO DIP relay Magnecraft W117 DIP 10
K3	SPST-NC DIP relay Magnecraft W117 DIP 13

set, the motion sensors gradually settle down. At some point, the motion of the spring will stop completely as the forces on it approach 180 degrees, and then it will start up again momentarily. The tamper delay circuitry senses this initial stop and unsets the delay, so that the tamper alarm will sound momentarily when the contacts close again. This is dependent to an extent on the sensitivity of the motion sensor, but serves as a handy check on the operation. Usually you are at your destination by the time the tamper circuitry arms itself, and you can tell if the beeper goes off whether or not you are too far away or if the unit is not working.

Additionally, these motion sensors are affected by temperature. If the sensitivity is set too close and the unit then heats up, such as after driving, it may be closed by the time you drive to your destination. If you then set the tamper delay, it will never release until the car cools off and the contacts release, which could take hours. The short beep you will usually hear is an indication that all is well.

Another check is made when you enter the vehicle. The action of opening a door and sitting on the seat should be enough to set off your beeper and the switch may then be turned off.

If you don't have your beeper with you one day, or other members of your family drive your car, a Sonalert hooked up as shown in Fig. 4(c) will remind them that you are transmitting if it sounds. It's very hard to be in the same car with a working Sonalert, so your transmitter and batteries will be preserved.

The entire alarm box can be mounted anywhere convenient, provided the two switches can be reached with a minimum of trouble. In my Chevrolet "Suburban," it is under the folding rear seat and near the door so that

Parts List — Alarm	
Q17, Q19, Q20	2N3904 or equivalent NPN
Q18	MPS-A14 or equivalent Darlington NPN
D29, 30, 31, 32	1N914, 1N4148, etc.
R60, R62, R63	2.2k ¼ Watt 10%
R61, R64, R65	4.7k ¼ Watt 10%
R66	6.8k ¼ Watt 10%
R67	100k ¼ Watt 10%
R68	500k Pot CTS X201R504B
R69	2.7k ¼ Watt 10%
R70	39 1 Watt
K4	4PDT Magnecraft W77CSX-1 or equivalent
C32A	.001 Ceramic disc or CK05
C33	1 uF Tantalum
C34	68 uF Tantalum

servicing is easy and the switches are within easy reach. The individual wires from the mating 15 pin conductor are made up into a harness with wire ties and run to the front of the car, where connections are made to the various devices. With this harness, a #14 gauge wire is also run, which connects to the battery terminal at the starter solenoid. This wire connects to the "+12 input" in the box. Another length of #14 wire goes from the "switched +12" terminal on the box to the power switch on the electronic siren. The function switch on this siren is set to the "yelp" mode.

The transmitter to be used is left up to the user. My version, as said before, uses the GE Voice Commander II board. The VC II or VC III are okay, and HT-200 boards are available at hamfests very inexpensively. If you cannot locate any of these, VHF Engineering sells an inexpensive kit which is 12 volt negative ground. Since it will not work directly with the positive ground arrangement used with the circuit board, a small relay should be used to switch the transmitter on or off by placing the contacts in series with the vehicle battery or an auxiliary 12 volt battery.

The operating frequency of the transmitter and pager must be judiciously chosen. 146.94 is too popular, repeater input frequencies are frowned upon, and use of the

commercial bands is a definite no. A choice could be 147.015, 146.475, or any other offbeat frequency. 146.94 was used in my first version with the HT-220 because I didn't want to "waste" a crystal position. When I switched to the pager, I kept this frequency at first; however, at hamfests .94 would be disrupted if someone leaned against the car and, at one, the special .94 repeater covered up my alarm signal completely.

At the time of writing, this new unit has been installed for two years and has exhibited complete reliability. The present car (bought two years ago) has been broken into 8 times. Six times the alarm went off as they opened the doors (I keep them unlocked to prevent breakage). Twice the tamper alarm went off in the middle of the night and as I hurriedly threw my clothes on, the pulsed tone changed to a steady tone and all hell broke loose outside. The thief in these cases had pried open a vent window without trying the door first, rolled the main window down, and opened the door by reaching inside. The motion circuitry detected the break-in and the alarm sensors detected the opening of a door.

Certain tamper signals have also alerted me to the fact that various things were happening. Once I caught a person trying to parallel park in front of me in a space too

small for his car. He backed into me and tried to push my car back, a poor thing to do to an automatic transmission left in park. Two children climbing on my car with hard shoes on were asked to get off, and other miscellaneous unintentional nudgings and movements were detected as they happened.

The battery gets charged overnight every two months or so, but rarely needs it. I charge these 1 Ah cells at a steady 100 mA and temporarily use a standby battery for protection.

Another use for a device like this is to build it into a larger chassis with an antenna attached and with built-in motion detectors. The unit is then portable and may be simply placed on the seat or floor of a car, trailer, camper, etc., or hung from the door of a house. On a float, it can function as a wireless swimming pool alarm. Store owners with large, lit signs that get vandalized in the night can put one in the sign. One can be installed in a motorcycle, boat (with different sensors), private plane, etc. Since the pager receiver does not "hear" anything until after the two-tone page signal, it can be left on at all times, even while in the charger, and no irritating chit-chat or interference will ever be apparent. The range of the system is sufficient that a reliable alert will be heard to a radius of at least a mile. ■

WE HAVE WHAT YOU NEED AT...



YD-844
Dynamic Mike

YAESU

ADVANCED COMMUNICATION EQUIPMENT

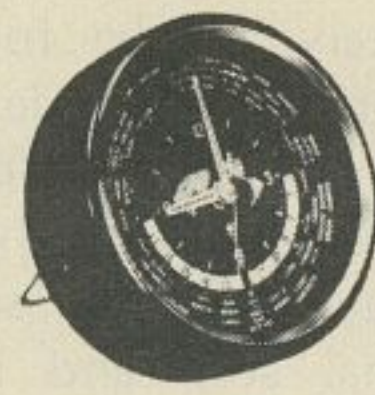

QTR-24
World Clock

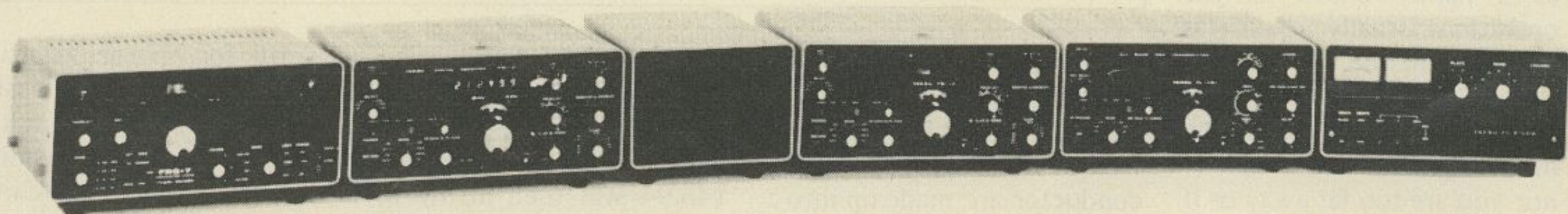

Left to right - FRG-7, Solid State Synthesized Communications Receiver • FR-101 Digital, Solid State Receiver • SP-101B, Speaker • FR-101, Digital Solid State Receiver • FL-101, 100 W Transmitter • FL-2100B, 1200 W PEP Input Linear Amplifier

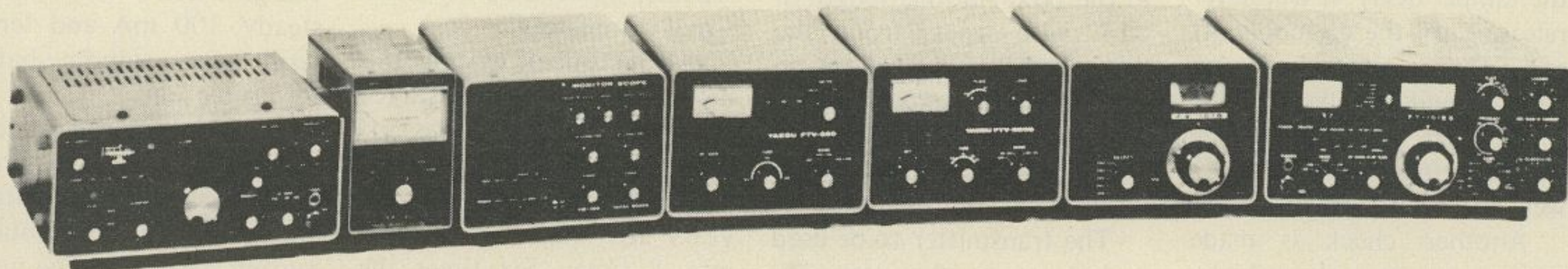

Left to right - FT-620B, 6 Meter Transceiver • YP-150, Dummy Load Wattmeter • YO-100, Monitor Scope • FTV-250, 2 Meter Transverter • FTV-650, 6 Meter Transverter • FV-101B, External VFO • FT-101E 160-10M Transceiver

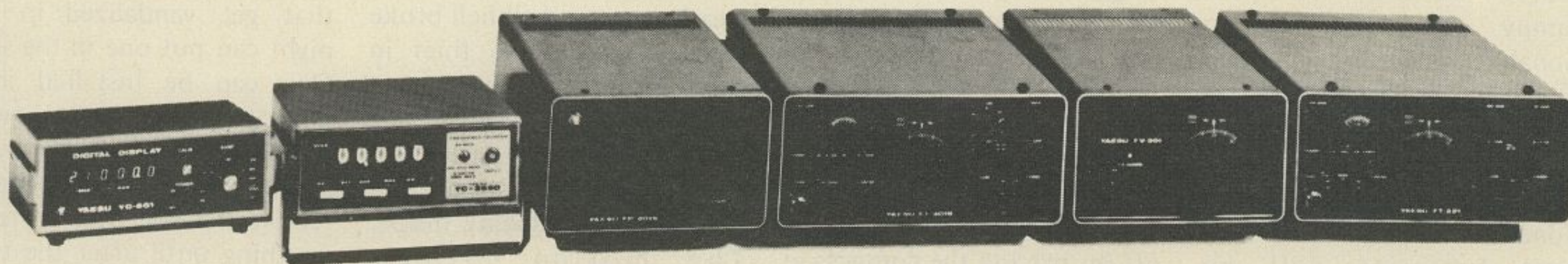

Left to right - YC-601, Digital Frequency Display • YC-355D, Frequency Counter • FP-301, AC Power Supply • FT-301S Digital, All Solid State Transceiver • FV-301, External VFO • FT-221, 144-148 All Solid State All Mode Transceiver

USED GEAR • TRADE UP • FREE UPS SHIPPING ON PREPAID ORDERS

\$2,000,000 HAM INVENTORY

HAMTRONICS-WHERE THE HAM IS KING

THE LOWEST POSSIBLE PRICES

KENWOOD

THE PACESETTER IN AMATEUR RADIO



TS-700A \$599.00

2M ALL MODE BASE/MOBILE TRANSCEIVER. SSB (upper and lower), FM, AM and CW. AC and DC. 4 MHz band coverage (144 to 148 MHz). Dial in receiver frequency and TS-700A automatically switches xmitter freq. 600 KHz for repeater operation. Xmit, Rcv capability on 44 Ch. with 11 xtals.



TR-7400A \$399.00

2M MOBILE TRANSCEIVER. Synthesized PLL. Selectable output, 25 watts or 10 watts. 6 Digit LED freq. display. 144-148 MHz, 800 CH. in 5 KHz steps. 600 KHz repeater offset. Continuous tone-coded squelch (CTSC). Tone Burst.



TS-820 \$869.00

SSB TRANSCEIVER. PLL RF Monitor Noise Blanker. Digital hold locks counter & display at any frequency, but allows VFO to tune normally. True RF compressor adjustable speech processor. IF shift control. RF attenuator. VOX, GAIN, ANTIVOX and VOX delay controls. RF negative feedback. Optional digital readout. DRS Dial. High stability FET VFO.



TS-520S \$649.00

SSB TRANSCEIVER. Proven in the shacks of thousands of discriminating hams, field day sites, DX and contest stations and mobile installations. Superb engineering and styling.

SP-520 \$22.95

Optional external speaker for better readability.

TV-502 \$249.00

TRANSVERTER. Puts you on 2M the easy way. 144-145.7 MHz or optional 145-146 MHz.

PS-5 \$79.00

POWER SUPPLY FOR TR8300. Designed especially for home QTH.



TR-7200A \$249.00

2M MOBILE/BASE FM TRANSCEIVER. Ignition interference control. 2 pole Xtal filter in IF rcvr. Protection for final stage transistor & reverse polarity connections. Priority Ch. switch. Quick release mount. LED CH. indicators. Switchable 10W or 1W output.



MC-50 \$39.50

Dynamic microphone designed expressly for amateur radio operation. Complete with PTT and LOCK switches, and a microphone plug. (600 or 50k ohm)



COMMUNICATIONS RECEIVER. 1.8 to 29.7 MHz, WWV and CB band. 50 MHz, 144 MHz converter optional. Stable VFO & oscillator for 5 fixed channels. 1 KHz dial readout. Xtal filters (SSB/8 pole, CW/8 pole, AM/6 pole). Squelch. S meter. Noise blanker.

S-599-\$19.94 R-599A-\$459.00 T599D-\$479.00

SSB TRANSMITTER. 3.5 to 29.7 MHz. Stable VFO. 1 KHz dial readout. 8 pole Xtal filter. AM Xmission available. Built-in AC pwr supply. Split frequency control available.



VFO-820 \$145.00

Designed exclusively for use with TS-820. RIT circuit and control switch. Fully compatible with optional digital display.

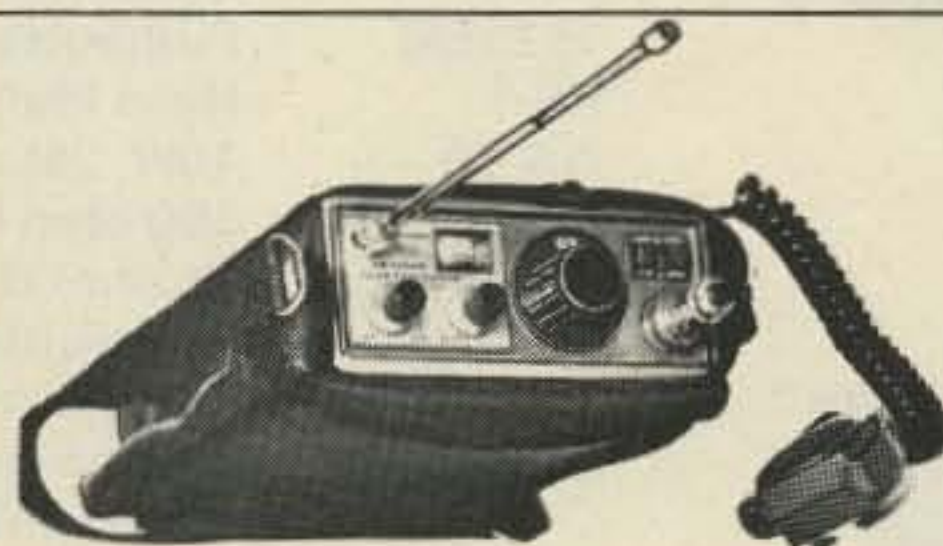

TR-2200A \$229.00

PORTABLE 2M FM TRANSCEIVER. 12 Ch. capacity. Removable telescoping antenna. External 12 VDC or internal NI-CAD batteries. 146-148 MHz. 6 CH. supplied. Switchable 2W or 400mW output.



R-300 \$239.00

ALL BAND COMMUNICATIONS RECEIVER. AC, batteries or external DC. 170 KHz to 30 MHz in 6 bands. Foreign broadcasts or ham radio in AM, SSB and CW. Dual gate MOS/FET transistors & double conversion. Band spread dial. 500 KHz marker.

VFO-520 (Not Shown) \$116.00

Solid State Remote VFO. RIT circuit with LED indicator.

MASTERCHARGE & BANKAMERICARD ACCEPTED

DIVISION OF TREVOSÉ ELECTRONICS

THE BIG 'H' FOR ALL YOUR HAM NEEDS!

WE HAVE WHAT YOU NEED AT...



DRAKE®

KNOWN FOR QUALITY THROUGHOUT THE WORLD



RECEIVERS

SSR-1	General Coverage, .5 to 300 MHz	\$350.00
SPR-4	Programmable, Solid State	\$629.00
DSR-2	VLF-HF Digital Synthesized SSB, AM, CW, ISB, RTTY	\$2950.00
R-4C	C-Line. HF. 160-10M	\$599.00
4NB	Noise Blanker for R-4C	\$70.00
5NB	Noise Blanker for SPR-4	\$70.00

TRANSMITTER

T-4XC	C-Line. HF. 160-10M	\$599.00
-------	---------------------	----------

TRANSCEIVERS

TR-4CW	80-10M. SSB, AM, CW	\$699.00
TR-33C	2M, FM, 12 CH. Portable	\$229.95
MMK-33	Mobile/Dash/Desk Mount for TR-33C	\$12.95
34PNB	Plug-In Noise Blanker for TR-4 Series	\$100.00
MMK-3	Mobile Mount for TR-4	\$7.00
RV-4C	Remote VFO for TR-4 CW	\$150.00
FF-1	Crystal Control for TR-4	\$46.95

SYNTHESIZER

FS-4	General Coverage for 4-Line and SPR-4	\$250.00
------	---------------------------------------	----------

LINEAR AMPLIFIER

L-4B	Linear and w/power supply & tubes	\$895.00
------	-----------------------------------	----------

MATCHING NETWORKS

MN-4	Antenna Matching Network. 200W	\$120.00
MN-2000	Antenna Matching Network. 1000W	\$240.00
RCS-4	Remote Control Antenna Switch	\$120.00

W-4	RF Wattmeter, 1.8 to 54 MHz	\$72.00
WV-4	RF Wattmeter, 20 to 200 MHz	\$84.00
7072	Hand Held Microphone	\$19.00
7075	Desk Top Microphone	\$39.00
1525EM	Pushbutton Encoding Microphone	\$49.95
HS-1	Head Phones	\$10.00
AA-10	10W, 2M Amplifier	\$49.95
TV-300-HP	300 ohm High Pass TV Set Filter	\$10.60
TV-75-HP	75 ohm High Pass TV Set Filter	\$13.25
TV-42-LP	Transmitter Low Pass Filter. 100W	\$14.60
TV-3300-LP	Transmitter Low Pass Filter. 1000W	\$26.60
TV-5200-LP	Transmitter Low Pass Filter. 1000W. 100W, 6M	\$26.60

USED GEAR • TRADE UP • FREE UPS SHIPPING ON PREPAID ORDERS

\$2,000,000 HAM INVENTORY

HAMTRONICS-WHERE THE HAM IS KING

THE LOWEST POSSIBLE PRICES

COLLINS AMATEUR EQUIPMENT



KWM-2A TRANSCEIVER \$3533.00
 Unmatched for mobile and fixed station applications. 175W on SSB, 160W on CW. Switch select up to 14 optional Xtals. Can be used for RTTY. Filter type SSB generation. Automatic load control. Inverse RF feedback. Reimability-tuned variable oscillator.

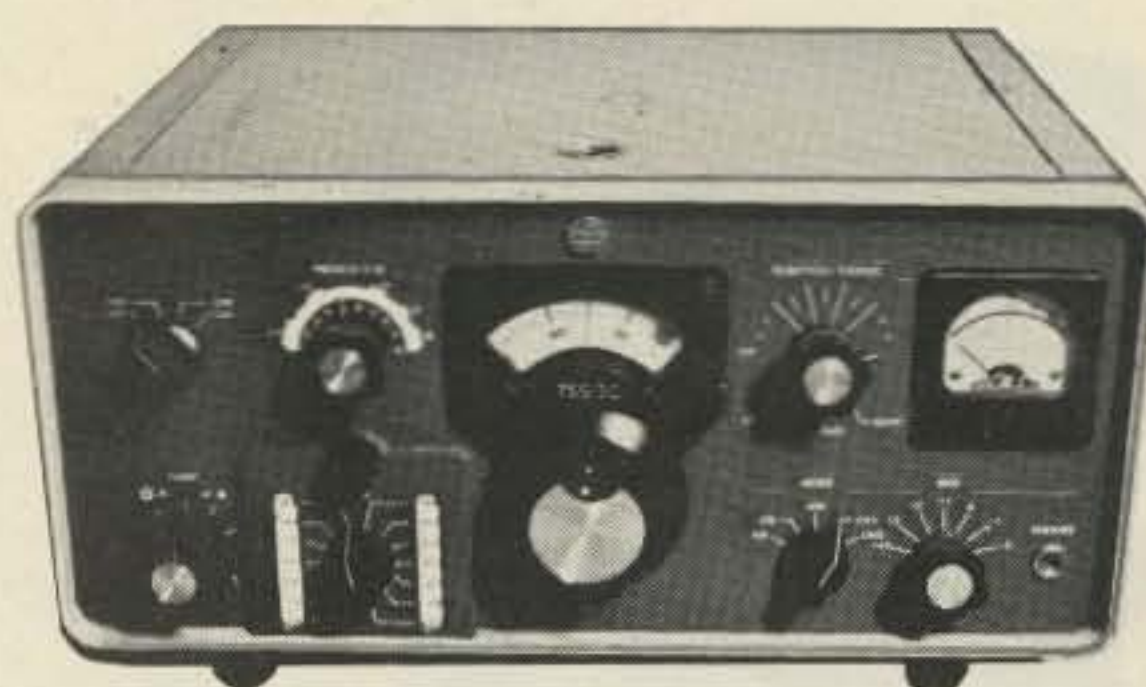

75S-3C RECEIVER \$2504.00
 Sharp selectivity. SSB, CW and RTTY. Single control rejection tuning. Variable BFO. Optional mechanical filters for CW, RTTY and AM. 2.1 KHz mechanical filter. Zener regulated oscillators. 3-position AGC.



32S-3A TRANSMITTER \$2597.00
 Covers all ham bands between 3.4 MHz and 30 MHz. Nominal output of 100W. 175W, SSB and 160W CW. Dual conversion. Automatic load control. RF inverse feedback. CW spotting control. Collins mechanical filter.

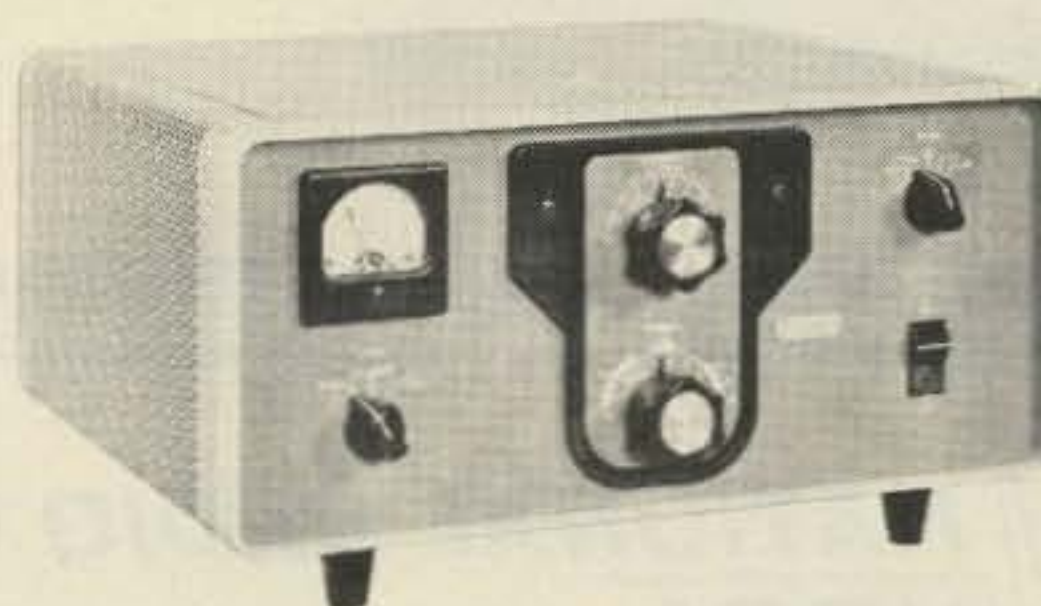

30L-1 LINEAR AMPLIFIER \$1536.00
 1000 watts PEP on SSB and 1000 Average on CW. Single control rejection tuning (50 dB). Variable BFO. 2.1 kHz Mechanical filter. Zener regulated oscillators. 3 position AGC. Exclusive comparator circuit.

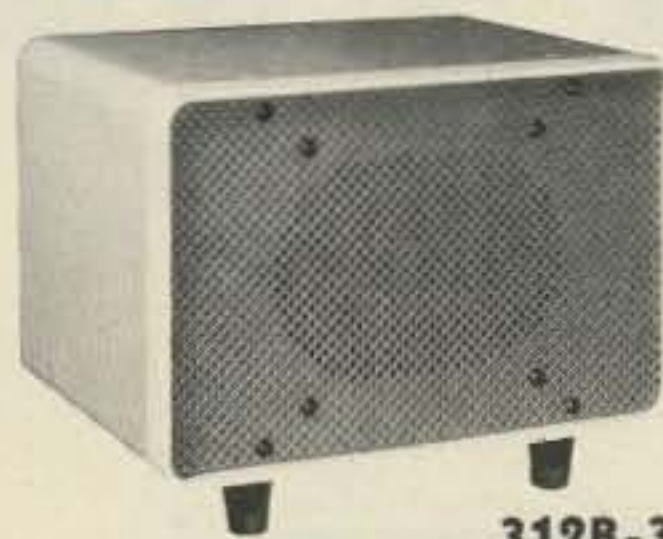

312B-3 SPEAKER
 \$80.00

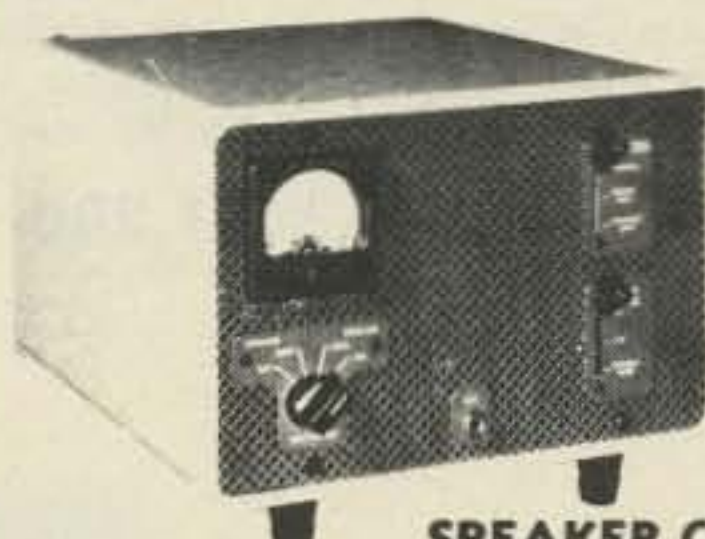

312B-4 SPEAKER CONSOLE
 \$546.00



312B-5 VFO CONSOLE
 \$1212.00

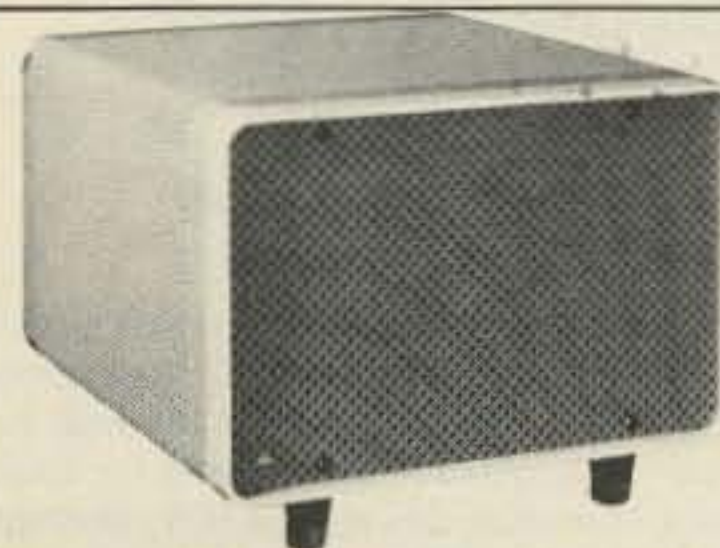

516F-2 AC POWER SUPPLY
 \$440.00



302C-3 DIRECTIONAL WATT METER
 \$360.00



DL-1 DUMMY LOAD
 \$270.00

THE BIG 'H' FOR ALL YOUR HAM NEEDS!

MASTERCHARGE & BANKAMERICARD ACCEPTED

HAMTRONICS

DIVISION OF TREVOSE ELECTRONICS
 4033 Brownsville Rd • Trevose, Pa. 19047

WE HAVE WHAT YOU NEED AT...

BIRD THRULINE® WATTMETER



MODEL 43

- BUY ONLY THE ELEMENTS YOU NEED AND ADD EXTRA RANGES AT ANY TIME
- READ RF WATTS DIRECTLY

Table 1
STANDARD
ELEMENTS

Power Range	Frequency Bands (MHz)					
	2-30	25-60	50-125	100-250	200-500	400-1000
5 watts	—	5A	5B	5C	5D	5E
10 watts	—	10A	10B	10C	10D	10E
25 watts	—	25A	25B	25C	25D	25E
50 watts	50H	50A	50B	50C	50D	50E
100 watts	100H	100A	100B	100C	100D	100E
250 watts	250H	250A	250B	250C	250D	250E
500 watts	500H	500A	500B	500C	500D	500E
1000 watts	1000H	1000A	1000B	1000C	1000D	1000E
2500 watts	2500H					
5000 watts	5000H					

Table 2
LOW-
POWER
ELEMENTS

1 watt	Cat. No.	2.5 watts	Cat. No.
60-80 MHz	060-1	60-80 MHz	060-2
80-95 MHz	080-1	80-95 MHz	080-2
95-125 MHz	095-1	95-150 MHz	095-2
110-160 MHz	110-1	150-250 MHz	150-2
150-250 MHz	150-1	200-300 MHz	200-2
200-300 MHz	200-1	250-450 MHz	250-2
275-450 MHz	275-1	400-850 MHz	400-2
425-850 MHz	425-1	800-950 MHz	800-2
800-950 MHz	800-1		

WE HAVE A COMPLETE STOCK OF ALL BIRD WATTMETERS AND SLUGS

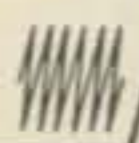

NATIONAL RADIO COMPANY, INC.

NRCI

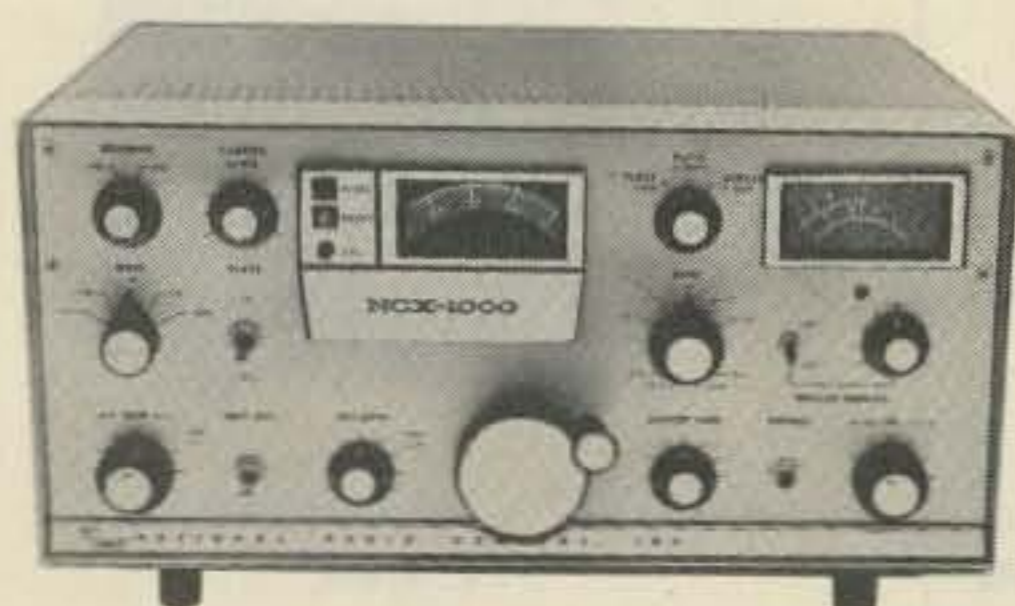

NCX-1000

The only 1000 watt, "single package" transceiver. Heavy duty design... results of 50 years of design leadership in amateur equipment. State of the art speech processing, linear amplifier, power supply, all in one package. Nothing extra to buy. Covers all amateur bands in the HF spectrum... AM, SS' CW' **\$1,600**

NCL-2000

Linear Amplifier. A full 10 dB gain. 20 watts in 2000 watts out. Can be driven with one watt. Continuous duty design utilizes two 8122 ceramic tetrode output tubes, designed for both AM and SSB operation. The industry standard for 12 years. Thousands in use all over the world.

\$1,200



HRO-500

The ultimate short wave receiver. This synthesized (phase lock loop) receiver incorporates all facilities for AM, Single Side Band (SSB), and CW reception in all frequencies from the bottom of the very low frequency band (VLF) to the top of the high frequency band (HF). National's "dead accurate" dial means no searching for transmissions. Dial up the frequency and it's there: aeronautical, marine, CB, amateur, military, etc. Continuous coverage. **\$3,000**

USED GEAR • TRADE UP • FREE UPS SHIPPING ON PREPAID ORDERS

\$2,000,000 HAM INVENTORY

HAMTRONICS - WHERE THE HAM IS KING

THE LOWEST POSSIBLE PRICES



ICOM

VHF/UHF AMATEUR & MARINE EQUIPMENT



VHF/UHF AMATEUR & MARINE EQUIPMENT

IC-245. 146 MHz FM 10W XCVR. LSI synthesizer with 4 digit LED readout. Xmit & Rcv frequencies independently programmable. 60 dB spurious attenuation.

\$499.00

IC-215. 2 METER FM PORTABLE. Three narrow filters for superb performance. 3W or 400 mW. 15 CH. capacity. MOS FET RF Amp & 5 tuned ckts. S-meter front panel.

\$229.00



\$249.00

IC-502. 6 METER SSB & CW PORTABLE XCVR. Includes antenna & battery pack. 3W PEP & stable VFO for fun & FB QSO's. Covers first 800 KHz of 6M band, where most activity is.



IC-211. 4 MEG, MULTI-MODE 2M XCVR. 144-145 MHz on SSB & CW, plus 146-147 MHz on FM. Work AMAT OSCAR six or seven. LSI synthesizer with 7 digit LED. MOS FET RF Amp, 5 helical cavities, FET mixer & 3 I.F. filters.

\$749.00



\$299.00

IC-22S. 145 MHz FM 10W XCVR. CMOS synthesizer can be set to any 15 KHz ch. between 146 & 148 MHz by diode matrix board. Spurious attenuation far better than FCC spec. 10W or 1W. IDC modulation control.



IC-21A. 146 MHz FM 10W XCVR. MOS FET RF Amp & 5 helical resonator filter, plus 3 I.F. filters. IDC modulation control. Variable output pwr: 500 MW to 10W Front panel discriminator meter. SWR bridge. 117 VAC and 13.6 VDC pwr supplies.

\$399.00

DV-21. DIGITAL VFO. Use with IC-21A to complete 2M band.

\$299.00



IC-202. 2 METER SSB PORTABLE XCVR. Puts sideband in your hand! Internal C batteries or external 12 VDC. 3W PEP. True I.F. noise blanker. 144.0, 144.2 on two other 200 KHz bands, selectable. Hamtronics stocks 145.2 and 145.8 - 146.0 MHz for calling frequency & satellite band.

\$259.00



IC-30A. 450 MHz FM LOW XCVR. 1W or 10W. Low noise MOS-FET RF Amp & 5 section helical filter. 22 CH. capacity. S-meter & relative power output meter. IDC modulation control.

\$399.00

THE BIG 'H' FOR ALL YOUR HAM NEEDS!

MASTERCHARGE & BANKAMERICARD ACCEPTED

HAMTRONICS

DIVISION OF TREVOSSE ELECTRONICS
4033 Brownsville Rd • Trevose, Pa. 19047

WE HAVE WHAT YOU NEED AT...

TEMPO

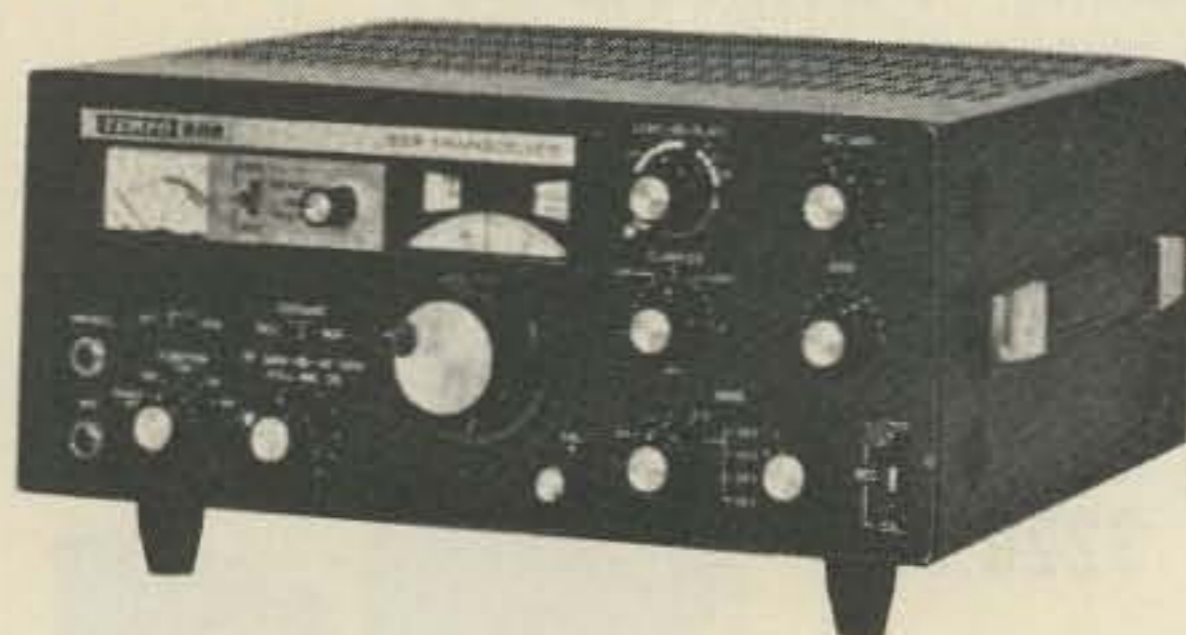

TEMPO ONE	HF Transceiver. 80-10M. USB, CW & AM	399.00
AC/ONE	Power Supply for TEMPO ONE	99.00
VF/ONE	External VFO for TEMPO ONE	109.00
TEMPO VHF/ONE	Transceiver. 2M. 144 to 148 MHz. PLL	399.00
TEMPO SSB/ONE	SSB Adapter for TEMPO VHF/ONE	199.00
TEMPO 2020	Transceiver. 80-10M. USB, LSB, CW and AM. PLL. Digital	759.00
FMH	2W, VHF/FM, 6 Ch. Hand Held. 144-148 MHz	199.00
RBF-1	Wattmeter & SWR Bridge	42.95
DM-20	Desk Mike. 600 or 50K ohm. PTT & Lock Switches	39.00
MS-2	4 Ch. Pocket Scanning Rcvr.	99.00

SWAN



700 CX	Transceiver. 700W PEP. SSB. 80-10M. USB, LSB or CW	649.95
VX-2	Plug-In VOX for 700 CX	44.95
SS-16B	Super Selective IF Filter for 700 CX	99.95
MARK II	Linear Amplifier Full Legal Power. W/100W input. 80-10 M.	849.95
1200 X	Portable Linear Amplifier. 1200W PEP. SSB. 700W, Ch. 300W, AM. 80-10M.	349.95
FP-1	Hybrid Telephone Patch. Connect Rcvr/Xmitter to Phone lines	64.95

ATLAS



210X	Transceiver. 10-80M. 200W	679.00
215X	Transceiver. 15-160M. 200W	679.00
OMK	Deluxe Mtg. Kit for 210X & 215X	48.00
220CS	AC Console for 210X & 215X	149.00
350-XL	Transceiver. SSB. Solid State. 10-160M. 350W.	995.00
DD6-XL	Digital Dial Readout for 350-XL	195.00
305	Plug-In Auxiliary VFO. For 350-XL	155.00
311	Plug-In Auxiliary Crystal Oscillator for 350-XL	135.00
350-PS	AC Pwr Supply w/Spkr & Phone Jack for 350-XL	195.00
DMK-XL	Mobile Mounting Bracket for 350-XL. Easy Plug-In	65.00



FC-76	Frequency Counter. 5 Digit LED	169.95
WM6200	In-Line Precision Wattmeter for 2M. 2 Scales to 200W. Reads SWR.	59.95
FS-2	SWR & Field Strength Meter	15.95
SWR-3	Pocket SWR Meter	12.95
SWR-1A	Relative Power Meter & SWR Bridge	25.95
W2000	In-Line Wattmeter. 3 Scales to 2000W. 3.5 to 30 MHz	59.95
WM-3000	Peak/RMS Wattmeter. Tells The Truth About SSB	79.95
FS-1	Pocket Field Strength Meter	10.95
WM1500	In-Line Wattmeter. 4 Scales to 1500W. 2 to 50 MHz	74.95
MARK II	Linear Amplifier. Full Legal Power. W/100W input. 80-10 M.	849.95
1200 X	Portable Linear Amplifier. 1200W PEP. SSB. 700W, CW. 300W, AM. 80-10M.	349.95

USED GEAR • TRADE UP • FREE UPS SHIPPING ON PREPAID ORDERS

\$2,000,000 HAM INVENTORY

THE LOWEST POSSIBLE PRICES

NYE VIKING

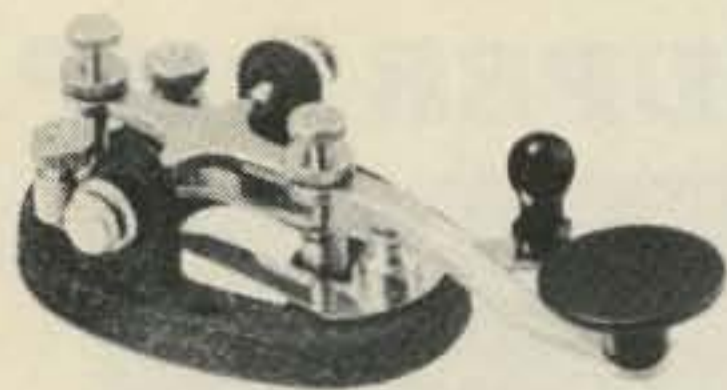

No. 114-310-003 \$8.25



No. 114-310-004GP \$50.00



No. 114-404-002 \$18.50



No. SSK-1 \$23.95



No. 250-46-1 \$36.50



No. 250-46-3 \$44.50



No. 250-20-1 \$19.95



No. 250-0025-003 \$212

NPC

2.5 AMP



12CB4 29.95

4 AMP



103R 39.95

6 AMP



104R 49.95

12 AMP

108 RM
99.95



25 AMP

109R 149.95



VIBROPLEX

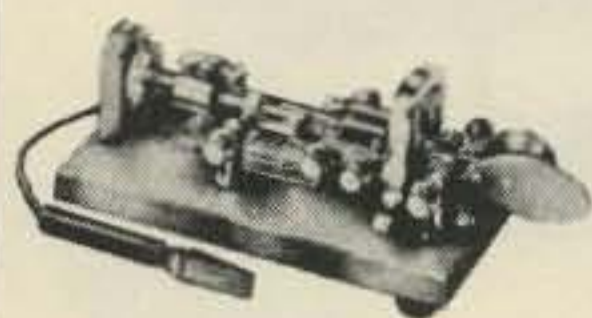

"PRESENTATION"
66.00

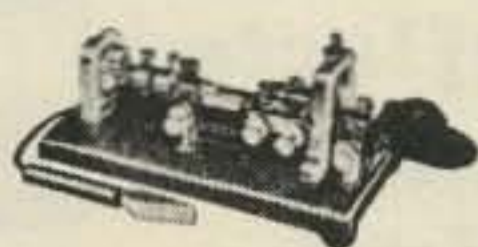

"ORIGINAL"
39.95



"LIGHTNING BUG"
39.95

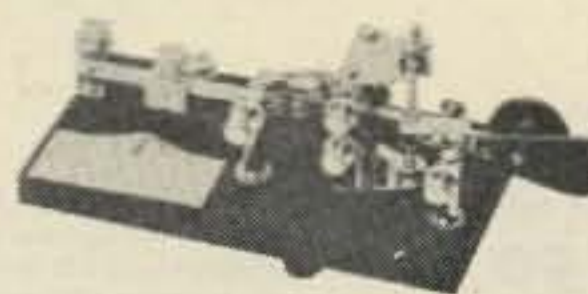

"CHAMPION"
31.50



VIBRO-KEYER
33.00

MASTERCHARGE & BANKAMERICARD ACCEPTED

HAMTRONICS

DIVISION OF TREVISE ELECTRONICS
4033 Brownsville Rd • Trevose, Pa. 19047

THE BIG 'H' FOR ALL YOUR HAM NEEDS!

WE HAVE WHAT YOU NEED AT...

Dentron 3 Kilowatt Tuner Matches Everything From 160 to 10

160-10 MAT

Built-In
Wattmeter
Front Panel Antenna
Selector for
Coax, Balanced
Line and Random
Wire.



only \$299.50

1000 to 1200 WATTS OUTPUT TO YOUR ANTENNA

Dentron SUPERAMP

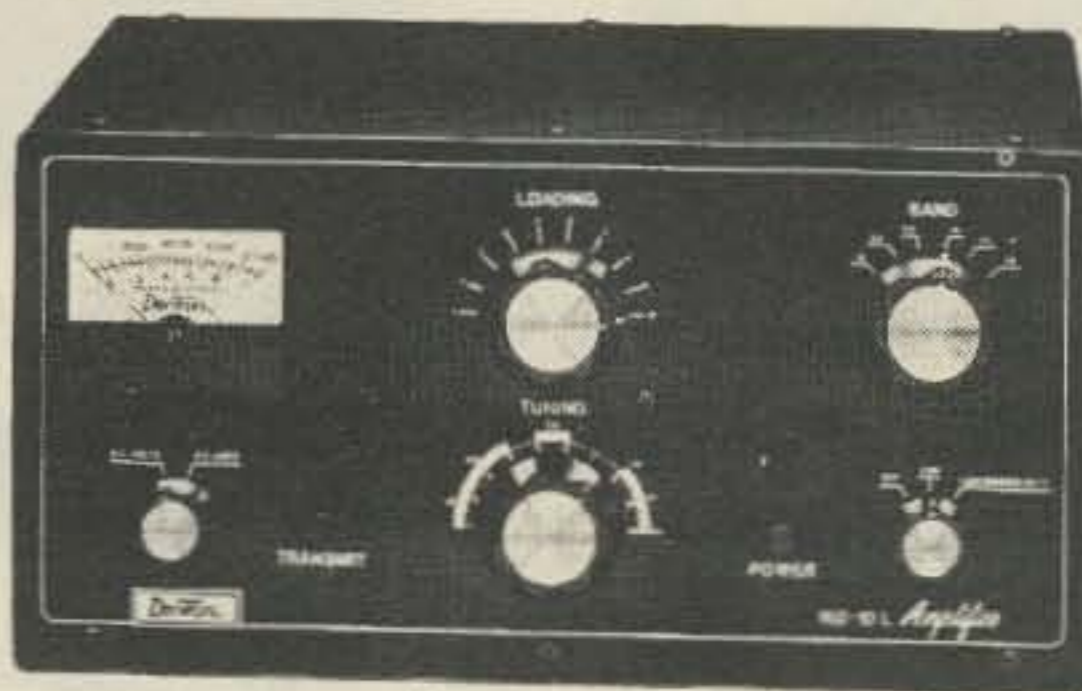

\$499.50

If the amplifier you're thinking of buying doesn't deliver at least 1000 to 1200 watts output, to the antenna, you're buying the wrong amplifier.

Our New Super Amp is sweeping the country because hams have realized that the DenTron Amplifier will deliver to the antenna, (output power), what other manufacturers rate as input power.

The Super Amp runs a full 2000 watts P.E.P. input on SSB, and 1000 watts DC on CW, RTTY or SSTV 160-10 meters, the maximum legal power.

The Super Amp is compact, low profile, has a solid one-piece cabinet assuring maximum TVI shielding.

The heart of our amplifier, the power supply, is a continuous duty, self-contained supply built for contest performance.

We mounted the 4 - 811 A's, industrial workhorse tubes, in a cooling chamber featuring the on-demand variable cooling system.

The hams at DenTron pride themselves on quality work, and we fight to keep prices down. That's why the dynamic DenTron Linear Amplifier beats them all at \$499.50.

NOW AVAILABLE WITH 572 B⁵ FOR **\$574.50**



Dentron Super Tuner

160-10 Meters
Balanced Line,
Coax, Random
or Long Wire

Maximum Power Transfer, Xmitter to Antenna.

1 KW Model \$129.50

3 KW Model \$229.50

Dentron ANTENNAS The Sky Openers

SKYMASTER

A fully developed and tested 27 foot vertical antenna covers entire 10, 15, 20, and 40 meter bands using only one cleverly applied wave trap. A full 1/4 wave antenna on 20 meters. Constructed of heavy seamless aluminum with a factory tuned and sealed HQ Trap, SKYMASTER is weatherproof and withstands winds up to 80 mph. Handles 2 KW power level and is for ground, roof or tower mounting. Radials included in our low price of

\$84.50

Also 80 m resonator for top mounting on SKYMASTER.

\$29.50

SKYCLAW

A tunable monoband high performance vertical antenna, designed for 40, 80, 160 meter operation. SKYCLAW gives you the following spectrum coverage:

BAND (Meters)	BANDWIDTH (kHz)
160	50
80	200
40	entire band

Tuning is easy and reliable. Rugged construction assures that this self-supporting unit is weatherproof and survives nicely in 100 mph winds. Handles full legal power limit.

\$79.50

EX-1

The DenTron EX-1 Vertical Antenna is designed for the performance minded antenna experimenter. The EX-1 is a full 40 meter, 1/4 wave, 33', self-supporting vertical. The EX-1 is the ideal vertical for phasing.

\$59.50



TRIM-TENNA

The antenna your neighbors will love. The new DenTron Trim-Tenna with 20 meter beam is designed for the discriminating amateur who wants fantastic performance in an environmentally appealing beam. It's really loaded! Up front there's a 13 foot 6 inch director with precision Hy-Q coils. And, 7 feet behind is a 16 foot driven element fed directly with 52 ohm coax. The Trim-Tenna mounts easily and what a difference in on-the-air performance between the Trim-Tenna and that dipole, long wire or inverted Vee you've been using. 4 & 5 Forward Gain Over Dipole.

\$129.50

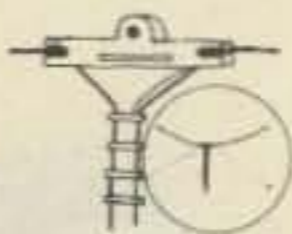

ALL BAND DOUBLET

This All Band Doublet or inverted Type Antenna covers 160 thru 10 meters. Has total length of 130 feet (14 ga. stranded copper) although it may be made shorter if necessary. This tuned Doublet is center fed through 100 feet of 450 ohm PVC covered balanced transmission line. The assembly is complete. Add rope to the ends and pull up into position. Tune with the DenTron Super Tuner and you're on 10 through 160 meters with one antenna! Now just for the DenTron All Band Doublet.

\$24.50

Dentron ANTENNA TUNER

The 80-10 Skymatcher

Here's an antenna tuner for 80 through 10 meters, handles 500 w P.E.P. and matches your 52 ohm transceiver to a random wire antenna.



- Continuous tuning 3.2 - 30 mc
- "L" network
- Ceramic 12 position rotary switch
- SO-239 receptional to transmitter
- Random wire tuner
- 3000 volt capacitor spacing
- Tapped inductor
- Ceramic antenna feed thru
- 7" W. 5" H. 8" D., Weight: 5 lbs.

\$59.50

Dentron W-2 PAD INLINE WATTMASTER

Read forward
and reflected
watts at the
same time



Tired of constant switching and guesswork?

Every serious ham knows he must read both forward and reverse wattage simultaneously for that perfect match. So upgrade with the DenTron W-2 Dual in line Wattmeter.

\$99.50

USED GEAR • TRADE UP • FREE UPS SHIPPING ON PREPAID ORDERS

\$2,000,000 HAM INVENTORY

HAMTRONICS-WHERE THE HAM IS KING

THE LOWEST POSSIBLE PRICES

TEN-TEC INC.

TRITON IV EQUIPMENT



TRANSCEIVERS

MODEL 540-200W, SSB/CW
3.5 - 30 MHz \$699.00

MODEL 544- DIGITAL, 200W
SSB/CW, 3.5 - 30 MHz
\$869.00

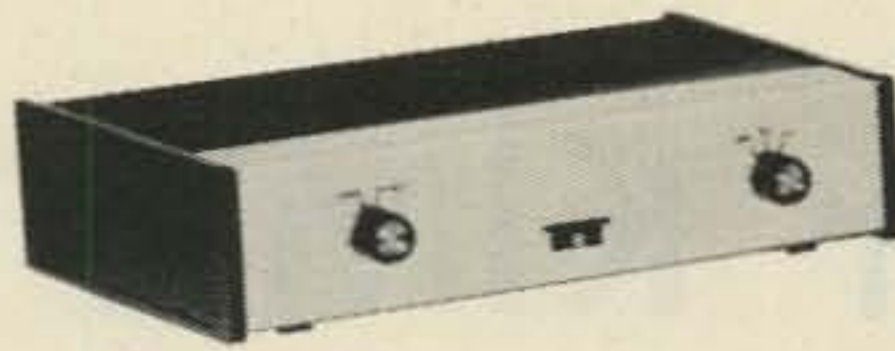

MODEL 240 \$97.00
ONE - SIXTY CONVERTER

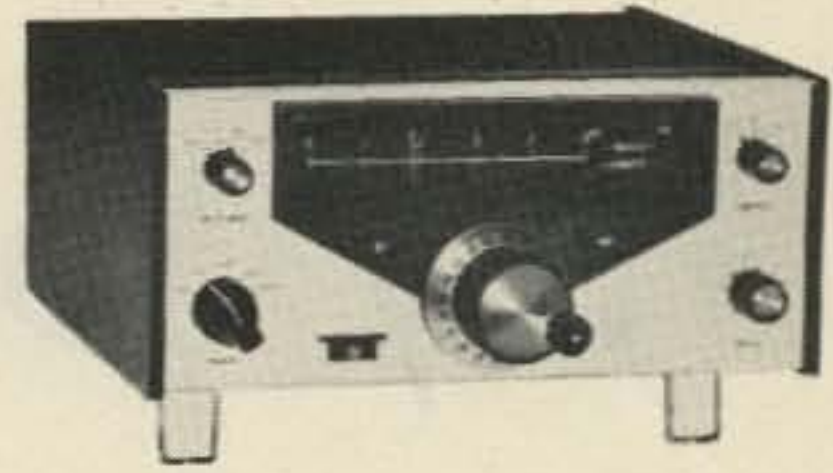

MODEL 242 \$169.00
REMOTE VFO

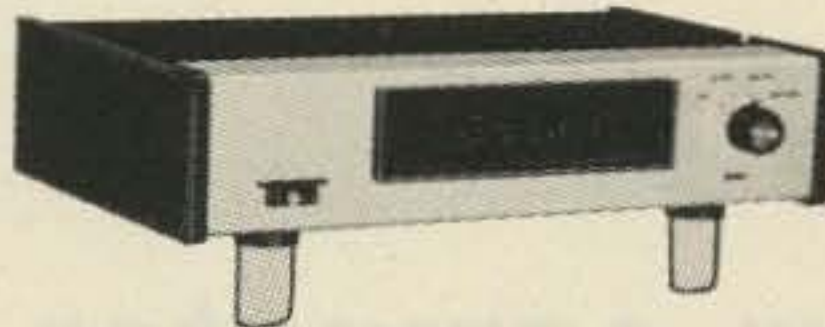

MODEL 244 \$197.00
DIGITAL READ OUT/COUNTER



MODEL 262-G \$139.00
DELUXE POWER SUPPLY

ARGONAUT

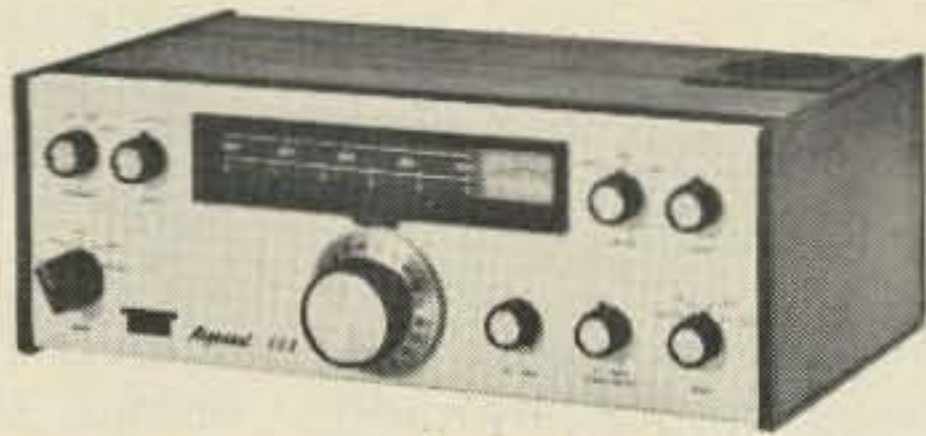

MODEL 509 \$359.00
SW, SSB/CW, 3.5-30 MHz

LINEAR AMPLIFIER

MODEL 405 \$159.00
100W, 3.5 - 30 MHz

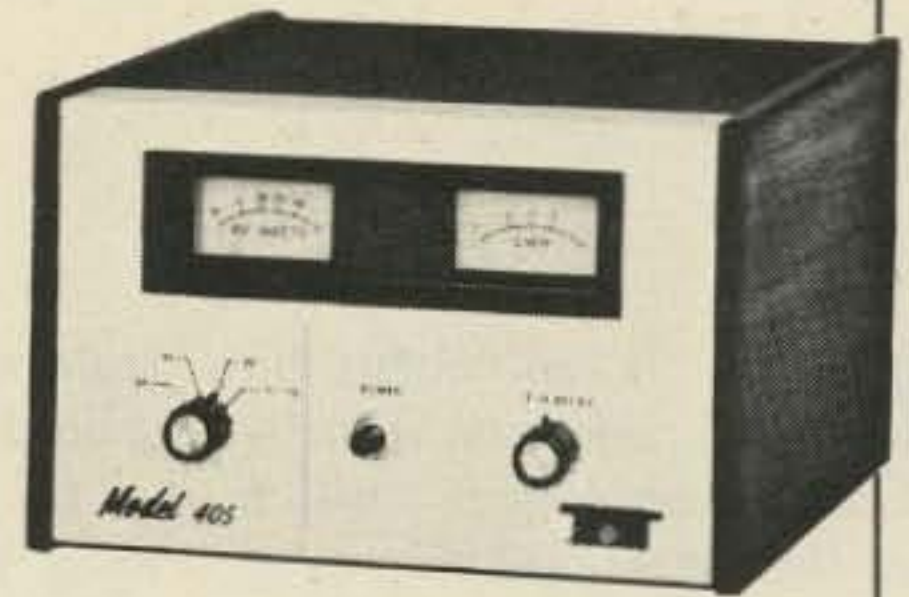

AMMETER
207 \$14.00

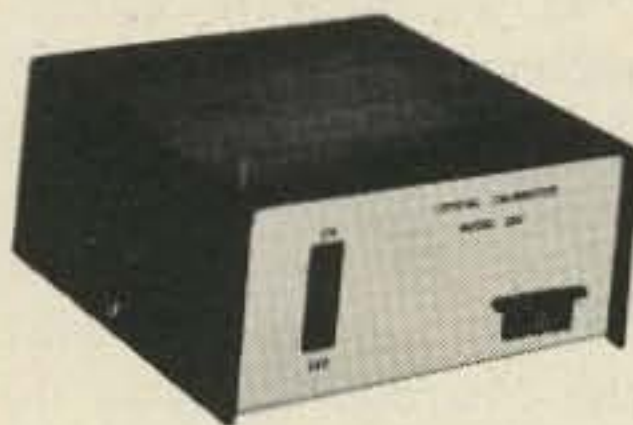

XTAL CALIBRATOR
206 \$29.00

KEYERS

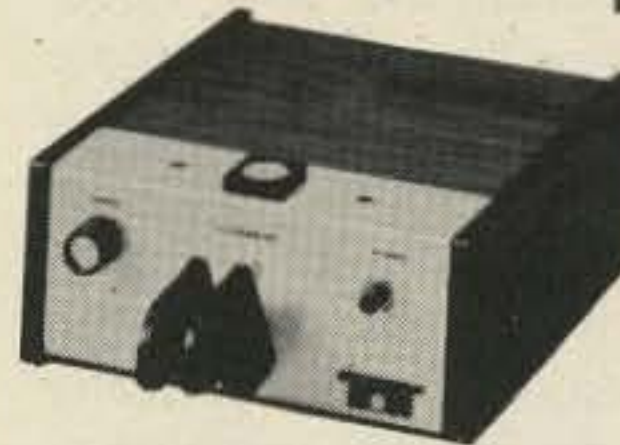

ELECTRONIC KR-50
\$110.00

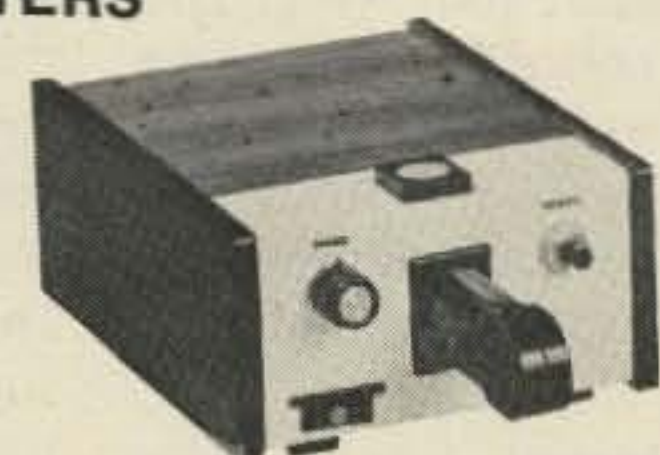

ELECTRONIC
KR20-A \$69.50



ELECTRONIC KR-5A
\$39.50

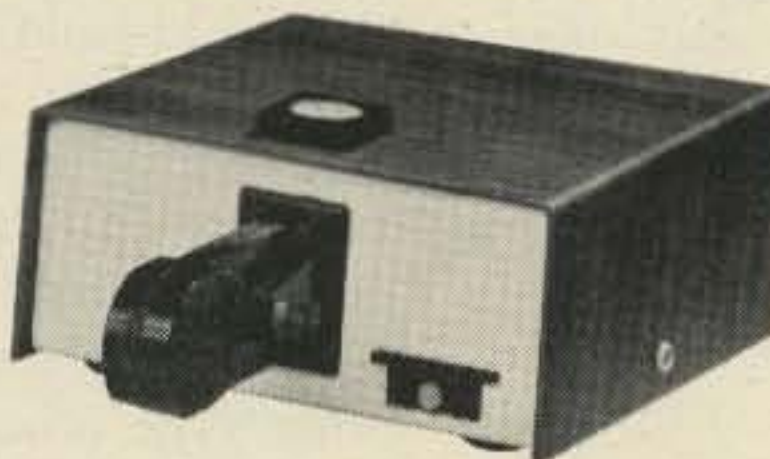

KR-2A \$17.00

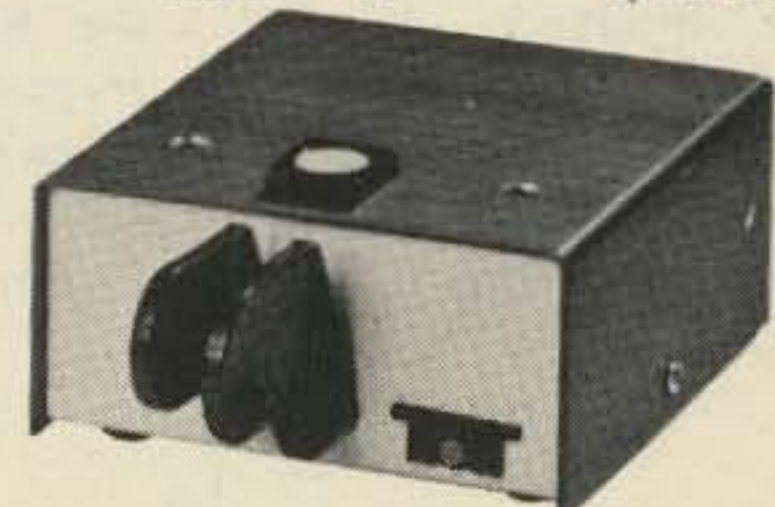

KR1-A \$35.00

MASTERCHARGE & BANKAMERICARD ACCEPTED

HAMTRONICS

DIVISION OF TREVISE ELECTRONICS

4033 Brownsville Rd • Trevose, Pa. 19047

THE BIG 'H' FOR ALL YOUR HAM NEEDS!

Try Your KIM-1

On RTTY

-- CUL on your computer

KIM-1 is an eight bit microprocessor sold by MOS Technology,¹ which uses the MCS 6502 chip as its central processing unit (CPU). KIM stands for "Keyboard Input Monitor" and describes the software residing in read only memory (ROM) on the two 6530 multipurpose 40 pin chips on the KIM-1 board.

My reason for choosing the KIM-1 was price. The whole KIM computer, with cassette interface, keypad, TTY interface, LED readouts for address and data, costs under \$250. For the beginner, there are some "bad"

features about it, which I should mention.

To use the KIM-1, you must build your own power supply and cabinet. Also, the user manual and other documentation is oriented more toward the computer prototyper than to the hobbyist. Very few examples are given in the documentation supplied, and the user really has to dig into the machine to get to know it. Software has been very scarce, but, since the KIM-1 users group was formed,² more and more software is becoming available.

On the positive side, MOS

Technology is making quite an inroad into their own software development. They will soon make a full math package available in ROM, as well as a complete editor-assembler (single pass type) in ROM also. To me, this is what is needed in the industry; by making the "firmware" a permanent part of the "hardware," you do not have to spend a large amount of time and trouble loading programs via cassette (which on KIM operates at about 135 baud).

The two programs included are not original. They are 6502 adaptations of programs which have already been published elsewhere for other type processors.^{3,4} To use these programs, it is assumed you have, along with KIM-1, a working CRT terminal with a serial I/O interface. I use an Infoton BASIC with a full-duplex 20

mA loop hooked to the KIM-1 20 mA loop terminals on the applications connector. I run my terminal at 4800 baud usually.

The Baudot Receive Program

The first program was developed out of sheer necessity. Since I am interested in amateur radioteletype (RTTY), I needed a way to quiet things down around the shack while copying press broadcasts and amateur stations. My Model 28 KSR compact is very noisy, and, since KIM-1 and my CRT terminal make no noise, it sure is a lot easier on the nerves.

This is the listing for the Baudot (5 level) receive converter (or monitor), which is in use daily at this station. The FSK converter I use is the ST-6 built from the HAL kit.⁵ The output of the ST-6, which I use to feed the computer, is the FSK line output, which is normally used to drive the FSK circuit of the amateur's transmitter. Irv Hoff, who designed the ST-6, in his wisdom chose the computer industry standard RS-232C levels for this output. This means that the output signal jumps in a discrete transition from -12 V to +12 V, which signify mark and space respectively. For more information on RTTY and the equipment you need to get started, see reference 6.

In order to make the ± 12 V mark-space levels compatible with the 0 and +5 volt levels needed by KIM-1, you must first construct an "interface." This interface is very simple, and uses only four electronic components. See Fig. 1.

Unlike the KIM-1 monitor, which is completely self-adjusting in regard to baud rate, this monitor requires that you load two values into locations 0274 and 0283 for the various speeds you wish to copy. See Fig. 2. You will notice locations 0227 to 023F were left blank. If you wish to incorporate "unshift on space" in your monitor,

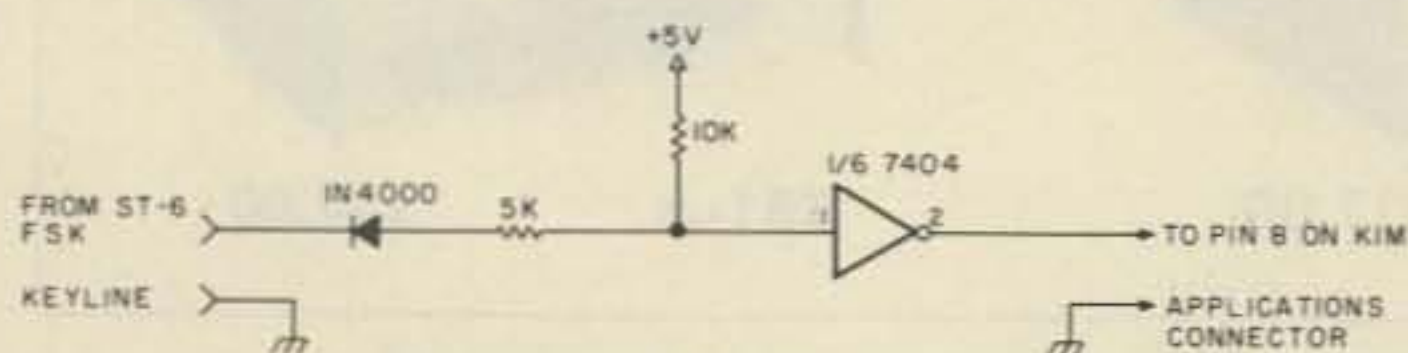

Fig. 1. Interface required to connect ST-6 FSK keyline (or any RS-232C level signal) to KIM-1.

simply insert the unshift on space routine given at the end of the listing in the locations designated (locations 0220 to 022A). You would use the listing without the "unshift on space" for copying weather broadcasts and the listing with "unshift on space" for press and amateur copy.

To use this Baudot monitor, construct the interface and check the output with a voltmeter before hooking it up to pin 8 of the applications connector. You can use your receiver calibrator to supply the necessary mark and space signals to the converter, and the output of the interface should be at TTL levels. If you get the correct levels, hook the output of the interface to pin 8 of the applications connector. Next, load the program into the KIM-1 (hopefully via cassette), and make sure you loaded the correct delay constants for the speed you wish to copy from Fig. 2. Remember, most US press broadcasts use 66 wpm, so be sure to change the delay constants. The computer is not as forgiving as the Model 28, which can receive 66 wpm RTTY with 60 wpm gears.

CW Transmit Routine

This routine is basically a 6502 version of the program mentioned in reference 4. It really comes in handy on the CW net I check into several times weekly. If you would like to hear a sample of the CW this routine produces, tune in the Liberty Net on 3750 kHz at 8 pm CST on Wednesday and Saturday nights. I have used the same nomenclature used by Sewell, so you should have no trouble following the 6502

Location	60 wpm	66 wpm	75 wpm	100 wpm
0274	0B	0A	08	08
0283	15	14	11	0D

Fig. 2. Delay constants to be loaded into locations 0274 and 0283 for various RTTY speeds.

algorithm.

The most important difference between the 6800 CPU and the 6502 chip is the method used by each for indirect addressing. The 6800 uses a full 16 bit index register, while the 6502 uses two 8 bit index registers. Thus, when crossing a page boundary (256 bytes/page) with the 6502 in the indexed addressing mode, you must use quite a few tricks to keep from putting out an invalid address when on the first byte of the new page. The method I used can be seen at locations 001A through 0021, and 004A through 004F.

The buffer in this routine (ASDRIVER) is 512 bytes long, and includes all of pages 2 and 3 of my unexpanded KIM-1. Thus, since my terminal has 80 characters/line, I can store about 6½ lines of text before overrunning the buffer. 512 bytes will keep you from getting too long-winded. If your KIM is expanded and has more than the 1K of memory mine has, you can be as long-winded as you like. This routine will automatically cross the page boundaries for you (I pity the poor guy on the other end, though).

You must construct an interface from the TTL level output of pin 14 of the applications connector to your transmitter. Since I use the Heath SB-400 which has about +25 V on the CW keyline, this interface is a little more involved than the one for the RTTY interface described above. However, it uses the same 7404 chip as

the RTTY interface, and both can be left connected together. See Fig. 3. If your transmitter will not work with this keyer, see the *TTL Cookbook* for other examples or the articles by Hoff in *RTTY Journal*. Don't forget to connect pin 14 of the 7404 chip to +5 volts and pin 7 to ground.

You will note in the comments for location 002B, "Is my case, "cursor left") and

this a cursor left?" What this means is that my Infoton terminal has a separate cursor control keypad to control the cursor without affecting the display. Infoton uses the hex code "1A" to indicate a cursor left or backspace. Backspace in this routine is used to correct any mistakes while using the buffered routine. You hit backspace (in

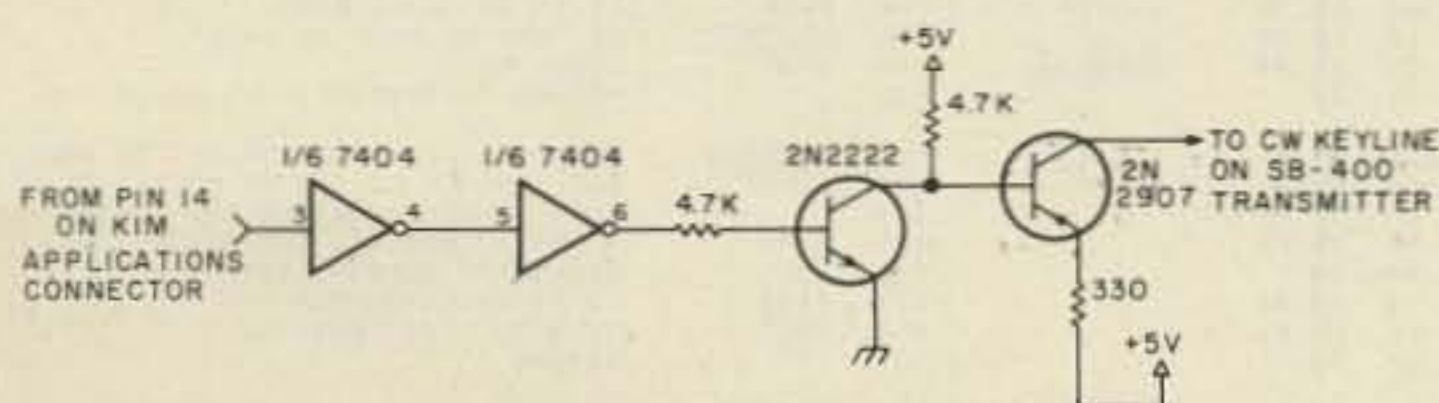

Fig. 3. Interface between KIM-1 and SB-400 transmitter. See text for source of other circuits covering other transmitters.

BAUDOT-ASCII ROUTINE

```

#200 2# 4# #2 BEGIN      JSR #24#          JUMP TO GETCHB ROUTINE
#3  A6 E1                LDX #5#          LOAD X W/5#E1
#5  E# 1B                CPX #51B         IS THIS BAUDOT "FIGS"?
#7  D# #3                BNE #2#C        IF NOT, GO TO #2#C
#9  4C #5 #2            JMP #215         IF SO, GO TO "FIGS" SUBROUTINE
#C  BD 9# #2            LDA #2#          LOAD ACC. W/2#9# + X, LETTERS
#20F 2# A# 1E          JSR OUTCH        PRINT ASCII CHAR. IN ACC.
#12  4C #8 #2            JMP BEGIN        GET NEXT CHARACTER
#15  BD #8 #2            LDA #2#*X        LOAD ACC. W/"FIGS" LOOKUP
#18  2# A# 1E          JSR OUTCH        PRINT ASCII CHAR. IN ACC.
#1B  2# 4# #2          JSR GETCHB      GET NEXT BAUDOT CHAR.
#1E  A6 E1                LDX #5#          LOAD X-POINTER W/5#E1
#22# E# 1F              CPX #51F         IS THIS BAUDOT "LETTERS"?
#22  D# E#              BNE "FIGS"      IF NOT, GO TO "FIGS"
#24  4C #C #2            JMP "LTRS"       JUMP TO #2#C

#227 TO #23F ## THESE LOCATIONS RESERVED FOR UNSHIFT ON SPACE AND OTHER
SPECIAL APPLICATIONS. SEE END OF LISTING FOR UNSHIFT
ON SPACE LISTING.

#24# 86 E#              GETCHB  STX TEMP          STORE X TEMPORARILY AT #5#E#
#42  A2 #5              LDX #5#          SET UP 5 BIT COUNT
#44  A9 #8              LDA #5#          LOAD ACC. W/5#8#
#46  8D #1 17          STA PADD         LOAD 5#8# INTO 17#1 (PADD)
#49  A9 #8              LDA #5#          SET UP PA7 AS INPUT
#4B  2C #7 17          BIT PA7         TEST PA7 FOR SPACE (START PULSE)
#4E  D# F#              BNE #249         IF NOT START PULSE, TRY AGAIN
#25# 2# 8# #2          JSR DELAY        DELAY ONE PULSE LENGTH
#53  2# 71 #2          JSR DEHALF       SAMPLE AT MIDDLE OF PULSE ONE
#56  AD #8 17          LDA 17#8#       LOAD ACC. W/INFO AT PAD
#59  29 #8              AND #5#          "AND" ACC W/5#8#
#5B  46 E1              LSR CHAR        SHIFT #5#E1 RIGHT ONE BIT
#5D  #5 E1              ORA CHAR        "OR" ACC W/5#E1
#25F 85 E1              STA CHAR        STORE RESULT AT #5#E1
#61  2# 8# #2          JSR DELAY        DELAY ONE BIT TIME
#64  CA                DEX             DECREMENT BIT COUNT BY ONE
#65  D# EF              BNE GET2        BRANCH ON X#F TO #256
#67  2# 71 #2          JSR DEHALF       DELAY 1/2 BIT TIME
#6A  46 E1              LSR #5#E1       SHIFT RIGHT ONE BIT
#6C  46 E1              LSR "           "
#6E  46 E1              LSR "           "
#27# 6#                RTS             RETURN TO START

#271 85 E2              DEHALF  STA TEMP          STORE ACC. TEMP. AT #5#E2
#73  A9 #8              LDA #5#          SET TIMER FOR 8# MS. DELAY
#75  8D #7 17          STA 17#7        START TIMER
#78  2C #7 17          BIT TIMER       IS TIMER FINISHED?
#7B  1# FB              BPL #278        IF NOT, TRY AGAIN
#7D  A5 E2              LDA #5#E2       RESTORE ACCUMULATOR
#7F  6#                RTS             RETURN

#28# 85 E2              DELAY  STA TEMP          STORE ACC. TEMP AT #5#E2
#82  A9 15              LDA #515        SET TIMER FOR 22 MS. DELAY
#84  8D #7 17          STA 17#7        START TIMER
#87  2C #7 17          BIT TIMER       IS TIMER FINISHED?
#8A  1# FB              BPL #287        IF NOT, TRY AGAIN
#8C  A5 E2              LDA #5#E2       RESTORE ACCUMULATOR
#8E  6#                RTS             RETURN

```

LOOKUP TABLE

#29# #8 - NOP	#28# #8 - NOP
#31 45 - E	#31 33 - 3
#32 #A - LINEFEED	#32 #A - LINEFEED
#33 41 - A	#33 2D - HYPHEN
#34 2# - SPACE	#34 2# - SPACE
#35 53 - S	#35 #8 - BELL (NOP)
#36 49 - I	#36 38 - 8
#37 55 - U	#37 37 - 7
#38 #D - CARRIAGE RET.	#38 #D - CARRIAGE RET.
#39 44 - D	#39 24 - 5
#40 52 - R	#40 34 - 4
#41 4A - J	#41 27 - APOSTROPHE
#42 4E - N	#42 2C - COMMA
#43 46 - F	#43 21 - EXCLAMATION POINT
#44 43 - C	#44 3A - COLON
#45 4B - K	#45 28 - OPEN PARENTHESIS
#46 54 - T	#46 35 - 5
#47 5A - Z	#47 22 - QUOTE
#48 4C - L	#48 29 - CLOSE PARENTHESIS
#49 57 - W	#49 32 - 2
#50 48 - H	#50 23 - 9
#51 59 - Y	#51 36 - 6
#52 58 - P	#52 3# - #
#53 51 - O	#53 3# - #
#54 4F - 0	#54 31 - 1
#55 42 - B	#55 39 - 9
#56 47 - G	#56 3F - ?
#57 #8 - FIGS (NOP)	#57 CA 25 - 6
#58 4D - M	#58 #8 - FIGS (NOP)
#59 58 - X	#59 2E - PERIOD
#60 56 - V	#60 2F - /
#61 #8 - LTRS (NOP)	#61 3B - SEMI-COLON
	#62 #8 - LTRS (NOP)

UNSHIFT ON SPACE ROUTINE

```

#22# E# #4              CPX #5#4         IS THIS A BAUDOT "SPACE"?
#22  F# E#              BEQ #2#C        IF SO, GO TO "LTRS"
#24  E# 1F              CPX #51F         IS THIS A BAUDOT "LETTERS"?
#26  D# ED              BNE "FIGS"      IF SO, GO TO #215
#228 4C #C #2          JMP "LTRS"       JUMP TO #2#C

```

Fig. 4. Special keys used on terminals and their CW equivalents.

!	-	ERROR
#	-	SK-
\$	-	AR	-...-
&	-	BT-
+	-	KN	-...-
=	-	AS-

type right over the mistake. Thus the double-decrement of the x-pointer in locations 002F and 0030. If your terminal uses another code for backspace, simply insert it in location 002C. Notice locations 0000 and 0001 in the listing. These are labeled ELSPEED and CHRSPEED. These locations are for timing constants used in the delay routines by the timer, at locations 00CF and 00DF. For normal CW, location 0000 contains the speed you desire (a value of hex 30 = 20 wpm, hex 60 = 10 wpm, etc.), and location 0001 contains the spacing between individual

characters, and should contain hex 03 (which means the spacing between characters will be equal to 3 dot lengths). Larger numbers in location 0000 give progressively slower CW speeds, and vice versa. When using the SINGLECH routine, location 0001 should contain hex 01. Notice that the buffered routine starts at location 0005 and the single character routine starts at location 0145. If you desire to switch from one to the other, you must stop KIM. In the KIM-1 user manual, the method for doing this is not made clear. You must load the NMI vector

(the vector you get by pushing the stop key on the keypad) into locations 17FA and 17FB. Then, when you push the stop button, the NMI line is brought low and signals an interrupt to the 6502 chip. Internally the 6502 completes its present instruction and jumps to locations 17FA and 17FB for directions on where to go to service the interrupt. The program counter will then address the location contained in 17FA and 17FB. MOS Technology recommends loading 1C00 into this location. But, you must load them in reverse, with the low order byte first. Thus, remember to always load 00 into location 17FA and 1C in location 17FB. This is the first thing you should do when bringing up the computer.

There is another peculiarity of KIM which is not stressed enough in the documentation. This concerns the use of the flag status register at location 00F1 while using the cassette interface. Since the 6502 chip has a decimal mode of arithmetic operation, and since the cassette interface will only work in the binary mode of operation, you must *always* clear the decimal flag before any cassette load or dump operations. Simply load hex 00 into location 00F1 before using the cassette.

To use this CW routine, load your program into the computer, and be sure to load your code speed into locations 0000 and 0001. If you wish to use the buffered output, go to location 0005,

CW OUTPUT ROUTINE

```

0000 ELSPEED
0001 CHRSPEED
0002 HOLDBYTE
0003 COUNT
0004 CW POINTER

0005 A9 01 ASORIVEP LDA #501 PLACE A 1 IN FIRST BIT, TO SET UP
0006 80 01 17 STA PADD0 OUTPUT BIT AT LOC. 1701 (PADD)
0007 A9 02 LDA #502 SET UP PAGE 2 TO RECEIVE CW CHARS
0008 85 19 STA STORE AT #019
0009 85 39 STA STORE AT #039
0010 85 44 STA STORE AT #044
0011 A2 00 LDX #500 SET POINTER (X-INDEX) TO ZERO
0012 20 SA 1E LOADLOOP JSR GETCH GO TO KIM "GETCH" ROUTINE
0013 90 00 02 STA #200 + X STORE ASCII CHAR. AT #200+X
0014 E0 FF CPX #5FF IS PAGE 2 FILLED WITH CHARS?
0015 D0 04 BNE LOC. #022 IF FULL, GO TO #022
0016 E6 19 INC #019 CHANGE 2 AT #019 TO A 3.
0017 90 39 INC #039 CHANGE 2 AT #039 TO A 3.
0018 E8 INX INCREMENT THE X-POINTER
0019 C9 03 CMP #503 IS THIS THE STOP BYTE?
0020 F0 13 BEQ NONEED3 IF A STOP, GO TO LOC. #034
0021 C9 0A CMP #50A IS THIS AN ASCII "LINEFEED"?
0022 F0 09 BEQ SENDIT IF SO, GO TO LOC. #034
0023 C9 1A CMP #51A IS THIS A "CURSOR LEFT"? (NOTE 1)
0024 D0 E5 BNE LOADLOOP IF NONE OF ABOVE, GET NEXT CHAR.
0025 CA DEX CA IF LAST CHAR WAS A CURSOR LEFT,
0026 4C 14 00 JMP LOADLOOP DECREMENT POINTER TWICE
0027 A9 03 SENDIT LDA #503 GET NEXT CHAR., AND STORE IN BUFF
0028 CA DEX PUT STOP BYTE IN ACCUMULATOR
0029 90 00 02 STA #200+X SUB. 1 FROM POINTER, FOR LINEFEED
0030 A2 00 LDX #500 BRACE STOP AT END OF CHAR. STRING
0031 20 42 00 JSR CWBUFFER CLEAR X-POINTER
0032 4C 05 00 JMP ASORIVEP OUTPUT CHARACTER IN CW
BEGIN AGAIN

0042 80 00 02 CWBUFFER LDA #200+X GET ASCII CHAR. IN BUFFER
0043 C9 03 CMP #503 IS THIS A STOP BYTE?
0044 D0 01 BNE CONTINUE IF NOT STOP, GO TO LOC. #04A
0045 60 RTS RETURN TO #03F
0046 E0 FF CONTINUE CPX #5FF IS PAGE 2 BUFFER EMPTIED YET?
0047 D0 02 BNE #050 IF NOT, CONTINUE AT #050
0048 E6 44 INC #044 IF PAGE 2 EMPTY, GO TO PAGE 3
0049 E8 INX INCREMENT X TO GET NEXT CHAR.
0050 86 04 STX CWPOINTER SAVE X AT LOCATION #004
0051 20 50 00 JSR TRANSMIT BEGIN TRANSMITTING
0052 A6 04 LDX CWPOINTER RETURN POINTER TO X-INDEX
0053 4C 42 00 JMP CWBUFFER GET NEXT CHAR. IN BUFFER

0058 20 06 00 TRANSMIT JSR CHARTOCW CONVERT ASCII CHAR. TO CW
0059 C9 00 CMP #500 IS THIS A "NULL" CHAR?
0060 D0 07 BNE NOTSPACE IF NOT, GO TO LOC. #069
0061 A0 01 LDY #501 SET NO OF CW ELEMENTS AT ONE
0062 84 03 STY COUNT STORE ELEMENT COUNT AT #003
0063 4C A1 00 JMP SPACENT BYPASS KEY-ON INSTRUCTION
0064 85 02 STA HOLDBYTE SAVE CW CHAR. AT #002
0065 18 CLC CLEAR CARRY FLAG (NOTP 2)
0066 2A ROL ROTATE CW CHAR. LEFT 1 BIT
0067 2A ROL
0068 2A ROL
0069 2A ROL
0070 29 07 AND #507 SET UP BIT COUNT AT < 7
0071 A8 TAY TRANSFER BIT COUNT TO Y-INDEX
0072 A5 02 LDA HOLDBYTE RETURN CW CHAR. TO ACC.
0073 C9 FF CMP #5FF IS THIS CODE FOR A CW "ERROR"?
0074 D0 09 BNE NOTERR IF NOT, CONTINUE AT #002
0075 A9 00 LDA #500 CLEAR ACC. TO ALL 0'S
0076 85 02 STA HOLDBYTE SET HOLDBYTE TO ALL 0'S
0077 A0 00 LDY #500 SET ELEMENT COUNT AT 0 BITS
0078 4C 8C 00 JMP COUNTOK OUTPUT 8 DITS FOR ERROR
0079 C0 06 CPY #506 IS THE BIT COUNT 6?
0080 30 06 BMI COUNTOK IF NOT 6, GO TO #08C
0081 98 TAY RETURN BIT COUNT TO ACC.
0082 29 06 AND #506 "AND" BIT COUNT IN ACC W/6
0083 A8 TAY RETURN BIT COUNT TO Y-INDEX
0084 A5 02 LDA HOLDBYTE RESTORE CW CHAR. TO ACC.
0085 84 03 STY COUNT STORE BIT COUNT IN LOC. #003
0086 05 07 ASL HOLDBYTE SHIFT LOC. #002 LEFT 1 BIT
0087 46 07 LSR HOLDBYTE SHIFT LOC. #002 RIGHT 1 BIT
0088 A0 01 LDY #501 SET WEIGHT FOR DIT IN Y-INDEX
0089 A9 01 LDA #501 LOAD ACC. W/#01
0090 24 02 BIT HOLDBYTE TEST FIRST ELEMENT FOR A DIT

```

```

0090 F0 02 BEQ SEND IF IT IS A DIT, GO TO #09C
0091 A0 03 LDY #503 SET WEIGHT FOR A DAH (3 DITS)
0092 A0 01 LDA #501 TURN ON KEY BY STORING A 1 IN
0093 80 01 17 STA PAD0 OUTPUT PORT (1700)
0094 20 CF 00 JSR ELDELAY GENERATE ELEMENT DELAY
0095 A9 00 LDA #500 TURN OFF KEY BY LOADING ALL 0'S
0096 80 01 17 STA PAD0 IN PAD (1700)
0097 20 DF 00 JSR DELAY_1 DELAY VALUE AT ELSPEED
0098 C6 03 DEC COUNT GET NEXT ELEMENT IN CHARACTER
0099 D0 00 BNE BITLOOP IF NOT ZERO, GET NEXT BIT (#09D)
0100 A4 01 LDY CHRSPEED SET DELAY FOR A DAH (3 DITS)
0101 20 CF 00 JSR ELDELAY DELAY A DAH
0102 85 00 RTS GET NEXT CHAR. FROM BUFFER
0103 29 7F CHARTOCW AND #57F STRIP OFF PARITY BIT
0104 38 SEC SET CARRY FLAG TO A 1
0105 E9 20 SBC #520 SUBTRACT OFFSET OF 32 DECIMAL
0106 30 0F BMI INVALAS IF NOT IN TABLE, TO LOC. #0CC
0107 8D C9 3F CMP #53F IS THIS LAST CHAR. IN TABLE?
0108 10 05 BPL NOTFINDAS YOU USED LOWER CASE LETTERS

```

LOOKUP TABLE

#100	## - SPACE	#120	## - NULL
#101	FF - ! (ERROR CODE)	21	42 - A
#102	D2 - "	22	81 - B
#103	E8 - # (SK)	23	85 - C
#104	AA - \$ (AR)	24	61 - D
#105	#0 - NULL	25	20 - E
#106	B1 - & (BT)	26	84 - F
#107	DE - '	27	63 - G
#108	ED - (28	80 - H
#109	ED -)	29	40 - I
#110	#0 - NULL	2A	8E - J
#111	AD - + (XM)	2B	65 - K
#112	F3 - ,	2C	82 - L
#113	E1 - -	2D	43 - M
#114	EA - .	2E	41 - N
#115	A9 - /	2F	67 - O
#116	BF - #	#130	86 - P
#117	BE - 1	31	88 - Q
#118	BC - 2	32	62 - R
#119	BB - 3	33	60 - S
#120	B0 - 4	34	21 - T
#121	A0 - 5	35	64 - U
#122	A1 - 6	36	88 - V
#123	A3 - 7	37	66 - W
#124	A7 - 8	38	89 - X
#125	AF - 9	39	8D - Y
#126	C7 - :	3A	83 - Z
#127	D5 - ;	3B	ED - (
#128	#0 - NULL	3C	#0 - NULL
#129	A2 - = (AS)	3D	ED -)
#130	#0 - NULL	3E	#0 - NULL
#131	CC - ?	3F	FF - DEL (ERROR)

SINGLE CHARACTER ROUTINE

```

0145 A9 01 SINGLECH LDA #501 LOAD ACC. W/#01
0146 80 01 17 STA PADD0 INITIALIZE DATA DIR. REGISTER
0147 A2 00 LDX #500 CLEAR X-INDEX
0148 20 SA 1E JSR GETCH JUMP TO KIM "GETCH" ROUTINE
0149 20 50 00 JSR TRANSMIT OUTPUT CHARACTER IN ACC.
0150 4C 4C 01 JMP SINGLELOOP GET NEXT CHARACTER AND CONTINUE

01C1 A8 GETENTRY TAY LOAD POINTER IN Y-INDEX
01C2 89 00 01 LDA #100+W LOAD ACC. W/CW CODE
01C3 60 RTS RETURN TO TRANSMIT
01C4 E9 20 NOTFINDAS SBC #520 SUBTRACT DECIMAL 32
01C5 C9 20 CMP #520 IS IT IN TABLE NOW?
01C6 CA 10 F5 CC A0 00 BPL GETENTRY OK, NOW GO BACK TO TABLE
01C7 CE 60 LDA #500 CLEAR ACC.
RTS RETURN TO TRANSMIT FOR VALID CHR.

01CF A5 01 ELDELAY LDA ELSPEED LOAD ACC. WITH NO. OF MS. IN #001
01D0 8D 07 17 STA TIMER SET TIME TO DIVIDE BY MILLISECS.
01D1 D4 07 17 BIT TEST TIMER FOR MINUS
01D2 07 10 FB BPL #004 IF NOT FINISHED, TRY AGAIN
01D3 09 00 DEY DECREMENT ELEMENT TIMER
01D4 C0 00 CPY #500 IS TIMER FINISHED?
01D5 DC 00 F1 BNE #0CF IF NOT, KEEP COUNTING
01D6 DE 60 RTS RETURN

01DF A5 00 DELAY_1 LDA #500 LOAD ACC. W/VALUE AT CHRSPEED
01E0 E1 0D 07 17 STA #1024 TIMER
01E1 2C 07 17 BIT IS TIMER FINISHED?
01E2 10 FB BPL IF NOT, KEEP COUNTING
01E3 E9 60 RTS RETURN

```

hit a "G", and type your message (up to 512 characters using the basic KIM). Do *not* hit any line feeds until you are ready to transmit, as this is the character which starts the transmit portion of the program. Let the terminal supply the returns and line feeds. If you make a mistake, hit backspace and type over it. When your message is complete and ready to transmit, simply hit a line feed, and you will hear some mighty fine CW going out. Fig. 4 lists

some special keys used for CW characters having no ASCII equivalents.

To use the single character routine, start the program at location 0145. The character you type will be output immediately after each key is hit. This routine is a must for break-in operation.

In summary, both of these routines have been in use for several months at my QTH. I had considered writing a CW receive routine, but, as Wayne Green W2NSD/1 mentioned

in his talk at the New Orleans Computerfest, most fists are so bad even the best algorithms cannot copy them unless the sender is using an electronic keyer. And, as he pointed out so well, CW is ten steps backward in technology and will remain so until hams get off their seats and write the FCC demanding the use of ASCII on the ham bands. ■

References

¹ MOS Technology Inc., 950 Rittenhouse Rd., Norristown PA 19401.

² KIM-1 User Notes, c/o Eric C. Rehnke, PO Box 33077, N. Royalton OH 44133.

³ Borgerson, "Baudot to ASCII," 73 Magazine, Nov. 1976, p. 172.

⁴ Sewell, "If Only Sam Morse Could See Us Now," Byte Magazine, October 1976, p. 42.

⁵ Hoff, "ST-6 Solid State Demodulator," RTTY Journal, Sept. 1970.

⁶ Green, "RTTY Handbook," 73 Magazine, Peterborough NH 03458, \$5.95.

⁷ Simpson, "A Date With Kim," Byte Magazine, May 1976. This article gives a complete description of the KIM-1 computer.

ATTENTION: HAM OPERATOR/COMPUTER OWNERS

At last the missing components for implementing a true automated ham shack are available and they are all products of International Data Systems, Inc. The following boards plug into any ALTAIR, IMSAI, or other S100 bus compatible computer and provide the needed hardware capability for maintaining time of day in a form the computer can easily manipulate, measure (and/or compute) the frequency of your transmitter and receiver up to 600MHz, decode Morse Code or RTTY, and key your transmitter for CW and RTTY operation. Extensive software is included with all modules and software is provided in MITS 8K BASIC, PICO BASIC 5, and Assembler source and object listings.

S100 BUS COMPATIBLE BOARDS (ALTAIR 8800/IMSAI 8080, etc.)

	USES	KIT PRICE
88-SPM Clock Module	Your computer constantly knows the time of day and can use it in applications such as tracking OSCAR, automatically time stamping log data for contests, or more trivial applications such as performing 10 minute station time or time of day clock display functions.	\$ 98.00
88-UFC Universal Frequency Counter	Use it to select from 4 software selectable signal inputs and compute signal frequency, event periods, or count total number of events. Use it to monitor and display transmit and receive frequency, automatic frequency logging for contests and contests, and even measure inside and outside temperature when used in conjunction with the TSM peripheral module listed below. Measures frequency to 600 MHz. Includes program to use 88-UFC to decode RTTY.	\$179.00

PERIPHERAL DEVICES FOR USE WITH ANY COMPUTER:

MCTX Morse Code Trainer/Keyer	This hardware/software package is the best thing to happen to ham radio since OSCAR. Use it to teach Morse Code or to key your transmitter. Provides double isolation between your computer and your transmitter. Generates audio sidetone for headphone or speaker. All software included! Uses "NEW CODE METHOD" in trainer mode.	\$ 29.00
TSM Temperature Sensing Module	Use it with the 88-UFC to measure temperature inside or outside. For temperature monitor and control applications or just to be able to report current conditions during your QSO. Resolution is 1 degree.	\$ 24.00

Terms: Payment with order or C.O.D. Delivery: Stock to 30 days.

Product descriptions available for all items listed above plus many non-ham related items.

Assembled units available at higher prices.

Telephone (703) 536-7373

IDS

INTERNATIONAL DATA SYSTEMS, INC.
400 North Washington Street, Suite 200, Falls Church, Virginia 22046, U.S.A.

IDS

110

**TVT-6
Low cost
Direct Video Display**

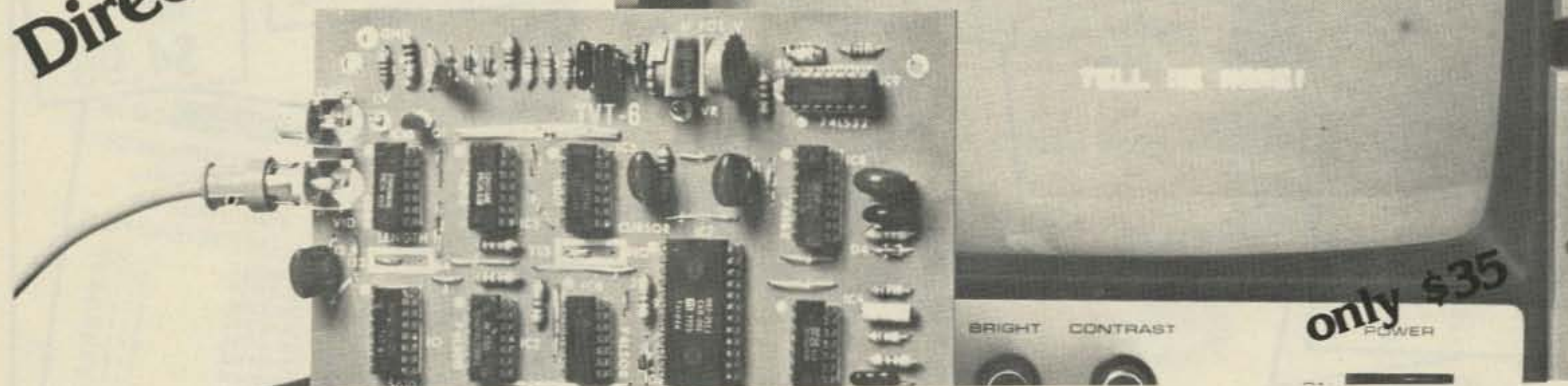

Don Lancaster's ingenious design provides software controllable options including:

- Scrolling • Full performance cursor
- Over 2K on-screen characters with only 3MHz bandwidth
- Variety of line/character formats including 16/32, 16/64 even 32/64
- User selectable line lengths

TELL ME MORE!

SEND FREE CATALOG

P9

Send instruction manual for the TVT-6 Kit with full operational details, \$1 enclosed.

Name: _____

MAIL TODAY To: Address: _____

City: _____ State: _____ Zip: _____

IAIA

ELECTRONICS, INC. DEPT. 10-H, 1020 W. WILSHIRE BLVD., OKLAHOMA CITY, OK 73116

Vector

8800V
Microcomputer/processor
Universal plugboard, use with S-100 bus. Com-
plete with heat sink & hardware. 5.3" x
10" x 1/16"

1-4 \$19.95
5-9 \$17.95
10-24 \$15.96

Vector

3662 6.5" x 4.5"
\$6.95

3662-2 9.6" x 4.5"
\$11.45

P pattern plugboards for
IC's Epoxy Glass 1/16"
44 pin con. spaced .156

Vector

3682 9.6" x 4.5"
\$10.97

3682-2 6.5" x 4.5"
\$9.81

Hi-Density Dual-In-Line
Plugboard for Wire Wrap
with Power & Grid Bus
Epoxy Glass 1/16" .44
pin con. spaced .156

Vector

3677 9.6" x 4.5"
\$10.38

3677-2 6.5" x 4.5"
\$9.28

Gen. Purpose D.I.P.
Boards with Bus Pattern
for Solder or Wire Wrap.
Epoxy Glass 1/16" .44
pin con. spaced .156

3690-12
Card Extender has 100 contacts — 50
per side on .125 centers — Attached
connector — is compatible with S-100
Bus Systems \$25.00

3690 6.5" 22/44 pin .156 ctrs. Ex-
tenders \$12.00

Vector

R644 P.C. receptacle 22/44 cont.
156 ctrs. pierced solder eyelets tails
gold \$7.35

R644-3 P.C. receptacle 22/44 cont.
156 ctrs. Wire Wrap tails gold \$4.49

R661 Dip solder tails on 140" spaced
rows for ALTAIR mother boards \$7.35

R661-1 .025" sq. 3 wrap length posts
(.62 long) on 250 spaced rows for
boards or Dip solder for IMSA) mother
boards gold \$5.85

R661-2 .025" sq. 1 wrap length posts
(.22 long) on 250 spaced rows for
boards or Dip solder for IMSA) mother
boards gold \$7.35

R661-3 pierced solder eyelet tails, gold
..... \$7.35

NLS

LM3A 3 dig 1% DC
LM3.5A 3 1/2 dig .5% DC
LM4A 4 dig .1% DC

Rechargeable batteries and charger in-
cluded
Measures DC Volts, AC Volts, Ohms and
Indication
Automatic polarity, decimal and overload
Measures DC Volts, AC Volts, Ohms and
Indication
Automatic polarity, decimal and overload
Adjustable range — NiCad batteries; also AC
Battery operating — NiCad batteries; also AC
Large LED display for easy reading without
interposition
Size 1 1/2" x 2 1/2" W x 4 1/2" D
1 1/2" hand operation
Leather case

\$125.
\$147.
\$190.
\$227

WRAP POST
for .042 dia. holes
(all boards on this page)
T-44 pkg. 100 \$2.28
T-44 pkg. 1000 \$14.00
A-13 hand installing tool \$2.80

SLIT-WRAP
Wraps insulated wire on .025" square posts
FOUR TIMES FASTER
than regular manual wrap-post tools

NO PRE-STRIPPING*
NO PRE-CUTTING*
SPOOL-FED WIRE*

*The spooled wire passes through the tool past a slitting edge
next to the wrap post. A narrow longitudinal cut is made in the
insulation where it presses the square post
corner the bare copper is incised by the sharp edge
(7 turns = 28 contacts)
insulation is left where wrapped but not between terminal posts
when let straight out of the tool.

P180 with two
100' spools
of 28 ga.
wire
\$24.95

P180-4T
includes
charger, wire
\$75.00

MS-15 MINISCOPE \$289
With Rechargeable Batteries & Charger Unit

• 15 megahertz bandwidth.
• External and internal trigger.
• Time base — .1 microsec. to 0.5 Sec/div - 21
settings ±3%.
• Battery or line operation.
• Automatic & line sync modes.
• Power consumption < 15 watts.
• Vertical Gain — .01 to 50 Div/12 settings ±3%.
• Viewing area 1.1" x 1.35"
• Case size 2.7" H x 5.4" W x 7.5" D, 3 pounds.
• Parts & labor guaranteed 1 year
• 10 to 1, 10 meg probe
• Leather carrying case

NLS

**LIQUID CRYSTAL DIGITAL
CLOCK-CALENDAR**

For Auto, Home, Office
• Small in size (2x2 1/2 x 1/2)
• Push button for seconds release for date.
• Clocks mount anywhere with either 3M double-
sided tape or VELCRO.
• 2 MODELS AVAILABLE:
LCD-101, portable model runs on self-contained
batteries for better than a year.
LCD-102, runs on 12 Volt system and is back-
lit.
LCD-101 or LCD-102
Your choice

Clear desk stand for
LCD-101

\$34.95
\$2.00

**DTS-431 Hi Voltage NPN
Transistor 3.95 ea. or 3/10.00**

High Voltage NPN Transistor
(Complete with mounting hardware)

V_{ceo} 400V
V_{ceo} 5V
V_{ceo} 400V
I_c 5A
I_B 2A
P_D 125W

**ACE • All-Circuit
Evaluator**
for fast, solderless,
plug-in circuit building
and testing

Just plug in any components with leads to .025" dia. inter-
connect with solid wire up to 20 ga. Assembled models tool
included

Kit	Part No.	Quantity	Price
100 (Kit)	728	8 (16 x 7)	\$18.95
200 (Kit)	872	8 (16 x 7)	\$28.95
300 (Kit)	1022	12 (16 x 7)	\$38.95
400 (Kit)	1222	12 (16 x 7)	\$48.95
500 (Kit)	1422	12 (16 x 7)	\$58.95
600 (Kit)	1622	12 (16 x 7)	\$68.95
700 (Kit)	1822	12 (16 x 7)	\$78.95
800 (Kit)	2022	12 (16 x 7)	\$88.95
900 (Kit)	2222	12 (16 x 7)	\$98.95
1000 (Kit)	2422	12 (16 x 7)	\$108.95

16 K EPROM

is first
to bring you
**FACTORY PRIME
T.I. TMS-2716JL**
16K EPROM programs
like a 2708.
\$39.95

100 K Joypot

\$4.95

**3 LEVEL
GOLD WIRE
WRAP SOCKETS**

Pin	1-24	25-49	50-99
8 pin	.47	.42	.37
10 pin	.45	.41	.37
14 pin	.39	.38	.37
16 pin	.43	.42	.40
18 pin	.75	.66	.62
22 pin	1.00	.97	.95
24 pin	1.00	.94	.75
28 pin	1.09	.98	.84
36 pin	1.59	1.45	1.30
40 pin	1.49	1.39	1.29

MICRO-KLIP
for .042 dia. holes
(all boards on this page)
T42-1 pkg. 100 \$1.50
T42-1 pkg. 1000 \$11.00
P-149 hand installing
tool \$2.03

SC-5
With
Rechargeable
Batteries &
Charger
Unit
\$89

FM-7
With
Rechargeable
Batteries &
Charger
Unit
\$195

Features include: • By using the new NLS SC-5 Prescaler, the range of
the FM-7 Frequency Meter, which is 10 Hz to 60 MHz, may be extended
to 512 MHz (the upper VHF & UHF frequency bands). • The FM-7 uti-
lizes an LED readout, providing 7-digit resolution. • The FM-7 can be
calibrated to an accuracy of 0.0001%. • The SC-5 is accurate to one
part per million. • Each unit has 30 millivolts sensitivity, is battery
powered and has a charger unit included. • Dimensions of each are 1.9"
H x 2.7" W x 3.9" D. • The units may be obtained separately or as a
"Frequency Duo" • Parts & Labor guaranteed 1 year.

\$1.50
\$18.00

SPECIAL

14CS2 100 for \$14.00
16CS2 100 for \$16.00
14 pin CS2 10 for \$2.00
16 pin CS2 8 for \$2.00

These low cost DIP sockets will accept
both standard width plugs and chips.
For use with chips, the sockets offer a low
profile height of only .125" above the board.
These sockets are end stackable.

**AY-5-1013
UART**
\$4.95
(TR1602A)
0 to 30 kbaud

IC TEST CLIPS

MODEL	Row-To-Row Dimension	PART NUMBER	PRICE
TC-8	3 IN.	923895	17.36
TC-14	3 IN.	923698	4.50
TC-16	3 IN.	923700	4.75
TC-16 LSI	5/8 IN.	923702	8.96
TC-20	3 IN.	923703	10.00
TC-22	4 IN.	923704	11.86
TC-24	5/8 IN.	923706	11.56
TC-28	5/8 IN.	923714	13.86
TC-36	5/8 IN.	923716	15.25
TC-40	5/8 IN.	923722	21.00

1/16 Vector BOARD
.042 dia holes on
0.1 spacing for IC's

Part No.	SIZE	PRICE
64P44-062XXP	4.5 x 6.5"	\$ 1.49
169P44-062XXP	4.5 x 17"	\$ 3.51

Part No.	SIZE	PRICE
64P44-062	4.5 x 6.5"	\$ 1.70
84P44-062	4.5 x 8.5"	\$ 2.10
169P44-062	4.5 x 17"	\$ 4.30
169P84-062	8.5 x 17"	\$ 6.39

EXAR INTEGRATED CIRCUITS

EXAR-208 10 Bit Successive Approximation
EXAR-210 10 Bit Successive Approximation
EXAR-212 10 Bit Successive Approximation
EXAR-214 10 Bit Successive Approximation
EXAR-216 10 Bit Successive Approximation
EXAR-218 10 Bit Successive Approximation
EXAR-220 10 Bit Successive Approximation
EXAR-222 10 Bit Successive Approximation
EXAR-224 10 Bit Successive Approximation
EXAR-226 10 Bit Successive Approximation
EXAR-228 10 Bit Successive Approximation
EXAR-230 10 Bit Successive Approximation
EXAR-232 10 Bit Successive Approximation
EXAR-234 10 Bit Successive Approximation
EXAR-236 10 Bit Successive Approximation
EXAR-238 10 Bit Successive Approximation
EXAR-240 10 Bit Successive Approximation
EXAR-242 10 Bit Successive Approximation
EXAR-244 10 Bit Successive Approximation
EXAR-246 10 Bit Successive Approximation
EXAR-248 10 Bit Successive Approximation
EXAR-250 10 Bit Successive Approximation
EXAR-252 10 Bit Successive Approximation
EXAR-254 10 Bit Successive Approximation
EXAR-256 10 Bit Successive Approximation
EXAR-258 10 Bit Successive Approximation
EXAR-260 10 Bit Successive Approximation
EXAR-262 10 Bit Successive Approximation
EXAR-264 10 Bit Successive Approximation
EXAR-266 10 Bit Successive Approximation
EXAR-268 10 Bit Successive Approximation
EXAR-270 10 Bit Successive Approximation
EXAR-272 10 Bit Successive Approximation
EXAR-274 10 Bit Successive Approximation
EXAR-276 10 Bit Successive Approximation
EXAR-278 10 Bit Successive Approximation
EXAR-280 10 Bit Successive Approximation
EXAR-282 10 Bit Successive Approximation
EXAR-284 10 Bit Successive Approximation
EXAR-286 10 Bit Successive Approximation
EXAR-288 10 Bit Successive Approximation
EXAR-290 10 Bit Successive Approximation
EXAR-292 10 Bit Successive Approximation
EXAR-294 10 Bit Successive Approximation
EXAR-296 10 Bit Successive Approximation
EXAR-298 10 Bit Successive Approximation
EXAR-300 10 Bit Successive Approximation

Price Breakthrough!
MA1003 CAR CLOCK
\$17.95

Bright Green Fluorescent Display Crys-
tal Time Base Assembled, just add
switches and 12 VDC.

**TAKE ADVANTAGE OF
THIS SPECIAL
PURCHASE OF
100% FACTORY PRIME PARTS**

CM4006AE	2.00
CM4007AE	8 / 1.00
CM4008AE	3 / 1.00
CM4011AE	8 / 1.00
CM4012AE	5 / 1.00
CM4013AE	4 / 1.00
CM4014AE	3 / 2.00
CM4015AE	3 / 2.00
CM4017AE	2 / 1.00
CM4018AE	4 / 1.00
CM4019AE	3 / 2.00
CM4020AE	1.00
CM4022AE	8 / 1.00
CM4023AE	3 / 1.00
CM4024AE	5 / 1.00
CM4025AE	7 / 1.00
CM4030AE	3 / 2.00
CM4035AE	2.00
CM4037AE	2 / 1.00
CM4041AE	1.00
CM4047AE	4 / 1.00
CM4049AE	4 / 1.00
CM4050AE	4 / 1.00
CM4116AE	4 / 1.00

PRIORITY ONE ELECTRONICS

10031 Woodley Ave. Sepulveda CA. 91343 P21

Terms: BAC, MC, Check, Money Order, C.O.D. CA. residents add 6% sales tax. Orders less than \$75.00 include 10% shipping
& handling; excess refunded. Just in case... please include your phone no. Prices good through 1977.

phone orders welcome (213) 893-8202
OEM and institutional inquiries invited.

Send for our latest brochure.
PRIORITy 1 ELECTRONICS a div. of the HEATH Group.

10% Discount on 100 pcs.
or More.
(Min. 25 per Part No.)
Quantities are limited.

SPECIAL WAREHOUSE SALE

THE BEST DEAL WE HAVE EVER OFFERED!

BRAND NEW
**ROYTRON 8-LEVEL
READER/PUNCH**

\$295.00

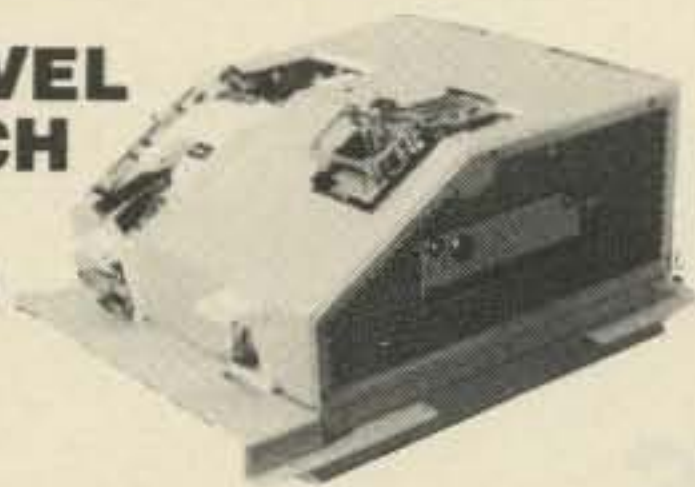

This paper tape I/O station operates at 50 cps. The mechanisms share a common drive motor but are electrically independent. 24 volt signals are required to interface the internal solenoids. An interfacing manual is included. Perfect for typesetting, program distribution, program entry and many other paper tape applications.

USE S-100 BOARDS WITH YOUR KIM-1

Now use low-cost and readily available S-100 compatible circuit boards with your KIM-1! The Kimsi from Forethought Products adapts the KIM Bus to the S-100 Bus so that you have access to hundreds of memory and interface boards.

The Kimsi accepts up to 8 S-100 edge connectors, provides on-board power regulation for the KIM-1 and contains the KIM to S-100 interface logic. One S-100 edge connector is included, the KIM to Kimsi connector set must be purchased separately.

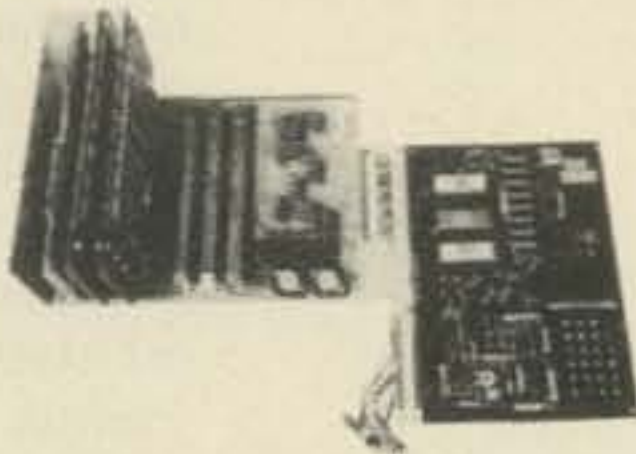

Item	Kit Price	Assembled Price
Kimsi Backplane/S-100 Adapter 8 slots for S-100 available	\$125	\$165
Kimsi Power Supply Unreg. +8@10A; +16@1A; -16@1A	60	75
KIM-1 incl. documentation Send for more information	N/A	245
KIM to Kimsi Connector Set Includes recorder cables	8	11
S-100 Edge Connector Kimsi accepts 8; 1 is supplied	5	7
Cassette Recorder for KIM-1 Hundreds sold for KIM use	N/A	55
4K Seals ROM Board Accepts up to 16 1702A or 5203's	119	179
4K Imsai RAM Board Bare minimum to run Tiny BASIC	139	239
8K Cromenco ROM Board Accepts up to 8 2708 EPROMs	145	245
8K Seals RAM Board Enough space for programs below	269	369
Poly Video Terminal Interface 16 x 64 Connects to a Monitor and Keyboard	210	280
Matrox 2480 Alpha-Numeric VRAM 24 lines of 80 char. (needs P39)	N/A	295
Matrox 256-ALT Video Graphics Board Displays 256 x 256 array	N/A	395
Itty Bitty Tiny BASIC 2.5K; kit is a paper tape	5	10
Focal (a DEC trademark) Includes floating points	N/A	40
6502 Assembler with Source This is NOT the MOS version	N/A	30

**SPECIAL! 10% off S-100 Boards
when ordered with Kimsi.**

ORDER FORM

Name _____
Address _____
City State Zip _____
Charge my BAC/VISA _____ M/C _____
Interbank # _____ Exp. Date _____
Card # _____
Signature _____

Please send me info on the new Commodore PET 2001 computer

Limited 90-day Warranty

Return non-working merchandise within 90 days for replacement or refund. Kits are warranted to be complete with working components. All items subject to prior sale.

ECONOMICAL KEYSTATIONS \$29.50

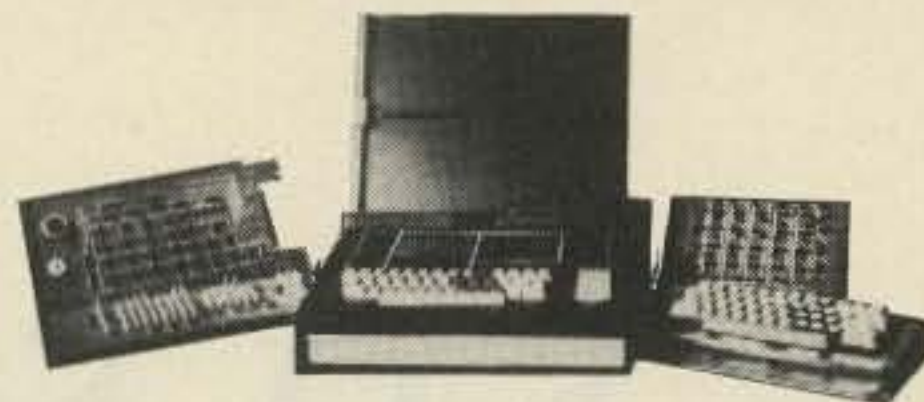

A super buy on these used keystations allows us to sell them at this low price. These attractive units contain a Hollerith-style keyboard which is easily modified to output ASCII alpha codes (we provide documentation). The interior of the enclosure is large enough for a KIM-1 and power supply. We also have a limited supply of keystation components:

Item	Price		
50 key keyboard	\$19	Incandescent Display Board	3
Mounts on 11.5" centers		Contains over 130 lamps	
Keystation Enclosure	19	Display Controller Board	5
Dimensions 16" x 16" x 4"		38 IC's and a Sonalert	
Copy Stand and Holder	5		
Mounts on top of enclosure			

MORE BARGAINS

Burroughs Self Scan Display Panel Model 0030 16 or 18 character display	\$32.50
Ultrasonic Latching Relay for Remote Control Operate 110v appliances from across the room	19.95
Data General 6012 CRT Terminal Brand new with numeric keypad: 4800 baud max.	1195.00
DEC PDP8/I or L with 4K core memory Table-top or floor models available	as low as 795.00

MATROX VIDEO RAMS AND GRAPHICS

Tops in the industry, please write for more info. See our KIM Corner for S-100 compatible boards.

MTX 816 Module (Upper Case only) Composite video output in 8 lines of 16 chars.	179.00
MTX 1632 Module (Upper and Lower Case) 16 x 32 display includes blink option	225.00
MTX 1632SL Module (Great with 256**2) Slave sync allows text superposition	225.00
MTX 2480 Circuit Board 24 x 80 requires high-persistence phosphor (P39)	395.00
MTX 256**2 Circuit Board 256 x 256 array graphics (multiples provide color)	630.00

BOOKS

Programming Microprocessors Including arithmetic with floating points	\$ 6.95
Build Your Own Working Robot Buster cries when he can't find his "food."	5.95
Telephone Accessories You Can Build Remote ringer, scrambler, dialer, answerer, etc.	3.95
Master Handbook of 1001 Practical Electronic Circuits Almost 1 1/2 inches thick	9.95
Basic BASIC A great text, many examples, questions and answers	7.95
Advanced BASIC Coordinate geometry; series polynomials, games	6.95
101 BASIC Games The now classic volume compiled by David Ahl	7.50
What to Do After You Hit Return Games from the People's Computer Company	6.95
CMOS Cookbook Don Lancaster explains CMOS low-power logic	9.95
Introduction to Microcomputers Volume I Adam Osborne explains the theory behind micros	7.50
Introduction to Microcomputers Volume II Then he reviews the current crop of micros	12.50
8080 Programming for Logic Design A whole book on 8080 implementation	7.50
6800 Programming for Logic Design A whole book on 6800 implementation	7.50
Some Common BASIC Programs Full of many useful and complete programs	7.50

Qty	Item	Price	Amount
Total for goods			
+4% Michigan Residents			
+4% Shipping and Handling			
+\$1 if order's under \$20			
Total Amount			

COMPUMART Inc. 1250 N. Main St. Ann Arbor, Mi. 48104 **994-4445**
A Division of Newman Computer Exchange, Inc. Dept. 73

S.D. Sales

Z-80 Review

-- quality at a good price

With the price of hobby computer equipment going from expensive to overpriced and, lately, to outrageous, I have been home brewing most of my computer equipment. This makes it more affordable, as the price of the components plus the cost of a wire-wrap Altair S-100 card is usually a small fraction of the price of the equivalent kit. I have designed and built a complete Altair S-100 bus computer for about \$100-150 less CPU card. This computer has all the panel functions of a commercial machine, such as the IMSAI, and performs equally. It was originally designed to use the somewhat obsolete 8080 CPU card that was removed from my other computer when I changed over to a Z-80. However, as anyone who has ever used both chips can tell you, once you have used a Z-80 you will not be able to tolerate the poor in-

struction set and processing inefficiency of the 8080. About that time I saw an ad for the \$149.95 Z-80 CPU card from S.D. Sales. It was fantastic and was at a price that was less than my first Z-80 card cost to build. Of course, the price of the Z-80 had dropped somewhat since I built my first card, but the price was still around the current cost of parts to build a card, so I ordered one.

Having built several micro-computer kits, and lived with poor documentation, poor quality boards, idiotic designs that were very hard to change, etc., I didn't really know what to expect at such a low price. But, past experience with S. D. Sales on parts orders had shown me that they were reputable, quick, and generally offered a good value with prime quality parts. This still did not completely prepare me for the surprise that I got when I

opened the package.

The PC board was one of the best quality boards I have ever seen. Fully solder masked, high quality plating, plated through holes ... everything! The design was really superb — two 5 V regulators with heat sinks (most CPUs really need two as the current required for all the buffers really heats up one), heavy power buses with a fantastic ground plane, silver mica caps, precut, preformed resistors (most resistors and caps were precut, preformed, and ready to insert in the PC board), a very thick book on the design, software, and hardware differences between the Z-80 and 8080, complete instructions for assembly, and a Z-80 manual. The ICs were all prime quality with very recent date codes. All of the component values (part numbers) were screened exceptionally clearly on the

component side of the board, and the IC numbers and component numbers are still visible after installing sockets (there were sockets provided for everything) and components.

The actual assembly of the board was one of the easiest and quickest assemblies of PC boards I've ever done. The instructions were excellent, and the preformed leads and clear screening made everything fall together. One or two resistor locations were somewhat obscure, as they did not wind up in the general numeric order of most of the parts and required a little searching. But there were only a couple of these, and they were solved after a few seconds of searching.

I popped the board into the computer and powered it up. Everything worked beautifully, the first time, and with no problems. I did have to make one minor modification to my VDM board (involving the bending of one pin on an IC) before I could initialize the screen. This was mentioned in the Z-80 manual that S. D. Sales provides (the kit manual), but I wanted to try it first to see if it was really necessary. They also mention a few modifications and changes (all very minor) to other boards to get them to work with the Z-80. This is necessary in the case of the VDM because of the timing difference between the Z-80 and 8080 (the Z-80 is in most cases faster). However, it works fine, and it was really thoughtful of S. D. Sales to point all of these differences out. (This is an example of the thorough and complete attention to detail and documentation that is typical of everything involved with the kit.) It is one of the truly fantastic bargains still available on the hobby micro-computer market today.

Speaking of fantastic bargains, S. D. Sales also makes a 4K low power memory board for the Altair S-100 bus that is an equal bargain, in that it has the same quality parts, is

equally well documented, easy to build, and costs less than the components to wire-wrap one. This is another well-designed, well-implemented piece of hardware. The board uses 4 regulators and runs very cool. Fast memory chips and good design allow super fast board access time. (The board has no provisions for wait states but works perfectly with a Z-80 CPU running at almost 3 MHz, which is far in excess of specs.) There are sockets for

everything. Run to the nearest phone and order a dozen or so right away, before they come to their senses and raise the price to what it should be. At \$89.95 you are robbing them blind.

The combination of the CPU and memory gives you the basis for a really super home brew computer with the addition of a panel, backplane and power supply. This will give you a complete machine, with a Z-80, 16K of reliable, low power STATIC

memory, and full I/O for about the cost of a bare IMSAI or the same with video output capability for the cost (or slightly less) of an Altair (the case, panel, 8080 CPU and power supply and nothing else).

In case this review seems too good to be true, you might remember the early days of 73 when I used to review ham radio equipment. I never was overly kind to a manufacturer that didn't deserve it and told it like it was.

I still feel the same today, and with the abundance of shoddy, overpriced computer equipment on the market (as well as a lot of very good equipment), these product reviews are an important guide as to what to buy or avoid. However, they should also be a useful guide, if honestly written, as to what is good and what is really a fantastic bargain. These boards from S. D. Sales definitely qualify for the category of fantastic bargain. ■

Manufactured & Guaranteed by
MOR-GAIN
2200T South 4th Street
Leavenworth, Kansas 66048
(913) 682-3142



Fully Air Tested - Thousands Already in Use

• 16 40% Copper Weld wire annealed to it handles like soft Copper wire - Rated for better than full legal power AM/CW or SSB-Coaxial or Balanced 50 to 75 ohm feedline - VSWR under 1.5 to 1 at most heights - Stainless Steel hardware - Drop Proof Insulators - Terrific Performance - No coils or traps to break down or change under weather conditions - Completely Assembled ready to put up - Guaranteed 1 year - ONE DESIGN DOES IT ALL.

BankAmericard and Mastercharge available

**EXCLUSIVE 66 FOOT,
75 THRU 10 METER DIPOLES**

NOTES

- Models prefaced '***' will be available 1/77.
- All models above are furnished with crimp/solder lugs.
- All models can be furnished with a SO-239 female coaxial connector at additional cost. The SO-239 mates with the standard PL-259 male coaxial cable connector. To order this factory installed option, add the letter 'A' after the model number. Example: 40-20 HD/A.
- 75 meter models are factory tuned to resonate at 3950 kHz. (SP) models are factory tuned to resonate at 3800 kHz. 80 meter models are factory tuned to resonate at 3650 kHz. See VSWR curves for other resonance data.

MODEL	BANDS (Meters)	PRICE	WEIGHT (Oz/Kg)	LENGTH (Ft/Mtrsl)
40-20 HD	40/20	\$49.50	26/7.3	36/10.9
***40-10 HD	40/20/15/10	59.50	36/1.01	36/10.9
80-40 HD	80/40 + 15	57.50	41/1.15	69/21.0
75-40 HD	75/40	55.00	40/1.12	66/20.1
75-40 HD (SP)	75/40	57.50	40/1.12	66/20.1
75-20 HD	75/40/20	66.50	44/1.23	66/20.1
75-20 HD (SP)	75/40/20	66.50	44/1.23	66/20.1
75-10 HD	75/40/20/15/10	74.50	48/1.34	66/20.1
75-10 HD (SP)	75/40/20/15/10	74.50	48/1.34	66/20.1
**80-10 HD	80/40/20/15/10	76.50	50/1.40	69/21.0

**NO TRAPS—NO COILS—
NO STUBS—NO CAPACITORS**

MOR-GAIN HD DIPOLES . . . • One half the length of conventional half-wave dipoles. • Multi-band, Multi-frequency. • Maximum efficiency - no traps, loading coils, or stubs. • Fully assembled and pre-tuned - no measuring, no cutting. • All weather rated - 1 KW AM, 2.5 KW CW or PEP SSB. • Proven performance - more than 15,000 have been delivered. • Permit use of the full capabilities of today's 5-band xcvrs. • One feedline for operation on all bands. • Lowest cost/benefit antenna on the market today. • Fast QSY - no feedline switching. • Highest performance for the Novice as well as the Extra-Class Op.

Write or phone for full information or contact your favorite dealer.

M11



EDITORIAL BY WAYNE GREEN

from page 15

been involved with, right from the start.

The above is not intended as bragging; it is to put what I am about to write into perspective. Note that there is no one involved with the ARRL or any other ham magazine with even a fraction of this background. I have been at the heart of amateur radio for a long time now, and I think I understand how the pieces of the puzzle fit together.

THE OVERALL PICTURE

Before we can adequately tackle an immediate problem, it is helpful to step back and take a long look at the whole situation. This keeps us from being too confused by the trees to see the forest.

Amateur radio exists because international allocations of frequencies have been set aside for it by the International Telecommunications Union (ITU), an international organizer of all radio frequencies and wire communications. The United States is a member nation of the ITU and has

agreed to abide by the rules which this body makes.

At each ITU frequency conference, amateur radio has lost frequencies. Old-timers remember when 20 meters went from 14 to 15 MHz and 40 meters from 7 to 8 MHz, etc.

1947 - ATLANTIC CITY

At this ITU conference, the major European nations got together with the U.S. and screwed the smaller nations of the world out of major portions of the shortwave bands. Radio was still primitive in many of the smaller countries, and their representatives didn't realize how the world would change in the next few years. The ITU at this time was firmly under the control of the U.S.

1959 - GENEVA

When this ITU conference came along, I had been editor of *CQ Magazine* for four years. I was selected by the State Department as one of the official representatives of amateur radio, along with Huntoon of the ARRL. I had visited the ITU the previous year and gotten the inside

story on what was in store for amateur radio at the '59 frequency conference . . . and it was a truly alarming story. When I found out what the positions were of some of the supposed "friendly" countries, I called the general manager of the ARRL, Budlong, and offered to put aside any differences between the two magazines in order to present a united front. Budlong, in blunt four letter words, said he didn't need any help from anyone. He personally had been running amateur radio for years and he would continue to run it . . . so go to hell.

When I arrived at Geneva a short while before the ITU conference was to begin, I was issued a five foot shelf of position papers to wade through. Each of the countries at the conference had proposed substantial changes in the frequency allocations in the 3-30 MHz band.

As I read through the positions of the various countries, I found that the predictions of the ITU hams had been, if anything, far too optimistic. Virtually every country proposed serious cuts in the ham bands . . . some in favor of shortwave broadcasting, some for mobile services, some for short range commercial services, etc. For example, the Wireless Institute of Australia is one of the world's more vocal ham groups, with considerable strength in their country . . . yet the official position of Australia was to cut all ham bands down to 50 kHz width!

If that sounds drastic, our good Asian friends in India officially proposed that all ham bands be cut to 20 kHz - worldwide - and they seemed to have a good deal of support from several smaller countries.

The mood of the hams at Geneva was glum. True, the official U.S. position was to back the present ham allocations and ask for no changes. But when I took the other delegates on the U.S. team out to breakfast, lunch, dinner, coffee, etc., I found that in virtually all cases, their confidential instructions were to reflect any losses to their service to the nearest ham band. In other words, if they lost 50 kHz of allocation, it would be taken from a ham band to give them back the lost 50 kHz. This is how the 14,350 to 14,400 segment of 20 meters was lost in 1947.

The more foreign delegates I talked with, the more the conference looked like it would turn out to be a slaughter for amateur radio. Budlong was there, but he was asleep much of the time. Huntoon was all tied up with entertaining visiting ARRL dignitaries and acting as secretary for a few committees.

The U.S. strategy was to try to get all frequency allocations in the 3-30 MHz segment postponed until the next ITU general meeting, scheduled for around 1969. This would pull the fat out of the fire on a lot of the shortwave allocations where the U.S. had a disproportionate share. The U.S.

Continued on page 174



Title Your Pix With A Micro

-- a useful SSTV accessory

Upon the successful completion of my SSTV picture generator program¹, I decided my next logical applications program would be one to title SSTV pictures. This project was selected since a majority of the programming was already written and debugged in my previous project. To accomplish this task, another piece of equipment was required. This piece of equipment is an SSTV scan converter. This equipment is quite interesting because it takes normal TV from a fast scan camera and converts it directly to SSTV. Since the TV is digitized in the process, it is quite easy to mix computer-generated video with

the camera video.

Prior to any system layout or programming, I decided upon a few ground rules which would affect the total project. These rules were:

1. The entire program must be coresident in the SWTPC memory with my SSTV generator program in 8K memory.
2. Little or no hardware interface would be required.
3. An MXV 200 Scan Converter would be used to generate the SSTV.²

The selection of the MXV 200 Scan Converter was an obvious one — I had one in the shack. But even beyond that, it is the only scan converter available with pins on

the main connector to pick up sync pulses and locations to mix the digital video. Other units could be adapted to this application (e.g., the Robot 400³).

As with my previous programming projects, the first steps required were to determine detailed programming specifications and then to draw flowcharts. Additionally, I decided to use a structured programming approach and modularize the program for ease in writing, debugging and making future changes.

For anyone attempting such a project, this is an absolute necessity. As a result of these steps, I had the program totally operational in three weeks. Try and accomplish the same project in

hardware logic design in such a time frame! This point demonstrates how powerful microprocessors are, and how easily the SWTPC 6800 System can be programmed.

MXV 200 Scan Converter

A fast scan camera is connected directly to the unit as shown in Fig. 1. The first stage is used to shape the signal, and, in the second stage, the sync pulses are stripped from the fast scan video. The fast scan sync pulses are used to clock the 1K shift register memory and to generate the slow scan sync. The shift register memory is then loaded at a slow scan rate into a digital-to-analog converter and then into a slow scan modulator. The important concept which is required for the whole thing to work is to slave the microprocessor to the scan converter. This was accomplished by attaching the horizontal and vertical sync signals to the SWTPC 6800 Peripheral Interface Adapter (PIA) input port (pins 1 and 2). The output from the SWTPC 6800 was taken from two pins of the output PIA port (pins 4 and 5). Two pins were required for output, one for background and the other for character dots. The whole setup is shown in Fig. 2.

The Software

The programming routines

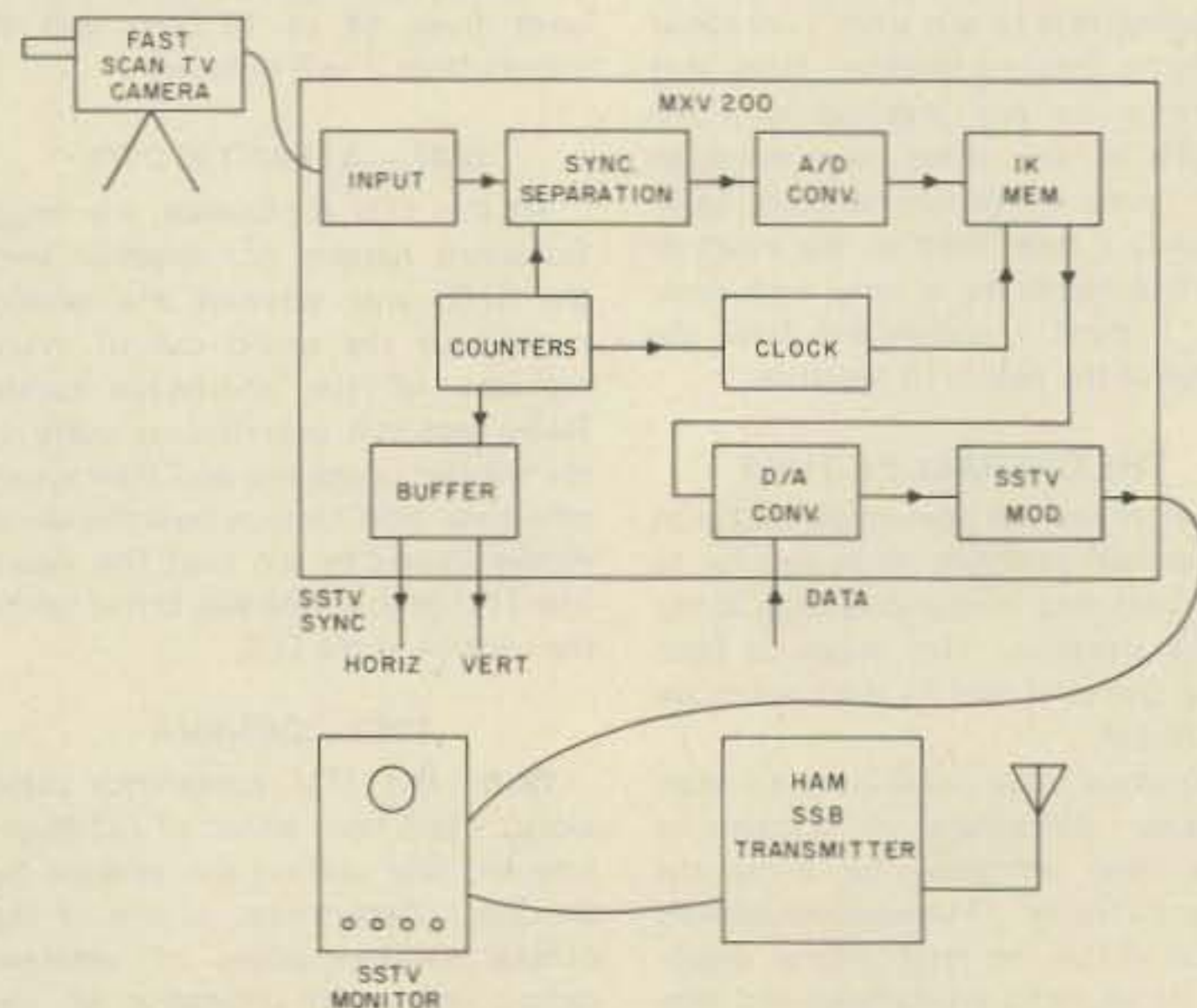
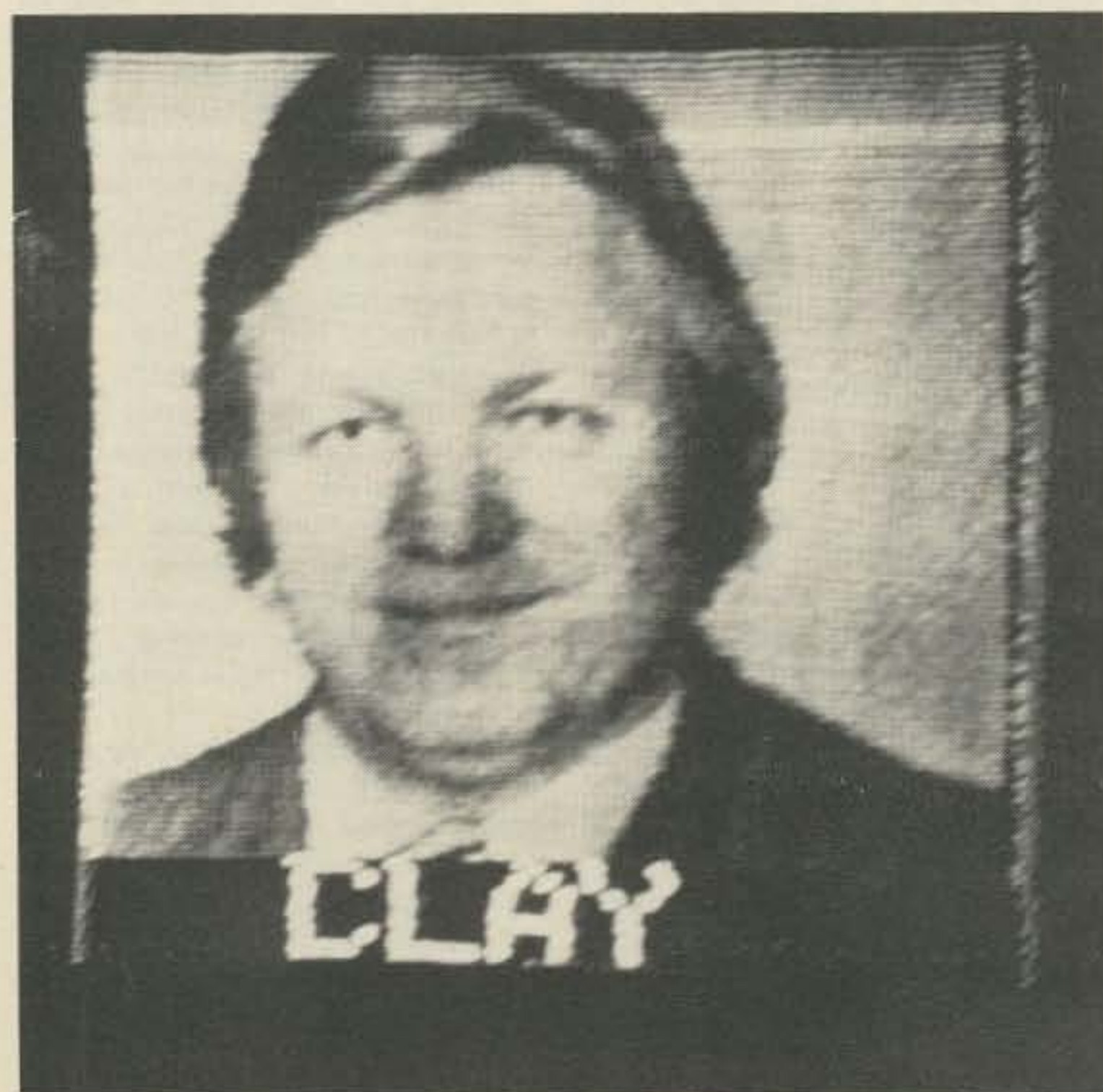

Fig. 1. MXV 200 Scan Converter block diagram.

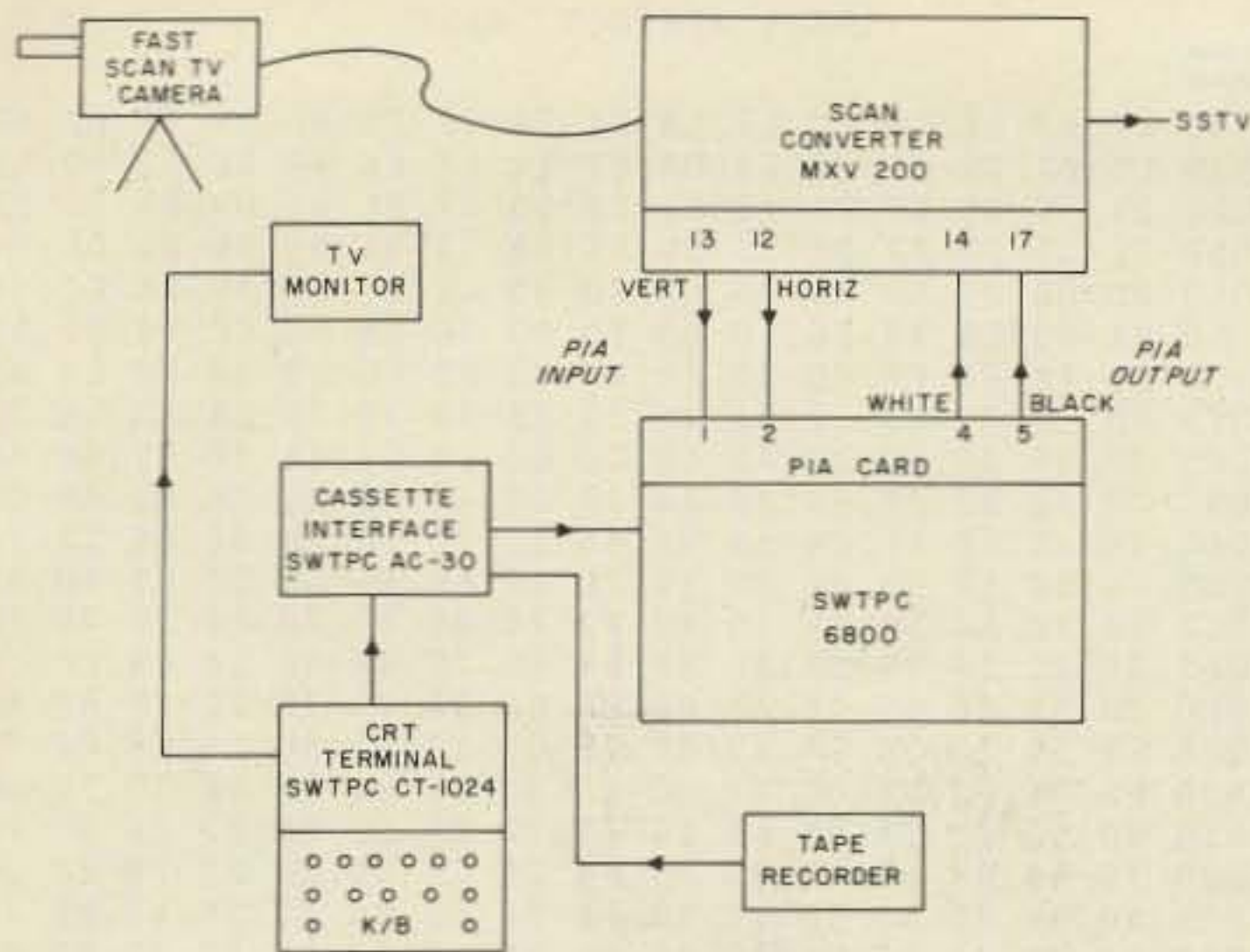

Fig. 2. Scan converter/computer interface.

used to generate the picture dots are similar to those used in my previous article. Therefore I will not discuss them in this article.

However, I will discuss the algorithms I used for picture sync and other significant changes. I will first start by listing a few of the features of the titler program.

1. The titler program mixes up to 10 lines of SWTPC 6800 generated characters with SSTV scan converter generated pictures.

2. The SWTPC 6800 computer connects directly to the MXV 200 and Robot 400 without a hardware interface.

3. Ten different titles can be stored in the SWTPC 6800 System's memory.

4. Titler program can place 1 line of 9 SSTV characters on any one of 9 locations of the SSTV picture.

5. Titler program can mix up to ten different formats which consist of picture loop/number/line.

6. Program includes a mini-monitor which allows the user to select the titler or generator program.

7. The mini-monitor allows the user to select either 50 or 60 Hz SSTV with the generator program.

8. The mini-monitor allows the user to select either white characters on a black background or black characters on a white background.

Fig. 3 shows the main line flow of the titler program

along with the subroutine names and a memory map. The SYNCV and SYNCH subroutines are two of the most important routines and function as follows:

1. The program senses the PIA, bit 1 or 2, and waits for it to go positive.

2. When the pulse goes positive, the program then waits for the bit to go to ground and then branches out of the routine.

As you can see, all that is now required is to count the horizontal sync pulses and, when the preprogrammed value matches the actual count, a line of slow scan characters are inserted into an SSTV picture.

The TRANS subroutine functions like the SSTV generator program. Fig. 4 contains a flowchart of this routine along with the memory counter locations used for storage of the various program constants.

The loading of the picture dots is similar to the generator program with one major exception — the picture dots are loaded immediately after the transmission of a titler line or prior to the start of the program. These are convenient times to perform operations of this type, since the computer would only be waiting for sync pulses.

Fig. 5 shows how the character dots are loaded into the picture dot buffer. The picture buffer consists of 126

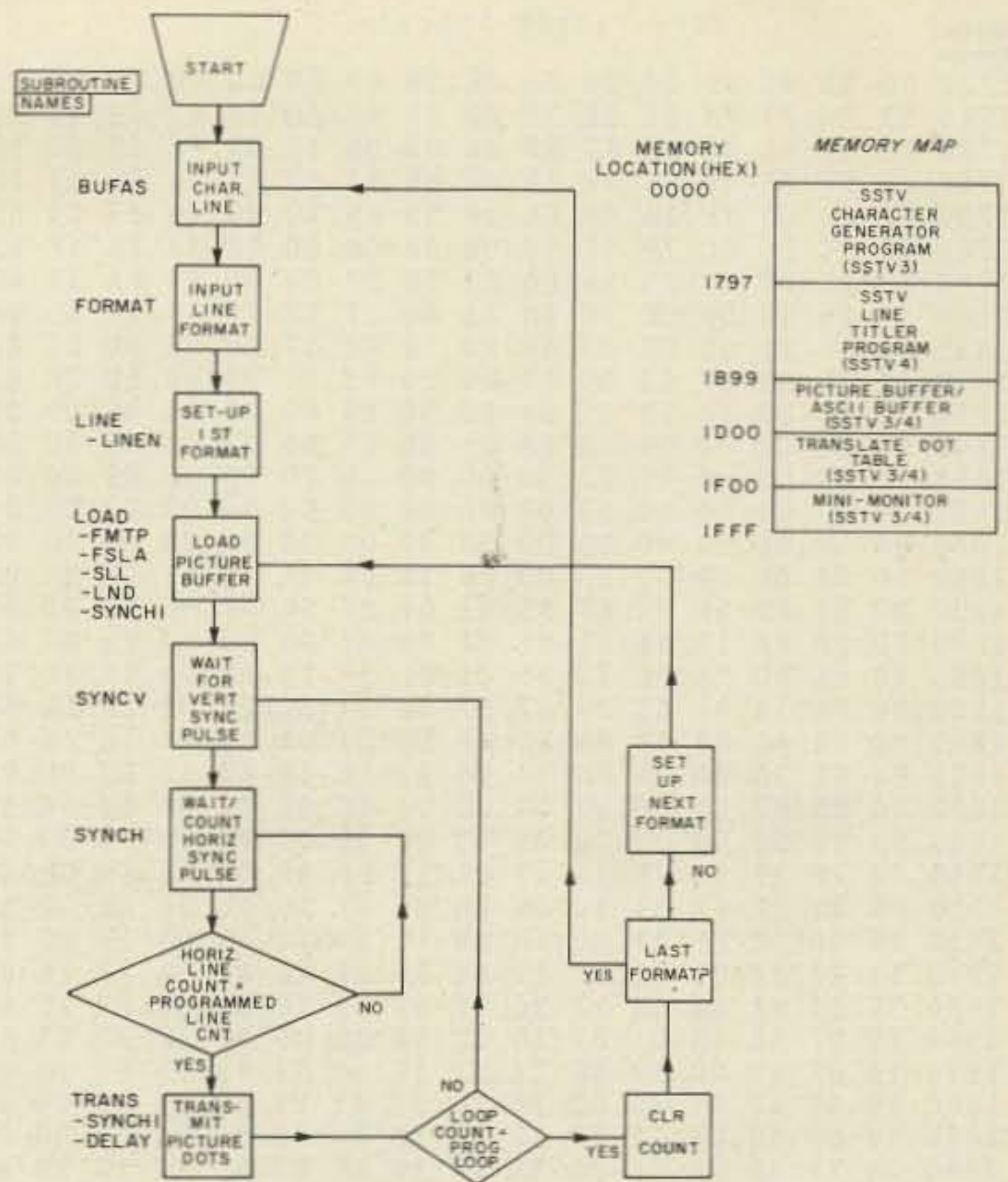

Fig. 3. Main line program.

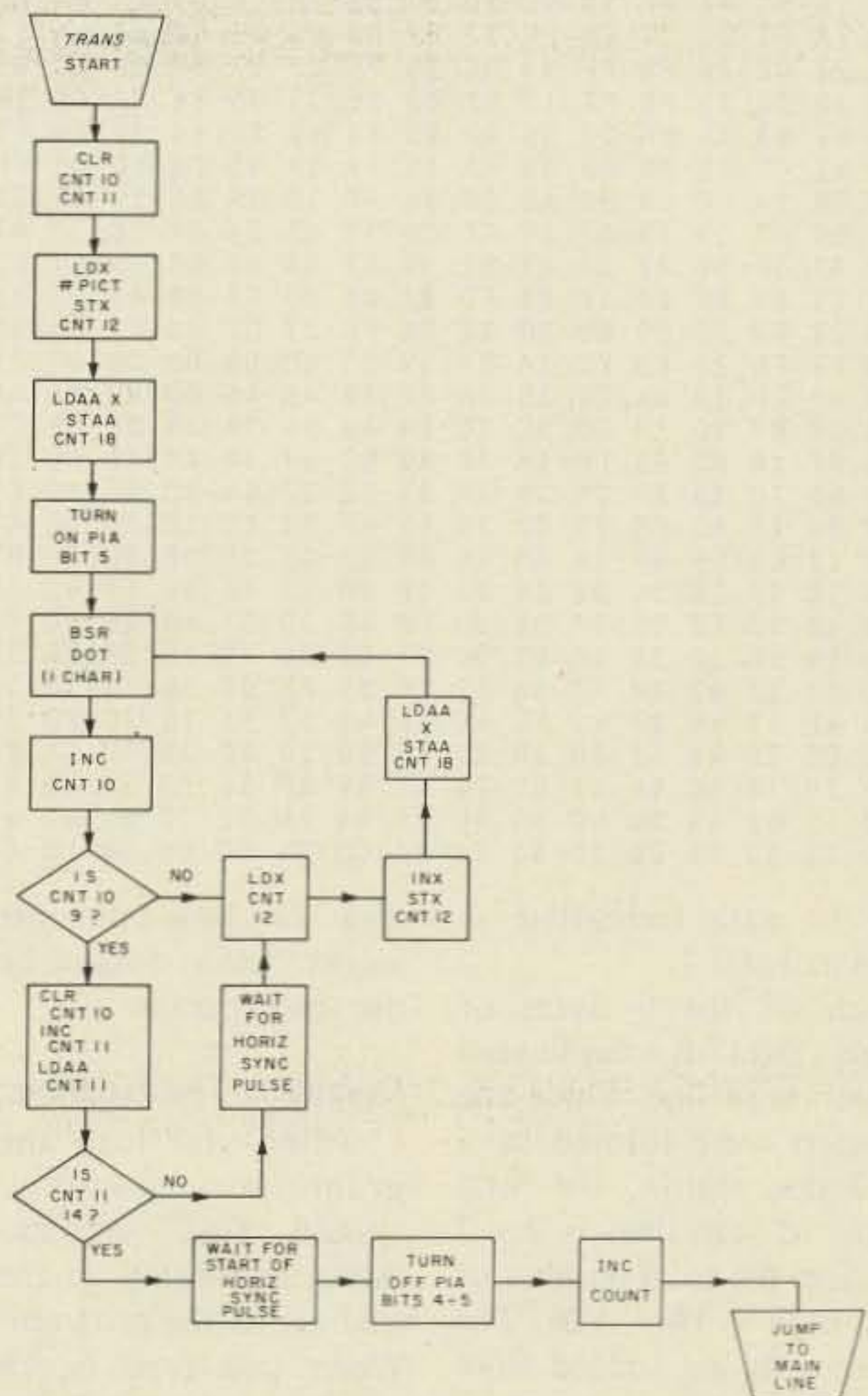

Fig. 4. Transmit picture line of 9 characters. COUNT = actual count of numbers of transmits. CNT 18 = temp. byte storage for picture dots. CNT 10 = character count. CNT 11 = Number of horizontal scan lines transmitted. CNT 12 = temp. storage for index register. PICT = address of picture dots in memory.

you see on the screen are shown in Photo 2. This routine is asking for an entry into the ASCII buffers of 9 characters. Ten buffers can be loaded (0-9). When you place an ASCII letter under the letter B, the program will then jump to the next routine.

The next routine is shown in Photo 3. This routine sets up the picture titles to be placed on the SSTV screen. The entry is formatted by the program in the order LOOP/PICTURE/LINE.

Up to ten of the above formats can be entered and the whole process will be terminated at the end of the tenth format, or when an ASCII letter is typed.

The following is a description of each format term:

1. Loop entry. Reply should be 1 to 9. This entry controls the number of SSTV frames which will contain the picture title you select. If you reply with a zero, 255 loops will be assumed. In order to recover from this condition, you must put a 00 in COUNT at location 1 AAD, or wait for 34 minutes of SSTV (255 frames).

2. Picture entry. This number corresponds to the picture buffer previously loaded. The reply should be 0 to 9.

3. Line entry. This reply selects the SSTV scan line at which the title will start. The reply should be 1 to 9. The following is a list of reply versus scan line:

Line no.	Scan Line
0 or 1	1
2	15
3	25
4	39
5	53
6	71
7	85
8	105
9	113

This concludes the description of how to use the program. Next, we'll discuss how to interface the SWTPC 6800 to the scan converters.

Interface Considerations

As I stated earlier, the

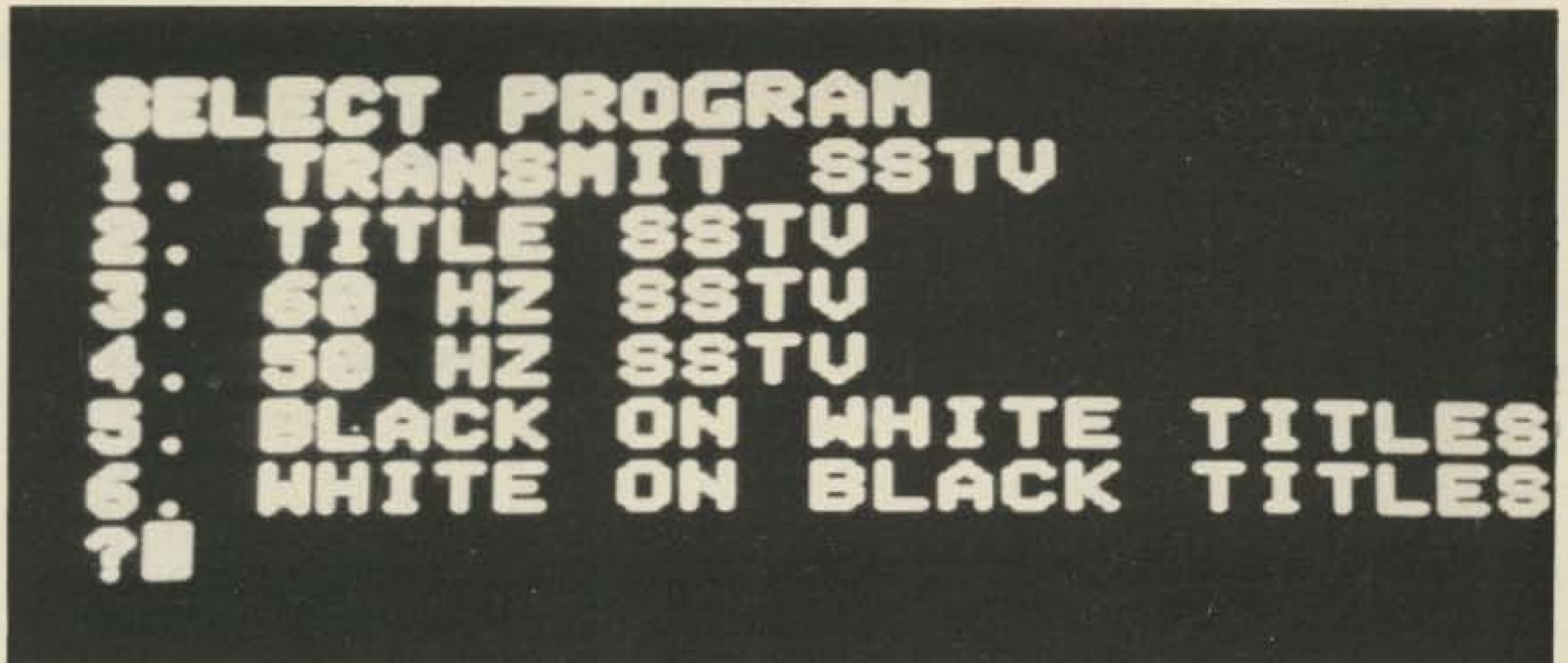

Photo 1. Mini-monitor routines.

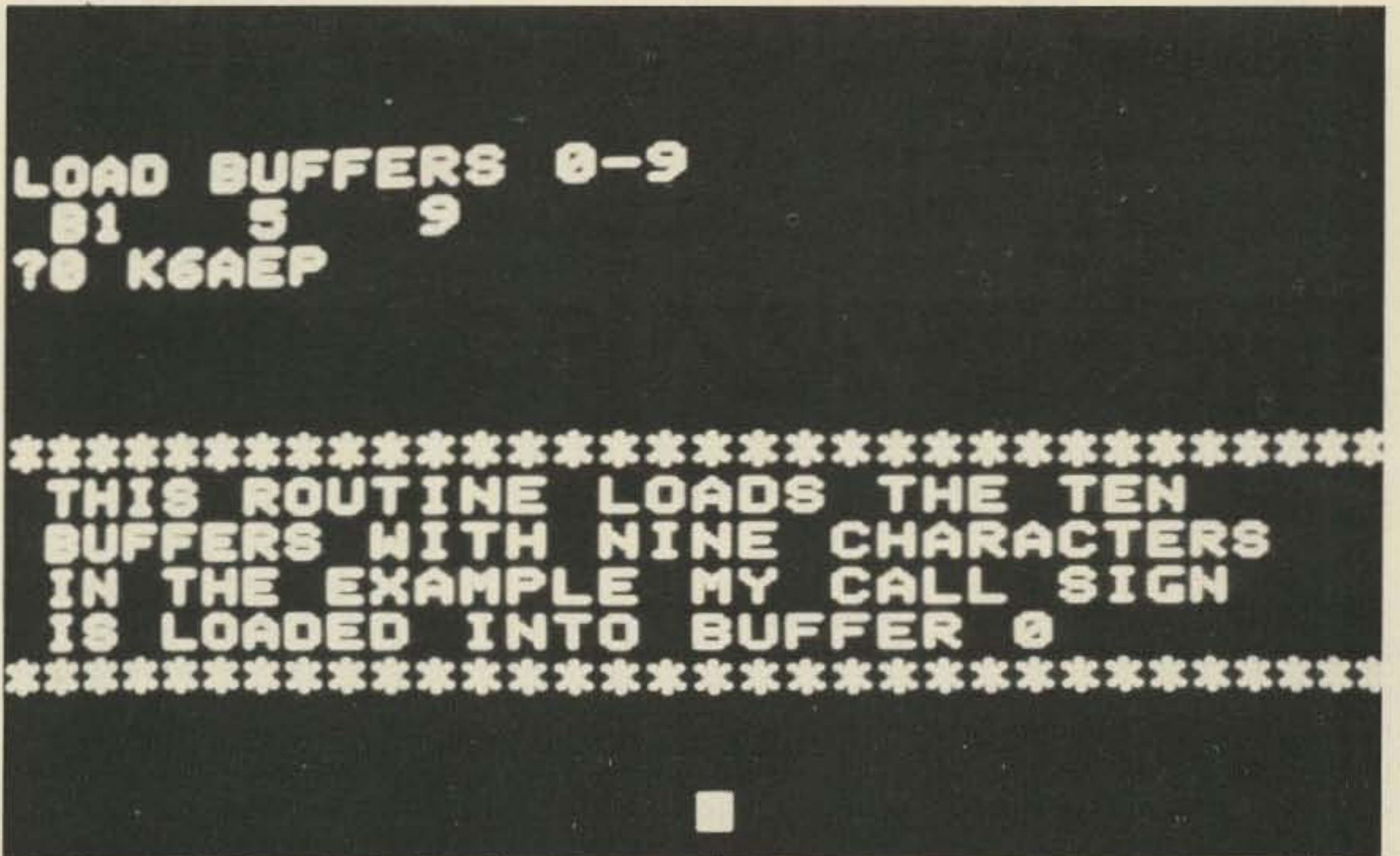

Photo 2. Titler program option.

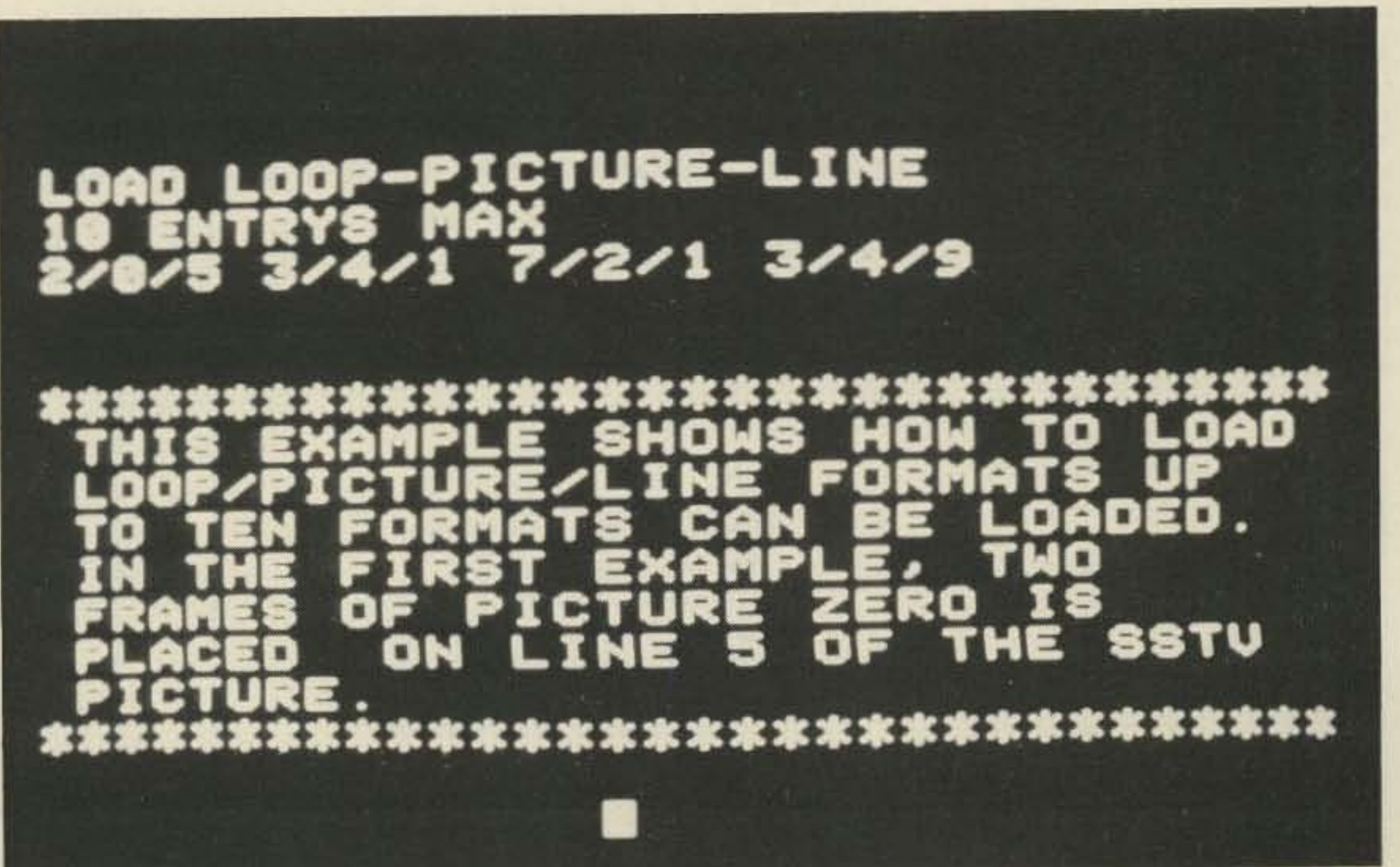

Photo 3. Entering (loading) picture titles.

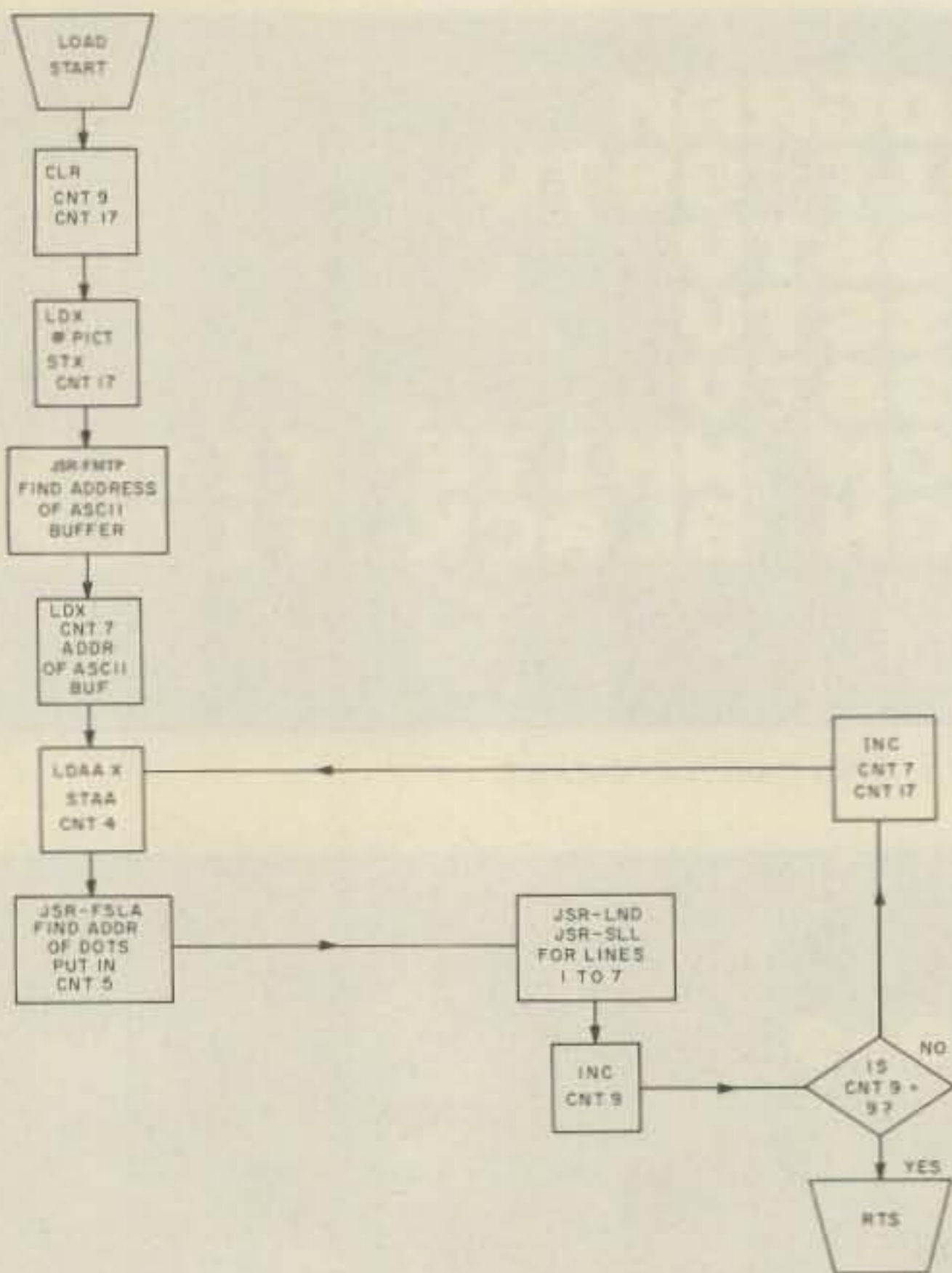

Fig. 5. Load character dots in picture. Memory counters: CNT 4 = ASCII character byte. CNT 5 = address of picture dots. CNT 7 = address of ASCII buffer. CNT 9 = character count. CNT 17 = address in picture buffer for dots.

MXV 200 is the easiest unit to interface to since all the correct signals are on the main connector. Table 2 lists the interconnection to both scan converters mentioned earlier.

The Robot 400 interface requires some additional comments from those listed in Table 2. The white control is obtained by removing U54 (74LS175) from its socket and bending pin 1 up. When installed on the board, a fine wire, #30, should be

connected to a free pin on the main connector and then interfaced to the computer. The black control is not available on the circuit board. However, pin 5 of S1 (memory reverse switch) can be used. Remove the wire from +5 volts on pin 5 of switch S1 and connect PIA bit 5 to it through a spare pin on the main connector. You may have to experiment somewhat in this area since I do not have a Robot 400 to attach to. You may have to

Character Position (bytes)

location	1	2	3	4	5	6	7	8	9
1B9A	1	2	3	4	5	6	7	8	9
1BA3	1	2	3	4	5	6	7	8	9

Table 1.

Unit	Signal	PIA Bit	Location
MXV 200	Vert Sync	input 1	pin 13
	Horiz Sync	input 2	pin 12
	White Cont	output 4	pin 14
	Black Cont	output 5	pin 17
Robot 400	Vert Sync	input 1	U44 pin 1
	Horiz Sync	input 2	U44 pin 2
	White Cont	output 4	U54 pin 1
	Black Cont	output 5	memory rev switch (S1)

Table 2.

experiment with the program constants to achieve the correct picture polarity. The program constants are located at locations 1B0D, 1B1B, and 1B29. These constants will have to be changed also in the mini-monitor.

If you decide to write about any questions, please include a self-addressed stamped envelope for my return answer.

This completes the functional description, operation and computer interface. I think a few words should be said regarding the SWTPC computer in general. The titler program assumes that MIKBUG is used and the following routines are used: E1D1 - Output one ASCII character; E1AC - Input one ASCII character; E07E - Output a character string.

Other system requirements are:

1. The output PIA address is side A at location 7, address 801C.
2. The input PIA is side B

address 801E. Prior to execution of the program, the PIA is initialized by the mini-monitor. If the user does not use the mini-monitor, the PIA must be conditioned in a similar manner for the PIA to function properly.

3. The SWTPC 6800 must have at least 8K of memory.

I would like to thank Mike Tallent W6MXV for his technical guidance with this project. Additionally, I would like to thank Clarence Munsey K6IV for his help in providing data on the interfacing to the Robot 400. ■

References

- 1 "SSTV Meets the SWTPC 6800," June 1977, 73 Magazine, C.W. Abrams K6AEP.
- 2 MXV 200 Scan Converter Unit can be obtained from Mike Tallent W6MXV in kit or PC board alone, \$35.00, contact Mike Tallent W6MXV, 6941 Lenwood Way, San Jose CA 95120.
- 3 Robot 400 Scan Converter, Robot Research Inc., 7591 Convoy Court, San Diego CA 92111.

NOT FOR EVERYONE...

The Antenna For The Purist

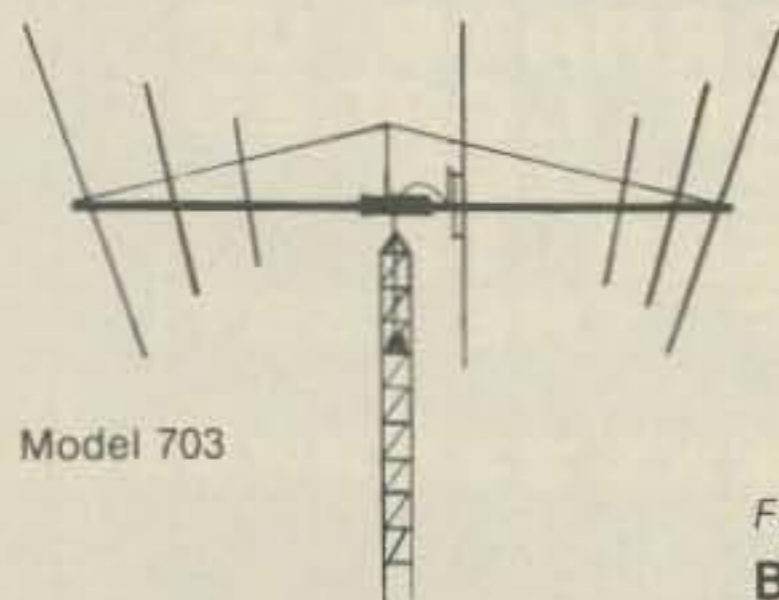

Model 703

- No Traps
- Seven Elements
- Three Bands (10-15-20)
- Single Feed Line
- Flexible Tuning
- Close To Mono-Bander Specs With Optimum Spacing For: High Forward Gain High F:B & F:S Ratios

For Specifications Write To:

BROOKFIELD MANUFACTURING CO.
50 Whippoorwill Road
Bethel, CT 06801
(203) 792-8944

\$395 Delivered U.S.A.
Except Alaska & Hawaii

B13

HANDY-TALKY OWNERS

Convert your rubber-ducky instantly into a PACE-TRAP FLYING-DUCKY! Permits use of your H-T in the car without loss of performance! Creates a low-profile mobile 2 meter antenna system as portable as the H-T. Folds the rip-off artists! Perfect for rental-car travelers!
50 pound pull magnetic mount holds at 100 mph even on vinyl-tops! Comes equipped with matched coax line and connectors to go with your handy-talky and rubber-ducky and provides solid mobile communications.
Complete mount and cable assembly for 10 second installation or removal with either F type or BNC type connectors. (Specify which) \$13.95 ea. p.p.d. Accessory 3/4 wave 2 meter roll-up whip for easy brief case packing. \$4.95 p.p.d. Check or money order to:

Order now for delivery on or about Oct. 15.

PACE-TRAPS Box 234
Middlebury, CT 06762
(203) 758-9228

P15

CANADIANS!

Eliminate the Customs Hassles.
Save Money and get Canadian
Warranties on IMSAI and S-100
compatible products.

IMSAI 8080 KIT \$ 838.00
ASS. \$1163.00

(Can. Duty & Fed. Tax Included).

AUTHORIZED DEALER

Send \$1.00 for complete IMSAI
Catalog.

We will develop complete applica-
tion systems.

Contact us for further information.

**Rotundra
Cybernetics** 

Box 1448, Calgary, Alta. T2P 2H9
Phone (403) 283-8076

R13

BUILD YOUR OWN VIDEO TERMINAL FOR \$85 PLUS*

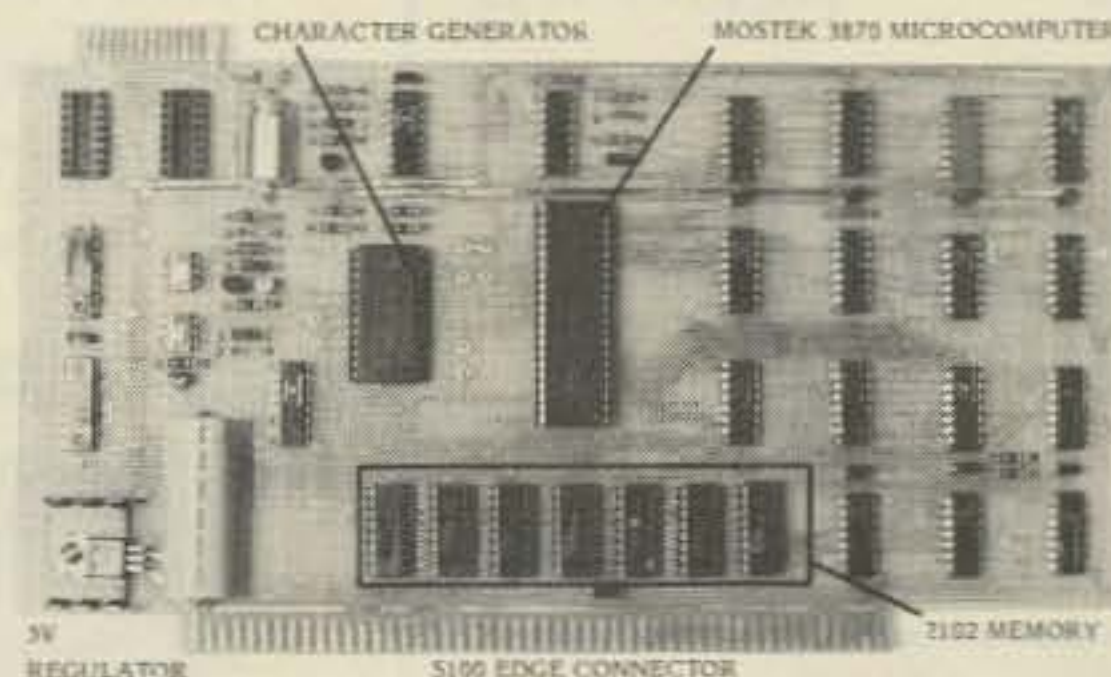

- Serial ASCII or BAUDOT
- Full X-Y Cursor control
- 128 Characters, including upper and lower case
- 16 lines X 64 characters
- S100 Compatability
- Operates on 7VDC unreg-ulated, 12.6 VAC @ 1.0 A

*The SCT-100 Single Card Terminal interfaces directly to any computer or modem having serial ASCII or BAUDOT capability. It requires only the addition of a standard ASCII keyboard, and a TV monitor. It is available as a partial kit for \$85.00 including the PC board, character generator ROM, and the 3870 micro-computer. The complete SCT-100 kit is \$155.00 (\$185.00 prewired & tested).

To order, call or write today. MC, BAC Accepted.

VECTRON P.O.Box #20887, Dallas, Texas, 75220
Phone (214) 350-5291

V13

TS-1 MICROMINIATURE ENCODER-DECODER

- Available in all EIA standard tones 67.0Hz-203.5Hz
- Microminiature in size, 1.25x2.0x.65" high
- Hi-pass tone rejection filter on board
- Powered by 6-16vdc, unregulated, at 3-9ma.
- Decode sensitivity better than 10mvRMS, bandwidth, ± 2 Hz max., limited
- Low distortion adjustable sinewave output
- Frequency accuracy, ± 25 Hz, frequency stability ± 1 Hz
- Encodes continuously and simultaneously during decode, independent of mike hang-up
- Totally immune to RF

Wired and tested, complete with
K-1 element

\$59.95

K-1 field replaceable, plug-in, frequency
determining elements

\$3.00 each

COMMUNICATIONS SPECIALISTS

P.O. BOX 153
BREA, CALIFORNIA 92621
(714) 998-3021

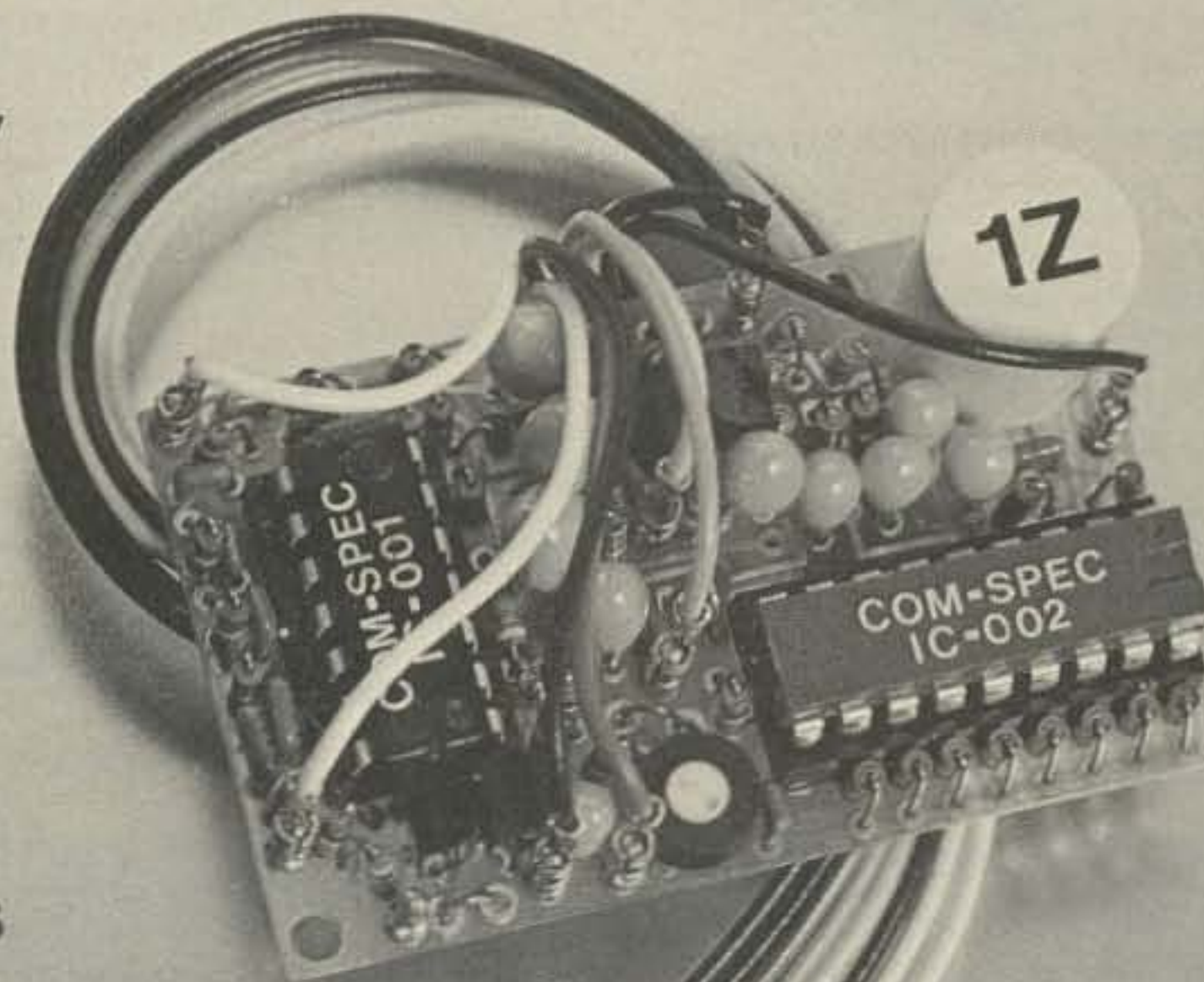

EVER WISH YOUR RECEIVER COULD HEAR THE WEAK ONES?

Almost every amateur and commercial VHF/UHF receiver can be more sensitive with these popular preamps. Over 7000 in use throughout the world!

P8 KIT \$7.95 **P16 W/T 16.95**

Recommended for mounting inside transceivers — only 1/2 x 2-3/8 inches



MODEL	RANGE
P8-30	20-83MHz
P8-150	83-190 MHz
P8-220	220-230 MHz
P16 (W/T)	Give exact freq.

P9 KIT \$9.95 **P14 W/T \$19.95**

Premium model where space permits — 1-1/2 x 3 inches. Ideal for OSCAR!

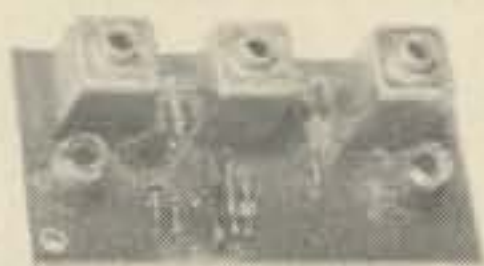

MODEL	RANGE
P9-30	26-88 MHz
P9-150	88-172 MHz
P9-220	172-230 MHz
P14 (W/T)	Give exact freq.

P15 KIT \$15.95
P35 W/T \$34.95

- Available for any band 380-520 MHz
- 20 dB gain



VHF AND UHF CONVERTERS

- Low noise FET front end
- All common i-f's
- Great for OSCAR!
- Low power drain
- Crystals available for any desired freq scheme



MODEL C25 VHF CONVERTER KIT (shown) \$25.95

- Models for 2M, 6M, 10M, 220 MHz, aircraft, com'l, etc.
- Stable cascode rf stage
- 0.3-0.5 uV sensitivity
- 10-20 dB gain
- Compact 2-1/2 x 4-1/2" pcb
- Any i-f 10-50 MHz
- Featured in HR mag article

MODEL U20-450 UHF CONVERTER \$19.95

- For 432-435 MHz ssb, atv, OSCAR, 450 MHz fm, aircraft, com'l, etc.
- Economy converter
- Use with P15 Preamp for optimum performance
- Any i-f 10-160 MHz

XTAL (either of above) \$5.50

FM/CW TRANSMITTER KITS



200 MW EXCITER MODULE KITS

T40-11 Eleven Channel Exciter for 2M, 6M, or 220 MHz..... \$39.95
T40-1 One Channel Exciter..... 34.95

T20 Tripler/Driver Module Kit, 150 mW 2M input, 200 mW 450 MHz output \$19.95

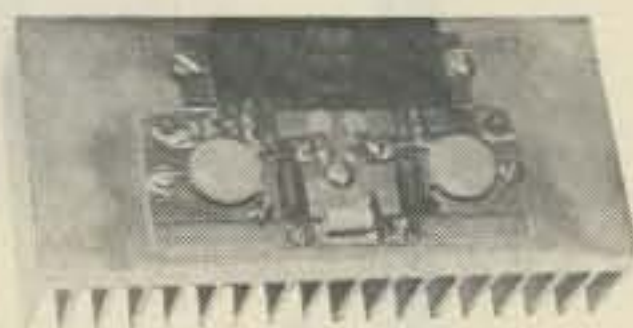

RF POWER AMPLIFIER MODULES

- NO TUNING
- VSWR PROTECTED
- 150 MW DRIVE
- COMPLETELY STABLE

T80-150, 140-175 MHz, 20-25W output, wired and tested, simply connect your cables..... \$79.95
T80-450, 430-470 MHz, 13-15W 79.95

TEST PROBE KITS



ONLY \$7.95/ea.

TE-3 RF Detector Probe for VTVM, good from 100 kHz to over 500 MHz
TE-4 Direct Probe for ac/ohms, etc.
TE-5 DC Probe w/res for 11 meg input VTVM
TE-6 Blocking Capacitor Probe for counter, signal generator, etc.
TE-7 Wideband Detector Probe for scopes
TE-8 High Z/ Low Capacitance scope probe



Larsen Antennas

We have a large stock of these popular whips. Pick the mount and whip which are right for you! All whips and mounts are interchangeable. Request catalog for more information.

LM-150 5/8 wave 2meter whip \$23.85
LM-220 5/8 wave 220 MHz whip... 23.85
LM-440 Colinear 450 MHz whip.... 23.85
Q 1/4 wave whip 144-450 MHz 2.65

MM-LM-K Magnet Mount..... \$14.60
LM-K 3/4" Blind Hole Mount.. 6.35
GC-LM-K Gutter Clip Mount..... 14.60
TLM-LM-K Trunk Lip Mount..... 14.05
AMB-K Trunk Gutter Mount..... 9.10



We have large stock of popular antennas. Call or write for quote or more information.

VHF/UHF FM RCVR KITS



VHF MODELS FOR ANY BAND 28-240 MHz

R60-(), 0.5-1 uV sens, incl VHF Converter and IF/Audio Boards..... \$64.95
R69-(), 0.2-0.4 uV sens, incl P9 Preamp, VHF Converter, and IF/Audio ... \$69.95
Crystals (We stock common freq and will gladly order specials)..... \$5.50



UHF MODELS FOR ANY BAND 380-520 MHz

R60-450, 5-10 uV economy rcvr, incl UHF Conv & IF/Audio Boards only.... \$59.95
R80-450, 2-5 uV sens monitor rcvr, incl UHF Conv, VHF Conv, and IF/Audio . \$84.95
R95-450, 0.4-1 uV sens rcvr, incl P15 Pre-amp, UHF Conv, VHF Conv, and IF-Audio Boards..... \$94.95

FAMOUS ANTENNAS **hy-gain** STOCKED IN DEPTH

REQUEST CATALOG FOR MORE DETAILS

14AVQ	10-40M Vertical	\$67.00
18AVT	10-80M Vertical	97.00
18HT	10-80M Hy-Tower Vert	279.95
TH3-MK3	Tribander	199.95
TH3-JR	Tribander	144.50
TH6-DXX	Tribander, 6 element	249.95
2BDQ	80-40M Trap Dipole	49.95
5BDQ	80-10M Trap Dipole	79.95
263	2M 5/8 wave Trunk Lip	28.95
265	2M 5/8 wave Mag Mt	29.95
214	14 el 2M Beam	26.95



SUPERIOR QUALITY ~ Yet only \$189.95

IF YOU'VE HEARD THE NEW HY-GAIN 2M HT, YOU ALREADY KNOW IT'S FANTASTIC! WE HAVE THEM IN STOCK COMPLETE WITH CRYSTALS AND ACCY'S

Inexpensive DC POWER SUPPLIES

Model	Price	Intermittent	Cont
12CB4	\$29.95	2.5A	1.5A
103R	39.95	4A	2.5A
104R	49.95	6A	4A
108RA	79.95	12A	8A
108RM*	99.95	12A	8A
109R*	149.95	25A	10A

*Indicates model which has panel meter(s)

hamtronics, inc.

182 S BELMONT RD., ROCHESTER, NY 14612

- CALL OR WRITE NOW FOR FREE CATALOG OR TO PLACE YOUR ORDER!
- PHONE 716-663-9254, 9AM-9PM EST DAILY.
- Use your credit card or C.O.D.
- Specify operating freq • Add \$1 shipping and handling.

ok[®] wire wrapping center ok[®]

ANOTHER UNIQUE PRODUCT
**DESIGNED, MANUFACTURED
AND MARKETED WORLDWIDE**
BY
OK MACHINE & TOOL CORPORATION

1

BATTERY WIRE-WRAPPING TOOL MODEL BW-630



\$34.95*

STRIP / WRAP / UNWRAP TOOL MODEL WSU-30

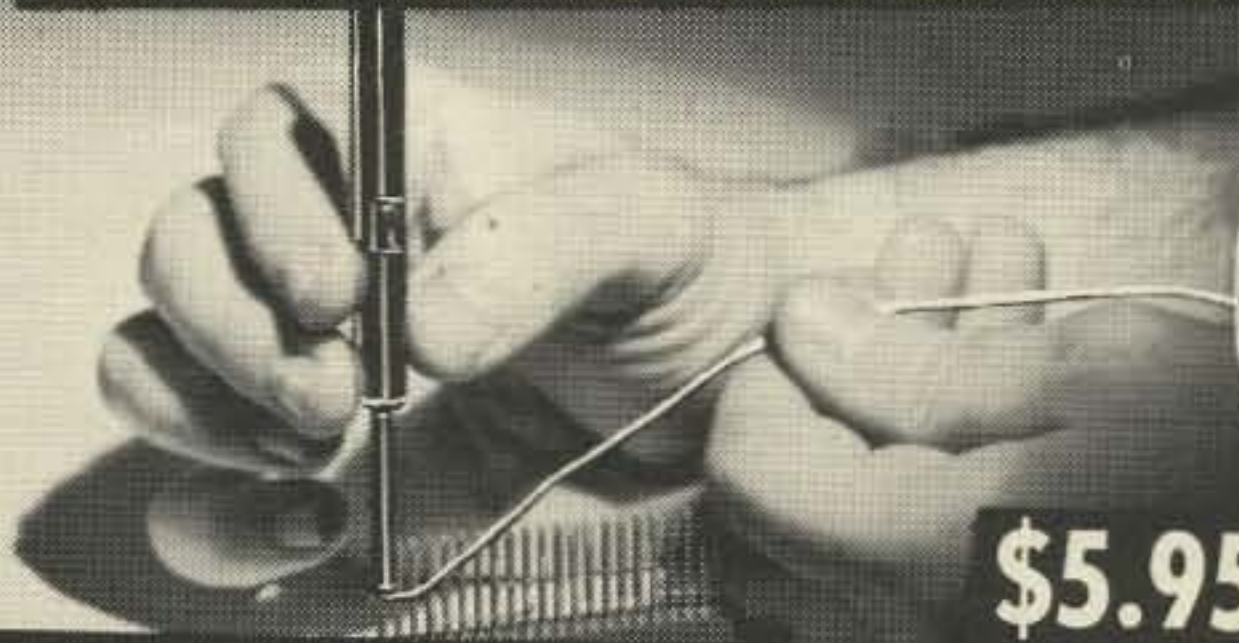

\$5.95*

2

ANOTHER UNIQUE PRODUCT
**DESIGNED, MANUFACTURED
AND MARKETED WORLDWIDE**
BY
OK MACHINE & TOOL CORPORATION

ANOTHER UNIQUE PRODUCT
**DESIGNED, MANUFACTURED
AND MARKETED WORLDWIDE**
BY
OK MACHINE & TOOL CORPORATION

3

WIRE DISPENSER MODEL
WD-30-B



THE DISPENSER WHICH
CUTS AND STRIPS
THE WIRE

\$3.45*

DIP IC INSERTION TOOL WITH PIN STRAIGHTENER
MODEL INS-1416

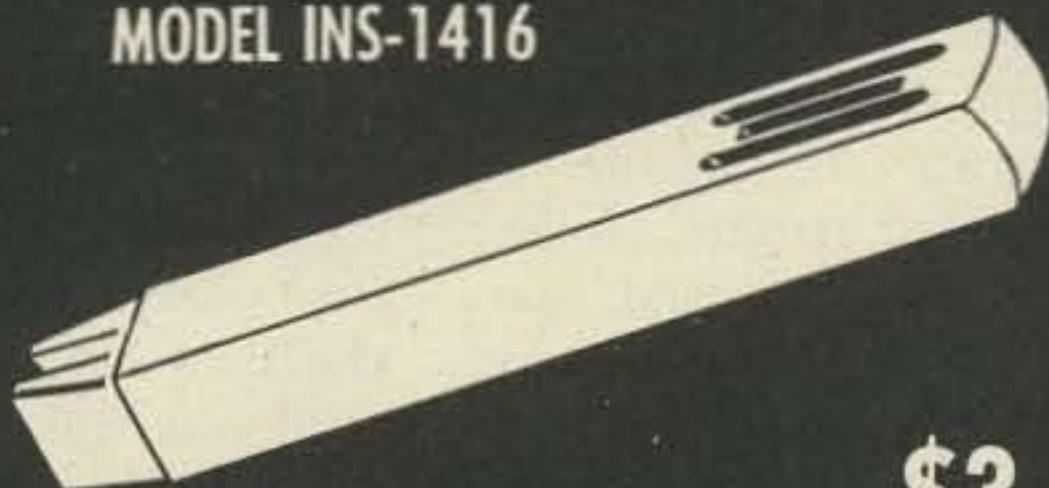

\$3.49*

4

ANOTHER UNIQUE PRODUCT
**DESIGNED, MANUFACTURED
AND MARKETED WORLDWIDE**
BY
OK MACHINE & TOOL CORPORATION

ANOTHER UNIQUE PRODUCT
**DESIGNED, MANUFACTURED
AND MARKETED WORLDWIDE**
BY
OK MACHINE & TOOL CORPORATION

5

WHAT'S ? NEXT

* MINIMUM ORDER \$25.00, SHIPPING CHARGE \$1.00, N.Y. CITY AND STATE RESIDENTS ADD TAX

OK MACHINE & TOOL CORPORATION

3455 Conner St., Bronx, N.Y. 10475 ■ (212) 994-6600 ■ Telex 125091

Mastering Network Operations

-- everything you need to know!

Across the amateur bands there are many nets . . . the rag chewers net, the old-timers net, YL net, and a host of others too numerous to describe. Some of these "networks" have an official purpose; others may exist for club activities or just friendly chitchat. It is through this article that I hope to open some eyes, so to speak, into network operations, especially for those who misuse our net frequencies and/or have little understanding of the system. Many newcomers don't understand the networks as related to amateur radio, so it seems appropriate to begin by answering a frequently asked question:

What Is a Network?

Start by imagining a large circle which represents all amateurs on a certain frequency. A point in the center of this circle is the control station. This station asks for check-ins from hams within the circle and logs them, stating whether they have traffic or are standing by. One by one he takes in call letters, and each station checked in establishes a tie or a communication bond with the net control. You can see that after a while a large net will form, which is actually many stations tied to a central point, or the control station.

But what some hams don't understand is how important nets can be to the amateur fraternity. Take, for instance,

military servicemen overseas who want to communicate with their loved ones back home. Without amateur nets, finding a particular city might be a long, tedious job. The same applies to maritime mobiles, aeronautical mobiles, and persons with urgent medical or priority traffic who may very well have short time limits.

Unless you're very lucky, finding a certain area may take hours, even with a crowded band! Going through a network can cut that down to just a few minutes.

How, Then, Can I Get Involved In Net Operations?

Becoming an active part of a network is not hard. The best place to start might be either the maritime mobile net or the intercontinental traffic net which meet every day on 14.313 MHz. Come there and you can count on good advice about network operations from a real down to business net. Just listen for a while. Then, when you feel you're ready, jump in head first.

But That's the Easy Part!

Order is needed for the proper functioning of a network. It would be absurd to operate without a control station or rules. Networks need not only members and traffic to handle, but also the smoothness and order that rules and regulations provide.

There are too many guys that leave cooperation up to

the control. They figure, "Oh well, it's his job to keep order." Ridiculous, isn't it? On that basis, the net control spends half his time screaming for quiet so the net can operate. If you hear someone using improper procedures or causing interference, why not move him off frequency and politely explain the rules to him?

So, you see, being a net member means more than checking in every once in a while and handling traffic. Each member should realize the purpose of the net and accordingly try to keep and enforce the rules. FCC chairman Richard Wiley told me in a recent interview that he considers amateurs "self-policing." On the average, I'm sure that's true. But the networks on 14.313 can be a pretty poor example of this! Just tune in some afternoon and grab an earful of unmodulated carriers, endless chains of CQs, and ear-splitting splatter from stations on nearby frequencies. You'll be lucky to hear the net control . . . and not only that, but the net control will be lucky to hear you!

On that note, I would like to present a network "primer for misunderstood procedures" which, I hope, will help get the garbage off the nets.

Checking In

Sounds simple, doesn't it? The misuse of this maneuver is so incredible it might even qualify for a round or two in

Ripley's.

Very basically, the check-in is a method used to enter a net. But before you rush right into a network, take the time to listen a few minutes. This enables you to catch up with the control and follow what he is doing. Then if you wish to check in, listen for the controller's signal. He'll call for check-ins when the way is clear for more stations. Do not take it upon yourself to check in. It only interferes with the process of handling traffic. Also, there may be special check-in calls, such as, "Check-ins, maritime mobiles only!" This means the controller only wants check-ins from maritime mobiles and for all others to stand by.

After waiting for the controller's signal, quickly and clearly give him your callsign, always remembering to keep it short and sweet. The control has no time to listen to inane chatter (such as your name, what the weather is like, your rig, and so on).

After you transmit your callsign, the control will respond in some way or another. If no response is given, wait again for a check-in signal and try once more. Depending on your output power and location with respect to the net control, it may take several tries before he acknowledges. In any case, the control usually responds by repeating your callsign and then either asking for further check-ins or telling you to "call your traffic" right away. When you're asked to call your traffic, don't rattle on! Just simply let the controller know who or where you wish to communicate with. (If you have no traffic, just say you're standing by.) Control may now do any one of a number of things. For example, WB4EZM checks in and is looking for Los Angeles. Net control may tell him to call Los Angeles, or do the calling himself. If there is a Los Angeles station already on frequency, control will hook WB4EZM and L.A.

together, and they will decide what frequency to move to. Suppose there is no Los Angeles station on the frequency. Then control will ask WB4EZM if he would like to have his traffic listed. If the reply is "yes," then WB4EZM remains on frequency in hopes that L.A. will come up soon. If the reply is "no," then the traffic is scratched from the controller's list and WB4EZM goes elsewhere.

Checking into a net is one of the easiest things in the world. But some guys don't get the picture.

In fact, the only person on a net to use the term "check-in" should be the controller, with the exception of stations with life-and-death, priority, or short-time traffic. But for most cases, don't call us, baby, we'll call you!!!

The Contact

Another one of those simple but misunderstood terms. Contact means that your station is on frequency and you would like to contact him. For instance, WB4EZM tunes into the net and hears Los Angeles check in and stand by on the frequency. At a convenient break in the controller's transmissions, WB4EZM says "contact," and he is hooked up with L.A. accordingly. Remember: Use "contact" only when you know for sure that the station you want is on frequency. Some hams use "contact" as a means of getting into a net, because the controller will usually respond to it immediately. They'll call for a station that isn't there and then say, "Oh, well, I thought I heard him!" This practice is unfair, and now many net controls will refuse to list these stations.

The Recheck

Not many problems with this one. It means, "I have moved off frequency with a station and contact was not established." In this case, the net control would ask you to call your station again and, if you receive no reply, give you

the option of waiting on the frequency in case he returns or another station in the same area pops up. Losing a station could have been caused by heavy QRM, QRN, or otherwise nasty band conditions. So, you see, a net not only provides a method of linking stations, but also a way of re-linking them if they don't hook up.

The Checkback

Easy to understand, but consistently confused with the recheck. Checkback means, "I have moved off frequency with a station. Contact was established, the traffic passed, and I would now like to check back into the network." The misuse of this term is pure laziness. Recheck is used for checkback, and vice versa, which leads the net control off track. Understanding net language is a necessity!

The Check-out

Rarely used, but nevertheless existent. Looking at it tells you the meaning: simply, "I wanna get the heck outa here." Although a polite way of leaving a net, its rare use stems from it almost being a time-waster. As a net control, I can honestly say that the absence of this term hasn't hampered operations. If you're not there, you're not there!

Relays

Without relay stations, efficiency would be greatly reduced. At the QTH here in northern Virginia, I am totally unable to copy ones, twos, some threes, a few fours, eights, and nines. Skip conditions just won't allow it on 20 meters during the daylight hours. Therefore, I need stations to pick up those I cannot copy ... relay stations. For example, I would use a station in Florida to receive traffic from up north and pass it along to me. Networks require the cooperation and patience of all their members to coordinate relay activities. But



that isn't the only use for relays. Many times a station will try to break the net because he cannot hear the net control.

If you hear someone needing a relay, you can be the one to help. First, make sure the net control can hear you. You'll know whether or not he can from previous conversations. Next, ask the breaking station to stand by. Then at an appropriate break in the controller's transmissions, transmit "relay." If control acknowledges, he will tell you to pick up the traffic from the station unable to copy him. One word of warning: Many net controllers will refuse to list stations who break the net and are able to copy control.

Courtesy To the Net Control

A controller has an incredible chore coordinating some 50 to 100 (or more) stations. And the only reward is the satisfaction of running a good, smooth net. Efficient

operation requires the help of all members. Don't leave it all up to the control. Here are some good guidelines to follow:

1. Politely ask all stations operating in the immediate vicinity of the net frequency to move elsewhere. If someone won't move, don't get nasty about it, just leave them be, and eventually they'll go away.
2. Aid the net control as a relay station, whenever possible.
3. Follow net procedures to the letter, and explain the rules to those who don't.
4. Become active! Use that phone patch where it is most needed!

The Three Cs

Well, here it is! The grand finale, and maybe you've already guessed my point. It's called the three Cs of network operation:

1. Courtesy — Always be courteous to the net control,

fellow members, and everyone else in the amateur society. Where does everyone else fit in? Just take a look . . . when you ask a station to move away from the net frequency, do it politely! Don't give the attitude that the nets want to take over everything within 5 kHz of the net frequency. Simply explain that the net needs breathing room to operate properly. Networks are a service, not a burden.

2. Cooperation — Try to get

along well with the controller and follow the rules. If you check into a net, say you're standing by and mention you have a phone patch. The net control could throw anything your way! Be prepared to help out in any way possible, whether it's acting as a relay or handling traffic.

3. Commitment — Commit yourself to a net. It doesn't have to be every day. It can even be once a week! Nets need stations to handle traffic. Wouldn't it be great if

you could check into a net, ask for a particular city or state, and hook up immediately? This is entirely possible if more people who have the time would at least monitor the nets for possible traffic!

I certainly hope you won't take this article lightly. Get in there! Find a net! Do your part! Here's a good way to get started:

The Maritime Mobile Service Net
14.313 kHz (20 meters)

7 days a week, starting around 1700 GMT.

The Intercontinental Traffic Net

14.313 kHz (20 meters)

7 days a week, with two operation times:

1. Morning — from band opening to around noon. Eastern time.

2. Evening — following maritime mobile net and continuing to band closing.

Note: Sometimes the IC net will not operate on Sundays. ■

THIS YEAR . . .

GET ON TOP WITH ALPHA

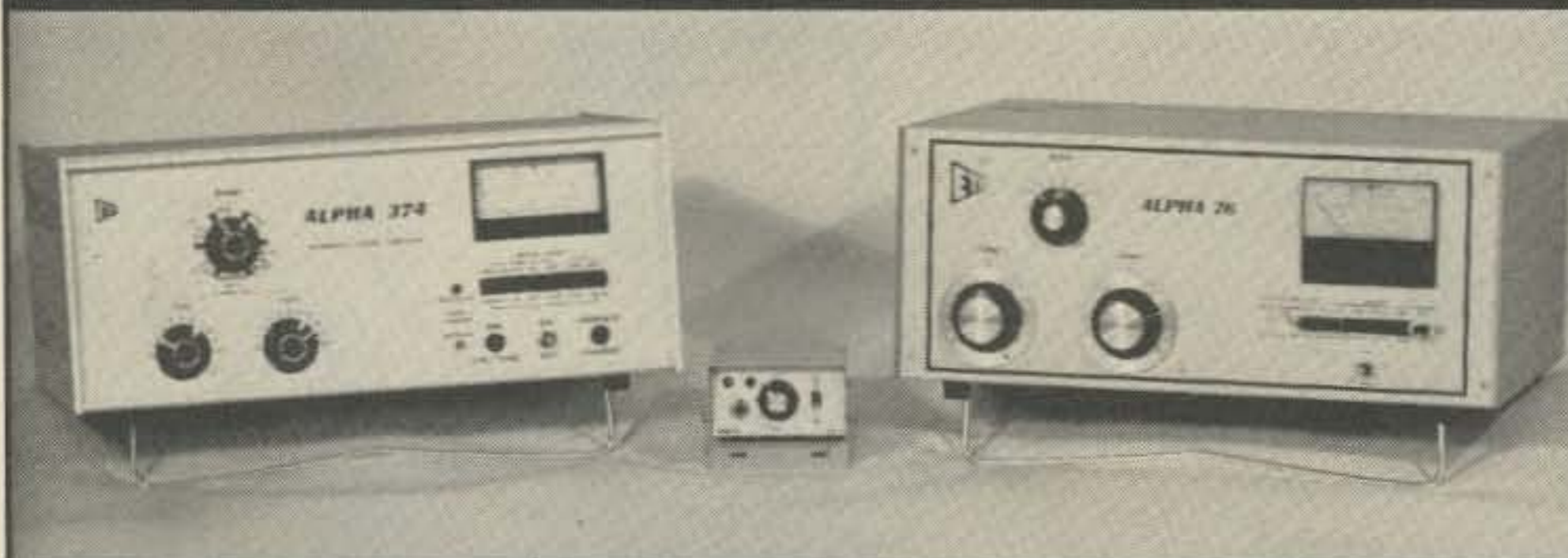

**A GREAT OPERATING YEAR IS STARTING RIGHT NOW.
SUNSPOTS ARE UP — CONDITIONS SHOULD BE THE BEST IN YEARS.
THOUSANDS OF ENTHUSIASTIC NEW AMATEURS ARE ON THE BANDS.
HAMMING WILL BE TERRIFIC —
BUT COMPETITION WILL BE ROUGH!**

**WHEN QRM RAGES AND THE PILE-UPS DEEPEN,
WOULDN'T YOU LIKE TO HAVE . . .**

- ALL THE ROCK-CRUSHING POWER YOUR LICENSE ALLOWS — on all modes — with no need to 'baby' your linear, no duty cycle or time limit at all?
- INSTANT BANDCHANGE 'NO-TUNE-UP' all the way from 10 through 80 meters, with the exclusive ALPHA 374?
- COVERAGE ALL THE WAY DOWN TO 160 METERS with the smooth-tuning, extra-rugged ALPHA 76 powerhouse?
- CRISP, PENETRATING "TALK POWER" — as much as 10 dB extra to 'punch through' when the going gets really tough, with the ALPHA/VOMAX split band speech processor? It's as effective as the best rf processor, lower in distortion, and very easy to use with any rig!
- THE PROTECTION OF A FACTORY WARRANTY THAT RUNS A FULL 18 MONTHS — six times as long as competitive units? [ETO tries to build every ALPHA to last forever . . . and we're making progress: not one single case of ALPHA 76, 77D, or 374 power transformer failure has ever been reported!]
- THE PURE PLEASURE OF OWNING ALPHA?

**ALPHA: SURE YOU CAN BUY A CHEAPER LINEAR —
BUT IS THAT REALLY WHAT YOU WANT?**

START ENJOYING THE ALPHA EDGE NOW. Call or visit your nearest ALPHA/ETO dealer, or ETO direct, right away, and you can have prompt delivery of your new ALPHA linear amplifier and ALPHA/VOMAX processor. While you're at it, ask for illustrated literature describing all ALPHA products in detail, as well as a copy of "Everything You Always Wanted to Know About (Comparing) Linears . . . But Didn't Know Whom to Ask."

ETO

**EHRHORN TECHNOLOGICAL OPERATIONS, INC.
BOX 708, CANON CITY, CO 81212 (303) 275-1613**

THE
CRITIC'S
CHOICE

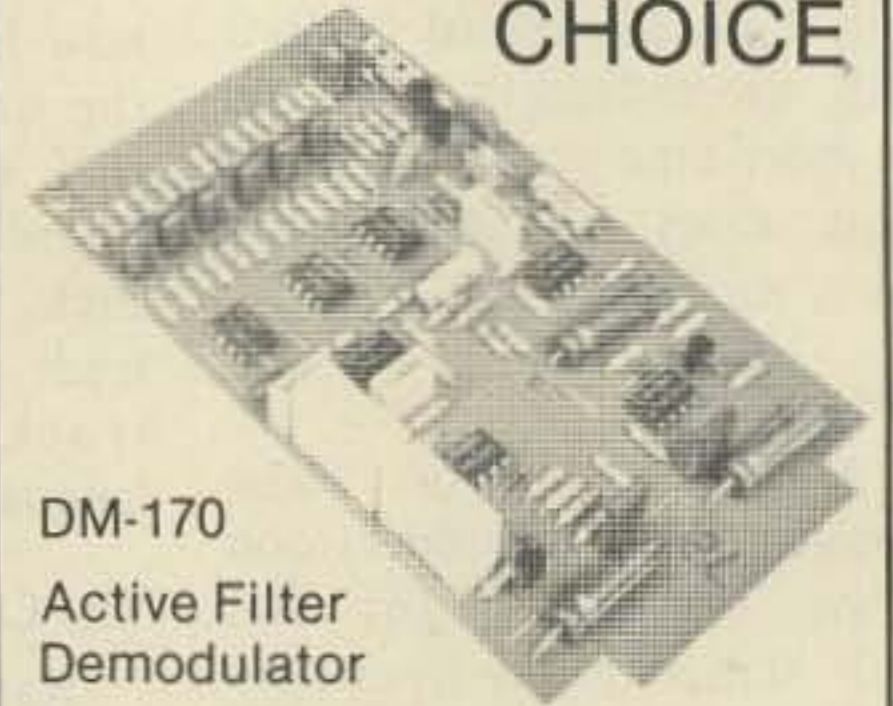

DM-170
Active Filter
Demodulator

Critical buyers are choosing the DM-170 RTTY demodulator to give them more features at lower cost. Write for information and compare. Discover what the critics have. \$39.95 Kit \$59.95 Wired

FLESHER CORP.

P.O. Box 976

Topeka, Kansas 66601

(913) 234-0198 F5



* You asked for it!

A \$70.00 digital multimeter kit

Now there's just no excuse for not having a digital multimeter at our low price. Our unit is based on the famous \$29.95 DVM kit you have heard about and has the following features:

DC volts: Better than 0.1% accuracy. Reads 0 to 1200 volts in 4 ranges

AC volts: Better than 0.3% accuracy. Reads 0 to 750 volts RMS/4 ranges

Ohms: Better than 0.2% accuracy. Reads from 0 ohms to 20 megohms

You get all parts including dual tracking, AC power supply, laser trimmed reference, and thick film attenuator.

CA res. add tax. Pls. inc. \$3.95 for postage handling.

As always we have calibration and repair service

Gary McClellan and Co. Box 2085
G11 1001 W. Imperial Hwy.
La Habra CA 90631

Try A Trapped Dipole

-- save copper and coax!

Often the need arises for a permanent low cost antenna. A dipole or inverted vee is a good choice. They are easy to install and cheap to build. One of the disadvantages of such antennas is that they are only usable on a single band, unless they are fed with an open feedline and an antenna tuner.

Most traps used in amateur radio multiband antennas are made of a lumped inductance and capacitance in parallel. I tried to overcome this.

By placing a trap 32 feet 6 inches from the feedpoint, a current maximum will occur at 7200 kHz. With the correct wire length on the outside end of the trap, the antenna can also show current maximum at the feedpoint for 3900 kHz. In both cases, the dipole functions as a half-wave dipole.

Why not add another antenna under the existing 80 and 40 meter wire, fed at the

same feedpoint, with another trap tuned for 21300 kHz? An outside wire of the correct length will give current maximum on 80, 40, 20 and 15 meters, all functioning as a halfwave dipole.

With the help of my XYL, I came up with this antenna. The information for construction follows. I hope it will do as well for you as mine does for me!

The dimensions given here are resonant at 3.9 MHz, 7.2 MHz, 14.3 MHz and 21.3 MHz. For 40 meters it's 160 turns, for 15 meters, 55 turns. Number 12 magnet wire is wound on a 1/2 inch rod, close wound. The coil is removed from the 1/2 inch rod and placed inside the 1/2 inch PVC pipe.

The PVC pipe is cut to 18 inches for 40 meters, 10 inches for 15 meters. The PVC is then placed inside the 7/8 inch ID, 1 inch OD aluminum tube. The alumi-

num is cut to 16-1/2 inches for 40 meters, 8-1/2 inches for 15 meters.

Drill a hole in the center (ends) of eight 1/2 inch PVC caps, and mount stainless steel eye bolts on them. (Cut off the eye bolts as short as possible, so they will not go into the PVC tube.) Now drill a hole to fit the #12 magnet wire below the eye bolt in each end cap. See Fig. 4.

Cement one end cap onto the PVC tube after bringing the end of the coil wire through the small hole. Secure a tin solder lug on one end of the aluminum tube, as shown in Fig. 3, with a pop rivet or small screw. Do not use aluminum or copper for the solder lug. Slide the aluminum tube over the PVC with the solder lug end first, and solder a jumper from the lug to the coil wire as close to the PVC cap as possible.

You are now ready to tune the traps. The traps were adjusted to frequency through the use of a grid-dip meter (checking on a receiver for accuracy). The coil can be changed quite easily if an extra turn or two is put on for adjusting purposes. The coil can also be wound with spacing and compressed or extended to get the traps exactly on frequency. Tune to 7.2 on 40 meters. Tune to 21.3 on 15 meters.

After the tuning is completed, the end cap can be cemented on. The two wires sticking out of the end caps are to be soldered to the antenna wires.

My antenna is supported in the center about 32 feet high and 10 feet at the ends. I show an swr of 1.2 to 1 on 3.9, 1.3 to 1 on 7.2, 1.3 to 1 on 14.3 and 1.2 to 1 on 21.3. The CW bands can be worked with the swr less than 2 to 1 on all CW bands.

The overall length is 106 feet, and it can be installed as an inverted vee in a lot less than 90 feet. ■

Parts List

- PVC cement
- 8 1/2" PVC caps
- 56" of 1/2" PVC pipe
- 1 balun, 1:1
- 4 ceramic insulators
- 135' of antenna wire
- 50" of 1" aluminum tubing (a discarded lawn chair will do)
- 80' of #12 magnet wire

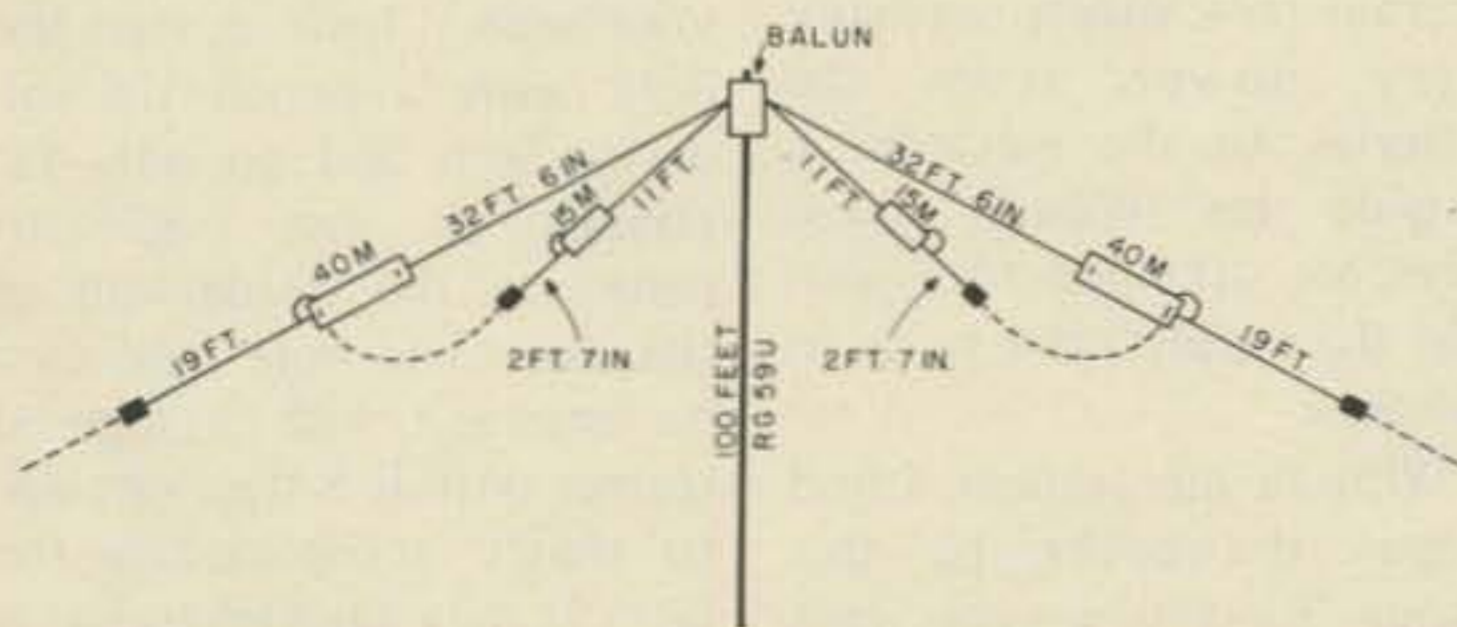

Fig. 1.

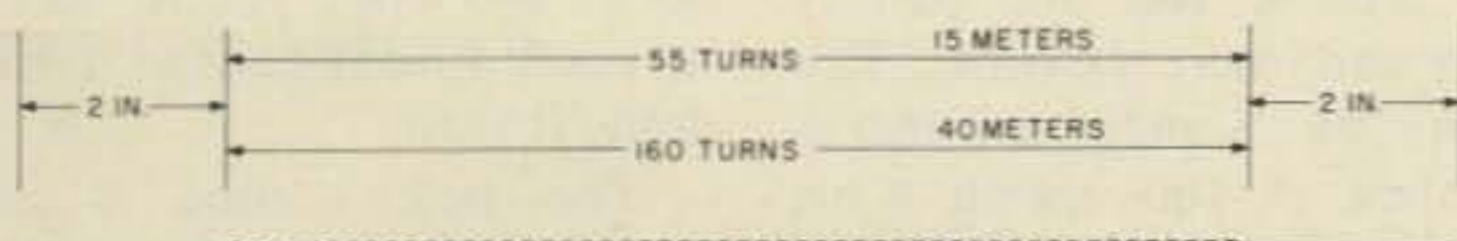
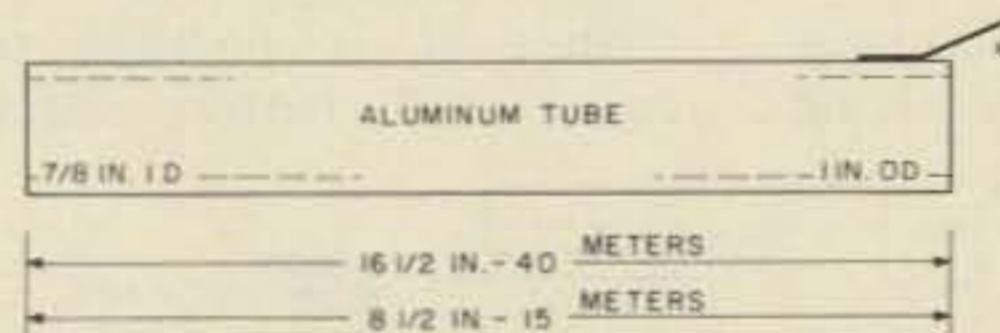
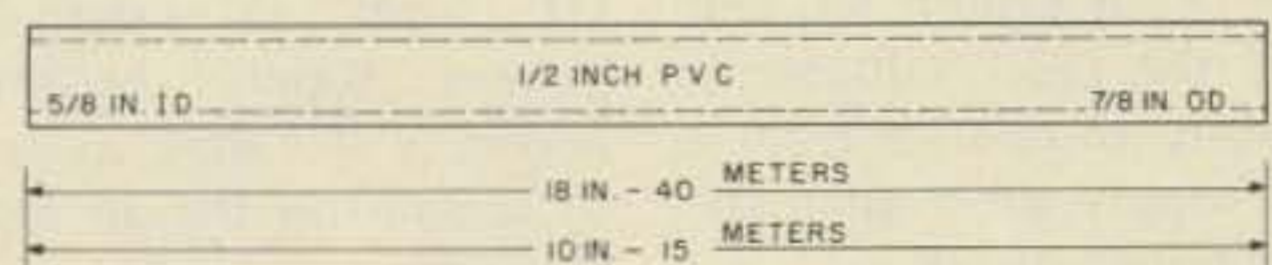

Fig. 2. Don't forget to leave 2" on each end of each coil.



* SECURE A TIN SOLDER LUG ON ONE END. NOTE! DO NOT USE COPPER OR ALUMINUM

Fig. 3.

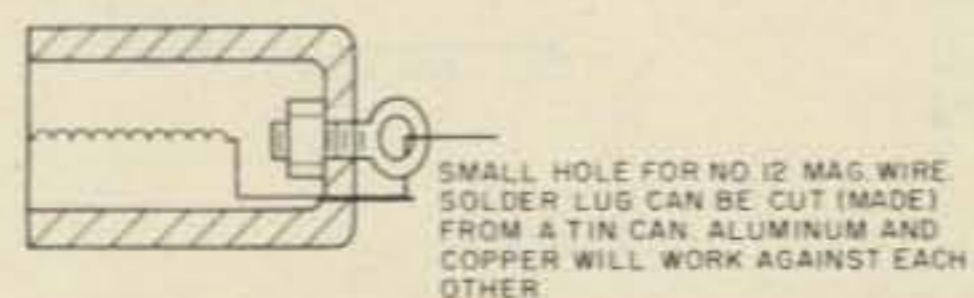

Fig. 4. The coil will expand to make a nice fit inside the PVC tube. The aluminum fits snugly over the PVC, and the cap rims help hold the aluminum tube in place. It all makes a very nice looking assembly.

Liberate Your Wilson HT

-- who needs nicads?

I am sure that many hams will agree with me that the Wilson HTs are among the best buys on the market. Their performance/price ratio is significantly greater than that of many other units intended for the same purpose. There are, however, several features which those other units offer which the Wilson could benefit by, and one of the most valuable is the ability to operate from a power supply other than the self-contained nicads.

As a ham with a large investment in low band

equipment and getting deeply involved in slow scan (more money), I cannot afford both a base and a portable/mobile 2 meter rig and must make my Wilson perform both functions. Since I'm a rag chewer by nature and the Wilson's nicads are useful only until their charge gives out, the ability to operate my HT from an external dc power supply became a necessity if I were to be able to remain on the air for any extended period of time.

While it is possible to access the battery pack

through the fitting at the top of the rig (only when the unit is turned on), this is both physically inconvenient and electrically unsound. There had to be another way.

One solution to my predicament was proposed by a friend who owns two battery trays for his own Wilson. He has taken the second tray (*sans* batteries), drilled a small hole in its base, and connected wires to the internal rails which normally carry power from the batteries to the electronics. Outside his Wilson, these wires are attached to a suitable dc supply, and he is in business.

With all due respect, I find several drawbacks to this system. First, when you want to switch from the nicads to external power, it is necessary to remove the one battery tray and insert the other. This can be somewhat inconvenient if you are in a big hurry or want to travel light.

Second, with those wires

coming out of the bottom of the rig, its equilibrium becomes rather unstable and, while I know from experience that the Wilson is capable of sustaining a fall of reasonable distance, I prefer to verify this knowledge as infrequently as possible. The only safe way of using this arrangement is with the rig lying on its back — somehow inelegant as well as inconvenient. Consequently, I tried a different approach.

I went about adding external dc capability to my Wilson by installing a jack in the side of the transceiver. The wiring is such that, normally, the rig functions as usual from the internal nicads. When the plug from the power supply is inserted, however, the batteries are disconnected from the rest of the rig, and dc from the outside world flows directly into the Wilson. An obvious advantage of this setup is that you never have to fuss with, or even consider, a second battery tray. A less obvious advantage is that while you are running the HT from outside power, you can be charging its batteries at the same time. More about the use of a second jack for charging purposes later.

Installation of the jack(s) is easy — all you really require is the nerve to puncture the hide of the HT. By no means should the hole be made with a drill — one slip or ill-timed sneeze could wreak havoc with the rig and your wallet! Instead, start the hole with a pencil tip soldering iron and go only far enough to just begin to penetrate the inside wall of the case. The hole may then be enlarged with a tapered reamer until it is the right size to snugly accommodate the jack. It may take several days to work up the courage to do this, but it's worth working up to and once you've done it, you'll find it hard to resist doing it again.

The jack I used is an enclosed miniature 1/8" normally-closed phone type

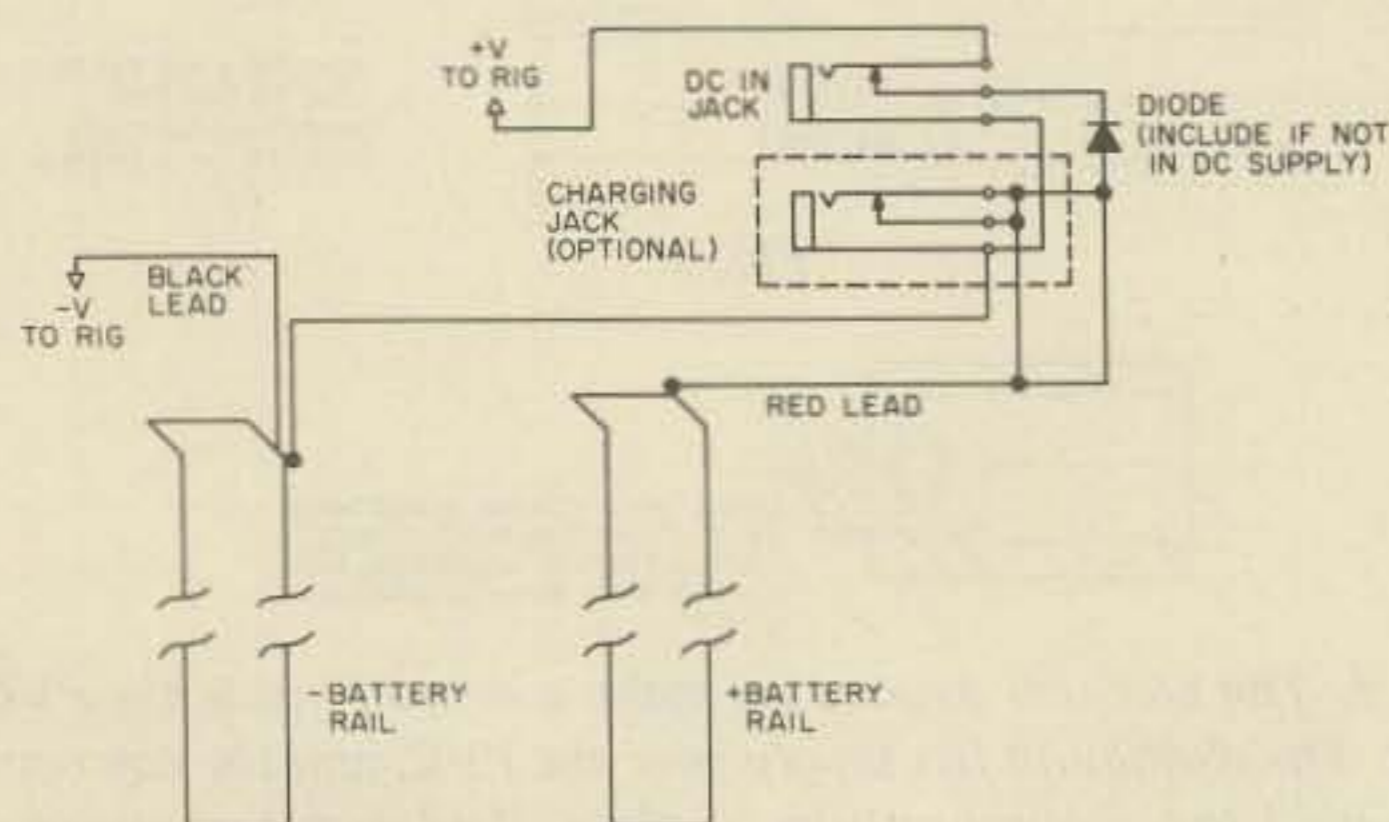

Fig. 1. Rear view of front half of Wilson case (not to scale).

(Radio Shack 274-296). Properly located, two of these will fit comfortably within the Wilson. The obvious – and probably only – place to install the jack is on the right-hand side of the unit (as seen from the front) in the front half just above the battery pack.

There is plenty of room if you pay attention to one or two details. Allowance should be made to clear the channel selector switch which will be just above the jack, and to clear the metal brace which, it would appear, serves to keep you from crushing the HT in your grip if you squeeze the PTT lever too enthusiastically. Careful planning will enable you to pinpoint the correct spot.

In working on my rig, I tread a little too cautiously and placed the dc jack a bit on the low side, probably because I was trying to avoid conflict with the trimpot for my touchtone pad. Even so, I still have room for the

addition of a charging jack, so, being forewarned, you should have no difficulties at all.

The unswitched terminal of the dc jack (see Fig. 1) is connected to the ground rail (black wire) of the battery tray slide. The hot lead (red, from the other rail) is broken and connected across the other two terminals of the jack. The battery side of this red lead should be connected to the switched terminal. This way the internal current flow will be normal when no plug is inserted, but insertion of the dc plug will break the battery line and allow current from the external supply through the rig's electronic innards.

Similarly, a second jack, for battery charging from the outside, may be installed ahead of the first and wired the same way. Normally, the HT will operate as usual, but with a plug inserted in the charger jack, the batteries will be placed in parallel with the

charger. While it is not recommended that the Wilson be operated from its, or any other, battery charger, with this arrangement it is possible to charge the batteries while operating from the external dc supply at the same time.

Incidentally, the power supply which I use was adapted from the one detailed by WA8WVF in the September, 1976, issue of 73. My supply uses smaller power tab type transistors, available from Radio Shack (276-636), which seem to function very comfortably at the level required by the Wilson.

An out-of-tolerance 15 V zener together with a diode in the line (for both slight voltage dropping and *reverse polarity protection*; install such a diode at the jack if your power supply doesn't incorporate one, to save your nicads unnecessary grief) feed my Wilson about half a volt more than it normally gets

from its battery pack, and the rig has been operating very happily and successfully in this fashion for a number of months.

My thanks to W2YHX and WA2UAQ for their inspiration and urging on to better things, and best of luck to you in making this simple, but extremely worthwhile, modification. ■

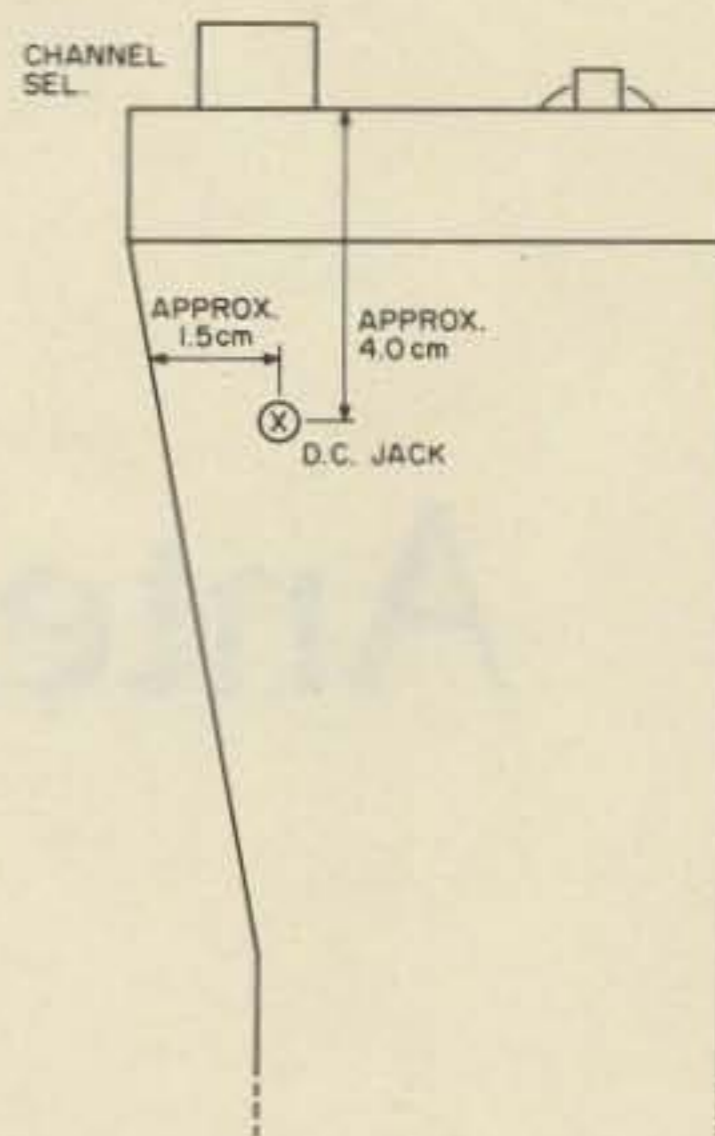
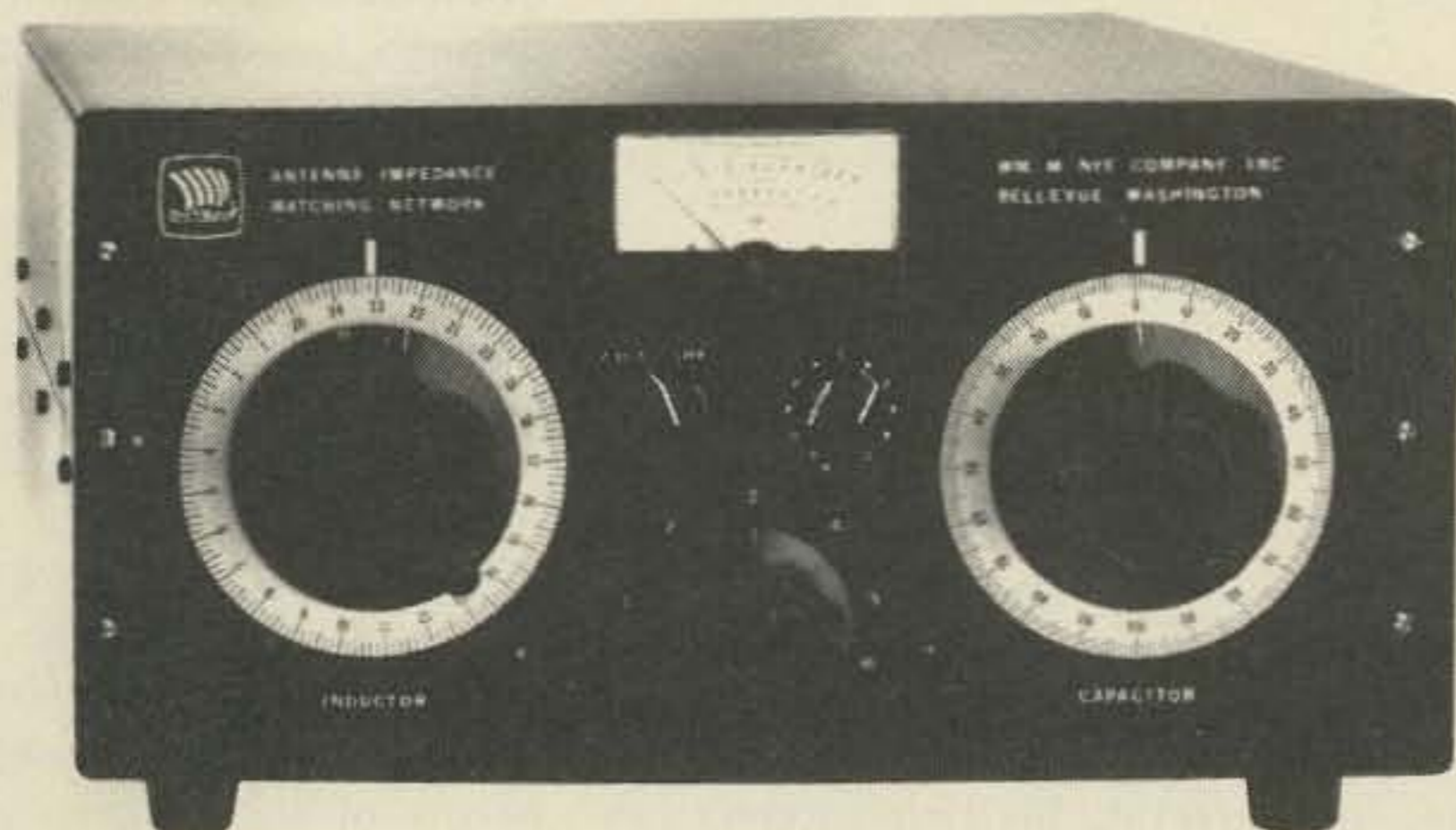

Fig. 2. Right side of Wilson 1402-SM showing approximate location of dc jack (not to scale).



Model MB II \$285
(with Balun) \$315

The NEW NYE "Matchmaker!" VIKING MB II

Antenna Impedance-matching Network
assures maximum perfectly matched
power to your antenna!

MB II provides:

- ★ Constant SWR monitoring. ★ Precision tuning of final amp. ★ Harmonic suppression.
- ★ Receiver input impedance-matching. ★ Maximum power transfer to antenna. ★ Continuous frequency coverage 1.6 to 30 MHz. ★ Precision tuning of any wire 1/8 wavelength or longer, with SWR of 1:1.

MB II features:

- ★ Finest quality, made-in-USA components. ★ Large, precision, easy-to-read dials with 360° readout. ★ Optional 3000 watt Balun for twin lead antennas.

Available at leading dealers throughout the U.S.A.

WM. M. NYE COMPANY, INC.

1614 - 130th Avenue N.E., Bellevue, WA 98005 * (206) 454-4524



Novice Antenna Specials

-- tips for that first antenna

William E. Hood W2FEZ
116 W. Park St.
Albion NY 14411

When a Novice receives his first license and is ready to get on the air, there comes the final portion of the volunteer examiner's responsibility which many either fail

to realize or completely forget. Here is a newly-licensed individual whose knowledge of amateur radio is largely theoretical — one for whom the minor technicalities of getting on the air can present a major stumbling block unless that individual who got him into this in the first place is still with him, ready to help

him over the few pitfalls in the process of getting started.

To the newly-licensed Novice, especially if he is a young person, the task of erecting his first antenna can be a formidable one. Then, if he makes one small mistake here or there, mistakes that the books don't always warn him against, he may be in for disappointment and discouragement. This article, then, is written with the beginner in mind, in hopes that it might help him to do the job right and start him out with an antenna that will properly introduce him to a truly rewarding hobby.

It's not nice to fool Mother Nature. She has her rules which, if obeyed, will serve you well and, if ignored, will trip you up. An antenna

is a piece of equipment all in itself. It must change the alternating currents generated by your transmitter into radio waves; it must change radio waves into alternating currents from which the receiver can then recover the intelligence. So long as the rules are met, you can make your antenna any way you like.

In part, the rules are: The antenna must run in a straight, or nearly straight, line. It *must* be resonant. It should be suspended as high above the ground as possible, and as clear as possible of substantially large, grounded objects. While there are many antennas that are exceptions to these rules, they apply to any kinds of antennas that are relatively easy to install and tune.

What Kind of Antenna Do You Want?

The vast majority of antennas used by amateurs transmitting on Novice frequencies are distributed through two classes: dipoles and endfed wires.

The Dipole

A dipole is made of two pieces of wire, strung end-to-end, with the coax feedline connected in the center. The overall length of the combined two pieces of wire must be one half wavelength. The exact size may vary with the kind of wire you use, the height of the antenna above the ground, the conductivity of the ground in your location, and a few other things. Here are some sizes that will get you into the right ballpark. (Note: these values are aimed at the centers of the Novice bands.)

80 meters	125' 7"
40 meters	65' 5½"
15 meters	22' 1½"
10 meters	16' 7½"

It is best if the antenna is run in a straight line, although some small amount of angle between the two halves can be tolerated. If you run the two halves side-by-side, as

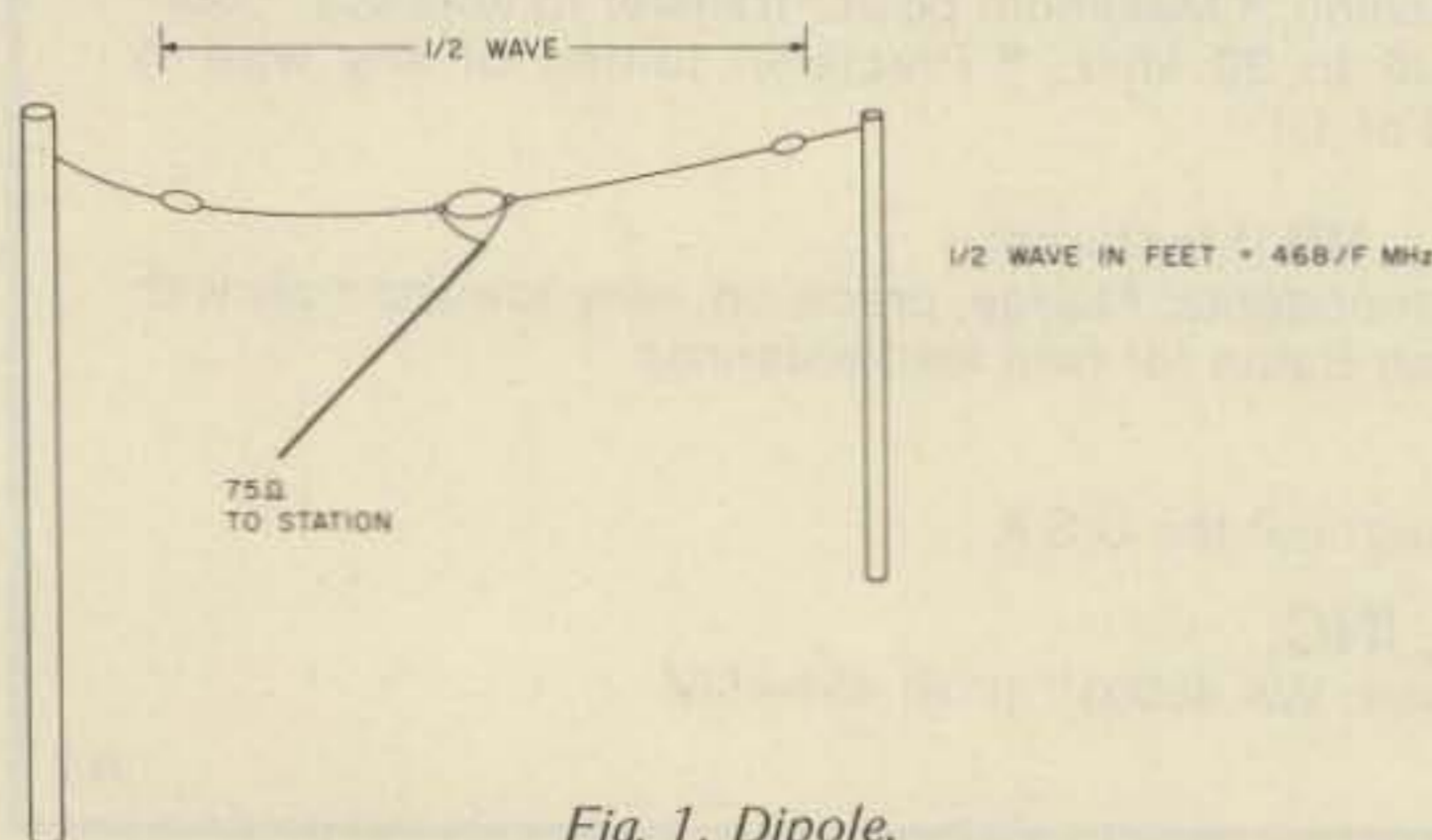

Fig. 1. Dipole.

one Novice almost did, it simply won't work! Support your wires with any strong insulating cord from trees, poles, buildings, or whatever happens to be handy. Fasten the cords to the antenna with glass, plastic, or ceramic insulators. In the center, use another insulator similar to those used at the ends.

Feed a dipole with 75 Ohm coaxial line. Type RG-59/U is adequate. You can use RG-11/U also, but it's bulky and expensive. Wrap the coax around the center insulator, tape it in place, and connect the conductors, one to each antenna wire.

The Inverted Vee

The inverted vee is a variation of the dipole that has provided excellent results for a great many hams. Unlike the dipole, the inverted vee is supported in the center, with the ends staked in place close to the ground. At this point, I will caution you to have the ends of the wires high enough that your neighborhood kid can't reach them. Otherwise, he'll be sure to grab them when you're transmitting, to the tune of a couple of thousand volts.

The angle between the two halves of an inverted vee should be between 90° and 120° for best results. The vee form factor changes the length needed to resonate your antenna. Here are the total lengths required for the Novice bands:

80 meters	124' 7"
40 meters	64' 11"
15 meters	21' 11"
10 meters	16' 6"

The inverted vee should be fed with 50 Ohm coax. Use type RG-58/U. RG-8/U can also be used, but it is more bulky and expensive.

The Endfed Wire

The endfed wire is the simplest of the antennas to erect, and can be the answer if your shack is on an upper floor. However, it requires a tuner, and can be a stinker to tune up for the first time.

Also, if it isn't tuned up right, it can produce stray rf voltages floating around your shack and showing up where least welcome.

The length of an endfed wire is the most tolerant of mistakes (among the three antennas discussed here). In fact, an experienced amateur can load up almost any random length of wire. Since it is brought directly to your shack, there is no feedline as such. The tuner can be connected to the antenna with either 50 or 75 Ohm coax, but not both.

For a tuner, you can use the "Lunch Box" tuner described in the November/December, 1975, issue of 73.

Bring the coax from your antenna, or tuner, through a coaxial lightning arrester, a low pass filter (if you use one), and a reflected power meter to the antenna relay or transceiver. Bring a wire from the lightning arrester, and a wire from each piece of equipment, to a common terminal in your shack, which will be your prime ground terminal. Don't depend on the shield in the coax for this connection. Run a heavy conductor from your prime ground terminal to your final earth-ground connection (a water pipe, driven rod, or several square feet of buried screen). A good ground is essential for the best operation of your station.

How to Tune Your Antenna

Generally, most antennas will work OK if cut from the basic antenna formulas, or if cut carefully to the sizes given in the preceding paragraphs. Once in a while you will find one needs further matching. We call the process "pruning." If the reflected power meter indicates a standing wave ratio of 2 or higher, you should prune the antenna. If the swr is 1.5 or less, leave it alone. Between 1.5 and 2, it's your decision.

It's a good idea to secure the help of an experienced amateur if you prune your antenna. With a little care and

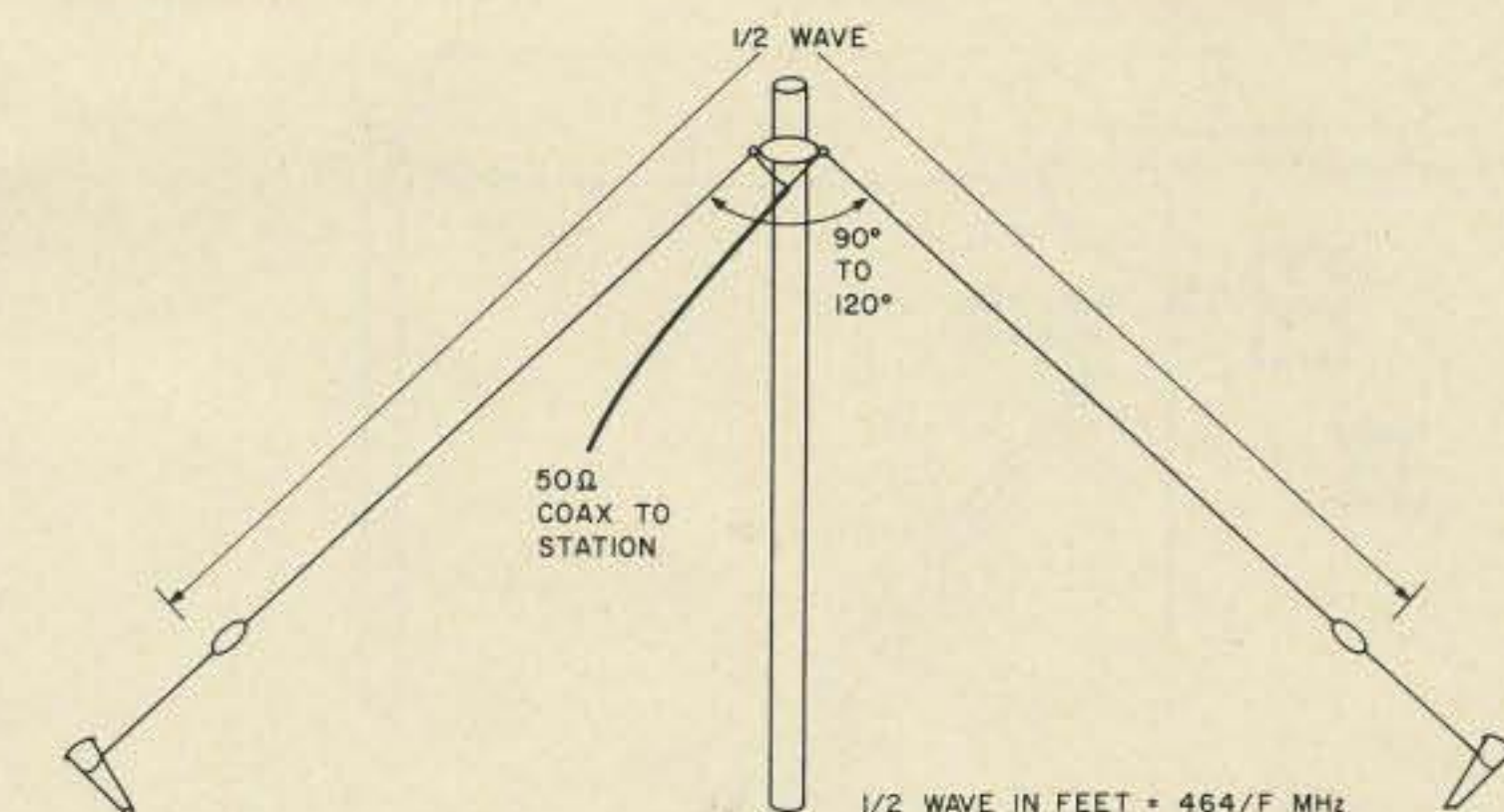

Fig. 2. Inverted vee.

common sense, however, you can do it yourself, and there's no time like the present to learn. You will need a grid dip meter. This can be borrowed from a local ham, if you can locate one, or it can often be located through a ham club. You will also need a receiver with a fairly accurate dial. *Never* depend on the dial calibrations of a grid dip meter unless it comes from a commercial lab. Even then be ready to question it.

The swr of the antenna can give you some idea which way you will have to go. If it is lowest at the high end of the band, the antenna is too short; if it is lowest at the low end of the band, the antenna is too long. To find out exactly how much to change the length, you must find out just where the antenna is resonant. That's where the grid dipper comes in.

Let's first consider the process of pruning a dipole. Support the dipole, stretched out in a straight line, at a height where you can easily reach it. Remove the coax and short the two halves together. Hold the grid dip meter with the coil just touching, but not making electrical contact with, the center of the antenna wire. Very slowly tune the grid dip meter through the suspected resonant frequency of the antenna. You will notice a pronounced dip in the meter reading. The bottom of this dip is at the resonant frequency of the antenna. Slowly move the coil away from the antenna, tuning back and forth over the resonant fre-

quency until the dip is barely noticeable. When the meter reads at the lowest point, it is tuned to the antenna's resonant frequency. Now tune your receiver until you zero-beat the meter's oscillation, and read the frequency from the receiver's dial.

If you are checking an inverted vee, leave it in place and connect a turn or two of wire across the end of the coax. Couple the coil of the grid dip meter into this link, and spot the resonant frequency as in the preceding paragraph.

Once you have the resonant frequency spotted, you're almost there. Now you must adjust the antenna length to make it resonant where you want it. If the resonant frequency is too high, the antenna must be lengthened; if it is too low, the antenna must be shortened. Just how much depends on how far off the antenna's frequency is from where you want it. Find the *difference* between the antenna's resonant frequency and the center frequency of the band you are using. Multiply that difference by the factor given below:

80 meters	0.4
40 meters	0.11
15 meters	0.01
10 meters	0.007

The result is the amount, in inches, that must be taken from or added to your antenna. Remove or add exactly half this amount to each half of the antenna, and recheck swr. If you did it right, you

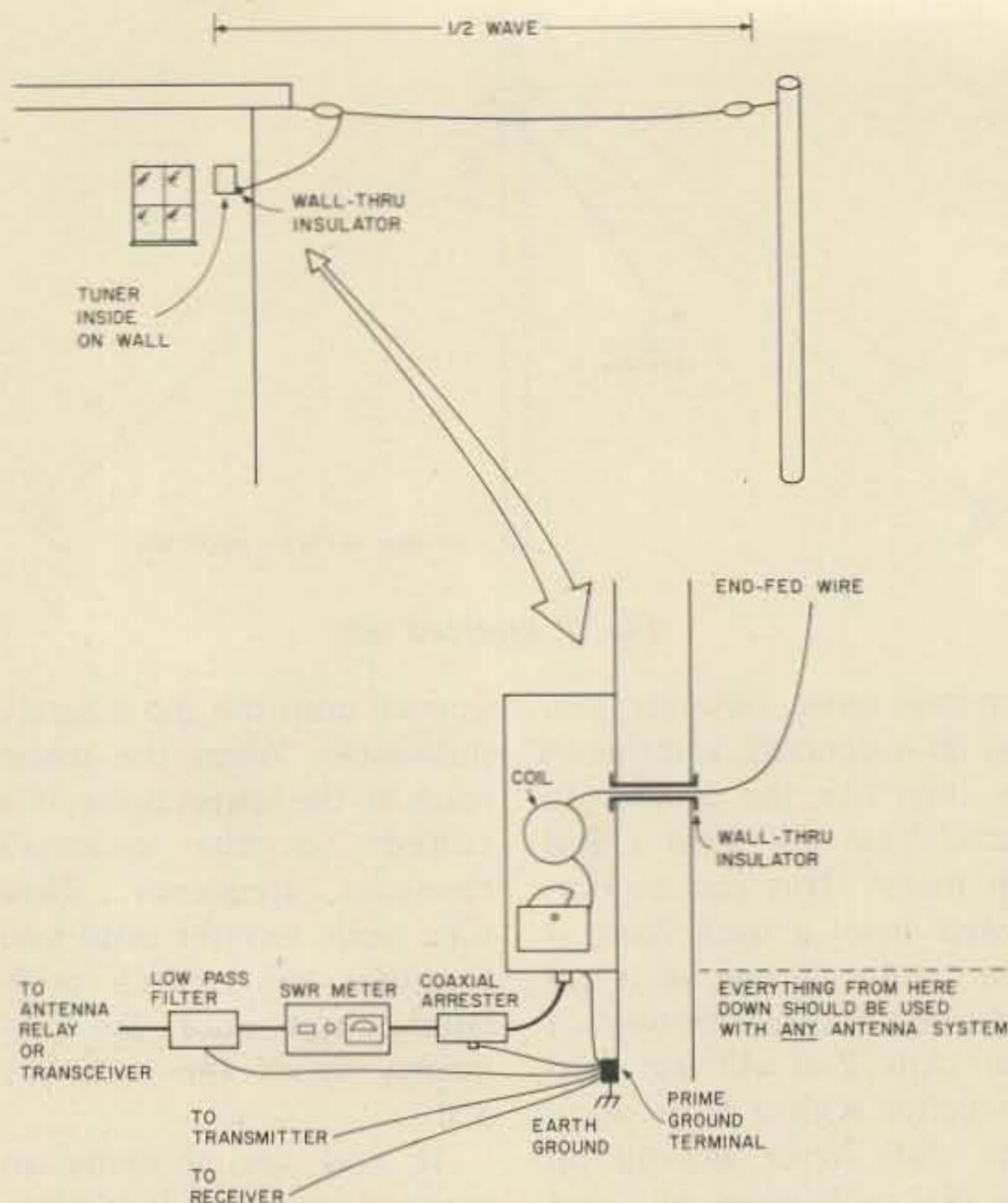

Fig. 3. Endfed wire.

will find a tremendous improvement.

Example: Charlie Brown finds his antenna is actually resonant at 6575 kHz. He wants it resonant at 7125 kHz. $7125 - 6575 = 550$. $550 \times 0.11 = 60.5$. Charlie cuts $30\frac{1}{4}$ inches from each half of his antenna, and it will resonate at 7125. The discrepancy has been exaggerated to better illustrate the principle.

Example: Linus finds his antenna is resonant at 3875 kHz, and he wants it at 3725. $3875 - 3725 = 150$. $150 \times 0.4 = 60$. He adds 30 inches to each half of his antenna, and it's resonant at 3725. Again,

the amount of difference shown is more than you're likely to come up against.

Tuning An Endfed Antenna

There isn't much need to adjust the length of an endfed antenna, since the tuner makes up for that. If you've never done it before, you may want to tune your transmitter into a dummy load first. This isn't absolutely necessary, however. A grid dip meter can help, but you can get by without it. If you don't have something to read swr, get it.

With a grid dip meter:

Connect the antenna to the tuner, disconnect the transmitter, and short the coax connector. Set the grid dip meter to the center of the band you are using, spotting the frequency on your receiver. Couple the grid dip meter into the tuner and adjust the capacitor until you get an indication on the meter. If the meter seems to be approaching an indication with the tuner capacitor fully meshed, add a turn to the tuner coil. If the meter seems to be approaching an indication with the tuner capacitor all the way out, remove a turn from the tuner coil.

Without a grid dip meter, or after finding resonance with a grid dip meter:

Reduce the drive level in your transmitter as far as you can and still get rf out. (At this point it helps if the transmitter has already been tuned into a 50 Ohm dummy load.) Set the swr meter for reflected power. Tune the capacitor in the tuner for a dip in swr. If it seems to be approaching a dip with the capacitor all the way in, turn off the transmitter and add a turn to the tuner coil. If it seems to be approaching a dip with the capacitor all the way out, turn off the transmitter and remove a turn from the tuner coil. *Never* touch the coil while the transmitter is operating, unless you get the jollies by being tickled with a few thousand volts of rf.

Once the tuner is resonated, increase the drive in

your transmitter and retune for a dip in swr. You may notice that you don't necessarily get the maximum forward drive at the same point where you get minimum swr. Redip the plate tuning of the transmitter, and you're ready to go. With subsequent changes in frequency, simply touch the tuner capacitor for minimum swr. It takes a bit of practice to get used to handling endfed antennas, but those who have mastered the art swear by them.

Having resonated an antenna, the next step is multi-band operation. With dipoles or inverted vees, there's nothing at all wrong with connecting several antennas to one piece of coax. They do become trickier to tune, however.

Trap antennas simply utilize the frequency selection characteristics of parallel wavetraps to provide an end of the antenna for one frequency while letting others go on to the ends of the wire. These can be resonated in the same manner as dipoles or inverted vees, remembering that the higher frequency portion, in the middle, must be resonated first, then the lower portion at the ends.

The techniques outlined here have been very basic — old hat to most amateurs, but I hope the Novice reader may find this article useful in getting over that all-important hurdle and getting on the air.

Good luck, and welcome to ham radio! ■

MULTI-BAND ANTENNA TRAPS

A pair of PACE-TRAPS and 106 feet of wire will give you a 5 band antenna system for 80 through 10 meters; or 55 feet of wire for a 4 band system covering 40 through 10! Insert a pair in your present 80 or 40 meter dipole and the multiband coverage is yours! Full instructions for installation furnished. Available in kw or 300 Watt models.

FG-6 Kw rated for 80 thru 10 meter systems \$17.95 a pair postpaid
 FG-4 Kw rated for 40 thru 10 meter systems \$17.95 a pair postpaid
 NG-5 300 Watt rated 80 thru 10 meter systems \$14.95 a pair postpaid
 NG-4 300 Watt rated 40 thru 10 meter systems \$14.95 a pair postpaid
 PS-1 No solder weather-proof center insulator \$4.95 each postpaid
 PS-1 Acrylic end insulators 6" long, lightweight \$2.00 a pair postpaid

ANTENNA WIRE:
 #12 Stranded Copper-weld. Handles like soft copper. Perfect for being spliced with no sag or stretch. .055/ft. 500 feet or more .048/ft. plus UPS. CW-1 112' wire as above cut to lengths for 5 band system. \$6.50 plus \$1. UPS. CW-2 56' same but cut for 4 band systems. \$3.50 plus UPS. KG 39/U 70 ohm TIMES WIRE coax. \$1.25/ft. plus UPS.

Check or MO to:

CT res. add 7% tax

Box 234
 Middlebury, CT 06762
 (203) 758-9228

P15

COAKIT

P.O. BOX 101-A, DUMONT, N. J. 07628

RF & AUDIO CONNECTORS & ACCESSORIES

5 PL259 UHF male	\$3.50	2 M359 UHF right	
5 SO239 UHF chassis		angle adaptor	\$3.25
female	\$3.50	1 UG224/U UHF splice	\$2.45
5 UG175/U adaptor	\$1.20	1 UG363/U UHF splice	\$2.75
5 UG176/U adaptor	\$1.20	3 UG260/U BNC male	\$2.70
2 PL259PO push-on		3 UG1094/U BNC	
UHF male	\$2.25	chassis female	\$2.40
2 PL258 UHF splice	\$2.10	1 Lightning Arrester	
1 M358 UHF "T"	\$2.80	in-line UHF	\$2.25

ALL ITEMS POSTPAID — NO C.O.D.'s
 SEND FOR FREE CATALOG

KENWOOD'S TR7400A

YAESU'S FT301D

SWAN'S SS747

DRAKE'S TR4CW

Call for competitive prices!

BankAmericard Master Charge

FRECK radio & supply
 co., inc.

252 Patton Ave., Asheville, N.C. 28801

PHONE: (704) 254-9551 F3



CHOOSE ONE OF THESE TWO GREAT 2-METER FM TRANSCEIVERS. BOTH SYNTHESIZED FOR STANDARD AND "ODD-BALL" REPEATER SPLITS!

Model FM-28 Check these outstanding features: Fully-synthesized from 144 to 148 MHz in 5 KHz steps. Bright six-digit frequency display. Supplied with simplex, plus 600 and minus 600 KHz offsets. Up to two additional "non-standard" offsets available. Clean 25 watt transmitter. 0.25 UV receiver with helical front end. Modular construction. All solid state. Complete with base station and mobile mounts, hardware, DC cable, microphone and manual. **Introductory priced at only \$359.95.**

Model FM-DX Compare the specifications of this unchallenged performer: 40 watt transmitter output. Extended frequency coverage from 143.5 to 148.5 MHz to facilitate MARS and CAP. Supplied with simplex, plus 600 and minus 600 KHz offsets. Up to three additional "non-standard" offsets available. LED frequency display. Selective, single conversion receiver. Rugged extruded chassis and modular construction will withstand the most severe environment. Engineered and built in USA. Shipped with mobile mounting hardware, power cables, microphone and manual. **Limited time pricing only \$499.00.**

Optional accessories: Include base station, power supplies, tone encoders, antennas and solid state power amplifiers. Write or telephone today for detailed specifications.

Count on Clegg superior service. Clegg's well staffed, well equipped organization is always available to you. Whether you need free product literature, replacement parts, service or just information, make a free Watts-line call from anywhere in the USA (except Pennsylvania) at no cost. Just dial 1-800-233-0250. In Pennsylvania, call (717) 299-7221 collect.

Should your Clegg product ever require service, you can expect the fastest turn-around time in the industry—typically 48 hours—almost always less than one week.

Direct to you. Because Clegg considers licensed amateurs a professional group, you can purchase directly from Clegg and save dealer and middleman markup. And you're protected.

All Clegg products are sold with a 10-day money-back guarantee.

To place your order, send check (Visa or Master Charge accepted) to Clegg Communications Corporation, 208 Centerville Road, Lancaster, Pennsylvania 17603. Better yet—phone us on our TOLL-FREE line and we'll ship today.

Clegg

Advanced technology in action!

Sound Operated Relay

-- for the ultimate security system

Ralph Taggart WB8DQT
602 So. Jefferson St.
Mason MI 48854

There are numerous occasions when it would be nice to have a relay circuit that could be conveniently triggered by sound. Applications include automatic recording of the output of a monitor receiver that is not equipped with a COR circuit, automatic recording of data

from any audio link, design of VOX circuits for RM or home brew sideband equipment — in short, lots of possibilities. In most of these applications, it would also be nice to have an adjustable time delay so that once triggered, the control circuit would remain actuated for a set period in the absence of further input, thus saving wear and tear on the recorder

when monitoring a channel where rapid callbacks could be expected, where data dropouts might occur, or in a VOX circuit where we would want to avoid cycling the relay during momentary speech pauses. A great many of the circuits that can accomplish the relay/time delay function have several drawbacks, including undue circuit complexity or unwanted variation in the time delay. While looking through application notes for the versatile Signetics NE-555 timer IC¹, I realized that this chip could be very effectively put to use in a VOX circuit, something which is probably done every day in industry, but an application which is little used in amateur designs.

A basic NE-555 timer circuit is shown in Fig. 1. If the input is momentarily pulled low, the timer will pull in the reed relay for a period determined by R and C in the timer circuit. The relay pull-in time can be computed from the formula $t = 1.1 RC$. If we use a 100k resistor for

R and a 47 mF capacitor for C, the relay would pull in for 1.1 (1x10⁵) (4.7x10⁻⁵) or approximately 5.2 seconds. By itself, this circuit is not ideal for VOX, for it is not possible to retrigger the circuit until the timing cycle has been completed. By adding a simple PNP transistor, as shown in Fig. 1(b), it is possible to retrigger it. This circuit is widely used as a missing pulse detector, for the output will remain high (relay pulled in) as long as trigger pulses continue to arrive. Used as a missing pulse detector, one would normally set the timer for a period slightly longer than the expected interval between pulses. As long as the pulses arrive on schedule, the timer is repetitively triggered, but it will drop out as soon as a pulse is missing from the input train. This circuit configuration can easily be used in a VOX mode, for if we can pull the input low with peaks in an audio waveform, the relay will close and remain closed as long as there is audio input. When the input audio ceases, the relay will drop out after a time period determined by the RC formula noted earlier.

All that is required to convert the missing pulse detector to an audio triggered circuit is the addition of a single transistor as noted in Fig. 2. If this transistor conducts, it will trigger the timer. By adjusting the 10k input pot to just short of the point where the timer is triggered — in other words, biasing the transistor to just short of the point where it is ready to take off — a very small audio voltage on the input will trigger the timer and keep the relay in as long as the audio signal is present. The circuit is more than sensitive enough to respond to a signal tapped off the speaker leads of a monitor receiver, keyer, intercom, or what have you. Obviously, if you want to use the relay with a monitor receiver, the receiver should be equipped with a squelch circuit, other-

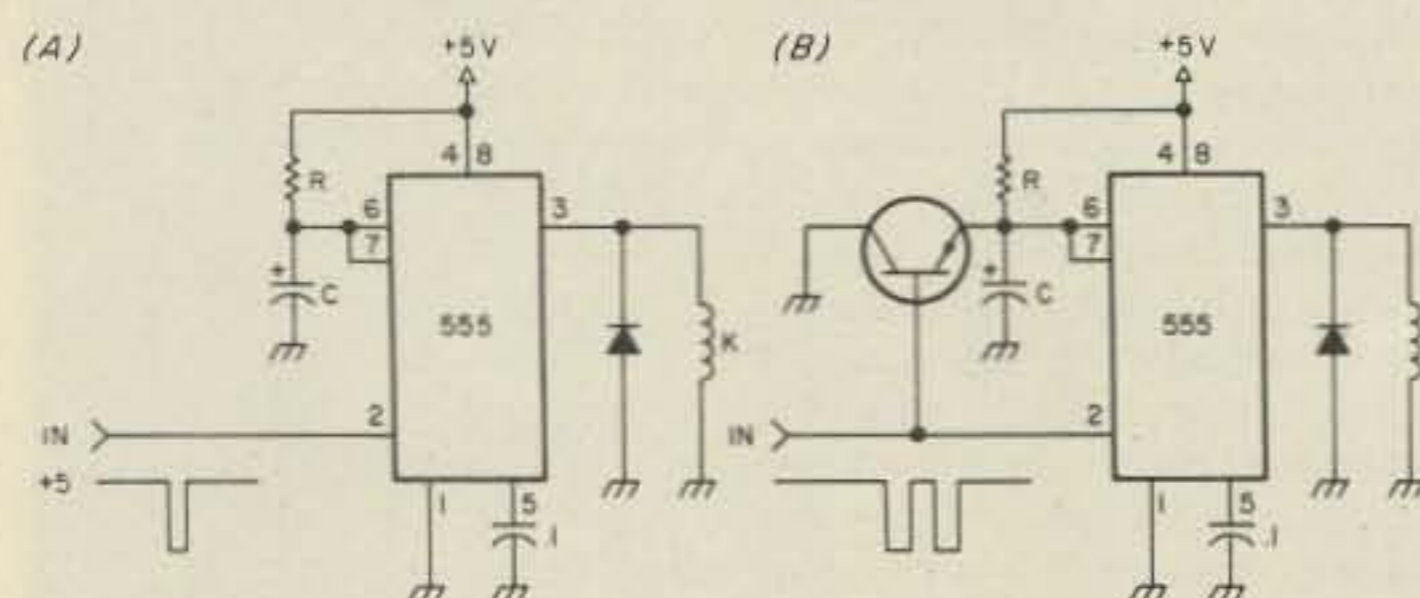

Fig. 1. Basic timer circuits for the NE-555. (a) Shows the basic timer. A momentary LOW at pin 2 causes the 5 volt reed relay (K) to pull in for a time period equal to $1.1RC$. This circuit cannot be triggered again until the timing cycle is completed. (b) Shows the addition of a PNP transistor that permits the circuit to be continuously triggered during a timing cycle. As long as the input lows continue to arrive within the timing period (again $1.1RC$), the relay will remain in the pulled-in condition. The relay will only drop out if a period of $1.1RC$ elapses between pulses.

Fig. 2. (a) The basic audio operated relay. Q1 is any general purpose NPN transistor, while Q2 is an equally non-critical PNP unit. The 10k input pot is adjusted (starting with 0 V on the base of Q1) to a point just short of where Q1 turns "ON" as indicated by K pulling in. The closer the bias is set to this point, the less audio voltage at the input required to trigger the circuit. K is any 5 V reed relay. With the values shown for R (100k pot) and C (47 mF/20 V tantalum capacitor), timing values from .05 to slightly over 5 seconds can be achieved. In practice, timing below approximately 0.25-0.5 seconds is impractical as the relay will cycle between syllables. Values in excess of 5 seconds can be obtained simply by increasing the values of R and C. (b) Shows the addition of a 22k series resistor to the 10k input pot if a 12 V supply is used. If voltage fluctuations are expected on the supply line, a 4-6 V 1 W zener can be added as shown. Adjust the value of the series resistor in this case to provide the proper regulated voltage at the top of the input pot with the expected supply variations. The timer will function quite well at 12 V if a suitable 12 V reed relay is used at K. The diode across the relay coil simply provides surge protection from the back EMF developed across the relay coil and any general purpose 1 A diode rated at 50 or more volts may be used.

wise the background noise will trigger the relay just as effectively as the voice signals or data we wish to record. The attack time of the circuit is limited only by the pull-in time of the relay, which is very short in the case of

typical reed relays. The timer will operate quite nicely at 12 volts, but in this case it is wise to include a series resistor at the top of the input pot shown in Fig. 2(b) to keep the base voltage to Q1 at a safe level. The timer will

retain its accuracy with very wide swings in supply voltage, but since the bias level is critical for Q, it would be wise to include a 4-6 V zener on the input pot to stabilize the bias voltage in a mobile installation or situations where an unregulated supply voltage is used. The chip will handle virtually any reed relays at 5 or 12 volts, but if you should require a larger relay in your application, you should consider using the reed relay to trigger the larger unit or interfacing a transistor at the timer output to pull in a conventional open frame or plug-in relay.

The handful of parts used

in the circuit are easily assembled on a small piece of perf-board and component placing is non-critical. This circuit has been used in a variety of applications in my own shack, including making tapes from the weather satellite receiver, logging calls on local "experimenter" simplex channels, automatically recording weather alerts, and in a variety of system control applications. It works like a charm despite the minimal component investment! ■

Reference

¹ Haney, L. M. (Ed.), 1973, *Calectro Digital Handbook*, G.C. Electronics, Rockford, Ill., 63 p.

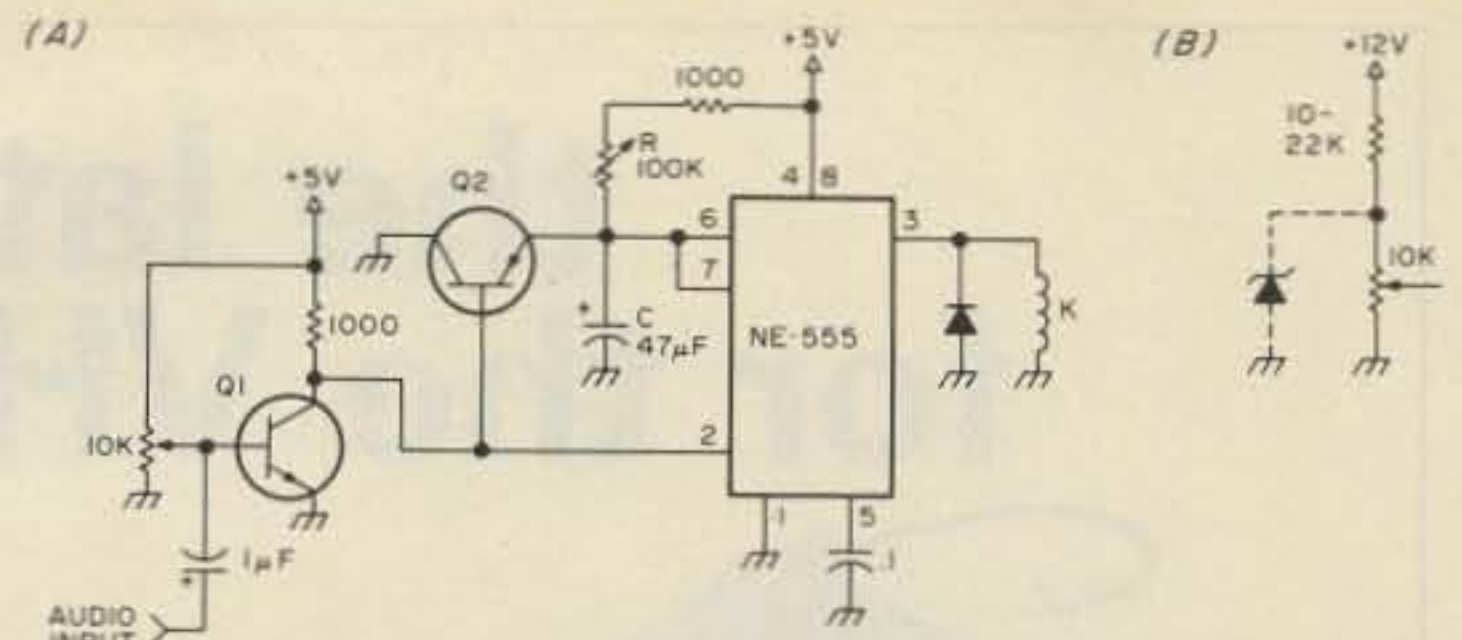

VERTICALS - DIPOLES - TRAPS - BALUNS

TRAP VERTICAL ANTENNAS

No antenna tuner needed — Full legal power limit — Fully assembled and ready for operation — No radials required — 1:1 VSWR to 50 OHM coax

MODEL	BANDS	HT	PRICE
TV-215	20 15	13'	\$34.95
TV-4215	40 20 15	22'	\$44.95
TV-84215	80 40 20 15	30'	\$69.95

HIGH PERFORMANCE COMPACT VERTICAL ANTENNAS

Uses "top loading" for reduced size and maximum efficiency — Use 2 or more to form a phased array — No antenna tuner needed — Folds to 5' package

MODEL	BANDS	HT	PRICE
CV-160	160	23'	\$44.95
CV-80	80	20'	\$39.95
CV-40	40,15	15'	\$34.95
CTV-8040	80/40/15	20'	\$59.95

AO-1 — 10 Meter Conversion Kit — add 10 meter coverage to any Antenna Sup. vertical . . . \$9.95

All verticals include ground post plus all mounting hardware

TO ORDER — Write or Phone — Include Shipping — Dipoles \$2.50 — Verticals \$3.00 — Florida residents, please add 4% sales tax

— Phone Orders Welcome — 9:30 to 5:00 — Monday thru Saturday 813 / 585-9688

Include Interbank No. and expiration date on credit card orders — 24 hour shipment, 30 day guarantee — For more info: SASE or 1st class stamp

APARTMENT - PORTABLE - TRAILER

AV-1 ALLTENNA
Use this portable antenna anywhere — Mounts on window sill or patio railing — Solves landlord problems — 80-10 meters — Change bands by switching preset inductance — Adjustable to 1:1 VSWR at any frequency — 13' maximum extended height — Light weight — Under 10 lbs. — Use on travel campers and vans — Mounts easily on ground post (included) or on side of camper or van — No antenna tuner needed — Full legal power limit — Fully assembled & ready for operation — No radials required — Folds to 5' package for easy storage — Export version folds to 3'

MODEL	BANDS	HT	PRICE
AV-1	80-10	13' (max)	\$49.95

FULL SIZE VERTICAL ANTENNA

Full quarter wave which can be configured for 10, 15 or 10 — No coils or traps — No tuner needed — VSWR less than 1.2:1 over each entire band — Folds to 5' package

MODEL	BANDS	HT	PRICE
FV-201510	20,15,10	16'	\$29.95

Z-1 BALUN \$9.95 postpaid
1:1 ratio, takes place of center insulator, helps eliminate TVI-coax fitting, full legal power

Coaxial cable & connector — RG58AU	50'	5.95
	100'	9.95
Aluminum radial wire — No. 8 heavy duty	100'	3.99
Nylon guy rope	100'	3.49

FULL SIZE DIPOLES

Model	Bands	Length	Price
D-80	80/75	130'	\$31.95
D-40	40,15	66'	\$28.95
D-20	20	33'	\$26.95
D-15	15	22'	\$25.95
D-10	10	16'	\$24.95

FULL SIZE PARALLEL DIPOLES — ONE FEED LINE

PD8040	80/75,40,15	130'	\$36.95
PD4020	40,20,15	66'	\$30.95
PD8010	80/75,40,20,15,10	130'	\$41.95
PD4010	40,20,15,10	66'	\$35.95

LIMITED SPACE DIPOLES

SP-160	160	130'	\$36.95
SP-80	80/75	63'	\$31.95
SP-40	40,15	33'	\$28.95

MSP-1 SHORT POLE COMPACT SYSTEM

MSP-1	80/75,40,15	70'	\$41.95
-------	-------------	-----	---------

ANTENNA SHORTENER KITS —

Same coils as the SP & MSP series — use with your own antenna

S-160	160	130'	\$12.95
S-80	80/75	63'	\$11.95
S-40	40,15	33'	\$10.95

TRAP DIPOLES — Adjusted — ready to go — Rated legal limit

TD-8040	80/75,40	78'	\$41.95
TD-4020	40,20	40'	\$36.95

TRAPS ALONE

T-8040	80/75,40	78'	\$12.95
T4020	40,20	40'	\$ 9.95

(All above are complete with balun, No. 14 antenna wire, ceramic, insulators, 100' nylon support rope, rated for full legal limit. Can be used as inverted V, MARS, SWL.)

ANTENNA SUPERMARKET P.O. Box 1682 Largo, Fl. 33540 813/585-9688

the latest gear for the VHF enthusiast



**Gamber-Johnson
Deluxe slide mount
\$17.88**

- Solid snap in design
- Attaches to radio mtg bkt (or directly to radio)
- Four molex pins for power and external speaker
- BNC RF slide connector
- pigtail UHF (SO-239) connections to radio and antenna
- designed for commercial use thru 1000 MHz

**Gamber-Johnson
Console floor mount
\$31.50**

- utilizes deluxe slide mount
- built in speaker
- mount attaches securely to floor

**extra slide mount
base \$8.40**
stationary half of deluxe slidemount allows use of radio in second car or location

WESTCOM



**Westcom
VHF Amplifiers**

Model	Band	Emission	P in	P out	Price
2M 3x30	144MHz	FM	1 - 4	30	72.95
2M 3x30L	144MHz	CW-FM-SSB/AM	1 - 4	30	82.95
2M 10x40	144MHz	FM	2 - 10	40	77.95
2M 15x80	144MHz	FM	5 - 15	80	129.95
2M 15x80L	144MHz	CW-FM-SSB/AM	5 - 15	80	139.95



**Power Supplies
Ruggedized DC**

Ideal for VHF Transceivers and Amplifiers

- 105-125 VAC, 50/60 Hz
- Fold back current limiting
- 13.8 VDC ± .05V
- UL listed & computer grade components
- One year warranty
- 5 mV peak-peak max ripple

Astron RS-6A \$49.95

4.5 ADC Continuous
6.0 ADC Intermittant
Recommended for up to
30 W amp's & xcvs

Astron RS-20A \$89.95

16 ADC Continuous
20 ADC Intermittant
Recommended for up to
120 W amp's

Astron RS-10A \$74.95

8 ADC Continuous
10 ADC Intermittant
Recommended for up to
70 W amp's

Astron RS-35A \$129.95

25 ADC Continuous
35 ADC Intermittant
Recommended for up to
180 W amp's

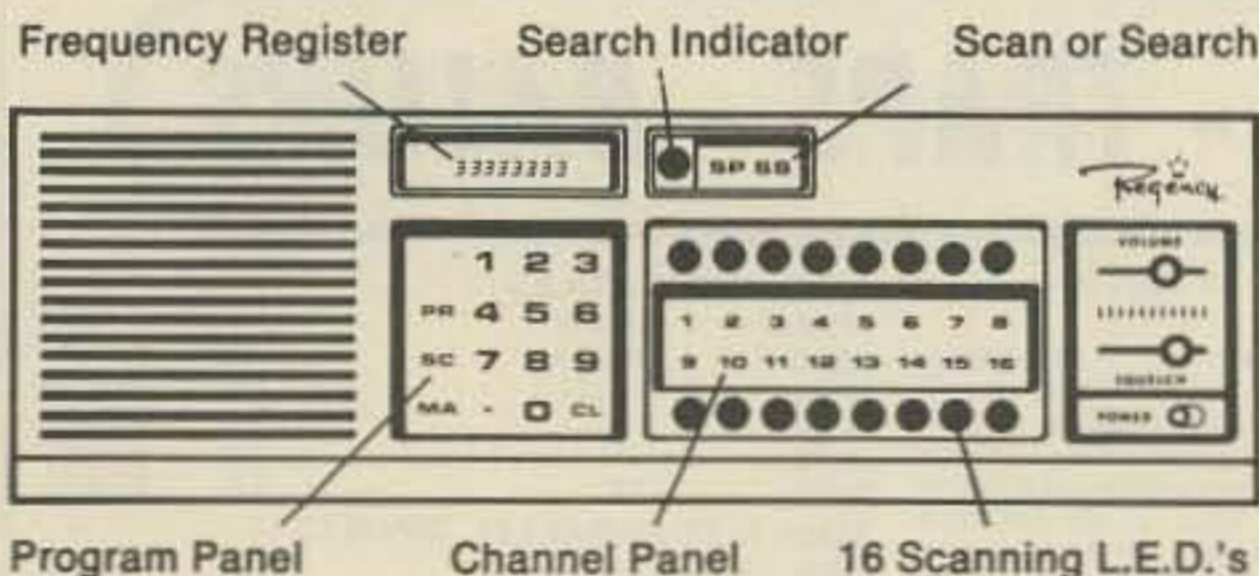

**Regency Digitally Programmable Scanner
with Keyboard Entry
special \$299**

Model ACT-T-16K

	Selectivity
 ± 7 KHz (min.) @ 6 DB
	± 15 KHz (max.) @ 60 DB
Frequency Range:	Squelch: (threshold)
Lo VHF .. 30- 50MHz	Lo VHF 0.4 μ V
Hi VHF . 146-174 MHz	Hi VHF 0.5 μ V
UHF . 440-512 MHz	UHF 0.6 μ V
Sensitivity:	Search Scan Range:(max)
(20 DB quieting)	Lo VHF 4000 channels
Lo VHF 0.5 μ V	Hi VHF 5600 channels
Hi VHF 0.6 μ V	UHF 5760 channels
UHF 0.7 μ V	



Larsen mobile antennas

1/8 wave, 3dB gain, 200 W rating

LM-150-K 2M roof mount \$30.20

LM-150 w/magnetic mount \$38.45

LM-150 w/trunk lid mount \$37.90

for Motorola NMO type mount add \$5.25

220 MHz and 450 MHz available at same price

Master Charge & B of A
We ship prepaid in USA
Calif. residents add 6% tax
Check with order or COD

10 day money back guarantee
full satisfaction guaranteed
Factory warranty on all items



WESTCOM

COMMUNICATIONS DIVISION 1320 Grand Ave. San Marcos, CA. 92069 (714) 744-0728

NEW for 220 MHz

FROM **Vhf engineering**



Synthesizer 220

Compatible with virtually all 220 transceivers; Clegg, Midland, Cobra, etc. . . .

The Synthesizer 220 is a 1/4 meter frequency synthesizer. Frequency is adjustable in 5 KHz steps from 220.00 MHz to 225.00 MHz with its digital readout thumb wheel switching. Transmit offsets are digitally programmed on a diode matrix, and can range from 100 KHz to 10 MHz. No additional components are necessary!

FEATURES

- T²L Logic
- Maximum offset versatility – easily programmed to any IF and transmitter offset between 100 KHz and 30 MHz in even 100 KHz increments.
- Simple jumper wire change enables use on rigs with 18, 9, 6 MHz transmit crystals.
- All frequencies locked to one master crystal oscillator.
- 2 pole output filter on receive line.
- Virtually no measurable difference in spurious outputs between crystal or SYN 220.
- Lockup time typically 150 milliseconds.
- Easily interfaced to most rigs.

SPECIFICATIONS

- Frequency: 220 – 225 MHz
- Transmit offsets: Simplex, +1.6 MHz, -1.6 MHz plus 3 additional field programmable offsets.
- Output: 3 volts to a 50^Ω load.
- Input voltage: 11 – 18 VDC at .900 amps.
- Size: 8" long x 5 1/2" wide x 2 1/4" high
20.32CM x 13.97CM x 5.715CM
- Complete kit including all electronics, crystal, thumb wheel switch, cabinet, etc.
- Shipping weight 2 lb. 4 oz.

KIT \$169.95 – Wired & Tested \$239.95

Prices and specifications are subject to change without notice. Export prices are slightly higher.

IN AREAS NOT SERVED BY A VHF ENGINEERING DEALER, SEND THIS ORDER FORM.

THE WORLD'S MOST COMPLETE LINE OF
VHF - FM KITS AND EQUIPMENT

Vhf engineering

DIVISION OF BROWNIAN ELECTRONICS CORP.

BOX H / 320 WATER ST. / BINGHAMTON, NY 13901
Phone 607-723-9574



ORDER FORM

Item	Price Each	Quantity	Total Price
Synthesizer 220 Kit	\$169.95		
Synthesizer 220 Wired & Tested	\$239.95		

Name _____ Total _____

Address _____ Shipping _____

City _____ NYS Resident

State _____ Sales Tax _____

State _____ Zip _____ Total

Master Charge or BankAmericard No. _____ Enclosed _____

Bank No. _____ Expiration Date _____

Traffic Handling Explained

-- a lost art?

Ralph A. Giffone WB2YKG
963 East 105th Street
Brooklyn NY 11236

I am sure that many of you have heard the terms ARPSC, AREC, and NTS. I am sure that you were as equally confused with those terms as you were with these: public service, traffic handling, emergency communications.

"What are they talking about?" you have probably asked yourself more than once, but probably gave up trying to understand soon after.

I am going to explain those terms and the ideas behind them, with the hope that it will cause you to take an interest and pursue that interest.

The National Traffic System (NTS) and the Amateur Radio Emergency Corps (AREC) are actually the Amateur Radio Public Service

Corps (ARPSC) divided into two parts: an emergency division (AREC) and a traffic division (NTS). The AREC is usually dormant during normal times (no emergency), whereas NTS is always active. This does not mean, however, that the AREC is not ready. It's standing by, to be activated in an emergency.

Since my main objective is to get you into traffic handling, I will try to give you as complete a background of NTS that is possible without getting too technical.

The NTS is a major network composed of many smaller, interdependent networks (nets, for short). These smaller nets are categorized (from biggest to smallest) as local nets, section nets, region nets, and area nets.

The purpose of NTS is to handle third party traffic during normal times and, ultimately, to pass emergency traffic during emergencies. By passing traffic, we not only

perform a public service, but we also train for the times when there can't be any mistakes, those life and death situations that we call emergencies.

You say you don't know what third party traffic is? You may think of third party traffic as any communication (phone patches, radiograms, etc.) transmitted via amateur radio for a third party (someone other than yourself). The bulk of the traffic handled on NTS are "radiograms." These radiograms (written messages in a standard form) may be relayed to their destination by way of the National Traffic System.

Let's see how NTS "gets you there" (your message, I mean).

Let's assume that you are living in New York City. Your neighbor wants to send birthday greetings to her Aunt Enna in Los Angeles, California. Here's how your message gets to California:

First, you must put the message in the ARRL's standard amateur message form (a minor and simple technicality). Next thing you would do is check into your section net, which is, in this case, the New York City-Long Island Section Net (NLI). A section net is composed of people from their respective ARRL section (NLI in this case). If you have any traffic whose destination is within the section, it can be passed directly on your section net.

Since your message is for California, and not within the NLI section, it must be taken to another net — a region net. A region net is composed of representatives from each of the respective section nets of that region. (By the way, this representative is called a liaison, and is the person who brings all the outgoing traffic of one net to another net.)

Since the NLI section is part of the second region, all the traffic coming from this net must go to the second region net (2RN). The liaison appointed for that night will take your message from you, and then check into 2RN with that same message.

There are four liaisons who check into the second region net, one from the New York State Section Net (NYS), one from the New Jersey Section Net (NJN), one from NLI (the one that you check into), and a station that will go to the Eastern Area Net. Now . . . if there is any traffic for any of the sections in the second region, it can be passed directly on this net. For example: The NYS liaison has one message for New Jersey. The liaison from NJN will take this message. He will take it back with him to his section net, when he checks in later, to be delivered to the proper town.

If there is any traffic whose destination is not within the region, it must be taken to yet another net, the Eastern Area Net (EAN). Such is the case with your message. Your message is for

California, and that is certainly not part of the second region. There will be a liaison at the second region net who will take your traffic to the Eastern Area Net.

If you can see the pattern now, you will note that California is not part of the EAN either, but must be sent to the Pacific Area Net (PAN).

When the liaison with your traffic checks into EAN, he will relay the message to an operator in the TransContinental Corps (TCC). TCC is the organization that relays messages to and fro between PAN, CAN, and EAN — Pacific, Central, and Eastern Area Nets respectively. The message will then be sent by way of TCC to the PAN. Your message then undergoes the previous processes in the

reverse order: From PAN (an area net), to the sixth region net (a region net), to the appropriate California section net.

The people who check into this section net are people from all over the section. A station in Los Angeles will check in and take your traffic. This station would then deliver your message to your neighbor's Aunt Enna by telephone and/or mail. He will usually take the time to explain how the message got there, so as not to baffle its recipient.

That is how your traffic gets from place to place within the National Traffic System. Would you believe that this usually takes place within about three hours?

There are three major pur-

poses (in my eye) of NTS and traffic handling: public service, emergency communications, and fun.

Most non-hams have a dim view of amateur radio because their only experience with radio has been that of TVI and RFI. Handling their traffic shows them that ham radio has a purpose, and can be useful to them. I used to have a problem with my neighbor, but once I started handling her traffic, she never mentioned anything again!

Knowing how nets operate and how you yourself must act on a net increases NTS's effectiveness during emergencies. We are not usually so lucky: Many inexperienced people check into nets (wanting to help, of course), but usually decrease the net's efficiency because of this inexperience. A well-trained amateur is NTS's biggest asset.

Traffic handling is fun. I cannot actually pinpoint the reason, but once I started, I was hooked.

By this time, I am sure that many of you would like to know more.

The first net that you can actually check into is the section net; it is unwise to check into a higher net if you lack the proper experience. The section net is, as I said before, composed of people from your respective ARRL section. Most section nets have a roster of about 30 people, but this usually depends on what the ham population is in that area. You realize, of course, that it is a rare occasion when more than half the net's membership checks in on any given night (this is especially true on CW nets). A section net with a roster of thirty will usually average six to twelve check-ins per night.

ARRL Operating Form #9 gives you the standard amateur message format. On the opposite side are Q signals and abbreviations for traffic net use.

AMATEUR MESSAGE FORM

Every message originated and handled should contain the following component parts in the order given.

I PREAMBLE

- Number (begin with 1 each month or year)
- Precedence (R, Q, P or EMERGENCY)
- Handling Instructions (optional, see text)
- Station of Origin (first amateur handler)
- Check (number of words/groups in text only)
- Place of Origin (not necessarily location of station of origin)
- Time Filed (optional with originating station)
- Date (must agree with date of time filed)

II ADDRESS (as complete as possible, include zip code and telephone number)

III TEXT (limit to 25 words or less, if possible)

IV SIGNATURE

CW MESSAGE EXAMPLE

I NR 1 R HXA WIAW 8 NEWINGTON CONN 1830Z July 1
 II DONALD R SMITH AA
 164 EAST SIXTH AVE AA
 NORTH RIVER CITY MO 60789 AA
 PHONE 733 3967 BT
 III HAPPY BIRTHDAY X SEE YOU SOON X LOVE BT
 IV DIANA AR

CW: Note that X, when used in the text as punctuation, counts as a word. The prosign AA separates the parts of the address, BT separates the address from the text and the text from the signature. AR marks end of message; this is followed by B if there is another message to follow, by N if this is the only or last message. It is customary to copy the preamble, parts of the address, text and signature on separate lines.

RTTY: Same as cw procedure above, except (1) use extra space between parts of address, instead of AA; (2) omit cw procedure sign BT to separate text from address and signature, using line spaces instead; (3) add a CFM line under the signature, consisting of all names, numerals and unusual words in the message in the order transmitted.

PHONE: In general, use prowords in place of procedural signals or prosigns. The above message on phone would go something like this: "Message Follows Number one, routine, HX Alpha, WIAW, check eight, Newington, Connecticut, one eight threes zero zulu, July one, to Donald Initial R Smith, Figures one six fower, East Sixth Avenue, North River City, Missouri zero zero seven eight nine, Fone seven thutree thutree, thutree nyen six eight. Break Happy Birthday X-ray see you soon X-ray love Break Diana, End of Message, Over." Speak in measured tones, emphasizing every syllable. Spell out phonetically all difficult or unusual words, but do not spell out common ones.

PRECEDENCES

The precedence will follow the message number. For example, on cw 207R or 207 EMERGENCY. On phone, "Two Zero Seven, Routine (or Emergency)."

EMERGENCY - Any message having life and death urgency to any person or group of persons, which is transmitted by amateur radio in the absence of regular commercial facilities. This includes official messages of welfare agencies during emergencies requesting supplies, materials or instructions vital to relief of stricken populace in emergency areas. During normal times, it will be very rare. On cw, this designation will always be spelled out. When in doubt, do not use it.

PRIORITY - Important messages having a specific time limit. Official messages not covered in the "Emergency" category. Press dispatches and other emergency-related traffic not of the utmost urgency. Notification of death or injury in a disaster area, personal or official. Use the abbreviation P on cw.

INQUIRY - Messages pertaining to the health or welfare of persons in a disaster should carry this precedence, which is abbreviated to Q on cw. These messages are handled after PRIORITY traffic but before ROUTINE.

ROUTINE - Most traffic in normal times will bear this designation. In disaster situations, traffic labeled "Routine" (R on cw) should be handled last, or not at all when circuits are busy with emergency, priority or inquiry traffic. Most traffic handled on amateur circuits in normal times will fall in this category.

Handling Instructions

HXA - (Followed by number.) Collect landline delivery authorized by addressee within ... miles. (If no number, authorization is unlimited.)

HXB - (Followed by number.) Cancel message if not delivered within ... hours of filing time; service originating station.

HXC - Report date and time of delivery (TOD) to originating station.

HXD - Report to originating station the identity of station from which received, plus date and time. Report identity of station to which relayed, plus date and time, or if delivered report date, time and method of delivery.

HXE - Delivering station get reply from addressee, originate message back.

HXF - (Followed by number.) Hold delivery until ... (date).

HXG - Delivery by mail or landline toll call not required. If toll or other expense involved, cancel message and service originating station.

This prosign (when used) will be inserted in the message preamble before the station of origin, thus: NR 207 R HXA50 WIAW 12. ... (etc.). If more than one HX prosign is used, they can be combined if no numbers are to be inserted; otherwise the HX should be repeated, thus: NR 207 R HXAC WIAW ... (etc.), but: NR 207 R HXA50 HXC WIAW ... (etc.). On phone, use phonetics for the letter or letters following the HX, to insure accuracy.

OPAD 9 R1075

ARRL, 225 Main St., Newington, CT 06111

ARRL QN SIGNALS FOR CW NET USE

- QNA*** Answer in prearranged order.
QNB* Act as relay Between...and...
QNC All net stations Copy.
 I have a message for all net stations.
QND* Net is Directed (controlled by net control station).
QNE* Entire net stand by.
QNF Net is Free (not controlled).
QNG Take over as net control station.
QNH Your net frequency is High.
QNI Net stations report In.*
 I am reporting into the net. (Follow with a list of traffic or QRU.)
QNJ Can you copy me?
 Can you copy...?
QNK* Transmit messages for...to...
QNL Your net frequency is Low.
QNM* You are QRMing the net. Stand by.
QNN Net control station is...
 What station has net control?
QNO Station is leaving the net.
QNP Unable to copy you.
 Unable to copy...
QNQ* Move frequency to...and wait for...to finish handling traffic. Then send him traffic for...
QNR* Answer...and Receive traffic.
QNS Following Stations are in the net.* (Follow with list.)
 Request list of stations in the net.
QNT I request permission to leave the net for...minutes.
QNU* The net has traffic for you. Stand by.
QNV* Establish contact with...on this frequency. If successful, move to...and send him traffic for...
QNW How do I route messages for...?
QNX You are excused from the net.*
 Request to be excused from the net.
QNY* Shift to another frequency (or to...kHz) to clear traffic with...
QNZ Zero beat your signal with mine.
 *For use only by the Net Control Station.

Notes on Use of QN Signals

The QN signals listed above are special ARRL signals for use in amateur cw nets only. They are not for use in casual amateur conversation. Other meanings that may be used in other services do not apply. Do not use QN signals on phone nets. Say it with words. QN signals need not be followed by a question mark, even though the meaning may be interrogatory.

INTERNATIONAL Q SIGNALS

A Q signal followed by a T asks a question. A Q signal without the T answers the question affirmatively, unless otherwise indicated. See the ARRL Handbook and Operating an Amateur Radio Station for an expanded list.

- QRA** What is the name of your station?
QRG What's my exact frequency?
QRH Does my frequency vary?
QRI How is my tone? (1-3)
QRK What is my signal intelligibility? (1-5)
QRL Are you busy?
QRM Is my transmission being interfered with?
QRN Are you troubled by static?
QRO Shall I increase transmitter power?
QRP Shall I decrease transmitter power?
QRO Shall I send faster?
QRS Shall I send slower?
QRT Shall I stop sending?
QRU Have you anything for me?
 (Answer in negative.)
QRV Are you ready?
QRW Shall I tell...you're calling him?
QRX When will you call again?
QRZ Who is calling me?
QSA What is my signal strength? (1-5)
QSB Are my signals fading?
QSD Are my signals mutilated?
QSG Shall I send...messages at a time?
QSK Can you work break-in?
QSL Can you acknowledge receipt?
QSM Shall I repeat the last message sent?
QSO Can you communicate with...direct?
QSP Will you relay to...?
QSV Shall I send a series of V's?
QSW Will you transmit on...?
QSX Will you listen for...on...?
QSY Shall I change frequency?
QSZ Shall I send each word/group more than once? (Answer, send twice or...)
QTA Shall I cancel number...?
QTB Do you agree with my word count? (Answer negative.)
QTC How many messages have you to send?
QTH What is your location?
QTI What is your time?
QTV Shall I stand guard for you...?
QTX Will you keep your station open for further communication with me?
QUA Have you news of...?

ABBREVIATIONS, PROSIGNS, PROWORDS

- CW** PHONE (meaning or purpose, exception obvious)
AA (Separation between parts of address or signature.)
AA All after (used to get fills).
AB All before (used to get fills).
ADEE Addressee (name of person to whom message addressed).
ADR Address (second part of message).
AR End of message (end of record copy).
ARL (Used with "check," indicates use of ARRL numbered message in text.)
AS Stand by; wait.
B More (another message to follow).
BK Break; break me; break-in. (Interrupt transmission on cw. Quick check on phone.)
BT Separation (break) between address and text; between text and signature.
C Correct; yes.
CFM Confirm. (Check me on this.)
CK Check.
DE From; this is (preceding identification).
FONE Phone; telephone.
HH (Error in sending. Transmission continues with last word correctly sent.)
HX (Handling instructions. Optional part of preamble.)
--- Initial(s). Single letter(s) to follow.
IM Repeat; I say again. (Difficult or unusual words or groups.)
K Go ahead; over; reply expected. (Invitation to transmit.)
N Negative, incorrect; no more. (No more messages to follow.)
NR Number. (Message follow.)
PBL Preamble (first part of message).
--- Read back. (Repeat as received.)
R Roger; point. (Received; decimal point.)
SIG Signed; signature (last part of message).
Out clear (end of communication, no reply expected).
TU Thank you.
WA Word after (used to get fills).
WB Word before (used to get fills).
.... Speak slower.
..... Speak faster.



THE AMERICAN RADIO RELAY LEAGUE

RADIOGRAM

VIA AMATEUR RADIO



NUMBER 197	STATION OF ORIGIN WB2YKG	CHECK 20	PLACE OF ORIGIN Brooklyn NY	TIME FILED 1930 Z	DATE Jan 17
---------------	-----------------------------	-------------	--------------------------------	----------------------	----------------

To
 ROBERT SMUTNY WB2WRT
 125 COCHRAN PLACE
 VALLEY STREAM NY 11581
 516 - 123 - 4567

THIS RADIO MESSAGE WAS RECEIVED AT

AMATEUR STATION _____ PHONE _____

OWNER _____

STREET ADDRESS _____

CITY AND STATE _____

HI BOB X THIS IS
 SHOW PEOPLE WHAT A RADIOGRAM
 RALPH WB2YKG

A SAMPLE RADIOGRAM DESIGNED TO
 MESSAGE BLANK IS X 73

SENDER'S ADDRESS AND PHONE NUMBER FOR REFERENCE					
REC'D	FROM STATION	LOCATED AT	DATE	TIME	OPERATOR
SENT	TO STATION				

YOUR REPLY TO THIS MESSAGE WILL BE HANDLED WITHOUT CHARGE BY THE RECEIVING STATION WHOSE ADDRESS IS SHOWN ABOVE. AMATEUR RADIO OPERATORS AND MEMBERS OF THE A.R.R.L. LICENSED BY THE FEDERAL COMMUNICATIONS COMMISSION, OFFER TO THE PUBLIC A MESSAGE SERVICE WITHIN THE U. S. A. AND ITS POSSESSIONS WHERE POSSIBLE. AS MESSAGES ARE HANDLED BY RADIO AMATEURS SOLELY FOR THE PLEASURE OF OPERATING, NO COMPENSATION CAN BE ACCEPTED BY A STATION OWNER, SO DELIVERY IS NOT GUARANTEED BY THE LEAGUE OR ITS MEMBER OPERATORS. AMATEURS ARE NOTED FOR THEIR WORK IN PUBLIC EMERGENCIES. FURTHER INFORMATION ON THIS INTERESTING HOBBY MAY BE OBTAINED DIRECTLY FROM A.R.R.L. HEADQUARTERS, NEWINGTON, CONN. LITHO.—U. S. A.

A radiogram message blank. Although not necessary for handling traffic, they do give your messages a "spiffy" look.

If you are in the dark as to what net meets in your area, you might send for the ARRL Net Directory (an SASE will bring a quick response). This lists all NTS nets, as well as other nets which do not have traffic handling as their main purpose. The net directory will help you find any NTS net. They are listed by state and frequency as well as by the net's name.

Most section CW nets meet anywhere from 6 pm and later (usually) and are almost exclusively on 80 meters. The phone nets, however, are of different case. They usually meet during the day or in the late afternoon. The area

phone nets usually meet on 40 meters (for obvious reasons).

There are generally three types of traffic nets: CW nets, phone nets, RTTY nets. All are quite useful, but for different purposes. RTTY comes in handy when you have to handle bulk traffic, that is, many messages all at once. Tape operation gives this advantage. Unfortunately, there are very, very few RTTY nets in NTS. Phone nets, as well as RTTY nets, are mainly for those who are experienced in traffic handling. CW nets are of two kinds: high speed and slow speed. The high speed net usually operates at a speed of

approximately 18 wpm and is usually composed of experienced traffic handlers.

A very valuable net to those beginning in traffic handling is the slow speed net. The slow speed net serves many purposes. One of its greatest purposes is to train inexperienced rookies and turn them into veteran traffic handlers. This net is for making mistakes and no one will look down on you for making them. (Don't get me wrong. I am not saying that high speed nets are for the experienced and that slow speed nets are for the inexperienced only. This would be terrible. The inexperienced must learn through the help

and examples set by the experienced. Believe me, everyone is usually willing to help.)

The slow speed net used to mainly train Novices, Generals, etc., but now with the new regulations, even Technicians can check into slow speed nets. Take my word, traffic handling will increase your code speed by plenty, and if you're a Tech or Novice who wants to upgrade, it will help a lot!

In time, if you become deeply involved in traffic handling, you may find your name printed in *QST* on the Public Service Honor Roll and Brass Pounder's League. But don't think that your name has to be there to be important. The fact is that every single person is important whether he passes thousands of messages or just one. Remember that without all the little people, the big people would have no one to relay their traffic to! No man is unimportant in NTS! No man is all-important, either. It's one big team doing a public service.

Traffic handling is surely something worth looking into. Not only can you perform a public service, you can also better yourself in one way or another as well. Don't think that you cannot be used if you don't have traffic; that's not true. NTS needs stations from everywhere to take traffic to everywhere. There is nothing preventing anyone from turning on his rig and checking into NTS. ■

Harry J. Miller
 991 42nd St.
 Sarasota FL 33580

When you're soldering small components, it can be a job to hold them, the soldering iron or gun, and the solder. The easy way is with a vise made with two spring-type clothespins.

Cut one leg shorter than the other, and then use small brads to nail the longer ends to the side of a small wood block. Place the item within the jaws of the two clothespins while you solder. ■

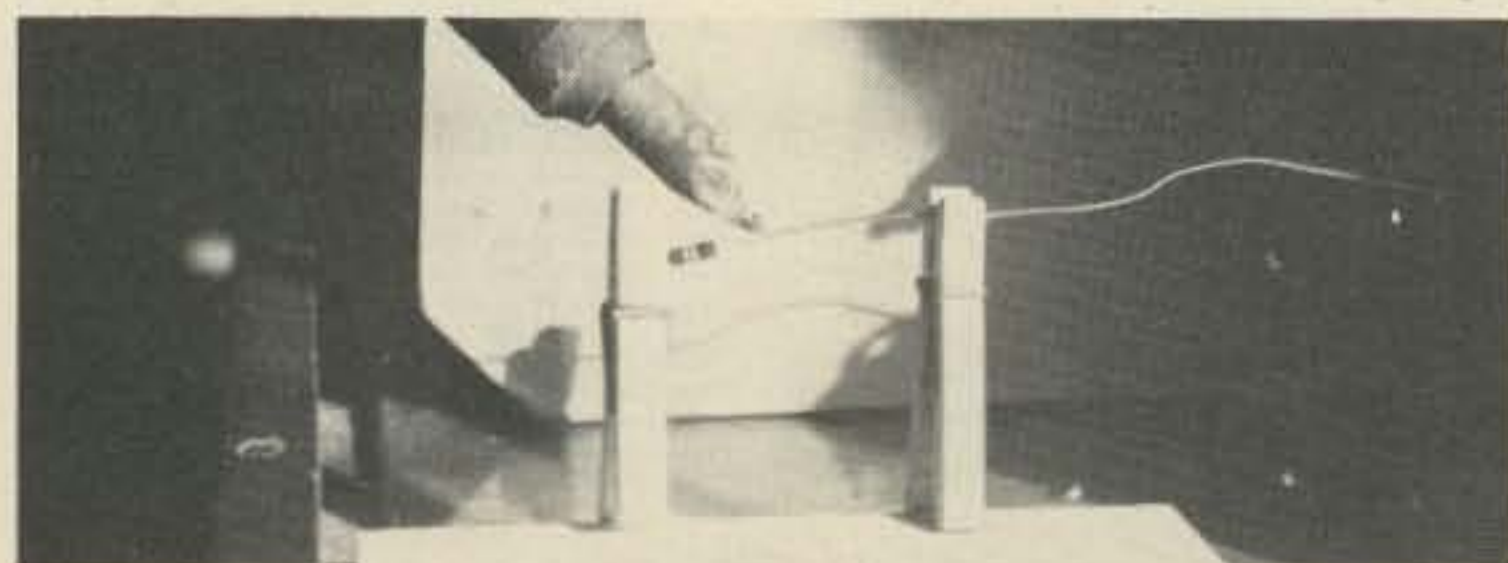

The Third Hand

-- how many times?



Now It's Crystal Clear

Yes, now ICOM helps you steer clear of all the hassles of channel crystals. The new **IC-22S** is the same surprising radio you've come to know and love as the **IC-22A**, except that it is totally crystal independent. **Zero crystals.** Solid state engineering enables you to program 23 channels of your choice without waiting. Now the ICOM performance you've demanded comes with the convenience you've wanted, with your new **IC-22S**.

VHF/UHF AMATEUR AND MARINE COMMUNICATION EQUIPMENT

Distributed by:



ICOM

ICOM WEST, INC.
Suite 3
13256 Northrup Way
Bellevue, Wash. 98005
(206) 747-9020

ICOM EAST, INC.
Suite 307
3331 Towerwood Drive
Dallas, Texas 75234
(214) 620-2780

Vehicle Security Systems

-- protect your rig

The theft of radio equipment and other such valuables from vehicles is a current problem that is getting more serious with every passing day. We are all concerned with this problem, and rightly so, because if someone's vehicle hasn't already been burglarized, the odds are that sooner or later it will. That may be a pessimistic statement, but we may as well face facts: More mobile

ham rigs are being stolen today than were stolen a few years ago before the rise in popularity of CB radios. The reason, as we are all aware, is that ham rigs are sometimes mistaken for CB rigs and are ripped off just the same.

As a result of this problem, many hams are taking preventive measures to protect their valuable property. Some of these measures include en-

graving driver's license numbers both outside and inside the unit and installing a quick disconnect mount to allow the rig to be easily removed and stored in the trunk. In addition, borrowing an idea from the CB market, there are a few swivel antenna mounts on the market that allow VHF antennas to be folded into the trunk along with the transceiver.

These measures are worth-

while, but we can always go one step further and include some type of security system as additional insurance against unwanted intrusion. Granted, if someone wants to break into a vehicle, nothing can really prevent him. However, if a security system in the vehicle goes off making some loud noises, most rip-off artists will usually run for cover, particularly if the attempted burglary is in an area where an alarm will draw a lot of attention, such as parking lots and busy streets.

The subject of building an electronic security system is not necessarily a new one, but there are new and unique ways such a system can be designed and built. This article describes a solid state security system designed around simple CMOS NOR gates for the ultimate in flexibility and reliability.

General Requirements of a Security System

Most of the commercial intrusion alarms on the market today generally fall into one of two categories:

1. Inexpensive alarms with an external key switch and no time delays, and
2. More expensive "electronic" alarms with exit/entry time delays and no external key switch.

The first (which I will refer to as key switch alarms), while being low in cost, are sometimes ineffective because of the visible external key switch which tips off the rip-off artist. He will usually do one of two things. He will reach under the battery compartment from beneath the vehicle and cut the battery cable, which disables the alarm. Or he can break the window, climb in, and make off with your rig without opening the door or setting off the alarm.

On the other extreme, the electronic systems with exit and entry delays have no visible key switch to tip off the burglar. This type is usually very effective because of the element of surprise,

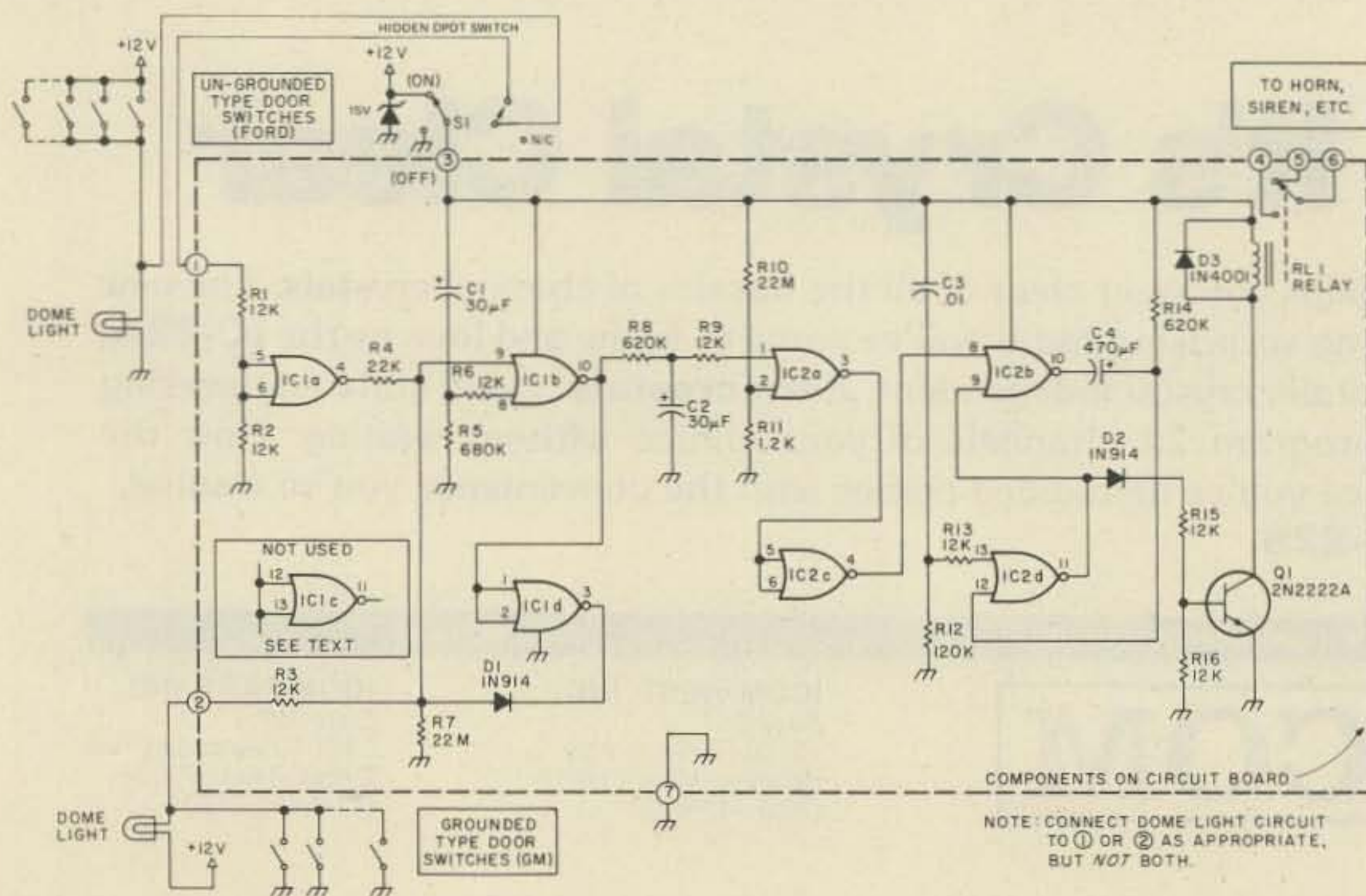

Fig. 1. Schematic diagram.

but can be expensive to purchase. In fact, the high cost of some of these sophisticated alarms has kept many hams from having the kind of protection they really need.

One solution to this problem is to build your own electronic system, thus keeping the cost low and protection high. Some of the features that an electronic alarm system should have are as follows:

1. Be able to operate over a wide voltage range and withstand the harsh electrical environment of a car's electrical system.
2. Exit and entry time delays to eliminate the need for an external key switch. The alarm is to be activated from within the car, before leaving.
3. To comply with the laws in some states, the alarm should have an automatic shut-off feature to turn the alarm (horn, siren, etc.) off after five minutes of sounding.
4. There should be negligible power drain on the battery until the alarm is triggered by an intruder.
5. The alarm should be easy to build and install, in addition to being low in cost.
6. Once the alarm is triggered, the operation sequence should be automatic and not affected by subsequent opening or closing of doors.

The alarm described in this article meets the above requirements and uses only two CMOS integrated circuits.

How It Works

Referring to the diagram shown in Fig. 1, the heart of the alarm system is comprised of two CMOS CD4001 2-input quad NOR gates which provide the switching logic for the system. These devices can operate over a wide voltage range (+5 V to +15 V) and are ideal for automotive applications.

The first CD4001 provides the sensor interface, latching circuitry and exit/entry time delays. The second CD4001 provides the output (through a transistor relay switch), as

well as an automatic shut-down time delay for the sounding device.

Two types of sensor inputs are provided: one for ungrounded door dome light switches usually found in Fords, and one for the grounded type door switches such as in General Motors cars. When the hidden switch within the vehicle is switched on, C1 begins charging through a 680k resistor to ground. However, until C1 is fully charged (about 15-20 seconds), pin 8 of IC1b is at a

high logic state. Since the output of a NOR gate is low if either or both inputs are high, the output of IC1b will remain low for the duration of C1 charging and regardless of whether the door switches are opened or closed.

However, once C1 is fully charged, pin 8 of IC1b is low, and opening a door will cause pin 9 of IC1b to also become low. When this occurs, the output of IC1b becomes high and two additional things happen. C2 begins charging through the 680k (R8) re-

sistor connected to the output (pin 10) of IC1b. This begins the entry time delay sequence. Also, since both input pins (1 and 2) of IC1d are also connected to pin 10 of IC1b, the output of IC1d (pin 3) switches to a low state, effectively grounding the cathode end of diode D1. When this happens, the input of IC1b is latched to a low state and will remain that way until the alarm is reset with the hidden switch. The alarm sequence will continue regardless of any subsequent

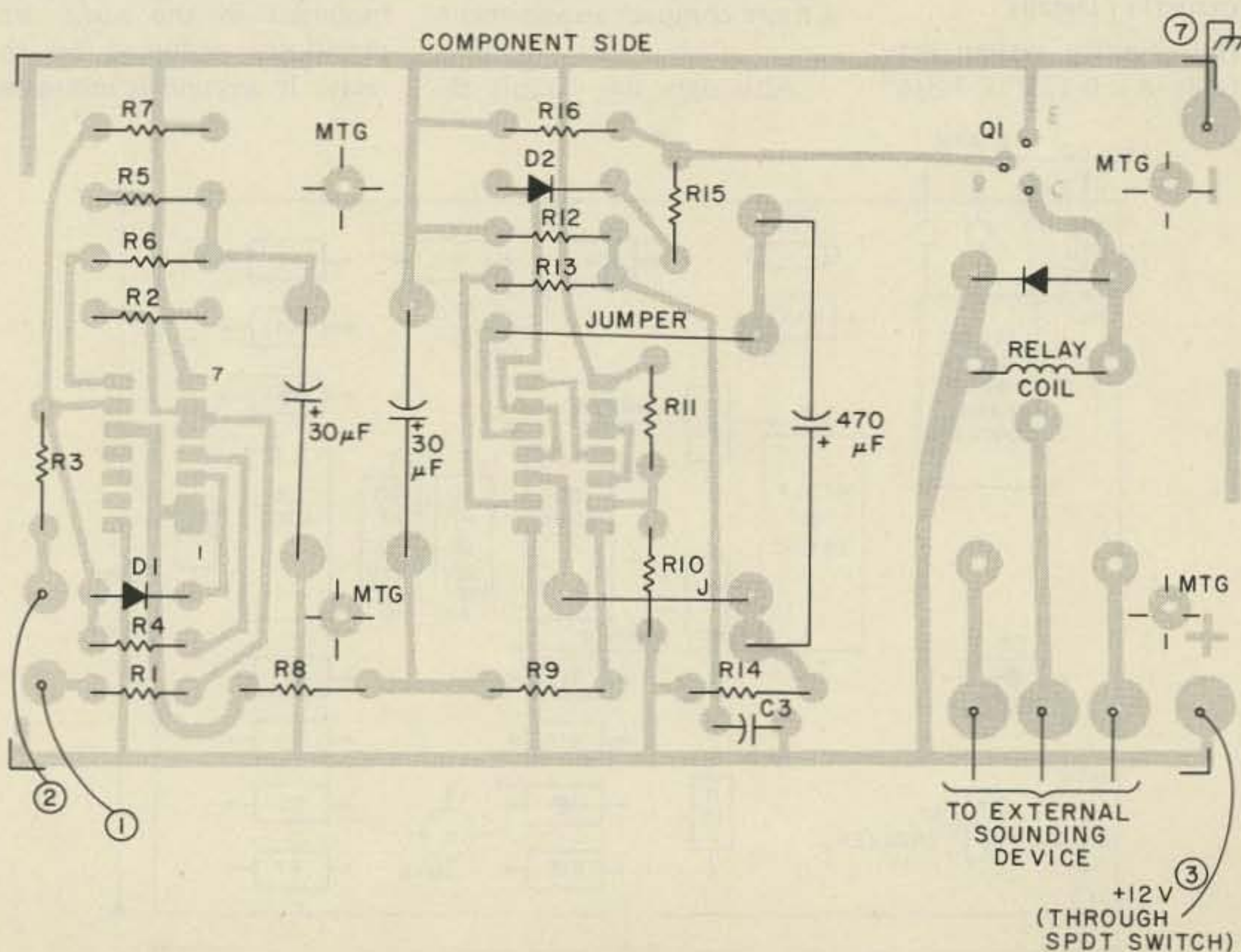
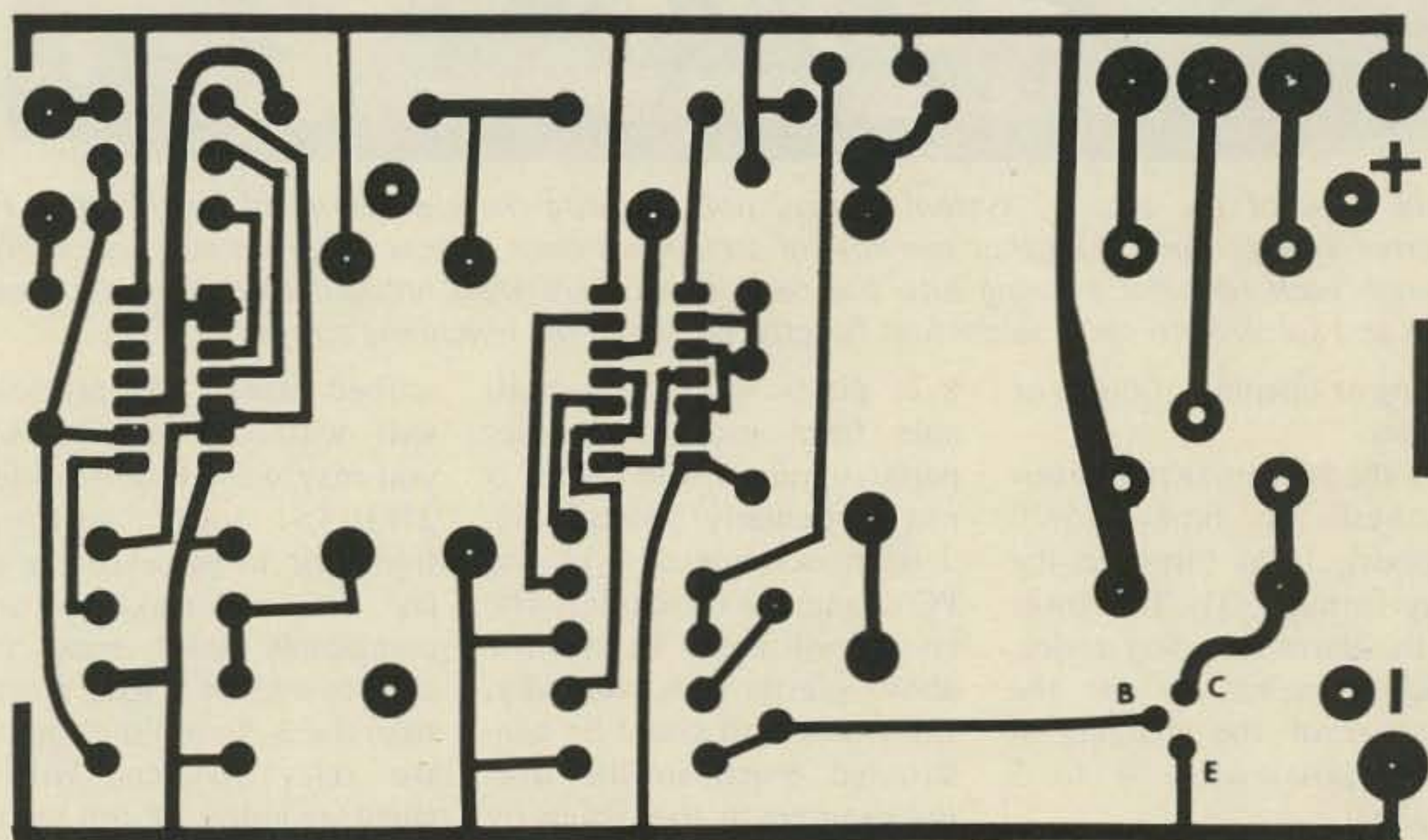
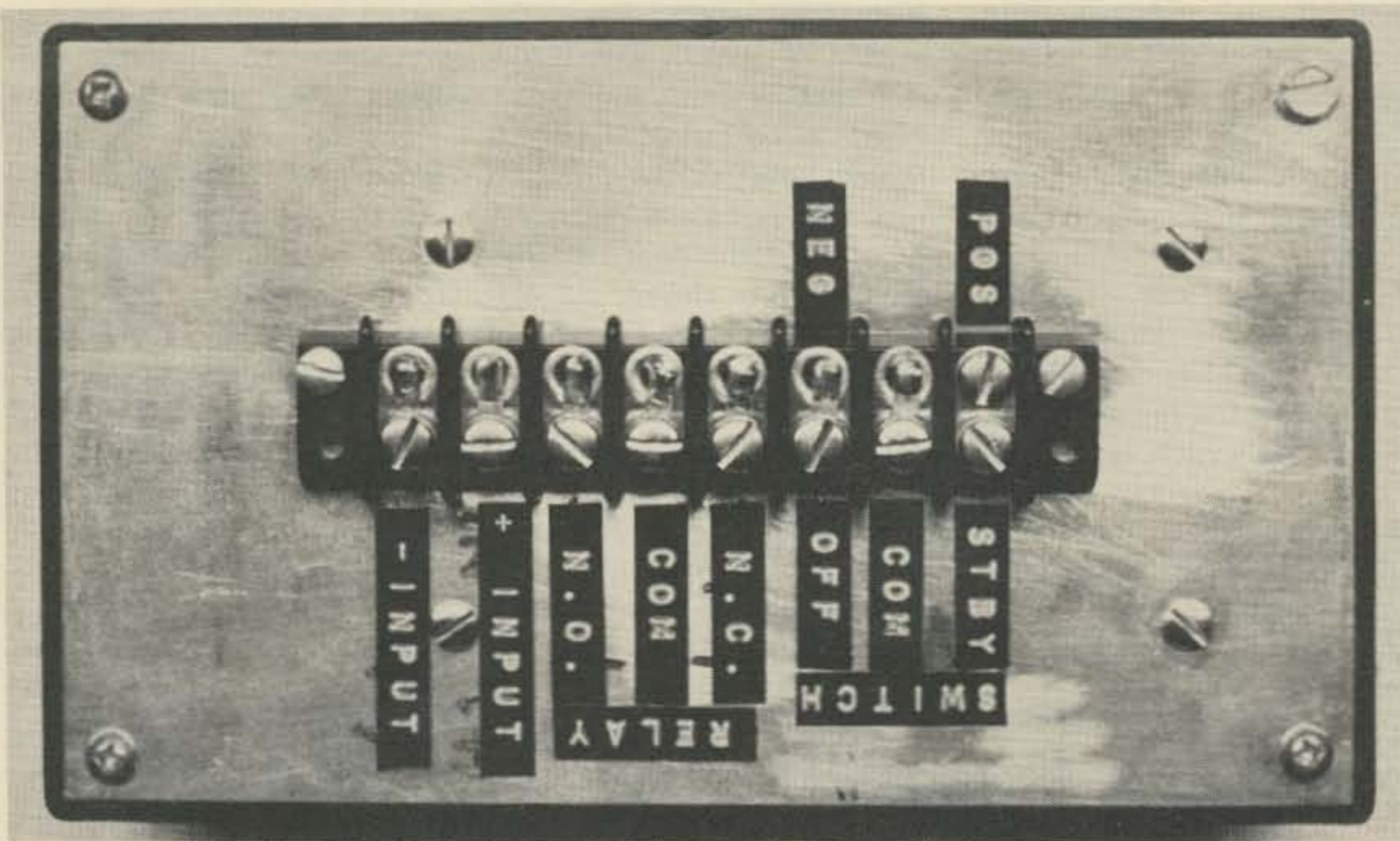

Fig. 2. Printed circuit board layout.



Front view of the security system control unit showing the eight-terminal barrier strip for external connections. Note that one row of screws has been removed and a small hole drilled through each terminal opening into the box. Leads were then brought through these access holes and soldered to small solder lugs for attachment to the remaining screws.

closing or opening of doors or sensors.

If the hidden switch is not reached in time (15-20 seconds), IC2d turns on the relay through Q1. This turns on the alarm sounding device, which remains on for the duration of the charging of C4 (approximately 4 to 5 minutes).

Construction Details

The security system may be built in a 6-1/4" x 3-3/4"

x 2" plastic instrument available from most electronics parts suppliers. The layout is not particularly critical. Fig. 2 is an example of a typical PC layout for the circuit. The layout will easily fit into the above plastic case. Actually, the entire unit could be constructed much smaller than the example in this article by redesigning the PC layout for a more compact arrangement.

Although the circuit de-

scribed works exceptionally well with the relay shown, you may want to substitute a 2N3055 power switching transistor in place of the relay. This will make the unit completely solid state and able to switch a load greater than the 3 Amps limitation of the relay contacts. With a slight redesign of the circuit board, the 2N3055 could be mounted in the same area previously occupied by the relay. If anyone is interested

in this feature, drop me a self-addressed stamped envelope, and I'll send you a schematic diagram of the circuit.

If the actual load of the alarm sounding device is greater than 3 Amps, and you want to build the alarm with the internal relay, just use its contacts to control a heavy-duty relay at the load. In this way, the amount of current to be switched is limited only to the rating of the contacts at the source.

The printed circuit is etched from a 3" x 5" phenolic or epoxy glass blank, using standard practices. It is strongly recommended that IC sockets or molex pins be used for the two ICs. The obvious reason for this is to allow replacement of the ICs (and also to protect the sensitive input terminals from static electric charges during soldering).

Checkout and Installation

After the circuit board has been etched and wired, it's time for the initial checkout. First check out all connections, and, when you are satisfied there are no wiring errors, insert the CD4001s, avoiding any hand contact with their input pins. Then apply power to the circuit (-V to pin 7 and +V to pin 3 on the external terminal strip, temporarily eliminating the hidden SPDT switch to be used in the actual installation).

Next, with an ohmmeter, check the relay contacts. Pins 5 and 6 should indicate a closed circuit, and pins 6 and 4 should indicate an open circuit. After the initial entry delay period, use a jumper wire to momentarily connect input pin 1 to +V. This should start the alarm sequence, and after 20-30 seconds, you should hear the relay operate. Check the contacts with your ohmmeter. Pins 4 and 6 should remain closed for about 4-5 minutes and then reopen.

Next, remove power and short pin 3 to ground to

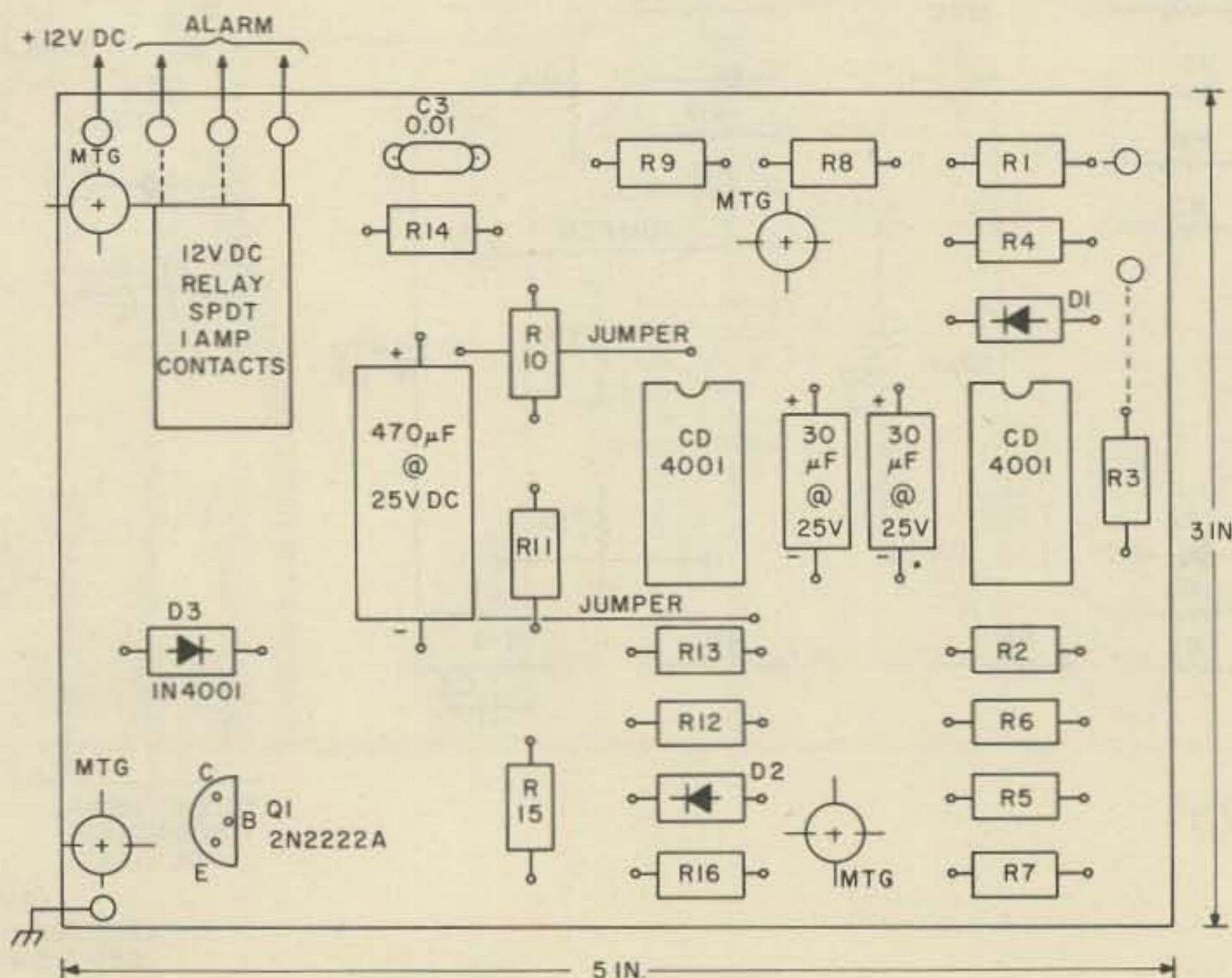
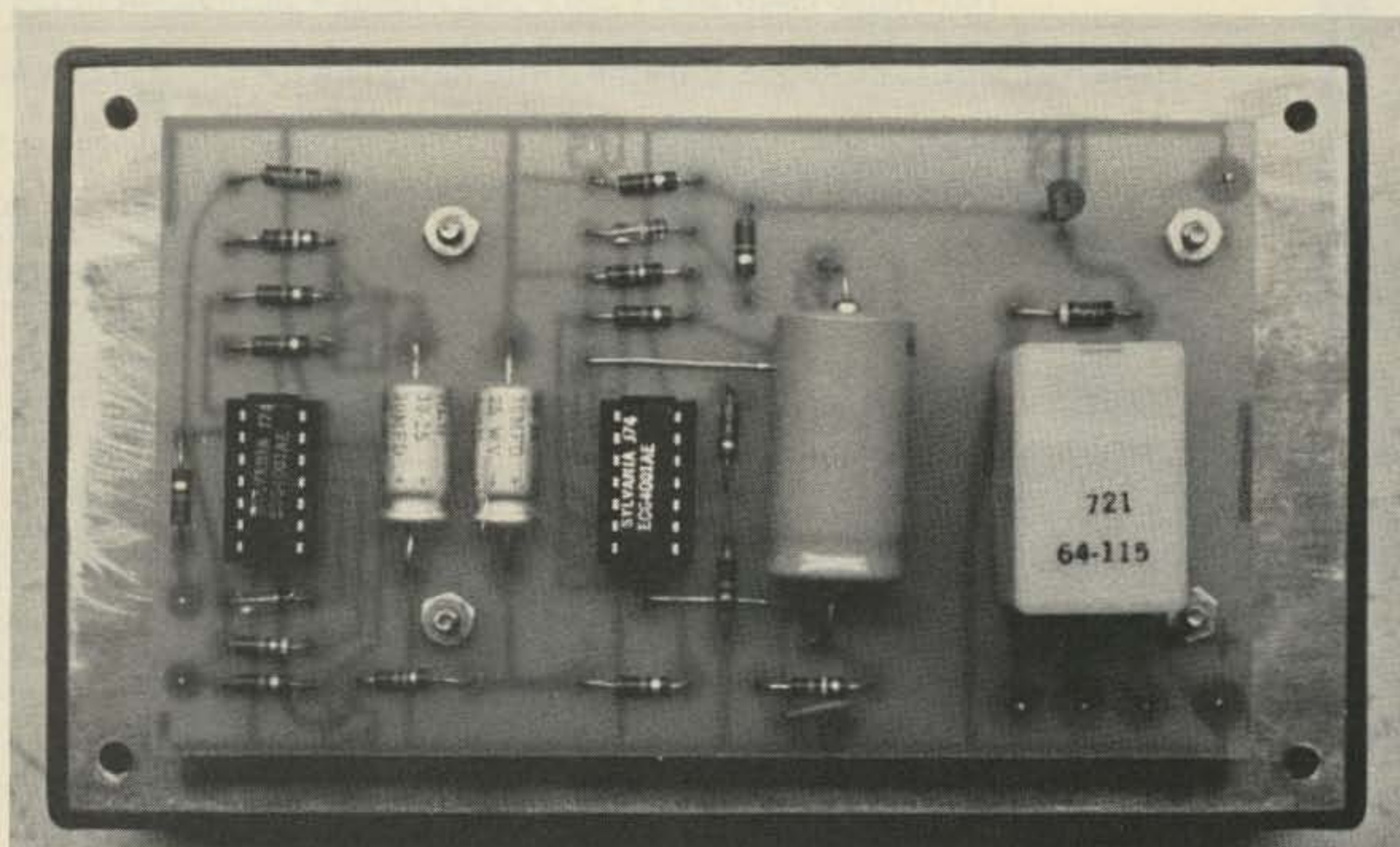

Fig. 3. Component placement.

discharge the electrolytics. This would be accomplished automatically when the unit is operated with the hidden SPDT switch (see the schematic diagram). Then restore power and wait for the initial exit time delay to reset. Repeat the previous check for input pin 3, but in this case momentarily connect the jumper from pin 3 to ground. After the entry time delay cycle completes, the output contacts of the relay should close and remain closed for 4-5 minutes. This completes the initial check-out and the unit is ready for installation into your car.

External connections are made through the barrier terminal strip as shown in Fig. 4. Power for the unit is derived from the car's fuse block, from a terminal that is not switched by the ignition switch.

The actual location for the unit may be anywhere in the vehicle that is away from view and preferably not easily reached. Also, the hidden switch should be installed at a convenient location that is not obvious to an intruder. The only remaining connection to be made is to the dome light circuit. Depending on your particular car, this connection may be to input pin 1 or 2 but not both. If your car uses ungrounded door switches, the connection



This photograph shows a top view of the PC board with the components in place. External connections are made to the board through the terminal strip on the opposite side of the aluminum panel.

will be to pin 1. (Note that this connection should be on the load side of the switch as shown on the schematic.) On the other hand, if your car uses grounded type door switches, input pin 2 should be used.

To complete the installation, you may want to add door switches to the two rear doors, trunk, and hood for total protection. As before, match the new door switches to your existing door switches and connect to the appropriate input terminal.

This security system should provide years of

troublefree operation, and hopefully will someday foil the plans of any would-be intruder. If it prevents an unauthorized entry on just one occasion, it will have more than paid for itself. In fact, the cost to build this system is so reasonable that you may want to build another for your home, apartment or camper. Power drain is so negligible that it can be operated from lantern batteries for years. Just use NC magnetic reed switches in series from +V to the input of the unused IC1c. Then connect

the output of this IC1c to input terminal 1 on the circuit board. As long as all switches are closed, the inputs are high and the output of IC1c is low. If a door is opened, the output of IC1c goes high and the normal alarm sequence is started.

As you can see, this circuit is very versatile and may be adapted to just about any alarm application. ■

References

1. "20 Easy-To-Build COSMOS Burglar Alarms - Part 2," *Radio-Electronics*, R.M. Marston, May, 1975, page 48.

Parts List

C1, C2	30 uF @ 25 volts electrolytic
C3	0.01 F bypass
C4	470 uF @ 25 volts electrolytic
D1, D2	1N914
D3	1N4001, 1A @ 1000 volts PIV
IC1, IC2	CD4001AE quad 2-input NOR gate
Q1	2N2222A NPN transistor
All resistors are 1/4 Watt, 10%	
R1, R2, R3, R6, R9,	
R13, R15, R16	12,000 Ohms
R4	22,000 Ohms
R5	680,000 Ohms
R8, R14	620,000 Ohms
R7, R10	22 megohms
R11	1200 Ohms
R12	120,000 Ohms

RL-1 SPDT relay with a 12 volt coil (Burstein-Applebee stock number 19A1823-3)

Misc IC sockets, plastic instrument case, terminal strip, circuit board

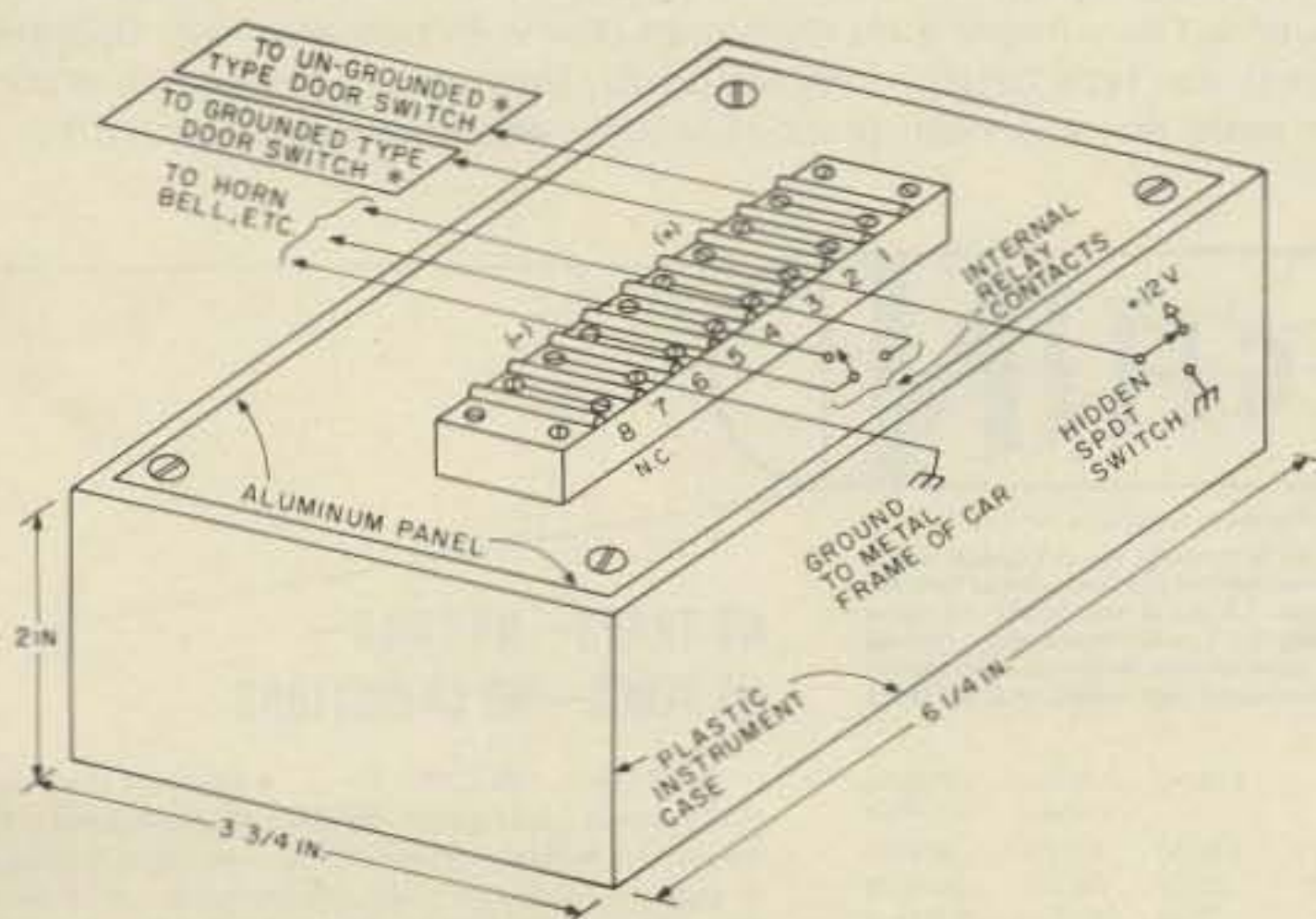

Fig. 4. External connections (not to scale). *Connect terminal 1 or 2, but not both, to the appropriate door switch (1 for ungrounded and 2 for grounded type switches).

GENERAL MULTI-PURPOSE V-O-Ms • DROP RESISTANT • HAND SIZE • MODEL 310 V-O-M • TYPE 3



Model 389
Cat. No. 10-2856 \$2.10
Vinyl pouch case

1. Drop-resistant, hand-size V-O-M with high-impact thermoplastic case.
2. 20,000 Ohms per volt DC and 5,000 Ohms per volt AC; diode overload protection with fused Rx1 Ohms range.
3. Single range switch; direct reading AC Amp range to facilitate clamp-on AC Ammeter usage.

RANGES

DC Volts: 0-3-12-60-300,1,200 (20,000 Ohms per Volt).
 AC Volts: 0-3-12-60-300-1,200 (5,000 Ohms per Volt).
 Ohms: 0-20k-200k-2M Ω -20M Ω (200 Ohm center scale on low range).
 DC Microamperes: 0-600 at 250 mV.
 DC Milliampere: 0-6-60-600 at 250 mV.
 Accuracy: ± 3% DC; ± 4% AC; (full scale).
 Scale Length: 2-1/8".
 Meter: Self-shielded; diode overload protected; spring backed jewels.
 Case: Molded, black, high impact thermoplastic with slide latch cover for access to batteries and fuse, 2-3/4" w x 1-5/16" d x 4-1/4" h.
 Batteries: NEDA 15V 220 (1), 1 1/2V 910F (1): Complete with 42" leads, alligator clips, batteries and instruction manual. Shpg. Wt. 2 lbs.
 Model 310 Cat. No. 3018 \$53.00

BOMAR Crystal Company
 Novice Crystals (Specify Band Only)
 TWO METERS
 Motorola HT 220 Crystals
 In Stock!
 CRYSTALS IN STOCK

Standard • Icom • Heathkit • Ken • Clegg • Regency • Wilson • VHF
 Eng • Drake • And Others! \$4.50 @ Lifetime Guarantee

Make/Model	Xmit Freq.	Rec. Freq.



ALL BAND PREAMPLIFIERS



- 6 THRU 160 METERS
- TWO MODELS AVAILABLE
- RECOMMENDED FOR RECEIVER USE ONLY
- INCLUDES POWER SUPPLY

MODEL PLF employs a dual gate FET providing noise figures of 1.5 to 3.4 db., depending upon the band. The weak signal performance of most receivers as well as image and spurious rejection are greatly improved. Overall gain is in excess of 20 db. Panel contains switching that transfers the antenna directly to the receiver or to the Preamp.

Model PLF 117V AC, 60 Hz. Wired & Tested ... \$44.00

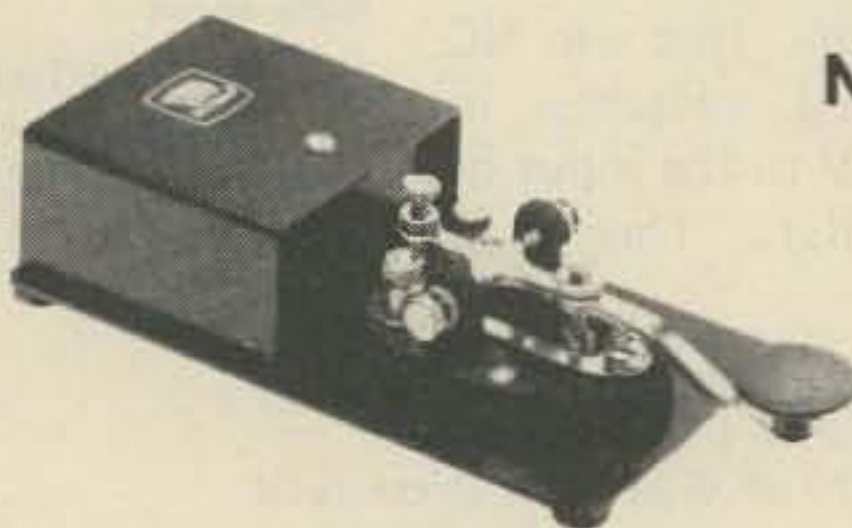

No. 114-404-002 \$18.50

NYE VIKING CODE PRACTICE SET



Get the RIGHT START!

With a NYE VIKING Code Practice Set you get a sure, smooth, Speed-X model 310-001 transmitting key, a linear circuit oscillator and amplifier, with a built-in 2" speaker, all mounted on a heavy duty aluminum base with non-skid feet. Operates on standard 9V transistor type battery (not included). Units can be connected in parallel so that two or more operators can practice sending and receiving to each other. List price, \$18.50.



Fully Air Tested - Thousands Already in Use

#16 40% Copper Weld wire annealed to it handles like soft Copper wire - Rated for better than full legal power AM/CW or SSB-Coaxial or Balanced 50 to 75 ohm feedline - VSWR under 1.5 to 1 at most heights - Stainless Steel hardware - Drop Proof Insulators - Terrific Performance - No coils or traps to break down or change under weather conditions - Completely Assembled ready to put up - Guaranteed 1 year - ONE DESIGN DOES IT ALL.

EXCLUSIVE 66 FOOT, 75 THRU 10 METER DIPOLES

NOTES

1. Models prefaced * ** will be available 1/77.
2. All models above are furnished with crimp/solder lugs.
3. All models can be furnished with a SO-239 female coaxial connector at additional cost. The SO-239 mates with the standard PL-259 male coaxial cable connector. To order this factory installed option, add the letter 'A' after the model number. Example: 40-20 HD/A.
4. 75 meter models are factory tuned to resonate at 3950 kHz. (SP) models are factory tuned to resonate at 3800 kHz. 80 meter models are factory tuned to resonate at 3650 kHz. See VSWR curves for other resonance data.

MODEL	BANDS (Meters)	PRICE	WEIGHT (Oz/Kg)	LENGTH (Ft/Mtrs)
40-20 HD	40/20	\$49.50	26/73	36/10.9
**40-10 HD	40/20/15/10	59.50	36/1.01	36/10.9
80-40 HD	80/40 + 15	57.50	41/1.15	69/21.0
75-40 HD	75/40	55.00	40/1.12	66/20.1
75-40 HD (SP)	75/40	57.50	40/1.12	66/20.1
75-20 HD	75/40/20	66.50	44/1.23	66/20.1
75-20 HD (SP)	75/40/20	66.50	44/1.23	66/20.1
75-10 HD	75/40/20/15/10	74.50	48/1.34	66/20.1
75-10 HD (SP)	75/40/20/15/10	74.50	48/1.34	66/20.1
**80-10 HD	80/40/20/15/10	76.50	50/1.40	69/21.0

NO TRAPS—NO COILS—NO STUBS—NO CAPACITORS

MOR-GAIN HD DIPOLES ... • One half the length of conventional half-wave dipoles. • Multi-band, Multi-frequency. • Maximum efficiency - no traps, loading coils, or stubs. • Fully assembled and pre-tuned - no measuring, no cutting. • All weather rated - 1 KW AM, 2.5 KW CW or PEP SSB. • Proven performance - more than 15,000 have been delivered. • Permit use of the full capabilities of today's 5-band xcvs. • One feedline for operation on all bands. • Lowest cost/benefit antenna on the market today. • Fast QSY - no feedline switching. • Highest performance for the Novice as well as the Extra-Class Op.

SST T-1 RANDOM WIRE ANTENNA TUNER



All band operation (160-10 meters) with most any random length wire. 200 Watt power capability. Ideal for portable or home operation. A must for Field Day. Size: 2 x 4-1/4 x 2-3/8. Built-in neon tune-up indicator. Guaranteed for 90 days. Compact — easy to use. Only \$29.95.



ASTATIC MICROPHONES

SILVER EAGLE — \$69.95

- T-UG8-D104, transistorized \$48.60
- T-UG9-D104, "Golden Eagle," transistorized \$95.40
- T-UG9-D104, "Silver Eagle," transistorized . \$69.95
- UG-D104, ceramic or crystal \$42.60



Model 200 V



Model 210



Model 220

CES Touch Tone Pads

- Model 200V — acoustic coupling. \$59.95
- Model 210 — for mounting on walkies or hand-helds. \$54.95
- Model 220 — CES can now offer you a TOUCH TONE back for Standard Communications hand-held radios. This is the complete back assembly with the TOUCH TONE encoder mounted and ready to plug into the private channel connector. Also included is a LED tone generator indicator and an external tone deviation adjustment. \$74.95.

talk power by **TPL**



TPL for an Economy Price? THAT'S RIGHT! introducing the ECONO-LINE

Model	Input	Output	Typical	Frequency	Price
702	5-20W	50-90W	10 in/70 out	143-149 MHz	\$139.00
702B	1-4W	50-80W	1 in/70 out	143-149 MHz	\$169.00

Now get TPL COMMUNICATIONS quality and reliability at an economy price. The new Econo-Line gives you everything that you've come to expect from TPL at a real cost reduction. The latest mechanical and electronic construction techniques combine to make the Econo-Line your best amplifier value. Unique broad-band circuitry requires no tuning throughout the entire 2-meter band and adjacent MARS channels. See these great new additions to the TPL COMMUNICATIONS product line at your favorite amateur radio dealer. For prices and specifications please write for our Amateur Products Summary! FCC type accepted power amplifiers also available. Please call or write for a copy of TPL's Commercial Products Summary.

SLINKY! Kit \$43.95

A LOT of antenna in a LITTLE space New Slinky® dipole* with helical loading radiates a good signal at 1/10 wavelength long!

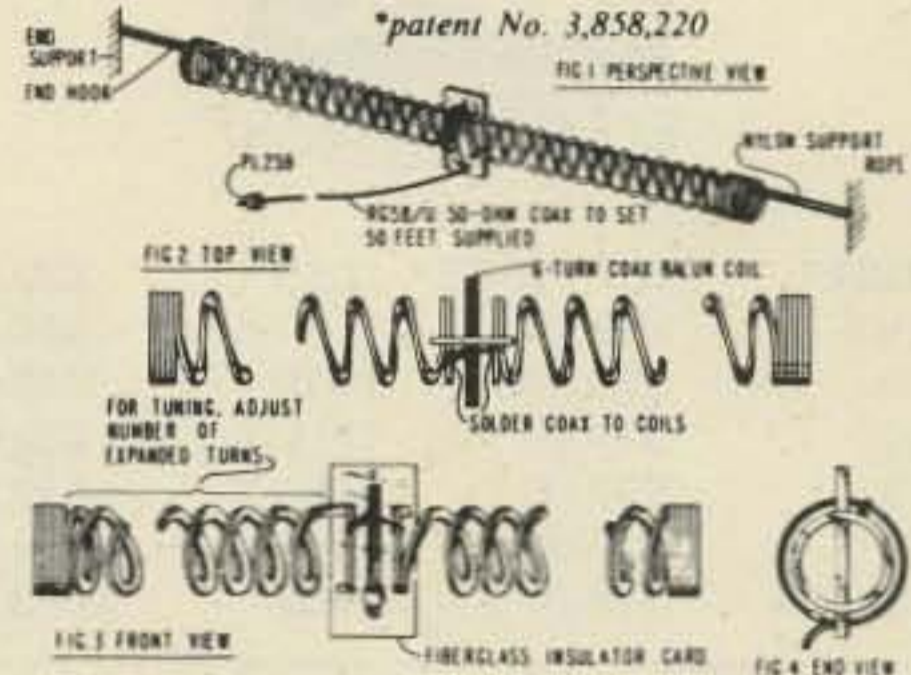

* This electrically small 80/75, 40, & 20 meter antenna operates at any length from 24 to 70 feet • no extra balun or transmatch needed • portable—erects & stores in minutes • small enough to fit in attic or apartment • full legal power • low SWR over complete 80/75, 40, & 20 meter bands • much lower atmospheric noise pickup than a vertical and needs no radials • kit includes a pair of specially-made 4-inch dia. by 4-inch long coils, containing 335 feet of radiating conductor, balun, 50 ft. RG58/U coax, PL259 connector, nylon rope & instruction manual • now in use by US Dept. of State, US Army, radio schools, plus thousands of hams the world over

YAESU



FT-301D



FT-101E TRANSCEIVER

FT 301	160M-10M Transceiver — 200 WPEP	\$769
FP 301 DIG	160M-10M Transceiver — 200 WPEP	935
FP 301	AC Power Supply	125
FP 301 CID	AC P.S. w/Clock and CW ID	209
FRG-7	General Cov. Synthesized Receiver	299
QTR-24	Yaesu World Clock	30
FT-101-E	XCVR W/Processor	729
160-10M		
FT-101EE	XCVR W/O Processor	649
160-10M		
FT-101EX	XCVR W/O Processor	589
160-10M	AC Only, Less Mike	399
FL-2100B	Linear Amplifier	199
FTV-650B	6M Transverter	199
FTV-250	2M Transverter	109
FV-101B	External VFO	22
SP-101B	Speaker	59
SP-101PB	Speaker/Patch	199
YO-100	Monitor Scope	29
YD-844	Dynamic Base Mike	15
FA-9	Cooling Fan	19
MMB-1	Mobile Mount	79
RFP-102	RF Speech Processor	40
XF-30C	600 Hz CW Filter	
FR-101S	160-2M/SW RCVR	489
SOLID STATE		
FR 101 DIG	160-2M/SW RCVR	599
SOLID STATE		
FT 301S	160-10M 40WPEP	559
FT 301S	160-10M 40WPEP Digital	765

Accessories:

FC-6	6M Converter	24
FC-2	2M Converter	25
FM-1	FM Detector	20
	Aux/SW Crystals	5
XF-30B	AM-Wide Filter	40
XF-30C	600 Hz CW Filter	40
XF-30D	FM Filter	49
SP-101B	Speaker	22
FL-101		
SOLID STATE	160-10M	
TRANSMITTER		525
Accessories:		
RFP-101	RF Speech Processor	79
MONITOR/TEST EQUIPMENT		
YC 500 J	500 MHz (10 PPM) Counter	249
YC 500 S	500 MHz (1 PPM) Counter	399
YC 500 E	500 MHz (0.02 PPM) Counter	537
YO-100	Monitor Scope	199
YP-150	Dummy Load/Watt Meter	69
YC-601	Digital Readout (101/401 series)	169
VHF FM & SSB	TRANSCEIVERS	
FT-620B	6M AM/CW/SSB	365
FT-221	2M AM/FM/CW/SSB	629
Accessories:		
MMB-4	Mobile Mount (FT-620B, FT-221)	19

TUFTS

Name _____ Call _____
 Address _____
 City _____ State _____ Zip _____
 Order: _____

MasterCharge
 American Express
 BankAmericard
 accepted on
 MOST items!

Radio Electronics
 209 Mystic Avenue
 Medford MA 02155
 (617) 395-8280

Check enclosed
 BankAmericard MasterCharge American Express
 Credit card # _____ Interbank # _____
 Signature _____ Card expiration date _____

Prices FOB Medford MA. All units can be shipped UPS. MA residents add 5% sales tax. Minimum \$3.00 for shipping & handling on all orders. \$10.00 merchandise minimum please.

FREE Gift With Every Order!

Cash orders over \$1200 deduct 5%. No other discounts offered. All sales final.

TUFTS RADIO CATALOG TUFTS RADIO

HAM RADIO / MOBILE COMMUNICATIONS



MODEL	NET PRICE	103R	\$39.95
12V4	\$19.95	*13 HM 4	\$41.95
600	\$20.50	104R	\$49.95
102	\$24.95	12/115	\$69.95
612	\$27.95	108RA	\$79.95
107	\$28.95	108RM	\$99.95
12 HM 4	\$29.95	109R	\$149.95

MODEL 12HM4

NPC 2.5 Amp Regulated Power Supply. Solid State. Short Circuit Protected.



ALSO! Available as 13 HM 4 with built-in loudspeaker.

	TYPICAL	MAXIMUM
Output Voltage	13.5 ± 5VDC	14VDC
Continuous Current	1.5 Amp	
Regulation	2.5 Amp	
Ripple/Noise	5 mV RMS	10 mV RMS

Case: 3" (H) x 4" (W) x 5 1/4" (D). Shipping Weight: 3 lbs.



MODEL 103R

NPC 4 Amp Regulated Power Supply. Solid State. Dual Overload Protection.



Converts 115 volts AC to 13.6 volts DC ± 200 millivolts. Handles 2.5 amps continuous and 4 amps max. Ideally suited for applications where no hum and DC stability are important such as CB transmission, small Ham radio transmitter, and high quality eight-track car stereos. Can also be used to trickle-charge 12 volt car batteries.

	TYPICAL	MAXIMUM
Output Voltage	13.6 ± 2 VDC	13.6 ± 3 VDC
Line/Load Regulation	20 mV	50 mV
Ripple/Noise	2 mV RMS	5 mV RMS
Transient Response	20 uSec	
Current Continuous	2.5 Amp	
Current Limit	4 Amp	
Current Foldback	1 Amp	

Case: 3" (H) x 4 1/4" (W) x 5 1/4" (D). Shipping Weight: 4 lbs.

MODEL 107

NPC 4 Amp Power Supply, 6 Amp Max. Solid State. Overload Protected



Functions silently in converting 115 volts AC to 12 volts DC. 4 amps continuous, 6 amps max. Enables anyone to enjoy CB radio, car 8-track cartridge, cassette player or car radio in a home or office.

Continuous Current (Full Load)	4 Amp
Output Voltage (No Load)	16 V max
Output Voltage (Full Load)	12 V min
Filtering Capacitor	10,000 uF
Ripple (Full Load)	5 V RMS
Short Circuit Protection	Thermal Breaker

Case: 3" (H) x 4 1/4" (W) x 5 1/4" (D). Shipping Weight: 5 lbs.

MODEL 109R

NPC 25 Amp Regulated Power Supply. 4-Way Protected. Output Voltage and Current Meters.



Extra heavy-duty unit quietly converts 115 volts AC to 13.6 volts DC ± 200 millivolts. 10 amps continuous, 25 amps max. All solid state. Features dual current overload, overvoltage and thermal protection. Ideally suited for operating mobile Ham radio and linear amplifier in your home or office. Excellent bench power supply for testing and servicing of mobile communications equipment.

	TYPICAL	MAXIMUM
Output Voltage	13.6 ± 2VDC	13.6 ± 3VDC
Line/Load Regulation	50 mV	100 mV
Ripple Noise	5 mV RMS	10 mV RMS
Transient Response	20 uSec	
Current Continuous	10 Amp	
Current Limit	26 Amp	
Overvoltage Protection	14.5 V	15 V
Thermal Overload	180°F	

Case: 4 1/4" (H) x 9" (W) x 8 1/2" (D) Shipping Weight: 15 lbs.

MODEL 12V4

NPC 1.75 Amp Power Supply. 3 Amp Max.



Functions silently in converting 115 volts AC to 12 volts DC. Ideally suited for most applications including 8-track stereo, burglar alarm, car radio and cassette tape player within power rating.

Continuous Current (Full Load)	1.75 Amp
Output Voltage (No Load)	16 V max
Output Voltage (Full Load)	12 V min
Filtering Capacitor	5,000 uF
Ripple (Full Load)	4 V RMS
Short Circuit Protection	Thermal Breaker

Case: 3" (H) x 4" (W) x 5 1/4" (D). Shipping Weight: 3 lbs.

MODEL 108RM

NPC 12 Amp Regulated Power Supply. Solid State. 3-Way Protected. Current Meter.



This heavy duty unit quietly converts 115 volts AC to 13.6 volts DC ± 200 millivolts. 8 amps continuous, 12 amps max. All solid state. Features dual current overload and overvoltage protection. Ideally suited for operating mobile Ham radio 2 meter AM-FM-SSB transceivers in your home or office. Can also be used to trickle-charge 12 volt car batteries.

	TYPICAL	MAXIMUM
Output Voltage	13.6 ± 2VDC	13.6 ± 3VDC
Line/Load Regulation	20 mV	50 mV
Ripple/Noise	2 mV RMS	5 mV RMS
Transient Response	20 uSec	
Current Continuous	8 Amp	
Current Limit	12 Amp	
Current Foldback	2.5 Amp	
Overvoltage Protection	14.5 V	15 V

Case: 4 1/4" (H) x 7 1/2" (W) x 5 1/4" (D). Shipping Weight: 9.5 lbs.

ALSO AVAILABLE AS MODEL 108RA WITHOUT METER AND OVERVOLTAGE PROTECTION.

MODEL 104R

NPC 6 Amp Power Supply Regulated. Solid State. Dual Overload Protection.



Converts 115 volts AC to 13.6 volts DC ± 200 millivolts. Handles 4 amps continuous and 6 amps max. Ideally suited for applications where excellent DC stability is important, such as CB transmission, small Ham radio transmitter, and high quality eight-track car stereos. Can be used to trickle-charge 12 volt car batteries.

	MAXIMUM	TYPICAL
Output Voltage	13.6 ± 2 VDC	13.6 ± 3 VDC
Line/Load Regulation	20 mV	50 mV
Ripple/Noise	2 mV RMS	5 mV RMS
Transient Response	20 uSec	
Current Continuous	4 Amp	
Current Limit	6 Amp	
Current Foldback	2 Amp	

Case: 3 1/2" (H) x 5 1/2" (W) x 6 1/2" (D). Shipping Weight: 6 lbs.

MODEL 102

NPC 2.5 Amp Power Supply. 4 Amp Max. Solid State. Overload Protected.



Functions silently in converting 115 volts AC to 12-volts DC. 2.5 amps continuous, 4 amps max. Enables anyone to enjoy CB radio, car 8-track cartridge, cassette tape player or car radio in a home or office.

Continuous Current (Full Load)	2.5 Amp
Output Voltage (No Load)	16 V max
Output Voltage (Full Load)	12 V min
Filtering Capacitor	5,000 uF
Ripple (Full Load)	6 V RMS
Short Circuit Protection	Thermal Breaker

Case: 3" (H) x 4 1/4" (W) x 5 1/4" (D). Shipping Weight: 4 lbs.

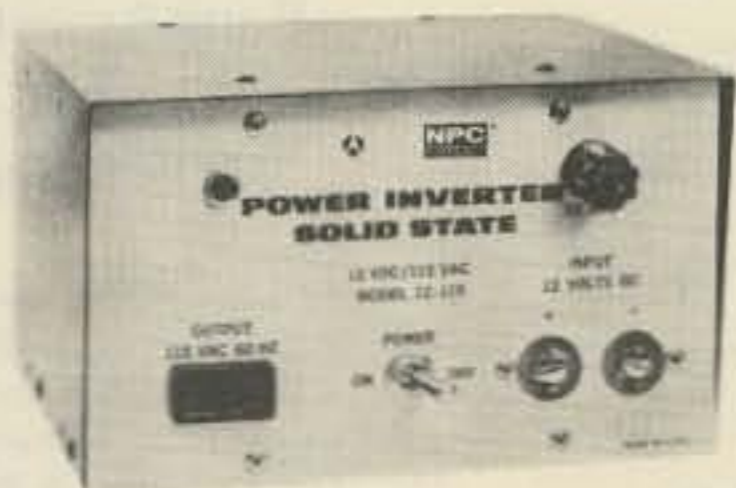

Output Voltage (No Load)	12 VDC 1N	14 VDC 1N
Output Voltage (Full Load)	115 V RMS	130 V RMS
Frequency (No Load)	100 V RMS	115 V RMS
Frequency (Full Load)	58 Hz	66 Hz
Power Continuous	54 Hz	62 Hz
Power Peak		200W
Parallel Connection		240W
		350W

All Values Are Typical

MARINE & RV

MODEL 12-115

NPC 12-115 Solid State Inverter. 200 W. Parallel Connection for Higher Power up to 350 W.

Converts 12 volts DC to 115 volts AC @ 60 Hz output. 200 watts continuous operation with peak power up to 240 watts. All silicon semiconductors assure high reliability at excessive ambient temperatures. The output voltage is a square wave. The inverter is not recommended where high transients are not tolerable.

The 12-115 allows you to have AC house current in your boat, car, truck, camper, house trailer, or houseboat. Will operate small household appliances, T.V., hand tools, electric shaver, AC radios, and lights within power rating. Built-in overload protection.

Case: 4 1/2" (H) x 7 1/2" (W) x 5 1/4" (D). Shipping Weight: 7 lbs.

MODEL 612

Model 612 Power Converter

NPC 612 converts 6 volt negative ground or 12 volt positive ground electrical systems to 12 volt negative ground operation. Provides full 3 amp continuous power. The inexpensive solution for installing car radios, stereo and cassette tape players, in vehicles with 6 volt negative ground or 12 volt positive ground systems. Case: 2 1/2" (H) x 3" (W) x 5" (D). Shipping Weight: 1 lb.





ARGONAUT #509

AMPLIFIER #405

ARGONAUT, MODEL 509

Covers all Amateur bands 10-80 meters. 9 MHz crystal filter. 2.5 kHz bandwidth. 1.7 shape factor @ 6/50 dB points. Power required 12-15 VDC @ 150 mA receive, 800 mA transmit at rated output. Construction: aluminum chassis, top and front panel, molded plastic end panels. Cream front panel, walnut vinyl top and end trim. Size: HWD 4 1/2" x 13" x 7". Weight 6 lbs.

LINEAR AMPLIFIER, MODEL 405

Covers all Amateur bands 10-80 meters. 50 watts output power, continuous sine

wave. RF wattmeter. SWR meter. Power required 12-15 VDC @ 8 A, max. Construction: aluminum chassis, top and front panel, molded plastic side panels. Cream front panel, walnut vinyl top and end trim. Size: HWD 4 1/2" x 7" x 8". Weight 2 1/2 lbs.

Argonaut, Model 509 \$359.00

Linear Amplifier, Model 405 . 159.00

Power Supply, Model 251 (Will power both units) 85.00

Power Supply, Model 210 (Will power Argonaut only) . . 30.00

The new ultra-modern fully solid-state TRITON makes operating easier and a lot more fun, without the limitations of vacuum tubes.

For one thing, you can change bands with the flick of a switch and no danger of off-resonance damage. And no deterioration of performance with age.

But that's not all. A superlative 8-pole i-f filter and less than 2% audio distortion, transmitting and receiving, makes it the smoothest and cleanest signal on the air.

The TRITON IV specifications are impeccable. For selectivity, stability and receiver sensitivity. And it has features such as full CW break-in, pre-selectable ALC, off-set tuning, separate AC power supply, 12 VDC operation, perfectly shaped CW wave form, built-in SWR bridge and on and on.

For new standards of SSB and CW communication, write for full details or talk it over with your TEN-TEC dealer. We'd like to tell you why "They

Don't Make 'Em Like They Used To" makes Ham Radio even more fun.

TRITON IV \$699.00

ACCESSORIES:

Model 240 One-Sixty Converter . . . \$ 97.00
Model 244 Digital Readout 197.00

Model 245 CW Filter \$25.00
Model 249 Noise Blanker 29.00
Model 252G Power Supply 109.00
Model 262G Power Supply/VOX . . 139.00



TEN-TEC
TRITON IV
Digital Model 544
\$869.00

KR20-A ELECTRONIC KEYS

A fine instrument for all-around high performance electronic keying. Paddle actuation force is factory adjusted for rhythmic smooth keying. Contact adjustments on front. Weighting factor factory set for optimum smoothness and articulation. Over-ride "straight key" conveniently located for emphasis, QRS sending or tune-up. Reed relay output. Side-tone generator with adjustable level. Self-completing characters. Plug-in circuit board. For 117 VAC, 50-60 Hz or 6-14 VDC. Finished in cream and walnut vinyl. Price \$69.50

KR5-A ELECTRONIC KEYS

Similar to KR20-A but without side-tone oscillator or AC power supply. Ideal for portable, mobile or fixed station. A great value that will give years of troublefree service. Housed in an attractive case with cream front, walnut vinyl top. For 6-14 VDC operation. Price \$39.50

KR1-A DELUXE DUAL PADDLE

Paddle assembly is that used in the KR50, housed in an attractive formed aluminum case. Price \$35.00

KR2-A SINGLE LEVER PADDLE

For keying conventional "TO" or discrete

character keys, as used in the KR20-A. Price \$17.00

KR50 ELECTRONIC KEYS

A completely automatic electronic keyer fully adjustable to your operating style and preference, speed, touch and weighting, the ratio of the length of dits and dahs to the space between them. Self-controlled keyer to transmit your thoughts clearly, articulately and almost effortlessly. The jambie (squeeze) feature allows the insertion of dits and dahs with perfect timing.

An automatic weighting system provides increased character to space ratio at slower speeds, decreasing as the speed is increased, keeping the balance between smoothness at low speeds and easy to copy higher speed. High intelligibility and rhythmic transmission is maintained at all speeds, automatically.

Memories provided for both dits and dahs but either may be defeated by switches on the rear panel. Thus, the KR50 may be operated as a full iambic (squeeze) keyer, with a single memory or as a conventional type keyer. All characters are self-completing. Price \$110.00

SPECIFICATIONS

Speed Range: 6-50 w.p.m.
Weighting Ratio Range: 50% to 150% of classical dit length.

Memories: Dit and dah. Individual defeat switches.

Paddle Actuation Force: 5-50 gms.
Power Source: 117VAC, 50-60 Hz, 6-14 VDC.

Finish: Cream front, walnut vinyl top and side panel trim.

Output: Reed relay. Contact rating 15 VA, 400 V. max.

Paddles: Torque drive with ball bearing pivot.

Side-tone: 500 Hz tone.
Adjustable output to 1 volt.
Size HWD: 2 1/2" x 5 1/2" x 8 1/4"
Weight: 1 3/4 lbs.

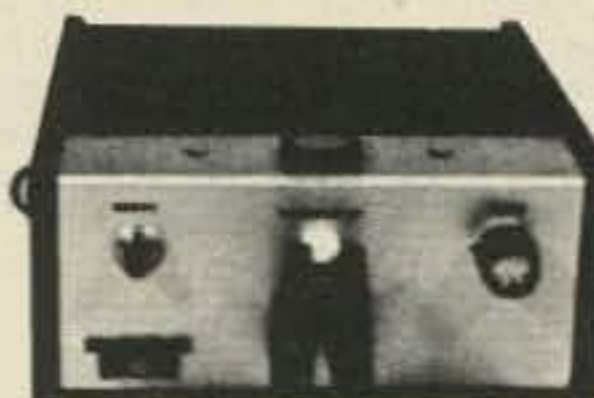

KR50



4 ELEMENT BEAM • 10-15-20 METERS

From one package you receive every component to quickly and easily assemble your beam. ATB-34's rugged construction, full power handling capability, broad band coverage, and four active elements will give you superior performance on all three bands. Our new coaxial traps are very high Q, resulting in extremely low ohmic losses and longer full performance elements. They are rated for 2KW power handling. Feed is direct 52 ohm through the 1-1 balun, supplied at no extra cost.

FREQUENCY COVERAGE		NOMINAL INPUT IMPEDANCE		ASSEMBLED WEIGHT	
14.00-14.35 MHz	Three Active Elements on Each Band	50 OHMS TAKES PL-259	18" (15.48 m) x 2.1/8" (5.4 cm) - 2" (5.1 cm)	SHIPPING WEIGHT:	42 lbs. (19.05 kg)
21.00-21.45 MHz		BOOM DIA/LENGTH	32" (8.13 m) x 1 1/2" (3.8 cm)	EST WIND SURVIVAL:	49 lbs. (22.23 kg)
28.50-29.50 MHz		ELEMENT DIA/MAX LENGTH	1.8" (4.57 cm) (labeled 5/8" (1.6 cm))	ELEMENT/BOOM MATERIAL:	8063-T832 HARD DRAWN, BRIGHT FINISH ALUMINUM TUBING
FORWARD GAIN:	7.5 DB ALL BANDS	TURNING RADIUS	18" (45.7 cm)	BALUN:	#12 WIRE, FERRITE CORE
FRONT TO BACK RATIO:	30 DB OPTIMUM	MAXIMUM SUPPORT MAST DIA	2 1/2" (6.35 cm)		
V.S.W.R.:	1.5:1 OR LESS AT RESONANCE	WIND SURFACE AREA	5.4 sq. ft. (50 m ²)		
POWER HANDLING:	2000 WATTS PEP				

Now You Can Receive The Weak Signals With The ALL NEW AMECO PREAMPLIFIER

Model PT-2 is a continuous tuning 6-160 meter Pre-Amp specifically designed for use with a transceiver. The PT-2 combines the features of the well-known PT with new sophisticated control circuitry that permits it to be added to virtually any transceiver with No modification. No serious ham can be without one.

- Improves sensitivity and signal-to-noise ratio.
- Boosts signals up to 26 db.
- For AM or SSB.
- Bypasses itself automatically when the transceiver is transmitting.
- FET amplifier gives superior cross modulation protection.
- Advanced solid-state circuitry.
- Simple to install.
- Improves immunity to transceiver front-end overload by use of its built-in attenuator.
- Provides master power control for station equipment.

MODEL PT-2

\$69.95

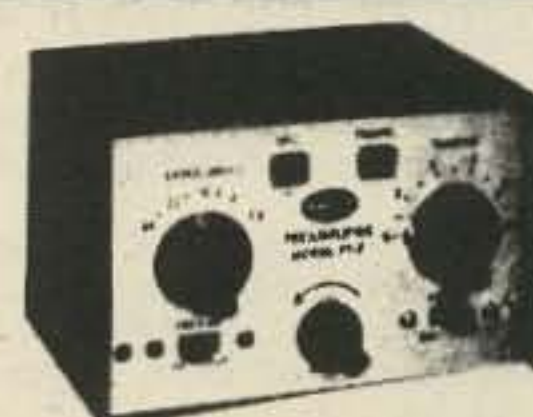

TUFTS RADIO CATALOG TUFTS RADIO

BIRD

The indispensable
BIRD model 43
THRULINE®
Wattmeter

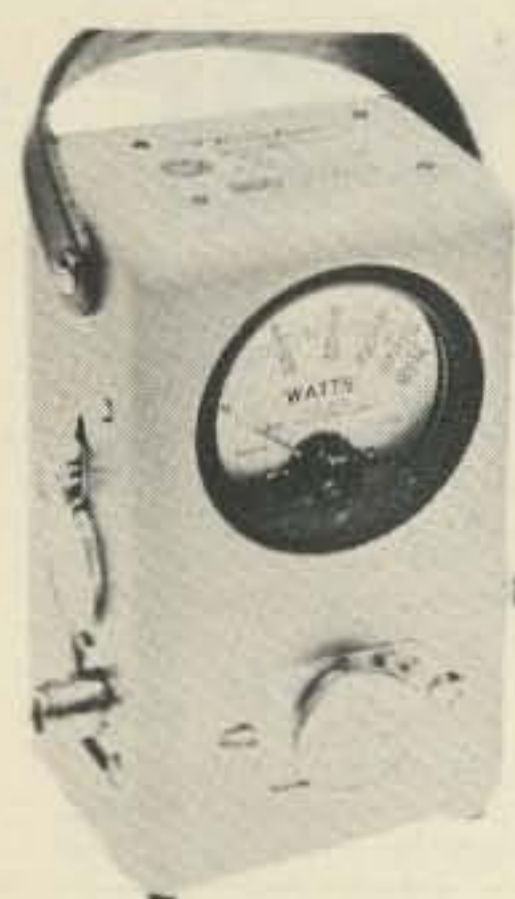

Read RF Watts Directly.
0.45-2300 MHz, 1-10,000 watts ±5%, Low Insertion VSWR—1.05.
Unequalled economy and flexibility: Buy only the element(s) covering your present frequency and power needs, add extra ranges later if your requirements expand.

Table 1
STANDARD
ELEMENTS
(CATALOG
NUMBERS)

Power Range	Frequency Bands (MHz)				
	2-30	25-60	100-250	200-500	400-1000
5 watts	—	5A	5C	5D	5E
10 watts	—	10A	10C	10D	10E
25 watts	—	25A	25C	25D	25E
50 watts	50H	50A	50C	50D	50E
100 watts	100H	100A	100C	100D	100E
250 watts	250H	250A	250C	250D	250E
500 watts	500H	500A	500C	500D	500E
1000 watts	1000H	1000A	1000C	1000D	1000E
2500 watts	2500H				
5000 watts	5000H				

MODEL	PRICE
43	\$120
Elements (Table 1) 2-30 MHz	42
Elements (Table 1) 25-1000 MHz	36
Carrying case for Model 43 & 6 elements	26
Carrying case for 12 elements	16

(Specify Type N or SO239 connectors)

BOMAR Crystal Company
Novice Crystals (Specify Band Only)
Two Meters
CRYSTALS IN STOCK
In Stock!
Motorola HT 220 Crystals

Standard • Icom • Heathkit • Ken • Clegg • Regency • Wilson • VHF Eng • Drake • And Others! \$4.50 @ Lifetime Guarantee

Make/Model	Xmit Freq.	Rec. Freq.

THE BIG SIGNAL "W2AU" BALUN

THE APPROVED LEADING HAM AND COMMERCIAL BALUN IN THE WORLD TODAY.

THE PROVEN BALUN

- HANDLES FULL 2 KW PEP AND THEN SOME. Broad-Banded 3 to 40 Mc.
- HELPS TVI PROBLEMS By Reducing Coax Line Radiation.
- NOW ALL STAINLESS STEEL HARDWARE. SO239 Double Silver Plated
- IMPROVES F/B RATIO By Reducing Coax Line Pick-Up.
- REPLACES CENTER INSULATOR. Withstands Antenna Pull of Over 600 Lbs.
- BUILT-IN LIGHTNING ARRESTER. Helps Protect Balun — Could Also Save Your Valuable Gear.
- BUILT-IN HANG-UP HOOK. Ideal for Inverted Vees, Multi-Band Antennas, Dipoles, Beam and Quads.

NOW BEING USED BY ALL BRANCHES OF THE U.S. ARMED FORCES, FAA, RCA, CIA, CANADIAN DEFENSE DEPT. PLUS THOUSANDS OF HAMMERS THE WORLD OVER.

THEY'RE BUILT TO LAST...
BIG SIGNALS DON'T JUST HAPPEN — GIVE YOUR ANTENNA A BREAK

Comes in 2 models. 1:1 matches 50 or 75 ohm unbalanced coax line to 50 or 75 ohm balanced load. 4:1 model matches 50 or 75 ohm unbalanced coax line to 200 or 300 ohm balanced load.

AVAILABLE AT ALL LEADING DEALERS. IF NOT, ORDER DIRECT

The big signal W2AU Balun reflects the type of quality that has kept our product out front and number 1 in Baluns the world over for the past 10 years. The originator of the Balun with a built-in lightning arrester and hang-up hook.

WE'LL GUARANTEE we offer balun, at any price, has all these features:

SERIES 31 — BNC CONNECTORS

Amphenol's BNC connectors are small, lightweight, weatherproof connectors with bayonet action for quick disconnect applications. Shells, coupling rings and male contacts are accurately machined from brass. Springs are made of beryllium copper. All parts in turn are ASTROplated® to give you connectors that can take constant handling, high temperatures and resist abrasion.

BNC BULKHEAD RECEPTACLE 31-221-385 UG-1094
Mates with any BNC plug. Receptacle can be mounted into panels up to 104" thick. \$1.25

BNC (M) TO UHF (F) ADAPTER 309-2900-385 UG 255
Adapts any BNC jack to any UHF plug. \$3.63

DOUBLE MATE ADAPTER 83-877-385
Both coupling rings are free turning. Connects 2 female components. \$2.72

JACK ADAPTER \$1.95
575-102-385 Adapts 83-1SP-385 to Motorola type auto antenna jack or pin jack.

PANEL RECEPTACLE 83-1R-385 SO239
Mounts with 4 fasteners in 21/32" diameter hole. \$1.17

PANEL RECEPTACLE 83-878-385 SO239SH
Mounts in single 21/32" diameter hole. Knurled lock nuts prevent turning. \$1.59

BNC ANGLE ADAPTER 31-009-385 UG-306
Adapts any BNC plug for right angle use. \$4.23

BNC TEE ADAPTER 31-008-385 UG-274
Adapts 2 BNC plugs to 31-003-385 or other female BNC type receptable. \$4.56

UG-273
575-102-385
BNC(F) TO UHF (M) ADAPTER 31-028-385 UG-273
Adapts any BNC plug to any UHF jack. \$2.39

PUSH-ON 83-1SP-385
83-5SP-385 Features an unthreaded, springy shell to push fit on female connectors. \$2.27

LIGHTNING ARRESTOR 575-105-385
Eliminates static build-up from antenna. Protects your valuable equipment against lightning damage. \$4.80

BNC PLUG 31-002-385 UG-88
Commonly used for communications antenna lead cables. For RG 55/U & RG 58/U cables. \$1.59

BNC STRAIGHT ADAPTER 31-219-385 UG-914
1 9/32" long, allows length of cables to be joined. Mates with BNC plugs. \$2.12

BNC PANEL RECEPTACLE 31-003-385 UG-290
Mounts with 4 fasteners in 29/64" diameter hole. \$1.74

SERIES 581 — PACKAGED CABLE ASSEMBLIES

All popular lengths are now available in your choice of RG 8/U or RG 58/U type low loss polyfoam dielectric cable. Installed PL-259 connectors are ASTROplated — Amphenol's new non-tarnishing finish — which has all the advantages of precious metal plus more heat, corrosion and abrasion resistors that silver ever had! These cable assemblies are ideal for CB, ham radio and other communications antenna installations and they are ready for immediate use.

RG 8/U TYPE POLYFOAM COAXIAL CABLE ASSEMBLIES

- 581-803 3-ft. with ASTROplated PL-259's on both ends. \$93.71
- 581-820 20-ft. with ASTROplated PL-259's on both ends. \$7.95
- 581-850 50-ft. with ASTROplated PL-259's on both ends. \$15.39
- 581-875 75-ft. with Astroplated PL-259's on both ends. \$21.10
- 581-8100 100-ft. with ASTROplated PL-259's on both ends. \$26.49

RG 58/U TYPE POLYFOAM COAXIAL CABLE ASSEMBLIES

- 581-5812 12-ft. with ASTROplated PL-259's on both ends. \$4.19
- 581-5820 20-ft. with ASTROplated PL-259's on one end and SPADE LUGS ON OTHER END. \$4.15
- 518-5820-2 20-ft. with ASTROplated PL-259's on both ends. \$4.89
- 581-5850 50-ft. with ASTROplated PL-259's on both ends. \$7.44
- 581-5875 75-ft. with ASTROplated PL-259's on both ends. \$9.28
- 581-58100 100-ft. with ASTROplated PL-259's on both ends. \$10.76

PL-259 ... 90¢
UG-175 (Adapter for RG 58U) ... 25¢



Now It's Crystal Clear

Yes, now ICOM helps you steer clear of all the hassles of channel crystals. The new **IC-22S** is the same surprising radio you've come to know and love as the **IC-22A**, except that it is totally crystal independent. **Zero crystals.** Solid state engineering enables you to program 23 channels of your choice without waiting. Now the ICOM performance you've demanded comes with the convenience you've wanted, with your new **IC-22S**. Price: \$299.00



IC-245 Transceiver

The VFO Revolution goes mobile with the unique, ICOM developed LSI synthesizer with 4 digit LED readout. The IC-245 offers the most for mobile on the market. The easy to use tuning knob moves accurately over 50 detent steps and assures excellent control as easily as steering the vehicle. With its optional adapter, the IC-245 puts you into all mode operation on 12V DC power with a compact dash-mounted transceiver. In FM, the synthesizer command frequency is displayed in 5 kHz steps from 146 to 148 MHz, and with the side band adapter the step rate drops to 100 Hz from 144 to 146 MHz. For maximum repeater flexibility, the transmit and receive frequencies are independently programmable on any separation. The IC-245 even comes equipped with a multiple pin Molex connector for remote control. The IC-245 is a product of the revolution in VFO design, from its new style front panel, to its excellent mechanical rigidity and Large Scale Integrated Circuitry. Your IC-245 will give you the most for mobile. \$499.00



THE NEW ICOM 4 MEG, MULTI-MODE, 2 METER RADIO - IC 211

ICOM introduces the first of a great new wave of amateur radios, with new styling, new versatility, new integration of functions. You've never before laid eyes on a radio like the IC-211, but you'll recognize what you've got when you first turn the single-knob frequency control on this compact new model. The IC-211 is fully synthesized in 100 Hz or 5 kHz steps, with dual tracking, optically coupled VFOs displayed by seven-segment LED readouts, providing any split. The IC-211 rolls through 4 megahertz as easily as a breaker through the surf. With its unique ICOM developed LSI synthesizer, the IC-211 is now the best "do everything" radio for 2 meters, with FM, USB, LSB and CW operation. \$749.00



Hold it!

Take hold of SSB with these two low cost twins. ICOM'S new portable **IC-202** and **IC-502** put it within your reach wherever you are. You can take it with you to the hill top, the highways, or the beach. Three portable watts PEP on two meters or six!

Hello, DX! The ICOM quality and excellent receiver characteristics of this pair make bulky converters and low band rigs unnecessary for getting started in SSB-VHF. You just add your linear amp, if you wish, connect to the antenna, and DX! With the **202** you may talk through OSCAR VI and VII! Even transceive with an "up" receiving converter! The **IC-502**, similarly, makes use of six meters in ways that you would have always liked but could never have before. In fact, there are so many things to try, it's like opening a new band.

Take hold of Single Side Band. Take hold of some excitement. Take two.

IC-202
2 Meter SSB • 3 Watts PEP • True IF Noise Blanker
Switched Dial Lights • Internal Batteries • 200KHz
VXO Tuning • 144.0, 144.2 + 2 More! • RIT!
Price: \$259.00

IC-502
6 Meter SSB • 3 Watts PEP • True IF Noise Blanker
Switched Dial Lights • Internal Batteries • 800KHz
VFO • RIT!
Price: \$249.00

Now ICOM Introduces 15 Channels of FM to Go! The New IC-215: the FM Grabber

This is ICOM's first FM portable, and it puts good times on the go. Change vehicles, walk through the park, climb a hill, and ICOM quality FM communications go right along with you. Long lasting internal batteries make portable FM really portable, while accessible features make conversion to external power and antenna fast and easy.

Grab for flexibility with the new **IC-215** FM portable.

- Front mounted controls and top mounted antenna
- Narrow filter (15KHz — compatible spacing)
- 15 channels (12 on dial / 3 priority)
- Fully collapsible antenna
- Compatible mount feature for flexible antenna
- Dual power (3 watts high / 400 mw low, nominal)
- External power and antenna easily accessible
- Lighted dial and meter



Price: \$229.00

Your new **IC-215** comes supplied with: 5 popular channels; handfield mic, with protective case; shoulder strap; connectors for external power and speaker; 9 long-life C batteries.



ICOM

TUFTS RADIO CATALOG TUFTS RADIO



**model 333
dummy load
wattmeter**

**Favorite Lightweight Portable—250 WATT RATING—
Air Cooled**

Ideal field service unit for mobile 2-way radio—CB, marine, business band. Best for QRP amateur use, CB, with zero to 5 watts full scale low power range.

• specifications

Frequency Range	DC to 300 MHz
VSWR	Less than 1.3:1 to 230 MHz
Power Range	250 watts intermittent
Wattmeter Ranges	0-5, 0-50, 0-125, 0-250
Connector	SO-239
Size	4" x 7" x 8"
Shipping Weight	2 lbs.
Price	\$96.50



—model 374 dummy load wattmeter—

Top of the Line—1500 WATT RATING—Oil Cooled

Our highest power combination unit. Rated to 1500 watts input (intermittent). Meter ranges are individually calibrated for highest accuracy.

• specifications

Frequency Range	DC to 300 MHz
VSWR	Less than 1.3:1 to 230 MHz
Power Range	1500 watts DC intermittent. Warning light* signals maximum heat limit.
Wattmeter Ranges	0-15, 0-50, 0-300, 0-1500
Input Connector	SO-239 (hermetically sealed)
Size	4-3/4" x 9" x 10-1/4"
Shipping Weight	12 lbs.
Price	\$215.00

LITTLE DIPPER

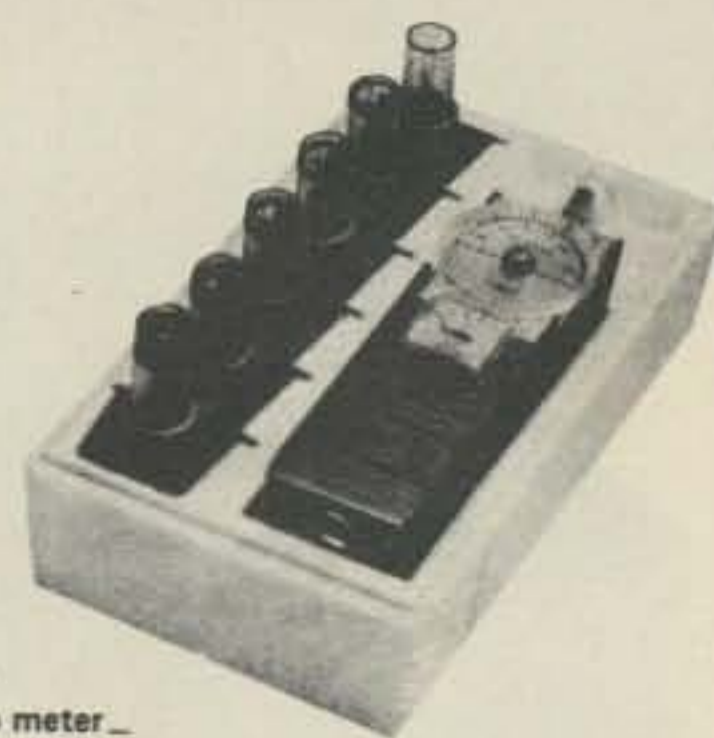

**model 331A
transistor dip meter**

Portable RF single generator, signal monitor, or absorption wavemeter. Lightweight (1 pound, 6 ounces with all coils), battery-powered unit is ideal for field use in testing transceivers, tuning antennas, etc. Can also be used to measure capacity, inductance, circuit Q, and other factors. Indispensable for experimenters, it is easily the most versatile instrument in the shop. Continuous coverage from 2 MHz to 230 MHz in seven ranges.

Unit consists of a transistorized RF dip oscillator and 100-microampere meter circuit. Meter circuit uses a single-transistor DC amplifier with a potentiometer in the emitter circuit to control meter sensitivity. A 3-position slide switch connects the meter circuit to the oscillator for dip measurements, to a diode for absorption wavemeter peak measurements, or provides audio modulation of the RF signal.

Frequency dial has a calibrated reference point for Q and bandwidth measurements. Each coil has its own frequency dial—there's no confusion with multiple markings or small, hard-to-read scales near the center of the dial.

• specifications

Frequency Coverage	2 MHz to 230 MHz in 7 overlapping ranges by plug-in coil assemblies: 2 MHz-4 MHz, 4 MHz-8 MHz, 8 MHz-16 MHz, 16 MHz-32 MHz, 32 MHz-64 MHz, 50 MHz-110 MHz, 110 MHz-230 MHz
Accuracy	±3%
Modulation	1000 Hz, 25% to 40%
Power	9-volt transistor battery, Burgess 2U6 or equivalent
Size	7" x 2-1/4" x 2-1/2"
Shipping Weight	1 lb., 6 oz.
Price	\$120.00



BARKER & WILLIAMSON, INC.



**Economy High Power Load—1500 WATT RATING—
Oil Cooled
model 384 dummy load**

For high power when all you need is the load.

• specifications

Frequency Range	DC to 300 MHz
VSWR	Less than 1.3:1 to 230 MHz
Power Range	1500 watts intermittent. Warning light* signals maximum heat limit.
Connector	SO-239 (hermetically sealed)
Size	4-3/4" x 9" x 10-1/2"
Shipping Weight	12 lbs.
Price	\$94.50



**High Power—1000 WATT RATING—Oil Cooled
model 334A dummy load wattmeter.**

Our most popular combination unit. Handles full amateur power. Meter ranges individually calibrated. Can be panel mounted.

• specifications

Frequency Range	DC to 300 MHz
VSWR	Less than 1.3:1 to 230 MHz
Power Range	1000 watts CW intermittent. Warning light* signals maximum heat limit.
Wattmeter Ranges	0-10, 0-100, 0-300, 0-1000
Input Connector	SO-239 (hermetically sealed)
Size	4-3/4" x 9" x 10-1/4"
Shipping Weight	12 lbs.
Price	\$174.00

WIDE RANGE ATTENUATOR

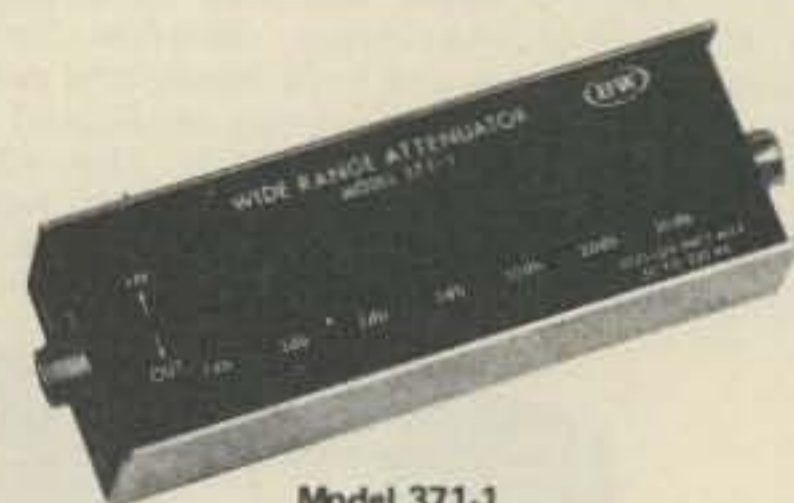

Model 371-1

Protect your receiver or converter from overload, or provide step attenuation of low-level RF signals from signal generators, preamplifiers, or converters. Seven rocker switches provide attenuation from 1 dB to 61 dB in 1-dB steps. Switches are marked in dB, 1-2-3-5-10-20-20. Sum of actuated switches (IN position) gives attenuation. With all switches in OUT position, there is NO insertion loss. Attenuator installs in coaxial line using UHF connectors.

• specifications

Power Capacity	1/4 watt
VSWR	1.3:1 maximum, DC to 225 MHz
Impedance	50 ohms
Accuracy	1 dB/dB, DC to 60 MHz 0.1 dB/dB ±0.5 dB, DC to 160 MHz 0.1 dB/dB ±1.0 dB, DC to 225 MHz
Size	8-1/2" x 2-1/2" x 2-1/4"
Shipping Weight	1-1/2 lbs.
Price	\$49.50

• Handle full 200 watts • low-low V.S.W.R. • Deliver 3 dB gain and more! • Pick the one that best fits your needs:

Larsen Kūlrod® Antennas

MAGNETIC MOUNT
stays put even at 100 mph!

MM-JM-150 for 144 MHz use }
MM-JM-220 for 220 MHz use } **Only \$38.50**
MM-JM-440 for 440 MHz use } complete

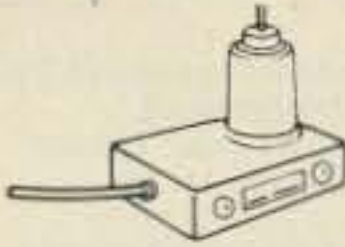

TRUNK LID MOUNT

No holes and low silhouette too!
TLM-JM-150 for 144 MHz use }
TLM-JM-220 for 220 MHz use } **Only \$38.50**
TLM-JM-440 for 440 MHz use } complete
And 1/4 wave antenna for trunk and magnetic mount — \$18.50

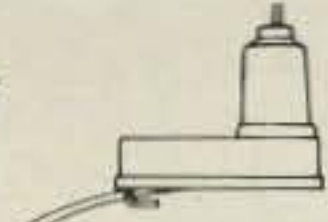

ROOF or FENDER MOUNT

Goes on quick and easy in 3/8" or 3/4" with fewest parts.
JM-150-K for 144 MHz use }
JM-220-K for 220 MHz use } **Only \$31.50**
JM-440-K for 440 MHz use } complete
And 1/4 wave antenna for roof and fender mounts \$11.50



Above antennas all complete with mounting hardware, coax, connector plug, allen wrench and complete instructions.

model 372 CLIPREAMP



Model 372 — \$27.50

Get maximum legal modulation without danger of splatter. Solid-state speech preamplifier and clipper for transmitters, public-address systems, and tape recorders needs no external power.

- specifications
- Input Impedance 100,000 ohms
- Input Levels 5 millivolts to 20 millivolts
- Voltage Gain 10 dB
- Output Level 60 millivolts
- Output Impedance 50,000 ohms
- Power 9-volt transistor battery, Burgess 2U6 or equivalent
- Size 2-3/4" x 3" x 4-1/2"
- Shipping Weight 7 oz.
- Connectors Terminal strip

COAXIAL ANTENNA CHANGEOVER RELAY

model 377

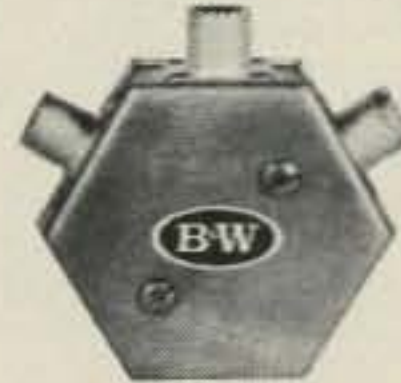

Model 377 — \$17.95

Economical and reliable. Can be operated from VOX circuit for completely automatic operation or from PTT or manual T/R switch. Receiver input is automatically grounded when the relay is in the Transmit position. Wide AC operating voltage range and low operating current.

- specifications
- Power Rating 1000 watts CW (2000 watts SSB)
- VSWR Less than 1.15:1, DC to 150 MHz
- Power Requirements 0.015 Amps, 48 to 130 volts AC
- Connectors UHF Type SO-238
- Dimensions 3-1/2" x 1-1/2"
- Shipping Weight 1 lb.

UNIVERSAL HYBRID COUPLER II PHONE PATCH

model 3002W and model 3001W



Model 300 2W with Compreamp — \$125.00

Connect your station to the telephone lines. Five switch-selectable modes give complete flexibility for patching the station to the line and for tape recording and playback to or from the line or the station. The hybrid circuit provides for effortless VOX operation of the phone patch. A built-in Compreamp speech preamplifier/limiter (in Model 3002W) increases the level of weak phone signals and also prevents overmodulation when the local telephone is used as the station microphone. (The Compreamp also functions as a preamplifier/limiter with the station microphone, if desired.)

- specifications
- Inputs from:
 - Line 600 ohms
 - Receiver 4 ohms
 - Microphone High impedance (50,000 ohms) crystal or dynamic
- Tape Recorder 4 ohms
- Outputs to:
 - Transmitter 50,000 ohms
 - Receiver Speaker 4 ohms
 - Tape Recorder 0.5 megohm
- Size 6-1/2" x 7-1/2" x 3"
- Shipping Weight 3-1/2 lbs.
- Power 9-volt battery, Burgess 2U6 or equivalent
- Connectors Phono



Model 359 — \$37.50



Increase your transmitter's effective speech power up to four times. Or use it with your tape recorder or public address system for improved performance. This two-stage, transistorized Audio Preamplifier/Limiter can be used with all types of transmitters. Powered by a long-lasting dry-cell battery—no external power needed. Installs without any wiring changes in your transmitter. Just connect the Compreamp between your microphone (50,000-ohm dynamic or high-impedance ceramic) and your transmitter's microphone input connector. Front-panel rocker switch lets you bypass the Compreamp when you want to. Compression level is adjustable, too.

- specifications
- Input Impedance 100,000 ohms
- Input Level 5 millivolts to 20 millivolts
- Voltage Gain 10 dB
- Output Level 60 millivolts
- Output Impedance 50,000 ohms
- Power 9-volt transistor battery, Burgess 2U6 or equivalent
- Size 2-3/4" x 3" x 4-1/2"
- Shipping Weight 6-1/2 oz.
- Connectors Terminal strip

COAXIAL SWITCHES AND ACCESSORIES

for antenna selection and RF switching

These high-quality switches have set the standard for the industry for years. Ceramic switches with silver-alloy contacts and silver-plated conductors give unmatched performance and reliability from audio frequencies to 150 MHz.

B&W coaxial switches are designed for use with 52- to 75-ohm non-reactive loads, and are power rated at 1000 watts AM, 2000 watts SSB. Connectors are UHF type. Insertion loss is negligible, and VSWR is less than 1.2:1 up to 150 MHz.

Crosstalk (measured at 30 MHz) is -45 dB between adjacent outlets and -60 dB between alternate outlets.

Models are available for desk, wall, or panel mounting, and with or without protective grounding of inactive outputs. Radial (side-mounted) connector models can be either wall or panel mounted; axial (backplate-mounted) connector models are for panel mounting only, save panel space.

Use the selector chart below to choose the models you need.

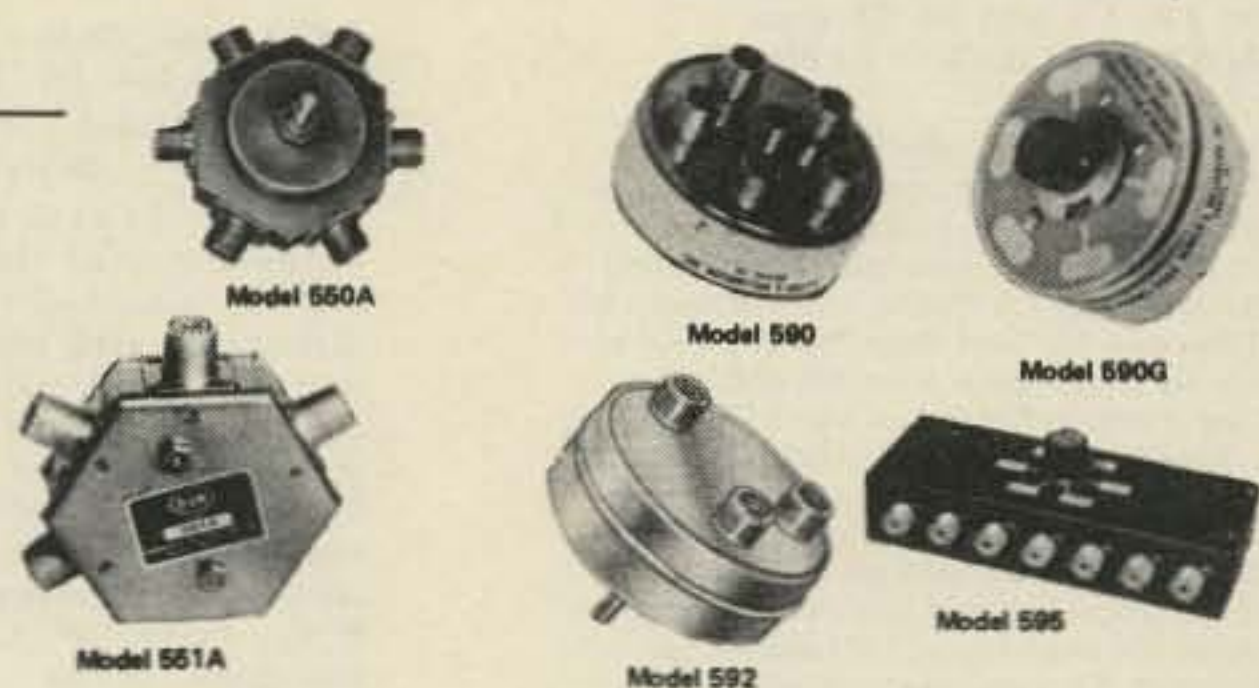

COAXIAL SWITCH SELECTOR CHART

Model	PRICE	Outputs	Connector Placement	Mounting			Automatic Grounding	Dial Plate	Remarks
				Panel	Wall	Desk			
375	18.95	6	Axial	x			x	Supplied	PROTAX switch. Grounds all except selected output circuit.
376	18.95	5	Radial	x	x		x	Supplied	PROTAX switch. Grounds all except selected output circuit. Sixth switch position grounds all outputs.
550A	14.00	5	Radial	x	x			DP-5	
550A-2	12.50	2	Radial	x	x			DP-2	
551A	17.50	2	Radial	x	x			DP-2	Special 2-pole, 2-position switch used to switch any RF device in or out of series connection in a coaxial line. See figure (over).
556	.95	-	-		x			-	Bracket only, for wall mounting of radial connector switches.
590	17.95	5	Axial	x				DP-5	
590G	17.95	5	Axial	x			x	Supplied	Grounds all except selected output circuit.
592	16.50	2	Axial	x				DP-2	
595	18.50	6	In-line		x	x	x		Grounds all except selected output circuit.

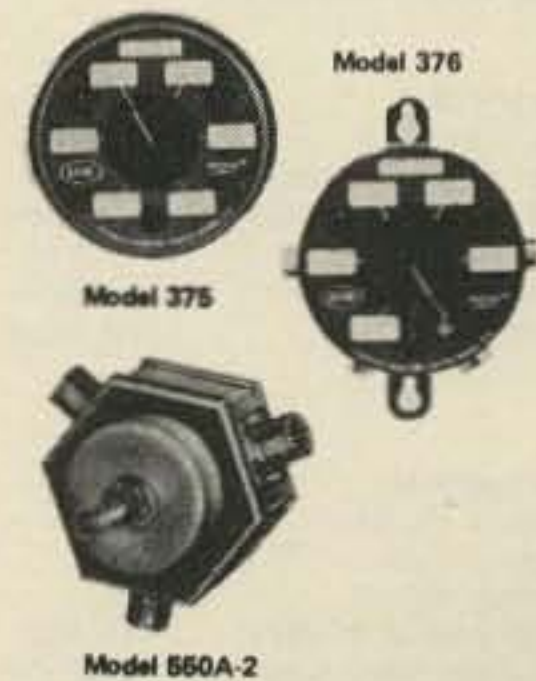

TUFTS RADIO CATALOG TUFTS RADIO

There is no substitute for quality, performance, or the satisfaction of owning the very best. Hence, the incomparable Hy-Gain 3750 Amateur transceiver. The 3750 covers all amateur bands 1.8-30 MHz (160-10 meters). It utilizes advanced Phase-Lock-Loop circuitry with dual gate MOS FET's at all critical RF amplifier and mixer stages. There's a rotating dial for easy band-scanning and an electronic frequency counter with digital readout and a memory display that remembers frequencies at the flip of a switch. And that's just the beginning. Matching speaker unit (3854) and complete external VFO (3855) also available. See the incomparable Hy-Gain 3750 at your radio dealer or write Department MM. There is no substitute.



3854 - \$59.95 3750 - \$1895.00 3855 - \$495.00

There is no substitute.

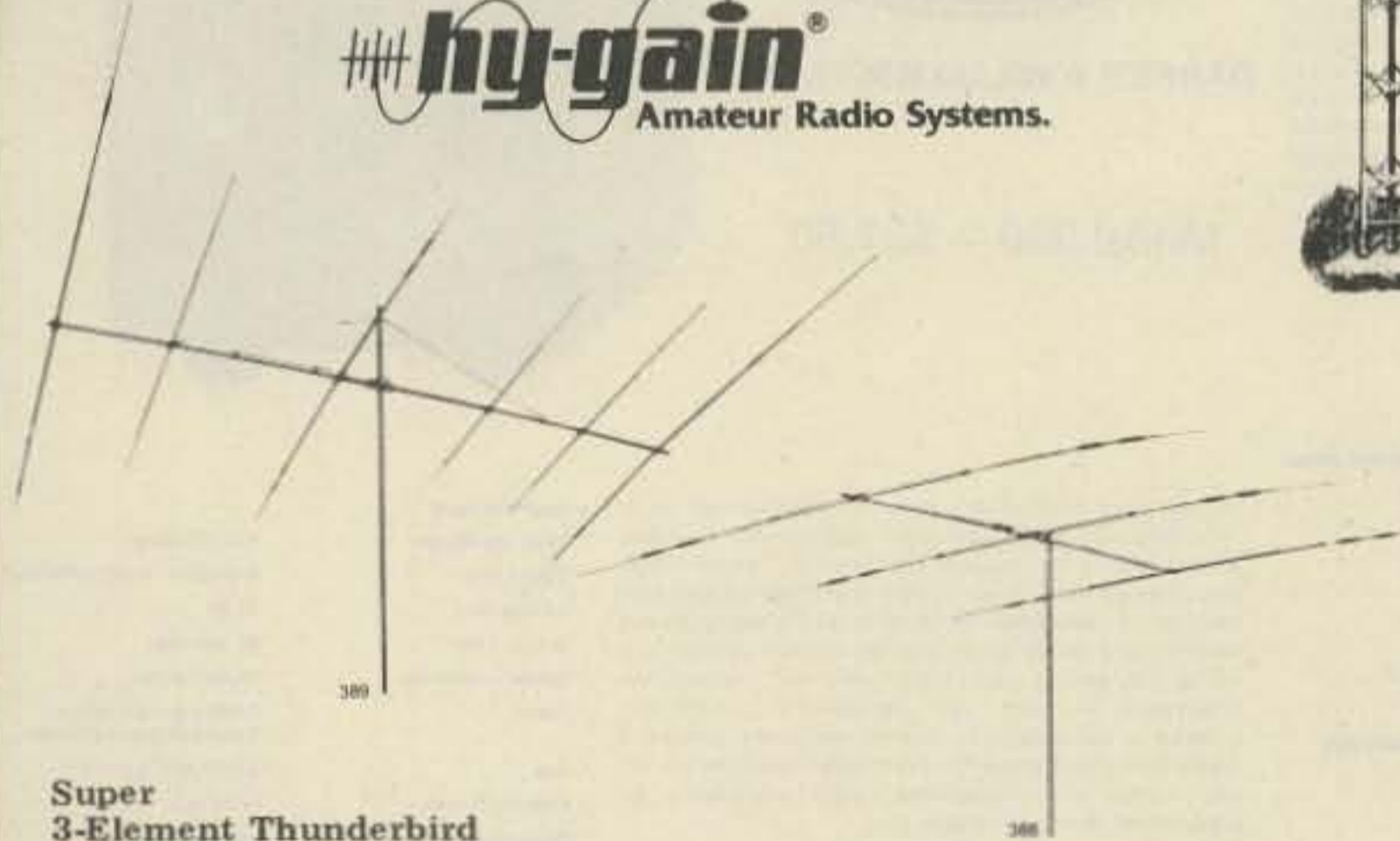

Super 3-Element Thunderbird for 10, 15 and 20 Meters Model TH3Mk3 - \$199.95

Hy-Gain's Super 3-element Thunderbird delivers outstanding performance on 10, 15 and 20 meters. The TH3Mk3 features separate and matched Hy-Q traps for each band, and feeds with 52 ohm coax. Hy-Gain Beta Match presents tapered impedance for most efficient 3 band matching, and provides DC ground to eliminate precipitation static. The TH3Mk3 delivers maximum F/B ratio, and SWR less than 1.5:1 at resonance on all bands. Its mechanically superior construction features taper swaged slotted tubing for easy adjustment and larger diameter. Comes equipped with heavy tiltable boom-to-mast clamp. Hy-Gain ferrite balun BN-86 is recommended for use with the TH3Mk3.

6-Element Super Thunderbird DX for 10, 15 and 20 Meters Model TH6DXX \$249.95 Separate HY-Q traps, featuring large diameter coils that develop an exceptionally favorable L/C ratio and very high Q, provide peak performance on each band whether working phone or CW. Exclusive Hy-Gain beta match, factory pretuned, insures maximum gain and F/B ratio without compromise. The TH6DXX feeds with 52 ohm coaxial cable and delivers less than 1.5:1 SWR on all bands. Mechanically superior construction features taper swaged, slotted tubing for easy adjustment and re-adjustment, and for larger diameter and less wind loading. Full circumference compression clamps replace self-tapping sheet metal screws. Includes large diameter, heavy gauge aluminum boom, heavy cast aluminum boom-to-mast clamp, and heavy gauge machine formed element-to-boom brackets. Hy-Gain's ferrite balun BN-86 is recommended for use with the TH6DXX.

	TH6DXX	TH3Mk3
Electrical		
Gain—average	8.7dB	8dB
Front-to-back ratio	25dB	25dB
SWR (at resonance)	Less than 1.5:1	Less than 1.5:1
Impedance	50 ohms	50 ohms
Power rating	Max legal	Max legal
Mechanical		
Longest element	31.1'	27'
Boom length	24'	14'
Turning radius	20'	15.7'
Wind load at 80 MPH	156 lbs.	103.2 lbs.
Maximum wind survival	100 MPH	100 MPH
Net weight	57 lbs.	36 lbs.
Mast diameter accepted	1 1/4" to 2 1/2"	1 1/4" to 2 1/2"
Surface area	6.1 sq. ft.	4.03 sq. ft.

HY-GAIN'S INCOMPARABLE HY-TOWER FOR 80 THRU 10 METERS

- Model 18HT**
- Outstanding Omni-Directional Performance
 - Automatic Band Switching
 - Installs on 4 sq. ft. of real estate
 - Completely Self-Supporting

By any standard of measurement, the Hy-Tower is unquestionably the finest multi-band vertical antenna system on the market today. Virtually indestructible, the Model 18HT features automatic band selection on 80 thru 10 meters through the use of a unique stub decoupling system which effectively isolates various sections of the antenna so that an electrical 1/4 wavelength (or odd multiple of a 1/4 wavelength) exists on all bands. Fed with 52 ohm coax, it takes maximum legal power ... delivers outstanding performance on all bands. With the addition of a base loading coil, it also delivers outstanding performance on 160 meters. Structurally, the Model 18HT is built to last a lifetime. Rugged hot-dipped galvanized 24 ft. tower requires no guyed supports. Top mast, which extends to a height of 50 Ft., is 6061ST6 tapered aluminum. All hardware is iridite treated to MIL specs. If you're looking for the epitome in vertical antenna systems, you'll want Hy-Tower, Shpg. Wt., 96.7 lbs. Order No. 182, Price: \$279.95
NEW Special hinged base assembly on Model 18HT allows complete assembly of antenna at ground level ... permits easy raising and lowering of the antenna.



BROAD BAND DOUBLET BALUN for 10 thru 80 meters Model BN-86 \$15.95



The model BN-86 balun provides optimum balance of power to both sides of any doublet and vastly improves the transfer of energy from feedline to antenna. Power capacity is 1 KW DC. Features weatherproof construction and built-in mounting brackets. \$15.95 Shpg. Wt. 1 lb. Order No. 242

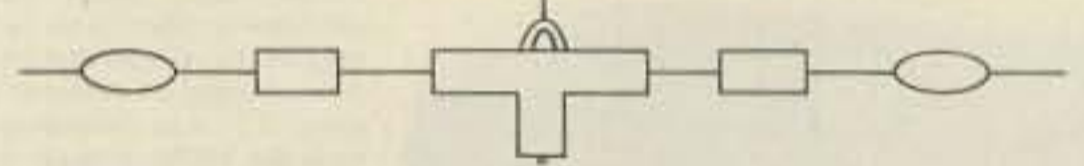

MULTI-BAND HY-Q TRAP DOUBLET'S Hy-Q Traps

- Install Horizontally or as Inverted V
- Super-Strength Aluminum Clad Wire
- Weatherproof Center and End Insulators

Installed horizontally or as an inverted V, Hy-Gain doublets with Hy-Q traps deliver true half wavelength performance on every design frequency. Matched traps, individually pretuned for each band feature large diameter coils that develop an exceptionally favorable L/C ratio and very high Q performance. Mechanically superior solid aluminum trap housings provide maximum protection and support to the loading coil. Fed with 52 ohm coax, Hy-Gain doublets employ super-strength aluminum clad single strand steel wire elements that defy deterioration from salt water and smoke ... will not stretch ... withstand hurricane-like winds. SWR less than 1.5:1 on all bands. Strong, lightweight, weatherproof center insulators are molded from high impact cyolac. Hardware is iridite treated to MIL specs. Heavily serrated 7-inch end insulators molded from high impact cyolac increase leakage path to approximately 12 inches.

MODEL 2BDQ for 40 and 80 meters. 100' 10 1/2" overall. Takes maximum legal power. Shpg. Wt., 7.5 lbs \$49.95 Order No. 380
MODEL 5BDQ for 10, 15, 20, 40 and 80 meters. 94' overall. Takes maximum power. Shpg. Wt., 12.2 lbs. \$79.95 Order No. 383



CENTER INSULATOR for Multi-Band Doublets Model CI

Strong lightweight, weatherproof Model CI is molded from high impact cyolac. Hardware is iridite treated to MIL specs. Accepts 1/4" or 3/4" coaxial. Shpg. Wt., 0.6 lbs. \$5.95 Order No. 155

MULTI-BAND ANTENNA Dipole Antenna - Model DIV-80 \$13.95

For 10 thru 80 meters - choice of one band
A dipole antenna for the individuals who prefer the "do-it-yourself" flexibility of custom-designing an antenna for your specific needs. (Work the frequencies you wish in the 10 through 80 meters bands). The DIV-80 features: Durable Copperweld wire for greater strength, Mosley Dipole Connector (DPC-1) for RG-8/U or RG-58/U coax and all the technical information you will need to construct your custom-designed antenna.



END INSULATORS for Doublets Model EI

Rugged 7-inch end insulators are molded from high impact cyolac that is heavily serrated to increase leakage path to approximately 12 inches. Available in pairs only. Shpg. Wt., 0.4 lbs. \$3.95 Order No. 156

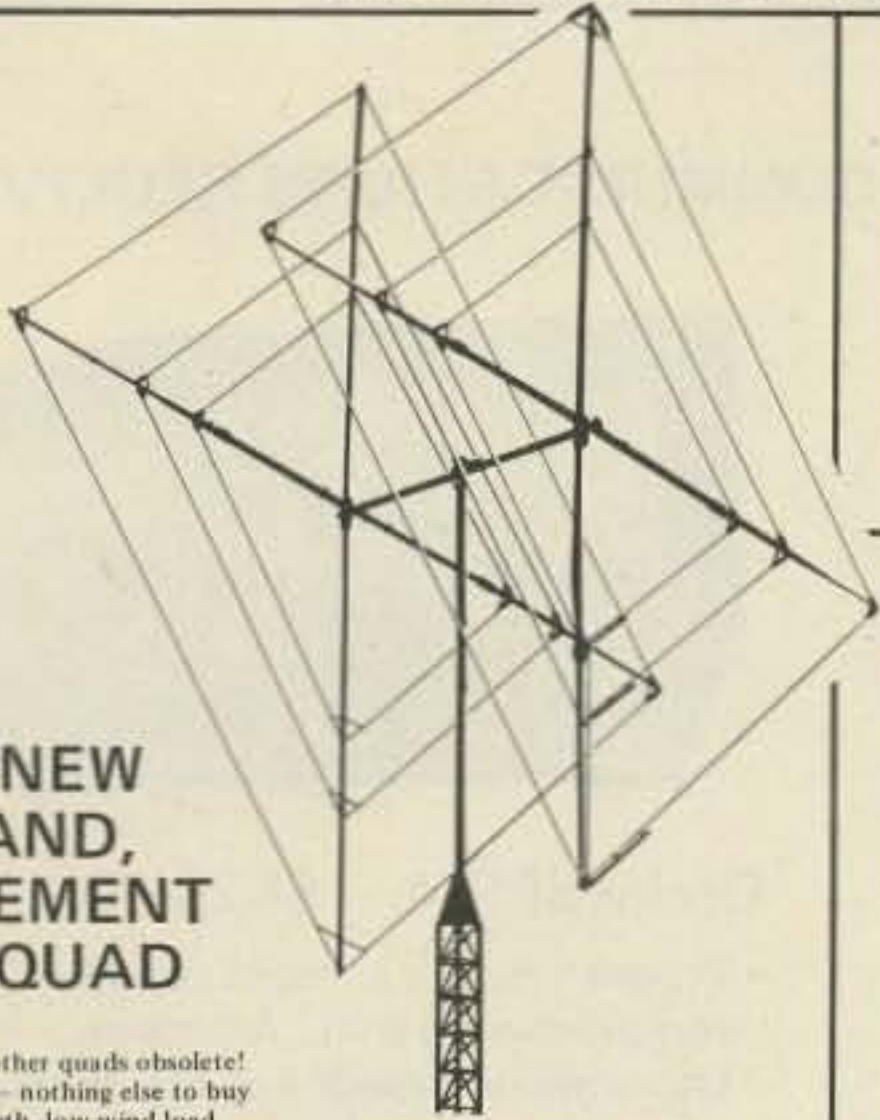

**ALL NEW
3-BAND,
2 ELEMENT
HY-QUAD**

■ Makes all other quads obsolete!
■ Complete - nothing else to buy
■ High strength, low wind load
The Hy-Quad from Hy-Gain makes all other quads obsolete! Here's why:
First, it's the only quad that is complete. There is nothing more to shop for or buy.
Secondly, it is uniquely designed so that it overcomes all of the previously undesirable features inherent in quads.
The all aluminum structure stays up! The single feed line and diamond shape simplifies feed line routing.
Hy-Gain's all new Hy-Quad will outdo all other quads because it's engineered to do just that. The Hy-Quad is new, it's superior, it's complete. It's the first quad to have everything: spreaders are broken up at strategic electrical points with Cycloc insulators / tri-band 2 element construction with individually resonated elements with no interaction / Hy-Quad requires only one feed line for all three bands / individually tuned gamma matches on each band with Hy-Gain exclusive vertex feed / full wave element loops require no tuning stubs, traps, loading coils or baluns / heavy duty mechanical construction of strong swaged aluminum tubing and die formed spreader-to-boom clamps / extra heavy duty universal boom-to-mast clamp that tilts and mounts on any mast 1 1/2" to 2 1/2" in diameter / aluminum stranded wire. You can open and close the bands with this antenna. You'll experience the thrill of real DX.

Order No. 244 Price: \$219.95

SPECIFICATIONS

Overall length of spreaders	25'5"	Forward gain	8.5 db
Turning radius	13'6"	Input impedance	52 ohms
Weight	42 lbs.	VSWR	1.2:1 or better at resonance on all bands
Boom diameter	2"	Power	Maximum legal
Boom length	8'	Front-to-back ratio	25-35 db depending upon electrical height
Mast diameter	1 1/2" to 2 1/2"	Polarization	Horizontal
Wind survival	100 mph		
Surface area	6.4 sq ft		
Wind load at 100 mph	256.0 lbs.		

The Versatile Model 18V for 80 thru 10 Meters

The Model 18V is a low-cost, highly efficient vertical antenna that can be tuned to any band .80 thru 10 meters... by a simple adjustment of the feed point on the matching base inductor. Fed with 52 ohm coax, this 18 ft. radiator is amazingly efficient for DX or local contact. Constructed of heavy gauge aluminum tubing, the Model 18V may be installed on a short, 1 1/2 inch mast driven into the ground. It is also adaptable to roof or tower mounting. Highly portable, the Model 18V can be quickly knocked down to an overall length of 5 ft. and easily re-assembled for field days and camping trips. Shpg. Wt., 5 lbs.
Order No. 193 Price: \$33.00

**WIDE BAND VERTICAL
for 80 - 10 Meters
Hy-Gain's 18 AVT/WB**

Take the wide band, omni-directional performance of Hy-Gain's famous 14AVQ/WB, add 80 meter capability plus extra-heavy duty construction - and you have the unrivalled new 18AVT/WB. In other words, you have quite an antenna.

- Automatic switching, five band capability is accomplished through the use of three beefed-up Hy-Q traps (featuring large diameter coils that develop an exceptionally favorable L/C ratio).
- Top loading coil.
- Across-the-band performance with just one furnished setting for each band (10 through 40).
- True 1/4 wave resonance on all bands.
- SWR of 2:1 or less at band edges.
- Radiation pattern has an outstandingly low angle whether roof top or ground mounted.

CONSTRUCTION... of extra-heavy duty tapered swaged seamless aluminum tubing with full circumference, corrosion resistant compression clamps at slotted tubing joints... is so rugged and rigid that, although the antenna is 25' in height, it can be mounted without guy wires, using a 12" double grip mast bracket, with recessed coax connector.

Order No. 386 Price: \$97.00



For 10, 15, and 20 Meters
New Hy-Gain Model 12 AVQ

Completely self-supporting, the Model 12AVQ features Hy-Q traps...12" double-grip mast bracket...taper swaged seamless aluminum construction with full circumference compression clamps at tubing joints. It delivers outstanding low angle radiation. SWR is 2:1 or less on all bands. Overall height is 13'6". Shipping weight 7.2 lbs. Price: \$47.00
Order No. 384

New, improved successor to the world's most popular vertical!

Hy-Gain Model 14 AVQ/WB for 40-10 Meters.

- Wide band performance with one setting (optimum settings for top performance furnished)
- New Hy-Q Traps • New 12" Double-Grip Mast Bracket • Taper Swaged Seamless Aluminum Construction

The Model 14AVQ/WB, new improved successor to the world famous Model 14AVQ, is a self-supporting, automatic band switching vertical that delivers omni-directional performance on 40 through 10 meters. Three separate Hy-Q traps featuring large diameter coils that develop an exceptionally favorable L/C ratio and a very high Q, provide peak performance by effectively isolating sections of the antenna so that a true 1/4 wave resonance exists on all bands. Outstandingly low angle radiation pattern makes DX and other long haul contacts easy. Superior mechanical features include solid aluminum housing for traps using air dielectric capacitor...heavy gauge taper swaged seamless aluminum radiator...full circumference compression clamps at tubing joints that are resistant to corrosion and wear...and a 12" double-grip mast bracket that insures maximum rigidity whether roof-top or ground mounted. The Model 14AVQ/WB also delivers excellent performance on 80 meters using Hy-Gain Model LC-80Q Loading Coil. Overall height is 18 feet. Shipping weight 9.2 lbs. Unsurpassed portability...outstanding for permanent installations. Price: \$67.00
Order No. 385

TYPICAL 14AVQ/WB VSWR CURVES

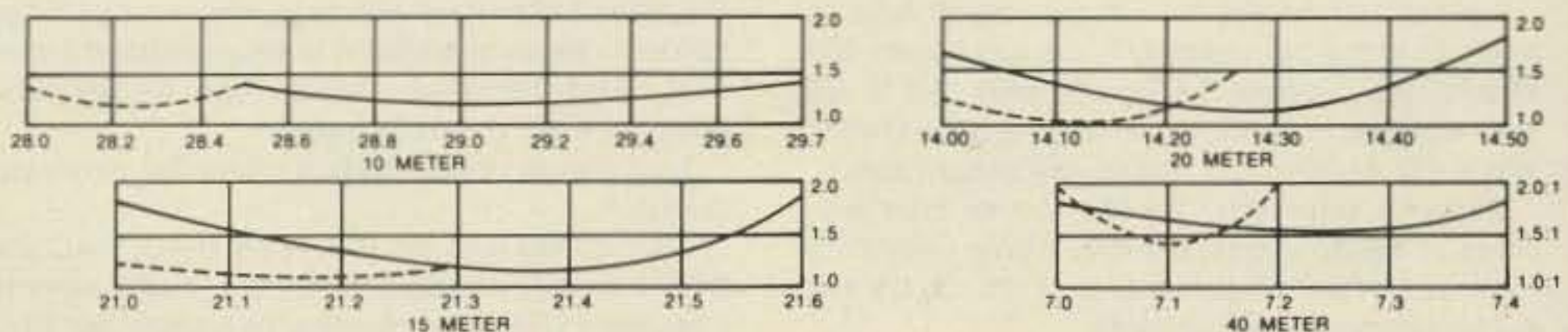

ROOF MOUNTING KIT - Model 14RMQ provides rugged support for Model 14AVQ/WB.

Order No. 184 Price: \$24.95

**Hy-Gain REEL TAPE PORTABLE DIPOLE
for 10 thru 80 Meters Model 18TD**

The most portable high performance dipole ever...

The Model 18TD is unquestionably the most foolproof high performance portable doublet antenna system ever developed. It has proven invaluable in providing reliable communications in vital military and commercial-applications throughout the world. Two stainless steel tapes, calibrated in meters, extend from either side of the main housing up to a total distance of 132 feet for 3.5 mc operation. 25 ft. lengths of polypropylene rope attached to each tape permits installation to poles, trees, buildings...whatever is available for forming a doublet antenna system. Integrated in the high impact housing is a frequency to length conversion chart calibrated to meter measurements on the tapes...makes installation foolproof. Feeds with 52 ohm coax. Delivers outstanding performance as a portable or permanent installation. Measures 10x5 1/2x2 inches retracted. Wt., 4.1 lbs.
Order No. 228 Price: \$94.95



Dentron MLA-2500 \$799.50

DenTron Radio has packed all the features a linear amplifier should have into their new MLA-2500. Any Ham who works it can tell you the MLA-2500 really was built to make amateur radio more fun.

- ALC circuit to prevent overloading
- 160 thru 10 meters
- 1000 watts DC input on CW, RTTY or SSTV Continuous Duty
- Variable forced air cooling system
- Self-contained continuous duty power supply
- Two EIMAC 8875 external anode ceramic/metal triodes operating in grounded grid
- Covers MARS frequencies without modifications
- 50 ohm input and output impedance
- Built-in RF wattmeter
- 117V or 234V AC 50-60 hz
- Third order distortion down at least 30 db
- Frequency range:
1.8MHz (1.8-2.5) 3.5MHz (3.4-4.6)
7MHz (6.0-9.0) 14MHz (11.0-16.0)
21MHz (16.0-22.0) 28MHz (28.0-30.0)
- 40 watts drive for 1 KW DC input
- Rack mounting kit available (19" rack)
- Size: 5 1/2" H x 14" W x 14" D Wt. 47 lbs.

Pipo Communications TROUBLE FREE TOUCH-TONE ENCODER

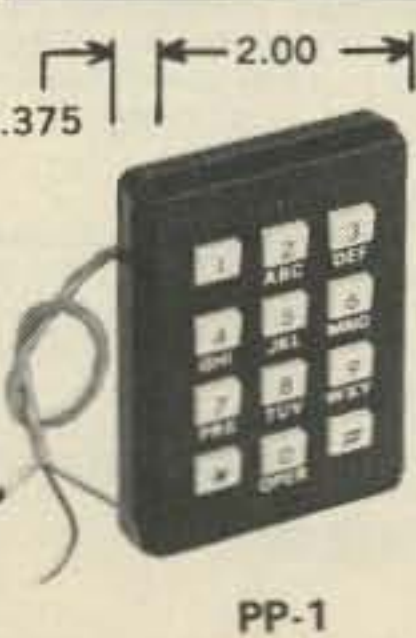

**POSITIVE TOUCH (KEYS DEPRESS) • MOBILE • HANDHELD
DESK MOUNT • NO POTTED PARTS (SERVICEABLE)
MIL. SPEC. COMPONENTS • NO RFI • SELF CONTAINED
XTAL CONTROLLED • LEVEL ADJUSTABLE FROM FRONT**

M series is for mounting to surfaces inaccessible from the rear; wall - mobile - systems interface - panels - test equipment, etc.
K series is self contained with a relay inside the encoder. When Keys are pressed contact closer occurs with a 2 sec. delay, (adjustable). Contacts are rated at 110ma @ 28 Volts switched, 500ma carry. PP-2K contains delay exclusion for the fourth column. However, by jumpering D 5, 4th column delay is restored.

Pipo Communications has developed a trouble free reliable instrument to be free of any defects for years. Unit is constructed with the best components available, without compromise in quality. Unit is operable from 4.5 - 50 Volts at temperatures from below 0 to +140°F. Output level will drive any transmitter or system. Adjustable output level is controlled with an extremely stable multi-turn trimpot, with access from the front of the encoder (not behind), saving time for level setting, which amounts to hours when involved with a system.

PP-1	505 12 Keys	PP-2	508 16 Keys	PP-1A	508 Foot Standard Comm Hand Held
PP-1K	505 Keyless Demand	PP-2K	508 Keyless Demand		
PP-1K	506 Hand Held	PP-2K	506 Hand Held		

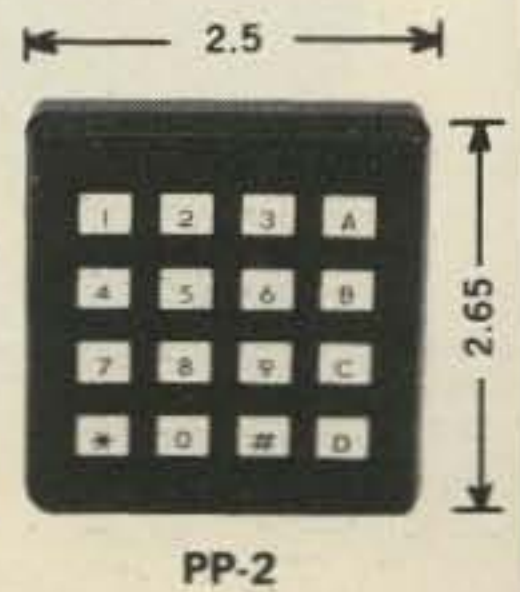

TUFTS RADIO CATALOG

-C - LINE AMATEUR EQUIPMENT



— COMMUNICATIONS RECEIVERS —



Drake R-4C

Solid State Linear permeability-tuned VFO with 1 kHz dial divisions. Gear driven dual circular dials. High mechanical, electrical and temperature stability.

Covers ham bands with crystals furnished. Covers all of 80, 40, 20 and 15 meters, and 28.5-29.0 MHz of 10 meters.

Covers 160 meters with accessory crystal. In addition to the ham bands, tunes any fifteen 500 kHz ranges between 1.5 and 30 MHz, 5.0 to 6.0 MHz not recommended. Can be used for MARS, WWV, CB, Marine and Shortwave broadcasts.

Superior selectivity: 2.4 kHz 8-pole filter provided in ssb positions. 8.0 kHz, 6 pole selectivity for a-m. Optional 8-pole filters of .25, .5, 1.5 and 6.0 kHz bandwidths available.

Tunable notch filter attenuates carriers within passband.

Smooth and precise passband tuning.

Transceive capability; may be used to transceive with the T-4X, T-4XB or T-4XC Transmitters. Illuminated dial shows which PTO is in use.

Usb, lsb, a-m and cw on all bands.

Agc with fast attack and two release times for ssb and a-m or fast release for break-in cw. Agc also may be switched off.

New high efficiency accessory noise blanker that operates in all modes.

Crystal lattice filter in first i-f prevents cross-modulation and desensitization due to strong adjacent channel signals.

Excellent overload and intermodulation characteristics.

25 kHz Calibrator permits working closer to band edges and segments.

Scratch resistant epoxy paint finish.

Price: \$599.00



Drake T-4XC

Solid State Linear permeability-tuned VFO with 1 kHz dial divisions. Gear driven dual circular dials. High mechanical, electrical and temperature stability.

Covers ham bands with crystals furnished. Covers all of 80, 40, 20 and 15 meters, and 28.5-29.0 MHz of 10 meters.

Covers 160 meters with accessory crystal. Four 500 kHz ranges in addition to the ham bands plus one fixed-frequency range can be switch-selected from the front panel.

Two 8-pole crystal lattice filters for sideband selection.

Transceives with the R-4, R-4A, R-4B, R-4C and SPR-4 Receivers. Switch on the T-4XC selects frequency control by receiver or transmitter PTO or independently. Illuminated dial shows which PTO is in use.

Usb, lsb, a-m and cw on all bands.

Controlled-carrier modulation for a-m is compatible with ssb linear amplifiers.

Automatic transmit-receive switching. Separate VOX time-delay adjustments for phone and cw. VOX gain is independent of microphone gain.

Choice of VOX or PTT. VOX can be disabled by front panel switch.

Adjustable pi network output.

Transmitting agc prevents flat-topping.

Meter reads relative output or plate current with switch on load control.

Built-in cw sidetone.

Spotting function for easy zero-beating.

Easily adaptable to RTTY, either fsk or afsk.

Compact size; rugged construction. Scratch resistant epoxy paint finish.

Price: \$599.00



Drake SPR-4 — \$629.00

- Programmable to meet specific requirements: SWL, Amateur, Laboratory, Broadcast, Marine Radio, etc.

- Direct frequency dialing: 150-500 kHz plus any 23 500 kHz ranges, 0.5 to 30 MHz

- FET circuitry, all solid state

- Linear dial, 1 kHz readout

- Band-widths for cw, ssb, a-m with built-in LC filter

- Crystals supplied for LW, seven SW, and bc bands

- Notch filter

- Built-in speaker



Drake DSR-2 — \$2950.00

- Continuous Coverage 10 kHz to 30 MHz

- Digital Synthesizer Frequency Control

- Frequency Displayed to 100 Hz

- All Solid State

- A-m, Ssb, Cw, RTTY, Isb

- Series Balanced Gate Noise Blanker

- Front End Protection

- Optional Features Available on Special Order

Power Supplies

Power Supplies for T-4, T-4X, T-4XB or T-4XC (The AC-4 can be housed in an MS-4 speaker cabinet).

Model No. 1501 Drake AC-4 \$120.00

Model No. 1505 Drake DC-4 \$135.00



Drake MS-4

Drake MS-4 Matching Speaker for use with R-4, R-4A, R-4B and R-4C Receivers. (Has space to house AC-3 and AC-4 Power Supplies)

Price: \$30.00

Accessories

DRAKE MICROPHONES

Wired for use with Drake transmitters and transceivers, for either push-to-talk or VOX. Type of operation is determined by the VOX control setting of the transmitter.



Desk Type Model No. 7075

- Type: Heavy Duty Ceramic Desk Top
- Cable: Four Foot, 3-Conductor, One Shield
- Output Level: Minus 54 dB (0 dB = 1 volt/microbar)
- Frequency Response: 80-7000 Hz
- Switching: Adapts to either push-to-talk or VOX

Price: \$39.00



Hand-Held Type Model No. 7072

- Type: Ceramic, hand held
- Cable: 11" Retracted, 5' extended, PVC 3 Cord, 1 shielded, Coil Cord
- Case: Cyclac
- Finish: Grey
- Output Level: Minus 65 dB (0 dB = 1 volt/microbar)
- Frequency Response: 300-3000 Hz
- Switching: Adapts to either push-to-talk or VOX

Price: \$19.00



Drake FS-4 Digital Synthesizer — \$250.00

The new solid state Drake FS-4 Synthesizer opens the door to a new world of continuous-tuning short wave! Combines synthesized general coverage flexibility with the selectivity, stability, frequency readout and reliability of the Drake R-4C or SPR-4 Receivers.

- Interfaces with all R-4 series receivers and T-4X series transmitters: (R-4, R-4A, R-4B, R-4C, SPR-4, T-4, T-4X, T-4XB and T-4XC), without modification.
- MHz range is set on FS-4, with kHz readout taken from receiver dial.
- Complete general coverage—no range crystals to buy.
- T-4/T-4X series transmitters transceive on any FS-4 frequency, when used with R-4 series receivers.
- Readout 1 kHz with Drake PTO.

Price: \$250.00

TUFTS RADIO CATALOG TUFTS RADIO



- Remote
- Motor Controlled

RCS-4

COAX ANTENNA SWITCH



- Control unit works on 110/220 VAC, 50/60 Hz, and supplies necessary DC to motor.
- Excellent for single coax feed to multiband quads or arrays of monobanders. The five positions allow a single coax feed to three beams and two dipoles, or other similar combinations.
- Control cable (not supplied) same as for HAM-M rotator.
- Selects antennas remotely, grounds all unused antennas. GND position grounds all antennas when leaving station. "Rain-Hat" construction shields motor and switches.
- Motor: 24 VAC, 2 amp. Lubrication good to -40°F.
- Switch RF Capability: Maximum legal limit. Price: \$120.00

MATCHING NETWORKS



MN-4 200 watts
MN-2000 2000 watts PEP

Price: \$120.00 Price: \$240.00

General: • Integral Wattmeter reads forward power in watts and VSWR directly; can be calibrated to read reflected power • Matches 50 ohm transmitter output to coax antenna feedline with VSWR of at least 5:1 • Covers ham bands 80 thru 10 meters • Switches in or out with front panel switch • Size: 5 1/2" H, 10 1/4" W, 8" D (14.0 x 27.3 x 20.3 cm), MN-2000, 14 1/2" D (36.5 cm).
• Continuous Duty Output: MN-4, 200 watts; MN-2000, 1000 watts (2000 watts PEP) • MN-2000 only: Up to 3 antenna connectors selected by front panel switch.



RF WATTMETERS

W-4 1.8-54 MHz Price: \$ 72.00
WV-4 20-200 MHz Price: \$ 84.00

Reads forward and reflected power directly in watts (VSWR from nomogram). Two scales in each direction. Size: 5 1/2" H, 3 1/4" W, 4" D (14.0 x 9.5 x 10.2 cm).

Model	Full Scale	Calibration Accuracy
W-4	200 watts 2000 watts	(5% of reading + 2 watts) ±(5% of reading + 20 watts)
WV-4	100 watts 1000 watts	±(5% of reading + 1 watt) ±(5% of reading + 10 watts)



SSR-1 COMMUNICATIONS RECEIVER

GENERAL: • All amateur bands 10 thru 80 meters in seven 600 kHz ranges • Solid State VFO with 1 kHz dial divisions • Modes SSB Upper and Lower, CW and AM • Built-in Sidetone and automatic T/R switching on CW • 30 tubes and semi-conductors • Dimensions: 5 1/2" H, 10 1/4" W, 14 1/2" D (14.0 x 27.3 x 36.5 cm), Wt.: 16 lbs. (7.3 kg).
TRANSMIT: • VOX or PTT on SSB or AM • Input Power: SSB, 300 watts P.E.P.; AM, 260 watts P.E.P. controlled carrier compatible with SSB linears; CW, 260 watts • Adjustable pi-network.
RECEIVE: • Sensitivity better than 1/2 µV for 10 dB S/N • I.F. Selectivity 2.1 kHz @ 6 dB, 3.6 kHz @ 60 dB. • AGC full on receive modes, variable with RF gain control, fast attack and slow release with noise pulse suppression • Diode Detector for AM reception.

Price: \$699.00
34-PNB Plug-in Noise Blanker 100.00
FF-1 Crystal Control Unit 46.95
MMK-3 Mobile Mount 7.00
RV-4C Remote VFO \$150.00

- Synthesized • General Coverage
- Low Cost • All Solid State • Built-in AC Power Supply • Selectable Sidebands
- Excellent Performance

PRELIMINARY SPECIFICATIONS: • Coverage: 500 kHz to 30 MHz • Frequency can be read accurately to better than 5 kHz • Sensitivity typically .5 microvolts for 10 dB S+N/N SSB and better than 2 microvolts for 10 dB S+N/N AM • Selectable sidebands • Built-in power supply: 117/234 VAC ± 20% • If the AC power source fails the unit switches automatically to an internal battery pack which uses eight D-cells (not supplied) • For reduced current drain on DC operation the dials do not light up unless a red pushbutton on the front panel is depressed.
The performance, versatility, size and low cost of the SSR-1 make it ideal for use as a stand-by amateur or novice-amateur receiver, short wave receiver, CB monitor receiver, or general purpose laboratory receiver.

Price: \$350.00



TR-4CW SIDEBAND TRANSCEIVER

POWER SUPPLIES
AC-4 Power Supply \$120.00
DC-4 Power Supply 135.00

2 METER FM PORTABLE TRANSCEIVER Model TR-33C



Amateur Net \$229.95

- SCPC* Frequency Control
- 12 Channels with Selectable Xmtr Offsets.
- All FET Front-end and Crystal Filter for Superb Receiver Intermod Rejection.
- Expanded Antenna Choice.
- Low Receiver Battery Drain.
- Traditional R. L. Drake Service Backup.
- Single Crystal Per Channel.

LINEAR AMPLIFIER Model L-4B



L-4B Linear Amplifier 895.00
• 2000 Watts PEP-SSB • Class B Grounded-Grid - two 3-500Z Tubes • Broad Band Tuned-Input • RF Negative Feedback • Transmitting AGC • Directional Wattmeter • Two Tautband Suspension Meters • L-4B 13-15/16" W, 7-7/8" H, 14-5/16" D. Wt.: 32 lbs. • Power Supply 6-3/4" W, 7-7/8" H, 11" D, Wt.: 43 lbs.
POWER SUPPLIES
AC 4 Power Supply \$120.00
DC 4 Power Supply 135.00

Touch-n-go with
DRAKE 1525EM
Push Button Encoding Mike



Drake 1525EM, microphone with tone encoder and connector for TR-33C, TR-22, TR-22C, ML-2 \$49.95

- Microphone and auto-patch encoder in single convenient package with coil cord and connector. Fully wired and ready for use.
- High accuracy IC tone generator, no frequency adjustments.
- High reliability Digitran® keyboard.
- Power for tone encoder obtained from transceiver through microphone cable. No battery required. Low current drain.
- Low output impedance allows use with almost all transceivers.
- Four pin microphone plug: directly connects to Drake TR-33C without any modification in transceiver. Compatible with all previous Drake and other 2 meter units with minor modifications.
- Tone level adjustable.
- Hang-up hook supplied.

why waste watts?

(SWR-1A \$25.95)



SWR-1 guards against power loss

If you're not pumping out all the power you're paying for, our little SWR-1 combination power meter and SWR bridge will tell you so. You read forward and reflected power simultaneously, up to 1000 watts RF and 1:1 to infinity VSWR at 3.5 to 150 MHz.

Got it all tuned up? Keep it that way with SWR-1. You can leave it right in your antenna circuit.



DELUXE 742 TRI-BAND MOBILE ANTENNA

- Automatically adjusts to proper resonance for 20, 40 and 75 meters.
- Power rated at 500 Watts P.E.P.
- Includes base section, automatic coil and whip top section.

Price: \$109.95

EXCLUSIVE DELUXE 5-BAND MOBILE 45 ANTENNA

- All band manual switching antenna for 10, 15, 20, 40 and 75 meters.
- Power rated at 1000 Watts P.E.P.
- Includes base section with mobile coil and six foot whip top section.

Price: \$119.95

JMR MOBIL-EAR™

Two-way-radio headset with superior fidelity Electret-Capacitor boom microphone and palm-held talk switch.

\$69.95



MODEL 1015-A

FOR BROADCAST-QUALITY TRANSMISSION AND RECEPTION FOR BOTH MOBILE UNITS AND BASE STATIONS.

- Boom-mounted electret-capacitor microphone delivers studio-quality, undistorted voice reproduction. Variable gain control lets you adjust for optimum modulation.
- Cushioned earcup lets you monitor in privacy - no speaker blare to disturb others. Blocks out environmental noises, too. Made of unbreakable ABS plastic.
- Headband self-adjusts for comfortable wear over long hours. Spring-flex hinge lets you slip headset on and off with just one hand. Reversible for right or left ear.
- Headset can be hung on standard microphone clip.
- Compact palm-held talk switch lets you keep both hands on the wheel for safer driving. Made of unbreakable ABS plastic.
- Built-in FET transistor amplifier adapts microphone output to any transceiver impedance.
- Compatible with most two-way radios including 40-channel CB units.
- Built-in Velcro pad for easy mounting of the talk switch.
- Made in U.S.A.

SWAN METERS HELP YOU GET IT ALL TOGETHER

These wattmeters tell you what's going on.

With one of these in-line wattmeters you'll know if you're getting it all together all the time. Need high accuracy? High power handling? Peak

power readings? For whatever purpose we've got the wattmeter for you. Use your Swan credit card. Applications at your dealer or write to us.



WM2000 In-Line Wattmeter With Muscle. Scales to 2000 watts. New flat-response directional coupler for maximum accuracy. \$59.95



WM3000 Peak-reading Wattmeter. Reads RMS power, then with the flick of a switch, true peak power of your single-sideband signal. That's what counts on SSB. \$79.95



WM1500 High-Accuracy In-Line Wattmeter. 10% full scale accuracy on 5, 50, 500 and 1500 watt scales. 2 to 30 MHz. Forward and reflected power. Use it for trouble-shooting, too. \$74.95



SWAN LINEAR AMPLIFIERS A Mark II 2000 watt P.E.P. full legal input power unit or the 1200X matching Cygnet 1200 watt P.E.P. input powerhouse with built-in power supply. The choice is yours. \$849.95



NEW Swan MMBX Impedance Matcher

It keeps your transmitter and your antenna on speaking terms for a song. Price: \$23.95

CYGNET 1200X PORTABLE LINEAR AMPLIFIER

To quadruple the output of the 300B Cygnet *de novo*, simply add this matching unit for more than a kilowatt of power. Complete with self-contained power supply and provision for external ALC, this Cygnet offers exceptionally high efficiency and linearity. \$349.95



Additional Swan products include: fixed and mobile antennas, VFO's telephone patch, VOX, wattmeter, microphones and mounting kits. As another extra service, only Swan Electronics offers factory-backed financing to the amateur radio community. Visit an authorized Swan Electronics dealer for complete details



SPECIFICATIONS

- Earphone impedance and type: 8 ohms, dynamic
- Microphone type: Electret capacitor
- Microphone frequency response: 200-6000 Hz
- Amplifier type: FET transistor, variable gain
- Amplifier battery 7-volt Mallory power: TR-175
- Switching: Relay or electronic

IDEAL FOR EVERY TWO-WAY RADIO COMMUNICATIONS NEED . . .

- CB operators • Amateur radio operators • Police and fire vehicles • Ambulances and emergency vehicles • Taxis and truckers • Marine pleasure and work boats • Construction and demolition crews • Industrial communications • Security patrols • Airport tower and ground crews • Remote broadcast and TV-camera crews • Foresters and fire-watch units •

A new precision clock which tells time anywhere in the world at a glance, has been announced by Yaesu Electronics Corporation. The time in any principal city or time zone can be simultaneously coordinated with local time on a 24 hour basis. After the initial setting, as the clock runs, a Time Zone Hour Disc advances automatically, showing correct time all over the world without further adjustment. The clock is especially designed to withstand shock and may be hung on a wall or placed on its desk mount. The clock will run an entire year on a single 1.5 volt flashlight battery and the mechanism starts as soon as the battery is inserted. It measures six inches in diameter by two and one half inches deep. An excellent item for the business office, ham radio operator, short wave listener, boat owner, and others who want an accurate dependable clock. Price: \$30.00 Amateur net.

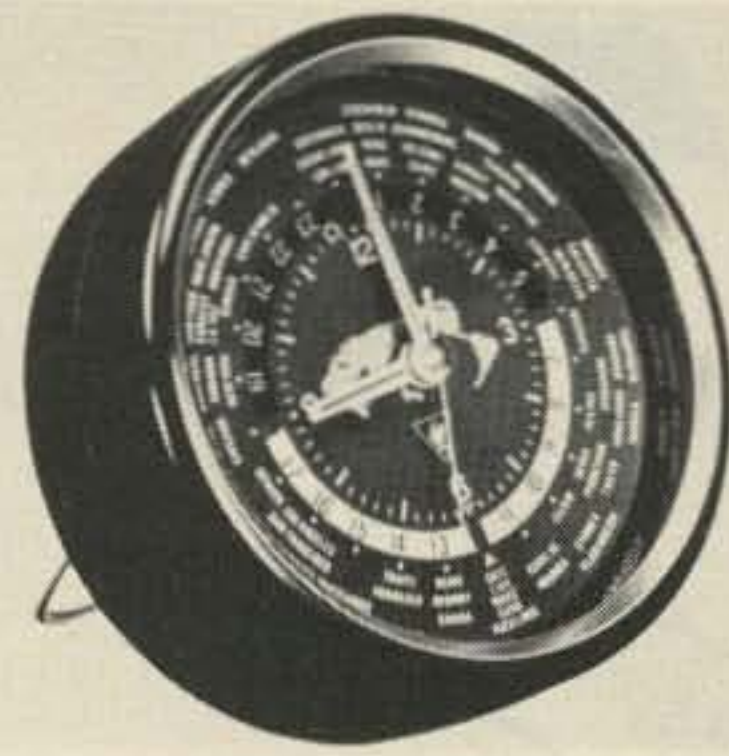

TUFTS RADIO CATALOG TUFTS RADIO

Educator II & Power Supply Kits



- KEY FEATURES**
- On-board clock.
 - 128 x 8 RAM
 - On-board provision for second 128 x 8 RAM
 - Resident executive provides for front panel control.
 - Built-in cassette interface for program load and record.
 - Search feature for program load from cassette provided.
 - Edge connectors provide full interface to peripheral interface adapter (PIA) and all address, data and control bus signals for system expansion.
 - Test-As-You-Build for accurate, error-free construction.
 - Easy, quick construction — one evening.
 - Support documentation aimed at teaching MPU theory and programming.
 - Completely self-contained. All parts included as well as complete construction manual.
 - Separate power supply required 5V @ 1.0 amps.

- KEY FEATURES**
- Designed specifically for the Educator II
 - Regulated 5.0 ± 5% volts d.c. output @ 1.0 amps.
 - 60 Hz real time clock available (approximately 5.1V peak-to-peak).
 - Complete kit — all parts, cabinet and construction manual.
 - Easy, one evening construction.

CUSTOMER INFORMATION

EDUCATOR II KIT PRICING INFORMATION:
Suggested Resale: \$169.95

ACCESSORIES TO COME IN NEAR FUTURE:
VIDEO DISPLAY
KEYBOARD
MODULE CARD RACK AND POWER SUPPLY
MEMORY MODULES
APPLICATIONS PROGRAMS ON CASSETTES

ACCESSORIES:
POWER SUPPLY (SEE PHOTO ABOVE):
Suggested Resale: \$29.95
ADDITIONAL 128 x 8 RAM (C4811):
Suggested Resale: \$19.04

WHEN SYSTEM 3000 BYTES you will never let go!



- **TEN FRONT-PANEL-PROGRAMMABLE PRIORITY CHANNELS** for storage of frequency, transmitter offset, and tone encoder/decoder mode/frequency.
- **BUILT-IN SCANNER** for automatic tuning in user-selected one or four MHz bands. Scan speed 2.5 sec/MHz, adjustable pause.
- **PRIORITY CHANNEL SILENT MONITOR** so you can operate on one frequency while monitoring another.
- **TWO FREQUENCY TONE ENCODER/DECODER** provides two selectable, fully adjustable, sub-audible tones for transmit and/or tone-coded squelch.
- **ANY TRANSMITTER OFFSET** without additional crystals.
- **AUDIO/VISUAL ALARM** to let you know when the monitored priority channel is occupied or when tone-coded squelch is activated.
- **ADVANCED PLL SYNTHESIZER** covers 144.000 — 147.995 MHz with full push-button tuning.
- **SUPERIOR RECEIVER** with sensitivity, selectivity and intermodulation characteristics that are more like military than amateur.
- **POWER OUTPUT ADJUSTABLE TO 25 WATTS.**
- **EXTRAORDINARY WARRANTY.** Every SYSTEM 3000 is warranted to be free from defects for two full years, and it is American made so servicing is no problem.
- **SMALL SIZE.** Designed for mobile and fixed operation, SYSTEM 3000 is only 5.3 inches wide, 2.6 inches high and 11 inches deep.
- **VERY COMPETITIVELY PRICED.** Introductory price is only \$499.



No. 114-320-003 — \$9.90
No. 114-322-003 — Brass — \$10.30
No. 114-320-001 — \$8.30
No. 114-322-001 — Brass — \$8.65
No. 114-310-003 — \$8.25
No. 114-312-003 — Brass — \$8.65

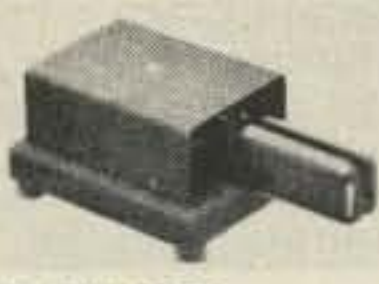

No. SSK-1 \$23.95
No. SSK-1CP-Chrome — \$29.95

NYE VIKING SPEED-X KEYS
NYE VIKING Standard Speed-X keys feature smooth, adjustable bearings, heavy-duty silver contacts, and are mounted on a heavy oval die cast base with black wrinkle finish. Available with standard, or Navy knob, with, or without switch, and with nickel or brass plated key arm and hardware.

Pamper yourself with a Gold-Plated NYE VIKING KEY!
Model No. 114-31C-004GP has all the smooth action features of NYE Speed-X keys in a special "presentation" model. All hardware is heavily gold plated and it is mounted on onyx-like jet black plastic sub-base. List price is \$50.00.

CODE PRACTICE SET
You get a sure, smooth, Speed-X model 310-001 transmitting key, linear circuit oscillator and amplifier, with a built-in 2" speaker, all mounted on a heavy duty aluminum base with non-skid feet. Operates on standard 9V transistor type battery (not included). List price, \$18.50.

PHONE PATCH Model No. 250-46-1 measures 6-1/2" wide, 2-1/4" high and 2-7/8" deep. List price, \$36.50. Model 250-46-3, designed for use with transceivers having a built-in speaker, has its own built-in 2" x 6" 2 watt speaker. Measures 6-1/2" wide, 2-1/4" high and 2-7/8" deep. List price, \$44.50.

Mosley

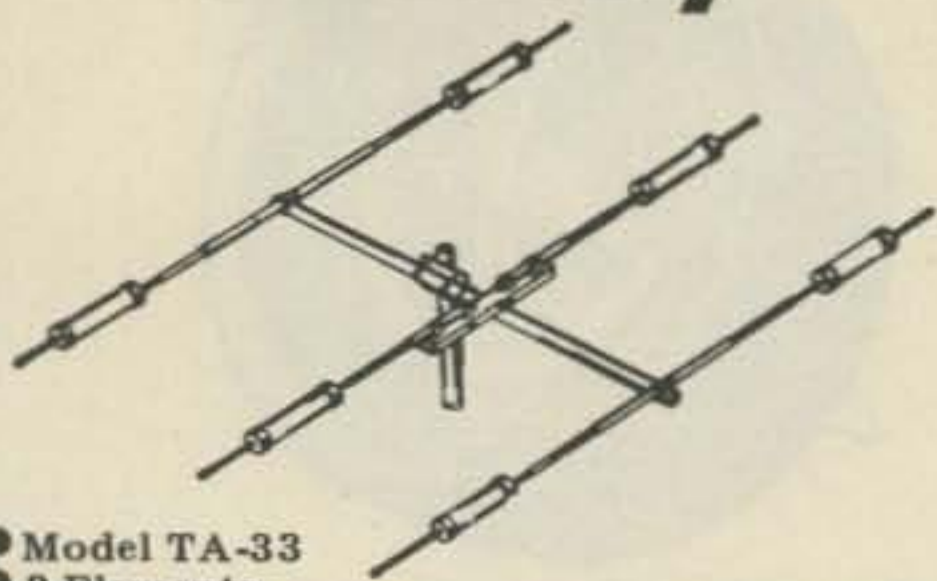

- Model TA-33
- 3 Elements
- 10.1 db Forward Gain (over isotropic source)
- 20 db Front-to-Back Ratio

The Mosley TA-33, 3-element beam provides outstanding 10, 15 and 20 meter performance. Exceptionally broadband — gives excellent results over full Ham bandwidth. Incorporating Mosley Famous Trap-Master traps. Power Rating — 2KW P.E.P. SSB. The TA-33 may also be used on 40 meters with TA-40KR conversion. Complete with hardware. \$206.50

**MULTI-BAND BEAMS
TRAP MASTER 33 ... 10, 15 & 20 Meters**

- Model TA-33Jr.
- 3 Elements
- 10.1 db Forward Gain (over isotropic source)
- 20 db Front-to-Back Ratio

The TA-33Jr ... incorporates Mosley Trap-Master Junior traps. This is the low power brother of the TA-33. Power Rating — 1 KW P.E.P. SSB. \$151.85

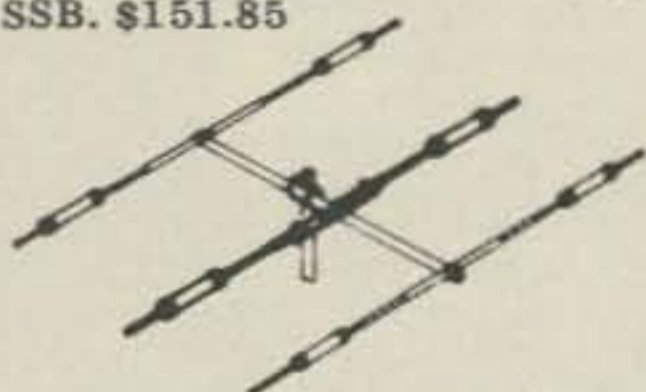

**TA-33JR. POWER CONVERSION KIT
MODEL MPK-3**

Owners of the Mosley Trap-Master TA-33Jr. may obtain higher power without buying an entirely new antenna. The addition of the MPK-3 (power conversion kit) converts the TA-33Jr. into essentially a new antenna with 750 watts AM/CW and 2000 watts P.E.P. SSB. \$52.25

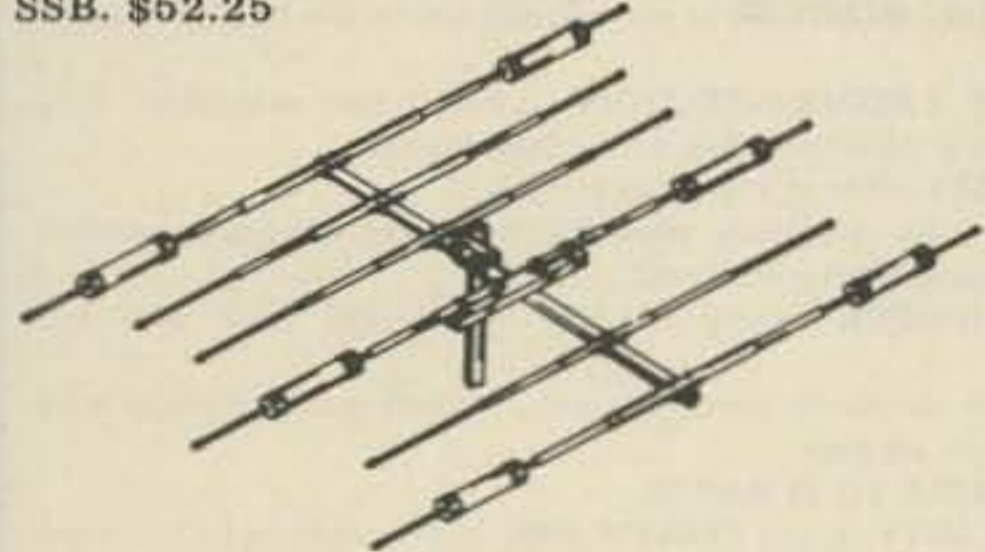

TRAP MASTER 36 ... 10, 15 & 20 Meters

- Model TA-36
- 6 Elements
- Forward Gain (over isotropic source) - 10.1 db on 15 & 20 meters, 11.1 db on 10 meters.

Front-to-Back Ratio on all bands. 20 db. This wide-spaced, six element configuration employs 4 operating elements on 10 meters, 3 operating elements on 15 meters, and 3 operating elements on 20 meters. Automatic bandswitching is accomplished through Mosley exclusively designed high impedance parallel resonant "Trap Circuit." The TA-36 is designed for 1000 watts AM/CW or 2000 watts P.E.P. SSB. Traps are weather and dirt proof, offering frequency stability under all weather conditions. \$335.25

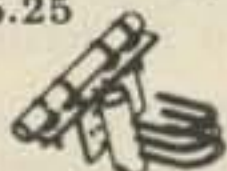

MOSLEY AK-60 MAST PLATE ADAPTER
Mast Plate Adapter for adapting your Mosley 1½" mounted beam to fit 2" OD mast. Complete with angle and hardware. \$11.15



**A brilliant new 2 meter transceiver
with every in-demand operating
feature and convenience
KLM MULTI - 2700 - \$ 795.95**

- ★ Synthesizer and VFO.
- ★ All modes: NBFM, WBFM, AM, SSB w/USB/LSB and CW.
 - Frequency synthesizer (PLL)
 - 3 Knob, 600 channels, 10 kHz steps.
 - VXO, plus or minus 7 kHz.
- ★ LED readout on synthesizer.
 - Standard 600 kHz splits plus ...
 - Two "oddball" splits.
- ★ OSCAR transceive 2 to 10 meter operation.
 - OSCAR receiver built-in.
 - Connectors on rear for separate 2

- meter and 10 meter antennas.
- Built-in VFO (continuous coverage, 144-148 MHz in 1.3 MHz segments. 1 kHz readout).
- 8 pole SSB filter plus two FM filters.
- 100 kHz crystal calibrator.
- Voice operated relay (VOX) or p-t-t.
- ★ Audio speech compression.
 - Noise blanker.
 - RIT, plus or minus 5 kHz.
 - Power out/"S" meter.
 - FM center deviation meter.
 - 10W minimum output power. NO TUNING!
 - Hi-Lo power provision.
 - Built-in AC/DC power supply.
 - Double conversion receiver. 16.9 MHz and 455 kHz I-Fs.
 - Receiver sensitivity:
 - FM: 0.5µV for 28 dB S/N.
 - SSB/CW: 0.25µV for 14 dB S/N.
 - AM: 2µV for 10 dB S/N.
 - Size: Inches: 5H, 14.88W, 12D.
 - MM: 128H, 378W, 305D.
 - Weight: 28 lbs. (13 KG).

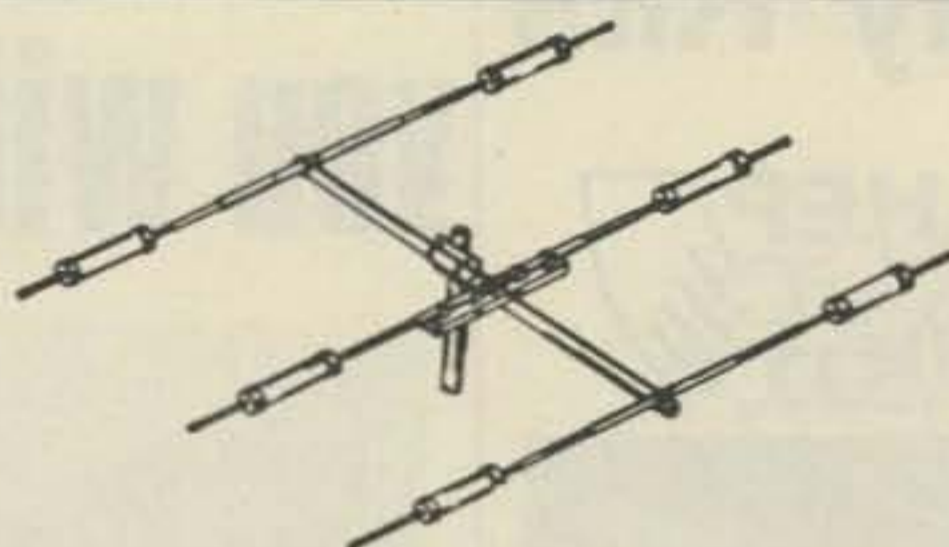

**CLASSIC-33 ... 10, 15 & 20 Meters
Model CL-33**

- 3 Elements
- 10.1 db Forward Gain (over isotropic source) on all bands.
- 20 db Front-to-Back Ratio on 15 & 20 meters, 15 db on 10 meters.

BRIDGING THE GAP ... The Classic 33, combines the best of two Mosley systems. Incorporating Mosley Classic Feed System for a "Balanced Capacitive Matching" system with a feed point impedance of 52 ohms at resonance, and the Famous Mosley Trap-Master Traps for "weather-proof" traps with resonant frequency stability. This extra sturdy multi-band beam, Model CL-33, for operation on 10, 15 & 20 meters features improved boom to element clamping, stainless steel hardware, balanced radiation and a longer boom for even wider element spacing. Power Rating — 2 KW P.E.P. SSB. Recommended mast size — 2" OD. Wind Load — 120 lbs. at 80 MPH. Approx. shipping weight — 45 lbs. \$232.50

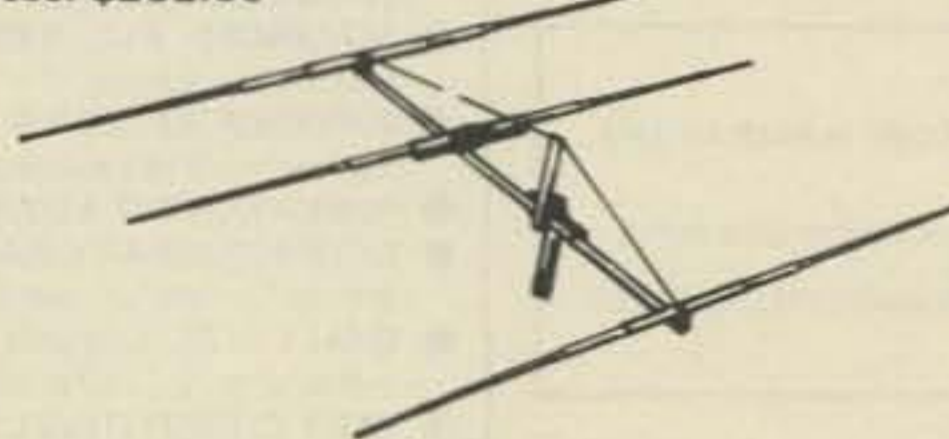

**CLASSIC-203 ... 20 Meters
Model CL-203**

- 3 Elements
- 10.1 db Forward Gain (over isotropic source)
- 20 db Front-to-Back Ratio

Incorporating the Mosley patented Classic Feed System, this full size 20 meter single-band beam has 1½" to 3/8" dia. "swaged" elements wide spaced on a 2" dia. 24' boom. Maximum element length—37' 8½". The high standards in quality construction established by Mosley in over a quarter-century of manufacturing is reflected in this mono-band ... Model CL-203. Boom-to-mast clamping assures stability with a time-tested arrangement of mast plate, cast aluminum clamping blocks and stainless steel U-bolts. The exclusive "Balanced Capacitive Matching" System has a nominal feed point impedance of 52 Ohms at 2 KW P.E.P. SSB. Recommended mast size—2" O.D. Approx. shipping wt: 42 lbs. via truck. \$227.65

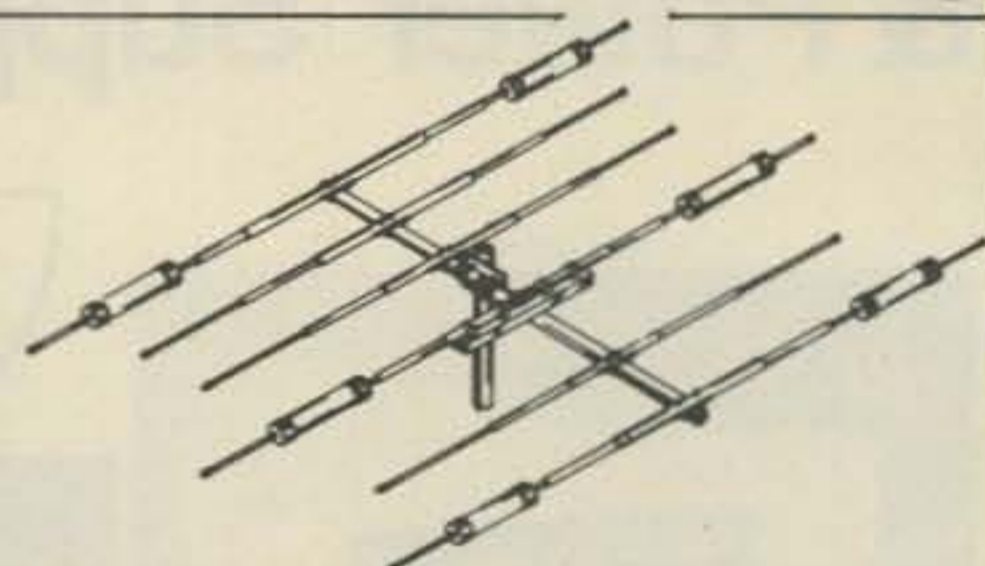

**CLASSIC-36 ... 10, 15 & 20 Meters
Model CL-36**

- 6 Elements
- 10.1 db Forward Gain (over isotropic source) on 15 & 20 meters, 11.1 db on 10 meters.
- 20 db Front-to-Back Ratio on all bands.

The Classic 36, like the smaller Classic 33, incorporates both the Mosley World-Famous Trap-Master Traps and the Mosley Classic Feed-System. Designed to operate on 10, 15 & 20 meters, this multi-band beam Model CL-36, employs the high standards of quality construction found in all Mosley products. The boom-to-mast clamping assures stability with a time-tested arrangement of mast plate, cast aluminum clamping blocks and stainless steel U-bolts. The exclusive "Balanced Capacitive Matching" system has a feed point impedance of 52 ohms at resonance. Wind Load — 210.1 lbs. at 80 MPH. Power Rating — 2 KW P.E.P. SSB. Recommended mast size — 2" OD. Approx. shipping weight — 71 lbs. via truck. \$310.65

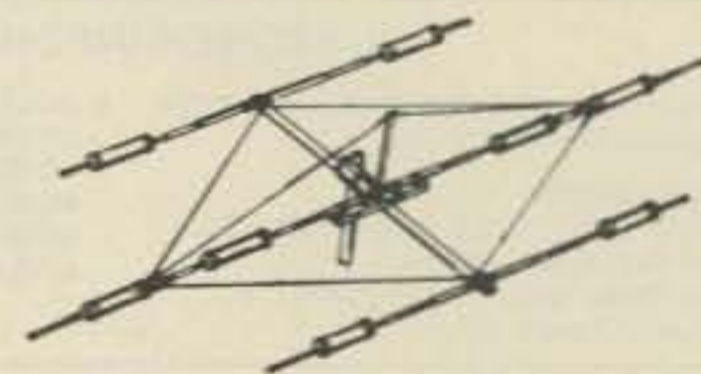

40 METER CONVERSION KIT MODEL TA-40KR

Work 40 meters in addition to 10, 15 & 20 meters by using a TA-40KR conversion kit on the radiator element of the TA-33 and TA-36. (Beams with broad band capacitive matching may not be converted!) Convert the TA-33Jr. with the MPK-3 (power conversion kit) before adding the TA-40KR kit. \$92.25

SIGNAL-MASTER ANTENNA

Beam Antenna ... Model S-402 for 40 meters For a top signal needed to push through forty meter QRM, the Mosley Signal Master S-402 will do the trick! This 100% rust-proof 2-element beauty constructed of rugged heavy-wall aluminum is designed and engineered to provide the performance you need for both DX hunting and relaxing in a QRM free rag-chewing session. Beam is fed through link coupling, resulting in an excellent match over the entire bandwidth. \$267.50

6 METER BEAMS

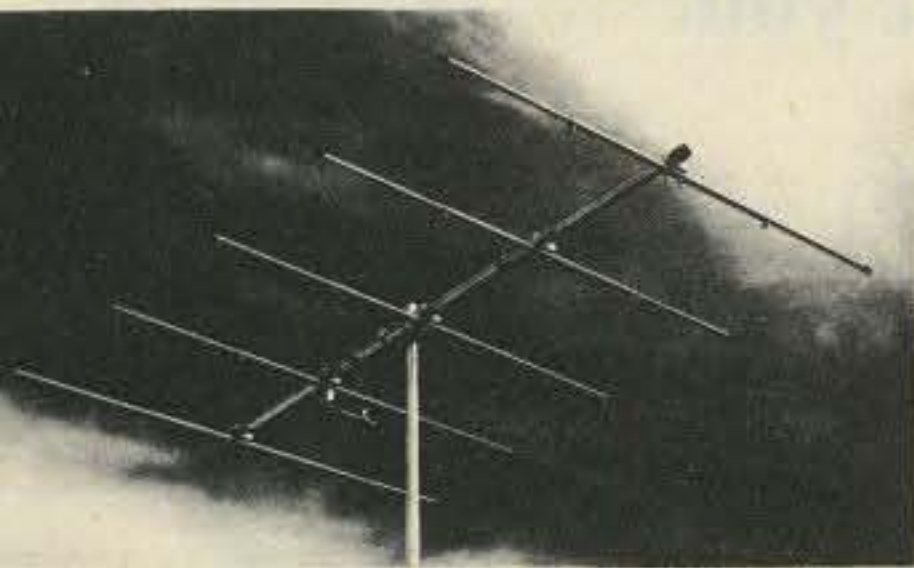

3-5-6-10 ELEMENTS

Proven performance from rugged, full size, 6 meter beams. Element spacings and lengths have been carefully engineered to give best pattern, high forward gain, good front to back ratio and broad frequency response.

Booms are .058 wall and elements are 3/4" - 5/8" .049 wall seamless chrome finish aluminum tubing. The 3 and 5 element beams have 1 3/8" - 1 1/4" booms. The 6 and 10 element beams have 1 5/8" - 1 1/2" booms. All brackets are heavy gauge formed aluminum. Bright finish cad plated bolts are adjustable for up to 1 5/8" mast on 3 and 5 element and 2" on 6 and 10 element beams. All models may be mounted for horizontal or vertical polarization.

New features include adjustable length elements, kilowatt Reddi Match and built-in coax fitting for direct 52 ohm feed. These beams are factory marked and supplied with instructions for quick assembly.

Description	3 element	5 element	6 element	10 element
Model No.	A50-3	A50-5	A50-6	A50-10
Boom Length	6"	12"	20"	24"
Longest El.	117"	117"	117"	117"
Turn Radius	6"	7' 6"	11'	13'
Fwd. Gain	7.5 dB	9.5 dB	11.5 dB	13 dB
F/B Ratio	20 dB	24 dB	26 dB	28 dB
Weight	7 lbs.	11 lbs.	18 lbs.	25 lbs.

new
RINGO RANGER
for FM

12.5 dB* - 6 dB**
Omnidirectional
GAIN
BASE STATION
ANTENNAS
FOR
MAXIMUM
PERFORMANCE
AND
VALUE

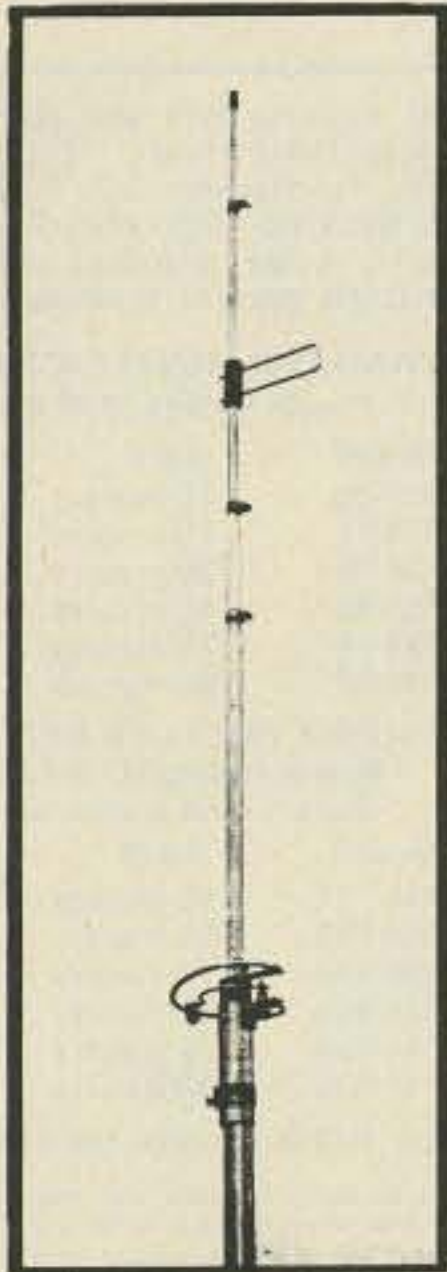

Cush Craft has created another first by making the world's most popular 2 meter antenna twice as good. The new Ringo Ranger is developed from the basic AR-2 with three half waves in phase and a one eighth wave matching stub. Ringo Ranger gives an extremely low angle of radiation for better signal coverage. It is tunable over a broad frequency range and perfectly matched to 52 ohm coax.

ARX-2, 137-160 MHz, 4 lbs., 112"
ARX-220, 220-225 MHz, 3 lbs., 75"
ARX-450, 435-450 MHz, 3 lbs., 39"

* Reference 1/2 wave dipole.
** Reference 1/4 wave whip used as gain standard by many manufacturers.

Work full quieting into more repeaters and extend the radius of your direct contacts with the new Ringo Ranger.

You can up date your present AR-2 Ringo with the simple addition of this extend. kit. The kit includes the phasing network and necessary element extensions. The only modifications required are easy to make saw slits in the top section of your antenna.

ARX-2K CONVERSION KIT

2 METER FM ANTENNAS

A-FM RINGO 3.75 dB Gain (reference 1/4 wave whip). Half wave length antennas with direct dc ground, 52 ohm feed takes PL-259, low angle of radiation with 1:1 SWR. Factory preassembled and ready to install, 6 meter partly preassembled, all but 450 MHz take 1 1/4" mast. There are more Ringos in use than all other FM antennas combined.

Model Number	AR-2	AR-25	AR-6	AR-220	AR-450
Frequency MHz	135-175	135-175	50-54	220-225	440-460
Power-Hdlg. Watts	100	500	100	100	250
Wind area sq. ft.	.21'	.21'	.37'	.20'	.10'

B-4 POLE Up to 9 dB Gain over a 1/2 wave dipole. Overall antenna length 147 MHz - 23' 220 MHz - 15', 435 MHz - 8', pattern 360° - 6 dB gain, 180° - 9 dB gain, 52 ohm feed takes PL 259 connector. Package includes 4 complete dipole assemblies on mounting booms, harness and all hardware. Vertical support mast not supplied.

AFM-4D 144-150 MHz, 1000 watts, wind area 2.58 sq. ft.
AFM-24D 220-225 MHz, 1000 watts, wind area 1.85 sq. ft.
AFM-44D 435-450 MHz, 1000 watts, wind area 1.13 sq. ft.

D-POWER PACK The big signal (22 element array) for 2 meter FM, uses two A147-11 yagis with a horizontal mounting boom, coaxial harness and all hardware. Forward gain 16 dB, F/B ratio 24 dB, 1/2 power beamwidth 42°, dimensions 144" x 80" x 40", turn radius 60", weight 15 lbs., 52 ohm feed takes PL-259 fitting.

A147-22 146-148 MHz, 1000 Watts, wind area 2.42 sq. ft.

D-YAGI STACKING KITS VPK includes horizontal mounting boom, harness, hardware and instructions for two vertically polarized yagis gives 3 dB gain over the single antenna.

A14-VPK, complete 4 element stacking kit
A14-SK, 4 element coax harness only
A147-VPK, complete 11 element stacking kit
A147-SK, 11 element coax harness only
A449-SK, 6 + 11 element coax harness only

E-4-6-11 ELEMENT YAGIS The standard of comparison in VHF-UHF communications, now cut for FM and vertical polarization. The four and six element models can be tower side mounted. All are rated at 1000 watts with direct 52 ohm feed and PL-259 connectors.

Model Number	A147-11	A-147-4	A449-11	A449-6	A220-11
Boom/Longest ele.	144"/40"	44"/40"	60"/13"	35"/26"	102"/26"
Wght./Turn radius	6 lbs., 72"	3 lbs., 44"	4 lbs., 60"	3 lbs., 18"	5 lbs., 51"
Gain/F/B ratio dB	13.2/28	9/20	13.2/28	11/25	13.2/28
1/2 Power beam	48°	66°	48°	60°	48°
Wind area sq. ft.	1.21	.43	.39	.30	.50
Frequency MHz	146-148	146-148	440-450	440-450	220-225

F-FM TWIST 12.4 dB Gain: Ten elements horizontal polarization for low end coverage and ten elements vertical polarization for FM coverage. Forward gain 12.4 dB, F/B ratio 22 dB, boom length 130", weight 10 lbs., longest element 40", 52 ohm Reddi Match driven elements take PL-259 connectors, uses two separate Feed lines.

A147-20T 145-147 MHz, 1000 watts, wind area 1.42 sq. ft.

HIGH PERFORMANCE VHF YAGIS

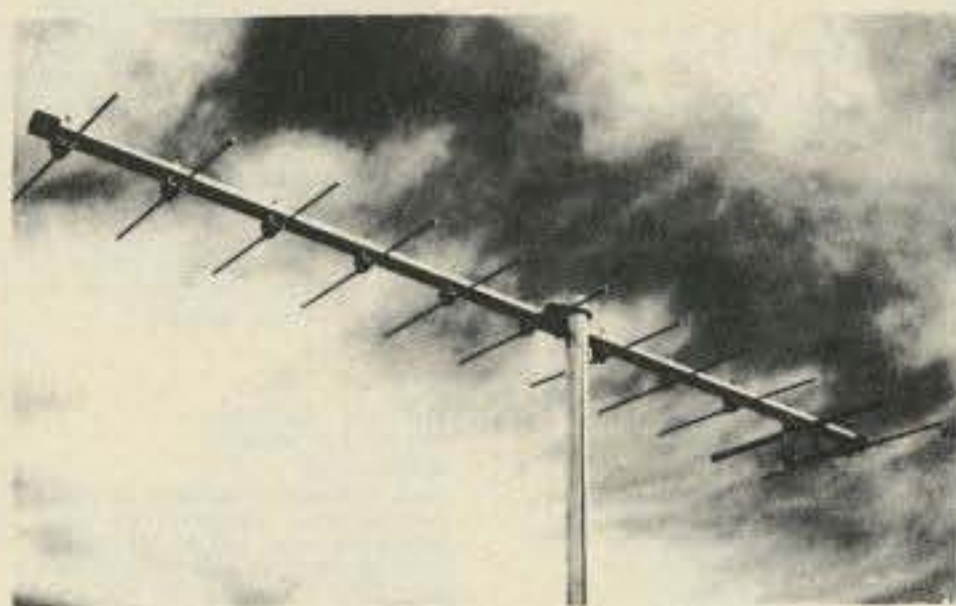

3/4, 1-1/4, 2 METER BEAMS

The standard of comparison in amateur VHF/UHF communications Cush Craft yagis combine all out performance and reliability with optimum size for ease of assembly and mounting at your site.

Lightweight yet rugged, the antennas have 3/16" O.D. solid aluminum elements with 5/16" center sections mounted on heavy duty formed brackets. Booms are 1" and 7/8" O.D. aluminum tubing. Mast mounts of 1/8" formed aluminum have adjustable u-bolts for up to 1-1/2" O.D. masts. They can be mounted for horizontal or vertical polarization. Complete instructions include data on 2 meter FM repeater operation.

New features include a kilowatt Reddi Match for direct 52 ohm coaxial feed with a standard PL-259 fitting. All elements are spaced at .2 wavelength and tapered for improved bandwidth.

Model No.	A144-7	A144-11	A220-11	A430-11
Description	2m	2m	1 1/2m	1 1/2m
Elements	7	11	11	11
Boom Length	98"	144"	102"	57"
Weight	4	6	4	3
Fwd. Gain	11 dB	13 dB	13 dB	13 dB
F/B Ratio	26 dB	28 dB	28 dB	28 dB
Fwd. Lobe @ 1/2 pwr. pt.	46	42	42	42
SWR @ Freq.	1 to 1	1 to 1	1 to 1	1 to 1

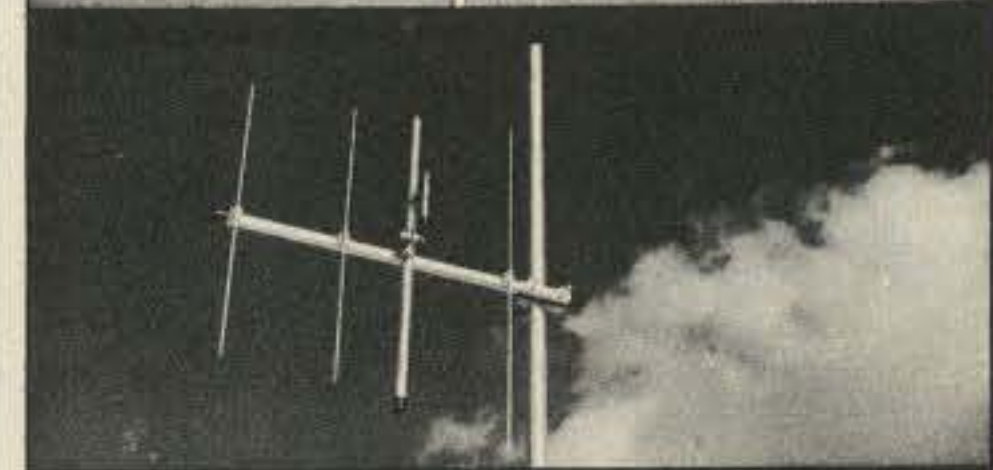
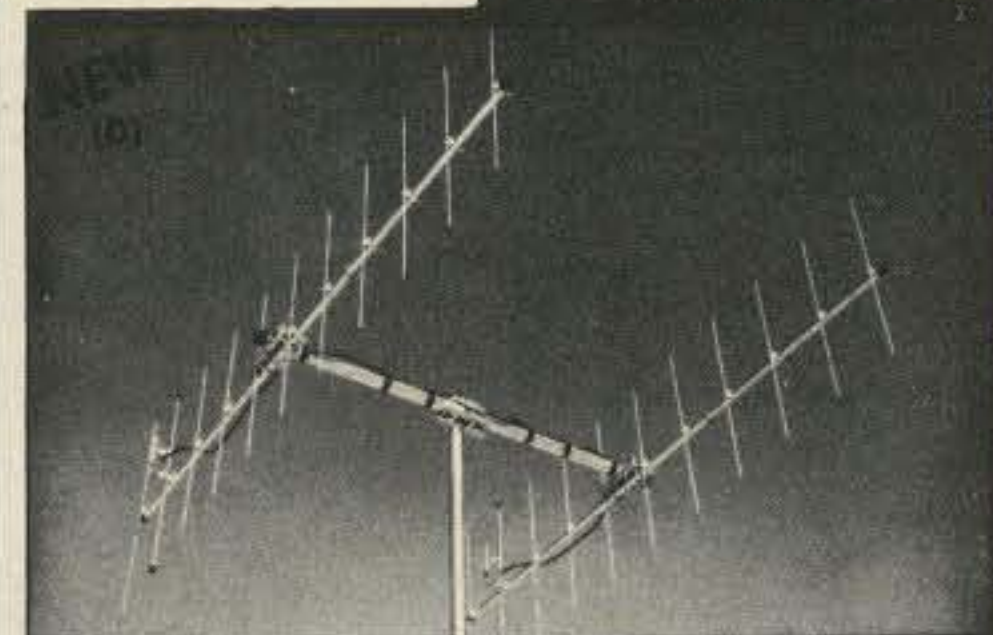
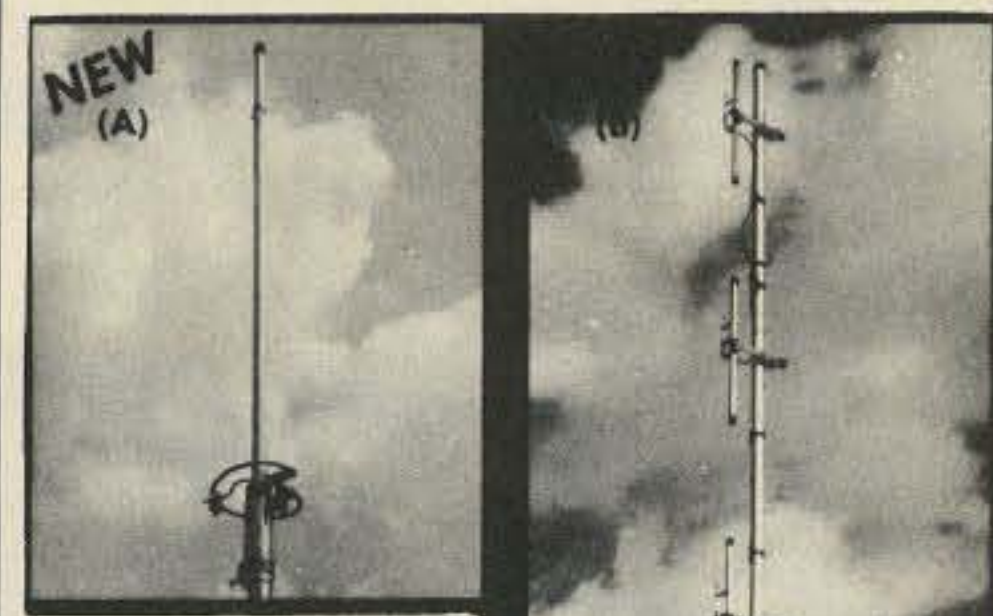

VHF/UHF BEAMS

A50-3	\$ 32.95	A144-7	21.95
A50-5	49.95	A144-11	32.95
A50-6	69.95	A430-11	24.95
A50-10	99.95		

AMATEUR FM ANTENNAS

A147-4	\$ 19.95	AFM-44D	54.95
A147-11	29.95	AR-2	21.95
A147-20T	54.95	AR-6	32.95
A147-22	84.95	AR-25	29.95
A220-7	21.95	AR-220	21.95
A220-11	27.95	AR-450	21.95
A449-6	21.95	ARX-2	32.95
A449-11	27.95	ARX-2K	13.95
AFM-4D	59.95	ARX-220	32.95
AFM-24D	57.95	ARX-450	32.95

Description:	144 MHz.		220 MHz.		432 MHz.	
	Model:	Price:	Model:	Price:	Model:	Price:
20 Element DX-Array	DX-120	42.95	DX-220	37.95	DX-420	32.95
Frame & Harness (40 El.)	DXK-140	59.95	DXK-240	54.95	DXK-440	39.95
Frame & Harness (80 El.)	DXK-180	109.95	DXK-280	89.95	DXK-480	79.95
1-1 52-ohm balun	DX-18N	12.95	DX-28N	12.95	DX-48N	12.95
Vert. Pol. Bracket (20 El.)	DX-VPB	9.95	DX-VPB	9.95	DX-VPB	9.95

TUFTS RADIO CATALOG TUFTS RAD



For all you hams with little cars ...
We've got the perfect mobile rig for you.



The Atlas 210x or 215x measures only 9½" wide x 9½" deep x only 3¼" high, yet the above photograph shows how easily the Atlas transceiver fits into a compact car. And there's plenty of room to spare for VHF gear and other accessory equipment. With the exclusive Atlas plug-in design, you can slip your Atlas in and out of your car in a matter of seconds. All connections are made automatically.

BUT DON'T LET THE SMALL SIZE FOOL YOU!

Even though the Atlas 210x and 215x transceivers are less than half the size and weight of other HF transceivers, the Atlas is truly a giant in performance.

200 WATTS POWER RATING!

This power level in a seven pound transceiver is incredible but true. Atlas transceivers give you all the talk power you need to work the world barefoot. Signal reports

constantly reflect great surprise at the signal strength in relation to the power rating.

FULL 5 BAND COVERAGE

The 210x covers 10-80 meters, while the 215x covers 15-160 meters. Adding the Atlas Model 10x Crystal Oscillator provides greatly increased frequency coverage for MARS and network operation.

NO TRANSMITTER TUNING OR LOADING CONTROLS

with Atlas' total broadbanding. With your Atlas you get instant QSY and band change.

MOST ADVANCED STATE OF THE ART SOLID STATE DESIGN

not only accounts for its light weight, but assures you years of top performance and trouble free operating pleasure.

PLUG-IN CIRCUIT BOARDS

and modular design provides for ease of servicing.

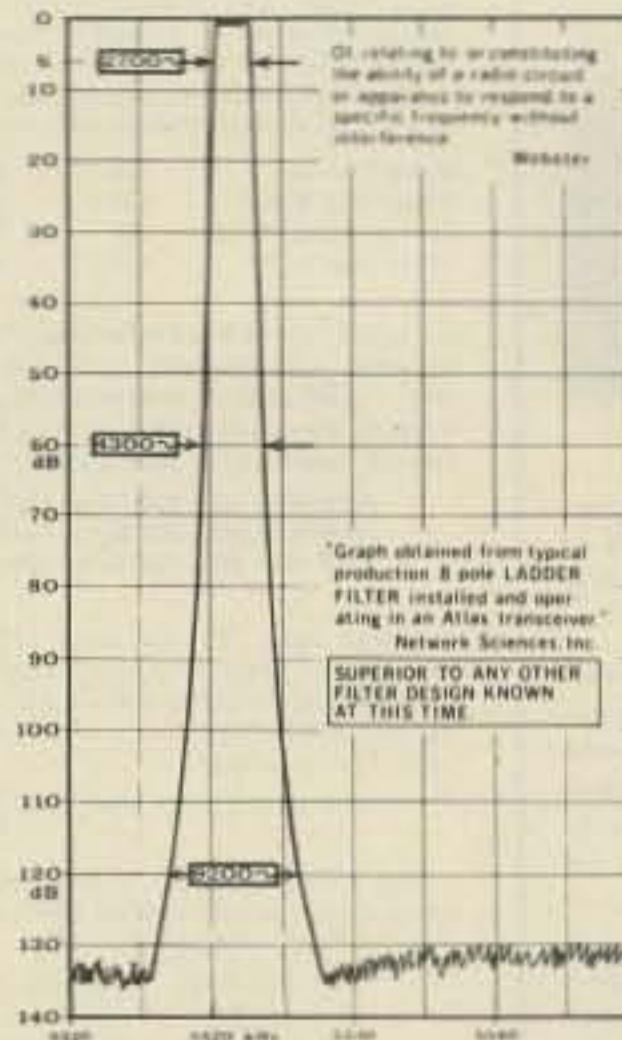

PHENOMENAL SELECTIVITY

The exclusive 8 pole crystal ladder filter used in Atlas transceivers represents a major breakthrough in filter design, with unprecedented skirt selectivity and ultimate rejection. As the above graph shows, this filter provides a 6 db bandwidth of 2700 Hertz, 60 db down of only 4300 Hertz, and a bandwidth of only 9200 Hertz at 120 db down! Ultimate rejection is in excess of 130 db; greater than the measuring limits of most test equipment.

EXCEPTIONAL IMMUNITY TO STRONG SIGNAL OVERLOAD AND CROSS MODULATION. The exclusive front end design in the receiver allows you to operate closer in frequency to strong neighboring signals than you have ever experienced before. If you have not yet operated an Atlas transceiver in a crowded band and compared it with any other receiver or transceiver, you have a real thrill coming.



A WORLD WIDE DEALER NETWORK TO SERVE YOU.

Whether you're driving a Honda in Kansas City or a Mercedes Benz in West Germany, there's an Atlas dealer near you.

- Atlas 210x or 215x \$675.00
- W/Noise Blanker 719.00
- ACCESSORIES:
- AC Console 110/220 V \$147.00
- Portable AC supply 110/220 V 100.00
- Plug-in Mobile Kit 48.00
- 10x Osc. Icc crystals 59.00
- Digital Dial DD-6B 329.00

For complete details see your Atlas dealer, or drop us a card and we'll mail you a brochure with dealer list.



AMATEUR ANTENNAS

"the home of originals"

STANDARD GAIN MOBILES

Two Meters

- 5/8 wavelength — 3.4 db gain over 1/4 wave mobile
- Frequency coverage—143 to 149 MHz
- Power rating—200 watts FM

MODEL BBLT-144

47" antenna complete with easy to install, no holes to drill, trunk lip mount, impact spring and 17 MIL SPEC RG-58-U and PL-259. Antenna removable from mount.

MODEL BBL-144

47" antenna mounts on any flat surface, roof, deck or fender in 3/8" hole. Includes impact spring, 17 MIL SPEC RG-58-U and PL-259. Antenna removable from mount.

Price: \$31.65

HUSTLER "BUCK-BUSTER"

MODEL SF-2

51" two meter, 5/8 wavelength, 3.4 db gain over 1/4 wave mobile. Designed with 3/8" base to fit your mount or a wide selection of Hustler mobile mounts. (Mount or cable not included).

Price: \$9.00

DELUXE MOBILE MOUNTS

For medium length, light weight antennas with 3/8" — 24 base.



- MODEL TLM**
Trunk lip mount for no holes installation on side or edge of trunk lid. Includes 17' RG-58-U connectors attached. Price: \$14.85
- MODEL HLM**
Deluxe trunk lip mount with 180 degree swivel ball for positioning antenna to vertical. Easy — no holes — installation. Includes 17' RG-58-U cable and connectors attached. Price: \$17.20
- MODEL GCM-1**
Rain gutter mount fits all shapes, angles even latest trim line gutters. Includes 180° swivel ball. Price: \$9.00

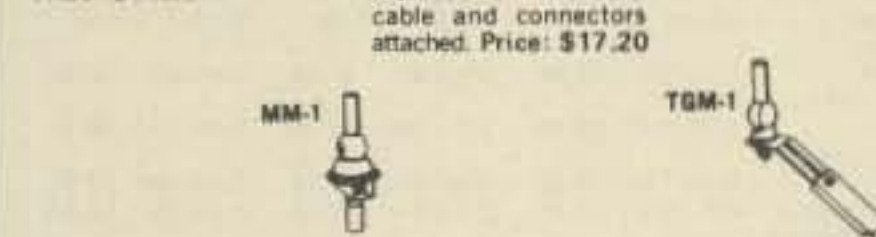

- MODEL MM-1**
Cowl mount installs in 1" hole. Includes 180° swivel ball and SO-239 connectors. Price: \$7.50
- MODEL TGM-1**
Trunk groove mount installs in hidden area of groove under trunk lid. Mounting hardware included. Price: \$8.00
- MODEL C-32**
Ball mount complete with mounting hardware. Price: \$8.20

SUPER GAIN MOBILES

Two Meters

- 5.2 db gain over 1/4 wave mobile antenna
- Frequency coverage—143-149 MHz
- SWR at resonance—1.1:1 typical
- Power rating—200 watts FM

TWO AND SIX METERS—TRUNK LIP MOUNT MODEL HFT

Four section telescopic antenna permits separate adjustment for simultaneous resonance on two and six meters. Operational height: 40". Complete with trunk lip mount, 17' MIL SPEC RG-58-U and factory attached PL-259. Price: \$22.55

VHF/UHF ANTENNA—ROOF MOUNT MODEL UHT-1

Field trimmable radiator for 1/4 wave operation on any frequency from 140 to 500 MHz. Cutting chart included. Mounts on any flat surface, roof, deck, fender in 3/8" hole. Includes 15' RG-58-U. Price: \$9.95

VHF/UHF ANTENNA—TRUNK LIP MOUNT MODEL THF

Field trimmable radiator permits quarter wave operation on any frequency from 140 to 500 MHz. Cutting chart included. Complete with trunk lip mount, 17' RG-58-U and PL-259. Price: \$16.55

RESONATOR SPRING—STAINLESS STEEL MODEL RSS-2

Installs between Hustler mast and resonator. Absorbs shock when antenna strikes overhanging obstructions. Supplied ready for easy installation. Price: \$ 5.80

QUICK DISCONNECT—100% STAINLESS STEEL MODEL QD-1

Remove antenna from mount with easy press and twist release. Compression spring and all parts 100% stainless steel. 3/8" — 24 threads—female one end, male the other. Price: \$16.95

FEED LINE MODEL L-14-240

Get known performance, maximum shielding for minimum noise pickup in this MIL SPEC 20' length of RG-58-U cable. Supplied with connectors at each end for use with ball or bumper mount and transceiver. Price: \$6.55

MODEL G5-144A — Deluxe, Two Meter Colinear for Repeater or any fixed station operation. 5 db gain over a 1/2 wave dipole. Maximum radiation at the horizon! Shunt fed with D.C. grounding. Radiator: 1/2 wave lower section, 3/4 wave phasing, 1/2 wave upper section. Height: 117" SWR at resonance: 1.2:1 or better. Power rating: 1,000 Watts FM. Wind survival: 100 MPH. Installs on vertical pipe up to 1 1/2" O.D. SO 239 coax connector. Price: \$67.55

MODEL CGT-144

Get big signal performance, superior receiving capability with this 85" colinear antenna. Easy installation on side or edge of trunk lip without drilling — complete with 17' MIL SPEC RG-58-U and PL-259. Price: \$41.30

MODEL CG-144

Same characteristics as CGT-144 supplied with 3/8" — 24 base to fit all mobile ball mounts—Length is 85". Mount and cable not included. Price: \$25.50

MODEL SSM-2

Heavy 2" reinforced stainless steel 180° adjustable ball mount easily supports any amateur mobile antenna. Includes cycloic base, steel lock-up plate and mounting hardware. Price: \$19.20

MODEL MO-1

For bumper mounting—Fold is at roof line 27" above base. Price: \$22.00

MODEL MO-2

For deck or fender mounting—Fold is at roof line 15" above base. Price: \$22.00

MODEL 4-BTV

Lowest SWR—PLUS. Bandwidth at its broadest! SWR 1.6 to 1 or better at band edges. Hustler exclusive trap covers "Spritz" extruded to otherwise unattainable close tolerances assuring accurate and permanent trap resonance. Solid one inch fiberglass trap forms for optimum electrical and mechanical stability. Extra heavy duty aluminum mounting bracket with low loss—high strength insulators. Mounting hardware included. All sections 1 1/4" heavy wall, high strength aluminum. Stainless steel clamps permitting adjustment without damage to the aluminum tubing. Guaranteed to be easiest assembly of any multi-band vertical. Antenna has 3/8" — 24 stud at top to accept RM-75 or RM-75-S Hustler resonator for 75 meter operation when desired. Top loading on 75 meters for broader bandwidth and higher radiation efficiency! Feed with any length 50 ohm coax. Power capability—full legal limit on SSB or CW. Mounting: Ground mount with or without radials, or roof mount with radials. Weight: 15 lbs. Price: \$99.95

All resonators are precision wound with optimized design for each band. Assembly includes 17-7 PH stainless steel adjustable tip rod for lowest SWR and band edge marker. Choose for medium or high power operation.

STANDARD HUSTLER RESONATORS

Power Rating: 400 Watts SSB

Model	Band	Price
RM-10	10 meters	\$ 6.50
RM-15	15 meters	6.95
RM-20	20 meters	7.30
RM-40	40 meters	13.20
RM-75	75 meters	15.50
RM-80	80 meters	15.95

SUPER HUSTLER RESONATORS

Power Rating: Legal Limit SSB

Supers have widest bandwidth

Model	Band	Price
RM-10S	10 meters	\$11.30
RM-15S	15 meters	12.65
RM-20S	20 meters	13.00
RM-40S	40 meters	15.50
RM-75S	75 meters	30.00
RM-80S	80 meters	30.40

For 6-10-15-20-40-75-80 Meters

Fold over mast for quick and easy interchange of resonators or entering a garage. When operating, mast is held vertical with shakeproof sleeve clutch. 54" mast also serves as 1/4 wavelength 6 meter antenna. Stainless steel base has 3/8" — 24 threads to fit mobile ball mount or bumper mount.

HUSTLER MASTS

The Majority Choice of Amateurs Throughout the World!

MODEL MO-2

For bumper mounting—Fold is at roof line 27" above base. Price: \$22.00

MODEL MO-1

For deck or fender mounting—Fold is at roof line 15" above base. Price: \$22.00

Covers 10 - 15 - 20 - 40 Meters

Only Hustler Gives One Setting for Whole Band Coverage

MODEL 4-BTV

Lowest SWR—PLUS. Bandwidth at its broadest! SWR 1.6 to 1 or better at band edges. Hustler exclusive trap covers "Spritz" extruded to otherwise unattainable close tolerances assuring accurate and permanent trap resonance. Solid one inch fiberglass trap forms for optimum electrical and mechanical stability. Extra heavy duty aluminum mounting bracket with low loss—high strength insulators. Mounting hardware included. All sections 1 1/4" heavy wall, high strength aluminum. Stainless steel clamps permitting adjustment without damage to the aluminum tubing. Guaranteed to be easiest assembly of any multi-band vertical. Antenna has 3/8" — 24 stud at top to accept RM-75 or RM-75-S Hustler resonator for 75 meter operation when desired. Top loading on 75 meters for broader bandwidth and higher radiation efficiency! Feed with any length 50 ohm coax. Power capability—full legal limit on SSB or CW. Mounting: Ground mount with or without radials, or roof mount with radials. Weight: 15 lbs. Price: \$99.95

SUPER AMP

from Dentron



If the amplifier you're thinking of buying doesn't deliver at least 1000 to 1200 watts output, to the antenna, you're buying the wrong amplifier.

Our New Super Amp is sweeping the country because hams have realized that the DenTron Amplifier will deliver to the antenna, (output power), what other manufacturers rate as input power.

The Super Amp runs a full 2000 watts P.E.P. input on SSB, and 1000 watts DC on CW, RTTY or SSTV 160-10 meters, the maximum legal power.

The Super Amp is compact, low profile, has a solid one-piece cabinet assuring maximum TVI shielding.

The heart of our amplifier, the power supply, is a continuous duty, self-contained supply built for contest performance.

We mounted the 4-572B's, industrial workhorse tubes, in a cooling chamber featuring the on-demand variable cooling system.

The hams at DenTron pride themselves on quality work, and we fight to keep prices down. That's why the dynamic DenTron Linear Amplifier beats them all

\$574.50

The 80-10 Skymatcher

Here's an antenna tuner for 80 through 10 meters, handles 500 w P.E.P. and matches your 52 ohm transceiver to a random wire antenna.



- Continuous tuning 3.2 - 30 mc
- "L" network
- Ceramic 12 position rotary switch
- SO-239 receptional to transmitter
- Random wire tuner
- 3000 volt capacitor spacing
- Tapped inductor
- Ceramic antenna feed thru
- 7" W. 5" H. 8" D., Weight: 5 lbs.

\$59.50

Read forward and reflected watts at the same time

Tired of constant switching and guesswork?

Every serious ham knows he must read both forward and reverse wattage simultaneously for that perfect match. So upgrade with the DenTron W-2 Dual in line Wattmeter.

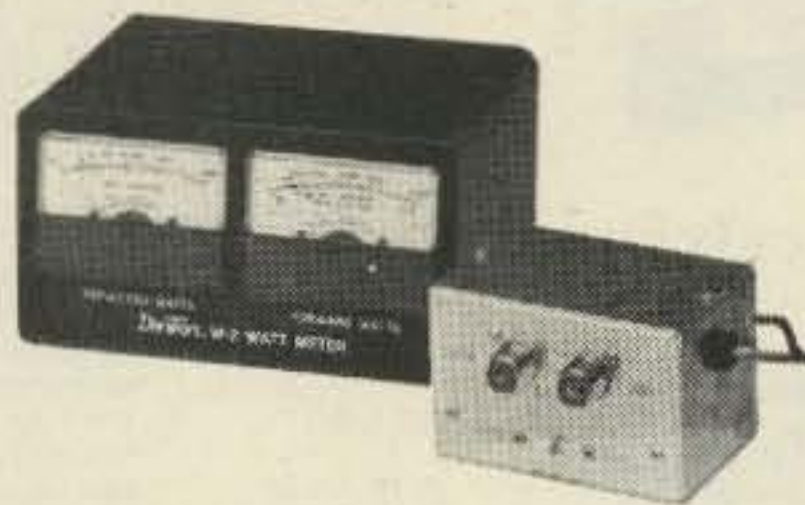

\$99.50

Match everything from 160 to 10 with the new 160-10 MAT

NEW: The Monitor Tuner was designed because of overwhelming demand. Hams told us they wanted a 3 kilowatt tuner with a built-in wattmeter, a front panel antenna selector for coax, balanced line and random wire. So we engineered the 160-10m Monitor Tuner. It's a lifetime investment at \$299.50.

\$299.50



Meet the SuperTuner

The DenTron Super Tuner tunes everything from 160-10 meters. Whether you have balanced line, coax cable, random or long wire, the Super Tuner will match the antenna impedance to your transmitter. All DenTron tuners give you maximum power transfer from your transmitter to your antenna, and isn't that where it really counts?

1 KW MODEL **\$129.50** 3 KW MODEL **\$229.50**

The Sky Openers

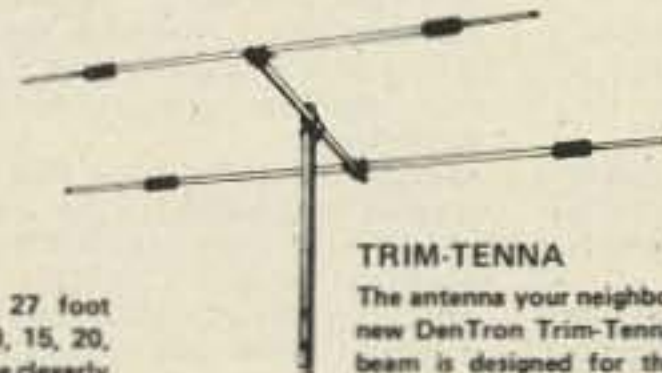

SKYMASTER

A fully developed and tested 27 foot vertical antenna covers entire 10, 15, 20, and 40 meter bands using only one cleverly applied wave trap. A full 1/4 wave antenna on 20 meters. Constructed of heavy seamless aluminum with a factory tuned and sealed HQ Trap, SKYMASTER is weatherproof and withstands winds up to 80 mph. Handles 2 KW power level and is for ground, roof or tower mounting. Radials included in our low price of

\$84.50

Also 80 m resonator for top mounting on SKYMASTER.

\$29.50

SKYCLAW

A tunable monoband high performance vertical antenna, designed for 40, 80, 160 meter operation. SKYCLAW gives you the following spectrum coverage:

BAND (Meters)	BANDWIDTH (kHz)
160	50
80	200
40	entire band

Tuning is easy and reliable. Rugged construction assures that this self-supporting unit is weatherproof and survives nicely in 100 mph winds. Handles full legal power limit.

\$79.50

EX-1

The DenTron EX-1 Vertical Antenna is designed for the performance minded antenna experimenter. The EX-1 is a full 40 meter, 3/4 wave, 33', self-supporting vertical. The EX-1 is the ideal vertical for phasing.

\$59.50

TRIM-TENNA

The antenna your neighbors will love. The new DenTron Trim-Tenna with 20 meter beam is designed for the discriminating amateur who wants fantastic performance in an environmentally appealing beam. It's really loaded! Up front there's a 13 foot 6 inch director with precision Hy-Q coils. And, 7 feet behind is a 16 foot driven element fed directly with 52 ohm coax. The Trim-Tenna mounts easily and what a difference in on-the-air performance between the Trim-Tenna and that dipole, long wire or inverted Vee you've been using. 4 & 6 Forward Gain Over Dipole.

\$129.50

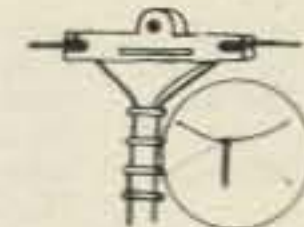

ALL BAND DOUBLET

This All Band Doublet or inverted Type Antenna covers 160 thru 10 meters. Has total length of 130 feet (14 ga. stranded copper) although it may be made shorter if necessary. This tuned Doublet is center fed through 100 feet of 450 ohm PVC covered balanced transmission line. The assembly is complete. Add rope to the ends and pull up into position. Tune with the DenTron Super Tuner and you're on 10 through 160 meters with one antenna! Now just for the DenTron All Band Doublet.

\$24.50

Dentron

DRAKE TVI FILTERS High Pass Filters for TV Sets

provide more than 40 dB attenuation at 52 MHz and lower. Protect the TV set from amateur transmitters 6-160 meters.



Drake TV-300-HP
Model No. 1603
For 300 ohm twin lead
Price: \$10.60



DRAKE TV-3300-LP
1000 watts max. below 30 MHz. Attenuation better than 80 dB above 41 MHz. Helps TV i-f interference, as well as TV front-end problems. Price: \$26.60 Model No. 1608



DRAKE TV-5200-LP
200 watts to 52 MHz. Ideal for six meters. For operation below six meters, use TV-3300-LP or TV-42-LP. Model No. 1609 Price: \$26.60



Drake TV-75-HP
Model No. 1610
For 75 ohm TV coaxial cable; TV type connectors installed
Price: \$13.25

DRAKE TV-42-LP Model No. 1605
is a four section filter designed with 43.2 MHz cut-off and extremely high attenuation in all TV channels for transmitters operating at 30 MHz and lower. Rated 100 watts input. Price: \$14.60

WORK ALL REPEATERS WITH OUR NEW SYNTHESIZER II



The Synthesizer II is a two meter frequency synthesizer. Frequency is adjustable in 5 kHz steps from 140.00 MHz to 149.995 MHz with its digital readout thumb wheel switching. Transmit offsets are digitally programmed on a diode matrix, and can range from 10 kHz to 10 MHz. No additional components are necessary!

Kit \$169.95 Wired and tested \$239.95

- RX28C 28-35 MHz FM receiver with 2 pole 10.7 MHz crystal filter . . . \$ 59.95
- RX28C W/T . . . same as above-wired & tested . . . 104.95
- RX50C Kit . . . 30-60 MHz rcvr w/2 pole 10.7 MHz crystal filter 59.95
- RX50C W/T . . . same as above-wired & tested . . . 104.95
- RX144C Kit . . . 140-170 MHz rcvr w/2 pole 10.7 MHz crystal filter 69.95
- RX144C W/T . . . same as above-wired & tested . . . 114.95
- RX220C Kit . . . 210-240 MHz rcvr w/2 pole 10.7 MHz crystal filter 69.95
- RX220C W/T . . . same as above-wired & tested . . . 114.95
- RX432C Kit . . . 432 MHz rcvr w/2 pole 10.7 MHz crystal filter 79.95
- RX432C W/T . . . same as above-wired & tested . . . 124.95
- TX50 transmitter exciter, 1 watt, 6 mtr. 39.95
- TX50 W/T . . . same as above-wired & tested . . . 59.95
- TX144B Kit . . . transmitter exciter-1 watt-2 mtrs 29.95
- TX144B W/T . . . same as above-wired & tested. . . 49.95
- TX220B Kit . . . transmitter exciter-1watt-220 MHz 29.95
- PA2501H Kit . . 2 mtr power amp-kit 1w in-25w out with solid state switching, case, connectors 59.95
- PA2501H W/T . . same as above-wired & tested . . . 74.95
- PA4010H Kit . . 2 mtr power amp-10w in-40w out-relay switching 59.95
- PA4010H W/T . . same as above-wired & tested . . . 74.95
- PA50/25 Kit . . 6 mtr power amp, 1w in, 25w out, less case, connectors & switching . . . 49.95
- PA50/25 W/T . . same as above, wired & tested . . . 69.95
- PA144/15 Kit . . 2 mtr power amp-1w in-15w out-less case, connectors and switching 39.95
- PA144/25 Kit . . same as PA144/15 kit but 25w . . . 49.95
- PA220/15 Kit . . similar to PA144/15 for 220 MHz 39.95
- PA432/10 Kit . . power amp-similar to PA144/15 except 10w and 432 MHz 49.95
- PA140/10 W/T . 10w in-140w out-2 mtr amp . . . 179.95
- PA140/30 W/T . 30w in-140w out-2 mtr amp . . . 159.95
- PS15C Kit . . . 15 amp-12 volt regulated power supply w/case, w/fold-back current limiting and overvoltage protection . . . 79.95
- PS15C W/T . . . same as above-wired & tested . . . 94.95
- PS25C Kit . . . 25 amp-12 volt regulated power supply w/case, w/fold-back current limiting and ovp 129.95
- PS25C W/T . . . same as above-wired & tested . . . 149.95
- PS25M Kit . . . same as PS25C with meters 149.95
- PS25M W/T . . . same as above-wired & tested . . . 169.95
- RPT50 Kit . . . repeater-6 meter 465.95
- RPT50 repeater-6 meter, wired & tested 695.95
- RPT144 Kit . . . repeater-2 mtr-15w-complete (less crystals) 465.95
- RPT220 Kit . . . repeater-220 MHz-15w-complete (less crystals) 465.95
- RPT432 Kit . . . repeater-10 watt-432 MHz (less crystals) 515.95
- RPT144 W/T . . . repeater-15 watt-2 mtr. 695.95
- RPT220 W/T . . . repeater-15 watt-220 MHz. 695.95
- RPT432 W/T . . . repeater-10 watt-432 MHz. 749.95
- DPLA50 6 mtr close spaced duplexer . . . 575.00
- TRX50 Kit . . . Complete 6 mtr FM transceiver kit, 20w out, 10 channel scan with case (less mike and crystals). 249.95
- TRX144 Kit . . . same as above, but 2 mtr & 15w out 219.95
- TRX220 Kit . . . same as above except for 220 MHz 219.95
- TRX432 Kit . . . same as above except 10 watt and 432MHz 254.95
- TRC-1 transceiver case only 19.95
- TRC-2 transceiver case and accessories . . 39.95
- SYN II Kit . . . 2 mtr synthesizer, transmitt offsets programmable from 100 KHz-10 MHz, (Mars offsets with optional adapters) 169.95
- SYN II W/T . . . same as above-wired & tested . . . 239.95
- MO-1 Kit Mars/cap offset optional 2.50
- TO-1 Kit 18 MHz optional tripler 2.50
- HT 144B Kit . . 2 mtr, 2w, 4 channel, hand held receiver with crystals for 146.52 simplex . . 129.95
- NICAD battery pack, 12 VDC, 1/2 amp. . . . 29.95
- BC12 battery charger for above 5.95
- Rubber Duck . 2 mtr, with male BNC connector . . 8.95

RECEIVERS

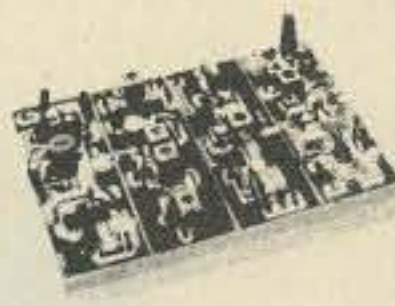

- RXCF accessory filter for above receiver kits gives 70 dB adjacent channel rejection 8.50
- RF28 Kit 10 mtr RF front end 10.7 MHz out 12.50
- RF50 Kit 6 mtr RF front end 10.7 MHz out 12.50
- RF144D Kit . . . 2 mtr RF front end 10.7 MHz out 17.50
- RF220D Kit . . . 220 MHz RF front end 10.7 MHz out 17.50
- RF432 Kit 432 MHz RF front end 10.7 MHz out 27.50
- IF 10.7F Kit . . 10.7 MHz IF module includes 2 pole crystal filter 27.50
- FM455 Kit 455 KHz IF stage plus FM detector 17.50
- AS2 Kit audio and squelch board 15.00

TRANSMITTERS

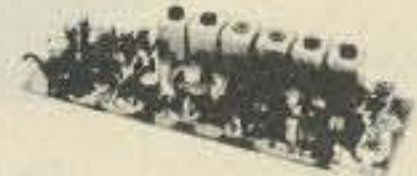

- TX220B W/T . . . same as above-wired & tested . . . 49.95
- TX432B Kit . . . transmitter exciter 432 MHz 39.95
- TX432B W/T . . . same as above-wired & tested . . . 59.95
- TX150 Kit 300 milliwatt, 2 mtr transmitter . . 19.95
- TX150 W/T . . . same as above-wired & tested . . . 29.95

POWER AMPLIFIERS



Blue Line RF power amp, wired & tested, emission-CW-FM-SSB/AM

Model	Frequency	Power Input	Power Output	
BLB 3/150	45-55MHz	3W	150W	TBA
BLC 10/70	140-160MHz	10W	70W	139.95
BLC 2/70	140-160MHz	2W	70W	159.95
BLC 10/150	140-160MHz	10W	150W	259.95
BLC 30/150	140-160MHz	30W	150W	239.95
BLD 2/60	220-230MHz	2W	60W	159.95
BLD 10/60	220-230MHz	10W	60W	139.95
BLD 10/120	220-230MHz	10W	120W	259.95
BLE 10/40	420-470MHz	10W	40W	139.95
BLE 2/40	420-470MHz	2W	40W	159.95
BLE 30/80	420-470MHz	30W	80W	259.95
BLE 10/80	420-470MHz	10W	80W	289.95

POWER SUPPLIES

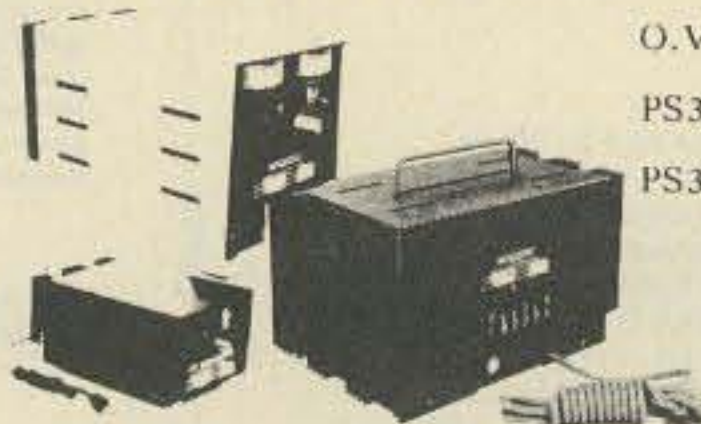

- O.V.P. adds over voltage protection to your power supplies, 15 VDC max, 9.95
- PS3A Kit 12 volt-power supply regulator card with fold-back current limiting . . . 8.95
- PS3012 W/T . . . new commercial duty 30 amp 12 VDC regulated power supply w/case, w/fold-back current limiting and overvoltage protection 239.95

REPEATERS



- DPLA144 2 mtr, 600 KHz spaced duplexer, wired and tuned to frequency . . . 379.95
- DPLA220 220 MHz duplexer, wired and tuned to frequency 379.95
- DPLA432 rack mount duplexer 319.95
- DSC-U double shielded duplexer cables with PL259 connectors (pr.) 25.00
- DSC-N same as above with type N connectors (pr.) 25.00

TRANSCEIVERS



OTHER PRODUCTS BY VHF ENGINEERING

- CD1 Kit 10 channel receive xtal deck w/diode switching. \$ 6.95
- CD2 Kit 10 channel xmit deck w/switch and trimmers 14.95
- CD3 Kit UHF version of CD1 deck, needed for 432 multi-channel operation. . 12.95
- COR2 Kit carrier operated relay. 19.95
- SC3 Kit 10 channel auto-scan adapter for RX with priority 19.95
- Crystals we stock most repeater and simplex pairs from 146.0-147.0 (each). . . 5.00
- CWID Kit 159 bit, field programmable, code identifier with built-in squelch tail and ID timers 39.95
- CWID wired and tested, not programmed 54.95
- CWID wired and tested, programmed . . 59.95
- MIC 1 2,000 ohm dynamic mike with P.T.T. and coil cord 12.95
- TS1 W/T tone squelch decoder 59.95
- TS1 W/T installed in repeater, including interface accessories 89.95
- TD3 Kit 2 tone decoder 29.95
- TD3 W/T same as above-wired & tested . . . 39.95
- HL144 W/T . . . 4 pole helical resonator, wired & tested, swept tuned to 144 MHz ban . . . 24.95
- HL220 W/T . . . same as above tuned to 220 MHz ban 24.95
- HL432 W/T . . . same as above tuned to 432 MHz ban 24.95

SYNTHESIZERS



WALKIE-TALKIES



THE WORLD'S MOST COMPLETE LINE OF VHF-FM KITS AND EQUIPMENT

KLM RF Power Amplifiers



- A simple, add-on-immediately RF amplifier.
 - Merely coax-connect amplifier between antenna and transceiver.
 - No tuning! Efficient strip-line broad band design.
 - Automatic! Internal RF-sensor-controlled relay connects amplifier whenever transmitter is switched on.
 - Manual, remote-position switching is optional.
 - Models for 6, 2, 1¼ meters, 70CM amateur bands plus MARS coverage.
 - Two types: **Class C** for FM/CW. **Linear** for SSB/AM/FM/CW.
 - Negligible insertion loss on receive.
 - American made by KLM.
- Highest quality, American-made "brand" transistors are fully protected for VSWR, short and overload, reverse polarity. Highly effective heat sinking assures long life, reliable performance. Black anodized containers...exclusive KLM extrusions, **have seven, full length fins on both sides!**

FREQ. (MHz)	MODEL NUMBER	PWR INP. (watts)	NOM. PWR OUT. (watts)	NOM. CUR. (amps.)†	SIZE	PRICE
50-54	PA4-80AL	4	80	10A	C*	164.95
144-148	PA2-12B	1-4	12	2	A	59.95
"	PA2-70B	1-4	70	10	C*	159.95
"	PA2-70BL	1-4	70	10	C*	169.95
"	PA2-140B	1-4	140	20	D	229.95
"	PA10-40B	5-15	40	5	B	83.95
"	PA10-40BL	5-15	40	5	B*	94.95
"	PA10-70B	5-15	70	8	C*	139.95
"	PA10-70BL	5-15	70	8	C*	149.95
144-148	PA10-80BL	5-15	80	10	C*	159.95
"	PA10-140B	5-15	140	18	D*	199.95
"	PA10-140BL	5-15	140	18	D*	215.95
"	PA10-160BL	5-15	160	22	D*	229.95
"	PA30-140B	15-45	140	15	D*	179.95
"	PA30-140BL	15-45	140	15	D*	189.95
219-226	PA2-70BC	1-4	70	10	C*	169.95
"	PA10-60BC	5-15	60	8	C	149.95
"	PA30-120BC	15-45	120	15	D*	189.95
400-470	PA2-40C	1-4	40	7	C*	149.95
"	PA10-35C	5-15	35	6	B*	119.95
"	PA10-35CL	5-15	35	6	B*	139.95
"	PA10-70C	5-15	70	13	D*	229.95
"	PA10-70CL	5-15	70	18	D*	249.95

†At 13.5VDC.

SIZES: inches: *A. 2.25x5x2 *B. 6.5x5x2 *C. 6.5x7.5x2 *D. 6.5x10x2
MM: 57x127x50.8 165x127x50.8 165x190x50.8 165x254x50.8
◊LINEAR AMPLIFIER †At 13.5VDC.

TEMPO



THE TEMPO 2020

- Phase lock-loop (PLL) oscillator circuit minimizes unwanted spurious responses.
- Hybrid Digital Frequency Presentation.
- Advanced Solid-state design...only 3 tubes.
- Built-in AC and 12 VDC power supplies.
- CW filter standard equipment...not an accessory.
- Rugged 6146-B final amplifier tubes.
- Cooling fan standard equipment...not an accessory.
- High performance noise-blanker is standard equipment...not an accessory.
- Built-in VOX and semi-break in CW keying.
- Crystal Calibrator and WWV receiving capability.
- Microphone provided.
- Dual RIT control allows both broad and narrow tuning.
- All-band 80 through 10 meter coverage.
- Multi-mode USB, LSB, CW and AM operation.
- Extraordinary receiver sensitivity (.3u S/N 10 db) and oscillator stability (100 Hz 30 min. after warm-up)
- Fixed channel crystal control on two available positions.
- RF Attenuator.
- Adjustable ALC action.
- Phone patch in and out jacks.
- Separate PTT jack for foot switch.
- Built-in speaker.
- The TEMPO 2020...\$759.00.
- Model 8120 external speaker...\$29.95. Model 8010 remote VFO...\$139.00.

ATLAS 350-XL



- ALL SOLID STATE
- 350 WATTS P.E.P. OR CW INPUT
- SSB TRANSCEIVER
- 10 THROUGH 160 METER COVERAGE



Illustrated with optional AC supply, Auxiliary VFO, and Digital Dial.

The all new Atlas 350-XL has all the exciting new features you want, plus superior performance and selectivity control never before possible. Price: \$995.00

• 10-160 METERS
Full coverage of all six amateur bands in 500 kHz segments. Primary frequency control provides highly stable operation. Also included is provision for adding up to 10 additional 500 kHz segments between 2 to 22 MHz by plugging in auxiliary crystals.

• 350 WATTS
P.E.P. and CW input. Enough power to work the world barefoot!

IDEAL FOR DESKTOP OR MOBILE OPERATION
Measuring just 5 in. high x 12 in. wide x 12½ in. deep, and weighing only 13 pounds, the Atlas 350-XL offers more features, performance and value than any other transceiver, regardless of size, on the market today!

- 350-PS matching AC supply — \$195.00
- DD-6XL plug-in digital dial readout \$195.00
- 305 plug-in auxiliary VFO — \$155.00
- 311 plug-in crystal oscillator — \$135.00
- DMK-XL plug-in mobile mounting kit — \$65.00

TEMPO VHF/ONE PLUS



The Tempo/ONE PLUS offers full 25 watt output or a selectable 3 to 15 watt low power output, remote tuning on the microphone, sideband operation with the SSB/ONE adapter, MARS operation capability, 5 KHz numerical LED, and all at a lower price than its time tested predecessor... the Tempo VHF ONE.

The Tempo VHF/One Plus is a VHF/FM transceiver for dependable communication on the 2 meter amateur band • Full 2 meter coverage, 144 to 148 MHz for both transmit and receive • Full phase lock synthesized (PLL) • Automatic repeater split — selectable up or down • Two built-in programmable channels • All solid state • 800 selectable receive frequencies with simplex and +600 kHz transmit frequencies for each receive channel. Price: \$399.00

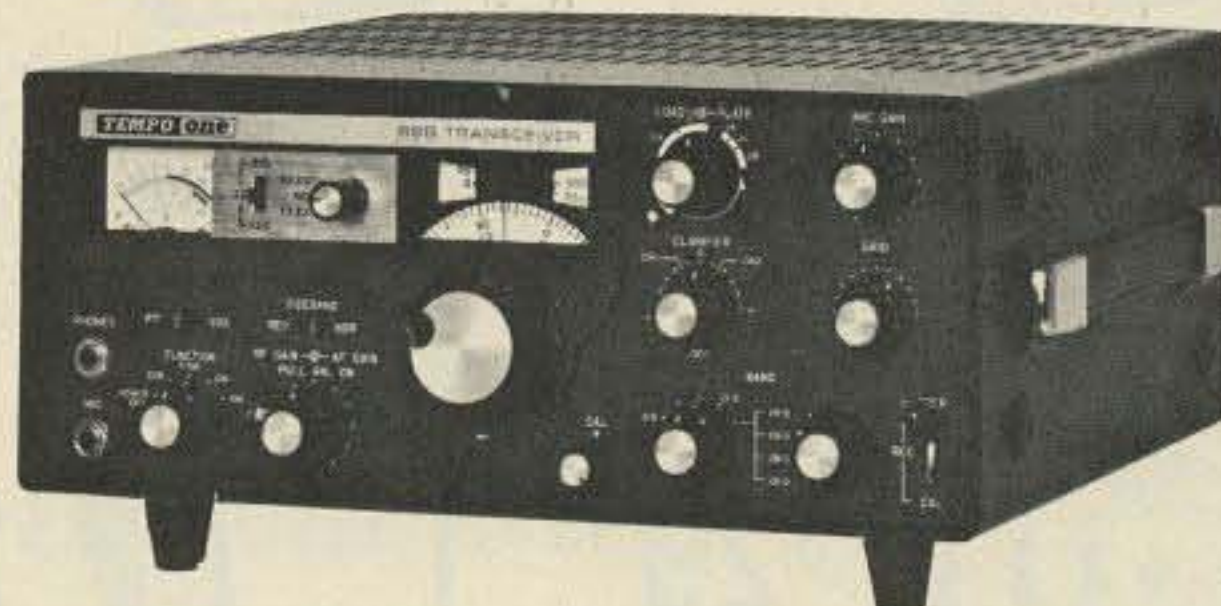

TEMPO ONE AC/ONE VF/ONE HF Transceiver. 80-10M. USB, CW & AM — \$399.00
Power supply for TEMPO ONE — \$99.00
External VFO for TEMPO ONE — \$199.00

TEMPO SSB/ONE
SSB adapter for the Tempo VHF/One
Selectable upper or lower sideband. * Plugs directly into the VHF/One with no modification. * Noise blanker built-in. * RIT and VXO for full frequency coverage. * \$225.00

TUFTS RADIO CATALOG TUFTS RADIO



SAVE YOUR RADIO!

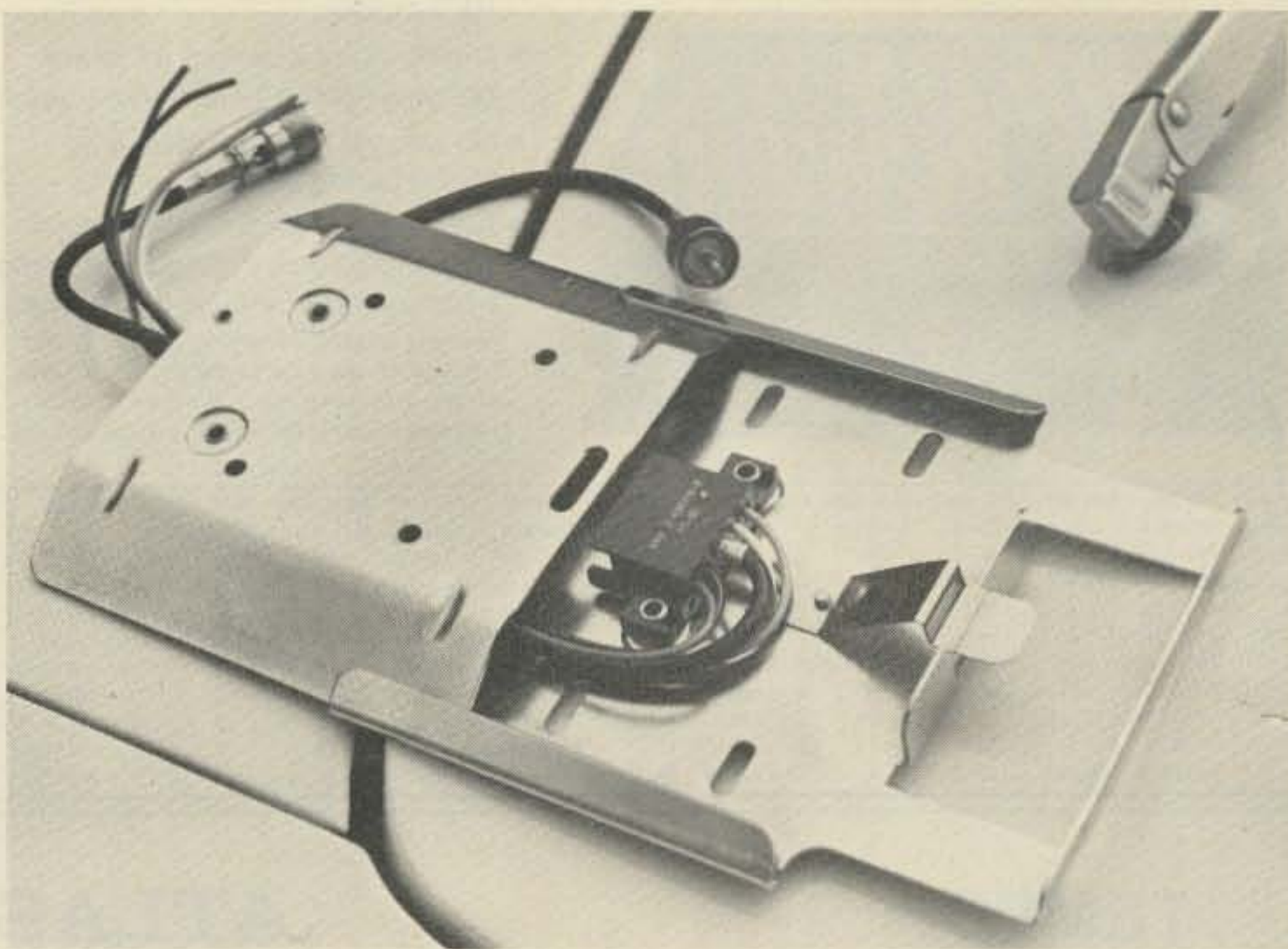

DESIGNED FOR COMMERCIAL USE UP TO 1000 MHZ.

The TUFTS SAVE-YOUR-RADIO bracket can save you a bundle . . . and a lot of hassle. Why worry about rig ripoff? The TUFTS SYR bracket mounts quickly and easily in your car and makes it possible to snap your rig out of its bracket when you park and put it out of sight.

The connector system has a special coaxial cable connector which will provide you with a lossless connection right up to 1000 MHz! No loss! In addition to the quick coax connector there are also four power and accessory connections which are made automatically when the rig is slid into its bracket . . . just what you

need for feeding power and loudspeaker connections to the set.

This is a rugged bracket and connector system . . . it'll take a beating. There is a hole on each side of the 16 gauge steel plate for a padlock in case you want to leave the rig for short periods in its bracket. They'll have to rip out the dash to get it . . . and it won't be the first time for that.

With two of these brackets you can bring the mobile rig into the house and use it in seconds. On trips you can take an AC supply for the rig and use it in your hotel room. Price: \$29.95

400% MORE RF POWER PLUGS BETWEEN YOUR MICROPHONE AND TRANSMITTER



\$ 49⁹⁵

LSP-520BX. 30 db dynamic range IC log amp and 3 active filters give clean audio. RF protected. 9 V battery. 3 conductor, 1/4" phone jacks for input and output. 2-3/16 x 3-1/4 x 4 inches.



\$ 59⁹⁵

LSP-520BX II. Same as LSP-520BX but in a beautiful 2-1/8 x 3-5/8 x 5-9/16 inch Ten-Tec enclosure with uncommitted 4 pin Mic Jack, output cable, rotary function switch.



\$ 27⁹⁵

CWF-2BX Super CW Filter

By far the leader. Over 5000 in use. Razor sharp selectivity. 80 Hz bandwidth, extremely steep skirts. No ringing. Plugs between receiver and phones or connect between audio stage for speaker operation.

• Selectable BW: 80, 110, 180 Hz • 60 dB down one octave from center freq. of 750 Hz for 80 Hz BW • Reduces noise 15 dB • 9 V battery • 2-3/16 x 3-1/4 x 4 in. • CWF-2PC, wired PC board, \$18.95 • CWF-2PCK, kit PC board \$15.95



\$ 49⁹⁵

CMOS-8043 Electronic Keyer

State of the art design uses CURTIS-8043 Keyer-on-a-chip.

• Built-in Key • Dot memory • Iambic operation with external squeeze key • 8 to 50 WPM • Sidetone and speaker • Speed, volume, tone, weight controls • Ultra reliable solid state keying +300 volts max. • 4 position switch for TUNE, OFF, ON, SIDETONE OFF • Uses 4 penlight cells • 2-3/16 x 3-1/4 x 4 inches



\$ 29⁹⁵

SBF-2BX SSB Filter

Dramatically improves readability.

• Optimizes your audio to reduce sideband splatter, remove low and high pitched QRM, hiss, static crashes, background noise, 60 and 120 Hz hum • Reduces fatigue during contest, DX, and ragchewing • Plugs between phones and receiver or connect between audio stage for speaker operation • Selectable bandwidth IC active audio filter • Uses 9 volt battery • 2-3/16 x 3-1/4 x 4 inches



\$ 27⁹⁵

MFJ-200BX Frequency Standard

Provides strong, precise markers every 100, 50, or 25 KHz well into VHF region.

• Exclusive circuitry suppresses all unwanted markers • Markers are gated for positive identification. CMOS IC's with transistor output. • No direct connection necessary • Uses 9 volt battery • Adjustable trimmer for zero beating to WWV • Switch selects 100, 50, 25 KHz or OFF • 2-3/16 x 3-1/4 x 4 inches



\$ 39⁹⁵

NEW

MFJ-16010 Antenna Tuner

Now you can operate all band — 160 thru 10 Meters — with a single random wire and run your full transceiver power output — up to 200 watts RF power OUTPUT.

• Small enough to carry in your hip pocket, 2-3/16 x 3-1/4 x 4 inches • Matches low and high impedances by interchanging input and output • SO-239 coaxial connectors • Unique wide range, high performance, 12 position tapped inductor. Uses two stacked toroid cores



\$ 15⁹⁵

NEW

CPO-555 Code Oscillator

For the Newcomer to learn the Morse code. For the Old Timer to polish his list. For the Code Instructor to teach his classes.

• Send crisp clear code with plenty of volume for classroom use • Self contained speaker, volume, tone controls, aluminum cabinet • 9 V battery • Top quality U.S. construction • Uses 555 IC timer • 2-3/16 x 3-1/4 x 4 inches TK-555, Optional Telegraph Key \$1.95



\$ 49⁹⁵

MFJ-1030BX Receiver Preselector

Clearly copy weak unreadable signals (increases signal 3 to 5 "S" units).

• More than 20 dB low noise gain • Separate input and output tuning controls give maximum gain and RF selectivity to significantly reject out-of-band signals and reduce image responses • Dual gate MOS FET for low noise, strong signal handling abilities • Completely stable • Optimized for 10 thru 30 MHz • 9 V battery • 2-1/8 x 3-5/8 x 5-9/16 inches



\$ 27⁹⁵

MFJ-40T QRP Transmitter

Work the world with 5 watts on 40 Meter CW.

• No tuning • Matches 50 ohm load • Clean output with low harmonic content • Power amplifier transistor protected against burnout • Switch selects 3 crystals or VFO input • 12 VDC • 2-3/16 x 3-1/4 x 4 inches MFJ-40V, Companion VFO \$27.95 MFJ-12DC, IC Regulated Power Supply, 1 amp, 12 VDC \$27.95

TELEX®

PROFESSIONAL HEADPHONES & HEADSETS

BOOM MIC HEADSETS

For the ultimate in communications convenience and efficiency select a boom mic headset. Long-time favorites of professional communications, boom mic headsets allow more personal mobility while always keeping the mic properly positioned for fast, precise voice transmission. Boom microphones are completely adjustable to allow perfect positioning. And, boom mic headsets leave both hands free to perform other tasks.

All models are supplied with "close-talking" microphones to limit ambient noise pick-up and provide superior intelligibility. Each model has a convenient, inline push-to-talk switch, which can be wired for either push-to-talk relay control or mic circuit interrupt for voice operated transmitters. The switch may be used as a momentary push-button or it can be locked in the down position. All models have tough, flexible, 8 foot cords which are stripped and tinned, unterminated. Communication grey with black trim.



MODEL CM-1320



MODEL C-1320



MODEL C-1210



MODEL C-610



MODEL CM-1210



MODEL CM-610



MODEL CM-1320S

MODEL C-610 Economical, dual receiver magnetic headphone. Delivers clear reception. Lightweight and comfortable yet ruggedly constructed for daily use. Ear-cushions seal out distracting noise and are removable for cleaning. Price: \$9.95

MODEL SWL-610 Similar to Model C-610 but with 2000 ohm impedance. Ideal for shortwave receivers requiring high impedance headphones. Price: \$9.95

MODEL C-1210 Medium priced, dual receiver dynamic headphone. Precise sound reproduction. Deluxe foam-filled earcushions are extremely comfortable for those long sessions. The removable cushions reduce ambient noise penetration and concentrate signal strength. Great for noisy environments or for digging out weak signals. Price: \$28.30

MODEL C-1320 Our finest communications headphone. Audiometric-type dual dynamic receivers assure the ultimate in reception and performance stability. Extremely sensitive receivers provide high output levels even from weak signals. Luxurious foam filled circumaural ear-cushions are removable for cleaning. Price: \$37.90

DUAL MUFF HEADPHONES

The following headphones offer outstanding sound quality and superb comfort for long term wearing. All the models have circumaural earcushions to seal out distracting ambient noise and concentrate the signal at your ear. Foam filled vinyl earcushions on Models C-1210 and C-1320 add an extra margin of comfort. Adjustable headbands and self-aligning earcups assure proper fit. All models are equipped with a five foot cord terminating in a standard .250" diameter phone plug and have 3.2 to 20 Ohm impedance. Communication grey with black trim.

MODEL CM-610 Lightweight, dual receiver magnetic headphone (similar to Model C-610). Ceramic boom microphone with -51 dB output. Can be used with any mobile or base station with high Z mic input and 3.2 to 20 ohm audio output. Price: \$42.80.

MODEL CM-1320 Deluxe dual receiver dynamic headphone with audiometric-type headphone elements (similar to Model C-1320). Ceramic boom microphone with -51 dB output. For use with any mobile or base station requiring high impedance mic input and 3.2 to 20 ohm audio output. Price: \$68.30.

MODEL CM-1210 Rugged, reliable, dual receiver dynamic headphone (similar to Model C-1210). Ceramic boom microphone with -51 dB output. For use with any mobile or base station with high Z input and 3.2 to 20 ohm audio output. Price: \$56.90.

MODEL CM-1320S Deluxe single receiver dynamic headphone with audiometric-type headphone element (similar to Model C-1320). Ceramic boom microphone with -51 dB output. For use with any mobile or base station requiring high impedance mic input and 3.2 to 20 ohm audio output. Price: \$54.50.

MODEL	C-610	SWL-610	C-1210	C-1320	CM-610	CM-1210	CM-1320	CM-1320S
Headphone Sensitivity Ref. 0002 Dynes/cm ² @1mW input, 1kHz	103dB SPL ±5dB	103dB SPL ±5dB	103dB SPL ±3dB	105dB SPL ±5dB	103dB SPL ±5dB	103dB SPL ±3dB	105dB SPL ±5dB	105dB SPL ±5dB
Headphone Frequency Response (useable)	40- 15,000 Hz	40- 15,000 Hz	20- 20,000 Hz	20- 20,000 Hz	40- 15,000 Hz	20- 20,000 Hz	20- 20,000 Hz	20- 20,000 Hz
Headphone Impedance	3.2- 20 ohms	2000 ohms	3.2- 20 ohms	3.2- 20 ohms	3.2- 20 ohms	3.2- 20 ohms	3.2- 20 ohms	3.2- 20 ohms
Microphone Frequency Response	-	-	-	-	50- 8000 Hz	50- 8000 Hz	50- 8000 Hz	50- 8000 Hz
Microphone Impedance	-	-	-	-	High	High	High	High
Microphone Sensitivity Below 1 volt/microbar at 1kHz	-	-	-	-	-51dB ±5dB	-51dB ±5dB	-51dB ±5dB	-51dB ±5dB
Cord	5'	5'	5'	5'	8' (2.4m)	8'	8'	8'
Plug	.250" dia.	.250" dia.	.250" dia.	.250" dia.	unter- minated	unter- minated	unter- minated	unter- minated
Gross Weight	8 oz. (227g)	8 oz.	12 oz. (341g)	15 oz. (426g)	12 oz.	15 oz.	18 oz. (511g)	12 oz. (341g)
Catalog Number	61630-063	61630-062	61210-031	61320-012	61630-064	61200-058	61320-013	61320-015

TUFTS RADIO CATALOG TUFTS RAD

TUFTS SELECTED TITLES OF POPULAR SAMS PUBLICATIONS

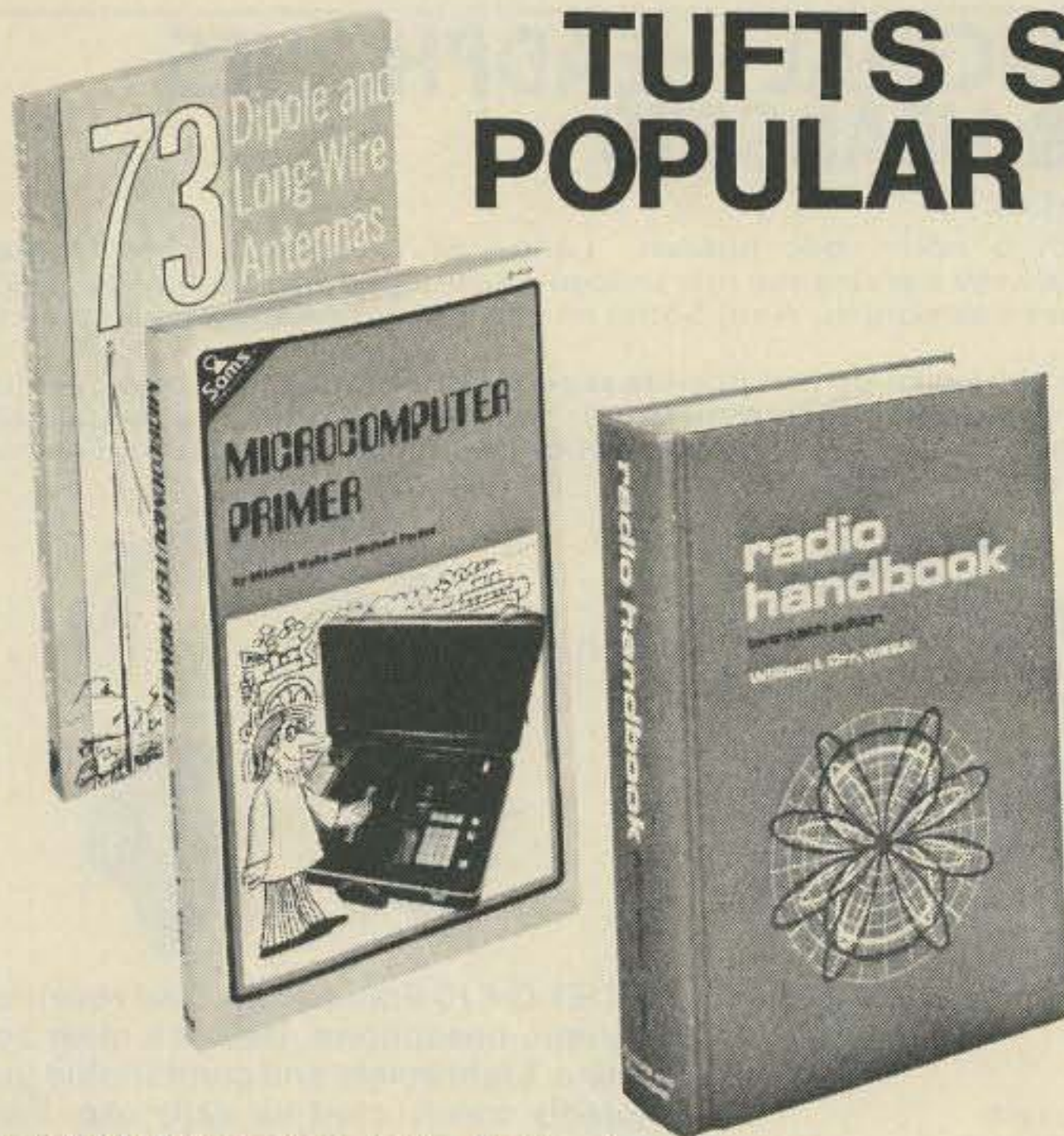

RADIO HANDBOOK (20th Edition)

by William I. Orr, W6SAI. A completely updated 20th edition of the famous communications handbook that is the electronics industry standard for engineers, technicians, and advanced amateurs. Explains in authoritative detail how to design and build all types of radiocommunications equipment. Contains greatly enlarged section on semiconductor and IC circuit design. Includes ssb design and equipment; rtty circuits; linear amplifiers, both solid-state and tube types; vhf and uhf transmitters and converters; as well as special-purpose and logic circuitry, plus completely revised chapter on electronics mathematics. 1080 pages; 6½ x 9¼; hardbound.

No. 24032 \$19.50

HAM AND CB ANTENNA DIMENSION CHARTS

by Edward M. Noll, W3FQJ. Tabulates dimension information in feet and inches for all the popular antenna configurations. Gives data for dipole antennas, quarter-wave verticals, two-element beams, quads, triangles, inverted dipoles, and inverted vees. Includes information for cutting transmission lines to a preferred wavelength, dimensioning phasing lines, cutting a matching stub, and spacing antenna elements. 64 pages; 6 x 9; softbound.

No. 24023 \$2.75

COMMERCIAL RADIOTELEPHONE LICENSE QUESTION & ANSWER STUDY GUIDE (3rd Edition)

by Edward M. Noll. Prepares the reader to take the examinations for the various grades of radiotelephone licenses. Emphasizes those subjects that are most important or most likely to be misunderstood. The questions are representative of those used in the FCC examinations. 304 pages; 6 x 9; softbound.

No. 24033 \$8.50

RADIO TRANSMITTER PRINCIPLES AND PROJECTS

by Edward M. Noll, W3FQJ. Devoted entirely to the subject of radio transmitters, this book is a helpful gathering of modern transmitter principles, ideas, circuits, techniques, and learn-by-doing projects. Covers Bipolar CW and A-M Transmitter Circuits, Transistor/Tube Circuits, Basic Principles of SSB-DSB Generation, Integrated Circuit Fundamentals, VHF/VHF Circuits and Principles, Frequency Modulation, and more. 320 pages; 5½ x 8½; softbound.

No. 24031 \$6.95

73 DIPOLE AND LONG-WIRE ANTENNAS

by Edward M. Noll, W3FQJ. Covers practically every type of wire antenna used by amateurs. Gives dimensions, configurations, and construction data for 73 different antennas, plus appendices covering construction of noise bridges, line tuners, and data on measuring resonant frequency, velocity factor, and swr. 160 pages; 5½ x 8½; softbound.

No. 24006 \$5.50

73 VERTICAL, BEAM, AND TRIANGLE ANTENNAS

by Edward M. Noll, W3FQJ. The second book in a series of practical antenna construction and design methods. Contains data on practically all types used by amateurs. Not a rehash of previously published data, but a compilation of the author's own experiments with various antenna configurations. The 73 different antennas have all been built and air-tested by the author. 160 pages; 5½ x 8½; softbound.

No. 24021 \$5.50

FIRST-CLASS RADIOTELEPHONE LICENSE HANDBOOK (4th Edition)

by Edward M. Noll. An excellent study guide for the first-class radiotelephone license examination. Contains all the material needed to pass Element IV of the FCC examination, including all the questions and answers found in the latest FCC Study Guide. Has three simulated examinations, presented in the multiple-choice form of the FCC tests, as well as answers and evaluations to help the reader find his weak areas. 416 pages; 5½ x 8½; softbound.

No. 21144 \$7.95

SECOND-CLASS RADIOTELEPHONE LICENSE HANDBOOK (5th Edition)

by Edward M. Noll. Provides all the study material needed to pass the FCC second-class radiotelephone license examination (Elements I, II, and III). All material is based on the FCC Study Guide and Reference Material for Commercial Operator Examination. Two tests are included to simulate the actual examination. 448 pages; 5½ x 8½; softbound.

No. 21111 \$7.95

THIRD-CLASS RADIOTELEPHONE LICENSE HANDBOOK (4th Edition)

by Edward M. Noll. Serves as a practical study guide for the aspiring radio operator as well as a ready reference for those working in the field. Designed as a study aid for obtaining licenses up to and including the Radiotelephone Third-Class Operator Permit with Broadcast Endorsement, this newest edition contains questions and answers similar to those given on the actual examination. 208 pages; 5½ x 8½; softbound.

No. 21353 \$5.95

CMOS COOKBOOK

by Don Lancaster. Tells all you need to know to understand and profitably use this inexpensive and genuinely fun to work with digital logic family. First an explanation of what CMOS is, how it works, and how to power it, plus usage rules, state testing, breadboarding, interface, and other basics is given. Then a minicatalog of over 100 devices, including pinouts and use descriptions is given. Subjects covered include gate fundamentals, tri-state logic, redundant logic design techniques, multivibrators, non-volatile memory techniques, clocked JK and D flip-flops, counter and register techniques, op amps, analog switches, phase-locked loops and much more. A must for the student, hobbyist, teachers, technician, or engineer who wants to learn about CMOS. Filled with practical applications. 416 pages; 5½ x 8½; softbound.

No. 21398 \$9.95

IC OP-AMP COOKBOOK

by Walter G. Jung. The first book of its kind to be published. Covers not only the basic theory of the IC op amp in great detail, but also includes over 250 practical circuit applications, liberally illustrated. Organized into three basic parts: introduction to the IC op amp and general considerations, practical circuit applications, and appendixes of manufacturers' reference material. 592 pages; 5½ x 8½; softbound.

No. 20969 \$12.95

IC TIMER COOKBOOK

by Walter Jung. Provides an excellent introduction to the field of IC timers by presenting a collection of various circuit "recipes" useful in applying the devices. Arranged in three parts, the first part gives basic and generalized information. Part II, the applications section, is the "meat" of the book and includes over 100 different circuits for a wide range of uses. Part III contains reproductions of manufacturers data sheets, second-source manufacturers, and more. This book is a valuable reference for the hobbyist, the technical or engineering student, or professional. 288 pages; 5½ x 8½; softbound.

No. 21416 \$9.95

TTL COOKBOOK

by Donald Lancaster. A complete and detailed guide to transistor-transistor logic (TTL). Explains what TTL is, how it works, and how to use it. Discusses practical applications, such as a digital counter and display system, events counter, electronic stopwatch, digital voltmeter, and a digital tachometer. 336 pages; 5½ x 8½; softbound.

No. 21035 \$8.95

HOW TO BUY & USE MINICOMPUTERS & MICROCOMPUTERS

by William Barden, Jr. Discusses these smaller computers and shows how they can be used in a variety of practical and recreational tasks in the home or business. Explains the basics of minicomputers and microcomputers, their hardware and software, peripheral devices available, and the various programming languages and techniques. Includes selection, buying, and programming your own system and gives detailed descriptions of currently available systems. 240 pages; 8½ x 11; softbound.

No. 21351 \$9.95

MICROCOMPUTER PRIMER

by Mitchell Waite and Michael Pardee. Introduces the beginner to the basic principles of the microcomputers. Discusses the five main parts of a Computer—Central processing unit, memory, input/output interfaces, and programs. The important characteristics of several well-known microprocessors are given and a chapter is included on programming your own microcomputer. 224 pages; 5½ x 8½; softbound.

No. 21404 \$7.95

THE 8080A BUGBOOK: MICROCOMPUTER INTERFACING AND PROGRAMMING

by Peter H. Rony, David G. Larsen, and Jonathan A. Titus. The principles, concepts, and applications of an 8-bit microcomputer based on the 8080 microprocessor IC chip. The emphasis is on the computer as a controller. Covers the four fundamental tasks of computer interfacing: (1) generation of strobe and device select pulses; (2) latching of accumulator output; (3) acquisition of input data by the accumulator; (4) generation of interrupt signals to the computer. Intended to help develop the skills needed to use an 8080-based breadboard microcomputer system. 5½ x 8½; softbound.

No. 21447 \$9.95

PRINTED CIRCUIT SUPPLIES

Pre-notched and routed blanks to fit S-100 bus type computers; also 22 pin sized blanks for .156 spacing. Positive acting resist; drill bit assortments; carbide bits; bubble etchers. W. H. Brady & Datak artwork.

Zapper strip/wrap/unwrap tool + 25 foot spool of #30 wire: \$6.00 ppd.

TRUMBULL COMPANY
833 Balra Dr., El Cerrito, CA 94530

COMPLETE YOUR SHACK



THE PERFECT ACCESSORY

only
\$15.95
INCLUDES POSTAGE AND HANDLING

- **PROFESSIONALIZE YOUR STATION**
- Avoid interruptions at home—your family and friends will know you're "ON THE AIR".
- Mount on desk or above door at your station—adjustable mounting bracket included.
- Plexiglass face plate enclosed in black satin-finish steel case.
- 1½-inch brilliantly illuminated RED letters. Unit size: 10¼" x 2¾" x 1¾".
- **AN OUTSTANDING GIFT ITEM.**

BULB(S) NOT INCLUDED

S-F AMATEUR RADIO SERVICES S33
P.O. BOX 10-20 GATEWAY STATION
CULVER CITY, CA 90230
Please send _____ signs @ \$15.95 each.
Post Paid—check or money order enclosed.
Calif. residents add 6%.

PLEASE PRINT

Name _____
Address _____
City _____
State _____ Zip _____



with
JAN QUARTZ CRYSTALS
for

- CB Synthesized • CB Standard
- General Communications
- Industry • Two-Meter
- Monitor • Scanners
- Marine VHF • Amateur Bands

Dependable USA Mfg. for

- Frequency Control
- Frequency Stability
- High Performance

Write or phone for more details Send 10¢ for our latest catalog



2400 Crystal Drive
Ft. Myers, Florida 33901
all Phones (813) 936-2397

J2

TEE/AX PRESENTS; THE FIRST

Coax Toggle Switch \$39.95
Coax Relay Version \$55.95

Patent Pending

TEE/AX, INC.

5701 N.W. 31st AVENUE
FT. LAUDERDALE,
FLORIDA 33309

*Distributor Inquiries
Invited*

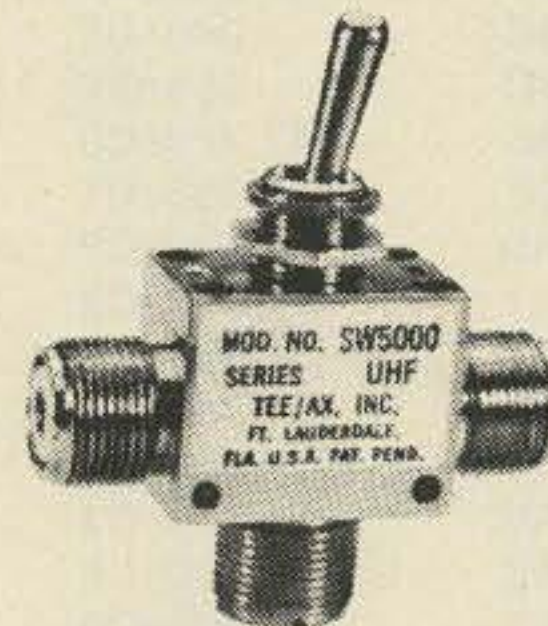

Model SW-5000

- 52 ohms
- SPDT, DPDT
- Power 1 KW
- All Brass Construction
- Teflon Insulated
- Captivated Internal Contacts
- Available in UHF, BNC, N, F, all series

Mail Orders Accepted — Add 75¢ for Postage

T19

One Cent Channels for the IC-22S

-- inflation fighter!

Bob Edgett WB2CBC
Waneta Edgett WA2HGQ
39 Dexter Parkway
Baldwinsville NY 13027

Frequency Hex	490=8C	147.000=AE	147.510=D0
	505=8D	015=AF	525=D1
146.010=6C	520=8E	147.030=B0	540=D2
025=6D	535=8F	045=B1	555=D3
040=6E	146.550=90	060=B2	570=D4
055=6F	565=91	075=B3	585=D5
146.070=70	580=92	090=B4	600=D6
085=71	595=93	105=B5	615=D7
100=72	610=94	120=B6	630=D8
115=73	625=95	135=B7	645=D9
130=74	640=96	150=B8	660=DA
145=75	655=97	165=B9	675=DB
160=76	670=98	180=BA	690=DC
175=77	685=99	195=BB	705=DD
190=78	700=9A	210=BC	720=DE
205=79	715=9B	225=BD	735=DF
220=7A	730=9C	240=BE	147.750=E0
235=7B	745=9D	255=BF	765=E1
250=7C	760=9E	147.270=C0	780=E2
265=7D	775=9F	285=C1	795=E3
280=7E	146.790=A0	300=C2	810=E4
295=7F	805=A1	315=C3	825=E5
146.310=80	820=A2	330=C4	840=E6
325=81	835=A3	345=C5	855=E7
340=82	850=A4	360=C6	870=E8
355=83	865=A5	375=C7	885=E9
370=84	880=A6	390=C8	900=EA
385=85	895=A7	405=C9	915=EB
400=86	910=A8	420=CA	930=EC
415=87	925=A9	435=CB	945=ED
430=88	940=AA	450=CC	960=EE
445=89	955=AB	465=CD	975=EF
460=8A	970=AC	480=CE	147.990=F0
475=8B	146.985=AD	495=CF	

Fig. 1. Hexadecimal for IC-22S.

any standard 15 kHz spacing. The location that was picked to mount the 8 position DIP switch was on the underside of the radio, between the matrix board and the front panel. This allows minimum wire length, convenience of operation, and very little modification to the unit.

The first item that is required is a small piece of vector or printed circuit board, approximately 1 3/8" by 1", to mount the switch on. The best source of this material might be one of your surplus computer boards from which you have removed a 16 pin integrated circuit. Due to the limited mounting space, this makes for an easier installation than using an IC socket and associated hardware.

Simply drill two #39 holes in the rear lip of the front panel to secure the printed circuit board. The right side of this PC material should be aligned with the position 19 of the matrix board to allow for ample mounting space. The first hole has already been drilled through the plastic portion, so it is only necessary to complete the hole through the metal portion. The second hole is drilled about 7/8" to the left. Countersink these holes to allow for installation of 2 #3 flat machine screws. Another piece of PC board material, 1-3/8" by 3/8", should be cut and drilled to be used as a shim (between the front panel lip and the PC material, which will have the switch mounted later). This will make the top of the switch block even with the cabinet cover assembly after it is reinstalled.

The recent arrival of Icom's new IC-22S has completely changed the 2 meter FM transceiver market. The most noted change is the decrease in cost, for a unit which has the features of a synthesizer. The IC-22S only requires you to program a diode matrix board for the common frequencies that you will be using with the 22 selector positions. This makes for very convenient operation, with an even greater advantage over a regular synthesized unit while in mobile use. We have been able to create the best of the crystal controlled rigs and the synthesized units, with a slight modification of the 22S.

The modification, which should cost only a little over \$2.00, simply consists of making use of the 23rd position of the selector switch, with the addition of a miniature 8 position DIP switch. This will allow for programming this position at any time, for any unusual frequency that you desire, at

It will be necessary to cut a slot with the dimensions 5/16" by 7/8" parallel to the front of this cover to allow for activating the switches after the cover is reinstalled. Viewing this cover from the front of the rig, the slot should be located 9/16" from the front and 1/2" from the right side. The next step is to

modify the matrix board by drilling 8 #60 holes in the right end of the matrix board, just to the left of the D0 through D7 markings on the board, making sure that they do not make contact with any of the conductive copper on the board. This will allow for the insertion of 8 diodes which will later be connected to a cable assembly, which will be connected to the 8 slide switches.

Mount the mini DIP switch to the PC board. Install 8 diodes with the anode end going through the new holes just drilled in the matrix board. Assemble a 3" 8 wire cable, using stranded wire to avoid breakage. It is best to use a color coded arrangement, as you will need to keep the wires in order for wiring into the switches. If coded wire is not available, it would be advisable to run one wire at a time, starting with diode D0 going to the right-hand-most switch. Continue in sequence until all positions

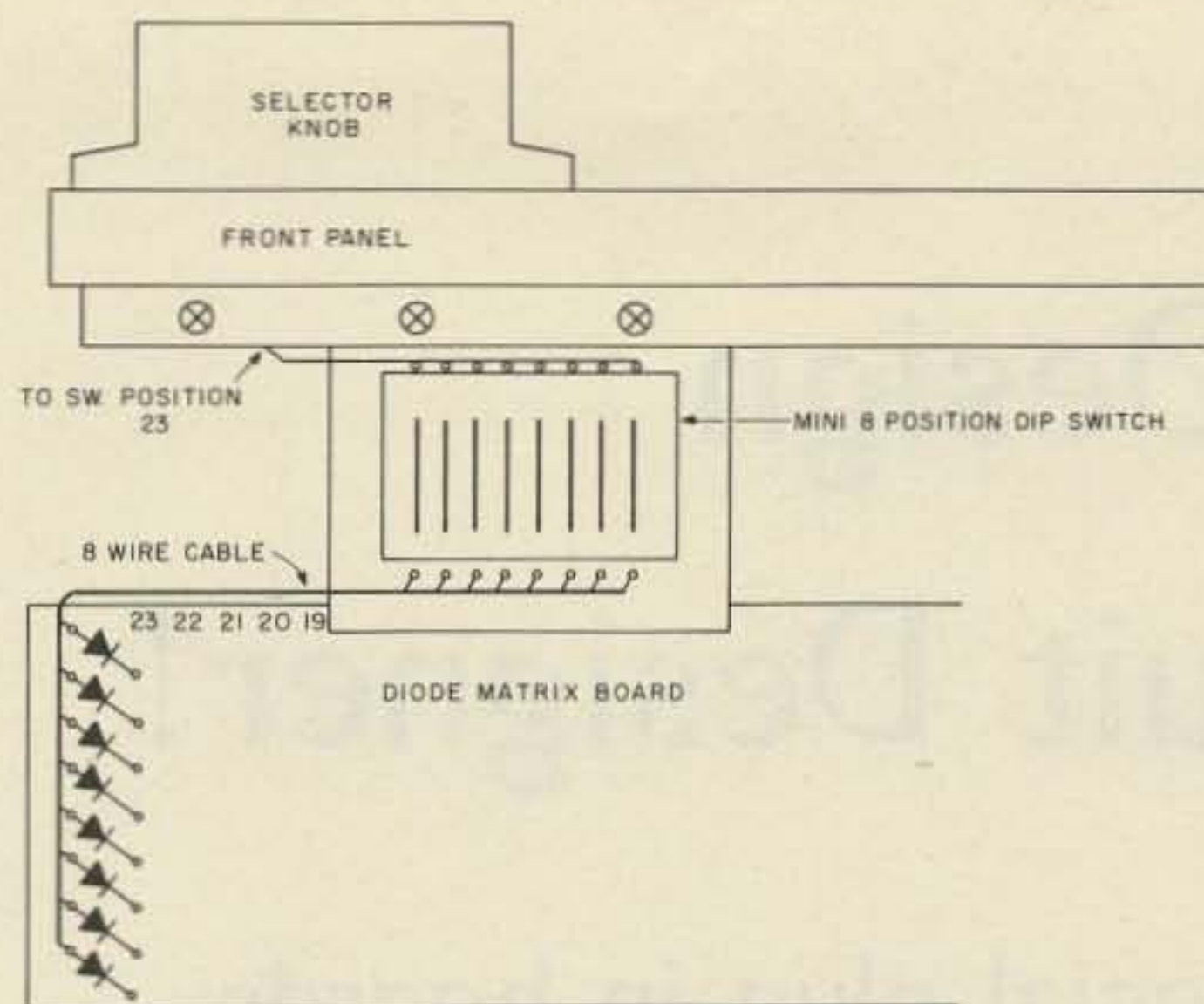

Fig. 2.

are wired. The next modification is to run a wire from the unused 23rd position of the selector switch to a common point of all of the 8 slide switches. Test for broken connections and solder bridges. Mount the matrix board and the switch unit with the necessary screws.

A note should be made at

this time on the actual programming of the switches. Anyone who is familiar with the hexadecimal system will have no problem in remembering how to program the unit. The layout is two hex bytes as follows: 00 to FF, which you can lay out as 8421 8421. An example: To program 146.55, you would

need hex 90, or 1001 0000 in the switches from left to right. As another example, 146.94 would equal hex AA, or 1010 1010 in the switches. After learning a couple of these reference frequencies, simply remember that each value of hex one equals a change of 15 kHz.

Another modification that can be done is use the small version of the hex (base 16) thumbwheel switches and mount 2 of them in the cover near the speaker, as there is sufficient room at that point. Others have run a cable to the accessory plug and used an external switch assembly. You could also use the octal thumbwheel switches, which are easier to obtain, but 3 are needed. Some people find it more confusing using the octal system, as it is more difficult to remember the frequencies.

Any of the above provides for a very practical synthesized unit at a reasonable cost. ■

Robert Cowan KL7IEP/1
PO Box 2143
Augusta ME 04330

Even in an area where repeaters are few and far between, such as Maine, it was easy to fill all 22 channels of the Icom 22S. When you start adding area repeater frequencies, a few essential simplex channels, and attempt to cover yourself for those trips to other locations, it is very easy to run out of available channels and wish you had "just one more."

While recently pondering the replacement of the final in my Icom only two days out of warranty, I noticed that the 22 channel diode matrix board had positions for 23 channels. On closer inspection it became apparent that the 23rd channel on the matrix board was not a mistake, but a bona fide operable set of holes which I could program to get that

extra channel.

There was no wire connected to the 23rd position on the matrix, so I quickly scrutinized the rotary channel selector and found that one pin following channel 22 was empty. At this point it crossed my mind that this could be a trap — there must have been some reason why Icom did not wire in the 23rd channel, and I was overlooking something very

obvious. I have been known to do that once or twice. Thinking that the unused connection might be grounded or in some other way be unusable, I checked the unused pin and several other connection points for anything that looked the least bit unusual. Nothing found.

Finally throwing caution to the wind and dedicated to making some mistake, I ran a small gauge wire from the

23rd row on the diode matrix to the empty pin on the rotary switch. Success! Now, when I select the dot following channel 22, I have access to yet another essential frequency. Frankly, I have no idea why Icom deleted channel 23 when building the 22S, but as long as I am able to expand my capabilities, I'm happy.

Now, if I had just one more channel... ■

The Missing Length

-- phantom IC-22S channel

Design

A Circuit Designer!

-- with special plug-in boards

Many amateurs are aware by now of the component plug-in boards that allow the test assembly of a circuit without soldering. These boards are produced by a number of manufacturers and utilized as the heart of various "circuit designer" pieces of equipment.

This article describes the use of such boards in a circuitry "test bed" configuration that is particularly well-suited to use by radio amateurs. The test bed contains many features found in the more elaborate, and expensive, "circuit designer" pieces of equipment. But the cost can be kept low, with the main cost being that only for the main plug-in component boards. Also, some measure-

ments were made on the boards which might be of interest to amateurs who want to experiment with rf as well as with audio circuits.

For those not acquainted with the plug-in boards, their basic makeup is shown in Fig. 1. Two basic boards are available — a circuit socket board and a bus strip board. Both come in various lengths. The circuit board has five tie points, which are all interconnected vertically on either side of a gap in the middle of the board. The gap is spaced so an IC or transistor can straddle it and plug directly into the board. The bus strip boards have two rows of interconnected tie points running horizontally, but grouped in clusters of 5 tie points each. One can, if desired, break the interconnection of the groups of 5 tie points running horizontally so as to produce 4 rows of tie points. Or, one can isolate one or more clusters of tie points and permanently connect them to input/output devices. Other components such as resistors and capacitors plug directly into the boards, and interconnections are made with #22 hookup wire plugged into the boards.

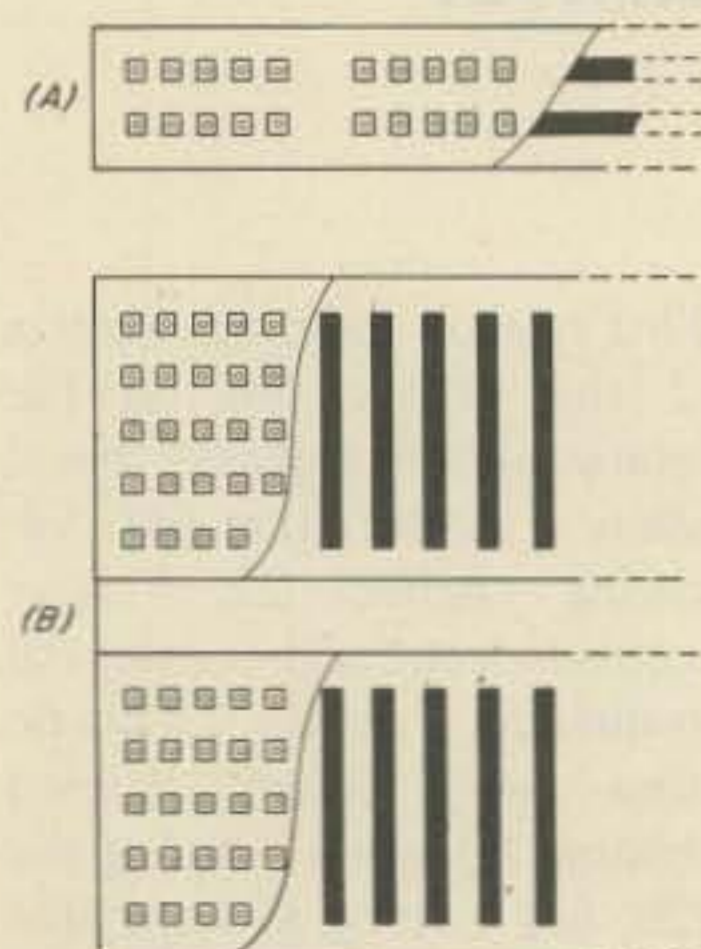

Fig. 1. This drawing shows how the internal metal binding strips are used to interconnect the component plug-in tie points on a bus strip (a) and a circuit socket (b).

Complete, rather elaborate radio receivers have been test-built using enough of these boards, but for the average amateur who builds a multiple transistor/IC amplifier, keyer, filter, speech processing device, etc., 3 boards only will suffice. The boards used in the example for this article are the Continental Specialties QT-595 circuit board, which is 6½ inches long and sells for \$12.50, and two matching QT-59B bus strips, which sell for \$2.50 each.

The boards are placed on top and towards one side of a 7" x 11" x 2" chassis. There is about 5/16" spacing between the circuit boards and the bus strips, but this is just an arbitrary spacing. The rest of the chassis has mounted on it various connectors for input/output connections, power supplies for linear and TTL ICs, metering provisions, and a built-in loudspeaker. Also, room has been left to the left of the circuit board to include a built-in rf or af signal generator for a really complete "circuit designer" configuration.

By carefully examining the arrangement shown in Fig. 2, one can envision how the various terminal posts and connectors are arranged. This

arrangement is a matter of personal preference, of course, but the arrangement shown has proved to be very convenient. Basically, two input and two output BNC sockets are used, and wired to binding posts near the circuit board. Two grounding binding posts are on either side of the circuit board near the lower bus strip. The -V binding post is centered below the lower bus strip. The two meter binding posts are to the left of the meter, and next to them are two more posts — one for a fixed +5 volt output and the other for the +V output. PL-59 type jacks are associated with the loudspeaker and with one input binding post for the quick connection of microphones and headphones using PL-59 plugs.

Three power supplies are available in the unit, but only *one* transformer, a 24 volt CT unit, is used. The 5 volt supply is regulated with an LM309K. The +V and -V supplies are regulated by zener diodes in a conventional regulator circuit. Either ±6 or ±12 volt outputs can be switch-selected. All the components for the power supply, except the transformer, are assembled on a piece of perforated board stock and mounted in any convenient location inside the chassis.

The circuit and bus strip boards come with a paper backing. If this is removed, one can readily see, for instance, how the tie points are interconnected on the bus strips and how they may be further broken down if desired. Since the circuit board would be used for rf circuit testing, it was thought best to better insulate the boards from the chassis. If available, the best thing would be to replace the paper backing with teflon tape. But embossing tape of the Dymo variety will also work fine.

Audio circuits and digital circuits can be pretty well "wired up" (that is, plugged into the circuit), as shown on

a schematic. The bus strip boards are used to run the ground, +V, and -V lines around the top and bottom of the circuit board. Rf circuits require a little more care in layout, since one must keep in mind the stray capacitances that exist around the boards. Bypassing can also be a problem, since it must be made with leads as short as possible to be effective. As regards stray capacitances, measurements showed the average insulated binding post will show about 7 pF to ground. A bus strip run (10 of the 5 clustered tie points) will show about 20 pF to ground. One of the 5 vertical tie points (on either side of the center channel of the circuit board) will show 2-3 pF to ground. Parallel running tie point clusters on the circuit board show about 2 pF between them. All these values are not too bad and can be lived with for many HF circuits, although VHF circuits would generally be impossible to lay out. A

greater problem with rf circuits is good bypassing. The solution to this might lie with placing a number of miniature ground lugs in the space between the bus strips and circuit board, and placing bypass capacitors between the circuit board tie points and the ground lugs as necessary for any given circuit.

Two banana plug sockets are installed below the lower bus strip on either side of the -V terminal. These are for the mounting of a plug in the front panel. The panel is not shown, but it is just a flat piece of aluminum stock drilled/punched randomly with cutouts to accommodate switches and potentiometers of various sizes.

In any case, for someone who likes to do any sort of circuit experimenting, the plug-in boards are highly recommended. Parts can be reused many times and one avoids those soldered-up, three dimensional, experimental lash-ups which look like modern art gone astray. ■

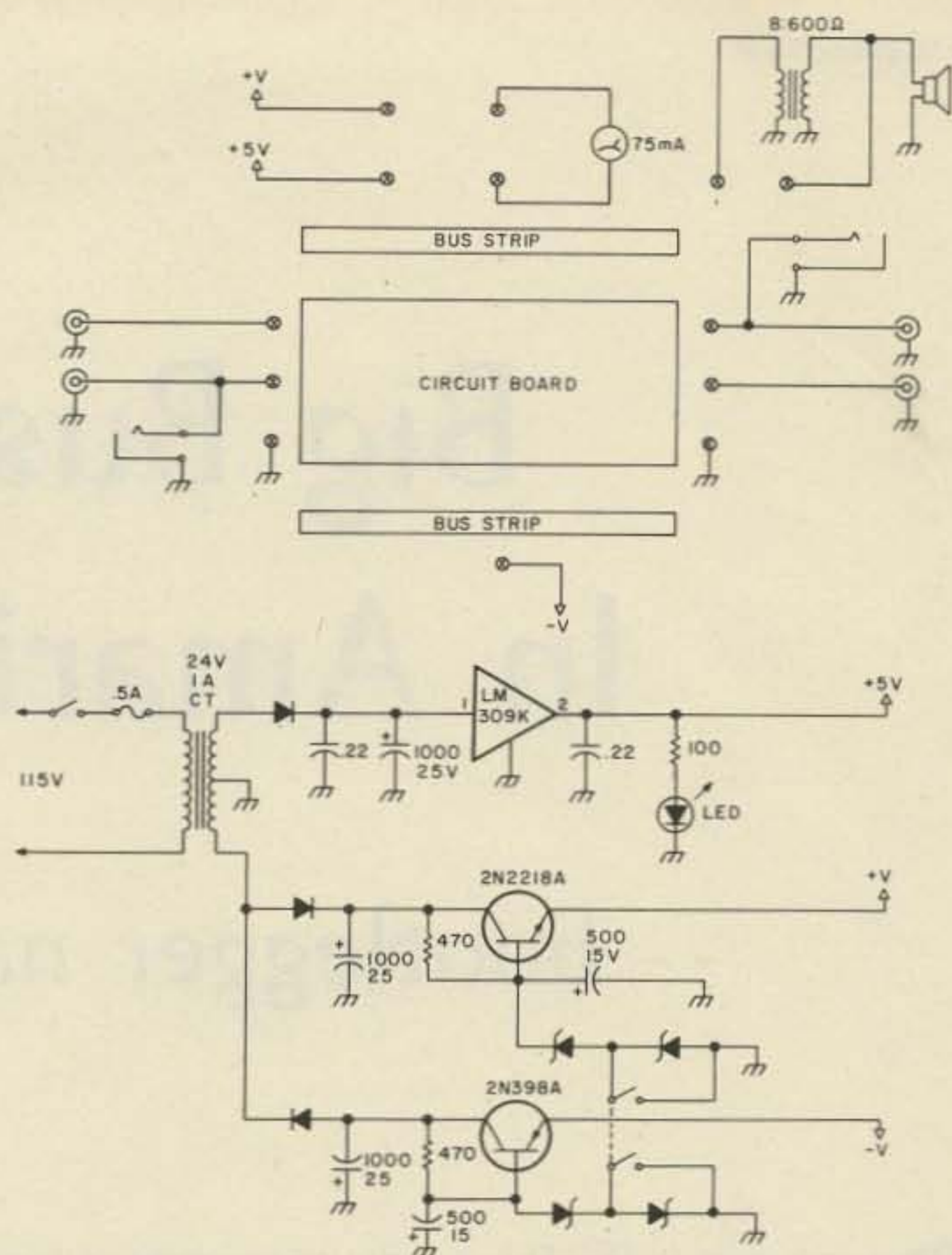

Fig. 2. Arrangement of the binding posts around the plug-in boards and the triple voltage power supply. The zeners are 6.2 volt types. By shorting out the lower zener, a selectable output of ± 6 or ± 12 volts is obtained.

Hank Olson W6GXN
Box 339
Menlo Park CA 94025

A simple overvoltage protection circuit can be built to not only protect a milliammeter (used as a voltmeter with a series resistor), but also provide a visual indication of the fact that the meter is in the "off scale" region.

For normal operation, Z1 (a 10 volt zener) has less than 10 volts across it, and R1 and R2 (in series) simply function as a 20 volt meter multiplier for the 0-1 mA meter. When E1 gets to 20 volts, Z1 conducts and turns on Q1, which draws current through R3 and the LED. The LED gives a visual indication of the overvoltage condition.

The zener Z1 is one of a series of Motorola diodes that have particularly sharp knees at low current. Other zeners

will work, of course, but the demarcation between "normal" and "overvoltage" will be less well defined. The values of R1, R2, R3 and the breakdown voltage of Z1 may be changed to suit one's particular voltage range. ■

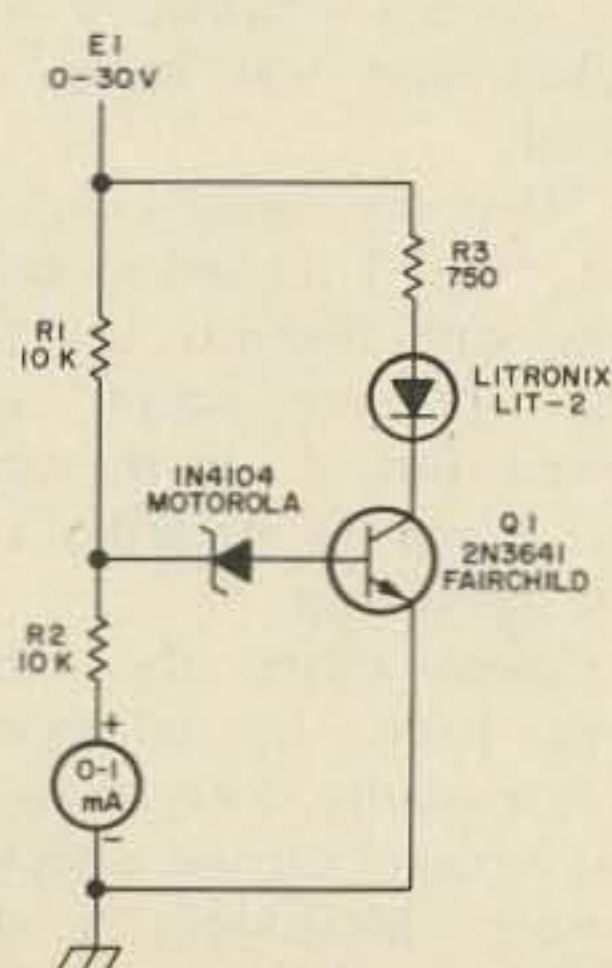

Fig. 1.

Sensitive Meters Saved

Big Bust In Amarillo

-- bootlegger nabbed!

Do not pass "GO." Do not collect \$200. In fact, Jim Krueger, go directly to jail.

It may sound like a game of Monopoly, but, in Amarillo, Texas, it was more like cops and robbers on July 7, 1977. Four hams nailed James Krueger, infamous haunter of repeaters and county jails from coast to coast. Krueger, known by more than a dozen different aliases and a number of bootlegged or "borrowed" calls, is now held on a federal charge, without bond, in the Potter County Jail, as a result of the actions of Joe Bethancourt WA7TUM/5, his wife, Mary Alice, Jim Wilhite W5RXC, Scott McDowell WB5JN, Joe Cowen WA5TUM, and his fiancée, Malinda Lyles.

Cowen, president of the Amarillo Repeater Society, and McDowell, repeater trustee, along with society technical committee heads, Wilhite and Bethancourt, had been on Krueger's trail at various times since he first appeared in the Amarillo area a year ago. Then he was using a legitimate call, WB9MRA, which he "stole" from a duly licensed Indiana ham.

But three weeks of bogus operation in June and July using a nonexistent call, WD7AAB, finally led to his arrest. It had been a game of hide and seek with DF loops, but quick-triggered Krueger was always on the move and kept his transmissions short. Most Amarillo amateurs played the game of chatting with Krueger, knowing all along that the committee of four was out chasing him.

Hams had first become suspicious of Krueger a year ago because of his unorthodox repeater habits — "WB9MRA, requests the patch" — at which time he would key up the touchtone autopatch access.

His old, white school bus, laden with CB slogans, antennas, and advertising for CB repair, was seen by Cowen last year, before it was known that he was illegally using another amateur's call. But Krueger became wise to the situation and disappeared last summer, before he could be apprehended.

During summer months, Krueger travels Interstate 40, working truck stops. This year he was recognized, by

the unmistakable Indiana twang of his voice and his well-known repeater habits, even though he was using the new call. One call to the FCC established that it was a fictitious set of numbers and letters. WD7AAB just didn't exist. A vehicle similar to his was spotted briefly by another local ham, John Gifford W5SYB, who immediately contacted Cowen. Cowen later saw the bus in the parking lot of a movie theater in Amarillo.

"I had gone to see 'Star Wars,' but I never made it," he said. Cowen and his fiancée, Malinda, saw a crowd in front of the theater and learned a projector had broken and was being repaired.

"That discouraged us," he said, "and I started to drive away, and Malinda saw the bus." It was vacant and parked. But, it was the same bus driven in Amarillo last year by Krueger.

Cowen called the other three hams, by telephone, from a nearby store, knowing that Krueger carried a pocket scanner. McDowell, a dispatcher for the Texas Department of Public Safety, put

local highway patrolmen on standby, and joined the stake-out crew — Cowen, Bethancourt, Wilhite, Miss Lyles, and three vehicles fitted with UHF gear on a commercial frequency for coordination without detection.

The stakeout started at 6:50 pm, and, finally at about 10:45 pm, Krueger came out of the theater and entered the bus. Before his exit, the hams, knowing from past experience that the bus had equipment to monitor 2 meter and law enforcement frequencies, had set up a communications system using Bethancourt's wife, Mary Alice, who was at home.

"We used the UHF gear to communicate with Mary Alice," Cowen said. "Then she'd talk to DPS holding on an open phone line."

Officers then made arrangements to stop the bus on Interstate 40, after it was trailed in James Bond fashion throughout the city by the four hams coordinating through Mrs. Bethancourt.

"We were just plain lucky," Cowen said, "that it turned out that Krueger was wanted by the FBI for unlawful flight to avoid prosecution, a fact that could not be confirmed until officers had learned his date of birth from the 'driver's license check stop' made by the highway patrolman.

"We knew that he was arrested in Indiana last year and jailed for dealing in stolen CB equipment," Cowen added, "and this year we got highway patrol cooperation because the registration tag on the bus did not fit the vehicle, according to information Scott McDowell was able to get out of Arizona, its state of registry."

Because of the mismatch of license tag to bus, Texas troopers had "just cause" to stop the thing and investigate.

"We hoped that some of the CB radios, or perhaps the Icom 2 meter gear he was using, would turn out to be stolen," Cowen said. "We had

tried last year and this year to get the FCC Field Enforcement Team interested. It seems that they could not have cared less, and we knew if we were to get Krueger off the air, it would have to be done on other charges, due to the lack of interest demonstrated by the FCC and the American Radio Relay League.

"I wrote the ARRL and the FCC last year about Krueger, and so did the legitimate holder of WB9MRA. As far as I know, neither of us even got an answer. I know I didn't," emphasized Cowen.

"However," Cowen stressed, "I think we may get some action this year from the FCC, for I hand-carried a written request to the FCC to investigate the situation to Texas Congressman Jack Hightower. We have tape recorded evidence against Krueger, and, by his own admission to the highway patrolman who stopped him and asked to see his amateur radio license, we know he is not a ham."

"Even the FBI has egg on its face after this deal," Cowen added. "Scott McDowell also phoned the local FBI Resident Agent to tell him that we were staking out Krueger, because he was in violation of federal law due to his illegal amateur radio operation. That agent didn't have much to say when he was phoned again later the same evening by Scott to inform him that he should



Ham hunters who nailed bootlegging operator James Krueger are (left to right) Joe Cowen WASTUM, Malinda Lyles, Mary Alice Bethancourt, and Joe Bethancourt WATTUM/5. Kneeling are (left) Jim Wilhite WSRXC and (right) Scott McDowell WB5JJN. Hams and two of their ladies are shown around a Dodge Ramcharger, one of the vehicles used to track the bootlegger, who is now in jail awaiting federal prosecution.

appear at the Amarillo DPS office to pick up his prisoner. The agent was completely uninterested in Krueger when we wanted him for violation of communication laws, but his interest picked up somewhat when he learned that we apprehended a fugitive under federal warrant."

"Some of the radios in the bus have had serial numbers ground off, and it is my understanding that checks are being made on all confiscated

equipment," Cowen said.

"We realize that Amarillo is a long haul from the nearest FCC office," he added, "but we feel that this case warrants further investigation, so hams will never again be bothered by James Krueger. We know the FCC is on our side, but at some point it is necessary to either enforce the rules we have or forget them altogether. If we forget them, however, then we have lost amateur radio to

the money-hungry EIA, with its lucrative CB industry, and the amateur frequencies will rot away to the tripe now found on 11 meters. I hate to see this happen, but we hams are powerless, it seems, to legally enforce the rules, and, without the FCC's help, we are completely vulnerable to any CB freak who has the bread to buy a radio. If Krueger had not been wanted on other charges, I'm afraid he'd still be on 2 meters." ■



**Adirondack
has it!**

Amateur Headquarters for the Northeast

**ADIRONDACK Radio
Supply**

185-191 West Main Street • P.O. Box 88
Amsterdam, N.Y. 12010 Tel. (518) 842-8350
Just 5 minutes from N.Y. Thruway — Exit 27

Right Way, Wrong Way, Navy Way -- or the 73 way

Learning the code can be approached in a systematic and rewarding way. Like the title suggests, there is a right way to go about it and there is a wrong way. And when you are finished arguing about these, there's the Navy way.

As for my credentials, I attended the Naval Radio Communications School some years ago, and there in the short period of three months became a "35-word-per-minute man." Subsequently, on board ship and with a year of radio watches behind me, I copied "px" (press wireless) with ease at 50 wpm while covering the International Calling Frequency with the other ear. No one, of course, writes with a stick (pencil) at that speed. We learned to copy the code directly onto a typewriter with a special tele-

graphic keyboard with almost identical upper and lower cases.

There are other ways of communicating intelligence by code. I learned land line telegraphy and blinking light as well. Land line takes a somewhat different code, the true Morse code, which is an alphanumerical setup, with five clicks for a "p" and spaces between the elements of a few characters. It is received with a sounder, a clicker instead of the beeper that hams are familiar with. Another code method is machine tracing of the impulses on a strip of paper (either by offset or broken trace) and then sight reading the result like an old 1929 Wall Street tycoon with his ticker tape.

The ham type code is known as the International Morse alphabet, adapted from the true Morse, the better to

hear the beeping sounds from a radio receiver with.

Some persons have a knack for the code, like a drummer has rhythm. Others will never learn it, like some people can't carry a tune in a satchel. There is a psychological synapse in the brain that can distinguish the difference between a short beep and a longer beep, which we shall henceforth call "dit" and "dah," respectively. Some people's heredity simply did not include the required synapse, and to these a dit is exactly as long as a dah and spaces between do not exist. The good code man finds this hard to believe, because code comes so easily for him, but the poor guy whom nature forgot can well believe it. More about this aspiring ham later.

The Navy taught its operators to send with a hand key. "Bugs" were verboten until

we could handle 18 wpm with the hand key with ease. We had to take a test before a gimlet eyed old shipboard operator before we got our "bug ticket." The test was first on our hand-key sending ability and, secondly, on our ease and familiarity with the semi-automatic T. L. McElroy Vibroplex, the bug. There was good reason for all this caution — listen to any code ham band, and you'll see why. The lives of many good men depended on the accuracy of sending and receiving the code on board ship. There was no phone wireless at one time, remember? And even when it first came into shipboard use, phone was far from dependable. Navy operators were taught to send clearly, at a speed no greater than could be received by the operator at the other end. Demerit points were accumulated for repeating portions of messages, for corrections, etc. The idea was to send so clearly and distinctly that the receiving operator got a perfect message the first time.

When I took my ham exam, some years after leaving the Navy, I petitioned the FCC examiner to use the typewriter instead of a pencil for receiving. He, though surprised and not quite sure the regulations permitted, agreed. He had a code sending machine that he used for making the test as fair as possible which he could set at any speed up to umpteen wpm. After I had done the required minimum speed test with obvious ease and accuracy, he asked me if I'd care to boost the rate. He advanced the speed about 10 wpm each minute, and at 55 wpm I began to make errors and to falter. That was the first time I knew with accuracy, after all my years of shipboard operating, just what my code ceiling was. Needless to say, I passed my ham ticket code exam the first time and, later, the ARRL 35 wpm certificate as well, thanks to Uncle Sam's Navy. I mention this for good reason.

There is an aspect of learning to send and receive the code that resembles a stairway landing: plateaus. You begin with individual characters and advance to recognition of character combinations. This recognition is at first a conscious act. You strive to make sense from the sounds and silences, and suddenly sense comes through. Instead of "dit dah stands for A," you suddenly recognize that "dit dah is A." There is a very important difference here, make no mistake about it! Then when you drop the "is" and *dit dah becomes A in truth within your consciousness*, you have ceased to translate, and are "thinking in code." That's important! It's the whole ball of wax.

I don't mean to make it all sound easy. Learning the code takes a lot of application of the seat of the pants to the chair, hard work and perseverance. You are learning a new language, just as surely as though you were studying Spanish, German, or Parsi. If you would study the science of communication, try Norbert Weiner's *Cybernetics*. You'll come out a better all around ham for having tackled it.

I contend that most of the trouble people have learning to send and receive code is with the teacher, yourself included when self-taught. Vital to your success is a positive mental attitude. One of the first mistakes every teacher makes is to teach you the code alphabet. Don't do it! At least, don't do it that way.

Get hold of a first grade reader and start at page one, letter one, word one. Each letter you don't know the Morse character for, look it up on a handy chart, and convert it to the phonetic: "B" = *dah dit dit dit*. Say it out loud: *dah dit dit dit*. Hear it. Send it on your hand key (stay away from semiautomatics and automatics until you can send fast and comfortably well with the hand key.) Do not, ever, say: *dash dot dot dot*. That is not what

you hear coming out of the speaker. You are learning to recognize code by sound, not sight (at this point at any rate).

By taking the letters as they come in a child's reader, you will be learning the code as it was meant to be learned by the inventor who was a much smarter man than he is generally given credit for. Note that the most frequently used letter in the English alphabet is "E". Note its counterpart in Morse: *dit*. Yes, he did take frequency of letters into consideration, and the International Morse improved upon this somewhat. And that's the way you should learn to recognize the Morse language, most frequently used letters first. You won't have to worry about how often you have to refer to the code chart — your natural laziness will soon commit the letters and their Morse counterparts to memory rather than go through the extra work of referring to the chart each time! It will come surprisingly naturally if you simply do it the Navy Way!

Now as you become better and better acquainted with the sounds, and the sounds become the letters, a point will be reached when you will suddenly find yourself recognizing two and three letter combinations. They will sound like a new Morse character that isn't in the alphabet: *dah, ditty ditty, dit*: the. The silences will take their places in the character if you are being careful not to slur in your sending and are making each character distinctly and with its spaces where they are intended and the length they are intended to have. You will be developing your ear, and you will be walking on the second plateau before you even realize it was a struggle to get there!

So you keep on going, and, after you have gone completely through the primer reader, do it again and then a third time. Now you will probably be ready to take on

a standard book, say a radio theory handbook, or a page of *73 Magazine*. Don't skip over the numerals. You've got to learn them now, and they are no more difficult than the letters. Do them the same way, by referring to the chart when you hit one you don't quite remember. Get with it and before long you will recognize a series of two and three letter words all as one character! You will have reached the leading edge of the third plateau. Keep pushing, keep practicing, and you'll be walking on third level with ease before you realize it was a tough nut to crack. When you do, you'll be receiving 15 wpm or better!

After that it's practice, practice, practice. There's another plateau at about 25 wpm, and another around 35 to 40. Once these humps are cleared and become comfortable, copying behind begins to sneak up on you, and your elation will know no bounds. Your code will have become a second language, just as surely as Hindi, Chinese or Russian. I once shared the radio shack with a guy who copied from 20 to 30 words behind! You can't possibly keep up with individual characters at that speed. The reason has to do with learning to type and its distinctive plateaus, word-combinations, etc.

There is a way of sending Morse with a hand key that is unbeatable for clarity and ease. You can send all day without getting tired if you will learn this method from the beginning: Raise your wrist slightly with each downward motion of the hand on the key, like Liberace on the piano only not quite so carried away. Don't grasp the key with a death grip; treat it reverently, lightly, caressingly. That way your muscles will remain almost relaxed. (Yes, I know that raising your wrist feels absolutely wrong at first. But persevere, and you'll never regret it.)

It takes a lot of hard work and determination to master the code, but I am certain

that too many potentially good hams make a hard, hard, bitter job out of it when really it's not that hard at all. It's simply a matter of starting out on the right foot — wups! Careful! You'll be accused soon enough of sending with your left foot!

And when you've been at it for a few years, and the birds and bedsprings begin talking to you in Morse, it's time for a vacation into the phone bands! Many a crack Navy op ended his radio career in a padded cell — there's a certain hazard attached to daily, year in and year out high speed code work.

What's tops in speed? Well, there's another little quirk of the human grey matter that blends a rhythm into a solid roar above a certain threshold. Even the best signalman begins to lose his differentiation of blinking lights at about 12 to 15 wpm. If he didn't he'd never be able to appreciate the movies or television. Same thing with code by ear. After some level around 50 to 75 wpm, individuals will find it's time to let the computer handle it.

There are dozens of little hints and kinks that can be passed along by old radio ops. For instance, you've got to push yourself to copy at a speed faster than is comfortable for you at any given time in your learning period. If you don't, you'll top out at a very low speed. It also means that you have to expect to make errors. Don't sweat it; let the errors fall where they may as you are climbing the speed ladder. When you have reached the level beyond which you don't feel the effort is worth the use to which you'll put the ability gained thereby, settle down at that speed and begin to perfect your accuracy. Keep away from swinging your sending. Another hint — if you make a mistake, don't go back over it. Keep on going with what you are copying. Trying to correct an error only causes you to miss what's coming. After you have learned to

copy behind the signal, there's plenty of time to correct minor errors.

Another hint — learn to receive on a typewriter, right from the beginning. There's a much better linkup between the code, your brain, and a typewriter key than between the brain and a pencil.

And after all this, if you try and try and pretty soon six months rolls around (at 2 hours a day) and you haven't passed 5 wpm, ask for help from a psychologist. It's just

possible you are one of the unfortunate few whose synapses never quite got together for that particular mental function. Then do some letter writing. Petition the FCC to let such bona fide proven-by-a-psychologist handicapped persons pass the test by reading written dot dashes from a moving tape. Because, chances are, even though you can't hear the difference in character lengths, if you are sighted you can learn to read the difference as fast as you

and I can read this printed page! Having known guys who could, whose job was to handle the automatic code printer in the radio shack, I'd say we have reached a point in our ham evolution where there's room for this particular exception.

Therefore, let nothing you dismay. You, too, can learn the code. As long as the majority of hams persist in maintaining the code test requirement for licensing, go along with them and show

them you've got what it takes to pass their silly old test. And who knows, maybe it's not so silly after all? Suppose, for instance, you were suddenly stranded on a desert island, and all you had to signal for help with was a simple, keyed transistor oscillator you whipped together out of a pocket radio? Once you learn the code, you'll be surprised at how much fun you can have with it, and, at infrequent times, how *valuable* it is to you! ■

Joyce F. Holland WA4WZL
Hiwassee College
Madisonville TN 37354

Living With the Family Ham

-- planning births, etc.

In many situations a ham marries a non-ham. Realizing that there is a scarcity of information available on how to cope as a non-ham in a ham world, I have compiled the following information dedicated to greater harmony in the lives of hams and their spouses.

1. Do learn the radio vocabulary.
 - PTT and CW are not real estate agencies.
 - XYL is not the abbrevia-

tion for xylophone.

— 73s and 88s are not just lock combinations.

— DX is not just a brand of gasoline.

2. Remain calm while as many as 5 antennas are installed on the roof. Describing to a stranger that you live in the house with 5 antennas leaves less chance for misunderstanding than describing a house with blue shutters.

3. Don't panic when the utility room gets transformed

into a ham shack.

4. Plan to serve meals at times that do not interfere with radio nets.

5. If possible, try to schedule the birth of children in mid-week so as not to interfere with hamfests.

6. Don't get upset if your spouse cannot coordinate 2 articles of clothing in the closet, but he is able to spot a new transceiver in a store window from across the street.

7. Don't get alarmed if the side is cut out of the broom closet to make way for a transceiver installation.

8. Even if they do just look like funny post cards to you, do not throw away QSL cards.

9. Do your homework. Have ready for curious friends and grocery bag boys at a moment's notice clear and logical answers to the following questions:

- a. Why do you have those funny license plates on your car?

- b. What kind of CB is that?

- c. Can you hear police calls on that?

- d. How far away can you talk to people?

- e. Can you talk to my friend in Guatemala (or Peru, or Liberia, etc.)?

10. Learn to reassure the neighbors when they ask if being a MARS member means you report the activities of the neighbors to the FBI.

11. If possible, study radio code and theory for your own license. Never under any circumstances comment that the code sounds to you like a confused woodpecker.

12. Relax and enjoy the benefits of your spouse's hobby. It does, after all, keep him (or her) home much more and is usually less dangerous than auto racing or scuba diving.

After almost 6 years of marriage to a ham, I took the test. In October, 1976, I was licensed as WA4WZL. ■

HOBBY HOUSE

Your Home
Hobby Center for
Quality Kits
and Projects

969 Ball Ave.,
Union, N. J. 07083
(201) 964-5206

SEND FOR FREE HOBBY HOUSE CATALOG
LOWEST PRICES ON PRIME COMPONENTS

Some Examples

HIGH POWER TRANSISTORS

Factory Prime	
2N 3055 NPN (ITT-TO-3 Case)	2/\$1.00
2N 2869 PNP (RCA-TO-3 Case)	2/\$1.00
DTS 410 NPN (GE TO-3 Case), Equiv. to ECG 162	2/\$1.00
2N 1184 PNP (RCA-TO-8 Case)	2/\$1.25

IN 4148 SWITCHING DIODES

Factory Prime, Taped & Reeled 50/\$1.00

1000 MFD 30 Volt Electrolytic Cap Axial Leads
5 for \$1.00

CAPACITOR ASSORTMENTS

Popular value disc & low leakage up to & including 1 MFD	40 for \$1.00
Tubular Electrolytics Ass't. from 1 MFD to 2000 MFD	15 for \$1.98



POTENTIOMETER ASSORTMENT

1K to 100K 12/\$1.00

HELIPOT

10 Turn, Wire Wound Potentiometer
500 Ohms, 5 Watts, 1/2% Linearity \$1.98



6 FT LINE CORDS 6 for \$1.00

250K SLIDE VOLUME CONTROLS BY MALLORY
4/\$1.00

2 AMP CIRCUIT BREAKER

Front Panel Mount Through 1/2" Diameter Hole
120 VAC, 32 VDC, Trips at 2.7 amps 2/\$1.00

GRAIN of WHEAT type chic. min. Display Lamps - Red or white	10 for \$1.00
Impedance Matching Transformers Miniature Audio type	15 for \$1.29
DRY REED SWITCH capsules Glass Sealed .5 amp 115 VAC	25 for \$1.98

5 volt, 6 Amp POWER SUPPLY KIT \$12.95 complete

Fixed: 6 Amp, 5 volt 1% Regulation
Adjustable: 5-12 volts Unregulated
Short Circuit Protection, Current Limiting

KIT INCLUDES:	• Heat Sink
• Transformer	• Comp. Grade Filter Cap
• Regulator	• Output Power Transistors
• Resistors	• Capacitors
• 4 Way Binding Posts	• Bridge Rectifier
	• Line Cord

Complete Instructions & Diagrams

AMPLIFIER & SPEAKER MODULE \$2.95 ea.

- Not a kit — Ready for Mounting
- 2 1/4" Speaker, 8 ohm
- 200 mw 12 volts
- Adjustable range

COMPUTER PRODUCTS

ALL PRIME, FACTORY, NEW

21L02-1, RAM low power, 45 ons	8 for \$12.50
1702A, EPROM Memory 1-5 ws	\$4.95 ea.
2708, PROM 1 k x 8 wv	\$21.95 ea.
8080A, Microprocessor 2 ws	\$9.95 ea.

PRICE BREAKTHROUGH!

Terms and Conditions

Orders Shipped Within 24 Hours.
\$5.00 Minimum Order. Telephone C.O.D.'s accepted.
\$15.00 Minimum Bank Americard/MasterCharge order.
Add \$1.00 Postage for orders under \$10.00
Outside Continental U.S. add postage - U.S. Funds.
N.J. Residents add 5% Sales Tax. Money Back Guarantee.



MA1003 MOBILE CLOCK
MODULE (National)
\$21.95 complete

Attaches directly to
9-12V Battery Automatic Nighttime
Dimming
Fluorescent Display gives Color Choice
(Red, Blue, Green or Yellow)
when used w/corresponding Color Filter
Includes — Module, Switches, Filter & Specs

PAIR OF 6" PIONEER PINCUSHION SPEAKERS

3.2 ohms, 7 1/2 watts \$3.95 pair

Pair of 4" Full Range Speakers

4.0 ohms \$2.95 pair

AC/DC WALL PLUG ADAPTOR-CHARGER

120 volt input/6 VDC 130MA-output \$1.00

6 RPM Gear Motor Syn. Timer Type \$2.95

VOLTAGE REGULATORS

Positive-To 220 Pkg.		Negative-To 220 Pkg.	
7805	\$1.00	7905	\$1.25
7806	1.00	7912	1.25
7812	1.00	7915	1.25
7815	1.00		
7824	1.00	LM309K To-3 Pkg.	1.25

7 SEG LED DISPLAYS

33" Type 707/MAN-1 14 Pin Dip
Common Anode or Cathode

\$59 ea. 10 for \$5.00

CLOCK CHIPS

MM5314	\$3.50	Plug type-12VAC 250MA 2.50
MM5316	3.50	PC Mnt.-12VAC 250MA... 1.50
MM5387 (Hi Cur.5316)	3.95	Bkt Mnt.-5VAC 6 Amp... 4.95
MM5375	3.95	

TRANSFORMERS

BRIDGES		IC SOCKETS	
1 1/2 Amp 200 volt	3/1.00	8,14,16,18 Pin	5 for 1.00
6 Amp 600 volt	3/2.00	24 Pin & 28 Pin	3 for 1.00
25 Amp 200 volts	3/5.00	40 Pin	2 for 1.00
2.5 Amp 1000 volt	5/1.00		

LED's

Jumbo Red LED's	10 for 1.00	100 for 9.00
25 Pk. LED's Ass'd. Sizes & Colors		2.50
Bi-Polar LED Red/Green		1.00

LED Kit - a \$4.00 Value — \$2.50

- Includes: • 1—Bipolar Red/Green
- 1—Hi Intensity • 3—Green, Jumbo
- 12—Red Assorted • 2—Yellow, Jumbo
- 4—Panel Mounts

SWITCHES

Pushbutton-Mon. On	3 for 1.00
Mini Toggle-SPDT	1.25
Mini Toggle-SPDT On-Center Off-Mon On	1.25
Mini Toggle-DPDT	1.50
Rocker SPDT	6 for 1.00
Rocker DPDT	5 for 1.00

WOOD CLOCK CABINETS

Includes: Filter & Back

Walnut Grain or
Black Leatherette Finish
\$5.00 ea.

Dimensions (Inside)
-A — 1-13/16"H, 5 1/2"W, 4 1/4"D-
B — 1 1/4"H, 4 3/4"W, 4 1/4"D
Extra Filters — Red, Smoke
Blue, Amber, & Green — \$6.00

Dual Range DVM/Multimeter Kit

DVM Kit only \$29.95 complete
Multimeter Kit incl. Power Supply \$44.95 complete
Features: 0 to +2, +2 etc. up to +200 volts DC
• Intersil CMOS Chip Set • Accuracy to within .001
• High Noise Rejection • Non Critical Components
Contains: PC Boards, large .50 Fairchild Readouts
All components, switches, complete Insts.
& Specs

\$9.95

Complete Clock Kit 4 DIGIT 12/24 HOUR

Includes: PC Board, 5316 Clock Chip, all components &
Power Supply

Features: Displays hrs. & min. - Switch to min. & seconds
• AM/PM Indicator • Elapsed Timer
• Fluorescent Display gives color choice
(Red, Blue, Green, or Amber) - specify
when used with corresponding Color Filter

OPTIONS: If alarm Function desired add \$2.50
(includes speaker & all components)
Plexiglas Case Kit - Red or Blue \$2.00

60 Hz. Crystal Time Base Kit \$4.95

Use with Digital Clocks for 12VDC or Portable Operation

KIT INCLUDES:
PC Board, 5369 Divider Chip
3.5795 MHZ XTAL & All Other Parts
Complete Instructions

Blinky/Flasher/Timing Kit \$2.50 each 5 for \$10.00

Kit includes:
P.C. Board, 555 Timer, all components
and a connector for a 9V Battery

6 Digit LED Stop-Watch Kit \$29.95 complete

Split Time Taylor Time

FEATURES: Reads minutes, seconds, & 100ths of seconds
6 bright easily readable digits
Needs only one 9 volt Xistor battery

KIT INCLUDES: • Hand held case designed for above
• Latest Technology Intersil Mos Chip # 7205
• 3.2768 MHz Crystal • Variable Trimmer Cap
• 2 mini slide & 3 MOM. PB Switches
• 3 pairs (6 digits) Double Digit LED Displays
P.C. BOARD for above

6 DIGIT LED MOBILE Clock Kit & Elapsed Timer



.4" Digits 12 or 24 Hr.
Quartz Crystal Controlled
12 Volt DC or AC operation

\$27.95 Complete
(less 9V battery)

- Protection from noise & High Impulses
- Display Blanking Capability
- Battery Back-Up Capability
- Size 4" x 1 1/4" x 4 1/2"
- Rugged High Impact ABS
- Recessed Front Switches

OPTION — AC Adaptor \$2.50

BIG-BRIGHT - .5" LED ALARM CLOCK 6 DIGIT AC or DC or ELAPSED TIMER KIT \$19.95 Complete

• PC Board Drilled & Silk Screened (Includes Xtal Time Base
Circuitry)
• 5375 Nat. Clock Chip & Fairchild Displays
• Includes EVERY part required for clock and all options except
Cabinet and Crystal Time Base components. If desired, see below
• Brightness Control • 24 Hr. Alarm w/snooze
• Freeze feat. on every mode • 0-60 Min. Elapsed Timer
• Field Tested over 1 Yr. • 12 Hr., 60 Hz oper.
Most Important — Complete Instructions, schematics Pictorials,
layouts — everything for trouble free assembly.

OPTIONS —
XTAL Time Base Components - \$2.95 when purchased w/clock
Wood Clock Cabinet - \$4.00 when purchased w/clock

12/24 Hr. Version of Above \$17.95
except no Alarm or Elapsed Timer



H23



Add Jazz To Your Tempo

-- with a few simple mods

Ronald R. Groshans WB8ZBJ
PO Box 727
Niles MI 49120



Microphone with clip installed.

I have been an amateur radio operator for about a year and have had to start on a financial shoestring. My first piece of equipment was a Tempo fmh HT. As my only means of communicating with my fellow hams, the HT went a lot of places with me. I soon discovered that the handie-talkie was not so handy as it was on the road. I tried hooking a carrying strap to the two provided eyelets, and this, too, proved unsatisfactory. I then put on my thinking cap in earnest.

I knew Motorola made a wide variety of HTs. I dug out my Motorola wish book (commonly called a catalog) and started my search for a better means of carrying my HT.

I discovered that there were two ways available to carry an HT in comfort. One way was by means of a case which attached to the belt. To use the HT one simply lifted it out of the case. Second was by means of a belt clip, the belt clip being permanently affixed to the unit. This second method I liked for two reasons; one, it was more secure, and, two, it turned out to be less expensive.

Having solved the problem of how to carry my HT, I started to work on the idea of a hand-held microphone accessory. This turned out to be more time-consuming than the belt clip. Therefore, since it would take time to work everything out on my microphone accessory, I decided to go ahead and put the belt clip on.

I went to a local Motorola parts sales and repair dealer and ordered what I needed. I placed an order for one belt clip, one fiber adhesive insulator, two screws, and one metal backing plate. The entire order came to a whopping grand total of \$3.67. The Motorola dealer did not happen to have these parts on hand, but ordered them for me. I had them in just about a week.

Now the hard part. I found a microphone with no problem. That was the easiest of this group of parts to find. I had a microphone, but I needed a means to connect it. After many long hours of searching, I settled on a connector made by ITT. A five piece connector system costs \$4.88.

After comparing the schematics for both the

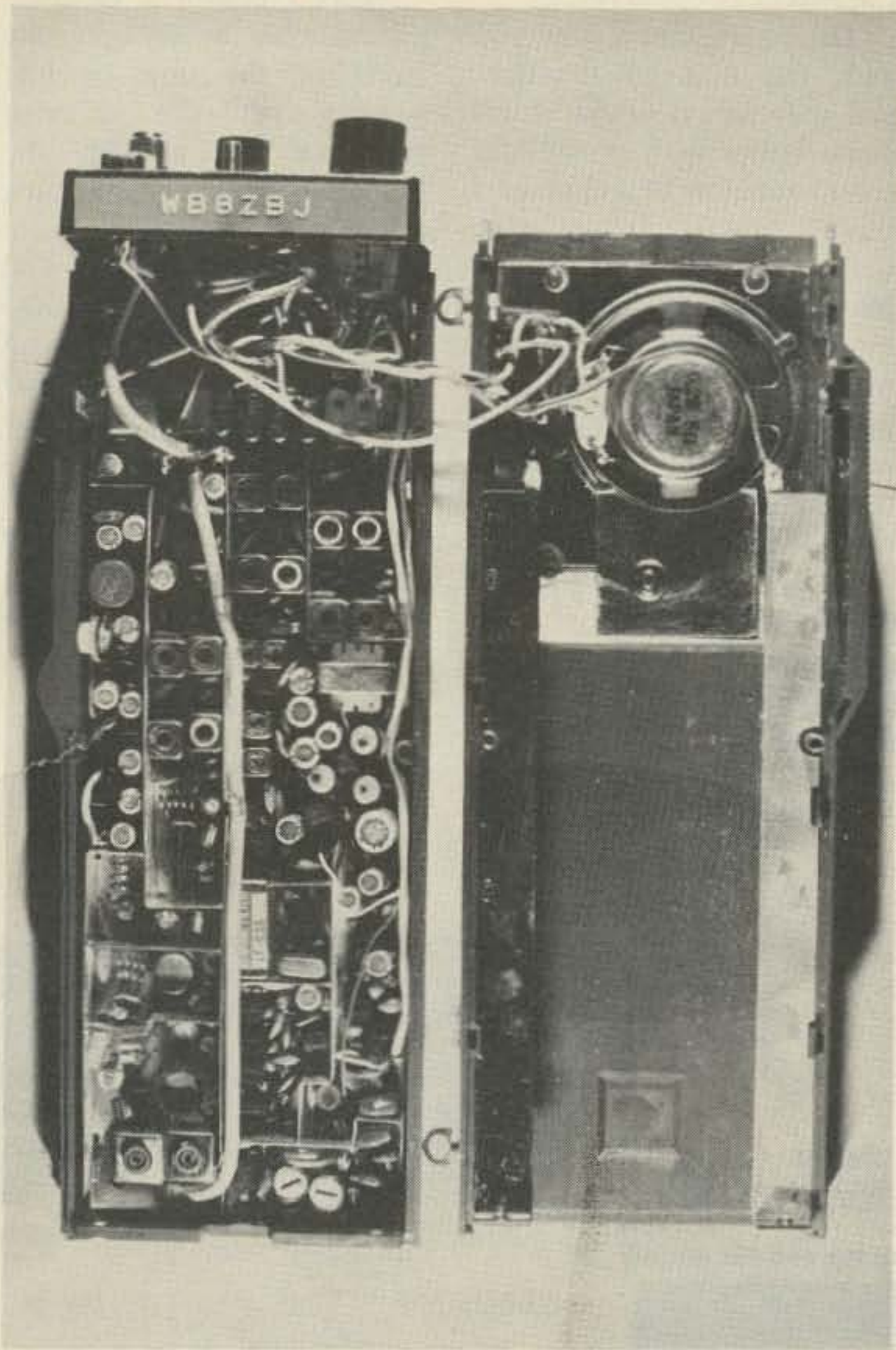

The inside of the Tempo after modification.

microphone and the HT, I discovered that the microphone switch alone would not handle the switching chores in the HT. Now here was a real problem. How does one get a manual slide switch to function from a remote hand-held microphone? I instantly thought of a relay operated switch. But most relays I had seen were way too big to fit into the limited space of the HT. Now I really had a problem, one that could kill this whole modification.

I dug into my parts catalogs and, after making a molehill out of a mountain, I found just what the doctor ordered. I found two Magnecraft relays that would work perfectly. Yes, I said two relays. Magnecraft manufactures all sizes of relays, and these two relays are the size of an integrated circuit, one DPDT and the

other an SPST. These two parts were the second most expensive items after the microphone. They cost a total of \$20.00 but are worth the cost for their size alone.

After waiting for four weeks for the relays and connectors, I could now go to the workbench. To start with, you need a small container to put the screws in. These are small screws and easy to lose. It is so hard to find a good screw — once you have one, you hate to lose it.

The first step involved the removal of all case parts. Then, taking the top plate and removing the useless meter, I inscribed the outline of the connector and filed the hole to fit. I found that I had to bend the tabs down on the connector in order for the connector to fit. To secure the connector, I liberally applied a plastic cement (commonly used to build

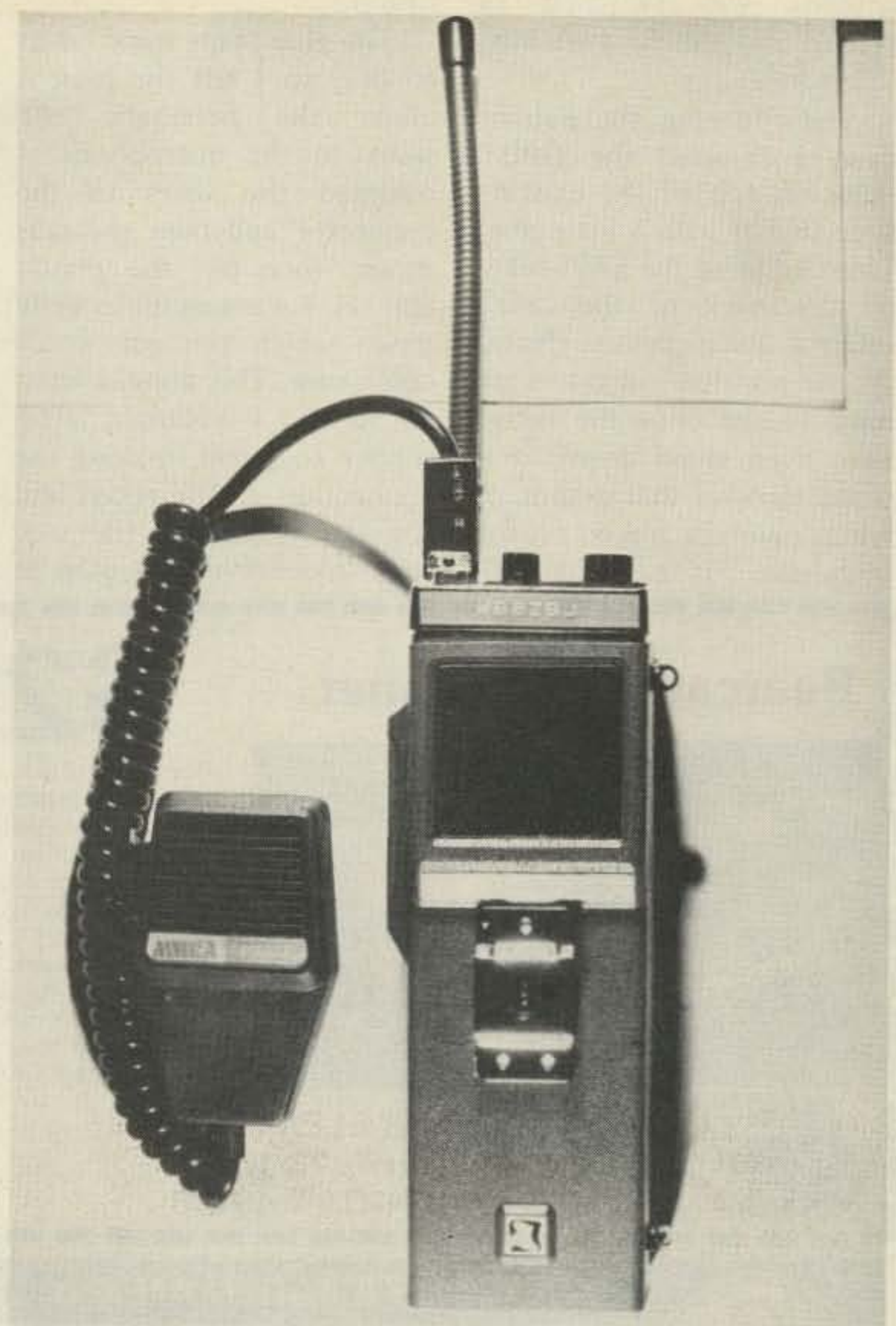

The Tempo fmh after modification.

plastic models). Setting this aside to dry, I then went to work on the circuit board.

For working on the circuit board you need to get out your surgeon's cap, gown, and mask as well as your trusty scalpel. The first step here was to locate both the B+ connections and the

antenna switch-over. Once locating these, I was ready to start the operation. My assistant handed me the soldering iron, and we were off. I removed the meter connections first. Then, with the scalpel, I made an incision to sever the printed circuit between the points where the

Parts List

Motorola Parts				
1-84206D81	clip	\$ 3.50	Req'd.	1
14-82643E25	insulator	\$.03		1
3-136666	screw	\$.04 ea.		2
64-82043D01	plate	\$.10		1
Magnecraft Parts				
W171DIP-14	SPST @ 12 V	\$ 5.00	Req'd	1
W172DIP-19	DPDT @ 12 V	\$14.95		1
ITT Parts				
DE-9P		\$ 1.48	Req'd	1
DE-9S		\$ 2.02		1
DE-110963-1		\$ 1.33		1
Radio Shack Parts				
21-923	microphone clip	\$ 1.29	Req'd	1
Mura Microphone				
	DX-120	\$29.95	Req'd	1

antenna was switched (3 places) and the B+ switching (3 places).

Then turning the patient over, I inserted the DPDT relay on top of the existing slide switch with a little glue. I also adhered the SPST relay to the back of the unit's internal microphone. (Note: As the position indicators are hard to see once the relays have been glued down, it is recommended that a spot of white paint be placed on the underside for easy identification.)

The glue takes some hours to dry, so I left the patient under the anesthetic and went to the microphone. I soldered the wires to the connector and bent the tabs down, then put the plastic clip on. I was careful to write down which pin got which color wire. This done, I went to lunch. I returned after supper to finish, making the connection to the relays and the circuit boards. (Be sure that shielded wire is used in

the antenna connections.) Depending upon how you wish the unit to function, you may wire it so that it will work either with or without the external mike. However, I have rarely used mine without the external microphone. I find it to be much more convenient with the microphone. If you wish only operation with the external microphone, you may omit the SPST relay and simply disconnect the internal microphone.

Next I placed a Realistic microphone holder on the front of the unit by just peeling off the adhesive protector and pressing the holder into place. One thing about that Realistic microphone holder is that if you have a touchtone pad on the front of your unit, you can put the holder on a leather strap and slide it on your belt. This group of modifications may be used on other HTs as well. ■

Bearcat[®] 210 Scanner **\$289.**



The Bearcat 210 super synthesized receiver scans and searches 32-50, 146-174 & 416-512 MHz without expensive crystals. Order now on our 24 hour toll-free credit card order line 800-521-4414. In Michigan and outside the U.S. call 313-994-4441. Add \$5.00 for shipping in U.S. or \$8.00 for air UPS to west coast. Charge cards or money orders only. Foreign orders invited. For additional information, write: Communications Electronics, P.O. Box 1002, Dept. 21, Ann Arbor, Michigan 48106.

COMMUNICATIONS ELECTRONICS
P.O. BOX 1002 DEPT. 73-10
ANN ARBOR, MICHIGAN 48106

DISCOVER CARD MASTERCARD

C5

**SELLING/TRADING
THINK MONEY!**

GET TOP DOLLAR FAST FOR YOUR NEW OR USED EQUIPMENT:

WE NEED AND WILL BUY: AN/ARC-51, -94, -102 -114, -115, -116, -131
AN/PRC-77 - AN-URC-9 - R-1051/URR
TPS-ID, 1-E RADAR UNITS OR COMPONENTS.
COLLINS 618-T OR LATE MODEL
MILITARY COMMUNICATIONS EQUIPMENT.

If you have any of above, or similar gear, phone us now - collect - at (213) 764-9030.

If you prefer, fill out and mail coupon below. Either way, your excess gear will fetch useful equipment or money you can spend!

COLUMBIA ELECTRONICS C51
BOX 9266, N. HOLLYWOOD, CA 91609

Dear Mike: Here's what I have to sell trade:

ITEM	PRICE WANTED	CONDITION

Name _____ please print
Address _____
City _____
State _____ Zip _____

COLUMBIA ELECTRONICS
7360 ATOLL AVE., P.O. BOX 9266
N. HOLLYWOOD, CA 91609

HERBACH & RADEMAN, INC.
**ELECTRONICS FOR
SCIENCE AND INDUSTRY**

POLISHER & GRINDER
A two-speed compact unit operating from four AA size cells (supplied). Ideal for a variety of applications in electronics, metalurgy, optics and lab. Useful for circuit board work, small parts and components where larger files and polishing tools do not fit.



H5-233A \$9⁹⁵

METAL & LIVE WIRE DETECTOR
A unique development in a low cost, hand-held device for detecting the presence of metal objects (wire, nails, pipe, reinforcing rods under plaster, wood, tile, concrete, brickwork, plastic or fabrics . . . multitude of metal detection applications . . . indicates "hot wiring".

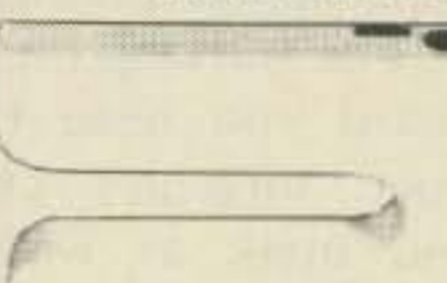

"LECTRO-PROBE" H5-159A \$49⁹⁵

SPECIAL PURCHASE
Enables us to offer VIZ test equipment instrument (formerly RCA Instruments) at a fraction of its normal cost. This versatile, bench type VOM can be employed in service shops, schools, industrial shops, etc. Many outstanding features . . . with high impact, low-silhouette case.

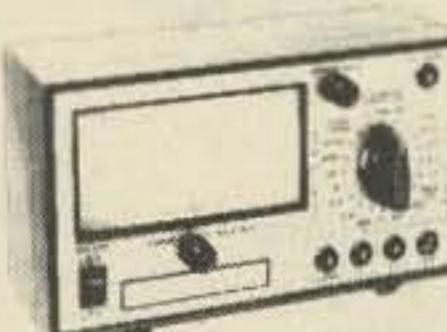

V5-136A \$34⁷⁵

HIGH TORQUE REVERSIBLE 6 OR 12 V. PM FIELD MOTOR
This beautiful, chrome finished, high efficiency field motor was originally designed as a "pedal assist" drive motor for bicycles. It will find many applications in mechanical drives where high starting torque is needed. Can also serve as a low power DC generator.

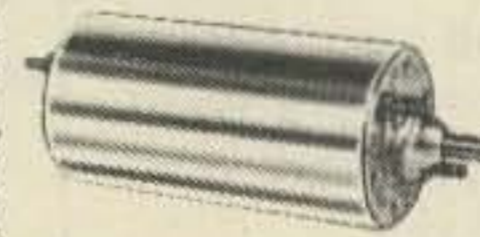

TM21K139A \$9⁹⁵ 6/'54⁰⁰ 12/'96⁰⁰

**OVER 43 YEARS . . .
SUPPLYING INDUSTRIAL
ELECTRONIC, SCIENTIFIC
AND ELECTRO-
MECHANICAL PRODUCTS
TO ENGINEERS,
SCIENTISTS, HOBBYISTS
AND GADGETEERS**

HERBACH & RADEMAN 401 E. ERIE AVE., PHILADELPHIA, PA. 19134 H21

PLEASE PLACE ME ON REGULAR CATALOG MAILING LIST
HUNDREDS OF UNIQUE, HARD-TO-FIND SPECIAL BUYS IN COMPLETELY ILLUSTRATED AND DESCRIBED CATALOG PREPARED 7 TIMES YEARLY.
NO PURCHASE NECESSARY TO RECEIVE CATALOG

ORDERING INSTRUCTIONS
SEND CHECK OR MONEY ORDER. SPECIFY QUANTITY, CATALOG NUMBER AND SHIPPING ADDRESS. ALL ITEMS ARE FULLY GUARANTEED. PLEASE PRINT CLEARLY.
ADD \$2.00 POSTAGE AND HANDLING

NAME _____
ADDRESS _____
CITY, STATE, ZIP _____
 HOME BUSINESS

'ROUND THE WORLD CRUISE'

Meet adventure head on!

Rapa, Tahiti, Moorea, Galapagos,
Zanzibar, Devil's Island, Madagascar,
Martinique, Samoa, Tutuila, Danger Island
aboard the world famous motor sailer Yankee
Trader.

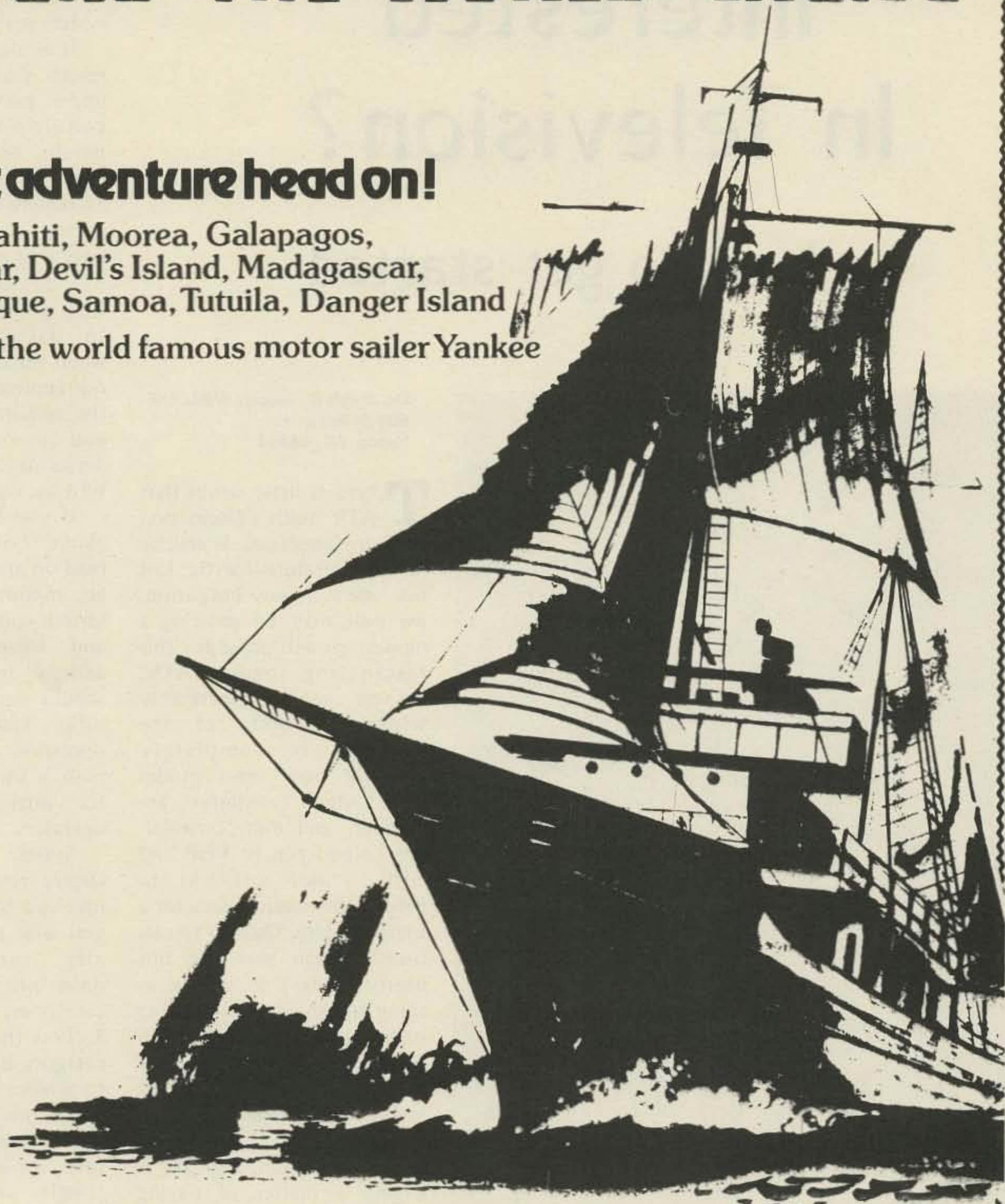

SPECIAL HAM DISCOUNT

Send me your color brochure on 10 day 'barefoot' vacations from \$250.

Name _____

Address _____

City _____ State _____ Zip _____

 **Windjammer Cruises.**

Post Office Box 120, Dept. 00, Miami Beach, Florida 33139.

Interested In Television?

-- how to get started

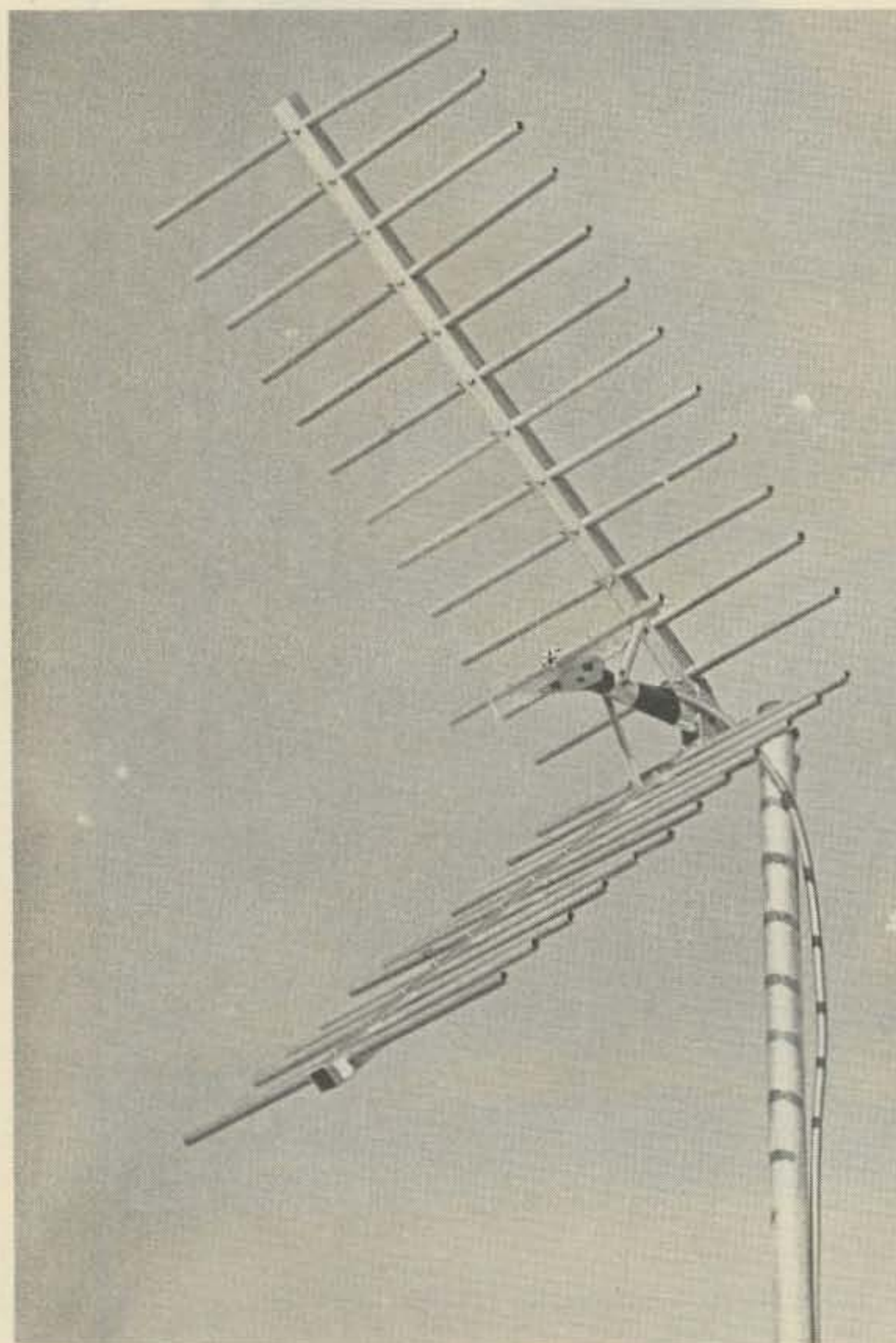

Fig. 1. A homemade corner reflector for ATV as constructed by WB8JXF. Maximum gain with such arrays is in the order of 10-12 dB, depending largely on the size of the reflector and its angle. This gain is easily realized, the antenna is simple to construct and match, and the array has a wide frontal lobe making aiming noncritical. These features make the corner reflector an ideal candidate for home construction where adequate facilities for precision antenna work are not available.

*Dr. Ralph E. Taggart WB8DQT
602 S. Jefferson
Mason MI 48854*

There is little doubt that ATV holds a fascination for many operators. If articles in the literature for the last few years are any indication, we well may be entering a modest growth phase for this fascinating mode. ATV, because of the incredibly wideband nature of the signals, is completely different from other modes with which amateurs are familiar, and even considerable experience in VHF and UHF is not sufficient to predict the requirements for a useful system. Quality results over a given path are not nearly so easy to achieve as some might suggest. Getting sufficiently good results to sustain local interest is a matter of being willing to invest a certain minimum amount of effort in setting up a quality system, and this is largely a matter of paying attention to innumerable details.

WB8JXF and myself have devoted a considerable period of time to developing the guidelines for an ATV system that would provide the kind of performance that would encourage others to give the mode a try. Some of the things we have discovered run counter to conventional wisdom, as expressed in many

articles on the subject, but we have taken the trouble to document all aspects of system performance. If you follow some of our recommendations, you can expect to have the same level of system performance.

It is all too easy to quote results that can be obtained under particularly favorable conditions of location, terrain, or band conditions. Our approach has been extremely conservative, for it is the average performance level that must bear the brunt of day-to-day operations. You will occasionally be able to do considerably better when conditions permit, but our approach will be to pitch the system in terms of what you can expect in the way of performance whenever you turn the equipment on!

If you have been thinking about trying ATV, why not read on and see what you can accomplish? If you are giving serious consideration to ATV, and there is no present activity in your area, you should convert at least one other station. A working operation over a reasonable path is usually a prerequisite for interesting still other operators.

System requirements are largely related to the range involved in the specific path you wish to cover. Functionally, requirements break down into a few general range categories:

1. Less than 5 miles. In this category it is usually possible to achieve true "line of sight" conditions. If this is the case, it is possible to get by with low power or relatively simple converters or antennas.
2. 5-10 miles. About 10 Watts average power output is required in this category, assuming that quality antennas and converters are employed. If not, still higher power will be needed.
3. 10-20 miles. 10-100 Watts power output will be required for this distance, depending largely on the remaining system elements and the

terrain along the intended path.

4. 20+ miles. Regular work over extended paths will require good antennas and converters and a power output of 100 to 1000 Watts depending upon the path. Even the best of stations will have difficulty maintaining quality pictures out beyond 40 miles.

Note particularly that these categories are based on normal band conditions. Real DX of up to a hundred miles or more will be a rare event, usually coupled with excellent band conditions. The quality of such long haul pictures is such that they are acceptable primarily because they are DX. To sustain a local level of ATV activity requires consistent coverage over a much smaller area with pictures of consistently good quality. The purpose of this article will be to describe the requirements for the various system elements to achieve this end. Those elements include the antenna system, the receiving converter, the basic ATV exciter, high power options, and the matter of voice transmission along with the pictures. We will discuss each of these separately, but you should keep in mind that the results you achieve will depend on the quality achieved with each link in the system at both ends of the circuit. The pictures that are possible over a given path will be critically dependent on the weakest link in your system, and the gradual increase in coverage is largely a matter of optimizing each element of the total ATV system.

Antennas

The keys to success here are gain and bandwidth. Unless you just want to work down the block, you should not consider anything less than 10 dB, and you should try for all the gain you can get. Yagi arrays are out for ATV, primarily due to their limited bandwidth. Commercial antennas are cut

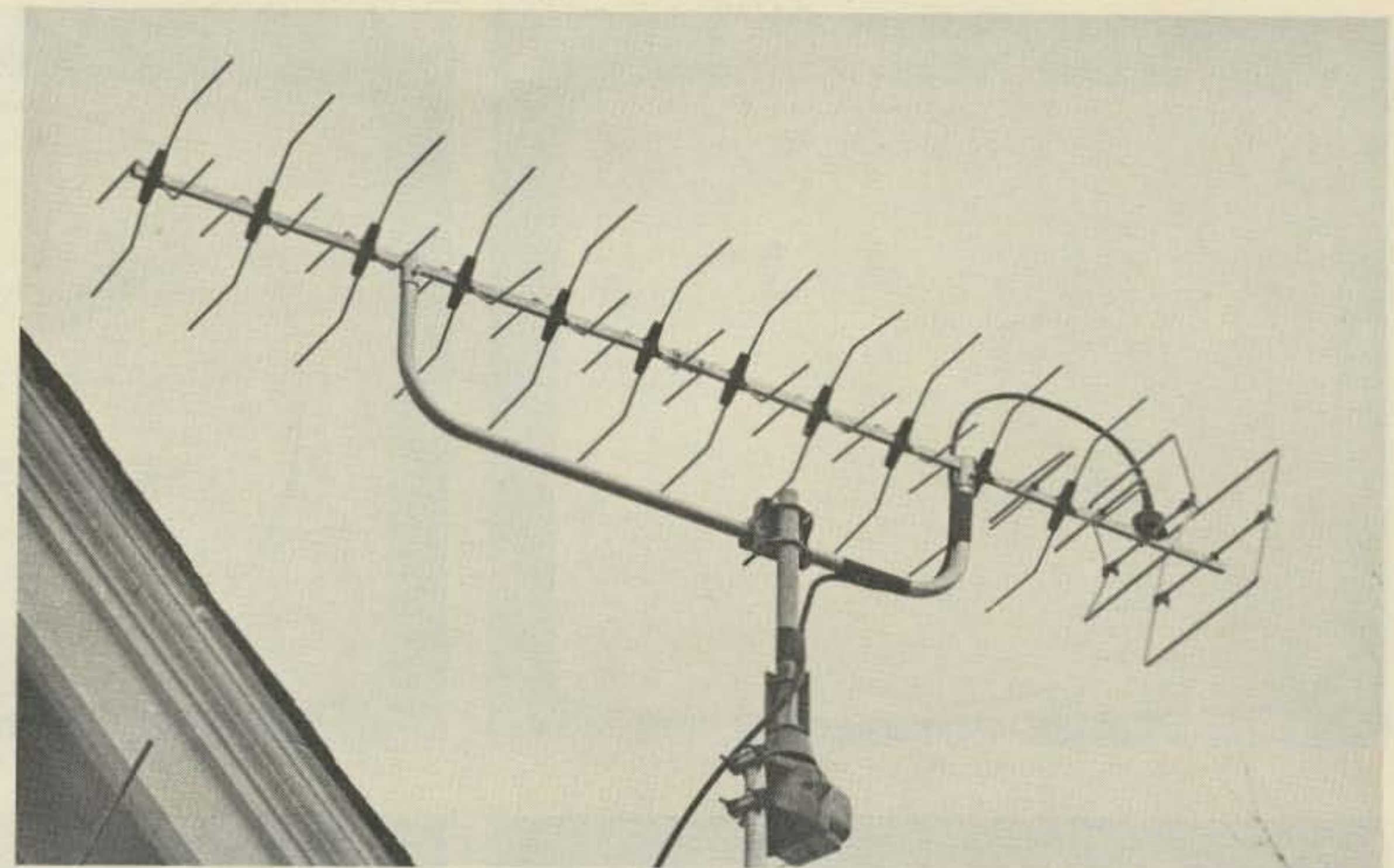

Fig. 2. The MBM48/70 antenna in use at the author's QTH. This antenna exhibits 17.3 dBi of gain and is essentially flat across the entire 420-450 MHz band. The driven element and reflector look somewhat like a combination of a quad and skeleton slot with two conventional directors transitioning into a series of cross-shaped elements each of which consists of four half-wave elements. Despite its unusual geometry, the antenna really performs as indicated by the specifications certified by the British Aerial Standards Commission and verified by our own tests. Like most high gain arrays, this one is extremely sharp in terms of pattern and is definitely not suitable for round tables, although it cannot be beaten for long haul point-to-point work.

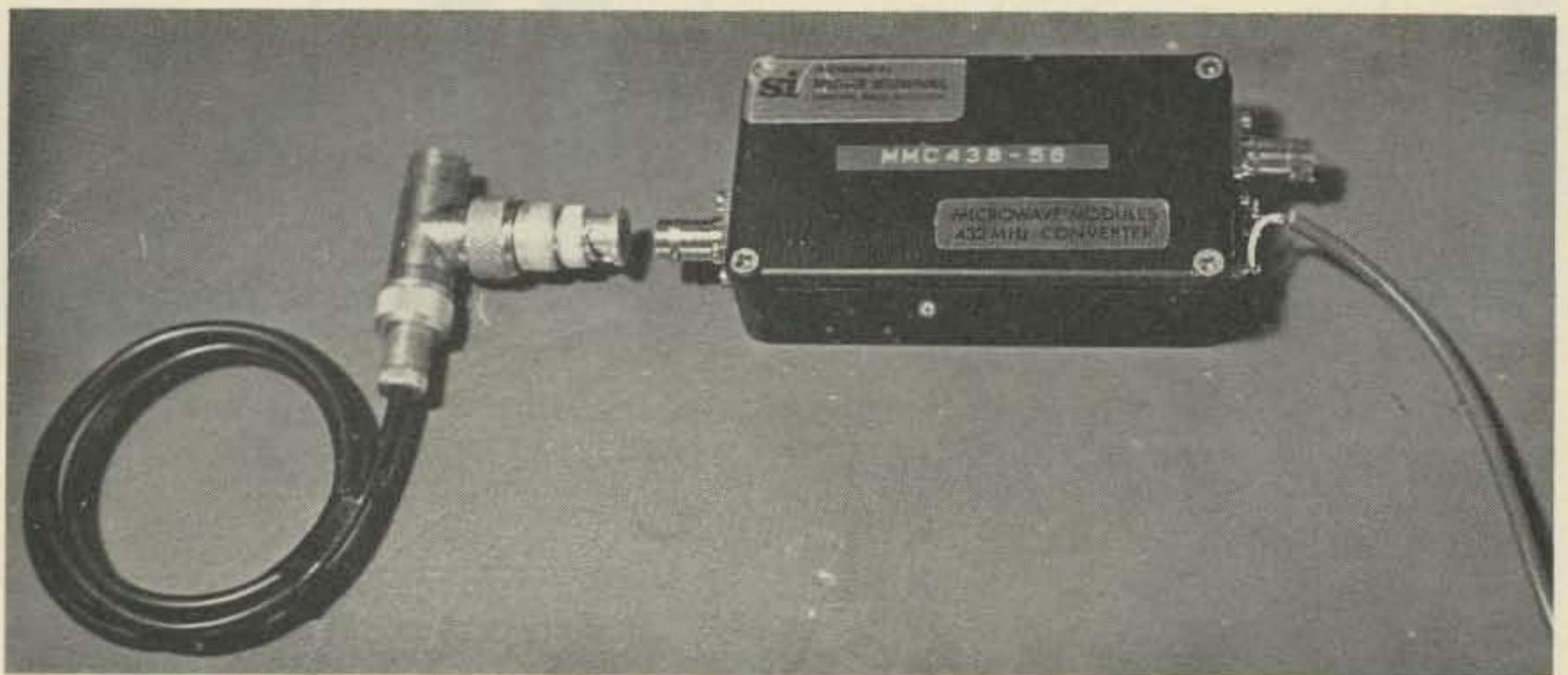

Fig. 3. One of the modified MMC 432/28 converters (MMC 438/56) used in our system. The photograph also shows the 1/4 wave stub for channel 6 which is used to remove a spurious mixer product between channel 6 and 23 in our area as described in the text. The use of such modern crystal controlled converters results in considerably better system performance than can be obtained with converted UHF TV tuners and outboard preamplifiers.

for the wrong parts of the band and even a home brew antenna cut for your operating frequency will noticeably restrict the resolution of the pictures.

The simplest antenna that will do a reliable job is a corner reflector such as the one illustrated in Fig. 1. Such antennas are easy to

construct,¹ are sufficiently broadband for TV use and are not critical to aim. About 10 dB gain is what can be expected. Several commercial antennas are designed to cover the entire 420-450 MHz band and thus can be used not only for TV, but for other modes as well. Table 1 summarizes some of these

antennas. The KLM models are well thought of in ATV circles, although we have not used them. Our favorite is the MBM48/70 from J. Beam of Great Britain. This antenna is flat across the entire band yet packs a respectable 17 dB of gain into quite a compact package. This antenna, illustrated in Fig. 2 and marketed

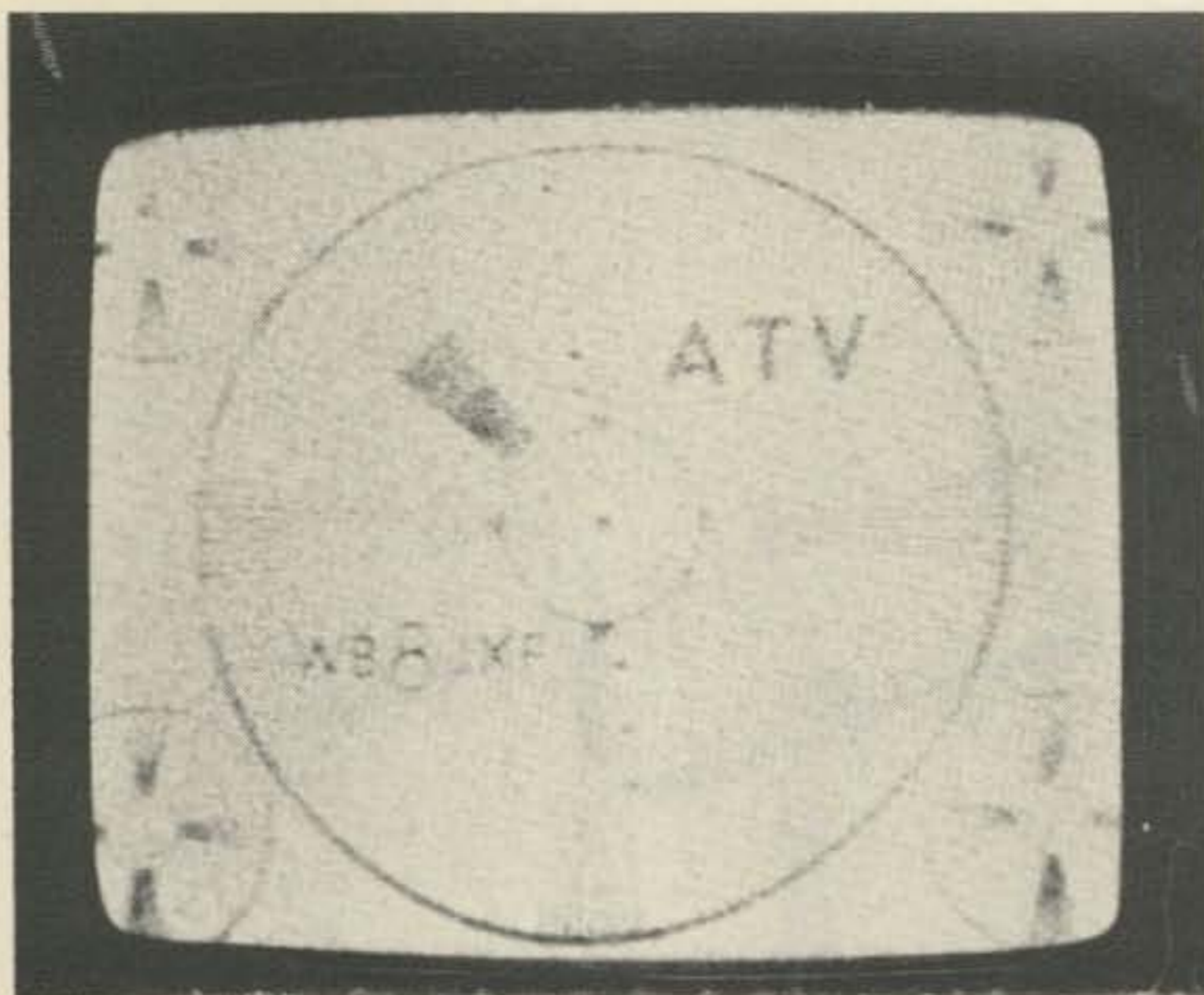

A

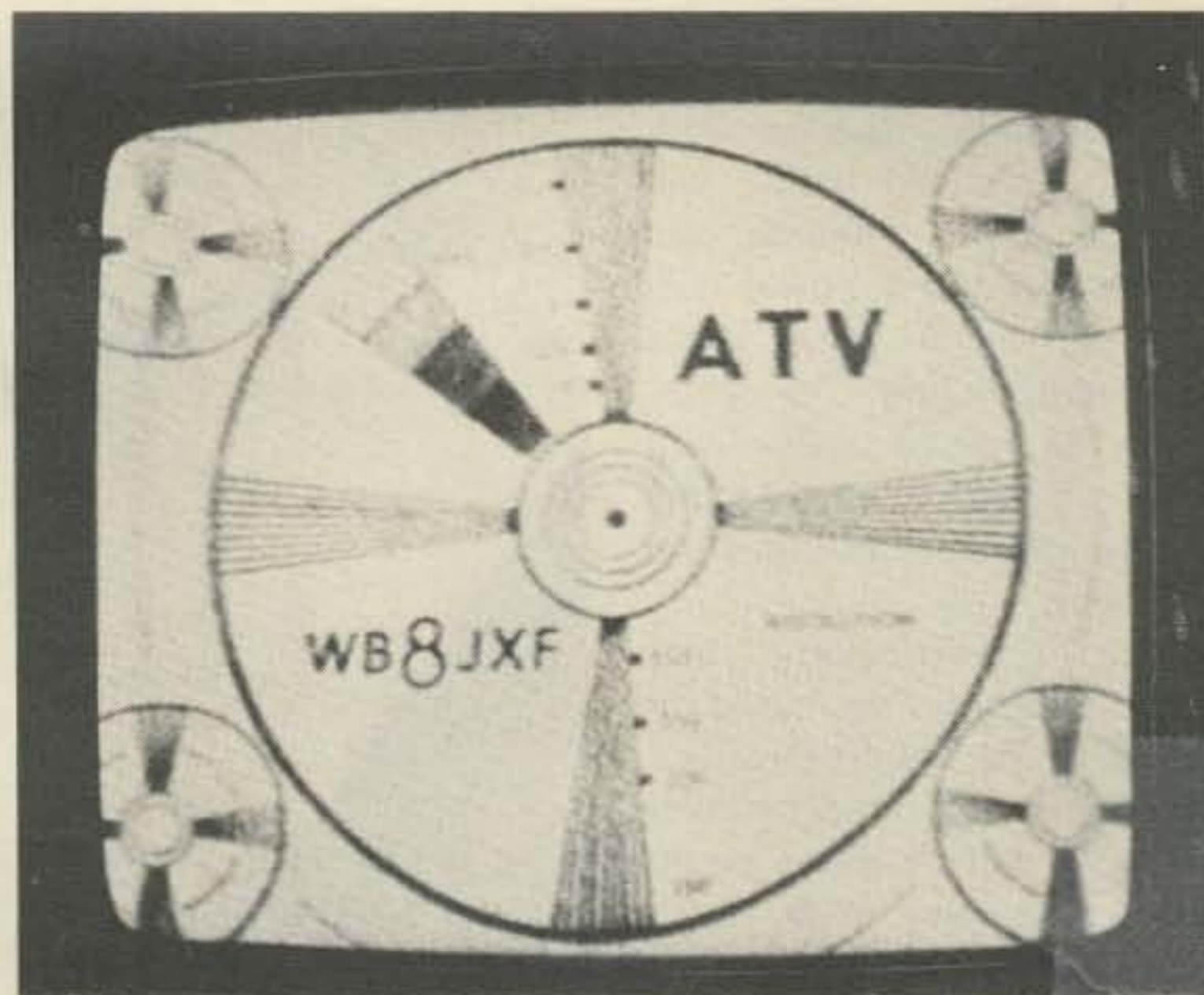

B

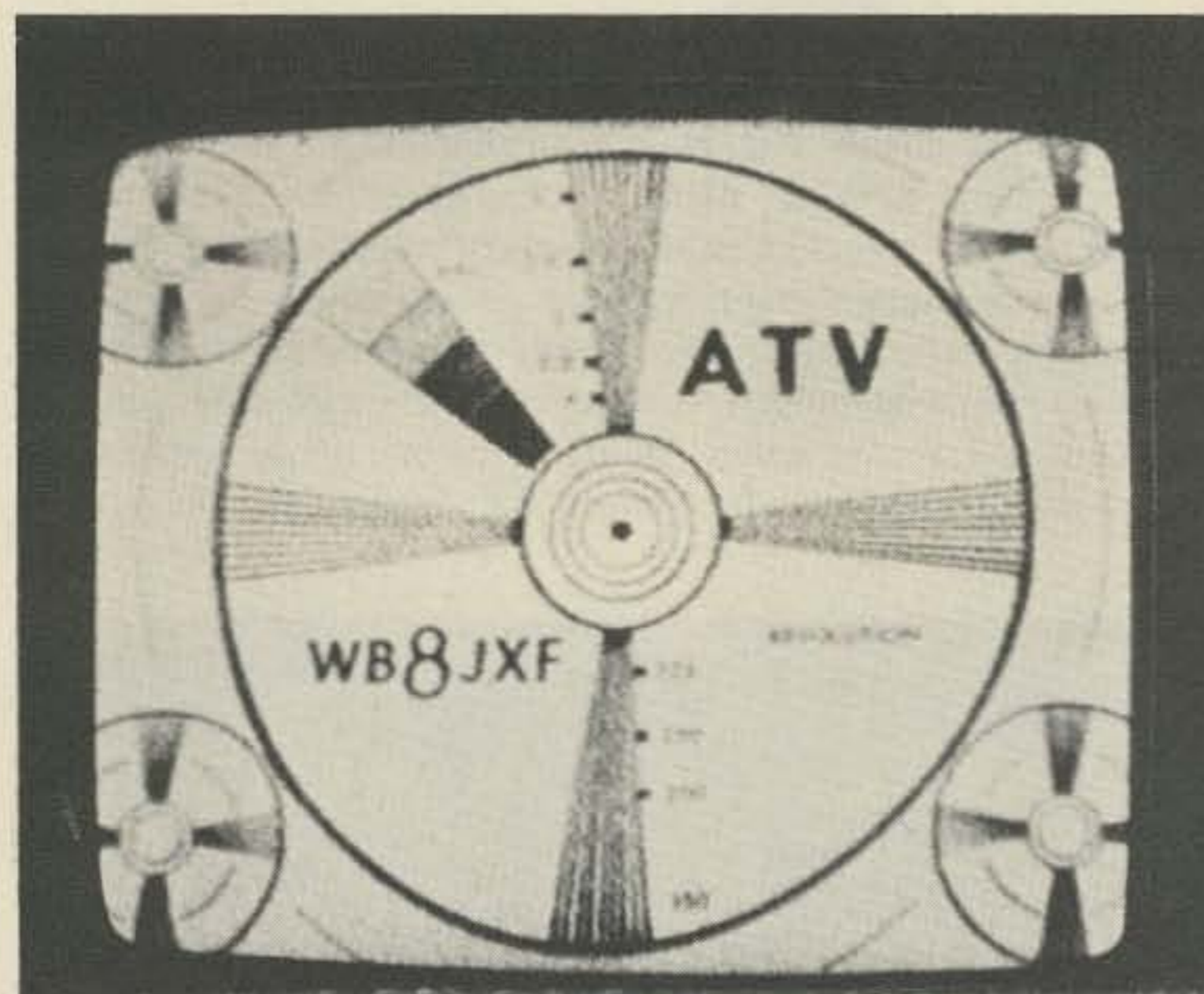

C

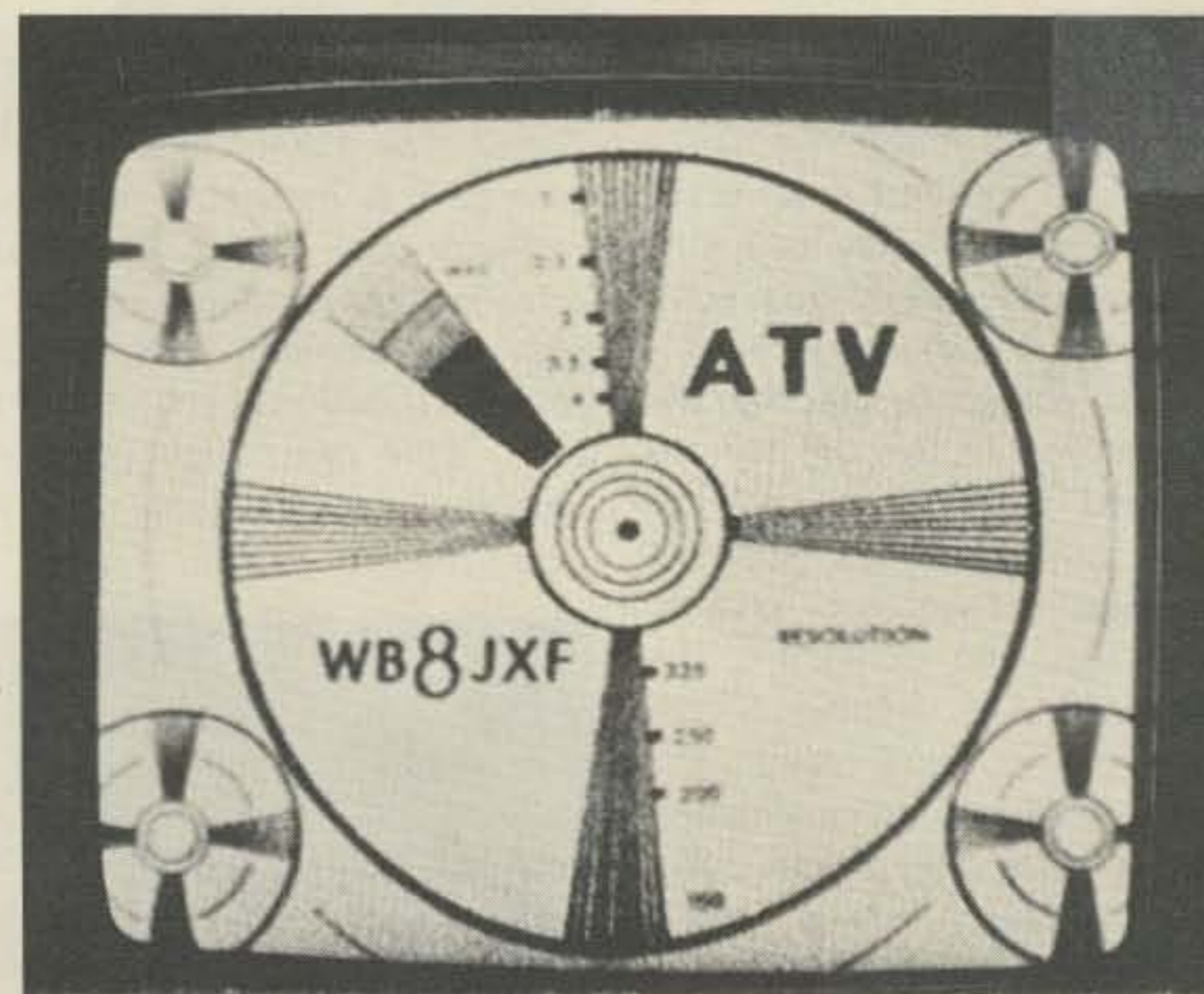

D

Fig. 4. Test transmission sequence from WB8JXF as received by the author using the MMC 438/56 converter. Antennas are those illustrated in Figs. 1 and 2, with 10 feet of antenna height at the transmitting end and 25 feet at the receiving end. The path is 8 miles over rolling low hills. Power levels are 10 Watts (A), 15 Watts (B), 20 Watts (C), and 30 Watts (D) average output. The important fact here is not the absolute power versus path length, for we have now reached the point where 5 Watts average power does as well over this path as 20-25 Watts in this test (by simply raising the antenna at WB8JXF's end). What is significant is the pronounced threshold effect for video signals. Even 1.5 dB additional system gain (B) will produce a surprisingly good picture; 3 dB is even better, as is 4.5 dB (D). Once you can see any video at all, a comparatively small increase in system gain at any point will give you a working operation. The other side of the coin is that if you are near the threshold, a similar small loss in system gain can ruin otherwise acceptable pictures! The proverbial "snow-free" pictures require at least 20 dB additional gain above the threshold, and you are not likely to get such pictures without line of sight conditions.

by Spectrum International, certainly has not received the attention that it merits based on performance.

Polarization is completely noncritical as long as it is matched at both ends of the circuit. You will probably be best off deciding between vertical or horizontal based on what other modes you might wish to play with on the band in addition to your

TV activity. Height and location of the antenna are prime factors, however, and care should be exercised to insure minimum run of transmission line to the station. The antenna should certainly clear local obstructions, and height gain increases nicely up to about 50 feet. Above this the increase in height gain is usually counteracted by increased line losses, so super

high antenna systems are really far from desirable.

There is considerable mystique about transmission lines for VHF and UHF work these days, and the feeling is that everyone should be using some form of hardline. Extensive measurements we have performed regarding direct line losses and system performance indicate that for runs of up to 50 feet there is

little to be gained by going to the more expensive hardline. Use a good brand name RG-8 type foam cable, and you will do just fine. This does not mean you should use CB type cables. These have low braid density, and the braid is rarely tinned or plated — both factors leading to excessive line losses. Short runs around the shack can be handled with RG-58 foam

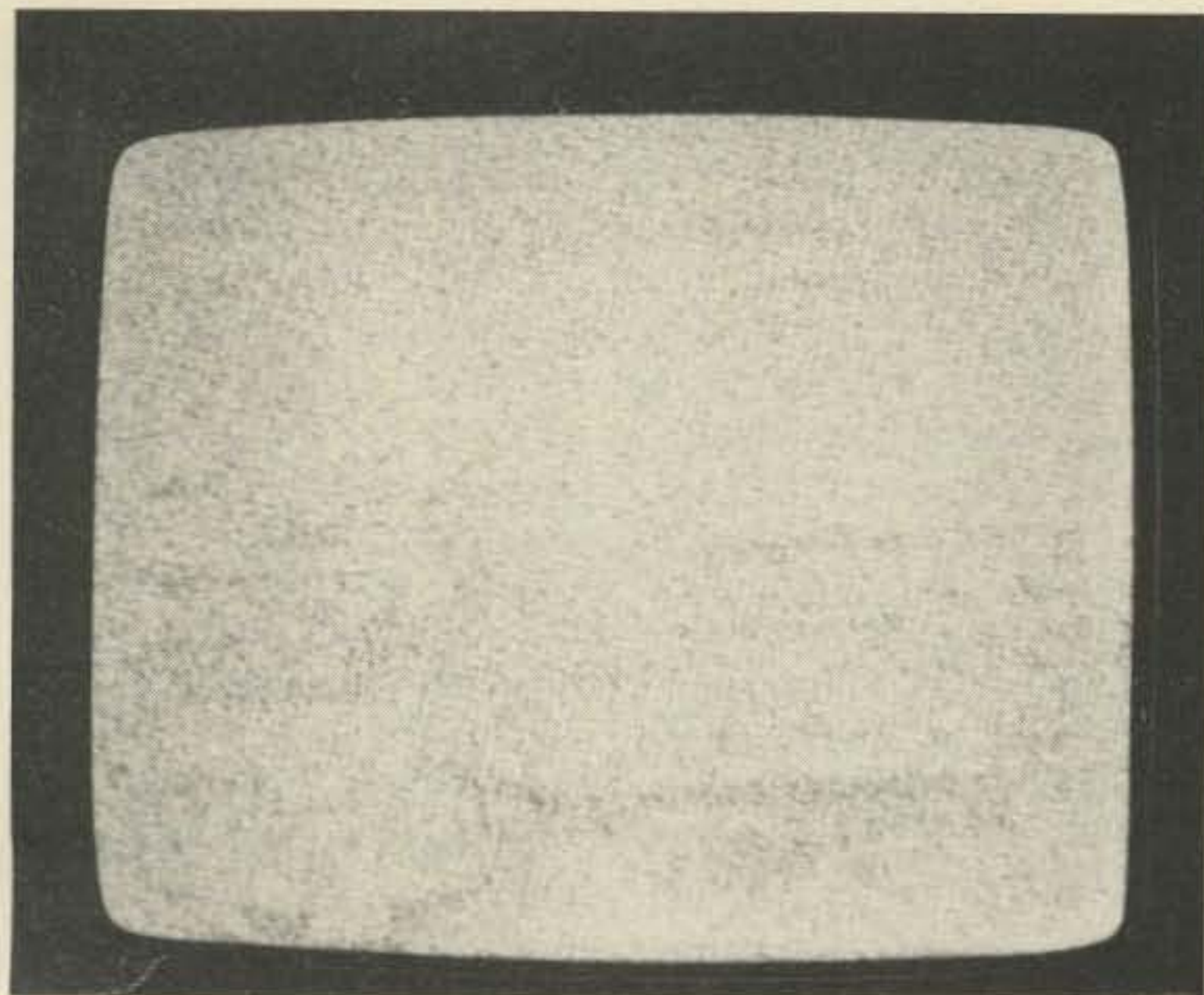

A

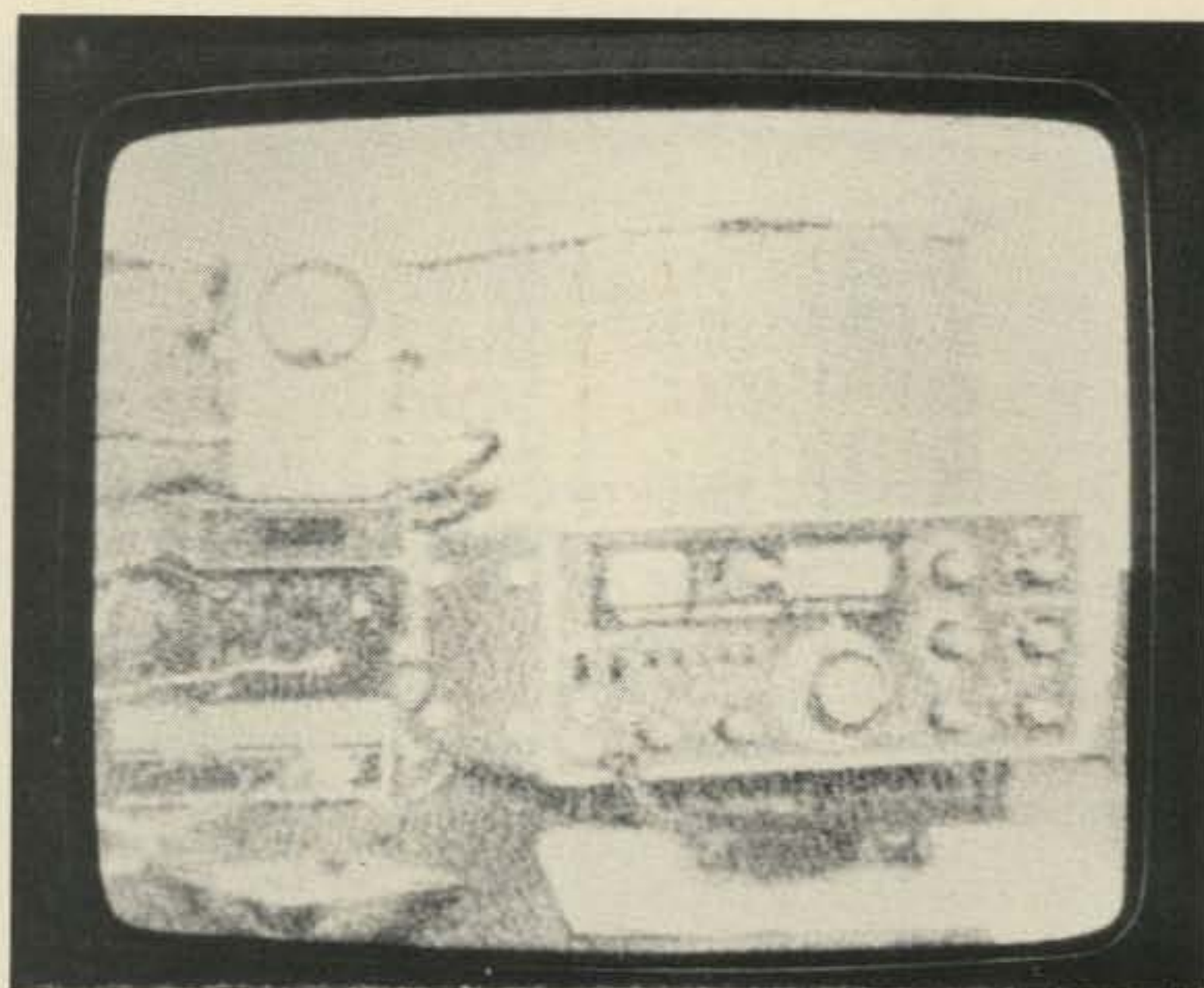

B

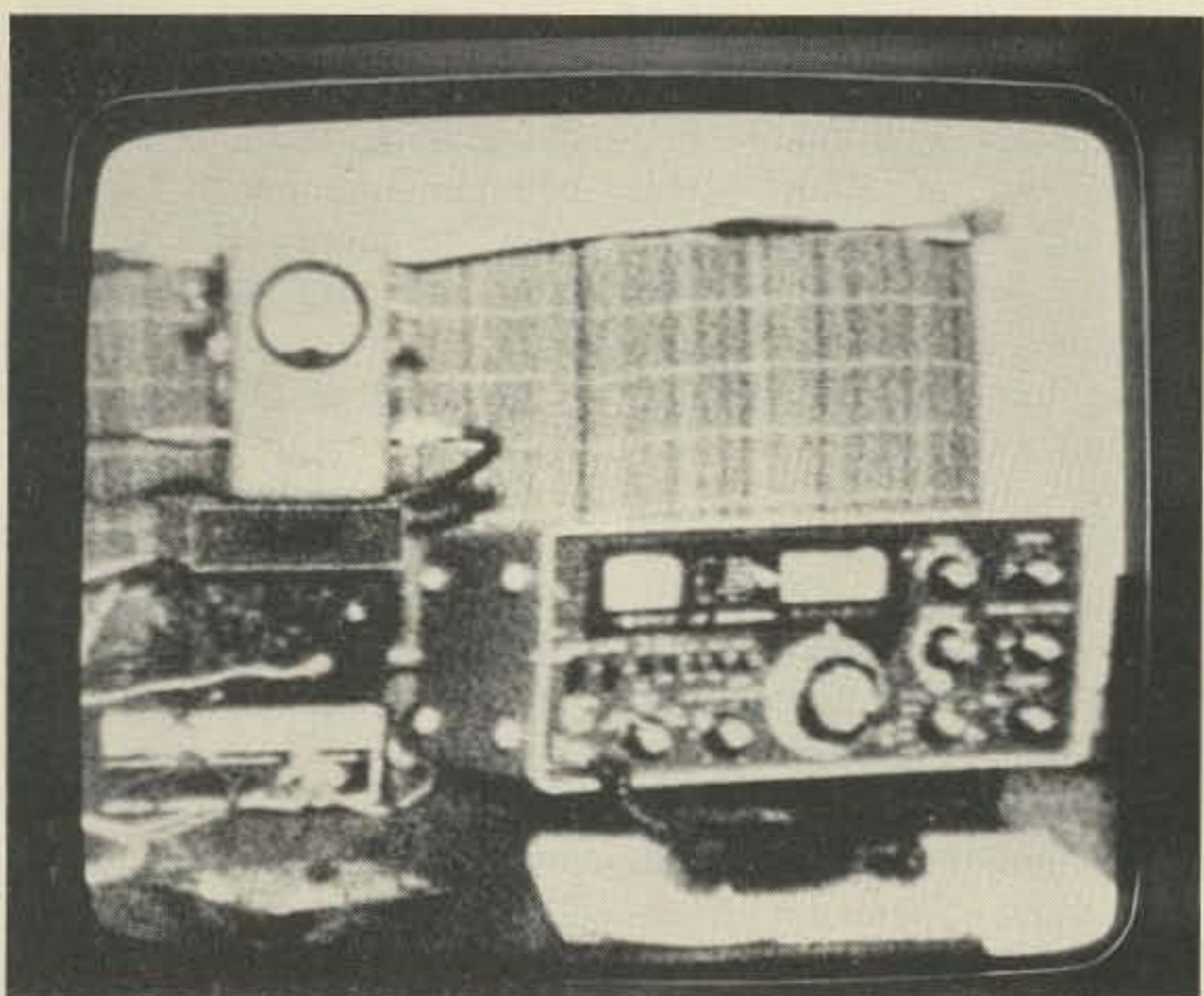

C

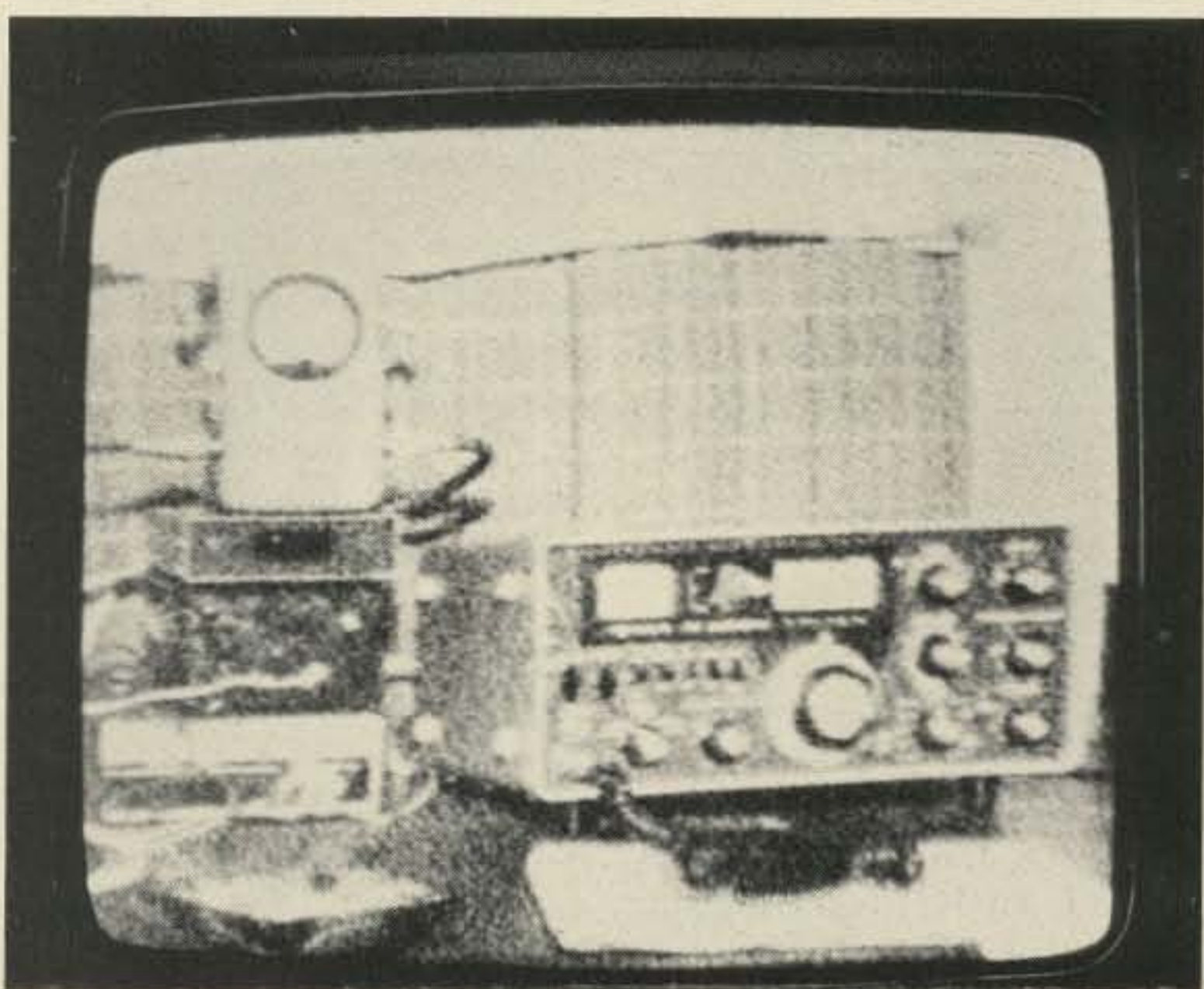

D

Fig. 5. A test transmission sequence similar to that of Fig. 4, except that power levels of 5 Watts (A), 10 Watts (B), 15 Watts (C), and 20 Watts (D) are shown. Again, the pronounced threshold effect over a signal range of 3-6 dB above visibility is clearly evident.

with good results up to power levels of 50 Watts or so. Higher power levels will cause noticeable line heating with 58 foam and you will have to go to the larger cable sizes.

Equally misleading are some of the opinions circulating about connectors. Most serious UHF operators use type N connectors for larger cable sizes, dropping to BNCs for RG-58 cable due to the impedance bumps caused when the typical UHF series connectors (SO-239, PL-259) are used. Although such impedance bumps are real, they will not result in noticeable degradation in system

performance if the venerable UHF connectors are installed properly. The newer solderless PL-259 connectors are ideal for use with RG-59 foam cables and are far less tedious to install than a BNC.

Model
420-470-14
420-450-27
1:1 balun for above
MBM48/70

Source
KLM
KLM
KLM
Spectrum International

Gain
13.7 dBi
16.7 dBi
17.3 dBi

Length
5 feet
10 feet
6.5 feet

Price
\$21.95
\$39.95
\$19.95
\$51.75

Table 1. Antennas suitable for use on ATV. Listed prices do not include postage. KLM Electronics is located at 17025 Laurel Road, Morgan Hill CA 95037. Spectrum International is located at Box 1084C, Concord MA 01742. The KLM antennas require the listed 1:1 balun, while the MBM48/70 can be fed directly with 50 Ohm cable. Stacked pairs or quad arrays may be employed for an additional 3 or 6 dB gain. KLM makes a variety of 2 and 4 port power dividers that vastly simplify the proper phasing and matching of larger arrays. A major advantage of these wideband antennas is that they are equally effective for other modes anywhere in the band.

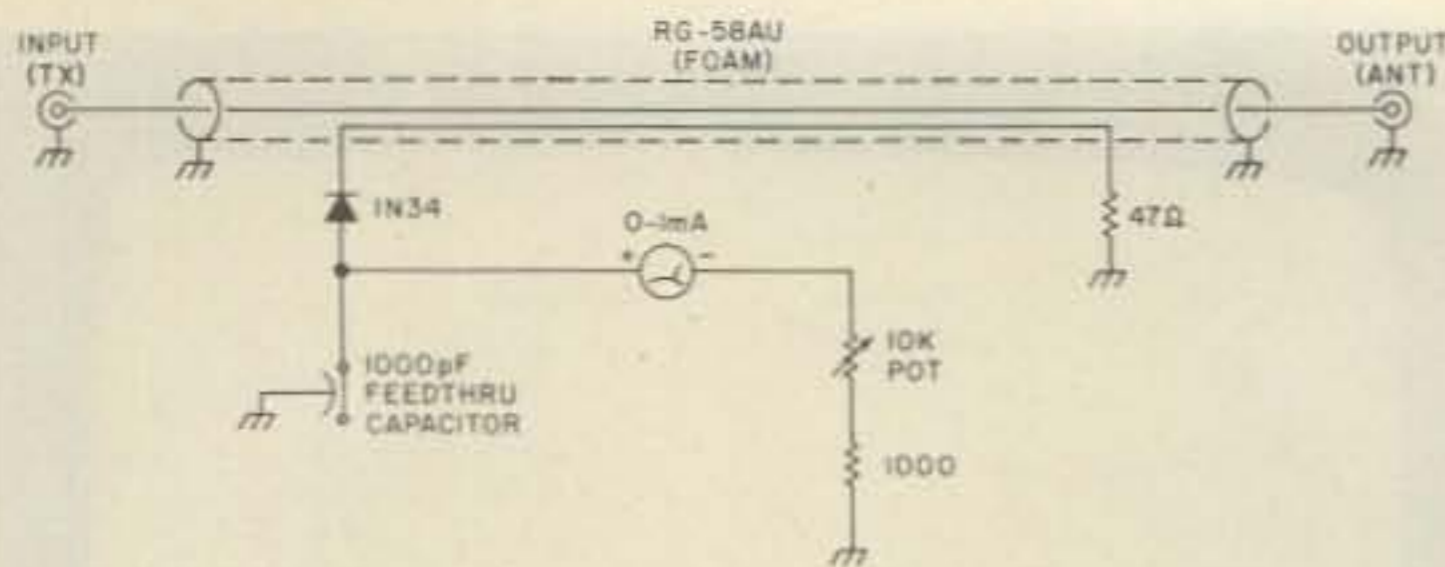

Fig. 6. In-line power output meter suitable for use on any VHF band. The coupling loop is a length of #24 enamel wire threaded under the shield of the braid of a length of RG-58 foam coax. Input and output connectors may be SO-239 bulkhead connectors but matching hoods (Amphenol 83-765) should be used to minimize the impedance anomalies at the connectors (see Fig. 7). Lead lengths for the terminating resistor (47 Ohms) and the 1N34 diode should be kept to a minimum. The diode is bypassed using a 1000 pF feedthrough capacitor. A button mica capacitor may be substituted but a conventional disc capacitor is unsuitable. The meter may be calibrated using a Bird or similar in-line wattmeter, with the 10k pot used to establish the desired full scale deflection.

shop the surplus outlets for military relays designed for use in the high UHF and low microwave region (like about 1 GHz). In any case, avoid 110 V relays, as these seem to have a tendency toward overheating coils and less than perfect performance.

Converters

A great deal of thought went into the subject of suitable converters. The conventional approach is to use a padded UHF tuner, usually with a quality preamp to compensate for the poor sensitivity of the tuner.² There are several objections to this approach. First of all, even the best of the outboard tuners employ passive diode mixers. This results in a mixer noise figure of 10-15 dB. A good preamp will have low noise and a gain of perhaps 20 dB. This gain is not sufficient to overcome the mixer losses and still set the system noise figure. The result is a higher system noise figure and a system loss of at least 10 dB compared to a system employing a low noise active mixer. The preamp does improve things considerably but you have not optimized either system gain or noise figure. The tunable feature of these converters was useful in the old days when self-excited transmitters

might be operating anywhere in the band (or out of it on occasion), but is of marginal utility today when transmitters should be crystal controlled. The tunable converter is really only useful over a few megahertz if the preamp is peaked for maximum performance in any case. You can go to a broadbanded preamp but this will cost in terms of both gain and noise figure.

The answer, of course, is to go to a conventional crystal controlled converter of the same type that would be employed for work at 432. The converter we use is manufactured by Microwave Modules of Great Britain and is marketed in this country by Spectrum International and others. The basic MMC 432/28 converter is designed for 432 input and 28 MHz output and costs \$65. For an additional \$20, SI will peak the front end to your video frequency, install a crystal to bring you out on any low VHF channel (we use channel 2), and repeak the i-f output circuits. Thus for \$85 you get a converter with a 6 MHz front end, a 3.5 dB noise figure and a total of 25 dB of conversion gain! This is cost competitive with the tuner-preamp approach if you tally up the cost of all the components of the latter

system, and will outperform the latter in terms of both system gain and noise figure. Other converter manufacturers (Vanguard, Janel, etc.) will do similar jobs, or you can build any of the modern converters in the literature, making appropriate changes in the crystal frequency, LO, and i-f output circuits. The fine tuning control of the TV set will swing you several MHz, permitting the signal to be centered as desired in the i-f passband of the TV set.

My own modified MMC 432 converter is shown in Fig. 3. We adopted a video frequency of 437.25 MHz for a very practical reason. Most converter manufacturers offer 432 units with 50 MHz i-f output as an option. If 432 comes out at 50.00 MHz, then 437.25 will come out at 55.25 MHz, which just happens to be the video carrier frequency for channel 2! Thus a crystal for 6 meter output can be used, saving the long wait for a special crystal order. The only additional modifications to the converter involve a retuning of the i-f output coil for 55-60 MHz and re-peaking the front end for the video frequency. Spectrum International labeled this version the MMC 438/56 and can deliver within a few days.

Fig. 3 also shows a fix for another kind of problem which you may encounter. In our area we have two powerful TV stations — one on channel 6 (video frequency of 83.25 MHz) and the other on channel 23 (video frequency of 525.25 MHz). Given our i-f, one of the many possible spurious mixer products falls right in our video window. Channel 6 is about 1 mile from WB8JXF's location, while channel 23 is less than 2 miles distant. He was faced with a very strong spurious signal while, even though I was about 9 miles from either station, I had a moderately strong image. After far too many evenings waiting for one or the other station to sign so we could get on with

our tests, we decided to solve the problem. One solution would be a strip-line or coaxial filter in the input line to the converter, but I decided to try a simpler solution first. A coaxial T connector was mounted at the converter input with a quarter wavelength of coax (electrical length) cut for channel 6 on one arm, with the antenna lead on the other. This stub had no effect on reception at 437.25 but completely removed the spurious signal. WB8JXF tried the same trick, and it worked perfectly despite the very high signal levels at his location. In-line filters may be required for some types of interference due to front end overloading, but if one of the offending components is on a VHF frequency this simpler approach may work equally well.

Converted TV tuners do have one major use — they are so insensitive (without a preamp) that they let you monitor your picture when operating at moderately high power levels. Simply pad down the LO in the UHF tuner of your set, and you will have that capability. Direct monitoring with the high performance converter is not really feasible as it will overload with outputs over a few Watts.

Another factor worth mentioning is the TV set used as the i-f. It makes little sense to use a junker from the back room of the local service shops when modern sensitive sets are available for so little. If you get one with a power transformer (not a hot chassis), it can even be converted for use as a video monitor. I use a Sony TV-770 with excellent results (\$139.95 at a discount store), but many other types are suitable and cost even less.

ATV Power Levels

Before discussing specific transmitter options we should have a realistic chat about power. The power requirements for ATV are directly

related to the path you intend to cover. The wide-band nature of TV, coupled with the performance of rf amps and the agc threshold of the TV set, results in a very pronounced threshold effect over any given path. Over a distance of up to a few miles a low powered transmitter (@ 1 Watt) will yield acceptable results provided line of sight conditions exist. The latter condition is increasingly unlikely as the path is stretched out, and it is amazing how fast the video signal disappears despite the fact that QRP voice communication is possible over the same path.

Power output is a difficult question to address in the case of TV since there are several reference levels that can be used, including peak power, black level, and average power output level. Peak power is equivalent to the power output of a properly set up transmitter-modulator combination during sync pulse intervals. An in-line wattmeter such as a Bird will measure peak power only when the camera is switched out of the modulator input. Let us say that the transmitter will grind out 10 Watts under such conditions. Provided things are set up properly, if the camera is switched in but the lens is capped we should get an approximation of the black level output. This should be about 75% of peak output or 7.5 Watts. If we uncap the lens on an average scene we would get an average power output reading typical of what would be obtained under normal operations. This average level should run about 50% of peak output, or about 5 Watts. The average power percentage (relative to peak) will obviously vary considerably with the subject but it is a convenient reference, and, unless otherwise noted, all test results will be quoted as average power output.

Fig. 4 shows one path test between WB8JXF and myself at various average power out-

put levels. Both of us are above average terrain and about 8 miles apart, with the intervening path consisting of gently rolling hills. Total system antenna gain is 27 dB (10 dB + 17 dB). Several intervening hills do not permit line of sight conditions at the antenna heights used in this and the following test. The first picture (10 Watts) is just at the threshold of visibility. Since the basic modulated exciter is running about 1 Watt output, additional system gain of 10 dB is required to reach the threshold of visibility. Note, however, that comparatively little additional gain is required to boost the picture from the threshold level to a point where it is quite acceptable. Referenced to the threshold, an additional 1.5 dB (15 Watts), 3 dB (20 Watts), and 4.5 dB (30 Watts) result in progressively better pictures. Depending upon your tolerance for snow, anywhere between 3 and 6 dB of additional gain will certainly produce acceptable pictures. Once you have boosted the signal to the point where it can be seen at the other end, comparatively little additional gain is needed to make the path usable. WB8JXF's antenna (a 10 dB corner reflector) was only 10 feet high for this test. Raising his antenna from 10 to 20 feet produces about 5 dB increase due to height gain, which means that pictures at the 10 Watt level would now be equivalent to those at 30 Watts with the previous antenna height. Note that all that is required is that the total system be increased by 3-6 dB, which can be achieved by any combination of factors at either end of the circuit. Conversely, a similar small drop in gain can have disastrous consequences if you are near the threshold in terms of system performance. Even over our short path it is easy to document small changes in path loss when operating at the 5-10 Watt average power output level.

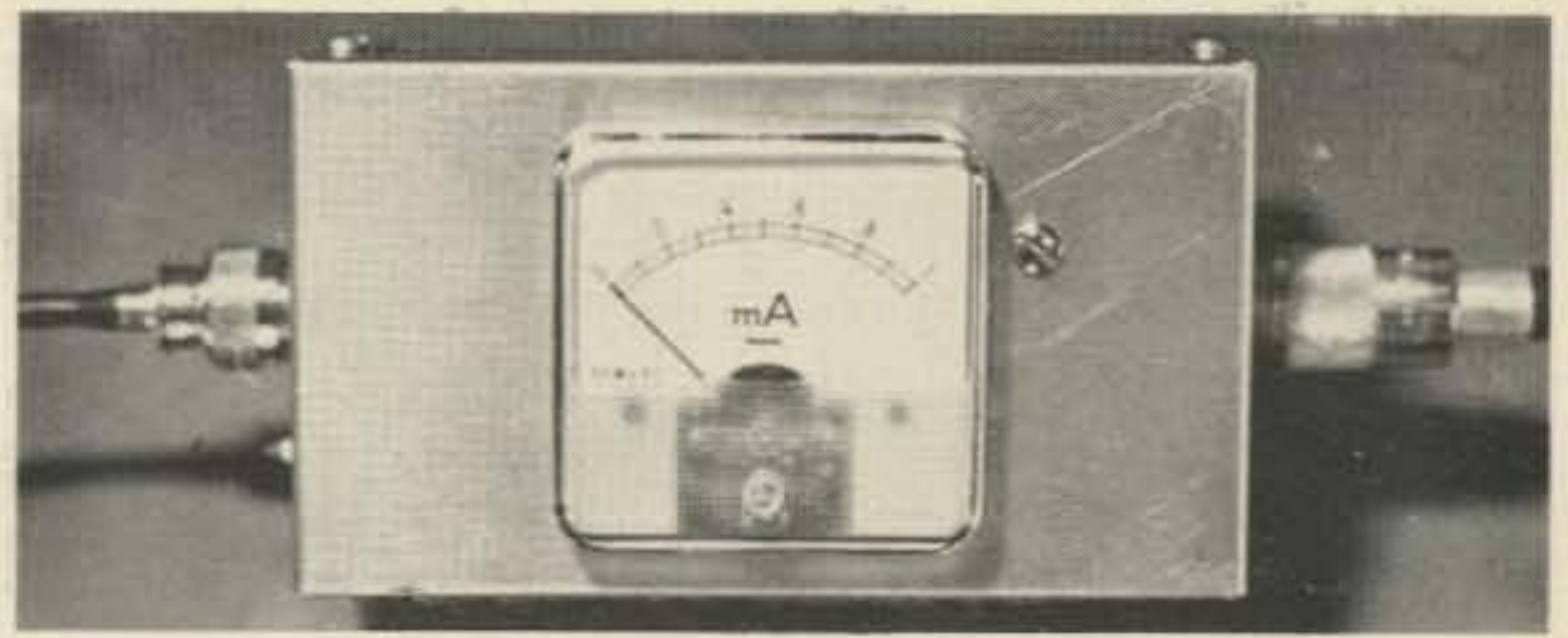

A

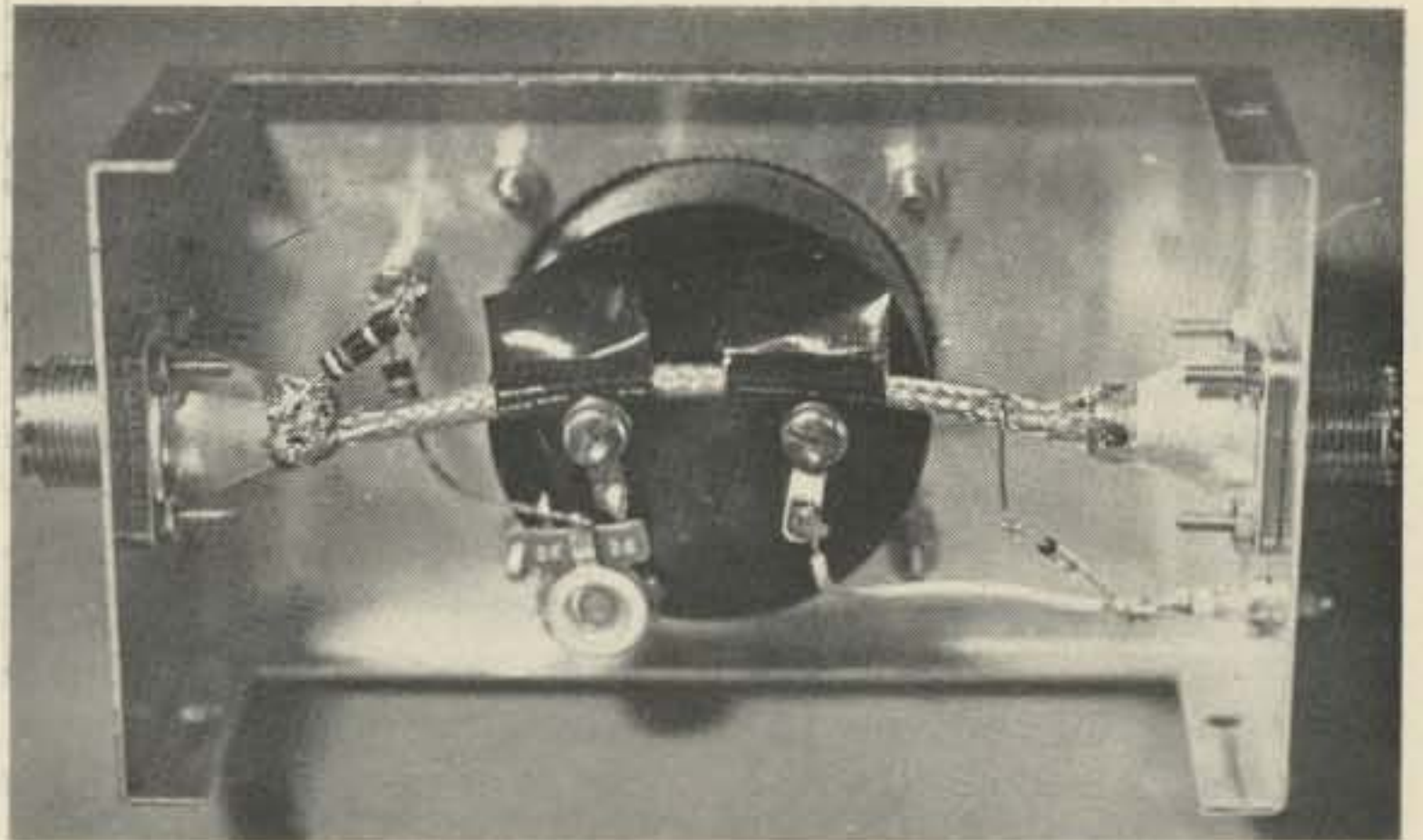

B

Fig. 7. External (A) and internal (B) views of the in-line power meter shown in Fig. 6. The meter is kept in the transmitter line at all times to monitor power output.

The changes amount to no more than 3 dB fluctuations in path loss, but if you want acceptable performance every evening you must incorporate that 3 dB as a buffer in the form of additional system gain.

Fig. 5 shows a similar test sequence, only this time the threshold was at 5 Watts average with power increments of 10, 15, and 20 Watts shown for comparison. This series, showing some of the station equipment, also shows the Bird wattmeter used to monitor power output — you are not getting estimates based on guesses from a #47 lamp!

There is no doubt that the most effective means of monitoring power output in the 420-450 MHz band is a Bird wattmeter with a suitable set of slugs for the power levels you wish to use. It is highly doubtful that without the use of WB8JXF's Bird we would now be sending pictures back and forth. The problem is of course that the little devils are expensive and, although it is usually possible to borrow one for a short

time to tune up a transmitter or check the antenna system, what is needed is an inexpensive yet reasonably accurate means of monitoring power output so that one needn't be afraid to tinker with the transmitter. The ever popular VHF Monomatch¹ works well for the lower VHF bands, but is more critical in layout to get a good null when used at 432. Numerous descriptions of more elegant directional couplers are available, but these are tedious to construct. It is possible to effectively modify the basic monomatch concept, however, if all we are interested in is measuring forward power. Such an approach is illustrated in schematic form in Fig. 6 and with photos in Fig. 7. This basic unit will effectively monitor power output up to about 100 Watts. If you run higher power, you can go to RG-8 foam cable and a shorter pickup loop. The internal pot can be set for full-scale deflection at any desired power level down to less than 1 Watt. Calibration is best accomplished using a Bird or

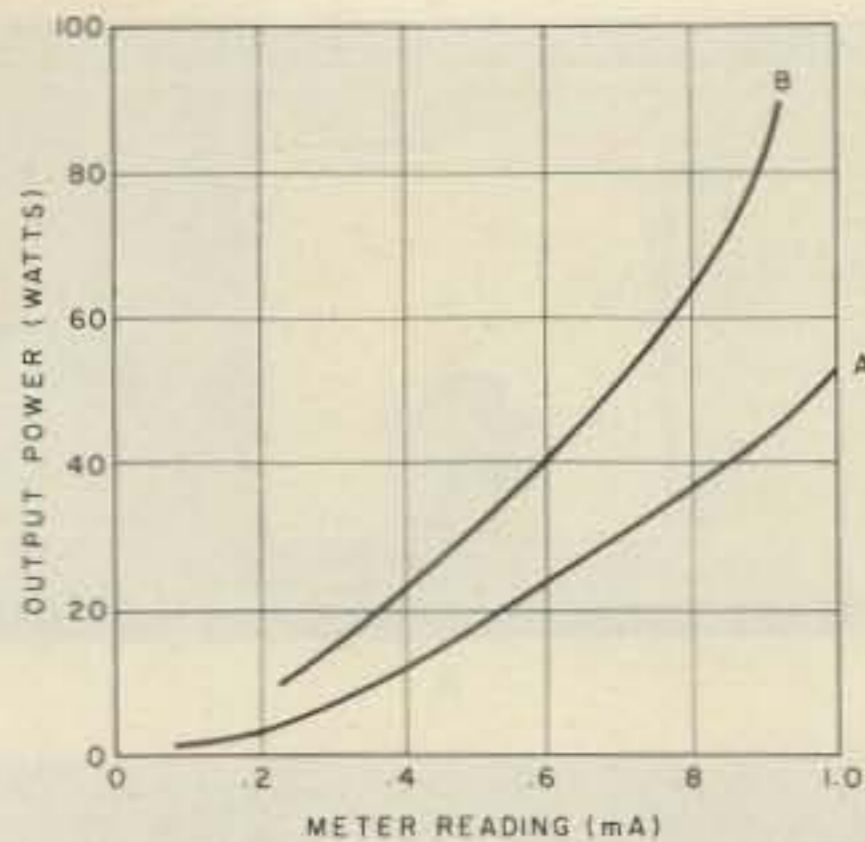

Fig. 8. Calibration curve for the author's in-line power meter. Curve A is for 432 MHz and curve B is for the two meter band. Provided the antenna system exhibits a low swr, once you have calibrated your meter you can reliably use it for power output measurements. The calibration curves will differ for each instrument, so there is no way to avoid the task of calibration if you want it to be useful.

similar unit for setup. A good 50 Ohm load is required, but this is easy at 432 — simply use 50-100 feet of RG-58/U (the older the better) terminated with a 50 Ohm resistor. Using the Bird as a reference, set the transmitter for the desired peak value (50 Watts for example) and then insert the meter into the line (starting with the pot at the maximum resistance setting). The pot is then advanced until full-scale meter deflection is obtained. Now reduce the transmitter power in steps (40, 30, 20 and 10 Watts for example), comparing the meter reading with the power as indicated by the Bird wattmeter. The meter may be used in several power ranges by switching in different pots with each range being calibrated as indicated. The adjustment pots should be internal to eliminate the urge to tinker with them and thus throw off your careful calibration at some later time. You can then use your meter readings to prepare a calibration curve. An example of such a curve is shown in Fig. 8. As long as you are working into a reasonable load (low swr) you will be able to estimate your power output quite nicely anywhere in the band. The meter can also be calibrated for other bands, but in that case you leave the pots as set for 432 and simply tabulate power output against

the meter readings. The fixed geometry of the pickup loop causes the instrument to be less sensitive at lower frequencies, as shown by the two meter curve included in Fig. 8.

See how interesting it is to read all the articles in 73 each month! Even if you never intend to operate TV, you now have a reference for a simple and cheap instrument (less than \$20) for keeping track of your power output in any mode on any VHF band.

Transmitters

There are many approaches that can be taken to arrive at a suitable transmitting system. One of the more common procedures is the modification of a commercial transmitter strip obtained on the surplus market. Some of these modulate quite easily with adequate bandwidth (RCA "Carfone" and G.E. "Prog Line"), while others are more difficult to use (Motorola T44). The primary advantage of this approach is that you have a well engineered transmitter operating at moderate power levels. The disadvantages are the bulky power supplies and the fact that replacement tubes are getting harder to find at reasonable prices. Both JXF and myself decided to opt for a more modern approach, starting with a basic crystal

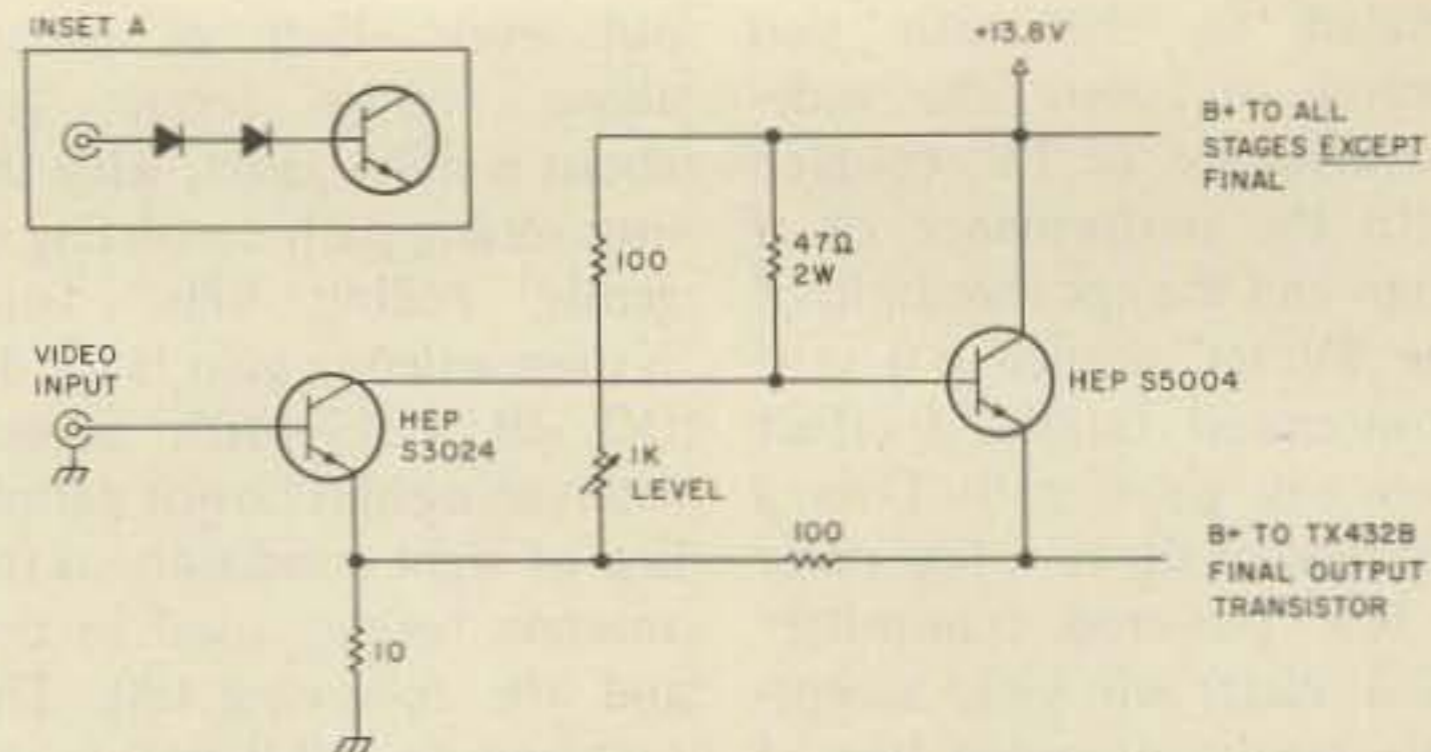

Fig. 9. Video modulator, designed by WB8JXF, for the TX-432B transmitter strip. Unless otherwise noted, fixed resistors are 1/2 Watt units. The 1k level control can be a 1/4 Watt PC pot mounted on the modulator board, or it can be a conventional panel mount control. Since it is usually not adjusted following setup, it is perhaps best to mount it internally to prevent tinkering. No heat sinks are required for use with the TX-432, but, if other transmitters are to be modulated (the modulator will sink up to 1/2 Amp), they may be required. Some tube-type cameras have a dc component in their output that will alter the bias on the input transistor. This can be eliminated by adding silicon diodes in series with the input (inset A) until the modulator provides proper video swing. 1N914 or other small signal diodes are fine here. No diodes will be required with solid state cameras. No terminating resistor is required at the input, as this function is taken care of by the input transistor itself. Several features contribute to the excellent performance of the modulator, including the use of high frequency transistors and the incorporation of dc coupling throughout.

controlled solid state exciter. The one we use is the TX-432B from VHF Engineering (see ads in 73). The kit for this strip costs \$39.95, and one approach to using it as a TV transmitter is described in "Simple Amateur TV Transmitter."³ The strip is constructed following the kit instructions, with the single modification involving re-orienting a single RFC so that B+ for the final can be brought out on a single land without using additional components. Attachment of the output coax to the board is critical for maximum output and stability. Short exposed leads are a must, and I achieved a 30% boost in output power by soldering the flange of a BNC connector directly to the foil groundplane with the center pin going directly to the rf output pin on the board. The object is to tune the exciter for maximum stable output into a 50 Ohm load. The final will take off on its own at certain tuning settings, and you should pull

the crystal to check for this possibility when you think it is tuned up. You will get between 1 and 1.5 Watts output at 13.8 V, depending upon your specific output transistor. If you are getting much more output, you should suspect self-oscillation. The transmitter strip is quite clean when properly tuned. Heat sinks are provided for the driver and final output transistors, but, in both versions we have built, the pre-driver has run uncomfortably warm, requiring an additional heat sink.

Reference 3 describes a video modulator for the exciter, but another circuit, designed by WB8JXF, is shown in Fig. 9. This modulator is essentially noncritical in terms of parts placement and lead length to the transmitter board, and has more than adequate bandwidth for use of an aural subcarrier audio system (more on that later). With the camera connected to the modulator, the level pot should be adjusted for a

power output of approximately 50% of what you obtain with the camera disconnected. The camera should be set up on a properly lighted subject for this step. Final setting of the level control can be optimized while watching the picture. At one extreme the video will "white out" with very little power output from the strip, while at the other extreme you will have plenty of contrast but the picture will become unstable as you gradually eliminate the sync threshold. With normal video input the output will be 50% of peak, rising to about 75% if the lens is capped. Some older tube-type cameras have a dc component in the output signal, which will mess up the bias on the input transistor or the modulator. This problem can be eliminated by adding one or more silicon diodes in series with the input to the base until you have knocked the dc component down to the point where you get good video swing. An old Dage camera I used required three such diodes in series. No diodes will be required for solid state cameras. Fig. 10 shows a photograph of my own exciter and video modulator.

When properly set up, the modulated exciter puts out a very nice picture that is limited in resolution only by the camera you employ. The main difficulty is that it simply does not have enough power to carry very far. I can shoot a nice picture around town (WB8JXF could do the same except that he doesn't live in a town!), but the picture quality drops off due to snow within a few miles. With everything optimized over the 8 mile path between us, we can exchange barely recognizable pictures with the basic exciter. The answer of course is higher power, and here WB8JXF and I took different routes, mostly to see what could be accomplished with various approaches.

The route I took involved

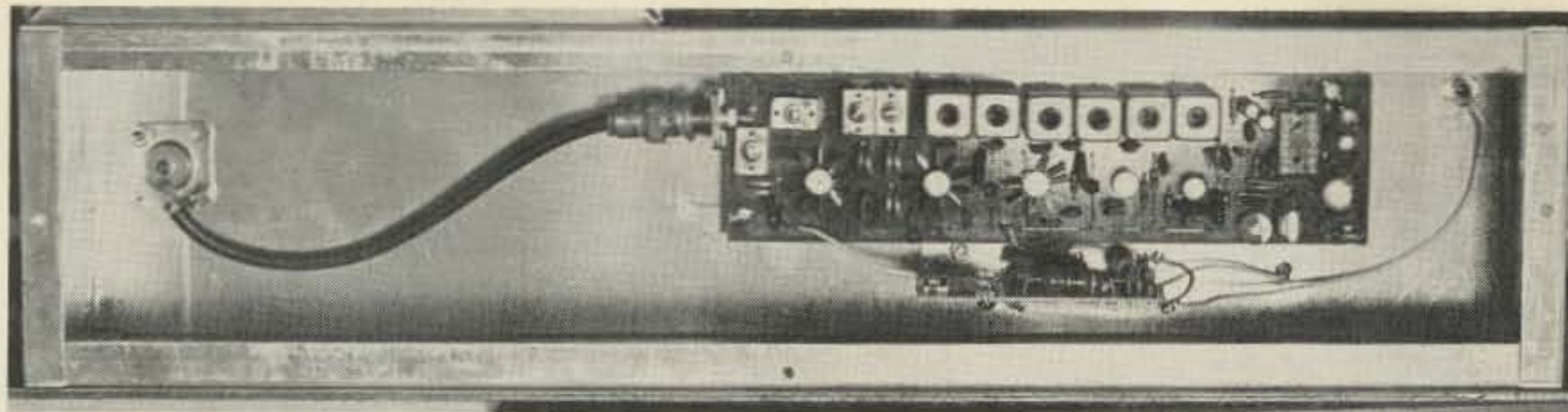

Fig. 10. The basic exciter and video modulator used in our ATV operations. In the author's version, shown here, the transmitter strip is mounted on standoffs with the modulator board mounted vertically next to the exciter strip. An extra large chassis was used, because I initially thought I would mount a power amplifier along with the exciter, but later decided to keep the exciter as an independent unit for demonstrations and portable work. A socket was used for the audio IC on the transmitter strip, but the IC is removed because the modulator is not being used at the present time. The additional heat sink added to one of the driver transistors (third from the left) shows clearly. A BNC connector is used to couple the rf off the board because this resulted in approximately 30% more power output than simply attaching the coax directly to the output pins.

the use of the Motorola MHW-710 power module as a linear amplifier. Reference 3 describes this as a "1 Watt in, 10 Watts out" module, but, as we shall see, this is not strictly correct. Two versions of the module are of interest to amateurs, depending upon your video frequency. The MHW-710-1 covers 400-440 MHz without tuning and the MHW-710-2 does the same over a 440-470 MHz frequency range. Both cost \$41.50 and are available from Motorola distributors across the country. The module is basically an IC that requires very few additional components to do its job. Fig. 11 shows the schematic of my power amplifier using this module. A photo of the module and associated components is shown in Fig. 12. The module is one of the easiest-to-use rf components I have ever come across, and the amplifier is simplicity personified. The whole thing is constructed in a small aluminum chassis using a piece of double-sided glass board to provide for short ground returns. The board is mounted to the inner surface of the chassis with several screws and the input connector, to assure that the inner copper surface is actually at ground potential. A cutout in the board is provided so that the module can be mounted directly to the metal chassis,

with thermal grease applied between the metal IC ground slab and the chassis surface. A large heat sink is mounted on the other side of the chassis, secured by the same screws that mount the IC. Use thermal grease at the interface between the heat sink and the chassis to assure good heat transfer. The amplifier is unconditionally stable if the

exposed ends of the coax cables are kept very short — particularly the output line. Subminiature RG-174 is used to minimize lead stress on the module. Grounded IC pins, coax shields, and the grounded side of the bypass capacitors are soldered directly to the copper ground plane. A power supply capable of delivering at least 4 Amps at

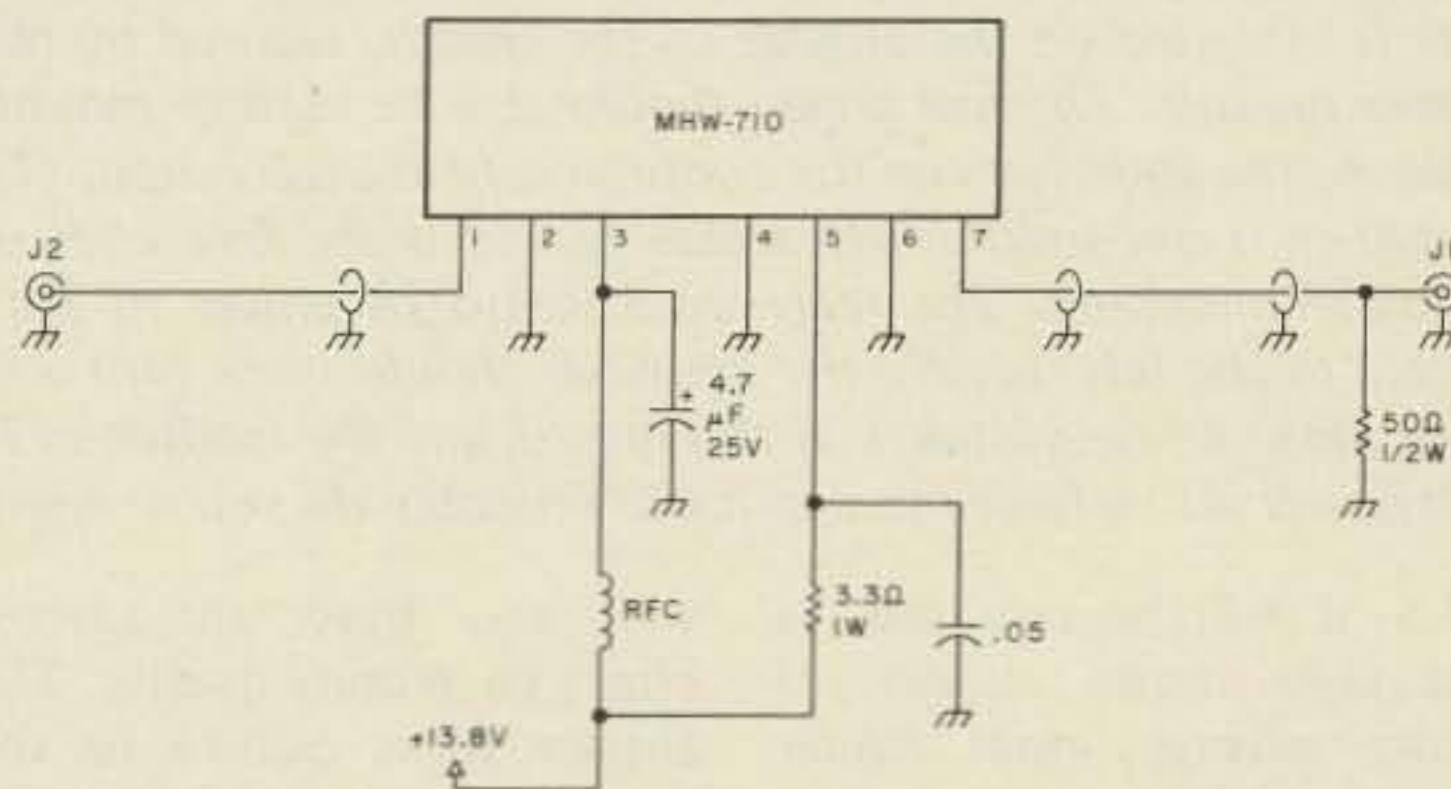

Fig. 11. Schematic for the circuit utilizing the Motorola MHW-710 power module in linear TV service. J1 is a Switchcraft 3501 FR phono jack. Interconnection to the module is made with a short lengths of RG-174 coax. A piece of double-sided circuit board with a cutout to accommodate the module (Fig. 12) permits short ground leads for input and output coax, bypass capacitors, and the grounded pins of the module. The schematic shows the IC pins as viewed from the top of the module. The metal slab of the module should be mounted directly to the aluminum chassis using thermal grease, with the heat sink mounted on the other side of the chassis in a similar manner. J2 is an SO-239 connector interconnected to the module with another short length of RG-174. Small coax is used to minimize lead stress on the module. Output lead length (exposed center conductor and shield at both ends of the output coax) should be kept to an absolute minimum. J1 is connected to the exciter by 50 feet of RG-174. This length is gradually trimmed until the proper drive level is obtained as outlined in the text. RFC — 8 turns #22 enamel on a 1 megohm 1 Watt resistor.

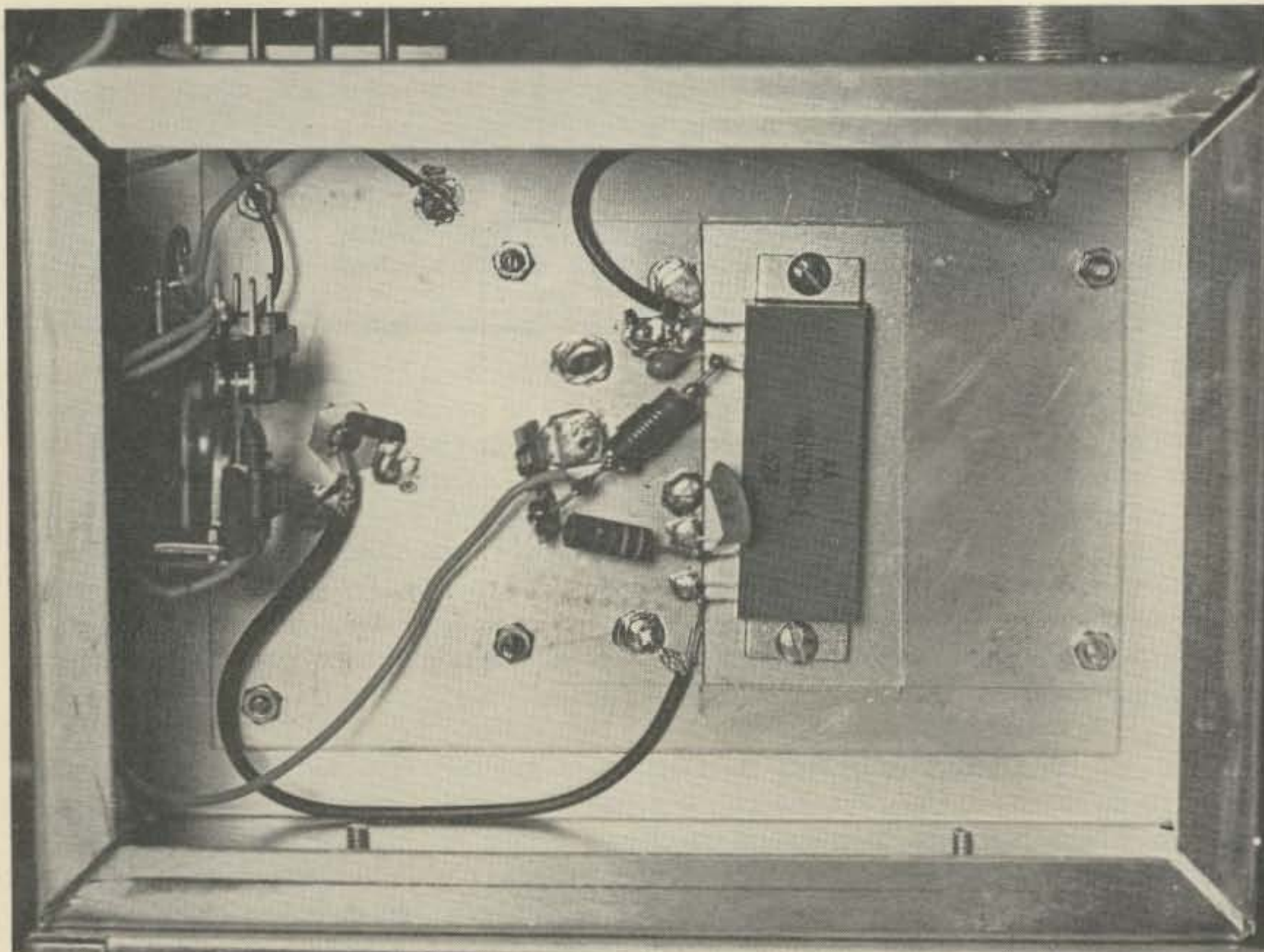

Fig. 12. Under-chassis view of the MHW-710 power amplifier circuit. A piece of double-sided glass PC board is mounted on the inside of the chassis surface to provide for direct ground returns for the power module pins, bypass capacitors, and the coax shields. This board is secured to the chassis with several screws and the input connector. A cutout in the board permits the metal mounting slab of the IC to be grounded directly to the aluminum chassis. Thermal grease is used to provide thermal coupling between the IC and the chassis. A large heat sink is mounted on the outside of the chassis, secured by the same screws used to mount the power module. Thermal grease should also be used in mounting the heat sink. Mounted in this fashion, the amplifier can run continuously at peak output (15 Watts) without overheating. The amplifier is unconditionally stable provided the free ends of the output coax are kept to an absolute minimum. The relay used to switch power to the amplifier during transmit is just visible to the left. Ideally the amplifier should work into a load with an swr of less than 2:1. I have made a few mistakes in this regard, and the module still works, but extended operation at full power into a large mismatch will probably do you in eventually.

13.8 V will be required, as the chip draws almost 40 Watts average input under modulation.

If driven directly by the modulated exciter, the module will put out almost 20 Watts, but very little modulation will be evident. Only 50 mW average drive is actually required, and the chip simply isn't linear when driven by 1 Watt from the exciter. The module performs excellently under modulation if we drop the drive level to the proper value, but we do not want to alter the tuning or voltage on the exciter, because this will alter its characteristics when modulated and will require that it be reset up if operated independently. Major changes in load

will also have an adverse effect on picture quality. The answer turns out to be the use of a moderate length of RG-174 coax for coupling between the exciter and the module. This small coax is very lossy at this frequency and will drop the power to the module very smoothly while maintaining the proper 50 Ohm load on the exciter. Start with 50 feet of this cable (it's only \$.08 per foot). With no camera connected to the modulator, gradually prune the coax while watching the power output from the amplifier. Slow down when you get to 10 Watts and begin checking with the camera to be sure that black level and average output are tracking at 75%

and 50% respectively. The module will not stay linear beyond 15 Watts peak, and I play it safe by stopping at 13 Watts. If you push for the last possible Watt, you will start infringing on the sync threshold, which will hurt your weak signal performance even if it is not noticeable in close. If you trim off a little too much coax, it's hard to put it back together, but you can recover by compensating with slight adjustment of the level control on the exciter. You should try to get it right using just the coax, however, for then you will have the exciter set up properly if you want to use it independently. Fig. 13 is a photograph of the complete transmitter, showing the coaxial coupling

and the heat sink on the power amplifier. The result is a solid state ATV transmitter that performs as well as a converted surplus strip and which can be built for \$100-130, including packaging.

The basic ATV transmitter just described puts out enough power to function well over normal paths of 10-12 miles, and it can also be used to drive an amplifier in the 50-100 Watt class. There are several ways to go in getting to this latter power level. If you want to stay in the solid state business, there are a number of solid state linears which will do the job nicely. KLM makes two amplifiers that will do the job. Their PA10-35CL (\$139.95) will put out 35-40 Watts (average) when driven by the basic transmitter, and the PA10-70CL (\$245.95) will deliver about 70 Watts under the same conditions. VHF Engineering has recently announced the introduction of a similar series of amplifiers. Both companies, and others as well, are tooling up for amplifiers that will deliver comparable outputs when driven by the basic TX-432B exciter, but amplifiers with 35-70 or more Watts out with 1-2 Watts of drive are expensive. Costwise, it is far cheaper to incorporate the MHW-710 module to get enough drive to use one of the less expensive 10 Watt input amplifiers. All of these amplifiers require a regulated high current supply. (The PA10-35 draws 6 Amps and the PA10-70 requires 18 Amps.) So some pretty hefty power supplies are in order. Many manufacturers are marketing supplies for use with solid state HF transceivers in the 200 Watt range, but check the specs carefully if you plan to avoid the hassle of building a supply. Many of the HF supplies are rated for SSB service, and it is the continuous ratings that you should heed in making a selection.

Solid state linears with

their requirements for massive power supplies make it reasonable to consider tube-type amplifiers for more power output, as suitable supplies are readily available and often cost less than a low voltage supply required for comparable output with a solid state linear. WB8JXF went this route using the basic TX-432B exciter described earlier. One of the nicest amplifiers for outputs in the 30-100 Watt range is the cavity configuration using a 4CX250 described in the *The Radio Amateur's VHF Manual*.⁴ This amplifier will deliver 30-40 Watts (average) on an 800 volt transceiver power supply and can push up to close to 100 Watts average at maximum rated voltage. Do not attempt to drive such an amplifier directly with the TX-432B exciter. WB8JXF did and lost the output transistor. It seems that the 250 tube series develops rather high rf grid voltages (a fact not mentioned enough in the literature), and the poor 2N5913 in the output of the exciter is only rated at 14 V on the collector! WB8JXF employs a 2C39 in grounded grid as a buffer between the exciter and the cavity, with excellent results. The 2C39 is set up to provide very little gain, and functions primarily to protect the exciter from the ravenous grid circuit of the cavity. Power output of the MHW-710 is more than adequate to drive such a cavity using lossy coupling, thus protecting the power module. If there is sufficient demand, WB8JXF could undoubtedly be persuaded to document his power train, which not only works well, but also employs some rather interesting ideas on coupling the exciter, 2C39, and cavity amplifier. If you want to go the limit on power, then the K2RIW kilowatt⁵ is probably the best route.

You will note that our system philosophy has involved the use of a well set up exciter with linear ampli-

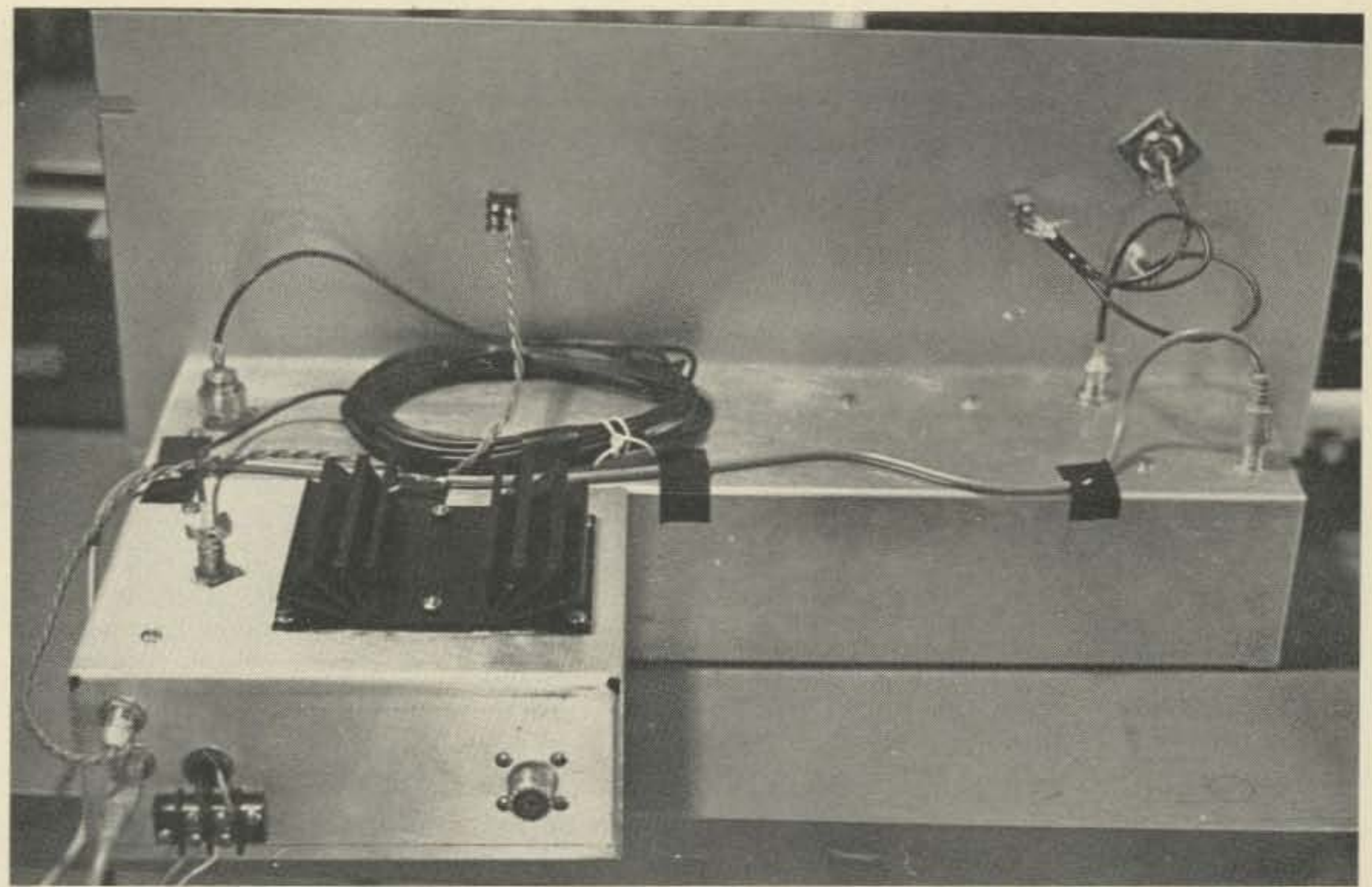

Fig. 13. Rear view of the complete basic ATV transmitter using the TX-432B exciter and video modulator (long chassis) and the MHW-710 power module (short chassis). The heat sink on the latter is visible, as is the coiled length of RG-174 used to drop the exciter power output to the proper drive level for the power amplifier. The front panel holds the TR switch, camera input and monitor output jacks, and video switch. The vacant space in the collection of boxes is for the cavity final (4CX250) which is presently under construction. An oversize panel is used to allow for metering and control hardware for this amplifier. 13.8 V comes into the power amplifier compartment and is jumpered over to the exciter. This permits power to be applied separately to the exciter if desired, with the latter connected directly to the antenna.

ers to get to the desired power output level. You will occasionally read that such strings of linears result in a loss of picture resolution. This simply is not so if the stages are tuned properly. The linear approach does have the advantage that the power train can be broken down to any useful intermediate power level for demonstrations and such — something that is not possible with a modulated final. When we are talking about high powered tube finals, linears would appear to present a problem with power output, since maximum efficiency with AM linears is limited to about 35%. An interesting fact discovered in our tests is that excellent video quality can be obtained in class B. The finals can thus be biased AB1 for local work and easily shifted to class B for really long haul schedules. The only effect of the latter operating conditions is a very slight compression of the grey scale,

which actually may improve subjective picture quality under conditions of high noise. The effect is hardly noticeable locally, but you can always shift back to AB1 for color or other critical applications. Given the flexibility of linear power trains, this approach seems to us to be better than grid modulation of the final, for there is little or no difference in effective power output at any given input when the power difference could actually make or break a contact. For those who might doubt, the test photographs of Figs. 4 and 5 were made with the cavity final operating in class B!

Sound

There are many ways to handle the matter of sound to go along with the pictures. The easiest way is, in our opinion, the best. It involves using your existing phone equipment on another VHF band (2 meters is ideal). This

gives you a reliable audio link that is so essential in setting up a system and permits voice communication without firing up the video gear. Another substantial advantage of this approach is that your audio commentary will receive maximum exposure and perhaps get you some new converts. If you put the voice up with the video signal, no one but your cronies will hear and you cut your chances of snagging new converts.

Another approach is to simultaneously FM modulate the exciter, recovering the audio on a separate FM receiver tuned to the carrier frequency. This is easy with the TX432B exciter since there is an FM modulator already on the board, but it is hard to keep sync buzz out of the receiver, particularly in the case of a signal that does not limit fully during video modulation.

Audio in conjunction with the TV receiver can be

accomplished in two ways. The first is the use of an aural subcarrier unit in which a voice modulated 4.5 MHz oscillator (FM) is mixed with the video at the input to the modulator of the TV transmitter. This results in two FM sidebands 4.5 MHz from the video signal. The upper one is demodulated as sound in the TV set. Several problems are associated with this method. First, the video amp must be flat to 4.5 MHz (the one in Fig. 5 is) to pass the FM subcarrier. The more power you apply in the subcarrier, the more you take from the picture signal, so compromise is required. The subcarrier unit must be designed so that it does not load the modulator input if a loss of resolution is to be avoided. A nice subcarrier circuit is described in "Practical Ideas for the ATV Enthusiast."⁶ The most elegant approach is to use another FM transmitter 4.5 MHz above your video carrier frequency. The most effective

sound level is achieved with an output level from the voice transmitter of 1/3 to 1/2 of the average video output. This ratio is in terms of the effective radiated power, so the antenna gain for the voice transmitter should be taken into consideration. Simple yagi arrays are fine here since the voice signal is narrowband.

Summary

This article has covered a lot of ground in attempting to document an effective ATV system. The system outlines provided are realistic, and if you are interested in trying ATV you can implement them with expectations of success. If you are within line of sight of an ATV repeater, you can undoubtedly get by with far less in the way of equipment, but our approach has been oriented toward point to point service. When band conditions are good, you will get even exceptional results

with a given power level, but you will have assembled the station with a realistic idea of what you can accomplish at any time.

I first got into ATV when virtually every item of equipment had to be built from scratch, and when you were done the technology was such that you occasionally wondered if it was worth the effort. Today the effort and costs are actually less than they used to be, and there is no comparison in terms of the results you can achieve.

ATV is a fascinating aspect of our hobby. You will have to tinker to optimize the system, but there is lots of room for real experimentation. The biggest stumbling block is simply getting an effective two-way operation going. I think we have developed some workable guidelines to make that task easier.

Once you are on you can branch out in any direction — color, Pong, microprocessors

via ATV time-sharing — you name it. The name of the game is both fun and a little education. If you do give it a try, you will not only enjoy demonstrating your efforts, but will also have accomplished something far more in the traditions of amateur radio than simply playing with store-bought goodies. For about what it would cost for a fancy FM toy, you can come up and join the video freaks for some real pioneering — why not give it your best shot?! ■

References

- ¹ *The Radio Amateur's VHF Manual*, ARRL, Newington CT (any edition).
- ² Brown, B., "Amateur TV Receiving System," *73*, June, 1976.
- ³ Brown, B., "Simple Amateur TV Transmitter," *73*, June, 1976.
- ⁴ *The Radio Amateur's VHF Manual*, ARRL, Newington CT, 2nd edition, p. 257.
- ⁵ Knadle, "A Strip-line Kilowatt Amplifier for 432 MHz," *QST*, April and May, 1972.
- ⁶ O'Hara, T. R., "Practical Ideas for the ATV Enthusiast, Part II," *QST*, February, 1975.



EDITORIAL BY WAYNE GREEN

from page 95

delegates found little enthusiasm for this move with the other countries, and head counts of the countries indicated that we were very far short of the needed majority.

On the opening day of the conference, the U.S. managed to get the Netherlands to start things off by proposing the 3-30 MHz postponement, sort of in the hopes that it wouldn't look as if the U.S. was pushing for it, and thus when it was defeated, it would not be a U.S. defeat. The entire assembly of the plenipotentiary meeting was thunderstruck when the Soviet Union rose and seconded the Netherlands motion. With a large number of small nations in the U.S.S.R. pocket, the motion was carried and amateur radio was saved until the next conference.

How did this happen? It was a pure fluke. Khrushchev had just visited the U.S. and been most cordially welcomed by Ike. When he returned home, he wanted to make sure that his good feelings toward the U.S. were reflected, and it happened that the

first opportunity to show friendship between the U.S.S.R. and the U.S. came at this ITU meeting in Geneva. When you consider that not long after this Gary Powers was shot down and the U.S.S.R. mood changed, you can appreciate how we lucked out.

1964 — THE ITU

As more and more of the emerging nations joined the ITU, the balance of power changed from the U.S./European block to the third world. The American Secretary General of the ITU was voted out and replaced by an Ethiopian. The American who really ran the ITU was fired and the whole place changed to reflect the new African/Asian influence.

After the Ethiopian Secretary General, they voted in one from India, with the second man in command from Australia. Remember, if you will, the 20 kHz ham band proposal of India and the 50 kHz proposal of Australia. Amateur radio no longer had good friends in high places.

1966 — I TRAVEL

With a possible frequency confer-

ence scheduled for 1969, it seemed like time to take stock. I decided to take a trip around the world and visit some of the countries that would be deciding the future of the ham bands at the ITU. My trip took me to Kenya, Uganda, Tanzania, Ethiopia, Sudan, Egypt, Lebanon, Syria, Iraq, Iran, Afghanistan, India, Nepal, Burma, Thailand, Singapore, Australia, New Zealand, New Caledonia, Fiji Islands, Western Samoa, American Samoa, Tahiti, and back to the U.S. I DXpeditioned from 15 of the countries, working tens of thousands of amateurs as I traveled.

In each country, I got together with the national amateur radio society of that country or with the local amateurs where there was no significant society. In several, I visited the ministers of communications to explain the importance of amateur radio to them and their countries.

One of the results of this trip was the development of the concept of having ham ambassadors visit smaller countries to point out the benefits to them of encouraging amateur radio. This was written up in my November, 1966, editorial in *73 Magazine* ... written while I was in Sydney, Australia.

While in Ethiopia, I got together with the ex-Secretary General of the ITU and explained amateur radio to him. He had very little background in it and became most enthusiastic when I pointed out the benefits to emerging nations of the hobby. I showed him

how people could be encouraged to learn electronics and communications on their own time and pretty much at their own expense, and thus become a very valuable resource for the country ... technicians and engineers. He suggested that I should get together with the current Secretary General of the ITU when I was in India, and he helped arrange a meeting.

In Delhi, I did meet with the Secretary General and discussed the importance of amateur radio to emerging nations with him. I pointed out that small country students normally think in terms of being lawyers, doctors, or civil servants, and the concept of an engineering career is lost. With amateur radio as an impetus, many of the students would want to try for technical school training and the country would benefit greatly.

Communications is the basis for growth of any civilization, and when a country has to import everything electrical and electronic, including technicians at \$200 a day from Sweden or Switzerland, they are able to buy very little in the way of telephone systems and radio communications. With local technicians, they would be able to buy much more.

The Secretary General was enthusiastic when I suggested that I could provide a sample set of amateur radio regulations for the ITU to make available and recommend to smaller

Continued on page 177

DOVETRON



MPC-1000C
Multipath-Diversity
Amateur Net: \$495.00

The MPC-1000C features MULTIPATH CORRECTION, IN-BAND DIVERSITY (single channel copy during deep selective fades) Operation and a PHASE-CONTINUOUS AFSK TONE KEYS. The Mark and Space channels are CONTINUOUSLY tuneable from 1200 to 3100 Hz. The internal RY GENERATOR and DUAL-MODE AUTOSTART (FSK or MARK) are standard, as are rear panel provisions for SIGNAL REGENERATION and SPEED CONVERSION peripherals.



MPC-1000CR
Signal Regeneration &
Up-Down Speed Conversion
Amateur Net: \$595.00

The MPC-1000CR combines all the features of the MPC-1000C with the TSR-200 SPEED CONVERTER-REGENERATOR. A front panel SIGNAL SPEED switch provides electronic "gear-shifting" between 60, 66, 75 and 100 WPM speeds. All incoming and outgoing signals are regenerated by a CMOS UART and a crystal-controlled DUAL-CLOCK to less than 0.5% bias distortion, providing an extremely low error rate on weak and badly distorted signals.



MPC-1000R
Dual-Uart Regeneration,
200 Character Fifo
Memory & Word Correction.
Amateur Net: \$820.00

The MPC-1000R combines the features of the MPC-1000CR with the TSR-500 SPEED CONVERTER-REGENERATOR and offers 200 characters of FIFO MEMORY, a DUAL-UART REGENERATOR that also provides local copy during all PRELOAD-RECIRCULATE functions, a WORD CORRECTION circuit that permits an incorrect word to be erased from memory by depressing the local keyboard's BLANK key, VARIABLE CHARACTER RATE and automatic BLANK/LTRS DIDDLE. Character OVER-RUN during down-speed conversion is prevented by an automatic CHARACTER RATE OVER-RIDE and TEE DEE INHIBIT circuit. Three preset AFSK TONE/SHIFT combinations are selectable from the front panel.

The MPC-1000R (80 characters of memory), MPC-1000CA (Tri-tone AFSK), MPC-1000CRA (Tri-tone Regenerator) and MPC-1000CS (Crypto-Scrambler) are also available.

Your QSL will bring complete specifications, or call: 213-682-3705.



627 Fremont Ave.
(P. O. Box 267)
South Pasadena, Ca. 91030

D23

NEW!

A \$29.95
DVM Kit.

Thanks to a product breakthrough, digital voltmeters are available at a bargain price. What are you waiting for?

- Features:
- 1) Uses new Motorola 3 1/2 digit DVM chip.
 - 2) Autozero, autopolarity with minus.
 - 3) Up to ±0.05% accuracy.
 - 4) Over-voltage protected, NO JUNK PARTS. Jumbo LED Display.
 - 5) Two voltage ranges: 0-199.9 mV, 0-1.999 V. Attenuators for higher ranges available, AC volts, Ohms ranges available.

Add \$1.50 for postage. CA residents add \$1.80 tax. Buy two and save \$3.00!

Gary McClellan and Co. Box 2085
1001 W. Imperial Hwy.
La Habra CA 90631

ALL BAND TRAP ANTENNA!



5 BAND OPERATION - ONLY ONE NEAT SMALL ANTENNA. FOR CONGESTED HOUSING AND APARTMENT DWELLERS!

FOR ALL AMATEUR HF TRANSMITTERS GUARANTEED FOR 1,000 WATTS POWER. LIGHT, NEAT WEATHERPROOF.

Complete as shown total length 102 ft. with 90ft. of 52 ohm RG58U coax and PL259 connector. Hi-Impact molded resonant traps. (wt. 3 oz. 1"x 5" long) You just tune to desired band for excellent reports! EXCELLENT FOR ALL WORLD - WIDE RECEIVERS AND AMATEUR TRANSMITTERS.

For NOVICE AND ALL CLASS AMATEURS! NO EXTRA TUNERS OR GADGETS NEEDED! ELIMINATES 5 SEPARATE ANTENNAS WITH EXCELLENT PERFORMANCE GUARANTEED. CAN BE USED IN ATTICS, TOPS OF BUILDINGS OR AS V,s IN MINIMUM SPACE, ETC. NO HAYWIRE HOUSE APPEARANCE! EASY INSTALLATION! FULL DETAILS FURNISHED.

80-40-20-15-10 meter bands. Complete \$39.95
40-20-15-10 meter bands. 54-ft. ant. \$38.95
20-15-10 meter bands. 24-ft. ant. \$37.95

SEND ONLY \$3.00 (cash, ck., mo.) and pay postman balance COD plus postage on arrival or send full price for pp. del. BANK AMERICARD - - - MASTER CHARGE - - - by mail or Ph 308-236-5333 Free info. available only from.

WESTERN ELECTRONICS Dept. A7- 10
Kearney, Nebraska, 68847

NEW!

\$32.50

plus \$1.50 s/h
NY res. add tax



Features: CMOS Electronic Keyer

- State-of-the-art CMOS circuitry
- Self completing dots and dashes
- Dot and dash memory
- Iambic keying with any squeeze paddle
- 5-50 WPM
- Speed, volume, tone controls, side tone and speaker
- Low current drain CMOS-battery operation
- Deluxe quarter-inch jacks for keying and output
- Handsome eggshell white base - woodgrain top
- Compact and portable - 1-7/8 x 4-1/4 x 6-1/4
- Grid block keying
- Wired and tested - fully guaranteed - less battery

TRAC

Electronics, Inc.
1106 Rand Bldg. T18
Buffalo NY 14203

Simple Electronic Siren

-- it's loud!

Ray Megirian K4DHC
606 SE 6th Avenue
Deerfield Beach FL 33441

"Whatcha makin' Dad?"

"A microcomputer, son."
"What's it do?"

"Well, when it is finished, I hope to program it so it will run my rig. Every fifteen minutes it will initiate a receiver scan of all the ham bands to search for rare DX. If a rare callsign is recognized, it will tune up the transmitter, select the best antenna, call the station, and sound an alarm so I can take over. It will also make out a QSL card and record the contact for my log."

"Oh."

"Why don't you go next door and play with Buddy so I can get this thing finished. It's costing me a bunch and I don't want to make any mistakes in the wiring."

"Yeah, ok. His dad just made Buddy a turn signal for his bike. He makes a lot of

neat things for Buddy. He's real smart. See you later, Pop."

Then it hits you. Is it really that long since you were pouring sand into a length of copper tubing so you could bend it into a tank coil for that super new 5 meter modulated oscillator?

And it can't possibly be so many years since you thrilled to the sound of Big Ben on 49 meters with a one-lunger on a cigar box chassis. Transistors? Who needed 'em! Your vacuum tube superregen ran on 6 volts with the grids reversed. Remember? Ah, those were the fun years.

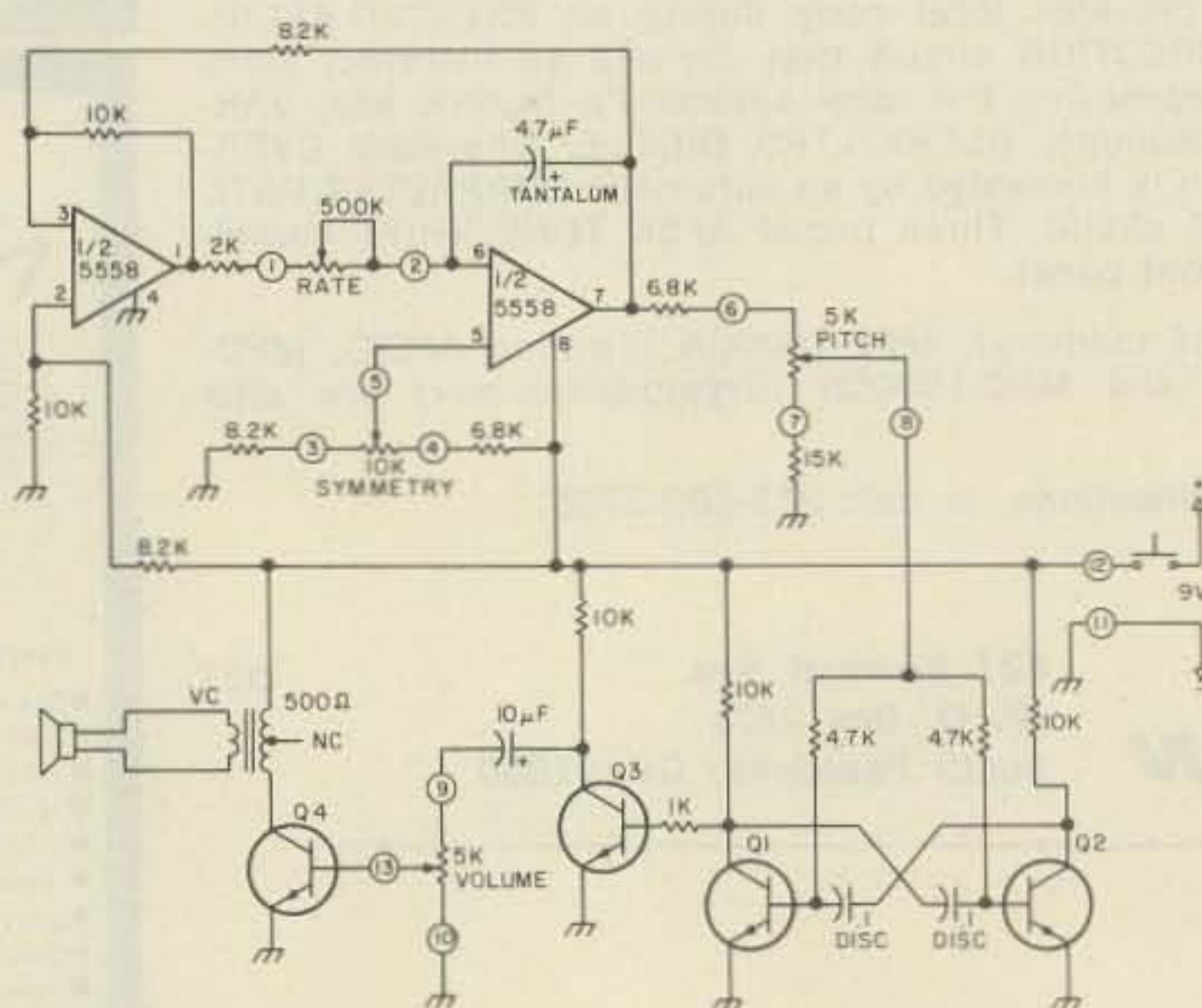

Fig. 1. Schematic for the electronic siren. The circled numbers correspond to numbered pads on the printed circuit board.

An Electronic Siren

Well, here is a fun thing you can build in a couple of hours that is guaranteed to make you a hero in the eyes of any youngster and just possibly the envy of your neighbors. What I'm selling is an electronic siren. Not a new idea by any means, but this one has enough operating controls to make it particularly appealing. The circuit is self-starting, simple, and runs on standard 9 volt radio batteries. Drain is low enough so you won't have to make a trip to the drug store every day for fresh batteries. You can vary the repetition rate from a long wail to a rapid warble, control the volume from soft to annoying, vary the pitch and the symmetry.

The circuit, as shown in Fig. 1, makes use of a type 5558 dual op amp and 4 NPN transistors as the active elements. The IC is used to generate a triangle wave much as any basic function generator. This triangle can be distorted by means of the symmetry control to form either a fast rise or a slow rise sawtooth. This signal is applied as base bias to the astable multivibrator formed by Q1 and Q2. As the level of the triangle or sawtooth rises and falls, the charging time for the cross-coupling capacitors varies and causes a change in multivibrator frequency. Output is taken from one side of the multivibrator and squared up by direct-coupled amplifier Q3. The audio output stage, Q4, is pulsed on and off by the square waves and provides plenty of noise with little expenditure of battery power.

The siren contains about 5 dollars worth of parts. Depending on the cost for an enclosure, the total outlay shouldn't exceed 10 bucks. All resistors are 1/4 Watt. The output transformer isn't critical. I used a 500 Ohm to voice coil type with PC leads for use with the board layout shown in Fig. 2. The tran-

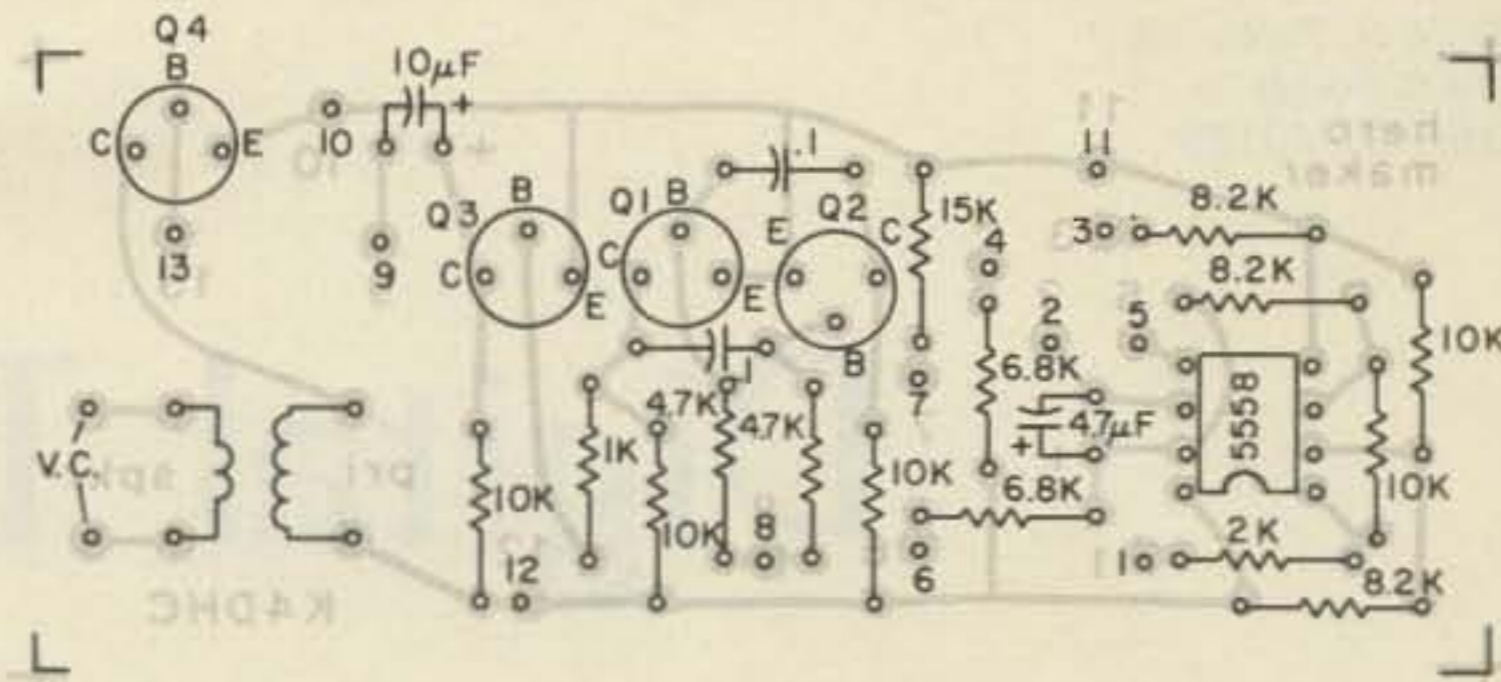
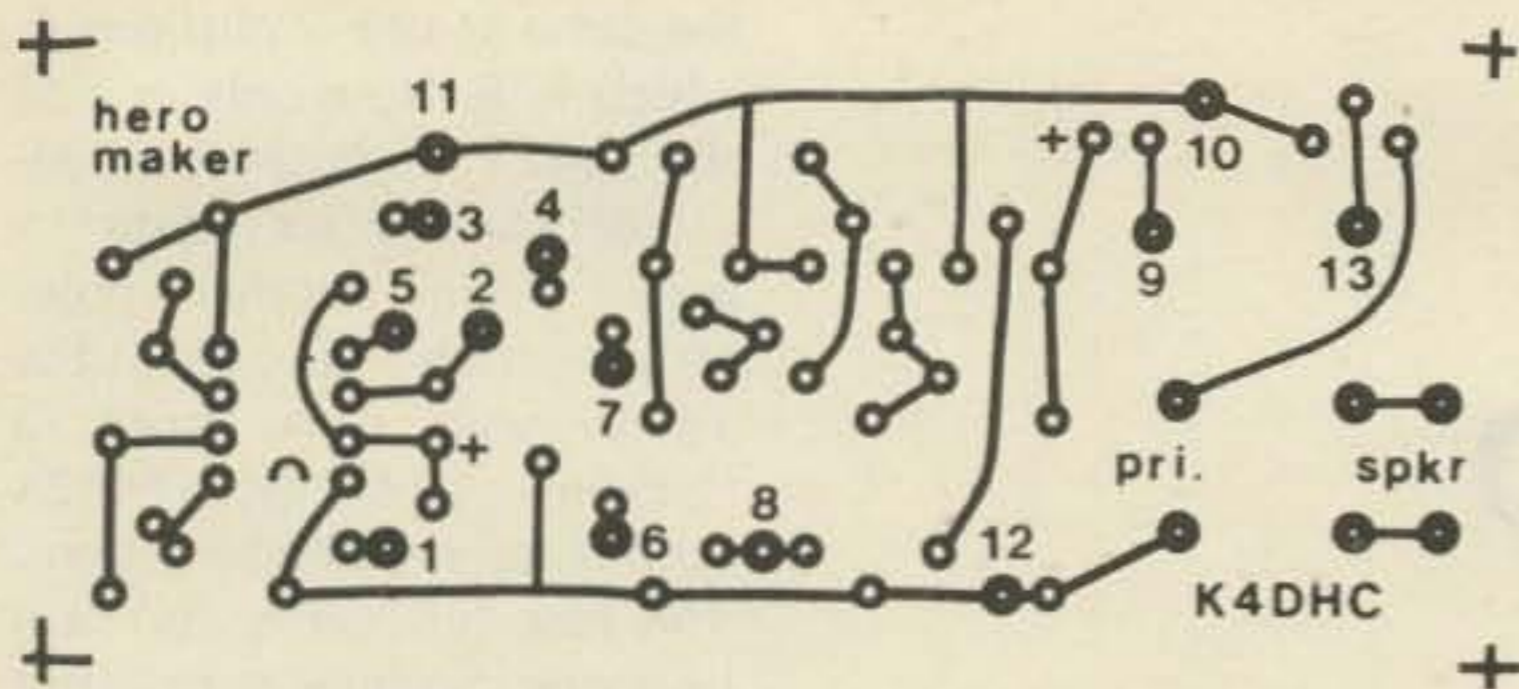

Fig. 2. PC pattern and parts placement for the Hero Maker.

sistors are NPN silicon units. Mine were house-numbered cheapies in TO-18 cans which I picked up years ago. The .1 uF capacitors are 50 volt discs. The 10 uF coupling capacitor in the audio section is an electrolytic. The 4.7 uF capacitor used in the integrator section of the triangle generator should be a tantalum unit for best results. I used a small dipped tantalum which fits the board layout. An axial lead type may be used by mounting it hairpin fashion. The operating switch can be either a push-button or a toggle switch to allow

hands-off operation when used on a bicycle.

Operation of the controls and their effect on the siren sounds will become apparent after a few minutes of use. The symmetry control is the only one whose purpose may elude you at first. The complete cycle consists of an audio tone which starts at a low frequency and rises to a high point before retracing its way back to the starting frequency. If the symmetry control is set at one end of its range, the rising wail of the siren can be stretched out to occupy the greatest portion

of the cycle time or the falling wail can be made longer with the control at the other extreme. Somewhere in between, a symmetrical triangle is generated and the rise and fall portions of the siren sound will be equally long. The pitch control varies the actual range of frequencies covered in one complete cycle and the rate pot controls the number of complete cycles per unit of time.

Most of the common siren sounds can be imitated with this toy and it will furnish hours of amusement for the youngsters, provided your

nerves hold out. If the kids do mount these on bicycles, it might be worth a little extra effort to make them removable. One of our neighbors' boys had his bicycle ripped off less than 12 hours after installing one of these sirens. It makes the prize just that much more enticing to a thief.

So there it is; your golden opportunity to be a hero. Why not put digital readouts, microprocessors, RAMs and ROMs out of your mind for a couple of hours while you build something just for the fun of it. Have a ball! ■



EDITORIAL BY WAYNE GREEN

from page 174

countries.

Upon returning from the three month trip around the world, I found the magazine in dire straits ... a month behind in production and almost bankrupt. I had to get things in hand and work hard for several months before I could get to the substantial job of writing a set of international amateur radio regulations. I was partly done with them when I read in the newspapers that the Secretary General had suddenly died. Well, so much for that project.

1969 - ITU

I visited the ITU in Geneva at every opportunity to keep in touch with what was going on under the surface. While the African/Asian countries were strong enough to influence the vote of the ITU on many matters, they were not well enough organized to force a general meeting to change the shortwave frequency allocations. The European nations were so far able to block every attempt at frequency talks.

1971 - ITU

With the African nations growing stronger, a satellite frequency conference was called for 1971 and the U.S. participated, with the ARRL representing amateurs worldwide. The ARRL went into the conference with 237,254.77 MHz of satellite frequencies allocated to amateur radio. They came out with 7.5 MHz ... and only 3 MHz of that above 150 MHz! Thus they managed to lose 237,247.27 MHz of the amateur satellite allocation.

This loss was duly reported in *QST*, with the explanation that the conference might have gone better if they had done their homework. If they had done as I suggested in my November, 1966, editorial, and sent ham representatives to visit the foreign countries to make them aware of the benefits of amateur radio to them, we might have thousands of megahertz of satellite frequencies today. They found many of the ITU delegates did not understand amateur radio and few had any knowledge of how it might benefit them.

Satellites were still pretty new in

1971, so the impact of the loss was not generally recognized. Now, as we think in terms of satellite communications as a way for amateurs of all countries of the world to get together via synchronous satellites, we are beginning to appreciate what has been lost ... and lost forever.

1979 - ITU

The next conference is scheduled for 1979, and there is no indication that it will be anything but a replay of the 1959 situation, only without the U.S.S.R. to pull our fat out of the fire. There will be even more pressure for eliminating the shortwave ham bands, and fewer friends to try to hold them for us.

The ARRL has been generating a smoke screen of proposals for new shortwave ham bands, none of which has been seriously accepted by even the U.S. delegation.

Do we yet have ham ambassadors visiting the third world countries to sell them on the value of amateur radio to their countries? You know the answer to that ... no.

1970 - JORDAN

While visiting Jordan and operating JY1 from the Royal Palace, I talked with His Majesty King Hussein about my plan for encouraging amateur radio in emerging nations as a way to get technically enthusiastic students who would then opt for engineering careers. Hussein asked me to explain the plan to his government, which I did ... and it was put into action,

despite a fierce civil war between Jordan and the resident Palestinians which began only a few days after I left.

I returned again to Jordan in 1973 and found that there were active ham clubs in every major city in Jordan, with over 500 licensed amateurs. The rules and regulations were essentially those I had prepared for them and sent over shortly after my return to the U.S. in 1970. As a result of the large number of technically interested youths in Jordan, the government was thinking in terms of setting up a radio crystal manufacturing plant and a small plant for making VHF transceivers. These would have been totally impossible projects just three years before.

In Jordan, the King supplied ham stations to each of the youth clubs and sent one man around to conduct code and theory classes. It worked.

The growth of amateur radio before the ARRL pushed through their "incentive licensing" plans was 11% per year. If the League had not insisted on trying to force amateurs to get higher class licenses by taking frequencies away from them if they did not, we might have seen amateur growth continuing at that level, and we might have about 1,250,000 amateurs today. With numbers like that, we would not be having to worry about losing 220 MHz and other UHF bands.

Continued on page 181

Digital To Audio Decoder

-- for the blind operator

About a year ago, I had an accident involving an exploding car battery whose shrapnel left me blind in one eye. As the anniversary of this unfortunate event passed me by, I got to thinking about how lucky I am to be blessed with sight and about those hams not so blessed. I thought how difficult it would be to do something most of us take for

granted, like reading a frequency counter or a digital voltmeter.

So here is a device which overcomes one of the many difficulties experienced by a blind person involved in any phase of electronics. In essence, it converts a binary coded decimal input, from any suitable piece of digital test gear, into a sequence of different tones — ten tones

representing the numbers zero to nine, and the length of the sequence equal to the number of digits displayed, plus a sign indicator, if desired.

Theory

Some readers unfamiliar with logic design may have a little trouble wading through the audio decoder's workings, while others of you have probably spent the last ten minutes exploring the schematic and now understand its working better than I do.

Perhaps the best place to start is with the sequence generator consisting of IC5, IC6, and IC7. IC5 is a familiar 555 timer connected for astable operation, which means that it generates sharp edged pulses, about twice a second as determined by time constant R10-C1. IC6, a decade counter, advances one count as the 555's output swings low. When the counter counts to nine, the next pulse resets its count to zero.

The count output, at terminals 1A, 2B, 4C, and 8D, is fed into IC7, which converts the 7490's BCD output to a one out of ten output. To clarify this a bit, suppose the 7490's outputs were 1A=0, 2B=1, 4C=1, 8D=0. This is

the same as one 2 plus one 4, which is 6. Now only one of the 7442's ten outputs is activated. Output six drops to zero. When another pulse arrives from the 555, the 7490 will now store a "seven" and the 7442's output seven will be a zero. The rest (including six) will be a one. So only one output is low at a time, and every tenth pulse starts the sequence over.

The sequencer drives the digit scanners IC1-IC3, aided by inverters in IC8. (An inverter changes a zero to a one and vice versa.) The idea is to look at one digit at a time and convert its number into a corresponding tone and then move on to the next digit and repeat the process. But I'm getting a little ahead of the story here; first the right digit has to be selected. The NAND gates in IC1, IC2, and IC3 are of the open collector variety. They provide one of two output states, much as a conventional NAND, but, instead of ones and zeroes, these put out high impedances instead of ones and zeroes as in the regular NANDs. *Caution:* These are 7401s or 7403s but *not* 7400s. The inputs to these open collector gates allow us to: 1) pass data from the data input terminals to the output terminals; and 2) make the gate outputs look like they are open switches. As long as we apply a data pass signal to only one of several gates whose outputs are tied together, the others look like they aren't there! The job of the sequencer, then, is to apply a "one" pass command to only those four gates that are the input path for the digit we want. Since the data is inverted by the digit scanners, IC4 reinverts the data to its proper form. Four gates must be used at a time, because it takes four bits to represent a number from zero to nine.

At this point, the four outputs of IC4 first mimic the 100s place of the connected digital test equipment,



Photo 1. Digital to audio decoder and Heathkit IB1100 frequency counter.

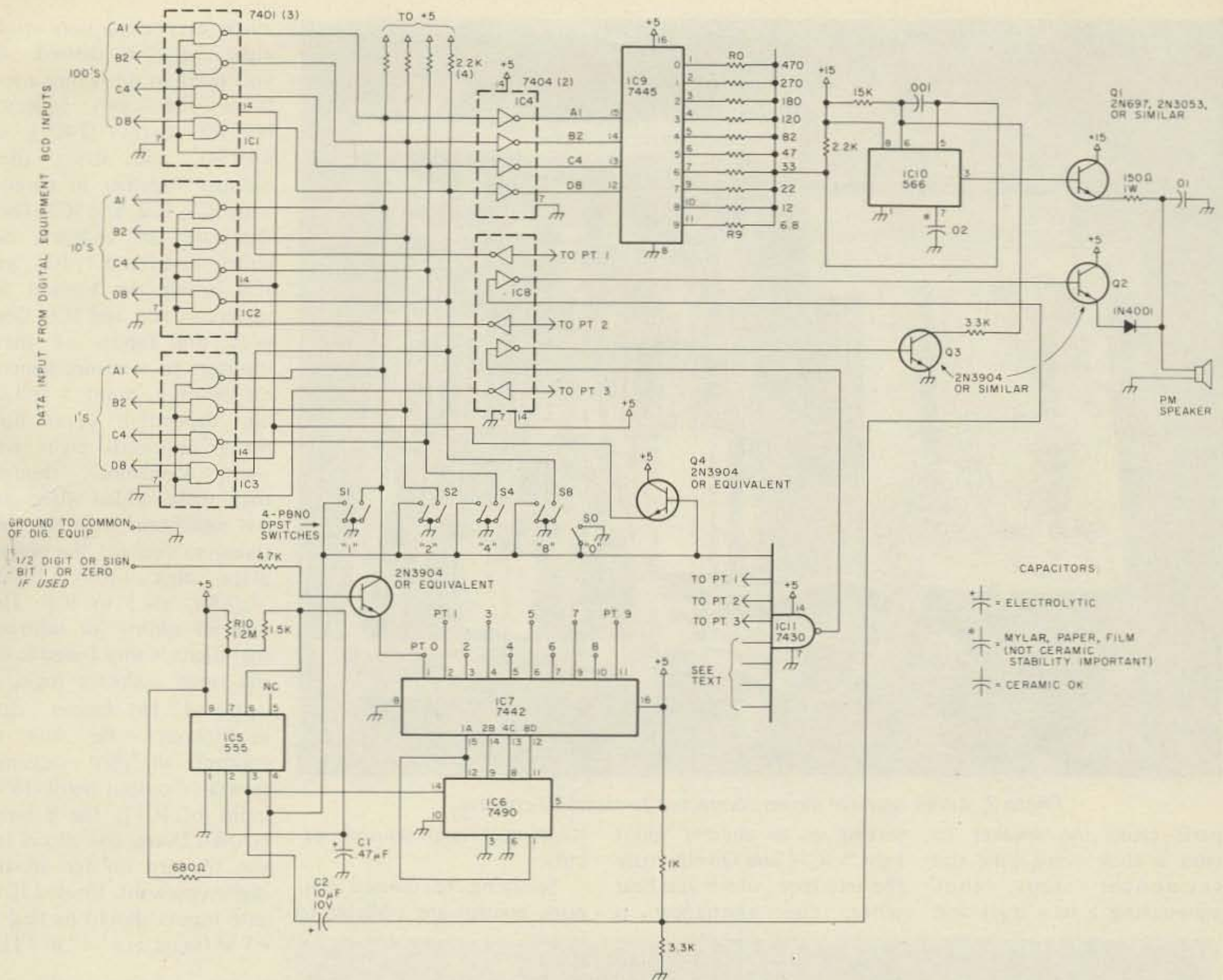

Fig. 1. Schematic of 3½-digit digital to audio decoder. Resistors should all be ¼ W ±10% or better, unless noted. If not specified, values are given in kΩ, i.e., 470 = 470k.

then the 10s place, and finally the 1s place, as the sequencer steps from 1 to 2 to 3. You may wonder what sequencer position zero does. It is the sign bit, in case you wish to connect the audio decoder to a digital VOM

with this feature, or use it to indicate overrange on a counter as I did.

IC4's output feeds IC9, which is another BCD, to one out of ten decoders, as we talked about in the sequencer. It has one

important difference though: Its outputs are open collector, just like the digit scanner gates. So once again, only the corresponding output of IC9 will be brought low for any given input number. This switches a different resistor into the voltage controlled oscillator circuit, IC10, which in turn causes it to see a

different voltage and generate a different tone. I set up the resistors to provide an increasing tone for increasing numbers. The resistors could be selected to play musical notes. Q1 merely amplifies the tone to drive a speaker.

Optional Features

C2, Q2, and associated

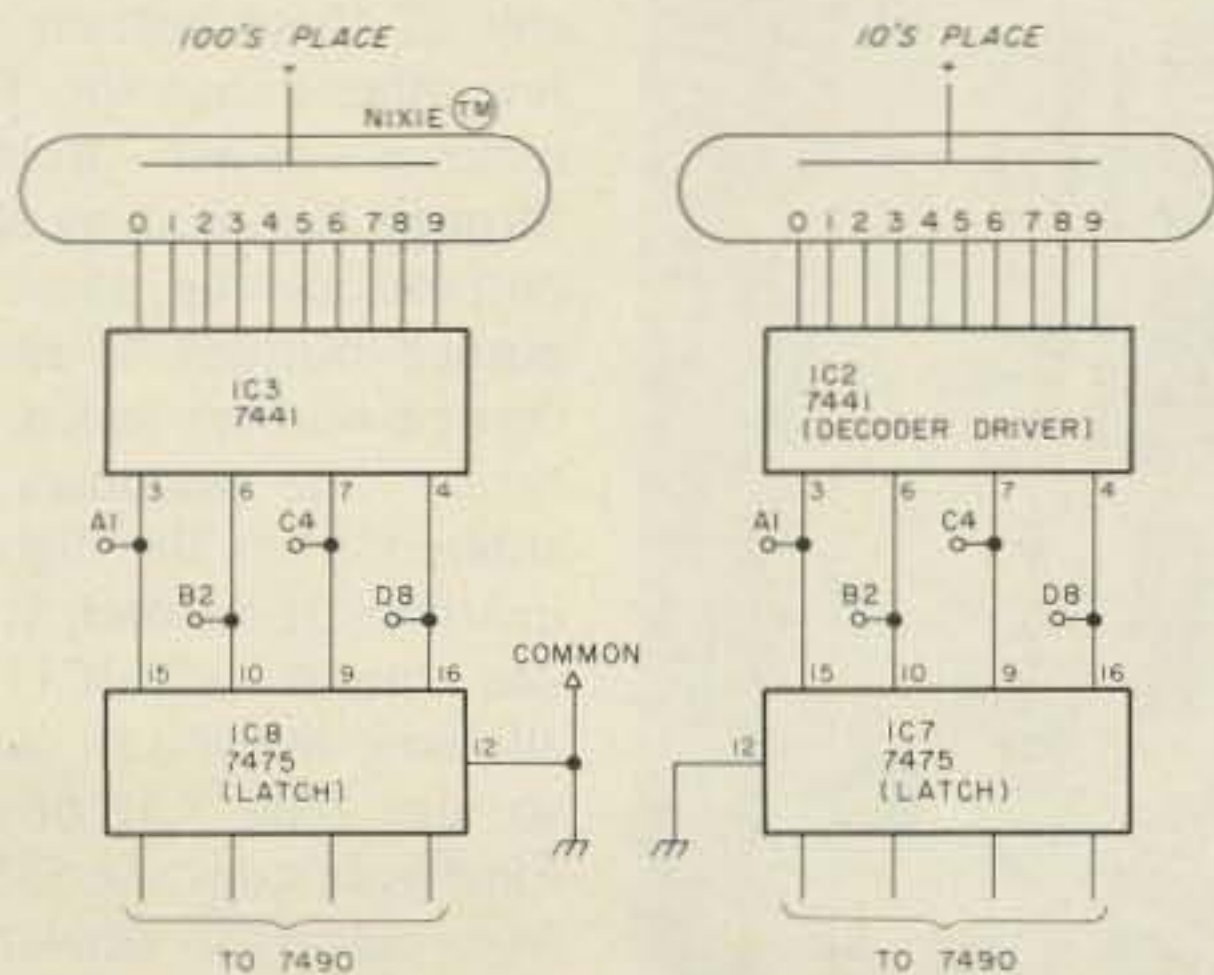

Fig. 2. Partial schematic of Heathkit IB1100 frequency counter showing where to connect inputs from audio decoder.

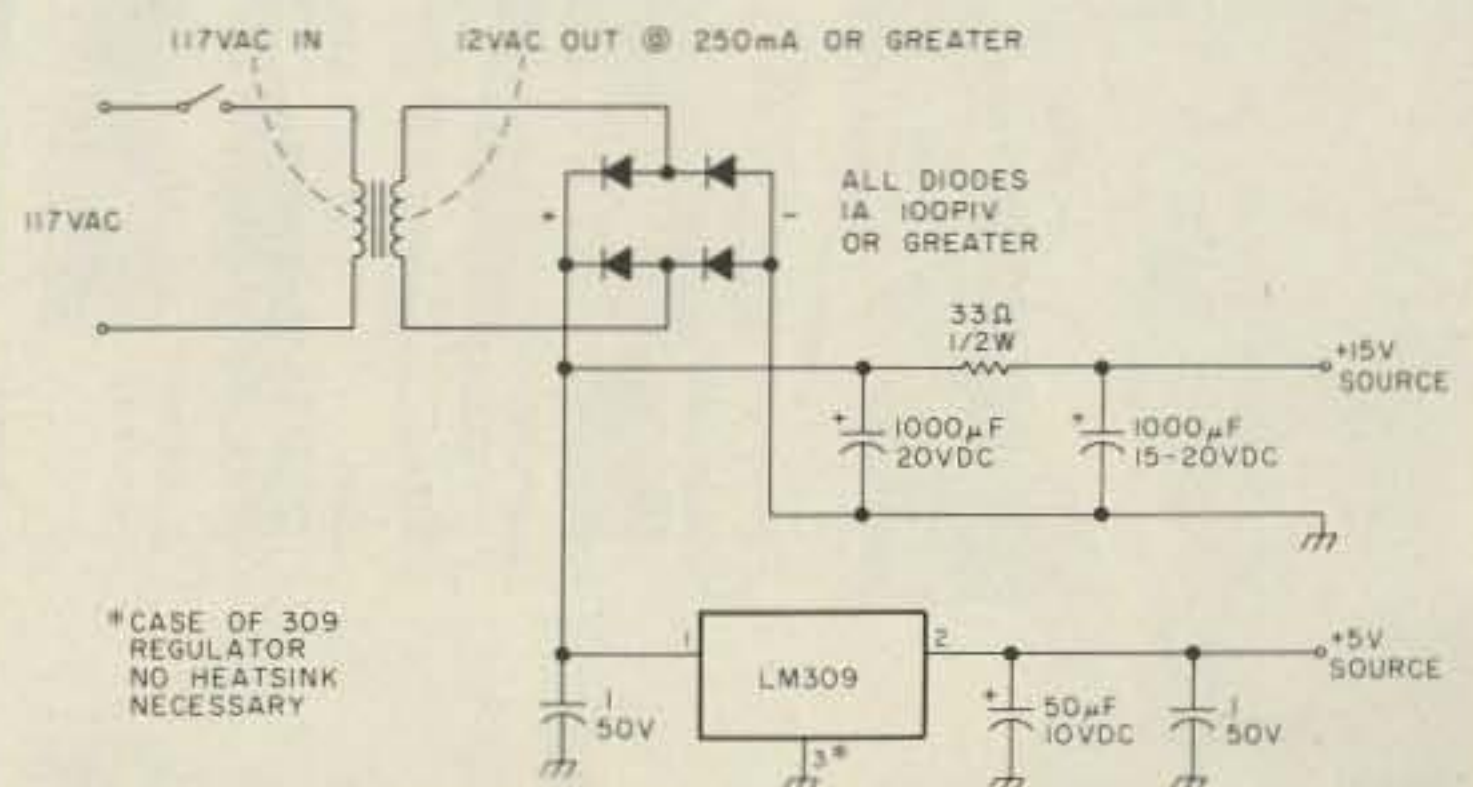

Fig. 3. 117 V ac input power supply for digital to audio decoder.

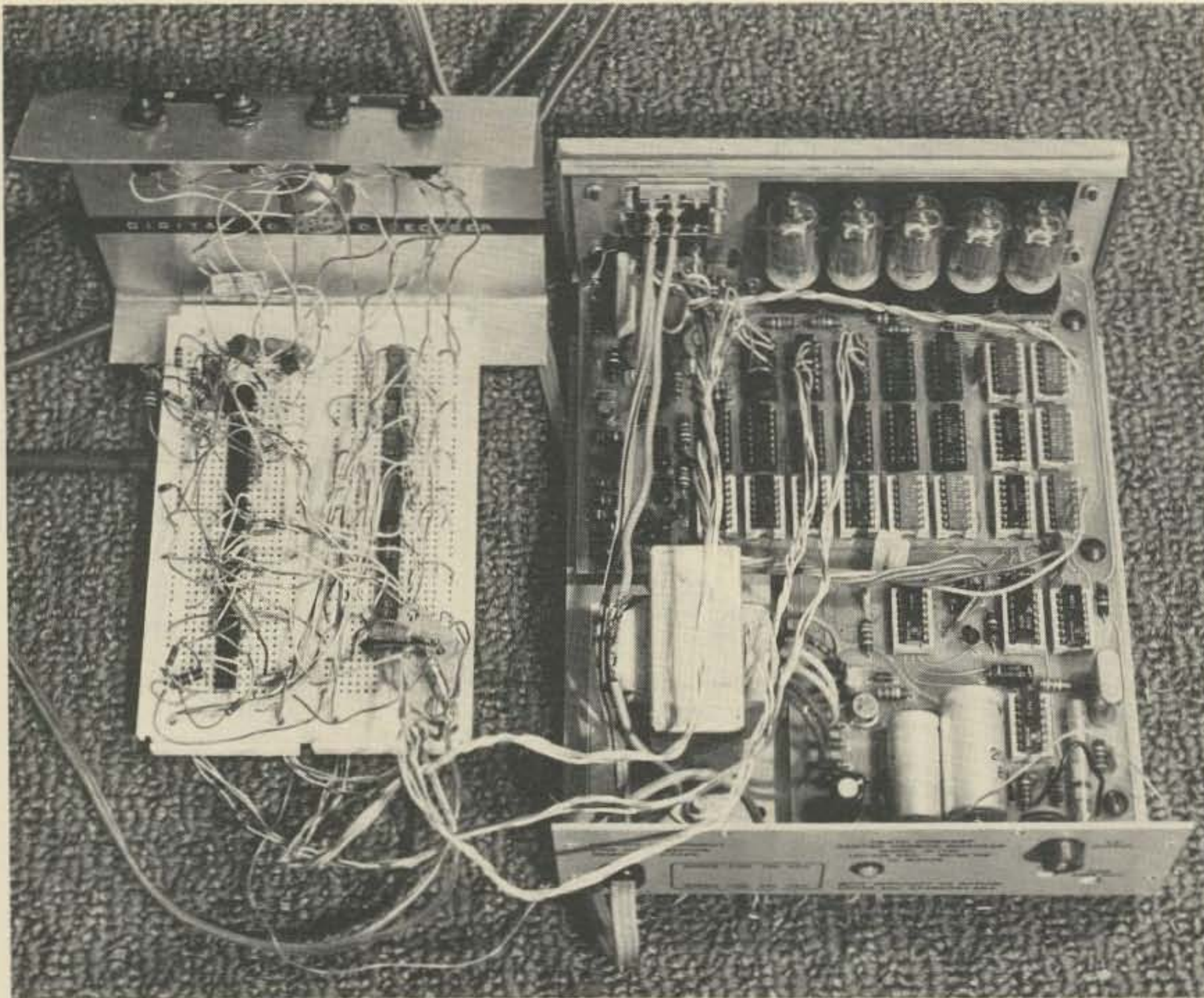

Photo 2. Audio decoder shown connected to Heathkit counter.

parts cause the speaker to emit a click every time the sequencer steps, thus announcing a new digit and

serving as an audible "pilot light." IC11 and Q3 eliminate the zero tone, which you hear when the sequencer is

stepping through unused outputs.

Speaking of unused outputs, enough are available to

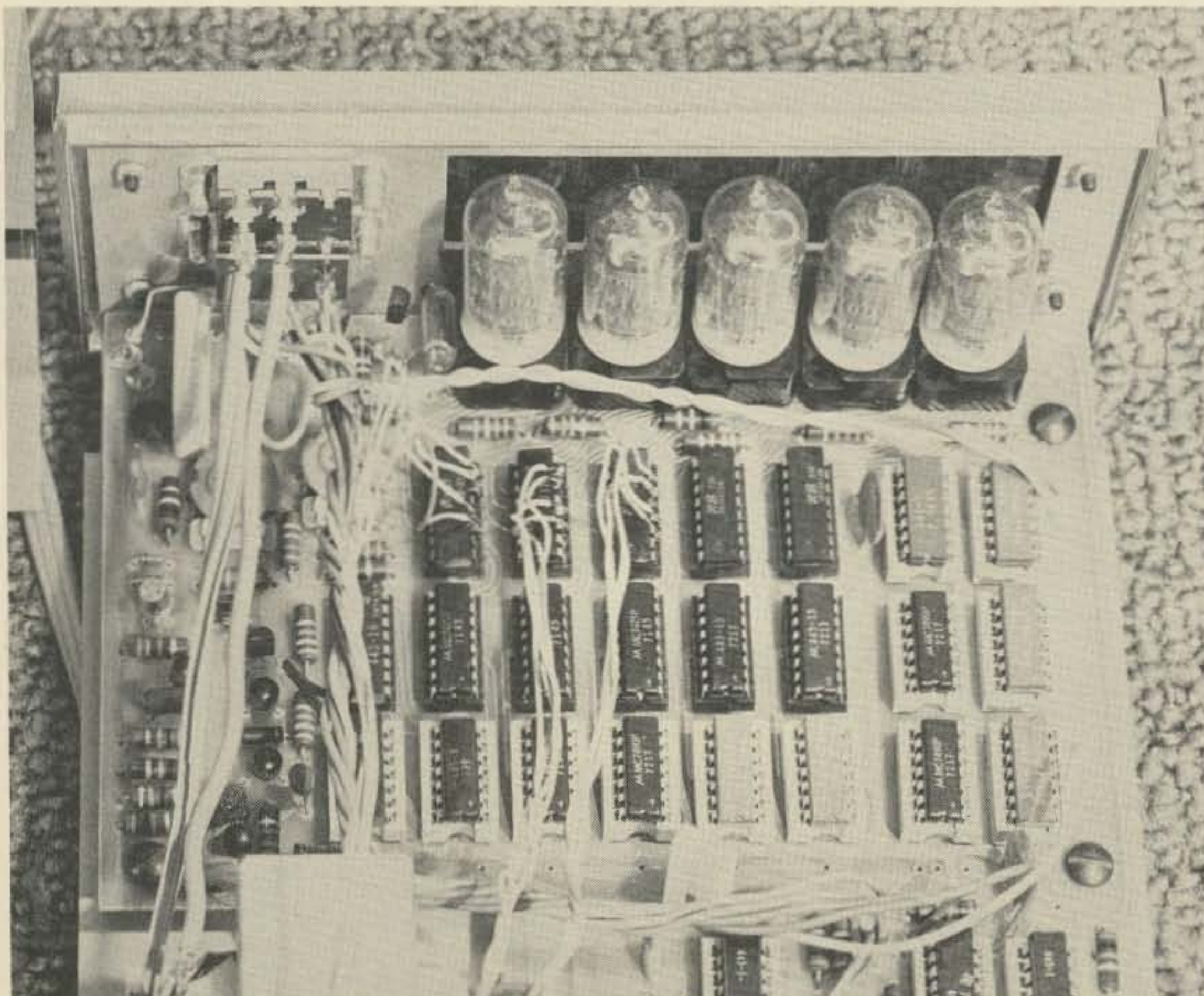

Fig. 3. 117 V ac input power supply for digital to audio decoder.

allow easy expansion up to eight digits, if desired. All you need to do is buy a few more 16¢ open collector NAND gates (7401s or 7403s), and string their outputs together in parallel with IC1, IC2, and IC3. Then duplicate the enabling circuitry used for IC1, IC2, and IC3, using the unused inverters in IC4 and IC8. Connect the inputs of these inverters to sequence generator point 4, point 5 and so on, depending upon how many additional digits you want. Remember, though, that these added digits are less significant than the first three, so connect the biggest place digit (100s, 1000s, 10,000s, etc.) to IC1. This ease of adding (or subtracting) digits is why I used lowly old open collector logic, as opposed to fancier data multiplexers. Be sure to connect all *used* sequence generator output points to an input of IC11, the 8 input NAND. Doing this allows the vco to turn on for all the digits you want. Unused IC11 gate inputs should be tied to +5 V (same as a "1" in TTL).

My last "optional" feature is probably not so optional. It gives the blind user the ability to hear what a number sounds like just by pushing the right combination of switches S1 through S8. For example, a "9" can be heard by pushing S1 and S8 simultaneously, or a "4" by pushing S4 alone. Pushing any of these buttons does a few other things, too. First, it removes power from IC1 through IC3, making all their outputs open up, allowing the pushed buttons to enter the desired number independently of the numbers being entered from the digital test instrument. Second, it brings one input of IC11 low, allowing the vco to function, so the tone can be heard. Finally, it stops the 555 timer from pulsing to allow hearing the tone alone. The switch marked S0 allows hearing the zero tone.

Interfacing

As it sits, this digital to audio decoder will not easily connect to every piece of digital test equipment, but it can be done! If the piece of test gear has an output connector labeled "BCD output," you're in. Most Heath frequency counters are usable, but you must solder to the circuit board. Connect the audio encoder's BCD inputs to test equipment's data latch outputs. Fig. 2 and

Photo 3 show how this is accomplished for a Heath IB1100 frequency counter.

Construction

In that only eleven ICs and a few other parts are used, I don't think a printed circuit board is worthwhile. As to the mechanical details, like switch placement, I strongly urge you to talk it over with the person for which the audio decoder is intended.

As to operation, what can

I really add? I went through most of it in the theory and optional features sections. When power is first applied, you should hear a clock every 1/2 second from the speaker, three tones after a few clicks, and then the same set of tones provided the numbers on the DVOM, counter, or whatever haven't changed. If you are in a hurry to try it out, as I was, you can take the 100s, 10s, and 1s input lines A1, B2, C4, and D8 and

tie some high and some low. Be careful, though, not to exceed 9 on any digit, or the results could be a bit confusing to say the least!

Although there may not be anything in it for you, except satisfaction, please don't look at this as "just another project." Look at it in the light of letting a blind person see some of the numbers we take for granted. Build one for a friend. ■



...de W2NSD/I

EDITORIAL BY WAYNE GREEN

from page 177

MY PREDICTION

From everything that I can see so far, I would suggest that amateur radio in the 1980s may be almost entirely a VHF affair, with 50 MHz and 144 MHz as our major bands. I suspect that Cowan and S-9 may win the day with a CB band on 220 MHz, since hams seem to be doing very little to stop him. This is the chap who publishes *CQ Magazine*.

Without any satellite bands to mention, and without long-range communications, the whole fabric of amateur radio will change. About half of the active amateurs are already on two meters... now the other half will either join them or try stamp collecting... or computers.

IT IS NOT TOO LATE

Since most of the ITU countries have not yet formulated their positions on the shortwave bands, we still have some time, if we hurry, for ham ambassadors to lobby for our hobby. Members of the QCWA would seem to be ideal ham ambassadors. These are the people who made amateur radio what it is today and it would seem to rest in their hands to make amateur radio whatever it is going to be tomorrow.

The QCWA member amateurs include a great number of the pioneers and innovators — people with the drive and enthusiasm to get things done. It is not surprising to find that many of these same people have become top men in the electronics industry. As part of their work, many of these men travel quite a bit and have good opportunities to see the heads of foreign countries and put in a good word, or perhaps a few thousand good words, for amateur radio. A little side trip to see the king or president of a country will not generally hurt business, if I may be guilty

of understatement.

No other group has such an elite membership as QCWA — just the type of people who could get an entry to a king and who would be able to sell the concept of amateur radio benefitting the country. Even if the ARRL wanted to spend money on such a project rather than their new million dollar wing of headquarters, they have no one of any stature to send out. Since QCWA members are already traveling, with their businesses paying the bills, there would be no cost to anyone for ambassadors.

QCWA members who are interested in the project should drop me a line and get a copy of a newsletter called "Amateur Radio, the Key to the Growth of a Country." There isn't much time to lose... unless you are a confirmed UHF addict and could care less about the low bands.

THE RADIO SHACK COMPUTER

"Most impressive" is my verdict on this one. When you see it and have a chance to try it out, you'll find it difficult not to like. They have packed a lot into what looks much like just a keyboard — it's the complete computer, with a Z-80 microprocessor, BASIC language on a ROM so it is right there ready to use as soon as you turn on the power, plus enough memory to tackle most things you might want to do. There is also the cassette interface system so all you have to do is plug in any ordinary cassette recorder to save and reload programs or data.

There are three sockets on the back panel of the computer — one for the monitor TV set, one for the little power supply which comes with it, and one for the cassette recorder.

The price for this? \$400 for the computer, and \$600 for the complete package of computer, TV monitor,



Radio Shack's complete TRS-80 Microcomputer System, consisting of a 53-key professional-type keyboard and microcomputer plus regulated power supply, computer-controlled data cassette recorder, and 12" video display monitor, is suitable for business, educational, and home applications. Available exclusively from Radio Shack stores and dealers, nationwide, for \$599.95.

and cassette recorder. Is it a coincidence that this is the same price as the PET?

Since I needed a computer system as a prop for a TV commercial I was making to advertise Computermania, I borrowed the computer and took it down to the TV station. Readers around the Boston area may have seen me operating it on the commercial, programming it to print out a short message for Computermania. The gist of the commercial was that here is a computer which would have cost over a million dollars just about ten years ago... now you can buy one for \$400... perhaps it is time to look into microcomputers for your business.

It's a very good-looking set and it worked like a charm.

It will be a while before production is up to full scale on this new system, so check into the larger Radio Shack stores from time to time. The first few production runs may go almost entirely by mail order, so you may have to buy one just to try it out... or at least keep an eye on your friends

in case they buy one.

The BASIC which comes with the system is an abbreviated version in 4K of ROM. They are working on a more expanded version and that will probably accompany their disk system which is scheduled for December. Yep, disks are coming... starting with single density single side, about 90K of storage. You can be sure this will grow to double density, double sides, etc.



Synthesize

Yourself!

-- practical experiments

Synthesizers are here to stay. Synthesizers are used in amateur and commercial transmitters, receivers, audio frequency generators, test equipment, and a multitude of devices for a large variety of purposes. They are used in applications that require the generation of

a large number of frequencies.

Prior to the invention of the digital integrated circuit, synthesizers were few and far between. The technology was known, but the necessary fundamental building blocks were not readily available.

Synthesizers were used, but they were cumbersome due to the large number of components required, and of course they were expensive to build and maintain. It wasn't until the advent of digital integrated circuits that synthesizers came into vogue because of the fact that digital ICs combined a large number of functions into a simple package. The "new" synthesizers are simple to construct, use few parts, and can be built inexpensively.

This article discusses the current generation of frequency synthesizers and provides an overview of the operation of the three common types of synthesizers in use today: the oscillator-mixer synthesizer, the period synthesizer, and the phase locked loop synthesizer. The greater portion of this article is devoted to the popular and versatile synthesizer, the phase locked loop, commonly known as the PLL synthesizer.

This article also describes simple synthesizer circuits and simple experiments using PLLs.

Those experimenters who are already experienced with synthesizers will notice that various topics have been glossed over or omitted in total. Those who have never worked with synthesizers should be able to read this article and make the simple circuits work.

Synthesis

Synthesis, by definition, is

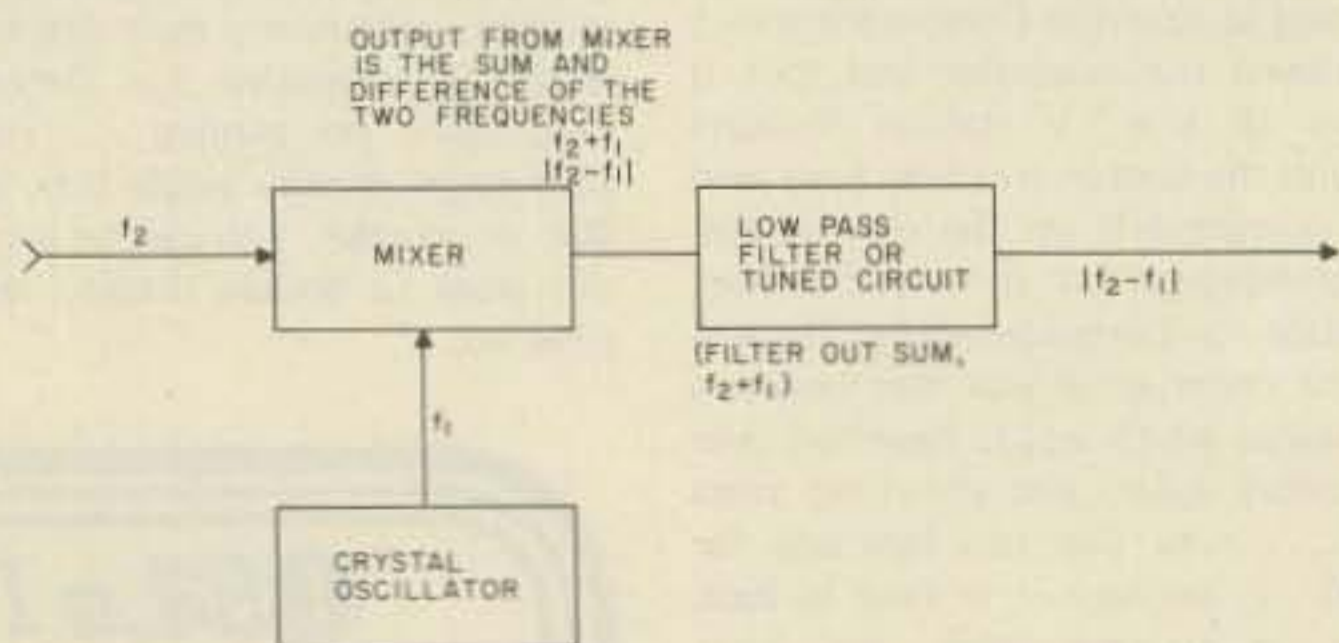

Fig. 1. Receiver mixer.

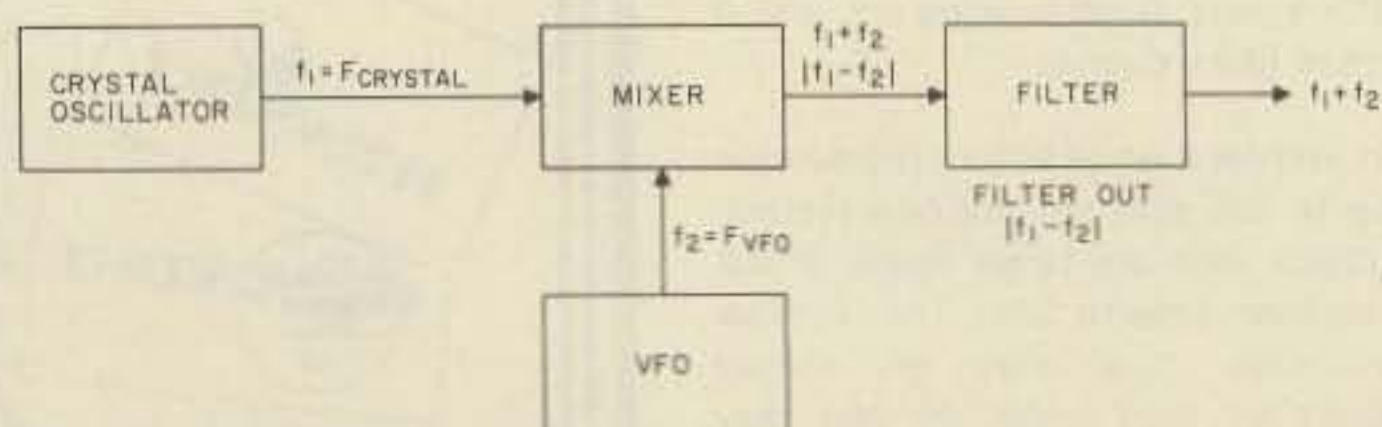

Fig. 2. Transmitter mixer.

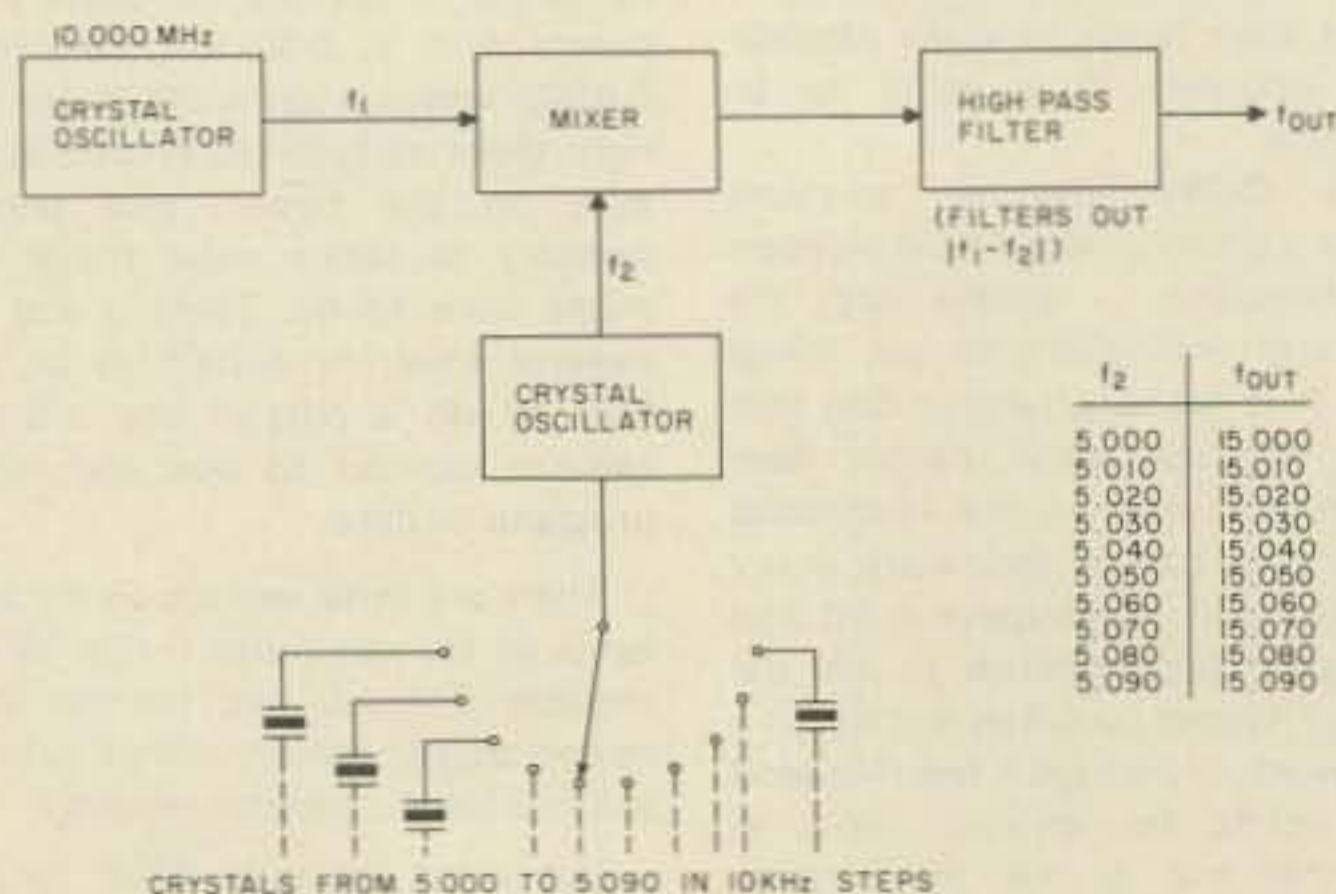

Fig. 3. Crystal-mixer synthesizer.

a process that takes building blocks and produces a finished product. The process need not be complex, but may be very simple and be applied to a variety of applications. The average experimenter seldom gives thought to the definition of synthesis; however, the average experimenter commonly uses processes which fit the definition.

The process of summing two voltages to produce a third voltage (a process used in many pieces of electronic equipment) is synthesis, and the process of mixing two frequencies together to produce a third frequency (heterodyning in a receiver) is synthesis.

Oscillator-Mixer Synthesis

Fig. 1 is a mixing circuit of a simple superheterodyne receiver. Frequency F_1 (the heterodyning frequency) mixes with frequency F_2 (the incoming signal) to produce a frequency in the i-f range. This technique is not commonly thought of as synthesis, but is thought of as mixing; however, it is frequency synthesis.

In Fig. 2, a variable frequency oscillator, or vfo, of a transmitter is mixed with a heterodyning crystal to produce an output in a given band. In this case, the output frequency will be variable and is determined by the expression, $F_{out} = F_{vfo} + F_{crystal}$. If the frequency of the vfo can be varied from 5.0 to 5.5 MHz and the mixing crystal is 10.0 MHz, then the "synthesized output" will be in the range of 15.0 to 15.5 MHz. (Note that mixing produces both the sum *and* the difference frequencies, but in this example the difference frequency is filtered out.)

While a synthesizer of this type is very useful and very common, it suffers from a serious problem — the problem of stability. Vfos drift by nature, due to temperature fluctuations, and are subject to frequency variation due to

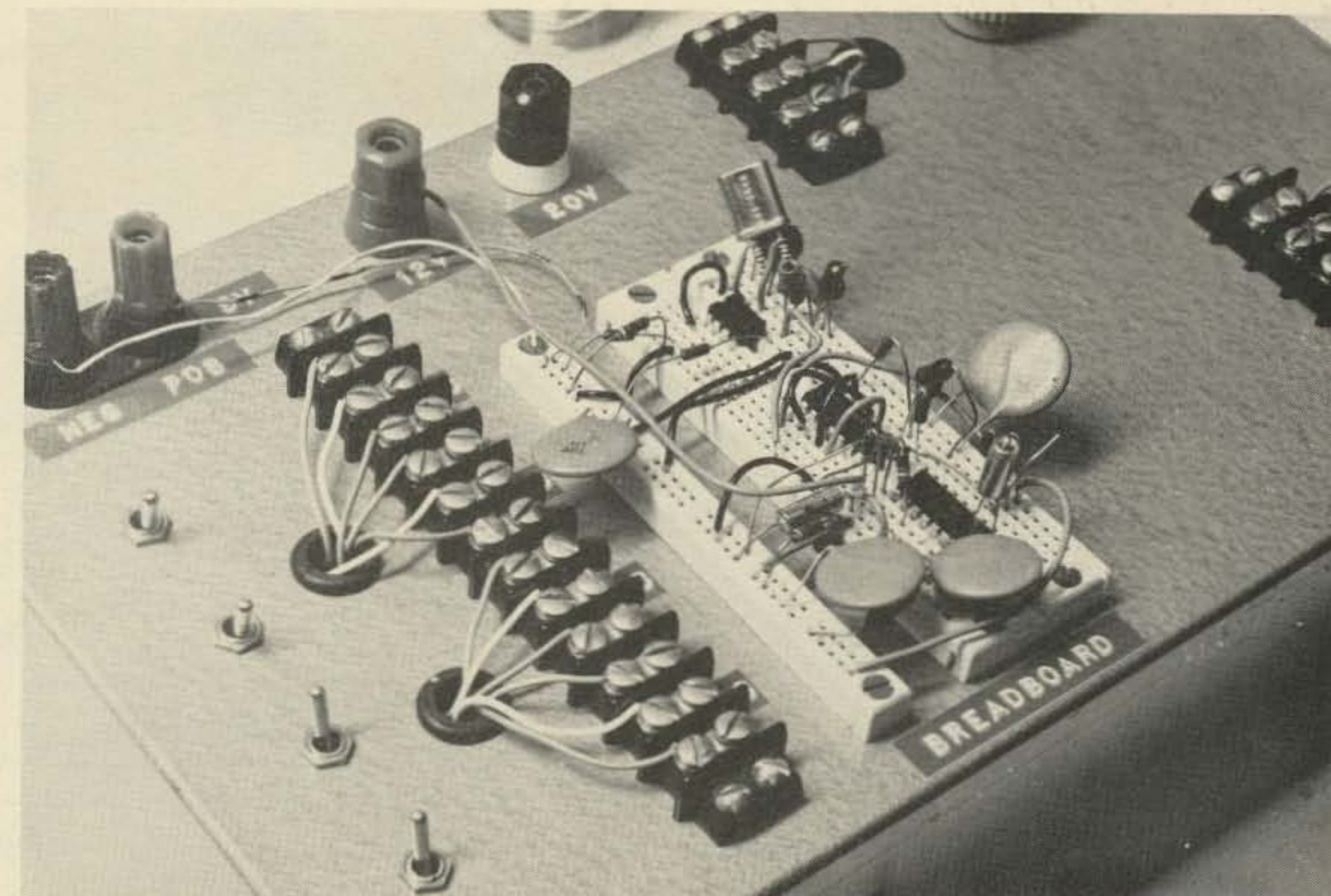

Simple single channel synthesizer built on a Continental Specialties breadboard.

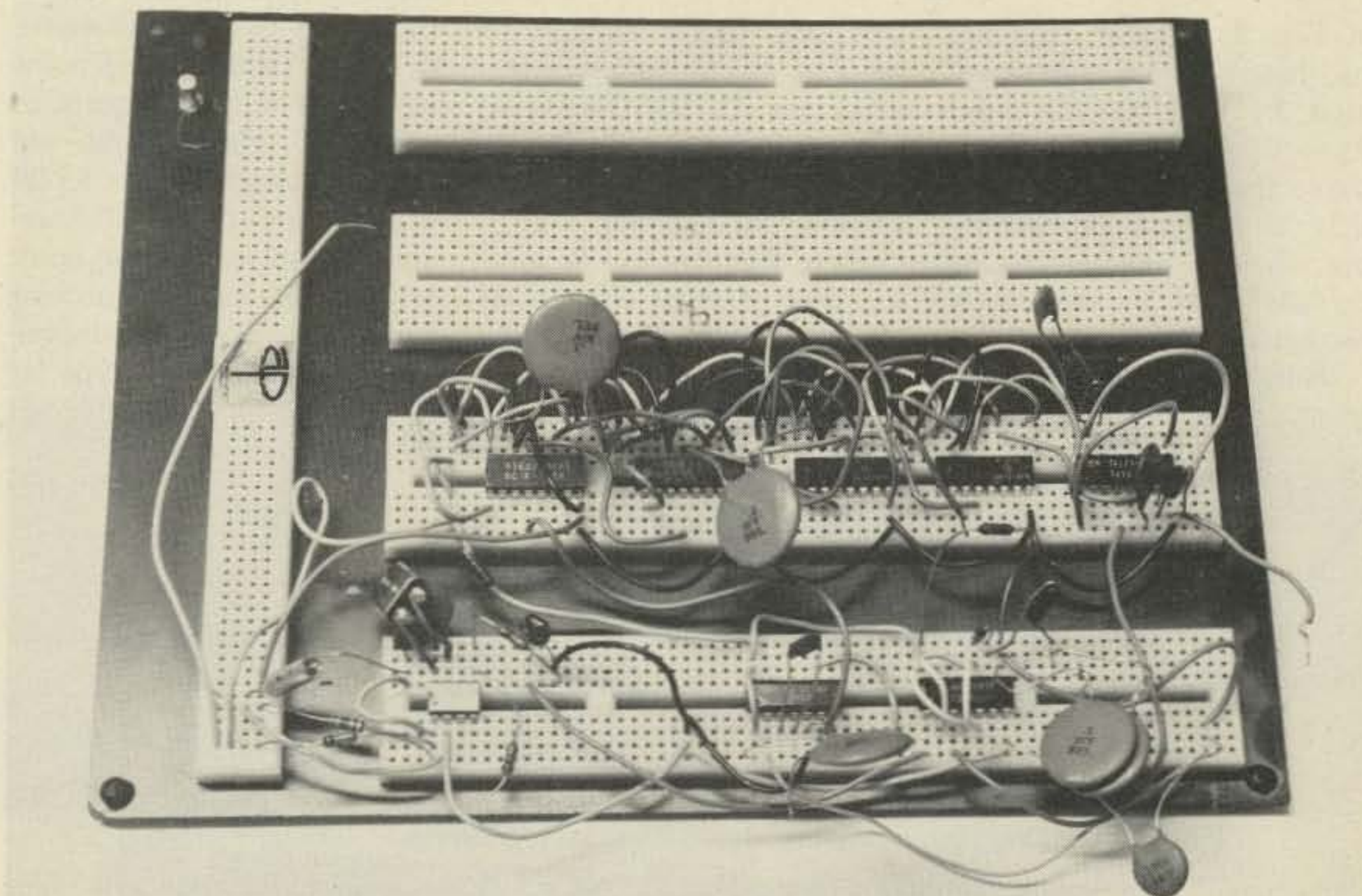

3 to 9 MHz synthesizer constructed in breadboard fashion.

vibration and the inadvertent bumping of the vfo dial. (And, of course, it is difficult to reset the dial back to its original position once it has been bumped.) Fig. 3 shows an improved version of the simple "synthesizer." In this example, the vfo is replaced with another crystal oscillator and a crystal switch. In the example given, ten crystals spaced 10 kHz apart are

mixed with the heterodyning crystal to produce ten discrete frequencies in the 15 MHz range, 10 kHz apart. The spacing of the output frequencies is called "channel spacing," and is related to the channel spacing of the "local oscillator" crystals.

The drawbacks to the circuit shown in Fig. 3 are very obvious. First of all, eleven crystals are needed to pro-

duce ten frequencies, and second, the output frequencies are limited to discrete frequencies or channels. Furthermore, all frequencies within a given band are not covered. From a cost standpoint, it would be better to use ten crystals at the desired frequencies than to use this circuit.

Fig. 4 is an improved version of the synthesizer shown

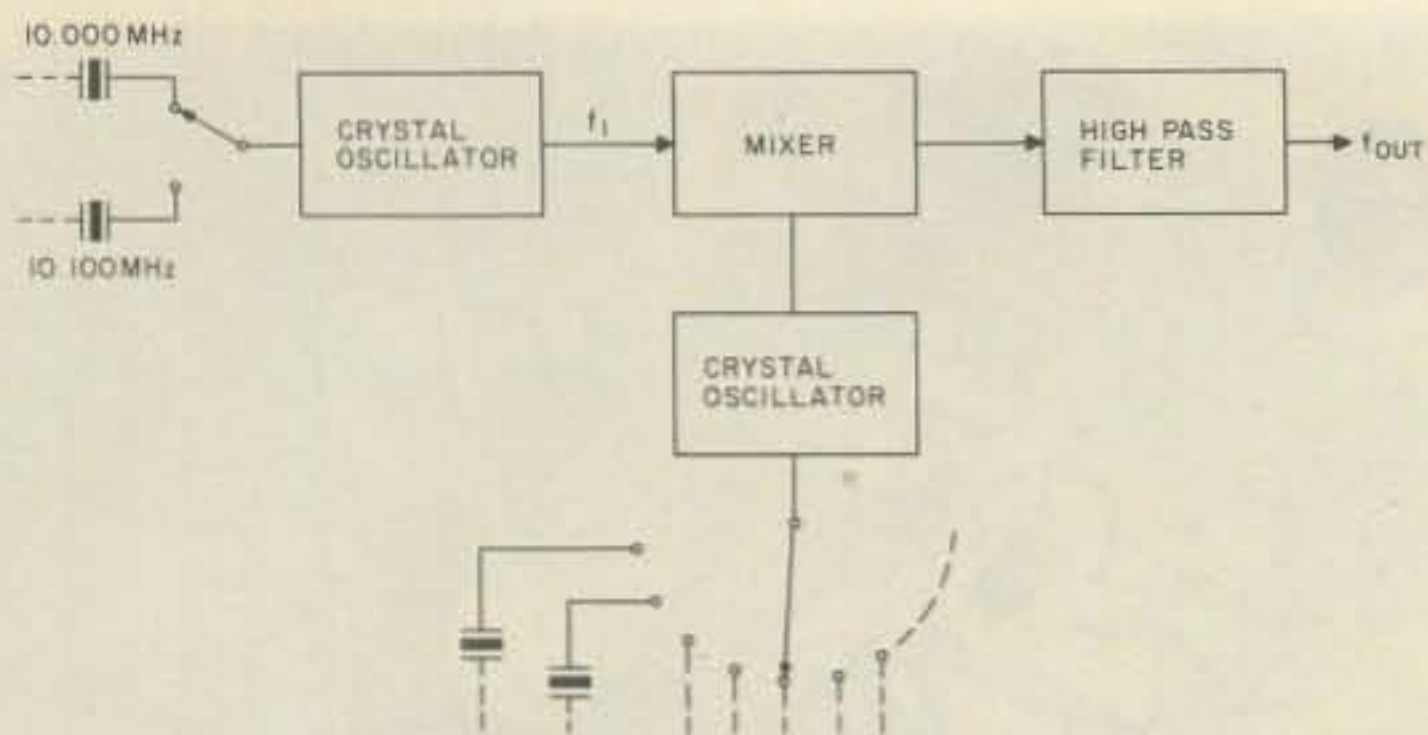

Fig. 4. Twenty frequency crystal-mixer synthesizer.

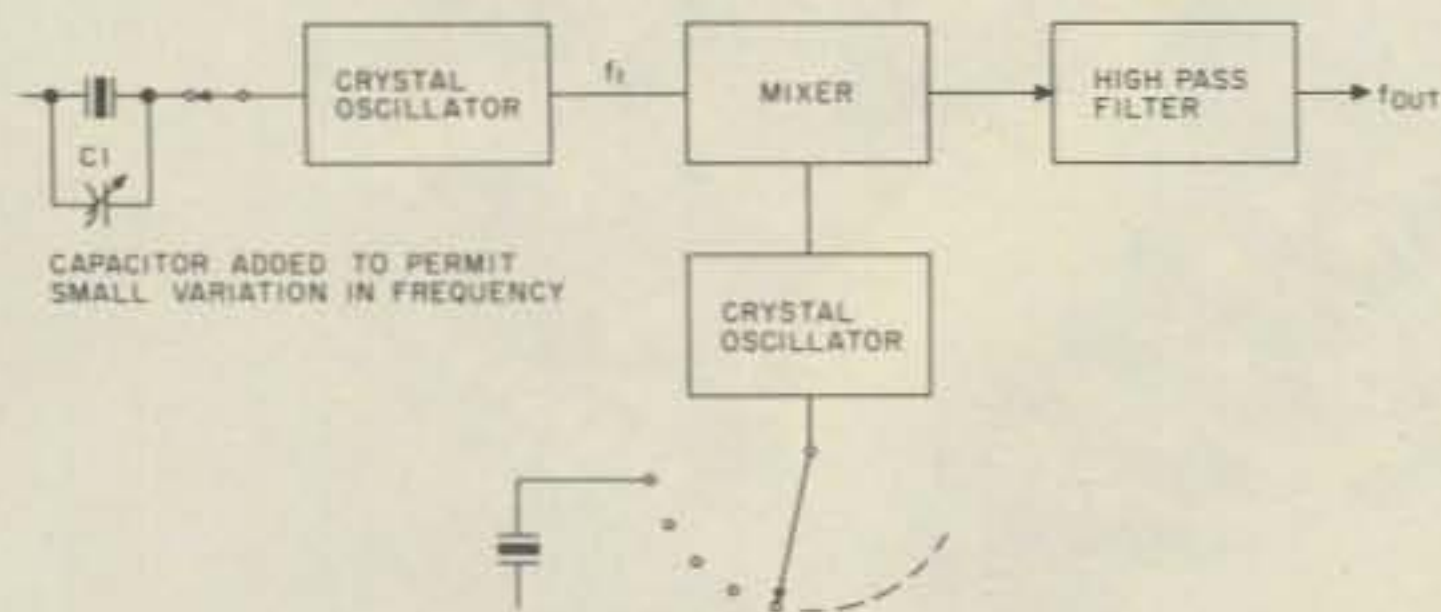

Fig. 5. Varying the frequency of a crystal-mixer synthesizer.

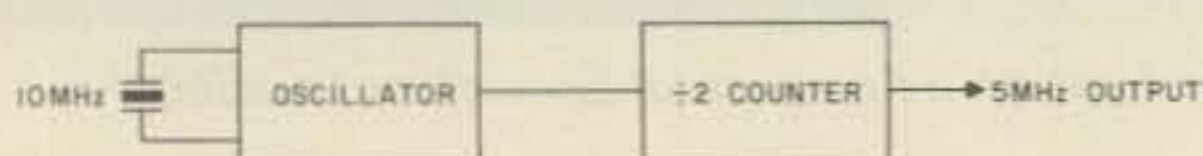

Fig. 6.

in Fig. 3. In this example, two heterodyning crystals are used, $F_1 = 10.000$ MHz and $F_2 = 10.100$ MHz. Table 1 shows the output frequencies that can be obtained by mixing the two heterodyning crystals with the ten local oscillator frequencies.

Note that in this case we

are using twelve crystals to generate twenty discrete frequencies. At this point we have an economical alternative to the use of twenty crystals to generate twenty discrete frequencies. We have a saving of eight crystals. If we add a third heterodyning crystal, we can generate

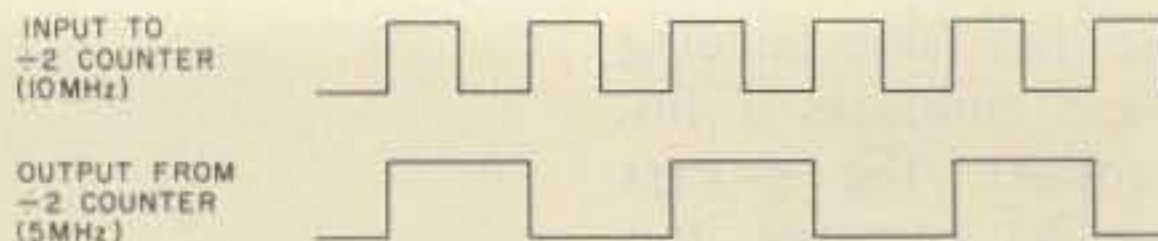

Fig. 7.

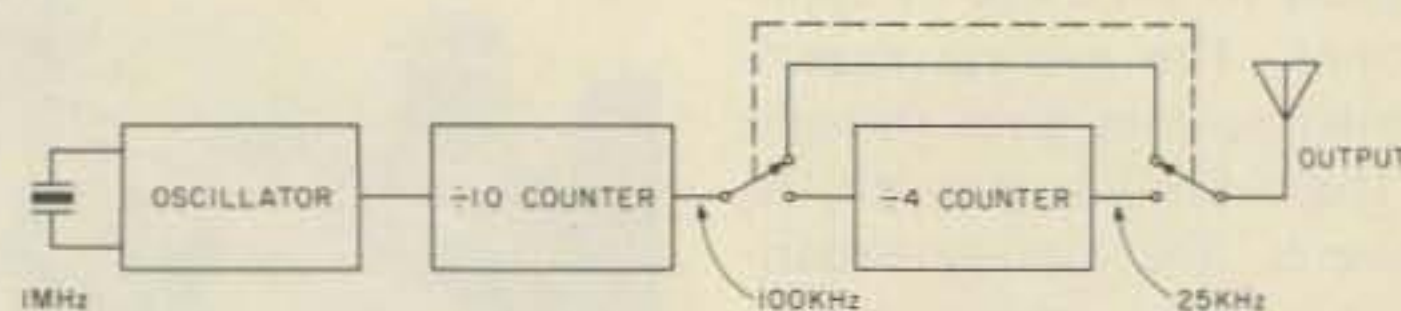

Fig. 8.

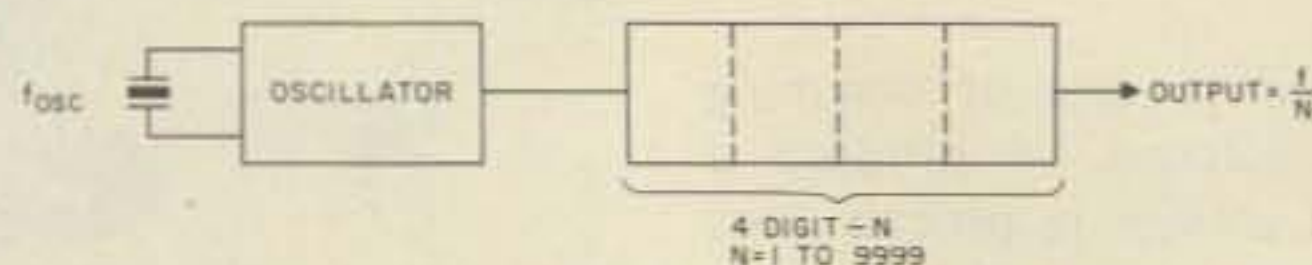

Fig. 9.

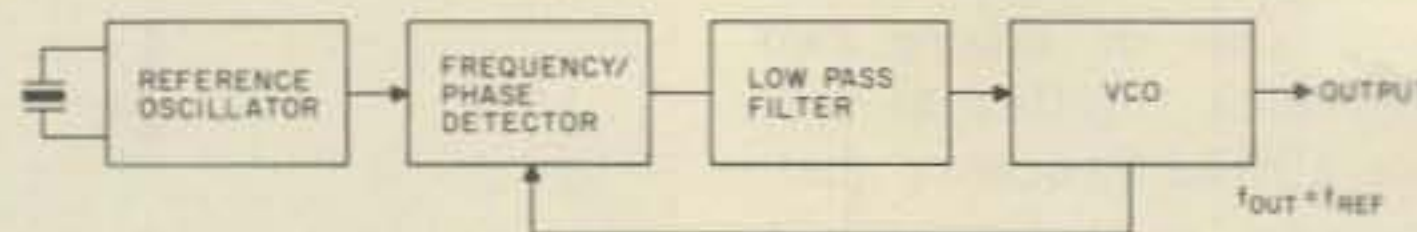

Fig. 10.

thirty discrete frequencies with thirteen crystals and save ourselves seventeen crystals. This process can be continued by adding heterodyning crystals to the point where all desired frequencies within a given band are generated; however, at \$5.00 and up per crystal, the designer soon reaches the point where a crystal-mixing synthesizer is not economically feasible. This type of

synthesizer is useful in cases where it is desirable to generate a limited number of stable, discrete frequencies in a simple manner.

The other drawback of the crystal-mixing type of synthesizer, as previously mentioned, is the problem that the output frequencies are discrete and that all frequencies within an entire band are not covered. Gaps occur in the frequency coverage of the unit. In many cases, such as VHF radiotelephone, this is not a serious drawback (since operation in the VHF radiotelephone bands is channeled to begin with); however, in the case of high frequency operation where fixed channels are not used, discrete frequency operation can present a problem. Fig. 5 shows a simple cure to permit continuous operation in the areas between channels. The trimmer capacitor C_1 , across the crystal, is varied and produces a small frequency variation of the frequency of the heterodyning crystal. If the channel spacing is small, the trimmer can permit coverage of all frequencies between channels. The addition of this trimmer does reduce stability a bit, but this reduction in stability in most cases is not too serious.

The crystal-mixing type of

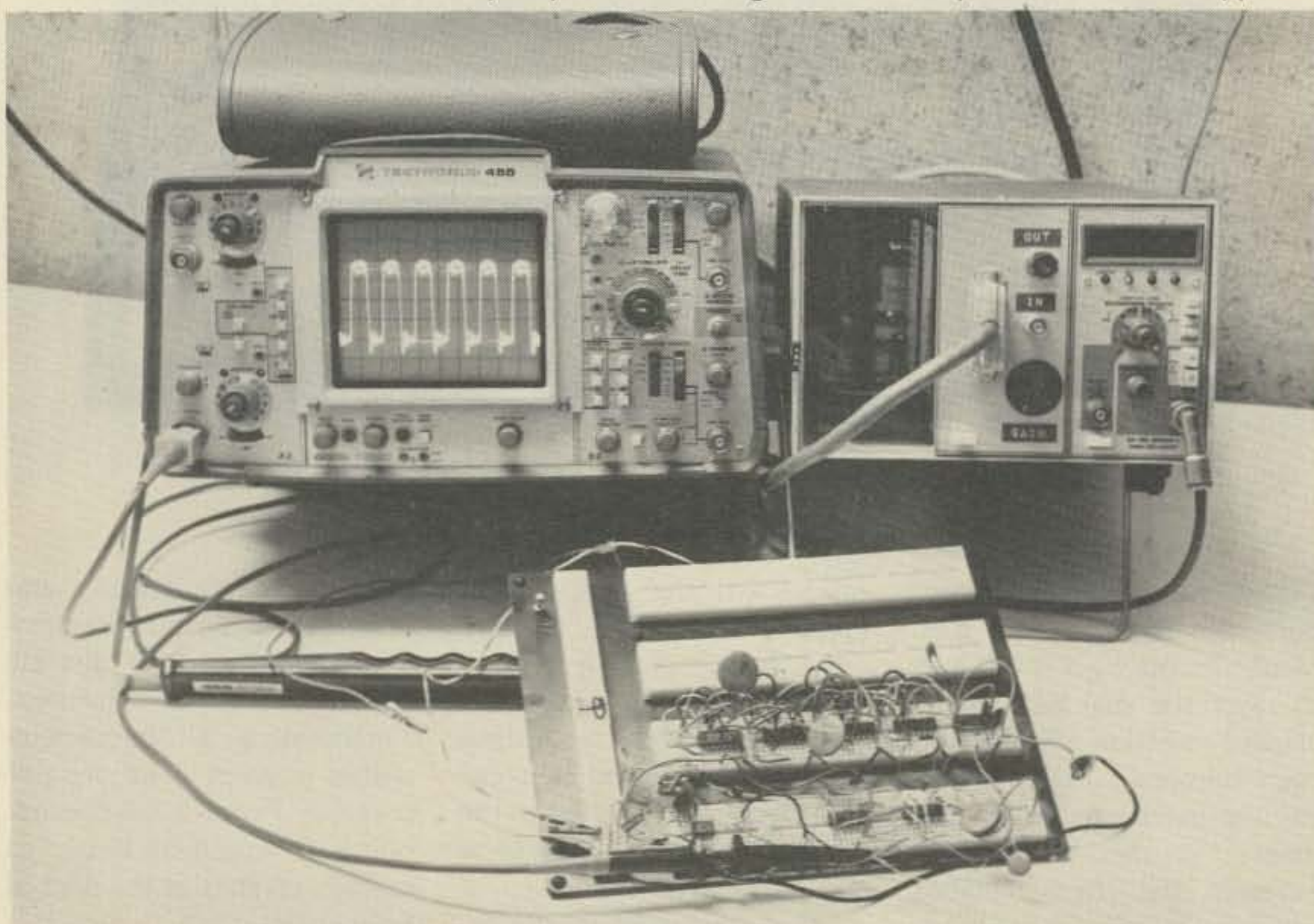

Test setup at W1HCl used for testing 3 to 9 MHz synthesizer. The scope trace shows ringing and noise on the vco signal, due to the random component layout and long lead lengths on the breadboard.

synthesizer is commonly used in amateur and commercial HF and VHF equipment; however, it is becoming less popular due to the high cost of crystals and the availability of the phase locked loop. Furthermore, some of these synthesizers that have been on the market in the past have suffered from a variety of problems and become somewhat unpopular. In some cases it was possible to have several crystals oscillating at one time, producing multiple output frequencies. (Of course, this problem could be put to good use if the operator desired to transmit on several frequencies simultaneously.)

Time Period Synthesis

Time period synthesis, according to some authors, encompasses a variety of techniques, including the phase locked loop. In this article, however, time period synthesis will be defined as a counting technique that generates a waveform with a time period proportional to some "N" number of counts of a standard oscillator. As an example, consider the crystal oscillator in Fig. 6 that feeds a digital divide by two counter. The divide by two counter generates one output pulse for every two input pulses. This is shown graphically in Fig. 7. This is a simple time period synthesizer. If the crystal operates

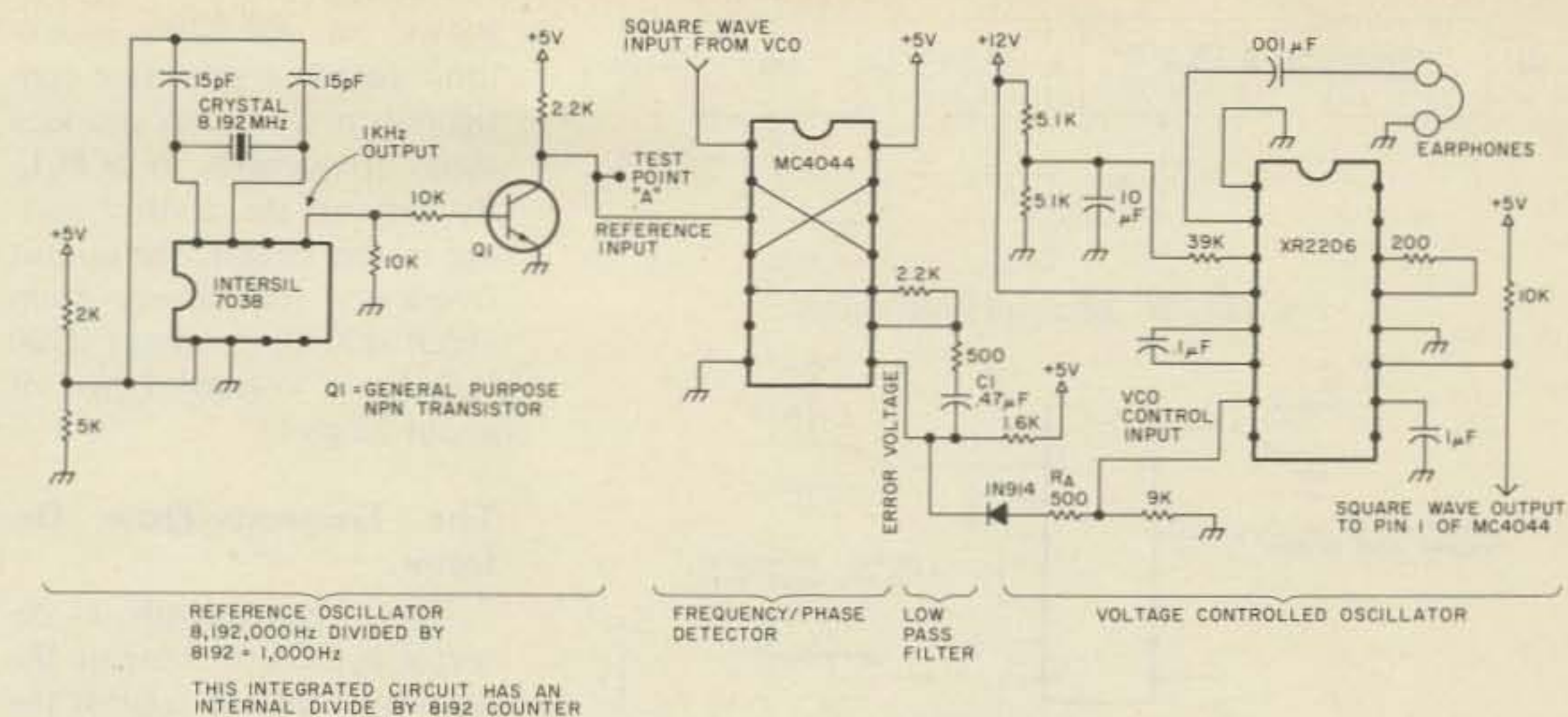

Fig. 11. Simple phase locked loop.

at 10 MHz, then the output from this simple synthesizer will be 5 MHz. This technique is used frequently in crystal calibrators found in many pieces of amateur equipment. Fig. 8 shows a block diagram of a typical calibrator. In this block diagram, a 1 MHz oscillator is fed into either a divide by ten or a divide by ten followed by a divide by 4. The outputs are either 100 kHz or 25 kHz. If a series of digital counters were connected together to form a four digit, divide by N counter, as shown in Fig. 9, then a versatile time period synthesizer could be constructed to produce a large number of frequencies.

One of the drawbacks of time period synthesis is that switch selection (in the divide by N counter) programs the number of counts to divide by, and the number N is not

the frequency. The expression for frequency for the time period synthesizer is

$$F_{out} = \frac{f_{osc}}{N}$$

where f_{osc} is the frequency of the standard oscillator.

Note that the frequency is inversely related to the number N. Table 2 gives a list of frequencies for selected values of N.

It is not possible to get standard channel spacing when incrementing N. When N is changed from 51 to 52, the frequency difference or channel spacing is 37,707.4 Hz, but when N is changed from 1001 to 1002, the spacing is 99.701 Hz. The channel spacing is not linear, and produces low frequencies for high values of N (in this case, frequencies in the audio range). Synthesizers of this type are difficult to use for most amateur applications.

One notable use of this type of synthesizer is found in the common "touchtone" generator ICs. These ICs pro-

vide a fixed series of dividers used to divide a master oscillator down to the proper audio frequency.

The Phase Locked Loop

The fundamental phase locked loop, as shown in Fig. 10, consists of a frequency standard or reference oscillator, a voltage controlled oscillator, a frequency/phase detector, and a low pass filter. In operation, the frequency and phase of the frequency standard is compared against the output of the voltage controlled oscillator. If there is a difference in frequency or phase, then an output voltage, or error signal, is produced by the frequency/phase detector. This output voltage is fed back into the voltage controlled oscillator to change its frequency. This fundamental phase locked loop is used to synchronize two oscillators together, and is not commonly used in amateur equipment in this fundamental form. This simple example can, however, be

f ₁	f ₂	f _{out}
10.000 MHz	5.000	15.000
10.000 MHz	5.010	.010
10.000 MHz	5.020	.020
10.000 MHz	5.030	.030
10.000 MHz	5.040	.040
10.000 MHz	5.050	.050
10.000 MHz	5.060	.060
10.000 MHz	5.070	.070
10.000 MHz	5.080	.080
10.000 MHz	5.090	.090
10.100 MHz	5.000	.100
10.100 MHz	5.010	.110
10.100 MHz	5.020	.120
10.100 MHz	5.030	.130
10.100 MHz	5.040	.140
10.100 MHz	5.050	.150
10.100 MHz	5.060	.160
10.100 MHz	5.070	.170
10.100 MHz	5.080	.180
10.100 MHz	5.090	.190

Table 1.

N	Output
1	100,000,000
2	50,000,000
10	10,000,000
50	2,000,000
51	1,960,784.3
52	1,923,076.9
100	1,000,000.00
101	990,999.01
102	980,392.16
1000	100,000.00
1001	99,900.100
1002	99,800.399
1003	99,700.897
9999	1,000.1

If $f_{osc} = 100,000,000$ Hz (100 MHz)

Table 2.

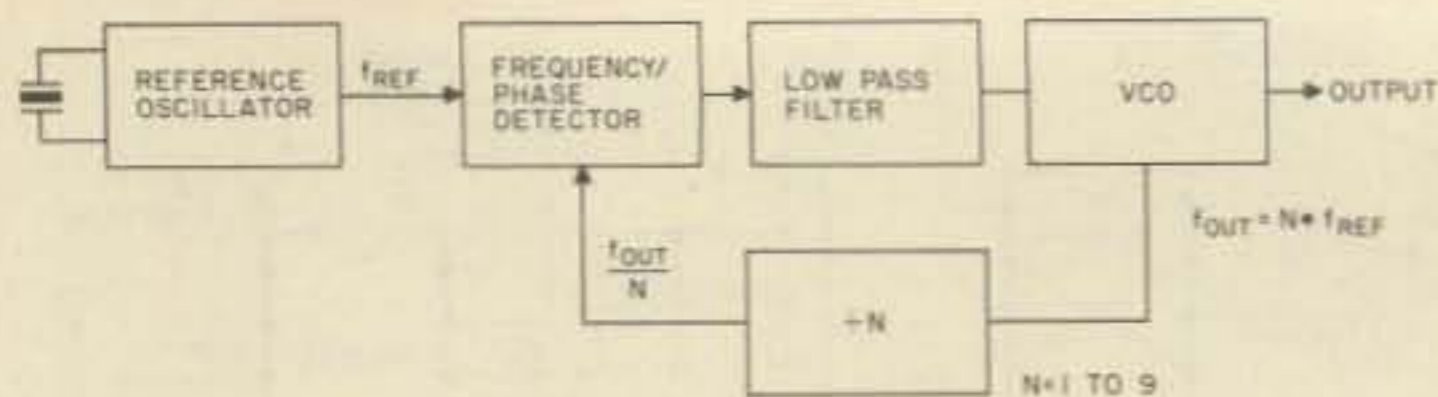

Fig. 12. "N" channel synthesizer.

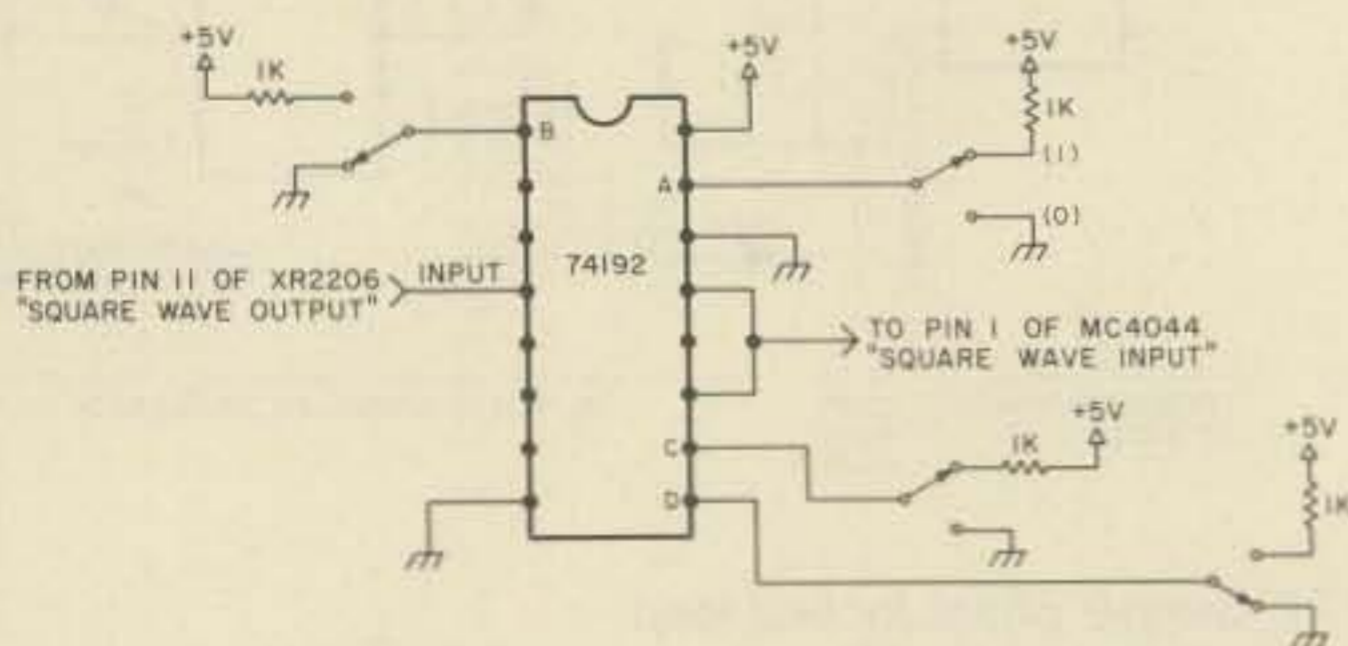

Fig. 13. Adding a $\div N$ counter to the simple PLL. Remove the old connection from pin 11 of the XR2206 to pin 1 of the MC4044. In this example, switches are set for $0101_2 = 5$.

used as a basis for understanding the PLL and some of the problems that occur in PLL operation.

The Reference Oscillator

The reference oscillator, or frequency standard, for a PLL system must be of high stability and is usually a crystal oscillator. This crystal oscillator may be used by itself, or it may be used in conjunction with a series of frequency dividers to produce a given output frequency. In the case where a series of dividers follows the crystal oscillator, the reference oscillator is in itself a "time period" synthesizer. The output of the reference oscillator is a determining factor in the channel spacing of the synthesizer, and, in the case of the synthesizers discussed in this article, is the same as the channel spacing.

Fig. 11 shows the circuit diagram for a simple reference oscillator. In this example, an 8.192000 MHz crystal is the frequency determining element and is followed by a divide by 8192 stage. The output of the reference oscillator is 1,000 Hz. The 7038 integrated circuit consists of an oscillator and an internal divide by 8192 counter.

The Vco

A voltage controlled oscil-

lator, or vco, is a special version of a vfo. In a vfo, the frequency is changed by manually moving the rotor of a variable capacitor or by manually moving the slug in a variable inductor. In a vco, the frequency is changed by applying a voltage to a device such as a variable capacitance diode in an oscillator circuit or by changing the bias on a multivibrator. A change in voltage will produce a change in frequency of the oscillator.

While the experimenter may build a vco from discrete components, it is convenient to use integrated circuit vcOs such as the Motorola MC4024 voltage controlled multivibrator or the Exar XR-2206 monolithic function generator.

The Motorola MC4024 will operate from audio frequencies to 25 MHz, produces a square wave output, and has a maximum control range of 3.5 to 1. The XR-2206 will operate from .01 Hz to 1 MHz, produces either square, triangle, or sine waves at the output, and has a maximum control range of 1000 to 1.

The control range of a vco (also called the sweep range) is defined as the ratio of the highest frequency to the lowest frequency that can be obtained by varying the control voltage while keeping all external components the same. For example, Fig. 11

shows an XR-2206 monolithic function generator configured as a vco to produce audio frequencies in a PLL. By varying the control voltage in this circuit, the output frequency will change from about 400 Hz to about 9500 Hz, for a control range of about 23 to 1.

The Frequency/Phase Detector

The frequency/phase detector is used to compare the output of the vco against the output from the reference oscillator. A typical frequency/phase detector is the Motorola MC4044. While the internal operation of this device is somewhat complex, the results of what it does are easy to see and understand.

Fig. 11 shows an MC4044 frequency/phase detector connected in a PLL. The low pass filter in this circuit is used to smooth the output and eliminate high frequency components in the output.

In this example, if the vco frequency is greater than the reference frequency, then the output will be in the range of about 2.5 to 5 volts. If the frequency is less than the reference voltage, then the output will be in the range of 2.5 to .8 volts.

As the name implies, the frequency/phase detector also detects phase differences between two signals. Consider the case where two signals are at the same frequency but are slightly out of phase with each other. In this case, there will also be an output voltage from the frequency/phase detector. This output voltage is a "phase error" voltage, and will remain constant when the loop is "locked," or in a stable condition. When the loop is not "locked," as when the frequency of the vco is in the process of changing, then this error voltage will be changing. Note that the error voltage may also remain constant if the loop is unable to lock up.

The Fundamental PLL

Fig. 11 shows a circuit

diagram for a simple PLL operating in the audio range. This circuit is a good circuit to use for experimentation, since the output is 1 kHz to 9 kHz in the audio range. A pair of earphones may be used on the output to determine if the circuit is operating correctly. An oscilloscope or counter is *not* needed to experiment with this PLL.

To use this circuit for experimentation, first disconnect the square wave output from pin 1 of the MC4024, and then connect the +5 V and +12 V as shown. Connect the earphones to test point A through a .01 uF capacitor. A 1 kHz tone, rich in harmonics, should be heard in the earphones. At this time, the output of the vco will be at about 9.5 kHz, the idling frequency of the vco. Now connect the earphones to the output of the vco, as shown on the schematic. Connect the square wave output of the MC4024 as shown. The output of the vco will change from 9.5 kHz to 1 kHz. Note that it is possible in this example for the PLL to lock to a frequency that is a multiple of 1 kHz, since a PLL can lock to a harmonic or sub-harmonic of the reference frequency. This property is useful for some applications; however, it would not be useful for amateur applications such as a two meter PLL.

It is difficult to explain the reasons for harmonic or sub-harmonic locking in simple terms. From a practical standpoint, this type of locking can occur due to poor design, or if the tuning range of the vco is too great. In this example, the potential problem of harmonic or sub-harmonic locking could be eliminated by limiting the tuning range of the PLL. A good rule of thumb is to limit the tuning range of the PLL to 3.5 to 1 or less.

Readers who wish to go into the fine details of the operation of frequency/phase

N	D	C	B	A
1	0	0	0	1
2	0	0	1	0
3	0	0	1	1
4	0	1	0	0
5	0	1	0	1
6	0	1	1	0
7	0	1	1	1
8	1	0	0	0
9	1	0	0	1

Table 3.

detectors, vcos, and PLLs in general are referred to reference 1. This reference gives a detailed, authoritative explanation of PLLs.

An "N" Channel PLL Synthesizer

The previous "simple PLL" might be called a single channel synthesizer, since its output is on a single channel and cannot be varied from that single channel. A more versatile synthesizer is shown in the block diagram in Fig. 12. This is a one digit "N" channel synthesizer where N can range from 1 to 9. The PLL is the same as the simple PLL, except that a divide by N counter has been placed between the vco and the frequency/phase detector. In operation, the PLL will increase the frequency of the vco such that the output of the vco divided by N is equal to the reference frequency. Thus the output of the vco is "N" times the reference, where N is an integer. If we modify Fig. 11 by adding a divide by N counter as shown in Fig. 13, we will have an N channel synthesizer where the theoretical output range would be 1 kHz to 9 kHz in 1 kHz steps, when N goes from 1 to 9.

As previously mentioned, PLLs can lock to the wrong harmonic if the tuning range of the PLL is too great. In this example, the tuning range of the PLL is about 9.5 to 1. The problems with the tuning range can be demonstrated by performing some very simple experiments with the "N" channel PLL. Again, these experiments can be performed with the use of earphones. A scope or counter is not required, but may be used if desired.

The 74192 divide by N counter can be programmed in BCD format to provide an N of 1 to 9. To program a number, first set all inputs to 0 by grounding. A number is programmed by setting a "1" into an input, according to Table 3. A one is set by connecting the input to +5 V through a 1k resistor.

To experiment with this simple PLL, first connect the earphones as shown. Next, program a 1, to get a 1 kHz tone, as shown in Fig. 14. A 1 kHz tone will be heard. Next, program a 2, 3, and 4, one at a time. Tones of 2, 3, and 4 kHz will be heard. This simple PLL should lock up for these values of N on the correct multiples of 1 kHz, but will probably not lock up for some other values of N. For example, when N = 5, the PLL may lock up on 1 kHz, and when N = 7, it may lock up on 3 kHz. This is an example of a PLL with too great a range. Changing R_a to a value of 1k will limit the range of the loop to about 4 to 1, just slightly greater than the recommended range. With this limit imposed, the loop will lock properly in the desired range of 1 to 4 kHz. An N of greater than 4 will give an output of about 4.7 kHz, and the loop will not be locked. In some cases, it may be necessary to wire in external logic or put limits on switches to prevent the "dialing in" of non-allowed values of N on the switches and the resultant locking to wrong frequencies.

Other Design Considerations for PLLs

While it is not possible in a short article to give complete design information and describe all design considerations for a PLL, there are some key points which must be mentioned.

In the general description of the components of the PLL, the filter was mentioned only briefly. The filter is an important part of the PLL, and must be chosen such that the loop locks up quickly but

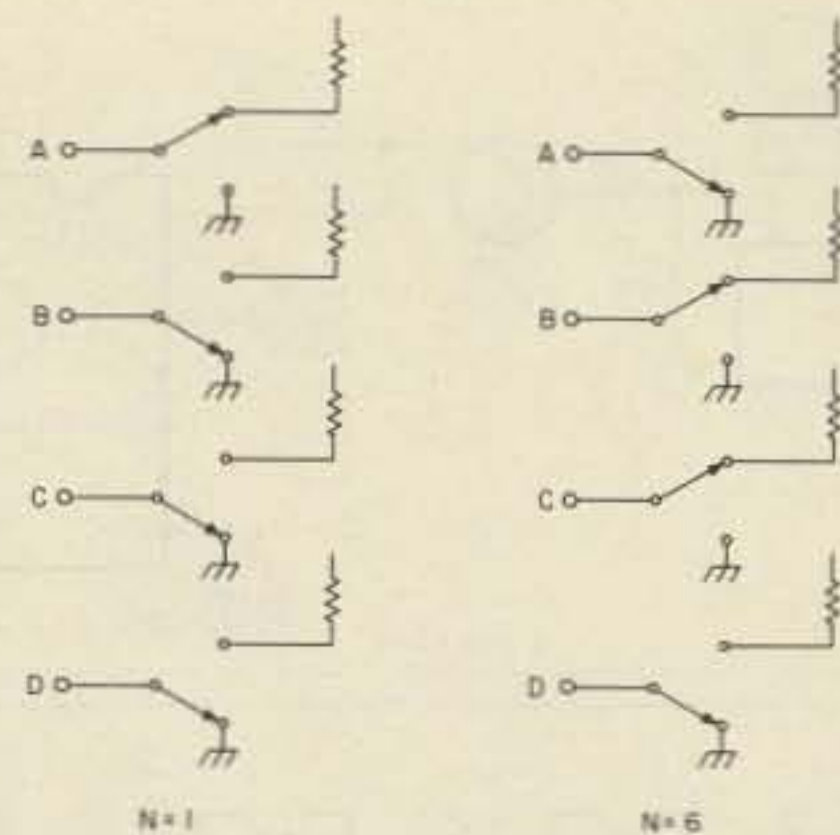

Fig. 14. Examples of programming the $\div N$ counter.

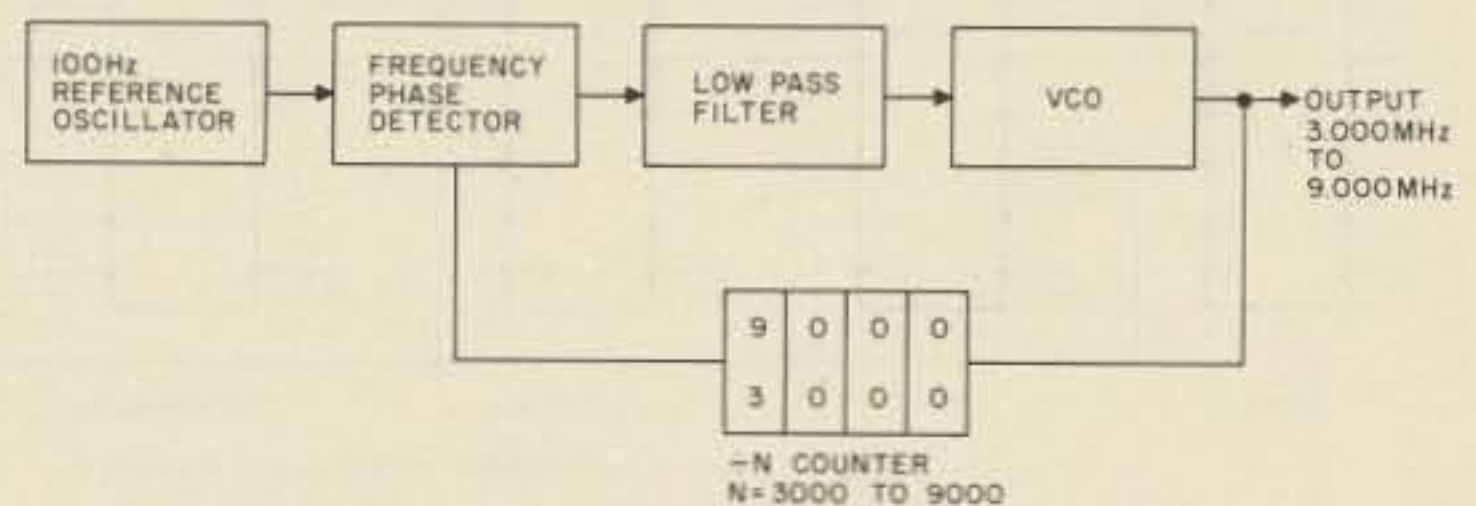

Fig. 15. HF PLL.

still filters out all high frequency components. If the filter is not correct, the loop could be too slow to respond, not operate correctly (producing distorted waveforms), or not lock properly. The value of the capacitor in the low pass filter may be determined experimentally by observing the control voltage on an oscilloscope. C_1 should be chosen just large enough so that the control voltage is pure dc with very little ripple. If a scope is connected to pin 8 of the MC4044 and C_1 is removed, the effects of poor filtering can be observed. High frequency components will be observed on the vco control line, and the output waveform will be distorted. (Reference 1 should be consulted for detailed filter requirements.)

Another consideration for a PLL is the stability of the oscillator. If the oscillator drifts, then the output will drift according to the following expression: $f_{\text{output drift}} = N \times f_{\text{reference drift}}$. For example, if the reference drifts by +10 Hz and $N = 4$, then the output will drift by +40 Hz.

Noise on the vco line can sometimes cause problems. These problems can be reduced by designing the vco so that a relatively large change

in control voltage is required to produce a relatively small percentage frequency change. In addition, it is important to sprinkle bypass capacitors liberally from the +5 V, +12 V, or other voltage lines to ground. A good practice is to place a .01 capacitor from the +V terminal of each IC to ground, keeping the leads as short as possible.

Rf can be a problem with PLLs. If rf sneaks into the wrong place within a PLL, the PLL can fail to lock or can lock at the wrong place, the vco can cease to operate, or a myriad of other problems can result. For these reasons, it is important to shield a PLL that is used with a transmitter, to prevent rf from the transmitter from getting back into the PLL synthesizer.

It is also important to remember that PLLs have square waves, rich in harmonics, coming out of the reference as well as the divide by N circuitry. These square waves can cause interference in nearby receiving equipment. It is important to shield a PLL synthesizer to prevent interference to other equipment.

A Synthesizer for the HF Bands

The synthesizer examples

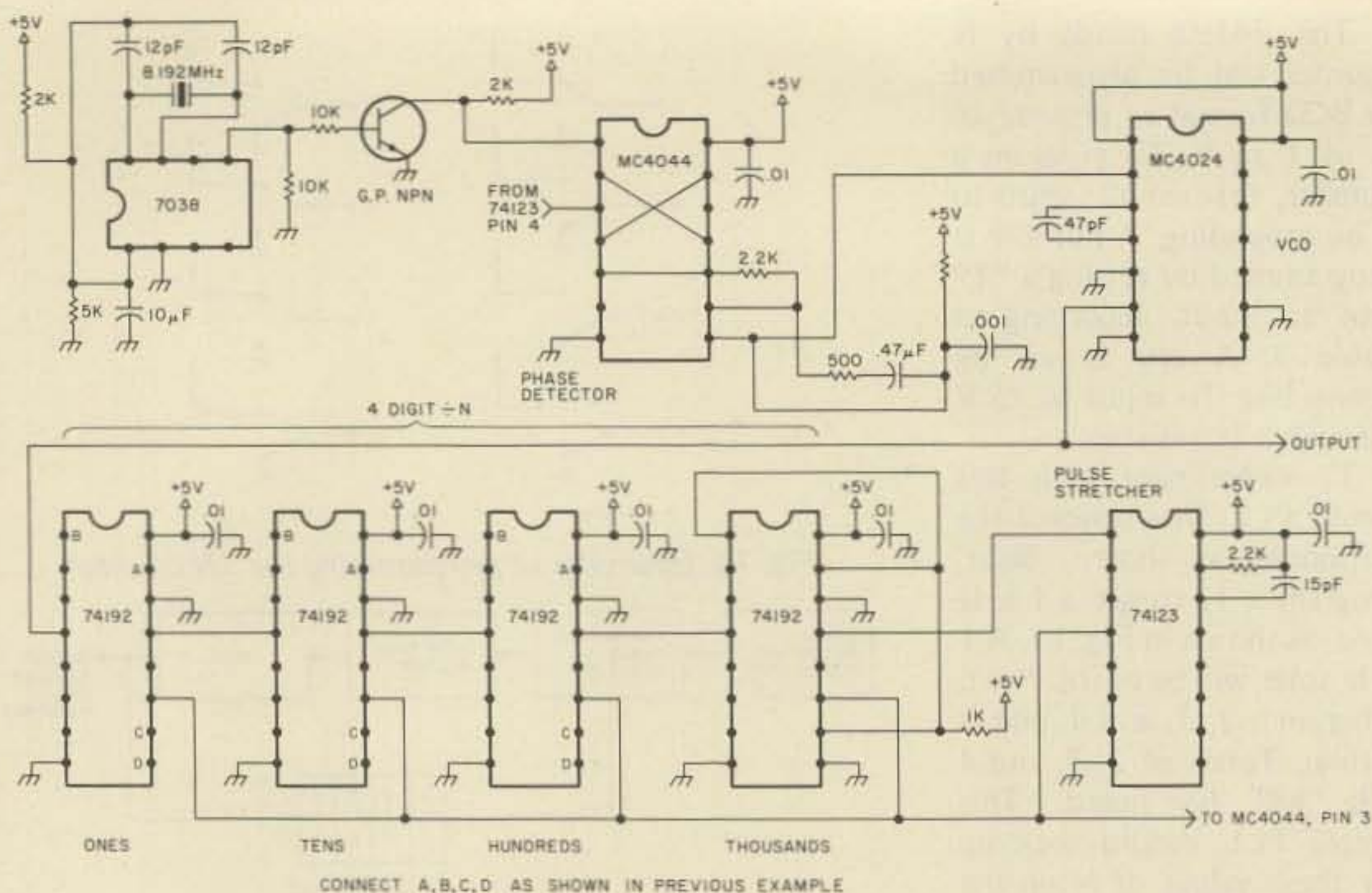

Fig. 16. HF synthesizer.

previously described operated in the audio range, a range ideally suited for experimentation. Synthesizers of general interest to the amateur may lie in the HF region. This section will discuss HF synthesizers.

In designing a synthesizer for HF use, two criteria must first be defined:

1. Output frequency range;
2. Channel spacing.

Consider an example where a synthesizer is required to operate with an output in the range of 3 to 9 MHz in 1 kHz steps. In this case, our PLL will have a range of about 3 to 1. The channel spacing would be 1 kHz, so the output of the reference oscillator must be 1 kHz. In all "direct" PLLs, a PLL where the output is used directly without mixing or multiplication of the output, the channel spacing is the same as the reference frequency. For other types of synthesizers, such as VHF synthesizers (where the output of the PLL is fed into a multiplier stage), the reference frequency is determined by the expression, $f_{\text{reference}} = (\text{channel spacing}) / (\text{total multiplication in multiplier stages})$. The range of this PLL synthesizer is to be from 3 to 9 MHz. Converting these

numbers to kHz, we get 3000 to 9000 kHz; thus, for 1 kHz channel spacing, N would have to range from 3000 to 9000. As can be seen, we require four digits for N. Thus, our divide by N counter would be a four digit divide by N counter.

Fig. 15 shows a block diagram for this PLL. Since the formula for a PLL is $f_{\text{out}} = N \times f_{\text{reference}}$, and since N can be any number from 1 to 9999 in this example, it seems likely that switches could be set so that N is outside of the desired range of 3000 to 9000. If N is set below the desired range, the vco will idle, but it will not lock at the lower limit of the vco. Likewise, if N is set above the desired range, then the vco would run at this upper limit. In some cases, a value of N outside the range can cause a PLL to lock on an incorrect frequency. Thus, it is a good idea to limit the allowable switch positions either electronically or mechanically. In the example shown in Fig. 16, the most significant digit is hardwired to a 7, so this synthesizer is electronically limited to the range 7000 to 7999. This limit is arbitrary, and may be changed if desired. If the experimenter wishes, the most significant digit could be

varied in the same manner as the other three digits.

Fig. 16 is a circuit diagram of a 7.000 to 7.999 MHz synthesizer. This synthesizer can be breadboarded in an evening, and should work the first time it is turned on. Each digit is programmed in BCD in the same manner as the simple audio PLL, except that the first digit is hardwired to a seven and does not change. As previously mentioned, the number 7 was chosen arbitrarily and may be changed. The vco in this PLL is a Motorola MC4024, which generates a square wave output. If a sine wave output were desired, then either a low pass filter would have to be placed on the output of the vco (to eliminate all frequencies above 7.999 MHz, for example), or a different vco would have to be used.

Note that this synthesizer radiates a lot of rf noise, so expect some possible interference in nearby receiving equipment.

The frequency output of this synthesizer may be measured on a counter, or its signal may be heard on a communications receiver. The sound of the signal as heard on a communications receiver will not be pure, due to the fact that this PLL uses a simple loop filter, which

allows some inherent modulation of the signal. Furthermore, the PLL divider stages and reference will radiate, causing noise in the receiver. Shielding will improve the sound of the signal, but will not make it perfect.

The 74123 is a monostable multivibrator and is provided to lengthen the reset pulse generated by the divide by N circuitry. When the divide by N circuitry counts to the programmed value, a reset pulse is used to reset the counters so that they may start counting again. For the 74192 ICs, this reset pulse must be at least 20 nanoseconds long to insure proper resetting. During this 20 ns reset period, the counters are not counting. At 7.5 MHz, the time from one cycle of the vco to the next would be 130 ns. If this time period from one cycle to the next of the vco is less than twice the reset time (in this case 40 ns), a missed count will occur, causing the output frequency to be off by one (in the least significant digit). This holds true in cases where the vco generates a square output. In cases where the vco generates sine waves to other waveforms, the period of the vco may have to be greater than the reset time by a factor of 4 or more.

If a missed count does occur, circuitry can be added to automatically compensate for the missing count.

Summary

This article has described the operation of synthesizers and has given simple circuits for experimentation. It is not meant to be the last word in synthesizers, but is meant to whet the appetite of the experimenter. The experimenter is encouraged to read the references given to gain a greater comprehension of the subject. ■

References

- 1 *Phase-Locked Loop Data Book*, Motorola, Inc., 1973.
- 2 *Instruction Manual for the SYN-II Synthesizer*, VHF Engineering, Binghamton NY 13902.



PROMISE Anything, But GIFT 73!

It's nearly that time of year again... time to start to plan your holiday gift giving and hope that the gift you select is the right size and shape and color for the receiver as well as the right price for your pocketbook... You're reading 73 now... You know what a big, thick informative magazine it is... And there will be no size, shape or color problem... The price is right too! Twelve issues for

only \$15. And we'll reduce the price of the second and third gift one year subscriptions too... Only \$14 per year for the second gift subscription and only \$12 per year for the third gift sub. Think about it, all those articles, projects and Wayne's provocative editorials to boot. And all those ads with bargains, bargains, bargains!

Certainly one (or more) of your friends is interested in hamming

and would appreciate your thoughtfulness in arranging for a copy of 73 to be delivered to his mailbox every month for a whole year. Not sure if your friend is a subscriber or not? We'll check for you... Be sure to include the call letters if at all possible. For notification of your gift to reach its destination before Christmas, please mail your subscription orders to us no later than December 5th.

ANY HAM who's hinting can give this ad to a friend as a "friendly reminder" of what he really wants.



YES, I WANT TO GIVE 73 MAGAZINE ONE YEAR SUBSCRIPTION GIFTS.

Please mail first gift subscription (\$15) to:

Name _____
 Call _____
 Address _____
 City _____
 State _____ Zip _____

New Renewal/Extension Don't know

YES, I WANT TO GIVE 73 MAGAZINE ONE YEAR SUBSCRIPTION GIFTS.

Please mail second gift subscription (\$14) to:

Name _____
 Call _____
 Address _____
 City _____
 State _____ Zip _____

New Renewal/Extension Don't know

Sign the card(s) as follows: _____

Enclosed (Total) \$ _____ Cash Check Money Order
 Bill: American Express BankAmericard
 Master Charge - Interbank # _____
 Card # _____ Exp. date _____
 Signature _____

FOR CREDIT CARD PURCHASES, PLEASE COMPLETE THE FOLLOWING: 10-77

Name _____ Call _____
 Address _____
 City _____ State _____ Zip _____

YES, I WANT TO GIVE 73 MAGAZINE ONE YEAR SUBSCRIPTION GIFTS.

Please mail third gift subscription (\$12) to:

Name _____
 Call _____
 Address _____
 City _____
 State _____ Zip _____

New Renewal/Extension Don't know

Oct 1977

Social Events

ERIE PA SEPT 25

The 2nd Annual Erie HamJam will be held Sunday, September 25, 1977 at Rainbow Gardens, Waldameer Park. Door prizes, flea market, forums, large indoor facilities. For more information write Radio Association of Erie, Inc., PO Box 844, Erie PA 16512.

NEW BERLIN IL SEPT 25

The Sangamon Valley Radio Club will hold its Second Annual Hamfest on Sunday, September 25, 1977 at the Sangamon County Fairgrounds, New Berlin, Illinois, 16 miles west of Springfield. Indoor display area and a covered pavilion. Food, refreshments, exhibits and ladies' activities. Overnight camping on grounds. Tickets \$1 advance; \$1.50 at gate. First prize — Wilson HT. Talk-in 146.28/.88 and .52. Info: Carole Churchill WB9QWR, 622 Magnolia, Rochester IL 62563.

BROOKLYN NY OCTOBER

The Kings County Repeater Association of Brooklyn, New York, announces the formation of its second Novice class licensing course (theory and code) to begin in October. Contact Carl Weintraub W2YHX, 629 Avenue "T", Brooklyn NY 11223 for full details.

WILLOW GROVE PA OCT 1

The Mid-Atlantic States VHF Conference will be held on Saturday, October 1, 1977 at the Treadway Inn on Easton Road (Route 611, Exit 27 of the Pennsylvania Turnpike) in Willow Grove, Pennsylvania on the day before Hamarama 77 (at nearby Warrington, Pennsylvania). The conference will be an all day VHF program moderated by prominent VHFers. Advance registration is \$2.50 (includes admission to Hamarama 77 on Sunday). Cocktail hour (cash bar) and get-together at 6:30 pm. Buffet dinner at 7:30 pm is \$8.00. Special rates for rooms overnight. For advance registration contact Ron

Whitsel WA3AXV, Chairman, PO Box 353, Southampton PA 18966, phone (215) 355-5730. Advance registration must be received by September 28, 1977. Indicate motel registration forms required.

HAMDEN CT OCT 1

The Oktoberfest Flea Market and Auction will be held October 1, 1977 (rain date Oct. 8). The event, sponsored by the WELI Amateur Radio Club (WA1HRC), will be held at Radio Towers Park, Benham Street, Hamden, Connecticut. Free admission, vendor spaces are \$5/ea. Talk-in on 52 direct or 01/61. More information call Doug WA1TUT (203) 389-6458.

MEMPHIS TN OCT 1-2

The Memphis Hamfest, bigger and better than the 4,500 who attended last year, will be held at State Technical Institute, I-40 at Macon Road, on Saturday and Sunday, October 1 and 2. Demonstrations, displays, MARS meetings, flea market, ladies' flea market, too! Hospitality Room, informal dinners, XYL entertainment, many outstanding prizes. Dealers and distributors welcome. For further information contact Harry Simpson W4SCF, PO Box 27015, Memphis, Tennessee 38127.

CEDAR RAPIDS IA OCT 2

The Cedar Valley Amateur Radio Club annual Hamfest will be held Sunday, October 2, 1977. Top prizes are Atlas 210X Xcvr, Wilson 1402 SM H/T, Heathkit HW-8 QRP CW Xcvr, Clegg FM-76 Xcvr, plus much more. Technical talks featuring Doug DeMaw W1FB. Manufacturers and dealers welcome. Talk-in on 146.16/.76, 146.52, 3.970, and 223.5 MHz. Advance tickets \$1.50, \$2.00 at the door. Write CVARC Hamfest, Box 994, Cedar Rapids IA 52406.

NEWPORT NH OCT 2

Autumnfest, the first annual hamfest of the Connecticut Valley FM Association, will be held on October 2, 1977, at the Community Center, Belknap Ave., off Rt. 10, north end of the Common. Flea market opens at 9 am — auction at 2 pm. Program includes antenna gain contest, fox hunt on 52 simplex, frequency and modulation checks by W1RNZ, and talks and demonstrations throughout the day. Donation: \$1.50 in advance — \$2.00 at the door. Talk-in on 16/76 or on 52 simplex.

WARRINGTON PA OCT 2

The Mt. Airy VHF Radio Club (the Packrats) are holding "Hamarama 77" at the Bucks County Drive-In Theater,

Route 611 (Easton Road), Warrington, Pennsylvania on Sunday, October 2, 1977, 8 am to 4 pm rain or shine. Registration \$1.50, tailgating \$2.00/space (bring your own table). Talk-in via W3CCX/3 on 52.525 and 146.52, WR3ACD on 222.98/224.58, WR3ADS on 147.63/147.03, and WR3AHC on 147.60/147.00. Advance registration to the Mid-Atlantic States VHF Conference includes admission to Hamarama. For information contact Ron Whitsel WA3AXV, Chairman, PO Box 353, Southampton PA 18966, phone (215) 355-5730.

BERRIEN SPRINGS MI OCT 2

The Blossomland annual fall Swap-Shop will be held Sunday, October 2 at the Berrien County Youth Fairgrounds, Berrien Springs, Michigan. Large and convenient facilities, prizes, refreshments, and fun. Open all night for setup. Table space restricted to radio and electronic items. Advance ticket donation \$1.50. Tables \$2. Talk-in 22/82 and 94. Write John Sullivan, PO Box 345, St. Joseph MI 49085. Make checks payable to Blossomland Hamfest.

EAST RUTHERFORD NJ OCT 8

The Knight Raiders VHF Club, K2DEL, presents its world famous Auction & Flea Market to be held at St. Joseph's Church of East Rutherford, New Jersey, Saturday, October 8, 1977 beginning at 10 am. Free admission — free parking. Flea market tables (in advance) \$5 full table, \$3 half table; (at door) \$6 full table, \$3.50 half table. Directions: take Rt. 17 north from Rt. 3 to East Rutherford, exit onto Paterson Plank Road, follow to traffic light with Diner on the corner, make sharp right, follow for one block, at light you will see St. Joseph's Church on your right, make right turn at corner and enter parking lot. For further information call: Bob Kovalski (210) 473-7113, evenings only. Talk-in on 146.52. Send reservations and make checks payable to: Knight Raiders VHF Club Inc., PO Box 1054, Passaic NJ 07055 (reservations close October 1).

SHREWSBURY MA OCT 8-9

The Heart Fund Hamboree (all proceeds to be given to the Heart Fund) will be held on October 8 and 9, 1977, at Simeon's Park on Route 9 in Shrewsbury MA. Program includes door prizes, trophies, special prizes and entertainment. For advance tickets send \$1.50 donation (orders must be received by Sept. 15) — \$2 donation at gate. Senior citizens and children 12 years or under free. For dealer space and ticket information write: Central Mass. 2-Way Radio Assoc., P.O. Box 154, Northboro MA 01532.

SYRACUSE NY OCT 8

The Radio Amateurs of Greater Syracuse presents the Syracuse Hamfest, October 8, 1977 from 9 am to 5

pm at the Syracuse Auto Auction, Route 11, Nedrow, New York. Easy access from Route 81, 5 miles south of Syracuse. Food available all day at reasonable prices. Large exhibitor area and flea market under cover. Exhibitors: \$13.00 (includes one 8-foot space, 8-foot table, two chairs and admission to hamfest). For further information; general info — RAGS Hamfest, Box 88, Liverpool NY 13088; exhibitors — Dale Mecomber WB2FJC, Box 87, Skaneateles Falls NY 13153.

YONKERS NY OCT 9

The Yonkers Amateur Radio Club is holding "Super Hamfest 77" on October 9, 1977 (rain date Oct. 16) from 9 am to 5 pm at Redmond Field, Cooke Avenue in Yonkers. Manufacturers' displays, door prizes, raffles, refreshments and a general auction are all in store. Buyers \$1, sellers \$3 — bring your own table. Talk-in 146.265, 146.865, 146.52 simplex. For further information contact Doug McArtin WA2AUJ, 411 Bellevue Ave., Yonkers NY 10703, (914) 423-0515.

WINDSOR LOCKS CT OCT 14-16

The Region 1 Air Force MARS Convention will be held on October 14, 15, 16, 1977 at the Howard Johnson's Conference Center, Center Street Exit I-91, Windsor Locks, Connecticut. 73 publisher Wayne Green will be guest speaker.

SAN MATEO CA OCT 15-16

The Greater Bay Area Hamfest and ARRL Pacific Division Convention will be a combined event this year held on Saturday and Sunday, October 15 and 16, at the Royal Coach Inn, centrally located on the San Francisco Peninsula just off the intersection of U.S. 101 and Route 92 in San Mateo. For more information contact the Greater Bay Area Hamfest, Box 751, San Mateo CA 94401.

TAYLOR MI OCT 16

The Repeater Association of Downriver Amateur Radio (R.A.D.A.R.) Hamfest will be held on October 16, 1977, at the Kennedy High School located in Taylor, Michigan, on Northline Road, east of Telegraph (U.S. 24). Door prizes and food. Admission \$2.00/YLs free. Reserved tables \$1. Open 9 am until 3 pm. Talk-in will be on 52-52, 34-94, 93-33. For further info write: R.A.D.A.R., Inc., PO Box 1023, Southgate, Michigan 48195.

ISLIP NY OCT 16

Hamfest and Giant Swap & Shop sponsored by LIMARC, the Long Island Mobile Amateur Radio Club, will be held on Sunday, October 16, 1977, at the Islip Speedway, Islip, New York. Gates open at 9:30 am to 4 pm. General admission \$1.50 (wives, children and sweethearts, free). Exhibitors and swappers \$2.50 per car

what do you
give the man
who has
everything?

See page 223

space. Featuring: amateur radio, CB, computer, amateur television, satellite, ARRL info, theory contest, LIMARC tune-up clinic, awards and door prizes. Located on Route 111, Islip Avenue, one block south of Exit 43 of the Southern State Parkway; trucks, campers and trailers use the Long Island Expressway Exit 56, Rte. 111, south to the speedway. For more information: Hank Wener WB2ALW, days (212) 355-0606, nights (516) 484-4322.

**VALPARAISO IN
OCT 16**

The new Annual Valpo Tech Hamfest and Fleamarket is Sunday, October 16, 1977, 7 am to 3:30 pm, on the Valparaiso Technical Institute campus, located on Lincolnway (US 130) at Yellowstone Road, west of downtown Valparaiso, Indiana. Held on the day after Valpo Tech Homecoming. Prestigious electronics school offering large storerooms of surplus test instruments, digital equipment, computer circuits, transmitter components, TV equipment, semiconductors, and much more, at give-away prices. Everything must go to make room for new labs. No charge for setup space. Room inside in case of rain. Hourly drawings beginning at 8 am for prizes. Main drawing at 2 pm. Talk-in on 146.94 MHz. Tickets \$1.50 advance, \$2.00 at the door. For advance tickets send \$1.50 each and an SASE to Dale E. Smiley WB9SFF, Operations V-P, Valpo Tech Alumni Association, Box 490, Valparaiso, Indiana 46383.

**WAKEFIELD MA
OCT 22**

The Quapanowitt Radio Association will hold its annual auction in St. Joseph's Parish Hall, Wakefield MA on Saturday, Oct. 22, 1977. Doors open at 10 am, auction starts at 11 am. Ten percent commission, no minimums. Talk-in on 146.52.

**GAITHERSBURG MD
OCT 23**

The Foundation for Amateur Radio will hold its annual hamfest at the Gaithersburg Fairgrounds, Gaithersburg, Maryland, on Sunday, October 23, 1977. Featured is a large flea market, food service, exhibits, ladies' events, supervised children's program, and many prizes. Main events are all indoors. Picnic grounds and free parking available; will be held rain or shine; participation fee is \$2.00; sales space for flea market is \$5.00 each on a first come basis; commercial exhibitors \$10.00 each, with pre-registration required prior to October 20th. For more information, write or call Hugh Turnbull W3ABC, 6903 Rhode Island Avenue, College Park, Maryland 20740, telephone (301) 927-1797.

**FORT LAUDERDALE FL
OCT 29-30**

The "International" Pan-American Ham/Exposition Jamboree will be held on October 29 and 30, 1977. Welcome: CB, ham and marine. For

further information contact: Broward Amateur Radio Club, Capt. S. F. "Red" Crise (Show Chairman) WA4ZRW, 3701 State Road 84, Fort Lauderdale FL 33312.

**PLYMOUTH IN
OCT 30**

The Radio and Electronics Swap and Shop, sponsored by the Marshall County Amateur Radio Club, will be held on Sunday, October 30, 1977, at the Plymouth, Indiana National Guard Armory, located at 1220 West Madison Street, from 8 am to 5 pm. Free tables, no charge for setup. Tickets \$2 at door. Food, drink and door prizes. Talk-in on 146.07-67 and 146.52 simplex. For further information contact Wayne Zehner WA9INM, Rt. 3, Box 526, Plymouth IN 46563.

**CLEARWATER BEACH FL
NOV 19-20**

The Florida Gulf Coast Amateur Radio Council is holding its 2nd annual convention on November 19 and 20, 1977 at the Sheraton Sand Key Hotel on Clearwater Beach FL. Official attendance at our last affair was placed in excess of 2200, and this year we expect to double that number as we increase the number of activities and size of the convention. For more information contact: Florida Gulf Coast Amateur Radio Council Inc., PO Box 157, Clearwater FL 33517.

**ELLCOTT CITY MD
NOV 27**

The Columbia Amateur Radio Association (CARA) will hold its CARA Hamfest on November 27, 1977, at the Ellicott City Armory in Ellicott City, Maryland. Program includes exhibits, flea market, prizes, and refreshments. All indoors. No tailgating. Talk-in on 147.99/39, 146.16/76, 146.52/52. For more info contact CARA, PO Box 850, Columbia MD 21044.

**HAZEL PARK MI
DEC 4**

The Hazel Park Amateur Radio Club is holding their 12th annual Swap & Shop on December 4, 1977, at the Hazel Park High School. Admission is \$1.00 at the door. Main prize tickets are available from Robert Numerick WB8ZPN, 23737 Couzens, Hazel Park MI 48030. Reserve table space is available from WB8ZPN.

NEW BOOK



The Challenge of 1601

See page 214

Original 
COMPUTERMANIA™
TEE SHIRTS!



Made from finest grade white cotton with 4 color imprint. ORDER NOW! (Supply limited.) Only \$5.50 ppd.

Please send me the following tee shirts @ \$5.50. Indicate quantity and size. (Adult sizes only.)

_____ Small \$ _____
 _____ Medium \$ _____
 _____ Large \$ _____
 _____ Extra Large \$ _____
 _____ Total Order \$ _____

Enclosed \$ _____ Cash Check
 American Express BankAmericard
 Money Order
 Master Charge

Credit card # _____

Interbank # _____

Expiration date _____

Signature _____

Name _____

Address _____

City _____

State _____ Zip _____ **U.S. & Canada Only. Others write for foreign prices.*

COMPUTERMANIAC TEE SHIRTS 73/10/77
 73 MAGAZINE • PETERBOROUGH NH 03458

MEET THE FAMILY!



Since our first ad in 73 a year ago, we have grown quite a bit! Now we can offer you more products with pioneering design and features.

MODEL 120 DC VOLTS/OHMS CALIBRATOR (far left)
One of our best sellers! This \$34.95 calibrator will allow you to calibrate all your Ohm ranges and the three critical dc volts ranges on your multimeters.

MODEL 101 DVOM KIT: (center top)
This quality VOM kit allows you to accurately measure dc volts, ac volts, and Ohms with 0.1%, 0.3%, and 0.2% accuracy. Only \$70.00 kit/90.00 wired.

MODEL 401 DIGITAL READOUT FUNCTION GENERATOR
Generate precision sine, triangle, and square wave signals. True 50 Ohm output, 4 digit counter. Counter detaches for reading external audio signals. Only \$99.95.

MODEL 303 200 MHZ POCKET COUNTER
Imagine measuring signals up to 200 MHz in 3 ranges with a 7 digit frequency counter that fits in your pocket! Also has $\pm 0.001\%$ accuracy and low battery indicator. \$129.95

Please write for more information, or order today!

Gary McClellan & Co.

P.O. Box 2085
1001 W. Imperial Hiway
LaHabra CA 90631

G10

Best for beginners . . . preferred by pro's!

NYE VIKING SPEED-X

Model 114-310-003

\$8.75

One of 8 models, all sure-handed . . . smooth operating . . . priced from \$6.95.



NYE VIKING SUPER SQUEEZE KEY

Fast, comfortable, easy . . . and fun!

Model SSK-1 (shown)

\$23.95

Model SSK-3 (has sub-base to hold any SPEED-X Key).

\$26.95

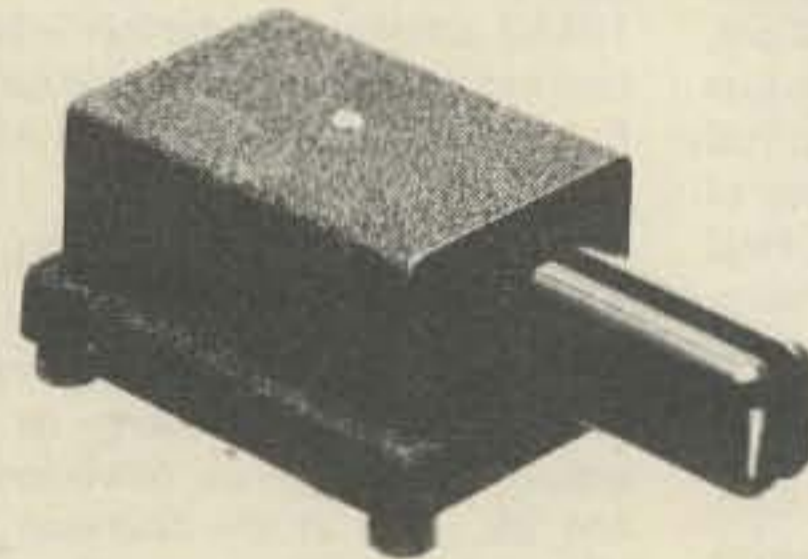

Whether you're a "brass pounder" or a "side swiper" insist on the sure, smooth *feel*, and the long-lasting *quality* that is built into every NYE VIKING KEY.

By the manufacturer of NYE VIKING Low Pass Filters, Phone Patches and Antenna Impedance-matching Tuners.



Available at leading dealers or write
WM. M. NYE COMPANY, INC.

1614 - 130th Ave. N.E., Bellevue, WA 98005 N4



Germantown Amateur Supply, Inc.

MEMPHIS, TENNESSEE

NO MONKEY BUSINESS!

- (A) Complete Service Facilities
- (B) Good Deals on most Brands
- (C) Shipping within 24 Hours
- (D) All inquiries handled by Active Hams with over 20 years experience in ham radio

CALL TOLL FREE
1-800-238-6168

MONDAY - SATURDAY 8:30-5:30
FOR YOUR SPECIAL.

G-12

Write: 3202 Summer Ave., Memphis, Tennessee 38112

Station Identifier

\$110



CWID-51 provides automatic ID for repeater stations in perfect Morse code. Has factory-programmed IC memory. Brochure describes CWID-51 and CWID-50 (\$75).

control signal co

5964 W. COLUMBIA PLACE
DENVER, COLORADO 80227

NEW!

A \$34.95

Meter Calibrator!

A quality volt-ohm calibrator at a break-through price! Why put off calibration of your VOM, VTVM, or digital multimeter?

Here's what you get:

- Check DC volts at 0.100 V, 1.000 V, and 10.000 V
 - Up to 0.02% accuracy on volts
 - Check ohms at 100Ω, 1k, 10k, 100k, and 1 meg.
 - Up to 0.1% accuracy on ohms
- Battery powered, uses 2-9 V batteries (not included)
Uses hybrid IC precision reference

Only \$34.95 each. Please add \$1.50 postage. CA residents add \$2.10 tax.

Gary McClellan and Co. Box 2085
1001 W. Imperial Hwy.
La Habra CA 90631
G10

INSTRUCTOGRAPH MORSE CODE

Since 1924 Instructograph has serviced the world with the most complete equipment ever devised for learning Continental code. You have complete control of sending & receiving **AT ANY SPEED YOU DESIRE** while machine is running, without changing tapes (not cassettes). A complete course for beginners incl. machine, 10 double sided tapes, key, manual, built-in speaker. Nothing else to buy. \$98.50 plus UPS 12lb. del. chg. Add 6% S.T. for Calif. del. For catalog on 45 advanced tapes write: Instructograph Co. Box 5032 Dept. 3, Glendale, CA 91201. (213)246-3902 or 245-2250.

MORSE CODE INSTRUCTOGRAPH

KAUFMAN BALUN

water tight BALUN



1-1 impedance match
For dipoles, beams, inverted "V",
and quads

- * Center insulator with BALUN \$13.50
- * Center insulator without BALUN \$8.50
- * Dragon Fly antenna construction sheet and drawing \$2.00

postpaid USA

Patent No.
D219106

3 Kw PEP
4 Ounces
Q1 Ferrite

KAUFMAN INDUSTRIES
603-424-2358
3 SHORT ST
REEDS FERRY NH 03054

K6

ATLAS 350XL DENTRON MLA 2500 WILSON HT's REPEATERS

MICRO-MODULE VHF and UHF CONVERTERS and TRANSVERTERS

Make your selection from the best of top national brands. Choose from dozens of models and a variety of equipment to handle anything from 160 meters to 1296 MHz. Products like the Atlas 350XL. Wilson HT's. Mosely Tri-bander. Clegg FM-DX, FM-76, Mark 3, TT-2. Micro-module VHF and UHF converters and transverters. Repeaters. Power supplies. And much more.

For details on this new supersales service, call toll FREE 800-233-0250, in Pa. call (717) 299-7221 collect. Or visit the new Clegg supersales center, 208 Centerville Road, Lancaster, Pa. 17603.



**NOW! A
NEW
SUPERSERVICE
TO FILL ALL
YOUR HAM NEEDS.**

Clegg

C3

Advanced technology in action!

ATLAS 350XL DENTRON MLA 2500 CLEGG MARK 3 TT-2

MOSLEY TRI-BANDERS POWER SUPPLIES CLEGG FM-DX FM-28 FM-76

SCR 1000

State of the Art in VHF FM Repeaters

NEW!
Spec Comm
Repeater/Duplexer
Pkgs. Fully Factory
Checked-out! Inquire.

Some
Plain
Talk
About
Repeaters -



Optional Cabinet \$130.00

Let's face it - your repeater group's success or failure hinges on the Quality and Reliability of your "Machine"! That's why the engineers at Spec Comm dedicated themselves to the production of the finest repeater available on the amateur market. The SCR1000 has been conservatively designed for years of trouble-free operation, and every consideration has been given to operator convenience and accessory interfacing. Features like full metering, lighted status indicators, full front panel control of every important repeater operating parameter, and accessory jacks for autopatch, xmtr. remote control, etc. And audio so good and so full, your 30 watts will sound like 100! Think about it, and think about your users. The purchase of a Spec Comm Repeater is a sound investment in your group's future, and they'll be thanking you for years to come. Sold Factory Direct only. \$899.95.

SEND FOR BROCHURE

Don't make a mistake - your group deserves the finest!

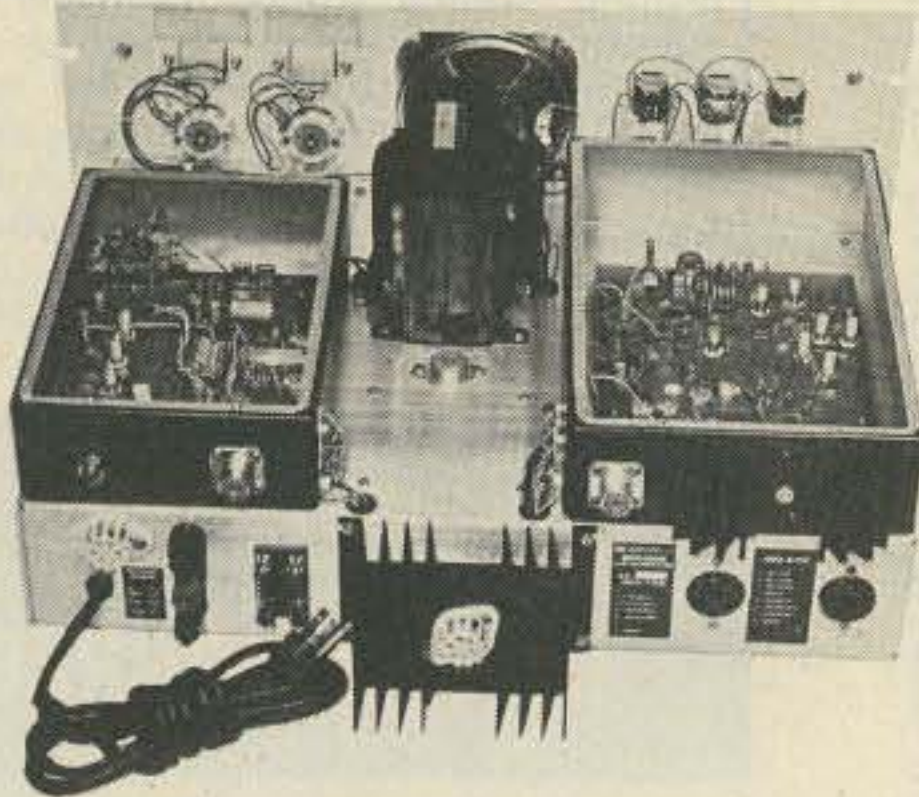

Custom 'Mods' Available: 'PL', 8 Pole Rcvr. Filter, Hi/Lo Power, Multi-Freq., etc. - Inquire.

Specifications

RF Output 30 Watts
Infinite VSWR proof
Sensitivity 0.3uV/20dB Qt.
Selectivity -6dB @ ±6.5 kHz;
-58dB @ ±15 kHz;
-90dB @ ±30 kHz.
(Sharper 8 Pole Fltr. Available)
Desense/Overload . . . W/1uV de-
sired signal, desense just begins @
approx. 50,000uV @ ±600kHz.
Spurious Response . . . -70dB min.

FEATURES

- Full Metering of critical levels.
- Front Panel Controls for timers & AF levels.
- Lighted push-buttons for control/test functions & status indicators
- State of the Art CMOS control logic & timers - No Relays!
- Built-in IDer - field programmable. Fully adjustable speed, pitch, time, etc.
- Exclusive Spec Comm MOSFET/Hot Carrier Diode rcvr. front end - greatly reduces 'desense' & IM problems!
- Built-in AC Supply w/instant btry. switchover for emergency pwr.
- Supplied with .0005% Sentry xtals and a Turner local mic.
- Jacks Provided for Remote Control, Auto-Patch, DC out, AF in/out, COR Switch, etc.
- True FM - For Rpt. Audio so good, it "sounds like direct"!

SPEC COMM REPEATER BOARDS

Inquire about complete shielded RCVR. & XMTR. Assemblies!



SCR100 Receiver Board

- Ext. wide dynamic range! Greatly reduces overload, 'desense', and IM.
- Sens. 0.3uV/20dB Qt.
- Sel. -6dB @ ±6.5KHz; -90dB @ ±30KHz, (-110dB w/opt. 8 Pole Fltr.)
- Exc. audio quality! Fast squelch! \$115.00 w/xtal, Asmbld. & Tested



SCT 100 Xmtr/Exciter Board

- 5-6 Wts. Output
- Infinite VSWR proof
- True FM for exc. audio quality
- Spurious -60dB
- With .0005% xtal. \$115.00 Asmbld. & Tested. ● BA-10 30 Wt. Amp Board & Heat Sink. 3 sec. LPF & rel. pwr. sensor. \$51.95 Asmbld. & Tested

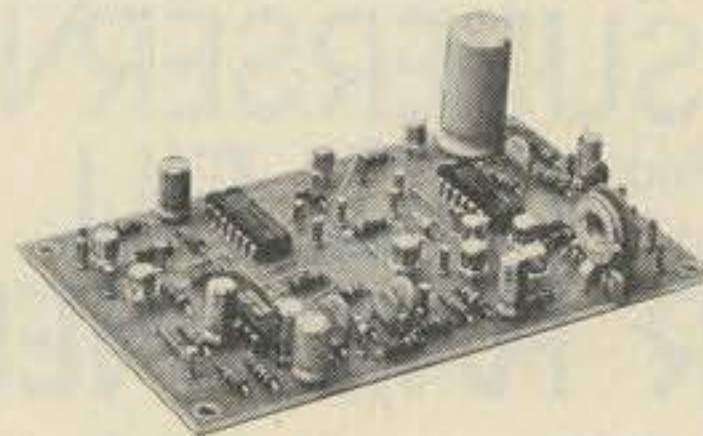

CTC100 COR/Timer/Control Board

- Complete COR circuitry
- Carrier 'Hang' & T.O. Timers
- Remote xmtr. control
- 100% Solid State
- Many other features \$32.95 Asmbld. & Tested

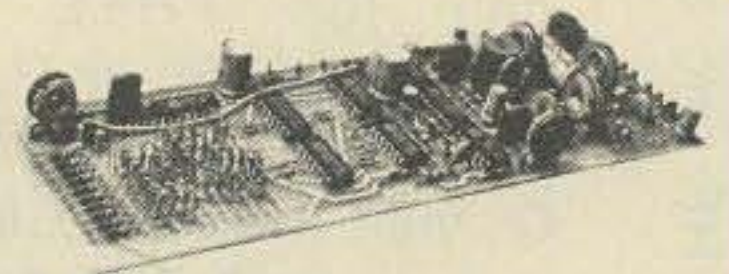

ID100 ID & Audio Mixer Board

- 100 bit diode programmable memory
 - Adjustable ID tone, speed, level, time
 - 4 Input AF Mixer & Local Mic amp
 - COR input & xmtr. hold
 - All CMOS logic
 - Many other features \$59.95 Asmbld./Tested/Programmed
- Send for Data Sheets!

Call or write today and get the details!

(Ship./Handl. - \$3.00. PA residents add 6% tax)



SPECTRUM COMMUNICATIONS

1055 W. Germantown Pk., Norristown PA 19401 (215) 631-1710

Formerly of Worcester PA

GET YOUR NEW RADIO AMATEUR CALLBOOKS

1977

ALL OF THESE EXTRA FEATURES INCLUDED

The **U.S. Callbook** has over 300,000 W & K listings. It lists calls, license classes, names and addresses plus the many valuable back-up charts and references you come to expect from the **Callbook**.

\$14.95
PLUS SHIPPING

Specialize in DX? Then you're looking for the **Foreign Callbook** with over 250,000 calls, names and addresses of radio amateurs outside the USA plus many valuable, additional features of interest to the DX'r.

\$13.95
PLUS SHIPPING



- International Radio Amateur Prefixes!
- Radio Amateur Prefixes by Countries!
- A.R.R.L. Phonetic Alphabet!
- Great Circle Bearings and Charts!
- International "Q" and "Z" Signals!
- World Standard Time Charts!
- International Postal Information!
- World Prefix Map!
- F.C.C. Examination Points!
- Where to Buy!
- Telegraphers' Abbreviations!
- DX Operating Code!
- A.R.R.L. Countries List!
- At Your Service — Amateur Radio Dealers!
- QSL Managers Around the World!
- World Wide QSL Bureaus!
- Census of Radio Amateurs of the World!
- Telegraph Codes!
- AMSAT — Oscar Users Directory!
- Slow Scan Television Directory!
- Reciprocal Licenses!
- Hawaii Included!
- Many Other Features!

*Respected worldwide as
the only complete authority
for radio amateur
QSL and QTH information.*

ORDER FORM

Item	Price Each	Shipping	Total Price
U. S. CALLBOOK	\$14.95	\$1.25	\$ 16.20
FOREIGN CALLBOOK	\$13.95	\$1.25	\$ 15.20

See your favorite electronics dealer or write direct for free catalog to the publisher.

Illinois residents only add 5% sales tax _____

Name _____ Total _____

Address _____

City _____

State _____ Zip _____ Total Enclosed _____

Master Charge No. _____ Interbank # _____

Bank _____ Expiration Date _____

RADIO AMATEUR
callbook INC.
Dept. B 925 Sherwood Drive
Lake Bluff, Ill. 60044

R1

NEW! FM144-10SXRII



All Solid State-PLL digital synthesized — No Crystals to buy! 5KHz steps — 144-149 MHz-LED digital readout PLUS MARS-CAP.*

- 5MHz Band Coverage — 1000 Channels (instead of the usual 2MHz to 4MHz — 400 to 800 Channels)
- Priority Channel
- Audio Output 4 Watts • 15 Watts Output
- Unequaled Receiver Sensitivity and Selectivity — 15 POLE FILTER, MONOLITHIC CRYSTAL FILTER AND AUTOMATIC TUNED RECEIVER FRONT END — COMPARE!!
- Superb Engineering and Superior Commercial Avionics Grade Quality and Construction Second to None at ANY PRICE.

- **FREQUENCY RANGE:** Receive: 144.00 to 148.995 MHz, 5 KHz steps (1000 channels). Transmit 144.00 to 148.995 MHz, 5 KHz steps (1000 channels) + MARSCAP.*
- **FULL DIGITAL READOUT:** Six easy to read LED digits provide direct frequency readout assuring accurate and simple selection of operating frequency.
- **AIRCRAFT TYPE FREQUENCY SELECTOR:** Large and small coaxially mounted knobs select 100KHz and 10KHz steps respectively. Switches click-stopped with a home position facilitate frequency changing without need to view LED'S while driving and provides the sightless amateur with full Braille dial as standard equipment.
- **FULL AUTOMATIC TUNING OF RECEIVER FRONT END:** DC output of PLL fed to varactor diodes in all front end R-F tuned circuits provides full sensitivity and optimum intermodulation rejection over the entire band. **No other amateur unit at any price** has this feature which is found in only the most sophisticated and expensive aircraft and commercial transceivers.
- **TRUE FM:** Not phase modulation — for superb emphasized hi-fi audio quality second to none.
- **FULLY REGULATED INTEGRAL POWER SUPPLIES:** Operating voltage for all circuits, i.e., 12v, 9v and 5v have independently regulated supplies. 12v regulator effective in keeping engine alternator noises out and protects final transistor from overload.

- **MONITOR LAMPS:** 2 LED'S on front panel indicate (1) incoming signal-channel busy, and (2) un-lock condition of phase locked loop.
- **DUPLEX FREQUENCY OFFSET:** 600KHz plus or minus, 5KHz steps. Plus simplex, any frequency.
- **MODULAR COMMERCIAL GRADE CONSTRUCTION:** 6 unitized modules eliminate stray coupling and facilitate ease of maintenance.
- **ACCESSORY SOCKET:** Fully wired for touch-tone, phone patch, and other accessories.
- **RECEIVE:** .25 uv sensitivity. **15 pole filter** as well as monolithic crystal filter and **automatic tuned LC circuits** provide superior skirt selectivity.
- **AUDIO OUTPUT: 4 WATTS.** Built in speaker.
- **HIGH/LOW POWER OUTPUT:** 15 watts and 1 watt, switch selected. Low power may be adjusted anywhere between 1 watt and 15 watts, fully protected—short or open SWR.
- **PRIORITY CHANNEL:** Instant selection by front panel switch. Diode matrix may be owner re-programmed to any frequency (146.52 provided).
- **DUAL METER:** Provides "S" reading on receive and power out on transmit.
- **OTHER FEATURES:** Dynamic microphone, mobile mount, external speaker jack, and much, much more. Size: 2 1/8 x 6 1/2 x 7 1/2. All cords, plugs, fuses, mobile mount, microphone hanger, etc., included. Weight 5 lbs.



NEW! 6 METER FM50-10SXRII

Same specifications as above except transmit/receive: 51.00-53.995 MHz. 600 channels
Introductory Price \$389.00



SUMMER SPECIAL
FM144-10SXRII
\$389.00
VALUE \$599.00
Regulated AC/PS
Model FMPS-4R ... \$49.00



NEW!
TONE ENCODER/DECODER
SC-12A ... 12 CHANNELS ... DUAL TONE
Introductory Price \$119.00



Touch-Tone Pad
MODEL FMTP-1
... \$59.00

Manufactured by one of the world's most distinguished Avionics manufacturers, Kyokuto Denshi Kaisha, Ltd.

First in the world with an all solid state 2 meter FM transceiver.

AMATEUR-WHOLESALE ELECTRONICS

8817 S.W. 129th Terrace, Miami, Florida 33176
Telephone (305) 233-3631 • Telex: 51-5628
U.S. DISTRIBUTOR

PLEASE ORDER FROM YOUR LOCAL
DEALER OR DIRECT IF UNAVAILABLE.
DEALER INQUIRIES INVITED.

Regional Sales & Service Centers:
Northeast: Buzzards Bay Electronics
Buzzards Bay, Mass.
East: Sanford Communications, Inc.
Colonia, N.J.
West: Consumer Communications, Inc.
Seattle, Wash.

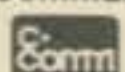



COMPARE! NEW SIGMA XR3000D LINEAR AMPLIFIER



INTRODUCTORY PRICE **\$789**

2 DAY AIR SHIPMENT ANYWHERE IN U.S. \$35. ALASKA AND HAWAII SLIGHTLY HIGHER.

- FULL BAND COVERAGE 160-10 METERS INCLUDING MARS.
- 2000+ WATTS P.E.P. SSB INPUT. 1000 WATTS INPUT CONTINUOUS DUTY, CW, RTTY & SSTV.
- TWO EIMAC 3-500Z CONSERVATIVELY RATED FINALS
- ALL MAJOR HV AND OTHER CIRCUIT COMPONENTS MOUNTED ON SINGLE G-10 GLASS PLUG IN BOARD. HAVE A SERVICE PROBLEM? (VERY UNLIKELY) JUST UNPLUG BOARD AND SEND TO US.
- HEAVY DUTY COMMERCIAL GRADE QUALITY AND CONSTRUCTION SECOND TO NO OTHER UNIT AT ANY PRICE!
- WEIGHT: 90 lbs. SIZE: 9 1/2" (h) x 16" (w) x 15 3/4" (d).

FEATURES

CUSTOM COMPUTER GRADE COMMERCIAL COMPONENTS, CAPACITORS, AND TUBE SOCKETS MANUFACTURED ESPECIALLY FOR HIGH POWER USE—HEAVY DUTY 10KW SILVER PLATED CERAMIC BAND SWITCHES • SILVER PLATED COPPER TUBING TANK COIL • HIGH 4" EASY TO READ METERS—MEASURE PLATE CURRENT, HIGH VOLTAGE, GRID CURRENT, AND RELATIVE RF OUTPUT • CONTINUOUS DUTY POWER SUPPLY BUILT IN • STATE OF THE ART ZENER DIODE STANDBY AND OPERATING BIAS PROVIDES REDUCED IDLING CURRENT AND GREATER OUTPUT EFFICIENCY • BUILT IN HUM FREE DC HEAVY DUTY ANTENNA CHANGE-OVER RELAYS • AC INPUT 110V OR 220V AC, 50-60Hz • TUNED INPUT CIRCUITS • ALC-REAR PANEL CONNECTIONS FOR ALC OUTPUT TO EXCITER AND FOR RELAY CONTROL • DOUBLE INTERNAL SHIELDING OF ALL RF ENCLOSURES • HEAVY DUTY CHASSIS AND CABINET CONSTRUCTION AND MUCH, MUCH MORE.



SIGMA RF-2000 SWR & POWER METER
Introductory Price **\$29** Cal PWR Scales 200W-2000W
Freq Range 3.5 - 150 MHz Please do not confuse the RF2000 with similar appearing lower priced units - RF2000 is an individually calibrated professional quality instrument - Unequaled at many times the price Size 7" (w) x 2 1/2" (h) x 2 1/3" (d).



NEW AM/FM ANALYZER SIGMA AF-250L

INTRODUCTORY PRICE **\$199**
Deviation/Modulation Meter - FM: 0-20 KHz, AM: 0-100%. Size: 5 1/2" (h) x 10 1/4" (w) x 7 1/4" (d)
Weight 7 lbs. Frequency: 1.8MHz-520MHz

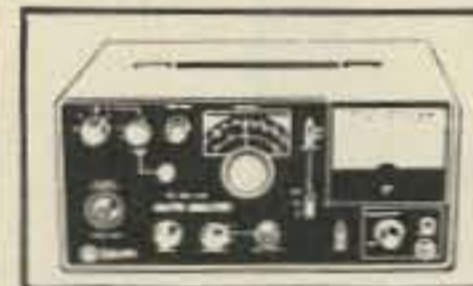

ALSO MODEL AF-251LW WITH BUILT IN 125 WATT CALIBRATED WATT METER & DUMMY LOAD. PRICE **\$289**. PLEASE WRITE FOR COMPLETE INFORMATION.

NEW—CDR HAM ROTATORS—Reg. \$159.95 \$125.

STANDARD NEW 2 METER FM TRANSCEIVERS Model SRC 146A SPECIAL SALE

SRC 146A	\$314
4 Xtals:34/94 and 94/94	NC
USA 2 Deluxe Base Charger	\$40
PT3644 Leather Case	\$10
AT 19 Rubber Ant and Whip	\$6
NI Cads	\$30

Reg. \$400

Our Price **\$289**

NEW!!! Touch Tone pad completely wired and ready to plug in-\$69.00



NEW! FMSC-2 SCANNER FOR KDK FM-144

14 CHANNEL PROGRAMMABLE
INTRODUCTORY PRICE \$109



NEW! 7400 SCANNER

FOR KENWOOD TR-7400A
14 CHANNEL PROGRAMMABLE
INTRODUCTORY PRICE \$109



FMSC-1 - \$169



7400 Scanner II-\$189

TWO NEW SCANNERS!

FMSC-1 Scanner for KDK FM 144 and 7400 Scanner II for Trio-Kenwood TR-7400A.
• Full scan 146 and 147 MHz consecutively or 1 MHz, or any MHz range • Scan rate: 1 MHz/2 seconds adjustable • Controls: Scan/Hold, Latch/Delay, 600 KHz offset (off, up, down), program 1 MHz • Simple installation.



ACCESSORIES FOR KDK FM 144

FMPS 4R	Regulated AC/PS	\$49
FMTP-1	Touch Tone Pad	\$59
FMTP-2	Touch Tone Pad with 10 Number Programmable Memory	\$99
FMMC-1	Microphone with Built in Touch Tone Pad	\$59
FMTD-1	Private Call Decoder for use with and Programed by Any Touch Tone Pad	\$129
SC-12A	Audible Tone Encoder Decoder	\$119
FMSC-1	Scanner - Random, Any Range	\$169
FMSC-2	Scanner - Programmable, 14 Channels	\$109
MARS CAP	Option Kit - Any Frequency, Any Split	\$12
FMDF-1	Offset Option Kit - 2 Extra Positions, Crystals Required	\$19
FMDF-2	-1 MHz Offset Option Kit (No Crystals To Buy)	\$19
FMTE-1	Sub Audible Tone (100 Hz - Adjustable 67 203 Hz)	\$29
FMAT-1	1/2 Wave Portable Antenna for Hotel Motel or Apartment	\$7.95
	Extra DC Cord & Plug	\$3.50
	ACC Socket 5 Pin Din Plug	\$1.50
	Owners Manual (Extra)	\$5.00
	Service Manual	\$2.00
	Mounting Bracket (Extra)	\$6.00



NEW — TEMPO 2020

A brilliant new SSB transceiver providing advanced engineering and unique operating features. Please write for information



YAESU FT 101E/FT 301D
TRANSCIVER'S
write for special deal.



NEW! \$285 NYE VIKING MODEL MB-II 3,000 WATTS

Antenna Impedance Matching Network. Copper ribbon-wound, silver plated variable inductor. Heavy duty 7000 volt variable output capacitor. 10,000 volt fixed capacitors. Silver plated RF conductors. Large precision, easy-to-read dials. 360° readout. Overload protection for SWR meter.

ATLAS 210X-215X and 350-XL

Please write for special bonus and package offers.



The indispensable
BIRD 43
THURLINE
WATTMETER
Authorized Bird
Distributor.
Please write for
special deal.

ATLAS, COLLINS, DEN-TRON, CUSHCRAFT, BIRD, STANDARD, KLM, HYGAIN, KENWOOD, TEMPO, MINI-PRO-DUCTS, MIDLAND, VHF MARINE, EIMAC, ICOM, AMCOMM, etc. Please write for quote.

AMATEUR-WHOLESALE ELECTRONICS

8817 S.W. 129th Terrace, Miami, Florida 33176

COURTEOUS PERSONAL SERVICE—SAME DAY SHIPMENT • Prices subject to change without notice.

TELEPHONE: (305) 233-3631 • TELEX 51-5628 • STORE HOURS: 10-5 MON.- FRI.

OUR CREW: S.I. GREGORY WA4KGU
Owner/Gen. Mgr.

J.R. MAGGIO Mgr.
W8CXL

S.E. GLICKMAN
WB4HFJ



A21

California Industrial

Post Office Box 3097 A • Torrance, California 90503



CALCULATOR WRIST WATCH

Designed for the on the go executive, that individual who has to make those on the spot decisions.

Handsome gold tone stainless steel watch features space age micro-circuitry. The MOS integrated circuit contains the equivalent of more than 10,000 transistors.

This LED wrist watch displays date, time, elapse seconds and also functions as an eight digit calculator with memory. Information stored in memory can be recalled at any later date, even weeks or months. Use this memory feature to store phone numbers, parking stall location or flight departure time.

Manufactured by one of California's leading aerospace contractors. Because of the discount price we have agreed not to publish the manufacturer's name.

Includes batteries, jewelry case and 18-month factory warranty.

\$149.50

ELECTRONIC ENTERTAINMENT CENTER

Tennis-Handball Hockey-Smash



Action-packed color entertainment for the whole family. Adjustable skill level controls allow players of all ages to compete in tennis, hockey and handball. This four game entertainment center turns your television into a video playground.

On screen scoring, live action sound and true component color makes this video center an excellent buy at only \$24.88. Complete with antenna box and AC adapter.

Color \$24.88

TELETYPE MODEL 43



New from Teletype, the Model 43 is capable of printing 132 ASCII characters per line. Send and receive data at 10 or 30 words per second. Keyboard generates all 128 ASCII code combinations. RS-232 interface, same as the popular Model 33. Data sheet sent upon request. Manufacturer suggested price \$1377.00, telephone for discount and availability.

We also have for sale a limited quantity of used Model 35's. Priced at only \$449.50

HEXADECIMAL KEYBOARD

Maxi-Switch hexadecimal keyboards are designed for microcomputer systems that require 4-bit output in standard hex code.

Each assembly consists of 16 hermetically sealed reed switches and TTL "one shot" debounce circuitry.

Reliable low friction acetal resin plungers are credited for the smooth operation and long life of this premium keyboard.

Requires single +5 volt supply.



\$29.95

DIGITAL ALARM CLOCK



Walnut-grained decorator clock features large .7" LED display which is driven by the new National MM5385 alarm clock chip. Preset 24-hour alarm function allows you to awaken at the same time each morning without resetting. Upon reaching the wake-up time, the clock's loudspeaker emits a gentle tone. Touch the snooze button and doze off for an additional 9 minutes of sleep. Clock also functions as a ten-minute elapse timer. "Alarm Set" indicator, AM-PM display.

CONNECTORS

RS-232
DB25P male plug & hood \$3.95
DB25S female \$3.95

100 PIN IMSAI/ALTAIR Edge Connector
Altair, Imsai compatible gold plated, dual 50 (125 centers) three tier wire wrap edge connector. 3 for \$13.50

SPERRY UNIVAC KEYBOARD
The famous Sperry Univac 1710 Hollerith keyboard assembly is now available from California Industrial for only \$24.88. The ideal computer input device for accountants and mathematicians. The numeric keys are placed on the lower three rows to resemble a ten key adding machine. This format allows one handed numeric data entry. Original cost was \$385. Used but guaranteed in excellent condition. Complete with documentation.

JOYSTICK \$5.50
This joystick feature four 100K potentiometers, that vary resistance proportional to the angle of the stick. Perfect for television games, quad stereo and radio controlled aircraft.

FREE MANUAL GRAPHITE DISPLAY GENERATOR
Modern technology has pioneered the development of this unique character printer. Our Manual Graphite Display Generator has the capability of producing the full upper and lower case ASCII set. Self-contained cursor assembly allows the operator to eliminate erroneously entered information. Each unit is manufactured to strict tolerances as prescribed by standards set forth by California Industrial. One free with every order.

Scotch BRAND DISKETTES
10 for \$45. IBM 3740 series and compatible drives.

CALCULATOR KEYBOARD
Ideal for keyless entry systems, burglar alarms, Touch Tone or hexadecimal computer input code.

Digital Clock
Manufactured for the Panasonic clock radio. The clock mechanism trips a microswitch upon reaching your preset wake-up time.

2708 \$24.95
8K UV Erasable MEMORY

SUPER RECTIFIER
BRIDGE RECTIFIER MOTOROLA 12 Amp. 50v. \$1.95

BNC CABLE
15 feet of RG-58U connector at ends \$3.50

2102AL 1k RAM 450ns \$1.19
Lowest Price Anywhere

MEMORY	
1702	5.95
82s23	2.95
82s123	2.95
2102	1.79
2102-1	1.89
21102	1.19

MICROCOMPUTER POWER SUPPLY KIT
Ideal supply for S-100 systems. Contains all the necessary components to produce 5 volts @ 10 A, ± 12 @ 2.5 A. (voltage actually higher). New surplus from Memorex Corporation. Kit includes 117 ac transformer, diodes, six computer grade electrolytics, chassis, circuit breaker and grounded power cord. Transformer has 5 output windings. Include \$9.00 shipping East of the Mississippi; \$4.00 for Calif.; all other States \$7.00.

SOLID-STATE MICRO BUZZER
1.5 TO 3 VDC \$1.98

Thumbwheel switch
Ten position BCD \$1.39 ea. 10 50 \$1.19 .89

SPDT MINIATURE TOGGLE SWITCH
\$1.98 ea. 10 50 100 1k \$1.88 .81 .73 .66

7400	.13	7475	.39
7401	.19	7476	3.99
7402	.19	7480	.79
7403	.19	7481	.99
7404	.19	7482	.99
7405	.19	7483	.49
7406	.19	7484	3.40
7407	.25	7485	2.79
7408	.25	7486	.49
7409	.25	7487	.99
7410	.19	7488	.49
7411	.25	7489	.49
7412	.35	7490	.99
7413	.49	7491	.99
7414	.79	7492	.49
7415	.39	7493	.49
7416	.39	7494	.79
7417	.39	7495	.79
7418	.39	7496	.79
7419	.39	7497	3.99
7420	.19	7498	1.19
7421	.49	7499	.49
7422	.49	7500	1.79
7423	.39	7501	1.99
7424	.39	7502	1.99
7425	.39	7503	1.99
7426	.39	7504	1.99
7427	.39	7505	1.99
7428	.39	7506	1.99
7429	.39	7507	1.99
7430	.39	7508	1.99
7431	.39	7509	1.99
7432	.39	7510	1.99
7433	.39	7511	1.99
7434	.39	7512	1.99
7435	.39	7513	1.99
7436	.39	7514	1.99
7437	.39	7515	1.99
7438	.39	7516	1.99
7439	.39	7517	1.99
7440	.39	7518	1.99
7441	.39	7519	1.99
7442	.39	7520	1.99
7443	.39	7521	1.99
7444	.39	7522	1.99
7445	.39	7523	1.99
7446	.39	7524	1.99
7447	.39	7525	1.99
7448	.39	7526	1.99
7449	.39	7527	1.99
7450	.39	7528	1.99
7451	.39	7529	1.99
7452	.39	7530	1.99
7453	.39	7531	1.99
7454	.39	7532	1.99
7455	.39	7533	1.99
7456	.39	7534	1.99
7457	.39	7535	1.99
7458	.39	7536	1.99
7459	.39	7537	1.99
7460	.39	7538	1.99
7461	.39	7539	1.99
7462	.39	7540	1.99
7463	.39	7541	1.99
7464	.39	7542	1.99
7465	.39	7543	1.99
7466	.39	7544	1.99
7467	.39	7545	1.99
7468	.39	7546	1.99
7469	.39	7547	1.99
7470	.39	7548	1.99
7471	.39	7549	1.99
7472	.39	7550	1.99
7473	.39	7551	1.99
7474	.39	7552	1.99
7475	.39	7553	1.99

LM741 \$1.09*

CPU's		CLOCK'S	
8080A	24.95	5314	3.95
8800	24.95	5316	4.95
280	69.95	5375	3.95

32 Conductor 59 Ft. RIBBON WIRE SPECTRA-STRIP

COMPUCORP Power Adapter
output 7vdc 1.4A \$4.98 shipping \$75

RELAYS SPDT MINIATURE
\$1.39 ea. 10 25 100 \$1.15 1.04 .89
Coil 5 or 12 Volt dc. 3 Amp Contacts P.C. Board Mount

CAPACITORS ELECTROLYTICS
ea. 10 50
4500/50v. \$1.99 1.35 1.19
1000/15v. \$55 49 45
.1 disc \$12 .09 .07
.01 disc .06 .05 .04

DIP Switch
\$1.75 ea. 10 25 100 \$1.63 1.52 1.29

Transistors
ea. 10 50 100
2N2222A .20 .18 .15
2N3055 .89 .84 .77 .65
MJ3055 .99 .94 .87 .75
2N3772 219 195 175 159
2N3904 .15 .11 .09 .07
2N3906 .15 .11 .09 .07

TRANSFORMER
Output: 12v. 175ma. \$1.98

9 foot Heavy duty grounded power cord and mating chassis connectors.
\$1.49

DISCOUNT Wire Wrap Center
IC SOCKETS
Wire Wrap solder
pin ea. 25 50 ea. 25 50
8 17 16 15
14 37 36 35 20 19 18
16 38 37 36 21 20 19
24 99 93 85 36 35 34
40 169 155 139 63 60 58
50ft. KYNAR WIRE WRAP \$1.98
500 1,000 11,000 \$9. \$15. \$105.

SOLAR CELLS
\$1.19
125mA. at 43V. Ideal for powering radio receivers or charging batteries.
10 100 \$98 \$85

Nicad 500mA "AA" FAST CHARGE
\$1.98

NEW

Frequency Counter

\$79⁹⁵ kit



UTILIZES NEW MOS-LSI CIRCUITRY

You've requested it, and now it's here! The CT-50 frequency counter kit has more features than counters selling for twice the price. Measuring frequency is now as easy as pushing a button, the CT-50 will automatically place the decimal point in all modes, giving you quick, reliable readings. Want to use the CT-50 mobile? No problem, it runs equally as well on 12 V dc as it does on 110 V ac. Want super accuracy? The CT-50 uses the popular TV color burst freq. of 3.579545 MHz for time base. Tap off a color TV with our adapter and get ultra accuracy — .001 ppm! The CT-50 offers professional quality at the unheard of price of \$79.95. Order yours today!

- CT-50, 60 MHz counter kit \$79.95
- CT-50 WT, 60 MHz counter, wired and tested 159.95
- CT-600, 600 MHz prescaler option for CT-50, add 29.95

SPECIFICATIONS

- Sensitivity: less than 25 mv.
- Frequency range: 5 Hz to 60 MHz, typically 65 MHz
- Gatettime: 1 second, 1/10 second, with automatic decimal point positioning on both direct and prescale
- Display: 8 digit red LED .4" height
- Accuracy: 10 ppm, .001 ppm with TV time base!
- Input: BNC, 1 megohm direct, 50 Ohm with prescale option
- Power: 110 V ac 5 Watts or 12 V dc @ 1 Amp
- Size: Approx. 6" x 4" x 2", high quality aluminum case

Color burst adapter for .001 ppm accuracy

CB-1, kit \$14.95

MINI-KITS

tone decoder kit

A complete tone decoder on a single PC Board. Features: 400-5000 Hz adjustable frequency range, voltage regulation, 567 IC. Useful for touch-tone decoding, tone burst detection, FSK demod, signaling, and many other uses. Use 7 for 12 button touchtone decoding. Runs on 5 to 12 volts.
Complete Kit, TD-1 \$4.95



SUPER-SNOOP AMPLIFIER

A super-sensitive amplifier which will pick up a pin drop at 15 feet! Great for monitoring baby's room or as a general purpose test amplifier. Full 2 watts of output, runs on 6 to 12 volts, uses any type of mike. Requires 8-45 ohm speaker.
Complete Kit, BN-9 \$4.95

FM WIRELESS MIKE KIT

Transmit up to 300' to any FM broadcast radio, uses any type of mike. Runs on 3 to 9 V. Type FM-2 has added super sensitive mike preamp.
FM-1 \$2.95 FM-2 \$4.95

COLOR ORGAN/MUSIC LIGHTS

See music come alive! 3 different lights flicker with music or voice. One light for lows, one for the mid-range and one for the highs. Each channel individually adjustable, and drives up to 300 watts. Great for parties, band music, nite clubs and more.
Complete Kit, ML-1 \$7.95

LED BLINKY KIT

A great attention getter which alternately flashes 2 Jumbo LEDs. Use for name badges, buttons, or warning type panel lights. Runs on 3 to 9 volts.
Complete Kit \$2.95

POWER SUPPLY KIT

Complete triple regulated power supply provides variable 15 volts at 200 mA and +5 volts at 1 Amp. 50 mV load regulation good filtering and small size. Kit less transformers. Requires 6-8 V at 1 Amp and 18 to 30 VCT.
Complete Kit, PS-3LT \$6.95



SIREN KIT

Produces upward and downward wail characteristic of police siren. 5 watts audio output, runs on 3-9 volts, uses 8-45 ohm speaker.
Complete Kit, SM-3 \$2.95

DECADE COUNTER PARTS

Includes: 7490A, 7475, 7447, LED readout, current limit resistors, and instructions on an easy to build low cost frequency counter.
Kit of parts, DCU-1 \$3.50



CLOCK KIT 6 digit 12/24 hour

Want a clock that looks good enough for your living room? Forget the competitor's kludges and try one of ours! Features: jumbo .4" digits, Polaroid lens filter, extruded aluminum case available in 5 colors, quality PC boards and super instructions. All parts are included, no extras to buy. Fully guaranteed. One to two hour assembly time. Colors: silver, gold, black, bronze, blue (specify).

- Clock kit, DC-5 \$22.95
- Alarm clock, DC-8, 12 hr only 24.95
- Mobile clock, DC-7 25.95
- Clock kit with 10 min ID timer, DC-10 ... 25.95
- Assembled and tested clocks available, add \$10.00

CHEAP CLOCK KIT \$8.95

- DC-4 Features: Does not include board or transformer
- 6 digit .4" LED
- 12 or 24 format
- PC Board \$2.95
- Transformer \$1.49

VIDEO TERMINAL KIT \$149.95

A compact 5 x 10-inch PC card that requires only an ASCII keyboard and a TV set to become a complete interactive terminal for connection to your microprocessor asynchronous interface. Its many features are single 5-volt supply, crystal-controlled sync and baud rates up to 9600 baud, 2 pages of 32 characters by 16 lines, read to and from memory, computer and keyboard-operated cursor and page control, parity error display and control, power-on initialization, full 64-character ASCII display, block-type see-thru cursor. Keyboard/computer control backspaces, forward spaces, line feeds, rev. line feeds, home, returns cursor. Also clears page, clears to end of line, selects page 1 or 2, reads from or to memory. The card requires 5 volts at approx. 900 ma and outputs standard 75 ohm composite video.

- TH3216 Kit \$149.95
- TH3216, Assembled and Tested 239.95
- VD-1, Video to RF Modulator Kit 6.95

CAR CLOCK KIT \$27.95



- 12/24-Hour 12-Volt AC or DC
- High Accuracy (1 minute/month)
- 6 jumbo .4" LED readouts
- Easy, no-polarity hookup
- Display blanks with ignition
- Case, mounting bracket included
- Super instructions
- Complete Kit, DC-11 \$27.95
- AUTO-DIMMER \$2.50
- Automatically adjusts display brightness according to ambient light level. For DC-11 Car Clock.

600 MHz PRESCALER



Extend the range of your counter to 600 MHz. Works with all counters. Less than 150 mv sensitivity. Specify 10 or 100. Wired, tested, PS-1B \$59.95
Kit, PS-1B \$44.95

30 watt 2 meter Power Amp

The famous RE class C power amp now available mail order! Four Watts in for 30 Watts out, 2 in for 15 out, 1 in for 8 out, incredible value, complete with all parts, instructions and details on T-R relay. Case not included.
Complete Kit, PA-1 \$22.95

CALENDAR ALARM CLOCK

Has every feature one could ever ask for. Kit includes everything except case, build it into wall, station or even car!
FEATURES:
● 6 Digits, .5" High LED ● 12/24 Hour Format
● Calendar shows mo./day ● Snooze button
● True 24 Hour Alarm ● 7001 chip does all!
● Battery back up with built-in on chip time base
Complete Kit, less case, DC-9 \$34.95

LINEAR		REGULATOR		TRANSISTORS	
5314 Clock	\$2.95	555	\$.50	78MG	\$1.49
74S00	.35	556	.75	309k	.89
74S112	.75	566	1.49	309H	.99
7447	.79	567	1.49	340K-12	.99
7473	.35	1458	.50	7805	.89
7475	.50	LED DRIVER		7812	.89
7490A	.55	75491	.50	7815	.89
74143	3.50	75492	.50	7818	.89

DIODES: 1KV,2.5A 5/\$1.00 100V,1A 10/\$1.00 1N914A type 50/\$2.00

LED DISPLAYS



- FND 35975
- FND 510 1.25
- DL 707 1.25
- HP 7730 1.25

Red Polaroid Filter ... 4.25" X 1.125"59

741 OP-AMP SPECIAL

Factory prime mini dip with both Xerox and 741 part numbers
10 for \$2.00

SOCKETS

- 14 PIN 5/\$1.00
- 16 PIN 5/\$1.00
- 24 PIN 2/\$1.00
- 40 PIN 3/\$2.00

FERRITE BEADS

- with info and specs
- 15/\$1.00
- 6 hole Balun Beads
- 5/\$1.00

ramsey electronics

P.O. Box 4072 Rochester NY 14610

(716) 271-6487

TELEPHONE ORDERS WELCOME

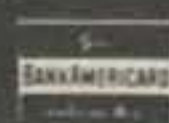

Satisfaction guaranteed or money refunded. C.O.D. add \$1.00. Orders under \$10.00 add \$.75. NY residents add 7% tax.

ADVA

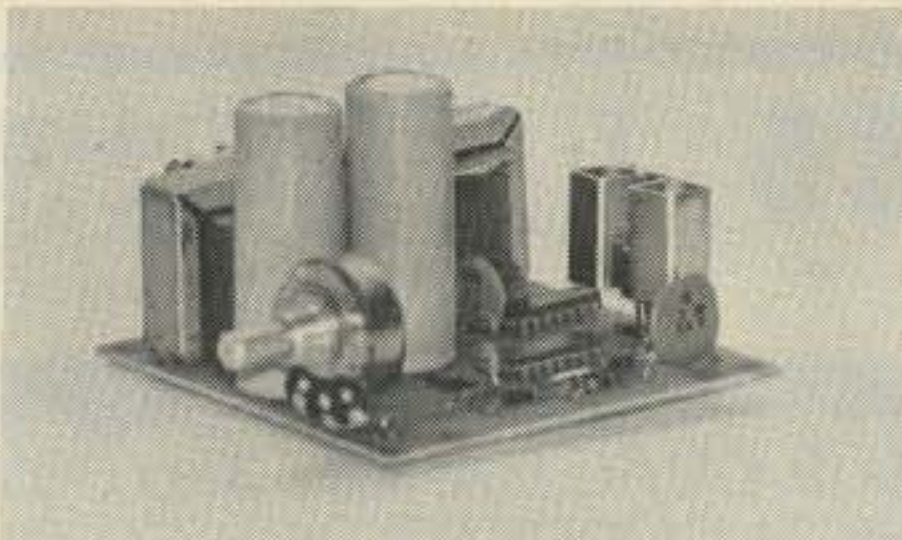

KIT \$11⁹⁵

ASSEMBLED \$17.95
ADD \$1.25 FOR
POSTAGE/HANDLING

VARIABLE POWER SUPPLY

- Continuously Variable from 2V to over 15V
- Short-Circuit Proof
- Typical Regulation of 0.1%
- Electronic Current Limiting at 300mA
- Very Low Output Ripple
- Fiberglass PC Board Mounts All Components
- Assemble in about One Hour
- Makes a Great Bench or Lab Power Supply
- Includes All Components except Case and Meters

OTHER ADVA KITS:

LOGIC PROBE KIT—Use with CMOS, TTL, DTL, RTL, HTL, HINIL and most MOS IC's. Built-in protection against polarity reversal and overvoltage. Draws only a few mA from circuit under test. Dual LED readout. Complete kit includes case and clip leads. **ONLY \$7.85**

FIXED REGULATED POWER SUPPLY KITS—Short-circuit proof with thermal current limiting. Compact size and typical regulation of 0.5% make these ideal for most electronic projects. Available for 5V @ 500mA, 6V @ 500mA, 9V @ 500mA, 12V @ 400mA, 15V @ 300mA. Specify voltage when ordering. **\$8.95 ea.**

These easy-to-assemble kits include all components, complete detailed instructions and plated fiberglass PC boards. Power supply kits do not include case or meters. Add \$1.25 per kit for postage and handling.

MAIL NOW! FREE DATA SHEETS supplied with many items from this ad. **FREE ON REQUEST**—741 Op Amp with every order of \$5 or more—749 Dual Op Amp or two E100 FET's with every order of \$10 or more, postmarked prior to 3/31/77. One free item per order. **ORDER TODAY**—All items subject to prior sale and prices subject to change without notice. All items are new surplus parts—100% functionally tested.

WRITE FOR FREE CATALOG #76 offering over 350 semiconductors carried in stock. Send 13¢ stamp.

TERMS: Send check or money order (U.S. funds) with order. We pay 1st Class postage to U.S., Canada and Mexico (except on kits). \$1.00 handling charge on orders under \$10. Calif. residents add 6% sales tax. Foreign orders add postage. COD orders—add \$1.00 service charge.

MORE SPECIALS:

RC4195DN ±15V @ 50mA VOLTAGE REGULATOR IC. Very easy to use. Makes a neat Highly Regulated ±15V Supply for OP AMP's, etc. Requires only unregulated DC (18-30V) and 2 bypass capacitors. With Data Sheet and Schematics. 8-pin mDIP **\$1.25**

LM741 FREO COMPENSATED OP AMP. μA741, MC1741, etc. mDIP 5/S1 **3/\$1**

MC1458 DUAL 741 OP AMP mDIP **3/\$1**

RC4558 DUAL 741 OP AMP mDIP **3/\$1**

2N3904 NPN TRANSISTOR AMPLIFIER/SWITCH to 50 mA β100 **6/\$1**

ZENERS—Specify Voltage 3.3, 3.9, 4.3, 5.1, 6.8, 8.2 400mW **4/\$1.00**

9.1, 10, 12, 15, 16, 18, 20, 22, 24, 27, or 33V (±10%) 1 Watt **3/\$1.00**

- MONEY-BACK GUARANTEE
- ALL TESTED AND GUARANTEED

ADVA ELECTRONICS
BOX 4181 K, WOODSIDE, CA 94062
Tel. (415) 851-0455

FREE

IC or FET's WITH
\$5 & \$10 ORDERS.†
DATA SHEETS
WITH MANY ITEMS.

DIODES ZENERS & RECTIFIERS	TRANSISTORS	TRANSISTORS	TRANSISTORS	LINEAR IC's
1N456 to 6/S1	2N706 \$0.24	2N4091 3/S1	2N5638 2/S1	LM340K-5 \$1.75
1N458 6/S1	2N718 .24	2N4092 \$0.75	2N5640 2/S1	LM340T-5 1.75
1N483 to 6/S1	2N720 .48	2N4121 3/S1	CP643 \$4.00	LM340T-6 1.75
1N486 6/S1	2N918 3/S1	2N4122 3/S1	CP650* \$5.00	LM340T-12 1.75
1N746 to 4/S1	2N1613 \$0.29	2N4124 5/S1	CP651 \$4.00	LM340T-15 1.75
1N750 4/S1	2N1711 .29	2N4248 5/S1	E100 4/S1	LM340T-24 1.75
1N914* 15/S1	2N1890 .38	2N4249 5/S1	E101 3/S1	LM376N* .55
1N962 to 4/S1	2N1893 .38	2N4250 4/S1	E102 3/S1	LM377N 2.50
1N974 4/S1	2N2219 .24	2N4274 5/S1	E175 3/S1	LM380N 1.29
1N3064 6/S1	2N2222 6/S1	2N4302 \$0.29	MPF102 to* 3/S1	NE555V* 2/\$1
1N3600 6/S1	2N2222A* 5/S1	2N4303 .29	MPF104 3/S1	NE556A \$0.90
1N4001* 12/S1	2N2369 5/S1	2N4338 \$1	MPF112 4/S1	LM709CN .29
1N4003 12/S1	2N2606 to \$2	2N4360M 2/S1	MPS6515 3/S1	LM709CN .29
1N4004 12/S1	2N2905 \$0.24	2N4391 \$1	SE1001 4/S1	LM723N 2/\$1
1N4005 10/S1	2N2905A .24	2N4392 \$0.90	SE1002 4/S1	LM723N* 3/\$1
1N4006 10/S1	2N2907* 5/S1	2N4416 2/S1	SE2001 4/S1	LM739N \$1.00
1N4148 15/S1	2N3553 \$1.50	2N4416A \$0.80	SE2002 4/S1	LM741CH 3/\$1
1N4154* 25/S1	2N3553 6/S1	2N4856 to \$1	SE5001 to 3/S1	LM741CN* 4/\$1
1N4370 to 2/S1	2N3563 6/S1	2N4861 \$1	SE5003 3/S1	LM741CN14 .34
1N4372 2/S1	2N3564 4/S1	2N4867E 2/S1	SE5020 \$3.00	LM747CN .65
1N4454 15/S1	2N3565 to 6/S1	2N4868E 2/S1	TIS73 to 3/S1	748C DIP .35
1N4728 to 3/S1	2N3568 6/S1	2N4881 \$2.50	TIS75 3/S1	749C DIP 1.00
1N5231 to 4/S1	2N3638 6/S1	2N4888 \$1	DIGITAL IC's	844CP mDIP .80
1N5236 4/S1	2N3638A 5/S1	2N4965 3/S1	MM5738N \$2.95	LM1304N 1.15
D5 144MHz \$5	2N3641 5/S1	2N5007 4/S1	SN7400N .16	LM1458N* 3/\$1
F7 432MHz \$5	2N3642 5/S1	2N5088 4/S1	SN7410N .16	LM2111N \$1.40
MV30 to \$1	2N3643 6/S1	2N5126 to 6/S1	SN7420N .16	XR2556CP 1.55
MV32 to \$1	2N3644 4/S1	2N5135 5/S1	SN7440N .16	2740DE 1.85
MV1620 to \$1	2N3646 4/S1	2N5138 5/S1	SN7451N .18	CA3028A 1.75
MV1634 \$1	2N3688 to 3/S1	2N5163 3/S1	SN7473N .36	CA3046 .84
MV1866 to \$2	2N3690 3/S1	2N5197 \$5.00	SN7475N .48	LM3075N1 1.45
MV1872 \$2	2N3691 to 4/S1	2N5199 2.50	SN7476N .35	CA3086* .55
MV2201 to \$1	2N3821 \$0.80	2N5210 3/S1	SN7490N .44	LM3900N .55
MV2205 \$1	2N3822 .70	2N5308 2/S1	LINEAR IC's	RC4194TK* 2.50
	2N3823 40	2N5397 \$1.50	LM100H \$7.50	RC4195DN* 1.25
	2N3866 75	2N5432 1.90	LM301AN .27	RC4195TK* 2.25
	2N3903 to* 6/S1	2N5457 3/S1	LM307H .27	LM4250CN 2.00
	2N3906 6/S1	2N5458 \$0.38	LM308N .88	LM4558DN .55
	2N3919 \$5.00	2N5484 3/S1	LM309K 1.25	NE555V .95
	2N3922 5.00	2N5486 2/S1	LM311N .90	NE556V .50
	2N3954 3.20	2N5543 \$3.00	LM320K-5 1.35	μA7805UC 1.25
	2N3958 1.15	2N5544 2.50	LM320K-12 1.35	8038 DIP* .35
	2N3970 1.00	2N5561 12.00	LM320K-15 1.35	DM75492 .80

***SUPER SPECIALS:**

1N914 100V/10mA Diode 20/S1	MPF102 200MHz RF Amp 3/\$1
1N4001 100V/1A Rect. 15/S1	40673 MOSFET RF Amp \$1.75
1N4154 30V 1N914 25/S1	LM324 Quad 741 Op Amp .94
BR1 50V 1/2A Bridge Rec 4/S1	LM376 Pos Volt Reg mDIP .55
2N2222A NPN Transistor 6/S1	NE555 Timer mDIP 2/\$1
2N2907 PNP Transistor 6/S1	LM723 2-37V Reg DIP 3/\$1
2N3055 Power Xistor 10A .69	LM741 Comp Op Amp mDIP 4/\$1
2N3904 NPN Amp/Sw β100 6/S1	LM1458 Dual 741 mDIP 3/\$1
2N3906 PNP Amp/Sw β100 6/S1	CA3086 5 Trans Array DIP .55
CP650 Power FET 1/2Amp \$5	RC4195DN ±15V/50mA mDIP 1.25
RF391 RF Power Amp Transistor 10-25W @ 3-30MHz TO-3 \$5.00	
555X Timer 1μs-1hr Different pinout from 555 (w/data) 3/\$1	
RC4194TK Dual Tracking Regulator ±0.2 to 30V @ 200mA TO-66 \$2.50	
RC4195TK Dual Tracking Regulator ±15V @ 100mA (TO-66) \$2.25	
8038 Waveform Generator ~11A Wave With Circuits & Data \$3.75	

SPECIALS — THIS MONTH ONLY

1N34	Germanium Diode 60V 10mA	10/\$1
1N6263	Hot Carrier Diode (HP2800, etc.)	\$1.00
2N918	UHF Transistor—Osc/Amp up to 1 GHz	4/\$1
2N3866	UHF Transistor—1 Watt at 432 MHz	\$0.75
RCA29	NPN Power Amp/Switch 30W TO-220	.70
LM741	Compensated Op Amp mDIP or DIP	6/\$1
LM1304	FM Multiplex Stereo Demodulator	\$0.99
LM2111	FM IF Amp/Limiter/Detector	.99
CA3028A	RF/IF Amplifier DC to 120 MHz	1.45
RC4136	Quad 741 Op Amp—Low-Noise	.95
LP-10	LOGIC PROBE Kit—TTL, CMOS, etc.	\$7.85
	(See Above — "OTHER ADVA KITS")	

ADVA

ELECTRONICS

BOX 4181 K
WOODSIDE, CA 94062
Tel. (415) 851-0455

A24

BULLET ELECTRONICS

P. O. BOX 19442E
DALLAS, TEXAS 75219
(214) 823-3240

B8

PHONE ORDERS ON MASTERCARD OR VISA CARDS

New! PS-14 HIGH CURRENT REGULATED POWER SUPPLY KIT

A low cost, no frills, heavy duty power supply. Designed for use and abuse!

12V @ 15A

Less Case, meters & jacks

- * Better than 200MV load and line regulation
- * Foldback Current Limiting
- * Short Circuit Protected
- * Thermal Shutdown
- * Adjustable Current Limiting
- * Less than 1% ripple.
- * 15 amps 11.5 to 14.5V
- * All parts supplied including heavy duty transformer.
- * Quality plated fiberglass PC board.

\$35.00
UPS SHIPPING PAID!

PS-12 DUAL RANGE 3 to 30V VARIABLE HIGH CURRENT POWER SUPPLY KIT

Less case, meters & jacks.

ALL THE FEATURES OF THE PS-14 PLUS:
Continuously variable from 3-15 and 14-30 volts, (2 ranges)

\$49.95

Note the PS-12 DOES NOT have thermal shutdown. Canadian orders include \$10.00 for shipping and insurance

UPS Shipping Paid!

OVERVOLTAGE PROTECTION KIT

Provides cheap insurance for your expensive equipment. Trip voltage is adjustable from 3 to 30 volts. Overvoltage instantly fires a 25A SCR and shorts the output to protect equipment. Should be used on units that are fused. Directly compatible with the PS-12 and PS-14. All electronics supplied. Drilled and plated PC board. (Order OVP-1)

\$6.95

A COMPLETE CAPACITOR DISCHARGE IGNITION KIT for **\$9.95**

You get all the electronics less the case and heat-sinks.

SPECIAL SALE! The response to our anniversary sale on CDI's was fantastic so here goes again...WHILE THEY LAST...Buy two CDI kits for \$9.95 each, get the third CDI kit for \$1.00!

2N6283 MOTOROLA HOUSE # DEVICE

\$1.00

20amp NPN Darlington with Hfe of over 5,000! VCE of 80V. Outperforms MJ3001 and MJ1000 devices. TO-3. Limited Qty.!

MK-05 MINI MOBILE CLOCK

The smallest and best priced mobile clock kit on the market. Designed to be a mobile clock from the ground up. There has been no compromise on quality.

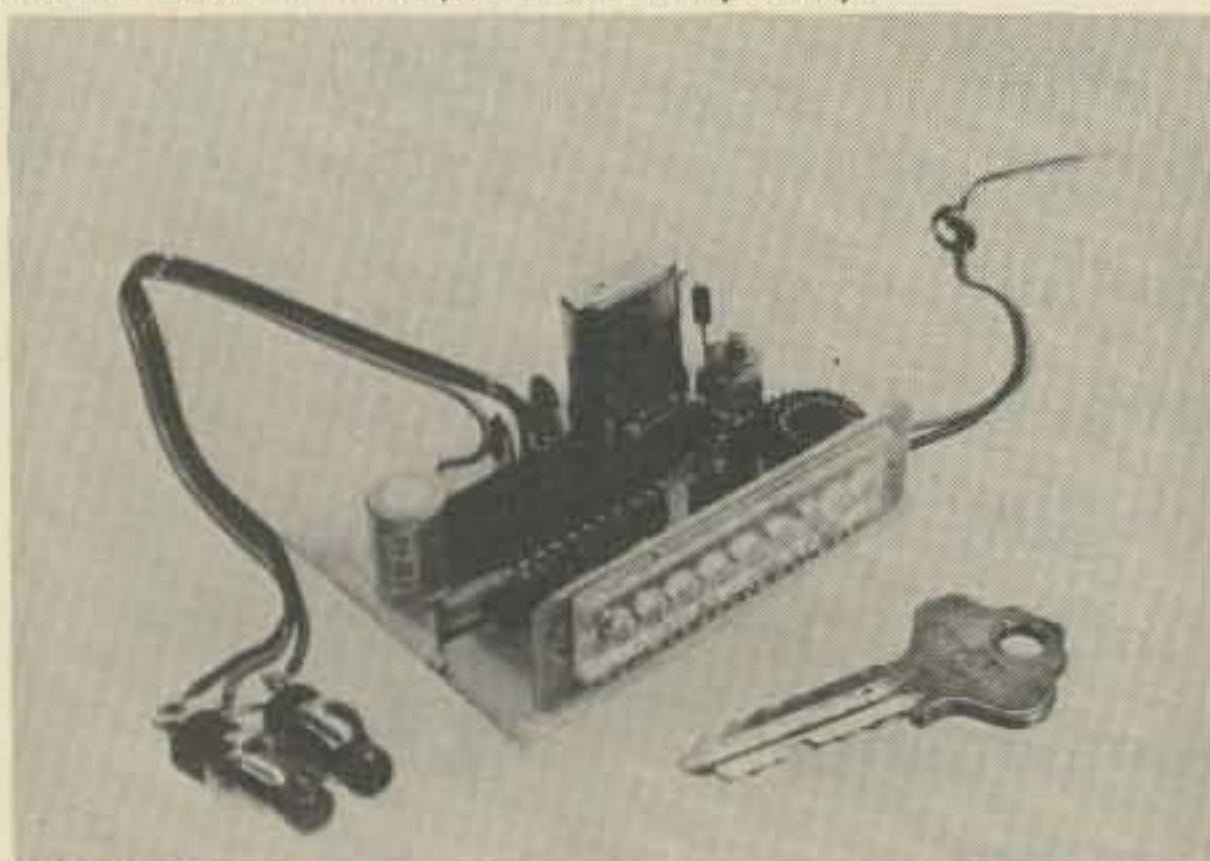

FEATURES:

- * Quartz crystal timebase
- * Toroid & zener noise & overvoltage protection.
- * Magnified .15", 6 digit LED readout.
- * Complete with presettable 24 hr. alarm.
- * 9-14 VDC @ 40 to 50 ma.
- * Readouts can be suppressed
- * EASY, QUICK ASSEMBLY
- * All components required included (you supply the speaker).
- * Top quality drilled and plated PC boards.

\$12.95

Small enough to mount in the instrument panel!

Clock board: 2.6" x 2"
Readout board: 2 3/8" x .75"

LM340-12 HOUSE # DEVICE TO-3

1 amp voltage regulator WITH SPECS. Built-in thermal and overvoltage protection.

89¢

CA3011 RCA's HIGH GAIN WIDE BAND IC IF AMP.

75 DB gain, 100 KHZ to over 20MHZ 10 lead TO-5 can. With Specs.

5 for \$2.00

MC1351P FM IF, LIMITER, DISCRIMINATOR

AND AF PREDRIVER IC IN A STAGGERED LEAD DIP PAK.

5 for \$3.00

MINI ELECTRONIC GRANDFATHER CLOCK KIT

Complete Electronics!

- * Chimes the hour (ie: 3 times for 3 O'clock)
- * Unique "swinging" LED pendulum
- * Tick tock sound matches pendulum swing.
- * Large 4 digit .5" LED readout
- * All CMOS construction
- * Complete electronics including transformer & speaker; drilled and plated PC boards measure 4.5" x 6.5"

\$39.95

BEAUTIFUL SOLID WALNUT

Custom case for above kit. Over 9 3/4" tall. **\$19.95**

- * No COD'S.
- * Send check or MO
- * MasterCard or VISA accepted.
- * Texas Residents add 5% sales tax.

- * Foreign orders add 10% (20% airmail)
- * Catalog included with each order
- * Orders over \$50. take 10% discount.

SPECIAL

All Phone Orders over \$10. from this ad will receive a FREE Warble Alarm Kit (\$2.50 value), during September.



NEW LSI TECHNOLOGY

FREQUENCY COUNTER

TAKE ADVANTAGE OF THIS NEW STATE-OF-THE-ART COUNTER FEATURING THE MANY BENEFITS OF CUSTOM LSI CIRCUITRY. THIS NEW TECHNOLOGY APPROACH TO INSTRUMENTATION YIELDS ENHANCED PERFORMANCE, SMALLER PHYSICAL SIZE, DRASTICALLY REDUCED POWER CONSUMPTION [PORTABLE BATTERY OPERATION IS NOW PRACTICAL], DEPENDABILITY, EASY ASSEMBLY AND REVOLUTIONARY LOWER PRICING!

- KIT#FC-50C 60 MHZ COUNTER WITH CABINET & P.S.
- KIT#PSL-650 650 MHZ PRESCALER [NOT SHOWN] 29.95
- MODEL#FC-50WT 60 MHZ COUNTER WIRED, TESTED & CAL. 165.95
- MODEL#FC-50/600WT. . . 600 MHZ COUNTER WIRED, TESTED & CAL. 199.95

\$119⁹⁵ COMPLETE!

SIZE:
3" High
6" Wide
5 1/2" Deep

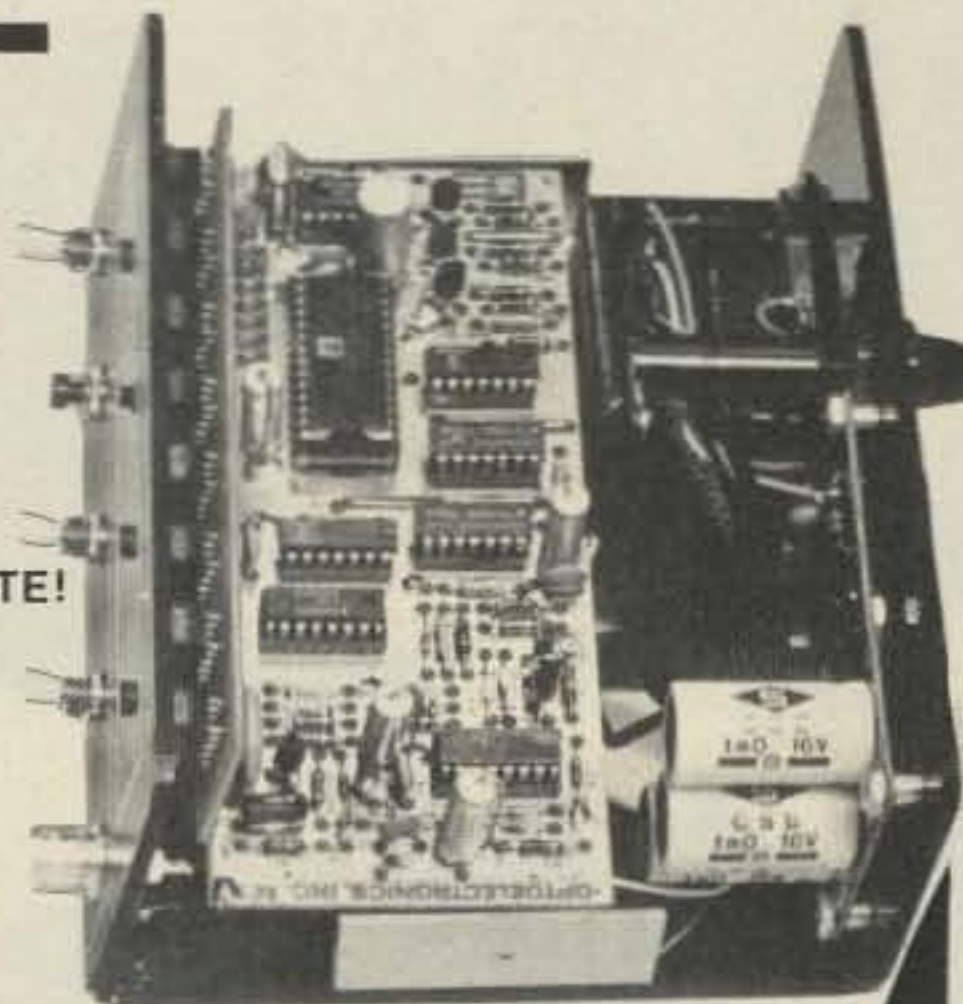

FEATURES AND SPECIFICATIONS:

DISPLAY: 8 RED LED DIGITS .4" CHARACTER HEIGHT
 GATE TIMES: 1 SECOND AND 1/10 SECOND
 PRESCALER WILL FIT INSIDE COUNTER CABINET
 RESOLUTION: 1 HZ AT 1 SECOND, 10 HZ AT 1/10 SECOND.
 FREQUENCY RANGE: 10 HZ TO 60 MHZ. [65 MHZ TYPICAL].
 SENSITIVITY: 10 MV RMS TO 50 MHZ, 20 MV RMS TO 60 MHZ TYP.
 INPUT IMPEDANCE: 1 MEGOHM AND 20 PF.
 [DIODE PROTECTED INPUT FOR OVER VOLTAGE PROTECTION.]
 ACCURACY: ± 1 PPM [± .0001%]; AFTER CALIBRATION TYPICAL.
 STABILITY: WITHIN 1 PPM PER HOUR AFTER WARM UP [.001% XTAL]
 IC PACKAGE COUNT: 8 [ALL SOCKETED]
 INTERNAL POWER SUPPLY: 5 V DC REGULATED.
 INPUT POWER REQUIRED: 8-12 VDC OR 115 VAC AT 50/60 HZ.
 POWER CONSUMPTION: 4 WATTS

KIT #FC-50C IS COMPLETE WITH PREDRILLED CHASSIS ALL HARDWARE AND STEP-BY-STEP INSTRUCTIONS. WIRED & TESTED UNITS ARE CALIBRATED AND GUARANTEED.

OPTOELECTRONICS, INC. FC-50



PLEXIGLAS CABINETS

Great for Clocks or any LED Digital project. Clear-Red Chassis serves as Bezel to increase contrast of digital displays.

- CABINET I**
3"H, 6 1/4"W, 5 1/2"D Black, White or Clear Cover
 - CABINET II**
2 1/2"H, 5"W, 4"D \$6.50 ea.
- RED OR GREY PLEXIGLAS FOR DIGITAL BEZELS
3"x6"x1/8" 95¢ ea. 4/*3

SEE THE WORKS Clock Kit Clear Plexiglas Stand

- 6 Big .4" digits
- 12 or 24 hr. time
- 3 set switches
- Plug transformer
- all parts included

Plexiglas is Pre-cut & drilled
Kit #850-4 CP

Size: 6"H, 4 1/2"W, 3"D
Assembled \$23⁵⁰ ea. 2/*45. \$29⁹⁵

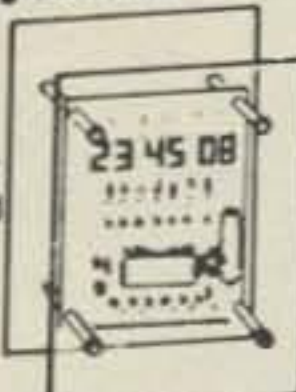

60 HZ. XTAL TIME BASE

Will enable Digital Clock Kits or Clock-Calendar Kits to operate from 12V DC.
 1"x2" PC Board
 Power Req: 5-15V (2.5 MA. TYP.)
 Easy 3 wire hookup
 Accuracy: ± 2PPM
 #TB-1 (Adjustable)
 Complete Kit \$4⁹⁵
 Wir & Cal \$9.95

SPECIAL PRICING! PRIME - HIGH SPEED RAM

21L02-3 400 NS
 LOW POWER - FACTORY FRESH

1-24	\$1.75 ea.	100-199	\$1.45 ea.
25-99	1.60 ea.	200-999	1.39 ea.
1000 AND OVER		\$1.29 ea.	

6-DIGIT LED CLOCK CALENDAR KIT DATE-TIME-SNOOZE ALARM & MORE... KIT 7001

FOR THE BUILDER THAT WANTS THE BEST. FEATURING 12 OR 24 HOUR TIME - 29-30-31 DAY CALENDAR. ALARM, SNOOZE AND AUX. TIMER CIRCUITS

Will alternate time (8 seconds) and date (2 seconds) or may be wired for time or date display only, with other functions on demand. Has built-in oscillator for battery back-up. A loud 24 hour alarm with a repeatable 10 minute snooze alarm, alarm set & timer set indicators. Includes 110 VAC/60Hz power pack with cord and top quality components through-out.

- KIT - 7001B WITH 6 - .5" DIGITS \$39.95
- KIT - 7001C WITH 4 - .6" DIGITS & 2 - .3" DIGITS FOR SECONDS \$42.95
- KIT - 7001X WITH 6 - .6" DIGITS \$45.95

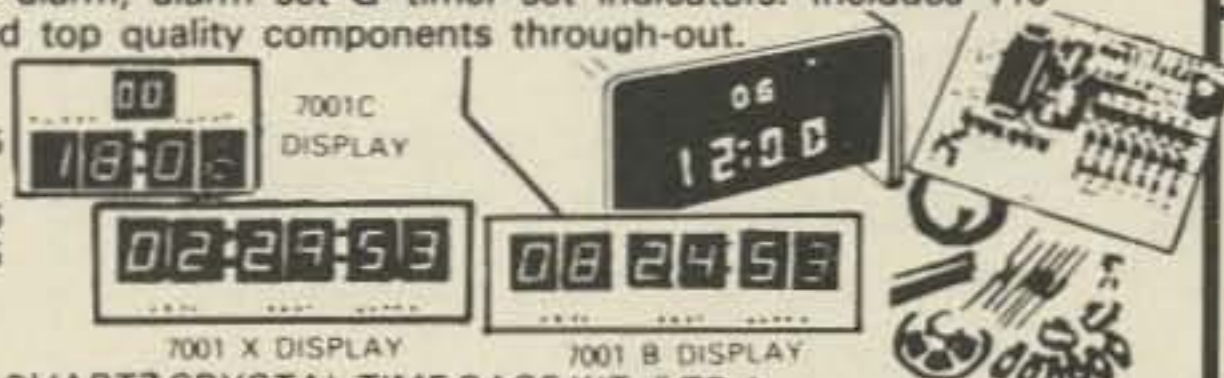

KITS ARE COMPLETE (LESS CABINET)

ALL 7001 KITS FIT CABINET I AND ACCEPT QUARTZ CRYSTAL TIME BASE KIT # TB-1

PRINTED CIRCUIT BOARDS for CT-7001 Kits sold separately with assembly info. PC Boards are drilled Fiberglass, solder plated and screened with component layout.

Specify for 7001

B, C or X - \$7.95

AUTO BURGLAR ALARM KIT

AN EASY TO ASSEMBLE AND EASY TO INSTALL ALARM PROVIDING MANY FEATURES NOT NORMALLY FOUND. KEYLESS ALARM HAS PROVISION FOR POS & GROUNDING SWITCHES OR SENSORS WILL PULSE HORN RELAY AT 1HZ RATE OR DRIVE SIREN. KIT PROVIDES PROGRAMMABLE TIME DELAYS FOR EXIT, ENTRY & ALARM PERIOD. UNIT MOUNTS UNDER DASH - REMOTE SWITCH CAN BE MOUNTED WHERE DESIRED CMOS RELIABILITY RESISTS FALSE ALARMS & PROVIDES FOR ULTRA DEPENDABLE ALARM. DON'T BE FOOLED BY LOW PRICES! THIS IS A TOP QUALITY COMPLETE KIT WITH ALL PARTS INCLUDING DETAILED DRAWINGS AND INSTRUCTIONS OR AVAILABLE WIRED AND TESTED



KIT #ALR-1 \$9.95
#ALR-1WT WIRED & TESTED \$19.95

VARIABLE REGULATED 1 AMP POWER SUPPLY KIT

- VARIABLE FROM 4 to 14V
 - SHORT CIRCUIT PROOF
 - 723 IC REGULATOR
 - 2N3055 PASS TRANSISTOR
 - CURRENT LIMITING AT 1 Amp
- KIT IS COMPLETE INCLUDING DRILLED & SOLDER PLATED FIBERGLASS PC BOARD AND ALL PARTS (Less TRANSFORMER) KIT#PS-01 \$8.95
 TRANSFORMER 24V CT will provide 300MA at 12V and 1 Amp at 5V. \$3.50

MOBILE LED CLOCK

12/24 HR .4" DIGITS!

MODEL 12 VOLT AC or #2001 DC POWERED

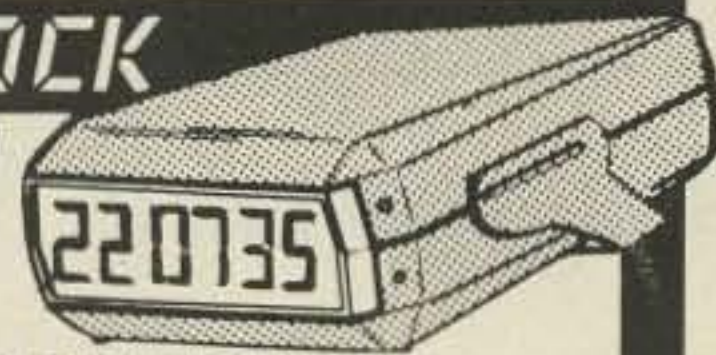

- 6 JUMBO .4" RED LED'S BEHIND RED FILTER LENS WITH CHROME RIM
- SET TIME FROM FRONT VIA HIDDEN SWITCHES • 12/24-Hr. TIME FORMAT
- STYLISH CHARCOAL GRAY CASE OF MOLDED HIGH TEMP. PLASTIC
- BRIDGE POWER INPUT CIRCUITRY - TWO WIRE NO POLARITY HOOK-UP
- OPTIONAL CONNECTION TO BLANK DISPLAY [Use When Key Off in Car, Etc.]
- TOP QUALITY PC BOARDS & COMPONENTS - INSTRUCTIONS.
- MOUNTING BRACKET INCLUDED

KIT #2001 \$27⁹⁵ 3 OR \$25⁹⁵ 115 VAC \$250
COMPLETE KIT EA. MORE ea. Power Pack #AC-1 EA.

ASSEMBLED UNITS WIRED & TESTED ORDER #2001 WT [LESS 9V. BATTERY] \$37⁹⁵ 3 OR \$35⁹⁵
Wired for 12-Hr. Op. if not otherwise specified. EA. MORE ea.

ORDER BY PHONE OR MAIL
COD ORDERS WELCOME

OPTOELECTRONICS, INC.

BOX 219 HOLLYWOOD, FLA. 33022
PHONE [305] 921-2056 / 921-4425

ORDERS TO USA & CANADA ADD 5% FOR SHIPPING, HANDLING & INSURANCE. ALL OTHERS ADD 10%. ADDITIONAL \$1.00 CHARGE FOR ORDERS UNDER \$15.00 - COD FEE \$1.00. FLA. RES. ADD 4% STATE TAX.



New!

Synthacoder



★ ALL NEW SYNTHESIZER/ENCODER FROM ENGINEERING SPECIALTIES
THE ULTIMATE IN FREQUENCY CONTROL FOR IC-22S OWNERS!

No more soldering diodes every time you want to try a new repeater!

Just plug the Synthacoder into the back of your radio, select channel 22, and the Synthacoder takes command of your radio — Giving you fingertip control of ALL frequencies.

- Front Panel Thumbwheel Control of All Channels!
- Fully Automatic Invalid Code Control!
- Small Size: 3¼" x 1½" x 6"
- Factory Wired and Tested
- Easy To Install

SPECIAL
only \$87.95
postpaid
CA Residents add 6% sales tax

Engineering Specialties

P.O. BOX 2233
1247 COMMERCIAL AVENUE
OXNARD CA 93030
(805) 486-0817

YES, I would like to purchase a Synthacoder for my IC-22S. Enclosed please find my \$87.95 (Price includes postage and handling). California residents add 6% sales tax.

\$_____ enclosed. Cash Check Money Order

Please charge my Master Charge BankAmericard

Credit card # _____

Interbank # _____

Expiration date _____

Signature _____

I'LL BITE! Please send more info.

I'M HOOKED! Please RUSH my Synthacoder.

Name _____

Call _____

Address _____

City _____

State _____

Zip _____

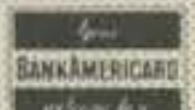

E12



ELECTRONICS

WE PAY POSTAGE!

P. O. Box 401247, Garland, Texas 75040 (214) 271-2461

16K E-PROM CARD

\$69.95 (KIT)

S-100 (1MSA1/ALTAIR) BUSS COMPATIBLE

IMAGINE HAVING 16K
OF SOFTWARE ON LINE AT ALL TIME!

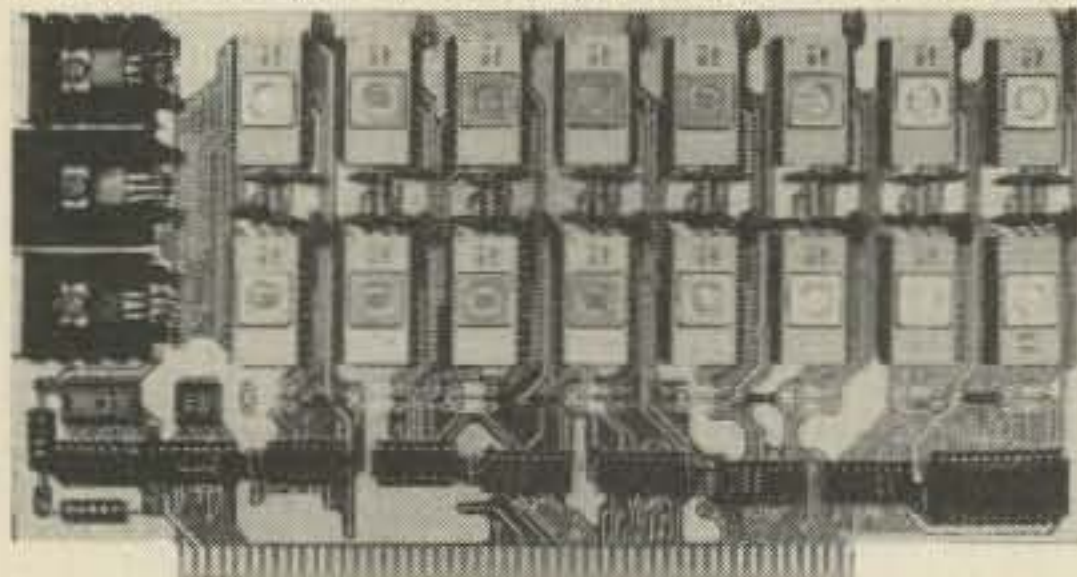

KIT FEATURES:

1. Double sided PC Board with solder mask and silk screen and Gold plated contact fingers.
2. Selectable wait states.
3. All address lines and data lines buffered!
4. All sockets included.
5. On card regulators.

USES
2708's!

DEALER INQUIRES INVITED

KIT INCLUDES ALL PARTS AND SOCKETS! (EXCEPT 2708's)

SPECIAL OFFER: Our 2708's (650 NS) are \$12.95 when purchased with above kit.

2708 1KX8 2708 EPROMS

Prime new units from a major U.S. mfg. 650 N. S. access time. Equivalent to four 1702A's in one package!

GOING INTO
BUSINESS
SALE!

\$15.75 each

8K LOW POWER RAM KIT

(S-100 BUSS COMPATIBLE)

\$149.00

(Kit of All
Parts and
Sockets)

The last word in RAM Kits. Uses 21L02-1 RAM's. All address and data lines fully buffered. PC Board is solder masked and silk screened and has gold plated contacts. Four regulators with heatsinks included.

OPCOA LED READOUT

SLA-1 Common Anode. .33 In. character size. The original high efficiency LED display.

\$.75 each
4 FOR \$2.50

741C OP AMPS

MINI DIP. Prime New Units. Has computer MFG's house number.

12 FOR \$2
100 FOR \$15

DISC CAPACITORS

.1 MFD 16 V. P.C. Leads Most Popular Value! P.C. Leads. By Sprague.

20 FOR \$1

TANTALUM CAPACITOR

1 MFD. 35 V. Kemet. Axial Lead. Best Value.

10 FOR \$1

T. I. ASCII CHARACTER GENERATOR

TMS 4103 JC. 28 PIN CER DIP. Has seven bit COLUMN Output for use with Matrix hard copy devices. With specs. **\$3.50**

MOTOROLA 7805R VOLTAGE REGULATOR

Same as standard 7805 except 750 MA OUTPUT. TO-220. 5VDC OUTPUT.

\$.44 each 10 FOR \$3.95

NATIONAL SEMI. MA1003 CAR CLOCK

Not a kit. Complete tested module. Works on 12 VDC, has on board time base. Sold by others at \$24.95. Big .30" Bright Green Digits. Same as used by Detroit in new cars.



\$19.95

EDGE CONNECTOR — \$1.50

1 AMP RECTIFIERS

House Numbered. Factory marked units. All meet 200 PIV minimum. Many up to 1,000 PIV!

30 FOR \$1 Full Leads

MPS-6566 - TO - 92

plastic. NPN.

VCEO-45 HFE 100 TO 400

10 FOR \$1

TRW POWER DARLINGTON

15 AMP 500V NPN. \$2 Each

HIGHSPEED SCR

TO-66 5 AMP 250 PIV. By Hutson. \$1.69 Each

TERMS: ORDERS UNDER \$15 ADD \$.75. NO C.O.D. WE ACCEPT VISA AND MASTER CHARGE CARDS. MONEY BACK GUARANTEE ON ALL ITEMS. TEXAS RESIDENTS ADD 5% SALES TAX.



ELECTRONICS

P. O. BOX 401247 • GARLAND, TEXAS 75040 • (214) 271-2461

D20

Did someone say "PARTS"?

CMOS

4000 dual 3 in NOR gate...	0.25
4001 quad 2 in NOR gate...	0.29
4002 dual 4 in NOR gate...	0.34
4007 dual comp pair+inv...	0.29
4008 4 bit full adder...	1.28
4009 inv hex buffer...	0.53
4010 noninv hex buffer...	0.53
4011 quad 2 in NAND gate...	0.29
4012 dual 4 in NAND gate...	0.29
4013 dual D FF w/ S and R...	0.50
4014 8 stage static SR...	1.23
4015 dual 4 stage stat SR...	0.90
4016 quad bilateral switch	0.45
4017 decade counter/div...	1.23
4019 quad AND/OR sel gate...	0.55
4020 14 stage binary cntr...	1.50
4021 8 stage static SR...	1.23
4022 ÷8 counter/divider...	1.20
4023 triple 3 in NAND...	0.29
4024 7 stage binary cntr...	1.03
4025 triple 3 in NOR gate...	0.29
4027 dual JK M-S FF...	0.75
4028 BCD to decimal decode	1.00
4029 presettable U/D cntr...	1.73
4030 quad EX-OR gate...	0.53
4033 decade counter/divid...	1.50
4037 triple AND/OR pairs...	0.50
4040 12 stage binary cntr...	1.50
4041 quad true/comp buffer	0.85
4042 quad clocked D latch...	0.85
4043 quad NOR R/S latch...	0.60
4044 quad NAND R/S latch...	0.60
4047 multivibrator...	1.63
4049 inv hex buffer...	0.50
4050 noninv hex buffer...	0.50
4051 8 ch multiplexer...	1.03
4052 dual 4 ch multiplexer	1.03
4053 triple 2 ch multiplex	1.03
4060 osc w/ 17 stge divide	1.48
4066 quad bilateral switch	0.58
4069/74C04 hex inverter...	0.33
4070 quad EX-OR gate...	0.60
4071 quad 2 in NOR gate...	0.33
4073 triple 3 in AND gate...	0.33
4075 triple 3 in OR gate...	0.33
4076/74C173 quad D FF...	1.63
4081 quad 2 in AND gate...	0.33
4116 fast quad bilat swit...	0.50
14511 binary to 7 seg drv	2.00

Low Power SCHOTTKY

74LS00.....	0.30
74LS01.....	0.30
74LS02.....	0.30
74LS04.....	0.33
74LS08.....	0.36
74LS10.....	0.30
74LS11.....	0.36
74LS12.....	0.33
74LS14.....	1.38
74LS15.....	0.30
74LS20.....	0.30
74LS21.....	0.33
74LS22.....	0.33
74LS26.....	0.43
74LS27.....	0.36
74LS30.....	0.30
74LS32.....	0.38
74LS37.....	0.45
74LS38.....	0.45
74LS42.....	0.98
74LS47.....	1.00
74LS48.....	1.00
74LS74.....	0.50
74LS75.....	0.68
74LS76.....	0.50

TERMS: Add 50¢ to orders under \$10. Please add 5% to cover shipping---more in the case of power supplies---excess refunded. We accept COD order if street address is included for UPS. To place BankAmericard®/VISA®/Mastercharge® orders (\$15 minimum) call our 24 hour order desk at (415) 562-0636.

74LS86.....	0.50
74LS109.....	0.50
74LS125.....	0.63
74LS126.....	0.63
74LS132.....	1.25
74LS138.....	1.10
74LS139.....	1.15
74LS151.....	0.95
74LS155.....	1.38
74LS157.....	0.95
74LS160.....	1.40
74LS161.....	1.40
74LS162.....	1.40
74LS163.....	1.40
74LS168.....	1.87
74LS169.....	1.87
74LS173.....	1.65
74LS174.....	1.25
74LS175.....	1.15
74LS240.....	1.88
74LS257.....	1.25
74LS258.....	1.25
74LS266.....	0.53
74LS283.....	1.20
74LS365/80LS95.....	0.75
74LS366/80LS96.....	0.75
74LS367/80LS97.....	0.75
74LS368/80LS98.....	0.75
74LS386.....	0.55
81LS95.....	1.13
81LS96.....	1.13
81LS97.....	1.13
81LS98.....	1.13

Transistors

2N2221 NPN unmarked TO-18..	7/51
2N2222 NPN unmarked TO-18..	5/51
2N2907A PNP hse # plastic..	5/51
2N3055 NPN TO-3 house #...	5/51
2N3904 NPN hse # TO-105...	7/51
2N3906 PNP hse # TO-105...	6/51
2N4400 NPN hse # plastic...	5/51
2N4917 PNP TO-106.....	5/51
2N4946 NPN TO-106.....	6/51
2N5449 NPN.....	6/51
D41D1 PNP TO-220 1A pwr...	\$0.50
TIP3055 tab case same as 2N3055	\$0.75
COMP PAIR TO-220 pkg. 5A Ic max	Hfe @ 3A 40 min. Bkdwn 40V \$1.50
2NRF-0 3 GHz RF power transistors for osc/amplifier applications. Guaranteed 100 mW out @ 1.5 GHz. TO-18 pkg.....	3/51.95
2NRF-1 2 GHz RF power transistor. Pout min @ 2 GHz 1.0W, Pin 310 mW, efficiency 30% @ 2 GHz. Similar to RCA 2N5470.....	\$4.95
2NRF-2 2 GHz RF power transistor. Pout 2.5W, Pd 8.7W, Pin 300 mW, efficiency 33%. Similar to RCA TA8407.....	\$5.95
2NRF-3 2 GHz RF power transistor. Pout 5.5W, Pd 21W, Pin 1.25W, efficiency 33%, similar to RCA 2N6269.....	\$6.95
2NRF-4 2 GHz RF power transistor. Pout 7.5W, Pd 29W, Pin 1.5W, efficiency 33%. Factory selected prime 2N6269.....	\$7.95

FET-1 dual NJFET VHF/UHF amp, TO-18.....	3/51
FET-2 NJFET VHF/UHF amp similar to 2N4416. TO-18.....	3/51
FET-3 dual NJFET low noise audio amp. TO-18.....	2/51
FET-4 general purpose NJFET. TO-18 package.....	4/51
FET-5 plug in replacement for 6AK5 tube.....	\$1.00

LINEARS

H=TO-99 M=minidip D=dip
K=TO-3 T=TO-220

201H tight spec 301.....	0.50
201M tight spec 301.....	0.50
301H op amp.....	0.30
301M op amp.....	0.30
304H negative regulator.....	0.75
305H positive regulator.....	0.75
308H fast op amp.....	1.00
308M op amp.....	1.00
309H +5V low current reg...	1.00
309K +5V 1A regulator.....	1.25
311H comparator.....	0.85
311M comparator.....	0.85
316H hi input Z op amp.....	2.50
318H fast op amp.....	1.00
320/12T -12V IA regulator..	1.75
324D quad op amp.....	1.50
339D single sup quad comp..	1.50
340/5T +5V 1A regulator....	1.35
340/6T +6V 1A regulator....	1.10
340/8K +8V 1A regulator....	1.50
340/8T +8V 1A regulator....	1.50
340/12T +12V 1A regulator..	1.35
340/15T +15V 1A regulator..	1.35
340/18K +18V 1A regulator..	1.35
340/24T +24V 1A regulator..	1.35
373D AM/FM/SSB IF detect...	1.95
377D dual 2W audio amp....	2.50
380D 2W audio amp.....	1.45
380M 1/2W audio amp.....	1.25
381D dual low noise preamp	1.65
382D dual low noise preamp	1.65
531M hi slew op amp.....	1.25
540H audio power driver....	2.75
555M timer.....	0.50
556D dual 555 timer.....	1.65
565D phase locked loop....	1.15
566M VCO w/ tri+sq out....	1.75
567M tone decode/PLL.....	1.85
723D precision regulator...	0.50
723H precision regulator...	0.60
725H instrumentation amp...	2.00
733H video amp.....	0.85
739D see 4739	
741H op amp.....	0.35
741M op amp.....	0.25
747D dual 741.....	0.70
748H uncompensated 741....	0.35
748M uncompensated 741....	0.35
1456/1556/5556M op amp....	1.50
1458M see 5558, 1558	
1496D balanced mod/demod...	0.90
1556H/1456M super op amp...	1.50
1556M/1456M super op amp...	1.50
1558 see 5558M	
1596 see 1496D	
3026H transistor array.....	1.25
3086D transistor array.....	0.75
4131H high gain op amp....	0.50
4136D quad lo noise amp....	1.95
4194D 50 mA bipolar regul...	1.50
4194TK 200 mA bipolar reg...	2.95
4195TK 200 mA bipolar reg...	2.25
4250H micropower op amp...	1.00
4558 see 1458	
4739D dual low noise amp...	1.65
4741H dual 741 op amp....	0.50
5556M see 1556M	
5558M dual 741 (see 1458)..	0.55

LED displays

LED-FND359 0.4" display	50¢ each; 10/\$4.00; 100/\$35.00
LED-FND503 0.5" common cath red display 95¢ ea.	10/\$8.50
LED-FND510 0.5" common anode red display 95¢ ea.	10/\$8.50
LED-FLV16 discrete LED approx .02". Red. Sim to 5020	6/\$1

Capacitors...

TANTALUM

CT0.47U	.47 uF 35V.....	4/\$1
CT2.2U	2.2 uF 20V.....	4/\$1
CT2.7U	2.7 uF 20V.....	4/\$1
CT3.3U	3.3 uF 15V.....	4/\$1
CT4.7U	4.7 uF 10V.....	4/\$1
CT22U	22 uF 10V.....	3/\$1
CT33U	33 uF 10V.....	3/\$1
CT39U	39 uF 10V.....	3/\$1
CT47U	47 uF 6V.....	3/\$1

disc

CD5pF	5 pF disc.....	10/0.50
CD43pF	43 pF disc.....	10/0.50
CD47pF	47 pF disc.....	10/0.50
CD68pF	68 pF disc.....	10/0.50
CD82pF	82 pF disc.....	10/0.50
CD.0027	.0027 uF 25V.....	10/0.50
CD.01	.01 uF 50V.....	10/0.75
CD.022	.022 uF 30V.....	10/0.75
CD.05	.05 uF 25V.....	10/1.00
CD.1	.1 uF 25V.....	10/1.25

TRIMMER

CV2/8P	2 - 8 pF.....	5/\$2
CV2.5/11P	2.5 - 11 pF.....	5/\$2
CV3/15P	3 - 15 pF.....	4/\$2
CV3.5/14P	3.5 pF - 14 pF...	4/\$2
CV4/12P	4 - 12 pF.....	4/\$2
CV5/25P	5 - 25 pF.....	4/\$2
CV5/30P	5 - 30 pF.....	4/\$2
CV5.5/18P	5.5 - 18 pF.....	4/\$2
CV6/30P	6 - 30 pF.....	4/\$2
CV7/25P	7 - 25 pF.....	4/\$2
CV8/50P	8 - 50 pF.....	3/\$2
CV9/35P	9 - 35 pF.....	3/\$2
CV9/45P	9 - 45 pF.....	3/\$2
CV15/60P	15 - 60 pF.....	3/\$2
Assortment of 10, no choice of values.....		10/\$2

mylar

CM.0039U	.0039 uF 50V.....	10/\$1
CM.005U	.005 uF 25V.....	10/\$1
CM.0068U	.0068 uF 50V.....	10/\$1
CM.01U	.01 uF 50V.....	10/\$1
CM.02U	.02 uF 50V.....	10/\$1
CM.022U	.022 uF 100V.....	10/\$1
CM.033U	.033 uF 50V.....	10/\$1
CM.047U	.047 uF 50V.....	10/\$1
CM.22U	.22 uF 50V.....	5/\$1
CM.33U	.33 uF 50V.....	4/\$1
CM2.0U	2.0 uF 200V.....	2/\$1
CM5.0U	5.0 uF 100V.....	2/\$1.50
CM10.0U	10.0 uF 100V.....	\$1.50

POLYSTYRENE

CP150P	150 pF PC mount..	10/\$1
CP180P	180 pF PC mount..	10/\$1
CP220P	220 pF PC mount..	10/\$1
CP270P	270 pF PC mount..	10/\$1
CP330P	330 pF PC mount..	10/\$1
CP390P	390 pF PC mount..	10/\$1
CP470P	470 pF PC mount..	10/\$1
CP560P	560 pF PC mount..	10/\$1
CP680P	680 pF PC mount..	10/\$1
CP820P	820 pF PC mount..	10/\$1
CP910P	910 pF PC mount..	10/\$1
CP1000P	1000 pF PC mount	10/\$1
CP1200P	1200 pF PC mount	10/\$1
CP1500P	1500 pF PC mount	10/\$1
CP1800P	1800 pF PC mount	10/\$1
CP2000P	2000 pF PC mount	10/\$1
CP2200P	2200 pF PC mount	10/\$1
CP3300P	3300 pF PC mount	10/\$1
CP3900P	3900 pF PC mount	10/\$1

GODBOUT

BILL GODBOUT ELECTRONICS
BOX 2355, OAKLAND AIRPORT, CA 94614

FREE FLYER: If you haven't see one of our flyers lately, you are in for a surprise. See, we keep finding all these neat parts to carry...and we keep generating new kits...now we have books, more music kits, esoteric ICs, more Vector products...in short, stuff that delights the heart of the electronics hobbyist. All you have to do to get your own copy is to send us your name and address. We'll take care of the rest.

7400N TTL		
SN7400N .16	SN7459A .25	SN74154N 1.00
SN7401N .21	SN7460N .22	SN74155N .99
SN7402N .16	SN7460N .45	SN74156N .99
SN7403N .16	SN7472N .39	SN74157N .99
SN7404N .16	SN7473N .37	SN74160N 1.25
SN7405N .24	SN7474N .32	SN74161N .99
SN7406N .20	SN7475N .50	SN74163N .99
SN7407N .29	SN7476N .32	SN74164N 1.10
SN7408N .25	SN7479N 5.00	SN74165N 1.10
SN7409N .25	SN7480N .50	SN74166N 1.25
SN7410N .18	SN7482N .98	SN74167N 5.50
SN7411N .30	SN7483N .70	SN74170N 2.10
SN7412N .33	SN7485N .69	SN74172N 6.95
SN7413N .45	SN7486N .39	SN74173N 1.50
SN7414N .70	SN7488N 3.50	SN74174N 1.25
SN7415N .35	SN7489N 2.49	SN74175N .99
SN7417N .35	SN7490N .45	SN74176N .90
SN7420N .21	SN7491N .75	SN74177N .90
SN7421N .33	SN7492N .48	SN74180N .99
SN7422N .49	SN7493N .49	SN74181N 2.49
SN7423N .37	SN7494N .79	SN74182N .95
SN7425N .29	SN7495A .89	SN74184N 1.95
SN7426N .29	SN7497N 4.00	SN74185A 2.20
SN7427N .37	SN74100N 1.00	SN74186A 15.00
SN7429N .42	SN74107N .39	SN74187N 6.00
SN7430N .26	SN74121N .39	SN74188N 3.95
SN7432N .31	SN74122N .39	SN74190N 1.19
SN7437N .27	SN74123N .50	SN74191N 1.25
SN7438N .27	SN74125N .60	SN74192N .89
SN7439N .25	SN74126N .60	SN74193N .89
SN7440N .25	SN74132N 1.09	SN74194N 1.25
SN7442N .59	SN74136N .95	SN74195A .75
SN7443N .75	SN74141N 1.15	SN74196N 1.25
SN7444N .75	SN74142N 4.00	SN74197N .75
SN7445N .75	SN74143N 4.50	SN74198A 1.75
SN7446N .81	SN74144N 4.50	SN74199A 1.75
SN7447N .69	SN74145N 1.15	SN74200N 5.59
SN7448N .79	SN74147N 2.35	SN74207N .90
SN7452N .26	SN74148N 2.00	SN74251N 1.79
SN7451N .27	SN74150N 1.00	SN74284N 6.00
SN7453N .27	SN74151N .79	SN74285A 6.00
SN7454N .28	SN74153N .89	SN74367N .75

Timeband by FAIRCHILD

— Watches —

Men's & Ladies

- Solid State
- Displays hour, minute, second, month & day
- Free set of replacement batteries
- Choose LED or LCD styles
- One year factory warranty



T249 White w/bracelet \$19.95
T248 Yellow w/bracelet \$22.95
LED



TC625 White w/strap \$29.95
TC624 Yellow w/strap \$34.95
LCD



T237 White w/bracelet \$22.95
T236 Yellow w/bracelet \$25.95
LED



TC437 White w/bracelet \$29.95
TC436 Yellow w/bracelet \$34.95
LCD

WIRE WRAP CENTER

HOBBY-WRAP TOOL-BW-630

- Battery Operated (Size C)
- Weighs ONLY 11 Ounces
- Wraps 30 AWG Wire onto Standard DIP Sockets (.025 inch)
- Complete with built-in bit and sleeve

\$34.95
(Batteries not included)



WIRE-WRAP KIT — WK-2-W

WRAP • STRIP • UNWRAP

- Tool for 30 AWG Wire
- Roll of 50 Ft. White or Blue 30 AWG Wire
- 50 pcs. each 1", 2", 3" & 4" lengths — pre-stripped wire.

\$11.95



WIRE WRAP TOOL WSU-30

WRAP • STRIP • UNWRAP — \$5.95

WIRE WRAP WIRE — 30 AWG

25 ft. min. \$1.25 50 ft. \$1.95 100 ft. \$2.95 1000 ft. \$15.00
SPECIFY COLOR — White - Yellow - Red - Green - Blue - Black

WIRE DISPENSER — WD-30

- 50 ft. roll 30 AWG KYNAR wire wrap wire \$3.45 ea.
- Cuts wire to desired length
- Strips 1" of insulation Specify — Blue-Yellow-White-Red

CHANNEL F™

FAIRCHILD VIDEO ENTERTAINMENT SYSTEM

- Freeze Action
- Speed Option
- Automatic time and scorekeeping
- Battery-free AC operation
- Dual controls with 8-way action
- Built-in Pro Hockey and Tennis games
- Easy hook-up on any B/W or Color TV
- Factory warranty

\$159.95



Channel F — additional cartridges — \$17.95 ea.

0811 — Tic-Tac-Toe/Shooting Gallery
0812 — Desert Fox/Shooting Gallery
0813 — Blackjack (1 or 2 players)
0814 — Spiffire (1 or 2 players)
0815 — Spacewar (2 players)
0816 — Magic Numbers (computer logic)
0819 — Drag strip (1 or 2 players)
0820 — Maze (2 players)
0822 — Baseball (2 players)

20% Discount for 100 Combined 7400's

CMOS

CD4000 .25	CD4040 2.45	74C00N .39
CD4001 .25	CD4042 1.90	74C02N .55
CD4002 .25	CD4044 1.50	74C04N .75
CD4006 2.50	CD4046 2.51	74C10N .65
CD4007 .25	CD4047 2.75	74C20N .85
CD4009 .59	CD4048 2.51	74C30N .65
CD4010 .59	CD4049 .79	74C42N 2.15
CD4011 .25	CD4050 .79	74C73N 1.50
CD4012 .25	CD4051 2.95	74C74 1.15
CD4013 .47	CD4052 2.95	74C90N 3.00
CD4016 .58	CD4053 9.95	74C98N 2.00
CD4017 1.35	CD4060 3.25	74C107N 1.25
CD4019 .55	CD4066 1.75	74C151 2.90
CD4020 1.49	CD4069 .45	74C154 4.00
CD4022 1.25	CD4070 .95	74C157 2.15
CD4023 .25	CD4071 .45	74C160 3.25
CD4024 1.50	CD4081 .45	74C161 3.25
CD4025 .25	CD4082 .45	74C163 3.00
CD4026 \$3.95	CD4088 6.75	74C164 3.25
CD4027 .69	CD4511 2.50	74C173 2.60
CD4028 1.65	CD4512 6.50	74C193 2.75
CD4029 2.90	CD4518 2.50	74C195 2.75
CD4030 .65	CD4520 2.70	MC4044 4.50
CD4035 1.85	MC14566 3.00	MC14016 .56

DISCRETE LEDs

125" dia. 185" dia. 200" dia. 190" dia. 205" dia.

KC209 Red 10:51	KC226 Red 5:51	KC256 Red 5:51	KC111 Red 10:51
KC209 Green 4:51	KC226 Green 4:51	KC256 Green 4:51	KC111 Green 4:51
KC209 Orange 4:51	KC226 Yellow 4:51	KC256 Yellow 4:51	KC111 Yellow 4:51
KC209 Yellow 4:51	KC226 Orange 4:51	KC256 Orange 4:51	KC111 Orange 4:51

DL707

DISPLAY LEDs

MAN 1 Common Anode 270 2.95	MAN 3640 Common Cathode-orange 300 1.75
MAN 2 5 x 7 Dot Matrix 300 4.95	MAN 4710 Common Anode-Red 400 1.95
MAN 3 Common Cathode 125 31.00	DL701 Common Anode-red ± 300 .99
MAN 4 Common Cathode 187 1.95	DL704 Common Cathode 300 .99
MAN 7 Common Anode 300 1.25	DL707 Common Anode 300 .99
MAN 7G Common Anode-green 300 1.55	MAN 4740 Common Anode-Red 400 .99
MAN 7H Common Anode-yellow 300 1.95	DL741 Common Anode 800 1.50
MAN 52 Common Anode-green 300 .99	DL 747 Common Anode 600 2.25
MAN 54 Common Anode-red 400 .99	DL 750 Common Cathode 600 2.49
MAN 74 Common Cathode 300 1.50	DL 338 Common Cathode 110 .50
MAN 84 Common Anode-yellow 300 .99	FND70 Common Cathode 250 .75
MAN 82 Common Cathode-yellow 300 .99	FND903 Common Cathode 500 1.00
MAN 3620 Common Anode -orange 300 1.75	FND907 Common Anode 500 1.00

LINEAR

LM300H .80	LM1496C .65
LM301H .35	LM1496N .85
LM301CN .35	LM1508V .85
LM302H .75	LM1812N 6.95
LM304H 1.00	LM2111N 1.95
LM305H .95	LM2901N 2.95
LM307CN .35	LM3053 1.50
LM308H 1.00	LM3065N .89
LM308CN 1.00	LM3900N .55
LM309H 1.10	NE501K 8.00
LM309CN 1.00	NE510A 6.00
LM309K .99	NE511H 3.00
LM310CN 2.95	NE536T 6.00
LM311H .90	NE540L 6.00
LM311N .90	NE550L .70
LM317K 6.50	NE555V .39
LM318CN 1.50	NE560B 5.00
LM319N 1.30	NE560H 5.00
LM320N 1.35	NE582B 5.00
LM320K-5 2 1.35	NE582C 1.25
LM320K-12 1.35	NE585N 1.75
LM320K-15 1.35	NE566CN 1.25
LM320T-5 1.75	NE567H 1.95
LM320T-5 Z 1.75	LM703CN .45
LM320T-8 1.75	LM709H .29
LM320T-12 1.75	LM709N .29
LM320T-15 1.75	LM710N .79
LM320T-24 1.75	LM711N .39
LM322K-5 9.95	LM723H .55
LM324N 1.80	LM723H .55
LM339N 1.70	LM733N 1.00
LM340K-5 1.95	LM739N 1.00
LM340K-8 1.95	LM741CN .35
LM340K-12 1.95	LM741CN .35
LM340K-15 1.95	LM741-14N .39
LM340K-24 1.95	LM747H .79
LM340T-5 1.75	LM747H .79
LM340T-6 1.75	LM748H .39
LM340T-8 1.75	LM748N .39
LM340T-12 1.75	LM1303N .90
LM340T-15 1.75	LM1304N 1.19
LM340T-18 1.75	LM1305N 1.80
LM340T-24 1.75	LM1307N .45
LM350N 1.00	LM1310N 2.95
LM351CN .65	LM1311N 1.65
	LM1414N 1.75

IC SOLDDERTAIL — LOW PROFILE (TIN) SOCKETS

8 pin 1.24	25-49 50-100	24 pin 1.24	25-49 50-100
9 pin \$ 1.17	16 15	28 pin \$ 3.38	37 36
14 pin 20 19	18 18	28 pin 45 44	43 43
16 pin 22 21	20 20	36 pin 60 59	58 58
18 pin 29 28	27 27	40 pin 63 62	61 61
22 pin 37 36	35 35		
14 pin \$ 2.27	25 24	28 pin \$.99	90 81
16 pin 30 27	25 25	36 pin 1.39 1.26	1.15 1.15
18 pin 35 32	30 30	40 pin 1.59 1.45	1.30 1.30
24 pin 49 45	42 42		

SOLDERTAIL STANDARD (TIN)

8 pin \$ 3.30	27 24	24 pin \$.70	63 57
14 pin 35 32	29 29	28 pin 1.10 1.00	90 90
16 pin 38 35	32 32	36 pin 1.75 1.40	1.26 1.26
18 pin 52 47	43 43	40 pin 1.75 1.59	1.45 1.45

SOLDERTAIL STANDARD (GOLD)

8 pin \$ 4.45	41 37	24 pin \$ 1.05	95 85
14 pin 39 38	37 37	28 pin 1.40 1.25	1.10 1.10
16 pin 43 42	41 41	36 pin 1.59 1.45	1.30 1.30
18 pin 75 66	62 62	40 pin 1.75 1.55	1.40 1.40

WIRE WRAP SOCKETS (GOLD) LEVEL #3

10 pin \$ 4.45	41 37	24 pin \$ 1.05	95 85
14 pin 39 38	37 37	28 pin 1.40 1.25	1.10 1.10
16 pin 43 42	41 41	36 pin 1.59 1.45	1.30 1.30
18 pin 75 66	62 62	40 pin 1.75 1.55	1.40 1.40

50 PCS. RESISTOR ASSORTMENTS \$1.75 PER ASST.

ASST. 1 5 ea.	10 OHM 12 OHM 15 OHM 18 OHM 22 OHM 27 OHM 33 OHM 39 OHM 47 OHM 56 OHM	1/4 WATT 5% — 50 PCS.
ASST. 2 5 ea.	68 OHM 82 OHM 100 OHM 120 OHM 150 OHM 180 OHM 220 OHM 270 OHM 330 OHM 390 OHM	1/4 WATT 5% — 50 PCS.
ASST. 3 5 ea.	470 OHM 560 OHM 680 OHM 820 OHM 1K	1/4 WATT 5% — 50 PCS.
ASST. 4 5 ea.	1.2K 1.5K 1.8K 2.2K 2.7K	1/4 WATT 5% — 50 PCS.
ASST. 5 5 ea.	3.3K 3.9K 4.7K 5.6K 6.8K	1/4 WATT 5% — 50 PCS.
ASST. 6 5 ea.	8.2K 10K 12K 15K 18K	1/4 WATT 5% — 50 PCS.
ASST. 7 5 ea.	22K 27K 33K 39K 47K	1/4 WATT 5% — 50 PCS.
ASST. 8 5 ea.	56K 68K 82K 100K 120K	1/4 WATT 5% — 50 PCS.
ASST. 9 5 ea.	150K 180K 220K 270K 330K	1/4 WATT 5% — 50 PCS.
ASST. 10 5 ea.	390K 470K 560K 680K 820K	1/4 WATT 5% — 50 PCS.
ASST. 11 5 ea.	1M 1.2M 1.5M 1.8M 2.2M	1/4 WATT 5% — 50 PCS.
ASST. 12 5 ea.	2.7M 3.3M 3.9M 4.7M 5.6M	1/4 WATT 5% — 50 PCS.

74LS00 TTL

74LS00 .25	74LS129 1.95
74LS02 .29	74LS131 1.55
74LS03 .25	74LS133 1.89
74LS04 .25	74LS135 1.55
74LS05 .29	74LS137 1.25
74LS06 .29	74LS139 2.25
74LS10 .25	74LS141 2.25
74LS11 .89	74LS143 1.95
74LS12 .75	74LS145 1.95
74LS13 1.25	74LS147 3.89
74LS14 1.75	74LS149 2.85
74LS16 .39	74LS151 2.85
74LS17 .39	74LS153 2.85
74LS18 .39	74LS155 2.85
74LS19 .39	74LS157 2.85
74LS20 .39	74LS159 2.85
74LS21 .39	74LS161 2.85
74LS22 .39	74LS163 2.85
74LS23 .39	74LS165 2.85
74LS24 .39	74LS167 2.85
74LS25 .39	74LS169 2.85
74LS26 .39	74LS171 2.85
74LS27 .39	74LS173 2.85
74LS28 .39	74LS175 2.85
74LS29 .39	74LS177 2.85
74LS30 .39	74LS179 2.85
74LS31 .39	74LS181 2.85
74LS32 .39	74LS183 2.85
74LS33 .39	74LS185 2.85
74LS34 .39	74LS187 2.85
74LS35 .39	74LS189 2.85
74LS36 .39	74LS191 2.85
74LS37 .39	74LS193 2.85
74LS38 .39	74LS195 2.85
74LS39 .39	74LS197 2.85
74LS40 .39	74LS199 2.85
74LS41 .39	74LS201 2.85
74LS42 .39	74LS203 2.85
74LS43 .39	74LS205 2.85
74LS44 .39	74LS207 2.85
74LS45 .39	74LS209 2.85
74LS46 .39	74LS211 2.85
74LS47 .39	74LS213 2.85
74LS48 .39	74LS215 2.85
74LS49 .39	74LS217 2.85
74LS50 .39	74LS219 2.85
74LS51 .39	74LS221 2.85
74LS52 .39	74LS223 2.85
74LS53 .39	74LS225 2.85

CLOCK CHIPS

MMS305 6 Digit, BCD Outputs, Reset PIN	\$9.95
MMS311 6 Digit, BCD Outputs, 12 or 24 Hour	4.95
MMS312 4 Digit, BCD Outputs, 1 PPS Output	4.95
MMS314 6 Digit, 12 or 24 Hour, 30 or 60 Hz	4.95
MMS316 4 Digit, Alarm, 1 PPS Output	6.95
MMS318 Video Clock Chip, For Use With (MMS341 - \$9.95)	9.95
CT7001 6 Digit, Calendar, Alarm, 12 or 24 Hour	5.95

NOW OPEN SATURDAYS

James ELECTRONICS

1021-A HOWARD AVE., SAN CARLOS, CA. 94070
PHONE ORDERS WELCOME — (415) 592-8097
All Advertised Prices Good Thru October

DATA HANDBOOKS

- 7400 Pin-out & Description of 5400/7400 ICs \$2.95
- CMOS Pin-out & Description of 4000 Series ICs \$2.95
- Linear Pin-out & Functional Description \$2.95

ALL THREE HANDBOOKS \$6.95

ZENERS — DIODES — RECTIFIERS

TYPE	VOLTS	W	PRICE	TYPE	VOLTS	W	PRICE
1N746	3.3	400m	4/1.00	1N4005	500 PIV	1 AMP	10/1.00
1N751A	5.1	400m	4/1.00	1N4006	600 PIV	1 AMP	10/1.00
1N752	5.6	400m	4/1.00	1N4007	1000 PIV	1 AMP	10/1.00
1N753	6.2	400m	4/1.00	1N3600	50	200m	6/1.00
1N754	6.8	400m	4/1.00	1N4148	75	10m	15/1.00
1N959	8.2	400m	8/1.00	1N4154	35	10m	1

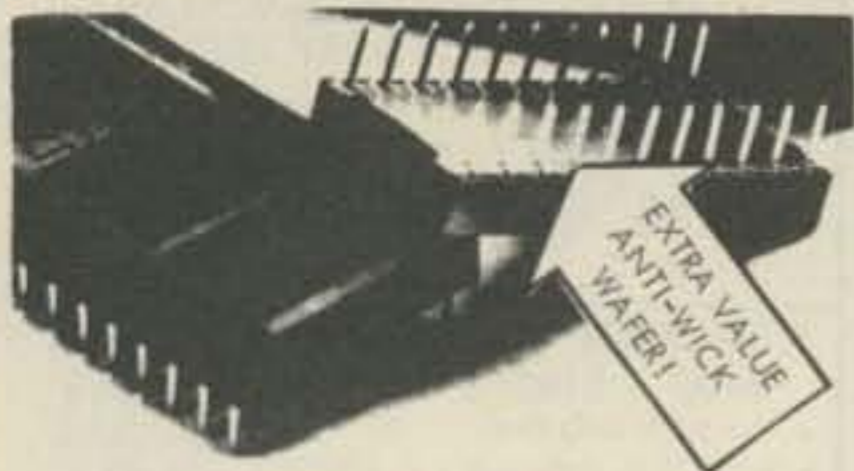

High quality sockets for IC's and PC interconnections. Check our prices and quality- you will see why TRI-TEK is fast becoming the leader in IC sockets.

Low Profile DIP Solder Tail (Tin)
End/Side stackable on .100" centers

	1-9	10-24	25-100
SKT-0802 8 pin	.15	.15	.14
1402 14pin	.18	.17	.16
1602 16pin	.20	.19	.18
1802 18pin	.27	.26	.25
2002 20pin	.29	.28	.27
2202 22pin	.35	.34	.33
2402 24pin	.36	.35	.34
2802 28pin	.42	.41	.40
4002 40pin	.60	.57	.53

3 Level Wire Wrap Gold

	1-9	10-24	25-100
SKT-1400	.38	.37	.36
1600	.42	.41	.40
1800	.73	.65	.59
2400	1.00	.91	.83
4000	1.69	1.51	1.37



RIBBON CABLE IC INTERCONNECTS

No. Of Pins	SINGLE END					
	6"	12"	18"	24"	36"	48"
14P	1.51	1.62	1.72	1.83	2.05	2.26
16P	1.64	1.76	1.87	1.99	2.21	2.44
24P	2.49	2.69	2.88	3.08	3.48	3.87
No. Of Pins	DOUBLE END					
	6"	12"	18"	24"	36"	48"
14P	2.76	2.87	2.97	3.08	3.30	3.51
16P	3.01	3.13	3.24	3.36	3.58	3.81
24P	4.55	4.75	4.94	5.14	5.54	5.93



PROFESSIONAL Keyboard Kit!

Check these professional features:

- ☆ 53 Keys, popular ASR-33 format!
- ☆ Rugged G-10 P.C. Board!
- ☆ Tri-mode MOS encoding!
- ☆ Two-Key Rollover!
- ☆ MOS-DTL-TTL Compatible outputs!
- ☆ Upper Case lockout!
- ☆ Data and Strobe inversion option!
- ☆ Low contact bounce!
- ☆ Selectable Parity!
- ☆ Custom Keycaps!
- ☆ Three User Definable Keys!
- ☆ MORE!

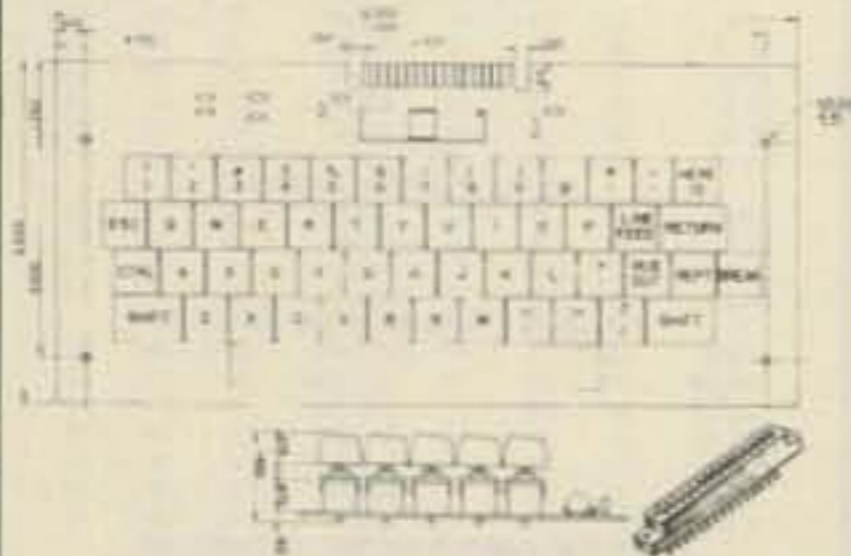

Model 753 Keyboard (with free connector).....\$59.95

Popular import germanium power transistor in TO-66
Used in many imported tape and record players, etc.
258367.....\$1.50



AMPLANNY

Says

"YOU KNOW WHAT THEY SAY ABOUT AN IDLE MIND..."

MRF475 NPN SILICON RF POWER TRANSISTOR

....designed primarily for use in single sideband linear amplifier output applications in citizens band and other communications equipment operating to 30 MHz.

- Characterized for Single Sideband and Large-Signal Amplifier Signal Amplifier Applications Utilizing Low-Level Modulation

- Specified 13.6 V, 30MHz Characteristics -
Output Power = 12 W (PEP)
Minimum Efficiency = 40% (SSB)
Output Power = 4.0 W (CW)
Minimum Efficiency = 50% (CW)
Minimum Power Gain = 10 dB (PEP & CW)

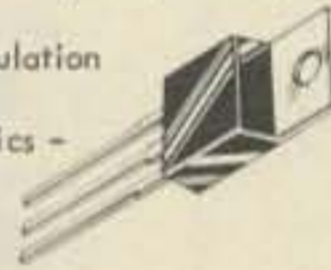

Rating	Symbol	Value	Unit
Collector-Emitter Voltage	V _{CEO}	15	Vdc
Collector Base Voltage	V _{CBO}	48	Vdc
Emitter Base Voltage	V _{EB0}	4.0	Vdc
Collector Current - Continuous	I _C	4.0	Aac
Total Device Dissipation @ T _c = 50°C	P _D	10	Watts
Derate above 50°C		0.3	W/°C
Operating and Storage Junction Temperature Range	T _j , T _{stg}	-65 to +150	°C

Direct replacement for 25C1969 for imported radios.
MRF-475.....\$4.82

2N5301 Super Tranny
200W 40V 30A NPN silicon transistor in TO-3. Perfect for Power Supply pass element. Made by Motorola for giant computer company who over stocked them - your gain.
2N5301 (House Mark).....\$1.25

Hi Voltage Hi Power NPN
G.E. D56W1 is a 1400V, 5A NPN transistor in TO-3 case. Used in Horizontal deflection driver for color T.V. or any hi voltage hi pulse energy applications.
D56W1.....\$2.55



MM74C935-1
3 1/2 digit DVM with multiplexed 7-segment output

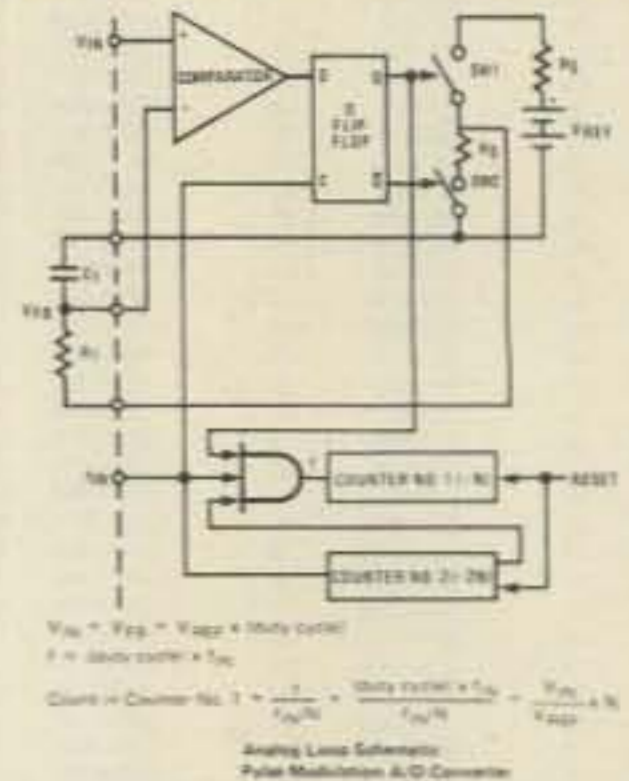

The MM74C935 Monolithic DVM circuit is manufactured using standard complementary MOS(CMOS) technology. A pulse modulation analog-to-digital conversion technique is used and requires no external precision components. In addition, this technique allows the use of a reference voltage that is the same polarity as the input voltage.

One 5V(TTL) power supply is required. Operating with an isolated supply allows the conversion of positive as well as negative voltages. The sign of the input voltage is automatically determined and output on the sign pin. If the power supply is not isolated, only one polarity of voltage may be converted.

The conversion rate is set by an internal oscillator. The frequency of the oscillator can be set by an external RC network or the oscillator can be driven from an external frequency source. When using the external RC network, a square wave output is available. It is important to note that great care has been taken to synchronize digit multiplexing with the A/D conversion timing to eliminate noise due to power supply transients.

The MM74C935 has been designed to drive 7-segment multiplexed LED displays directly with the aid of external digit buffers and segment resistors. Under condition of overrange, the overflow output will go high and the display will read +OFL or -OFL, depending on whether the input voltage is positive or negative. In addition to this, the most significant digit is blanked when zero.

A start conversion input and a conversion complete output are included

FEATURES:

- Operates from single 5V supply
- Converts 0V to ±1.999V
- Multiplexed 7-segment
- Drives segments directly
- No external precision component necessary
- Medium speed - 200ms/conversion
- All inputs and outputs TTL compatible
- Internal clock set with RC network or driven externally
- No offset adjust required
- Overrange indicated by +OFL or -OFL display reading and OFLO output
- Analog inputs in applications shown can withstand ±200 Volts

APPLICATIONS:

- Low cost digital power supply readouts
- Low cost digital multimeters
- Low cost digital panel meters
- Eliminate analog multiplexing by using remote A/D converters
- Convert analog transducers (temperature, pressure, displacement, etc.) to digital transducers

MM74C935N-1.....with specs.....\$16.98
Specs only for 74C935.....\$5.90

LM336Z Reference diode
Precision 2V reference to be used with MM74C935-1 DVM chip.
LM336Z.....\$2.40



tri-tek, inc.
6522 NORTH 43RD AVENUE,
GLENDALE, ARIZONA 85301



We pay surface shipping on all orders over \$10 US, \$15 foreign in US funds. Please add extra for first class or air mail. Excess will be refunded. Orders under \$10, add \$1 handling. Please add 50c insurance. Master charge and Bank America cards welcome, (\$20 minimum). Telephone orders may be placed 10AM to 5:30PM daily, Mon thru Fri. Call 602-931-4528, or 602-931-6949. Check reader service card or send stamp for our latest flyers packed with new and surplus electronic components.

ALDELCO ELECTRONIC CENTER NOW OPEN!

Kits, Books, Boards, Magazines. Special 2102LI 8 for \$17.50. 8080A CPU Chip \$19.95. We stock OK Battery Operated Wire Tool \$34.95, OK Hand Wire Wrapped Tool \$5.95. 7400 ICs CMOS, Timers PLL's IC Sockets. All kinds of transistors, rectifiers and diodes. Plus other electronic parts.

Add 5% for shipping. Minimum order \$10.00 Out of USA send certified check or money order, include shipping costs.

BUILD THE W7BBX PROGRAMMABLE KEYS. SOLID STATE PARTS WITH IC SOCKETS \$42.00. WE CAN SUPPLY THE FOUR PC BOARDS AND COMPREHENSIVE CONSTRUCTION MANUAL - ALL FOR ONLY \$29.95.

AL and PHIL say:

If you're in our neighborhood DROP IN and say Hello. If you're too far away to visit, give us a phone call at 516 378-4555, and we'll be glad to take your order over the phone. We have Master Charge and BankAmericard. Orders can also be sent COD, either UPS or U.S. Mail. Store hours are 9:30 AM to 5:00 PM, Monday to Saturday. Wednesday evenings till 9:00 PM. Give us a try. You'll like our friendly service but more than that you'll enjoy Aldelco Quality in everything we sell. Want our catalog quickly? Send a first class stamp. If you're not in a rush, circle the reader service card in the back of the magazine.

#22 PVC Stranded hook up wire
50' roll \$1.00
OK Wire Hand Tool
WSU 30 5.95
WSU30M (modified wrap) . 6.95
Battery operated wire-wrap tool
BW 630 Wraps #30 wire 34.95
New! Model BW 2628. Wraps
#26 + #28 wire \$39.95
Batteries not included.

● RECTIFIERS

2 amp 50 volt 20 for \$1.00
2 amp 1000 volt 10 for \$1.00
2 amp 1500 volt .5 for 1.00
6 amp 100 volt69
10 amp stud 50 volt .. 1.50
10 amp stud 600 volt . 4.50
40 amp stud 50 volt .. 1.20
40 amp stud 750 volt . 2.05

BRIDGES

2 amp T05 50 volt35
2 amp T05 200 volt50
2 amp T05 600 volt .. 1.25
3 amp 50 volt50
3 amp 400 volt 1.10
25 amp 200 volt 1.50
25 amp 600 volt 5.50
25 amp 1000 volt ... 8.50

● ALDELCO BOOKSHELF

Howard W. Sams Books
TTL Cookbook \$8.95
CMOS Cookbook 9.95
IC Timer Cookbook 9.95
TV Typewriter
Cookbook 9.95
Microcomputer Primer 7.95
How to Buy & Use
Microcomputers 9.95
add \$1.00 per book order for shipping

● FETS

40673 1.55
MPF10255
2N381935
2N545750
2N545850
2N545955
2N548550

● DARLINGTON

MPSA 1380
MPSA 1440
2W530650

● SCR

C 106A55
C 106B65
C 122B85

LOGIC PROBE KIT

Aldelco is now the sole distributor of the DIGAPEAKE - a logic probe kit. Now you can buy direct and save. Probe measures logic 1, logic 0, and pulsing circuits conditions formerly sold for \$14.95.

SPECIAL \$11.95

ACCUKEYER KIT. Similar to the famous ARRL Handbook version, Kit includes PC board, IC sockets, ICs, speaker switch and all parts and instructions.

ONLY \$19.95

ACCUKEYER MEMORY KIT

Adaptable to many keyers. Can store 2 canned messages of 30 characters each. PC board IC sockets, ICs instructions and all parts. \$19.95

#26 RIBBON CABLE

Solid colors
14 Strand \$.25 ft
20 Strand45 ft
26 Strand50 ft
40 Strand90 ft
50 Strand 1.00 ft

● NEW IMPROVED ALARM CLOCK

Digital alarm clock • Six big .5 display LEDs
• New on board AC Transformer • 12 Hour format with 24 hour Alarm • Snooze Feature • Elapsed time indicator.

A natural for cars, campers and mobile homes. Use on 12 volt dc with optional crystal time base (not including cabinet) \$19.95

● CRYSTAL TIME BASE KIT \$4.95

Optional cabinet - in simulated walnut grain or black leather \$4.95
Plastic cabinets - blue, black, white or smoke \$3.95

Red clock filters \$.60

12 or 24 hour DIGITAL CLOCK KIT uses .5 display LED. 5314 clock chip fits our standard cabinet. Freeze feature \$18.95

VARIABLE POWER SUPPLIES

PS-5 5-15 volt dc 600 mA \$6.95
PS-12 12-28 volt dc 600 mA \$6.95

Add \$1.00 per kit shipping

ZENERS

1N4746 to 1N759 400 Mw ea. .25
1N4728 to 1N4764 1 watt28
1N5333 to 1N5378 5 watt 2.10
1N2970 to 1N3005 10 watt 2.40
1N3305 to 1N3340 50 watt 4.75

AL 215 (GE 215) \$4.50
AL 216 (GE 216) 7.95
2N305599
2N3904 or 2N390625
2N5496 or 2N610870
MJE340 (2N5655) 1.10
741 or 709 14 Pin DIP25
555 Timer49
556 Dual 555 1.50
1N914-1N4148 15 for .99
1N34-1N60-1N64 10 for .99
CA 3028 Dif. Amp 1.50
4060 CMOS 2.00
LM309K Volt Reg 1.10
MJ3055 2.20
5313 Clock Chip 3.95
5314 Clock Chip 4.50
82S23 3.95
2N610389
LM709 or 741 Min DIP Op Amp45
LM741CE T05 Op Amp45
14 or 16 Pin IC Sockets30

RF DEVICES

2N3375 3W 400 MHz \$5.50
2N3866 1W 400 MHz 1.15
2N5589 3W 175 MHz 4.75
2N5590 10W 175 MHz 7.80
2N5591 25W 175 MHz 10.95
2SC517 3.95
2SC1226 1.25
2N6080 4W 175 MHz 5.40
2N6081 15W 175 MHz 8.45
2N6082 25W 175 MHz 10.95
2N6083 30W 175 MHz 12.30
2N6084 40W 175 MHz 16.30
2SC1306 4.30
2SC1307 5.25
2N2876 special 10.95

ALDELCO KITS

NOW! 
2 Dual Digital 12-24 hour clock kits

MODEL ALD5:

Six big .5 display LEDs in an attractive black plastic cabinet with a red front filter. Great for a ham or broadcast station. Set one clock to GMT the other to local time. Or have a 24 hour format on one clock and 12 hour on the other. Freeze feature lets the clock be set to the second. Each clock is controlled separately. Cabinet measures 2 1/4" x 4 1/4" x 9 1/4". Complete Kit \$44.95.

MODEL ALD7:

Four bright .3 nixie tube display. Cabinet is an attractive deep blue including front filter. Will display seconds at the push of a button. An asset to any station. Cabinet size is 2 1/4" x 3" x 9 1/4". Complete Kit \$34.95.

7400 SERIES

7400 18	747650	74177 1.35	74LS153 1.89
7401 18	748050	7418095	74LS155 1.55
7402 20	7482 1.75	74181 3.75	74LS160 2.25
7403 20	7485 1.15	7418275	74LS161 2.25
7404 25	748645	74191 1.50	74LS163 2.25
7405 25	7489 2.49	74192 1.50	74LS169 2.25
7406 45	749060	74193 1.45	74LS173 1.95
7407 45	749280	74194 1.45	74LS175 1.85
7408 25	749380	74196 1.25	74LS190 2.60
7410 20	749495	74199 2.25	74LS191 2.85
7411 30	749590	74283 2.25	74LS193 2.85
7413 85	749685		74LS195 2.00
7414 70	74100 1.25	74LS SERIES	74LS196 2.00
7416 45	7410445	74LS0039	74LS197 1.75
7417 45	7410545	74LS0239	74LS257 1.75
7420 25	7410750	74LS0445	74LS365 1.75
7421 40	7412155	74LS0839	74LS366 1.75
7425 45	7412260	74LS1039	74LS368 1.75
7427 40	74123 1.05	74LS1139	74LS390 3.75
7430 20	7412565	74LS2039	74H SERIES
7432 32	74141 1.25	74LS2139	74H0033
7437 50	74145 1.25	74LS2239	74H0135
7438 1.05	74148 2.25	74LS3039	74H0431
7444 1.10	74150 1.10	74LS3745	74H1033
7445 1.10	74151 1.00	74LS3845	74H2133
7446 1.45	74153 1.35	74LS7465	74H3033
744790	74154 1.70	74LS9095	74H4033
7448 1.15	74155 1.35	74LS9395	74S SERIES
745050	74156 1.35	74LS11379	74S0445
7451 20	74157 1.35	74LS11465	74S4030
7453 20	74160 1.35	74LS132 1.55	74S153 2.25
7454 20	74161 1.45	74LS13845	74S158 2.00
7460 20	74162 1.50	74LS13945	74S175 2.25
7470 45	74164 1.70	74LS151 1.55	

Aldelco presents a

NEW

Frequency Counter and digital clock kit in one cabinet

12 or 24 hour digital clock
Six .3 display LEDs



Frequency counter typical 100 Hz to 40 MHz accuracy .0001%

Switchable from counter to clock. Clock maintains time while frequency counter is in use. Can be wired for either 4 or 6 digit clock. Small size makes attractive unit for auto or boat. Operates on 12 volt DC. Plug in power supply is available for 110 volt AC use. Comes complete with instructions. Cabinet and all parts assembled unit ... \$139.95. Optional 110 volt AC supply \$5.95
Kit only \$99.95

Frequency counter kit with memory similar to above but without digital clock \$99.95.

Assembled unit \$139.95
110 V ac power supply \$5.95

ALDELCO

2281A BABYLON TURNPIKE, MERRICK NY 11566
516-378-4555

S.D. SALES CO. P.O. BOX 28810 -A DALLAS, TEXAS 75228

★ Imsai - Altair "A" Compatible Kits ★

Dealer inquiries welcome on these items:

Z-80 CPU BOARD

From the same people who brought you the \$89.95 4K RAM KIT. We were not the first to introduce an Imsai/Altair compatible Z-80 Card, but we do feel that ours has the best design and quality for the lowest price! The advance features of the Z-80 such as an expanded set of 158 instructions, 8080A software compatibility, and operation from a single 5VDC supply, are all well known. What makes our card different is the extra care we took in the hardware design. The CPU card will always stop on an M1 state. We also generate TRUE SYNC on card, to insure that the rest of our system functions properly. Dynamic memory refresh and NMI are bought out for your use. Believe it or not, not all of our competitors have gone to the extra trouble of doing this. As always this kit includes all parts, all sockets, and complete instructions for ease of assembly. Because of our past experience with our 4K kit we suggest that you order early. All orders will be shipped on a strict first come first served basis. Kit includes Zilog Manual and all parts. Kit shipped with 2 MHz crystals.

Z-80 Chip & Manual - \$49.95; Add \$5.00 for Z-80A
Z-80 Manual - \$7.50 Separately.

Complete kit - \$149.

4K LOW POWER RAM

IMSAI AND ALTAIR 8080 PLUG IN COMPATIBLE. USES LOW POWER STATIC 21L02 - 1 500ns. RAM's. FULLY BUFFERED, DRASTICALLY REDUCED POWER CONSUMPTION, ON BOARD REGULATED, ALL SOCKETS AND PARTS INCLUDED. QUALITY PLATED THROUGH PC BOARD. For 250 ns RAM's add \$10.

THE WHOLE WORKS

\$89.95 kit

NEW! DESIGN CONSOLETTA KIT - \$89.95

S.D. Sales announces the inexpensive way to beat the wire wrap jungle. Our latest kit gives you 124 solderless quick connect terminals, enough for eight 16 pin IC's and provides 50 x 8 common buss matrix. Has regulated +5VDC and +/- 15VDC, all at 1 AMP. Voltage regulation at 100%. Also includes a pulse generator variable from 10hz to 50mhz and .01 sec. to 100 nano seconds. Generator output is +5V. In kit form only and includes all parts, sockets; front panel measures 7 1/4"x8 1/4", and hardware. case not available.

CAR/BOAT KIT *New Item!*
\$34.95

Music to your Ears!

MUSICAL HORN

Musical Horn kit for car, boat or home. Plays any tune from Mozart to Led Zeppelin. Change tunes in seconds; complete solid state electronics. Standard or custom tunes available at \$6.95 each. (You supply the sheet music - we supply electronics for your favorite tune.) One song supplied with original order. Standard tunes available: DIXIE - EYES OF TEXAS - ON WISCONSIN - YANKEE DOODLE DANDY - NOTRE DAME FIGHT SONG - PINK PANTHER - AGGIE WAR SONG - ANCHORS AWAY - NEVER ON SUNDAY - BRIDGE OVER RIVER QUI - CANDY MAN - Standard 2 inch 8 ohm speaker supplied. Power horn available for car/boat kit.

HOME KIT
\$26.90

Kit includes speaker which operates from your door bell. When door bell is pushed your favorite tune is played. Car/boat kit includes speaker which operates from car/boat horn ring. Allow 4 weeks delivery on both kits.

Limited Quantity!
\$9.95 kit

6 DIGIT ALARM CLOCK KIT

We made a fantastic kit even better. Redesigned to take advantage of the latest advances in IC technology. Features: Litronix Dual 1/2" displays, Mostek 50250 super clock chip, single I.C. segment driver, SCR digit drivers. Greatly simplified construction. More reliable and easier to build. Kit includes all necessary parts (except case). For P.C. board add \$3.00; AC XFMR add \$1.50. Do not confuse with Non-Alarm kits sold by our competition! Eliminate the hassle - avoid the 5314!

NEW! WITH JUMBO LED READOUTS!

1000 MFD Filter Caps Rated 35 WVDC Up-right style with PC leads. Most popular value for hobbyists. 4/\$1.00	SLIDE SWITCH Assortment Our best seller. Includes miniature and standard sizes, single and multi-position units. All new. 12/\$1.00	POWER RESISTOR 15 OHM 25W BY CLAROSTAT 75¢ ea.	RESISTOR ASSORTMENT 1/4W 5% & 10% PC leads. A good mix of values! Special! 200/\$2.	P.C. LEAD DIODES 1N4148/1N914 100/\$2. 1N4002 - 1A 100 PIV 40/\$1.	THERMISTORS MEPCO - NEW! 1.5K OHM 5/\$1.00	DISC CAP ASSORTMENT P.C. Leads. At least 10 different values. Includes .001, .01, .05 plus other standard values. 60/\$1.00
---	---	--	---	---	---	---

AMD-1702A
Huge Factory Purchase

FACTORY PRIME UNITS! BRAND NEW!
1.5 Micro-Seconds Access Time.
10/\$40. \$4.95 ea.

★ *Special!* ★

3.579545 MHz Time Base Crystal \$1.25
28 PIN SOCKETS 3 for \$1.00

11,000 MFD 50WVDC Computer Grade Cap \$3.00 each
39 MFD 16 V Mallory Electrolytic 15 for \$1.00

FACTORY PRIME!
21L02-1

Not only are our RAM'S faster than a speeding bullet but they are now very low power. We are pleased to offer prime new 21L02-1 Low Power and Super Fast RAM's. Allows you to STRETCH your power supply farther and at the same time keep the wait light off!

500ns 8/\$12.95
250ns 8/\$15.95

IC'S REMOVED FROM PC BOARDS ALL TESTED; FULL SPEC.

IC's from XEROX

1402 A Shift Regulator - 50c
MH0025CN - 55c

7400 - 9c	7430 - 9c	7493 - 26c
7402 - 9c	7440 - 9c	74121 - 22c
7404 - 9c	7437 - 10c	74123 - 32c
7406 - 11c	7438 - 10c	74151 - 9c
7407 - 11c	7451 - 9c	74155 - 22c
7410 - 9c	7474 - 16c	74193 - 35c
7416 - 13c	7475 - 24c	8233 - 35c
7420 - 9c	7486 - 16c	Intel - 1302 - 45c

Great Buy!

MK50397-\$8.95

S.D. Sales Exclusive! Elapsed time IC. Specially modified six digit counter circuit to measure 59 min., 59 sec., 99/100 sec. Perfect for dark room timers, chess timers or any timing applications. Supplied with data sheet and applications.

MOS 6 Digit Up/Down Counter

40 PIN DIP. Everything you ever wanted in a counter chip. Features: Direct LED segment drive, single power supply (12 VDC TYPE), six decades up/down, pre-loadable counter, separate pre-loadable compare register with compare out-put. BCD and seven segment outputs; internal scan oscillator, CMOS compatible, leading zero blanking. 1MHZ. count input frequency.

\$12.95

CALL IN YOUR BANK-AMERICARD OR MASTER CHARGE ORDER IN ON OUR CONTINENTAL UNITED STATES TOLL FREE WATTS LINE:

Texas Residents Call Collect:

214/271-0022

1-800-527-3460

TERMS:

Money Back Guarantee!

NO COD'S. TEXAS RESIDENTS ADD 5% SALES TAX. ADD 5% OF ORDER FOR POSTAGE & HANDLING. ORDERS UNDER \$10.00 ADD 75c. FOREIGN ORDERS - U.S. FUNDS ONLY!

Orders over \$15. - Choose \$1. FREE MERCHANDISE!

Calling
All Hams...

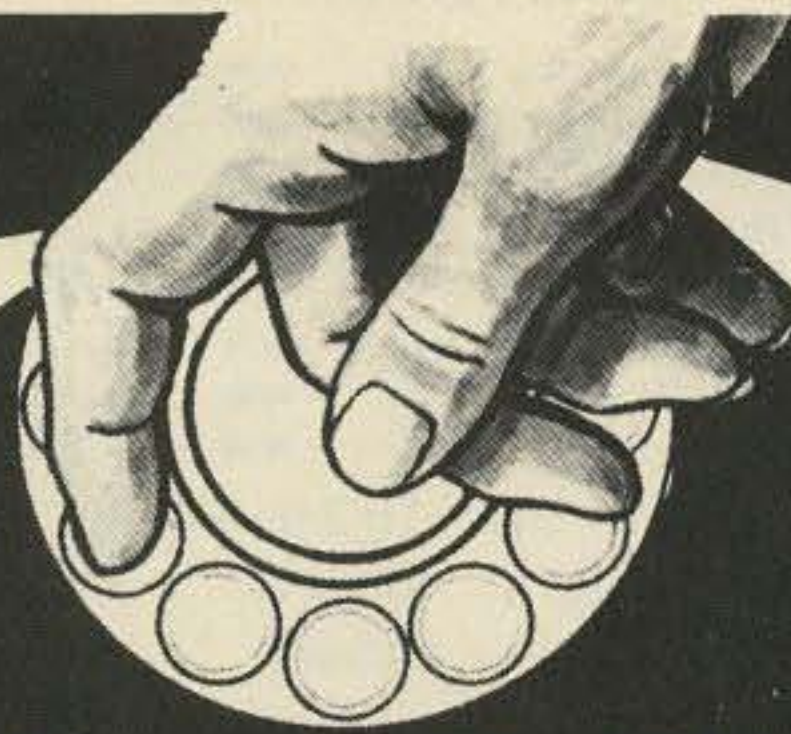

...All Hams
Call Us!

It's Toll Free... So Dial Away!

1-800-325-3636

for the famous
HAM KEYS



Model HK-1

- Dual-lever squeeze paddle
- Use with HK-5 or any electronic keyer
- Heavy base with non-slip rubber feet
- Paddles reversible for wide- or close-finger spacing

\$29⁹⁵

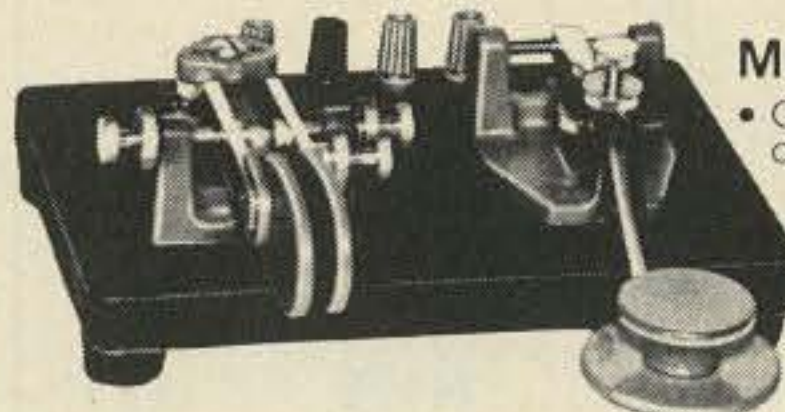

Model HK-4

- Combination of HK-1 and HK-3 on same base

\$44⁹⁵

Terminals, red or black, \$ 75 each

- Base only with rubber feet \$12.00

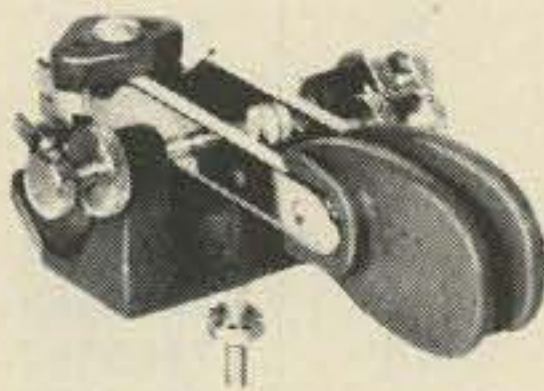

Model HK-2

- Same as HK-1 less base for incorporation in own keyer

\$19⁹⁵



**Model HK-5
Electronic Keyer**

- Iambic Circuit for squeeze keying
- Self-completing dots and dashes
- Dot memory

- Battery operated with provision for external power

\$69⁹⁵



Model HK-3

- Deluxe straight key
- Heavy base... no need to attach to desk
- Velvet smooth action

\$16⁹⁵

Model HK-3A

- Same as above less base \$9.95

Navy type knob, only \$2.75

- Built-in side-tone monitor
- Speed, volume, tone and weight controls
- Grid block or direct keying
- For use with external paddle, such as HK-1

FOR NEW OR USED AMATEUR RADIO GEAR... we're specialists and carry *in stock* most of the famous-brand lines. Or, we will talk trade.

FOR FAST, DOOR-STEP DELIVERY... give us a call. You'll be amazed; for we guarantee we'll ship your equipment the same day. Plus, most shipments are **PRE-PAID**.

TO SAVE MONEY... join thousands of our satisfied customers who buy from us as easily as from their local supplier. So, remember your call is *Toll Free*.



We welcome your Master Charge or Bank Americard

HAM RADIO CENTER, INC.



8340-42 Olive Blvd. P.O. Box 28271 St. Louis, MO 63132

DIODES/ZENERS				SOCKETS/BRIDGES				TRANSISTORS, LEDS, etc.					
1N914	100v	10mA	.05	8-pin	pcb	.25	ww	.45	2N2222	NPN		.15	
1N4004	400v	1A	.08	14-pin	pcb	.25	ww	.40	2N2907	PNP		.15	
1N4005	600v	1A	.08	16-pin	pcb	.25	ww	.40	2N3740	PNP	1A	60v	.25
1N4007	1000v	1A	.15	18-pin	pcb	.25	ww	.75	2N3906	PNP			.10
1N4148	75v	10mA	.03	22-pin	pcb	.45	ww	1.25	2N3054	NPN			.35
1N753A	6.2v	z	.25	24-pin	pcb	.35	ww	1.25	2N3055	NPN	15A	60v	.50
1N758A	10v	z	.25	28-pin	pcb	.35	ww	1.45	T1P125	PNP	Darlington		.35
1N759A	12v	z	.25	40-pin	pcb	.50	ww	1.95	LED Green, Red, Clear				.15
1N4733	5.1v	z	.25	Molex pins	.01	To-3 Sockets	.25	D.L.747	7 seg 5/8" high com-anode			1.95	
1N5243	13v	z	.25	2 Amp Bridge		100-prv	1.20	XAN72	7 seg com-anode			1.50	
1N5244B	14v	z	.25	25 Amp Bridge		200-prv	1.95	FND 359	Red 7 seg com-cathode			1.25	
1N5245B	15v	z	.25										

C MOS		- T T L -									
4000	.15	7400	.15	7473	.25	74176	1.25	74H72	.55	74S133	.45
4001	.20	7401	.15	7474	.35	74180	.85	74H101	.75	74S140	.75
4002	.20	7402	.20	7475	.35	74181	2.75	74H103	.75	74S151	.35
4004	3.95	7403	.20	7476	.30	74182	.95	74H106	.95	74S153	.35
4006	1.20	7404	.15	7480	.55	74190	1.75			74S157	.80
4007	.35	7405	.25	7481	.75	74191	1.35			74S158	.35
4008	1.20	7406	.35	7483	.95	74192	1.65	74L00	.35	74S194	1.05
4009	.30	7407	.55	7485	.95	74193	.85	74L02	.35	74S257(8123)	.25
4010	.45	7408	.25	7486	.30	74194	1.25	74L03	.30		
4011	.20	7409	.15	7489	1.35	74195	.95	74L04	.35		
4012	.20	7410	.10	7490	.55	74196	1.25	74L10	.35	74LS00	.45
4013	.40	7411	.25	7491	.95	74197	1.25	74L20	.35	74LS01	.45
4014	1.10	7412	.30	7492	.95	74198	2.35	74L30	.45	74LS02	.45
4015	.95	7413	.45	7493	.40	74221	1.00	74L47	1.95	74LS04	.45
4016	.35	7414	1.10	7494	1.25	74367	.85	74L51	.45	74LS05	.55
4017	1.10	7416	.25	7495	.60			74L55	.65	74LS08	.45
4018	1.10	7417	.40	7496	.80			74L72	.45	74LS09	.45
4019	.70	7420	.15			75108A	.35	74L73	.40	74LS10	.45
4020	.85	7426	.30			75110	.35	74L74	.45	74LS11	.45
4021	1.35	7427	.45	74100	1.85	75491	.50	74L75	.55	74LS20	.40
4022	.95	7430	.15	74107	.35	75492	.50	74L93	.55	74LS21	.25
4023	.25	7432	.30	74121	.35			74L123	.55	74LS22	.25
4024	.75	7437	.35	74122	.55					74LS32	.40
4025	.35	7438	.35	74123	.55	74H00	.25			74LS37	.40
4026	1.95	7440	.25	74125	.45	74H01	.25	74S00	.55	74LS40	.55
4027	.50	7441	1.15	74126	.35	74H04	.25	74S02	.55	74LS42	1.75
4028	.95	7442	.55	74132	1.35	74H05	.25	74S03	.40	74LS51	.65
4030	.35	7443	.85	74141	1.00	74H08	.35	74S04	.35	74LS74	.75
4033	1.95	7444	.45	74150	1.00	74H10	.35	74S05	.35	74LS86	.75
4034	2.45	7445	.80	74151	.75	74H11	.25	74S08	.35	74LS90	1.30
4035	1.25	7446	.95	74153	.95	74H15	.30	74S10	.35	74LS93	1.00
4040	1.35	7447	.95	74154	1.05	74H20	.30	74S11	.35	74LS107	.95
4041	.69	7448	.95	74156	1.15	74H21	.25	74S20	.35	74LS123	1.00
4042	.95	7450	.25	74157	.65	74H22	.40	74S40	.25	74LS151	.75
4043	1.25	7451	.25	74161	.85	74H30	.25	74S50	.25	74LS153	1.20
4044	.95	7453	.20	74163	.95	74H40	.25	74S51	.45	74LS157	.85
4046	1.50	7454	.25	74164	.60	74H50	.25	74S64	.25	74LS164	1.90
4049	.80	7460	.40	74165	1.50	74H51	.25	74S74	.40	74LS367	.85
4050	.60	7470	.45	74166	1.35	74H52	.15	74S112	.90	74LS368	.70
4066	1.35	7472	.45	74175	.80	74H53J	.25	74S114	1.30		
4069	.40					74H55	.25				
4071	.35										
4082	.45										

9000 SERIES		LINEARS, REGULATORS, etc.							
9301	.85	8266	.35	LM320K5 (7905)	1.65	LM340T-24	.95	LM723	.50
9309	.35	8836	.95	LM320K12	1.65	LM340K-12	2.15	LM725	1.75
9322	.85	MCT2	.95	LM320T12	1.25	LM340K-15	1.25	LM739	1.50
95H03	.55	8038	3.95	LM320T15	1.65	LM340K-18	1.25	LM741 8-14	.20
9601	.75	LM201	.75	LM339	.95	LM340K-24	.95	LM747	1.10
9602	.50	LM301	.25	7805 (340T-5)	.95	LM373	2.95	LM1307	1.25
		LM308 (Mini)	.75	LM340T-12	1.00	LM380	.95	LM1458	.95
		LM309H	.65	LM340T-15	1.00	LM709(8,14 PIN)	.25	LM3900	.50
		LM309K(340K-5)	.85	LM340T-18	1.00	LM711	.45	LM75451	.65
		LM310	1.15					NE555	.50
		LM311D(Mini)	.75					NE556	.95
		LM318 (Mini)	.65					NE565	.95

MEMORY CLOCKS	
74S188 (8223)	3.00
1702A	7.95
MM5314	3.00
MM5316	3.50
2102-1	1.75
2102L-1	1.95
TMS6011NC	6.95
8080AD	15.00
8T13	1.50
8T23	1.50
8T24	2.00
2107B-4	4.95

INTEGRATED CIRCUITS UNLIMITED

7889 Clairemont Mesa Blvd. San Diego, CA 92111 (714) 278-4394

All orders shipped prepaid No minimum (Calif. only)
Open accounts invited COD orders accepted

Discounts available at OEM Quantities
California Residents add 6% Sales Tax

Free 24 Hour Phone 800-854-2211 MasterCharge / BankAmericard

19

HOT NEWS!

FEATURING THE BARGAINS OF THE MONTH!!!!

POLY PAKS[®] IS THE WORLD'S LARGEST ELECTRONIC DISCOUNT SUPERMARKET
OCTOBER - 1977 73 MAG. SPECIALS

RCA High quality "POCKET" VOM
• 1000 ohms per volt
Model WV-539A. Features 1% precision, movements diode protected against burnout. Measures DC volts 0-15-150-1000; AC volts 0-15-150-1000; DC current 0-150ma; resistance X1000. Sensitivity 1000 ohms/volt AC-DC. Uses penlite cell, not included. Size 2 3/8 x 3 1/2 x 1 3/4". Wt. 5 ozs. Cat. No. 10A3921

\$8.88

QUAD AM-FM-MPX TUNER AMP BUILT-IN QUAD STEREO TAPE PLAYER

Save \$10 Now

For 2 and 4 spkrs.

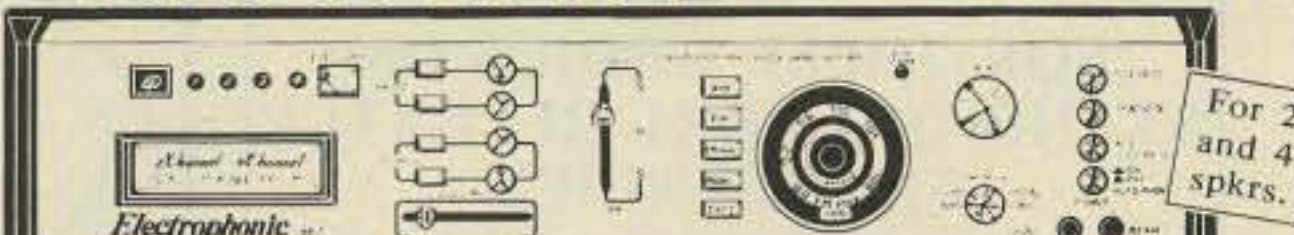

MOTHERBOARD EDGE CONNECTOR
106 pins (53 each side). Use with IMSAI & ALTAIR! 0.125" pin ctrs, goldplated 3/8" wire wrap leads. Open ends, fit wide PC boards. 8 ozs. Cat. No. 10A3987

\$3.95

The "Satellite" **TRW 900 MHz UHF POWER TRANSISTOR**
2 for \$9. NPN! CB'ers, Hams take note! Replaces many transmitter driver and output transistors. TO-181 case, 3/8" dia, with 1/2" leads. Two emitter leads. Bvceo 25V, Hfe (beta) 30-60, Ic max 1.25 amps. No. 10A3942 **\$4.95**

\$5.50 TV GAME & HI-FI JOY STICK
• Includes four 100K pots
For TV & computer games, and quadrophonic balancing! 1 1/2 x 1 1/2 x 1". With 1" handle. Wt. 6 ozs. Cat. No. 10A3808

Cat. No. 10A3971

This Month Only... **69.95**

Reg. \$79.95 at Poly Paks!

- 5 watts per channel x 4 RMS, 20W total.
- Psychedelic panel lighting effect.
- Brushed aluminum Streamlined styling.

The finest unit we've ever offered. The "SYMPHONY" plays quad 8-track tapes in full dimension quad. Also features Matrix-Quad, derives quad sound from stereo records, tapes and FM. 136" phono input cables and has outputs for 4 speakers, jacks for "Quad tape-output", and terminals for external FM antenna. Fits easily into wall, console, or cabinet of your own design. FM stereo indicator. Pushbutton switches select stereo, matrix, 4D discrete, power On/Off, Bass and treble slide control. Additional multifunction switch selects AM, FM, FM-MPX, phono, tape; blue panel lights indicate these functions. Master slide volume control with individual balance controls for each channel. Output jacks for quad headphones. Tape deck panel light indicates when a quad tape is inserted. Other lamps indicate the track being played. 115 VAC. Size: 22 x 5 x 8" deep. Wt. 9 lbs.

TTW'S We know we have the lowest prices!!

BUY 10 **15% OFF**
BUY 100 **25% OFF**

Order by Cat. No. 10A1981

NOISE-CANCELLING CB-HAM MIKE
Cuts noise of machinery, highway for clear transmission!
• Fits virtually all rigs, everywhere!
Lo-impedance, freq. resp: 300-5000 Hz. With 6' coiled cord. Includes instructions for 100's of CBs. Wt. 20 ozs. No. 10A3902

\$6.66

J. C. PENNEY'S 8-Track TAPE TRANSPORT

• 115 VAC fan-cooled motor
• Slides easily into modular cabinet.

Excellent replacement or design your own quality tape system! Automatic or manual track selection with program indicator lights. Player shuts off automatically when tape is removed. Built-in low-distortion preamp and wow free motor. With input & output cables. Requires external power supply. With instructions. Size 9 x 6 x 3 1/2". Wt. 4 lbs. Cat. No. 10A3010

\$12.95

• Shielded preamp

Type	Sale	Sale	• Type No
SN7400	\$0.14	SN7400	.20
SN7401	.14	SN7401	.14
SN7402	.14	SN7402	.14
SN7403	.14	SN7403	.14
SN7404	.14	SN7404	.14
SN7405	.18	SN7405	.18
SN7406	.19	SN7406	.19
SN7407	.24	SN7407	.24
SN7410	.14	SN7410	.14
SN7411	.19	SN7411	.19
SN7413	.39	SN7413	.39
SN7414	.61	SN7414	.61
SN7416	.24	SN7416	.24
SN7417	.24	SN7417	.24
SN7420	.14	SN7420	.14
SN7423	.26	SN7423	.26
SN7427	.26	SN7427	.26
SN7430	.14	SN7430	.14
SN7432	.24	SN7432	.24
SN7437	.24	SN7437	.24
SN7438	.24	SN7438	.24
SN7440	.14	SN7440	.14
SN7441	.79	SN7441	.79
SN7442	.49	SN7442	.49
SN7443	.61	SN7443	.61
SN7444	.61	SN7444	.61
SN7445	.69	SN7445	.69
SN7447	.69	SN7447	.69
SN7450	.14	SN7450	.14
SN7451	.14	SN7451	.14
SN7453	.14	SN7453	.14
SN7454	.14	SN7454	.14
SN7455	.14	SN7455	.14
SN7460	.20	SN7460	.20
SN7462	.14	SN7462	.14
SN7464	.14	SN7464	.14
SN7465	.14	SN7465	.14
SN7470	.28	SN7470	.28
SN7471	.69	SN7471	.69
SN7472	.26	SN7472	.26
SN7473	.31	SN7473	.31
SN7474	.31	SN7474	.31
SN7475	.48	SN7475	.48
SN7476	.33	SN7476	.33
SN7478	.79	SN7478	.79
SN7480	.33	SN7480	.33
SN7482	.59	SN7482	.59
SN7483	.69	SN7483	.69
SN7485	.88	SN7485	.88
SN7486	.29	SN7486	.29
SN7488	2.95	SN7488	2.95
SN7490	.69	SN7490	.69
SN7491	.63	SN7491	.63
SN7492	.45	SN7492	.45
SN7493	.45	SN7493	.45
SN7494	.69	SN7494	.69
SN7495	.69	SN7495	.69
SN7496	.69	SN7496	.69
SN7498	.69	SN7498	.69
SN74107	.29	SN74107	.29
SN74112	.19	SN74112	.19
SN74113	.19	SN74113	.19
SN74114	.19	SN74114	.19
SN74121	.31	SN74121	.31
SN74123	.49	SN74123	.49
SN74125	.39	SN74125	.39
SN74126	.39	SN74126	.39
SN74132	.83	SN74132	.83
SN74140	1.00	SN74140	1.00
SN74141	.92	SN74141	.92
SN74145	.89	SN74145	.89
SN74148	1.25	SN74148	1.25
SN74153	.63	SN74153	.63
SN74154	.99	SN74154	.99
SN74155	.78	SN74155	.78
SN74156	.68	SN74156	.68
SN74157	.64	SN74157	.64
SN74160	.89	SN74160	.89
SN74161	.87	SN74161	.87
SN74163	.87	SN74163	.87
SN74164	.95	SN74164	.95
SN74165	.95	SN74165	.95
SN74166	1.15	SN74166	1.15
SN74172	1.19	SN74172	1.19
SN74173	.93	SN74173	.93
SN74175	.88	SN74175	.88
SN74177	.77	SN74177	.77
SN74179	1.49	SN74179	1.49
SN74180	.69	SN74180	.69
SN74181	1.95	SN74181	1.95
SN74182	.69	SN74182	.69
SN74190	1.15	SN74190	1.15
SN74191	.99	SN74191	.99
SN74192	.83	SN74192	.83
SN74193	.83	SN74193	.83
SN74194	.83	SN74194	.83
SN74195	.75	SN74195	.75
SN74197	.75	SN74197	.75
SN74199	1.69	SN74199	1.69
SN74200	5.50	SN74200	5.50
SN74251	1.39	SN74251	1.39
SN74284	4.25	SN74284	4.25
SN74285	4.25	SN74285	4.25

ECCO 10-POSITION BCD THUMBWHEEL SWITCH
1-2-4-8 BCD encoding! Positions labeled 0-7, F, L. (F coded for 8, L coded for 9). White numerals on a black background. Ecco 800 series. 1 1/4 x 1 1/4 x 1/2". Cat. No. 10A3846

\$1.49

1-AMP REGULATED POWER SUPPLY

Your choice **\$8.88** KIT ea.

New! Easy to assemble! Uses LM340K positive voltage regulator. Reverse leads for a negative supply. Buy 2 for a ± power supply! With transformer, regulator, PC board & all components. Complete kit, nothing else to buy. Wt. 4 lbs. Cat. No. 10A3854 5
10A3857 12
10A3858 15

GE NI-CAD POWER PAKS
AA penlite cells, ganged in series! 1.25V each cell. Rechargeable! Wt. 2 oz. per cell. No. Cells Volts Sale
10A3688 2 2.5 \$2.50
10A3689 3 3.75 3.50
10A3690 4 5. 4.50

DUAL 6-WATT STEREO AMP
LM-379... for AM-FM's, phonos, tape recorders, & more!! 6 watts x 2 RMS into 8 ohms, 5% THD, AVO 90 db type, 75 db channel separation. Supply 10-35 VDC. With specs. 2 for Cat. No. 10A3447 **\$9**

POLY PAKS "RAMS" 2102-1 PRICES
New from top U.S.A. makers. Tested for 500 nsec. speed. Cat. No. 10A3548

\$9.95

BARREL KITS TEST 'EM YOURSELF 'N SAVE! EXCLUSIVE GUARANTEED 50% YIELD ON UNTESTED.....

Buy 10 BARREL KITS AND CHOOSE THE 11TH KIT FREE

BARREL KIT #203 CALCULATOR KEYBOARDS 10 for \$1.98 It's true! 20-key, 4 function keyboards at ridiculous give-away. Wt. 12 ozs. Cat. No. 10A3524	BARREL KIT #253 LINE CORDS 8 for \$1.98 100's of AC power uses! Heavy-duty, 6-ft. long, 18 gage. White vinyl insulation & molded plug. Wt. 8 ozs. Cat. No. 10A3843	BARREL KIT #200 6 DIGIT READOUT MODULES 5 for \$1.98 Barrels and barrels and no time to test. Calculator and driver chips beneath epoxy on back. Wt. 6 ozs. 10A3515	BARREL KIT #244 HOBBY 1702A ROMS 3 for \$1.98 Hobby fallouts of the famous erasable programmable ROM. 2048 bit. Cat. No. 10A3729	BARREL KIT #239 SHIELDED CABLE 40-ft. \$1.98 For mikes, stereos; 1-cond. plus shield, 22 ga, vinyl jacket. Wt. 1 lb. Cat. No. 10A3577	BARREL KIT #225 SOUND TRIGGERS 3 for \$1.98 "Hand clap" sensitizes crystal mike amplifier, triggers SCR. Use for alarms, etel Wt. 6 ozs. No. 10A3625
BARREL KIT #205 MINI BLOCK CAPACITORS 50 for \$1.98 Unbelievable! Worth \$50. High precision submini caps for all applications. Wt. 3 ozs. No. 10A3528	BARREL KIT #201 6V INDICATORS w/leads 15 for \$1.98 Test lamp manufacturer dumps inventory! Worth 69¢ ea. Like grain-o-wheat. Cat. No. 10A3526 hobby	BARREL KIT #194 10 AMP INLINE BRIDGES 20 for \$1.98 Factory dumped in barrels. We can't test 'em, but for the price you can't go wrong. Hobby. Wt. 8 ozs. Cat. No. 10A3475	BARREL KIT #188 400 PARTS \$1.98 Includes resistors, caps, diodes, IC's, for PC work, some on PC boards. Dumped into barrels by factories. 100% material. Wt. 12 ozs. Cat. No. 10A3401	BARREL KIT #182 JUMBO RED LEDS 15 for \$1.98 100% material, user cancellation from factory dumps, 3V 10 mils. For 100's of projects, red lens. Cat. No. 10A3369	BARREL KIT #163 MINI TRIM POTS 30 for \$1.98 Asst. values 100 to 1 meg What a buy. Single turn. 3/4 W. Wt. 6 oz. 10A3345
BARREL KIT #161 "POP" PLASTIC TRANSISTORS 25 for \$1.98 Calculator maker dumps 2N3904's with some 2N3906's of 100% material. TO-92. Preformed. Cat. No. 10A3343	BARREL KIT #160 HOBBY VOLTAGE REGULATORS 10 for \$1.98 LM-309K TO-3 barreled, but by the pound, but who wants to check 'em? Your gain. Wt. 20 ozs. 10A3330	BARREL KIT #138 PANEL SWITCHES 30 for \$1.98 9 ozs. Did you hear of OAK? Another eqpt maker barreled all types of rotaries, electric, slides, etc. 10A3268	BARREL KIT #128 MINI-DIP IC'S 100 for \$1.98 741's, LM380, 703, 507, 555, who knows? Factory mixed, you test. Untested and hobby. Wt. 1 lb. Cat. No. 10A3245	BARREL KIT #126 UPRIGHT ELECTROS 40 for \$1.98 1mf to 300mf in mixture of voltages. 100% marked 'n good. 10A3226	BARREL KIT #115 MOLEX 100% GOOD SOCKETS 150 for \$1.98 Calculator maker dump! We got a zillion of 'em.
BARREL KIT #109 TERMINAL STRIPS 100 for \$1.98 Wide asst. of terminal strip connectors, from 1 contact up. Strip manufacturers barrel dump is your gain. Wt. 1 lb. Cat. No. 10A3136	BARREL KIT #104 SLIDE VOLUME CONTROLS 10 for \$1.98 Cat. No. 10A3057	BARREL KIT #101 RESISTOR SPECIAL 200 for \$1.98 Includes: 1/8, 1/4, 1/2, 1, 2-watt, carbon, 8 oz. 100% good. 10A3054	BARREL KIT #99 PHOTO ELECTRIC CELLS 10 for \$1.98 Asst. GE types, CDS types. Mixed by factory. Big job for us to separate. 100% good. Cat. No. 10A3052	BARREL KIT #93 HALF WATTERS 200 for \$1.98 Resistor factory tried to fool us by mixing 100% color-coded resistors in barrel. But value is there. 4 oz. 10A3046 Untested	BARREL KIT #87 NAT. IC BONANZA! 100 for \$1.98 Hobby and untested, factory mixed in barrels. Linear, 7400's, ROMS, DTL's, registers, clock and calculator chips and more. Wt. 12 ozs. Cat. No. 10A2860
BARREL KIT #83 LM-340T VOLTAGE REGULATORS 15 for \$1.98 Factory rejects, hobby, cosmetic rejects. May include 5, 6, 12, 15, 18 or 24 volts, TO-220 power tab. Wt. 4 ozs. Cat. No. 10A2635	BARREL KIT #71 CAPACITOR SPECIAL 100 pcs. \$1.98 micas, molded, plastics, ceramics, discs, etc. Nifty 100% good. Cat. No. 10A2738	BARREL KIT #68 2 WATTERS 100 for \$1.98 100% good. Suppliers throw 'em in the barrel. It's a li'l gold mine. All marked. Cat. No. 10A2735	BARREL KIT #61 POLYSTYRENE CAPS 100 for \$1.98 Finest caps made. As a gamble we bought 10 barrels from factory, mixed values; all good. Cat. No. 10A2729	BARREL KIT #58 SLIDE SWITCHES 30 for \$1.98 All shapes, sizes, spst, apdt, momentaries, etc. Tremendous shop pak for 100's of switching projects. Cat. No. 10A2726 100% good	BARREL KIT #40 HOBBY PNP POWER TRANSISTORS 15 for \$1.98 Popular germanium and silicon TO-3's, factory "off spec" and fallouts. 100% hobby, no opens, no shorts! Wt. 16 ozs. Cat. 10A2618
BARREL KIT #31 METALLIC RESISTORS 100 for \$1.98 Made mostly by Corning, the finest resistor made. Mostly 1/2 watters. 1% to 5% tol. & a barrel of values. Cat. No. 10A2609	BARREL KIT #30 PREFORMED RESISTORS 200 for \$1.98 We got barrels of 1/4 and 1/2 watters for pc use. 100: 1/4, 100 1/2 watters. No. 10A2608 100% good	BARREL KIT #27 PREFORMED DISCS 150 for \$1.98 Hi-Fi mfr's shelf inventory but he dumped 'em in barrels. Preformed, for PC use. Mixed values too! 10A2605	BARREL KIT #26 PLASTIC TRANSISTORS 100 for \$1.98 Untested and hobby transistors, TO-92 (TO-18), asst. 2N numbers, asst. manufacturers. Wt. 8 ozs. 10A2604	BARREL KIT #24 HIGH VOLTAGE RECTIFIERS 200 for \$1.98 Up to 12,000 volts, 4 mils. epoxy, axial leads. Cat. No. 10A2602	BARREL KIT #20 LONG LEAD DISCS 100 for \$1.98 "auction sale". Prime, marked only. Long leads. Cat. 10A2598 100% good
BARREL KIT #14 PRECISION RESISTORS 200 for \$1.98 Marked and unmarked 1/4, 1/2, 2 watts. No 10A2428	BARREL KIT #7 VOLUME CONTROL 30 for \$1.98 100% good Singles, duals, variety of values, styles, big ones - small ones. Cat. 10A2421	BARREL KIT #3 1N4148/914 SWITCHING DIODES 100 for \$1.98 Imagine famous switching diodes at these prices! Cat. No. 10A2418 Untested.	BARREL KIT #1 SN7400 DIP IC'S 75 for \$1.98 Marked 14 and 16 pin dips, may include gates, flip-flops, registers, counters, who knows? Untested, hobby. Wt. 14 ozs. 10A2415	Terms: Add postage Rated: net 30 Phone : Wakefield, Mass. (617) 245-3829 Retail: 16-18 Del Carmine St., Wakefield.	

POLY PAKS P.O. BOX 942A LYNNFIELD, MA. 01940

SALE Send for FREE Fall-Winter CATALOG C.O.D.'s MAY BE PHONED

Armchair Copy



Shortwave Listening

Our ONLY occupation is supplying everything you need to tune the mediumwave and shortwave bands—and identify what you hear. Our NEW mini-catalog details Barlow Wadley, Drake and Yaesu receivers, WORLD RADIO TV HANDBOOK, logs, receiving antennas & tuners, calibrators, FM or TV guides, AM pattern maps, QSL albums, ITU publications, RTTY displays, CONFIDENTIAL FREQUENCY LIST, clocks and all SWL books.

GILFER ASSOCIATES, INC

P.O. Box 239, Park Ridge, NJ 07656

G6

2 METER CRYSTALS MANY IN STOCK

FOR THESE RADIOS ON
STANDARD ARRL REPEATER
FREQUENCIES

Clegg HT-146	Regency HR-212
Drake TR-22	Regency HR-2B
Drake TR-33 (rec only)	Regency HR-312
Drake TR-72	Regency HR-2MS
Genave	S.B.E.
Heathkit HW-2021 (rec only)	Sonar 1802-3-4, 3601
Heathkit HW-202	Standard 146/826
Icom/VHF Eng	Standard Horizon
Ken/Wilson	Swan FM 2X
Lafayette HA-146	Tempo FMH
Midland 13-505	Trio/Kenwood
Regency HR-2	Trio/Kenwood TR2200
	Trio/Kenwood TR7200

**\$3.95 EACH — IN QUANTITIES
OF 10 OR MORE, \$3.50 EACH**

Certified check or money order only —
NO CODs

ROLIN DISTRIBUTORS

P.O. Box 436
Dunelle NJ 08812

R15

PROUD OF YOUR CALL? . . WORRIED ABOUT THEFT?

Identify your FM transceiver with
automatic code on each trans-
mission.

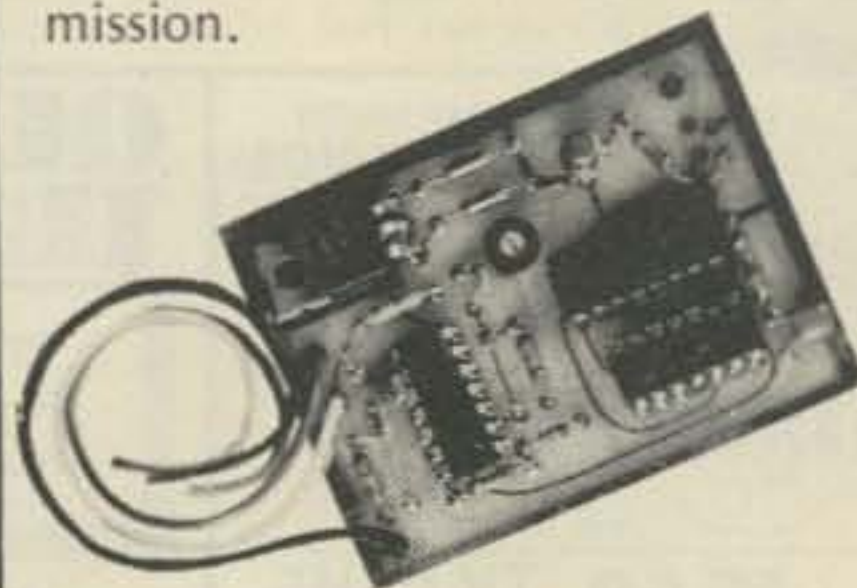

SMALL: 2" x 2 5/8" x 5/16"
Installation: Only THREE wires

WARRANTY

Returnable for full refund within
ten day trial period. One year for
repair or replacement.

PRICE \$39.95 Ppd + \$2.40
CA. SALES TAX

Your call sign programmed at
factory, please be sure to state
call sign when ordering.

AUTOCODE

8116 Glider Ave, Dept S
Los Angeles, Ca. 90045
(213) 645-1892

A36

THE CHALLENGE OF 160

ARE YOU IN A RUT? Tired of talking to the same characters on 75 every evening? If so, perhaps it's time to try a new band — something different and exciting. Consider 160 meters. The "Top Band" is different from any other amateur allocation. Its propagation characteristics are unique, resembling the standard AM broadcast band. Amateur radio's roots can be traced to 160, as it was there (actually, 200 meters) that amateur radio began.

If you are remotely interested in 160 meter operation, 73's newest book, *The Challenge of 160*, is for you. Si Dunn, the author, has compiled a complete reference for the new and experienced 160 operator. Eleven chapters cover everything from receiving and transmitting equipment to antenna and ground systems. Weather effects upon propagation are discussed, as well as operating tips. An interesting introduction provides an insight into the origins of amateur radio — complete with pictures and comments about Stew Perry W1BB, the "King of 160."

This reference is heavily illustrated . . . and complete schematics are provided for construction projects. An additional reading index of related articles and publications is provided — as you are sure to become excited with 160 operating after reading *The Challenge of 160*. Price: \$4.95.

Use the order card in the back of the magazine or itemize your order on a separate paper & mail to: 73 Radio Bookshop/Peterborough NH 03458. Be sure to include check or detailed credit card information.



NEW

for '77
Only

\$145

less batteries
and crystals



ECM-5B MK-II fm modulation meter

- 0-6KHz peak reading linear scale, meets commercial standards
- Operates 25MHz to 500MHz
- Crystal controlled for easy operation
- Audio/scope output with earphone
- Options: NICAD power PAK \$34.95

Charger \$29.95

Write or call for complete information. Send check or money order for \$145 plus \$1.75 for shipping. Indiana residents add 4% sales tax. Crystals for 146.94MHz: \$4.95. All other freq: \$7.95.

ECM

ECM Corporation
412 N. Weinbach Ave.
Evansville IN 47711
812-476-2121 E1

SST T-I RANDOM WIRE ANTENNA TUNER

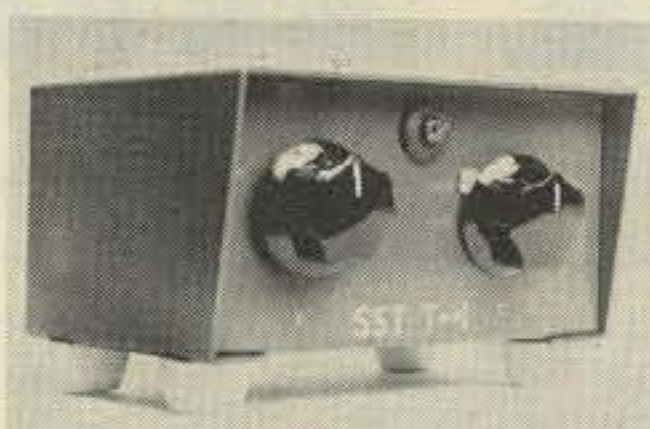

Allband operation (160-10 meters) with any random length of wire. 200 watt output power capability — will work with virtually any transceiver. Ideal for portable or home operation. Great for apartments and hotel rooms — simply run a wire inside, out a window, or anyplace available. Toroid inductor for small size: 3X4-1/4X2-3/8. Built-in neon tune-up indicator. SO-239 connector. Guaranteed for 1 yr., 10 day trial. IF NOT SATISFIED RETURN FOR A FULL REFUND! COD OK BY PHONE

THE ORIGINAL RANDOM WIRE ANTENNA TUNER — in use by amateurs for 5 years.

COMPACT ••• only \$29.95
EASY TO USE POSTPAID. (ADD SALES TAX IN CALIF.)

SST Electronics, (213) 376-5887
S10 P.O. Box 1, Lawndale CA 90260

D & V RADIO PARTS

12805 W. Sarle, R#2 Freeland, Michigan 48623

MILLEN

10031 Counter Dial	28.10
16250	43.25
26100RM	10.20
34107	1.40
34154	4.30
34300-500	1.05
16520A	24.75
19335	14.90
34108	1.40
34156	5.85
34300-1000	1.10

CARDWELL CONDENSER CORP.

149-8	11.15	160-130	3.75
154-10	38.10	154-507	50.85
167-3	6.90	167-12	15.75
167-21	7.65	167-22	8.90
167-53	16.95	154-30	31.90
APC-50B	5.25	APC-140B	5.75
HF-50	6.90	HF-140	7.05
MC-250-M	13.65	MC-325-M	17.55

E. F. JOHNSON

189-0501-005 thru 0509 Series . . . 1.35

B&W MINI-DUCTORS

3018	2.05	3019	2.15
3022	2.35	3025	4.45
3027/3907-1	4.55	3029/3905-1	5.05

NO MINIMUM ORDER

\$1.35 SHIPPING USA & CANADA
FIRST CLASS STAMP FOR FLYER

Are YOU a computer hobbyist

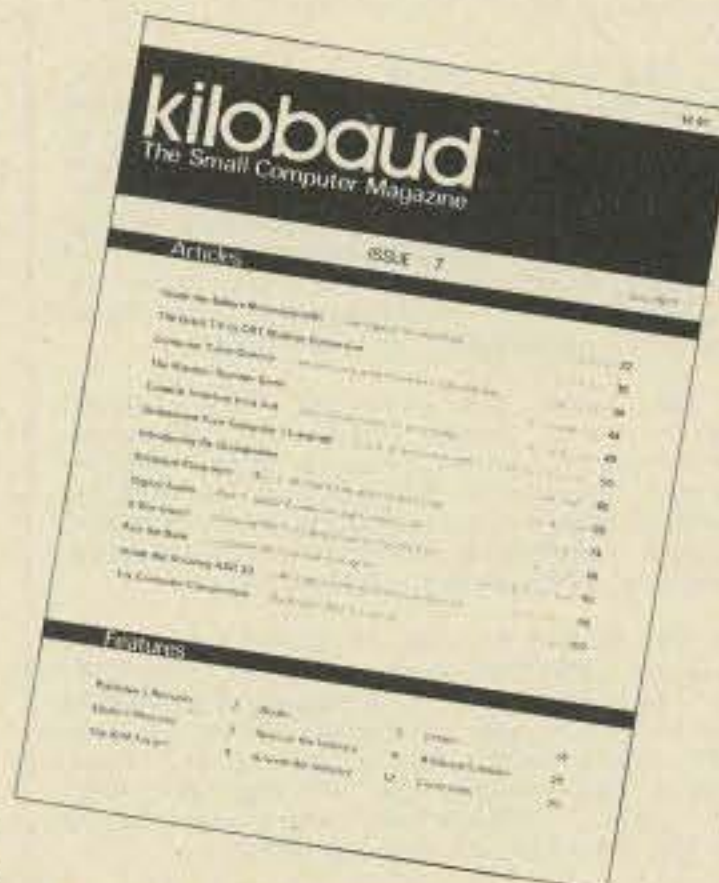

— yet?

If you are like the rest of us you've been reading about microcomputers . . . you're excited about them . . . but there is so much to understand and it all seems so complicated that there is no way to understand it. Hogwash.

A brand new magazine is being published for computer hobbyists . . . for people who are beginners . . . neophytes . . . novices . . . people who have no idea what a vectored interrupt is, but just the same want to learn about computers and have fun.

A home computer system can cost you a bundle if you don't know what you are doing. Kilobaud could save you a lot of money . . . others have learned the hard way. Kilobaud is a sort of giant club newsletter for computer hobbyists . . . a place to tell each other about the problems they've had . . . and the solutions. It's a magazine filled with great articles . . . all written so you'll be able to understand them (for a change).

You want to know about hardware? Read about the new MITS Z-80 CPU in Kilobaud, simply explained by the chap who designed the circuit. Or how about the best-selling TDL Z-80 CPU . . . the designer has written about it in Kilobaud too. You're wondering about what cassette system to use? You can go crazy on this one . . . but before flipping out, read the Hal Walker article in Kilobaud and find out what the problems are . . . and the solutions.

What do you do with the confounded things after you've gotten them working? The programs are in Kilobaud . . . lot's of them.

MAKE MONEY

Perhaps you've been thinking of the computer hobby as a way to get into a small business. Why not? This is going to be an enormous field in a couple of years and you can bet that those on the ground floor will have the best chance at the gold ring. Kilobaud will help you learn how to get into manufacturing . . . to become a dealer . . . a manufacturer's representative . . . a service bureau . . . a writer. Never before has there been an opportunity like this . . . so don't miff it . . . grab hold and start getting your feet wet. It'll not only pay off well in the long run, you'll have a ball every minute of the way.

KILOBAUD IS BRAND NEW

The first issue was January 1977 . . . and the magazine is the fastest growing and best accepted magazine in the hobby computer field already. You doubt that? Just stop in at any hobby computer store and ask anyone you see. Kilobaud is outselling all other magazines combined . . . which says something considering the cover price of \$2. It's full of good articles and has a sense of humor. There are more articles in Kilobaud than you can read in a day . . . most readers comment that Kilobaud just has to be read from cover to cover and this takes several days. It's packed.

CONTROVERSIAL?

You bet! Kilobaud calls a spade a spade, with no pulled punches.

DO YOU WANT TO LEARN COMPUTERS?

Some magazines emphasize OEM systems . . . some are written more for computer scientists . . . Kilobaud is written for and by its readers . . . the hobbyists. You'll find great articles in there by well known hobbyists such as Don Lancaster . . . Don Alexander . . . Pete Stark . . . Dennis Brown . . . Hal Walker . . . Art Childs . . . Sheila Clark . . . and many more. The emphasis is fun.

TRY A SUBSCRIPTION

The cover price is \$2 (that's \$24 a year), but the subscription rate is only \$15 for the year . . . a saving of \$9.00. You can pay for it with your credit card (BankAmericard, Master Charge, American Express) or you can even be billed directly. Send in the below coupon . . . or call TOLL FREE 800-258-5473 (during office hours). Please have your credit card handy.

Your subscription will start with the next published issue, so allow about six weeks for any apparent action. If you would like to be filled in with the back issues they are \$3 each and at last count some were still available.

YES! Start my one year Kilobaud subscription for \$15 with the next published issue.

Name _____ Call _____
Address _____
City _____ State _____ Zip _____

\$15.00 enclosed. Cash Check Money Order

Bill: Master Charge BankAmericard American Express

Card # _____ Interbank # _____
Signature _____ Exp. date _____

Bill me direct. (I've signed above)

*Subscription will start with next published issue. Allow six weeks for processing.

Toll Free Subscription Number (800) 258-5473

kilobaud

PETERBOROUGH NH 03458

73/10/77

WHAT HAVE YOU MISSED?

JUNE 63. Surplus Issue: DMQ-2 Beacon Tx on 220, increasing ARC-2 transceiver selectivity, PE-97A pwr supply conversion, BC-348 bandspread, inductance tester, converting BC-230 tx, beginner's rx using BC-453, recvr motor-tuning, transistor cw monitor, BC-442 ant relay conversion, mobile loading coils, increasing Two-er selectivity, TV with the ART-26 tx, TRC-8 rx on 220, ARC-5 hf rx & tx, ARC-3 tx on 2M.

AUG 63. Battery-op 6M stn, diode noise gen, video modulation, magic T-R switch, ant gain, halo mods, cw breakin, VEE beam design, coax losses, RF wattmeter, TX Tube Guide, diode pwr supply, "Lunchbox" squeech, SWR explanation, vertical ant info, info on Windom ant.

OCT 63. WBFM transceiver ideas, HF propagation, cheap fone patch, remote-tuned Yagi, construction hints, ant coupler, S5 Vertical, filament xformer construction, 2M nuvistor converter, Lafayette HE-35 mods, Buyer's Guide to Rx & Tx, product detector, novel Hi-C VFO, radio astronomy, panadaptor "if" converter, compact mike amp.

FEB 64. 2M multichannel exciter, rx design ideas, magic t/r switch, loudspeaker enclosures, 40M 2W tx, look at test equipment, radio grounds, 40M ZL Special ant, neutralization.

MAY 67. Quad Issue: 432 Quad-quad-quad, expanded HF quad, Two el quad, miniquad, 40M quad, quad experiments, half-quad, three el quad, 20M quad, tilt-over quad, easy-to-erect quad, Quad Bibliography, FET vfo, tube troubleshooting, HF dummy load, understanding "dB," HF SSB/cw rx, geometric circuit design, GSB-201 transceiver, FET converter for 10-20M, hi-pass rx filters.

JULY 67. VE ham radio, VEB hams, dsb adaptor, home brew tower, transistor design, "39 World's Fair, gnd plane ant, G4ZU beam, SSTV monitor, UHF FET preamps, IC "if" strip, vertical ant, VHF/UHF dipper, tower hints, scope monitoring, operating desk, S-Line crossband, hi-school ham club, Heath HR-10 mods.

OCT 67. HF solid state rx, rugged rotator, designing slug-tuned coils, FET converter, SSTV pix gen, VHF log-periodics, rotatable dipole, gamma-match cap, old-time dxing, modern dxing.

JUNE 68. Surplus Issue: Transformer tricks, BC-1206 rx, APS-13 ATW tx, low voltage dc supply, surplus scopes, FM rig commercial xtal types, Wilcox F-3 rx, restoring old equipment, 75A1 rx mods, TRA-19 on 432, freq counter uses, transceiver pwr supply, uses for cheap tape recorders, Surplus Conversion Bibliography, RT-209 walkie on 2M, ARC-1 guard rx, RTTY tx TIJ.

JULY 68. Wooden tower construction, tilt-over towers, erecting a telephone pole, IC AF osc, "dB" explained, ham club tips (Part 1).

SEPT 68. Mobile vhf, 432 FET preamps, converting TV Tuners, xtal osc stability, parallel-Tee design, moonbounce rhombic, 6M xciter (corrections Jan 69), 6M transceiver (corrections Jan 69), 2M dsb amp, ham club tips (Part 3).

NOV 68. SSB xtal filters, solid state troubleshooting, IC freq counter (many errors & omissions), "cv" transformers, space comm odyssey, pulsar info, thin-wire ants, 40M transistor cw tx/rx, BC-348M double conversion, multifunction tester, copper wire specs, thermostat applications, hi-voltage transistor list, ham club tips (Part 5).

JAN 69. Suppressor compressor, HW-12 on 160, beam tuning, AC voltage control, 2M transistor tx, LC power reducer, spectrum analysis info, 6M transistor rx, operating console, RTTY autostart, calculating osc stability, lo-pwr 40 cw tx, sequential relay switching, sightless operator's bridge, ham club tips (Part 7).

FEB 69. SSTV camera mod for fast-scan, tri-band linear, selective af filter, unijunction transistor info, Nikola Tesla biography, mobile installation hints, extra-class license study (Part 1).

MAR 69. Surplus issue: TCS tx mods, cheap compressor/amp, RXZ calculations, transistor keyer, better balanced modulator, transistor oscillators, using blowers, half-wave feedline info, Surplus Conversion Bibliography, extra license study (Part 2).

APR 69. 2-channel scope amp, rx preamp, Two-er PTT, variable DC load, SWR bridge, 100 kHz marker gene, some transistor specs, SB-610 monitorscope mods, portable 6M AM tx, 2M converter, extra license study (Part 3).

MAY 69. 2M Turnstile, 2M Slot, rx attenuator, generator filter, short VEE, quad tuning, using antennascopes, measuring ant gain, phone patch regs, SWR indicator, 160M short verticals, 15M antenna, HF propagation angles, FSK exciter, KW summy load, hi-power linear, extra license study (part 4), all-band curtain array.

JUNE 69. Microwave pwr generation, 6M ssb tx, 432 er tx/rx, 6M converter, 2M 5/8 wave whip, UHF tv tuners, ATW video modulator, UHF FET preamps, RTTY monitorscope, extra license study (part 5), building uhf cavities, mini-VEE for 10-20M, vhf vfo.

JULY 69. AM modulator, SSTV sig gen, 6M kw linear, 432 KW amp, 432 er tx/rx, 6M IC converter, radio-controlled models, RTTY IC

The back issues of 73 are a gold mine of interesting articles . . . just take a look at what's been covered . . . every possible interest. This is the most important library you can have for hamming.

The supply of these back issues is very limited . . . and when these are gone, that will be it. Don't miss out by procrastinating.

Single issues \$1.50 each (before 1976)

Ten back issues (your choice) \$12 postpaid in US.

Twenty-five back issues (your choice) \$20 postpaid in US.

Twenty-five back issues (our choice) \$10 postpaid in US.

TU, audio notch filter, VRC-19 conversion, tube substitution, 2M transistor xciter, extra license study (part 6), hf FET vfo.

AUG 69. FET regen for 3.5 MHz up, FM crystal switching, 5/8 wave vertical, introduction to ICs, RTTY tone gen, good/bad transistor checker, 2M AM tx, measure transistor Ft, 160M propagation, triac applications, simple IF sweep gen, transistor keyer, SB-100 on 6M, xtal freq measurement, extra license study (part 7), FM deviation meter, qrp am 6M tx, circular quads, FM noise figure, transistor parameter tracer.

SEPT 69. Tunnel diode theory, magic tee, soldering techniques, wave travel theory, cable shielding, transistor theory, AM noise limiter, AFSK gen, transistor amp debugging, measure meter resistance, diode-stack pwr supply, transistor testing, 2½W 6M tx, HX-10 neutralizing, capacitor useage, radio propagation, AM mod percentage, extra class license study (part 8), 3-400Z linear, ATW vidicon camera, 2 transistor testers, FET compressor, rf plate choke.

OCT 69. Super gain 40M ant, FET chirper, telephone info, scope calibrator, thyristor surge protector, slower tuning rates, identify calibrator harmonics, FM adaptor for AM tx, CB sets on 6M, proportional control xtal oven, xtal filter installation, Q-multiplier, transceiver pwr supply, extra class study (part 9).

NOV 69. NCX-3 on 6M, IF notch filters, dial calibration, HW32A external VFO, 6M converter, feedline info, rf z-bridge, fm mobile hints, umbrella ant, 432-er tx (part 1), pwr supply tricks with diodes, transistor keyer, transistor bias design, xtal vhf sign gen, electronic variac, SB33 mods, extra class study (part 10), SB34 linear improvements.

DEC 69. Transistor-diode checker, dummy load/attenuator, tuned filter chokes, band-switching Swan 250 & TV-2, 88mh selectivity, match exercise, rti xtal calibrator, transistor pa design, hv mobile p.s., 1-10 GHz frequency meter, CB rig on 6M, extra license study (part 11), 1970 buyer's guide.

JAN 70. Transceiver accessory unit, bench power supply, SSTV color method, base-tuned center-loaded ant, 6M bandpass filter, extra license study (part 12), rectifier diode useage, facsimile info.

FEB 70. 18-inch 15M dipole, 6M converter, high-density pc board, camper-mobile hints, 2M freq synthesizer, encoding/decoding for repeaters, DX-35 mods, panoramic vhf rx, variable-Z HF mobile mount, extra license study (part 13), linear IC info, qrp 40M tx, IC Q-multiplier.

MAR 70. Gdo applications, charger for drycells, FM freq meter, pc board construction, ham fm standards, cheap rf wattmeter, multifreq fm osc, "IF" system modules (part 1), Six-er mods, gdo dip lite, Motorola 41V conversion, cw monitor, buying surplus logic, SSQ-23A sonobuoy conversion, GRC9 rx/tx conversion, extra class study (part 14), intro to vhf fm.

APR 70. Noise blanker, 2M hotcarrier diode converter, repeater controller, understanding COR repeater, 7/8 wave 2M ant, extra class study (part 15), inexpensive semiconductors, removing surplus meters, linear amp bias regulator, hi performance if amp & agc system, SSB bfo for shortwave radio, vacuum tube load box, general fm dope & repeater guide, meggering your ant.

MAY 70. Comments on "fm docket" #18803, future of cw, fm-am rx aligner, 5/8 wave verticals, using 2M intelligently, auto burglar alarms, pwr supplies from surplus components, "IF" system modules (part 2), vhf FET preamps, educated "idiot" lites, postage-stamp 6M tx, extra class study (part 16), Bishop IFNL, low-band police monitor, mobile cw tx, Wichita auto patch.

JUNE 70. DRR ant, vfo circuit, remote SWR indicator, indoor hf vertical, two rx on one antenna, environment & coax loss, 2-el trap verticals, buying surplus, two 40M qrp tx, 21dB 2M beam, extra class study (part 17).

DEC 70. Solid-state vhf exciter, delta fre control for SSB, 2M transistor FM tx, HW100 offset tuning, "little gate" dipper, 3500Z hf linear, general class study (part 5), "trans-test"

(no good - errors!), transistor p.s. current limiter.

JAN 71. Split fones for dxing, Heath Ten-er mods, cw duty cycle, repeater zero-beater, HEP IC projects, 10-15-20M parabolic ideas, lightning protection, IC rx accessory, attic ants, double-balanced mixers, permanent marker tool, ham license study questions.

FEB 71. Metal locator, varactor theory, AFSK unit, SSTV patch box, ATV hints, RTTY tuning indicator, tone encoder/decoder, 220 MHz converter, SSTV magnetic deflection, IC code osc, 6M tx beeper, general class study (part 6), RTTY intro, perf-board terminal, low-ohmmeter.

MAR 71. IC audio filter, IC 6M converter, trap vertical ideas, digi counter info, surplus equipment identification, hf linear, simple fone patch, repeater audio mixer, digi RTTY accessories, coathanger gndplane, general class study (part 7).

APR 71. Intro to fm, noise keyer, repeater problems, Motorola HT-12A microwave repeater linking, digi keyer, portable 2M fm rx/tx, repeater info, fm marketplace, meter ev, detector modulator, simple sig gen, toucan hookups, hf preselector, 10M 12W tx.

MAY 71. 75M mobile whip, 2M preamp, transistor amp design, 10M dsb tx, portable fm transceiver directory, audio compressor clipper, transistor LM frequency, 450 MHz link tx, simple af filter, 1 tube 2M transceiver, surplus 2M power amp, general class study (part 8).

JUNE 71. 2M beam experiments, 3-el 2M quad, multi-band dipole patterns, weather balloon vertical, pocket-pager squeech, two-er vfo, tuning mobile whips, transistor pwr supply, capacity decade box, 40M gain ant, general class study (part 9).

JULY 71. IC audio processor, audio sig gen, cw filter, 2M fm osc, 2M collinear vertical, FM supplier directory, Motorola G-strip conversion, transistor beta tester, general class study (part 10).

AUG 71. Ham facsimile (part 1), 500 Watt linear, dimensions for July collinear, 4-tube 80/40 station, vfo digi readout, Jupiter on 15M, general class study (part 11), pink ticket wavemeter.

SEPT 71. Transformerless power supplies, solid state tv camera, IC substitution, two rf wattmeters, IC compressor-agc, multichannel HT-200, ham facsimile (part 2), causes of manmade noise, vfo with tracking mixer, general class study (part 12), transistor heat-sinking, IC pulse gen, fone-patch isolation, hcd wattmeters.

OCT 71. Emergency repeater cor, transceiver power supply, predicting meteor showers, digi switching, reverse-current battery charger, passive repeaters, earth grounds, audio "tailoring" filters, Swan 350 mods.

NOV 71. 3-el 75M beam, motor-tuned gnd-plane, 2M gain vertical, transistor biasing, split-site repeater, fox-hunting, audio filter, transistor/diode tester, xtal tester, 6M kw amp, 10-15-20M quad, transistor pi-net final, ant feedline, communications dbs, 2300 MHz exciter.

AUG 72. SSTV intro, speech processor, fm repeater info, test probe construction, GE proglie ac supply, 432 rf testing, preamp-compressor, Six-er mods, fone patch, Two-er info, solar info, SCR regulator for HVPS, "ideal" xtal osc, fm rx adaptor, auto theft alarm.

SEPT 72. Plumbicon tv camera, WWVB 60 kHz rx, cigartube sig gen, cw active filter, rf testing at 1296-3500 GHz, balun ant feed, transistor power supply, IC 6M rx, IC fm/am detector (part 2), active filter design (part 3), K2OAW freq counter (part 3), 2M freq synthesizer (part 1).

OCT 72. Corrections for Aug. fm rx adaptor, 2M freq synthesizer (part 2), 6M transistor vfo, nano-ampere meter, time-freq measurement (part 1), active filter design (part 4), repeater timer, extra-class Q&A (part 3), balloon vertical, ID gen, time delay relay, 432 filter ideas, DC AC inverter, hc-diode converter, rti decade and nixie driver, plus-minus supply for ICs.

NOV 72. Hf transistor power amps, RTTY seical, IC trf rx, transistor keyer, emergency power, 220 MHz preamp, double-delta ant, simple converter using modules, hf RF tester, "lumped line" osc, 2M freq synthesizer (part 3), K2OAW counter errata, 2M preamp, extra class Q&A (part 4), hi-Z voltmeter, Nikola Tesla story, vhf swr meter, transistor regen rx, 432 SSB transverter, AC arc welder, intro to computers, hybrid am modulator, HR10 rx mods, 10M transistor am tx, 40M gndplane, IC logic demonstrator, overload protection, if/f sweep generator, digi freq counter, aural tx tuning.

DEC 72. SSTV scope analyzer, 2M fm rx, tone burst encoder and decoder, universal if amp, autopatch hookup, LM380N info, voltage variable cap info, 2M 18 watt amp, SSB modulation monitor, xtal freq/activity meter, 10A var. dc supply, transmission line uses, radio astronomy, inductance meter, 75 to 20M transverter, LED info, 40M preamp, transistor vfo, 1972 index, 2M preamp.

JAN 73. HT-220 touchtone, 3-el 20M vagi, 50 MHz freq counter, speech processor, 2-tone gen, fm test set, tilt-over tower, 6M converter using modules, tuneable af filter, six band linear, 10M IF tuner, diode noise limiter, cw/ssb agc, HW22a transceiver 40M mod, HAL ID-1 mod.

FEB 73. CW inl gen, tone operated relay, toroidal quadrature ant, active filter, time freq measurement (part 2), repeater timing control, SSTV circuits (part 1), 2M converter using modules, multifunction metering, FET biasing, freq counter preamp, TR22 hi-power mod, transistor rf power amps (part 1), light bulb rf power indicators, 75A4 filters, capacitance measurement, Gonset 201 mod, world time info.

APR 73. FM deviation meter, 2M FET preamp, two 2M power amps, repeater control (part 1), repeater licensing, European 2M fm, fm scanner adaptor, RCA CMU15 mods, lightning detector, cb alignment gadget, transistor rf power amps (part 2), repeater economics.

JUNE 73. 220 MHz sig gen, uhf power meter, repeater licensing info, RTTY autoswitch, 40M hybrid vfo tx, ant polar mount, 10-15-20M quad, K2OAW counter mods, double coax ant, ham summer job, tone decoder, field strength meter, nicad battery pack, ohm meter, FCC regs (part 1).

AUG 73. Log-periodics (part 1), tone burst gen, rf power amp design, transistor radio intercom, 160M ant, SSTV monitor, low cost freq counter, VOM design, qrp 40M tx, 432 MHz exciter, fm audio processing, FCC regs (part 3).

SEPT 73. Repeater control system, log-periodics (part 2), 2M rx calibrator, PLL ic applications, TT pad hookup, Heath HW7 "s" meter, Oscar-6 doppler, 2M coaxial ant, 2M converter, IC keyer, measure ant Z, FCC regs (part 4).

OCT 73. GE Pocketmate mods, microwave freq measurement, CA3102E 2M frontend, 2 kw hf linear, rf wattmeter, meter repair, 60/40 dipole, IC "hi" gen, vhf freq multiplier, FCC regs (part 5).

NOV 73. 450 MHz exciter, intro to ATV circuits, nicad voltage monitor, autopatch connections, IC meter amplifier, TR22 ac supply, indoor vertical, IC af filter, momentary power failure protection, 160M ant acoupler, Motorola HT info, SSTV-15B, Class-B af amp, FCC regs (part 6).

DEC 73. Code speed display, 2M kw amp, IC keyer, 803B waveform gen, helical resonator design, sensitive rf voltmeter, proximity control switch, IC tester, sequential tone decoder, 2M portable beam, electronic calculator math, cw filter design, FCC regs (part 7).

FEB 74. SSTV monitor info, IC audio amps, scope sweep gen, 15/20M vertical, telephone line control system, pc board construction, var-Q af filter, blown-fuse indicator, 40m cw stn with Ten-Tec modules, simple preamp-compressor, single IC rx, "432-er" final assembly, transistor keying circuit, 7-segment readout with nixie driver.

APR 74. Vox for repeaters, tone operated relay, hf transverter, 10-to-2m tx converter, remote control panel for scanner, RCA m tx tuning, subaudible tone gen, FCC regs (part 9), Repeater Atlas.

MAY 74. Cd car ignition, audio compressor info, interference suppression for boats, auto burglar alarms, 2m ic preamp, 10m fet converter.

JULY 74. 4-1000A linear, universal freq gen, universal afsk gen, 555 IC timer, 80M phased array, 135 kHz-432 MHz preamps, 10M qrp am tx, 3000 vdc supply, how to read diagrams.

AUG 74. Toroidal directional wattmeters, 450 MHz FET preamp, use gdo to find "c". Trimline tt pad hookup, R390 & R392 rx mods, tracking cw filter, aural voltmeter, universal regulated supply, sstv scan converter, rti logic problems, ID timer.

SEPT 74. MOSKEY electronic keyer (part 1), ex warning system, Heath 10-103 scope mods, qrp 6M am tx, rf speech clipper, audio noise limiter, vx satellite on SSTV monitor, universal IC tester, miniature rig construction, tower construction, infinite rf attenuator, electronic

(More)

photo-flash ideas, IC "select object."

OCT 74. Microtransistor circuits, synthesized HT 220 (part 1), repeater government, regulated 5 vdc supply, fm selcal, removable mobile ants, Motorola metering, 2M vertical collinear, Motorola model code, 2M coaxial dipole, 1.6 MHz if strip, MOSKEY electronic keyer (part 2), carbon mike circuit, hi power to-pass filter, 6M preamp, 3 wire dipole, ATV sync gen, NCX-5 mods, mobile whip for apartment dwellers, sstv auto vertical trig.

NOV 74. K2OAW counter update, regulated 5 vdc supply, wind direction indicator, synthesized HT 220 (part 2), 20M 3-el beam, auto-patch pad hookups, double-stub ant match, novice class instruction, digi swr meter (part 1), 6M converter (1.6 MHz if), "C-bridge," MOSKEY electronic keyer (part 3), Aug, sstv scan converter errata, repeater off-freq indicator.

DEC 74. Care of nicads, wind speed/direction indicator, wx satellite video converter, electronic keyer, hints for novices, unknown meter scales, SSTV tape ideas, TTL logic probe, public service band converter, tuned-diode test receivers, digi swr meter (part 2), telephone pole beam support, rhombic antennas, 1974 Index

FEB 75. Heath HO 10 scope mod for SSTV, electronic keyer, digital satellite orbital timer, Oscar 7 operation, satellite orbital prediction, Heath SB 102 mods, comparing FM & AM, repeater engineering, Robot 80 A sstv camera mod, neutralizing Heath SB 110A, "Bounceless" IC switch, tape keyer for cw tx.

APR 75. \$50 walky for 2M, 2M scanning synthesizer, 88 mH toroid info, 8-function repeater controller, nicad battery precautions, FR22C preamp, telephone attachment regs, Guide to 2M Hand-held Transceivers, 2M 7-el beam, basic telephone systems (part 1), 10 min ID timer, modified hf Hustler mobile ant for 2M, 15M quad modified for 20M, 2M collinear beam, R-11A surplus rx conversion, 5/16 wave 2M ant, Hallicrafters SX-111 rx mods, 160M cw tx.

AUG 75. 146/432 MHz Helical ants (part 2), 10 min ID timer, digi swr computer (part 1), debugging rf feedback, DVM byer's guide, wx satellite monitor, cmos "accu-keyer," pc board method, sweep-tube final precautions, compact multiband dipoles, small digital clock, accessory vfo for hf transceiver, modern non-Morse codes, multi-function gen, 2M scanning synthesizer errata, KP-202 walky charger, 10M multi-element beam.

SEPT 75. Calculating freq counter, wx satellite FAX system (part 1), IC millivoltmeter, three-button TT decoder, troubleshooting sstv pix, 40M dx ants, 146/432 MHz helical ants (conclusion), digi swr computer (conclusion), read relay for cw bk in, NE555 preset timer, power failure alarm, portable grp rig power unit, precision 10 vdc reference standard, 135 kHz if strip, telephone handsets with fm transceivers,

Since there's little to get stale in back issues of 73 (our magazine is not padded ... like others ... with reams of activity reports), you'll have a fantastic time reading them. Most of the articles are still exciting to read ... and old editorials are even more fun for most of the dire predictions by Green have now come to pass. Incentive licensing was every bit the debacle he predicted ... and more. You'll really get a kick out of the back issues.

Motorola T 44 tx mod for ATV, 0.60 MHz synthesizer (part 10, ham radio PR).

OCT 75. A deluxe TTY keyboard (part 1), Op Amps: a basic primer, an introduction to microprocessors, 2m Synthesizer (conclusion), Satellite Fax System (conclusion), regulated supplies (dispelling the mystery), Digital Logic made simple, FCC interview, a contest uP system, digital clock time bases, the operating desk, QRP 432, ham PR.

NOV-DEC 75. Blockbuster double issue! Flip-flops exposed, breakthrough in fast scan ATV, strobing displays is cool, the tuned lunch box (antenna tuner for HF transceivers), a deluxe TTY keyboard (part 2), the 127' rotating mast, less than \$100 multi-purpose scope for your shack (part 1), predicting third order intermod, feedline primer, QRMing the Third Reich, why tubes haven't died, instant circuits - build your own IC test rig, the K2OAW synthesizer PROM-oted, a ham's intro to microprocessing, Ground Fault Interrupter (a keep alive circuit for yourself), a \$1 strip chart recorder, an even simpler clock osc., the Fun City surplus scene, updating the Heath IB-1101 counter, 256 pages!

JAN 76. Chicks - Really Simplified, De-Stress in your Ham-M, An Automatic Dialer for the Deluxe M-1000, Ring Dead Nicads to Life, The Computer OSO Man - Metered Counter, Save Money on Cook, How to Use a Bargain Surplus Keyboard, Impair your hearing with the FRAMER, and more. The first 72 in new format (includes 1975 Index to 72).

FEB 76. Build a StarNet Communicator - Treklike Special, Synthesized IC Frequency Standard, You Can Make Photo PC Boards, How's Your Speech Quality?, ASCII to Baudot Converter, RTTY Autocall - the Digital Way, Improving the FT-101, Night DXing on 10 and 15m, Really Soap Up Your 2m Receiver, Put Your SB-10 on 160m.

MAR 76. Special Surplus Issue - T-1000 Receiver Strips, Surplus Circuit Boards - Space Age Junque, A PC Board Binoculars - Is It All Gone?, Stereo - A New Type of Stereo - Build This Exciting New TVT, The

Smart Power Supply, How to Use Surplus Pots.

APR 76. Special FM Issue - A Program - Put That AM Rig on FM, A COR for your Receiver - Your Regency, Long Distance Call - The TT Decoder, One IC Tone Burst, The Versatile TTY Generator, The PLL - Explains the R-22 Tip, Computers Are Ridiculously Simple.

MAY 76. Special Antenna Issue - The Magnificent Seven Microhelix, An Allband Inverted Vee, Closed Loop Antenna Tuning, The 75-80m Broadbander, The Magic of a Matchmaker, How to Coax Your Antenna, 40m DXing - City Style, The Secret 2m Mobile Antenna, An Inverted Vee for 160/80m, The Dipole Dangler, Amateur Weather Satellite Reception, Scan Your HR212, A Very Cheap I/O - the Model 15, Code Converter Using PROMs, A Nifty Cassette-Computer System, The Ins and Outs of TTL, Build a CW Memory, 5/8 Wave Power for Your HT, 555 Timer Sweep Circuit for SSTV, AM is Not Dead - It Never Existed at All, Computer Languages - Simplified.

JUN 76. VHF Special - Super COR - Digital of Course!, Touchtone Decoder - Using a Calculator Readout, Simple Amateur TV Transmitter, Amateur TV Receiving System, Mobile Autodialer, Autocall '76 - Using a Touchtone Decoder, Build This Lab Type Bridge - and Measure Transformer Impedances, How These Triangle Things Work - a Sort of Op Amp Handbook, Those Exciting Memory Chips - RAMs, ROMs, PROMs, etc., ASCII/Baudot with a PROM - for Ribbonless RTTY on Computers, Aim Your Beam Right - With a Programmable Calculator.

JUL 76. Perfect CW - Drive 'em Crazy with the Keycoder I, The Mini-Mite Allband QRP Rig - A Mighty 7 Watts, A Fun Counter Project - Under \$50, Build a FAX from Scratch - Then Get Satellite Pictures and Other Things, Der Repeatermeister - Repeater Control with ID, The Giant Nixie Clock, Creative SSTV Programming, CW Regenerator/Processor, What's Up on 156 MHz?, TT Pad for the Wilson HT, Power Supply Testing - To Save Your Digital Circuits, A RTTY/Computer Display Unit, Your Computer Can Talk Morse, Gain for Your HT - a Half Wave Whip, The Super Transmatch, Simple VHF Monitor.

AUG 76. How Do You Use ICs? - Fundamentals, Surviving Miniature Low Band Antenna - the DRRR (part II), MINI-MOS - the Best Keyer Yet?, The Skiffert's Delight Breadboard - Cheap Imitation of a Commercial IC DIP Board, More PLL Magic, The Logic Grabber - Selected Interval Logic Tracer, Global Calculations for the DXer - Using a Hand Calculator, Instant Counter Calibration - Using Your TV Set, Simple 450 MHz Rig - Go ATV With a \$42.50 Module, The First Computer Controlled Ham Station - Grand Prize Winner, The Which Chip Dilemma - 4, 8, 12, or 16 bits: pros and cons, Meaningful Conversations with your Computer - What All Those Mysterious Languages Are All About, A Baudot Monitor/Editor System, A Logic Probe You Can Hear, Satellite Orbit Prediction - Using a Pocket Calculator, FSK with the SB-401, Build the Safari RTTY Terminal, El Cheapo Signal Tracer - Test Gear for the Cheapkate.

SEP 76. The Surprising DRRR Low Noise Antenna (part II), Ultra-simple Regulation with New IC - Power Supply Design Greatly Simplified, Can an Indoor Antenna Work - Making the Best Out of a Bad Bargain, Inexpensive 12 Volts for Your Base Station, A Test Lab Bonanza - Using a Transistor Radio, Protect Your VHF Converter - Novel Antenna Relay, Ridiculously Simple RTTY System, How to Catch a CBeT, A 450 MHz Transceiver for Under \$130, Space Age Junque II, PROM Memory Revisited, Eight Trace Scope Adapter, The PROM Zapper, Sneaky Baudot - With an ASCII Keyboard!, Simple Graphics Terminal - Using surplus, Counters are Not Magic - They're Simple.

OCT 76. Build a Weird 2 Band Mobile Antenna, Build a Counter for Your Receiver, How do You Use ICs? (part III), QRP Fun on 40 and 80 - Have a Real Ball with Just 5 Watts, The Hybrid Quad - Low Windload, Expense, Hassle!, Frequency Detector for Your Counter, Programmable CW ID Unit - for RTTY, Repeater, Mobile, etc., New ICs for the Counter Culture - Simpler Counters with Less Used Power, Is My Rig Working or Not? - Build an Effective Radiated Field Meter and Know!, Quickie Collinear for 15 and 10 - a Satisfaction Guaranteed, Build a Super Standard - Goes Right Down to 1 Hz, The Incredible Lambda Diode, Mechanical RTTY Buffer, Have You Used a Triac Yet?, How to Interface a Clock Chip - Baudot, BCD, or ASCII Conversion, A TTL Tester - Great for Unmarked Bargain ICs, The New Ham Programmer - Making Those Confounded iAP Work, BASIC? What's That? - the Basis of BASIC, The Soft Art of Programming (part II).

NOV 76. Blockbuster 256 pg issue! Confess Iron Top, Bicycle Mobile, Build a Simple Lab Scope - Costs Less Than \$70!, Get on Six with Surplus - The El Cheapo RT-70 is a Natural, The Beam Saver - Rotor Memory System, Updated Universal Frequency Generator, The Shirt Pocket Touchtone, Liquid Crystal Display Guide, Self-Powered Mike Preamp, The Wind Counter, The SB is Not Dead!, The Amazing Inverted L - Antenna for 20, 40, and 80m, Battery Chargers Exposed, How Do You Use ICs? (part III), Thirty Years of Ham RTTY, Big Noise Burglar Alarm, Dandy Digital Dial Decoder, Weather Satellite Display Control, Ham Time-Sharing is Here for You!, The Soft Art of Programming (part III), OSCAR Orbits on Your Altair, ASCII/Baudot Converter for Your TVT, The Smoke Tester - Power Supply Tester, The Man Who Invented AC - Tesla, the Greatest Pioneer of Them All!, Baudot to ASCII - You Want to Learn Programming? Baudot and BASIC - an Interpreter for a Baudot Computer, Toward a More Perfect Touchtone Decoder, Using a Wireless Broadcaster, The Quiet Spy - Amateur Uncovers Spy Ring in the US!, The Benefits of Sidetone Monitoring - And How to Do It.

DEC 76. Go Tone for Ten - Simple Subaudible Encoder, World's Simplest Five Band Receiver?, How Do You Use ICs? (part IV), A Super Cheapo CW IDer, The ZF Special Antenna, CT7001 Clock-buster, Saving a CBeT, A Ham's Computer, What's All This LSI Bunk? - an Ostrich's Eye View of the Microprocessor, The Soft Art of Programming (part III), Put Snap into Your SSTV Pictures - Using a \$20 Frequency Standard, What's all This Wire-Wrap Stuff? - Talk About Cold Solder Joints!, Exploding the Power Myth, Exploding the SWR Myth, The IC-22 Walkie - Portabilization with Nicads, Watch DX with a Spectrum Analyzer, DXing with a Weather Map.

HOLIDAY 76. 55 article issue! An Inexpensive 400 Watt HF amplifier, How Do You Use ICs? (part VI), Mobile Smokey Detector - 10.5 GHz: Use It or Lose It!, Add RIT to Your Transceiver, DXpedition: Memories for a Lifetime - Reflections of HK1TL, Design Your Own QRP Dummy Load, Fairlane Super Charger - Multi-rate 100!, The Amazing 15' Antenna for 160m, Replacing the Keefe Switch - Simple TR System for the Novice, Now You Can Synthesize - the VHF Engineering Approach to 2m Happiness, Hutchinson's Remedy - the Chapter CW Machine, The Mod Squad Does the Pocket Scanner - Radio Shack Pro-4 Update, TR-22 Mod Squad, What Computers Can and Can't Do, A Ham Shack Fax Handler - Program in BASIC for QSLs, Repeaters, etc., Print Your Own Logbook - On Your Nearest Computer, Showing Your HT, Cash In on the CB - Initialization for Fun and Profit, Tuning Those Big Antenna Coils, The 2m Mod Squad Tackles the Weather Radio - and Wins!, Hamming by Laser, A 60 Foot Antenna on a 20 Foot Lot - Solving a 40m Novice problem, Dual Voltage Power Supply, An Autopatch Busy Signal, Inside the GLS - a Gurdy Look at a Synthesizer, How to Bug an Automatic Keyer, A 450 Duplexer - That Fits in Your Car, Will Silver-Zinc Replace the Nicad?

BACK ISSUES

73 MAGAZINE CLASSICS

- JUNE 63
- AUG 63
- OCT 63
- FEB 64
- MAY 67
- JULY 67
- OCT 67
- JUNE 68
- JULY 68
- SEPT 68
- NOV 68
- JAN 69
- FEB 69
- MAR 69
- APR 69
- MAY 69
- JUNE 69
- JULY 69
- AUG 69
- SEPT 69
- OCT 69
- NOV 69
- DEC 69
- JAN 70
- FEB 70
- MAR 70
- APR 70
- MAY 70
- JUNE 70
- DEC 70
- JAN 71
- FEB 71
- MAR 71
- MAY 71
- JUNE 71
- JULY 71
- AUG 71
- SEPT 71
- OCT 71
- NOV 71
- AUG 72
- SEPT 72
- OCT 72
- NOV 72
- DEC 72
- JAN 73
- FEB 73
- APR 73
- JUNE 73
- AUG 73
- SEPT 73
- OCT 73
- NOV 73
- DEC 73
- FEB 74
- APR 74
- MAY 74
- JULY 74
- AUG 74
- SEPT 74
- OCT 74
- NOV 74
- DEC 74
- FEB 75
- APR 75
- AUG 75
- SEPT 75
- OCT 75
- NOV/DEC 75
- FEB 76
- MAY 76
- JUNE 76
- JULY 76
- AUG 76
- SEPT 76
- OCT 76
- NOV 76
- DEC 76
- HOLIDAY 76

- \$1.50 - single issues (indicate your choice at left) issues @ \$1.50
- \$12 - ten issues (indicate your choice at left)
- \$20 - 25 issues (indicate your choice at left)
- \$10 - 25 issues, our choice '66-'70 '71-'75 '76
- Cash, check, money order enclosed.

Name _____

Call _____

Address _____

City _____

State _____ Zip _____

Charge: American Express BankAmericard Master Charge

Credit card # _____ Interbank # _____

Expiration date _____

Signature _____

(Add \$1.00 handling charge for orders less than \$4.00)

US & CANADA ONLY

SEND TO: 73 BACK ISSUES PETERBOROUGH NH 03458

10/77

RADIO BOOKSHOP

The *ONLY* Complete License Study Guides

- **NOVICE STUDY GUIDE** — Here is a completely new study guide and reference book for the potential ham. This is not a question/answer memorization course. Electronic and radio fundamentals are presented and explained in an easy-to-understand fashion, preparing the beginner for the Novice exam. Includes the latest FCC amateur regulations, as well as application forms. Easily the best path into the exciting world of ham radio! \$4.95.
- **GENERAL CLASS STUDY GUIDE** — A complete theory course for the prospective General or Technician. This reference explains transistor, amplifier, and general radio theory, while preparing the Novice for the "big" ticket. After getting your ticket, you'll use this guide again and again as an electronic reference source. Not a question/answer guide that becomes dated when the FCC updates the amateur exams. \$5.95.
- **ADVANCED CLASS STUDY GUIDE** — Ready to upgrade your license? To prevent retaking the FCC theory exam, you need the 73 Advanced theory guide. SSB, antenna theory, transmitters, and electronic measuring techniques are covered in detail in this easy-to-follow study guide. Special modes and techniques, such as RTTY, are also treated. An engineering degree is *not* necessary to master Advanced theory — try this book before visiting the examiner's office! \$3.95.
- **EXTRA CLASS LICENSE STUDY GUIDE** — Before going for your 1 x 2 call, it pays to be a master of the Extra class electronic theory. This study guide is the logical extension of the 73 theory course. All the theory necessary to pass the exam is presented. Antennas, transmission lines, swr are discussed, as well as noise, propagation, and specialized communication techniques. This book is not a classroom lecture or memorization guide, but rather a logical presentation of the material that must be *understood* before attempting the Extra exam. Save yourself a return trip to the FCC and try the 73 method first! \$5.95.



novice theory tapes

Startling Learning Breakthrough

You'll be astounded at how really simple the theory is when you hear it explained on these tapes. Three tapes of theory and one of questions and answers from the latest Novice exams give you the edge you need to breeze through your exam.

73 is interested in helping get more amateurs, so we're giving you the complete set of our tapes for the incredibly low price of **ONLY \$15.95**.

Scientists have proven that you learn faster by listening than by reading because you can play a cassette tape over and over in your spare time — even while you're driving! You get more and more info each time you hear it.

You can't progress without solid fundamentals. These four hour-long tapes give you all the basics you'll need to pass the Novice exam easily. You'll have an understanding of the basics which will be invaluable to you for the rest of your life! Can you afford to take your Novice exam without first listening to your tapes?

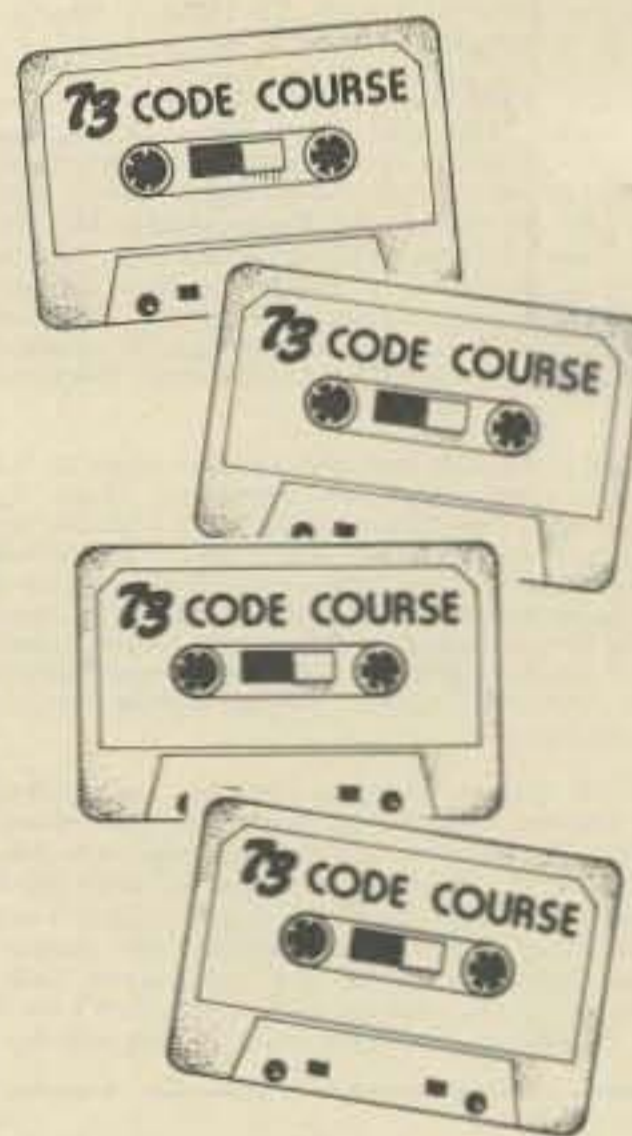

FOUR TAPES for \$15.95 \$4.95 EACH

5 WPM This is the beginning tape for people who do not know the code at all. It takes them through the 26 letters, 10 numbers and necessary punctuation, complete with practice every step of the way using the newest blitz teaching techniques. It is almost miraculous! In one hour many people — including kids of ten — are able to master the code. The ease of learning gives confidence to beginners who might otherwise drop out.

NEW CODE SYSTEM — Four Speeds Available

6+ WPM This is the practice tape for the Novice and Technician licenses. It is made up of one solid hour of code, sent at the official FCC standard (no other tape we've heard uses these standards, so many people flunk the code when they are suddenly — under pressure — faced with characters sent at 13 wpm and spaced for 5 wpm). This tape is not memorizable, unlike the zany 5 wpm tape, since the code groups are entirely random characters sent in groups of five. Practice this one during lunch, while in the car,

anywhere, and you'll be more than prepared for the easy FCC exam.

13+ WPM Code groups again, at a brisk 13 per so you will be at ease when you sit down in front of the steely eyed government inspector and he starts sending you plain language at only 13 per. You need this extra margin to overcome the panic which is universal in the test situations. When you've spent your money and time to take the test you'll thank heavens you had this back-breaking tape.

20+ WPM Code is what gets you when you go for the Extra Class license. It is so embarrassing to panic out just because you didn't prepare yourself with this tape. Though this is only one word faster, the code groups are so difficult that you'll almost fall asleep copying the FCC stuff by comparison. Users report that they can't believe how easy 20 per really is with this fantastic one hour tape. No one who can copy these tapes can possibly fail the FCC test. Remove all fear of the code forever with these tapes.

ONLY 4 for \$15.95! 73 is in the publishing business, not tapes, so these are priced much lower than anyone else could sell them. Have you ever seen one hour cassettes for under \$6? For 1st class mail add 25¢ per tape ordered.

**RADIO AMATEURS
TALK TO THE WORLD!!**
...ask me about it!

BUMPER STICKERS:
RADIO AMATEURS TALK TO THE WORLD!!
AUTHORIZED VEHICLE
SUPPORT YOUR LOCAL POLICE
50¢ each; any 3 for \$1.00

BINDERS — Red Binders with gold lettering keep your 1976 & 1977 73s safe from being lost or damaged. Each binder holds 12 issues. \$6.00 ea., 2 for \$11.00.

BACK ISSUE BUNDLE! 73 Magazine Classics, issues containing hundreds of articles & projects. Great for nostalgia buffs. 20 copies (all different) for \$8.00.

**LIBRARY SHELF
BOOK BOXES**
\$2.00 each
2/\$3.00 • 8/\$10.00

QSLs!

**ONLY \$7.50
for 250,
\$12.50 for 500,
\$20.00 for 1000!**



Style W — Black type, blue world

How can 73 make such beautiful cards, printed on the best coated stock, available for about half the regular cost?

The world and satellite are printed in blue, your name, address and call are in black. The QSO information is a standard form on the back. **DOMESTIC ORDERS ONLY**
ALLOW 6-8 WEEKS FOR DELIVERY.

Use the order card or itemize your order on a separate piece of paper and mail to:

73 Radio Bookshop • Peterborough NH 03458 Be sure to include check or detailed credit card information.

Note: Prices subject to change without notice on books not published by 73 Magazine.

RADIO BOOKSHOP

RADIO BOOKSHOP

● **WEATHER SATELLITE HANDBOOK** Simple equipment and methods for getting good pictures from the weather satellite. Antennas, receivers, monitors, facsimile you can build, tracking, automatic control (you don't even have to be home). Dr. Taggart WB8DQT \$4.95.

● **REPEATER ATLAS** Hundreds of new listings . . . by both location and frequency . . . dual listing, invaluable for your car . . . find those repeaters as you travel. This is the ONLY complete list of repeaters being published. Almost 3000 repeaters listed in this issue . . . repeaters from all over the entire world. Only \$1.95.

● **VHF ANTENNA HANDBOOK** The NEW VHF Antenna Handbook details the theory, design and construction of hundreds of different VHF and UHF antennas . . . A practical book written for the average amateur who takes joy in building, not full of complex formulas for the design engineer. Packed with fabulous antenna projects you can build. \$4.95.

● **THE CHALLENGE OF 160** is the newest book in the 73 technical library, dedicated to 160 meter operating. Si Dunn provides all necessary information to get started on this unique band. The all-important antenna and ground systems are described in detail. The introduction contains interesting photos of Stew Perry's (the King of 160) shack. This reference is a must for new and experienced "Top Band" operators. Price: \$4.95.



● **COAX HANDBOOK** The world's only handbook devoted exclusively to coax, feedlines and connectors. Special price only \$1.50.

● **VOL. I COMPONENT TESTERS** . . . how to build transistor testers (8), diode testers (3), IC testers (3), voltmeters and VTVMs (9), ohmmeters (8 different kinds), inductance (3), capacity (9), Q measurement, crystal checking (6), temperature (2), aural meters for the blind (3) and all sorts of miscellaneous data on meters . . . using them, making them more versatile, making standards. Invaluable book, \$4.95.

● **VOL. II AUDIO FREQUENCY TESTERS** . . . jam packed full of all kinds of audio frequency test equipment. If you're into SSB, RTTY, SSTV, etc., this book is a must for you . . . a good book for hi-fi addicts and experimenters tool \$4.95.

● **VOL. III RADIO FREQUENCY TESTERS** Radio frequency waves, the common denominator of Amateur Radio. Such items as SWR, antenna impedance, line impedance, rf output and field strength; detailed instructions on testing these items includes sections on signal generators, crystal calibrators, grid dip oscillators, noise generators, dummy loads and much more. \$4.95.

● **THE NEW RTTY HANDBOOK** is a brand new 1977 edition and the only up-to-date RTTY book available. The state of the art has been changing radically and has made all previous RTTY books obsolete. It has the latest circuits, great for the newcomer and the expert alike . . . Only \$5.95.



● **73 VERTICAL, BEAM AND TRIANGLE ANTENNAS** by Edward M. Noll W3FQJ Describes 73 different antennas for amateurs. Each design is the result of the author's own experiments: each has actually been built and air-tested. Includes appendices covering the construction of noise bridges and antenna line tuners, as well as methods for measuring resonant frequency, velocity factor, and standing-wave ratios. 160 pages. \$5.50.

● **IC OP-AMP COOKBOOK** by Walter G. Jung. Covers not only the basic theory of the IC op amp in great detail, but also includes over 250 practical circuit applications, liberally illustrated. 592 pages, 5½ x 8½, softbound \$12.95.

● **73 DIPOLE AND LONG-WIRE ANTENNAS** by Edward M. Noll W3FQJ This is the first collection of virtually every type of wire antenna used by amateurs. Includes dimensions, configurations, and detailed construction data for 73 different antenna types. Appendices describe the construction of noise bridges, line tuners, and data on measuring resonant frequency, velocity factor, and swr. 160 pages. \$5.50.

● **RF AND DIGITAL TEST EQUIPMENT YOU CAN BUILD** Rf burst, function, square wave generators, variable length pulse generators — 100 kHz marker, i-f and rf sweep generators, audio osc, af/rf signal injector, 146 MHz synthesizer, digital readouts for counters, several counters, prescaler, microwavemeter, etc. 252 pages. \$5.95.

● **SSTV HANDBOOK** This excellent book tells all about it, from its history and basics to the present state of the art techniques. Contains chapters on circuits, monitors, cameras, color SSTV, test equipment and much more. Hardbound \$7, softbound \$5.

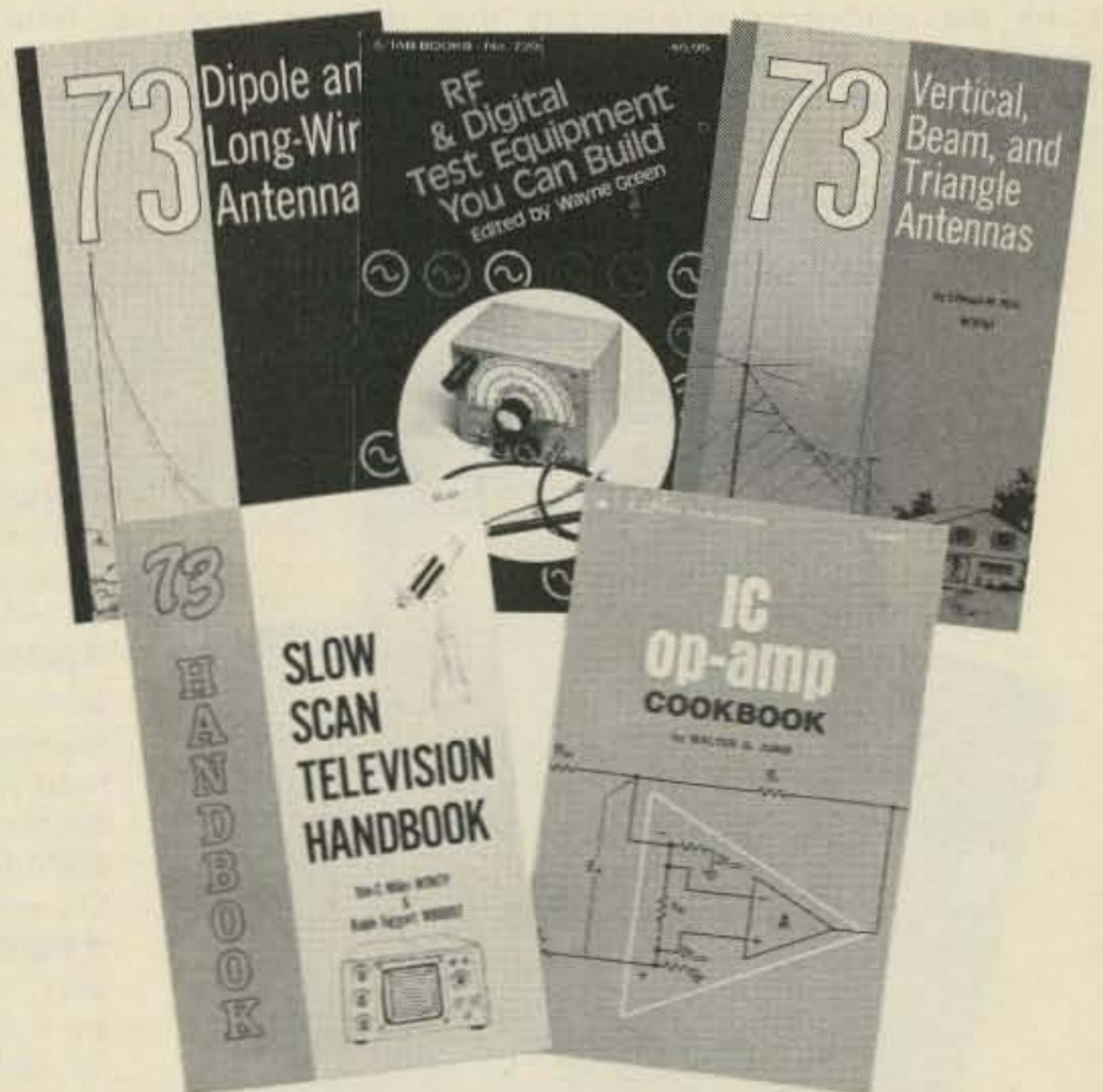

Use the order card or itemize your order on a separate piece of paper and mail to:
73 Radio Bookshop • Peterborough NH 03458 Be sure to include check or detailed credit card information.
Note: Prices subject to change without notice on books not published by 73 Magazine.

RADIO BOOKSHOP

● **RTL COOKBOOK** by Donald Lancaster. Explains the how and why of RTL (Resistor-Transistor Logic) and gives design information that can be put to practical use. Gives a multitude of digital applications ranging from the basic switch to the sophisticated counter. 240 pages; 5½ x 8½; softbound. \$5.50.

● **TTL COOKBOOK** by Donald Lancaster. Explains what TTL is, how it works, and how to use it. Discusses practical applications, such as a digital counter and display system, events counter, electronic stopwatch, digital voltmeter, and a digital tachometer. 336 pages; 5½ x 8½; softbound. \$8.95.

● **TVT COOKBOOK** by Donald Lancaster. Describes the use of a standard television receiver as a microprocessor CRT terminal. Explains and describes character generation, cursor control and interface information in typical, easy-to-understand Lancaster style. This book is a required text for both the microcomputer enthusiast and the amateur RTTY operator who desires a quiet alternative to noisy teletype machines. \$9.95.

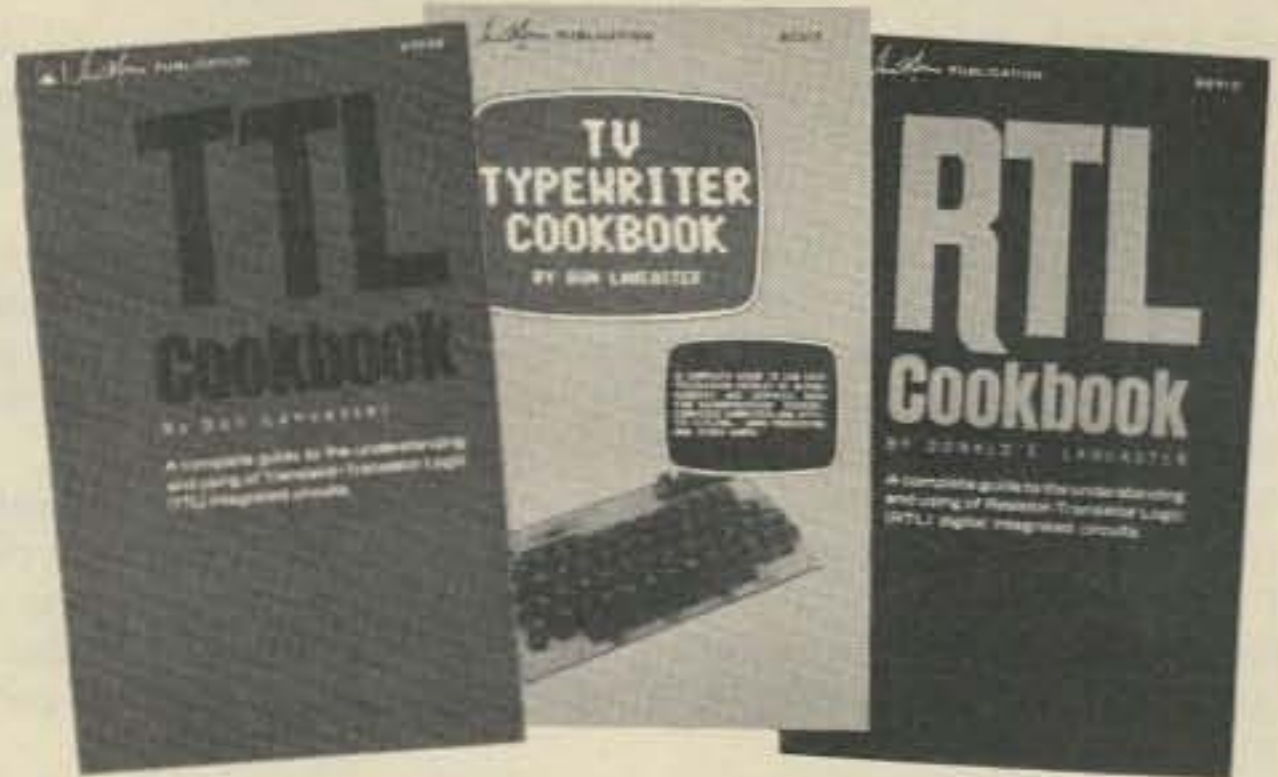

● **WHAT TO DO AFTER YOU HIT RETURN** PCC's first book of computer games ... 48 different computer games you can play in BASIC ... programs, descriptions, muchly illustrated. Lunar Landing, Hammurabi, King, Civil 2, Qubic 5, Taxman, Star Trek, Crash, Market, etc. \$6.95.

● **101 GAMES IN BASIC** Okay, so once you get your computer up and running in BASIC, then what? Then you need some programs in BASIC, that's what. This book has 101 games for you, from very simple to real buggers. You get the games, a description of the games, the listing to put in your computer and a sample run to show you how they work. Fun. Any one game will be worth more than the price of the book for the fun you and your family will have with it. \$7.50.

● **BASIC** by Bob Albrecht, etc. Self-teaching guide to the computer language you will need to know for use with your microcomputer. 324 pages. This is one of the easiest ways to learn computer programming. \$4.95.

● **THE UNDERGROUND BUYING GUIDE** Here is a handy guide for the electronics enthusiast. Over 600 sources of equipment and literature are provided; some are mail-order-only outfits that do not advertise. Sources are listed alphabetically, by service or product, and by state. The guide is cross-referenced for ease of use. Electronic publishing houses are also listed. Published by PMS Publishing Co., \$5.95 each.

● **FASCINATING WORLD OF RADIO COMMUNICATION** Interesting stories in the history of radio pioneering and discovery. Also includes the fundamentals of broadcast band DXing. A must for every radio amateur. \$3.95.

● **PRACTICAL TEST INSTRUMENTS YOU CAN BUILD** 37 simple test instruments you can make — covers VOMs, VTVMs, semiconductor testing units, dip meters, wattmeters, and just about anything else you might need around the test lab and ham shack. \$4.95.

● **1001 PRACTICAL ELECTRONIC CIRCUITS** Tab's new 1001 circuits is available for only \$9.95 ppd. The next time you want a circuit for just about anything, eat your heart out that you didn't send for this book the first time you read about it. You'd better order the book right away, before they run out. \$9.95.

● **HOW TO MAKE BETTER QSLs** Be proud of your QSL cards ... have a card which gets front space on every hamshack wall ... win prizes at hamfests. The only way to have a truly outstanding card is to make it yourself ... which is easy when you have this new book. \$2.00.

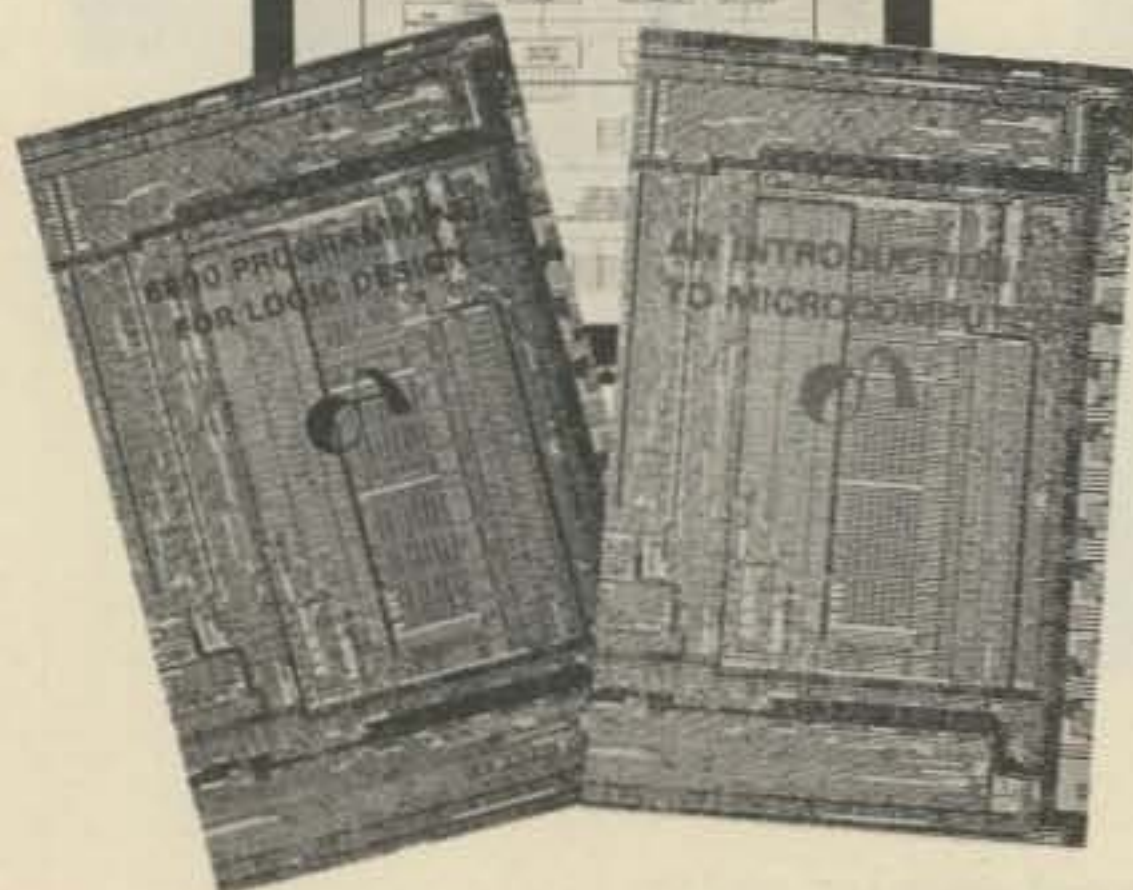
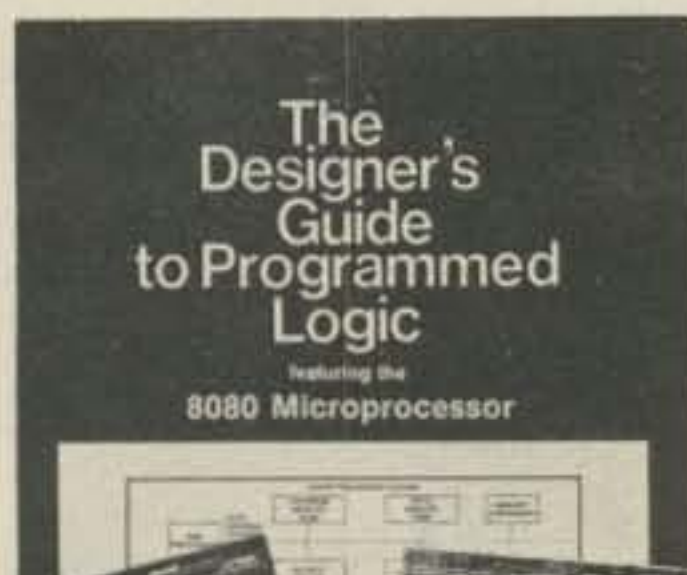

● **AN INTRODUCTION TO MICROCOMPUTERS, VOLS. 1 AND 2** At last! Someone has finally written a book containing hardware details about most of the popular micro chips available to computerists. *An Introduction to Microcomputers*, Volumes 1 and 2, by Adam Osborne Associates, are references dealing with microcomputer architecture in general and specifically with details about most of the common chips. These books are not software-oriented, but are invaluable for the hobbyist who is into building his own interfaces and processors. Volume 1 is dedicated to general hardware theory related to micros, and Volume 2 discusses the practical details of each micro chip. (Detailed review in *Kilobaud* #2) Published by Osborne Associates, Vol. I — \$7.50; Vol. II — \$12.50.

● **8080 PROGRAMMING FOR LOGIC DESIGN** Here is an ideal reference for the person desiring an in-depth understanding of the 8080 processor. The work is application-oriented, and the 8080 is discussed in light of replacing conventional, hard-wired logic systems. Both hardware and software is described. Practical design considerations are provided for the individual wishing to implement an 8080-based control system. (Detailed review in *Kilobaud* #1) Published by Osborne Associates, \$7.50.

● **6800 PROGRAMMING FOR LOGIC DESIGN** Oriented toward the industrial user, this book describes the process by which conventional logic can be replaced by a 6800 microprocessor. Both hardware and software techniques are discussed, as well as interface information. This reference, and its companion dedicated to 8080 users, provide practical information that allows an experimenter to design a complete micro control system from the "ground up." An excellent reference! Published by Osborne Associates, \$7.50.

Use the order card or itemize your order on a separate piece of paper and mail to:
73 Radio Bookshop • Peterborough NH 03458 Be sure to include check or detailed credit card information.
Note: Prices subject to change without notice on books not published by 73 Magazine.

RADIO BOOKSHOP

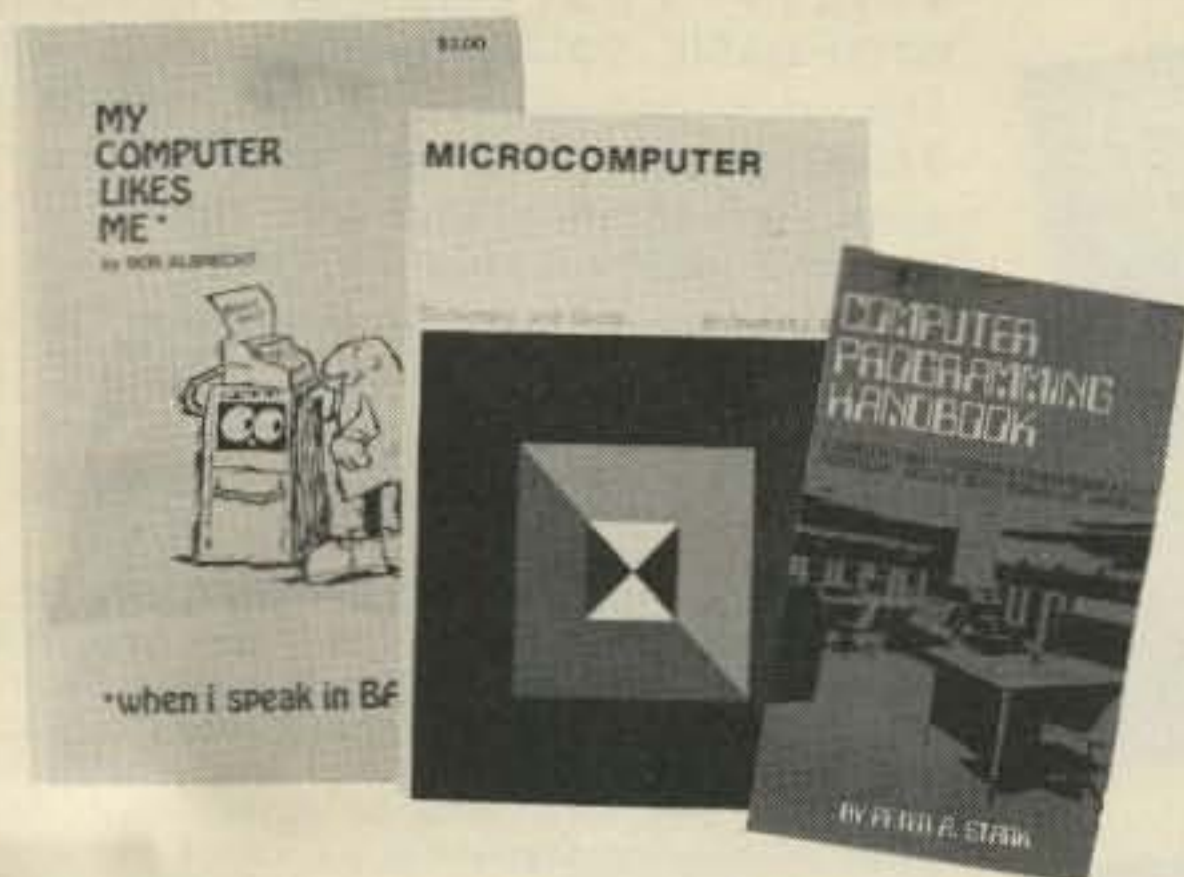

● **BRAND NEW DICTIONARY** This new microcomputer dictionary fills the urgent need for all computer people, engineers, scientists, industrialists, communications people — as professionals, amateurs, teachers, or students — to become quickly acquainted with the terminology and nomenclature of a new revolution in computer control capabilities in areas that pervade most of man's daily activities.

Over 5000 definitions and explanations of terms and concepts (704 pages) relating to microprocessors, microcomputers and microcontrollers. There are also separate appendices on: programmable calculators; math and statistics definitions; flowchart symbols and techniques; binary number systems and switching theory; symbol charts and tables; summaries of BASIC, FORTRAN and APL. In addition there is a comprehensive electronics/computer abbreviations and acronyms section. \$15.95.

● **COMPUTER PROGRAMMING HANDBOOK** by Peter Stark. A complete guide to computer programming and data processing. Includes many worked out examples and history of computers. \$8.95.

● **MY COMPUTER LIKES ME ... WHEN I SPEAK BASIC** An introduction to BASIC ... simple enough for your kids. If you want to teach BASIC to anyone quickly, this booklet is the way to go. \$2.00.

● **SCELBI'S GALAXY GAME FOR THE "6800"** Here's a new twist in computer games by Scelbi Computer Consulting and Robert Findley/Raymond Edwards. The game, "Galaxy," pits the operator of a spaceship against alien craft, as well as such variables as speed, time, and ammunition. No two games are the same! This game is described in *Galaxy Game for the 6800*, published by Scelbi Computer Consulting, Inc. \$14.95.

● **6800 SOFTWARE GOURMET GUIDE & COOKBOOK** If you have been spending too much time developing routines for your 6800 microprocessor, try the new book by Scelbi Computing and Robert Findley. This manual, *6800 Software Gourmet Guide and Cookbook*, describes sorting, searching, and many other routines for the 8080 user. \$9.95.

● **8080 SOFTWARE GOURMET GUIDE AND COOKBOOK** If you have been spending too much time developing simple routines for your 8080, try this new book by Scelbi Computing and Robert Findley. This manual, *8080 Software Gourmet Guide and Cookbook*, describes sorting, searching, and many other routines for the 8080 user. \$9.95.

● **CMOS COOKBOOK** by Don Lancaster, pub. Howard W. Sams Company. Another winner from Don Lancaster, author of the famous *RTL* and *TTL Cookbooks*. The *CMOS Cookbook* details the application of CMOS, the low power logic family suitable for most applications presently dominated by TTL. The book follows the style of the original Cookbooks. Eight chapters cover all facets of CMOS logic, and the work is prefaced by 100 pages detailing the characteristics of most CMOS circuits. The *CMOS Cookbook* is required reading for every serious digital experimenter. \$9.95.

● **HOBBY COMPUTERS ARE HERE** If you (or a friend) want to come up to speed on how computers work ... hardware and software ... this is an excellent book. It starts with the fundamentals and explains the circuits, the basics of programming, along with a couple TVT construction projects, ASCII-Baudot, etc. This book has the highest recommendations as a teaching aid for newcomers. \$4.95.



● **THE STORY OF COMPUTERS** by Donald D. Spencer is to computer books what *Dick and Jane* is to novels ... extremely elementary, gives the non-computerist a fair idea of what the hobbyist is talking about when he speaks computer lingo. Attempts to explain what computers are and can do to a spouse, child or any un-electronics-minded friend. \$4.95.

● **MICROCOMPUTER PRIMER** by Mitchell Waite and Michael Pardee, pub. by Howard W. Sams Company. If you are afraid to get involved with microcomputers for fear of not understanding them, worry no longer! The *Microcomputer Primer* describes basic computer theory, explains numbering systems, and introduces the reader to the world of programming. This book does not elaborate on specific systems or chips, but describes the world of microcomputing in "real world" terminology. There is probably no better way of getting involved with the exciting new hobby of microcomputing. \$7.95.



● **INTRODUCTION TO MICROPROCESSORS** by Charles Rockwell of MICROLOG. Here is an ideal reference for the individual desiring to understand the hardware aspects of microprocessor systems. This book describes the hardware details of computer devices in terms the beginner can understand, instead of treating the micro chip as a "black box." Addressing schemes, registers, control, and memory are all explained, and general information about hardware systems is provided. Specific systems are not described and programming is only briefly discussed. *Introduction To Microprocessors* is a hardware introduction ... and a good one. \$17.50 US and Canada, \$20 elsewhere.



● **THE NEW HOBBY COMPUTERS!** This book takes it from where "Hobby Computers Are Here" leaves off, with chapters on Large Scale Integration, how to choose a microprocessor chip, an introduction to programming, low cost I/O for a computer, computer arithmetic, checking memory boards, a Baudot monitor/editor system, an audible logic probe for finding those tough problems, a ham's computer, a computer QSO machine ... and much, much more! Everything of interest is there in one volume, ready to be enjoyed by you. \$4.95.

● **KILOBAUD** The Small Computer Magazine Software & Hardware exposed to the core. Written for the non-PhD computer hobbyist who wants to know what's new. \$2.00 each at the newsstand, \$15.00 for 1 year subscription. Back issues \$3.00 per copy.

Use the order card or itemize your order on a separate piece of paper and mail to:
73 Radio Bookshop • Peterborough NH 03458 Be sure to include check or detailed credit card information.
Note: Prices subject to change without notice on books not published by 73 Magazine.

RADIO BOOKSHOP

● **COMPUTER DICTIONARY** by Donald D. Spencer. A compendium of computer terms for beginners and professionals alike. The *Computer Dictionary* by Donald D. Spencer defines words and acronyms used by computerists in a clear, easy to understand style. Over 2000 definitions are provided. This reference is a must for the individual getting started in the world of microcomputers. The *Computer Dictionary* by Donald D. Spencer; published by Camelot Press, \$5.95.

● **CHEMISTRY WITH A COMPUTER** by Paul A. Cauchon. An exciting new chemistry book which contains a collection of tutorial, simulation and problem-generation computer programs. Tutorials provide individualization of assignment, immediate evaluation of responses and a new set of problems with each run. Simulations provide models of lengthy laboratory experimentation beyond the limited classroom timeframe and enhancement of course studies by encouraging pre-laboratory research. Problem-generating programs provide individualized sets of questions on a given topic. Can be used with almost any chemistry course at the high school or college level. All programs are written in BASIC, the most popular and easy to learn educational programming language. \$9.95.

● **TYCHON'S 8080 OCTAL CODE CARD** Slide rule-like aid for programming and debugging 8080 software . . . contains all the mnemonics and corresponding octal codes. Instructions are color coded to indicate which flags are affected during execution. Pocket sized card only 6½x3 inches provides neat, logical format for quick reference. Back side of card is printed with an ASCII code chart for 128 characters plus the 8080 status word and register pair codes. Also available, Tychon's *8080 Hex Code Card*, same as above only has hex codes instead of octal. Only \$3.00 each.

● **FUZZBUSTER** Radar Detector judged most dependable, fastest and overall BEST by Wayne Green in a side by side three month study of all the other radar detectors on the market. Specially priced at \$95.00.

● **LIGHTED TRAVEL DESK** Handy little gadget, looks like a clipboard with a light and plugs into the cigarette lighter of your car. Read books or maps easily in the car, great for note taking if you come up with ideas while driving . . . helps make riding in the car a little more enjoyable for kids who can use it for puzzles or playing games at night. Only \$7.50.

● **PERIODICAL GUIDE FOR COMPUTERISTS** This is a 20 page book which indexes over 1,000 personal computing articles for the entire year of 1976 from Byte, Creative Computing, Digital Design, Dr. Dobbs Journal, EDN, Electronic Design, Electronics, Interface Age, Microtek, Peoples Computer Company, Popular Electronics, QST, Radio Electronics, SCCS Interface and 73 Amateur Radio. Articles are indexed under more than 100 subject categories. Price \$2.50.

● **A QUICK LOOK AT BASIC** by Donald D. Spencer. Here is a perfect reference for the beginning programmer. *A Quick Look at BASIC* assumes that the reader has no previous programming experience. This book is a self-teaching guide for the individual desiring to learn the fundamentals of BASIC, the most common hobbyist programming language. Price: \$4.95

Use the order card or itemize your order on a separate piece of paper and mail to: 73 Radio Bookshop • Peterborough NH 03458. Be sure to include check or detailed credit card information. Note: Prices subject to change without notice on books not published by 73 Magazine.

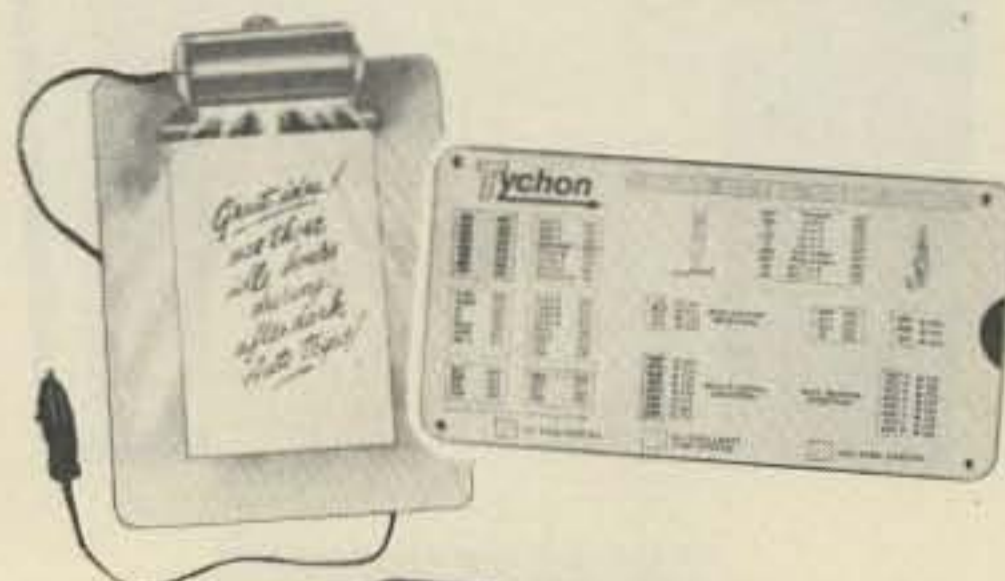
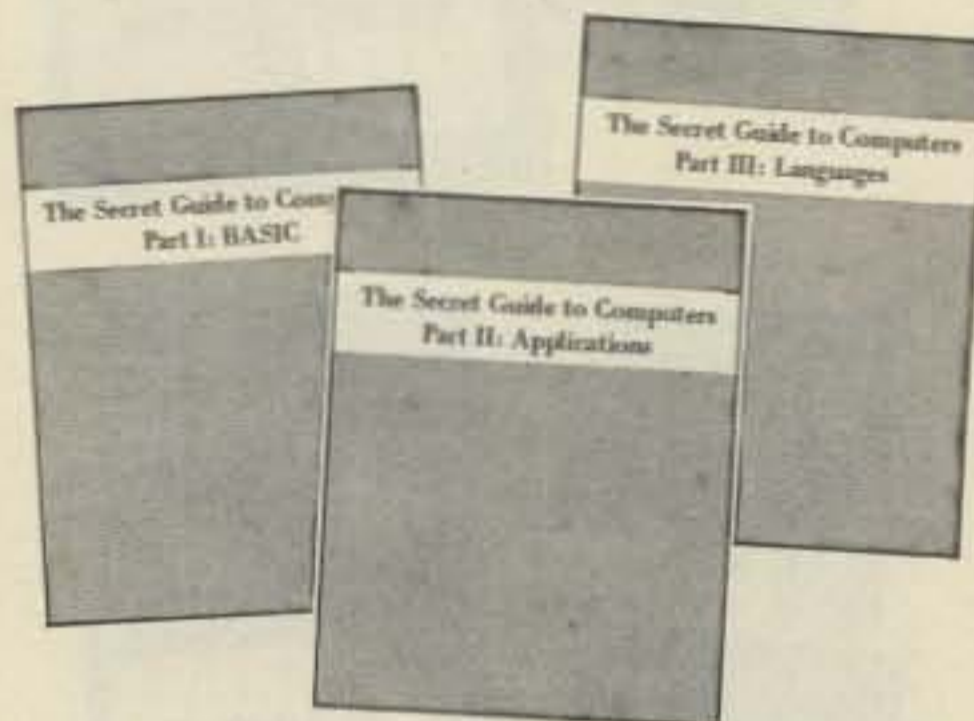
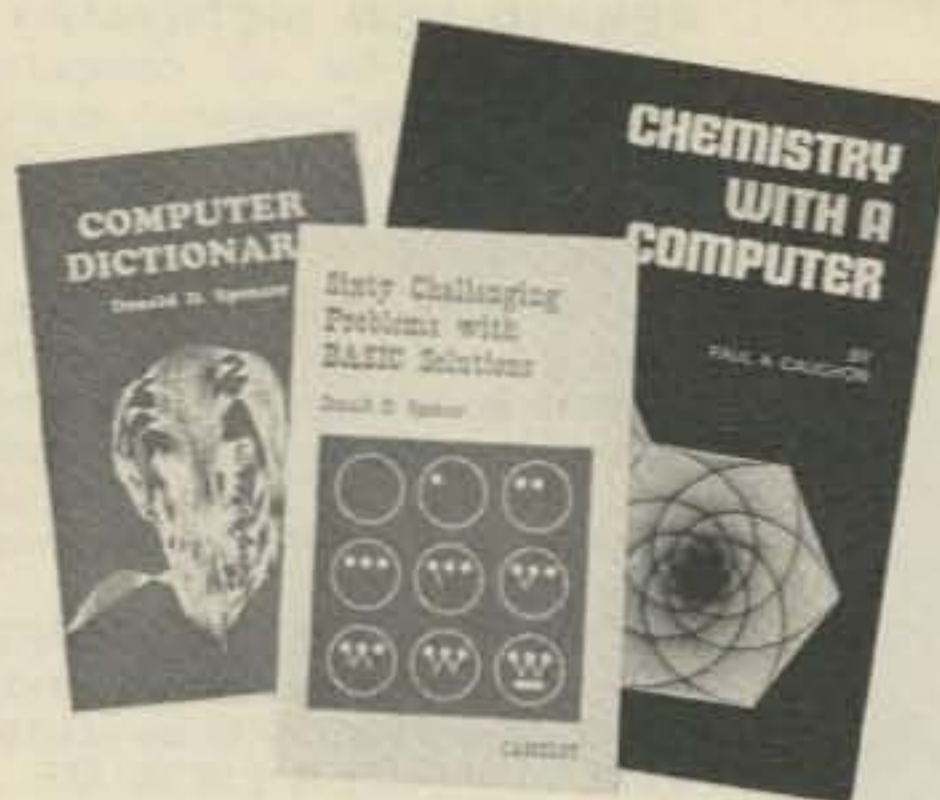

● **SIXTY CHALLENGING PROBLEMS WITH BASIC SOLUTIONS** Donald Spencer. This book provides the serious student of BASIC programming with sixty interesting problems and their solutions. None of the problems require a knowledge of math above algebra and should interest the casual user of BASIC on hobby machines. A number of game programs are also provided, as well as programs for financial interest, conversions, and numeric manipulations. Price: \$6.95

● **SOME COMMON BASIC PROGRAMS** published by Adam Osborne & Associates, Inc. Perfect for non-technical computerists requiring ready-to-use programs. Business programs like depreciation formulas, loan payment solutions and loan interest rates; math routines containing statistical packages and polynomial derivations . . . plus miscellaneous programs. Most routines are short and some provide optional statements that can be inserted into the code to slightly modify the results. Invaluable for the user who is not an experienced programmer. All will operate in the stand-alone mode. \$7.50 paperback.

● **THE SECRET GUIDE TO COMPUTERS** Parts 1, 2, 3 by Russ Walker. Have you been "getting ready" to learn programming for the last six months? Tired of starting at your micro, waiting for some output? Bits and bytes have you down? If you can identify with any of these problems and need help with programming, this series of books is for you. This has taught second graders how to program. Part One discusses computers in general, and after reading for ten minutes you will be writing simple BASIC programs! The reference employs a step-by-step teaching process, the end result being a working knowledge of BASIC.

Part Two discusses computer applications. It's one thing to master the syntax of a language such as BASIC and another to solve problems using the new tool. Walker discusses that mythical creature known as "logic", and provides useful techniques in problem solving. The reference follows the light-hearted style of the first section.

Part Three describes programming languages. Ever heard of APL and QLISP? If not, you will enjoy this part of the series. BASIC is not the only language used to program computers, and as the hobby industry grows additional languages will become commonplace. Plan ahead! Get in on the secret now — with **THE SECRET GUIDE TO COMPUTERS**. Published by Russ Walker, 7th edition, \$3.50 each.

● **FORTRAN PROGRAMMING** By Donald Spencer. If you are familiar with BASIC you will appreciate the additional capabilities of FORTRAN, a computer language with most of BASIC's features, and much more! FORTRAN was designed for complex numeric calculations; and possesses extended I/O capability. It is easily learned, as it is an English-like computer language. **FORTRAN PROGRAMMING** is written for the beginning FORTRAN programmer. His reference, in conjunction with the **FORTRAN WORKBOOK**, provides the student of computer languages with an easy method of mastering FORTRAN. Basic rules of syntax are discussed, as well as the use of "built-in" functions and I/O procedures \$7.50.

● **FORTRAN WORKBOOK** By Donald Spencer. Provides practical examples and problems to solve. Flowcharting, necessary for most programming applications, is also discussed. Almost all micros support BASIC — it won't be long before FORTRAN is commonplace. Don't miss the programming boat . . . learn FORTRAN; and be ready for the next language boom! \$3.95.

what do you give the man who has everything?

a box to put it in.



73 Magazine, as thick as it is, is more like a floppy when it comes to standing on the bookshelf. Enter the new 73 Magazine Library Shelf Boxes, sturdy corrugated cardboard boxes which will hold your magazines on the shelf and keep them from flopping around.

Yes, we know all about binders . . . we have them too . . . and we sell them, but binders are a drag when you want one copy of a magazine. And they cost like sin (which costs plenty).

Just to be rotten (a talent we are trying to develop, but which comes hard), we have self-sticking labels for the boxes, not only for 73 Magazine, but also for Kilobaud . . . and for Personal Computing, Radio Electronics, Popular Electronics, Interface Age, and . . . yep . . . Byte. Heh, heh! Just ask for whatever stickers you want and we'll throw 'em in with your box order. Hams may want our labels for CQ, QST or Ham Radio, if they get any of those magazines. This is a way you can buy one set of matching boxes and line 'em up on your shelf . . . looks very nice that way.

The boxes are a white color and are particularly resistant to dirt, a real plus for white boxes. There's some kind of funny plastic finish on 'em.

You'll probably do like most people who have tried these so far and order one or two for starters . . . then get a couple dozen. The postage on these is the killer . . . so one box costs \$2.00 postpaid and \$1.50 for each additional box, 7 for \$10.

Unless the magazine gets whole lot fatter than it is right now these boxes should hold a full year of 73 . . . or Kilobaud.

One side is cut low to permit you to see the binding of the magazine . . . and note that we are now printing the information on the top part of the binding so it will show in these boxes. You can put the boxes on your shelves with the bindings showing or with just the white board showing, there are little marks to help you center your labels on either side.

Your magazine library is your prime reference, so keep it handy and keep it neat with these strong library shelf boxes.

Send me _____ boxes for 73 Magazine Shelf Storage at \$2.00 for the first box and \$1.50 for each additional box, or 7 for \$10. Include the following labels: _____

\$ _____ Enclosed Cash Check M.O.

Bill: American Express BankAmericard

Master Charge - Interbank # _____

Card # _____ Expiration date _____

Signature _____

Name _____

Address _____

City _____ State _____ Zip _____

73 MAGAZINE LIBRARY SHELF BOXES

Peterborough NH 03458

or call Toll Free (800) 258-5473

NH & Evenings (800) 251-6771 10/77

call us



...tell us you love us

Also tell us your credit card number so we can enter a subscription for you. A subscription saves you a bundle of money . . . just figure it out. At \$2 a copy you're spending \$24 a year, yet a subscription costs a lousy \$15. Nine dollars may not be a lot today, but that's no reason to just throw it away because you don't want to bother to pick up the phone.

Three years of 73 . . . if you figured out what that costs you'd send in a subscription instantly. Not having calculators that go out that far (allowing for the usual inflation, increases in postage, rising paper prices, and a new car for Wayne . . . a copy of 73 will probably be \$5 three years from now), no one at 73 has definitely been able to calculate the exact cost of three more years on the newsstand. One thing is for sure, it's going to be a lot more than the current three year \$36 subscription rate, which is an obvious rip-off. Call in your three year subscription and make us rue the day we came up with that low number.

It's toll free:

800-258-5473

and someone

is usually around during office hours to take your order, credit card number (Master Charge, BankAmericard or American Express). While you're calling what would it hurt to get Kilobaud too? And maybe a few books for the bathroom.

If the line is busy tear out the card bound in the back of the magazine . . . just inside the back cover . . .

While you are tearing out cards it is high time for you to mark up the reader's service card and send that in too. A good response convinces advertisers to run more ads . . . you get more pages of magazine. It's a good investment.

73·peterborough nh 03458

CUSTOM TRANSFORMERS



HEAVY DUTY REPLACEMENT TRANSFORMERS*

Collins 30S-1 Plate Transformer	\$165.00
Collins 516F-2 Power Transformer	95.00
Hunter 2000B Plate Transformer	125.00
ETO A-770 Plate Transformer	125.00
Henry 2K Plate Transformer	140.00
Henry 2K-2 Plate Transformer	165.00
Henry 2K-2A Plate Transformer	135.00
Henry 2K-4 Plate Transformer	165.00
Henry 3K-A Plate Transformer	165.00
Heath Marauder HX-10 Transformer	95.00
Gonset GSB-100 Transformer	95.00
National NCL-2000 Power Transformer	125.00
Gonset GSB-201 Power Transformer	135.00

SPECIALS

Plate XFMR. 4600 VAC @ 1.5A ICAS 230 VAC 60 Hz primary, Wt. 60 LB	\$195.00
Plate XFMR. 3500 VAC @ 1.0A ICAS 230 VAC 60 Hz primary, Wt. 41 LB	125.00
Plate XFMR. 3000 VAC @ 0.7A ICAS 115/230 VAC 60 Hz pri, Wt. 27 LB	95.00
Plate XFMR. 6000 VCT @ 0.8A CCS 115/230 VAC 60 Hz pri, Wt. 41 LB	135.00
FIL XFMR. 7.5 VCT @ 21A CCS 117 VAC 60 Hz primary Wt. 8 LB	29.95
FIL Choke bifilar wound 30 AMP RF Filament Choke on 1/2x7 rod	8.95
DC Filter Choke 8.0 Hy @ 1.5 ADC	150.00
DC Swinging Choke: 30 Hy @ 0.15A to 5.0 Hy @ 1.0ADC	100.00
DC Filter Capacitors 100 MFD @4000 VDC	\$75.00

*All heavy duty replacement transformers are electrically superior to original equipment(s). All transformers are manufactured to rigid commercial quality specifications and each carries a 24 month guarantee!

Write today for a free quotation on any transformer, Choke, or saturable reactor.

Peter W. Dahl Co.

4007 Fort Blvd. • El Paso, Texas 79930

Telephone (915) 566-5365 or (915) 751-4856

D6

propagation

by
J. H. Nelson

EASTERN UNITED STATES TO:

GMT:	00	02	04	06	08	10	12	14	16	18	20	22
ALASKA	14	7	7	7	3A	3A	3A	7	7	14	14	14
ARGENTINA	14	7B	7B	7B	7	7	14	14A	21	21	21	14A
AUSTRALIA	14	7B	7B	7B	7B	7B	7B	14	14	14	14	21
CANAL ZONE	14	7	7	7	7	7	14	14A	21	21	21	14A
ENGLAND	7	7	3A	3A	7	7	14	14A	14A	14	14	7
HAWAII	14	7B	7B	7	7	7	7	7B	14	14	14A	14A
INDIA	7	7	7B	7B	7B	7B	14	14	7B	7B	7	7
JAPAN	14	7B	7B	7B	7	7	7	7	7	7B	7B	14
MEXICO	14	7	7	7	7	7	7	14	14	14	14A	14A
PHILIPPINES	14	7B	7B	7B	7B	7B	7	7	7	7B	7B	14
PUERTO RICO	7	7	7	7	7	7	14	14	14	14	14A	14
SOUTH AFRICA	7	7	7	7	7B	14	21	21	21	21	14A	14
U. S. S. R.	7	7	3A	7	7	7B	14	14	14	14B	7B	7
WEST COAST	14	7A	7	7	7	7	7	14	14	14	14A	14A

CENTRAL UNITED STATES TO:

ALASKA	14	7A	7	7	3A	3A	3A	7	7	14	14	14
ARGENTINA	14	7B	7B	7B	7	7	7B	14	21	21	21	21
AUSTRALIA	21	14	7B	7B	7B	7B	7B	7	14	14	14	21
CANAL ZONE	14	7	7	7	7	7	7	14A	21	21	21	21
ENGLAND	7	7	3A	3A	7	3A	7B	14	14	14	14	7
HAWAII	14A	14	7	7	7	7	7	7	14	14A	21	21
INDIA	7	7	7B	7B	7B	3B	3B	7	14	7	7	7
JAPAN	14	14B	7B	7B	7	7	7	7	7	7B	7B	14
MEXICO	14	7	7	7	7	3A	7	7A	14	14	14	14
PHILIPPINES	14	14	7B	7B	3B	7B	3B	7	7	7	7B	14
PUERTO RICO	14	7	7	7	7	7	7A	14	14A	14A	21	14A
SOUTH AFRICA	7	7	7	7	7B	7B	14	14	14	14A	14A	14
U. S. S. R.	7	3A	3A	3A	7	7B	7B	14	14	7B	7B	7B

WESTERN UNITED STATES TO:

ALASKA	14	14	7	7	3	3	3	7	7	14	14	14
ARGENTINA	14	14	7B	7B	7	7	7B	14	21	21	21	21
AUSTRALIA	21	21	14	7B	7B	7B	7B	7	14	14	14	21
CANAL ZONE	14	7A	7	7	7	7	7	14	21	21	21	21
ENGLAND	7	7	3A	3A	7	3A	7	7	14	14	14B	7B
HAWAII	21	21	14	7	7	7	7	7	14	14A	21	21
INDIA	7A	14	7B	7B	3B	3B	3B	7	7	7	7	7
JAPAN	14	14	14B	7B	7	7	7	7	7	7B	14B	14
MEXICO	14	14B	7	7	7	7	7	7A	14	14	14A	14A
PHILIPPINES	14	14	14	7B	7B	7B	7	7	7	7	7B	14
PUERTO RICO	14	7	7	7	7	7	7	14	14	14A	21	21
SOUTH AFRICA	7A	7	7	7	7B	7B	7B	14	14	14	14A	14
U. S. S. R.	7	7	7	7	7B	7B	7B	7	14	14	7B	7B
EAST COAST	14	7A	7	7	7	7	7	14	14	14	14A	14A

A = Next higher frequency may also be useful
 B = Difficult circuit this period
 F = Fair
 G = Good
 P = Poor

Let us know 8 weeks in advance so that you won't miss a single issue of *73 Magazine*. Attach old label where indicated and print new address in space provided. Also include your mailing label whenever you write concerning your subscription. It helps us serve you promptly.

Write to: **73 magazine**
 Peterborough NH 03458

Address change only Payment enclosed
 Extend subscription (1 extra BONUS issue)
 Enter new subscription Bill me later
 1 year \$15.00 (I've signed below)

Signature _____

name _____ call _____

address _____

city _____ state _____ zip _____

If you have no label handy, print OLD address here.

name _____ call _____

address _____

city _____ state _____ zip _____

1977		OCTOBER					1977
SUN	MON	TUE	WED	THU	FRI	SAT	
LAST QUARTER ☾	NEW MOON ☉	LAST QUARTER ☾	FULL MOON ☀			1 F	
2 F	3 G	4 G	5 G	6 G	7 P	8 P	
9 F	10 F	11 G	12 G	13 G	14 F	15 F	
16 F	17 F	18 F	19 F	20 G	21 G	22 G	
23 G/G	24 F/G	25 G	26 G	27 G	28 F	29 F	

**THE WORLD MAY ARGUE . . .
BUT THE UNITED NATIONS AGREES
ON YAESU, OF COURSE ! !**



Photo shows the 100% Yaesu station recently installed at the United Nations Headquarters in New York City. Delegates and visitors use it for amateur radio contacts to their friends all over the world.

The United Nations Amateur Radio Station, K2UN, includes two FT-101E's, FL-2100B linears, SP-101PB speaker patches, FV-101B external VFO's, YC-355D counters, YD-844 desk microphones, FT-221R two meter all mode transceiver, and QTR-24 world time clock. Look for K2UN on the air and get one of their beautiful QSL cards!

A similar station is in operation at the International Telecommunications Headquarters in Geneva, Switzerland, with the call sign 4U1 ITU.

Yes, the world of amateur radio agrees, **YAESU IS THE RADIO.**



YAESU
The radio.

1077

YAESU ELECTRONICS CORP., 15954 Downey Ave., Paramount, CA 90723 (213) 633-4007
YAESU ELECTRONICS CORP., Eastern Service Ctr., 613 Redna Ter., Cincinnati, OH 45215

TS-700S



WITH DIGITAL FREQUENCY DISPLAY

... INCLUDES RECEIVER PRE-AMP, VOX, SEMI-BREAK IN, CW SIDETONE AND, OF COURSE, ALL OF THE FINE, TIME-PROVEN CHARACTERISTICS OF THE ORIGINAL TS-700A. IT'S STILL ALL MODE, 144-148 MHz AND THE NEW VFO-700S GIVES YOU ADDED FLEXIBILITY.

THE TS-700S/VFO-700S, KENWOOD'S BRIGHT NEW APPROACH TO THE 2-METER BAND.

TRIO-KENWOOD COMMUNICATIONS INC. 1111 WEST WALNUT/COMPTON, CALIFORNIA 90220

 **KENWOOD**
... pioneer in amateur radio