

73 Magazine

for Radio Amateurs

- 24 **A Keyer? Who Needs Another Keyer?**
—would you believe a \$2 keyer?..... W6APZ
- 30 **Official FCC RFI Report**
—curing radio and TVI..... FCC
- 46 **Hey, Old-Timers!
The Breadboard Is Back!**
—jiffy up those IC circuits..... WA7NEV
- 52 **Fake 'Em Out With Remote Control**
—TT-operated control unit..... W4VGZ
- 58 **Now—A Digital Capacitance Meter!**
—simple construction project..... W3KBM
- 62 **DMM Survival Course**
—“all” about using digital multimeters... McClellan
- 72 **What Happened To SSTV?**
—is it dead or alive?..... K4TWJ
- 76 **Build This Excitingly Simple Receiver**
..... K4DHC
- 80 **Can Hams Counter Police Radar?**
—electronic warfare: another step..... WA4WDL
- 84 **Why Not Go First Class?**
—FM, RTTY, ID, PL, TT, etc.!..... W9CGI
- 92 **Diary Of A Survivor**
—cyberosis victim tells all..... WA6PPZ
- 100 **How Good Is the North Star Disk?**
—and why is it getting so popular?..... Bosen
- 103 **Pseudorandomness Is Just
Not Good Enough**
—true random happiness with a Z-80..... WA1PTZ
- 106 **Beethoven Need Not Fear**
—a little night music on the micro..... G8HBR
- 110 **Hex Converter
For True-Blue Octalists**
—BASIC program..... Dolinear
- 111 **The Cheaper Beeper**
—“Bell” for your CRT RTTY or uP..... VE2BVW
- 112 **Semi-Instant Program Loading**
—bauding up the SWT 6800..... WB4GXE
- 116 **The Super Select-o-Ject**
—kill rotten QRM with this filter system..... W8FX/4
- 120 **The IG-102 Goes Transistor!**
—tubeless portability for this
Heath signal generator..... Rossnick
- 124 **The Miser's Delight Repeater Controller**
—the very ID!..... W2PMX
- 128 **Another Ten Minute Timer?**
—yup..... N9MX, K9MX
- 134 **Make Antenna Tuning A Joy**
—instant swr bridge..... K5QY
- 146 **If You Want To Know Where You Are**
—loran-C receiver: part II..... Burhans
- 154 **Home-Canned Dummy**
—cheap half-gallon load..... WB2BWJ, WA2JZR
- 156 **De-Zap Strap**
—so you can MOS around..... W6SWZ
- 158 **No, Not Another 22S Mod?**
—yes, another Icom 22S mod..... VE2TM
- 160 **Scare the Hell Out Of Burglars**
—ham shack alarm system..... WA6WUI
- 162 **The COR Goes Solid State**
—turning two Midland rigs into a
repeater..... WA6ILQ



Our tree has many branches

At Henry Radio, we are proud that amateurs not only in the United States but throughout the free world look to us as their pre-eminent supplier of fine communications equipment. For fifty years this has been our principal business and it still is.

Most amateurs don't fully understand, however, the manner in which we have grown and grown so that every year we are better equipped to provide a genuine service to the world amateur fraternity and at the same time extend our unique blend of responsible, expert service to many electronic services in addition to the amateurs.

Our tree has indeed grown many new and sturdy branches. Yes, as always we distribute all the available high quality amateur equipment. In addition, we manufacture a full line of linear amplifiers that have become world famous for quality and reliability. These have provided the standard of reference in amateur radio for many years and are widely employed by commercial and government users. More recently our tube amplifiers have been supplemented by a broad line of solid state amplifiers for the HF, VHF and UHF bands. Many of these amplifiers are type accepted by the FCC for business, Public service, RCC and marine two-way service.

Out of this program has grown an entire new operation providing high quality FM handhelds, mobiles and fixed station transceivers for all these services. Moreover, as an off-shoot of our vacuum tube amplifier program we now supply R.F. power generators to industry. These are used as plasma generators in thin film plating and other exotic scientific processes.

What does all this mean to our most important customers, the amateur radio operators of the world. Simply this. As Henry Radio grows these sturdy new branches on our tree of electronic expertise, we continually strengthen our ability to help the amateurs of the world satisfy their communications requirements. As always, we offer expert, responsible assistance, the kind amateurs need and want. Wherever you live in the world, we invite you to turn to Henry Radio, the pioneer in service to the amateur radio fraternity.

Henry Radio

11240 W. Olympic Blvd., Los Angeles, Calif. 90064 213/477-6701
 931 N. Euclid, Anaheim, Calif. 92801 714/772-9200
 Butler, Missouri 64730 816/679-3127

IF YOU'RE NOT DESIGNING WITH A CSC PROTO-BOARD, LOOK AT ALL YOU'RE MISSING.

Utility—Models are available with or without built-in regulated power supplies (fixed or adjustable).

Economy—Eliminate heat and mechanical damage to expensive parts. Save money by re-using components.

Versatility—Use with virtually all types of parts, including resistors, capacitors, transistors, DIP's, TO-5's, LED's, transformers, relays, pots, etc. Most plug in directly, in seconds.

Durability—All Proto-Board models are carefully constructed of premium materials, designed and tested for long, trouble-free service.

Expandability—Proto-Board units can be instantly interconnected for greater capacity.

Visibility—All parts are instantly and easily visible, for quick circuit analysis and diagramming.

Speed—Assemble, test and modify circuits as fast as you can push in or pull out a lead. Save hours on every project.

Adaptability—Use in design, packaging, inspection, QC, etc. Works with most types of circuits, in many, many applications.

Flexibility—Use independently, or in conjunction with other accessories, such as scopes, counters, CSC Proto-Clip™ connectors, Design Mate™ test equipment, etc. One Proto-Board unit can serve a thousand applications.

Accessibility—All parts are instantly and easily accessible, for quick signal tracing, circuit modifications, etc.

Variety—A wide variety of models are available with capacities ranging from 630 to 3060 solderless tie-points (6 to 32 14-pin DIP's), to fit every technical and budget requirement.



Whatever type of electronic circuits you work with, you can do more in less time with CSC's solderless Proto-Board systems. As fast and easy as pushing in or pulling out a lead, you can design, test and modify circuits at will. Components plug into rugged 5-point terminals, and jumpers, where needed, are lengths of #22 AWG solid wire. In the same time you took to read this ad, you could be well on your way to assembling a new circuit.

CSC PROTO-BOARD SOLDERLESS BREADBOARDS

MODEL NUMBER	NO. OF SOLDERLESS TIE-POINTS	IC CAPACITY (14-PIN DIP'S)	MANUFACTURER'S SUGG. LIST	OTHER FEATURES
PB-6	630	6	\$15.95	Kit—10-minute assembly
PB-100	760	10	19.95	Kit—with larger capacity
PB-101	940	10	29.95	8 distribution buses, higher capacity
PB-102	1240	12	39.95	Large capacity, moderate price
PB-103	2250	24	59.95	Even larger capacity, only 2.7¢ per tie-point
PB-104	3060	32	79.95	Largest capacity, lowest price per tie-point
PB-203	2250	24	80.00	Built-in 1% regulated 5V, 1A low-ripple power supply
PB-203A	2250	24	129.95	As above plus separate ½-amp +15V and -15V internally adjustable regulated power supplies

Order today. Call 203-624-3103 (East Coast) or 415-421-8872 (West Coast): 9 a.m.-5 p.m. local time. Major credit cards accepted. Or see your CSC dealer. Prices slightly higher outside USA.

CONTINENTAL SPECIALTIES CORPORATION



70 Fulton Terrace, Box 1942, New Haven, CT 06509
203-624-3103 TWX 710-465-1227

WEST COAST: 351 California St., San Francisco, CA 94104,
415-421-8872 TWX 910-372-7992

GREAT BRITAIN: CSC UK LTD., Spur Road, North Feltham Trading Estate,
Feltham, Middlesex, England, 01-890-0782 Int'l Telex: 851-881-3669

C9

© 1978 Continental Specialties Corp.
Prices and specifications subject to change without notice.



IC-22S, Small wonder

ICOM's matchless mobile **IC-22S** has, since its introduction, been the standard against which all other VHF mobile transceivers have been measured. It is a prime example of ICOM's quality engineering, peak performance and phenomenal flexibility blended into one splendidly simple and affordable radio. Small wonder that the **IC-22S** has been the most popular radio that ICOM has ever offered.

Built to be viable operating hardware for years to come, with a magnificent high sensitivity receiver and instant programming and reprogramming of any 22 of 256 possible frequencies, the **IC-22S** is priced for the mobile beginner and the multi-vehicle serious VHF enthusiast. Small wonder that many hams own and operate more than one **IC-22S**.

With Touch Tone adaptability, quick change mobile mount, external speaker provisions, optional AC base power supply and other great flexible growth characteristics, the **IC-22S** is the perfectly affordable radio for those to whom present performance and future possibilities are important. Small wonder.

All ICOM radios significantly exceed FCC Specifications limiting spurious emissions.

Specifications: Frequency Range: 146-148 MHz Voltage: 13.8 V DC negative ground Current Required: TX, 2 amps at 10 W, 0.9 amp at 1 w; RX, 700 ma at max audio Size: 58mm(h) x 156mm(w) x 218mm(d) Weight: 1.9 Kg Number of Channels: 22 selected from 256 possible Power Output: 10 W or 1 W, selected Modulation Width: 5 KHz Microphone Impedance: 500 ohms Spurious Level: -60 dB below carrier Modulation Acceptance: 16F3 Receiver Sensitivity: .4 mv for 20 dB quieting Spurious Response: 60 dB or more attenuation Bandpass: ± 7.5 KHz/-6 dB; ±15 KHz/-60 dB Squelch Sensitivity: -8 dB below 1 mv

HF/VHF/UHF AMATEUR AND MARINE COMMUNICATION EQUIPMENT

DISTRIBUTED BY:



ICOM

ICOM WEST, INC.
Suite 3
13256 Northrup Way
Bellevue, Wash. 98005
(206) 747-9020

ICOM EAST, INC.
Suite 307
3331 Towerwood Drive
Dallas, Texas 75234
(214) 620-2780

ICOM CANADA
7087 Victoria Drive
Vancouver B.C. V5P 3Y9
Canada
(604) 321-1833

Spring Cheer is Here!

A CHORUS OF VALUE FROM . . .
featuring . . .

Write today for our latest Bulletin/Used Equipment list. . .

DENTRON MLA-2500



160 thru 10 Meter Amplifier

While they last . . . **Only \$799⁵⁰***

REG. \$899⁵⁰ *THESE OFFERS STRICTLY "CASH"
NO TRADES OR BANK CARDS

Burghardt INC.

AMATEUR CENTER

"America's Most Reliable Amateur Radio Dealer"

SAVE \$100 AND MORE!

"When it comes to
**FAST DELIVERY, HONEST
DEALING + PROMPT/DEPENDABLE
S-E-R-V-I-C-E,**
we don't just advertise it —
WE GIVE IT!

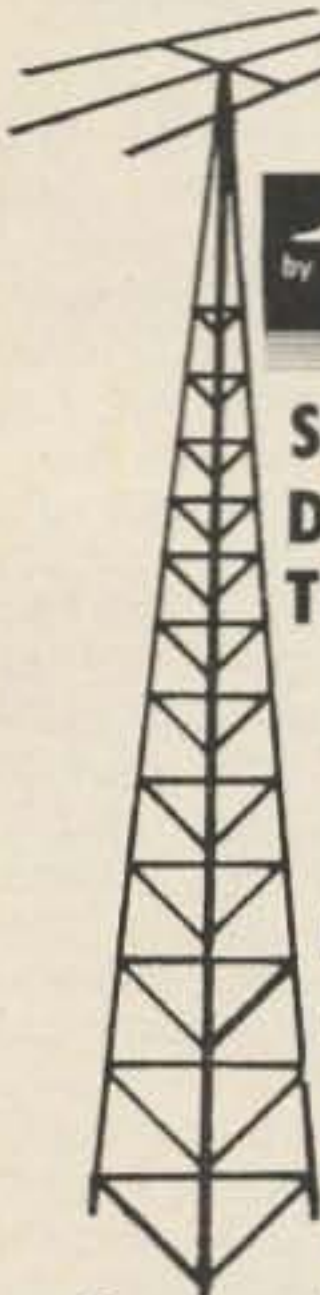

TRISTAO TOWER POWER

SUPER "PACKAGE" DEALS on all new ROHN, TRI-EX and TRISTAO TOWERS are our SPECIALTY!

CALL or WRITE TODAY for FULL/FREE INFORMATION and our everyday "down-to-earth" PACKAGE QUOTE!

CDE HAM-III

New/Improved Heavy Duty Rotor with Control
NOW ONLY

\$129.95* (LESS CABLE) **Wilson**

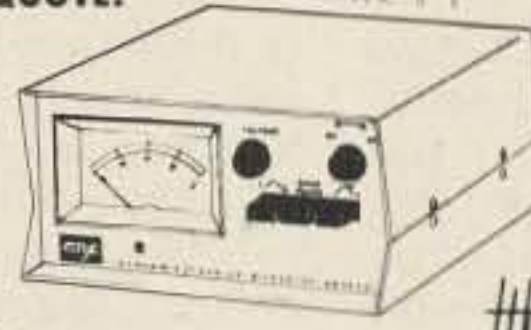

hy-gain

MAIL AND TELEPHONE ORDERS "WELCOMED" . . . They're our business!!

SERVICE?? NO PROBLEM! It's OUR Policy.

cushcraft

Mosley

* TERMS: "CASH" means CHECK, MONEY ORDER or C.O.D.

SPECIAL TRI-BAND BEAM OFFER SAVE 10% PLUS

SWING INTO SPRING with a NEW 10-15-20-METER BEAM! 10% "CASH" SAVINGS NOW IN EFFECT on these popular TRI-BAND BEAMS! AND . . . with "PACKAGE" PURCHASE of selected TRI-BANDERS . . . you can BUY A NEW CDE HAM-III ROTOR for LESS THAN ONE HUNDRED DOLLARS! LIMITED — ORDER NOW & SAVE! CALL or WRITE TODAY . . .

MAKE/MODEL	SPECIFICATIONS	REGULAR PRICE	SPECIAL "CASH" PRICES*	
			BEAM ONLY	BEAM & ROTOR
CUSHCRAFT ATB-34	4-Element 2-KW	\$259.95	\$233.95	\$335.25
HY-GAIN TH3-JR.	3-Element/300W	\$144.50	\$129.95	\$242.50
HY-GAIN TH3-MK3	3-Element/1KW	\$199.95	\$179.95	\$289.95
HY-GAIN TH6-DXX	6-Element/2KW	\$249.95	\$224.95	\$329.95
MOSLEY TA-33-JR	3-Element/1KW	\$151.85	\$136.50	\$247.50
MOSLEY TA-33	3-Element/2KW	\$206.50	\$185.00	\$294.50
MOSLEY TA-36	6-Element/2KW	\$335.25	\$299.95	\$399.95
MOSLEY CL-33	3-Element/2KW	\$232.50	\$209.00	\$317.25
MOSLEY CL-36	6-Element/2KW	\$310.65	\$279.50	\$384.50
WILSON SYSTEM I	4-Element/2KW	\$274.95	\$247.50	\$353.50
WILSON SYSTEM II	3-Element/2KW	\$219.95	\$197.95	\$307.00

FREIGHT: ALL SHIPPING CHARGES "COLLECT" — F.O.B. WATERTOWN!

PHONE NO. (605)-886-7314 P.O. BOX 73 WATERTOWN, SOUTH DAKOTA 57201

73 STAFF

EDITOR/PUBLISHER
Wayne Green W2NSD/1

EXECUTIVE VICE PRESIDENT
Sherry Smythe

ADMINISTRATIVE ASSISTANT
Dotty Gibson

MANAGING EDITOR
John C. Burnett

ASSISTANT MANAGING EDITOR
Susan G. Philbrick

EDITORIAL ASSISTANT
Beth Turin-Weston

VO EDITOR
John Craig

BOOK PUBLICATIONS
Jeffrey D. DeTray WB8BTH/1
Christopher E. Smith

PRODUCTION MANAGER
Lynn Panciera-Fraser

ART DEPARTMENT
Craig Brown
Gayle Cabana
Bob Drew
Carl Jackson
Michael Murphy
Weston Parker
Noel R. Self WB1ARP
Robin M. Sloan

PRINT SHOP MANAGER
Michael Potter

PRINTING
William Carling
Dwight Perry

PHOTOGRAPHY
Bill Heydolph
Tedd Cluff

TYPESETTING
Barbara J. Latti
Pauline Halvonn
Jennifer Johansson
Marie Walz

BOOKKEEPER
Knud E. M. Keller KV4GG/1

CIRCULATION
Barbara Block
Fran Dillon
Florence Goldman
Valerie Horn
Dominique Smith

DATA ENTRY
Judy Waterman
Judy Brumaghim
Linda Cate
Mary Kinzel

DIRECTOR OF MARKETING
Daniel D. Savage

MERCHANDISING MANAGER
Robert R. LaPointe

AREA REP MANAGER
Cynthia Gray

SHIPPING
Theresa Toussaint
Sue Chandler
Ethan Perry
Steve Coombs
Bill Barry

PLANT MAINTENANCE
Michael Coutu
Lorraine Pickering

RECEPTIONIST
Doni Jarvis

ASSOCIATES
Robert Baker WB2GFE
E. H. Barnett WB6IX
Schley Cox WB9LHO
Tom DiBlase WB8KZD
Terry Fox WB4JFI
W. Sanger Green
Dave Ingram K4TWJ
Larry Kahner WB2NEL
Joe Kasser G3CCZ
Bill Pasternak WABITF
John Schultz W4FA
Walter Scott K8DIZ
Peter Stark K2OAW
Bill Turner WA6AB1

COMPUTER PROGRAMMING
Richard J. Dykema
Ron Cooke
Steven B. Lionel

ADVERTISING
Aline Coutu
Marcia Stone
Ila Witty



NEVER SAY DIE

...de W2NSD/1

EDITORIAL BY WAYNE GREEN

THE INSIDE SCOOP

There are a lot of things that I just can't print in 73. There are many things which are going on which aren't apparent and which you might never know about. I'll be talking about some of these things during my talk at the Birmingham Hamfest this year. Try to be there. The hamfest is May 13-14th. They have over 70 booths already sold and are expecting to have over 110 exhibitors by hamfest time. It should be a whale of a show.

Yes, I'll be talking a good deal about the present state of amateur radio... what is really happening with the FCC... what we can do about it. I'll also try to bring you up to date on what ham bands we may still have after the ITU meeting next year in Geneva.

In addition to Birmingham, I'll also be talking at Atlanta again this year. The Atlanta Hamfest/Computerfest (June 3-4) is shaping up to be even bigger than last year. Just about every major manufacturer is already signed up to exhibit and some are getting ready to show some hot new items. Atlanta has a special place in my heart because the city has such ambience. Oh, Dayton is big, but Atlanta has much more entertainment and some fantastic restaurants. Dayton has nothing to compare with Aunt Fanny's... or Stone Mountain... or Underground Atlanta. Besides that, Chaz Cone puts on one hell of a hamfest.

Speaking of Dayton... since I didn't get put on the speaking schedule for the Hamvention, I'll be going out to Long Beach for a computer show that weekend. Sorry to miss everyone... perhaps next year. 73 will have a booth at the Hamvention, of course.

FCC VS AMATEURS

Despite the testimony of several individual amateurs,

representatives of several amateur equipment manufacturers (Drake, Heath, DenTron), and the Amateur Radio Manufacturer's Association (ARMA), all of whom vigorously opposed the Commission plan to penalize amateurs for troubles the Commission is having with CBers and HFers, the Commission went 100% against amateur radio and ruled that amateur equipment can no longer have a 10m band built into amplifiers.

The ruling actually will go far beyond that. The details of the ruling were delayed and, as of this writing, were still not definite. But we do have some strong hints as to what the final ruling will contain.

For instance, we can expect that in the future all linear amplifiers will require a minimum of 50 Watts drive, with no input attenuation permitted. The maximum gain permitted will be 6 dB. That means that a kW amplifier will have to have a minimum of 250 Watts drive.

Linears will no longer be allowed to be carrier operated. This will not be much of a problem for ham linears, which are designed for sideband use and almost always have an external switching line.

A tougher requirement will be for linears to have zero gain in the 26-28 MHz band, but still have the maximum 6 dB gain in the 24-26 and 28-35 MHz bands. I have a feeling that no engineer ever went even close to being in on that requirement. Sure, it can be done, but the trap to do that will be expensive and easier to remove than California emission control gear. Once removed or bypassed, the trap will be ineffective and the amplifier will be perking happily away on 10m... or 11m.

The Commission apparently does not intend to make it illegal for an amateur to modify a linear, but it would be illegal for a manufacturer to provide in-

structions or to make the conversion easy. Will it be illegal for S9 magazine to publish conversions for all popular ham amplifiers to fit them out for 11m? I doubt if the FCC could make such a restriction stick, so the chances seem good that this stupid situation is just going to get worse and worse, with the FCC piling restrictions on anyone handy in frustration.

The Commission seems definitely headed towards a dealer registration of all ham gear sold, particularly for used equipment. Just how this would be accomplished for mail-order sales is a mystery. It might well do away with all further mail-order sales of ham gear.

Obviously, the FCC is going to have to set up a whole new staff to handle the ham equipment sale and registration situation. They will have to be sure to be at every hamfest and convention, picnics, auctions, etc., to make sure that no ham gear with an 11m position on it is sold... that no 10m amplifier is sold to anyone but a card-carrying ham, etc. The estimates are that this field force will have to have a minimum of four people in each of the 50 states... plus generous travel expenses. The chief of each group will probably be making \$18,500 per year, his assistant about \$16,750 per year, and the two people who have to do all the work would get about \$13,000 per year each. That's over \$3 million just in salaries. Add to that their official cars, offices, secretarial help, forms, telephone expenses, etc., and you have a budget of around \$10 million, minimum.

But what if the FCC isn't able to get that much money to staff this new branch? The answer will probably be as before—until the FCC can furnish a person to monitor sales at hamfests, there will be no sales at hamfests. No flea markets... no booths permitting sales of ham gear. When the FCC set up those incredibly silly rules for repeaters, this was their answer to the logjam of applications... no repeaters.

IT IS POLITICS

Trying to reason with the FCC is like trying to reason with any other branch of the government... it is senseless. Business learned this a long time ago and they discovered the system which does work: the lobby. Yes, I know, I've been trying to get a lobby going for amateur radio for 20 years. Well, look at what the lack of a lobby has done for us, starting with the "incentive licensing"

73 Magazine is published monthly by 73, Inc., Peterborough NH 03458. Subscription rates in the U.S. and Canada are \$15 for one year, \$26 for two years, and \$36 for three years. Outside the U.S. and Canada, write for rates. Second class postage paid at Peterborough NH 03458 and at additional mailing offices. Publication No. 700420. Phone: 603-924-3873. Entire contents copyright 1978 by 73, Inc. INCLUDE OLD ADDRESS AND ZIP CODE WITH ADDRESS CHANGE NOTIFICATION. Microfilm edition—University Microfilm, Ann Arbor MI 48106.

Continued on page 130

IT'S NEW... IT'S UNIQUE... AND IT'S TRULY USEFUL. IT'S KENWOOD'S SM-220 STATION MONITOR. THE SM-220'S UNEXCELLED VERSATILITY ALLOWS YOU TO MONITOR YOUR TRANSMISSIONS, MONITOR INCOMING SIGNALS, AND MONITOR THE AMOUNT AND STRENGTH OF BAND ACTIVITY* AND PERFORMS AS A GENERAL-PURPOSE 10 MHz OSCILLOSCOPE, AS WELL.

Kenwood offers this totally unique unit as a perfect compliment to your TS-820S or TS-520S station.** The SM-220 permits you to monitor your transmitted signals, thus assuring optimum linearity and maximum performance. With the addition of the BS-5 or BS-8 Pan Display option you will be able to determine visually the location and strength of adjacent signals without tuning your receiver off frequency. The choice of options allows you to adapt the SM-220 to either the TS-820S or TS-520S, depending on which rig you now have or may acquire.

The SM-220 has a built-in two-tone audio generator with full provisions for tuning your exciter and linear amplifier (160 m through 2 m).

All this costs little more than a general-purpose oscilloscope. And, of course, it's pure Kenwood quality.

*With BS-5 or BS-8 option

**For other models check with appropriate manufacturer for compatibility.

SM-220



Function: Selects operation mode: OSC/RTTY: General testing of station equipment, experimental design of new equipment, or troubleshooting; display of receiver IF output allows you to give "signal quality reports"

Power ON indicator.
Power switch.

Intensity: Controls brightness of scope display.

Band Scope: (Pan Display) With BS-5 or BS-8 option, allows you to "see" the signals on both sides of your operating frequency without tuning your receiver off frequency. Useful for determining "band conditions", band crowding, source of interference from adjacent stations... a visual display of what you would hear if you tuned across the band, without having to touch your receiver's dial.

Focus: Controls sharpness of scope display.

Vertical Attenuator: Precision step attenuator (gain control) switch adjusts vertical input level.

Vertical Input: Accepts IF input, RTTY input or oscilloscope input.

Vertical Gain: Potentiometer to fine-adjust vertical input level.

Adjusts display along vertical axis.



Adjusts display along horizontal axis.

Sweep Range: Step switch controls sweep band width or switches horizontal input/external sync terminal "ON"

RF Attenuator: Level control used in MONI/TRAP mode.

Tone: Step switch selects Wien bridge tone generators: 1000 Hz, 1575 Hz or both tones simultaneously.

Out: Output of the audio generator can be connected to the transceiver's microphone input for "two-tone test"; Also for trapezoidal test of transceiver linear amplifier.

Synchronization Marker: Selects internal or external sync (similar to horizontal hold on TV). Turns On or Off the built-in marker which shows operator where his receiver is actually tuned.

Scan Width: Selects width of "window" or receive band display when using the Pan Display option. (100 kHz or 20 kHz)

Variable sweep control/External gain: Controls (1) sweep speed of display in any sweep range. (2) optional Pan Display (Band Scope) speed of display. (3) level of horizontal input/external synchronization input when sweep range is in RTTY/Ext or Trap.

Horizontal Input/External Sync: Accepts either (1) RTTY input for tuning. (2) external sync input for test (oscilloscope functions). (3) external oscillator for Lissajous display.

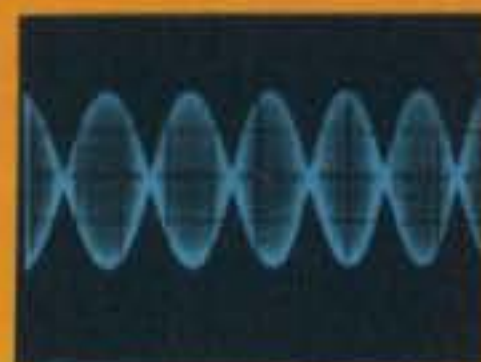

Two-Tone Wave Envelope
For "performance" tune-ups or checking proper transceiver operation.



Pan Display Use to check source of interference during "QSO" without moving off-frequency. Also determines location and strength of adjacent frequencies. (Requires BS-5 or BS-8 option)



Keyed Waveform Shows detail of CW keying. Use to monitor the quality of your CW note. (Photo shows ideal waveform produced by TS-820S.)

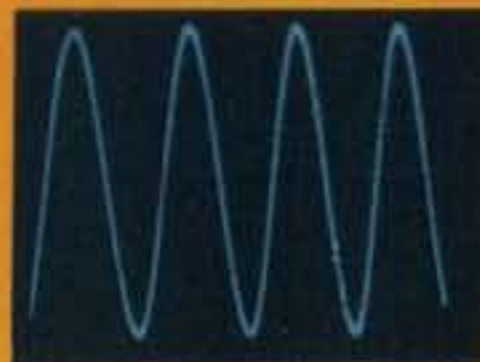

Oscilloscope Operation (1 kHz) Oscillator function allows Sine, square wave. Lissajous patterns for testing or design work.



Trapezoid (TS-820S w/ TL-922) Shows linearity of power amplifier. Used primarily for testing.



Wave Envelope shows full SSB voice modulation, with processor on (full compression), and "clean signal" at full power.



ou goons don't ever proof
lousy manuscripts from bat
bunch of rocks in
you liars and you in
I insist that you print ev
tell Ma Bell that she shou

LETTERS

LOOKING FOR A MICRO

It was good to see the article "Looking For a Micro?" in the Feb., '78, 73 Magazine. As an owner of a KIM-1 and an Apple II (both 6502-based machines), I welcome another 6502 owner.

It's obvious, though, that Francis hasn't seen the computer timing comparisons in *Kilobaud*, the ones where the 6502-based machines run at least twice as fast as the 8080-and Z-80-based equipment.

I think he will also find the 6502 instruction set considerably more flexible once he gets into it. He is way ahead, though, when he observes that KIM-1 offers more for the money than any other single board computer.

Another point that attests to the programming power of the 6502: KIM-1 will play a credible game of chess in only 1K of memory. Reports are that the same level of play using an 8080 took 4K. I think Francis will find he has more computer than he realized. I wish him the same pleasure many other KIM-1 owners (including me) have experienced.

**Chuck Carpenter W5USJ
Carrollton TX**

*The PET is also 6502-based.—
Wayne.*

Concerning the article in the February issue of 73 entitled "Looking For a Micro?—consider the KIM-1": I find the author Francis J. O'Reilly to have given some misinformation about the 6502 uP chip.

The author states "... This means the 6502 can execute up to approximately 250,000 instructions per second. This is only half as fast as the machines that use the 8080A; however, it is still fast enough for most applications."

This last sentence to me is just not so. I deal with the 6502 chip by selling the Ohio Scientific Instruments line of products. This is the chip they use most often and I would like to share with you some of their comments on the different uP chips.

In their winter, 1977, catalog, OSI states, "The Z-80 is an enhanced 8080... the 6502 is an enhanced 6800.

"To further discuss the Z-80 and 6502, we must introduce two important concepts—clock speed and instruction (or op code) execution time. Microprocessors are rated by clock speed, that is, 1 MHz, 2 MHz, etc. However, comparing clock speeds of two different processors is like comparing apples to oranges. The reason is that different processors require different numbers of clock cycles to execute an op code such as an ADD. The Z-80 generally requires two to three times as many clock cycles to execute an instruction as does the 6502. ... The result is that the 6502 is generally twice as fast as a Z-80 for a given clock speed ..."

If the 6502 is twice as fast for a given clock speed as the Z-80, then there is no way on this earth that the 8080A can be faster than the 6502. The proof of the pudding is to read Tom Rugg and Phil Feldman's "Basic Timing Comparisons" in the October issue of *Kilobaud*. Four out of the top five computers run used the 6502 chip. I know that this was supposed to be a timing comparison of BASICs, but in my opinion, the BASIC run is only as fast as the chip running it.

The second objection I have is the idea of spending a goodly amount of money for either an ASR-33 or a video terminal for such a small system. Not that I have anything against the KIM, but I have found most KIM owners to be out of the experimenter's mold, using home brew interfaces and preferring to work with the more efficient and faster machine language. Most KIM owners can run some pretty complex programs using only the onboard memory.

For those wanting a more sophisticated system, one designed for use with either a video terminal or a Teletype™, I would suggest either a full blown system, such as the OSI Challenger II or III, or one of the newer mini-systems, such as the OSI Challenger IIP. The only additional hardware needed to run the Challenger IIP is an rf modulator, such as the Pixie-Verter, and a television set, either black and white or color.

I suggest that, unless you are a do-it-yourselfer who also likes to write programs in machine language, you stay away from

KIM.

**Steve Carroll WB4MQD
Memphis TN**

Note: I suggest that any person interested in really learning about microcomputers will do far better to start out with a small system such as the KIM... and have a lot of fun to boot.—Wayne.

GENERATING CHAOS

I have been a Novice for less than two months, which is odd since my professional experience in electronics goes back nearly twenty years.

First, let me say that I love amateur radio. I am completely taken with the hobby, and I am working hard on upgrading.

Now for my complaint: I am still quite slow with CW. It takes me some time to complete a QSO. On several occasions, I have had the transmissions I am trying to copy buried under CQs, unbroken carriers, and what I will call "garbage" for want of a polite and more descriptive term. I fear the QRM has been deliberate.

Where is the highly vaunted courtesy of ham radio? Everyone must start somewhere in amateur radio. Although I probably know more theory than many long-time hams, I must struggle with the code. While I realize it is probably frustrating for some of the speed demons to listen while I, or someone like me, struggles to get through RST and QTH, I would ask for patience. Perhaps, someday, one of us "lids" will patiently help a faster operator with theory. (By the way, your code tapes are great.)

Without courtesy and patience, we won't have a hobby, but merely a group of people who expend valuable energy generating chaos. Under those conditions, I am afraid amateur radio will not fare well in the crucial years to come.

**William F. Brain IV WD5HYN
Houston TX**

Back in the early days, when there were but two hams on the air, the second was busy jamming the first.—Wayne.

PROTECTION

I just finished reading the article, "Build A 3½ Digit DVM," by Tim Ahrens WA5VQK, and it looks great. I would like to pass on a few things to your readers for better results from this project.

First, some kind of overload protection is a necessity on this meter, as an overload of even moderate size can kill the

DVM chip, and perhaps your weekly budget at \$14.25 a pop! Here's how:

Just add this circuit to the input of the DVM chip, and your meter will be safe from the majority of overloads and rf jolts. Note that the VAG input on the chip goes directly to the attenuator. This is necessary to cut noise pickup (readings jump around) and prevent voltage pickup between the chip and attenuator.

After the novelty of a DVM wears off, more accuracy will be desirable. The circuit shown is about 1 to 3% with battery power. Adding a 7805 regulated power supply will get you under 1%. But, for best results, replace the zener in Fig. 5 with a Motorola MC-1403 U or Analog Devices AD-580 precision reference. And then replace the attenuator with matched precision resistors. If you do these things, you can get to well within 0.1% accuracy. Fantastic accuracy for such a low-priced project!

I have worked with this DVM chip since it came out, and I am well acquainted with its idiosyncrasies! Also, Motorola has lots of application info on it. See AN-769 for hookup info on an autoranging digital multimeter.

**Gary McClellan
La Habra CA**

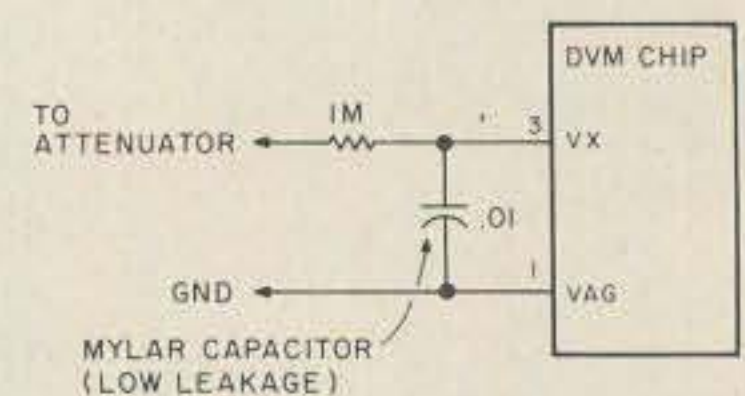

Protection circuit.

MIGHTY ATLAS

Aside from the obvious advantage of small size and convenience, Atlas Radio products are backed by what must be the most outstanding customer service department in the history of ham radio.

On two different occasions, my 210-X has been returned to Clint Call W6OFT, the company's customer service manager, for repairs, adjustments, or alignments. It has never cost me a cent.

This is especially commendable in view of the fact that the unit was technically out of warranty and in one case the return was made because some clown had put the thing on 11 meters before I purchased it. A new dial was installed, and the radio was "gone through" and returned in 30 days with a specification sheet checkout report.

Continued on page 184

think of yourself as an **antenna expert!** —you select your components!

1 Get optimum performance band for band. Choose from medium or high power resonators for your favorite bands.

2 Fold over, 360° swivel mast for quick band change or easy garaging. Select from two versions, fender/deck or bumper mount location.

3 Stainless steel ball mount, 180° adjustable, commercial duty for superior mechanical and electrical performance.

4 Get exceptional reports, broadest bandwidth, lowest SWR. Use with any convenient length 50 ohm coax. Matching devices not required.

5 For convenience, use the Hustler stainless steel resonator spring, and special design quick disconnect.

...and you'll mobile with the experts' foremost choice...

HUSTLER

Get fixed station reports from your mobile—operate 6-10-15-20-40-75 or 80 meters with the experts and join the vast majority using Hustler for nearly two decades.



Model SSM-2 Ball Mount



Model QD-1 Quick Disconnect



Model RSS-2 Resonator Spring



Model BM-1 Bumper Mount



Model L-14-240 Mil Spec 50 Ohm Feedline



Model MO-1 For Deck or Fender Location



Model MO-2 For Bumper Mount Location



Super Resonators RM(S) 2 KW PEP Greatest Coverage

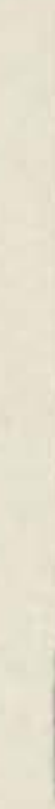

Standard Resonators RM 400 Watts PEP

"the home of originals"

HUSTLER

Available from all distributors who recognize the best.

new-tronics corporation

15800 Commerce Park Drive
Brookpark, Ohio 44142
(216) 267-3150

N2

HUSTLER ANTENNA PRODUCTS—for sixteen years—original designs—created and manufactured by American ingenuity, labor and materials—used by communicators throughout the world.

Hustler designs are patented under one or more of the following assigned to New-Tronics Corporation 3287732, 3513472, 3419869, 3873985, 3327311, 3599214, 3582951.

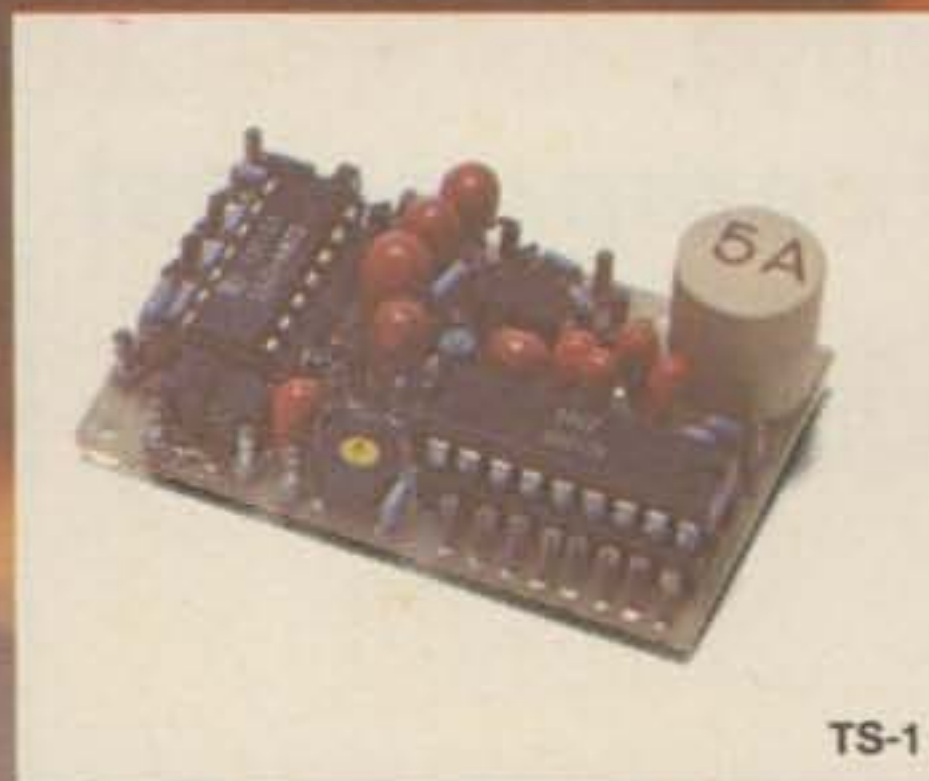

TS-1

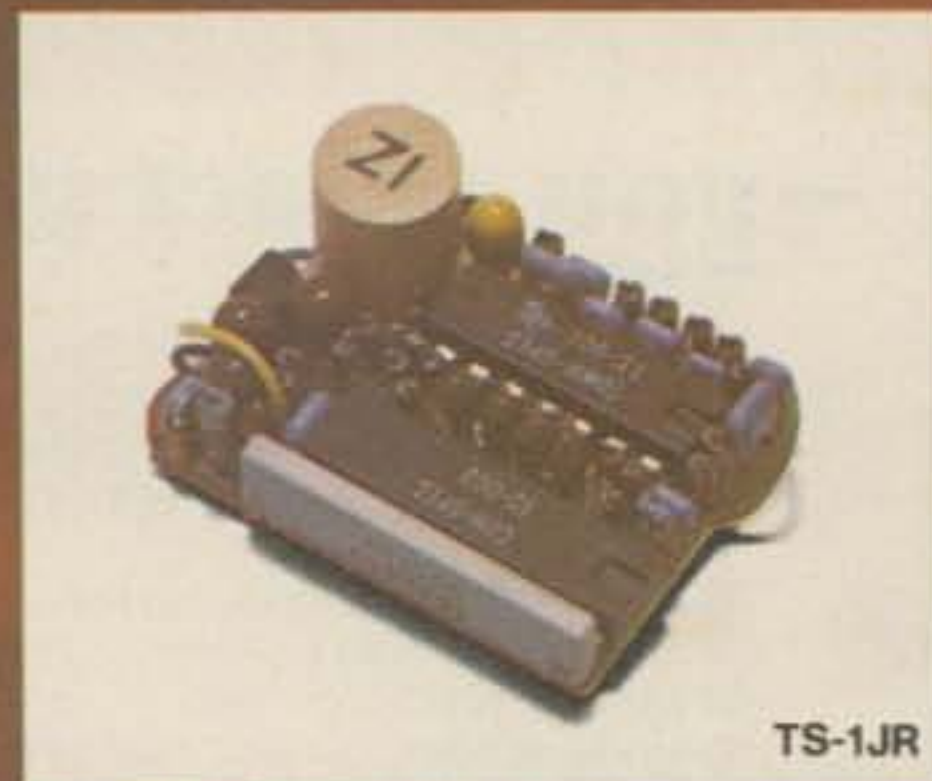

TS-1JR

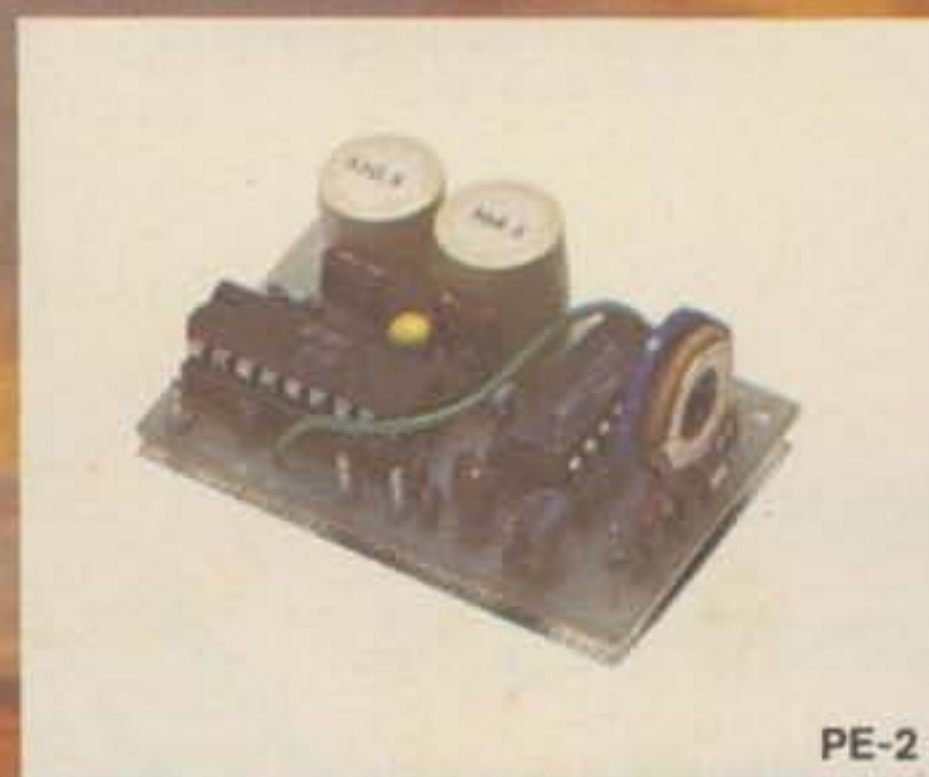

PE-2



SD-1

THE DAWNING

The age of tone control has come to Amateur Radio. What better way to utilize our ever diminishing resource of frequency spectrum? Sub-audible tone control allows several repeaters to share the same channel with minimal geographic separation. It allows protection from intermod and interference for repeaters, remote base stations, and autopatches. It even allows silent monitoring of our crowded simplex channels.

We make the most reliable and complete line of tone products available. All are totally immune to RF, use plug-in, field replaceable, frequency determining elements for low cost and the most accurate and stable frequency control possible. Our impeccable 1 day delivery is unmatched in the industry and you are protected by a full 1 year warranty when our products are returned to the factory for repair. Isn't it time for you to get into the New Age of tone control?



ME-3



TE-8



TE-12

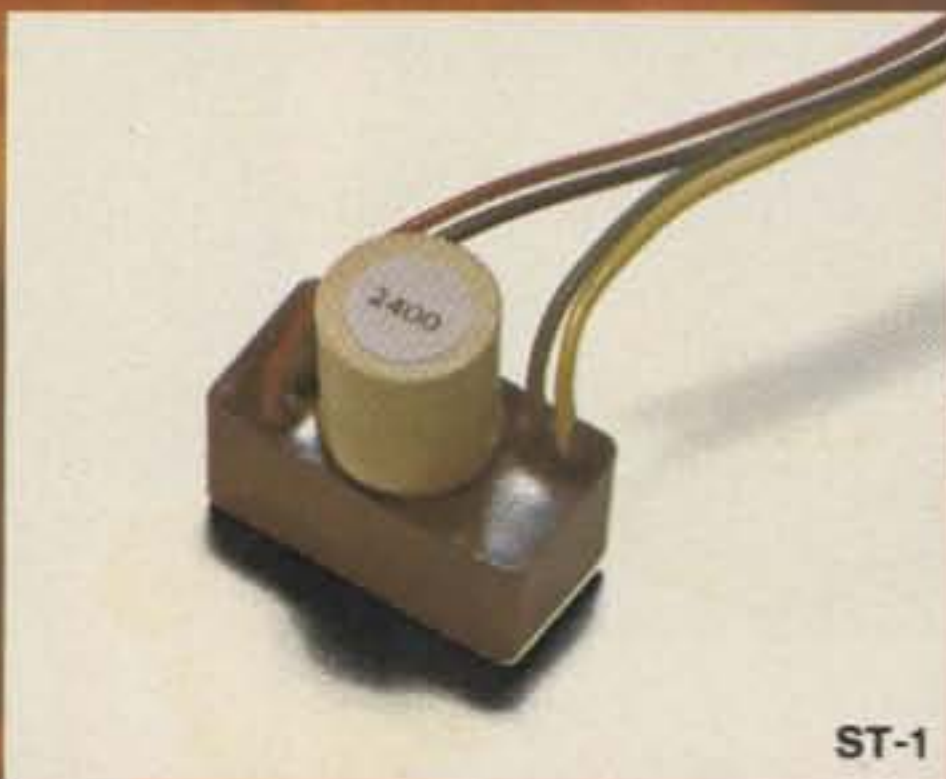

SD-1

OF A NEW AGE.

TS-1 Sub-Audible Encoder-Decoder • Microminiature in size, 1.25" x 2.0" x .65" • Encodes and decodes simultaneously • **\$59.95** complete with K-1 element.

TS-1JR Sub-Audible Encoder-Decoder • Microminiature version of the TS-1 measuring just 1.0" x 1.25" x .65", for hand-held units • **\$79.95** complete with K-1 element.

ME-3 Sub-Audible Encoder • Microminiature in size, measures .45" x 1.1" x .6" • Instant start-up • **\$29.95** complete with K-1 element.

TE-8 Eight-Tone Sub-Audible Encoder • Measures 2.6" x 2.0" x .7" • Frequency selection made by either a pull to ground or to supply • **\$69.95** with 8 K-1 elements.

PE-2 Two-Tone Sequential Encoder for paging • Two call unit • Measures 1.25" x 2.0" x .65" • **\$49.95** with 2K-2 elements.

SD-1 Two-Tone Sequential Decoder • Frequency range is 268.5 - 2109.4 Hz • Measures 1.2" x 1.67" x .65" • Momentary output for horn relay, latched output for call light and receiver muting built-in • **\$59.95** with 2 K-2 elements.

TE-12 Twelve-Tone Sub-Audible or Burst-Tone Encoder • Frequency range is 67.0 - 263.0 Hz sub-audible or 1650 - 4200 Hz burst-tone • Measures 4.25" x 2.5" x 1.5" • **\$79.95** with 12 K-1 elements.

ST-1 Burst-Tone Encoder • Measures .95" x .5" x .5" plus K-1 measurements • Frequency range is 1650 - 4200 Hz • **\$29.95** with K-1 element.



**COMMUNICATIONS
SPECIALISTS**

426 W. Taft Ave., Orange, CA 92667
(714) 998-3021

Faces, Places



Jim Joyce XE1UFA and Lou Ramirez XE1VW stood atop this volcano on Revillagigedo while taking a break from last year's XF4JJ DXpedition.



N. R. Gopal VU2GO was one of several hams whose expert net operation resulted in an emergency airlift of medication from Italy to a six-year-old leukemia victim in India.



Eric Shalkhauser W9CI (Washington IL), author of *The History of Ham Radio*, was captured on film at the national QCWA open board meeting in Chicago.



Ever worked two YLs at the same time? You might, if you hear Stephanie Miller WB2VKB (left), age 10, or her sister Suzanne WB2VKB, age 12. The two girls from Scotia NY work all bands, but prefer the excitement of the 80 meter Novice band.

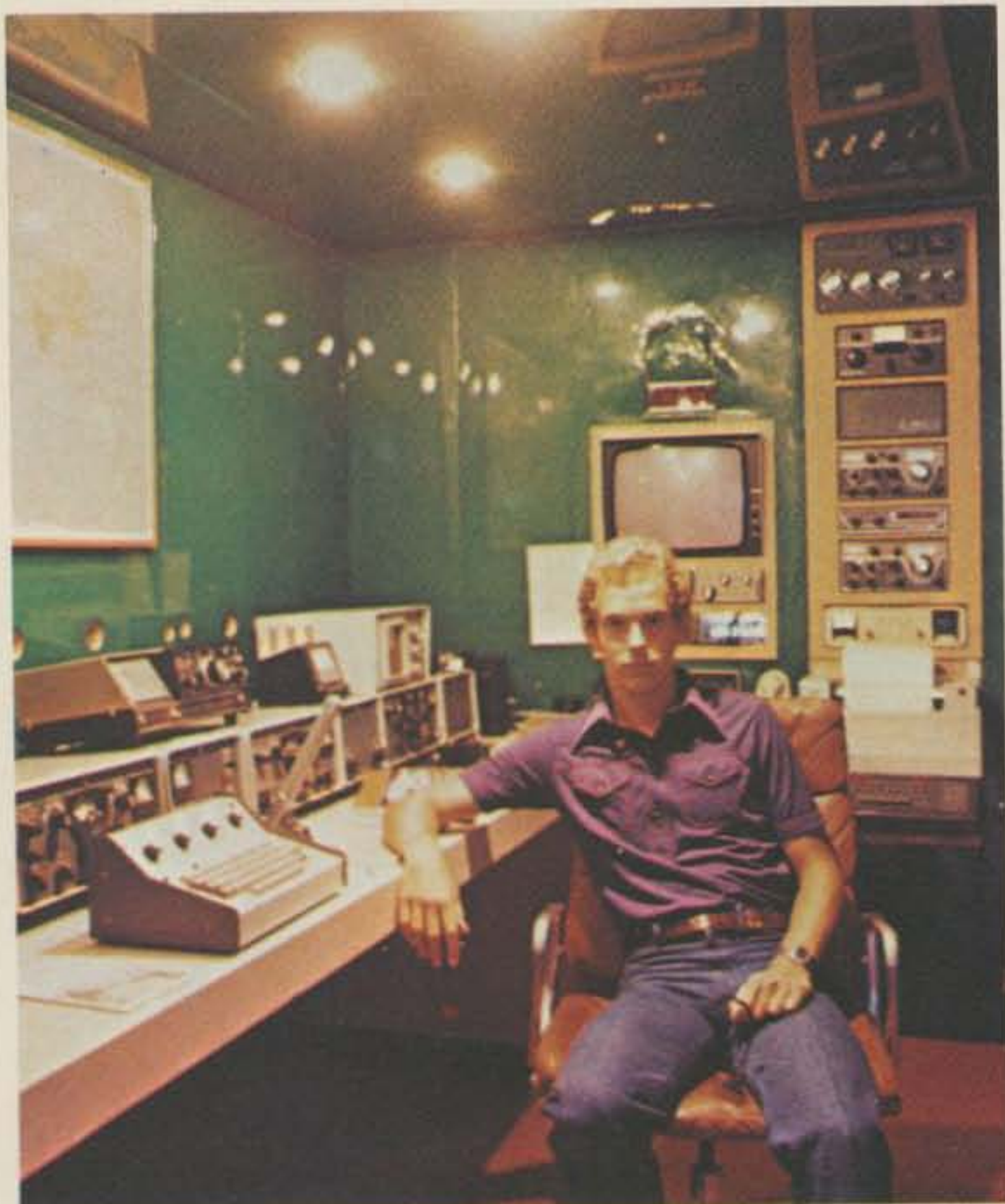

H. S. H. the Crown Prince Albert of Monaco paid a visit to the shack of Alexis Demcenko 3A2GX/F0AZS/I1ALX (photo courtesy of 3A2GX, via W4WFL/3A0JE).



Dr. Karl Brownstein W6PSI (center), his wife Joan W6PSE (left), and son Harvey WB6YNQ (right), owners of Integrated Circuits Unlimited, were recently feted at a banquet in San Diego, where they received awards both from State Senator Bob Wilson and from the San Diego Police Department.

Put TEN-TEC At The Top Of Your Accessory List

It figures that the leader in solid-state HF technology would be the leader in solid-state HF accessories. So, when it's time to add to your operating equipment, look to the leader — TEN-TEC.

A. NEW TEN-TEC Model 247 Antenna Tuner — \$69

So unique there is a patent pending, the 247 features a 47-tap toroid with silver plated 18 gauge wire, silver plated tap selector and 1kV variable capacitors in a universal Transmatch circuit. Matches 50-75 ohm outputs to a variety of load impedances, balanced and unbalanced (built-in balun). Antennas such as dipoles, inverted "V"s, long random wires, Windoms, beams, rhombics, mobile whips, Zepp, Hertz and similar types can be matched from 1.8 to 30 MHz. Power rating: 200 watts, rf, continuous duty. Attractive aluminum case with black end panels.

B. NEW TEN-TEC Model 277 Antenna Tuner/SWR Bridge — \$85

Same unique features of model 247 above plus built-in SWR bridge and meter that shows ratios up to 5:1. Handsome black and gray styling. Matches Century 21.

C. TEN-TEC KR50 Ultramatic Keyer — \$110

The keyer you control. Dual memories, individually defeatable, for operation as full iambic (squeeze) keyer, with single memory, or as conventional keyer. Self-completing characters. Adjustable automatic weighting (50 to 150%) determined by speed setting, paddle force (5-50 gms), speed (6-50 wpm), and 500 Hz side-tone level (to 1 v.) 117 VAC, 50-60 Hz or 6-14 VDC.

D. TEN-TEC KR20-A Electronic Keyer — \$69.50

Speed 6-50 wpm. Factory adjusted paddle return force and weighting. Self-completing characters. Adjustable side-tone level. 117 VAC, 50-60 Hz or 6-14 VDC.

E. TEN-TEC KR5-A Electronic Keyer — \$39.50

Same as KR20-A less side-tone and power supply. 6-14 VDC.

F. TEN-TEC KR1-A Deluxe Dual Paddle — \$35

Same paddle as KR50; for iambic or conventional keyers.

G. TEN-TEC KR2-A Single Lever Paddle — \$17

Same paddle as KR20-A; for "TO" or discrete character keyers.

H. TEN-TEC 206-A 25/100 kHz Crystal Calibrator — \$29

Pulsed output for easy identification. 9-12 VDC.

I. TEN-TEC 208 CW Filter — \$29

Four stage audio active filter provides 150 Hz bandwidth centered at 750 Hz. Two selectivity switch positions. 9-12 VDC.

J. TEN-TEC 244 Digital Readout/Frequency Counter — \$197

Six digits show transmitted and received frequencies to hundreds of Hertz. LSI circuitry. 9 MHz preset information. Mode Switch selects freq. band or counter operation. 12-14 VDC.

K. NEW TEN-TEC 262M AC Power Supply with VOX — \$145

Solid-state; built-in ammeter. Output: 13 VDC $\pm 0.5V$, to 18 A. Regulation better than 1%. Electronic circuit breaker. Mic. input: 2 megohms. VOX gain and delay control. Adjustable delay, 0.1 to 1 sec.

L. NEW TEN-TEC 252M AC Power Supply — \$119

Same as 262M except less VOX.

M. TEN-TEC 215P Ceramic Microphone — \$29.50

Use hand-held or at desk with matching stand included. Optimum articulation, smooth response free of power limiting peaks, impervious to temp. or humidity extremes. PTT switch, cable and 3-circuit plug. Black and gray.

N. TEN-TEC 210 AC Power Supply — \$34

Solid-state. Output: 13 VDC, $\pm 0.5 V$, to 1.2 A. Regulation better than 1%.

O. TEN-TEC Blank Enclosures — from \$7

Five sizes, finished to match 540/544.

See your TEN-TEC dealer or write for full details.



THE BEST THING NEXT TO A TEN-TEC TRANSCEIVER (or any other) IS A TEN-TEC ACCESSORY

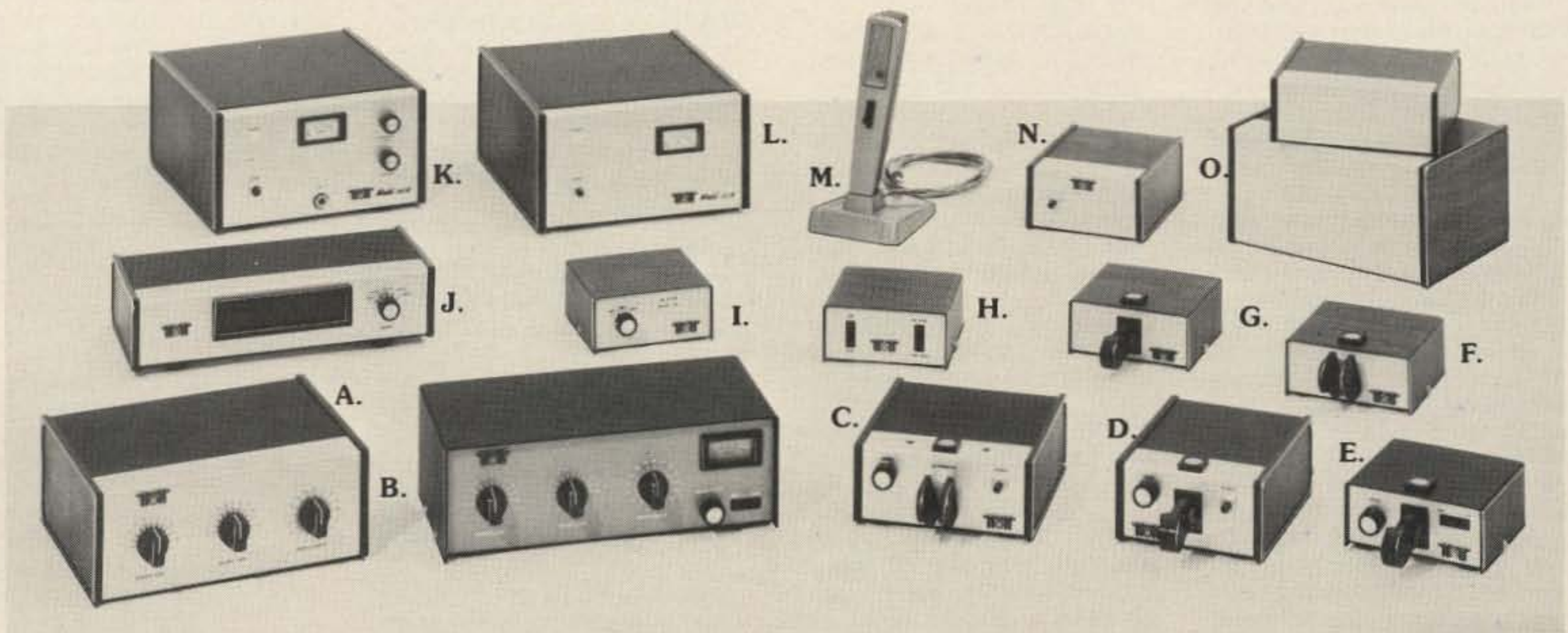

Looking West

Bill Pasternak WA6ITF
24854-C Newhall Ave.
Newhall CA 91321

The SCRA held its election meeting on February 11, with Paul McClure WA6HGK of San Diego becoming its chairman for the 1978 calendar year. Elected along with Paul were Will Anderson AA6DD as vice chairman, Sybil Albright W6GIC as secretary, and Vic Murrall as treasurer. Paul, a relative unknown in FM political circles until about two years ago, has indicated that he intends to continue the overall unification program started two years ago under then chairman Bob Thornburg and to work toward finding ways to include more spectrum users within the structure of the organization. Important to this work is the SCRA/SANDRA/220 Club all-day seminar to be held on September 23, 1978. Titled the "First National Voluntary Coordination, Band Planning, and Technical Advances Seminar," the meeting hopes to unite coordinators and council leaders from all over the nation with other concerned spectrum users for a day of interchange leading to ongoing dialogue and perhaps some form of national voluntary band planning council for VHF and UHF. If you wish to attend or present your point of view at this meeting, I suggest that you drop a note to the SCRA, PO Box 2606, Culver City, California 90230, before June 15. There are already a number of interesting people scheduled and, if all goes well, I should have a tentative program outline for you either next month or soon thereafter. LW will be there and we hope you will be, too.

Regular readers of Looking West have noted that we say little about 450 MHz FM activity. There is a reason for this: until now, there has been little to say. For the most part, UHF FM in this area consists of many rather "super private" repeaters and remote base systems, along with a myriad of auxiliary link and control channels for just about everything in the relay world one might imagine. If I had to categorize 450 out here, the only simple description I could give it in relation to FM is that it is a "private band." Open format relay communication centers around the two meter band and, to a lesser degree, the 220 band. However, this does not mean that there are no open UHF repeaters on the 3/4 meter

band. However, until recently, there were no publicized listings of these systems.

In October of 1977, the Southern California Repeater Remote Base Association published a listing of what they term "public repeaters." In glancing over said list, one finds eight such entities. Of the eight, one (W6SD) I know has not been active for a good number of years, which leaves us with a total of seven open format repeaters on 450. Not many, when one considers that estimates of total numbers of operational systems run into figures exceeding three hundred, but at least it's a start. If you come here from another area with a 450 radio, I had better warn you that though we utilize the national standard of 5 MHz between input and output, our channels are inverted from the rest of the country's. Therefore, any receive crystals you have will be listening on an input if they happen to fall on one, and you will be transmitting on a system output. So, if you plan to try and operate 450 while visiting Southern California, be aware that it will necessitate your purchasing special crystals usable only here. For those interested, the following are the seven 450 repeaters that I believe are active, according to the SCRRBA listing:

WR6AKU—Palos Verdes: 440.5 in, 445.5 out, L.A. coverage
WR6AAA—Catalina Island: 442.0 in, 447.0 out, coastal coverage San Diego to Ventura
WR6AOX—Sulphur Mountain: 442.325 in, 447.325 out, Ventura area coverage
WR6AZN—Table Mountain: 442.325 in, 447.325 out, high desert
WR6ANP—Crestline: 443.35 in, 448.35 out, Riverside County and adjacent areas
WR6AII—Palomar Mountain: 444.425 in, 449.425 out, San Diego
WR6ACF—Mt. Otay: 444.500 in, 449.50 out, San Diego, SANDRA-sponsored

There are two notes that should be added to the above listing. Let me quote from the SCRRBA newsletter: "1—SCRRBA believes the above data to be correct, but is not responsible for its ultimate accuracy. 2—No impression is intended or implied that the amateur frequency bands which SCRRBA coordinates are devoid of activity except

that listed above. The above listings represent in actuality only a very tiny percent of the total Southern California activities. Repeaters and remote base stations not listed above are coordinated as private machines; such machines generally do not welcome visitors."

The visitor to Southern California is far better off with a two meter or 220 MHz radio, but for those intrepid souls wishing to venture forth into the domain of Southern California UHF FM, we present the foregoing with a thanks to SCRRBA for providing the input. If any of you get around to exploring the above, please drop me a note and let me know what you find.

I had a rather interesting conversation the other evening with Chris Boone WB5ITT, who informed me about the current state of six meter FM activity in the Houston, Texas, area. The big piece of information coming from Chris was the announcement of WR5APC, a new six meter open autopatch repeater that will soon be linked with a sister machine in Beaumont, Texas, via 10 GHz microwave. At present, APC is operational in test mode on 53.12 in, 52.525 out. By the time you read this, it should be located at its permanent home atop the 1,000' channel 8 TV tower and operational on a final channel pair of 53.28 in and 52.68 out. Therefore, it's suggested that potential users equip themselves for the .28/.68 pair. Though the autopatch facilities will also be "open," i.e., available to all users, the access coding is not yet available. Chris also noted that the new repeater will also be an outlet for the Texas Intercity Relay System, a linking facility developed to help cope with keeping communication lines open in time of disaster. There are a lot of kudos to be given in this project, with special recognition going to Merle Taylor WB5EPI, trustee of WR5APC.

Los Angeles County RACES has been on standby alert for the past two days, though they have not yet been called up. Virtually every LA repeater has

been called upon to handle emergency-related traffic at one time or another, though as of this date there have been no organized LA area operations started. One repeater, a private 220 autopatch with the callsign WR6AWQ, has been operational with the Salvation Army as a telephone interlink from the heavily damaged Coldwater Canyon/Mulholland Drive area, with both mobile and hand-held units at the disaster scene. Even the infamous 76ers have gotten involved in the disaster relief efforts both two weeks ago and again with the current flooding, going out to help other amateurs protect their homes and property by digging drainage runoffs, sandbagging potential flood areas, and doing the myriad of other things one does when Mother Nature unleashes her wrath upon humanity. It will take weeks before we know who did what to help whom, but one thing is clear: An emergency struck and, as usual, the amateurs were there to lend a helping hand. All are to be congratulated.

In outlying areas, reports are very scarce. For the past three days, however, all normal operation on the WR6AOX Sulphur Mountain/Ventura .28/.88 repeater has been suspended and the system is geared to handling emergency and health and welfare traffic. AOX has been working with amateurs in the area from Simi Valley to north of Ventura in this effort. It's been said on the air they will continue until the emergency is over, much to the credit of a dedicated amateur organization. Again, there may be other things going on that LW knows nothing about at this time, so watch for updates in coming months. If you have input, either write LW with it or call the LW Hotline at (805)-259-8243. It's still raining—many areas of LA and vicinity are flooded, homes have slid off hillsides, mud is everywhere, and no one seems to know when the skies will close. Last year we were in the middle of a serious drought; this year, well, anyone have plans for an ark?

Ham Help

I would like to have some info on where I can write to for the purchase of parts for a Gonset G50 and HQ-110.

B. Labore K1WPT
471 Calef Road
Manchester NH 03103

I would like to get in touch with a qualified company or in-

dividual who can align a Hamerlund HQ-180 receiver. I can furnish alignment instructions as contained in the owner's manual. I would prefer someone in the Southeast if possible.

George P. Firmin WA4FSK
2435 Cajun Dr., NE
Marietta GA 30066

BOARDS INSIDE CABINET

- 1 CARR OSC unit
- 2 VOX unit
- 3 AF unit
- 4 IF unit
- 5 Filter unit
- 6 Noise Blanker/RF Processor
- 7 Rectifier unit
- 8 Rectifier unit
- 9 Power XFMR
- 10 Final Amplifier unit
- 11 VCO unit
- 12 TUNE control
- 13 PLL unit
- 14 RF unit
- 15 Counter Display unit
- 16 FM unit

FT-901DM

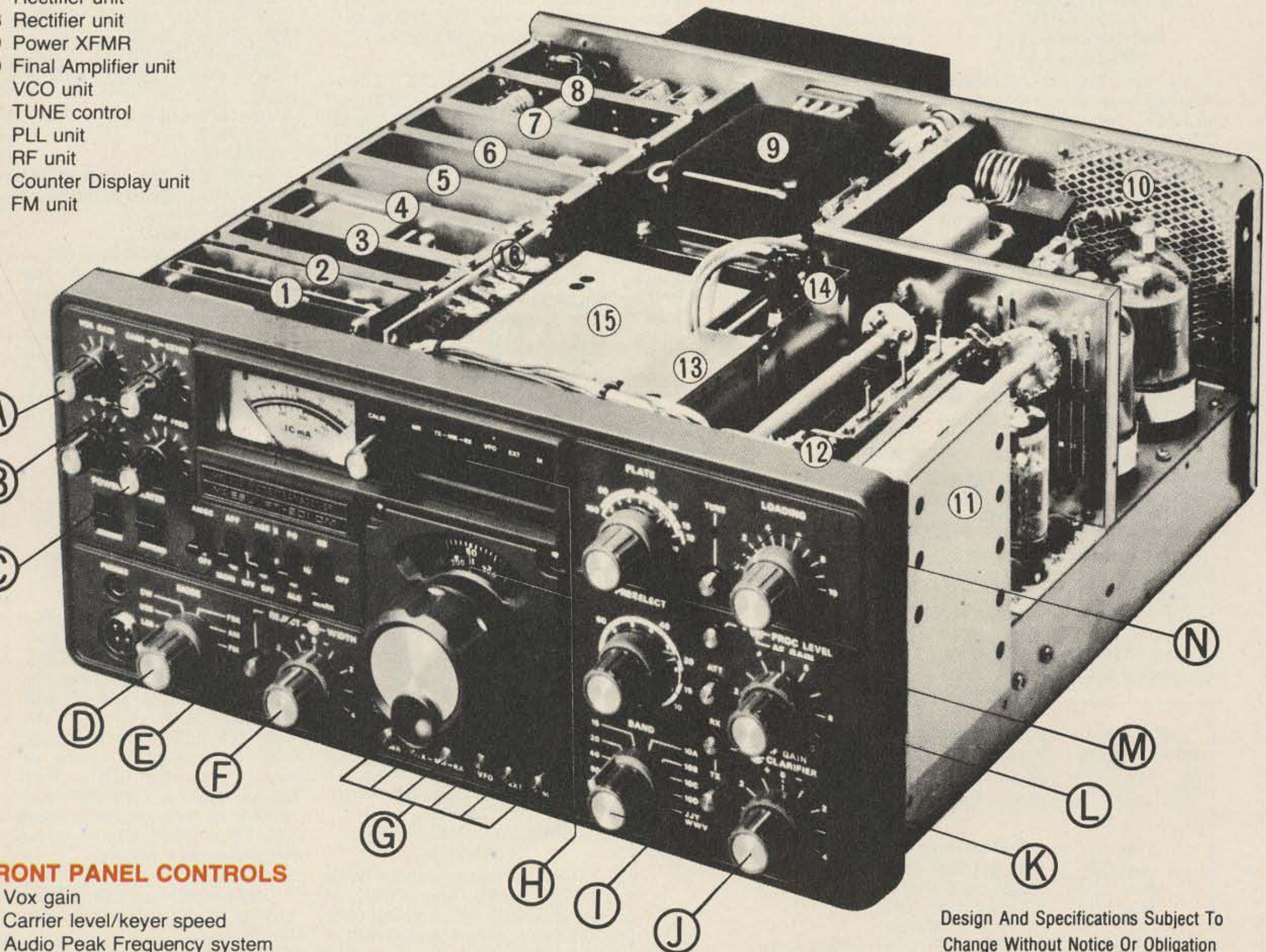

FRONT PANEL CONTROLS

- A Vox gain
- B Carrier level/keyer speed
- C Audio Peak Frequency system
- D MODE switch (SSB, CW, FSK, AM, FM)
- E Crystal calibrator/Noise blanker
- F Rejection tuning/variable IF passband tuning
- G Frequency memory system
- H Digital plus analog frequency readout
- I Band switch (160-10 meters + WWV/JJY receive)
- J Clarifier control
- K RX/TX Clarifier selector
- L RF Processor level
- M RF attenuator
- N TUNE control (Places transmitter in "TUNE" condition for ten seconds, then returns to "receive" condition to protect final tubes from excessive key-down time)

Design And Specifications Subject To Change Without Notice Or Obligation



THE SYMBOL OF TECHNICAL EXCELLENCE

YAESU

The smart radio

1C78



YAESU ELECTRONICS CORP., 15954 Downey Ave., Paramount, CA 90723 (213) 633-4007
YAESU ELECTRONICS CORP., Eastern Service Ctr., 613 Redna Ter., Cincinnati, OH 45215

Editor:
Robert Baker WB2GFE
15 Windsor Dr.
Atco NJ 08004

CONTESTS

SOWP ANNIVERSARY CW QSO PARTY

Full GMT period of
May 4 and 5

The Society of Wireless Pioneers will celebrate its 10th birthday with this on-the-air CW QSO party. The call will be CQ SOWP on all bands, 55 kHz up from the low end. Novice members should use the center portion of each Novice band. For the benefit of those who cannot participate for the full time, it is suggested that part-time participants make their CQ calls on the even hours. Exchange information should include the following as a minimum—handle, SOWP membership number, and QTH. Additional information is optional. A special certificate has been designed and will be awarded to all members who make a minimum of 10 contacts with fellow members on CW. To qualify for the certificate, members should send a list of contacts showing date, time, call, and SOWP numbers to the Society's Vice President for awards, Pete Fernandez W4SM, 129 Hialeah Road, Greenville SC 29607. In addition,

a self-addressed, stamped envelope must accompany all requests for the certificate.

GEORGIA QSO PARTY

Starts: 2000 GMT
Saturday, May 6
Ends: 0200 GMT
Monday, May 8

Sponsored by the Columbus ARC, there are no time or power restrictions, and contacts may be made once on phone and once on CW on each band. Oscar counts as one band. GA mobile or portable stations count as a separate station in each county.

EXCHANGE:

QSO number, RS(T), and QTH—county for GA; state, province, or country for others. GA to GA contacts are permitted.

SCORING:

Each completed contact counts 2 points. GA stations multiply QSO points by number of different states and VE provinces worked. DX stations may be worked for QSO points, but do not count as multipliers. Others multiply QSO points by

number of GA counties (159 max.). No repeater QSOs permitted, except via Oscar!

FREQUENCIES:

CW—1805, 3590, 7060, 14060, 21060, 28050; SSB—3900, 3975, 7245, 14290, 21360, 28600; Novices—3718, 7125, 21110, 28110. Try 160m at 0300 GMT, 10m on the hour, and 15m on the half hour during daylight hours.

AWARDS:

Certificates to highest scoring station in each state, province, country, and GA county. Other certificates as warranted. Plaques to highest scorers outside GA and GA mobile/portables.

ENTRIES:

Logs should show: date/time in GMT, call, exchange sent/rcvd, band, emission type, and multipliers claimed. Checklists appreciated. Include a signed declaration (usual) and mail your entry to Columbus ARC, c/o Jeanne J. Hunting K4RHU, 2701 Peabody Ave., Columbus GA 31904. Entries should be postmarked no later than June 5. Include a large SASE with 24 cents postage for results. Note: Novices should designate their logs as such!

MASSACHUSETTS QSO PARTY

Starts: 1200 GMT Saturday,
May 13
Ends: 2200 GMT Sunday,
May 14

This contest is sponsored by W1FJI, N1AS, and K1KJT. A station may be worked once per band; phone and CW considered separate bands, but no cross-band or repeater QSOs permitted. MASS stations may work each other, but out-of-state stations must work only MASS stations. Special class for Novices and Techs who operate CW within Novice bands only. Novices sign CALL/N; Techs sign CALL/T. In this class, Novices and Techs will compete against each other. Submit separate logs and summary sheets for this class.

SCORING:

Count 2 points per completed QSO. Out-of-state stations multiply total QSO points by total MASS counties worked (14 max.). MASS stations multiply total QSO points by total MASS counties worked plus ARRL sections for total score. Note: DX counts for QSO points only with no multipliers.

FREQUENCIES:

CW—1810, 3560, 7060, 14060, 21060, 28060.

Phone—1820, 3960, 7260, 14290, 21390, 28590, 50.110, 146.52.

Novice/Techs—3720, 7120, 21120, 28120.

EXCHANGE:

MASS stations send RS(T) and county, others send RS(T) and ARRL section.

ENTRIES/AWARDS:

Appropriate awards given to top scorers, including top Novices and Techs on Novice CW bands only. Submit logs and summary sheets along with large SASE for awards and results to: A. Marshall W1FJI, 60 Meadow Road, Westport MA 02790. Mailing deadline is June 30.

MICHIGAN QSO PARTY

Operating periods:
1800 GMT Saturday, May 20
to
0300 GMT Sunday, May 21
1100 GMT Sunday, May 21
to
0200 GMT Monday, May 22

The contest is again sponsored by the Oak Park ARC. Phone and CW are combined into one contest and MI stations can work other MI stations for multipliers. A station may be contacted once on each band/mode. Portables/mobiles may be contacted as new contacts each time their county changes. No repeater QSOs allowed.

EXCHANGE:

RS(T), QSO number, QTH—county for MI; state or country for others.

SCORING:

Phone QSOs count 1 point per QSO, CW = 2 points, OSCAR = 5 points. Multipliers are only counted once. MI stations: QSO points times (states + countries + MI counties). KL7 and KH6 count as states. VE counts as a country. Max. multiplier = 80. Non-MI: QSO points times MI counties. Max. multiplier = 83. Score 5 points each club station QSO with W8MB. VHF-only entries: same as above except multipliers per VHF band are added together for total multiplier.

FREQUENCIES:

Phone—1815, 3905, 7280, 14280, 21380, 28580.

CW—1810, 3540, 3725, 7035, 7125, 14035, 21035, 21125, 28035, 28125.

VHF—50.125 and 145.025.

AWARDS/ENTRIES:

CALENDAR

May 4-5	SOWP Anniversary CW QSO Party
May 6-8	Georgia QSO Party
May 13-14	MASS QSO Party
May 20-22	Kansas QSO Party MICH QSO Party
June 3-4	IARS/CHC/FHC/HTH QSO Party VE-10 Contest MINN QSO Party
June 10-11	ARRL VHF QSO Party
June 17-18	WVA QSO Party
June 24-25	ARRL Field Day First REF Ten Day
July 1-2	Seven Land QSO Party
July 4	ARRL Straight Key Night
July 8-9	IARU Radiosport Competition
July 15-16	10-10 Net Summer QSO Party VHF Space Net Contest
July 22-24	Rhode Island QSO Party
July 29-31	CW County Hunters Contest
Aug 19-20	New Jersey QSO Party
Sept 9-10	ARRL VHF QSO Party
Sept 16-17	Scandinavian Activity Contest—CW
Sept 23-24	Scandinavian Activity Contest—Phone Delta QSO Party
Oct 14-15	ARRL CD Party—CW
Oct 21-22	ARRL CD Party—Phone
Nov 4-5	ARRL Sweepstakes—CW
Nov 11	OK DX Contest
Nov 18-19	ARRL Sweepstakes—Phone Second REF Ten Day
Dec 2-3	ARRL 160 Meter Contest
Dec 9-10	ARRL 10 Meter Contest

Continued on page 186



The parameters of the Palomar PTR-130k are the outer perimeters of logic technology.

Never before has any transceiver approached the capabilities of the Palomar PTR 130k!

It's the first completely multi-functional transceiver ever made available to the public!

The Palomar PTR 130k is a miniaturized mobile transceiver

capable of operating in 100 cycle resolution from 100 KHz to 30 Mhz in all modes of transmission and reception. Instant frequency selection is available with the touch of a finger.

The Palomar PTR 130k.

technology is pure space age . . . the price is strictly down-to-earth.

Send for our full color brochure to:

Palomar Electronics Corporation

665 Opper Street

Escondido, CA 92025

Telephone: (714) 746-2666



TECHNOLOGY AT THE SPEED OF SOUND

FCC Math

John F. Leahy WB6CKN
P.O. Box 539
Gonzales CA 93926

Yep, we're there, our final installment! And if you've managed to stay with us all this way, you are now well on your way to mastery of the math skills required for even the most difficult FCC exam. Now it's only a matter of practice, using number equations and the various other tricks of the game, until you have such confidence that even the most skilled FCC operative will be unable to rattle you come exam time.

In this installment, we'll cover one final, rather exotic but nevertheless necessary, topic called logarithms. Then we'll see a bit more algebra. And that'll be it! We're finished. You take it from there. And my guess is you'll have little trouble with math from here on out.

Logarithms, usually shortened to logs, simply, are nothing more nor less than exponents of ten in our case. There's another system of logs based on a really exotic number, something like π , with the symbol e , that has a value about 2.72, but goes on forever like π . The idea is the same. Logs are simply exponents. Thus the log of 1000 is 3. In symbols, $\log_{10} 1000 = 3$. You often see the subscript 10 omitted, and we'll do so from now on since in our discussion it'll only be logs of ten that we'll deal with.

Likewise, $\log 10 = 1$, $\log 100,000 = 5$, and $\log 1 = 0$, since, remember, 1 is 10^0 .

Before we go any further, a word about the place of logs in electronics. It just so happens that some of the laws of nature (for example, human hearing) follow logarithmic curves (graphically speaking) rather than straight lines, circles, or what have you. What this means is that logarithms turn out to be a factor (multiplier) in many formulas, etc. The power ratio formula for decibels comes immediately to mind: $\text{dB} = 10 \log (P_1/P_2)$. And there are the characteristic impedance formulas, etc. Page through the license manual or whatever and you'll find all sorts of such formulas. So logs are important.

So far, the only logs we've seen were powers of ten. But the formulas require us to find logs of all kinds of numbers, numbers like 372 or 0.000259 or 86,000,000. How the heck do we find logarithms for numbers like that?

Well, back to square roots a minute or two. Say we want to find the square root of 8405. Remember the technique we used. Change the number to an even power of ten so we can divide by 2. 8.405×10^3 becomes 84.05×10^2 and that is about 9.2×10^1 or 92. But supposing we left our number in the form 8.405×10^3 , took $\frac{1}{2}$ of the exponent 3, and found the square root of 8.405. That's finding the square root alright, but look how strange it appears. $3 \div 2$ is 1.5. Square root of 8.4 is perhaps 2.9. So the square root of 8405 is about 92 or else $2.9 \times 10^{1.5}$. That means that 92 and $2.9 \times 10^{1.5}$ are about the same number, if the rules and laws of math are consistent. Let's say they're exactly equal. Then we have the equation $92 = 2.9 \times 10^{1.5}$. Bring the 2.9 down to the bottom of the other side and we get: $92/2.9 = 10^{1.5}$. Divide the left side to get: $31.7 = 10^{1.5}$. Ye gads, decimal exponents! Yep, that's the name of the game. It turns out that any number can be expressed as a power of ten alone if you're willing to use decimal exponents. And nature seems to have been put together actually using those decimal exponents! The exponent is a logarithm. Thus $\log 31.7 = 1.5$ from our work above. Mathematicians have worked out huge tables of logarithms, going through a process something like that above. Of course, slide rules and now calculators give the logarithm of any number very quickly and easily. All you need remember, for calculation purposes, is that logarithms are exponents of ten. With that in mind, you can instantly give the first part (called the characteristic, the part to the left of the decimal point) of the log of any number. Log 372, then is 2. (two point) and then something after the point; log 86,000,000 is 7. (seven point) and then something after the point, etc.

Actually, if you just get the part to the left of the decimal point, you have enough for many computations. For example, using the power formula mentioned earlier in the case of an amplifier that brings a signal up from 10 to 100 Watts, we have: $\text{dB} = 10 \log (100/10) - (100/10) = 10$. Log 10 is 1 (10 is 10^1 , and that 1 is the log). And 10×1 is simply 10. So we have a 10 dB gain for a ten-fold increase in power. But careful here! From those results you might guess that a three-fold increase in power is going to give a 3 dB gain. But log 3 is about 0.5; multiply that by 10, and we get 5 dB.

Actually, *doubling* power is a 3 dB gain, since $\log 2 = 0.3$.

It's often good to know the first digit that comes after the decimal point when working with logs. So here's a little table that some people keep in mind:

number	1	2	3	4	5	6	7	8	9	10
log	0.1	0.3	0.5	0.6	0.7	0.8	0.85	0.9	0.95	1

Notice how logs are far apart for the lower numbers, then start bunching up after 6. With the aid of that table, we can do sufficiently accurate computations for FCC exams.

A few more examples, then an exercise: What's log 27? 27 is 2.7×10^1 . From the 10^1 we get 1. From the 2.7 (which is close to 3) we get 0.5. Put them together for 1.5 (not precise, but close enough!). Log 8,915 is about 3.95. Log 64,000,000 is 7.8.

You'll notice we didn't go into numbers smaller than 1. We could do so easily enough, but it's not necessary, so we'll skip it. Any algebra book will cover that if you want to see how to handle negative exponents with logs.

Exercise 1: (Work and answers at end)

- (1) Find the log of: (a) 59 (b) 3 (c) 11,100 (d) 679,000,000
- (2) Find the dB gain (or loss) in each case: (a) Input 5 W, output 40 W (b) Input 0.03 W, output 2 W

A word of warning. Don't attempt to find square roots using odd exponents of ten. We only did that to develop the idea of logarithms. The simple and obvious way to do square roots if you don't have a calculator that does it for you is with even powers of ten as we saw in our last installment.

Now a bit more algebra and we'll be finished—a general technique for separating letters and numbers, thereby isolating (solving for) a particular letter (which stands for a certain physical dimension or whatever).

We've already seen about doing the same thing to things that are equal, and how that produces things that are still equal. Combine that reasoning with a tendency to be opposite or do the opposite, and you've got another powerful tool at your disposal.

We've seen this already, but never had it spelled out. Take an example. $I = E/R$. To solve that for R using principles we've already seen, we would bring the R up to the left and the I (which is up to the left) down to the right, getting $R = E/I$. Notice that in the original, R is dividing E. The opposite of dividing is multiplying. Multiply both sides of that $I = E/R$ by R and you get $IR = E$. Notice that now I is multiplying R. The opposite of multiplying is dividing, so divide both sides by I and you get $R = E/I$. We've done the same thing to both sides of the equation in each case, and we did the opposite of the operation that was indicated. Doing this enabled us to get the different forms of Ohm's Law, but using a logical method that works always for even the most difficult formulas.

To sum up all that we've learned about transforming formulas from one form into another, here are the approaches we can use. (1) We can make up a number equation (it has to be a true equality, of course) in the same form as the formula under consideration. (2) We can do the same thing to both sides of a formula (add to, subtract from, multiply by, divide into, take the square root, square, etc.) and still have a correct formula. (3) Frequently, the thing you want to do to both sides is the opposite of the indicated operation (if there's a multiplication, you want to divide; if there's an addition, you want to subtract, etc.).

And one final bit about handling addition and subtraction: If the addition or subtraction is *in the bottom* or if something is multiplying or dividing the things that are being added or subtracted, it is usually necessary to first *carry out* the multiplication or division, or else the things added or subtracted *have to be handled together as a unit*. That may seem rather confusing. But we've already seen it in operation and we'll see it once again in this final problem below.

$Z = RX/\sqrt{R^2 + X^2}$ is the formula for impedance at a given frequency with a resistance and reactance in parallel. Supposing we know the impedance and resistance but want to find what the reactance is. In other words, we want to solve for X. Here's how we go about it. First, multiply both sides by $\sqrt{R^2 + X^2}$ as a unit. This'll cancel them out on the right, and we now have: $Z\sqrt{R^2 + X^2} = RX$. Next we want to do an opposite, the opposite of an indicated operation, namely finding the square root. The opposite of finding square root is squaring, so let's now square both sides. Since these are multiplications and additions, we can square the things multiplied separately, but the addition part is handled as a unit. And we are squaring both sides, so we still have a true equation: $Z^2(R^2 + X^2) = R^2X^2$. Note that squaring a number that has a square root sign around it just gets rid of the square root sign:

Continued on page 130



Years Ahead With Yaesu!

Introducing . . .

THE ALL-NEW YAESU FT-227R 144-148 MHz 800 CHANNEL

1980's RADIO
TODAY!

"MEMORIZER"!



Compare These Features And You'll Know What We Mean When We Say "Years Ahead With Yaesu"

- one knob channel selection using optical sensing to select 800 channels
- memory circuit that allows instant return to any frequency selected between 144-148 MHz
- large 4 digit LED frequency readout
- fully synthesized frequency control, using PLL techniques in 5 KHz steps
- built-in tone burst, plus optional tone squelch encoder/decoder
- spurious well below minus 60dB requirement—superior cross modulation, overload and image rejection
- standard 600 KHz offsets plus any split within the band using the memory circuit
- automatic final protection, PLL "unlock" protection and busy channel indicator
- selectable 10 watt/1 watt output

See this sensational new two meter transceiver at your YAESU DEALER now!

Yaesu Electronics Corp., 15954 Downey Ave.,
Paramount, CA 90723 • (213) 633-4007
Eastern Service Ctr., 613 Redna Terrace
Cincinnati, OH 45215

YAESU
The radio.

New Products

NEW ALL-CIRCUIT EVALUATORS FROM A P

A P Products announces the introduction of their all new Powerace all-circuit evaluators.

All Powerace models feature industry-accepted Super-Strip SS-2s and will accept all DIP sizes, plus TO-5s and discretes with leads to .032" diameter.

The Powerace line includes three power breadboards, models 101, 102, and 103. All three models offer 256 5-tie-point terminals and 16 25-tie-point buses, fused power supply, and ground plane.

New Powerace 101 has a variable 5-15 V dc, 600 mA power supply with line and load regulation $<3\%$ @ 120 V ac $\pm 8\%$. Ripple and noise are ≤ 10 mV @ full load. In addition, Powerace 101 features a 0-15 V dc meter (5% full scale accuracy) and a voltage adjust knob. Suggested retail price for Powerace 101 is \$84.95.

Powerace 102 has a fixed 5 V dc, 1 Amp power supply with line and load regulation $<1\%$ @ 120 V ac $\pm 8\%$. Ripple and noise are ≤ 10 mV @ full load. Powerace 102 has four slide switches with logic 0 or logic 1 output, and two momentary slide switches each with a debounce circuit to give positive or negative pulse output. In addition, Powerace 102 has 4 LEDs (one with positive or negative pulse memory), one debounced push-button with 8 msec positive or negative pulse output, and one clock generator (1, 10, 100, 1k, 10k, and 100k Hz). Suggested retail price for Powerace 102 is \$114.95.

A P's new Powerace 103 features fixed 5 V dc, 750 mA power supply, fixed +15 V dc, 250 mA power supply, and -15 V dc, 250 mA power supply, with tracking. Line and load regulation are $<1\%$ at 120 V ac $\pm 8\%$. Ripple and noise are ≤ 10 mV @ full load. Powerace 103 has a 15-0-15 V dc meter (5% full scale accuracy), two LEDs, two slide switches with logic 0 or

logic 1 output, and two momentary slide switches each with debounce circuit to give positive or negative pulse output. Suggested retail price for the Powerace 103 is \$124.95.

For further information, contact Ken Braund, Product Marketing Manager, A P Products, 72 Corwin Drive, Box 110, Painesville OH 44077.

NEW DENTRON MT-2000A ANTENNA TUNER

Today's low-band amateur setups fit into two basic categories—the high-power stations and the low-power, 100-200 Watt stations. In an effort to give full-power operators a choice on the matter of which tuner suits their needs, DenTron announces a new version of the MT-3000A Ultimate Tuner, the MT-2000A. Both tuners are identical in power handling capabilities (3 kW PEP) and styling (the same all-metal low profile construction), but the MT-2000A is built without the dual wattmeters, built-in dummy load, and antenna selection switch found in the MT-3000A. Instead, the MT-2000A offers two unique features of its own—a front panel lightning protection switch and a front panel bypass switch for taking the tuner completely out of your antenna system. The best feature of the MT-2000A is probably its price—only \$199.50 suggested retail. The MT-2000A is a 3 kW tuner for a 1 kW price, and it includes all the features that have made DenTron tuners famous—styling, power handling capabilities, all-American components, and a pride in workmanship that makes the MT-2000A a great addition to any ham shack. The MT-2000A (continuous tuning from 1.8-30 MHz) matches virtually any feedline, coax, balanced, or random wire, and has built-in heavy-duty 4:1 balun, harmonic attenuation, ceramic rotary switch with 18 positions and 12-Amp capacity, 6000-volt capacitor spacing, and low pro-

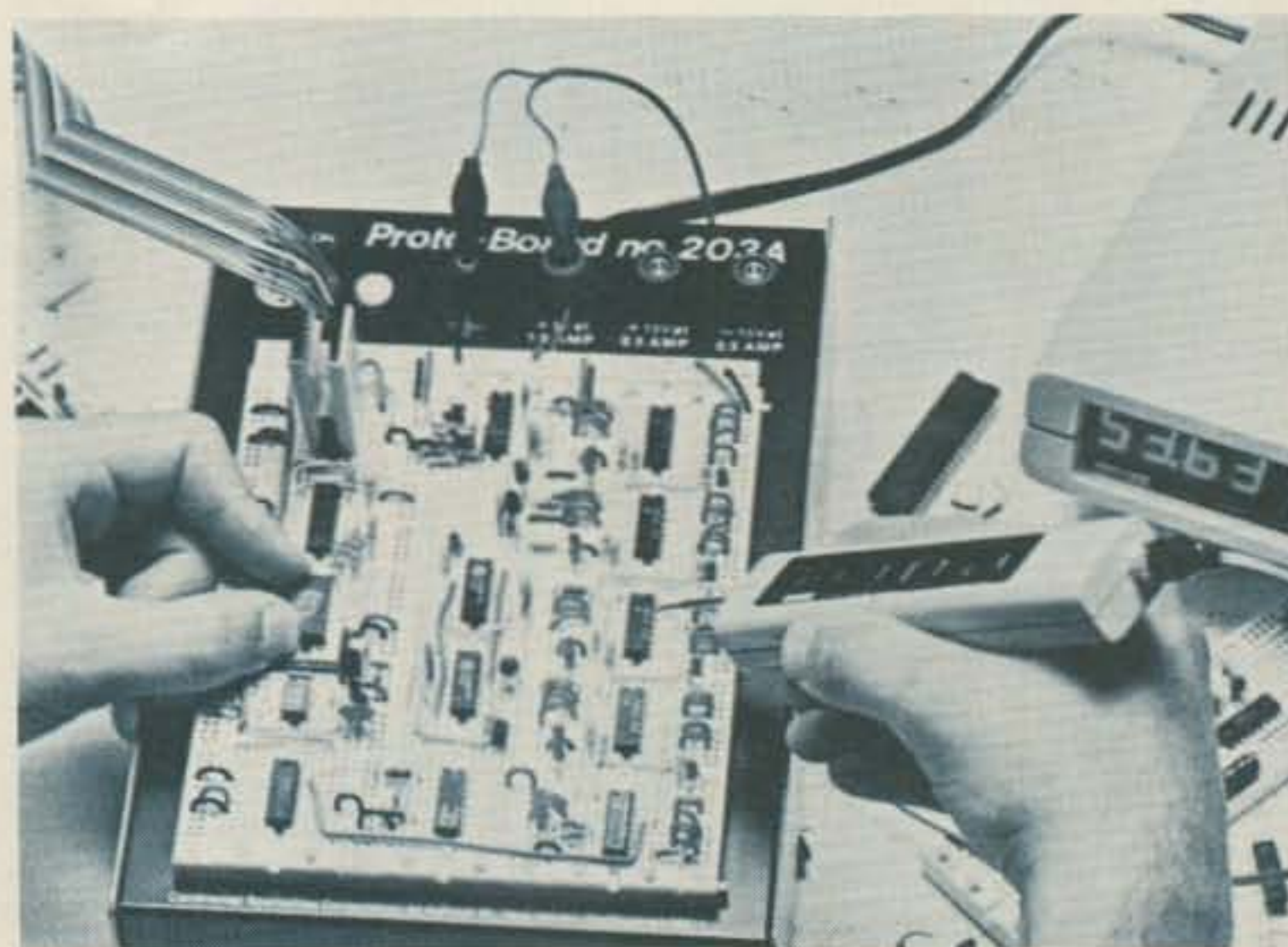

CSC Proto-Board 203A.

file styling, 5" x 14" x 15". DenTron Radio Co., Inc., 2100 Enterprise Parkway, Twinsburg OH 44087.

THE PROTO-BOARD®

Breadboarding 1978 style has sure changed from the old tube days of experimenting. What old-timer would have even imagined that we would have breadboard units, complete with built-in power supplies! The new Continental Specialties 203A board has all of the voltages you'll need for building digital circuits... plus 5 V and ± 15 V. ICs and parts can then be plugged right into the board to make up any circuit you find in a magazine article or cook up yourself. It's a lot easier to put a new circuit together this way than to solder it to perfboard. This way, if you want to change any part value or try out some extra bypassing, you just plug in the part.

Some of the breadboards we've tried are built with cheapo materials, and, after a few parts have been plugged

into the holes, the springs are so loose you can't depend on the contact. Continental goes to a lot of trouble and expense to make sure that their holes will last. If you think this is just a bunch of bull, go ahead and find out for yourself... the hard way.

The CSC Proto-Board 203A is built on a very sturdy box so it won't go drifting around your workbench when you are aiming logic tracers at it. It's a quality product... and the price reflects this at \$129.95. For this price, you get the breadboard and three power supplies. That's right, CSC does not use one supply with three taps; both of the 15 V supplies are adjustable, and all three are voltage regulated.

This breadboard is designed to facilitate test setups of TTL, CMOS, op amps, video amps, comparators, PLL, etc. What are you waiting for?

Continental Specialties Corporation, 70 Fulton Terrace, New Haven CT 06509.



A P's new Powerace models.

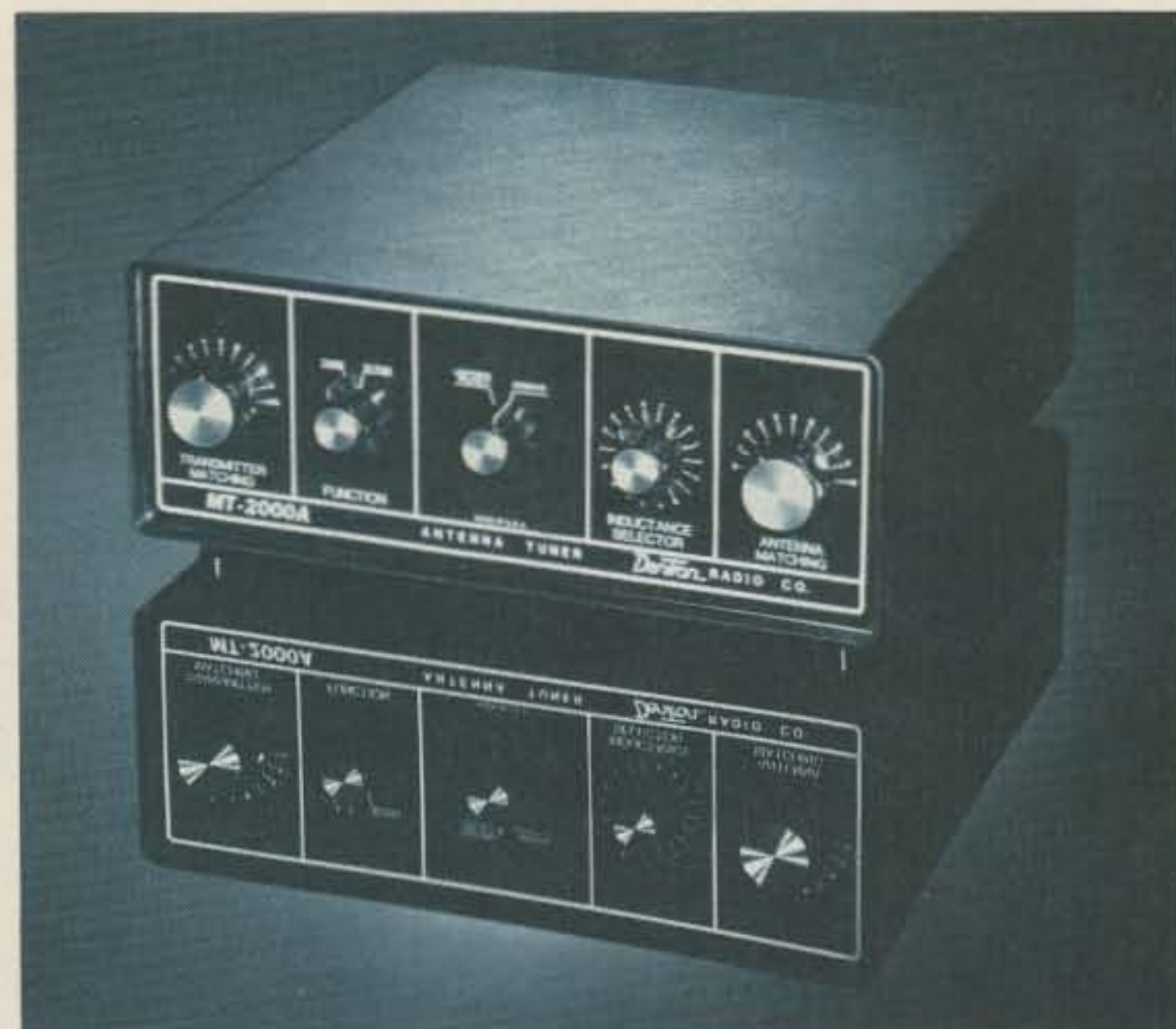

MT-2000A antenna tuner from DenTron.

THE NEW INDUSTRY STANDARD OF PERFORMANCE... IS THE **Wilson** SYSTEM ONE!

A DX'ers delight operating 20 meters on a full 26' boom with 4 elements, 4 operational elements on 20-15-10, plus separate reflector element on 10 meters for correct monoband spacing. Featured are the large diameter High-Q traps, Beta matching system, heavy duty taper swaged elements, rugged boom to element mounting . . . **and value priced!** Additional features: • SWR less than 1.5 to 1 on all bands • 10 dB Gain • 20-25 dB Front-to-Back Ratio.

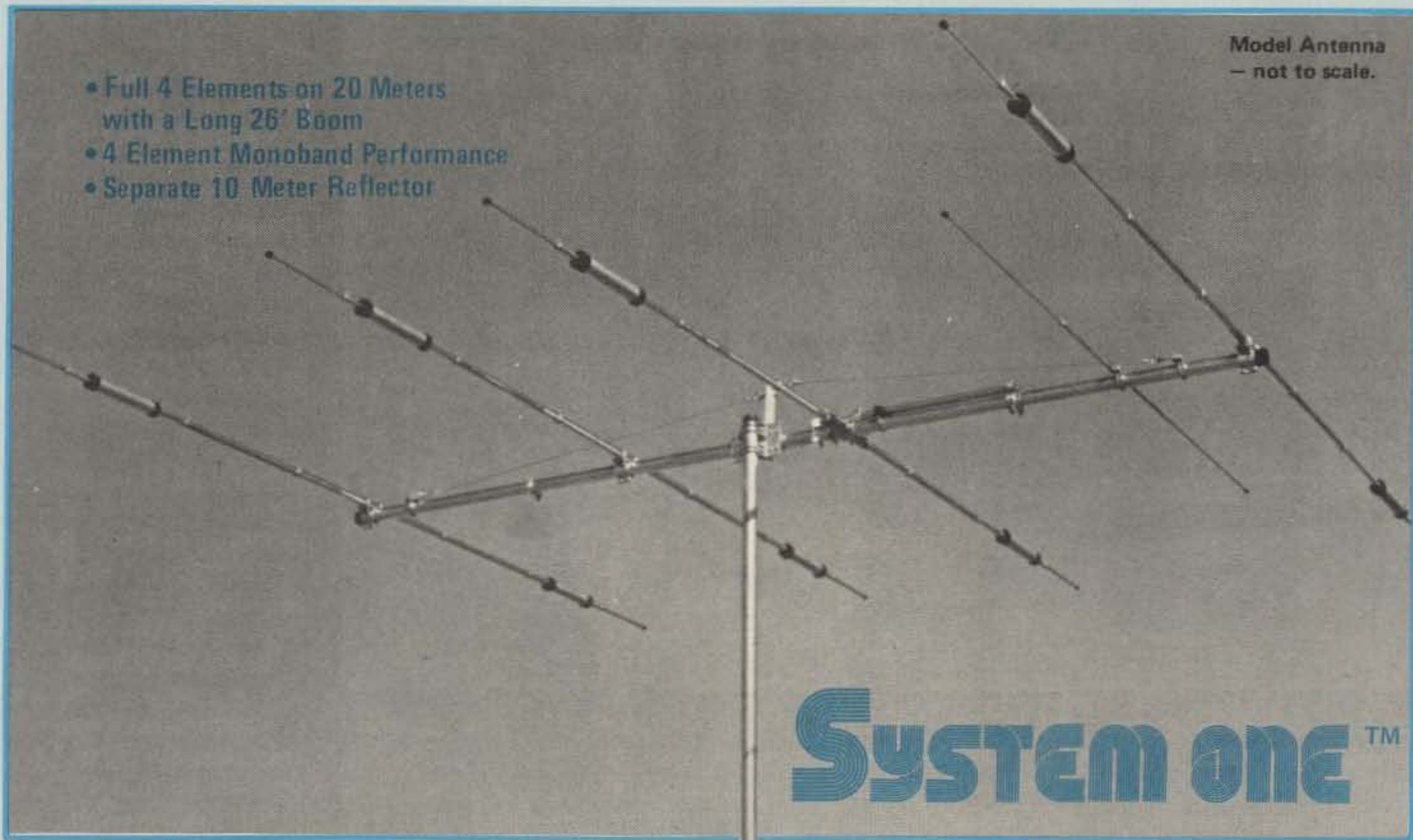

- Full 4 Elements on 20 Meters with a Long 26' Boom
- 4 Element Monoband Performance
- Separate 10 Meter Reflector

Model Antenna
— not to scale.

SYSTEM ONE™

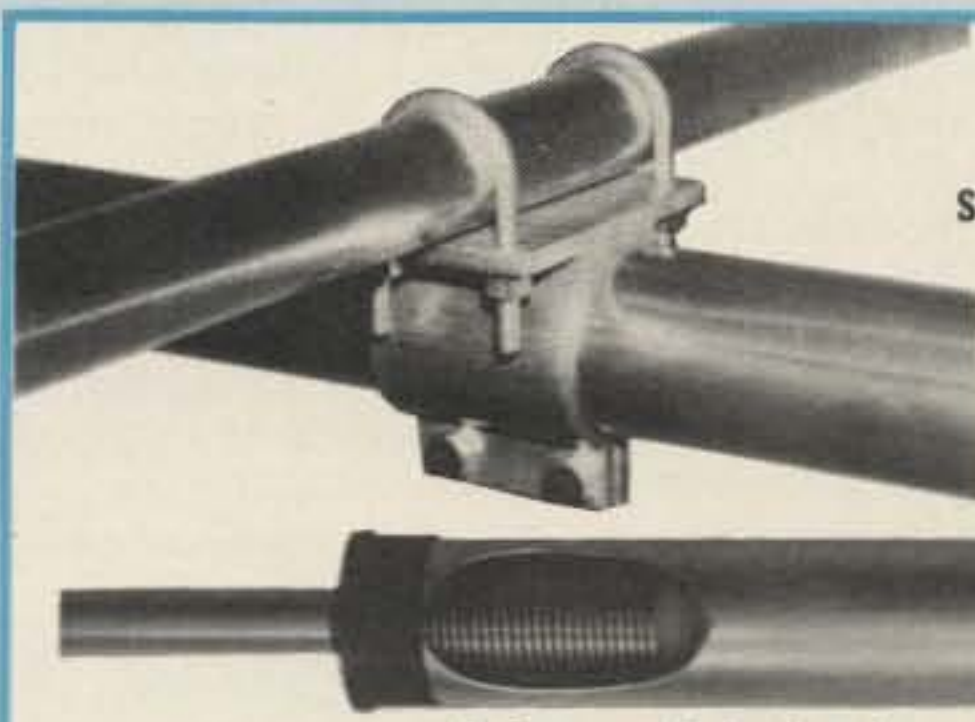

The mechanically superior construction uses heavy duty boom to element extrusion.



Insulated driven element with precision Beta match and heavy duty element mounts. Shown with Wilson's new optional Torrid Core B-50-A Balun.

Advanced design large diameter High-Q Traps for minimum loss and maximum power capacity

SPECIFICATIONS: SY-1

Matching Method Beta	Boom Length 26'	Required Mast Diameter 2" O.D.
Band MHz 14-21-28	Boom Diameter 2" O.D.	Surface Area 8.6 sq. ft.
Maximum Power Input Legal Limit	No. of Elements 5	Windload at 78 mph 215 lbs.
VSWR (at Resonance) 1.5 to 1	Longest Element 26' 7"	Shipping Weight 65 lbs.
Impedance 50 ohms	Turning Radius 18' 6"	UPS Shipment in 2 Cartons
Gain 10 dB	F/B Ratio 20-25 dB	

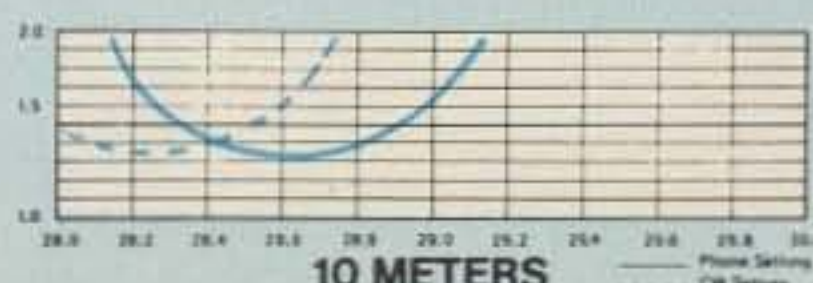
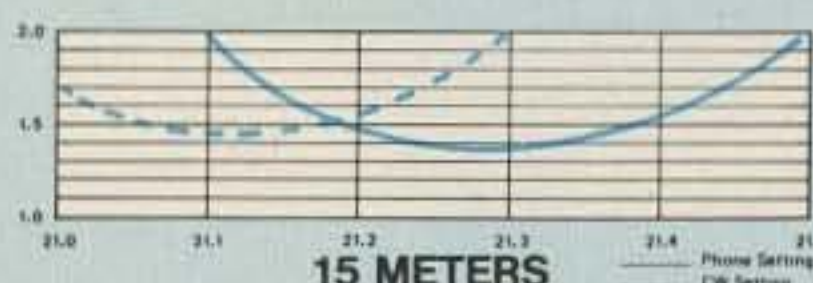
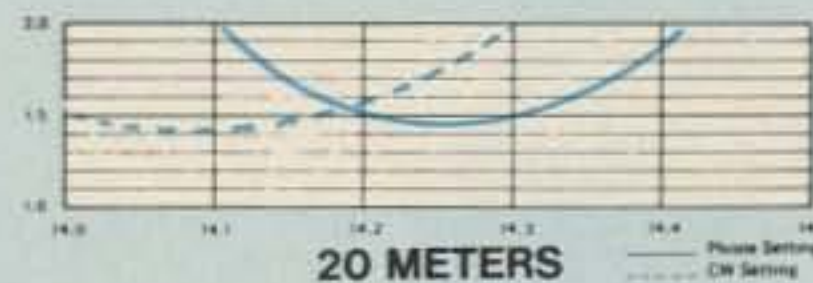

DEALERSHIPS AVAILABLE!!!
We are looking for new Dealers for certain areas of the country. If you are interested, contact us for details.

Wilson Electronics Corp.

4288 So. Polaris • P. O. Box 19000 • Las Vegas, Nevada 89119
Phone (702) 739-1931 • Telex 684-522

W2



Icom's IC-701 digital transceiver.

ICOM'S IC-701 DIGITAL TRANSCEIVER

The long-awaited entry of Icom (Inoue Communication Equipment Corporation) into the HF transceiver market happened in March, 1978, with the introduction of the IC-701 synthesized, 160 meter through 10 meter, digital transceiver. Packed into a small case of the same cross section as the extremely popular IC-211 and only a few centimeters longer, are all of the features expected in an HF transceiver, plus many more. Features such as continuous electronically variable filter width in SSB and RTTY and built-in standard and narrow filter widths for CW mean that virtually all usual extra cost accessories are standard with the IC-701. Some of the more outstanding no-extra-cost features are: digital readout, two VFOs, all solid state, continuous duty on SSTV, RTTY, and the famous light chopper VFO dial. Priced at \$1,499.00 including the

transceiver, ac supply speaker, and SM-2 microphone, the IC-701 is considered to be simply the best amateur transceiver for the serious operator.

For a list of dealers where the IC-701 may be seen, contact *Icom East, Inc.*, 3331 Towerwood drive, Suite #307, Dallas TX 75234 or *Icom West, Inc.*, 13256 Northrup Way, Suite #3, Bellevue WA 98005. In Canada, contact *Icom Canada*, 7087 Victoria Drive, Vancouver, BC V5P 3Y9.

ASTROLITE TYPE 436B HEADSET

Can a headset spoil you? You bet! If it is the Astrolite type 436B combination earphone/microphone headset. After using the headset for several weeks, switching back to conventional loudspeaker/desk mike operation felt awkward and inconvenient and it was awkward and inconvenient.

It did take a few evenings to

begin to fully appreciate the advantages of the comfortable, lightweight unit. The large, soft, and easy-on-the-ears cushions on the earphones make it possible to wear the headset for hours at a time without fatigue or discomfort. The cushions also provide a useful 5 dB of attenuation of background sounds, making it easy to concentrate on the desired signal without undue distraction.

The dynamic microphone is easily positioned for optimum pickup and does an excellent job with most currently available amateur equipment, particularly the Yaesu and Trio-Kenwood rigs it was tried with during the test period.

After a few minutes use, I realized that the Astrolite headset was so comfortable and easy to use that I was no more conscious of its presence than I was of my wristwatch or my contact lenses. And, best of all, I was no longer stuck in front of the old desk mike. I could turn, move about the operating position, or get up and find a book or magazine on the other side of the shack and return to my chair without interruption.

The joy of hands-free operation and the freedom to move about while making a contact have to be experienced to be fully appreciated, and once they are, you'll find it hard to ever consider returning to the old method of operating.

What about CW? The Astrolite type 436B headset does a fine job on CW as well as SSB, FM, and AM, and if you prefer not to have the mike in place while using the key, just swing it back out of the way.

The phones are independently wired or can be wired monaurally, according to your particular requirements, making them especially convenient if, for example, you use a second receiver for split frequency

operation, monitoring a 2 meter link.

If you would like to add a new dimension to your operating, try the Astrolite type 436B headset. Once you do, you'll be surprised that you could ever be happy operating without it.

In addition to the type 436B, Astrolite offers several other versions, including a single-phone model and one with a noise-cancelling mike as well as single- and double-earphone units without mike.

For complete information on all Astrolite models, contact *Television Equipment Associates, Inc.*, Box 260, Boway Road, South Salem NY 10590.

Morgan W. Godwin W4WFL
Peterborough NH

DM-1 DESIGN MATE™ ADDS POWER, METERING TO SOLDERING BREADBOARDS

Continental Specialties Corporation has demonstrated a very definite understanding of the needs of the electronic designer in their Design Mate 1.

This self-contained unit adds the versatility of a 5-to-15 volt variable regulated power supply and a 0-to-15 V dc voltmeter to a very capable configuration of solderless breadboard terminal and bus strips.

The output of the DM-1 variable regulated power supply is 5-to-15 V dc at up to 600 milliamps for up to 9 Watts of circuit drive. The 0-to-15 volt dc meter boasts 5% accuracy and, like the power supply, is brought out to its own binding posts on the face of the Design Mate case. This permits it to be used to set up the power supply voltage, then reconnected to measure voltage parameters within the circuit being designed.

The load and line regulation is better than 1%, the ripple and noise less than 20 mV at

Continued on page 51



Astrolite type 436B headset.



CSC Design Mate 1 circuit designer.

MADISON BIG SIGNAL BUYS

OMNI-J 2-meter mobile or portable antenna. 3/8" thread, 5-dB gain (1.5-dB gain over conventional 5/8-wave mobile whip antenna). \$29.95; 450 MHz \$27.95. Guaranteed results.

BIRD 43 WATTMETERS PLUS SLUGS IN STOCK. *PREPAID FREIGHT*

MIDLAND 23-136 dual meter reads SWR and relative power. Handles 1 kW from 3-150 MHz. \$21.95

Benchner keyer paddles \$39.95
Chrome Model \$49.95

Yaesu FT901 DM Call for quote

Teletower crank up masts:

40' w/breakover \$299.00
55' W/breakover \$399.00

VHF SPECIALS: Kenwood TS 700S List ... \$729 Call for quote

KLM: Antennas, Linears, Accessories All In Stock - FREE balun w/2 meter base antenna.

JANEL PREAMPS: In Stock.

Technical Books (ARRL, AMECO, Sams, Tab, Rider, etc.)

HAM X ROTOR (New Model) Turns 28 sq. ft. of antenna List ... \$325 Order Now Your Price - \$249.00

CDE HAM 3 \$129.00

SWAN METERS: WM 6200 VHF Wattmeter \$49.95; SWR 3 Mobile \$9.95

TELEX HEADSETS: In Stock

CETRON 572B..... \$27.95 ea.

ADEL nibbling tool, \$6.45; punch \$3.50

CABLE 5/32", 6-strand, soft-drawn guy cable. For mast or light tower, 3¢ foot.

BELDEN COAX CABLE: 8237 RG8 21¢ ft. 8214 RG8 foam 25¢ ft., 8448

8-wire rotor cable 16¢ ft., 8210 72 ohm

kw twinlead \$19/100 ft., 8235 300 ohm

kw twinlead \$12/100 ft., Amphenol

silver-plate PL 259 59¢ ea. UG175 adapt-

er 19¢, PL-258 dbl female \$1.00.

Times 1/2" foam hardline 60¢ ft.

Connectors..... \$15 ea.

NYLON CORD 5000 ft. + per roll \$15.00

BELDEN 14 gauge copper stranded antenna wire..... \$5.00/100 ft.

BELDEN 9888 Double Shield RG8

Foam-direct bury - 100% braid 39¢/ft.

22 gauge plastic covered ant. wire for long wire, radials..... \$3.50/1000 ft.

KESTER SOLDER 1 lb. 60/40, .062

..... \$6.50

Leader - Amateur Test Equip. - 10%

off list.

Mallory 2.5A/1000PIV epoxy diode 19¢

ea. .001 MFD 20KV CAP \$1.95

Bearcat 210 Scanner \$249.00.

Call for quotes on:

Yaesu FT 901DM Kenwood TS520S

FT 625 TS820S

FT 225 TR7400A

All in sealed cartons. Call for

quotes on items not listed

Special Orders Welcome

TERMS: All prices FOB Houston. Prices

subject to change without notice. All

Items Guaranteed. Some items subject to

prior sale. Send letterhead for Amateur

dealers price list. Texas residents add 5%

tax. Please add postage estimate, excess

refunded.

MADISON M35

ELECTRONICS SUPPLY, INC.

1508 McKinney • Houston TX 77002

(713) 658-0268 • Nites (713) 497-5683



Amplivox headsets & headphones

Lots of firms make good headsets. Amplivox makes good headsets which are really comfortable. To start out, they are lighter in weight. Then we use soft, comfortable, ear-enveloping foam cushions, and a padded headband. The earphones and microphone adjust to any head size and correctly position the mike to minimize sibilant sounds. The cable has two screened mike leads to eliminate cross talk.

You probably have seen most major network TV sportscasters using Astrolite headsets for play-by-play—that probably tells you something about their technical performance.

Model 2636 B—double phones—200 ohm independently wired, close talking 400 ohm dynamic mike, bifurcated cable for separate mike and phone plug \$121

Model 2656 B single phone—200 ohm—close talking 400 ohm dynamic mike, bifurcated cable \$96

Headphones

Model 2630 B independently wired headphone—200 ohm \$59

All sales subject to ten-day approval.

T30

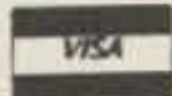

Dealer inquiries invited.



Literature on request from

Television Equipment Associates, Inc



Box 260, South Salem, N.Y. 10590

Tel: 914-763-8893

TWX: 710-575-2600

TOWER/TUNER

RESONATES YOUR TOWER
ON 40, AND 80 !

NOW available for 160 meters



Imagine using your entire tower and present beam system as a complete low angle radiator on 40 and 80 meters. It is common knowledge that a dipole or inverted-vee must be at least 1/2 wave length high (120 feet high on 80 meters!) in order for it to be a low angle radiator. But your existing tower, if fed with the Stuart Electronics **TOWER TUNER** can be made to be an optimum low angle radiator on 40 and 80 meters. The Stuart

TOWER TUNER can be installed and easily adjusted to a low swr on any tower no matter what the size or type. Tower can be grounded or not. Radials not necessary. No more haywire appearance of dipoles and I-V's. Even your wife will love it. The Stuart **TOWER TUNER** takes up virtually no extra space but greatly outperforms dipoles and I-V's at the same height plus it is easily adjustable from ground level. Start making better contacts on the 40 and 80 meter bands with an antenna system that really gets out. The Stuart **TOWER TUNER** will handle 500 watts output.



We are so confident that you will like it that we offer a 30 day money back guarantee if you are in any way dissatisfied. Price of \$129.95 includes shipping in continental United States.

STUART ELECTRONICS

578 KENNEDY RD.
AKRON, OHIO 44305
(216) 798-9431

A Keyer?

Who Needs Another Keyer?

— would you believe a \$2 keyer?

With a total parts cost of less than two dollars and two evenings worth of spare time, I built the squeeze key shown in Photo A. For those unfamiliar with this area of CW, as I was until recently, a squeeze key can be used, like

any other paddle, with most keyers, but it has the advantage that many letters and punctuation marks can be formed with less effort by gently squeezing the paddles together. The work in sending CW with a squeeze key is performed by the thumb and

first finger. Compare that minor motion to the recommended way of sending CW with a straight key or with the hand movement required when using a bug. Good CW is not only easier to send with this squeeze key, but it can be fun. If I, who have op-

erated only on phone for the past twenty years, feel CW can be fun with a squeeze key, there is a good chance that you, too, will enjoy it.

My desire to obtain my Extra class license motivated me to begin studying CW again, and I'd never really liked CW. The idea that sending CW might be easier with a keyer was sufficient motivation for me to build the Accu-Keyer.* The keyer worked well when I touched the dot or dash wire to ground, but I found that a clumsy way to send code. Not being interested in CW as an operating mode, I did not want to invest \$20 to \$40 in a paddle. Yet I needed something to make my keyer work, so I could get my Extra class ticket. This article describes how easily and inexpensively I solved the problem. Drawings and photos are included so you can duplicate this squeeze key. Instructions are provided on how to adjust the travel and tension of the key. The last section contains many possible modifications that you can make to this basic squeeze key to tailor it to your station and your desires.

Criteria

The photographs of the finished key give a good indication of how I applied my basic criteria for building this key:

1. Simple approach;
2. Readily available materials;
3. Inexpensive.

When I realized that a good squeeze key requires very little movement of the paddles when properly adjusted, it followed that there would be little wear on the moving parts. To me this meant that machined pivots or bearings were not needed. Wood, screws, and bolts should work fine. What could be simpler?

Materials

The materials consist of common 6-32, 10-32, and

*"The WB4VVF Accu-Keyer," QST, August, 1973, p. 19.

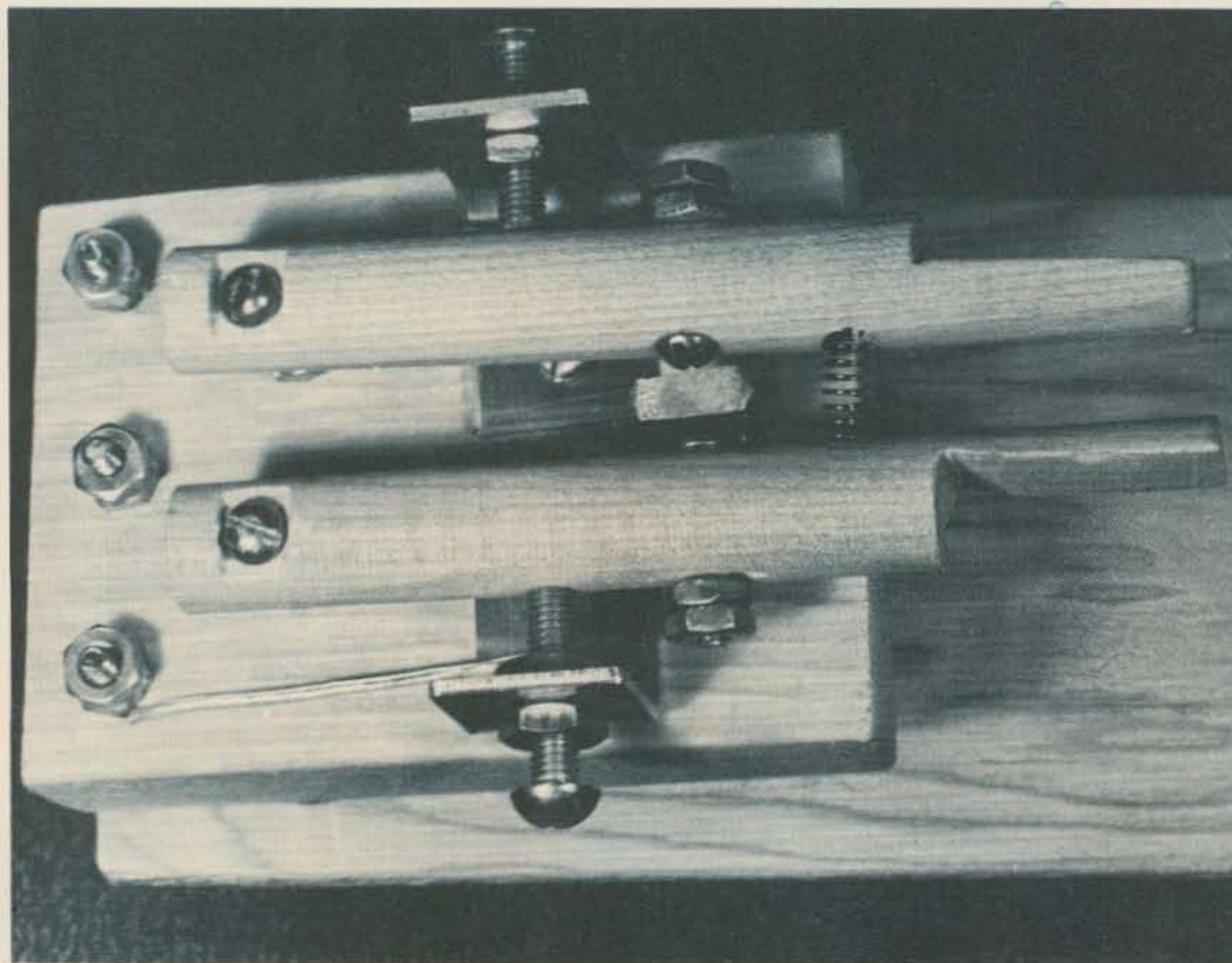

Photo A. Two-dollar squeeze key.

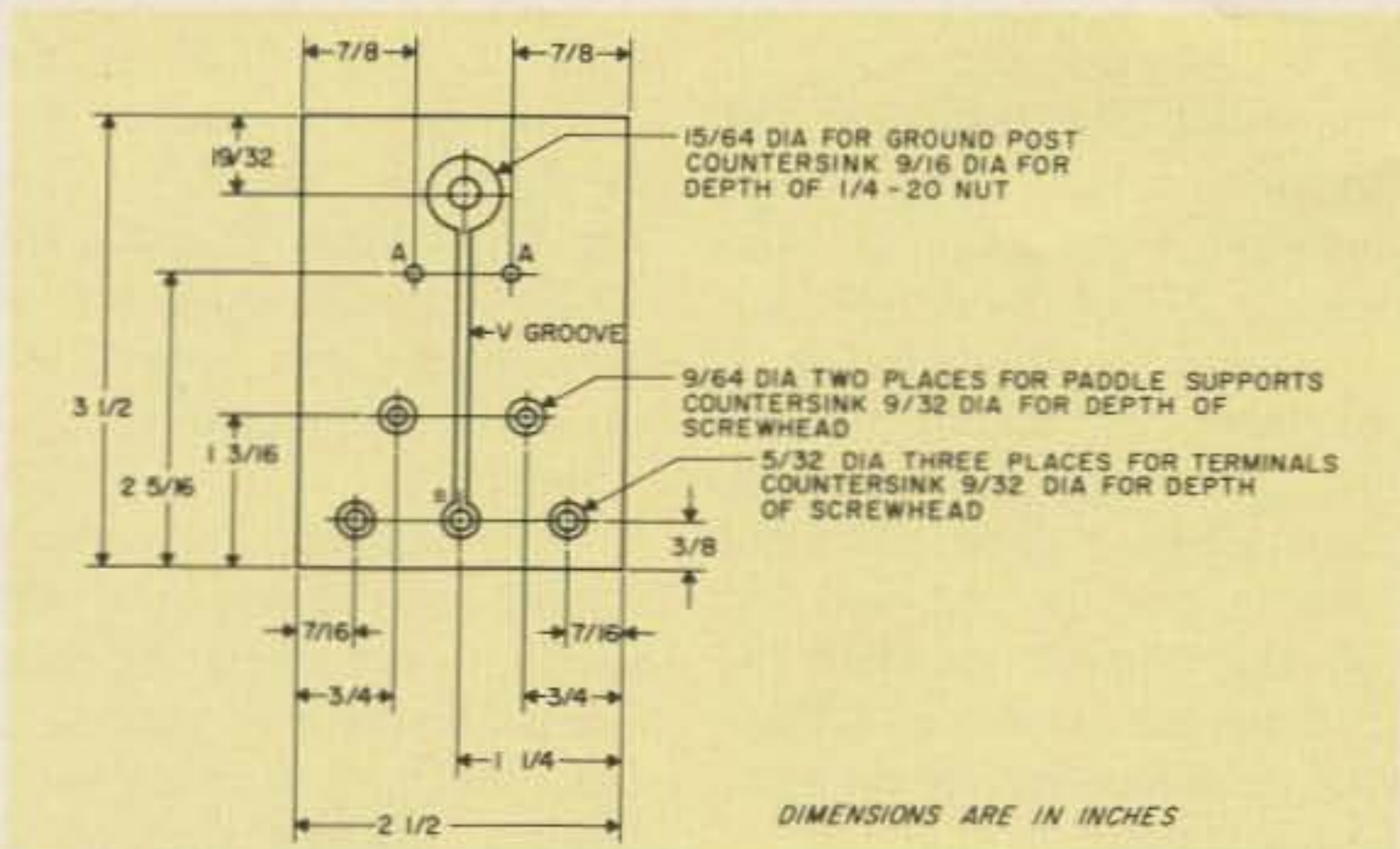

Fig. 1. Base, bottom view.

1/4-20 hardware. For a base, I used a 2 1/2" by 3 1/2" by 3/4" block of softwood. Hardwood might be more durable, but almost anything you can find in the scrap box at your local lumber yard will do. The required piece could even be cut from the end of a discarded orange crate.

The paddles were built from 1/2" diameter hardwood dowel rod, which I bought at my local hardware store for 39¢ for a three-foot length. As only eight inches are needed, you can save some money by sharing the dowel with other hams who are interested in building this project.

My original plan for the paddle travel adjust brackets was to use small wood blocks for these also. They were to be screwed down to the base with a horizontal hole drilled through for the 10-32 adjust screws. As I reached that phase of the project, a few 1/16" thick aluminum scraps left from a panel cutout caught my eye. For me, these were simpler to use than the wood, so the aluminum scraps were used.

The tension adjust spring came from a discarded ball-point pen. It is the spring that makes the point retract when you push on the top of the pen. Unscrew the pen in the center and remove the empty cartridge. Usually the spring will come out, adhering to the cartridge near the point end. I routinely remove this spring and put it in my miscellaneous hardware box be-

fore throwing away a used pen.

Parts Construction

Once I had assembled the material, I began making the parts for the squeeze key.

Base

I began by drilling the two 9/64" holes in the base for the two paddle supports. These should be just smaller than the screw diameter, so the 6-32 hardware will fit snugly. This helps keep the paddles firmly in position. Then I drilled the three 5/32" holes for the dot, dash, and ground terminals. I strongly

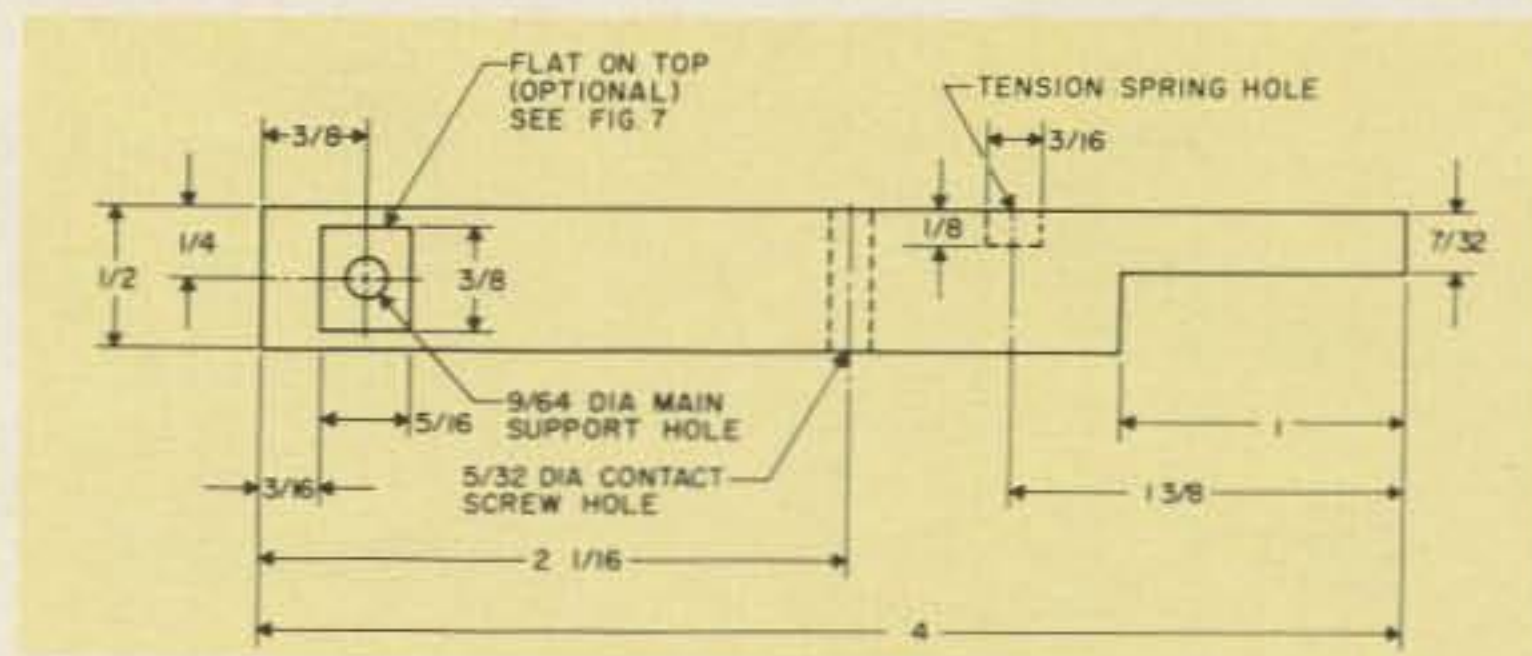

Fig. 2. Paddle detail (make two).

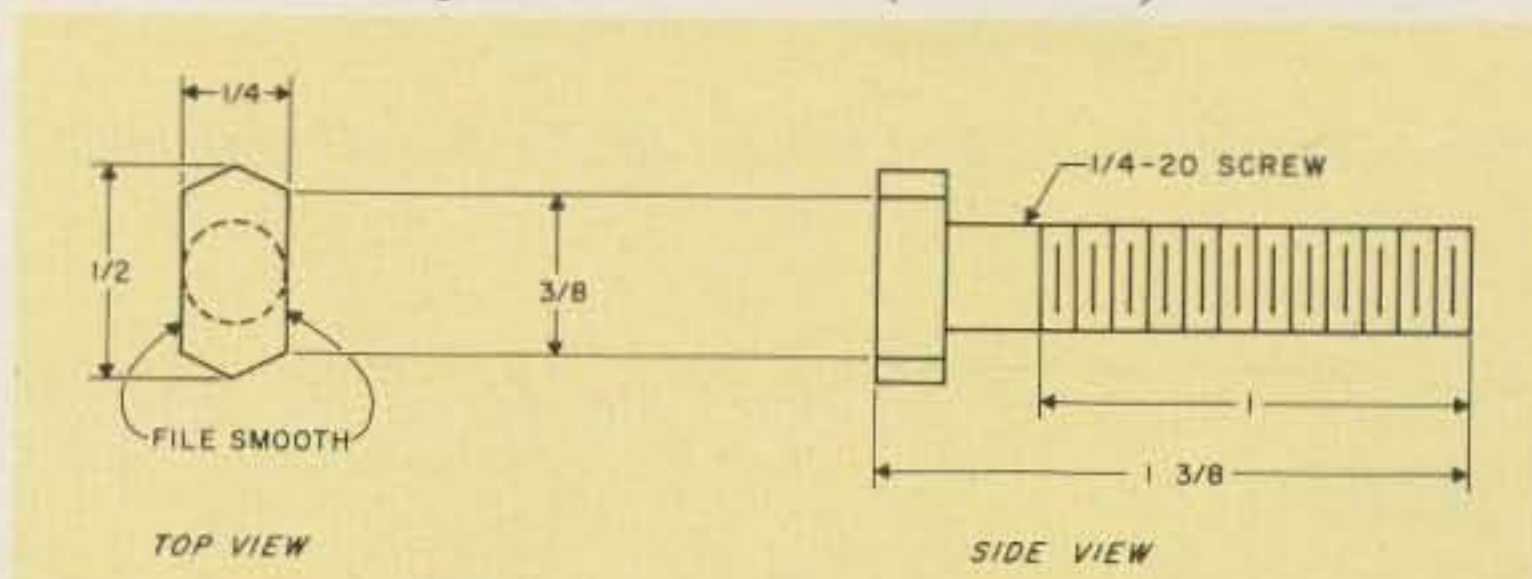

Fig. 3. 1/4-20 hex-head screw modification for ground post.

recommend using a vise to hold the wood block prior to drilling the 15/64" hole. Use a piece of cardboard on each side of the base to prevent the vise jaw from marking the wood. Clamping the wood will prevent nicked fingers if the drill bit snags on the wood and the wood base spins out of your hands. It takes a few minutes more to secure the block before

drilling, but my experience (and sore fingers) attest to the wisdom of using a vise or clamp for drilling large holes in small pieces of material.

On the top side of the base, I drilled two 5/64" holes at location A, 1/4 inch into the block, to make starter holes for the wood screws that hold the travel adjust brackets. To permit the key to sit flat on my

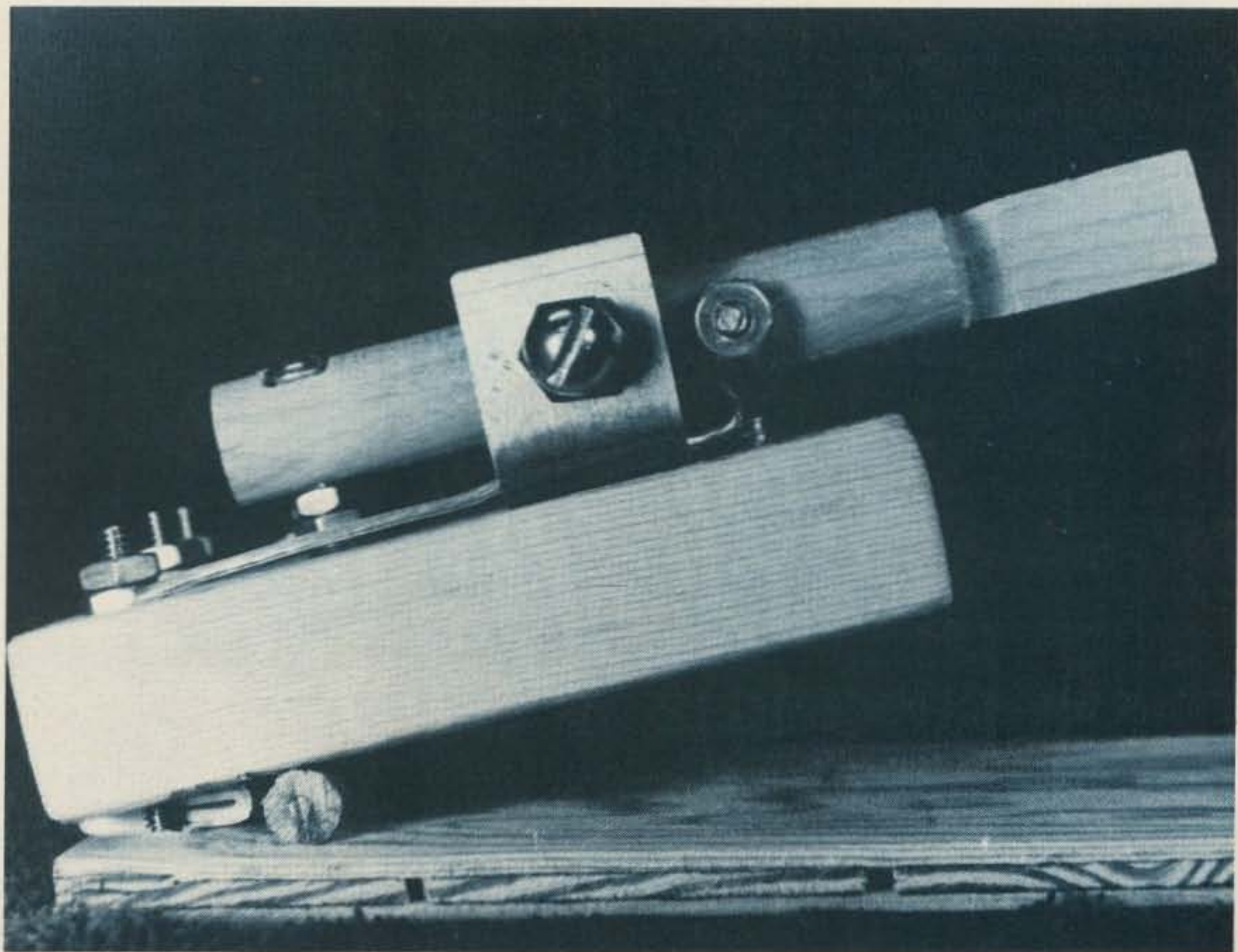

Photo B. Left side view of squeeze key.

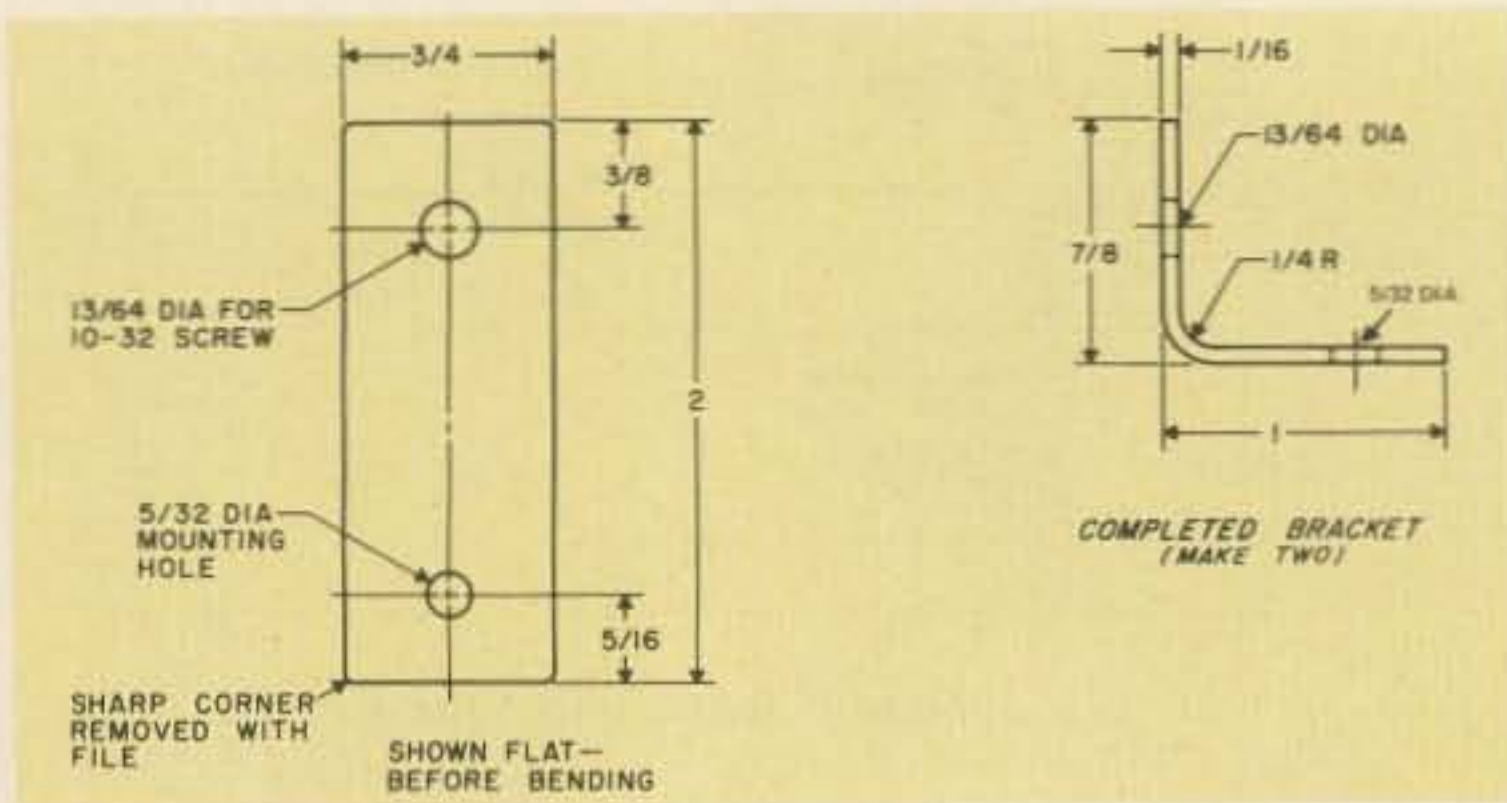

Fig. 4. Paddle travel adjust bracket (material is 1/4" aluminum).

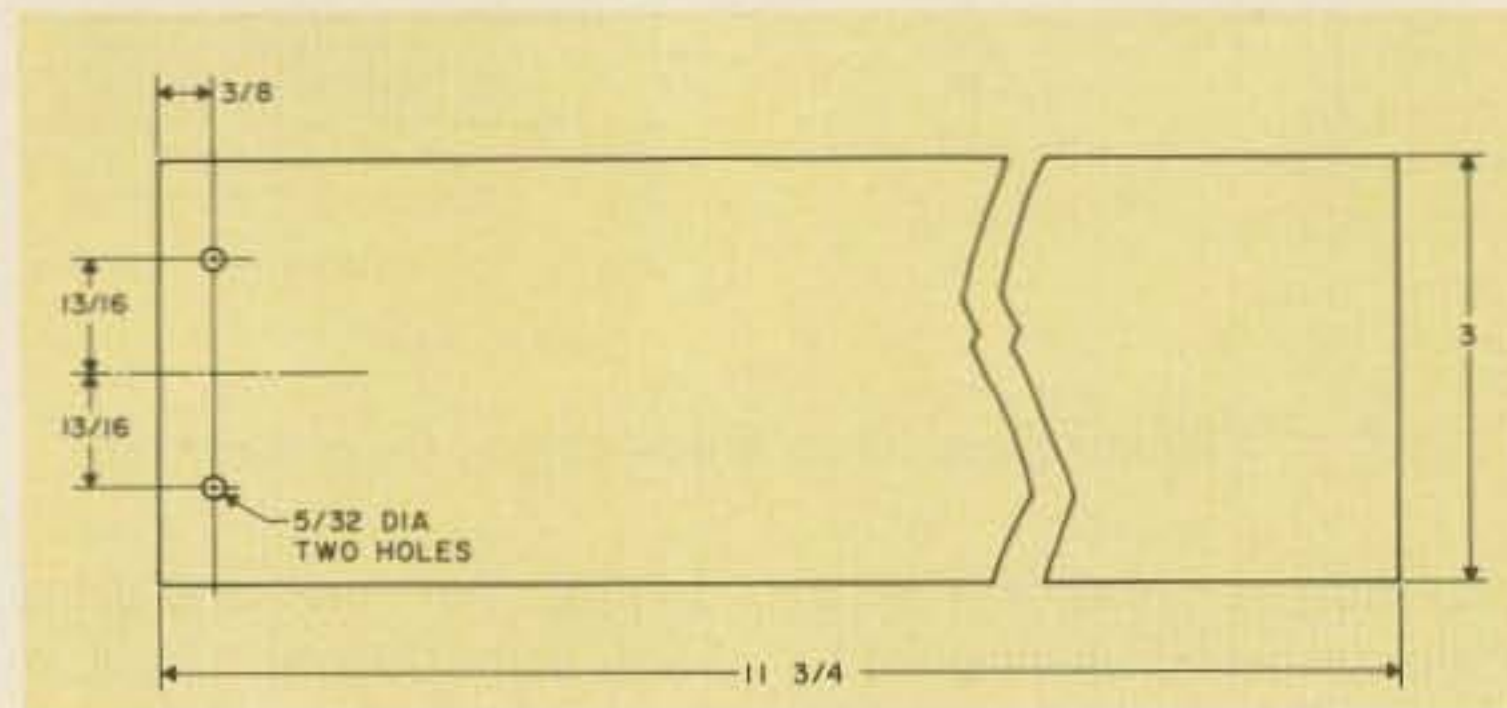

Fig. 5. Armrest.

operating desk, I countersunk holes for the 1/4-20 nut and 6-32 screw heads. See Fig. 1 for the detail of the base bottom. For the same reason, I made a groove down the bottom center of the base for the ground wire.

Paddles

The paddles were the next part I made. I cut a four-inch length of dowel for each

paddle. Gently clamping the dowel in a vise (again using cardboard to protect the dowel), I drilled the 9/64" main support hole. By rotating the dowel 90°, I was able to drill the 5/32" hole for the contact screw and the 3/16" diameter by 1/8" deep hole for the tension spring. Note that the diameter of the hole for the spring might have

to be adjusted, depending on the exact dimensions of the spring you use. Using a coping saw, I cut away approximately 2/3 of the dowel for a 1" length, as shown in Fig. 2, to form the paddle handle. The two paddles are identical, but, when making the right paddle, put the optional flat on the bottom so when the paddles are assembled (Photo A), both flats will be on top.

Ground Post

The ground post is made from a 1/4-20 hex-head screw. I used a hacksaw to cut the head as shown in Fig. 3 and filed both sides smooth. To hold the screw during cutting, I ran two nuts part way up on the screw and snugged them up to prevent the screw from turning. Then I clamped the jaws of the vise around the nuts while I sawed and filed the top.

Paddle Travel Adjust Brackets

The paddle travel adjust brackets require only two holes: one hole for mounting and one hole that just passes the 10-32 adjustment screw. These holes are easier to drill while the aluminum is flat. I bent the aluminum in a vise by tapping gently with a hammer until the desired 90° angle resulted. As you can see

from a close look at the photographs, a sharp 90° bend is not required. (See Fig. 4.) It is desirable that the 10-32 screws hit the center of each paddle, but even 1/16" off center is not critical.

Armrest

Not wanting to commit myself to screwing down the paddle to my operating desk, I opted to make an armrest to keep the base in place while sending. I used a piece of 1/4" plywood for the armrest, but a side slat from an orange crate sanded smooth would work well. Scrounge one from your friendly supermarket. Adjust the length to fit your arm. About two and one-half inches longer than the distance from the tip of your center finger to your elbow would be ideal. I used a shorter board, as the wrist is virtually motionless, but I believe that a board extending to the elbow would add greater stability. A three-inch width for the armrest worked well for me, but, if your arms are large, a four-inch width might be more comfortable. Fig. 5 shows my armrest.

Key Height Adjust Block

To adjust the height of the paddle handles above the desk, I used a 2 1/2" length of an ordinary hexagonal wood pencil. This was easily cut off with a coping saw and still left about 4 1/2" of pencil, which I used for copying code. Several pieces of cardboard were used between the base and armrest for additional support. See the side view photograph (Photo B).

Assembly of the Squeeze Key

With all the parts made, the first thing I assembled was the 1/4-20 screw ground post. This was threaded into the hole, which I'd intentionally made just smaller than the screw, so it would bite the wood. Strip the ends of a four-inch length of #20 stranded wire, and wrap it around the bottom of the screw prior to putting the nut on the bottom. Run the nut up snugly into the countersunk hole, but be careful not

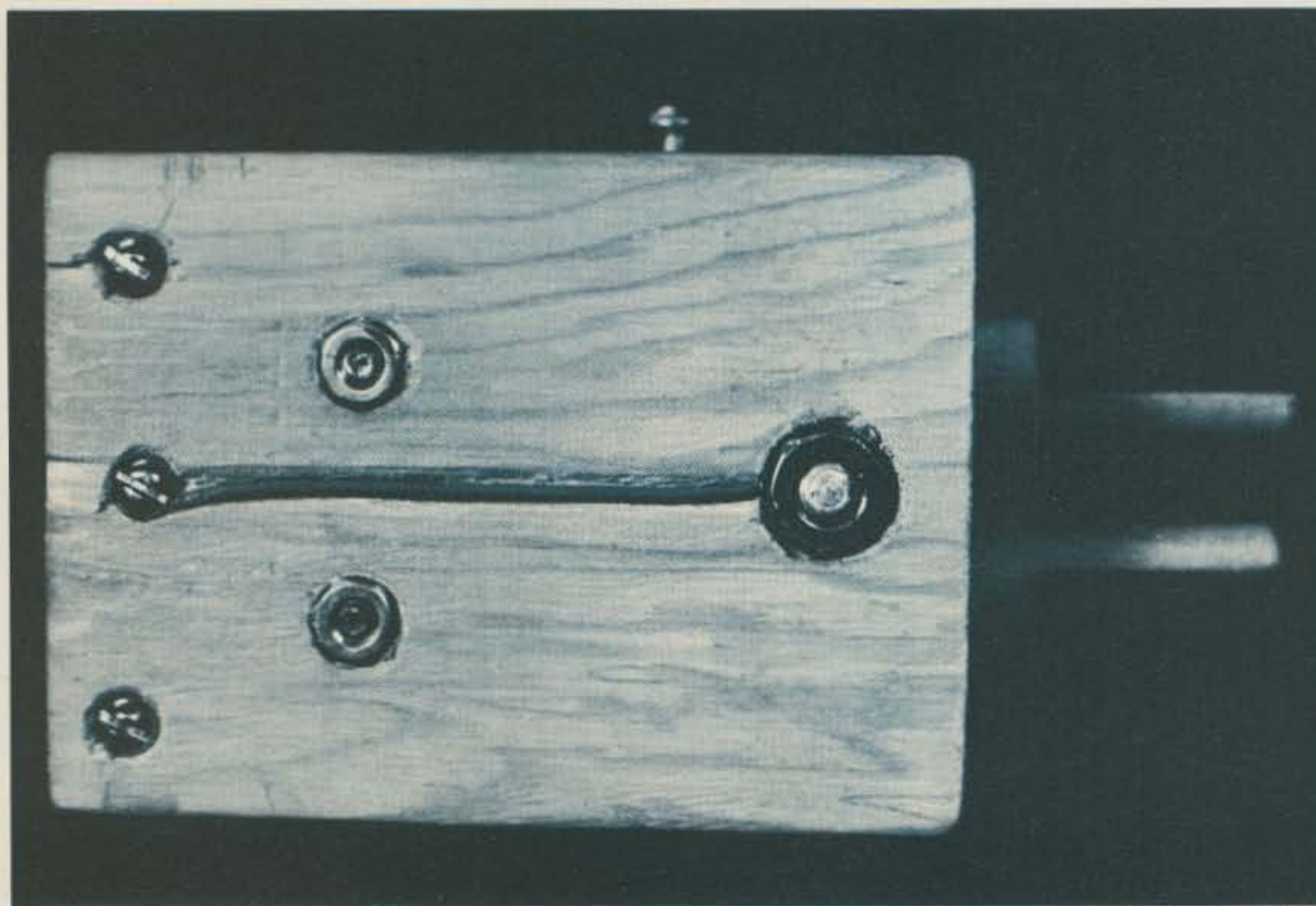

Photo C. Bottom view of base.

to pull the screw through the wood. Align the cut screw head as shown in the top view photograph (Photo D).

The paddle adjust brackets are more easily mounted before the paddles are mounted. I secured them in place, using one 1/2"-long wood screw (with large head) for each bracket. The use of only one screw per bracket provides a fine adjustment of paddle travel, as will be discussed later. See Fig. 6.

The center binding post screw is assembled next. I dressed the ground wire from the 1/4-20 screw in the groove on the bottom side of the base. After inserting the 6-32 x 1" screw through the center hole B of Fig. 1, I wrapped the other bare end of the ground wire around the head of the screw used as the ground binding post. A nut on the top side of the base secured the screw in place.

Attach a 6-32 x 3/4" screw to each paddle with a single 6-32 nut. These are the dot-dash contacts. The screw head should be positioned toward the center of the paddle to contact the 1/4-20 ground post. Cut two four-inch lengths of #20 stranded wire, and wrap the bare end of each wire around the 6-32 dot-dash contact screws protruding from the nut. Secure this wire with a second 6-32 nut on each paddle. Mount each paddle to the base, as shown in Fig. 7. The nuts on each side of the base secure the screw in a vertical position. The extra nuts and washer under the paddle are used as spacers. Adjust the height of the paddles so that the dot-dash contact screw heads hit the flattened head of the 1/4-20 center ground post.

The 10-32 x 3/4" screws are mounted as shown in the detail of Fig. 6. These screws must be loose to allow the paddles to separate for insertion of the tension spring. I cut off and discarded the tightly coiled ends of the pen spring. The remaining part of the spring is space wound. I

inserted one end of the spring into one tension spring hole in the paddle. By compressing the spring to one side using a small screwdriver, I was able to slip the second end into the tension spring hole of the other paddle. I then used a pair of pliers in one hand and a needle-nose pliers in the other to clamp the 10-32 nuts on either side of the paddle adjust brackets. For initial adjustment of the 10-32 travel adjust screws, I would suggest allowing 1/16" between the paddle contact screw and the center ground post.

Mounting of the dot-dash binding posts is next. If an armrest board is used, these 6-32 x 1 1/2" screws should be inserted through the armrest and then through the base. The bare end of the wire from each paddle dot-dash contact should be wrapped around the screw, and then the first nut (see Fig. 7) should be tightened down, sandwiching the wire between the nut and the top of the base. Be sure to leave slack in this wire to allow the paddles to move freely. The second nut is used to connect the wires from the keyer to the squeeze key. I used a hexagonal pencil between the base and the armrest to attain the desired angle to suit my hand. These binding post screws adequately sandwich the pencil in place, so no glue is necessary. If an armrest board is not used, assembly of the

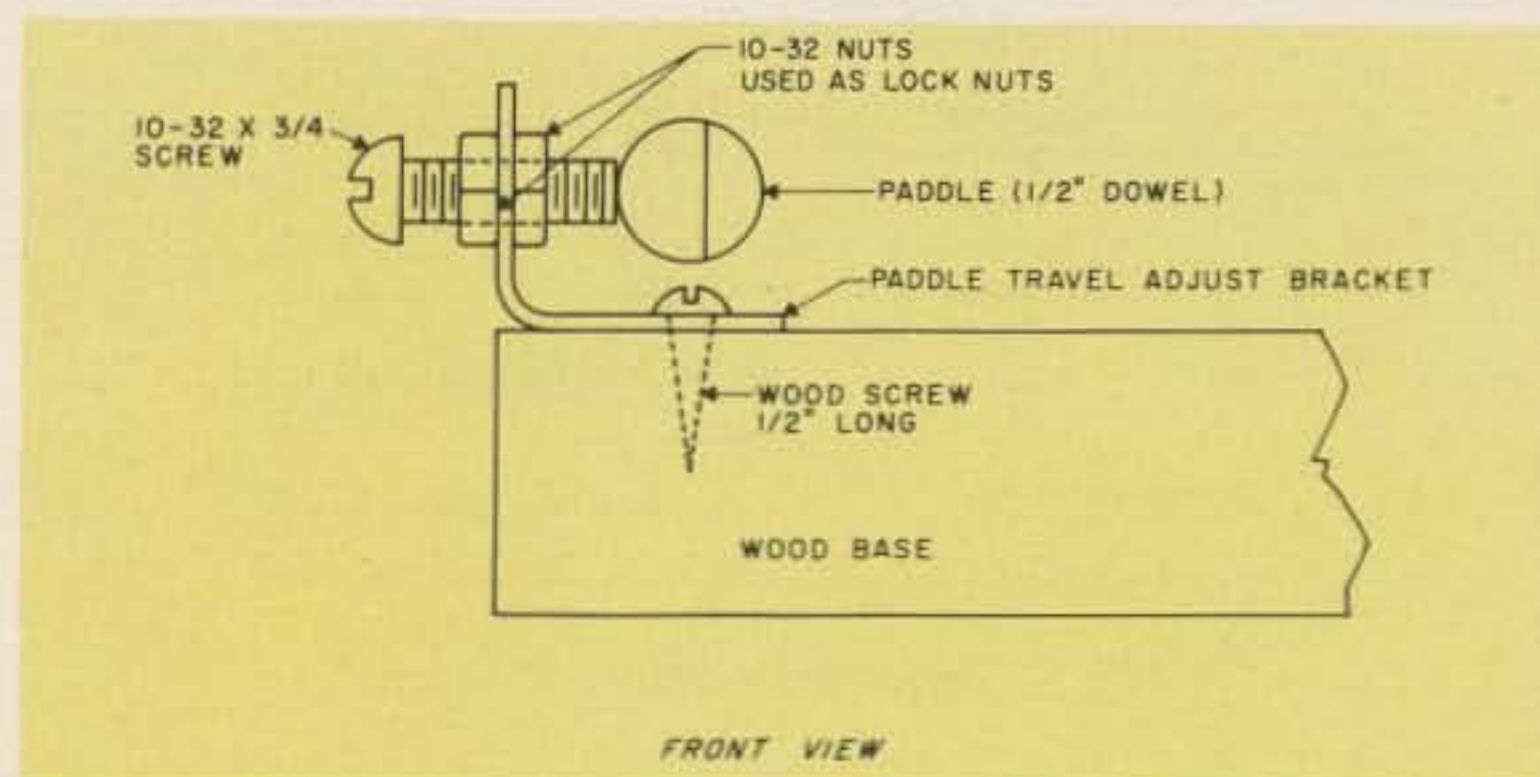

Fig. 6. Paddle adjust screw.

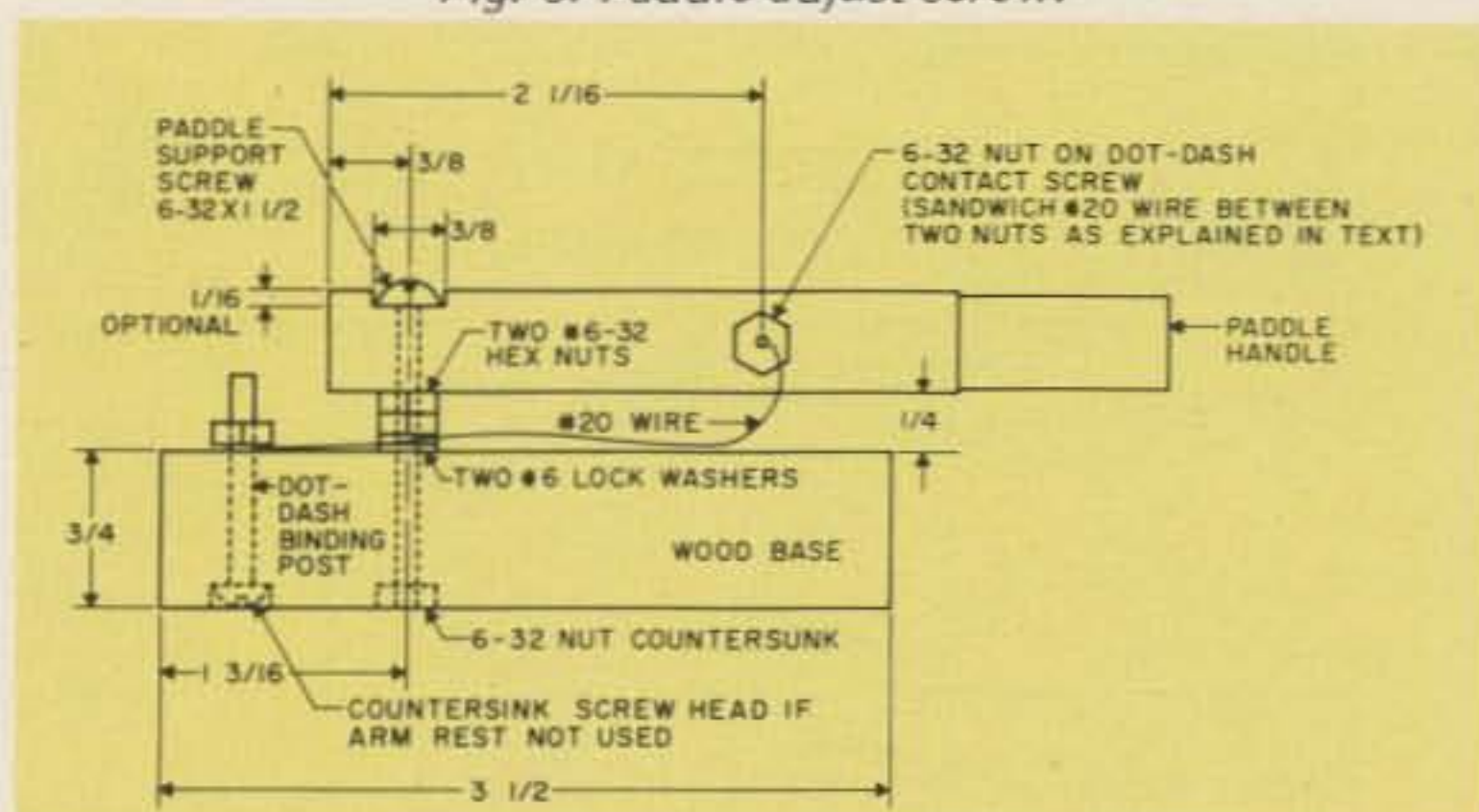

Fig. 7. Assembly of paddle to base. This side view shows the main support screw detail.

dot-dash binding posts is identical to that described above, except the one thickness of the armrest board is eliminated. In this case, binding post screws that are 1/2" shorter than shown could be used.

Adjustment

Prior to adjusting the squeeze key, run wires from the binding posts on the base to your keyer. This will permit you to try out the key and get the feel of sending with this type of key. Even if you have never used a paddle

before, whatever does not feel comfortable will soon become obvious. There are three basic adjustments that can be made to tailor this key to your fist:

1. Angle of the key base to the horizontal (i.e., height of paddle handles);
2. Dot and dash paddle travel;
3. Paddle tension.

The angle that sets the paddle handles in the best position for your fist can be found by loosening the dot-dash binding posts and changing the position of the pencil backwards or forwards.

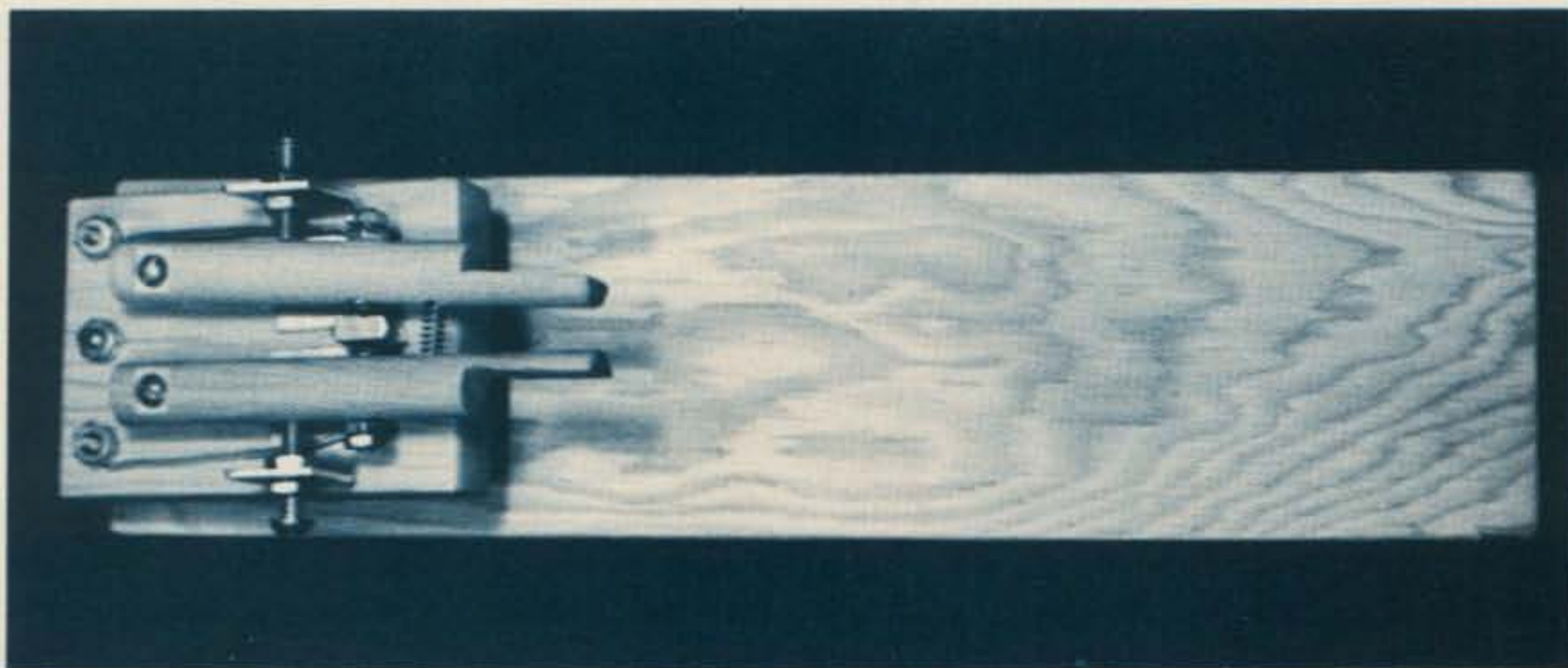

Photo D. Top view showing key and full armrest rest.

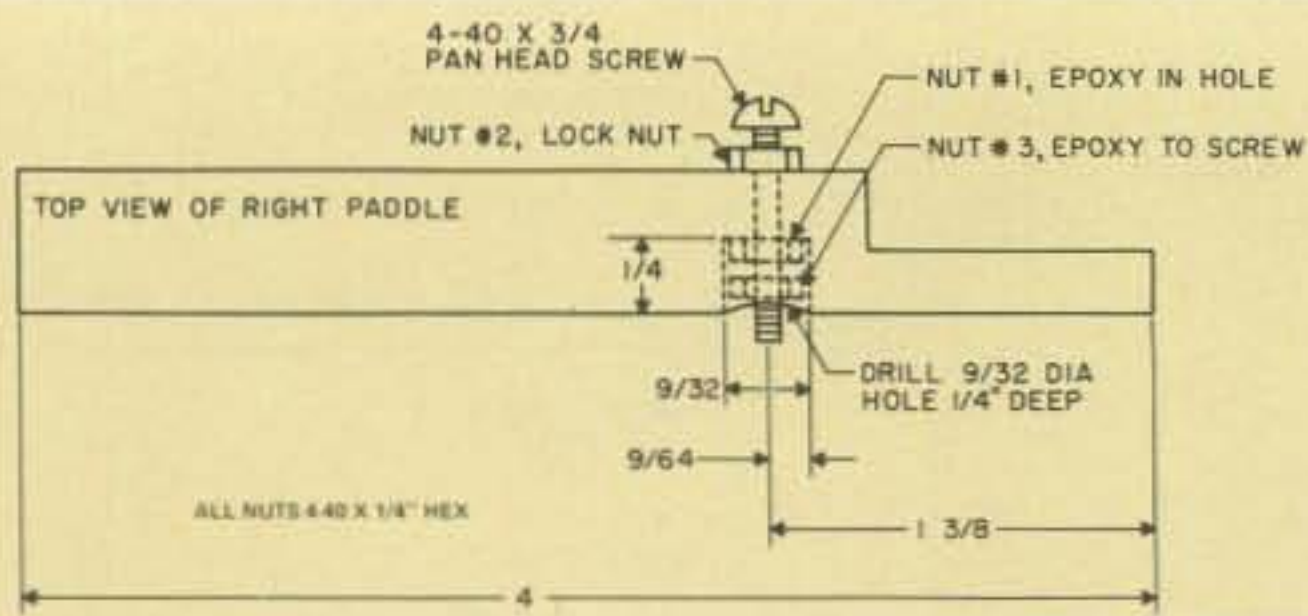

Fig. 8. Tension adjustment screw.

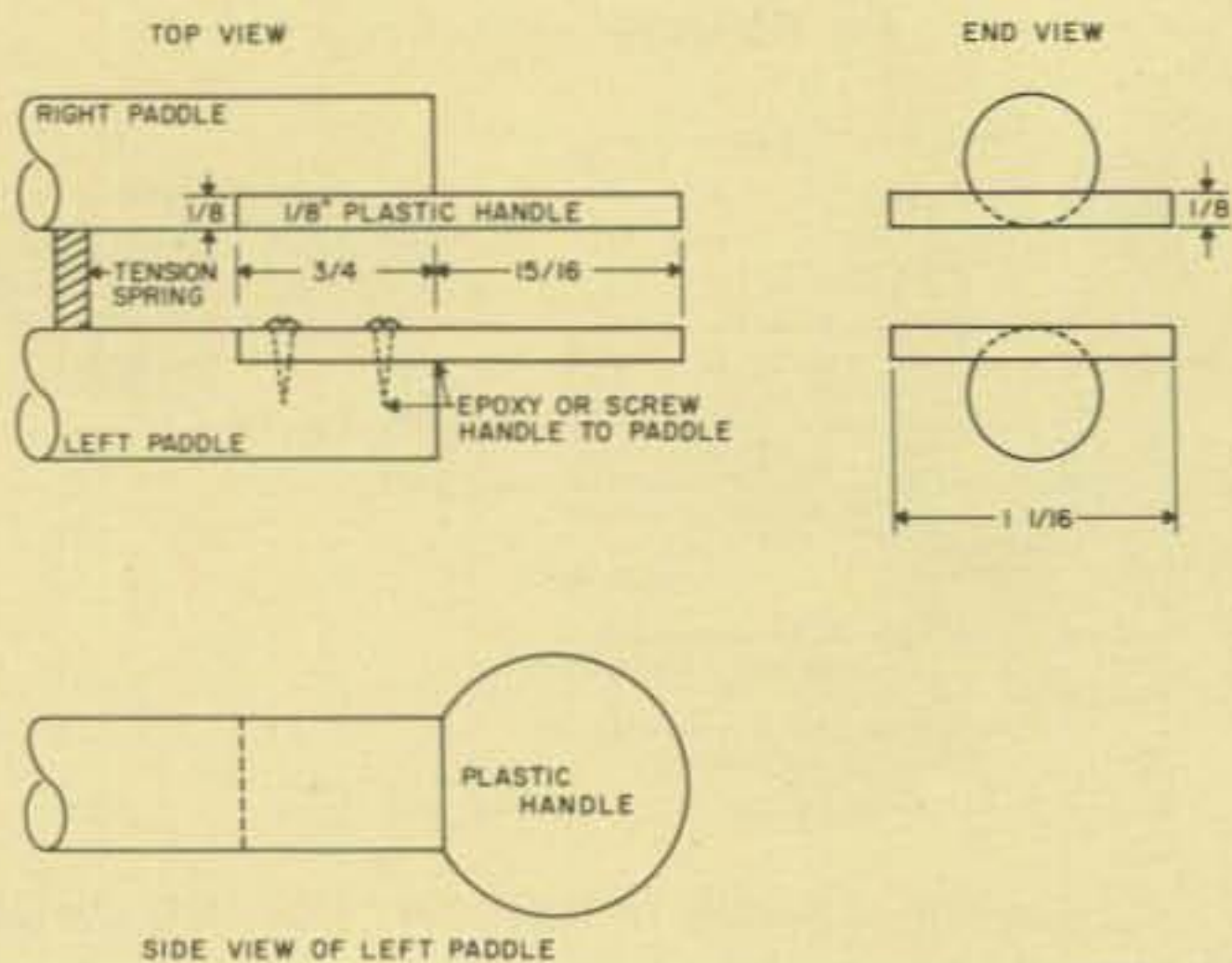

Fig. 9. Plastic paddle handles.

If you prefer the paddle handles to be low, the pencil may be eliminated.

Paddle travel has two adjustments per paddle. These interact to some degree with spring tension. I found that when I reduced the paddle travel, the tension had to be lowered also. The obvious adjustment is the 10-32 screws. After loosening the nut closest to the paddle with a long-nosed pliers, a screwdriver can be used to run the screw in or out as needed. You can obtain a finer adjustment by pivoting the dash paddle adjust bracket clockwise about its mounting screw. This makes the edge of the 10-32 screw hit the paddle and closes the gap. The dot paddle adjust bracket can be pivoted counterclockwise to close the gap.

Paddle tension adjustment is simple but irreversible. It consists of removing the spring and clipping off a turn or two with wire cutters and replacing the spring. This process is repeated along with the paddle travel adjustment until the desired feel is ob-

tained. The irreversibility of this adjustment is compensated for by the zero cost of the pen springs. If one spring is cut too short, the next one can be made a bit longer. You could keep two or three spring lengths on hand if you wish to change the paddle tension, such as for a large change in sending speed.

Key Improvements Possible

The approach I have used in building this key probably qualifies as the simplest, which satisfies my present needs for building up my code speed. With more time and a little more cost, it is possible to add improvements to this key which might better meet your needs.

You could make the key look more professional by eliminating the armrest board. A lead block could be epoxied or screwed to the wood base to add weight and keep the key in one place. Holes could then be drilled and tapped for rubber or other nonskid feet, which would add stability. The lead and choice of feet size could

be used to raise the key to the desired height for convenient keying. Be sure to add a layer of insulation between the wood base and the lead so as not to short out the contacts. A sheet of cardboard, cloth, or felt would be adequate for the low voltages found in most keys.

To make paddle travel adjustment easier, one 10-32 nut could be epoxied to each adjust bracket. This would prevent unwanted screw movement during the adjustment process and would probably eliminate the need for a lock nut for home station use.

You could add a tension adjustment screw to eliminate trimming the length of the spring to secure the desired tension. One tension spring hole, say in the left paddle, should be built normally as described. The right paddle can be drilled as shown in the sketch of Fig. 8. The depth of this hole should exceed the thickness of the two nuts by 1/16". Drill a hole horizontally to provide a snug fit for a 4-40 screw. One thin nut, #1 in Fig. 8, should be epoxied in the 9/32" hole, keeping the epoxy out of the threads. When dry, run a second nut, #2 in Fig. 8, up on the 4-40 screw. Then the screw can be threaded through the hole, nut #1, and nut #3. With 1/16" to 1/8" of the end of the screw protruding beyond nut #3, epoxy the nut in place on the screw. With this improvement, the left end of the spring goes into the tension spring hole in the left paddle, but the right end slips over the end of the screw. To adjust the tension, simply loosen nut #2 (the lock nut) and turn the screw in to increase tension or out to reduce tension. When the desired tension is achieved, tighten the lock nut.

The first reaction of our South Peninsula Amateur Radio Klub (SPARK) Extra class study group was, "Did you build it out of clothespins?" This was the inspira-

tion for a possible variation on the design. A wooden clothespin could be cut in half to make the two paddles. A similar and possibly easier approach would be to use a plastic clothespin. Using a pliers, the center spring could be removed, leaving two plastic pieces for the paddles. A less expensive material for the paddles would be difficult to find!

If you prefer the feel of plastic to wood, round or oval plastic paddle handles could be added to the wood dowel paddles. An empty Scotch tape dispenser is an inexpensive source of material, or you could buy 1/8" thick lucite. Cut the plastic to the size and shape you wish, and sand the edges. Instead of cutting the dowel handles as shown, the ends of the dowels could be slotted to accept the thin plastic pieces. Pre-drill clearance holes in the plastic and secure the pieces in place with small wood screws. If you wish to have the paddle handles closer together, reverse the flat side on the dowel paddles, as shown in Fig. 9.

You can improve the appearance of the key by carefully sanding and varnishing the wood parts. This would also help keep the key looking clean and new. The varnish should be applied to the bare wood parts; you'll want to avoid getting the varnish on a key contact or in adjustment screw threads.

Summary

This article has described how I built a simple but effective squeeze key in approximately six hours for less than two dollars in materials that were readily available. I have really enjoyed using this key. I get a kick out of the idea that something so simple that I made can be so useful. Even if you have a squeeze key for the home station, this key is so easy to build that you could make it and use it for your portable or field day rig. ■

Yesterday you could admire LED digital tuning in short wave.* Today you can afford it.



Introducing Panasonic's Command Series™ top-of-the-line RF-4800. Everything you want in short wave. Except the price. Like a five-digit LED frequency display. It's so accurate (within 1 kHz, to be exact), you can tune in a station, even before it's broadcasting. And with the RF-4800's eight short wave bands, you can choose any broadcast between 1.6 and 31 MHz. That's the full frequency range. That's Panasonic.

And what you see on the outside is just a small part of what Panasonic gives you inside. There's a double superheterodyne system for enhanced reception stability and selectivity as well as image rejection. An input-tuned RF amplifier with a 3-ganged variable tuning capacitor for exceptional sensitivity and frequency linearity. Ladder-type ceramic filters to reduce frequency interference. And even an antenna trimmer that changes the front-end capacitance for maximum reception from minimal broadcast signals.

To help you control all that sophisticated

circuitry, Panasonic's RF-4800 gives you all these sophisticated controls. Like an all-gear-drive tuning control to prevent "backlash." Separate wide/narrow bandwidth selectors for optimum reception even in crowded conditions. Adjustable calibration for easy tuning to exact frequencies. A BFO pitch control. RF-gain control for increased selectivity in busy signal areas. An ANL switch. Even separate bass and treble controls.

And if all that short wave isn't enough. There's more. Like SSB (single sideband) amateur radio. All 40 CB channels. Ship to shore.

Even Morse communications. AC/DC operation. And with Panasonic's 4" full-range speaker, the big sound of AM and FM will really sound big.

The RF-4800. If you had a short wave receiver as good. You wouldn't still be reading. You'd be listening.

*The ability to receive short wave broadcasts will vary with antenna size, time of day, operator's geographic location and other factors. You may need an optional outside antenna to receive distant short wave broadcasts.



Panasonic®
just slightly ahead of our time.



Normal picture. Use this normal picture for comparison with the other pictures shown in this series.

Reprinted from *How To Identify & Resolve Radio-TV Interference Problems*, U.S. Government Printing Office, Washington DC 20402, 1977.

Official FCC RFI Report

— curing radio and TVI

During the past few years, tremendous advances have been made in the field of radio and television communications. Communications by radio and television from any point on the Earth, and sometimes from points beyond the Earth, have now become commonplace. In recent years, the growth of two-way radio, permitting personal communications from motor vehicles and homes, has been explosive.

These advances in communication technology are not without problems. The radio frequency spectrum is becoming crowded, and interference problems, due to a lack of compatibility between the different radio systems, are becoming widespread. This is evidenced by the thousands of complaints of interference to home electronic entertainment equipment (television, stereo, electronic organ, telephone, tape recorder and other audio equipment) received by the Federal Communications Commission (FCC) each year.

Most of these interference problems can be traced to one or more of the following

Normal picture. Use this normal picture for comparison with the other pictures shown in this series.

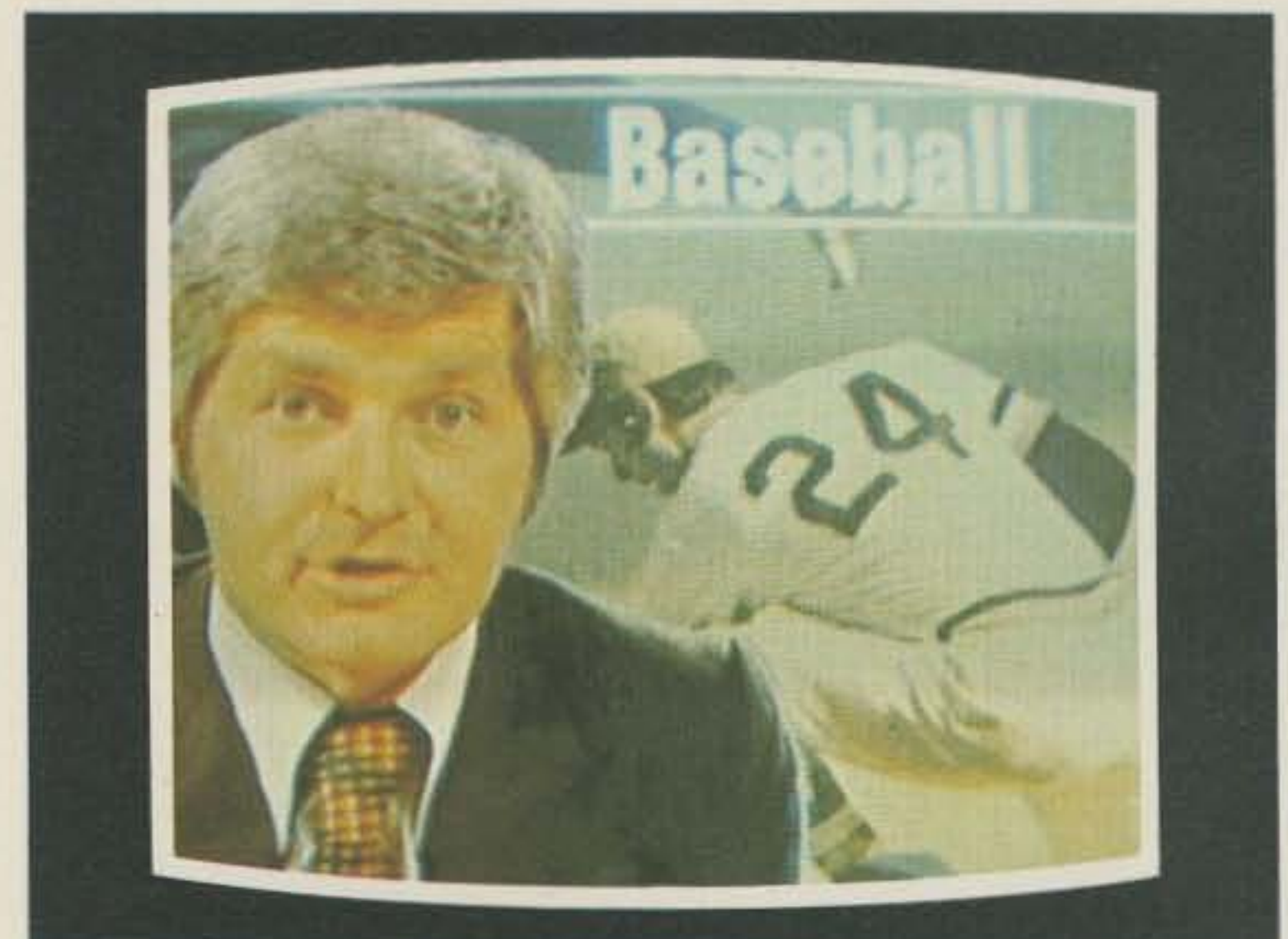

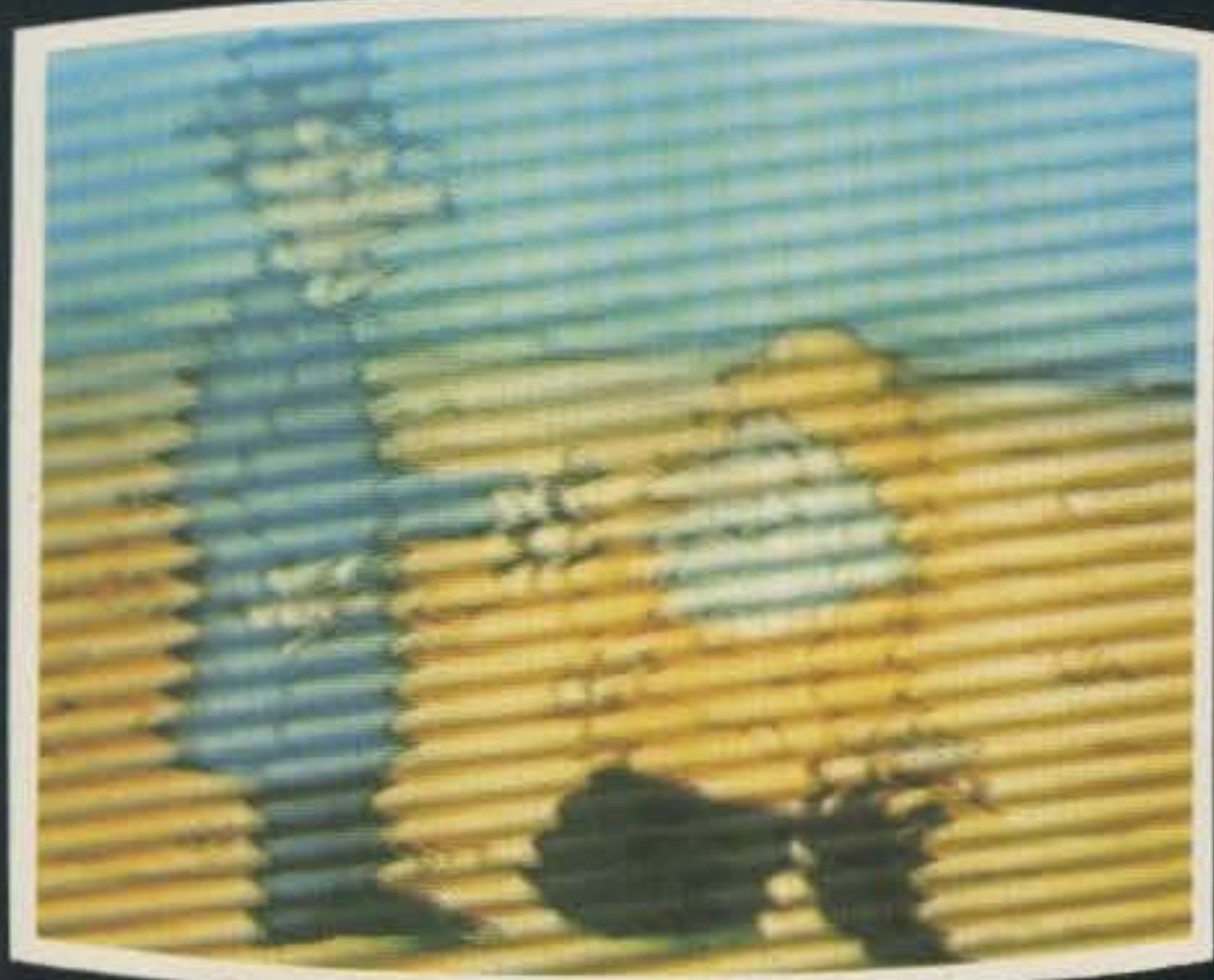

Radio transmitter interference. This is what your picture looks like when it is picking up the transmission of CB, amateur, police, or other radio transmitters. It will normally affect VHF channels only. You may notice that the interference pattern changes or moves as the radio transmitter operator talks. Do not confuse this interference with a horizontal control problem.

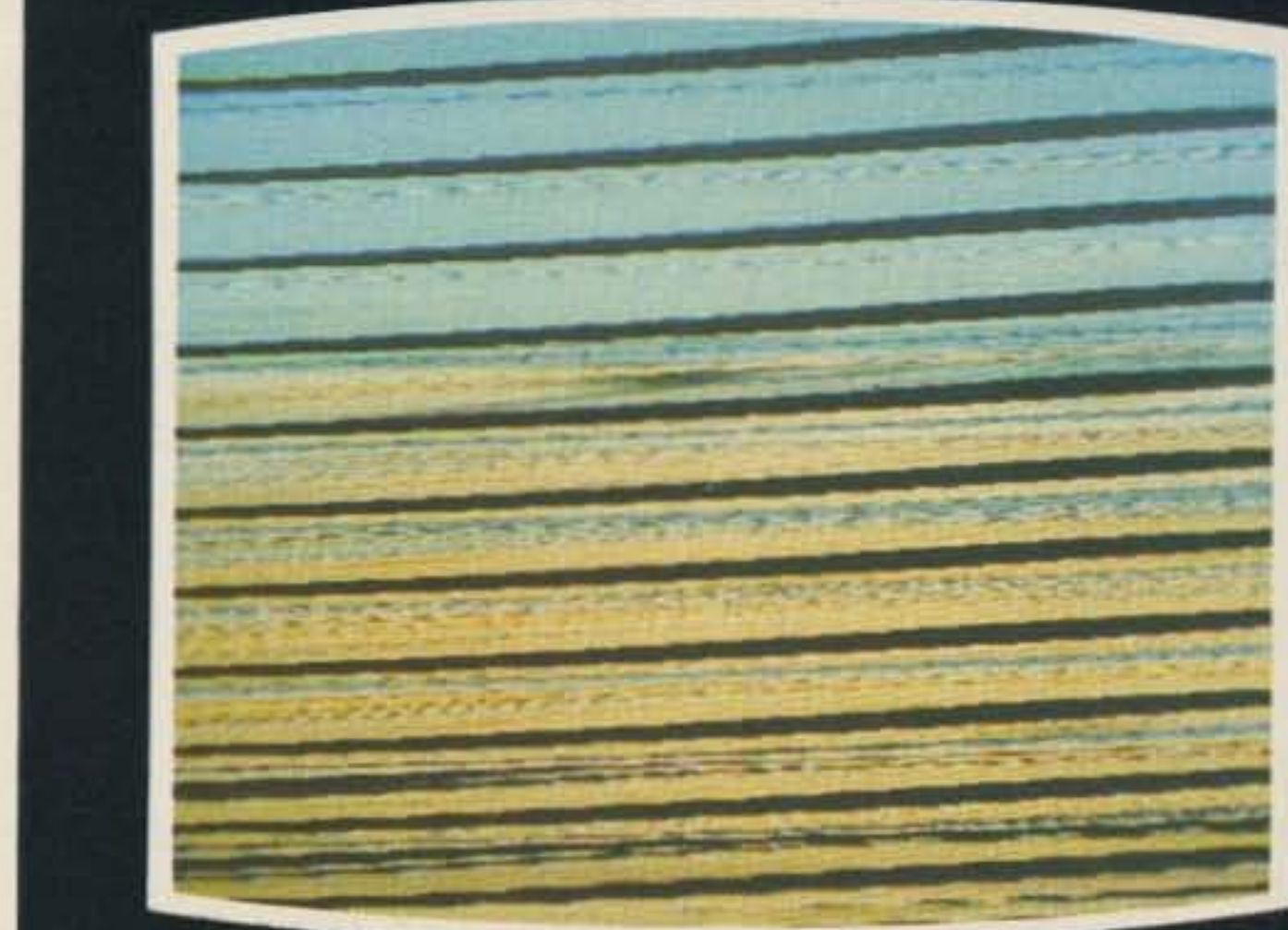

Horizontal control problem. When your set requires adjustment of the horizontal hold control or replacement of a bad tube or component, the above pattern will appear on your TV picture. The sound, if affected, may contain a high pitch tone. To eliminate, simply adjust your horizontal hold control or call your service representative to replace the bad tube or component.

factors:

1. Characteristics of the receiving system, e.g., television receiver or antenna systems design and installation.

2. Environment of the receiving system, e.g., distance from television transmitter and intervening terrain or presence of nearby radio transmitter.

3. Characteristics of radio frequency generating devices, e.g., Citizens Band (CB) radio transmitters or other radio transmitters.

4. Practices of radio transmitter operator, e.g., CB user operating an illegal overpower transmitter or amplifier.

The control of some of the above factors is within the

jurisdiction of the Federal Communications Commission. For example, the Commission has technical standards for radio transmitting devices such as CB transmitters; these technical standards were strengthened by the Commission, effective

January 1, 1977. Also, the Commission has rules concerning the way in which radio transmitters are operated.

Obviously, control of some of the above factors is *not* within the jurisdiction of the Commission. The quality

Electrical interference. This is what your television picture looks like when your set is reacting to any of the following devices operated in or near your home: hair dryers, electric shavers, mixers, blenders, power saws, vehicle ignition systems, and other similar devices. When this type of interference is occurring, you may also hear a sizzling or buzzing sound along with the sound of the TV program. Do not confuse this interference with a poor TV signal.

Poor TV signal. This is the type of television picture you will be receiving if you are far away from the TV transmitter site or if there is a building or mountain between you and the TV station. A defective antenna, improper antenna orientation, or disconnected or broken lead-in wire may also cause this problem. The sound of your TV usually will not be affected unless the TV signal is extremely weak. You can improve the quality of the signal by installing a higher antenna, using a directional antenna or a signal amplifier, or repairing the lead-in wire. Check with your TV sales and service representative on antenna systems available.



of the television signal received at your home is one such factor, because such quality is most often influenced by the distance you live from the television station and the intervening terrain. Also, the Commission has no standards for the design and installation of television receivers and associated antenna systems. As you will find in this article, many interference problems can be corrected by modification and improvement of the television receiving systems.

The purpose of this article is to help you identify and resolve interference problems which you can correct. By reading it, you will discover that identifying and resolving interference can be an interesting challenge. You will not only be doing your own detective work in locating the source, but you also will be resolving the problem by following the suggestions contained in the "Home Remedies" section.

As you begin to identify the type of interference you are experiencing, keep in mind that not only must your equipment be able to receive and amplify the desired signal, but it also must reject all unwanted signals and noise. This means that, even if the equipment allegedly causing the interference is being properly operated, it is still possible to experience interference.

If you have followed the home remedies suggested, and the interference continues, you may want to contact your service representative for assistance. When you contact your service representative, we suggest that you provide that person with a copy of the Service Representatives section of this article. This section has been designed specifically for a technician's use. There is also a section directed to the radio operator which you may wish to show to the operator of the radio transmitter that is allegedly causing you inter-

ference.

If you find, after following the guidelines for resolving interference that are provided in this article, that you still are experiencing interference problems, you may want to contact one of the Sources for Assistance listed in Appendix A.

We hope this article will serve as a useful tool in helping you to resolve your interference problem.

Caution: To avoid the possibility of a shock hazard, fire, or violation of your equipment warranty, any *internal* modifications of your equipment should be done *only* by a qualified service representative.

IDENTIFYING INTERFERENCE TO TELEVISION

See photos.

HOME REMEDIES FOR RESOLVING RADIO TRANSMITTER TV INTERFERENCE

Installing A High Pass Filter

There are no set procedures for eliminating television interference — it is a matter of eliminating the most likely sources of interference a step at a time. The first step is to install an inexpensive high pass filter on the back of your TV set. In making this installation, follow these procedures:

1. Determine the type of antenna wire that is connected to your TV set. There are two possibilities:

Coaxial cable — a round lead-in wire which requires a filter "impedance" of 75 Ohms. (See Fig. 1A.)

Twin lead wire — a flat wire which requires a filter "impedance" of 300 Ohms. (See Fig. 1B.)

2. Purchase the filter which matches the type of antenna wire coming from your set. The "impedance" information mentioned above will be on the filter label. *Do not* use a combination of twin lead and coaxial cable without proper matching



Normal picture. Use this normal picture for comparison with the other pictures shown in this series.

transformers (often called baluns). Filters are available in most stores that sell or repair television sets. Fig. 2 provides a small example of what high pass filters look like.

3. Carefully read the instructions that are provided with the filter. You will be installing the filter on the back of your TV set, as near to the antenna terminal as possible. The antenna terminal and the filter terminal will look like either Fig. 1A or 1B, depending upon the type of wire you are using — coaxial or twin lead.

4. If you are on a cable system, you may still install the filter at the antenna

terminal. However, if the interference continues, contact the cable company repair service for assistance. *Do not* attempt to modify the cable system yourself.

5. The following information on installing the filter should answer any additional questions you may have.

a. Disconnect the antenna wire (twin lead or coaxial) from the television set antenna terminals.

b. Connect the wire from the antenna to the input terminals of the filter.

c. For twin lead wire, connect a very short (1" to 2") "jumper"

Normal picture. Use this normal picture for comparison with the other pictures shown in this series.





FM interference. Interference from a nearby FM broadcast station will cause this type of pattern to appear on your TV screen. Although it normally will affect TV channel 6 only, one additional channel in the channel 2-13 series may occasionally be affected. It sometimes affects both the picture and sound of your set. Note that the interference pattern may change or vary with the sound of the FM broadcast station program, not the sound of the TV program. Do not confuse this interference with a fine tuning problem.



Fine tuning problem. This is the type of pattern which will appear on your screen if the fine tuner of the TV set is not properly adjusted. Although it looks similar to FM interference, you will note that the pattern changes with the sound of the TV program. Readjust the fine tuning control of the TV set to eliminate the problem.

wire from the antenna input terminals of the set to the filter (see Fig. 3). For coaxial cable, it will be necessary to

obtain a jumper cable that has the proper connectors already installed. (This can be purchased at the time

you buy the coaxial filter.)

d. Be sure that, in the case of *twin lead wire*, the actual wires are making contact with the terminals. For *coaxial cable*, be sure the connector plugs are

properly installed on the coaxial cable.

e. If you have an amplifier in your antenna system, you should have a filter installed ahead of the amplifier and another filter ahead of the TV receiver

Co-channel interference. This is the type of pattern which will appear on your screen when your set is simultaneously receiving two TV signals. Note that the two images are different, as though one picture has been placed on top of the other. Co-channel interference is due to either atmospheric conditions or the location of your home in relation to the location of the TV stations. If the problem is from atmospheric conditions, little can be done to correct it. However, the problem is usually temporary. If it is caused by the location of your home in relation to the location of the TV stations, use of a highly directional antenna may help to eliminate the problem. Do not confuse this interference with ghosting.

Ghosting. This is the type of picture you will see when 1) the TV signal is reflected, or 2) the TV antenna or antenna lead-in wire is in poor condition. When "ghosting" occurs, it means that the TV signal is being reflected off a mountain, building, or other man-made structure, with the signals being sent over different paths to your TV set and arriving at slightly different times. With "ghosting," note that the two images are the same. Rotation of your TV antenna to a new position or installation of shielded lead-in wire may resolve this problem. If rotation of the antenna does not resolve the problem, have a service representative check the condition and/or placement of the antenna and antenna lead-in wire.



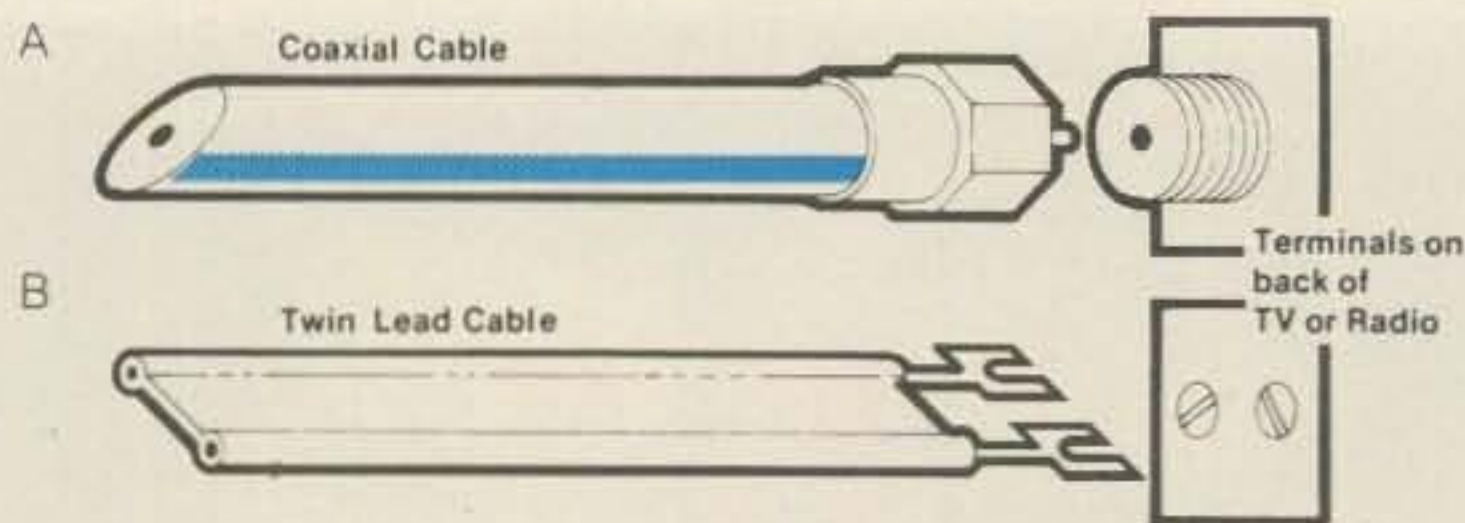

Fig. 1.

input terminals (see Fig. 4). If the amplifier is located close to the receiver, then install the filter before the amplifier only.

Note: *Booster* amplifiers usually are located near the back of the TV set; *mast-mounted* (outdoor) amplifiers are usually located on the antenna; and *distribution* amplifiers are usually located somewhere in the distribution system. If a distribution amplifier is in your antenna system, then be sure to trace the entire length of the antenna system, because amplifiers are usually in out-of-the-way places (for example—clothes closets, basements, etc.).

f. The connecting wires between the filter and amplifier, and between the amplifier and antenna terminal, should be as short as possible.

g. The instructions provided with the filter you bought may call for a ground connection. The wire should be as short as possible and connected between the high pass filter ground terminal and a metallic cold water pipe or a ground rod. Use bell wire for this connection (see Fig. 3). Bell wire can be obtained from most variety stores.

h. If installation of the filter at the TV antenna terminals does not entirely eliminate the interference, you should then contact

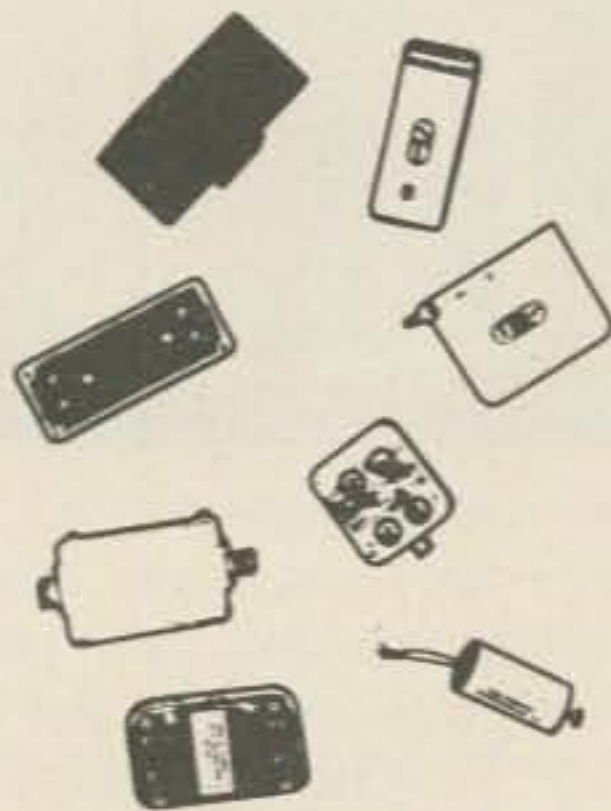

Fig. 2. Montage of filters.

your service representative to install a high pass filter inside the TV set at the tuner input terminals. *Internal* modifications to your set should be done **ONLY** by a service representative. Information to assist your service representative is contained in the Technical Information For Service Representatives section.

HOME REMEDIES FOR RESOLVING ELECTRICAL TV INTERFERENCE

Electrical interference is caused by two sources:

1. Vehicle ignition systems, and
2. Electrical devices.

The first step in attempting to resolve electrical interference problems is to locate the source of interference.

Interference From Vehicle Ignition System

1. Ignition interference sounds like a "popping" noise in the sound system of your TV that rises in intensity; the "pops" occur closer and closer together as the speed of the engine speeds up. This can be caused by any vehicle ignition system, such as

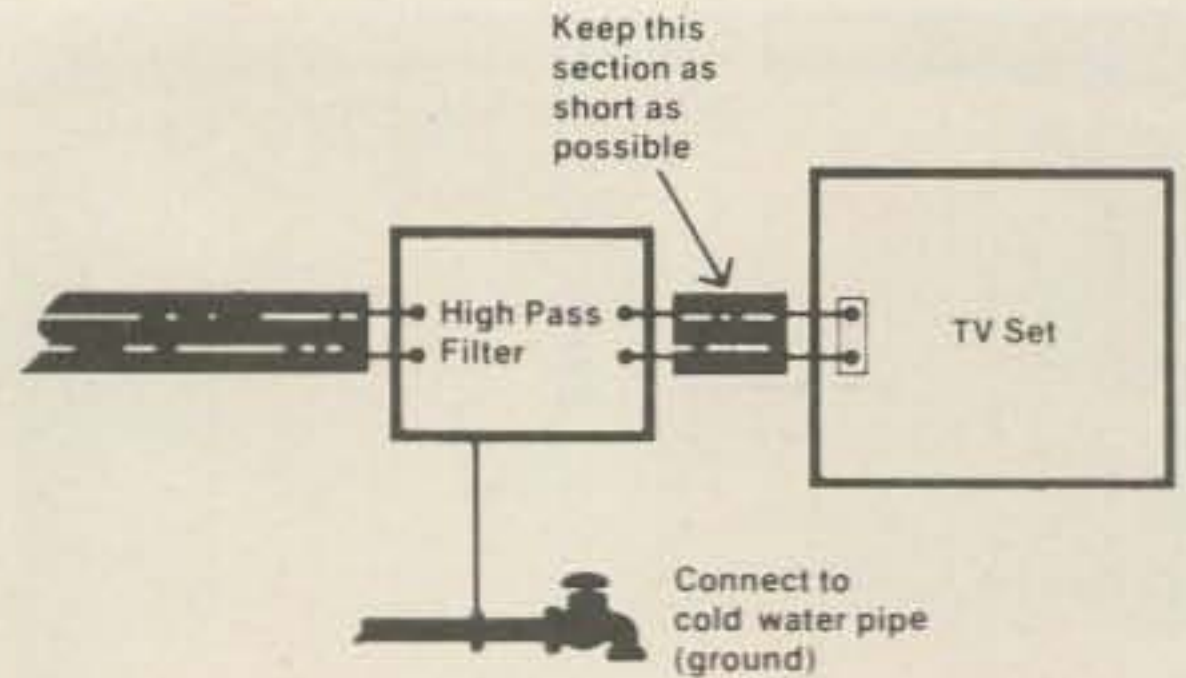

Fig. 3.

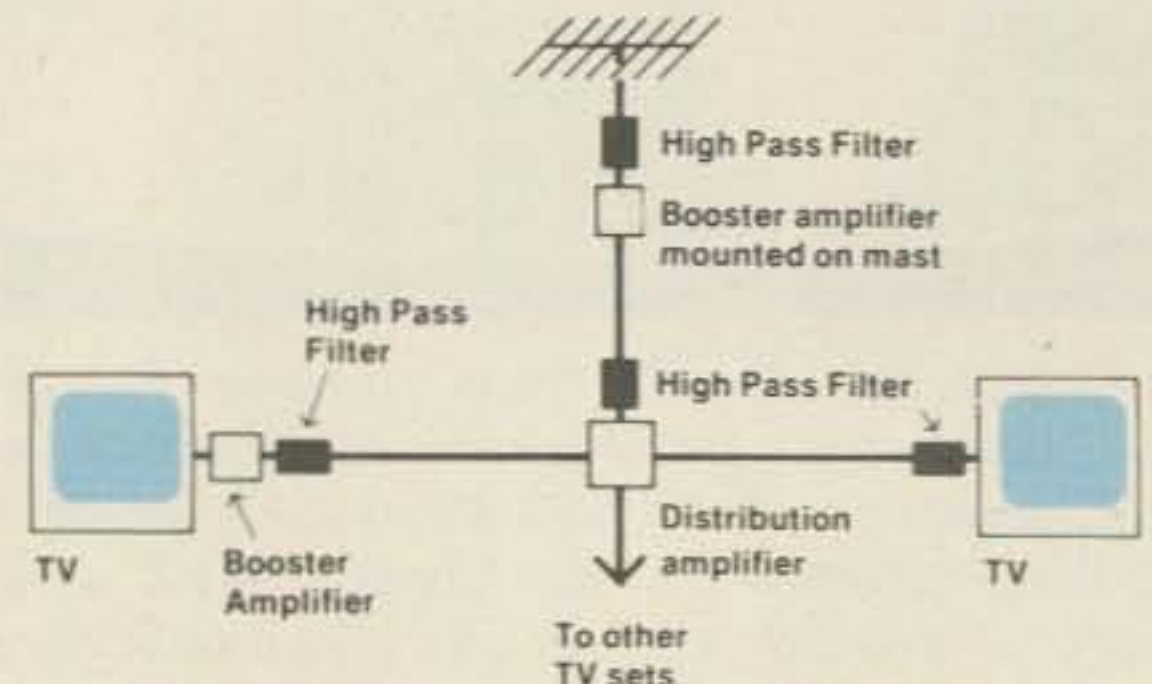

Fig. 4.

gasoline-operated lawn mowers, snowmobiles, automobiles, etc.

2. If the interference is to television receivers, you may hear the same popping noise in the sound and also see "dancing dots" in the picture of the set. You may only see the interference, and not hear the "popping" noise in the sound.

3. If your own vehicle is causing interference, you may wish to install a commercially-manufactured kit in your vehicle to reduce the ignition noise. Other remedial measures include relocating your antenna, raising the antenna, and using shielded lead-in antenna wire.

Interference From Electrical Devices

1. Any one or more of the following electrical devices may be causing the interference you are experiencing on your television set or AM/FM radio: electric razor, vacuum cleaner, fan, drill, electric blanket, bake oven, fluorescent light, arc light, light dimmer control, relay, static from machinery, lightning arrestor, adding machine, cash register, circuit breaker, ultraviolet lamp, germicidal lamp, defective

wiring, loose fuse, arc welder, switch contact (such as on dishwashers and other home appliances), refrigerator, water pump, sewing machine, light blinker (including Christmas tree light blinker), electric heating pad, aquarium warmer, neon sign, door bell circuit/transformer, toy (such as electric train), sign flasher, antifriction bearing, printing press static eliminator, calculator, insulator, incandescent lamp (new or old), sun lamp, electrical pole (ground wire cut or poor contact), loose electrical connection, electric fence unit, furnace control, power company transformer, smoke precipitator.

2. In attempting to locate the specific device causing the interference, consider the following suggestions:

- a. If you have a portable radio that is affected by the interference, use the radio as a detection device to assist in locating the source of interference. With the portable radio, move from room to room and determine in which room the interference appears to be the loudest. Then look for one of the devices

listed above and unplug it to see if the interference disappears. If several devices listed above are in the room, unplug them, one at a time, until the interference disappears.

b. If a portable radio is not affected, you can go to the main fuse or circuit breaker box in your home, remove one fuse at a time, or shut off one breaker at a time, and see if the interference goes away.

c. If it does not go away when the first fuse or circuit breaker is off, replace the fuse or turn the circuit breaker back on and continue on until the interference does disappear. When the circuit that supplies the power to the TV or radio is turned off, it will be necessary to plug that device into some other circuit to determine if the interference is being generated by a device in the same room as your TV or radio.

d. When the interference disappears with a fuse removed or circuit breaker off, you should go to the room supplied by that circuit and look for any of the devices listed above. If any of the listed devices are found in the room, replace the fuse or turn the circuit breaker back on. Then unplug the device suspected of causing the interference. If several devices are in the room, unplug them, one at a time.

3. If you are unable to locate within your own home the device that is causing the problem, the interference may be coming from a device located in your neighbor's home. With the cooperation of your neighbor, follow the same procedures described above.

4. If your investigation

leads you to suspect that a power line or power company equipment is the source of interference, you should contact the power company to assist you in resolving the problem.

5. Short duration interference, such as that from electric drills and saws, may be very costly to attempt to eliminate; you may just want to "live with it."

6. To *resolve* electrical interference, modifications must be made to the interfering device. This should only be done by a qualified service representative. Information for your service representative is contained in the Technical Information For Service Representatives section.

HOME REMEDIES FOR RESOLVING FM TV INTERFERENCE

The installation of an inexpensive FM band rejection filter is the first step to take in resolving FM interference. In making this installation, follow these procedures:

1. Determine the type of antenna wire you have connected to your TV set. There are two possibilities:

Coaxial cable — a round lead-in wire which requires a filter "impedance" of 75 Ohms (see Fig. 1A).

Twin lead wire — a flat wire which requires a filter "impedance" of 300 Ohms (see Fig. 1B).

2. Purchase the appropriate filter, according to the type of antenna wire you have. The "impedance" information mentioned above will be on the filter label. *Do not* use a combination of twin lead and coaxial cable without proper matching transformers (often called baluns). Filters are available in most stores that sell or repair television sets.

3. Carefully read the instructions that are provided with the filter. You will be installing the filter on the back of your TV set, as near to the antenna terminal as possible. The antenna

terminal and the filter terminal will look like either Fig. 1A or 1B, depending upon the type of wire you are using — coaxial cable or twin lead wire.

4. If you are on a cable system, you may still install the same FM band rejection filter at the antenna terminal. However, if the interference continues, contact the cable company repair service for assistance. *Do not* attempt to modify the cable system yourself.

5. The following information on installing the filter should answer any additional questions you may have.

a. Disconnect the antenna wire (twin lead or coaxial) from the television set antenna terminals.

b. Connect the wire from the antenna to the input terminals of the filter.

c. For twin lead wire, connect a very short (1" to 2") "jumper" wire from the antenna input terminals of the set to the filter (see Fig. 3). For coaxial cable, it will be necessary to obtain a jumper cable that has the proper connectors already installed.

d. Be sure that, in the case of *twin lead wire*, the actual wires are making contact with the terminals. For *coaxial cable*, be sure the connector plugs are properly installed on the coaxial cable.

e. If you have an amplifier in your antenna system, you should have a filter installed before the amplifier and another filter ahead of the TV receiver input terminals (see Fig. 4). If the amplifier is located close to the receiver, then install the filter before the amplifier only.

Note: *Booster* amplifiers usually are located near the back of the TV

set; *mast-mounted* (outdoor) amplifiers are usually located on the antenna; and *distribution* amplifiers are usually located somewhere in the distribution system. If a distribution amplifier is in your antenna system, then be sure to trace the entire length of the antenna system, because amplifiers are usually in out-of-the-way places (for example — clothes closets, basements, etc.).

f. The connecting wires between the filter and amplifier, and between the amplifier and antenna terminal, should be as short as possible.

g. The instructions provided with the filter you bought may call for a ground connection. The wire should be as short as possible and connected between the FM band rejection filter ground terminal and a metallic cold water pipe or a ground rod. Use bell wire for this connection (see Fig. 3). Bell wire can be obtained from most variety stores.

h. If the filter does not entirely eliminate the interference, you should call your service representative. The Technical Information For Service Representatives section is provided to assist the service representative.

HOME REMEDIES FOR RESOLVING AUDIO INTERFERENCE

Interference to audio devices, such as tape recorders, record players, electronic organs, telephones, hi-fi amplifiers, etc., is caused when the equipment responds to the transmission of a nearby radio transmitter.

Audio interference (often called audio rectification) may also affect the sound (audio) portion of your TV

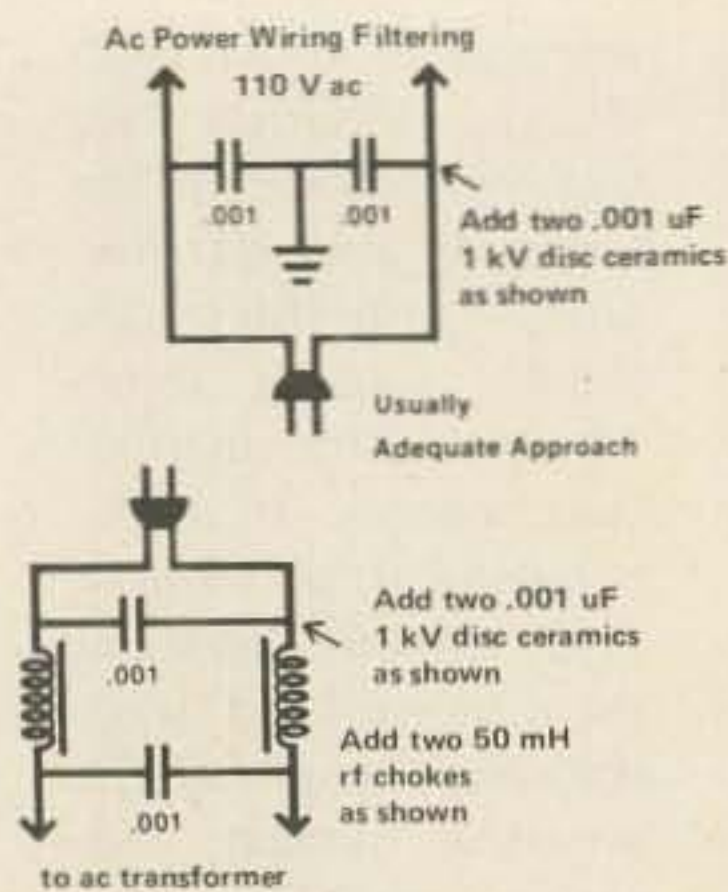

Fig. 5.

and AM/FM radio.

When this type of interference is occurring, you will hear the voice transmissions of the radio transmitter and/or the volume level of the audio device you are using may decrease.

Audio interference is a condition that usually requires internal modification of your equipment. For safety reasons, it is recommended that any modifications be made by a qualified service representative.

Due to the complexity of resolving interference to an electronic organ, again, servicing should be done only by an experienced service representative. More detailed information should be obtained from the equipment manufacturer.

For telephone interference, contact your local telephone company. They can install a 1542A or similar inductor in the telephone instrument to resolve the problem. The information provided in this article applies primarily to privately-owned equipment and should not be applied to equipment owned by the telephone company. Bell System personnel can obtain additional data in Section 500-150-100 of the "Bell System Practices — Plant Series" manual.

For all other audio devices, you may wish to take the following steps before calling your service representative.

1. Replace *unshielded* wire between the amplifier and speakers with *shielded*

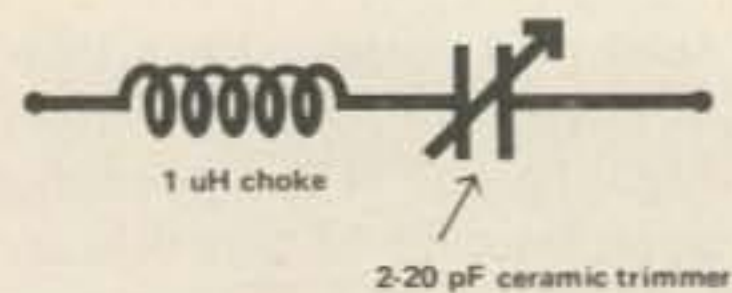

Fig. 6.

wire.

2. Ground the affected equipment to a metallic cold water pipe or ground rod. A ground connection can be made with a short piece of bell wire which can be obtained at most variety stores. Do not ground "ac-dc" type devices. Normally, devices which may safely be grounded will provide a grounding terminal. If no terminal is provided, then you should consult a qualified service representative for advice.

3. If the interference is not eliminated after taking these steps, you must call a qualified service representative. The Technical Information For Service Representatives section is provided to assist your service representative in resolving the problem. You may also wish to discuss the matter with the operator of the radio transmitter, sharing the information in the Radio Operator Guidelines section of this article.

TECHNICAL INFO FOR SERVICE REPRESENTATIVES

Resolving Radio Transmitter Interference

There are no set procedures for eliminating television interference — it is a matter of eliminating the most likely sources of interference a step at a time. You may be required to take several steps before the interference problem is resolved. Once you have installed the filter called for, or made the adjustment that you were instructed to do, leave the modifications in place and proceed to the next step.

To begin, check to see if a high pass filter has been installed on the TV set at the antenna terminals. If the interference is still present after the installation of a high

pass filter, proceed with the following steps:

Check Radio Transmitter

1. Contact the operator of the radio transmitter identified as the source and, with his/her cooperation, determine if the transmitter is operating properly. You may also wish to share the Radio Operator Guidelines section of this article with the operator. Areas of concern should be:

- Is the transmitter properly grounded? (This means a good radio frequency ground. A single piece of wire to a ground rod may be an open circuit to rf.)
- Are harmonics and/or spurious emissions present?
- Is the transmitter cabinet radiating energy?

2. If the transmitter is not grounded, connect the chassis to a good earth ground with large diameter wire or copper strap. This should assist in eliminating radiation of energy from the cabinet.

3. Next, install a low pass filter on the transmitter antenna circuit to see if any difference occurs in the interference pattern. If a change occurs, the interference is probably caused by harmonics and/or spurious emissions from the transmitter. If no change occurs in the interference pattern, it is probably being generated at some point in the TV reception system.

Check TV Reception System

1. Conduct a visual inspection of the TV antenna, lead-in wire, and lightning arrestors. This may reveal a source of trouble. Corroded connections or deteriorated lead-in wire could be at fault and should be repaired.

2. Assuming no faulty conditions are found, or if found, they are corrected, and the interference is still present, look for an amplifier in the line. Amplifiers are highly susceptible to radio frequency (rf) energy.

Note: *Booster* amplifiers usually are located near the back of the TV set; *mast-mounted* (outdoor) amplifiers are usually located on the antenna; and *distribution* amplifiers are usually located somewhere in the distribution system. If a distribution amplifier is in the antenna system, then be sure to trace the entire length of the antenna system, because amplifiers are usually in out-of-the-way places (for example — clothes closets, basements, etc.).

3. If an amplifier is in the system, remove it from the circuit. If you find that this eliminates the interference, reconnect the amplifier, but protect the amplifier by a) grounding, b) enclosing it in a metallic rf-proof housing and grounding the housing, or c) installing a high pass filter at the input to the amplifier. If one filter improves the condition but does not entirely eliminate the interference, install two filters in series.

4. If no amplifier is utilized, or the interference still persists after following one or all of the above steps, check the TV receiver system. *Check TV Receiver System*

1. An ac power line rf filter should be installed to determine if the rf from the transmitter is entering the TV via the power cord. (A line filter may be either purchased or constructed by following the schematic in Fig. 5.)

2. If no change is found with the power line filter installed and the antenna disconnected, then the set itself is responding to the rf energy.

3. The most likely internal circuit in the set to be affected by a radio transmitter is the tuner. Disconnect the antenna input lead inside the set directly at the tuner. If the interference is eliminated, then install a high pass filter at the tuner.

4. If the interference is still present after installing the filter at the tuner, it will be necessary to refer to service data for the set and check each stage of the set

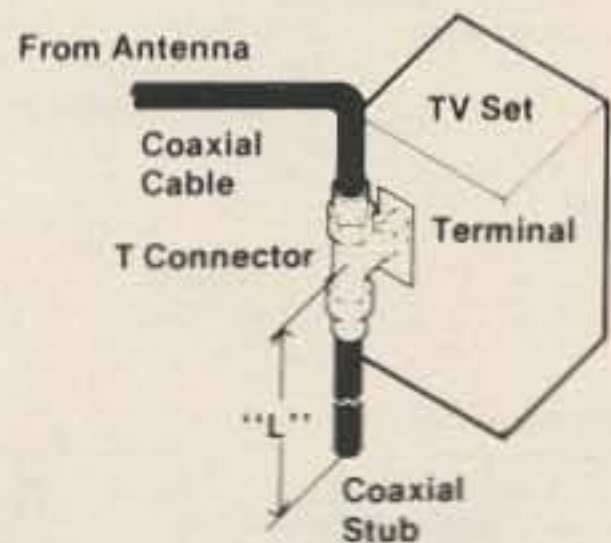
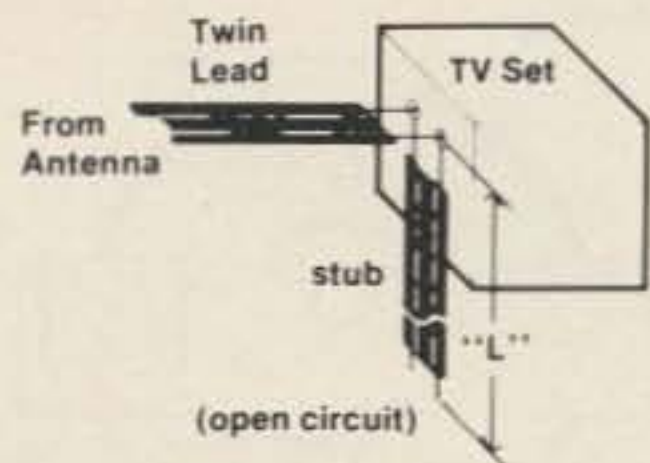

Fig. 7.

for undesired response.

CB Interference To TV Channel 2

1. Second harmonic interference from a CB transmitter to channel 2 television may exist even though the transmitter meets FCC specifications for harmonic radiation. In such cases, a tuned filter across the antenna terminals of the television should help. The filter may be an inductor and capacitor in series as in Fig. 6. The filter should be tuned for minimum interference.

2. A second method is to put an open circuit, quarter-wave, tuned stub across the antenna terminals. The stub should be made of the same type of wire as the antenna input terminals of the television. The initial stub length should be 37" for RG-59/U coax or 48" for 300-Ohm twin lead.

3. After connecting the stub, cut the unterminated end of the stub off in 1/8" to 1/4" sections until the interference is eliminated. Refer to Fig. 7. For harmonics falling on other TV channels, such as channel 5, 6, or 9, the length of the stub may be appropriately shortened according to the following formula.

$$\text{Length in inches} = \frac{2952V}{f}$$

where V = velocity factor of line and f = frequency in

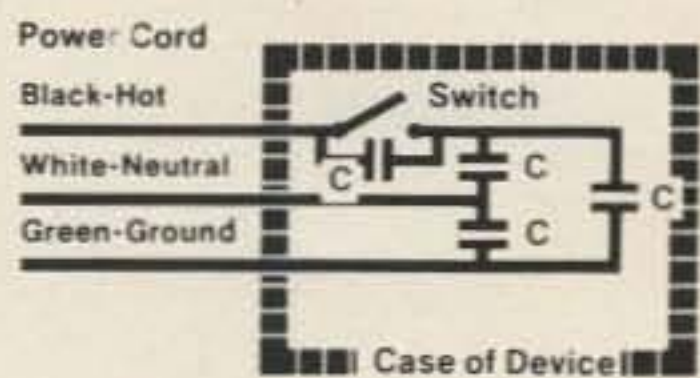

Fig. 8. C = .001 uF, disc ceramic.

megahertz.

Amateur Interference To TV Channel 2

1. One additional type of interference from a nearby transmitter is unique to the amateur 6 meter band — 50-54 MHz. Since 6 meters is immediately adjacent to channel 2 television (54-60 MHz), interference to channel 2 may occur.

2. In most cases, installation of an open circuit, quarter-wave, tuned stub at the antenna terminals of the television set should be effective. It should be connected as shown in Fig. 7.

3. If RG-59/U is used as the TV lead-in wire, the initial length of the stub should be 42". If 300-Ohm twin lead is used, the initial length should be 53".

4. After the stub is attached to the television, begin cutting off the unterminated end of the stub 1/8" to 1/4" at a time until the interference is eliminated. If the interference is reduced, but not eliminated by this method, add a second stub directly to the input terminals of the tuner. The theoretical final length of the stub should be:

$$\text{Length in inches} = \frac{2952V}{f}$$

where V = velocity factor of line and f = frequency in megahertz.

5. If the interference continues, share the information in the Radio Operator Guidelines section with the operator of the radio transmitter.

Resolving Electrical Interference

1. Please read through the procedures outlined in the Home Remedies section before proceeding. If the



Fig. 9.

steps in the previous section have been taken, you should now know the source of the interference.

2. Before proceeding with the following steps to modify the device located as the source of interference, you should check the local electrical codes to determine if the device may be modified, and whether a licensed electrician must modify the device.

Caution: All bypassing of devices with capacitors should be done with extreme care to insure that the capacitors do not short out the ac line. Dangerous voltages exist which can cause electrocution if mishandled. Also, avoid power wiring which can cause the full ac line voltage to appear on the case of the device.

3. Since interference from an electric drill or saw may be of short duration, we suggest no modifications be made to the device (mainly because it may be very difficult and time-consuming to modify the device). If, however, interference is of long duration and you wish to take on this task, proceed as follows:

a. Interference from a drill or saw is actually caused by arcing between the brushes and commutator. The interference then is transmitted through the power cord. Bypassing each side of the line to ground with a capacitor, and each side to the other, may be helpful. Also, bypass the switch. Fig. 8 shows the schematic involved. The bypassing should be internal to the device in question.

4. Electric blankets, fish tank heaters, and other thermostatically-controlled appliances with worn and

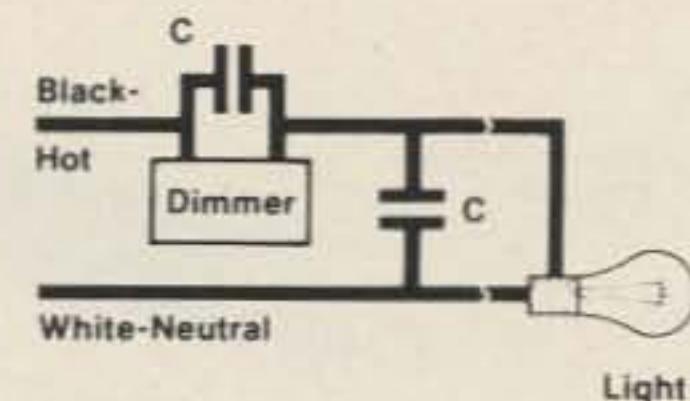

Fig. 10. C = .001 uF, disc ceramic.

pitted contacts cause interference because of contact arcing of the breaker points. This can be eliminated by bypassing the contacts with a .001 uF capacitor or replacing the worn or pitted contacts. (See Fig. 9.)

5. Defective devices such as doorbell transformers should be replaced.

6. Dimmer switches that utilize an scr or triac can produce tremendous interference which is very difficult to eliminate. This is due to the approximate square wave output that is produced by the switching at the scr or triac. However, bypassing in a manner shown in Fig. 10 may be helpful.

7. Since resolving electrical interference has to proceed on a case-by-case basis, you should always consider adequately bypassing any component of the circuit that arcs or distorts the ac sine wave with ceramic condensers.

Resolving FM Interference

There are no set procedures for eliminating FM interference — it is a matter of eliminating the most likely sources of interference a step at a time. You may be required to take several steps before the interference problem is resolved. Once you have installed the filter called for, or made the adjustment that you were instructed to do, leave the modifications in place and proceed to the next step.

1. To begin, check to see if an FM band rejection filter has been installed on the TV set at the antenna terminals. If not, read the Home Remedies section of this article.

2. If the installation of an

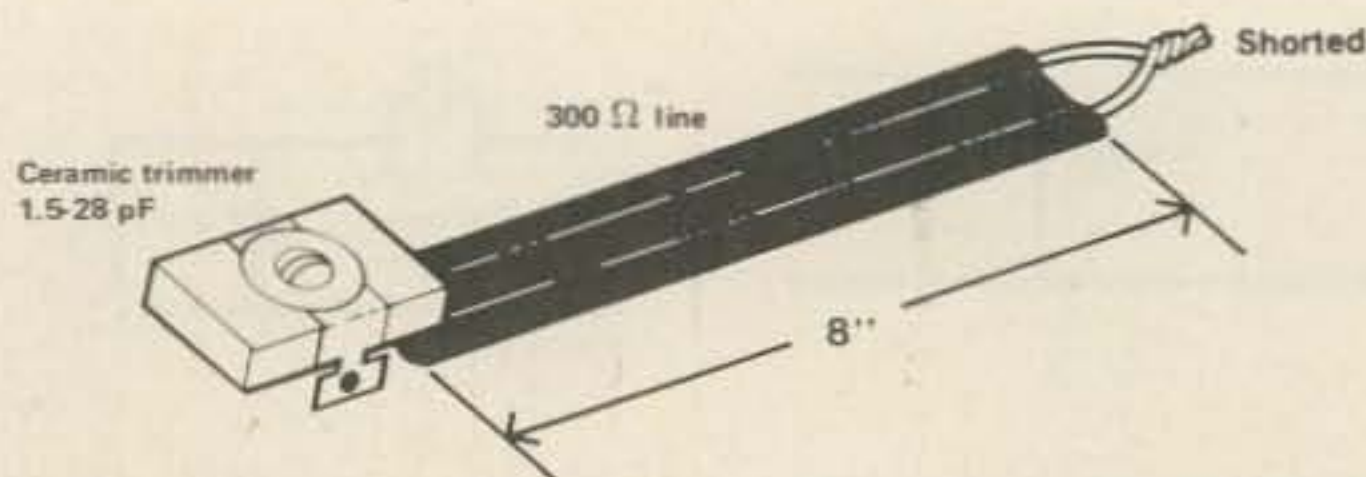

Fig. 11.

FM band rejection filter is not effective, then a tuned stub trap should be constructed (see example in Fig. 11). The trap should be placed on and parallel to the lead-in and tuned for minimum interference. Then slide the trap along the line to further reduce interference. Finally, tape the trap to the lead-in in the most effective position.

3. Another type of stub, called an open circuit quarter-wave type, can be made from the same type of wire as the antenna lead-in wire (see Fig. 12). The initial length of the stub should be 24" for RG-59/U coaxial cable or 29" for 300-Ohm twin lead wire. For other cables, the initial length can be determined by the general formula:

$$\text{Length in inches} = (35) (\text{Velocity factor of line})$$

Note: If "F"-type tee connectors are not available, you may use BNC-type connectors.

4. If connecting the stub to the antenna terminals is not completely effective, connect a second stub of the same length directly to the input terminals of the tuner, inside the television set. This should eliminate the interference.

Resolving Audio Interference

1. Audio interference is defined as reception of radio frequency (rf) energy by an audio amplifier. The rf energy is then rectified, or, more properly, "detected," by an electron tube, transistor, diode, poor solder joint or ground, or integrated circuit. The detected signal is then treated identically as a normal audio signal appearing at the amplifier input terminals. The effects of

audio interference vary with the type of modulation employed by the transmitter. The following list shows expected effects:

AM — The voice or music will be heard as any normal audio signal applied to the amplifier. The voice or music may be extremely loud and slightly distorted.

SSB (Single Sideband) — The voice will sound practically unintelligible and garbled.

FM — Usually no sound will be heard; however, a decrease in the volume of the amplifier will be noted when the radio transmitter is on. Clicks may be heard when a two-way radio transmitter is keyed and unkeyed. A "frying" noise (such as bacon sizzling) may also be heard.

TV — Audio rectification of a TV signal will sound like a buzz. The buzz will change its sound as the television picture changes.

2. In attempting to isolate where in the audio chain the rectification is taking place, check to determine if the volume control has any effect on the interference. If the volume of the interfering signal changes with a change in the volume control, then the rectification is occurring *before* the volume control. If the volume control has minimal or no effect, the rectification is occurring *after* the volume control. You should next proceed to the appropriate set of solutions. If the solutions described below do not resolve the audio interference problem, contact the manufacturer of the audio device for further assistance.

Rectification Before the Volume Control

1. A multiple input audio

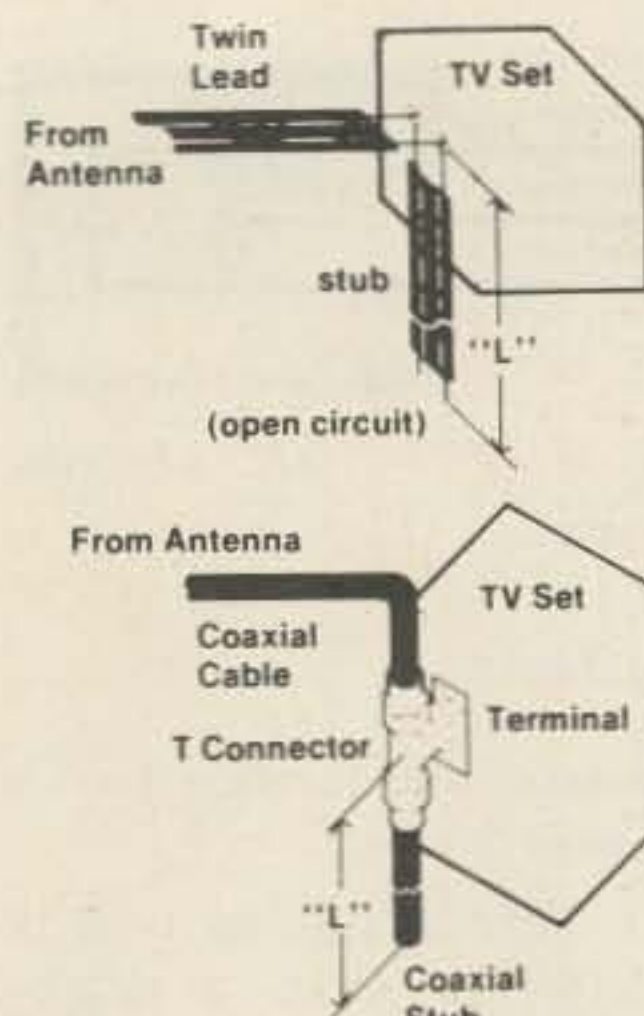

Fig. 12.

amplifier may be susceptible to audio interference on only one or some of the available inputs. Generally, low-level, high-impedance inputs, such as those in turntables, cartridges, tape heads, or microphones, are the most susceptible. If, for example, the only input affected is from a turntable, then disconnect the turntable cartridge from the amplifier at the input terminals of the amplifier.

2. If the interference is eliminated, then the cartridge, or wire between the cartridge and amplifier, is sensing the rf. Proper grounding, connections, shielding, and rf bypassing are the keys to solving audio rectification. Often, a "process of elimination" approach must be used.

Grounding

1. All grounding should be to a good earth ground such as a metallic cold water pipe or 8' ground rod. Ground leads should be as short as possible. Remember, a dc ground may appear as an open circuit to rf energy. Ground leads should be of as large a diameter wire as practicable. Finally, grounding of the chassis, shields of speaker leads, and other external connections should be made to a common point to avoid ground loops. (Ground loops are circuits that form a dc ground, but contain rf-circulating currents.) Fig. 13 shows the correct and incorrect methods of grounding components.

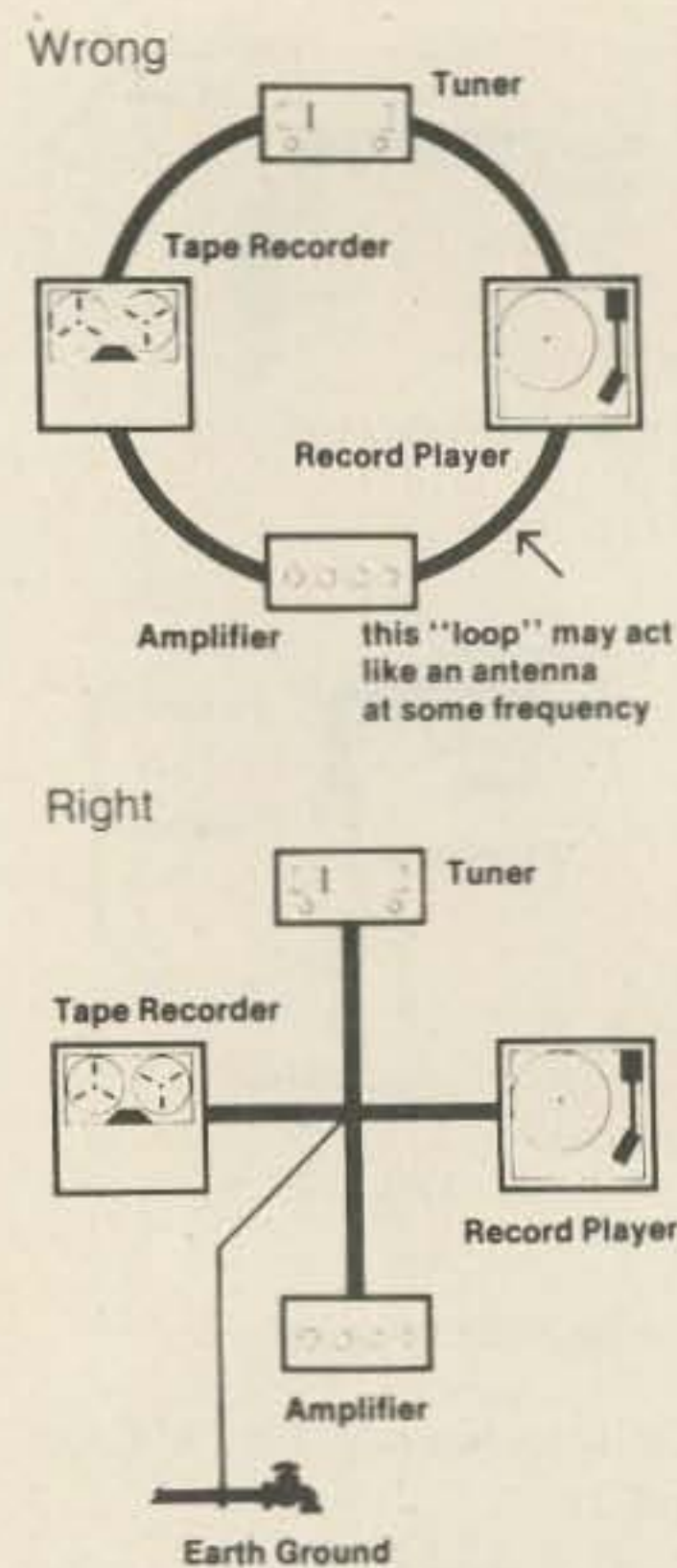

Fig. 13.

Caution: Some equipment chassis are at line voltage potential and cannot be connected directly to ground. In these circumstances, a ceramic capacitor of 0.001 uF at 1 kV should be placed in the ground lead. This capacitor appears as a short to rf, but as an open circuit to ac.

Shielding

1. All speaker leads from audio equipment should be made of two conductor shielded wires. The shield should be grounded only at the amplifier end, and should not be used as an audio conductor. The two internal wires should be connected to the speaker.

Power Line Filter

1. Rf may be entering the audio device through the ac power line. Several power line filters are commercially available. If necessary, a power line filter like the one shown in Fig. 5 may be constructed, placing the filter as close as possible to the point where the ac cord enters the amplifier.

Poor Electrical Connections

1. Occasionally, poor solder connections or old electrolytic capacitors may be the cause of the audio rectifi-

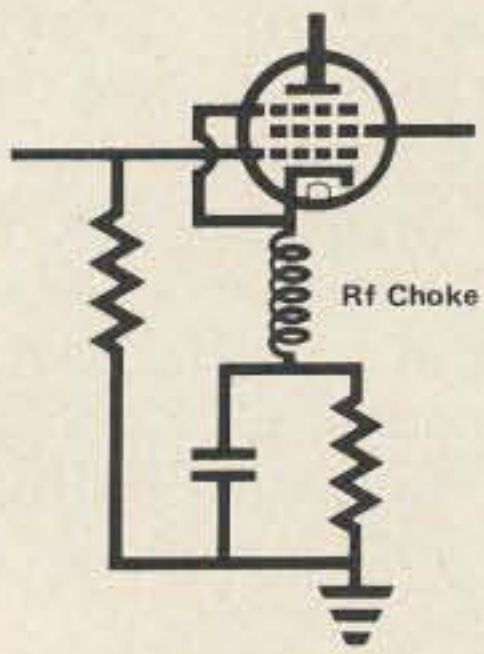

Fig. 14.

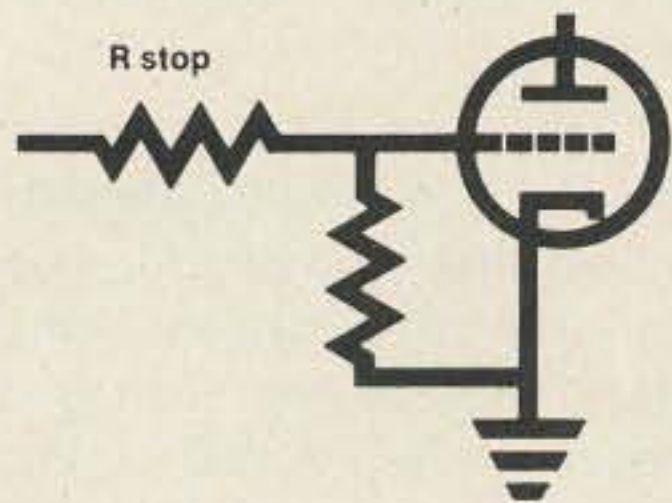

Fig. 15.

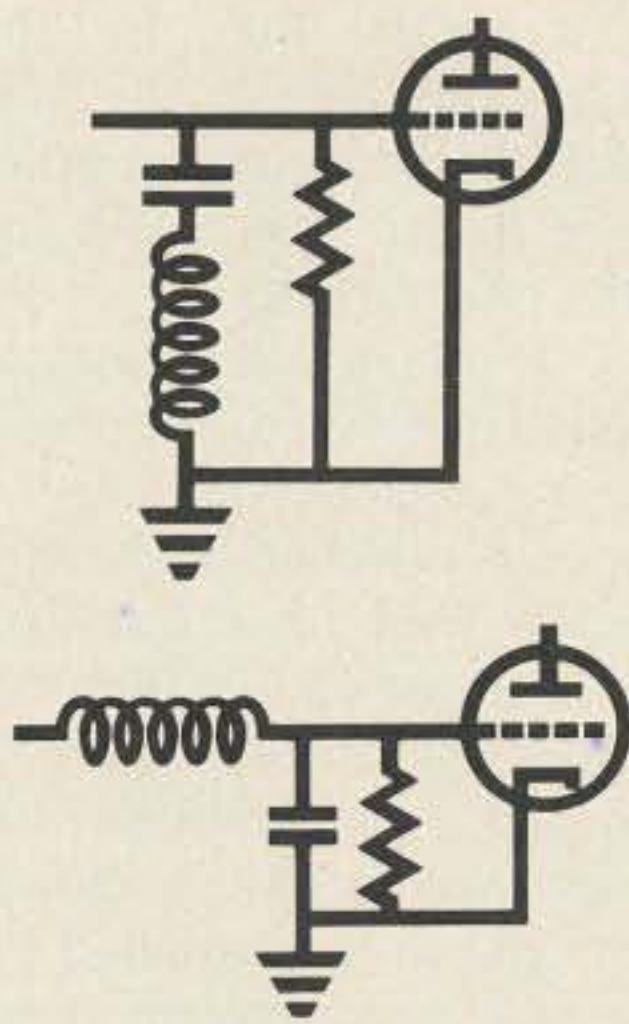

Fig. 16. A combination RC filter is shown in Fig. 17 with the recommended values.

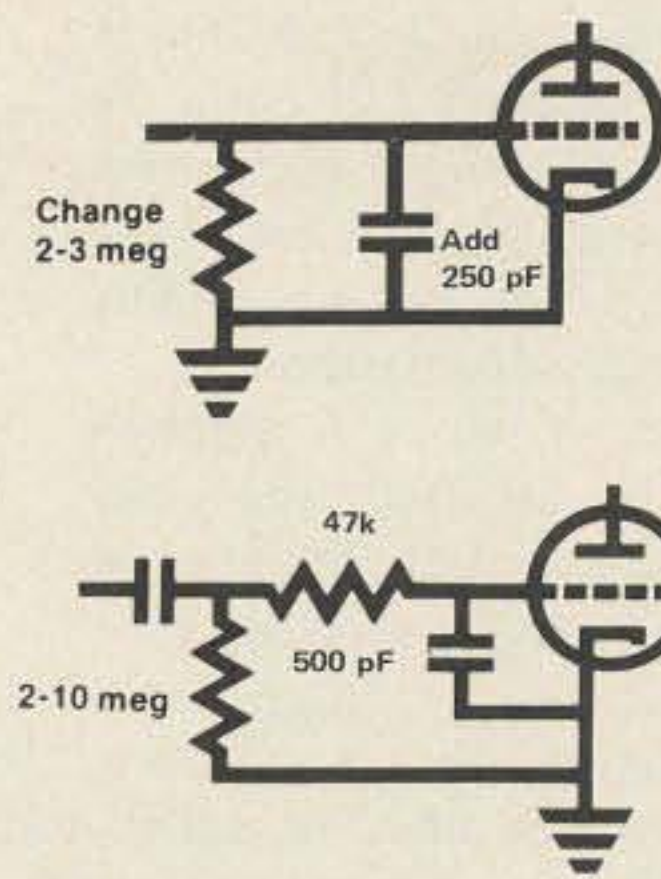

Fig. 17.

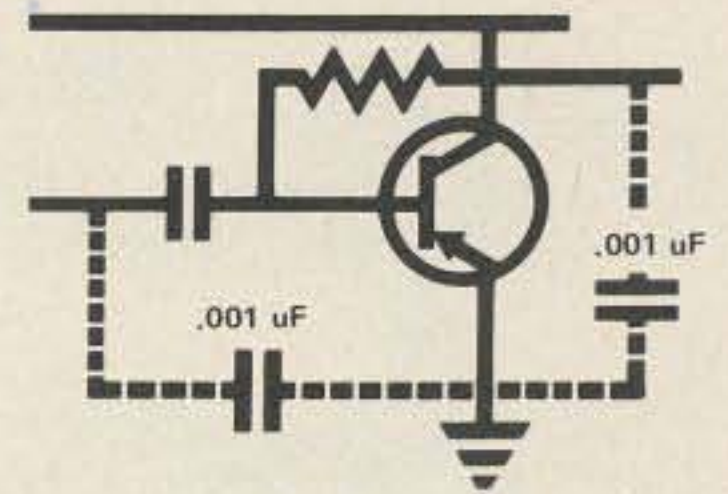

Fig. 18.

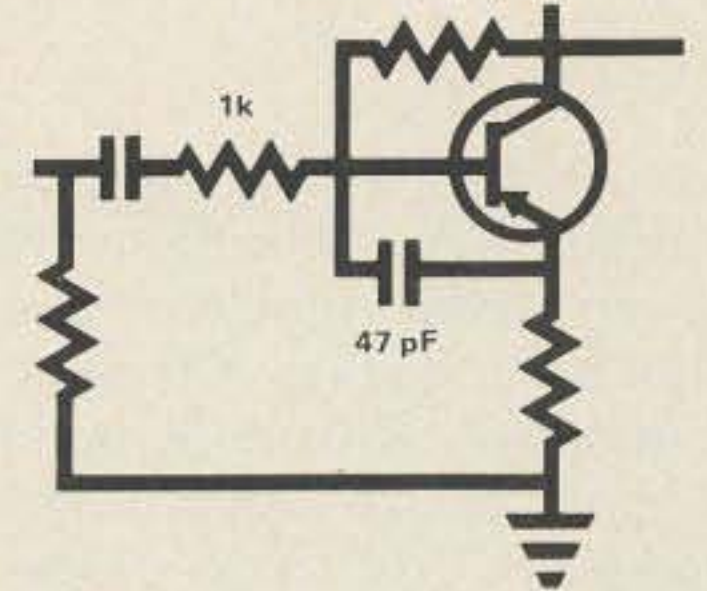
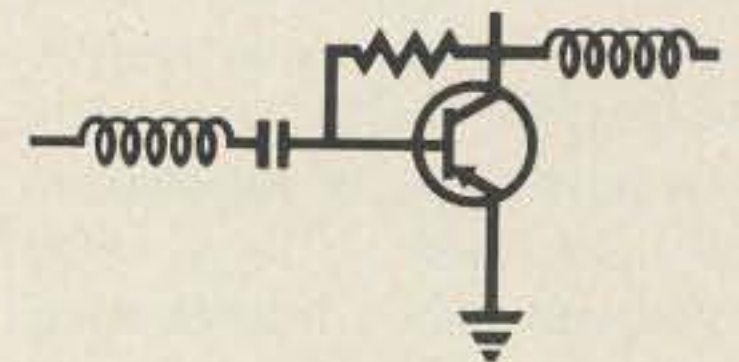

Fig. 19.



1.5 mH - up to 20 MHz
500 uH - 20 to 50 MHz
100 uH - 50 to 500 MHz

Fig. 20.

cation problem. If tests to this point have failed, try resoldering all connections in the amplifier and replacing electrolytic capacitors. Before actually replacing the electrolytic capacitor, try paralleling the capacitor with another one of like value. This should reveal the presence of a bad capacitor.

Rectification After the Volume Control

1. When the volume control is in its minimum position and the interference is still heard, then an rf filter is required in the audio amplifier. It is extremely important that the filter does not affect the audio response of the amplifier.

Tube-Type Equipment

1. Interference in tube-type equipment can be avoided by connecting an rf choke (ranging in value from 2 millihenrys to 5 millihenrys) in the upper end of the cathode circuit, as shown in Fig. 14.

2. The choke coil must not be bypassed by a capacitor because the dc resistance of such coil is generally quite low and the bias voltage is not greatly affected. However, if the dc resistance does affect the bias voltage, the value of the bias resistor may be decreased to compensate for the dc resistance of the

choke.

3. A grid-stopping or "swamping" resistor can also be employed. A resistor, ranging in value from 1k to 75k Ohms, can be connected in series with the grid as shown in Fig. 15.

4. Capacitors, rf chokes, and resistors can be used in combinations to make filters to eliminate the interference. For circuits such as those shown in Fig. 16, use a choke of 2 to 6 microhenrys and a capacitor of about 10 picofarads. A combination rf filter is shown in Fig. 17 with the recommended values.

Transistor Equipment

1. Interference in transistor equipment can usually be eliminated with the use of a shunt capacitor as shown in Fig. 18. A resistor/capacitor combination can be used as shown in Fig. 19. It is important that the filter network does not affect the biasing of the transistor or the frequency response of the amplifier.

2. The values of the capacitors used are not critical, but there are some pitfalls to look out for in using capacitors. For example, ceramic caps are best, whereas paper caps do not work at radio frequencies.

3. Leads should be kept as short as possible. Grounds should be made directly to the emitter and not to the chassis or other grounds,

since they may have more rf than the signal lead. If the signal increases, then a ground loop has been created, and the inductor method should be tried.

4. In areas of high rf energy, the inductor approach is more effective than the shunt capacitor. An rf choke can be used in series with the input and output leads of the amplifier stage, since the rf can enter a stage through either. This method and the values are shown in Fig. 20.

Electronic Organs

1. Organ circuits can be isolated by the use of the Swell Pedal, band box volume, or tabs (draw bars). By adjusting each one of these different controls, the effect on the interference can be noted. If the volume of the interference changes, the rf is being detected by the amplifier at a point before that particular control. If the volume of the interference does not change, then the interference is being detected after that control.

2. Using this method, the point at which the rf is entering the organ can be determined, and the appropriate filter, as described above, can be inserted into the circuit.

Telephones

1. Telephone rf interference can be eliminated by the use of a 1542A or similar inductor. This inductor must be installed inside the phone and not at the baseboard. To install the inductor inside the

phone, the corners of the plastic container will have to be removed. If the phone is too small for the inductor (e.g., the "Princess" telephone), then a pair of 2.5 mH chokes (75 mA or higher) must be installed inside the phone, one on each side of the line and as close to the 211A equalizing network as possible.

Note: The information provided here applies primarily to privately-owned equipment and should not be applied to equipment owned by the telephone company. Telephone company-owned equipment should be modified only by telephone company personnel. Bell System personnel can obtain additional data in Section 500-150-100 of the "Bell System Practices - Plant Series" manual.

RADIO TRANSMITTER OPERATOR GUIDELINES Resolution Of Interference For Radio Transmitter Operators

Although some inter-

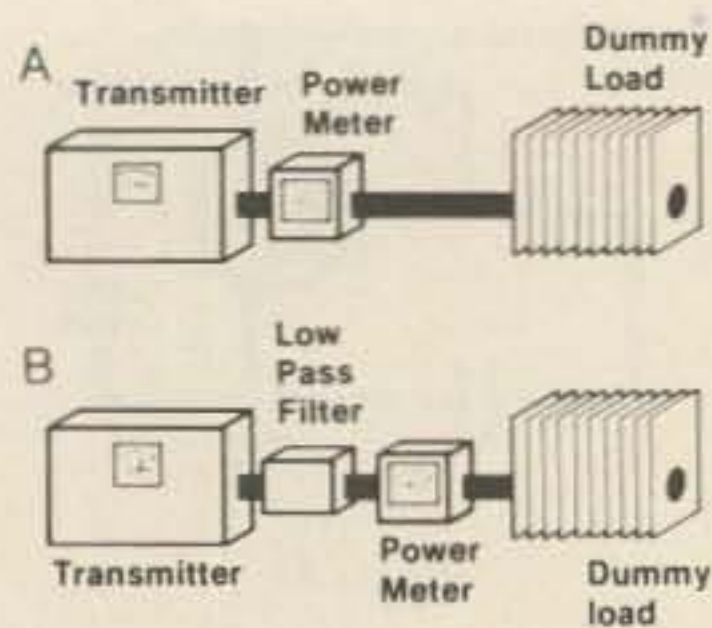

Fig. 21.

ference problems can be attributed to television receivers, such problems can also be traced to CB radio transmitters. Therefore, upon receipt of an interference complaint from your neighbor(s), you should take all steps possible to insure that your radio transmitter is not causing the interference. Voluntary installation of a low pass filter, or other steps as outlined below, may eliminate the interference, and may prevent you from receiving an order from the Commission to implement these measures. You are not, however, required to service or add filtering to the complainant's television, and should not take any such action without the full cooperation of your neighbors.

You are cautioned that the use of an amateur transceiver on the Citizens Band is illegal. Further, the use of external rf power amplifiers with CB transceivers is illegal. Both actions may subject you to Commission actions or criminal penalties.

Generally, transmitter equipment that is commercially manufactured and type-accepted by the Commission has precautions built into the set to reduce harmonic radiation. Harmonics are radiations that are multiples of the operating frequency. However, you should follow the steps outlined below to insure that your radio equipment is operating properly.

1. If television interference is occurring, note which channels are affected.

- a. Lower harmonics of CB generally affect TV

channels 2, 5, 6, and 9. Therefore, if one or more of these channels is affected, your transmitter is probably radiating harmonics.

- b. If all TV channels are affected, the problem is more likely to be in the TV receiver.

2. If the interference is caused by harmonics, a spectrum analyzer, calibrated field intensity meter, or frequency selective voltmeter can be used to accurately measure harmonic and spurious radiations from your transmitter. If any lead-in devices, such as standing wave ratio (swr) meters are used, measurements should be made with the inline device both installed and removed. This may help identify the interference and lead you to the source. These are complex measurements and should normally be made only by experienced technicians.

3. If it appears that your transmitter is at fault, you should first make sure the chassis of the set is secured to the metal case of the radio by tightening the screws holding the chassis and case together. Then assure that the case of the transmitter is grounded to a good earth ground (metallic cold water pipe or 8 foot ground rod). Solid conductor wire (of at least #10 gauge) or copper ribbon should be used as a ground lead. The lead should be as short as possible.

4. By installing one or more low pass filters in the transmitter antenna lead, you will reduce the chances of unnecessary harmonic radiation. A low pass filter allows frequencies up to 30 or 50 megahertz (MHz), depending on brand, to pass through unattenuated to the antenna while effectively shorting out harmonic radiation. To make this test, connect the equipment as in Fig. 21 and take a power reading. If only an swr bridge is available, calibrate it in the forward direction to

the calibrate line in the meter. Then insert the low pass filter and make another power measurement. *Do not* retune the transmitter.

5. If you notice a decrease in output power on a power meter, operating to a properly matched load with the low pass filter installed, this is an indication that harmonic content may be present. Even though the meter reading may be lower with the filter installed, it does not mean that the transmitter absolutely has harmonic radiation. Slight detuning of the transmitter by the filter may cause a lower indication.

6. At amateur power levels, corroded metal connections in the area of the transmitting antenna may act like diodes and generate harmonics which may radiate. This type of problem can be found by vibrating suspected offenders such as galvanized downspouts, metal fences, clotheslines, etc., while viewing the affected television set. Sudden changes in the interference pattern which correspond to the vibration should be noted. This test requires an observer at the TV receiver, someone to "shake" suspicious metal objects in the area, and another person to key (but *not* modulate) the transmitter involved.

7. Finally, some transmitters may actually be radiating harmonic and spurious energy from their cabinet or through the power lines. Try operating the transmitter into a shielded dummy load. If the interference is still present, then cabinet or power line radiation is indicated. A power line filter should be installed. Several types are commercially available. For low power transmitters, the filter in Fig. 5 may be used.

8. Continued interference with the power line filter installed points toward cabinet radiation. An earth ground should eliminate cabinet radiation.

9. Local television inter-

ference (TVI) committees dedicated to resolving CB-TV problems now are being established. For assistance in locating a TVI committee in your area, contact: International CB Radio Operators Association (CBA), PO Box 1020, Roanoke VA 24005.

Resolution Of Interference For Amateur Transmitter Operators

1. If you have a linear amplifier on your amateur transmitting equipment, use two low pass filters. One filter should be installed between the actual transmitter (exciter) and the input to the linear amplifier. (This prevents harmonics generated in the exciter from reaching the linear amplifier.) The second filter should be installed at the output of the linear amplifier to reduce harmonic and spurious content.

2. One unique interference problem to TV channel 2 is from an amateur transmitter operating on the 6 meter band. This is due to the close proximity of the frequencies involved. You may wish to follow the procedures outlined in the Technical Information For Service Representatives section to eliminate this type of interference. You are not, however, required to service or add filtering to the complainant's television, and should not take any such action without the full cooperation of your neighbor.

3. Local television interference (TVI) committees are available to assist you in resolving interference problems. Contact the nearest FCC district office (see addresses in Appendix B) or the American Radio Relay League, Newington, Connecticut, for assistance in locating a TVI committee in your area.

Radio Transmitter Operator Guidelines For Resolving Audio Interference

Although audio inter-

ference (often called audio rectification) is usually resolved by modification of the affected device, you as a radio operator can take certain steps to reduce the possibility of audio rectification by eliminating circulating radio frequency (rf) currents in grounds and metal objects in the area.

1. Your radio transmitting equipment should be effectively grounded to a metallic cold water pipe or a ground rod driven into the ground at least 8 feet. The ground lead must be at least #10 wire or copper ribbon. The greater the surface area of the ground lead, the more effective it will be. Also, the ground lead should be as short as possible.

2. You are reminded that you are licensed to use only the amount of power necessary to establish communications. Operating with excessive power is likely to cause audio interference problems.

3. If you need assistance in performing the above modifications to your equipment, you can contact the dealer or manufacturer representatives. Also, an FCC-licensed service representative may be able to assist you. ■

References

1. *The Audio Cyclopaedia*, Howard M. Tremline, Howard W. Sams and Co., Inc.
2. *Radio Handbook*, William I. Orr, Editors and Engineers, Ltd.
3. *The Radio Amateur's Handbook*, American Radio Relay League.
4. *Thomas Tech-Flash*, Thomas Organ Co., Sepulveda, California.
5. "Filtering RF Interference in Audio Equipment," R. S. MacCollister, *Journal of the Audio Engineering Society*, April, 1968, pages 210, 212, 214.
6. "Stopping Telephone Interference," Irvin M. Hoff, *QST*, March, 1968, pages 46-47.

APPENDIX A

Sources For Assistance In Resolving Television Interference

If you have followed the instructions outlined in this article and the problem still exists, you may want to contact one of the sources listed below for assistance and further information.

When contacting these people,

please forward with your request the information requested in Appendix C.

In most cases, the addresses listed for associations and manufacturers are for national headquarters. Once your inquiry is received, it will be sent to the local representative for response.

The assistance of FCC district office staff is also available to you. If you have taken all the steps suggested in this article and the problem still exists, there may be something unique to your interference problem. By furnishing the information requested in Appendix C to your nearest FCC district office, an FCC staff member may be able to determine what additional steps are needed to resolve your interference problem.

Associations

**Director of Consumer Affairs
Electronic Industries Association (EIA)**
2001 Eye Street, NW
Washington, D.C. 20006
Telephone: 202 457-4900

Manufacturer Service Representatives

(The information contained in this listing has been supplied by the American Radio Relay League (ARRL), Newington, Connecticut.)

Institutional Listing

Admiral

Admiral Group
Rockwell International Corp.
1701 East Woodfield Road
Schaumburg, IL 60172

Primary Products Distributed and Remarks:

RFI complaints are usually handled by the local Admiral dealer service technician. National Service personnel are available to assist the technician when needed. Admiral maintains its own staff of technical representatives who travel in the field and may be called upon to assist the dealer technician with difficult problems including RFI. Admiral provides technicians with various instruction bulletins dealing with RF interference suppression. RFI complaints should be referred to the local Admiral dealer. If front end overload or cross modulation occurs in areas of extremely high level of transmitter radiation, the National Services Division has suitable traps available at no charge to the customer.

National Service Division
Box 2845
Bloomington, IL 60701

Akal

Akal America, Ltd.
2139 E. Del Amo Blvd.
Compton, CA 90220

Primary Products Distributed and Remarks:

Akal products include audio tape recorders, video tape recorder, AM/FM receivers, speaker systems and related accessory products. Inquiries related to RFI should be addressed to:

Akal America, Ltd.
Customer Service Dept.
2139 E. Del Amo Blvd.
Compton, CA 90229

Upon receipt of these inquiries, we will investigate the situation, and to our utmost try to resolve the customer's problems.

Allen Organ Company

Macungie, PA 16162

Primary Products Distributed and Remarks:

Electronic Organs. When a complaint is received via the dealer, Allen Organ Co. sends the dealer an informational service bulletin on RFI and sufficient components to cover all amplifiers in the affected instrument. This service is offered at no cost to the customer. Refer RFI problems to the local Allen dealer.

Altec Lansing

Sound Products Division
1515 S. Manchester Avenue
Anaheim, CA 92803

Primary Products Distributed and Remarks

Customer RFI problems are referred to the local authorized Altec Warranty stations located nationwide and denoted by an information card furnished with each piece of equipment. Unusual situations are, at the option of the warranty station, referred to:

Altec Customer Service
1515 W. Katella Avenue
Anaheim, CA 92803

Or:

Engineering Department
1515 S. Manchester Avenue
Anaheim, CA 92803
Attention: Chief Engineer, Electronics

Arvin Industries, Inc.

15th Street
Columbus, Indiana 47201

Primary Products Distributed and Remarks

Radios—8 Track Players
Customer problems involving RFI should be referred to the Manager of Field Service.

Audio Research Corporation

2843 Twenty-Sixth Avenue, S.
Minneapolis, Minnesota 55406

Primary Products Distributed and Remarks

Amplifiers—Pre-Amplifiers + Accessories

In the event of an RFI problem, customer may write to:

Chief Engineer
Audio Research Corp.
Box 6003
Minneapolis, MN 55406

Baldwin Piano & Organ Company

1801 Gilbert Avenue
Cincinnati, Ohio 45202

Primary Products Distributed and Remarks

Electronic Organs

RFI complaints are usually handled by the local Baldwin service technician. Factory personnel are available to assist the technician when needed. Baldwin maintains its own staff of technical representatives who travel in the field and may be called upon to assist the dealer technician with difficult problems, including RFI. Baldwin provides technicians with a detailed instruction bulletin entitled "Hints on Suppressing RF Interference".

RFI complaints should be referred to the local Baldwin dealer.

Benjamin Electronic Sound Company

790 Park Avenue
Huntington, NY 11743

Primary Products Distributed and Remarks

Manufacturers and distributors of ELAC Miracord record changers, Concord AM/FM receivers and CEC manual turntables.

RFI problems should be directed to the Service Manager in Huntington. Price of required modifications will depend upon equipment warranty status.

Capehart Corporation

5th Street
Norwich, Connecticut 06360

Primary Products Distributed and Remarks

Stereo Console Phonographs and Radios

Capehart Corp. asks that if an RFI problem develops in their product, the customer refer the matter to the attention of the General Manager.

Conn Organ Corporation

1101 East Beardsley Ave.
Elkhart, Indiana 46514

Primary Products Distributed and Remarks

Electronic Organs

RFI complaints should be referred to the local Conn dealer, whether equipment is in or out of warranty. Factory assistance is available to the dealer if he is unable to correct the problem.

RFI problems encountered within term of instrument warranty are usually corrected by the selling dealer without cost to the organ owner.

Curtis Mathes Manufacturing Co.

P. O. Box 151
Athens, Texas 75751

Primary Products Distributed and Remarks

Color TV; Stereo (100% solid state) in portable, consol. and combination configurations.

Customer complaints involving RFI should first be resolved at the retail dealer level. If not satisfied, then complaint should be made in writing to the Consumer Relations Department, giving all details of problem, along with model, serial number, date of sale, dealer, and service history. Each complaint will be handled individually.

Dumont

(See Capehart Corporation)

Dynaco-Dynakit Division of Tyco Laboratories

Coles Road
P. O. Box 88
Blackwood, New Jersey 08012

Primary Products Distributed and Remarks

Amplifiers, Pre-Amplifiers, Tuners, Integrated Amplifiers, and Kits.

Inquiries related to RFI involving Dynaco products should be addressed to the Customer Service Department.

Dynaco has available for owners of Dynakits an excellent information sheet on solving RFI problems.

Elpa Marketing Industries, Inc.

Thorens Building
New Hyde Park, N.Y. 11040

Primary Products Distributed and Remarks

Thorens turntables, Reel-to-Reel tape recorders.

Complaints are handled with respect to parts and labor on an individual basis. Necessary modifications for RFI are made on a no-charge basis, parts and labor, during the term of instrument warranty. Beyond warranty, modification parts are available free of charge. Customer then pays for labor involved in the installation of the parts.

Emerson Quiet Kool Company

16th & Coles Streets
Jersey City, New Jersey 07302

Primary Products Distributed and Remarks

Televisions, Radios and Recorders.

Customer should refer RFI problems or inquiries related to Emerson or Dumont products to the National Service Manager for special handling.

Fisher Corporation

21314 Lassen Street
Chatsworth, CA 91311

Primary Products Distributed and Remarks

Fisher Corp. asks that RFI problems involving Fisher products be handled by reference to one of the following:

1. Request assistance from the local selling dealer;
2. Request assistance from the local Fisher Authorized Service Station (a list is packed with every Fisher unit);
3. Contact Fisher Service Coordination Group.

Fisher's Service Coordination Group maintains close communications with Fisher Authorized Service Stations and engineering departments, and works under the supervision of the National Service Manager.

Garrard Plessey Consumer Products

100 Commercial Street
Plainview, L.I., New York 11803

Primary Products Distributed and Remarks

Garrard Single Play and Multiple Play Automatic Turntables.

Garrard advises the consumer on methods which may eliminate RFI. In unique cases where the suggestions are ineffective, customer should refer the RFI problem to the Assistant Service Manager. Any RFI problems which are referred to Garrard are always handled on a no-charge basis.

General Electric Company

Television Business Department
College Blvd.
Portsmouth, VA 23705

Primary Products Distributed and Remarks

GE Television Receivers.

RFI problems should be referred to the nearest GE Customer Care Service Operation. If GE Customer Care Service is unable to correct the RFI, the customer should refer the problem to the Television Business Dept., Attention: Manager, Product Service.

GE Radios, Record Players and other Audio Products.

All RFI problems involving audio products should be referred to:

Manager, Customer Services,
Audio Electronics Department
Electronics Park
Syracuse, New York 13201

Gulbransen

A Division of CBS, Inc.
8501 West Higgins Road
Chicago, Illinois 60631

Primary Products Distributed and Remarks

Electronic Organs.

Gulbransen cooperates with dealers and customers in offering suggested RFI solutions. Gulbransen does not reimburse the consumer for servicing. However, when extreme cases are encountered due to proximity of the transmitter and relative power, the dealer may sometimes absorb the cost of servicing RFI problems.

Customers should refer RFI problems to the local dealer. Inquiries may be directed to the Customer Service Supervisor.

Hammond Organ Company

11700 Copenhagen Court
Franklin Park, Illinois 60131

Primary Products Distributed and Remarks

Organs.

Hammond maintains a staff of Technical Service Representatives who become directly involved in RFI cases that the dealer's service personnel are unable to solve. Hammond states that the services of engineering and technical field service departments under its control are provided to consumer and dealer alike without charge, whether or not a product is within warranty.

RFI problems should be referred to the local Hammond dealer.

The Hammond Technical Service Department asks that it be informed of any unique interference problem involving the Hammond instrument.

Harman-Kardon, Inc.

Subsidiary of Jervis Corp.
55 Ames Court
Plainville, New York 11803

Primary Products Distributed and Remarks

Receivers, Amplifiers, Turntables, AM/FM Tuners, Preamps, Record Players, Tape Recorders.

Customers should refer RFI problems to the Manager of Customer Service.

Customer RFI problems are handled on an individual basis. If local, the customer is invited to bring the affected set into the plant. Non-local customers are referred to the nearest warranty station. Corrective action is provided at no cost to the customer.

Heath Schlumberger Company

Benton Harbor, MI 49022

Primary Products Distributed and Remarks

AM/FM Radio, Television, Audio Systems (Kits), Transmitter Kits.

Heath Company suggests that for fastest service on matters related to RFI, regardless of the product involved customers may now reach the Technical Consultation Department by either writing directly to that department or by using a new direct line telephone system to the department (616) 982-3302. DO NOT write to an individual.

Hitachi Sales Corporation of America
401 W. Artesia Boulevard
Compton, California 90220

Primary Products
Distributed and Remarks

Televisions, Radios, Tape Products.
Customers with RFI problems should contact the service manager of the nearest regional office.

Western Regional Office
401 W. Artesia Blvd.
Compton, CA 90220
Mid-Eastern Regional Office
1400 Morse Avenue
Eik Grove Village, IL 60007
Mid-Western Regional Office
World Trade Center, 183
2050 Stemmons Freeway
Dallas, Texas 75207

J.C. Penny Company, Inc.
1301 Avenue of the Americas
New York, New York 10019

Primary Products
Distributed and Remarks

J.C. Penny Company asks that customers with RFI problems contact their nearest J.C. Penny store for personal assistance.

JVC America, Inc.
50-35 56th Road
Maspeth, New York 11378

Primary Products
Distributed and Remarks

Amplifiers, Tuners, Receivers, Televisions.

Inquiries related to RFI involving JVC products may be referred to the office of the Chief Engineer.

Kenwood Electronics, Inc.
15777 South Broadway
Gardena, California 90248

Primary Products
Distributed and Remarks

Receivers, Tuners, Amplifiers, Turntables.

Kenwood asks that customers with RFI problems take the affected unit to an authorized service center where adjustments will be made at no cost to the customer if the product is properly registered with Kenwood and within warranty. It is suggested that prior authorization for the return be obtained from Kenwood.

KLH Research and Development Corporation
30 Cross Street
Cambridge, Mass. 02139

Primary Products
Distributed and Remarks

Radio Receivers, Turntables, Music Systems.

KLH initially provides the customer with a listing of suggested steps for isolating and correcting RFI. If self-help does not resolve the problem, the customer may write to the Manager, Customer Service for authorization to return the affected unit to the factory. Return can then be made through contact with the nearest KLH factory authorized service station.

KLH absorbs the cost of service for units returned to the factory for any RFI problem. Customer bears the responsibility for shipping the unit to and from the repairing service station.

Lafayette Radio Electronics Corporation
111 Jericho Turnpike
Syosset, L.I., New York 11791

Primary Products
Distributed and Remarks

AM/FM radio, Home Entertainment Audio Products. Customers should refer RFI problems involving Lafayette products to the local dealer. If the dealer cannot alleviate the problem, the customer may contact the Vice President, Engineering.

Magnavox Consumer Electronics Company
1700 Magnavox Way
Fort Wayne, Indiana 46804

Primary Products
Distributed and Remarks

Televisions, Multi-Channel Receivers, Record Changers. Customers should direct RFI problems involving Magnavox products to the nearest of the nine Magnavox service offices.

Pacific Division
1360 San Mateo Avenue
So. San Francisco, CA 94080

Los Angeles Division
2645 Maricopa Street
Torrance, CA 90503

Southwestern Division
8813 John Carpenter Highway
Dallas, Texas 75247

Great Plains Division
7510 Frontage Road
Skokie, Illinois 60076

Great Lakes Division
24092 Detroit Road
Westlake, Ohio 44145

Southeastern Division
1898 Leland Drive
Marietta, Georgia 30062

Northeastern Division
607 North Avenue, Door 17
Wakefield, Mass. 01880

New York Division
161 East Union Avenue
East Rutherford, N.J. 07073

Mid-Atlantic Division
2201 Route 38, Suite 750
Cherry Hill, N.J. 08034

MGA Mitsubishi Electric Corporation
Melco Sales, Inc.
3030 East Victoria Street
Compton, California 90221

Primary Products
Distributed and Remarks

Melco Sales, Inc. is the sales and service representative for the Mitsubishi Electric Corporation. RFI reports from the field, beyond the dealers capability

to resolve, in which Melco Sales becomes involved, are handled on an individual basis. All attempts will be made to give customer satisfaction.

Melco Sales suggests that requests for assistance be addressed to its Compton, CA address, or the Service Department may be contacted by telephone on a toll free number (800) 421-1132. Ask for the National Service Manager.

Midland International Corporation
Consumer Products Division
P. O. Box 1903
Kansas City, Missouri 64147

Primary Products
Distributed and Remarks

Portable Black and White and Color Television Receivers.

Midland asks that, should any RFI problems be encountered with the Midland product, individuals should write the General Services Manager or call (816) 842-0511.

Montgomery Ward
Corporate Offices
535 West Chicago Avenue
P. O. Box 8339
Chicago, Illinois 60680

Primary Products
Distributed and Remarks

Televisions, Radios, Audio Products.

Service for RFI should be obtained from the nearest Montgomery Ward location. If service is not obtainable locally, customer may write to the Customer Service Product Manager at the Corporate Offices. The Montgomery Ward field service organization can call upon factory and corporate engineering talent for assistance with difficult RFI problems.

Morantz

(See Superscope)

Nikko Electric Corporation of America
16270 Raymer Street
Van Nuys, CA 91406

Primary Products
Distributed and Remarks

Stereo receivers, Tuners and Amplifiers, Combination Preamp, Main amp pairs.

For information and assistance with any Nikko Electric products, inquiries should be made to the Service Department, Attention: National Service Manager.

Norlin Music, Inc.
737 North Cicero Avenue
Lincolnwood, Illinois 60465

Primary Products
Distributed and Remarks

Lowrey Electronic Organs
Norlin offers local service organizations technical help in treating RFI through the Norlin Service Manager.

Customers should refer RFI problems to the local Lowrey dealer.

North American Phillips Corporation
100 E. 42nd Street
New York, New York 10017

Primary Products
Distributed and Remarks

Each RFI situation is handled individually by the Service Manager of the particular division whose product is involved. Inquiries related to RFI should be addressed to the proper division of North American Phillips Corporation.

Nutone Division

Scovill Housing Products Group
Madison & Red Bank Roads
Cincinnati, Ohio 45227

Primary Products
Distributed and Remarks

Radios, Intercoms, AM radios.

Refer RFI problems to Consumer Relations Department for handling.

Panasonic Company
Division of Matsushita Electric
Corporation of America
50 Meadowlands Parkway
Secaucus, New Jersey 07094

Primary Products
Distributed and Remarks

When instances of RFI occur, the customer should contact Panasonic in Secaucus.

Customers should provide model number, serial number and information concerning the problem. Upon review, the customer will be contacted advising them where to return their unit for corrective repair. Panasonic will absorb both parts and labor costs in these instances.

Philco (Television)

(See GTE Sylvania)

Quasar Electronics Corporation
9401 West Grand Avenue
Franklin Park, Illinois 60131
Attention: Consumer Relations Manager

Primary Products
Distributed and Remarks

For a high-pass filter, consumer should write Quasar and should include model and serial number of the receiver, frequency of the interference signal (if known), and whether sound or picture, or both, are affected. The Quasar distributor serving the local area should be contacted relative to any other interference problem that is unique to Quasar products.

Radio Shack
National Headquarters
2617 West Seventh Street
Fort Worth, Texas 76107

Primary Products
Distributed and Remarks

AM/FM Radios, Home Entertainment Audio Products. Customers who encounter unique interference problems involving Radio Shack audio products may write to the Product Development Manager or the National Quality Control Manager.

RCA Consumer Electronics
600 N. Sherman Drive
Indianapolis, Indiana 46201

Primary Products
Distributed and Remarks

RFI problems involving both television and audio products may be referred to RCA Consumer Electronics 1-455.

Requests for filters should include model and serial number of the equipment. Filter installation charges will be the customer's responsibility.

Rodgers Organ Company
1300 N. East 25th Avenue
Hillsboro, Oregon 97223

Primary Products
Distributed and Remarks

RFI problems involving the Rodgers Organ may be referred to Custom Organ Test Dept.

Sansui Electronics Corporation
201 East 42nd Street
New York, New York 10017

Primary Products
Distributed and Remarks

RFI problems should be directed to the attention of the Vice President, 201 Communications Inc. (212) 867-3325.

201 Communications, Inc. is the advertising and public relations agency representing the Sansui. They will direct the customer to the appropriate Sansui Service Center. They state that all Sansui products are carefully checked prior to final engineering commitments for susceptibility to RFI. Units are often taken to high RF level areas such as New York City to determine any design flaws.

Sanyo Electric, Inc.
Electronics Division
1200 W. Artesia Blvd.
Compton, CA 90220

Primary Products
Distributed and Remarks

In the event an RFI problem should occur, the customer is requested to take the set to the nearest Sanyo Authorized Repair Station.

Transportation to and from the shop is the responsibility of the customer. Should the shop not alleviate the problem, either the customer or the shop should contact the Field Service Manager in Compton (213) 537-5830.

Schober Organ Corporation
43 West 61st Street
New York, New York 10023

Primary Products
Distributed and Remarks

Organ Kits.
Customers with RFI problems are supplied with the necessary parts, free of charge, to correct the trouble.

Schober Organ Corp. also assists customers in location of the offending stages in the organ.

Refer RFI problems to the Development Engineer.

H. H. Scott, Inc.
111 Powder Mill Road
Maynard, Mass. 01754

Primary Products
Distributed and Remarks

Manufacturer and importer of AM/FM Tuners-Receivers and Stereo Amplifiers used in Hi-Fi Systems.

Manufacturer offers simple instruction sheet to aid customers in resolving problems involving RF pickup. The information includes suggestions about suitable equipment grounding, power line bypassing, and hints and suggestions on how to determine where RF is entering the equipment.

Refer RFI problems to the Engineering Dept.

Scientific Audio Electronics, Inc.
P. O. Box 60271 Terminal Annex
Los Angeles, CA 90060

Primary Products
Distributed and Remarks

Refer all RFI inquiries to the attention of the National Marketing Manager.

Sears-Roebuck & Company
BSC-41-03
Sears Tower
Chicago, Illinois 60684

Primary Products
Distributed and Remarks

Televisions, Radios, Audio Products.

Sears asks that customers with an RFI problem involving a Sears product contact the nearest Sears Service Department for assistance.

Sharp Electronics Corporation
10 Keystone Place
Box 588
Paramus, N.J. 07652

Primary Products
Distributed and Remarks

Manufacturer of Television and Radio Receivers.

Sharp Electronics will, with proof of purchase, supply to any TV owner who complains of interference, a Drake TV-300 high-pass filter at no charge. Audio rectification problems are handled on an individual basis by the service department. Refer all Sharp Electronics RFI problems to the Service Department.

Sherwood California Laboratories, Inc.
4300 N. California Avenue
Chicago, Illinois 60618

Primary Products
Distributed and Remarks

Receivers, Amplifiers, Tuners.

Customers with interference problems should contact the Service Laboratory Manager.

Sony Corporation

(See Superscope)
Consumer Audio Tape Products Only.

Shure Brothers, Inc.
222 Hartrey Avenue
Evanston, Illinois 60204

Primary Products
Distributed and Remarks

Microphones and Electronic Components.

Manufacturer recommends the use of balanced line, low impedance microphones, cables. If the RFI problem persists after taking this step, the consumer should contact Shure Brothers with specifics so that they may be able to help solve the problem. Refer RFI problems to Customer Service Manager.

Superscope Corporate Offices
20525 Northhoff Street
Chatsworth, CA 91311

Primary Products
Distributed and Remarks

Superscope/Marantz AM/FM receivers, tuners, amplifiers, tape recorders, record players, and audio systems. Sony consumer audio tape products.

In the event of special RFI cases, resulting from extremely high RF fields, contact the Technical Services Department at Superscope Corporate Offices.

Modifications necessary to resolve such RFI problems are provided customers on an individual basis.

GTE Sylvania, Inc.
Entertainment Products Group
Group Headquarters
700 Ellicott Street
Batavia, N.Y. 14020

Primary Products
Distributed and Remarks

Televisions, AM/FM Tuners, Radios, Amplifiers.

Consumers should first contact the dealer. Factory Field Service and Field Engineering personnel work together to solve many of the TVI and Audio Rectification problems. The dealers are in touch with the manufacturer's services that will help resolve the problem. RFI problems are handled on an individual basis.

Sylvania has available for their technicians an excellent pictorial TVI training manual titled, "Diagnosis, Identification and Elimination" of TVI.

Tanberg of America, Inc.
Labriola Court
Armonk, New York 10504

Primary Products
Distributed and Remarks

Receivers.

When RFI occurs in Tanberg products, the manufacturer suggests that the unit be returned to them. "We will do any modification possible to eliminate the RFI." Prior authorization should be obtained from the Technical Manager prior to return of the unit.

Tenna Corporation
19201 Cranwood Parkway
Cleveland, Ohio 44128

Primary Products
Distributed and Remarks

Tenna Corp. has not produced home entertainment equipment within the past two years, but will be glad to help out all within a consumer complaint regarding RFI. Will install a circuit change at no cost except postage and handling. All unique RFI problems may be referred to the National Service Manager.

Thomas Organ Company
7310 North Lehigh Avenue
Chicago, Illinois 60648

Primary Products
Distributed and Remarks

Electronic Organs.

Refer RFI complaints to the dealer. RFI is usually resolved at this level. If the manufacturer's field service is made aware of a consumer complaint regarding RFI, the field service will contact the seller and advise that person on how to eliminate the problem. Should that fail, "we continue to pursue the problem utilizing our own people."

Thomas has six field service engineers. In the event of a call for assistance, an engineer personally contacts the consumer by telephone, makes an appointment to visit the home of the consumer to correct the RFI condition, with or without the dealer's technician. "We do not charge the consumer for this service."

Toshiba America, Inc.
41-06 Delong Street
Flushing, N.Y. 11355

Primary Products
Distributed and Remarks

Televisions, Radios, Tape Products, Amplifiers, Tuners, Receivers.

Customers should contact the nearest Regional Office Service Manager for obtaining assistance in resolving RFI problems.

Eastern Regional Office
41-06 Delong Street
Flushing, N.Y. 11355

Southwest Regional Office
3225 E. Carpenter Freeway
Irving, Texas 75062

Western Regional Office
19515 S. Vermont Avenue
Torrance, CA 90502

U.S. Pioneer Electronics Corp.
75 Oxford Drive
Moonachie, N.J. 07074

Primary Products
Distributed and Remarks

Consumers should contact the nearest Regional Service Manager. Pioneer makes available to their technicians an excellent service manual titled, "Hi-Fi 1 Counter-measures."

Eastern Regional Office
75 Oxford Drive
Moonachie, N.J. 07074

Midwest Regional Office
1500 Greenleaf Avenue
Eik Grove Village, Illinois

Western Regional Office
13300 South Estrella Avenue
Gardena, California

Yamaha International Corporation
6600 Orangethorpe Avenue
Buena Park, CA 90622

**Primary Products
Distributed and Remarks**

Electronic Organs

Yamaha organization attempts to cure each RFI problem on an individual basis. Yamaha supplies all necessary technical information at no charge. If interference is due to design error, Yamaha takes steps at its own expense to remedy the problem.

Refer RFI problems to the local dealer. The dealers are kept well informed and current on RFI countermeasures.

Zenith Radio Corporation
11000 Seymour Avenue
Franklin Park, IL 60131

**Primary Products
Distributed and Remarks**

Televisions, Radios, Audio Systems.

Zenith gives consideration to handling and providing relief for RFI problems on a case-by-case basis. RFI problems should be referred to the Service Division. RFI referrals should include model and serial number of the affected product.

Customers with a unique, difficult RFI problem may direct a letter to the National Service Manager

Anchorage, Alaska 99510
Phone: Area Code 907 265-5201

CALIFORNIA, Los Angeles
3711 Long Beach Blvd.
Suite 501
Long Beach, California 90807
Phone: Area Code 213 426-4451

CALIFORNIA, San Diego
Fox Theatre Building
1245 Seventh Avenue
San Diego, California 92101
Phone: Area Code 714 293-5460

CALIFORNIA, San Francisco
323A Customhouse
555 Battery Street
San Francisco, California 94111
Phone: Area Code 415 556-7700

COLORADO, Denver
Suite 2925 Executive Tower
1405 Curtis Street
Denver, Colorado 80202
Phone: Area Code 303 837-4054

**DISTRICT OF COLUMBIA
(WASHINGTON, D.C.)**
1919 M Street N.W. Room 411
Washington, D.C. 20554
Phone: Area Code 202 632-8834

FLORIDA, Miami
919 Federal Building
51 S.W. First Avenue
Miami, Florida 33130
Phone: Area Code 305 350-5541

FLORIDA, Tampa
Barnett Office Bldg., Rm 809
1000 Ashley Drive
Tampa, Florida 33602
Phone: Area Code 813 228-2872

GEORGIA, Atlanta
Room 440, Massell Bldg.
1365 Peachtree St. N.E.
Atlanta, Georgia 30309
Phone: Area Code 404 881-3084

GEORGIA, Savannah
238 Federal Office Bldg. and Courthouse
125 Bull Street, P.O. Box 8004
Savannah, Georgia 31402

Phone: Area Code 912 232-4321 ext. 320

HAWAII, Honolulu
502 Federal Building
P.O. Box 1021
335 Merchant Street
Honolulu, Hawaii 96808
Phone: Area Code 808 546-5640

ILLINOIS, Chicago
3935 Federal Building
230 South Dearborn Street
Chicago, Illinois 60604
Phone: Area Code 312 353-0195

LOUISIANA, New Orleans
829 F. Edward Hebert Federal Bldg.
600 South Street
New Orleans, Louisiana 70130
Phone: Area Code 504 589-2094

MARYLAND, Baltimore
George M. Fallon Federal Building
Room 823 31 Hopkins Plaza
Baltimore, Maryland 21201
Phone: Area Code 301 962-2728

MASSACHUSETTS, Boston
1600 Customhouse
165 State Street
Boston, Massachusetts 02109
Phone: Area Code 617 223-6609

MICHIGAN, Detroit
1054 Federal Building
231 W. Lafayette Street
Detroit, Michigan 48226
Phone: Area Code 313 226-6078

MINNESOTA, St. Paul
691 Federal Building
316 N. Robert Street
St. Paul, Minnesota 55101
Phone: Area Code 612 725-7810

MISSOURI, Kansas City
1703 Federal Building
601 East 12th Street
Kansas City, Missouri 64106
Phone: Area Code 816 374-6155

NEW YORK, Buffalo
1307 Federal Building
111 W. Huron Street at Delaware Ave.
Buffalo, New York 14202

Phone: Area Code 716 842-3216

NEW YORK, New York
201 Varick St.
New York, New York 10014
Phone: Area Code 212 620-3437

OREGON, Portland
1782 Federal Office Bldg.
1220 S.W. 3rd Avenue.
Portland, Oregon 97204
Phone: Area Code 503 221-3098

PENNSYLVANIA, Philadelphia
11425 James A. Byrne Federal Courthouse
601 Market Street
Philadelphia, Pennsylvania 19106
Phone: Area Code 215 597-4411

PUERTO RICO, San Juan
U.S. Post Office and Courthouse
Room 323 P.O. Box 2987
San Juan, Puerto Rico 00903
Phone: Area Code 809 753-4567

TEXAS, Beaumont
Room 323, Federal Building
300 Willow Street
Beaumont, Texas 77701
Phone: Area Code 713 838-0271

TEXAS, Dallas
Earle Cabell Federal Bldg.
Room 13E7, 1100 Commerce Street
Dallas, Texas 75242
Phone: Area Code 214 749-1719

TEXAS, Houston
5636 Federal Building
515 Rusk Avenue
Houston, Texas 77002
Phone: Area Code 713 226-5624

VIRGINIA, Norfolk
Military Circle
870 North Military Highway
Norfolk, Virginia 23502
Phone: Area Code 804 461-6472

WASHINGTON, Seattle
3256 Federal Bldg.
915 Second Avenue
Seattle, Washington 98174
Phone: Area Code 206 442-7653

APPENDIX B

Addresses Of FCC District Offices

Listed below are the addresses and telephone numbers of the FCC district offices. This list is alphabetical by state, and also includes offices in Puerto Rico and the District of Columbia (Washington DC).

You are reminded that the information requested in Appendix C will be required in order that a staff member may analyze your interference problem. Please forward this information by mail.

ALASKA, Anchorage
U.S. Post Office Building Room G63
4th & G Street, P.O. Box 644

APPENDIX C

In requesting assistance from the association, manufacturer, dealer, or FCC district office, the following information will be helpful in analyzing your problem.

Date _____

1. Your name: _____

Address: _____

Phone Number: _____

2. If known, radio transmitter operator's:

Name: _____

Address: _____

Call Sign: _____

Hours of Operation: _____

3. Type of interference identified:

- Radio Transmitter Electrical
 Co-Channel FM
 Audio

4. a. TV Channels affected: _____

b. AM/FM Frequencies affected: _____

5. If you are experiencing either FM or Co-Channel interference, estimate the distance of the interfering station from the location of your home: _____ (miles).

6. Were suggested home remedies made?

- Yes No

Please explain (be specific): _____

7. a. Was service representative called:

- Yes No

b. If yes, were suggested modifications made? Yes No

Please explain (be specific): _____

8. a. If a radio transmitter is involved, was the operator contacted? Yes No

b. If yes, what was the result of that conversation? _____

c. Were suggested transmitter modifications made? Yes No

Please explain (be specific): _____

9. At what time of day does the interference usually occur and how long does it last?

10. Give Make, Model Number, and the Year Purchased, of your TV or AM/FM receiver. _____

11. Was the level of interference affected in any way by the modifications suggested in this bulletin? Yes No

Comments: _____

12. Describe fully the sound or noise made by the interference and, if the TV picture is affected, please provide a drawing of what the interference pattern looks like. (Use separate sheet.)

13. a. Are any of your neighbors experiencing the same type of interference?

- Yes No

If yes, on a separate sheet, indicate their names, addresses, and type equipment receiving the interference; TV, AM/FM radio, electronic organ, etc.

b. Was the information provided in this bulletin shared with your neighbors?

- Yes No

If yes, please explain what modifications were made to their equipment and if the modifications eliminated or reduced the level of interference. (Use separate sheet if necessary.)

The "ULTIMATE" in CW Reception!

COPY ONE®

\$99.95



ACTUAL SIZE
3 1/2" WIDE
2 3/8" HIGH
4 3/8" DEEP

COPY ONE IS NOT A FILTER! This station accessory is a must for the discriminating amateur who operates CW, whether he is an avid CW op or one who engages in CW for proficiency. The CW signal is **processed** (not filtered) in a manner which allows true **ULTIMATE STATION REJECTION**, a mode which has been previously unavailable. The circuitry* is **totally unique** (patent pending), a must for emergency CW operations. If you haven't had the opportunity to operate a **COPY ONE**, ORDER YOURS TODAY!

COPY ONE CW PROCESSOR SPECIFICATIONS & FEATURES:

- Ultimate station rejection (almost unbelievable but true!)
- Pitch & volume independent of receiver or transceiver
- Full quieting (i.e., no background noise) without squelch
- COPY ONE is not a filter, there is absolutely no ringing or background noise
- Plugs into transceiver or receiver/transmitter combo without modification
- Discriminates signals in 80 to 100 cycle increments
- Full break-in CW operation
- Includes 115 volt AC power supply or may be battery operated
- Built in code practice oscillator
- LED lock-up controls front panel mounted

ORDER YOURS TODAY!
send \$99.95 by check
or money order to:

LOGITRONICS, INC.

3135 North Cole Road Boise, Idaho 83704 [208] 377-1562

L11

The 1978 Atlanta HamFestival and Georgia State ARRL Convention June 3-4, 1978

Downtown Atlanta Marriott Hotel

- GIANT covered Fleamarket/Swapshop!
- More than 50 Forums/Meetings!
- FCC Exams!
- Parking for thousands of cars!
- 140 Major Exhibits!
- Special MICROPROCESSOR Section!
- Programs for Ladies & Children!
- Activities Galore!

Registration: \$3 per person IN ADVANCE, \$4 at the door
Ladies & Children FREE!

If you do not receive a Preregistration Packet by May 1st, write:

Atlanta HamFestival 1978
100 Woodlawn Drive
Marietta, Georgia 30067

or call Area 404/971-HAMS anytime day or night (PLEASE DO NOT CALL BEFORE MAY 1st)

Hotel Rate: \$26 per day single OR double!

Write for Hotel Reservations to:

Marriott Hotel • Courtland at International Blvd. • Atlanta, GA 30303
or phone: Area 404/659-6500 and hurry, hurry, hurry!

THE BEST HAMFEST IN THE WORLD!



IC-215 FM

PORTABLE/MOBILE

- 15 channels (12 on dial/3 priority)
- Fully collapsible antenna or "rubber duck"
- Compatible mount for mobile operation
- Dual power (3 watts high/400mw low)
- External power and antenna easily accessible for mobile operation
- Lighted dial and meter
- Double-size, long-lasting internal batteries with optional Ni-Cd pack and charger available

ICOM's **IC-215** is the FM radio that puts good times on the go. Now an outstanding mobile mount and quick-change features for external power, speaker and antenna conversions make moving from base, to vehicle, to hill top fast and easy: and the **IC-215 portable/mobile** provides continuous contact for even the busiest FM enthusiast.

The **IC-215's** three narrow filters provide quality not usually found in portable VHF equipment. With 15 channel capacity and an MOS FET RF amp with 5 tuned circuits in the front end, the **IC-215** gives optimum FM portable performance.

You'll be carrying quality, performance and versatility with your **IC-215 FM portable/mobile**.

Specifications: Frequency Range: 146-148 MHz Voltage: 13.8 VDC negative ground Size: 183mm(h) x 61mm(w) x 162mm(d)
 Weight: 1.9 kg Number of Channels: 15 total, 12 on main switch, 3 priority Power Output: 3.0 W or 0.5 W Microphone Impedance: 600 ohms Spurious Level: lower than -60 dB Receiver Sensitivity: 4 dB below 1 UV or lower Spurious Response: 60 dB or better

All ICOM radios significantly exceed FCC specifications limiting spurious emissions.

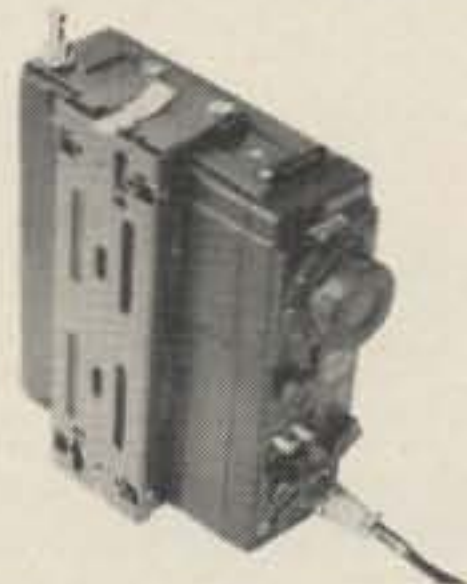

This new mobile mount is now available for your **IC-215**. Fast insertion and removal is a snap, and the mount is collapsible when not in use.

HF/VHF/UHF AMATEUR AND MARINE COMMUNICATION EQUIPMENT

DISTRIBUTED BY:



ICOM

ICOM WEST, INC.
Suite 3
13256 Northrup Way
Bellevue, Wash. 98005
(206) 747-9020

ICOM EAST, INC.
Suite 307
3331 Towerwood Drive
Dallas, Texas 75234
(214) 620-2780

ICOM CANADA
7087 Victoria Drive
Vancouver B.C. V5P 3Y9
Canada
(604) 321-1833

Hey, Old-Timers! The Breadboard Is Back!

—jiffy up those IC circuits

Rod Hallen WA7NEV
P.O. Box 73
Tombstone AZ 85638

Are you afraid of integrated circuits? If so, why? ICs are complex little devils, but wiring them together is simple enough. I used to shy away from IC projects because of the apparent complexity, unless a nice ready-made printed circuit board was available. I felt that way until I found a quick, simple way to copy a circuit out of a magazine or design one of my own. Enter the plug-in breadboard.

This is not a how-it-works piece; this is a how-to-do-it article. There have been many

good articles written on how ICs work and what they will do. Look back over the past few years of *73 Magazine* to see what I mean.^{1,2,3}

A full-blown schematic of the inner workings of almost any integrated circuit is enough to scare all but the most electronically oriented technician, but you don't have to understand ICs to be able to use them. Consider the black box; you don't know or care what's in the box or how it works. All you need to know is that you get a certain output for a given input — a cause-and-effect relationship. A television receiver can be considered a black box; as long as a valid signal is on the input channel,

you will get the audio and video that you want out of the box, even if you don't know how it works.

Look at the integrated circuit in the same manner. It has input and output leads, all well defined. A given input will always give the same output. This article will deal mostly with digital ICs. Look over some of the schematics in recent magazine issues, and compare those built up of digital ICs with those made with transistors or tubes (if you can find tubes still being used). One thing that will be obvious is the almost total lack of supporting components such as resistors and capacitors. Digital circuits, except for the clocks, are

composed almost entirely of ICs connected together. Transistors are usually used when it is necessary to drive a larger load than the IC, with its small heat-dissipating capacity, can handle.

A linear IC is more complex in that it compares more with the amplifiers in the tube and transistor layouts. A digital IC is really a bunch of switches, and electronic switches hadn't been used long before ICs came along. The first electronic computers were tube-type. They were very large, very inefficient, and great for heating buildings.

The IC Breadboards

What do you need to put together the circuits you read about in the magazines or the ones you come up with on your own? First you need a means of trying out the design, making changes, and adding a few ideas later. You should be able to do all of this without soldering and unsoldering dozens of connections each time. This is where the IC plug-in breadboard comes in (Photo A).

The boards used here were provided by Continental Specialties Corporation,⁴ which manufactures many different models, shapes, and sizes of boards. The QT-series board is of high quality and is

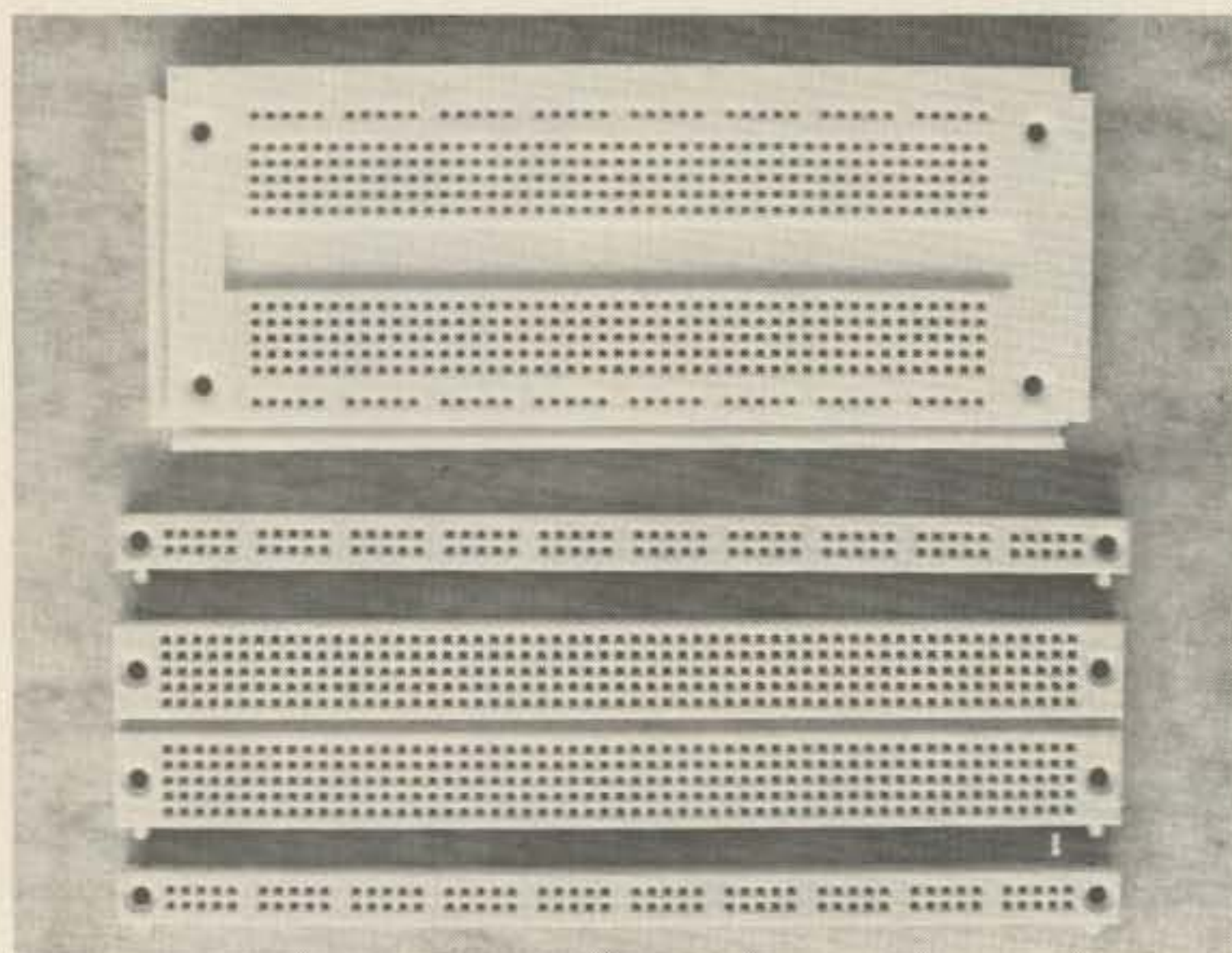

Photo A. IC plug-in breadboards. At the top is the CSC QT-59S flanked by the QT-59B bus strips. At the bottom is the CSC Experimenter 600 board.

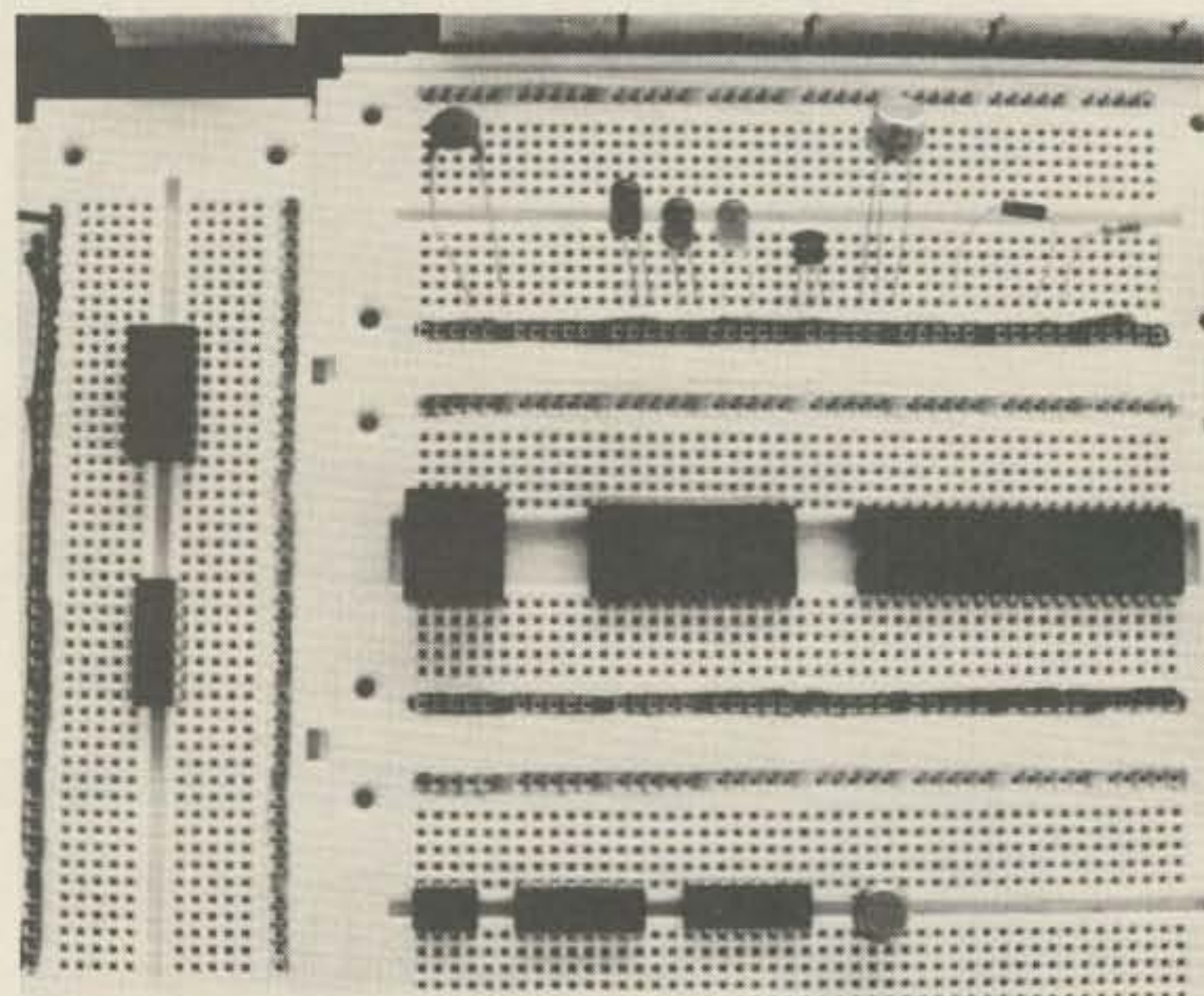

Photo B. Various components mounted on the CSC Experimenter 300 and 600 breadboards.

designed for those who do a great deal of this kind of work. The Experimenter series combines the IC board and the bus strips in one piece. These latter boards are good quality, are lower in price, and are quite suitable for this use.

ICs are plugged in along the center of the board, and short jumpers and components interconnect the pins according to the design schematic. The bus strips are connected to battery and ground and then cross-connected to various points in the circuit, as required. The Experimenter 300 is designed to be used with 14- and 16-pin ICs, and the Experimenter 600 is used with the larger IC packages, such as those with 24 and 40 pins. The large ICs will also work on the 300, but they cover up more of the connectors, allowing fewer jumpers to a given pin.

Other components — transistors, resistors, and capacitors — can be plugged in also and jumpered into the

circuit. Each bus strip is one continuous series of connections and can be used anywhere along the board. The connector that each IC pin plugs into has 4 additional points that can be used for jumpering (Photo B).

Data Books

The next items you need are data books. Just as tube and transistor manuals give basic information on using these components, data books, put out by the semiconductor manufacturers, cover details on their integrated circuit products. Since all of the major IC fabricators make all of the more popular ICs, the data books from one source will cover just about all that you will need to know. These books come in two principal editions, one for digital ICs and one for linear ICs.

There are also some specialized data books, but these are the two you'll use most. They may be purchased from any of the companies that advertise ICs for sale.

Texas Instruments, National Semiconductor, and Fairchild all put out good ones, and the information they contain is well worth the very low price.

These books not only list all of the electrical characteristics of the various ICs, the physical dimensions, and pin connections, but also suggest applications of many types.

The Power Supply

Next you need a power supply or supplies, depending on the needs of the given circuit. A basic requirement is a +5 V dc supply, as all TTL and CMOS digital ICs use this value. Linear ICs use various voltages, both plus and minus. Further on, I'll describe the construction of a supply that will take care of most situations.

Since this supply will have a variable output, you will want some type of voltmeter to set the output voltage each time you use it. A VOM, VTVM, or similar meter will serve this function, but I chose to dedicate a meter to

do this in order to have a continuous readout. I think that this is the best way, and I'll show you how to use just about any meter you can get your hands on to do the job.

The Logic Probe

And, last but not least, you'll need a logic probe. I said earlier that a digital IC is nothing more than a bunch of switches. A logic probe will tell whether these switches are operated (high) or unoperated (low). If a switch is operated, you should see about +5 volts on its output, and, if it is unoperated, you should see ground. A VOM or VTVM will obviously give this information, but a logic probe is easier and more convenient to use. I'll discuss how to build one of these before I'm through.

You will, of course, need a selection of ICs to work with. All of the components, except the transformer and the meter, used in this article were purchased from James Electronics.⁵ I deal with them because their service is

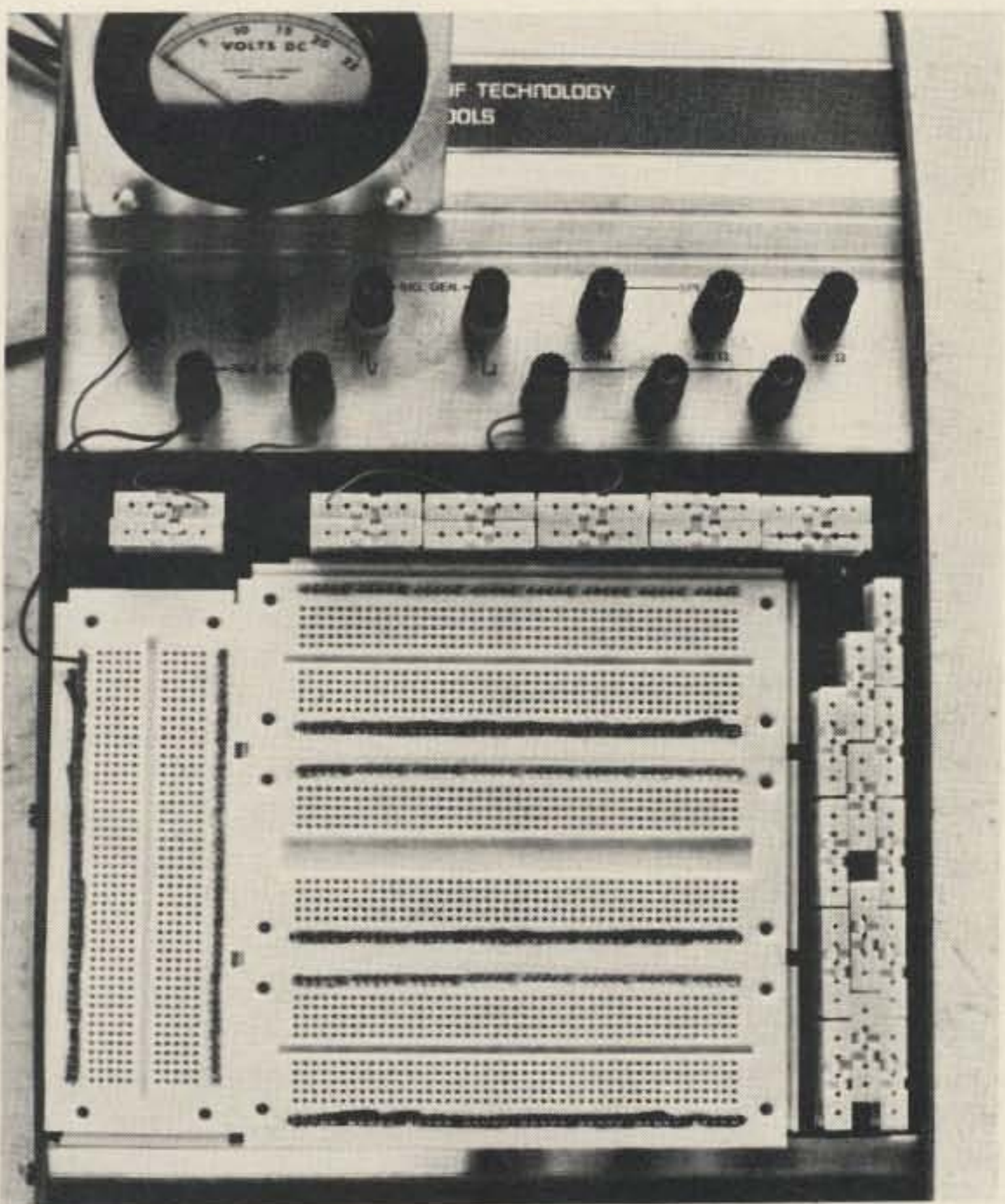

Photo C. The breadboards attached to the front of the modified Bell and Howell design console.



Photo D. Every breadboard needs a bread pan. Here is a bread pan used instead of a metal chassis. The bread pan is cheaper and easier to work with.

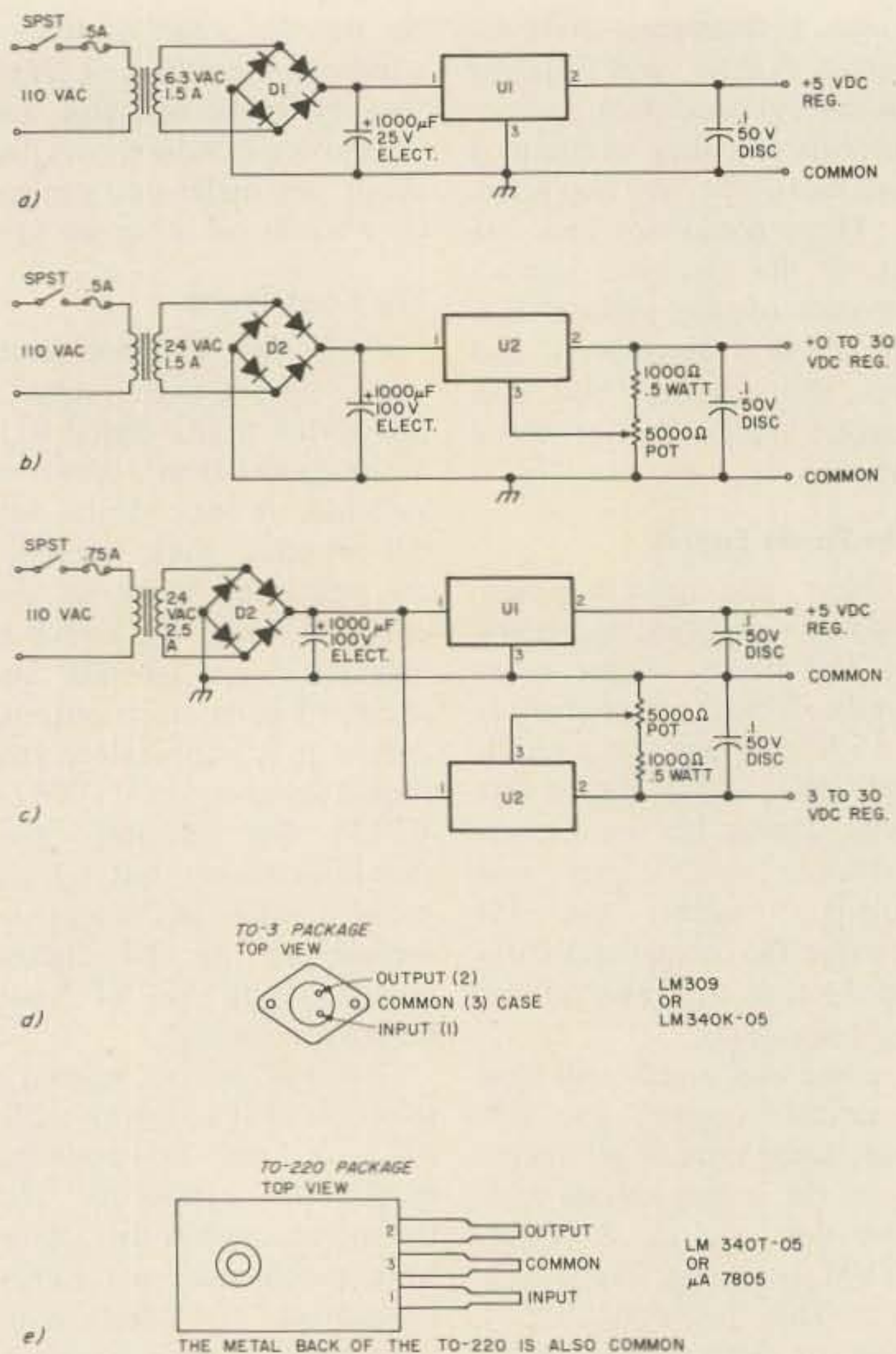

Fig. 1. (a) A 5-volt, 1-Ampere regulated power supply; (b) A 0-to 30-volt, 1-Ampere regulated power supply; (c) A combination of (a) and (b); (d) and (e) show the connections for the TO-3 and TO-220 regulator packages. D1 — four 1-Amp, 50-volt diodes or equivalent diode bridge; D2 — four 2-Amp, 100-volt diodes or equivalent diode bridge; U1, U2 — LM340T-05, LM340K-05, LM309K, or 7805 regulator.

outstanding. I have never waited more than 7 days for any merchandise, and I have always received everything exactly as ordered. Having had many unpleasant experiences, both in and out of the electronics field, with mail-order firms, I can recommend this company very highly.

Putting It All Together

I mounted my breadboards with double-sided tape on a design console (Photo C) which came as part of a Bell and Howell electronics correspondence course. After I jumpered to the wrong bus a few times, I marked the positive bus red and the ground bus black with wide felt-tip markers. The console

came with plug-in connectors, which were used as the Bell and Howell method of breadboarding, but they are much too large for ICs.

The console contains a 0-to 30-volt variable supply, a tunable sine and square wave audio oscillator, filament and high-voltage supplies for tube circuits, and a speaker. I modified some of its features to fit in with my IC designing interests. I left the variable supply as it was, but I mounted a 0- to 25-volt dc meter on top and wired it to give a continuous readout. I used the 6.3-volt filament winding to power a +5 V dc regulated supply. The LEDs of a logic probe are mounted into the top of the meter bracket.

Since you probably don't have a console like this, why not build one? You can use a metal chassis about 9" x 12" x 3" turned upside down or a piece of wood about 9" x 12" x 1". If you choose the latter, a smaller 5" x 9" x 3" chassis can be mounted on the rear of the wood to house the electronics. Since you're concerned with breadboarding, a small bread pan could serve this purpose (Photo D). In either case, the breadboards can be mounted with double-sided tape or permanently attached with screws. Put rubber feet or tape on the bottom of the chassis to keep it from scratching the furniture, especially if you have to work on the dining room table. A piece of cloth glued to the bottom of the wooden version would serve as well.

Build your supplies on the breadboard, and then mount them on the chassis. Fig. 1(a) is a +5 V dc regulated supply. Fig. 1(b) is a supply that varies from 3 to 30 V dc depending on the position of the 5k pot, and Fig. 1(c) simplifies the whole setup by combining both of them into one (Photo E).

All four regulators listed for U1 and U2 will put out up to one Ampere regulated. If the output is shorted, too much current is drawn, or the regulator overheats, it will shut itself down. It is therefore almost impossible to damage it. All of these regulators automatically ground the common (#3) terminal when they are attached to a metal chassis or heat sink. See Fig. 1(d) or 1(e). This is okay in most cases, such as U1 in Fig. 1(a) or 1(c), but, when the common terminal is floated above ground, as U2 is in Fig. 1(b) or 1(c), it must be insulated from the heat sink. In this instance, the common terminal is brought to the wiper of the 5k pot.

After testing the supply to be sure it is going to work, transfer all of the components from the breadboard to the chassis. Heat sinks and

silicone grease should definitely be used if you hope to draw the full rated current. The heat sinks should be mounted outside the chassis so that air can circulate around them. Point-to-point wiring can be used, and the layout is not critical. Attach the diode bridge to the side of the chassis. Put the regulators on the back wall with lugs under the grounded mounting screws, and run all of the grounded components to the lugs. Combination banana plug/binding posts are great for connecting from the supply to the breadboard bus strips. Use your VOM or VTVM to check the output voltages of both supplies. If you don't get a solid +5 V dc from the fixed supply and about 3 to 30 V dc from your variable supply, check your wiring again. The maximum voltage from the variable supply will depend on the voltage of your transformer. Please note that any of the supplies shown in Fig. 1 can be made into negative supplies by grounding the positive output and connecting all of the grounded connections together but not grounding them. The point marked common on the schematic then becomes your negative output.

The Voltmeter

The built-in voltmeter can be just about any meter you have lying around, or an inexpensive one can be purchased. In junking out some old carrier equipment recently, I came up with ten 0 to 10 milliammeters. Just to show how versatile meters can be, I have modified one of these to measure 0 to 120 mills so that I can monitor the current in my Teletype[®] loop. Another reads 0 to 100 Amperes and is inserted in my 12 V dc battery system. (My HF-VHF-UHF ham station is all battery powered, but that's another story.) Yet another watches my battery voltage and the charger that keeps the battery up.

Obviously then, a meter

can be made to measure ranges other than the one it was designed for. A meter gives an indication of the amount of current flowing through it, and, if you put a resistance in series with it, you can control the amount of current that flows for a given voltage. That is Ohm's law. See Fig. 2(a).

Suppose that you want a meter that will read 0 to 25 V dc, such as I used with my design console. There are formulas that you can use to find the series resistance needed for a given voltage reading, but they require that you know the internal resistance of the meter. Finding that internal resistance is tricky — you can't just measure it with an ohmmeter. Please don't try it — you might ruin the meter, and it isn't necessary anyhow.

There is an easy way. I put my VOM across the output of the variable supply and the meter I want to use in series with a 5000-Ohm variable resistor in parallel with the VOM. See Fig. 2(b). Then I set the supply for 25 V dc as read on the VOM, adjust the pot until the meter reads full scale, and I've got a 0 to 25 V dc voltmeter. If I drop the supply voltage until the VOM reads 12½ volts, the meter should read half scale. Next I disconnect the 5k pot, measure the resistance I've set

into it, and find a fixed value to replace it. Mine turned out to be pretty close to 1500 Ohms, and I put a 1000-Ohm resistor and a 510-Ohm resistor in series. The meter with the series resistor or resistors is connected permanently across the variable supply, and you've freed your VOM for other chores.

The reason I chose 25 volts full scale, even though the supply puts out more than that, is because that makes each mark on the scale equal to ¼ volt. If I had set it up to read 0 to 50 volts, for instance, each mark would have been ½ volt, making for less accurate settings. You seldom need more than 25 volts anyway.

In order to be able to read the meter easily, I removed the case and painted over the old numerals and lettering with flat white paint. When the paint was dry, I renumbered the scale 0 to 25 in 5-volt steps and wrote "volts dc" below it. I used rub-on transfers for this job, but a small artist's brush and black paint or a fine-tip felt marking pen would do a good job if you're careful.

The Logic Probe

Now the logic probe — as I said earlier, you need a way of determining what is happening in a digital logic circuit. If you are building a

two meter scanner, for instance, and it doesn't work, you can use the probe to find out where you are going wrong.

If you touch the probe of Fig. 3(a) to a point in the circuit that is at +5 V dc (high), the LED will light, but, if the point is low, the LED will not light. If you have a pulsing battery at that point, the LED will pulse. It's a good logic probe, yes? No! If you touch the probe to a point that is open (no battery or ground), the LED will not light, indicating a ground where there is not one. Fig. 3(b) is the opposite situation — light if you touch ground and no light if you touch an open or battery. That's still not good enough. Figs. 3(c) and 3(d) combine both conditions, so one LED or the other will light up when you are probing, and an open will give no indication. A pulsing battery and ground will light the LEDs alternately. The 7400 NAND gate, which is wired as an inverter, and the 7404 inverter prevent the battery flowing through one LED from lighting the other LED falsely.

Build up 3(c) or 3(d) on your breadboard (Photo F). Fig. 3(e) shows the battery and ground connection for either IC. Try probing the battery and ground outputs of your power supply, and

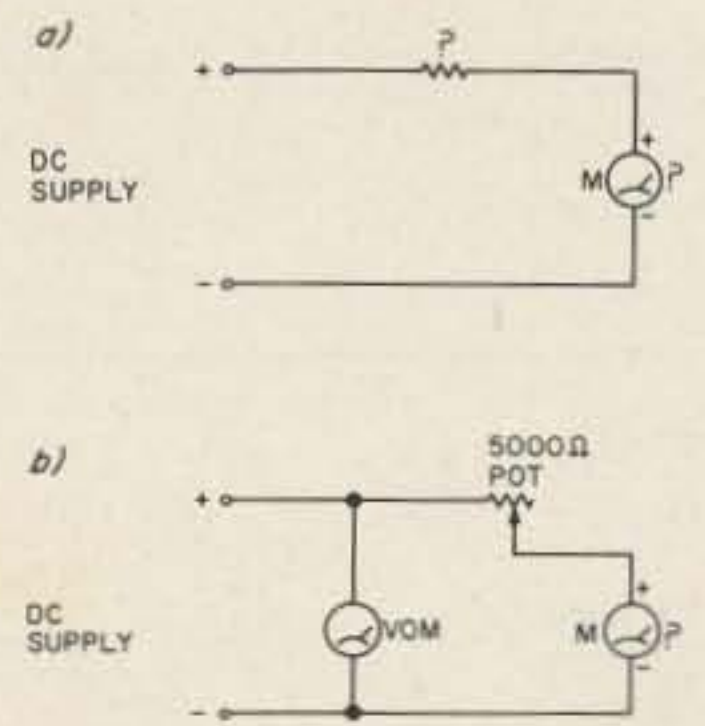

Fig. 2. (a) A milliammeter used to measure voltage; (b) this shows how to determine the value of series resistance needed for a given full-scale reading.

see which LED lights for each. A distinctive display, one that is easier to interpret, is made by using a green LED for a high indication and a red LED to indicate a low condition. Don't forget that LEDs are diodes and must be biased in a forward direction. On all of the LEDs I've seen, that means the shorter lead toward the battery (positive) and the longer lead toward ground.

Now you'll want to take the logic probe components off the breadboard and build them permanently into your power supply chassis. For a simple circuit like this, I think the easiest way to put it together is to mount the IC on its back in a convenient place with a little glue and wire directly to its pins. I put

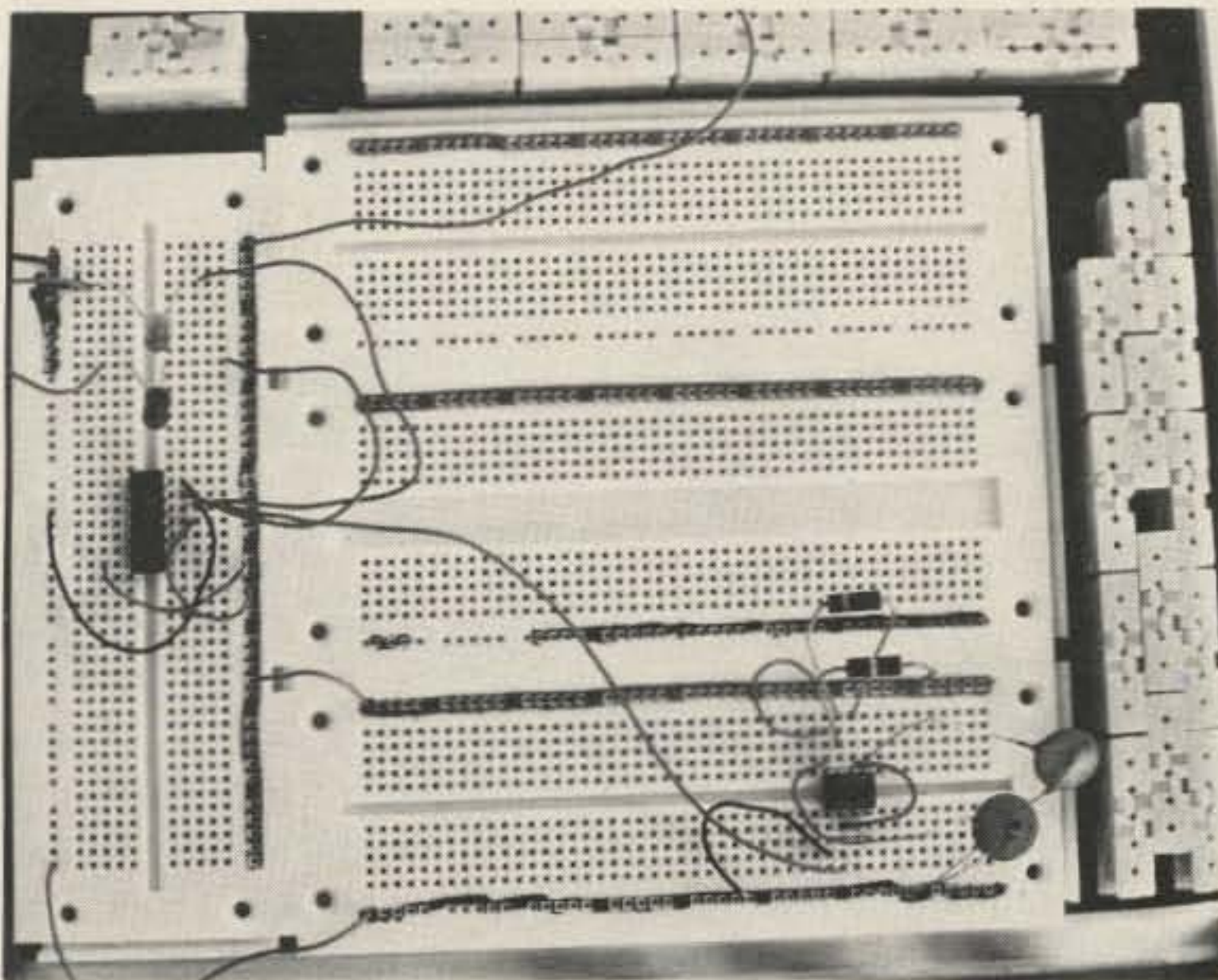

Photo E. Fig. 1(c) as it looks built up on the boards.

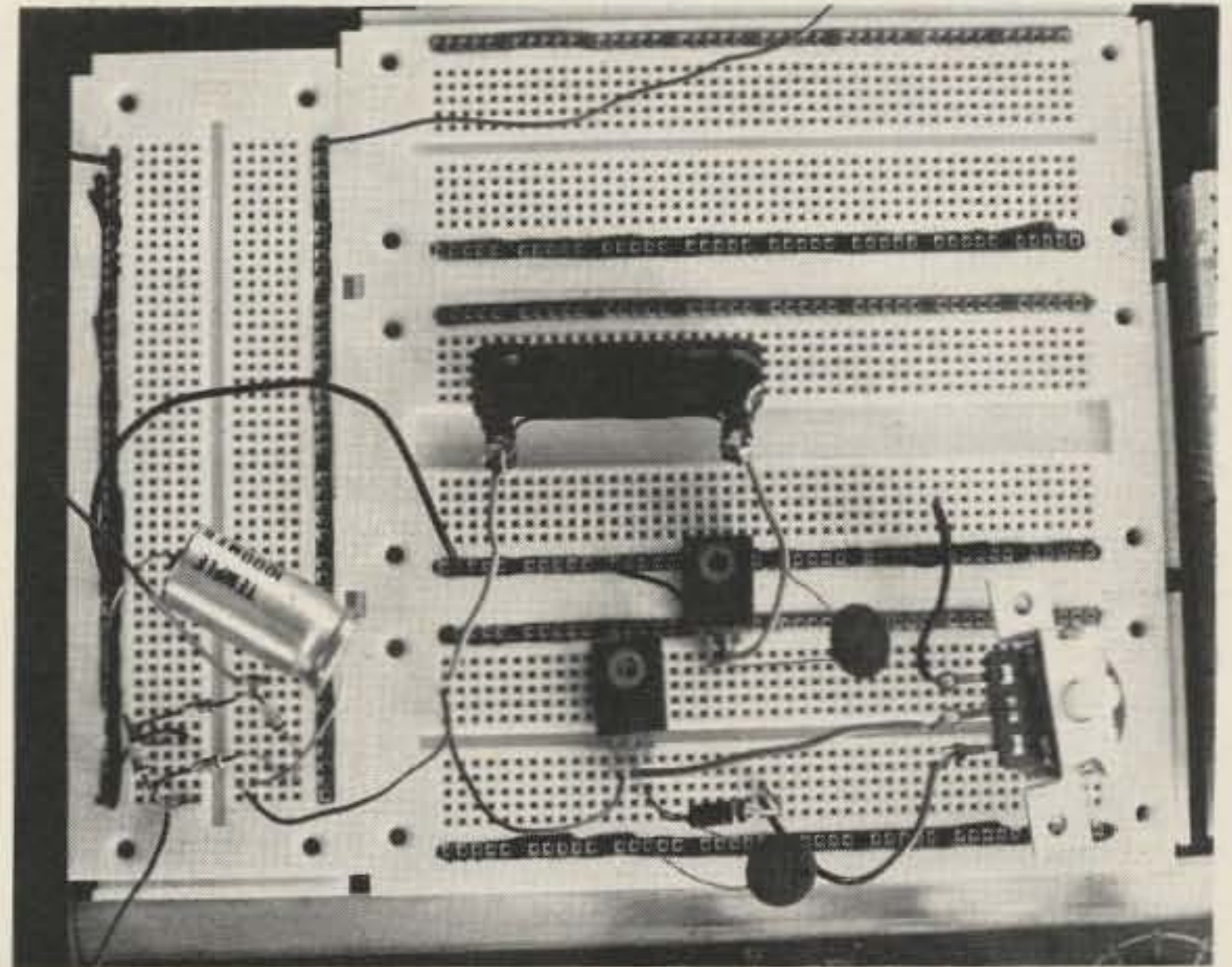

Photo F. Figs. 3(c) and 4 built up on the breadboards.

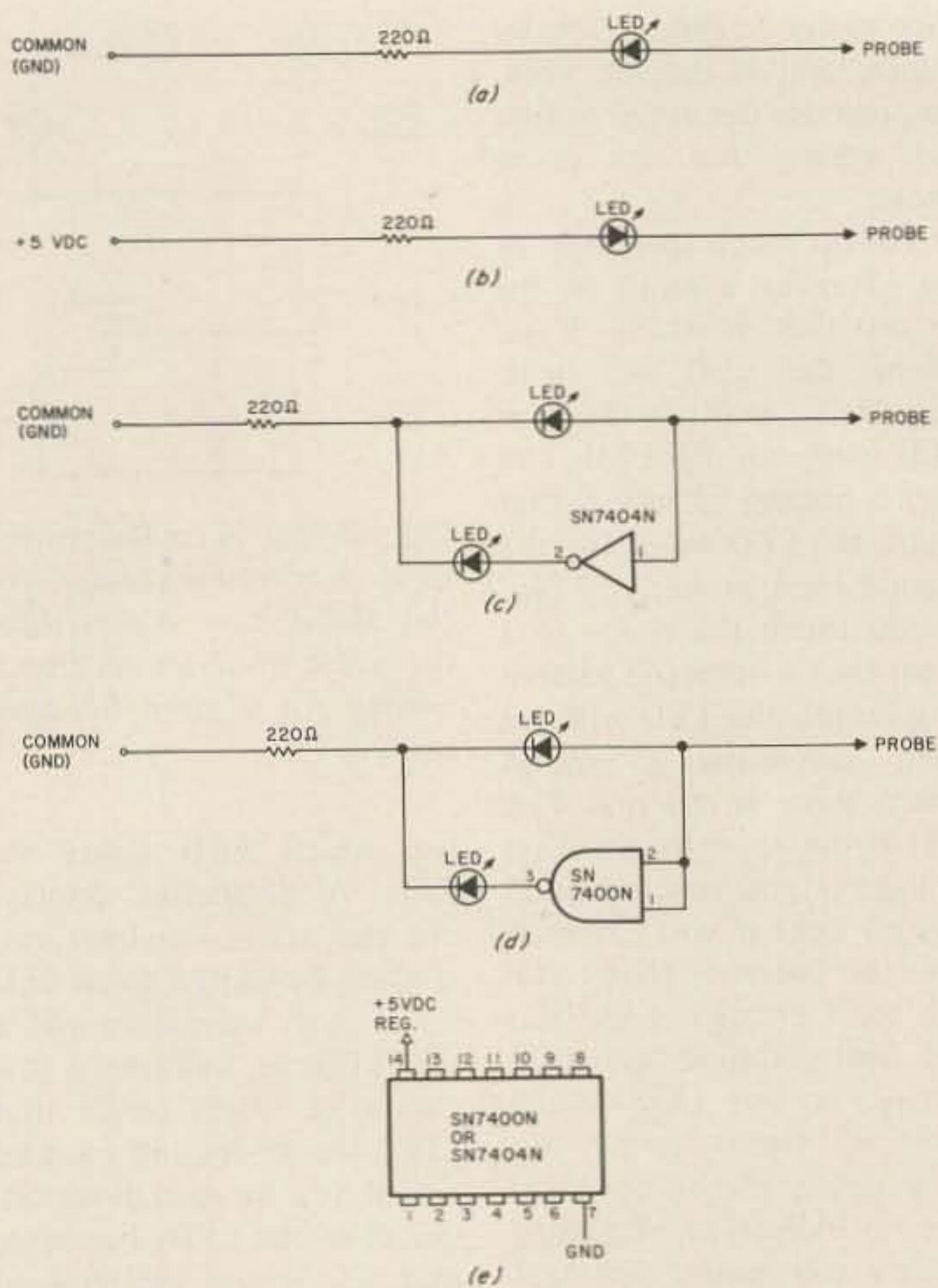

Fig. 3. Various logic probes. (c) and (d) are the best. (e) A drawing of the battery and ground connections for the SN7400N and SN7404N integrated circuits.

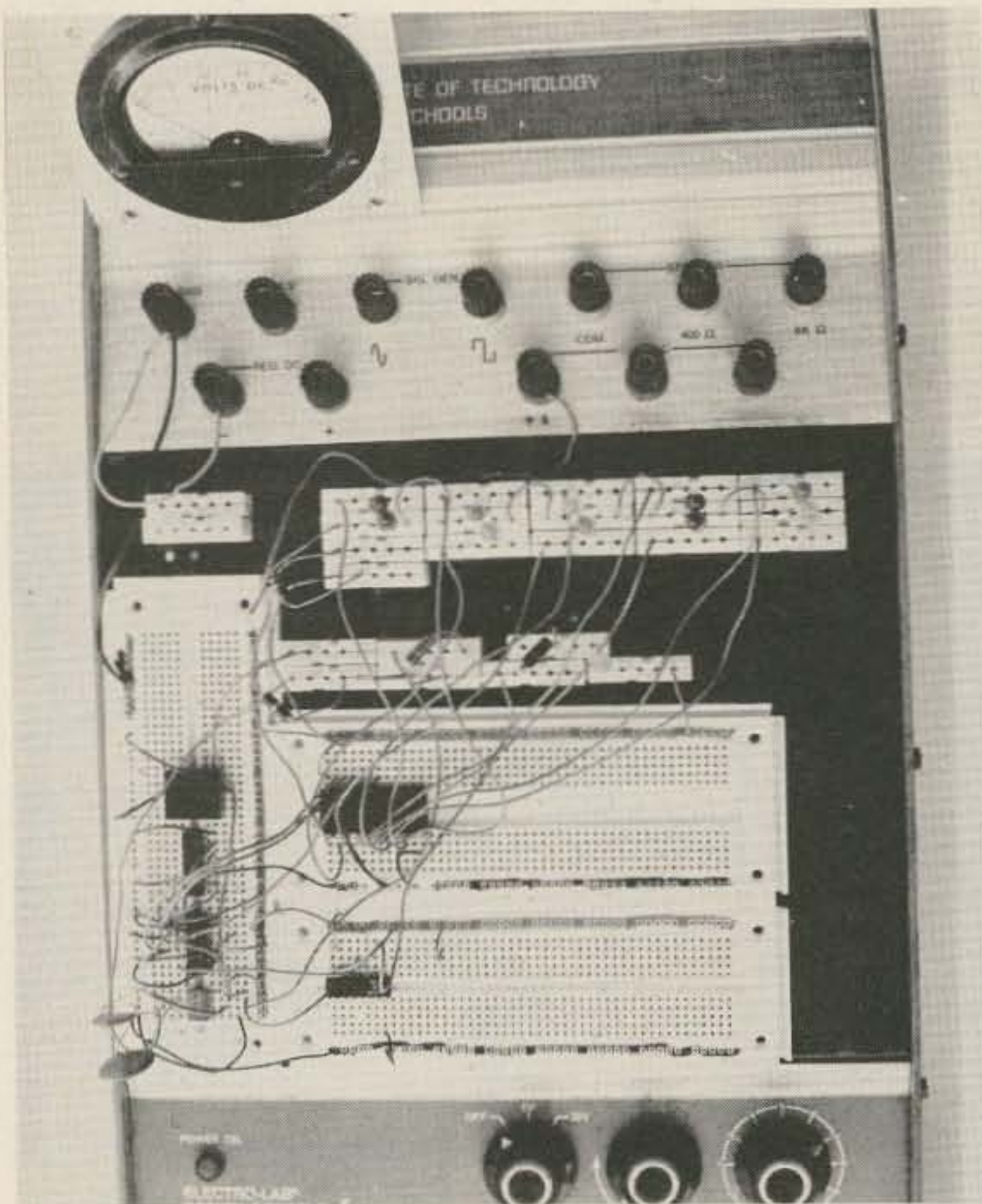

Photo G. The "Grass Roots Scanner" in its developmental stage.

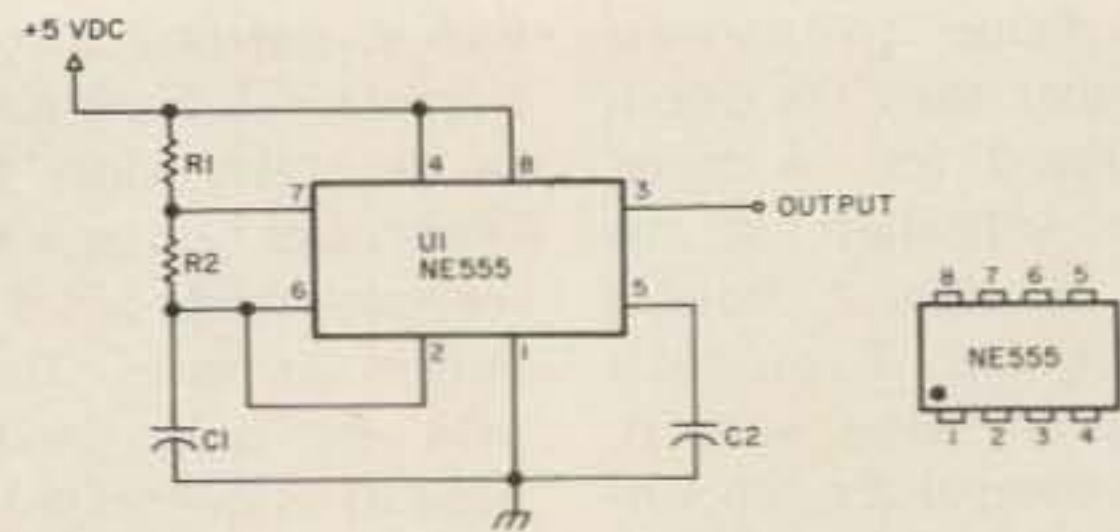

Fig. 4. Schematic of a pulse generator utilizing the NE555 integrated circuit timer. C1 — .1 mF disc ceramic; C2 — .01 mF disc ceramic; R1 — 1 megohm, ¼ Watt; R2 — 1.5 megohm, ¼ Watt; U1 — NE555, LM555, etc.

the LEDs in the bracket which holds the dc voltmeter. They can be installed in the face or top of the chassis by drilling a hole the same diameter as the head. The rim at the back will prevent it from going completely through the hole, and a little glue will keep it in place.

There are much more sophisticated probes available, but this will serve your basic needs. If you decide you want a better one later when you get more involved, you can easily add one.³

Now What?

Okay, you have a breadboard design console built up, your power supply works, and so does your logic probe. Now what do you do with it? Let's breadboard a simple pulse generator and look it over a bit. See Fig. 4.

The 555 IC is basically a timer, but you can also use it as a pulse generator or as an oscillator. Almost every IC design that needs an oscillator, clock, or timer uses the 555, a very versatile and popular chip.

Lay out Fig. 4 on your breadboard, but leave the power off while doing the wiring. I use 24-gauge wire in different colors: red for power, black for ground, and green, white, and brown for miscellaneous wiring. This makes jumper tracing easier when I'm looking for a wire that I put in the wrong place. I cut some one-inch, some two-inch, and some three-inch pieces in each color and strip ¼ inch off each end. I keep the different lengths in plastic margarine cups, and, when I need a jumper, it's all

stripped and ready.

Install the IC first, connect the resistors and capacitors from pin to pin shown, and then jumper pin 6 to pin 2 and pin 4 to pin 8. Ground pin 1, and run Vcc (+5 V dc) to pin 4, and you are ready. Turn on your power supply and touch the logic probe to pin 3 of the 555. The two LEDs in the logic probe should light alternately, which tells you that the output of the 555 is periodically changing from battery (high) to ground (low). Turn off the power, remove C1, replace it with a .02 mF capacitor, restore power, and again probe pin 3 of the IC. The LEDs should pulse much faster now. In fact, they might even be flashing so fast now that they both appear to be on all of the time.

The value of C1 controls the output timing of your pulse generator. Remove the .02 mF capacitor, put two .1 mF capacitors in parallel from pin 6 to ground (pin 1), and now you've really slowed things down. Increasing the capacity of C1 reduces the frequency, and the opposite has also been shown to be true. You can get it to pulse so slowly that it is possible to go out and eat lunch between pulses if you use enough capacity. Check your linear data book on the 555 for more information on this.

Varying R1 or R2 will also affect the timing. Replace R2 with a 4.7 megohm resistor. What happened? Use a 5-meg pot for R2, and you can vary the timing at will.

A few words of caution: Don't use wire larger than 22 gauge for jumpers, as it is

quite possible to damage the breadboard connectors. Don't use resistors larger than 1/4 Watt or any other components whose leads are larger than that. Use care in removing ICs from the boards. Unless you have a very steady hand, you're liable to end up with a lot of bent pins. Heath provides a tool with its kits for this job that is nothing more than an L-shaped piece of metal about 1/8-inch wide. The short side of the L is slipped

into the channel on the board under the IC, and a gentle prying motion does it quick and simple. Before I got one of these, I used to slide the tip of a very small screwdriver into the channel and raise it up.

Okay, you've started! Pick some simple circuits in the magazines or look some of the basic ICs up in the data book, hook them up, and see what they will do. Try the SN7400, SN7448, and SN7490. The 7400 is a group

of gates, the 7448 is a decoder and LED driver, and the 7490 is a decade counter. I'll use these ICs in a forthcoming article I call the "Grass Roots Scanner." It's simple, super cheap, and it does the job. It will scan ten channels and give LED or digital readout of the channel selected.

If reading this article hasn't convinced you that building and designing with ICs can be easy and fun, try some of the ideas presented

here, and maybe you'll convince yourself. ■

References

1. "How Do You Use ICs?", *73 Magazine*, August, 1976, p. 24; October, 1976, p. 38; November, 1976, p. 106; December, 1976, p. 36; Holiday, 1976, p. 24.
2. "The Ins and Outs of TTL," *73 Magazine*, May, 1976, p. 96.
3. "The TTL One Shot," *73 Magazine*, February, 1977, p. 56.
4. Continental Specialties Corporation, P.O. Box 1942, New Haven CT 06509.
5. James Electronics, 1021 Howard Avenue, San Carlos CA 94070.

New Products

from page 22

full load.

The whole package weighs only 3 lbs. and is priced at \$69.95 for the 117 V ac 60 Hz version. A 220 V 50/60 Hz version is available for 10% more.

The Design Mate 1 is very well suited to a number of applications where the ease with which it permits designing in broad strokes is advantageous. These include the R & D test bench, schools, universities, and training institutions, and personal use.

Like all Design Mate units, the DM-1 comes completely assembled with detailed instructions and special application notes.

For further information, contact *Continental Specialties Corporation*, 70 Fulton Terrace, New Haven CT 06509.

NEW FROM YAESU— THE FC-301 ANTENNA TUNER

The FC-301 antenna tuner is designed for low- and medium-power applications in the HF

amateur bands from 160 through 10 meters.

The FC-301 comes equipped with three UHF type female coax receptacles, and a threaded terminal to accept a single wire (long wire) antenna.

Antenna tuners are used to minimize the effects of swr on feedlines, and allow a receiver or transmitter to "look into" its design impedance, regardless of the antenna involved.

The FC-301 has both swr metering and power output metering, which is found only in the highest quality tuners on the market today.

Priced at \$159.00, the FC-301 is available at authorized Yaesu dealers everywhere. *Yaesu Electronics Corporation*, 15954 Downey Ave., PO Box 498, Paramount CA 90723.

HEINEMANN OFFERS SAMPLE RE-CIRK-IT PROTECTOR FOR \$1.00 AND A BLOWN FUSE

Heinemann Electric Co. has announced a program whereby it will send a sample of its new

Re-Cirk-ItR circuit protector, the modern successor to the fuse, for a dollar and a blown fuse.

The Re-Cirk-It protects like a fuse but is resettable. It is cost competitive with fuses and fuseholders, installs in the same panel space as a conventional 5/8"-diameter fuseholder, and is attractive enough to be placed on front panels.

The Re-Cirk-It protector trips instantaneously on short circuits and with delay on sustained overloads. It can only be electrically tripped, and it can't be turned off or held against a fault.

The Re-Cirk-It protector helps equipment manufacturers and users by eliminating nuisance service calls due to blown fuses. For the equipment user, it ends the bother of finding a fresh fuse and the inherent danger that the wrong size replacement will be used.

The protector is available for quick delivery in a wide range of current ratings from 0.25 through 10 A. It is UL-recognized and CSA-approved as a component protector.

To participate in the special offer (which runs through December, 1978), a blown fuse and \$1.00 should be sent to

Heinemann Special Re-Cirk-It Offer, PO Box CN01908, Trenton NJ 08608.

For further information about the Re-Cirk-It protector, request Bulletin KD-4001 from *Heinemann Electric Co.*, Magnetic Drive, Trenton NJ 08650.

NEW 2 METER SSB TRANSVERTER FROM HAMTRONICS

Hamtronics, Inc., announces a new 2 meter SSB transverter, just in time for OSCAR mode J operation. Of course, it may also be used for mode A and simplex activity as well. The new model VX2 transverter is constructed on a 3 x 7 1/2 inch G-10 PC board. The kit is easy to build and align, with test points at each stage.

It is intended for use with 10 meter SSB exciters, but some have been used with recycled 11 meter SSB units for inexpensive OSCAR operation. Various frequency schemes are available to accommodate different types of exciters. The transverter requires only 5 mW of drive to provide 2 W PEP output. Many of the newer exciters have a low power output, and

Continued on page 55



Yaesu's new FC-301 antenna tuner.

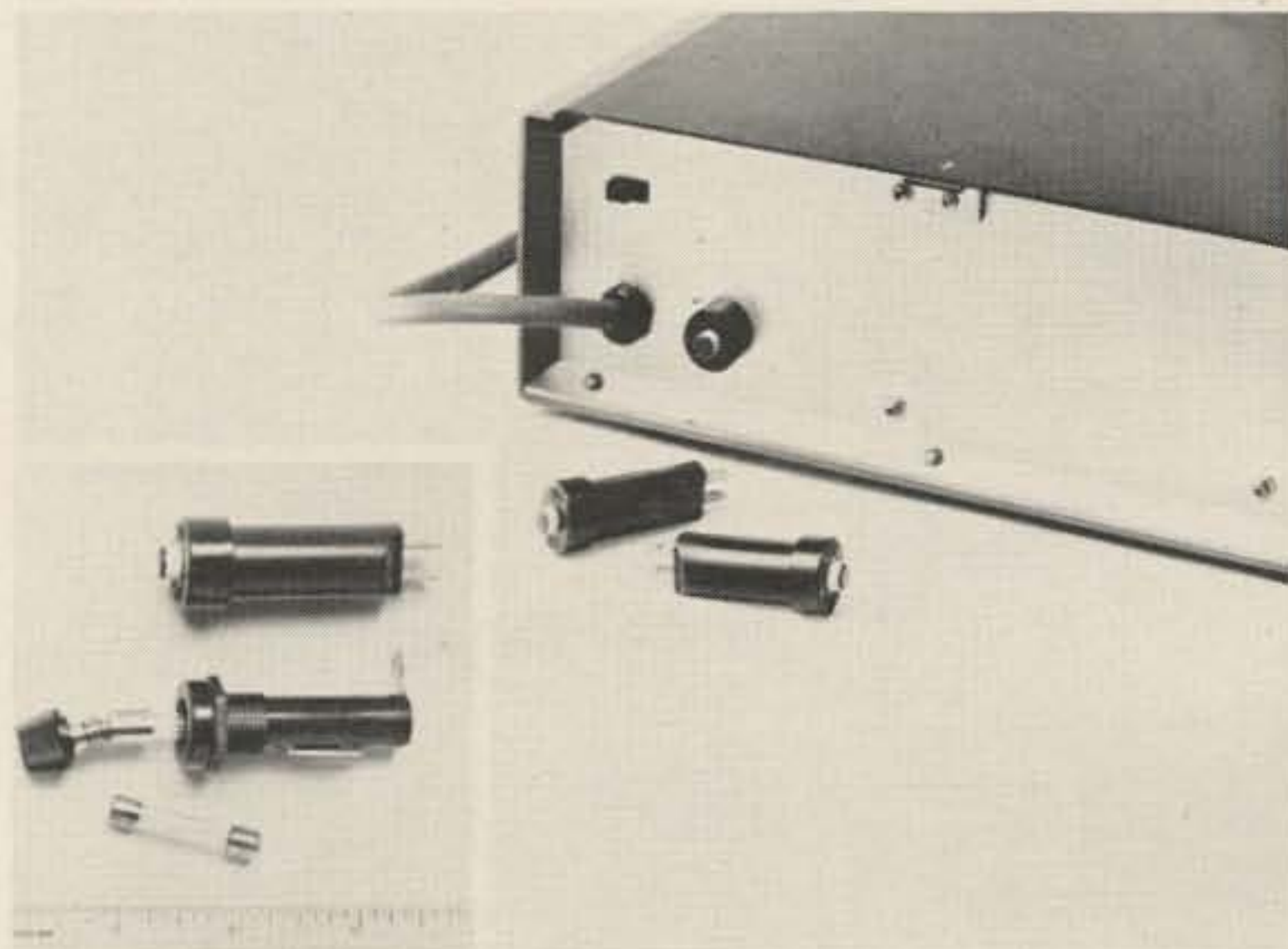

Heinemann's Re-Cirk-It protector.

Fake 'Em Out With Remote Control

— TT-operated control unit

E. E. Buffington W4VGZ
2736 Woodbury Drive
Burlington NC 27215

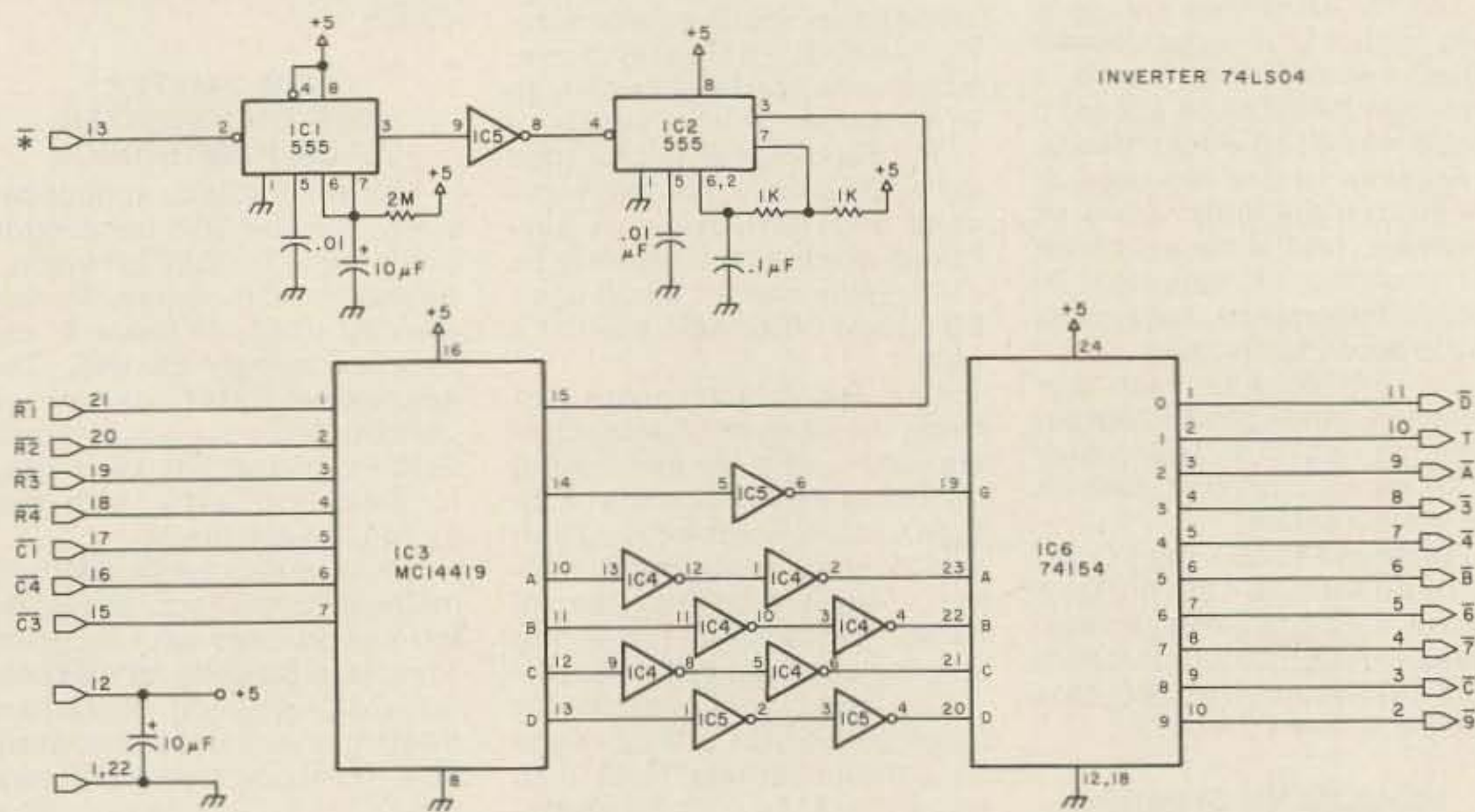

Fig. 1. Decoder/demultiplexer (DEMUX).

You have the repeater's squelch threshold set so that the carrier-operated switch is operating on less than 0.1 microvolt. Really great! You can work the weak ones and pull in those mobiles out on the fringe. Now button the machine up, lock the lock, and head back down the mountain. The road is rocky and bumpy, so be careful that you don't punch a hole in your oil pan. Ride the brakes, and keep the car in low gear. As you near home, you access the auto-patch to give Honey a call. The call goes through and begins to ring. Now, for some reason, all you hear is noise. It seems that a station 70 miles away is working through a repeater 130 miles away on the same frequency, and all you hear is noise.

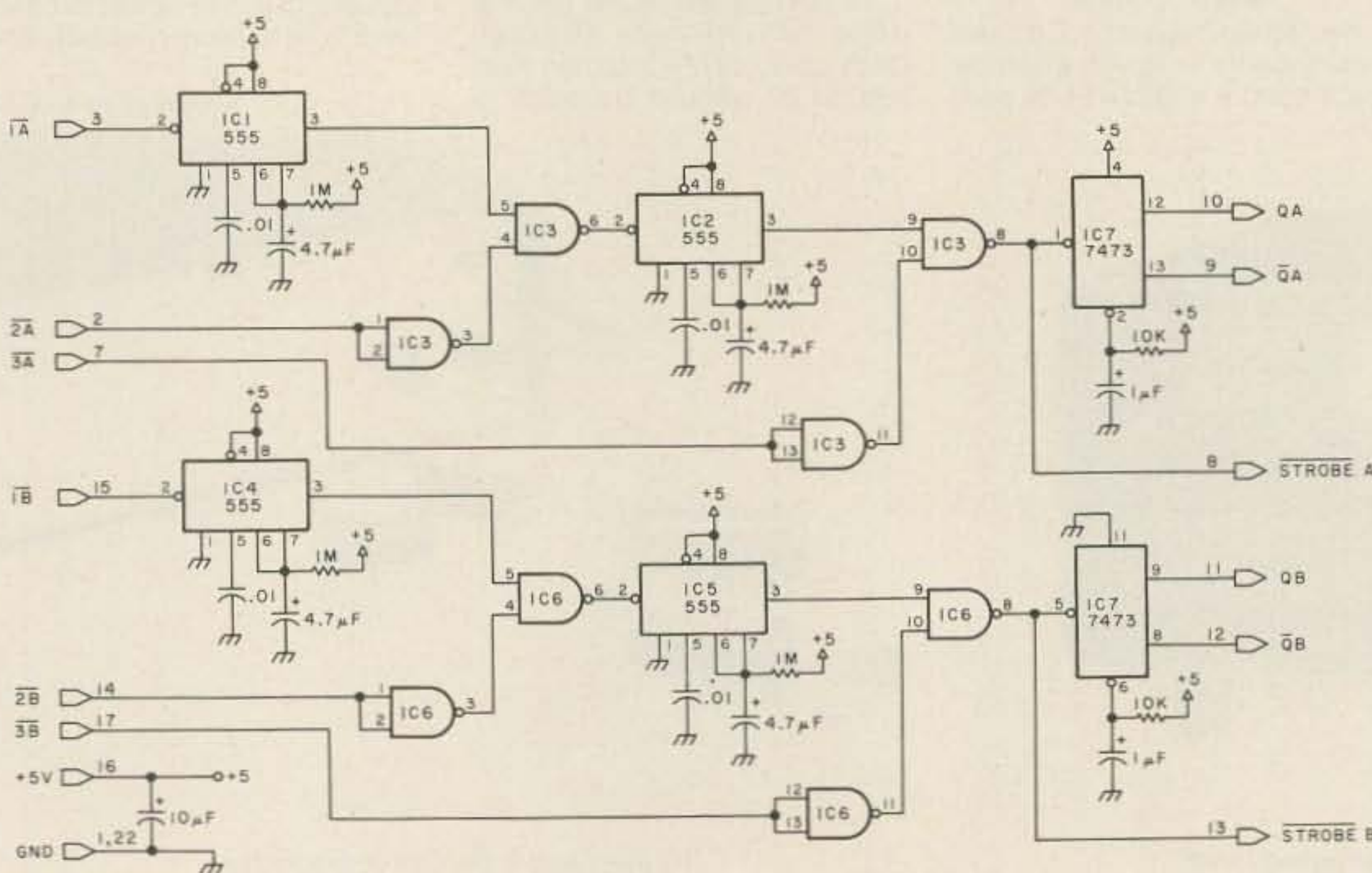

Fig. 2. Dual 3-input sequencer. All gates — SN7400N.

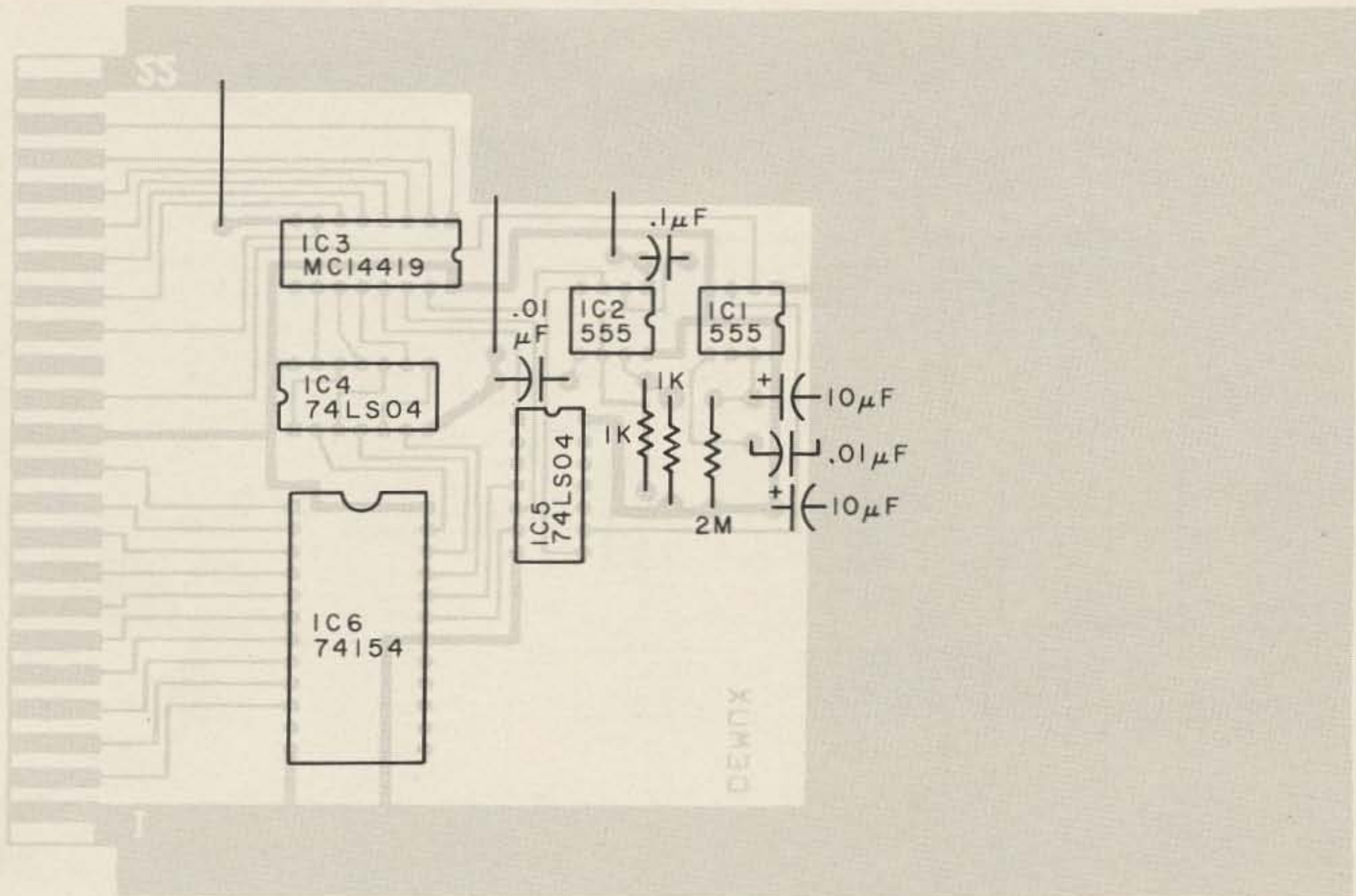

Fig. 3(a). Component layout — DEMUX.

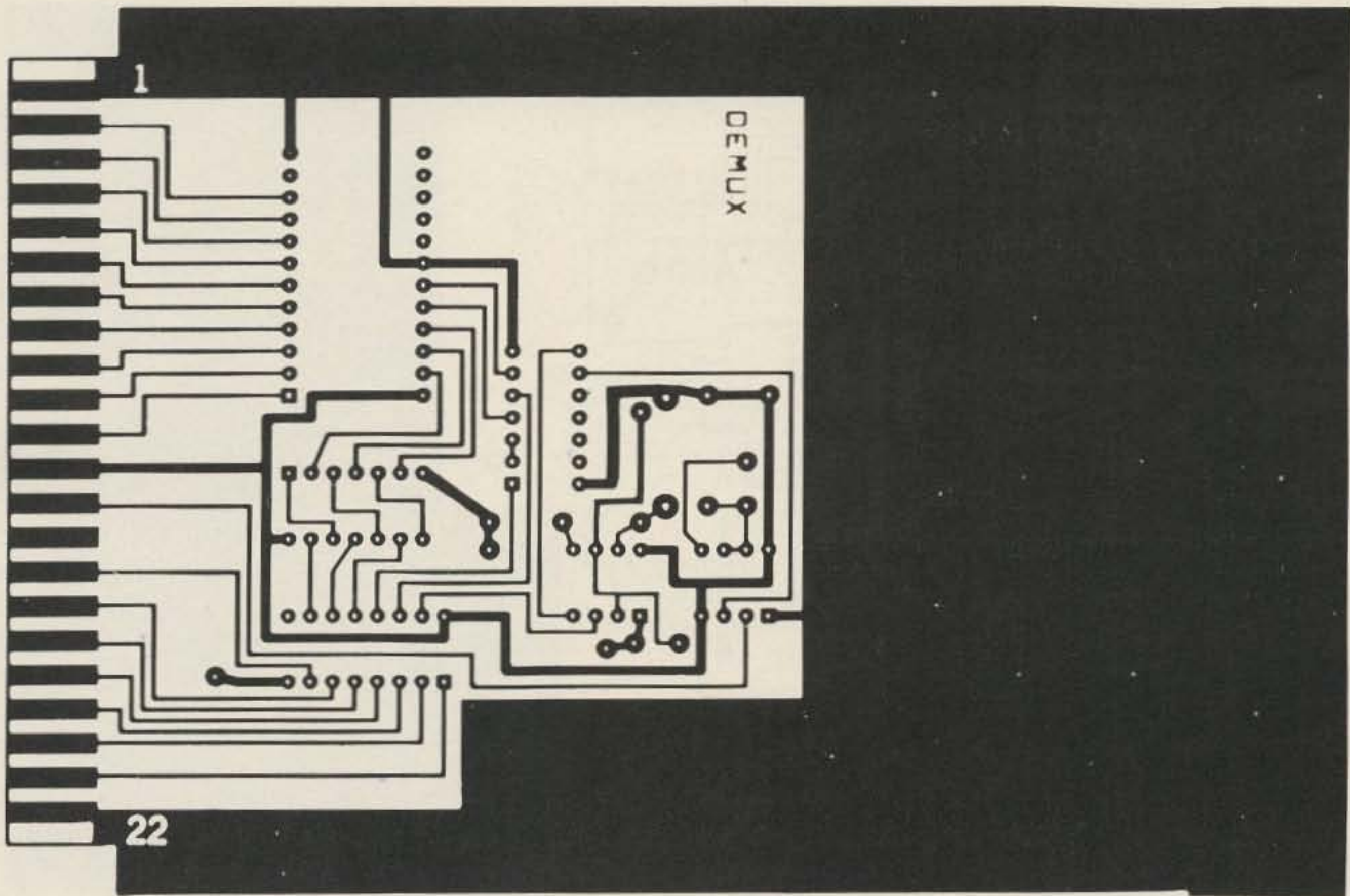

Fig. 3(b). PC board — DEMUX.

When Honey answers the phone, all she hears is noise. Quickly you touchtone™ 1A3, the noise disappears, and you hear Honey's voice.

What happened? Is this magic? No, it's just the appli-

cation of the circuits described in this article. The three-digit touchtone code caused a resistor to be switched from across the squelch pot. This raised the squelch threshold so that it

takes a 0.4-microvolt signal to operate the COS.

Two circuit boards are necessary to accomplish this magic. The decoder/demultiplexer (DEMUX) and the sequencer circuit board mas-

ters, parts layouts, and schematics are provided so that you can duplicate this handy project.

Decoder/Demultiplexer

The key-pad-to-binary

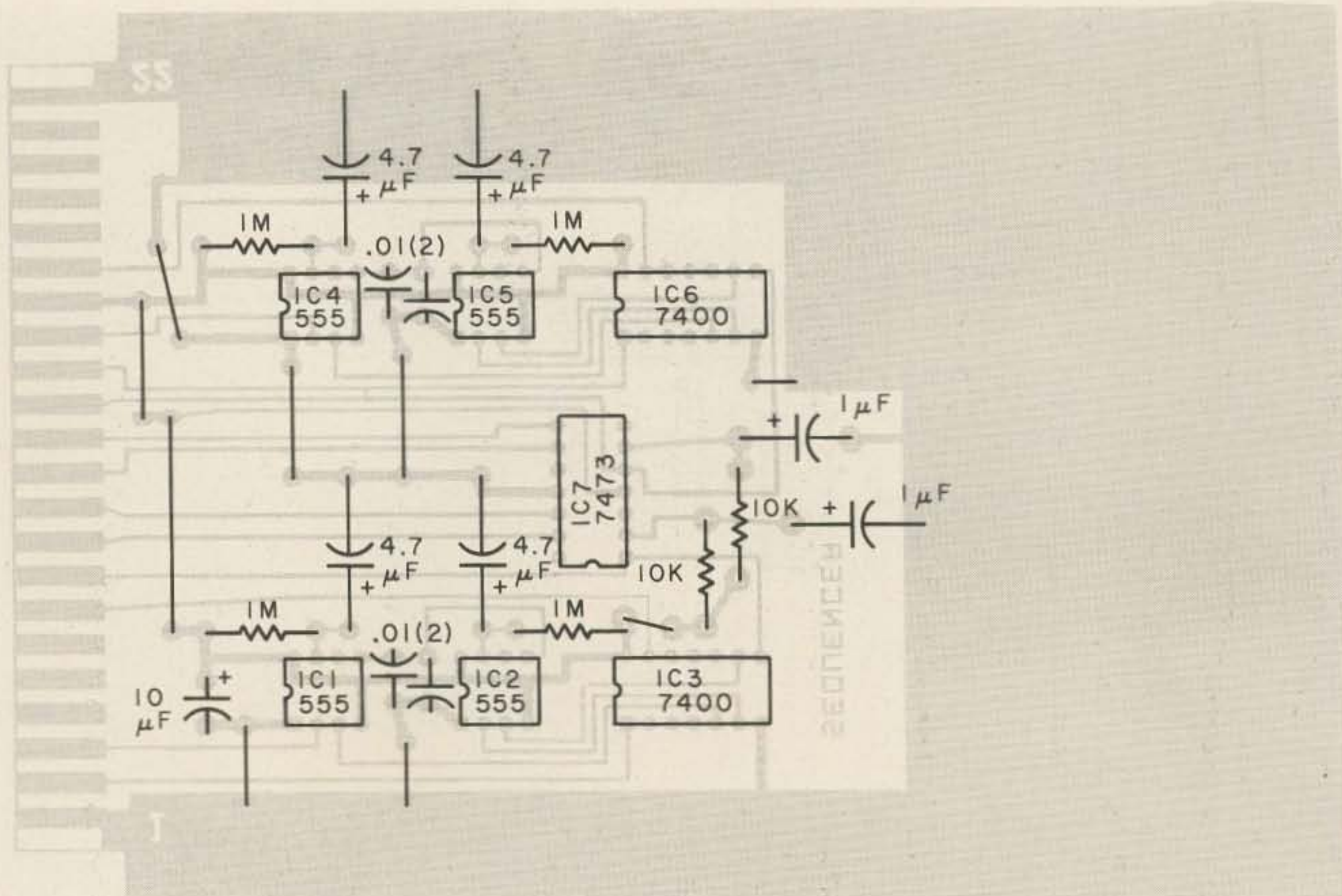

Fig. 4(a). Component layout - sequencer.

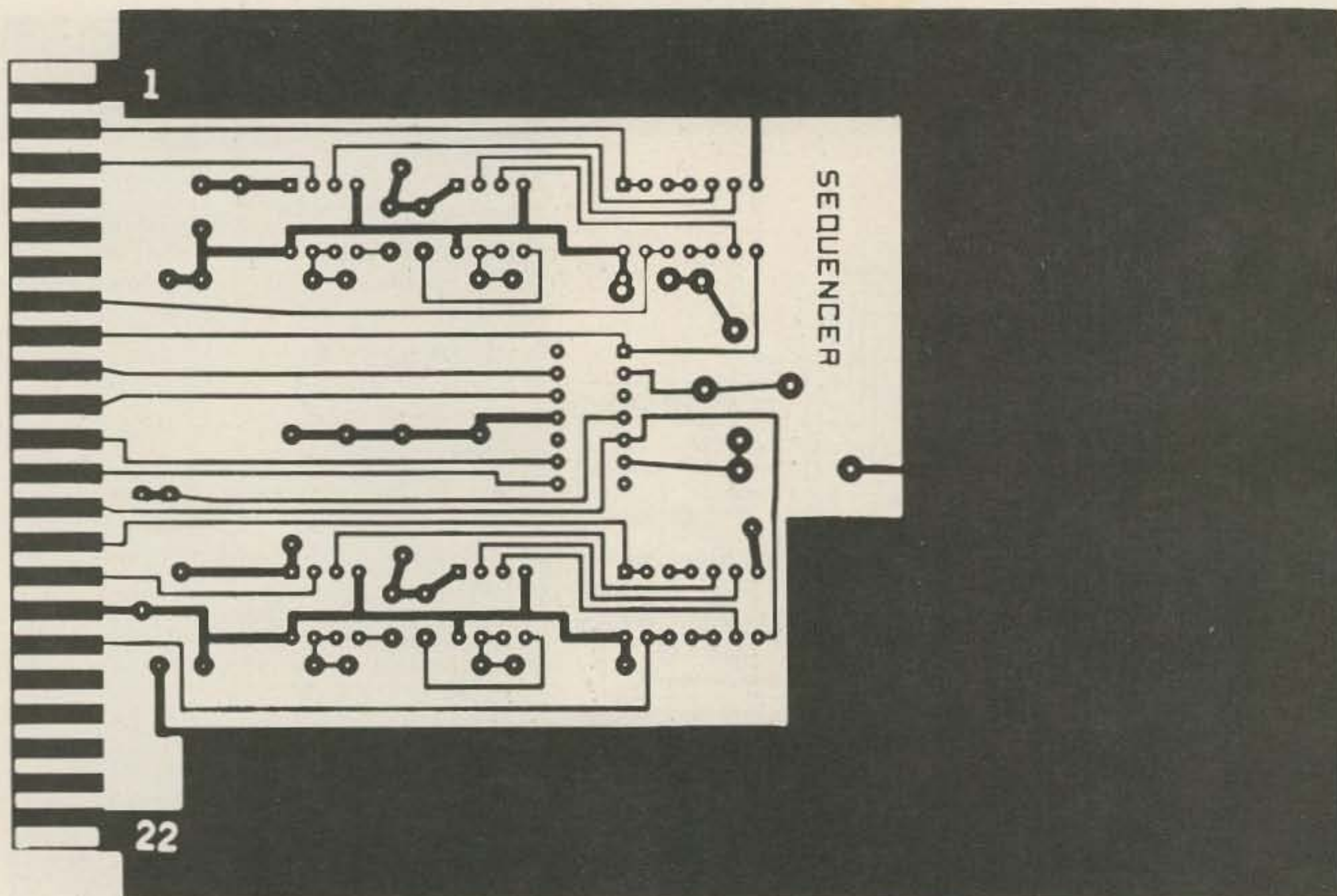

Fig. 4(b). PC board - sequencer.

converter MC14419 that I used in the digital autopatch in the April, 1977, issue of *73 Magazine* is used here, except that column 4 is inputted instead of column 2. This neat trick I owe to Ed Tipler

WA6KYZ. You have ten outputs, except that 2, 5, 8, and 0 now represent A, B, C, and D.

A 555 timer connected as a single-shot disables the decoder for 20 seconds so that

regular phone number dialing will not be decoded in the case where all numbers (no column 4) are used for your sequence. If you plan to always have a fourth-column digit in your code, you could

eliminate this chip. The other 555 timer chip is an oscillator running at approximately 10 kilohertz, furnishing a clock to the MC14419.

A row-column match (both inputs low for 80 clock

Parts List

DEMUX

1	MC14419
2	74LS04
1	74154
2	555 timer
2	1k, 1/4 W
1	1 meg, 1/4 W
2	.01 uF disc ceramic
1	.1 uF disc ceramic
2	10 uF dipped tantalum

Sequencer

4	555 timer
2	7400
1	7473
4	eg, 1/4 W
2	10k, 1/4 W
4	.01 uF disc ceramic
4	4.7 uF tantalum
2	1 uF tantalum

Parts and circuit boards can be obtained from O. C. Stafford, 427 S. Benbow Rd., Greensboro NC 27401.

pulses) generates only one strobe pulse. The 74LS04 is used as an interface between CMOS and TTL. This strobe appears on one of the output lines of the 74154.

Sequencer

Two of these circuits are provided per board. If you need more, just add more boards. To the input labeled 1, you connect the output of the DEMUX that you want for the first digit in your sequence. The 2 and 3 inputs are connected similarly. A pulse on the first input starts the 5-second timer; a pulse on the second, if present during the 5-second rundown of the first timer, causes the second 5-second timer to start. This enables the third input to change the state of the J-K flip-flop and output a strobe pulse. This strobe pulse could

be connected back to the input of the next sequencer to implement a five-digit code. You will notice that a capacitor to ground and a 10k Ohm resistor connected to +5 V clear pins 2 and 6 of the flip-flop. This assures that the output pins 12 and 9 will be low after a power interruption.

Applications

Fig. 5 shows several applications. Some are general in nature, and others are more specific, namely, remote control of squelch.

Fig. 5(a) is a simple transistor switch. Punch out the sequence on your key pad, and the transistor saturates. Punch it out again, and the transistor is off. The addition of the relay, Fig. 5(b), needs no explanation. Fig. 5(c) is a little more sophisticated, as one sequence is needed to turn it on and another to turn it off. This would be useful in the squelch example, Fig. 6.

There are generally two ways of setting the squelch. One is to control the level of noise, and the other is to set a dc level. The method used in your receiver can be determined by examination of the schematic or by reading the instruction book. In the first case, a higher amount of noise to the squelch circuit will yield a higher squelch threshold. In the dc case, you may have to get out the old voltmeter to see how the thing works. Note the change in role of the original pot in

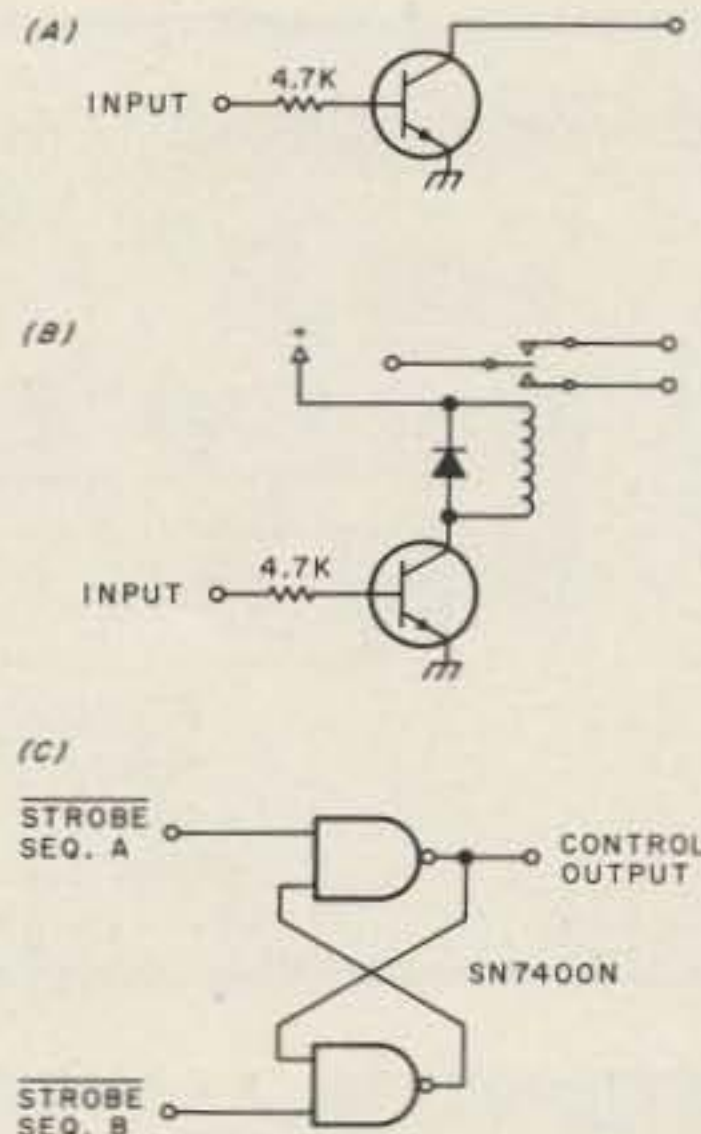

Fig. 5. General applications. (a) Saturated switch; (b) Relay control; (c) Strobe from sequencer "A" will cause the output to be high. A strobe from sequencer "B" will cause the output to be low.

the case of the noise-adjusted squelch.

Other applications include setting the output power level, starting a recorded message, and linking to another repeater (super coverage!).

It's surprising how much trouble intermod can be. Many repeaters are troubled by this plague, and, until the culprit can be found and remedial action taken, there is a surprisingly effective cure. A 6 dB pad connected in front of the receiver will do far more than a 6 dB reduction of intermod as you are reducing the "local oscillator" injection to the nonlinear circuits in your receiver which

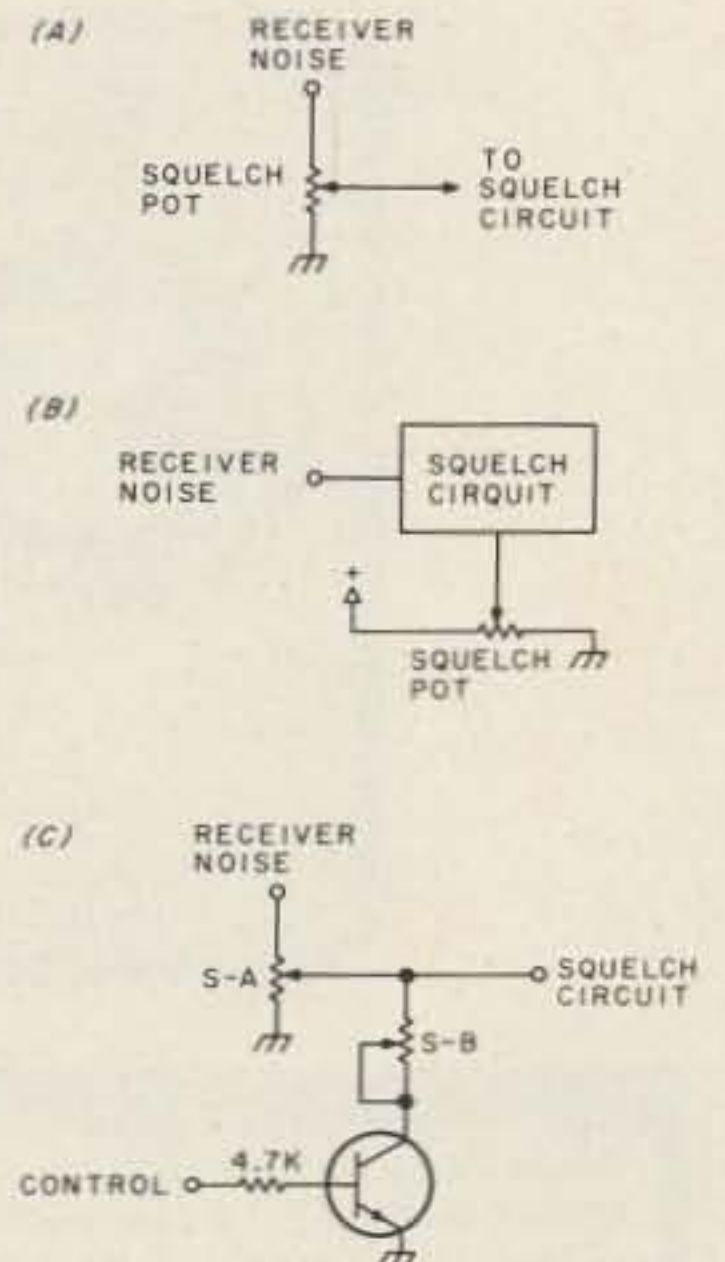

Fig. 6. (a) Squelch pot controls noise; (b) Squelch pot controls voltage threshold; (c) Set pot S-B for maximum squelch sensitivity. Set pot S-A for desired higher threshold. Some interaction should be expected.

are doing the mixing. This 6 dB pad can, in some cases, eliminate over 20 dB of intermod. Try it, if you don't believe it! Now, it won't do anything if the mixing is taking place external to your system (in a corroded antenna connection, for instance).

How about time or temperature on command? And better yet, how about your ideas? Why don't you share them with me? If 73 will print the stuff I send them, they surely will print your ideas. Think about it, and then act on it. ■

New Products

from page 51

older ones can either be modified or used with an attenuator to provide the required drive.

Perhaps the best feature of this new transverter kit is the economical price—only \$59.95. Two linear power amplifiers are available for higher power output. A model LPA2-15 provides 15 W PEP; model LPA2-70 provides 70 W PEP output. A cyclac case is also available

for the transverter and PA as an option.

For more information, call (716)-663-9254 or write for free catalog on these and other VHF and UHF kits, including preamps and converters for OSCAR. Hamtronics, Inc., 182-F Belmont Rd., Rochester NY 14612.

MC-3 MOBILE CHARGER FROM STANDARD

Standard Communications Corp., announces the availability

of a mobile-type battery charger designed for use with their hand-held transceivers. The model MC-3 is designed specifically for charging nicad batteries of hand-held transceivers encased by a leather carrying case.

For complete details, see your Standard dealer or write to Standard Communications Corp., PO Box 92151, Los Angeles CA 90009.

DESIGN MATE™ CASES OFFER BUILDERS ATTRACTIVE, INEXPENSIVE OPTIONS

After long offering a product line that encourages the design and development of

new electronic circuits, Continental Specialties Corporation now offers the do-it-yourselfer a place to put them. Their Design Mate cases are attractive, inexpensive answers to housing prototype electronic circuits.

These are the same cases that CSC uses to house its popular Design Mate series of test instruments. They are made of high-impact insulated plastic in one piece. They feature a slope front panel, a metal bottom, and include mounting screws.

There are two models of the CSC Design Mate case: the

Continued on page 60

2 METER CRYSTALS MANY IN STOCK

FOR THESE RADIOS ON
STANDARD ARRL REPEATER
FREQUENCIES

Clegg HT-146	Regency HR-212
Drake TR-22	Regency HR-2B
Drake TR-33 (rec only)	Regency HR-312
Drake TR-72	Regency HR-2MS
Genave	S.B.E.
Heathkit HW-2021 (rec only)	Sonar 1802-3-4, 3601
Heathkit HW-202	Standard 146/826
Icom/VHF Eng	Standard Horizon
Ken/Wilson	Swan FM 2X
Lafayette HA-146	Tempo FMH
Midland 13-505	Trio/Kenwood
Regency HR-2	Trio/Kenwood TR2200
	Trio/Kenwood TR7200

\$3.95 EACH – IN QUANTITIES
OF 10 OR MORE, \$3.50 EACH

Certified check or money order only —
NO CODs

ROLIN DISTRIBUTORS

P.O. Box 436
Dunellen NJ 08812
(201)469-1219

R15

2-METER MOBILE

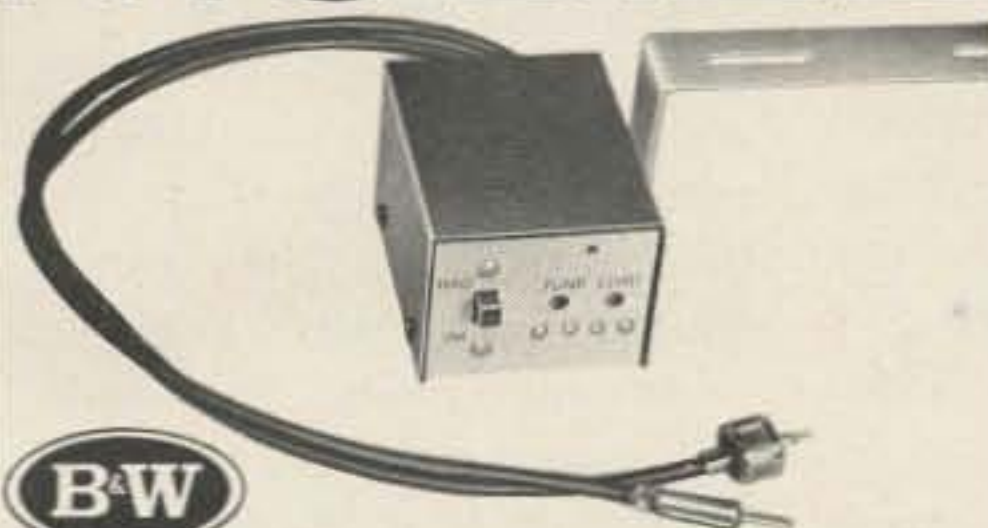

B&W AT-200 Antenna Matcher

Use your car's AM/FM antenna for
your 2-meter mobile rig.—Eliminate
the two-antenna tip-off to thieves,
without the nuisance of hideaways.

Save the cost of a 2-meter mobile
antenna.

AT-200 tunes from the front panel
for maximum output, minimum
VSWR (1.2:1 or less for most car
antennas).

\$24.95 at your B&W dealer.

Made in the U.S.A. by **B&W**

Barker & Williamson, Inc.

10 Canal Street, Bristol, PA 19007 **B23**

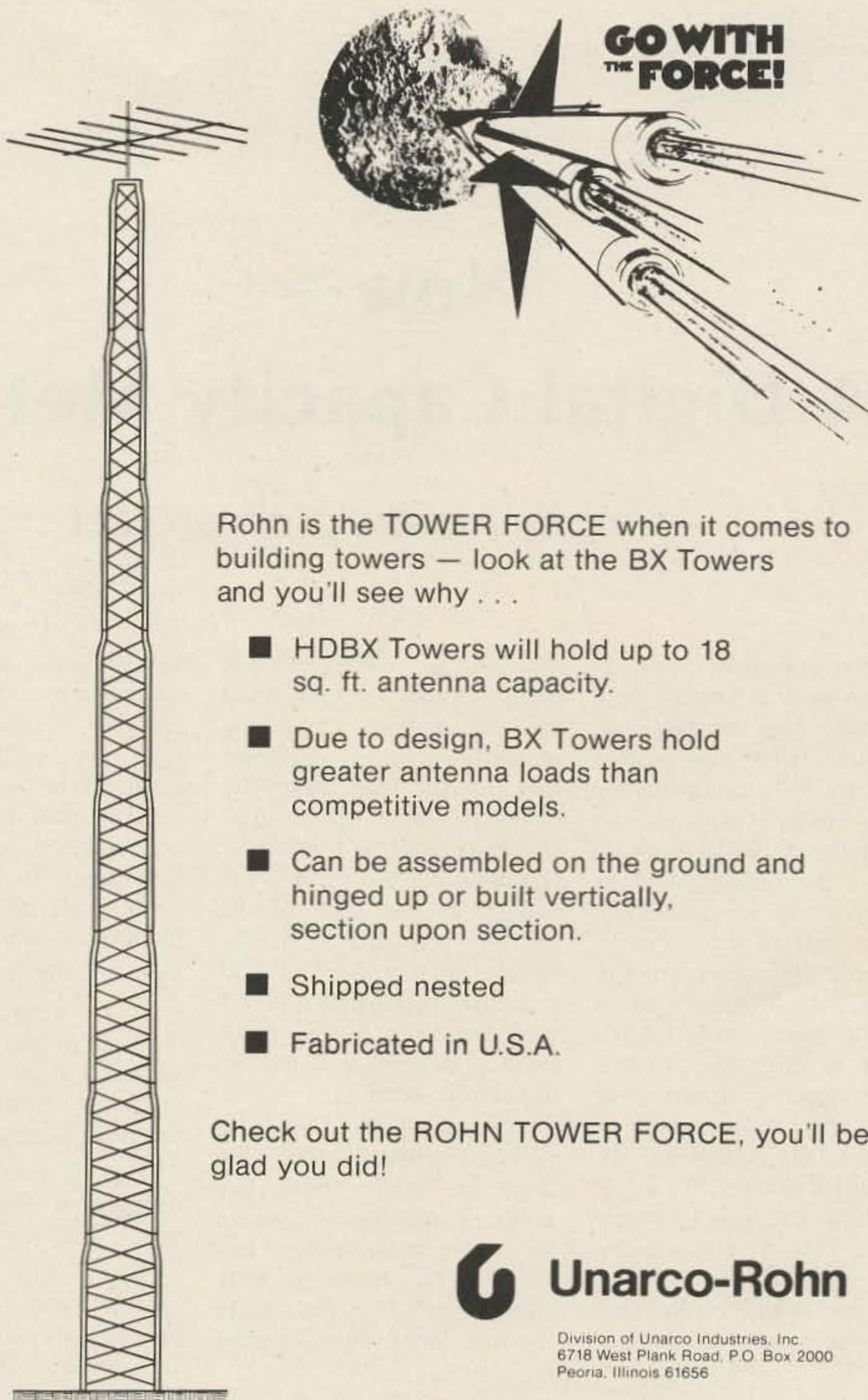

Rohn is the TOWER FORCE when it comes to
building towers — look at the BX Towers
and you'll see why . . .

- HDBX Towers will hold up to 18
sq. ft. antenna capacity.
- Due to design, BX Towers hold
greater antenna loads than
competitive models.
- Can be assembled on the ground and
hinged up or built vertically,
section upon section.
- Shipped nested
- Fabricated in U.S.A.

Check out the ROHN TOWER FORCE, you'll be
glad you did!

Unarco-Rohn

Division of Unarco Industries, Inc.
6718 West Plank Road, P.O. Box 2000
Peoria, Illinois 61656

Iron Powder and Ferrite **TOROIDAL CORES**

Wide selection - Large stock
Fast, one-day service
Technical data with each order
Write for free Tech-Data-Flyer

AMIDON
Associates

12033 Otsego Street, North Hollywood, Calif. 91607

In Germany: Elektronikladen, Wilhelm - Mellies Str. 88
4930 Detmold 18, West Germany. **A26**



Now— A Digital Capacity Meter!

—simple construction project

There are many means of taking the measure of a capacitor. For the range of capacitors that the instrument to be described can handle (approximately one microfarad to 99,900 microfarads), the best method to refer to is time versus voltage. Mother Nature and science reached a detente relating the charge or discharge of a capacitor versus time for the charge or discharge to reach some specific limit. The charge limit reaches 63% of the applied voltage in RC seconds, where R is in megohms and C is in microfarads. Thus, if you were to apply exactly ten volts to a capacitor which you made sure was totally discharged,

through a resistor of 1 megohm, and you monitored the voltage rise across the capacitor with a voltmeter that did not load down the circuit, you could use a stopwatch to time the number of seconds it took for the voltage to hit 63% of 10 volts, or 6.3 volts. It is easy to see that a 1-microfarad capacitor would time out at 1 second and that a 100-microfarad condenser would time out at 100 seconds.

You could work the same general method using the discharge curve, but your point of measurement would be when the voltage had fallen 37% from a fully charged capacitor. Herein lies the rub, for it is much harder

to tell when a capacitor is fully charged than fully discharged. It takes about six RC time constants for a capacitor to charge to about 99% of final full charge, so you would have time to read the paper if the capacitor under discussion was a 92,000-microfarad unit from your favorite computer.

Fig. 1 diagrams the basics required to translate the time-versus-voltage method of capacitor measurement into terms of electronic hardware.

Fig. 2 is the schematic diagram of the actual unit, which works as follows:

Note the "Function" switch S-1-a, 1-b, 1-c (three-pole, double-throw). In the Off position, this switch performs the following three tasks:

1. It provides a short across the capacitor connected to the test leads so that you start out with a fully discharged capacitor.
2. It blocks the flow of 60 Hz timing pulses to the counting system, which consists of a squaring circuit followed by a divide-by-six counter which produces 10-Hertz pulses.
3. It makes the reset terminals of the three 7490 decade counters HIGH, which is the condition required to make the three-digit display show all zeros prior to making a count.

In the Test position of this switch, the following conditions prevail:

1. The short is removed from the capacitor under test, and it is connected to the measuring circuitry which starts out basically with the range switch S-2 (one-pole, four-positions) and the 741 op amp used as a comparator.
2. It connects the 60 Hz timing waveform to the sine wave squaring circuit which uses two sections of the 7408 AND gate package.
3. It puts a ground on the 7490 reset line so that the counters will now be enabled to count.

Switch S-2 is the range switch, giving scaling factors of one, ten, one hundred, and one thousand. The zener-regulated nine volts positive is applied to the capacitor under test through one of these range resistors. Notice that the inverting input of the op amp is connected to a positive voltage through a voltage divider. Under conditions where the positive voltage to this input is greater in magnitude than the positive voltage applied to the noninverting input, the output of the op amp (pin 6) is highly negative. When the charging voltage of the capacitor under test reaches and just slightly exceeds the reference voltage on the inverting input, then pin 6 (output) goes highly positive.

In this fashion, by changing output polarity, the comparator gives a fixed point in time when the charging voltage just exceeds the reference voltage applied to the inverting input of the op amp.

Now all you have to do is provide a means of automatically starting a "clock" coincident with the start of the charging cycle and use the flip-flop of the comparator to stop the clock. Then the capacity of the unit under test is merely the multiplier of the range switch times the number of full and fractional seconds shown on the three-digit readout.

Photos by WA3PTC

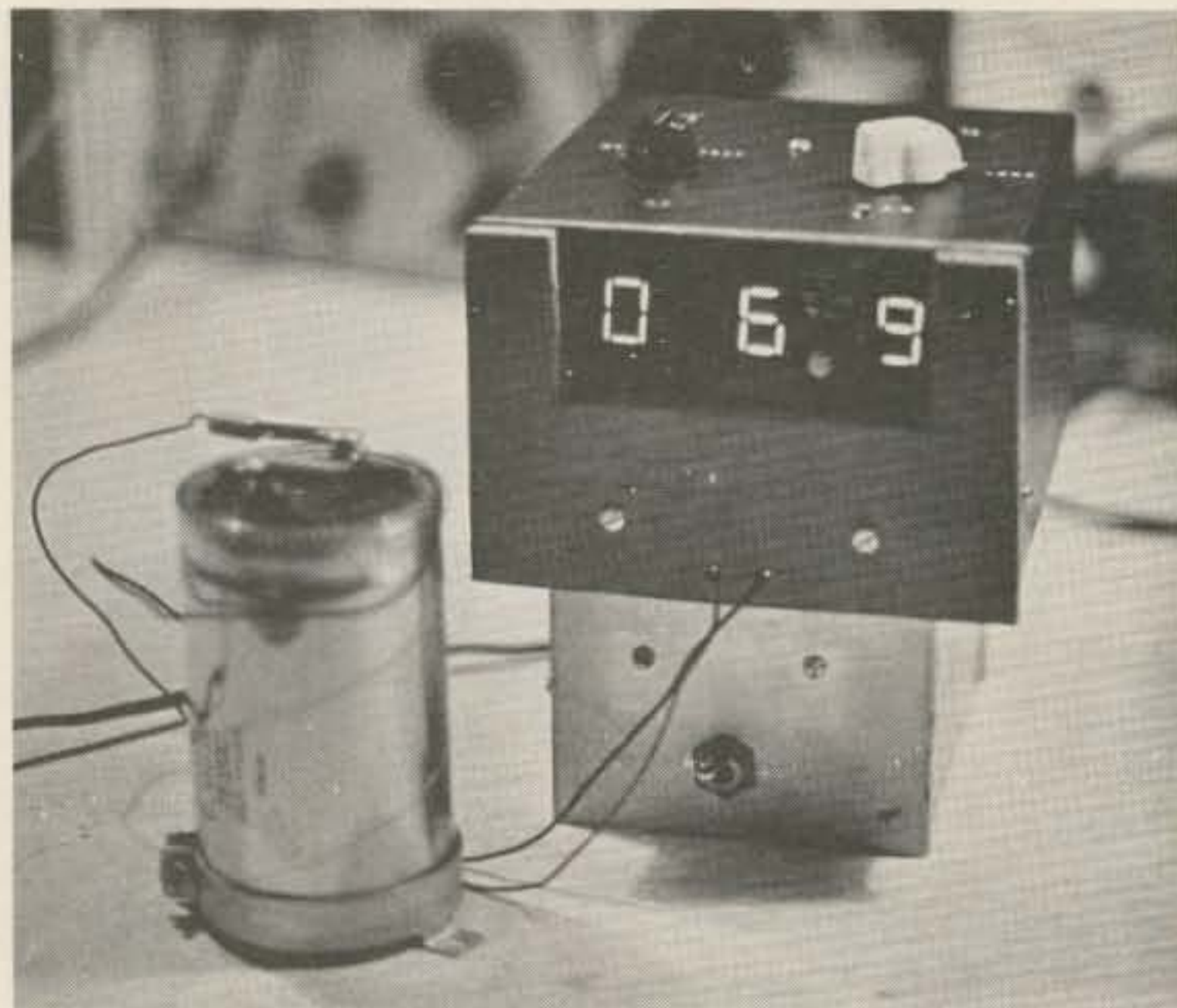

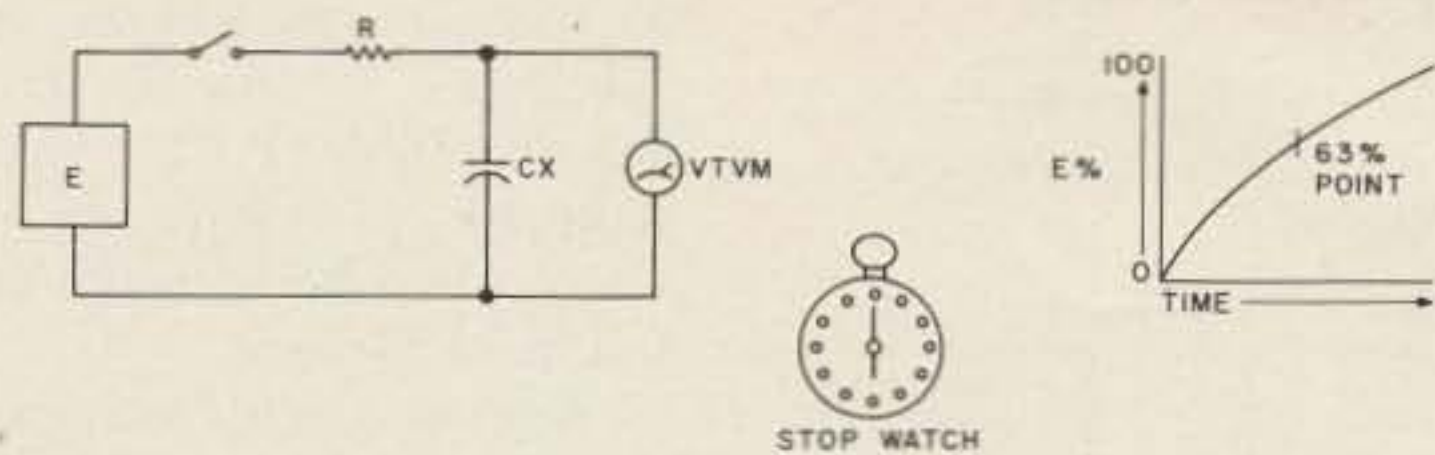

Fig. 1. Basic concept of capacitor measurement using time versus charging voltage rise.

Tackling the bits and pieces of how this all happens, consider the output swing of pin 6 of the comparator. It goes from approximately minus 8 to plus 8 volts in the course of normal operation. The function of Q1 (2N3904) is to convert this voltage swing to standard voltage levels acceptable to the TTL logic blocks used in the unit. In addition to this interfacing function (the only buzzword so far), the output from the collector is inverted in polarity, which you will see is needed to fit the rest of the circuit functions.

Since the timing chain starts in the power supplies, I'll say just a word about that here. The 5-volt supply is run of the mill with a 1-Amp capacity regulated by an LM309K. You can lash up any kind of a plus and minus 9-volt supply you care to for the op amp, but it must be zener regulated, at the least. From the transformer for this split supply, you need to provide a source of 60 Hz voltage from a voltage divider (1.3 to 1.5 volts ac), the only proviso being that the leg of the divider to ground should be about 1500 Ohms or less. This is so the squaring circuit which is next in line sees a reasonably low impedance.

The low-voltage ac goes to the two sections of the 7408 through a diode. The output amplitude is a rather decent 60 Hz square wave, about four volts in amplitude. This square wave is applied to the divide-by-six section of a 7492, which results in a 10 Hz output.

The digital readout section consists of three 7490 decade dividers, each of which is connected to a 7447 seven-

segment decoder driver. If you skip over some of the intermediate control circuitry and merely connect the 10 Hz to this three-digit divider/display chain, the display would consist of the right-hand digit showing tenths of seconds, the middle digit showing unit seconds, and the left-hand digit showing tens of seconds.

Now let's backtrack and see how to connect the leg bone to the ankle bone. You now have the comparator, the range switching, and the 2N3904 interface, and all you have to do is use it to stop the clock when the charge on the capacitor under test reaches the comparator reference voltage.

Interpose some logic circuitry between the 10 Hz pulses from the 7492 and the three-digit counter display as follows. A third section of the 7408 AND gate package is used as a gate. One side of this gate is fed by the 7492 with its 10 Hz output. The second input to this gate is a series chain of the output of the 2N3904 feeding into a 7474 D-type flip-flop used as a synchronizer. The output, Q, of this flip-flop then goes to the 7408 section being used as a gate.

The 7474 makes sure that you always get a full final pulse or count through the gate no matter when the comparator triggers at the end of the measuring cycle. Note that its clock input is fed from the 10 Hz source.

Now let's take a quick trip through the whole shebang to see what happens when you measure a capacitor.

Suppose you have an electrolytic which is marked 6 uF, and you want to check

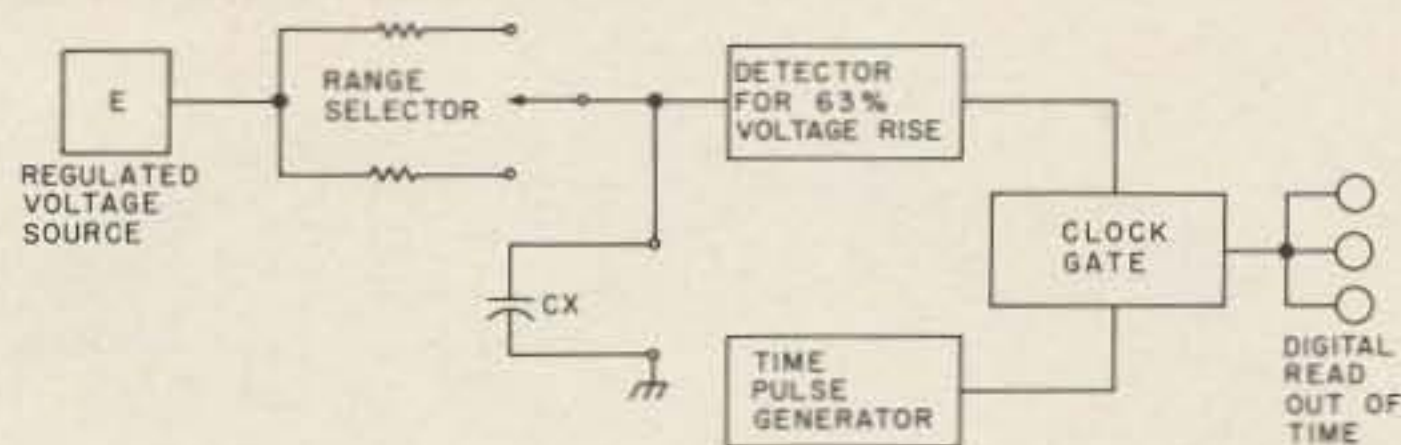

Fig. 1. (a). Basic translation into electronic hardware.

it. With the function switch in the Off position, you connect the test leads to the capacitor, being careful to observe polarity. The test voltage does not exceed 5 volts. In passing, if the capacitor has not been in service, take the time to form it for a few short minutes at near its rated voltage, or your reading can be way out of the ball park.

Set the range switch to Times One, as this will basically measure up to 10 uF, which will be shown by a readout of 10.0 (this range will really go up to 99.9 uF, but it will take 99.9 seconds to do so, which makes another range more logical for a larger capacitor).

When you throw the function switch to Test, things begin to happen. The short is removed from the capacitor, and it begins to charge. The 60 Hz is squared up and divided by six, feeding the gate and the synchronizer.

The 7490 counter chain has had its reset bus grounded so that it can count any pulses coming its way. The output of the op amp is now highly negative, making the collector of the 2N3904 high (positive 5 volts). This high is applied to the D-input of the 7474, and the first low-to-high transition of the 10 Hz signal applied to its clock input causes its Q-output to go high (and stay high). This TTL high is passed to the clock pulse gate, causing 10 Hz pulses to be passed to the 7490 divider/readout chain, and the readout begins.

When the charging cycle finishes, tripping the comparator output positive, this makes the collector of the 2N3904 go negative. On the very next low-to-high transition of the 10 Hz clock which is applied to the 7474, the Q of this flip-flop goes low, which shuts off the time pulses to the 7490 count/display chain. Now you

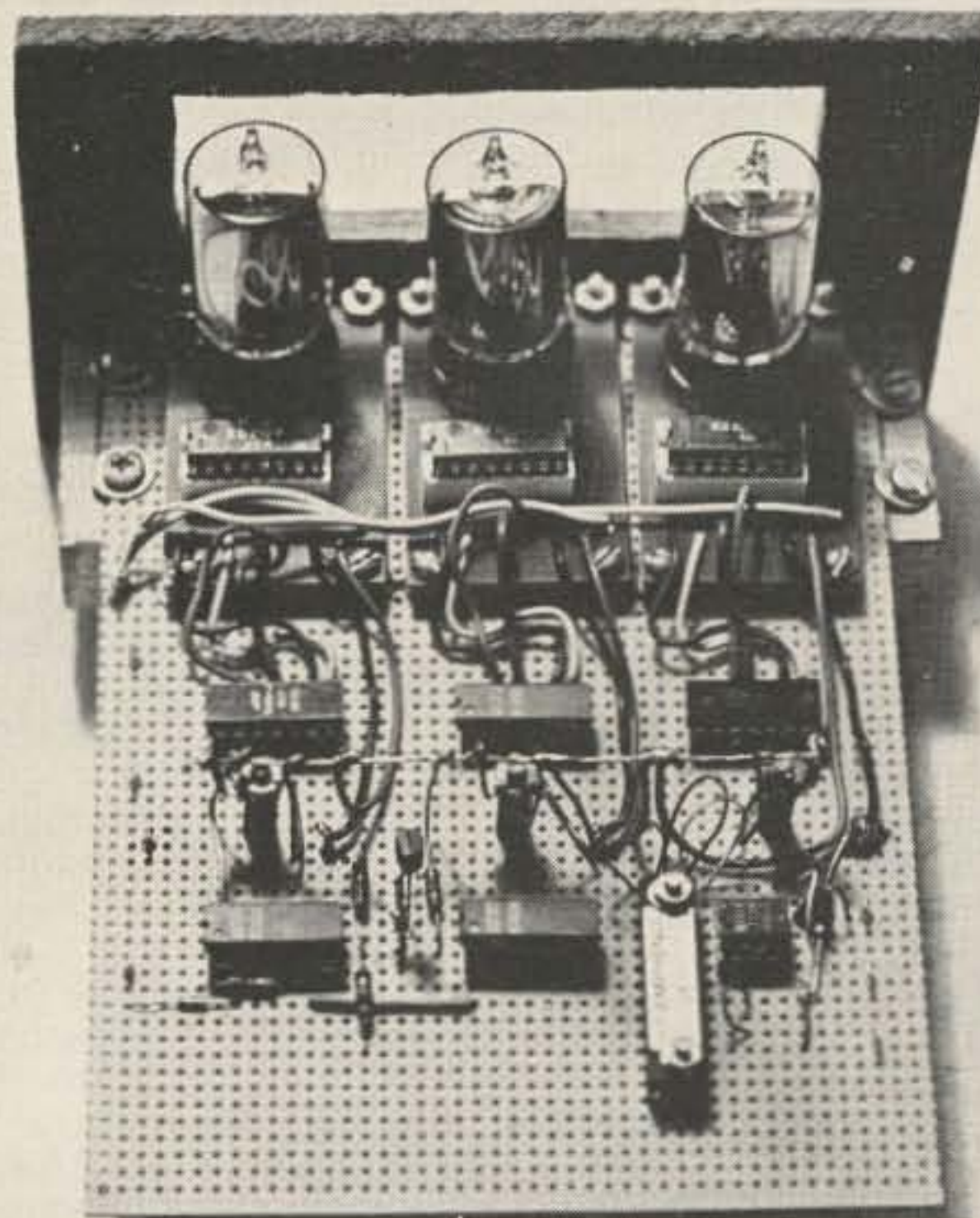

Regardless of your original reasons for becoming a ham—you want your hobby to be a source of pleasure. Whether you are a DX'er, Rag Chewer or OSCAR freak, you want the greatest enjoyment your budget and available time will permit. Clegg can help you get the most from your hobby!

To assure receiving the best "enjoyment/dollar" ratio here are several factors to consider when purchasing your new rig—

Choose the right piece of equipment for your specific operating preference! The best gear for the fellow down the street who spends all his operating hours rag chewing on 3999 may not be the best selection for you.

Select the leader best prepared and dedicated to keeping you satisfied with your purchase — from the moment you unpack your new equipment on

through the many years you'll be operating it.

Clegg stocks most leading brands of ham equipment and accessories. Like DRAKE, DENTRON, KLM, YAESU, ALPHA, WILSON, ICOM and KENWOOD rigs. Mosley, Hustler, ASP, KLM and Cushcraft antennas. Plus MICRO-MODULE and MFJ accessories. Naturally we feature the Clegg proprietary line of VHF transceivers and accessories. But we are at your service no matter what brand you choose.

If enjoyment, dollar value and service are important to you — then talk to the professionals at Clegg. Telephone toll-free 1-800-233-0250. In Pennsylvania call collect - 717-299-7221. Clegg Communications Corp, 1911 Old Homestead Lane, Greenfield Industrial Park East, Lancaster, PA 17601.

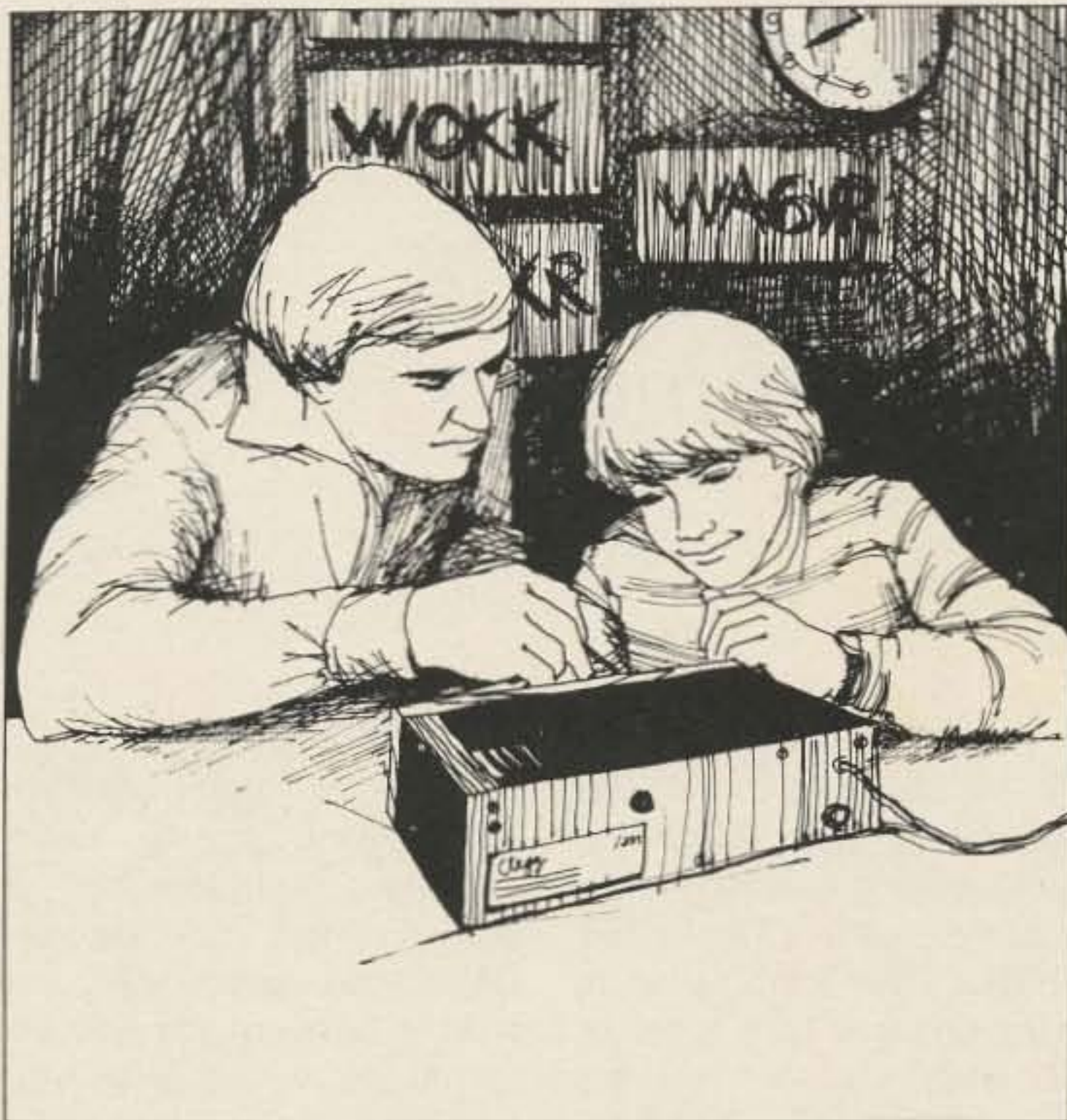

HAM RADIO IS FOR YOUR ENJOYMENT!

Clegg offers you three options when you purchase a major piece of ham gear.

1) Prior to shipping we unpack your unit and compare its performance with the manufacturer's specifications. If any deficiencies are found they are corrected before the unit is shipped. In this way you are assured of avoiding the disappointment of having a "sick" radio when you unpack the carton. We offer this "Pretest Plan" instead of a price discount and strongly recommend this option on complex equipment like transceivers.

2) If you prefer to purchase for price, we offer reasonable discounts on most equipment. We ship you a unit in its factory sealed carton directly from our stocks. Should you encounter problems with the equipment, you will still receive fast service under the terms of the manufacturer's warranty.

3) For the perfectionist we perform a complete laboratory check-out of your purchase and record all measurements of sensitivity, selectivity, spectrum purity, power output and other important data. Trained technicians make a thorough realignment to assure maximum performance. All test results and records are provided to you. Naturally, this service is costly and offered at a surcharge over the list price of the equipment. However, you are assured that your purchase is not only free from problems but measures up to the operating standards the original design engineer intended.

Clegg

FOR RELIABILITY

c3

DMM Survival Course

— "all" about using digital multimeters

If you are one of the great many people who have bought a digital multimeter, congratulations! That digital multimeter will do much in the way of simplifying your measurement chores and, hopefully, make ham radio more fun. But, like most pieces of equipment, the digital multimeter has its own peculiarities, some of which may not be fully discussed in the owner's manual. Your digital multimeter (hereafter DMM) can lie to you and give inaccurate readings consistently if you misuse it. And, worse, it can be damaged if misused.

It's awfully tempting to write a long list of dos and don'ts at this point, but not everything I have to say will fit neatly into a do/don't chart. I would suggest starting with these basics:

First, check over your test leads, especially if you are using ones from your shop that didn't come with the DMM. Check for broken insulation and broken connectors; if you find any, replace, replace, replace. I have found that quite often people try to "get by" with ratty old test leads, and that

can be dangerous. To this end, we at Gary McClellan and Company supply gratis a set of test leads with our 101 DVOM. There's no sense in taking chances with a set of bad leads. So, if you are getting a new set, what kind of test leads should you get? Get one with an insulated alligator clip and the other with a standard test prod. The leads should be about 3' to 4' long, with shorter lengths desirable (reduces noise pickup).

Now for some general operating hints: Surprisingly, a good many manufacturers of DMMs do not take the time to talk about using their products. So, as a result, you are assumed to be proficient at using DMMs, and that is a huge mistake. First, let's look at the basics. A DMM operates just like an analog VOM or VTVM, for the most part. You select the function you want (ac/dc volts or current or Ohms). Then you select the range you want to match what you are measuring. If you don't know the voltage, current, or resistance in the circuit under test, you always start at the highest range and work down

through the ranges until you get a good strong reading (ideally, midscale on an analog meter). You use your DMM the same way, but written between the lines is a lot to go wrong with your meter.

The first place you must watch is when you change functions. Always change functions before making any measurements. There are two reasons. First, in some meters, you can jolt the Ohms section with a voltage or current strong enough to damage it. And second, if your meter has push-buttons, you can nudge several at one time, applying destructive voltages to several parts of the meter. Blowing, say, the Ohms section and the ac volts section is not funny. This is why we use a quality rotary switch in our instrument to lessen the chance of multiple damages. But never switch functions when measuring a live circuit. You can switch from resistance to volts (and vice versa) in a dead circuit and then power it up, but even this is not wise.

Another thing you must be especially careful of is changing ranges. On a meter

with push-buttons, this is especially important because you can press several on most meters and that means trouble. It is wise to select the highest range, measure, remove probes, select range, etc., procedure when measuring volts and current. I strongly recommend removing the leads and selecting range, especially when measuring high voltages (1 kV or so) or any current. If you don't, you may have destructive arcing inside an attenuator resistor or at the switch contacts. Arcs are also murder on the CMOS circuitry used in modern DMMs. Need I say more? You can safely change ranges when measuring resistance without lifting the probes, however. But be careful when measuring voltage and current.

Always think safety when using a DMM. Nowadays, you don't see a lot of high-voltage gear, but, nevertheless, it's there in linears and TV sets. Don't ever rush a measurement on one of those high-voltage circuits without taking some precautions. Make sure your meter can read the voltage you are going to measure (most DMMs will read up to 1200 volts dc and 750 volts rms ac). If not, get a high-voltage probe for your meter. The Heath IMA-100-10 probe will let you safely measure up to 30 kV. You should always connect the probe to the equipment and then apply power and check the reading. If you can't do it this way, keep one hand in your pocket when measuring. Also, it is wise to have a rubber mat in your shop — especially if you work in a damp basement. Stand on it when working with high voltages. As for the meter, tie the ground lead to the ground or common input jack, even if you are measuring negative voltages. In some meters, the metal case is tied to the gnd/com jack, and that can be hazardous. In general, use common sense when using a DMM, and use it safely. And don't place it on a high shelf

where you can pull it off by the leads and get beamed or have it fall into a piece of live equipment.

Now that we have looked at some general stuff, let's look at a few specifics. These are things that will cause errors in your readings, some of which can be amazingly consistently wrong. Surely, by now, most people believe that a digital readout can lie just as well as an analog one can. Yet, at one time, there were folks who believed that, if it's digital, it must be right. This was especially true with digital clocks, which look super accurate, but, of course, can be super accurate if you subtract, say, 5 minutes. DMMs are like that, and the voltages, currents, and resistances they measure can throw you off if they are not pure dc, ac, or resistive. Also, the meter has tolerances that add to or subtract from the readings.

Let's look at instrument tolerances first because they are easier to understand. Your meter has what is known as a "basic accuracy" spec, or the best accuracy spec of the meter. This is always the dc volts function and usually the lowest range. Typical basic accuracy is on the order of $0.1\% \pm 1$ count. A "count" is plus/minus a "1" added/subtracted to the farthest right-hand digit. So say you are measuring 1.500 volts. You have an accuracy of plus/minus 0.002 volts ($1.5 \times 0.1\%$), or a range of readings of 1.502 V (+ 0.1%) to 1.498 V (- 0.1%). Then add the 1 count accuracy spec, and you get 1.503 V, 1.501 V or 1.499 V, 1.497 V. So, you see, these specs add up. For best accuracy, always try to fill up all $3\frac{1}{2}$ digits with numbers, for the more numbers you show, the greater your accuracy. A reading of 1.500 read on your DMM's 2-volt range can be more accurate than a reading of 01.50 on your meter's 20-volt range. Keep this in mind; it also holds true on ac and Ohms functions.

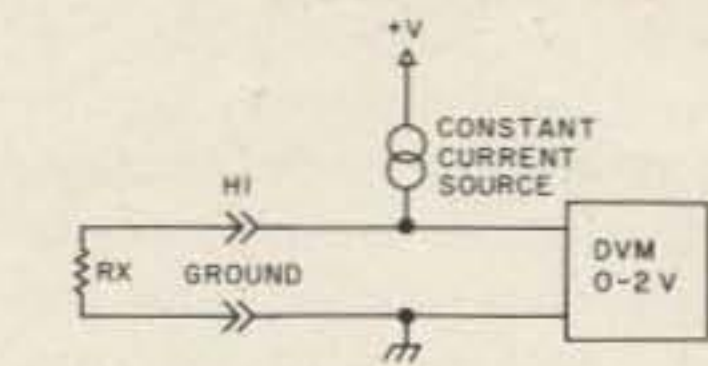

Fig. 1. Basic Ohms circuitry. The constant current source is very vulnerable.

The ac section of your meter adds some error to your measurements, above the basic accuracy of your DMM. The ac accuracy is the basic accuracy plus the accuracy of the ac/dc converter in your meter. The number is always larger than the basic accuracy. Your meter will probably have an accuracy of $\pm 0.5\%$, provided that you are measuring a low-distortion sine wave and are within the frequency response limits of your meter. This is very important because waveform and frequency have a powerful effect upon your accuracy. Also, noise pickup will raise hob with your readings. For best results, measure sine waves (note that some manuals give correction charts for other waveforms — these are usually the better meters) of low distortion of 1% and under. Stay within the maximum frequency limits — well within them. Use shielded cable to cut noise pickup when measuring signals either from high-impedance sources (100k and up) or on signals below 1 volt. Measure ac signals this way, and you should get the best accuracy from your meter. So how do you determine a low-distortion waveform? Check with a scope if you have one handy. A rule of thumb: Don't trust any signal dirtier than the ac power line. The frequency response limits should be stated in your manual; if not, assume about 50 Hz to 1 kHz. Most meters will go from 30 Hz to 5kHz with full accuracy, and some will go to 100 kHz with reduced input voltage and reduced accuracy.

Your Ohms section also adds error to the basic accuracy of your meter, but there

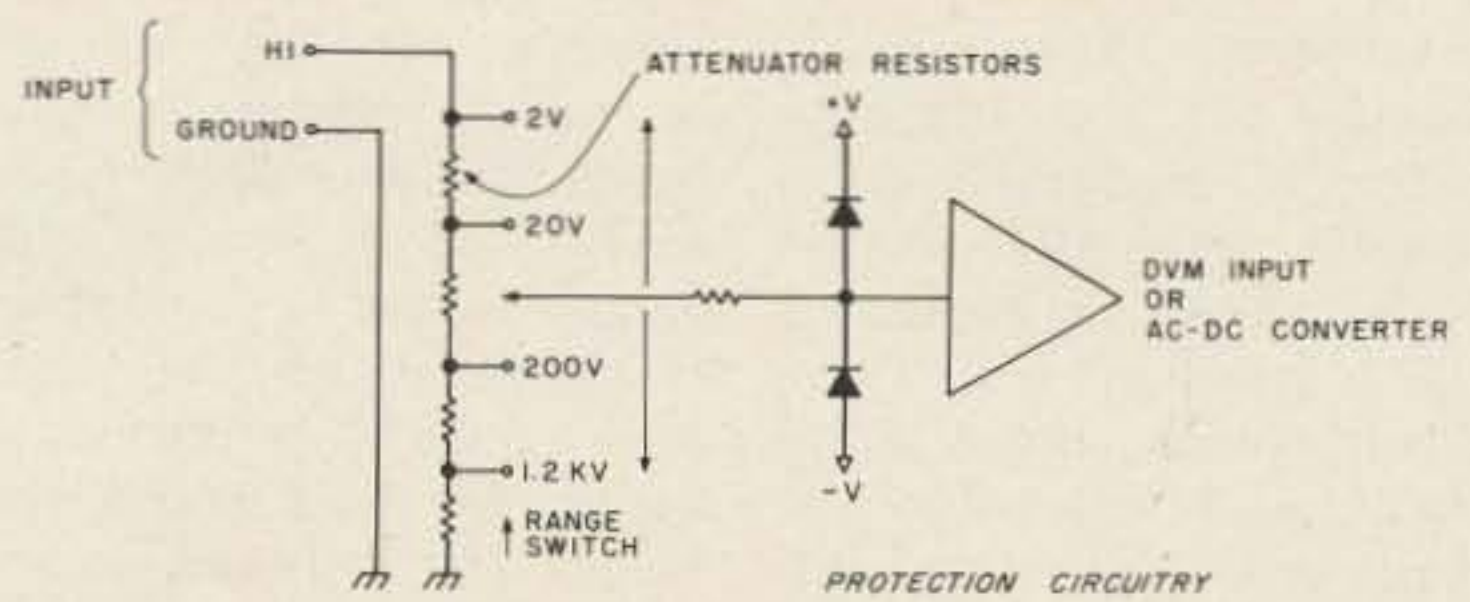

Fig. 2. Ac or dc volts input circuitry. The resistor and diodes on the op amp are protection circuitry.

aren't as many sources of error as the ac volts function. The main things you need to concern yourself about are that you never apply voltage to the Ohms circuit and that you try to get as many numbers as possible displayed for greatest accuracy. Remember that a reading of, say, 1.200k is better than 01.20k because it is less susceptible to the ± 1 count error and the Ohms accuracy. If you are making in-circuit measurements, watch out for semiconductor junctions, which can be turned on by the ohmmeter. Some DMMs put as much as 15 volts on the part under test. If you get strange readings, disconnect one side of the part and then check its resistance. On very high-resistance measurements, you may discover that the readings jump around quite a bit. This can be caused by several things, but it is mainly due to hum pickup on the leads. Either tie a 0.05 uF capacitor (use mylar) across the leads, or plug the part directly into the front panel jacks. You will notice this on the 2-meg and 20-meg ranges, and it can be quite annoying. The cure is simple.

Finally, there are the current ranges. The accuracy of most low-cost DMMs is a joke, with 1 to 5% being typical. We deliberately left off current ranges on our Gary McClellan and Company 101 DMM because we couldn't get good accuracy at low cost, which reflects poorly in terms of the other accuracy specs of an otherwise high-quality meter. So, when you measure current, your analog meter may be more accurate.

Here are a few tips for measuring current: Always use a range higher than the current you are going to measure. Never change ranges while you are measuring current. You may damage (pitting of contact surfaces) your DMM's switches. If you are measuring current, check to be sure that your circuitry is working properly. Drops through the meter (known as "insertion loss") will sometimes kill your circuitry. This is especially true with TTL logic. Some meters drop 2 volts with 2 Amps, and that 2 volts will stop your TTL dead in its tracks. If this happens to you, put your meter on 2 volts ac/dc and measure the drop across a 0.1-Ohm, 10-Watt resistor. A reading of 0.200 is 2 Amps, of course.

You should be aware that terrible things can happen to your meter or equipment if you seriously overload your meter. Personally, my big sin is putting voltage on the current shunts of my laboratory meters; the result is usually a blown fuse in the meter. However, others are not so lucky. You can very easily avoid damage to your meter simply by not rushing.

Most overloads do not damage your meter. But, nevertheless, there are several ways to kill a DMM, so let's look at them. The Ohms function is vulnerable, with the bottom range being the most vulnerable (usually 200 Ohms or 2k Ohms). The most current is available on these ranges, and that is difficult to protect. Believe me, the Ohms protection circuitry is one of the big things that separates the under \$100 meters from the over \$300

instruments. The protection circuitry in the expensive meters is costly and often complex, often more so than the circuitry being protected. Fig. 1 shows the basic Ohms circuit; voltage applied to the input usually takes the constant current source in a puff of smoke. In our meter, we use an expendable resistor. If it blows, the other ranges stay unharmed and perfectly usable. One outfit uses an SCR crowbar circuit, shorting the Ohms jack and hopefully blowing a 2-Amp fuse inside the meter. This meter can cause extensive damage to the equipment you are measuring, so be careful.

Needless to say, never, never put any voltage on your meter while it is in the Ohms function.

The ac/dc voltage ranges are pretty well protected in most DMMs by diode/resistor clamps, so it is not always that you can blow up these parts of your meter. Fig. 2 shows a typical input circuit.

However, very high voltages or pulsed voltages can raise havoc with your DMM. Never exceed the maximum ac/dc voltage ratings of your meter. If necessary, get the Heath high-voltage probe mentioned earlier. On most meters, this means 750 volts rms ac and 1200 volts dc. If you exceed these ratings by much, you risk arcing inside the DMM switches and range resistors. If you arc much inside a range resistor, you change its value permanently. Watch that voltage. TVs are murder in this respect; they have many relatively low voltages with very high pulses present. If the schematic says, "Do not measure," believe it. The same is true with rf fields.

The current ranges don't need too much comment. Just be sure to never exceed the ratings of a range, otherwise you may "strain" a resistor. Don't try to measure, say, 2 Amps on the 20 mA range.

Why all the comments on

overload? Simple. Today, if you damage a piece of equipment, it goes to the factory. With a DMM, it not only gets fixed, but recalibrated as well. And that usually goes for kit DMMs, too. I may be overstating my case, but a little careful use of your DMM can save grief. DMMs are getting better and tougher to blow up, but you can still do it. They are a little easier than a VOM to damage right now. Be reasonably careful and you won't have any problems.

DMMI?

Strange as it may seem, DMMs can cause RFI problems. This is especially true of the ones with plastic cases. You may have discovered this problem already if you work on sensitive communications equipment. Just clipping the ground lead to the chassis of an HF receiver or transceiver is often enough to create a loud broadband buzz in the speaker. This is primarily

caused by the multiplexed display in the DMM, and the noise floats down the test leads. Unlike these instruments, the Gary McClellan and Company model 101 DVOM uses both a metal case and a direct drive display, making repair of communications equipment possible with less noise pickup. If you have encountered this problem, your best recourse is to use a regular analog VOM or VTVM, leaving the DMM for less critical chores. You can certainly use that noisy DMM for a signal generator if you wish. Besides us, B and K Instruments is now paying attention to this problem by metal coating the inside of the case to cut radiation.

That just about does it for using a DMM. As you have read, it's not really so hard to use, and, if you pay just a little attention to the peculiarities of the DMM, you should be rewarded with the best accuracy your unit has to offer. ■



The LEADER In the Northwest!

ATLAS • ICOM • KENWOOD • YAESU



Kenwood TS-520S
\$739.00



Atlas 350-XL
\$995.00



Yaesu
FT-101E \$799.00
FT-101EE \$759.00



Kenwood TS-820S
\$1098.00



ABC
COMMUNICATIONS

A46



Yaesu FT-301D — \$935.00



17550 15th Ave. N.E. • Seattle WA 98155 • (206) 364-8300

TO PLACE ORDER
CALL TOLL FREE
IN STATE OF WASH.
1-(800) 562-7625

Other locations: (Walk-in customers only) • Bellevue — 12001 N. E. 12th • Everett — 6920 Evergreen Way • Open Mon. thru Sat.

AT LAST! For the amateur on the move—The BRISTOL HAM-10 and HAM-100 MOBILE TRANSCEIVERS



Bristol is pleased to announce the first low cost channelized mobile transceivers designed and engineered exclusively for use in the 10 METER BAND.

Brought to you by the people who provide the world with the famous military manpack radios.

For the first time anywhere, 10 METER BAND CHANNELIZED MOBILE TRANSCEIVERS are available at popular prices. There are no comparable mobile units which CAN TRULY CLAIM all of these additional features:

- Available in 2 models
HAM-10 — Low power — 10 watts
HAM-100 — High power — 100 watts and 10 watts
- 40 channels selected in the least-used portion of the band (with channel 40 overlap to hear OSCAR in the future.)
- Ultra-low spurious emissions to prevent RFI & TVI.
- Bristol's patented Phase Lock Loop frequency synthesizer* for precision frequency control.
- Selectable transmit power capability — 100 watts for extended range or 10 watts for short range — at the flick of a switch!
- Lightweight & compact.
- 100% solid state design for improved reliability.
- External jack for a speaker.
- Automatic Noise Limiter to reduce engine and atmospheric noise.
- Delta tune adjustment to tune in other operators who are off frequency.
- S/RFP meter, LED modulation indicator, squelch control, all mounting hardware, microphone, and more.
- Full factory warranty & service backed up by RF engineers and skilled technicians.



SPECIFICATIONS

Frequency	28.965 to 29.405 MHz
Channels	40
Receiver Sensitivity	0.7 uv for 10 db
	$\frac{S+N}{N}$
Modulation	AM
Spurious Signal Suppression	more than 60 db
Harmonic Signal Suppression	more than 45 db
Input Power:	
HAM-100	13.8 vdc; 0.5A Rec. 8.0A Tx
HAM-10	13.8 vdc; 0.5A Rec. 1.5A Tx
Dimensions:	
HAM-100	6.5"W x 2.4"H x 9.75"D
HAM-10	6.5"W x 2.4"H x 7.75"D
Weight:	
HAM-100	4.5 lbs
HAM-10	3.5 lbs

*Patent Number 3,748,589 Bristol Electronics, Inc.

FOR A LIMITED TIME ONLY — BY MAIL ORDER DIRECT FROM THE FACTORY
HAM-10 — only \$149.95 HAM-100 — only \$264.95

Please enter my order for Bristol HAM Transceivers:

() HAM-10(s) @ \$149.95 Total Price _____

() HAM-100(s) @ \$264.95 Total Price _____

Allow at least three
(3) weeks for delivery

Add \$2.50 for shipping and handling. (Mass. residents add 5% sales tax).

Check or money order enclosed. OR

Charge my VISA or Master Charge No. Bank No. _____

Signature _____ NO COD's PLEASE

NAME _____ CALL _____

STREET _____

CITY OR TOWN _____ STATE _____ Zip _____



BRISTOL ELECTRONICS, INC. *be*

651 ORCHARD ST, NEW BEDFORD, MA 02744 (617) 997-3181 TELEX 929421

Makers of digital depth indicators, VHF-FM transceivers, wind instruments, knotmeters, and the famous U.S. Army field radio.

Dealer Inquiries Invited

B24

PART 2—FREQUENCY ALLOCATIONS AND RADIO TREATY MATTERS; GENERAL RULES AND REGULATIONS

PART 97—AMATEUR RADIO SERVICE

Prohibiting the Marketing of External Radio Frequency Power Amplifiers Capable of Operation on any Frequency From 24 to 35 MHz and Requiring Type Acceptance of Equipment Marketed for Use in the Amateur Radio Service

AGENCY: Federal Communications Commission.

ACTION: Final rule.

SUMMARY: This document requires a grant of type acceptance from the Commission prior to the manufacturing or marketing of any external radio frequency power amplifier in the Amateur Radio Service and requires that any external amplifier not be capable of operation in the frequency range of 24 to 35 MHz. This action was taken in response to the large number of amplifiers currently being produced for illegal operation in the Citizens Band Radio Service and by unlicensed operators. It should reduce the availability of this equipment to these operators and therefore will result in a substantial reduction of interference to other users of the radio spectrum.

EFFECTIVE DATE: April 28, 1978.

ADDRESS: Federal Communications Commission, Washington, D.C. 20554.

FOR FURTHER INFORMATION CONTACT:

John A. Reed, Office of Chief Engineer, 202-632-7093.

SUPPLEMENTARY INFORMATION: Adopted: February 16, 1978. Released: March 20, 1978.

By the Commission: Commissioner White concurring in part and dissenting in part and issuing a statement.

In the matter of amendment of Parts 2 and 97 of the Commission's Rules to require type acceptance of equipment marketed for use in the Amateur Radio Service; and amendment of Part 2 of the Commission's Rules to prohibit the marketing of external radio frequency power amplifiers capable of operation on any frequency from 24 to 35 MHz.

1. Notices of Proposed Rulemaking in the above captioned matters were released on February 28, 1977. The deadline for the submission of comments was May 25, 1977, and for the submission of reply comments was June 6, 1977. In response to petitions received from the R. L. Drake Co., the Heath Co. and the American Radio Relay League, Inc., these dates were extended to June 24, 1977, for filing comments and to July 6, 1977, for filing reply comments. The report comment date was further extended to July 13, 1977, in response to a petition filed by the R. L. Drake Co. In response to a petition by the American Radio Relay League, Inc., oral arguments were held on December 1, 1977, to allow interested parties to present their ideas to the Commission en banc.

2. Docket 21117 proposed to require type acceptance pursuant to Part 2 of our rules for all amateur transmitters and external radio frequency power amplifiers. Various other changes were also proposed including increasing the level of spurious and harmonic suppression to 43+10 log (power in watts) decibels below the mean power output of the transmitter or amplifier for all emissions outside of the amateur band being used and exempting the individual amateur operator from the type acceptance requirements.

3. Docket 21116 proposed to prohibit the marketing of any external radio frequency power amplifier capable of operation on any frequency or frequencies between 24 and 35 MHz. An exception was proposed to this restriction for any licensed amateur operator

with a general or higher class license who wished to construct not more than one unit of the same model for use at his licensed amateur radio station.

4. Docket 21117, there were 199 individuals and organizations who filed comments, 3 of whom filed reply comments, 6 of whom filed (and were accepted as) late comments, and 1 who filed and was accepted as a late reply comment. Docket 2116 received 282 comments from various individuals and organizations, 3 of which filed reply comments, 5 of which filed and were accepted for late comments, and 1 which filed and was accepted as a late reply comment. In addition, 11 parties participated in the oral arguments for both dockets with 4 parties filing supplementary comments. While specific references are not generally made to any individual comment, the public is assured that all comments and reply comments were carefully reviewed and considered before reaching our decision in this proceeding.

THE PROBLEM

5. During fiscal year 1976, FCC field installations received 80,816 complaints of electromagnetic interference. This interference was primarily to television reception. Of these complaints, 83 percent were associated with the operation of transmitters in the Citizens Band Radio Service. In an attempt to determine the major causes of such interference, a study was conducted by the Commission's Field Operations Bureau in which 72 sample cases were randomly selected and investigated. These sample cases were limited to interference to television reception involving CB transmitter and were selected over several months covering the entire United States in order to insure a random sample. From this study, it was determined that in at least 46 percent of the samples the interference was due to the illegal use of an external radio frequency power amplifier. The study also showed that in fiscal year 1976 a lower bound on the number experiencing interference to television reception associated with the operation of CB stations probably lies somewhere between 1 and 10 million persons with the best estimate being 4 million persons. Projections for fiscal year 1979 are that between 3 and 21 million persons (best estimate—9 million) will experience TVI associated with CB operation.

6. The number of interference complaints being received by the Commission is increasing at an alarming rate, primarily due to the Citizens Band Radio Service and the illegal operation of external amplifiers in that service. The Commission has attempted to deal with the problem of these amplifiers in the past, notably through rule making in Docket 20118 (40 FR 1243, 50 FCC 2d 310) which added a new Section 2.815 to the marketing rules in Part 2. This section prohibited the marketing of any external radio frequency power amplifier capable of being used with a transmitter operating on any frequency or frequencies between 24 and 35 MHz with certain exceptions. These exceptions allowed the continued marketing of these amplifiers operating in this frequency range provided the equipment also had amplification capability over the following frequency ranges: 7000 7300 kHz, 14,000 14,350 kHz, 21 21.45 MHz, and 28 29.70 MHz.

7. Unfortunately, the action in Docket 20118 was ineffective as it was concerned solely with the production of then available single band amplifiers for the CB service and it further was based on the assumptions that amateur equipment would not be used in the CB service. However, almost immediately after the issuance of the Report and Order in that docket, there appeared on the market a device commonly called a "broad-band linear." These devices were marketed ostensibly for use in the Amateur Radio Service and were constructed to meet the strict requirements of our rules, inasmuch as they claimed to

provide for operation on the frequency bands specified under our exemption. However, these devices were intended solely for use in the Citizens Band Radio Service and for use by unlicensed operators, contrary to the intent of our rules. In addition, these devices had an even greater potential for interference due to the higher level of spurious emissions which were generated.

8. Docket 21116 was therefore issued in combination with Docket 21117 to close this "loop-hole" in our regulations that permits the manufacture of amplifiers capable of being used with CB equipment. In this regard, the Commission is removing the "loop-hole" in our regulations that allows the manufacture and marketing of amplifiers capable of operation in the frequency range of 24 to 35 MHz. This is being accomplished by amending our regulations, as discussed later in this order and shown in the attached appendix, to prohibit the manufacture, importation, or marketing of any amplifier capable of operation on any frequency or frequencies between 24 and 35 MHz.

9. There are a number of manufacturers and suppliers of external amplifiers that are not complying with the current emission limitations specified in Section 97.73 (Docket 20777, released March 10, 1977, FCC 77-157) of the Commission's Rules, contributing to the interference problem. This section requires an out-of-band emission attenuation of 40 decibels below the mean power of the fundamental without exceeding 50 milliwatts for any 5 watt or higher powered amplifier or transmitter operating below 30 MHz. While this requirement has only recently become effective for amateur transmitters, it has been in effect since April 15, 1977, for all external amplifiers and is retroactive for these amplifiers, regardless of the date of purchase or manufacture. Many of these amplifiers have been tested by our Laboratory Division and, to date, only a few have complied with this requirement.

10. The Commission has decided not to require type acceptance of amateur transmitters at this time as the emission limitations of Section 97.73 have only recently gone into effect for these transmitters. It cannot be demonstrated that such a program would be necessary to reduce their interference potential. However, the external amplifier manufacturers have continued to supply their products for illegal operation in the CB service and for use by unlicensed operators, and; in addition, many have not begun to modify their equipment to meet the new emission standards. For these reasons, the Commission has decided to bring those amplifiers operating below 144 MHz (the 2 meter band) under our type acceptance program for a limited, 3 year period. This requirement will enable the Commission to determine prior to the initial marketing of the equipment whether it meets our technical standards and is intended for use in the Amateur Radio Service. The methods used in this determination will be discussed in detail later in this Order.

COMMENTS RECEIVED

11. Many of the comments received in these dockets recommended that the Commission introduce a requirement that a valid amateur license be shown as a prerequisite for purchasing any amateur equipment. Such a proposal is currently before the Commission in a number of petitions for rule-making such as RM-2839 filed by the San Antonio Repeater Organization.

12. No other viable alternatives were proposed in these dockets other than the showing of a license, previously mentioned. While the majority of comments were against both the banning of amplifiers capable of operation between 24 and 35 MHz and the type acceptance of amateur equipment, many stated that they would accept such a requirement if the Commission was sure that it would be effective and if no other viable alternative was available. We are of the opinion that requiring type acceptance for a limited time and banning any amplifiers capable of operation in the above frequency range satisfies both of these requirements. The 3-year time period for

type acceptance will allow the Commission the time to investigate other methods of reducing the problems caused by the illegal operation of these amplifiers while still attacking the immediate problem. If at the end of this 3-year period it is determined that the type acceptance requirement is still necessary and that it has indeed reduced the problems caused by these amplifiers, this program can be continued by further Commission action.

RULE AMENDMENTS

13. Attached as an appendix are the revised rules which ban the use (under Part 97), manufacture, importation, and marketing of: (1) any external radio frequency power amplifier capable of operation below 144 MHz which has not been type accepted, and (2) any external radio frequency power amplifier capable of operation in the frequency range of 24 to 35 MHz. Many of these rule changes have been placed in Part 2 of the Commission's Regulations. In order to make clear to the public our intent in these revisions, each section is discussed below.

Section 2.815. This section has been modified to remove the exemption that formerly allowed the marketing of external amplifiers capable of operation in the frequency range of 24 to 35 MHz if amplification capability was also provided in other specified frequency bands. As of the effective date of these regulations, the manufacture, importation, and marketing of any external amplifier capable of operation from 24 to 35 MHz will be prohibited. In addition, the manufacture, importation, or marketing of any amplifier capable of operation below 144 MHz will also be prohibited unless a grant of type acceptance has been issued for that equipment. However, this latter prohibition has been worded to allow the necessary manufacture of a limited number of amplifiers in order to make the tests needed for obtaining a grant of type acceptance. A limited number of amplifiers would be considered to be no more than 10, unless some justification can be submitted to the Commission to demonstrate why it would be necessary to manufacture a larger quantity. (Manufacturers and equipment dealers should also note Paragraph 15 of this Order which details how a waiver of this marketing requirement may be obtained for present inventory.)

While this section prohibits the manufacture of any external amplifier capable of operation below 144 MHz with the exception of those which have been type accepted, this Commission has no intention of preventing the continued manufacture or marketing of external radio frequency power amplifiers designed for Industrial, Scientific, or Medical (ISM) applications. In this regard, the Commission will entertain requests for a waiver of this section from those ISM manufacturers. However, the manufacturers of external amplifiers designed for operation in the Citizens Band Radio Service or for other illegal applications should note that there are considerable differences between ISM equipment and amateur equipment. There is, therefore, very little chance of one of the manufacturers of these illegal amplifiers obtaining such a waiver. If such a waiver was granted through error, the waiver could be revoked and the manufacturer denied the right to manufacture or market any more of his equipment. This could possibly occur if any amplifier which was manufactured under such a waiver was discovered being used outside of its intended operation.

In addition to the above prohibitions, new Paragraphs (d) and (e) have been added. These paragraphs are designed to allow the licensed amateur radio operator to construct an amplifier (not from a kit which is also required to obtain a grant of type acceptance) which operates in the frequency range of 24 to 35 MHz or in any frequency range below 144 MHz and to market that amplifier to another licensed amateur operator for use at his own amateur station, without regard to the type acceptance requirements or the 24 to 35 MHz frequency ban requirements. However, any construction or modification of this equipment is only allowed if the amateur opera-

tor does the construction or modification, and that amateur operator has a license of the appropriate type which allows him to use such equipment. In addition, the requirements contained in Sections 97.75 and 97.76 of the amateur regulation must be met, and no more than one unit of a particular model amplifier can be constructed or modified in any 1 calendar year without obtaining a grant of type acceptance.

Section 2.983. This section has been amended to exempt the amateur amplifier from most of the required measurements for type acceptance. The only measurements which will be required are for spurious emissions radiated at the antenna terminal and the field strength of the spurious radiations which are emitted from the cabinet. These measurements are incorporated by reference in Section 2.1005 and are contained in Sections 2.991 and 2.993 of the Commission's Regulations.

Section 2.1001. This section has been revised to allow individual licensed amateur radio operators the ability to modify their own equipment without regard to type acceptance provisions. While the modified amplifier will still be required to meet the emission limitations of Section 97.73 and any other technical requirements for the amateur service, the amplifier may be modified in whatever manner the amateur operator desires provided the equipment will only be used at a licensed amateur radio station and further provided that the amateur operator who performs the modification possesses a license of the appropriate type that allows him to use the equipment being modified. Modifications specified by equipment manufacturers or suppliers will not be allowed unless the manufacturer or supplier has obtained the necessary permission from the Commission as detailed in Paragraph (b) or has obtained a new grant of type acceptance incorporating such modifications. In addition, no modification of these amplifiers will be allowed without a new grant of type acceptance or written permission from the Commission, as detailed in Paragraph (b) of this section, if the equipment is not used solely at a specific licensed amateur radio station. Any modifications made in this manner are the responsibility of the station licensee who shall also remain responsible for insuring that this modified equipment will still comply with all of the applicable technical standards in Part 97.

Section 2.1005. A new section has been added to cover the type acceptance requirements of amateur equipment. There are a number of points made in this section which require that each paragraph be discussed:

(a) This paragraph references the appropriate sections under our type acceptance regulations. These sections cover all information pertaining to the grant such as identification of the equipment; reasons for dismissal of the application; changes in the equipment, its identification, or the name of the grantee; FCC inspection; and various other aspects. In addition, the specific test sections are referenced. To obtain a grant of type acceptance for an external amplifier, in addition to the data required by Section 2.983, test results must be submitted in accordance with Section 2.991, the measurement of the spurious emissions at the antenna terminal, and with Section 2.993, the measurement of the field strength of spurious radiations emitted from the cabinet, power leads, and other elements of the amplifier under test.

(b) This paragraph simply states the test parameters for making the spurious emission tests. While many of the received comments stated that to require such tests of amateur equipment would be cost prohibitive, increasing the cost of equipment to the consumer, the Commission is not of this opinion. No piece of radio equipment from any service should be marketed before a number of samples are tested to determine that the equipment is in compliance with our regulations. As these tests should be performed regardless of the requirement for type acceptance, the only additional expense that type acceptance would cost the manufacturer or supplier is the few

hours of paperwork to compile the application and the time delay in marketing during which the Commission processes this application.

(c) This paragraph describes the type acceptance procedure for kits, including an example of the required identification label. This material is fairly straightforward and should not require further explanation. However, it should be noted that Section 97.3 (aa) defines an external radio frequency power amplifier kit as any number of electronic parts usually provided with a schematic or printed circuit board which when assembled in accordance with instructions results in an external amplifier, even if additional parts of any type are required to complete the assembly.

(d) This paragraph simply restates the Commission's ability, as defined in Section 2.915(a)(2) of our regulations, to deny a grant of type acceptance, even though the equipment complies with the applicable technical standards, if it is found that to not issue such a grant would serve the public interest, convenience and necessity by preventing the use of these amplifiers in any radio service other than the Amateur Radio Service. The Commission could therefore deny a grant of type acceptance for any amplifier it felt was designed for use by a CB or unlicensed operator. The points which would be considered in making this determination are listed in Section 97.77.

14. In addition to the rule changes in Part 2, a number of changes are also made to Part 97 of the Commission's Regulations. These changes detail how the requirements for type acceptance will affect the individual amateur operator and also specify the technical requirements for type acceptance. As with the discussion of the changes in Part 2, each section will be covered separately.

Section 97.3. This section has been amended to add a definition of an external radio frequency power amplifier and an external radio frequency power amplifier kit.

Section 97.75. This section requires, as of the effective date and for 3 years following that date, that every external radio frequency power amplifier capable of operation below 144 MHz which is used at an amateur radio station be of a type which has received a grant of type acceptance for use under Part 97. However, a number of exemptions to this type acceptance requirement are detailed, all requiring that the equipment be used only at a licensed amateur radio station. Of particular interest should be Subparagraph (a)(2) which states that any external amplifier originally purchased before the effective date may continue to be used without regard to the type acceptance requirement. This would also apply to any amplifier purchased after the effective date from another licensed amateur radio operator or from a dealer who purchased the amplifier used from another licensed amateur radio operator, as long as the amplifier was originally purchased before the effective date. The sale of this equipment is permitted under Section 97.76. However, as previously mentioned, this applies only to those amplifiers in use at an amateur radio station which, by definition, is currently licensed. Any amplifier in use in another radio service is not grandfathered under this clause.

Also of interest in this section should be Subparagraph (a)(6) which states that any amplifier originally purchased after the effective date of these regulations may also be used without regard to the type acceptance requirement if the amplifier was marketed under the marketing waiver explained in Paragraph 16 of this order. As before, this would also apply to any amplifier marketed under this waiver which was purchased after the effective date from another licensed amateur radio operator or from a dealer who purchased the amplifier used from another licensed amateur operator. However, this amplifier must still be for use only at a licensed amateur radio station.

While the rest of this Section is fairly self-explanatory, it should be noted that any amplifier purchased from another licensed amateur operator or from a dealer is also exempted from the type acceptance requirement if the amplifier was: (1) modified by

another licensed amateur operator who possessed a license of the appropriate type which allowed him to use the equipment being modified, (2) constructed (not from an amplifier kit) by another licensed amateur operator, or (3) constructed by a licensed amateur operator from a kit purchased before the effective date of these regulations. However, all of these exemptions require that the amplifier be used only at a licensed amateur radio station.

It should also be noted that this section limits the construction (not from a kit) or modification of these amplifiers to only one unit of a particular model amplifier per calendar year. Any amplifiers constructed or modified in excess of this limit must be type accepted.

Finally, Paragraph (b) of this section references the Commission's "Radio Equipment List, Equipment Acceptable for Licensing." Any amplifier on this list as being approved for use under Part 97 may be used in the Amateur Radio Service.

Section 97.76. This section requires, as of the effective date and for 3 years following that date, that every external radio frequency power amplifier capable of operation below 144 MHz which is marketed, manufactured, imported or modified for use in the Amateur Radio Service be of a type which has received a grant of type acceptance for use under Part 97. The term "modified for use" does not mean that an amateur operator cannot modify an amplifier that has not been type accepted for use under Part 97. Rather, it means that any amplifier which is modified to be used in the Amateur Radio Service which is then manufactured, marketed or imported for use in that service must also have obtained a grant of type acceptance.

Specific exemptions are listed in this section for the individual amateur operator. As long as the construction (not from a kit) or modification is performed by a licensed amateur operator, this equipment may be sold to another licensed amateur operator for use at his amateur radio station. Any modifications must be performed by an amateur licensee whose license affords him the privileges of using the equipment being modified. This equipment may also be sold to a dealer who, in turn, is required to sell the amplifier to another licensed amateur radio operator for use at his amateur station. While this may sound like requiring the presentation of an amateur license for sale of this amplifier, this is not the case. Sections 2.803 and 2.815 prohibit the marketing of those amplifiers that do not possess a grant of type acceptance. However, the individual amateur operator has essentially been exempted from this requirement, as detailed in this section and Section 97.75. Therefore, as long as the sale is to an amateur radio operator for use at his amateur, there is no violation of our marketing rules. Any sale of this equipment to any other person would be in violation of Sections 2.803 and 2.815 in addition to any other applicable sections of the FCC Regulations. In this regard, it will be the responsibility of the person making the sale, either the dealer or the amateur operator, to determine that the purchaser is qualified to use the amplifier.

As with Section 97.75, particular interest should be given to Subparagraphs (a)(2) and (a)(6). These subparagraphs are explained in the discussion of Section 97.75 and would allow the continued marketing of any amplifier originally purchased before the effective date or purchased after the effective date, subject to the conditions stated in that discussion and these regulations. It should be noted that the construction (not from a kit) or modification of these amplifiers is limited to only one unit of a particular model amplifier per calendar year. Any amplifiers constructed or modified in excess of this limit must be type accepted in order to be marketed.

This section, in combination with Section 97.75 will still allow the amateur operator to construct his own equipment; to modify his equipment, equipment from any other radio service or the equipment of another amateur operator; to service the equipment of another licensed amateur operator; and to construct one unit of a particular model amplifier per calendar year without obtaining a grant of

type acceptance provided, in all cases, that the amplifier meets the applicable technical requirements after any of the above changes and the amplifier is for use only at a licensed amateur radio station.

Section 97.77. This section provides the technical standards which an external amplifier must meet before a grant of type acceptance will be issued. The emission limitations specified are those presently in Section 97.73. The decrease from the amount of attenuation originally proposed was done in an attempt to prevent legitimate amateur manufacturers from having to perform a major redesign of their equipment. Rather, the Commission is of the opinion that the licensed amateur operator is quite capable of solving any interference problems which may occur and should, therefore, not have to bear the economic burden that would result if a tighter standard was imposed. In addition, the need for further attenuation has not been demonstrated. While the requirement to attenuate spurious emissions at least 40 decibels below the mean power of the fundamental for operation below 30 MHz will prevent the manufacture of the majority of the "broad-band linears," any amplifier submitted for type acceptance would also have to meet this specification when connected to a transmitter meeting this requirement even if the amplifier is turned off. Testing at our Laboratory Division has shown that some of the so-called "linears" are not capable of this.

Also included in this section are the specifications to demonstrate that the amplifier is not capable of operation on any frequency in the range of 24 to 35 MHz, required by Section 2.815. In order to comply with this requirement, the amplifier shall not be capable of amplifying any input signal in the frequency range of 26 to 28 MHz. In addition, no more than 6 decibels of amplification (mean radio frequency input power versus mean output power of the amplifier) will be allowed in the frequency ranges of 24 to 26 MHz and 28 to 35 MHz.

A list is also given in this section for a number of design features which would normally preclude an amplifier from obtaining a grant of type acceptance. These features are, currently, the major design differences between legitimate amateur equipment and the illegal amplifiers. Amateur transmitters designed for operation below 144 MHz (the 2 meter band) are provided with an external relay contact for use with the external amplifier. This relay contact is used to place the amplifier in the transmit mode; however, such a contact is prohibited on CB transmitters. The manufacturers of illegal amplifiers must therefore provide sensing internal to the amplifier which detects the input radio frequency signal and places the amplifier in the transmit mode. Such internal sensing on any amplifier designed for operation below 144 MHz would disqualify that equipment from receiving a grant of type acceptance, as the sensing would serve no purpose but to increase the initial level of spurious emissions from transients when the amplifier is first keyed.

In addition to the including of internal RF sensing, amplifiers designed for use with a CB transmitter must provide more gain in order to amplify a 4-watt input signal as opposed to the 100-watt signal usually produced by an amateur transmitter. The Commission will then look for the provision of more gain, not power supply limited gain, designed into the amplifier than necessary to operate in the amateur service. While an input signal below which the amplifier would not operate could have been specified, it was felt that such a requirement would be too easy to defeat to have much effect. The requirement that the amplifier be designed to a certain gain limitation would generally require a total redesign of the amplifier for modification. In this regard, the Commission would not accept an amplifier with an attenuation in the input stage, especially a variable attenuation, as this could be used to defeat the purpose of this section. We realize that there are a small number of legitimate manufacturers or QRP (low power) equipment which needs to boost a low level signal of about 4 or 5 watts. The Commission is

aware of these manufacturers and, realizing that they produce amplifiers for this operation in very small quantities, would entertain a request for a waiver of this requirement with certain restrictions dependent on the request.

15. As these rule amendments will become effective 30 days after their date of publication in the FEDERAL REGISTER, a number of marketing problems are expected to develop concerning that equipment still in the manufacturer's or dealer's inventory. As this Commission has no intention of halting the marketing of those amplifiers manufactured prior to the effective date which appear to be designed solely for operation in the Amateur Radio Service, we are prepared to issue a waiver for up to 1 year for this marketing restriction, as specified in Sections 2.815(b), 2.815(c), and 97.76, for specific models of amplifiers. No waiver of these requirements will be issued to any individual or dealer. Rather, the manufacturer or importer of this equipment will be required to submit to the Commission's Laboratory Division a sample of each model amplifier and all of the information required for obtaining a grant of type acceptance, as shown in Sections 2.983 and 97.77. The information required in Section 97.77(c) need not be submitted for this waiver request as Section 2.815(b) will not apply for this equipment. In addition to this material, we are also requiring the submission by the manufacturer or importer of the number of units of each model still in inventory, or projected to be in inventory, as of the effective date of these regulations. After the Commission has reviewed all of this material and inspected the amplifier, a waiver of the marketing requirements, as specified above, will be issued for any amplifier which complies with all of the type acceptance requirements, exclusive of Section 97.77(c), and appears to be designed solely for operation in the Amateur Radio Service. However, we wish to emphasize that this waiver will apply strictly to the marketing of those amplifiers or amplifier kits manufactured prior to the effective date of these regulations and will not exempt any equipment from the manufacturing requirements contained in Sections 2.815(b), 2.815(c), and 97.77.

CONCLUSIONS

16. In view of the foregoing, we are of the opinion that the amended rules as described above and in the attached appendix are in the public interest, convenience, and necessity. Authority for these amendments is contained in Sections 4(i), 302, 303(e), 303(f), and 303(r) of the Communications Act of 1934, as amended. Accordingly, it is ordered, effective April 28, 1978, that Parts 2 and 97 of the Commission's Rules and Regulations are amended as set out in the attached appendix. It is further ordered that this proceeding is continued.

(Secs. 4, 303, 48 Stat., as amended, 1066, 1082, Sec. 302, 82 Stat., 290; 47 U.S.C. 154, 302, 303.)

FEDERAL COMMUNICATIONS
COMMISSION,*
WILLIAM J. TRICARICO,
Secretary.

APPENDIX

A. Part 2 is amended as follows:

1. Section 2.815 is amended by deleting Paragraphs (b), (c), and (d) and by adding new Paragraphs (b), (c), (d), and (e) to read as follows:

§ 2.815 External radio frequency power amplifiers.

(b) After April 27, 1978, no person shall manufacture, sell or lease, offer for sale or lease (including advertising for sale or lease), or import, ship, or distribute for the purpose of selling or leasing or offering for sale or lease, any external radio frequency power amplifier or amplifier kit capable of operation on any frequency or frequencies between 24 and 35 MHz.

NOTE.—For purposes of this part, the amplifier will be deemed incapable of operation between 24 and 35 MHz if—

(1) The amplifier has no more than 6 decibels of gain between 24 and 26 MHz and between 28 and 35 MHz. (This gain is deter-

*See attached Statement of Commissioner White.

mined by the ratio of the input RF driving signal (mean power measurement) to the mean RF output power of the amplifier.); and

(2) The amplifier exhibits no amplification (0 decibels of gain) between 26 and 28 MHz.

(c) After April 27, 1978, and until April 28, 1981, no person shall manufacture, sell or lease, offer for sale or lease (including advertising for sale or lease), or import, ship, or distribute for the purpose of selling or leasing or offering for sale or lease, any external radio frequency power amplifier or amplifier kit capable of operation on any frequency or frequencies below 144 MHz unless the amplifier has received a grant of type acceptance in accordance with Subpart J of this part and Subpart C of Part 97 or other relevant Parts of this Chapter. No more than 10 external radio frequency power amplifiers or amplifier kits may be constructed for evaluation purposes in preparation for the submission of an application for a grant of type acceptance.

(d) The proscription in Paragraph (b) of this section shall not apply to the marketing, as defined in that paragraph, by a licensed amateur radio operator to another licensed amateur radio operator of an external radio frequency power amplifier fabricated in not more than one unit of the same model in a calendar year by that operator provided the amplifier is for the amateur operator's personal use at his licensed amateur radio station and the requirements of Sections 97.75 and 97.76 of this chapter are met.

(e) The proscription in Paragraph (c) of this section shall not apply in the marketing, as defined in that paragraph, by a licensed amateur radio operator to another licensed amateur radio operator of an external radio frequency power amplifier if the amplifier is for the amateur operator's personal use at his licensed amateur radio station and the requirements of Sections 97.75 and 97.76 of this chapter are met.

2. Section 2.983 is amended by adding a new Paragraph (i) to read as follows:

§ 2.983 Application for type acceptance.

(i) The application for type acceptance of an external radio frequency power amplifier under Part 97 of this chapter need not be accompanied by the data required by Paragraph (e) of this section. In lieu thereof, measurements shall be submitted to show compliance with the technical specifications in Subpart C of Part 97 of this chapter and such information as required by Section 2.1005 of this part.

3. Section 2.1001 is amended by revising the text of Paragraph (e) and adding a new Paragraph (f) to read as follows:

§ 2.1001 Changes in type accepted equipment.

(e) Users shall not modify their own equipment except as provided by Paragraphs (b) and (f) of this section.

(f) Equipment type accepted for use in the Amateur Radio Service pursuant to the requirements of Part 97 of this chapter may be modified without regard to the conditions specified in Paragraph (b) of this section, provided the following conditions are met:

(1) Any person performing such modifications on equipment used under Part 97 of this chapter must possess a valid amateur radio operator license of the class required for the use of the equipment being modified.

(2) Modifications must pursuant to this paragraph be limited to equipment used at licensed amateur radio stations.

(3) Modifications specified or performed by equipment manufacturers or suppliers must be in accordance with the requirements set forth in Paragraph (b) of this section.

(4) Modifications specified or performed by licensees in the Amateur Radio Service on equipment other than that at specific licensed amateur radio stations must be in accordance with the requirements set forth in

Paragraph (b) of this section.

(5) The station licensee shall be responsible for insuring that modified equipment used at his station will comply with the applicable technical standards in Part 97 of this chapter.

4. A new § 2.1005 is added to read as follows:

§ 2.1005 Equipment for use in the Amateur Radio Service.

(a) The general provisions of Sections 2.981, 2.983, 2.991, 2.993, 2.997, 2.999, 2.1001, and 2.1003 shall apply to application for and grants of type acceptance for equipment operated under the requirements of Part 97 of this chapter, the Amateur Radio Service.

(b) When performing the tests specified in Sections 2.991 and 2.993 of this part, the center of the transmitted bandwidth shall be within the operating frequency band by an amount equal to 50 percent of the bandwidth utilized for the tests. In addition, said tests shall be made on at least one frequency in each of the bands within which the equipment is capable of tuning.

(c) Any supplier of an external radio frequency power amplifier kit as defined by Subsection 97.3(aa) of this chapter shall comply with the following requirements:

(1) Assembly of one unit of a specific type shall be made in exact accordance with the instructions being supplied with the product being marketed. If all of the necessary components are not normally furnished with the kit, assembly shall be made using the recommended components.

(2) The measurement data required for type acceptance shall be obtained for this unit and submitted with the type acceptance application. Unless otherwise requested, it is not necessary to submit this unit with the application.

(3) A copy of the exact instructions which will be provided for assembly of the equipment shall be provided in addition to other material required by Section 2.983 of this part.

(4) The identification label required by sections 2.925 and 2.1003 of this part shall be permanently affixed to the assembled unit and shall be of sufficient size so as to be easily read. The following information shall be shown on the label:

(Name of Grantee of Type Acceptance)

FCC ID: (The number assigned to the equipment by the Grantor)

This amplifier can be expected to comply with part 97 of the FCC Regulations when assembled and aligned in strict accordance with the instruction manual using components supplied with the kit or an exact equivalent thereof.

(Title and signature of responsible representative of Grantee)

STATEMENT OF COMPLIANCE

I state that I have constructed this equipment in accordance with the instruction manual and using the parts furnished by the supplier of this kit.

(Signature) (Date)

(Amateur call sign) (Class of license)

(Expiration date of license)

(To be signed by the person responsible for proper assembly of kit.)

(5) If requested, an unassembled unit shall be provided for assembly and test by the Commission. Shipping charges to and from the Commission's Laboratory shall be borne by the applicant for type acceptance.

(d) Type acceptance of external radio frequency power amplifiers and amplifier kits may be denied when denial serves the public interest, convenience, and necessity by preventing the use of these amplifiers in services other than the Amateur Radio Service. Other uses of these amplifiers, such as in the Citizens Band Radio Service, is prohibited (section 95.509 of this Chapter). Examples of features which may result in the denial of type

acceptance are contained in section 97.77 of this Chapter.

B. Part 97 is amended as follows:

1. In § 97.3, new definitions of external radio frequency power amplifier and external radio frequency power amplifier kit are added as new paragraphs (z) and (aa), as follows:

§ 97.3 Definitions.

(z) External radio frequency power amplifier. Any device which, (1) when used in conjunction with a radio transmitter as a signal source, is capable of amplification of that signal, and (2) is not an integral part of the transmitter as manufactured.

(aa) External radio frequency power amplifier kit. Any number of electronic parts, usually provided with a schematic diagram or printed circuit board, which, when assembled in accordance with instructions, results in an external radio frequency power amplifier, even if additional parts of any type are required to complete assembly.

§ 97.75 [Redesignated]

2. § 97.75 is redesignated § 97.74.

3. A new § 97.75 is added, as follows:

§ 97.75 Use of external radio frequency (RF) power amplifiers.

(a) Until April 28, 1981, any external radio frequency (RF) power amplifier used or attached at any amateur radio station shall be type accepted in accordance with subpart J of part 2 of the FCC's Rules for operation in the Amateur Radio Service, unless one or more of the following conditions are met:

(1) The amplifier is not capable of operation on any frequency or frequencies below 144 MHz;

(2) The amplifier was originally purchased before April 28, 1978;

(3) The amplifier was—
(i) Constructed by the licensee, not from an external RF power amplifier kit, for use at his amateur radio station;

(ii) Purchased by the licensee as an external RF power amplifier kit before April 28, 1978, for use at his amateur radio station; or

(iii) Modified by the licensee for use at his amateur radio station in accordance with § 2.1001 of the FCC's Rules;

(4) The amplifier was purchased by the licensee from another amateur radio operator who—

(i) Constructed the amplifier, but not from an external RF power amplifier kit;

(ii) Purchased the amplifier as an external RF power amplifier kit before April 28, 1978, for use at his amateur radio station; or

(iii) Modified the amplifier for use at his amateur radio station in accordance with § 2.1001 of the FCC's Rules;

(5) The external Power amplifier was purchased from a dealer who obtained it from an amateur radio operator who—

(i) Constructed the amplifier, but not from an external RF power amplifier kit;

(ii) Purchased the amplifier as an external RF power amplifier kit before April 28, 1978, for use at his amateur radio station; or

(iii) Modified the amplifier for use at his amateur radio station in accordance with § 2.1001 of the FCC's Rules; or

(6) The amplifier was originally purchased after April 27, 1978, and has been issued a marketing waiver by the FCC.

(b) A list of type accepted equipment may be inspected at FCC headquarters in Washington, D.C., or at any FCC field office. Any external RF power amplifier appearing on this list as type accepted for use in the Amateur Radio Service may be used in the Amateur Radio Service.

NOTE.—No more than one unit of one model of an external RF power amplifier shall be constructed or modified during any calendar year by an amateur radio operator for use in the Amateur Radio Service without a grant of type acceptance.

4. A new § 97.76 is added, as follows:

§ 97.76 Requirements for type acceptance of external radio frequency (RF) power amplifiers and external radio frequency power amplifier kits.

(a) Until April 28, 1981, any external radio frequency (RF) power amplifier or external RF power amplifier kit marketed (as defined in § 2.815), manufactured, imported, or modified for use in the Amateur Radio Service shall be type accepted for use in the Amateur Radio Service in accordance with subpart J of part 2 of the FCC's Rules. This requirement does not apply if one or more of the following conditions are met:

(1) The amplifier is not capable of operation on any frequency or frequencies below 144 MHz;

(2) The amplifier was originally purchased before April 28, 1978, by an amateur radio operator for use at his amateur radio station;

(3) The amplifier was constructed or modified by an amateur radio operator for use at his amateur radio station in accordance with § 2.1001 of the FCC's Rules;

(4) The amplifier was constructed or modified by an amateur radio operator in accordance with § 2.1001 of the FCC's Rules and sold to another amateur radio operator or to a dealer;

(5) The amplifier was constructed or modified by an amateur radio operator in accordance with § 2.1001 of the FCC's Rules and sold by a dealer to an amateur radio operator for use at his amateur radio station; or

(6) The amplifier was manufactured before and has been issued a marketing waiver by the FCC.

(b) No more than one unit of one model of an external RF power amplifier shall be constructed or modified during any calendar year by an amateur radio operator for use in the Amateur Radio Service without a grant of type acceptance.

(c) A list of type accepted equipment may be inspected at FCC headquarters in Washington, D.C., or at any FCC field office. Any external RF power amplifier appearing on this list as type accepted for use in the Amateur Radio Service may be marketed for use in the Amateur Radio Service.

§ 97.77 [Redesignated]

5. § 97.77 in subpart D is redesignated § 97.78.

6. A new § 97.77 is added at the end of subpart C, as follows:

§ 97.77 Standards for type acceptance of external radio frequency (RF) power amplifiers and external radio frequency power amplifier kits.

(a) An external radio frequency (RF)

power amplifier or external RF power amplifier kit will receive a grant of type acceptance under this part only if a grant of type acceptance would serve the public interest, convenience, or necessity.

(b) To receive a grant of type acceptance under this part, an external RF power amplifier shall meet the emission limitations of § 97.73 when the amplifier is—

(1) Operated at its full output power;

(2) Placed in the "standby" or "off" positions, but still connected to the transmitter; and

(3) Driven with at least 50 watts mean radio frequency input power (unless a higher drive level is specified).

(c) To receive a grant of type acceptance under this part, an external RF power amplifier shall not be capable of operation on any frequency or frequencies between 24.00 MHz and 35.00 MHz. The amplifier will be deemed incapable of operation between 24.00 MHz and 35.00 MHz if—

(1) The amplifier has no more than 6 decibels of gain between 24.00 MHz and 28.00 MHz and between 28.00 MHz and 35.00 MHz. (This gain is determined by the ratio of the input RF driving signal (mean power measurement) to the mean RF output power of the amplifier); and

(2) The amplifier exhibits no amplification (0 decibels of gain) between 26.00 MHz and 28.00 MHz.

(d) Type acceptance of external radio frequency power amplifiers or amplifier kits may be denied when denial serves the public interest, convenience, or necessity by preventing the use of these amplifiers in services other than the Amateur Radio Service. Other uses of these amplifiers, such as in the Citizens Band Radio Service, is prohibited (section 95.509). Examples of features which may result in dismissal or denial of an application for type acceptance of an external RF power amplifier include, but are not limited to, the following:

(1) Any accessible wiring which, when altered, would permit operation of the amplifier in a manner contrary to the FCC's Rules;

(2) Circuit boards or similar circuitry to facilitate the addition of components to change the amplifier's operating characteristics in a manner contrary to the FCC's Rules.

(3) Instructions for operation or modification of the amplifier in a

manner contrary to the FCC's Rules;

(4) Any internal or external controls or adjustments to facilitate operation of the amplifier in a manner contrary to the FCC's Rules.

(5) Any internal radio frequency sensing circuitry or any external switch, the purpose of which is to place the amplifier in the transmit mode;

(6) The incorporation of more gain in the amplifier than is necessary to operate in the Amateur Radio Service. For purposes of this paragraph, an amplifier must meet the following requirements:

(i) No amplifier shall be capable of achieving designed output (or designed d.c. input) power when driven with less than 50 watts mean radio frequency input power;

(ii) No amplifier shall be capable of amplifying the input RF driving signal by more than 13 decibels. (This gain limitation is determined by the ratio of the input RF driving signal (mean power) to the mean RF output power of the amplifier.) If the amplifier has a designed d.c. input power of less than 1,000 watts, the gain allowance is reduced accordingly. For example, an amplifier with a designed d.c. input power of 500 watts shall not be capable of amplifying the input RF driving signal (mean power measurement) by more than 10 decibels, compared to the mean RF output power of the amplifier);

(iii) The amplifier shall not exhibit more gain than permitted by paragraph (d)(6)(ii) of this section when driven by a radio frequency input signal of less than 50 watts mean power; and

(iv) The amplifier shall be capable of sustained operation at its designed power level.

(7) Any attenuation in the input of the amplifier which, when removed or modified, would permit the amplifier to function at its designed output power when driven by a radio frequency input signal of less than 50 watts mean power.

STATEMENT OF COMMISSIONER WHITE CONCURRING IN PART AND DISSENTING IN PART

IN RE: THE COMMISSION'S DECISION TO PROHIBIT THE SALE OF POWER AMPLIFIERS CAPABLE OF OPERATION ON ANY FREQUENCY FROM 24 TO 35 MHz

The Commission in its Report and Order has adopted rules which require both type acceptance of amplifiers capable of oper-

ation below 144 MHz and a ban of linear power amplifiers capable of operation on any frequency between 24 and 35 MHz. The type acceptance proposal is all that is necessary, at this time, to effectuate the Commission's prohibitions regarding the manufacture, marketing, importation, and use of linear amplifiers which are capable of being used illegally with CB sets. The majority, by imposing a ban in addition to type acceptance, which itself is in effect a ban on the sale of illegal power amplifiers, has instituted additional regulations where none are necessary, i.e., the Commission is guilty of regulatory overkill. Therefore, as a strong proponent of deregulation, I must dissent to that part of the Commission's decision which imposes a ban on the sale of linear power amplifiers.

The Commission by imposing a ban is trying to help solve the problem of TV interference. I too wish to see this problem solved, but there is no evidence that the imposition of a ban will solve the TV interference problem. A study by the Field Operations Bureau showed that linear amplifiers were associated with approximately 45 percent of all CB-TV interference cases. But the use of linear amplifiers with CB sets is already illegal. There is ample evidence that those who are intent upon breaking the law will continue to do so and that those who wish to circumvent the ban will find ways to do so. The type acceptance proposal, in effect, would ban the manufacture of linear amplifiers capable of being coupled to the low-level output power of a CB set. The proposed type acceptance program would not prohibit the manufacture of linear amplifiers capable of being coupled to amateur or other legitimate types of equipment with much higher output power levels. The proposed ban adds another layer of regulation with no evidence that the proposed type acceptance program alone would not be as effective.

The Commission by its proposed ban would remove equipment from the market which is available to amateurs and others who are not the cause of the problem. In fact, amateurs have assisted the Commission in its enforcement problems both in policing their own ranks and in uncovering the illegal use of CB since that the latter can be disruptive of their own service. The ban also will remove linear amplifiers in the 24 to 35 MHz frequency range from the product lines of the legitimate manufacturers and perhaps cause economic harm to small manufacturers and retailers. The Commission has intruded into the marketplace with an unnecessary ban for a purpose admitted by the staff to be largely cosmetic in nature. But the Commission, when asked about TV-interference, proudly can say: "See what we have done."

"The Extent and Nature of Television Reception Difficulties Associated with CB Radio Transmissions," FCC/FOB/PD&E 77-02, July 1977.

Social Events

MEADVILLE PA MAY 6

The 4th Annual North-western Pennsylvania Hamfest will be held on May 6th at the Crawford County Fairgrounds, Meadville PA. Gates open at 8:00. \$2 prize ticket required for admission—\$1 to display. Children free. Hourly door prizes; refreshments; commercial displays welcome. Indoors if rain. Talk-in on 04/64 and 52. Details: CARS, PO Box 653, Meadville PA 16335.

JOHNSON CITY NY MAY 6

The Southern Tier Amateur Radio Clubs take pleasure in announcing their 19th annual hamfest and dinner. This gala affair will occur on May 6, 1978, at the Lutheran Fellowship Recreation Center, Johnson City, New York, 3.7 miles north of NY Route 17, exit 71N on Stella Ireland Road. There will be 4 acres of flea market park-

ing, technical talks, prizes, displays, exhibits, refreshments, etc. Tickets are \$2 for general admission, \$7 for the banquet (includes general admission). No extra charge for flea market parking. Inside tables are available for \$5 each by reservation only. Additional information or tickets can be obtained by writing STARC, PO Box 11, Endicott NY 13760.

HOWARD COUNTY MD MAY 7

The Potomac Area VHF Society will hold its seventh annual hamfest on Sunday, May 7, 1978, from 8 am to 5 pm at the Howard County Fairgrounds approximately 25 miles north of Washington DC, and 15 miles west of Baltimore, Maryland, at the intersection of I-70 and Maryland Route 32. Registration of \$3 includes flea market or tailgate sales. Professional food and beverage catering and unlimited parking will be

available. Talk-in on 146.52. For further information, contact Paul H. Rose WA3NZL, 25116 Oak Drive, Damascus MD 20750.

LOGANSPORT IN MAY 7

The Cass County Amateur Radio Club hamfest will be held on Sunday, May 7, 1978, from 7:00 am to 4:00 pm at the 4-H fairgrounds. Go north of Logansport on Highway 25 approximately one mile, turn right, and follow the QSY signs. Advance tickets are \$1.50; tickets will be \$2.00 at the gate. Outside setup is free, undercover \$1.00. Bring your own tables. Talk-in on 146.52 and the Logansport repeater 147.78/18. For information, write to Dave Rothermel K9DVL, RFD 4, Box 146 G, Logansport, Indiana 46947.

BROWNFIELD TX MAY 7

The Terry County Amateur Radio Club will hold its annual swapfest on May 7, 1978, in the National Guard Armory, Brownfield, Texas. For more informa-

tion, contact Viola Simmons W5FBM, 1603 East Tate, Brownfield, Texas 79316.

LAS VEGAS NV MAY 12-14

The 23rd Annual West Coast VHF Conference will be held at the Stardust Hotel, Las Vegas Strip at Convention Center Drive.

Conference highlights: technical program arranged by the San Bernardino Microwave Society, hospitality room, informal technical and operating sessions, noise figure measurements contest, antenna gain measurements contest, prize drawing, 24-hour adult entertainment! World-famous resort hotel with all facilities. Look for the Stardust sign east of I-15. Take the Sahara Ave. or Dunes-Flamingo exit. Advance registration fee is \$4.00 per person (\$5.00 at the door). Make checks payable to: West Coast VHF Conference, 510 South Rose St., Las Vegas NV 89106.

VANCOUVER WA MAY 13-14

On May 13-14, the Clark

County Amateur Radio Club will hold its annual Ft. Vancouver Hamfair, and everyone is invited to join in the fun. It is held at the Clark County Fairgrounds right off Interstate 5, just north of Vancouver, Washington. Registration is \$3 per person, and anyone who pre-registers by May 5th will get an extra drawing ticket. The prizes are too many to list, but the grand prize will be a Kenwood TS-820S transceiver. Dinner will be catered and will cost \$4.25 for adult meal tickets and \$2.00 for children under 12 years. A pancake breakfast will be served on Sunday for donations only. There will be activities for hams and families all weekend. Camping with electricity is available for \$2.50 per night. Everything from technical seminars to women's and children's activities to a huge swap and shop will be going on all weekend. Make checks payable to Ft. Vancouver Hamfair for registration and dinner tickets. Mail to Jack Ellis K7SUQ at 9610 SE 6th St., Vancouver WA 98664.

DEERFIELD NH MAY 13

The Hosstraders net will hold its fifth annual tailgate swapfest Saturday, May 13, at the Deerfield, New Hampshire, fairgrounds (covered building in case of rain). Admission is one dollar; no commission or percentage. Commercial dealers are welcome at the same rate. Excess revenues benefit Boston Burns Unit of the Shriners' Hospital for Crippled Children. Last year we donated \$430.80. Talk-in on .52, 146.40-147.00, 3940 kHz. If you have questions, send SASE to Joe Demasco K1ROG, Star Rt., Box 56, Bucksport ME 04416 or Norm Blake WA1IVB, PO Box 32, Cornish ME 04020 or check the Hosstraders net on Sundays at 4 pm on 3940 kHz.

EASTON MD MAY 14

The fourth annual Easton Amateur Radio Society hamfest will be held on May 14, rain or shine, from 10 am to 4 pm. The location will be 5 miles north of Easton, on Rte. 50 at the Talbot County Agricultural Center. From the Baltimore or Washington DC areas, go across the Chesapeake Bay Bridge and follow Rte. 50 east for 21 miles from the bridge. The exact location is between mile markers 60 and 61. There will be hamfest signs on Rte. 50, north and south. Talk-in on 52 and 146.445/147.045 repeater in Cambridge. There will be some tables, both inside and outside, and fairly priced refreshments. Lots of room for tables and tailgaters.

Donation is \$2, with an additional \$2 for tables or tailgaters. Write Robert L. Roberts, Jr. K3ONU, PO Box 781, Easton MD 21601, or phone (301)-822-0943 after 6 pm.

WAUKESHA WI MAY 14

The spring swapfest of the Milwaukee UHF Society will be held on Sunday, May 14, 1978, at the Waukesha County Expo Center. Starting time is 7:00 am. Indoor space is available on an advanced reservation basis at \$3.00 per table. Admission to the grounds is \$1.50 in advance, \$2.00 at the gate. There will be prizes, beer, and brats! Directions: I-94 to Waukesha Co. F, south to FT, west to Expo. For information, write to Swapfest, PO Box 49, North Prairie, Wisconsin 53153.

WEST LIBERTY OH MAY 14

The Champaign Logan Amateur Radio Club, Inc., will hold its annual hamfest on Sunday, May 14, 1978, at the West Liberty Lions Park, West Liberty, Ohio. Free admission; trunk sales; tables are \$1.00. Door prizes. Talk-in on 146.52.

WARMINSTER PA MAY 14

The Warminster Amateur Radio Club's fourth annual "HAMMART," flea market, and auction will be held on Sunday, May 14, from 9 am to 4 pm at William Tennent Senior High School, Street Road (Route 132), 2 miles east of York Road (Route 263), Warminster, Bucks County PA. Registration is \$1.00, tailgating \$2.00 additional. No indoor selling; bring your own tables. Talk-in on 146.16-76 and 146.52. For further information, write: Horace Carter K3KT, 38 Hickory Lane, Doylestown PA 18901 or call (215)-345-6816.

BENSENVILLE IL MAY 20

The Radio Amateur Megacycle Society of Chicago will sponsor its second annual VHF antenna gain measuring contest on Saturday, May 20. The starting time is 1 pm. It will be held on the grounds of the Flick-Reedy Corporation, at Thorndale and York Roads in Bensenville, just northwest of Chicago. Antenna categories will include 2 meters, 1 1/4 meters, and 430 and 446 MHz. Antennas for higher bands may be measured, but advance notice must be given to assure that proper equipment is provided. Certificates stating the antenna's gain will be awarded for each entry, and prizes will be awarded for the highest gain antenna in each category. A

donation of 50 cents per antenna will be requested to help defray costs of certificates, etc. A detailed information sheet, including directions, is available from Joe LeKostaj WB9GOJ, 2558 N. McVicker Ave., Chicago, Illinois 60639.

CADILLAC MI MAY 20

The Wexaukee ARA will hold its 18th annual swap and shop on Saturday, May 20th, from 9 am until 4 pm at the National Guard Armory, 415 Haynes St., Cadillac, Michigan. Tickets will be \$2.00. Free parking will be available, and there will be a lunch counter. Talk-in on 146.37/97. Ham pilots can fly in to our beautiful airport and community. Transportation to and from the armory provided free.

DURHAM NC MAY 20-21

The Durham FM Association will hold the 5th annual "Durhamfest" on Saturday, May 20, and Sunday, May 21, 1978, at the South Square Shopping Center in Durham, North Carolina. Seminars have been arranged to cover a broad range of topics from micro-processors and slow scan television to TVI prevention, along with getting started in ham radio.

WABASH IN MAY 21

The Wabash County Amateur Radio Club's 10th annual hamfest will be held on Sunday, May 21, 1978, rain or shine, at the Wabash County 4-H fairgrounds in Wabash. Large flea market (no table or setup charge), technical forums, bingo, free parking, and lots of good food at reasonable prices. Advance admission is \$2.00; \$2.50 at the gate. Children under 12 free. Write Dave Nagel WD9BDZ, 555 Valley Brook Lane, Wabash IN 46992.

SANDUSKY OH MAY 21

The Vacationland Hamfest will be held Sunday, May 21, 1978, at the Erie County Fairgrounds, Sandusky, Ohio. Come rain or shine. There will be tables indoors and 8 acres for trunk sales. Talk-in on 146.52 simplex. Admission will be \$1.50 in advance, \$2.00 at the gate. Write to the Erie Amateur Radio Society, PO Box 2037, Sandusky OH 44870.

LAWRENCE KS MAY 21

The Douglas County Amateur Radio Club will hold its third annual auction on Sun-

day, May 21, at the Douglas County 4-H Fairgrounds, Building 21. Doors open at 9 am, with the auction starting at 1 pm. Door prizes and refreshments. Talk-in on 16/76 and 52. For more information, write to Joan Soutar WB0YPW, 1919 Melholand, Lawrence KS 66044.

TRENTON TN MAY 21

The annual Humboldt Amateur Radio Club hamfest will be held on Sunday, May 21, at Shady Acres City Park in Trenton, Tennessee. There will be a flea market, prizes, ladies' activities, and light lunches. Talk-in on 37/97. For further information, contact Ed Holmes W4IGW, 501 N. 18th Ave., Humboldt TN 38343.

PITTSBURGH PA MAY 21

The 24th annual Breeze Shooters' hamfest will be held Sunday, May 21, 1978, at White Swan Park, Parkway West (Rt. 60), near the Greater Pittsburgh International Airport. There will be six main prizes, women's prizes, a home brew contest, refreshments, and an amusement park for the harmonics (discount ride tickets available at hamfest). It's western Pennsylvania's largest ham event. Admission, flea market, and parking are free! Talk-in on 29.0 and 28/88. Contact Richard Evanuk WA3LUM, 311 Evergreen Ave., Pittsburgh PA 15209, for information.

EVANSVILLE IN MAY 21

The Tri-State Amateur Radio Society will hold its annual hamfest on Sunday, May 21, 1978. The location is the Vanderburgh County 4-H Fairgrounds north of Evansville, Indiana. Good food, bingo, and a large flea market for all. Two grand prizes to be given away. No admission fee. Come join the fun! For more information, write to Steve Harris WB9OYD, R 2, Box 81G, Mt. Vernon IN 47620. Talk-in on 75/15, 19/79, or 52.

IRVINGTON NJ MAY 21

The Irvington Radio Amateur Club—K2GQ—will hold its annual hamfest on Sunday, May 21, 1978. It will be from 9 am till 4 pm at the P.A.L. Building, 285 Union Ave., Irvington NJ 07011, located at exit 143 north and 143A south on the Garden State Parkway. Talk-in on 146.34/94 and 52. Refreshments and prizes. Table rental will be \$3.00. Contact Peter Kawonczyk WB2FAS at the above address or Ed WA2MYZ at (201)-687-3240 evenings.

SST T-1 RANDOM WIRE ANTENNA TUNER



All band operation (160-10 meters) with any random length of wire. 200 watt **output** power capability—will work with virtually any transceiver. Ideal for portable or home operation. Great for apartments and hotel rooms—simply run a wire inside, out a window, or anyplace available. Toroid inductor for small size: 4-1/4" X 2-3/8" X 3." Built-in neon tune-up indicator. SO-239 connector. Attractive bronze finished enclosure.

only **\$29.95**

THE ORIGINAL Random Wire Antenna Tuner. . . in use by amateurs for 6 years.

sst t-2 ULTRA TUNER

Tunes out SWR on any coax fed antenna as well as random wires. Works great on all bands (160-10 meters) with any transceiver running up to 200 watts power output.

Increases usable bandwidth of any antenna. Tunes out SWR on mobile whips from inside your car.

Uses toroid inductor and specially made capacitors for small size: 5 1/4" x 2 1/4" x 2 1/2." Rugged, yet compact. Attractive bronze finished enclosure. SO-239 coax connectors are used for transmitter input and coax fed antennas. Convenient binding posts are provided for random wire and ground connections.



only **\$39.95**

sst t-3 IMPEDANCE TRANSFORMER only **\$19.95**

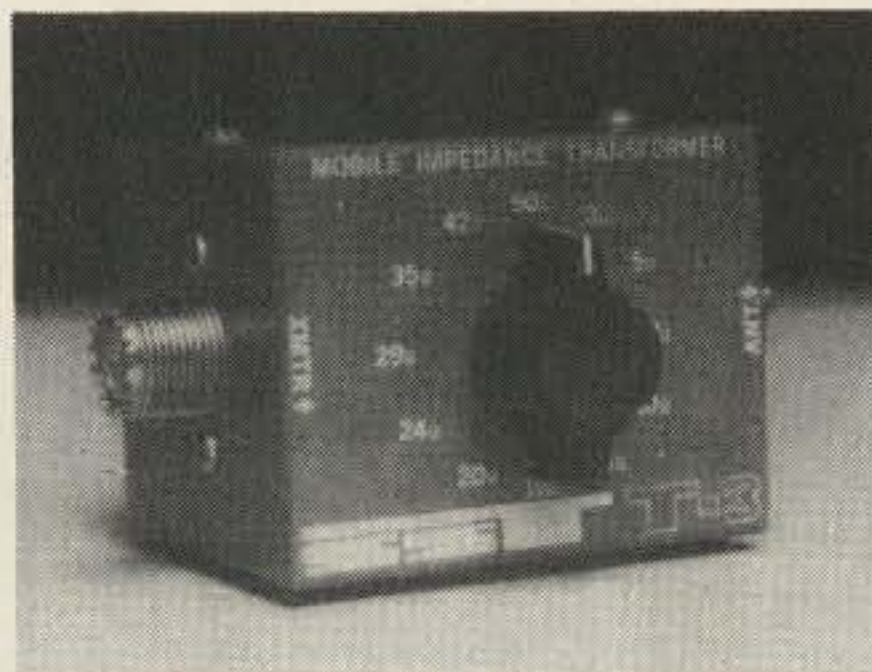

Matches 52 ohm coax to the lower impedance of a mobile whip or vertical. 12 position switch with taps spread between 3 and 52 ohms. Broadband from 1-30 MHz. Will work with virtually any transceiver—300 watt output power capability. SO-239 connectors. Toroid inductor for small size: 2-3/4" X 2" X 2-1/4." Attractive bronze finish.

GUARANTEE

All SST products are guaranteed for 1 year. In addition, they may be returned within 10 days for a full refund (less shipping) if you are not satisfied for any reason. Please add \$2 for shipping and handling. Calif. residents, please add sales tax. COD orders OK by phone.

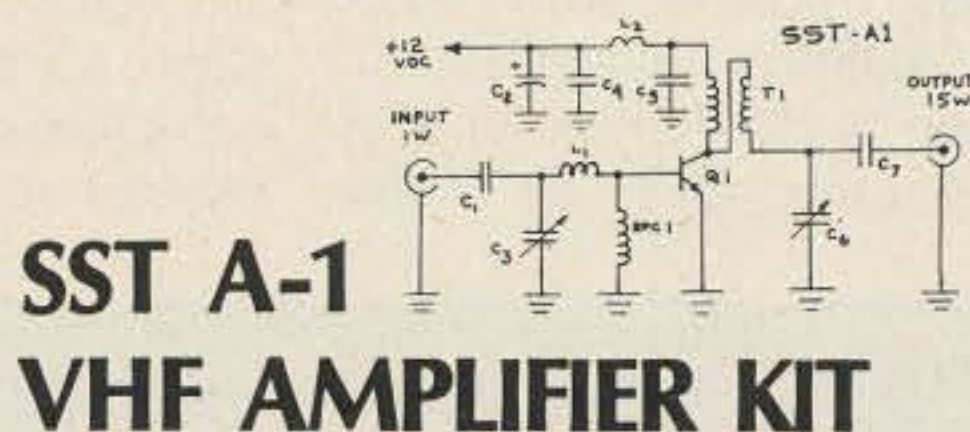

SST A-1 VHF AMPLIFIER KIT

1 watt input gives you 15 watts output across the entire 2 meter band without re-tuning. This easy to build kit (approx. 1/2 hr. assembly) includes everything you need for a complete amplifier. All top quality components. Compatible with all 1-3 watt 2 meter transceivers.

Kit includes:

- Etched & drilled G-10 epoxy solder plated board.
- Heat sink & mounting hardware. All components — including pre-wound coils.
- Top quality TRW RF power transistor.
- Complete assembly instructions with details on a carrier operated T/R switch.

only **\$29.95**

\$49.95 wired & tested

What Happened To SSTV?

— is it dead or alive?

One of the most exciting new areas of amateur radio communication today is the dimension of slow scan television. No other mode can offer such unique avenues to enjoyment as this window on the world for amateur radio. As the science fiction-type sounds of SSTV are heard on the high-frequency bands, hundreds of amateurs exchange pictures with other slow scanners on a person-to-person basis, view pictures of Mars while they are trans-

mitted from mission control, contact foreign amateurs and get a video tour of their city, or receive schematics of new items directly from their designer. The applications of SSTV are, like its distance limitations, endless.

Other pictures rolling down an SSTV monitor screen can range from weather satellite pictures that are being retransmitted by a slow scanner with satellite equipment, scenes of an African sunset, and views of

wild parrots in Nicaragua to pictures of historical places in the west or scenes of an exotic island in the Pacific. Video capabilities definitely expand horizons for today's radio amateurs!

What SSTV Is — and Isn't

As conventional television uses fast scanning rates and includes large quantities of video information (called picture elements, or pixels), it must be transmitted on ultra-high frequencies where the necessary frequency spectrum (approximately 4 MHz) is

available. Slow scan TV, however, is composed of simple audio tones which can be transmitted using conventional single sideband gear. This narrow bandwidth television (approximately 1100 Hz) is accomplished by reducing scanning rates approximately 1,000 times and lowering pixel counts.

As shown in Fig. 1, the range of frequencies used in SSTV are from 1200 Hz to 2300 Hz. 1200 Hz horizontal and vertical sync pulses are used to initiate the scanning of each line and the start of each picture. They are separated according to their time periods. Horizontal sync pulses are five milliseconds duration each 66 milliseconds, while vertical sync pulses are 60 milliseconds each 8 seconds. This comprising situation produces 120-line pictures which require 8 seconds for transmission. The resultant pictures, which are a series of stills, are then viewed on an extended readout cathode ray tube (radar type). (One of SSTV's latest innovations, the digital scan converter, allows SSTV pictures to be continuously viewed on a regular TV set. Newly developed digital techniques also permit these converters to store and

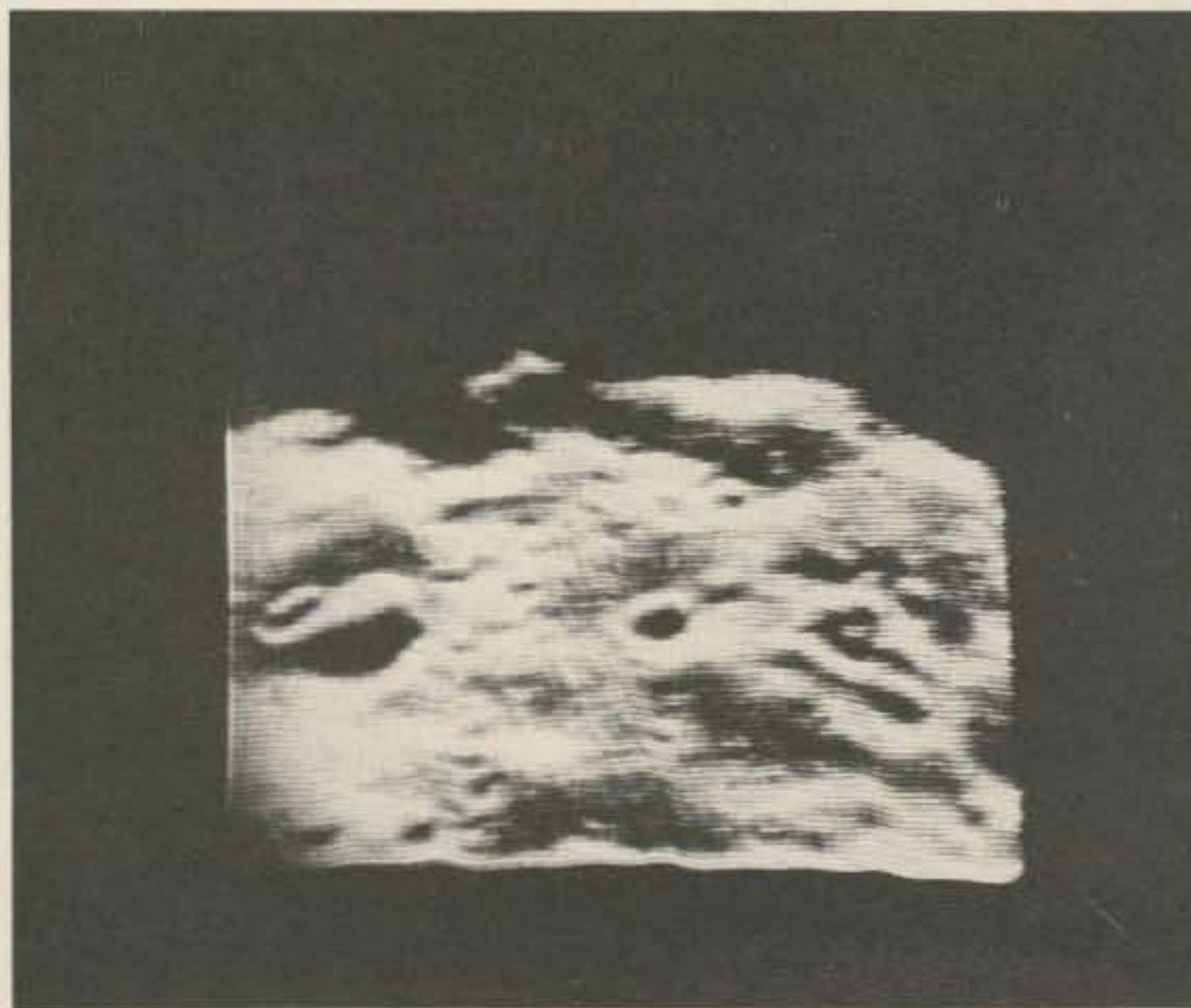

Classic SSTV picture of Phobos, the second moon of Mars. This picture was received at Jet Propulsion Lab as Viking 6 passed within 500 miles of Phobos while en route to Mars. The picture was then retransmitted on SSTV to amateurs around the world by N6V. Picture aspect is approximately 8 miles wide. The large crater on the left is .8 miles wide.

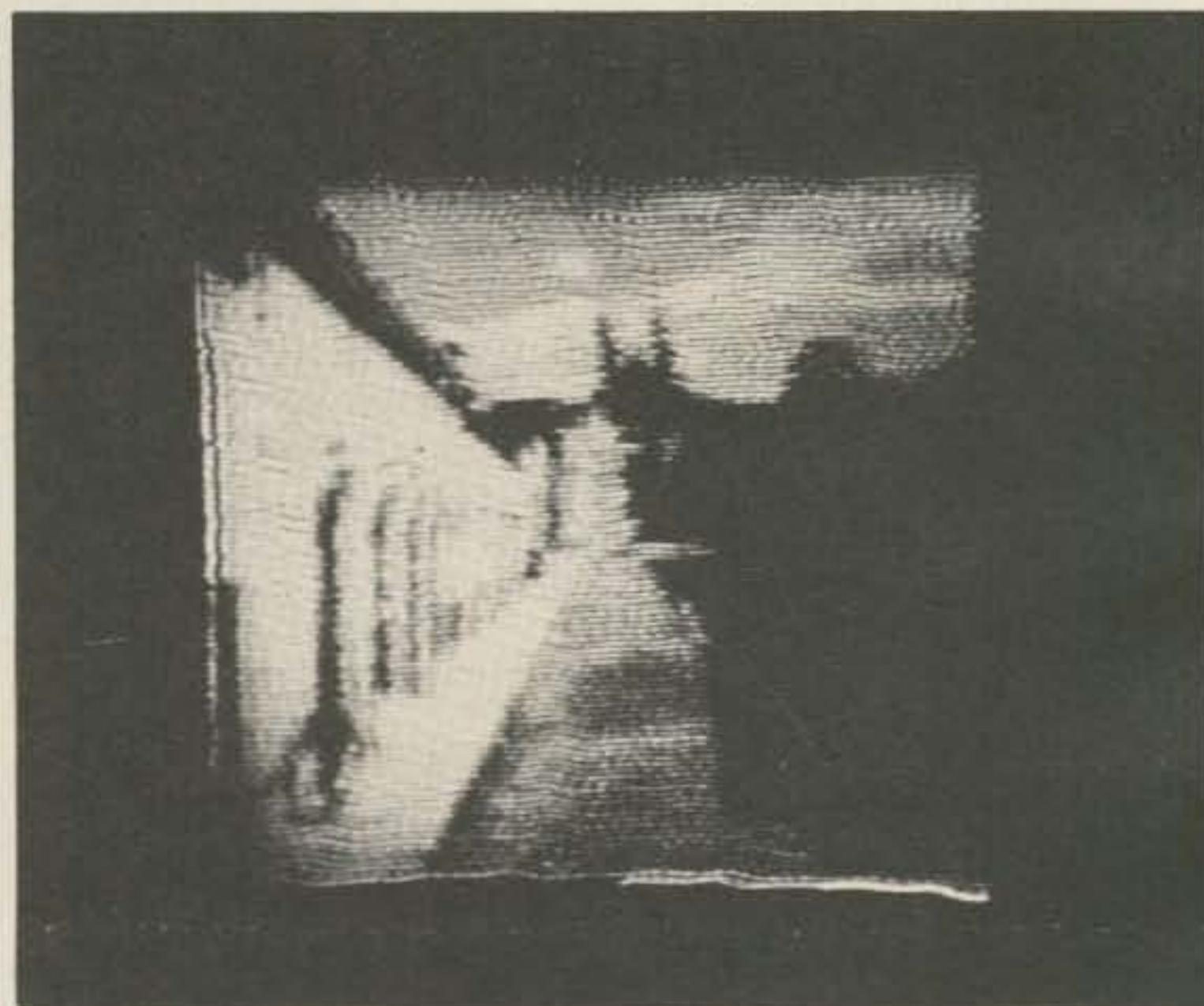

This scene of a neighborhood street was transmitted on 20 meters SSTV by XE2JSC in Mexico City. Late afternoon sun shaded the right side of the picture. The bottom line is a 5-step grey scale.

reconstruct consecutive pictures, thus producing limited motion SSTV.)

Although basic slow scan TV isn't an extremely high-resolution full-motion system, it serves an extremely unique purpose. It allows amateurs to actually view the people they contact, a capability that was previously only a dream.

SSTV for the Existing Amateur Setup

The interconnection of slow scan gear to an amateur station is quite simple, and the necessary time from carton to contact is a leisurely evening's activity. If you know how to connect the components of a stereo system, then you can easily wire an SSTV setup. The SSTV monitor merely plugs into a rig's speaker jack while the camera connects to the mike jack. Most SSTV units incorporate a switching arrangement which allows either the microphone or SSTV camera to drive the transmitter's audio input. Preliminary adjustments for contrast and brightness take only a few minutes, and you're ready for video fun!

As several manufacturers include their camera's power

supply and video switching inside their SSTV monitor, I suggest you start with units of the same brand. The same goes for their fast scan viewfinders. Later, you can add your own personal touches.

If you like to build your own gear, you'll be glad to learn that most of the presently popular circuits are available on printed circuit boards from various SSTVers. The best way to learn what's available and who's producing boards is by inquiring during the SSTV net which meets each Saturday at 1800 GMT on 14,230 kHz. The gang welcomes newcomers and is always anxious to help with information or problems.

Understanding SSTV Gear

The popular misconception that slow scan television is complicated and expensive is inaccurate. The cash outlay for a commercially manufactured setup is approximately the same as that required for a synthesized 2 meter rig. Amateurs interested in a less expensive method can home brew their SSTV gear, and the total investment will range from 50 to 150 dollars.

There are presently three common types of SSTV gear: P7 cathode ray tube moni-

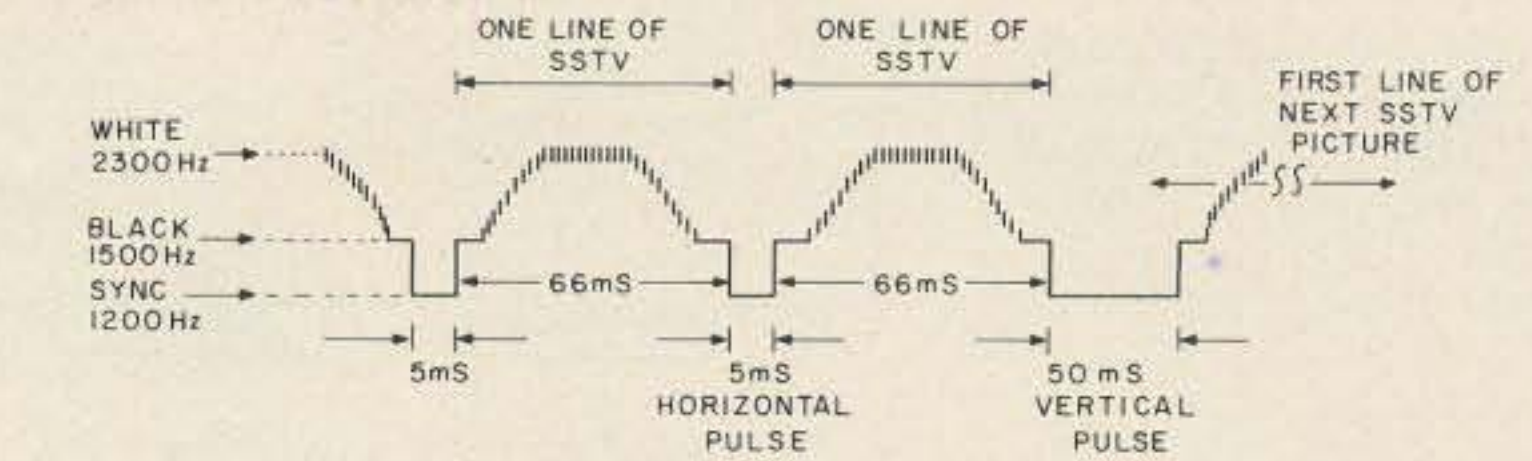

Fig. 1. Format of signals used in SSTV.

tors, fast scan sampling cameras, and digit scan converters. As the basic operation associated with any of these units employs similar concepts, a brief description of each one follows.

P7 Monitors

The functional diagram of a typical P7 monitor is shown in Fig. 2. Incoming SSTV tones are initially applied to a limiter/amplifier, where they are clipped of amplitude variations (noise pulses, etc.) and amplified to a usable level. This signal is then applied to the sync and video detectors. The video detector is simply a tuned circuit which is resonant at 2300 Hz, thus its output level is determined by the frequency of incoming tones. This voltage is boosted by 2 or 3 video amplifiers (these are actually dc amplifiers, similar to the type used in a receiver's S-meter circuitry) and applied to the picture tube as video modulation.

During this same time, the sync selector (another tuned circuit that's resonant at 1200 Hz) passes sync pulses to the 15 Hz amplifier and vertical timing circuit. The 15 Hz amplifier boosts incoming pulses so they can trigger the horizontal sweep generator, while the vertical's dc amplifier boosts its pulses so they can trigger the vertical sweep generator. The vertical timing circuit merely assures that short, rapidly occurring horizontal sync pulses aren't mistaken for long, slowly occurring vertical sync pulses. When the sweep generators are triggered by sync pulses, they produce sawtooth waves which sweep the monitor's screen. The overall results are that brightness variations modulating the picture tube's beam are placed at appropriate points on the screen by deflection circuitry, thus reproducing the SSTV picture. Although specific monitor designs may vary,

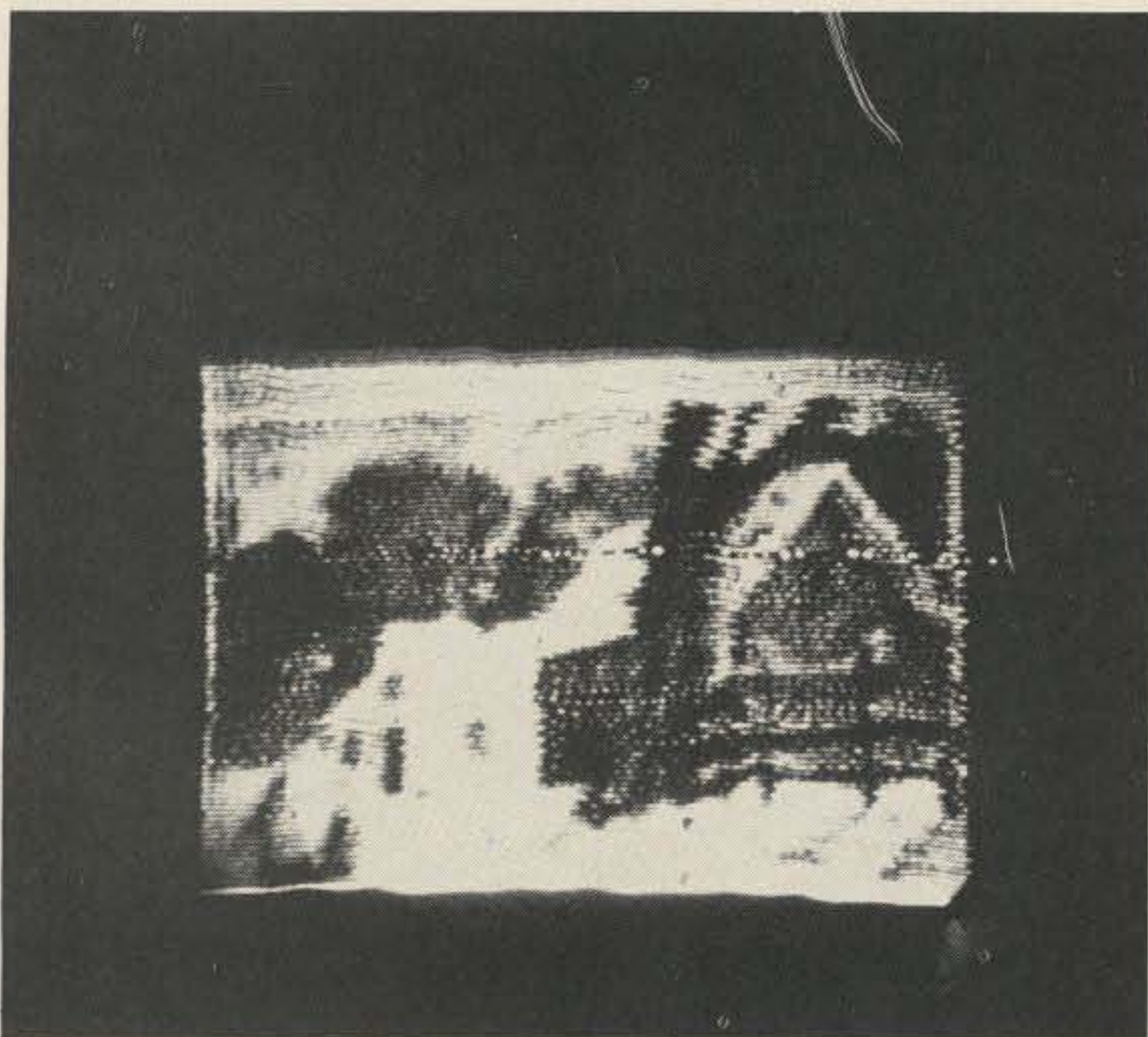

SSTV picture of a New England snowfall in the early months of 1977. This picture was received on 20 meters during adverse band conditions.



CQ as received from ON4DN in Belgium during a yearly SSTV contest.

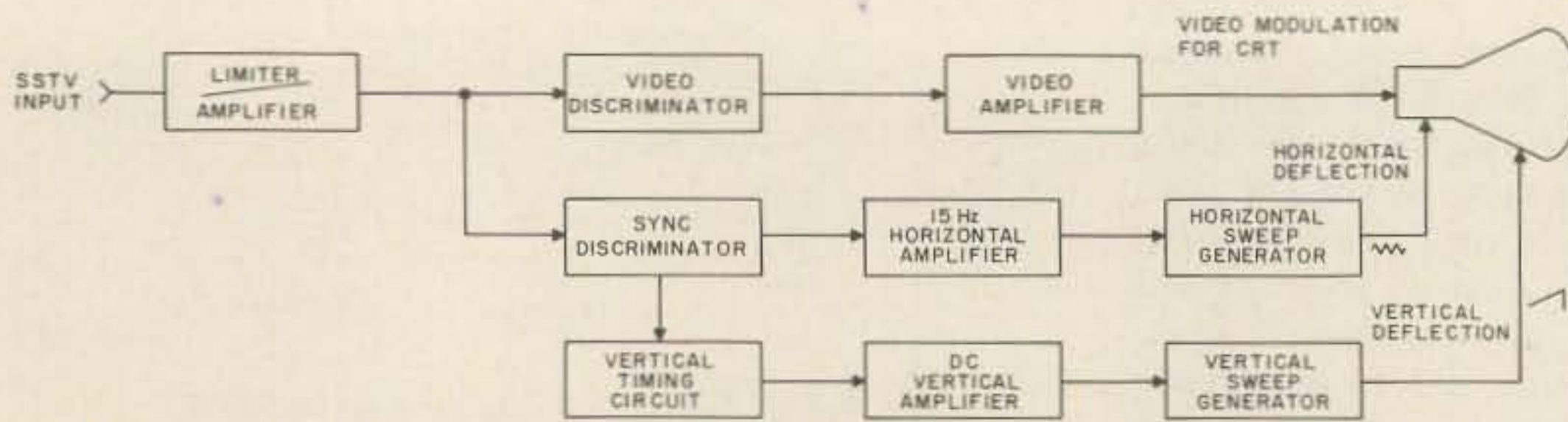

Fig. 2. Functional diagram of typical P7 monitor.

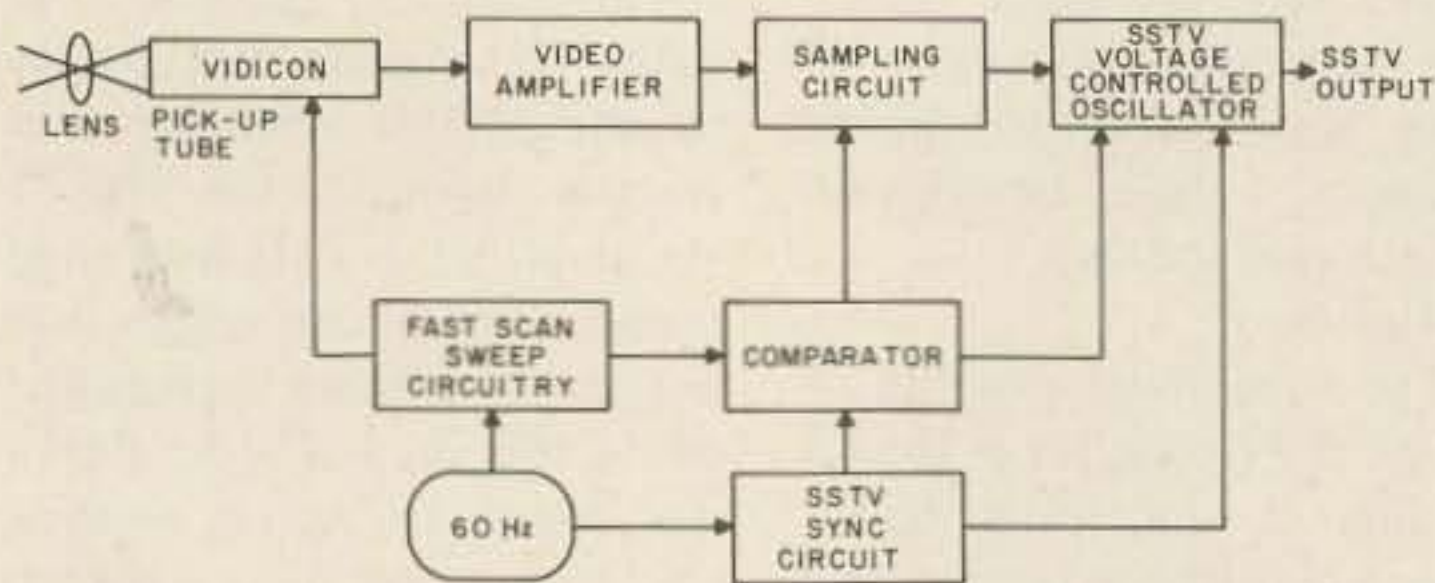

Fig. 3. Functional diagrams of sampling camera.

their functional concepts are similar to the previous description.

Sampling Cameras

Basically, sampling cameras employ fast scan circuitry to operate their vidicon tube, and specific parts of each vertical scan are used to produce each horizontal line of slow scan. Approximately 128 of these line-generating operations are required to produce an SSTV picture.

Referring to Fig. 3, the

vidicon, which is being operated by the fast scan sweep circuitry, outputs to the video amplifier. Next, the sampling circuit selects specific picture elements and directs them to the SSTV oscillator. Operation of the sampler is being controlled by a comparator circuit. This comparator simply decides when the fast and slow scan sweeps are at the proper locations, and sends an enable pulse to the sampler at that time. Output samples are

varying voltages which shift the voltage controlled oscillator, thus generating SSTV. At the end of each slow scan line, the SSTV sync circuitry shifts the voltage controlled oscillator to a specific voltage level (output frequency), thus inserting sync pulses. A full SSTV picture is produced after approximately 128 of these operations. Sampling techniques aren't as complex as they may seem. Integrated circuits are used to perform specific functions, and we merely let them do their thing. The previously discussed voltage controlled oscillator, for example, may be an inexpensive IC (NE555) which simply plugs in and produces a tone, its exact frequency being controlled by the voltage applied to it.

Digital Scan Converters

In the same manner that two modes, transmit and receive, are used for radio com-

munications, there are also two modes of digital scan conversion: fast to slow and slow to fast. Both of these modes use the same basic concept of converting incoming video to digitalized equivalents and accelerating or decelerating them approximately 1,000 times, then converting them back to analog equivalents at the desired scan format. Precise clocking controls all input/output functions. Incoming sync pulses usually initiate specific clock functions. The following is a simplified description of slow-to-fast-scan digital scan conversion. See Fig. 4.

Incoming SSTV is amplified and limited, then separated according to its video/sync content. The sync pulses are used to initiate various clocking functions. During this same time, video information is converted to digitalized equivalents and moved into a time buffer register. The digitalized video information will wait in the buffer until clocking directs it to the main memory. After the main memory has been loaded, its input is closed, and the data is accelerated approximately 1,000 times. Finally, the memory's output

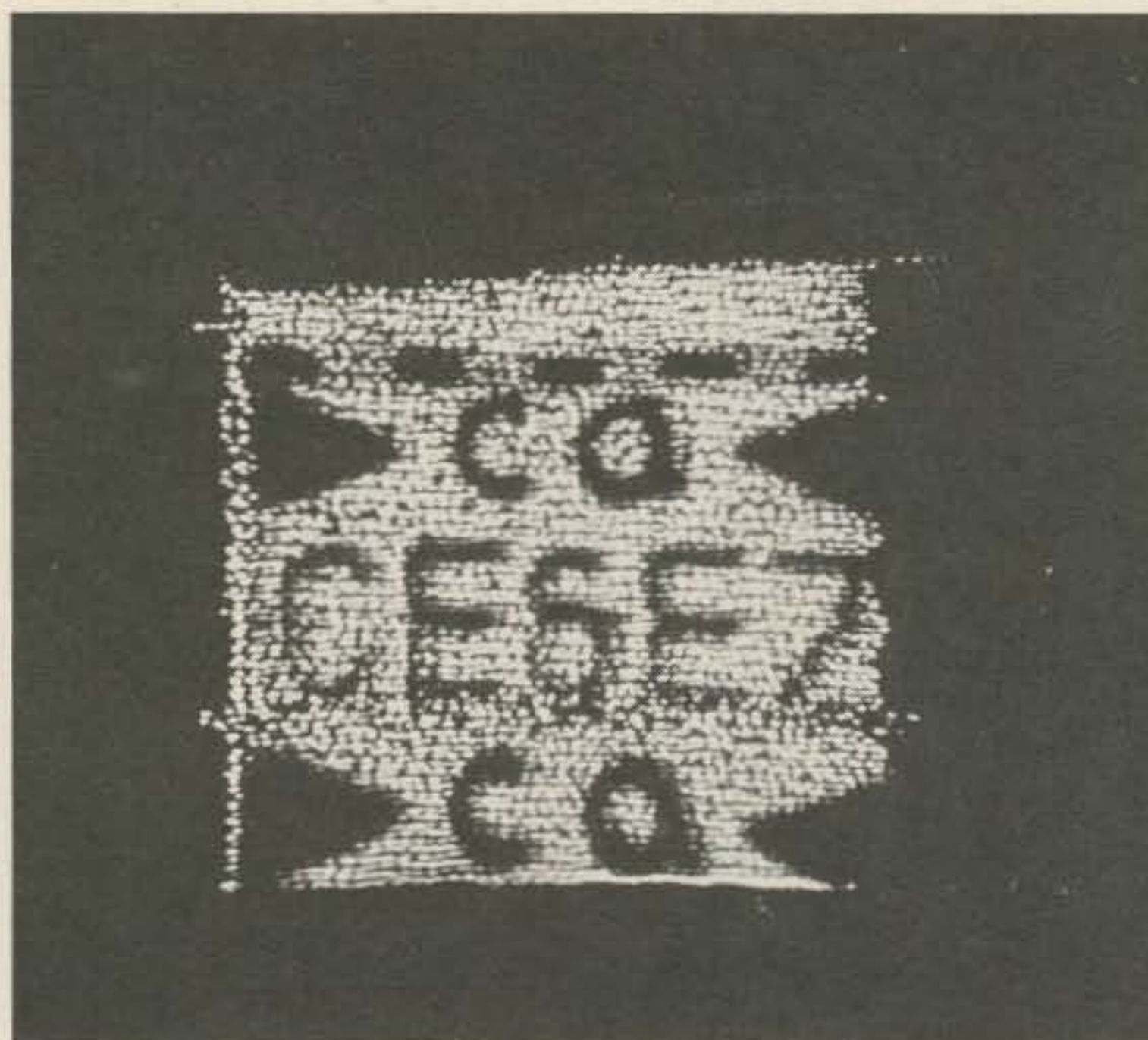

CQ received from CE6EZ in Chile during poor band conditions. This audio fell into the noise level, although his S-3 pictures were still visible.



ID of KH6DEH in Hawaii as received in Alabama. The missed lines near the top of the picture were due to a brief burst of noise.

is opened, and the data is D/A converted. The resultant voltages then modulate a VHF oscillator which connects to the antenna terminals of a regular home TV. Clocking also inserts specific levels at the proper times for generating fast scan sync pulses. Since the information is being read out of the memory much faster than it's being written into the memory, clocking also recirculates the video data as necessary.

This discussion of SSTV gear has become slightly complex, so I would again like to emphasize that you don't need to be an electronic wizard to build or enjoy SSTV gear. The advent of PC boarding allows anyone to construct even the most complex gear and assures its success.

On the Air With SSTV

Once the SSTV gear is working closed-circuit fashion (camera output connected to monitor input), you're ready

to connect the HF rig and enjoy video communications. Tune the popular SSTV frequencies, and watch some incoming pictures for a while to get the knack of slow scan. Notice how SSTV expands QSOs rather than merely generating them — how complex pictures require explanation, how they are affected by QRM, etc. Although some slow scanners call CQ exclusively by video, I suggest you use audio and occasionally add a single SSTV picture. This relaxed approach encourages more replies (especially from lightly-equipped SSTVers) while giving your rig a chance to breathe. The duty cycle for SSTV is the same as CW — 100%. Don't

make lengthy picture transmissions before learning your rig's capabilities. Your finals will thank you. Usually, the SSTV level is adjusted to equal half of your audio level. If your rig produces 500 Watts output on SSB, for example, set your SSTV level so the rig produces 250 Watts during picture transmissions.

Also, a group of previously recorded pictures will prove indispensable during those awkward first QSO times.

Finally, I suggest you begin your SSTV fun casually. Don't try to set the world on fire overnight. Amateurs who come on strong with new modes tend to burn out quickly, while the smooth pacers last.

Conclusion

The challenging world of SSTV is a constantly changing and progressive field. Recent advancements include motion SSTV, color SSTV, 3-D, computer processed pictures, and much more. If you're the type of person who enjoys staying on top of innovations and being a pacesetter, I'm sure you'll find the world of SSTV a true haven.

SSTV activity can be found daily on 3845, 7170, 14230, 21340, and 28680 kHz, with 14230 and 3845 kHz being the most popular. Consider this a personal invitation to join our gang. We'll look forward to seeing you. ■

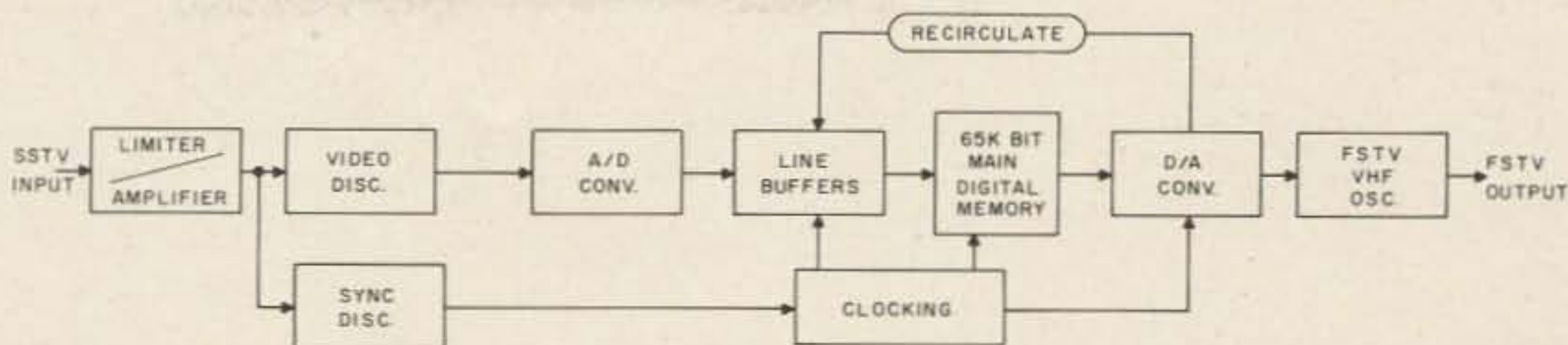

Fig. 4. Functional diagram of digital scan converter.

FROM MURCH ELECTRONICS the UT2000A

THE ULTIMATE TRANSMATCH



Similar to the one in Lew McCoy's article
July 1970 QST also 1976 Handbook

- Use with any coax or end fed random wire antenna, ideal for apartment dwellers
- 2 kW P.E.P. (1 kW continuous) 1:1 SWR to transmitter
- 10-80 continuous, including MARS
- Use with any wattmeter or SWR indicator
- Heavy duty throughout (4000 volt capacitors)
- Rotary Inductor with turns counter for precise and rapid tuning

12" w 12" d x 5½ h, 12 lbs shipping weight

MODEL UT-2000A

\$139.95 + SHIPPING

MULTIBAND ANTENNA 10 - 80 M

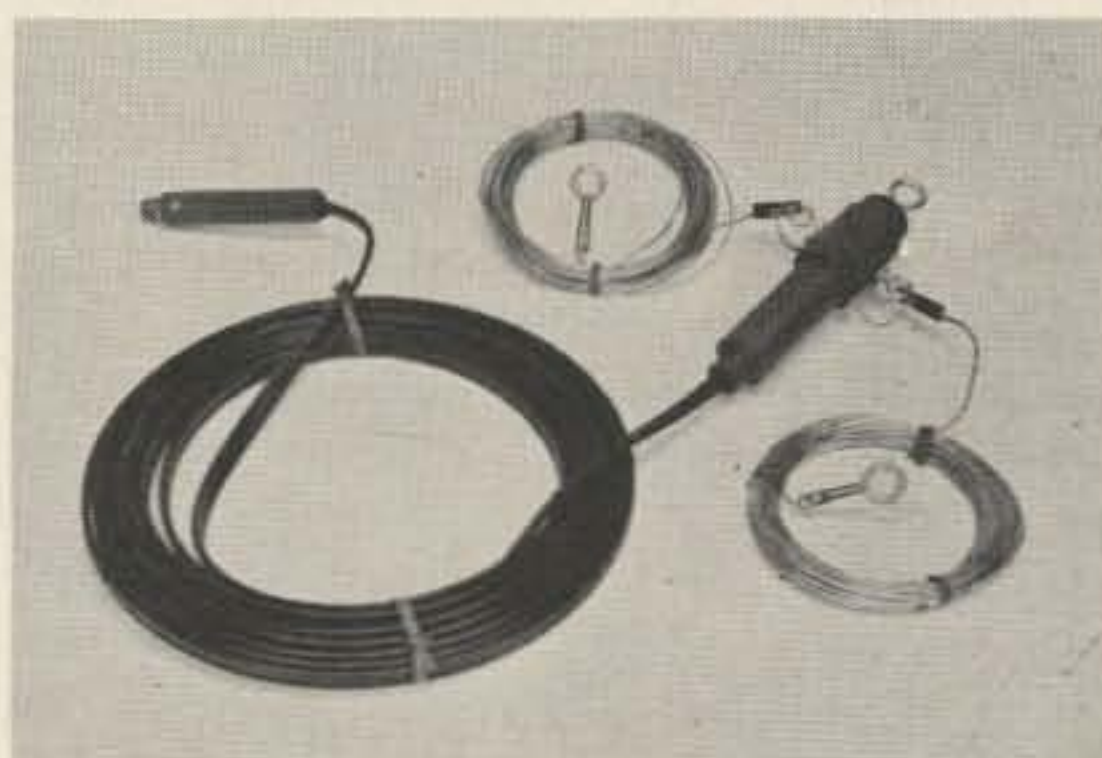

- Field Proven 4 years
- Sealed center insulator, 102 ft. wire, 30 feet heavy duty twin lead
- Coax fitting to connect twin lead to 52 ohm transmission line (68 feet or more, not included)
- Ready to use. Great on all bands when used with the Ultimate Transmatch

MODEL 68A, 2000 w P.E.P.

\$44.50 p.p.

MURCH ELECTRONICS INC.

Box 35 Franklin Maine 04634

M43

Phone 207-565-3312

Build This Excitingly Simple Receiver

Ray Megirian K4DHC
606 SE 6th Avenue
Deerfield Beach FL 33441

You may or may not be familiar with the various versions of miniaturized communications receivers I've presented over the past 6 years as part of my Minicom series. Although I'm up to an MK VI version at this writing, circumstances have arisen which prompted a decision to revisit the MK III.

The Original MK III

The original MK III Minicom¹ was an electronically tuned 80 meter receiver designed around the Motorola MVAM1 triple varactor. This solid state device took the place of the normal 3-gang variable capacitor used to tune the rf, mixer, and vfo tank circuits. At \$13.50 for the MVAM1, I considered the

receiver to be more of a novelty than anything else. I included it in my article merely to show existing possibilities to further shrink receiver size, never dreaming of the kind of interest it would arouse.

As has been said about most living things, they start to die the moment they're born. The MK III may not have been a living thing, but it sure died in a hurry. While the article was awaiting publication, Motorola ceased production of the MVAM1. Although the MK III was only one of several ideas covered in the original article, almost everyone who wrote to me was interested solely in duplicating the MK III and nothing else. The question of whether or not they'd have gone ahead after learning what it would cost became academic at that point, and all I could do was pass along the bad news and watch the

tears.

New Hope

After the demise of the MVAM1, Motorola introduced the MVAM115 single varactor diode. It, too, was designed for electronic tuning of AM radios and had a high capacitance ratio along with a Q of 150 or better. To make it even more worthwhile, 3 of the new diodes would cost only about a third the price of the old MVAM1. With all this going for it, it was time to bring the MK III back to life. In short order, I obtained some MVAM115s and got to work.

The results were all I could have hoped for during the breadboard experiments, and, as soon as all the variables had been optimized, a PC was laid out and a finished receiver built. Surprisingly, it worked right off, and all I could assume was that Murphy was on vacation or

had passed on.

Why Diode Tuning?

Besides a considerable saving in bulk, electronic tuning raises some other interesting possibilities. The tuning pot is connected by wire to the receiver assembly and thus allows remote tuning, if desired. The PC portion of a receiver can be tucked away in a corner of the cabinet, while the tuning pot can be panel mounted without the worry of mechanical linkage to turn the shaft of a variable capacitor. Preset voltages can be switch selected for often used frequencies. A second pot controlling a fraction of a volt can have its output summed with the main tuning voltage to allow bandspreading over very small portions of the dial. In the modern vernacular, this is known as "incremental tuning." Other ideas, such as being able to reverse the voltage so as to reverse the direction of tuning, come to mind when we are faced with this problem in connection with converters. You may think of more as you get involved with this method of tuning.

Circuit Description

Overall, the new MK III seems to work better than the original did. Although no diode selection was made, tracking seems to be as good as that using a conventional 3-gang variable capacitor. Different sets of diodes picked at random were used in the breadboard and the finished PC board with equal results.

A few minor changes were made in the updated version of the receiver. A Motorola MFE521 transistor is used in the rf stage in place of the 40841. A 723 IC regulator is also new, replacing the MFC6030 formerly used. A couple of resistors have also been added to enhance matching to the Murata filters used for i-f selectivity. Everything else is the same as the original.

With the values shown, the

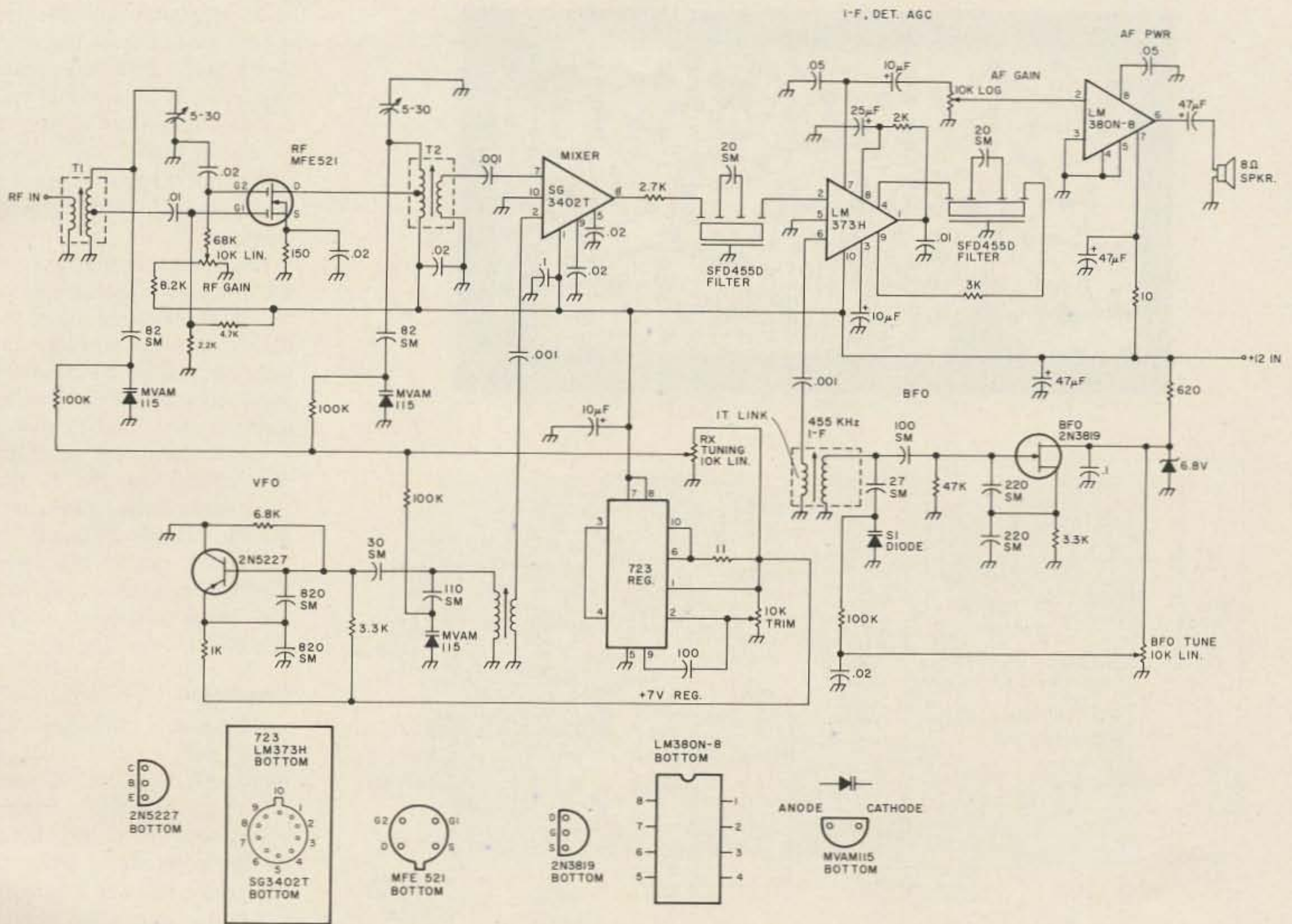

Fig. 1. Complete receiver schematic. All resistors are 1/4 Watt, 5%. All polarized capacitors are dipped tantalum. All SM capacitors are silver mica. Remaining capacitors are low-voltage discs. Whole numbers are pF unless marked otherwise. Decimal values are in uF.

tuning range of 3.5 to 4.0 MHz is covered in 180 degrees of rotation of the tuning pot shaft. This makes it easy to use conventional dials.

Because the tuning voltage must be very stable, a voltage regulator is used in place of a zener diode. A 3-volt input-to-output differential is required by the regulator, so, with 7 volts out, the input must be kept above 10 volts. With a 723, the minimum output with the configuration shown is about 7 volts, which, fortunately, is adequate for our needs. The regulator also powers the vfo.

Construction

There are 3 coils or transformers to wind and one i-f transformer to be modified before construction begins. If you've read other Minicom

articles, you know I use standard 3/8"-square 455 kHz transistor i-f transformers for a lot of my construction work. In this case, T1 and T2 are wound on stripped-down i-f transformers using salvaged wire. Refer to Fig. 3 for winding instructions. The vfo tank coil is pie-wound on a slug-tuned form. The bfo tank consists of a standard transistor i-f transformer whose secondary has been modified to one turn. This can be accomplished by gently breaking the secondary leads right close to the core with tweezers and unsoldering the remaining wire at each pin. Wind a new one-turn link over the existing windings, and solder the ends to the same pins used by the original winding.

Since it was all being redone, I thought I'd make

this version smaller by mounting the resistors and diodes hairpin fashion. The resulting layout is 2.1" wide by 3.9" long, almost a half inch narrower than the old receiver.

All resistors are 1/4-Watt, 5% units with one lead bent around a full 180 degrees so that they can be mounted vertically in closely spaced holes. Diodes are mounted similarly. All polarized capacitors are dipped tantalum. All other capacitors are low-voltage discs, except where silver micas are indicated.

The two 5-30 pF trimmers are very small 5 mm types. These, as well as some of the other parts, may give you trouble when searching for sources. If you send me an SASE and a list of your needs, I'll let you know what

spares I have and what they cost.

After all parts have been mounted, you'll have quite a few empty holes left over. These are meant for connecting leads to external controls and for dc power. The PC layout shows where everything goes. Some holes will not necessarily be used, such as all grounds located around the copper border. These are for convenience and not specifically assigned. You will also find spare pads for +12 volts and +7 volts regulated.

Testing and Operation

With a 12-volt supply, the receiver should draw between 50 and 60 mA with no signal. A meter in series with the power lead or a metered supply can be used for the initial smoke test in order to

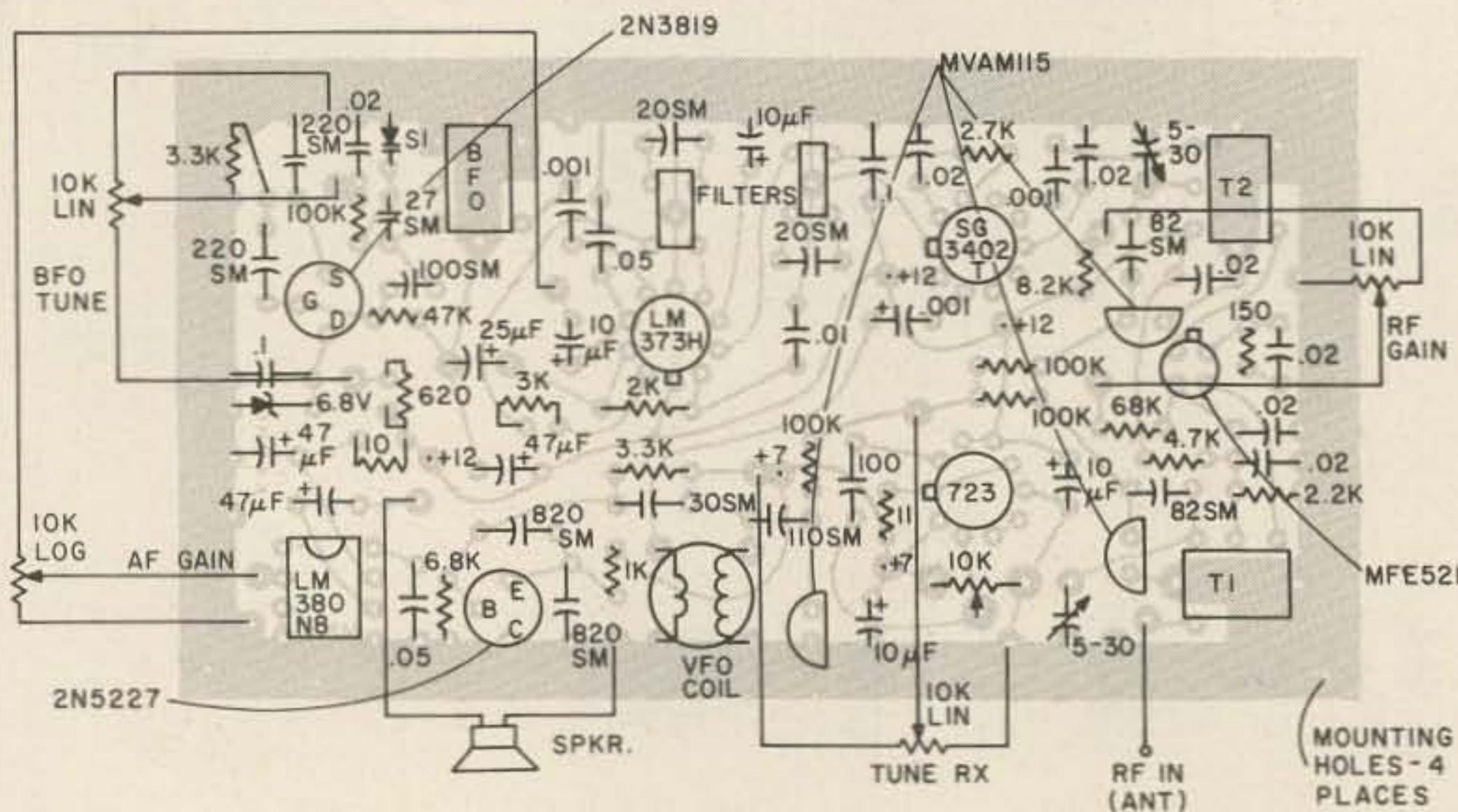
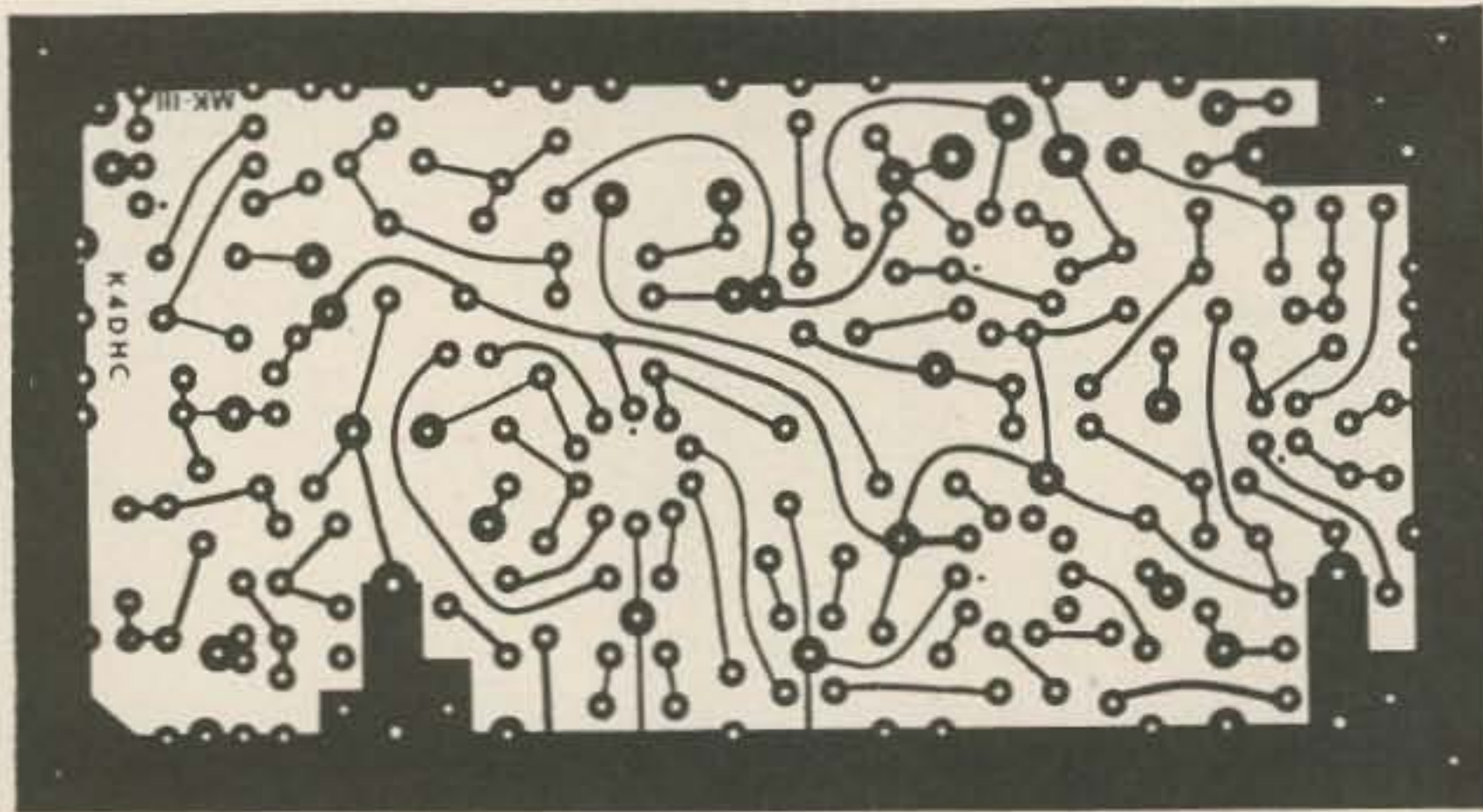

Fig. 2. PC board and component layout. Mount the ceramic filters so the circle on top of the case is towards the 20 pF coupling capacitors.

determine that there are no shorts or faulty parts. If drain is normal, the following procedure should have you receiving signals in 15 minutes or so.

Using a voltmeter, adjust the trimmer resistor for an output of 7 volts from the regulator. Make sure the regulator is working by varying the voltage from the power supply up to 14 volts and down to 9 volts. You should

lose regulation at about 10 volts.

Next, turn the rf and af gain controls to maximum and the bfo to mid position. Slowly run the slug in the bfo transformer out towards the top of the can. When you hit 455 kHz, you'll hear a rushing noise with two peaks and a null in between as the core is rotated. Set the slug to the null point which is zero beat. Make sure turning the bfo

tuning control varies the frequency on both sides of zero beat.

The remaining alignment steps should be done with the 180-degree operating range of the tuning pot centered so that the excess travel is equally divided at both ends. Some sort of vernier drive is a necessity, and a scale should be mated with the drive so calibration points can be marked off.

Set the tuning pot to the low end starting point and check the vfo frequency. It should be at approximately 3.0 MHz. I use my scope, but a counter can be used. If you have no convenient way of reading this frequency, use brute force. Feed in a hefty signal at 3.5 MHz and rotate the slug in the vfo tank coil until you pick up the signal. The gain controls should still

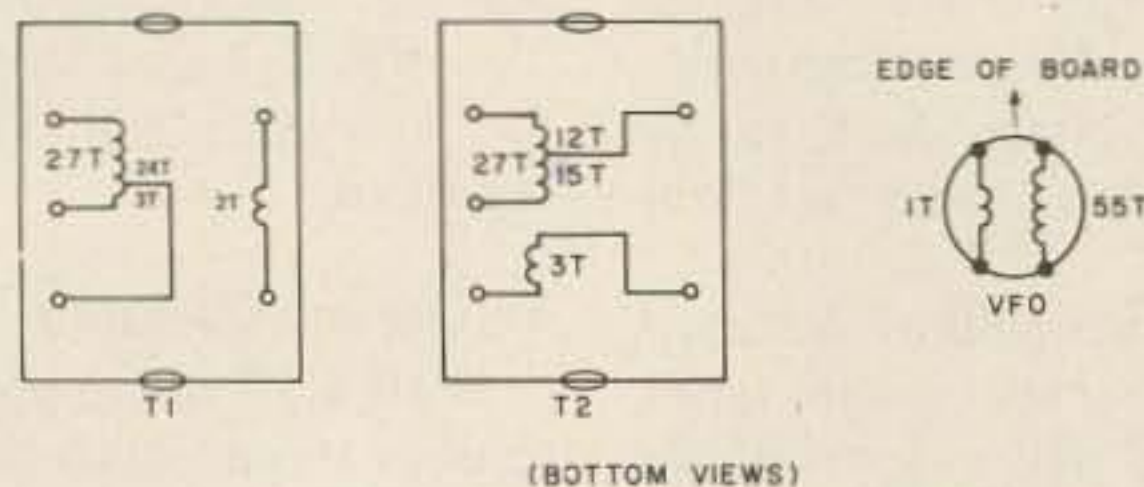

(BOTTOM VIEWS)

Fig. 3. T1 and T2 are wound on stripped 455 kHz transistor i-f transformers using salvaged wire. The vfo tank coil is pie-wound with 7/44 litz wire on a Gowanda series 7 coil form with carbonyl E core. The 1-turn link is wound over the pie.

be at maximum and the vfo at zero beat. Adjust the slugs in T1 and T2 for maximum response. At this point, you can turn down the af gain to a comfortable level and reduce the rf signal to prevent overloading of the receiver front end.

Once the low end has been set, run the signal generator up to 4.0 MHz, and rotate the tuning pot up towards the high end until you find the signal. The two ceramic trimmers across T1 and T2 should be peaked with the generator level set at a low level. Repeat these steps several times until good tracking is achieved.

Finally, mark off intermediate frequencies on your dial with whatever spacing you desire.

Conclusion

Using the LM373 in circuits such as this aids in miniaturization, but it leaves one major drawback. The agc system internal to the LM373 is not compatible with the rest of the receiver. I have, on occasion, added supplementary agc circuitry to receivers using the LM373, but, in those cases, space was not a problem. The only alternative is a manual rf gain control, as was used here.

Although the MK III makes a dandy little 80 meter receiver all by itself, it is also an excellent tunable i-f system for a multiband converter. I used the converter (since revised) shown in the MK IV² receiver article in conjunction with this tuner and achieved 5-band operation in a very small package.

The diode tuning was also applied to a more elaborate receiver similar to the MK IV and resulted in more features per cubic inch than any Minicom to date. Who knows, perhaps the variable capacitor's days are numbered. ■

References

1. Ray Megirian K4DHC, "Design Ideas For Miniature Communications Receivers," *Ham Radio*, April, 1976.
2. Ray Megirian K4DHC, "The Minicom Receiver," 73, April, 1977.

HAMTRONICS USED GEAR • TEST EQUIPMENT • SPECIALS

30-DAY GUARANTEE ■ 90-DAY FULL CREDIT TRADE-IN ■ FREE SHIPPING VIA UPS ONLY

Limited quantities. First come, first served. (if weight or size exceeds UPS max., we will ship freight collect)

Allied AX-190 Receiver \$159	TR-22 2 Meter 140 T-4X Transmitter 339 TR-72 2 Meter FM 225 AC-4 AC Supply 95 TR-4-C Transceiver 449 CC-1 Console CPS-1 Supply SC-2 Conv SC-6 Conv SC-1 Calibrator The above all assembled complete pkg. Only \$200	HT-37 Transmitter 159 HT-40 Transmitter 49 SX-99 Receiver 99 SX-117 Receiver 189 SR-150 Xcvr 259 SR-160 Xcvr 159 SX-146 Receiver 175 HT-44 Transmitter 159 SX-111 Receiver 149 SX-122 Receiver 249 S-36 UHF Receiver 125	Johnson 1-KW Matchbox/SWR \$195 Courier Linear 139 Ranger I Transmitter 85 Ranger II Transmitter 139 Valiant I Transmitter 129 Invader 2000 Xmitt 495	Standard SRC-146 HT \$149 826 M Trnscvr 195 SRC-144 395 SRC-851T 250	Tempo Tempo one Xcvr \$299 AC One Supply 79 FMH 2M H.T. 149 CL-220 Trnscr 220 MC 179 FMH 2M w/Talkie 149		
Ameco PV-50 \$ 9 CN-50 29 CN-144 39 TX-62 79 621 VFO 45	Dycomm 10-0 2 M Ampl \$125 35-0 401N 110 Out 130 470-25 450 MC 120 P-1416 16 Amp Supply 95	Hammarlund HQ-110 A VHF Receiver \$189 HQ-110C Receiver 119 HQ-110AC Receiver 149 HQ-145X Receiver 169 HQ-170C Receiver 159 HQ-180 Receiver 379 HQ-215 Receiver 259 SP-600 Receiver 179 HX-50 Transmitter 169	Kenwood T-599 Transmitter \$289 R-599 Receiver 289 TS-520 Tranc 429 QR-666 259 QR-666 Receiver 239 TV 502 Transverter 179	Swan 700-CX Xcvr \$459 260 Cygnet 289 279 Cygnet 329 500 Xcvr 299 500 CX Xcvr 389 117-XC AC Supply 95 14X DC Module 39 MK II Linear 475 KK VI 6 Meter 550 250 C 6M Xcvr 349 FM 2X2M Xcvr 169 FM-1210A 2M 249 350 Transceiver 269 350C Xcvr 299 600R Receiver 339 600T Transmitter 399 410 VFO 79	Ten Tec PM-3 Trnscr \$ 49 Argonaut Xcvr 199 KR-40 Keyer 79 RX-10 Receiver 49 S-30 Signalizer 29 Triton II 479		
B&W Waters Nuvertor 2+6 Conv. \$ 75 6100 SSB Xmitter 395 670 SSB Adaptor 39 Co-Dax Keyer 95	Eico 720 Transmitter \$ 49 722 VFO 39 730 Modulator 39	Heathkit SB-300 Receiver \$199 SB-301 Receiver 229 HR-10-B Receiver 69 SB-303 Receiver 269 SB-220 Linear Amp 449 SB-102 Trivcvt 379 DX-60B Transmitter 69 HW-32 Transmitter 85 HW-100 Transceiver 249 SB-100 Transceiver 299 SB-401 Transmitter 249 SB-101 Transceiver 349 SB-650 Digital Freq. Display 149 HW-30 Twoer 29 Also Sixer 29 H-10 Monitor 69 VHF-1 Seneca 79 HW-12 Transmitter 75 HP-23 AC Supply 49 HP-23B AC Supply 59 HW-202 2M FM Xcvt 159 SB-620 Spectrum Analyz 120 SB-102 Xcvt 369 SB-610 Scope 95 HA-20 6m Linear 125 SB-634 Console 175 SB-604 Spkr 29.50 SB-644 VFO 129.50 SB-230 Linear 359 SB-104 Transceiver 625	Knigh T-60 Transmitter \$ 39 r-100 Receiver 59 TR-108 Trancur 2M 79	Lafayette HA-800 Receiver \$ 89 HP-350 Receiver 149 HE-45 Transceiver 49	Yaesu FT-401 Xcvt \$499 FRDX 400SD Rec 325 FT 2 Auto 2M FM 249 FT-101B Xcvt 549 FL-2100B Linear 295 FV-101 VFO 79 101E Xcvt Demo 695		
Central Electronics 100V Transmitter 325 MM-2 Scope 69 20-A SSB Adaptor 79	Elmac AF-67 Transmitter \$ 45 PMR-8 Receiver 79	Midland 509 H.T. \$149	Millen 92200 Transmatch \$149 90651-A Grid Dipper 95	National NC-270 Receiver \$119 NC-300 Receiver 129 NCX-5 Transceiver 279 NCX-5MK II Transcvt 299 NC-303 Receiver 199 AC-500 AC Supply 69 NCX-500 Transceiver 199 NCX-3 Transceiver 169 NC-190 Receiver 149 NC-105 Receiver 69	Test Equipment Bargains Boonton "Q" Meter \$295 Tektronix 5140 249 Tektronix 545A 950 5 3/54A Plug-in wide band preamp . . 75 Hickok 695 Generator 69 Bendix BC221 Freq Meter 39 Polarad Spectrum Analyzers A84T. . . 1695 Hewlett Packard 400C. 75 Precision E-400 Signal Generator. . . 125 Electro Impulse Spectrum Analyzer . . 395 Dyna/Sciences Model 330 Digital Multimeter 195 Hewlett Packard 4905A Ultra Sonic Detector 550 Hewlett Packard 120A Scope. 250 TS-323/UR Frequency Meter. 175 Hewlett Packard 4910B Open Fault Locator 650 Bird Mod 43 80 General Radio 650A 150 Measurements Mod 80. 195 Nems Clark 1400. 495 Ballantine 300H 175 PACO Scope Mod-S-50 75 Singer FM-10C 3495 Simpson 260 V.O.M. 49.50		
Clegg 22'er FM \$129 66'er 6M Xcvt 115 99'er 6M Xcvt 59 Interceptor BRCUR 275 Ant Pre Amp 22 All Bander 69 HT-146 125 2 Vess 259 FM-27-B Xcvt 325	Genave GTX22M FM \$165 GTX-200 2M FM 149	Regency HR-2B 2M FM \$169 HR-220 FM 220 MC 185 AR-2 2M Amplifier 85 HR-25 2M FM 225 HR-6 Meter FM 189	SBE SB-34 Transceiver \$249 SB-33 Transceiver 189 SB-144 2M FM 175 SBZ-LP Linear 179	Globe/Galaxy VHF 6+2 Transm \$ 39 Chief Transmitter 39 Galaxy III Xcvt 159 Galaxy V Xcvt 189 Galaxy V Mk II 239 GT-550 Xcvt 279 GT-500A Xcvt 329 AC-400 Supply 79 FM-210 2M FM 95	Drake 2A Receiver \$149 2B Receiver 189 2AQ SPKR QMULT 29 R4 Receiver 289 R4-B Receiver 349 R4-C Receiver 399 MS-4 Speaker 19 2NT Transmitter 125 2NT Transmitter 99 TR-6 695	Gonset Com II 2M \$ 75 Com II 6M 69 Com IV 2M 129 GC-105 2M 115 G-28 Xcvt 149 G-50 Xcvt 149	ICOM IC-21 2M FM Xcvt \$299 IC-230 Demo 369 IC-22A 2M FM Xcvt 185 IC-30A 432 MCFM 269



ICOM IC22S

Regular \$299, save \$50; buy an ICOM IC22S for \$299 (no trades) and take a \$50 credit for another purchase.



KENWOOD TR-2200A

Regular \$229, save \$30; buy a Kenwood TR2200A for \$229 (no trades) and take a \$30 credit for another purchase.



MIDLAND 13-510

Regular \$399, save \$50; buy a Midland 13-510 for \$399 (no trades) and take a \$50 credit for another purchase.



KENWOOD

TS820 \$ 919.00
 TS80S \$1098.00



YAESU

FT101E - 799.00
 FT101EE - 759.00
 FT101EX - 699.00



DRAKE

TR4CW - \$799.00

MAIL & PHONE ORDERS WELCOMED. BANK AMERICARD ACCEPTED. ALL UNITS GUARANTEED

HAMTRONICS

DIVISION OF

Trevoze Electronics

4033 BROWNSVILLE ROAD
 TREVOSE, PA. 19047
 Telephone:
 (215) 357-1400
 (215) 757-5300

Can Hams Counter Police Radar?

—*electronic warfare: another step*

There is a growing interest among amateur radio operators in the development of a simple and inexpensive method to jam or otherwise defeat police radar units. This

article is written to discuss the various methods I have used and to offer some suggestions for future work.

Electronic warfare is a highly-developed military

science, the purpose of which is to render useless the electronic sensor and communications equipment of the enemy. This article will be limited to the narrow realm

Note: Don't let that complex synthesizer fake you out. All you need is a common audio oscillator, not a laboratory generator like Fig. 2. *73* takes no stand in the developing warfare between police radar and hams interested in countermeasures. The more we read about it, the more convinced we are that police radar should be outlawed as an invasion of person by possibly damaging microwave radiation. — Ed.



of CW Doppler radar jamming.

The best place to start is to obtain an accurate description of the hostile unit, the police radar. A block diagram of typical police radar is shown in Fig. 1. The radar consists of an unmodulated CW source, either a klystron or a solid state Gunn or Impatt oscillator, a duplexer to isolate the transmitter and receiver, a common antenna, a detector-mixer, and an audio-frequency meter. Typical transmitter output power is in the neighborhood of 10 to 100 milliwatts. The transmitter frequency is 10,525 MHz, very close to the 10,000 to 10,500 MHz amateur band. Typical antenna gain is between 10 and 20 dB.

In operation, radiation from the oscillator passes through the duplexer to the antenna, where it is radiated in a narrow beam. Energy striking cars is Doppler-shifted by an amount proportionate to the car's velocity. The reflected energy is picked up by the antenna and fed to the detector-mixer. Some of the transmitter output is mixed with the reflected signal. The detector-mixer, usually a simple point-contact diode of the 1N23 series or a hot carrier diode in the newer units, detects the difference frequency, which is measured by the audio-frequency meter and displayed as mph on a meter or LED display.

An audio-frequency meter is used because the Doppler shift is approximately 31.4 Hz per mile per hour velocity, or a speed of 100 mph produces a Doppler shift of 3140 Hz.

Methods of Deception

1. CW Jamming

This is the first method amateurs consider, but it is actually one of the least effective and most expensive. To use this method requires operation outside the amateur band. It also would be necessary to use a scanning

receiver, i.e., a spectrum analyzer, and a voltage-controlled jammer oscillator. The receiver is needed to lock onto the exact radar frequency, because the radar transmitter is not of crystal stability. Then the jammer must be offset from the radar's frequency by an amount equal to the desired false Doppler shift. Again, this method is expensive and requires operation outside the amateur band.

2. Noise Jamming

Noise jamming is a technique pioneered for use against radars in the 1940s and is still effective today, but it's not for amateurs who wish to retain their licenses. Noise jamming consists of modulating a transmitter with broadband noise. The bandwidth of the noise spectrum is made large enough to cover the operating band of the hostile radar. Covering the police radar band would require a noise bandwidth of 10 MHz. The radar's receiver has a bandwidth of only 10 kHz. The result is that, by having to spread the jamming energy over ten megahertz of which only ten kilohertz is effective, only one-thousandth of the jammer power is being used. Also, this method requires operation outside the amateur band.

3. Baseband Jamming

This method is the least expensive and most reliable method that I have tried. The method is simple and does not require operation outside the amateur band. It involves transmitting a tone-modulated carrier within the amateur band. Since police radars have an untuned front end, the detector-mixer will act as a detector for frequencies outside the police radar band. If the jammer transmitter, operating inside the 3 cm amateur band, is amplitude-modulated by, say, 3140 Hz, the detector-mixer will detect the 3140 Hz tone and display a speed of 100 mph. Hence, the radar can be deceived into

reading any desired speed by merely modulating an oscillator by a tone corresponding to the equivalent Doppler shift for that speed. I have been able to deceive radar units as far away as one mile using this scheme with a 15-milliwatt Gunn oscillator and a 15 dB gain horn antenna. The schematic of the unit is included in Figs. 2 and 3. Fig. 2 shows the phase locked synthesizer used to generate equivalent speeds of 1 to 99 mph with thumb-wheel switches. The design is a hybrid of CMOS and TTL logic because the parts were on hand. The design is not optimum, but it does work. Fig. 3 shows the modulator which switches the Gunn diode oscillator on and off. The photographs show the

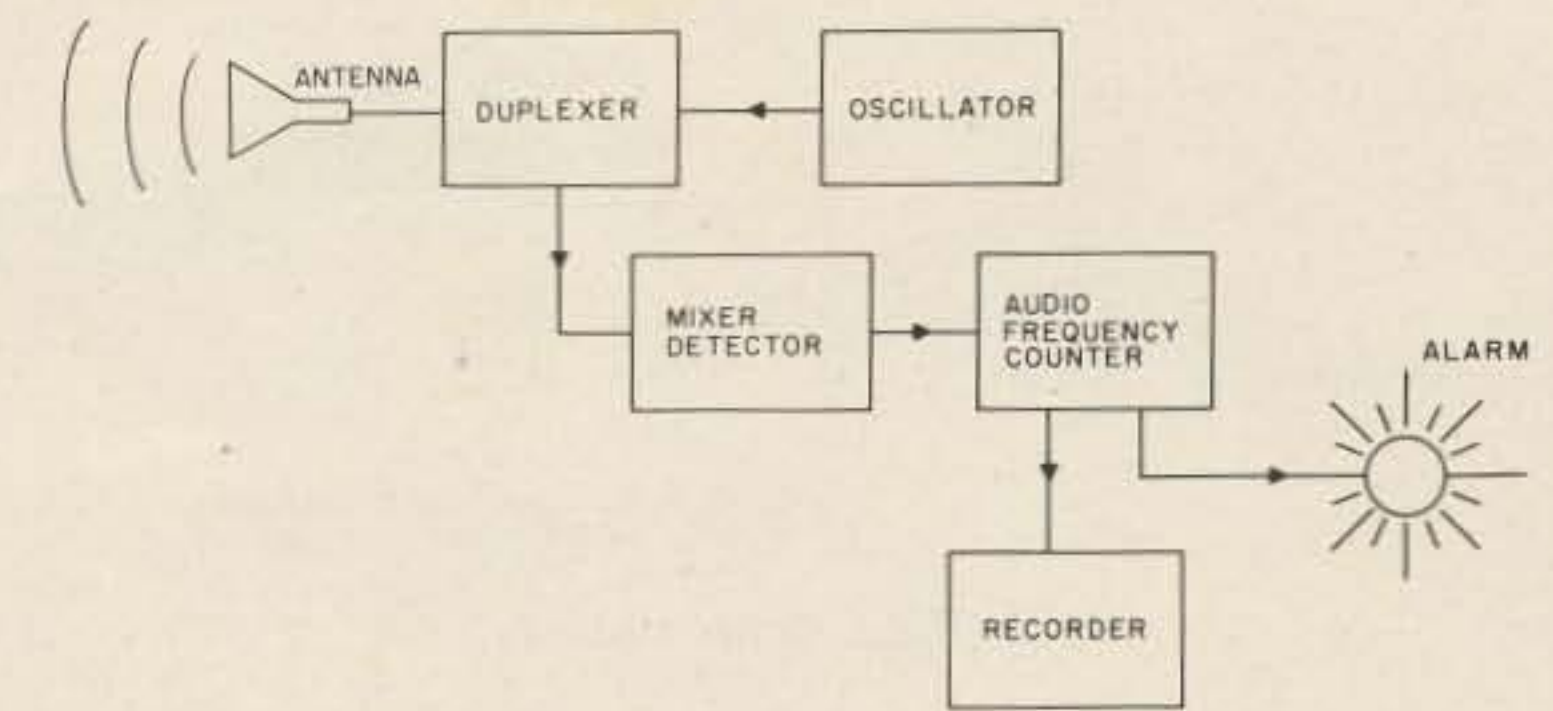

Fig. 1. Simplified block diagram of police radar.

car used for the tests.

4. Passive Jamming

This area is most interesting in that no transmitter is used. In baseband jamming, the deception is accomplished by transmitting a tone-modulated carrier whose modulation frequency corresponds with the desired Doppler frequency. In passive jamming, it is the reflected

radar signal which is modulated to produce the deception. This is accomplished by varying the apparent size or radar cross section of your car. Using an inflatable car and varying the air pressure would work, but a simpler technique is to use an antenna with a varying impedance load. A test unit was constructed with a small horn

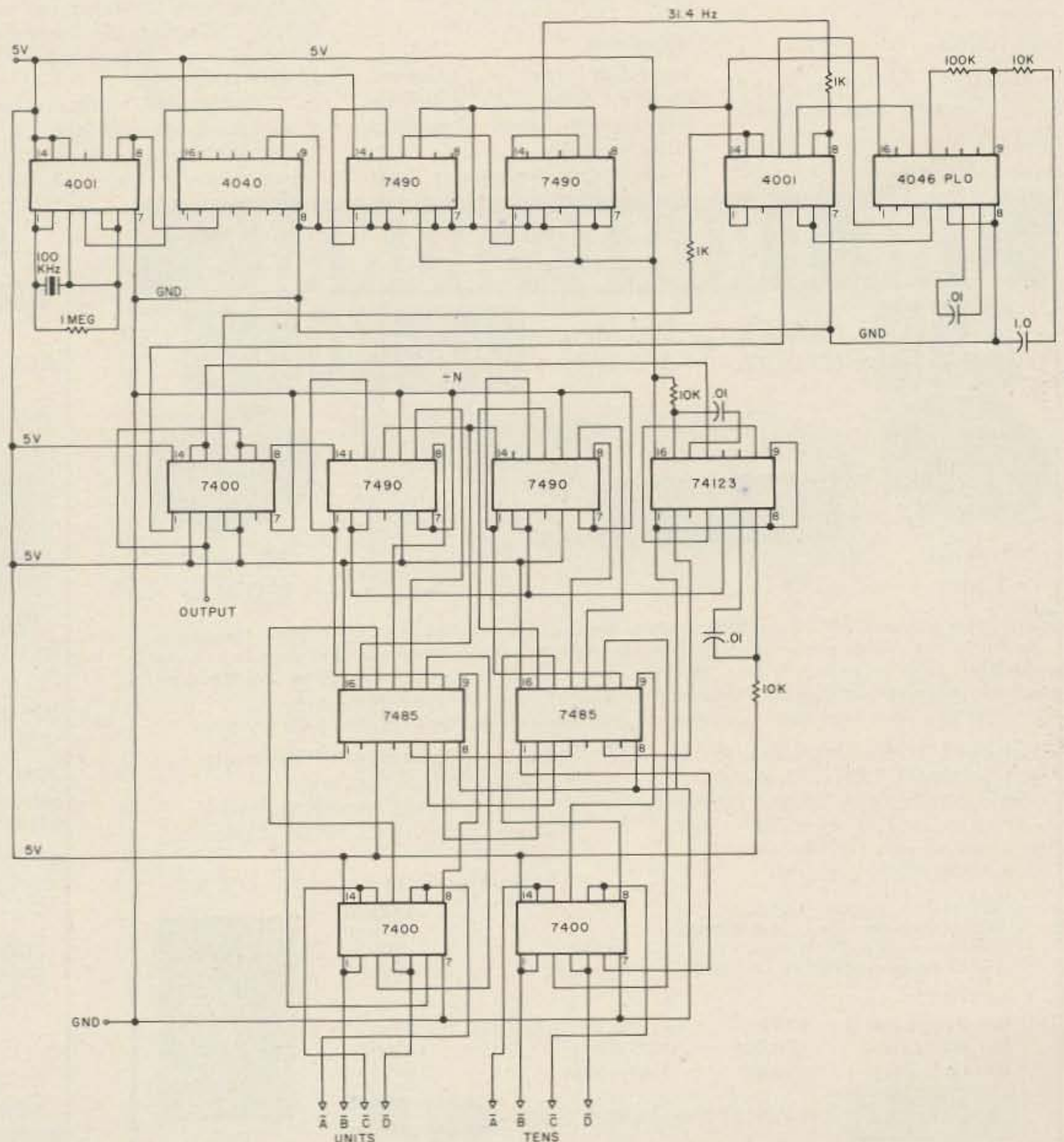
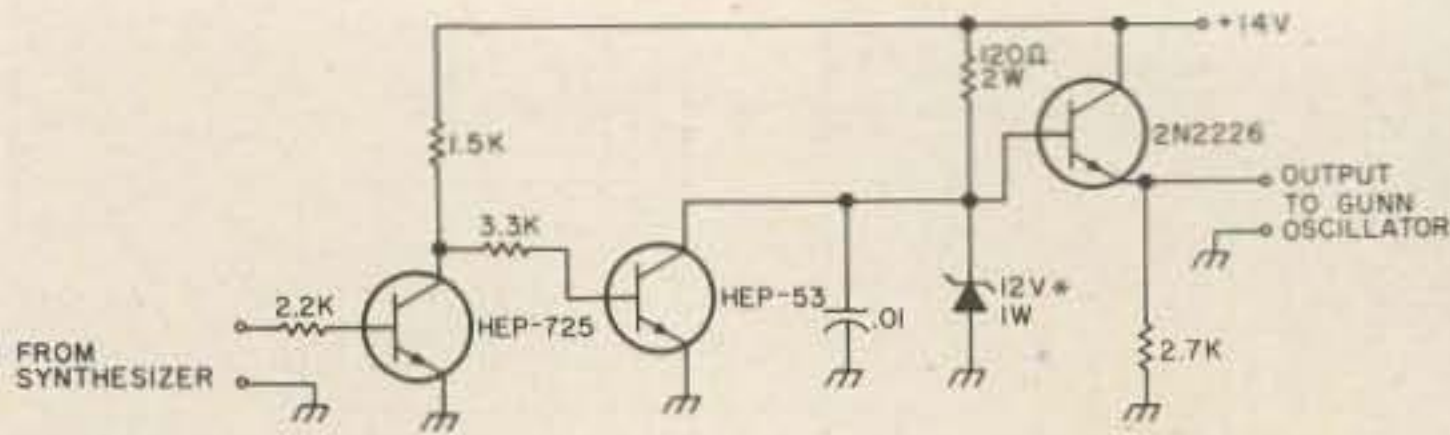

Fig. 2. Phase locked synthesizer.



*DEPENDS ON GUNN DIODE OPERATING VOLTAGE (V_{ZENER} + V_{GUNN} + 6V)

Fig. 3. Gunn diode modulator.

antenna, pin diode switch, and dummy load. The switch is used to alternately terminate the antenna with the matched dummy load or a dead short. The net effect is an amplitude-modulated reflected wave that is capable of deceiving the police radar at ranges of only 20 yards. However, the addition of larger and more advanced antenna designs is expected to increase this range significantly.

Conclusion

Baseband jamming is the most effective and economic method for deceiving police radars. The circuitry is within

amateur capabilities. A listing of suggested literature is included and is recommended for potential designers. This article has been limited in scope and theory with the intent that interested amateurs will be able to build workable equipment using these simple guidelines. This article does not cover the full legal problems, and, for that reason, it would be interesting to hear from lawyer amateurs. ■

References

1. *Principles of Electronic Warfare*, Robert J. Schlesinger, Prentice-Hall, Inc., Englewood Cliffs NJ, 1961.
2. *Radar Countermeasures, Radar*

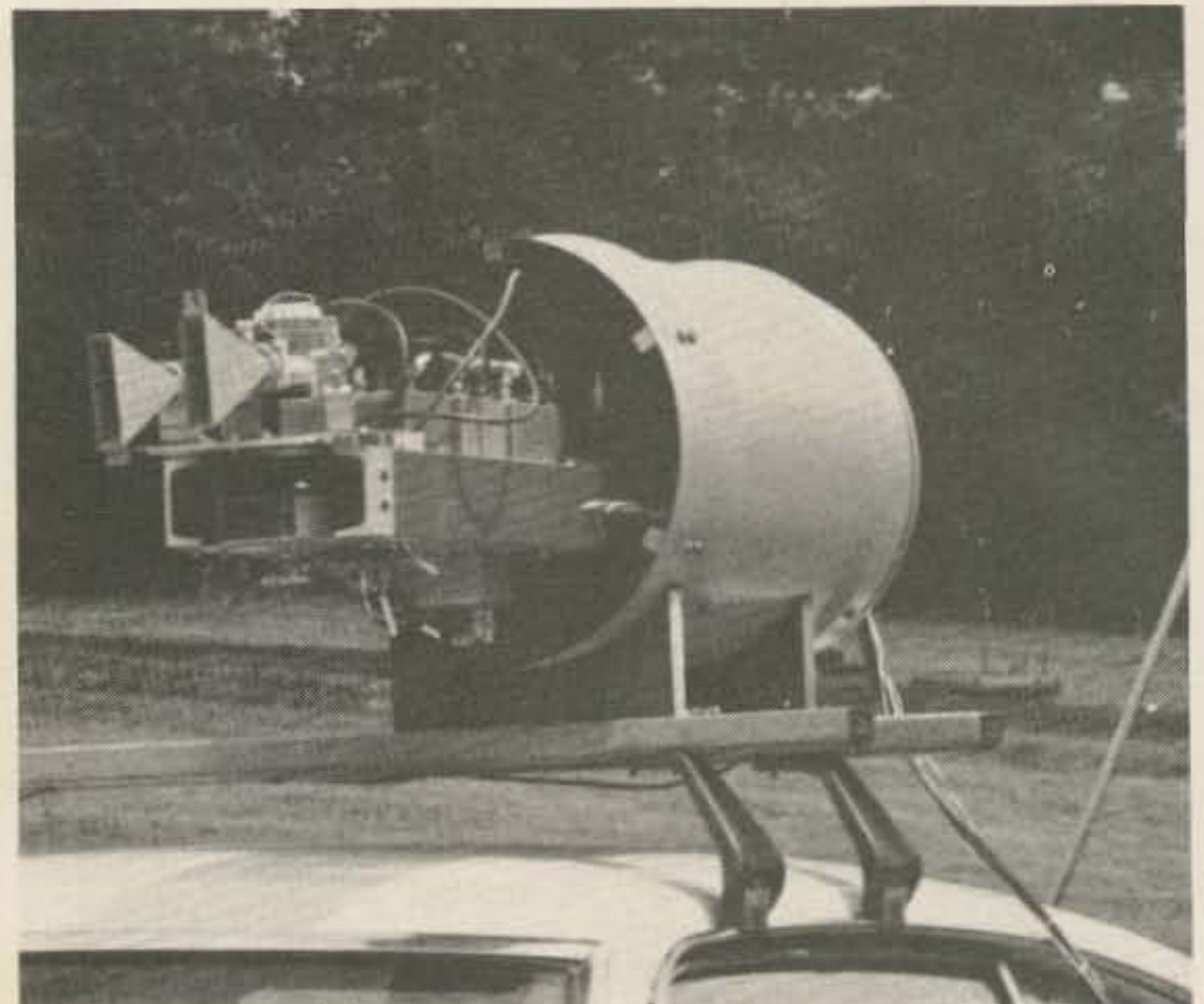

Technique, A.N. Volzhin and V. A. Yanovich, (translation of *Anti-Radar*, Military Publishing House of the Ministry of Defense of the U.S.S.R., Moscow, 1960). Available from Clearinghouse for Federal Scientific & Technical Information, Springfield VA 22151, AD682311.

3. "ECM Primer," *MicroWaves*, November, 1969, pp. 44-79.
4. "A Method of Modulation of Standard Radar Target Signals,"

G. P. Beryulev and V. V. Kostarev, *Radio Engineering and Electronic Physics*, Vol. 18, November, 1973, pp. 1759-1762.

5. "Mobile Smokey Detector," S. M. Oiberg W1SNN, 73, December, 1976, pp. 32-35.
6. "The World of X-Band," Bill Hoisington K1CLL, 73, March, 1974, pp. 33-44.
7. "Mobile 2.455 KMC Radar Receiver," Paul Barton W6JAT, 73, March, 1962, pp. 18-20.

"THE PROFESSIONALS"

NEW MODEL CTR-2A 500 MHz & 1 GHz COUNTERS

NEW
Period
Measurement

1 us to
1 sec.



NEW
Built-in
Pre-Amp

10 mv @
150 MHz

The New Model CTR-2A Series Counters are designed and built to the highest standards to fulfill the needs of commercial communications, engineering labs and serious experimentors. With an accuracy of + .00005% (oven option) the CTR-2A can handle the most critical measurements and is about half the cost of other commercial counters.

If you need a reliable counter at an affordable price, the CTR-2A is the answer.

- Built-in Pre-Amp 10 mv @ 150 MHz
- 8 Digit .3" LED Display
- High Stability TCXO Time Base
- Built-in VHF-UHF Prescaler
- Automatic Dp Placement
- TCXO Std. ± 2 ppm
- Period Measurement (Optional)
- Input Diode Protected
- 12V-DC Operation (Optional)
- Oven Controlled Crystal (Optional) ± .5 ppm
- Selectable Gate Times - .1 & 1 sec.

500 MHz Kit CTR-2A-500K	\$249.95
500 MHz Assembled CTR-2A-500A	349.95
1GHz Kit CTR-2A-1000K	399.95
1GHz Assembled CTR-2A-1000A	549.95

OPTIONS

02) Oven Crystal	\$49.95	05) 10 sec. Time Base	\$ 5.00
03) .43" LED	10.00	06) Period	15.00
04) 12 V-DC	10.00	07) Handle	10.00

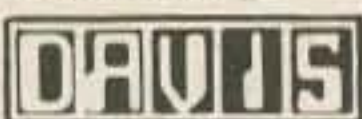

See you at the Dayton Show

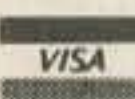

PROBES
Hi-Z
\$15.00
•
Low Pass
\$15.00
D10

DAVIS ELECTRONICS 636 Sheridan Dr., Tonawanda, N.Y. 14150 716/874-5848

SURPLUS TRANSFORMERS

ALL 115 VAC 60 Hz PRIMARIES



#SS-HW-201P;
2000 VCT 500 MA (700
MA intermittent); 7x5½
x5", 32 lbs.
Used \$27.50

#SS-S-P243;
900 VCT 250 MA; 4½x4¼x
3¾", 15 lbs. Used, \$9.95

#84103AD1;
500 VCT 250 MA; one side tapped 50, 75, 120, 175 V;
12.6 V 3 A; 4½x3½x4½", 15 lbs. Unused, \$9.95

#25D84455DC1; 40 V 15 A; 5¼x5¼x4½",
18 lbs. Unused \$9.95

#PV-175-9; 15 V 3 A; 13 V 2 A; 6.3 V 7 A; with
regulator capacitor; 4½x3¾x3¾", 13 lbs.
Unused \$5.95

#P601719; 12 V 9 A; 44 V 2.5 A; 12.9 V 3.2 A;
12.9 V 2 A; 5¼x4¼x4¼", 22 lbs. Unused, \$12.95

WE ALSO STOCK
COMPUTER GRADE CAPACITORS,
STUD RECTIFIERS, and HEATSINKS.

WRITE FOR NEW '78 CATALOG.

All prices F.O.B. Lima, Ohio.

Please allow for shipping charges. F1

Use your B/A, VISA, or M/C Card.

Address Dept. 73 • Phone: 419/227-6573

FAIR RADIO SALES

1016 E. EUREKA • Box 1105 • LIMA, OHIO • 45802

2-Meter FM Mobile... P.L.L. Synthesized... UNDER \$400!

Midland's Model 13-510 Gives Full 2-Meter Band Coverage with 800 Discrete Channels, L.E.D. Readout, 25-Watt Power

Midland's 2-meter mobile has been designed around a precision P.L.L. tuner that delivers 400 frequencies in 10 KHz steps from 144.00 to 148.00 MHz, with a 5 KHz shift-up giving 400 more. In addition, for repeater operation, 4 crystal controlled offsets are available with ± 600 Hz supplied.

The dual conversion receiver has a multiple FET front end with helical resonator, monolithic and crystal filters in the IF stages. The transmitter, rated for 25-watt full power, is switchable to 1-watt.

Fully modular construction includes automatic SWR and polarity protection, internal DC filtering and electronic switching. And there are connectors for optional tone burst and discriminator meter, as well as external speaker.

It's rugged in its tough metal cabinet. It's reliable with extensive use of integrated circuits in its all solid state design. High performance mobile microphone, latch-on mobile bracket and desk stand are included. All you need to do is add an antenna like Midland's Model 18-940 trunk mount or Model 18-941 magnet mount, hook up 13.8-volt negative ground DC power, and get on the air with Midland.

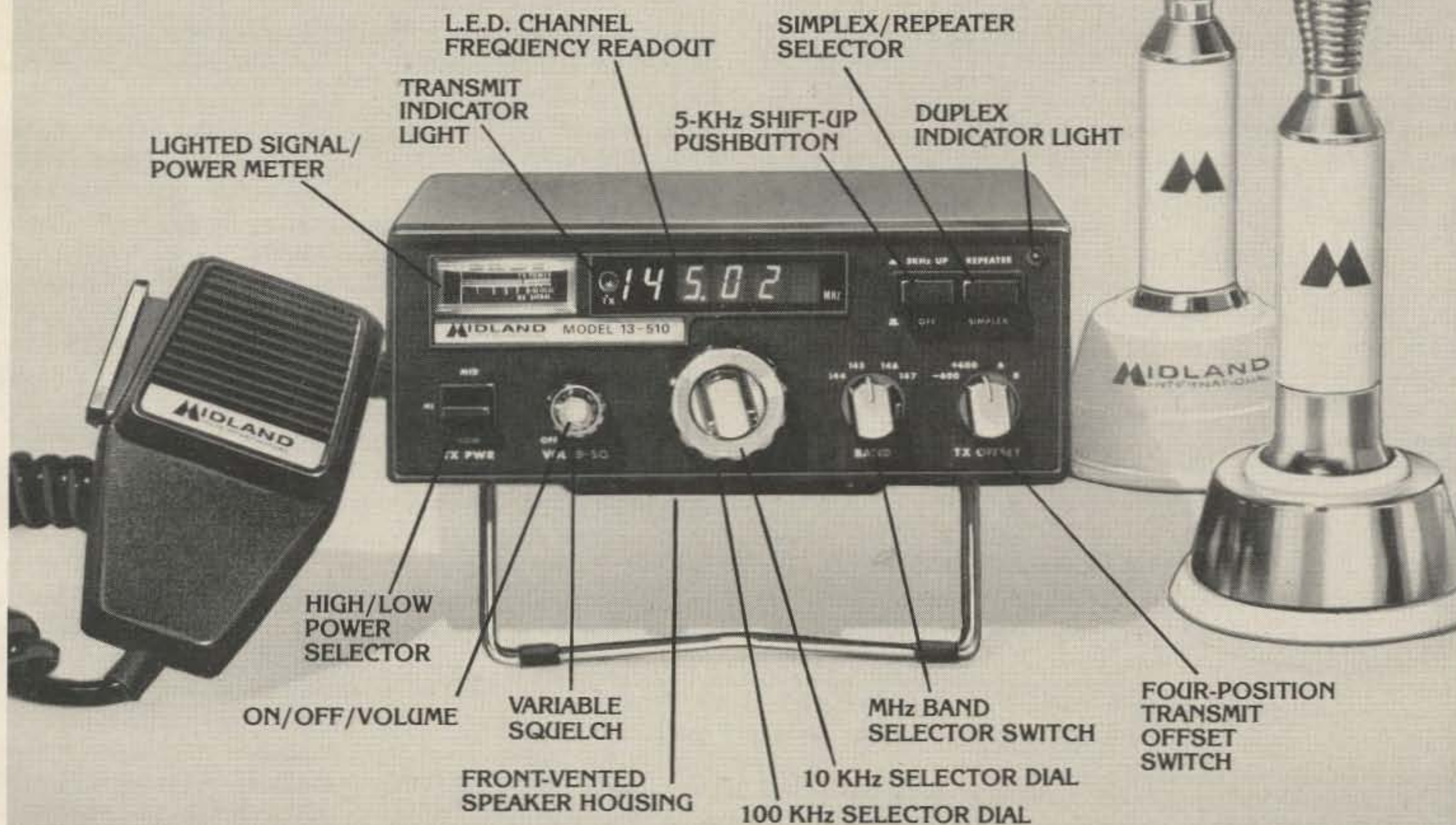

 **MIDLAND**
INTERNATIONAL

Want to know more? Write: Midland Amateur, P.O. Box 1903, Kansas City, Missouri 64141

Why Not Go First Class?

—FM, RTTY, ID, PL, TT, etc.!

David J. Brown W9CGI
RR5, Box 39
Noblesville IN 46060

If you have ever gotten the daylight knocked out of you, blown up a touch-tone™ pad with the microphone dc on the mike-high line of a Motorola transmitter, been strangled on the 30-odd leads between the FM and your Teletype®, or, like me, all the above — read on. If you would just like to have the ultimate in pleasure in FM (all types) and RTTY operation, this article should appeal to you. It brings together all the audio lines and PTT circuits under one roof (chassis), where it becomes not only a joy to manage and work on, but also, more importantly, a pleasure to operate.

Since the principle RTTY activity hereabouts is on FM

at 146.40 MHz, it became a natural to couple all the audio and control circuits of the RTTY and FM into one box and include all the tone control gear I have, to boot. With these ideas in mind, the ESP unit was begun. You'll see why the ESP title really fits if you build one, as you'll begin to think the little box is reading your mind. The unit includes:

1. Audio input controls for:
 - a. Hand microphone (local) on FM rack (voice);
 - b. Handset (telephone) on console desk (voice);
 - c. Auxiliary audio input (repeat or tape) (voice);
 - d. Tone control (burst, continuous, dial pulse) (tone);
 - e. Touchtone control (TT pads) (tone);
 - f. Teletype tones (mark-space-shift ID) (tone);
 - g. Automatic IDer for voice or TTY (tone);

h. CW tone on voice and mark shift on TTY.

2. Keying control automatically tied to modes of 1.

3. Indicators to tell what is or is not happening and enough controls to balance audio levels on all inputs.

The circuit schematic is pretty straightforward in the area of the relay controls and the relays themselves. They merely switch the keying line to ground, with the top set shown, and place audio into a common audio microphone input audio line through the bottom set. It is the control of these relays and the tones, voice, etc., that is the heart of this equipment. I will try to show here what goes on by taking one function or mode at a time, working from the left of Fig. 1, the voice circuits, through the right of Fig. 2, the tone circuits.

Beginning with the left of Fig. 1, I wanted a means of

playing back audio tape recordings of earlier events over the FM. Primarily, this happened when I went to a TVT-type RTTY arrangement from my older and noisy Model 19. My only way to store information became audio tape, replacing the old 5-level paper tape. The audio output of tape recorders is about 4 to 8 Ohms, so I included a small 4/8-Ohm winding to 600-Ohm winding audio transformer. This allows any low-impedance output (speaker) to be played into the FM transmitter. This later led to the use of another radio output into the transformer and on into the FM transmitter input (repeater). Since all my Motorola receivers are on the upstairs back-porch and my shack is in the basement, I had long before added COR relays to the 6m, 2m, and 3/4m receivers. That way I could detect activity on one band while listening to another band by lighting lights on a 5-button-type office phone I use as a control head.

Pushing one of the push-button lights chooses which transmitter/receiver is in use and has microphone/speaker hooked to it. The red button is used for a transmit button. It was easy to route the COR contacts into this new system as well, and have the facility of an emergency repeater for our storm season around here.

Next is the normal hand-microphone circuit, which is just like control head use except for the pot for level control. If you have a microphone or handset that just makes it for level, set the modulation pot in the transmitter up in the transmitter for proper deviation with the remote (mike location) pot set at 50% to 75%. This will leave you range on all the circuits at the ESP unit. The audio and PTT button are merely routed through the microphone relay to allow other audios into the same line. The PTT button on the microphone now keys the

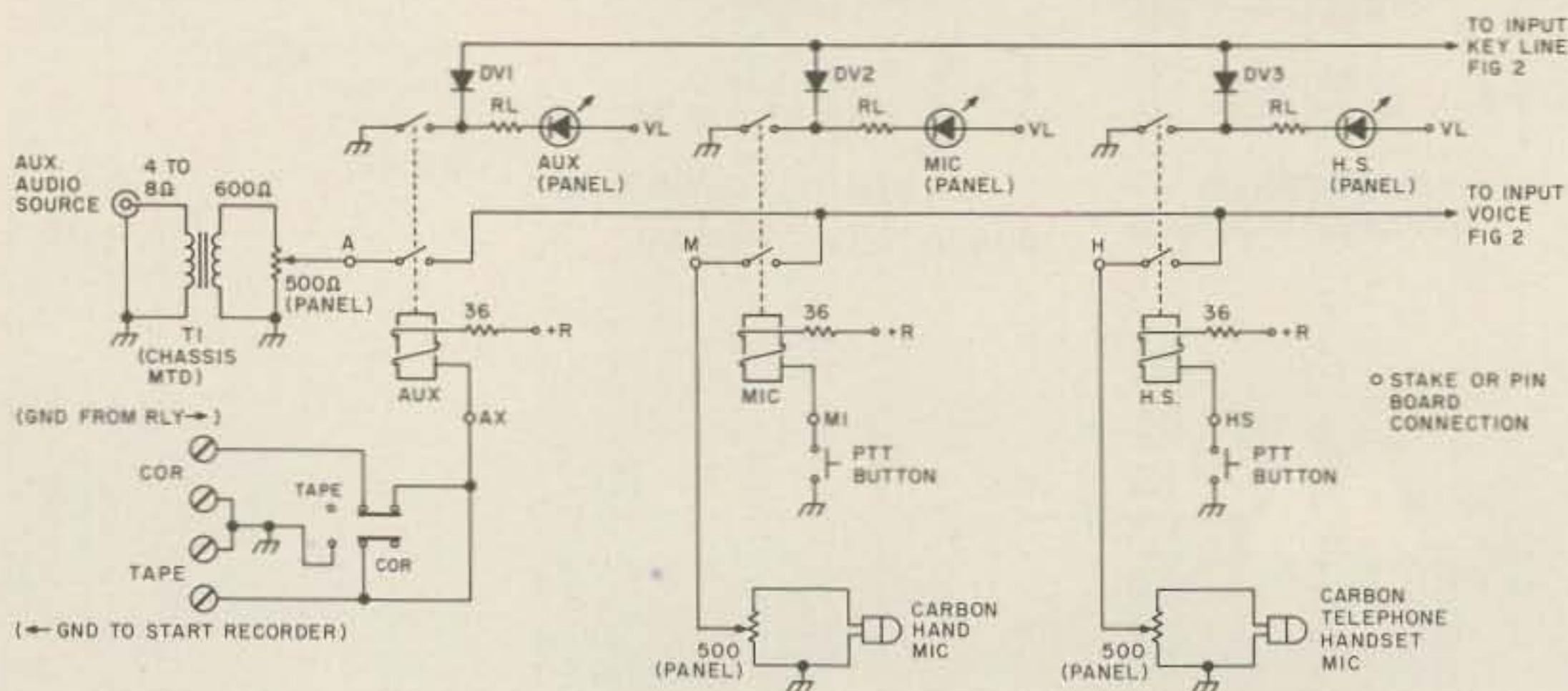

Fig. 1. Voice unit.

relay rather than the transmitter directly.

The handset needs little more explanation than the hand microphone. It is just a second microphone in a telephone style handset and is used at the main radio console/desk.

This completes the voice circuits — very simple — and takes us to Fig. 2 — not so simple. Skip over the circuit marked TEC for a minute, as it has rather broad implications over several of the tone circuits. Follow the key line to the right where diodes D1, D5, and D6 are located. D1 allows any of the voice circuits to close the key line regardless of the tone relays in or out (total voice control), but not the reverse. You can talk over or with any of the tones you care to. D5 keys the tone relay on whenever a voice circuit line closes the key line to ground (i.e., each time the microphone is keyed). D6 feeds the tone

function switch, S2, center arm. For a continuous tone always on while the microphone is keyed, the switch is put in C/T for continuous tone (i.e., subaudible tone used on tone access repeaters). For a burst tone (whistle-up repeaters, etc.), S2 is put in B/T for burst tone. I used a tone generator described by WB5BAF, and he states a burst tone of about 0.4 seconds for the values given in the base of the transistor (10k, 35 uF). Set the 10k pots for the frequencies F1 to F5 desired. A total resistance in the range and one frequency pot for 1800 Hz is 28k Ohms, or 20k Ohms for 2400 Hz. That will get you started. The tone oscillator is used for all the single-tone functions. The dial (telephone type) keys this oscillator on via D7 for the relay and D8 for the oscillator. Use the close-and-hold set of contacts when the dial is rotated to stop. The

pulse set of contacts shorts to ground the audio output from the oscillator, except when x number of pulses (chosen by the number you dial) allows the oscillator output through by opening x times. That takes care of three of the single-tone functions.

The fourth single-tone function is a bit more complex in routing, but not in use. Have you ever gone too many minutes between IDs during a particularly interesting conversation? It is easy to do and could get hard to explain to the FCC. Why chance it? With S2 in the ID position, every time the voice circuits are keyed, a ground is placed on the center wiper arm of S2, as explained above, via D6. Continue on through D11 to the start input of the ID block. Before you go to Fig. 3 and the ID unit, note D12 on this same start line. For future reference, it performs D11's func-

tion when a ground is applied from the RTTY console.

Going now to Fig. 3, the right-hand block is an unmodified TTL K20AW repeater ID board from 73 Magazine, February, 1973. This IDer has worked so well for me in other applications that I used it here. It requires a positive pulse to start it and gives out a high-to-low TTL keying pulse train (K) and a low-to-high TTL hold command to keep the transmitter on for the full call even if you let up on the mike button. This combination of controlling signals is not quite enough to run the ESP unit, thus the W9CGI control unit on the left and center of Fig. 3.

Entering the left side of the control board at the "start" pin, we'll do the easy command first. The push-button allows testing the call loaded in the ID board and the code speed over the audio monitor, without keying up

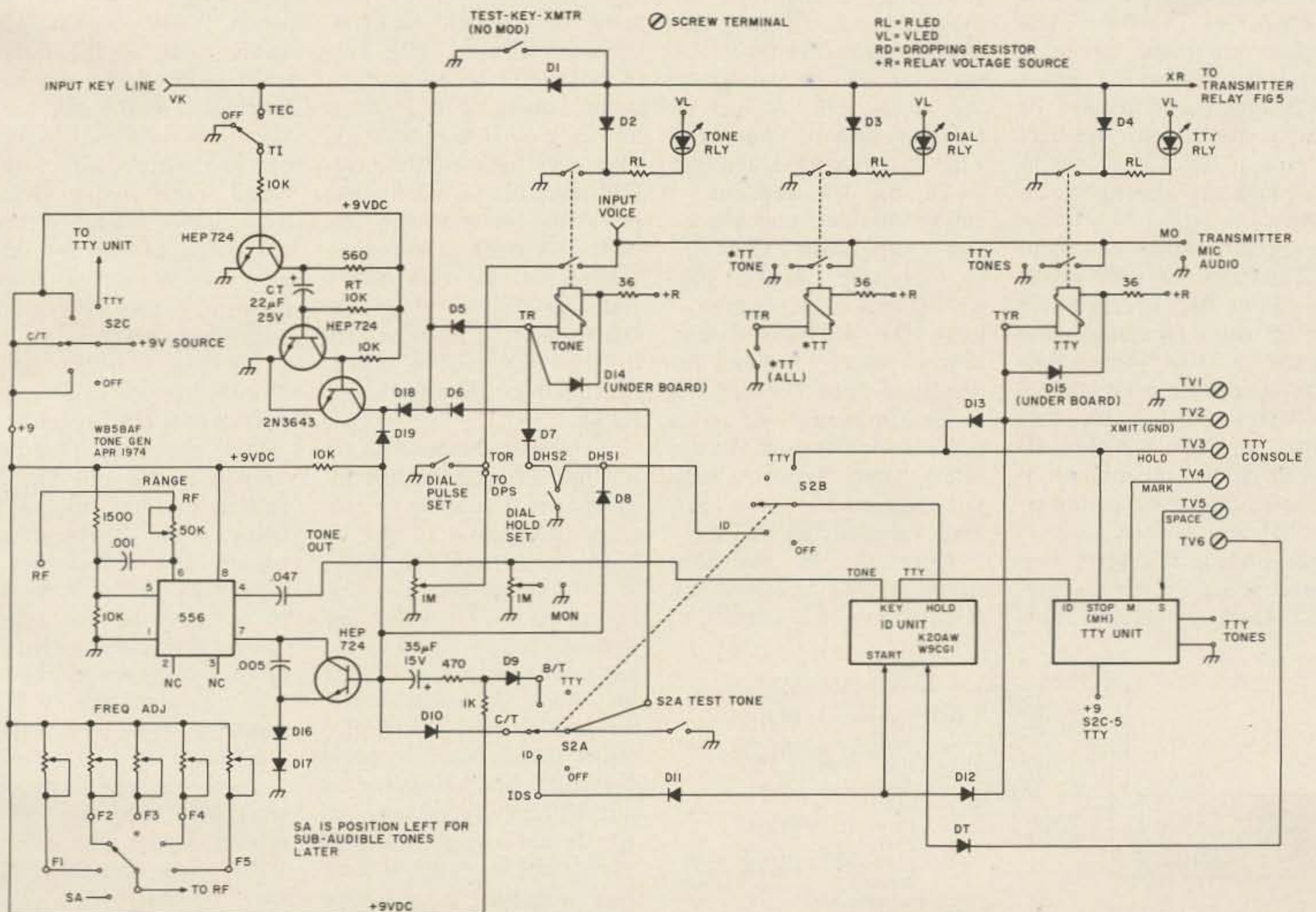

Fig. 2. Tone unit.

included in this ESP unit and only requires control signals from the TVT to run it. Terminals 4 and 5 perform this mark-space control from the TVT. Line 2 is the ground from the TVT to control the transmitter. Pin 1, of course, gives the two locations a common ground reference.

I'll first discuss the TTY unit's tie-in and the reason for its inclusion in the ESP unit. The input marked ID on the TTY unit block is the hold-ground from the ID unit via S2b when in TTY mode. In this mode, it forces the machine into a mark-hold tone output. It does not defeat the keyboard of the Teletype in my case. My reason for this is that I am using a TVT and a keyboard unit with 64 characters of FIFO buffer memory which will store up to that many characters and hold them as long as the FIFO output clock is disabled. This disable line is the same line as line 3 of the 6 terminals to the TVT. It holds the FIFO output clock off, thus stopping the output of mark-space commands, but still storing the information in the memory. The instant the hold line goes high again (end of ID), the FIFO unloads and transmits at full machine speed until it catches up with your typing again. Diode Dt is used to get the "Here-is" key of the keyboard over to the tone and ID units of the ESP unit. It keys the ID unit just as the control unit of the ID block, but it bypasses the low minute timer for a "Here-is" ID whenever you punch the "Here-is" key.

The key line from the control to the TTY unit in the TTY mode, as stated earlier, is a low-going TTL pulse train and is used in the TTY unit to do a small mark-shift for ID. This is common practice, but it is usually done with a hand key. It keeps the other guy's machine from running "open" and chattering away or printing garbage as does the usual CW-A1, CW-A2, or voice ID.

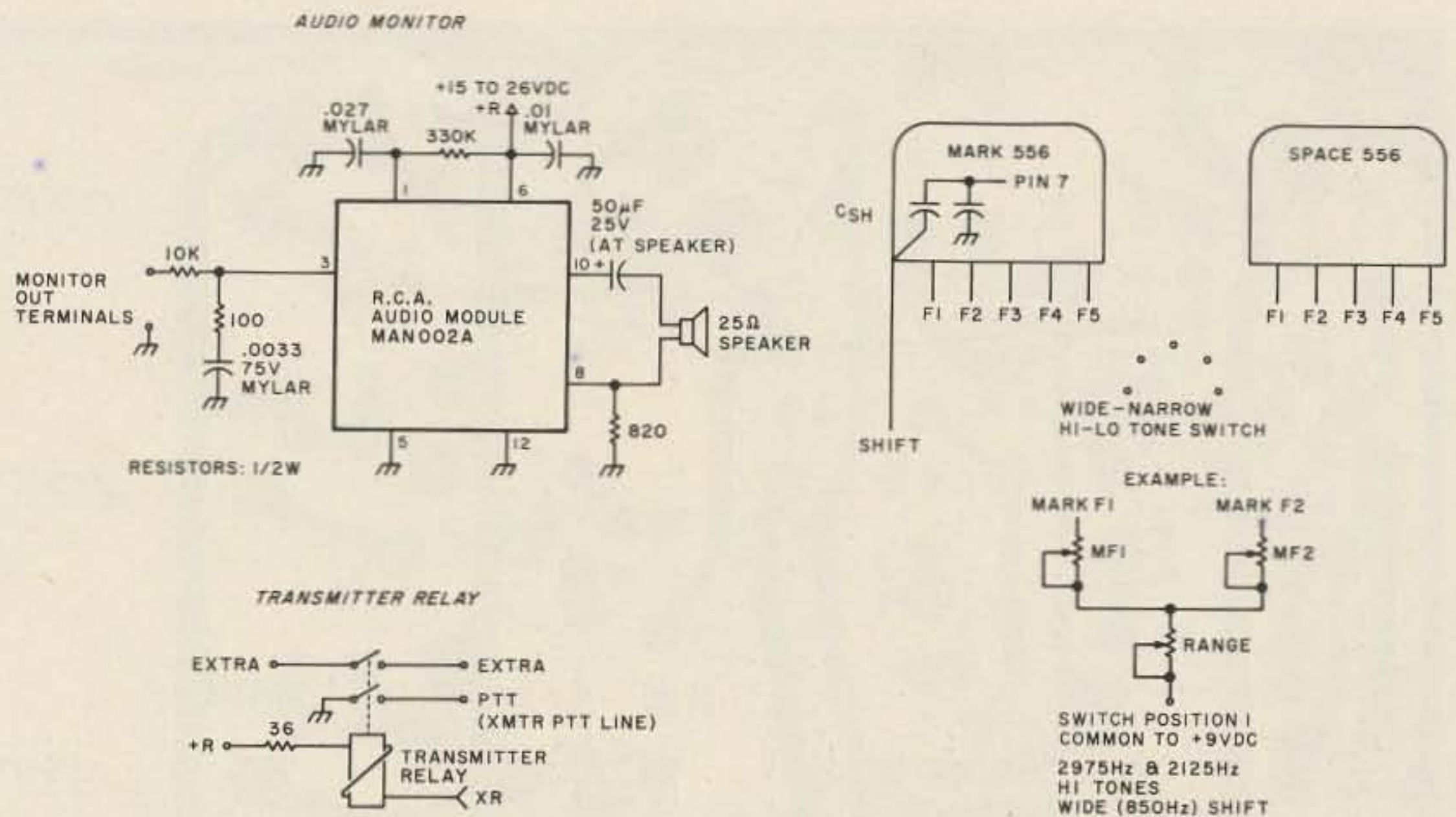

Fig. 5. Miscellaneous parts.

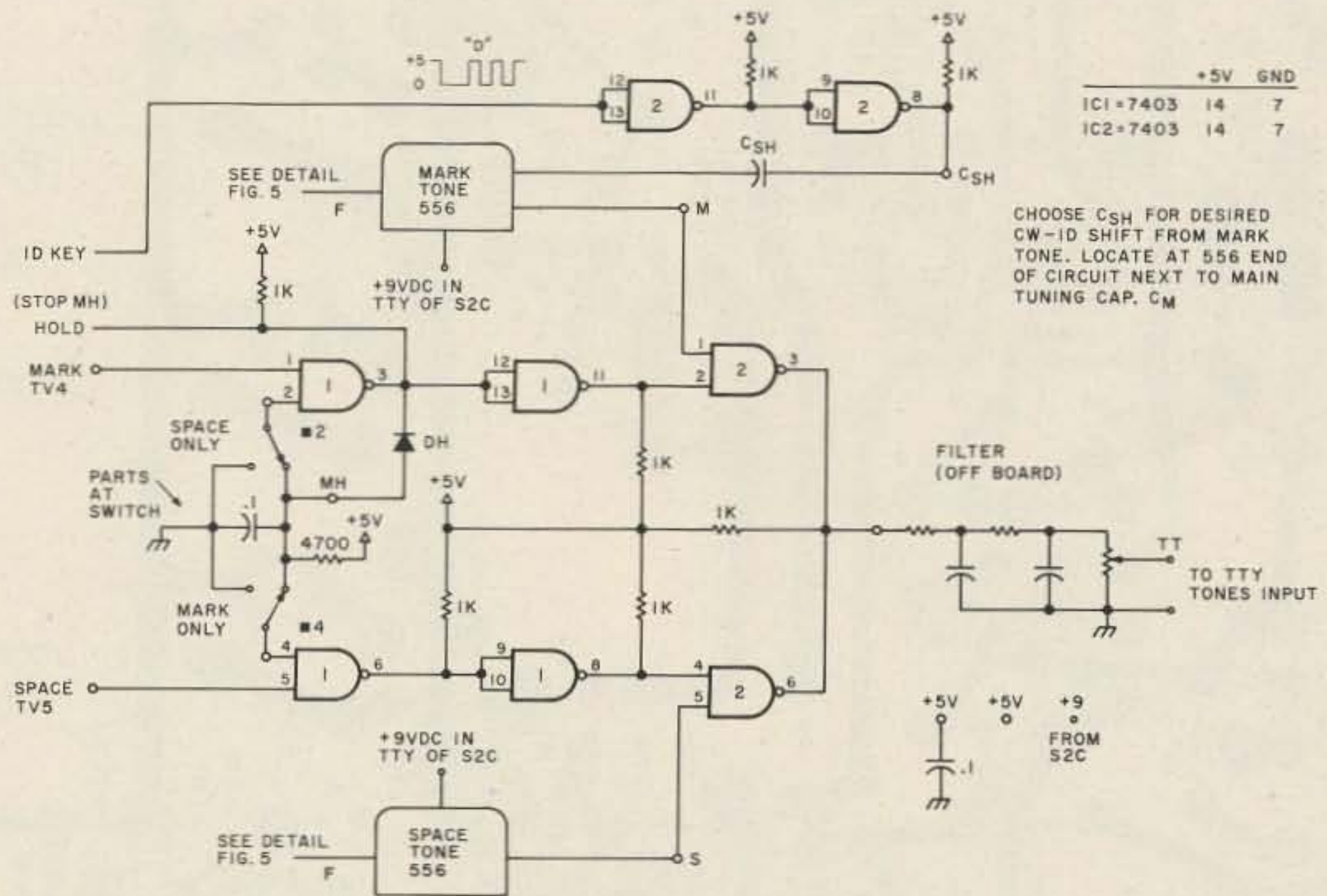

Fig. 6. TTY control unit.

This way, his machine still sees a mark-hold (or almost mark-hold when ID shifting).

Here's a bit more on the TTY console wiring before we cover the TTY unit itself (Fig. 6). Line 2 is a hard ground from a transmit switch in the RTTY console (across lines 1 and 2). This switch happens to be paralleled by a set of relay contacts in my RTTY console, controlled by the keyboard via a 7400 R/S flip-flop. I have two of the unused ASCII keys marked XMIT and RCV that flip or flop this R/S for very neat

control, but that is of no consequence to this article. The ground enters the ESP unit on line 2 of the 6 terminals. It starts the ID unit via D12, immediately forcing an ID buffer FIFO hold condition. I can go right ahead and type the beginning of the message, as explained. Line 2 turns on the TTY relay directly. Diode D13 is used as the TTY ID hold-in for the TTY relay. This allows for the fact that you might go to transmit at the TTY console and right back to receive (pretty quickly in my R/S type) in the middle

of the ID unit trying to ID. The hold-ground via D13 prevents partial IDs from occurring. Diodes D14 and D15 in Fig. 2 are field collapse diodes across relays to protect transistor keying devices (transistors) from being reverse pulsed. They have nothing to do with any of the diode steering and control diodes.

Now on to the TTY unit in Fig. 6. This is the control and tone-generating unit for TTY operation. The actual tone generators are not shown, but they are 556 oscillators just like the

run-up error in frequencies when S2 is in the TTY position. The +5 V dc can be switched around with a fourth section of S2, if desired, as it is only needed in the ID and TTY modes. I run the ID all the time whenever not in a tone mode, and mine comes on with the ESP unit on/off switch. The first half of the IC1, a 7403 quad 2-input NAND gate with open collector outputs, is used to allow for mark-only or space-only sending, should you desire. By shutting off the mark or space side enabling circuitry, you allow only one tone out. A high on the space input line (line 5 from the TVT) is TTL high for a space tone output. For the CW ID, a ground from the ID control unit hold line makes IC1, pins 9 and 10 low, IC1, pin 8 high, IC2, pin 2 high, and the mark tone is held on for the duration of the identification cycle. Dh disables the first half of IC1 mark-space inputs by making one input of each low. Thus the output tries to go and stay high and ignores the other input of each gate. This effectively disables the TVT inputs even if the FIFO sneaks one or two through (depends on your KB/TVT).

Mark and space normal TTY tones are produced just as the hold tone is generated. Whenever pin 3 of IC1 for mark or pin 6 of IC1 for space is driven low by the TVT inputs going high, the proper tone is allowed through the output pins 3 and 6 of IC2 and is sent to the filter. This filter is just like the one used by K2OAW in his IDer article. The filter output feeds the TTY tone terminals of Fig. 2.

The CW ID (TTY) from the ID unit is a low-going TTL and drives $\frac{1}{4}$ of IC2 as an inverter. This is fed to another $\frac{1}{4}$ of IC2 to give an open collector for keying a capacitor (Csh) in parallel with the .005 uF tuning capacitor on pin 7 of the mark generator. This Csh, when chosen properly, gives a

small shift downward in frequency from the mark tone. The shift is not enough to trigger the space decoding network at the receiving end. It is usually chosen for about 20% of the difference in the shift used, i.e., 34 to 40 Hz down from mark on 170 Hz shift and 150 to 170 Hz down on 850 Hz shift.

That covers all the voice

and tone circuits except the one TEC I skipped over earlier. TEC is my little joke for "tail-end Charlie." If you date back to World War II surplus days, this was the tail gunner in a bomber crew and also the nickname of a piece of equipment modified by hams for 450 MHz work back then. It is a "tail end" for the ESP unit as well. Whenever

the TEC switch is in TEC position, it detects the keying line going back up to the +R voltage and triggers another pulse circuit whose pulse length is chosen by Rt, Ct for about the same 0.4 seconds as the burst-tone circuit. The tone relay is held in by D18, the transmitter relay is held in by the keying line path through D18 and D1,

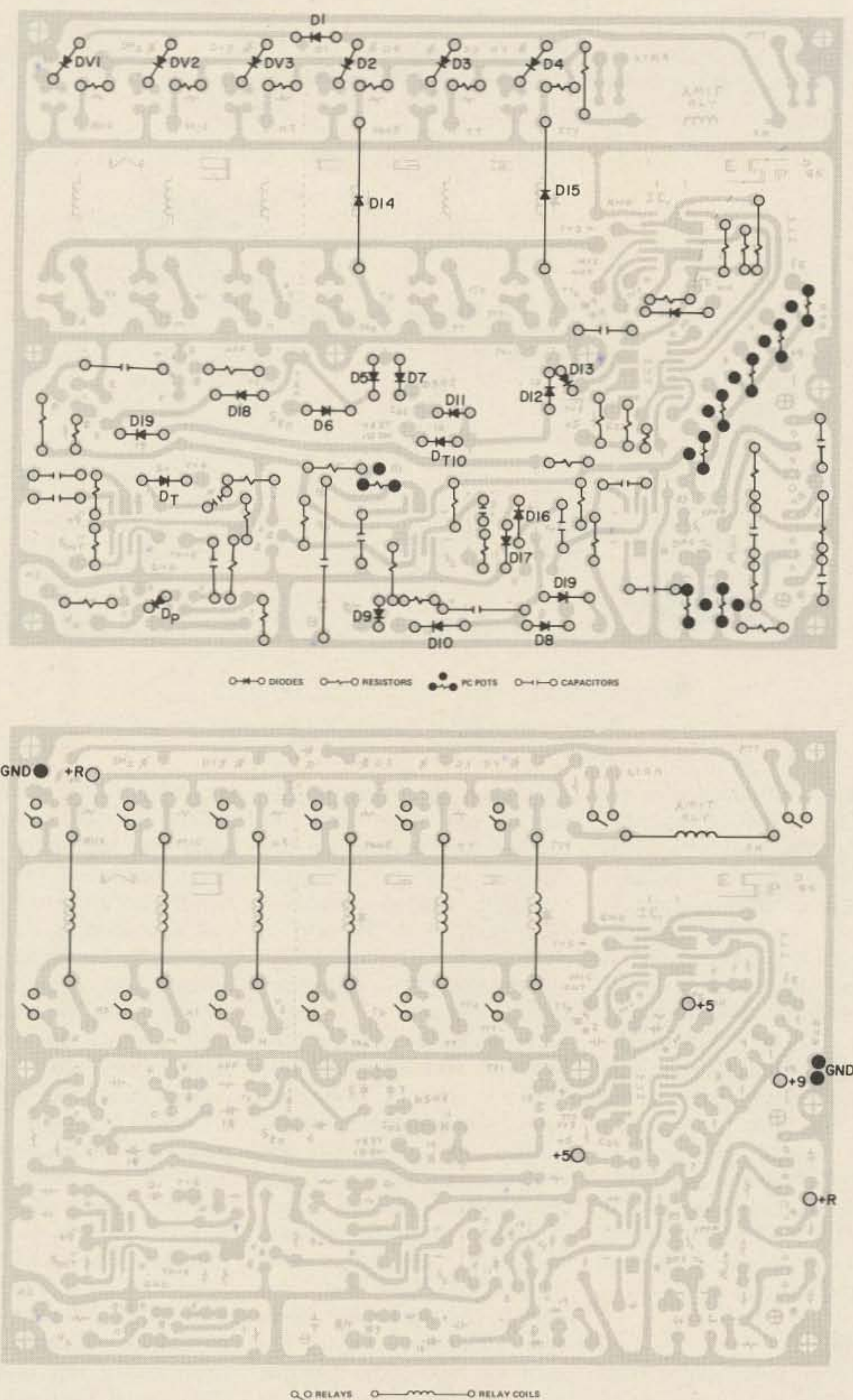

Fig. 8. Component layouts.

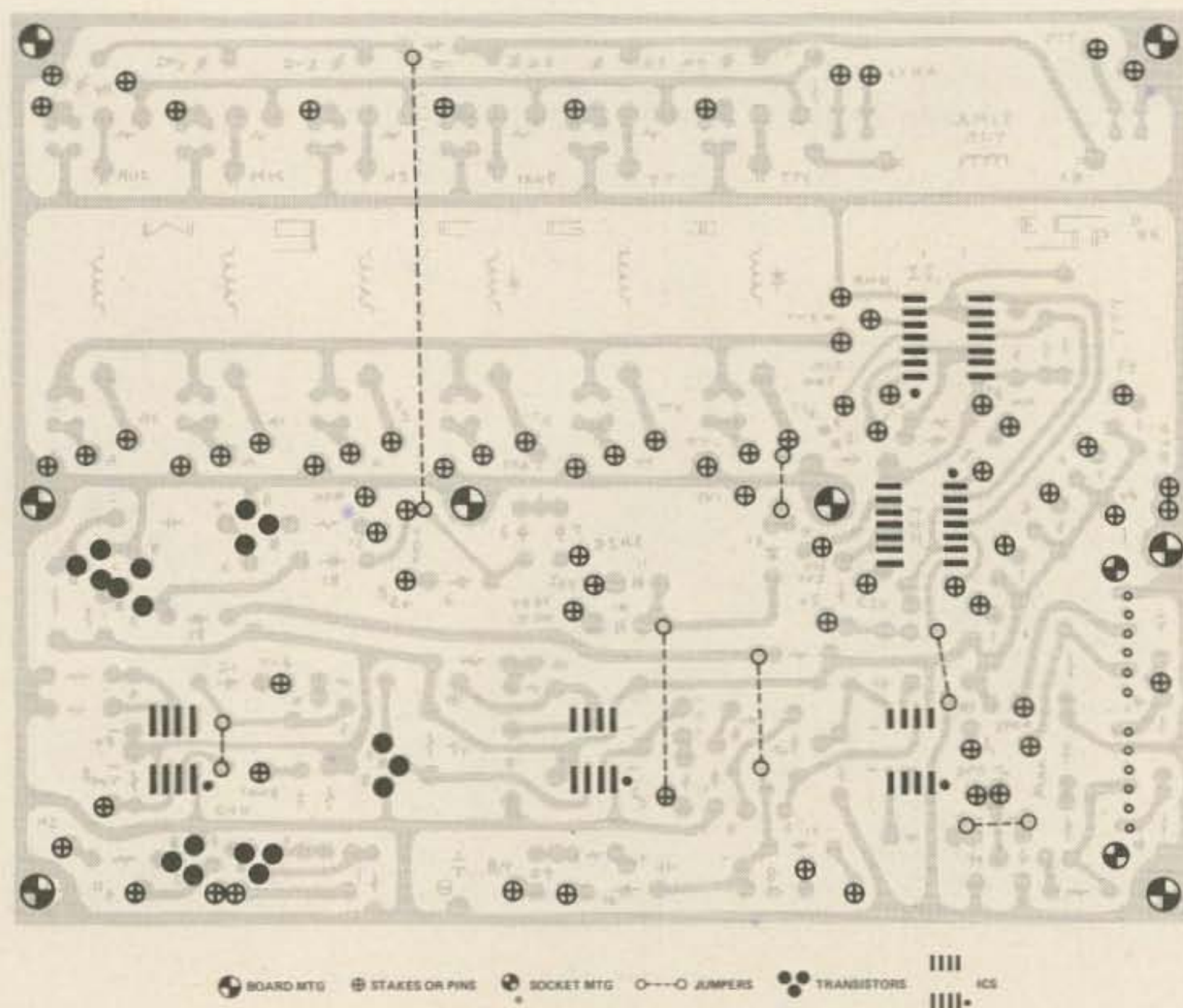

Fig. 8. Component layouts (continued).

and the continuous tone by D19, for a 0.4-second burst tone at the end of a transmission. This is especially useful in rough copy simplex, when it is often hard to understand and know when it is turned back over to you. If you set up the tone for this at about 800 Hz, it really comes through in good fashion, even when conditions are up and down or just plain lousy. There would be a path through D18, D6, and D9 or D10 if the unit were in B/T or C/T tone mode, but this way I can set up for ID front end and B/T rear tone.

Sidelights

Several cute side effects have come out of the use of the ESP unit, not the least of which is the fact that I can now go downstairs, set up a couple of switches, and operate, instead of cable changing and going crazy. Before, to go from voice to TTY to voice meant plugging and unplugging the microphone 4-pin connector, hooking up the key for CW ID, and enough other junk to keep me from running RTTY half the time. I used a large panel on the ESP unit and

included 4 meters across the top. I can read from the receiver test octal socket the limiter current (signal strength) and discriminator (deviation). With the help of 3 friends with frequency-synthesis-type transmitters (mean average of 3 for a fairly accurate guess), I calibrated the discriminator meter in kHz deviation and can now help others get transmitters on frequency and deviation set right — or at least closer! A third meter from an older panel (also Motorola) and the same panel's roll clock were also added. The third meter reads the audio in either the common mike-audio high line going to the transmitter or the receiver audio coming down to the shack. The meter is a VU dBm/600-Ohm model. Of course, a commercial-quality mobile speaker was added to the panel.

The fourth meter was an older Simpson that matched the others in style and had a 100 mA full-scale movement. I opened it up (carefully) and added small red lines (press-on) at the 20 and 60 mA marks. I use it to monitor RTTY loop current. I feed

the loop from a series-pass supply like so many you have seen. The exception is that I bring out even lower base current circuitry to the panel and a pot, and, by controlling the voltage on the base, I also control the supply output voltage and, therefore, the loop current over a small range. Three older Motorola control heads were gutted for a 4-pin microphone connector on the back apron for each of the voice circuit inputs. The volume and squelch controls were panel mounted also (remember, 3 bands — 3 receivers — 6 controls). Power on/off indication was replaced by a neon on the ESP unit on/off line, so the 3 green lights are used like the phone lights controlled by the COR relays to show band activity. The red lights were used normally to show which transmitter is operating. This is really neat in the COR-repeat mode, as you can tell at a glance the audio from what is going to where! The nice chromed switches are used for several of the functions where possible. Panel space is also needed for the TT unit pad and the rotary phone dial

salvaged from an older 300-series phone. One of the control head microphones is used as the local microphone. (Like most of you, I got all the three bands' equipment as mobiles originally.) I built the entire unit into an aluminum chassis (inverted) that is 3" high by 17" wide by 12" deep. (Bud AC418 with BPA1528 cover. This leaves lots of room for the ESP, ID board, RTTY board, power supplies, etc., and a lot of back apron room for all the cable connections to the FM and TVT.) If you rack mount, as I did, consider modifying the rack for drawer slides like you have on your kitchen drawers. They are inexpensive, available at most hardware stores and lumberyards, and plenty heavy-duty for light equipment. It's great when servicing the gear or adding to it. The only special parts are the module used for the audio monitor, which is an RCA sound output module from an XL-100 series chassis, and its companion 12-pin socket. The module is a MAN002A. The board is laid out for relays by ECI Model 401 DPST, 12 V dc, 145-Ohm coil. They are called tiny-T relays, and I run them off the +15 V dc (+R) through 33- or 36-Ohm, 1/2 W resistors. All the NPN switching transistors can be small signal/switching types in the 100 mA category, like 2N706 or HEP724, except that, for the ones driving relays, you may want something a bit stronger, like a 2N3643. All non-power supply diodes are small switching types of 50 V piv and 100 mA or so. The relays draw around 82 mA, so if you have heavier diodes, use, say, a 500 mA variety.

One small thought: For those who want the sub-audible part, too, see the article by WB6GON in the December, 1976, *73 Magazine*. I haven't completed mine yet, or I would have included it, too. Let's see if my ESP can read your mind. ■

INTER-OFFICE MEMO

TO: TOM BALL, Sales Manager
 FROM: ROBERT BROWN, Chief Engineer

Here is the information on our "B" series of repeaters.
 All features are standard on all units; kits as well as wired.
 All checks indicate this is the hottest repeater on the market.

Standard features on all
 repeaters
 (Kit or Wired & Tested)
 B series.

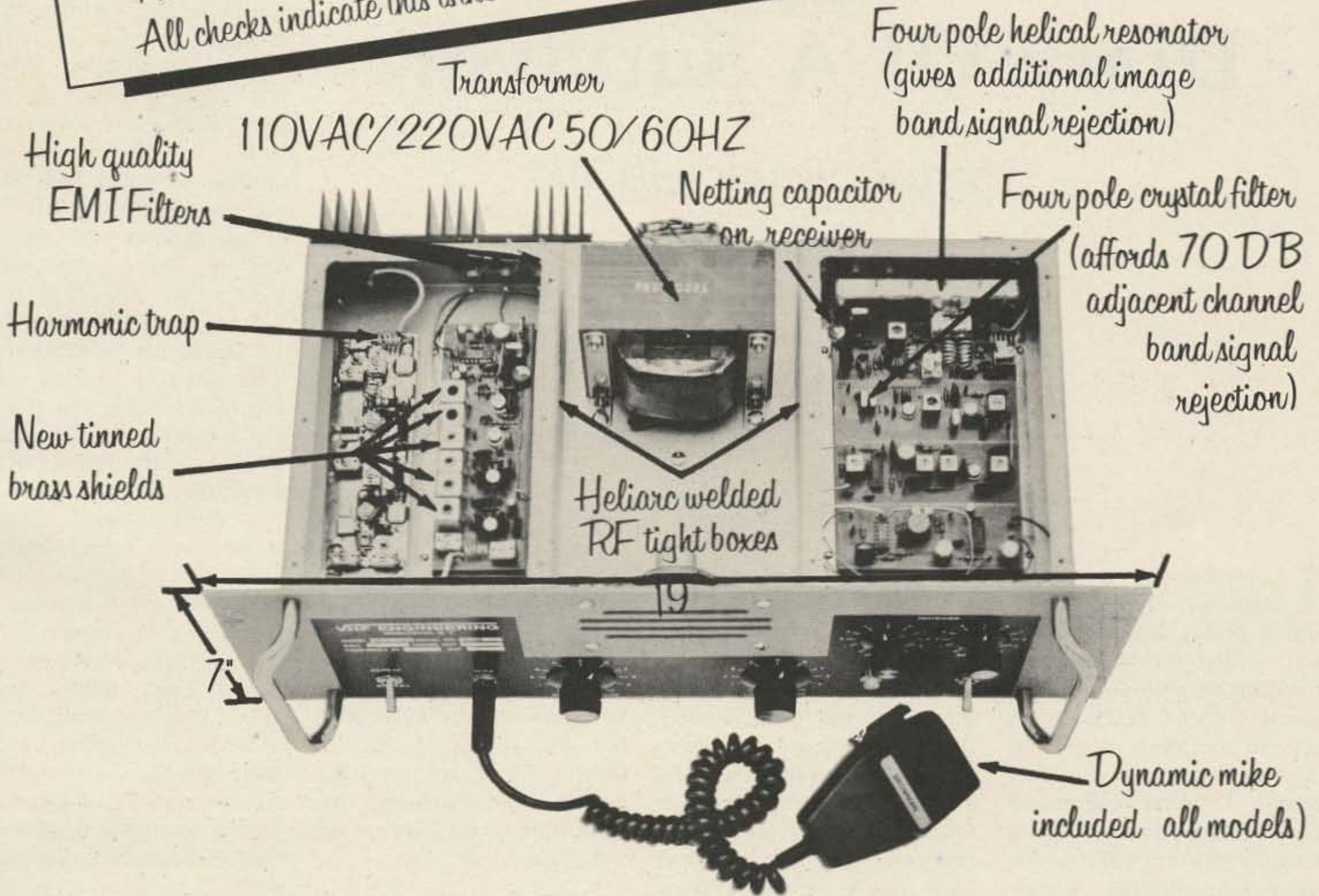

Not shown in photo is new power supply. Has fold back current limiting (you can short supply & will not damage it), also over voltage protection (a short in the supply will shut it down so repeater is not damaged.) Don't forget our CWID with its 159 bit field programable memory.

Bob

PRICES

RPT 144B Kit Repeater-2 meter-15w-complete (less crystals) 499.95
RPT 220B Kit Repeater-220 MHz-15w-complete (less crystals) 499.95
RPT 432B Kit Repeater-432MHz-10w-complete (less crystals) 579.95
RPT 144B W/T Repeater-2 meter-15w-factory wired and tested 799.95
RPT 220B.W/T Repeater-220 MHz-15w-factory wired and tested 799.95
RPT 432B W/T Repeater-432 MHz-10w-factory wired and tested 849.95



Diary Of A Survivor

—cyberosis victim tells all

I remember the day well — December 17, 1976. It was a Friday evening, and I was settled down in a big comfortable chair in my ham shack. With my feet propped up on the desk, my mind drifted into a favorite daydream — contemplation of the ultimate amateur radio contest station. Visions of a computer-controlled station and logging system danced in my head . . . no more dupe sheets, no more hours of recopying food- and drink-stained scribbled log sheets, no more writer's-cramped hand. The possibilities were endless, but, alas, it was only a daydream.

The next day I was visiting Ham Radio Outlet. My mission was merely to buy a balun. While doing the mandatory browsing, I picked up a copy of the Holiday, 1976, issue of *73 Magazine*. I hadn't read *73* in years. Imagine my surprise, delight, and utter amazement when I saw that it contained an article about a

computer-controlled amateur radio station.

Beginner

I virtually inhaled that article and the rest of the I/O section. I needed to know more. I sent off for *73's Hobby Computers Are Here*. I felt like I had been living under a rock for two years. How could this have been going on around me without my knowing?

Feeling guilty about it for the first time, I remembered that I had refused to take a computer class as an undergraduate. Why? Well, I lived in a fraternity on one side of campus, and the computer center was as far as you could go on the other side. School! It hit me — now I'd take that course. The winter catalogue for UCLA Extension had just arrived in the mail. A course was being offered called "Introduction to Business Information Systems." That was close enough! Tuition was steep at \$105, plus a \$15

lab fee, plus \$12 for a parking permit. I ran to the bookstore to get the text — another \$18. The text read like, "Everything I Always Wanted to Know About Computers but was Afraid to Ask." I finished it before the class started. Unfortunately, the best thing about the class was the book.

After the third week, I didn't go to class. In fact, I walked out in the middle of the third class after the prof explained binary numbers for the third time. He had insulted my intelligence the week before by showing film strips about computers designed for fourth graders. I had had it with him. Apart from the text, the only other valuable part of the class was the lab, where I learned some BASIC and got a program to run.

Tip number one: Spend your dollars on books and magazines, not classes.

In the interim, *Hobby*

Computers Are Here arrived. It's an anthology of articles and editorials from the I/O portion of *73* — great introductory material! I remember it took me a half hour to plow through the workings of a multivibrator flip-flop. But it came.

By then, I had been going great guns for a month, sponging up microcomputer knowledge, reading furiously. Then a curious phenomenon overtook me — the classic middle American over-achiever syndrome. Where was I going? What was my goal? When I had gotten into ham radio, the objective was obvious: Get that ticket and get on the air! The license manual was my bible. What I had to learn was clear. Progress was easy to measure (i.e., copying 100 percent at 10 words per minute, etc.). With microcomputers, that wasn't the case. No license was required. I didn't know what I didn't know. Was I frustrated!

I did the only thing I could do — read more. By now, it was magazine time. Fortunately, I had access to the Micropolis Library, which contains almost every issue of almost every hobby magazine. I didn't understand half of what I read at first, but the more I read, the more I increased my knowledge base. By the second or third time I read an article or an advertisement, I started to grasp what was being discussed. It seems funny now, but it took me three weeks to learn what I/O stood for.

After reading magazines for a while, I was ready for Adam Osborne's *Introduction to Microprocessors*. Again, I started out not understanding much of what I read. I did pick up some of the basic concepts, which helped everything fall into place. It was a struggle to read, but very worthwhile.

While in my magazine reading stage, I started visiting computer stores. Being in Los Angeles, I was blessed with a handful within twenty

minutes driving time (everything is a twenty-minute drive in Los Angeles). For the first couple visits, I looked over shoulders. Usually they were the shoulders of a twelve-year-old who knew so much more than I did it was frightening. It took three visits to get over "terminal fright" and actually sit down and try some Star Trek.

I found that most clerks in computer stores can't help but talk over beginners' heads. It's hard not to do. Now, when I show a friend my computer, I use terms that are second nature to me, like I/O, port, address, etc. It's easy to forget how long it took me to understand them.

Tip number two: Find a mentor (or two or three).

A microcomputer mentor is the equivalent of the ham's Elmer. Mentors must be chosen carefully. Your mentor must have the ability to make complicated things simple. He (or she) must have the patience to run over things a third time, when you've forgotten the answer to the question you asked last week and the week before. Your mentor must be able to assure you that you will be able to get up and running, even though that board you built won't work. Most important, your mentor needs to be an accomplished troubleshooter with an adequate test bench. Few people can be all those things. That's why you probably need more than one mentor. Also, few people have the time to do all those things with you. I find I can "time-share" my three main mentors, get all of my questions answered and problems solved, and not alienate any one of them by being a pain in the neck.

I've been very lucky in finding mentors. In fact, I have specialized mentors. Mentor Ken is basically a software man. Mentor Steve is a self-proclaimed I/O expert, and mentor Phil is a hardware man.

Where do you find a

mentor? The most obvious place is at computer club meetings. Computer shows are also a good place.

Tip number three: Join a computer club.

Chances are some club member will already have solved the problems you are facing. You will also make new friends and probably gain access to their computers until you get your own. The

odds are also that you'll be exposed to a lot of different computers. The hands-on experience can help you when the time comes to choose which microcomputer to buy.

Tip number four: Go to a personal computing show.

Admission is a couple of bucks, and it's worth it just in the literature you can pick up. If you have any questions

about a specific piece of equipment, you'll probably find the designer in the manufacturer's booth. There's also a chance that you can win a door prize. The first computer show I went to resulted in my winning an eight-week course in BASIC. If I had paid the \$100 they were charging for the course, I would have felt ripped off. For free, it was decent. My

Photos by Stefanie Felix

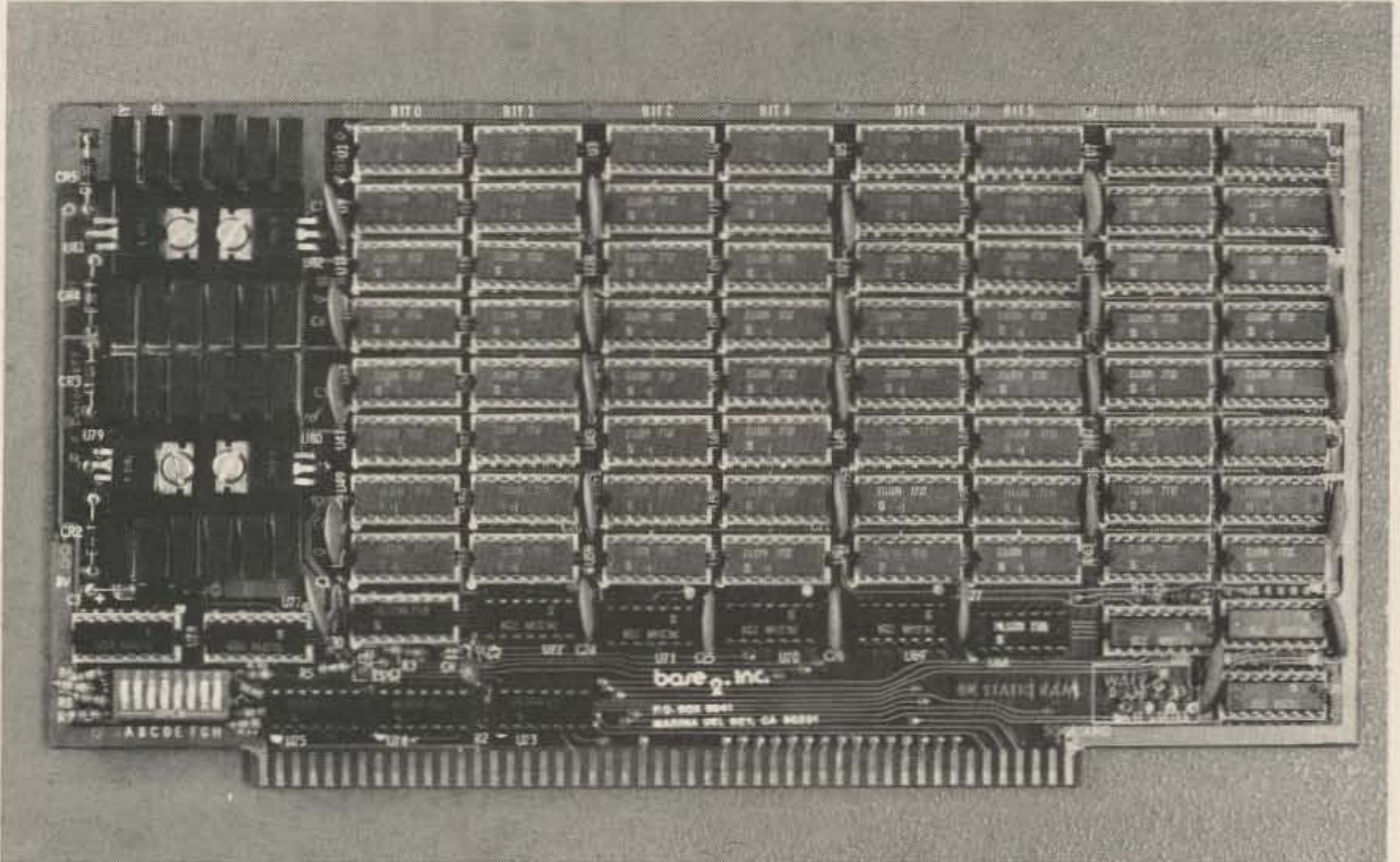

Base 2, Inc., 8K, 450 ns static RAM memory board. At \$124, you can have 64K for a kilobuck.

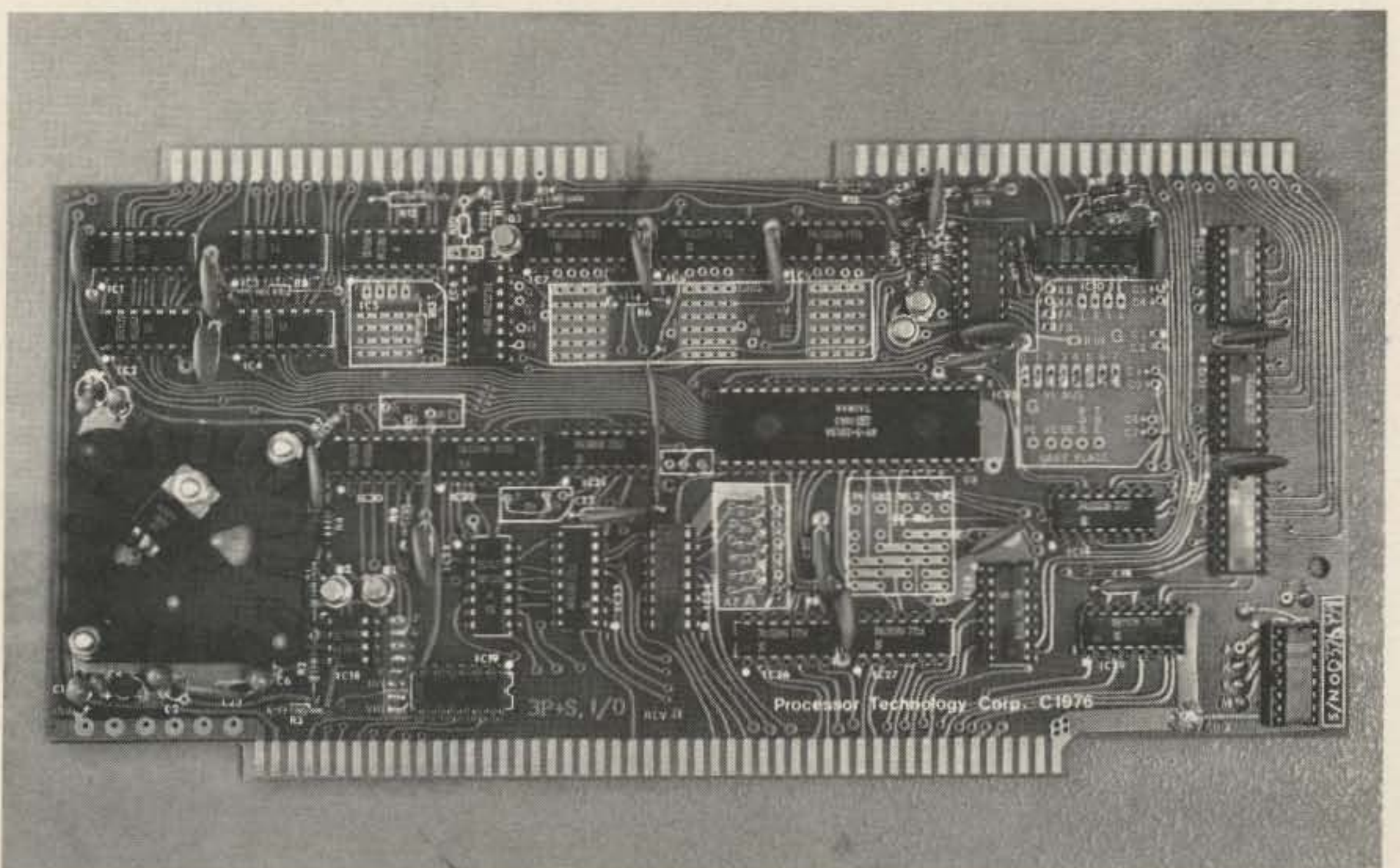

Processor Technology 3P + S I/O board. Note the extra IC in the lower right corner added to buffer the keyboard.

conclusion is that tip one still applies.

Novice

In April, I attended the first West Coast Computer Faire. During dinner at one of the banquets, I mentioned that I had just graduated myself from a beginner to a novice as far as microcomputers were concerned. I was asked the difference. It's easy. A beginner doesn't know what he doesn't know, while a novice knows what he doesn't know.

When you know what you don't know, you know enough to start thinking about buying your own system. I decided I wanted to build mine. I hadn't built anything since I was an amateur radio Novice, and what I had built then often didn't work. That had made me an appliance operator once I'd gotten my General license. I didn't want to be afraid to open up my computer and pull it apart.

To get my feet wet with a printed circuit board project, I bought a twenty-four-hour clock kit. What a shock that turned out to be. I remember using a huge 1,000-Watt soldering gun to build my

Novice transmitter (that was a project that worked). Now I had to get a 25-Watt iron. When I bought it, my thought was, "Can this melt solder?" Well, I quickly found that the key to working with a PC board is the proper tools. That clock was a disaster because I didn't have a vise, a very small tip on the soldering iron, or a solder sucker. I was shocked when the clock almost worked. I say almost because one segment of each digit was out. When I got the fixed board back from the supplier, I found that the problem had been that I didn't know I was supposed to clip the component leads close to the board. Since it was a sandwich construction, the long leads had shorted something out. After that experience, I don't know why I decided to go ahead and build my computer.

Tip number five. Get the proper tools.

I'm not going to go into tools in depth. They've been covered in other articles. Two things I found that are mandatory are a PC board holder and a smock. PanaVise makes a beautiful PC board holder. Their whole setup is very expensive (about \$45). How-

ever, you can use the PC board holder (about \$15) squeezed in a cheap vise, and it will do the job. There is nothing more frustrating than chasing a PC board around the workbench when you've got a soldering iron in one hand, solder hanging out of your mouth, and a needle-nose pliers in the other hand.

Any smock that covers you down to the knees will do. I learned the hard way after I burned a hole in a nice pair of pants when some solder flicked off the sponge I was cleaning the iron on.

Also, get a very, very small pointed tip for your iron. You can't believe how close some of those pads are on the PC boards.

Tip number six: Know what you are buying.

Now let me tell you some things I learned, much to my dismay, after I bought my Imsai. I bought the Imsai because I wanted something in kit form that had a front panel. Mentor Steve had built both the Imsai and the Altair, and his recommendation of the Imsai was good enough for me.

After making the decision to take the plunge, I phoned half a dozen stores to get the

cheapest price. Prices varied from \$651 to \$751. Some gave lower prices but without the 22-slot mother board. Since then, I've seen them for as little as \$599 with the 22-slot mother board. The price is deceiving. You can't do anything with what you get for that price.

You don't get any memory. With the 22-slot mother board, you get only two edge connectors. Surprise — edge connectors list at \$7 each. Multiply that times the twenty you need, plus card guides at 25¢ a shot, and you're looking at an additional \$150. You don't get a fan (about \$20). You don't get IC sockets (about \$12 for the CPU and front panel boards).

You have to buy the sockets. If you know about the problem in advance, you can save some money by going mail order. You can wait on the fan. When you do get one, spend the extra money and get a whisper fan. I didn't, and I wish I had. Anyone want a nonwhisper fan, cheap?

Now for the edge connectors. You must get them. If you only get a few, you are going to have to take the whole computer apart sometime in the future when you want to expand (and you will eventually). I wound up buying twenty wire-wrap edge connectors from Jade Company for about \$3.10 each. You may wish to spend an extra buck per connector and get solder tail connectors. Putting in wire-wrap connectors is a major chore. It took me literally twelve hours to insert, solder, clip the posts, and check for shorts. It took literally one half hour to get the first connector in the mother board. That's not counting the twenty minutes I spent the first time I tried the first one, before quitting in a screaming fit. By the time I got to the twentieth, I had it down to a two-minute job. The idea is start on one side, place pressure on the top of the edge connector

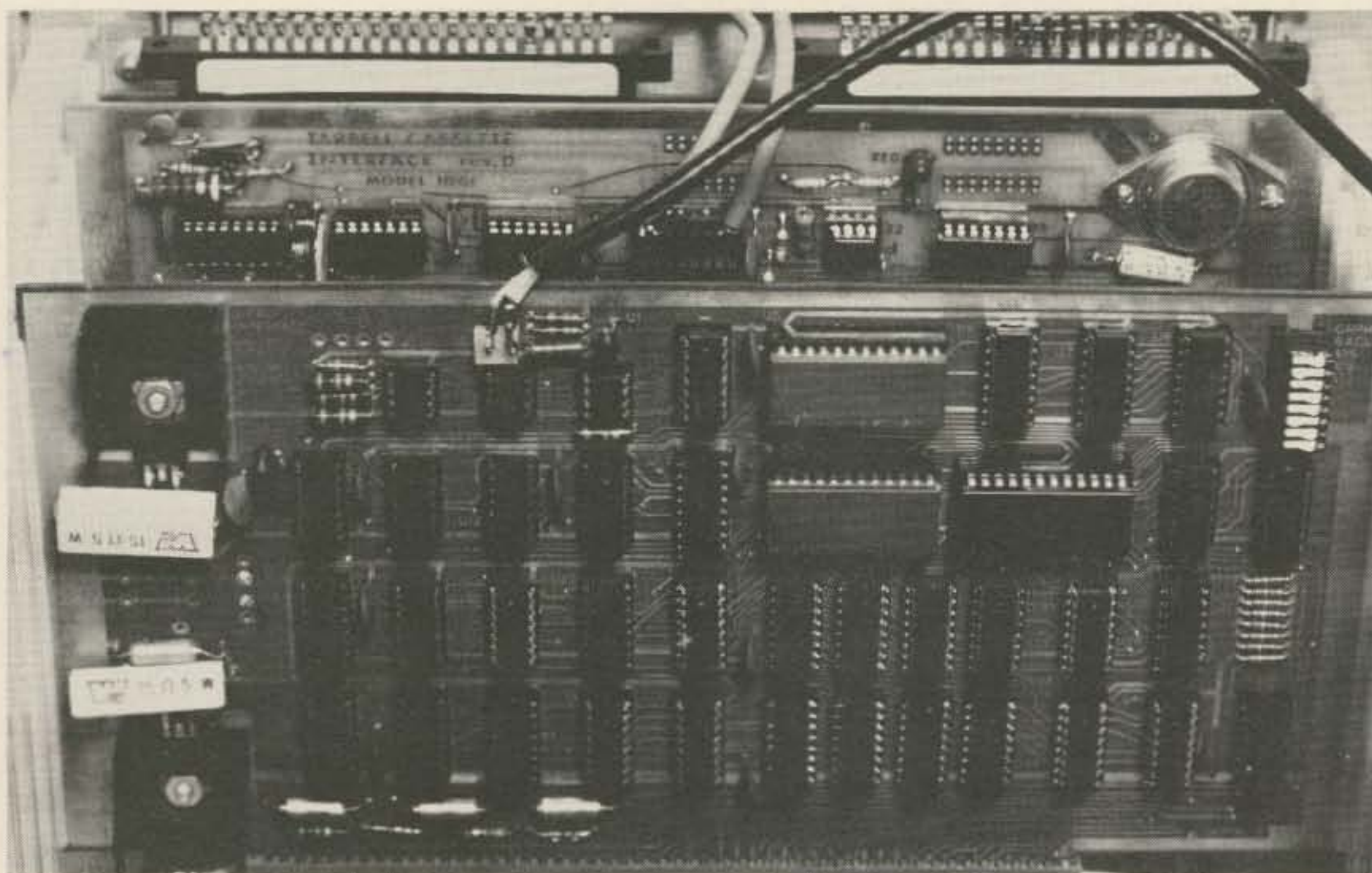

Solid State Music VB1 video board in the mother board with the Tarbell cassette interface and 3P+S edge connectors to the rear.

with one hand, and use the needle-nose to pull the pins into the holes with the other hand. Use a continuity tester after soldering each connector. Check both adjacent and opposite pins. That's 150 checks per connector — very time-consuming, but necessary. If you don't check until the end, and there's a short on the mother board, good luck. You'll need it.

I ought to digress back to the day toward the end of April when I actually took possession of my Imsai. When I got back to the office, I opened the box. That was as far as I got for two days. I carefully extracted the manual first and read it cover to cover.

After reading the manual, I got up enough nerve to dig deeper in the box. Under a large cardboard square were three smaller boxes. The first one I opened was empty! Uh-oh! As it turned out, all the parts were there, the empty box was just filler, as were thousands of those little white plastic wormy-looking things which filled an entire wastepaper basket. For the next two days, I opened up the parts boxes and checked against the parts list, warming up for getting under way. Soon I ran out of excuses. It was time to get down to construction.

My Imsai went together without a hitch (except for the mother board). I found the assembly instructions to be adequate, although sometimes confusing on the first reading. I took my time, and it wound up taking about 50 hours, including mother board. I was flattered when my mentors Steve and Ken complimented me on how good a soldering job I did.

I might add that I built my computer on my office desk. That's probably the only benefit to starting a law practice without an established clientele. I share office space in a suite with my father, and, on the first day that I had tools and parts spread out all over my desk, with a

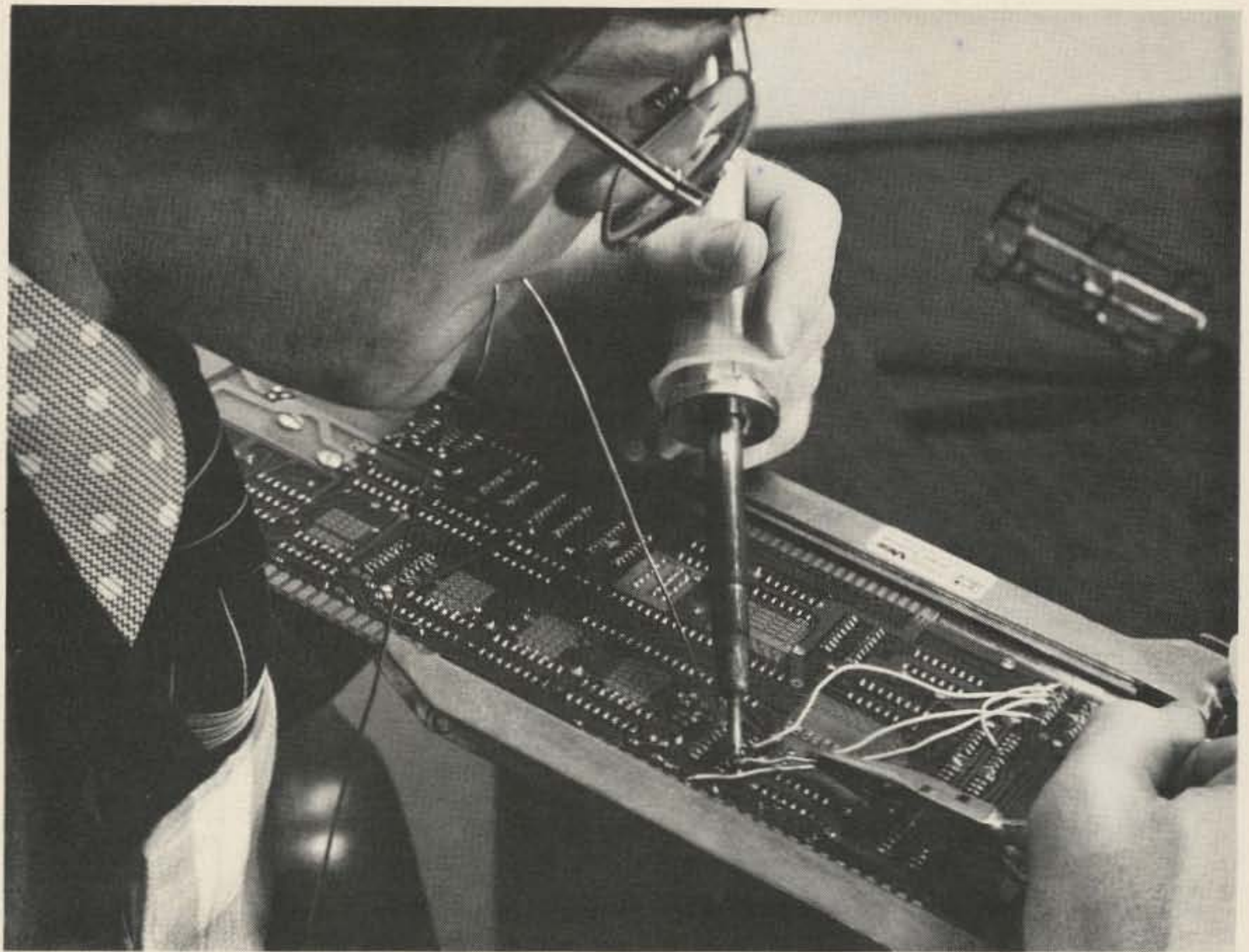

Demonstrating the 4-handed soldering technique.

smock over my suit, his comment was, "Ken, this building isn't zoned for manufacturing."

Tip number seven: IC pins are numbered in a "U".

I only made one error in building the Imsai. That was on the modification which makes sure the board comes up in wait after power-up. It required a few jumpers. No one told me that IC pins are numbered in a "U", which means that, on a sixteen-pin IC, top left is pin 1, bottom left is pin 8, bottom right is pin 9, and top right is pin 16. I had counted from top to bottom and then jumped up to the top again.

My Imsai didn't work, even after correcting my error. Even the mentors couldn't solve the problem, notwithstanding a few midnight troubleshooting sessions.

I knew the problem wasn't in the MPU board because it had worked in Steve's computer, even though it didn't work at first. Steve removed each chip, chip by chip, puckered up and blew hard into each socket, and then

replaced the chips. I laughed when he did it, but, believe it or not, the darn thing worked in his computer then. Talk about being finicky.

The front panel board wouldn't work, though, even after Steve applied his magic lungs. I even substituted every chip from mentor Ken's working Imsai.

Fortunately, I had bought my Imsai from a store with expert technicians, the Byte Shop of Tarzana. They found the problem (traces shorted because of defective etching) and fixed it in two days.

After borrowing a 4K memory board from mentor Phil, I was, in a manner of speaking, up and running. Unfortunately, all I could do was play "chase the bit." That grows old very fast.

Intermediate

Having built a microcomputer, I considered myself no longer a novice. Perhaps it is presumptuous to consider myself an intermediate. I guess it's that overachiever syndrome in me. In any event, once you get the basic computer built, it's time to

enter the terminal stage in your hobbyist career.

At first, the attraction of an eighty-character line and twenty-four lines plus the "professional" look led me to believe I wanted something like the ADM-3. The cost wound up leading me to assemble a keyboard, monitor, I/O board, and video board. It was funny how it all came together for me. I spent some time one morning trying to find a black-and-white twelve-inch Hitachi TV because I had seen a good article in *Kilobaud* on converting it to a monitor. Believe it or not, in a city the size of Los Angeles, I couldn't find what I wanted. I was interrupted in the middle of my quest by mentor Steve, who told me to start my clock running, as he had a legal problem. It turns out he also had a nine-inch Sanyo monitor he didn't need.

The same day I heard of a computer store going out of business. I picked up a Southwest Tech keyboard and enclosure for \$60. Also the same day, mentor Phil said he



During the building phase. Note that the PanaVise PC board holder is used with a cheap vise as a base. Also note the smock. (Note, too, that the XYL is looking over the author's shoulder, as usual.)

had a video board he couldn't use. Add a Processor Tech 3P + S, and I was in business. I got the 3P + S because that's what my mentors had. Conforming to your mentor's configuration is an important consideration. It makes things much easier.

Putting the 3P + S together was a breeze. Understanding how to use it was something else. There are so many options and ways to configure that board that it can blow your mind. Fortunately, my mentors rose to the task.

To interface the keyboard with the Imsai, I knew I had to use a parallel port on the 3P + S for the seven data bits and the parity bit. The keyboard needed plus five volts and minus twelve volts dc. I also had to hook up something called KP. Plus five volts was easy, as the 3P + S pin connection diagram showed it. Minus twelve volts looked like a problem until

mentor Steve folded out the schematic and pointed to minus twelve volts clear as day at pin D of connector J1 (and I have the audacity to call myself an intermediate?).

The KP was something else. I understood it meant key press and that it was there to tell the computer that a key was pressed so it could get the data from the appropriate parallel port. Mentor Steve explained that most BASICs look at port 0, bit 0 for status information and port 1 for data. Like magic, it fell into place. KP to input port 0, bit 0, data to input port 1, bits 0 to 7. The only option I had to worry about was to make sure that 3P + S channel A was port 0 and channel B was port 1, so as to conform to the software.

Then mentor Steve gave me a little routine so that when I pressed a key, the ASCII representation showed up at the Imsai's programmed

output port. The routine was only fourteen bytes long. After some soldering on the 3P + S connectors, I toggled the routine in, hit a key, and lit some LEDs. But the wrong ones came on. After a few minutes, I realized that what was happening was that the ASCII representation was inverted. Then I remembered the same thing happened in the system functional test from the Imsai *User's Manual*. The programmed output board requires a complement instruction to correctly represent the data displayed. Imagine my delight to have found a bug in the routine my mentor gave me and then to have corrected it.

I had been given a Solid State Music VB1 video board by mentor Phil. The price couldn't be beaten, but, unfortunately, it caused me many problems. The video board's software had to be patched into BASIC. I knew virtually nothing about assembly language programming, and there was no way I could do the patching.

While waiting to hear from Solid State Music regarding the patches, I loaded the "Teletype® simulator" software which comes with the VB1. I found that, when I hit a character on the keyboard, about 250 of that character appeared on the screen. Mentor Steve to the rescue! He found that an additional IC was required on the 3P + S in order to "condition" the strobe. The keyboard and 3P + S manuals didn't mention this.

I got a two-page letter from Solid State Music outlining the patches to BASIC. That was all Steve needed to get BASIC running with the VB1. My terminal was complete.

Before I got BASIC running, I built a Tarbell cassette board. I planned to use it with my second string stereo cassette deck. With mentor Ken's help, I hooked up the recorder to the cassette interface and started the sync stream. Nothing happened.

Tip number eight: You really do need a cheap cassette recorder.

The problem with the stereo recorder was that it had a 300-Ohm output impedance. The Tarbell board requires 100 Ohms. I traded the stereo recorder to my brother for a portable recorder, and I was in business. Mentor Ken had given me a music program. I toggled in the cassette bootstrap, hit run, and started the cassette. The audio generated from programs sounds terrible! I hit reset, turned on an AM portable radio, put it next to the Imsai, and it emitted nothing but a low-pitched whine. I adjusted the volume and tone control on the recorder and tried it again. This time when I hit run, the familiar notes of "A Bicycle Built for Two" emanated from the radio. My right fist shot in the air as I shouted a triumphant "yes!" The rest of the office poured in. "Listen," I said, "it does something." I even called my wife. When she picked up the phone, the Imsai serenaded her. When the tune finished and I told her what it was, she simply said, "Oh, I thought it was a breather call." Sometimes I get no respect.

It turned out that my brother's recorder didn't record. So I bought a Sears \$39.95 recorder on sale for \$29.95. It works fine. It doesn't require the mods the J. C. Penney recorder does (see "A Clean Cassette," *Kilobaud*, June, 1977) because it doesn't have a tone control and the built-in mike goes off when a jack is plugged in "aux."

Tip number nine: Memory.

I should mention that I bought an 8K static RAM board from Base 2, Inc., in Marina Del Rey, California. They sell a 450-nanosecond kit version fully socketed for \$124. Because they were a new company, I only bought one board at first. It works fine, and you can't beat the

price. I now have three of their boards. They run a little warm, but, at that price, you can buy 64K for a kilobuck. Now do you see why you want those edge connectors?

That's where I am today. Now I am dangerous. I'm in the process of shopping for a hard copy device. I'm also just getting into the software jungle.

It's funny. When I built the bare Imsai, Steve told me the worst was behind me. That was the only time he has been dead wrong since I've known him. To tell you the truth, every step of the way was as much of a challenge as the last. The 3P + S option problem seemed insurmountable. Then it fell into place. Then the problems using my stereo cassette deck arose. Those were mastered. Then there were the VB1/BASIC software problems.

But I've learned a lot, and now I have a fully functional computer system. I also have an excuse to throw an "up and running" party and show



Fun time has arrived!

off my computer to my friends. Maybe I'll have a name-the-computer contest.

By the way, by next November, I'll have that ultimate computer-controlled

contest station that used to be a daydream. Watch out for me in the CW sweepstakes. ■

CALL TOLL FREE

1-800-228-4097

for Quality Ham Radio Products at Discount Prices

- ETO ALPHA 76
List \$1195 only \$1050
- ETO ALPHA 374
List \$1595 only \$1395
- CDE HAM III ROTOR
only \$125
- CDE TAIL TWISTER
only \$249
- ASTRO 200A
List \$1095 only \$965
- DENTRON MLA -2500
List \$899.50 only \$799.50
- DRAKE R4c or T4xc
List \$699 only \$609
- DRAKE TR-4cw
List \$799 only \$699
- DRAKE L4B Linear
List \$995 only \$869

- HY-GAIN 3806 2 meter
hand-held with NI-CAD PAK,
charger, and service manual
Value \$238.90 only \$199
- ICOM 22S Transceiver
List \$299 only \$249
- ICOM 211 Transceiver
List \$749 only \$649
- ICOM IC-701
List \$1,499 only \$1,350
- KENWOOD TS-520s
List \$739 only \$660
- MIDLAND 13-510
List \$399 only \$359
- TEN-TEC #544 digital
List \$869 only \$759

- KENWOOD TS-820s
Reg. \$1098 only \$980
- TEN-TEC #540 Triton
List \$699 only \$619
- YAESU FT-301 (dial)
with AC Power Supply and
CW Filter Value \$966 only \$769
- YAESU FT-301d (digital)
with AC Power Supply and
CW Filter Value \$1,132 only \$935
- YAESU FT-101E
Reg \$799 only \$709
- YAESU FRG-7 Receiver
Reg. \$315 only \$269
- YAESU FT-901 DM
Reg. \$1,299 only \$1,165



Communications Center

The Radio Store

C58



443 N. 48th, Lincoln, Nebraska 68504

In Nebraska Call (402)466-8402

ELECTRONIC SYSTEMS

P.O. Box 9641 San Jose CA 95157
(408) 374-5984

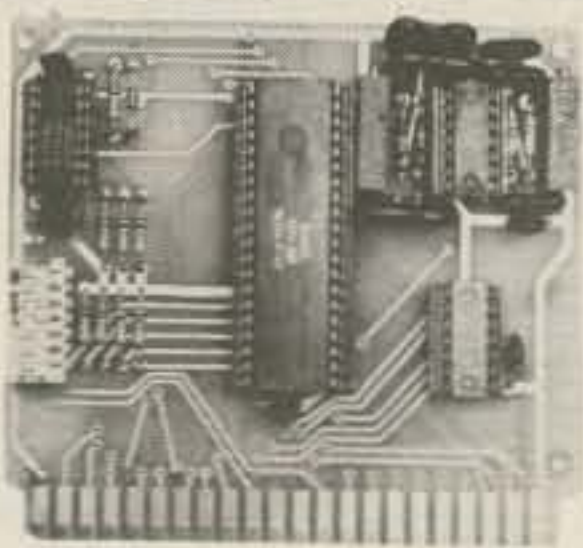

UART & BAUD RATE GENERATOR

Part no. 101

- Converts serial to parallel and parallel to serial
- Low cost on board baud rate generator
- Baud rates: 110, 150, 300, 600, 1200, and 2400
- Low power drain +5 volts and -12 volts required
- TTL compatible
- All characters contain a start bit, 5 to 8 data bits, 1 or 2 stop bits, and either odd or even parity.
- All connections go to a 44 pin gold plated edge connector
- Board only \$12.00; with parts \$35.00

8K STATIC RAM

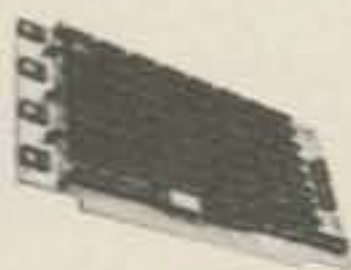

Part no. 300

- 8K Altair bus memory
- Uses 2102 Static memory chips
- Memory protect
- Gold contacts
- Wait states
- On board regulator
- S-100 bus compatible
- Vector input option
- TRI state buffered
- Board only \$22.50; with parts \$160.00

RS-232/TTL INTERFACE



Part no. 232

- Converts TTL to RS-232, and converts RS-232 to TTL
- Two separate circuits
- Requires -12 and +12 volts
- All connections go to a 10 pin gold plated edge connector
- Board only \$4.50; with parts \$7.00

DC POWER SUPPLY



Part no. 6085

- Board supplies a regulated +5 volts at 3 amps., +12, -12, and -5 volts at 1 amp.
- Circuit has filters, rectifiers, and regulators.
- Power required is 8 volts AC at 3 amps., and 24 volts AC C.T. at 1.5 amps.
- Board only \$12.50

TIDMA

Part no. 112

- Tape Interface Direct Memory Access
- Record and play programs without bootstrap loader (no prom) has FSK encoder/decoder for direct connections to low cost recorder at 625 baud rate, and direct connections for inputs and outputs to a digital recorder at any baud rate.
- S-100 bus compatible
- Board only \$35.00; with parts \$110.00

Part no. 111

TAPE INTERFACE



- Play and record Kansas City Standard tapes
- Converts a low cost tape recorder to a digital recorder
- Works up to 1200 baud
- Digital in and out are TTL-serial
- Output of board connects to mic. in of recorder
- Earphone of recorder connects to input on board
- Requires +5 volts, low power drain
- Board \$7.60; with parts \$27.50
- No coils

Part no. 107

RF MODULATOR



- Converts video to AM modulated RF, Channels 2 or 3
- Power required is 12 volts AC C.T., or +5 volts DC
- Board \$7.60; with parts \$13.50

Apple II Serial I/O Interface



- Part No. 2
- Baud rates up to 30,000
 - Plugs into Apple Peripheral connector
 - Low-current drain
 - RS-232 Input and Output
- SOFTWARE
- Input and Output routine from monitor or BASIC to teletype or other serial printer.
 - Program for using an Apple II for a video or an intelligent terminal. Board only - \$15.00; with parts - \$42.00; assembled and tested - \$62.00.

TELEVISION TYPEWRITER

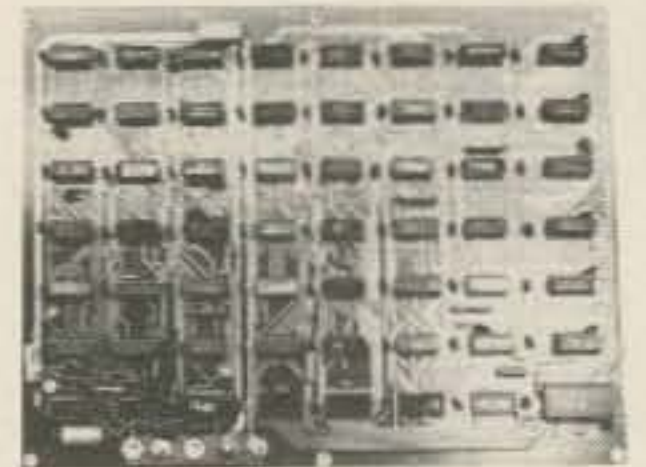

Part no. 106

- Stand alone TVT
- 32 char/line, 16 lines, modifications for 64 char/line included
- Parallel ASCII (TTL) input
- Video output
- 1K on board memory
- Output for computer controlled cursor
- Auto scroll
- Non-destructive cursor
- Cursor inputs: up, down, left, right, home, EOL, EOS
- Scroll up, down
- Requires +5 volts at 1.5 amps, and -12 volts at 30 mA
- Board only \$39.00; with parts \$145.00

MODEM



Part no. 109

- Type 103
- Full or half duplex
- Works up to 300 baud
- Originate or Answer
- No coils, only low cost components
- TTL input and output-serial
- Connect 8 ohm speaker and crystal mic. directly to board
- Uses XR FSK demodulator
- Requires +5 volts
- Board \$7.60; with parts \$27.50

To Order:



Mention part number and description. For parts kits add "A" to part number. Shipping paid for orders accompanied by check, money order, or Master Charge, BankAmericard, or VISA number, expiration date and signature. Shipping charges added to C.O.D. orders. California residents add 6.5% for tax. Parts kits include sockets for all ICs, components, and circuit board. Documentation is included with all products. Dealer inquiries invited. 24 Hour Order Line: (408) 374-5984.

E21

SUBSCRIBE TO KILOBAUD NOW AND GET THIS \$5 BOOK FREE!

HOBBY COMPUTERS ARE HERE!

HERE'S YOUR CHANCE to get the best selling book in the hobby computer field . . . for free . . . our gift when you try Kilobaud Magazine on a trial subscription. If the magazine isn't all we say and a lot more . . . if you are willing to be without it . . . just ask for a refund and keep the book.

Hobby Computers Are Here is for the beginner . . . it starts out with the fundamentals of microcomputers . . . shows how all of the basic parts of a computer system work . . . gates, flip-flops, TTL logic, keyboards, video generators, I/O systems, CPUs . . . it is a whole basic education in microcomputers. That's why more copies of this book have been sold than any other in the field.

Okay, so the book is great, what about *Kilobaud*? If you know anyone who is getting *Kilobaud* just ask them . . . if not, take a peek at a copy (if there are any left) in your local computer store . . . and you'll find out why *Kilobaud* is the fastest growing magazine in the hobby computer field. It's written by the readers and in simple language . . . you'll find yourself getting many hours of enjoyment out of each issue.

SUBSCRIBE. Never mind the \$2 per copy . . . which comes out to \$24 a year. The subscription rate is only \$15 for a year and WE'LL THROW IN THE \$5 BOOK FREE. Charge it to your Master Charge, BankAmericard or American Express. If you are in a hurry, you can call it in on our toll free 800 number and your book will be on its way to you, along with the current issue of *Kilobaud*.



Toll free subscription number 800-258-5473

KBS-1-73-5-7:

kilobaud
peterborough nh 03458

How Good Is the North Star Disk?

—and why is it getting so popular?

Photos by Guy Malmberg

How would you like to be able to turn your system off at night, come back the next morning, flip 2 or 3 switches, and be running complex BASIC programs in 15 seconds? There are several ways of accomplishing this, ranging from keeping a BASIC interpreter in PROM and files on tape to buying a powerful disk drive and controller.

Commercial computers have used a number of inter-

esting schemes to accomplish an "autoload" — Eniac used a large switch panel organized as memory words. Early Control Data computers used spinning cams to close switches and load data words into memory. Recent modern minicomputers have made good use of direct storage access disk systems to take over the memory system and stuff a bootstrap program from the first sector of a disk to the first few memory loca-

tions.

Most of these methods, however, have been too complicated and expensive for home use. But there is at least one happy exception to this trend — the North Star Micro-Disk System. For about \$700 (the cost of 3 disk packs on a large main-frame system), you can have the kind of performance described above.

The North Star Micro-Disk System is similar to other

floppy disk systems in many respects, but the price was kept at a minimum by eliminating some of the frills without making major sacrifices in performance. Incidentally, some of these frills have also been eliminated by other manufacturers without comparable price reductions.

One of the differences between the North Star system and more conventional floppy systems is the use of a minifloppy drive instead of a full-sized drive. This decreases the total amount of data that can be saved on a disk. The minifloppy drive can store 89.6 kilobytes of information as formatted by the North Star controller. Also, this is not a direct storage access device. It uses a memory-mapped I/O system similar to the kind of input/output commonly used in a 6800 microprocessor system. This is, however, still much faster than most tape systems that could be purchased on a hobbyist's budget. The North Star minifloppy format is somewhat less capable of storing large amounts of data than other minifloppy systems which utilize double or quad density data packing. Still, 89.6 kilobytes leave sufficient room for a great many programs on a single diskette, and swapping diskettes takes just 5 or 10 seconds. Also, lower data density may result in higher data integrity.

There are 4 main components in the North Star disk system: the drive, the controller, the disk operating software, and the BASIC interpreter. Let's examine them one at a time.

The Disk Drive

North Star uses the Shugart SA400 minifloppy diskette storage drive. This is good news for the hobbyist because Shugart is one of the major names in floppy disk technology, and many of the parts (notably the read/write head) have similar or identical counterparts with the very

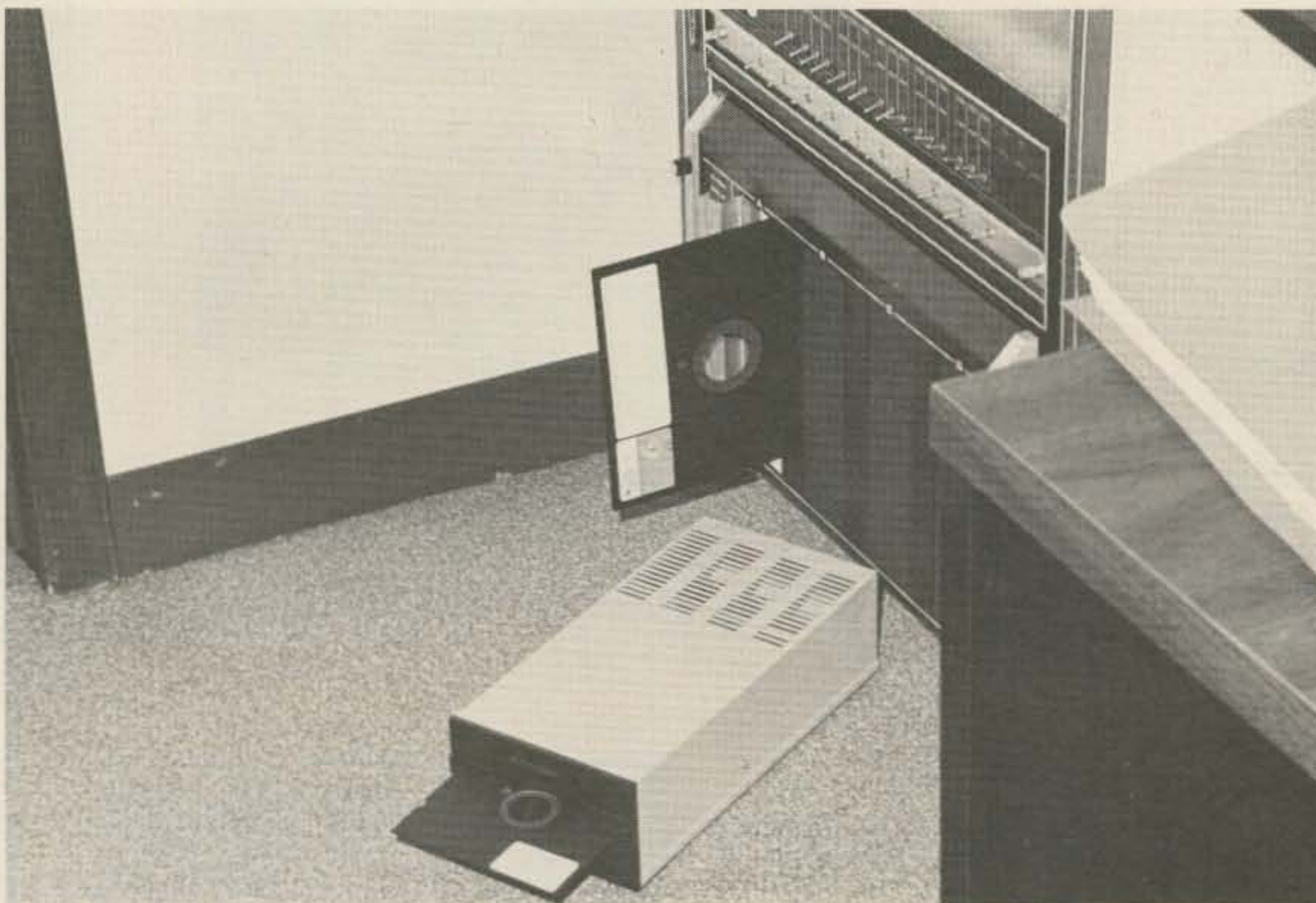

Photo A. If you are familiar with full-sized floppy systems, this photo will give you an idea of the new size of things. Both diskettes have been pulled halfway out of the drives for comparison.

successful SA800 drive. The drive is solidly built and appears very rugged. Most of my disk drive experience has been with huge capacity rigid disks, and I was surprised to notice that there are no provisions for alignment of the minifloppy. I was assured by the technicians at North Star that there have been no problems with diskette interchangeability since one of the recent modifications to their controller board, but I had a great deal of trouble reading the diskette originally shipped to me (containing the disk operating system and BASIC). I took it to my distributor, and he had similar troubles reading it. Autoloading from it took about 20 minutes because so many repeats were necessary due to errors detected with the cyclic redundancy checking software. As it turned out, I can reliably read the diskettes I write, my distributor can read the diskettes he writes, but we can't read each other's diskettes very well, and neither of us had much luck reading the stuff I got from North Star.

The diskette is hard sectored for 10 sectors per track and 35 tracks per disk, with the first 4 sectors dedicated to the file directory. Two hundred fifty-six bytes of data storage are available on each sector, and a preamble of 16 bytes of zeros and a special sync character precedes the data. The data is followed by one check byte. This format differs somewhat from that used by large-capacity rigid disk drive manufacturers in that it does not allow address verification. This is an interesting area of sacrifice. Many large-disk systems verify the disk address after every seek to make sure the drive has gone to the correct track and sector. Floppy systems do not do this. It has caused no problem in my system and is an example of eliminating the icing while preserving the cake. I think it is worth it for a

hobbyist or small business, but, for a big business whose file entries represent thousands or millions of dollars, it may be a serious drawback.

The diskette may be write protected with a piece of masking tape folded over a cutout in the cardboard carrier — very clever. When protected, the drive will not write even if (erroneously) told to do so by the disk controller.

The drive comes without a cabinet, but my distributor didn't charge me for one of the pretty (blue) jobs you see in the photographs. Incidentally, there is room inside that little box for a small power supply, too, and, even though I didn't pay the \$40 they wanted for it, they shipped me the PC board and regulators, anyway, so I could tap into the unregulated power from my computer. I was pleasantly surprised at that, but it got me into some trouble later. The +12-volt supply draws a lot of current when the motor starts up, and I had to beef it up before the drive would run reliably.

I was also impressed by the head-seeking mechanism.

They have used a stepper motor to spin a disk in small increments. The disk has a spiral groove in it, and what looks like a ball bearing rides this spiral in and out, pushing the head carriage mechanism toward or away from the center of the disk. On long seeks, you can hear the stepper motor make a fluttering sound at each track. Track-to-track access is advertised at 40 milliseconds, which means a 35-track seek will take about 1.4 seconds.

North Star charges about \$400 for this disk drive, but, if you order directly from the factory, you can get it for about \$355.

The Disk Controller

The disk controller is implemented on a single S-100 compatible PC board which has been silk-screened and solder-masked to increase ease of assembly. Sockets are included for every IC, and, if my experience is typical, it is a good idea. Even though I never had to replace parts, I swapped a lot of them around in order to test them because of timing problems I had.

They used a lot of clever

unorthodox hardware tricks on this board. For example, their use of memory-mapped I/O, rather than standard 8080 I/O ports, surprised me. The disk controller looks like a 1K block of variable speed read only memory to the system software, with each disk command decoded not from data sent out from the accumulator, but from the contents of the address bus. Status and disk data are given to the CPU on the memory data in lines as if the data were retrieved from system ROM, and, when data is not available as fast as the CPU wants it, "wait" states are introduced exactly as if the CPU were waiting for slow memory. This scheme does not tie up any of the 256 input or output ports of the 8080, but it does use 1K of address space starting at address E000 in the standard version. North Star may have saved a little money with this method because they don't have to decode the data out lines, but I think there were other reasons for their choice of memory-mapped I/O. It may be possible to use the North Star controller with a



Photo B. It is interesting to compare the minidrive with a giant rigid disk system. This photo illustrates the relative sizes. Ball-park ratios for data capacity are 300 to 1. For price, the ratio is 1 to 18, and the large drive transfers data about 20 times as fast as the mini.

minimum of modifications in a 6800 or similar system because of this choice.

Incidentally, I was able to use the North Star controller concurrently with a Godbout 8K PROM board with both addressed at E000, but with the PROMs of the Godbout board removed from E000 to EFFF. Software package 1 owners, take note.

Note a few other interesting hardware tricks. There are 3 PROMs on the board; two are conventional program storage devices for bootstrap and low-level disk routines, and the third sits on the upper 8 address lines to decode board selection, bootstrap PROM selection, status requests, or the availability of a byte of data to be written on the disk. There is also an on-board clock instead of an attempt to use the 8080 system clock. This may be due to the current trend of using the Z-80 and other microprocessors with different clock speeds. Also, the engineers at North Star have allowed the option of using XRDY instead of PRDY to synchronize CPU speed with memory speed.

The other functions implemented by hardware are: Sync byte detection is directly decoded from the disk and presented as a status flag to the CPU, and a power-on clear eliminates the necessity of resetting the

board at turn-on time. (I wish my memory boards had this feature; most of the 15 seconds it takes to autoloading are spent unprotecting RAM.)

A function not implemented by hardware is error checking. Most disk systems use hardware to do a cyclic redundancy check or an error correction code. North Star does a CRC in software. Also, address marks are conventionally written on a disk by the controlling hardware and verified at seek time. This is not done in the North Star system, as previously mentioned.

I found a couple of problems with the disk controller. First, current-model PC boards (#MDC A-2) need a modification which requires cutting a run and adding a jumper. This is documented in an errata sheet included with the kit. Unfortunately for me, this didn't solve all my problems. I found my board was sometimes unable to set a flip-flop used to inform the CPU of "write" status, and the software would just hang in a loop waiting for it. I spent many hours with a scope trying to make this problem go away and finally succeeded by making a minor modification to the PC board. I discussed this with North Star and they were very alarmed, claiming that no one else has ever had a similar problem and that I

probably have a bad chip.

The Disk Operating System

I think this is one of the real strengths of the North Star system. It provides the ability to load, save, execute, or access files by name or disk location. Names may be up to 8 characters long. Up to 256 different file types may be defined, and 4 are predefined with the system. They are:

Type 0: Default type. All files are type 0 until explicitly changed.

Type 1: Machine language (executable) program.

Type 2: BASIC program. Can be loaded or saved from BASIC.

Type 3: BASIC data file. Can be read or written by BASIC.

Interfacing with system hardware is provided by a good documentation package and memory space for the user to write his or her own I/O and initialization routines. The guidelines provided are thorough, and I have seen the DOS successfully interfaced to a POLY-88, a 3P+S, and a line printer with relative ease.

There are 16 commands available from the CRT. Most of them specify the file name, and some also specify drive number (1 to 3), disk addresses, RAM addresses, and number of sectors to be operated upon. These commands are shown in Table 1.

I am so pleased with the DOS that it is hard to specify a weakness of any kind. But it would be very nice to have

the ability to flag and skip over bad tracks on a diskette. I really don't know if this should be called a weakness of the DOS or of the controller hardware, but it would certainly be helpful.

North Star BASIC

I am also quite pleased with North Star's implementation of BASIC. It is much better than the 5K version I had been using, even though it uses 10K of RAM to do it.

I have noticed that it is much slower at number crunching than I had expected, but it calculates 8 significant digits instead of the more common six, and the slower speed is probably a good marketing strategy for North Star, whose second major product is a hardware floating point board designed to speed up number crunching.

As shipped from the factory, North Star BASIC expects to find 16K of RAM starting at address 2000 hex. It does not overwrite the disk operating system, although some commands of the DOS bomb BASIC. (It's a small loss when it only takes 5 seconds to reload.) BASIC uses the upper 4K (approximately) for program storage, and documentation is provided for expanding or moving the program storage space.

Major strengths of the BASIC package are shown in Table 2. Additionally, all of the standard features you'd expect to find in a good

1.	LI	List the disk directory of the optionally specified drive. The following information is returned: file names, lengths, starting addresses, and types.
2.	CR	Create a new file. CRT specifies name, length, and optional starting disk address.
3.	DE	Delete a file.
4.	CO	Compact file space, eliminating blank areas.
5.	TY	Change the type of a file.
6.	GO	Load and execute a type 1 file.
7.	GA	Set the "go address" of a type 1 file.
8.	JP	Jump to the address specified in HEX from the CRT.
9.	LF	Load a file to RAM.
10.	SF	Save a file from RAM.
11.	CF	Copy a file (same or different disk, different names).
12.	CD	Copy an entire diskette (multiple drive systems).
13.	RD	Read a # of blocks from disk to RAM.
14.	WR	Write a # of blocks from RAM to disk.
15.	IN	Initialize a new diskette.
16.	DT	Drive test: writes a changing pattern all over the diskette, then reads and checks it. This is useful for checking a diskette for bad spots.

Table 1.

1.	A line editor which has several commands for copying or changing portions of old lines.
2.	Formatted output similar to FORTRAN.
3.	Multiple-line user-defined functions.
4.	String and substring manipulation.
5.	Boolean operators: and, or, not.
6.	Memory examine and fill (decimal memory values).
7.	8080 in and out capabilities.
8.	Machine language subroutine calling with interface to DE and HL register pairs.
9.	# of bytes of program storage remaining can be calculated.
10.	Natural logs and antilogs.
11.	Random and sequential disk file accessing.
12.	Trigonometry (sine and cosine only).
13.	Multiple dimensioned arrays.
14.	Renumber.

Table 2.

BASIC package are available with North Star BASIC.

As for its weaknesses, once again, it is hard to criticize a software package as sophisticated as this one, especially at this price. Less capable BASIC interpreters have been sold for thousands of dollars with no hardware and very little documentation provided.

For a price which I considered very reasonable, I recently received from the factory a software update on

a diskette. This time I was able to read the diskette perfectly. Included are ARCTANGENT and "CHAIN," the latter allowing one BASIC program to call and execute another BASIC program from the disk. I consider this an indication that they intend to give good support to this product.

Conclusions

Overall, I am very pleased with the North Star disk system. I am convinced that,

dollar for dollar, it is the best investment to be had in the area of mass storage for computers today. Extra bonuses are the great disk operating system and the good implementation of BASIC.

Nevertheless, it is a big project. I have built each part of my system from the ground up, and this has been, by a big margin, the most difficult of all, including home brewing my own CPU from Altair PC boards and home brew components,

cabinet, power supply, back plane, etc.

I recommend to those of you interested in buying this product that, if you don't have a solid background in hardware and access to a good dual-channel oscilloscope, buy it assembled and tested. It may have been just bad luck on my part, but, even though I never had to replace a bad component or redo a connection, it still took me almost 2 weeks to get it running flawlessly. ■

John Rheinstein WA1PTZ
10 Gould Road
Lexington MA 02173

Most versions of BASIC have a built-in function RND(X), which is used to obtain pseudorandom numbers. These numbers are called pseudorandom because a deterministic algorithm is utilized to generate the desired numbers. While not truly a random sequence, the output from a good random number generator is a sequence of numbers which passes various statistical tests for randomness. Unfortunately, not all random number generators' output sequences may reasonably be considered to be random.

The Z-80 has a 7-bit refresh register, the R-register, which may be used to generate truly random numbers. In this article, I shall indicate how I accomplished this on a Digital Group Z-80 system using Maxi-BASIC. Minor variations should allow the technique to be used with other versions of BASIC running on Z-80 microcomputers.

Maxi-BASIC has a built-in function CALL (argument). This function calls a machine language subroutine which starts at the location given by the argument (in decimal). The CALL function returns to the calling program the integer which is in the HL

register when the machine language subroutine returns.

The simple program listed below serves the purpose of zeroing the H-register and loading the R-register into the L-register.

```
046 000g LD H,0
355 137g LD A,R
157g LD L,A
311g RET
```

This subroutine uses 6 memory locations and may be placed wherever convenient. I use 005 350g (1512₁₀) as the starting location. A sample calling sequence in BASIC is given below.

```
10 INPUT X
.
.
.
200 LET Z = CALL(1512)
210 LET Z = Z/128
```

In this calling sequence, statement 200 returns an integer between (and including) 0 and 127. Statement 210 normalizes this to the range 0 to 1. Statement 10 is, perhaps, a surprise. However, if it is not used, then you cannot be assured of obtaining a truly random sequence of numbers. There should be an INPUT statement in the program, whether needed or not, prior to each

call for a random number.

The R-register is a counter which is incremented every time an instruction is fetched — several hundred thousand times per second, usually. The current contents of the counter are sampled by the LD A,R instruction. We randomize the intervals at which the R-register is sampled by means of the INPUT statement. This statement requires a response, a keyboard input. It is the random length of time required for this response that is responsible for the truly random sequence of numbers produced. ■

Pseudorandomness Is Just Not Good Enough

—true random happiness with a Z-80



wire wrapping center

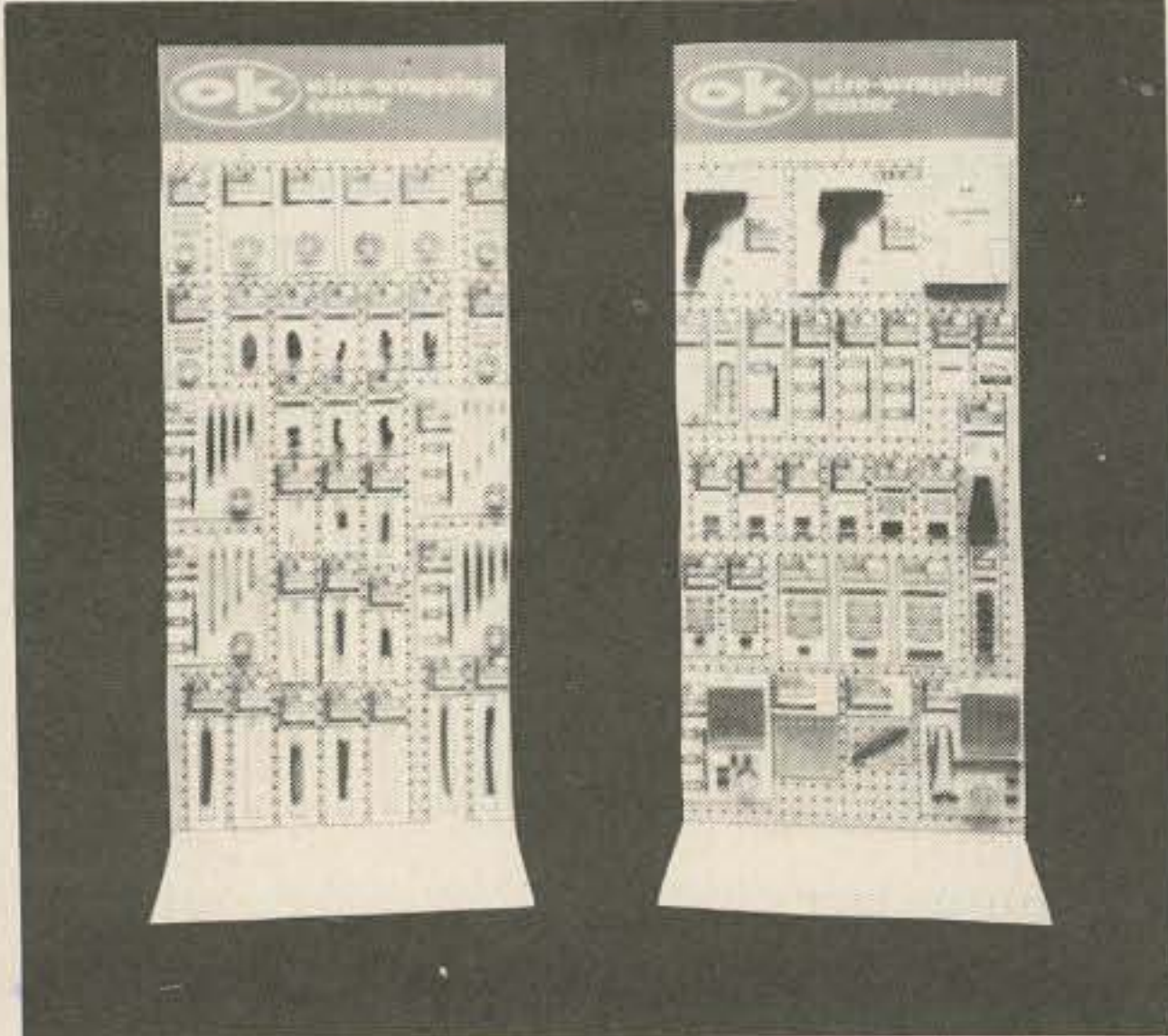

for quality electronic parts and tools.

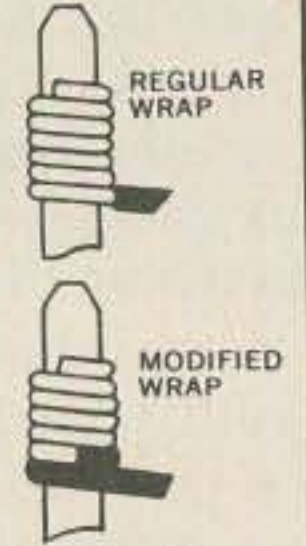

Wire-wrapping, stripping, unwrapping tool for AWG 30 on .025 (0,63mm) Square Post.

HOBBY WRAP TOOL

Regular Wrap	WSU-30	\$6.95
Modified Wrap	WSU-30M	\$7.95

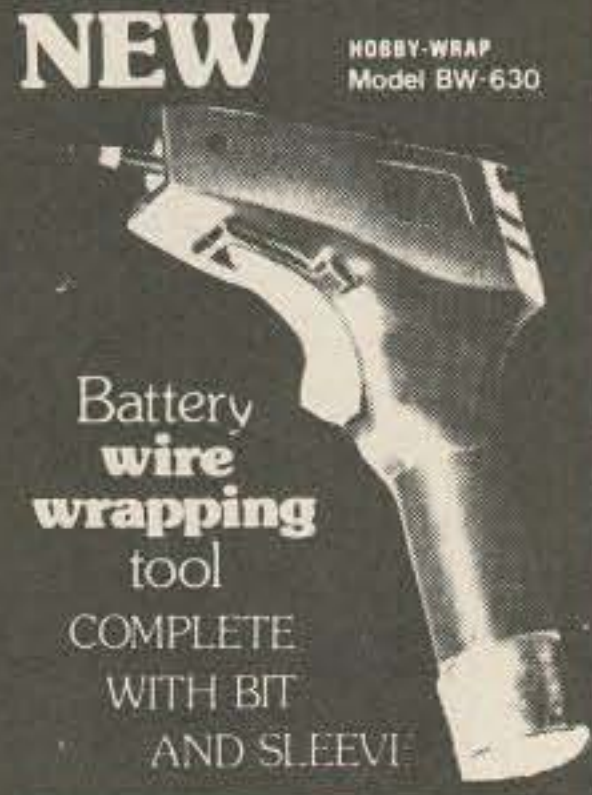

WIRE-WRAPPING TOOL

For .025" (0,63mm) sq. post "MODIFIED" wrap, positive indexing, anti-overwrapping device.

For AWG 30	BW-630	\$34.95*
For AWG 26-28	BW-2628	\$39.95*

Bit for AWG 30	BT-30	\$3.95
Bit for AWG 26-28	BT-2628	\$7.95

*USE "C" SIZE NI-CAD BATTERIES (NOT INCLUDED)



WIRE-WRAPPING KITS

Contains: Hobby Wrap Tool WSU-30, (50 ft.) Roll of wire Prestripped wire 1" to 4" lengths (50 wires per package) stripped 1" both ends.

Wire Wrapping Kit. (Blue)	WK-2-B	\$12.95
Wire Wrapping Kit. (Yellow)	WK-2-Y	\$12.95
Wire Wrapping Kit. (White)	WK-2-W	\$12.95
Wire Wrapping Kit (Red)	WK-2-R	\$12.95

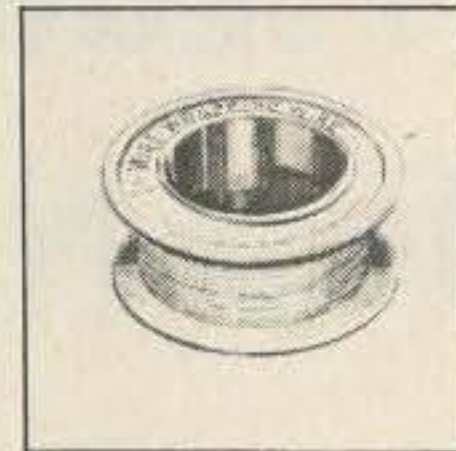

ROLLS OF WIRE

Wire for wire-wrapping AWG-30 (0.25mm) KYNAR® wire, 50 ft. roll, silver plated, solid conductor, easy stripping.

30-AWG Blue Wire, 50ft. Roll	R-30B-0050	\$1.98
30-AWG Yellow Wire 50ft. Roll	R-30Y-0050	\$1.98
30-AWG White Wire, 50ft. Roll	R-30W-0050	\$1.98
30-AWG Red Wire, 50ft. Roll	R-30R-0050	\$1.98

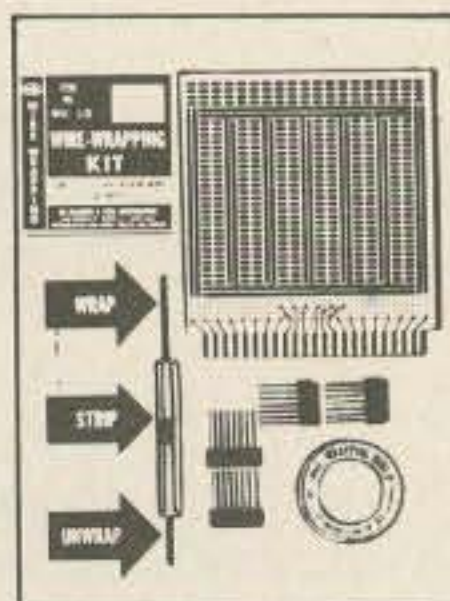

WIRE-WRAPPING KIT

Contains: Hobby Wrap Tool WSU-30, Roll of wire R-30B-0050, (2) 14 DIP's, (2) 16 DIP's and Hobby Board H-PCB-1.

Wire-Wrapping Kit	WK-3B (Blue)	\$16.95
-------------------	--------------	---------



WIRE DISPENSER

- With 50 ft. Roll of AWG 30 KYNAR® wire-wrapping wire.
- Cuts the wire to length.
- Strips 1" of insulation.
- Refillable (For refills, see above)

Blue Wire	WD-30-B	\$3.95
Yellow Wire	WD-30-Y	\$3.95
White Wire	WD-30-W	\$3.95
Red Wire	WD-30-R	\$3.95

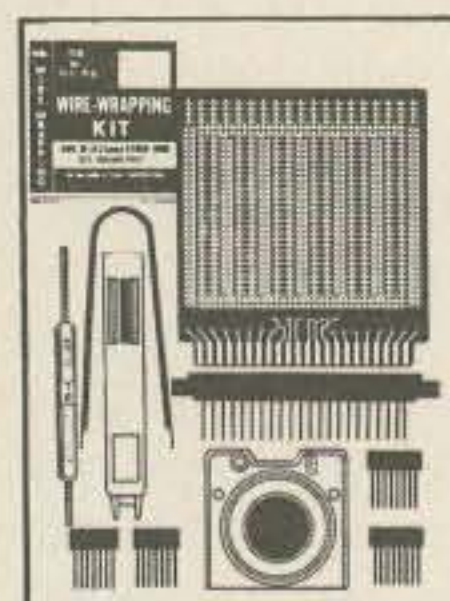

WIRE-WRAPPING KIT

Contains: Hobby Wrap Tool WSU-30 M, Wire Dispenser WD-30-B, (2) 14 DIP's, (2) 16 DIP's, Hobby Board H-PCB-1, DIP/IC Insertion Tool INS-1416 and DIP/IC Extractor Tool EX-1

Wire-Wrapping Kit	WK-4B (Blue)	\$25.99
-------------------	--------------	---------

PRE CUT PRE STRIPPED WIRE

Wire for wire-wrapping, AWG-30 (0.25mm) KYNAR® wire, 50 wires per package stripped 1" both ends.

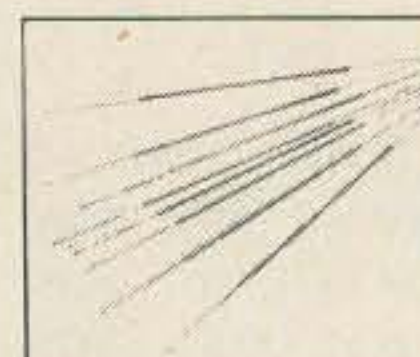

30-AWG blue Wire, 1" Long	30-B-50-010	\$.99
30-AWG Yellow Wire, 1" Long	30-Y-50-010	\$.99
30-AWG White Wire, 1" Long	30-W-50-010	\$.99
30-AWG Red Wire, 1" Long	30-R-50-010	\$.99
30-AWG Blue Wire, 2" Long	30-B-50-020	\$ 1.07
30-AWG Yellow Wire, 2" Long	30-Y-50-020	\$ 1.07
30-AWG White Wire, 2" Long	30-W-50-020	\$ 1.07
30-AWG Red Wire, 2" Long	30-R-50-020	\$ 1.07
30-AWG Blue Wire, 3" Long	30-B-50-030	\$ 1.16
30-AWG Yellow Wire, 3" Long	30-Y-50-030	\$ 1.16
30-AWG White Wire, 3" Long	30-W-50-030	\$ 1.16
30-AWG Red Wire, 3" Long	30-R-50-030	\$ 1.16
30-AWG Blue Wire, 4" Long	30-B-50-040	\$ 1.23
30-AWG Yellow Wire, 4" Long	30-Y-50-040	\$ 1.23
30-AWG White Wire, 4" Long	30-W-50-040	\$ 1.23
30-AWG Red Wire, 4" Long	30-R-50-040	\$ 1.23
30-AWG Blue Wire, 5" Long	30-B-50-050	\$ 1.30
30-AWG Yellow Wire, 5" Long	30-Y-50-050	\$ 1.30
30-AWG White Wire, 5" Long	30-W-50-050	\$ 1.30
30-AWG Red Wire, 5" Long	30-R-50-050	\$ 1.30
30-AWG Blue Wire, 6" Long	30-B-50-060	\$ 1.38
30-AWG Yellow Wire, 6" Long	30-Y-50-060	\$ 1.38
30-AWG White Wire, 6" Long	30-W-50-060	\$ 1.38
30-AWG Red Wire, 6" Long	30-R-50-060	\$ 1.38

© KYNAR-PENNWALT

MINIMUM ORDER \$25.00, SHIPPING CHARGE \$1.00, N.Y. CITY AND STATE RESIDENTS ADD TAX

OK MACHINE & TOOL CORPORATION

3455 Conner St., Bronx, N.Y. 10475 ■ (212) 994-6600 ■ Telex 125091



DIP/IC INSERTION TOOL WITH PIN STRAIGHTENER

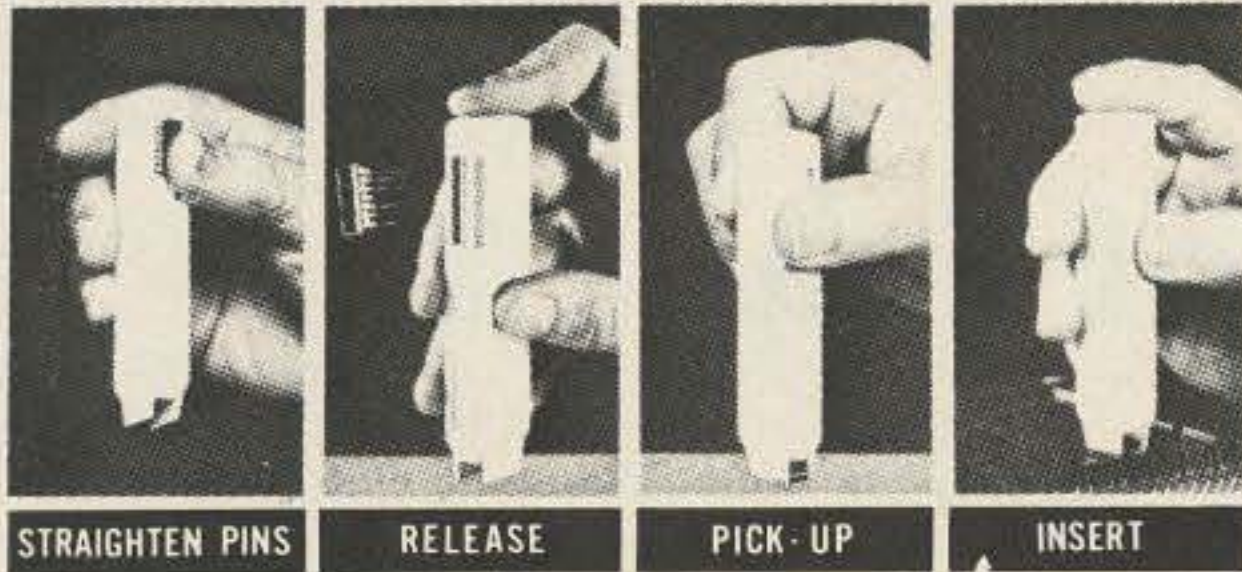

STRAIGHTEN PINS RELEASE PICK-UP INSERT

14-16 Pin Dip IC Inserter	INS-1416	\$3.49
---------------------------	----------	--------

DIP/IC EXTRACTOR TOOL

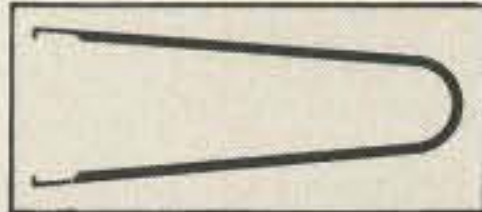

The EX-1 Extractor is ideally suited for hobbyist or lab engineer. Featuring one piece spring steel construction. It will extract all LSI, MSI and SSI devices of from 8 to 24 pins.

Extractor Tool	EX-1	\$1.49
----------------	------	--------

P.C. BOARD

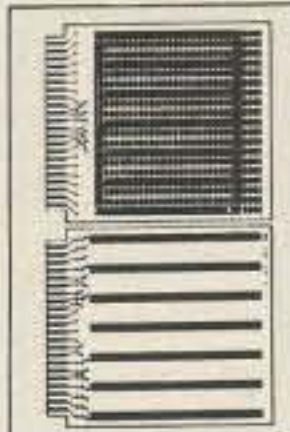

The 4 x 4.5 x 1/16 inch board is made of glass coated EPOXY Laminate and features solder coated 1 oz. copper pads. The board has provision for a 22/44 two sided edge connector, with contacts on standard .156 spacing. Edge contacts are non-dedicated for maximum flexibility. The board contains a matrix of .040 in. diameter holes on .100 inch centers. The component side contains 76 two-hole pads that can accommodate any DIP size from 6-40 pins, as well as discrete components. Typical density is 18 of 14-Pin or 16-Pin DIP's. Components may be soldered directly to the board or intermediate sockets may be used for soldering or wire-wrapping.

Two independent bus systems are provided for voltage and ground on both sides of the board. In addition, the component side contains 14 individual busses running the full length of the board for complete wiring flexibility. These busses enable access from edge contacts to distant components. These busses can also serve to augment the voltage or ground busses, and may be cut to length for particular applications.

Hobby Board	H-PCB-1	\$4.99
-------------	---------	--------

PC CARD GUIDES



TR-1 consists of 2 guides precision molded with unique spring finger action that dampens shock and vibration, yet permits smooth insertion or extraction. Guides accommodate any card thickness from .040-.100 inches.

QUANTITY - ONE PAIR (2 pcs.)

Card Guides	TR-1	\$1.89
-------------	------	--------

PC CARD GUIDES & BRACKETS

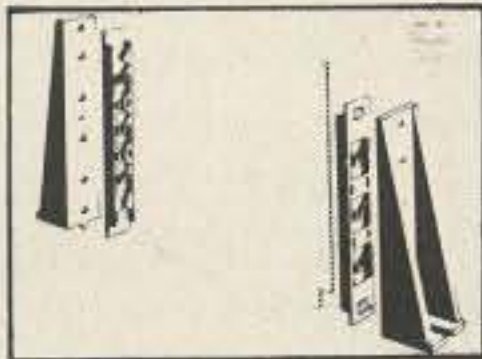

TRS-2 kit includes 2 TR-1 guides plus 2 mounting brackets. Support brackets feature unique stabilizing post that permits secure mounting with only 1 screw.

QUANTITY - ONE SET (4 pcs.)

Guides & Brackets	TRS-2	\$3.79
-------------------	-------	--------

QUANTITY - ONE SET (4 pcs.)

PC EDGE CONNECTOR

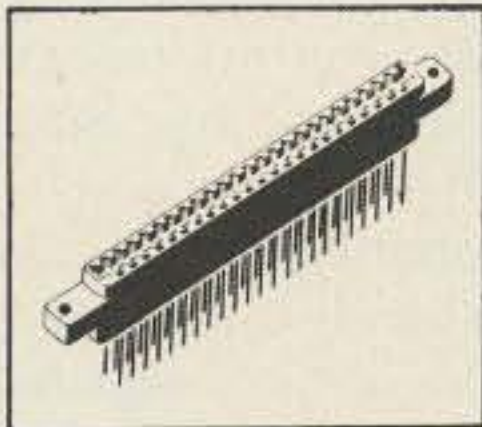

44 Pin, dual read out, .156" (3,96 mm) Contact Spacing, .025" (0,63 mm) square wire-wrapping pins.

P.C. Edge Connector	CON-1	\$3.49
---------------------	-------	--------

P.C.B. TERMINAL STRIPS

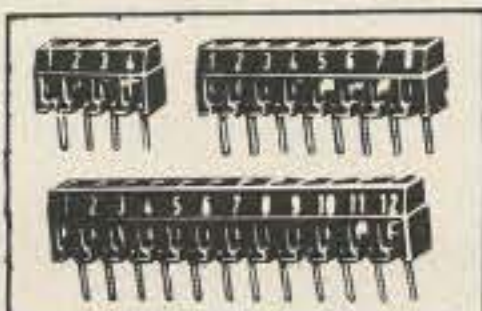

The TS strips provide positive screw activated clamping action, accommodate wire sizes 14-30 AWG (1,8-0,25mm). Pins are solder plated copper, .042 inch (1mm) diameter, on .200 inch (5mm) centers.

4-Pole	TS- 4	\$1.39
8-Pole	TS- 8	\$1.89
12-Pole	TS-12	\$2.59

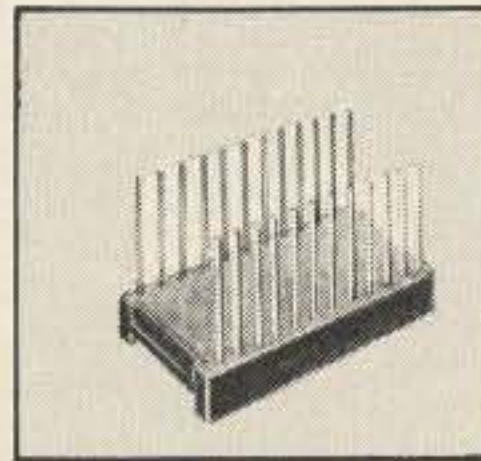

DIP SOCKET

Dual-in-line package, 3 level wire-wrapping, phosphor bronze contact, gold plated pins .025 (0,63mm) sq., .100 (2,54mm) center spacing.

14 Pin Dip Socket	14 Dip	\$0.79
16 Pin Dip Socket	16 Dip	\$0.89

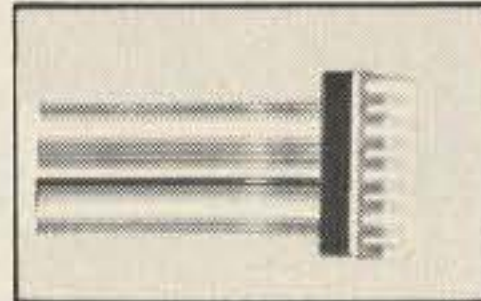

RIBBON CABLE ASSEMBLY SINGLE ENDED

With 14 Pin Dip Plug 24" Long (609mm)	SE14-24	\$3.55
With 16 Pin Dip Plug 24" Long (609mm)	SE16-24	\$3.75

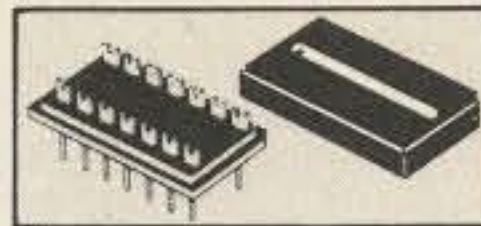

DIP PLUG WITH COVER FOR USE WITH RIBBON CABLE

14 Pin Plug & Cover	14-PLG	\$1.45
16 Pin Plug & Cover	16-PLG	\$1.59

QUANTITY: 2 PLUGS, 2 COVERS

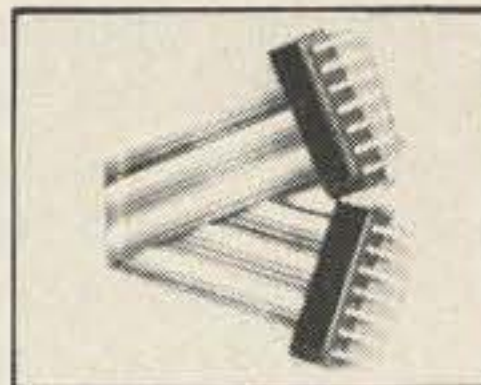

RIBBON CABLE ASSEMBLY DOUBLE ENDED

With 14 Pin Dip Plug -2" Long	DE 14-2	\$3.75
With 14 Pin Dip Plug -4" Long	DE 14-4	\$3.85
With 14 Pin Dip Plug -8" Long	DE 14-8	\$3.95
With 16 Pin Dip Plug -2" Long	DE 16-2	\$4.15
With 16 Pin Dip Plug -4" Long	DE 16-4	\$4.25
With 16 Pin Dip Plug -8" Long	DE 16-8	\$4.35

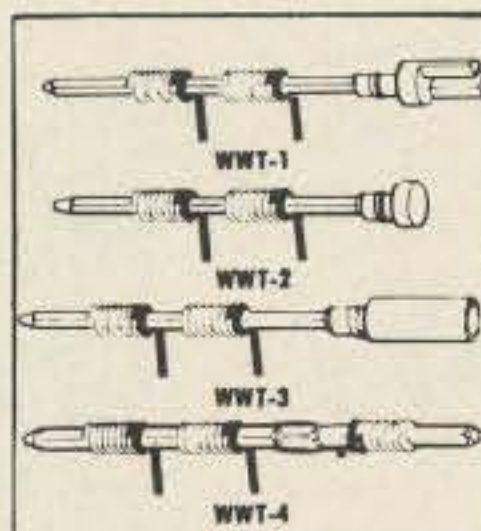

TERMINALS

- .025 (0,63mm) Square Post
- 3 Level Wire-Wrapping
- Gold Plated

Slotted Terminal	WWT-1	\$2.98
Single Sided Terminal	WWT-2	\$2.98
IC Socket Terminal	WWT-3	\$3.98
Double Sided Terminal	WWT-4	\$1.98

25 PER PACKAGE

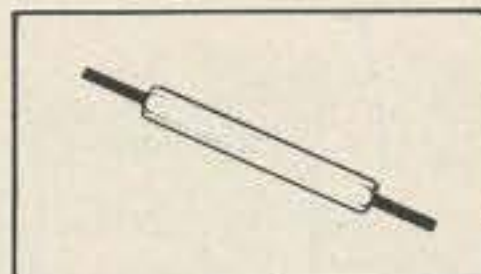

TERMINAL INSERTING TOOL

For inserting WWT-1, WWT-2, WWT-3, and WWT-4 Terminals into .040 (1,01mm) Dia. Holes.

INS-1	\$2.49
-------	--------



WIRE CUT AND STRIP TOOL

Easy to operate... place wires (up to 4) in stripping slot with ends extending beyond cutter blades... press tool and pull... wire is cut and stripped to proper "wire-wrapping" length. The hardened steel cutting blades and sturdy construction of the tool insure long life.

Strip length easily adjustable for your applications.

DESCRIPTION	MODEL NUMBER	ADJUSTABLE "SHINER" LENGTH OF STRIPPED WIRE		Price
		INCHES	TO INCHES	
24 ga. Wire Cut and Strip Tool	ST-100-24	1 1/8"	1 1/4"	\$ 8.75
26 ga. Wire Cut and Strip Tool	ST-100-26	1 1/8"	1 1/4"	\$ 8.75
26 ga. Wire Cut and Strip Tool	ST-100-26-875	7/8"	1 1/8"	\$ 8.75
28 ga. Wire Cut and Strip Tool	ST-100-28	7/8"	1 1/8"	\$11.50
30 ga. Wire Cut and Strip Tool	ST-100-30	7/8"	1 1/8"	\$11.50

THE ABOVE LIST OF CUT AND STRIP TOOLS ARE NOT APPLICABLE FOR MYLENE OR TEFLON INSULATION

MINIMUM ORDER \$25.00. SHIPPING CHARGE \$1.00. N.Y. CITY AND STATE RESIDENTS ADD TAX

OK MACHINE & TOOL CORPORATION

3455 Conner St., Bronx, N.Y. 10475 ■ (212) 994-6600 ■ Telex 125091

05

Beethoven Need Not Fear

—a little night music on the micro

Mike K. Cook G8HBR
71 Thatch Leach Lane
Whitefield, Manchester
England M2S 6EN

“Here it is,” I said to my girlfriend, while pointing at a maze of wires, switches and LEDs mounted on a piece of 1’6” x 6” wood. “It’s a microprocessor, a computer,” I added in an attempt to prevent her face from

dropping any more.

“Is that why you couldn’t take me out this last fortnight?” She scowled, and I could hear the inevitable question forming, “What does it do?”

“Well . . . er . . . anything

and everything — it makes conventional electronics totally obsolete.” That seemed to stall her for a second.

“Why isn’t it doing anything?”

“Well, that’s because I haven’t learned to drive it yet. I’ll have to find out how to play it.”

“Play it?” She sounded more enthusiastic. “Will it play tunes?”

“No, what I meant was . . . but wait a minute, that’s not a bad idea. I could, yes, perhaps a loop, raise flag . . .” I muttered to myself in totally technical terminology, leaving her even more bemused.

“So will it?” she interrupted.

“Yes, it’ll even compose its own tunes — a little electronic Beethoven.” She smiled, and I was more than a little relieved that this forty-legged beast was not going to ruffle the course of true love.

And that’s how I started playing tunes on my microprocessor system.

I’ll briefly describe the system. Hobby computers are unknown in England. Nothing (at the time of this writing) is available commercially in this country, so, if you want anything, you have to make it yourself. Being a student, I couldn’t afford anything fancy. After a brief look around the stockist’s, I decided to buy a Signetics 2650 microprocessor. It had a single voltage rail, a single-phase clock (you can stop the clock), separate sense, and flag input/output. The whole unit was TTL compatible, so it required no expensive data bus buffering. The outputs were latched and brought to eight LEDs. I used 256 x 8 bits of memory, and I programmed it by switching the inputs to the RAM, writing up the word on the switches, and pressing a “write in memory” button. When the program is entered, the memory is switched over to the microprocessor, and the program runs. When an input is required, the micro-

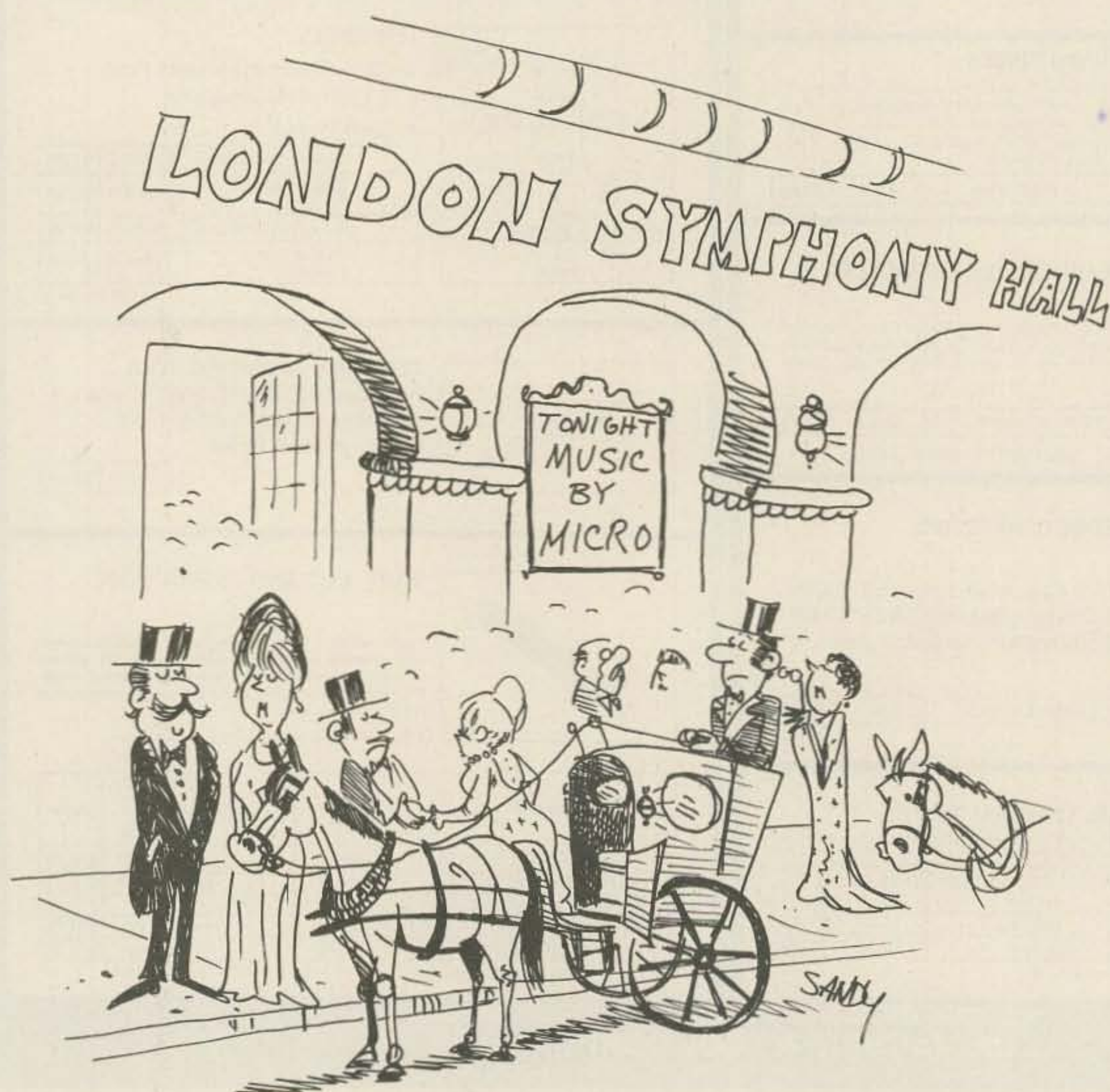

processor stops until a "continue" button is pressed, indicating valid data on the input switches. It's not the most sophisticated of setups, but it will do for a start!

So, armed with this system, I set to work. I will not detail the listings of my program here, as 2650 machine code is not everybody's idea of a barrel of laughs. The flow diagrams and description should enable anyone to program the machine, and, if you are running BASIC, they will be very short when compared with the machine language. As I mentioned before, the Signetics 2650 has a flag output, which is a single-bit latched output, and this was used for early experiments, although one of the data bus outputs could do.

The Fundamental Techniques

To produce a single tone, a software delay loop is used. When completed, the flag is raised (a "1" is put on the output), and the delay loop is entered again; when completed, the flag is lowered. The delay is caused by loading a number into a register and de-incrementing the register until it is empty. The length of the delay and, hence, the frequency of the note produced are dependent upon the number loaded and the clock frequency of the microprocessor. The Signetics 2650 is a static device, that is, the clock will work down to dc. This gives great flexibility in producing a variety of outputs. In the delay loop, dummy operations can be placed to take more time, thus making longer delays; in my case, there is a "no operation" instruction which takes up two machine cycles or six clock cycles. With a crystal-controlled clock, the number of clock cycles in the loop can be calculated to give an exact frequency.

Well, a single tone is not going to satisfy anybody for very long. So the next step was to make the number loaded into the delay loop

programmable from the input switches. You now have 356 tones to play with. As they are not on any chromatic scale, some of them don't sound all that good. Also, some will be spaced so close together that there will be little audible difference between them. But it's a start, and you can work out what number loaded into the delay will give what note. Once you have a feel for this, you can start working on your first computer tune. The problem is that the number fed into the delay loop must be changed every few seconds. This can be done by using the interrupt. An external oscillator is used to fire the interrupt. When interrupted, the microprocessor will select a number from a pre-programmed "lookup" table and use it to make a tone until it is next interrupted. If the interrupt oscillator is set at about 1 Hz, simple tunes can be produced.

If a long note is needed, the same note is put in the lookup table several times. The way to implement a lookup table will vary depending upon the language you are going to use, but they are all simple and follow the basic form of code-conversion routines used in most systems. A number can be used that is decoded by the program as a blank. When the number is taken out of the lookup store, it is tested, and, if it is the specified one, the

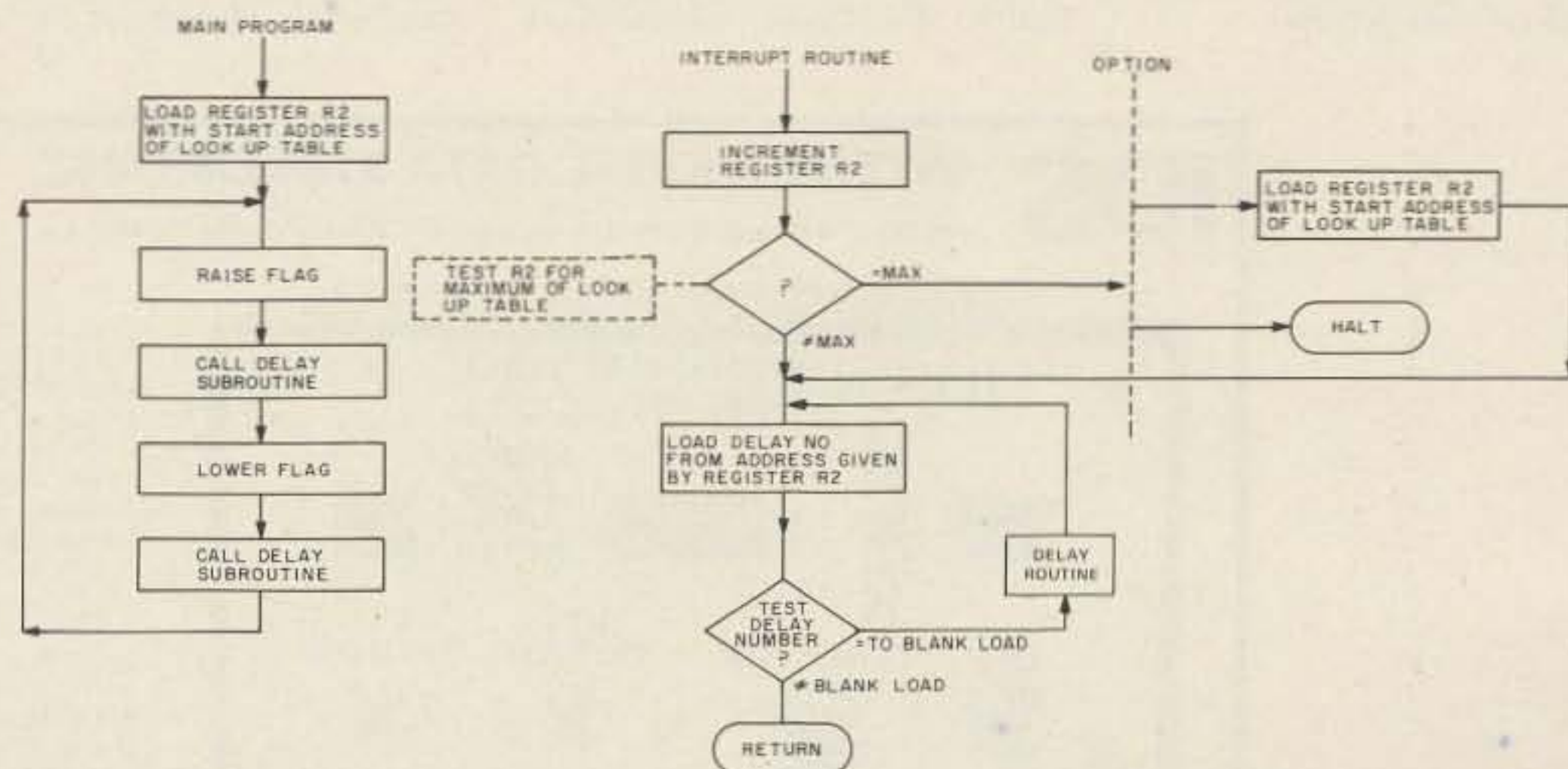

Fig. 3. Program to produce a simple tune. The option in the interrupt routine will produce a single or a repetitive tune.

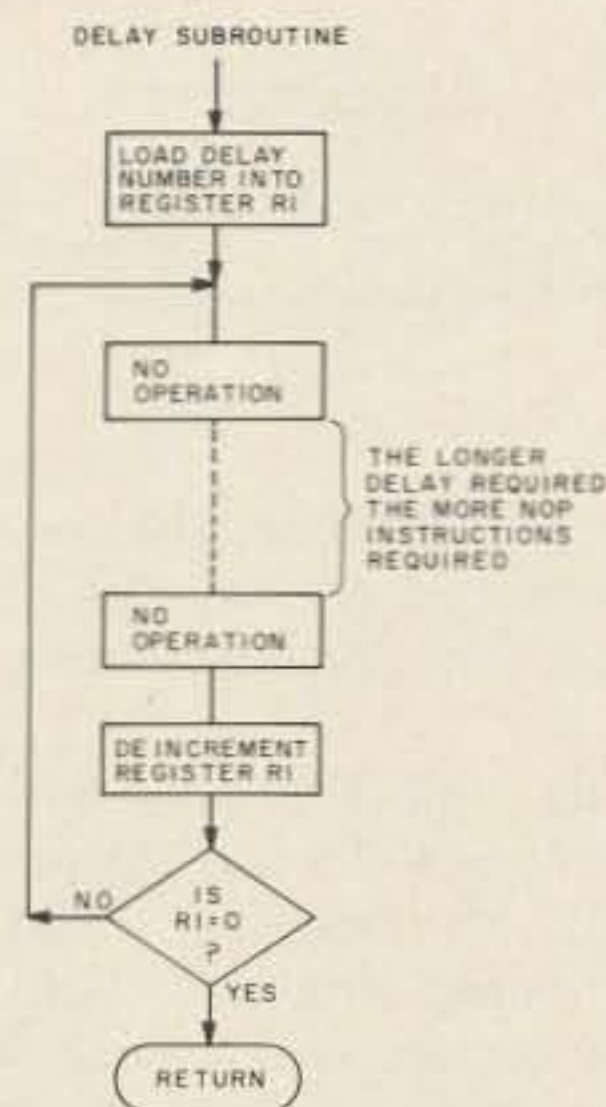

Fig. 1. Delay subroutine.

program will halt or go into a loop with no raising or lowering of the flag. The lookup table can be set to scan once and stop or to scan continuously, thus producing a repetitive tone. I reckon I have the first microprocessor that plays "God Save the Queen." Who will be the first to produce "The Star-Spangled Banner?"

A Different Approach

Having given my girl this toy to play with, I was hard put to get time on my own machine. (Have you ever heard a piano and microprocessor duet?) But, in the times I could get on it, I had another idea: Dispense with the interrupter (for the time being), and get the microprocessor to produce its own tune. I could take the numbers for conversion into tones not from a lookup

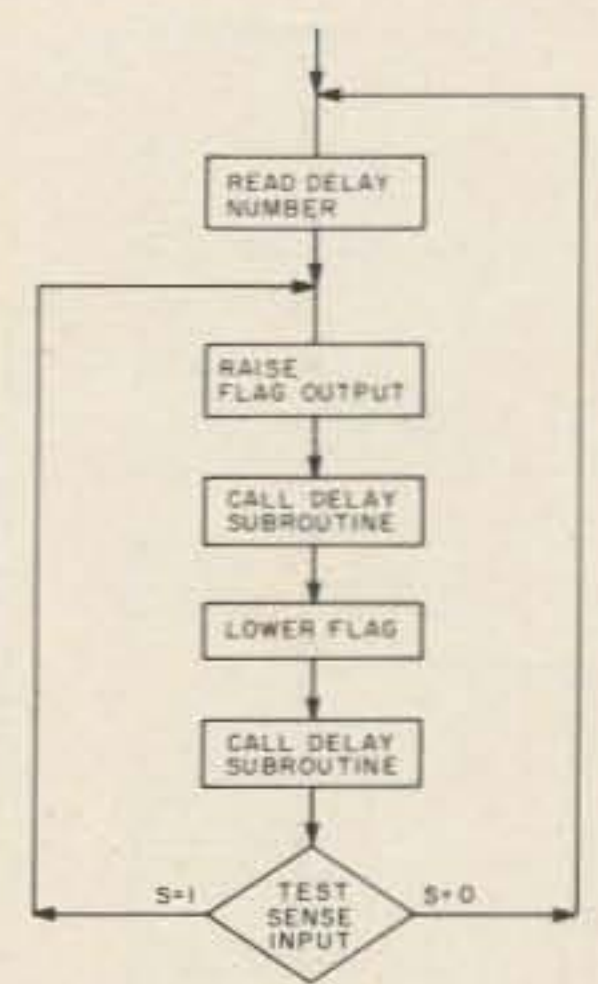

Fig. 2. Simple tone-producing program. The tone produced by any number read in will be continually produced until the sense input is switched to "0". The program will then accept another number. In this way, you can see which numbers produce which notes.

table, but from the program that generates the tones itself. This means that the microprocessor is playing its own instructions — a sort of autobiography! I also said dispense with the interrupt oscillator, so what do you replace it with? If the output is counted and a new number put in the delay loop every 256 cycles, then low notes will appear to last a long time and the high notes for a very short time. The program was worked out and loaded by hand (about forty instructions) and run. The results were rather surprising. It sounded like a computer. The low notes, on for a longer

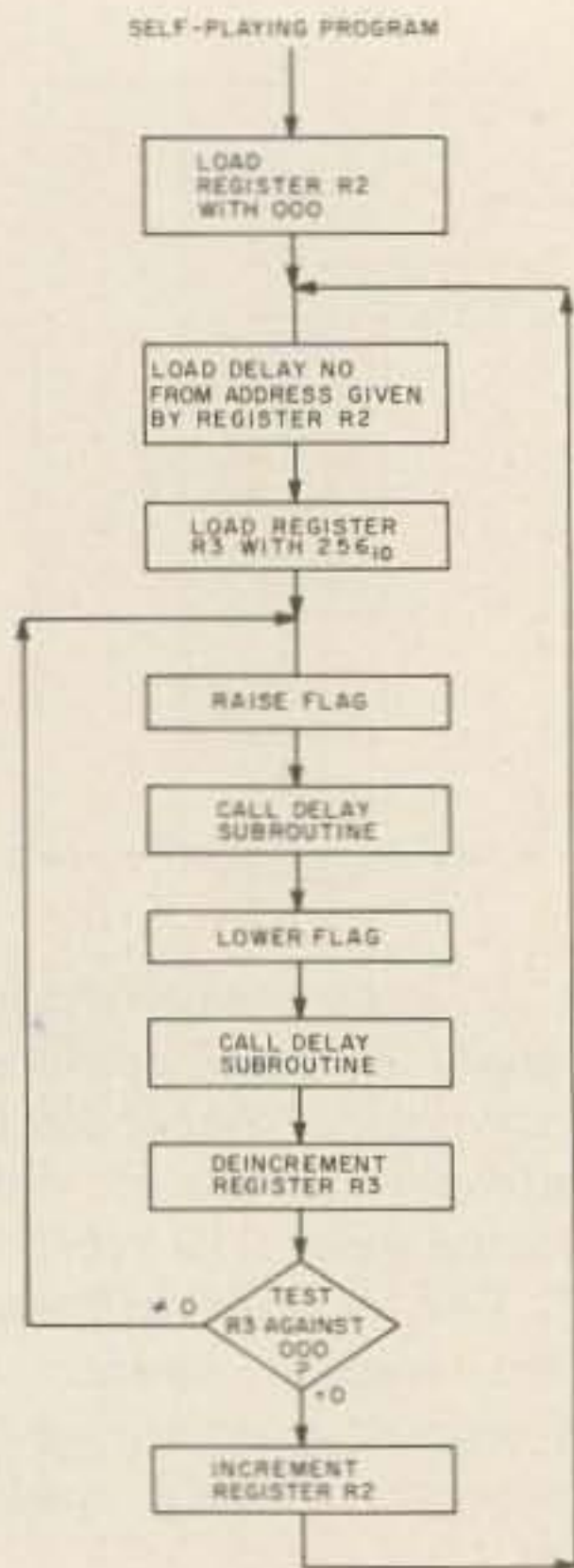

Fig. 4. Self-playing program.

time, sounded like a rhythmic base accompaniment, while the shorter high notes sounded like virtuoso improvising. The interesting thing was that, although I knew there was only one note being produced at a time (only one output), it sounded as if two instruments were playing together. The base-like rhythm seemed to be "continued." This program universally met with the reaction, "Well, it sounds like a computer, even though it doesn't look like one!" Since most of these critics had never seen or heard a computer, I don't know how they knew.

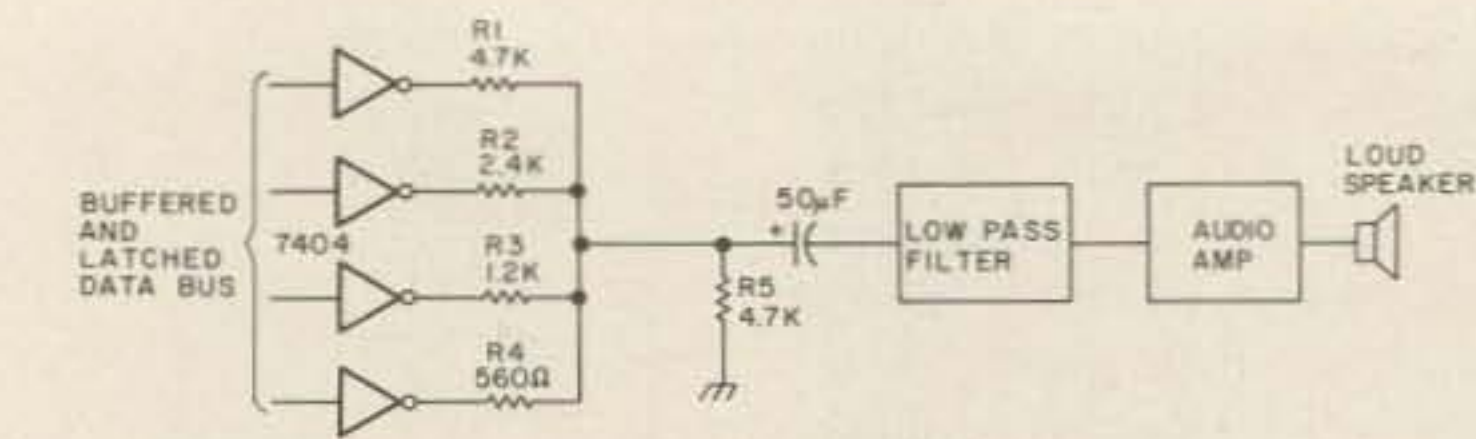

Fig. 5. Circuit of D/A converter for producing different audio waveforms. The low-pass filter may not be required in certain applications or if a constant frequency whine is tolerable.

By now I'd really gotten the bug, and I was asking all sorts of questions: "Can a computer sing the blues?" Not content with a single flag output, I turned to the data bus. Here I could have up to eight different square waves generated at once, but, by then, I was beginning to think, "Can we get a different noise out of this machine?" So I made a simple digital-to-analog converter and brought back the interrupt oscillator.

The Hardware

The digital-to-analog converter is very simple. I chose to have a 4-bit one, since I could make it out of junk box resistors and have two on the data bus. It works quite simply. The output of the data bus is latched and buffered. Then it is passed through resistors R1-4 to a summing resistor, R5. The voltage on R5 depends on the logic levels on R1-4. With the values shown, a different voltage will be produced for each combination of inputs, that is, 16 different levels. The idea is to change the output every 0.1 ms or so. Here again, the delay program is

used to produce an output at regular intervals. The time of the delay will determine what frequency whine will be produced, as well as the note. The frequency of the whine will be the same as the delay time. This can sound quite alright when the microprocessor is playing one of its own compositions, but it can be a bit annoying if it is playing a tune. This can be eliminated by placing a low-pass filter between the output on R5 and the audio amplifier. This will cut off the whine and let the notes you are creating come through.

If the register that is outputted is incremented, a sawtooth waveform will be produced as the counter ramps up to a maximum and then, on the next count, is zero. If a software instruction detects the presence of a maximum number and then causes it to de-increment, a triangle waveform can be produced. The frequency can be altered by not incrementing every time, but every other time. You can now produce even a sine wave, if you have trig function subroutines on your machine. However, produc-

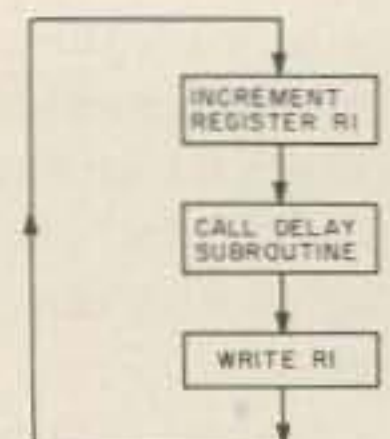

Fig. 6. Simple program to produce a sawtooth waveform. The sawtooth frequency will be given from 16 times the delay time.

tion of tunes by this method is more difficult than in the earlier case. I found that each note required its own subroutine to produce it, which means that you need seven subroutines for a scale. However, it also means that you can have different sounds of notes, as well as frequencies, in a tune.

Where this method scored was in computer compositions. They really were quite good! To gain even more flexibility, an 8-bit D/A converter would be ideal, and I am saving up for one of those.

Finale

Having now gained approval for my little pet, whenever it is not singing to me, I try to do some work with it on what I originally intended it for — applications around my ham shack. But what is this? "Yes, dear, it can do most things. Yes, it can play games on TV, not just Ping-Pong™; no, other games, too. Well, perhaps I could just . . ." Oh no, here we go again! ■

IDS INTERNATIONAL DATA SYSTEMS, INC. Telephone
400 North Washington Street, Suite 200, Falls Church, Virginia 22046 U.S.A. (703) 536-7373

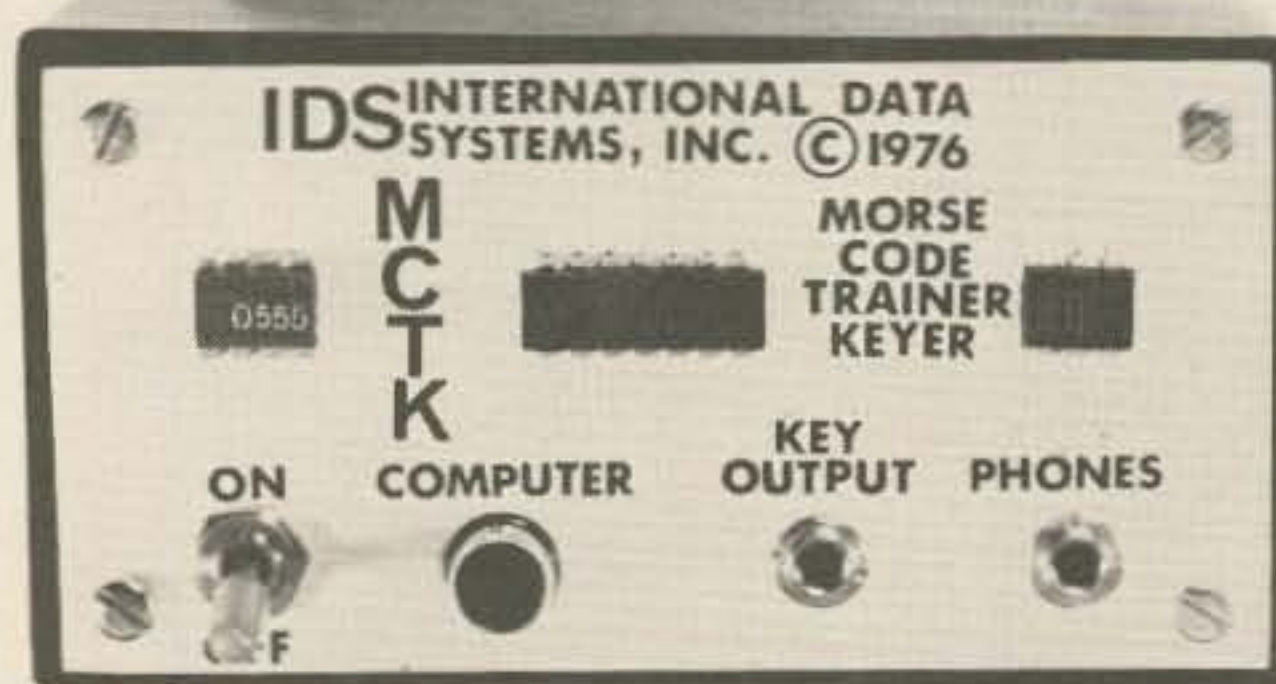

MORSE CODE TRAINER/KEYER! The MCTK is a hardware/software package which allows your computer to TEACH Morse Code, key your transmitter, and send prestored messages. Uses "New Code Method" for Morse training. The MCTK is optically isolated from your computer and is also mechanically isolated from your transmitter! BASIC programs are included written in MITS BASIC, PICO BASIC5, and North Star BASIC. Kit Price \$29.00. Delivery is from stock.

110

Write or call for detailed product brochures. Many other items available. Payment with order shipped prepaid. Master Charge.

MS-15 MINISCOPE \$289.00 MS-15 MINISCOPE



SC-5
With Rechargeable Batteries & Charger Unit **\$89**

FM-7
With Rechargeable Batteries & Charger Unit **\$195**

Features include: • By using the new NLS SC-5 Prescaler, the range of the FM-7 Frequency Meter, which is 10 Hz to 60 MHz, may be extended to 512 MHz (the upper VHF & UHF frequency bands). • The FM-7 utilizes an LED readout, providing 7-digit resolution. • The FM-7 can be calibrated to an accuracy of 0.00001%. • The SC-5 is accurate to one part per million. • Each unit has 30 millivolts sensitivity, is battery powered and has a charger unit included. • Dimensions of each are 1.9" H x 2.7" W x 3.9" D. • The units may be obtained separately or as a "Frequency Duo." • Parts & Labor guaranteed 1 year.

Tilt stand option..... **\$ 3.50**
Leather case..... **\$16.00**

MS-15 MINISCOPE \$289
With Rechargeable Batteries & Charger Unit



• 15 megahertz bandwidth.
• External and internal trigger.
• Time base — .1 microsec. to 0.5 Sec/div - 21 settings, ± 3%.
• Battery or line operation.
• Automatic & line sync modes.
• Power consumption < 15 watts.
• Vertical Gain — .01 to 50 V/div - 12 settings ± 3%.
• Viewing area 1.1" x 1.35".
• Case size 2.7"H x 6.4"W x 7.5"D, 3 pounds.
• Parts & Labor guaranteed 1 year.
• 10 to 1, 10 meg probe..... **\$24.50**
• Leather carrying case..... **\$30.00**

NEW VOLKSMETERS!
With LCD Display—
Excellent Readability in Direct Sunlight!



10% LM-300
Full three digits **\$99.50***

0.5% LM-350
3 1/2 digits **\$125.00***

FEATURES

- Measures DC volts, AC volts, ohms and current.
- Automatic polarity, decimal and overload indication.
- No zero adjustment and no full scale ohms adjust.
- Large LCD display for easy reading without interpolation.
- Size: 1.9" H x 2.7" W x 4.0" D.
- Parts and labor guaranteed for one year.

SPECIFICATIONS

MODE	RANGE	ACCURACY 1% (100)	ACCURACY 0.5% (100)	DEFLECTION	INPUT RESISTANCE	TEST CURRENT
MULTI DC*	10	±0.5%	±0.2%	100°	10 MΩ	
	100	±0.5%	±0.2%	100°	10 MΩ	
	1000	±0.5%	±0.2%	100°	10 MΩ	
MULTI AC*	10	±0.5%	±0.2%	100°	10 MΩ	
	100	±0.5%	±0.2%	100°	10 MΩ	
	1000	±0.5%	±0.2%	100°	10 MΩ	
RESISTANCE*	10	±0.5%	±0.2%	100°	10 MΩ	1 mA
	100	±0.5%	±0.2%	100°	10 MΩ	1 mA
	1000	±0.5%	±0.2%	100°	10 MΩ	1 mA
CURRENT	1 mA	±0.5%	±0.2%	100°	10 MΩ	1 mA
	10 mA	±0.5%	±0.2%	100°	10 MΩ	10 mA
	100 mA	±0.5%	±0.2%	100°	10 MΩ	100 mA

Tilt Stand Option, add **\$3.50**
Leather Case **\$16.00**
3AA NiCad-Batts. & Charger **\$12.00**

Standard AA-size batteries provide up to 20 hours of operation. Rechargeable NiCad batteries and charger unit available as optional equipment. *Batteries not included.

LEDU MG 10A
List \$72.00



Perfectly balanced, fluorescent lighting with precision magnifier lens. For prof'l, techni & hobbyist. Has die cast protective shade, inst. start 3 diopter lens, 42" reach.

\$44.95 SPECIAL

with 7.5 fluorescent lamp (required) **\$48.95**
Colors: Gray or Black
Chromium Brown
2 choices please

• 15 megahertz bandwidth.
• External and internal trigger.
• Time base — .1 microsec. to 0.5 Sec/div - 21 settings, ± 3%.
• Battery or line operation.
• Automatic & line sync modes.
• Power consumption < 15 watts.
• Vertical Gain — .01 to 50 V/div - 12 settings ± 3%.
• Viewing area 1.1" x 1.35".
• Case size 2.7"H x 6.4"W x 7.5"D, 3 pounds.
• Parts & Labor guaranteed 1 year.
• 10 to 1, 10 meg probe..... **\$24.50**
• Leather carrying case..... **\$30.00**

PROBE 1¢ with the purchase of SCOPE and the MENTION of this MAGAZINE

8803 MOTHER BOARD FOR \$100 BUS MICRO-COMPUTERS



• Kit includes 12 tantalum capacitors for +5, +12, -12 buses and insulated mounting spacers.
• Wiring side shown. Component side bare epoxy glass with white markings for component locations.
• 670 epoxy glass board with 2 surge capacitor, laser plated and .038 diameter holes for leads.
• Solder mask with solder windows on etched circuits to avoid accidental short circuits.
• Mounts 11 receptacles with 100 contacts (2 rows) on .125 centers with .250 row spacing. Vector part number R881-2, or mounts 10 receptacles plus interconnections to smaller mother board for expansion.
• Includes etched circuits and instructions for option of active, pull-up, or floating terminations.
• Large buses: +5V and GND (10 AMP), ±12V or 16V (7 AMP). Current ratings are per MIL-STD-275 with 10PC rule.
• Fits in Vector pak enclosures.
• Fits in IMSAI 8800 microcomputer as expansion board.

Price: \$29.50

Vector Plugboards



8800V
Universal Microcomputer/processor plugboard, use with S-100 bus. Complete with heat sink & hardware. 5.3" x 10" x 1/16"

1-4	5-9	10-24
\$19.95	\$17.95	\$15.95

8801-1
Same as 8800V except plain, less power buses & heat sink.

1-4	5-9	10-24
\$14.95	\$13.45	\$11.95

3677 9.6" x 4.5"
\$10.90

3677-2 6.5" x 4.5"
\$9.74

Hi-Density Dual-In-Line Plugboard for Wire Wrap with Power & Grd. Bus Epoxy Glass 1/16" 44 pin con. spaced .156

3662 6.5" x 4.5"
\$7.65

3662-2 9.6" x 4.5"
\$11.45

Gen. Purpose D.I.P. Boards with Bus Pattern for Solder or Wire Wrap. Epoxy Glass 1/16" 44 pin con. spaced .156

R644 P.C. receptacle 22/44 cont.
156 chs. pierced solder eyelets tails gold **\$3.45**

R644-3 P.C. receptacle 22/44 cont.
156 chs. Wire Wrap tails gold **\$4.49**

S-100 Bus P.C. Edge Connectors

R681 DIP solder tails on .140" spaced rows for ALTAIR mother boards. Fits .042" dia holes, gold **\$7.35**

R681-1 .025" sq., 3 wrap lengths posts (.62 long) on .250 spaced rows, gold. **\$5.00**

R681-2 .025" sq., 1 wrap length posts (.22 long) on .250 spaced rows for wrapping or DIP solder for IMSAI mother boards, gold. **\$5.85**

R681-3 pierced solder eyelet tails, gold. **\$7.35**

1/16" Vector BOARD
.042 dia holes on 0.1 spacing for IC's

Phenolic

PART NO.	SIZE	PRICE
64P44-062XXP	4.5 x 6.5"	\$ 1.49
169P44-062XXP	4.5 x 17"	\$ 3.51

Epoxy Glass

PART NO.	SIZE	PRICE
64P44-062	4.5 x 6.5"	\$ 1.70
84P44-062	4.5 x 8.5"	\$ 2.10
169P44-062	4.5 x 17"	\$ 4.30
169P84-062	8.5 x 17"	\$ 6.39

SLIT-N-WRAP
Wraps insulated wire on .025" square posts **FOUR TIMES FASTER** than regular manual wrap post tools.



\$24.50

P180 with two 100' spools of 28 ga. wire **\$75.00**

P160-4T includes charger, wire **\$75.00**

NO PRE-STRIPPING*
NO PRE-CUTTING*
SPOOL-FED WIRE*

*The spooled wire passes through the tool past a sliding edge next to the wrap post. A narrow longitudinal cut is made in the insulation where it presses the square post corner. The bare copper is centered by the sharp edge (17 burrless .08 contact).

*Houston is 0.015" wire wrapped tool not broken terminal post, when not straight out of the tool.

SLIT-N-WRAP WIRE
NO. 28 GAGE INSULATED WIRE, 100' SPOOLS

W28-2-A-Pkg. 3. Clear W28-2-C-Pkg. 3. Clear W28-2-B-Pkg. 3. Red W28-2-D-Pkg. 3. Blue

2708 8K 450 ns

EPROM FACTORY PRIME

1-9	\$12.00
10-24	\$11.50

25 + Call for Price

14 & 16 PIN 3 LEVEL WIRE WRAP SOCKETS

14-T3 100 for	\$30.00
16-T3 100 for	\$30.00
50 of ea. for	\$32.00

ACE • All- for fast, solderless, circuit plug-in circuit building Evaluator and testing

Just plug in any components with leads to .032" dia. Interconnect with solid wire up to 20 ga. Assembled models tool

ACE Model No.	Ta Pins	SP Capacity	Ma Pins	Board Size (inches)	Price Each
200-K (kit)	728	8 (16 x 1)	2	4-9/16 x 5-9/16	\$18.95
208 (assem.)	877	8 (16 x 1)	8	4-9/16 x 5-9/16	\$8.95
201-K (kit)	1032	12 (14 x 1)	2	16 x 7	\$4.95
212 (assem.)	1224	12 (14 x 1)	8	4-9/16 x 7	\$4.95
218 (assem.)	1760	18 (14 x 1)	10	6-1/2 x 7-1/8	\$6.95
227 (assem.)	2712	27 (14 x 1)	28	8 x 9-1/4	\$9.95
236 (assem.)	3648	36 (14 x 1)	36	4 10-1/4 x 9-1/4	\$9.95

Gold plated aluminum baseboard, non-conductive end stop terminals, 4 rubber feet.

SALE

LIQUID CRYSTAL DIGITAL CLOCK-CALENDAR

- For Auto, Home, Office
- Small in size (2x2 1/2 x 1 1/2)
- Push button for seconds release for date.
- Clocks mount anywhere with either 3M double-sided tape or VELCRO, included.
- 2 MODELS AVAILABLE:
LCD-101, portable model runs on self-contained batteries for better than a year.
LCD-102, runs on 12 Volt system and is back-lighted.
- LCD-101 or LCD-102 your choice **\$34.95..**
- Clear desk stand for **\$2.00**



3 LEVEL GOLD WIRE WRAP SOCKETS

	1-24	25-49	50-99
8 pin	.47	.42	.37
10 pin	.45	.41	.37
14 pin	.39	.38	.37
16 pin	.43	.42	.40
18 pin	.75	.68	.62
22 pin	1.00	.97	.95
24 pin	1.00	.94	.75
28 pin	1.09	.98	.84
36 pin	1.59	1.45	1.30
40 pin	1.49	1.39	1.29

Vector MICRO-KLIP for .042 dia. holes (all boards on this page)

T42-1 pkg. 100 **\$ 1.50**
T42-1 pkg. 1000 **\$11.00**
P-149 hand installing tool **\$ 2.03**

.8" LED ALARM CLOCK

12 hr. LED Alarm Clock uses 3 1/2 digit .8" LED Display with AM/PM indicators and colors. Direct drive. PIN to PIN interface with **\$1998A** I.C. Just add switches, AC Supply, Alarm, Display and I.C. only.

\$7.95 or 2/\$15.00

Price Breakthrough! \$17.95

MA1003 CAR CLOCK

Bright Green Fluorescent Display Crystal Time Base Assembled, just add switches and 12 VDC.

SPECIAL

14CS2 100 for \$14.00
16CS2 100 for \$16.00
14 pin CS2 10 for \$2.00
16 pin CS2 8 for \$2.00

These low cost DIP sockets will accept both standard width plugs and chips. For use with chips, the sockets offer a low profile height of only .125" above the board. These sockets are end stackable.

WRAP POST for .042 dia. holes (all boards on this page)

T-44 pkg. 100 **\$ 2.28**
T-44 pkg. 1000 **\$14.00**
A-13 hand installing tool **\$ 2.80**

PRIORITY ONE ELECTRONICS

10031C Woodley Ave. Sepulveda CA. 91343

Terms: VISA, MC, BAC, check, Money Order, C.O.D., U.S. Funds Only CA residents add 6% sales tax. Minimum order \$10.00. Orders less than \$75.00 include 10% shipping and handling, excess refunded. Just in case please include your phone no. "Sorry, no over the counter sales" Good thru June 15, 1978

Send for our latest brochure. phone orders welcome (213) 893-8202 OEM and Institutional inquiries invited.

24 PIN DIP PLUGS WITH COVERS

3 / \$1.00
40 / \$10.00

MS-15 MINISCOPE \$289.00

MS-15 MINISCOPE \$289.00

MS-15 MINISCOPE \$289.00

Hex Converter For True-Blue Octalists

— BASIC program

There are many good programs around to do an exhaustive memory test or other utility-type function. I am usually anxious to try all of them.

More often than not, these programs are listed in hexadecimal. This causes a small delay while I manually convert them to octal, since mine is an octal machine. In-

variably, the first time I key in the program, it does not work.

My first reaction (refusing to accept my own fallibility) is to conclude that the maga-

zine must have printed it incorrectly. On the off chance that I might have made an error, I next check to see that I keyed it in correctly. Alas! I find an error, correct it, and run it again. You guessed it! It still doesn't work. As a last resort, I check my conversion to octal (a tedious process at best). Normally, this also turns up at least one error.

Frequently, an hour or more may have passed before the first successful execution. Sometimes, at this point, I no longer care.

I can think of no way to avoid errors in keying in the octal data, other than taking greater care. However, I have written a program to do the conversion from hexadecimal to octal. This reduces the probability of error in one area, at least.

The program to do the conversion is shown in Fig. 1. The operation of the program is very simple: You will first be asked the starting address and base in which it is given. Any base from 2 to 16 may be specified, but you will probably want to use 8 or 16. Next, you input the hexa-

```

0 ' PROGRAM:      HEXOCTAL
  WRITTEN:      MAY, 1977
  WRITTEN BY:   IRWIN DOLINER

  ** INITIALIZE SYSTEM **

10 CLEAR(2000)
20 H9=INT((FRE(0)-400)/4)
30 DIMH$(H9),C$(15)
40 FORI=0TO15:READC$(I):NEXTI

  ** GET ADDRESS AND DATA TO BE CONVERTED **

100 PRINT"STARTING ADDRESS,BASE";INPUTN$,B$
110 D=B9:GOSUB2000
120 A=N
130 PRINT"INPUT HEX DATA"
140 FOR H=0TOH9
150 INPUTH$:IFLEFT$(H$,1)="S"GOTO300
160 IF LEN(H$)=2*INT(LEN(H$)/2) GOTO 190
170 PRINT"NOT VALID HEX BYTES"
180 GOTO 150
190 GOSUB3000
200 NEXTH

  ** PRINT HEXADECIMAL AND OCTAL LISTING **

300 PRINT:PRINT:PRINT"---HEX---  ---OCTAL---"
310 PRINT"ADDR  INST  ADDR  INST"
320 PRINT"====  ===  ===  ==="
330 PRINT
340 F$=""
350 D=16:B=8
360 FOR C=0TOH-1
370 N$=H$(C):GOSUB2000:GOSUB1000
380 O$=P$
390 B=16
400 N=A:GOSUB1000
410 O$=P$
420 B=8
430 GOSUB1000
440 A=A+1
450 IFLEN(P$)<3THENP$="0"+P$:GOTO450

460 IFLEN(O$)<3THENO$="0"+O$:GOTO460
470 PRINTUSINGF$;Q$,N$,P$,O$
480 NEXTC
490 GOTO4010

  ** CONVERT FROM DECIMAL TO BASE B **

1000 P$=""
1010 I=0
1020 J=N
1030 K=INT(J/B)
1040 I=J-B*K
1050 P$=C$(I)+P$
1060 J=K
1070 IFJ>0GOTO1030
1080 RETURN

  ** CONVERT FROM BASE B TO DECIMAL **

2000 L=LEN(N$):M=1:N=0
2010 FORI=1TOL
2020 R$=MID$(N$,L-I+1,1)
2030 FORJ=0TOD-1
2040 IFR$=C$(J)GOTO2070
2050 NEXTJ
2060 PRINT"INVALID CHARACTER IN ";N$:STOP
2070 N=N+J*M
2080 M=M*D
2090 NEXTI
2100 RETURN

  ** SPLIT HEX DATA INTO TWO CHARACTER LONG STRINGS **

3000 H$(H)=LEFT$(H$,2)
3010 IFLEN(H$)<3THENRETURN
3020 H=H+1
3030 H$=RIGHT$(H$,LEN(H$)-2)
3040 GOTO3000

  ** RESTORE SYSTEM **

4000 DATA 0,1,2,3,4,5,6,7,8,9,A,B,C,D,E,F
4010 CLEAR(200):END
OK

```

Fig. 1.

```

RUN
STARTING ADDRESS,BASE? 10,16
INPUT HEX DATA
? 1455FF123456ABCDEF11
? S

---HEX--- --OCTAL---
ADDR INST ADDR INST
=====
10 14 020 024
11 55 021 125

```

Fig. 2.

decimal data. You may enter it as a single string (up to 254 characters long) or in several smaller strings. The only limitation is that the length of the string be even (representing whole bytes).

When done, you enter "S" on the next prompt. Figs. 2 and 3 show two ways of entering the same hex data, and the resultant output.

```

12 FF 022 377
13 12 023 022
14 34 024 064
15 56 025 126
16 AB 026 253
17 CD 027 315
18 EF 030 357
19 AA 031 252
1A 12 032 022
1B 34 033 064
1C AC 034 254
1D DF 035 337
1E 11 036 021
OK

```

```

RUN
STARTING ADDRESS,BASE? 20,8
INPUT HEX DATA
? 1455
? FF
? 1234
? 56AB
? CD
? EF
? AA1234
? ACDF
? 11
? S

---HEX--- --OCTAL---
ADDR INST ADDR INST
=====
10 14 020 024
11 55 021 125
12 FF 022 377
13 12 023 022
14 34 024 064
15 56 025 126
16 AB 026 253
17 CD 027 315
18 EF 030 357
19 AA 031 252
1A 12 032 022
1B 34 033 064
1C AC 034 254
1D DF 035 337
1E 11 036 021
OK

```

Fig. 3.

The program will print the address and data in both hexadecimal and octal, in one byte increments. This allows

double-checking the hexadecimal data before the tedious job of keying in the octal. ■

In the August, 1977, issue of *Kilobaud*, there was a short article on a tone generator for a microprocessor. While the idea is great and the circuit is simple, \$7.95 for the DIP-alarm seems a bit steep. While it is probably best for the software freaks, it can be done less expensively by using junk box parts. See Fig. 1. While it isn't all that original, it is different from a lot of keyed 555 tone generators. I have often noticed with distress that people enable a 555 by grounding pin 1. Pin 4 is actually labeled "enable," and this circuit makes use of it. The transistor acts as an inverter to make things compatible with the information in the article mentioned above.

Perhaps the easiest method of construction would be to find a junked transistor radio and use the speaker and case from it. This would save you having to go to the trouble of mounting the speaker in some other box along with the extra trouble of drilling holes for the sound. None of the component values are critical. By changing either R1 or C1, the frequency can be changed. With the values shown, the frequency is about 600 Hz. For the transistor, I used an unmarked type off a computer circuit board, and just about anything will work.

If you want a tone when a "high" is applied to the tone generator, just disconnect the transistor and apply the signal

from the uP directly to pin 4. For those of you interested in using the generator as a code practice oscillator, connect the side of the 100k resistor marked "from computer port" to the 5-volt supply, and connect your key from point "X" to ground.

Also, note that this circuit does not have to be run off 5 volts. It will work on anything from about 5 volts to 15 volts. As a CPO, it would probably be easier to use a 9-volt battery. If you're using CMOS in your uP and don't have a 5-volt supply, this cir-

cuit is particularly nice.

Well, I hope that this little article has helped some of

you to save some money, and just remember that simplest is not always cheapest. ■

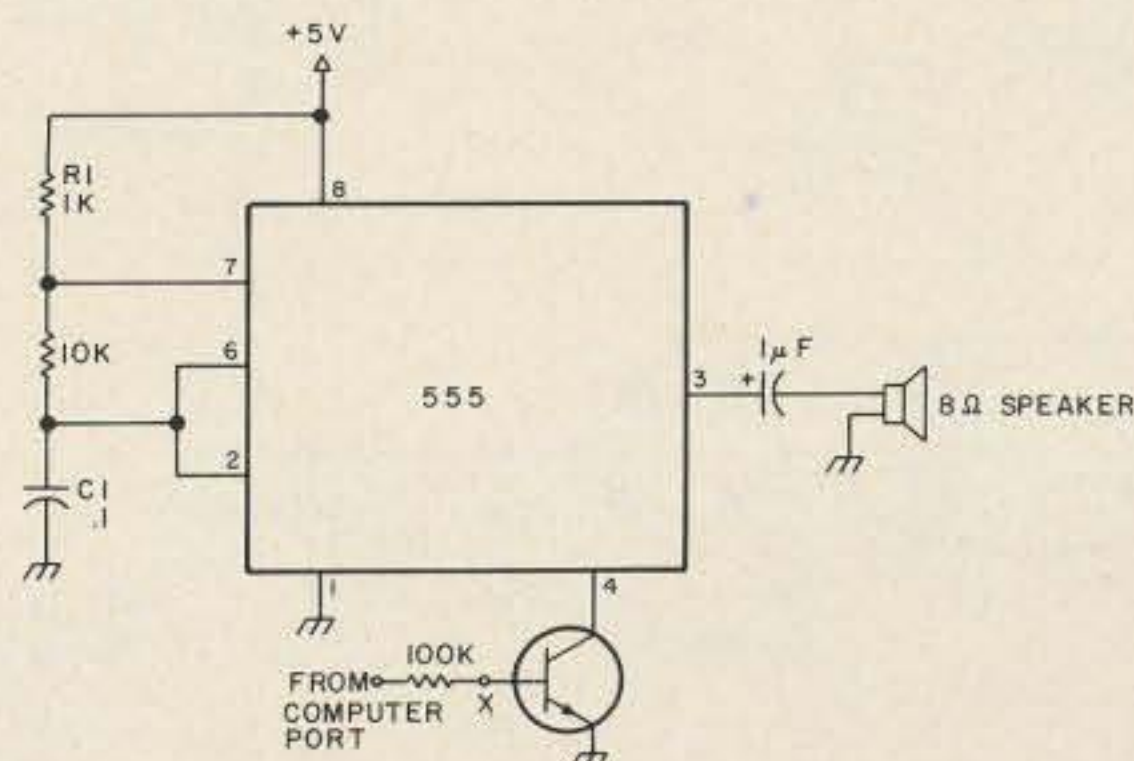

Fig. 1.

Michael Black VE2BVW
16 Anwoth Road
Montreal, Quebec
Canada H3Y 2E7

The Cheaper Beeper

— "Bell" for your CRT RTTY or uP

Meanwhile, circuits that had been used by digital tape recorder manufacturers were breadboarded and tested. The circuit decided upon was a takeoff of that used by National Multiplex Corporation in their Model CC-7 digital cassette recorder. It had the advantages of simplicity, economy, and parts availability. The circuit finally used in the conversion is shown in Fig. 1 and in the photographs. It was built on a Radio Shack plug-in perf-board and installed in a plug-in socket that was mounted in the tape recorder where the original electronics were removed (any plug-in board could be used).

How It Works

Remember now that you aren't dealing with audio in the sense of mark and space tones. The only purpose for the speaker circuit is to give an audible indication that data is being transmitted in the load mode. No audio signal is available in the save mode.

In essence, what you are doing is recording and playing back a full dc saturation of the magnetic tape. This method is also referred to as "no return to zero" (NRZ) because, unlike audio tones where you rest between the transmitted mark and space tones, there is no stop as the voltage swing passes zero. The dc saturations of the magnetic tape swing from about +5 volts to about -5 volts. I say "about" because it's not exact, and any combination that will record and play back without bombing is alright.

Looking at the data input circuit to IC1a, Q1 and Q2 are protective diodes which prevent the input from exceeding +5 volts and from dropping below zero volts. In conjunction with R1, this limits the RS-232 input or TTY level input to protect IC1a from input overvoltage. R2 and R3 are the biasing network which biases the second input to IC1a to about 1.2 volts so that the data

input swings from about 0 volts to 3 to 5 volts and causes an output voltage shift from about -5 volts to about +5 volts. The output of IC1a is fed through the current-limiting resistor, R4, to the switch-controlled record and playback head of the recorder. About 1.5 milliamps of recording current is available at the head, which is sufficient to accomplish total saturation of the tape. If the record current is too low, it will not be sufficient to erase data when you rerecord over

previous data.

IC1b is the preamplifier for the playback mode. Output of this high-gain amplifier is controlled by R7, the gain pot. (Some trial and error will be required here, but a good starting point, is about 0.1 volts peak-to-peak.) This padding circuit controls the input of IC2a, which is used as an expander amplifier. As the gain exceeds about 30 to 1, it is no longer linear and rapidly jumps to the maximum output level of the amplifier as Q3 and Q4 clamp the feed-

back voltage.

IC3a and IC3b provide clipping of the signal. Cross bias controls one negative side and one positive side so that a signal below the bias level goes unnoticed. The output voltage of each section of IC3 is at 5 volts until a received signal exceeds either bias level, at which time it causes a negative swing which would appear on a scope, as shown in Fig. 4. The outputs of IC3a and IC3b are negative spikes which trigger gates of IC4a and IC4b, the RS flip-

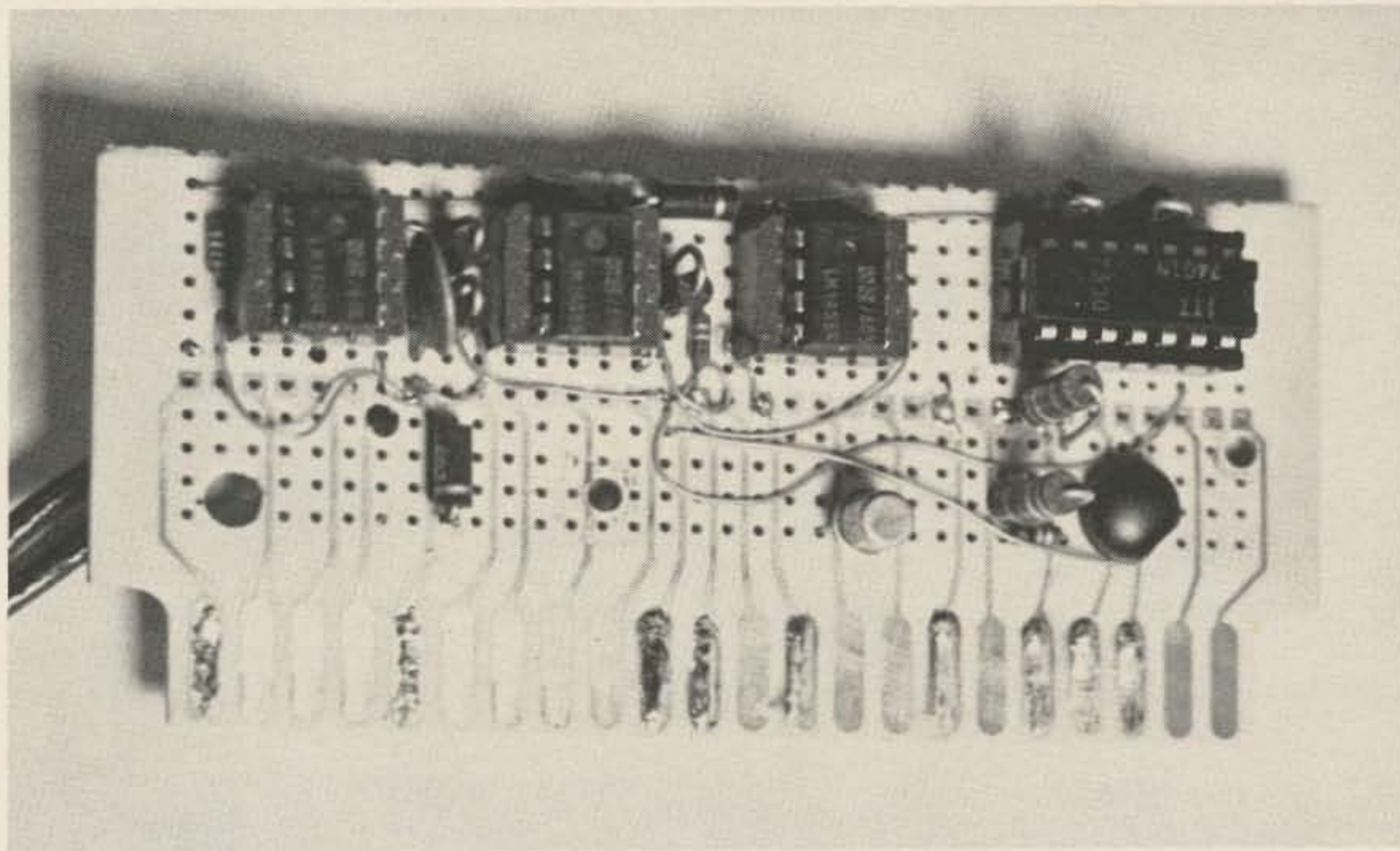

Photo A. Front side of electronics board.

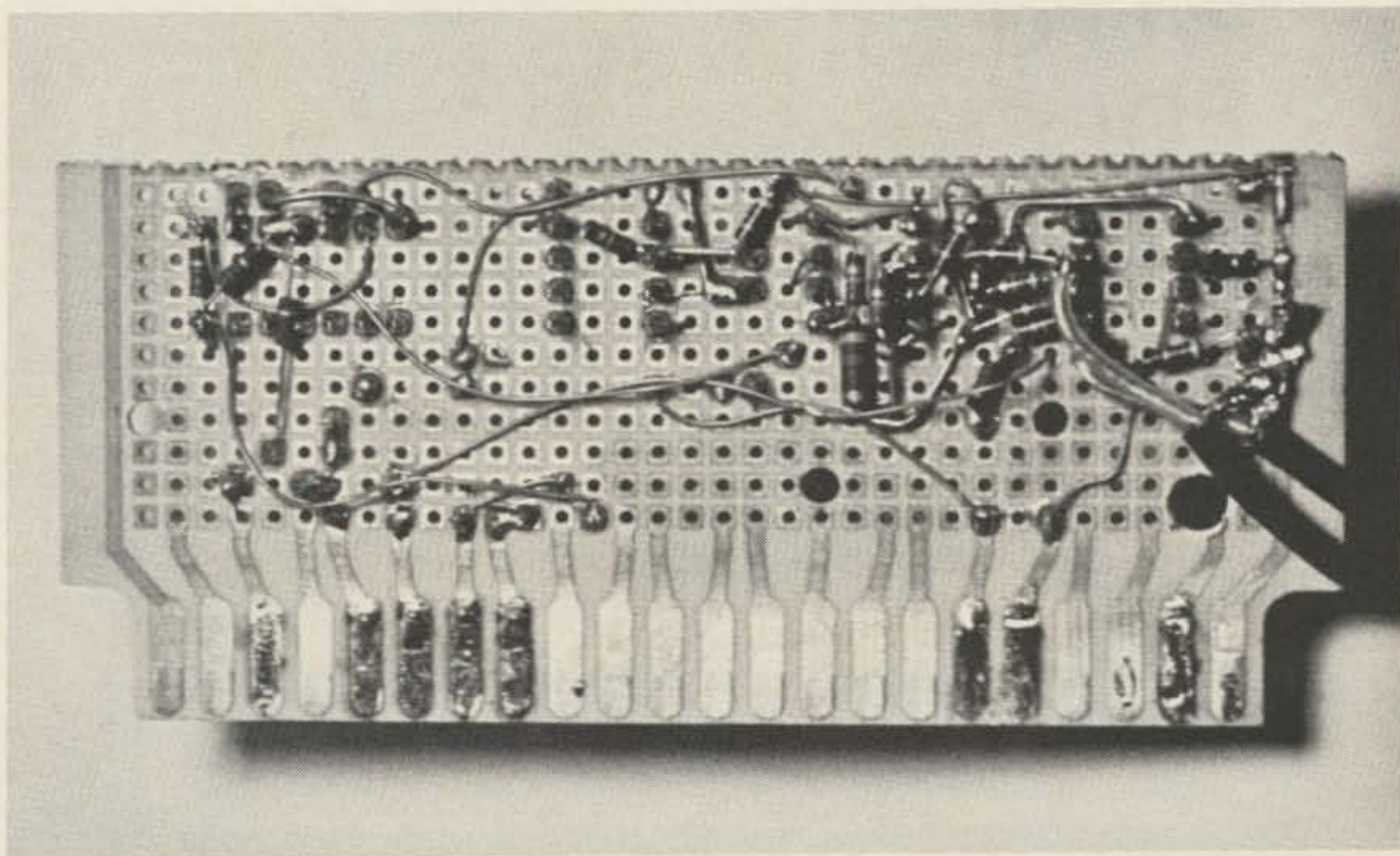

Photo B. Flip side of electronics board.

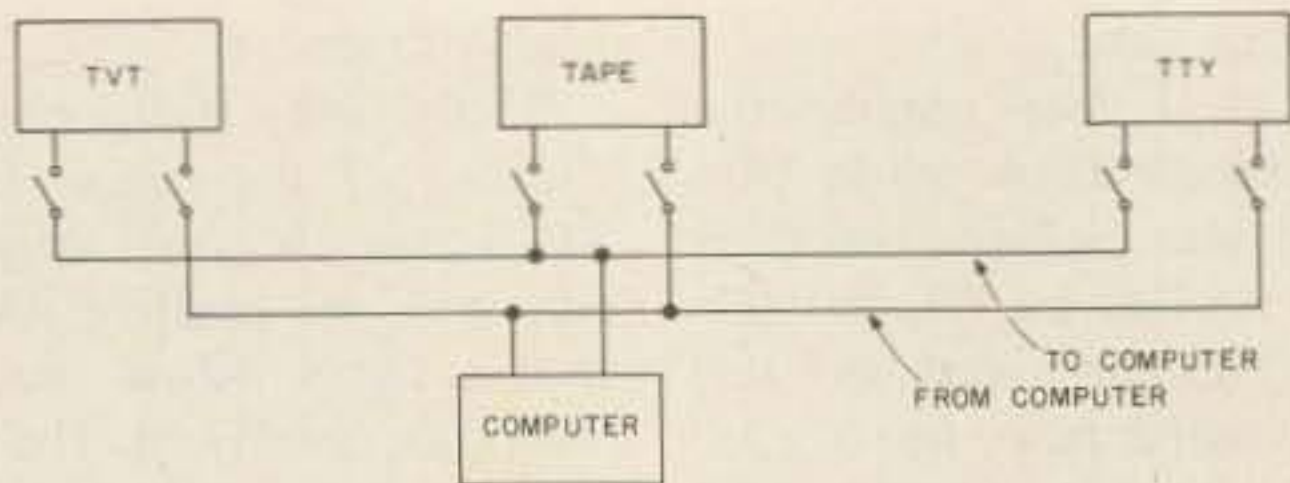

Fig. 2. Switching configuration.

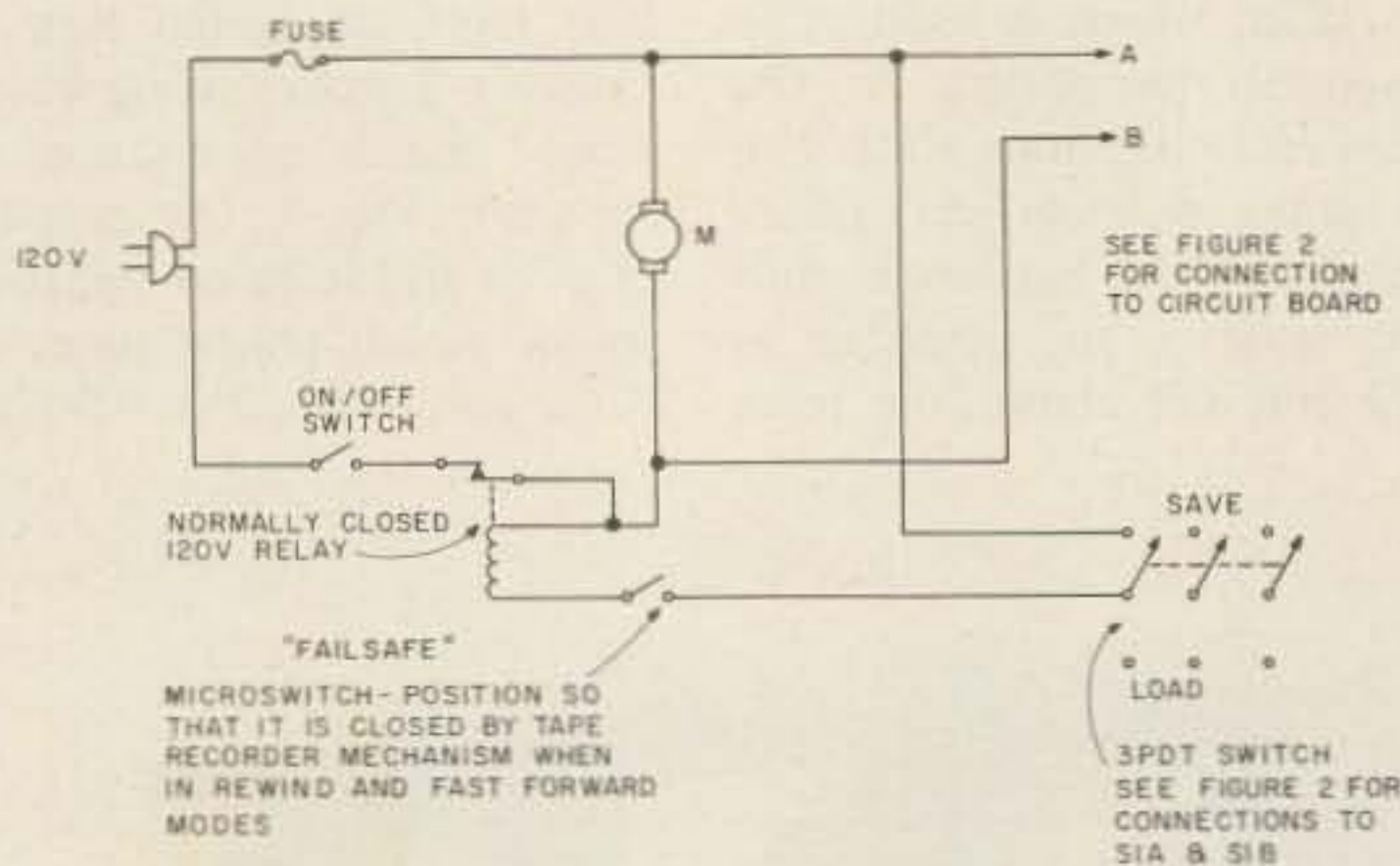

Fig. 2(a). On/off and fail-safe switches. "Fail safe" may be omitted, but rewinding or using fast forward while the load/save switch is in the save position will obliterate data stored on the tape.

flops. The Q and \bar{Q} outputs of the flip-flops are purely digital in form. These outputs are buffered by transistor Q5, which acts as an inverter and provides drive for external

RS-232 or TTY devices. Transistor Q7 connects the input of IC2a to -6 volts through the play/record switch which keeps the output in the mark state during start-up.

Using the Recorder

The digital data recorders reconstructed from old reel-to-reel machines have been successfully used with SWTPC 6800 and Imsai 8080 microcomputers. Basically what must be done is to isolate, by switches or relays, the RS-232 power supplies used by the TV terminal, the Teletype™ (if you have one), and the tape recorder. Such a switching arrangement is shown in Fig. 2. If you choose to use a more personalized arrangement to suit your preference and your microcomputer installation, the only thing to remember is that you have to isolate the RS-232 supplies.

Operating instructions are relatively simple and straightforward. For the purpose of this article, I will describe the operation using the switching arrangement shown in Fig. 2.

Record Procedure

To save a program by recording it on tape, it must first be entered into memory by some means, i.e., from a keyboard, paper tape, or

audio cassette. The data to be saved must be stored in memory.

Using the operating system that you have resident, set up addresses of the program to be saved if you are dealing with a machine language program, or use whatever means you save a program with for your BASIC (or other) interpreter.

Make sure that the baud rate selector switch is set to the speed at which you want the program recorded (usually the fastest possible).

Assuming you are using a TV terminal, the TVT switches to the computer should be on; all others should be off. Then turn the TAP switch from computer on.

Turn the tape recorder motor on, and give it a few seconds to come up to speed. Put a tape reel on your recorder. Place the play/record switch in the record position, and start the recorder, noting the reading of the turns counter for retrieval of the program or data at a later time. Initiate the program-save procedure of your microcomputer.

Watch the data being recorded on your monitor. If for some reason the program bombs, you usually get a string of question marks from the UART or some similar indication of trouble on the screen. When the program is recorded, turn the tape recorder off, place the play/record switch in the play position, and turn the TAP from computer switch to off.

You should now have the program loaded on magnetic tape at the baud rate you selected. SWTPC 8K BASIC, which took 15 minutes to load from paper tape at 110 baud, was recorded at 1200 baud and could be loaded in less than 3 minutes. Computers like the Imsai that can be loaded at 9600 baud only take a "zip" to load.

Load Procedure

Using a program saved from your computer on mag-

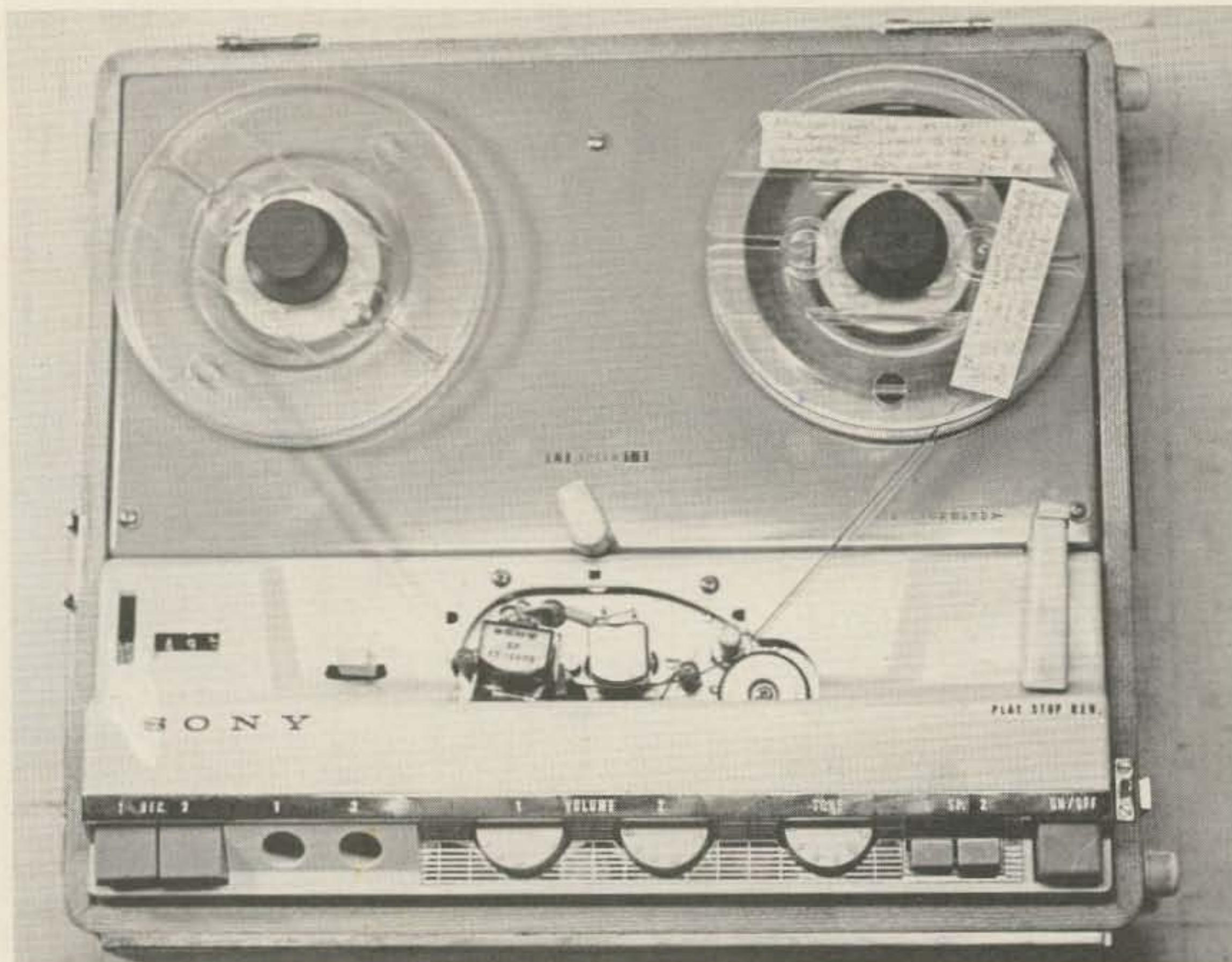

Photo C. Recorder loaded with tape.

netic tape, put the reel on your recorder and advance it to the start of your program. In the load mode, the recorder's speaker is activated to assist you in cuing up your program. You should hear an irregular buzz, buzz, buzz as the data is read from the tape.

Using your operating system, activate your computer to load a program. Check your baud rate selector switch to make sure it's set to take the same speed as the program (again, usually as fast as possible).

Assuming again that you are using a TV terminal, the TVT switches to-computer and from-computer should be on; all others should be off. Then turn the TVT-to-computer switch off and the TAP-to-computer switch on (this isolates the RS-232 supplies).

Turn the tape recorder motor on, and give it a few seconds to get up to speed. Place the play/record switch

in the play position, and start the tape recorder.

The data being loaded can be monitored by listening to the speaker and, if you are loading a BASIC program, by watching the TV monitor. Machine language programs usually don't print on the monitor unless they bomb, and then it's a string of question marks or garbage. A BASIC program will print out on the monitor as it is loaded. When the buzz, buzz, buzz stops, the program is loaded. Turn the TAP-to-computer switch off and the TVT-to-computer switch on. Stop the tape recorder. You are now in keyboard control and can initiate the program using your microcomputer's operating system.

Advantages

You now have a digital data system for your microcomputer with the capability of saving and loading programs at high speeds. A five-inch reel of tape will store a

tremendous amount of data and many programs. Depending on the speed you run your tape recorder, you probably will never use more than ten reels. It's suggested that you use quality audio tape, such as you would use for recording music, but, as long as it isn't too "dusty," almost any tape will do. Clean the heads, guides, and capstan with alcohol and a Q-Tip™ occasionally, and you are in business.

All of the parts for the conversion, including the transformer and capacitors for the RS-232 supply, were ordered from James Electronics for less than \$20.00. The tape recorder has been in continuous use on two microcomputer systems for almost a year and has required zero maintenance other than head cleaning.

Digital data recording is highly recommended as a simple, economical, and effective means of high-speed data and program save and load.

Parts List

IC1-3	1458
IC4	7401
Q1-7	1N914 (or equiv.)
Q8	2N3643
Q9	2N3638
Q10	1-Amp bridge rectifier

Conclusion

Probably the only drawback in the system is the switching arrangement and the fact that I haven't been able to use the tapes for exchanging data with other hobbyists. By using a dual-trace scope, the heads of the tape recorders could probably be aligned so that tapes could be exchanged for like systems. I am considering solenoids for switches so that I can put the tape recorder under software control and use it for interactive mass data storage. If anyone cares to give me some helpful advice, I would certainly appreciate it. As you can see, I didn't "reinvent this wheel," and I won't with the switching if I find the brainwork has already been done. ■

AMATEUR COMPUTING 78

**Sheraton National Motor Hotel
Arlington, VA July 22-23**

- Personal Computers
- Amateur Telecomputing
- Commercial Exhibits
- Lectures and Seminars
- Club Activities
- Amateur Displays

Registration at door \$5. Avoid waiting in line—to pre-register send check for \$4 payable to AMRAD to PO Box 682, McLean, VA 22101. Write for details. Booths available. For AC78 hotel reservations call (703) 521-1900 or write Sheraton National Motor Hotel, Columbia Pike and Washington Blvd., Arlington, VA 22204 and mention AC78.

F24

TELETYPE® MODEL 33 ASR

COMPUTER I/O COMPLETE WITH:

- Tape Punch
- Ready to Go
- Tape Reader
- Line/Local Wired
- Guaranteed 30 Days

\$840⁰⁰

INCLUDING PACKING
F.O.B. - N.J. FACTORY



If it's for TELETYPE® We Have It.

If you don't see what you need, CALL or WRITE!

COMPLETE COVER READY TO INSTALL	\$ 35.00
COPY HOLDER (182036)	\$ 14.00
TAPE UNWINDER (12" NEW)	\$ 55.00
WIND UP PAPER TAPE WINDER (1")	\$ 52.00
ELECTRIC PAPER WINDER (LPW-300 NEW)	\$ 50.00
DEC TYPE READER RUNCARD	\$ 45.00
ACOUSTIC COUPLER	
OMNITEK 501A (NEW)	\$160.00
READER POWER PACK (182134)	\$ 35.00
EIA RS-232 INTERFACE	\$ 55.00
ACOUSTIC COVERS with FAN (NEW)	\$258.00



TELETYPEWRITER COMMUNICATIONS SPECIALISTS

550 Springfield Avenue • Berkeley Heights, N. J. 07922
(201) 464-5310 • TWX: 710-986-3016 • TELEX: 13-6479

T13

SUBSIDIARY OF VAN'S W2DLT ELECTRONICS.

The Super Select-o-Ject

—kill rotten QRM
with this filter system



After reading a highly complimentary review of the Autek Research QF-1 R-C Active Audio Filter in another amateur publication,* I decided that the unit would make an excellent addition to the shack. It would be useful not only for SSB and CW work with the Tempo 2020, but also for serious BC band listening and SWling with the FRG-7 general-coverage synthesized communications receiver in use at W8FX.

The unit, as supplied by the manufacturer, comes complete with input cables and output jack, being designed to simply plug into the headphone or speaker jack of practically any transceiver or receiver and drive either speaker or headphones to full volume. It has its own 1-Watt amplifier, as well as a self-contained ac-operated power supply. It features three modes of operation — low-pass, notch, and peak functions. In the low-pass mode, the unit provides a classic filter shape for SSB or AM reception, rejecting static, high-frequency receiver hiss, and adjacent-channel splatter, and with adjustable filter cut-off anywhere from 250 to 2500 cycles. The notch function allows very deep (up to 70 dB), narrowband rejection of heterodynes, TV oscillator buzz, and CB channel beats, and it is also adjustable over the 250-to-2500-cycle range with variable notch depth and width. In the peak mode, a "natural" for serious CW work, a narrow bandpass response for very sharp selectivity as low as 50 cycles can be obtained, yet it can be adjusted to a flat condition with the continuously-variable front panel controls.

Upon receiving the QF-1, I determined that it very handily met "specs" and was, indeed, an exceptionally fine unit, equaling or exceeding the manufacturer's claims in

*QST, "Product Review," March, 1977.

every way. In CW work, for example, it was possible to leave the Tempo 2020's tuning alone and actually tune in, virtually QRM-free, several CW stations inside the Tempo's excellent 600-cycle i-f filter passband — shades of the old "Select-o-Ject" of yesterday!

As supplied by Auttek, the unit is designed to be inserted between the receiver and speaker or headphones. However, at W8FX, both the 2020 and FRG-7 are in use for HF work, so I needed some sort of switching device for convenience and flexibility of operation. The configuration I decided on would allow direct routing of either or both units' audio outputs to their respective speakers or through the QF-1 for processing. I also incorporated a conventional phone jack with speaker/phone switching in the device. As a final touch, a switch was added to cut in an alternate set of selectivity-determining resistors to substantially increase selectivity down to as low as 10-15 cycles for possible future moonbounce CW work. Use of the ultra-sharp position is a bit too narrow for regular CW reception, inducing a good deal of filter "ringing." The moonbouncer might want to try using a strip-chart recorder, as suggested by Auttek in their instruction manual.

What evolved is the circuit shown in Fig. 1, incorporated into a Radio Shack #270-230 Bakelite™ constructor's box, measuring 3¼" x 2-1/8" x 1-1/8", which was mounted at the top rear of the QF-1 case. No physical modification of the QF-1 is required other than enlarging one of the ventilation holes at the top of the cabinet and installing a rubber grommet to allow the passing through of a short length of 7-conductor cable which connects the switchbox to the appropriate points in the filter circuit. The 15-Ohm resistors effectively parallel R4 and R9 on the Auttek filter board, re-

ducing their effective value to about 20% of nominal (47 Ohms) for selectable super-sharp CW work when the unit is used in the "peak" function. (In some models, R4 and R9 are 390 Ohms each, instead of the 47-Ohm units in my model. In such a case, the value of the paralleled resistors would be increased to about 100 Ohms to reduce the effective value of R4 and R9 to 20% of nominal.)

As there is no pilot lamp on the QF-1, a small LED installed in the side of the Bakelite™ minibox indicates whether or not the unit is on. A 9.1-volt zener diode provides a source of regulated dc to the box for future use and for a source of voltage for the LED. An SPST mini toggle switch allows selection of headphone or speaker operation from the filter output. The small "pot" and the extra mini toggle switch appearing on the front of the box are not connected, but are reserved for use with future mods.

All input and output cabling to both the receiver and the speakers is routed

through the switchbox installed atop the QF-1; however, the audio cable, which previously served as the input to the filter and which connected to the receiver output, is reconnected to the *output* side of the filter (a convenient internal takeoff point is the front-panel headphone jack on the QF-1). It may then be connected to either an ac voltmeter or vertical scope input to aid in peaking or "notching out" signals, which becomes fairly critical in the narrowest selectivity positions. I use a Heath SB-610 Monitorscope as the display unit, connecting the

cable to the vertical input terminal at the rear of the scope. Employing the scope as a visual tuning aid has been particularly useful in running with the 10 to 15 kHz bandwidth modification installed. It is also helpful in touching up filter alignment (R8 trim-pot). Also, I have installed a "Y" adaptor on this cable so that it simultaneously feeds both the scope and a little FM rebroadcaster unit which is used in conjunction with an Archer/Radio Shack AM/FM headset for hands-off cord-free listening. The Archer unit is light enough not to become

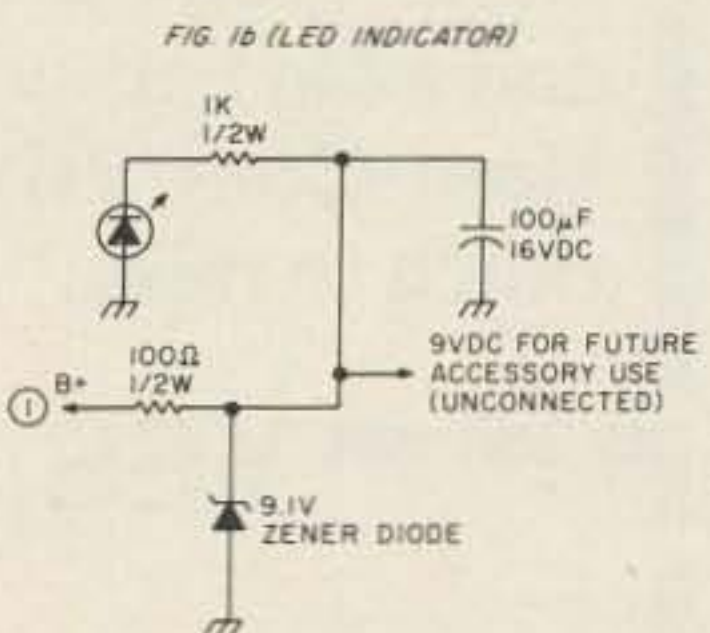
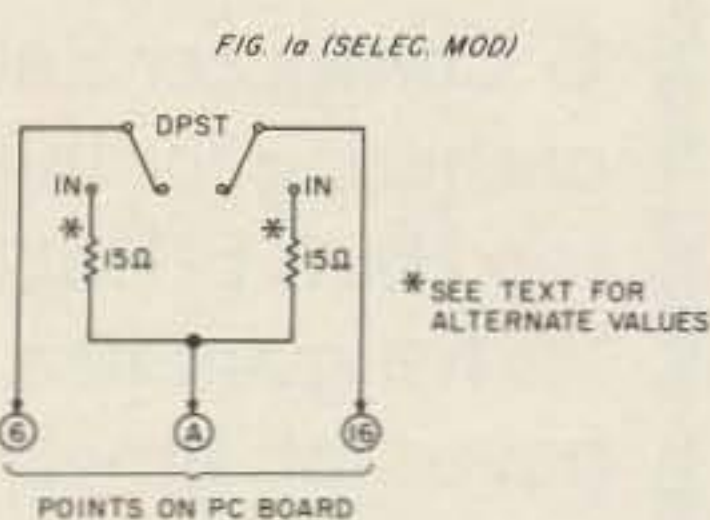
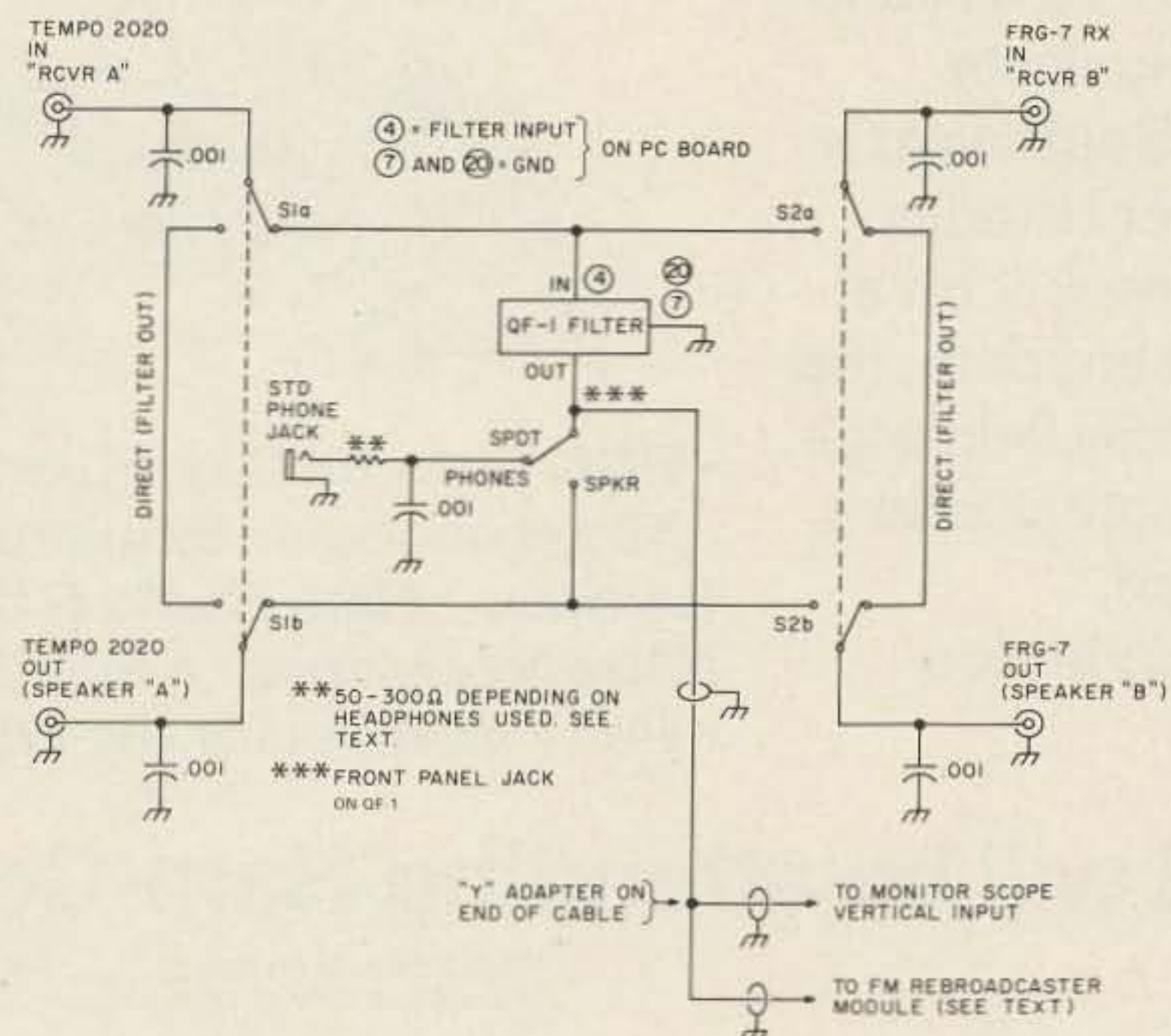
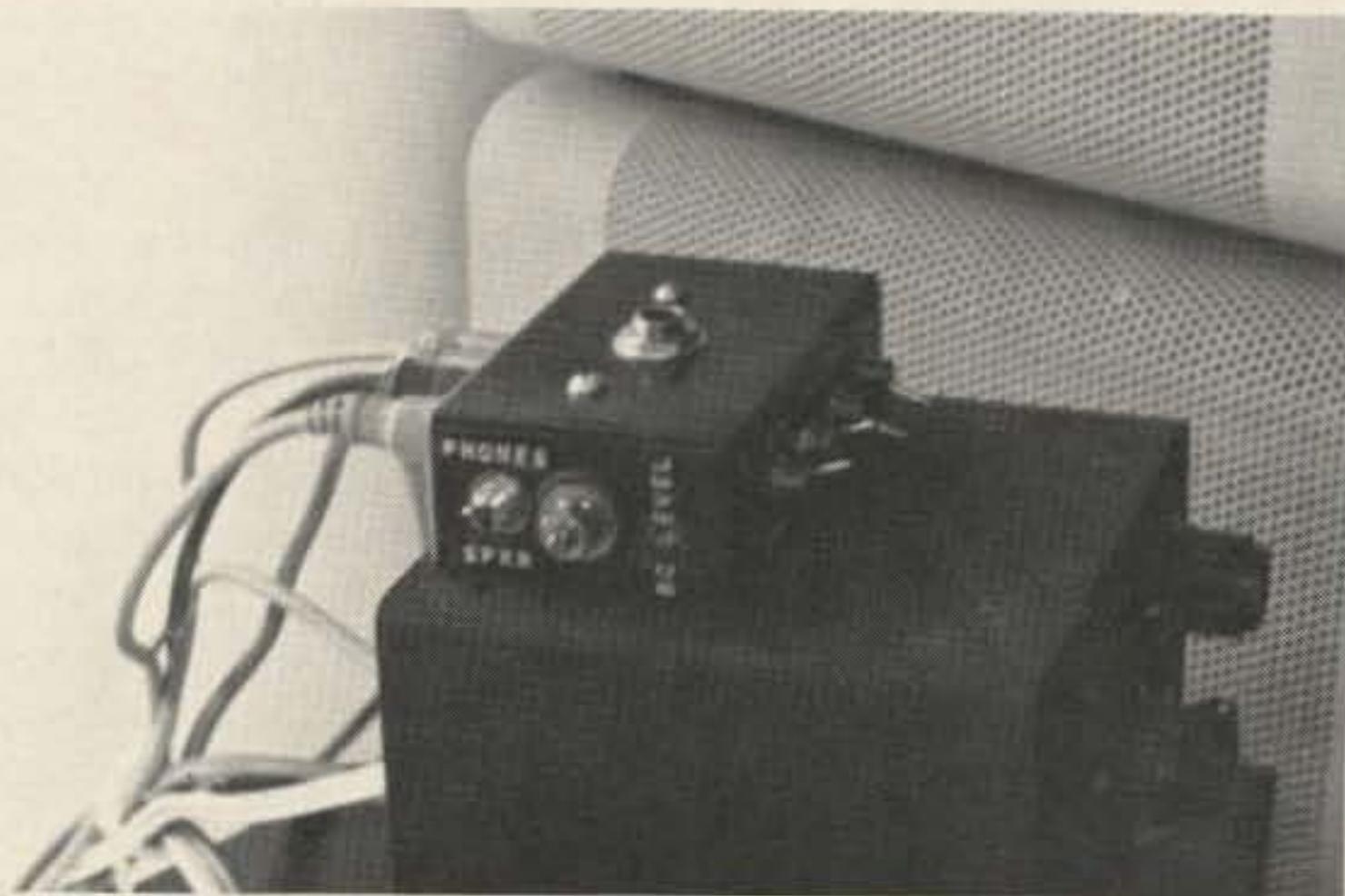

Fig. 1. All components are mounted in a Bakelite™ box which is mounted atop a QF-1 filter enclosure. The circled numbers and letters refer to QF-1 PC board terminal points labeled in the QF-1 instruction book. Seven-conductor cable routes all connections from the switch box to the QF-1 board. The "in" and "out" connectors are RCA phono jacks. The former QF-1 input cable is rewired to filter output (same point electrically as the front panel speaker/headphone jack) to provide output to the scope and the FM rebroadcaster module. The S1 and S2 sections are ganged (S1 and S2 are DPDT mini toggle switches).

uncomfortable over extended periods of operation.

The Autek filter comes adequately bypassed and filtered for RFI protection and should not normally give any trouble even when used with high-powered rigs (unless there is an inordinate amount of rf floating around the shack). However, installing the outboard switchbox could pose some RFI problems, due to signal pickup on the cabling; therefore, the bypass capacitors shown in Fig. 1 shouldn't be omitted from the circuit. In stubborn cases of pickup of signal from your own transmitter, try installing 1 to 5 mH rf chokes in series with the filter input, and/or try connecting a good ground directly to the case. If problems with hum pickup are experienced with low-impedance hi-fi-type headphones, they can be reduced or eliminated by experimentally connecting a 50- to 300-Ohm, 1/2-Watt resistor in series with the headphone

lead. I have had no problems with either rf pickup or hum.

The results obtained using the filter/switchbox combination have far exceeded expectations. The QF-1 is certainly one of the best active audio filters available at any price (much improved over the old tube-type "Select-o-Ject" of fifties vintage). Used in conjunction with the switchbox, efficient use can be made of two separate receivers without the usual Rube Goldberg rat's nest of cabling or the inconvenience of manually plugging and unplugging the filter.

Even when interference isn't a problem, I find that running the filter in the circuit at moderate selectivity settings actually enhances audio quality with respect to both receivers and adds a certain presence to received signals, particularly on SSB. I have found that, for general-purpose monitoring, running in the low-pass mode with

selectivity almost flat makes for very pleasant listening, cutting down considerably on splatter, hiss, and other objectionable noise. While the filter can be used to best advantage on CW, due to its super-sharp selectivity capabilities, it can be used with good results on SSB and even for serious BCB listening and SWLing, cutting down substantially on adjacent-channel interference and heterodynes.

At W8FX, the switchbox is used in conjunction with the Autek QF-1 filter, but, with some changes in wiring and the addition of a compact audio power amp module (Sanken and Ramsey both have available compact units generating up to a couple Watts of audio) and a source of power, the unit can be adapted for use with the MFJ SBF-2BX SSB filter or MFJ CWF-2BX CW filter. A larger enclosure would be required to house the power module and a small low-voltage power supply, if these

filters are used. If a phone patch is used, connect it on the output side of the switchbox to allow processed audio to be fed to the patch.

As a sidelight for the economy-minded ham, who might own a transceiver such as the TS-520 or 820 or one of the Yaesu series which does not come with the (expensive) optional CW filter, MFJ manufactures a little-known mini CW filter board, for \$11.95, which offers selectable 110 Hz and 180 Hz selectivity. It can plug into the receiver phone jack to directly drive headphones or be installed inside the receiver cabinet between audio stages for speaker operation. Requiring 6 to 30 V dc for operation, it offers good possibilities as a substitute for obtaining more expensive filters for the casual CW operator.

Whichever filter you use, build this little switchbox to increase its versatility in your ham shack. ■

Come to Dallas!!

Join thousands of Ham Radio & Computer Enthusiasts gathering for the Southwest's top Ham & Hacker Huddle. With a giant flea market on a paved lot, timely seminars, top trade exhibits, family field trips, ladies' programs, great prizes, and a big barbeque, **Ham-Com/78** will be too much to miss.



- FCC Tests All Day • Giant Flea Market
- Microprocessor Seminar • Antenna Seminar • Ham Radio & the Law • RTTY and Microprocessors • AMSAT Demonstrations
- Fun Activities for the Whole Family

YES, I will be attending Ham-Com/78!

NAME _____

ADDRESS _____

CITY _____

STATE _____ ZIP _____

Send check or money order to:

Ham-Com/78, 3321 Towerwood Drive, Suite 101, Dallas, Texas 75234

Please issue, in my name, _____ Pre-Registrations for Ham-Com/78 @ \$5.00/person \$ _____

We will need rooms for _____ people @ \$16.00/person (double occupancy) \$ _____

Please reserve _____ Flea Market spaces (each space is a one car parking slot) @ \$3.00 ea \$ _____

I have enclosed my check or money order for \$

THE INCOMPARABLE SYSTEM 3000A



HAS A BUILT-IN \$450 DISCOUNT

\$450 discount? When you buy SYSTEM 3000A, you're getting \$1000+ worth of unequalled performance for \$549. Examine the unique features of SYSTEM 3000A, add up what it would cost to duplicate (if you could) this small, feature-filled radio and you will quickly realize what a remarkable bargain you're getting. By marrying the best transceiver available to a microcomputer-controlled PLL synthesizer, **Edgecom** has produced a 2-meter FM system with such unique and incomparable operating flexibility it is almost unbelievable. A few of the extraordinary features of SYSTEM 3000A found in no other transceiver are:

***TWENTY FRONT-PANEL-PROGRAMMABLE CHANNELS.** Just dial in the frequency and transmitter offset, press the Enter switch and you're in memory. Two channels are instantly recallable as priority channels at the flip of a switch.

***TWO BUILT-IN SCANNERS** with adjustable pause and pause-defeat features. One scanner lets you tune the band in one or four MHz segments. The other scans the memory.

***MEMORY-CHANNEL MONITOR.** Lets you operate on one frequency while monitoring one or more others.

***ANY TRANSMITTER OFFSET.** In addition to the standard ± 600 kHz you can program any offset from 5 kHz to 4 MHz.

***FULL TWO-YEAR WARRANTY.** Every SYSTEM 3000A is warranted to be free of defects for two years. And it is American made so servicing is no problem.

Combine these, and the other unique operating features of SYSTEM 3000A with a receiver of unsurpassed selectivity and intermod performance, a transmitter that produces over 25 watts of (adjustable) power and you have a fantastic \$1000+ transceiver for the remarkable price of \$549.

SYSTEM 3000A . . . PERFORMANCE THAT CHALLENGES YOUR IMAGINATION
See one at selected dealers or write for more information.

Edgecom Inc.

E18
2909 Oregon Ct.—A3 • Torrance CA 90503 • (213) 533-0433

EXPORT INQUIRIES H & H Industries • Box 639 • Redondo Beach CA 90277

The IG-102 Goes Transistor!

—tubeless portability for this Heath signal generator

The Heath IG-102 radio frequency signal generator is a versatile general-purpose wide-range instrument of conventional vacuum-tube design which has been catalogued for several years. For those who have acquired the IG-102 in the past and those who are still looking for a good signal generator at a moderate price, this article provides a simple, economic, and fast means of conversion for portability without sacrificing the original qualities. Modification of the IG-102 gives the instrument new capabilities, as follows:

1. Battery operation utilizing either dry cells or a nickel cadmium rechargeable bank capable of supplying 7 to 9 volts at a maximum current of 10 to 16 mA.

2. With the use of rechargeable nickel cadmium cells of approximately 1.2 volts per cell, 6 to 8 cells are sufficient to provide the required operating supply voltage. The basic radio frequency circuit will operate with a minimum of 4 volts throughout its frequency range. For charging purposes, a self-contained battery-

charging circuit is used which employs the original components (these can be dispensed with if dry cells are installed).*

3. All tube sections are replaced by four field effect transistors, such as those available from Radio Shack — #276-1623** — or Calctro — #K 4-634.

Procedure for Modification

The following step-by-step instructions apply to changes and additions to the basic IG-102 radio frequency signal generator. Accordingly, the original instruction manual and drawings are used for reference to detail the modification procedure. This procedure involves simple

* Installation of the battery supply is simple, since there is ample chassis space available to mount battery brackets for accommodating the battery units.

** Some of these Radio Shack #276-1623 packages contain assortments of both rf and af field effect transistors. In testing them, the af types will not oscillate. One particular type which responds well at radio frequencies is the 2N5951. The white-black types are af and do not oscillate at radio frequencies; also, the metallic types are unsuitable.

changes, installation of new components, and constructions. Before undertaking the modifications, I advise that you spend some time studying and reviewing the basic circuit and assembly to become familiar with the original layout. Additionally, study the details of the field effect transistor connection lead designations. In the assortment provided in Radio Shack's #276-1623, three types are referred to in the designation of leads. With reasonable care, there should be no difficulty using any of the transistor types.

1. Refer to Fig. 1, a copy of the original circuit.

2. Remove all tubes, if the set has already been constructed.

3. Unsolder and disconnect power transformer connections (filament supply line and high-voltage rectifier-filter system), and reconnect the power supply components as shown in Fig. 2, using additional components as needed.

4. Solder a 75-Ohm, ½-Watt carbon resistor across the R2 (33k, 2 W) decoupling resistor used in the original circuit.

5. Solder a 90-Ohm, ½-Watt carbon resistor across the R6 (4.9k, 2 W) decoupling resistor used in the original circuit.

6. Spot solder one radio frequency field effect transistor across tube socket V1B, terminals 1-2-3, using the lead references given in the transistor package instruction sheet. However, if transistors are selected from the 8-transistor assortment given in Radio Shack's packet #276-1623, then lead orientation should be followed as per the drawing supplied in the packet.

To mount the transistor on the tube socket, do the following: Hold each lead with long-nose pliers (for a heat sink) as solder is applied. Use a 35- to 40-Watt pencil iron with a small blade tip 1/8" wide, and solder alloy 60-40. Apply a small drop of solder to the end of each lead. After thinning the leads, spread them to match the spacing of the lugs on the tube socket. Apply each lead to the required tube socket terminal, as designated above (to facilitate connections, also apply fresh solder to the

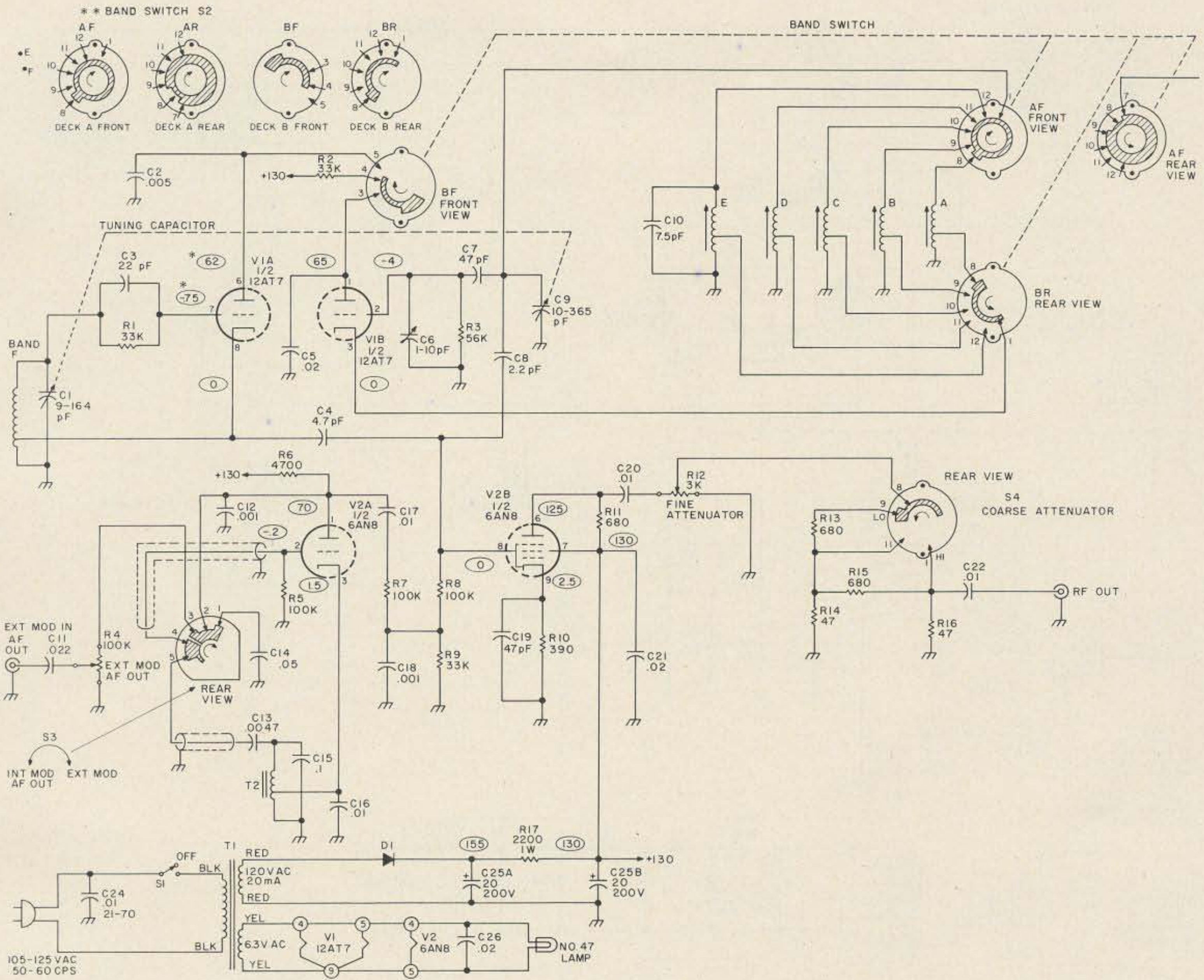

Fig. 1. Original IG-102 circuit.

tube-socket terminals).

In spreading the transistor leads, a slight bend on the wire ends will help in making surface-to-surface contact for soldering. With the pliers, hold each lead against the surface of the required tube-socket terminal, and apply the iron to the opposite side of the terminal until solder flows well to form a good spot-solder joint. No mechanical connection is necessary to complicate the procedure. Once the first transistor lead is soldered, it will make the transistor self-supporting, and the remaining solder operation will be easily handled and completed. Remember to use the long-nose pliers as a heat sink for "pushing" the transistor leads against the tube socket ter-

minals when soldering. Care in soldering and applying the transistor leads will insure success and avoid thermal or mechanical damage to the components.

7. Following the same technique for soldering as explained in step #6, apply and connect another rf field effect transistor across the tube socket 1A, terminals 6, 7, and 8.

8. Apply and connect the third rf field transistor to tube socket 2B, terminals 6, 8, and 9.

9. Apply the fourth field effect transistor to tube socket 2A, terminals 1, 2, and 3. (If another type of FET transistor is used, make certain that the proper transistor leads are used to make connections.) Again, it may

be more convenient for making connections to turn the transistor over (round side up) and cross the D and G leads (use insulated sleeving).

Step #9 completes the modification conversion of the basic IG-102 rf signal generator. Additionally, I installed rear tip jacks with the circuit connection leads to

permit external testing of the battery supply (+) and (-).

Test, Operation, and Adjustment

1. Before applying battery power to the circuit, check the positive-to-ground resistance to make certain that there is no short circuit or abnormally low resistance reading due to a defective

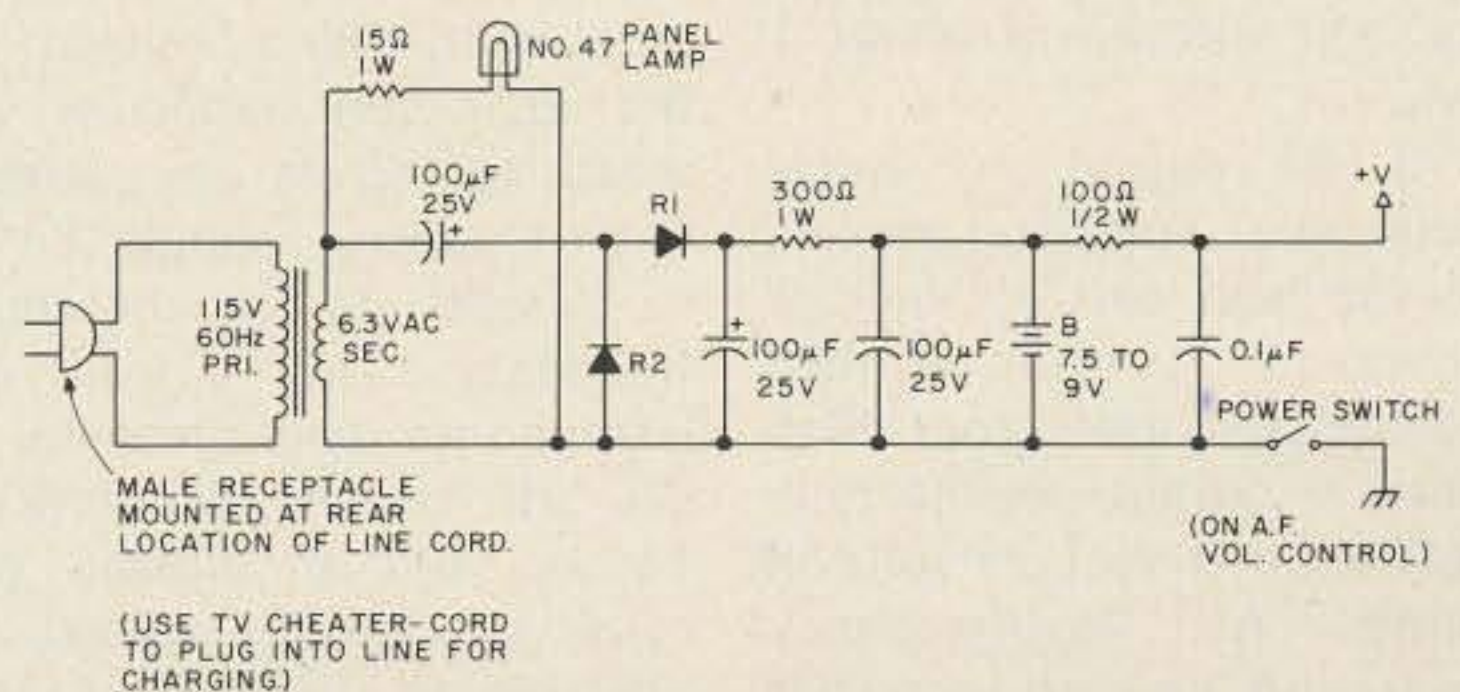

Fig. 2.

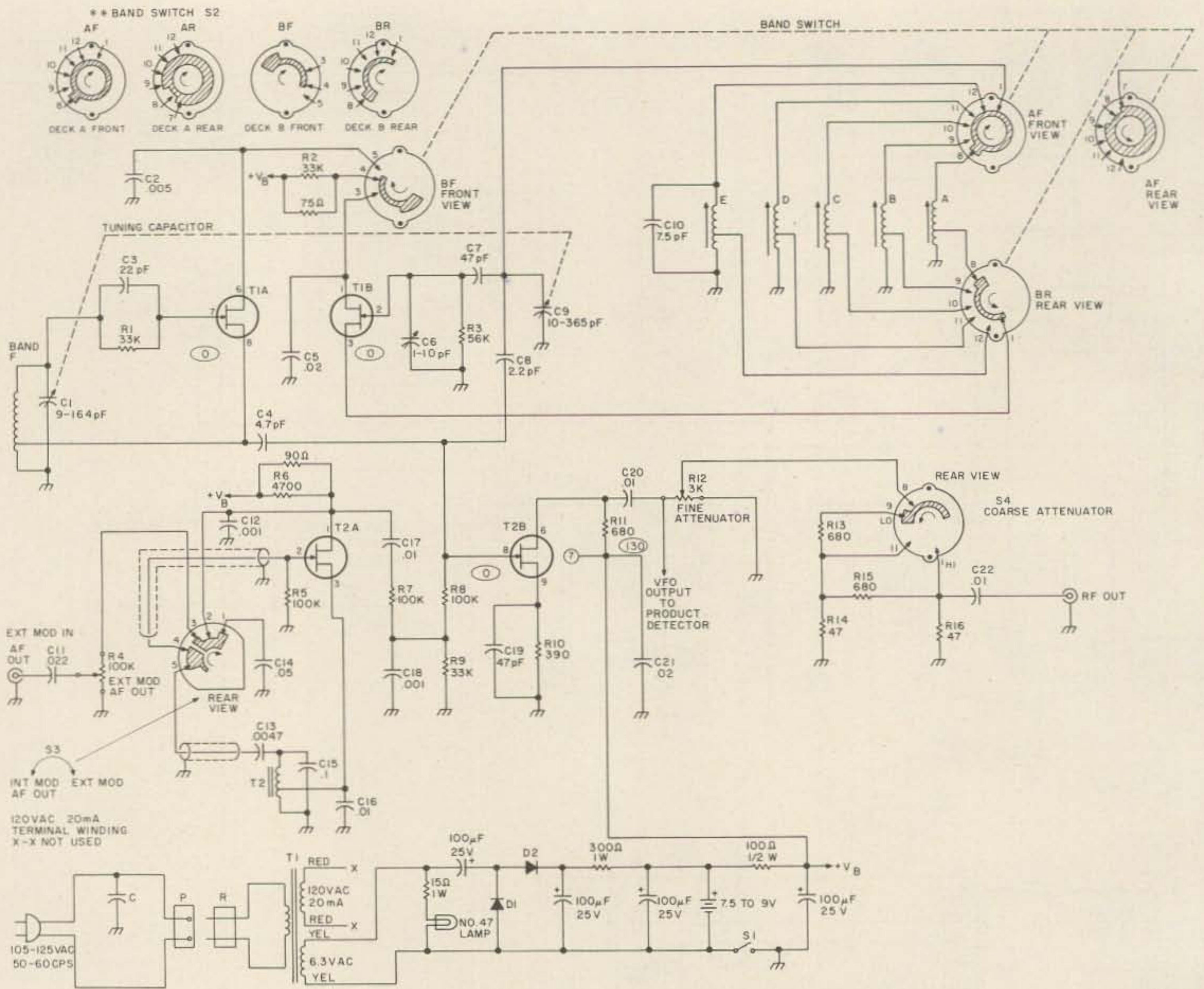

Fig. 3. Modified IG-102 circuit. T1A, T1B, T2A, and T2B — four rf FETs equivalent to Radio Shack package #276-1623 or Callectro #K 4634.

component or wiring condition. Rotate the bandswitch while checking the resistance to ground (which should be several hundred Ohms, at least).

2. Insert a milliammeter in series with the battery, and check the direct current on all bands, which should be 7 to 15 mA. Switching in the audio tone oscillator-modulator will increase it about 1 mA.

3. Rf output. A diode detector rf voltmeter applied to the high end of the fine attenuator control (turned counterclockwise for minimum rf output) should indicate about 1 to 1.25 volts on band "A" (low-frequency end), and, on each successive band, it will drop off pro-

gressively. Nevertheless, rf output should be detectable on all bands.

Vary the tuning on each band from low to high end — the rf voltage should vary smoothly (usually decreasing) without the sudden jumps or falloff usually associated with parasitic absorption conditions.

4. Audio tone oscillator modulator. The ac output of the audio tone oscillator, as measured across the audio output control, should be 1 to 2 volts. Check the tone frequency with a pair of headphones connected to a 0.1 uF coupling capacitor. Finally, use an allband receiver or grid-dip meter, if available, to check the rf output frequency. The frequency

response in each band should be within a few percent and not need any alignment or tuning adjustments.

Heterodyning with broadcast stations will show excellent frequency stability. On band "F", use an identifiable FM station to spot check the frequency calibration in the 88 to 108 MHz range. I found it necessary to "squeeze" the rf coil to about one-half its original length to get good frequency alignment. Use the long-nose pliers to squeeze turns. To check against an FM station, turn the audio modulation on, connect the rf cable, and bring it near the FM receiver's vertical antenna. A good clean modulation note should be heard when the signal generator

passes through an FM station.

Conclusion

I modified the original circuit by converting to the battery-operated solid state design, as described. In addition, a three-crystal oscillator frequency-spotting standard was installed with a product detector and audio amplifier speaker section. This combination provides frequency check intervals of 100 kHz, 1.0 MHz, and 10 MHz, for spot-checking the internal six-band vfo or for external testing. Using the crystal standard, heterodyne testing showed excellent frequency tracking and calibration through the six bands. Since there is ample chassis space available, the three-crystal

The Miser's Delight Repeater Controller

—the very ID!

It all started when WR2AKV decided to go on vacation. Repeaters must have strong unions, because this one hasn't been heard from since. Steve WB2ZSE modified a GE Prog desktop base, and another WR2AKV was on the job. The only problem was that the original repeater had been borrowed, and the control circuitry went with it. We still had the old Ma Bell touchtone™ decoder, but we needed something for more immediate control. Since I am cheap above all else, I decided to see if I could design a controller for the new repeater for less than the purchase price of a store-bought one.

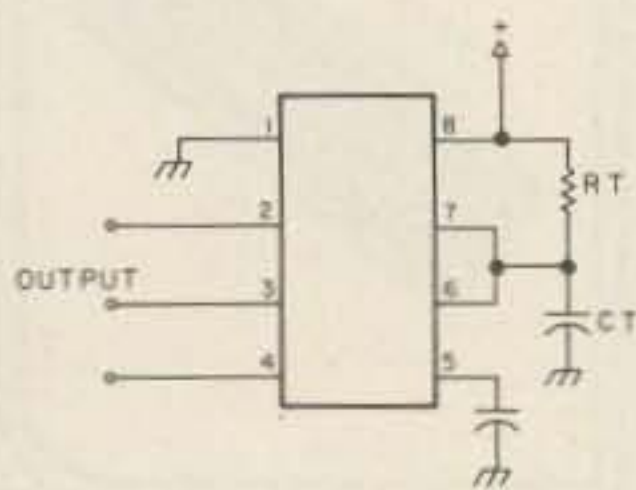

Fig. 1. 555 resettable timer.

The controller had to meet a number of logical criteria:

1. Variable time-out timer.
2. Variable squelch-tail timer (the time the transmitter stays on after you drop your carrier; the short burst of noise as you drop it is called the squelch burst).
3. ID after the input carrier is dropped, so the ID can be kept nice and loud and not take out the repeated audio.
4. ID on cold start-up (after the repeater has been sitting idle for more than the ID interval), but the repeater should not turn itself on just to ID.
5. Reset the time-out timer on loss of the input signal, as opposed to requiring the repeater transmitter to drop out.
6. Have as few parts as possible (preferably none!) because parts cost money!

In keeping with the last, but most important, rule, I etched up a board for the K4EEU ID, violated prime directive number 6 (had to

buy a few parts), and we had a working ID.

The next step was to look at the above criteria through the rules of logic, and the best answer seemed to be the 555 operated as a resettable timer. According to rule 6, I should have used one 555 and one 556, but the increased complexity (and the possible need to go to double-sided board or a lot of jumpers) justified the negligible price difference. In Fig. 1, if either pin 2 or pin 4 of the 555 is low, the output on pin 3 is low. If both pins are high, the output will be high for a length of time determined by the time constant $R_T \cdot C_T$. At the end of this time, pin 3 will go low. If pin 2 is now brought low and then high, the output will go high when pin 2 goes high, and it will stay high for another time constant. That seems simple enough — just have two such timers operating in a sort of back-to-back configuration. One of them has pin 3 going

high when there is an input signal, and it stays high for the duration of the time-out period. The other one has pin 3 going high when the signal leaves the receiver, and it stays high for the squelch-tail time. The transmitter will be on the air if either one has a high on pin 3. A third timer counts a little less than 3 minutes and then allows the COR to start the ID the next time a signal leaves the receiver. This obeys rules 3 and 4. The only thing left is that nasty little rule 6. So, after getting the thing to work and then removing parts until just one more removal will stop it from working, I arrive at Fig. 2.

We start with the repeater having been inactive for some time so that, due to the +5 volts on pin 4 and a high on pin 2, IC3 (the ID timer) has timed out, and pin 3 is at ground potential. The situation over at IC1 is the same, except that pin 4 gets its high from the output of IC5a. When the COR input goes to ground, it gets delayed just enough by the input circuitry so that pin 6 of IC4 goes low after any contact bounce. This sends a positive-going pulse to pin 3 of IC5d. This is inverted to a negative-going pulse at pin 4, resetting IC2. The high from pin 6, IC4, brings pin 4 of IC2 high, and IC2 starts timing, resulting in +5 volts on pin 3, which is fed to the relay driver transistor, turning the transmitter on. If a signal stays on the input for more than the time-out time, IC2 times out, pin 3 goes low, and the transmitter goes off the air. So much for rules 1 and 5.

With loss of received signal, the output of IC5a goes high, putting +5 volts on IC1, pin 4. The capacitor feeding pin 5, IC5b converts this to a positive-going pulse which, when inverted by IC5b, resets IC1. This starts IC1 timing for the squelch-tail time, producing a high on pin 3 for this duration. Add this high to the high coming from pin

3, IC2, and the relay driver is on for the duration of the input signal plus a squelch tail (assuming that IC2 hasn't timed out). There is a third diode feeding the relay driver. This diode is fed by the ID generator, so the repeater doesn't drop out while it is identifying. (See Fig. 3 for the modifications to the K4EEU ID.)

All this time, pin 3, IC3 has been at zero volts. This low is inverted by IC5e to a high on pin 10, effectively taking D2 out of the circuit. When there is a signal on the input steady state, pin 6, IC5b is high, so pin 8 is low, pulling pin 13 low. This is inverted by IC5f, producing a high on pin 12, which does nothing for the K4EEU IDer. When the input carrier is dropped, IC5b, pin 5 gets a positive-going pulse, and the entire chain is reversed in polarity, so that IC5c, pin 8 goes high for the duration of the pulse on pin 5. This high is inverted by IC5f (as before) to produce a low-going pulse to the IDer, thus starting it. The low-going pulse on pin 12 also resets IC3 (via its pin 2), bringing IC3, pin 3 high (for the ID time duration). This high is inverted in IC5e, producing a low on pin 10 and holding IC5f, pin 13 low, even if the COR is subsequently dropped, until IC3 times out. Referring to Fig. 3, when the low-going pulse is applied to the start flip-flop in the ID, it is applied to the point labeled "to point 1." This sets the flip-flop and brings the other connection (labeled "to point 2") high. This is used as transmitter turn-on voltage, keeping the transmitter on for the duration of the ID.

Due to the fast action of the circuits involved, if the contact debouncing circuit (the input circuitry of IC4) was not included, saving some parts, the first contact bounce from the COR (and it will bounce a few times) would appear to be the COR dropping out, and the ID would start. With the de-

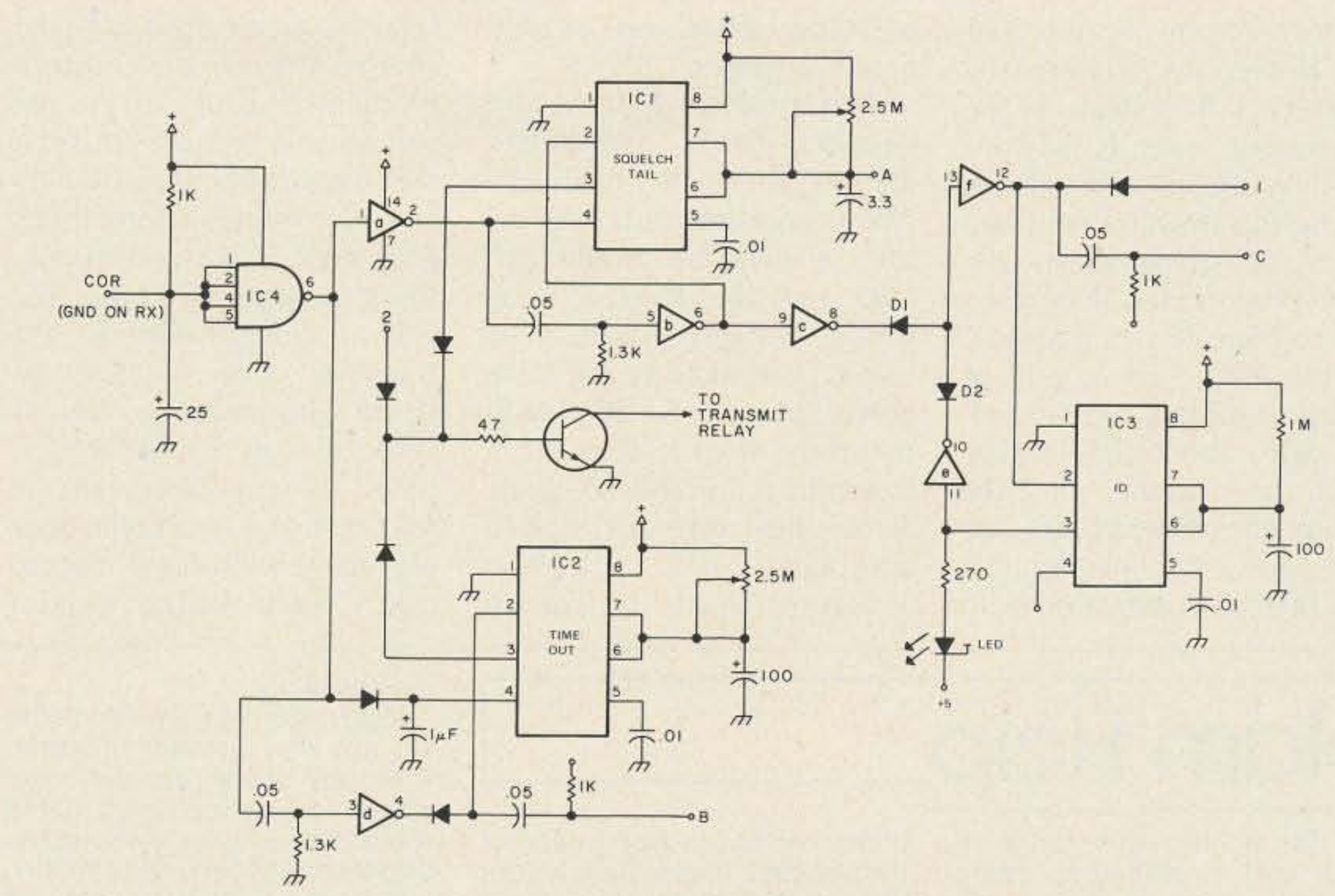

Fig. 2. IC1-3 — 555; IC4 — 7413; IC5a-f — 7404. The diodes can be any silicon diodes: The transistor is dependent on the current requirements of the transmit relay — anything from 2N222 to 2N5655.

bouncing, the ID will only start when the input signal drops.

One fortuitous error developed in the final wiring of the repeater. Steve decided to wire the receiver audio through the COR so that, when the COR dropped out, there would be no audio coupled to the transmitter. (I still don't see where it would come from.) Due to the fact that the K4EEU IDer has very high level audio coming out of it and we are coupling into the mike input of the transmitter, we ended up with quite a large value of series resistance between the ID and the transmitter input. If the COR is picked up during the ID, the voltage division effect caused by the receiver impedance drops the ID to about 1 kHz deviation. So we not only make provisions to keep the ID from stepping on anyone, but also, if someone steps on the ID, it is nice about it and lets his audio go through.

With the values shown, the ID time is about 2:45, the time-out time is variable from 0 to about 7 minutes, and the squelch tail is variable from 0 to 12 seconds (dependent on

the tolerance of the timing capacitors). This squelch-tail time is a bit longer than needed, but the only correction, without getting a custom-made pot (which would probably cost more than the whole controller), would be a 1-meg pot and a 250k series resistor. The fixed resistor costs money, and they don't charge for pots by value (yet!).

The external connection point on IC1, pins 6 and 7 (point A) is controlled by the touchtone™ function decoder, and, if it raised to +5 volts, there will be no squelch tail, which is invaluable for discouraging kerchunkers. If they don't hear it coming back, they leave it alone! The external connection to the ID start line (point C) is grounded to start the ID before IC3 has timed out. Grounding this point will also reset IC3, so the next ID will be 2:45 after the manual ID, just as if the repeater had IDed itself. This function can be left off (simply delete the resistor and capacitor at point C) if it is not wanted. The external connection to IC2, pin 2 will reset IC2 if some dummy like me (I have been

told that I can probably time out '52 direct) forgets when to shut up. This one goes to ground to reset. Of course, if the long-winded one (a plague on his thumb) is running 50 Watts from on top of the repeater, you won't be able to override his signal to reset the timer, so just let him talk to himself.

In view of the requirement to eliminate everything, how about the capacitor from IC2, pin 4 going to ground and the diode feeding it? The system has a tendency to act so fast that IC2 turns off at loss of received signal faster than IC1 can start the squelch tail. This can destroy a good relay, so it is an insurance policy. If your transmit relay is big and sluggish, you could probably save another two parts.

One area that is a bit tricky is the use of the 1.3k

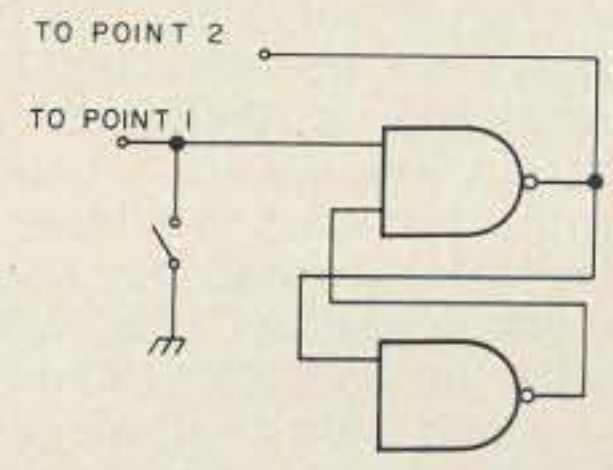

Fig. 3. Modifications to K4EEU ID.

resistors at pins 3 and 5 of IC5. If they are too large, the inverters will remain in the low output state. If they are too low, the resulting pulses will be too small to be of any use. 1.2k seems to be the lower limit, and 1.5k is just a bit too high. If you have any trouble here, use a pot or substitution box, and, starting with about 2.5, slowly lower the resistance until the output pin (of whichever section you are adjusting) just goes high. Use the next small-

er value. That was exactly how I arrived at 1.3k.

One problem that we did have was that the transmitter seemed loath to turn off. About one time out of three, the squelch tail would run out, and the blasted thing would retrigger itself. The culprit proved to be the spike generated by the T/R relay in the Prog when it went from transmit to receive. A diode across the relay coil solved that one.

Getting back to rule 6

(again?), I put the LED (and another one on the collector of the transistor) in the circuit so that I could see what was happening without clipping on a meter or something, and, since it didn't cost anything to leave it in, I did. The one on the collector of the transistor can be left on (from the collector to +5 volts through a 270-Ohm resistor) if your relay runs on 5-6 volts. A 12-volt relay supply here will cause permanently dark LEDs, without

some resistor adjustment.

The circuit is very simple to build on perfboard, but, if you want to keep everything neat, I can supply 4" x 6" PC boards, drilled, with 22 edge fingers etched on but uncommitted, for \$8. If you have any trouble, drop me a note with an SASE.

Thanks to Steve and to Bernie WB2DQH for the use of their experience, knowledge, shop, tools, test equipment, and time. ■

Ham Help

I am writing this letter in hope that it will keep some other young prospective hams from making the same mistake I did. I became interested in ham radio in August, 1976. This interest was kindled by a person who had just moved to our town and was studying code for his Novice exam. I guess you could say that I had always been interested in radio but had never heard of amateur radio before. A neighbor had given me an old telegraph key and sounder, which I had messed around with from time to time.

The mention of Morse code aroused my interest, because I had always wanted to learn what all those little dots and dashes meant. On the spot, I volunteered my services to help him learn the code if he in turn would teach me. After a couple of nights of practice, I had the letters down pat. Wow! Just like that, I had learned something that I thought would take months.

With this newfound talent, I was ready to take on anything. I was therefore quite easily convinced to go all the way and get my speed up for the Novice exam. As I mentioned before, I had no knowledge of or interest in ham radio. When this guy gave me the facts about ham radio, it just about blew me over.

Maybe I should mention here that this man had a brother who was a licensed General and was crazy about radio! This guy almost lived, ate, and slept just to work his rig. Well, this guy kept our interest up for the 3 months it took us to get up to 7 wpm. After we had our speed up, we contacted this man's brother (he lived about 40 miles away) and said that we were ready to take our test. We drove to this guy's town and took our code test at some other ham's

house. After the worst case of the shakes I've ever had, we got through the test. Hey! Now, that wasn't so tough! If that's all there is to it, no sweat! Oh, so little did I know!

After we finished the code test, we made another date to take the written test. Now, this was the first I'd ever heard of any type of written test. I was shaken! But this guy's brother said not to sweat it, it's real simple stuff. Sure it is! He said that it was some questions on operating procedure, rules and regs, and some simple radio theory. Operating procedures, rules, and regulations sounded like it wouldn't be too tough. But radio theory! It had better be simple.

Well, he gave us a Novice study guide and told us to go over the questions for a couple of weeks, come back to his place, and he'd clear up any questions we'd have. Okay, that sounded simple enough. We took it home and studied the questions. In fact, about all we did is memorize the book. In two weeks, we went back to his place for a whole day of just going over this stuff. Gee, this was simple if that was all there was to radio theory. He told us to come back in a couple of weeks to take the written exam.

At about this point, I became worried about (if I did pass this exam) what I would do for a radio. My friend told me that there was no problem, that he'd buy one and I could use it. With that little problem out of the way, I kept up on my code and kept studying for the exam. I took it and passed it okay, but only on operation and rules and regulations. The thing was, none of the questions on this test were the ones from the book. Oh, well, I guess I could forget that as long as I could get my license and start mak-

ing contacts.

Well, about two weeks after we got our licenses, I asked this guy (he'd passed, too) when he was going to get a radio. He said, to my surprise, that he *might* get one someday, but for the meantime he'd lost interest. It made me kind of mad, but I figured I could get along without him. I'd just have to get my own radio!

That's how I came across my first issue of *73 Magazine*, the December, 1976, one. It blew my mind. About all I could understand was the advertisements! Now I realize what had happened. I was taught how to pass the test, not anything about ham radio. Man, I was mad—I still get kind of angry when I think about it. Needless to say, it was the end of a relationship.

One of the things I did learn from that first issue was that there was no way I could afford a radio. My only income was 5 dollars a week for working from my folks. With my knowledge of electronics (hah!), building a radio was entirely out of the question.

Things lay dormant for quite awhile, about six months. Occasionally, I'd pick up an issue of *73* to page through. Every issue made me more angry about what had happened to me. I picked up a little knowledge from each issue, and from library books, so that I at least knew how to figure resistance and identify some simple components.

At about that time, my prayers were answered. Our small town lacked someone to fix TVs, radios, etc. We finally got someone who moved in and started to do these things. It just happened that our old set had been acting up. The man was called and asked to come and take a look. Well, this guy came and started to work on this set. Naturally, I watched with a great deal of interest.

He asked me if I knew anything about electronics. I

told him much the same story I have just told you, whereupon he told me that before moving here and becoming a repairman, he had worked for a major radio company as just about the only person involved on a full-time basis with radar. He commended me for my dedication in trying to learn about this subject. He said that any time I had a question about radio I could just come and see him.

In the past year, I've learned more about electronics than I ever thought possible. I still don't know very much, but at least I'm back on the track again. Still, one bad thing has come of all this: I still don't have a radio, have never operated one, and wouldn't even know how if someone gave me one. I've all but forgotten the code; I can't find anyone who's interested. I am the only amateur within miles.

My repairman friend gave me an older six-channel CB that I am trying to get transmitting so that I can use it on 10 meter CW. He also gave me an old oscilloscope for nothing. He told me to play with it, that I'd probably learn something. Even if I do get the 10 meter rig going, I still wouldn't know how to make a contact.

Well, so much for my hopeless case. As I said when I started this letter, I'd hate to see this happen to someone else. Unfortunately, our high school does not have a basic electronics course, or my problem would have been solved. I think that something should be done about this type of thing. Oh, learning by rote is an easy way to get into amateur radio, but is it the *right* way? I don't think so, and I think you'd probably say the same thing. Something has to be done.

Novice classes seem like a darn good idea. The only trouble is finding one. I'd love to go to one! But where are they?

Mark Malm WB0YHW
PO Box 323
Flasher ND 58535

SCR 1000 - Standard of Comparison

In Repeaters - Now Available with Autopatch!

Autopatch Features:

- Normal patch, or secure "reverse" patch
- 3 digit anti-falsing access — single digit disconnect
- 3 digit on-off control of repeater transmitter
- 4 sec. time limit on access
- Built-in adjustable time-out function — patch shuts down in 30-90 sec. if no carrier is received
- Wide range audio AGC on input and output.
- User can mute phone line audio simply by keying his mic button — prevents embarrassing language from being repeated
- Patch access and repeater control — either over the air or over the land line



2Mtr. & 220 MHz!

Now Spec Comm has taken the hassle out of putting an autopatch repeater on the air! The SCR1000/SCAP is a fully self-contained 30 watt repeater with built-in autopatch and land line control. You simply plug in the phone line, hook up the duplexer, and you're on the air! The usual months of problems are eliminated! The SCR1000/SCAP has been meticulously engineered to provide the smoothest performing patch together with a positive land line control of the repeater. The system is fully assembled, set-up and checked-out in our lab.

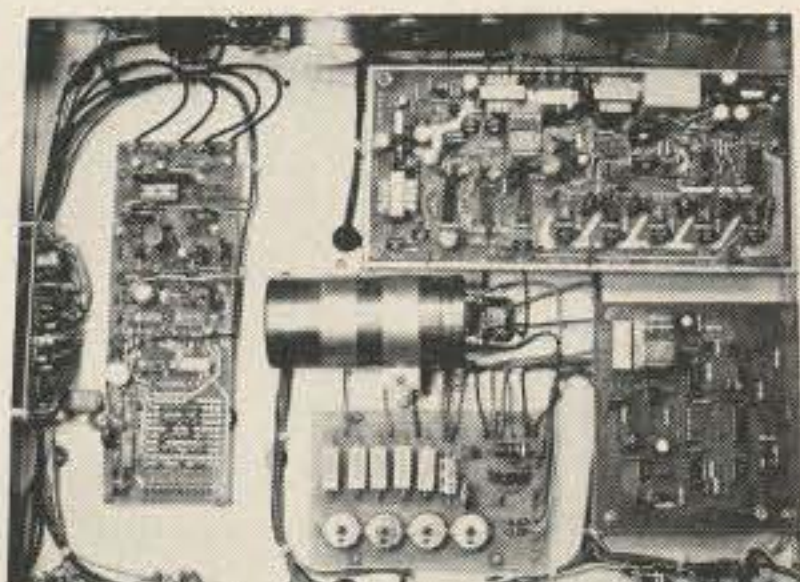

Under chassis view of SCR1000 with Autopatch installed.

- **The SCR1000**—simply the finest repeater available on the amateur market... and often compared to "commercial" units selling for 3-4 times the price! This is a 30 Wt. unit, with a very sensitive & selective receiver. Included is a built-in AC Supply, CW IDer, full metering and lighted status indicators/control push-buttons, crystals, local mic, etc. Also provided are jacks for emergency power, remote control, autopatch, etc.
- **A full complement of options are available:** Duplexers, Cable, 'PL', HI/LO Power, Autopatch, Racks, etc. Please inquire.
- **The Spec Comm Repeater System**... a sound investment... available only by direct factory order. Get your order in A.S.A.P.

SCR 1000 Specifications

RF Output 30 Watts typ.
 Infinite VSWR proof
 Sensitivity 0.3uV/20dB Qt.
 Selectivity... -6dB @ ± 6.5 kHz;
 -55dB @ ± 15 kHz;
 -90dB @ ± 30 kHz.
 (Sharper 8 Pole Fltr, Available)
 Desense/Overload... W/1uV
 desired signal, desense just
 begins @ approx. 50,000uV @
 ± 600 kHz.
 Spurious Response . -70dB min.

- State of the Art CMOS** control logic & timers—No Relays!
- Built-in CW IDer**—Low current draw. Fully adjustable speed, pitch, time, etc.
- Exclusive Spec Comm **MOS-FET/Hot Carrier Diode** rcvr. front end—greatly reduces 'desense' & IM problems!
- Built-in AC Supply** w/instant btry. switchover for emergency pwr.
- Supplied with .0005%** Sentry xtals and a Turner local mic.
- Jacks Provided** for Remote Control, Auto-Patch, DC out, AF in/out, COR Switch, etc.
- True FM**—For Rpt. Audio so good, it "sounds like direct"!

FEATURES

- Full Metering** of critical levels.
- Front Panel Controls** for timers & AF levels.
- Lighted push-buttons** for control/test functions & status indicators

SCR 1000 WITH FL-6 PRESELECTOR.....\$1035.00
 SCR 1000 WITHOUT PRESELECTOR.....\$ 950.00
 SCR 1000 SCAP & FL-6 PRESELECTOR.....\$1585.00
 SCR 1000 SCAP FL-6 WP641 DUPLEXER.....\$2080.00

Commercial prices somewhat higher.

See our April 73 Ad for more details!
 (Add \$3.75 ship/handling. PA residents add 6% tax.)

Send for Data Sheets!

SPEC-COMM REPEATER BOARDS, SUB-ASSEMBLIES & ACCESSORIES

2M & 220 MHz!

- **FL-6 Preselector.** Rcvr. Front-End Filter/Preamp. Exc. rejection of strong "out of band" sigs. + improves sensitivity.....\$85.00
- **SCR100 Receiver Board.** w/xtal.....\$115.00 (8 Pole IF Filter + \$18.95)
- **SCR100 Receiver Assembly.** SCR100 mounted in shielded housing.\$185.00
- **SCT110 Xmtr./Exciter Bd.** 7 or 10 Wt. bd. \$135.00 w/xtal. BA-10 30 Wt. Amp. bd. & Ht. Sink.....\$51.95
- **SCT110 Transmitter Assembly.** SCT110 mounted in shielded housing....\$199.95 (30 Wt. Amp. + \$62.00)
- **CTC100 COR/Timer/Control Bd.**\$35.00
- **ID250 CW ID/AF Mixer Bd.** Programmed\$65.00
- **SCAP Autopatch Bd.** \$225.00
- **RPCM "Reverse Patch" & control bd.**\$79.95
- **TTC100 Touch Tone Control bd.** 3 digit ON, 3 digit OFF.....\$79.95
- **TRA-1 Timer Reset Annunciator Bd.**\$20.95
- **WP641 Duplexer.** ...\$495.00



SPECTRUM COMMUNICATIONS

1055 W. Germantown Pk., Norristown PA 19401 (215) 631-1710

S8

David Boyd K9MX
601 Pioneer Ct.
Waukegan IL 60085

Max Boyd N9MX
Route 2, Box 960
Collinsville IL 62234

Another Ten Minute Timer?

— *yup*

is designed for a special purpose, like preventing an HT or mobile rig from timing out a repeater, or includes fancy functions, like an automatic reset provision or a digital elapsed-time display or some other hybrid function that limits its versatility and raises its cost. For a father of four (including a set of twins) and a retired soldier, they all cost too much.

Since both of us are a bit long-winded, we sometimes forget the time in a QSO, so what we needed was a simple timer capable of triggering an audible alarm every ten minutes. Of course, it had to be simple enough that it could be built entirely from our junk boxes.

The result is a super simple timer that is flexible enough to allow for the addition of all sorts of nice features at a future time. The version we built consists of a single NE555 (any 555 IC will do) and has a simple audio oscillator installed on the same board. The delay can be fixed at any value you choose simply by selecting the proper combination of resistance (R1) and capacitance (C1). A pot covering a suitable range can be employed if you need a variable delay. If you do use a pot, it will probably take a little trial and error to calibrate it correctly. But, for most of us, an infinite range of possible delays is seldom needed (and, besides, we only had a pot for one of the two timers we

Just about every other issue of every amateur magazine carries an article on a clock or timer of some sort. Unfortunately, most are involved enough that the average ham junk box lacks at least a few of the components (usually the most expensive ones). And, usually, each one

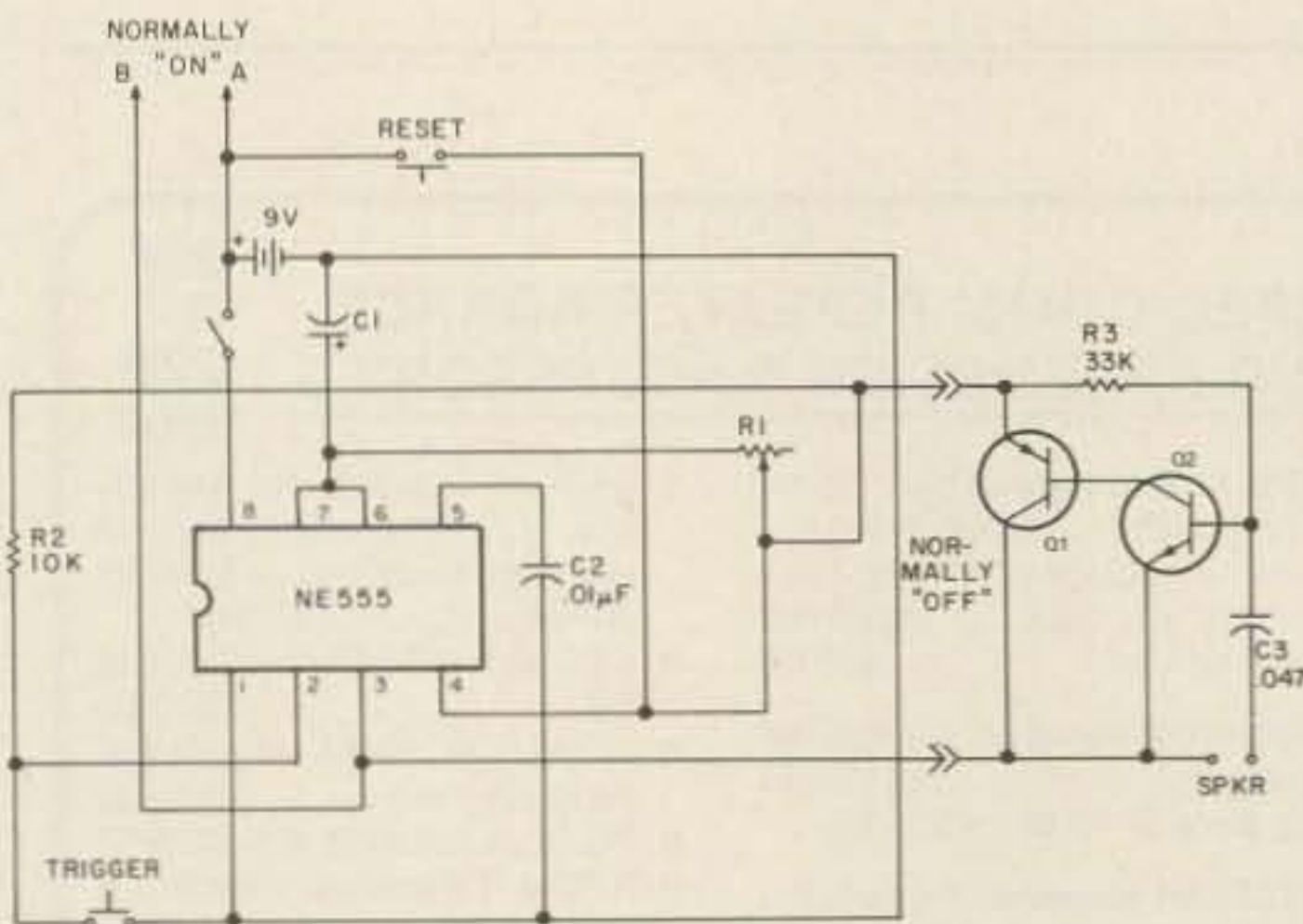

Fig. 1. Schematic.

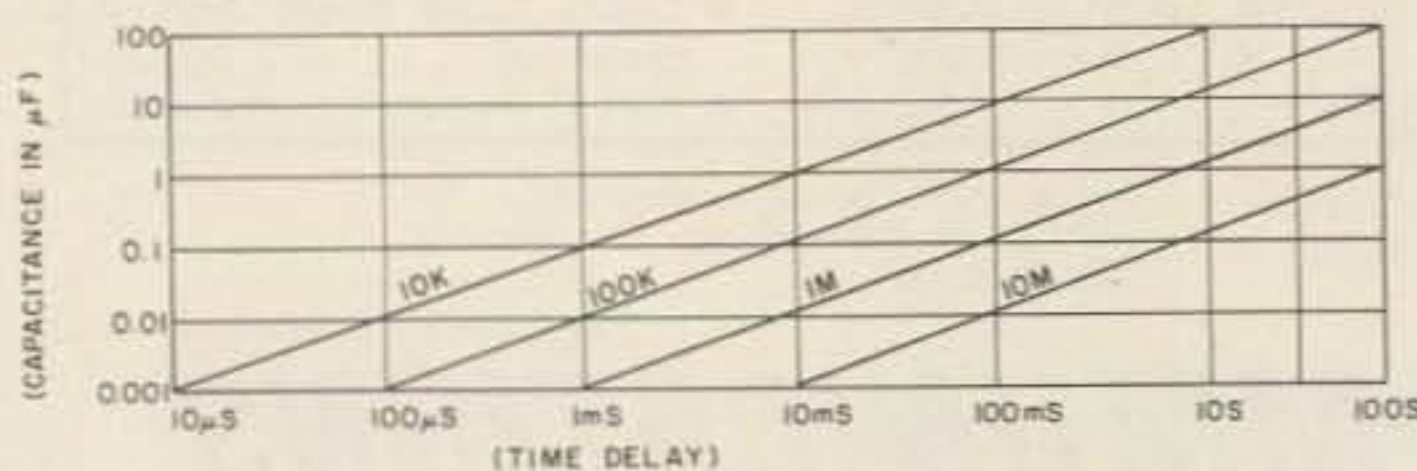
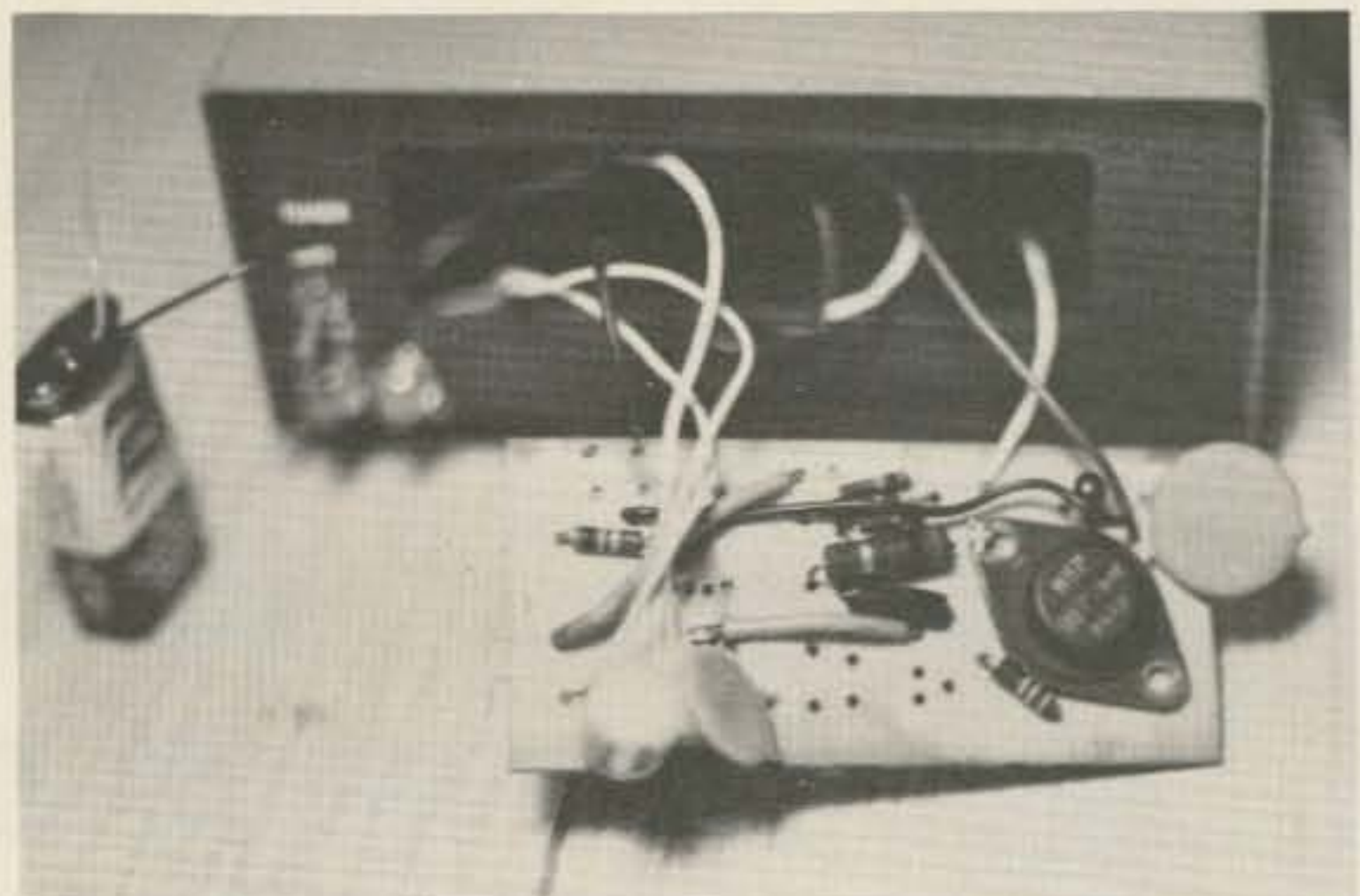
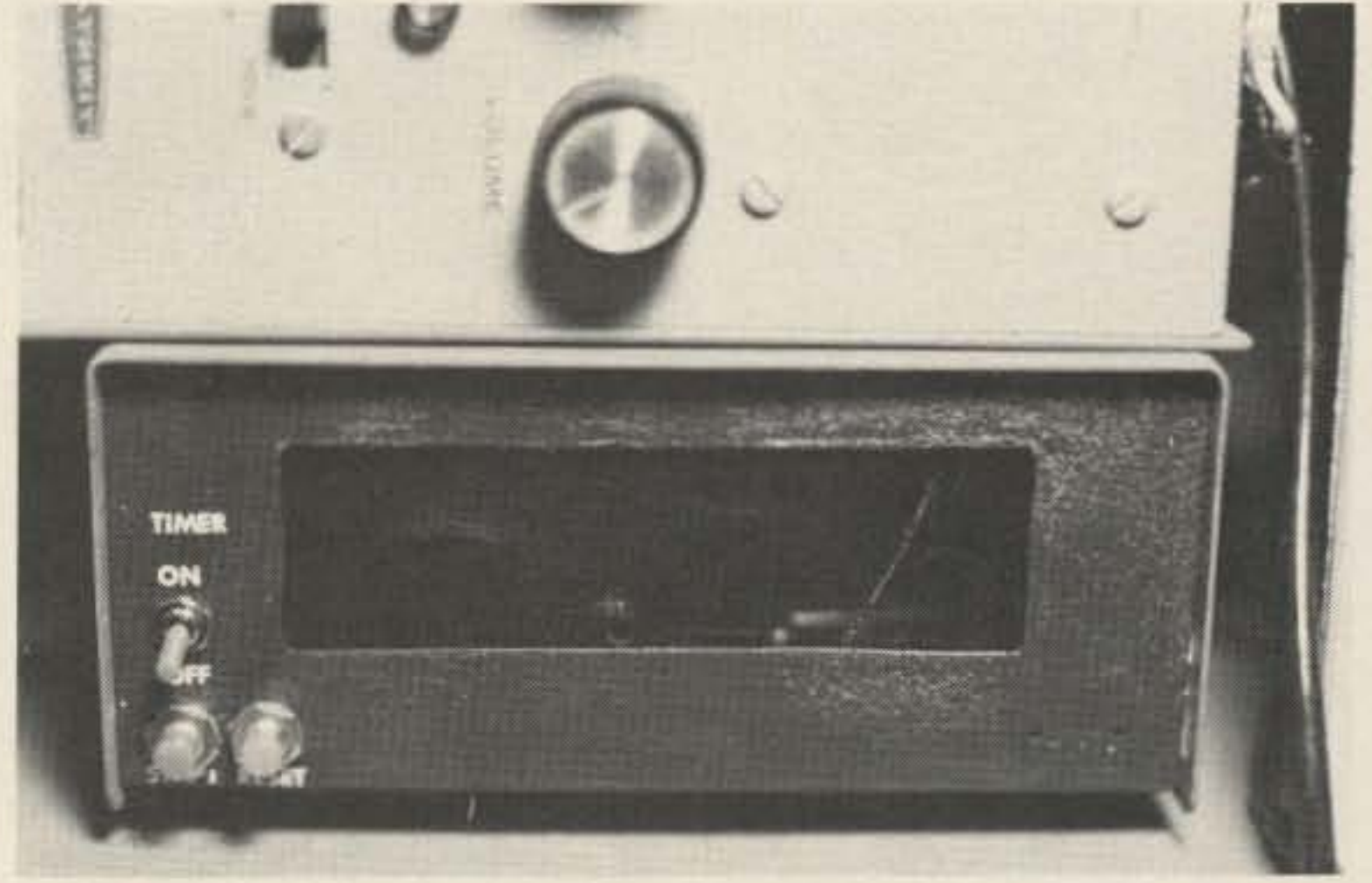
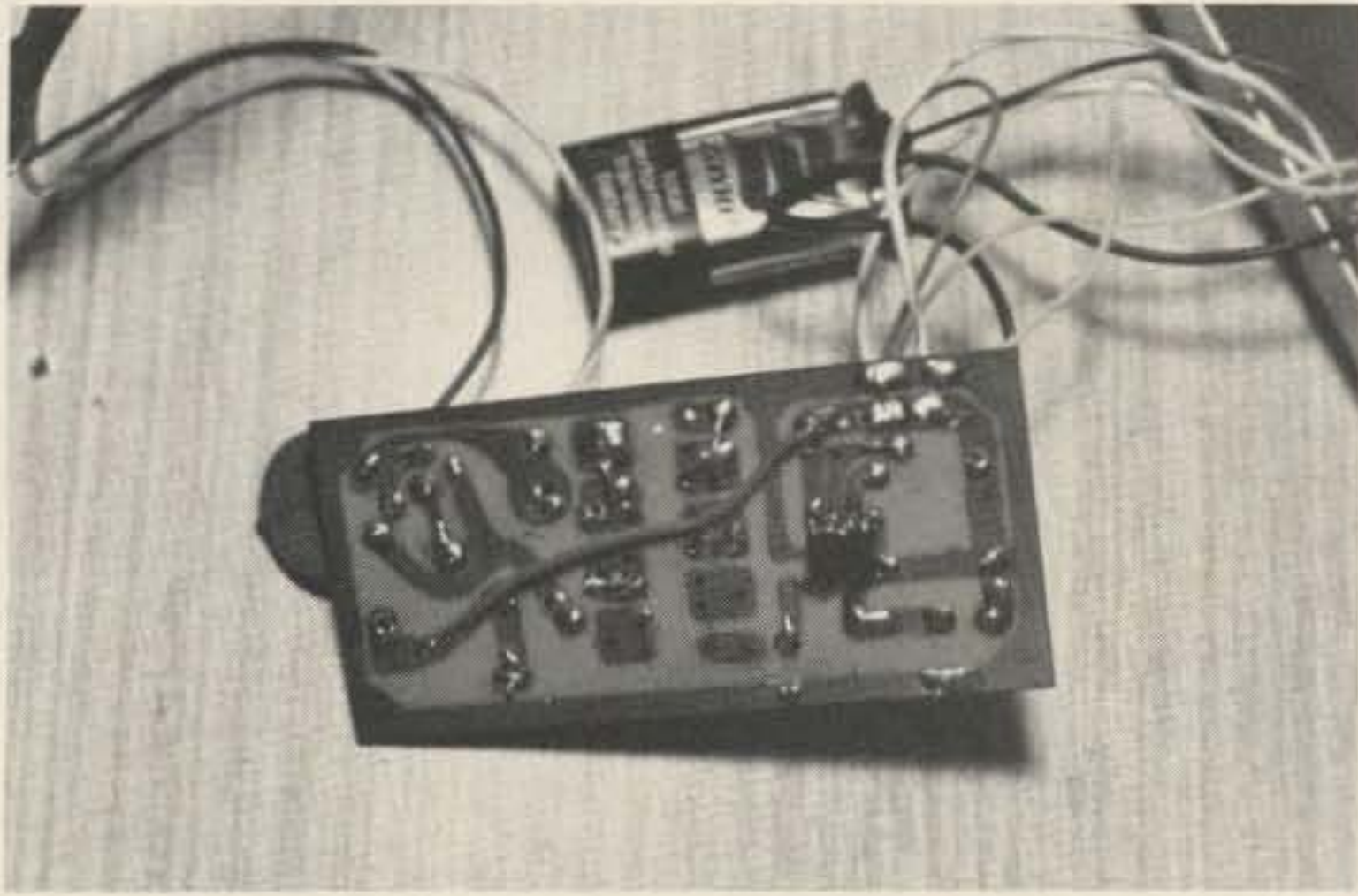

Fig. 2.





The jumper wire to the oscillator shown in this prototype is not needed in the version shown in the template. This board demonstrates an important caution: If you use a photo process, make sure you don't reverse the mask when exposing the sensitized board. If you do, you'll have to put the IC on the foil side of the board, as we did here.

built). So we included several "pads" to permit fixed value resistors to be switched in and out. By wiring them in series, they can be switched in one at a time, increasing the length of the delay in predetermined increments of, say, five seconds, 30 seconds, one minute, or whatever you choose (or your junk box can handle).

Computing the time delay is simple. Just multiply the value of C1 times the value of the delay resistor (R1). For example, a 100-microfarad capacitor and a 10,000-Ohm resistor give you: $.000100f \times 10,000 \text{ Ohms} = 1 \text{ second}$. Make sure you watch those decimals. For those not mathematically inclined, just

use the simple graph¹ shown in Fig. 2.

Actually, as the chart demonstrates, the length of the delay is not exactly as the

Later on, a clock and a few other useful devices will go into this cabinet, so the timer controls have been clustered on one side. Obviously, simpler packages can be used for your timer.

simple R x C formula would imply. There is, of course, some internal capacitance and resistance (and other factors) in both the IC and the associated circuitry which affects the length of the delay. Nevertheless, R x C or the

graph will provide good starting points.

The audio oscillator is the simplest part of the timer. Any NPN and any PNP transistor will work, but Q1 should be a power type. A heat sink should not be neces-

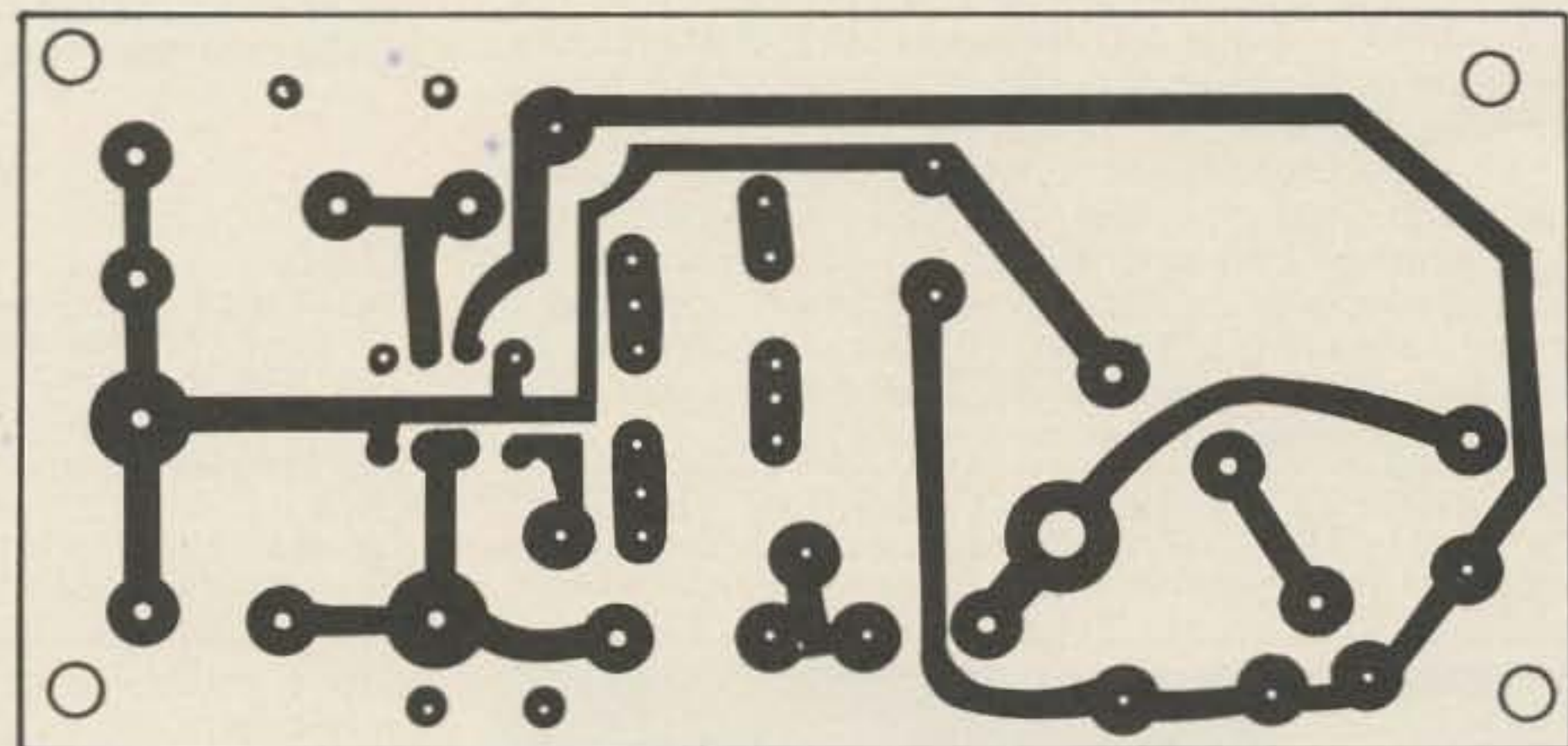

Fig. 3. PC board.

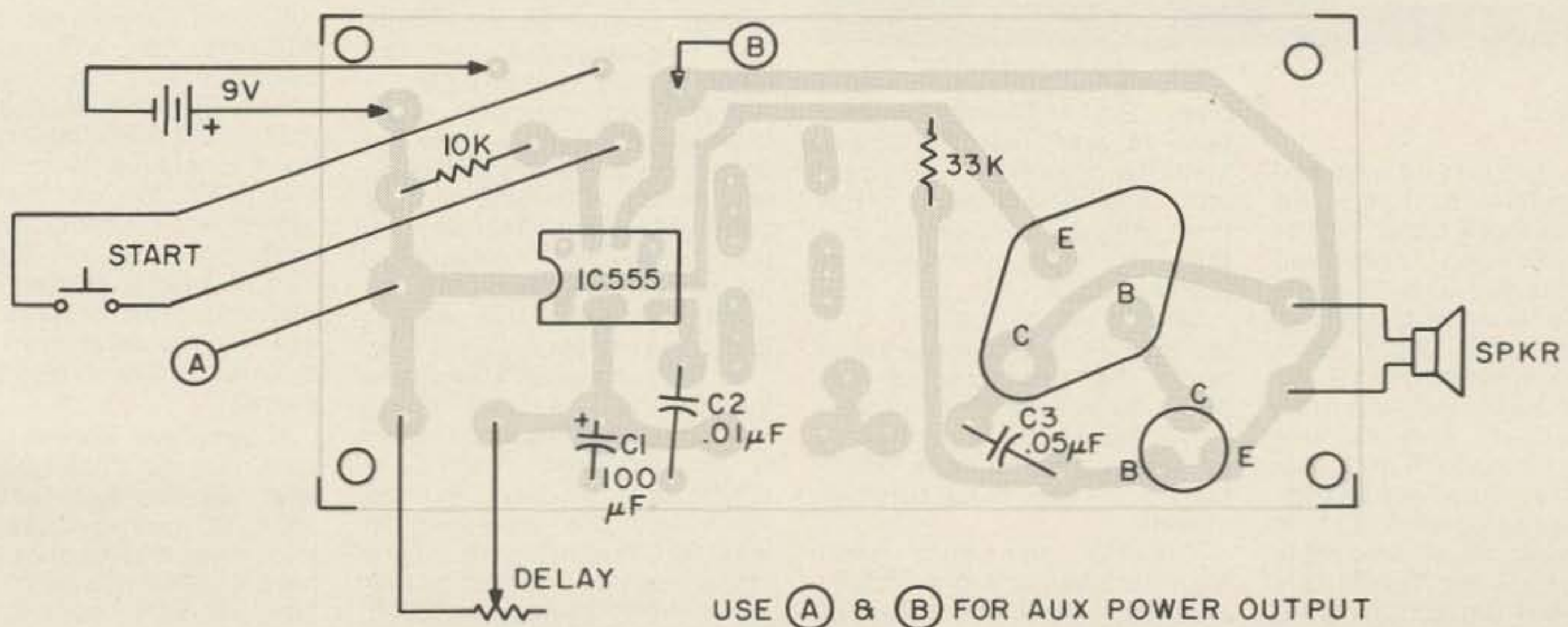

Fig. 4. Component layout (shown from foil side).

sary, and the frequency of the audio note is determined by R3 and C3. The values shown seem to work well, but your junk box should determine which values you use. If you want to fancy it up a little, use a pot for R3, and you can vary the tone to meet your tastes. You can also add a reset function (they can be awfully convenient) by placing a normally-open/momentarily-closed switch across pins 4 and 8. An on/off switch

should definitely be included in the battery line, of course, unless you intend to replace batteries every day. In normal use, a 9-volt transistor battery should last several months without replacement. (Both of ours were in operation for more than six months before one finally needed a new battery.)

While we have used only the simplest circuitry here, the possibilities are innumerable. For example, pins 8 and 3 of the IC (A and B on

the PC template) will provide a normally "on" output to drive an LED while the device is timing. (Of course, the battery is not going to last as long if you do that.) Pins 1 and 3 provide the normally "off" switch that we use to drive the audio oscillator. (Incidentally, the 555 outputs, when driven by a 9-volt battery, run about 6 volts.) It would be a simple matter to have this first timer light an LED or trigger a relay which lights a sign reading

"IDENTIFY." You could have another 555 triggered at the same time as the light to allow you 10 or 15 seconds to hit the reset button before the audio alarm goes off. Or you could have it trigger an audio alarm fifteen seconds before it shuts down your transmitter to keep you from timing out the repeater. The possibilities are limited only by your imagination. ■

Reference

¹ From the Archer Technical Data Sheet for "Timer, RS555."

FCC Math

from page 18

$(\sqrt{R^2 + X^2})^2 = R^2 + X^2$. Squaring is just undoing square rooting! Multiply out that left-hand side to get: $Z^2R^2 + Z^2X^2 = R^2X^2$. Now subtract Z^2X^2 from both sides (doing the opposite of addition indicated) to get: $Z^2R^2 = R^2X^2 - Z^2X^2$ (subtracting from the right just gets rid of the Z^2X^2 entirely. If you have $7 + 4 = 11$, for example, and subtract 4 from both sides, you get $7 = 7$. You got rid of the 4 on the left.) Now pull that reverse dealie we've done before, to get: $Z^2R^2 = X^2(R^2 - Z^2)$. Now divide both sides by $(R^2 - Z^2)$ as a unit, getting rid of it on the right and putting it down on the bottom left: $Z^2R^2/(R^2 - Z^2) = X^2$. We're almost there. Just one more opposite, the opposite of squaring, to undo that X^2 . So we now take the square root of both sides, recognizing, again, that top left can be handled separately from the bottom, which has to be handled as a unit. That gives $ZR/\sqrt{R^2 - Z^2} = X$, which is what we want, X by itself on one side, everything else on the other. Now, just putting whatever values I have for Z and R, I can find X fairly easily. Say, for example, Z is 5000 Ohms and R is 20,000, we have $X = (5000)(20,000)/\sqrt{20,000^2 + 5000^2}$, which you can work out rather easily with powers of ten now, can't you?*

*That's $(5 \times 10^3)(2 \times 10^4)/\sqrt{(4 \times 10^8) + (25 \times 10^8)}$ which is $10 \times 10^7/\sqrt{400,000,000 + 25,000,000} = 10 \times 10^7/\sqrt{375,000,000}$. 375,000,000 is about 4×10^8 , the square root of which is 2×10^4 . Dividing that into the top gives 5×10^3 or 5000 Ohms.

Admittedly, that was one heck of a lot of algebra we just did. The only way one gets a feel for what order to do things in is with lots of practice. The object is always to get one thing by itself on one side with everything else on the other. Making up number equations, with small numbers, is the quick way of finding out what is and what is not going to get us where we want to go. If something doesn't work with numbers, it sure as heck won't work with letters either.

And a final recommendation: Get a license manual, study guide, or whatever and practice, practice, practice wiggling the various formulas into alternate forms. Check yourself by making up a true number equation for the original and seeing if the same numbers work for the same letters in the final equation you derived. If it doesn't, you've made a mistake somewhere. If it does, you've done correct work. With such practice, you will soon be a totally confident master of electronics math!

WORK AND ANSWERS

Exercise 1:

- (1) (a) 59 is 5.9×10^1 , about 6×10^1 , hence logarithm is 1.8.
 (b) 3 is 3×10^0 , hence $\log 3 = 0.5$.
 (c) 11,100 is 1.11×10^4 , about 1×10^4 , log is 4.0.
 (d) 679,000,000 is about 7×10^8 , hence log is 8.85 or so.
- (2) (a) $10 \log(40/5)$ is $10 \log 8$, which is $10 \log(8 \times 10^0)$; $\log(8 \times 10^0)$ is 0.9. 10×0.9 is 9 dB.
 (b) $10 \log(2/0.03)$ is $10 \log(200/3)$ or $10 \log 67$ approximately. 67 is about 7×10^1 , whose log is 1.85 or so; 10 times that is 18.5 dB more or less.

serious measures to protect our hobby.

WHAT WILL 1988 BE LIKE?

Crystal balls are never too clear, but perhaps we can look ahead in amateur radio a bit just by looking back over the last few decades and the changes they have brought.

Some new invention could radically change history, of course, as could the loss of all ham bands at Geneva in 1979, but if we project what information we have right now into the future, we may get a fairly accurate picture of life on the ham bands ten years from now.

In 1968, we could clearly see the future for two meter FM and repeaters, so the current activity on that mode was quite predictable. Indeed, I think you'll find me predicting at least 50,000 active FMers in my 1969 editorials. I missed on that for we now have about 75,000. Compared to the 2,000 active in those days, my projection was

reasonable.

There are two significant technological events which will, I think, have a lot to do with amateur radio ten years hence. One is the advent of the microcomputer, which I expect will bring us perhaps 100,000 RTTYers, but with systems beyond present day imagining in use. The other change will be the use of narrowband modulation techniques for both voice and RTTY. We can see, right now, the possibility of 5 kHz repeater splits on the VHF bands using folded audio transmission (FAT)... and who knows what even better systems will be evolved in ten years.

If amateur license growth continues as it has for the last year, we can look for almost 1,600,000 hams by 1988. I think we'll make that number. We will have 400,000 this year. By the time we get to 800,000, I sus-

Continued on page 136



...de W2NSD/I

EDITORIAL BY WAYNE GREEN

from page 6

disaster. That lost us over one million amateurs, hams we would have had if the growth of the hobby had continued through the 60s and 70s as it had in the late 40s and 50s. A lobby certainly could have prevented that disaster.

Then came the repeater rules... another almost unbelievable debacle. A good lobby certainly would have headed that massive stupidity off at the pass. Now, again we are deeply in need of a lobby. The FCC is by no means through dumping on us and we have little in the way of any muscle to fight

back. The ARRL did its very best to ward off the linear amplifier rules and they lost utterly and completely... but then, they have no lobby and thus very little in the way of political clout.

Should we decide that it is worthwhile to fight for amateur radio, the signatures on the petitions will be of enormous help. This is the sort of clout that gets respect from politicians... like FCC commissioners.

The FCC has done great harm to amateur radio and apparently has in mind further harm, so it is getting to be time for us to take some more

DSI

Be the one who's on FREQUENCY!!

With your *DSI Counter*. . .save the shop cost of tweaking xtals. . . know your frequency. . .from 160 meters through 450 MHz. Now *DSI* offers *the most* counter for your dollar. Latest state-of-the-art technology. . .*DSI* advanced LSI design far exceeds outdated TTL. Go with the leader . . .buy a *DSI FREQUENCY* counter and **SAVE TIME & MONEY!!**

NOT A KIT



MODEL 3500 \$139.95



MODEL 3600A \$189.95
Includes oven timebase

500 MHz Frequency Counter

- Includes 500 MHz Prescaler — Not an addon
- 7 Large bright — 1/2 inch LED Readouts
- Temperature compensated crystal timebase
- Accuracy 1 PPM Typ
- Sensitivity 50 MvRms 150 & 250 MHz 150 MvRms 450 MHz
- Gate time light
- No direct RF connection Required
- AC or DC operation
- 50 Hz to 500 MHz typ
- Comprehensive owners manual with complete accurate schematics
- Factory assembled & tested

600 MHz Frequency Counter

- Includes oven compensated crystal timebase
- Includes built-in 600MHz Prescaler-Not and addon
- 8 Large bright — 1/2 inch LED Readouts
- Two timebases 0.1 sec & 1. sec
- Resolution 1 Hz Direct 10 Hz Prescaled
- Sensitivity 20 MvRms @ 150 & 220 MHz 100 MvRms 450 MHz
- Accuracy .5 PPM over temperature
- Oven light & Gate time light
- Automatic Decimal point placement
- NO DIRECT RF CONNECTION Required.
- Comprehensive owners manual with complete accurate schematics
- AC or DC operation
- 50 Hz to 600 MHz Typ.
- Factory assembled & tested

Use it in the car or on the bench. . .take it to the repeater site. . .high-impact case. . .light weight—but rugged. . .Designed with the latest readily available LSI, CMOS, Schottky, Mecl-integrated circuits.

NEW PRODUCTS

- 250 MHz 7 Digit Battery operated hand held counter \$109.95 available mid-January.
- 3 1/2 Digit Bench Digital Multi-meter AC or Battery operated \$99.95 available mid-February.

Strongest Warranty in the Counter Field. ONE Year Parts and Labor we pay the return shipping. Plus . . . Satisfaction guaranteed . . . Dennis Romack . . . WA6OYI . . . VP-Marketing, DSI.

D25

TO ORDER CALL COLLECT (714) 565-8402

Name _____ Call _____
 Address _____
 City _____ State _____ Zip _____
 Phone: _____
 Order: _____
 Check enclosed Please send more information on your full line of Instruments and Accessories.
 BankAmericard MasterCard VISA R.E.
 Credit card # _____ Card expiration date _____ Signature _____

DSI INSTRUMENTS INC.
Div. Diversified Security Ind, Inc.

We pay shipping charges anywhere in the U.S.A. UPS Brown or P.P. — CA Residents please add 6% state sales tax.

- American Express
- Bank of America
- MasterCard
- VISA

7914 Ronson Road No. G, San Diego, CA 92111

FOR THE HAM

A BELT BUCKLE
From The COLORADO SILVER CO



APPROX. SIZE 2 1/2 x 3 1/2 INCHES
CAST IN SOLID BRONZE
ENGRAVED WITH CARE

This buckle can be yours for only \$12.50, plus \$1.00 for postage.

COLORADO SILVER CO., DEPT. H
P.O. BOX 1755, ASPEN, CO. 81611
COLO. RES. ADD 3%



C63

TROUBLE FREE TOUCH - TONE ENCODER



POSITIVE TOUCH (KEYS DEPRESS) • MOBILE • HANDHELD
POSITIVE MOUNT • NO POTTED PARTS (SERVICEABLE)
MIL SPEC. COMPONENTS • NO RFI • SELF CONTAINED
XTAL CONTROLLED • LEVEL ADJUSTMENT FROM FRONT

Supplied with: Instructions, schematic, template, hardware. Operating Voltage: 4.5 - 60V. PP-1A, designed for Standard Communications Handhelds.

(California residents add 6% sales tax.)

PP-1=\$55.00, PP-2=\$58.00, PP-1A=\$58.00

PP-1M=\$55.00, PP-2M=\$58.00, M series-Mobile

PP-1K=\$66.00, PP-2K=\$69.00.

K-series = Self Contained Delay Relay
LETTERING OF UNITS OPTIONAL

Available at: Ham Radio Center (800) 325-3636

Denver Colo., CW Electronics (303) 893-5525

Medford, MA, Tufts (617) 395-8280

Los Angeles, Henry Radio (213) 272-0861

New York City, Harrison (800) 645-9187

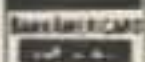
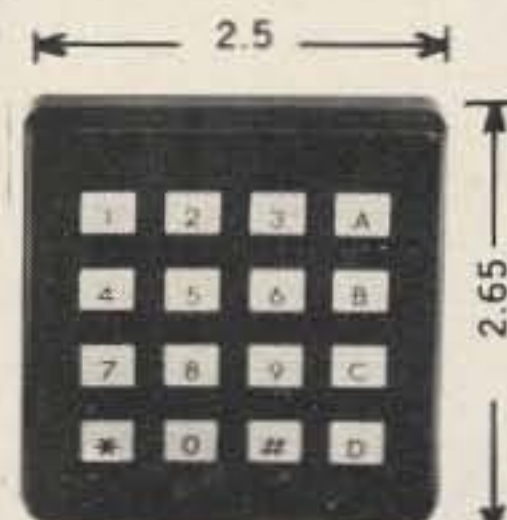

PP-1

PP-2



Mail Order To **Pipo Communications**

P.O. Box 3435 Dept C
Hollywood, California 90028
213/852-1515

DOVETRON



MPC-1000C

Multipath Correction
In-Band Diversity &
AFSK Tone Keyer

Amateur Net: \$545.00

Standard features include CONTINUOUSLY tuneable Mark and Space channels (1000 Hz to 3200 Hz), Dual Mode (MARK or FSK) Autostart and internal high level neutral loop keyer (20 to 60 ml). Both EIA and MIL FSK outputs are provided for direct interface to microprocessor and video terminal peripherals.



MPC-1000CR

Signal Regeneration &
Speed Conversion

Amateur Net: \$645.00

A front panel switch permits internal TSR-200 Signal Regenerator-Speed converter assembly to electronically "gear-shift" between 60, 67, 75 and 100 WPM. All incoming and outgoing signals are regenerated to less than 0.5% bias distortion. Also available with DIGITAL Autostart (TSR-200D): Amateur Net: \$695.00



MPC-1000R/ TSR-500

Dual UART Regeneration,
Speed Conversion, 200
Char. Memory, Word Cor-
rection & DIGITAL
Autostart

Amateur Net: \$895.00*

The MPC-1000R/TSR-500 provides Preloading and Recirculation of the 200 character FIFO Memory, a keyboard-controlled Word Correction circuit, Variable Character Rate, Tee Dee Inhibit, Blank/LTRS Diddle, a Triple Tone-Pair AFSK Tone Keyer and a Character Recognition/Speed Determination DIGITAL (DAS-100) Autostart mode.

*The MPC-1000R is also available without a TSR assembly and functions as a MPC-1000C with a Triple Tone-Pair AFSK Tone Keyer. This "Basic-R" permits future expansion with a TSR-100, TSR-200, TSR-200D or TSR-500 by simply lifting the lid and plugging in the appropriate TSR assembly: Amateur Net (Basic-R): \$595.00

Your QSL will bring complete specifications, or call: 213-682-3705.

D23



627 FREMONT AVENUE
(P. O. BOX 267)
SOUTH PASADENA, CA. 91030

TORRESTRONICS Universal Digital Frequency Readout Kit



FEATURES: 25 MV. Sensitivity 1 to 50 MHz. Frequency input 100 kHz, 10 kHz, 1 kHz, 100 Hz. Resolution readout uses MAN 7 LED displays. Built-in power supply. Fully programmable; will operate with any receiver or transceiver. Connects directly at the injection output for Drake, Kenwood and Heathkit receivers (no modifications to the receiver). Many others. Made to fit inside a Ten-Tec JW-6 Enclosure (2.25" x 6" x 6"). \$85.00 Kit. \$7.00 Enclosure. \$89.95 Kit + Enclosure. Ohio residents add 4.5% tax.

PRICE: \$85.00 Kit. \$7.00 Enclosure. \$89.95 Kit + Enclosure. Ohio residents add 4.5% tax. All prices include shipping cost (USA only). T32

TORRESTRONICS, INC.
4850 Hollywreath Court
Dayton, Ohio 45424

ORDER TODAY !!

Make Antenna Tuning A Joy

— instant swr bridge

Vswr measurement is widely used by radio amateurs for adjusting and matching their antennas. This article shows how I save myself a lot of walking and how I tune my antennas. I started out with a model

190B Tektronix constant amplitude signal generator, which is easy to obtain now on the surplus market. I modified the signal generator slightly, built a 50-Ohm resistance bridge, and merged them to come up with an extremely stable and accurate vswr bridge. If you don't want to modify your generator, you could build only the resistance bridge portion.

The 190B signal generator is perfect for this vswr bridge because of its constant output level, which means that once the incident (for-

ward) voltage is set, you can tune a very large frequency band without needing to readjust every few kilohertz or so. And there are other advantages. The frequency range covers 160 through 10 meters. With my generator-bridge arrangement, everything is complete in one package, so it's handy to use. Because of its low output level, there is no QRM radiated into space.

First you'll need a schematic of the signal generator to study. The following steps describe how to modify the signal generator and install the resistance bridge:

1. Remove the external attenuator pad and its socket from the unit. (Note which pins the wires are on.) Fabricate a 1½-inch-square aluminum plate to mount an SO-239 rf socket, and attach the socket to the unit.

2. Drill a 5/16-inch-diameter hole midway between the power switch and the SO-239 rf connector. Refer to Fig. 1. This hole will be for the vswr function switch. (See schematic for parts list.)

3. Remove V50, a 12AU7 tube used as the meter amplifier, and discard it.

4. Build the 50-Ohm resistance bridge according to the schematic shown in Fig. 2.

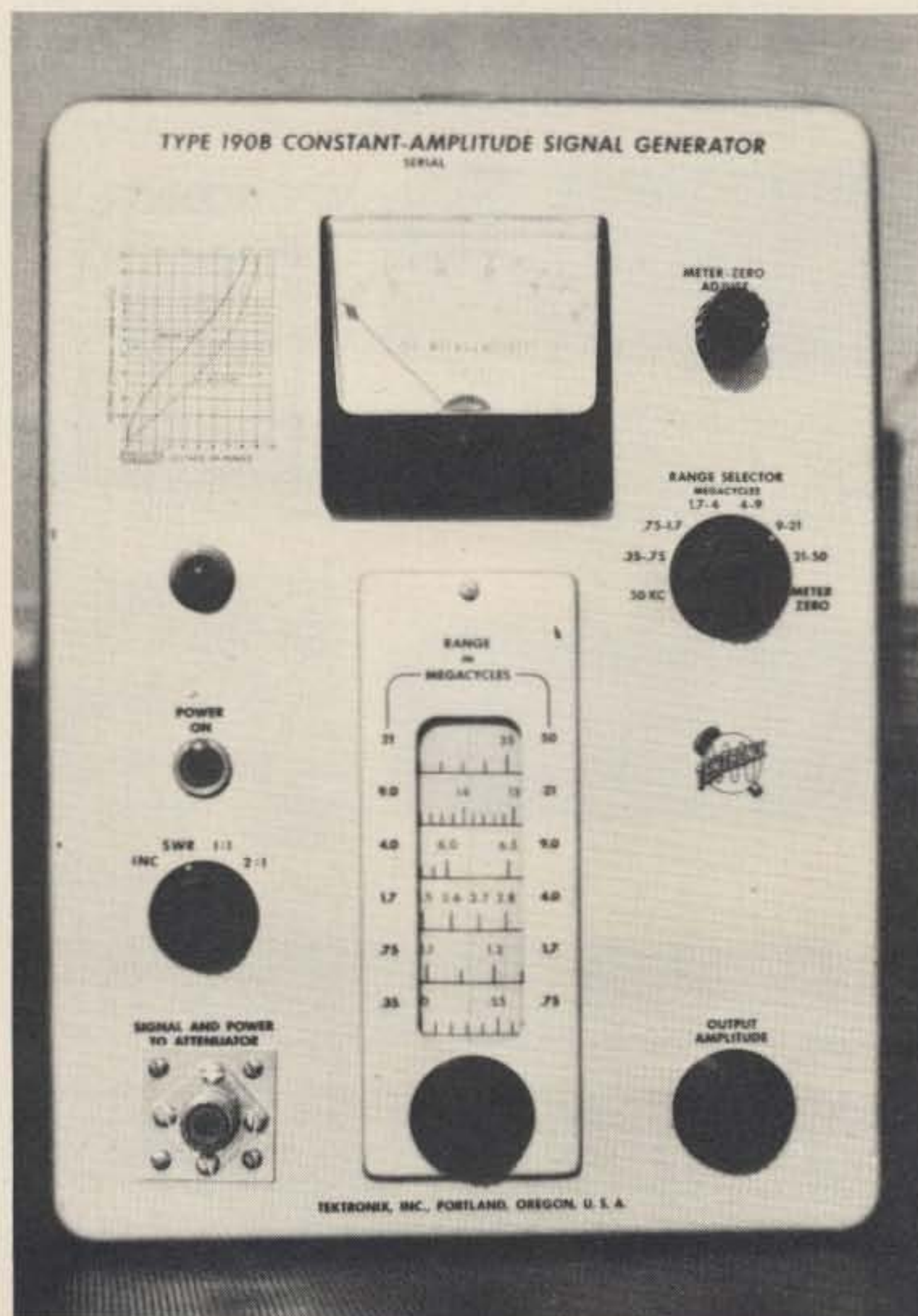

Fig. 1. Completed vswr bridge using modified Tek 190B generator.

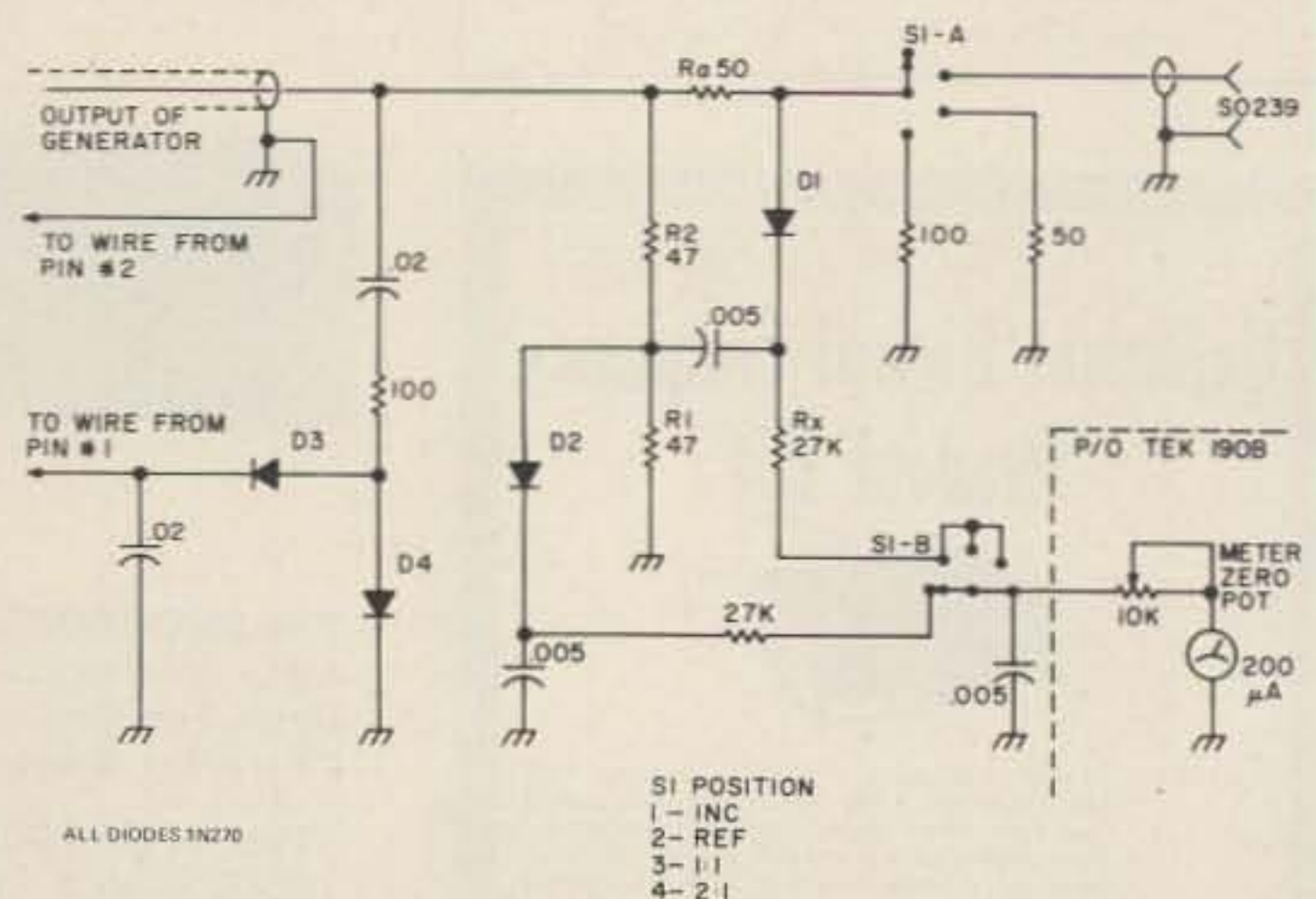

Fig. 2. This is the circuit of the 50-Ohm resistance bridge. R1 should match R2. RX should be trimmed so that incident (fwd) voltage equals reflected voltage. The 1:1 and 2:1 positions of switch S1 are simply 50-Ohm and 100-Ohm resistors to ground. When switched in, these positions give a quick self-check of the unit. D3 and D4 are the feedback diodes for the Tektronix 190B generator. All diodes = 1N270.

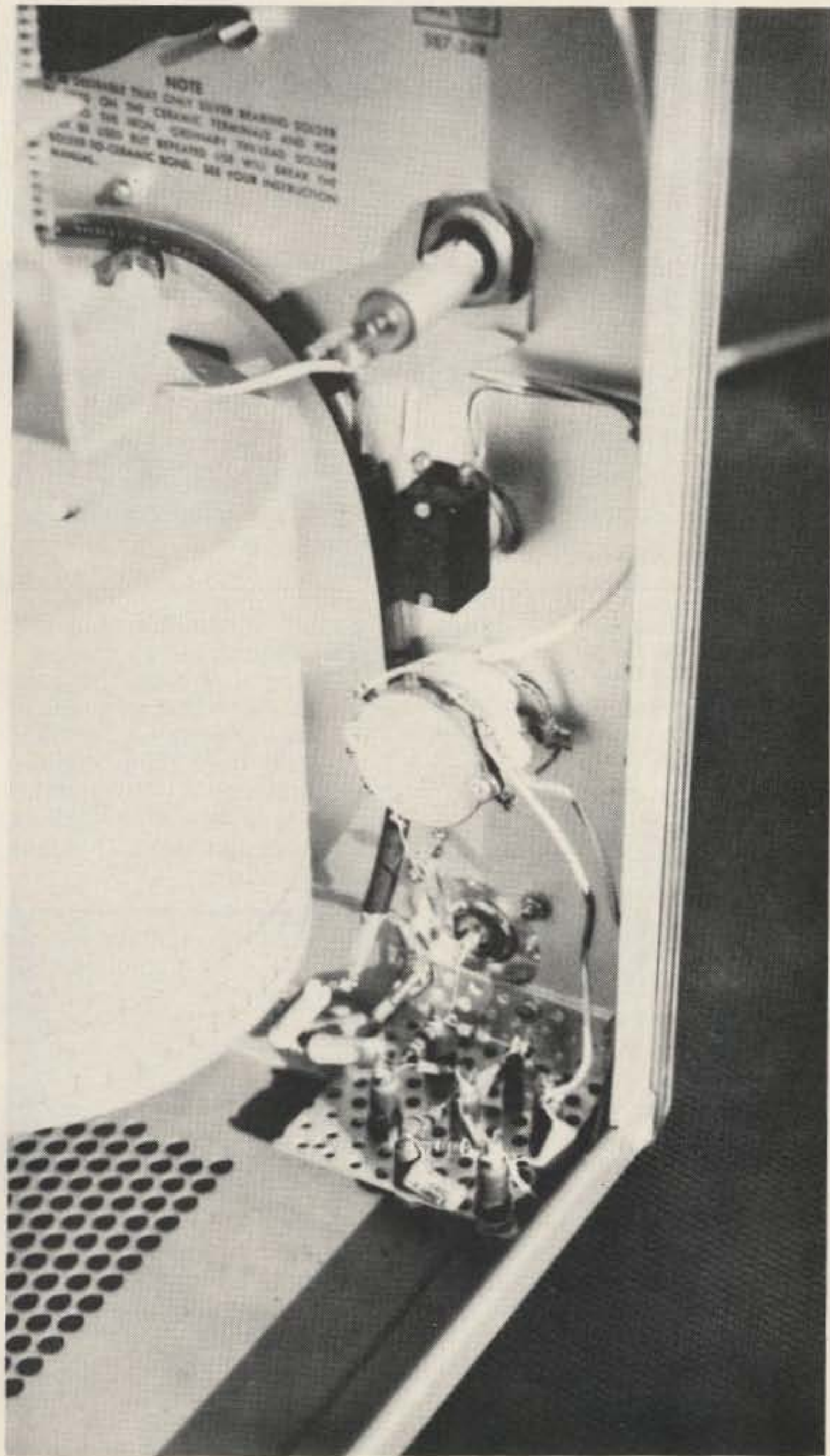

Fig. 3. Location of the resistance bridge and switch S1 inside the generator.

Caution should be used in the wire dress because the frequencies will range up to 50 MHz. The circuit is similar to the bridge described in the *ARRL Antenna Handbook*. Further information may be obtained there if needed.

5. Install the resistance bridge in the 190B signal generator as shown in Fig. 3.

6. Remove the wire from pin 3 of the attenuator socket (blue/white/yellow). It was a heater voltage supply on older units.

7. Ground the wire from pin 2 of the attenuator socket (white/red) at the newly installed SO-239 socket. The

coax shield also connects at this point.

8. Connect the wire from pin 1 of the attenuator socket (white/blue) to the resistance bridge in Fig. 2.

9. Replace the 500-Ohm meter-zero pot with a 10,000-Ohm pot. Rewire as shown in Fig. 2.

10. If desired, the existing meter can be replaced (Fig. 1), but it's not necessary. I changed mine because of the scale markings.

11. Install the four-position swr function switch in the 5/16-inch drilled hole, as shown in Fig. 3, and wire to the resistance bridge as shown

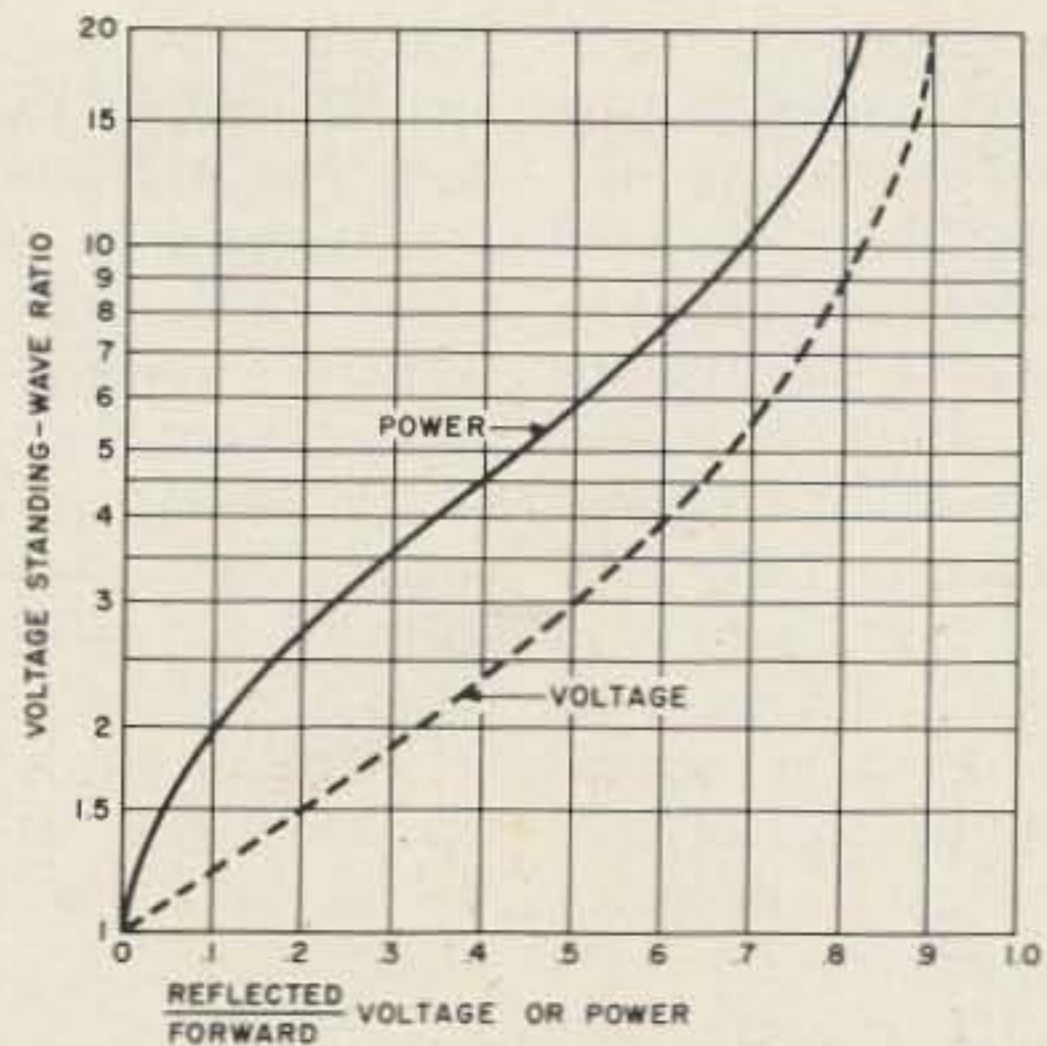

Fig. 4. Chart for finding vswr when ratio of reflected to forward voltage is known.

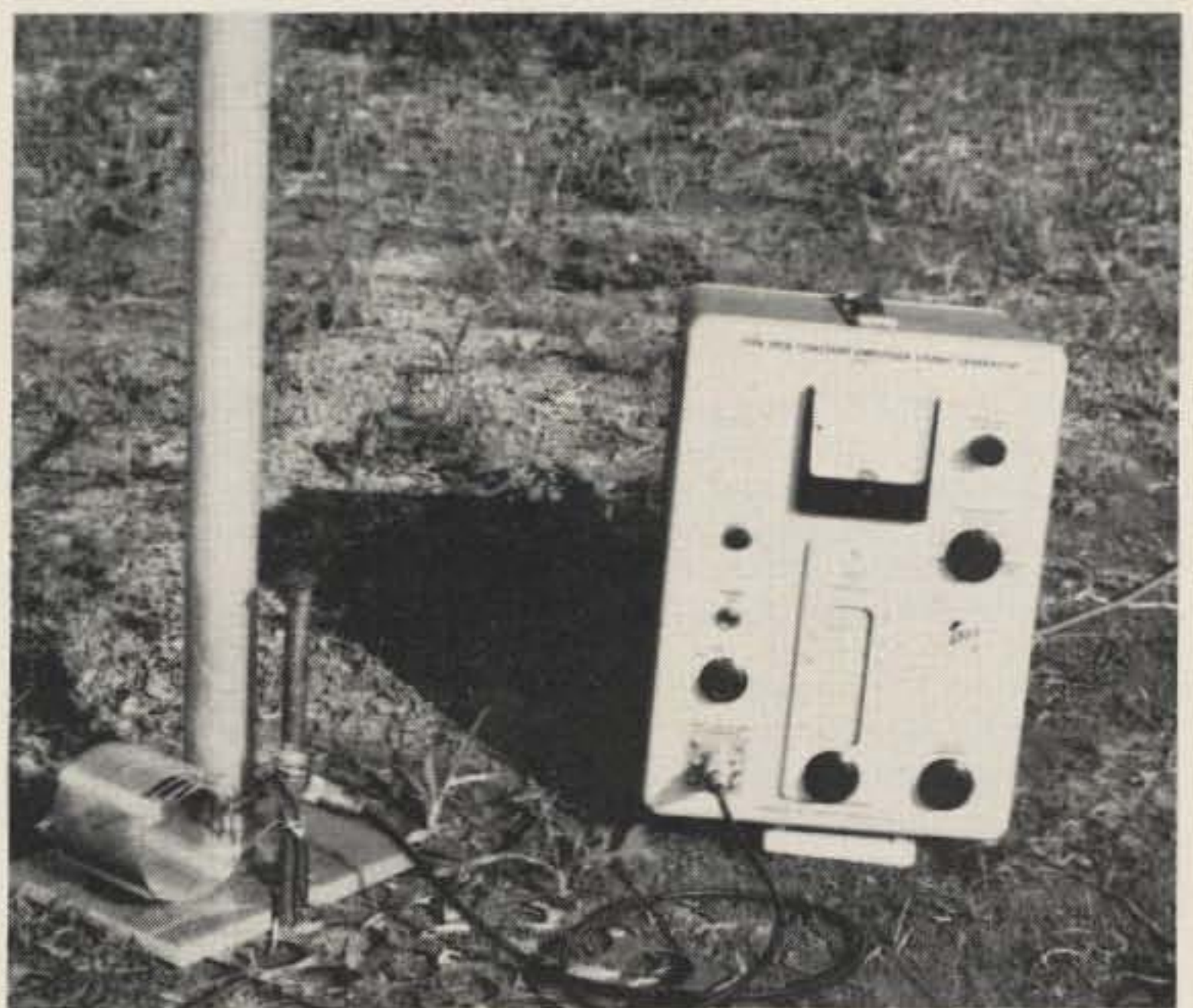

Fig. 5. The vswr bridge is easily carried to the antenna. Shown is the bridge at a vertical antenna using a tapped coil match.

in the schematic (Fig. 2).

12. A chart for determining vswr is shown in Fig. 4. Copy it or cut it out and tape it to your unit. See Fig. 1. Calibration is simple. After the unit is complete, turn it on. Do not have a load connected to the coax connector. Adjust the incident voltage (INC) for full scale, then switch to the SWR position. The meter should read the same in each position. If it doesn't, trim RX until the meter reads the same. Now, switch to the 1:1 position. The meter should fall to zero, indicating a balanced 50-Ohm load into the bridge. Switch to the 2:1 position. The meter should read approxi-

mately 30% of full scale, indicating about 2:1 vswr. If all this happens, box it up.

Now the beauty of this device takes hold! Because the generator's output is constant, when you vary the frequency dial, the meter will track your vswr curve over the entire amateur band you're testing. The first thing you will notice is that somewhere there is a dip, which is the resonant point of the antenna. The amount of dip indicates the impedance (in vswr). This dip will then give the necessary clue for any adjustments.

An example of how it works is shown in Fig. 5. My 160/80 meter vertical uses a

coil to ground and is fed at the center. I started first on 160 meters with a long coil, tapped it at the center, and then fed this tap to the generator-bridge. I adjusted the generator dial until I obtained a dip (which was at 1.7 MHz). I tuned back to 1.815 MHz and started shorting the turns on the long coil until a dip occurred. Next I started moving the tap up and down on the coil until zero indication occurred, and I had 1:1 vswr on 160 meters. I also

wanted my vertical to operate on 80 meters, so I set the generator-bridge to 3.8 MHz and repeated the operation. I next installed a band-switching system. To test it out, I went into the ham shack, turned on the transmitter, and checked both forward and reflected power with my station wattmeter. Needless to say, it turned out to be exactly as the Tektronix 190B generator-bridge indicated.

There are several other

possibilities for the generator-bridge. A 500-Ohm pot could be substituted for the 50-Ohm Ra resistor to give the bridge an impedance range of 0-500 Ohms, or a complete LC impedance bridge could be installed for maximum use of the generator-bridge. Old coax can be tested with the generator-bridge by shorting one end of the piece being tested and measuring the vswr. The loss in decibels can then be calculated. If nothing else, the

generator-bridge is a very good test rf generator to have in your ham shack. I've adjusted beams with gamma matches, verticals (both trapped and monoband), dipoles, inverted vees, and even mobile antennas using my generator-bridge.

I feel it's the most practical and economical antenna tuning aid I've used in my antenna experimentation and hope that this article will help you with your antenna tuning problems. ■



...de W2NSD/I

EDITORIAL BY WAYNE GREEN

from page 130

pect we'll run out of people with enough guts to try and pass the current license exams and we'll have to go to a Communicator license type approach to convince the more lazy to try the hobby.

WHAT ABOUT THE MICROWAVES?

The short distances possible on these frequencies reduces their value for hams. As gear gets easier to build and buy for the 1200 MHz band, we may expand our repeater systems into that band... particularly for wideband communications such as TV and some computer-to-computer work. But the permanent loss of all frequencies above 450 MHz for any kind of satellite communications will undoubtedly be the most serious loss in the history of amateur radio.

Satellite communications between any two amateurs in the world would have been possible in the 1980s if we had not lost the frequencies in their entirety at the ITU in 1971. Read the ARRL report in QST on this loss, where they admit it was due to poor planning on their part.

COOPER SUED

The State Attorney General's office in California has entered a suit against Rick Cooper for misleading consumers. The suit, filed in Los Angeles, asked that Cooper, doing business through a post office box in Van Nuys as the Communications Attorney Service, be ordered to stop disseminating

false information about himself and his service.

According to a newspaper account, among the unproven claims made in ads during 1977 were that he and two partners were licensed to practice law, that he holds a Master's Degree and PhD, and that his company is associated with attorneys in Atlanta, New York, Chicago. The suit also charges that Cooper has exaggerated his claims as to the numbers of subscribers to his service, the size of his staff, and the amount of money someone can save by subscribing to his service.

Cooper seems to have gone underground for the time being, with reports that his phones have been disconnected.

THE PETITION

How does this square up with a need for a petition to be signed by every amateur in the country? There are two major reasons why we should redouble our efforts to get every amateur, and every member of a ham family, and every friend to sign a petition and send it to me.

First, just because Cooper is getting some flack doesn't mean that he is out of the picture by any means.

Second, and far more important, the petition opposes all actions aimed at destroying amateur radio, and the main source of this danger right now is the FCC itself! Amateur radio has just been dealt a whopping disaster by the Commission... and another even worse one is well on its way. It is now apparent that there is just no use trying to deal with the FCC on a

reasonable and intelligent basis... they are a political body and react only to political pressures. Hence the value of the petition.

BRISTOL COMES CLEAN



We were anxious to check out the new Bristol Ham-100 rig to see what kind of engineering had been done on it. Anyone who has looked at many of the 27 MHz CB rigs on a spectrum analyzer knows how dirty the outputs of many rigs have been. The Ham-100 is a converted (by the factory) CB transceiver. It was first converted and retuned to 10 meters, then a 100 Watt amplifier was added to the back of the set. Considering the mayhem many of the CB rigs are causing when they are fed into an illegal amplifier, the need for a really clean output can be appreciated.

Bristol chief engineer Joe Fox drove up a Ham-100 from Rhode Island and we put it on a spectrum analyzer.

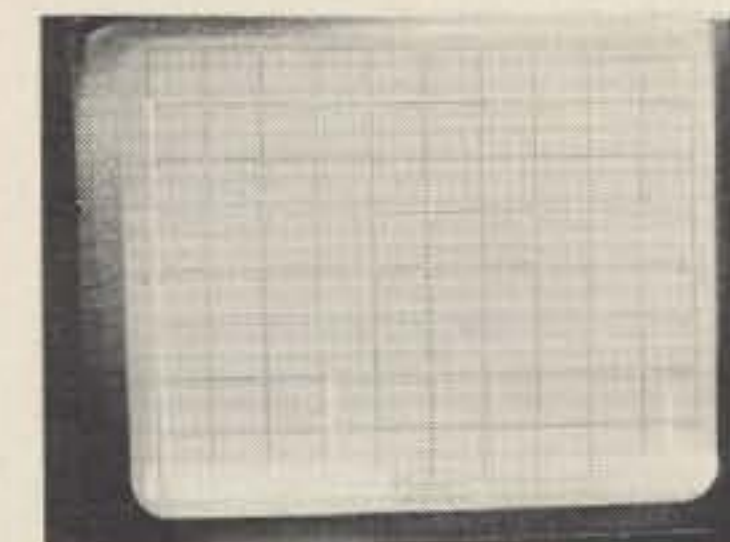

As you can see, the second harmonic output of the Ham-100 is 50 dB below the fundamental. How much is that in Watts? If we figure the rig is putting out around 75 Watts, this would put the second har-

monic at about 3/4 of a mW (.00075 Watts).

The third harmonic doesn't show very well due to a lack of sync between my camera and the scope, but I think you can make it out at -60 dB, which is less than a tenth of a milliwatt. The fourth harmonic is easier to see at -55 dB.

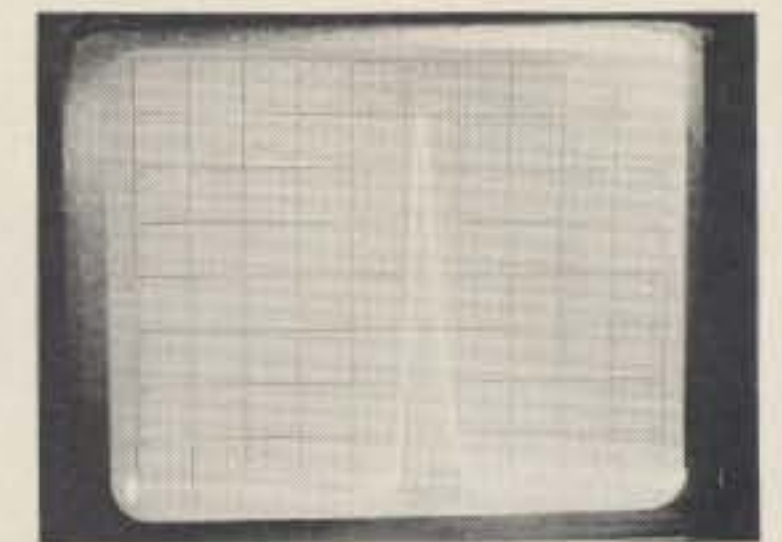

Next, I wanted to check the skirts of the carrier to make sure that the modulation was even and no splatter was present, even at 100% modulation. The photo shows the almost amazing cleanness of the signal. That's with full modulation.

In all, the Ham-100 checked out very clean. I don't think we'll be seeing any TVI from these sets which can be laid to the transmitter. Ten meters is one of the worst bands for TVI, so the cleanness of this rig is important.

10 METERS

Sadly, I find that a group of amateurs in southern California is pushing for a different ten meter channelized standard. This takes me back just a few years to when the two meter groups in that area wanted to ignore the rest of the country. They got furious with me when I came out and spoke to a statewide meeting of repeater groups and told them that channel standardization would have to come... even to southern California. The many rugged individualists there fought as long as they could... and finally gave in.

Continued on page 188



**CALL TOLL FREE
1-800-535-9598**

LA. RESIDENTS CALL COLLECT

AUTHORIZED DEALER FOR...

 **KENWOOD**

 **DRAKE**



ICOM

YAESU!



**ROHN FOLD OVER TOWERS
ATLAS • BIRD • CDE • DENTRON
ETO • HUSTLER • HY-GAIN
KLM • LARSEN • MOSLEY
SWAN • TEMPO • TEN-TEC
TRI-EX • WILSON • CUSHCRAFT**

★ **ATTENTION SB-220 OWNERS** ★

MODERNIZE YOUR SB-220 WITH AN ELECTRONIC BIAS SWITCH

- * EXTEND FINAL TUBE LIFE BY 20-30 %
- * REDUCE HEAT GENERATED DUE TO IDLING PLATE CURRENT
- * CONSERVE ENERGY AND \$\$\$\$ ON YOUR POWER BILL
- * INSTALLS IN 15-20 MINUTES - ALL HARDWARE FURNISHED
- * PROFESSIONAL QUALITY CIRCUIT BOARD ASSEMBLY -- 5.6" X 1.6"
- * MODELS FOR OTHER AMPLIFIERS AVAILABLE SOON

\$39.50 PLUS \$1.50 SHIPPING

90 DAY WARRANTY

MONEY BACK GUARANTEE

DIGITAL ELECTRONICS INC.

1201 ANNUNCIATION ST.
P.O. BOX 30566
NEW ORLEANS, LA. 70190
PHONE 504-568-9879

D27

JOYSTICK

Ideal for TV Games, Audio, Computer Games, etc. Features four 100K Center Tapped Pots.
\$3.50 ea. 3/\$10.00



ALCO MEP-10 CERAMIC TERMINAL STRIP 10 Terminals.
\$.50 ea. - 10/\$4.00



TRIMPOTS
500 ohm
1K-5K-20K-25K 5/75c

DIP RELAY

SPDT 5 v. coil. Contacts 8 VA at .250 A. \$1.00 ea.



All merchandise 100% guaranteed. Please include postage with your order.
Write for FREE Catalogue. CHICAGOLAND- Our Store Open Daily at 10:00 A.M. R18

R.W. ELECTRONICS, INC.

3203 North Western Avenue
Chicago, Illinois 60618
312 248-2480



SUPERLIGHT 20 METER BEAM

FOR PORTABLES, MM's, DXPEDITIONS

- Half the weight 8 lb.
- Several times the bandwidth 300 kHz
- Sharper directivity 4 el.
- Goes high cheaply for DX \$149

Island Antennas
Block Island, RI 02807
Custom antennas our specialty. 119

RADIO WORLD

CENTRAL NEW YORK'S FASTEST GROWING HAM DEALER



FT 101E



ICOM-211



DENTRON MLA 2500



TEMP-2020

Featuring Yaesu, Icom, Drake, Atlas, Dentron, Ten-Tec, Swan, Regency, Standard, Tempo, KLM, Hy-Gain, Mosley, Larsen, Midland, Wilson, Southwest Technical Products. We service everything we sell! Write or call for quote. YOU WON'T BE DISAPPOINTED.

We are just a few minutes off the NYS Thruway (I-90) Exit 32 R19

RADIO WORLD

ONEIDA COUNTY AIRPORT
TERMINAL BUILDING
ORISKANY, NY 13424
315-337-2622

Warren K2IXN

Bob WA2MSH

THE CRITIC'S CHOICE

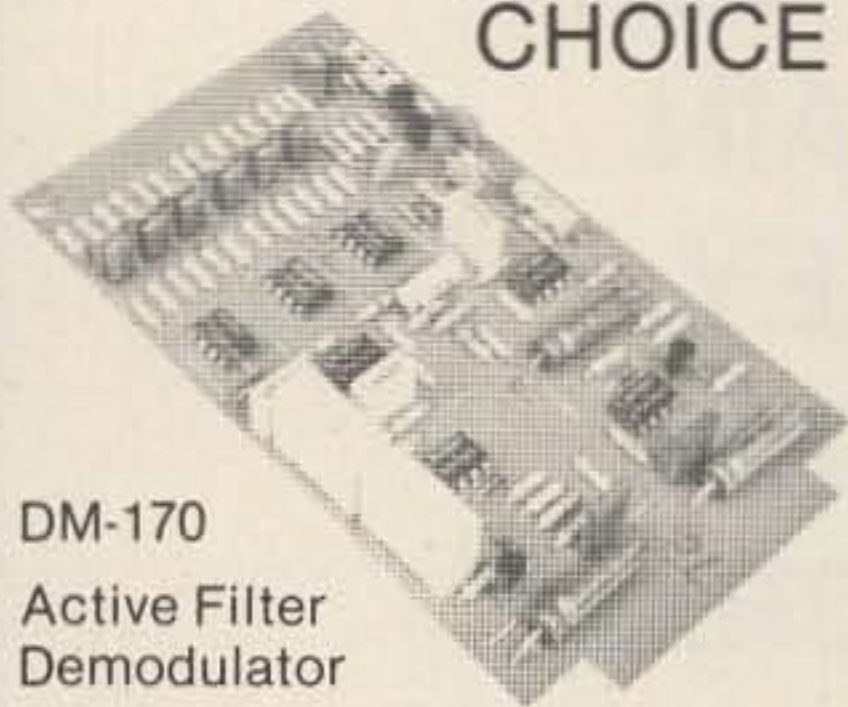

DM-170
Active Filter
Demodulator

Critical buyers are choosing the DM-170 RTTY demodulator to give them more features at lower cost. Write for information and compare. Discover what the critics have. \$39.95 Kit \$59.95 Wired

FLESHER CORP.

P.O. Box 976
Topeka, Kansas 66601
(913) 234-0198 F5

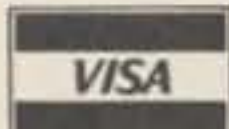

1315 BLUFF CITY HWY., BRISTOL, TN. 37620

Rusk Electronics Inc.

Quality Electronics Department Store



FT-101E

YAESU HF SSB FT-101E
160 thru 10M \$799.00 Retail

COMPLETE LINES
TEMPO
KDK
HYGAIN
DENTRON
CUSHCRAFT
LARSEN

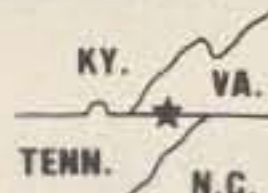

WRITE FOR SPECIAL PRICES

CALL BOB BROWN WA4HAA
FOR SPECIAL QUOTE

615-764-0831 or 968-5343 R21

KENWOOD'S TS-520S



YAESU'S

FT301D

WANT TO TRADE - UPGRADE? Call us - for best quote. Large assortment of clean used equipment on hand.

50th Year Serving Amateurs
W4WL - W4VOV - K4RJY
Visa Master Charge

FRECK radio & supply

252 Patton Ave., Asheville, N.C. 28801 F3
PHONE: (704) 254-9551

10 METER LINEAR KIT FOR ALL QRP AND MODIFIED CB TRANSCEIVERS

Frequency Range—10 Meters only
Drive Power Required—1 watt min., 4 watt max.
Input Power—13.8 VDC—7.5 Amps—100 Watts
Input Impedance—50 Ohms unbalanced
SWR less than 1.5 to 1
Output Impedance—50 to 75 Ohms unbalanced
Harmonic Suppression—40 DB plus—individual traps for second and third harmonics
Dimensions: 3 1/4" x 2 1/4" x 5"
Weight: 1.5 Lbs.



Kit: Model 101 Linear AM-FM-CW-SSB Modes \$95.00

Kit: Model 102—Same as Model 101 with a pre amplifier for additional receiver gain \$105.00

Add \$2.00 for shipping and handling
Allow 3 weeks for delivery
Money Order—Certified Check—COD
California Residents add 6% sales tax



SUBMINIATURE INSTRUMENTS CORP. S47

3147 Durahart St. • Riverside, California 92507 • 714/884-7133

ALL BAND TRAP ANTENNAS!



ALL 5 BAND OPERATION - ONLY ONE NEAT SMALL ANTENNA. FOR CONGESTED HOUSING AND APARTMENT DWELLERS! LIGHT, NEAT - ALMOST INVISIBLE!

FOR ALL MAKES AMATEUR HF TRANSMITTERS - TRANSCEIVERS - GUARANTEED FOR 2,000 WATTS PEP. POWER. FOR NOVICE AND ALL CLASS AMATEURS!

COMPLETE Ready to put up with 30 ft. Dacron end support cords! Wt. 3 lbs., 1"X5" MOLDED RESONANT TRAPS - just switch your transmitter to desired band for EXCELLENT PERFORMANCE! NO TUNERS OR BALUNS NEEDED! CAN BE USED IN ATTICS, TOPS OF BUILDINGS. INVERTED V's IN MINIMUM SPACE. NO CENTER SUPPORT NEEDED, NO HAYWIRE HOUSE APPEARANCE COMPLETELY ASSEMBLED. No tuning - cutting - soldering - measuring - JUST HANG IT, AND USE IT! SWR IS 1.2 AT RESONANCE THOUSANDS IN USE - EASIEST INSTALLATION!

80-40-20-15-10 meter bands---102 ft. with 90 ft. RG58U coax - connector -Model 998BU... \$49.95
40-20-15-10 meter bands---54 ft. with 90 ft. RG58U coax - connector -Model 1001BU... \$48.95
20-15-10 meter bands--- 26ft. with 90 ft. RG58U coax - connector -Model 1007BU... \$47.95

Send only \$5.00 (cash, ck., mo.) and pay postman balance plus COD postage OR SEND FULL PRICE FOR POST PAID DEL. IN USA (Canada is \$5.00 extra) or order by MAIL OR PHONE with BankAmericard VISA - MASTER CHARGE - OR AM EXP. Give number and ex. date. Ph 1-308-236-5333 week days. We ship in 2-3 days. INFLATION? PRICES MAY INCREASE - SAVE - ORDER NOW! INFO. AVAILABLE FROM. WESTERN ELECTRONICS Dept. A7-5 Kearney, Nebraska, 68847

**AMATEUR
TELEVISION
ON
439.25 MHz**

**INTERESTED? ACTIVITY IS
INCREASING EVERYWHERE
YOU CAN GET ACTIVE IN YOUR
AREA WITH OUR PRODUCTS—**

**AMIB FSTV CONVERTER
complete \$150.00**

**AX10B FSTV TRANSMITTER
complete \$385.00**

**CALL 812-336-4775, OR WRITE US,
FOR COMPLETE DETAILS**

**APTRON
LABORATORIES**
PO BOX 323
BLOOMINGTON, INDIANA, 47401

PCP™ TYPE-A PATENT PENDING

PCP TYPE-A TRANSFER FILM lifts the ink DIRECTLY from printed page!
(NO CHEMICALS or PHOTOGRAPHY required!)

Only additional materials required are: Sensitized boards, developer, & etchant!

**SEE POPULAR ELECTRONICS
FEB '78 ISSUE!**

FINALLY you can make HIGH QUALITY printed circuit boards directly from magazine construction articles! Can also be used to make specialized meter faces, front panel decals, component placement decals & others.

Small Pkg. 6pcs 4x6 \$5.49
Med. Pkg. 4pcs 6x9 \$6.95
Large Pkg. 3pcs 9x12 \$7.95

PCP

PRINTED CIRCUIT PRODUCTS CO.
P.O. BOX 4034
HELENA, MT 59601

REGULATED POWER SUPPLY

- Fully regulated, dual protected, 13.8 volts
- Illuminated on/off switch
- Hammertone metal case

33 Amp (30 Amp continuous)... \$119.95
20 Amp (16 amp. cont.) \$74.95
8 Amp (6 amp. cont.) \$39.95

TIMES CABLE

RG-8U - 100' multiples 18¢/ft.
RG-213U - (Non-contaminating jacket)
-100' multiples 22¢/ft.
1/2" Aluminum Jacketed hardline - 75 ohm.
1000' rolls only 29¢/ft.
PL259 connectors 25/50¢ ea.
or 100/45¢ ea. POSTPAID

UNIVERSAL TOWERS

SUPER DISCOUNTS —
S.A.S.E. for brochure and prices!

Send S.A.S.E. for additional information. Include shipping charges with check or money order. (Ohio residents add 4 1/2% sales tax).

JRS ELECTRONICS

P.O. Box 1893—Cincinnati, Ohio 45201



... at last ...
your shack organized!

A beautiful piece of furniture — your XYL will love it!

\$13995 S-F RADIO DESK
Deluxe - Ready to Assemble

Designed with angled rear shelf for your viewing comfort and ease of operation.

FINISHES: Walnut or Teak Stain.
Also available in Unfinished Birch, \$124.95.

Additional Information on Request.

Checks, Money Orders, BankAmericard
and Master Charge Accepted.

F.O.B. Culver City. (In Calif. Add 6% Sales Tax.)

S33

S-F AMATEUR RADIO SERVICES

4384 KEYSTONE AVENUE • CULVER CITY, CALIF. 90230 — PHONE (213) 837-4870

KEY ELECTRONICS

P. O. BOX 3506 SCHEENECTADY, N. Y. 12303

GOOD PRICES

Same day service — New Merchandise — No Surplus

Linear ICs

UA555 Timer 8 minidip \$.45 ea.
CA3140 4.5 MHz wide band op amp 8 minidip \$1.20 ea.

Electrolytic Capacitors: (Miniature Aluminum)

10 uF 35 V axial .15 ea. 100 uF 25 V radial .25 ea.
47 uF 25 V axial .17 ea. 220 uF 25 V radial .31 ea.
1000 uF 25 V axial .55 ea. 470 uF 25 V radial .32 ea.

Transistors:

MPS 2222A .25 ea. 5/\$1.00 2N3904 .25 ea. 5/\$1.00
MPS 2907A .25 ea. 5/\$1.00 2N3906 .25 ea. 5/\$1.00

Send check or money order. N.Y.S. residents add 4% sales tax.
\$1.00 shipping and handling charge for orders under \$15.00.

Send .25 for complete list of merchandise.

\$5.00 minimum order. K14

Sere-Rose & Spencer
Electronics

1465 WELLS STATION ROAD
MEMPHIS, TENN. 38108

PH (901) 683-9125—685-8461

Authorized Dealer

DRAKE—ICOM—KENWOOD
REGENCY—TEMPO—DENTRON

CALL OR WRITE
FOR BEST DEAL

S39

TOUCH TONE — SPECIALS



RETAIL

Model 200 Trendline touchtone handset complete with push-to-talk ... \$79.50
Model 100 WE, ITT, or S/C 12 button Encoder assembled w/box & cable \$27.50
Model 105 Same as Model 100 with automatic transmitter keying delay kit \$33.50
Model 110 Same as Model 100 but with speaker and amplifier/less cable \$39.50
Model 50 Automatic transmitter keying and delay kit \$ 7.50
12 button touch tone pads reconditioned with 90 day warranty \$14.00
Touch Tone pad housings \$ 4.25
Repair Touch Tone Pad Repair \$ 6.25
ITT 347C 9 Station Touch Tone intercom suitable for auto patch \$110.00
Special Used 12 button Touch Tone Pads guaranteed to work on arrival — limited quantity \$10.00

Florida residents add 4% sales tax. FOB Leesburg shipping allowed on prepaid orders of \$25.00 or more. Others include \$1.00 postage and handling.

TELEPHONE EQUIPMENT COMPANY T31

Post Office Box 596 Leesburg, Florida 32748 (904) 728-2730

Call Toll Free 1-800-633-3410 for HF rigs:

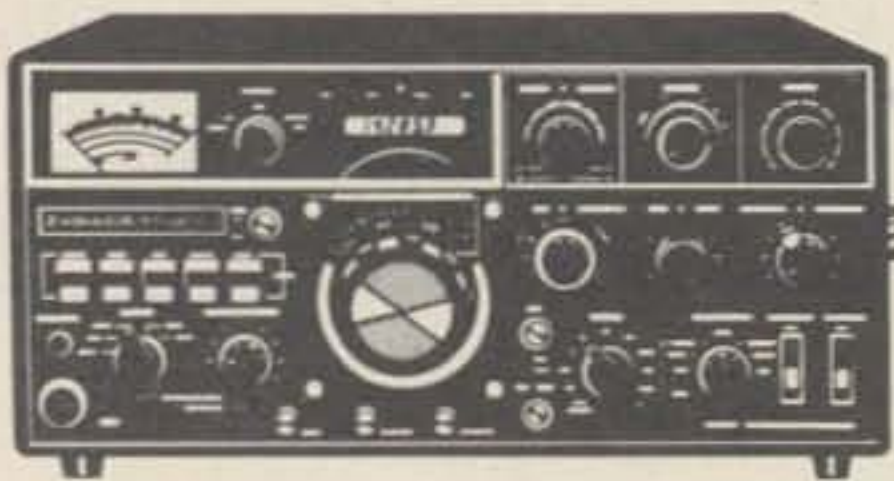

KENWOOD TS-820S transceiver

TS-820S features: • Factory installed digital frequency readout • 160 thru 10 meter coverage • Integral IF shift • RF speech processor • VOX • Noise blanker • PLL • Built-in 25 KHz calibrator • CW sidetone & semi-break-in • IF OUT, RTTY, & XVTR • 200W PEP input.

1098.00 list price. Call for quote.



YAESU FT-101E transceiver

FT-101E is completely solid-state • Coverage: 160 thru 10 meters • Built-in AC/DC power supplies • Built-in RF speech processor • 260 watts PEP on SSB, 180 watts on CW, 80 watts on AM • Solid-state VFO • VOX • Auto break-in CW sidetone • WWV/JJY reception • Heater switch.

799.00 list price. Call for quote.



DRAKE TR-4CW transceiver

• Coverage: 80 thru 10 meters • 300W PEP on SSB, 260W on CW & AM • 500 Hz CW filter • RIT • Wide-range receiving AGC • Solid-state VFO • Shifted-carrier CW • VOX or PTT • Output impedance is adjustable • CW semi-break-in • Transceive or separate PTO.

799.00 list price. Call for quote.

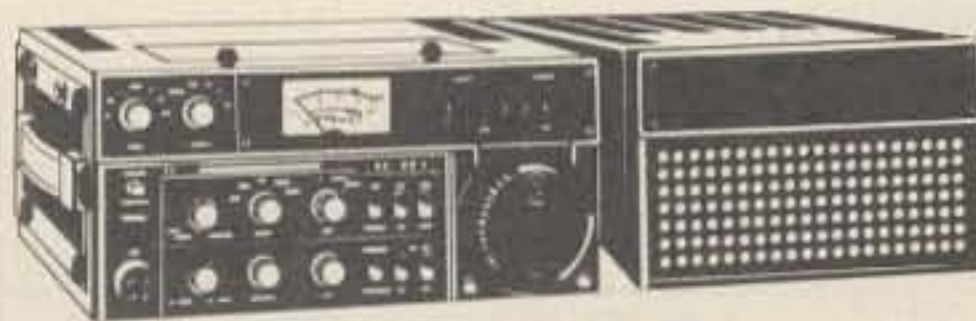

ICOM IC-701 HF transceiver

The NEW IC-701 features: • Solid-state • RF speech processor • 100 W continuous on all bands, all modes • USB, LSB, CW, CW-N, RTTY operation • Double balanced Schottky Diode Mixer used in boty RX/TX • Dual built-in digital VFO • Price includes mic & power supply.

1495.00 list price. Call for quote.

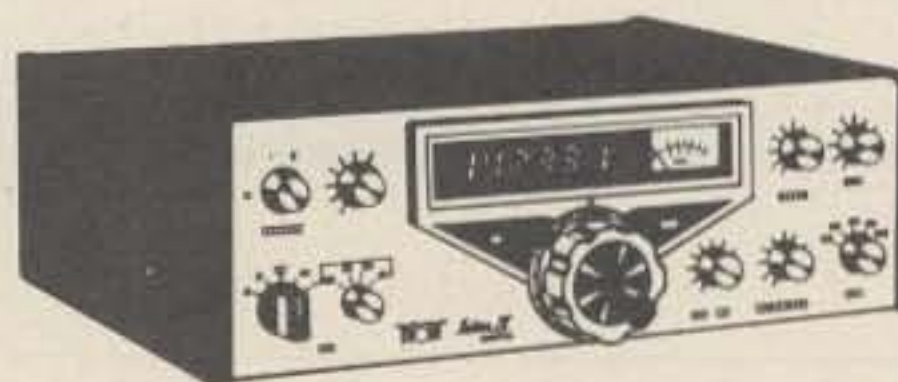

TEN-TEC 544 digital HF transceiver

The 544 features: • 3.5 to 30 MHz coverage • Totally solid-state • Instant band change • 8-pole crystal IF filter • Large LED digital readout • 200W input on all bands • WWV at 10 & 15 MHz • Full CW break-in • "S" meter and SWR bridge • 100% duty cycle, full power for RTTY & SSTV.

869.00 list price. Call for quote.



TEN-TEC Century 21 CW transceiver

Features: • Full break-in • 70 watts input • Solid-state • Built-in speaker • Receives CW or SSB • Instant band change • Offset receiver tuning • Overload protection • Sidetone with adjustable level • Regulated power supply • 80 thru 20 meters with crystals supplied.

299.00 list price. Call for quote.

Remember, you can Call Toll Free: **1-800-633-3410** in the U.S.A. or call **1-800-292-8668** in Alabama for our low price quote. Store hours: 9:00 AM til 5:30 PM, Monday thru Friday.

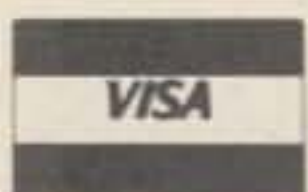

Long's Electronics



L9

MAIL ORDERS: P.O. BOX 11347 BIRMINGHAM, AL 35202 • STREET ADDRESS: 2808 7TH AVENUE SOUTH BIRMINGHAM, ALABAMA 35233



Call Toll Free 1-800-633-3410 for tower supplies:

ROHN 25G 50 foot tower

The 25G comes complete with four 10 ft. sections, plus an 8 ft. 25AG-3 (3 inch) OD top section. All Rohn towers are "Hot Dip" galvanized in house. This means your tower resists corrosion better than any other tower, because 2 oz. of molten zinc per sq. ft. of surface is fused to the steel, inside and out.

178.50 Call for yours today.



ROHN tower accessories

SB25G 3'4" short base for concrete.	
List price 24.30	17.00
BPC25G concrete base plate.	
List price 40.55	28.40
SBH25G 3'4" hinged short base for concrete.	
List price 40.00	28.00
BPH25G hinged base plate for concrete.	
List price 59.50	41.65
HB25AG 0 to 15 in. house bracket.	
List price 19.05	13.35
HB25BG 15 59 24 in. house bracket.	
List price 23.80	16.65
HB25CG 24 to 36 in. house bracket.	
List price 28.55	20.00
AS25G accessory shelf for CDE-44, HAM II, HAM III, & Tail Twister rotors.	
List price 11.90	8.35
25G 10 ft. tower section.	
List price 73.80	39.00

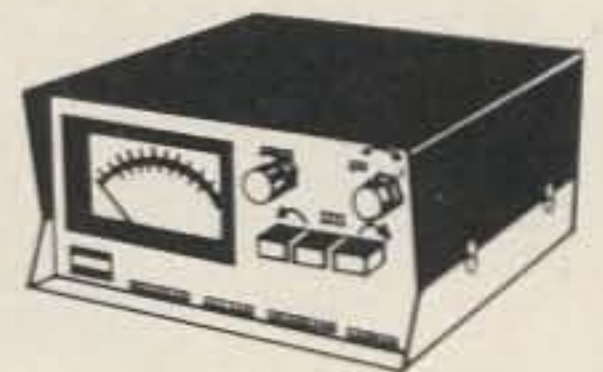

CDE Ham III antenna rotor

The Ham III rotor sets new levels of rotor performance! Snap action switched wedge brake & rotational controls brings pinpoint accuracy to any directional beam. New motor and brake designs, pre-offers pre-brake action & stronger lock-in place action.

159.95 list price. Call for quote.



CDE Tail Twister T²X antenna rotor

The CDE Tail Twister is designed to handle antennas up to 28 sq. ft. Rotator features: • Installation inside tower • 138 ball bearings (3 races) • Control box has: 110-120 VAC input, Dimensions are 8 3/4" W x 8 1/4" D x 4 3/8" H, Line cord is 3 wire (grounded)

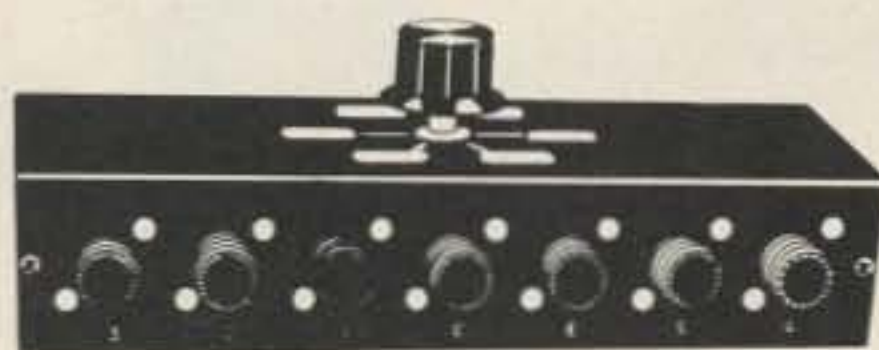

B&W 595 coax switch

The B&W 6-position coax switch features: • 6 antenna outputs • 2 KW PEP power rating • VSWR: less than 1.2:1 up to 150 MHz • Grounds all unused antennas. A perfect addition to any ham shack. Order today.

18.50 Call for yours today.

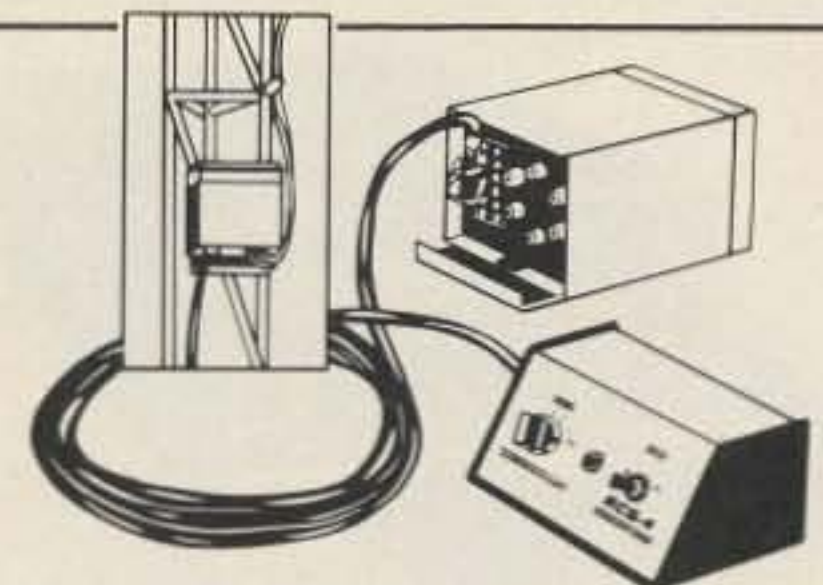

DRAKE RCS-4 remote coax switch

The RCS-4 motor-drive coax switch allows remote selection of up to five antennas • Grounds all unused antennas • Front panel indicator monitors antenna selection interval • Adverse weather protection • SO-239 connectors provided • Handles 2000 W PEP • Available in 120 VAC or 240 VAC.

120.00 list price. Call for quote.

Remember, you can Call Toll Free: **1-800-633-3410** in the U.S.A. or call **1-800-292-8668** in Alabama for our low price quote. Store hours: 9:00 AM til 5:30 PM, Monday thru Friday.



Long's Electronics



L9

MAIL ORDERS: P.O. BOX 11347 BIRMINGHAM, AL 35202 • STREET ADDRESS: 2808 7TH AVENUE SOUTH BIRMINGHAM, ALABAMA 35233

Call Toll Free 1-800-633-3410 for mobile 2m rigs:

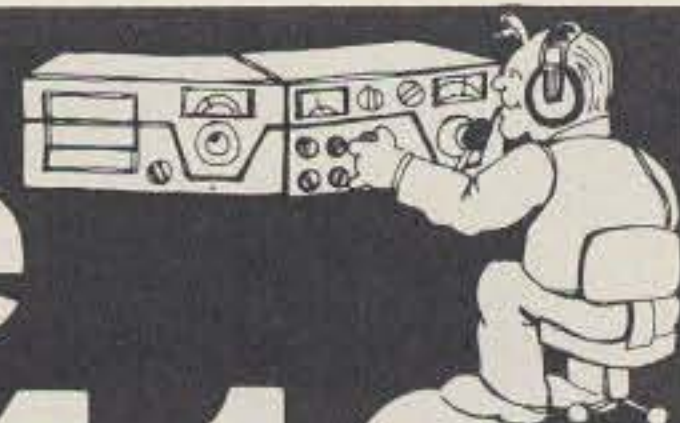

KENWOOD TR-7500 2m FM transceiver

Features: • PLL synthesized • 100 channels (88 pre-programmed, 12 extra diode programmable) • Single knob channel selection • 2-digit LED frequency display • Powered tone pad connection • Helical resonators • 10 watts HI output, 1 watt LOW output.

299.00 list price. Call for quote.

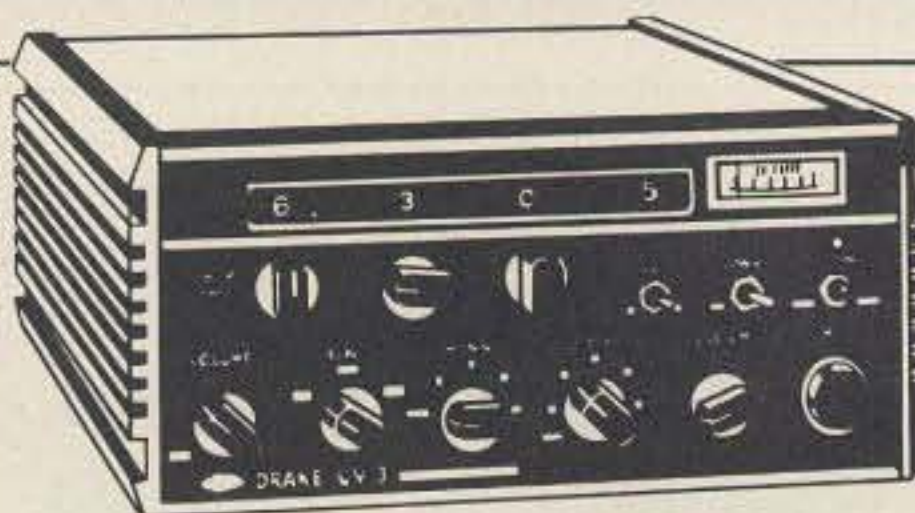

DRAKE UV-3 uhf, vhf, fm 3 band rig

The NEW Drake UV-3 features: • Full synthesized, 5 KHz steps, digital readout on each band • FM coverage on 2m, 1 $\frac{1}{4}$ m, $\frac{3}{4}$ m bands depending on model purchased • Scan feature • Squelch • Mobile or fixed station • 1 $\frac{1}{4}$ m & $\frac{3}{4}$ m bands, optional 175.00 each, factory installed • HI power: 25 watts, LOW power: 1 watt, adjustable.

595.00 list price. Call for quote.

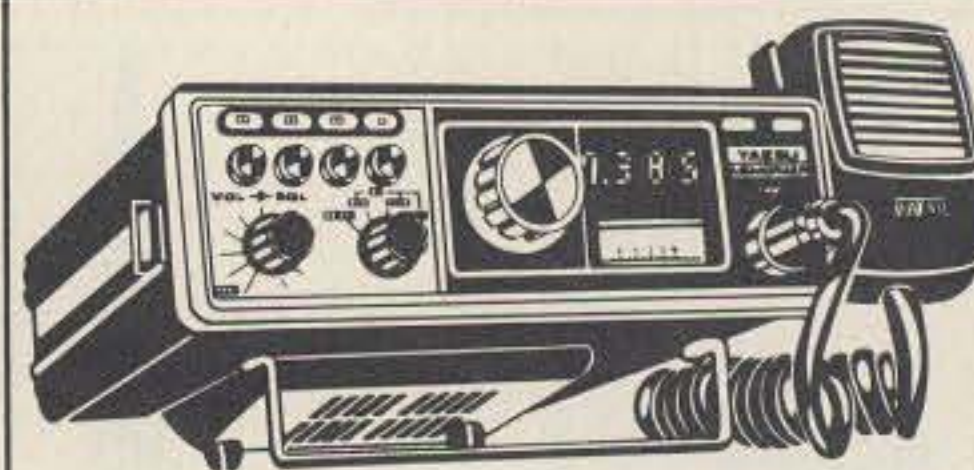

YAESU FT-227R "Memorizer"

• One knob channel selection using optical sensing to select 800 channels
• Memory circuit allows instant return to any frequency between 144-148 MHz
• 4-digit LED frequency readout
• Fully synthesized frequency control
• Selectable 10 watt HI/1 watt LOW output and much more!

319.00 Call for yours today.



KENWOOD TR-7400A 2m FM transceiver

Features: • CTCSS provisions, encode and decode • 25 watt output RF • Solid-state final stage • LED readout • PLL gives 800 discrete channels • Repeater offset circuit • PLL unlock protection circuit • MOS FET.

399.00 list price. Call for quote.



ICOM IC-211 2m transceiver

Features: • 144 to 148 MHz coverage • Modes: SSB, CW, FM • LSI synthesizer PLL • 4-digit LED readout • Pulse-type noise blanker • VOX, anti-vox • Semi-break-in CW • Built-in SWR bridge • CW monitor and more!

749.00 list price. Call for quote.



ICOM IC-245 2m transceiver

The IC-245 features: • LSI synthesizer PLL • 4-digit LED readout • TX & RX frequencies are independently programmable on any separation
• Receiver front-end is a balance of low noise, high-gain MOS-FET & 5 section filter • TX output: 10 W PEP.

499.00 list price. Call for quote.

Remember, you can Call Toll Free: 1-800-633-3410 in the U.S.A. or call 1-800-292-8668 in Alabama for our low price quote. Store hours: 9:00 AM til 5:30 PM, Monday thru Friday.



Long's Electronics



L9

MAIL ORDERS: P.O. BOX 11347 BIRMINGHAM, AL 35202 • STREET ADDRESS: 2808 7TH AVENUE SOUTH BIRMINGHAM, ALABAMA 35233

Call Toll Free 1-800-633-3410 for mobile antennas:



ANTLER A-280 2m mobile antenna

The A-280 is as close to the ideal antenna as you can get. Features:

- Precision tuned coil
- 47" tapered 17-7 stainless steel whip
- VSWR: less than 1.3
- Certified 3 dB gain
- Magnetic mount has roof-top stability to withstand winds up to 100 MPH.



39.95 list price. Call for quoted.

LARSEN LM-150 antenna

The $\frac{5}{8}$ wave length 2 meter antenna consists of a 49" stainless steel rod, quadruple plated, and coil for 144-174 MHz. Coil threads $\frac{5}{16}$ " x 24 threads. 3 dB gain over a $\frac{1}{4}$ wave antenna.

23.85 Call for yours today.

Both antennas are compatible with the Larsen MM-LM.

LARSEN "Q" Model antenna

Features:

- $\frac{1}{4}$ wave for 136-512 MHz
- Whip is 17-7 stainless steel and quadruple plated
- Handles 200 W output
- Mounting materials are supplied.

2.65 Call for yours today.

HYGAIN 276 60" bumper mount mast

The HyGain 276 is a 60" fiberglass mast designed as a bumper mount for the 280 coil antenna series. 276 terminates with a $\frac{3}{8}$ " x 24 thread stud and can accommodate several other HyGain antenna accessories.

19.95 Call for yours today.

HUSTLER BBLT-144 $\frac{5}{8}$ antenna

• 3.4 dB gain over $\frac{1}{4}$ wave antennas
• 200 watts FM power rating • Whip & mount, 52" high • 1.1:1 typical SWR at resonance • Sturdy stainless steel impact spring • 17-7 stainless radiator
• Trunk lip mount, easy installation, no drilling.

33.75 Call for quote today.



HYGAIN 280 series mobile coil/antennas

The 280 series coil/antennas are mandrel wound and baked in fiberglass to prevent weathering and reduce heat drift. Rugged ABS end caps, solid brass end caps, 17-7 stainless whips. All have $\frac{3}{8}$ " x 24 base studs. Call for yours today.

280 10 meter resonator	14.95
281 15 meter resonator	16.95
282 20 meter resonator	17.95
283 40 meter resonator	19.95
284 75/80 meter resonator	24.95

HUSTLER RM resonators

All resonators are precision wound with optimized design for each band. Assembly includes 17-7 stainless steel adjustable tip rod for lowest SWR and band edge marker. Choose for medium or high power operation. Power rating: 400 watts SSB. Call for yours today.

RM-10 meter resonator	6.50
RM-15 meter resonator	6.95
RM-20 meter resonator	7.30
RM-40 meter resonator	13.20
RM-75 meter resonator	15.50
RM-80 meter resonator	15.95

Remember, you can Call Toll Free: **1-800-633-3410** in the U.S.A. or call **1-800-292-8668** in Alabama for our low price quote. Store hours: 9:00 AM til 5:30 PM, Monday thru Friday.



Long's Electronics



MAIL ORDERS: P.O. BOX 11347 BIRMINGHAM, AL 35202 • STREET ADDRESS: 2808 7TH AVENUE SOUTH BIRMINGHAM, ALABAMA 35233



Call Toll Free 1-800-633-3410 for mobile accessories:



DRAKE 1525 EM mic

The auto-patch encoder and mike are a single unit, fully wired and ready to use

- High accuracy IC tone generator, no frequency adjustments
- High reliability Digitran® keyboard
- Power for tone encoder from transceiver via mike cable
- Low output impedance
- 4-pin plug.

49.95 Call for yours today.

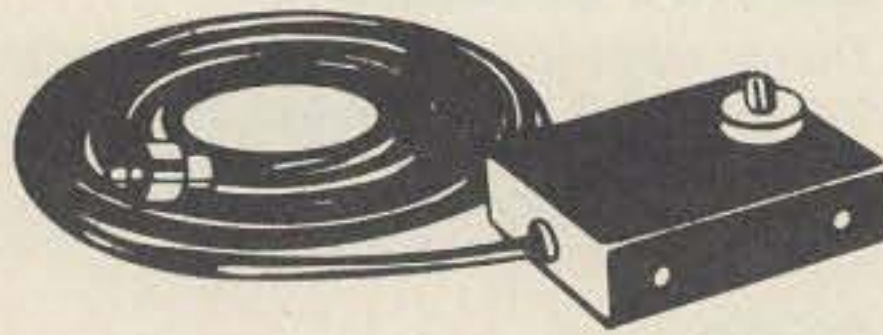

LARSEN MM-LM magnetic mount

- Roof-hugging low silhouette
- Grips any ferrous surface
- Magnets guaranteed permanent in ordinary use
- Full capacitance coupling
- Complete with 12' of RG-58 A/U coax & connector
- Will accept antenna with 5/16" x 24 threads.

14.60 Call for yours today.



SHURE 414A hand-held mic

Ideal for your mobile transceiver. One-half the size of most hand mikes. Has an omnidirectional polar pattern. Frequency response: 400 to 4000 Hz. High impedance, output level: 54.5 dB. Controlled magnetic mic element designed for SSB. High impedance: 50K ohms.

25.00 Call for yours today.

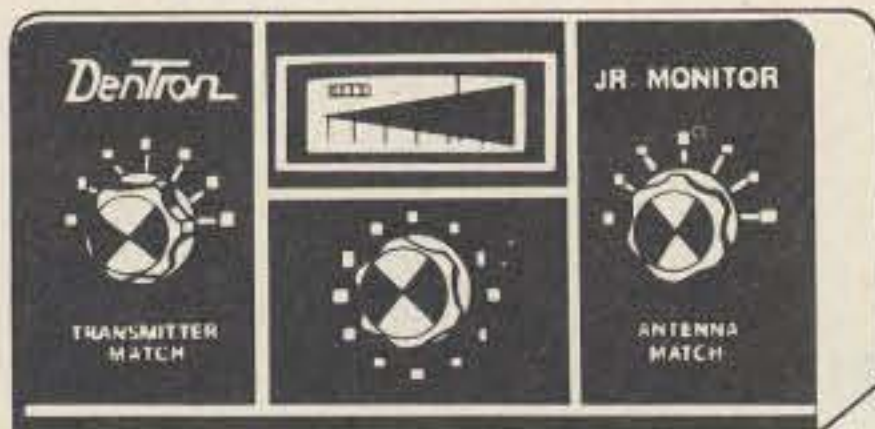

DENTRON Jr. Monitor antenna tuner

The Jr. Monitor antenna tuner/matching network has it all in one neat 5 1/4" x 2 3/4" x 6" cabinet

- Continuous tuning, 1.8 to 30 MHz
- Forward reading relative output power meter
- 300 watt power capability
- Built-in encapsulated balun, plus much, much more!

79.95 Call for yours today.



MFJ-901 Versa Tuner

The 901 features the same efficient air wound coil of the 941 — for more watts out! The coil inductor has 12 positions. The tuner will match everything from 160 to 10 meters. 200 watts RF output. 1:4 balun and SO-239 connectors. Works great mobile.

59.95 Call for yours today.

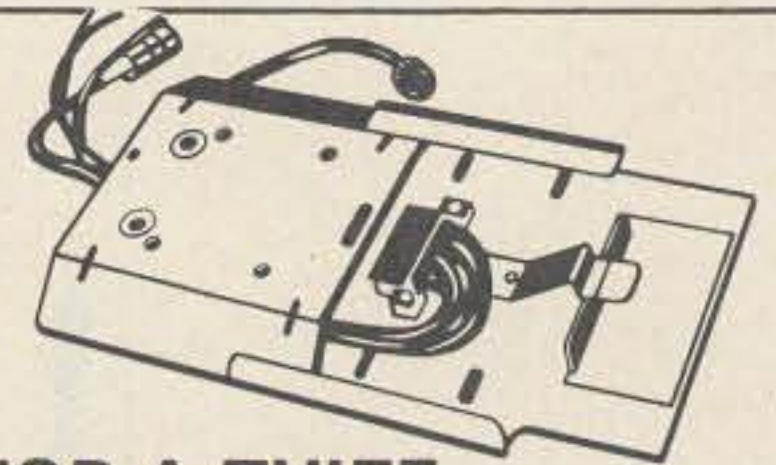

STOP-A-THIEF slide-out mounting bracket

The SDI-1000 slide-out bracket will protect your mobile rig from "sticky fingers". It features a modified AMP Dulatch connector system which houses the AMP Miniature Coaxicon coaxial cable contact. 4 power & accessory contacts are gold-plated. VSWR does not exceed 1.3 to 1.0 up 1000 MHz

29.95 Call for yours today.

Remember, you can Call Toll Free: **1-800-633-3410** in the U.S.A. or call **1-800-292-8668** in Alabama for our low price quote. Store hours: 9:00 AM til 5:30 PM, Monday thru Friday.



Long's Electronics



MAIL ORDERS: P.O. BOX 11347 BIRMINGHAM, AL 35202 • STREET ADDRESS: 2808 7TH AVENUE SOUTH BIRMINGHAM, ALABAMA 35233



Call Toll Free 1-800-633-3410 for accessories:



The Big Signal W2AU BALUN

- Handles full 2 KW PEP and more
- Helps TVI problems by reducing coax line radiation
- Stainless steel hardware
- Improves F/B ratio
- Replaces center insulator
- Built-in lightning arrester
- 1:1 matches 50 or 75 ohm unbalanced to 50 or 75 ohm balanced load.

14.95 Call for yours today.



SHURE 444 desk microphone

Economical station mic. Has PTT switch, adjustable head height, solid, high impact plastic construction. Frequency response: 300 to 3000 Hz. Omnidirectional polar pattern. Controlled magnetic mic element designed for SSB. High impedance: 50K ohms.

35.00 Call for yours today.



KENWOOD AT-200 antenna tuner

The NEW AT-200 is designed for your TS-820 or TS-520 series rig. It features:

- Antenna coupler
- Thru-line RF watt meter
- SWR meter
- Antenna switch
- Band coverage: 1.8 to 30 MHz
- Watt meter has 2 ranges: 20W and 200W
- 4 outputs: 2 coax, 1 wire antenna and 1 dummy load.

149.00 list price. Call for quote.



COVER CRAFT dust covers

Made of tough, clear vinyl plastic with a "pearlized" texture finish. All seams are machine stitched for maximum strength. Keep your equipment clean and it will need less maintenance. We carry covers for Kenwood, Yaesu, Icom, Drake, Ten-Tec, CDE, and Dentrion.

3.95 most sizes.



NEW DENTRON Big Dummy Load

Now you can tune-up off the air with Dentron's Big Dummy Load. All full power dummy load, it has a flat SWR, full frequency coverage from 1.8 to 300 MHz. A high grade industrial cooling oil is furnished with the unit. Fully assembled and warrantied. Help cut out the QRM factor NOW!

29.50 Call for yours today.



YAESU SP-101PB speaker/phone patch

The SP-101PB features:

- A shaped response speaker from 300 to 3000 Hz
- Built-in hybrid phone path with individual gain controls
- VU meter. Full VOX operation
- Receiver input impedance: 4 or 600 ohm
- Output impedance: 600 ohm or high impedance.

64.00 Call for yours today.

Remember, you can Call Toll Free: **1-800-633-3410** in the U.S.A. or call **1-800-292-8668** in Alabama for our low price quote. Store hours: 9:00 AM til 5:30 PM, Monday thru Friday.



Long's Electronics



L9

MAIL ORDERS: P.O. BOX 11347 BIRMINGHAM, AL 35202 • STREET ADDRESS: 2808 7TH AVENUE SOUTH BIRMINGHAM, ALABAMA 35233

If You Want To Know Where You Are

—loran-C receiver: part II

R. W. Burhans
Dept. of Electrical Engineering
Ohio University
Athens OH 45701

The general principles of loran-C were described in Part I of this article (73, April, 1978). In this section, I will present a minimal hardware system for amateur time-frequency and simple navigation experiments. The Mini-L 100 kHz front end uses an envelope processing rf

method for direct generation of an estimate of the shape of each original pulse as transmitted. The technique is called "autocorrelation" because the timing edge information obtained is all based on the received signal and is not "cross-correlated" with a local oscillator source. Of course, an external clock is used ultimately to make time-interval estimates with computers or digital hardware, but this is after the fact of initial pulse envelope detection. Many commercial loran-C receivers use cross-correlation methods where the signal is continuously sampled with respect to the local clock at the rf carrier level and the clock sample phase maintained "in-lock" with the loran-C signal through a set of multiplexed phase locked loops. The autocorrelation method used in Mini-L is not the best available for loran-C, but it is probably one of the simplest and can provide 1-microsecond timing precision up to 600 miles with proper care in operation.

Antenna Preamp

A JFET preamplifier provides impedance transformation from an E-field whip or wire antenna to a 600-Ohm line level sufficient to drive a short length of coaxial cable to the receiver. A circuit is shown in Fig. 1(a). There is a slight phase shift due to the cable, but this can be ignored in most cases, since it is a constant. Power for the preamp comes up the same coax cable. In some installations, cable ground loops and common code 60 Hz noise may be a problem. A modification of the preamp output to drive a balanced shielded transmission line is shown in Fig. 2. This requires an additional transformer at the receiver end to extract the signal. The output transformer tap may be grounded and used to drive two separate receivers, such as a loran-C and a VLF receiver, as shown in Fig. 2.

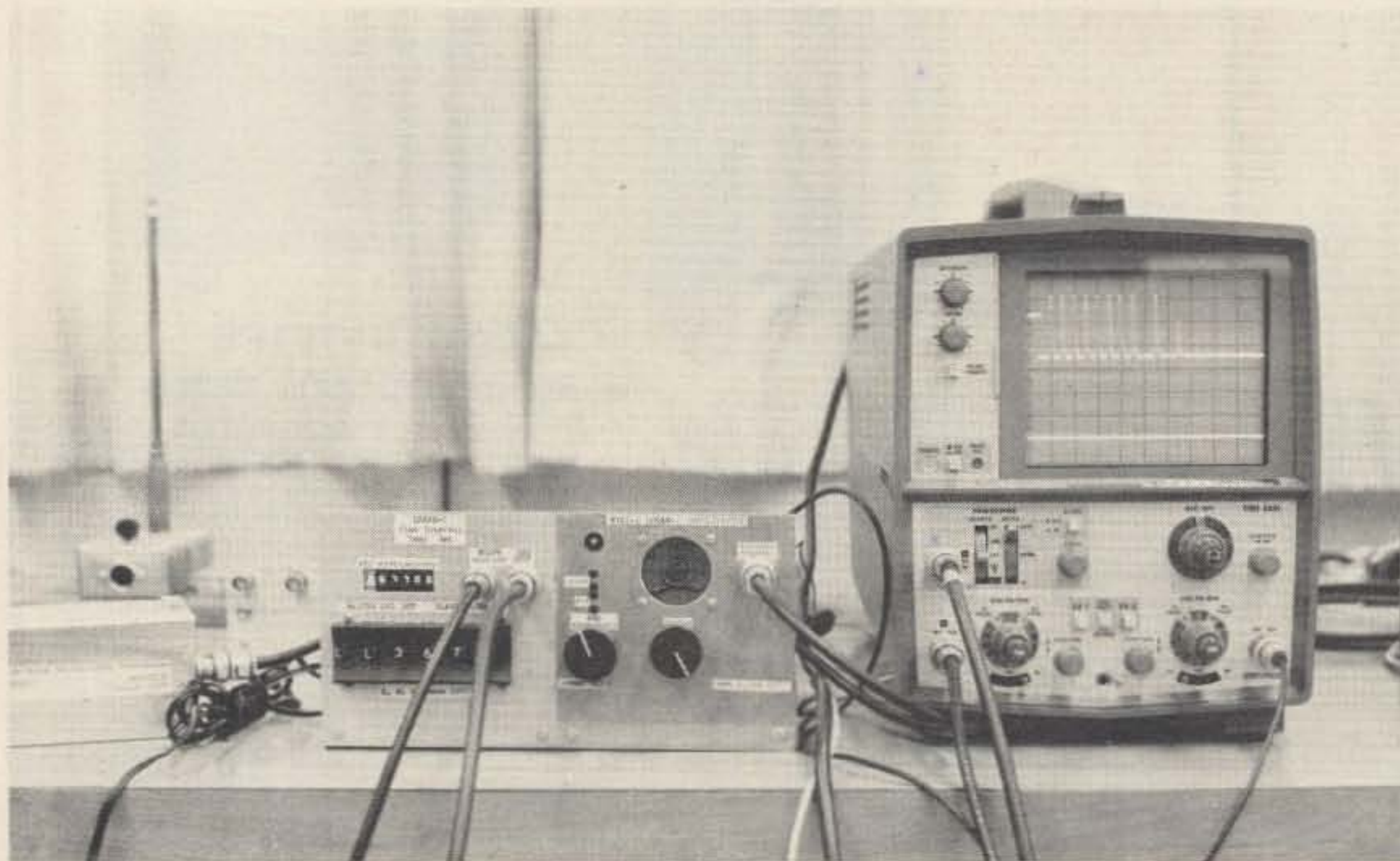

Experimental Mini-L with GRI rate generator and scope trace locked to master station at Cape Fear NC (east coast 99,300 GRI). The shorter pulse to the right of the ninth pulse is an interference noise pulse. The lower trace, hardly visible, is the IRQ 10 μ s output. This also shows interference.

The use of a 600-Ohm line audio transformer as an output coupling device provides a low-pass filter for loran-C and VLF signals. This is an advantage, since it tends to reduce cross-modulation and noise effects in the main receiver caused by broadcast band, LF beacons, or short wave transmitters. A Mouser 80TM011 600 c-t to 1.5k c-t transformer provides a step up when used as the output transformer at the receiver end with the 600-Ohm side connected to the balanced transmission line. The particular transformer used will pass frequencies to about 300 kHz, but the upper cutoff may be changed by the capacitor (C), as illustrated, to restrict the range for different loran-C or omega VLF uses. Fig. 1(c) shows diode static charge limiters. This was an experimental model where the diode limiters caused cross-modulation from local transmitters. It is suggested that the diodes not be used. Another method is to use series, opposed polarity, zener diodes which can be mounted by cutting away part of the original diode foil pattern of Fig. 1(b).

Antennas can be anything from a 1 meter vertical whip to a wire of 10 meters or more, with best performance obtained when the antenna is mounted in the clear. A vertical antenna is best, but quite satisfactory performance is obtained from one run at a slant, such as from an insulated pole on a rooftop down to a window feed-through insulator at the pre-amp. Precipitation static is a problem in aircraft installations. Semiconducting coatings on the wire help reduce this, and often a coated blade-type capacitive antenna is used, mounted on the bottom of the aircraft near the tail. Dry, blowing snow and some rainstorms also produce precipitation static in ground installations, which can be recognized with an audio monitor as a slow buildup of a buzzing sound

with sharp crackle noises sweeping through the audio spectrum at different repetition rates.

Rf Processor

The heart of the Mini-L circuit is a Fairchild uA721PC, AM/FM receiver subsystem IC. This chip contains four functional blocks and a bias regulator. Fig. 3 is a circuit diagram of the rf front end. A pair of T-notch traps help eliminate interference at 88 kHz and 122 kHz for the east coast chain, or they may be tuned to 60 kHz and 119 kHz for interference rejection on the west coast chain. I-f transformers are all standard 20k to 5k, 455 kHz diode output types (Mouser Electronics type 80IF103HK — black slug — is suggested). They are tuned with a .0033 mF polystyrene capacitor to bring the range down to 100 kHz for T1, T4, and T5. T2 and T3 are input traps on either side of the loran carrier frequency. The 100 kHz transformers are rather broadband in this circuit because of the loading of the full winding, not using the tap, across the low-impedance circuits on the uA721 chip. Alignment is achieved with a stable CW source, such as a function generator with pin 13 of the uA721 or the test point from transformer T4 secondary as an output monitor with a scope. Peak T1 at 100 kHz, null T2 at 88 kHz (or 60 kHz), null T3 at 122 kHz (or 119 kHz), peak T4 at 98 kHz, and peak T5 at 100 kHz with the generator coupled to the input terminal through a capacitor and suitable attenuator. Use a relatively low rf gain and low agc threshold setting for initial alignment. The 3 dB bandwidth will generally be in the range of 18 kHz to 23 kHz.

The Q-notch resistors should be adjusted for the best null, going back and forth between tuning the null of T2 and T3 and the respective Q resistors. A deeper null may be obtained for T2

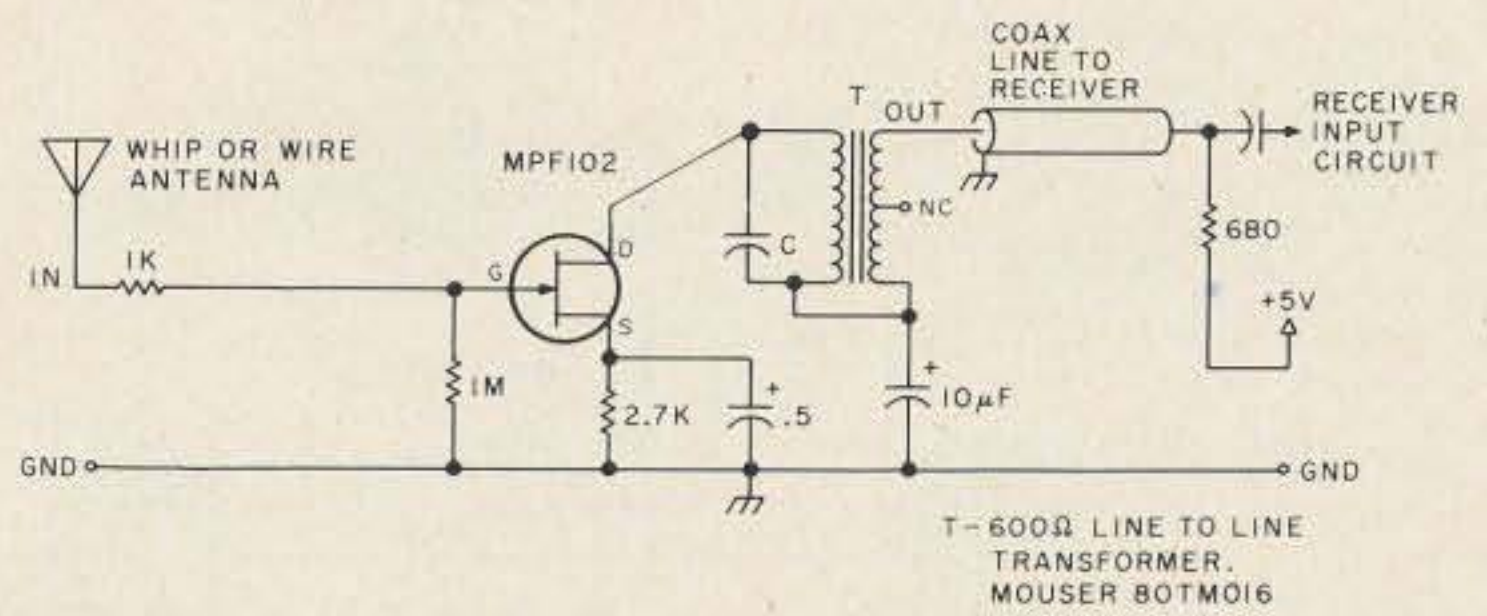

Fig. 1(a). VLF preamplifier circuit.

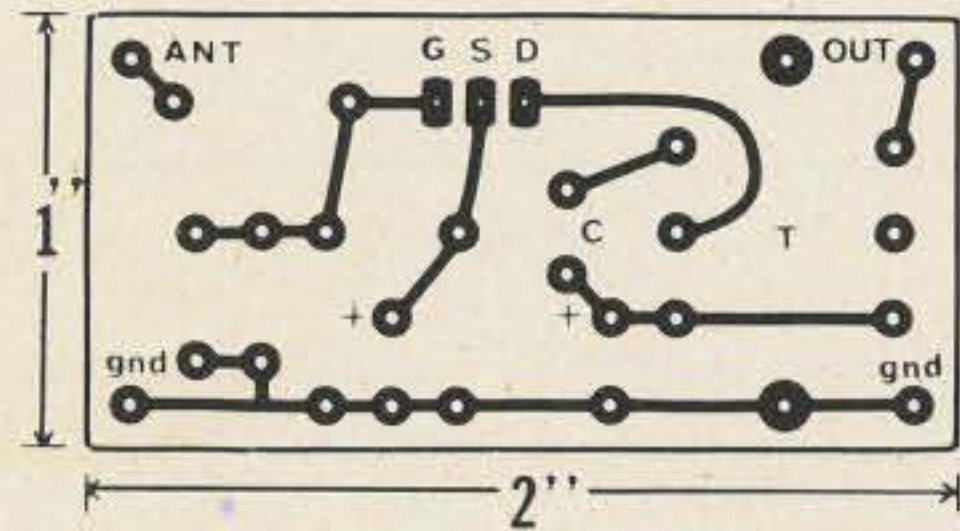
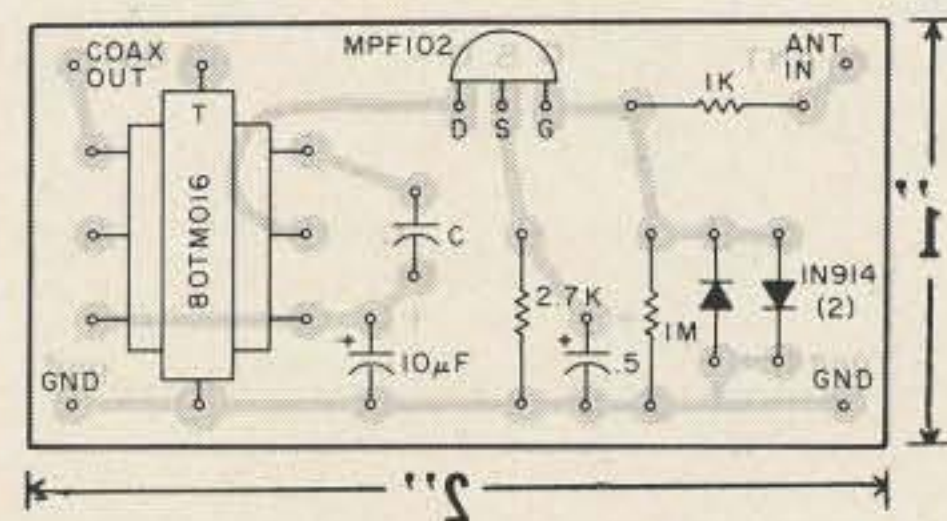

Fig. 1(b). Mini-O, Mini-L preamp PC board.



INPUT IMPEDANCE	1 MEGOHM
OUTPUT IMPEDANCE	600 OHMS
GAIN	+1 TO +3dB
BANDWIDTH	3 TO 300 KHz, NO C
	3 TO 130 KHz, C=500pF
	3 TO 30 KHz, C=5000pF

Fig. 1(c). Mini-O, Mini-L preamp component placement diagram.

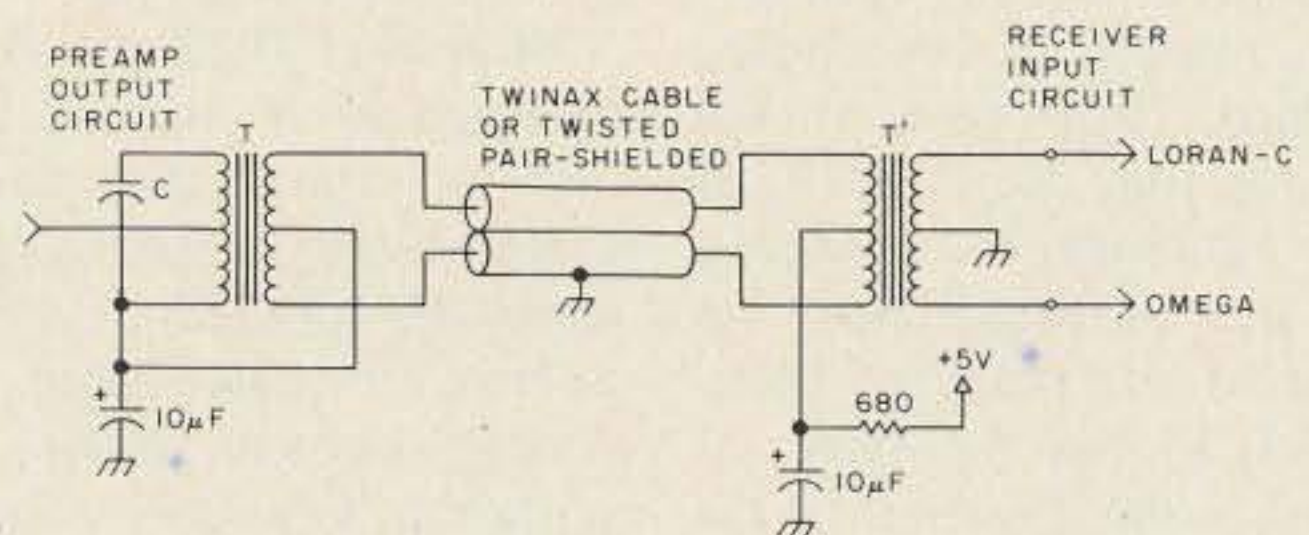

Fig. 2. Common mode ground loop noise reduction method. T — Mouser 80TM016, 600-Ohm c-t line-to-line output transformer.

by a slight adjustment of the Q-multiplier trimpot associated with this trap only. The traps may be user adjusted for other interference, depending on the location. For example, in Europe, interference in the 90 kHz range is sometimes severe. Particularly, the low-side trap should be tuned for the highest Q with the Q-multiplier tweaking adjustment for minimal disturbance of the desired 20 kHz system band-

width. If you do not have interference problems, tune the traps to 80 kHz and 120 kHz. For narrowband DX reception, the tuning may be altered as described later.

Transformer T5 is particularly critical in the circuit of Fig. 3. This drives the autocorrelation detector, which provides a marked improvement in the detection of pulse envelopes when compared to conventional diode AM detectors. It turns

aid of a good external clock and GRI rate generator, it is possible to pick out individual loran-C stations at long range. We regularly receive Newfoundland in Ohio by careful tweaking this way and could even use it to check our local frequency standards where the desired measurement precision is within a millisecond or so per day.

The T-notch traps may also be used to alter the bandwidth by setting the traps at something like 95 kHz and 105 kHz, which has the effect of producing a sharper center frequency peak of only 3 kHz bandwidth or so at 100 kHz. The side skirts may be further reduced by placing a tuned circuit between the preamplifier and the main Mini-L board with appropriate isolation of the dc supply to the preamplifier on the primary side of the additional tuned transformer. All of these experiments tend to reduce the precision of loran-C but are of interest for those who wish to use loran-C only for checking local clocks and frequency standards.

Some of the more complex military loran-C receiver systems have two front ends. One is a very narrow band loop for tracking the peaks of the signals and identifying the main GRI. The other is a wider band tracking loop for measurement of the time intervals. A third system is also found in some commercial receivers in the form of an extra channel or tuned rf voltmeter to help identify interference and to aid in adjusting traps connected to the wide band channel.

Envelope Deriver

In the first versions of Mini-L, a number of different comparator circuits were tried in an attempt to generate a pulse edge at the 50% point or 3rd cycle of the rising pulse envelope. The best compromise at this time appears to be a derivative-adder circuit operated from

point C of the agc bus monitor point shown in Fig. 4. This circuit has a fairly wide 10:1 dynamic range and is intended to detect the inflection point of the original input signal. It combines a differentiator; adder with gain; automatic bias control of the dc, signal, and noise level with an integrator; and, finally, a stabilized gain block using a comparator as a high-speed operational amplifier. The inflection point is degraded in the front end due to the limited rf bandwidth and is often difficult to observe at low rf gain because amplifier II may cut off the signal as it goes down into the noise. Thus the agc level control should be set for a maximum swing of the pulse envelope. Also, the rf gain should be adjusted so that almost all the signals desired are full limiting and the noise level shows appreciably on the baseline. The agc control operates best when low gain is the +5 V end of the pot, increasing gain to a peak at about midway between +V and ground at the CW end. Under these conditions, the

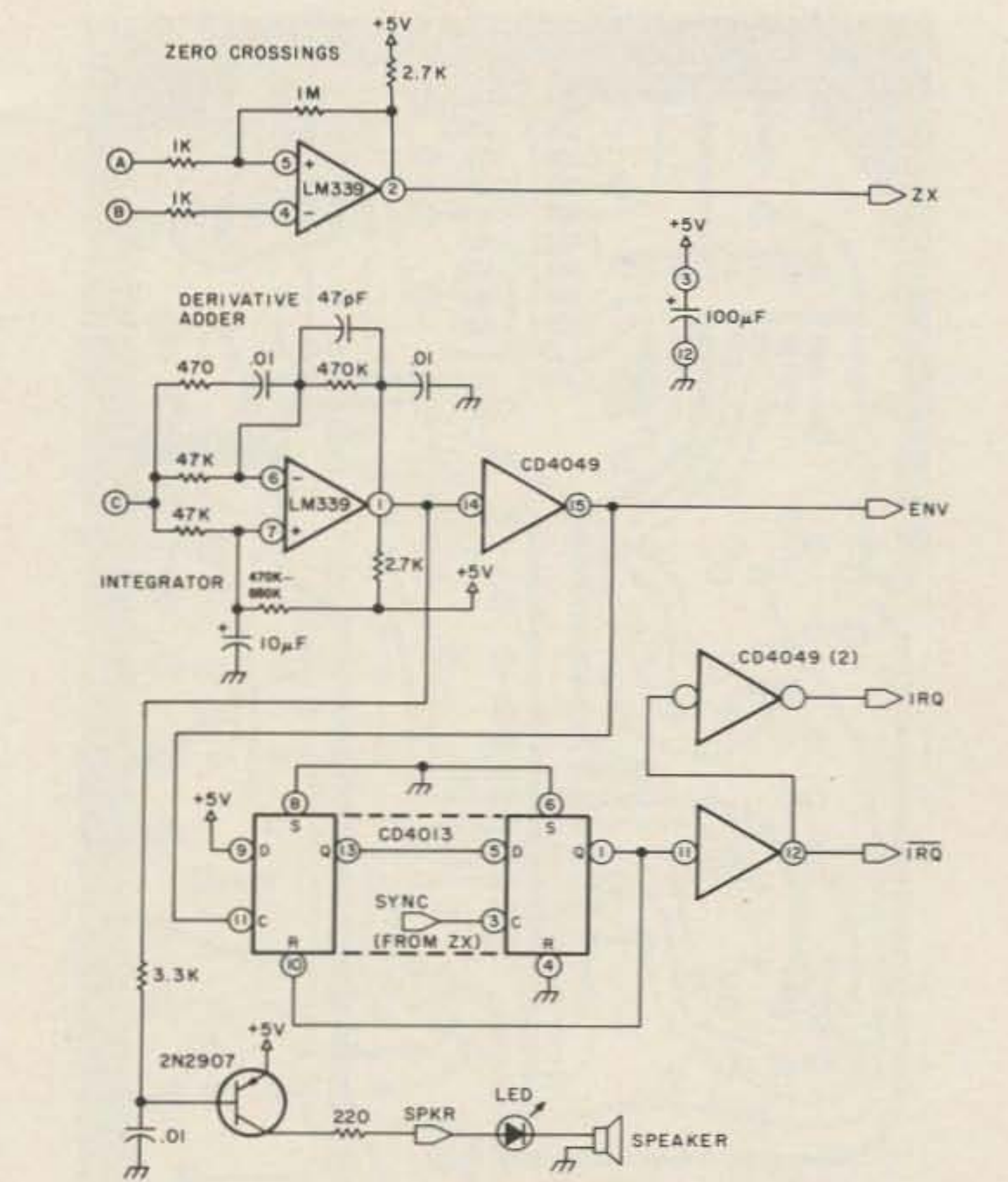
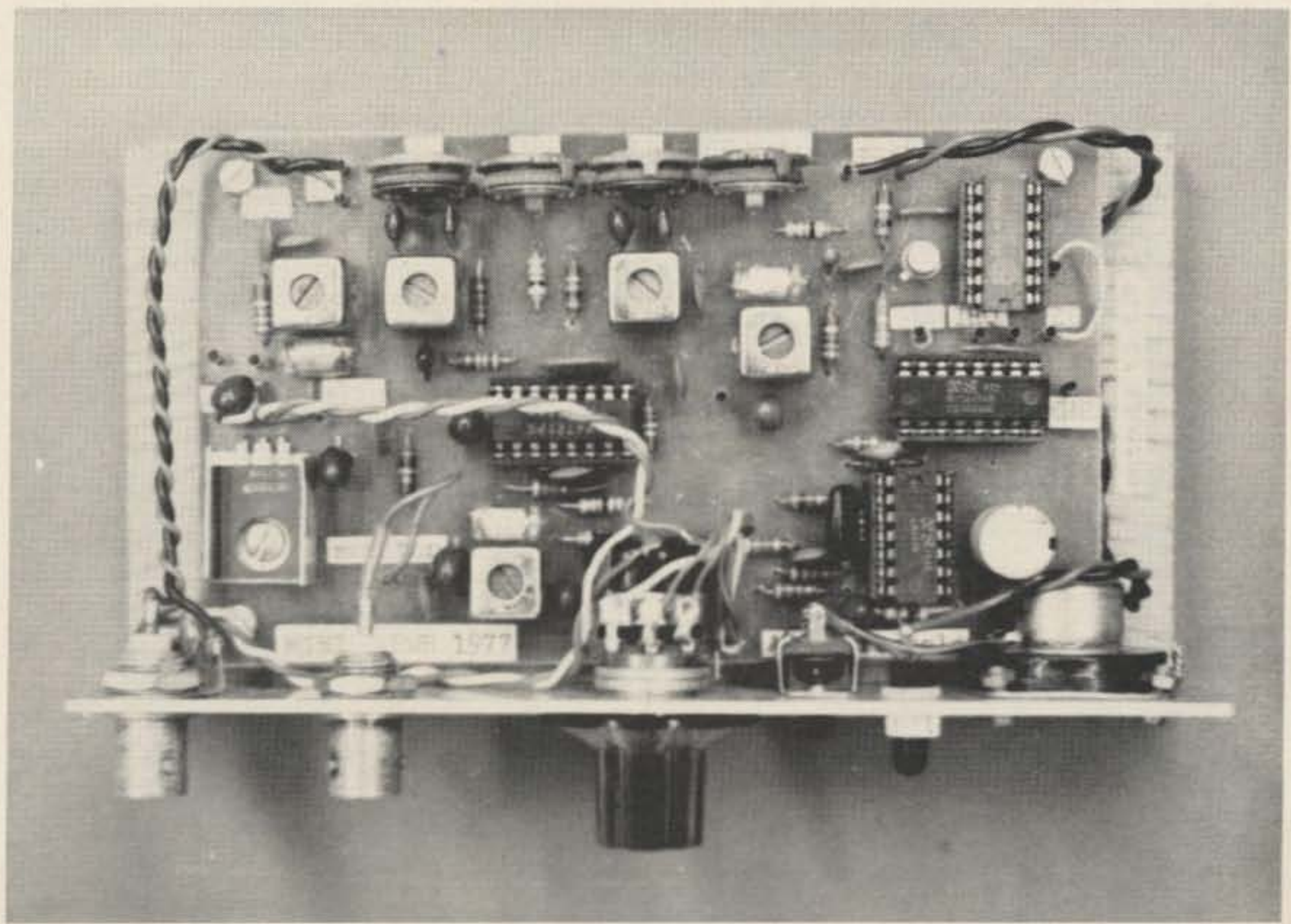

Fig. 4. Mini-L envelope deriver.

derivative-adder circuit will be firing on what it estimates is the inflection point of the input, which may appear as if it is too late but will usually be correct at nearly the 3rd cycle. To further insure that a good estimate of the proper starting point is made, a one-and-only-one synchronizer triggers on the nearest 100 kHz zero crossing after this



Assembled prototype Mini-L circuit board with agc control, LED and monitor speaker (top view), BNC fittings for input from the preamp, and the output envelope monitor point.

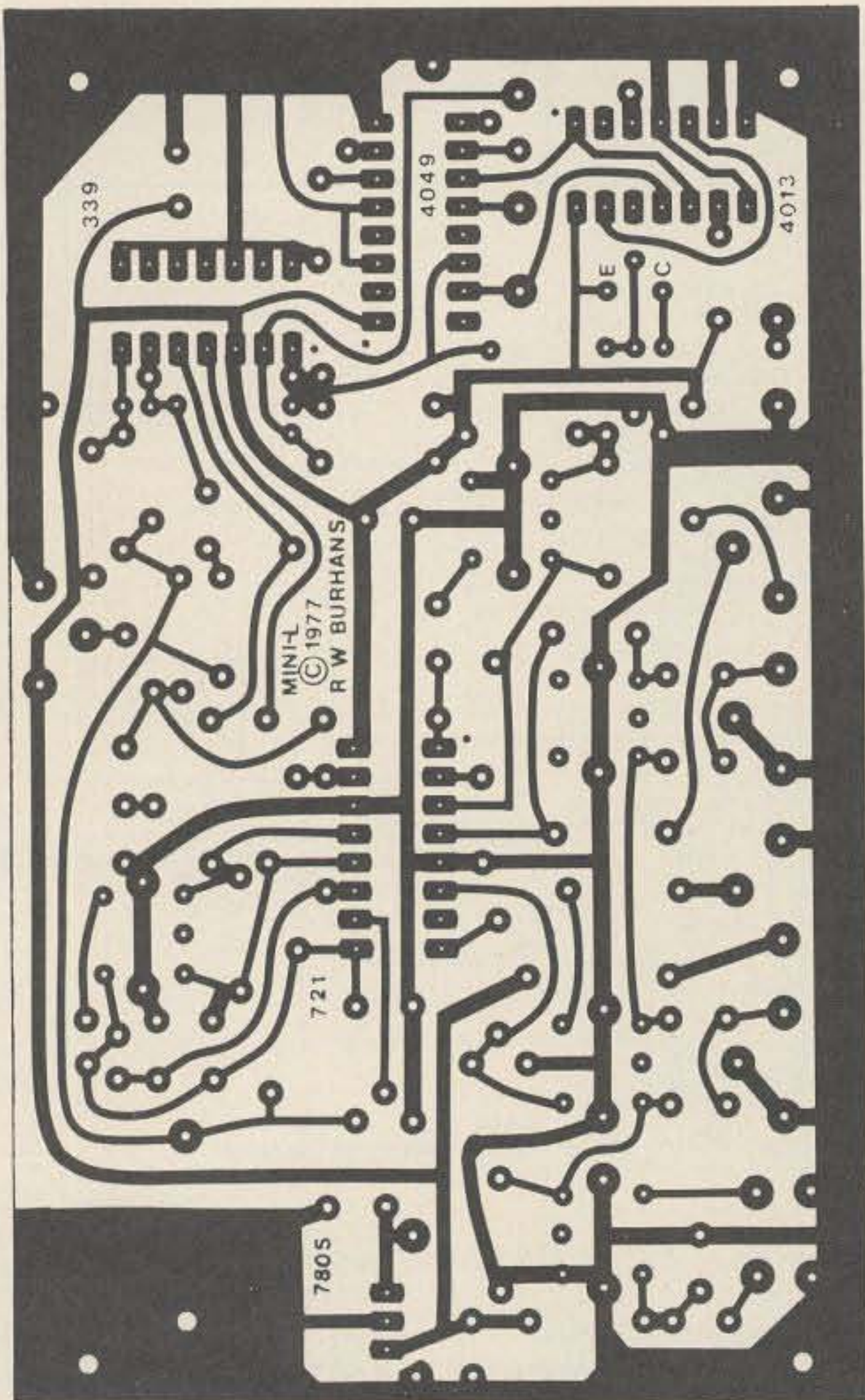

Fig. 5. Mini-L PC board.

envelope comparator triggers on. A jumper on the circuit board is used to connect the ZX output to the sync input, but this can be changed so that the user could apply more sophisticated external sampling to the output of the derivative-adder. The time constants of the envelope deriver circuit could also be changed if anyone feels a need to do this. The net result here is a single $10 \mu\text{s}$ $\overline{\text{IRQ}}$ or IRQ pulse (interrupt request to external timing software or hardware) for each loran envelope detected. These pulses become the basic digital output for time-interval measurements. Of course, these output pulses are contaminated with noise, and it is up to the user digital or software processing to figure out where the true loran-C data is by external cross-correlation and averaging techniques.

the other signals and, with the aid of an external GRI rate timer, estimate about where each of the other stations should be on a scope trace.

Circuit Boards

Illustrations of the foil pattern and parts placement for the Mini-L board are shown in Figs. 5 and 6. Care should be exercised in handling the i-f transformers. The cup core ferrite material is fragile and can break away from the can if excess force is used to turn the core. When mounted in place and soldered at the ground tabs, these transformers are quite rugged. They are found in transistor AM radios by the millions.

The general key to successful assembly of Mini-L is tender loving care with all the components and use of a fine set of hand tools with a low-wattage soldering iron. The board should be polished clean prior to soldering, with 0000 steel wool or a scouring cleanser, washed with clean water or alcohol, and dried. It is also a good idea to inspect the board for slight foil defects or burrs on holes and to carefully clean these up before wiring.

Monitors

The envelope deriver output also drives a loudspeaker and LED connected in series external to the Mini-L board. This indicating method is handy for setting the rf gain and agc threshold in the absence of an oscilloscope. A good full sound of many loran-C signals buzzing away and an almost steady glow of the LED usually provide a proper operating point. This should be checked with a scope connected to point C to determine the proper combination of sight and sound when all usable signals are limiting across the scope trace. For initial search and acquisition of the desired chain, the agc threshold control may be turned down so that only one predominant signal is triggering the LED and speaker. This will usually be the nearest loran-C station to the observer. Then, having identified this one station, the observer can increase the threshold to start observing

Frequency Standard Calibration

Hardware for checking frequency standards or clocks operating at multiples of 1 MHz can be reasonably simple. Fig. 7 is an example of a GRI rate timer to be used as the sync source for a triggered sweep oscilloscope display. A 10 kHz signal obtained by dividing a local 1 MHz standard by 100 is used as the input to a BCD programmable divider chain. Any GRI rate may be set on the thumbwheel switches, or the divider could be hardwired for a particular rate in a given area.

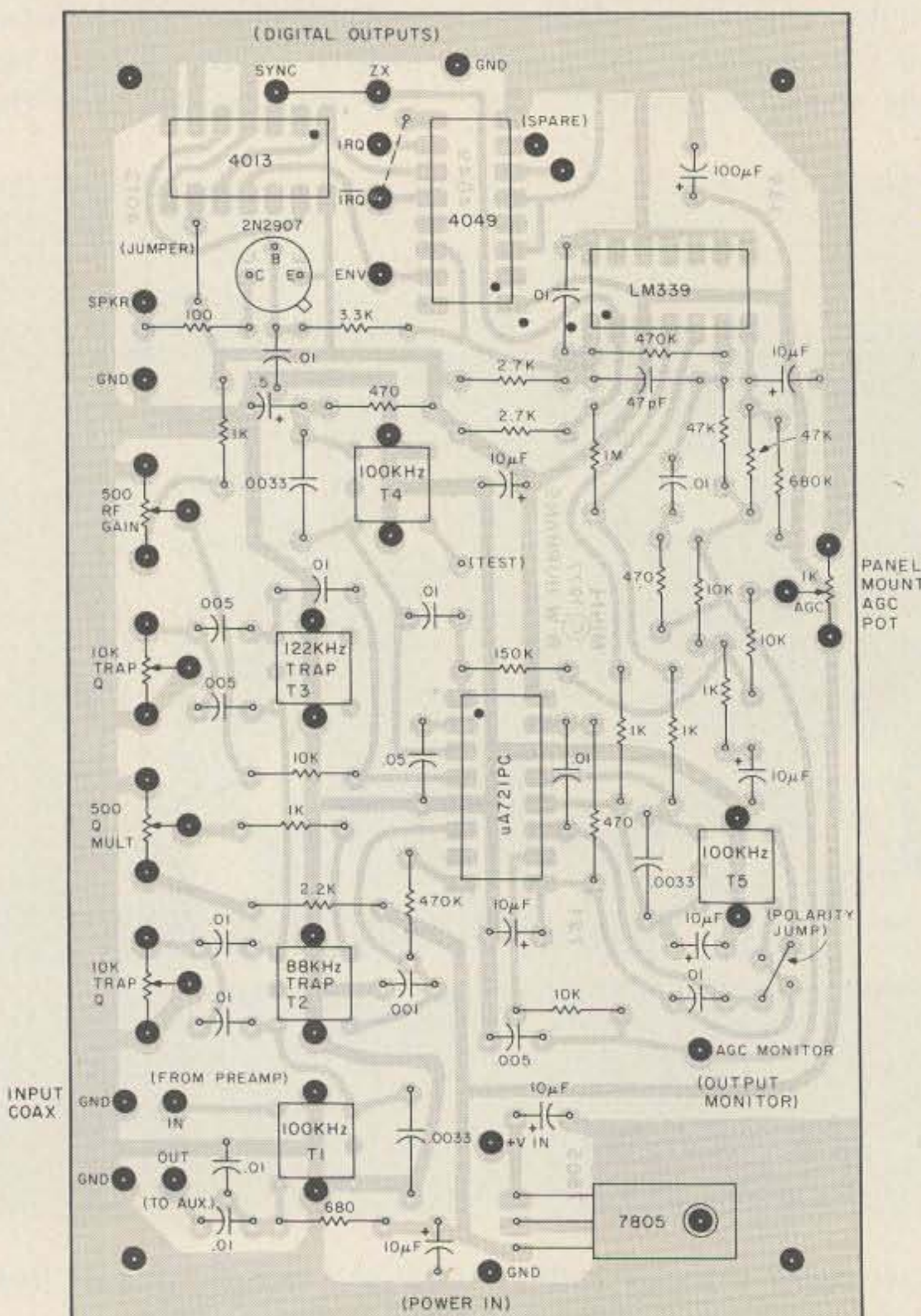

Fig. 6. Mini-L board component placement.

The envelope signal from Mini-L point C is the vertical input to the scope, and the output pulse from Fig. 7 is used to synchronize the scope sweep at the desired GRI rate. The loran-C pulses for the selected rate should be standing still, if you have a good 1 MHz clock, except for cross-chain interference from distant stations or loran-D. The circuit may be used to determine clock offset errors and long-term aging by observing the time it takes for the stable loran-C chain to drift a given amount to the right or left of wherever you started observing a particular station signal. $\Delta t/t$, or the local clock offset, can be estimated directly here. For a precision standard in the range of offsets like 1×10^{-9} , a daily check on the position of a particular station pulse signal expanded on the scope trace, with the GRI rate source kept operating continuously, plotted over a few weeks, gives the clock aging rate estimate.

By selecting additional outputs, without feedback from the same counter chain, it is possible to generate identifying pulses with known TDs and to place these on a second trace of a dual-channel scope. Then, by momentarily speeding up the clock by flicking the GRI rate BCD switches 100 μ s slower or faster, you can position these pulses with respect to any of the signals and estimate the time differences.

A crude loran-A mode time-interval counter has been fabricated experimentally based on a time circuit starting with Fig. 7. The loran-C master station is first positioned with a scope trace at the left edge with the first pulse just visible. The GRI rate pulse triggers the scope sweep and also turns on a flip-flop when the next IRQ arrives from Mini-L. The second set of BCD switches from the same counter chain is positioned so the pulse is just before the desired slave. Then the next IRQ from

Mini-L for the slave pulse time estimate turns off the flip-flop. The on-off time of the flip-flop becomes the time interval, first master IRQ to first slave IRQ. A CMOS 7208 counter chip connected as a time-interval meter or period counter at 1 MHz then can be made to be direct reading in microseconds for this pulse-to-pulse time interval. Single measurements, even repeating at 10 times per second (about this for 99,300 GRI), give erratic readings when the noise level is high, but they do illustrate the idea of loran-C. The U.S. Coast Guard does not recommend using loran-A methods for loran-C, but they can be quite educational in the first stages of trying to understand the system. Some existing loran-C receivers use variations of this method by suitably gating all 8 of the detected pulses with respect to all 8 of the desired slave time intervals and averaging over at least two GRI periods to arrive at a time-interval number. The digital hardware rapidly becomes a complex mess, particularly when you are not allowed to use an oscilloscope for initial positioning and identification of stations.

A quite complex all-TTL down-counter version of a timer which locks to a single station of a loran-C chain, including the phase code, has been reported by Kramer (G. Kramer, "Loran-C Timing Receivers," *Frequency Technology*, Vol. 8, #8-9, pp. 13-17, August-September, 1970). His circuit is primarily intended as a time-frequency standard reference, but it might be expanded to include some time-interval measurements.

KIM GRI Timer

For those who have a KIM-1 microcomputer, a 22-instruction timer routine is usually simpler than fabricating a digital hardware GRI source. The program uses the interval timer on the

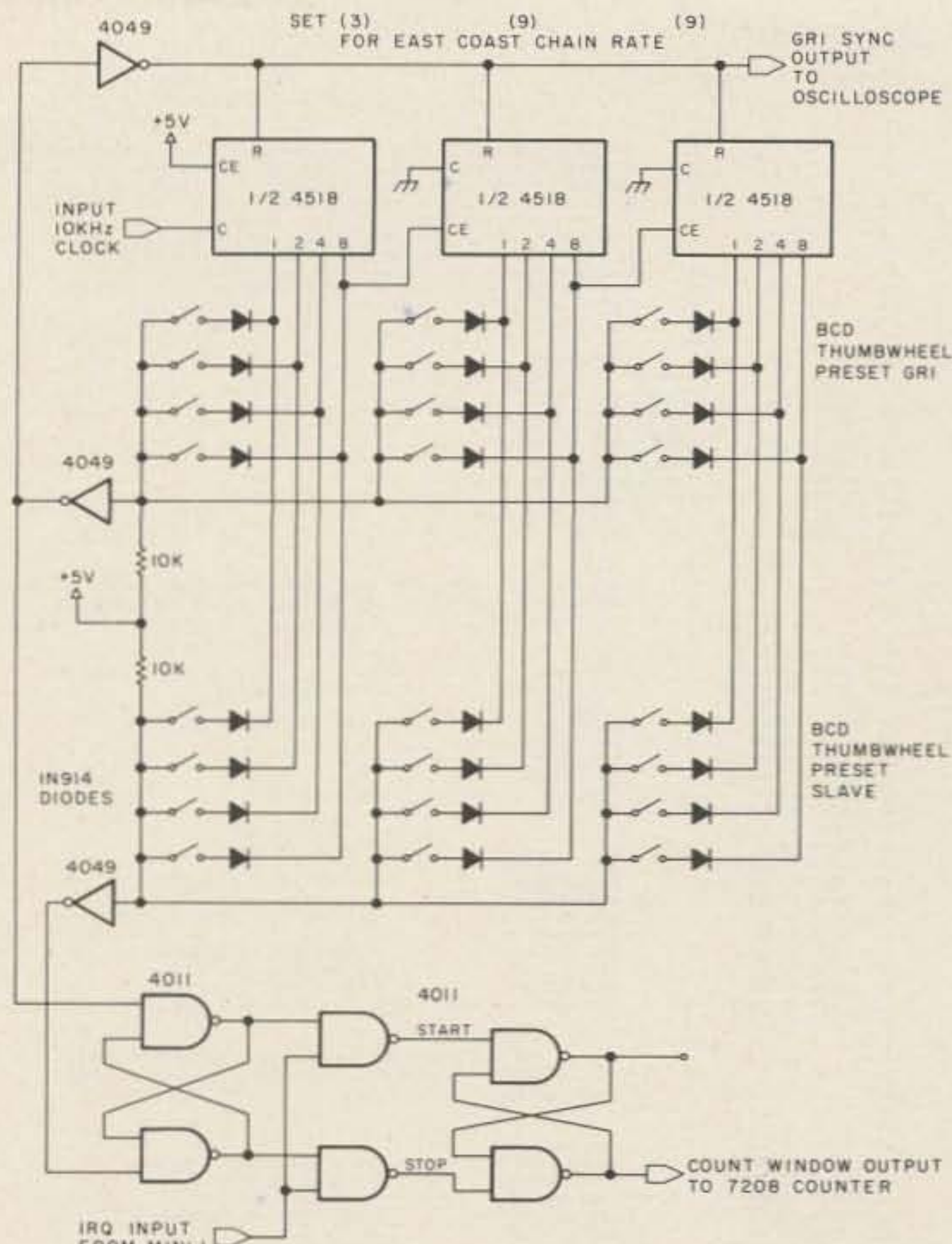

Fig. 7. GRI rate generator with slave window timer.

6530 PIA chip with a BIT test and BPL compare instruction, after first setting the required time delay numbers for 1024, 64, 8, or 1 clock cycles. An additional trim delay with an NOP instruction allows setting the total timeout to the desired GRI interval. The 1 MHz clock on board KIM should

be set within ± 10 Hz with a trimmer capacitor, if possible. (See *KIM/6502 User Notes*, #5, page 10, May, 1977, for KIM clock modifications if your clock frequency is not close to 1 MHz.) This program generates a 99,300-microsecond interval for the east coast chain with a short 5 μ s pulse output. Other GRI

```

      Jean Burdick, K1BPT ©
      EXECUTING BEGIN...

      END PASS 11  0 ERRORS

      1          8
      2          8
      3          8
      4          8
      5          8
      6          8
      7          8
      8          8
      9 1700          ORG $1700
     10 1700          DDIR EDU $1701
     11 1700          OUTPUT EDU $1700
     12 1700          T1024 EDU $1707
     13 1700          TA4 EDU $1706
     14 1700          TB EDU $1705
     15 1700          T1 EDU $1704
     16 1700          TIME1 EDU $60
     17 1700          TIME2 EDU $0E
     18 1700          TIME3 EDU $34
     19 1700 DD
     20 1701 1E
     21 1702 A9 01          LDA #01
     22 1704 9D 01 17          STA DDIR
     23 1707 A9 01          LDA #01
     24 1709 8D 00 17          STA OUTPUT
     25 170C A9 00          LDA #00
     26 170E 9D 00 17          STA OUTPUT
     27 1711 A9 40          LDA #TIME1
     28 1715 8D 07 17          STA T1024
     29 1716 2C 04 17 DELAY1 BIT T1
     30 1719 10 FB          BPL DELAY1
     31 171F A9 0E          LDA #TIME2
     32 1720 8D 06 17          STA T64
     33 1720 2C 04 17 DELAY2 BIT T1
     34 1723 10 FB          BPL DELAY2
     35 1725 A9 34          LDA #TIME3
     36 1727 8D 04 17          STA T1
     37 172A 2C 04 17 DELAY3 BIT T1
     38 172D 10 FB          BPL DELAY3
     39 172F EA          NOP
     40 1730 4C 07 17          JMP START
     41          END

      CLEAR DECIMAL
      CLEAR CARRY
      1701 DDIR SET PWD AD OUTPUT
      TRIM PWD ON
      TRIM PWD OFF
      DELAY TIME 1024
      COMPARE BIT 7
      WHEN N=0
      DELAY TIME 64
      COMPARE BIT 7
      DELAY 3 WHEN N=0
      DELAY TRIM TO 1US

      END PASS 21  0 ERRORS
  
```

Table 1.

END PASS 1: 0 ERRORS

```

1 *
2 *
3 * THIS PROGRAM WAS DESIGNED TO FIND LORAN MASTER STATIONS
4 * USING A REAL TIME INTERRUPT GENERATED BY THE MINI L
5 * HARDWARE FRONT END. THE CRITERIA FOR THE TEST ARE:
6 * A SERIES OF 8 PULSES SPACED 1MS FOLLOWED BY ONE PULSE
7 * AT 2MS. AT THIS TIME A POSITIVE GOING PULSE WILL
8 * APPEAR ON THE KIM PIA PA1 OUTPUT PORT PIN. AFTER FINDING
9 * A MASTER STATION THE SOFTWARE WILL BEGIN AGAIN TO FIND
10 * ANOTHER MASTER STATION MEETING THE CRITERIA.
11 * ALSO AT THE LAST PULSE OF THE 8 PULSE GROUP AN OUTPUT
12 * PULSE WILL APPEAR ON THE KIM PIA PA0 OUTPUT PORT.
13 *
14 *
15 0000 ORG 0000
16 0000 VIRG EQU $17FE
17 0000 XBTIME EQU $170D
18 0000 GRIBET EQU $170F
19 0000 OUTPUT EQU $1700
20 0000 DDIR EQU $1701
21 0000 STDP EQU $1C00
22 0000 TOFF EQU $1706
23 0000 2E XIRQ ADR LIRQ
24 0001 00 SFLAGS BSS 1
25 0002 00 EVCTR BSS 1
26
27 *
28 * THIS IS THE START POINT FOR THE ROUTINE. WE INITIALIZE THE
29 * IRQ VECTORS AND SET UP THE SOFTWARE FLAGS AND COUNTERS.
30 *
31 *
32 0003 7B VSET SEI DISABLE IRQ
33 0004 A9 00 LDA #$00
34 0006 8D FF 17 STA VIRG+1 STORE IRQ VECTOR
35 0009 A5 00 LDA XIRQ
36 000B 8D FE 17 STA VIRG STORE LSB OF IRQ VECTOR
37 000E A9 0B OUTSET LDA #$0B
38 0010 8D 01 17 STA DDIR
39 0013 4C 19 00 JMP BEGIN
40 0016 68 AGAIN PLA
41 0017 68 PLA
42 0018 68 PLA
43 0019 7B BEGIN SEI
44 001A A9 01 LDA #$01
45 001C 85 01 STA SFLAGS SET MASTER FIND FLAG
46 001E A9 0B LDA #$0B
47 0020 8D 00 17 STA OUTPUT CLEAR INTERRUPT LATCH - MASTER PULSE
48 0023 A9 00 LDA #$00
49 0025 B5 02 STA EVCTR CLEAR ENVELOPE COUNTER
50 0027 5B CLI UNBLANK IRQ
51 0028 8D 00 17 STA OUTPUT ENABLE INTERRUPT LATCH
52 002B 4C 2B 00 SELF JMP SELF WAIT
53
54 *
55 * THIS IS THE BEGINNING OF THE INTERRUPT SERVICE SEQUENCE
56 * THIS IS WHERE THE TEST FOR THE LORAN VS TIMER INTERRUPTS
57 * IS DETERMINED.
58 *
59 *
60 002E A9 04 LIRQ LDA #$04
61 0030 2B 00 17 AND OUTPUT CHECK FOR TIMEOUT INTERRUPT
62 0033 F0 4C BEQ TIRQ TIMER INTERRUPT
63 0035 A9 80 LDA #$80 LORAN INTERRUPT SERVICE STARTS HERE
64 0037 25 01 AND SFLAGS CHECK FOR TIME OUT SET
65 0039 F0 09 BEQ CONT NO
66 003B AD 06 17 LDA TOFF DISABLE TIME OUT INTERRUPT
67 003E A9 7F LDA #$7F
68 0040 25 01 AND SFLAGS
69 0042 B5 01 STA SFLAGS CLEAR TIME OUT
70
71 *
72 * THIS IS WHERE THE ENVELOPES ARE COUNTED AND THE STATUS
73 * FLAGS (SFLAGS) ARE CHANGED AND TESTED TO DETERMINE THE
74 * FLOW OF THE PROGRAM.
75 *
76 *
77 0044 A9 01 CONT LDA #$01
78 0046 25 01 AND SFLAGS TEST FOR MASTER SEARCH SET
79 0048 F0 2B BEQ N1 NOT SET
80 004A E4 02 INC EVCTR YES SET
81 004C A9 0B LDA #$0B
82 004E C5 02 CMP EVCTR LOOKING FOR 8TH PULSE
83 0050 F0 0B BEQ PNINE YES
84 0052 A9 6A LDA #$6A NO
85 0054 8D 0D 17 STA XBTIME SET TIME OUT FOR 1MS
86 0057 4C AC 00 JMP RTN CLEAR INTERRUPT LATCH
87 005A A9 01 PNINE LDA #$01
88 005C 8D 00 17 STA OUTPUT PULSE PIA PA0 HIGH
89 005F A9 00 LDA #$00
90 0061 8D 00 17 STA OUTPUT PULSE PIA PA0 LOW
91 0064 A9 03 LDA #$03
92 0066 45 01 EOR SFLAGS CLEAR MASTER SEARCH SET MASTER FOUND
93 0068 B5 01 STA SFLAGS
94 006A A9 E7 LDA #$E7
95 006C 8D 0D 17 STA XBTIME SET TIME FOR 2MS
96 006F 4C AC 00 JMP RTN CLEAR INTERRUPT LATCH
97 0072 A9 02 N1 LDA #$02
98 0074 25 01 AND SFLAGS CHECK FOR MASTER FOUND
99 0076 F0 04 BEQ N2 NO (ERRORS)
100 0078 8D 00 17 STA OUTPUT YES OUTPUT MASTER FOUND PULSE
101 007B 4C 16 00 JMP AGAIN CONTINUE TO LOOK AGAIN
102 007E 4C 00 1C N2 JMP STOP ERROR
103
104 *
105 * THIS IS WHERE THE TIMER INTERRUPT SERVICE STARTS. WE ENTER
106 * HERE FROM THR LIRQ ROUTINE ABOVE. THIS ROUTINE TAKES
107 * CARE OF ALL INTERRUPTS GENERATED BY THE TIMER ON KIM.
108 *
109 *
110 0081 A9 0B TIRQ LDA #$0B
111 0083 8D 00 17 STA OUTPUT DISABLE LORAN IRQ
112 0086 A9 80 LDA #$80
113 0088 25 01 AND SFLAGS CHECK FOR TIME OUT
114 008A D0 0E BNE SET SET
115 008C A9 80 LDA #$80 TIME OUT NOT SET ROUTINE STARTS HERE
116 008E 05 01 ORA SFLAGS
117 0090 B5 01 STA SFLAGS SET TIME OUT FLAG
118 0092 A9 0B LDA #$0B
119 0094 8D 0D 17 STA XBTIME START TIME OUT
120 0097 4C A1 00 JMP CLEAR CLEAR INTERRUPT LATCH
121 009A 7B SET SEI NO ENVELOPE FOUND
122 009B 8D 06 17 STA TOFF DISABLE TIMEOUT INTERRUPT
123 009E 4C 16 00 JMP AGAIN
124 00A1 A9 0B CLEAR LDA #$0B
125 00A3 8D 00 17 STA OUTPUT CLEAR INTERRUPT LATCH
126 00A6 A9 00 LDA #$00
127 00A8 8D 00 17 STA OUTPUT ENABLE INTERRUPT LATCH
128 00AB 40 RTN RTI
129 00AC A9 0B RTN LDA #$0B
130 00AE 8D 00 17 STA OUTPUT DISABLE INTERRUPT LATCH
131 00B1 40 RTI
132 END

```

END PASS 2: 0 ERRORS

R:

Table 2.

rates could be programmed by changing the delay constants and trim NOP. The output of the timer on port PA0 is used to synchronize

the oscilloscope sweep while observing the Mini-L envelope signals on the Y-input. This display inherently checks the KIM 1 MHz clock versus the

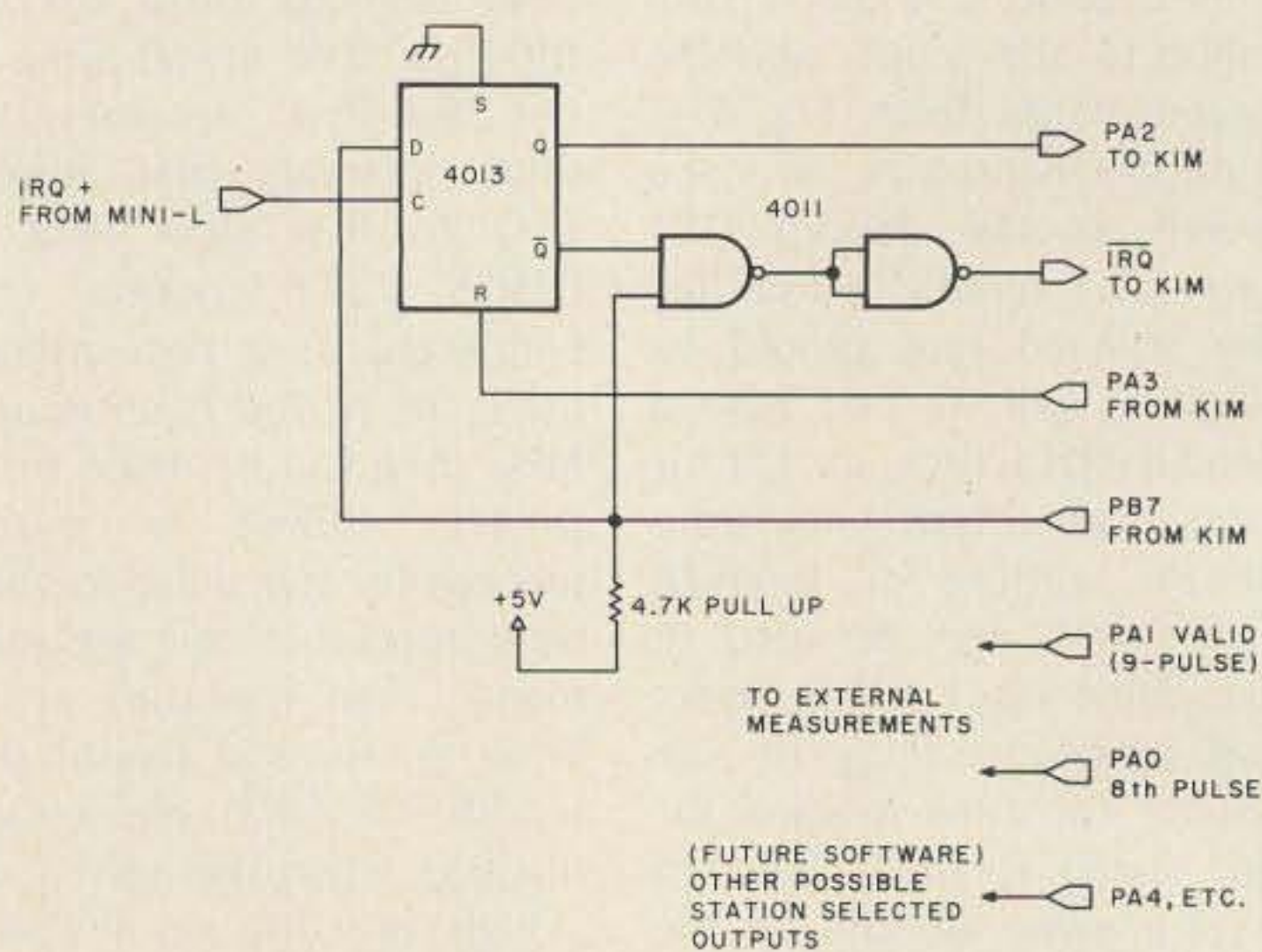

Fig. 8. Composite master sync hardware.

loran-C signals.

A listing of this short program is illustrated in Table 1. The program is located in the RAM scratchpad area of the 6530 chip on KIM starting at 1780, thus saving all of page zero for other uses. While the program works well as it stands, it would be difficult to expand to include time-interval measurements because the KIM clock inherently has to cycle through the timer in order to generate the desired interval. Other timing techniques are required for more sophisticated loran-C time-interval measurements.

Composite Master Sync Software Ideas

Software methods which depend on detecting eight 1 ms space pulse envelopes before providing an output and also detect the 9th pulse after a 2 ms delay have been devised by Jim Nickum, electrical engineering student here at Ohio University. We call this a composite envelope method, since it depends on detecting all 8 or 9 of the properly spaced pulses before generating an output. This is contrasted to envelope cycle matching methods which measure pulse to pulse or cycle to cycle of all 8 sets of pulses. Nickum's routine requires less than a page of KIM-1 memory and uses the

interval timer on the 6530 PIA chip. The program listing is shown in Table 2. Fig. 8 is the interface for the composite master sync routine.

PA0 is programmed to provide an output pulse after each 8-pulse group. PA1 is programmed to provide an output after a 9-pulse group. There is some delay and jitter in the position of these output pulses with respect to the end of the master and slave pulse groups. However, this delay is relatively constant so that a rough measurement of time interval may be obtained by observing the signals on a scope trace. The program is useful for educational purposes with a dual-channel scope and triggered sweep.

The program is reliable as it stands in that it only provides a proper output when a valid set of 8- or 9-pulse groups are detected. However, noise and cross-chain interference often prevent an output pulse from appearing. During severe thundershower weather with spherics activity at the 100/minute rate, many of the loran-C pulse groups will be missed. However, it is still possible to obtain information because those 8-pulse groups that are found will have the correct relative spacing in time, even if they occur only every other frame with some master or slave groups missing. This idea of generating a composite envelope signal is still rather

Time-Frequency Notices

The U.S. Naval Observatory, 34th and Massachusetts Ave., N.W., Washington DC 20390, publishes a weekly "Daily Phase Values and Time Differences - Series 4" tabulation of the loran-C, omega VLF, and network TV frequency standard stability compared to each other and to cesium atomic clock time. This information is obtained by a worldwide monitoring network with a measurement precision of 1×10^{-14} per day. Loran-C stations are typically maintained by making small changes every few weeks, like 0.01 microseconds, so that all chains are accurate to at least 0.1 microseconds (1×10^{-12}) at any given time. A subscription to this service is available by filing a qualification form with the USNO. They also have other bulletins available describing how to convert received loran-C pulse time of reception to UTC time of day and other information on the dissemination of very precise time-frequency data. Radio amateurs interested in this precision timekeeping should write to the USNO for a catalog of their services.

Parts List

The following items are available:

- | | |
|--|--------|
| (1) Set of two circuit boards, Mini-L and preamp - | \$8.50 |
| (2) Reprint of 73 articles on Mini-L receiver - | \$1.50 |
| (3) Set of i-f cans and tuning capacitors for Mini-L - | \$4.95 |
- Send check or money order, no COD, payable to: R. W. Burhans, 161 Grosvenor St., Athens OH 45701. Ohio residents add 4% tax to total. Items postpaid by 1st class mail.

Additional items on VLF receivers, reports, and software are available or in preparation. Write for information, including an SASE.

The Fairchild uA721PC integrated circuit was at Fairchild distributors as of June, 1977.

Mouser Electronics, 11511 Woodside Ave., Lakeside CA 92040, stocks transformers and all the resistors and capacitors used in Mini-L (minimum order is \$20).

The LM339, CD4013, CD4049, 2N2907, MPF102, 7805, and 1N914s are available from a number of dealers advertising in the pages of *Kilobaud* and *73* magazines.

like loran-A and would not provide high precision. The program might be used as part of a more sophisticated time-interval processor, where it serves something like the search and track mode of operations to find the desired chain.

Future Hardware and Software

The real problem for time-interval measurements is still more complex. One of the most recent marine receivers (Texas Instruments model TI9000 @ \$2095) uses high speed TI 9900 series microprocessors with 100-nano-second multiplexed PLLs for 3rd cycle matching to the pulse envelope. In our labs, we are experimenting with a KIM-1 6502 microcomputer by preprocessing the loran-C edge information with an external high-speed word generator. We estimate that about 4K words of processor memory will be required to

do the job.

We are also working on a manual search, autotrack receiver, all in CMOS hardware. A 10-chip digital phase locked loop is used for each station. Three loops are required for a simple marine type of receiver, with a 6-chip readout and control system. A small scope such as the new NLS MS-15 Miniscope is used as a signal acquisition aid.

The best receivers now and in the future will use PLL methods, locking to selected cycles of the loran-C carrier signal. The present Mini-L rf board is capable of being modified to provide the proper input signals. Future articles will present some of these concepts as they go from the breadboard stage into a packaged system.

Navigation software for use with time-interval numbers is still another problem. At this point, it appears that two separate microprocessor systems would be best, since

the time-interval processor is going to have to work fairly hard and steadily to keep up with the loran-C signals. Thus, an additional micro system is suggested to solve the coordinate transformation problem, which is a whole new story for future navigators.

Summary

The idea of Mini-L is presented to suggest different methods that the skilled experimenter can use with loran-C signals. The front-end hardware can be fabricated at quite low cost for an envelope-type processing system. The suggested hardware and software experiments are primarily educational and are not intended to be used as a finished navigation system or time-interval measurement device. Of primary interest to

the radio amateur are the relatively simple methods of using loran-C for frequency standard calibration, even at long range beyond the normal recommended navigation coverage.

Acknowledgements

This article has been prepared as a technical spin-off from a more comprehensive study of loran-C supported by NASA Langley Research Center, Grant NGR 36-009-017. The help of Dr. Robert W. Lilley and Mr. James Nickum on the software processing problems is gratefully acknowledged. I also wish to thank the more than 50 individual customers who have obtained prototype Mini-L board materials for helping to expand the general knowledge of loran-C for the low-budget experimenter. ■

Hi Pro Mk I 50 - 144 - 220 and 450 Commercially Rated REPEATERS

M36

Other Frequencies
on Special Order
Economically
Priced

- * A state-of-the-art, full-feature repeater that boasts broad range temperature and electrical stability for use in an uncontrolled environment
- * Low current drain - A plus for emergency 12 volt standby battery operation
- * The receiver develops maximum usable sensitivity and sideband rejection
- * The transmitter develops 15 Watts (220) 16 Watts (144) of clean rf and a faithful reproduction of the input signal insuring an extremely good sounding repeater
- * Includes a high quality dynamic microphone and a detailed instruction manual

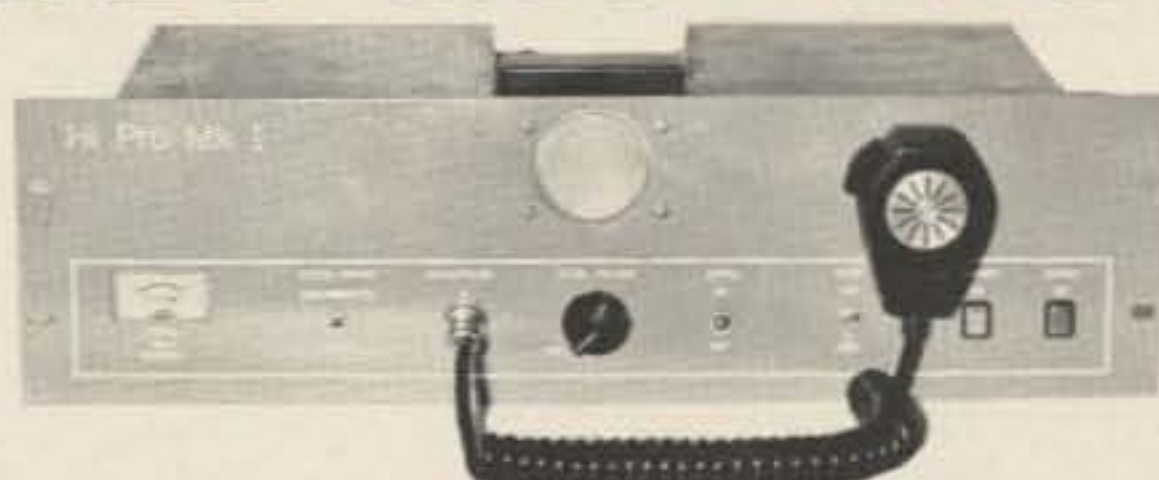

MATCHING CABINET
AVAILABLE

- * Size of repeater panel 5 1/4" x 19" x 13"
- * Metering of discriminator and signal level
- * Receiver sensitivity S-N/4 at 0.25 uV - 12 dB
- * Distortion 0.1% or better

U.S. Currency Plus Shipping

50 MHz \$789.95

PA Res. add 6% tax

144 + 220 MHz \$699.95

450 MHz \$799.95

Maggiore Electronic Laboratory

M36

845 WESTTOWN RD.

WEST CHESTER, PA. 19380

PHONE 215 436-6051

Home-Canned Dummy

— cheap half-gallon load

Michael J. Di Julio WB2BWJ
97 Woodside Rd.
Maplewood NJ 07040

Steven B. Waldman WA2JZR
5 Victoria Court
Morganville NJ 07751

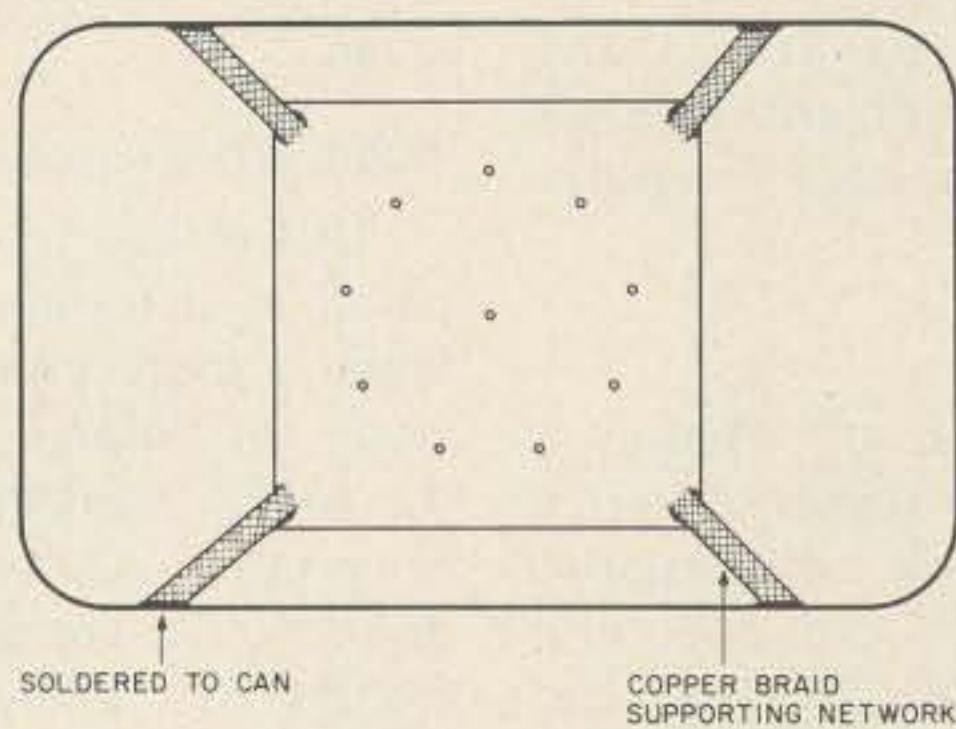

Fig. 1. Bottom view of the can.

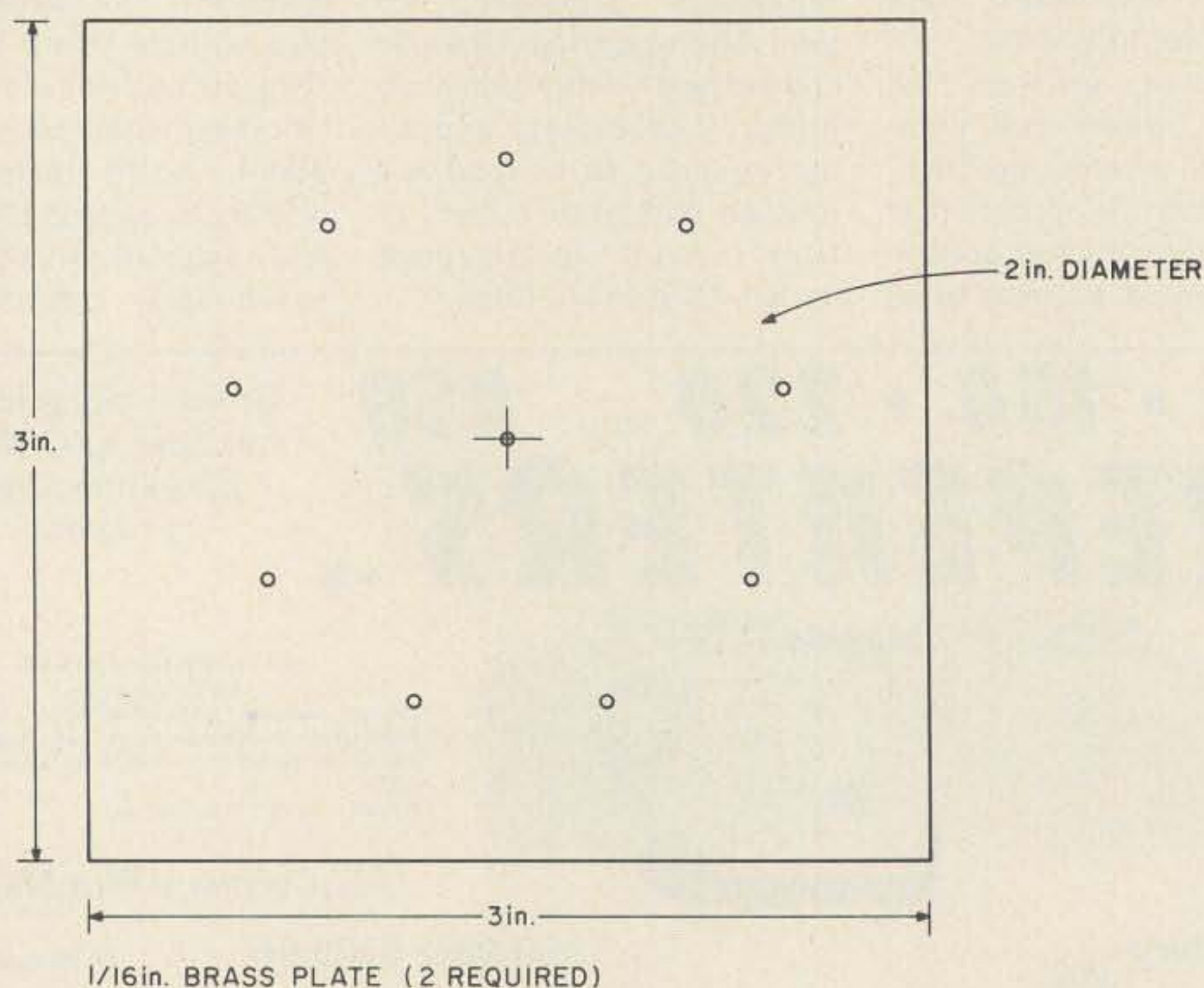

Fig. 2.

In today's times of high prices, it is nice to know that home brew dummy loads are still within the price range of the poorest amateur. Each of our half-gallon gallons was constructed for less than \$3.00 using readily available materials.

One-gallon paint thinner cans were prepared for the project by cutting off their bottoms with an ordinary can opener. This was followed by a thorough washing and drying procedure to remove

any trace of the flammable contents. Next, twenty 470-Ohm, two-Watt 10% resistors (ten for each load) were sorted between the two of us so that we had equal numbers of high and low values. This gave us parallel combinations that were very close to 50 Ohms. Each group of ten was then soldered between two 3" x 3" pieces of 1/16" brass plate pre-drilled to accept nine resistors in a 2"-diameter circle with the tenth one in the middle.

A hole was then punched on top of the can to accept a suitable connector. In our case, a flange-mount SO-239 was the choice. The flange of the connector was soldered to the can to make an oil-tight connection. The rear of the connector was also epoxied over to prevent oil seepage through the center conductor.

The resistor network was then mounted in the can, supported by a 2" length of heavy-gauge wire soldered from the center pin of the connector to one side of the resistor assembly. Four pieces of copper braid were soldered to the bottom of the resistor network at each corner and then soldered to the can for support and to provide a good ground plane.

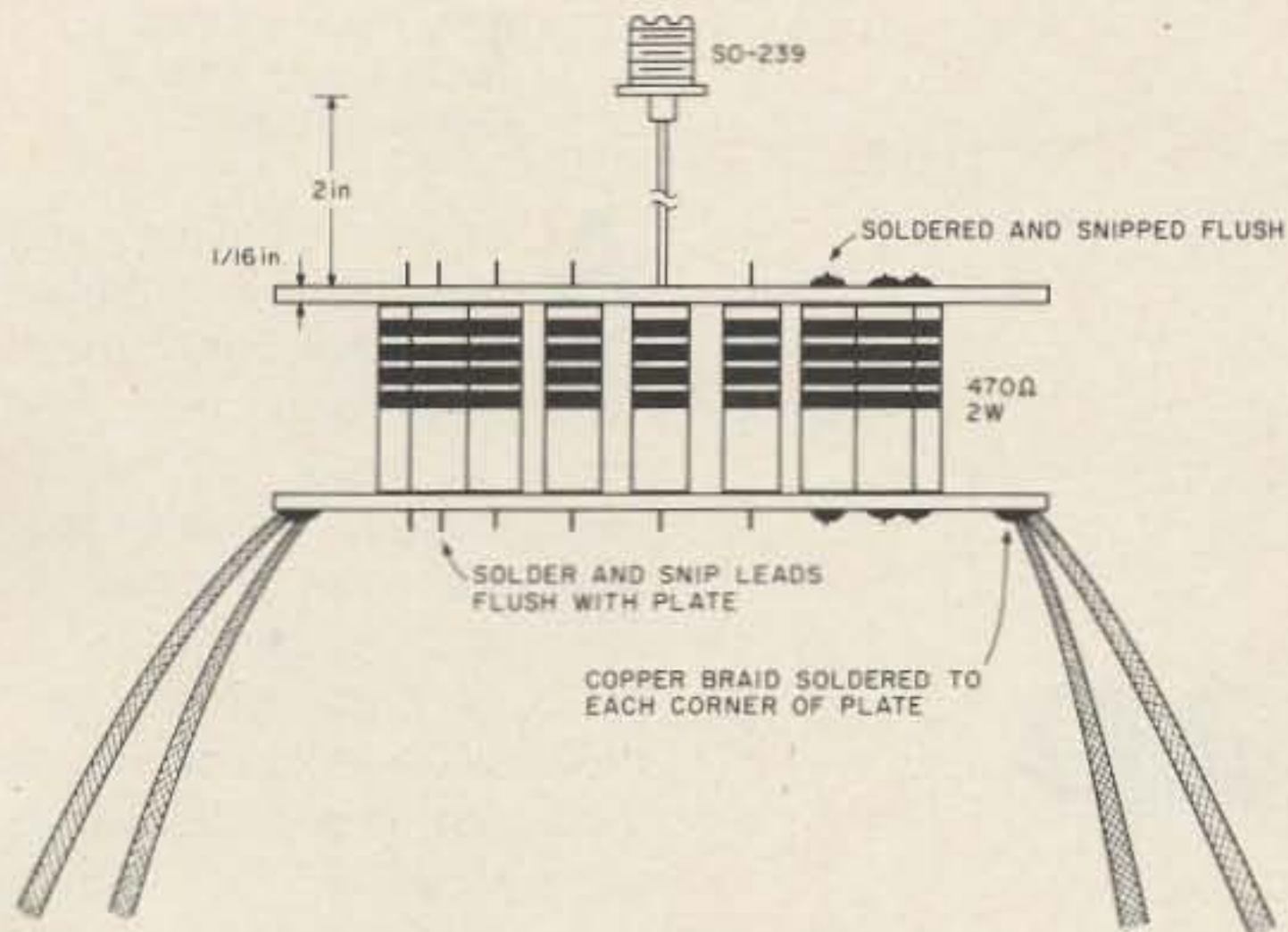

Fig. 3. Resistor network.

The can was sealed by cutting a piece of 1/16" copperclad PC board approximately 1/4" larger than the base and soldering this to the bottom of the can.

Testing the load on a Hewlett-Packard network analyzer model 8407A showed that the loads were purely resistive at 50 Ohms up to 32 MHz. The can was filled with a gallon of 30- or

40-weight motor oil (the cheapest brand available). The dummy load was designed for transmitters in the 200-Watt class, but it is able to take at least twice that power. It is advisable to loosen or take off the cap of the dummy load when in use to vent any expanding oil or fumes that may come off when the load is used at high power. ■



**Germtown
Amateur
Supply,
Inc.**

MEMPHIS, TENNESSEE

NO MONKEY BUSINESS!

- (A) Complete Service Facilities
- (B) Good Deals on most Brands
- (C) Shipping within 24 Hours
- (D) All inquiries handled by Active Hams with over 20 years experience in ham radio

CALL TOLL FREE
1-800-238-6168

IN TENNESSEE, CALL 901-452-4276
MONDAY - SATURDAY 8:30-5:30
FOR YOUR SPECIAL.

CUSTOM HIGH POWER AMPLIFIERS G-12

Write: 3202 Summer Ave., Memphis, Tennessee 38112

New!
Please don't squeeze the
Feather Touch.



only
\$69.95

Kantronics Feather Touch keyer

Why keep wrestling with the **mechanics** in your **electronic** keyer?

The **Kantronics Feather Touch keyer** has moved the "state-of-the-art" in electronic keying years ahead! By engineering a **truly electronic**, electronic keyer, **we've eliminated the most cumbersome part of sending Morse code**: the adjusting and readjusting of mechanical connections.

The **Feather Touch** responds to your lightest touch, freeing you from slapping, sloshing or squeezing. Order your **Feather Touch** now, or write for information and a list of authorized dealers.

At Kantronics, we think sending Morse code should be an art, not an effort.

Order now!

KANTRONICS
The Lightweight Champs.

K13

1202 East 23rd St
Lawrence, Kansas 66044

Telephone 913-842-7745

A. A. Wicks W6SWZ
30646 Rigger Road
Agoura CA 91301

De-Zap Strap

—so you can MOS around

Anyone handling and working with uninsulated, gate-protected, metal oxide semiconductor field effect transistor (MOSFET) devices should be aware that static electrical charges accumulated on a person's body are quite sufficient to "zap" these devices into oblivion, as far as operational capabilities are concerned.

It is standard operating practice, now, for the manufacturer to supply these devices with all connection pins shorted together — quite often by foil or a metal clip. It is prudent, and a good technical practice, to maintain one's body at ground potential whenever handling these critical units, right from the time of removing them from their packaging until they are installed in a circuit. (They should *never* be installed or removed from a "live" circuit, whether you are grounded or not!)

A very simple grounding strap may be constructed, which permits you to "ground" your body, thus maintaining it at ground potential at all times when you may be handling a MOSFET.

Materials required for this important tool are:

- 1 Length of metallic flat braid, 7/16-inch (preferred)
- 1 Resistor, 220k Ohms, ¼ Watt or larger
- 1 Alligator clip, 2-inch
- Eyelets and snap fasteners, size no. 15 (3/8-inch)

One source of the latter items is the Scovill Sewing Notions Division of the Scovill Manufacturing Company, Spartanburg, South Carolina. These are available, eight sets to a package, at sewing supply stores or notion counters anywhere. The contents comprise metal rings with protruding points, metal rings with a groove in

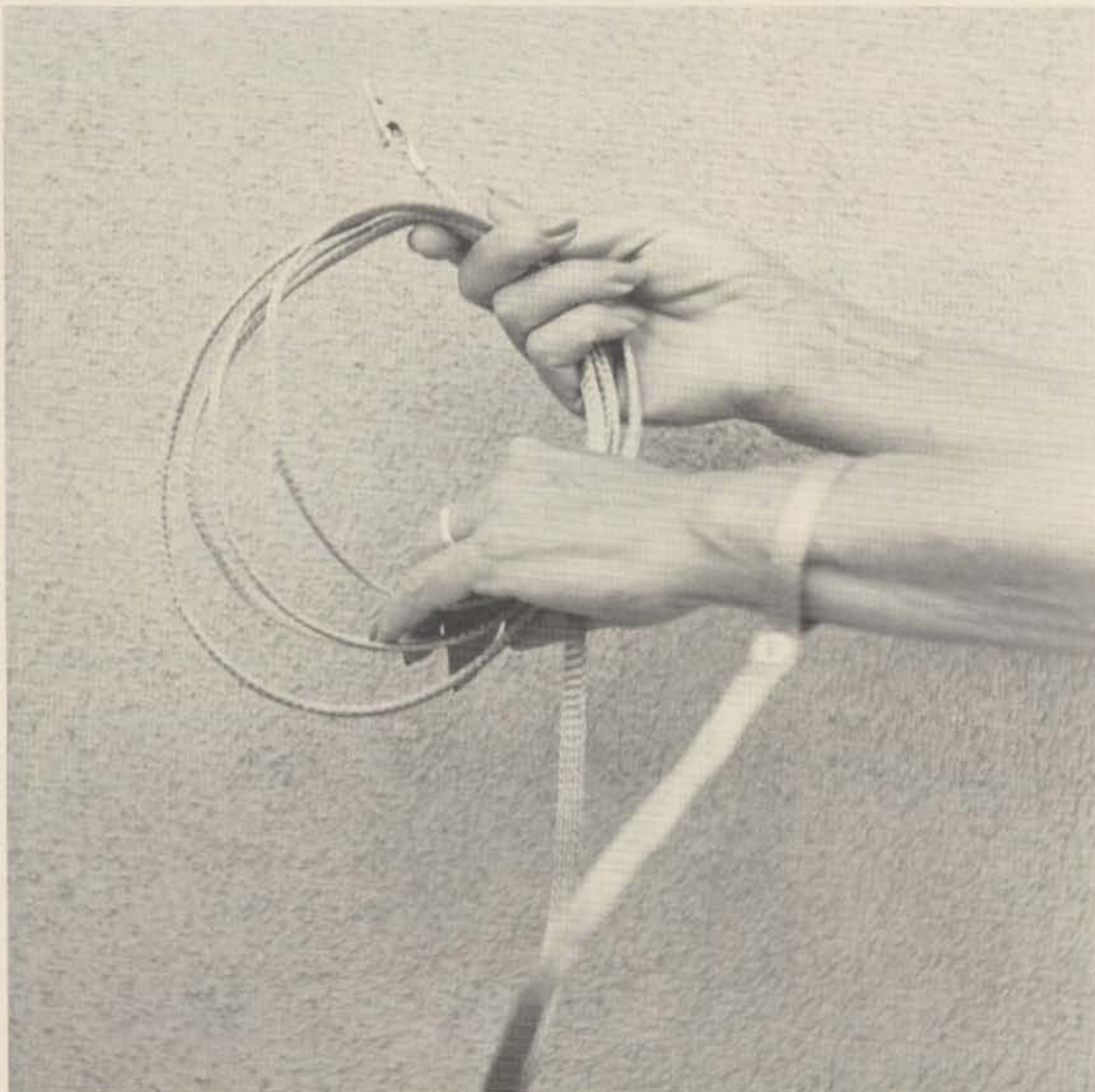

Completed grounding strap attached to user's wrist. Alligator clip is attached to earth ground.

them, and metal rings with one protruding stud.

The following standard tools will be required: hammer, soldering iron (minimum 100 Watts), flat file (smooth cut), hand or electric drill with 3/32-inch drill bit, and metal-trimming shears or side-cutting pliers. Two additional items you'll need are a pencil with an eraser-tipped end and a wooden spool used for sewing thread. (It's a temporary use — so it may be either empty or wound with thread for this application.)

The length of metal braid should be sufficient to go from your wrist, at the place where you will be working with a MOSFET device, to the nearest good earth ground. Rather than make this length excessive (six feet is a recommended maximum), your work should be taken closer to a grounded location.

Procedure

Place the flat braid snugly

around your wrist to determine the position of the snap fastener. Allow sufficient braid for finishing off the end (one or two inches). Mark the position of the fastener — a felt-tip pen will do this nicely.

Place an eyelet ring with points on it on a smooth hard surface, with the points facing upwards. Place the side of the braid that will become the outside surface of the strap on top of the eyelet, using the previously marked position on the braid as a guide. Using the pencil-end eraser, press the braid down on the eyelet so that all of the eyelet points protrude as much as possible through the braid.

The plain rings that come with the eyelet kit will have one side marked with a color spot. Place this marked side down over the protruding points of the eyelet, insuring that all points are guided into the groove in the ring.

Carefully place the end of the wooden spool over the ring, so that the hole in the spool centers over the hole in the ring. Hammer the end of the spool sharply until the ring is secure on the points. (Correctly installed, you should be unable to insert your fingernail between the ring and the braid.) If the center hole of the ring is hammered too severely, it will be damaged, and you must remove both rings and start over.

Repeat the second step above at the point where the snap stud contained in the kit will be installed. Before installing the stud, check its position for snugness on your wrist, so that the stud will be able to enter the ring straight and parallel, without excessive side strain.

Place the stud on the installed ring with the stud projection up. Again using the spool, with the center hole of the spool clearing the stud, hammer the stud onto the

ring projections, as previously described.

Carefully drill the exposed braid material from within the center of the first installed ring.

Apply solder to both sides of the braid, from the end of the braid up to and around the stud. Only sufficient solder need be applied to slightly stiffen the braid, and to hold in place the individual wires comprising the braid.

Trim and file the end of the braid for appearance and to provide a gripping tab about 1/4-inch away from the stud.

Install and solder the 220k resistor and the alligator clip to the other end of the braid. This completes the grounding strap.

In order to use the tool, wrap the braid around your wrist (preferably the wrist of the hand that will be holding the MOSFET), snap the eyelet fastener together, and attach the clip to earth ground. ■

BRITT'S

2-Way Radio Service

2508 North Atlanta Road
Belmont Hills Center
Smyrna,
Georgia 30080

North Georgia's

only Authorized Yaesu Dealer

Yaesu	Vibroplex keys
Mosley Antenna	B & W
Cush-Craft	Swan meters
Rohn-Tower	Hustler
C.D.E. Rotors	Saxton
Shure	ARRL Books
Wilson	Call Books
M F J	Tempo

TPL 2 Meter Amplifiers
Complete service facilities

Phone (404) 432-8006

B29

New!

Better than a pet rock!



K13

only
\$69.95

Kantronics Freedom VFO

With almost 350,000 licensed amateurs on the air, variable frequency operation isn't a luxury, it's a necessity.

If you've tried to operate a rock-bound transmitter on the HF bands today, you know there must be a better way. There is.

The **Kantronics Freedom VFO** will drive the high impedance oscillator tubes of transmitters like the HW-16, DX-60, DX-35 and other "oldie-but-goodies."

The **Freedom VFO** sets you free to roam from 3.650 to 3.750 MHz and 7.000 to 7.200 MHz.

Give your pet rocks to a trusted friend and order a Freedom VFO today. Or write us for information and a list of authorized **Kantronics** dealers.

Order now!

KANTRONICS
The Lightweight Champs.

1202 East 23rd St
Lawrence, Kansas 66044

Telephone 913-842-7745

No, Not Another 22S Mod?

— yes, another Icom 22S mod

The addition of a DIP 8 SPST switch to the Icom 22S will give you the capability of switching in diodes to obtain any frequency you may unexpectedly want. With it you can check the possibility of hitting a repeater before soldering in the diodes. Adding the DIP does

not require programming your board in any special sequence.

Normally, with 22 channels you will have all you need for your location; the idea of the DIP is to give you an extra flexible channel to cover the unexpected.

One DIP, 8 diodes, and very little sweat do the job for about \$2.50.

On channel 23 of the board, solder a diode, banded end down, in each of the holes opposite the diode numbers. No connections are made to the channel 23 horizontal crossbar.

To the other end of each diode, solder a wire. Run all 8 wires between the meter and the rotary switch toward the top cover where the DIP will

be located.

A 9th wire is connected to position 23 on the rotary switch. This is the only contact on the switch with no connection to it and is accessible from the top near the meter.

The DIP is mounted on a piece of perforated board cut to the same width as the DIP, but long enough to allow for mounting a screw with a spacer at each end.

Wires from the diodes are soldered to each of the 8 pins on one side of the DIP. Make sure to get the wires in the right order.

The single wire from the rotary switch is connected to the other 8 pins, tying them all together. Wires should be soldered as close to the board as possible, making the DIP solid in the board.

Mount the DIP on the top cover in line with the center of the meter. The center line of the DIP is 3/4 of an inch back from the edge of the top cover flange. If mounted further back or more to the left, it will not clear other components.

The mounting hole should be the same size and shape as the DIP and cut for a tight fit.

Two screws with spacers hold the assembly to the cover.

If you have wired the switches in the logical manner, SW 1 is D0 through

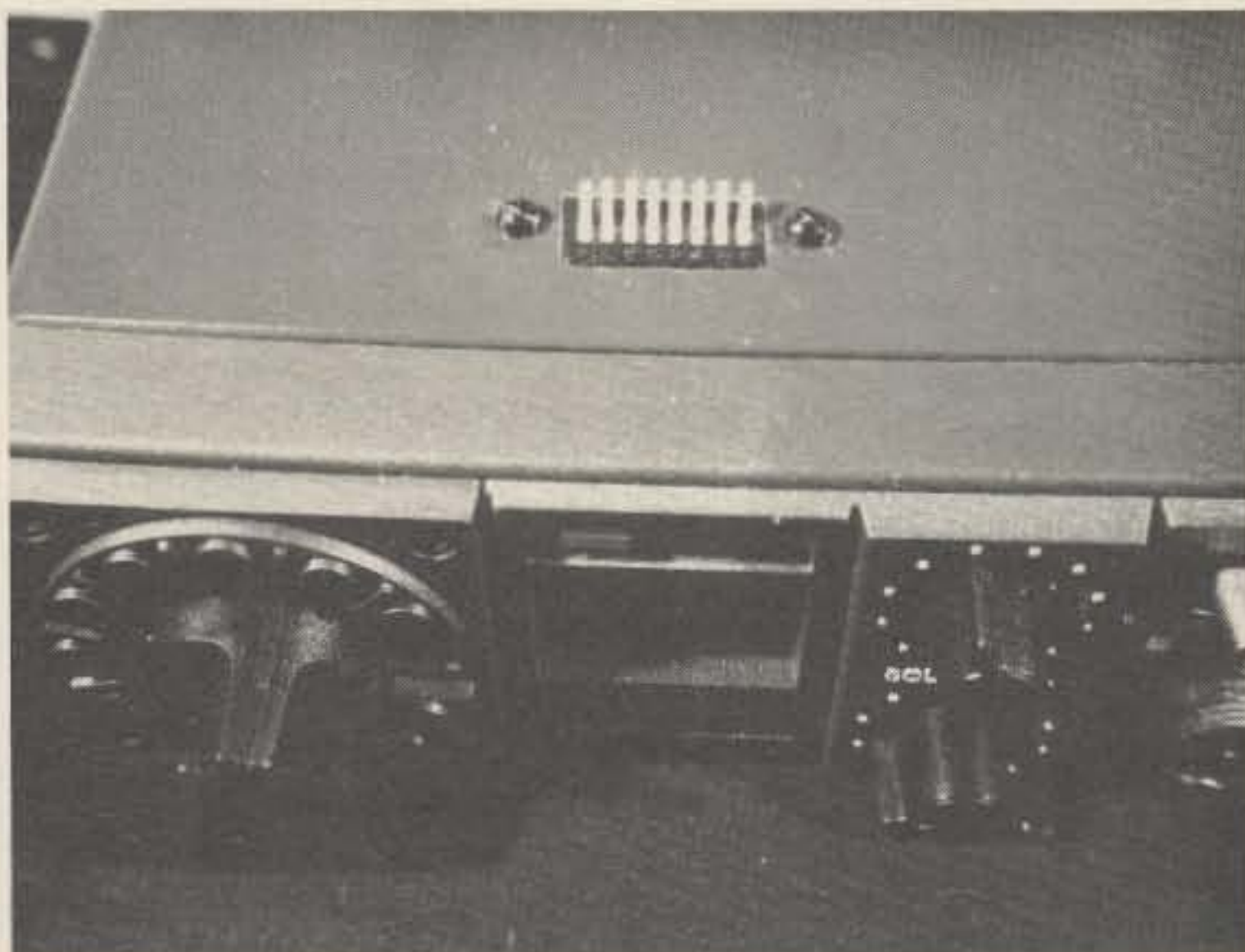

Location of DIP flush with top cover of 22S.

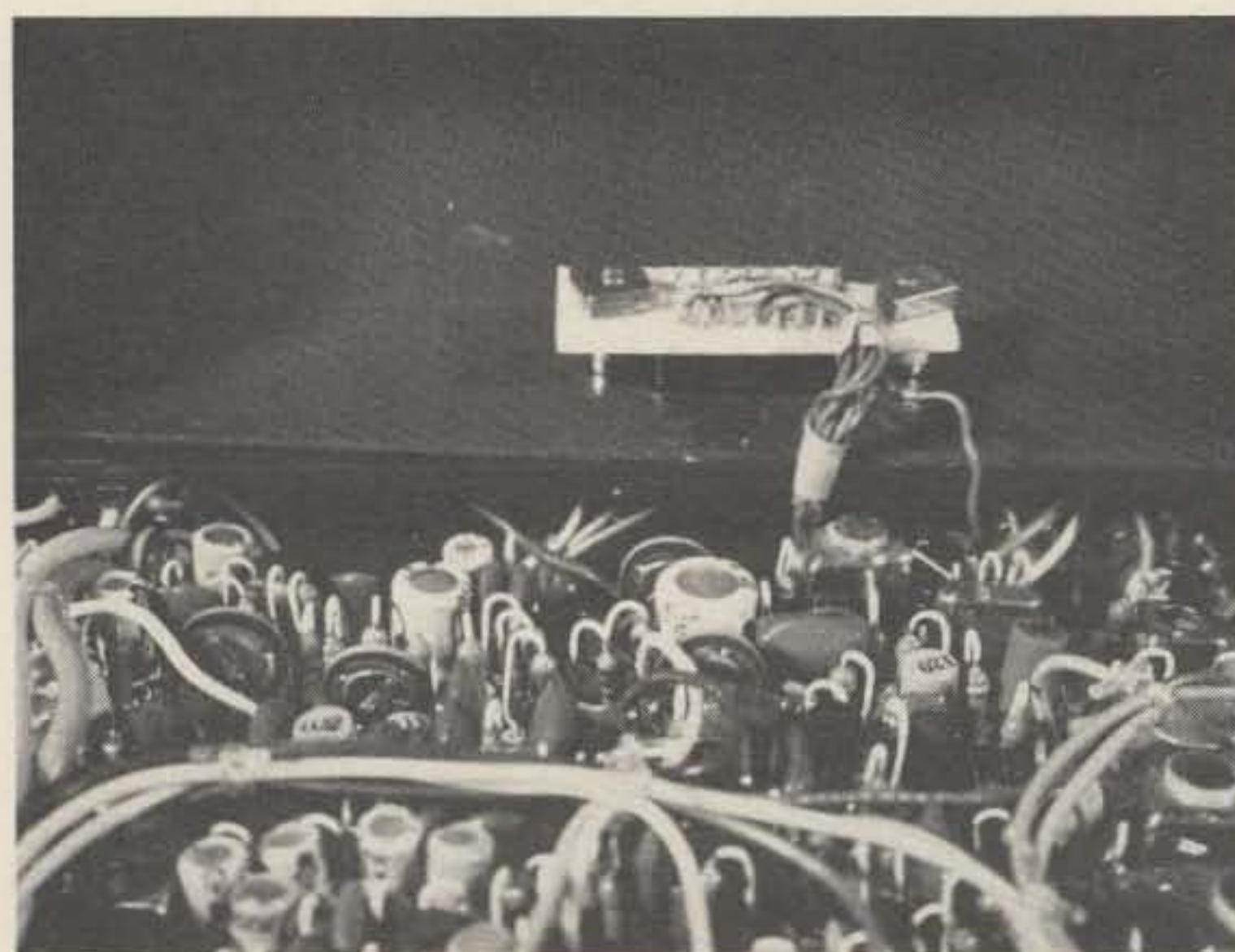

Internal view of DIP mounted on top cover of 22S.

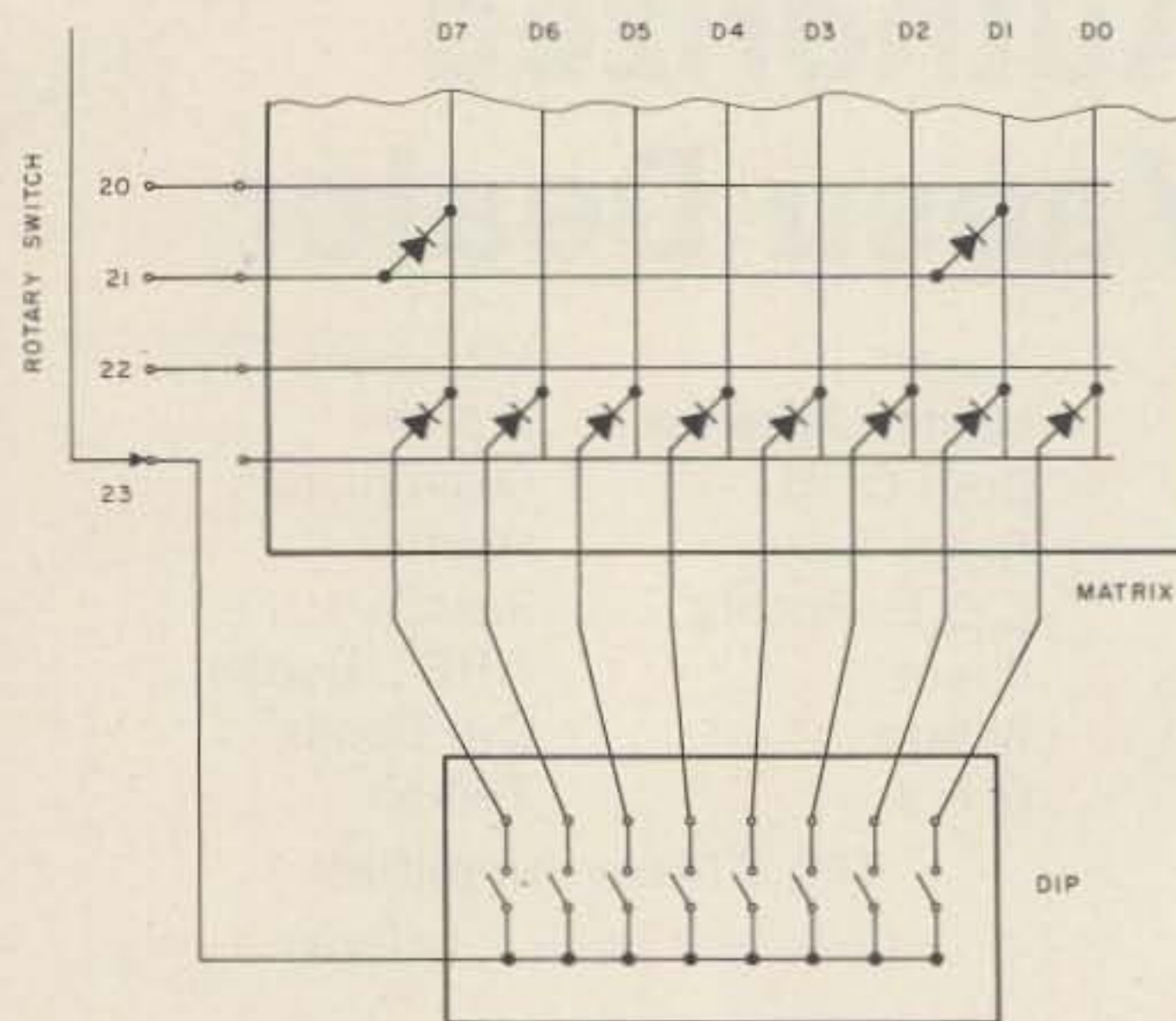

Fig. 1.

DIP (8 STSP) SWITCHES

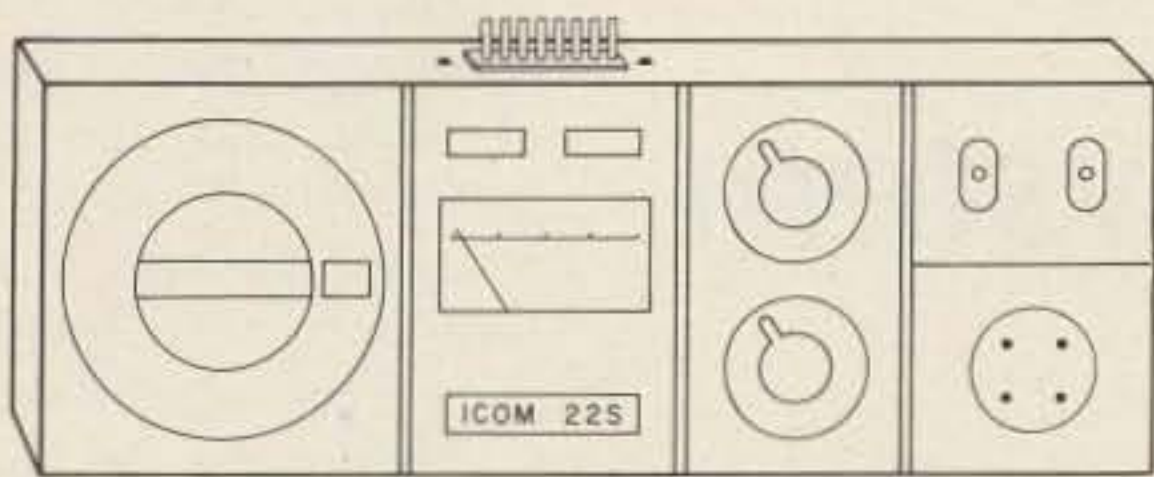
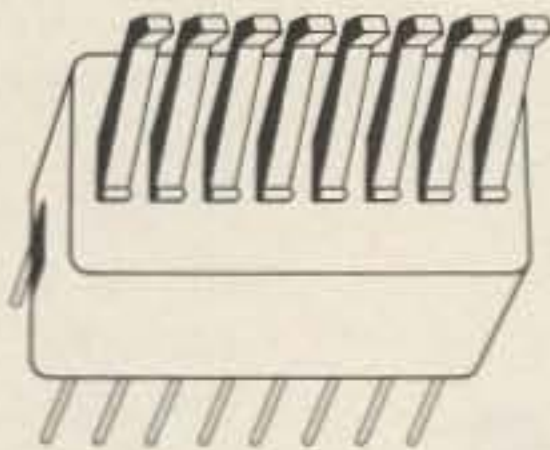
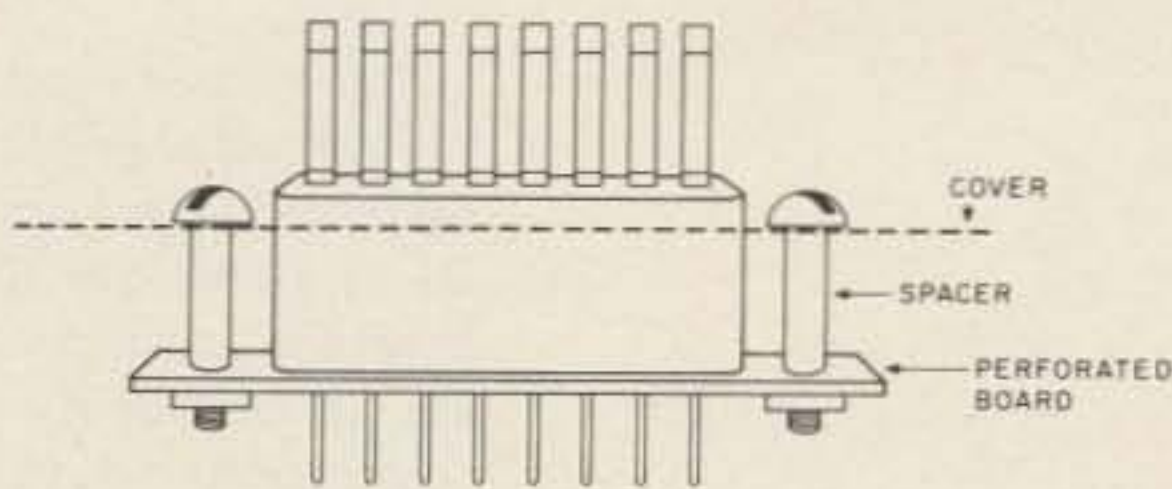
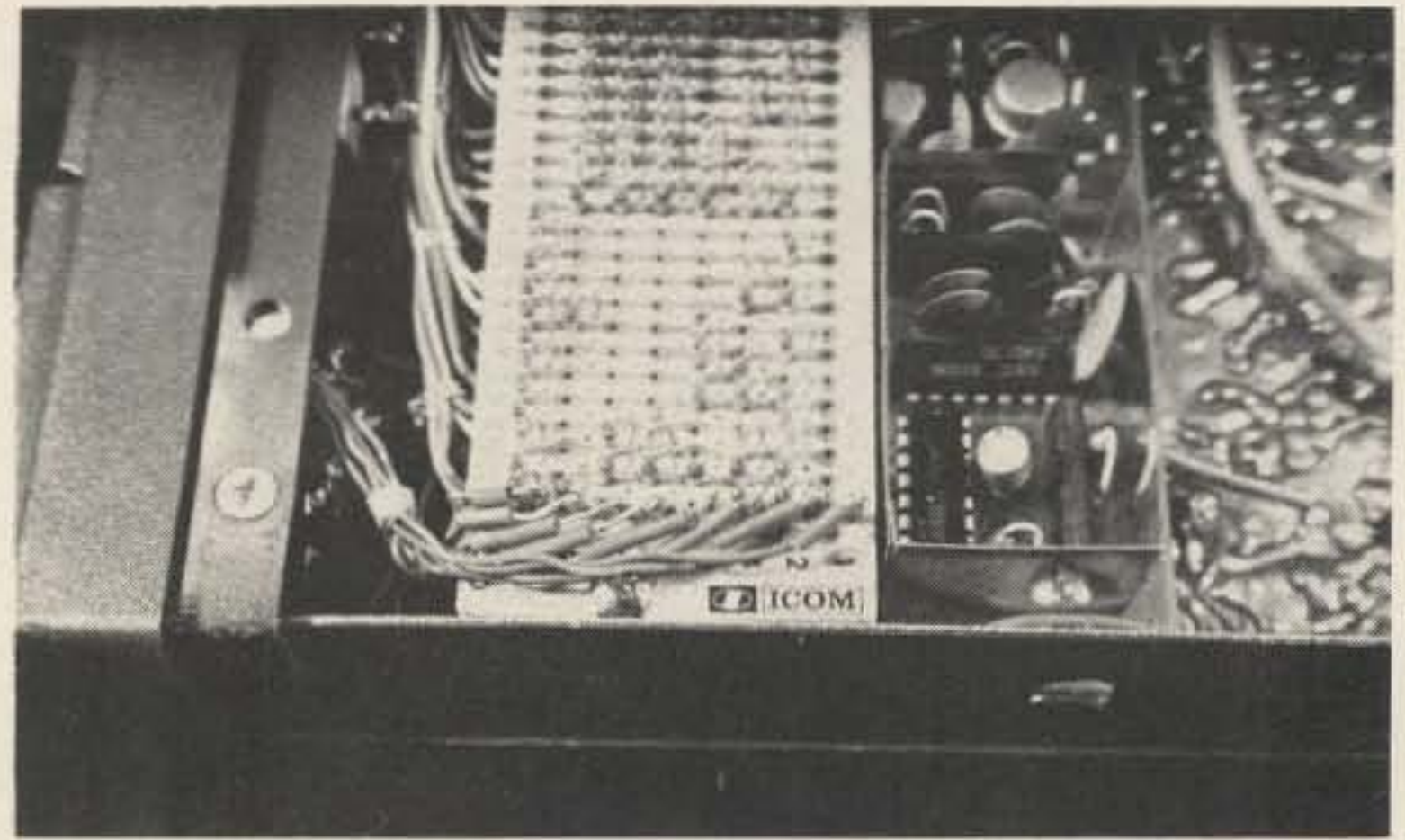

Fig. 2.

SW 8 which is D7, you can use your 22S charts or a formula supplied to program a frequency.



Connections to channel 23 on board of 22S.

However, not using any calculations at all, just a "flick of your DIP" number 8 will put you right on 146.31. Once any frequency is programmed, your switches, 1 to 8, will add or subtract 15, 30, 60, 120, 240, 480, 960, and 1920 kHz to (from) your programmed frequency. With SW 8 on, adding SW 2 gives you 146.34, etc.

A simple method to program a frequency from scratch is to think of your frequency in its form

generally referred to on the air. 146.520 is referred to as simply 52.

Add to this the number 161 and "flick your DIP" to obtain the resultant number. You have programmed the desired frequency (switches represent 1.5, 3, 6, 12, etc.).

Example: 146.550 becomes 55. $55 + 161 = 216$ [SW 8 (192) + SW 5 (24)].

In the 147 MHz range, add 100. 147.270 is not 27, but 127. $127 + 161 = 288$ (switches 8 and 7). ■

STOP



Dentron • Tempo • Wilson • Larsen • Cushcraft • Hy-Gain and many more.

Before you buy your next Ham Radio "STOP" and take time to send or call for our price sheets. You won't be sorry you did. We service what we sell. Charge it! with BANKAMERICARD or MASTERCARD or we will ship C.O.D.

Jim WB2JON

Roy WB2PMM

BANKAMERICARD (716) 235-7540 MASTERCARD

Amateur Radio of Rochester

1185 SCOTTSVILLE RD., ROCHESTER, NEW YORK 14624 A51

NEW!

\$36.50

plus \$1.50 s/h
NY res. add tax



Features: CMOS Electronic Keyer

- State-of-the-art CMOS circuitry
- Self completing dots and dashes
- Dot and dash memory
- Iambic keying with any squeeze paddle
- 5-50 WPM
- Speed, volume, tone controls, side tone and speaker
- Low current drain CMOS-battery operation
- Deluxe quarter-inch jacks for keying and output
- Handsome eggshell white base — woodgrain top
- Compact and portable — 1-7/8 x 4-1/4 x 6-1/4
- Grid block keying
- Wired and tested — fully guaranteed — less battery

Dealer inquiries invited

TRAC

Electronics, Inc.
1106 Rand Bldg.

Buffalo NY 14203 T18

glued the magnet to the edge of the door with rubber cement (RTV). The switch portion is set into the door frame above the magnet in a normal manner.

Outside one of the doors you will need a keyed shunt switch. The purpose of this switch is to short out one door sensor so that you can get in and out of the house without setting off the alarm. I ran these switch wires and all other switch wires all the way back to the control box. That way, even though the switch lock is permanently mounted by the front door, I can select any other door to shunt. For instance, I can connect this switch to shunt the kitchen door. Now if a good lock-picker comes along, he may disarm this switch thinking he has shunted the front door and set it off by entering through that door instead of the kitchen door. This means I have the inconvenience of walking to the front of the

house to arm and disarm the kitchen door, but just think of the surprise an intruder would have when he found out he had not disarmed the proper door for entry.

I placed alarm bells in the attic against the outside vents at each end of the house. Placing the bells inside the attic prevents anyone from tampering with them.

Unless you set off the alarm, and it remains on for an extended period of time without ac power, the battery should last almost to its shelf life. The big secret of this system is to find a sensitive relay (will respond with 3 to 10 mA) with contacts that will handle relatively high currents (2 to 3 Amps).

Operation is as simple as 1, 2, 3. First be sure all switches are off. Then:

1. Turn on the system power switch.
2. Press and release the momentary action switch. If no one is stepping on the carpet (parallel) sensors, and

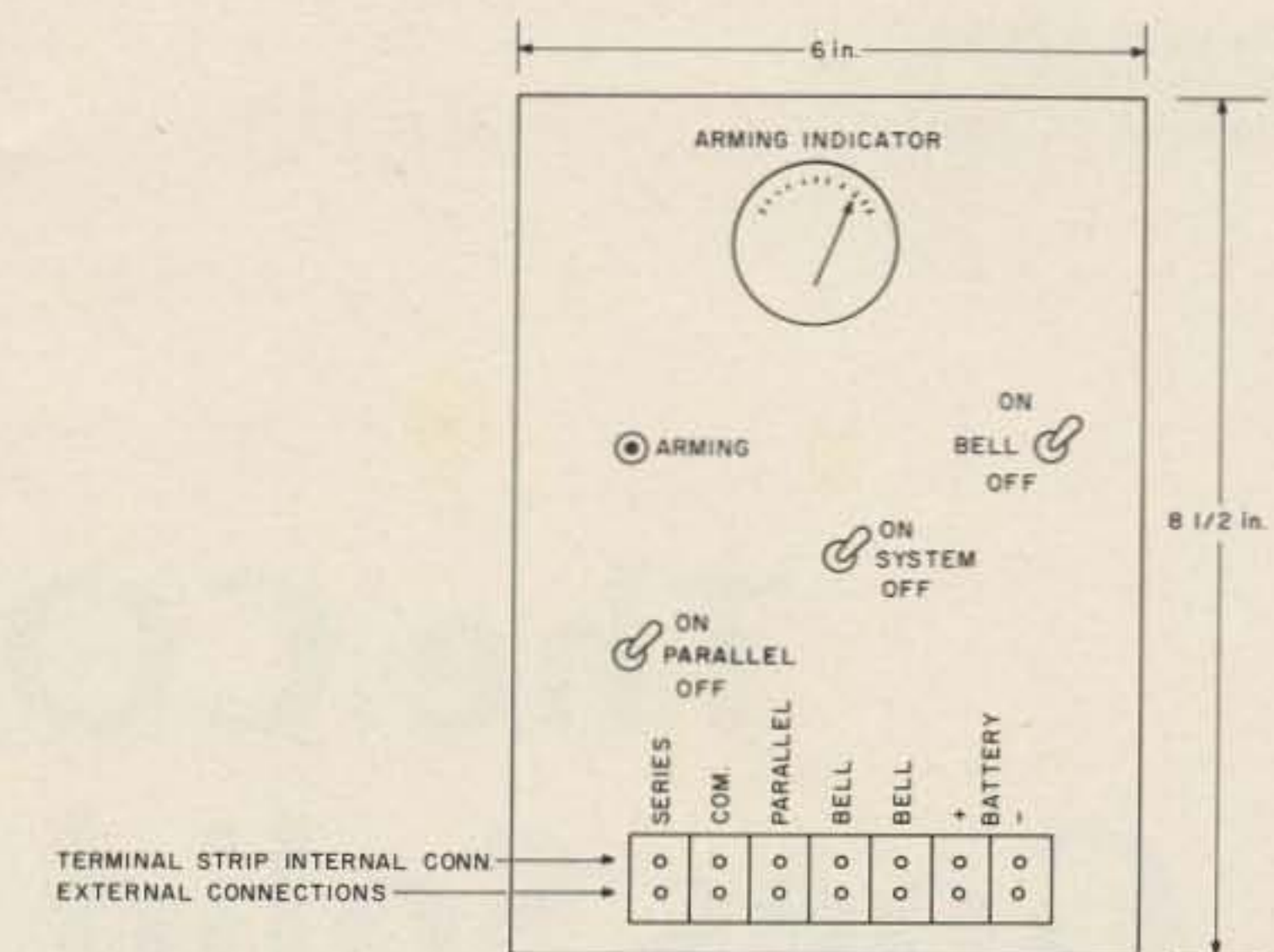

Fig. 2. Alarm front panel. All parts not shown are just hung on or glued to the back of the 1/16" aluminum. Panel width was selected to fit onto wall studs in a hidden place.

all the door and window (series) sensors are closed, there will be a meter indication. This energizes the relay, which then bypasses the momentary action switch.

3. Switch the bell switch to ON.

You are now armed and secured. Walk out the

shunted sensor door, open the keyed shunt switch, and the last door is armed. Momentarily opening any series switch or closing any parallel switch causes a loss of power to the relay. This sets off the alarm. The only way to turn it off is at the control box. ■

SPRING SUPER SPECIAL!

This is the new model that covers all 3 bands in any combination, works AC/DC, has one year warranty.

ALL 10 CRYSTALS INCLUDED FREE (\$50 + VALUE) WITH THE REGENCY ACTR106 AT ...

\$129

AND — WE SHIP PREPAID!

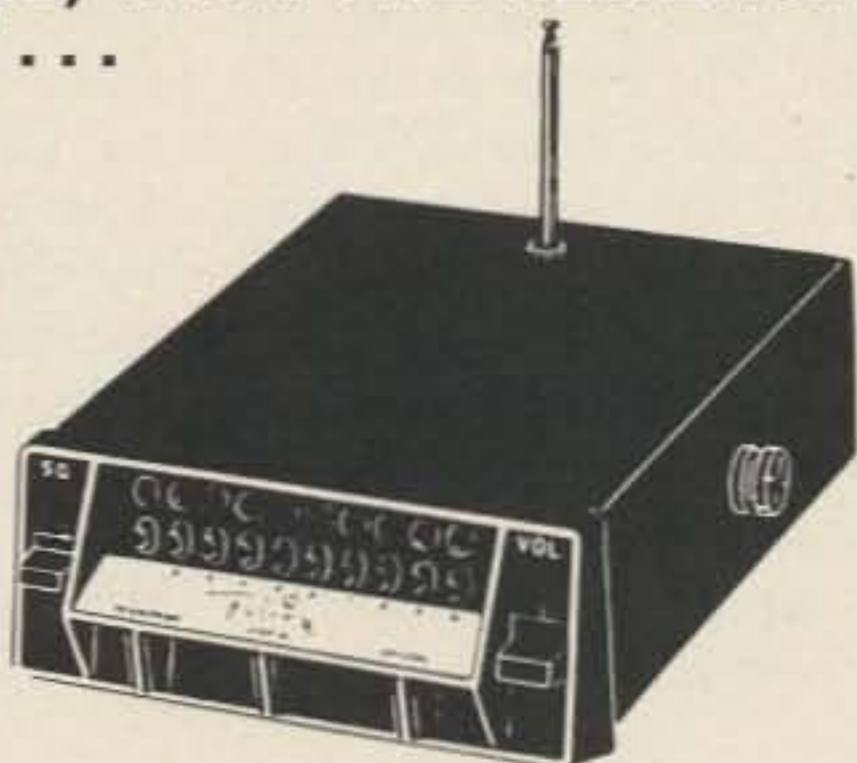

MONEY ORDERS, CASHIER'S CHECKS, BANKAMERICARD AND MASTERCARD SHIPPED WITHIN 24 HOURS. BE SURE TO SPECIFY CLEARLY THE EXACT FREQUENCIES OF THE 10 CRYSTALS YOU WANT.

714-635-1033

COMMUNICATIONS CENTER

915 N. EUCLID, DEPT. 7, ANAHEIM, CA. 92801
CAL. RESIDENTS ADD 6% SALES TAX.

C68

VHF



We have a portable direction finder that REALLY works—on AM, FM, pulsed signals and random noise! Unique left-right DF allows you to take accurate bearings even on short bursts, with no 180° ambiguity. Its 3 dB antenna gain and .06 uV typical DF sensitivity allow this crystal-controlled unit to hear and positively track a weak signal at very long ranges—while built-in RF gain control with 120 dB range permits DF to within a few feet of the transmitter.

The DF is battery-powered, can be used with accessory antennas, and is 12/24V for use in vehicles or aircraft. This is a factory-built, guaranteed unit—not a kit. It has been successful in locating malicious interference, as well as hidden transmitters in "T-hunts," ELTs, and noise sources in RFI situations.

Prices start at under \$175. Write or call for information on our complete line of portable, airborne, vehicle, and fixed DF systems.

L-TRONICS

5546 Cathedral Oaks Rd.,
Amateur Dept.
Santa Barbara, CA 93111

W6GUX

WD6ESW

L10

The COR Goes Solid State

— turning two Midland rigs into a repeater

This article describes a simple carrier-operated switch for the Midland 13-509 220 MHz radio. There are several uses for such a device, ranging from switch-

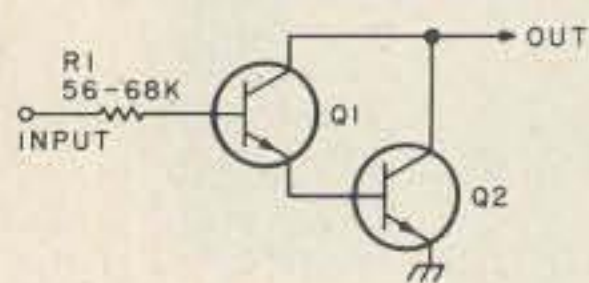

Fig. 1. The basic circuit. Q1 and Q2 are general purpose NPN (see text).

ing the meter light in your mobile to get rid of the night-time under-dash searchlight, to switching off the AM-FM that Detroit installed, to switching the external amplifier-speaker in that noisy truck, or even to keying the transmitter in a repeater.

This unit is almost idiot-proof. In its simplest form, Fig. 1, it requires 1 resistor and 2 transistors.

This circuit was originally developed to key the transmitter in our breadboard re-

peater. That conglomeration grew and grew, and is a much-modified 220 Midland reboxed and bolted into an old Motorola J-series cabinet.

Since then, other uses have appeared. One of them, shown in Fig. 2, is in my mobile. The extra diodes are there to isolate the COS from the PTT line, yet allow either to turn the lamp on. The extra resistor is there to shunt the switch and keep the lamp warm, but not hot. In the computer industry, it is called a "keep-alive" resistor. The idea behind it is that a lamp

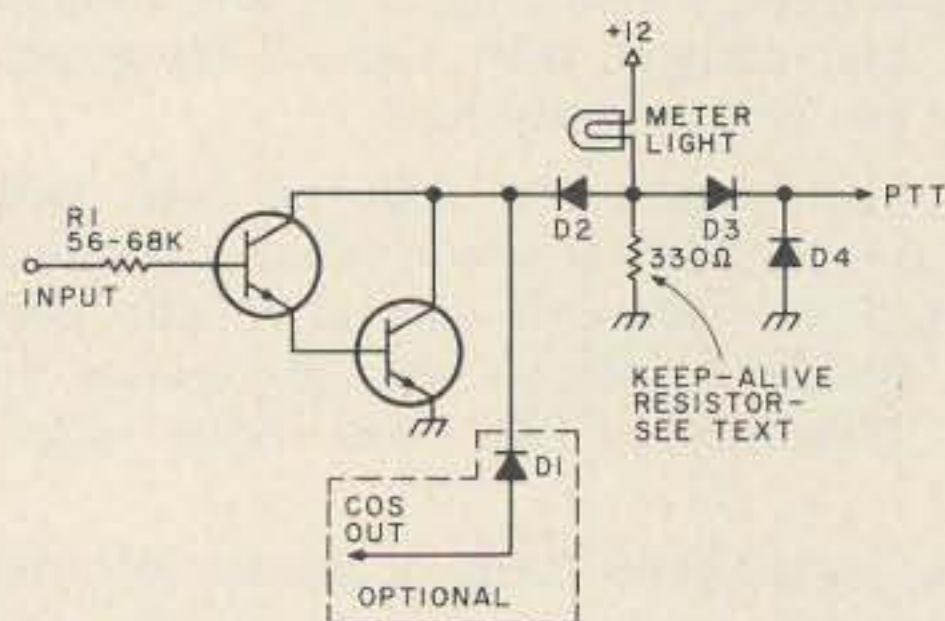

Fig. 2. My mobile. The diodes used were surplus 1N4001s, but any general-purpose silicon should work. D1 is optional; I ran it to pin 4 of the mike socket. D2 and D3 allow either to turn on the meter light. D4 kills the PTT relay transient.

that is switched from dull red to white hot and back will last longer than one that is switched from dead cold to white hot and back. If you have seen pictures of some of the IBM 360 series, some of which have hundreds of lamps, you can appreciate the importance that they hang on lamp life.

Before any extensive work is planned, I suggest that you purchase the service manual (#13-22084) from Midland, P.O. Box 19032, Kansas City MO 64141. It costs \$2.00, is 27 pages long, and what it doesn't cover isn't needed.

The radio has gone through 3 versions, which I have named, for lack of anything better, the blackface (the original), the tanface, and the current version, the brownface (chocolate bar color). The manual covers the blackface, but the only differences in the others are some parts values and the dye in the plastic.

To get back to the COS, the operation is fairly simple, but, for full understanding, some information on how Midland's squelch works should be presented. A partial receiver schematic is shown in Fig. 3.

Normally, in a squelched condition, incoming noise from the discriminator is rectified by D4 and D5, filtered by C89, voltage divided by R54 and R55, filtered again by C91, and fed to TR13, saturating it and effectively grounding its collector. This shorts both the bias and audio to TR14, squelching the receiver.

However, when a signal

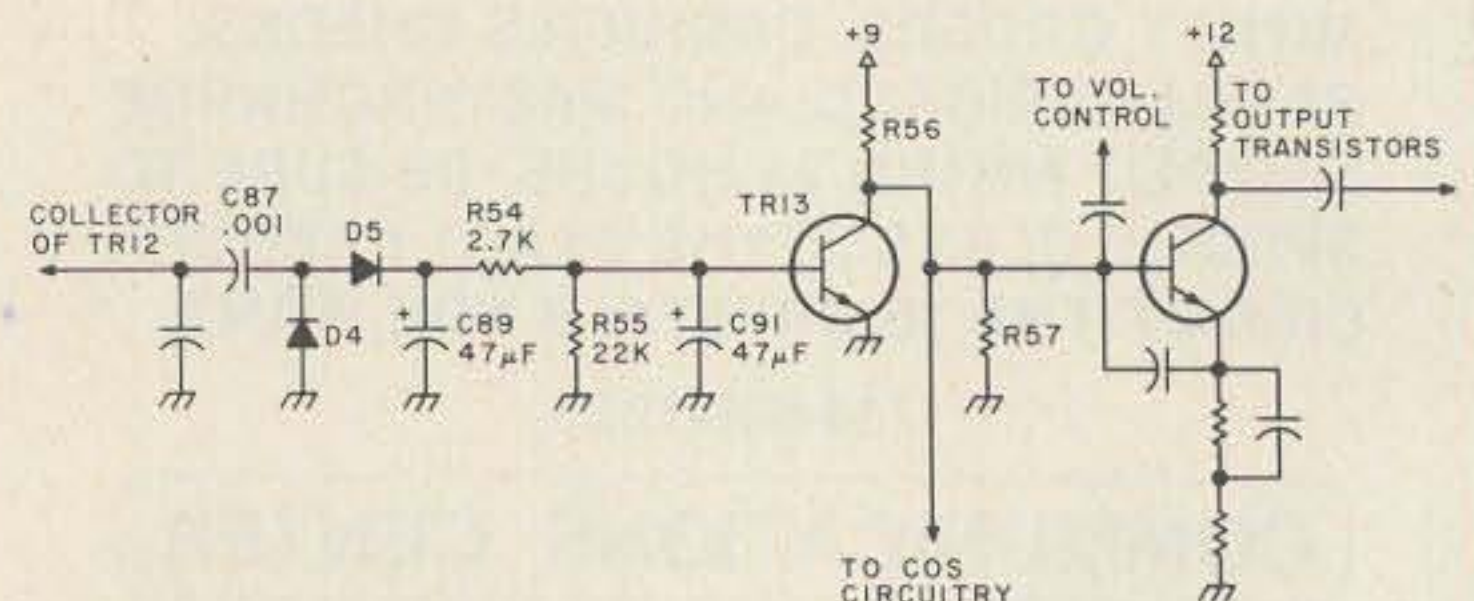

Fig. 3. The Midland 13-509 squelch circuit. The workings are in the text.

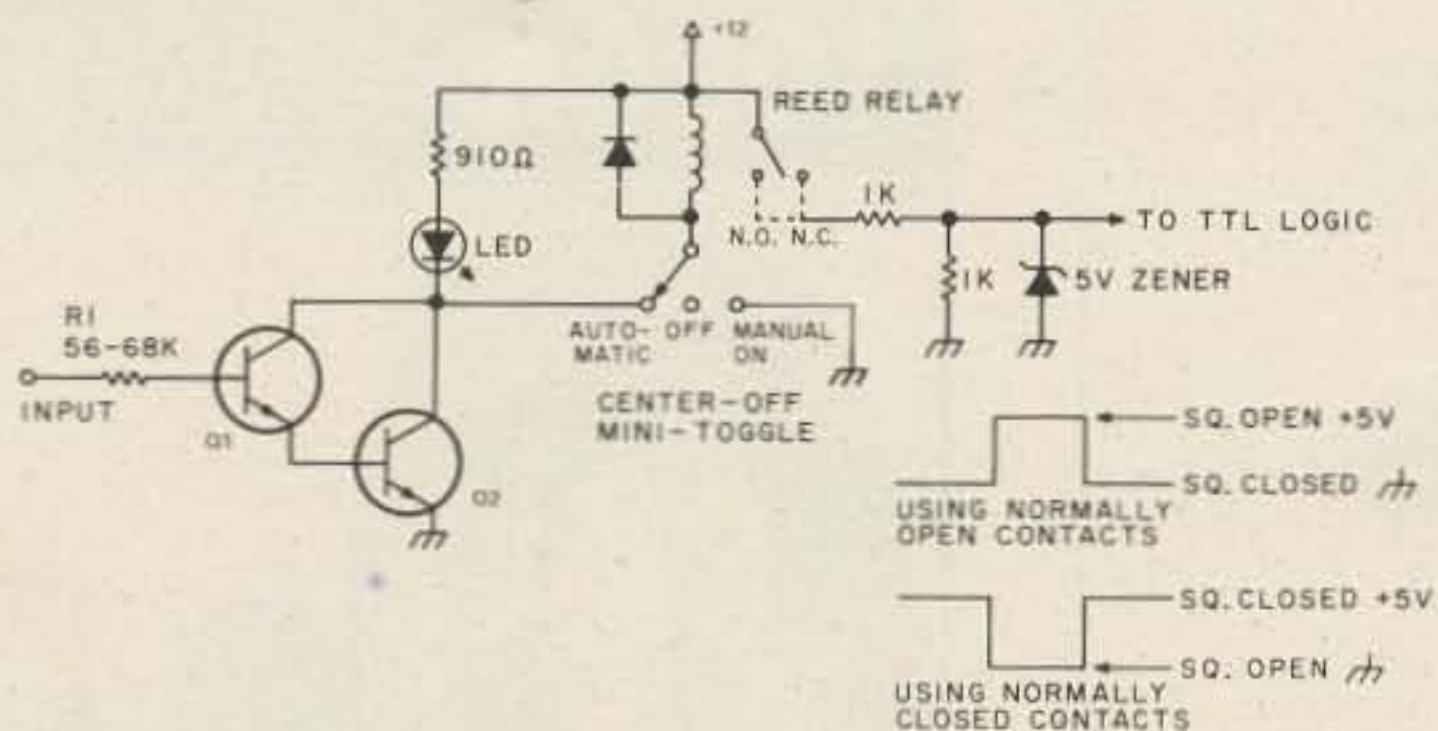

Fig. 4. The first implementation in a repeater. The reed relay was used to get complete isolation from RX to logic. The only limitation on relay size is Q2's max. collector current.

comes in, the noise to D4 and D5 goes away, and the voltage across C89 drops, cutting off TR13 and enabling TR14 to conduct and pass audio.

I can find no useful purpose in C91, except to lengthen the squelch tail. I pulled it out of my mobile and was very pleased with the results. In fact, our repeater no longer has C91 in its receiver. Try it; you can always put it back if you don't like it.

We now see that Midland already has TR13 functioning

as a switch, with its collector grounded when squelched and at about 2 volts when unsquelched. We can simply pick off the collector voltage with a high impedance amplifier and switch a light bulb, fire a cannon, close a reed relay, key a transmitter, or whatever our hearts desire.

All of the circuits shown in the figures are the same, except for external differences. The basic circuit is a Darlington pair, a characteristic of which is that the circuit's total gain is the product

of the individual transistors. As an example, the circuit in my mobile uses 2N2222s which are rated at 50, which puts the total gain at a theoretical 2500. Almost anything will work, as long as the leakage current is fairly low. I wouldn't mix silicon and germanium, however. 2N708s, 2N3866s, 2N3638s, 2N2219s, 2N2102s, and 2N1711s have all been tried, plus some 2-for-a-nickel TO-5s at the local surplus store. There is no restriction that the two transistors have to be identical, either. The only adjustment that might be required is to vary the value of the series base resistor. For extra current han-

dling capability, the output transistor could be a power unit like a 2N3055 or something similar.

Installation is not critical, as there are no rf or critical capacitances floating around. Just make sure that you don't defeat the hinge action of the circuit board.

Well, there you have it — a simple, cheap, and quick project which even my father WB6SOX can understand — and he claims to have gotten lost when they put the fourth element in the vacuum tube!

If, after all this, anyone has questions, I will be happy to answer them, but be warned — no SASE = no answer. ■

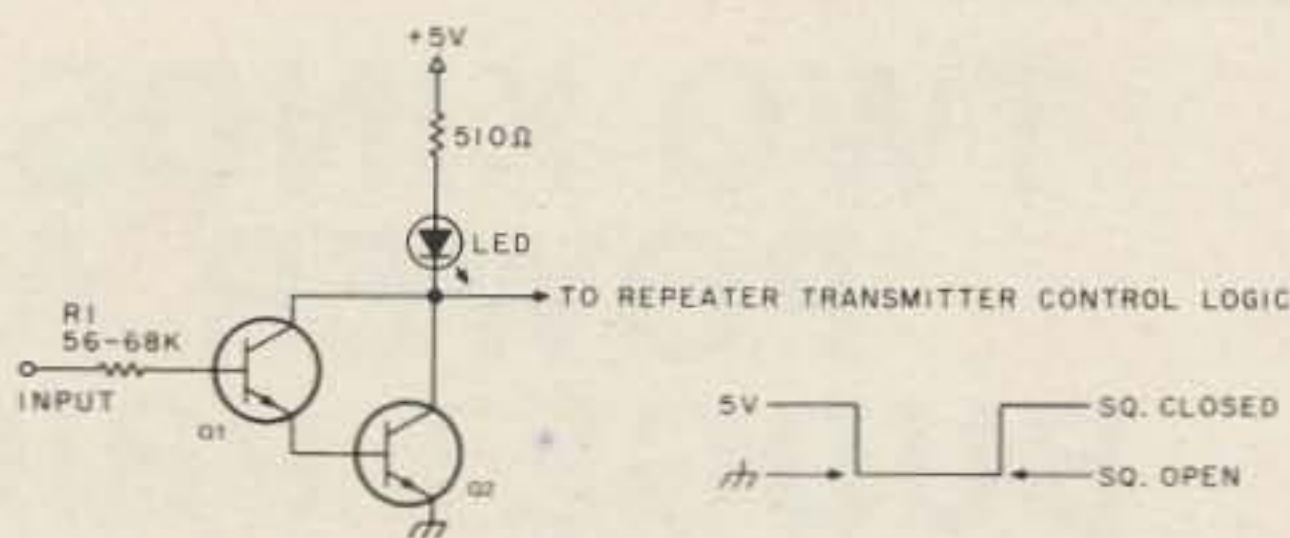

Fig. 5. The current repeater configuration.

ZZZ Electronics Z1

422 Armour Circle N.E.
ATLANTA, GEORGIA
30324

OWNER • JOHN FEARON
W4WKP

SWAN
TEN-TEC
STONER PRO 80-10
LARSEN
ALUMA TOWERS
MARDEN
2 MTR XTALS
Lifetime Guar. '75-92 est.

GOLD LINE
SHURE MICS
SAXTON WIRE
PRODUCTS

TAB BOOKS
COLUMBIA WIRE
DENTRON
ICOM

NEW IN ATLANTA!
COME BY OR CALL.....
WM-WA4SVY
ChasLis - WB4GJU

PHONE 404-8760631

RG-8X
Mini RG-8
12¢ per ft

MASTER CHARGE
AND
VISA ACCEPTED

WILSON
KLM
CUSH CRAFT
KDK FM 2015R
TURNER MICS
MOSLEY
CDE ROTORS
TELEX HEADSETS
WAHL ISOTIP
ARRL BOOKS
PRIMO MICS
UNGAR
NEWTRONICS
HUSTLER

CALLBOOK MAG.

MLA-2500 \$799.50

IC22S OWNERS SCANNER KIT

COMPLETE KIT \$29.95
PREASSEMBLED AND TESTED BOARD \$39.95

- Your scanner shouldn't cost almost as much as your rig.
- Continuously scans 2m band from 145.35-147.975 in 1.5 kHz steps.
- LED indicator tells when rig is scanning.
- Switch modification on mike allows you to scan past or lock on to any occupied frequency.
- Memory circuit allows scanner to hold last frequency locked in for at least 2 hours after power is turned off.
- Uses one matrix position leaving the other 21 usable for manual programming.
- Complete kit with detailed instructions, install inside rig, no obtrusive external connections, no drilling, rig could be returned to original condition if desired.

IC22S FREQUENCY DISPLAY KIT

Why squint at your channel selector or check charts to know where you are on the band?

- Shows the programmed frequency, tracks the simplex-duplex function.
- Works with ANY external programming system, as well as the internal channel-selector.
- Full six digit display, not 3 1/2 like the others.
- No-hole mount — Small size (5.5wx1.2Hx2D) box mounts inconspicuously in the mobile, or under the radio as a stand.
- Plugs into the 9 pin accessory socket, can be removed at any time.
- Easy one night construction and installation, sockets provided for all ICs, very comprehensive instruction manual.
- A perfect match for our scanner kit.

COMPLETE KIT \$59.95
CABINET EXTRA \$8.00
PREASSEMBLED AND TESTED UNIT (CABINET INCLUDED) \$67.95

ADD 5% FOR POSTAGE AND HANDLING

DEALER INQUIRIES INVITED

V16
750 LUCERNE RD
SUITE 120
MONTREAL, QUEBEC
CANADA H3R 2H6

TWO KINDS OF POWER AT BUDGET PRICES

An add-on unit, no internal connections or adjustments required to associated equipment. Standard Amplifier Models operate FM, Linear Models operate all modes: SSB, FM, AM, RTTY, CW, etc. "Microstrip" design provides high stability and optimum performance over wide bandwidth. Factory adjusted, no tuning required. Mobile mounting bracket included. RF sensing T/R switching, adjustable dropout delay. Remote keying capability. Thermally coupled biasing. Reverse Voltage protected and fused. Conservatively rated with oversized heat sink. Red LED indicators for monitoring DC and RF. VSWR protected — Ninety day material and workmanship warranty.



1. Tough, low-priced 2 meter VHF amplifiers

MODEL NO.	INPUT POWER (watts)	MIN OUTPUT (at max input)	NOM CURRENT 13.8 VDC	PRICE
2M 10X40	4-10	40	5	\$ 77.95
2M 15X50	5-15	50	6	\$ 89.95
2M 15X50L*	2-15	50	6	\$ 99.95
2M 15X80	5-15	80	11	\$129.95
2M 15X80L*	2-15	80	11	\$139.95

*Linear; AM, CW, FM, SSB, RTTY. Linear models work well with low power transmitters of 2-3 watts to yield 20-30 w output. size: 4 1/8 x 5 1/2 x 2 5/8
 technical specifications and data subject to change without notice

2. Rugged, low-priced DC power supplies

- Ideal for VHF amplifiers
- 105-125 VAC, 50/60 Hz
- Fold back current limiting
- 13.8 VDC \pm .05V
- UL listed & computer grade components
- One year warranty
- 5 mV peak-peak max ripple
- Crowbar over voltage protection



RS-50A 50 amp. available soon	RS-12A \$69.95 9 ADC Continuous 12 ADC Intermittant Recommended for up to 80 W amp's.	RS-7A \$49.95 5 ADC Continuous 7 ADC Intermittant Recommended for up to 50 W amp's or 30 watt transmitters.
Factory warranty on all items 10 day money back guarantee	RS-20A \$89.95 16 ADC Continuous 20 ADC Intermittant Recommended for up to 120 W amp's.	RS-35A \$129.95 25A Continuous 35A Intermittant Recommended for up to 250 Watt Amp's

Order thru your dealer or write direct

TOROID CORES

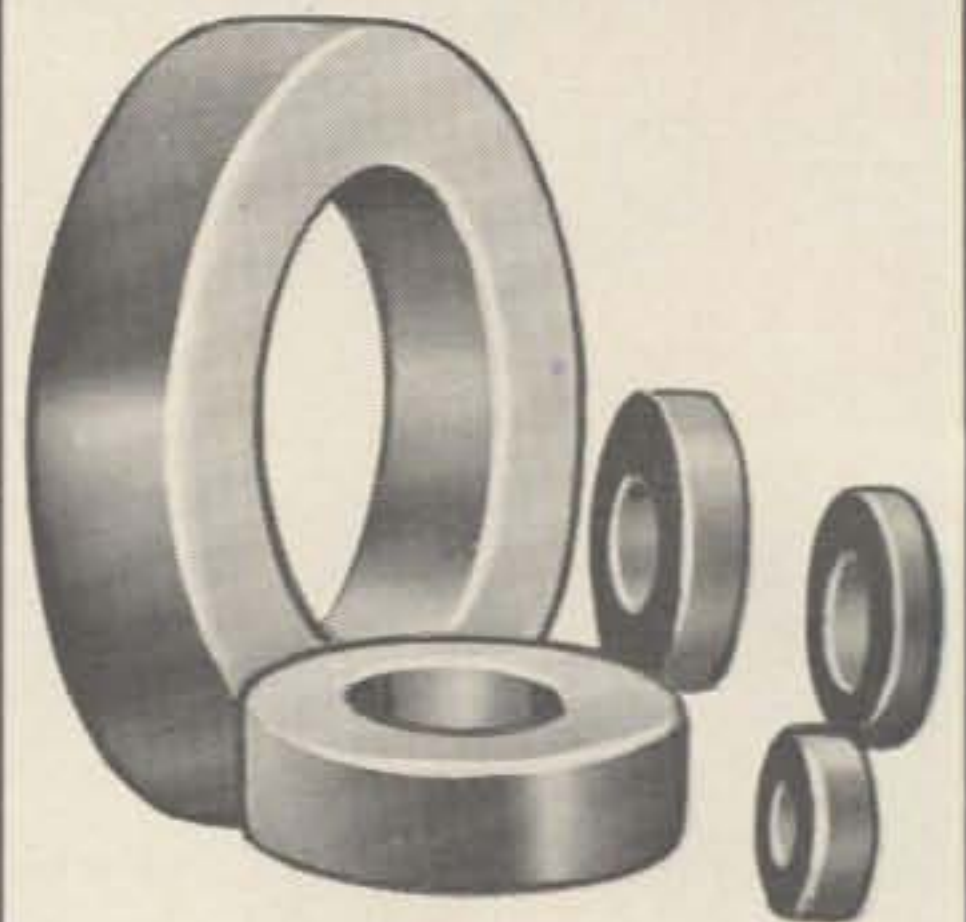

- ✓ All the popular sizes and mixes.
- ✓ Fast Service. Same day shipment via first class mail or air.
- ✓ No minimum order.

IRON POWDER TOROIDS:

CORE SIZE	MIX 2 5-30 MHz u = 10	MIX 6 10-90 MHz u = 8.5	MIX 12 60-200 MHz u = 4	SIZE OD (in.)	PRICE USA \$
T-200	120			2.00	3.25
T-106	135			1.06	1.50
T-80	55	45		.80	.80
T-68	57	47	21	.68	.65
T-50	51	40	18	.50	.55
T-25	34	27	12	.25	.40

RF FERRITE TOROIDS:

CORE SIZE	MIX Q1 u=125 .1-70 MHz	MIX Q2 u = 40 10-150 MHz	SIZE OD (in.)	PRICE USA \$
F-240	1300	400	2.40	6.00
F-125	900	300	1.25	3.00
F-87	600	190	.87	2.05
F-50	500	190	.50	1.25
F-37	400	140	.37	1.25
F-23	190	60	.23	1.10

Chart shows uH per 100 turns.

FERRITE BEADS:



\$2.00 DOZEN

WIDE BAND CHOKES



95¢ EACH

TO ORDER: Specify both core size and mix for toroids. Packing and shipping 50 cents per order USA and Canada. Californians add 6% sales tax.

Fast service. Free brochure and winding chart on request.

P1

PALOMAR ENGINEERS
 BOX 455, ESCONDIDO, CA 92025
 Phone: (714) 747-3343

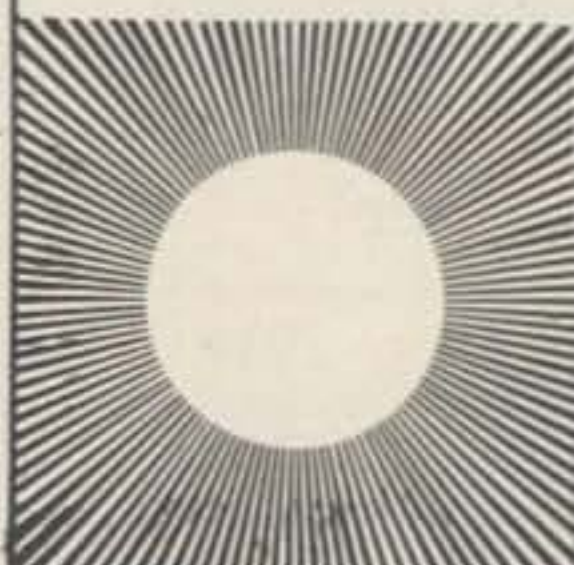

WESTCOM
 ENGINEERING

1320 Grand Avenue San Marcos
 California 92069 (714) 744-0728

slinky

Slinky! \$43.95 Kit A LOT of antenna in a LITTLE space New Slinky® dipole* with helical loading radiates a good signal at 1/10 wavelength long!

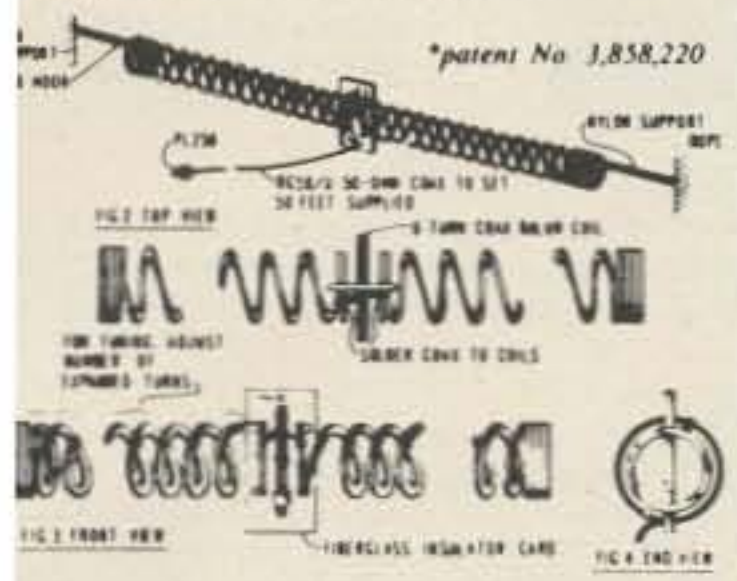

This electrically small 80/75, 40 & 20 meter antenna operates at any length from 24 to 70 ft. • no extra balun or transmatch needed • portable — erects & stores in minutes • small enough to fit in attic or apt. • full legal power • low SWR over complete 80/75, 40 & 20 meter bands • much lower atmospheric noise pick-up than a vertical & needs no radials • kit incl. a pr. of specially-made 1/2" dia. by 4" long coils, containing 335 ft. of radiating conductor, balun, 50 ft. RG58/U coax, PL259 connector, nylon rope & manual.

ASTATIC MICROPHONES

UPS-D104 transistorized w/push bar base \$64.
 UDS-D104 transistorized \$52.
 UGS-D104 "Silver Eagle" transistorized \$71.
 HG-D104 ceramic or crystal \$48.

HY-GAIN'S MODEL 269

Continuously loaded VHF antenna designed for portable and walkie-talkie applications. Constructed to withstand rough handling, completely insulated with special vinyl coating, it can be bent at all angles without destroying or cracking protective finish. Cannot be accidentally shorted out.

RUBBER DUCKIES

No. 269 — Fits Standard, Motorola, Hy Gain \$8.00
 No. 274 — BNE Base \$9.00
 No. 226 — TNC Base Wilson 5 Watts \$10.00
 No. 228 — "F" Base & Wilson 2 Watt & Tempo \$10.00
 No. 273 — SO 239 Base, Kenwood, Drake \$9.00

YAESU



FT-301 or FT-301D	
FT101E	160-10M XCVR \$799
FT101EE	160-10M XCVR 759
FT101EX	160-10M XCVR 699
FL2100B	Linear Amplifier 479
FTV650B	6M Transverter 239
FTV250	2M Transverter 275
FV101B	External VFO 125
SP101B	Speaker 25
SP101PB	Speaker/Patch 64
FA-9	Cooling Fan 18
RFP102	RF Proc. Early 101EE 79
XF30C	CW Filter 40
XF30B	AM Filter 40
DC-1	DC-DC Converter (EX) 50
RFP104	RF Proc. Late 101EE 79
FT7	FT101 Service Manual 25
FT7	80-10 M XCVR 40W PEP 499
ALL SOLID STATE TRANSCEIVERS	
FT301S	160-10M 40W PEP 559
FT301SDig	160-10M 40W PEP 750
FT301	160-10M 240W PEP 769
FT301Dig	160-10M 240W PEP 935
ACCESSORIES	
FFDX50	52 Low Pass Filter 34
FC301	Ant. Tuner 159
ERB	Ext. Relay Box 17
LL301	Phone Patch 49
FL110	Wide Band SSB/CW Amp. 165
FV301	VFO 125
FP301	AC P/S FT301/301S 157
FP301D	AC P/S w/clock and CW Identifier 239
YO301	Monitor Scope 263
SP120	Speaker FT301/221R 25
XF90B	AM Filter 40
XF90C	FM Filter 40
XF92A	SSB & Proc. Filter 45

FR101S	160-2M/SW RCVR	599
FR101SDig	160-10M/SW RCVR	749
FC-6	6M Converter	24
FC-2	2M Converter	25
FM-1	FM Detector	20
XF30D	FM Filter	40
	AUX/SW Crystals	5
RFP101	RF Proc. (FL101)	79
FL101	S/S 160-10M XMTTR	649
VHF FM & SSB XCVR		
FT227B	2M FM Mobile XCVR	\$319
FT221R	2M AM/FM/CW/SSB XCVR	688
FT620B	6M AM/CW/SSB	365
PB1424	Marker Unit 620B	25
	FT221 Service Manual	15
MOBILE MOUNT BRACKETS		
MMB-1	FT101	23
MMB-2	FT2A	23
MMB-4	620B, 221, 301	23
MONITOR TEST EQUIPMENT		
YO100	Monitor Scope	\$246
YP150	Dummyload Watt Meter	78
YC601	Dig. Readout 101/401	199
YC221	Dig. Readout 221/221R	119
FREQUENCY COUNTERS		
YC500J	500 MHz 10 PPM	239
YC500S	500 MHz 1 PPM	399
YC500E	500 MHz 0.02 PPM	537
MICROPHONES — MISCELLANEOUS		
YH55	Lo-Z Headphone	15
YD844	Hi-Z Base Mike	29
YD844L	Lo-Z Base Mike	29
YD846	Hi-Z Mike 101EX/401B	16
YM86	Lo-Z Hand Mike	16
SP401PB	Speaker/Patch (401)	59
XF31C	600 Hz CW Filter 401	40
FRG-7 Receiver		
	1 to 9	\$315
	10 to 25	315
	26 to 49	315
	50 and up	315
QTR-24 World Clock		
	1 to 9	30
	10 to 25	30
	26 to 49	30
	50 and up	30
	FT-901DM	\$1299
	FT-901D	1149
	FT-901DE	1149
	FT-901SD	1115
	FM Unit	40
	AM or CW Filter	40
	Keyer Unit	40
	Memory Unit	125
	DC-DC	50

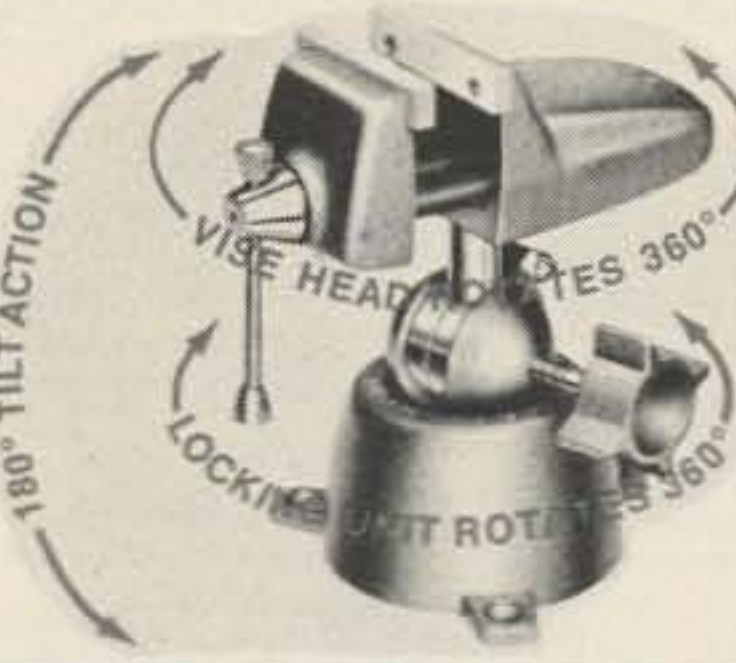

PANAVISE offers a variety of interchangeable work holding heads, bases and accessories for every imaginable function. But, just because it's small, doesn't mean you can't use PANAVISE for some pretty rugged work. It's a vise every craftsman deserves.

MODEL 300 Original Base
 Designed for all normal permanent installations. Three lugs spaced 120 degrees apart provide maximum mounting stability. Overall height: 3-13/16" (97 mm). Base diameter: 5" (127 mm).

MODEL 303 Original Vise Head
 Wide 2 1/2" (63 mm) jaws open to 2 1/4" (57 mm). Head is pressure diecast aluminum alloy, with steel and brass inserts. Hammertone gray/green finish. Replaceable nylon jaws. Price: \$21.95

TUFTS SELECTED TITLES OF SAMS PUBLICATIONS



IC OP-AMP COOKBOOK by Walter D. Jung. The first book of its kind to be published. Covers not only the basic theory of the IC op amp in great detail, but also includes over 250 practical circuit applications, liberally illustrated. Organized into three basic parts: introduction to the IC op amp and general considerations, practical circuit applications, and appendices of manufacturers' reference material. 392 pages, 6 1/2 x 9 1/2, softbound. No. 20985 \$12.95
IC TIMER COOKBOOK by Walter Jung. Provides an excellent introduction to the field of IC timers by presenting a collection of various circuit "recipes" useful in applying the devices. Arranged in three parts, the first part gives basic and generalized information. Part II, the applications section, is the "meat" of the book and includes over 100 different circuits for a wide range of uses. Part III contains reproductions of manufacturers' data sheets, second-source manufacturers, and more. This book is a valuable reference for the hobbyist, the technical or engineering student, or professional. 288 pages, 6 1/2 x 9 1/2, softbound. No. 21416 \$9.95

RADIO HANDBOOK (20th Edition) by William F. Orr, W6SAI. A completely updated 20th edition of the famous communications handbook that is the electronics industry standard for engineers, technicians, and advanced amateurs. Explains in authoritative detail how to design and build all types of radio communications equipment. Contains greatly enlarged sections on semiconductor and IC circuit design, includes solid-state design and equipment, city circuits, linear amplifiers, both solid-state and tube types, vhf and uhf transmitters and converters, as well as special-purpose and logic circuitry, plus completely revised chapters on electronics mathematics. 1082 pages, 6 1/2 x 9 1/2, hardbound. No. 24032 \$19.95
CMOS COOKBOOK by Don Lancaster. Tells all you need to know to understand and profitably use this inexpensive and genuinely fun to work with digital logic family. First an explanation of what CMOS is, how it works, and how to power it, plus usage rules, static testing, troubleshooting, interfaces, and other basics is given. Then a miscellany of over 100 devices, including circuits and use descriptions is given. Subjects covered include gate fundamentals, tri-state logic, redundant logic design techniques, multivibrators, non-volatile memory techniques, clocked JK and D flip-flops, counter and register techniques, op amps, analog switches, phase-locked loops and much more. A must for the student, hobbyist, teacher, technician, or engineer who wants to learn about CMOS. Filled with practical applications. 418 pages, 6 1/2 x 9 1/2, softbound. No. 21256 \$9.95

Master Charge
 American Express
 VISA Visa

Name _____ Call _____
 Address _____
 City _____ State _____ Zip _____
 Order: _____
 Check enclosed Visa Master Charge American Express
 Credit card # _____
 Signature _____ Card expiration date _____

TUFTS

Radio Electronics
 209 Mystic Avenue
 Medford MA 02155
 (617) 395-8280
FREE Gift With Every Order!

TUFTS RADIO CATALOG



MODEL	NET PRICE	103R	\$39.95
12V4	\$19.95	*13 HM 4	\$41.95
600	\$20.50	104R	\$49.95
102	\$24.95	12/115	\$69.95
612	\$27.95	108RA	\$79.95
107	\$28.95	108RM	\$99.95



MODEL 109R

NPC 25 Amp Regulated Power Supply, 4-Way Protected, Output Voltage and Current Meters.

Extra heavy-duty unit quietly converts 115 volts AC to 13.6 volts DC ± 200 millivolts, 10 amps continuous, 25 amps max. All solid state. Features dual current overload, overvoltage and thermal protection. Ideally suited for operating mobile Ham radio and linear amplifier in your home or office. Excellent bench power supply for testing and servicing of mobile communications equipment.

	TYPICAL	MAXIMUM
Output Voltage	13.6 ± 2VDC	13.6 ± 3VDC
Line/Load Regulation	50 mV	100 mV
Ripple/Noise	5 mV RMS	10 mV RMS
Transient Response	20 µSec	
Current Continuous	10 Amp	
Current Limit	25 Amp	
Overvoltage Protection	14.5 V	15 V
Thermal Overload	180°F	

Case: 4 1/2" (H) x 3" (W) x 8 1/2" (D). Shipping Weight: 15 lbs.

MODEL 108RM

NPC 12 Amp Regulated Power Supply, Solid State, 3-Way Protected, Current Meter.

This heavy duty unit quietly converts 115 volts AC to 13.6 volts DC ± 200 millivolts, 8 amps continuous, 12 amps max. All solid state. Features dual current overload and overvoltage protection. Ideally suited for operating mobile Ham radio 2 meter AM-FM-SSB transceivers in your home or office. Can also be used to trickle-charge 12 volt car batteries.

	TYPICAL	MAXIMUM
Output Voltage	13.6 ± 2VDC	13.6 ± 3VDC
Line/Load Regulation	20 mV	50 mV
Ripple/Noise	2 mV RMS	5 mV RMS
Transient Response	20 µSec	
Current Continuous	8 Amp	
Current Limit	12 Amp	
Current Foldback	2.5 Amp	
Overvoltage Protection	14.5 V	15 V

Case: 4 1/2" (H) x 7 1/2" (W) x 5 1/2" (D). Shipping Weight: 9.5 lbs.

ALSO AVAILABLE AS MODEL 108RA WITHOUT METER AND OVERVOLTAGE PROTECTION.

MODEL 107

NPC 4 Amp Power Supply, 6 Amp Max. Solid State, Overload Protected



Functions silently in converting 115 volts AC to 12 volts DC, 4 amps continuous, 6 amps max. Enables anyone to enjoy CB radio, car 8-track cartridge, cassette player or car radio in a home or office.

Continuous Current (Full Load)	4 Amp
Output Voltage (No Load)	16 V max
Output Voltage (Full Load)	12 V min
Filtering Capacitor	10,000 µF
Ripple (Full Load)	5 V RMS
Short Circuit Protection	Thermal Breaker

Case: 3" (H) x 4 1/4" (W) x 5 1/4" (D). Shipping Weight: 5 lbs.

MODEL 104R

NPC 6 Amp Power Supply Regulated, Solid State, Dual Overload Protection.

Converts 115 volts AC to 13.6 volts DC ± 200 millivolts. Handles 4 amps continuous and 6 amps max. Ideally suited for applications where excellent DC stability is important, such as CB transmission, small Ham radio transmitter, and high quality eight-track car stereos. Can be used to trickle-charge 12 volt car batteries.

	MAXIMUM	TYPICAL
Output Voltage	13.6 ± 2 VDC	13.6 ± 3 VDC
Line/Load Regulation	20 mV	50 mV
Ripple/Noise	2 mV RMS	5 mV RMS
Transient Response	20 µSec	
Current Continuous	4 Amp	
Current Limit	6 Amp	
Current Foldback	2 Amp	

Case: 3" (H) x 5" (W) x 6" (D). Shipping Weight: 8 lbs.

MODEL 12V4

NPC 1.75 Amp Power Supply, 3 Amp Max.



Functions silently in converting 115 volts AC to 12 volts DC. Ideally suited for most applications including 8-track stereo, burglar alarm, car radio and cassette tape player within power rating.

Continuous Current (Full Load)	1.75 Amp
Output Voltage (No Load)	16 V max
Output Voltage (Full Load)	12 V min
Filtering Capacitor	5,000 µF
Ripple (Full Load)	4 V RMS
Short Circuit Protection	Thermal Breaker

Case: 3" (H) x 4" (W) x 5 1/4" (D). Shipping Weight: 3 lbs.



MODEL 103R

NPC 4 Amp Regulated Power Supply, Solid State, Dual Overload Protection.

Converts 115 volts AC to 13.6 volts DC ± 200 millivolts. Handles 2.5 amps continuous and 4 amps max. Ideally suited for applications where no hum and DC stability are important such as CB transmission, small Ham radio transmitter, and high quality eight-track car stereos. Can also be used to trickle-charge 12 volt car batteries.

	TYPICAL	MAXIMUM
Output Voltage	13.6 ± 2 VDC	13.6 ± 3 VDC
Line/Load Regulation	20 mV	50 mV
Ripple/Noise	2 mV RMS	5 mV RMS
Transient Response	20 µSec	
Current Continuous	2.5 Amp	
Current Limit	4 Amp	
Current Foldback	1 Amp	

Case: 3" (H) x 4 1/4" (W) x 5 1/4" (D). Shipping Weight: 4 lbs.



MODEL 102

NPC 2.5 Amp Power Supply, 4 Amp Max, Solid State, Overload Protected.

Functions silently in converting 115 volts AC to 12-volts DC. 2.5 amps continuous, 4 amps max. Enables anyone to enjoy CB radio, car 8-track cartridge, cassette tape player or car radio in a home or office.

Continuous Current (Full Load)	2.5 Amp
Output Voltage (No Load)	16 V max
Output Voltage (Full Load)	12 V min
Filtering Capacitor	5,000 µF
Ripple (Full Load)	5 V RMS
Short Circuit Protection	Thermal Breaker

Case: 3" (H) x 4 1/4" (W) x 5 1/4" (D). Shipping Weight: 4 lbs.



ADVANCED ELECTRONIC APPLICATIONS, INC.

The AUTO DIALER that really works!

- you get 18 numbers from a 1-2 punch
- for making Quick and Safe Auto-Patch Calls
- with Key-Pad Programmable Memory



Model AD-1 \$129.95

Check These Features:

- Automatically dials with 1 or 2 buttons
- Exclusive MOS Microprocessor
- Automatic Push-to-talk
- Programmable tone duration
- Programmable time between tones
- High quality tactile Key-Pad
- Built in speaker
- Program RAM memory with Key-Pad (10 numbers in less than a minute)
- Optional ROM adds 8 permanent numbers
- Crystal controlled
- Mates with virtually all amateur FM transceivers

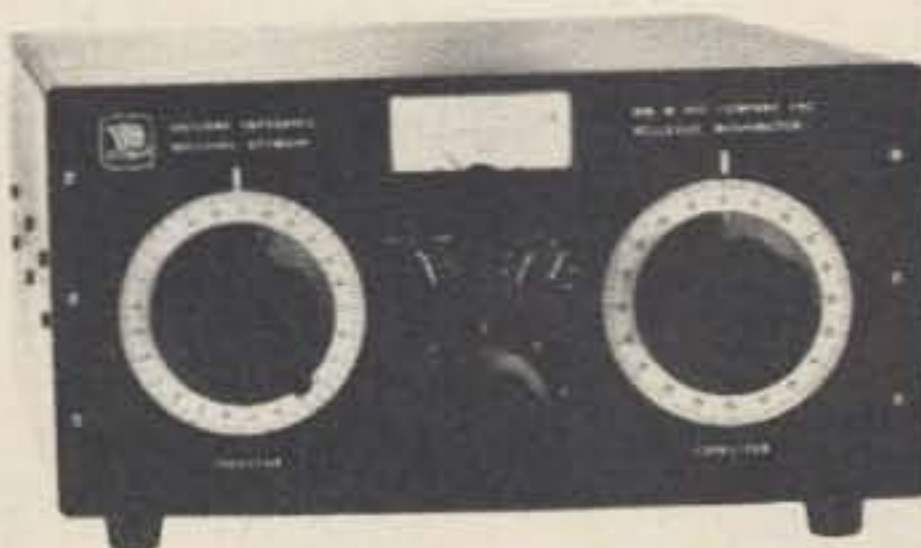

Model MB II \$285 (with Balun) \$315

MB II provides:

- * Constant SWR monitoring.
- * Precision tuning of final amp.
- * Harmonic suppression.
- * Receiver input impedance-matching.
- * Maximum power transfer to antenna.
- * Continuous frequency coverage 1.6 to 30 MHz.
- * Precision tuning of any wire 1/4 wavelength or longer, with SWR of 1:1.

MB II features:

- * Finest quality, made-in-USA components.
- * Large, precision, easy-to-read dials with 360° readout.
- * Optional 3000 watt Balun for twin lead antennas.

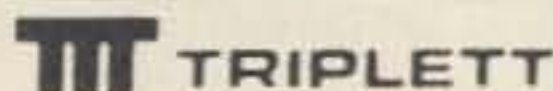

- Drop-resistant, hand-size V-O-M with high-impact thermoplastic case.
- 20,000 Ohms per volt DC and 5,000 Ohms per volt AC; diode overload protection with fused Rx1 Ohms range.
- Single range switch; direct reading AC Amp range to facilitate clamp-on AC Ammeter usage.

RANGES

DC VOLTS: 0-3-12-60-300, 1,

200 (20,000 Ohms per Volt), AC VOLTS: 0-3-12-60-300-1, 200 (5,000 Ohms per Volt), OHMS: 0-20k-200k-2m Ω -20m Ω (200 Ohm center scale on low range), DC MICROAMPERES: 0-600 at 250 mV, DC MILLIAMPERES: 0-6-60-600 at 250 mV, ACCURACY: ±3% DC; ±4% AC (full scale), SCALE LENGTH: 2-1/8", METER: Self-shielded; diode overload protected; spring backed jewels, CASE: Molded, black, high impact thermoplastic with slide latch cover for access to batteries and fuse, 2-3/4" w x 1-5/16" d x 4-1/4" h, BATTERIES: NEDA 15V 220 (1), 1 1/2V 910F (1); Complete with 42" leads, alligator clips, batteries and instruction manual. Shpg. Wt. 2 lbs. MODEL 310 Cat. No. 3018\$53.00

AUTOPATCH — Ready to go!

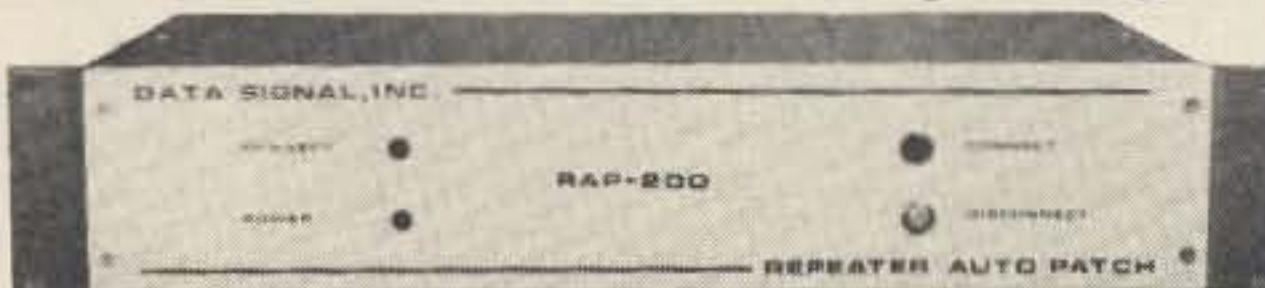

A Complete Autopatch facility that requires only a repeater and a telephone line. Features include single-digit access/disconnect, direct dialing from mobile or hand-held radios, adjustable amplifiers for transmitter and telephone audio, and tone-burst transponder for acknowledgement of patch disconnect.

RAP-200 P. C. Card
RAP-200R Rack Mount

\$199.50
\$249.50

Autek Research QF-1 Active Filter
For CW & SSB
\$55



AUTEK pioneered the ACTIVE AUDIO FILTER way back in 1972. Today, their

fantastic performance is widely acclaimed. But, today, we're still way ahead with the most advanced — our QF-1. Thousands are already in use improving Yaesu, Kenwood, Drake, Swan, Atlas Tempo, Collins, etc. Hooks up in minutes to ANY rig. Plugs into phone jack. Drives a speaker with 1 watt, or phones. Its secret is an exclusive "infinitely-variable" cascaded design. You can vary frequency over the ENTIRE audio range — 250 to 2500 Hz — in all positions. Vary selectivity 40:1 or more. Instantly zero-in on signals or optimize response! PEAK CW or voice with 50 Hz bandwidth, variable to 2000 Hz. Imagine what the NARROWEST CW FILTER MADE will do to QRM! Reject whistles, carriers, etc with the most flexible NOTCH you've heard. Wide or narrow. Depth to 70 dB. Cope with SSB hiss and splatter in LOW PASS. Steep skirts in all positions add to your rigs skirts.

EXPERIENCE the Ultimate in Scanners



The Touch™
by Regency

- Over 15,000 frequencies at your fingertips
- Scans the Channels in 1.3 Seconds
- Special Weather Alert™ and Priority Scan features

\$289.00

2 METER FM PORTABLE TRANSCEIVER Model TR-33C



- Amateur Net \$229.95
- SCPC* Frequency Control
- 12 Channels with Selectable Xmtr Offsets.
- All FET Front-end and Crystal Filter for Superb Receiver Intermod Rejection.
- Expanded Antenna Choice.
- Low Receiver Battery Drain.
- Traditional R. L. Drake Service Backup.
- Single Crystal Per Channel.

LINEAR AMPLIFIER Model L-4B

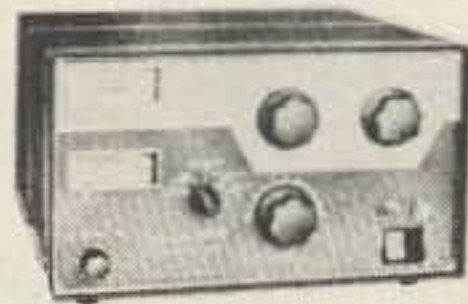

L-4B Linear Amplifier . . \$995.00
 • 2000 Watts PEP-SSB • Class B Grounded-Grid — two 3-500Z Tubes • Broad Band Tuned-Input • RF Negative Feedback • Transmitting AGC • Directional Wattmeter • Two Tautband Suspension Meters • L-4B 13-15/16" W, 7-7/8" H, 14-5/16" D. Wt.: 32 lbs. • Power Supply 6-3/4" W, 7-7/8" H, 11" D, Wt.: 43 lbs.
POWER SUPPLIES
 AC 4 Power Supply . . . \$120.00
 DC 4 Power Supply 135.00



Drake T-4XC
 Solid State Linear permeability-tuned VFO with 1 kHz dial divisions. Gear driven dual circular dials. High mechanical, electrical and temperature stability. Covers ham bands with crystals furnished. Covers all of 80, 40, 20 and 15 meters, and 28.5-29.0 MHz of 10 meters.
 Covers 160 meters with accessory crystal. Four 500 kHz ranges in addition to the ham bands plus one fixed-frequency range can be switch-selected from the front panel. Price: \$699.00



Drake R-4C
 Solid State Linear permeability-tuned VFO with 1 kHz dial divisions. Gear driven dual circular dials. High mechanical, electrical and temperature stability. Covers ham bands with crystals furnished. Covers all of 80, 40, 20 and 15 meters, and 28.5-29.0 MHz of 10 meters.
 Covers 160 meters with accessory crystal. In addition to the ham bands, tunes any fifteen 500 kHz ranges between 1.5 and 30 MHz, 5.0 to 6.0 MHz not recommended. Can be used for MARS, WWV, CB, Marine and Shortwave broadcasts. Price: \$699.00



Touch-n-go with DRAKE 1525EM Push-Button Encoding Mike
 Drake 1525EM, microphone with tone encoder and connector for TR-33C, TR-22, TR-22C, ML-2 — \$49.95
 • Microphone and auto-patch encoder in single convenient package with coil cord and connector.

- tor. Fully wired and ready for use.
- High accuracy IC tone generator, no frequency adjustments.
- High reliability Digitran® keyboard.
- Power for tone encoder obtained from transceiver through microphone cable. No battery required. Low current drain.
- Low output impedance allows use with almost all transceivers.
- Four pin microphone plug: directly connects to Drake TR-33C without any modification in transceiver. Compatible with all previous Drake and other 2 meter units with minor modifications.
- Tone level adjustable.
- Hang-up hook supplied.



Drake SPR-4



Drake DSR-2

DRAKE TVI FILTERS
 High Pass Filters for TV sets provide more than 40 dB attenuation at 52 MHz and lower. Protect the TV set from amateur transmitters 6-160 meters.
 Drake TV-300-HP Model No. 1603. For 300 ohm twin lead \$10.60

Drake TV-3300-LP Model 1608 1000 watts max. below 30 MHz. Attenuation better than 80 dB above 41 MHz. Helps TV i-f interference, as well as TV front-end problems. \$26.60
 Drake TV-75-HP Model No. 1610. For 75 ohm TV coaxial cable; TV type connectors installed \$13.25

LOW PASS FILTERS FOR TRANSMITTERS have four pi sections for sharp cut off below channel 2, and to attenuate transmitter harmonics falling in any TV channel and fm band. 52 ohm. SO-239 connectors built in.
 DRAKE TV-5200-LP Model No. 1609. 200 watts to 52 MHz. Ideal for six meters. For operation

below six meters, use TV-3300-LP or TV-42-LP. \$26.60
 DRAKE TV-42-LP Model No. 1605 is a four section filter designed with 43.2 MHz cut-off and extremely high attenuation in all TV channels for transmitters operating at 30 MHz and lower. Rated 100 watts input. \$14.60

Communications Receivers and Accessories			
1242	DSR-2	VLF-HF Digital Synthesized Communications Laboratory Receiver SSB, AM, CW, RTTY, ISB	\$3200.00
1211	R4C	Amateur HF Receiver, 160-10 meters	699.00
1217	4-NB	Noise Blanker for R4C	74.00
7011	FL-250	Accessory I.F. Filter	52.00
7013	FL-500	Accessory I.F. Filter	52.00
7015	FL-1500	Accessory I.F. Filter	52.00
7017	FL-4000	Accessory I.F. Filter	52.00
7019	FL-6000	Accessory I.F. Filter	52.00
1221	SPR-4	Solid State Programmable Receiver	699.00
1227	5-NB	Noise Blanker for SPR-4	80.00
1229	DC-PC	12VDC power cord (fits cigarette lighter)	5.00
6006	Dial	Plain crystal selector dial for SPR-4	3.00
1223	SCC-4	100 kHz Calibrator	22.00
7001	Kit	Aeronautical Overseas—7 crystals	36.40
7002	Kit	Amateur Band—6 crystals	31.20
7003	Kit	Citizen Band—1 crystal & freq. chart	5.25
7004	Kit	Marine Band—11 crystals	57.20
7005	Kit	MARS—5 crystals	26.00
7006	Kit	Teletype Commercial-UPI/AP/Stock Market/Weather, etc. 4 crystals	20.80
7007	Kit	Time & Frequency Standard—WWV 5 crystals	26.00
7008	Kit	Tropical Broadcast—3 crystals	15.60
Transmitters			
1411	T4XC	Amateur HF Transmitter 160-10 meters	699.00
Transceivers and Accessories			
8333	TR33C	2-meter FM transceiver, 12 channel portable	229.95
1333	MMK-33	Mobile/Dash/Desk Mount for TR33C	12.95
1312	TR4Cw	80-10 meter Amateur Radio SSB/CW Transceiver, RIT AND CW Filter included.	799.00
1317	34PNB	Plug-in Noise Blanker for TR-4 and TR4C above Serial No. 31320 and TR4Cw. For factory installation add \$10.00	100.00
1313	MMK-3	Mobile Mounting Kit for TR4 and TR6	10.95
1319	RV4C	Remote VFO for TR4C and TR4Cw	170.00
1330	UMK-3	Remote Trunk Kit for UV-3 System	69.95
1340	UV-3	144	595.00
1343*	UV-3	144-220	695.00
1344*	UV-3	144-440	695.00
1346*	UV-3	144-220-440	795.00
1359*	UV-3E	144-430, European model	695.00
Power Supplies			
1501	AC-4	110/220V power supply for all R.L. Drake transmitters and transceivers	150.00
1504	PS-3	AC Supply (120/240 V.A.C.) for any UV-3 model	89.95
1505	DC-4	12 VDC power supply for all Drake transmitters, transceivers & receivers	160.00

Major Accessories & Miscellaneous			
1520	FS-4	Frequency Synthesizer	300.00
1523	Interface Kit	For SPR-4/FS-4	10.00
1524	Split Freq.	Adaptor FS-4/4-Line	10.00
1519	L4B	Linear Amplifier with Power Supply & Tubes	995.00
1508	MN4C	Antenna Matching Network, 160-10 meters, 250 watts.	165.00
1509	MN2000	Antenna Matching Network, 2000 watts	250.00
1510	B-1000	4:1 Balun Designed for use with MN4C	24.95
1511	MS-4	Matching Speaker for R4B, R4C, SPR-4, SW4A, TR4 and TR6	33.00
1513	W-4	HF RF Wattmeter 1.8 to 54 mHz 200/2000 watts	79.00
1515	WV-4	VHF RF Wattmeter 20 to 200 mHz 100/1000 watts	89.00
1525	1525EM	Encoder microphone w/plug for TR33C/UV-3	49.95
7079	7079	Vinyl Case for TR33C	9.95
3501	RP-500	Protects receivers operating in range 10 kHz to 30 mHz from RF voltages of up to 500 V RMS from 50 ohm antenna	90.00
1518	RCS-4	Remote Control Antenna Switch	120.00
Crystals*		Crystals for 2C/R4B/R4C/SW4A/T4XB/T4XC/SPR4/ML2/TR4C/TR4CW	5.25
		Crystals for fixed frequency operation of tunable units/2NT	7.85
		Crystals for TR22	7.85
		Crystals for TR72/TR33C	6.30
Receivers			
8201	SSR-1	Solid state general coverage synthesized shortwave receiver .5 to 30.0 mHz, continuous tuning.	350.00
8202	DC-PC	SSR-1 DCPC power cord	5.00
Books			
		TR4C/T4XC/R4C/2C/TR4CW	5.00
		All other Instruction Manuals	3.50
		DSR-2 Manual	20.00
		World Radio & TV Handbook	10.95
7040			
High Pass Filters			
1603	TV300HP	High Pass Filter for 300 ohm twin lead	10.60
1610	TV75HP	High Pass Filter for 75 ohm TV coax, type F connectors	13.25
Low Pass Filters for Transmitters			
1605	TV42LP	For transmitting below 30 mHz, 100 watt continuous/50 ohms/SO-239 connectors	14.60
1608	TV3300LP	1000 watts continuous to 30 mHz with sharp cutoff above 30 mHz/50 ohms/SO-239 connectors	26.60
1609	TV5200LP	100 watts continuous on 6 meter amateur band	26.60

TUFTS RADIO CATALOG TUFTS RADIO



MODEL	DESCRIPTION	AMATEUR PRICE
BEAMS		
TB4HA	4 Element 20/15/10. All four elements function all bands and are full sized	\$259.95
TB3HA	3 Element 20/15/10	\$199.95
TB2A	2 Element 20/15/10	\$129.95
MB40H	2 Element 40 meter	\$199.95
VERTICALS		
1040V	10-40 Golden Swan Trap	\$122.95
75-MK	75 meter add-on kit for 1040V	\$ 39.95
4010V	10-40 Slim-line trap	\$ 74.95
75-AK	75 meter add-on kit for 4010V	\$ 39.95
MOBILE		
45	75/40/20/15/10, 1000W PEP Gold Plated contacts, Manual band switching	\$119.95
742	75/40/20, 500W PEP, no manual switching required. Fully automatic after initial tune-up to desired frequency.	\$109.95
M34	20/15/10 slim line tri-bander 500W PEP. Coil for 40 or 80 or 160 with top section may be added to make unit four bander.	\$ 52.75
M34T	Top section used with 40/80 or 160 coils. Not required for basic M34.	\$ 5.25
M34E	Base extender rod for use when mounting M34 on bumper.	\$ 6.45
M34/160	160 meter coil (M34T required)	\$ 16.95
M34/80	80 meter coil (M34T required)	\$ 15.50
M34/40	40 meter coil (M34T required)	\$ 14.95

*M34/11 27 MHz coil available only upon special request. Delivery six weeks. \$16.95. May be utilized in lieu of 10 meter coil on basic M34.

NEW TRANSCEIVERS



750 CW - \$679.95

If you're ready for 700 loud-talking watts, you're ready for the new 750CW. 700 watts P.E.P. input on SSB. 400 watts DC input on CW. CW audio filter selectable 80 or 100 Hz. CW sidetone monitor with adjustable pitch and volume control. 80 through 10 meters, USB, LSB, CW. Selectable 25 or 100 kHz crystal calibrator. Standard 5.5 Mhz, 2.7 Hz bandwidth crystal filter or optional accessory 16 pole filter available with 140 Db ultimate rejection. Accessories: VX-2 Vox, MK-II Linear amplifier, DD-76 Digital Dial. The 750CW is a CW man's dream come true. What's more there's a long list of accessories you can add later for increased performance.



350A - \$599.95

300 watts P.E.P. input SSB. 200 watts DC input on CW. 80 through 10 meters, USB, LSB, CW. 5.5 Mhz, 2.7 kHz bandwidth crystal filter. Oscillators are solid state and IC regulated for stability. CW sidetone monitor with adjustable pitch and volume. CW audio filter 80 and 100 Hz selectable. Built in 117 VAC power supply and speaker. (220 VAC power supply available on special request). Accessories: VX-2 Vox, 14A DC Converter, 1200X linear amplifier, Crystal Calibrator (350A only).



350D - \$699.95

Same basic features as 350A except added feature of: 6 Digit LED frequency display with readout to 100 Hz. Both the 350A and the 350D are compatible with the same line of Swan accessories that has built a reputation for reliability and performance that's second to none, including linear amplifiers to boost your power to the legal limit. So they're perfect for novices or anyone else because you can build capability as you need it.

OUR NEW M-34 EXPANDABLE MOBILE ANTENNAS

The M-34 mobile antenna gives you 10, 15, and 20 meters and great performance in a tough, rugged design for only \$52.75. Then whenever you want it you can buy the optional 160, 80 or 40 meter coil and top section for \$20.00 to \$25.00 depending on the band and make a full-capability four-bander out of it. One that never needs coil changes or adjustments after initial tuning. What's more, at no extra cost you get features like 500 watts PEP, low standing wave ratio at resonance, independent resonance adjustments on each of the four bands, exceptional bandwidth and a neat, clean, low-wind-resistance profile that also goes great with mobile homes, motor homes and apartments. That's the kind of innovative, problem-solving thinking that goes into Swan mobile antennas. Not just the M-34 but these, too:

742 Automatic. Swan automates mobile antennas with the 742 tri-band antenna. Work 20, 40 or 75 meters with your 742 without need for coil change or other adjustments after initial tuning. A high Q mobile antenna designed for maximum efficiency capable of 500 watts PEP \$109.95

Mobile 45. This switch-adjustable 5-band antenna features a Swan HI-Q coil and positive-stop, 9-position switch with GOLD-PLATED contacts. Select 10, 15, 20, 40 plus five positions for 75 meters and go to work knowing this rugged antenna is doing its job \$119.95



SWAN METERS



THESE WATTMETERS TELL YOU WHAT'S GOING ON. With one of these in-line wattmeters you'll know if you're getting it all together all the time. Need high accuracy? High power handling? Peak power readings? For whatever purpose we've got the wattmeter for you.

WM2000 IN-LINE WATT-METER WITH MUSCLE. Scales to 2000 watts. New flat-response directional coupler for maximum accuracy. \$49.95

WM3000 PEAK-READING WATTMETER. Reads RMS power, then with the flick of a switch, true peak power of your single-sideband signal. That's what counts on SSB, \$66.95

WM1500 HIGH-ACCURACY IN-LINE WATTMETER. 10% full scale accuracy on 5, 50, 500 and 1500 watt scales, 2 to 30 MHz. Forward and reflected power. Use it for troubleshooting, too. \$64.95



THE SWAN METER SHOWCASE.



Sniffs out radiated power wherever it is. This little unit is so compact it could measure relative radiated power in your pocket. Telescoping antenna and a frequency range of 1.5 MHz all the way to 200 MHz. **PS-1 Field Strength Meter** \$13.95



Easy-on-the-pocket pocket SWR. Mighty mite SWR meter with high accuracy. SWR-3 gives you 1:1 to 3:1 SWR at 50 ohms on frequencies from 1.7 to 55 MHz. Precision PC board directional coupler makes it a solid value at a rock-bottom price. **SWR-3 Pocket SWR Meter** \$14.95



SWR bridge bridges the price barrier. This little jewel gives you relative forward power and SWR on two 100 microampere meters at a remarkably low price. Indicates 1:1 to infinity VSWR of up to 1000-watt signals on frequencies from 3.5 to 150 MHz. With low insertion loss, it's great for mobile operations, too. **SWR-1A Power Meter and SWR Bridge** \$29.95



At last. A precision wattmeter for the 6 and 2-meter man. We design the WM-6200 for the upper-band man who needs to know with 7% accuracy. Reads power of 50 to 150 MHz signals on two scales to 200 watts plus SWR on expanded range scale from 1:1 to 3:1 with 3% accuracy. **WM-6200 In-Line Wattmeter** \$63.95



Put your power up in lights. The new WMD-6200 does everything our WM-6200 does and ends guesswork, interpolation errors and eyestrain besides with a 4-digit readout. 50 to 150 MHz, power to 200 watts with an accuracy of 10%. SWR from 1:1 to 19.99:1 with 3% accuracy. **WMD-6200 Digital SWR Power Meter** \$262.00 (requires AC source)

The new WM-200A does it all. As an in-line wattmeter it gives you power to 200 watts on two scales plus SWR from 1:1 to 3:1 for signals from 50 to 150 MHz. And as a peak reader it reads true peak envelope power of your voice modulated signal. Flat response forward or reflected power on scales to 200 watts in switch-selected RMS or peak. **WM-200A Peak Reading Wattmeter** \$87.95



Nifty little meter just for VHF mobile. This brand new, easy-to-install swivel-mount unit is the perfect illuminated wattmeter for 2-meter mobile. Compact and capable, it gives you two scales, 0-20 watts and 0-200 watts at 10% accuracy. SWR from 1:1 to 3:1. Frequencies from 50 to 150 MHz. **WMM-200 SWR Power Meter** \$45.95



DenTron MLA-2500 \$799.50

DenTron Radio has packed all the features a linear amplifier should have into their new MLA-2500. Any Ham who works it can tell you the MLA-2500 really was built to make amateur radio more fun.

- ALC circuit to prevent overloading
- 160 thru 10 meters
- 1000 watts DC input on CW, RTTY or SSB TV Continuous Duty
- Variable forced air cooling system
- Self-contained continuous duty power supply
- Two EIMAC 8875 external anode ceramic/metal triodes operating in grounded grid
- Covers MARS frequencies without modifications
- 50 ohm input and output impedance
- Built-in RF wattmeter
- 117V or 234V AC 50-60 Hz

- Third order distortion down at least 30 db
- Frequency range: 1.8MHz (1.8-2.5) 3.5MHz (3.4-4.6) 7MHz (6.0-9.0) 14MHz (11.0-16.0) 21MHz (16.0-22.0) 28MHz (28.0-30.0)
- 40 watts drive for 1 KW DC input
- Rack mounting kit available (19" rack)
- Size: 5 1/2" H x 14" W x 14" D. Wt. 47 lbs.

Novice Crystals (Specify Band Only)

BOMAR Crystal Company

TWO METERS
CRYSTALS IN STOCK
Motorola HT 220 Crystals
In Stock!

Standard • Icom • Heathkit • Ken • Clegg • Regency • Wilson • VHF Eng • Drake • And Others! \$4.50 @ Lifetime Guarantee

Make/Model	Xmit Freq.	Rec. Freq.

PROGRAMMABLE CMOS KEYS



AUTEK RESEARCH

CALLS CQ WHILE YOU RELAX!
Also remembers name, QTH, contest exchanges, etc.
MODEL MK-1
ONLY \$99.50

- 4 Messages
- Instant record or reprogram
- Designed for Novice, as well as CW "Pro" and Contest OP

An Advanced Programmable Keyer - Yet Priced Lower Than Many Ordinary Keyers

Programmable memory keyers are the biggest advance to come along in years for CW. When you use one, CW truly becomes FUN again! Until the MK-1, quality memory keyers cost \$150 to \$400. But now, anyone can afford a "miniature computer," instead of an ordinary keyer. It's an investment in enjoyable operation for years to come. And an incredible bargain at our breakthrough low price!

ADVANCED "MOS" MEMORY

- Just tap button to start any of four messages.
- You record CQ, contest exchanges, name, QTH, or anything you want in the four messages.
- Record instantly by simply sending the message.
- Play out recording as often as desired.
- Change by simply recording over the old message. No factory-programmed extra cost IC's to buy.
- Large 1024 bit total memory stores about 100 characters. Each message holds about 25 characters, depending on character length and pauses, e.g., "CQ CQ DE W6DYD W6DYD CQ TEST K"
- "Combine C/D" switch combines 2 of the 4 messages for extra length of about 50 characters, e.g., "QTH IS LA LA NAME IS BILL BILL RIG HR IS KW ES BEAM ES NEW MEMORY KEYS"
- REPEAT SWITCH repeats message forever until reset. Very useful for longer CQ's, or leave a moderate pause at end of CQ. If no answer, the keyer automatically repeats the CQ until answered. YOU SIT BACK AND WAIT FOR A CALL!
- ADDED CONTEST FEATURES. Instant memory reset with button, or by tapping paddle when playing. Tapping message button restarts message.

PLUS A GREAT AUTOMATIC KEYS

- Dot AND dash memories "forgive" your minor timing mistakes. Most keyers have just a dot memory or none at all. The MK-1 makes sending easier.
- IAMBIC OPERATION. Squeezing dot and dash paddles produces alternate dots and dashes, making it easier to send letters such as C, F, K, Q, R, etc. Most keyers put out only dots, or only dashes when paddles are squeezed, making you work harder.
- FULL CMOS construction. No TTL logic to heat up or draw heavy current. Battery operation if desired. (50 ma. @ 9V., 60 ma. @ 12 V., typical)
- SELF-COMPLETING characters. Jamproof.
- Extensive RFI protection. 8-50+ WPM.
- Silent transistor output. No clicking relays to fail. (Max. 2300 V., -15 ma. grid blocked rigs, +200 ma. cathode keyed rigs, at key)
- TRIGGERED CLOCK (except when recording) starts instantly at key closure. No confusing wait, or need for you to "keep time," as with many keyers.
- Built-in monitor/speaker. Volume control (panel). Widely adjustable tone (internal trimpot).

To prevent loss of recorded messages when AC power is lost, a 9 V. battery may be connected to the rear battery input. No power is drawn from a battery if AC power is on. This makes the MK-1 ideal for field day or expeditions. The MK-1 may be left on continuously in fixed stations, if desired. (Draws less than 1.5 watts AC). The MK-1 may be used with any paddle. A dual-lever (squeeze) paddle is recommended to take advantage of iambic operation, but a single-lever paddle will also work.

115 VAC or 9-14 VDC. 6x3x5". 2.5 lbs. Handsome light-gray panel with silver lettering. Black steel case. Comes assembled and tested with full instructions, 15 day home trial, and the famous Autek 1 year parts and labor warranty. Made in U.S.A.

introducing the unbelievable

ALDA 103

Totally solid state SSB Transceiver • 80 through 20 meters • 250 watts

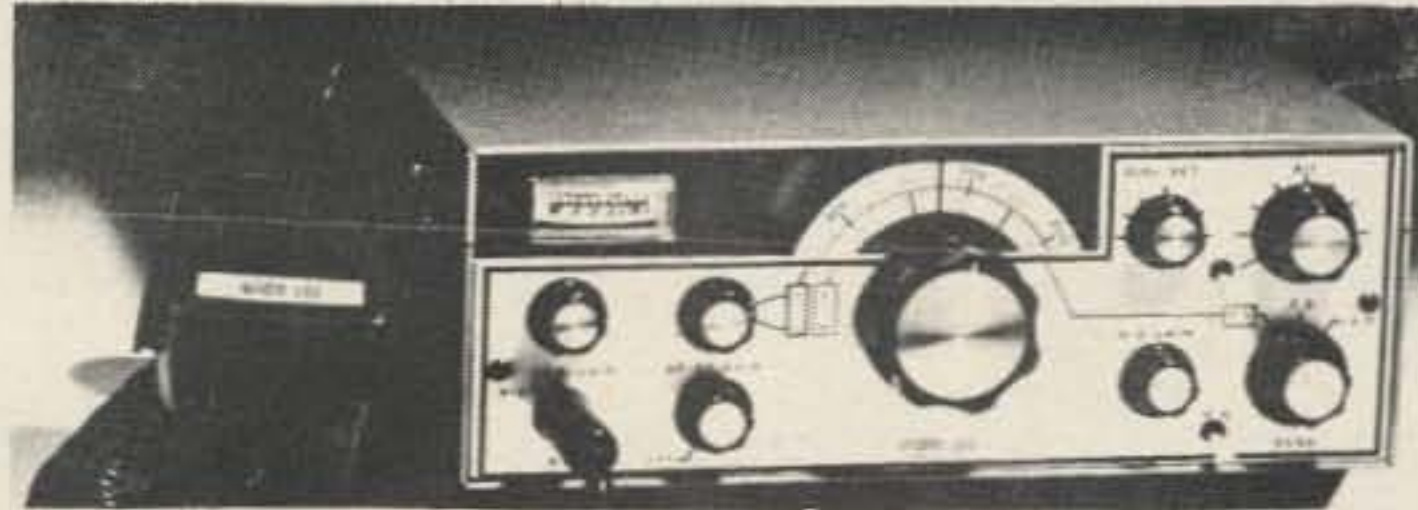

Now, for under \$500, you can get the best deal in the ham radio market today for compactness, power and performance - the new ALDA 103. Unbelievable, but true.

Both brand new novices looking for that ideal first transceiver and seasoned hams wanting to treat themselves to a great second unit for mobile operation will turn on to the ALDA 103's totally broad-banded features. Can you believe fully automatic CW keying with automatic side step and RIT, too, so you can QSO with any make of transceiver without constant frequency corrections? Or an intermod intercept point of better than 10 dbm? Or the tremendous stability of a VFO oscillator covering 5 to 5.5 MHz (not switched)? And that's just a sampling of the 103's superlative specs.

You won't believe the ALDA 103's clean, simplified engineering and serviceability until you see it for yourself. So see the ALDA 103 today.

Price: \$495 including microphone and mobile mount, too.



KR-400 Azimuth Rotator
Medium duty rotator, supports 400 lbs (181 KG). Ideal for Long Boomers, HF tribanders, VHF arrays. Motor disc brake same as KR-500, also limit switches. Rotation is 1 min./360°. Accommodates masts 1.5-2.5"D (38-63.5 mm). Supplied with functional direction indicator. 115VAC, 50/60 Hz.

Shipping weight is approx. 18 lbs. (8.16 KG). \$129.95

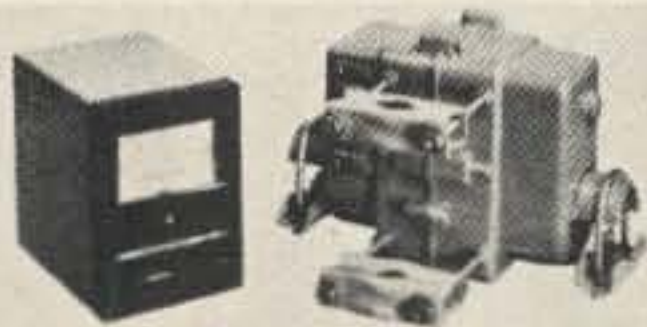

KR-500 Elevation Rotator
KR-500 provides 180° boom rotation for antennas used in OSCAR, EME, etc. Heavy duty, can be used with stacked arrays. Rotation, 1 min. for 180°. Limit switches. Motor disc brake holds to 1750 inch-pounds (2000 cm-KG). Accommodates booms 1.25-1.625"D (31.75-41.27 mm), masts to 1.5-2.5"D (38-63.5 mm). Weatherproof. Attractive direction indicator. 115VAC, 50/60Hz. 14 lbs. (6.34 KG). \$169.95

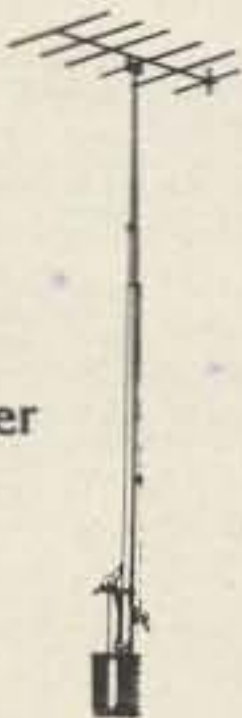

The only completely free-standing, telescoping, breakover tower you can buy.

The only completely free-standing, telescoping, breakover tower you can buy.

They telescope. Crank up or down easily to pinpoint best reception.

They breakover. Your feet never have to leave the ground when you pull maintenance - even on our tallest breakover tower.

One-piece price. You get the whole tower, ready to install. No extra charges for base plates, guy wire, etc.

Old-fashioned craftsmanship. Every Tele-Tow'r is cut, assembled, and welded by hand.

Old-fashioned value. Orville Bond found a way to make better towers for less money. Our model 40, which we believe is the most durable, convenient non-breakover 40-footer you can buy, is \$199.50. Our Breakover Model 55, the only tower you can buy that is totally free-standing, telescoping, and a breakover, is just under \$500.

Completely free-standing. No guy wires, no brackets. Yet, by stretching the windload over the entire tower, we've made them stronger than wired or bracketed towers.

55 Concrete Sleeve	\$32.00
40 Concrete Sleeve	\$32.50
Model 40 (extends from 23'-40')	\$224.21
Model 55 (extends from 23'-55')	\$410.16
Breakover Model 40 (extends from 23'-40', with breakover at ground level)	\$381.30
Breakover Model 55 (extends from 23'-55', with breakover at ground level)	\$572.65

TELE TOWER



Two NEW Rotors from Cornell-Dubilier

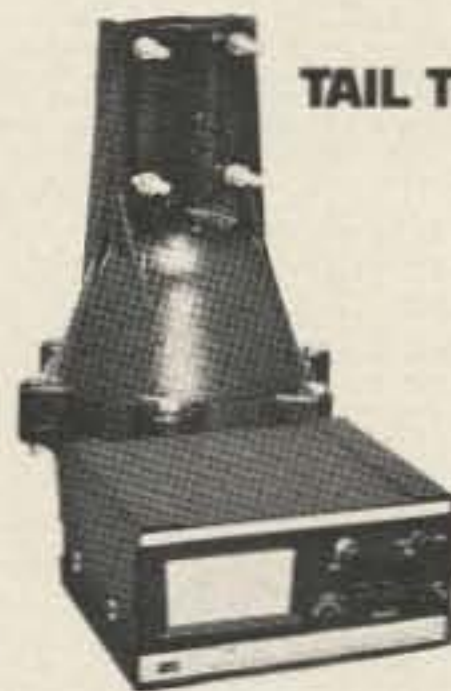

TAIL TWISTER™



HAM III

- For the New Super Communications Antennas
- New Thickwall Casting
- New Steel Ring Gear
- New Metal Pinion Gear
- New Motor Prebrake
- New Super Wedge Brake
- New L.E.D. Control Box
- Safe 26 Volt Operation

Designed for the newest of the king-size communications antennas, the TAIL TWISTER™ is the ultimate in antenna rotational devices. The TAIL TWISTER™ starts with a deluxe control box featuring snap action controls for brake and directional controls; L.E.D. indicators signal rotation and brake operation, while the illuminated meter provides direction readout. This new control box couples to the newest bell rotor principle, the TAIL TWISTER™ is a brand new design with thickwall castings and six bolt assembly. A brand new motor with prebrake action brings the antenna system to an easy stop, while the massive square front brake wedge locks the assembly in place. A new stainless steel spur gear system provides final drive

into a new steel ring gear for total reliability. Triple race, 138 ball bearing assembly carries dead weight and maintains horizontal stability.

An optional heavy duty lower mast adaptor is available for lighter loads with mast mounting. Price: \$259.00

The HAM III sets new levels of performance. Snap action switched wedge brake and rotational controls brings pinpoint accuracy to large directional arrays popular in communications. A new motor provides pre-brake action to assist in slowing down rotational mass, and the new thicker wedge brake offers far stronger lock-in phase action. To take full advantage of this new design, the HAM III is designed for in-tower mounting. A new optional heavy duty lower mast adaptor is available when the HAM III is to be mast mounted with smaller arrays. A stainless steel spur gear system multiplies the torque into the dual race 98 ball bearing support assembly assuring years of trouble free performance. Price: \$139.00.

TUFTS RADIO CATALOG TUFTS RADIO

FINCO 2 meter Stinger A 2-10—\$41.15

The model Stinger A 2-10 is a high performance wide spaced ten-element 2-meter yagi designed for the serious VHF operator. Utilizing the Stinger construction features, the A 2-10 is almost indestructible no matter what weather conditions are encountered. Complete coverage of the 2-meter band and low V.S.W.R. is assured through the use of non-linear spaced elements thus also achieving maximum forward gain. Power rating — 2,000 watts P.E.P.

The A 2-10 can be mounted for vertical polarization, there by making the antenna quite useful in repeater accessing, or mounted for horizontal polarization for station to station VHF DX work. Additional bays of the A 2-10 can be easily stacked for even greater gain and front-to-back ratio.

SPECIFICATIONS — A 2-10	
ELECTRICAL—	MECHANICAL—
Forward Gain 13.8dB	Boom Length 10 ft.
Front-to-Back Ratio 25dB	Longest Element 42 in.
V.S.W.R. (at resonance) 1.1:1	Turning Radius 71 in.
Half Power Beam Width 40°	Maximum Surface Area 2.36 sq. ft.
Bandwidth 144 to 148 MHz	Wind Load at 80 MPH 26.2 lbs.
Impedance 50 Ohms	Weight 9.8 lbs.
Matching System Adjustable Gamma	

Stinger A 2-5—\$25.60

The model Stinger A 2-5 is a five-element high gain antenna similar to the A 2-10 but having physically less of a profile. The A 2-5 finds excellent application as a portable antenna as it disassembles into a very compact package. Like the A 2-10, the antenna can be mounted for vertical or horizontal polarization for repeater or general coverage work. Constructed of the Stinger heavy duty materials, the A 2-5 is ideal for locations encountering adverse weather conditions. Power rating 2,000 watts P.E.P.

SPECIFICATIONS — A 2-5	
ELECTRICAL—	MECHANICAL—
Forward Gain 9.5dB	Boom Length 5.5 ft.
Front-to-Back Ratio 22dB	Longest Element 41 in.
V.S.W.R. (at resonance) 1.1:1	Turning Radius 42 in.
Half Power Beam Width 51°	Maximum Surface Area 1.23 sq. ft.
Bandwidth 144 to 148 MHz	Wind Load at 80 MPH 13.3 lbs.
Impedance 50 Ohms	Weight 6.5 lbs.
Matching System Adjustable Gamma	

Stinger A 2+2—\$41.75

The model Stinger A 2+2 is a ten-element, dual polarization 2-meter antenna designed for OSCAR communications or where switching from horizontal to vertical polarization is required. The A 2+2 can even be phased to operate on both horizontal and vertical polarization at the same time. This is not only ideal for OSCAR work but gives your station versatility for ground communications.

Wide, non-linear element spacing gives the A 2+2 superior gain, however, since it is a five element beam in one given plane, the half power beam width does not make satellite tracking difficult because of sharp directivity. The dual gamma match assemblies provide for a very low V.S.W.R. and will withstand 2,000 watts P.E.P.

The Stinger construction features make the A 2+2 extremely heavy duty. Provisions are made for mounting the antenna at the end of the boom — for azimuth control — or at the middle of the boom for normal applications.

SPECIFICATIONS — A 2+2	
ELECTRICAL—	MECHANICAL—
Forward Gain 9.5dB	Boom Length 6 ft.
Circular Gain 10.5dB	Longest Element 41 in.
Front-to-Back Ratio 22dB	Turning Radius 5.5 ft.
Half Power Beam Width 52°	Center Mount 3.4 ft.
Horizontal Polarization—	Maximum Surface Area 1.51 sq. ft.
E Plane 52° H Plane 58°	Wind Load at 80 MPH 13.4 lbs.
Vertical Polarization—	Weight 11 lbs.
E Plane 58° H Plane 52°	
Circular Polarization—	
E Plane 52° H Plane 52°	
Bandwidth 144 to 148 MHz	
Impedance 50 Ohms	
Matching System Adjustable Gamma	

1 1/4 meter Stinger A 1 1/4—\$29.65

The model Stinger A 1 1/4 is a ten element 1 1/4-meter (220 MHz) high performance yagi designed for all 220 MHz communication needs. Designed to be mounted in either the vertical or horizontal plane, the A 1 1/4 is adaptable for OSCAR, repeater, or general communication work. Incorporating the Stinger heavy duty elements, boom and boom to mast assemblies, the antenna easily withstands 120 mph wind loads under 1/4" ice conditions. A low loss gamma matching system assures a low V.S.W.R. and is power rated at 1,000 watts.

SPECIFICATIONS — A 1 1/4	
ELECTRICAL—	MECHANICAL—
Forward Gain 13.8dB	Boom Length 8 ft.
Front-to-Back Ratio 25dB	Longest Element 28 in.
V.S.W.R. (at resonance) 1.2:1	Turning Radius 4.3 ft.
Half Power Beam Width 40°	Maximum Surface Area 1.32 sq. ft.
Bandwidth 220 to 226 MHz	Wind Load at 80 MPH 17.9 lbs.
Impedance 50 Ohms	Weight 8 lbs.
Matching System Adjustable Gamma	

STINGER 10 meter Stinger A 10-4—\$57.15

The model Stinger A 10-4 is a wide spaced, full size, high gain four element 10-meter monobander designed for optimum DX performance. Utilizing the exclusive Stinger Series square boom construction, the A 10-4 is light enough to be easily stacked for an additional 3 dB gain yet strong enough to withstand the most adverse weather conditions. The highly efficient gamma match system easily withstands 2,000 watts P.E.P. of power and maintains a relatively low V.S.W.R. across the entire 10-meter amateur band.

SPECIFICATIONS — A 10-4	
ELECTRICAL—	MECHANICAL—
Forward Gain 10dB	Boom Length 16 ft.
Front-to-Back Ratio 25dB	Longest Element 18.2 ft.
V.S.W.R. (at resonance) 1.1:1	Turning Radius 7.4 ft.
Half Power Beam Width 55°	Maximum Surface Area 4.4 sq. ft.
Bandwidth 28 to 30 MHz	Wind Load at 80 MPH 118 lbs.
Impedance 50 Ohms	Weight 12.5 lbs.
Matching System Adjustable Gamma	

6 meter Stinger A 6-5—\$41.95

The model Stinger A6-5 is a highly directional 6-meter five element beam specifically designed for maximum forward gain with a "no compromise" front to back ratio. The elements are constructed of high tensile strength seamless aluminum tubing plus the exclusive Stinger square boom and bracket assemblies. For maximum power transfer and low V.S.W.R., a carefully designed gamma matching assembly capable of withstanding 2,000 watts P.E.P. is incorporated. Wide element spacing assures optimum DX performance and good operating efficiency across the entire 50 to 54 MHz 6-meter band. The square boom allows optional vertical mounting for accessing 6-meter repeaters.

SPECIFICATIONS — A 6-5	
ELECTRICAL—	MECHANICAL—
Forward Gain 11dB	Boom Length 13 ft.
Front-to-Back Ratio 25dB	Longest Element 10 ft.
V.S.W.R. (at resonance) 1.1:1	Turning Radius 8.3 ft.
Half Power Beam Width 52°	Maximum Surface Area 3.23 sq. ft.
Bandwidth 50 to 54 MHz	Wind Load at 80 MPH 40.2 lbs.
Impedance 50 ohms	Weight 11.5 lbs.
Matching System Adjustable Gamma	

Stinger A 6-3—\$27.30

The model Stinger A 6-3 is a 3-element high gain 6-meter beam similar to the A 6-5 but expressly designed for the casual 6-meter enthusiast. The A 6-3 also finds excellent application for portable use as it disassembles into a compact package. Due to the units light weight and minimal wind load, the antenna is ideal for double stacked and quad stacked arrays for the real 6-meter DXer. The A 6-3 is rated at 2,000 watts P.E.P. and incorporates a square boom and high tensile strength aluminum elements.

SPECIFICATIONS — A 6-3	
ELECTRICAL—	MECHANICAL—
Forward Gain 7.0dB	Boom Length 6.0 ft.
Front-to-Back Ratio 21.0dB	Longest Element 10 ft.
V.S.W.R. (at resonance) 1.1:1	Turning Radius 5.4 ft.
Half Power Beam Width 60°	Maximum Surface Area 1.75 sq. ft.
Bandwidth 50 to 54 MHz	Wind Load at 80 MPH 17.6 lbs.
Impedance 50 Ohms	Weight 7 lbs.
Matching System Adjustable Gamma	

6 and 2 meter Stinger A 62—\$68.60

The model Stinger A 62 is a truly remarkable combination 6 and 2-meter beam designed for optimum performance on both bands yet only requiring ONE transmission line. This is accomplished through the use of exclusive phasing elements to accomplish dual band operation with no sacrifice to either band — NO SWITCHING REQUIRED!

On 2-meters, the A 62 has 6 collinear elements — equivalent to three 1/2 λ 6-element yagis stacked side by side — thus giving outstanding performance. Maximum forward gain is assured on 6-meters through the use of four wide spaced elements. The heavy duty Stinger construction is used throughout so that the antenna will withstand 100 mph plus wind loads.

The A 62 is ideal for mounting on the same mast as your tri-band or other antenna thus easily opening up the world of 6 and 2-meter VHF communication.

SPECIFICATIONS — A 62	
ELECTRICAL—	MECHANICAL—
Forward Gain 6 meters 9.5dB	Boom Length 10.1 ft.
2 meters 12.0dB	Longest Element 10 ft.
Front-to-Back Ratio 6 meters 19dB	Turning Radius 6.7 ft.
2 meters 22dB	Maximum Surface Area 4.48 sq. ft.
V.S.W.R. (6 & 2 meters) 1.1:1	Wind Load at 80 MPH 43 lbs.
Half Power Beam Width 40° to 55°	Weight 13.8 lbs.
Bandwidth 6 meters 50 to 54 MHz	
2 meters 144 to 148 MHz	
Impedance 50 ohms	
Matching System Adjustable Gamma	

ENGINEERING FEATURES

Antenna design engineering is a specialty at FINCO. Top quality lab standard test equipment is used throughout the development and design of all antennas. The FINCO antenna test range has been carefully checked for erroneous reflection characteristics that could cause errors in antenna designs. Shown is the sophisticated stub and matching system that has been developed for the Stinger A62, 6 and 2-meter dual band beam. No traps or coils to burn out or detune, thus assuring you of the highest possible performance on both 6 and 2-meters.

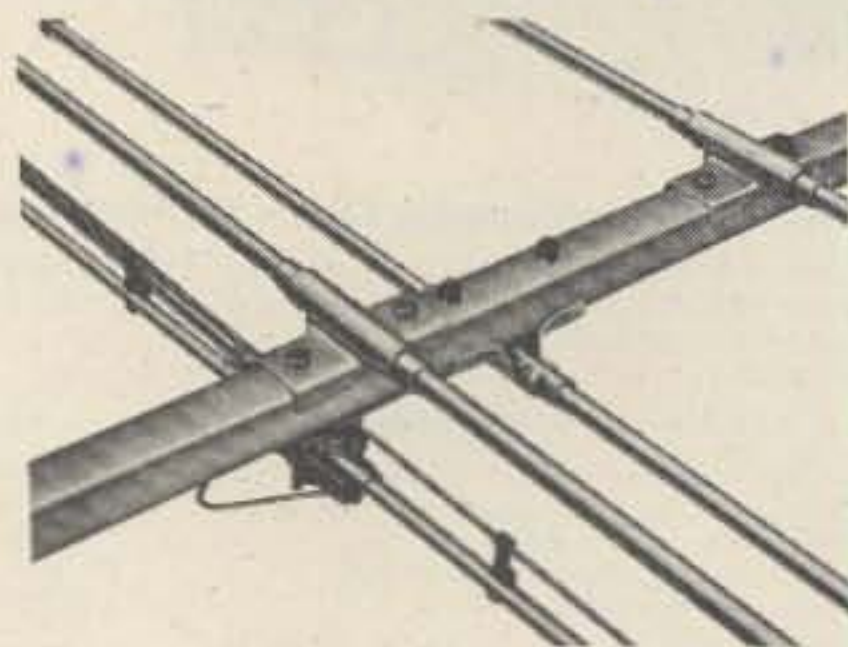

Exclusive Stinger square boom construction is used on all amateur antennas. The 1 3/4" square booms are of .064 wall high tensile strength aluminum which is many times stronger than its round counter part. Also, special bracket assemblies have been developed to allow instant element to boom alignment — plus they stay aligned in the highest wind and ice loads. All elements are of thick wall high tensile strength aircraft quality aluminum.



All Stinger Series Amateur Antennas incorporate heavy duty fully adjustable gamma matching systems to allow for maximum power transfer. The design provides for minimum V.S.W.R. and a wide bandwidth. A built in SO-238 type connector assembly is utilized plus the matching systems are power rated at 2,000 watts P.E.P.

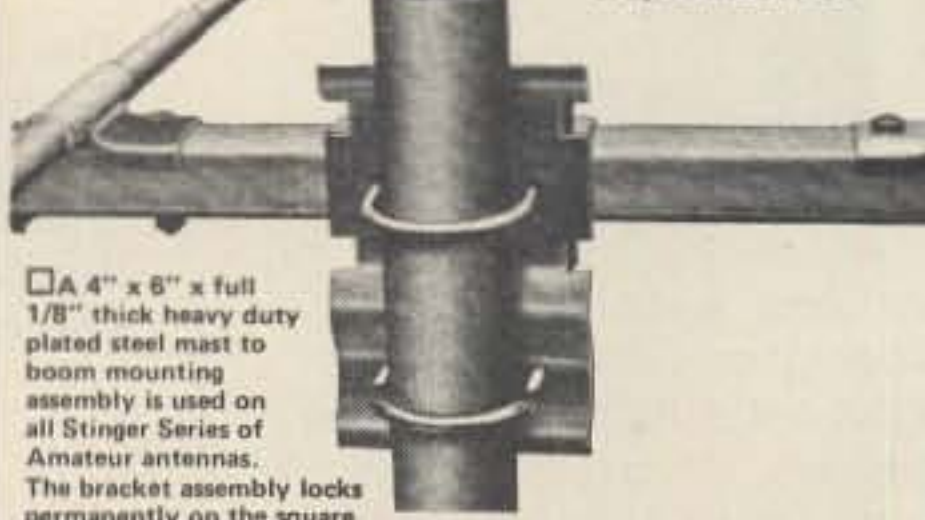

A 4" x 6" x full 1/8" thick heavy duty plated steel mast to boom mounting assembly is used on all Stinger Series of Amateur antennas. The bracket assembly locks permanently on the square boom and thus withstands high wind loads and torque without twisting or becoming misaligned. The assembly accepts mast diameters of up to 2" O.D. Provisions for mounting either in a vertical or horizontal plane is incorporated in several models.

ROHN NO. 25G TOWER & ACCESSORIES



- SB25G 3/4" SHORT BASE section for concrete — \$17.90
- SBh25G* 3/4" HINGED SHORT BASE section for concrete — \$29.15
- HGB25G* 3' HINGED GROUND BASE (use without concrete) — \$58.35
- SDB25G* SINGLE DRIVE-IN BASE — \$25.00
- BPH25G* HINGED BASE PLATE for concrete — \$50.00
- FR25G* FLAT ROOF MOUNT — \$34.10
- PR25G* PEAK ROOF MOUNT — 26.25
- *Note: Towers mounted on these bases must be bracketed or guyed.
- RP25G ROTOR POST — \$4.40
- AS25G ACCESSORY SHELF (for mounting Ham-M rotor) — \$8.35
- GA25G GUY ASSEMBLY with torque bars — \$15.85
- GB25G GUY BRACKET ONLY without torque bars — \$10.00
- Adjustable House Brackets
- HB25AG 0-15" — \$14.15
- HB25BG 0-24" — \$17.50
- HB25CG 0-36" — \$20.85
- Eave Brackets
- EB2515G 15" — \$8.35
- EB2524G 24" — \$9.15
- EB2525G UNIVERSAL EAVE BRACKET — \$10.00
- TB-2 THRUST BEARING — \$41.65
- TB-3 HEAVY DUTY THRUST BEARING — \$58.35
- WP25G WORK PLATFORM — \$24.60
- Side Arm
- SA25G-224 — \$45.70
- SA25G-524 — \$45.70
- 24" SIDE ARM
- SAB25G-2 — \$28.90
- SIDE ARM BRACKET — \$28.90
- SA25G-67 67" SIDE ARM — \$45.70
- UHF25G SIDE ARM MOUNT (for UHF & FM antenna) — \$6.65
- BPC25G* CONCRETE BASE PLATE — \$29.60
- 25G — (10' straight section of tower) — \$49.50
- 25AG-3 — (top section 2 1/4" tube type; 2" mast fits snugly inside) — \$55.00
- 25AG-4 — (top section, upper end terminates in 11" flat plate for mounting TB-2 or TB-3 thrust bearing) — \$55.00
- 3/8" TBE&J — (turnbuckles 3/8" x 6" 6,000 lbs ultimate strength) — \$8.45 each.
- 3/16" CCM — cable clamps — 45¢ ea.
- 1/4" TH — thimbles — 30¢ ea.
- 1/2" TBE&J — (1/2" x 12" turnbuckles; 11,000 lbs. ultimate strength) — \$14.35 each.
- 3/16" EHS — Guy wire:
 - 250' — \$27.50
 - 500' — \$55.00
 - 1000' — \$110.00
- GAC-25-3 — concrete guy anchor — \$16.65 each

TELEX

PROFESSIONAL HEADPHONES & HEADSETS

BOOM MIC HEADSETS

For the ultimate in communications convenience and efficiency select a boom mic headset. Long-time favorites of professional communications, boom mic headsets allow more personal mobility while always keeping the mic properly positioned for fast, precise voice transmissions. Boom microphones are completely adjustable to allow perfect positioning. And, boom mic headsets leave both hands free to perform other tasks.

All models are supplied with "close talking" microphones to limit ambient noise pick-up and provide superior intelligibility. Each model has a convenient, inline push-to-talk switch, which can be wired for either push-to-talk relay control or mic circuit interrupt for voice operated transmitters. The switch may be used as a momentary push button or it can be locked in the down position. All models have tough, flexible, 8-foot cords which are stripped and tinned, unterminated. Communication grey with black trim.

MODEL	C-610	SWL-610	C-1210	C-1320	CM-610	CM-1210	CM-1320	CM-1320S
Headphone Sensitivity Ref. 0002 Dynes/cm ² @ 1mW input, 1kHz	103dB SPL ±5dB	103dB SPL ±5dB	103dB SPL ±3dB	105dB SPL ±5dB	103dB SPL ±5dB	103dB SPL ±3dB	105dB SPL ±5dB	105dB SPL ±5dB
Headphone Impedance	32 20 ohms	2000 ohms	32 20 ohms	32 20 ohms	32 20 ohms	32 20 ohms	32 20 ohms	32 20 ohms
Microphone Frequency Response					50 8000 Hz	50 8000 Hz	50 8000 Hz	50 8000 Hz
Microphone Impedance					High	High	High	High
Microphone Sensitivity Below 1 volt/microbar at 1kHz					-51dB ±5dB	-51dB ±5dB	-51dB ±5dB	-51dB ±5dB
Price:	\$9.95	\$11.65	\$28.30	\$37.90	\$42.80	\$56.90	\$68.30	\$54.50



the indispensable
BIRD 43
THRULINE
WATTMETER



Power Range	Frequency Bands (MHz)				
	2-30	25-60	100-250	200-500	400-1000
5 watts	—	5A	5C	5D	5E
10 watts	—	10A	10C	10D	10E
25 watts	—	25A	25C	25D	25E
50 watts	50H	50A	50C	50D	50E
100 watts	100H	100A	100C	100D	100E
250 watts	250H	250A	250C	250D	250E
500 watts	500H	500A	500C	500D	500E
1000 watts	1000H	1000A	1000C	1000D	1000E
2500 watts	2500H	—	—	—	—
5000 watts	5000H	—	—	—	—

MODEL 43
Elements (Table 1) 2-30 MHz \$120
Elements (Table 1) 25-1000 MHz 42
Carrying case for Model 43 & 6 elements 36
Carrying case for 12 elements 26
16

READ RF WATTS DIRECTLY! (Specify Type N or SO239 connectors) 0.45 – 2300 MHz, 1-10,000 Watts ±5%, low insertion VSWR – 1.05. Unequaled economy and flexibility. Buy only the element(s) covering your present frequency and power needs, add extra ranges later if your requirements expand.

Now you can receive the weak signals with the Ameco PT-2 pre-amplifier!

Model PT-2 is a continuous tuning 6-160 meter Pre-Amp specifically designed for use with a transceiver. The PT-2 combines the features of the well-known PT with new sophisticated control circuitry that permits it to be added to virtually any transceiver with No modification. No serious ham can be without one. Price: \$69.95.



- Improves sensitivity and signal-to-noise ratio.
- Boosts signals up to 26 db.
- For AM or SSB.
- Bypasses itself automatically when the transceiver is transmitting.
- FET amplifier gives superior cross modulation protection.
- Simple to install.
- Advanced solid-state circuitry.
- Improves immunity to transceiver front-end overload by use of its built-in attenuator.
- Provides master power control for station equipment.

ALL BAND PREAMPLIFIERS



- 6 THRU 160 METERS
- TWO MODELS AVAILABLE
- RECOMMENDED FOR RECEIVER USE ONLY
- INCLUDES POWER SUPPLY

MODEL PLF employs a dual gate FET providing noise figures of 1.5 to 3.4 db., depending upon the band. The weak signal performance of most receivers as well as image and spurious rejection are greatly improved. Overall gain is in excess of 20 db. Panel contains switching that transfers the antenna directly to the receiver or to the Preamp. Model PLF 117V AC, 60 Hz. Wired & Tested \$44.00
Model PCLP Uses nuvistor \$44.00

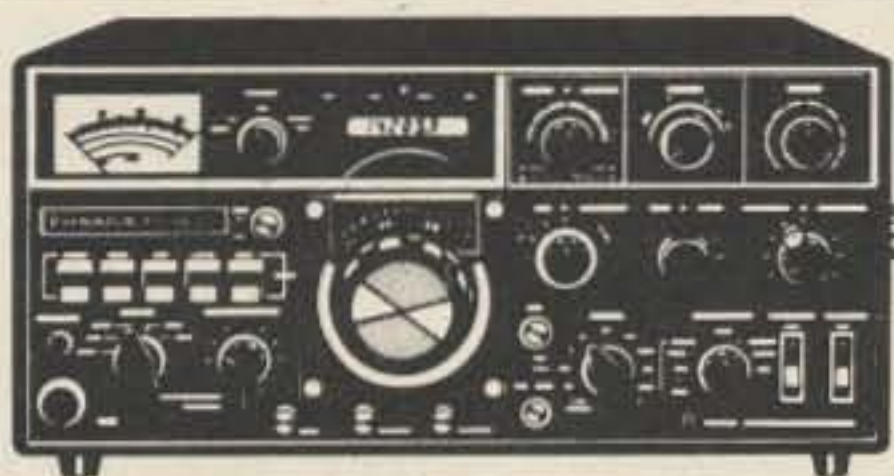

The NEW KENWOOD TS-820S transceiver

TS-820S now has factory installed digital readout • 160 thru 10 meter coverage • 200 watts PEP • Integral IF shift • Noise blanker • VOX & PLL circuitry • DRS dial • IF out, RTTY, XVTR capabilities • Phone patch IN and OUT terminals • RF speech processor. \$1098.00.

KENWOOD PRICE LIST

Model	Description	Price
HF EQUIPMENT 820 PACESETTER SERIES		
TS-820S	TS-820 Deluxe Transceiver with Digital Display (DG-1) installed. 160-10 meters, IF shift	1,098.00
TS-820	Deluxe HF Transceiver 160-10 meters, RF speech processor, IF shift, RF negative feedback	919.00
DG-1	Digital Frequency Display for TS-820	179.00
VFO-820	Deluxe Remote VFO for 820 Series. Includes its own RIT circuit; frequency reads out on transceiver's digital display	149.00
SP-820	Deluxe External Speaker. Includes audio filters for added versatility on receive; 2 audio inputs	49.00
CW-820	500 Hz CW Filter for TS-820	49.00
520 SERIES		
TS-520S	160-10 HF Transceiver. Digital Display (option) speech processor, RF attenuator, super noise blanker	739.00
DG-5	Digital Display for TS-520S. Doubles as a frequency counter, too! Adaptable to TS-520 and 599 series	189.00
VFO-520S	Remote VFO for TS-520S. Built in RIT circuit provides super operating flexibility	135.00
SP-520	Matching External Speaker for TS-520S. 8 Ohms. Frequency response 100-5000 Hz	30.00
CW-520	500 Hz CW Filter for TS-520	49.00
599D Series		
R-599D	160-10 Solid State Amateur Receiver. 2 and 6 meters (optional). SSB, CW, AM, FM Transceives/splits with T-599D	549.00
T-599D	80-10 Meter Amateur Transmitter. Solid State (except driver and finals). Semi break-in, sidetone, built in power supply	549.00
S-599	External Speaker for 599 Series. 8 Ohms. Frequency response: 100-5000 Hz	25.00
CC-29A	2 Meter Converter for R-599D	35.00
CC-69A	6 Meter Converter for R-599D	35.00
FM-599A	FM Filter for R-599D	45.00
HF MISCELLANEOUS		
R-300	All Band Communications Receiver. 170 kHz to 30 MHz – 6 bands, AC/DC/Batteries; built in speaker	249.00

AT-200	Antenna Tuner. Includes an antenna coupler, SWR meter, power meter, antenna switch, 200W Deluxe 160-10 Linear Amplifier. 2 KW PEP	149.00
TL-922	2 x 3-500Z tubes, rugged built in power supply	TBA
DK-520	Digital Adaptor Kit (TS-520)	
DS-1A	DC-DC Converter for TS-820/TS-520S Series	65.00
VHF/UHF EQUIPMENT		
TS-600	6 Meter All Mode Transceiver. SSB, CW, F.M, AM, 10 watts. Built in AC/DC power supplies	699.00
TS-700S	2 Meter All Mode Transceiver. SSB, CW, F.M, AM, semi break-in, CW sidetone. Digital readout, receiver pre-amp	729.00
VFO-700S	External VFO for TS-700S. Frequency displays on TS-700S. Special "frequency check" feature	129.00
SP-70	8 Ohms External Speaker Matches TS-600 and TS-700S. Excellent frequency response	30.00
TR-2200A	2 Meter Portable Transceiver. FM, 12 channels (6 supplied); NI-CAD batteries, charger are included	229.00
TR-7400A	2 Meter Synthesized Transceiver. 25 Watts, 800 channels, 4 MHz, continuous tone-coded squelch (option)	399.00
TR-7500	2 Meter FM Transceiver; digital readout, one knob channel selector system, 10 watts output	299.00
TR-8300	70 CM FM Transceiver. 23 channels (3 supplied). 10 watts, broadband design	299.00
TV-502S	2 Meter Transverter, 8 watts; SSB and CW easily hooks up to 520/820 Series	TBA
TV-506	6 Meter Transverter, 10 watts; SSB and CW, easily hooks up to 520/820 Series	249.00
OTHER ACCESSORIES		
HS-4	KENWOOD Headphone set (8 Ohms)	16.00
MB-1A	Mobile bracket for TR-2200 A	13.00
MC-50	Dynamic Microphone for all KENWOOD stations (Hi/Lo Z)	39.50
PS-5	AC Power Supply; 12 VDC @ 3.5 Amps, matches TR-8300; built-in digital clock with timer	79.00
PS-6	AC Power Supply; 12 VDC @ 3.5 Amps; matches TR-7500; 8 Ohm speaker included	79.00
PS-8	AC Power Supply; 12 VDC @ 8 Amps; matches TR-7400A; well regulated; current limiting	129.00
VOX-3	VOX Unit for TS-700A and TS-600	25.00

TUFTS RADIO CATALOG



THE TEMPO 2020

- Phase lock-loop (PLL) oscillator circuit minimizes unwanted spurious responses.
- Hybrid Digital Frequency Presentation.
- Advanced Solid-state design...only 3 tubes.
- Built-in AC and 12 VDC power supplies.
- CW filter standard equipment...not an accessory.
- Rugged 614B-B final amplifier tubes.
- Cooling fan standard equipment...not an accessory.

- High performance noise-blanker is standard equipment...not an accessory.
- Built-in VOX and semi-break in CW keying.
- Crystal Calibrator and WWV receiving capability.
- Microphone provided.
- Dual RIT control allows both broad and narrow tuning.
- All band 80 through 10 meter coverage.
- Multi-mode USB, LSB, CW and AM operation.
- Extraordinary receiver sensitivity (.3u S/N 10 db) and oscillator stability (100 Hz 30 min. after warm-up)
- Fixed channel crystal control on two available positions.
- RF Attenuator.
- Adjustable ALC action.
- Phone patch in and out jacks.
- Separate PTT jack for foot switch.
- Built-in speaker.
- The TEMPO 2020...\$759.00.
- Model 8120 external speaker...\$29.95. Model 8010 remote VFO...\$139.00.



TEMPO ONE — HF Transceiver 80-10M USB, CW & AM — \$399.00

AC/ONE — Power supply for TEMPO ONE — \$99.00
 VF/ONE — External VFO for TEMPO ONE — \$109.00
 TEMPO SSB/ONE
 SSB adapter for the Tempo VHF/One
 *Selectable upper or lower sideband * Plugs directly into the VHF/One with no modification * Noise blanker built-in. * RIT and VXO for full frequency coverage * \$225.00



KLM RF Power Amplifiers

- A simple, add-on-immediately RF amplifier.
- Merely coax-connect amplifier between antenna and transceiver.
- No tuning! Efficient strip-line broad band design.
- Automatic! Internal RF-sensor-controlled relay connects amplifier whenever transmitter is switched on.

Highest quality, American-made "brand" transistors are fully protected for VSWR, short and overload, reverse polarity. Highly effective heat sinking assures long life, reliable performance. Black anodized containers...exclusive KLM extrusions, have seven, full length fins on both sides!

- Manual, remote-position switching is optional.
- Models for 6,2,1 1/4 meters, 70CM amateur bands plus MARS coverage.
- Two types: **Class C** for FM/CW. **Linear** for SSB/AM/FM/CW.
- Negligible insertion loss on receive.
- American made by KLM.

New Model	List Price
PA 2-25B	\$ 69.95
PA 4-70BL	189.95
PA 15-40BL	109.95
PA 15-80BL	179.95
PA 15-160BL	259.95
PA 45-140BL	219.95

PA 4-70BC	189.95
PA 15-60BC	164.95
PA 45-120BC	209.95
PA 4-40C	169.95
PA 15-35CL	154.95
PA 15-110CL	279.95

ATLAS 350-XL

- ALL SOLID STATE
- 350 WATTS P.E.P. OR CW INPUT
- SSB TRANSCEIVER
- 10 THROUGH 160 METER COVERAGE



Illustrated with optional AC supply, Auxiliary VFO, and Digital Dial.

The all new Atlas 350-XL has all the exciting new features you want, plus superior performance and selectivity control never before possible. Price: \$995.00

- 10-160 Meters
- Full coverage of all six amateur bands in 500 kHz segments. Primary frequency control provides highly stable operation. Also included is provision for adding up to 10 additional 500 kHz segments between 2 to 22 MHz by plugging in auxiliary crystals.
- 350 WATTS P.E.P. and CW input. Enough power to work the world bare-foot!

IDEAL FOR DESKTOP OR MOBILE OPERATION
 Measuring just 5 in. high x 12 in. wide x 12 1/2 in. deep, and weighing only 13 pounds, the Atlas 350-XL offers more features, performance and value than any other transceiver, regardless of size, on the market today!

- 350-PS matching AC supply — \$225.00
- DD-6XL plug-in digital dial readout — \$229.00
- 305 plug-in auxiliary VFO — \$155.00
- 311 plug-in crystal oscillator — \$135.00
- DMK-XL plug-in mobile mounting kit — \$65.00

DELUXE RECEIVER PREAMPLIFIERS

Ideal for Receivers — Converters
 High Gain — Low Noise

FEATURES:

- Small size
- Increases sensitivity of most receivers
- Gold-plated copper shielding
- Single or double stage models
- Diode protected, dual-gated FETs

SPECIFICATIONS:
 Power: 6 VDC to 18 VDC (12 VDC recommended)
 Size: a. Single stage: 1" x 1 1/4" x 1/2"
 b. Double stage: 2" x 1 1/4" x 1/2"
 MOSFET: FT 0601, 500 MHz, dual-gate diode protected MOSFET

When ordering be sure to specify:
 1. frequency of operation
 2. single or double band stage
 3. kit or assembled version

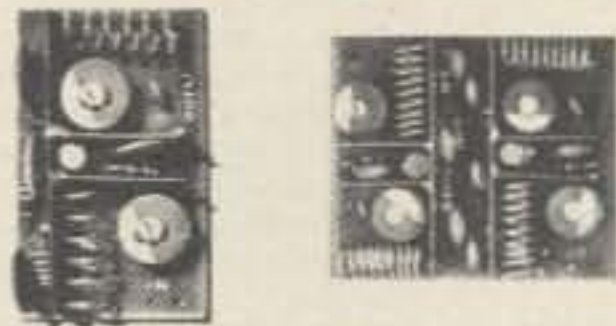

FREQ. (MHz)	USE	STAGES	DELUXE PREAMPLIFIER GAIN dB	NF dB	WIRED
50 to 54	6 METER	SINGLE	25	2	\$15.50
		DOUBLE	48	2	\$28.50
108 to 144	VHF AIRCRAFT	SINGLE	20	2.5	\$14.50
		DOUBLE	40	2.5	\$26.50
135 to 139	SATELLITE	SINGLE	20	2.5	\$14.50
		DOUBLE	40	2.5	\$26.50
144 to 148	2 METER	SINGLE	20	2.5	\$14.50
		DOUBLE	40	2.5	\$26.50
146 to 174	HIGH BAND	SINGLE	20	2.5	\$14.50
		DOUBLE	40	2.5	\$26.50
220 to 225	1 1/4 METER	SINGLE	18	2.5	\$14.50
		DOUBLE	35	2.5	\$26.50
225 to 300	UHF AIRCRAFT	SINGLE	15	2.5	\$14.50
		DOUBLE	30	2.5	\$26.50

DATA SIGNAL, INC.

TEMPO VHF/ONE PLUS
 The Tempo/ONE PLUS offers full 25 watt output or a selectable 3 to 15 watt low power output, remote tuning on the microphone, sideband operation with the SSB/ONE adapter, MARS operation capability, 5 kHz numerical LED, and all at a lower price than its time tested predecessor... the Tempo VHF ONE.



The Tempo VHF/One Plus is a VHF/FM transceiver for dependable communication on the 2 meter amateur band • Full 2 meter coverage, 144 to 148 MHz for both transmit and receive •

Full phase lock synthesized (PLL)
 • Automatic repeater split — selectable up or down • Two built-in programmable channels • All solid state • 800 selectable receive frequencies with simplex and +600 kHz transmit frequencies for each receive channel. Price: \$399.00

THE BIG SIGNAL



UNADILLA "W2AU" BALUN
 \$14.95
 Features: 5/8" HARDWARE, HANG-UP HOOK, FULLY ENCLOSED, BUILT-IN LIGHTNING ARRESTER, SILVER PLATED SO-228.

THE OLD RELIABLE



REYCO "W2VS" ANTENNA COILS
 \$21.95 pair
 Features: ALUM./POLY CAPACITOR, WEATHERIZED COIL, KW-40, MACHINING-GROOVED POLY COIL FORM.

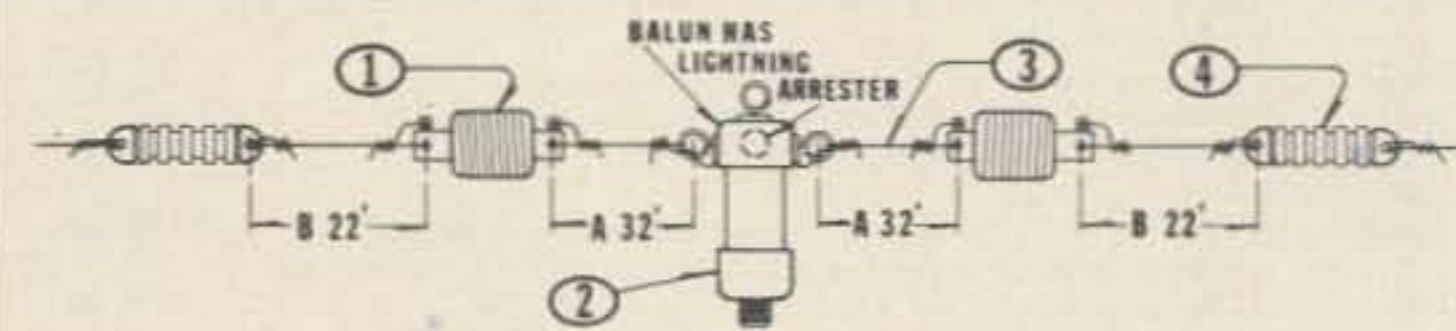

W2AU/W2VS • 5 BAND 10/80 METER ANTENNA KIT by UNADILLA/REYCO

GIVES YOU OPERATION ON 10 • 15 • 20 • 40 • 80 METERS
 (DESIGNED CLOSELY TO 5 BAND TRAP DIPOLE PARAMETERS PER A.R.R.L. HANDBOOK, HF ANTENNA CHAPTER 21 'A MULTIBAND TRAP ANTENNA')

& ARMED FORCES FACILITIES — AROUND THE WORLD — FOR OVER 10 YEARS!
COMPLETE KIT (Nothing else needed)

- 2 ea. W2VS REYCO KW-40 TRAPS
- 1 ea. W2AU 'BIG SIGNAL' BALUN 1:1
- 120 Ft. RUGGED #14-7 Strand Copper Wire
- 2 ea. W2AU SHATTERPROOF END-sulators
- INSTRUCTIONS
- \$48.25

Every Component of This Kit is a Highly Crafted, old Line UNADILLA/REYCO Product Time Tested by HAMS, COMMERCIAL





DIP/IC INSERTION TOOL with PIN STRAIGHTENER



14-16 Pin Dip IC Inserter INS-1416 \$3.49

DIP/IC EXTRACTOR TOOL

The EX-1 Extractor is ideally suited for hobbyist or lab engineer. Featuring one piece spring steel construction, it will extract all LSI, MSI and SSI devices of from 8 to 24 pins.

Extractor Tool EX-1 \$1.49

P.C. BOARD

The 4 x 4.5 x 1.16 inch board is made of glass coated EPOXY Laminate and features solder coated 1 oz. copper pads. The board has provision for a 22/44 two sided edge connector, with contacts on standard .156 spacing. Edge contacts are non-dedicated for maximum flexibility.

The board contains a matrix of .040 in. diameter holes on .100 inch centers. The component side contains 76 two-hole pads that can accommodate any DIP size from 6-40 pins, as well as discrete components. Typical density is 18 of 14-Pin or 16-Pin DIP's. Components may be soldered directly to the board or intermediate sockets may be used for soldering or wire-wrapping.

Two independent bus systems are provided for voltage and ground on both sides of the board. In addition, the component side contains 14 individual busses running the full length of the board for complete wiring flexibility. These busses enable access from edge contacts to distant components. These busses can also serve to augment the voltage or ground busses, and may be cut to length for particular applications.

Hobby Board H-PCB-1 \$4.99

PC CARD GUIDES

TR-1 consists of 2 guides precision molded with unique spring finger action that dampens shock and vibration, yet permits smooth insertion or extraction. Guides accommodate any card thickness from .040-100 inches.

Card Guides TR-1 \$1.89

PC CARD GUIDES & BRACKETS

TRS-2 kit includes 2 TR-1 guides plus 2 mounting brackets. Support brackets feature unique stabilizing post that permits secure mounting with only 1 screw.

Guides & Brackets TRS-2 \$3.79

PC EDGE CONNECTOR

44 Pin, dual read out, .156" (3.96 mm) Contact Spacing, .025" (0.63 mm) square wire-wrapping pins.

P.C. Edge Connector CON-1 \$3.49

P.C.B. TERMINAL STRIPS

The TS strips provide positive screw activated clamping action, accommodate wire sizes 14-30 AWG (1.8-0.25mm). Pins are solder plated copper, .042 inch (1.1mm) diameter, on .200 inch (5mm) centers.

4-Pole TS-4 \$1.39
8-Pole TS-8 \$1.89
12-Pole TS-12 \$2.59

WIRE-WRAPPING KIT

Contains: Hobby Wrap Tool WSU-30 M, Wire Dispenser WD-30-B, (2) 14 DIP's, (2) 16 DIP's, Hobby Board H-PCB-1, DIP/IC Insertion Tool INS-1416 and DIP/IC Extractor Tool EX-1

Wire-Wrapping Kit WK-4B (Blue) \$25.99



HOBBY WRAP TOOL

Wire-wrapping, stripping, unwrapping tool for AWG 30 on .025 (0.63mm) Square Post.

Regular Wrap WSU-30 \$6.95
Modified Wrap WSU-30M \$7.95

NEW HOBBY WRAP Model BW 630



Battery wire wrapping complete with bit and sleeve

WIRE-WRAPPING TOOL

For .025" (0.63mm) sq. post "MODIFIED" wrap, positive indexing, anti-overwrapping device.

For AWG 30 BW-630 \$34.95*
For AWG 26-28 BW-2628 \$39.95*

Bit for AWG 30 BT-30 \$3.95
Bit for AWG 26-28 BT-2628 \$7.95

*USE "C" SIZE NI-CAD BATTERIES (NOT INCLUDED)

ROLLS OF WIRE

Wire for wire-wrapping AWG-30 (0.25mm) KYNAR® wire, 50 ft. roll, silver plated, solid conductor, easy stripping.

30 AWG Blue Wire 50ft. Roll R-30B-0050 \$1.98
30 AWG Yellow Wire 50ft. Roll R-30Y-0050 \$1.98
30 AWG White Wire 50ft. Roll R-30W-0050 \$1.98
30 AWG Red Wire 50ft. Roll R-30R-0050 \$1.98

WIRE DISPENSER

With 50 ft. Roll of AWG 30 KYNAR® wire-wrapping wire.
Cuts the wire to length.
Strips 1" of insulation.
Refillable (For refills, see above)

Blue Wire WD-30-B \$3.95
Yellow Wire WD-30-Y \$3.95
White Wire WD-30-W \$3.95
Red Wire WD-30-R \$3.95

PRE CUT PRE STRIPPED WIRE

Wire for wire-wrapping AWG-30 (0.25mm) KYNAR® wire, 50 wires per package stripped 1" both ends.



30 AWG Blue Wire 1' Long	30 R 50-010	\$.99
30 AWG Yellow Wire 1' Long	30 Y 50-010	\$.99
30 AWG White Wire 1' Long	30 W 50-010	\$.99
30 AWG Red Wire 1' Long	30 R 50-010	\$.99
30 AWG Blue Wire 2' Long	30 B 50-020	\$ 1.07
30 AWG Yellow Wire 2' Long	30 Y 50-020	\$ 1.07
30 AWG White Wire 2' Long	30 W 50-020	\$ 1.07
30 AWG Red Wire 2' Long	30 R 50-020	\$ 1.07
30 AWG Blue Wire 3' Long	30 B 50-030	\$ 1.16
30 AWG Yellow Wire 3' Long	30 Y 50-030	\$ 1.16
30 AWG White Wire 3' Long	30 W 50-030	\$ 1.16
30 AWG Red Wire 3' Long	30 R 50-030	\$ 1.16
30 AWG Blue Wire 4' Long	30 B 50-040	\$ 1.23
30 AWG Yellow Wire 4' Long	30 Y 50-040	\$ 1.23
30 AWG White Wire 4' Long	30 W 50-040	\$ 1.23
30 AWG Red Wire 4' Long	30 R 50-040	\$ 1.23
30 AWG Blue Wire 5' Long	30 B 50-050	\$ 1.30
30 AWG Yellow Wire 5' Long	30 Y 50-050	\$ 1.30
30 AWG White Wire 5' Long	30 W 50-050	\$ 1.30
30 AWG Red Wire 5' Long	30 R 50-050	\$ 1.30
30 AWG Blue Wire 6' Long	30 B 50-060	\$ 1.38
30 AWG Yellow Wire 6' Long	30 Y 50-060	\$ 1.38
30 AWG White Wire 6' Long	30 W 50-060	\$ 1.38
30 AWG Red Wire 6' Long	30 R 50-060	\$ 1.38

WIRE-WRAPPING KIT

Contains: Hobby Wrap Tool WSU-30, Roll of wire R-30B-0050, (2) 14 DIP's, (2) 16 DIP's and Hobby Board H-PCB-1.

Wire-Wrapping Kit WK-3B (Blue) \$16.95

DIP SOCKET

Dual-in-line package, 3 level wire-wrapping, phosphor bronze contact, gold plated pins .025 (0.63mm) sq., .100 (2.54mm) center spacing.

14 Pin Dip Socket 14 Dip \$0.79
16 Pin Dip Socket 16 Dip \$0.89

RIBBON CABLE ASSEMBLY SINGLE ENDED

With 14 Pin Dip Plug 24" Long (609mm) SE14-24 \$3.55
With 16 Pin Dip Plug 24" Long (609mm) SE16-24 \$3.75

DIP PLUG WITH COVER FOR USE WITH RIBBON CABLE

14 Pin Plug & Cover 14-PLG \$1.45
16 Pin Plug & Cover 16-PLG \$1.59

QUANTITY: 2 PLUGS, 2 COVERS

RIBBON CABLE ASSEMBLY DOUBLE ENDED

With 14 Pin Dip Plug -2" Long DE 14-2 \$3.75
With 14 Pin Dip Plug -4" Long DE 14-4 \$3.85
With 14 Pin Dip Plug -8" Long DE 14-8 \$3.95
With 16 Pin Dip Plug -2" Long DE 16-2 \$4.15
With 16 Pin Dip Plug -4" Long DE 16-4 \$4.25
With 16 Pin Dip Plug -8" Long DE 16-8 \$4.35

TERMINALS

.025 (0.63mm) Square Post
3 Level Wire-Wrapping
Gold Plated

Slotted Terminal WWT-1 \$2.98
Single Sided Terminal WWT-2 \$2.98
IC Socket Terminal WWT-3 \$3.98
Double Sided Terminal WWT-4 \$1.98

25 PER PACKAGE

TERMINAL INSERTING TOOL

For inserting WWT-1, WWT-2, WWT-3, and WWT-4 Terminals into .040 (1.01mm) Dia. Holes.

INS-1 \$2.49

WIRE CUT AND STRIP TOOL

Easy to operate... place wires (up to 4) in stripping slot with ends extending beyond cutter blades... press tool and pull... wire is cut and stripped to proper "wire-wrapping" length. The hardened steel cutting blades and sturdy construction of the tool insure long life.

Strip length easily adjustable for your applications.

DESCRIPTION	MODEL NUMBER	ADJUSTABLE "SHINER" LENGTH OF STRIPPED WIRE INCHES TO INCHES	Price
24 ga. Wire Cut and Strip Tool	ST-100-24	1 1/4" — 1 3/4"	\$ 8.75
26 ga. Wire Cut and Strip Tool	ST-100-26	1 1/4" — 1 3/4"	\$ 8.75
28 ga. Wire Cut and Strip Tool	ST-100-28-875	7/8" — 1 1/4"	\$ 8.75
28 ga. Wire Cut and Strip Tool	ST-100-28	7/8" — 1 1/4"	\$11.50
30 ga. Wire Cut and Strip Tool	ST-100-30	7/8" — 1 1/4"	\$11.50

THE ABOVE LIST OF CUT AND STRIP TOOLS ARE NOT APPLICABLE FOR WIRE OR TYPON INSULATION

WIRE-WRAPPING KITS

Contains: Hobby Wrap Tool WSU-30, (50 ft.) Roll of wire Prestripped wire 1" to 4" lengths (50 wires per package) stripped 1" both ends.

Wire Wrapping Kit (Blue) WK-2-B \$12.95
Wire Wrapping Kit (Yellow) WK-2-Y \$12.95
Wire Wrapping Kit (White) WK-2-W \$12.95
Wire Wrapping Kit (Red) WK-2-R \$12.95

HI-Q BALUN

- For dipoles, yagis, inverted vees, doublets & quads
- For full legal power & more
- Puts power in antenna
- Broadbanded 3-40Mhz.
- Small, light, weather-proof
- 1:1 Impedance ratio
- Replaces center insulator
- Helps eliminate TVI
- Fully Guaranteed

\$9.95 PPD U.S.A.

Van Gorden Engineering

DUST COVERS

• Our covers are custom designed to protect all popular equipment models. • They are made of rugged high quality vinyl and are machine stitched for extra strength. • They add that professional look to your station. • Most covers are priced at \$3.95.

From Texas... "I would like to say how surprised I was as to how much quality you put into your covers" ... Mr. Mark Canada
From Calif. ... "Not only did they fit exactly as specified, but the quality of workmanship is most satisfactory" ... Mr. Dwight Baum
From Pa. ... "That special order cover is excellent! Your the greatest" ... Mr. Rod Phillips

COVER CRAFT

Model 200 V
Model 210
Model 220

CES Touch Tone Pads

- Model 200 V - acoustic coupling, \$49.95
- Model 210 - for mounting on walkies or hand-helds, \$39.95
- Model 220 - CES can now offer you a TOUCH TONE back for Standard Communications hand-held radios. This is the complete back assembly with the TOUCH TONE encoder mounted and ready to plug into the private channel connector. Also included is a LED tone generator indicator and an external tone deviation adjustment, \$59.95

TUFTS RADIO CATALOG

ATB-34



4 ELEMENT BEAM

10-15-20 METERS

Cushcraft engineers have incorporated more than 30 years of design experience into the best 3 band HF beam available today. ATB-34 has superb performance with three active elements on each band, the convenience of easy assembly and modest dimensions. Value through heavy duty all aluminum construction and a price complete with 1-1 balun.

SPECIFICATIONS		
FORWARD GAIN -	EXCELLENT	LONGEST ELEMENT - 32.8'
F/B RATIO -	30 dB	TURNING RADIUS - 18.9'
VSWR -	1.5-1	WIND SFC - 5.4 Sq.Ft
POWER HANDLING -	2000 WATTS PEP	WEIGHT - 42 Lbs
BOOM LENGTH/DIA. -	18' x 2 1/8"	WIND SURVIVAL - 90 MPH

UPS SHIPPABLE \$239.95 COMPLETE

ENJOY A NEW WORLD OF DX COMMUNICATIONS WITH ATB-34

VHF - UHF DX-ARRAYS 144, 220, 430 mhz

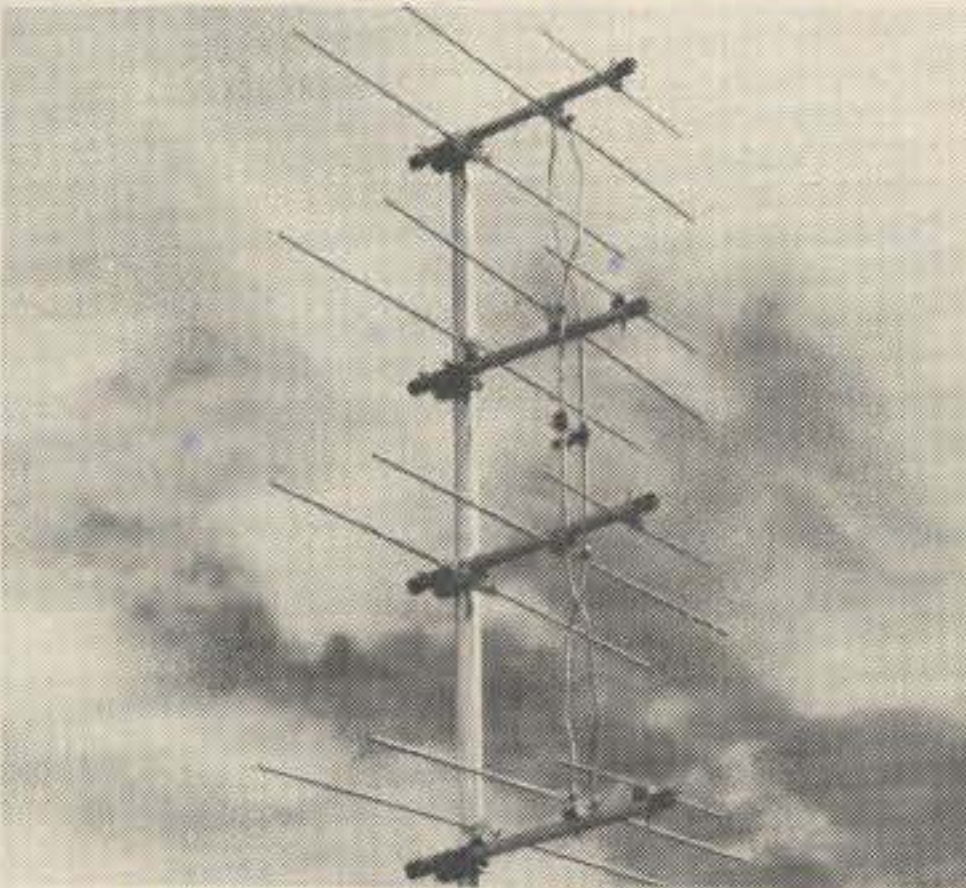

20 ELEMENT DX - ARRAYS

20 ELEMENT SPECIFICATIONS			
Forward Gain	14.2 db	Impedance	52 ohms
F/B Ratio	20 db	VSWR at Frequency	1 - 1
Fwd. Lobe at 1/2 Pwr. Point		Bandwidth W/VSWR	
horizontal	48°	Less than 2 - 1	4 mhz
vertical	26°	Power Handling	2 KW PEP
		144 Mhz	220 Mhz
Height	118"		432 Mhz
Width x Depth	75" x 30"	78"	42"
Turning Radius	48"	53" x 20"	29" x 11"
Maximum Mast Dia.	1 1/2"	32"	18"
Net Weight Lbs.	8	1 1/2"	1 1/2"
		7	6

Vertical support mast not supplied			
2 METER DX-120	1 1/4 METER	DX-220	3/4 METER DX-420
Am. Net \$42.95		\$37.95	\$32.95

40 ELEMENT DX - ARRAYS

40 ELEMENT SPECIFICATIONS			
Forward Gain	17 db	Impedance	52 ohms
F/B Ratio	20 db	VSWR at Frequency	1 - 1
Fwd. Lobe at 1/2 Pwr. Point		Bandwidth W/VSWR	
horizontal	32°	Less than 2 - 1	4 mhz
vertical	26°	Power Handling	2 KW PEP
		144 Mhz	220 Mhz
Height	118"		432 Mhz
Width x Depth	192" x 30"	78"	42"
Turning Radius	101"	132" x 20"	72" x 11"
Maximum Mast Dia.	2 1/2"	65"	38"
Net Weight Lbs.	32	2 1/2"	2 1/2"
Wind Rating	90 mph	90 mph	90 mph
Stack Kit No.	DXK-140	DXK-240	DXK-440
Amateur Net	\$59.95	\$54.95	\$39.95

80 ELEMENT DX - ARRAYS

80 ELEMENT SPECIFICATIONS			
Forward Gain	20 db	Impedance	52 ohms
F/B Ratio	20 db	VSWR at Frequency	1 - 1
Fwd. Lobe at 1/2 Pwr. Point		Bandwidth W/VSWR	
horizontal	32°	Less than 2 - 1	4 mhz
vertical	12°	Power Handling	2 KW PEP
		144 Mhz	220 Mhz
Height	275"		432 Mhz
Width x Depth	192" x 30"	182"	97"
Turning Radius	101"	132" x 20"	72" x 11"
Maximum Mast Dia.	2 1/2"	65"	38"
Net Weight Lbs.	64	2 1/2"	2 1/2"
Wind Rating	90 mph	90 mph	90 mph
Stack Kit No.	DXK-180	DXK-280	DXK-480
Amateur Net	\$109.95	\$89.95	\$79.95

HF MONOBEAMS 10 15 20 METERS

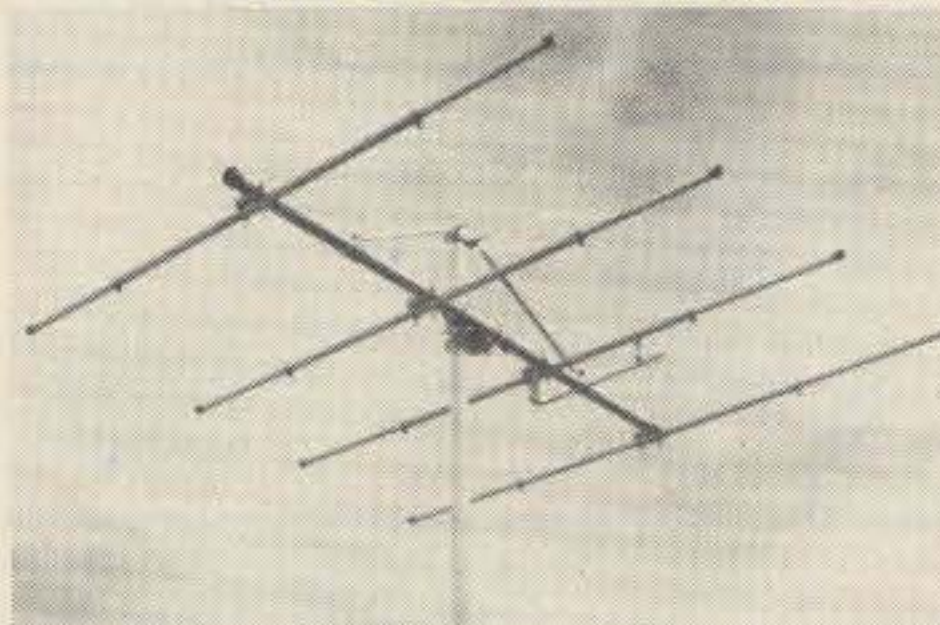

10 METERS

3 ELEMENT BEAM: You can have an outstanding signal using this compact three element beam. It is easily mounted on a lightweight rotator and takes only a limited amount of space. MODEL NO. A28-3 \$69.95

4 ELEMENT BEAM: A real DX'er's beam for the active ham who wants a top signal on 10 meters. Mount on a good ham rotator. MODEL NO. A28-4 \$79.95

SPECIFICATIONS	A28-3	A28-4
BOOM	1 1/2" x 10'	1 5/8" x 18'
LONGEST ELEMENT	17' 6"	18'
ELEMENT DIAMETER	7/8" - 1/2"	7/8" - 3/4"
TURNING RADIUS	10'	14' 3"
FORWARD GAIN	8 db	10 db
FRONT TO BACK	22 db	25 db
SWR @ FREQUENCY	1 to 1	1 to 1
WEIGHT	11 lbs.	21 lbs.

15 METERS

3 ELEMENT BEAM: A high quality beam which can be mounted on a mast with other antennas. A heavy duty TV rotator will handle it. MODEL NO. A21-3 \$89.95

4 ELEMENT BEAM: For the 15 meter enthusiast this beam will give real DX performance. When mounted on a good ham rotator it will withstand the most adverse weather conditions. MODEL NO. A21-4 \$119.95

SPECIFICATIONS	A21-3	A21-4
BOOM	1 5/8" x 12'	1 3/4" x 21' 6"
LONGEST ELEMENT	22' 10"	22' 10"
ELEMENT DIAMETER	7/8" - 3/4"	7/8" - 3/4"
TURNING RADIUS	13' - 3"	15' - 8"
FORWARD GAIN	8 db	10 db
FRONT TO BACK	22 db	25 db
SWR @ FREQUENCY	1 to 1	1 to 1
WEIGHT	16 lbs.	32 lbs.

20 METERS

2 ELEMENT BEAM: Full size beam performance for the active 20 meter ham with limited space and budget. MODEL NO. A14-2 \$109.95

3 ELEMENT BEAM: A real DX'er's beam with full .15 wavelength element spacing. The heavy duty construction gives years of trouble free service. MODEL NO. A14-3 \$139.95

SPECIFICATIONS	A14-2	A14-3
BOOM	1 5/8" x 10'	1 5/8" x 20' 6"
LONGEST ELEMENT	35' 10"	35' 10"
ELEMENT DIAMETER	1 1/8" - 3/4"	1 1/8" - 3/4"
TURNING RADIUS	18'	21'
FORWARD GAIN	5 db	8 db
F/B RATIO	13 db	22 db
SWR @ FREQUENCY	1 to 1	1 to 1
WEIGHT	20 lbs.	35 lbs.



World Radio TV Handbook 1978

A Complete Directory of International Radio and Television. The most exhaustive and authoritative guide to broadcasting and television stations around the world today. **WORLD RADIO TV HANDBOOK 1978** is an indispensable manual for anyone with a working interest in radio and television. Features:

- Names and addresses of broadcast companies and stations by country
- Names and titles of leading officials and personnel
- Listing by frequency of shortwave stations around the world
- Program data including frequencies, wave lengths, transmitter power, call signs, times, announcements (in each language)

Plus, a special, in-depth editorial section with professional articles, suggestions and tips—and much, much more. **WORLD RADIO TV HANDBOOK 1978** is available now for only \$11.95.

HF Verticals 10-80 Meters

- efficient top ring • fiberglass trap forms • enameled wire coils • solid aluminum capacitors • no tuning required • full compression clamps • omnidirectional coverage • reinforced base • mast or ground mounting • pre-marked sections • easy assembly • superior quality

3 BAND 20-15 meters/Model ATV-3	\$49.95
4 BAND 4*20*15*10 meters/Model ATV-4	\$89.95
5 BAND 80*40*20*15*10 meters/Model ATV-5	\$109.95



Speak up.

We know all about up. In fact, we're number one from the ground up...when it comes to amateur communications towers. We've been building them for HAMS for more than two decades.

Whether you're thinking crank-up, guyed or free-standing, check with us first. We're Tri-Ex. Reliable, dependable.

When we say number one from the ground up, we're talking about towers like Tri-Ex's new "Big W" shown here. It's a free-standing crank-up with a height of 80-ft, providing good DX capability at low cost. Ideal for serious HAMS.

Model W51 (51' Self-supporting) \$850.00



SST T-1 RANDOM WIRE ANTENNA TUNER

All band operation (160-10 meters) with any random length of wire. 200 watt output power capability — will work with virtually any transceiver. Ideal for portable or home operation. Great for apartments and hotel rooms — simply run a wire inside, out a window, or anyplace available. Toroid inductor for small size: 4-1/4" x 2-3/8" x 3". Built-in neon tune-up indicator. SO-239 connector. Attractive bronze finished enclosure. Only \$29.95

SST T-2 ULTRA TUNER

Tunes out SWR on any coax fed antenna as well as random wires. Works great on all bands (160-10 meters) with any transceiver running up to 200 watts power output. Increases usable bandwidth of any antenna. Tunes out SWR on mobile whips from inside your car. Uses toroid inductor and specially made capacitors for small size: 5 1/4" x 2 1/4" x 2 1/2". Rugged, yet compact. Attractive bronze finished enclosure. SO-239 coax connectors are used for transmitter input and coax fed antennas. Convenient binding posts are provided for random wire and ground connections. Only \$49.95

SST T-3 IMPEDANCE TRANSFORMER

Matches 52 ohm coax to the lower impedance of a mobile whip or vertical. 12 position switch with taps spread between 3 and 52 ohms. Broadband from 1-30 MHz. Will work with virtually any transceiver — 300 watt output power capability. SO-239 connectors. Toroid inductor for small size: 2-3/4" x 2" x 2-1/4". Attractive bronze finish. Only \$19.95

6 METER BEAMS

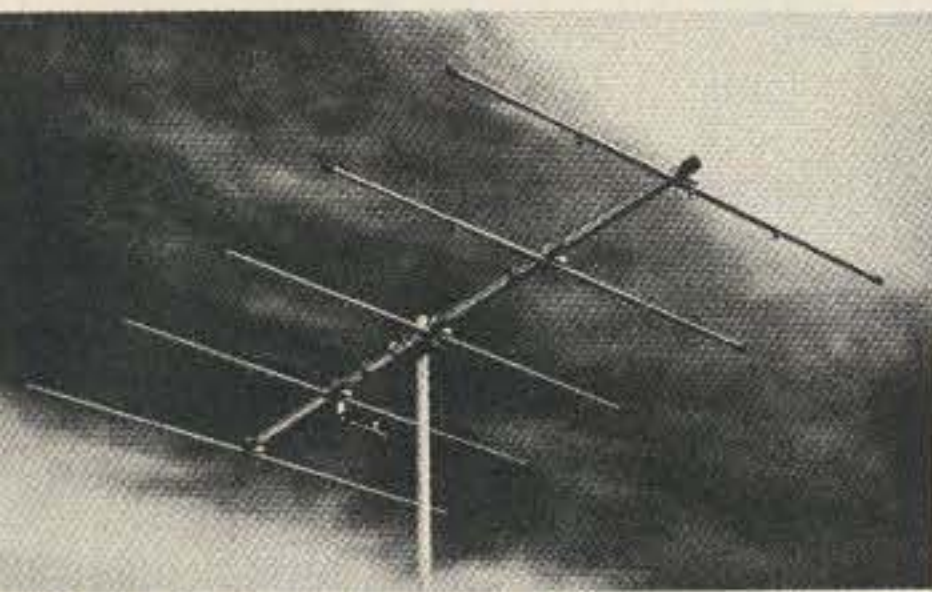

3-5-6-10 ELEMENTS

Proven performance from rugged, full size, 6 meter beams. Element spacings and lengths have been carefully engineered to give best pattern, high forward gain, good front to back ratio and broad frequency response.

Booms are .058 wall and elements are 3/4" - 5/8" .049 wall seamless chrome finish aluminum tubing. The 3 and 5 element beams have 1 3/8" - 1 1/4" booms. The 6 and 10 element beams have 1 5/8" - 1 1/2" booms. All brackets are heavy gauge formed aluminum. Bright finish cad plated bolts are adjustable for up to 1 5/8" mast on 3 and 5 element and 2" on 6 and 10 element beams. All models may be mounted for horizontal or vertical polarization.

New features include adjustable length elements, kilowatt Reddi Match and built-in coax fitting for direct 52 ohm feed. These beams are factory marked and supplied with instructions for quick assembly.

Description	3 element	5 element	6 element	10 element
Model No.	A50-3	A50-5	A50-6	A50-10
Boom Length	6"	12"	20"	24"
Longest El.	117"	117"	117"	117"
Turn Radius	6"	7' 6"	11'	13'
Fwd. Gain	7.5 dB	9.5 dB	11.5 dB	13 dB
F/B Ratio	20 dB	24 dB	26 dB	28 dB
Weight	7 lbs.	11 lbs.	18 lbs.	25 lbs.

COAXIAL DUAL STACKING KITS

Double your effective radiated power by stacking 6 meter beams. Cush Craft coaxial stacking kits provide a simple and efficient method for realizing 3 db additional gain while maintaining the superior characteristics of our single beams. The stacking kits are complete with RG-59/U cable and preassembled fittings for direct 52 ohm feed.

MODEL NO.	FOR STACKING	AMATEUR NET
A53-SK	A50-3 or A50-5	\$15.95
A61-SK	A50-6 or A50-10	\$17.95



4.5 dB* - 6 dB**
Omnidirectional GAIN
BASE STATION ANTENNAS FOR MAXIMUM PERFORMANCE AND VALUE



Cush Craft has created another first by making the world's most popular 2 meter antenna twice as good. The new Ringo Ranger is developed from the basic AR-2 with three half waves in phase and a one eighth wave matching stub. Ringo Ranger gives an extremely low angle of radiation for better signal coverage. It is tunable over a broad frequency range and perfectly matched to 52 ohm coax.

- ARX-2, 137-160 MHz, 4 lbs., 112"
- ARX-220, 220-225 MHz, 3 lbs., 75"
- ARX-450, 435-450 MHz, 3 lbs., 39"

* Reference 1/2 wave dipole.
** Reference 1/4 wave whip used as gain standard by many manufacturers.

Work full quieting into more repeaters and extend the radius of your direct contacts with the new Ringo Ranger.

You can up date your present AR-2 Ringo with the simple addition of this extended kit. The kit includes the phasing network and necessary element extensions. The only modifications required are easy to make saw cuts in the top section of your antenna.

ARX-2K CONVERSION KIT

2 METER FM ANTENNAS

A-FM RINGO 3.75 dB Gain (reference 1/4 wave whip). Half wave length antennas with direct dc ground, 52 ohm feed takes PL-259, low angle of radiation with 1-1 SWR. Factory preassembled and ready to install, 6 meter partly preassembled, all but 450 MHz take 1 1/4" mast. There are more Ringos in use than all other FM antennas combined.

Model Number	AR-2	AR-25	AR-6	AR-220	AR-450
Frequency MHz	135-175	135-175	50-54	220-225	440-460
Power-Hdly. Watts	100	500	100	100	250
Wind area sq. ft.	.21'	.21'	.37'	.20'	.10'

B-4 POLE Up to 9 dB Gain over a 1/2 wave dipole. Overall antenna length 147 MHz - 23' 220 MHz - 15', 435 MHz - 8', pattern 360° = 6 dB gain, 180° = 9 dB gain, 52 ohm feed takes PL 259 connector. Package includes 4 complete dipole assemblies on mounting booms, harness and all hardware. Vertical support mast not supplied.

- AFM-4D 144-150 MHz, 1000 watts, wind area 2.58 sq. ft.
- AFM-24D 220-225 MHz, 1000 watts, wind area 1.85 sq. ft.
- AFM-44D 435-450 MHz, 1000 watts, wind area 1.13 sq. ft.

D-POWER PACK The big signal (22 element array) for 2 meter FM, uses two A147-11 yagis with a horizontal mounting boom, coaxial harness and all hardware. Forward gain 16 dB, F/B ratio 24 dB, 1/2 power beamwidth 42°, dimensions 144" x 80" x 40", turn radius 60", weight 15 lbs., 52 ohm feed takes PL-259 fitting.

A147-22 146 - 148 MHz, 1000 Watts, wind area 2.42 sq. ft.

D-YAGI STACKING KITS VPK includes horizontal mounting boom, harness, hardware and instructions for two vertically polarized yagis gives 3 dB gain over the single antenna.

- A14-VPK, complete 4 element stacking kit
- A14-SK, 4 element coax harness only
- A147-VPK, complete 11 element stacking kit
- A147-SK, 11 element coax harness only
- A449-SK, 6 + 11 element coax harness only

E-4-6-11 ELEMENT YAGIS The standard of comparison in VHF-UHF communications, now cut for FM and vertical polarization. The four and six element models can be tower side mounted. All are rated at 1000 watts with direct 52 ohm feed and PL-259 connectors.

Model Number	A147-11	A-147-4	A449-11	A449-6	A220-11
Boom/Longest ele.	144"/40"	44"/40"	60"/13"	35"/26"	102"/26"
Wght./Turn radius	6 lbs., 72"	3 lbs., 44"	4 lbs., 60"	3 lbs., 18"	5 lbs., 51"
Gain/F/B ratio dB	13.2/28	9/20	13.2/28	11/25	13.2/28
1/2 Power beam	48°	66°	48°	60°	48°
Wind area sq. ft.	1.21	.43	.39	.30	.50
Frequency MHz	146-148	146-148	440-450	440-450	220-225

F-FM TWIST 12.4 dB Gain: Ten elements horizontal polarization for low end coverage and ten elements vertical polarization for FM coverage. Forward gain 12.4 dB, F/B ratio 22 dB, boom length 130", weight 10 lbs., longest element 40", 52 ohm Reddi Match driven elements take PL-259 connectors, uses two separate Feed lines.

A147-20T 145 - 147 MHz, 1000 watts, wind area 1.42 sq. ft.

HIGH PERFORMANCE VHF YAGIS

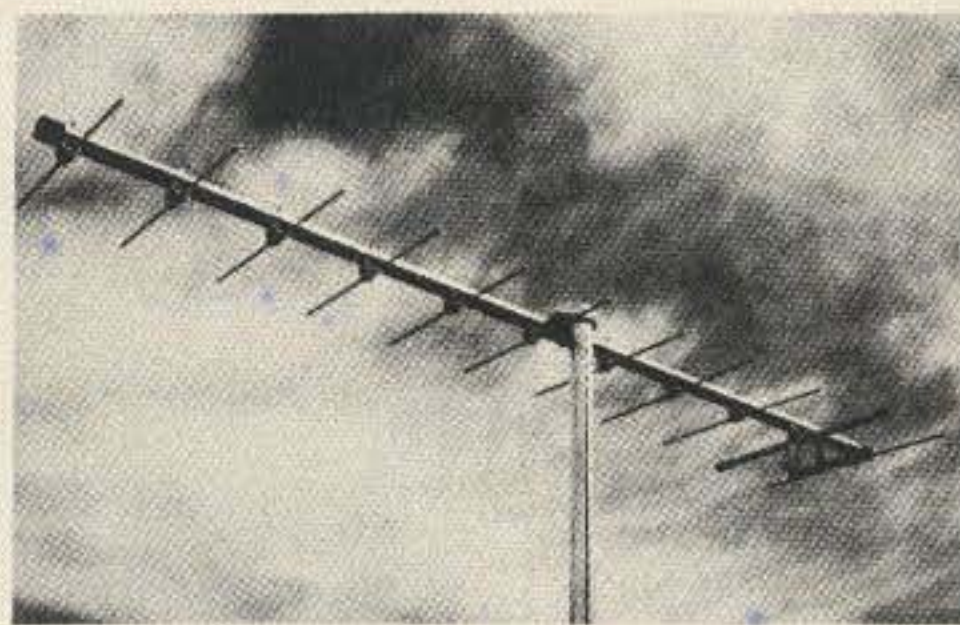

3/4, 1-1/4, 2 METER BEAMS

The standard of comparison in amateur VHF/UHF communications Cush Craft yagis combine all out performance and reliability with optimum size for ease of assembly and mounting at your site.

Lightweight yet rugged, the antennas have 3/16" O.D. solid aluminum elements with 5/16" center sections mounted on heavy duty formed brackets. Booms are 1" and 7/8" O.D. aluminum tubing. Mast mounts of 1/8" formed aluminum have adjustable u-bolts for up to 1-1/2" O.D. masts. They can be mounted for horizontal or vertical polarization. Complete instructions include data on 2 meter FM repeater operation.

New features include a kilowatt Reddi Match for direct 52 ohm coaxial feed with a standard PL-259 fitting. All elements are spaced at .2 wavelength and tapered for improved bandwidth.

Model No.	A144-7	A144-11	A220-11	A430-11
Description	2m	2m	1 1/2m	1 1/2m
Elements	7	11	11	11
Boom Length	98"	144"	102"	57"
Weight	4	6	4	3
Fwd. Gain	11 dB	13 dB	13 dB	13 dB
F/B Ratio	26 dB	28 dB	28 dB	28 dB
Fwd. Lobe @ 1/2 pwr. pt.	46	42	42	42
SWR @ Freq.	1 to 1	1 to 1	1 to 1	1 to 1

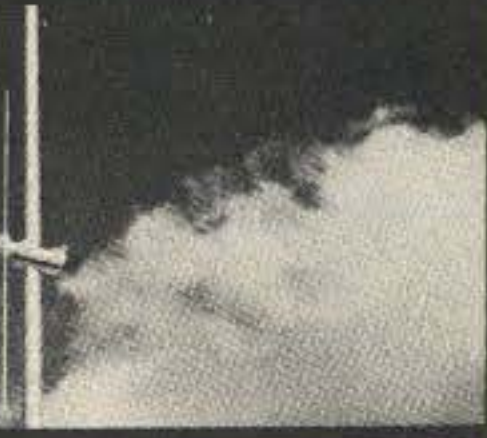
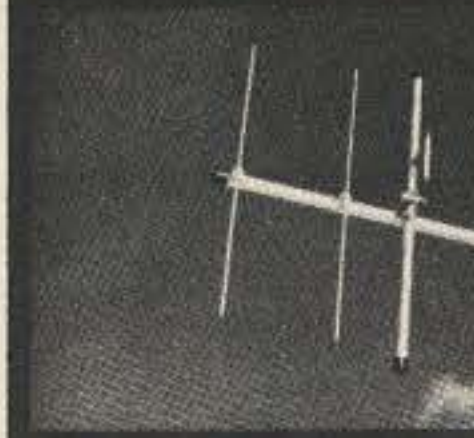
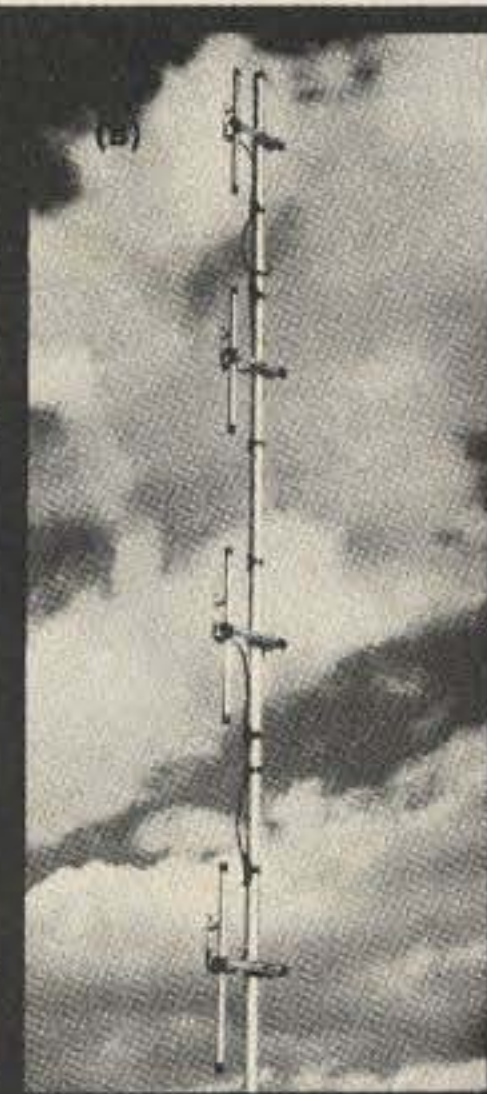

VHF/UHF BEAMS

A50-3	\$ 32.95	A144-7	21.95
A50-5	49.95	A144-11	32.95
A50-6	69.95	A430-11	24.95
A50-10	99.95		

AMATEUR FM ANTENNAS

A147-4	\$ 19.95	AFM-44D	54.95
A147-11	29.95	AR-2	21.95
A147-20T	54.95	AR-6	32.95
A147-22	84.95	AR-25	29.95
A220-7	21.95	AR-220	21.95
A220-11	27.95	AR-450	21.95
A449-6	21.95	ARX-2	32.95
A449-11	27.95	ARX-2K	13.95
AFM-4D	59.95	ARX-220	32.95
AFM-24D	57.95	ARX-450	32.95

Description:	144 MHz.		220 MHz.		432 MHz.	
	Model:	Price:	Model:	Price:	Model:	Price:
20 Element DX-Array	DX-120	42.95	DX-220	37.95	DX-420	32.95
Frame & Harness (40 El.)	DXK-140	59.95	DXK-240	54.95	DXK-440	39.95
Frame & Harness (80 El.)	DXK-180	109.95	DXK-280	89.95	DXK-480	79.95
1-1 52-ohm balun	DX-18N	12.95	DX-28N	12.95	DX-48N	12.95
Vert. Pol. Bracket (20 El.)	DX-VPB	9.95	DX-VPB	9.95	DX-VPB	9.95

TUFTS RADIO CATALOG TUFTS RAD



For all you hams with little cars ...
We've got the perfect mobile rig for you.



The Atlas 210x or 215x measures only 9 1/2" wide x 9 1/2" deep x only 3 1/4" high, yet the above photograph shows how easily the Atlas transceiver fits into a compact car. And there's plenty of room to spare for VHF gear and other accessory equipment. With the exclusive Atlas plug-in design, you can slip your Atlas in and out of your car in a matter of seconds. All connections are made automatically.

BUT DON'T LET THE SMALL SIZE FOOL YOU!

Even though the Atlas 210x and 215x transceivers are less than half the size and weight of other HF transceivers, the Atlas is truly a giant in performance.

200 WATTS POWER RATING!

This power level in a seven pound transceiver is incredible but true. Atlas transceivers give you all the talk power you need to work the world barefoot. Signal reports

constantly reflect great surprise at the signal strength in relation to the power rating.

FULL 5 BAND COVERAGE

The 210x covers 10-80 meters, while the 215x covers 15-160 meters. Adding the Atlas Model 10x Crystal Oscillator provides greatly increased frequency coverage for MARS and network operation.

NO TRANSMITTER TUNING OR LOADING CONTROLS

with Atlas' total broadbanding. With your Atlas you get instant QSY and band change.

MOST ADVANCED STATE OF THE ART SOLID STATE DESIGN

not only accounts for its light weight, but assures you years of top performance and trouble free operating pleasure.

PLUG-IN CIRCUIT BOARDS

and modular design provides for ease of servicing.

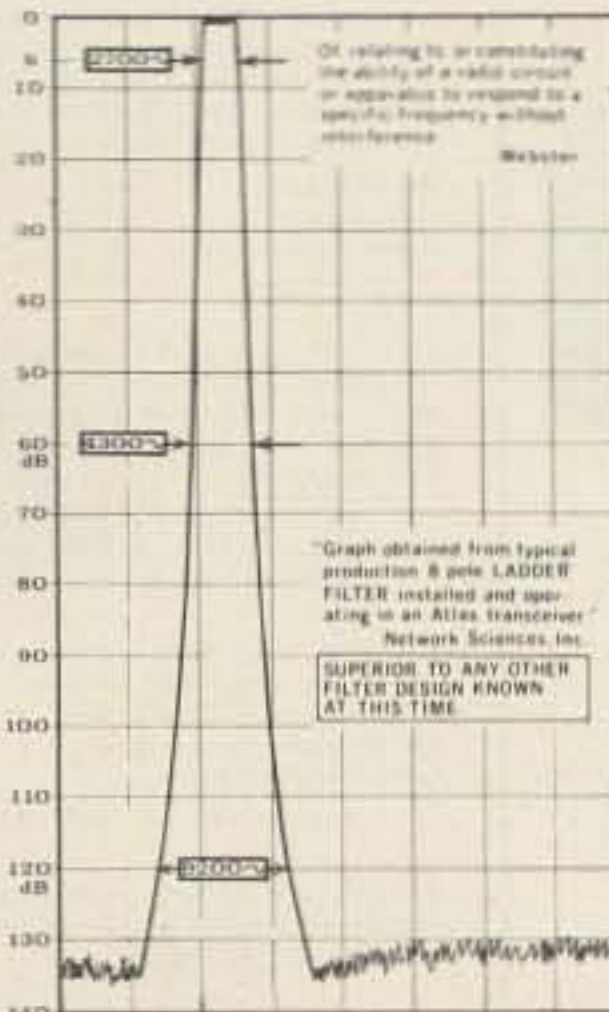

PHENOMENAL SELECTIVITY

The exclusive 8 pole crystal ladder filter used in Atlas transceivers represents a major breakthrough in filter design, with unprecedented skirt selectivity and ultimate rejection. As the above graph shows, this filter provides a 6 db bandwidth of 2700 Hertz, 60 db down of only 4300 Hertz, and a bandwidth of only 9200 Hertz at 120 db down! Ultimate rejection is in excess of 130 db; greater than the measuring limits of most test equipment.

EXCEPTIONAL IMMUNITY TO STRONG SIGNAL OVERLOAD AND CROSS MODULATION. The exclusive front end design in the receiver allows you to operate closer in frequency to strong neighboring signals than you have ever experienced before. If you have not yet operated an Atlas transceiver in a crowded band and compared it with any other receiver or transceiver, you have a real thrill coming.



A WORLD WIDE DEALER NETWORK TO SERVE YOU.

Whether you're driving a Honda in Kansas City or a Mercedes Benz in West Germany, there's an Atlas dealer near you.

- Atlas 210X or 215X \$765.00
- w/noise blander \$810.00
- Accessories:
- AC Console 110/220 V \$155.00
- Portable AC supply 110/220 V \$105.00
- Plug-in mobile kit \$55.00
- 10X Osc. less crystals \$65.00
- Digital Dial DD-6B \$235.00

For complete details see your Atlas dealer, or drop us a card and we'll mail you a brochure with dealer list.



AMATEUR ANTENNAS

"the home of originals"

STANDARD GAIN MOBILES

Two Meters

- 5/8 wavelength — 3.4 db gain over 1/4 wave mobile
- Frequency coverage—143 to 149 MHz
- Power rating—200 watts FM

MODEL BBL-144

47" antenna complete with easy to install, no holes to drill, trunk lip mount, impact spring and 17 MIL SPEC RG-58-U and PL-259. Antenna removable from mount.

Price: \$33.75

MODEL BBL-144

47" antenna mounts on any flat surface, roof, deck or fender in 3/4" hole. Includes impact spring, 17 MIL SPEC RG-58-U and PL-259. Antenna removable from mount.

Price: \$31.65

HUSTLER "BUCK-BUSTER"

MODEL SF-2

51" two meter, 5/8 wavelength, 3.4 db gain over 1/4 wave mobile. Designed with 3/4" base to fit your mount or a wide selection of Hustler mobile mounts. (Mount or cable not included).

Price: \$9.00

DELUXE MOBILE MOUNTS

For medium length, light weight antennas with 3/4" base.



MODEL TLM

Trunk lip mount for no holes installation on side or edge of trunk lid. Includes 17' RG-58-U connectors attached.

Price: \$14.85



MODEL HLM

Deluxe trunk lip mount with 180 degree swivel ball for positioning antenna to vertical. Easy — no holes — installation. Includes 17' RG-58-U cable and connectors attached. Price: \$17.20



MODEL GCM-1

Rain gutter mount fits all shapes, angles even latest trim line gutters. Includes 180° swivel ball. Price: \$9.00

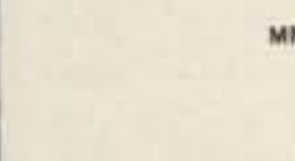

MODEL MM-1

Cowl mount installs in 1" hole. Includes 180° swivel ball and SO-239 connectors. Price: \$7.50



MODEL TGM-1

Trunk groove mount installs in hidden area of groove under trunk lid. Mounting hardware included. Price: \$8.00



MODEL C-32

Ball mount complete with mounting hardware. Price: \$8.20

SUPER GAIN MOBILES

Two Meters

- 5.2 db gain over 1/4 wave mobile antenna
- Frequency coverage—143-149 MHz
- SWR at resonance—1.1:1 typical
- Power rating—200 watts FM

TWO AND SIX METERS—TRUNK LIP MOUNT

MODEL HFT

Four section telescopic antenna permits separate adjustment for simultaneous resonance on two and six meters. Operational height: 40". Complete with trunk lip mount, 17 MIL SPEC RG-58-U and factory attached PL-259.

Price: \$22.55

VHF/UHF ANTENNA—ROOF MOUNT

MODEL UHT-1

Field trimmable radiator for 1/4 wave operation on any frequency from 140 to 500 MHz. Cutting chart included. Mounts on any flat surface, roof, deck, fender in 3/4" hole. Includes 15' RG-58-U.

Price: \$9.95

VHF/UHF ANTENNA—TRUNK LIP MOUNT

MODEL THF

Field trimmable radiator permits quarter wave operation on any frequency from 140 to 500 MHz. Cutting chart included. Complete with trunk lip mount, 17' RG-58-U and PL-259. Price: \$16.55

RESONATOR SPRING—STAINLESS STEEL

MODEL RSS-2

Installs between Hustler mast and resonator. Absorbs shock when antenna strikes overhanging obstructions. Supplied ready for easy installation. Price: \$ 9.95

QUICK DISCONNECT—100% STAINLESS STEEL

MODEL QD-1

Remove antenna from mount with easy press and twist release. Compression spring and all parts 100% stainless steel. 3/4" base—female one end, male the other. Price: \$16.95

FEED LINE

MODEL L-14-240

Get known performance, maximum shielding for minimum noise pickup in this MIL SPEC 20' length of RG-58-U cable. Supplied with connectors attached for use with ball or bumper mount and transceiver. Price: \$6.55

MODEL G6-144A

Deluxe, Two Meter Colinear for Repeater or any fixed station operation. 6 db gain over a 1/2 wave dipole. Maximum radiation at the horizon! Shunt fed with D.C. grounding. Radiator, 1/2 wave lower section, 1/2 wave phasing 1/2 wave upper section. Height, 117". SWR at resonance: 1.2:1 or better. Power rating: 1,000 Watts FM. Wind survival: 100 MPH. Installs on vertical pipe up to 1 1/2" O.D. SO-239 coax connector. Price: \$67.55

MODEL CGT-144

Get big signal performance, superior receiving capability with this 85" colinear antenna. Easy installation on side or edge of trunk lip without drilling—complete with 17 MIL SPEC RG-58-U and PL-259. Price: \$41.30

MODEL CG-144

Same characteristics as CGT-144 supplied with 3/4" base to fit all mobile ball mounts—Length is 85". Mount and cable not included. Price: \$25.50

VHF/UHF ANTENNA—TRUNK LIP MOUNT

MODEL THF

Field trimmable radiator permits quarter wave operation on any frequency from 140 to 500 MHz. Cutting chart included. Complete with trunk lip mount, 17' RG-58-U and PL-259. Price: \$16.55

STAINLESS STEEL BALL MOUNT FOR DECK, FENDER OR ANY FLAT SURFACE

MODEL SSM-2

Heavy 2" reinforced stainless steel 180° adjustable ball mount easily supports any amateur mobile antenna. Includes cyclical base, steel back-up plate and mounting hardware. Price: \$19.20

MODEL G6-144A

Deluxe, Two Meter Colinear for Repeater or any fixed station operation. 6 db gain over a 1/2 wave dipole. Maximum radiation at the horizon! Shunt fed with D.C. grounding. Radiator, 1/2 wave lower section, 1/2 wave phasing 1/2 wave upper section. Height, 117". SWR at resonance: 1.2:1 or better. Power rating: 1,000 Watts FM. Wind survival: 100 MPH. Installs on vertical pipe up to 1 1/2" O.D. SO-239 coax connector. Price: \$67.55

All resonators are precision wound with optimized design for each band. Assembly includes 17-7 PH stainless steel adjustable tip rod for lowest SWR and band edge marker. Choose for medium or high power operation.

STANDARD HUSTLER RESONATORS

Power Rating: 400 Watts SSB

Model	Band	Price
RM-10	10 meters	\$ 6.50
RM-15	15 meters	6.95
RM-20	20 meters	7.30
RM-40	40 meters	13.20
RM-75	75 meters	15.50
RM-80	80 meters	15.95

SUPER HUSTLER RESONATORS

Power Rating: Legal Limit SSB

Supers have widest bandwidth

Model	Band	Price
RM-10S	10 meters	\$11.30
RM-15S	15 meters	12.65
RM-20S	20 meters	13.00
RM-40S	40 meters	15.50
RM-75S	75 meters	30.00
RM-80S	80 meters	30.40

For 6-10-15-20-40-75-80 Meters

Fold over mast for quick and easy interchange of resonators or entering a garage. When operating, mast is held vertical with shakeproof sleeve clutch. 54" mast also serves as 1/4 wavelength 6 meter antenna. Stainless steel base has 3/4" threads to fit mobile ball mount or bumper mount.

HUSTLER MASTS

The Majority Choice of Amateurs Throughout the World!

MODEL MD-2

For bumper mounting—Fold is at roof line 27" above base. Price: \$22.00

MODEL MD-1

For deck or fender mounting—Fold is at roof line 15" above base. Price: \$22.00

Covers 10 - 15 - 20 - 40 Meters

Only Hustler Gives One Setting for Whole Band Coverage

MODEL 4-BTV

- Lowest SWR—PLUS.
- Bandwidth at its broadest! SWR 1.6 to 1 or better at band edges.
- Hustler exclusive trap covers "Spritz" extruded to otherwise unattainable close tolerances assuring accurate and permanent trap resonance.
- Solid one inch fiberglass trap forms for optimum electrical and mechanical stability.
- Extra heavy duty aluminum mounting bracket with low loss — high strength insulators. Mounting hardware included.
- All sections 1 1/4" heavy wall, high

MODEL MM-1

Price: \$7.50

MODEL TGM-1

Price: \$8.00

MODEL C-32

Price: \$8.20

MODEL SSM-2

Price: \$19.20

MODEL QD-1

Price: \$16.95

MODEL L-14-240

Price: \$6.55

MODEL G6-144A

Price: \$67.55

Length: 21' 5" MODEL 4-BTV Weight: 15 lbs. Price: \$99.95

This NEW MFJ Versa Tuner II . . .



has SWR and dual range wattmeter, antenna switch, efficient airwound inductor, built-in balun. Up to 300 watts RF output. Matches everything from 160 thru 10 meters: dipoles, inverted vees, random wires, verticals, mobile whips, beams, balance lines, coax lines. \$79.95.

Antenna matching capacitor. 208 pf. 1000 volt spacing.

Sets power range, 300 and 30 watts. Pull for SWR.

Meter reads SWR and RF watts in 2 ranges.

Efficient airwound inductor gives more watts out and less losses.

Transmitter matching capacitor. 208 pf. 1000 volt spacing.

Only MFJ gives you this MFJ-941 Versa Tuner II with all these features at this price:

A SWR and dual range wattmeter (300 and 30 watts full scale) lets you measure RF power output for simplified tuning.

An antenna switch lets you select 2 coax fed antennas, random wire or balance line, and tuner bypass.

A new efficient airwound inductor (12 positions) gives you less losses than a tapped toroid for more watts out.

A 1:4 balun for balance lines. 1000 volt capacitor spacing. Mounting brackets for mobile installations (not shown).

With the NEW MFJ Versa Tuner II you can run your full transceiver power output — up to 300 watts RF power output — and match your

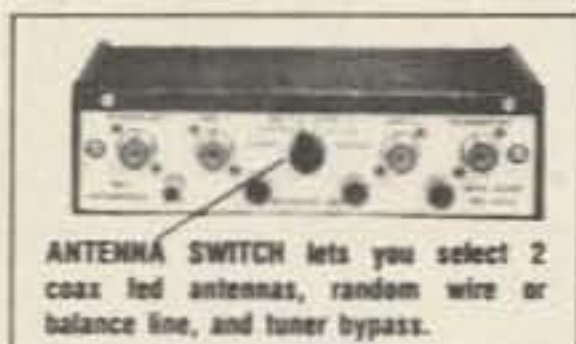

ANTENNA SWITCH lets you select 2 coax fed antennas, random wire or balance line, and tuner bypass.

transmitter to any feedline from 160 thru 10 Meters whether you have coax cable, balance line, or random wire.

You can tune out the SWR on your dipole, inverted vee, random wire, vertical, mobile whip, beam, quad, or whatever you have.

You can even operate all bands with just

one existing antenna. No need to put up separate antennas for each band.

Increase the usable bandwidth of your mobile whip by tuning out the SWR from inside your car. Works great with all solid state rigs (like the Atlas) and with all tube type rigs.

It travels well, too. Its ultra compact size 5x2x6 inches fits easily in a small corner of your suitcase.

This beautiful little tuner is housed in a deluxe eggshell white Ten-Tec enclosure with walnut grain sides.

S0-239 coax connectors are provided for transmitter input and coax fed antennas. Quality live wire binding posts are used for the balance line inputs (2), random wire input (1), and ground (1).



\$59.95

BRAND NEW

MFJ-901 VERSA TUNER

New efficient airwound coil for more watts out.

Only MFJ uses an efficient airwound inductor (12 positions) in this class of tuners to give you more watts out and less losses than a tapped toroid. Matches everything from 160 thru 10 Meters. Dipoles, inverted vees, random wires, vee's, mobile whips, beams, balance lines, coax lines. Up to 200 watts RF output. 1-4 balun for balance lines. Tune out the SWR of your mobile whip from inside your car. Works with all rigs. Ultra compact 5x2x6 inches. S0-239 connectors. 5 way binding posts. Ten Tec enclosure.



\$49.95

BRAND NEW

MFJ-900 ECONO TUNER

Same as MFJ-901 Versa Tuner, but does not have built-in balun for balance lines. Tunes coax lines and random wires.



\$49.95

BRAND NEW

MFJ-202 RF NOISE BRIDGE

This MFJ RF Noise Bridge lets you adjust your antenna quickly for maximum performance. Measure resonant frequency, radiation resistance and reactance. Exclusive range extender and expanded capacitance range (± 150 pf) gives you much extended measuring range.

Tells resonant frequency and whether to shorten or lengthen your antenna for minimum SWR. Adjust your single or multi-band dipole, inverted vee, beam, vertical, mobile whip or random system for maximum performance. 1 to 100 MHz. S0-239 connectors. 2x3x4 inches. 9 volt battery.



\$39.95

MFJ-16010 RANDOM WIRE TUNER

Operate 160 thru 10 Meters. Up to 200 watts RF output. Matches high and low impedances. 12 position inductor. S0-239 connectors. 2x3x4 inches. Matches 25 to 200 ohms at 1.8 MHz.

400% MORE RF POWER

PLUGS BETWEEN YOUR MICROPHONE AND TRANSMITTER



\$49.95

LSP-520BX. 30 db dynamic range IC log amp and 3 active filters give clean audio. RF protected. 9 V battery. 3 conductor, 1/4" phone jacks for input and output. 2-3/16 x 3-1/4 x 4 inches.



\$59.95

LSP-520BX II. Same as LSP-520BX but in a beautiful 2-1/8 x 3-5/8 x 5-9/16 inch Ten-Tec enclosure with uncommitted 4 pin Mic jack, output cable, rotary function switch.



\$17.95

NEW

CPO-555 Code Oscillator

For the Newcomer to learn the Morse code. For the Old Timer to polish his list. For the Code Instructor to teach his classes.

• Send crisp clear code with plenty of volume for classroom use • Self contained speaker, volume, tone controls, aluminum cabinet • 9 V battery • Top quality U.S. construction • Uses 555 IC timer • 2-3/16 x 3-1/4 x 4 inches



\$29.95

CWF-2BX Super CW Filter

By far the leader. Over 5000 in use. Razor sharp selectivity. 80 Hz bandwidth, extremely steep skirts. No ringing. Plugs between receiver and phones or connect between audio stage for speaker operation.

• Selectable BW, 80, 110, 180 Hz • 60 dB down one octave from center freq. of 750 Hz for 80 Hz BW • Reduces noise 15 dB • 9 V battery • 2-3/16 x 3-1/4 x 4 in.



\$54.95

CMOS-8043 Electronic Keyer

State of the art design uses CURTIS-8043 Keyer-on-a-chip.

• Built-in Key • Dot memory • Iambic operation with external squeeze key • 8 to 50 WPM • Sidetone and speaker • Speed, volume, tone, weight controls • Ultra reliable solid state keying • 300 volts max • 4 position switch for TUNE, OFF, ON, SIDETONE OFF • Uses 4 penlight cells • 2-3/16 x 3-1/4 x 4 inches



\$29.95

MFJ-40T QRP Transmitter

Work the world with 5 watts on 40 Meter CW. • No tuning • Matches 50 ohm load • Clean output with low harmonic content • Power amplifier transistor protected against burnout • Switch selects 3 crystals or VFO input • 12 VDC • 2-3/16 x 3-1/4 x 4 inches

MFJ-40V, Companion VFO \$27.95
MFJ-12DC, IC Regulated Power Supply, 1 amp, 12 VDC \$27.95



\$29.95

SBF-2BX SSB Filter

Dramatically improves readability.

• Optimizes your audio to reduce sideband splatter, remove low and high pitched QRM, hiss, static crashes, background noise, 60 and 120 Hz hum • Reduces fatigue during contest, DX, and ragchewing • Plugs between phones and receiver or connect between audio stage for speaker operation • Selectable bandwidth IC active audio filter • Uses 9 volt battery • 2-3/16 x 3-1/4 x 4 inches



\$27.95

MFJ-200BX Frequency Standard

Provides strong, precise markers every 100, 50, or 25 KHz well into VHF region.

• Exclusive circuitry suppresses all unwanted markers • Markers are gated for positive identification. CMOS IC's with transistor output • No direct connection necessary • Uses 9 volt battery • Adjustable trimmer for zero beating to WWV • Switch selects 100, 50, 25 KHz or OFF • 2-3/16 x 3-1/4 x 4 inches



\$49.95

MFJ-1030BX Receiver Preselector

Clearly copy weak unreadable signals (increases signal 3 to 5 "S" units).

• More than 20 dB low noise gain • Separate input and output tuning controls give maximum gain and RF selectivity to significantly reject out-of-band signals and reduce image responses • Dual gate MOS FET for low noise, strong signal handling abilities • Completely stable • Optimized for 10 thru 30 MHz • 9 V battery • 2-1/8 x 3-5/8 x 5-9/16 inches

THE HAM-KEY NOW 5 MODELS

NEW MODEL HK-5 ELECTRONIC KEYS \$69.95



- Iambic circuit for squeeze keying.
- Self completing dots & dashes.
- Dot memory.
- Battery operated with provisions for external power.
- Built-in side-tone monitor.
- Speed, Volume, tone & weight controls.
- Grid-block or direct keying.
- Use with external paddle such as HK-1.



Model HK-1 \$29.95

- Dual lever squeeze paddle.
- Use with HK-5 or any electronic keyer.
- Heavy base with non-slip rubber feet.
- Paddles reversible for wide or close finger spacing.



Model HK-2 \$19.95

- Same as HK-1, less base for those who wish to incorporate in their own Keyer.



Model HK-3 \$16.95

- Deluxe straight key.
- Heavy base, no need to attach to desk.
- Velvet smooth action.

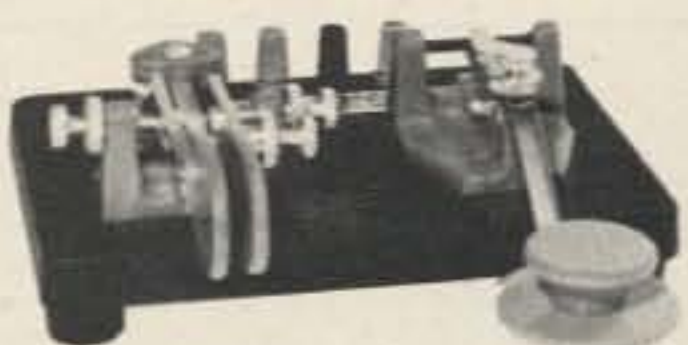

Model HK-4 \$44.95

- Combination on HK-1 & HK-3 on same base.

TUFTS RADIO CATALOG TUFTS RADIO

Vhf engineering

THE WORLD'S MOST COMPLETE LINE OF VHF-FM KITS AND EQUIPMENT

RX28C	28-35 MHz FM receiver with 2 pole 10.7 MHz crystal filter	\$ 64.95
RX28C W/T	same as above—wired & tested	117.95
RX50C Kit	30-60 MHz rcvr w/2 pole 10.7 MHz crystal filter	64.95
RX50C W/T	same as above—wired & tested	117.95
RX144C Kit	140-170 MHz rcvr w/2 pole 10.7 MHz crystal filter	74.95
RX114C W/T	same as above—wired & tested	119.95
RX220C Kit	210-240 MHz rcvr w/2 pole 10.7 MHz crystal filter	74.95
RX220C W/T	same as above—wired & tested	117.95
RX432C Kit	432 MHz rcvr w/2 pole 10.7 MHz crystal filter	84.95
RX432C W/T	same as above—wired & tested	129.95

RECEIVERS

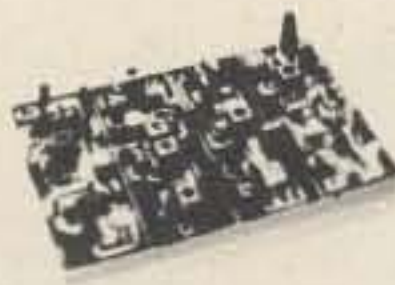

RXCF	accessory filter for above receiver kits gives 70 dB adjacent channel rejection	8.95
RF28 Kit	10 mtr RF front end 10.7 MHz out	13.50
RF50 Kit	6 mtr RF front end 10.7 MHz out	13.50
RF144D Kit	2 mtr RF front end 10.7 MHz out	18.50
RF220D Kit	220 MHz RF front end 10.7 MHz out	18.50
RF432 Kit	432 MHz RF front end 10.7 MHz out	29.50
IF 10.7F Kit	10.7 MHz IF module includes 2 pole crystal filter	29.50
FM455 Kit	455 KHz IF stage plus FM detector	18.50
AS2 Kit	audio and squelch board	16.00

TX50	transmitter exciter, 1 watt, 6 mtr.	44.95
TX50 W/T	same as above—wired & tested	64.95
TX144B Kit	transmitter exciter—1 watt—2 mtrs	34.95
TX144B W/T	same as above—wired & tested	59.95
TX220B Kit	transmitter exciter—1 watt—220 MHz	34.95

TRANSMITTERS



TX220B W/T	same as above—wired & tested	59.95
TX432B Kit	transmitter exciter 432 MHz	49.95
TX432B W/T	same as above—wired & tested	79.95
TX150 Kit	300 milliwatt, 2 mtr transmitter	24.95
TX150 W/T	same as above—wired & tested	39.95

PA2501H Kit	2 mtr power amp—kit 1w in—25w out with solid state switching, case, connectors	64.95
PA4010H Kit	2 mtr power amp—10w in—40w out—relay switching	64.95
PA50/25 Kit	6 mtr power amp, 1w in, 25w out, less case, connectors & switching	54.95
PA144/15 Kit	2 mtr power amp—1w in—15w out—less case, connectors and switching	44.95
PA144/25 Kit	same as PA144/15 kit but 25w	54.95
PA220/15 Kit	similar to PA144/15 for 220 MHz	44.95
PA432/10 Kit	power amp—similar to PA144/15 except 10w and 432 MHz	54.95
PA140/10 W/T	10w in—140w out—2 mtr amp	219.95
PA140/30 W/T	30w in—140w out—2 mtr amp	189.95

POWER AMPLIFIERS

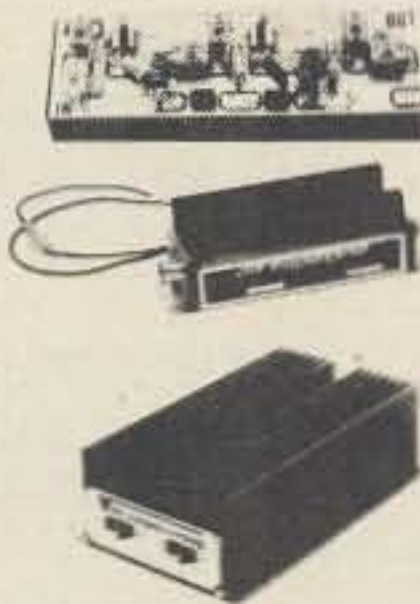

Blue Line	RF power amp, wired & tested, emission—CW-FM-SSB/AM			
Model	BAND	Power Input	Power Output	
BLC 10/70	144 MHz	10W	70W	149.95
BLC 2/70	144 MHz	2W	70W	169.95
BLC 10/150	144 MHz	10W	150W	259.95
BLC 30/150	144 MHz	30W	150W	239.95
BLD 2/60	220 MHz	2W	60W	164.95
BLD 10/60	220 MHz	10W	60W	159.95
BLD 10/120	220 MHz	10W	120W	259.95
BLE 10/40	420 MHz	10W	40W	179.95
BLE 2/40	420 MHz	2W	40W	179.95
BLE 30/80	420 MHz	30W	80W	259.95
BLE 10/80	420 MHz	10W	80W	289.95

PS15C Kit	15 amp—12 volt regulated power supply w/case, w/fold-back current limiting and overvoltage protection	94.95
PS15C W/T	same as above—wired & tested	124.95
PS25M Kit	25 amp—12 volt regulated power supply w/case, w/fold-back current limiting and ovp, with meter	154.95
PS 25M W/T	same as above—wired & tested	179.95

POWER SUPPLIES

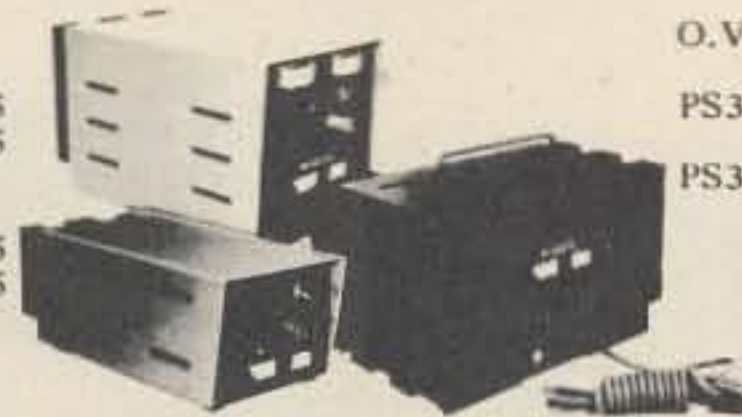

O.V.P.	adds over voltage protection to your power supplies, 15 VDC max.	12.95
PS3A Kit	12 volt—power supply regulator card with fold-back current limiting	10.95
PS3012 W/T	new commercial duty 30 amp 12 VDC regulated power supply w/case, w/fold-back current limiting and overvoltage protection	249.95

RPT50 Kit	repeater—6 meter	499.95
RPT50	repeater—6 meter, wired & tested	799.95
RPT144 Kit	repeater—2 mtr—15w—complete (less crystals)	499.95
RPT220 Kit	repeater—220 MHz—15w—complete (less crystals)	499.95
RPT432 Kit	repeater—10 watt—432 MHz (less crystals)	579.95
RPT144 W/T	repeater—15 watt—2 mtr	799.95
RPT220 W/T	repeater—15 watt—220 MHz	799.95
RPT432 W/T	repeater—10 watt—432 MHz	849.95

REPEATERS



DPLA50	6 mtr close spaced duplexer	575.95
DPLA144	2 mtr, 600 KHz spaced duplexer, wired and tuned to frequency	379.95
DPLA220	220 MHz duplexer, wired and tuned to frequency	379.95
DPLA432	rack mount duplexer	319.95
DSC-U	double shielded duplexer cables with PL259 connectors (pr.)	25.00
DSC-N	same as above with type N connectors (pr.)	25.00

TRX50 Kit	Complete 6 mtr FM transceiver kit, 20w out, 10 channel scan with case (less mike and crystals)	244.95
TRX144 Kit	same as above, but 2 mtr & 15w out	234.95
TRX220 Kit	same as above except for 220 MHz	234.95
TRX432 Kit	same as above except 10 watt and 432MHz	254.95
TRC-1	transceiver case only	29.95
TRC-2	transceiver case and accessories	49.95

TRANSCEIVERS



OTHER PRODUCTS BY VHF ENGINEERING

CD1 Kit	10 channel receive xtal deck w/diode switching	\$ 7.95
CD2 Kit	10 channel xmit deck w/switch and trimmers	15.50
CD3 Kit	UHF version of CD1 deck, needed for 432 multi-channel operation	13.50
COR2 Kit	carrier operated relay	22.75
SC3 Kit	10 channel auto-scan adapter for RX with priority	19.95
Crystals	we stock most repeater and simplex pairs from 146.0-147.0 (each)	5.00
CWID Kit	159 bit, field programmable, code identifier with built-in squelch tail and ID timers	39.95
CWID	wired and tested, not programmed	54.95
CWID	wired and tested, programmed	59.95
MIC 1	2,000 ohm dynamic mike with P.T.T. and coil cord	12.95
TS1 W/T	tone squelch decoder	59.95
TS1 W/T	installed in repeater, including interface accessories	89.95
TD3 Kit	2 tone decoder	35.95
TD3 W/T	same as above—wired & tested	59.95
HL144 W/T	4 pole helical resonator, wired & tested, swept tuned to 144 MHz ban	29.95
HL220 W/T	same as above tuned to 220 MHz ban	29.95
HL432 W/T	same as above tuned to 432 MHz ban	29.95

SYN II Kit	2 mtr synthesizer, transmit offsets programmable from 100 KHz—10MHz, (Mars offsets with optional adapters)	169.95
SYN II W/T	same as above—wired & tested	239.95
SYN 220 Kit	same as SYN II Kit except 220-225 MHz	169.95
SYN 220 W/T	same as above—wired & tested	239.95

SYNTHESIZERS



HATRY electronics

500 Ledyard St., Hartford CT 06114
203-527-1881

(1 block east of Wethersfield Ave. off Airport Rd.
Rte. 6)

See Ward W1WRQ — John W1JJR
or
Dave WA1HFE

HEADQUARTERS for 2M FM

Tempo VHF/ONE, SSB/ONE adaptor, Tempo VHF amplifiers, FMH-2, FMH-5; Drake TR 33C, AA 10, AC 10; Regency HR 2B, HR 312, AR 2, P 110 & crystals for all lines listed above.

FM GAIN ANTENNAS

For mobile, fixed or portable operation by Cush-Craft, Hy-Gain, Antenna Specialists & New-Tronics.

ANTENNA STUFF

Open wire feedline — #18, #14, #12 ga. bare copperweld wire — #14, #12 enamel copper — insulators — W2AU baluns 1-1 or 4-1 — lowloss coax cable — Rohn 25G towers & accessories — Blitzbug lightning arrestors — glassline guy — B&W antenna switches — Belden 72 & 300 ohm KW twinlead — Amphenol UHF & BNC connectors.

AMATEUR GEAR

Drake, Swan, Tempo, Ten-Tec, Dentron, Regency, Mosley, Hy-Gain, CushCraft.

(Canadian Amateurs Send U.S. Funds Only)
F.O.B. Hartford
Please include postage

CONNECTICUT'S OLDEST HAM STORE

H15

FREQUENCY COUNTERS

FREE

By popular demand we are continuing to offer a Fairchild Clock, Module FCS-8100A (suggested retail \$20) with any purchase of \$99 or more from 73 advertisements.



Previously kitted for Crescomm Inc. by Hal-Tronix

COMPLETE KITS: CONSISTING OF EVERY ESSENTIAL PART NEEDED TO MAKE YOUR COUNTER COMPLETE. **HAL-600A** 7-DIGIT COUNTER WITH FREQUENCY RANGE OF ZERO TO 600 MHz. FEATURES TWO INPUTS: ONE FOR LOW FREQUENCY AND ONE FOR HIGH FREQUENCY; AUTOMATIC ZERO SUPPRESSION. TIME BASE IS 1.0 SEC OR .1 SEC GATE WITH OPTIONAL 10 SEC GATE AVAILABLE. ACCURACY $\pm .001\%$. UTILIZES 10-MHz CRYSTAL 5 PPM.

COMPLETE KIT \$149.00

HAL-300A 7-DIGIT COUNTER WITH FREQUENCY RANGE OF ZERO TO 300 MHz. FEATURES TWO INPUTS: ONE FOR LOW FREQUENCY AND ONE FOR HIGH FREQUENCY; AUTOMATIC ZERO SUPPRESSION. TIME BASE IS 1.0 SEC OR .1 SEC GATE WITH OPTIONAL 10 SEC GATE AVAILABLE. ACCURACY $\pm .001\%$. UTILIZES 10-MHz CRYSTAL 5 PPM.

COMPLETE KIT \$124.00

HAL-50A 8-DIGIT COUNTER WITH FREQUENCY RANGE OF ZERO TO 50 MHz OR BETTER. AUTOMATIC DECIMAL POINT, ZERO SUPPRESSION UPON DEMAND. FEATURES TWO INPUTS: ONE FOR LOW FREQUENCY INPUT, AND ONE ON PANEL FOR USE WITH ANY INTERNALLY MOUNTED HAL-TRONIX PRE-SCALER FOR WHICH PROVISIONS HAVE ALREADY BEEN MADE. 1.0 SEC AND .1 SEC TIME GATES. ACCURACY $\pm .001\%$. UTILIZES 10-MHz CRYSTAL 5 PPM.

COMPLETE KIT \$124.00

HAL-TRONIX BASIC COUNTER KITS STILL AVAILABLE

THE FOLLOWING MATERIAL DOES NOT COME WITH THE BASIC KIT: THE CABINET, TRANSFORMER, SWITCHES, COAX FITTINGS, FILTER LENS, FUSE HOLDER, T-03 SOCKET, POWER CORD AND MOUNTING HARDWARE.

HAL-600X (Same Specifications as HAL-600A) \$124.00

HAL-300X (Same Specifications as HAL-300A) \$99.00

HAL-50X (Same Specifications as HAL-50A) \$99.00

PRE-SCALER KITS

HAL-0-300PRE (Pre-drilled G10 board and all components) \$19.95

HAL-0-300P/A (Same as above but with preamp) \$29.95

HAL-0-600PRE (Pre-drilled G10 board and all components) \$39.95

PRE-BUILT COUNTERS AVAILABLE

(HAL-600A — \$229.00) (HAL-300A — \$199.00) HAL-50A — \$199.00). ALLOW 4- TO 6-WEEK DELIVERY ON PRE-BUILT UNITS.



"HAL" HAROLD C. NOWLAND
WBZXH

HAL-TRONIX
P. O. BOX 1101
SOUTHGATE, MICH. 48195
PHONE (313) 285-1782

SHIPPING ORDERS OVER \$15.00 WILL BE SHIPPED POSTPAID EXCEPT ON ITEMS WHERE ADDITIONAL CHARGES ARE REQUESTED. ON ORDERS LESS THAN \$15.00
INFORMATION: PLEASE INCLUDE ADDITIONAL \$1.00 FOR HANDLING AND MAILING CHARGES.

SEND SASE FOR FREE FLYER

H24

RTTY Loop

Marc I. Leavey, M.D. WA3AJR
4006 Winlee Road
Randallstown MD 21133

This month, we complete the first year of "RTTY Loop." A lot of ground has been covered, from basics to beneficients. Above all, however, let's not forget that Teletype is fun! I'll try to explore some of that entertainment right now.

Starting simply, have you ever seen a kid around a Model 15? The next time you have children in the shack, relatives, neighbors, or foundlings, put the printer on local loop and let it idle. Something magical happens when a child discovers that noisy, overgrown, electric typewriter. Kids from three to a hundred have become enraptured; they sit at the keyboard for hours, just typing their names or ringing the bell. The child in all of us is excited, and it makes a fascinating introduction to the world of amateur radio.

One of those things that always gets them is RTTY art. The technique for producing your own TTY pictures is not complicated, and has been covered in 73 and QST in the past. The first step is to acquire some RTTY pictures that someone else (preferably experienced) has produced. The easiest way to do that is to tune

around the HF bands looking for a long taped transmission. Very frequently, you will find that such a transmission is a picture being sent. If you know anyone in your area who is a RTTY nut, he or she may well have a stockpile of artwork to share with you. And "Any good pictures to send?" is always a good question during a QSO.

Once you have looked at a few pictures, such as the ones printed (albeit much reduced) here this month, you will notice that there are three major ways of producing these pictures.

The first, and easiest for the beginner to master, is the use of one character, frequently "X" or "M", to form a block drawing or grid pattern. Letters are relatively easy to produce with this technique, and even simple pictures can be made by the neophyte. Variations on this method include using different letters to coordinate with the large design, or to spell out a message within a message.

While block drawing with one character can produce recognizable pictures, there is a limit to the resolution you can get with just a grid. To try to obtain finer detail, many RTTY pictures use various characters to provide shape or slope of their own. Typical characters used include the /, (,), and !, and

```

HAPPYFATHERSDAYHAPPYFATHERSDAYHAPPYFATHERSDAYHAPPYFATHERSDAYHAPPYFATHERS
APPYFATHERSDAY
PYFATHERSD
FATHER
YFATHERSDAYH FATHER HAPPYFATHERS APPYFA SDAYHAPPYFAT
YFATHERSDAYH FATHER HAPPYFATHERS APPYFA SDAYHAPPYFAT
YFATHERSDAYH FATHER HAPPYFATHERS APPYFA SDAYHAPPYFAT
YFATHERSDAYH FATHER HAPPYFATHERS APPYFA SDAYHAPPYFAT
YFATHERSDAYH FATHER HAPPYFATHERS APPYFA SDAYHAPPYFAT
YFATHERSDAYH FATHER HAPPYFATHERS APPYFA SDAYHAPPYFAT
PYFATHER HAPPYFATHERS APPYFA SDAYHAPPYFAT
APPYFATHER HAPPYFATHERS APPYFA SDAYHAPPYFAT
YFATHERSDAYHAPPYFATHER HAPPYFATHERS APPYFA SDAYHAPPYFAT
YFATHERSDAYHAPPYFATHER HAPPYFATHERS APPYFA SDAYHAPPYFAT
YFATHERSDAYHAPPYFATHER HAPPYFATHERS APPYFA SDAYHAPPYFAT
YFATHERSDAYHAPPYFATHER HAPPYFATHERS APPYFA SDAYHAPPYFAT
YFATHERSDAYHAPPYFATHER HAPPYFATHERS APPYFA SDAYHAPPYFAT
YFATHERSDAYHAPPYFATHERSD YHAPPYFA SDAYHAPPYFAT
YFATHERSDAYHAPPYFATHERSD DAYHAPPYFA SDAYHAPPYFAT
HAPPYFATHERSDAYHAPPYFATHERSDAYHAPPYFATHERSDAYHAPPYFATHERSDAYHAPPYFATHERS
    
```

Fig. 1.

the letters A, V, and O. By using a combination of the block technique and letter-shape bordering, fairly nice work can be produced with a small amount of work.

The most tedious, beautiful, and difficult to master RTTY art uses various characters to simulate halftone shades. Typically, shading from dark to light is accomplished as:

MMMMMMMMHHHHHHIIIIII:::.....
with multiple variations and occasional overprinting. For many years, some of the finest examples of this type of RTTY art have been done by Don Royer WA6PIR out in Encino, California. Back in January, 1972, Don had an article on page 13 of 73 that went into detail on this technique and included many striking examples.

To attempt to illustrate these techniques, three examples of RTTY art are printed here. Fig. 1

is an example of the first technique. Notice that the letters forming the background spell out a message which elaborates on the overall design. Fig. 2 demonstrates the "bordering" technique. Here, blank space rather than blocked-in letters contributes to the feeling of a line drawing rather than a typed picture. Finally, Fig. 3 shows what can be done with carefully executed shading to produce a beautiful picture.

Moving from the visual to the audible, have you ever played a tune on your TTY? It has two bells, you know, and a number of tunes can be played, in rhythm, by pounding out the BELL character, other characters for timing, and occasional use of the end-of-line bell. At Christmas time, one frequently hears "Jingle Bells," often with simultaneous greetings printed out. Other tunes

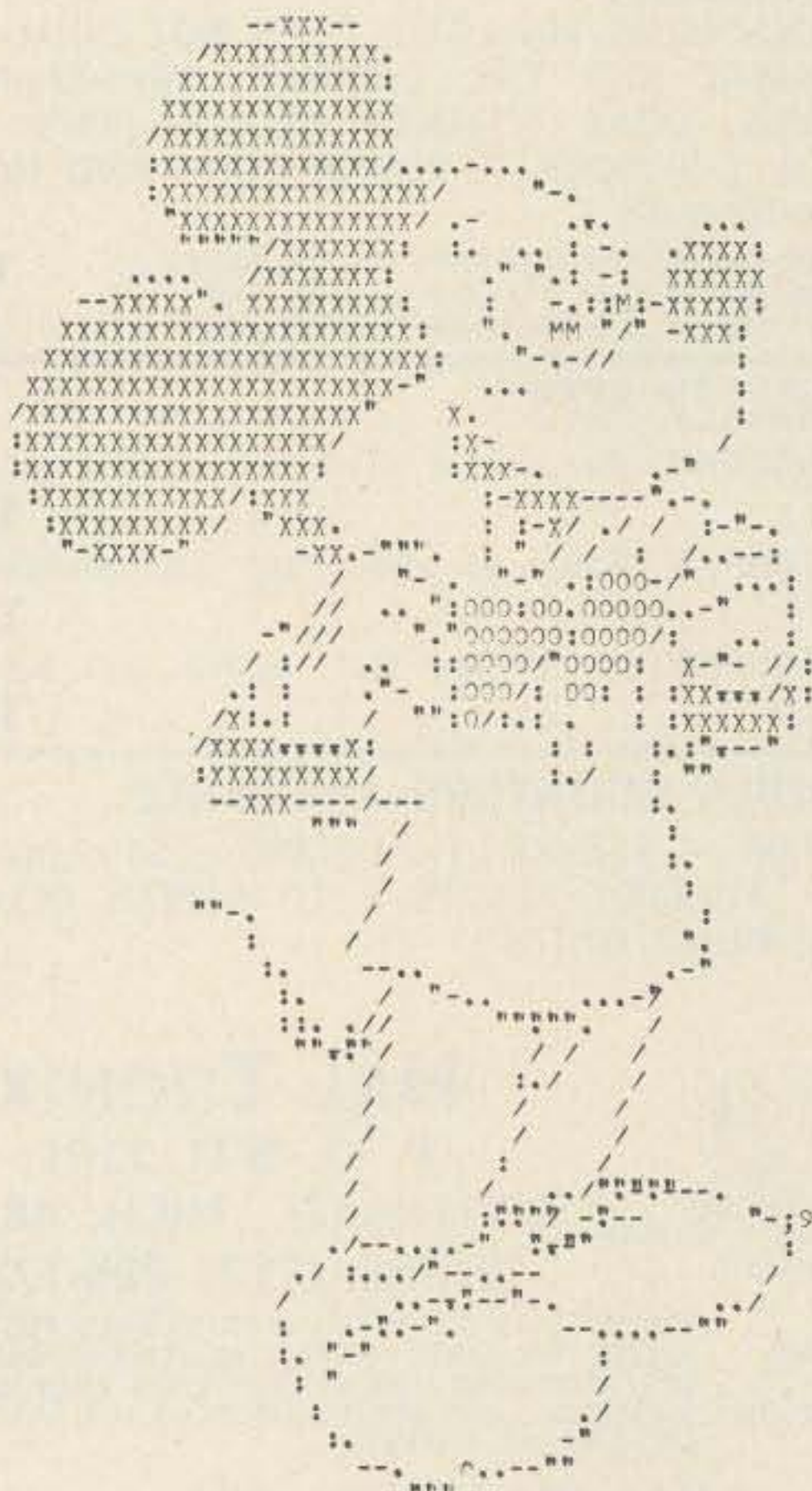

Fig. 2.

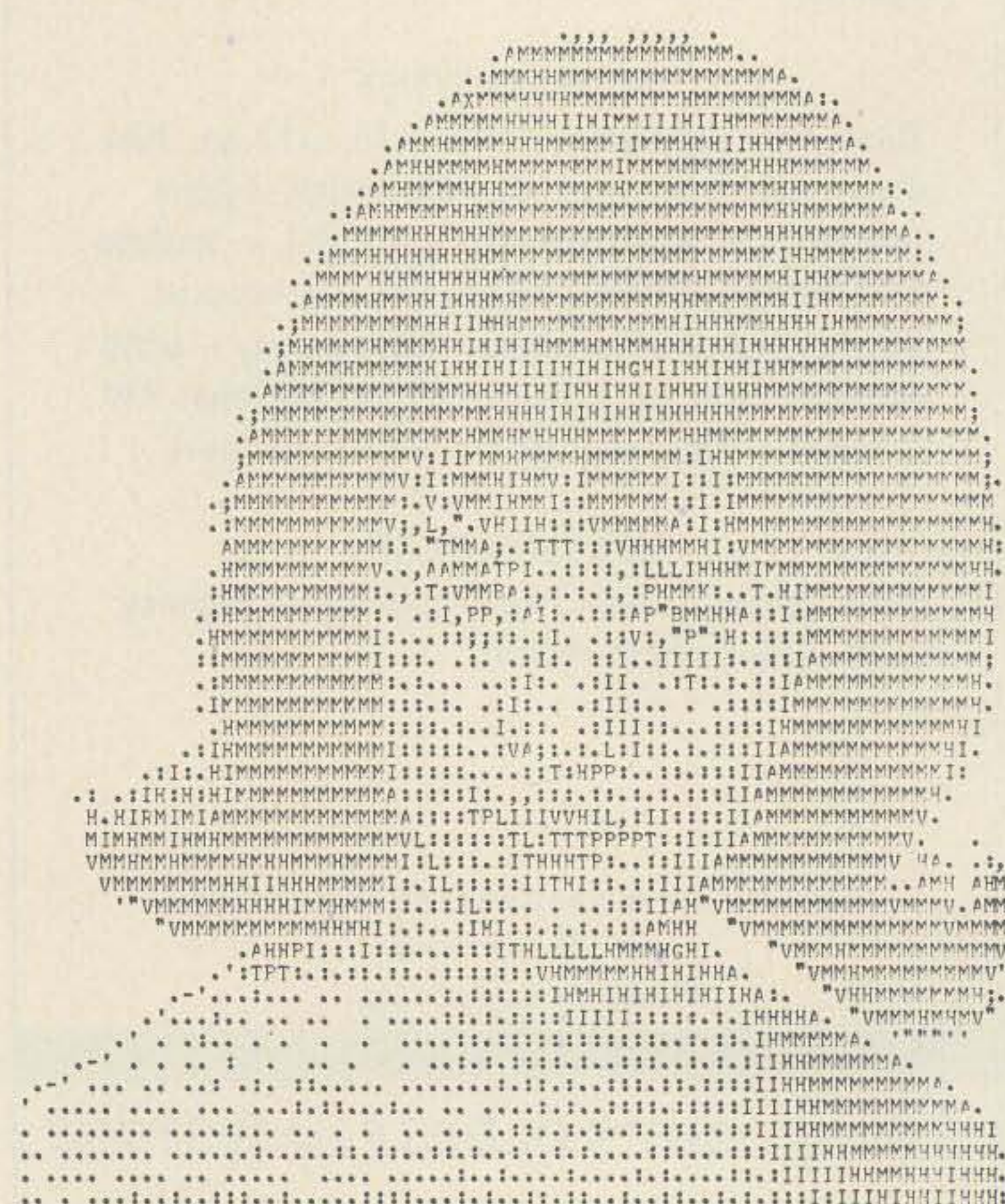

Fig. 3.

TO GET CHARACTER	TYPE EXACTLY
A	V S S V
B	L T R S Y Y R
C	C Z Z R
D	L T R S Z Z C
E	L T R S Y Y Z
F	L T R S S S E
G	C Z B R C R
H	L T R S S P C S P C L T R S
I	Z Z L T R S Z Z
J	C R T T K
K	L T R S S P C R Z
L	L T R S T T T
M	L T R S L F S P C L F L T R S
N	L T R S L F S P C R L T R S
O	C Z Z C
P	V S S I
Q	C Z B C T
R	L T R S S F P
S	L Y Y D
T	E E L T R S E E
U	K T T K
V	A N T N A
W	L T R S C R S P C C R L T R S
X	Z R S P C R Z
Y	E L F M L F E
Z	Z B Y W Z
1	L L T R S T
2	B Y Y L
3	Z Y Y C
4	U S P C S P C L T R S
5	J W W F
6	C Y Y N
7	Z D S A
8	F I G S Y Y F I G S
9	L F Y Y C
0	E C Z Y B C T

- * ABBREVIATIONS *
- * USED: *
- L T R S: LETTERS
- F I G S: FIGURES
- S P C: SPACE
- L F: LINE FEED
- C R: CARRIAGE RETURN
- * USE "BLANK" KEY *
- * TO SPACE *
- * BETWEEN *
- * CHARACTERS. *

Fig. 4.

are possible, based on your personal sense of rhythm. The basic method involves inserting printing or non-printing (i.e., LTRS or FIGS) characters between BELLS so as to output the proper timing. Try it!

Finally, have you ever tried tapewriting? By carefully choosing your characters, the pattern of holes punched in TTY tape can form any letter or character. Now, while this may not seem like much, give it some thought. Crazy things like "Happy Birthday, Bob!" can be sent to a station after telling him to turn on his tape punch. Fig. 4 diagrams which characters to use for the commonly used letters and numbers. A convincing simulation of a moving light display (a la Times Square) can be produced by enclosing a loop of tape appropriately punched (like FCC Bans CB Operation . . .) in a box with a motor to move the tape and rear lighting. Just the thing to perk up the model railroad.

Got a letter this month from Lee Crawford W1PJA/3 in Wilmington, Delaware, who is looking for a source of TTY equipment. I don't know what to suggest, Lee. I hesitate to start listing an "equipment exchange" in this column for several reasons. Besides the problems of implied endorsement, the lead time on this col-

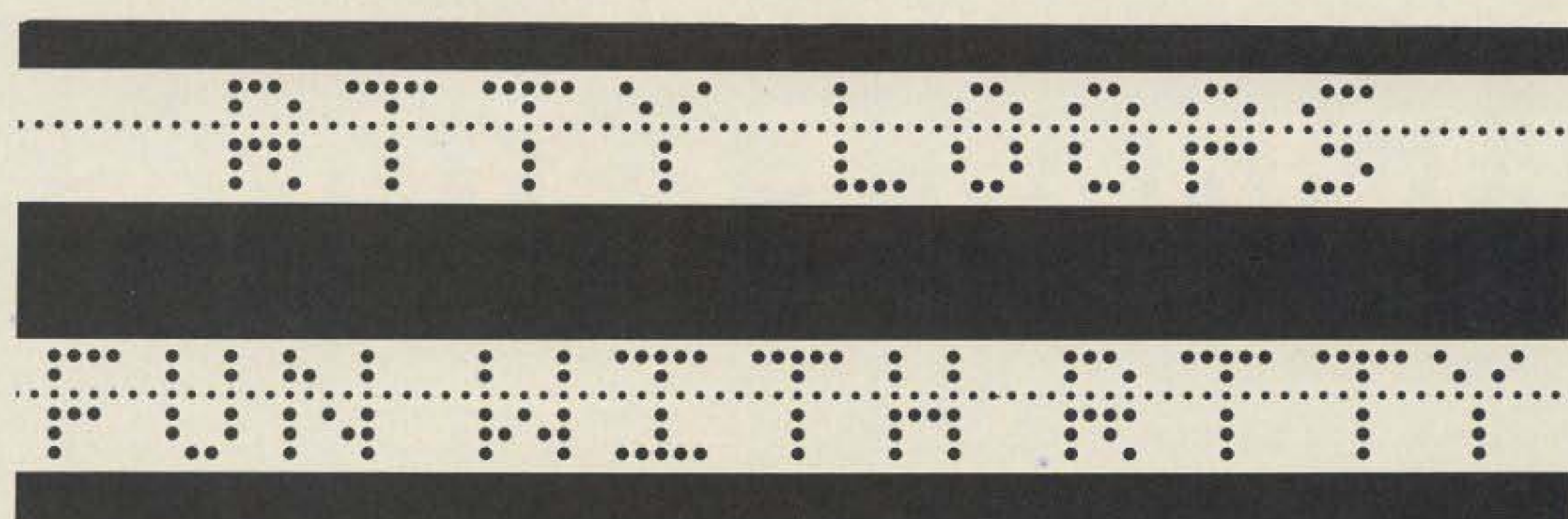

Fig. 5. Tapewriting example.

umn makes any semblance of timely notices difficult. By the time I could tell you all about an item, two or three months may have gone by and it could well have been sold. It would be far better for anyone with equipment to sell to take out a small ad in 73. Perhaps if enough RTTY ads were received, Wayne could be persuaded to lump them all in one place for easy reference. Meanwhile, if anyone in the Wilmington area knows of a machine that is available, Lee's looking!

A note from Mark Wilson W0ZSU (wonder if he is the magician?) asks again about

the so-called "RTTY" position on the Heath SB-303 receiver. Mark, this was evidently designed for a companion that got shoved aside when the new digital line came out. The reason that it does not work with the SB-401 transmitter is that transmit and receive frequencies end up offset more than one kHz. The keyer circuit which was originally shown in 73 in August, 1976, and reprinted in this column a few months back and in the new *RTTY Handbook* is a good one which many hams have used to get this otherwise fine transmitter on RTTY.

Next month we will delve into more exotic types of RTTY, in particular, using a computer to receive amateur RTTY transmissions. I don't know how many of you have home computers, but I do, and it's one of the most fascinating aspects of this hobby. As I'm sure you have been reading, a microcomputer can do all kinds of things. For example, this month's column was written and edited on my SWTPC 6800 system, using a simple line editor.

More next month; meanwhile, have fun!

Ham Help

Some time ago, I wrote asking for the schematic of the RME HF 10-20. Here are the results of your "Ham Help":

1. Hamgram from W7LNG via WB6PVH with info on where I could get the schematic.
2. Letter from W9IOG with two addresses where I might get the information.
3. A photofact copy of the gear

from W7DYD.

4. A Xerox™ copy of the gear from WB3BLR.

Who on Earth would do such a wonderful job? The answer is none but that gang of hams you and I associate with. I wish you would publish a special thanks to the hams I have mentioned above, possibly in "Ham Help" so they will be sure to

see it. Again, many thanks to all concerned.

George N. Andrews WA6DWV
San Diego CA

I have a defective crystal I want to return to the manufacturer, but I can't find out from anyone who that is! The crystal says "K-W K4" on the side. Does anyone know the manufacturer?

Marvin Moss W4UXJ
PO Box 28601
Atlanta GA 30328

Oscar Orbits

The listed data tells you the time and place OSCAR crosses the equator in an ascending orbit for the first time each day. To calculate successive orbits, make a list of the first orbit number and the next twelve orbits for that day. List the time of the first orbit. Each successive orbit is 115 minutes later (two hours less five minutes). The chart gives the longitude of the first crossing. Add 29° for each succeeding orbit. When OSCAR is ascending on the other side of the world, it will descend over you. To find the equatorial descending longitude, subtract 166 degrees from the ascending longitude. To find the time it passes the North Pole, add 29 minutes to the time it passes the equator. You should be able to hear OSCAR when it is within 45 degrees of you. The easiest way to do this is to take a globe and draw a circle with a radius of 2480 miles (4000 kilometers) from the home QTH. If it passes right overhead, you should be able to hear it for about 24 minutes total. OSCAR will pass an imaginary line drawn from San Francisco to Norfolk about 12 minutes after passing the equator. Add about a minute for each 200 miles that you live north of this line. If OSCAR passes 15 degrees from you, add another minute; at 30 degrees, three minutes; at 45 degrees, ten minutes. Mode A: 145.85-.95 MHz uplink, 29.4-29.5 MHz downlink, beacon at 29.502 MHz. Mode B: 432.125-.175 MHz uplink, 145.975-.925 MHz downlink, beacon at 145.972 MHz.

Oscar 7 Orbital Information

Orbit	Date (May)	Time (GMT)	Longitude of Eq. Crossing °W
15814 Bbn	1	0001:07	57.5
15827 Bbn	2	0055:25	71.0
15840 Abn	3	0149:42	84.6
15852 Bbn	4	0049:02	69.5
15865 Bbn	5	0143:20	83.1
15877 Abn	6	0042:40	67.9
15890 Bbn	7	0136:57	81.5
15902 Bbn	8	0036:18	66.3
15915 Abn	9	0130:35	79.9
15927 Bbn	10	0029:56	64.8
15940 Bbn	11	0124:13	78.4
15952 Abn	12	0023:34	63.2
15965 Bbn	13	0117:51	76.8
15977 Bbn	14	0017:11	61.7
15990 Abn	15	0111:29	75.2
16002 Bbn	16	0010:49	60.1
16015 Bbn	17	0105:06	73.7
16027 Abn	18	0004:27	58.5
16040 Bbn	19	0058:44	72.1
16053 Bbn	20	0153:01	85.7
16065 Abn	21	0052:22	70.5
16078 Bbn	22	0146:39	84.1
16090 Bbn	23	0046:00	69.0
16103 Abn	24	0140:17	82.6
16115 Bbn	25	0039:37	67.4
16128 Bbn	26	0133:55	81.0
16140 Abn	27	0033:15	65.9
16153 Bbn	28	0127:33	79.4
16165 Bbn	29	0026:53	64.3
16178 Abn	30	0121:10	77.9
16190 Bbn	31	0020:31	62.7

Super Terminals with Hidden Features

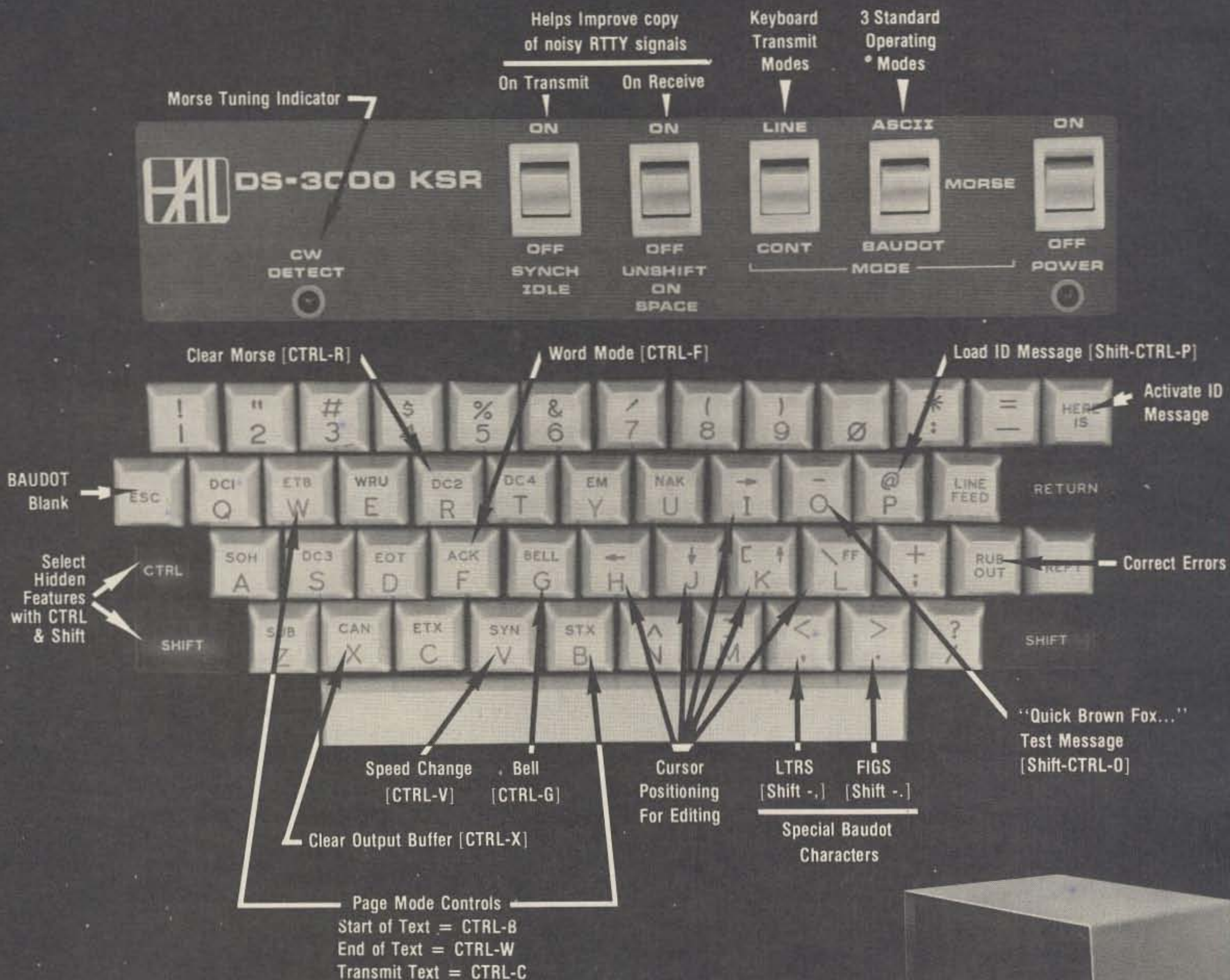

For super operator convenience, Our keyboard works in MORSE, BAUDOT, and ASCII codes and controls the terminal, too. You can edit a message, program the HERE IS message, send the "QUICK BROWN FOX..." test message, change speeds, and change the terminal modes, all from the keyboard itself. In fact, the KOS (Keyboard Operated Switch) feature even turns the transmitter on and off from the keyboard. The DS-3000 KSR also features full-length 72 character lines (16 lines per screen), 5 speeds of BAUDOT and ASCII RTTY and Morse code from 1 to 175 wpm (Version 3), and word wrap-around to prevent splitting of words at the end of a line. When combined with the HAL ST-6000 Demodulator, you have the ULTIMATE in RTTY equipment.

DS-3000 KSR Version 3 (MORSE, BAUDOT, ASCII) \$1575.00
 DS-3000 KSR Version 2 (BAUDOT & ASCII only) \$1195.00

Write for our latest catalog & RTTY guide.



HAL COMMUNICATIONS CORP.
 Box 365
 Urbana, Illinois 61801
 217-367-7373



For our Overseas customers:
 see HAL equipment at:
 Richter & Co.; Hannover
 I.E.C. Interrelco; Bissone
 Vicom Imports; Auburn, Vic., Australia

Full Features and Superior Performance

ST-6000 RTTY DEMODULATOR

Select Rx & Tx Shifts
 Accurately Tuned Rx Filters
 Crystal Controlled Tx Tones
 True Transceive Operation

Invert Both Rx Demod.,
 and Tx Tones

Data Status Indicators
 Loop 1 Post-Autostart Pre-Autostart

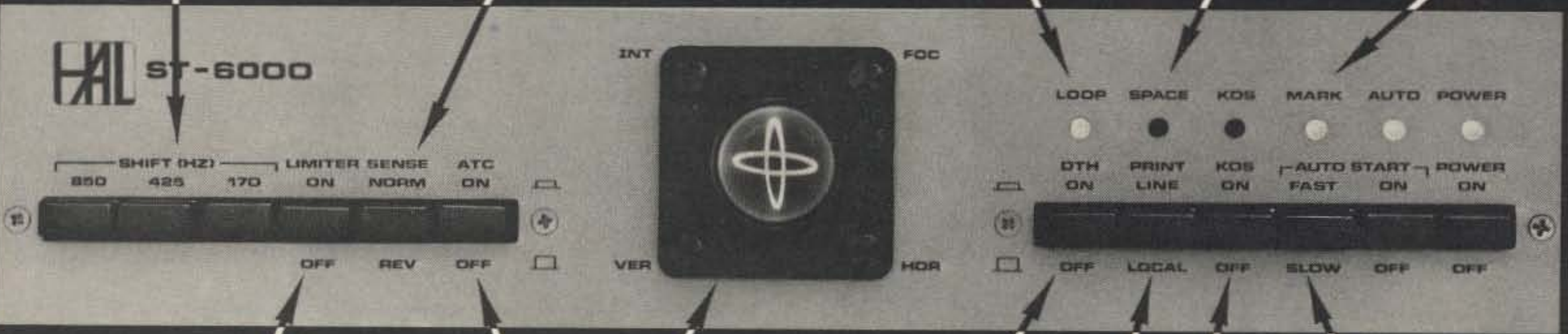

Hard-Limiting [FM]
 or
 Non-Limiting [AM]
 Reception

Correct for
 Bias Distortion

Correct For
 Multi-Path Distortion

Local Loop Operation

Autostart with:
 ◦ Motor Control
 ◦ Mark Hold
 ◦ Antispace

Tuning Oscilloscope
 [Front Panel Controls]
 Meter Indicator Option
 Also Available

Automatic Tx/Rx Station
 Control with Keyboard
 Operated Switch [KOS]

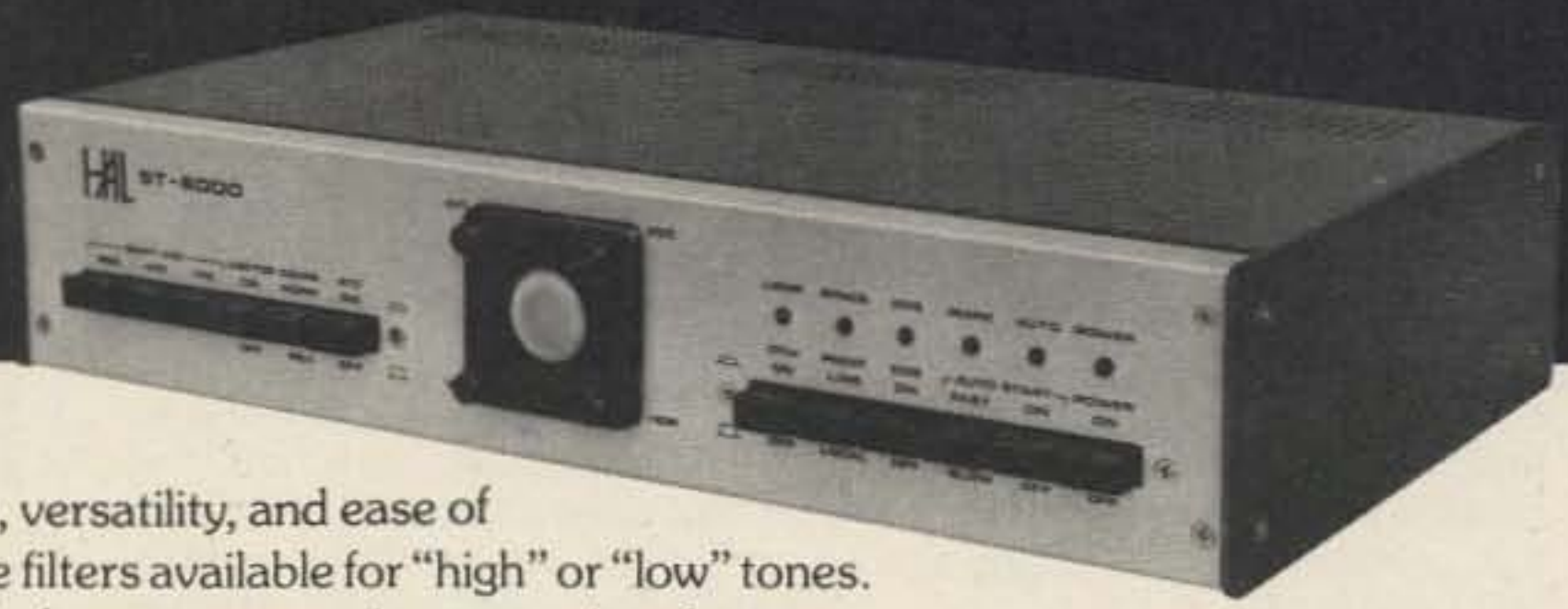

Why not have the best?

The HAL ST-6000 Demodulator offers outstanding performance, versatility, and ease of operation. The Receive Demodulator features multiple-pole active filters available for "high" or "low" tones. These filters are frequency-matched to the transmit tone crystals for true transceive operation. Input bandpass filters, discriminator filters, and post-detection filters are carefully designed and tested for optimum weak-signal recovery. The ST-6000 has an internal loop power supply, 2 loop keyers, RS-232, MIL-188C, and CMOS data I/O, and rear panel connections to data and control circuits for connection to UART and computer devices. Use it with the HAL DS-3000 KSR for the best in RTTY performance.

\$595.00

Write today for HAL's latest RTTY catalog.



HAL COMMUNICATIONS CORP.
 Box 365
 Urbana, Illinois 61801
 217-367-7373



For our Overseas customers:
 see HAL equipment at:
 Richter & Co.; Hannover
 I.E.C. Interrelco; Bissone
 Vicom Imports; Auburn, Vic., Australia

ou goons don't ever proof-
lousy manuscripts from bat
bunch of rock on
you lie and you're in
I insist that you print ev
tell Ma Bell that she shou

LETTERS

from page 8

The second return trip required some delicate and potentially expensive repairs. The radio, which arrived yesterday, was not only in top shape, but again had the checkout spec sheet showing that the transmitter and receiver had been realigned, finals replaced, and other repairs/adjustments had been made. Again, no charge.

Yessiree, that \$1500 for a new 350-XL doesn't seem so high after all.

I'm convinced! Just imagine what a wonderful world this would be if all customers were treated like Atlas treats theirs.

Joseph H. Cowen WA5TUM
Beeville TX

GOOD-BYE VEGAS

I wonder how many other hams were treated as I was in Las Vegas by the Sahara Hotel, where the SAROC convention was held.

I had paid for my hotel room a month in advance, and had received confirmation of my reservation.

I arrived at the Sahara Hotel at 11:30 pm Friday and asked for my room. I was told that there were no rooms available, even though I had paid for one in advance. Needless to say, I blew my top, but to no avail. They put me up in a motel about 4 miles away for that night.

At that time, I had lost my taste for SAROC, Las Vegas, conventions, slots, etc. I asked for my money back the next morning, had a few words with the convention chairman, and left Las Vegas.

I don't think I will ever attend another SAROC after that treatment. How can you depend on the Hotel Sahara word any more?

Am curious how many other hams received the same treatment.

Ralph Saroyan W6JPU
Fresno CA

JOKING?

It's just great to see how the FCC can still keep its sense of humor while laboring so hard under its immense workload.

Take the proposal in Docket 21135 about club calls. Processing these applications under current procedures can hardly amount to more than just checking to see if all of the boxes on the form are filled in, and that the form itself is signed. Approval, I would imagine, is pretty much automatic.

Now, to ease the administrative burden, the Commission will only grant calls where the application demonstrates a "compelling need" for a club call, if the proposal is enacted. I can see it in my mind's eye: Instead of a clerk (or a computer) scanning a form and wielding a rubber stamp, a committee will convene to weigh the merits of each application. No doubt there'll be an appeals procedure, and some mechanism for seeking a review of the full Commission.

The proposal is so absurd that it can only be a joke.

It is only a joke, isn't it?

Alan J. Gottesman W2TY
West Caldwell NJ

Sure, just as much of a joke as the equally (or more) stupid ban on ham amplifiers with 10m on them.—Wayne.

FOR THE DEFENSE

I just read the letter by an unidentified and apparently disgruntled author reporting deliberate illegal operation on the 7268 kHz "Waterway Net."

I became aware of this net about six months ago while in the "Islands" afoot. Since that time, I have signed in whenever possible. During that time, I have not heard any illegal operation. I have heard traffic refused to areas not covered with a third party agreement, and callsigns requested when neglected.

This net gives priority to low powered MMs, and otherwise has friendly discussions, mostly about weather and boats.

I have heard advice given to a boater in 15-foot seas with a balky engine, and directions to safe harbors when bad weather is expected. In short, the conduct, ethics, operation, and goals of the net have been very good during my acquaintance with it.

From the sidelines, I have

noticed attempts of some to dominate the net without success. Perhaps resentment prompted the unsigned letter in the February issue of 73.

Allen Bell W4IKV
Cape Canaveral FL

GREEDY?

Re your editorial, January, '78: Please keep your greedy hands off that part of the 20 meter band where sanity still prevails—from 14.100 to 14.200. We on this side of the Atlantic have only one hope of having a phone QSO within Europe or to some DX area outside of the USA, and that hope lies within that 100 kHz where the linear amplifier is still the exception rather than the rule.

My compliments on your magazine—excellent in quality and quantity.

Sean Linehan
Castleknock, Dublin
Ireland

Don't be stingy.—Wayne.

A WONDERFUL LIFE

It took me three years to find the receiver and transmitter to do the things I wanted and not become obsolete in a few years.

When I decided to subscribe to a magazine, I looked at all of them. 73 seemed to be the one that won't become obsolete either.

Sometimes I see letters that object to some of the articles in 73. When I read one that doesn't seem to interest me, it may spark interest in someone else. It was one of those articles that finally interested me enough to start building your excellent projects using ICs.

Ham Help

Wanted: Information on Hallicrafters Model SBT-20 SSB/CW transceiver. I need any or all of the following: 1. schematic, 2. manual, and 3. xtal freq. formula. I will be glad to purchase. Any material loaned to me will be returned. Any postage expense will be reimbursed.

Ralph Irish WA8GDT
PO Box 122
Utica MI 48087

For the longest time, I have been looking for, unsuccessfully I might add, a place where I can purchase a tie bar having my callsign engraved on it. It also has a little microphone

Driving 40 miles to the city and not finding what I needed turned me to your advertisers. People like Integrated Circuits Unlimited and DSI Instruments must be praised. You can order what you want, no postage or handling charges to figure, and receive it in five to seven days from the other side of the USA. So why leave the shack?

Your magazine and advertisers make being an amateur a wonderful life.

Colin C. Corke WB2RNS
Albion NY

Bliss is 73 and some Colorado Kool-Aid.—Wayne.

GONZO

Please advise those who have been following the many articles of W7JSW (W. J. Hosking) that neither the printed circuit boards nor the assembled units are available from Contact Electronic Research and Development as mentioned in the Jan., '78, issue (pg. 167). This outfit appears to be out of business, as I sent them an order and had it returned.

Patrick Sheedy
Groveland NY

Shhh.—Wayne.

VE2AED VIBES

I recently installed the VE2AED Electronics scanner (advertised in the March, 1978, 73) in an IC-22S. The scanner was a pleasure to build and a joy to use. Hats off to VE2AED. Thanks to 73 for a fine mag.

G. D. Fender W6SZX
Santee CA

We're getting a lot of good vibes on this.—Wayne.

soldered onto the tie bar. A ham I know has one, but the company that made it cannot get the tie bars any longer. Any help in locating a company that sells this type of tie bar would be appreciated.

David K. Gordon WB2YUJ
PO Box 775
Holbrook NY 11741

I need a copy, or an original, of an edition of G.E. Ham News, circa 1952. Subject matter: the *Harmoniker*. I will pay \$10.00 to the first supplier, so write first. Advance thanks.

Carl Witt W6ZTK
Box 5608
Buena Park CA 90620

JBW

SPECIALIZES IN 220 MHz EQUIPMENT!

NEW JBW 220 MHz REPEATER NOW AVAILABLE!

The JBW 220 MHz Repeater is an expandable unit. Tested in the Los Angeles area, the JBW Repeater has proven itself reliable in the midst of heavy interference by many TV stations and other repeaters. Options and accessories available to meet most specifications.

Contact JBW for pricing!

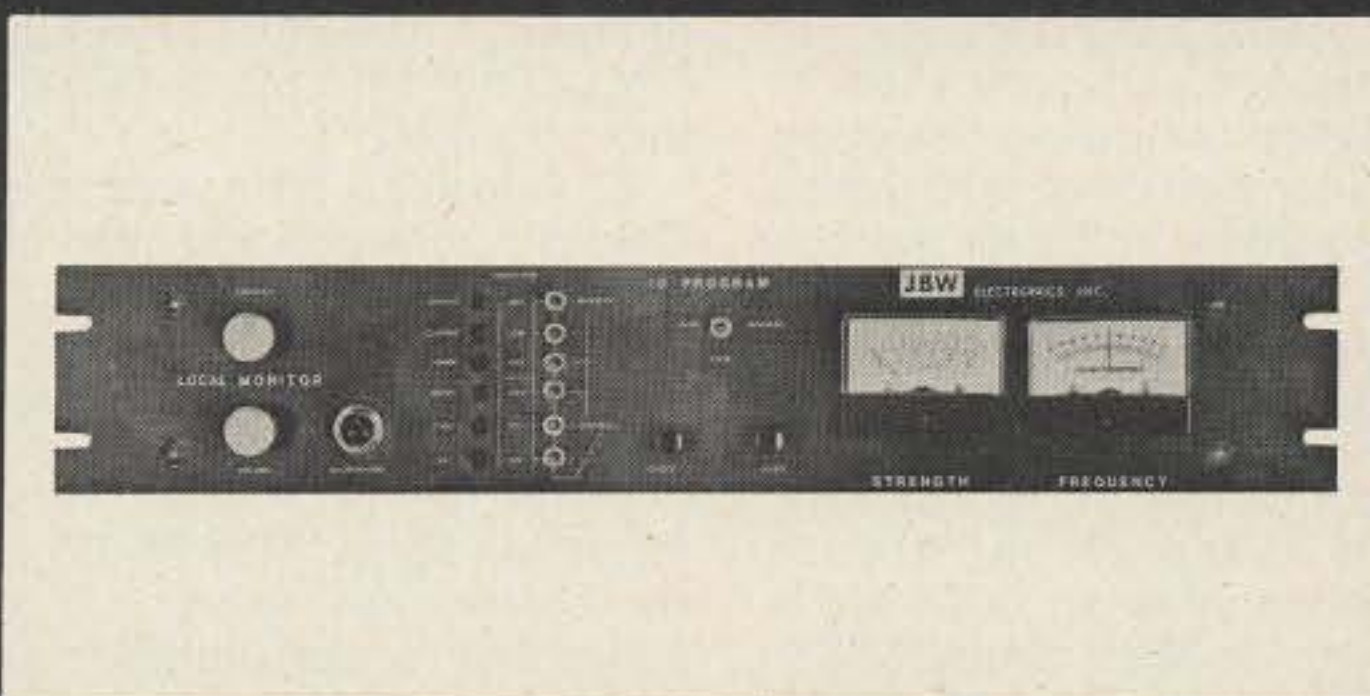

CRYSTALS IN STOCK:

MIDLAND 13-509
COBRA 200
CLEGG 76
WILSON HAND-HELD

\$10.00 per pair

GUARANTEE

If any of our crystals go bad at any time, JBW Electronics will exchange at no charge with crystals out of stock. Proof of purchase is required.

JBW ELECTRONICS ALSO FEATURES:

ESC 220 MHz Synthesizers (Synthecoders)

LUNAR Amplifiers, Preamps & Antennas

MIDLAND Product Line

Contact JBW for prices!

IN STOCK!

PIPO TOUCHTONE PADS — COAX — ROTORS
CONNECTORS — GUY WIRE — POLES — AND MUCH MORE!

CALL US! WRITE US! SEE US! DO SOMETHING!

JBW

ELECTRONICS, INC.

18618-2 PARTHENIA ST. • NORTHRIDGE, CA 91324

(213) 993-5159

J9

CONTESTS

from page 16

Only single-operator entries qualify for awards. Several trophies, plaques, and certificates will be given as appropriate. Party contacts do not count toward the Michigan Achievement Award unless one fact about MI is communicated during the QSO. For all entries, a summary sheet is requested showing scoring and other pertinent info (name and address in block letters, and a signed declaration that all rules and regulations have been observed). MI stations include club name for combined club score. Results will be final on July 31 and will be mailed to all entries. Mailing deadline is June 30 to: Mark Shaw K8ED, 3810 Woodman, Troy MI 48084.

This will be the 20th year that hams have had their own program to publicize Michigan and its products. Just as in the past, the Governor will award Achievement Certificates to hams who take an active part in telling the world of Michigan's unlimited resources, opportunities, and advantages. Certificates are awarded on the following

basis:

1. A Michigan ham submits log information and names and addresses (if possible) of 15 or more contacts made to out-of-state or DX hams with information regarding Michigan.

2. An out-of-state ham, including Canada, submits log information and names and addresses (if possible) of at least 5 MI hams who relate facts to him about MI.

3. A foreign ham, excluding Canada, submits log information and name, address, and call letters for at least one MI ham who has told him about MI.

Only QSOs made during Michigan Week, May 20-27, will be considered valid. All applications for certificates must be postmarked by July 1, 1978, and mailed to Governor William Milliken, Lansing MI 48902.

KANSAS QSO PARTY
Starts: 2000 GMT Saturday,
May 20
Ends: 0200 GMT Monday,
May 22

This contest is sponsored by the Central Kansas Radio Club of Salina. Work each station

once per band per mode. Remember that CW and phone segments are separate bands.
EXCHANGE:

KS send RS(T) and county; others send RS(T) and state/province/country.

FREQUENCIES:

Look for CW 55 kHz up from the bottom of the band, and phone 25 kHz above the Advanced/General split. Novices try 20 kHz above the lower band limit.

SCORING:

KS stations multiply number of QSOs times sum of states, provinces, and ARRL countries worked. Others multiply total KS contacts times the number of KS counties worked (105 max.).

ENTRIES:

Include a checklist of stations worked if logs contain 100 or more QSOs. Send logs to: Robert Davis K0FPC, 1857 South 4th, Salina KS 67401. Be sure to include name and address. SASE is not required for summary of results.

SOUTH JERSEY COUNTIES AWARD (SJC)

This award is issued by the Southern Counties ARA of New Jersey for contacts with the following number of stations in each of the 8 counties in southern NJ: continental US = 3 stations/county; DX = 2 sta-

tions/county.

In lieu of contacting 2 different stations, the same station may be contacted on 2 different bands. The required counties are: Atlantic, Burlington, Camden, Cape May, Cumberland, Gloucester, Ocean, and Salem.

All contacts after Jan. 1, 1976, are valid and certificates will be issued in CW, SSB, and mixed modes. Either QSLs or GCR list (confirmed by 2 other hams) must accompany the application. Fees are \$1.00 or 5 IRCs. Send applications to award manager: Louis Dvorsky N2IT, 2508 Leeds Avenue, Northfield NJ 08225.

WINDHAM COUNTY AWARD—CONNECTICUT

Submit QSL cards or statement showing log info plus statement from another amateur certifying QSOs shown. CT stations work 7 Windham county amateurs, W/VE work 5, and DX work 3. Certificates will be endorsed for specific modes or bands if desired. Gold stamp available free for anyone who works all 15 Windham County towns. Application fee is \$2 for W/VE and \$1 for DX. Apply to: Eastern CT ARA Awards Committee, c/o W. A. Wilson, Jr. K1OQG, RFD 1 Box 138, Pomfret Center CT 06259.

Corrections

As I am now able to see my article in print ("Computerized Global Calculations," p. 106, Dec., 77), I see one small mistake. On line 330 of the program listing, it is shown $C1 = ABS(L1 + I3)$. The lower-case letter *l* in *I3* could make it look like the number thirteen. One person wrote to me to mention that error, but most others never mentioned it. I thank you very much for printing that article, as I have enjoyed the response.

Carl Wagar VE3EKR
Waterloo, Ontario
Canada

Pat Gowen G3IOR has pointed out that our title for his article ("Predicting OSCAR Propagation") in our November, 1977, special OSCAR issue of 73 seemed to suffer itself from anomalous propagation! The article was mainly intended to show how normal terrestrial propagation and conditions could be detected and predicted by the satellites' signal behavior, and to evidence the value of OSCAR to non-OSCAR operators when

pursuing their own DX, be it HF, VHF, UHF, or auroral. We should have used his original title "Predicting Propagation by OSCAR." Also, since publication, the reference given for the AMSAT-UK Librarian, G8KME, for copies, has since changed to his new callsign, G4FYS.

John C. Burnett
Managing Editor

It is quite timely and in accord with the widening horizons of amateur radio that 73 Magazine publishes such articles as "Inexpensive EKG Encoder" by WA3AJR (February, 1978). I enjoyed reading the article and applaud its author for his innovative approach to a hardware that would be beyond the financial reach of most hams if it had to be commercially purchased.

However, I am puzzled by Fig. 6, in which you reproduce a typical transmitted EKG tracing. It is upside down! Since the author of the article is a physician-ham, I must come to an inevitable conclusion that

your illustration department has goofed. But I wonder if the author is aware of the fact that the originator of this EKG tracing is suffering from a borderline case of first-degree heart block (abnormally prolonged delay in electrical conduction through the AV node). While this type of tracing may be seen in a healthy individual, it more often is a manifestation of various forms of heart disease or the drug treatment for them.

C. S. Song, M.D. N6HF
Stockton CA

Whenever I have the time, I read 73 Magazine, which I believe is the best amateur radio periodical.

I certainly enjoyed the article, "Inexpensive EKG Encoder," in February's issue. However, the EKG recording on p. 22 is printed upside down. The importance of this observation pertains to the fact that the proper time sequence is reversed, right to left.

If the leads are reversed, as stated in this fine article, the output will be inverted, an appearance quite different than that displayed in the article.

Thank you again for 73

Magazine, a fine contribution to amateur radio.

Barry Bittman, M.D. WA2HCP
Bloomfield NJ

Our thanks to the 20,000 doctors who pointed this out.—Ed.

While looking over my KIM-1 RTTY article on page 68 of the February, 1978, issue of 73, I noticed that the UART pin numbers shown in Figs. 2 and 4 are incorrect. The correct pinouts are as follows: DAV—19; XR—18; RD5—8; RD4—9; RD3—10; RD2—11; RD1—12.

The other figures appear to be correct. My apologies for not catching this sooner, and I can't explain the error!

The 3351 FIFO chip may not be available from the usual advertisers in 73 and other magazines. A possible source may be Peter Bertelli W6KS, 5262 Yost Place, San Diego CA 92109. The cost is \$14.00 postpaid. Pete has been supplying the 3351 and other parts for the UT-4 as a courtesy to the RTTY fraternity. The 3351 is an MOS chip, so it should be handled accordingly.

Clifton W. Pittelkau W4CQI
Warrenton VA

CALL TOLL FREE

1-800-228-4097

Antenna Sale!

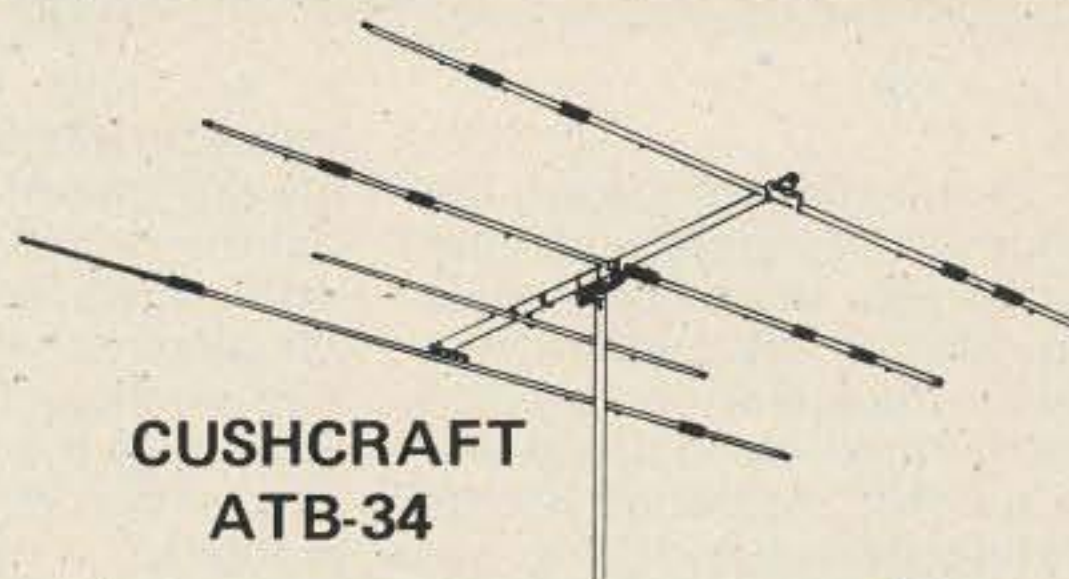

CUSHCRAFT
ATB-34

MOSLEY		Regular	Special
Classic 33	3 ele. 10, 15, 20 Mtr. beam	\$232.50	\$189.95
Classic 36	6 ele. 10, 15, 20 Mtr. beam	310.65	249.95
TA-33	3 ele. 10, 15, 20 Mtr. beam	206.50	169.95
TA-36	6 ele. 10, 15, 20 Mtr. beam	335.25	279.95
TA-33 Jr.	3 ele. 10, 15, 20 Mtr. beam	151.85	129.95
TA-40KR	40 Mtr. add on	92.25	74.95

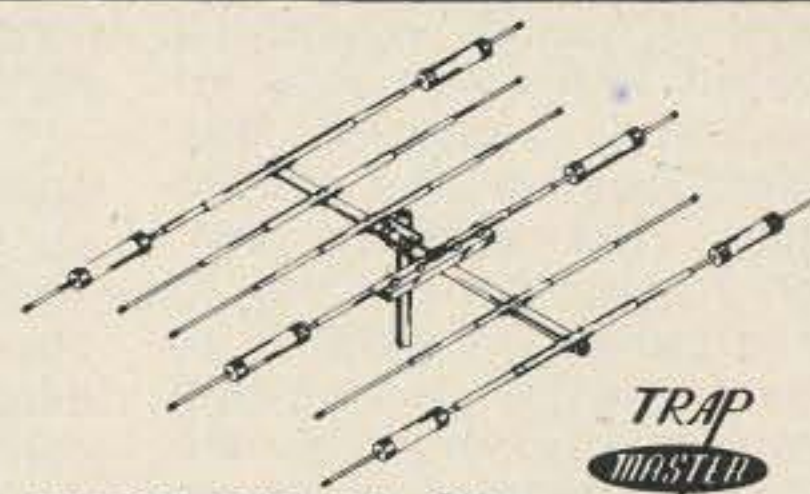

MOSLEY CL-36

CUSHCRAFT		Regular	Special
ATB-34	4 ele. 10, 15, 20 Mtr. beam	239.95	199.95
ARX-2	2 Mtr. Ringo Ranger	32.95	29.95
A147-20T	2 Mtr. Twist	54.95	47.95
A144-10T	10 ele. Twist 2 Mtr.	34.95	31.95
A144-20T	20 ele. Twist 2 Mtr.	54.95	47.95
A14T-MB	Mounting Boom	15.95	14.95

HUSTLER		Regular	Special
4BTV	10-40 Mtr. Trap Vertical	99.95	82.95
RM-75	75 Meter Resonator	15.50	13.50
RM-75s	75 Meter Super Resonator	30.00	26.50
G6-144-A	6 db. 2 Mtr. Base Colinear	67.55	57.95

HY-GAIN		Regular	Special
TH6-DXX	Super Thunderbird	249.95	209.95
TH3-MK3	3 ele. 10, 15, 20 Mtr. beam	199.95	169.95
Hy-Quad	2 ele. Quad 10, 15, 20 Mtr.	219.95	189.95
TH3-Jr.	3 ele. 10, 15, 20 Mtr. beam	144.50	129.95
18 HT	Hy-Tower 10-80 Mtr. Vertical	279.95	239.95
14AVQ/WB	10-40 Mtr. Trap Vertical	67.00	57.00
18AVT/WB	10-80 Mtr. Trap Vertical	97.00	84.95
203	3 ele. 2 Mtr. beam	12.95	
205	5 ele. 2 Mtr. beam	16.95	
208	8 ele. 2 Mtr. beam	19.95	
214	14 ele. 2 Mtr. beam	26.95	

WILSON		Regular	Special
System One	5 ele. 10, 15, 20 Mtr. beam	259.95	239.95
System Two	4 ele. 10, 15, 20 Mtr. beam	199.95	185.00

CDE ROTORS

Ham III	\$125.00
T2X Tail Twister	\$249.00
CD-44	\$105.00

Call for SUPER price on Consolidated Tower and Berk-Tec Coax Cable



18HT

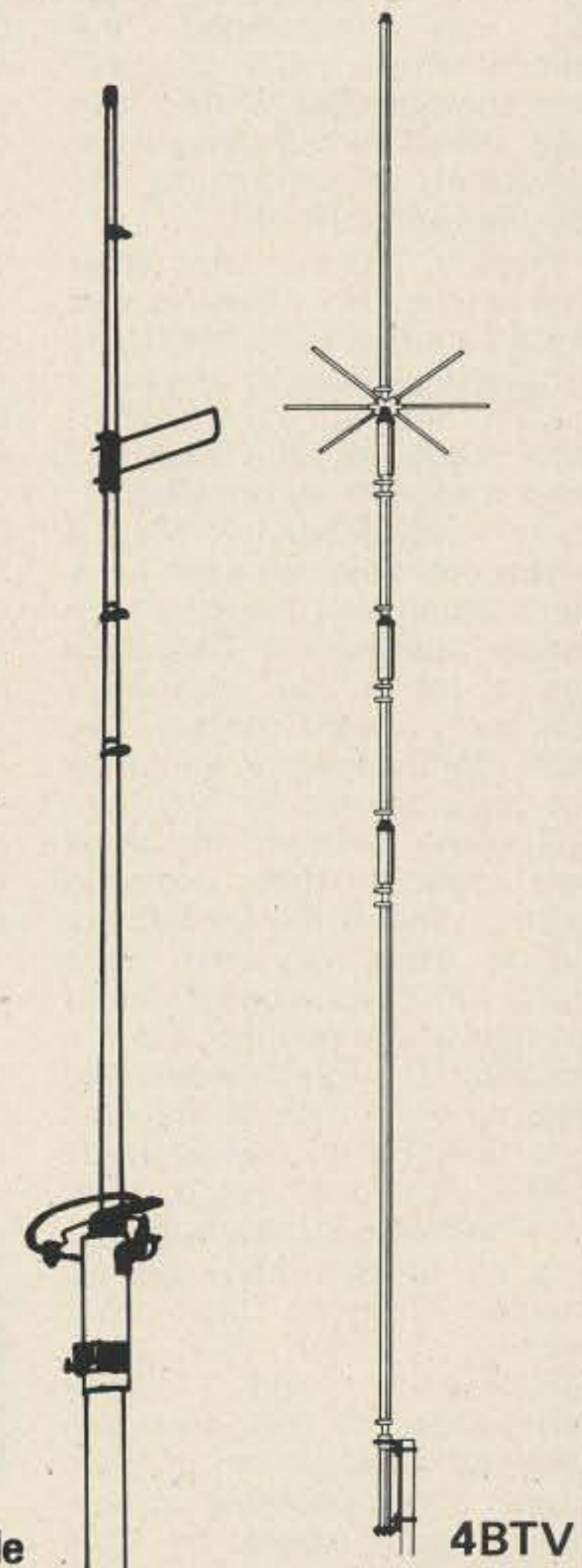

RINGO
RANGER



4BTV

Open seven days a week

Communications Center

The Radio Store

C58



443 N. 48th, Lincoln, Nebraska 68504

In Nebraska Call (402) 466-8402



NEVER SAY DIE

...de W2NSD/I

EDITORIAL BY WAYNE GREEN

from page 136

With the 10m band plan, the Californians seem to favor putting the four Watt AM signals right down in the midst of the kilowatt sideband operators. I hope there will be no battle over this, but that the better system will win out because it turns out to benefit more people.

When I started publishing proposed 10m conversions of CB rigs in 73, I explained that we were looking for a plan to support. The present plan, which I modestly call the 73 plan and which will probably be known as the QST plan in a couple of years, emerged as the hands-down winner as far as my mail is concerned. Once this was announced, the furious letters began to arrive from southern California... an area which had been almost completely silent before the plan was announced.

Frankly, I don't care what plan is used. My objective was to start a new area for amateurs to have fun and to try and put it in a part of a ham band where it would cause as little trouble to other amateurs as possible... all to keep down the wars. I suspect that the same temperament which was involved with people moving to California has a lot to do with their tendency toward getting into wars. While repeater wars may not have started in southern California, certainly the most well known of them occurred there... and some are still going on. They may have gone along with the 2m band plan of the rest of the country, but the southern Californians are still fighting every inch of the way. Two meter FM in Los Angeles is unlike anything you'll hear anywhere else in the world.

Is all of this bad? By no means. One of the great benefits of all this combativeness and competitiveness of that area has been the development of techniques and pioneering of new ideas which could be considered a model for others. Without all that warring, would a Gronk Network have evolved? I do hope someone will write a short history of this network, now that most of its activities have been made legal. In many ways, the hams of southern California are years ahead of other areas.

Perhaps, in their enthusiasm

to try and mate sideband kilowatts and super QRP AM on the low end of 10m phone, the California group will come up with some technological advancements which will make this practical. Until then, I think I'll stick to the two meg up plan and let 'em struggle with their problems... problems which are going to get aggravated considerably as the sunspots perk up.

The 10m plan which looks good to me moves all CB rigs up exactly 2 MHz. This puts channel 1 on 28.965 MHz. I propose that channel 1 be used for listening and brief calling, with contacts moved up to channels 5 and higher. Channel 4, on 29.050 MHz, I propose for beacon stations. These will permit us to know instantly when and to where the band is open. Often 10m will open up and no one will notice it since everyone is listening. Beacons will help this situation.

Beacons will also help with automatic recording of propagation, which could help us better understand the workings of this band.

The 2 MHz up plan puts the low-powered channelized communications in that part of 10m which has been least used... above most SSB operations and below the FM and satellite work. It seems like an ideal spot.

Both Bristol and Standard are endorsing this plan. I know of no manufacturers endorsing any other plan.

WIN SOME, LOSE SOME



One of the dangers of scheduling a hamfest-auction in New Hampshire in January is snow. Sure enough, the day before the hamfest in Manchester, New Hampshire, the snow fell. It fell in great quantities, to the delight of ski areas. This did not help the hamfest, unfortunately. Here we see Lyle Kaufman showing his baluns to an admiring crowd, helped by his daughter

when more obscure technical details were needed.



Most of the New Hampshire computer stores set up exhibits. Here we see an Algorithmics system being demonstrated at the Microcomputers, Inc., table. Algorithmics has a corker of a word processing system, complete with software and their own keyboard, which is specially designed for word processing.

The hamfest was organized by the Interstate Repeater Society, which would be more popular with me if the name was changed slightly to provide a different set of initials. Herman Haberman WA1NYS was the factotum and did a large part of the organizational work. Better weather next year, Herman.

SAN JOSE WAS HAMMY

The second large west coast computer show was in San Jose in early March. It was packed. In case you are still trying not to notice how much microcomputers have infiltrated into amateur radio, I might tell you that several hundred hams checked in at the Kilobaud booth at San Jose. And one of the major demonstrations throughout the show was the fine exhibit put on by the local RTTY group. They had a bang-up exhibit and opened a lot of microcomputer hobbyists' eyes to what amateur radio can do.

The Digital Group was wowing 'em with their Ham Board, just recently put into production. This is a single board that gives you RTTY, SSTV, and CW. The only catch is that it is designed only for the DG system; however, I'll bet it won't be long before we have some articles on using it with other systems... such as the TRS-80 and PET.

The Radio Shack exhibit was so packed I had to jump up and down to see who was up front showing their latest hardware, the 16K model (\$889) and their new printer (\$599). Commodore's PET (\$795) exhibit was just as packed. I didn't find a chance to get close to either exhibit until the show was closing up on Sunday evening.

On the day after the show, Sherry and I were given a tour of the nearby PET plant, where zillions of PETs were being put together.



Commodore is not anxious to let out their production figures, but you can see from the photograph that they are turning 'em out in large numbers. Each system is burnt in for 48 hours, thus turning up about 99% of the bummers before shipment. Those few which do fail are zipped into a repair lab with a giant computer system which digs right in and checks everything out in a flash. This makes repairs take but a few minutes.

The production line has been growing rapidly as Commodore has tried to keep up with the demand. To give you an idea of the demand, several dealers were complaining that they could sell ten times as many PETs as they were being allotted.

Our next stop on the way back to New Hampshire was in Fort Worth/Dallas. There we first visited Icom and got a hands-on look at their new low band rig. Even at \$1500 I predict this is going to be a sellout. Bill Mueller had the rig set up with a remote digital tuner, one which could be programmed to check pretuned channels on any band or else just tune up and down any band with the push of a button. I'll be surprised if this isn't the way all rigs will go before long.



This is the IC-701 with the remote tuning control. On top of it is a HAL 6000 RTTY unit. The 701 seems to have everything a ham could want these days.

Not far from the Icom office is Art Housholder's AGL Electronics store. Bill took us down to see Art and we all had lunch at a great Mexican restaurant in the shopping plaza with AGL. Their nachos were superb... as were their sopaipillas. This made up for the disaster we suffered the evening before at Dallas' Baby Doe Mine Restaurant. There, after a three-hour wait in a disco lounge which just about deafened us and drove me up

the wall, we were served burnt and hardened duck. The others with us didn't make out much better, so we all left without eating. We tried to talk with the manager, but he was uninterested in our problems.

From Dallas, we drove to Fort Worth to visit Radio Shack. Say, if you can get anywhere near Ft. Worth, be sure to see the Tandy plaza complex in downtown Ft. Worth. It is amazing ... with two 19-story buildings already finished and a 45-floor building getting started next to them. The bottom floors have a shopping plaza built in. The big centers of attraction are a giant Radio Shack store, a Tandy Telephone store, and a Tandy Computer Center. In the middle of the indoor plaza is an ice skating rink. Our host was Hy Siegel K9CCN/5, who was getting around on crutches after breaking his leg skating in the center.

Despite his crutches, Hy zipped us all over the 19-floor building, getting me in for talks with most of the top brass of the organization, showing us the lab where all new products are checked out exhaustively before being added to the Radio Shack line, and finally taking us to the TRS-80 plant not far away.

The Tandy complex is so big that they have built a special subway which goes from the ground floor of one building to a group of giant parking lots several blocks away. How many private subways have you seen? The subway goes to four different stations around the parking lots and then returns to the Tandy Center.



Here are some of the TRS-80 systems being burnt in. Radio Shack runs them for 24 hours, looking for problems, very few of which develop. This is just one part of the burn-in department, so you can't really get a count on their total production from a head count of this group.

We have both the TRS-80 and a PET in the lab at 73/Kilobaud, so we are able to check all programs submitted for these systems before publishing them or putting them out on cassettes.

Hams keep calling up wanting to know which system I think is the best. Honestly, each system is so different

FM

ANTENNAS

146-220-440 MHz

by  **cushcraft**

DIRECTIONAL GAIN BEAMS

- Direct 52 ohm feed
- Rugged
- Seamless aluminum construction

...and high performance make for years of trouble free activity with any CUSHCRAFT FM Beam.

BEAMS



POWER PACK



DIRECTIONAL GAIN ARRAYS

Stacked for increased performance, CUSHCRAFT Power Pack arrays come complete. Ready for use when full quieting results are needed to access distant repeaters or long haul simplex contacts.

OMNIDIRECTIONAL GAIN ANTENNAS

CUSHCRAFT'S

- Ringos
- Rangers
- Stacked 4-pole

antennas are recognized world wide for their low angle of radiation, ease of assembly, and tremendous performance on all amateur FM frequencies.

Regardless of the FM frequency, rely on Cushcraft to deliver

"FULL QUIETING

C67 PERFORMANCE".

4 POLE



RINGO



RANGER



IN STOCK WITH DISTRIBUTORS WORLDWIDE



cushcraft

CORPORATION

P.O. BOX 4680, MANCHESTER, N.H. 03108



from the other that it is difficult to make any overall decision like that. The TRS-80, the PET, the Apple II, and so on are all excellent systems and they will do just about anything you could ask in computing ... if you have enough memory in them, if you have the peripherals you need, and the biggest if of all, IF you have the programs to get them to do what you want.

All of the systems available, from the under \$250 KIM microcomputer right on up through the Apple II at a bit over \$1,200, are fine for beginners to learn ... to learn about how computers work and to learn programming. And each of these can be sold without much of a loss, if any, if you decide to go to some other system. For the time being, none of these systems have an available S-100 interface, so the hundreds of S-100 boards can't be simply used with them.

This will not be a fact for long.

In general, if you want to go to a bigger system, one based on the S-100 bus, you will have to spend more like \$2,000 to \$3,000. But this will be expandable for a long time to come and will work with the bulk of the specialized boards being made ... for music, for art, for controlling things, for connecting to the phone, etc.

You'll begin to understand more about all this if you start reading *Kilobaud*. This is the only microcomputer magazine being published for the beginners in the field.

WESTLINK LIVES

Every week Bill Hendershot produces a five- to ten-minute ham news broadcast. This is put on tape cassettes and mailed to the subscribers. The tapes are then played over many of the repeaters around the country to bring radio amateurs up to date on what is going on.

Bill generally shies away from controversy in these broadcasts. He gets his news from the FCC, from HRR, and other sources. In many cases, he calls the people making the news and tapes his interviews with them.

Bill's WESTLINK programs have been one of the better ways to keep up with the continuing circus of Rick Cooper, an effort which has cost Bill a lot of long distance phone calls. There is some new phase to the Cooper epic every week.

Repeater groups interested in keeping their members up to

date on the news of amateur radio should get in touch with Bill. Write to WESTLINK, 12731 Rajah Street, Sylmar CA 91342, for details and costs.

The tapes are professionally done and are quite legal to play over the air, either on the low bands or over a repeater.

EQUIPMENT COSTS GOING UP

Since the FCC seems to be making no provisions for reimbursing manufacturers for the extra cost of designing ham equipment according to the new regulations, it is a safe bet that amateurs will be the ones to pick up the tab.

In addition to the higher costs of equipment, we will also have to foot the costs of dealers keeping and reporting the records they will have to manage. This probably won't amount to more than \$4 or \$5 per unit, but it will mount up in the long run.

How is a dealer to know if the license being shown by a purchaser is a legitimate license? The process will have to be lengthy and costly to make sure that the dealer does not get in trouble by selling ham gear to someone who is actually not a ham.

Tell me ... is this what you want to happen? Are you willing to foot this bill just because the FCC doesn't have the guts to tackle the CB and HFer problem directly?

YAESU PREVIEW

The inside scoop is that Yaesu has two new VHF trans-

ceivers coming out. These should be on hand by summer. One is for six meters and the other for two. These will have digital plus analog displays, be all mode (including SSB), operate on the standard splits of 1 MHz on six meters and 600 kHz on two meters, and have a new type of noise blanker which is said to really work, optional fixed channels, ac/dc operation, optional frequency memory, semi-break-in CW with sidetone, programmable tone burst generator, discriminator meter ... etc. For CW DX fans, there is a CW filter option for the six meter rig.

MORE HELP WANTED

Despite the recent addition to our staff of two computer technicians, a computer programmer or two, a ham technician, a couple of marketing people, more ad people, etc., we are still unable to keep up with the growth of the business in several aspects.

One major need is for an experienced ham with considerable background and the ability to write. This would be an assistant editor position for 73 which would include handling the new products section of the magazine, screening articles for publication, helping with the testing of new products and writing them up, etc.

The usual resumé is not relevant to this work—we need to know about your hamming background, what articles you've had published, etc. Write to Wayne Green, 73, Inc., Peterborough NH 03458.

Chain Letter Petition in Support of Amateur Radio

Before doing anything else, make at least five photocopies of this petition and give or send these copies to friends, neighbors, radio club members, hams you have contacted, etc. They do not have to be radio amateurs, but just people who realize the importance to the community, to our country, and to the world of amateur radio. We don't want to lose our bands to CBers and a dictatorship.

The Petition

We, the undersigned, being American citizens, do hereby indicate our support of amateur radio and our opposition to any efforts to destroy this valuable service. Since radio amateurs have been directly responsible for developing and pioneering virtually every communications technique in use today, furnish an invaluable source of engineers and technicians for our government and industry, and furnish efficient communications during any emergencies, we cannot afford to let this important resource be wiped out.

Name _____ Address _____ City _____ State _____ Zip _____

Name _____ Address _____ City _____ State _____ Zip _____

Name _____ Address _____ City _____ State _____ Zip _____

Name _____ Address _____ City _____ State _____ Zip _____

Name _____ Address _____ City _____ State _____ Zip _____

Support this political action to preserve amateur radio. Send your petition to:

Wayne Green

73 Magazine, Peterborough NH 03458

73/5/78

Amateur Radio Supply of Nashville, Inc.

ARSON, INC.

STORE HOURS
 Mon. - Fri. 9 AM - 5 PM
 Sun. 1 PM - 6 PM

615 South Gallatin Road, Madison, Tennessee 37115 • (615) 868-4956

A40

Authorized dealer for: Kenwood • Yaesu • Drake • Icom •
 • Dentron • Ten-Tec • Wilson • Tempo • Swan • Standard •
 • KLM • Larsen • Cushcraft • B & W • CDE • Newtronics
 (Hustler) • NYE • and others.

These ARSON, INC. policies have satisfied thousands nationwide.

- | | |
|--|---|
| 1. Credit cards Welcome (except on "specials") | 5. Free Catalog |
| 2. Trades invited. | 6. Cost of telephone calls will be deducted from your order. |
| 3. Fast — to your door — delivery via UPS. | 7. Assurance of fair dealing through our nationwide reputation. |
| 4. Large inventory of major lines — most items are in stock NOW! | 8. We're "burning" to make Hot Deals at A.R.S.O.N., Inc. |

**NOW - - - - A full line Ham Store with these
 Same Policies in ATLANTA - - ARSON ATLANTA, INC.**

Amateur Radio Supply of North Atlanta, Inc.

ARSON ATLANTA, INC.

Pinetree Plaza Shopping Center • 5269-6 Buford Highway, Doraville GA 30340 • (405) 455-1771

TRADE WITH US AND BENEFIT FROM OUR VOLUME BUYING

These are a few of our "HOT" Grand OPENING Specials

<p>YAESU</p>  <p>101E Buy at \$799.00 Get Free FV101B Remote VFO List \$125.00 Send cashiers check or M.O. Shipping will be collect.</p>	<p>The Memorizer</p>  <p>Yaesu FT 227R Fully Syn 2M FM List \$315.00 Call for Super Quote</p>	<p>Kenwood</p>  <p>7400A 25 watts Fully syn. 2M FM List \$399.00 Call for Super Quote</p>	<p>CDE Ham III</p>  <p>Ham III rotor \$124.00 Shipping included to Cont. USA Ham III rotor plus 100 ft. rotor cable \$139.00 Ham III rotor plus 100 ft. each - rotor cable and RG-8U foam coax \$162.00 Send cashiers check or M.O.</p>
<p>limited to available quantities — prices subject to change</p>			

ATLANTA (405) 455-1771

NASHVILLE (615) 868-4956

We're "burning" to make "HOT" deals at ARSON ATLANTA, INC.

May 1978



J.M. INDUSTRIES

ELECTRONIC COMPONENTS
EQUIPMENT HARDWARE
1922 N.E. 148th STREET
N. MIAMI, FLA. 33181
(305) 947-1479

ZENER DIODES	IC's	DIODES	DIP SWITCHES	RESISTORS	SLIDE SWITCH	We guarantee it to be worth \$25.00 \$3.95	GRAB BAG #1		
IN751A 5.1—400mW 11V—1W 62V—1½W Any 10—1 value \$1.00—.15 ea.	DM74L72—.30 DM7476N—.30 SN72747—.50 DM74L74N—.50 NE555—.45	IN4000 12/1.00 IN4001 12/1.00 IN4002 12/1.00 IN4003 12/1.00 IN4004 12/1.00 IN4005 10/1.00 IN4006 10/1.00 IN4007 10/1.00	SPST-slide action 4 Switch Unit 5 Switch Unit 6 Switch Unit 7 Switch Unit 8 Switch Unit 4, 5, 6 pos.—1.25 ea 7, 8 pos.—1.25 ea	Assorted bag of 100 pieces Most popular values—¼ & ½ w 1.95/bag 2/\$3.50	2 pole—3 pos. Has holes for mounting w/ 1¼" mtg. center .12 10/1.00				
POLYSTYRENE CAPS	AXIAL ELECTROLYTICS	TWIST LOCK CAPACITORS		TRANSFORMER	BLOWERS		We guarantee it to be worth \$50.00 \$7.95	GRAB BAG #2	
6200 pF 33V 5% 7500 pF 33V 5% 7500 pF 100V 5% 12000 pF 100V 5% 15000 pF 33V 5% 15000 pF 100V 5% 12000 pF 33V 5% 10/1.00	50/100 V \$.25 ea. 150/105 V \$.50 ea. 220/25 V \$.25 ea. 330/60 V \$.50 ea. 400/75 V \$.50 ea. 500/50 V \$.50 ea. 1000/50 V \$.75 ea. 2000/25 V \$.50 ea.	Over 50,000 in stock All values—send value or values needed \$.75 each 10/6.00 Any quantity—Any value		Constant voltage 115/220 V In. 40 V CT 1.3 Amp 20 V CT 2 Amp \$2.95 each 2/\$5.00	Open frame type motor, quick connect terminals. Input: 120 V, 60 Hz, 100 Watts. Rated 120 CFM @ "0" static pressure. Size: Inlet, 3" x 8½"; Outlet, 2" x 8½" O/A Size: 11-¾" x 3-½" x 6 lbs. *RFE \$9.95				
TANTALUM-AXIAL	TRANSISTORS	SIGNAL DIODE SPECIAL		RF DEVICES	MICRO-SWITCHES		We guarantee it to be worth \$50.00 \$7.95	GRAB BAG #2	
4.7 m—35 V—20% .47 m—35 V—20% 1.2 m—20 V—20% 10 m—25 V—20% .015 m—35 V—5% Any 10 \$2.00 1 m—50 V .35 ea	2N914 .30 2N2222 .25 2N3055 .50 2N3725 .90 2N3905 4/1.00 2N3906 4/1.00 2N5086 4/1.00	ITT—Cathode banded IN4148 20 for \$1.00 50 for \$2.00 100 for \$3.00 250 for \$6.00 500 for \$10.00		2N5589 4.50 2N5590 7.50 2N5591 10.50 2N6080 5.00 2N6081 8.00 2N6082 10.05 2N6083 11.95	New-pulled from equip. assorted sizes consists of E-33's, 23's etc. 15 for \$1.00				
LAMPS/BULBS	PULSE TXFR.	7-SEG LED		T.T.L.		T.T.L.		NEW ITEMS	
NE-2 Long Lead chic. min. #327 Your Choice 10/\$1.00	Sprague #11Z2100 \$1.00 ea. 2 for \$1.75	TI L322P \$1.10 ea. .5" red 2/\$2.00		7400 .15 7401 .15 7402 .20 7403 .20 7404 .15 7405 .25 7406 .35 7407 .55 7408 .25 7409 .15 7410 .10 7411 .25 7412 .35 7413 .45 7414 1.10 7416 .25 7417 .40 7420 .15 7426 .35 7427 .45 7430 .15 7432 .30 7437 .35 7438 .35 7440 .25 7441 1.10 7442 .55 7443 .85 7444 .45 7445 .80 7445 .90 7447 .90 7448 .90 7450 .25 7451 .25		7473 .25 7474 .35 7475 .30 7476 .30 7480 .50 7481 .70 7483 .90 7485 .90 7486 .30 7489 1.30 7490 .55 7491 .95 7492 .95 7493 .40 7494 1.20 7495 .60 7496 .80 74100 1.85 74107 .35 74121 .35 74122 .55 74123 .55 74125 .45 74126 .35 74132 1.30 74141 1.00 74150 1.00 74151 .75 74153 .95 74154 1.00 74156 1.10 74157 .60 74161 .80			
Haydon Timing Motors 120V 60C 5W 4RPM 12V 60C 2.5W 4RPM *RFE Your Choice \$3.00		MERCHANDISE WITH EVERY \$15.00 WORTH OF MATERIAL		ALLEN BRADLEY RELAY Type BX ac 4no-4nc P/N 700—BZ440A1A \$15.00 each					
PANEL LIGHT ASS'Y	DIPPED TANTALUM	CERAMIC DISC	MYLAR FILM						
Grimes #A7075-5 Blue w/cap & all hardware 4/\$1.00	.1/35 V } \$.25 .15/35 V } each .22/35 V } .33/35 V } .68/35 V } 10/ 1.0/35 V } \$2.25	10 pF 50 V } 22pF50V } \$.05 47pF50V } each 100pF50V } 25/ 220pF50V } \$1.00 470 pF 50 V }	.001 m—100 V .0022 m—100 V .0047 m—100 V .01 mF—100 V \$.10 each 12/1.00						
DIPPED MICAS	DIODE	COUNTERS	ELECTROLYTICS						
Assorted values and voltages All prime—just mixed up 10/1.00 25/2.00	Microwave Diode IN23B—Sylvania 100 MC—150 KMC \$.60	Veeder Root 120V 50/60 Cycle 5 place—approx. 1¾W x 1"K x 2"L *RFE \$2.50	Axial lead— Assorted—25V up to 150 V—unmarked You test & save 15/1.00						
WHAT'S IT	MISC IC—DIODES	DISC CAPS	POTS						
We don't know but maybe you do. Has motors gears, micro switch *RFE \$1.50	SD-46 diode .10 AE-906 IC .25 25C185 txtr. .75 TV19 txtr. .25 TR 2N 2925 .25 TV 41 txtr. .25 SD34 diode .10	.01—100V ¼" Lead Spacing ARCO TCP-RO1 20/\$1.00	CTS ½" Bushing ½" shaft 10K—\$.35 100K—\$.35 4 meg/40K dual \$.75						

TERMS: Orders under \$10.00 please add \$1.00—Money back guarantee on all items. Please add sufficient shipping charges—Florida residents add 4% sales tax CODs accepted with 25% deposit on orders of \$50.00 or more *RFE—REMOVED FROM EQUIPMENT J10

ASSOCIATED RADIO

AMERICA'S #1 Real Amateur Radio Store



OUR
32ND
YEAR

Actual current photos of some of our reconditioned equipment.

We have hundreds of reconditioned items. Save big with confidence. Reconditioned units carry a guarantee.

We trade - USED on NEW or USED on USED

We sell - ALL major brands NEW & USED

We buy - Many types of amateur equipment.

ASSOCIATED RADIO

8012 CONSER BOX 4327

OVERLAND PARK, KANSAS 66204

913-381-5900



CALL US WITH YOUR REQUIREMENTS

NOTE:

WE ALSO SELL MUCH OF OUR TRADE-IN EQUIPMENT BEFORE WE RECONDITION IT. THIS WE SELL AT GREATLY REDUCED PRICE. REAL BARGAINS FOR THE EXPERIENCED HAM. SEND \$1.00 AND YOUR NAME - CALL LETTERS AND ADDRESS TO US AND WE'LL SEND YOU NOT ONLY OUR REGULAR CATALOG BUT A CURRENT LIST OF UNSERVICED BARGAINS.

A50

NEW!

Synthacoder 509



Ask about Group Purchases

ONLY
\$129⁹⁵
postpaid

Take Command of 220 MHz!

The Synthacoder 509 represents the first of a totally new generation of frequency synthesizers, based on the latest advances in CMOS-LSI techniques. "Matrix Modules", which contain programming diodes, make adding new channels a cinch. Simply snip the leads on the diodes not needed, plug it in, and you are **On The Air!** Our unique interface design allows you to use your existing crystal positions even though the synthesizer has been installed. The Synthacoder is also easily adapted for **Scanning** and **External Frequency Control**. To sum it up—We are sure that you will find the new Synthacoder 509 **Everything You Want** in a 220 MHz synthesizer—And at a **Price Comparable to Crystals!**

- * SIMPLE TO INTERFACE - Three wires and no holes!
- * FULL COVERAGE - 220-225 MHz in 20 KHz steps
- * MATRIX PROGRAMMABLE - No more crystals
- * EXCLUSIVE "MATRIX MODULES" - Program in seconds
- * FULL MODE CONTROL - Simplex, Repeater, Reverse
- * LOW POWER CMOS - Draws only 60 ma
- * FULLY ASSEMBLED AND CALIBRATED - Not a kit
- * FITS MIDLAND, COBRA, and CLEGG 220 MHz transceivers

Engineering Specialties

P.O. BOX 2233
1247 COMMERCIAL AVENUE
OXNARD, CA 93030
(805) 486-0817

735

- I'LL BITE! Please send more info.
 I'M HOOKED! Please RUSH my Synthacoder.

YES, I would like to purchase a Synthacoder for my 220 radio. Enclosed please find my \$129.95 (Price includes postage and handling). California residents add 6% sales tax.

\$ _____ enclosed. Check Money Order
Please charge my Master Charge BankAmericard
Credit card # _____
Interbank # _____
Expiration date _____
Signature _____

Name _____ Call _____
Address _____
City _____ State _____ Zip _____

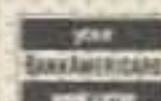

GET YOUR NEW RADIO AMATEUR CALLBOOKS

1978

The **U.S. Callbook** has over 350,000 W & K listings. It lists calls, license classes, names and addresses plus the many valuable back-up charts and references you come to expect from the **Callbook**.

\$14.95
PLUS SHIPPING

Specialize in DX? Then you're looking for the **Foreign Callbook** with over 280,000 calls, names and addresses of radio amateurs outside the USA plus many valuable, additional features of interest to the DX'er.

\$13.95
PLUS SHIPPING

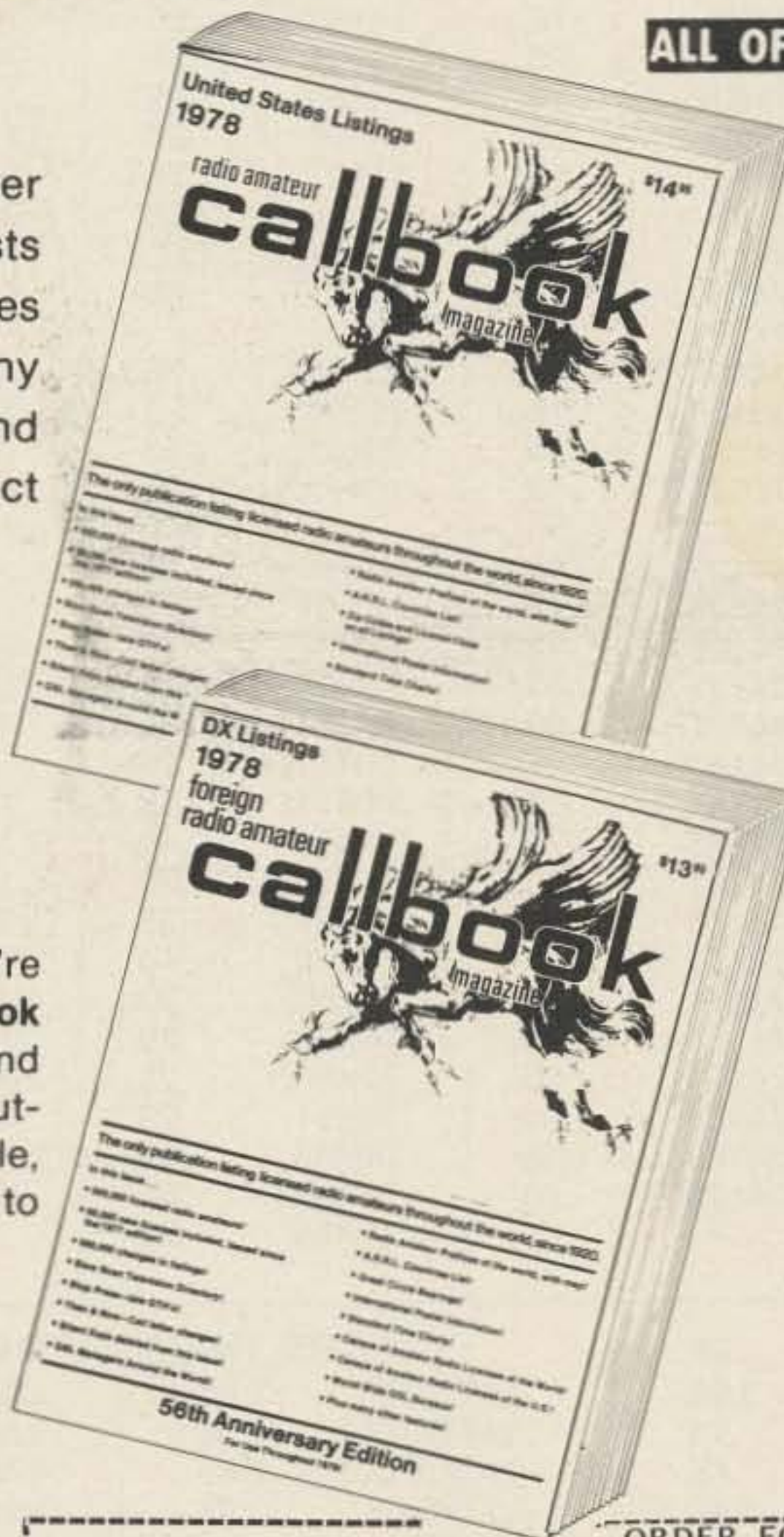

ALL OF THESE EXTRA FEATURES INCLUDED

- International Radio Amateur Prefixes!
- Radio Amateur Prefixes by Countries!
- A.R.R.L. Phonetic Alphabet!
- Great Circle Bearings and Charts!
- International "Q" and "Z" Signals!
- World Standard Time Charts!
- International Postal Information!
- World Prefix Map!
- F.C.C. Examination Points!
- Where to Buy!
- Telegraphers' Abbreviations!
- DX Operating Code!
- A.R.R.L. Countries List!
- At Your Service — Amateur Radio Dealers!
- QSL Managers Around the World!
- World Wide QSL Bureaus!
- Census of Radio Amateurs of the World!
- Telegraph Codes!
- AMSAT — Oscar Users Directory!
- Slow Scan Television Directory!
- Reciprocal Licenses!
- Hawaii Included!
- Many Other Features!

*Respected worldwide as
the only complete authority
for radio amateur
QSL and QTH information.*

Save \$1.50 order both send \$30.40

See your favorite electronics dealer or write direct for free catalog to the publisher.

RADIO AMATEUR **callbook** INC.
Dept. B 925 Sherwood Drive
Lake Bluff, Ill. 60044

R1

ORDER FORM

Item	Price Each	Shipping	Total Price
<input type="checkbox"/> U. S. CALLBOOK	\$14.95	\$1.50	\$16.45
<input type="checkbox"/> FOREIGN CALLBOOK	\$13.95	\$1.50	\$15.45

Illinois residents only add 5% sales tax _____

Name _____ Total _____

Address _____

City _____

State _____ Zip _____ Total Enclosed _____

Charge: BankAmericard Master Charge Interbank # _____

Credit card # _____ Expiration date _____

Signature _____

10 AMP - POWER TABS!
SCRS! TRIACS!
QUADRACS!
 Order by Cat. No. and voltage!
 #SA1448 - TRIACS #SA1730 - SCR
 #SA1590 - QUADRACS

PRV	Sale	2 for
50	\$.55	\$.56
100	.69	.70
200	.88	.89
400	1.19	1.20
600	1.59	1.60

THIS SPECIAL ONE CENT SALE IS FOR MAGAZINE ADS ONLY

POLY PAKS' PENNY-PINCHING ONE CENT SALE

THESE ONE-CENTERS ARE THE CENT-CIBLE WAY TO SHOP AND SAVE!

POLY PAKS® BIGGEST 1¢ GIVEAWAY SALE!

IT MAKES "CENTS" TO GIVE OUR CUSTOMERS THE BEST BARGAINS!

TTL'S, BUY ONE AT SALE PRICE, GET 2ND FOR ONLY 1¢ MORE

Order By Cat. No. 5A1961 & Type No.

Type	Each	2 for	Type	Each	2 for
SN7400	\$.19	\$.20	SN7445	\$.99	1.00
SN7401	.19	.20	SN7446	1.35	1.36
SN7403	.19	.20	SN7447	1.25	1.26
SN7404	.25	.26	SN7448	1.35	1.36
SN7405	.19	.20	SN7450	.19	.20
SN7406	.19	.20	SN7451	.19	.20
SN7408	.21	.22	SN7453	.19	.20
SN7410	.19	.20	SN7454	.19	.20
SN7413	.39	.40	SN7455	.19	.20
SN7414	.65	.66	SN7460	.19	.20
SN7416	.29	.30	SN7462	.19	.20
SN7420	.19	.20	SN7464	.19	.20
SN7423	.29	.30	SN7465	.19	.20
SN7426	.25	.26	SN7471	.25	.26
SN7427	.25	.26	SN7472	.25	.26
SN7430	.29	.30	SN7473	.55	.56
SN7432	.25	.26	SN7474	.29	.30
SN7437	.25	.26	SN7475	.79	.80
SN7438	.29	.30	SN7476	.59	.60
SN7440	.19	.20	SN7478	.59	.60
SN7442	.69	.70	SN7480	.29	.30
SN7443	.69	.70	SN7482	.39	.40
SN7444	.65	.66			

POP-AMPS AT "CENT-CIBLE" PRICES

Case code: T=TO-220 Power Tab; V=Mini dip; K=TO-3; H=TO-5; N=DIP.

Type	Each	2 for	Type	Each	2 for
LM300H	\$4.49	\$5.50	LM370N-H	1.29	1.30
LM301H-V	.45	.46	LM374H	1.79	1.80
LM308V-H	.79	.80	LM376V	.29	.30
LM309K	1.29	1.30	LM377N	2.25	2.26
LM311H-V	.79	.80	LM381N	1.69	1.70
LM318V	1.29	1.30	LM531H	1.49	1.50
LM320H-5, 12, 18	1.29	1.30	LM532H-N	.29	.30
LM320K-18	1.29	1.30	LM555V	.75	.76
LM320T-6, 5	1.29	1.30	LM556V	.79	.80
LM322N	1.19	1.20	LM561N	1.00	1.01
LM324N	1.75	1.76	LM565N	.99	1.00
LM339N	1.09	1.10	LM703H	.49	.50
LM340K-5, 6, 8, 12, 15, 18,	1.29	1.30	LM704H	.29	.30
LM340T-5, 6, 8, 12, 15, 18, 24	1.29	1.30	LM709N-H	.25	.26
LM350N	.59	.60	LM710N	.39	.40
			LM733N	.79	.80
			LM739N	.89	.90

1N4000 Epoxy Rectifiers

Cat. No.	Type No.	PIV	Price	1¢ MORE!
SA2377	1N4001	50	10 for \$.65	20 for .66
SA2378	1N4002	100	10 for .75	20 for .76
SA2379	1N4003	200	10 for .85	20 for .86
SA2380	1N4004	400	10 for .95	20 for 1.00
SA2381	1N4005	600	10 for 1.29	20 for 1.30
SA2382	1N4006	800	10 for 1.39	20 for 1.40

1.5 AMP BULLET RECTIFIERS!

PRV	10 for	20 for
50V	\$.59	\$.60
100V	.69	.70
200V	.79	.80
400V	.89	.90
600V	1.09	1.10
800V	1.19	1.20

MICRO MINI TOGGLE SWITCHES!

3 Amps, 125 VAC contacts, with chrome handles, complete with mounting hardware.

Cat. No.	Type	Sale	2 for
SA3936	SPDT	\$1.29	\$1.30
SA5085	SPDT*	1.39	1.40
SA4037	DPDT	1.45	1.46
SA5087	4PDT*	1.95	1.96

LYTIC KLINIC Electrolytic capacitors

UF	V	Style	Sale	1¢ SALE
10	15	P.C.	10 for \$1.00	20 for \$1.01
50	15	P.C.	8 for 1.00	16 for 1.01
15	25	P.C.	8 for 1.00	16 for 1.01
50	25	P.C.	6 for 1.00	12 for 1.01
20	15	Axial	10 for 1.00	20 for 1.01
20	15	P.C.	10 for 1.00	20 for 1.01

6 AMP CARTWHEEL RECTIFIERS

PIV	50	100	200	400	600	800	1000
SALE	\$.29	2 for \$.30	.36	.45	.51	.79	.91
1¢ SALE		2 for .37	2 for .46	2 for .62	2 for .80	2 for .91	2 for 1.20

LEDS!

YOUR CHOICE 5 for \$1.00
 1¢ SALE 10 for \$1.01

Order by Cat. No.

- #SA2135 JUMBO RED LEDS
- #SA2137 MICRO RED LEDS
- #SA2790 JUMBO RED CLEAR LEDS
- #SA2792 JUMBO TAPERED AMBER
- #SA2140 MICRO GREEN LEDS

ZENERS!

Order by Cat. No. SA5210 & voltage & wattage!

1 Watt	Sale	1¢ SALE
7.5V	5 for \$1.10	10 for \$1.01
8.2V	5 for 1.10	10 for 1.01
9.1V	5 for 1.10	10 for 1.01
11V	5 for 1.10	10 for 1.01
12V	5 for 1.10	10 for 1.01
15V	5 for 1.10	10 for 1.01

5 Watts Sale 1¢ SALE

3.3V	3 for \$1.6	6 for \$1.01
6V	3 for 1.6	6 for 1.01
6.2V	3 for 1.6	6 for 1.01
8.2V	3 for 1.6	6 for 1.01
9.1V	3 for 1.6	6 for 1.01
12V	3 for 1.6	6 for 1.01
15V	3 for 1.6	6 for 1.01
18V	3 for 1.6	6 for 1.01
24V	3 for 1.6	6 for 1.01
30V	3 for 1.6	6 for 1.01

THIS NEW LIST OF "ONE-CENTERS" HELPS FIGHT INFLATION!

Quan.	Description (Order by Cat. No. in parenthesis)	Sale	1¢ SALE
1	WOODGRAIN CABINET, 3 1/2 x 10 x 1/4" deep, spkrs, alarms. (#SA5201)	\$1.49	2 for \$1.50
1	LCD THERMOMETER "TAPE", 88-108° F, 7" x 1". (#SA5195)	1.00	2 for 1.01
1	JOYSTICK, four 100K pots, with knob (#SA3808A)	4.95	2 for 4.96
1	ECCO THUMBWHEEL SWITCH, BCD, 0-7 (#SA2870A)	1.49	2 for 1.50
1	8-TRACK TAPE TRANSPORT, with preamp (#SA3010)	9.95	2 for 9.96
1	PLESSEY TV SIDEBAND FILTER, for chan. 3 or 4 (#SA3975)	1.95	2 for 1.96
5	TRANSISTORS, 2N3904 equal, NPN, switching (#SA5209)	1.00	10 for 1.01
1	METER, 50uA, 1 1/2" square, 0-20db (#SA3705)	1.19	2 for 1.20
1	SPST RELAY, norm. open 12-24 VDC, 1250 ohms, dip style (#SA5175)	1.00	2 for 1.01
1	VEEDER ROOT COUNTER, 000-999, resettable, panel mt. (#SA5081)	1.49	2 for 1.50
2	DUAL GATE MOSFET, sim. to 3N200, 3N187, for RF & Mixer (#SA5101)	1.00	4 for 1.01
1	8-TRACK TAPE HEAD, with plug 'n' cord (#SA3468)	2.50	2 for 2.51
10	CALCULATOR KEYBOARDS, 20 keys and more (#SA3524)	\$2.00	20 for \$2.01
15	SLIDE VOLUME CONTROLS, asstd values (#SA3057)	2.00	30 for 2.01
10	CRYSTALS, may include CB, Ham & more (#SA3250)	2.00	20 for 2.01
150	MOLEX IC SOCKETS, on a strap, cut to length (#SA3144)	2.00	300 for 2.01
100	TERMINAL STRIPS, from 2 lugs up (#SA3136)	2.00	200 for 2.01
30	NE-2NEON LAMPS, all 100% good (#SA2613)	2.00	60 for 2.01
40-ft.	SHIELDED CABLE, 1 cond, mikes, phones, (#SA3577)	2.00	80 ft for 2.01
50	TRANSISTOR ELECTROS, asstd values, styles (#SA2747)	2.00	100 for 2.01
3	SOUND TRIGGERS, sound triggers scr w/amp (#SA3625)	2.00	6 for 2.01
15	6V TEST INDICATORS, leads, grain-o-wheat (#SA3526)	2.00	30 for 2.01
100	CAPACITOR SPECIAL, discs, mylar, lytics, more (#SA2738)	2.00	200 for 2.10
30	MINI TRIMPOTS, to 1 meg, 1 turn, 1/4W (#SA3345)	2.00	60 for 2.01
10	VOLTAGE REGULATORS, hobby LM320, 340, TO-3 (#SA3330)	2.00	20 for 2.01
30	PANEL SWITCHES, slides, rotaries, mod, etc (#SA3268)	2.00	60 for 2.01
200	RESISTOR SPECIAL, 1/4 to 1W, carbon, metal (#SA3054)	2.00	400 for 2.01
200	HALF WATTERS, resistors, carbon, metal (#SA3046)	2.00	400 for 2.01
100	NATIONAL IC BONANZA, linears, 7400s ROMS (#SA2860)	2.00	200 for 2.01
40	HOBBY LEDS, asstd types, mostly useable (#SA2859)	2.00	80 for 2.01
15	LM340T VOLTAGE REGULATORS, 5 to 24V, TO-220 (#SA2635)	2.00	30 for 2.01
100	TWO WATTERS, resistors, carbon-metal marked (#SA2735)	2.00	200 for 2.01
100	POLYSTYRENE CAPS, asstd values, voltage, hi-Q (#SA2729)	2.00	200 for 2.01
50	THERMISTORS, resistors that change with temp (#SA4069)	2.00	100 for 2.01
20	BRIDGES, untested, 2, 4, 6, 10, amp, full wave (#SA4022)	2.00	40 for 2.01
25	LAMP SOCKET SETS, micro, 1.5V, T2 (#SA3957)	2.00	50 for 2.01
15	MIXED READOUTS, hobby, untested, .127, .3, 5, etc. (#SA3619)	2.00	30 for 2.01
150	QUARTER WATTERS, resistors, metal film, marked (#SA3413)	2.00	300 for 2.01
100	PLASTIC TRANSISTORS, untested, RO-92 (#SA2604)	2.00	200 for 2.01
200	PREFORMED RESISTORS, 1/4, 1/2, 1W, marked, asstd (#SA2608)	2.00	400 for 2.01
200	PRECISION RESISTORS, 1/4, 1W, 1%, 2% marked (#SA2428)	2.00	400 for 2.01
60	DIPPED MYLARS, shiny finish, asstd values (#SA2597)	2.00	120 for 2.01
30	VOLUME CONTROLS, audio, linear, asstd values (#SA2421)	2.00	60 for 2.01
5	7.5 VOLT ZENER DIODES, 1 watt (#SA5187)	1.00	10 for 1.01
5	9.1 VOLT ZENER DIODES, 1 watt (#SA5188)	1.00	10 for 1.01
30-ft.	WIRE WRAP WIRE, 30 gauge (#SA3803)	1.19	60-ft for 1.20
5	TANTALUM CAPS, 2.2uF, 25V (#SA5189)	1.00	10 for 1.01
1	ALARM CLOCK CHIP, MM5316, 4-digits (#SA1759)	2.95	2 for 2.96
5	PANCAKE PHOTOCELLS, 600 to 15K ohms (#SA2939)	1.00	10 for 1.01
1	100KHZ MARKER CRYSTALS, approx for marker gen. (#SA3896)	1.95	2 for 1.96
1	MOTHERBOARD EDGE CONNECTOR, 106 pins, .125" (#SA3987)	3.50	2 for 3.51
1	48-PIN EDGE CONNECTOR, .156" spacing (#SA3963)	1.95	2 for 1.96
1	JOYSTICK, two 10K pots, for computers, TV games (#SA5037)	2.95	2 for 2.96
1	CHARACTER GENERATOR, 5 x 7 Mostek MK 2002P (#SA3898)	4.95	2 for 4.96

READOUTS!

Quan.	Description	Sale	ONE CENT SALE
3	3 1/2" DIGIT LCD WRISTWATCH DISPLAY, (#SA3960)	\$1.19	6 for \$1.20
1	GE FLUORESCENT NIXIES, 7-seg, blue (#SA3684)	1.00	2 for 1.01
2	SPERRY FLAT NIXIES, orange dual digit (#SA5014)	1.19	4 for 1.20
2	SPERRY FLAT NIXIES, orange, 3", 1 1/2" dig (#SA5015)	1.19	4 for 1.20
6	MAN-3 BUBBLE READOUT, 19" red, com cath. (#SA3338)	1.00	12 for 1.01
2	MAN-4 READOUT, bubble, red, com anode (#SA1503)	1.00	4 for 1.01
2	FND-10 BLOCK READOUT, .122" com cathode (#SA2082)	1.19	4 for 1.20
1	8-DIGIT READOUT, led, com cathode, red (#SA5190)	1.95	2 for 1.96
1	FND-503, .5" red, com cathode, 7-seg. (#SA2949)	1.50	2 for 1.51

SPEAKERS!

Quan.	Description	Each	2 for
1	6" TWIN CONE SPEAKER, hi-fi, for car n/home (#SA5059)	\$4.50	\$4.51
2	2 1/2" x 5" OVAL SPEAKER, 8 ohms (#SA2553)	1.49	1.50
2	2 x 6" OVAL SPEAKER, 8 ohms (#SA3454)	1.49	1.50

MICROPHONES!

Quan.	Description	Each	2 for
1	CONDENSOR MIKES, sensitive, 500 ohms, 1 1/2V (#SA3178)	\$4.95	\$4.96
1	COMMUNICATIONS MIKE, 500 ohms, CB-HAM (#SA4074)	4.50	4.51
1	NOISE CANCELLING MIKE, Ham-CB, 500 ohms (#SA3902)	6.95	6.96

RELAYS!

Quan.	Description	Each	2 for
1	SPDT 12V BLOCK RELAY, 5A contacts (#SA4032)	\$1.98	\$1.99
1	SPDT 12V REED RELAY, 1A contacts (#SA4094)	1.49	1.50
1	SPDT 12V SENSITIVE, 2000 ohm coil (#SA3044A)	1.95	1.96

AMPLIFIERS!

Quan.	Description	Each	2 for
1	8 WATTS ON A BOARD, with built-in preamp (#SA5040)	\$5.95	\$5.96
1	9 WATTS ON A CHIP, Toshiba TA7205 (#SA5057)	4.95	4.96
3	WATTS ON A CHIP, G-E PA 263 (#SA1522)	1.50	1.51

TRANSFORMERS!

Quan.	Description	Each	2 for
1	12V TRANSFORMER, 300ma, pc leads, 110prl (#SA3412)	\$1.49	\$1.51
1	12V TRANSFORMER, 1A, 110/220prl, open frame (#SA4040)	2.95	2.96
1	24VCT TRANSFORMER, 300ma, open frame, 110prl (#SA3323)	1.95	1.96
1	2.9V PLUG-IN TRANSFORMER, 125ma, 110V prl. (#SA4098)	1.95	1.96

DIP SWITCHES!

Quan.	Description	Each	2 for
2	SWITCHES ON A DIP (#SA3668)	\$.77	\$.78
3	SWITCHES ON A DIP (#SA3669)	.88	.89
6	SWITCHES ON A DIP (#SA3671)	1.29	1.30

IC SOCKETS!

Quan.	Description	4 for	8 for
-------	-------------	-------	-------

ADVA

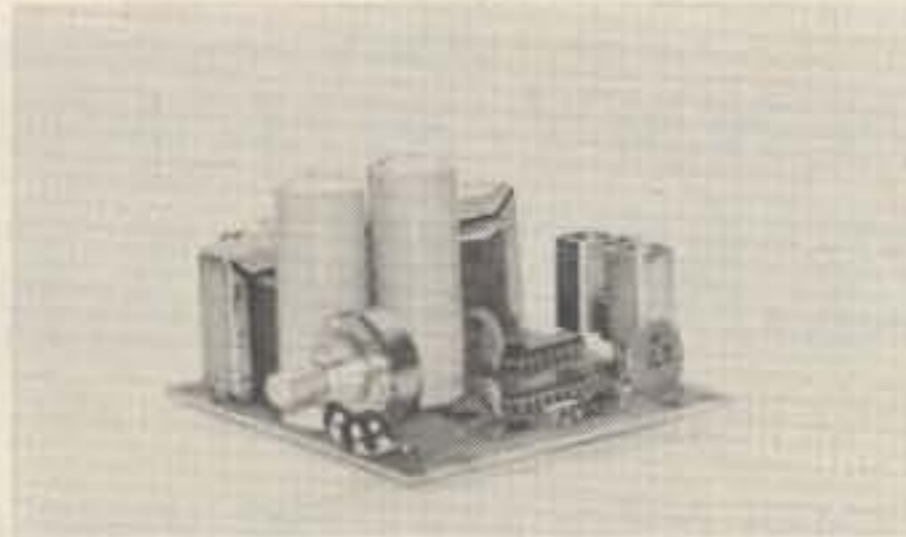

KIT \$11⁹⁵

ASSEMBLED \$17.95
ADD \$1.25 FOR
POSTAGE/HANDLING

VARIABLE POWER SUPPLY

- Continuously Variable from 2V to over 15V
- Short-Circuit Proof
- Typical Regulation of 0.1%
- Electronic Current Limiting at 300mA
- Very Low Output Ripple
- Fiberglass PC Board Mounts All Components
- Assemble in about One Hour
- Makes a Great Bench or Lab Power Supply
- Includes All Components except Case and Meters

OTHER ADVA KITS:

LOGIC PROBE KIT—Use with CMOS, TTL, DTL, RTL, HTL, HNL and most MOS IC's. Built-in protection against polarity reversal and overvoltage. Draws only a few mA from circuit under test. Dual LED readout. Complete kit includes case and clip leads. **ONLY \$7.85**

FIXED REGULATED POWER SUPPLY KITS—Short-circuit proof, with thermal current limiting. Compact size and typical regulation of 0.5% make these ideal for most electronic projects. Available for 5V @ 500mA, 6V @ 500mA, 9V @ 500mA, 12V @ 400mA, 15V @ 300mA. Specify voltage when ordering. **\$8.95 ea.**

These easy-to-assemble kits include all components, complete detailed instructions and plated fiberglass PC boards. Power supply kits do not include case or meters. Add \$1.25 per kit for postage and handling.

MAIL NOW! FREE DATA SHEETS supplied with many items from this ad. FREE ON REQUEST—741 Op Amp with every order of \$5 or more—749 Dual Op Amp or two E100 FET's with every order of \$10 or more, postmarked prior to 12/31/77. One free item per order. ORDER TODAY—All items subject to prior sale and prices subject to change without notice. All items are new surplus parts—100% functionally tested.

WRITE FOR FREE CATALOG #77 offering over 700 semiconductors carried in stock. Send 13¢ stamp.

TERMS: Send check or money order (U.S. funds) with order. Add 5% postage for U.S., Canada and Mexico. \$1.00 handling charge on orders under \$10. Calif. residents add 6% sales tax. Foreign orders add 10% postage. COD orders—add \$1.00 service charge.

MORE SPECIALS:

RC4195DN ±15V @ 50mA VOLTAGE REGULATOR IC. Very easy to use. Makes a neat Highly Regulated ±15V Supply for OP AMP's, etc. Requires only unregulated DC (18-30V) and 2 bypass capacitors. With Data Sheet and Schematics. 8-pin mDIP **\$1.25**

RC4136 Quad 741 Low-Noise Op Amp mDIP **\$0.95**

LM1304 FM Multiplex Stereo Demodulator DIP **0.99**

LM2111 FM IF Subsystem (IF Amp, Det., Limiter) DIP **0.99**

1N6263 Hot Carrier Diode 0.4V @ 1mA 0.1ns DO-35 **1.00**

ZENERS—Specify Voltage 3.3, 3.9, 4.3, 5.1, 6.8, 8.2 400mW 4/\$1.00
9.1, 10, 12, 15, 16, 18, 20, 22, 24, 27, or 33V (±10%) 1 Watt 3/\$1.00

- MONEY-BACK GUARANTEE
- ALL TESTED AND GUARANTEED

ADVA

ELECTRONICS
BOX 4181 EP, WOODSIDE, CA 94062
Tel. (415) 851-0455

FREE

IC or FET's WITH
\$5 & \$10 ORDERS.†
DATA SHEETS
WITH MANY ITEMS.

DIODES	TRANSISTORS	TRANSISTORS	TRANSISTORS	LINEAR IC's
ZENERS & RECTIFIERS	2N706 \$0.25	2N4091 3/51	2N5538 2/51	LM340K-5 \$1.20
1N456 to 1N458 6/51	2N718 .24	2N4092 \$0.75	2N5540 2/51	LM340T-5 1.20
1N483 to 1N488 6/51	2N720 .48	2N4121 3/51	CP643 \$4.00	LM340T-6 1.20
1N748 to 1N758 4/51	2N918 3/51	2N4122 3/51	CP650* \$5.00	LM340T-12 1.20
1N914* 15/51	2N1513 \$0.29	2N4124 5/51	CP651 \$4.00	LM340T-15 1.20
1N922 to 1N974 4/51	2N1711 .29	2N4240 5/51	E100 4/51	LM340T-24 1.20
1N2064 6/51	2N1890 .38	2N4249 5/51	E101 3/51	LM375H* .55
1N2066 6/51	2N1893 .38	2N4250 4/51	E102 3/51	LM377N 2.50
1N4001* 12/51	2N2219 .24	2N4274 5/51	E175 3/51	LM3888N 1.20
1N4002 12/51	2N2222 6/51	2N4302 \$0.29	MPF102 (to*)	NE555V* 2/51
1N4003 12/51	2N2222A 5/51	2N4303 .29	MPF104 3/51	NE556A \$0.80
1N4004 12/51	2N2268 5/51	2N4338 \$1	MPF112 4/51	LM709CN .28
1N4005 10/51	2N2606 to 22 2N4351 \$1	2N4352 \$0.50	MP6615 3/51	LM709CN 2.8
1N4006 10/51	2N2609 to 22 2N4351 \$1	2N4352 \$0.50	SE1001 4/51	LM723H 2/51
1N4007 10/51	2N2609 to 22 2N4351 \$1	2N4352 \$0.50	SE1002 4/51	LM723H* 3/51
1N4148 15/51	2N2907* 5/51	2N4415 2/51	SE2001 4/51	LM739N \$1.80
1N4154* 25/51	2N3553 \$1.50	2N4415A \$0.80	SE2002 4/51	LM741CN 3/51
1N4270 to 1N4272 2/51	2N3553 3/51	2N4850 to 21 2N4851 \$1	SE3001 to 3/51	LM741CN* 4/51
1N4454 15/51	2N3553 3/51	2N4851 \$1	SE3003 3/51	LM741CN14 .34
1N4728 to 1N4753 3/51	2N3554 4/51	2N4857E 2/51	SE3026 \$3.00	LM747CN .85
1N5221 to 1N5228 4/51	2N3555 to 6/51	2N4888E 2/51	T1573 to 3/51	748CJ DIP .35
	2N3638 6/51	2N4881 \$2.50	T1575 3/51	749CJ DIP 1.00
	2N3638A 5/51	2N4888 \$1		844CP mDIP .80
	2N3641 5/51	2N4865 3/51	DIGITAL IC's	LM1304N 1.15
	2N3642 5/51	2N4865 3/51	MM5738N \$2.80	LM1458N* 3/51
	2N3643 6/51	2N5007 4/51	SN7400N .16	LM2111N \$1.40
	2N3644 4/51	2N5008 4/51	SN7410N .16	XR2590CIP 1.50
	2N3646 4/51	2N5126 to 6/51	SN7420N .16	Z740DE 1.80
	2N3688 to 3/51	2N5126 6/51	SN7420N .16	CA3028A 1.75
	2N3690 3/51	2N5129 5/51	SN7421N .18	CA3046 .84
	2N3691 to 4/51	2N5163 3/51	SN7473N .36	LM3075N1 1.40
	2N3694 4/51	2N5167 \$5.00	SN7475N .48	CA3088* .62
	2N3821 \$0.80	2N5198 2.50	SN7476N .36	LM3900N .55
	2N3822 .70	2N5210 3/51	SN7490N .44	RC4194D 1.80
	2N3823 .48	2N5208 2/51	LINEAR IC's	RC4194TK* 2.50
	2N3856 .75	2N5208 2/51	LM100H \$7.50	RC41950N* 1.25
	2N3902 to* 6/51	2N5432 1.90	LM301AN .27	RC4195TK* 2.25
	2N3906 5/51	2N5457 3/51	LM307H .27	LM4250CN 2.00
	2N3918 \$5.00	2N5458 \$0.38	LM308N .88	RC6580N .55
	2N3922 5.00	2N5485 2/51	LM309K .04	NE555V .95
	2N3954 3.20	2N5543 \$3.00	LM311N .80	NE556V .50
	2N3958 1.15	2N5544 2.50	LM320K-12 1.35	µA7805UC 1.25
	2N3970 1.80	2N5551 12.00	LM320K-15 1.35	8038 DIP* 3.75
				DM7548Z .80

*SUPER SPECIALS:

1N34 Germanium Diode	10/51	FSA2501M Diode Array	2/51
1N914 100V/10mA Diode	20/51	MPF102 200MHz RF Amp	3/51
1N4001 50V/1A Rectifier	15/51	40673 MOSFET RF Amp	\$1.75
1N4154 30V 1N914	25/51	LM324 Quad 741 Op Amp	.94
BR1 50V 1/4A Bridge Rec	4/51	LM376 Pos Volt Reg mDIP	.55
2N2222 NPN Transistor	6/51	NE555 Timer mDIP	.38
2N2907 PNP Transistor	6/51	LM723 2-37V Reg DIP	3/51
2N3055 Power Xistor 10A	\$0.75	LM741 Comp Op Amp mDIP	6/51
2N3904 NPN Amp/Sw β100	6/51	LM1458 Dual 741 mDIP	3/51
2N3906 PNP Amp/Sw β100	6/51	CA3085 5 Trans Array DIP	.62
CP650 Power FET 1/2Amp	\$5	RCA29 Par Xistor 1A 30W	.70
RF391 RF Power Amp Transistor 10-25W @ 3-30MHz TO-3	\$5.00		
555X Timer 1µs-1hr Different pinout from 555 (w/data)	3/51		
RC4194TK Dual Tracking Regulator ±0.2 to 30V @ 200mA TO-66	\$2.50		
RC4195TK Dual Tracking Regulator ±15V @ 100mA (TO-66)	\$2.25		
8038 Waveform Generator ~1V Wave With Circuits & Data	\$3.75		

SPECIALS—THIS MONTH ONLY

1N34A Germanium Diode 60V 10mA	10/\$1	LM308H Low Bias Current Op Amp- Super 709	\$0.84
1N270 Germanium Diode 80V 200mA	4/\$1	LM309K 5 Volt Regulator	TO-3 .84
1N914 Silicon Diode 100V 10mA	25/\$1	LM317K Adjustable Voltage Regulator	2-37V 3.50
1N6263 Hot Carrier Diode (HP2800, etc.)	\$1.00	LM380N 2 Watt Audio Power Amplifier	DIP .94
F7 Power Varactor 1-2W Out @ 432MHz (Specs & Circuits included with F7)	\$2.00	NE565A Phase Locked Loop	DIP .94
DIODE GRAB BAG—Mixed zeners, rectifiers, etc.	50/\$1	LM723CN Precision Voltage Regulator	DIP 3/51
2N706 NPN High-Speed Switch 75ns	4/\$1	LM747 Dual 741 Compensated Op Amp	DIP 2/51
2N918 UHF Transistor—Osc/Amp up to 1 GHz	4/\$1	2102 1024-Bit Static RAM (1024 x 1)	DIP \$1.75
2N2609 P-Channel FET Amplifier 2500µmhos	\$1.00	2740DE FET-Input Op Amp- like NE 536/µA740	1.95
2N2920 NPN Dual Transistor 3mV Match β225	2.95	CA3018A 4-Transistor Array/Darlington	.99
2N3904 NPN Amp/Switch β100 40V 200mA	8/\$1	CA3028A RF/IF Amplifier DC to 120MHz	1.45
2N4122 PNP RF Amplifier & Switch	3/\$1	CA3075E FM IF Amp/Limiter/Detector	DIP 1.45
2N4869E N-Channel Audio FET Super Low-Noise	2/\$1	RC4558 Dual High Gain Op Amp	mDIP 3/51
2N4888 150 Volt PNP Transistor for Keyer	2/\$1	N5556V Precision Fast Op Amp	mDIP 2/51
E112 N-Channel FET VHF RF Amp	3/\$1	N5558V Dual Hi Gain Op Amp- Comp.	mDIP 3/51
TIS74 N-Channel FET High-Speed Switch 40Ω	3/\$1	8038 Function Generator/VCO with circuits	\$3.75
TO-220 Mounting Kit-Mica insulator & bushing	10/\$1	8223 256-Bit PROM (32 x 8) 50ns	2.89
		LP-10 LOGIC PROBE kit—TTL, CMOS, etc. Machined case included—1/2 hr. assembly	\$7.85

SEND FOR ADVA'S NEW 1978 CATALOG
OVER 700 SEMICONDUCTORS, KITS, CAPACITORS, ETC.—SEND 13¢ STAMP.

ADVA

ELECTRONICS

BOX 4181 EP
WOODSIDE, CA 94062
Tel. (415) 851-0455

hobbi house

Send for Free Hobbi House Catalog
969 BALL AVE., UNION, N.J. 07083
 Retail Store Open Mon.—Sat., 9 to 6

TERMS AND CONDITIONS

Add \$1.50 postage and handling for all orders within U.S.. COD orders -- add \$2.00 for postage and handling.

\$7. Min. order. Phone orders accepted.
 \$15 Min B.A./Visa, Master Charge orders.
 N.J. Residents add 5% Sales Tax

Outside Continental U.S. send U.S.funds only, and include sufficient postage for first class mail.

OPTO SPECIALS

Cat. #	Order by Cat. # & Type #	Price
01	7 seg. Display 33" 707 MAN 1 C.A. or C.C.	.59 ea. or 10/\$5.00
03	Diffused Jumbo Red Leds 0.2"	7/\$1.00, 100/\$11.00
04	DL741 Jumbo Displays C.A.	\$1.35
05	25PK LEDS ASSTD Sizes & Colors	\$2.50
06	Jumbo Red Leds	10/\$1.00, 100/\$9.00
07	9 digit display by National	\$1.00



**MA1003
 MOBILE CLOCK
 MODULE (National)**
 \$18⁹⁵ complete

Attaches directly to 9-12V Battery. Automatic Nighttime Dimming. Fluorescent Display gives Color Choice (Red, Blue, Green or Yellow) when used w/corresponding Color Filter. Includes — Module, Switches, & Filter

ALUMINUM CASE WITH FILTER. \$5.75
 (switches included with clock kit). In Silver, Black and Gold. Filter colors — red, blue, green, or yellow.

LM555 TIMERS3/.99

SWITCHES

Cat. #	Order by Cat. # & Type #	Price
M9	Sound Actuated Switch	.85
M10	Dry Reed Switch, 5 AMP, 115 VAC	25/\$1.98
M13	250 K Slide Volume Control By Mallory	4/\$1.00
M51	DPDT Momentary Slide Switch	10/\$1.00
M52	DPDT Slide Switch Low Profile	10/\$1.00
M53	DPDT Slide Switch Long Button	10/\$1.00
M56	DP4T Slide Switch	10/\$1.00

ADAPTORS

Cat. #	Order by Cat. # & Type #	Price
M16	AC DC 120 V input 6 UDC 130 MA output	\$1.00
M65	AC Input 120 VAC, 3.7w/output 9 UDC, 100 MA	\$1.50

SPECIALS

Cat. #	Order by Cat. # & Type #	Price
M12	6" Pioneer Pincusion speakers, 3.2 OHMS, 7½ watts	\$3.95 a pair
M17	8 FT. Stereo Extension Cord. RCA plugs at both ends.	2/\$1.99
M33	16 Pin Strip sockets, By AMP	10/\$1.00
M41	6 FT. Line Cords	6/\$1.00
M49	6 DC Battery Holder	3/\$1.00
M29	SPDT 12 Volt Relay 5 AMP contact, Plug in style	\$1.00
M35	Variable Trimmer Cap 3-18 PF, 50 volt	5/\$1.00
M48	2.5 MEG Trimmer Pot	5/\$1.00
M69	50K Trim Pot, Pc mount thum wheel	10/\$1.00

Your Store for Prime Components — Money Back Guarantee on all Orders!
 Toll-Free Wats Line — 800-631-7485 • Open Saturdays
 In New Jersey Call (201) 964-5206

lowest prices

H23

Zener Diodes

Cat. #	Order by Cat. # & Type #	Price
D1	5.1V 1 watt	10/\$1.00
D4	22V 1 watt	10/\$1.00
D5	3.9V 400MW	10/\$1.00
D7	6.8V 400MW	10/\$1.00
D8	8.2V 400MW	10/\$1.00
D10	30V 400MW	10/\$1.00
D11	10V 1 Watt	10/\$1.00

Rectifiers

Cat. #	Order by Cat. # & Type #	Price
D2	IN1084	4/\$1.00
D3	IN4384	10/\$1.00
D6	IN645	10/\$1.00
D13	35AMP 50V DO-5 Case	2/\$1.00
D14	25AMP 200V Bridge Rect.	\$1.75
D23	IN4148 Switching Diode	50/\$1.00
D16	IN4001	10/.55
D17	IN4002	10/.65
D18	IN4003	10/.75
D19	IN4004	10/.85
D20	IN4005	10/.95
D21	IN4006	10/\$1.00
D22	IN4007	10/\$1.00

DISC Caps

Cat. #	Order by Cat. # & Type #	Price
C1	680 MMF 500V±10%	20/\$1.00
C2	200 MMF 500V±10% P.C.	20/\$1.00
C3	390 MMF 400V±10%	20/\$1.00
C4	220 μF 500V±10% P.C.	20/\$1.00
C5	820 PF 1000V±10% P.C.	20/\$1.00
C6	27 PF 500V±10%	20/\$1.00
C7	470 μF 2kV±20%	20/\$1.00
C8	470 PF 2kV±20%	20/\$1.00
C34	.03 μF 100V±20% P.C.	?0/\$1.00
C41	16 μF 500V±5% P.C.	20/\$1.00
C42	.001 PF 100V±10% P.C.	20/\$1.00
C45	.1 MF 50V±10%	20/\$1.00
C47	15 PF 100V±10% P.C.	20/\$1.00
C49	22 μF 750V±10% P.C.	20/\$1.00
C52	22 PF 500V±10%	20/\$1.00
C54	100 PF 100V±10%	20/\$1.00
C57	16 PF 500V±5% P.C.	20/\$1.00
C59	22 PF 150V±10% P.C.	20/\$1.00
C61	22 PF 200V±10%	20/\$1.00
C62	33 PF 100V±5%	20/\$1.00

IC SOCKETS.

Cat. #	Order by Cat. # & Type #	Price
M1	Grain of Wheat Display Lamps	10/\$1.00
M2	8 PIN	5/\$1.00
M3	14 PIN	5/\$1.00
M4	16 PIN	5/\$1.00
M5	18 PIN	5/\$1.00
M6	24 PIN	2/\$1.00
M7	28 PIN	2/\$1.00
M8	40 PIN	2/\$1.00

Transformers

Cat. #	Order by Cat. # & Type #	Price
M22	Mini Audio 1" square	10/\$1.99
M32	70 Volt Line Transformer, 10 watts	\$2.90
M40	6.3 Volts 1.2 amp	\$1.49

Transistors

CAT #	Order by Catalog # & Type #	Price
T1	2N918 ITT	5/\$1.00
T2	2N2904 ITT	5/\$1.00
T3	2N2219 ITT	5/\$1.00
T4	2N4949 House #	2/\$1.00
T5	MPS5172 MOTO	10/\$1.00
T6	2N3638 S.S.	10/\$1.00
T7	2N2102 House #	5/\$1.00
T8	3N140 Fet N Channel	2/\$1.00
T9	2N2907 ITT	5/\$1.00
T10	2N914 ITT	5/\$1.00
T11	2N2369A ITT	10/\$1.00
T12	2N2368 ITT	10/\$1.00
T13	2N706 MOTO	10/\$1.00
T15	D41E1 Ge P. C.	10/\$1.00
T16	2N3416 Sprague	5/\$1.00
T17	MPS2369 ITT	10/\$1.00
T18	MPS3704 ITT	10/\$1.00
T19	2N708 MOTO	5/\$1.00
T20	2N3055 S. S.	2/\$1.00

Electrolytics — all Axial Leads

CAT. #	Order by Cat. # & Type #	Price
C15	.15 μF 400 V	5/\$1.00
C16	1 μF 50 V	5/\$1.00
C17	10 μF 50 V	5/\$1.00
C18	1.0 μF 200 V	5/\$1.00
C19	25 μF 25 V	5/\$1.00
C20	5 μF 25 V	5/\$1.00
C21	500 μF 15 V	5/\$1.00
C22	1500 μF 3V	5/\$1.00
C24	1000 μF 6V	5/\$1.00
C25	2000 μF 2.5V	5/\$1.00
C40	500 μF 50V	4/\$1.00
C46	4.7 μF 50V	4/\$1.00
C53	4.7 μF 35 V	4/\$1.00
C56	220 μF 16 V	4/\$1.00
C63	1000MFD 35V	4/\$1.00

Tantalum, Axial Leads

Cat.#	Order by Cat. # & Type#	Price
C13	.047 μF 200 V	10/\$1.00
C44	1MF 35V	10/\$1.00
C48	15 μF 35V	10/\$1.00

Voltage Regulators

Cat. #	Order by Cat. # & Type #	Price
1C1	7805 Pos.	\$1.00
1C2	7815 Pos.	\$1.00
1C3	7806 Pos.	\$1.00
1C4	7905 Neg.	\$1.25
1C5	7812 Pos.	\$1.00
1C6	7824 Pos.	\$1.00
1C7	7915 Neg.	\$1.25

Mylar Caps

Cat.	Order by Cat. # & Type #	Price
C9	1.0 100V±5%	10/\$1.00
C11	.018MF 400V±10%	10/\$1.00
C12	.47 μF 100V±10%	10/\$1.00

SPECIAL

WESTINGHOUSE TUBES — BOXED AND BRANDED

1V2	1.50	6CG3/W3/Q3	2.50	6HB7	2.40	6LQ6/6JE6C	4.85
2AV2	2.00	6CJ3/6CH3	2.50	6HM5/6HA5	2.30	6Z10/6J10	4.30
3A3C	3.10	6DW4B	2.50	6HZ6	2.00	8FQ7/8C67	2.00
3AT2B	3.00	6EA8	2.50	6JC6A	2.65	12AT7/ECC81	2.00
3CU3A	3.75	6EJ7/EF184	2.20	6JS6C	4.50	12AU7/ECC82	2.00
3DB3/3CY3	3.30	6EW6	2.20	6JU8A	2.60	12AX7/ECC83	2.00
3HM5/3HA5	2.50	6FQ7/6CG7	1.85	6KD6	4.90	12BY7A/V/Q	2.20
5GH8A	2.75	6GF7A	3.20	6KE8	3.60	12HG7/6N7A	3.30
6AQ5A	2.00	6GH8A	2.00	6KT8	3.25	17JZ8	2.50
6AU6A	2.00	6GJ7/ECF801	2.25	6KZ8	2.40	23Z9	3.00
6BK4C/EL4A	4.50	6GM6	2.50	6LGC	3.80	33GY7A	3.75
8BL8/ECF80	1.75	6GU7	2.50	6LB6	4.75	36MC6	5.00
						38HE7	3.85

NEW

Frequency Counter

\$79⁹⁵ kit



UTILIZES NEW MOS-LSI CIRCUITRY

You've requested it, and now it's here! The CT-50 frequency counter kit has more features than counters selling for twice the price. Measuring frequency is now as easy as pushing a button, the CT-50 will automatically place the decimal point in all modes, giving you quick, reliable readings. Want to use the CT-50 mobile? No problem, it runs equally as well on 12 V dc as it does on 110 V ac. Want super accuracy? The CT-50 uses the popular TV color burst freq. of 3.579545 MHz for time base. Tap off a color TV with our adapter and get ultra accuracy — .001 ppm! The CT-50 offers professional quality at the unheard of price of \$79.95. Order yours today!

SPECIFICATIONS

Sensitivity: less than 25 mv.
 Frequency range: 5 Hz to 60 MHz, typically 65 MHz
 Gate time: 1 second, 1/10 second, with automatic decimal point positioning on both direct and prescale
 Display: 8 digit red LED .4" height
 Accuracy: 10 ppm, .001 ppm with TV time base!
 Input: BNC, 1 megohm direct, 50 Ohm with prescale option
 Power: 110 V ac 5 Watts or 12 V dc @ 1 Amp
 Size: Approx. 6" x 4" x 2", high quality aluminum case

- CT-50, 60 MHz counter kit \$79.95
- CT-50 WT, 60 MHz counter, wired and tested 159.95
- CT-600, 600 MHz prescaler option for CT-50, add 29.95

- Color burst adapter for .001 ppm accuracy
- CB-1, kit \$14.95

MINI-KITS



CLOCK KIT 6 digit 12/24 hour

Want a clock that looks good enough for your living room? Forget the competitor's kludges and try one of ours! Features: jumbo .4" digits, Polaroid lens filter, extruded aluminum case available in 5 colors, quality PC boards and super instructions. All parts are included, no extras to buy. Fully guaranteed. One to two hour assembly time. Colors: silver, gold, black, bronze, blue (specify).

- Clock kit, DC-5 \$22.95
- Alarm clock, DC-8, 12 hr only 24.95
- Mobile clock, DC-7 25.95
- Clock kit with 10 min ID timer, DC-10 ... 25.95
- Assembled and tested clocks available, add \$10.00

VIDEO TERMINAL KIT \$149.95

A compact 5 x 10-inch PC card that requires only an ASCII keyboard and a TV set to become a complete interactive terminal for connection to your microprocessor synchronous interface. Its many features are single 5-volt supply, crystal controlled sync and baud rates (up to 9600 baud), 2 pages of 32 characters by 16 lines, read to and from memory, computer and keyboard-operated cursor and page control, parity error display and control, power-on initialization, full 64-character ASCII display, block-type see-thru cursor, keyboard/computer control backspaces, forward spaces, line feeds, rev. line feeds, home, returns cursor. Also clears page, clears to end of line, selects page 1 or 2, reads from or to memory. The card requires 5 volts at approx. 900 ma and outputs standard 75 ohm composite video.

- TH3216 Kit \$149.95
- TH3216, Assembled and Tested 239.95
- VD-1, Video to RF Modulator Kit 6.95

TONE DECODER KIT

A complete tone decoder on a single PC Board. Features: 400-5000 Hz adjustable frequency range, voltage regulation, 567 IC. Useful for touch-tone decoding, tone burst detection, FSK demod, signaling, and many other uses. Use 7 for 12 button touchtone decoding. Runs on 5 to 12 volts.

- Complete Kit, TD-1 \$4.95



SUPER SLEUTH AMPLIFIER

A super-sensitive amplifier which will pick up a pin drop at 15 feet! Great for monitoring baby's room or as a general purpose test amplifier. Full 2 watts of output, runs on 6 to 12 volts, uses any type of mike. Requires 8-45 ohm speaker.

- Complete Kit, BN-9 \$4.95

FM WIRELESS MIKE KIT

Transmit up to 300' to any FM broadcast radio, uses any type of mike. Runs on 3 to 9 V. Type FM-2 has added super sensitive mike preamp.

- FM-1 \$2.95
- FM-2 \$4.95

COLOR ORGAN/MUSIC LIGHTS

See music come alive! 3 different lights flicker with music or voice. One light for lows, one for the mid-range and one for the highs. Each channel individually adjustable, and drives up to 300 watts. Great for parties, band music, nite clubs and more.

- Complete Kit, ML-1 \$7.95

LED Blinky KIT

A great attention getter which alternately flashes 2 Jumbo LEDs. Use for name badges, buttons, or warning type panel lights. Runs on 3 to 9 volts.

- Complete Kit \$2.95

POWER SUPPLY KIT

Complete triple regulated power supply provides variable ±15 volts at 200 mA and ±5 volts at 1 Amp. 50 mV load regulation good filtering and small size. Kit less transformers. Requires 6-8 V at 1 Amp and 18 to 30 VCT.

- Complete Kit, PS-3LT \$6.95



SIREN KIT

Produces upward and downward wail characteristic of police siren. 5 watts audio output, runs on 3-9 volts, uses 8-45 ohm speaker.

- Complete Kit, SM-3 \$2.95

DECADE COUNTER PARTS

Includes: 7490A, 7475, 7447, LED readout, current limit resistors, and instructions on an easy to build low cost frequency counter.

- Kit of parts, DCU-1 \$3.50

CHEAP CLOCK KIT \$8.95

- DC-4 Features: Does not include board or transformer
- 6 digit .4" LED
- 12 or 24 format
- PC Board \$2.95
- Transformer \$1.49

CAR CLOCK KIT \$27.95



- 12/24 Hour 12-Volt AC or DC
- High Accuracy (1 minute/month)
- 6 jumbo .4" LED readouts
- Easy, no-polarity hookup
- Display blanks with ignition
- Case, mounting bracket included
- Super instructions
- Complete Kit, DC-11 \$27.95
- AUTO-DIMMER \$2.50
- Automatically adjusts display brightness according to ambient light level. For DC 11 Car Clock.

600 MHz PRESCALER



Extend the range of your counter to 600 MHz. Works with all counters. Less than 150 mv sensitivity. Specify ±10 or ±100. Wired, tested, PS-1B \$59.95

30 watt 2 meter Power Amp

The famous RE class C power amp now available mail order! Four Watts in for 30 Watts out, 2 in for 15 out, 1 in for 8 out, incredible value, complete with all parts, instructions and details on T-R relay. Case not included.

- Complete Kit, PA-1 \$22.95

CALENDAR ALARM CLOCK

Has every feature one could ever ask for. Kit includes everything except case, build it into wall, station or even car!

- FEATURES:
- 6 Digits, .5" High LED
- Calendar shows mo./day
- True 24 Hour Alarm
- Battery back up with built-in on chip time base
- 12/24 Hour Format
- Snooze button
- 7001 chip does all!
- Complete Kit, less case, DC-9 \$34.95

LINEAR		REGULATOR		TRANSISTORS	
5314 Clock	\$2.95	555	\$.50	78MG	\$1.49
74S00	.35	556	.75	309k	.89
74S112	.75	566	1.49	309H	.99
7447	.79	567	1.49	340K-12	.99
7473	.35	1458	.50	7805	.89
7475	.50	LED DRIVER		7812	.89
7490A	.55	75491	.50	7815	.89
74143	3.50	75492	.50	7818	.89

DIODES: 1KV,2.5A 5/\$1.00 100V,1A 10/\$1.00 1N914A type 50/\$2.00

LED DISPLAYS

- FND 35975
- FND 510 1.25
- DL 707 1.25
- HP 7730 1.25



Red Polaroid Filter ... 4.25" X 1.125"59

741 OP-AMP SPECIAL

Factory prime mini dip with both Xerox and 741 part numbers

- 10 for \$2.00

SOCKETS

- 14 PIN 5/\$1.00
- 16 PIN 5/\$1.00
- 24 PIN 2/\$1.00
- 40 PIN 3/\$2.00

FERRITE BEADS

- with info and specs
- 15/\$1.00
- 6 hole Balun Beads
- 5/\$1.00

ramsey electronics

P.O. Box 4072 Rochester NY 14610

(716) 271-6487

TELEPHONE ORDERS WELCOME



Satisfaction guaranteed or money refunded. COD, add \$1.00. Orders under \$10 add \$.75. NY residents add 7% tax. Add 5% for postage, insurance, and handling. Minimum order \$6.00.

THINKING ABOUT OSCAR?

Here are some helpful suggestions -

FAMOUS HAMTRONICS PREAMPS

let you hear the weak ones!

Great for OSCAR, SSB, FM, ATV. Over 10,000 in use throughout the world on all types of receivers.

P9 Kit \$12.95

P14 Wired \$24.95

Deluxe vhf model for applications where space permits.



- 1-1/2 x 3" • Covers any 4 MHz band • 12 Vdc
- Ideal for OSCAR • Diode protection • 20dB gain

MODEL	RANGE
P9-LO	26-88 MHz
P9-HI	88-172 MHz
P9-220	172-230 MHz
P14 Wired	Give exact band



P8 Kit \$10.95

P16 Wired \$21.95

Miniature VHF model for tight spaces - size only 1/2 x 2-3/8 inches.

- Covers any 4 MHz band
- 20 dB gain • 12 Vdc

MODEL	RANGE
P8-LO	20-83 MHz
P8-HI	83-190 MHz
P8-220	220-230 MHz
P16 Wired	Give exact band

P15 Kit \$18.95

P35 Wired \$34.95

- Covers any 6 MHz band in UHF range of 380-520 MHz
- 20 dB gain • Low noise



FM/CW TRANSMITTER KITS

BUILD UP YOUR OWN GEAR FOR OSCAR CW OPERATION, FM REPEATERS, CONTROL LINKS

- Professional Sounding Audio • Free of Spurs
- Completely Stable • Built-in Testing Aids



T40 11 Channel 200 MW Exciter Kit for 2M or 6M band..... \$39.95

T20 Tripler/Driver Kit. Use with T40 for operation on 432-450 MHz band..... \$19.95



T80 RF POWER AMPLIFIER MODULES FOR ABOVE

- No tuning • VSWR Protected • Wired and Tested
- Rated for Continuous Duty - Great for Repeaters

T80-150: 140-175 MHz, 20-25W output \$79.95
T80-450: 430-470 MHz, 13-15W output \$79.95

AT LAST! A 2 METER SSB TRANSVERTER

At a price you can afford

Use inexpensive recycled 10 or 11 meter ssb exciter on 2 meters.

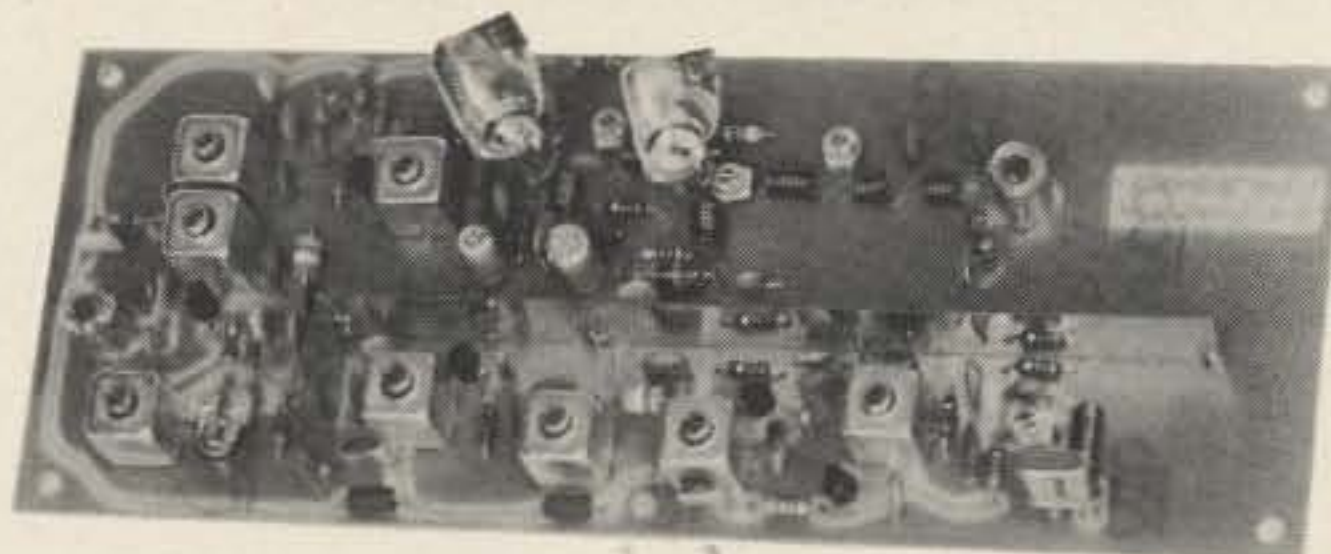

FEATURES:

- Linear Converter for SSB, CW, FM, etc.
- A fraction of the price of other units
- 2W p.e.p. output with 5 MW of drive
- Use low power tap on exciter or attenuator pad
- Easy to align with built-in test points

VX2-() TRANSVERTER KIT \$59.95

A25 Optional Cabinet for Xverter&PA \$20

Frequency Schemes Available:

VX2-4	28-30 = 144-146	□	Other frequency ranges available on special order
VX2-5	28-29 = 145-146	□	
VX2-6	26-28 = 144-146	□	

2M LINEAR POWER AMPLIFIERS:

LPA 2-15 Kit	15 W p.e.p.	\$69.95
LPA 2-70 Kit	70 W p.e.p.	\$139.95

New VHF&UHF Converter Kits

let you receive OSCAR signals and other exciting SSB, CW, & FM activity on your present HF receiver.



either one
- ONLY \$34.95
including crystal



MODEL	RF RANGE (MHZ)	I-F RANGE
C50	50-52	28-30
C144	144-146	28-30
C145	145-147 (OSCAR)	28-30
C146	146-148	28-30
C110	Aircraft	28-30
C220	220 band	28-30
Special	Other i-f & rf ranges available	

MODEL	RF RANGE (MHZ)	I-F RANGE
C432-2	432-434	28-30
C432-5	435-437 (OSCAR)	28-30
C432-7	427.25	61.25
C432-9	439.25	61.25
Special	Other i-f & rf ranges available	
A9 Extruded Alum Case/Connectors		\$12.95

VHF/UHF FM RCVR KITS

- ★ NEW GENERATION RECEIVERS
- ★ MORE SENSITIVE ★ MORE SELECTIVE (70 or 100 dB)
- ★ COMMERCIAL GRADE DESIGN
- ★ EASY TO ALIGN WITH BUILT-IN TEST CKTS
- ★ LOWER OVERALL COST THAN EVER BEFORE



R70 6-channel VHF Receiver Kit for 2M, 6M, 10M, 220 MHz, or com'l bands..... \$69.95
Optional xtal filter for 100 dB adj chan 10.00



R90 UHF Receiver Kit for any 2 MHz segment of 380-520 MHz band..... \$89.95

* FREE 1978 CATALOG *

40 PAGE CATALOG IS YOURS FOR THE ASKING!

IT'S EASY TO ORDER!

☛ CALL OR WRITE NOW FOR FREE CATALOG OR TO PLACE ORDER!

☛ PHONE 716-663-9254. (Answering service evenings and weekends for your convenience. Personal service 9-5 eastern time.)

☛ Use credit card, c.o.d., check, m.o.

☛ Add \$2.00 shipping & handling.

IN CANADA, send to Comtec; 5605 Westluka Ave; Montreal, Que H4W 2N3 or phone 514-482-2640. Add 28% to cover duty, tax, and exchange rate.

hamtronics, inc.

182-D Belmont Rd; Rochester, NY 14612 H16

BULLET ELECTRONICS

PHONE ORDERS ON MASTERCARD OR VISA CARDS

P.O. BOX 19442E
DALLAS, TX. 75219
(214)823-3240 B8

PS-14 HIGH CURRENT REGULATED POWER SUPPLY KIT

- * Better than 200MV load and line regulation
- * Foldback Current Limiting
- * Short Circuit Protected
- * Thermal Shutdown
- * Adjustable Current Limiting
- * Less than 1% ripple.
- * 15 amps 11.5 to 14.5V
- * All parts supplied including heavy duty transformer.
- * Quality plated fiberglass PC board.

Less Case,
meters & jacks

39.95

UPS SHIPPING
PAID!

MK-03A CLOCK/TIMER KIT

Features 24 hour Zulu time and up to 24 hours of elapsed time on the same set of six digit LED readouts. Totally independent operation of both functions. Clock has pre-settable alarm with 10 minute snooze. Timer has reset, hold, and count functions. Full noise and overvoltage protection. 24 hour only. Readouts has dimmer feature or they can be turned off without disturbing the clock or timer. Timebase included (.01% accuracy). Because of the many options and mounting considerations the case and switches are not included. Switches are standard types. Will fit inside standard aircraft instrument case.

9-14VDC

150MA W/readouts on
40MA W/readouts off

28.95

OVERVOLTAGE PROTECTION KIT 6.95

Provides cheap insurance for your expensive equipment. Trip voltage is adjustable from 3 to 30 volts. Overvoltage instantly fires a 25A SCR and shorts the output to protect equipment. Should be used on units that are fused. Directly compatible with the PS-12 and PS-14. All electronics supplied. Drilled and plated PC board. (Order OVP-1)

POWER SUPPLY METERS

Quality 3/4" meters for the P-S14. 0-15VDC & 0-25A. Matched set, individually packaged. NOT SURPLUS!

12.95/set

WARBLE ALARM Kit

A fun EASY kit to assemble that emits an ear piercing 10 watt dual tone scream. Resembles European siren sound. Great for alarms or toys. Operates from 5-12VDC at up to 1 amp (using 12VDC*8 ohm speaker). Over five thousand have been sold. All parts including PC board, less speaker. ORDER WB-02

2.50

ULTRASONIC SENDER RECEIVER KIT US-02

NEW! TOTAL SECURITY! Completely invisible ultrasonic (23KHZ) sound beam works like a photoelectric beam but is unaffected by light, heat or noise. Separate Transmitter and Receiver can be used from 6 inches to 25 feet! A solid object breaking the beam causes an output to go low that will sink up to 150 MA to Drive a Relay, TRIAC, etc. Complete electronics are provided. Works on 12VDC (unregulated) and draws less than 100 MA. Use it for burglar alarms, object counters, automatic door openers, automatic door bells, electronic rat trap(?) and more.

COMPLETE KIT LESS CASES **21.50**

Optional entry delay and Alarm Timeout Circuit **3.95**
will source or sink up to 200 MA DC.

MOBILE CLOCK CALENDAR KIT

Seems like everybody sells digital clock kits, however we have the only low cost **DIGITAL CLOCK / CALENDAR** for Mobile operation. We provide quality plated through hole boards and step-by-step instructions, parts overlays and schematics. This clock has many features and we supply all the parts but a small speaker. Fantastic for car, boat or Van.
*Integral Timebase (.01% ACC)
*Large 4 DIGIT LED display with AM/PM indicators
*Flashing colon at 1HZ rate
*Special noise and overvoltage protection for mobile use
*Auxiliary output will drive relay or TRIAC to control external equipment

23.50 NO CASE

12 VAC XFMR for 110 VAC **1.50**
24 Hour Format add **2.00**

All Parts Are Prime & Guaranteed!



PICK A PAIR!

8A Complimentary Darlington Power Transistors. MJ900 PNP, MJ1000 NPN. 90 Watts. Build high power audio amps.

Buy a Pair for \$3.00!

MC1469R

500ma positive regulator. 3 to 30 volts. with complete specs and applications.
\$1.25 - house no.

Special!

Limited Qty!
LM567 Tone Decoders while they last!
99c

Heatshrink Tubing

A very good asst. of 3/32", 1/8", 3/16", 1/4" & 7/16" 6" lengths 12 pcs.
75c

This item FREE with purchase of 15.00 or more

Multicolored 26 Conductor Ribbon Cable No. 28 wire with a woven binder. Super Flexible!
10' roll - **\$2.95**

220mfd @25V Axial Cap **7/\$1.00**

500mfd @35V Axial Cap **5/\$1.00**

1100mfd @ 35 Axial Capacitor **4/\$1.00** Sprague

#30 Silver Plated

Wirewrap wire with Kynar® jacket. 4 colors available, 100 ft. of each color.

\$4.95 (400')

CA3011

100Khz to over 20Mhz. Good for IF's and low frequency Complete Specs!

50¢ each

MC1351P

MC1351P FM IF AMP. 14 pin IC. Complete FM sound subsystem, similar to LM2111 house no.

3 / \$1.00

General Purpose NPN

2N3569 Fairchild Vceo = 60V Hfe to 300. 800MW power, epoxy TO-5. Limited Qty!

6 for \$1.00

MICRO TRIMMER CAPS
Tiny 4-40 pfd trimmer used originally in watches!
3/\$1.00

FANTASTIC SOUND SYNTHESIZER 76477

Brand new from TI. Make any sound under the sun with this 28 pin gem! Single IC contains: Noise generator, super low frequency OSC, VCO, one shot, mixer envelope control and amp. Works from a single 5 to 9VDC source. With 8 page manual. **\$3.95 each**

MG-01 ELECTRONIC GRANDFATHER CLOCK

While we are talking about clocks check out the MINI GRANDFATHER CLOCK Reviewed in April 1978 **RADIO ELECTRONICS**. We have the only kit in the world with all the below listed features. The biggest problem is to describe how unique and fascinating this timepiece really is! The LED "Swinging" Pendulum and Matching Tick-Tock Sound are available only on our clock. In addition the electronic "bell" notes each hour (ie 3 times for 3 o'clock). Housed in the optional Solid Hardwood Case, the unit makes a beautiful addition to any room.

*1/2" 4 DIGIT LED READOUT
*Adjustable tone & duration on chime
*Simulated swinging LED Pendulum
*All CMOS Construction
*Quality plated boards
*All electronics switches and XFMR included

39.95 KIT 59.95 ASEMB.

Optional Solid Hardwood Case for MG-01 Clock over 10 inches tall. Includes Ruby front. Unassembled. **SOLID HARDWOOD 17.95 SOLID WALNUT 19.95**

Miniature 7K Pot w/switch PC Mount or panel mount 1/8" shaft .49 Black plastic knob for above: **FREE**

LIMITED QTY Computer Grade FILTER CAP Screw Terminals 2" X 5/16" 9500 mfd@75V 2.95 or 4/9.95

SPECIAL SALE TIL 312 LED Common Anode 7 Segment Readout .3" Character Size Standard Pinout while they last **.65** 6/3.00

ZENER GRAB BAG. A very nice assortment of 10 different voltages between 2.7v and 30 VDC in 400 MW, 1/2W and 1W. All are prime units but most have Mfg's. numbers. We supply a cross reference sheet to standard numbers. **SPECIAL PRICE 10 pieces 1.00**

THE SMALL PRINT

- * No COD's
- * Check or MO
- * MC/VISA
- * TX residence add 5% Sales tax
- * Orders under \$10 add .75 handling
- * All orders add 5% for shipping & handling
- * Orders over \$50 take 10% discount
- * Foreign address add 10% for shipping

600 MHZ. FREQUENCY COUNTER ±0.1 PPM TCXO

OPTO-8000.1

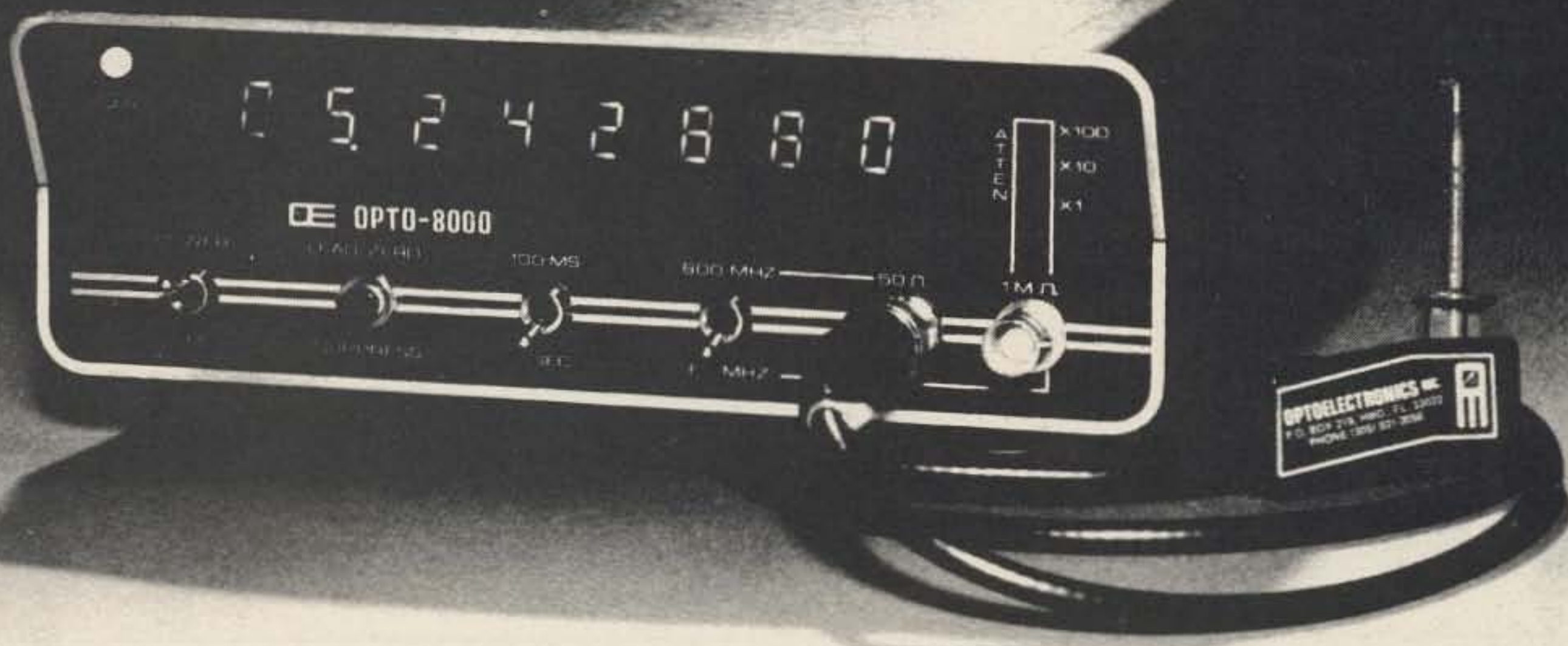

This new instrument has taken a giant step in front of the multitude of counters now available. The Opto-8000.1 boasts a combination of features and specifications not found in units costing several times its price. Accuracy of ± 0.1 PPM or better — *Guaranteed* — with a factory-adjusted, sealed TCXO (Temperature Compensated Xtal Oscillator). **Even kits require no adjustment for guaranteed accuracy!** Built-in, selectable-step attenuator, rugged and attractive, black anodized aluminum case (.090" thick aluminum) with tilt bail. 50 Ohm and 1 Megohm inputs, both with amplifier circuits for super sensitivity and both diode/overload protected. Front panel includes "Lead Zero Blanking Control" and a gate period indicator LED. AC and DC power cords with plugs included.

SPECIFICATIONS:

Time Base—TCXO ± 0.1 PPM GUARANTEED!
 Frequency Range—10 Hz to 600 MHz
 Resolution—1 Hz to 60 MHz; 10 Hz to 600 MHz
 Decimal Point—Automatic
 All IC's socketed (kits and factory-wired)
 Display—8 digit LED
 Gate Times—1 second and 1/10 second
 Selectable Input Attenuation—X1, X10, X100
 Input Connectors Type —BNC
 Approximate Size—3" h x 7½" w x 6½" d
 Approximate Weight—2½ pounds
 Cabinet—black anodized aluminum (.090" thickness)
 Input Power—9-15 VDC, 115 VAC 50/60 Hz
 or internal batteries

OPTO-8000.1 Factory Wired **\$299.95**
 OPTO-8000.1K Kit **\$249.95**

ACCESSORIES:

Battery-Pack Option—Internal Ni-Cad Batteries and charging unit **\$19.95**
 Probes: P-100—DC Probe, may also be used with scope **\$13.95**
 P-101—LO-Pass Probe, very useful at audio frequencies **\$16.95**
 P-102—High Impedance Probe, ideal general purpose usage **\$16.95**
 VHF RF Pick-Up Antenna-Rubber Duck w/BNC #Duck-4H **\$12.50**
 Right Angle BNC adapter #RA-BNC **\$ 2.95**

FC-50 — Opto-8000 Conversion Kits:

Owners of FC-50 counters with #PSL-650 Prescaler can use this kit to convert their units to the Opto-8000 style case, including most of the features.

FC-50 — Opto-8000 **Kit \$59.95**
 *FC-50 — Opto-8000F **Factory Update \$99.95**
 FC-50 — Opto-8000.1 (w/TCXO) **Kit \$109.95**
 *FC-50 — Opto-8000.1F **Factory Update \$149.95**
 *Units returned for factory update must be completely assembled and operational

TERMS: Orders to U.S. and Canada, add 5% to maximum of \$10.00 per order for shipping, handling and insurance. To all other countries, add 10% of total order. Florida residents add 4% state tax. C.O.D. fee: \$1.00. Personal checks must clear before merchandise is shipped.



OPTOELECTRONICS, INC.

5821 NE 14 Avenue
 Ft. Lauderdale, FL 33334
 Phones: (305) 771-2050 771-2051
 Phone orders accepted 6 days, until 7 p.m.



New!

16K E-PROM CARD

IMAGINE HAVING 16K OF SOFTWARE ON LINE AT ALL TIME!

S-100 (Imsai/Altair) Buss Compatible!

Uses
2708's!

KIT FEATURES:

1. Double sided PC board with solder mask and silk screen and gold plated contact fingers.
 2. Selectable wait states.
 3. All address lines & data lines buffered!
 4. All sockets included.
 5. On card regulators.
- KIT INCLUDES ALL PARTS AND SOCKETS (except 2708's). Add \$25. for assembled and tested.**

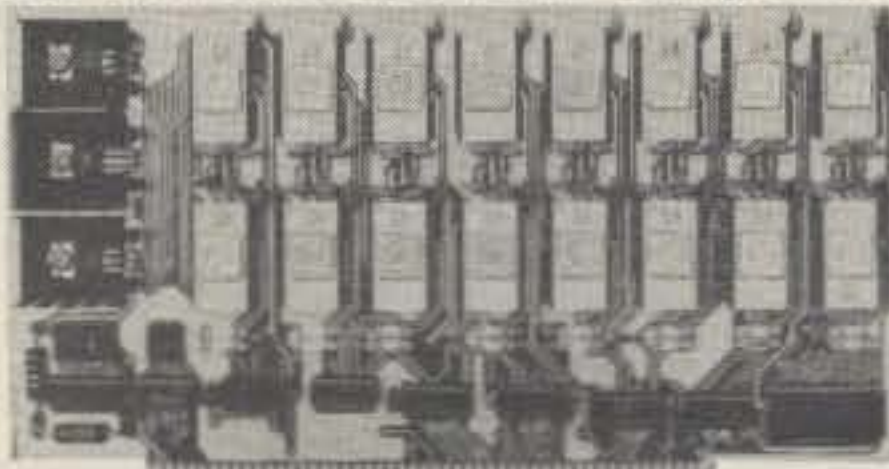

DEALER INQUIRIES INVITED!

PRICE CUT!

\$57.50 kit

WAS \$69.95

SPECIAL OFFER:

Our 2708's (450NS) are \$12.95 when purchased with above kit.

Fully Static!

8K LOW POWER RAM KIT - \$149.00

S-100 (Imsai/Altair) Buss Compatible!

KIT FEATURES:

1. Doubled sided PC Board with solder mask and silk screen layout. Gold plated contact fingers.
2. All sockets included.
3. Fully buffered on all address and data lines.
4. Phantom is jumper selectable to pin 67.
5. FOUR 7805 regulators are provided on card.

ADD \$20 FOR 250NS

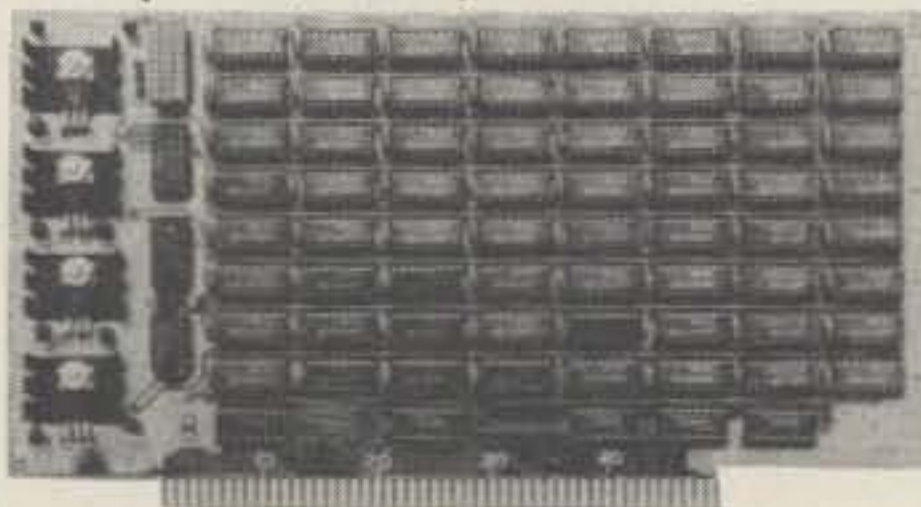

USES 21L02 RAM'S!

Fully Assembled & Burned In \$179.00

Blank PC Board w/ Documentation \$29.95

Low Profile Socket Set 13.50
Support IC's (TTL & Regulators) \$9.75

Bypass CAP's (Disc & Tantalums) \$4.50

MOTOROLA QUAD OP - AMP
MC 3401. PIN FOR PIN SUB.
FOR POPULAR LM 3900.
3 FOR \$1

ALARM CLOCK CHIP
N.S. MM5375AA. Six Digits.
With full Data. **New!**
\$1.95 each

FULL WAVE BRIDGE
4 AMP. 200 PIV.
69c EA. 10 FOR \$5.75

NOT ASSOCIATED WITH DIGITAL
RESEARCH OF CALIFORNIA, THE
SUPPLIERS OF CPM SOFTWARE.

MOTOROLA 7805R VOLTAGE REGULATOR
Same as standard 7805 except 750 MA output.
TO-220. 5VDC output.
44c each or 10 for \$3.95

450 NS! 2708 EPROMS 450NS!
Now full speed! Prime new units from a major U.S. Mfg. 450 N.S.
Access time. 1K x 8. Equiv. to 4-1702 A's in one package.
Special Offer: \$12.95 each when purchased with our 16K EPROM kit!
\$15.75 ea.

Z-80 PROGRAMMING MANUAL
By Mostek, The major Z-80 second source. The most detailed explanation ever on the working of the Z-80 CPU CHIPS. At least one full page on each of the 158 Z-80 instructions. A MUST reference manual for any user of the Z-80. 300 pages. Just off the press! A D.R.C. exclusive!
\$12.95

CMOS SPECIAL!

CD 4001 - 5 for \$1. CD4040 - \$1. each
CD 4011 - 5 for \$1. CD4042 - 2 for \$1.
CD 4013 - 3 for \$1. CD 4049 - 3 for \$1.

POWER RECTIFIER #2 Motorola
Stud Mount. 1N1187.
35 AMPS. 300 PIV.
Military Quality! \$1.19 ea. or 4/\$3.50

3 AMP RECTIFIER 4 for Metal Case \$1.00
1N4721. Axial Lead. 200 PIV.
HEAVY DUTY!
House numbered

4K STATIC RAM'S
2114. The new industry standard. Arranged as 1K x4. Equivalent to 4-21 L02's in 1 package! 18 pin DIP. 2 chips give 1Kx8.
2/\$24. 8/\$85.

OPCOA LED READOUT
SLA-1. Common Anode.
.33 inch character size.
The original high efficiency LED display. 75c ea.
or 4 for \$2.50

EXPERIMENTER'S CRYSTAL
262.144KHZ. This frequency is 2 to the 18th power. Easily divided down to any power of 2, and even to 1HZ. New by CTS-Knight. A \$5. value!
\$1.25 each.

GE Ni-Cad Battery Pack
3 Cell pack, gives 4 volts at 900MAH. Brand new, factory fresh. Each cell is 2/3 "C" size. \$4.50 /pack.
Buy 3 packs (12 volts) for \$10.95. Limited stock!

741C OP AMPS
Mini Dip. Prime new units. Has computer Mfg's house number.
12/\$2. 100/\$15.

Disc Capacitors
.1 MFD 16V. P.C. leads. Most popular value. By Sprague.
20/\$1.00

HEAVY DUTY!
Full Wave Bridge
25AMP 50PIV
\$1.25

Tantalum Capacitors
1 MFD. .35V. By Kemet. Axial Lead.
Best Value! 10/\$1.

New! REAL TIME
Computer Clock Chip
N.S. MM5313. Features BOTH 7 segment and BCD outputs. 28 Pin DIP. \$4.95 with Data

Jumbo Red Leds
New by G.E. Like MV5024. Number SSL-22.
6/\$1. 25/\$3.75

MALLORY FILTER CAP
1500 MFD 16V. UPRIGHT
3 for \$1 10 for \$2.95

GE 10 AMP Triac
SC146D. House no. To-220 case. Rated 10 amps 400PIV.
75cea. 3/\$2.

LS SERIES TTL
74LS00 - 33c 74LS74 - 49c
74LS02 - 35c 74LS90 - 69c
74LS04 - 35c 74LS138 - 89c
74LS08 - 35c 74LS154 - 1.49
74LS10 - 33c 74LS175 - 1.10
74LS20 - 33c 74LS367 - 75c
74LS73 - 49c 74LS368 - 85c

Digital Research Corporation

(OF TEXAS)

P. O. BOX 401247 • GARLAND, TEXAS 75040 • (214) 271-2461

TERMS: Orders under \$15. add 75c. No COD's. We accept VISA, MasterCard and American Express Cards. Money Back Guarantee on all items! Texas Residents add 5% Sales Tax. WE PAY POSTAGE!

**MALLORY ELECTROLYTIC
FILTER CAPACITOR**



1500 MFD. 16 WVDC.
Radial Leads. Factory Fresh!

3 FOR \$1 10 FOR \$2.95

Perfect for Power Supplies!
Small Size: 1 1/4 x 5/8 Inches.

**PC BOARD
EDGE CONNECTORS**



75¢

4 FOR \$2.50

36 Pin. Gold Plated. Solder Tail. .156 IN. Spacing. Double Rows of 18 Pins. For standard thickness (.062) PC Boards Major U.S. Mfg.

**FAIRCHILD JUMBO
RED LED'S**

#FLV 110. Same style as used on IMSAI front panels. Super prime new units.

5 FOR \$1
100 FOR \$17.50

Telephone Eqmt. Component Board

Production over-run. Super good assortment of parts, all easily removed. Has four 47 MFD - 35V Tantalums plus 7 other asst. tantalums. Also includes 7 assorted transistors, 5 pot-core style variable inductors, over 30 assorted resistors, 1 transformer, and 5 diodes. 3 1/2 x 7 1/2 IN.

Brand New.  \$2.99 ea.

TTL SPECIALS

7496 — 5 Bit Universal Shift Register 4 FOR \$1
74L93 — New By T.I. Low Power 4 Bit Counter 3 FOR \$1

Mylar Capacitor

1 MFD. 400 WVDC.

2 FOR \$1

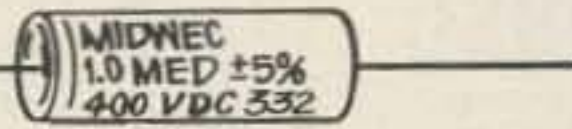

RCA TRIAC #2

#40536. Rated 3 AMP 400 PIV.
TO-5 Case Mounted on Heatsink.

75¢ 3 FOR \$2

POWER RESISTORS

1 OHM 15W. 5%

3/\$1.00

3.16 OHM 2W. 5%

5/\$1.00

More Tantalum Caps

4.7 MFD 20V — 6/\$1.00

22 MFD 20V — 4/\$1.00

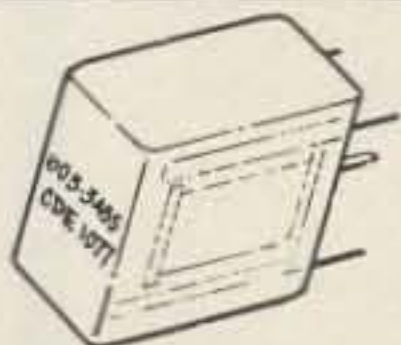

12VDC Relay by CDE.
SPDT. Coil is 280 ohm.
Small Size. \$1.29

75¢

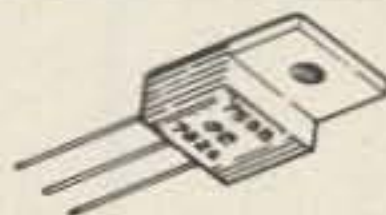

GE
TRIAC

GE 10 AMP Triac

SC146D. House no. To-220 case.
Rated 10 amps 400PIV.
75¢ ea.

3/\$2.00

EXPERIMENTER'S CRYSTAL

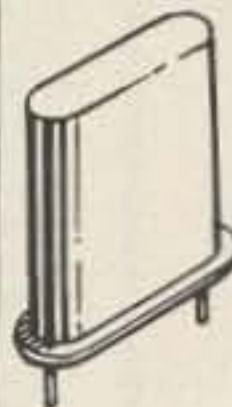

262. 144KHZ. This frequency is 2 to the 18th power. Easily divided down to any power of 2, and even to 1HZ. New by CTS-Knight. A \$5 value!

\$1.25 each

DALE POWER RESISTOR

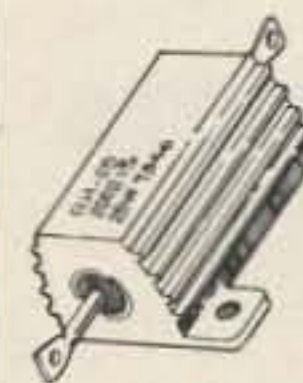

200 OHM 25 WATTS
1%. #RH-25
2 FOR \$1

GE NICAD!

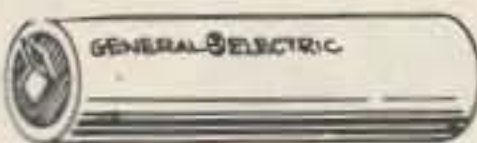

GE Ni-Cad Battery Pack
3 Cell pack, gives 4 volts at 900MAH. Brand new, factory fresh. Each cell is 2/3 "C" size. \$4.50/pack.
Buy 3 packs (12 volts) for \$10.95. Limited stock!

POWER SUPPLY TRANSFORMER

MFG. FOR ROCKWELL. Fully Encased Style.
PRI:115 VAC SEC:24 VAC at 2 AMPS.
And 15 VAC at 100 MA. Has a copper shield between PRI. and SEC.

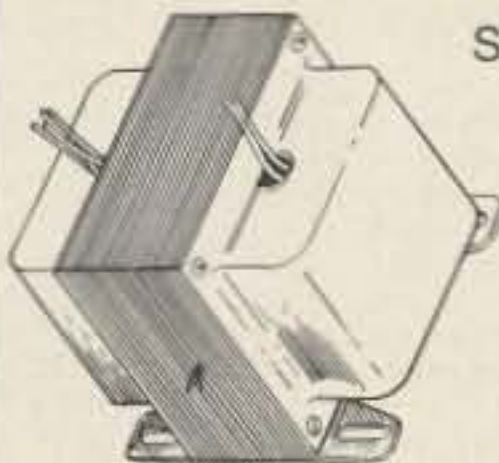

SUPER QUALITY! \$3.99 each

HEAVY DUTY!

PRODUCTION OVER-RUN

2 1/2 x 3 x 2 1/4 IN.

RF CHOKE

225 UH. 2 AMPS.
By DEC.
FERRITE CORE

3 FOR \$1

CERAMIC CAPACITOR

1000 PF. 500 WVDC
Tubular, Dog Bone Style.
Low Temp. Coefficient,
Super Stable.

20 for \$1

NATIONAL SEMICONDUCTOR

SIX DIGIT ALARM CLOCK CHIP

National's second generation clock chip.
24 Pin Dip. Super easy to use.

FEATURES:

- 12 HOUR DISPLAY ★ 24 HOUR ALARM
- 4 OR 6 DIGITS ★ ALARM TONE OUTPUT
- SNOOZE ALARM ★ EASY LED INTERFACE
- POWER FAIL IND. ★ BRIGHTNESS CONTROL
- AM/PM INDICATION ★ SINGLE POWER SUPPLY
- FAST AND SLOW SET ★ LOW POWER

WE SUPPLY FULL DATA, SPECS.

MM5375AA

\$1.95 each

COMPARE AT TWO
OR THREE TIMES
OUR PRICE!

**HUGE
SPECIAL
PURCHASE!**

D20

SPECIAL OFFER!

← With purchase of Clock Chip at left.
T.I. COMMON ANODE LED READOUTS
#TIL-312 .33 INCH.

59¢ ea.

HIGH EFFICIENCY!
A PERFECT MATE.

BUILD YOUR OWN CLOCK!

← WE SUPPLY DATA!

VOLTAGE REGULATORS

TO-220 Case. Rated 1 AMP. Major Brand! All full spec.

- 7805 — 5VDC POS. — 1.19
- 7812 — 12VDC POS. — 1.19
- 7824 — 24VDC POS. — 1.19
- 7905 — 5 VDC NEG. — 1.29

Buy any 3 — Deduct 10%!

Digital Research Corporation

(OF TEXAS)
P. O. BOX 401247 • GARLAND, TEXAS 75040 • (214) 271-2461

LOTS A PARTS:

resistors

**QUARTER WATT, 10% (some 5%)
**AVAILABLE ONLY IN QUANTITIES:

100 OF ANY ONE VALUE.....\$1.70
1000 OF ANY ONE VALUE.....\$15.30

Choose from the following (in ohms)

1.0	27	470	8.2K	150K
1.2	30	510	9.1K	160K
1.5	33	560	10K	180K
1.8	36	620	11K	200K
2.2	39	680	12K	220K
2.4	43	750	13K	240K
2.7	47	820	15K	270K
3.0	51	910	16K	300K
3.3	56	1K	18K	330K
3.6	62	1.1K	20K	360K
3.9	68	1.2K	22K	390K
4.3	75	1.3K	24K	430K
4.7	82	1.5K	27K	470K
5.1	91	1.6K	30K	510K
5.6	100	1.8K	33K	560K
6.2	110	2.0K	36K	620K
6.8	120	2.2K	39K	680K
7.5	130	2.4K	43K	750K
8.2	150	2.7K	47K	820K
9.1	160	3.0K	51K	910K
10	180	3.3K	56K	1.0M
11	200	3.6K	62K	1.1M
12	220	3.9K	68K	1.2M
13	240	4.3K	75K	1.3M
15	270	4.7K	82K	1.5M
16	300	5.1K	91K	1.6M
18	330	5.6K	100K	1.8M
20	360	6.2K	110K	2.0M
22	390	6.8K	120K	2.2M
24	430	7.5K	130K	

sockets

LOW PROFILE SOCKETS
Solder tail, tin plated

#SKL8	8 pin	10/\$1.85
#SKL14	14 pin	10/\$1.95
#SKL16	16 pin	10/\$2.15
#SKL18	18 pin	8/\$2.25
#SKL20	20 pin	8/\$2.75
#SKL22	22 pin	8/\$2.95
#SKL24	24 pin	3/\$1.10
#SKL36	36 pin	5/\$2.75
#SKL40	40 pin	2/\$1.25

WIRE WRAP SOCKETS
3 level, gold plated

#SK3W14	14 pin	10/\$3.85
#SK3W16	16 pin	10/\$4.25
#SK3W18	18 pin	\$0.75
#SK3W20	20 pin	\$0.88
#SK3W22	22 pin	\$1.00
#SK3W24	24 pin	\$1.00
#SK3W28	28 pin	\$1.35
#SK3W36	36 pin	\$1.55
#SK3W40	40 pin	\$1.75

Low power Schottky

74LS00	\$0.30	74LS151	\$0.95
74LS01	0.30	74LS155	1.38
74LS02	0.30	74LS157	0.95
74LS04	0.33	74LS160	1.40
74LS08	0.36	74LS161	1.40
74LS10	0.30	74LS162	1.40
74LS11	0.36	74LS163	1.40
74LS12	0.33	74LS168	1.87
74LS14	1.38	74LS169	1.87
74LS15	0.30	74LS173	1.65
74LS20	0.30	74LS174	1.25
74LS21	0.33	74LS175	1.15
74LS22	0.33	74LS195	1.30
74LS26	0.43	74LS240	1.88
74LS27	0.36	74LS257	1.25
74LS30	0.30	74LS258	1.25
74LS32	0.38	74LS266	0.53
74LS37	0.45	74LS283	1.20
74LS38	0.45	74LS365/	
74LS42	0.98	80LS95	0.75
74LS47	1.00	74LS366/	
74LS48	0.98	80LS96	0.75
74LS74	0.50	74LS367/	
74LS75	0.68	80LS97	0.75
74LS76	0.50	74LS368/	
74LS86	0.50	80LS98	0.75
74LS109	0.50	74LS386	0.55
74LS125	0.63	81LS95	1.13
74LS126	0.63	81LS96	1.13
74LS132	1.25	81LS97	1.13
74LS138	1.10	81LS98	1.13
74LS139	1.15		

capacitors

TANTALUM

CT0.47U	.47 uF 35V	4/\$1
CT2.2U	2.2 uF 20V	4/\$1
CT2.7U	2.7 uF 20V	4/\$1
CT3.3U	3.3 uF 15V	4/\$1
CT4.7U	4.7 uF 10V	4/\$1
CT22U	22 uF 10V	3/\$1
CT33U	33 uF 10V	3/\$1
CT39U	39 uF 10V	3/\$1
CT47U	47 uF 6V	3/\$1

disc

CD5pF	5 pF disc	10/0.50
CD43pF	43 pF disc	10/0.50
CD47pF	47 pF disc	10/0.50
CD68pF	68 pF disc	10/0.50
CD82pF	82 pF disc	10/0.50
CD.0027	.0027 uF 25V	10/0.50
CD.01	.01 uF 50V	10/0.75
CD.022	.022 uF 30V	10/0.75
CD.05	.05 uF 25V	10/1.00
CD.1	.1 uF 25V	10/1.25

TRIMMER

CV2/8P	2-8 pF	5/\$2
CV2.5/11P	2.5-11 pF	5/\$2
CV3/15P	3-15 pF	4/\$2
CV3.5/14P	3.5-14 pF	4/\$2
CV4/12P	4-12 pF	4/\$2
CV5/25P	5-25 pF	4/\$2
CV5/30P	5-30 pF	4/\$2
CV5.5/18P	5.5-18 pF	4/\$2
CV6/30P	6-30 pF	4/\$2
CV7/25P	7-25 pF	4/\$2
CV8/50P	8-50 pF	3/\$2
CV9/35P	9-35 pF	3/\$2
CV9/45P	9-45 pF	3/\$2
CV15/60P	15-60 pF	3/\$2

Assortment of 10, no choice of values.....10/\$2

mylar

CM.0039U	.0039 uF 50V	10/\$1
CM.005U	.005 uF 25V	10/\$1
CM.0068U	.0068 uF 50V	10/\$1
CM.01U	.01 uF 50V	10/\$1
CM.02U	.02 uF 50V	10/\$1
CM.022U	.022 uF 100V	10/\$1
CM.033U	.033 uF 50V	10/\$1
CM.047U	.047 uF 50V	10/\$1
CM.22U	.22 uF 50V	5/\$1
CM.33U	.33 uF 50V	4/\$1
CM2.0U	2.0 uF 200V	2/\$1
CM5.0U	5.0 uF 100V	2/\$1.50
CM10.0U	10.0 uF 100V	\$1.50

POLYSTYRENE

CP150P	150 pF PC mount	10/\$1
CP180P	180 pF PC mount	10/\$1
CP220P	220 pF PC mount	10/\$1
CP270P	270 pF PC mount	10/\$1
CP330P	330 pF PC mount	10/\$1
CP390P	390 pF PC mount	10/\$1
CP470P	470 pF PC mount	10/\$1
CP560P	560 pF PC mount	10/\$1
CP680P	680 pF PC mount	10/\$1
CP820P	820 pF PC mount	10/\$1
CP910P	910 pF PC mount	10/\$1
CP1000P	1000 pF PC mount	10/\$1
CP1200P	1200 pF PC mount	10/\$1
CP1500P	1500 pF PC mount	10/\$1
CP1800P	1800 pF PC mount	10/\$1
CP2000P	2000 pF PC mount	10/\$1
CP2200P	2200 pF PC mount	10/\$1
CP3300P	3300 pF PC mount	10/\$1
CP3900P	3900 pF PC mount	10/\$1

TERMS: Please allow up to 5% for shipping; excess refunded. Californians add sales tax. COD orders accepted with street address so UPS can find you. For VISA*/Mastercharge* orders (\$15 minimum) call our 24 hour order desk at (415) 562-0636. Prices good through cover month of magazine.

FREE FLYER: Actually, our flyer has gotten so thick we're going to have to start calling it a catalogue...send for it!

GODBOUT

G4
BILL GODBOUT ELECTRONICS
BOX 2355, OAKLAND AIRPORT, CA 94614

H=TO-99 M=minidip D=dip
K=TO-3 T=TO-220

201H tight spec 301	0.50
201M tight spec 301	0.50
301H op amp	0.30
301M op amp	0.30
304H negative regulator	0.75
305H positive regulator	0.75
308H fast op amp	1.00
308M op amp	1.00
309H +5V low current reg	1.00
309K +5V 1A regulator	1.25
311H comparator	0.85
311M comparator	0.85
316H hi Input Z op amp	2.50
318H fast op amp	1.00
320/12T -12V 1A regulator	1.75
324D quad op amp	1.50
339D single sup quad comp	1.50
340/5T +5V 1A regulator	1.35
340/6T +6V 1A regulator	1.10
340/8K +8V 1A regulator	1.50
340/8T +8V 1A regulator	1.50
340/12T +12V 1A regulator	1.35
340/15T +15V 1A regulator	1.35
340/18K +18V 1A regulator	1.35
340/24T +24V 1A regulator	1.35
373D AM/FM/SSB IF detect	1.95
377D dual 2W audio amp	2.50
380D 2W audio amp	1.45
380M 1W audio amp	1.25
381D dual low noise preamp	1.65
382D dual low noise preamp	1.65
531M hi slew op amp	1.25
540H audio power driver	2.75
555M timer	0.50
556D dual 555 timer	1.65
565D phase locked loop	1.15
566M VCO w/ tri+sq out	1.75
567M tone decode/PLL	1.85
723D precision regulator	0.50
723H precision regulator	0.60
725H instrumentation amp	2.00
733H video amp	0.85
739D see 4739	
741H op amp	0.35
741M op amp	0.25
747D dual 741	0.70
748H uncompensated 741	0.35
748M uncompensated 741	0.35
1456/1556/5556M op amp	1.50
1458M see 5558, 1558	
1496D balanced mod/demod	0.90
1556H/1456H super op amp	1.50
1556M/1456M super op amp	1.50
1558 see 5558M	
1596 see 1496D	
3026H transistor array	1.25
3086D transistor array	0.75
4131H high gain op amp	0.50
4136D quad low noise amp	1.95
4194D 50 mA bipolar regul	1.50
4194TK 200 mA bipolar reg	2.95
4195TK 200 mA bipolar reg	2.25
4250H micropower op amp	1.00
4558 see 1458	
4739D dual low noise amp	1.65

trimpots

TRIMPOTS single turn PC mount; 1/2 watt.	
250 ohms	5/\$1.00
500 ohms	5/\$1.00
1K	5/\$1.00
2.5K	5/\$1.00
3K	5/\$1.00
10K	5/\$1.00
50K	5/\$1.00
1M	5/\$1.00

Transistors

2N2221 NPN unmarked TO-18	7/51
2N2222 NPN unmarked TO-18	5/51
2N2907A PNP hse # plastic	5/51
2N3055 NPN TO-3 house #	50.75
2N3904 NPN hse # TO-105	7/51
2N3906 PNP hse # TO-105	6/51
2N4400 NPN hse # plastic	5/51
2N4917 PNP TO-106	5/51
2N4946 NPN TO-106	6/51
2N5449 NPN	6/51
04101 PNP TO-220 1A pwr	\$0.50
TIP3055 tab case same as 2N3055	\$0.75

COMP PAIR TO-220 pkg. 5A lc max Hfe @ 3A 40 min. Bkwn 40V \$1.50

2NRF-0 3 GHz RF power transistors for osc/amplifier applications. Guaranteed 100 mW out @ 1.5 GHz. TO-18 pkg. 3/\$1.95

2NRF-1 2 GHz RF power transistor. Pout min @ 2 GHz 1.0W, Pin 310 mW, efficiency 30% @ 2 GHz. Similar to RCA 2N5470. \$4.95

2NRF-2 2 GHz RF power transistor. Pout 2.5W, Pd 8.7W, Pin 300 mW, efficiency 33%. Similar to RCA TAB407. \$5.95

2NRF-3 2 GHz RF power transistor. Pout 5.5W, Pd 21W, Pin 1.25W, efficiency 33%, similar to RCA 2N6269. \$6.95

2NRF-4 2 GHz RF power transistor. Pout 7.5W, Pd 29W, Pin 1.5W, efficiency 33%. Factory selected prime 2N6269. \$7.95

FET-1 dual NJFET VHF/UHF amp, TO-18	3/51
FET-2 NJFET VHF/UHF amp similar to 2N4416. TO-18	3/51
FET-3 dual NJFET low noise audio amp. TO-18	2/51
FET-4 general purpose NJFET. TO-18 package	4/51
FET-5 plug in replacement for 6AK5 tube	\$1.00

CMOS

4000 dual 3 in NOR gate	0.25
4001 quad 2 in NOR gate	0.29
4002 dual 4 in NOR gate	0.34
4007 dual comp pair+inv.	0.29
4008 4 bit full adder	1.28
4009 inv hex buffer	0.53
4010 noninv hex buffer	0.53
4011 quad 2 in NAND gate	0.29
4012 dual 4 in NAND gate	0.29
4013 dual D FF w/ S and R	0.50
4014 8 stage static SR	1.23
4015 dual 4 stage stat SR	0.90
4016 quad bilateral switch	0.45
4017 decade counter/div	1.23
4019 quad AND/OR sel gate	0.55
4020 14 stage binary cntr	1.50
4021 8 stage static SR	1.23
4022 +8 counter/divider	1.20
4023 triple 3 in NAND	0.29
4024 7 stage binary cntr	1.03
4025 triple 3 in NOR gate	0.29
4027 dual JK M-S FF	0.75
4028 BCD to decimal decoder	1.00
4029 presettable U/D cntr	1.73
4030 quad EX-OR gate	0.53
4033 decade counter/divid	1.50
4037 triple AND/OR pairs	0.50
4040 12 stage binary cntr	1.50
4041 quad true/comp buffer	0.85
4042 quad clocked D latch	0.85
4043 quad NOR R/S latch	0.60
4044 quad NAND R/S latch	0.60
4047 multivibrator	1.63
4049 inv hex buffer	0.50
4050 noninv hex buffer	0.50
4051 8 ch multiplexer	1.03
4052 dual 4 ch multiplexer	1.03
4053 triple 2 ch multiplex	1.03
4060 osc w/ 17 stge divide	1.48
4066 quad bilateral switch	0.58
4069/ hex inverter	0.33
74C04	
4070 quad EX-OR gate	0.60
4071 quad 2 in NOR gate	0.33
4073 triple 3 in AND gate	0.33
4075 triple 3 in OR gate	0.33
4076/	
74C173 quad D FF	1.63
4081 quad 2 in AND gate	0.33
4116 fast quad bilat swit	0.50
14511 binary to 7 seg drv	2.00

SOCKET JUMPERS

Mates with two rows of .025" sq. or dia. posts on patterns of .100" centers and shielded receptacles. Probe access holes in back. Choice of 6" or 18" length.

Part No.	No. of Contacts	Length	Price
924003-18R	26	18"	\$ 5.38 ea.
924003-06R	26	6"	4.78 ea.
924005-18R	40	18"	8.27 ea.
924005-06R	40	6"	7.33 ea.
924006-18R	50	18"	10.31 ea.
924006-06R	50	6"	9.15 ea.

JUMPER HEADERS

Solder to PC boards for instant plug-in access via socket-connector jumpers. .025" sq. posts. Choice of straight or right angle.

Part No.	No. of Posts	Angle	Price
923863-R	26	straight	\$1.28 ea.
923873-R	26	right angle	1.52 ea.
923865-R	40	straight	1.94 ea.
923875-R	40	right angle	2.30 ea.
923866-R	50	straight	2.36 ea.
923876-R	50	right angle	2.82 ea.

INTRA-CONNECTOR

Provides both straight and right angle functions. Mates with standard .10" x .10" dual row connectors (i.e. 3m, Ainsley, etc.) Permits quick testing of inaccessible lines.

Part No.: 922576-26 No. of contacts: 26 Price \$6.90 ea.

INTRA-SWITCH

Permits instant line-by-line switching for diagnostic or QA testing. Switches actuated with pencil or probe tip. Mates with standard .10" x .10" dual-row connectors. Low profile design. Switch buttons recessed to eliminate accidental switching.

Part No.: IS-26 No. of contacts: 26 Price \$13.80 ea.

CRYSTALS

THESE FREQUENCIES ONLY

Part #	Frequency	Case/Style	Price
CY1A	1.000 MHz	HC33/U	\$5.95
CY2A	2.000 MHz	HC33/U	\$5.95
CY2.01	2.010 MHz	HC33/U	\$.99
CY3A	4.000 MHz	HC18/U	\$4.95
CY7A	5.000 MHz	HC18/U	\$4.95
CY12A	10.000 MHz	HC18/U	\$4.95
CY14A	14.31818 MHz	HC18/U	\$4.95
CY19A	18.000 MHz	HC18/U	\$4.95
CY22A	20.000 MHz	HC18/U	\$4.95
CY30B	32.000 MHz	HC18/U	\$4.95

CONNECTORS PRINTED CIRCUIT EDGE-CARD

156 Spacing-Tin-Double Read-Out

Bifurcated Contacts — Fits .054 to .070 P.C. Cards

15/30	PINS (Solder Eyelet)	\$1.95
18/36	PINS (Solder Eyelet)	\$2.49
22/44	PINS (Solder Eyelet)	\$2.95
50/100A (.100 Spacing)	PINS (Wire Wrap)	\$6.95

25 PIN-D SUBMINATURE (RS232)

DB25P	PLUG	\$3.25
DB25S	SOCKET	\$4.95
DB51226-1	COVER FOR 25S/25P	\$1.75

LOTS OF POTS

Untested 3/8" square Spectrol Trimpots

Single-turn Printed Circuit Potentiometers

GB134	3 ea. of: 10-20-25-50	= 24 pcs.	\$2.95
GB135	3 ea. of: 100-200-250-500 ohm	= 24 pcs.	\$2.95
GB136	3 ea. of: 1K-2K-2.5K-5K	= 24 pcs.	\$2.95
	10K-20K-25K-50K		
	100K-200K-250K-500K		
	1Meg-2Meg-2.5Meg-5Meg		

(Values subject to substitution within each group.)

EXTRA SAVINGS Buy all 3 (GB134, 135 & 136) for only \$7.49

SWITCHES

1/8" mounting holes	1-9	10+
TOGGLE (sub-miniature)		
JMT121	SPDT on-off-on	\$1.95 \$1.43
JMT123	SPDT on-none-on	1.65 1.21
JMT221	DPDT on-off-on	2.55 1.87
JMT223	DPDT on-none-on	2.15 1.58
TOGGLE (Printed Circuit)		
MPC121	SPDT on-off-on	\$2.05 \$1.53
MPC123	SPDT on-none-on	1.75 1.31
MPC221	DPDT on-off-on	2.65 1.97
MPC223	DPDT on-none-on	2.25 1.68
PUSH BUTTON		
PB123	SPDT maintained	1.95 1.47
PB126	SPDT momentary	1.95 1.47
PUSH BUTTON Miniature		
MS102	DPST momentary open	.35 .30
MS103	SPST momentary closed	.35 .30
DIPSWITCH		
206-4	8 pin dip 4 switch	1.75 1.85
206-7	14 pin dip 7 switch	1.95 1.85
206-8	16 pin dip 8 switch	2.25 2.15

1/16 VECTOR BOARD

0.1" Hole Spacing	Part No.	P-Pattern L	W	Price 1-9	10 up
PHENOLIC	64P44 062XXXP	4.50	6.50	1.72	1.54
	169P44 062XXXP	4.50	17.00	3.69	3.32
EPOXY	64P44 062WE	4.50	6.50	2.07	1.86
	84P44 062WE	4.50	8.50	2.56	2.31
GLASS	169P44 062WE	4.50	17.00	5.04	4.53
	169P44 062WE	8.50	17.00	9.23	8.26
EPOXY GLASS COPPER CLAD	169P44 062WEC1	4.50	17.00	6.80	6.12

INSTRUMENT/CLOCK CASE

Injection molded unit. Complete with red bezel. 4 1/2" x 4" x 1-9/16"

\$3.49

MICROPROCESSOR COMPONENTS

8080A CPU	\$10.95	Z80 CPU	\$24.95
8212 8 Bit Input/Output	4.95	CDP1802 CPU	19.95
8214 Priority Interrupt Control	7.95	MC6800 8 Bit MPU	19.95
8216 Bi-Directional Bus Driver	4.95	MC6810A 128 x 8 Static RAM	5.95
8224 Clock Generator/Driver	5.95	MC6820 Periph. Interface Adapter	7.95
8228 System Controller Bus Driver	5.95	MC6830L8 1024 x 8 Bit ROM	14.95

CPU'S		RAM'S	
8080A Super 8088	\$10.95	256 x 1 Static	\$ 1.49
2650 8 Bit MPU	26.50	256 x 4 Static	5.95
P8085 CPU	29.95	1024 x 1 Static	1.75
		4096 x 1 Dynamic	4.95
		256 x 4 Static	5.95
		4K Static	14.95
		16 x 4 Static	1.75
		256 x 4 Static	5.95
		256 x 4 Static	6.95
		16 x 4 Static	3.49
		1024 x 1 Static	1.95
		256 x 1 Static	6.95
		256 x 1 Static	2.95
		4K Dynamic 16 Pin	5.95
		Dynamic 16 Pin	29.95

SR'S		PROMS	
2504 1024 Dynamic	\$ 3.95	1702A 2048 Famos	\$ 5.95
2518 Hex 32 BIT	4.95	5203 2048 Famos	14.95
2519 Hex 40 BIT	4.00	82S23 32 x 8 Open C	5.00
2522 Dual 132 Bit SSR	2.95	82S123 32 x 8 Tristate	5.00
2524 512 Dynamic	.99	74S287 1024 Static	7.95
2525 1024 Dynamic	2.95	3601 256 x 4 Fast	3.95
2527 Dual 256 BIT	2.95	2708 8K Eprom	10.95
2528 Dual 250 Bit Static	4.00	2716 T.I. 16K Eprom	29.95
2529 Dual 512 BIT	4.00	2716 Intel 16K Eprom	59.95
2532 Quad 80 BIT	2.95	6301-1 1024 Tri-State Bipolar	3.49
2533 1024 Static	2.95	6300-1 256 Open Collector Bipolar	2.95
3341 Fila	6.95		
74LS670 16 x 4 Reg	1.95		

UART'S		ROM'S	
AY-5-1013 30K Baud	\$ 5.95	2513(2140) Char. Gen-upper case	\$ 9.95
		2513(3021) Char. Gen-lower case	9.95
		2516 Char. Gen.	10.95
		MM5230 2048 BIT (512 x 4 on 256 x 8)	1.95

SPECIAL REQUESTED ITEMS

FCM3817	\$5.00	11C90	19.95	7205	19.95	9368	3.95
AY-3-8500-1	7.50	4N33	3.95	ICM7045	24.95	LD110/111	25.00/set
AY-5-9100	14.95	8T20	7.50	ICM7207	7.50	95H90	11.95
AY-5-9200	14.95	8T97	1.50	ICM7208	19.95	MC3061P	3.50
AY-5-9500	4.95	HD0165	7.95	ICM7209	7.50	MC4016 (74416)	7.50
AY-5-2376	14.95	MCM6571	13.50	MKS0240	17.50	MC1408L7	4.95
9374	1.50	MCM6574	13.50	DS0026CH	3.75	MC1408L8	5.75
82S115	19.95	MCM6575	13.50	TIL308	10.50	74C922	9.95

PARATRONICS

Featured on February's Front Cover of Popular Electronics

Logic Analyzer Kit Model 100A \$229.00/kit

- Analyzes any type of digital system
- Checks data rates in excess of 8 million words per second
- Trouble shoot TTL, CMOS, DTL, RTL, Schottky and MOS families
- Displays 16 logic states up to 8 digits wide
- See ones and zeros displayed on your CRT, octal or hexadecimal format
- Tests circuits under actual operating conditions
- Easy to assemble — comes with step-by-step construction manual which includes 80 pages on logic analyzer operation. (Model 100A Manual - \$4.95)

Model 100A Model 10

Some applications are:

- Troubleshooting microprocessor address, instruction, and data flow
- Examine contents of ROMS
- Tracing operation of control logic
- Checking counter and shift register operation
- Monitoring I/O sequences
- Verifying proper system operations during testing

PARATRONICS TRIGGER EXPANDER - Model 10

Adds 16 additional bits. Provides digital delay and qualification of input clock and 24-bit trigger word. — Connects direct to Model 100A for integrated unit.

Model 10 Kit - \$229.00
Baseplate — \$9.95
Model 10 Manual — \$4.95

BK PRECISION 3 1/2-Digit Portable DMM

Model 2800 \$99.95

- Overload Protected
- 3" high LED Display
- Battery or AC operation
- Auto Zeroing
- 1mv, 1Va, 0.1 ohm resolution
- Overrange reading
- 10 meg input impedance
- DC Accuracy 1% typical

Ranges: DC Voltage ±0-1000V/AC Voltage: 0-1000V
Freq. Response: 50-400 HZ
DC/AC Current: 0-100mA
Resistance: 0-10 meg ohm
Size: 6.4" x 4.4" x 2"

Accessories:
AC Adapter BC-28 \$9.00
Rechargeable Batteries BP-26 20.00
Carrying Case LC-28 7.50

CSC 100 MHz 8-Digit Counter

MAX-100 \$134.95

- 20 Hz-100 MHz Range
- 6" LED Display
- Crystal-controlled timebase
- Fully Automatic
- Portable — completely self-contained
- Size — 1.75" x 7.36" x 5.63"

Four power sources, i.e. batteries, 110 or 220V with charger 12V with auto lighter adapter and external 7.2-10V power supply

ACCESSORIES FOR MAX 100:
Mobile Charger Eliminator use power from car battery Model 100 — CLA \$3.95
Charger/Eliminator use 110 V AC Model 100 — CAI \$9.95

CONTINENTAL SPECIALTIES PROTO BOARD 6

Other CS Proto Boards

PB100 - 4.5" x 6"	\$ 19.95
PB101 - 5.8" x 4.5"	29.95
PB102 - 7" x 4.5"	39.95
PB103 - 9" x 6"	59.95
PB104 - 9.5" x 8"	79.95
PB203 - 9.75 x 6 1/2 x 2 3/4	80.00
PB203A - 9.75 x 6 1/2 x 2 3/4	129.95

(includes power supply)

LOGIC MONITOR for DTL, HTL, TTL or CMOS Devices \$74.95

QT PROTO STRIPS

QT type	#holes	price
QT-59S	590	12.50
QT-59B	bus strip	2.50
QT-47S	470	10.00
QT-47B	bus strip	2.25
QT-35S	350	8.50
QT-35B	bus strip	2.00
QT-18S	180	4.75
QT-12S	120	3.75
QT-8S	80	3.25
QT-7S	70	3.00

Experimenter 300 \$ 9.95
Experimenter 600 \$10.95

PROTO CLIPS

14 PIN	\$4.50
16 PIN	4.75
24 PIN	8.50
40 PIN	13.75

DESIGN MATES

DM1 - Circuit Designer	\$69.95
DM2 - Function Generator	\$74.95
DM3 - RC Bridge	\$74.95

The Incredible "Pennywhistle 103"

\$129.95 Kit Only

The Pennywhistle 103 is capable of recording data to and from audio tape without critical speed requirements for the recorder and it is able to communicate directly with another modem and terminal for telephone "hamming" and communications for the deaf. In addition, it is free of critical adjustments and is built with non-precision, readily available parts.

Data Transmission Method Frequency-Shift Keying, full-duplex (half-duplex selectable).

Maximum Data Rate 300 Baud

Data Format Asynchronous Serial (return to mark level required between each character).

Receive Channel Frequencies 2025 Hz for space, 2225 Hz for mark.

Transmit Channel Frequencies Switch selectable: Low (normal) = 1070 space, 1270 mark; High = 025 space, 225 mark.

Receive Sensitivity -46 dbm acoustically coupled.

Transmit Level -15 dbm nominal. Adjustable from -6 dbm to -20 dbm.

Receive Frequency Tolerance Frequency reference automatically adjusts to allow for operation between 1800 Hz and 2400 Hz.

Digital Data Interface EIA RS-232C or 20 mA current loop (receiver is optoisolated and non-polar).

Power Requirements 120 VAC, single phase, 10 Watts.

Physical All components mount on a single 5" by 9" printed circuit board. All components included.

Requires a VOM, Audio Oscillator, Frequency Counter and/or Oscilloscope to align.

The Original the 3rd Hand \$9.95 each

*Leaves two hands free for working

*Clamps on edge of bench, table or work bench

*Position board on angle or flat position for soldering or clipping

*Sturdy, aluminum construction for hobbyist, manufacturer or school rooms

DIGITAL STOPWATCH

- Bright 6 Digit LED Display
- Times to 59 minutes 59 seconds
- Crystal Controlled Time Base
- Three Stopwatches in One
- Times Single Event — Split & Taylor
- Size 4.5" x 2.15" x .90" (4 1/2 ounces)
- Uses 3 Penlite Cells.

Kit — \$39.95
Assembled — \$49.95
Heavy Duty Carry Case \$5.95

Stop Watch Chip Only (7205) \$19.95

IMC 3 1/2 DIGIT DPM KIT

Model KB500 DPM Kit \$49.00
Model KB503 5V Power Kit \$17.50

- New Bipolar Unit
- Auto Zeroing
- 5" LED
- Auto Polarity
- Low Power
- Single IC Unit

JE700 CLOCK

The JE700 is a low cost digital clock, but is a very high quality unit. The unit features a simulated walnut case with dimensions of 6" x 2 1/2" x 1". It utilizes a MAN72 high brightness readout, and the MM5314 clock chip.

12 or 24 Hour

115 VAC KIT ONLY \$16.95

HEXADECIMAL ENCODER 19-KEY PAD

- 1 - 0
- ABCDEF
- Shift Key
- 2 Optional Keys

\$10.95 each

New 63 KEY KEYBOARD \$29.95 IN STOCK

This keyboard features 63 unencased SPST keys, unattached to any kind of P.C.B. A very solid molded plastic 13" x 4" base suits most applications.

HD0165 Encoder Chip (encodes 16 Keys) \$7.95 ea.
AY-5-2376 Encoder Chip (encodes 88 Keys) \$14.95 ea.

JE803 PROBE \$9.95 Per Kit

The Logic Probe is a unit which is for the most part, indispensable in trouble shooting logic families TTL, DTL, RTL, CMOS. It derives the power it needs to operate directly off of the circuit under test, drawing a scant 10 mA max. It uses a MAN3 readout to indicate any of the following states by these symbols: (H) - 1 (LOW) - 0 (PULSE) - P. The Probe can detect high frequency pulses to 45 MHz. It can't be used at MOS levels or circuit damage will result.

\$9.95 Per Kit

printed circuit board

T-1 5V 1A Supply

This is a standard TTL power supply using the well known LM309K regulator IC to provide a solid 1 AMP of current at 5 volts. We try to make things easy for you by providing everything you need in one package, including the hardware for only:

JE225 \$9.95 Per Kit

Spec Sheets - 25c — Send 35c Stamp for 1978 Catalog
Dealer Information Available

Now Open SATURDAYS

James ELECTRONICS

1021-A HOWARD AVE., SAN CARLOS, CA. 94070
PHONE ORDERS WELCOME — (415) 592-8097
Advertised Prices Good Thru May

New 1978A CATALOG NOW AVAILABLE

J1

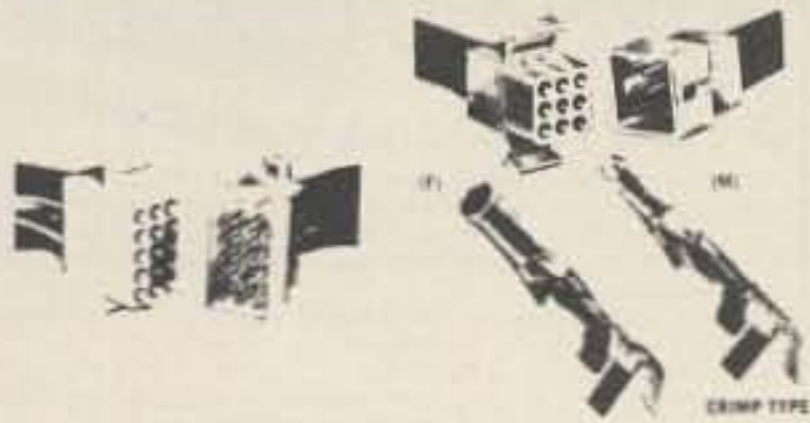

Complete Connectors

Per Pkg.	Type No.	Class	Description	Mfg. by Molex	Price Ea. Pkg.
5	1625-1PRT	Min. (.062")	1 Circuit		\$1.75
3	1625-2PRT	"	2 Circuit		1.90
3	1625-3PRT	"	3 Circuit		2.10
2	1625-4PRT	"	4 Circuit		2.10
2	1625-5PRT	"	5 Circuit		2.20
2	1625-6PRT	"	6 Circuit		2.35
1	1649-8PRT	"	8 Circuit		1.55
1	1625-9PRT	"	9 Circuit		1.75
1	1625-12PRT	"	12 Circuit		1.90
1	1625-15PRT	"	15 Circuit		2.30
1	1625-24PRT	"	24 Circuit		3.25
1	1772-36PRT	"	36 Circuit		4.55
5	1619PRT	Std. (.093")	1 Circuit		1.75
3	1545PRT	"	2 Circuit		1.90
3	1396PRT	"	3 Circuit		2.10
2	1490PRT	"	4 Circuit		2.10
2	1653PRT	"	5 Circuit		2.20
2	1261PRT	"	6 Circuit		2.35
1	1292PRT	"	9 Circuit		1.80
1	1360PRT	"	12 Circuit		1.90
1	1375PRT	"	15 Circuit		2.45

Prototype hand tools combine efficiency with economy. Ideal for prototype or limited production runs.

HT 1919 for .093" pin dia. terminals. \$8.95 each

HT 1921 for .062" pin dia. terminals. \$8.95 each



Econo-Extractor removes terminal from nylon connector housing with smoothness and ease.

HT 2054 for extracting .093" pin dia. terminals. \$2.25 each
HT 2023 for extracting .062" pin dia. terminals. \$2.25 each



Deluxe ejector tools, spring loaded for simple, efficient removal of terminal from nylon connector housing extracts either male or female terminals of same pin diameter.

HT 2038 for extracting .093" pin dia. terminals. \$6.70 each

HT 1010-282 Replacement tip for HT 2038. \$2.50 each

HT 2285 for extracting .062" pin dia. terminals. \$6.70 each

HT 1672-3 replacement tip for HT 2285. \$2.50 each



INTEGRATED CIRCUITS

555 Timer 8 pin mini-DIP	.49
741 Compensated OP-Amp 8 pin DIP	.37
LM 1889N RF Video Modulator	7.45
CA3130 Bipolar/Mos-FET Op Amp	1.19
CA3140 MOS-FET Op Amp, Bi-polar out	.99
LM3909 Lo Voltage Led Pulsar	1.50
LM3911 Temp Control CHIP	1.50
Signetics 2504TA 1024 bit S.R. memory (1404A)	\$1.75
MCM 6571P Character Generator	1.95
MCM6571AP Character Generator	1.95
LM399H Temp Stabilized Zener	5.95
AF 100-1CJ Active Filter, State Variable	7.50
LM2907N Tachometer F/V Converter	2.85
LM1812N Ultra-sonic Transceiver	9.15
LM1815 Adaptive Sense Amp for Tachometer	5.73
S25188 Hex 32 bit Shift Register	\$2.95
TL170 TO-92 Hall effect switch w/spec sheets	1.25
MC14409P Telephone Rotary Pulsar	10.98
MC14419P Touch Pad Converter for 14409	4.25
MC14411P Baud Rate Generator	11.98
MC14412VP CMOS Modem Chip	16.95
MM57109N Number Cruncher Micro	18.95
74C915 7 Segment to BCD Converter	2.99
74C922 16 Key Keyboard Encoder	6.35
74C923 20 key Keyboard Encoder	6.45
74C925 4 Decade Counter w/latches	12.00
74C926 4 Decade Counter w/carry	12.00
74C935-1 3 1/2 Digit DVM CMOS Chip	16.98
9601 Retriggerable One shot	.50
MC4015P Hi Speed quad "D" low power TTL	\$1.00

DATA ACQUISITIONS SUBSYSTEM

ADC0817 is a 40 pin CMOS I.C. with an 8-bit analog-to-digital converter, a 16 channel multiplexer and micro processor compatible control logic. Converter features high impedance chopper stabilized comparator, voltage divider with analog switch tree and a successive approximation register. Latched Tri-State outputs for easy u-processor interface. Require only 15 mW of power from single 5V supply. Fast, 100uS conversion time.
ADC0817.....(40 pin DIP).....\$29.88
Spec sheets.....\$1.00



Annie Sez:

If you're racing around looking for quality and service, be a winner and make TRI-TEK your next stop for parts—

HEAT SINKS

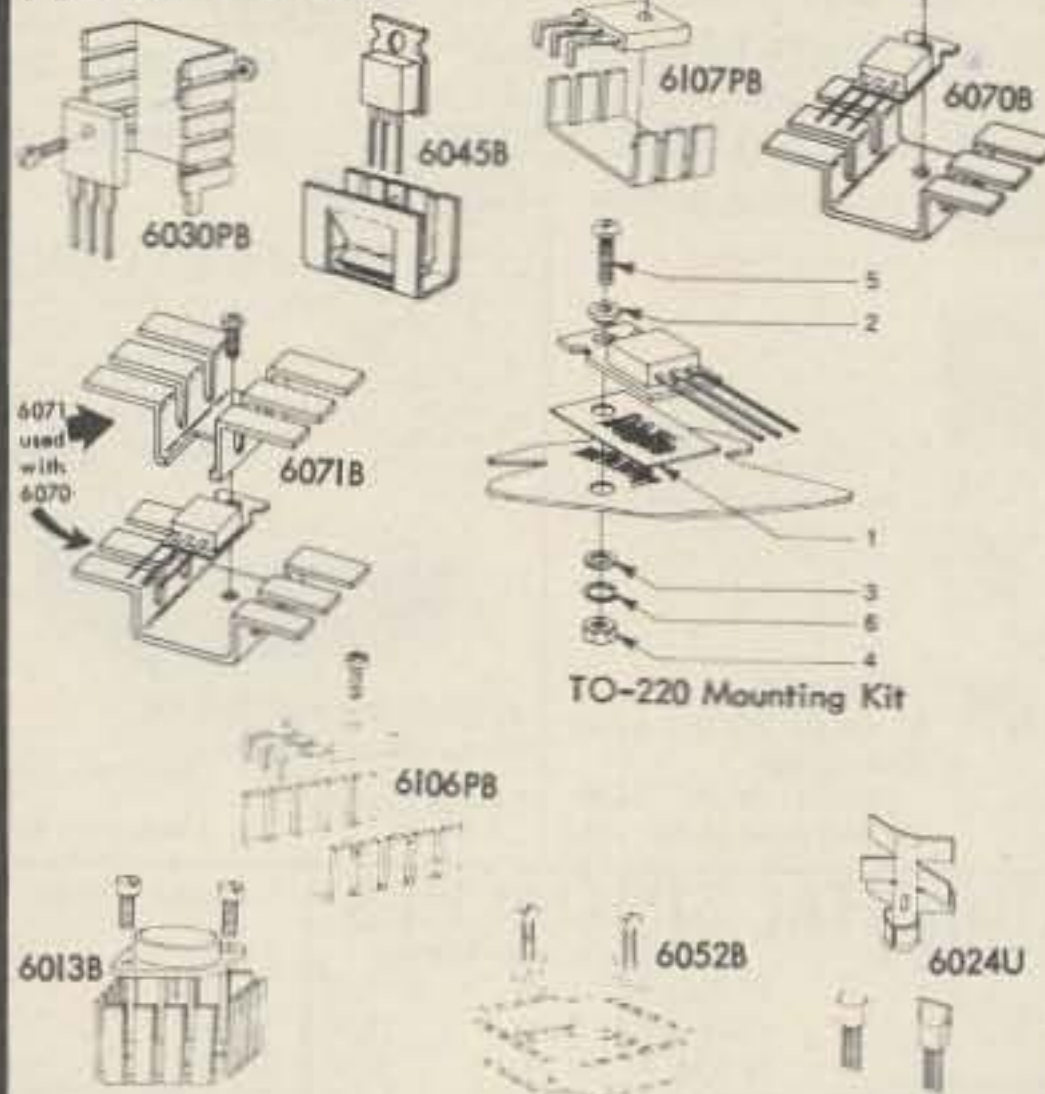

Economical 1 piece heat sinks for plastic power parts in TO-220 and Motorola cases 77, 90, 199, and TO-126. All are black anodized aluminum. "B" series is anodized after forming. "PB" series is anodized prior to forming.

THM 6030PB Vertical	25¢, 5/\$1.00, 10/\$1.90
THM 6045B Slip Over	30¢, 4/\$1.00, 10/\$2.00
THM 6070B Extra Disipation Horiz.	35¢, 3/\$1.00, 10/\$3.00
THM 6071B Top Hat for 6070	35¢, 3/\$1.00, 10/\$3.00
THM 6106PB Flat With Fingers	30¢, 4/\$1.00, 10/\$2.00
THM 6107PB Smaller Size Flat	25¢, 5/\$1.00, 10/\$1.90
THM 6013B TO-3 Diamond	69¢, 4/\$2.50, 10/\$5.00
THM 6024-U Unfinished TO-92	10/\$1.00, 100/\$5.00
THM-6052B TO-3 Square	60¢, 5/\$2.50, 10/\$4.25
TO-220 6 Piece Mounting Kit - Handy Package	...25¢

P. C. BOARD TERMINAL STRIP

Molded body encloses positive screw activated clamp which will accommodate wire sizes 14-30 AWG. Contacts and pins are solder plated copper. Pins are on .200 inch (5.08mm) for standard P. C. mounting. 10Amp rating. Compare our prices before you buy.

4 pole	TS-2504	.99
8 pole	TS-2508	1.49
12 pole	TS-2512	2.19



S-100 BUS CONNECTORS (IMSAI TYPE)

Gold, Solder tail for Mother boards \$4.50, 4/\$17.00
Tin-Nickel, (NASGLO) Solder tail \$3.75, 4/\$14.00
Gold, wire-wrap.....\$4.50, 4/\$17.00
Tin-Nickel, (NASGLO) wire-wrap \$3.75, 4/\$14.00

HEX DARLINGTON ARRAY

MCI413P is a 16 pin DIP package with (6) 50V 500mA Darlingtons pairs.

MCI413P.....\$1.59
Specs/Apps......30¢

I.C. SOCKETS

Lo Profile Tin Solder Tail Dip Sockets

8 pin	10/\$1.50	100/\$14.00	1000/\$120.00
14 pin	10/\$1.70	100/\$16.00	1000/\$140.00
16 pin	10/\$1.90	100/\$18.00	1000/\$160.00

VOLTAGE REGULATORS

7805-06-08-12-15-24 TO220	95¢	5/\$4.50
7905-06-08-12-15-24 TO 220	95¢	5/\$4.50
78L05A-12-15 4% 100 mA TO-92 Plastic		50¢
78H05KC 5V 5A TO-3		9.15
78H12KC 12V 5A TO-3		9.15
78H15KC 15V 5A TO-3		9.15
Lm317K 1.5A Adjustable TO-3		4.99
Lm317T 1.5A Adjustable TO-220		3.99
Lm317MP .5A Adjustable TO-202		13.95
TL430C Adjustable Zener Think About It		1.50
TL497C Switching Reg. & Inductor		9.50
RCA CA 3085 100 mA Adjustable		.60

ADJUSTABLE NEGATIVE REGULATOR

LM337 is the compliment to the popular LM317 positive adjustable regulator. Capable of 1.5Amp from -1.2V to -37V.

LM337K.....(TO-3 Metal).....\$5.99
LM337T.....(TO-220 Plastic).....\$4.65
Specs and applications.....60¢

DIODES AND BRIDGES

IN4003 200 V 1 amp	12/\$1.00
IN4004 400 V 1 amp	10/\$1.00
IN4148 Hi Speed Signal	15/\$1.00 100/\$5.00
D-600 115 V, 100 mA Hi Speed Signal	20/\$1.00
D2131 200 V, 25A Stud	85¢
D2135 400 V, 25A Stud	1.00
D2138 600 V, 25A Stud	1.55
D3289R 200 V, 160A Stud Anode	5.85
D3909-4 50 V, 45A Fast Recovery	2.00
IN4732A-47A 1W 5% Zeners	4/\$1.00
13 Assorted Brand New Zener Diodes	1.00
50V 3 amp Epoxy Bridge	79¢
200V 30 amp Bridge	2.00
600V 4 amp Epoxy Bridge	1.49
600V 3 amp Stud Bridge	.89
SI-2 200V, 1.5A Gold Leads	15/\$1.00
D1A-0030 30V DIAC	10/\$1.00
100V 2.5 WATT ZENER	
IN5051A Epoxy Zener with heavy silver leads25¢

MISCELLANEOUS

RG-174 Miniature 50Ω coax	50'/4.25
WSU-30 Wire Wrap/unwrap tool	5.95
WSU-30M Modified Wrap/unwrap tool	6.95
BW-630 Battery Operated Wrap Tool	34.95
-Free Wire with any Wrap Tool-	
Miniature Square .05/100V Monolithic Cap	10/2.00
FND5002 .125" C.C. 7 Seg. Read-out	49¢, 10/\$3.95
2N4036 90V, 1A PNP Silicon TO-5	.50
2N6101 80V, 10A NON HI GAIN TO-220	.50
6.3 VCT, 1.2A Transformer F41X	2.49
12V, 1A Transformer with 6' Power Cord	2.88

Fairchild Linear Data Book. Huge volume has 17 chapters of data, applications and definitions. Probably the biggest volume of its type today.....\$4.50ppd

Fairchild Bipolar Memory Data Book. ROMS, PROMS and RAMS are covered in this work with full engineering data. Price includes shipping!.....\$3.75

NEW NATIONAL DATA BOOK

1978 Edition of Nationals discrete devices data book. 9 big sections of data plus extensive glossary of terms and test diagrams. Covers bi-polar small signal and power devices as well as F.E.T.s.....\$3.95

Raytheon Micro Computer Components Book. Covers Raytheon's offerings in the field from the micro-puter to memories and adapters.....\$2.95ppd



TRI-TEK, INC.
7808 North 27th Avenue
Phoenix, Arizona 85021
(602) 995-9352

T1

- Please give street address for UPS shipping when possible.
- C.O.D. NO parcel post C.O.D.
- UPS C.O.D. Add 85¢ to order.
- Any correspondence not connected with your order, please use separate sheet and include SASE for reply.
- Orders less than \$10 (\$15 foreign) please add \$1 handling.
- Prices are subject to change without notice.
- Any refunds will be by check, not credit vouchers.
- Terms: Check, money order, credit card, net 30 days to rated firms, schools and government agencies.

- If we should be temporarily out of stock on an item, it will be placed on back order. If we cannot ship in 30 days, you will be notified of the expected shipping date and furnished with a postage paid card with which to cancel your order if desired.
- We pay surface shipping only in USA, Canada and Mexico.
- For premium shipping (first class, special handling, etc.) add extra. Extra will be refunded.
- Foreign orders (except Canada and Mexico) estimate and add shipping. Extra will be refunded.

Charge card telephone orders (\$20 min.) will be accepted 9-5:30 P.M. except weekends.
Telephone 995-9352. No collect calls please.

ALDELCO ELECTRONIC CENTER

NEW!
THE FUTURE NOW!
FM2015R



Does Your Unit Cover The New Sub-band 144.5 - 146.5 MHz? The FM2015R Does. PLUS MARS-CAP!

All Solid State-CMOS PLL digital synthesized - No Crystals to Buy! 5KHz steps - 144 - 149 MHz-LED digital readout PLUS MARS-CAP.*

• 5 MHz Band Coverage - 1000 Channels (instead of the usual 2MHz to 4MHz-400 to 800 Channels) • 4 CHANNEL RAM IC MEMORY WITH SCANNING • MULTIPLE FREQUENCY OFFSETS • ELECTRONIC AUTO TUNING - TRANSMIT AND RECEIVE • INTERNAL MULTIPURPOSE TONE OSCILLATOR • RIT • DISCRIMINATOR METER - 15 Watts Output - Unequaled Receiver Sensitivity and Selectivity - 15 POLE FILTER, MONOLITHIC CRYSTAL FILTER AND AUTOMATIC TUNED RECEIVER FRONT END, COMPARE! • Superb Engineering and Superior Commercial Avionics Grade Quality and Construction Second to None at ANY PRICE.

INTRODUCTORY PRICE

\$399.00

Regulated AC/PS Model FMPS-4R \$48.00

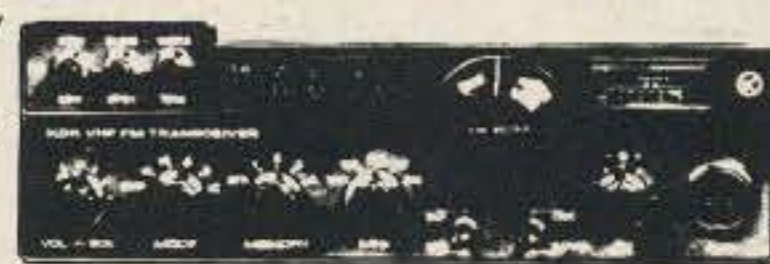

TRANSFORMERS

110/18 VAC 1 Amp.....\$1.50
110/12 VAC 300 mA.....1.25
110/20-40 VAC 2 Amps.....2.50
110/5 VAC 6 Amps.....4.95
SPECIAL 110/12 VAC plug in 500 mA.....1.50
For each 1-5 Xmfrs add \$1.00 shipping

TURNER HAND MICROPHONE

DYNAMIC PTT MODEL J360 DM
Medium Impedance (600-5000 Ohms)
Freq. Resp. 100-5000 Hz.
ONLY \$10.95

40 Channel CB Switch

Cherry #R40B-00AA **ONLY \$9.95**

MINIATURE SWITCHES

SPST on off on.....\$.99
DPDT on off on.....1.59
DPDT on off.....1.59
DPDT on off (wire wrap leads) . 1.99

SPEAKERS

2" 8 Ohm Round. \$.65
2 1/4" 8 Ohm Round... .75
2 1/2" 8 Ohm Round.. 1.00
2 1/2" 100 Ohm Round.. 1.25
2 1/2"x5" 8 Ohm Oval... 1.95
add 10¢ per speaker shipping

MALLORY POTS 1/8" Shaft

50 K Ohms #4 Taper..\$.99
100 K Ohms #1 Taper....99
50 K Ohms 1/4" Shaft....59
100 K Ohms 1/4" Shaft....59

ANSLEY 16 PIN PLUG

609-M161 with cover..\$.79

CRYSTAL SOCKETS

holds 8 HC25U.....\$.89
Single HC25U.....39

MURATA FILTER

10.7 mA.....\$1.49

RECTIFIERS

2 amp 50 volt 20 for \$1.00
2 amp 1000 volt 10 for \$1.00
2 amp 1500 volt .5 for 1.00
10 amp stud 50 volt .. 1.50
10 amp stud 600 volt . 4.50
40 amp stud 50 volt .. 1.20
40 amp stud 750 volt . 2.05
100 amp. stud 200 v. 8.50

BRIDGES

2 amp T05 50 volt... .35
2 amp T05 200 volt... .50
2 amp T05 600 volt.. 1.25
3 amp. 50 volt......50
3 amp. 400 volt..... 1.10
25 amp. 200 volt..... 1.50
25 amp. 600 volt..... 5.50
25 amp. 1000 volt... 8.50

LOGIC PROBE KIT

Aldelco is now the sole distributor of the DIGAPEAKE-A logic probe kit. Now you can buy direct and save. Probe measures logic 1, logic 0, and pulsing circuits conditions formerly sold for \$14.95.

SPECIAL \$11.95

FETS

40673.....1.55
MPF102......55
2N3819......35
2N5457......50
2N5458......50
2N5459......55
2N5485......50

DARLINGTON

MPSA 13......80
MPSA 14......40
2N5306......50

SCR

C 106A......55
C 106B......65
C 122B......85

CLOCK CHIPS

5313.....3.49
5314.....3.49
5316.....3.95
5375.....3.95
CT7001.....6.95

ALDELCO KITS

ALARM CLOCK KIT

6 Big 0.5 LED Displays * On Board AC Transformer * 12 Hour Format with 24 Hour Alarm * Snooze Feature * Elapsed Timer. Timer feature makes this Popular in Broadcast Stations. It's a natural for cars, boats and campers when used with optional crystal time base. Fits our standard cabinet. \$19.95
Crystal time base when purchased with clock \$2.95

12 or 24 HOUR DIGITAL CLOCK KIT

Uses 0.5 Display LED. 5314 Clock Chip. Freeze feature for accurate set, fits our standard cabinet. **ONLY \$18.95**

CLOCK CABINETS

ea. \$4.95

WOODGRAIN OR BLACK LEATHER

CRYSTAL TIME BASE KIT.

Includes PC Board, Crystal, all parts and instructions. **\$4.95**

CLOCK FILTERS. Blue, Red, Green, Amber or Smoke

\$.60

ADJUSTABLE POWER SUPPLY KITS

5-15 Volts 500 MA **\$6.95**
12-28 Volts 500 MA **6.95**

RF DEVICES

2N2876	18W	200 MHz	T060	\$12.35
2N3375	3.0W	400 MHz	T060	5.60
2N3553	2.5W	175 MHz	T039	1.40
2N3866	1.0W	400 MHz	T039	1.25
2N3926	7.0W	175 MHz	T060	6.30
2N4427	1.0W	175 MHz	T039	1.35
2N5589	3.0W	175 MHz	MT71	4.75
2N5590	10W	175 MHz	MT72	7.80
2N5591	25W	175 MHz	MT72	10.25
2N5913	1.75W	175 MHz	T039	1.70
2N6080	4.0W	175 MHz	MT72	5.40
2N6081	15W	175 MHz	MT72	8.45
2N6082	25W	175 MHz	MT72	10.95
2N6083	30W	175 MHz	MT72	12.30
2N6084	40W	175 MHz	MT72	16.30
2N6094	4.0W	175 MHz	X106 PNP	6.60
2N6095	15W	175 MHz	X106 PNP	8.50
2N6096	30W	175 MHz	X106 PNP	10.35
2N6097	40W	175 MHz	X106 PNP	20.00
GE28	12W	50 MHz	X51	2.15
GE46	6.0W	27 MHz	T05	6.42
GE215	5.5W	50 MHz	T0220	4.65
GE216	15W	50 MHz	T0220	8.97
GE226	10W	50 MHz	X81	2.00

ZENERS

1N746 to 1N759	400 Mw	ea.	25
1N4728 to 1N4764	1 watt		28
1N5333 to 1N5378	5 watt		2.10
1N2970 to 1N3005	10 watt		2.40
1N3305 to 1N3340	50 watt		4.75

2N3055	99
2N3904 or 2N3906	25
2N5496 or 2N6108	70
741 or 709 14 Pin DIP	25
555 Timer	49
1N914-1N4148	15 for 99
1N34-1N60-1N64	10 for 99
CA 3028 Dif. Amp	1.50
LM309K Volt Reg	1.10
2N5401 (rep 2N4888)	95
2N2369	20
2N6103	89
LM709 or 741 Min DIP Op Amp	45
14 or 16 Pin IC Sockets	30

DUAL DIGITAL 12/24 HOUR CLOCK KIT NOW WITH A NEW WALNUT GRAIN WOOD CABINET



Features:

12 or 24 Hour Operation on either clock
Each Clock separately controlled
Freeze feature for time set
Easy assembly for clock and cabinet

MODEL ALD 5-W **ONLY \$49.95**

Same kit as above in unassembled Black

Plastic cabinet with Red Filter.

Model ALD 5-P

Only \$44.95



NEW!

Tunable 420 MHz
Fast Scan TV
Converter



NEW

TURNABLE HAM TV CONVERTER

Receive Fast Scan Amateur TV in the 420 to 450 MHz Band with any TV set. Low noise, high gain rf Amp with Varactor tuned input and outputs. Built in AC supply. Comes in two tone walnut & beige cabinet measuring 1 7/8" x 4 1/4" x 4 1/8". Factory wired with 2 year guarantee.....\$49.95
Kit (critical circuits prewired).....\$39.95

ALDELCO DOES IT AGAIN—ANOTHER UNBELIEVABLE VALUE—OUR BATTERY OPERATED FREQUENCY COUNTER & DIGITAL CLOCK NOW AVAILABLE—ASSEMBLED AND TESTED AT THE KIT PRICE **ONLY! \$99.95**



COMPARE OUR FEATURES—COMPARE THEIR FEATURES THEN—COMPARE OUR PRICE AGAINST THEIRS

- *Portable use when 8 AA Batteries are installed
- Comes in attractive Black & White metal cabinet
- Leds turn off to conserve battery power
- Freq. Range 100 Hz to 40 MHz Typical
- Mobile use 12 Volt DC input makes ideal mobile set up
- .00005% accuracy and rock stable
- Switchable from counter to clock without losing time
- 110 Volt Power Supply/Battery Charger option—perfect for use in Ham Shack
- Clock can be either 4 or 6 digit, 12 or 24 hour
- Clock keeps time even in off position
- Six big 0.4 Display leds.

8 Gould or GE size AA NiCad Batteries.....\$17.50
110 Volt AC Plug In Power Supply & Battery Charger.....4.95
Coming Soon 600 MHz Presealer

ACCUKEYER KIT



Board Measures 2-5/8" x 4-3/8"

Similar to the famous ARRL Handbook version, kit includes PC board, IC sockets, ICs, speaker switch and all parts and instructions.

ONLY \$19.95

ACCUKEYER MEMORY KIT

Adaptable to many keyers. Can store 2 canned messages of 30 characters each. PC board IC sockets, ICs instructions and all parts. **\$19.95**

ALDELCO

2281A BABYLON TURNPIKE, MERRICK NY 11566
516-378-4555

Add 5% Shipping. Add \$1.00 for orders under \$10.00. Out of U.S.A., Mexico or Canada add 15% shipping and certified check or money order in U.S. Funds

(Cut on dotted line and keep next to your radio equipment)

(Cut on dotted line and keep next to your radio equipment)

DIAL DIRECT

DIAL FREE!

NO CHARGE TO CALLING PARTY

1-800-325-3636

The ONLY NUMBER you'll ever need!

*** FOR THE FAMOUS HAM-KEY™ AND HAM-KEYER™**

We make squeeze-paddle and straight-key models... all for use with our brand-new, improved electronic keyer.

*** FOR NEW OR USED AMATEUR RADIO GEAR**

... we're specialists and carry in stock most of the famous-brand lines. Or, we will talk trade.

*** FOR FAST, DOOR-STEP DELIVERY**

... give us a call. You'll be amazed; for we guarantee we'll ship your equipment the same day. Plus, most shipments are PRE-PAID.

*** TO SAVE MONEY**

... join thousands of our satisfied customers who buy from us as easily as from their local supplier. So, remember your call is Toll Free.



TM Trade-Mark

HAM RADIO CENTER

8340-42 Olive Blvd. P.O. Box 28271 St. Louis, MO 63132

H2



7294 N.W. 54 STREET
MIAMI, FLORIDA 33166

SURPLUS ELECTRONICS CORP.

PHONE: (305) 887-8228

TWX: 810-848-6085

WHOLESALE - RETAIL

S43

<p>RADIO TRANSMITTER Type T-20/ARC-5 5.3 to 7 MHz Brand new—Never used— Tubes alone are worth the price \$24.95 ONLY 50 LEFT</p>	<p>— NORTH ELECTRIC TRANSFORMER — 117 V 50/60 Hz—Multiple windings will produce: + 24 V dc—50 Amp + 12 V dc—100 Amp - 12 V dc—50 Amp Other voltages can be obtained, complete with specification sheets—Limited Qty. \$49.95 \$49.95</p>		<p>KESTER #44—SOLDER 63/37 Alloy .032 diameter. —5lb. Spools Only— \$6.00 per lb.</p> <p>12 Vdc SIRENS Very Loud \$8.95</p>
<p>SURPRISE PACKAGE Resistors, Caps, Semis, Pots, Relays, etc. We guarantee it to be \$25.00 worth of material. Every package is different. \$5.00</p>	<p>TEXAS INSTRUMENT KEYBOARD \$1.95 ea., 5 for \$8.00 10 for \$13.95</p>  <p>Has 3 slide switches—28 different keys— keypads re- movable by removing 4 screws.</p>		<p>CERAMIC PRECISION CAPS-ERIE 47 pF—100 V 220 pF—100 V \$.10 ea. 470 pF—100 V 500 pF—100 V 15 for \$1.00 560 pF—100 V 1000 pF—100 V 50 for \$3.25 2000 pF—100 V</p>
<p>STANCOR TRANSFORMER #P-6463 Filament Style 117V in—Multiple 6.0-6.5- or 7.0 Volts 13 Amps center tapped— \$5.95 ea 2 for \$10.00</p>	<p>SIGNAL DIODE 1N4148 \$ 5.00 per hundred \$25.00 per thousand or, 15 for \$1.00</p> <p>WIRE WOUND RESISTORS .1 Ohm—5 W .10 Ohm—10 W @ 15¢ each</p>	<p>POWER MATCH CONVERTER Pearce-Simpson —Max Loads 30 Watts converts: for positive 6 to 12 Vdc } or negative 6 to 18 Vdc } ground systems 12 to 24 Vdc } 3 1/2" x 3 1/2" x 2" \$7.95</p>	<p>STANCOR TRANSFORMER #P-8180R—117 V in— 25.2 V ct at 1 Amp \$3.00 ea., 2 for \$5.00 3 for \$6.50</p>
<p>PANEL METERS 2 1/4" x 2 1/4" also 2 1/4" x 3" 10-0-10 dc Amps } \$4.50 ea 0-20 dc Volts } 25-0-25 dc Volts } 2 for 0-25 dc Volts } \$7.50 0-50 ac Volts } -Shunt Required-</p>	<p>—STANCOR TRANSFORMER— #GSD 200 or #GSD 400 Auto Isolation 230 V in—115 V out 1500 RMS test voltage—GSD 200 is 200 VA—GSD 400 is 400 VA— complete with cord and receptacle— YOUR CHOICE \$11.95</p>		<p>MUFFIN FANS 3 Blades, 110 Vac, 4 3/4" sq. Removed from equipment— Excellent condition—\$4.95</p> <p>NEON PANEL LIGHT 110 Vac, Amber, w/ built-in resistor & wire leads—3 for \$1.50</p>
<p>POWER SUPPLY 110 AC to 12 VDC 550 mA 23 Watts 3 1/2" w x 4" h x 6 1/2" d \$9.95</p>	<p>HOOK-UP WIRE Size 20 or 22— various colors— no color selection solid \$6.00/1000' \$10.00/2000'</p>	<p>POLYFOAM COAX—50R Equal to RG174 \$4.95/100' Low Loss Polyfoam Coax Cable</p>	<p>TRIMMER CAPS Small enough to fit in your watch— 3.5 to 20 pF 5 to 30 pF 7 to 40 pF \$.75 ea., 2 for \$1.25 5 for \$3.00</p>
<p>Heavy Duty Instrument Case Grey vinyl over wood—inside also lined w/ vinyl & foam padding. Flip- top w/ handle and keylock w/ key. inside dem. 4 1/2" D x 8 1/4" W x 10" H \$25.00 value—\$9.95</p> <p>Varo Bridge Rectifier 10 amps, 220 Vdc—\$1.50</p>	<p>—STANCOR TRANSFORMER— #P-8158 Power—117V—200 dc mA 6.3 V at 2.0-4.0—or 4.25 Amps #P-8155 Power—117V—90 dc mA 5 V at 2 Amps or 6.3 V at 5.15 Amps YOUR CHOICE \$7.95</p>		<p>JOY STICK For TV games and hi fi with four, 100K pots 2 3/4" X 2 3/4" X 1" with 1" handle—\$4.95</p>

SPECIALS—SPECIALS—SPECIALS—SPECIALS—SPECIALS—SPECIALS—SPECIALS—SPECIALS

<p>Computer Grade Caps 1000 mf—50 V 10000 mf—20 V 8000 mf—50 V 36000 mf—15 V 63000 mf—15 V \$2.50 ea.</p>	<p>CTS DIP Switches 6 position 7 position 8 position \$1.25 ea., 2 for \$2.00</p>	<p>Trimmer Cap Arco/Elmenco PC-402 2 to 20 pF \$.60 ea. 5 for \$2.50, 15 for \$5.00</p>	<p>MASSA Ultrasonic Transducer 37 or 40 kHz \$1.50 ea. 2 for \$2.50, 5 for \$5.00</p>	<p>Relay—P & B 4 PDT—110 Vdc 6050 Ohm coil 10 Amp contacts \$1.50 ea., 2 for \$2.75, 3 for \$3.25</p>	<p>Bourns Trimpot #200L—1—201M 200 Ohm \$1.50 ea., 2 for \$2.50, 5 for \$6.75</p> 	<p>Stancor Transformer #P-8650 Step down/Isolation 117Vpai-12V6.5Amp. w/cord & receptacle \$5.95</p>
---	--	---	---	---	---	--

TERMS: All material guaranteed • If for any reason you are not satisfied, our products may be returned within 10 days for a full refund (less shipping). Please add \$3 for shipping and handling on all orders. Additional 5% charge for shipping any item over 5 lbs. COD's accepted for orders totaling \$50.00 or more. All orders shipped UPS unless otherwise specified. Florida residents please add 4% sales tax. Minimum order \$15.00.

EQUIPMENT / COMPONENTS / WIRE & CABLE / ACCESSORIES

1977 KIB BACK ISSUES

<p>kilobaud The Computer Hobbyist Magazine</p> <p>ISSUE #1 January 1977</p> <p>Articles</p> <p>Is the 280 the Wave of the Future? ... 20</p> <p>Why Do Many Computers Language? ... 24</p> <p>How a Memory Works ... 26</p> <p>Software Exchange ... introducing the rocky road ... 28</p> <p>Practical Microcomputer Programming ... Part 1: Logical Instructions ... 30</p> <p>Well, Your Micro's Built ... unless do you grow from here ... 34</p> <p>Computer Control of the World! ... 36</p> <p>... turning an external device on and off with your computer ... 38</p> <p>Wax Stripping ... Try it! ... 40</p> <p>The Hobbyist's Operating System ... Part 1: Introduction and Master Plan ... 42</p> <p>Solving Some of the Software Interchange Problems ... 44</p> <p>Welcome to Assembly Language Programming ... 46</p> <p>Programming 'T's Simple! ... 48</p> <p>Structured Programming ... under the hood ... 50</p> <p>Computers in Golf ... help for the handicapper! ... 52</p> <p>Computer Wishes ... 54</p> <p>What's that Digital Group Really Doing? ... 56</p> <p>How to Use the New P1-A6 Printer ... 58</p> <p>First ... let your micro call for help! ... 60</p> <p>A Television Alternative ... 62</p> <p>Whoever Knows the Trifiditer Has won ... 64</p> <p>Structured BASIC ... a negative view by Dr. Conway, the author of BASIC ... 66</p> <p>So Games on a Chip ... TV tournament time ... 68</p> <p>Features</p> <p>Publisher's Remarks ... 2 Letters ... 7 The BASIC Forum ... 10</p> <p>Editor's Remarks ... 4 Books ... 11 Around the Industry ... 10</p> <p>News of the Industry ... 8 Looking Ahead ... 11 Glossary ... 13</p>	<p>kilobaud The Small Computer Magazine</p> <p>ISSUE #2 February 1977</p> <p>Articles</p> <p>ZAP! ... 18</p> <p>Checking Those Naughty Bits ... 22</p> <p>Why Do Many Computers Language? ... 24</p> <p>The Resizable Apple Computer ... 26</p> <p>Beats the Trumpet ... 28</p> <p>Chess ... 30</p> <p>Will the 280 Crush All Competitors? ... 32</p> <p>Practical Microcomputer Programming ... Part 2: Operating Systems ... 34</p> <p>The Trouble with New Storage Systems ... 36</p> <p>A Useful Law Payment Program ... 38</p> <p>Subscribers ... a plea for the DR-52 ... 40</p> <p>RCA True Again ... with the 1802 ... 42</p> <p>Found a Use for Your Computer ... a clock program for the KIM ... 44</p> <p>Supplementing a Serial Keyboard ... 46</p> <p>All the Rage ... 48</p> <p>RCA True Again ... with the 1802 ... 50</p> <p>3000 vs. 280 ... How fast could you compare to 3000? ... 52</p> <p>Can 8080 Programming Give you the Extraordinary Program ... 54</p> <p>7 & 8 ... Right? ... 56</p> <p>Learning Objectives ... 58</p> <p>How to Write the Simple Case ... 60</p> <p>Making Money to Risk ... 62</p> <p>The 8080 You May Have Missed ... 64</p> <p>The "X" in "Byte" Banded ... 66</p> <p>A 8080 Stage Theater ... 68</p> <p>Computerized Statements ... the answer to late paying customers ... 70</p> <p>Features</p> <p>Publisher's Remarks ... 2 Around the Industry ... 8 The BASIC Forum ... 13</p> <p>Editor's Remarks ... 4 News of the Industry ... 10 Letters ... 14</p> <p>Books ... 4 Looking Ahead ... 12 Glossary ... 12</p>	<p>kilobaud The Small Computer Magazine</p> <p>ISSUE #3 March 1977</p> <p>Articles</p> <p>Practical Microcomputer Programming ... Part 3: Software Tools ... 18</p> <p>The Motorola Way! ... a hobbyist's review of the MZKB001 ... 24</p> <p>Let's Hear it for the 8080! ... an easy building project ... 26</p> <p>The Power Test Case ... build your own case reader ... 28</p> <p>Connections for Fred ... which have a better choice ... 30</p> <p>A New Approach to the 8080 ... the April 2002 ... 32</p> <p>Interplay with the CPU ... the new from within ... 34</p> <p>Only Two Sides ... add a few with this controller ... 36</p> <p>Priority Data ... what's the real story? ... 38</p> <p>The August 11 ... a hobbyist's view ... 40</p> <p>How to Use the 8080 of Your Own Money ... a new game program ... 42</p> <p>Using the "8080" Terminal ... 44</p> <p>External Bus Storage ... Part 2: Digital and Audio Cassette Systems ... 46</p> <p>Make Your 8080 Smarter ... a cheap memory controller ... 48</p> <p>Stop Bug Now! ... take time to design your next program ... 50</p> <p>Using the "8080" Terminal ... 52</p> <p>The Story Details of Cassette Storage ... 54</p> <p>The Fun of Learning BASIC ... do you can write your own program ... 56</p> <p>Super-Talk ... joining up the Digital Group TTY ... 58</p> <p>Features</p> <p>Publisher's Remarks ... 2 News of the Industry ... 4 Looking Ahead ... 13</p> <p>Editor's Remarks ... 4 Letters ... 10 Glossary ... 13</p>	<p>kilobaud The Small Computer Magazine</p> <p>ISSUE #4 April 1977</p> <p>Articles</p> <p>Language Expert ... an insight into microcomputer design ... 18</p> <p>Obvious Logic ... Part 2: Some Basic Applications ... 20</p> <p>Build an Eight Channel Multiplexer for Your Scope ... 22</p> <p>Sorting Numbers ... an application of person sorting techniques ... 24</p> <p>Number Flipping Program ... simplifying the desktop ... 26</p> <p>Meet the TurboKIM Interface ... 28</p> <p>Scope Traces ... a digital design aid ... 30</p> <p>The Hobbyist's Operating System ... Part 2: Command Language Programming ... 32</p> <p>The Non-Printing Obstacle ... 34</p> <p>BASIC - The Easy Way ... 36</p> <p>Now You Can Use Software Timing Loops ... 38</p> <p>KIM-1 Memory Expansion ... adding memory to the popular system B & P ... 40</p> <p>Heavy Duty Power Supply ... just for an extra system ... 42</p> <p>Digital Audio ... the next revolution in sound? ... 44</p> <p>Hi-Lo ... makes your friends when they visit ... 46</p> <p>Interfacing the Reading World ... 48</p> <p>Everything about Semiconductor Memory ... at last it's available for BASIC ... 50</p> <p>KIM-1 Memory Expansion ... application of a few microcomputer elements ... 52</p> <p>Automatic Memory Dump ... easy dump program for 8080 users ... 54</p> <p>Hangover! ... a new possibility ... 56</p> <p>Now - BASIC for the 8080 - Even! ... 58</p> <p>Microprogramming ... an insight into microcomputer design ... 60</p> <p>Computerized Balances ... graphic display for kids (and parents) ... 62</p> <p>Features</p> <p>Publisher's Remarks ... 2 The BASIC Forum ... 12</p> <p>Editor's Remarks ... 4 News of the Industry ... 14</p> <p>Books ... 4 Letters ... 10</p> <p>Lookahead ... 8 Corrections ... 10</p> <p>Around the Industry ... 10 Glossary ... 12</p>
<p>kilobaud The Small Computer Magazine</p> <p>ISSUE #5 May 1977</p> <p>Articles</p> <p>Disked Logic ... Part 3: Data Conversion and Special Functions ... 24</p> <p>Cure Those End-of-Memory Blues ... with a safe analysis program ... 26</p> <p>Make Your Investment Count ... the inside view of a custom 8080 ... 28</p> <p>Speed Up Your 8080 ... 30</p> <p>Who's Ahead of RS-232C ... data communications explained ... 32</p> <p>Is it Right ... or Left? ... understanding sign design conventions ... 34</p> <p>Know Yourself! ... confessions of a 20-bus ... 36</p> <p>Personalizing System Expansions ... a revealing look at the front-end ... 38</p> <p>Investment Expert ... Part 2: Implementing an Individual Drive System ... 40</p> <p>Digital Audio ... Part 2: Generating that Musical Sound ... 42</p> <p>Isn't it Great ... how an existing application into a program ... 44</p> <p>Adding "This" to Your System ... a handbook for computer games ... 46</p> <p>Long Lander ... 48</p> <p>Stance Relay Telephone Modem ... with a solid-state relay ... 50</p> <p>Structured BASIC & Better! ... 52</p> <p>Kilobaud Classroom ... Part 1: Getting the Ball Rolling ... 54</p> <p>A Home Computer Pioneer ... profile of Don Tittel ... 56</p> <p>Features</p> <p>Publisher's Remarks ... 2 Books ... 12</p> <p>Editor's Remarks ... 4 Around the Industry ... 14</p> <p>Hardware & Software Review ... 4 The BASIC Forum ... 12</p> <p>News of the Industry ... 8 Letters ... 10</p> <p>Lookahead ... 10 Glossary ... 12</p>	<p>kilobaud The Small Computer Magazine</p> <p>ISSUE #6 June 1977</p> <p>Articles</p> <p>Build Your Own Interface ... from a professional ... 22</p> <p>Computer Club Promotional Techniques ... when you can't afford Madison Ave ... 24</p> <p>Antidote for ... a program antidote for ... 26</p> <p>Put a Mile in Your Shoe ... getting started with zero bucks! ... 28</p> <p>Timeliness Alert! ... software game for the 8080 ... 30</p> <p>Build a Pulse Generator ... a useful software tool ... 32</p> <p>A TTY for Your KIM ... if a price you can't believe ... 34</p> <p>The BYTEDESTROYER ... review of an EPROM eraser ... 36</p> <p>BASIC Testing Comparison ... information for speed freaks ... 38</p> <p>Solving Keyboard Interface Problems ... avoid you before a GART? ... 40</p> <p>A Clean Queue ... getting the most from microcomputer resources ... 42</p> <p>Try a Design Example ... for practical hardware prototyping ... 44</p> <p>Try Some Energy ... experimental answer to the energy crisis ... 46</p> <p>Structured Billing System ... in BASIC for the small business ... 48</p> <p>Kilobaud Classroom ... No. 2: Gears and Flip-Flop Explained ... 50</p> <p>Computerized Typewriting ... an introduction to word processing ... 52</p> <p>Introducing the World's Cheapest Computer ... a 200 SCMP ... 54</p> <p>My Friend is a Computer Junkie ... 56</p> <p>Features</p> <p>Publisher's Remarks ... 2 Letters ... 14</p> <p>Editor's Remarks ... 4 Books ... 12</p> <p>The BASIC Forum ... 7 Glossary ... 12</p> <p>News of the Industry ... 8 Corrections ... 14</p>	<p>kilobaud The Small Computer Magazine</p> <p>ISSUE #7 July 1977</p> <p>Articles</p> <p>Inside the Sphero Microcontroller ... intelligence for anything ... 22</p> <p>The Great TV to CRT Monitor Converter ... 24</p> <p>Computer Tune Detector ... an interview with Alexander John Wilkey ... 26</p> <p>The Random Number Game ... 28</p> <p>Converts Interface First Aid ... see your problem to get going ... 30</p> <p>Understand Your Computer's Language ... a look at instruction sets ... 32</p> <p>Introducing the Classroom ... 34</p> <p>Kilobaud Classroom ... No. 3: At Flip-Flop and Clocked Logic ... 36</p> <p>Digital Audio ... Part 3: Signal Expansion and Compression ... 38</p> <p>It Was Great ... reviewing The First West Coast Computer Faire ... 40</p> <p>Put the Book ... computer design-maker program ... 42</p> <p>Inside the Amazing ADR 32 ... checking out the most popular terminal ... 44</p> <p>Try Computer Competition ... both new and it's good! ... 46</p> <p>Features</p> <p>Publisher's Remarks ... 2 Books ... 8 Letters ... 14</p> <p>Editor's Remarks ... 4 News of the Industry ... 8 Kilobaud Calendar ... 26</p> <p>The KIM Forum ... 4 Around the Industry ... 12 Corrections ... 26</p>	<p>kilobaud The Small Computer Magazine</p> <p>ISSUE #8 August 1977</p> <p>Articles</p> <p>Convert (I/O) Format ... standards are still needed! ... 18</p> <p>Expand Your KIM ... with a new 8K board ... 20</p> <p>Trigger Your Oscilloscope ... add value to expensive scopes ... 22</p> <p>Salvage Your Program ... high computer system ... 24</p> <p>Random Integer Program ... for games, sorting, or statistics ... 26</p> <p>Test It With Your Micro ... the micro as a reliable test instrument ... 28</p> <p>Heavy Duty Alter Power Supply ... plenty of power for peripherals ... 30</p> <p>Is the KIM-1 For Every 12 ... find out if it's for you! ... 32</p> <p>Electronic Design by Computer ... simplify your next project! ... 34</p> <p>Understand Your Computer's Language ... Part 2: Instruction Sets ... 36</p> <p>Enter the Address Computer ... build the unique live generation interface ... 38</p> <p>Time Bomb Game ... already names are required ... 40</p> <p>Try a Do-As Program ... it will even balance your checkbook ... 42</p> <p>Soon, You Will Be an Amateur! ... 44</p> <p>SWTP 48 BASIC News ... implementing it on the 8080 ... 46</p> <p>Heads! ... introduction to decimal operations ... 48</p> <p>Start a One Man Computer Club ... put yourself on the map ... 50</p> <p>Troubleshooting Your Software ... a new program for the 8080 ... 52</p> <p>Cure that Hot Power Supply ... 54</p> <p>Features</p> <p>Publisher's Remarks ... 2 Books ... 10</p> <p>Editor's Remarks ... 4 The BASIC Forum ... 12</p> <p>Legal/Business Forum ... 4 Letters ... 11</p> <p>The KIM Forum ... 7 Corrections ... 10</p> <p>News of the Industry ... 8 Kilobaud Calendar ... 14</p>
<p>kilobaud The Small Computer Magazine</p> <p>ISSUE #9 September 1977</p> <p>Articles</p> <p>Build Your Own ASCII Keyboard ... with serial and parallel output ... 22</p> <p>The Ultimate Personal Computer ... 24</p> <p>Talk Your Computer's Language ... which level do you need? ... 26</p> <p>A PET For Every Home ... a look at the Commodore PET 2001 ... 28</p> <p>Kilobaud Classroom ... No. 4: PC boards and power supplies ... 30</p> <p>Bank Extension ... a visit with the memory people ... 32</p> <p>Try an 8080 Emulator ... reliable debugging technique ... 34</p> <p>Build a 200 EPROM Programmer ... for the 8080 4K chip ... 36</p> <p>Power MIBSD Load Technique ... use binary normal ... 38</p> <p>Decoding Device Control Codes ... use a UART, naturally ... 40</p> <p>Talbot Approximate Format ... when you need a 16-bit at a time ... 42</p> <p>Ballast in BASIC ... test for an old game ... 44</p> <p>Using an Inverse PROM ... how to relocate monitor programs ... 46</p> <p>Wings Overboard Game ... bring 'em back alive! ... 48</p> <p>Starting a Business! ... profits in a word ... 50</p> <p>Features</p> <p>Publisher's Remarks ... 2 Books ... 11</p> <p>Editor's Remarks ... 4 Letters ... 12</p> <p>The Hobbyist Forum ... 4 Around the Industry ... 10</p> <p>Legal/Business Forum ... 4 Kilobaud Calendar ... 10</p> <p>The BASIC Forum ... 7 Glossary ... 10</p> <p>New Products ... 8</p>	<p>kilobaud The Small Computer Magazine</p> <p>ISSUE #10 October 1977</p> <p>Articles</p> <p>BASIC Testing Comparison ... revised and updated! ... 20</p> <p>Learn and Earn ... BASIC and business programming ... 22</p> <p>Heaven Time! ... a look at your ... 24</p> <p>Simon Tupper's Program ... understanding computer speed capabilities ... 26</p> <p>Beats the Apple Box ... it's not as complicated as you think! ... 28</p> <p>Put Your Intel on the Road ... it's not far! ... 30</p> <p>3D Computer Graphics ... you don't need glasses! ... 32</p> <p>Memory Troubleshooting Techniques ... here's a list for a while ... 34</p> <p>Understand Your Interrupted ... real time clock applications ... 36</p> <p>Kilobaud Classroom ... No. 5: Software Input Functions ... 38</p> <p>Digital Group MAIL News ... how come? ... 40</p> <p>Use ASCII Control Codes ... for universal control ... 42</p> <p>Defused Components ... save a penny to save a life ... 44</p> <p>The WONDRAITH ... computer assisted instruction ... 46</p> <p>Time for Telesharing? ... come here and share! ... 48</p> <p>Build a Universal I/O Board ... for your Altair ... 50</p> <p>Features</p> <p>Publisher's Remarks ... 2 Around the Industry ... 14</p> <p>Editor's Remarks ... 4 The Hobbyist Forum ... 16</p> <p>Legal/Business Forum ... 4 Kilobaud Calendar ... 10</p> <p>New Products ... 8 Corrections ... 10</p> <p>Books ... 8 Kilobaud Calendar ... 10</p> <p>Letters ... 10 Contact! ... 16</p>	<p>kilobaud The Small Computer Magazine</p> <p>ISSUE #11 November 1977</p> <p>Articles</p> <p>Everything about Assemblers! ... just basic hand-coding ... 24</p> <p>Your Image Control ... just it before saving you ... 26</p> <p>License Program ... will you date it? ... 28</p> <p>Consider a MITE Program ... alternative to the ASP-53 ... 30</p> <p>Test of Substituting Chips ... probe your problem ... 32</p> <p>Break Through Characters ... mode for the SWTP 48-40 ... 34</p> <p>Magnetic Bubble Memory ... new technology ... 36</p> <p>Reliable Conversion Techniques ... try some for A/D and D/A ... 38</p> <p>Seamlessly, Hardware and Software ... profit to the max! ... 40</p> <p>Hyper about Slow Load Times! ... KIM Hyperbase is an alternative ... 42</p> <p>Interested in Commercial Programming? ... some points to consider ... 44</p> <p>Kilobaud Classroom ... No. 6: Voltage, Current and Power Supplies ... 46</p> <p>Expand Your KIM! ... with Altair's old friends ... 48</p> <p>Enhance Your Memory ... with some information retrieval ... 50</p> <p>Build the 280 Modem ... use the MC14432 and a UART ... 52</p> <p>Another Look at Benchmark Programs ... in the eye of the beholder! ... 54</p> <p>So, of Substituting Game ... an alternative to chess? ... 56</p> <p>Payroll Program ... for small businesses! ... 58</p> <p>SCMP Game Board ... add an inexpensive TTY ... 60</p> <p>Features</p> <p>Publisher's Remarks ... 4 Around the Industry ... 17</p> <p>Editor's Remarks ... 8 The Hobbyist Forum ... 19</p> <p>New Products ... 10 Books ... 19</p> <p>The BASIC Forum ... 12 Letters ... 20</p> <p>Legal/Business Forum ... 4 Kilobaud Calendar ... 10</p> <p>The KIM Forum ... 16 Contact! ... 18</p>	<p>kilobaud The Small Computer Magazine</p> <p>ISSUE #12 December 1977</p> <p>Articles</p> <p>TTY Hardware Design ... Part 1: Instruction decoder and scan ... 30</p> <p>Expand Your KIM ... Part 2: getting to the next level ... 32</p> <p>Payroll Program (Continued) ... accurate technique ... 34</p> <p>The Business Market ... and the business of going after it ... 36</p> <p>ALL GAPS ... should be left to rest! ... 38</p> <p>The "Learning Machine" ... next step program ... 40</p> <p>Kilobaud Classroom ... No. 7: Arithmetic, Divide and Up Logic ... 42</p> <p>Complex Guide to Logic Diagrams ... the right old way ... 44</p> <p>The Twelve Days of Christmas ... 46</p> <p>Paper Tape: It's Here to Stay ... a look at the CP-804 ... 48</p> <p>Tampan Foot! ... 50</p> <p>Who Needs a Backup? ... analyze your stock at home ... 52</p> <p>Here's HUEY! ... your calculator for the 8080 ... 54</p> <p>Graph Loading! ... real time Lunar Lander game ... 56</p> <p>File Structures Simplified ... help your own operating system ... 58</p> <p>Features</p> <p>Publisher's Remarks ... 4 The BASIC Forum ... 17</p> <p>Editor's Remarks ... 8 Letters ... 21</p> <p>Around the Industry ... 7 1977 INDEX ... 10</p> <p>Books ... 8 Contact! ... 12</p> <p>New Products ... 12 Corrections ... 12</p> <p>Legal/Business Forum ... 19</p>

All issues subject to availability!

Issue #1—\$5.00; #2 thru #12—\$3 ea.; #13 & #14—\$10 ea. ___ issues SEPT 77—\$3

Please send Kilobaud back issues: ___ issues OCT 77—\$3

___ issues JAN 77—\$5 ___ issues MAY 77—\$3 ___ issues NOV 77—\$3

___ issues FEB 77—\$3 ___ issues JUNE 77—\$3 ___ issues DEC 77—\$3

___ issues MAR 77—\$3 ___ issues JUL 77—\$3 ___ issues JAN 78—\$10

___ issues APR 77—\$3 ___ issues AUG 77—\$3 ___ issues FEB 78—\$10

TOTAL: _____

Have credit card # handy and call
TOLL FREE (800) 258-5473
Kilobaud • Peterborough NH 03458

73/5/78

Add \$1.00 shipping & handling for each order.

BankAmericard/Visa Master Charge American Express

Card # _____ Expiration date _____

Signature _____

Name _____

Address _____

City _____ State _____ Zip _____

call us ... tell us

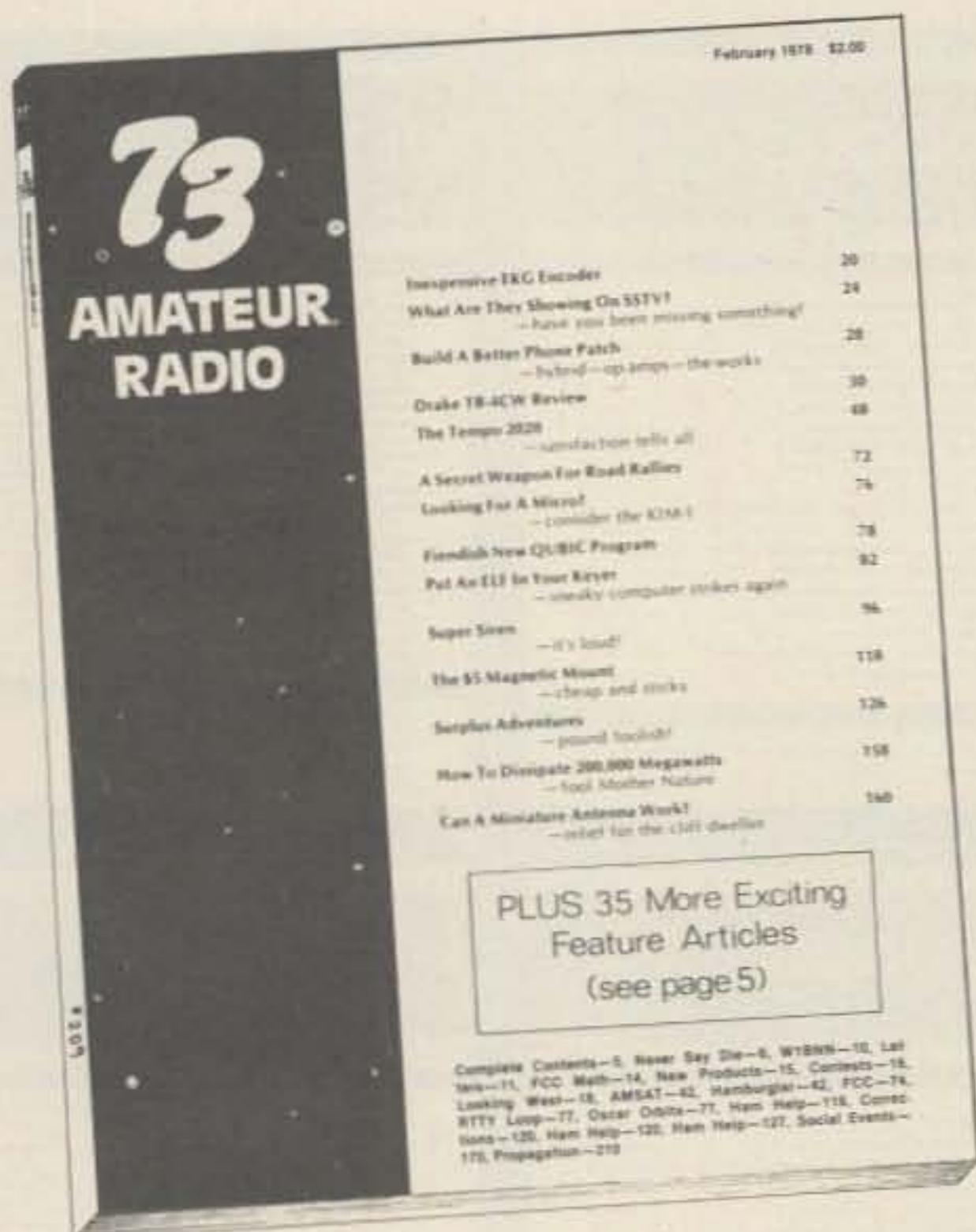

you want to
SUBSCRIBE!

Also tell us your credit card number so we can enter the subscription for you. A subscription saves you a bundle of money . . . just figure it out. At \$2 a copy you're spending \$24 a year, yet a subscription costs a lousy \$15. Nine dollars may not be a lot today, but that's no reason to just throw it away because you don't want to bother to pick up the phone.

Three years of 73? If you figured out what the costs are you'd send in a subscription instantly. Not having calculators that go out that far (allowing for the usual inflation, increases in postage, rising paper prices, and a new car for Wayne . . . a copy of 73 will probably be \$5 three years from now), no one at 73 has definitely been able to calculate the exact cost of three more years on the newsstand. One thing is for sure, it's going to be a lot more than the current three year \$36 subscription rate, which is an obvious rip-off. Call in your three year subscription and make us rue the day we came up with that low number.

It's toll free

800-258-5473

and someone is usually around during office hours to take your order, credit card number (Master Charge, BankAmericard or American Express). While you're calling what would it hurt to get Kilobaud too? And maybe a few books for the bathroom.

If the line is busy tear out the card bound in the back of the magazine . . . just inside the back cover . . .

While you are tearing out cards it is high time for you to mark up the reader's service part too. A good response convinces advertisers to run more ads . . . you get more pages of magazine. It's a good investment.

73 Peterborough NH 03458

CUSTOM TRANSFORMERS



HEAVY DUTY REPLACEMENT TRANSFORMERS*

Collins 30S-1 Plate Transformer	\$165.00
Collins 516F-2 Power Transformer	95.00
Hunter 2000B Plate Transformer	125.00
ETO A-77D Plate Transformer	125.00
Henry 2K Plate Transformer	140.00
Henry 2K-2 Plate Transformer	165.00
Henry 2K-2A Plate Transformer	135.00
Henry 2K-4 Plate Transformer	165.00
Henry 3K-A Plate Transformer	165.00
Heath Marauder HX-10 Transformer	95.00
Gonset GSB-100 Transformer	95.00
National NCL-2000 Power Transformer	125.00
Gonset GSB-201 Power Transformer	135.00

SPECIALS

Plate XFMR. 4600 VAC @ 1.5A ICAS 230 VAC 60 Hz primary, Wt. 60 LB	\$195.00
Plate XFMR. 3500 VAC @ 1.0A ICAS 230 VAC 60 Hz primary, Wt. 41 LB	125.00
Plate XFMR. 3000 VAC @ 0.7A ICAS 115/230 VAC 60 Hz pri, Wt. 27 LB	95.00
Plate XFMR. 6000 VCT @ 0.8A CCS 115/230 VAC 60 Hz pri, Wt. 41 LB	135.00
FIL XFMR. 7.5 VCT @ 21A CCS 117 VAC 60 Hz primary Wt. 8 LB	29.95
FIL Choke bifilar wound 30 AMP RF Filament Choke on 1/2x7 rod	8.95
DC Filter Choke 8.0 Hy @ 1.5 ADC	150.00
DC Swinging Choke: 30 Hy @ 0.15A to 5.0 Hy @ 1.0ADC	100.00
DC Filter Capacitors 100 MFD @4000 VDC	\$75.00

*All heavy duty replacement transformers are electrically superior to original equipment(s). All transformers are manufactured to rigid commercial quality specifications and each carries a 24 month guarantee!

Write today for a free quotation on any transformer, Choke, or saturable reactor.

Peter W. Dahl Co.

4007 Fort Blvd. • El Paso, Texas 79930

Telephone (915) 566-5365 or (915) 751-4856

D6

MOVING?

Let us know 8 weeks in advance so that you won't miss a single issue of 73 Magazine. Attach old label where indicated and print new address in space provided. Also include your mailing label whenever you write concerning your subscription. It helps us serve you promptly.

Write to: **73 magazine**
 Peterborough NH 03458

Address change only Payment enclosed
 Extend subscription (1 extra BONUS issue)
 Enter new subscription Bill me later
 1 year \$15.00 (I've signed below)

Signature _____

If you have no label handy, print OLD address here.

AFFIX LABEL

name _____ call _____

address _____

city _____ state _____ zip _____

name _____ call _____

address _____

city _____ state _____ zip _____

How would you like to make some extra money in your spare time to help you build your ham station? Wouldn't you like to be able to get the latest in ham gear? The fact is that your hobby *can* pay for itself.

At the same time that you are making money, you will also be helping amateur radio to grow by helping to interest newcomers in the hobby . . . and we need all of the new amateurs we can get, as you know.

73 Magazine is looking for Area Representatives to distribute 73 Magazine and Kilobaud to newsstands, bookstores, discount stores, supermarkets, drugstores, etc. In addition to distribution of the monthly copies of these magazines, Area Representatives would also sell magazines, books, and subscriptions at hamfests, ham auctions, and other local ham events. Radio stores, CB dealers, etc., can also be serviced by Area Representatives.

Make Extra Money! Help Amateur Radio Grow! Distribute 73 to Everyone!

Here's a way to enjoy your hobby, to be a real part of it, and to make money while you are having fun. It sure doesn't seem much like work. Area Representatives who are successful will be offered the opportunity to increase their business by taking on additional special interest magazines for newsstand distribution. The business can grow to any size you wish.

73 sells well on the newsstands. Tests in several areas show that even though every magazine rack in an area is stocked with copies of 73, at least one or two copies are sold from even the smallest of racks. 73 interests hams, SWLs, Cbers, experimenters, students, computer hobbyists, electronics professionals, technicians, etc.

If you are interested in details on how you can earn from \$50 to \$500 (or even more) a month, write to Cynthia Gray, Bulk Sales Manager. Once you sign up you'll get monthly shipments of magazines which are to be sold on consignment (the store only has to pay for the copies sold each month) and keep back issues in stock for sale at hamfests, etc.

Just think, with a few hours' work each month you might be able to have a fantastic ham station before the end of 1978. Drop Cynthia a line and get started . . . if you are the kind of person who gets things done and can carry things through.

73 Magazine • Peterborough, NH 03458

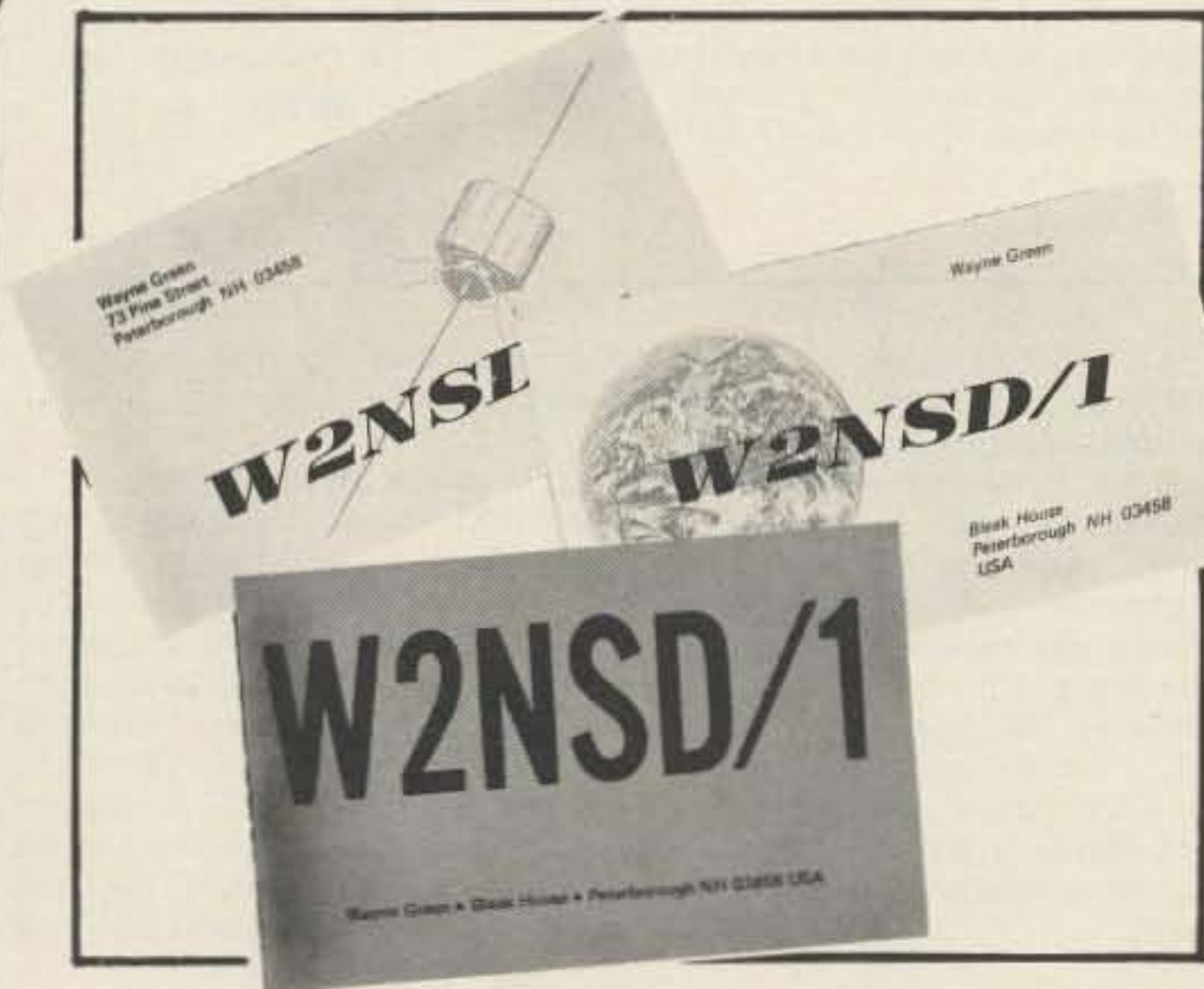

QSL CARDS

You want your QSL card to stand out on every wall, don't you? Well, here's some which no shack visitor in the world will be able to miss. It's got jet black call letters . . . great big call letters that can be read all the way across the room—black letters on a bright yellow background to make them really stand out. When pictures of DX shacks are published in the magazines you'll see your card clearly. Order style Y.

Equally impressive are styles W and X. These are white cards with black type—style W has a blue world, style X a

blue satellite. Both are top quality QSLs you'll be proud to send.

How can 73 turn out these **fantastic** QSL cards at about half the cost of having them made elsewhere? These are done as a fill-in between printing books and other items in the 73 Print Shop. That's why we don't promise anything faster than **8 weeks** delivery. We usually get them out a lot faster than that, but we could get tied up with a new edition of the Repeater Atlas or something and be slow.

The regular QSO information is printed on the back of the card . . . all you need to have the card acceptable for any awards. There's room to list your equipment on the back, if you want. A nice gift idea, too! Actual size: 5½" x 3½".

Please send me the following QSL cards:

Style: W X Y

Quantity: 250 — \$8.95 500 — \$13.95

ADD \$1.00 SHIPPING & HANDLING CHARGE.

\$ _____ Enclosed. Cash Check Money Order

American Express BankAmericard Master Charge

Credit card # _____

Exp. date _____

Signature _____

Name _____ Call _____

Address _____

City _____ State _____ Zip _____

U.S.A. Orders Only

73 Magazine—QSLs
Peterborough NH 03458

73/5/78

RADIO BOOKSHOP

● **NOVICE STUDY GUIDE** — Here is a completely new study guide and reference book for the potential ham. This is not a question/answer memorization course. Electronic and radio fundamentals are presented and explained in an easy-to-understand fashion, preparing the beginner for the Novice exam. Includes the latest FCC amateur regulations, as well as application forms. Easily the best path into the exciting world of ham radio! \$4.95.*

● **GENERAL CLASS STUDY GUIDE** — A complete theory course for the prospective General or Technician. This reference explains transistor, amplifier, and general radio theory, while preparing the Novice for the "big" ticket. After getting your ticket, you'll use this guide again and again as an electronic reference source. Not a question/answer guide that becomes dated when the FCC updates the amateur exams. \$5.95.*

● **ADVANCED CLASS STUDY GUIDE** — Ready to upgrade your license? To prevent retaking the FCC theory exam, you need the 73 Advanced theory guide. SSB, antenna theory, transmitters, and electronic measuring techniques are covered in detail in this easy-to-follow study guide. Special modes and techniques, such as RTTY, are also treated. An engineering degree is *not* necessary to master Advanced theory — try this book before visiting the examiner's office! \$5.95.*

● **EXTRA CLASS LICENSE STUDY GUIDE** — Before going for your 1 x 2 call, it pays to be a master of the Extra class electronic theory. This study guide is the logical extension of the 73 theory course. All the theory necessary to pass the exam is presented. Antennas, transmission lines, swr are discussed, as well as noise, propagation, and specialized communication techniques. This book is not a classroom lecture or memorization guide, but rather a logical presentation of the material that must be *understood* before attempting the Extra exam. Save yourself a return trip to the FCC and try the 73 method first! \$5.95.*

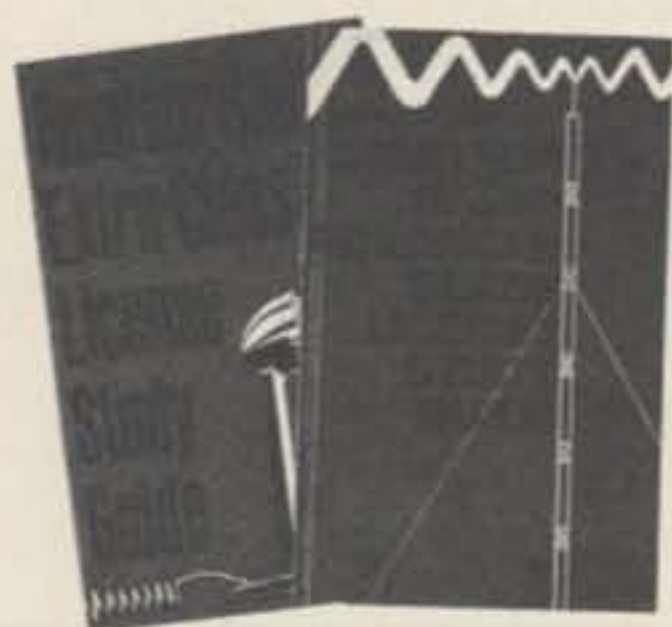

novice theory tapes

Startling Learning Breakthrough

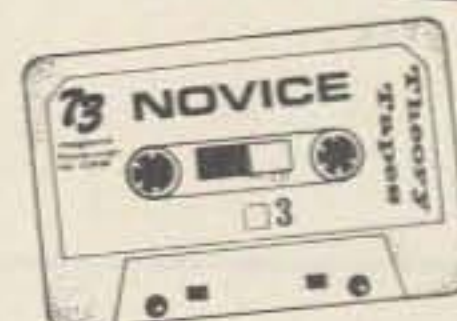
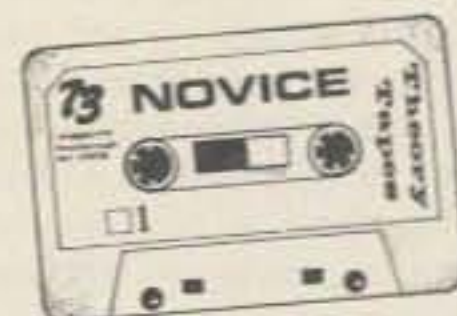

● **NOVICE THEORY TAPES** Startling Learning Breakthrough. You'll be astounded at how really simple the theory is when you hear it explained on these tapes. Three tapes of theory and one of questions and answers from the latest Novice exams give you the edge you need to breeze through your exam. 73 is interested in helping get more amateurs, so we're giving you the complete set of our tapes for the incredibly low price of ONLY \$15.95.*

Scientists have proven that you learn faster by listening than by reading because you can play a cassette tape over and over in your spare time — even while you're driving! You get more and more info each time you hear it.

You can't progress without solid fundamentals. These four hour-long tapes give you all the basics you'll need to pass the Novice exam easily. You'll have an understanding of the basics which will be invaluable to you for the rest of your life! Can you afford to take your Novice exam without first listening to these tapes? Set of 4 — \$15.95.*

73 CODE SYSTEM TAPES



Four tapes for \$15.95
\$4.95 each!

"GENESIS"

5 WPM This is the beginning tape for people who do not know the code at all. It takes them through the 26 letters, 10 numbers and necessary punctuation, complete with practice every step of the way using the newest blitz teaching techniques. It is almost miraculous! In one hour many people — including kids of ten — are able to master the code. The ease of learning gives confidence to beginners who might otherwise drop out.

"THE STICKLER"

6+ WPM This is the practice tape for the Novice and Technician licenses. It is made up of one solid hour of code, sent at the official FCC standard (no other tape we've heard uses these standards, so many people flunk the code when they are suddenly — under pressure — faced with characters sent at 13 wpm and spaced for 5 wpm). This tape is not memorizable, unlike the zany 5 wpm tape, since the code groups are entirely random characters sent in groups of five. Practice this one during lunch, while in the car, anywhere, and you'll be more

than prepared for the easy FCC exam.

"BACK BREAKER"

13+ WPM Code groups again, at a brisk 13 per so you will be at ease when you sit down in front of the steely-eyed government inspector and he starts sending you plain language at only 13 per. You need this extra margin to overcome the panic which is universal in the test situations. When you've spent your money and time to take the test, you'll thank heavens you had this back-breaking tape.

"COURAGEOUS"

20+ WPM Code is what gets you when you go for the Extra Class license. It is so embarrassing to panic out just because you didn't prepare yourself with this tape. Though this is only one word faster, the code groups are so difficult that you'll almost fall asleep copying the FCC stuff by comparison. Users report that they can't believe how easy 20 per really is with this fantastic one hour tape. No one who can copy these tapes can possibly fail the FCC test. Remove all fear of the code forever with these tapes.

SSTV

● **SLOW SCAN TELEVISION TAPE** Prize winning programs from the 73 SSTV contest. Excellent for Demo! \$5.95.*



Use the order card in the back of this magazine or itemize your order on a separate piece of paper and mail to:
73 Radio Bookshop • Peterborough, NH 03458. Be sure to include check or detailed credit card information.
* Add \$1.00 shipping & handling charge for each order. Note: Price subject to change on books not published by 73 Magazine.

RADIO BOOKSHOP

● **WEATHER SATELLITE HANDBOOK** Simple equipment and methods for getting good pictures from the weather satellite. Antennas, receivers, monitors, facsimile you can build, tracking, automatic control (you don't even have to be home). Dr. Taggart WB8DQT \$4.95.*

● **NEW REPEATER ATLAS of the ENTIRE World**, 150% as big as any list ever available — nearly 900 more repeaters listed. New improved maps that show the location by frequency of every repeater in the States. Only \$1.95.*

● **VHF ANTENNA HANDBOOK** The NEW VHF Antenna Handbook details the theory, design and construction of hundreds of different VHF and UHF antennas . . . A practical book written for the average amateur who takes joy in building, not full of complex formulas for the design engineer. Packed with fabulous antenna projects you can build. \$4.95.*

● **THE CHALLENGE OF 160** is the newest book in the 73 technical library, dedicated to 160 meter operating. Si Dunn provides all necessary information to get started on this unique band. The all-important antenna and ground systems are described in detail. The introduction contains interesting photos of Stew Perry's (the King of 160) shack. This reference is a must for new and experienced "Top Band" operators. Price: \$4.95.*

● **BEHIND THE DIAL** by Bob Grove. Get more fun out of shortwave listening with this interesting guide to receivers, antennas, frequencies and interference. \$4.95.*



● **INTRODUCTION TO RTTY** A beginner's guide to radioteletype including teletypewriter fundamentals, signals, distortion and RTTY art. You can be a RTTY artist! A 73 publication. \$2.00.*

● **VOL. I COMPONENT TESTERS** . . . how to build transistor testers (8), diode testers (3), IC testers (3), voltmeters and VTVMs (9), ohmmeters (8 different kinds), inductance (3), capacity (9), Q measurement, crystal checking (6), temperature (2), aural meters for the blind (3) and all sorts of miscellaneous data on meters . . . using them, making them more versatile, making standards. Invaluable book, \$4.95.*

● **VOL. II AUDIO FREQUENCY TESTERS** . . . jam packed with all kinds of audio frequency test equipment. If you're into SSB, RTTY, SSTV, etc., this book is a must for you . . . a good book for hi-fi addicts and experimenters too! \$4.95.*

● **VOL. III RADIO FREQUENCY TESTERS** Radio frequency waves, the common denominator of Amateur Radio. Such items as SWR, antenna impedance, line impedance, rf output and field strength; detailed instructions on testing these items includes sections on signal generators, crystal calibrators, grid dip oscillators, noise generators, dummy loads and much more. \$4.95.*

● **VOL. IV IC TEST EQUIPMENT** Become a troubleshooting wizard. All you need to know about pulse, audio and sync generators, frequency counters, digital component testers, logic probes and more! Plus a cumulative index for all four volumes of the 73 Test Equipment Library. \$4.95.*

● **THE NEW RTTY HANDBOOK** is a new edition and the only up-to-date RTTY book available. The state of the art has been changing radically and has made all previous RTTY books obsolete. It has the latest circuits, great for the newcomer and expert alike. \$5.95.*



● **73 VERTICAL, BEAM AND TRIANGLE ANTENNAS** by Edward M. Noll W3FQJ Describes 73 different antennas for amateurs. Each design is the result of the author's own experiments: each has actually been built and air-tested. Includes appendices covering the construction of noise bridges and antenna line tuners, as well as methods for measuring resonant frequency, velocity factor, and standing-wave ratios. 160 pages. \$5.50.*

● **IC OP-AMP COOKBOOK** by Walter G. Jung. Covers not only the basic theory of the IC op amp in great detail, but also includes over 250 practical circuit applications, liberally illustrated. 592 pages, 5½ x 8½, softbound \$12.95.*

● **73 DIPOLE AND LONG-WIRE ANTENNAS** by Edward M. Noll W3FQJ This is the first collection of virtually every type of wire antenna used by amateurs. Includes dimensions, configurations, and detailed construction data for 73 different antenna types. Appendices describe the construction of noise bridges, line tuners, and data on measuring resonant frequency, velocity factor, and swr. \$5.50.*

● **RF AND DIGITAL TEST EQUIPMENT YOU CAN BUILD** Rf burst, function, square wave generators, variable length pulse generators — 100 kHz marker, i-f and rf sweep generators, audio osc, af/rf signal injector, 146 MHz synthesizer, digital readouts for counters, several counters, prescaler, microwavemeter, etc. 252 pages. \$5.95.*

● **SSTV HANDBOOK** This excellent book tells all about it, from its history and basics to the present state of the art techniques. Contains chapters on circuits, monitors, cameras, color SSTV, test equipment and much more. Hardbound \$7, softbound \$5.*



Use the order card in the back of this magazine or itemize your order on a separate piece of paper and mail to:
73 Radio Bookshop • Peterborough, NH 03458. Be sure to include check or detailed credit card information.

*Add \$1.00 shipping & handling charge for each order. Note: Price subject to change on books not published by 73 Magazine.

RADIO BOOKSHOP

RADIO BOOKSHOP

● **RTL COOKBOOK** by Donald Lancaster. Explains the how and why of RTL (Resistor-Transistor Logic) and gives design information that can be put to practical use. Gives a multitude of digital applications ranging from the basic switch to the sophisticated counter. 240 pages; 5½ x 8½; softbound. \$5.50.*

● **TTL COOKBOOK** by Donald Lancaster. Explains what TTL is, how it works, and how to use it. Discusses practical applications, such as a digital counter and display system, events counter, electronic stopwatch, digital voltmeter, and a digital tachometer. 336 pages; 5½ x 8½; softbound. \$8.95.*

● **TVT COOKBOOK** by Donald Lancaster. Describes the use of a standard television receiver as a microprocessor CRT terminal. Explains and describes character generation, cursor control and interface information in typical, easy-to-understand Lancaster style. This book is a required text for both the microcomputer enthusiast and the amateur RTTY operator who desires a quiet alternative to noisy teletype machines. \$9.95.*



● **FASCINATING WORLD OF RADIO COMMUNICATION** Interesting stories in the history of radio pioneering and discovery. Also includes the fundamentals of broadcast band DXing. A must for every radio amateur. \$3.95.*

● **PRACTICAL TEST INSTRUMENTS YOU CAN BUILD** 37 simple test instruments you can make — covers VOMs, VTVMs, semiconductor testing units, dip meters, wattmeters, and just about anything else you might need around the test lab and ham shack. \$4.95.*

● **1001 PRACTICAL ELECTRONIC CIRCUITS** Tab's new 1001 circuits is available for only \$9.95 ppd. The next time you want a circuit for just about anything, eat your heart out that you didn't send for this book the first time you read about it. You'd better order the book right away, before they run out. \$9.95.*

● **HOW TO MAKE BETTER QSLs** Be proud of your QSL cards ... have a card which gets front space on every hamshack wall ... win prizes at hamfests. The only way to have a truly outstanding card is to make it yourself, which is easy when you have this new book. \$2.00*

● **WHAT TO DO AFTER YOU HIT RETURN** PCC's first book of computer games ... 48 different computer games you can play in BASIC ... programs, descriptions, muchly illustrated. Lunar Landing, Hammurabi, King, Civil 2, Qubic 5, Taxman, Star Trek, Crash, Market, etc. \$6.95.*

● **BASIC COMPUTER GAMES—MICROCOMPUTER EDITION** (formerly *101 BASIC Computer Games*) More than 100 games, from very simple to real buggers. Included is description of the games, the listing to put in your computer and a sample run to show you how they work. Any one game is worth more than the price of the book for the fun you will have! \$7.50.*

● **BASIC** by Bob Albrecht. Self-teaching guide to the computer language you will need to know for use with your microcomputer. 324 pages. This is one of the easiest ways to learn computer programming. \$4.95.*

● **THE UNDERGROUND BUYING GUIDE** Here is a handy guide for the electronics enthusiast. Over 600 sources of equipment and literature are provided; some are mail-order-only outfits that do not advertise. Sources are listed alphabetically, by service or product, and by state. The guide is cross-referenced for ease of use. Electronic publishing houses are also listed. Published by PMS Publishing Co., \$5.95.*

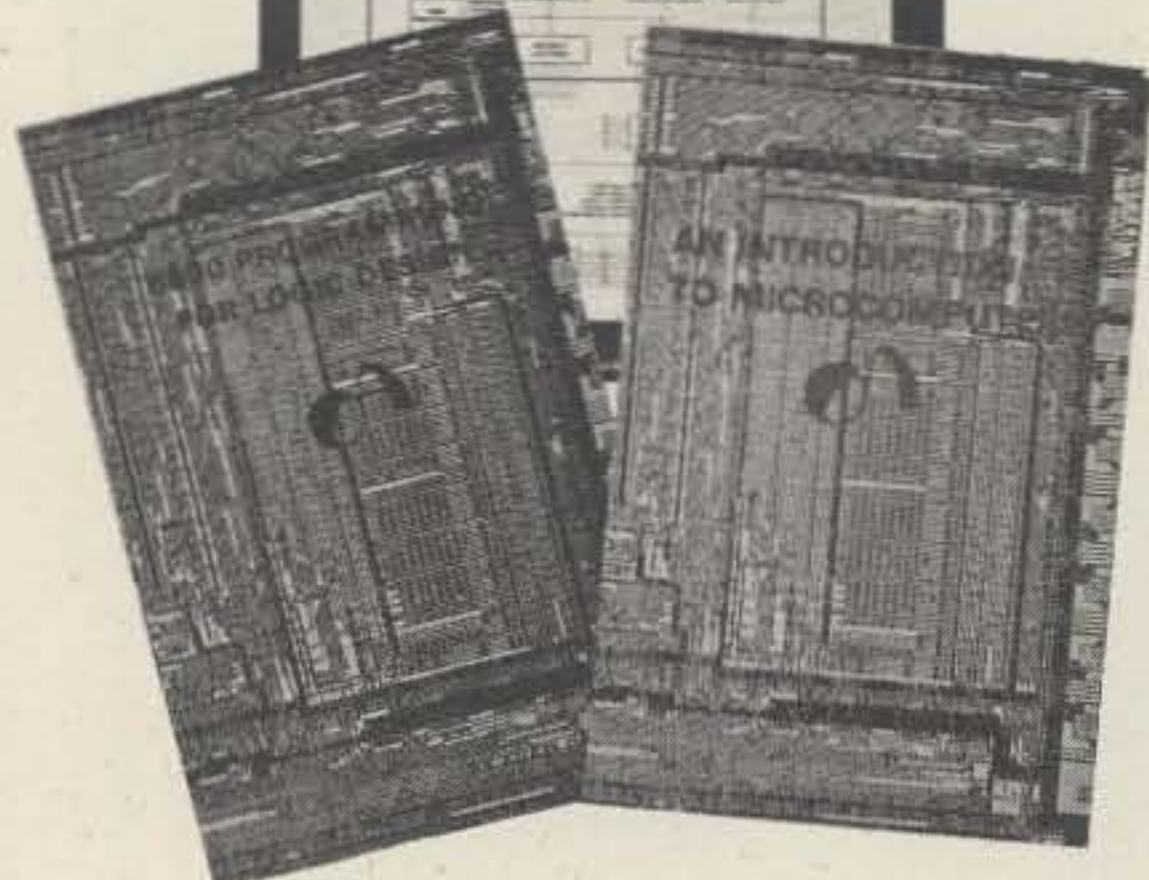
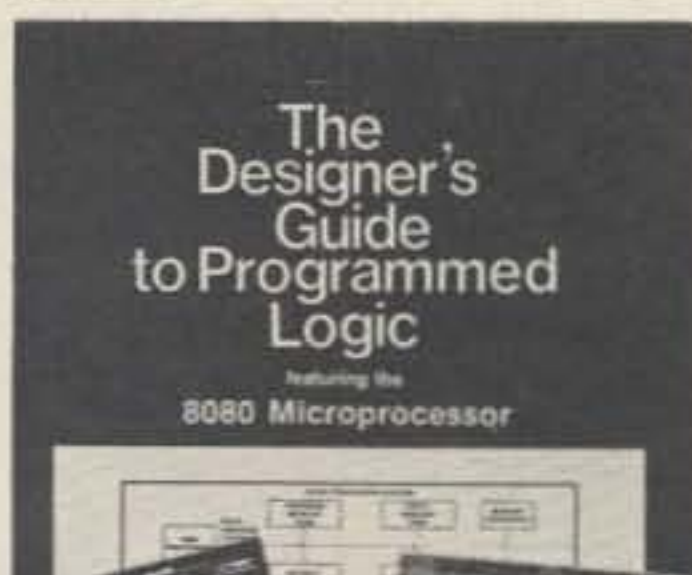

● **AN INTRODUCTION TO MICROCOMPUTERS, VOLS. 1 AND 2** by Adam Osborne Associates, are references dealing with microcomputer architecture in general and specifically with details about most of the common chips. These books are not software-oriented, but are invaluable for the hobbyist who is into building his own interfaces and processors. Volume 1 is dedicated to general hardware theory related to micros, and Volume 2 discusses the practical details of each micro chip. (Detailed review in *Kilobaud* #2) Published by Osborne Associates, Vol. I — \$7.50*; Vol. II — \$12.50.*

● **8080 PROGRAMMING FOR LOGIC DESIGN** Ideal reference for the person desiring an in-depth understanding of the 8080 processor. The work is application-oriented, and the 8080 is discussed in light of replacing conventional, hard-wired logic systems. Both hardware and software is described. Practical design considerations are provided for the implementation of an 8080-based control system. (Detailed review in *Kilobaud* #1) Published by Osborne Associates, \$7.50.*

● **6800 PROGRAMMING FOR LOGIC DESIGN** Oriented toward the industrial user, describes the process by which conventional logic can be replaced by a 6800 microprocessor. Hardware, software, and interfacing techniques are discussed. This reference provides practical information that allows an experimenter to design a complete micro control system from the "ground up." An excellent reference! Published by Osborne Associates. \$7.50.*

Use the order card in the back of this magazine or itemize your order on a separate piece of paper and mail to:
73 Radio Bookshop • Peterborough, NH 03458. Be sure to include check or detailed credit card information.

* Add \$1.00 shipping & handling charge for each order. Note: Price subject to change on books not published by 73 Magazine.

RADIO BOOKSHOP

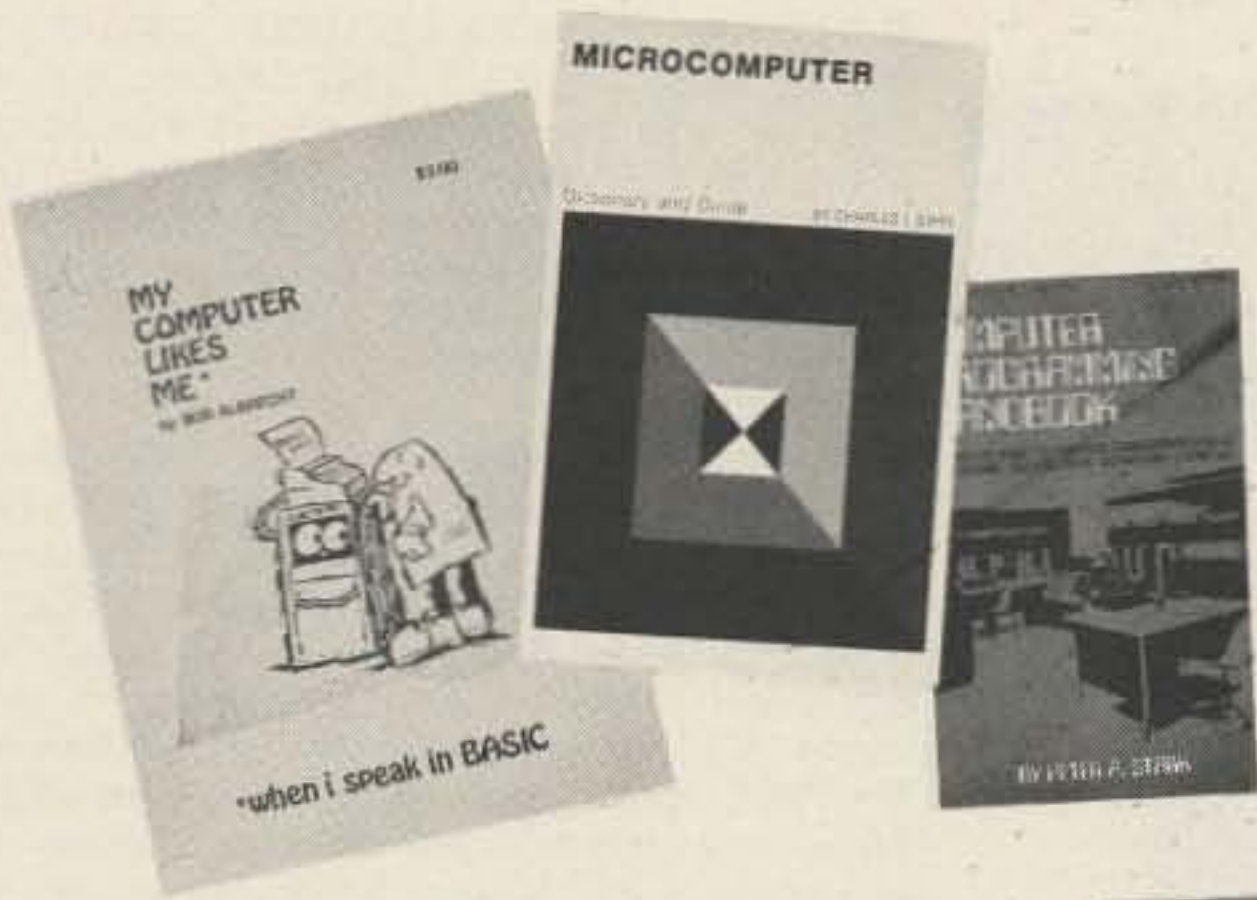

● **MICROCOMPUTER DICTIONARY** fills the urgent need to become quickly acquainted with the terminology and nomenclature of the revolution in computers. Over 5000 definitions of terms and concepts (704 pages) relating to microprocessors, microcomputers and microcontrollers. There is also a comprehensive electronics/computer abbreviations and acronyms section. \$15.95.*

● **COMPUTER PROGRAMMING HANDBOOK** by Peter Stark. A complete guide to computer programming and data processing. Includes many worked out examples and history of computers. \$9.95.*

● **MY COMPUTER LIKES ME ... WHEN I SPEAK BASIC** An introduction to BASIC ... simple enough for your kids. If you want to teach BASIC to anyone quickly, this booklet is the way to go. \$2.00.*

● **SCELBI'S GALAXY GAME FOR THE "6800"** "Galaxy" pits the operator of a spaceship against alien craft, as well as such variables as speed, time, and ammunition. No two games are the same! \$14.95.*

● **6800 SOFTWARE GOURMET GUIDE & COOKBOOK** This manual describes sorting, searching, and many other routines for the 8080 user. \$9.95.*

● **8080 SOFTWARE GOURMET GUIDE AND COOKBOOK** Describes sorting, searching, and many other routines for the 8080 user. \$9.95.*

● **CMOS COOKBOOK** by Don Lancaster. Another winner from the author of the *RTL* and *TTL Cookbooks*. Details the application of CMOS, the low power logic family suitable for most applications presently dominated by TTL. Eight chapters cover all facets of CMOS logic, prefaced by 100 pages detailing the characteristics of most CMOS circuits. Required reading for every serious digital experimenter. \$9.95.*

● **HOBBY COMPUTERS ARE HERE** If you (or a friend) want to come up to speed on how computers work ... hardware and software ... this is an excellent book. It starts with the fundamentals and explains the circuits, the basics of programming, along with a couple TVT construction projects, ASCII-Baudot, etc. It has the highest recommendations as a teaching aid for newcomers. \$4.95.*

● **FUN WITH COMPUTERS AND BASIC** by Donald D. Spencer, contains an easy-to-understand explanation of the BASIC Programming Language and is intended for persons who have had no previous exposure to computer programming but want to learn BASIC quickly, easily, and interestingly. Over half the book is devoted to problems using games, puzzles, and mathematical recreations (you don't need a math background to understand most of the problems in this book). A superior book for self-teaching and learning computer programming. \$6.95.*



● **THE STORY OF COMPUTERS** by Donald D. Spencer is to computer books what *Dick and Jane* is to novels ... extremely elementary, gives the non-computerist a fair idea of what the hobbyist is talking about when he speaks computer lingo. Attempts to explain what computers are and can do. \$4.95.*

● **MICROCOMPUTER PRIMER** by Mitchell Waite and Michael Pardee. Describes basic computer theory, describes the world of microcomputing in "real world" terminology, explains numbering systems, and introduces the reader to the world of programming. There is probably no better way of getting involved with the exciting new hobby of microcomputing. \$7.95.*

● **INTRODUCTION TO MICROPROCESSORS** by Charles Rockwell of MICROLOG. An ideal reference for the individual desiring to understand the hardware aspects of microprocessor systems. Describes the hardware details of computer devices in terms the beginner can understand, instead of treating the micro chip as "black box." Addressing schemes, registers, control, and memory are all explained. General information about hardware systems is provided. Specific systems are not described and programming is only briefly discussed. \$17.50* US and Canada, \$20 elsewhere.

● **THE NEW HOBBY COMPUTERS!** This book takes it from where "Hobby Computers Are Here" leaves off, with chapters on Large Scale Integration, how to choose a microprocessor chip, an introduction to programming, low cost I/O for a computer, computer arithmetic, checking memory boards, a Baudot monitor/editor system, an audible logic probe for finding those tough problems, a ham's computer, a computer QSO machine ... and much, much more! \$4.95.*

● **KILOBAUD** The Small Computer Magazine written for the non-PhD computer hobbyist who wants to know what's new. \$2.00 each at the newsstand, \$15.00 for 1 year sub.



Use the order card in the back of this magazine or itemize your order on a separate piece of paper and mail to:
73 Radio Bookshop • Peterborough, NH 03458. Be sure to include check or detailed credit card information.

*Add \$1.00 shipping & handling charge for each order. Note: Price subject to change on books not published by 73 Magazine.

RADIO BOOKSHOP

● **COMPUTER DICTIONARY** by Donald D. Spencer. Defines words and acronyms used by computerists in a clear, easy to understand style. Over 2000 definitions are provided. This reference is a must for the individual getting started in the world of microcomputers. Published by Camelot Press, \$5.95.*

● **CHEMISTRY WITH A COMPUTER** by Paul A. Cauchon. Contains a collection of tutorial, simulation and problem-generation computer programs. Simulations provide models of lengthy laboratory experimentation beyond the limited classroom timeframe and enhancement of course studies by encouraging pre-laboratory research. Useable with almost any chemistry course at the high school or college level. Written in BASIC. Price \$9.95.*

● **TYCHON'S 8080 OCTAL CODE CARD** Slide rule-like aid for programming and debugging 8080 software... contains all the mnemonics and corresponding octal codes. Only 6½x3 inches, provides neat, logical format for quick reference. Back side of card is printed with an ASCII code chart for 128 characters plus the 8080 status word and register pair codes. Also available, Tychon's 8080 Hex Code Card, same as above only has hex codes instead of octal. Only \$3.00* each.



● **1976 PERIODICAL GUIDE FOR COMPUTERISTS** is a 20 page book which indexes over 1,000 personal computing articles for the entire year of 1976 from Byte, Creative Computing, Digital Design, Dr. Dobbs Journal, EDN, Electronic Design, Electronics, Interface Age, Microtek, Peoples Computer Company, Popular Electronics, QST, Radio Electronics, SCCS Interface and 73. Articles are indexed under more than 100 subject categories. Price \$3.00.* New January - June 1977 Edition - \$3.00.*

● **A QUICK LOOK AT BASIC** by Donald D. Spencer. A perfect reference for the beginning programmer. Assumes that the reader has no previous programming experience. A self-teaching guide for the individual desiring to learn the fundamentals of BASIC, the most common hobbyist programming language. Price: \$4.95*

● **HOME COMPUTERS: 2¹⁰ Questions & Answers** by Rich Didday. Two books aimed exclusively at the novice computer hobbyist/home computer user. Written in a rather unusual style which has a beginner asking questions which are answered by a person with a substantial background in computers and personal computing. The questions are just the kind beginners come up with... and the answers are presented in easy-to-understand terms (usually with a diagram to illustrate the point). Both the hardware and software aspects of home computing are covered from A to Z. An index in both books makes them ideal as reference material for anyone. Volume I: Hardware - \$7.95*; Volume 2: Software - \$6.95*.

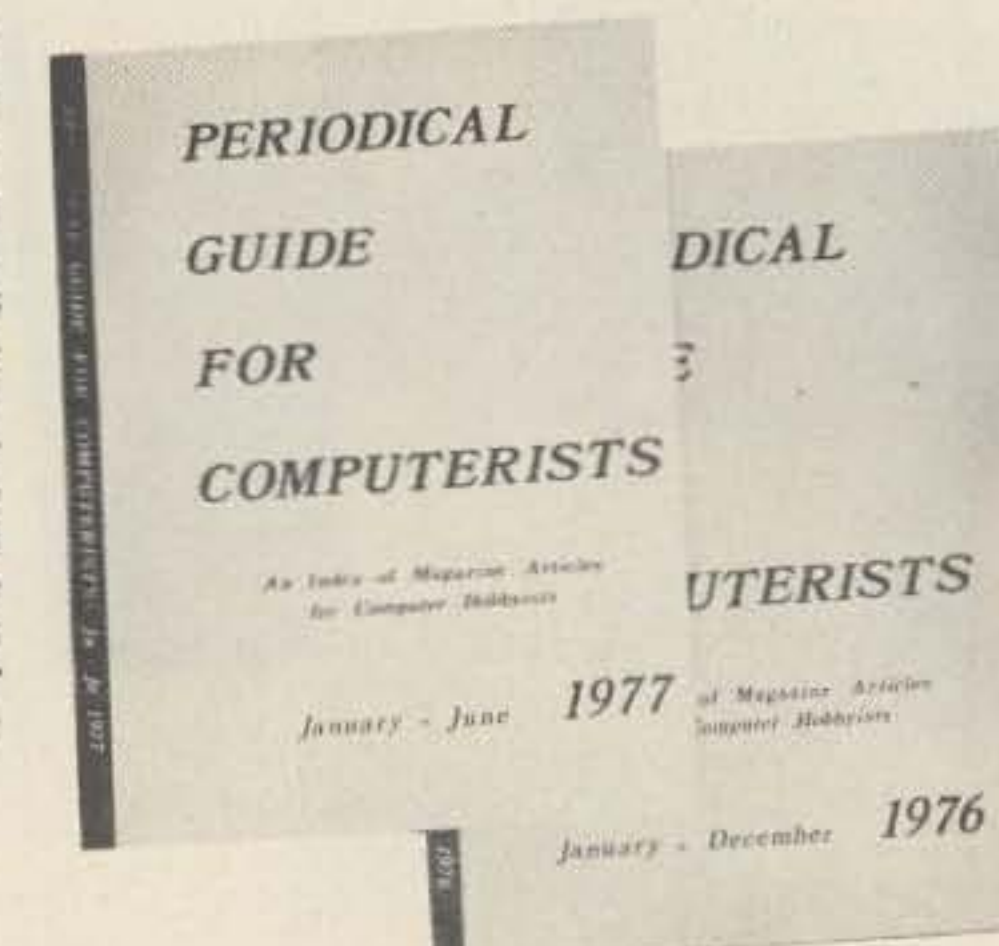
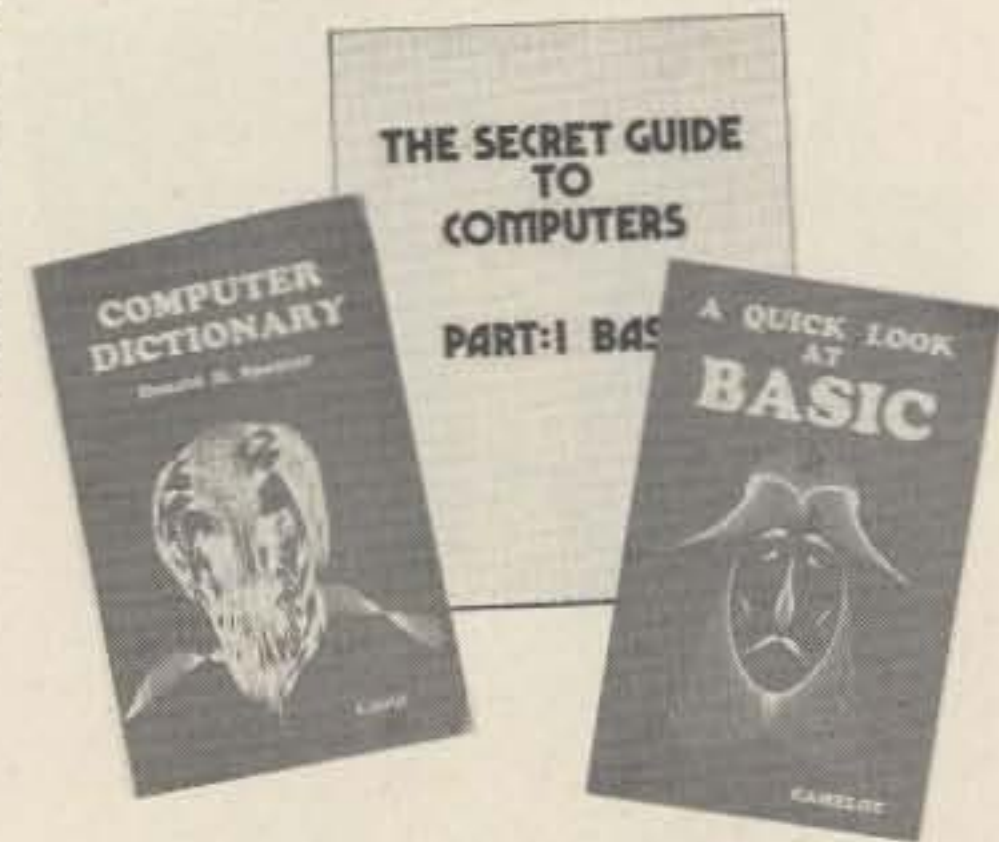

● **SIXTY CHALLENGING PROBLEMS WITH BASIC SOLUTIONS** Donald Spencer. Provides the serious student of BASIC programming with interesting problems and solutions. No knowledge of math above algebra required. Includes games, programs for financial interest, conversions and numeric manipulations. Price: \$6.95*

● **SOME COMMON BASIC PROGRAMS** published by Adam Osborne & Associates, Inc. Perfect for non-technical computerists requiring ready to use programs. Business programs like depreciation formulas, loan payment solutions and loan interest rates; math routines containing statistical packages and polynomial derivations... plus miscellaneous programs. Invaluable for the user who is not an experienced programmer. All will operate in the stand-alone mode. \$7.50* paperback.

● **THE SECRET GUIDE TO COMPUTERS** Parts 1, 2, and 3 by Russ Walter. Part One describes computers in general, and after reading for ten minutes you will be writing simple BASIC programs! Employs a step-by-step teaching process, the end result being a working knowledge of BASIC. Part Two discusses computer applications. It's one thing to master the syntax of a language such as BASIC and another to solve problems using the new tool. This also provides useful techniques in problem solving. Part Three describes programming languages. Ever heard of APL and QLISP? BASIC is not the only language used to program computers, and as the hobby industry grows additional languages will become commonplace. 7th edition. Part I - \$2.75*; Part II - \$2.50*; Part III - \$3.50.*

● **FORTRAN PROGRAMMING** By Donald Spencer. If you are familiar with BASIC you will appreciate the additional capabilities of FORTRAN, a computer language with most of BASIC's features, and much more! FORTRAN was designed for complex numeric calculations; and possesses extended I/O capability. It is easily learned, as it is an English-like computer language. \$7.95.

● **FORTRAN WORKBOOK** by Donald Spencer. Provides practical examples and problems to solve. Almost all micros support BASIC - it won't be long before FORTRAN is commonplace. Don't miss the programming boat... learn FORTRAN; and be ready for the next language boom! \$4.95.*

● **Scientific Research Instruments' BASIC SOFTWARE LIBRARY** is a complete do-it-yourself kit. Written in everybody's BASIC immediately executable in ANY computer with at least 4K, no other peripherals needed. Over 700 pages of source codes, descriptions and instructions. Vol. I contains business and recreational programs and is 300 pages. Vol. II is 260 pages and contains math, engineering, statistics and plotting programs. Vol. III contains money managing, advanced business programs such as billing, A/R, inventory, payroll, etc. Vol. IV contains general purpose programs like loans, rates, retirement, plus games: Poker, Enterprise (take charge while Capt. Kirk is away), Football and more! Vol. V is filled with experimenter's programs including games, pictures and misc. problems like "logic." Vols. I & II \$24.95* each, Vol. III \$39.95,* Vol. IV & V \$9.95 each.*

Use the order card in the back of this magazine or itemize your order on a separate piece of paper and mail to:
73 Radio Bookshop • Peterborough, NH 03458. Be sure to include check or detailed credit card information.

*Add \$1.00 shipping & handling charge for each order. Note: Price subject to change on books not published by 73 Magazine.

RADIO BOOKSHOP

● **THE COMPUTER QUIZ BOOK** by Donald D. Spencer is written for readers who would like to test themselves on basic computer concepts. It may be used effectively by students, teachers, laymen, programmers, personal computer users, or anyone else interested in checking their knowledge of computer concepts. \$5.95.*

● **MASTER HANDBOOK OF HAM RADIO CIRCUITS** This is an encyclopedia of amateur radio circuits, gleaned from past issues of 73 Magazine and carefully selected according to application. You'll find many you've never seen before, some new twists on the tried and true, and several that have been long forgotten but are well worth remembering. Whether your interest ranges from ragchewing to EME, from CW to slow-scan TV, from DX to county nets, this handbook will be a welcome addition to your shack. \$8.95.*

● **HOW TO BUY & USE MINICOMPUTERS AND MICROCOMPUTERS** by Wm. Barden, Jr. This book discusses these smaller brethren of computers and shows how the reader can become a part of the revolution — how he can own and use a functioning computer system in his home to do a variety of practical or recreational tasks. \$9.95.*

● **HOW TO PROGRAM MICROCOMPUTERS** by Wm. Barden, Jr. Here is a guide to assembly language programming of the Intel 8080, Motorola MC6800, and MOS Technology MCS6502 microprocessors. It is written especially for beginning programmers with hobbyist microcomputers based on one of these three chips. The topics covered range from data manipulations at the bit level up to data handling of tables and lists, and from simple adds and subtracts up to floating-point operations. \$8.95.*

● **YOUR OWN COMPUTER** by M. Waite and M. Pardee. The personal computer has been touted as the next consumer product. But most individuals still wonder why. Much technical material has been written but there is little material for the average individual without an extensive background in electronics. This book removes the stigma of complexity that surrounds the computer and has succeeded in providing a simple easy-to-understand guide to these units. \$1.95.*

● **IC TIMER COOKBOOK** by Walter Jung. This book provides an excellent introduction to the field of IC timers and their applications for anyone involved in modern solid-state electronics — from hobbyist, to technical and engineering student, to practicing technician or engineer. Not only does it contain many practical and useful circuits, it is also a valuable reference of basic theoretical information. \$9.95.*

● **ADVANCED BASIC — Applications and Problems** by James Coan is for those who want to extend their expertise with BASIC. Offers advanced techniques and applications. \$6.95.*

Introduction to RTTY

A Beginners Guide To Radioteletype



● **MICROPROCESSORS FROM CHIPS TO SYSTEMS** by Rodney Zaks is a complete and detailed introduction to microprocessors and microcomputer systems. No preliminary knowledge of computers or microprocessors is required to read this book, although a basic engineering knowledge is naturally an advantage. Intended for all wishing to understand the concepts, techniques and components of microprocessors in a short time. \$9.95.*

● **MICROPROCESSOR INTERFACING TECHNIQUES** by Austin Lesea & Rodney Zaks will teach you how to interconnect a complete system and interface it to all the usual peripherals. It covers hardware and software skills and techniques, including the use and design of model buses such as the IEEE 488 or S100. \$9.95.*

● **THE "COMPULATOR" BOOK — Building Super Calculators & Minicomputer Hardware with Calculator Chips** by R. P. Haviland provides ideas, design info and printed circuit boards for calculator chip projects, measure time, tie-in with a Teletype to create a virtually infinite memory system, and countless other functions. \$7.95.*

● **MICROPROCESSOR PROGRAMMING for Computer Hobbyists** by Neill Graham is for the hobbyist interested in intermediate and advanced techniques of programming and data structuring. Written to take up where the computer manufacturers' instruction manuals and the introductory programming language texts leave off. \$8.95.*

● **DISCOVERING BASIC — A Problem Solving Approach** by Robert E. Smith deals with progressively more complex problems which allow the reader to discover the vocabulary of BASIC language as he develops skill and confidence in putting it to work. Clear and concise explanations. Problems used cover a wide range of interests — insurance, geometry, puzzles, economics, etc. \$6.85.*

● **BUILD-IT BOOK OF DIGITAL ELECTRONIC TIMEPIECES** by Robert Haviland is a data-packed guide to building every time-keeping device you can imagine: rugged ship-board clocks, second-splitting digital IC chronometers, decorator digital clocks, a precision timer, a frequency-period meter, a tide and moon clock, an automatic alarm setter, etc. Includes full-size printed circuit board layouts. \$6.95.*

● **THE 8080A BUGBOOK—MICROCOMPUTER INTERFACING AND PROGRAMMING** is written for the 8080 user who has a knowledge of digital elements and operations. This book will be invaluable, as it explains the fundamental tasks of microcomputer interfacing and the associated microcomputer I/O programming for 8080-based microcomputers. Only \$9.95.*

● **INTRODUCTION TO RTTY** A beginner's guide to radioteletype including teletypewriter fundamentals, signals, distortion and RTTY art. You can be a RTTY artist! A 73 publication. \$2.00.*

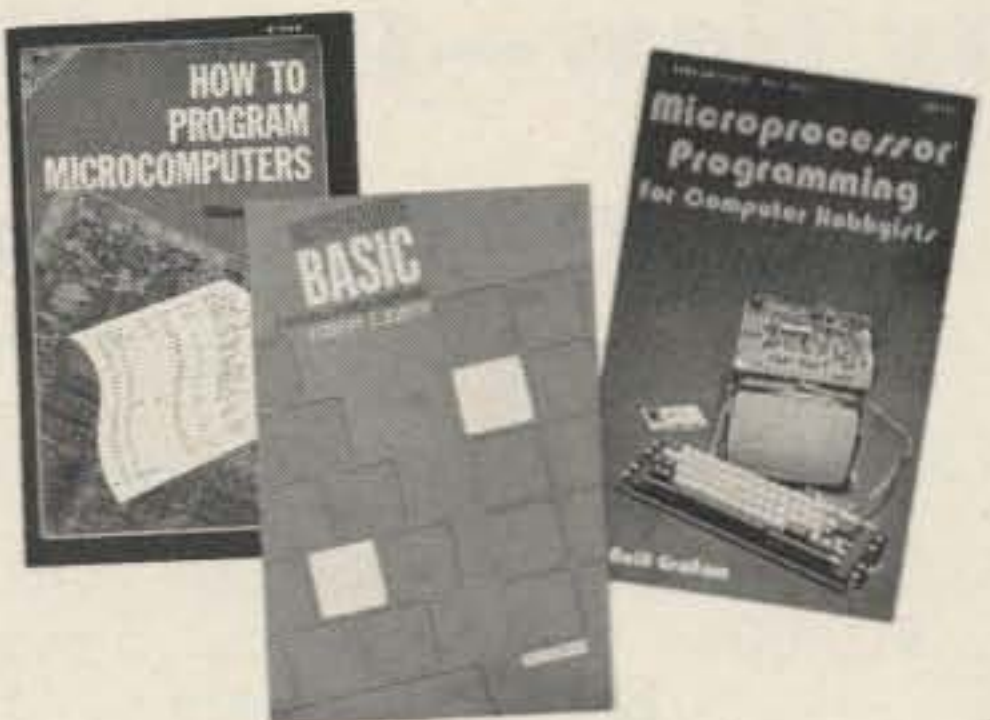

Use the order card in the back of this magazine or itemize your order on a separate piece of paper and mail to: 73 Radio Bookshop • Peterborough, NH 03458. Be sure to include check or detailed credit card information.

*Add \$1.00 shipping & handling charge for each order. Note: Price subject to change on books not published by 73 Magazine.

BAG-A-BUNCH OF 73 BACK ISSUES!*



Your Choice/Our Choice Special
\$1 per Issue
 (Minimum order 5 issues, your choice)
OR 25 Issues Our Choice—\$10.00

- Vintage—1960 thru 1965**
- Mid-years—1966 thru 1971**
- Nearly New—1972 thru 1977**

*** pre-1978 issues.**

<table border="0"> <tr><td><input type="checkbox"/> JUNE 63</td><td><input type="checkbox"/> MAY 70</td><td><input type="checkbox"/> NOV 73</td></tr> <tr><td><input type="checkbox"/> AUG 63</td><td><input type="checkbox"/> JUNE 70</td><td><input type="checkbox"/> DEC 73</td></tr> <tr><td><input type="checkbox"/> OCT 63</td><td><input type="checkbox"/> DEC 70</td><td><input type="checkbox"/> FEB 74</td></tr> <tr><td><input type="checkbox"/> FEB 64</td><td><input type="checkbox"/> JAN 71</td><td><input type="checkbox"/> APR 74</td></tr> <tr><td><input type="checkbox"/> MAY 67</td><td><input type="checkbox"/> FEB 71</td><td><input type="checkbox"/> MAY 74</td></tr> <tr><td><input type="checkbox"/> JULY 67</td><td><input type="checkbox"/> MAR 71</td><td><input type="checkbox"/> JULY 74</td></tr> <tr><td><input type="checkbox"/> OCT 67</td><td><input type="checkbox"/> MAY 71</td><td><input type="checkbox"/> AUG 74</td></tr> <tr><td><input type="checkbox"/> JUNE 68</td><td><input type="checkbox"/> JUNE 71</td><td><input type="checkbox"/> SEPT 74</td></tr> <tr><td><input type="checkbox"/> JULY 68</td><td><input type="checkbox"/> JULY 71</td><td><input type="checkbox"/> OCT 74</td></tr> <tr><td><input type="checkbox"/> SEPT 68</td><td><input type="checkbox"/> AUG 71</td><td><input type="checkbox"/> NOV 74</td></tr> <tr><td><input type="checkbox"/> JAN 69</td><td><input type="checkbox"/> SEPT 71</td><td><input type="checkbox"/> DEC 74</td></tr> <tr><td><input type="checkbox"/> FEB 69</td><td><input type="checkbox"/> OCT 71</td><td><input type="checkbox"/> FEB 75</td></tr> <tr><td><input type="checkbox"/> MAR 69</td><td><input type="checkbox"/> NOV 71</td><td><input type="checkbox"/> APR 75</td></tr> <tr><td><input type="checkbox"/> APR 69</td><td><input type="checkbox"/> AUG 72</td><td><input type="checkbox"/> AUG 75</td></tr> <tr><td><input type="checkbox"/> MAY 69</td><td><input type="checkbox"/> SEPT 72</td><td><input type="checkbox"/> SEPT 75</td></tr> <tr><td><input type="checkbox"/> JUNE 69</td><td><input type="checkbox"/> OCT 72</td><td><input type="checkbox"/> OCT 75</td></tr> <tr><td><input type="checkbox"/> JULY 69</td><td><input type="checkbox"/> NOV 72</td><td><input type="checkbox"/> NOV/DEC 75</td></tr> <tr><td><input type="checkbox"/> AUG 69</td><td><input type="checkbox"/> DEC 72</td><td><input type="checkbox"/> JAN 76</td></tr> <tr><td><input type="checkbox"/> SEPT 69</td><td><input type="checkbox"/> JAN 73</td><td><input type="checkbox"/> FEB 76</td></tr> <tr><td><input type="checkbox"/> OCT 69</td><td><input type="checkbox"/> APR 73</td><td><input type="checkbox"/> MAR 76</td></tr> <tr><td><input type="checkbox"/> NOV 69</td><td><input type="checkbox"/> JUNE 73</td><td><input type="checkbox"/> MAY 76</td></tr> <tr><td><input type="checkbox"/> DEC 69</td><td><input type="checkbox"/> AUG 73</td><td><input type="checkbox"/> JUNE 76</td></tr> <tr><td><input type="checkbox"/> JAN 70</td><td><input type="checkbox"/> SEPT 73</td><td><input type="checkbox"/> JULY 76</td></tr> <tr><td><input type="checkbox"/> FEB 70</td><td><input type="checkbox"/> OCT 73</td><td><input type="checkbox"/> AUG 76</td></tr> <tr><td><input type="checkbox"/> MAR 70</td><td></td><td><input type="checkbox"/> SEPT 76</td></tr> <tr><td><input type="checkbox"/> APR 70</td><td></td><td><input type="checkbox"/> OCT 76</td></tr> <tr><td></td><td></td><td><input type="checkbox"/> NOV 76</td></tr> <tr><td></td><td></td><td><input type="checkbox"/> DEC 76</td></tr> <tr><td></td><td></td><td><input type="checkbox"/> HOLIDAY 76</td></tr> </table>	<input type="checkbox"/> JUNE 63	<input type="checkbox"/> MAY 70	<input type="checkbox"/> NOV 73	<input type="checkbox"/> AUG 63	<input type="checkbox"/> JUNE 70	<input type="checkbox"/> DEC 73	<input type="checkbox"/> OCT 63	<input type="checkbox"/> DEC 70	<input type="checkbox"/> FEB 74	<input type="checkbox"/> FEB 64	<input type="checkbox"/> JAN 71	<input type="checkbox"/> APR 74	<input type="checkbox"/> MAY 67	<input type="checkbox"/> FEB 71	<input type="checkbox"/> MAY 74	<input type="checkbox"/> JULY 67	<input type="checkbox"/> MAR 71	<input type="checkbox"/> JULY 74	<input type="checkbox"/> OCT 67	<input type="checkbox"/> MAY 71	<input type="checkbox"/> AUG 74	<input type="checkbox"/> JUNE 68	<input type="checkbox"/> JUNE 71	<input type="checkbox"/> SEPT 74	<input type="checkbox"/> JULY 68	<input type="checkbox"/> JULY 71	<input type="checkbox"/> OCT 74	<input type="checkbox"/> SEPT 68	<input type="checkbox"/> AUG 71	<input type="checkbox"/> NOV 74	<input type="checkbox"/> JAN 69	<input type="checkbox"/> SEPT 71	<input type="checkbox"/> DEC 74	<input type="checkbox"/> FEB 69	<input type="checkbox"/> OCT 71	<input type="checkbox"/> FEB 75	<input type="checkbox"/> MAR 69	<input type="checkbox"/> NOV 71	<input type="checkbox"/> APR 75	<input type="checkbox"/> APR 69	<input type="checkbox"/> AUG 72	<input type="checkbox"/> AUG 75	<input type="checkbox"/> MAY 69	<input type="checkbox"/> SEPT 72	<input type="checkbox"/> SEPT 75	<input type="checkbox"/> JUNE 69	<input type="checkbox"/> OCT 72	<input type="checkbox"/> OCT 75	<input type="checkbox"/> JULY 69	<input type="checkbox"/> NOV 72	<input type="checkbox"/> NOV/DEC 75	<input type="checkbox"/> AUG 69	<input type="checkbox"/> DEC 72	<input type="checkbox"/> JAN 76	<input type="checkbox"/> SEPT 69	<input type="checkbox"/> JAN 73	<input type="checkbox"/> FEB 76	<input type="checkbox"/> OCT 69	<input type="checkbox"/> APR 73	<input type="checkbox"/> MAR 76	<input type="checkbox"/> NOV 69	<input type="checkbox"/> JUNE 73	<input type="checkbox"/> MAY 76	<input type="checkbox"/> DEC 69	<input type="checkbox"/> AUG 73	<input type="checkbox"/> JUNE 76	<input type="checkbox"/> JAN 70	<input type="checkbox"/> SEPT 73	<input type="checkbox"/> JULY 76	<input type="checkbox"/> FEB 70	<input type="checkbox"/> OCT 73	<input type="checkbox"/> AUG 76	<input type="checkbox"/> MAR 70		<input type="checkbox"/> SEPT 76	<input type="checkbox"/> APR 70		<input type="checkbox"/> OCT 76			<input type="checkbox"/> NOV 76			<input type="checkbox"/> DEC 76			<input type="checkbox"/> HOLIDAY 76	<p>73 Magazine Back Issue Classics (All 1977 issues are still available!)</p> <p><input type="checkbox"/> \$5.00* — 5 Issues (indicate your choice at left)</p> <p><input type="checkbox"/> \$10.00* — 25 issues — our choice</p> <p>\$ _____ Enclosed. <input type="checkbox"/> Cash <input type="checkbox"/> Check <input type="checkbox"/> Money order</p> <p><input type="checkbox"/> American Express <input type="checkbox"/> BankAmericard/VISA <input type="checkbox"/> Master Charge</p> <p>Credit Card # _____ Expiration date _____</p> <p>Signature _____</p> <p><input type="checkbox"/> Vintage <input type="checkbox"/> Mid-years <input type="checkbox"/> Nearly new</p> <p>Name _____</p> <p>Address _____</p> <p>City _____ State _____ Zip _____</p> <p>*Add \$1.00 shipping and handling charge.</p>
<input type="checkbox"/> JUNE 63	<input type="checkbox"/> MAY 70	<input type="checkbox"/> NOV 73																																																																																						
<input type="checkbox"/> AUG 63	<input type="checkbox"/> JUNE 70	<input type="checkbox"/> DEC 73																																																																																						
<input type="checkbox"/> OCT 63	<input type="checkbox"/> DEC 70	<input type="checkbox"/> FEB 74																																																																																						
<input type="checkbox"/> FEB 64	<input type="checkbox"/> JAN 71	<input type="checkbox"/> APR 74																																																																																						
<input type="checkbox"/> MAY 67	<input type="checkbox"/> FEB 71	<input type="checkbox"/> MAY 74																																																																																						
<input type="checkbox"/> JULY 67	<input type="checkbox"/> MAR 71	<input type="checkbox"/> JULY 74																																																																																						
<input type="checkbox"/> OCT 67	<input type="checkbox"/> MAY 71	<input type="checkbox"/> AUG 74																																																																																						
<input type="checkbox"/> JUNE 68	<input type="checkbox"/> JUNE 71	<input type="checkbox"/> SEPT 74																																																																																						
<input type="checkbox"/> JULY 68	<input type="checkbox"/> JULY 71	<input type="checkbox"/> OCT 74																																																																																						
<input type="checkbox"/> SEPT 68	<input type="checkbox"/> AUG 71	<input type="checkbox"/> NOV 74																																																																																						
<input type="checkbox"/> JAN 69	<input type="checkbox"/> SEPT 71	<input type="checkbox"/> DEC 74																																																																																						
<input type="checkbox"/> FEB 69	<input type="checkbox"/> OCT 71	<input type="checkbox"/> FEB 75																																																																																						
<input type="checkbox"/> MAR 69	<input type="checkbox"/> NOV 71	<input type="checkbox"/> APR 75																																																																																						
<input type="checkbox"/> APR 69	<input type="checkbox"/> AUG 72	<input type="checkbox"/> AUG 75																																																																																						
<input type="checkbox"/> MAY 69	<input type="checkbox"/> SEPT 72	<input type="checkbox"/> SEPT 75																																																																																						
<input type="checkbox"/> JUNE 69	<input type="checkbox"/> OCT 72	<input type="checkbox"/> OCT 75																																																																																						
<input type="checkbox"/> JULY 69	<input type="checkbox"/> NOV 72	<input type="checkbox"/> NOV/DEC 75																																																																																						
<input type="checkbox"/> AUG 69	<input type="checkbox"/> DEC 72	<input type="checkbox"/> JAN 76																																																																																						
<input type="checkbox"/> SEPT 69	<input type="checkbox"/> JAN 73	<input type="checkbox"/> FEB 76																																																																																						
<input type="checkbox"/> OCT 69	<input type="checkbox"/> APR 73	<input type="checkbox"/> MAR 76																																																																																						
<input type="checkbox"/> NOV 69	<input type="checkbox"/> JUNE 73	<input type="checkbox"/> MAY 76																																																																																						
<input type="checkbox"/> DEC 69	<input type="checkbox"/> AUG 73	<input type="checkbox"/> JUNE 76																																																																																						
<input type="checkbox"/> JAN 70	<input type="checkbox"/> SEPT 73	<input type="checkbox"/> JULY 76																																																																																						
<input type="checkbox"/> FEB 70	<input type="checkbox"/> OCT 73	<input type="checkbox"/> AUG 76																																																																																						
<input type="checkbox"/> MAR 70		<input type="checkbox"/> SEPT 76																																																																																						
<input type="checkbox"/> APR 70		<input type="checkbox"/> OCT 76																																																																																						
		<input type="checkbox"/> NOV 76																																																																																						
		<input type="checkbox"/> DEC 76																																																																																						
		<input type="checkbox"/> HOLIDAY 76																																																																																						

73 magazine
 Peterborough NH
 03458

73/5/78

**Bargain
Corner**

**Savings of
\$20.00-\$30.00 on
cassette tapes!!**

**10 digitally certified C60
tapes for only \$19.00
Bought individually you pay
up to \$4.00-\$5.00 per tape!!!
Interested? Read on . . .**

You probably know that if you want to be sure of saving a program on a cassette you must have good tape . . . very good tape. The best for this use is digitally certified tape. This is specially made cassette tape which is guaranteed not to have any drop outs. Normally this digitally certified tape is so expensive that most hobbyists try to make do with the better grades of audio tape. This is why so many programs lose bits here and there.

Kilobaud, by virtue of its buying power, has been able to get some top grade BASF digitally certified cassettes and make them available at ordinary audio tape prices. Our main business is publishing magazines and books, so when we are able to come up with a deal like this we like to pass it along to you at the lowest price we can. In this case we can send you, postpaid in the U.S., ten digitally certified C-60 cassettes for only \$19.

These are 60 minute cassettes so you'll be able to store enormous amounts of programs and data on them. We don't know how long we'll be able to make this incredible deal available to you, so rush your order and stock up while the bargain lasts. These prices are subject to change without notice . . . possibly with our next stocking order from the manufacturer who may discover that he's charged us too little.

Use order card in the back of this magazine or itemize your order and send to:

73 Magazine • Peterborough NH 03458

**Hot
Item!!**

**WEATHER
SATELLITE
HANDBOOK
\$4.95**

*Weather Satellite Antenna Systems,
Receivers, How To Find & Track
Satellites . . .*



A complete satellite ground station can be built for less than the cost of a good television set! And you don't have to be a mechanical or electrical genius, either. This text is fully illustrated and you will find information on simple equipment, methods for producing good pictures from the weather satellite, antennas, receivers, monitors, tracking & automatic control.

Use the order card in the back of this magazine or itemize your order and send to:

73 Magazine • Peterborough NH 03458

SEND FOR THESE GREAT BOOKS TODAY!



● **HOBBY COMPUTERS ARE HERE** If you (or a friend) want to come up to speed on how computers work . . . hardware and software . . . this is an excellent book. It starts with the fundamentals and explains the circuits, the basics of programming, along with a couple of TVT construction projects, ASCII-Baudot, etc. This book has the highest recommendations as a teaching aid for newcomers. \$4.95

● **THE NEW HOBBY COMPUTERS!** This book takes it from where "Hobby Computers Are Here" leaves off, with chapters on Large Scale Integration, how to choose a microprocessor chip, an introduction to programming, low cost I/O for a computer, computer arithmetic, checking memory boards, a Baudot monitor/editor system, an audible logic probe for finding those tough problems, a ham's computer, a computer QSO machine . . . and much, much more! Everything of interest is there in one volume. Don't miss this tremendous value! Only \$4.95

Have your credit card handy and call toll-free 800-258-5473, or use the card in the back of this magazine and send your check to:

73 Book Dept. • Peterborough NH 03458

(Be sure to include \$1.00 per order for shipping & handling.)

**The New RTTY Handbook
Revised & Up to Date!
\$5.95**

The only up-to-date RTTY HANDBOOK available. The state-of-the-art is changing radically and has made all other RTTY books obsolete. Includes the latest equipment, terminal units, frequency shift-keying, tuning aids, RTTY art and accessories. \$5.95.*



Edited by 73 Magazine Staff

**Use the order card in the back of this magazine or itemize your order and send to:*

73 Magazine • Peterborough NH 03458

The Challenge of 160!

Tired of talking to the same characters on 75 every evening? Perhaps it's time to try a new band — something different and exciting. Consider 160 meters. The "Top Band" is different from any other amateur allocation. Its propagation characteristics are unique, resembling the standard AM broadcast band. Amateur radio's roots can be traced to 160, as it was there (actually, 200 meters) that amateur radio began.

If you are remotely interested in 160 meter operation, *The Challenge of 160*, is for you. Si Dunn, the author, has compiled a complete reference for the new and experienced 160 operator. Eleven chapters cover everything from receiving and transmitting equipment to antenna and ground systems. This reference is heavily illustrated and complete schematics are provided for construction projects. Price: \$4.95.

Use the order card in the back of the magazine or itemize your order on a separate paper & mail to: 73 Radio Bookshop/Peterborough NH 03458. Be sure to include check or detailed credit card information.



NEW BOOK!
... \$4.95*

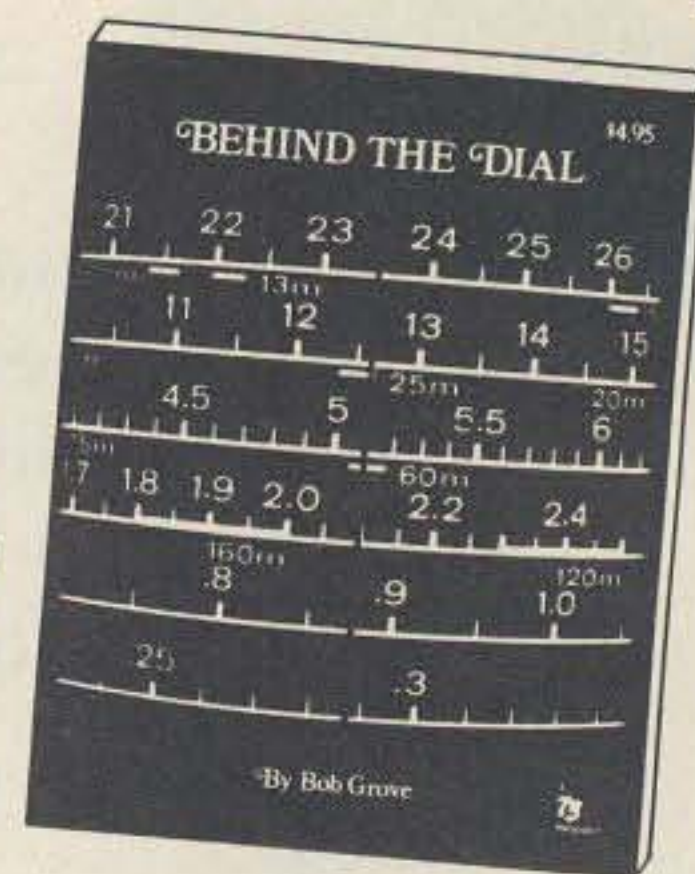

BEHIND THE DIAL By Bob Grove

Get more fun out of shortwave listening with this interesting guide to receivers, antennas, frequencies, and interference. Contains the following chapters:

- *The Electromagnetic Spectrum: A Review*
- *Users of the Radio Spectrum*
- *Surveillance*
- *Station Layout Considerations*
- *Antenna Systems*
- *Interference*

Use the order card in the back of this magazine or itemize your order on a separate piece of paper. (Be sure to include check or detailed credit card information.) *Add \$1.00 shipping & handling charge for each order and mail to:

73 Radio Bookshop • Peterborough NH 03458

73 Magazine's TEST EQUIPMENT LIBRARY

● **VOLUME I: COMPONENT TESTERS** How to build transistor testers, diode testers, IC testers, voltmeters and VTVM's. Crystal checking, temperature, aural meters for the blind, and loads of other miscellaneous data on meters ... using them, making them more versatile. This is an invaluable book at \$4.95.*

● **VOL. II: AUDIO FREQUENCY TESTERS** This volume is jam packed with all kinds of audio frequency test equipment. If you're into SSB, RTTY, SSTV, etc., this book is a must for you ... a great book for hi-fi addicts and experimenters, too! \$4.95.*



● **VOL. III: RADIO FREQUENCY TESTERS** Radio frequency waves, the common denominator of Amateur Radio. Such items as SWR, antenna impedance, line impedance, rf output and field strength; detailed instructions on testing these items includes sections on signal generators, crystal calibrators, grid dip oscillators, noise generators, dummy loads and much more. \$4.95.*

● **VOLUME IV: IC TEST EQUIPMENT** Become a troubleshooting wizard! ICs have greatly simplified even the most sophisticated pieces of test equipment, making them fun to build. You can save thousands of dollars by building your own equipment and have a test lab which would make a university jealous.

A brand new book, IC TEST EQUIPMENT, has construction projects for making 37 pieces of test equipment. Square wave generator, pulse generator, timer, audio synthesizer, AFSK generator, sync generator, counter, capacity meter, etc. Order this book today and get started building your own lab. \$4.95.*

Use the order card in the back of the magazine or itemize your order on a separate piece of paper and mail to
73 MAGAZINE, Peterborough NH 03458
or phone toll free 800-258-5473.

Be sure to include check or detailed credit information. *Add \$1 shipping and handling charge for each order.

PROPAGATION

by
J. H. Nelson

Revised Repeater Atlas
of the entire world

**MORE LISTINGS
THAN
EVER
BEFORE!**

Our NEW edition is 150% as big as any list ever available - nearly 900 more listings than the previous editions. Plus new improved maps show the location by frequency of every repeater in the states.

Only \$1.95

Use order card in the back of this magazine or itemize your order separately. Add \$1.00 shipping & handling per order, and send to:

73 Radio Bookshop
Peterborough NH 03458

Complete Novice Class Study Kit

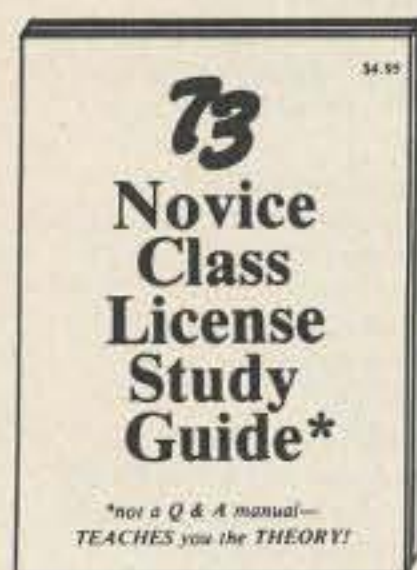

- NOVICE CLASS HANDBOOK
- 4 NOVICE THEORY TAPES
- BEGINNER CODE TAPE (5 WPM)
- 6+ WPM PRACTICE CODE TAPE

SAVE \$5.80!!

All the study aids you need to become a ham
for only \$25.00.

(See page 216 for detailed description of this BARGAIN.)

Use order card in the back of this magazine or itemize your order and send to:

73 MAGAZINE • Peterborough NH 03458

EASTERN UNITED STATES TO:

	GMT:	00	02	04	06	08	10	12	14	16	18	20	22
ALASKA	14	14	7	7	7	7	7	7	7	7	7	7	7A
ARGENTINA	14	14	14	7	7	7	14	14	14A	21	21	14A	
AUSTRALIA	14	14	7B	7B	7B	7	7	7	7	7	14	14	
CANAL ZONE	14	14	7A	7	7	7	7	14	14	14	14	14A	
ENGLAND	7A	7	7	7	7	7	14	14	14	14	14	14	
HAWAII	14	14	7B	7B	7	7	7	7	7A	14	14	14	
INDIA	7	7B	7B	7B	7B	7B	14	14	14	14	14	7	
JAPAN	14	7A	7B	7	7	7	7	7	7	7	7A	14	
MEXICO	14	14	7	7	7	7	7	7	7A	14	14	14	
PHILIPPINES	14	14	7B	7B	7B	7B	7B	7	7	7	14B	14	
PUERTO RICO	14	7A	7	7	7	7	7	7	7A	14	14	14	
SOUTH AFRICA	7B	7	3A	7	7B	14B	14	14	14	21	14	14B	
U. S. S. R.	7	7	7	7	7	7	7	7A	14	14	14	14	7A
WEST COAST	14	14	7A	7	7	7	7	14	14	14	14	14	

CENTRAL UNITED STATES TO:

ALASKA	14	14	14	7	7	7	7	7	7	7	7	7	14
ARGENTINA	14	14	14	7	7	7	14	14	14	14	14A	21	
AUSTRALIA	14	14	14	7B	7B	7	7	7	7	7	14	14	
CANAL ZONE	14A	14	7A	7	7	7	7	14	14	14	14	14A	
ENGLAND	7A	7	7	7	7	7	7	7A	14	14	14	14	
HAWAII	14	14	7A	7B	7	7	7	7	14	14	14	14	
INDIA	7	7B	7B	7B	7B	7B	7B	7B	14	14	14	7A	
JAPAN	14	14	14	7B	7	7	7	7	7	7	7A	14	
MEXICO	14	14	7	7	7	7	7	7	7	14	14	14	
PHILIPPINES	14	14	14	7B	7B	7B	7B	7	7	7	14B	14	
PUERTO RICO	14	14	7	7	7	7	14	14	14	14	14	14	
SOUTH AFRICA	7B	7	3A	7	7B	7B	14	14	14	14	14	14B	
U. S. S. R.	7	7	7	7	7	7	7	7	7	7A	14	14	7A

WESTERN UNITED STATES TO:

ALASKA	7A	14	7A	7	7	7	7	7	7	7	7	7	7A
ARGENTINA	14A	14	14	7	7	7	7	14	14	14	14A	21	
AUSTRALIA	14A	21	21	14	14	7	7	7	7	7	14	14A	
CANAL ZONE	14A	14	14	7	7	7	7	14	14	14	14	14	
ENGLAND	7A	7B	7	7	7	7	7B	7B	7A	14	14	14	
HAWAII	14A	21	14	14	7	7	7	7	14	14	14	14	
INDIA	14	14	14	7B	7B	7B	7B	7B	7	7	7	7A	
JAPAN	14	14	14	7A	7B	7	7	7	7	7	14	14	
MEXICO	14	14	14	7	7	7	7	7	14	14	14	14	
PHILIPPINES	14	14	14	14	7B	7B	7B	7	7	14B	14	14	
PUERTO RICO	14	14	7A	7	7	7	7	14	14	14	14	14	
SOUTH AFRICA	7B	7B	3A	7	7B	7B	7B	7B	14B	14	14	14B	
U. S. S. R.	7	7	7	7	7	7	7	7	14	14	7	7	
EAST COAST	14	14	7A	7	7	7	7	14	14	14	14	14	

- A = Next higher frequency may also be useful
- B = Difficult circuit this period
- F = Fair
- G = Good
- P = Poor

may

sun	mon	tue	wed	thu	fri	sat
	1	2	3	4	5	6
	G	F	F	P	P	F
7	8	9	10	11	12	13
G	G	G	F	G	G	G
14	15	16	17	18	19	20
G	G	G	G	G	G	F
21	22	23	24	25	26	27
F	P	P	P	F	G	G
28	29	30	31		☉	☽
G	G	G	G		14 15	14 22 14 31

IS HARD COPY STORAGE A PROBLEM?



73, as thick as it is, is more like a floppy when it comes to standing on the bookshelf. Try the 73 Library Shelf Boxes, . . . sturdy corrugated white dirt resistant cardboard boxes which will keep them from flopping around. We have self-sticking labels for the boxes, too, not only for 73, but also for *Kilobaud* . . . and for *CQ*, *QST*, *Ham Radio*, *Personal Computing*, *Radio Electronics*, *Interface Age*, and *Byte*. Ask for whatever stickers you want with your box order. They hold a full year of 73 . . . or *Kilobaud*. Your magazine library is your prime reference, keep it handy and keep it neat with these strong library shelf boxes . . . One box is \$2.00, 2 boxes are \$3.00 and eight boxes are \$10.00. Be sure to specify which labels we should send. Have your credit card handy and call our toll-free order number 800-258-5473, or use the order card in the back of the magazine and mail to:

73 LIBRARY SHELF BOXES Peterborough, NH 03458

For a little bit extra YOU CAN go first class!

. . . . And binders for your 73 Magazines are the first class way to go.

Your back issues of 73 are your very best encyclopedia of electronics and you don't want to take any chances on losing any of them. If you put them into the handsome 73 Binders, you'll have your copies when you want them . . . and all together with that yearly index in the December issue. Why is it that the article you need the most is always in a missing issue? Let's see . . . did Charlie borrow it or did it get lost when we cleaned up last year? Get a binder . . . only \$6.50 in red with gold lettering. Two for \$12.00.



Use the order card in the back of the magazine or itemize your order on a separate paper & mail to:

73 Magazine Binders
Peterborough NH 03458

Be sure to include check or detailed credit card information. Add \$1.00 shipping & handling charge for each order.

73 magazine

ADVERTISER index

- A46 ABC Communications 64
- A1 Adirondack Radio Supply 56
- A24 Adva Electronics 198
- A2 Aldelco 209
- A47 Aluma Tower Company 56
- * Amateur Computing 78 115
- A40 Amateur Radio Supply of Nashville, Inc. 191
- A40 Amateur Radio Supply of North Atlanta, Inc. 191
- A51 Amateur Radio of Rochester 159
- A26 Amidon Associates 57
- A6 Apron Laboratories 139
- A50 Associated Radio 193
- A15 Atlanta Ham Festival 44
- B23 Barker & Williamson 57
- B24 Bristol Electronics 65
- B29 Britt 2 Way Radio 157
- B8 Bullet Electronics 202
- B30 Burghardt Amateur Center 5
- C1 CeCo Communications, Inc. 132
- C3 Clegg 61
- C21 Coakit 133
- C63 Colorado Silver Company 133
- C68 Communications Center, CA 161
- C58 Communications Center, NE 97, 187
- C6 Communications Specialists 10, 11
- C9 Continental Specialties 3
- C67 Cushcraft 189
- D6 Peter W. Dahl Company 214
- D10 Davis Electronics 82
- D27 Digital Electronics 137
- D20 Digital Research Corporation 204, 205
- D25 Diversified Security Industries 131
- D23 Davetron 133
- E1 ECM Corporation 132
- E19 Edgecom 119
- E21 Electronic Systems 98
- E12 Engineering Specialties 194
- F1 Fair Radio Sales 82
- F5 Fleisher Corporation 138
- F3 Freck Radio & Supply 138
- G12 Germanlowen Amateur Supply 155
- G4 Godbout 206
- * HAL Communications Corp. 182, 183
- H24 Hal-Tronix 179
- * Ham Com/76 118
- H2 Ham Radio Center 211
- H16 Hamtronics NY 201
- H8 Hamtronics PA 79
- H15 Hatry 179
- H3 Henry Radio Cll
- H23 Hobbi House 199
- I1 ICOM 4, 45
- I9 Integrated Circuits, Unltd. 196
- I10 International Data Systems, Inc. 108
- I19 Island Antennas 138
- J6 Jade Computer Products 210
- J1 James Electronics 207
- J2 Jan Crystals 56
- J9 JBW Electronics, Inc. 185
- J10 JM Industries 192
- J8 JRS Electronics 139
- K13 Kantronic 155, 157
- * Kenwood CIV, 7
- K14 Key Electronics 139
- KB Kilobaud 99
- L11 Logitronics 44
- L9 Long's Electronics 140-145
- L10 L-Tronics 161
- M35 Madison Electronics Supply 23
- M36 Maggiore Electronic Labs 153
- M41 Midland International 83
- M43 Murch Electronics, Inc. 75
- N2 New-Tronics 9
- O5 OK Machine & Tool 104, 105
- O3 Optoelectronics 203
- P15 Pace-Traps 132
- P30 Palomar Electronics 17
- P1 Palomar Engineers 164
- P31 Panasonic 29
- P29 Pipa Communications 133
- P2 Poly Paks 197
- P26 Printed Circuit Products 139
- P21 Priority One 109
- O3 Quest Electronics 56
- R1 Radio Amateur Callbook 195
- * Radio World 138
- R8 Ramsey Electronics 200
- R15 Rolin Distributors 57
- R21 Rush Electronics 138
- R18 RW Electronics 138
- S39 Sera-Rose & Spencer 139
- S33 S-F Amateur Radio Services 139
- S8 Spectrum Communications 127
- S10 SST Electronics 71
- S38 Stuart Electronics 23
- S47 Subminiature Instruments Corporation 138
- S43 Surplus Electronics 212
- T31 Telephone Equipment Company 139
- T13 Teletypewriter Communication Specialists 115
- T30 Television Equipment Associates 23
- * Ten Tec 13
- T32 Torrestronics, Inc. 133
- T18 Trac Electronics, Inc. 159
- T1 Tri-Tek, Inc. 208
- T3 Tufts Radio Electronics 165-178
- U2 Unarco-Rohn 57
- V1 Vanguard Labs 132
- V16 VE 2 AED 163
- V5 VHF Engineering 91
- W17 Westcom Engineering 164
- W18 Western Electronics 138
- W2 Wilson Electronics 21
- X1 Xitex 132
- Y1 Yaesu Electronics Corporation CIII, 15, 19
- Z1 ZZZ Electronics, Inc. 163

From 73 . . . 99, 213-226

*Reader Service inquiries not honored.

BOOKS —etc.

- Advanced BASIC \$6.95
- BASIC New 2nd Edition \$4.95
- BASIC Software Library
- Vol. I — \$24.95; Vol. II — \$24.95
- Vol. III — \$39.95; Vol. IV — \$9.95
- Vol. V — \$9.95
- Behind the Dial \$4.95
- Build-it Book of Digital Electronic Timepieces \$6.95
- Chemistry with a Computer \$9.95
- CMOS Cookbook \$9.95
- "Compulator" Book \$7.95
- Computer Dictionary \$5.95
- Computer Programming Handbook \$9.95
- Computer Quiz Book \$5.95
- 73 Dipole & Long Wire Antennas \$5.50
- Discovering Basic \$6.85
- Fascinating World of Radio Communication \$3.95
- Fortran Programming \$7.95
- Fortran Workbook \$4.95
- Fun with Computers and BASIC \$6.95
- Hobby Computers Are Here! \$4.95
- Home Computers 210 Questions and Answers
- Vol. I — \$7.95; Vol. II — \$6.95
- How To Buy & Use Minicomputers & Microcomputers \$9.95
- How To Make Better QSLs \$2.00
- How To Program Microcomputers \$8.95
- IC OP Amp Cookbook \$12.95
- IC Timer Cookbook \$9.95
- An Introduction to Microcomputers
- Vol. I — \$7.50; Vol. II — \$12.50
- Introduction to Microprocessors \$17.50
- Introduction to RTTY \$2.00
- Master Handbook of Ham Radio Circuits \$8.95
- Microcomputer Dictionary \$15.95
- Microcomputer Primer \$7.95
- Microprocessors from Chips to Systems \$9.95
- Microprocessor Interfacing Techniques \$9.95
- Microprocessor Programming for Computer Hobbyists \$8.95
- My Computer Likes Me . . . When I Speak BASIC \$2.00
- New Hobby Computers \$4.95
- Periodical Guide for Computerists 1976 \$3.00
- Jan.—June '77 \$3.00
- A Quick Look At BASIC \$4.95
- RF Digital Test Equipment You can Build \$5.95
- Revised Repeater Atlas of the Entire World \$1.95
- RTL Cookbook \$5.50
- The New RTTY Handbook \$5.95
- Scelbi's Galaxy Game for the 6800 \$14.95
- The Secret Guide to Computers
- Part I — \$2.75; Part II — \$2.50
- Part III — \$3.50
- Some Common Basic Programs \$7.50
- SSTV Handbook — Hard \$7.00; Soft — \$5.00
- The Story of Computers \$4.95
- Study Guides
- Novice \$4.95 Advanced \$5.95
- General \$5.95 Extra Class \$5.95
- Test Equipment Library
- Vol. I Component Testers \$4.95
- Vol. II Audio Frequency Testers \$4.95
- Vol. III Radio Frequency Testers \$4.95
- Vol. IV IC Test Equipment \$4.95
- TTL Cookbook \$8.95
- TVT Cookbook \$9.95
- Tychon's 8080 Hex Code Card \$3.00
- Tychon's 8080 Octal Code Card \$3.00
- The Underground Buying Guide \$5.95
- VHF Ant. Handbook \$4.95
- Vertical Beam and Triangle Antennas \$5.50
- Weather Satellite Handbook \$4.95
- What To Do After You Hit Return \$8.00
- Your Own Computer \$1.95
- 60 Challenging Problems With BASIC Solutions \$6.95
- 101 BASIC Computer Games \$7.50
- 1001 Practical Electronic Circuits \$9.95
- 6800 Software Gourmet Guide and Cookbook \$9.95
- 8008 Software Gourmet Guide and Cookbook \$9.95
- 6800 Programming for Logic Design \$7.50
- 8080 Programming for Logic Design \$7.50
- 8080 A Bugbook — \$9.95
- Back issue Bundles 25 different copies \$10.00
- 73 Binders \$6.00 ea.; 2 for \$11.00
- Kilobaud 1 year sub. \$15.00
- 73 1 year sub. \$15.00
- Bumper Stickers 50¢ ea.; Any 3 for \$1.00
- Code Tapes \$4.95 ea.; 4/\$15.95
- 5 WPM 13+ WPM 6+ WPM 20+ WPM
- Computermania T-shirts \$5.50
- Library Shelf Boxes \$2 ea.; \$1.50 ea. additional box.
- Novice Theory Tapes \$15.95 (set of 4)
- QSLs — Styles W, X, or Y 250 — \$8.95;
- 500 — \$14.95

WIN A LIFETIME OF 73!

Here is your chance to win a Lifetime Subscription to 73 in our monthly reader service drawing. Circle the appropriate reader service # for desired company brochures, data sheets or catalogs and mail to 73. Include your zip code, please. LIMIT: 25 requests.

- | | | | | | | | | | |
|-----|-----|-----|-----|-----|-----|-----|-----|-----|-----|
| A46 | A15 | C58 | E19 | H8 | J9 | M41 | P26 | S10 | U2 |
| A1 | B23 | C6 | E21 | H15 | J10 | M43 | P21 | S38 | V1 |
| A24 | B24 | C9 | E12 | H3 | J8 | N2 | Q3 | S47 | V16 |
| A2 | B29 | C67 | F1 | H23 | K13 | O5 | R1 | S43 | V5 |
| A47 | B8 | D6 | F5 | I1 | K14 | O3 | R8 | T31 | W17 |
| A40 | B30 | D10 | F3 | I9 | KB | P15 | R15 | T13 | W18 |
| A40 | C1 | D27 | G12 | I10 | L11 | P30 | R21 | T30 | W2 |
| A51 | C3 | D20 | G4 | I19 | L9 | P1 | R18 | T32 | X1 |
| A26 | C21 | D25 | H24 | J6 | L10 | P31 | S39 | T18 | Y1 |
| A6 | C63 | D23 | H2 | J1 | M35 | P29 | S33 | T1 | Z1 |
| A50 | C68 | E1 | H16 | J2 | M36 | P2 | S8 | T3 | |

This month's **ARTICLE WINNER** (title page number): _____

Name _____

Address _____

City _____ State _____ Zip _____

A5/78



POLL

Age _____

Job title: _____

Education: High School
 College Masters PhD

Approximate investment in radio equipment in 1975: \$ _____

1976 \$ _____; 1977 \$ _____

Possible investment in 1978 \$ _____

What equipment have you (make, model) _____

How long does it take you to read all the articles in 73? _____

Including yourself, how many people read your copy of 73? _____

PLACE STAMP HERE

73 magazine
 peterborough, n.h.
 03458

Attn: Reader Service

SUBSCRIBE! 1 year @ \$15* 3 years @ \$36* Life Sub @ \$195**
 73 Magazine Kilobaud
 Renewal—Expira. date _____ *U.S. & Canada only. (U.S. currency, please)
 New subscription **U.S. only

Please send me the following 73 products:

Quantity	Description	Unit Price	Total

Please print or type! Coupon expires in 60 days. Shipping & Handling Charge \$1.00
 Total _____

Enclosed \$ _____ Cash Check Money order
 Bill: American Express BankAmericard/Visa Master Charge

Credit Card # _____

Expiration date _____ Signature _____

Name _____

Address _____

City _____ State _____ Zip _____

A5/78



POLL

Age _____

Job title: _____

Education: High School
 College Masters PhD

Approximate investment in radio equip-
ment in 1975: \$ _____;

1976 \$ _____; 1977 \$ _____;

Possible investment in 1978 \$ _____

What equipment have you (make, model)

How long does it take you to read all the ar-
ticles in 73? _____

Including yourself, how many people read
your copy of 73? _____

PLACE
STAMP
HERE

73 magazine
peterborough, n.h.
03458

Attn: Reader Service

WIN A LIFETIME OF 73!

Here is your chance to win a Lifetime Subscription to 73 in our monthly reader service drawing. Circle the appropriate reader service # for desired company brochures, data sheets or catalogs and mail to 73. Include your zip code, please. LIMIT: 25 requests.

A46	A15	C58	E19	H8	J9	M41	P26	S10	U2
A1	B23	C6	E21	H15	J10	M43	P21	S38	V1
A24	B24	C9	E12	H3	J8	N2	Q3	S47	V16
A2	B29	C67	F1	H23	K13	O5	R1	S43	V5
A47	B8	D6	F5	I1	K14	O3	R8	T31	W17
A40	B30	D10	F3	I9	KB	P15	R15	T13	W18
A40	C1	D27	G12	I10	L11	P30	R21	T30	W2
A51	C3	D20	G4	I19	L9	P1	R18	T32	X1
A26	C21	D25	H24	J6	L10	P31	S39	T18	Y1
A6	C63	D23	H2	J1	M35	P29	S33	T1	Z1
A50	C68	E1	H16	J2	M36	P2	S8	T3	

This month's **ARTICLE WINNER** (title page number): _____

Name _____

Address _____

City _____ State _____ Zip _____

A5/78

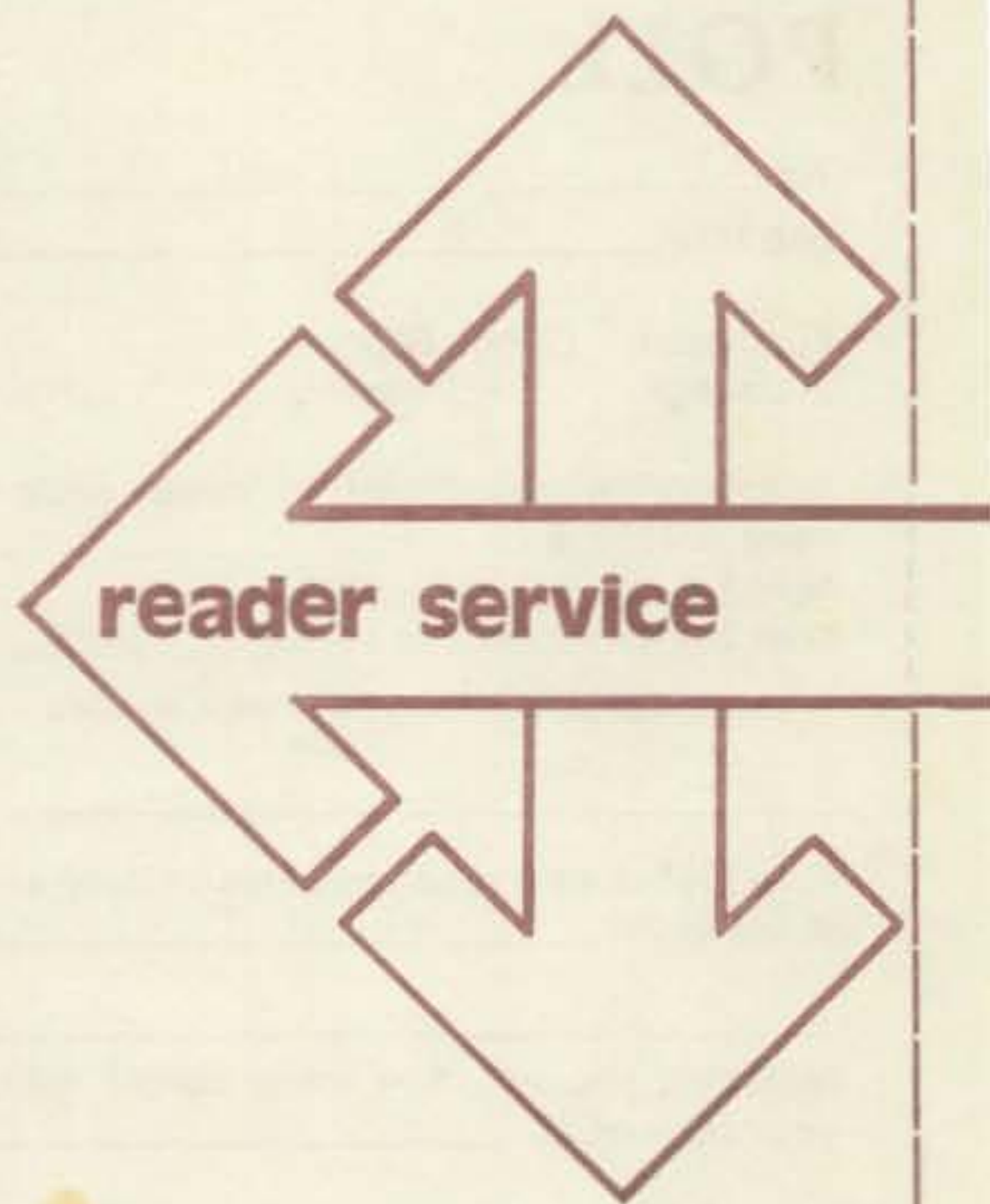

POLL

Age _____

Job title: _____

Education: High School
 College Masters PhD

Approximate investment in radio equip-
ment in 1975: \$ _____;

1976 \$ _____; 1977 \$ _____;

Possible investment in 1978 \$ _____

What equipment have you (make, model)

How long does it take you to read all the ar-
ticles in 73? _____

Including yourself, how many people read
your copy of 73? _____

PLACE
STAMP
HERE

73 magazine
peterborough, n.h.
03458

Attn: Marketing

FT-901DM

COMPETITION-GRADE HF TRANSCEIVER

SPEAK TO THE WORLD IN ANY MODE



Price And Specifications Subject To
Change Without Notice Or Obligation



YAESU
The smart radio

YAESU ELECTRONICS CORP., 15954 Downey Ave., Paramount, CA 90723 (213) 633-4007
YAESU ELECTRONICS CORP., Eastern Service Ctr., 613 Redna Ter., Cincinnati, OH 45215

TS-700SP



STILL THE SAME FINE, TIME PROVEN RIG. BUT NOW WITH THE SIMPLE ADDITION OF A PLUG-IN CRYSTAL, THE TS-700SP WILL BE ABLE TO UTILIZE THE NEW REPEATER SUB-BAND WHEN IT BECOMES AVAILABLE. STILL FEATURES ALL OF THE FINE ATTRIBUTES OF THE TS-700S: A DIGITAL FREQUENCY DISPLAY, RECEIVER PRE-AMP, VOX, SEMI-BREAK IN, AND CW SIDETONE. OF COURSE, IT'S ALL MODE, 144-148 MHZ, VFO CONTROLLED... AND KENWOOD QUALITY THROUGHOUT.

