

73 Magazine

for Radio Amateurs

- 26 **Radio Row Revisited**
—it's alive and well in Tokyo..... W8JJO
- 28 **How To Work Europe With An HT**
—hint: requires trans-Atlantic plane
fare..... WB9PYM
- 34 **What? CB Repeaters?!**
—perfectly legal, too..... WA4EOX
- 38 **A Complete X-Band Transmitter**
—easy to build..... W1SNN
- 44 **Shock!!!**
—what to do when Thor's hammer
falls..... McAlister
- 48 **The PVC Portable**
—a "go anywhere" 2m ground plane..... WA6RJK
- 51 **The Amazing Mobile Life Preserver**
—simple, but effective..... W2EVM
- 52 **Power Line DX**
—(almost) wireless remote control..... N2CX
- 58 **Ruddy Good Show!**
—2 meters in the Mother Country..... G3WDI
- 60 **Rock Steady**
—touchtone™ stability for Heath's
HW-2021..... WA5RON
- 64 **In the Eye of the Beholder**
—ugly transformers make beautiful power
supplies..... WB6JYK
- 72 **The End of Rf Feedback**
—here's how the pros do it..... K4TWJ
- 74 **The Heavyweight**
—a keyer base that stays put..... K9MX
- 76 **Sleight of Hand**
—getting 12 V from 24-V transformers..... K4SE
- 78 **CB to 10**
—part IX: a pair of Radio Shack rigs..... WB2UYI
- 80 **In Search Of Stability**
—temperature-compensated crystal
oscillators..... Burhans
- 82 **On Your Mark!**
—RTTY tips for the TS-820..... WA4KIL, K4FK
- 84 **A WWV Primer**
—become a calibration freak..... W8FX/4
- 90 **The Swiss Fork Special**
—half-a-beam space saver..... Staff
- 92 **The End of the Rat's Nest**
—a sensible operating console..... WB9FRM
- 94 **2001 - 3**
—a ham odyssey..... WA5SNZ
- 100 **The Calculating KIM-1**
—calculator versatility for any KIM.... Lasher
- 106 **A No-Cost Digital Clock**
—use your programmable calculator... N8RK
- 108 **The BASICS of L-Network Design**
—your micro makes it simple..... K7SBK
- 112 **Hung Up On Autopatch?**
—build this frustration fighter..... WA6THG
- 114 **Updating the Wilson 1402**
—making a good rig better..... WA9RAQ
- 115 **Quick Check For TT Pads**
—test for flea market bargains..... K3BPP
- 118 **The Op Amp Beam Heading Indicator**
—modernize your antenna system..... K0BV
- 120 **Super Charger**
—keeps nicads up to snuff..... WA7YGB
- 126 **HW-101 Owners, Check This!**
—RIT mod for the good old HW-101... HB9BLU
- 128 **Sidetone Is A Must**
—improves your fist enormously..... VE3EKR
- 132 **The Tiny Tone Repeater Saver**
—super-small tone burst system..... W4VGZ
- 141 **Dispense It Right!**
—simple tips for wire and cord..... W4RYO
- 142 **Ham Radio Is NOT A Rich Man's Hobby**
—another myth exploded..... WA6NCX/1
- 148 **The Toggled 22**
—simplified program for your IC-22S... Fletcher
- 150 **Custom-Make Your Key Paddle**
—the iambic Zephyr..... W6JB
- 151 **Don't Let Your Battery Die**
—extend its life with this simple timer... WB8TXG
- 152 **New Life For Double Sideband?**
—awake, ye pioneers, and get cracking... K1IO
- 156 **Time And Tide—Digitally**
—march to a different drummer..... WA1TNG
- 160 **The Sneaky J**
—for cliff dwellers and other
unfortunates..... W8FX/4
- 168 **The End of Autopatch Embarrassment**
—don't get caught with your Micoder™
down..... W4CUG
- 176 **The "Do It All" Digital Clock**
—it's even programmable..... K6UGT
- 180 **More CW Fun With Break-In Keying**
—how it works..... WB0KTH
- 184 **Poor Man's Cruise Control**
—better than the commercial jobs..... W9CGI

HALF A CENTURY OF SERVICE

Fifty years ago in 1928, Henry Radio first offered to help amateur radio operators solve their communications problems. Today Amateurs, not only in the United States but throughout the free world, still look to Henry Radio as their pre-eminent supplier of fine communications equipment. Fifty years is a long time in the life of an individual. It is a long time in the history of amateur radio. So we are proud to be celebrating our fiftieth anniversary of service to Amateur Radio. We believe it says something important about Henry Radio and about the pioneering contributions we have made to our industry.

From the beginning, we offered personalized service. Service that recognized that every person's needs were as individual as each person is unique.

We were the first to offer low cost time sales of Amateur equipment. We were among the first to trade for used equipment.

Even then we had an expert service department to assure that each

piece of equipment operated the way it should. We pioneered "satisfaction guaranteed" and the ten day free trial policy. Then as now we recognized our obligation to provide amateurs everywhere with fine equipment and good service.

At Henry Radio we don't know any other way of doing business. Since we have been active amateurs for all these years, we know the correct answers when we ask ourselves, "Is this the way I would want to be served if I were a customer of Henry Radio?"

Looking back, 50 years seems a long time. Looking ahead we feel like eager youngsters impatient to know the exciting new experiences that the next 50 years will bring. Eager to help our amateur friends all over the world share the unique communication thrills that only amateur radio can provide.

May we help you?



11240 W. Olympic Blvd., Los Angeles, Calif. 90064 213/477-6701
931 N. Euclid, Anaheim, Calif. 92801 714/772-9200
Butler, Missouri 64730 816/679-3127

Henry Radio

THE NEW INDUSTRY STANDARD OF PERFORMANCE... IS THE **Wilson** SYSTEM ONE!

A DX'er's delight operating 20 meters on a full 26' boom with 4 elements, 4 operational elements on 20-15-10, plus separate reflector element on 10 meters for correct monoband spacing. Featured are the large diameter High-Q traps, Beta matching system, heavy duty taper swaged elements, rugged boom to element mounting . . . **and value priced!** Additional features: • SWR less than 1.5 to 1 on all bands • 10 dB Gain • 20-25 dB Front-to-Back Ratio.

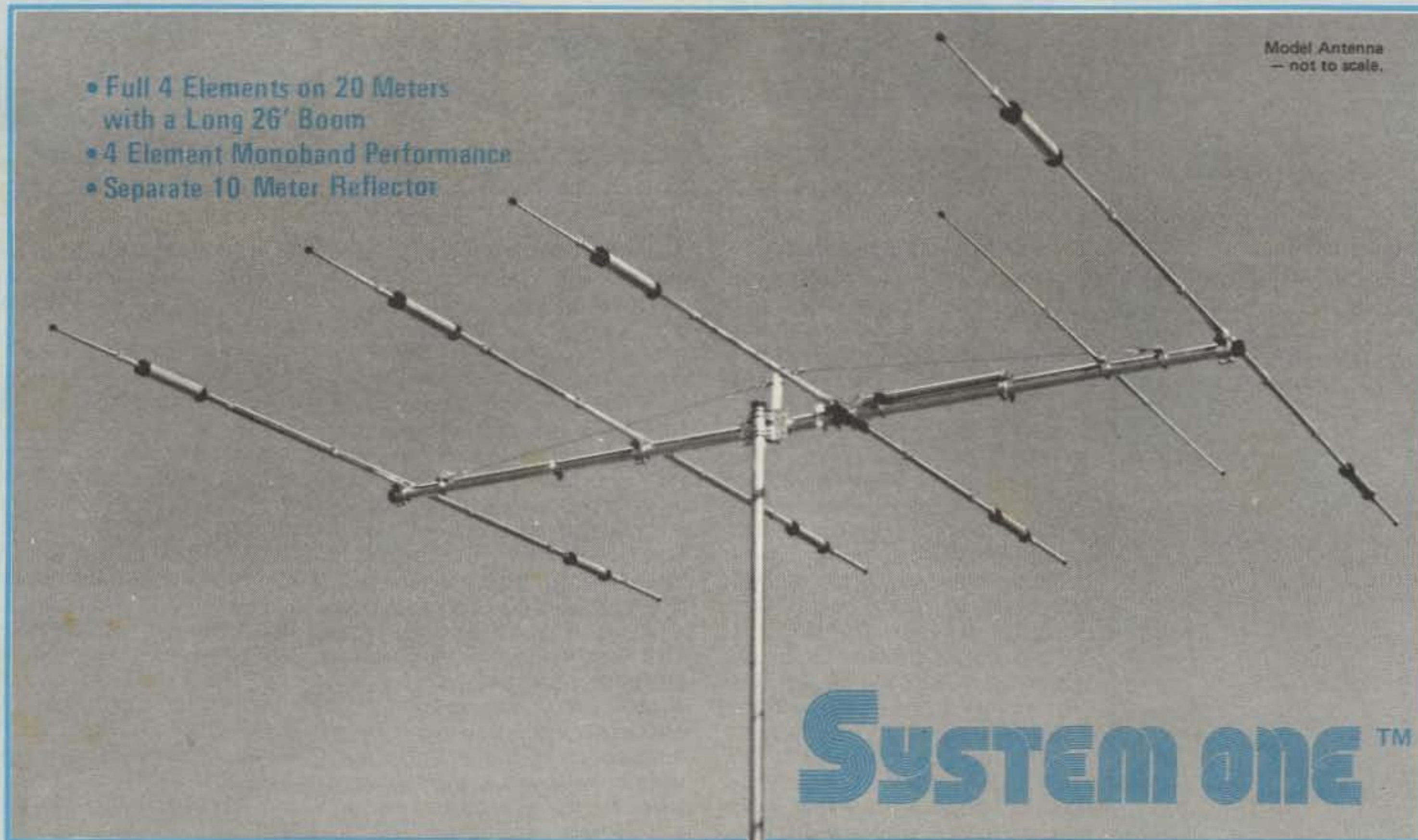

Model Antenna
— not to scale.

- Full 4 Elements on 20 Meters with a Long 26' Boom
- 4 Element Monoband Performance
- Separate 10 Meter Reflector

SYSTEM ONE™



The mechanically superior construction uses heavy duty boom to element extrusion.

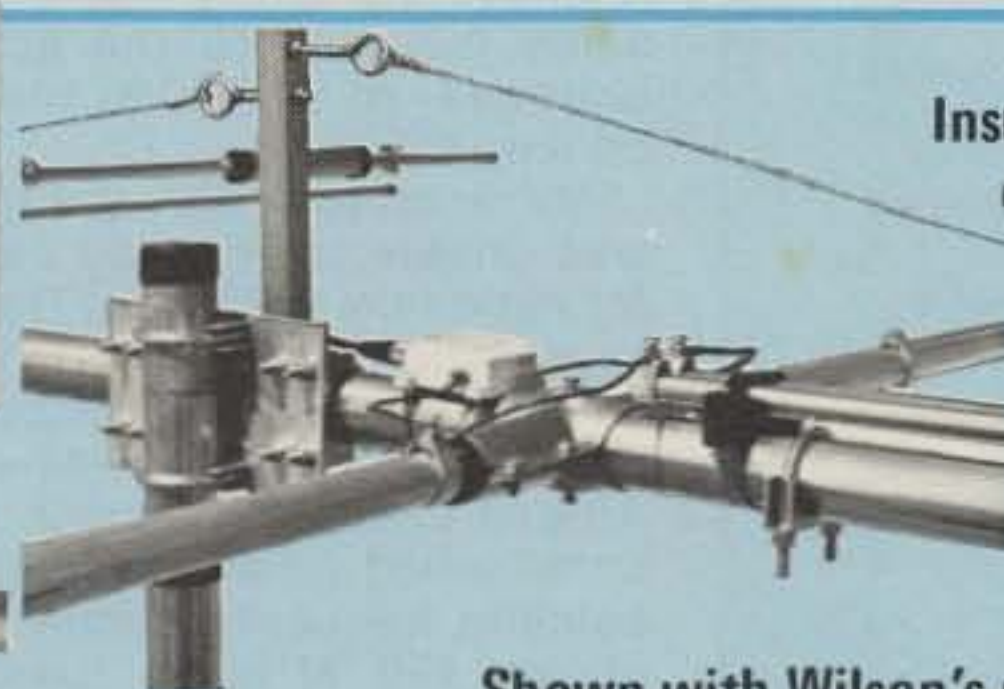

Insulated driven element with precision Beta match and heavy duty element mounts.

Shown with Wilson's new optional Toroid Core BN-50-A Balun.



Advanced design large diameter High-Q Traps for minimum loss and maximum power capacity

SPECIFICATIONS: SY-1

| | | | | | |
|-------------------------------|-------------|---------------------------|----------|----------------------------------|-------------|
| Matching Method | Beta | Boom Length | 26' | Required Mast Diameter | 2" O.D. |
| Band MHz | 14-21-28 | Boom Diameter | 2" O.D. | Surface Area | 8.6 sq. ft. |
| Maximum Power Input | Legal Limit | No. of Elements | 5 | Windload at 78 mph | 215 lbs. |
| VSWR (at Resonance) | 1.5 to 1 | Longest Element | 26' 7" | Shipping Weight | 65 lbs. |
| Impedance | 50 ohms | Turning Radius | 18' 6" | UPS Shipment in 2 Cartons | |
| Gain | 10 dB | F/B Ratio | 20-25 dB | | |

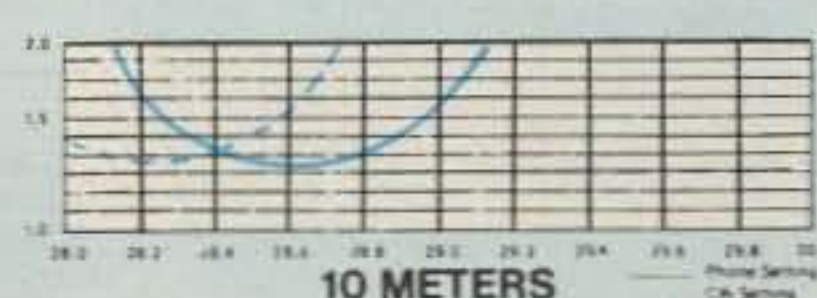
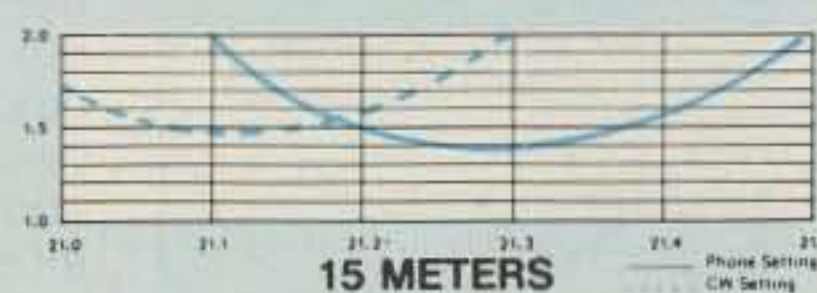
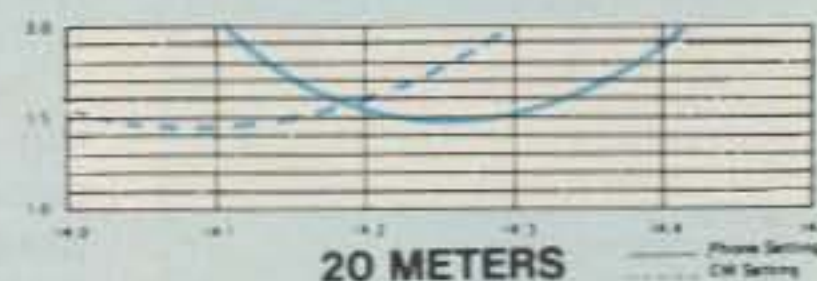

DEALERSHIPS AVAILABLE!!!
We are looking for new Dealers for certain areas of the country. If you are interested, contact us for details.

Wilson Electronics Corp.

4288 So. Polaris • P. O. Box 19000 • Las Vegas, Nevada 89119
Phone (702) 739-1931 • Telex 684-522

W2

Staff

EDITOR/PUBLISHER
Wayne Green W2NSD/1

EXECUTIVE VICE PRESIDENT
Sherry Smythe

ASSISTANT PUBLISHER
Jeffrey D. DeTray WB8BTH/1

ADMINISTRATIVE ASSISTANT
Dotty Gibson

ASSISTANT BUSINESS MANAGER
Robert R. LaPointe

MANAGING EDITOR
John C. Burnett

ASSISTANT MANAGING EDITOR
Susan G. Philbrick

NEWS EDITOR
Gene Smarte WB6TOV/1

BOOK PUBLICATIONS
Christopher E. Smith

PRODUCTION MANAGER
Lynn Panciera-Fraser

ART DEPARTMENT
Craig Brown
Gayle Cabana
Bob Drew
Bruce Hedlin
Carl Jackson
James Lamothe
Dion Owens
Noel R. Self WB1ARP
Robin M. Sloan

PRINTING
Gary Steinbach
Andy Comeau
Dan Morgan

PHOTOGRAPHY
Bill Heydolph
Tedd Cluff

TYPESETTING
Barbara J. Latti
Jennifer Johansson
Mary Kinzel
Marie Walz

BOOKKEEPER
Knud E. M. Keller KV4GG/1

CIRCULATION
Barbara Block
Laura Barnicle

DATA ENTRY
Judy Brumaghim
Linda Cate
Mary Kinzel

DIRECTOR OF MARKETING
Daniel D. Savage

BULK SALES MANAGER
Judy Waterman

SHIPPING
Theresa Toussaint
Sue Chandler
Ethan Perry
Bill Barry

RECEPTIONIST
Doni Jarvis

ASSOCIATES
Robert Baker WB2GFE
E. H. Barnett WB0IX
Schley Cox WB9LHO
Tom DiBiase WB8KZD
Terry Fox WB4JFI
W. Sanger Green
Dave Ingram K4TWJ
Larry Kahaner WB2NEL
Joe Kasser G3ZCZ
Bill Pasternak WA6ITF
John Schultz W4FA
Waller Scott K8DIZ
Peter Stark K2OAW
Bill Turner WA8ABI

COMPUTER PROGRAMMING
Richard J. Dykema
Ron Cooke
Steven B. Lionel

CUSTOMER SERVICE
Florence Goldman
Joyce Tarr

ADVERTISING
Aline Coutu
Marcia Stone
William G. York
Nancy Ciampa

W2NSD/1 NEVER SAY DIE

editorial by Wayne Green



ARMA GETS MOVING

One of the main features of the Atlanta Hamfest this year was a meeting of the Amateur Radio Manufacturer's Association (ARMA). The main subject of the meeting was a report of the results of my visit a few days earlier to the ITU in Geneva. I went there to find out what the feeling was of the amateurs at the ITU as far as prospects for the continuation of the amateur radio allocations which might result from WARC next year.

U.S. amateurs seem to be optimistic, mostly as the result of the report of the actions of the WARC preliminary conference within our own country. The news that the U.S. position asks for several new ham bands in the shortwave bands is encouraging, until you have some input as to the actual chances of such a theory coming off.

My report to ARMA was that I was unable to find any cause for optimism at Geneva. The recent actions of the ITU have been to express the solidity of the Black Block, a 44-vote African steamroller which has so far wiped out all the amateur satellite frequency allocations above 450 MHz (a loss of 237,249 MHz in the amateur allocation) and made hash of the marine band allocation, defying all technical and scientific advice in the process.

In general, the African feeling is this: 10 percent of the people of the world grabbed 90 percent of the frequencies at the 1947 WARC, they prevented any changes being made at the next WARC in 1959, they prevented any WARC at all in 1969, and now, in 1979, the chickens all come home to roost and the

Africans are set to really get even.

Amateur radio is of incredible value to these countries—we know that, but they don't. They think of ham radio as a white man's hobby, and they have some pretty negative feelings about the whole matter. My proposal for ARMA is to organize a drive to fund a mission to go to some of these black countries to see if it might be possible to get them to give the Jordon scheme a try. In 1970, despite a very brisk civil war in Jordon, ham club stations were set up in every youth club in the country and classes were run to teach amateur radio theory and code. Within three years, they had active ham stations going everywhere and over 500 licensed amateurs. Within just three years, Jordon went from having no technicians to having a large number, enough so that they could consider setting up an electronics manufacturing facility.

Also heard was a testimony from Noel Eaton, the president of IARU, the ARRL's international arm. Noel was asked to explain what the ARRL and their IARU had done to prevent a situation such as had taken place in 1971 when we lost the satellite microwave ham bands. He said that IARU had worked only in those countries where they had member societies, a fact which was dismaying since there are no amateur societies possible in countries where amateur radio is virtually undeveloped, and these are the countries with the votes which we need so badly next year at Geneva. ARMA will be asking everyone—manufacturers, dealers, and individual

hams—to contribute to a fund to send a mission to some of these Black Block countries and make the effort to try and get them interested for their own benefit in developing amateur radio and in supporting it next year at Geneva. The amount of money needed is insignificant really, \$10 to \$20 per week for a period of three months for every firm in the field, plus donations from amateurs who care enough to try to preserve amateur radio. By mid-July, it should have been apparent if amateurs and the ham industries are supporting this *emergency* plan. There is very little time left to try to influence the WARC decision, so if we are unable to get this going immediately, it'll be too late.

BRAVO FOR FRED

Fred Goldstein, who was one of our editors a couple years back, has some good ideas for those of you with pioneering blood still left unclotted. His article two years ago, "AM Is Not Dead, It Never Existed At All," upset a lot of old-timers. His current article may just do the same to sidewinders. Is it really possible that double sideband may be more band conservative than single sideband? How can a 6 kHz wide signal conserve more band than a 2.7 kHz signal?

Fred doesn't go into this aspect of the situation, but G.E. brought it up back in the '50s when they were trying to get DSB accepted by the military over SSB. Frankly, as I've written several times down through the years, I think G.E. may have had the better system and that Collins outfoxed them politically when they laid Collins

Don't be Fooled!

Not all dealers are Kenwood dealers...and all dealers who carry Kenwood products are not Authorized Kenwood dealers. But when you see this plaque you'll know you're in the right place.

Only an Authorized Kenwood dealer offers factory trained service technicians and sales personnel, an extensive stock of spare parts and a direct line of communications with factory technicians. He offers the complete Kenwood line...the finest line of Amateur Radio equipment available.

Kenwood is unique in the industry, offering seminars for its dealers' personnel, bringing the latest information from the factory to the people you deal with. This is just one more example of the ways in which Kenwood has become the Pacesetter of Amateur Radio.

When you buy Kenwood...you buy the best.

ALABAMA, Long's Electronics, Birmingham • ALASKA, Reliable Electronics, Anchorage • ARIZONA, Power Communications, Phoenix • CALIFORNIA, Ham Radio Outlet, Burlingame - Ham Radio Outlet, Van Nuys - Ham Radio Outlet, Anaheim - Henry Radio Company, Anaheim - Henry Radio, Incorporated, Los Angeles - Webster Radio, Fresno • COLORADO, CW Electronics, Denver • IOWA, HI Inc., Council Bluffs • FLORIDA, Amateur Electronic Supply, Orlando - Amateur Radio Center, Miami - Grice Electronics, Pensacola • HAWAII, Lafayette Radio Company, Honolulu • ILLINOIS, Erickson Communications, Chicago - Klaus Radio, Peoria • INDIANA, Graham Electronics, Indianapolis - Hoosier Electronics, Terre Haute - Kryder Electronics, Fort Wayne • KANSAS, Associated Radio, Overland Park • LOUISIANA, Digital Electronics, New Orleans • MAINE, Craig Radio Company, Portsmouth • MARYLAND, Electronic International Service, Wheaton • Professional Electronics, Baltimore • MASSACHUSETTS, Tufts Electronics, Medford • MICHIGAN, Electronic Distributors, Muskegon - Radio Supply and Engineering, Clawson • MINNESOTA, Electronic Center, Minneapolis • MISSOURI, Ham Radio Center, St. Louis - Henry Radio Company,



Butler - Midcom Electronics, St. Louis • MONTANA, Conley Radio Center, Billings • NEBRASKA, Communications Center, Lincoln • NEW MEXICO, Electronic Module, Hobbs • NEW YORK, Adirondack Radio Supply, Amsterdam - Harrison Radio, Farmingdale • NORTH CAROLINA, Freck Radio Supply, Asheville - Vickers Electronics, Durham • OHIO, Amateur Electronic Supply, Wickliffe - Srepc Electronics, Dayton • OKLAHOMA, Derrick Electronics, Broken Arrow - Radio, Incorporated, Tulsa • OREGON, Portland Radio, Medford - Portland Radio, Portland • PENNSYLVANIA, Electronic Exchange, Souderton - Hamtronics, Trevose - JRS Distributors, York • SOUTH CAROLINA, Accutek, Incorporated, Greenville • SOUTH DAKOTA, Burghardt Amateur Center, Watertown • TENNESSEE, Amateur Radio Supply of Nashville, Madison - Sere-Rose and Spencer, Memphis • TEXAS, AGL Electronics, Dallas - Douglas Electronics, Corpus Christi - Electronics Center, Dallas - Madison Electronics, Houston • UTAH, Manwill Supply Company, Salt Lake City • WASHINGTON, Amateur Radio Supply Company, Seattle - ABC Communications, Seattle • WISCONSIN, Amateur Electronic Supply, Milwaukee.

As of May 31, 1978

TRIO-KENWOOD COMMUNICATIONS INC.
1111 WEST WALNUT/COMPTON, CA 90220

ham gear on the top brass of the SAC. I sure wish someone who was on the inside of that intrigue would spill the beans in an article.

From my vantage point, it appeared as if Mort Kahn W2KR and Don Merten K2AAA (hmmm, what was Don's *real* call? I think it was W2UOL) had a deal with Art Collins W0CXX to get SSB accepted by the Air Force. Mort, who had sold out his Temco (transmitter manufacture) interests to Otis Elevator for a few megabucks, had the clout to pull it off. They all got after General Curtis LeMay, the head of SAC, and General Griswold, his second in command (both hams), to try out the Collins sideband gear on SAC planes.

The results were fantastic as compared with the old AM rigs, so SAC went SSB, dragging the Air Force and then the other services with them. Hams of the '50s will remember the hamming-around-the-world flights on SAC planes with Mort, Don, LeMay, Griswold, or even a high FCC official operating. I talked to 'em all many times.

While Collins was putting on the demonstrations from SAC planes, with extra ham stations set up for LeMay in his office, his car, his boat, his home, etc. (I may have been a bit more generous than Collins, but that was the way I heard it at the time), General Electric, with an obviously superior communica-

tions system, waited around for the military to find out about it. They never did. Call it lobbying, call it salesmanship—SSB won out totally.

G.E. was, as Fred hints, before their time. Their system of synchronous detection was good, but it was too complicated for those days. The changing of the transmitter for double sideband was duck soup, but the detector for the receiver was horrendous, requiring about twenty tubes for any decent performance. Today this would require one inexpensive IC. That's progress.

Okay, you want to know how it is possible for a 6 kHz wide signal to conserve radio spectrum better than a 2.7 kHz signal, right? The number of signals you can tune in successfully in a given band is the critical number, not how wide each signal is. With synchronous detection, we pass signals which appear on both sidebands, but reject those which appear on only one. Thus you can have two DSB signals only a few Hz apart and you will be able to tune each one in with minimal interference, while SSB signals must be 2.7 kHz apart, at the least.

We won't know exactly how close together and what variations in signal strength we can handle until experiments have been made using modern components. We do know that we can handle about 55 SSB chan-

nels within the amateur 20m phone band (150 kHz width). The tests of the '50s, using tube-type detectors, indicated that we could pack almost ten times that number of stations in the same band at one time using DSB.

Before putting Collins or the Air Force down, remember that the Air Force needs to get signals through from their bases to their planes. They are not fighting interference from other stations as hams are, so all they need is the ability to copy weak signals through noise. As far as that is concerned, there is probably little difference between SSB and DSB. The military acceptance of SSB got several firms into production of this type of

equipment, so DSB experimenting fell by the wayside.

Perhaps it is time for amateurs to pick up the ball again and get into experimenting with DSB... it could hold more promise for alleviating interference on our bands than any other development, and it's been with us for over twenty years.

APRIL WINNER

Since more readers used their Reader Service card ballots to vote for his article than to vote for any other, L.A. Erwin, Jr. WA4FDE of Lyman SC has been named April's "Most Popular Article" award winner. A check for \$100 has been sent to him for "How Sunspots Work."

Ham Help

I am stationed in the United Kingdom and need a 1700 Hz tone to key 2m repeaters. I would like to get in touch with anyone who has installed one on a Tempo VHF/One Plus.

Charles Moore WD5DXX
10TRW Box 935
APO NY 09238

I have a stock ARC-2/RT-91 receiver-transmitter. The last article I read in connection with the ARC-2 was from Roy Pofenberg, on its conversion, in October, 1962. I need more information: proper operation (procedural type), and dos and don'ts. I would appreciate a copy of the military "operation & maintenance" manual (will pay for expenses). All ARC-2 owners are welcome to write in and share typical problems and solutions with me.

H. Koutsoupakis
34 24 29 Street B.
Astoria NY 11106

I need a schematic/manual or any information on the Elmac PMR-6A receiver. I will buy or copy and return.

John Barclay WD8BPI
1115 Talley Ave.
Zanesville OH 43701

I need an rf coil K38816-1 for a Hammarlund HQ-100 receiver.

R. E. Vail WB2NZQ
56 Ridgewood Ave.
Yonkers NY 10704

I'd like to get a 100-kHz crystal calibrator, model HA-7, for a Hallicrafters four-band communications receiver, model SX-122, any condition. Could somebody help me?

Paul Tremblay
8 Westfield St.
Biddeford ME 04005

Around the 25th of March, I was able to get into Minneapolis for the first time since last year. You see, I'm disabled, thanks to a stroke. When I was in town, I saw your magazine for the first time and I bought the April issue. When I got to page 164 (about the dial telephone), I almost passed out.

Although I'm trying to get my Novice ticket, when I saw this article, I had hope that one of my problems would be solved. Sadly, the right side of my body is partly paralyzed, and it is hard for me to coordinate my right arm to dial a telephone number. The solution? Push-buttons!

I wrote to every company listed in your article, and as of this day, I have all the parts except one: I need just one of those 4.7 mH (or 5 mH) inductors that's between 2 of the ICs. Per your article, I wrote to the Cramer Company in Newton, Mass., and they refused to sell me one. I have not yet found anyone else who has a substitute.

Please! Can anyone help?

Ronald C. Peterson
Route 1, Box 151
Clear Lake MN 55319

Help!

I have just gotten my General ticket and purchased a reconditioned Heath HW-12 transceiver. To my dismay, I was unable to get an operator's manual or schematic. If any of you hams could help me, I would be grateful. Please inform me of the cost involved and your address or send them to me with a bill. Thanks.

Kenneth R. Scott WD4OYO
Rt. 1, Box 317
Princeton NC 27569
(919)-689-2306

Corrections

I would like to note one error in my article ("The Invisible All-band Antenna," June, 1978)—the captions of the photographs on page 93 are reversed.

Gary H. Toncre WA4FYZ
Miami FL

We goofed. We overlooked one major and two minor errors in the proofs for our article, "Another Ten Minute Timer?", in the May, 1978, issue. We can only plead lack of experience in correcting proofs.

Here are the corrections:

1) In the schematic, the collector of Q1 should be connected through C3 to the base of Q2. It should not be connected to the emitter of Q2.

2) All the solder pads that seem to be isolated are part of the ground circuit. They should all be connected by a grounding foil going around the circuit board.

3) Cut the foil between the emitter and base of Q2 (the little transistor).

We sincerely apologize for any inconvenience caused by

these errors. Thanks to N4NN for bringing them to our attention. We promise to be more careful next time (experience is a great teacher!).

David Boyd K9MX
Waukegan IL
Max Boyd N9MX
Collinsville IL

Things look quite different in print! My article in the June issue on page 118 ("Enjoy All Bands With A Remote Tuner") contains an error. I reference the use of two step-down transformers back to back, to keep the 120 ac off the tower. This is wrong. What I meant was that the *control cable* has only the 24 V ac and not the primary (line) 120 ac. Of course, the 120-volt side of the transformer *does put 120 ac on the tower*. But it's inside the remote tuner where proper insulation, etc., can be used. I thought it important to make this point clear as a safety measure.

H. M. Rosenthal KL7AE
Anchorage AK

IC-211, the 2meter Maximizer

COMPUTER-COMPATIBLE 4 MHz TRANSCEIVER WITH 2 VFO'S



ICOM's **IC-211** maximizes band coverage, speed, performance and convenience like no other transceiver in the 2 meter world. This Maximizer's single-knob dial provides all 4 MHz in a flash, right to your single fingertip! The **IC-211** maximizes read-out speed with positively no time lag or backlash in display stability, even in modes using 100 Hz steps. The **IC-211**'s freewheeling dial, with its superb inertia clutch, is instantly coordinated with the high speed, computer circuitry controlled synthesizer's seven digit read-out using an optical chopper. There is absolutely no mechanical connection between the smooth, bearing mounted flywheel knob and the **two dual-tracking VFO's**, which come built into your **IC-211**.

- **Single knob frequency selection:** The **IC-211** is synthesized with convenient single knob frequency selection over the entire 4 MHz. No more fussing with two or more knobs just to check what is going on around the band. One easy spin of the dial does it all.
- **Two VFO's built in:** The second VFO, which is an optional tack-on with most other transceivers, is an integral feature in every **IC-211**.
- **Variable offset:** Any offset from 10 KHz through 4 MHz, in multiples of 10 KHz, can be programmed with the LSI synthesizer.
- **Remote programing:** The **IC-211** LSI chip provides for input of touch tone and programing data from an external source, such as the microprocessor controlled accessory which will also provide scan and other functions (available summer '78). Computer control from a PIA interface is also possible (data available on request).
- **FM stability on SSB and CW:** The **IC-211** synthesis of 100 Hz steps makes SSB as stable as FM. This extended range of operation is attracting many FM'ers who have been operating on the direct channels and have now discovered SSB.

The **IC-211** is the very best and most versatile 2 meter transceiver made: that's all. For more information and your own hands-on demonstration, see your ICOM dealer. While maximizing performance, the **IC-211** minimizes impatience: yours is ready for delivery now.

Maximize the new repeater band: both the **IC-211** and the **IC-245/SSB** operate the new FCC repeater spectrum with no modification.

All ICOM radios significantly exceed FCC specifications limiting spurious emissions.

Specifications: Frequency Coverage: 144.00 to 148.00 MHz Modes: SSB (A3J), FM (F3), CW (A1) Supply Voltage: DC, 13.8V ± 15%; AC 117V ± 10% Size: 111mm(h) x 241mm(w) x 264mm(d) Weight: 6.8 Kg TX Output: A3J, 10W (PEP); A1 & F3, 10W Spurious Radiation: -60 dB below Carrier Microphone Impedance: 600 Ohms Sensitivity: A3J & A1, 0.5 microvolt 10 dB S+N/N; F3, 0.6 microvolt for 20 dB quieting Spurious Response: -60 dB or better Synthesizer Frequency Range: 144.00 MHz to 148.00 MHz Synthesizer Step Size: 100 Hz or 5 KHz for SSB, 5 KHz for FM

Supplied with hand held microphone, AC cord, DC cord, fuses and owner's manual.

Specifications are subject to change without notice.

HF/VHF/UHF AMATEUR AND MARINE COMMUNICATION EQUIPMENT

DISTRIBUTED BY:



ICOM

ICOM WEST, INC.
Suite 3
13256 Northrup Way
Bellevue, Wash. 98005
(206) 747-9020

ICOM EAST, INC.
Suite 307
3331 Towerwood Drive
Dallas, Texas 75234
(214) 620-2780

ICOM CANADA
7087 Victoria Drive
Vancouver B.C. V5P 3Y9
Canada
(604) 321-1833

ou goons don't ever proof
lousy manuscripts from bat
bunch of rocks to give on
you like and you're in
I insist that you print ev
tell Ma Bell that she shou

LETTERS

UP YOUR NOSE

Letter to the Editor, QST

We have read much of the literature regarding ham radio and have received the impression that hams are supposed to be helpful, friendly, courteous, and kind. We are supposed to say nice things over the air so that others who are listening might get a favorable impression about our hobby.

We believe that when it comes to Richard L. Baldwin W1RU, editor of QST and General Manager of the American Radio Relay League, it becomes a case of do what I say, not as I do.

We refer to an unfortunate incident where Mr. Baldwin told a feeble joke at the Annual ARRL Convention Banquet (N.Y. State) held during the Rochester NY Hamfest. The butt of this joke was Wayne Green, the publisher of a rival magazine, 73.

It was a bad joke told in bad taste, and we believe that Mr. Baldwin told it to impress some of the officers of the ARRL who were present in the room. The real kicker, sports fans, was the fact that Mr. Wayne Green was not there to defend himself.

Mr. Baldwin W1RU, may the ghost of Hiram Percy Maxim fly up your nose.

Lee Grills WB2ZHD
Wayne King N2WK
Jim See WB2JON
Geneseo NY

INSENSITIVITY

I felt compelled to respond to Hans J. Miller's letter in the June, 1978, issue of 73 and share my ARRL experience with him. Unfortunately, Hans, Wayne is correct about the insensitivity of the ARRL to the individual amateur's plight. In response to your comment about ousting officials via elections, you have my sincere sympathy and good luck.

In the two years of my hamming career, I have had occasion to write the ARRL three times—twice to obtain a source of reference material for a project I was working on, and just recently to contest the election of a vice director who I feel is engaging in some rather

questionable operating practices not representative of his office.

The ARRL response to both of my technical inquiries was identical. They stated that there was a shortage of personnel and that they could not provide individual designs for every amateur that wrote in. Now you tell me how a request for a source of reference material gets turned into a request for an individual design. I can understand one request being misunderstood, but not two.

My letters to Richard Baldwin and Harry Dannals concerning the vice director problem got an even better response. Mr. Dannals did not even acknowledge my letter. Mr. Baldwin sent me a reply which essentially passed the buck to the director. The director never responded, nor did the vice director. At this point, I am undecided whether or not to pursue the problem.

The only time I have been able to break the snowstorm at HQ involved the use of the telephone. I had about a 20-minute QSO with Doug DeMaw that was very informative and enjoyable. Your ideas about what the ARRL should be are very laudable and I wish you luck in your dealings with HQ. From my own experience, however, I cannot paint a very rosy picture. Mine is only one man's opinion, but perhaps others will feel interested enough to comment.

Richard P. Markey, Jr. WB3CFG
Lebanon PA

TESTING

Regarding "Naive Ideas" (June, 1978), particularly, ham exams and the FCC:

I feel that it would be counterproductive to put the entire licensing system into the hands of the various ham clubs. I wouldn't be concerned about the *competent* applicant passing the tests under such a setup, but I would be concerned about the number of cronies who would also end up with licenses.

It brings to mind my experience (years ago) as a Boy Scout leader confronted with the offspring of various local poobahs who ended up loaded

with merit badges, reflecting more badge than merit.

I agree that many clubs are making a commendable contribution by aggressive and excellent training programs. To award them complete licensing power would, in effect, provide the temptation for the club to evaluate its own programs, and confirm that, yes, they certainly are excellent.

Personally, I could see merit in authorizing *qualified* clubs to administer and certify tests for all grades except Extra, with the certified results forwarded to FCC for review and license issuance. I think the Extra class license should continue to require appearance before an FCC examiner. I also feel that an applicant for any grade where club-administered tests were admissible should have the option of taking the test before the FCC if desired—not all hams are "joiners."

Whatever its faults, the system of FCC-administered tests has the advantage of a dispassionate and impersonal treatment of the applicant. I intend to have an Extra class license some day, and would like to feel that I was qualified and competent enough to pass the exam before the FCC.

Just to be sure that I have your attention, I might suggest that the intermediate grade license tests, administered by the *authorized* club, could be routed through the ARRL for certification of the club's qualifications, before license issuance.

W.W. Parker WA6BDP
Laguna Niguel CA

FREE TANIA!

Last time I heard you, Wayne, was on KMOX one night when Jim White had Jack Anderson there, answering his little jewel of an article about the amateur bands that should be given up to CBers. But you have talked to Bob Heil, our club president, more often, I'm sure. He has a fine radio club in Marissa. I wish the Egyptian Radio Club were more like the Marissa club. There's no discrimination in Marissa.

Not so with the Egyptian Radio Club. I'm a woman with an Extra class license, and wanted to support their repeater simply because I talk to so many very nice gentlemen on it that I felt I was "free-loading" and wanted to join to financially support it.

My best buddy and I put our applications in. A paper was circulated telling the members to vote against us because we were women, and no other reason. So I asked several members if it was a men's club.

They said no. Now, I'm no women's libber, and I will never join the Boy Scouts or a men's club, but we were assured that it was all right, this was a radio club. Yet I withdrew my application by certified letter and asked for my money (\$39.00) back. Bernice Tielemann left hers in, only to be voted out by 2 votes, for no other reason than that she was a woman.

I got an anonymous letter saying I should withdraw (after I had already done so) and not attend the meeting solely because I was a female, and you can see a photostat of the letter if you want to. Then, when I got on that frequency (a supposedly open repeater), these few people put carriers on me until I had to quit, just because I'm a woman.

It's not the whole club, Wayne, just a few within it. And it's supposedly not a men's club. Can they rightfully do this to Bernice and me? What can we do about it?

Tania Miller WB9TKC
Freeburg IL

HOSSTRADIN'

Thank you for the publicity help you gave the Hosstraders Fifth Annual Tailgate Swapfest (May 13 at Deerfield NH) in your "Social Events" column. We doubled our last year's attendance and netted \$1140.50 which we gave to the Boston Burns Center of the Shriners' Hospital for Crippled Children.

Your subscription contributions were very much appreciated. K1PJ got the *Kilobaud* sub and K1JGO will be reading 73 for the next year, at least.

Norman Blake WA1IVB
Cornish ME

ATLAS AMEN

I want to add my amen to WA5TUM's letter printed in your May issue regarding the service given to Atlas customers by that Oceanside manufacturer.

A couple of months ago, I purchased a used Atlas 210 from a local dealer. The rig was certified by the dealer's service department as "OK."

Imagine my dismay when I got it home and found it wouldn't work at all. However, the next day I had a business obligation down in San Diego so I stopped by Atlas in Oceanside on the way down.

Clint Call W6OFT graciously listened to my story and told me to stop by on my way back to Los Angeles that afternoon. I arrived in Oceanside about 2:30 and called Clint. He told me "everything" was wrong with

the 210, and that they were still working on it. Could I stay in Oceanside till 4:30, which is Atlas' closing time? I could.

I got to the Atlas plant at quarter after four, and Clint said his technician was still working on it. 4:30 came and went. Clint told me the technician would stay and work overtime to get the rig fixed.

At about 5, the technician, whose name I didn't get, handed me the 210. He said he had everything fixed except for improving the sensitivity on the ten meter band, but figured I would rather have it almost completely fixed than leave it over, since he knew how frustrating it was to have a new rig and not be able to get on the air with it immediately. He also told me that the next time I was visiting Oceanside Atlas would complete the work.

There was never a mention of money. Strictly no charge.

Guess what brand of radio I'll buy when I get ready to buy a new one?

**Larry Forbes AA6US
Los Angeles CA**

3A2FB

No one epitomized the true ham spirit more than Raymond De Vos 3A2FB. Always ready to help his fellow amateurs, Raymond extended his hospitality upon our first meeting in 1973 and I came to think of him as a friend and advisor.

He assisted me in obtaining my Monagasque license and helped in countless ways to make my visits to that tiny principality more interesting and enjoyable. A true gentleman, Raymond always found the time to make you feel at home and to make each stay, short or long, one to remember with added fondness because of his kindness and courtesy.

Thus the recent death of Raymond De Vos leaves me and all of his many friends much poorer for his passing. 3A2FB is now silent but never to be forgotten.

**Morgan W. Godwin
W4WFL/3A0JE
West Peterborough NH**

PRESTO!

For years I had been telling myself to upgrade, as I've been a Tech since 1970. Actually, VHF is my bag in ham radio and I enjoy 6N2 SSB/CW and some FM. But still, I "just had to do it!" Well, I spent much time on 40 and 15 CW working on my code speed, but I was suffering from the old 10 wpm hump, as I learned the code in the '60s "the old way." Well, down to

the local radio store, and for a slim \$4.95, presto, a 73 13+ wpm code tape! Then into the closet to insult myself hour after hour! "Boy," I said to myself, "you are dumb," but before I knew it, WOW! I was actually copying that stuff! 5 days after the tape was purchased, I attacked the FCC office and one hour later I was (am) an Advanced ticket-holder! I would say I spent about 12 to 15 hours with the tape, and as the instructions said, the FCC test was so slow that I almost fell asleep between words! Well, not actually, due to the case of nerves I had! But the overtraining of the 13+ tape is just what I needed!

Many thanks to the 73 code tape system and I highly recommend it to all.

**William R. Shaw WA4MMP
Coronado CA**

ECARS

ECARS is going full steam ahead. Now that propagation is almost back to "normal" with short skip on 7 MHz, the East Coast Amateur Radio Service (ECARS) is alive and well on 7255 all day every day. The officers and members invite any ARS with or without traffic to join us. For those who are not familiar with the net, ECARS is a service net (main purpose is to conserve frequency space) where one can make contact and move off frequency. We do give priority to mobiles. You can usually find someone to rag chew and discuss your favorite interest, e.g., photography, chess, gardening, fishing, camping, and/or phone patching to a friend or relative. ECARS is a great place to meet your sked. Please join us on 7255. Membership is not required to participate on ECARS. We welcome one and all—the more the merrier. Please write to K3FEC for additional info, at 10103 Ashwood Dr., Kensington MD 20795. An SASE, please.

**David L. Byer W3LMP
Silver Spring MD**

LONGING FOR LORAN

Just a very short note to let you know that I was most impressed with two articles in the April and May issues of 73.

Both issues contained articles by Ralph Burhans, a non-ham looking for a place in which to publish a related but not direct electronics application. Your publication has long been known as one in which such efforts can be rewarded.

Ralph and I have been on the phone this morning taking care of a number of details on this

item and we find a great deal of identification here in the Loran-C subject. Further, I have some idea that there is far more interest than he has experienced in Ohio and on the east coast.

It would appear then that I would like to see Ralph considered for further publication of Loran-C information. As you know, some of us who teach engineering often are considered very theoretical—but things are changing and many of us remember the technicians from which we came.

Your considering further publication of items such as these and those by other experimenters in the VLFs would be most interesting.

**Cliff Buttschardt
W6HDO/K7RR
Los Osos CA**

GRIPING

I am writing in response to several statements in the May issue of 73.

In the Letters section, WB4MQD fears spending a lot of money "... for such a small system" (meaning the KIM). The KIM is now a system to grow with. Most hams I know want to get started with a minimal financial outlay. Working on such a simple level is the key to understanding more about computers; playing "Star Trek" all day is not. When one feels ready to expand, memory is easily added. Tom Pittman's Tiny BASIC costs a meager \$5 and fits in about 2K. The road goes on... TTY, more RAM, EPROM, Assembler, Standard BASIC, Floppy disks... you get the picture.

Oh, yes. Wayne Green made a mistake. Forethought Products, Inc., makes a KIM-to-S-100 adapter. It retails for \$125. While on the subject, I

Ham Help

I am writing to thank you for publishing my letter in the February issue of 73.

As a result, we had many kind letters offering us hospitality in all parts of the states. We were only able to visit a few people on our short trip, but they made us most welcome and really showed us something of the country, taking us to places we would never have found on our own.

We are now looking forward to next year when they will be visiting us. Thanks to your magazine, we have found some very good friends and experienced a marvelous holiday.

**Pat Stott
Ovingham, England**

would like to destroy an old myth. That myth is that "if it's not S-100, it's not any good." Baloney. Sure, any product suffers without the excellent hardware support given to the S-100 bus. But that's no reason to knock it down. For instance, the Digital Group even makes a voice I/O board for their system. Enterprising hobbyists have given two-way Morse capabilities, and RTTY, too, to KIM. So, non-S-100 systems still have a lot to offer.

Thanks for letting me gripe.

**Barry Polley
Dallas TX**

WHITHER SIMPLEX?

After driving nearly 1800 miles this past week with 2 meter FM along, I have one question: Where has simplex operation gone?

In some areas, repeaters are abundant and used consistently, but go to 146.52 or .94 or .76 and give a general call—nothing. In the more remote areas, those out of reach of repeaters, the same thing—nothing.

Yes, I realize there may be no one with 2m capability near, but after driving nearly 800 miles, giving out calls every ten to 15 minutes and still nothing, I began to wonder. I sure did meet quite a few cars, but no hams on 2m FM? There were a few contacts, even one with an aeronautical mobile, but most only after moving off a repeater.

Come on, try simplex; it's fun and more personal, without the constant breakers who sometimes inhabit repeaters.

Thanks to all who helped pass those many miles on 2m simplex.

**Chuck Gasaway WA7CPT
Klamath Falls OR**

I'm trying to get into amateur radio and need a push. I hear people talking on the Table Mountain repeater on my 8-band radio and it sounds like they are amateurs who could help me in this area.

**David L. Burrows
PO Box 198
Wrightwood CA 92397**

I am in need of an operation and maintenance manual for a Hallicrafters general coverage receiver Model S-108. An original would be nice, but I would accept a good copy at a reasonable cost.

**Daryl L. Borgman WB1DXN
RFD 1, Buck St.
Pembroke NH 03275**

RTTY Loop

Marc I. Leavey, M.D. WA3AJR
4006 Winlee Road
Randallstown MD 21133

This month we will discuss bias and other forms of distortion. No, I don't mean civil rights; what I am talking about are various forms of ailments that are peculiar to RTTY.

A while back, I mentioned "bias distortion" and deferred explaining it to a future column. Well, welcome to the future! As you may remember, RTTY is sent as 22 msec pulses, five in a row, followed by a 31 msec space (stop) pulse. Now, what would happen if the doo-hickey that initiated a mark, be it relay, tube, or solid state, was a tad sluggish in responding to the TTY signal? Fig. 1(a) shows such a situation, known as *spacing bias distortion*. Note that it lengthens the space interval. Similarly, if the mark initiation is too swift, *marking bias distortion* is produced, lengthening the mark. This is graphically illustrated in Fig. 1(b). But, you might ask, how does such a thing occur? The easiest way to understand it is by envisioning a polar relay. Recall that a polar relay, unlike a "regular" relay, has no spring to return the armature to neutral. Rather, it uses two sets of electromagnets to switch from mark to space. If the armature is not perfectly centered, slightly more force will be required to pull the armature to one side than the other, thereby delaying the initiation of that pulse. Okay, you interject, but I don't use a polar relay! Why should I worry? You should worry because all is not square waves in the world of TTY. Fig. 2 shows my point. Although you think of the TTY pulse as square waves, in point of fact they are anything but. Filtering and inherent capacitance smooth the abrupt transitions to produce the

waveshapes illustrated here. If the "turn-on" and "turn-off" points are as shown, it can be seen that mark will start late and be prolonged. A similar situation can be envisioned for space.

Through all of this, we have been dealing with bias distortion, which affects the space-to-mark transition. A similar form of distortion affects the mark-to-space transition, called *end distortion*. A delay in this transition would prolong the mark and is called *marking end distortion*. Premature transition truncates the mark to produce a long space and is called *spacing end distortion*. Fig. 3 illustrates these entities.

The bias distortions described above affect individual marks and spaces in such a way that the entire character length is not affected. But, what if the motor powering the TTY (or the oscillator clock in a solid state terminal) was a tad off? In this instance, the entire character would be sent a trifle fast or slow. Although the relationship of all elements would be preserved, their absolute values would change.

By this point, realizing all that can go wrong with a TTY signal, it may seem amazing that the darned thing works at all! But several features of the TTY design aid in correcting all but the most severe of distortions.

First of all, remember that RTTY is a start-stop code. That 31 msec stop pulse is not just cosmetic, it really *does* something! While it looks as though the TTY machine prints continuously, it really *stops* for an instant during each stop pulse. The machine would be just as happy with a one-pulse-length 22 msec stop. In fact, early Western Union machines used just that format, and were called "65 speed" to reflect the slight acceleration from "60 speed." But, by enforcing a mandatory rest after each character, the machine is able to compensate for character-to-character timing errors and keep them from accumulating. Working in conjunction with this is the range selector, which we explored briefly while considering the computer program to receive RTTY. The machine does not decode the entire data pulse, but only a small window. Thus, if the pulses are shortened by spacing end distortion or a slightly fast machine, advancing the window to early in the pulse interval will produce good copy. Similarly, spacing

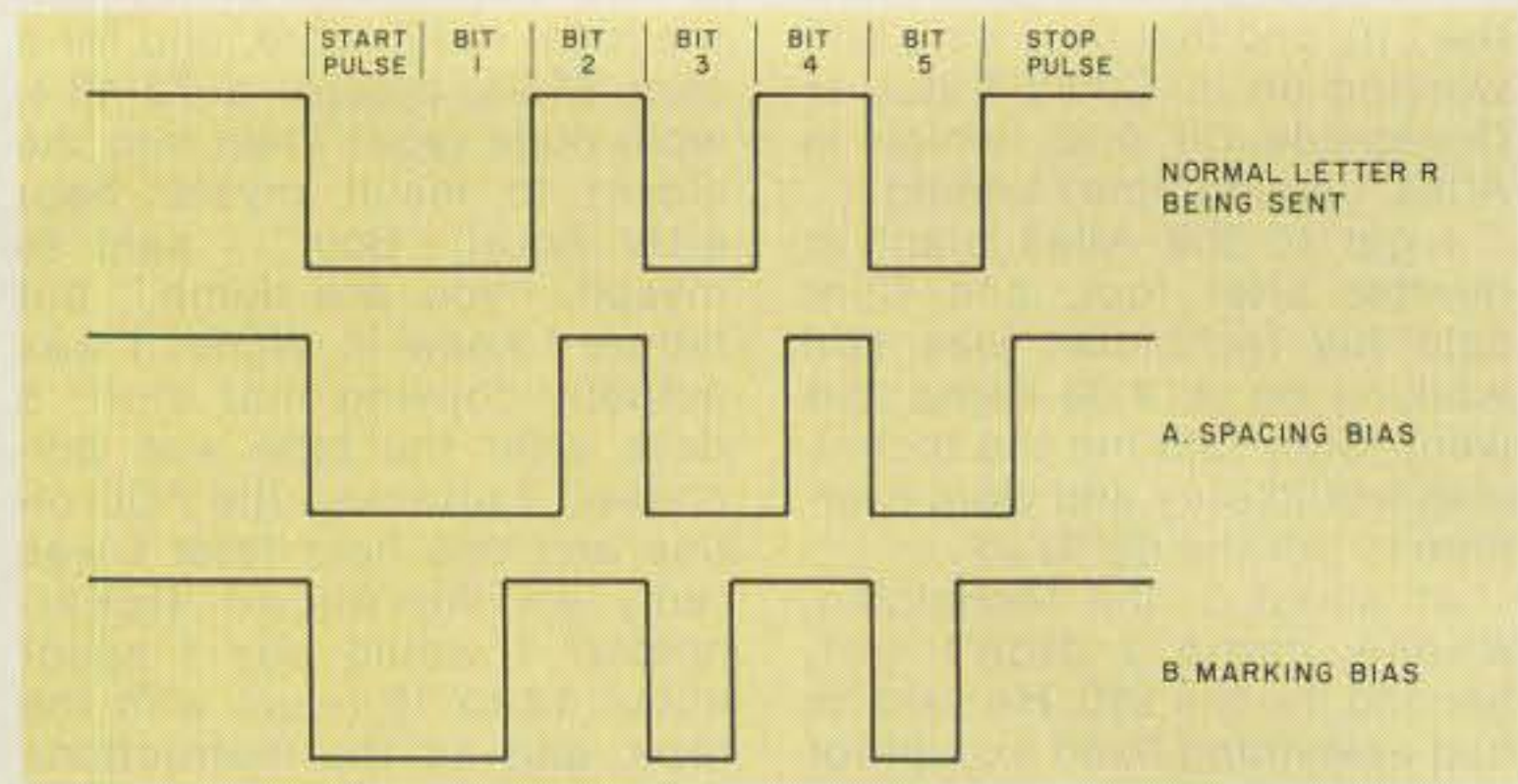

Fig. 1. Bias distortion.

bias shortened pulses, or a slow motor, can be corrected, to a point, by retarding the range selector.

The proper technique to use to adjust the range selector starts with a machine speed "RYRY" tape sent on local loop. While receiving such a tape, the range selector is advanced until perfect copy is lost, then retarded to a similar point on the low end. The two limits are averaged, and the range selector set to that mean. For example, if limits of 82 and 26 are obtained, the range selector is set to $(82 + 26)/2$, or 54.

Another form of distortion rather peculiar to RTTY is called "selective fading." Any one of us has heard a CW signal drop out for a dit or two, then bounce back. What may not be evident, however, is that one signal may fade, and another, less than a kilohertz away, may be unaffected. Since RTTY is really two CW signals separated by less than 900 Hz, it is entirely possible for the mark or space to fade out, all by itself. This is easily dem-

onstrated on a CRT viewing the familiar "cross" RTTY display. While working the rig and observing the pattern, either the mark or space ellipse will frequently disappear independently. An early method of coping with selective fading was through diversity reception. This takes advantage of the fact that just as signals 900 Hz separated might fade independently, so might signals received from stations several hundred meters apart. One amateur application of diversity is found in QST, April, 1966. The reason that diversity has not been of recent application is due to the fact that the RTTY signal has redundancy built in. Modern converters are able to use this redundancy to obtain full information from either the mark or space, thus granting a degree of immunity from selective fading.

More on tap for next month. I'm delighted at the response on the computer program and support material, and will try to publish more as it is developed. Keep those questions coming in, and look for *your* name in the RTTY Loop!

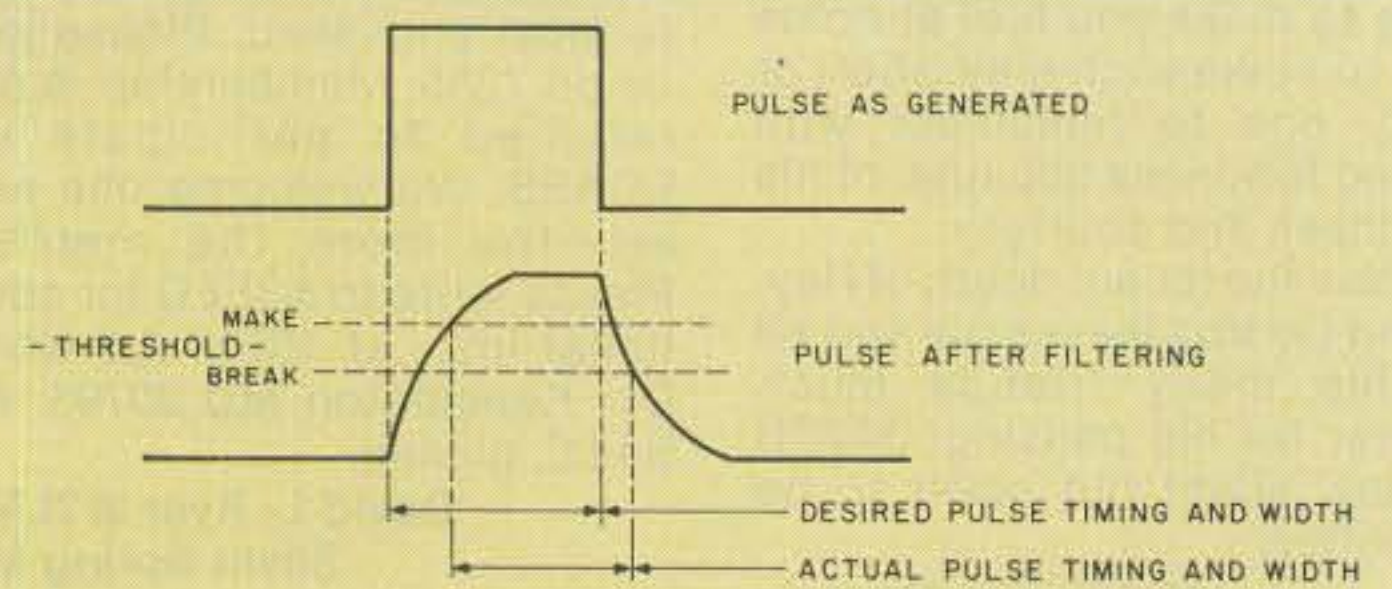

Fig. 2. Origin of distortion.

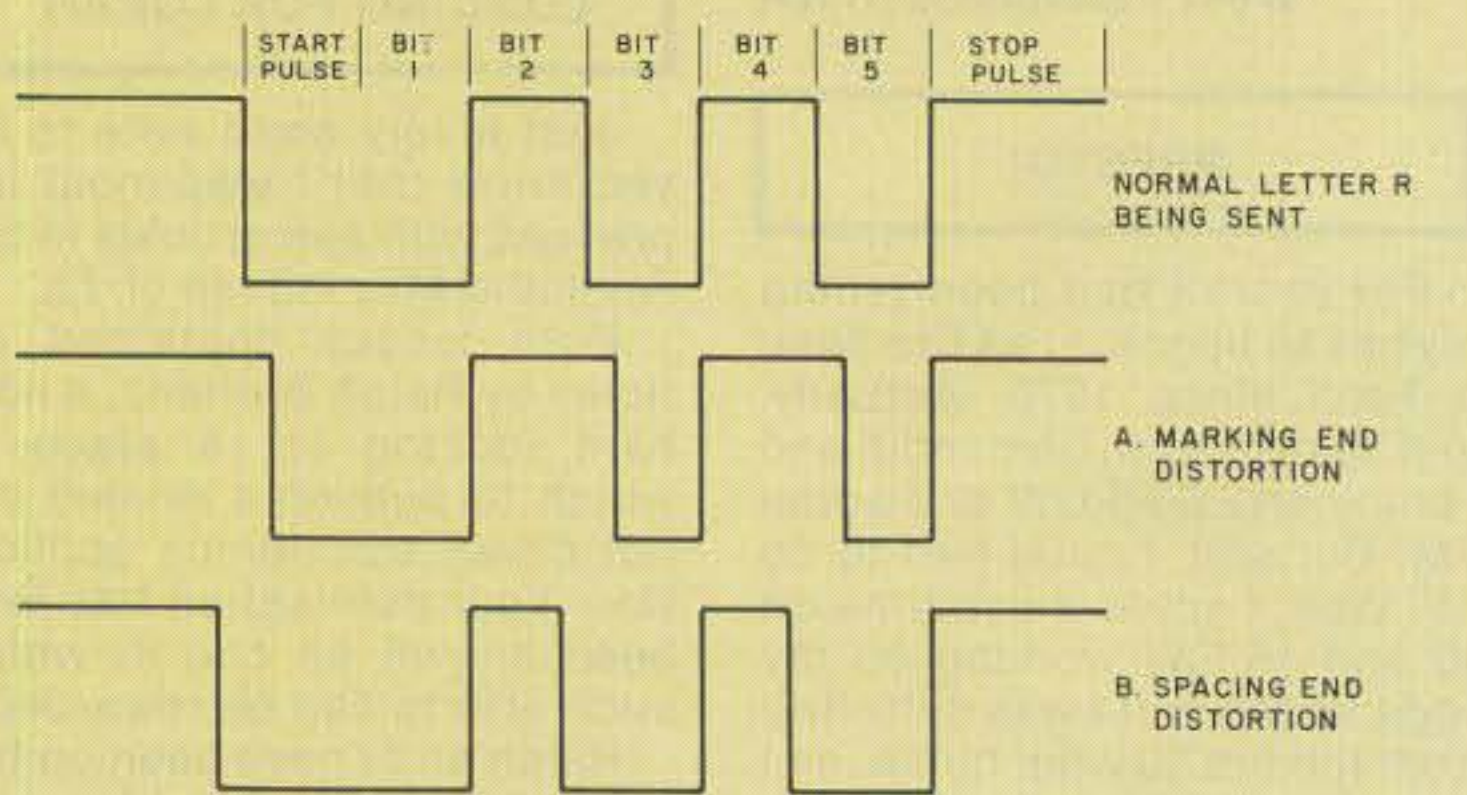

Fig. 3. End distortion.



The evolution of the MLA

When the MLA-2500 was first introduced it was a new concept in high performance amplifiers. Low and sleek yet powerful enough for the military. Some wondered . . . needlessly.

A promise kept.

The MLA-2500 promised 2000 watts PEP input on SSB. A heavy duty power supply. Two Eimac 8875's. And as thousands of Amateurs across the world have proven, the MLA-2500 delivers!

Now DenTron is pleased to bring you **The new MLA-2500 B.** Inherently the same as the original MLA-2500, the B model includes all of the above specifications plus a few refinements. New high-low power switching for consistent efficiency at both the 1KW and 2KW power levels, and 160 - 15 meters.

Tested and proven.

What better test for an amplifier than the Clipperton DXpedition? Even after 32,000 QSO's, and an accidental dunk in the ocean, the same 3 MLA-2500's are still amplifying other rare DXpeditions around the world - listen for them.

Convinced? Isn't it time you owned the amplifier that powered Clipperton and thousands upon thousands of radio stations throughout the world?

MLA-2500 B \$899.50.



DenTron[®]
Radio Co., Inc.

2100 Enterprise Parkway
Twinsburg, Ohio 44087
(216)425-3173

Editor:
Robert Baker WB2GFE
15 Windsor Dr.
Atco NJ 08004

CONTESTS

8th SARTG WORLDWIDE RTTY CONTEST

Contest Periods:

0000 to 0800 GMT Saturday,
August 19
1600 to 2400 GMT Saturday,
August 19
0800 to 1600 GMT Sunday,
August 20

Sponsored again by the Scandinavian Amateur Radio Teletype Group, classes include single op, multi op-single transmitter, and SWLs. Use all bands 80 to 10 meters, but only two-way RTTY QSOs will count. The same station may be worked once on each band for QSO and multiplier credits.

EXCHANGE:

RST and QSO number.

SCORING:

QSOs with your own country count 5 points, other countries in the same continent count 10 points, and other continents count 15 points. In USA, Canada, and Australia, each call district will be considered as a separate country. Use the DXCC list for all other countries. Note: Contact with a station which would count as a multiplier (country) must be found in at least 5 logs, or contest log from the multiplier station must be received in order to be valid. Final score is the QSO points times the sum of multipliers (countries). SWLs

use the same rules for scoring, but based on stations and messages copied!

AWARDS:

To top stations in each class, country, USA, Canadian, and Australian call district.

ENTRIES:

Logs must be received by October 10. The logs should contain: band, date/time in GMT, callsign, exchanges sent/received, points and multipliers. Use a separate sheet for each band and enclose a summary sheet showing the scoring, classification, callsign, name and address. Comments will be very much appreciated. Send logs to: SARTG Contest and Award Mgr., C. J. Jensen OZ2CJ, Meisnersgade 5, 8900 Randers, Denmark.

CAN-AM CONTEST

Contest Periods:

Phone—0000 to 2400 GMT
August 19
CW—0000 to 2400 GMT
August 20

**** both days for full 24-hour periods!**

The objective of the contest sponsored by the Canadian DX Association is to increase friendship among Canadian and American amateurs and to provide a means of measuring the performance of their operating skills and equip-

ment. Competition categories include: single operator (stations operated by the station licensee), multi-operator/single-transmitter (stations operated by more than one operator or single operator other than the licensee, or club stations), and club competition. All bands 160 through 10 meters are permitted, while it is recommended that you use the US general portion of the bands on phone and CW. The same station can be contacted once on each band and mode. Stations operating from outside their own call area must sign slash and the area they are operating from. Multi-operator stations must stay on the band at least 10 minutes before they can make contact on another band. Phone and CW sections of the contest are considered separate contests. However, combined scores for phone and CW will be used for overall competition.

EXCHANGE:

Signal report plus sequential QSO number starting with 001, plus multiplier area abbreviation, in that order: e.g., 59001NJ or 599 002 NJ. Multiplier area abbreviation is the usual two-letter postal abbreviation for the 50 US states, CN for Caribbean (KC4, KG4, KS4, KV4, KZ5), PC for Pacific (rest of US possessions). Canadians will use: NF—VO1/VO2; NB—VE1 New Brunswick; NS—Nova Scotia; PE—Prince Edward Isl.; SI—Sable and St. Paul Isl.; PQ—VE2; ON—VE3; MB—VE4; SK—VE5; AT—VE6; BC—VE7; NW—VE8 NWT; YU—Yukon.

Multipliers are 50 US states, 2 US possessions (Caribbean, Pacific), 10 Canadian provinces, 2 territories (NWT, Yukon), 1 islands (Sable, St. Paul). Total of 65 multipliers per band; maximum possible on all bands is 390. American to American or Canadian to Canadian QSOs count 2 points per QSO, American to Canadians

and vice versa QSOs count 3 points each. The final score is the result of the total QSO points from all bands multiplied by the sum of the multipliers from all bands. Remember that phone and CW are separate contests. Claimed scores will be calculated by the Contest Committee as a result of the addition of phone and CW scores.

AWARDS:

First place certificates will be awarded in each multiplier area on both modes in single-operator category. Top five multi-operator stations will receive certificates for high combined phone and CW scores. All scores will be published in QST. Free one year subscriptions to *Long Skip*, the CANADX bulletin, will be awarded to the 5 US stations. Trophies and plaques will be awarded to the overall single-operator combined phone and CW American and Canadian champions as well as multi-op champion combined modes and highest club score. The club award will be based on the 5 best scores on CW made by the club members. A club officer must submit the summary showing the callsigns and scores. Each station is eligible for one trophy only. In a case where one station qualifies for another trophy, the less significant trophy goes to the next eligible station.

ENTRIES:

All times must be kept in GMT in logs submitted. Indicate multipliers the first time only on each band. Log must be checked for duplicate contacts, correct QSO points and multipliers. *Do not use* separate logs for each band. Each entry must consist of: log sheets, summary sheet showing all scoring information, category of competition, operator's name and callsign, address of the station, and signed declaration. Entries

CALENDAR

| | |
|------------|---|
| Aug 19-20 | CAN-AM Contest |
| Aug 26-27 | SARTG Worldwide RTTY Contest Ohio Interstate QSO Party All Asian CW Contest |
| Sept 2-4 | Four-Land QSO Party |
| Sept 9-10 | Pennsylvania QSO Party ARRL VHF QSO Party |
| Sept 16-18 | Washington State QSO Party Scandinavian Activity Contest—CW |
| Sept 23-24 | Scandinavian Activity Contest—SSB Delta QSO Party |
| Oct 7-9 | QRP QSO Party VK/ZL/Oceania DX Contest—Phone & RTTY |
| Oct 14-15 | VK/ZL/Oceania DX Contest—CW Nine-Land QSO Party ARRL CD Party—CW |
| Oct 21-22 | ARRL CD Party—Phone |
| Oct 28-29 | CQ Worldwide DX—Phone |
| Nov 4-5 | ARRL Sweepstakes—CW |
| Nov 11 | OK DX Contest |
| Nov 11-12 | IPA Contest |
| Nov 18-19 | ARRL Sweepstakes—Phone |
| Nov 25-26 | CQ Worldwide DX—CW |
| Dec 2-3 | ARRL 160 Meter Contest TOPS CW Contest |
| Dec 9-10 | ARRL 10 Meter Contest |

RESULTS

RESULTS OF THE 1977 TOPS CW CONTEST

| | |
|--------|---------------|
| YU3TYX | 85,137 points |
| HA8UB | 82,544 |
| OK2BNR | 80,115 |

Of the 203 entries submitted, only 2 were from the US, with K4TQ finishing above N8FU.

with over 200 QSOs must include check sheets for each band. Official logs, check sheets, and summary sheets are available from CANADX; a large SASE with Canadian stamps will bring you samples. Violation of national amateur radio regulations or the rules of the contest, unsportsmanlike conduct, taking credit for excessive duplicate contacts, and unverified QSOs or multipliers will be deemed sufficient cause for disqualification. Incorrectly logged calls will be counted as unverifiable contacts. Actions and decisions of the CANADX Contest Committee are official and final. All entries must be postmarked no later than Sept. 30 and mailed to: Canadian DX Assn.—CC, Box 292, Don Mills, Ont., Canada M3C 2S2.

OHIO INTERSTATE QSO PARTY

Contest Periods:
1200 to 2200 EDT both days,
August 26 & 27

Sponsored by the Ohio Council of Amateur Radio Clubs and the Farout Amateur Radio Club (Kettering OH). Ohio stations work anyone while others work only Ohio stations. A station may be worked once per band per mode. Multi-multi is not allowed!

EXCHANGE:

Serial QSO number, state, province, or Ohio county.

SCORING:

Ohio stations multiply number of QSOs by number of states and Ohio counties worked. Others multiply number of QSOs by the number of Ohio counties worked.

AWARDS:

Awards for top Ohio score, top out-of-state score, top mobile. Certificates for top entry from each Ohio county and each state/province. Special award for working three or more Farout members.

ENTRIES:

All entries must include a legible log, dupe sheets for each band/mode worked, a list of all multipliers claimed, claimed score, and a statement that all rules were observed. All entries must be postmarked by Sept. 15. Send all entries and an SASE for results to: Frank Stillwell WB8OFR, 5326 Brainard Drive, Kettering OH 45440.

FOUR-LAND QSO PARTY
Starts: 1800 GMT Saturday,
September 2
Ends: 0200 GMT Monday,
September 4

Sponsored by the Fourth US Call District Amateur Radio Association of the IARS, Inc., to make the many counties in the eight fourth district states available to the contestants.

RESULTS

RESULTS OF THE FIRST 73 SSTV CONTEST

Judging by on-the-air activity during the 73 SSTV contest which was held during early March, 1978, this affair was a rollicking success. Some problems were experienced during this first-time event; however, the entanglements were quickly resolved and everyone reported thoroughly enjoying the contest. Our description of proper log scoring techniques was rather vague, so most of the gang arrived at their final score using different methods. I rectified this situation by re-tallying all logs using a common scoring method.

Many of the contest awards were presented at the Dayton Convention SSTV Forum. The Dayton Amateur Radio Club donated a beautiful plaque which went to this year's winner, Bob King, Jr. WD5GXI. Since "Bob Junior" couldn't attend the Dayton Convention, his father, Bob King, Sr. W5IXK, accepted the plaque for him. I also presented the 73 Magazine certificates to contest winners at that time. I have now mailed certificates to categorical winners not attending the Dayton Convention, and filed all entries received.

Brooks Kendall W1JKF and I would like to thank all of you for your outstanding support and involvement in this contest. Barring unforeseen circumstances, another U.S.-sponsored contest will be scheduled for next year. However, Brooks and I will definitely do our best to see that everything goes smoother at that time.

Dave Ingram K4TWJ
Associate Editor, 73

Final Scores—73 SSTV Contest 1978

| Call | | Total Points | |
|--------|-----------------|--------------|-------------------------------|
| WD5GXI | Bob King, Jr. | 45,440 | Overall Winner, First in U.S. |
| N6WQ | Roland | 18,252 | Second in U.S. |
| WB3APB | William Watt II | 17,280 | Third in U.S. |
| W9ET | Jerry Ayers | 10,062 | Fourth in U.S. |
| K6SVP | Dick Piety | 8,742 | Second in California |
| W3CPR | | 7,900 | Second in Third U.S. District |
| W6WDL | Bobby Hargis | 6,210 | Third in California |
| WA0QIT | Leslie Taylor | 5,340 | First in W0 District |
| WB0ZOM | Melvin Gassert | 4,940 | Second in W0 District |
| WB9OGS | John Groezmeger | 3,916 | Second in Ninth U.S. District |
| K8EMI | Robertson | 3,276 | First in Eighth U.S. District |
| K4DLR | Mel Malkove | 2,970 | First in Fourth U.S. District |
| K0TW | Thomas Workman | 306 | First with Lowest Score |



WD5GXI, contest winner, and KL7HAE during contest exchange on 20 meters. Camera movement causes slight blurring of picture.



Here's Dick K6SVP "knocking out" the video QSOs during SSTV contest. Dick worked several European stations on 15 meters SSTV with low power.

Contest Comments:

"I was very pleased with the way Slow Scanners conducted themselves on the air, and it was the most fun I've had with amateur radio in a long while. Thank goodness for the magic marker pen and scissors, although my living room looked like a 'paper zoo' after the contest."—Tom W3CPR

"Our first SSTV contest, and it was a blast!"—Harry W2GND

"Busier than a one-armed paperhanger with this contest."—VE3CFR

"I wish we had had a U.S. SSTV Contest sooner."—WA9USE

"Where did all those new calls come from?"—Dave K4TWJ

"Contest was most fun I've had yet on SSTV. Almost fell out of my chair when I worked several European SSTV's 'barefoot'."—Dick K6SVP

"Think I blew my linear."—WB3APB

RESULTS

RESULTS OF THE 8th WORLD TELECOMMUNICATIONS DAY CONTEST

First place team trophies for both phone and CW went to Lithuania, with UP2NK topping the list. Second place team trophies went to France, and third went to Brazil. First place individual gold medals went to UP2NK on phone and EA2IA on CW. Second place silver medals went to HW6ITU for phone and UP2NK on CW. Third place bronze medals went to UR2QI on phone and UP2SA on CW. First place club stations were UK2GKW on phone and UK2BBB on CW. From the USA entries submitted, W2LEJ finished first on phone with W7ULC first on CW.

The same station may be worked on each band and/or mode fixed, and repeated again if operated portable or mobile, and from each different county. Fourth call district stations may work other stations within the 4th call district.

EXCHANGES:

RS(T), county and state for 4th call district, state/province or country for others.

SCORING:

Fourth call district stations score 1 point for WIVE QSOs, 3 points for DX contacts (includes KH6 & KL7). Final score is total points times states plus provinces (counted only once).

All others score 2 points for each QSO times the sum of 4th district states plus 4th district counties. Count each state and each county only once.

FREQUENCIES:

Novices: 3710, 7110, 21110, 28110 (± 10 kHz). Phone: 3940, 7260, 14340, 21360, 28600. CW: 3575, 7060, 14070, 21090, 28090 (± 10 kHz).

AWARDS:

Certificates to top scorers in each state, VE province, and country. Second and third place awards when scores warrant. High Honor Trophy Award certificate to high scorer in four-land; high W/K out of 4-land; VE and DX country. Also county awards to 4th call district states and special awards to the Novices, SLWers, and blind/handicapped.

ENTRIES:

Contestants must mail logs with score within 30 days of the end of the contest to 4th Call District ARA, Attn: Bob Knapp W4OMW, 105 Dupont Circle, Greenville NC 27834. Please include an SASE for a copy of the results.

STATEN ISLAND AWARD

The Staten Island ARA wishes to announce this award available to any amateur who can prove contact with 10 hams on Staten Island. Applicants must submit QSL cards from 10

different stations with return postage for the cards plus \$1 to cover the costs of administering the certificate. Send to G. W. Ryan WA2ZPG, 14 Seacrest Avenue, Staten Island NY 10312.

WORKED ALL BRAZIL AWARD (WAB)

The WAB award has been instituted by Liga de Amadores Brasileiros de Radio Emissao (LABRE) to encourage interest in the Brazilian areas. The award is for confirmed contacts with stations in Brasilia, Distrito Federal and the 22 states, and is available to amateurs everywhere in the world. A special ribbon "TBT" shall be attached to the award for confirmed contacts with the 4 Brazilian territories. Confirmations must be forwarded direct to LABRE Headquarters-Awards Manager, PO Box 07/0004 Brasilia DF, Brazil CEP:70000. All applications must be forwarded to the LABRE by registered mail, with 10 IRCs or equivalent for handling postage.

All stations contacted must be regular amateur stations working in the authorized amateur bands or with stations licensed to work amateur bands. All stations must be contacted from the same call areas, where such areas exist, or from the same country in cases where there are no call areas. One exception is allowed to this rule: Where a station is moved from one call area to another, or from one country to another, all contacts must be made from within a radius of 150 miles from the initial location. All contacts must be with "land stations"; contacts with ships, anchored or otherwise, and with aircraft are not allowed. Contacts may be over any period of years, provided only that all contacts be made under the provisions of the above rules and by the same station license; contacts may

have been made under different call letters in the same area (of country) if the license for all was the same. All confirmations must be submitted exactly as received from the stations worked. A log checked by the Awards Manager of the applicant's country, or by two licensed amateurs, shall be accepted. Compliance with the determinations of the international conventions, national laws and rules in force, fair play

and good sportsmanship in operating are required of all amateurs working for the WAB award. A minimum readability of "3" shall be recorded on each confirmation submitted. The minimum signal tone report of "5" is required for all CW confirmations. Decisions of the LABRE awards divisions regarding interpretation of the rules as here printed or later amended shall be final.

Ham Help

I have a copy of the April issue of 73 and have read the article entitled: "Danger—Microwave Radiation." I also recently read an article in the Oct., 1977, issue of *Consumer Reports* on the subject of CB radios. The concluding paragraph on page 565 states:

"Note well: CB radios emit electromagnetic waves when used to transmit. Very little is known about the long-term effect of such radiation on human beings. Inside a car, the radiation level was too low for us to measure on our instruments. Outside a car, at a distance of 12 inches from the antenna, we measured a radiation level of three milliwatts per square centimeter. Since the possible effects of this kind of radiation are unknown, prudence dictates that you avoid transmitting while standing outside a car close to the antenna. We would also recommend against mounting an antenna close to the car's windows."

In the 73 article, Mr. Thornburg states in part: "Really, what I am saying is that danger exists at UHF and even VHF frequencies, as well. Don't radiate 100 Watts of UHF less than 5 feet (RNF) from your body."

I recently took the Novice test and expect my license momentarily. I have not purchased any equipment yet because of some questions I have, including the danger of radiation.

I've been told that the Novice bands are considered in the HF range and not as much a hazard as VHF. However, the *Consumer Reports* article speaks of even a lower band with less power.

I live in an apartment building on the top floor near many TV outdoor antennas which may create problems of interference, in addition. Because of landlord restriction, I may have to resort to an indoor random-length antenna,

though I'm hoping for a whip antenna outside the window. I am concerned from both a radiation and interference standpoint. A random-length would necessarily have to be wound around the room, and radiation could be a hazard I might not want to risk.

With an indoor antenna, I may need more power, which might be bad both from the radiation and interference standpoints, the latter especially in this densely populated area. My wife has an arrested malignancy which further complicates the situation.

I am looking for a solution to this problem, but have been unable to get any advice thus far. I do not even have any idea of what kind of equipment to buy, whether to buy a used CW-only transceiver or one that can be later upgraded.

I would appreciate any suggestions or recommendations that can be offered. I have no technical background.

Morton Hahn
5000 15 Ave.
Brooklyn NY 11219

I have been a subscriber to 73 for quite a few years and believe it's the best as a ham publication.

I have a request for information which I hope someone can assist me with.

Is there a company or a known individual that can or will custom-design a solid state circuit for a person such as myself for either their own use or for possible future patentable idea/design? I am of the old "tube-type" school. I quit design and application when s/s was beginning, and, try as I will, I just cannot use it. The devices or circuits are not complicated or unusual, but they are beyond my knowledge.

I would appreciate it greatly if someone could advise me as to a company or an individual who could assist me.

J. H. Burgess K4HNW
Route 13, Box 42
Morgan LaFee Lane
Fort Myers FL 33901

if the **HUSTLER** 4-BTV weighs 39% more... what do others leave out?

HUSTLER FIXED STATION FOUR BAND VERTICAL

The 4-BTV is longer for greater aperture, larger in diameter for strength and bandwidth, heavier traps for precision and safety factor. Individually, each subassembly weighs more to collectively give you an antenna designed for convenience of assembly and installation, a wide margin in mechanical stability and far superior electrical performance.

- **Lowest SWR** — PLUS!
- Bandwidth at its **broadest!** SWR 1.6 to 1 or better at band edges.
- Hustler exclusive trap covers "**Spritz**" extruded to otherwise unattainable close tolerances assuring accurate and permanent trap resonance.
- Solid one inch **fiberglass trap forms** for optimum electrical and mechanical stability.
- Extra heavy duty aluminum mounting bracket with **low loss** — **high strength** insulators.
- All sections **1 1/4" heavy wall**, high strength aluminum. Length 21'5".
- **Stainless steel clamps** permitting adjustment without damage to the aluminum tubing.
- Guaranteed to be **easiest assembly** of any multi-band vertical.
- Antenna has 3/8"-24 stud at top to accept RM-75 or RM-75-S Hustler resonator for **75 meter operation** when desired.
- Top loading on 75 meters for broader bandwidth and **higher radiation efficiency!**
- Feed with **any length** 50 ohm coax.
- Power capability — **full legal limit** on SSB and CW.
- Ground mount with or without radials; roof mount with radials.

one setting for total band coverage!

40 THROUGH 10 METERS



"the home of originals"

New-Tronics patents: 3287732, 3513472, 3327311, 3419869, 3599214, 3873985, 3582951, 1017857 (Canada).

new-tronics corporation

ANTENNA Engineers, Designers, Manufacturers
15800 commerce park drive
brookpark, ohio 44142
(216) 267-3150

**MODEL
4-BTV
15 POUNDS**

Available from all distributors
who recognize the best!

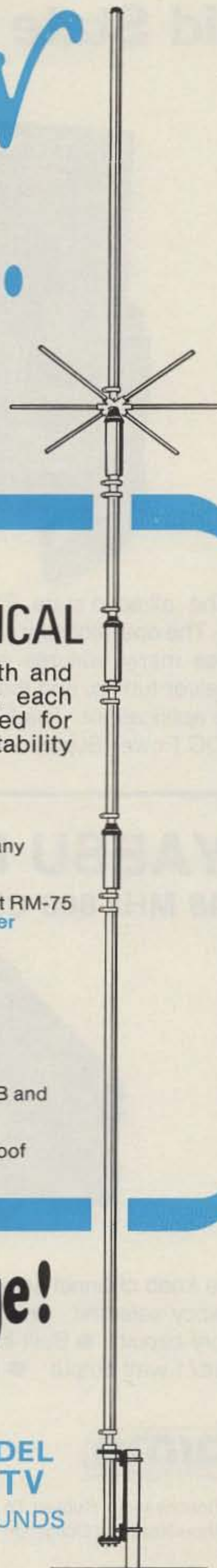

New YAESU FT-7 20 Watt Solid State 80-10 Meter HF Transceiver



The all-solid state FT-7 transceiver provides high performance on the 80 through 10 meter bands. The operator may select upper or lower sideband or CW operation, and the compact package provides many features engineered for convenience while mobile. A single knob provides all transceiver tuning, and the state-of-art noise blanker minimizes impulse-type noise often found in mobile applications. The FT-7 is designed for operation directly from 12 volt car battery or Yaesu's FP-7 DC Power Supply.

YAESU FT-227R

144-148 MHz 800 Channel "Memorizer"



- One knob channel selection, 144-148 MHz
- Memory circuit that allows instant return to any frequency selected
- Fully synthesized in 5 KHz steps
- 600 KHz offset plus any split using memory circuit
- Built-in tone burst
- Optional tone squelch encoder/decoder
- Selectable 10 watt/1 watt output
- Operates directly from 12 volt car battery or Yaesu's FP-4 Power Supply



Price And Specifications Subject To
Change Without Notice Or Obligation

YAESU
The radio.



Y1

578

YAESU ELECTRONICS CORP., 15954 Downey Ave., Paramount, CA 90723 (213) 633-4007
YAESU ELECTRONICS CORP., Eastern Service Ctr., 613 Redna Ter., Cincinnati, OH 45215

AMATEUR RADIO SERVICE

Administration of Operator Examinations

AGENCY: Federal Communications Commission.

ACTION: Final rules.

SUMMARY: The FCC is amending its amateur radio rules to permit the engineers in charge of its various field offices to issue Amateur Code Credit Certificates. Upon presentation of a properly completed certificate, an applicant for an amateur operator license will be given examination credit for the telegraphy speed shown on the certificate. The FCC is acting in response to many complaints that it has no such examination credit program and expects that the issuance of Amateur Code Credit Certificates will relieve both applicants and the FCC of unnecessary work and effort.

EFFECTIVE DATE: June 16, 1978.

ADDRESSES: Federal Communications Commission, 1919 M Street NW., Washington, D.C. 20554.

FOR FURTHER INFORMATION CONTACT:

Mr. Gregory M. Jones, Personal Radio Division, Safety and Special Radio Services Bureau, 202-634-6619 (not a toll-free number).

SUPPLEMENTARY INFORMATION:

Adopted: May 31, 1978.

Released: June 7, 1978.

Order. In the matter of amendment of the FCC's rules concerning the administration of operator examinations in the amateur radio service.

1. The Commission is amending its rules concerning the administration of operator examinations in the amateur radio service.

BACKGROUND

2. Under existing examination procedure, an applicant for an FCC-supervised amateur radio operator license must appear at an FCC field office or designated examining point for examination. Depending on the class of operator license for which the applicant is applying, he must successfully complete certain examination "elements", in accordance with the following schedule (see § 97.23 of the Commission's rules):

Class of Operator License and Required Examination Elements

Amateur Extra—1(C) (20 word per minute telegraphy test); 2 (basic amateur operation); 3 (general amateur practice); 4(A) (intermediate amateur practice); 4(B) (advanced amateur practice).
Advanced—1(B) (13 word per minute telegraphy test), 2, 3, and 4(A).
General—1(B), 2, and 3.
Technician—1(A) (5 word per minute telegraphy test), 2, and 3.
Novice (not administered at FCC field offices)—1(A) and 2.

3. Section 97.25(a) of the rules states that a licensed amateur operator applying for a higher class operator license will be given examination credit for the examination elements included in the examination for the class of operator license he already holds. For example, an applicant for the general class operator license who holds a technician class license at the time of his examination will be given examination credit for examination elements 2 and 3 and need only successfully complete examination element 1(B) to obtain the general class license.

THE PROBLEM

4. It has come to our attention that many amateur licensees are not entirely satisfied with the present rule concerning examination credit in the amateur service. In particular, we have been receiving many informal requests to amend the rules to extend examination credit to an applicant for each examination element he passes, regardless of whether the applicant goes on to complete the entire examination successfully. For example, if an appli-

cant for a general class operator license who holds no amateur license at the time of his general class examination were to pass examination element 1(B) (13 word per minute code test) but fail examination element 3 (general amateur practice), he would be given examination credit for element 1(B) upon reexamination. He would not be required to retake the 13 word per minute telegraphy test, because he would have passed it once already under FCC supervision.

THE SOLUTION

5. We believe there to be no reason to continue to require that an applicant for an amateur operator license retake examination elements he has already completed successfully, and we are by this order amending parts 0, 1, and 97 of the FCC's rules to permit the issuance of Amateur Code Credit Certificates (FCC Form 845) by the engineers in charge of the various FCC field offices. Amateur Code Credit Certificates will be issued to applicants for amateur operator licenses who pass telegraphy examination elements 1(A), 1(B), or 1(C) but who fail the written examination elements associated with the telegraphy examinations. Upon presentation of a properly completed Amateur Code Credit Certificate, an applicant for an amateur operator license will be given credit for the code speed listed on the amateur Code Credit Certificate. Thus, an unlicensed applicant for a general class license who passes examination element 1(B) but who fails examination element 3 will, upon reexamination, be given credit for examination element 1(B). To obtain the general class license the applicant would have to complete only elements 2 and 3. An Amateur Code Credit Certificate will be valid for a period of 1 year from the date of its issuance and must be presented at the field office at which the examination was undertaken.

6. We believe the amendments we are adopting will make it simpler and less tedious for applicants for amateur operator licenses to obtain such licenses. We also believe our service to applicants for amateur operator licenses will improve, because we will not have to administer what are essentially unnecessary telegraphy examinations. (A reduction in the number of examinations we administer is critical, in view of the extremely large number of applicants now seeking to become amateur radio operators.)

CONCLUSION

7. Authority for these amendments appears in sections 4(i), 5(d), and 303 of the Communications Act of 1934, as amended. Because the manner in which amateur radio examinations are conducted is a matter of internal agency procedure, the prior notice and public procedure provisions of the Administrative Procedure Act, 5 U.S.C. 553, are not applicable.

8. Accordingly, the Commission orders that parts 0, 1, and 97 of its rules are amended as set forth below effective June 16, 1978.

(Secs. 4, 5, 303, 48 Stat., as amended, 1066, 1068, 1082 (47 U.S.C. 154, 155, 303).)

FEDERAL COMMUNICATIONS COMMISSION,¹
WILLIAM J. TRICARICO,
Secretary.

Parts 0, 1, and 97 of Chapter I of Title 47 of the Code of Federal Regulations are amended, as follows:

PART 0—COMMISSION ORGANIZATION

1. In § 0.314, a new paragraph, (w), is added, as follows:

§ 0.314 Additional authority delegated.

(w) To issue Amateur Code Credit Certificates, under the provisions of

¹Commissioners Ferris, Chairman; and Brown absent.

Part 97 of this chapter.

PART 1—PRACTICE AND PROCEDURE

2. In § 1.922 a new form, FCC Form 845, is added, as follows:

§ 1.922 Forms to be used.

FCC Form and Title

845—Amateur Code Credit Certificate.

PART 97—AMATEUR RADIO SERVICE

3. In § 97.25, paragraphs (b), (c), and

(d) are redesignated paragraphs (c), (d), and (e), respectively, and a new paragraph (b) is added, as follows:

§ 97.25 Examination credit.

(b) Upon presentation of a properly completed Amateur Code Credit Certificate, FCC Form 845, the FCC shall give the applicant for an amateur radio operator license examination credit for the code speed listed on the Amateur Code Credit Certificate. An Amateur Code Credit Certificate is valid for a period of 1 year from the date of its issuance and will be honored only at the FCC field office that issued the Amateur Code Credit Certificate.

Ham Help

Thanks for publishing my letter in your May issue of *73 Magazine*. It's been a real help. Within a month of its being published, I've received over 20 letters offering help or equipment. But I'd have to say I was helped the most by the Bismarck Amateur Radio Club. I was contacted by one of their members and asked to attend a monthly meeting. After attending this meeting, I've found that amateurs aren't such a bad lot, after all. Their club voted to give me a free one-year membership. By the time you receive this letter, I will probably have already purchased a used Heath Novice station. Again I'd like to thank *73 Magazine* and all the other hams who wrote to me.

Mark Malm WB0YHW
Flasher ND

I recently salvaged a Knight-kit R100a general coverage receiver and a Hickok 195B oscilloscope, and I'm having trouble finding manuals or schematics for either. If anyone can help me out with either of these pieces of equipment, it would be greatly appreciated. I would, of course, reimburse any duplicating or mailing expenses incurred.

John Vercellino WB9OVV
4636 Pershing
Downers Grove IL 60515

I need a copy of the schematic for the old Heathkit VF-1 vfo.

John C. Brown WB4PRF
Box 37
Eva TN 38333

I need operation and maintenance manuals and schematics for the four items below. I am willing to post a deposit for prompt return of documentation. Phone (203)-357-8000, extension 394 if nearby or write address below.

The four items are: Dumont oscillograph, type 241, serial 5255; Dumont oscillograph, type 303-AH1, serial 6812; Central Electronics 20-A SSB ex-

citer; and its traditional vfo, the BC-459 revision. Thanks.

Lloyd Yost K2YJP
70 Mt. Pleasant Ave.
Stratford CT 06497

I am attempting to build a small windmill power plant (portable). I have obtained some small permanent magnet alternators from a local surplus yard. They were made around 1957 to 1960 by the TKM Electric Co. of Rochester, N.Y. Some of them need replacement parts before they will work on my windmill, but alas, TKM has slipped into a dark black hole and fallen out of sight. Does anyone out there know about TKM or anyone who perhaps used to work for TKM? Any info would be greatly appreciated.

Also, anyone who's trying to build a small portable windmill and is interested in exchanging ideas, please contact me; it's free. I've been able to get better than 150 Watts of power at 1500 rpm out of these 8-lb. PM generators!

Rick Christensen
Route 3, Box 630
Provo UT 84601

I would appreciate a frequency curve plot with a schematic diagram utilizing same for the following Collins mechanical filter: type F250-A67, serial 11M2, p/n 526 9039 00.

I wrote Collins Manufacturing Co. but have not received any answers to my requests. Any help would be sincerely appreciated.

George G. Boehle K2IHK
9437 109th Ave.
Ozone Park, L.I., NY 11417

I am in desperate need of the manual, schematic, and manufacturer's address for the CCTV camera model MC-920 manufactured by The Ness Corp., Japan.

Jeffrey K. White WD8OXK
PO Box 767
Athens OH 45701

Looking West

Bill Pasternak WA6ITF
24854-C Newhall Ave.
Newhall CA 91321

John Walker WB6MHF has an autopatch system here in Los Angeles, and it's a bit different than most. You see, it's not a repeater. For that matter, it's not even a remote base. John in Los Angeles and another group in San Diego have perfected a very novel radio-to-telephone interlink called a "simplex autopatch." Coordinators, take note! After this gets published, you might have a new entity to worry about finding a home for.

According to John, he first got the idea for his system from reading an article in 73 on just such a concept. He and the members of his group took hold of the idea and refined it into a working system. They then operated it in "test configuration" at John's house for a few months. After "proofing" was complete, it was moved to a mountaintop location. All the experimentation, tests, and work have led to an amateur autopatch that utilizes but one discrete channel. Talk about spectrum conservation! That's one giant step for the ARS!

Want to know how a simplex autopatch works? As I understand it, the heart of this "magic talking box" is not a radio, but rather a KIM-1 microprocessor. The KIM makes it all tick. The processor handles everything from control to system security. The radio portion of the system can be just about anything from an IC-22 or Midland 13-509 to a Motorola MICOR. Virtually anything will work. At all times, the system receiver is listening; in John's case, it listens not only for a carrier but also for certain control tones. Upon having a system user come up on channel and simply ID, a transmitter is activated. When the user lets up the PTT, he then hears the system transmitter come back to him. However, the carrier is not steady. It pulses on and off. The "off" period is the "receive" window, wherein the receiver is looking for another command from "Joe User." So, Joe punches a sequence of numbers on his tone pad, lets go of the PTT button, and, like magic, a dial tone like Ma Bell's is heard. Again, the system is pulsing the receiver and transmitter to provide a "receive window." Each time Joe User keys up, he automatically locks the transmitter off, so now he dials his call as he would on any other auto-

patch. While conversing with his party, the user will continue to hear the receive window, which sounds like a "tick" or small crackle and is easy to get used to. He carries on his conversation and then functions the thing down. Again, the system reverts to the listen-only mode until such time as it is again needed. Since "primary control" is via another dedicated telephone line and user control is "secondary," it therefore meets all the current FCC criteria. But for what?

Well, it's not a repeater; this we know. Is it then a remote base? Not if you judge it by the normal criteria for that classification of operation. There is but one radio link and that is on a single discrete frequency. In essence, John's system is a whole new ball of wax—a "simplex repeating system"—and that's why I suggested that coordinators take note. With its success in LA and in San Diego, and with the crowded spectrum that many of us are forced to live with, the time is right for this third generation relay device.

During my interview with John, he hinted strongly that if there were enough interest shown, he would be more than happy to write an article for 73 describing in detail how a simplex autopatch works and how one can be built. Therefore, if this concept does tickle your fancy, drop him a note via this column and we will see what can be done. It's up to you!

THE I LOVE A PARADE DEPARTMENT

I wish I had some pictures to go along with this commentary. Actually, I do, but it's kind of hard to publish 1200 or so feet of motion picture film.

Let's go back about twelve years. It was in the spring of 1966 that amateur radio first became a part of a New York City "Big Event." Back then, no one involved could imagine that this "happening" would grow to such an immense size and that amateur radio would come to play such an important part. I can remember sitting at the very first organizational meeting as Andy Feldman WB2FXN, then Assistant EC for Brooklyn AREC, explained the part that we would play in the third annual Salute to Israel Parade up New York's famed Fifth Avenue.

In those days, we were all AM on six meters. It was easy to tell the VHF amateurs back then. The CBers were the guys with

the whips, and the six meterites were the nuts running around with "basketball hoops" on the backs of their cars. How many of you still remember the Hy-Par Saturn 6 halo? That's what we used at the first Parade with which we were involved. There were halos, squalos (square halos, if you can picture that one), and a lot of Gonset Communicator IIIs. The last Parade I went to was in 1972, just a few months prior to our move to LA. By that time, the event was three times the size it was in '66, and we amateurs were using two meter FM. Our "gain whips" made us look more like the CB crowd than hams.

Last February, I found out that I could get a week's vacation that would correspond with the 1978 Dayton Hamvention. A call from Lou K2VMR informed me that the weekend following Dayton would be the Parade. A call to my friendly travel agent brought word that Delta had a neat money-saving package. That is, if I didn't mind stopping in Atlanta en route to anywhere. The price was right, so why not? We confirmed Dayton and NYC, made some reservations for a hotel and rental cars, and awaited departure day. It was during this waiting period that I made the decision to film the amateur radio activity surrounding the Parade in good old-fashioned movie format rather than in stills.

Departure day arrived. Wayne Green was speaking at Cerritos College, so Al Ogden W6SPK drove me down to Wayne's appearance and then we left for LA International. Well, the rest was a comedy of errors. I never made it to Dayton, but early Monday morning my TWA L-1011 made a textbook landing at JFK International and we began a week of groundwork that we hoped would lead to a successful film. It did, and I am busy these days editing. It should be ready by summer's end. Right now, it's more important to tell the Parade's story.

This year, some 40 amateurs from the New York metropolitan area, aided by a few volunteers from as far away as San Diego, California, managed to provide a communications network for a New York City parade that proved to be one of the biggest in that city's history. Official New York City police figures estimated the number of spectators at over one million, including the guest of honor, Israeli Prime Minister Menachem Begin. The number of marchers was placed at better than 100,000.

What then, you may ask, was the contribution of a mere forty amateurs? Simply this: They

held the whole thing together and kept it moving. Without the amateur communications network, a network which this year utilized two repeaters and multiple simplex channels on both two meters and 450 MHz, it would have been impossible for those responsible for the event to know what was happening along the line of march and in the formation areas. It would have been almost impossible to dispatch emergency medical aid when and where it was needed. Suffice it to say that Parade officials credit the communications afforded by amateur radio as being one of the backbones of the march. In fact, one official, the Parade's overall director, Barbara Taylor, is herself an amateur. WB2HGK credits her present amateur license directly to the exposure she received while working with members of the New York amateur community in planning the Parade over the years. I guess that you can just hold out so long when you are working hand-in-hand with amateur operators on a continual basis. Barbara is an excellent example of this.

The last planning session prior to the event itself took place at around 5:00 am, this year, on Sunday, May 10th. Not wanting to travel in from Long Island where I was staying, I imposed upon the hospitality of Hank K2SSQ for the evening and at around 4:30 am made my way downtown to this meeting. Meeting? I guess "party" might be a better term. All those in positions of responsibility were gathered for a "Good Luck Breakfast," probably their last chance for a bite until the finish about twelve hours hence. Soon, the man who had put together the entire network of amateur communicators arrived. I have known Lou Belsky K2VMR for better than 20 years now; there is no better organizer to be found in the ranks of the amateur service. When Andy dropped out of the position a few years back, Lou stepped in and has been with it ever since. He had brought many innovations with him, such as diversity simplex and multiple repeaters, to enable ongoing communications over the entire route through the canyons of Manhattan. With Prime Minister Begin as guest and overall security very tight, instantaneous communication was essential. To make sure of such, Lou had enlisted the aid of a number of area experts in two-way VHF communications.

By 7:00 am, we were all on the corner of 57th Street and Fifth Avenue. Shortly, a large green bus pulled up. I was in-

Continued on page 31

BOARDS INSIDE CABINET

- CARR OSC unit
- VOX unit
- AF unit
- IF unit
- Filter unit
- Noise Blanker/RF Processor
- Rectifier unit
- Rectifier unit
- Power XFMR
- Final Amplifier unit
- VCO unit
- TUNE control
- PLL unit
- RF unit
- Counter Display unit
- FM unit

FT-901DM

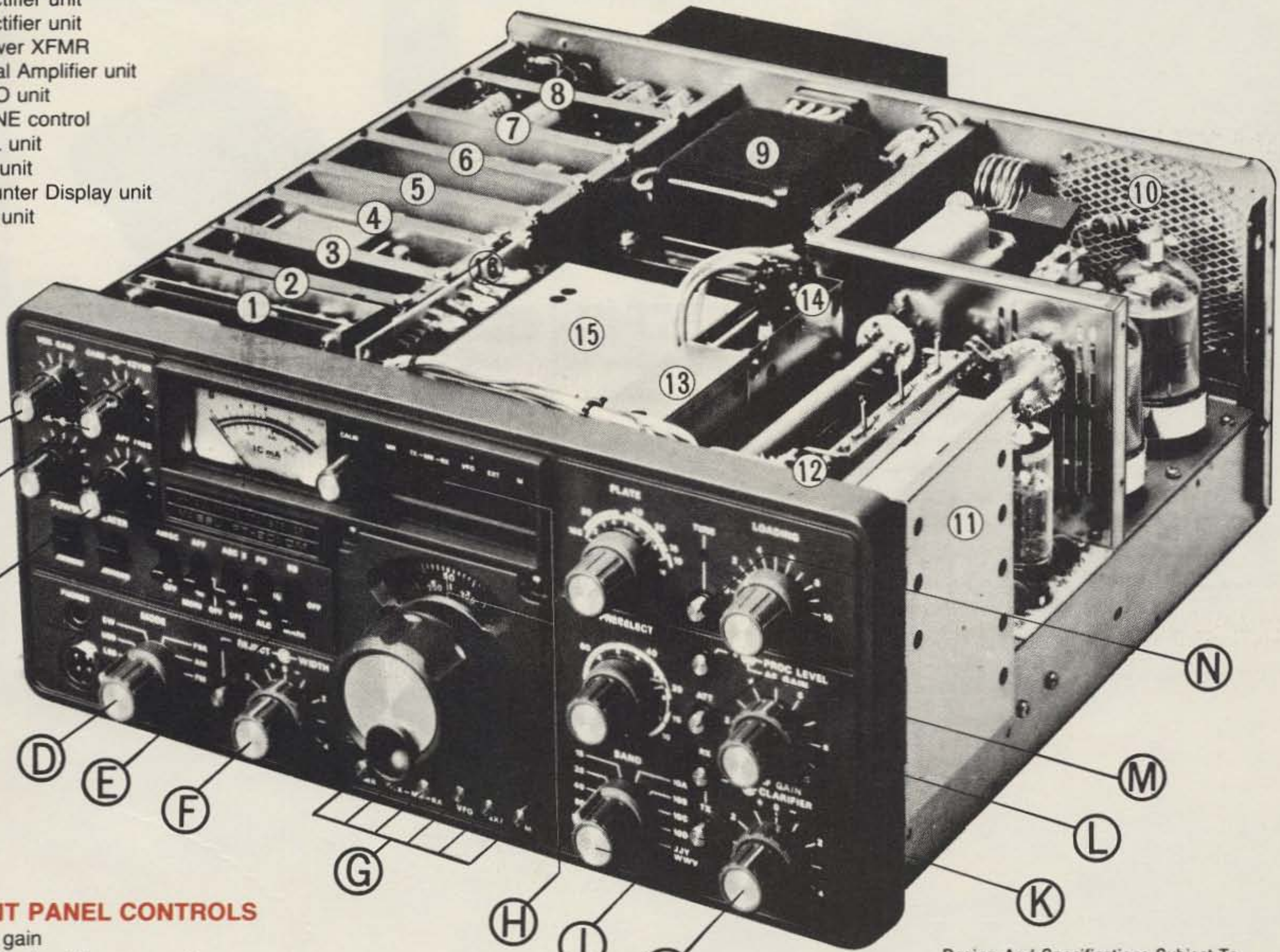

FRONT PANEL CONTROLS

- Vox gain
- Carrier level/keyer speed
- Audio Peak Frequency system
- MODE switch (SSB, CW, FSK, AM, FM)
- Crystal calibrator/Noise blanker
- Rejection tuning/variable IF passband tuning
- Frequency memory system
- Digital plus analog frequency readout
- Band switch (160-10 meters + WWV/JJY receive)
- Clarifier control
- RX/TX Clarifier selector
- RF Processor level
- RF attenuator
- TUNE control (Places transmitter in "TUNE" condition for ten seconds, then returns to "receive" condition to protect final tubes from excessive key-down time)

Design And Specifications Subject To Change Without Notice Or Obligation



THE SYMBOL OF TECHNICAL EXCELLENCE

YAESU
The smart radio

1C78



YAESU ELECTRONICS CORP., 15954 Downey Ave., Paramount, CA 90723 (213) 633-4007
YAESU ELECTRONICS CORP., Eastern Service Ctr., 613 Redna Ter., Cincinnati, OH 45215

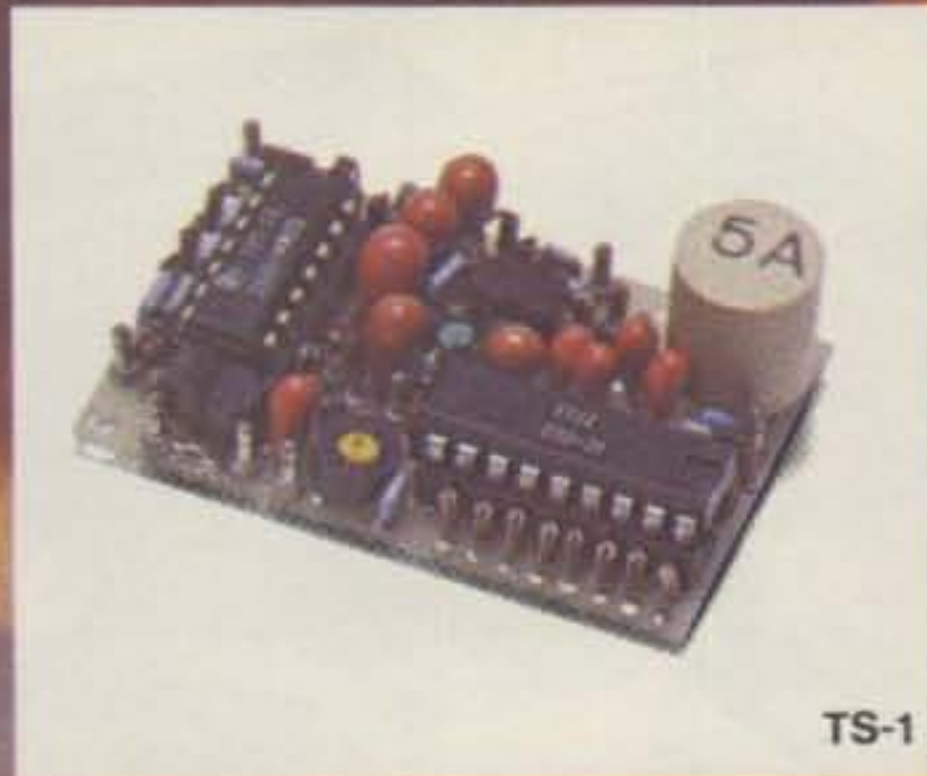

TS-1

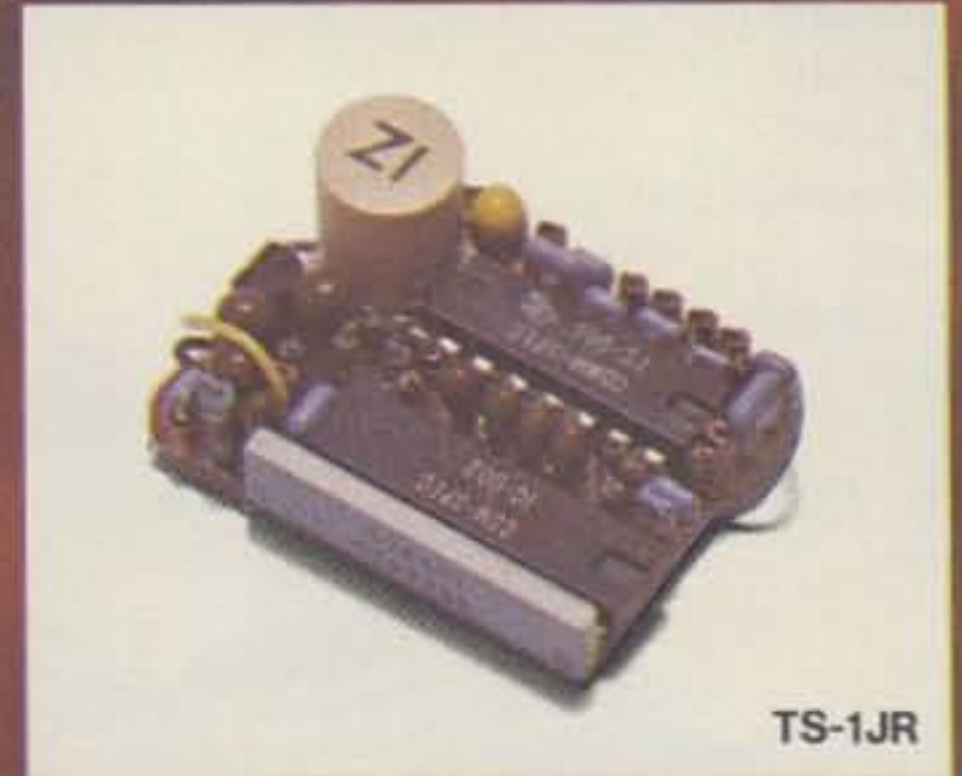

TS-1JR

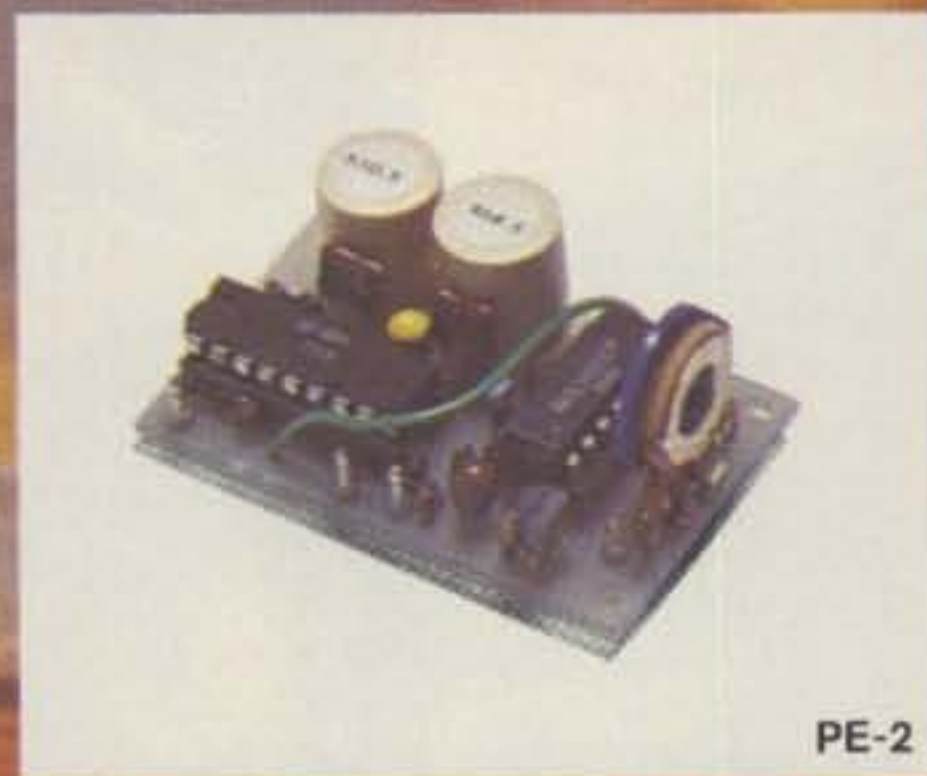

PE-2

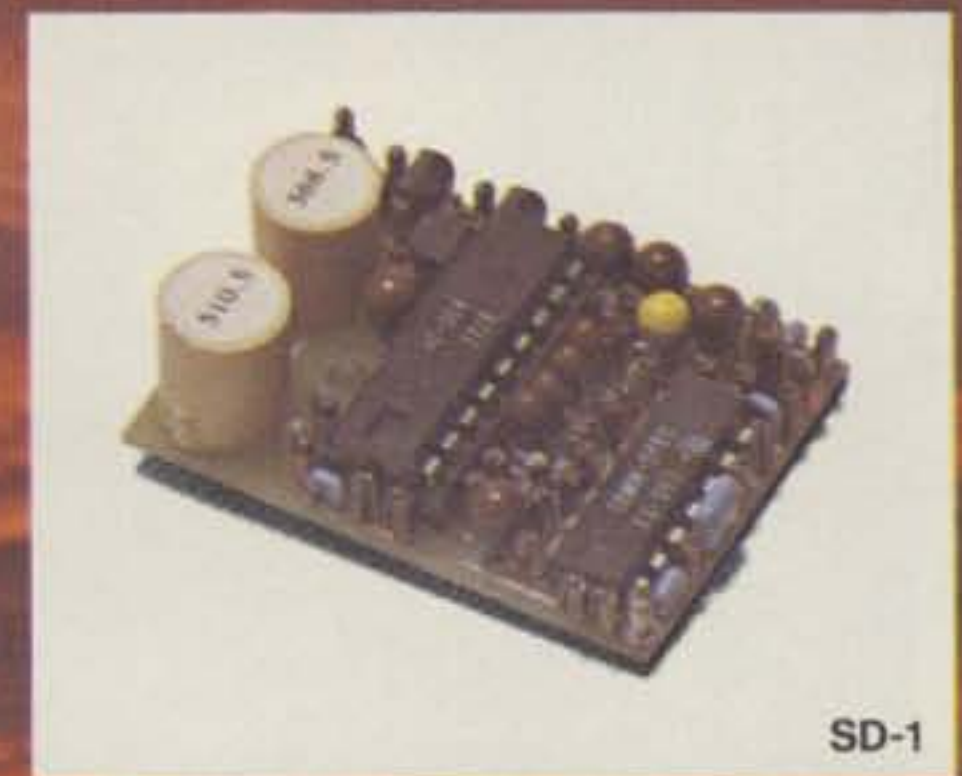

SD-1

THE DAWNING

The age of tone control has come to Amateur Radio. What better way to utilize our ever diminishing resource of frequency spectrum? Sub-audible tone control allows several repeaters to share the same channel with minimal geographic separation. It allows protection from intermod and interference for repeaters, remote base stations, and autopatches. It even allows silent monitoring of our crowded simplex channels.

We make the most reliable and complete line of tone products available. All are totally immune to RF, use plug-in, field replaceable, frequency determining elements for low cost and the most accurate and stable frequency control possible. Our impeccable 1 day delivery is unmatched in the industry and you are protected by a full 1 year warranty when our products are returned to the factory for repair. Isn't it time for you to get into the New Age of tone control?



ME-3



TE-8

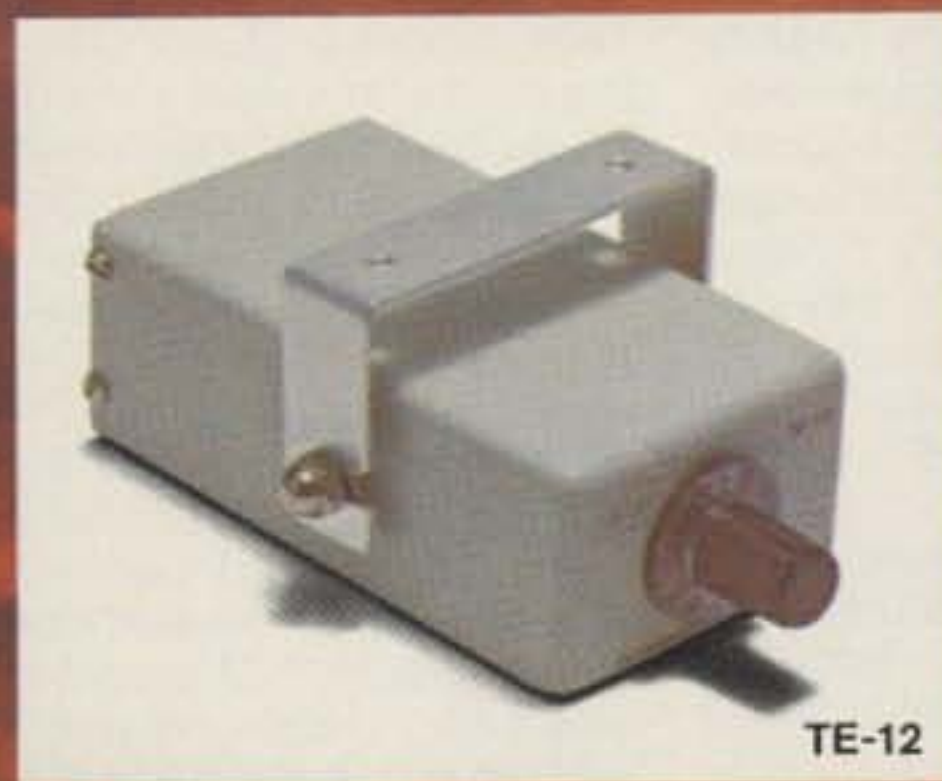

TE-12

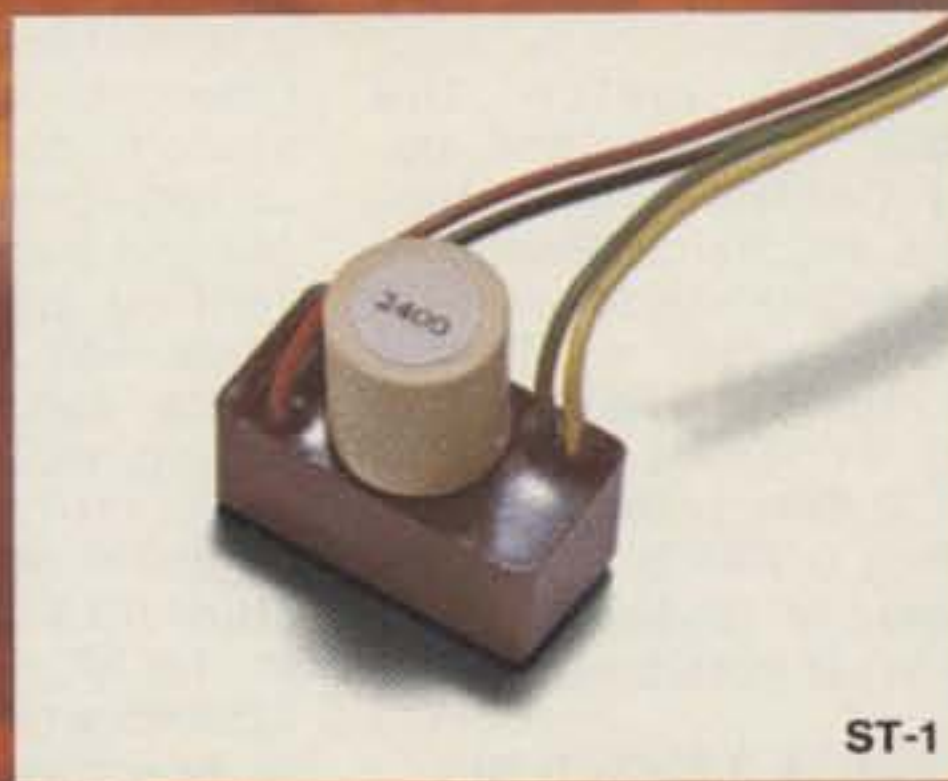

ST-1

OF A NEW AGE.

TS-1 Sub-Audible Encoder-Decoder • Microminiature in size, 1.25" x 2.0" x .65" • Encodes and decodes simultaneously • **\$59.95** complete with K-1 element.

TS-1JR Sub-Audible Encoder-Decoder • Microminiature version of the TS-1 measuring just 1.0" x 1.25" x .65", for hand-held units • **\$79.95** complete with K-1 element.

ME-3 Sub-Audible Encoder • Microminiature in size, measures .45" x 1.1" x .6" • Instant start-up • **\$29.95** complete with K-1 element.

TE-8 Eight-Tone Sub-Audible Encoder • Measures 2.6" x 2.0" x .7" • Frequency selection made by either a pull to ground or to supply • **\$69.95** with 8 K-1 elements.

PE-2 Two-Tone Sequential Encoder for paging • Two call unit • Measures 1.25" x 2.0" x .65" • **\$49.95** with 2K-2 elements.

SD-1 Two-Tone Sequential Decoder • Frequency range is 268.5 - 2109.4 Hz • Measures 1.2" x 1.67" x .65" • Momentary output for horn relay, latched output for call light and receiver muting built-in • **\$59.95** with 2 K-2 elements.

TE-12 Twelve-Tone Sub-Audible or Burst-Tone Encoder • Frequency range is 67.0 - 263.0 Hz sub-audible or 1650 - 4200 Hz burst-tone • Measures 4.25" x 2.5" x 1.5" • **\$79.95** with 12 K-1 elements.

ST-1 Burst-Tone Encoder • Measures .95" x .5" x .5" plus K-1 measurements • Frequency range is 1650 - 4200 Hz • **\$29.95** with K-1 element.



**COMMUNICATIONS
SPECIALISTS**

426 W. Taft Ave., Orange, CA 92667
(714) 998-3021

New Products

DENTRON MT-2000A ANTENNA TUNER

Being a somewhat lazy sort when it comes to things like changing antennas and feedlines, I find a good, wide-range antenna tuner an invaluable operating aid. Recently, I wanted to use a 500-Watt amplifier on 15 meters without changing the RG-58 feedline to the antenna to the heavier RG-8-type coax. Experience and advice indicated that if I could get the SWR down to 1.5:1 or under, the RG-58 would handle the higher power without breaking down.

Unfortunately, no matter how carefully I adjusted the antenna, I simply couldn't get the SWR down to the desired level. Then a bit of serendipity appeared on the scene in the form of a new DenTron MT-2000A antenna tuner.

The MT-2000A was connected between the wattmeter (a DenTron W-2) and the antenna feedline, and adjusted for maximum received signal. Then a few Watts of rf was applied for final tune-up. With just a slight bit of tweaking of the transmitter and antenna matching controls on the tuner, the SWR was brought down to where the indicator needle on the W-2's reflected power meter did not budge off the peg on the low end of the scale.

Voila! Success! For the past few weeks I've been able to run the amplifier at 500 Watts without any sign of difficulty. With the use of the MT-2000A, the RG-58 is holding up fine and my signal reports are consistently better than they were prior to using the amplifier. Results have been equally pleasing when I have used the tuner to match my other antennas, a 66-ft. random wire and a multiband dipole.

The DenTron MT-2000A is

designed to match your transmitter to virtually any feedline, balanced or unbalanced, as well as to random wires. Frequency coverage is continuous from 1.8-30 MHz, and power capability 3 kW PEP. Features include front panel switching for lightning protection and to take the tuner out of the circuit when desired. There is also a heavy-duty, 3-core, 4:1 balun, an 18-position, 12-Amp, ceramic rotary inductance selector switch, and 6000-volt capacitor plate spacing.

Add the DenTron W-2 dual-meter wattmeter and Big Dummy dummy load, and you'll have a full-power tuner setup capable of handling virtually any matching and tune-up job you may have.

Styled to match the MLA-2500 amplifier and upcoming DenTron transceiver, receivers and transmitters, the MT-2000A antenna tuner measures 5 1/4" x 14" x 14" and weighs 18 lbs. The price is \$199.50. DenTron Radio Co., Inc., 2100 Enterprise Parkway, Twinsburg OH 44087.

Morgan W. Godwin W4WFL
West Peterborough NH

UPGRADED 2 METER RIG FROM HEATH

Heath Company has made available an improved version of their HW-2036 frequency-synthesized 2 meter transceiver kit, the HW-2036A.

The HW-2036A has the same features and specifications as the HW-2036, except that the newer version allows operation on any 4 MHz segment of the transceiver's 143.5 to 148.5 MHz operating range. For those not already familiar with Heath's 2 meter rig, it features a phase-locked synthesizer/vco loop for switch-selectable QSY operation, and choice of simplex or standard ± 600 kHz split



The Heath HW-2036A.

operation. An auxiliary switch lets the operator choose his own offset.

The HW-2036A's synthesizer is locked to a precision 10 MHz timebase. A NAND gate logic system displays locked/unlocked status and inhibits out-of-band transmissions by preventing transmitter key-up. Other HW-2036A features include subaudible tone encoding, built-in 5 and 11 V dc regulators, hash filter/regulator, and gimbal mount. A standard PTT mike is included in the kit mail order price of \$269.95 when the HW-2036A-2 is specified. When the HW-2036A-1 is specified, the PTT mike is replaced by the HD-1984 Micoder II combination mike/autopatch. The HW-2036A-1 sells for \$289.95. Both prices are mail order FOB, Benton Harbor, Michigan.

For more information about the upgraded HW-2036A and a free catalog, write Heath Company, Dept. 350-640, Benton Harbor MI 49022.

KANTRONICS 8040-B RECEIVER

When UPS recently delivered a Kantronics 8040-B receiver, I was in the middle of several

projects so I stuck it in a closet to await the arrival of the promised companion transmitter. I should have known better! Temptation and curiosity got the best of me, and a short time later I had the carton open and the unit sitting on the operating desk.

In looking over the receiver, I discovered that the antenna jack on the rear panel was an RCA-type. No problem! Having a Heathkit receiver that uses the same type of connector, I already had several cables made up with RCA plugs on one end and PL-259s on the other, so I did not need to use the plug supplied by the manufacturer.

With the antenna connection resolved, I then went looking for 9-volt transistor radio batteries, since the 8040-B uses two for power. Locating one in the junk box and robbing another from a little pocket portable, I installed them in the battery clips mounted on the inside back panel of the receiver.

The 8040-B is designed to work with a low impedance antenna such as a half-wave coaxed dipole. It will also give a good account of itself when connected to a simple random



DenTron's MT-2000A antenna tuner.



Kantronics' 8040-B receiver.

wire, particularly if it is 65 feet or longer. Reception can be optimized by tweaking up the preselector coils for each band (using the plastic adjustment tool included with the unit).

In my own case, with the receiver connected through a small antenna tuner to a 40-meter half-wave endfed wire, I turned it on and, after I touched things up a bit with the tuner, signals on the Novice portion of 40 meters poured in. Later in the day, I switched to 80 meters—with equally favorable results. The vernier dial works smoothly, and its tuning rate of almost seven turns to one complete rotation of the tuning capacitor provides plenty of bandspread to separate the signals.

With the exception of the front-panel-mounted tuning capacitor, af and rf gain controls, bandswitch and power on/off switch, and the audio output and antenna input jacks on the rear, all components are contained on one small circuit board. A pair of low impedance earphones or an 8-Ohm speaker may be plugged into the audio output jack.

Contained in an attractive black and grey case measuring 3 x 5 x 7 inches and weighing only a few ounces, the 8040-B lends itself nicely to portable operation. The receiver, a pair of lightweight phones, and a small coil of antenna wire will take up very little space and add only ounces to your load if you are backpacking. Combined with a small QRP transmitter such as Kantronics' one-Watt 40 meter CW rig, the Rock Hound, you can have a complete and highly portable station to carry wherever you go. Actually, applications for the receiver are limited only by your imagination; if you are like me, new ones will keep popping into your mind every time you use it.

Having used the little receiver under widely varying conditions for several weeks at home and as a portable, I have concluded that you get a lot for

your money when you buy one.

The Kantronics 8040-B is a state-of-the-art direct conversion receiver that does a first rate job of receiving CW signals on the 3.650-3.750 and 7.050-7.150 MHz segments of the 80 and 40 meter bands—for the affordable price of \$79.95. Combined with the soon-to-be-announced companion transmitter (vfo-controlled and in the 10-Watt power class), newcomer and experienced amateur alike can have a compact and effective means for fixed station or portable operation at a reasonable price. *Kantronics, Inc., 1202 East 23rd Street, Lawrence KS 66044.*

Morgan W. Godwin W4WFL
West Peterborough NH

NEW HAMTRONICS CATALOG

Hamtronics, Inc., has announced publication of a new catalog crammed with goodies for VHF/UHF and OSCAR enthusiasts and two-way radio shops.

The 40-page catalog features a new line of VHF transmitting converters and linear power amplifiers, new 2-Watt FM transmitters, VHF and UHF receiver converters, VHF and UHF FM receiver kits, receiver preamps, test probe kits, power supplies, tone pads and tone encoder microphones, antennas, and many more items of interest to the active ham. For a copy of the new 4 x 5½ inch catalog, send a self-addressed stamped envelope to *Hamtronics, Inc., 182-F Belmont Rd., Rochester NY 14612.*

RECEIVER DIGITAL READOUT ATTACHMENT

A 4-digit LED frequency readout attachment for Wadley loop circuit receivers has been announced by Gilfer Associates, Inc. Currently available Wadley loop receivers include the R. L. Drake SSR-1 and the Yaesu FRG-7.

Called the GAR-7, the readout is easily coupled to the kilohertz oscillator in either receiver, using a manufacturer-supplied cable assembly. The



The MFJ-400 8043 Econo Keyer.

megahertz setting in the Wadley loop receiver is preset by a drift canceling circuit, and only the kilohertz and hundreds of Hertz (000.0) need be read by the GAR-7.

The accuracy of the GAR-7 readout is better than ± 10 Hz, and the use of a very low clock frequency eliminates spurs and birdies that plague standard offset counters attached to Wadley loops. Powered by 117 volts, the GAR-7 measures 2½" x 8¾" x 5". Available from stock for \$179.00. Additional details are available from *Gilfer Associates, Inc., 52 Park Avenue, PO Box 239, Park Ridge NJ 07656; (201)-391-7887.*

NEW MFJ ECONOMY KEYSER

The MFJ-400 8043 Econo Keyer from MFJ Enterprises is a reliable, full-featured economy keyer which uses the Curtis-8043 keyer-on-a-chip.

The panel controls consist of a speed control (8 to 50 wpm) that you pull to tune and a volume control with an on/off switch.

It has an internal weight control that lets you adjust the dot-dash space ratio for a distinctive signal to penetrate through heavy QRM for solid DX contacts.

The keyer has an internal tone control for its built-in sidetone and speaker.

There are two 3-conductor quarter-inch phone jacks for

output keying and key paddle input.

It requires an external squeeze key for iambic operation, and has dot memory, instant start, self-completing dots and dashes, and jam-proof spacing. Its reliable solid state keying output can handle -300 V at 10 mA maximum for grid block keying and +300 V at 100 mA maximum for cathode-keyed and solid state transmitters. It uses a 9-volt battery, measures 3 x 2 x 4 inches, and has a blue top and white bottom.

MFJ provides a 30-day money-back trial period. If you are not satisfied, you may return it within 30 days for a full refund (less shipping). MFJ also provides a one-year unconditional warranty.

The MFJ-400 8043 Econo Keyer is available from MFJ Enterprises for \$39.95 plus \$2.00 shipping and handling. To order, call toll-free (800)-647-8660, or mail your order to *MFJ Enterprises, PO Box 494, Mississippi State MS 39762.*

HIGH-QUALITY, LOW-COST DAVIS 600 MHz MINI FREQUENCY COUNTER INTRODUCED

A versatile, high-quality 600 MHz frequency counter offering superior accuracy, sensitivity and reliability—yet costing less than many 20, 30



New receiver digital readout attachment from Gilfer Associates.



The Davis 600 MHz mini frequency counter.

and even 100 MHz counters—has been introduced by Davis Electronics. Designed for 115 V or 12 V operation, available factory-assembled or in kit form for even greater savings, the Davis 7208 VHF-UHF frequency counter incorporates the latest LSI technology in a wide range, portable instrument measuring only 5½" x 6" x 2" and weighing a mere 1¾ lbs.

Superior features of the Davis 7208 include durable, all-metal cabinet for rf shielding, large 8-digit LED display, push-button switches, built-in pre-scaler, gate light, crystal timebase, and automatic Dp placement. The compact unit comes complete with IC sockets and input cable.

Available low-cost options are crystal oven, nicad rechargeable battery feature for total portability, and built-in VHF-UHF preamp for direct measurement of low level rf signals in rf generators, receivers, etc.

The Davis 7208 has a frequency range of from 10 Hz to 600 MHz, with 0.1 and 1.0 sec. gate time; resolution is 1 Hz with 1.0 sec. gate and 10 Hz with 0.1 sec. gate, and sensitivity is from 10 mV @ 60 MHz and 100 mV @ 600 MHz (or 10 mV @ 150 MHz with built-in preamp option). Input impedance is 1 megohm/20 pF to 60 MHz and 50 Ohms above 60 MHz, and maximum safe input is 120 V rms to 10 MHz and 2 V rms above 60 MHz. Timebase specifications include frequency of 5.242880 MHz (std. or oven crystal) and accuracy of ±1 ppm after cal. (std.) or ±.5 ppm after cal. (oven crystal). Short-term stability is ±1 ppm/hr. after warm-up, while long-term (aging) is ±1 ppm/month (std.) or ±.5 ppm/month (oven crystal).

The 600 MHz kit (7208K), costing \$149.95, comes com-

plete with all parts, drilled and plated-through glass PC boards, cabinet, switches, and hardware, plus detailed assembly manual and calibrating instructions. Assembly time is about 4 hrs., and all parts are guaranteed 90 days. Factory service is available, if needed, at \$25.00 plus shipping. A factory-assembled 600 MHz unit (7208A) costs \$199.95 (plus \$2.00 shipping) and is calibrated to specifications and guaranteed for one year; the transformer is guaranteed for life. The option prices are: (01) crystal oven, \$39.95; (02) rechargeable nicad batteries, \$39.95; (03) carrying handle, \$5.00; and (04) built-in VHF-UHF preamp, \$10.00. For further information, contact *Davis Electronics, 636 Sheridan Drive, Dept. 808, Tonawanda NY 14150; (716)-874-5848.*

KANTRONICS ROCK HOUND QRPp TRANSMITTER

I normally avoid using the adjective "cute" like it was the plague when writing about amateur equipment. After all, how can anything described as being cute be taken seriously? Well, Kantronics has pulled it off with their new "Rock Hound."

A one-Watt, crystal-controlled 40 meter CW transmitter tucked into a 2" x 4" x 3" plastic case, the "Rock Hound" is cute! And it really works.

Setting the little rig up for operation couldn't be simpler. An antenna is attached to the RCA-type jack on the front panel. The transmitter expects to see an impedance of 50 Ohms, and there is an internally-adjustable pi output network to peak power output. A key is connected to the center pin of the standard quarter-inch phone plug provided with the unit. The other side of the key is attached to



OK Machine and Tool's model WK-5B wire-wrapping kit.

the positive terminal of a 12 to 15 V dc power supply or battery. The ground side of the phone plug is then connected to the negative terminal of your power source. Finally, with the phone plug put into the jack on the front panel, you are ready to go on the air.

Connecting the "Rock Hound" to my 40 meter half-wave endfed wire through an antenna tuner, I found that the little rig puts out a quite respectable and effective signal. The transmitter came with a crystal (optional) for 7.125 MHz, but I cheated a bit and dug several more out of the junk box to provide greater flexibility. The transmitter can also be driven by a vfo by plugging its output into the crystal socket.

Like fly-fishing, QRPp operation isn't nearly as difficult as some of the "experts" would lead you to believe. It does, however, require a good measure of patience and, of course, enthusiasm is invaluable. With very low power, it is generally not worth the effort to spend time calling CQ. If you have an assortment of crystals or a vfo, you should tune around until you hear a loud signal calling CW or about to sign with another station. Then zero beat or, if you are crystal-controlled, get as close to the other station's frequency as possible and call them when they stand by. Your batting average may not be too high, at least for a while, but when you do make a contact with QRPp, the satisfaction is terrific.

The Kantronics Rock Hound is lots of fun, and at only \$20.00 you can certainly afford to enjoy the challenge and pleasure of very low power operation. The optional crystal is available for \$3.00. *Kantronics, Inc., 1202 East 23rd Street, Lawrence KS 66044.*

**Morgan W. Godwin W4WFL
West Peterborough NH**

WIRE-WRAPPING KIT

Model WK-5B is a unique new wire-wrapping kit that contains a complete range of tools and parts for prototype and hobby applications, all conveniently packaged in a handy, durable plastic carrying case.

The kit includes the model BW-630 battery wire-wrapping tool, complete with bit and sleeve; the model WSU-30, a remarkable new hand wire-wrapping/unwrapping/stripping tool; a universal PC board; an edge connector with wire-wrapping terminals; a set of PC card guides and brackets; a mini-shear with safety clip; industrial quality 14-, 16-, 24-, and 40-pin DIP sockets; an assortment of wire-wrapping terminals; a DIP inserter; a DIP extractor; and a unique 3-color wire dispenser complete with 50 feet each of red, white, and blue Kynar® insulated, silver-plated solid AWG 30 copper wire.

Priced at \$74.95, the WK-5B wire-wrapping kit is available from your local electronics distributor or directly from *OK Machine and Tool Corporation, 3455 Conner Street, Bronx NY 10475.*

THE TRAC-KEY

Trac Electronics, Inc., has introduced a new twin paddle squeeze key. The new Trac-Key features an extra heavy base with non-skid feet (so the key does not move when in use), adjustable contact spacing, touch tension (allowing comfort keying), smooth, friction-free paddle movement, and five-way binding posts, all on a handsome crinkle-finish base with rich red paddles. The Trac-Key is compatible with the Trac CMOS Electronic Keyer or any other keyer.

The Trac-Key is available direct from Trac for \$25.95 (plus \$2.00 shipping and handling), or through local dealers



The Rock Hound from Kantronics.

WE'LL KEEP YOUR COMMUNICATIONS NEEDS FROM GETTING OUT OF HAND.

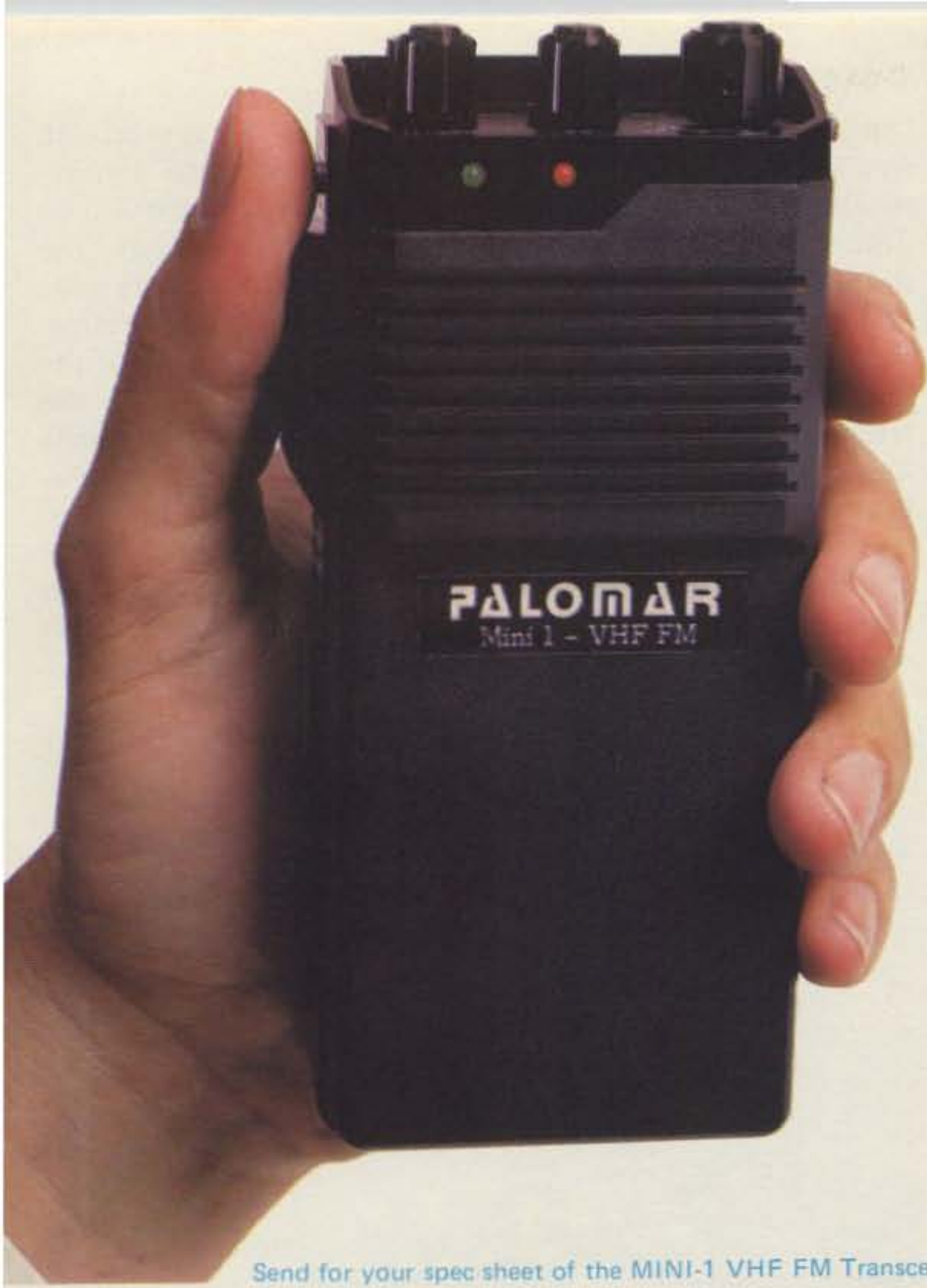

Introducing the PALOMAR MINI-1 VHF FM TRANSCEIVER . . . the Amateur Hand-Held set that's small enough to fit in your palm.

You're never out of touch with thousands of repeaters, so you're never out of touch with home . . . associates . . . friends. The PALOMAR

MINI-1 operates normal in the Amateur 144-148 VHF region and with the AUTO-PATCH OPTION, you can access the telephone repeater and communicate through the telephone system.

The PALOMAR MINI-1 VHF FM TRANSCEIVER is only 152 mm high by 67 mm wide. Transmitter minimum output is one watt of power, with a total of 18 channels available, utilizing up-down split, down-up split or simplex, all with only 6 crystals.

The PALOMAR MINI-1 VHF FM TRANSCEIVER . . . it has all your communications needs well in hand.



*Worth every dollar.
(And about the same size!)*



Send for your spec sheet of the MINI-1 VHF FM Transceiver to: PALOMAR ELECTRONICS, 665 OPPER STREET, ESCONDIDO, CA 92025

The parameters of the Palomar PTR-130k are the outer perimeters of logic technology.

Never before has any transceiver approached the capabilities of the Palomar PTR-130k!

It's the first completely multi-functional transceiver ever made available to the public!

The Palomar PTR-130k is a miniaturized mobile transceiver

capable of operating in 100 cycle resolution from 100 KHz to 30 MHz in all modes of transmission and reception. Instant frequency selection is available with the touch of a finger.

The Palomar PTR-130k.

technology is pure space age . . . the price is strictly down-to-earth. Send for our full color brochure to:
Palomar Electronics Corporation
665 Opper Street
Escondido, CA 92025
Telephone: (714) 746-2666



TECHNOLOGY AT THE SPEED OF SOUND

Old-timers will remember the radio row of yore in every city of any size in the United States where all the electronic parts wholesalers used to huddle their shops together in one part of town as if for mutual support. A ham who wanted a receiver or a resistor could browse from one to the other until he found the best one for the best price.

Radio row still exists—in

Tokyo. I suppose there's hardly a ham active today who has not heard of Akihabara (say hockey harbor, rah!—then leave off the first H, and you've got it). The prices are not what they were before the dollar did its nose dive with respect to the yen in the fall of 1977 and winter of 1978, but the parts and the products are all still available there.

When in Tokyo, take the

Japanese National Railway's local elevated train to the Akihabara station. Come down the steps to the street and follow the line of display cases of radio gear to the lobby. There will be doors to the left and to the right, both leading to the street and both to the acres of radio row in Tokyo. You will come upon a scene like that shown in Photo A—buildings with floors

full of gear, not spread out, but jammed into innumerable tiny booths. Up on top of the buildings, the demonstration antennas beautify the Tokyo skyline.

The ground floors of the buildings are open to the street and lined with little shops selling parts, television sets, high-fidelity gear, and tubes. Get a little closer and have a look at the varieties of cable and coax available. Or peer in-

*Brad Field W8JJO
16725 Fenmore
Detroit MI 48235*

Radio Row Revisited

*—it's alive and well
in Tokyo*



Photo A. Akihabara—one of the buildings seen from the Japanese railway station.

to the dark aisles leading to the uncharted interior of the building.

Inside is an endless row of booths, all of them crammed with gear and parts. One shop, for instance, sells four or five kinds of switches. Another, the shop shown in Photo C, has test gear, each item labeled with a sign begging the reader to ask how big a discount he can get.

In between these interior shops are stairwells leading upward. When you get upstairs, you'll find UHF and VHF transceivers, walls full of them, with no two exactly alike.

You can climb up further still and have a look at some antennas, as in Photo D. Those two in the foreground are Masanori Suzuki JH1CNC and Dave Bell W6AQ. Readers who have seen the movie "Ham's Wide World" will recognize Dave Bell's name as that movie's producer. He was in Japan in the fall of 1977, when these photographs were taken, on several errands, one of which was to shoot some film for another movie on ham radio.

Meanwhile, don't rush out to buy a plane ticket to Tokyo just to go to Akihabara—not yet, at any rate. Japanese prices are no longer low. And Tokyo remains one of the most expensive cities in the world. Furthermore, a large portion of the gear on display here is aimed at the lucrative Japanese Novice market: ten Watts maximum, phone only, 80, 40, 15, and 10 meters and VHF. Only about ten percent of the Japanese amateurs have a higher class of license.

But, if you're going to be in Tokyo anyway, don't miss it. A Sunday is best because, at noon, they close the main street to automobiles and put out tables and chairs. The little



Photo B. Booths open to the street in Akihabara.

kids come out and play, and everyone has a good time. You will, too. Just remember: The maximum that will go through Japanese parcel post is ten kilograms, 22 lbs., per box. If you get anything heavier than that, you'll have to carry it on the plane. ■



Photo C. A test-gear shop. A place like this is one of the few places in Japan where prices are negotiable.



Photo D. A small corner of the antenna display at one of the larger ham dealers. Left—JH1CNC; right—W6AQ.

How To Work Europe With An HT

—hint: requires trans-Atlantic plane fare

As thousands of Americans discover each year, a trip to Europe represents a delightful and memorable vacation — historical settings, magnificent scenery, and interesting customs. But to add a whole new dimension to your European vacation, take along your 2m FM handie-talkie. The DX contacts that you can make on 2m offer a fine opportunity to learn about foreign hamming, the country, and the customs.

The purpose of this article is to tell you about some of the preparations that should be made before your trip and to describe the fun you can have during your trip. Although operating 2m FM in Europe is really easy and convenient, there are several things that you should know ahead of time. I found that the most difficult part of operating a 2m rig in England and Germany was getting the answers to several key questions ahead of time. I could

not find one complete source which answered all of my questions. Consequently, I spent a lot of time before each trip in correspondence and research. Fortunately, however, you can benefit from my pretrip trials and tribulations. Consider what follows as the "ABCs of 2m FMing in Europe."

Your choice of rigs will be related to what you already have or can beg, borrow, or build — plus how you plan to travel about in Europe. Although I had the choice of taking either my mobile rig or my handie-talkie, I quickly opted for the handie-talkie because of its portability and light weight. When you and the XYL compare the items of clothing, photographic equipment, etc., with the number of bags you want to carry and your weight allowance (usually 44 pounds per person), you will probably reach the same conclusion that I did. Further, the fine system of repeaters which exists in Germany and England will insure that two Watts through a rubber ducky will make all the QSOs you can log.

Preparations

The first step in planning your FM trip to Europe will

be to obtain a reciprocal license from the countries that you plan to visit. Generally speaking, your reciprocal license will carry privileges comparable to the ones you now hold. An excellent source of information on reciprocal licensing is *The International VHF-FM Guide*, compiled and produced by G3UHK and G8AUU (order from Julian Baldwin G3UHK, 41 Castle Drive, Maidenhead, Berks., SL6 6DB, England, for \$3 or 14 IRCs). This little booklet covers all the countries in Europe, plus a few others, and provides such licensing details as: information you need to supply, mailing addresses, costs, etc. The *Guide* also contains listings of repeater channels by city and country.

Allow plenty of time — at least two or three months — to obtain your reciprocal license. The vagaries of the mail system and the possible need to provide additional information may stretch out the process. For example, I found that my reciprocal license from England required several exchanges of letters over about two months, whereas I received the German license within three weeks. Incidentally, a reciprocal license from Great



Photo A. A minimum of equipment is needed for 2m FM operation in Europe. In addition to a transceiver, take your external microphone fitted with a piggyback tone burst, charger for the nicads, 220/110 V ac converter, and an extra set of nicads.

Britain may be mailed only to your intended address in England; your German license can be mailed to your home QTH before you leave.

The question of powering your rig is fairly easy to answer. Assuming that your rig uses nicads, you will need to provide a means for recharging them during your stay in Europe. Since the standard in Europe is 220 V ac, you will need a 220/110-volt converter as well as your charger. Be sure to match the power requirements of the converter and the charger. Also, it is advisable to choose a converter which uses a transformer rather than resistors to drop the voltage. Depending upon the charge rate of your setup, you may want to take along an extra set of nicads to increase operating flexibility.

The number and frequency of crystals for your rig will depend upon your itinerary in the countries you plan to visit. European 2m repeater FM channels have the same offset as in the USA but cover input frequencies from 145.000 to 145.225 MHz in 0.025 MHz steps. The outputs of the repeaters range from 145.600 through 145.825 MHz. The 10 repeater channels within this band are identified as channel R0 through channel R9. The *International VHF-FM Guide* will provide you with accurate data on the repeater channels found in various cities.

Incidentally, you will find only one channel in each city, unlike most cities in the United States which have several 2m repeaters. The limited number of repeaters makes for a lot of activity and generally fairly short time-out durations. For example, the London repeater, GB3LO, has a time-out of 60 seconds; the Munich repeater, DB0ZM, times out in 80 seconds.

Regarding simplex, there are five channels between 145.500 MHz (S20, the calling channel) and 145.600

MHz, each separated by 0.025 MHz. The principal working channel is S22, 145.550 MHz.

Because several cities in the same country will have the same repeater channels, you won't need to crystal up for more than a couple of channels. And, while two channels may not cover every city you visit, they will give you quite a bit of action.

Obviously, 2m crystals in the 145 MHz band are not standard with American crystal manufacturers, so you will need to order them special from any of the several crystal-grinding firms. The time required for delivery of your crystals will vary, so allow four to six weeks. I found, however, that Sentry shipped my 145 MHz crystals within one week after receiving my order.

Almost all of the European repeaters require a 1,750 Hz tone burst for access. If you are blessed with a good natural whistle you can probably whistle them up. Unfortunately, my built-in whistle is not very reliable, so I opted to build a tone burst for use in Europe. Inasmuch as tone bursts are needed on few stateside repeaters, I decided not to build the burst permanently into my handie-talkie but to build it as a plug-in piggyback unit on the external microphone of my Wilson 1402. This arrangement worked fine and I am able to use the miniplug on the microphone case for my autopatch touch-tone™ back in the States.

Finally, your preparations should include packing a few American ham magazines and a minilog. The ham magazines can be used as gifts and interest items during QSOs. Most European hams have never seen one of our ham magazines and would certainly welcome the opportunity to either have one or look at one.

Assembling a Tone Burst

One of the neatest and

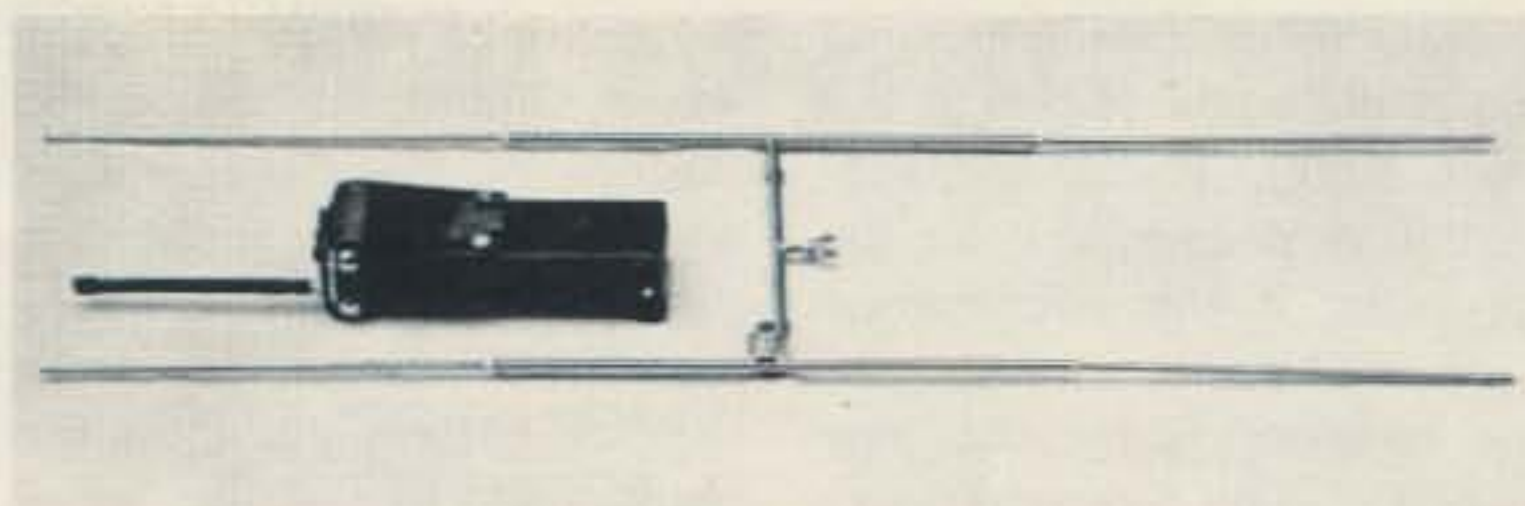

Photo B. The HB9CV 2m antenna weighs about 10 oz. and provides 5 dB gain. Length of the director is 95.6 cm; the reflector, 103 cm. Spacing between elements is 25 cm. The above model is sold commercially in Germany where it is popular.

simplest ways to build an outboard tone burst for temporary attachment to your external microphone is to use a prebuilt unit such as is available from Lye Communications in England (238 Stamford Road, Brierley Hill, West Midlands, DY5 2QE, England; cost is £4; an \$8 bank draft covers the unit and airmail shipment). The module is built on a small PC board measuring about 2¼" by 1-7/8" and less than ½" thick with the components. The burst is a stable 1,750 Hz tone with a duration of approximately 600 ms. Any dc voltage between 9 and 15 may be used. Drain is only 8 mA at 12 V dc. Power can be supplied either from your handie-talkie or from an outboard 9 V transistor battery.

Although a number of tone burst circuits have been

published for building one from scratch, I found that rounding up the components would be difficult and would have cost more than the ready-to-use Lye unit. As shown in the photo, I built my tone burst into a small Bakelite™ box measuring 3¼" x 2-1/8" x 1-1/8".

With the exception of the Lye unit, all parts are available from Radio Shack or your junk box. The cost of buying all of the parts new (see Parts List) is less than \$12.00.

After you have all the necessary parts, you can build the outboard tone burst assembly in less than two hours. Start by opening the back of the external microphone and locating the two points which will feed the tone to the transmitter when you press the momentary-

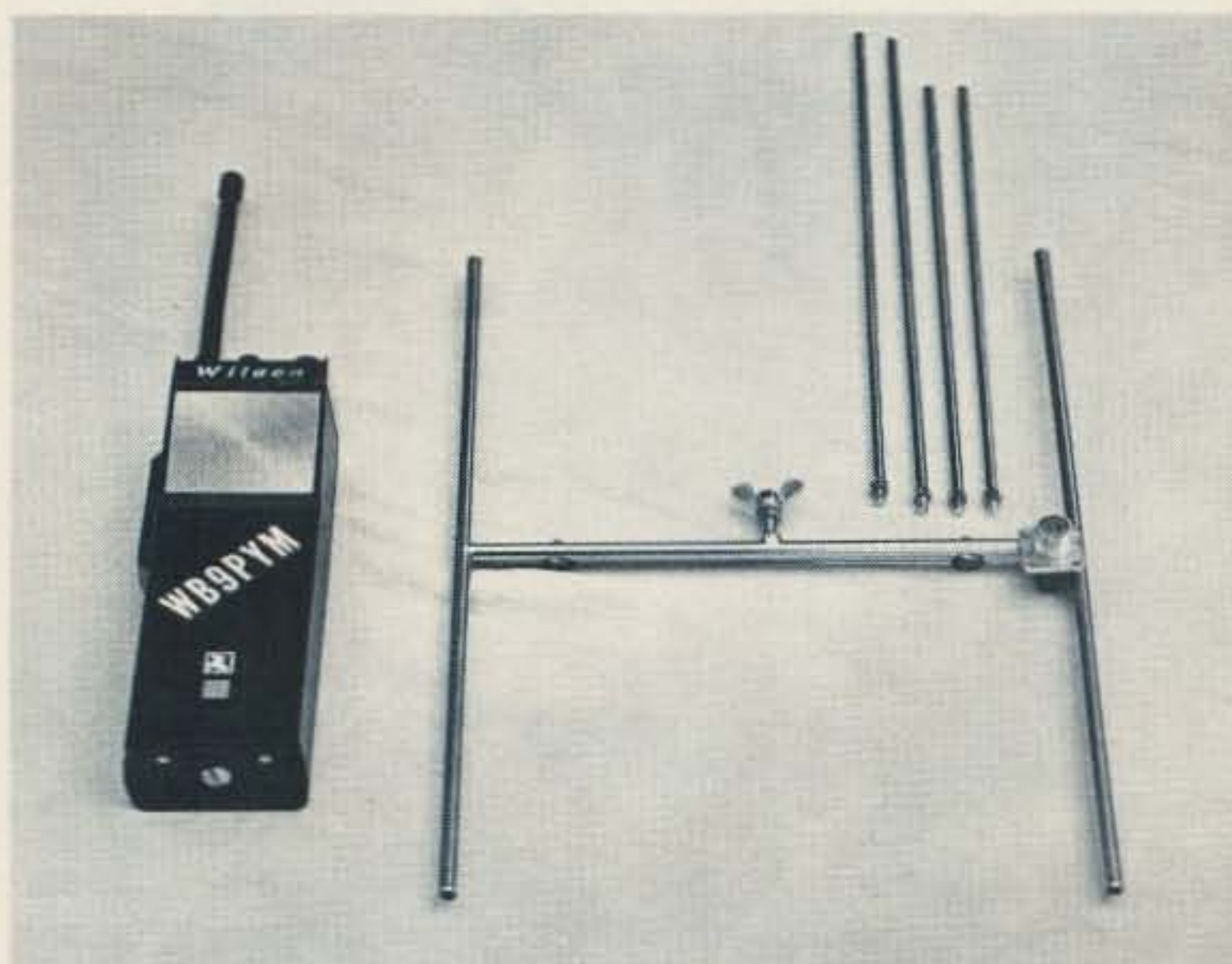

Photo C. For storing this German version of the HB9CV antenna, the end sections can be unscrewed. The H-section measures about 10" x 15".

contact switch (while pressing the push-to-talk switch at the same time). Install the sub-miniature phone jack on the top side of the microphone case and connect the jack to the two points for the tone audio. The unobtrusive modification of your external microphone provides the means for injecting either a tone burst or a touchtone signal.

The next step is to prepare the outboard tone burst assembly. Remove and discard the aluminum cover that comes with the Bakelite box and then carve the exposed edges so they match the contour of the back side of the mike case. The Bakelite is easy to work with an X-acto™ knife. Drill three holes in the box: one for the leads from the transistor battery; one on the top of the box for the connection to the subminiature phone jack; and the third hole, also on top of the box for the momentary-contact push-button switch. Next, solder four leads to the Lye module, according to their instructions, so that pressing the push switch produces the tone burst through the phone jack. After testing the completed assem-

bly to make sure it works the way it should, fasten it to the bottom of the Bakelite box with epoxy; also epoxy the two sets of leads so they won't pull out (leads from the 9 V battery and from the phone jack). Finally, using plastic tape, attach the transistor battery to the bottom of the box, as shown in Photo D. The entire assembly is now ready to attach to the back of the microphone case — also with plastic tape for easy removal.

Operating

At last, the magic moment has arrived. After spending seven hours, more or less, winging across the Atlantic under cramped conditions — if, like most of us, you've travelled by charter airline — you've landed, struggled with your luggage through customs, and have checked into a hotel or *gasthaus* and are about ready for a few hours of horizontal QRT to take care of the jet lag. But first you must unpack the 2m rig and check out the local repeater.

The chances are that, as soon as you turn on the rig, you will hear a QSO. One thing will be strange to you

when you listen to a repeater for the first time in either England or Germany — the local hams talk very fast, and, while the British amateurs speak English, you will probably find it difficult to understand some of the words. In Germany, most of the QSOs are, naturally, in German, but you will find that there are a lot of hams who speak English — many of them as well or better than you or I. And as soon as you can slip a word in edgewise, you'll announce your call and see what happens. As soon as the local operators hear an obviously American accent and a call which indicates a reciprocal license, you may create a pileup as everyone wants to work you. Most of the hams will want to exchange QSL cards, "via the bureau" to save postage. (Make sure you have envelopes on file with the bureau.)

I found that special attention was required to understand the various calls and especially to keep handles straight, since some of the first names were new to me. Also, the first time you hear a new term that is in common local use, you may do a double take, e.g., "listening through" in England or "73 and 55" in Germany.

It would be an advantage to speak German in working German operators, but I found that, despite my total lack of fluency in the German language, there were enough hams who spoke English, especially in larger cities such as Munich.

There is no problem in finding interesting topics during QSOs. About the only problem I had was trying to remember the very short time-outs. The universal subjects of rigs, antennas (aerials in England), and home QTH were usually followed by my inquiries on the location of local ham stores, radio clubs, and ham publications.

Your 2m contacts can be a source of information on interesting events that would

never be listed in the standard tourist guides. For example, during a QSO in Munich, I learned about a festival being held one sunny Sunday afternoon near the Olympic Stadium. Some 30 Bavarian dancing and marching groups in native costumes provided a unique set of color slides, as well as some unforgettable sausages and beer in an enormous tent.

HB9CV 2m Antenna

Although the HB9CV antenna is used extensively by 2m operators in Germany, and apparently has been around for some time, it is unknown to most American hams. During an eyeball QSO with Ed DJ7CW in Munich, I watched in amazement as he easily worked full quieting into the Zugspitze repeater, DBØZU, more than 80 km away through an HB9CV mounted on his first-floor apartment balcony. I promptly purchased a commercial model of the antenna at a Munich ham store. This little beauty is shown in Photos B and C.

The HB9CV, a version of the ZL-Special, provides 5 dB gain. The antenna I purchased for the equivalent of about \$18 makes a great traveling companion for a handie-talkie; it weighs about 10 oz. — less than the magazine you are reading. The end sections can be unscrewed for storage or travel. When the end sections of the elements are removed, the center "H-section" measures only 25.8 cm by 38 cm (10" by 15") and easily fits into a small suitcase or even a briefcase. The overall size of the fully assembled unit is: director — 95.6 cm; reflector — 103 cm; and spacing between elements — 25.8 cm. There is an SO-239 for the coax feedline and a 30 pF condenser connected between the SO-239 and the feedpoint.

The HB9CV is not made commercially in the USA but would be easy to build from 6 mm diameter brass tubing. Construction details can be

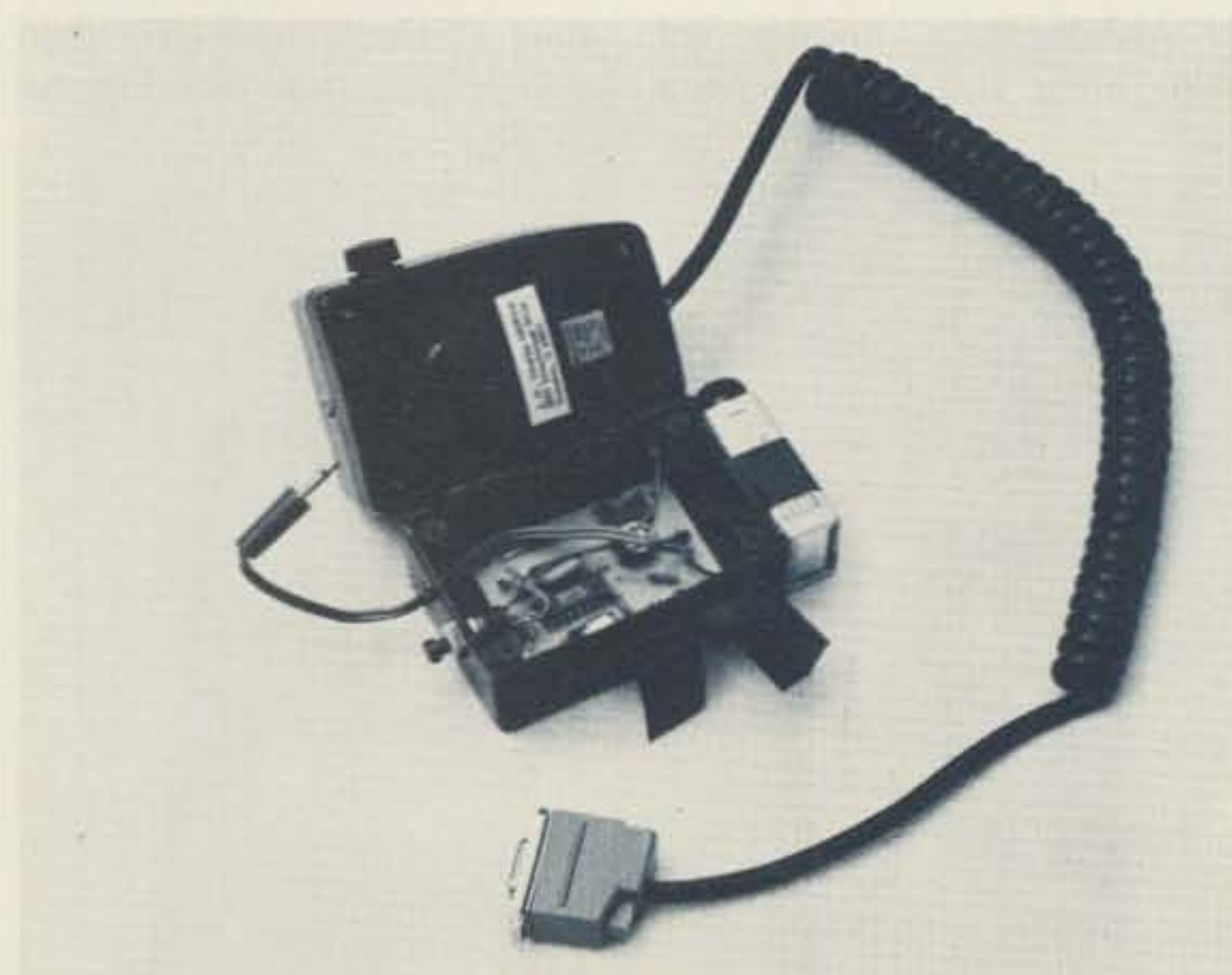

Photo D. Piggyback tone burst unit mounted in a small Bakelite box is shown with the external microphone. The unit is taped to the back of the microphone case for use. Burst input is provided through the miniature jack on top of the mike case. The momentary-contact push-button switch activates the tone burst.

found in volume 2 of the recently published *RSGB Radio Communication Handbook*, page 14.24. Incidentally, aside from general 2m work, this antenna is ideally suited to fox hunting because of its light weight and high gain.

Eyeball QSO

Two meter FM operating is always fun in Europe, but, for me, the high points of my vacation trips to England and

Germany were the eyeball QSOs with some of the hams I met on 145 MHz. After spending a few hours in the QTH of Mike G3WMQ, near London, or Ed DJ7CW, in Munich, we knew much more about each other's country in general and hamming than we could ever have known otherwise. And while you disappear into the ham shack for an eyeball QSO, your XYL can have a fascinating visit with her counterpart about

harmonics, recipes, or whatever. After you and your XYL have experienced this stimulating style of person-to-

person diplomacy, you will be convinced that there is nothing like 2m Fming in Europe. ■

Parts List

- Lye Communications tone burst module
- Bakelite box, mini utility case (Radio Shack no. 270-230)
- SPST miniature momentary-contact push-button switch, normally open (Radio Shack No. 257-1547)
- 2-conductor 3/32" subminiature phone plug (Radio Shack no. 274-289)
- Subminiature phone jack, 3/32" (Radio Shack no. 274-275)
- 9-volt transistor battery clip (Radio Shack no. 270-325)
- Miscellaneous: epoxy, hook-up wire, 9-volt transistor battery, plastic tape

Looking West

from page 18

formed by Lou that this was to be the Mobile Command Post for all communications. The driver-owner was Roger Mion WA2UMD. As I sat talking with Roger, I could not help but remember back to the days when my bright red VW van served the same purpose—though it was a lot more crowded. Roger's bus was equipped with all the comforts of home, including running water, heating and cooling, and a neat little KDK radio that was the mainstay of the network. Soon Roger, Lee, and a few of the others excused themselves, donned tool belts, and explained that they were going to install the "portable command machine" on a few of the local skyscrapers. It was a programmable split-site box interlinked on UHF. While the WR2AHU repeater, located atop the RCA Building, was to be the main communications channel (backed up by .52 and .94 simplex), the portable unit provided by Roger and his associates was an added measure of security. It was at about this time that people in droves, both amateurs and marchers, began to arrive. Quickly, the amateurs were given their individual assignments by Linda WB2GZW, issued the proper identification for themselves and their vehicles, and had their radios checked to be sure that all were operating on frequency. The latter service was courtesy of DSI's VP-Marketing, Dennis Romack WB6OYI, who offered the use of the contents of his sample case for the day. By 8:30 am, everyone had reached his assigned location (including Dennis, who wound up on 59th Street and 5th

Avenue with his HT-220). Linda began a net callup over AHU. As I stood there watching her perform, I was very taken. With expertise and class, she called up and ran this net for the next six solid hours. No one could fluster her, and when she told a field operator to stand by, he did so. I was in awe of that gal. Even when some warped mind decided to get his kicks by jamming parade communications (on the AHU system), she kept her cool. New York has its share of sickies, and this had been expected. Everyone knew exactly what to do and what channel to go to. Quite soon, one warped individual was left with no one to listen to him.

Soon it became "hot and heavy." Messages from all over the place were pouring into the Command Center. Each one

was expertly handled and expedited. I have no exact figures on the number of pieces of traffic handled, but it was easily in the high hundreds—probably over the 650 mark. It was big city amateur radio at its best.

Who are these amateurs and why do they do it? They come from many of the area repeaters and clubs, including LIMARC, the Metropolitan Repeater Association, the Kings County Repeater Association, the WR2AHU repeater group, the Red Cross Amateur Repeater Club, and many other organizations too numerous to mention. They come from all walks of life, and even though this is a parade meant to honor Israel each year on its birthday, the amateurs involved represent a cross section of faiths and nationalities. I asked many why they were participating. All gave about the same answer. To paraphrase, "It's a job that amateur radio can accomplish better than any other service, and we are amateurs of this

area. It's our obligation."

The Parade ended at about 5:30; it had been scheduled to end at 4:00, but events like this usually run late. I was heading back to LA that evening and had to make a 9:00 pm flight out of Kennedy. After some quick good-byes, the nose of the rented Toyota was pointed across the 59th Street bridge and out onto the Long Island Expressway. That's about the last I remember until I awoke somewhere near Las Vegas. I had slept through takeoff and most of the trip. As I eased back in the seat, I reminisced. I thought of how funny it was that I could be sitting at 30,000' plus after six or seven hours ago having walked up and down Fifth Avenue photographing amateurs doing what they loved the most. In the flight bag under my seat was about 1200 feet of film that would go to the lab the following day. The 1011 flew on, quietly and smoothly. Its destination, the City of Angels. Home.

OSCAR Orbits

The listed data tells you the time and place OSCAR crosses the equator in an ascending orbit for the first time each day. To calculate successive orbits, make a list of the first orbit number and the next twelve orbits for that day. List the time of the first orbit. Each successive orbit is 115 minutes later (two hours less five minutes). The chart gives the longitude of the first crossing. Add 29° for each succeeding orbit. When OSCAR is ascending on the other side of the world, it will descend over you. To find the equatorial descending longitude, subtract 166 degrees from the ascending longitude. To find the time it passes the North Pole, add 29 minutes to the time it passes the equator. You should be able to hear OSCAR when it is within 45 degrees of you. The easiest way to do this is to take a globe and draw a circle with a radius of 2480 miles (4000 kilometers) from the home QTH. If it passes right overhead, you should be able to hear it for about 24 minutes total. OSCAR will pass an imaginary line drawn from San Francisco to Norfolk about 12 minutes after passing the equator. Add about a minute for each 200 miles that you live north of this line. If OSCAR passes 15 degrees from you, add another minute; at 30 degrees, three minutes; at 45 degrees, ten minutes. Mode A: 145.85-.95 MHz uplink, 29.4-29.5 MHz downlink, beacon at 29.502 MHz. Mode B: 432.125-.175 MHz uplink, 145.975-.925 MHz downlink, beacon at 145.972 MHz.

Oscar 7 Orbital Information

| Orbit | Date (Aug) | Time (GMT) | Longitude of Eq. Crossing °W |
|-----------|------------|------------|------------------------------|
| 16967 Abn | 1 | 0052:56 | 71.7 |
| 16980 Bbn | 2 | 0147:13 | 85.3 |
| 16992 Bbn | 3 | 0046:34 | 70.2 |
| 17005 Abn | 4 | 0140:51 | 83.8 |
| 17017 Bbn | 5 | 0040:12 | 68.6 |
| 17030 Bbn | 6 | 0134:29 | 82.2 |
| 17042 Abn | 7 | 0033:50 | 67.0 |
| 17055 Bbn | 8 | 0128:07 | 80.6 |
| 17067 Bbn | 9 | 0027:27 | 65.5 |
| 17080 Abn | 10 | 0121:45 | 79.1 |
| 17092 Bbn | 11 | 0021:05 | 63.9 |
| 17105 Bbn | 12 | 0115:23 | 77.5 |
| 17117 Abn | 13 | 0014:43 | 62.4 |
| 17130 Bbn | 14 | 0109:00 | 75.9 |
| 17142 Bbn | 15 | 0008:21 | 60.8 |
| 17155 Abn | 16 | 0102:38 | 74.4 |
| 17167 Bbn | 17 | 0001:59 | 59.2 |
| 17180 Bbn | 18 | 0056:16 | 72.8 |
| 17193 Abn | 19 | 0150:33 | 86.4 |
| 17205 Bbn | 20 | 0049:54 | 71.3 |
| 17218 Bbn | 21 | 0144:11 | 84.8 |
| 17230 Abn | 22 | 0043:32 | 69.7 |
| 17243 Bbn | 23 | 0137:49 | 83.3 |
| 17255 Bbn | 24 | 0037:10 | 68.1 |
| 17268 Abn | 25 | 0131:27 | 81.7 |
| 17280 Bbn | 26 | 0030:47 | 66.6 |
| 17293 Bbn | 27 | 0125:05 | 80.2 |
| 17305 Abn | 28 | 0024:25 | 65.0 |
| 17318 Bbn | 29 | 0118:42 | 78.6 |
| 17330 Bbn | 30 | 0018:03 | 63.4 |
| 17343 Abn | 31 | 0112:20 | 77.0 |

THE INCOMPARABLE SYSTEM 3000A



HAS A BUILT-IN \$450 DISCOUNT

\$450 discount? When you buy SYSTEM 3000A, you're getting \$1000+ worth of unequalled performance for \$549. Examine the unique features of SYSTEM 3000A, add up what it would cost to duplicate (if you could) this small, feature-filled radio and you will quickly realize what a remarkable bargain you're getting. By marrying the best transceiver available to a microcomputer-controlled PLL synthesizer, **Edgecom** has produced a 2-meter FM system with such unique and incomparable operating flexibility it is almost unbelievable. A few of the extraordinary features of SYSTEM 3000A found in no other transceiver are:

***TWENTY FRONT-PANEL-PROGRAMMABLE CHANNELS.** Just dial in the frequency and transmitter offset, press the Enter switch and you're in memory. Two channels are instantly recallable as priority channels at the flip of a switch.

***TWO BUILT-IN SCANNERS** with adjustable pause and pause-defeat features. One scanner lets you tune the band in one or four MHz segments. The other scans the memory.

***MEMORY-CHANNEL MONITOR.** Lets you operate on one frequency while monitoring one or more others.

***ANY TRANSMITTER OFFSET.** In addition to the standard ± 600 kHz you can program any offset from 5 kHz to 4 MHz.

***FULL TWO-YEAR WARRANTY.** Every SYSTEM 3000A is warranted to be free of defects for two years. And it is American made so servicing is no problem.

Combine these, and the other unique operating features of SYSTEM 3000A with a receiver of unsurpassed selectivity and intermod performance, a transmitter that produces over 25 watts of (adjustable) power and you have a fantastic \$1000+ transceiver for the remarkable price of \$549.

SYSTEM 3000A . . . PERFORMANCE THAT CHALLENGES YOUR IMAGINATION
See one at selected dealers or write for more information.

Edgecom Inc.

2909 Oregon Ct.—A3 • Torrance CA 90503 • (213) 533-0433

EXPORT INQUIRIES H & H Industries • Box 639 • Redondo Beach CA 90277

E19

NOW FROM EDGECOM . . . ANOTHER INCREDIBLE BARGAIN



THE FMS-25 . . . ONLY \$439

For the discriminating amateur desiring the maximum operating flexibility at the lowest possible price, **EDGECOM** proudly presents the **FMS-25** 2-meter FM transceiver. Featuring the same receiver/transmitter and several of the outstanding features that have made the **EDGECOM SYSTEM 3000A** the industry standard, the **FMS-25** provides superior performance for the same price you would normally pay for a "bare-bones" radio. Compare the fantastic features of the **FMS-25** with the other transceivers on the market and you will quickly conclude that there is no question of which one offers the most for the least amount. Some of the many features of the **FMS-25** are:

- **BUILT-IN SCANNER**
- **TEN FRONT-PANEL-PROGRAMMABLE MEMORY CHANNELS**
- **ANY TRANSMITTER OFFSET**
- **ELECTRONIC PUSH-BUTTON TUNING**
- **25 WATTS OUTPUT**
- **SUPERIOR INTERMODULATION PERFORMANCE**

Like the **SYSTEM 3000A**, the **FMS-25** also enjoys a full two-year warranty, it's American made and it is small (the photo above is full size). The **FMS-25** . . . at the unbelievable price of \$439 you're getting the best transceiver available with free scanner, a free amplifier, and a free ten channel memory. See the fantastic **FMS-25** at selected dealers or write for a descriptive brochure.

FMS-25 . . . PERFORMANCE THAT CHALLENGES YOUR IMAGINATION

Edgecom Inc. E19

2909 Oregon Ct.—A3 • Torrance CA 90503 • (213) 533-0433

EXPORT INQUIRIES H & H Industries • Box 639 • Redondo Beach CA 90277

What? CB Repeaters?!

—perfectly legal, too

This is an article about repeaters for CB use. Before you start firing off nasty letters about such heresy, be advised that I am not referring to the familiar Class D Citizens Radio Service on eleven meters, but rather to Class A CB, more formally known as the General Mobile Radio Service. Class A CB is located on sixteen channels between 460 and 470 MHz, uses the FM mode, and allows the use of repeaters to increase range, just as amateurs have been doing for years on two meters and other VHF/UHF bands.

The most immediate question is: Why should amateurs

be interested in Class A CB when there are so many other bands where strictly amateur repeaters can be used? There are some good reasons, such as:

1) Class A is CB with the same licensing requirements (form 400) and permissible business and personal uses as the Class D service. That might seem to be a disadvantage at first glance, but think a little bit. You are free from many of the more nit-picking and bothersome requirements of the amateur rules, such as third-party logging and prohibitions on commercial use. Using your local two meter repeater for

coordinating hamfest activities might not be legitimate under paragraph 97.112 of the FCC rules, but no such problem exists under Class A CB.

2) You must request a specific frequency from the FCC on your application for a Class A license and must restrict operation to the channel assigned. That must seem like a megabummer for any true-blue ham, but it's actually a boon to all those who want a really closed repeater! You and a group of your buddies can jointly apply for a specific channel, share the same Class A repeater, and you have your own private system.

3) Class A is uncrowded even in metropolitan areas. Only about 5000 licenses are currently outstanding, and not all of those are active.

4) Both hams and non-hams can share in and participate in a repeater communications system similar in range and performance to those systems on the 450 MHz amateur band. An amateur club could set up a Class A repeater system for the use of its members who are licensed amateurs, their un-

licensed spouses and children, Novices who have no amateur phone privileges, and even those who are working on their tickets. Class A, in fact, offers the potential to become a band for the type of no-code, easy-license operations envisioned under the proposal for the Communicator Class amateur license!

Class A CB is by no means a new development, having been established by the FCC back in 1947. Originally, 75 channels were assigned to Class A, but these have now been cut back to a grand total of sixteen available frequencies. For repeater service, only eight channels — pairs of input and output frequencies — are available. Input and output frequencies are separated by 5 MHz, and only mobile and hand-held units are allowed to work through the repeater systems. Base stations are only allowed simplex operation on eight frequencies. However, "remote base" operation is permitted in the same manner that it is employed by amateurs in the VHF/UHF bands.

Class A development has languished mainly due to the lack of suitable equipment



Standard's GMR-1 is especially designed for Class A CB use.

for the band. In the early years, operation was AM and without repeaters, which meant that the operating range was little more than shouting distance. With the introduction of Class D, manufacturers and potential users stampeded from 70 cm to 11 meters, and Class A was essentially forgotten.

In recent years, UHF has been increasingly used by various business, industrial, and safety radio services, and these services have created a demand for reliable, state-of-the-art UHF equipment. Simple retuning allows much of this equipment to be used for Class A. At least one manufacturer, Standard Communications, is currently marketing gear designed specifically for Class A, and others are expected to soon follow. Complete base and mobile radio systems, hand-held units, and fully-assembled repeaters are all being marketed today for Class A. Some dealers are even of-

fering to install and maintain repeaters for Class A users. Use of the repeater is available by renting a tone encoder to gain access, with costs starting at \$5.00 a month.

Class A is now FM instead of AM, and maximum power is 50 Watts, although some areas are restricted to 15 Watts. These are generally the same areas where amateur operation on 420-450 MHz is restricted. You'll also find that you must specify the number of base and mobile units (including hand-held and marine units) on your application form. If you find that you later add more units to your Class A system than specified on your license, it will be necessary to file for a modification of your license. You will also be restricted to the mode of authorization and output power authorized on your Class A license. However, since you specify the mode of emission and transmitter power on your appli-

cation form, this is not as restrictive as it may sound. You must use only accepted equipment in Class A service. But you may freely change or substitute equipment as long as it is the same mode and equal to or less than the power output specified on your license.

Application for a Class A license is made on FCC form 400 (except in the Chicago area, where it's form 425). You must also purchase (\$1.00 or less) a copy of part 95 of the FCC rules pertaining to the Class A service from the Government Printing Office. FCC form 400 is a bit different from those you may have seen in the past from the FCC. It must be completed on a typewriter and contains several sheets of carbon paper. One of the carbon copies is validated by the FCC and returned to the applicant. It serves as his license.

Class A may be an idea whose time has come. With

the FCC looking for a UHF band for CB and a still continuing demand for a code-free "Communicator" amateur license, Class A has the potential to at least partially satisfy both demands. One channel pair could be designated as the UHF equivalent of Class D channel 19 for travelers, and repeaters for this channel could be established along major highways. The other channels could be used by the "Communicators" for repeater operation as the FCC envisioned under their proposal for a code-free ham license.

All this is in the future, however. For the present, Class A is a very viable alternative for repeater groups who want to escape the two meter crowd or to establish a truly private repeater system. One escapes some of the more confining aspects of the amateur regulations, as well. It's the best of both CB and amateur radio — who could ask for more? ■

New Products

from page 24

throughout the US and Canada. *Trac Electronics, Inc., 1106 Rand Building, Buffalo NY 14203.*

NEW MFJ 24-HOUR DIGITAL CLOCK

MFJ Enterprises is marketing a new 24-hour digital clock with huge 1-5/8-inch digits that you can see from clear across the room. This is one clock strictly for your ham shack, one

that you can leave set to GMT.

The alarm can remind you of a sked or, if used with the snooze function, it can act as an ID timer to buzz you at 8-minute intervals.

It carries a one-year limited warranty by MFJ Enterprises, and a 30-day money-back trial period. If you are not satisfied, you may return it within 30 days for a full refund (less shipping). The clock lists for \$29.95 (include \$2.00 for shipping and handling).



MFJ's new 24-hour digital clock.

To order, call toll-free (800)-647-8660, or mail the order to *MFJ Enterprises, PO Box 494, Mississippi State MS 39762.*

DENTRON W-2 WATTMETER

Today's increasingly expensive equipment and crowded band conditions make it more important than ever that appropriate precautions be taken to protect your rig from damage and to avoid unnecessary interference to other operators. One of the simplest and most effective measures you can

take to ensure proper operation of your gear is to use a wattmeter for tune-up and as a constant monitor while transmitting.

DenTron's W-2 wattmeter, with its dual meters that let you read both forward and reflected power at the same time, is an attractive answer to the problem of ensuring that your rig is operating efficiently into a properly matched load. Another thoughtful touch is the removable sensing element. By

Continued on page 62



DenTron's W-2 wattmeter.

Antenna Baluns



All Palomar Engineers products are made in U.S.A. Since 1965, manufacturers of Amateur Radio equipment only.

1 Kw CW, 3 Kw PEP input. For dipoles, inverted Vees, beams, quads. Dependable. Takes temporary overloads in stride.

Specify 1:1 or 4:1 ratio.

Model 1K \$16.95



2 Kw CW, 6 Kw PEP input. Far more rugged than any other balun made for amateur use.

Specify 1:1 or 4:1 ratio.

Model 2K \$32.50



2 Kw CW, 6 Kw PEP input. Our heavy duty balun with mounting bracket for 2" mast or boom.

Specify 1:1 or 4:1 ratio.

Beam Balun \$37.50

Only Palomar Baluns Have All These Features

- RF toroidal core for highest efficiency.
- Teflon insulated wire.
- Stainless steel hardware. Won't rust.
- Epoxy filled case. Waterproof.
- Wideband 1.7 to 30 MHz.
- White case to reflect the sun.
- Lightning protection built in.

Free brochure sent on request

How many lightweight baluns have you burned out already? Install the balun that will stay up there working year after year.

Order direct. Add \$2 shipping/handling. California residents add sales tax.

Palomar Engineers

Box 455, Escondido, CA. 92025 • Phone: [714] 747-3343

TOWER/TUNER™

RESONATES YOUR TOWER
ON 40, 80 AND 160 !

NOW
available for 160
meters



Now you can easily use your entire tower and present beam system as a complete low angle radiator on 40, 80 and 160 meters. It is common knowledge that a dipole or inverted-vee must be at least 1/2 wave length high (120 feet on 80 meters!) in order for it to be a low angle radiator. But your existing tower, if fed with the Stuart Electronics **TOWER TUNER**, can be made to be an optimum low angle radiator on 40, 80 and 160 meters. The Stuart **TOWER TUNER** can be installed and easily adjusted to a low swr on any tower no matter what the size or type. Tower can be grounded or not. Radials not necessary. No more haywire appearance of dipoles and I-V's. Even your wife will love it. The Stuart **TOWER TUNER** takes up virtually no extra space but greatly outperforms dipoles and I-V's at the same height plus it is easily adjustable from ground level. Start making better contacts on the 40, 80 and 160 meter bands with an antenna system that really gets out. The Stuart **TOWER TUNER** will handle 500 watts output.

PATENT PENDING



We are so confident that you will like it that we offer a 30 day money back guarantee if you are in any way dissatisfied. Priced from \$129.95 includes shipping in continental United States.

STUART ELECTRONICS

Dept. 9
578 KENNEDY RD.
AKRON, OHIO 44305
(216) 798-9431

S38

DESIGN a voice command system with the Siliconix CODEC

Enter the Siliconix CODEC Design Contest and win an Apple II — the world's best-selling personal computer — or another great prize. All you have to do is use Siliconix' CODEC to design a microprocessor-based system which responds to your spoken words (or talks back to you). Our CODEC is a two-chip set: the DF331 coder is a high-speed serial output A/D converter — a complete subsystem-on-a-chip; the DF332 decoder converts high-speed digital bit streams into analog signals. The system you design must be capable of understanding or speaking at least 16 words.

Here's what you can win:

1st prize: Apple II personal computer (retail value \$1,445). A completely self-contained computer system with high resolution color graphics in 15 colors (with color TV); BASIC in ROM, 16K bytes of RAM, built-in video interface, cassette I/O, four A/D inputs with two game paddles supplied, eight peripheral slots, three TTL inputs and four TTL outputs. Apple II plugs into any standard TV using a modulator.

2nd prize: Siliconix LCD Stopwatch-In-A-Wristwatch. Features time, day, date, plus split timing stopwatch functions.

3rd prize: Siliconix LED Stopwatch. Includes split timing function.

4th prize: Siliconix Telephone Timer. Includes start/stop and timeout.

5th prize: Siliconix LED Stopwatch. Features a digital start/stop timer.

All entries must be accompanied by our official entry blank. Get yours, along with complete contest rules, data sheets and other information, by filling out the coupon below.



& WIN an Apple!®

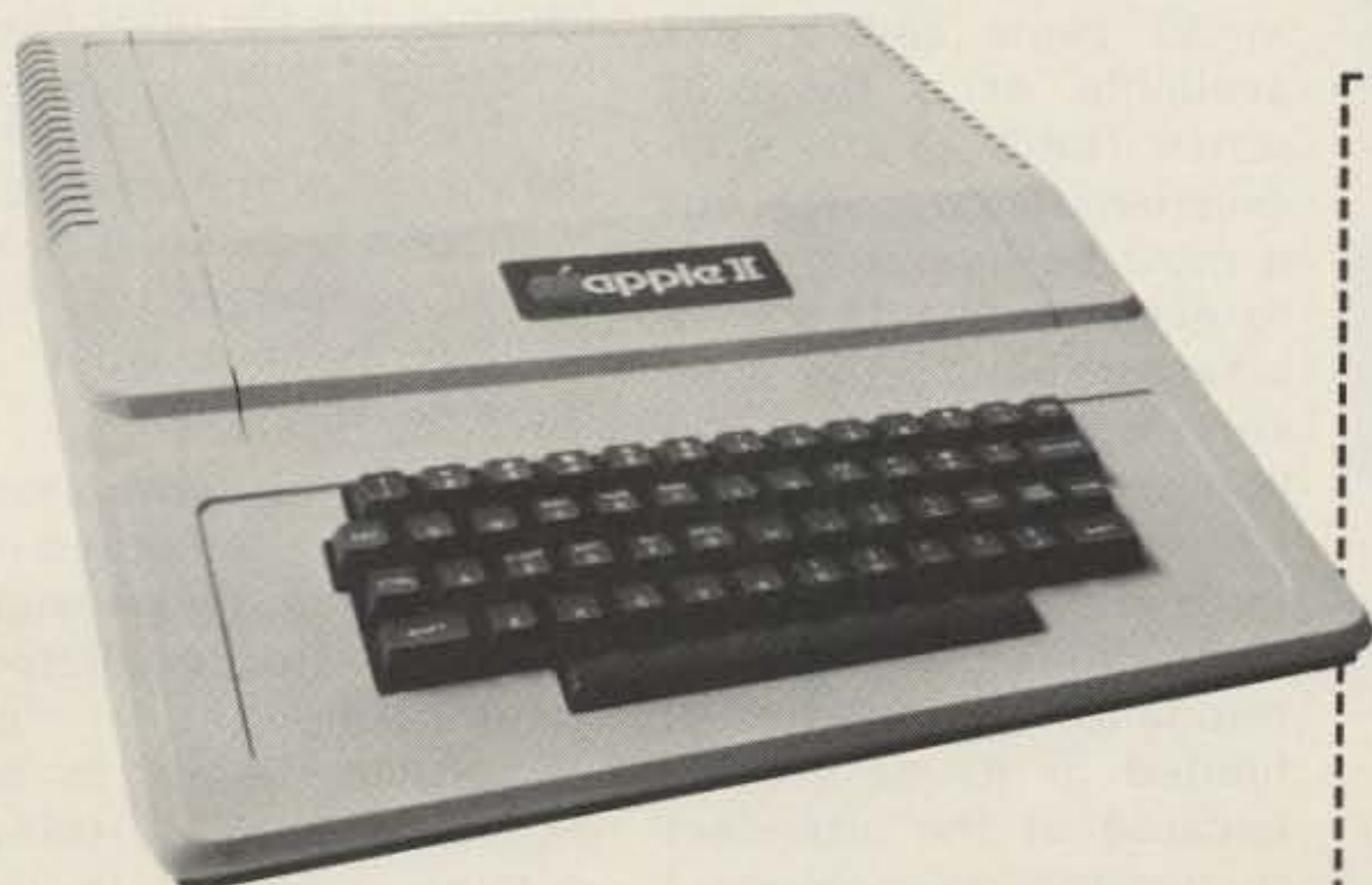

S57

Mail to:

Siliconix CODEC Design Contest
2201 Laurelwood Road
Santa Clara, CA 95054

Yes, I want to know more about the Siliconix CODEC Design Contest. Please send me details and the official entry blank.

Name: _____ Title: _____

Company: _____ (Optional)

Address: _____ Mail Station: _____

City: _____ State: _____ Zip: _____

A Complete X-Band Transmitter

—easy to build

Microwave experimenters in the X-band often require a signal source that has a means of adjusting the output amplitude and frequency. Frequency calibration is also desirable. The above characteristics can be found in standard signal sources, most of which are war surplus and have disappeared from the surplus dealers' shelves or from laboratory stock rooms which had friendly hams operating them. To be sure, these items are still available from micro-

wave manufacturers, but they're at prices well beyond the amateur's means.

The construction of a signal generator which can have laboratory features is not too difficult. The requirements for laboratory standards are much more stringent than most amateurs need, so some of these features can be omitted.

At W1SNN, I constructed a signal source which serves two purposes. It serves as a signal source and as a low-power

transmitter. It has an internal power supply, a modulator, a frequency control, an output attenuator, and a means of measuring the frequency on which the oscillator is operating.

A klystron tube is used because I had it in the shack. A Gunn diode oscillator could be substituted without too much trouble, although the modulator would have to be considerably modified. Klystron tubes are still found on the surplus market. These tubes, for the most part, are the type which were used as receiver local oscillators. The 2K25, also known as the 723a/b, sold for as little as 50 cents and is still available, as is the BMI series. The 2K25 makes an excellent signal source, but it must be operated upon to get it in the 10.5 GHz amateur band. The BMI series uses a heated bellows to tune to the frequency desired; the bellows heat up, expand, and change the cavity resonance. It therefore is limited in its desirability because of the attendant tuning/stability problems. I

was lucky enough to find a Varian X-13-B, which tunes through the band of interest by adjusting the reflector voltage and fine tuning the cavity with a micrometer barrel which is attached in a manner that allows the cavity to be distorted via pressure exerted from the barrel.

The description of the operation of this and many other fine signal sources can be found in the references given at the conclusion of this article, so I will address myself to the business of construction of the signal generator. The choice of the tube must be yours, but this article will be centered around the 2K25 klystron because it is the most easily acquired tube. The price of this tube is still within the means of the amateur, even for a new one. It is, of course, no longer sold for fifty cents, but what is these days?

The signal generator/transmitter is composed of five sections: power supply, modulator, oscillator, attenuator, and rf indicator. In the set to be described here, a transmitting horn is incor-

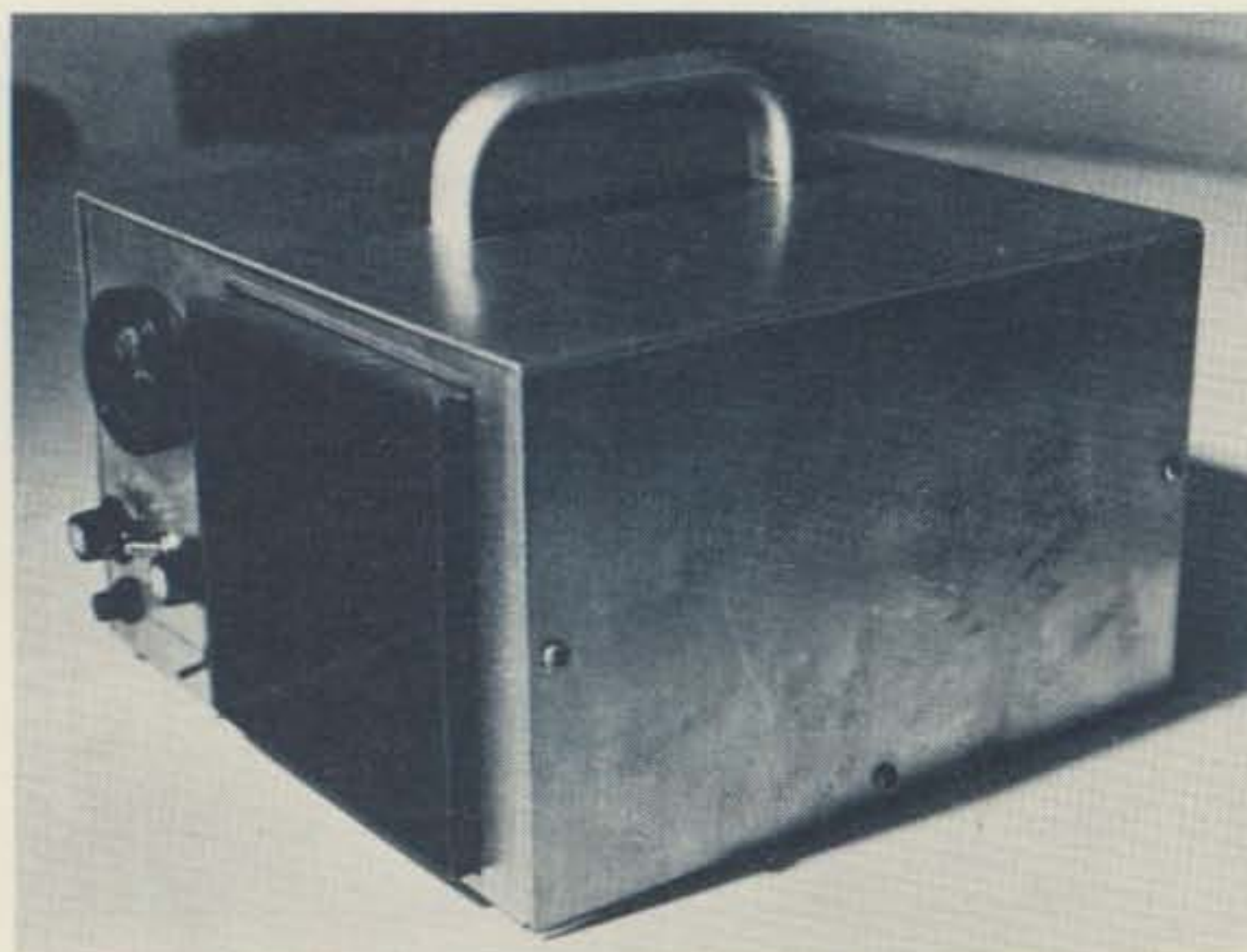

An X-band signal generator/transmitter, klystron oscillator power supply, and all components required.

porated into the same chassis. This can be omitted if you wish. The output of the generator can then be terminated in an output flange.

The power supply is very straightforward, consisting of a full-wave rectifier and filter designed to be free of ripple. It consists of two sections. The main supply supplies +300 volts at 75 mA. A capacitor input filter choke capacitor combination is used in this supply. The second supply is for the reflector of the klystron, which also requires good filtering, but, since the drain on this element is in the microampere region, a simple RC filter is used. Heavy filtering is used on each section to improve on the short-term stability of the klystron oscillator, which is voltage-tuned. Vacuum-tube regulators could be incorporated to improve upon this last feature but would not greatly reduce the drift in the oscillator tube, which is also temperature-sensitive due to the cavity construction. This idea was not attempted and is not recommended unless the added expense is your bag.

The modulator consists of a single transistor amplifier, which will give more than adequate modulation. The reflector of the klystron is modulated by the amplifier, and, since the reflector current is very small, equally small modulating currents are required. For the most part, the modulation will be FM, depending upon how hard the tube is pushed. A panel control to determine the modulation level has been incorporated.

Perhaps the part of the unit most difficult to construct will be the klystron tube mount, the level attenuator, and the rf output detector which is used to determine the output level. This group of components is constructed on one

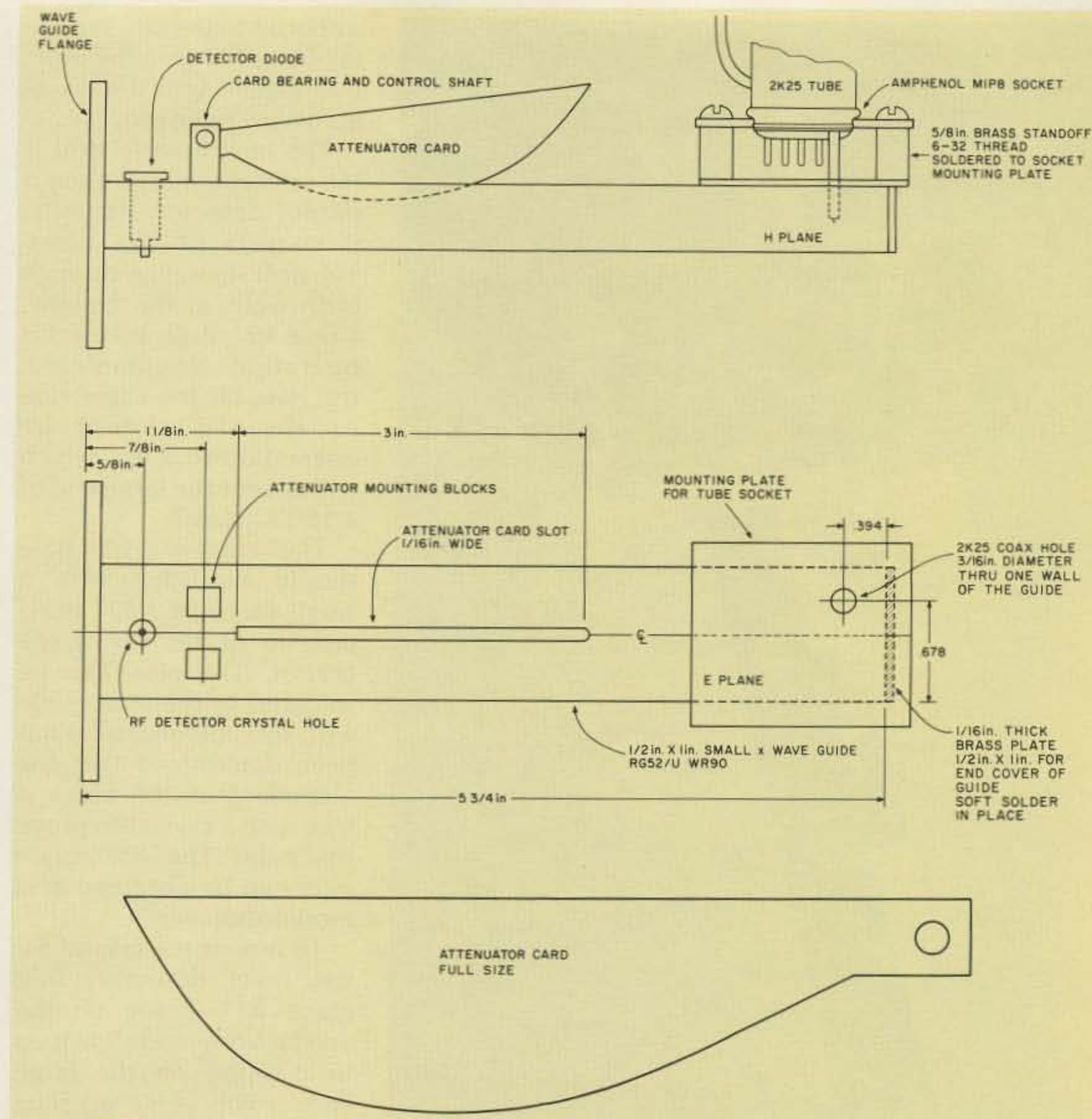

Fig. 1. Waveguide tube mount for the 2K25 klystron attenuator and rf level detector.

single piece of waveguide. No machine shop work is required. All of the work was done at W1SNN with hand tools in the cellar workshop.

The first part of the rf assembly will be the construction of the attenuator. It is a "flap" attenuator, consisting of a section of resistance card that dips into the waveguide through the center of the E-plane. These attenuators were common on the surplus market, and, if one is available to you, by all means use it. The attenuator at this station uses a right-angle gear drive so that the control dial can be conveniently located on the main panel. It may be brought out of the side of the chassis, if

you prefer.

The rf indicator consists of a crystal detector mounted near the output end of the waveguide. A potentiometer and a microammeter connected as a voltmeter to the crystal complete the detector. This equipment may be omitted if you prefer. It is easily constructed and is very useful in making comparison and frequency measurements. Its exclusion, therefore, should be carefully considered on the basis of price only.

The antenna incorporated in this set is a pyramidal horn described in an earlier issue of 73,⁴ so the construction details will not be given in this article. The horn antenna can be substituted for with

whatever gain standard horn is available, saving a great deal of the construction work.

As is shown in the drawings and photographs, the chassis is packaging for the unit so that it can easily be transported. No blower is incorporated because the klystron does not require additional cooling. However, if a different device is used in substitution for a 2K25 tube, be sure to determine if it requires external cooling.

Let's get on with the construction of the waveguide assembly. Acquire a six-inch section of waveguide. This is a little longer than required, but, by the time the ends are squared off, it will be just right. First, with a machinist's square, mark

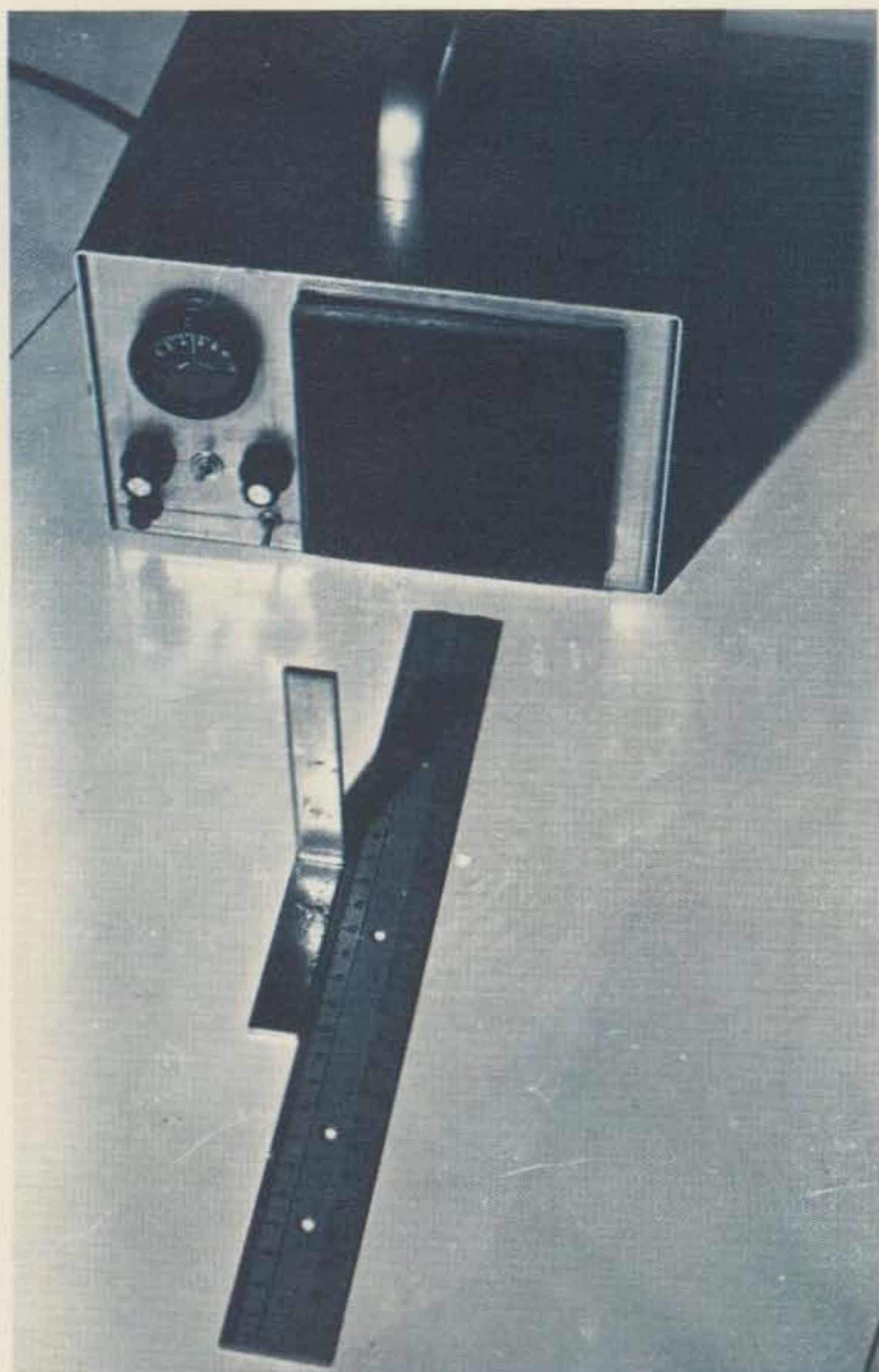

Frequency measurement—not really the hard way.

off each end so that the scribe lines will show intersecting marks on all sides of each end as square corners. The distance between these should be $5\frac{3}{4}$ inches. Cut the ends carefully with a hacksaw on the lines. File each cut smooth. Remove all burrs, and clean these cuts so that they may be soldered. Steel wool or sandpaper should be used for this purpose.

This first pair of cuts to the guide determines the overall length and the position of the waveguide coupling hole for the klystron. Be sure that the length is that which is specified in the drawings, or you may have difficulty acquiring full power output from the klystron.

Next, lay out the line

through the E-plane center of the guide which will be cut as a slit $\frac{1}{16}$ of an inch wide. This slit allows the piece of resistance card to enter the waveguide. To cut the slit carefully, center punch ten places in line on the centerline so that the punch marks are very close to one another but not touching. Then drill ten holes with a number 43 drill. By careful manipulation of the drill, these holes will be in line and can be opened to start the slit. A hacksaw blade can then be inserted in the cut and the slit further lengthened to 3 inches. This sounds like a lot of work, but once the holes are in place, it goes very fast. When the slit has been completed, insert a flat jeweler's file, and

smooth file the cut, removing burrs. Be sure the burrs that extend into the waveguide are removed.

The next hole to drill is the crystal mount for the rf output detector. Actually, it consists of two holes. The drill should go through both walls in the E-plane. Use a $\frac{1}{8}$ " drill. When this operation is completed, the hole on the same side as the slit should be opened up to $\frac{5}{16}$ ", which will accept the large end of a 1N23 crystal.

The remaining $\frac{1}{8}$ " hole should be fitted with a small piece of $\frac{3}{32}$ " brass pipe to fit the tip of the crystal. The pipe can be soldered to the waveguide with soft solder after it has been determined that the alignment of the holes is true. Use a crystal to prove this point. The $\frac{3}{32}$ " brass pipe can be obtained at a model shop.

To mount the crystal for the level detector, first place a $\frac{1}{4}$ " lug on the crystal body and slide it up to position on the large end. It will come up snug against the flange. Bend the lug so that it can be soldered. Now fit a $\frac{1}{4}$ " fiber shoulder washer on the crystal body, snug against the lug. Be sure that the shoulder faces the tip end of the diode. Lay this assembly to one side until all soldering is completed.

The attenuator mounting consists of two $\frac{1}{4}$ " square blocks $\frac{3}{4}$ " high, soldered at the position located in the drawing so that they straddle the attenuator slot. A $\frac{1}{8}$ " hole is line-drilled through the sides of each block, which then can be fitted with a small axle for the attenuator card. The card is then epoxied to the shaft. A $\frac{1}{8}$ " to $\frac{1}{4}$ " coupling is attached to the axle so that a control shaft which fits a conventional dial can be added.

When this job is com-

plete, solder a $\frac{1}{2}$ " x 1" plate over the end of the waveguide which is closest to the tube socket for the klystron. On the opposite end, solder in place a UG-39/U waveguide flange.

To complete the klystron mounting, it will be necessary to modify an octal tube socket to fit the klystron tube. Inspect the tube, and note that it has a small piece of coaxial cable made of metal tubing protruding from the pin end of the tube. One end of the coaxial cable has a small length of Teflon™ covering a short section of the inner conductor of the coax. This is the coupling antenna used to inject the rf output of the klystron into the waveguide. The coupling depends upon the location of the entry hole in the wall of the waveguide and the depth that the antenna extends into the waveguide. The octal tube socket should have a mounting assembly attached to it. Usually it is held in place with a spring washer or is molded in place. The specified socket is still listed in catalogs, since tubes have not completely disappeared from the scene. Choose a socket, and remove the contact from pin 4. Open the pin hole to accept and freely pass the coaxial output of the klystron tube. Some sockets will have a hole large enough and will not require modification. The socket used at W1SNN is an Amphenol type MIP8.

The tube socket is mounted to a small plate approximately $1\frac{1}{2}$ " square. Solder two $\frac{5}{8}$ " threaded bushings in a position that will allow the antenna probe of the klystron tube to clear the hole in the waveguide wall intended for it. A similar hole will have to be added to the mounting plate. Once the location is determined, which will depend on the socket type, the

plate can be soldered to the waveguide permanently.

The attenuator card can be constructed from a piece of resistance card made for that purpose. It is beyond the scope of most amateurs to try to manufacture this component. Its cost is reasonable and it goes without saying that it should be purchased.

The card material is a resistance material deposited on a backing and affixed to a piece of hard, nonconductive material. It acts as an absorber of the microwave energy propagated down the length of waveguide. By making the length and depth of the card sufficient, attenuation values that run in excess of 30 dB (with respect to the power level) can be achieved when the card is fully inserted in the guide. A very good impedance match is maintained because of the length of the card. When ordering this material, specify 200 Ohms to the square inch as the resistance value. If you are lucky, you may still find this on the surplus market. In the event that you can't find it, sources of supply are listed in the references at the conclusion of this article.

To cut the resistance card, simply scribe the outline as shown in the drawing, being careful not to disturb the surface of the card. Then, with a sharp knife, cut through the scribe marks. When the cutting process is complete, file the edges smooth and to the contour shown in the drawing. Departure from the shape shown will cause the attenuation rate to bunch up near the lower levels. The card is quite thin, but not as fragile as it appears. The card should clear the slot as it enters so that wear on the resistance material will be nonexistent.

When all of the wave-

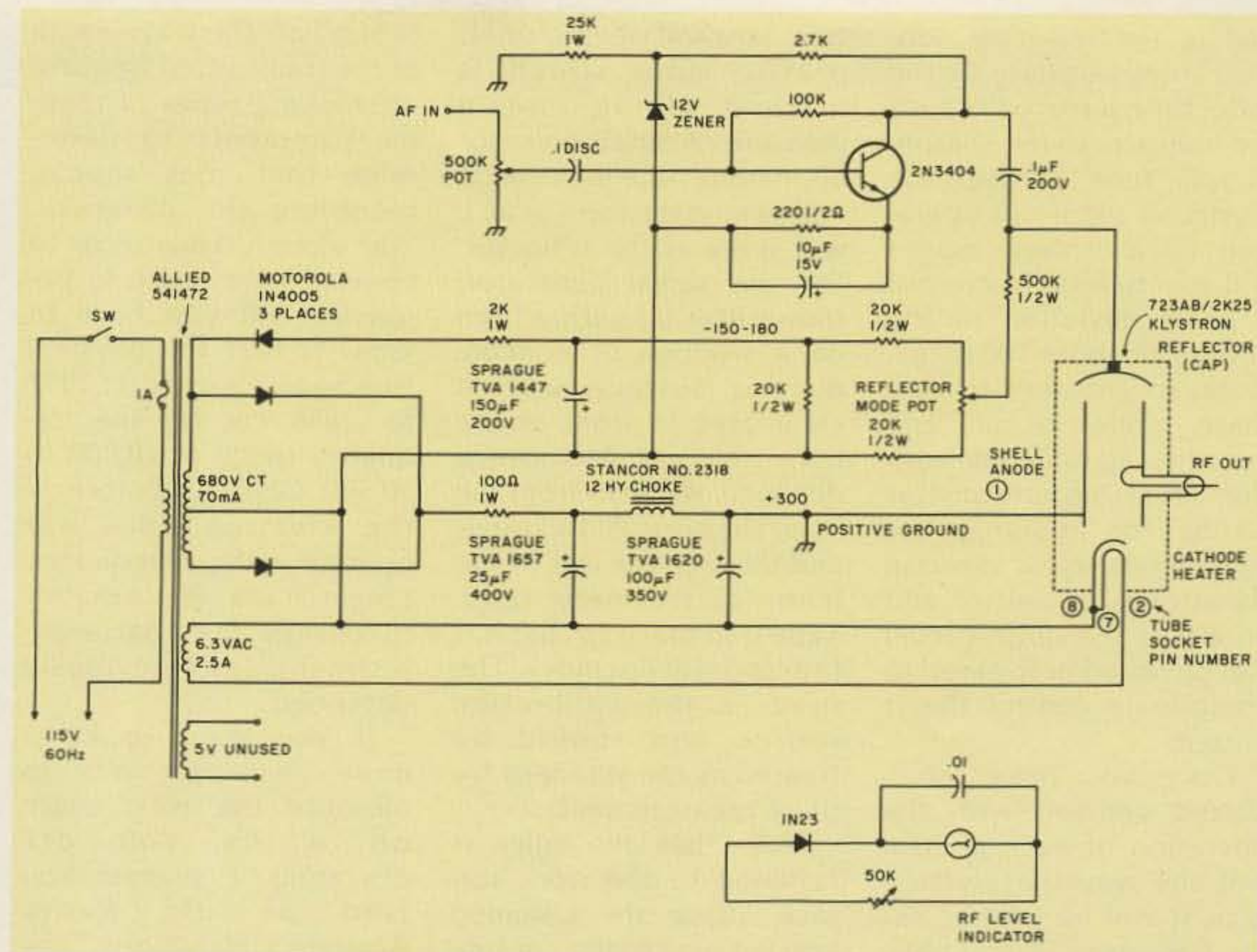

Fig. 2. Klystron power supply and modulator.

guide work has been completed, install the components, making sure that the tube socket wiring is completed before installing it. Then decide what kind of cabinet or container you will use, if you decide not to use the one shown in the drawings. Make clamp mountings for the waveguide, as shown, and construct the power supply and attenuator control. The meter and level setting for it can be installed, and you will be ready for testing after a slight modification is made to the klystron bellows.

In order to put a 2K25 klystron tube on frequency in the 10 GHz segment of the amateur band, it is necessary to raise the operating frequency above the normal range of the tube. It is quite simple and does not require excessive modification to the tube.

Simply rotate the square brass tuning control, which is fastened to the tuning strut, full clockwise until the strut opens to approximately 3/16". This action

loosens the bellows so that it can be distorted to the higher range position. Now, with a pair of long-nose pliers, loosen the bellows nut and back it off to the top of the adjusting screw, which is the coarse adjustment. The nut will loosen to the top of the screw, which is about three threads more than those engaged, and will be in view before the adjustment is made. After backing this nut to the new position, tighten the bottom nut to bear against the bottom of the same coarse adjustment. Now turn the square brass tuning control counterclockwise, and tighten the bellows.

Install the klystron carefully into the socket, making sure that the antenna probe slides into the hole in the waveguide so that it just exposes the end of the coax.

Mount the waveguide components into the cabinet, or whatever your choice of chassis is, so that they are free of vibration and accessible for the

preliminary adjustment. The unit pictured and shown in the drawing is complete with a horn antenna, since it is used as a transmitter. It makes a fine portable setup for testing waveguide and other components, since the horn is easily removed at the flange. In any case, connect a horn radiator to the output of the waveguide.

With the rf level indicator (which should be a 0 to 1 milliammeter connected to the rf detector diode) in place and the level control potentiometer set to half level, turn on the power, and wait until the filament of the tube comes to temperature, which will take about thirty seconds. Snap the dc power switch on, pull the flag attenuator out of the waveguide by adjusting the attenuator control, and slowly adjust the reflector control until the meter shows an indication. The level may go off scale, so increase the potentiometer setting and continue ad-

justing the reflector control. Three positions on the reflector control will cause the indicator to rise sharply as you "tune" through the klystron's modes of operation. Each of these modes will electronically control a small deviation in frequency of about 100 megahertz, so get used to how these modes occur, and become acquainted with the level potentiometer setting for midrange for each mode. Now exercise the attenuator control, and note that the output level can be raised or lowered to completely control the rf output.

Once you have familiarized yourself with the operation of each control and the way the klystron acts, it will be time to set the frequency. If you have a waveguide frequency meter which is calibrated, choose one of the reflector modes—preferably the middle one—and adjust the control for the "middle" of the mode. Adjust the attenuator so that attenuation is minimum and connect the wave meter to the output flange. Adjust the wave meter for a reaction on the wave meter indicator. Track the wave meter with the reflector control to determine where 10.200 GHz falls. If you find that you must move to the third mode, readjust the two nuts on the tuning strut, as well as the brass tuning block, starting with the block first. Once the frequency is located, carefully make a mark on the reflector dial for this frequency. Then find the limits of the band, and mark it again.

If you do not have an X-band wave meter at your disposal, you will have to resort to the method that the early microwave people used. It is as accurate as you use it and will certainly locate the band limits for you.

To set up for this opera-

tion, you will need a small plastic ruler which is marked off in metric measure. A small piece of aluminum one-inch wide and bent in the form of an L will serve as the reflector. Set the signal generator/transmitter up with a horn on a wooden or nonconducting surface with a clear area in front of the horn antenna. Measure a distance of 15 cm from the lip of the horn. At this point and through the axis of the horn, lay the meter ruler. Tape it in place so that it is firm and will not move. The ruler is the calibration source and should be treated as the standard for these measurements.

Now that the ruler is fastened to the work surface, place the L-shaped bracket next to the cm side of the ruler. Tape a pin to the bracket so that it points to the calibrations on the ruler. Fasten the pin so that it won't move. Now proceed to fire up the generator as before, and locate the middle mode by adjusting the reflector potentiometer so that the mode is peaked on the rf indicator meter. Move the L-shaped bracket parallel with the ruler so that it bears on the ruler. Move the bracket toward the horn and away from it a few times, and notice that the rf indicator fluctuates rapidly as you move the bracket. It will also fluctuate as you move your hands or any other object in front of the horn.

Now move the L-shaped bracket, parallel to the meter ruler, toward the horn from about the middle of the ruler. Remember that your hands will influence the readings, so try to hold them flat to the work surface as you move the bracket through a minimum and a maximum reading on the rf indicator. Be sure to note the reading on the ruler; the distance between these two points

is one half the wavelength of the transmitted frequency. Make a series of these measurements to determine that they repeat, recording the distances. You already know how to convert wavelength to frequency. All you have to know is that the physical free space length is .2997 to .2855 cm for the frequency range of 10.000 to 10.500 GHz. As before, if the klystron does not operate in these frequency ranges, it is a simple matter to change the coarse adjustment, as previously described.

If you want to know more about the way to measure the wavelength on which you are operating. I suggest you find an old *Radio Amateur's Handbook*. The issues prior to 1955 had a good amount of data on lecher wires.

Since a lecher line is really an open wire transmission line, attention must be given to the correction in length, which is usually foreshortened by capacitance and inductance between the wires. Although this factor is small, it is there, and it affects the accuracy of the measurements. In the free space case, which is the method I use, there will be no problem with the foreshortening effect. Simply find the two points where the reaction takes place, measure the distance between them, and you have the measurement as a half wavelength. As you can see, the measurement must be very carefully made. All components in use must remain stationary except the L-shaped reflector. If this part could be moved with the precision of a metric micrometer, the accuracy would be improved far beyond your needs. It is important that you establish the band edges, since other services surround you; the police operate at 10.525

GHz \pm 25 MHz, and you don't want to interfere with the police radar frequency, do you?

The modulator in the signal generator/transmitter is a single transistor amplifier that is used to amplify a microphone, audio oscillator, or whatever you decide to modulate with, except video. For the most part, modulation is FM. Deviation is dependent upon the setting of the gain control.

You may want to investigate the possibilities of using a Gunn diode oscillator in place of the klystron. There are several available, complete with horns, if you have the money, or you could use the unit described in this magazine as the "Mobile Smokey Detector."³ It's as easy to build and test as is most microwave gear found in 73.

If you decide to construct this unit and use it on a field day for another band multiplier, look for me on 10.250 GHz. A parabolic reflector six feet in diameter makes the output of this unit formidable. The QRM up there isn't too bad from other amateurs, but it is quite often experienced from radar. The band is a lot of fun to work on—hope to see you there. ■

References

1. *The Microwave Engineer's Handbook*, 1963, Horizon House, Brookline MA.
2. *Technique of Microwave Measurement*, Radiation Laboratory Series, Volume 11, Chapter 2, "The 723 Family of Reflex Klystrons."
3. "Mobile Smokey Detector," Stirling Olberg W1SNN, 73 *Magazine*, Holiday, 1976.
4. "A Brass Horn For X-Band," Stirling Olberg W1SNN, 73 *Magazine*, March, 1978.
5. The attenuator card material is available from these manufacturers: Filmohm Corp., 48 W. 25th St., New York NY; Emerson and Cummings, Inc., 869 Washington St., Canton MA; Film Resistors, Inc. (HyTronics), 242 Ridgedale Ave., Morristown NJ.



If you can't hear them...



**Dx'ing
Contesting • Ragchewing
Traffic Handling**

There's a Telex Headphone that will let you do it better. Sure, sometimes you just can't hear them. But if there's a chance, it's easier with a Telex headphone. There's one for every discriminating choice. At better ham outlets everywhere, or write ...

PRODUCTS OF SOUND RESEARCH
TELEX
COMMUNICATIONS, INC. T33

9600 ALDRICH AVE. SO., MINNEAPOLIS, MN 55420 U.S.A.
telephone: 612-884-4051, telex: 29-7053

Europe: 22, rue de la Legion-d'Honneur, 93200 St. Denis, France,
telephone: 820-98-46, telex: 63-0013

**Pound for pound,
there is no match for the**

Vhf engineering PS-25M Power Supply

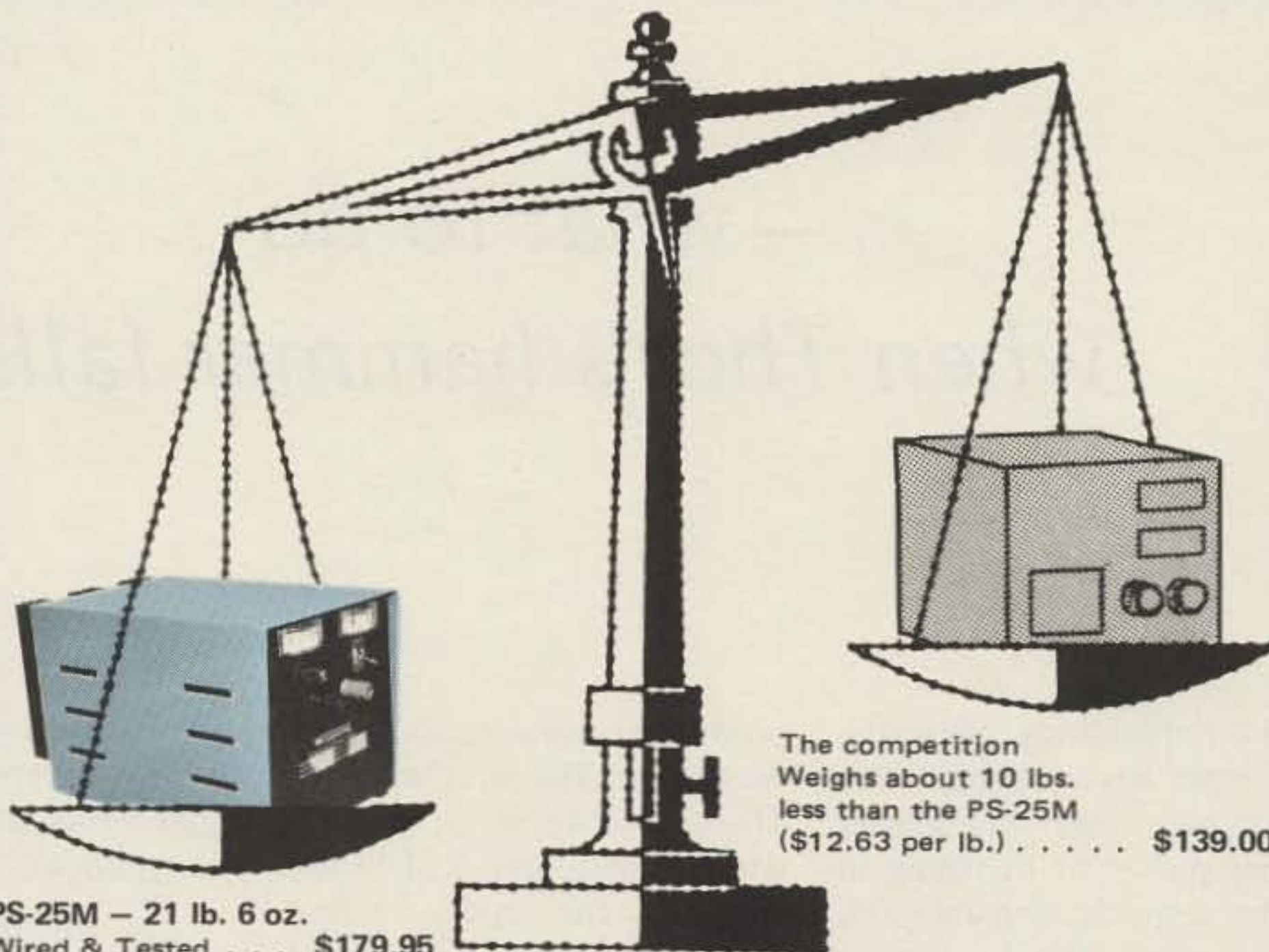

PS-25M — 21 lb. 6 oz.
Wired & Tested . . . \$179.95
(\$8.42 per lb.)
Kit (\$7.25 per lb.) . \$154.95

The competition
Weights about 10 lbs.
less than the PS-25M
(\$12.63 per lb.) \$139.00

25 Amp regulated power supply with fold back current limiting, over voltage and transient protection. Also, output voltage and current meters

You might find a cheaper power supply, but you can't find one as well built with top quality components. Other power supplies with lighter weight transformers and components are no match for the VHF engineering PS-25M. It is rated at 20 amps continuous duty (not 10 amps). This power means extra dependability and versatility when you need it.

FEATURES

- Over-voltage protection crowbar.
- Electrostatic shield for added transient surge protection.
- A foldback output limiter operates for loads outside of the operating range.
- Isolation from ground. The circuit is isolated from the case and ground.
- 115/220 volt input — 50/60 cycle.
- Units are factory wired for 110 volt AC, 50/60 cycle power. A simple jumper will reconfigure the input for 220 volt AC, 50/60 cycles.
- Temperature range-operating 0 to +55 C.
- Black anodized aluminum heatsink.

SPECIFICATIONS

- Voltage Output:
adjustable between 11-15V
- Load Regulation:
2% from no load to 20 amps
- Current Output:
25 amps intermittent
(50% duty cycle)
20 amps continuous
- Ripple:
50 mV at 20 amps
- Weight:
25 pounds
- Size:
12 1/4" x 6 1/4" x 7 1/2"



Division of Brownian Electronics Corp. V5

320 WATER STREET / BINGHAMTON, N.Y. 13901 / Phone 607-723-9574

Prices and specifications subject to change without notice. / Export prices slightly higher.



Shock!!!

— what to do when Thor's hammer falls

For thousands of years, man has respected the awesome and sometimes deadly power of lightning in myths, legends, and religion. The classical Greeks saw in lightning the anger of Zeus; the fierce Norsemen attributed it to the hammer of Thor; the ancient Hebrews recognized it as a demonstration of the wrath of God. On the other hand, man-made electricity is fairly new. The first medically-recorded death due to man-made current was in 1879. Nowadays, fatalities through electrocution outnumber those due to lightning 5 to 1. Every year, about 1,000 Americans die because of accidents involving electric current. Many more are injured, sometimes severely. Some of these tragedies could have been prevented altogether. The tragedy is compounded because appropriate first aid might have saved some of the unfortunate victims.

What happens in an electrical accident? As electricity courses through the human body on its way to ground, it

produces several serious consequences. The first is burns. There are two kinds of electrical burns. So-called "flash burns" occur on the surface of the body and are caused by the intense heat of arcing electricity. When an electrical accident causes a fire, this can burn an unconscious victim also. About 5 percent of all admissions to special burn treatment units in the United States are caused by electrical accidents. Surface burns are the ones which we can see. They may leave bad scars, but often they are not the worst burns caused by electricity. The greatest damage may occur inside the body, where the heat generated by electrical current causes muscles, bones, nervous tissue, and vital organs to literally fry. Some victims who do not die immediately succumb later to kidney failure or to massive infections in destroyed tissues. If a victim survives a serious accident, a good deal of dead tissue must sometimes be removed surgically. Even years after an electrical accident, problems may

remain: A victim may never recover nervous system functions which are wiped out by a large shock.

Electric shock can interfere with the electrochemical operation of the heart, causing it to stop beating. This situation is, of course, deadly. High-voltage shock sometimes destroys or severely impairs that part of the nervous system which controls breathing, with the result that the victim cannot breathe on his own. This, too, kills.

In an electrical accident, people can also sustain severe injuries not directly attributable to electric current. If a person falls from an antenna or ladder, for example, he can get fractures. Those of the neck and spine may be quite dangerous.

Which shocks are the worst ones? That depends on several capricious factors. As a rule, high voltage is more dangerous than low voltage, but this is inconstant. People have survived very large shocks; conversely, some have

died from surprisingly small ones. The duration of a shock is an important factor affecting survival or injury. In this respect, these accidents are particularly vicious because electricity causes muscles to go into spasm (or *tetany*), and this sometimes prevents a victim from letting go of a live source. Perhaps the least predictable considerations are the grounding of the victim and the conductivity of his skin. Whether the skin is sweaty or dry can mean the difference between life and death during an electrical accident. Since it is the flow of current through the body which produces injury, the location to which the current is applied has a profound effect on the degree of damage. A shock traveling from head to grounded feet traverses the whole body and all its vital parts, often with disastrous consequences. On the other hand, a shock of equal magnitude traveling only from ankle to foot will likely hurt that foot but leave the rest of the body relatively intact. Finally, the physical condition of the victim undoubtedly influences his ability to withstand an electrical shock.

Because many of the circumstances affecting the severity of an electrical accident occur unpredictably, it is impossible to guess outside the most general guidelines the full potential danger in any given situation. The moral is simple: All electricity deserves respect.

Who is most at risk? As might be expected, occupational hazard is an important factor. The greatest number of deaths from electrocution occur among electricians and linemen. Among nonprofessionals, the most common circumstance leading to fatal injury is the do-it-yourself erection of antennas or masts in the neighborhood of high-tension lines.

Everybody knows that high voltage is dangerous, and so we all know enough to be

careful with it. However, many are not aware, or do not believe, that even regular household current has occasionally killed or injured people. One cannot over-emphasize the importance of caution to all people who work with any kind of electrical devices.

Although electronics hobbyists and radio amateurs are more aware of the hazards than most people, accidents do occur even among this select group. I knew a ham who was nearly killed years ago by a particularly sneaky accident. One night, a storm felled some old bare power lines onto his antenna. When he attempted to make some changes at the receiver end the next morning, he received more than he bargained for — a dreadful shock which hospitalized him. There is little defense against insidious dangers such as this, except suspicion. Build antennas securely and as far away from power lines as possible. Inspect antennas regularly after heavy weather. Ground equipment effectively so that unexpected current will flow through the ground cable, instead of through you! These are elementary cautions which most of you would consider obvious — but the penalties for ignoring them can be merciless.

Emergency Resuscitation

For any number of reasons, a person may stop breathing, and/or his heart will stop beating. Electrocutation is the case in point, but some equally valid examples are heart attacks, drowning, poisoning, suffocation, and severe automobile accidents. The point is this: Unless breathing and circulation of the blood are restored quickly, accident becomes a sudden and unexpected death. Until recent times, nothing could be done in these circumstances. Today, however, ordinary people can sometimes work seeming miracles through the techniques of emergency resuscitation.

“Rescue breathing” restores respiratory functions to a victim. When this technique is combined with artificial circulation of the blood, the procedure is called “Basic Life Support,” “Cardiopulmonary Resuscitation,” or CPR for short. Occasionally, when someone witnesses an accident, only rescue breathing is needed. In unwitnessed accidents, however, when rescue is not immediate, full CPR is almost always required.

CPR is an exact discipline, and, in unskilled hands, it has its own dangers. However, it

can be learned by people in all walks of life. The following points are an introduction to these techniques, but the *only* way to really learn emergency resuscitation is by practicing it on a special mannequin under the guidance of a qualified teacher. More on that later.

If you should come upon an unconscious victim, take immediate action to summon help, and assess the patient for the “ABCs of emergency resuscitation.”

1. Do not waste time. Do not leave the victim, but call at once for help, because you

will need it. Send another person to call an ambulance. If no one else is around to hear you call, proceed on your own, but *do not leave the victim*.

2. Never “resuscitate” anyone who does not need it! People can lose consciousness for many other reasons besides respiratory and cardiac arrest. Before going ahead with each step of the “ABCs,” assess the victim quickly but carefully to see if it is necessary to proceed.

“A” — Airway

Be sure that the victim has

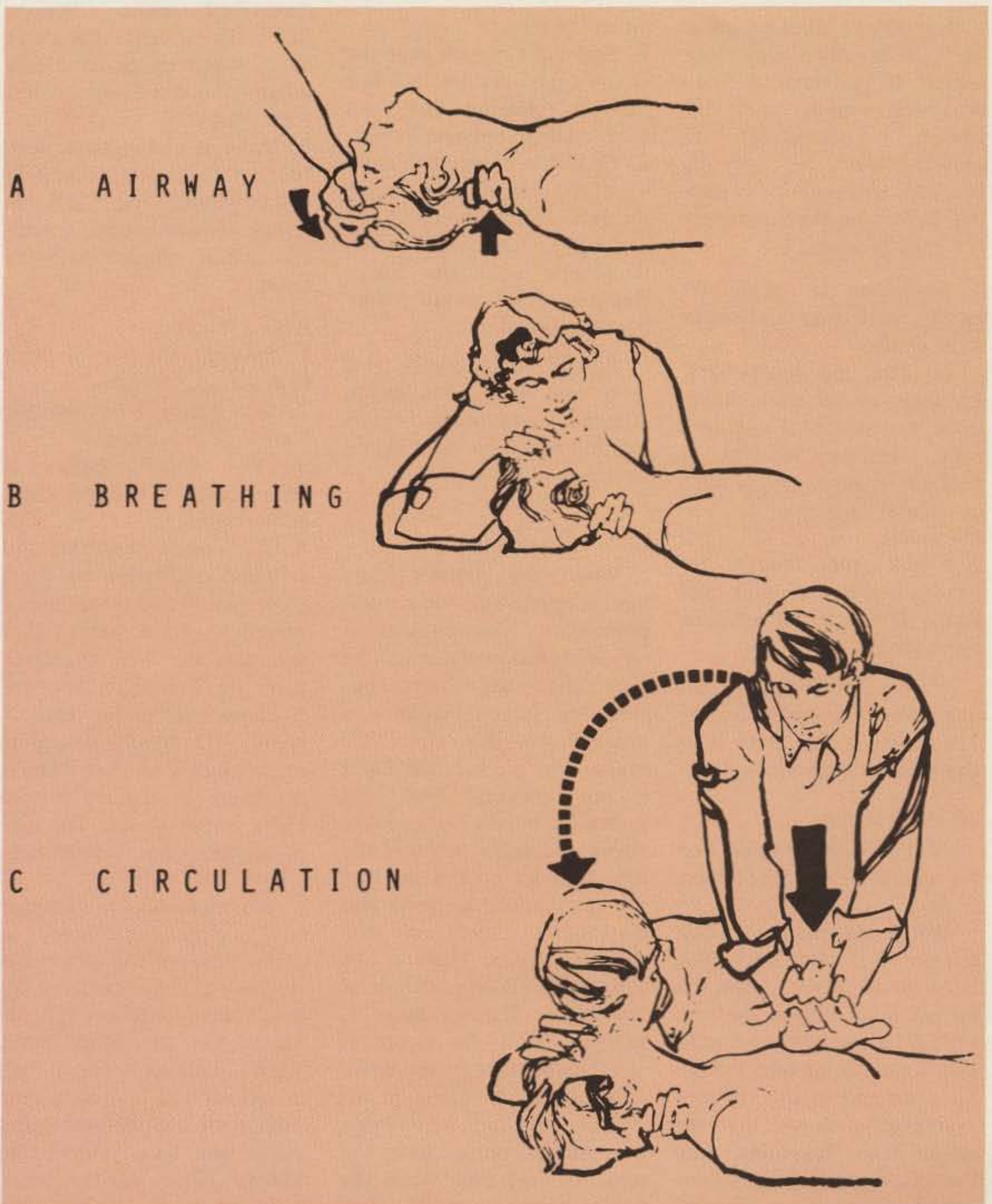

Fig. 1. The ABCs of Basic Life Support. Courtesy of the American Heart Association and the Ontario Heart Foundation.

1. Do not panic. Panic will not save the victim; it may get you hurt.
2. If the victim remains in contact with live current, switch it off. If this cannot be done quickly, remove the victim with a wooden pole or some other insulator. *Do not touch him directly.* Some would-be rescuers have met a sorry end in just that way.
3. If there is immediate danger of fire, get yourself and the victim (who may be confused or unconscious) to a safe place quickly.
4. If the victim is unconscious, proceed as follows:
5. Shout out for help. Send someone to call an ambulance. *Do not leave the victim* to do these things yourself because every second counts. If no help is available, you will have to work alone to save the victim until help eventually arrives. *Get to work immediately!*
6. "A" — Airway. Clear and straighten the victim's airway.
7. "B" — Breathing. If necessary, apply rescue breathing.
8. "C" — Circulation. If required, perform Basic Life Support.
9. Do not stop for anything until victim recovers, help arrives and takes over, or you are actually exhausted.
10. Do not move the victim once CPR is begun, unless you have training in advanced techniques not discussed here.
11. When qualified help arrives, the victim can be transported to medical help.

Table 1. First aid for cases of electrical shock.

a clear airway through which he can breathe. Use your senses: If you hear difficult breathing sounds (as if the person is strangling), his airway may be partially blocked. If there is no breathing, it may be that his airway is totally blocked.

1. Straighten out the victim's airway, so that he can breathe most easily.

(a) Tilt the head back, keeping one of your hands under the back of the victim's neck. Be very careful of possible fractures of the neck or spinal injuries due to the shock.

2. Check the mouth for foreign bodies, including false teeth. If there are any, remove them.

Having performed these maneuvers, as shown in Fig. 1, you will enable air to enter the victim's lungs easily.

"B" — Breathing

Is the victim breathing on his own, now that the airway is clear?

Watch the patient's chest to see if it rises and falls. Look to see if the victim has turned blue around the lips. Listen for breathing sounds. Feel for escaping breath from the nose and mouth. If your examination shows that the victim is *not* breathing, only then is rescue breathing required.

1. With the airway straightened, as described above,

pinch the nose.

2. Seal your mouth over the victim's and breathe in 4 fast puffs, releasing the seal momentarily between them.

3. Commence rescue breathing at the rate of once every 5 seconds. Watch the chest rise and fall, to make sure that air is getting into the lungs. Remove your mouth fully between breaths.

Rescue breathing is used alone only when a victim has stopped spontaneous breathing, but when his heart is still beating.

"C" — Circulation

When the victim's heart has stopped, too, full cardiopulmonary resuscitation is required. But how can you be sure that the heart has stopped? It is dangerous to proceed to this step "C" unless you are sure the heart is not working! Feel very carefully in the groove between the voice box and the long muscles on the sides of the neck for the strong and bounding pulses of the carotid arteries. There is one carotid artery on each side of the neck. If this pulse is present, then the heart is still beating. Forget the wrist! Feeling for the pulse in the wrist is an old wives' tale, because that pulse can be too weak to feel even when the heart is beating properly. But, if there is no pulse in the neck, then there is no effec-

tive heartbeat, and full CPR is necessary to save the victim.

If you are all alone (1 rescuer) —

1. Put the patient on his back on a firm surface — the floor, not the bed.

2. Put the heel of one hand on the lower half of the victim's breastbone. Put your other hand on top of this hand, as shown in the picture.
3. Compress the victim's chest 1½ to 2 inches and release, at a rate of 15 compressions in 10 seconds.

4. At the end of the 15th compression, give the victim 2 quick lung inflations (as described under "Breathing"). Then repeat the cycle of 15 compressions and two breaths, 15 compressions and 2 breaths, etc.

5. Make it a smooth action. Half of the time is spent in compression, and half in release. Avoid jumpy, pounding action on the patient's chest.

With 2 rescuers —

1. Position the victim on a firm surface, as above.

2. One person is responsible for rescue breathing.

3. The other rescuer is responsible for external chest compression.

4. The rescue breathing and artificial circulation by chest compression are done just as described above, except that the rates are different. When there are 2 rescuers, there are 5 compressions for each 1 breath. The breaths should be made quickly so that there is no break in the rhythm of chest compressions. The rate of compressions is similar to above.

Whether you are alone or have help, check every so often to see if the victim has recovered. If he groans or his eyes open, recovery is obvious. On the other hand, some patients remain unconscious and immobile even after their own breathing and circulation have returned to normal. Check for this possibility occasionally, since your efforts to resuscitate the victim may succeed.

Don't give up! Most importantly, do not stop for anything, unless resuscitation succeeds, medical personnel or other responsible people take over, or you are too physically exhausted to continue. Hang in there. It could save a life.

Getting Proper Training

Cardiopulmonary resuscitation is a lifesaving procedure, but it is also an exacting one. It must be learned by taking an approved course involving extensive practice on specially-constructed mannequins. Improperly performed, CPR is at the least useless, and, if it is done badly or when not medically required, it is extremely dangerous. Complications of the procedure include fractured ribs, damage to the heart, punctured and collapsed lungs, liver lacerations, and ruptured spleen. This does not mean that one should be afraid to use CPR — an unblemished corpse is no consolation. However, it does mean that one should learn how and when to do CPR properly. CPR is an important new first aid procedure. A standardized training program in Basic Life Support has been developed and is available through the American Heart Association, Red Cross, YMCA, state and local Heart Associations, and medical societies. In Canada, contact the Canadian Heart Foundation, its provincial affiliates, or the Red Cross. Some of these organizations also have excellent illustrated material for public distribution and education. For example, the Ontario Heart Foundation supplied the literature from which the illustration for this article was taken.

Knowledge of lifesaving emergency techniques is like seat belts. We all pray that we will never need to put it to the test. But, should we ever be in a critical situation caused by electric shock or something else, this knowledge could prove itself beyond value. ■

MADISON SUPER SUMMER BUYS

NEW OMNI-J 2-meter mobile or portable antenna. 3/8" thread. 5-dB gain (1.5-dB gain over conventional 5/8-wave mobile whip antenna). **\$29.95**, 220-MHz **\$27.95**, 450 MHz **\$27.95**. Guaranteed results.

KLM: Antennas, Linears, Accessories All in Stock. Free balun w/2 meter base antenna.

FINCO AMATEUR BEAMS In Stock—Call! A62 6 and 2 Meter **\$61.00**

2 + 2 Horiz/vertical **\$37.50**

BIRD 43 Wattmeter plus slugs, in stock, prepaid freight.

BENCHER keyer paddles in stock **\$39.95**; chrome **\$49.95**

YAESU

FT-301D + Free FP301 **\$935**

FT-301 + Free FP301 **\$769**

YAESU FT-901D series **Call for Quote**

TELE-TOWER: 40' w/breakover **\$299**

55' w/breakover **\$399**

MICROWAVE MODULES MMT 432-28S **\$259**

UPS Paid.

F9FT TONNA antennas: 144/16 el. **\$55.95**

9/19 OSCAR **\$53.00**

JANEL Preamps QSA-5 **\$39.95**

TECHNICAL BOOKS: ARRL, Sams, TAB, TI, Rider, Radio Pub., Callbook, Cowan, TEPABCO, many others. . . call

HAM X ROTOR (New Model) Turns 28 sq. ft. of antenna.

List **\$325**. In stock **Your Price \$249**

CDE HAM-III **\$129.00**

SWAN METERS: WM 6200 VHF Wattmeter **\$49.95**

SWR 3 Mobile **\$9.95**

TELEX HEADSETS: **In stock**

CETRON 572B **\$27.95 ea.**

RAYTHEON 572B **\$24.95**

ADEL nibbling tool, **\$6.45**; punch **\$3.50**

CABLE 5/32", 6-strand, soft-drawn guy cable. For mast or light tower, **3¢** foot.

BELDEN COAX CABLE: 9888 double shield RG8 foam coax, 100% braid, suitable for direct bury **39¢** ft., 8237

RG8 21¢ ft., 8214 RG8 foam **25¢/ft.**, 8448 8-wire rotor cable **16¢** ft., 8210 72 ohm kw twinlead **\$19/100 ft.**, 8235

300 ohm kw twinlead **\$12/100 ft.**, Amphenol PL-259, silverplated **59¢**, UG175 adapter **19¢**, PL-258 dbi female **\$1.00**. BNC female chassis mount **59¢** ea;

BELDEN 14 gauge cop. stranded antenna wire **\$5/100 ft.**

TIMES 1/2" foam hardline **60¢/ft.** connectors **\$15 ea.**

KESTER SOLDER 1 lb. 60/40 .062 **\$6.50**

LEADER — GDM LDM815 **\$89.95**

MALLORY 2.5A/1000 PIV epoxy diode **19¢ ea.**

.001 MFD 20KV CAP **\$1.95**

GE receiving tubes **50% off list**

GE6146B, 8950 **\$7.95 ea.**

SWAN 750CW + Free PSU-3 **\$675**

SAY Electronic Power Supplies

Completely Regulated 13.8 to 20 volts dc, variable. Separate volt and amp meters. Dual protection against over voltage and over current.

4 amp **\$59.95**
8 amp **\$109.95**
20 amp **\$159.95**

CALL FOR QUOTES ON: YAESU FT-301D, FT301, FT-227R, KENWOOD TS520S, TS820S, FT-901DM, FT-101E, ALDA, AM-COMM, VHF-ONE PLUS & ETO-ALPHA. ALL IN SEALED CARTONS. CALL FOR QUOTES ON ITEMS NOT LISTED. THIS MONTH'S SPECIAL: KENWOOD TR7500 \$249. BEARCAT 250—SOON!

**CALL FOR FAST QUOTES
SPECIAL ORDERS WELCOME**

TERMS: All prices FOB Houston. Prices subject to change without notice. All items Guaranteed. Some items subject to prior sale. Send letterhead for Amateur dealers price list. Texas residents add 5% tax. Please add postage estimate.

MADISON M35
ELECTRONICS SUPPLY, INC.

1508 MCKINNEY
713/658-0268

HOUSTON, TEXAS 77002
Nites 713/497-5683

new FROM ALLIANCE!

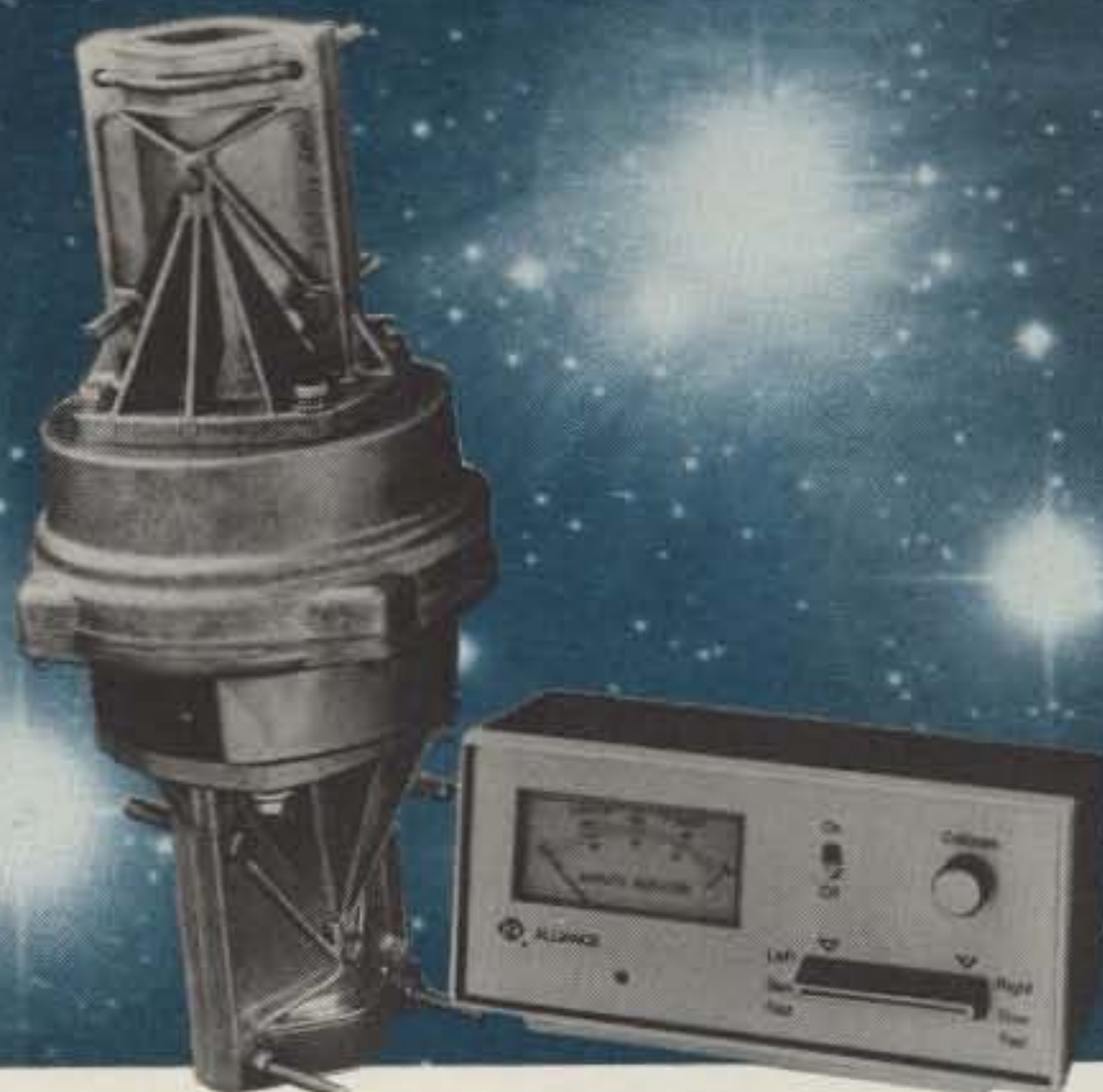

HD-73 HEAVY-DUTY ROTATOR

with exclusive Dual-Speed Control!

For antennas up to 10.7 sq. ft. of wind load area. Mast support bracket design permits easy centering and offers a positive drive no-slip option. Automatic brake action cushions stops to reduce inertia stresses. Unique control unit features DUAL-SPEED rotation with one five-position switch. SPECIFICATIONS: Max. wind load bending moment—10,000 in.-lbs. (side-thrust overturning); Starting torque — 400 in.-lbs.; Hardened steel drive gears; Bearings — 100-3/8" diameter (hardened); Meter — D'Arsonval, taut band (backlighted). There's much, much more — so get the whole story!

Mail this coupon for complete details!

YES! Send me complete details on the new HD-73!
 Give me the name of my nearest dealer!

NAME _____

ADDRESS _____

CITY _____

STATE _____ ZIP _____



The **ALLIANCE** Manufacturing Co., Inc., Alliance, Ohio 44601
A NORTH AMERICAN PHILIPS COMPANY **A57**

Maker of the famous Antenna Rotator . . . Alliance Tenna-Rotor® . . . "TV's Better Color Getter!"

© 1978 The Alliance Mfg. Co., Inc.

The PVC Portable

—a “go anywhere” 2m ground plane

Lewis Tarnopol WA6RJK
164 South Kingsley Drive
Los Angeles CA 90004

In this article, I want to tell you about a neat little 2 meter, 1/4-wave antenna that a good friend of mine, Rick WB6TAE, de-

signed for me. It's made out of PVC pipe tubing (used for indoor and outdoor electrical and water runs, depending on the local code), which can be obtained at almost any hardware or lumber store. If you're interested in an antenna which costs less than five dollars, read on.

Although my pictures tend to be self-explanatory, let me describe the internal workings of this antenna. One central radiator and 4 ground radials are mounted on a standard SO-239 connector, which in turn is mounted in a 3/4" PVC cap. The cap slips over a convenient length of PVC tubing, and there it is! Your antenna coax is merely fed through the pipe and then screwed onto the SO-239 connector. You can then permanently glue the cap to the pipe with PVC cement.

Construction

Building this antenna is a cinch, and assembly time is less than an hour. You will need: one 3/4" PVC cap; one 7' length of 3/4" PVC tubing, any color; 9 feet of 12-gauge galvanized wire (it's a few inches more than you'll need, so you can make mistakes); 1 SO-239 connector; and PVC glue or epoxy.

Start by drilling a hole in the center of the cap just big enough for the SO-239 to go into. If you drill your hole carefully (I used a reamer), you can screw the connector into the hole. It will thread itself. If you do go overboard, just plan on using some epoxy or PVC cement to make the mount rock solid. Now cut your center radiator and radials (five 19-1/8" lengths) from the galvanized wire. This length will put you in the 146-147.99 range with less than 1.2:1 swr. This length will also work in the rest of the 2 meter band with only a slight increase in swr. I might add that brazing (welding) rods or coat hangers can also be used, but they will have to be sprayed with Krylon after assembly in order to be weatherproof.

File clean 1/2" from one end of each wire, so a clean solder contact can be made. Now file a nick 1/4" from one end in each of the four wires. Using a pair of pliers, bend these nicked ends 90°, so they slip into each of the four holes in the SO-239. Use a soldering gun in the 100-Watt or higher range and solder the four radials permanently in. Make sure the nuts holding the tip in your gun are tight — it does make a difference. Now solder in the center radiator. Screw or glue this newly-acquired wire thingy into the PVC cap, and there it is. Any length of coax with a PL-259 connector will screw onto your pipe dream antenna. Choose a 7' or so length of PVC pipe and feed the end of the coax you'll be using through it. Screw the 2 connectors together, glue the cap down, and voilà!

You can now carry your pipe dream antenna around like a flag pole, clamp it to your roof or your bike, or do what I did on the 4th of July. I took it



Completed antenna leaning against author's car.

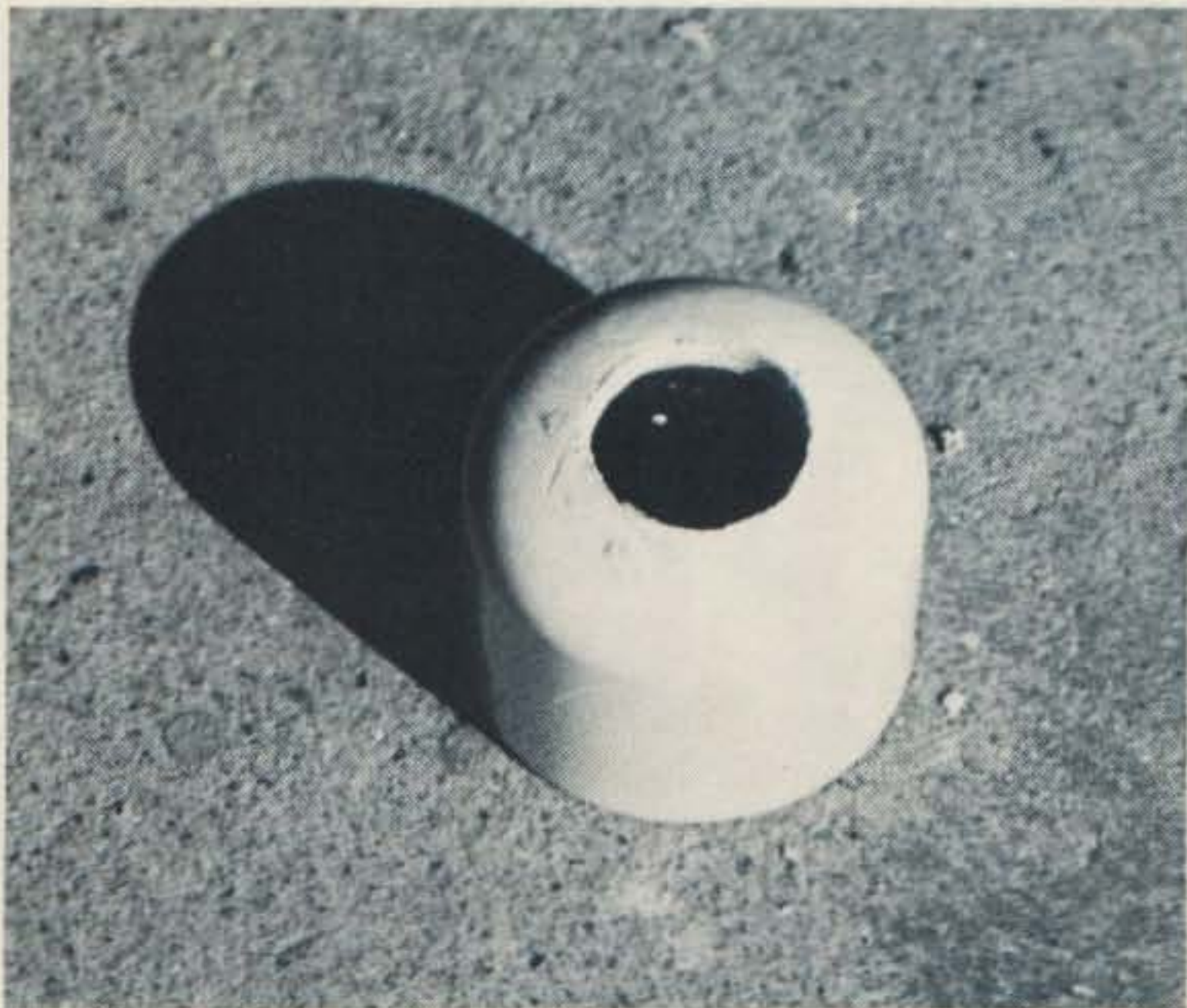

A close-up of the first step...drill a hole in the PVC cap large enough for the SO-239.

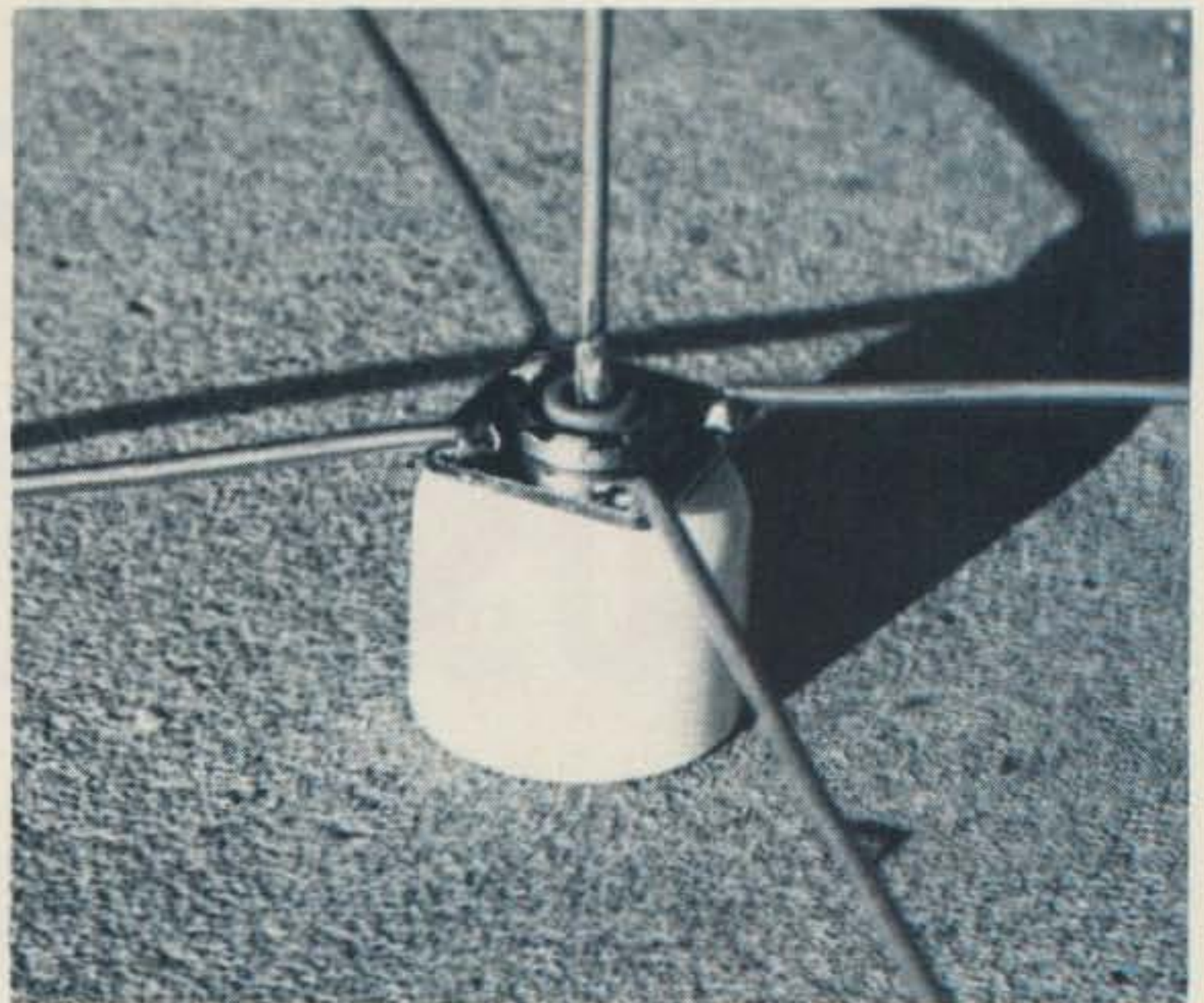

A close-up of the SO-239, with radials and center radiator soldered in place, mounted in a PVC cap.

with me to the beach and pushed it down into the sand, and there it stood as I transmitted—a veritable beacon among the darkness of magnet mounts. And speaking of magnet mounts, of which I own

one, this antenna outperformed the mag mount under all conditions. I made tests with each antenna occupying the same spot. I told Rick my results, and he suggested that the ground plane of a

mag mount spike is less than perfect, and I have to agree.

In addition to the 1/4-wave configuration described here, a Larsen 5/8-wave antenna coil that screws directly onto the

SO-239 can be bought. Change your radiator dimensions to accommodate this coil, and enjoy a 5/8-wave pipe dream. Any way you look at it, this is one pipe dream that won't go up in smoke. ■

Perfect CW is Automatic with TEN-TEC ULTRAMATIC KEYERS

(A) TEN-TEC KR50 Deluxe Dual-Memory, Dual-Paddle Keyer — \$110

Here's the completely automatic electronic keyer you control. Fully adjustable to your own operating style and preference for speed, touch and weighting (ratio of length of dits and dahs to space between them). Dual memories individually defeatable, for operation as full iambic (squeeze) keyer, or with single memory, or as conventional keyer. Self-completing characters. User-adjusted fixed or automatic weighting (50-150%) controlled by speed setting. Adjustable paddle force (5-50 gms). Adjustable speed (6-50 wpm). 500 Hz side-tone oscillator. Built-in "straight key" button. Operates on 117 VAC, 50-60 Hz or 6-14 VDC.

(B) TEN-TEC KR20-A Electronic Single-Paddle Keyer — \$69.50

Factory adjusted actuation force for smooth keying; factory set weighting factor for smoothness and articulation. Self-completing characters. Adjustable speed (6-50 wpm). 500 Hz side-tone oscillator. Built-in "straight-key" button. Operates on 117 VAC, 50-60 Hz or 6-14 VDC.

(C) TEN-TEC KR5-A Electronic Keyer — \$39.50

Same as KR20-A less side-tone and power supply. Operates on 6-14 VDC.

(D) TEN-TEC KR1-A Deluxe Dual Paddle — \$35

Same paddle as KR50; for iambic or conventional keyers.

(E) TEN-TEC KR2-A Single Paddle — \$17

Same paddle as KR20-A; for "TO" or discrete character keyers.

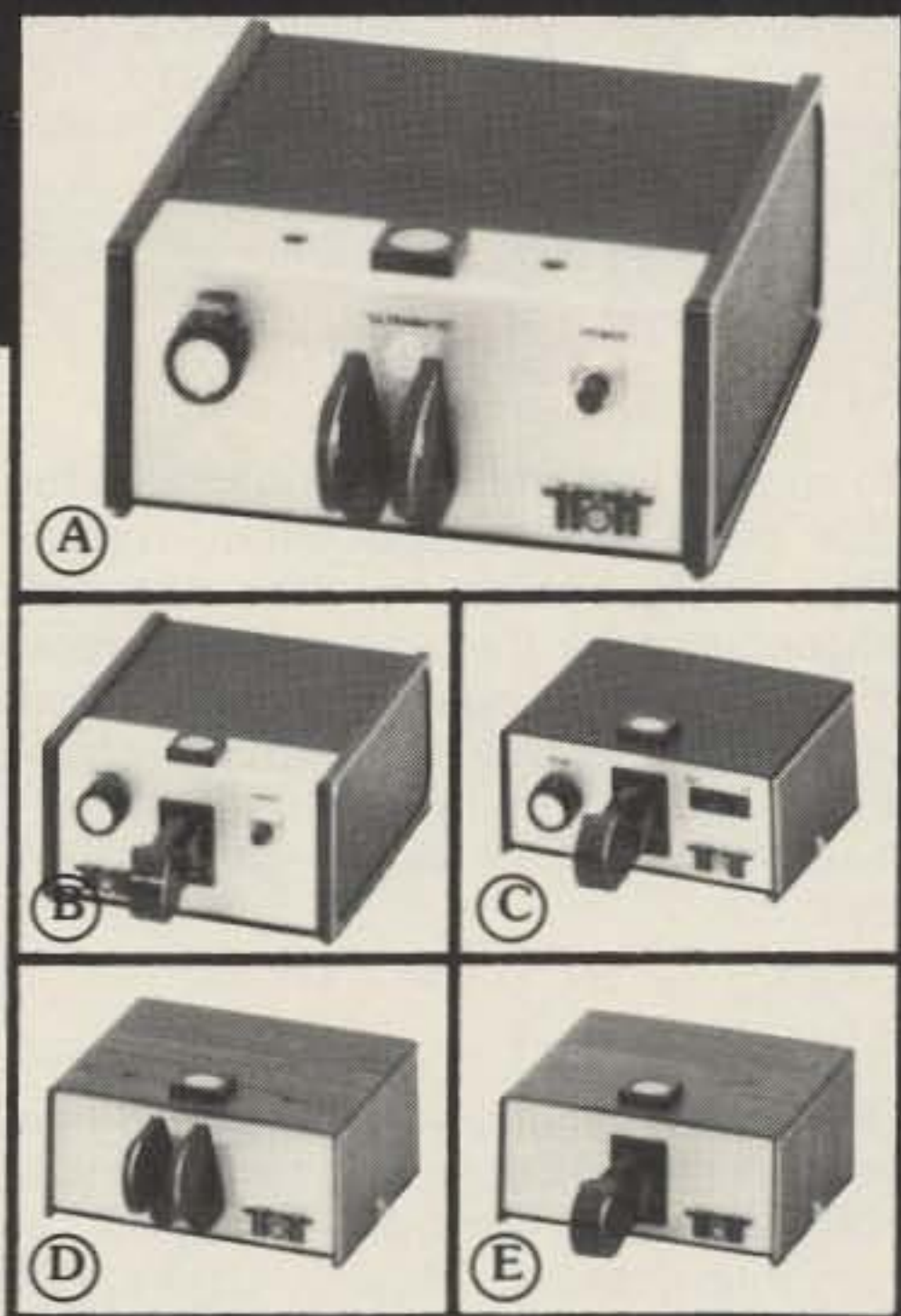

TEN-TEC, INC.
SEVIERVILLE, TENNESSEE 37862
EXPORT: 5715 LINCOLN AVE., CHICAGO, ILL. 60648



EXTRA

Hamfest News

EXTRA

Special Edition For Those Seeking a Good Time

73 pages — 15¢

THOUSANDS in PRIZES Biggest Show in the East

N.E. Convention Escapes to Country

Conventioneers and city dwellers alike breathed a sigh of relief when the news was released from Newington. The New England ARRL Convention, formerly held in Boston for several years was moved to the tiny hamlet of Boxborough, Massachusetts on Interstate Route 495. Free parking and easy access were given as two main reasons for the move. Home of the big show will be the Sheraton Boxborough Hotel, Exit 28, Route 495.

Prizes Awarded Both Days of Show

Through the generous cooperation of the manufacturers and exhibitors lucky conventioneers will be taking home transceivers, antennas, microphones, amplifiers . . . the list goes on endlessly.

The event is a non-profit affair and surplus funds go directly into the prize fund.

Husband Claims Attack by Wife

No sooner had the terrific programs for the YL's been announced when reports of OM's being beaten by their spouses for refusing to take them along were received at convention headquarters. Sponsors were quick to point out that the fashion shows and bus tours would keep the YL's busy while the OM was buying new equipment.

Every Manufacturer Will Attend

Virtually everybody who is anybody will be there. A partial listing at presstime included Icom, HyGain, Dentron, Tufts, 73, Spectrum International, Mosley, Drake, ARRL, Ham Radio, Yaesu, CushCraft, Robot, Atlas, Ten-Tec, Digital Group, CQ, Kenwood, Byte, Tri-Ex, Hamtronics, Harrison, Science Workshop, TPL, ETO, Newtronics, HAL, Heath, etc., etc.



FLEA MARKET

at the 1978 New England
ARRL CONVENTION

October 14 & 15
Saturday & Sunday

Outdoors & Indoors
PERMITS \$2 per space EACH DAY PERMITS \$4 per table

First Come — Best Spaces!

10 A.M.-5 P.M.

TELL YOUR FRIENDS!

Discount Coupons Mailed September 8th 23,700 Sent to New England Hams

Registration will be \$4 early bird, \$5 at the door. If you were in the spring 1978 callbook you were sent a flyer. You can order tickets directly from the ticket chairman: George Stewart, W1ZQQ, 17 Barnes Avenue, East Boston, Ma. 02128. Children under 16 admitted free. Hotel reservations should be made directly with the Sheraton Boxborough, Boxborough, Massachusetts 01719.

The Amazing Mobile Life Preserver

— simple, but effective

Howard A. Goodman W2EVM
71 Mandalay Drive
Poughkeepsie NY 12603

I have both read and heard of several cases where rigs were stolen from locked automobile trunks because the thieves were tipped off to the possible presence of equipment by the usual underdash mounting bracket. Not wishing my two meter transceiver to become another such statistic, I began to search for an alternate way of mounting the rig so that when removed from the dash for storage in the trunk, nothing would remain behind to indicate its former presence. The method to be described, although quite simple, may prove effective in stopping a rip-off before it starts.

Take the original mounting bracket and cut as shown in Fig. 1. Discard the center portion so that two L-shaped "ears" remain. If not already present, add a

.173-inch diameter hole to the horizontal portion of each "ear" for mounting to the dashboard. Assemble the "ears" to the sides of the rig so that they point away from each other. Now measure the distance between the holes in the two ears, and transfer this dimension to the underdash location where the rig is to be mounted.

Drill two .250-inch diameter holes through the dashboard sheetmetal, and, using a Pop-rivet tool, attach a threaded insert (USM No. ATPR-8 or equivalent) at each hole location. Installation of rig to dashboard is then completed with two 8-32 thumbscrews of the type used to attach screen inserts to aluminum storm doors and should be readily obtainable at a hardware store or aluminum products dealer.

Removal of the rig for temporary storage is simply a matter of disconnecting power and antenna cables and removing the two thumbscrews. Rig and mounting brackets are

removed as one and nothing is left behind to attract potential thieves. For best results, it is recommended

that this mounting scheme be used with a removable antenna and standard-issue license tags. ■

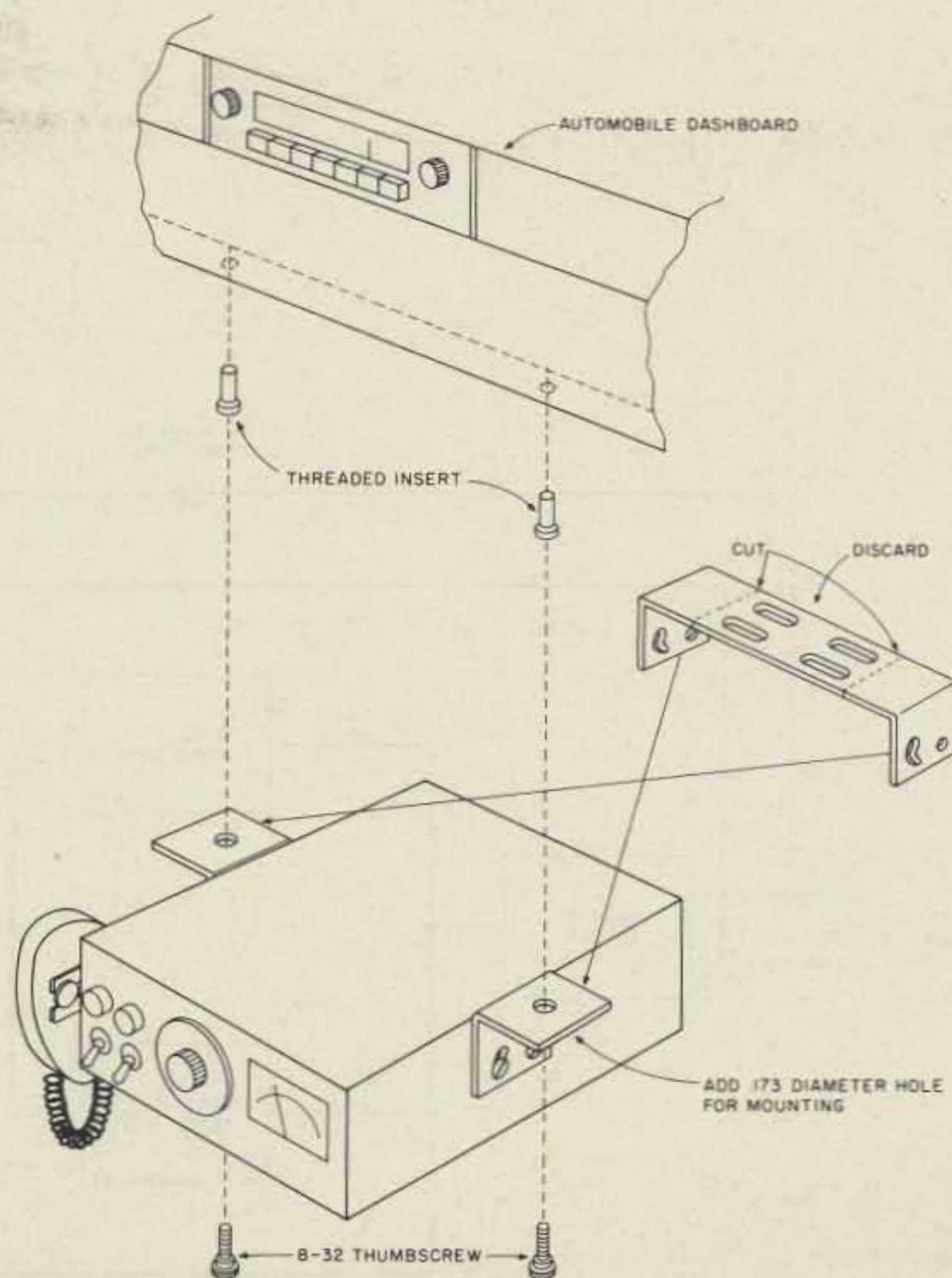

Fig. 1. Mounting bracket modification.

Power Line DX

—(almost) wireless
remote control

Like many hams, I'm interested in radio as more than just a medium for yakking. Radio frequency signals can be employed for a variety of things far beyond ham-type uses. This article shows how "wired wireless" (WW) signaling can be used for remote control functions.

The system shown here is used presently for a rather mundane function. It controls lighting from a remote location external to a house. However, it could be used to switch almost anything electrical or electronic within or outside a house. The only limitation is that there must be a common power line between the transmitting and receiving circuits. Such functions as controlling an antenna switching relay right at the antenna, turning on and off ham shack equipment from anywhere in the house, or even turning on a coffee-pot from the bedroom come to mind immediately. I'm sure you can think of many more applications. Additionally, the circuits included in this system can be used individually for wireless intercoms, burglar alarms, or remote monitors.

Getting Interested

As I hinted above, WW has fascinated me for quite some time. My first exposure was via the so-called wireless intercoms. Naturally, the "wireless" part is not strictly true (just like the British term wireless used for radio). There are interconnecting wires between the intercoms, but no extra wiring. They operate by transmitting rf signals through the 110-volt power lines. Each unit is like a low-power transmitter/receiver combination. Rather than transmitting electromagnetic waves through space via antennas, the signals are conducted through the power line. The useful part of sending signals this way is that there is no need to worry about extra wiring or antennas — the signal path is free.

Aside from wireless inter-

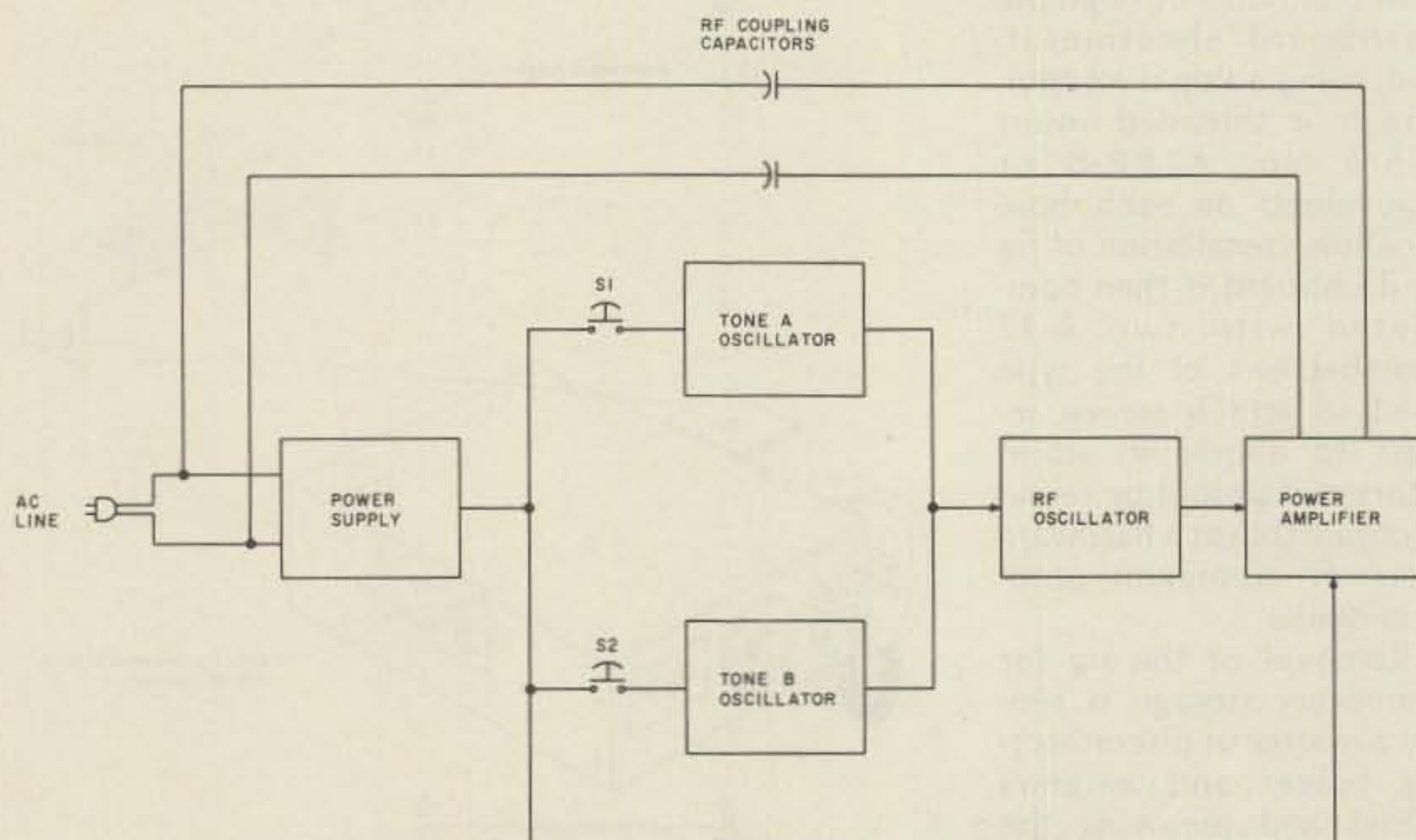

Fig. 1. Transmitter block diagram.

coms, there are numerous other devices using the same or similar techniques. Many burglar alarm installations, where additional wires are awkward or impossible, use WW signaling. Heathkit sells a home alarm system using plug-in sensors and a central unit designed along these lines. Lafayette Radio and others also sell remote-control devices for home appliances that signal via the ac line.

Those of you who live near modern schools may have noticed a funny whistle in your TV or radio at the same time that the school bells ring. This, too, is a form of WW system in which a master control sends coded signals through the school's power wiring to control the bells. Some of them also set the school's clocks exactly with another set of signals.

Large power companies have made their high-voltage long-distance transmission wires serve double duty. They send supervisory and voice communication information on rf carriers along with the low-frequency power. Increasing usage, too, is being made of WW signals for load shedding to turn off non-critical electrical appliances during peak power demand times.

Digging Deeper

Although information about these various systems is usually scanty, I devour any piece of it I can find. Wireless intercoms introduced themselves to me through a friend's request to repair a nonworking pair. The operating frequency (about 200 kHz) was listed on the label, but very little additional information was. Naturally, I also traced out the schematic. As luck would have it, the heart of the matter was an assortment of inscrutable rectangular coils in small metal cans bearing the inscription "Made in Japan."

Similarly, I once ran across some wireless remote controls sold by Lafayette Radio.

Tracing out the schematic diagram showed that the basic circuit was extremely simple. The transmitter portion was an ordinary one-transistor oscillator that ran somewhere between 100 and 200 kHz. Two oriental coils were used, one as a tuned circuit in the oscillator and the other apparently as an rf transformer used to match a transistor output amplifier to the ac line.

The receiver also used two transistors and two coils. The first was an amplifier connected to the power line via a link-coupled tuned transformer. Output from this amplifier was coupled through a second tuned inductor to the second transistor. As I remember, the second transistor acted as a detector and power switch to turn on a relay when rf was present at the power frequency.

Heathkit uses a similar system and circuitry for their home alarm system. Each sensor unit (fire, smoke, door switch, freezer warning, etc.) has a special transmitter module consisting of an astable multivibrator operating just below 100 kHz. The multivibrator is fed with half-wave unfiltered 60 Hz dc power, causing the output to be rf pulse amplitude-modulated at 60 Hz. It sends rf through the power line through a power resistor connected to one side of the multi which draws extra current for half of each rf cycle.

In the Heathkit receiver, there are a couple of tuned rf amplifiers (again with special inductors) which feed an AM detector. The detector picks 60 Hz modulation off the incoming carrier. A second detector then senses this 60 Hz audio and turns on an SCR and relay.

Other commercial wireless burglar alarm systems use similar techniques. However, they must be more selective and reliable, so they require better selectivity. Some I've

seen use ceramic resonators in both sending and receiving units. These resonators behave like the more expensive quartz crystals used in radio communications. They enhance the transmitters' frequency stability and give the receivers good selectivity to discriminate against noise and stray signals.

Still another class of equipment that uses power lines for signal transmission is home entertainment equipment. About ten years ago, a few record changer/tuner combinations were sold with remote speaker capability. There was a small modulated oscillator connected between the record changer and the power line. The remote speakers each had a small receiver which intercepted the signal from the ac wiring and fed it to an internal audio

amplifier and speaker. Although I never learned the circuitry of these gems, I did learn that they used an FM signal between 400 and 500 kHz. In fact, there was also one high-quality system that transmitted stereo via two different carriers between 400 and 500 kHz.

General Characteristics

Now let me summarize a few things I learned while investigating the previously mentioned systems. First, they use the power lines for their transmission medium. Second, they usually use frequencies between 50 kHz and 500 kHz.

Transmitter power levels are usually only a few milliwatts in home use, although the power companies may use several Watts for their long-distance systems. I measured receiver sensitivities of about

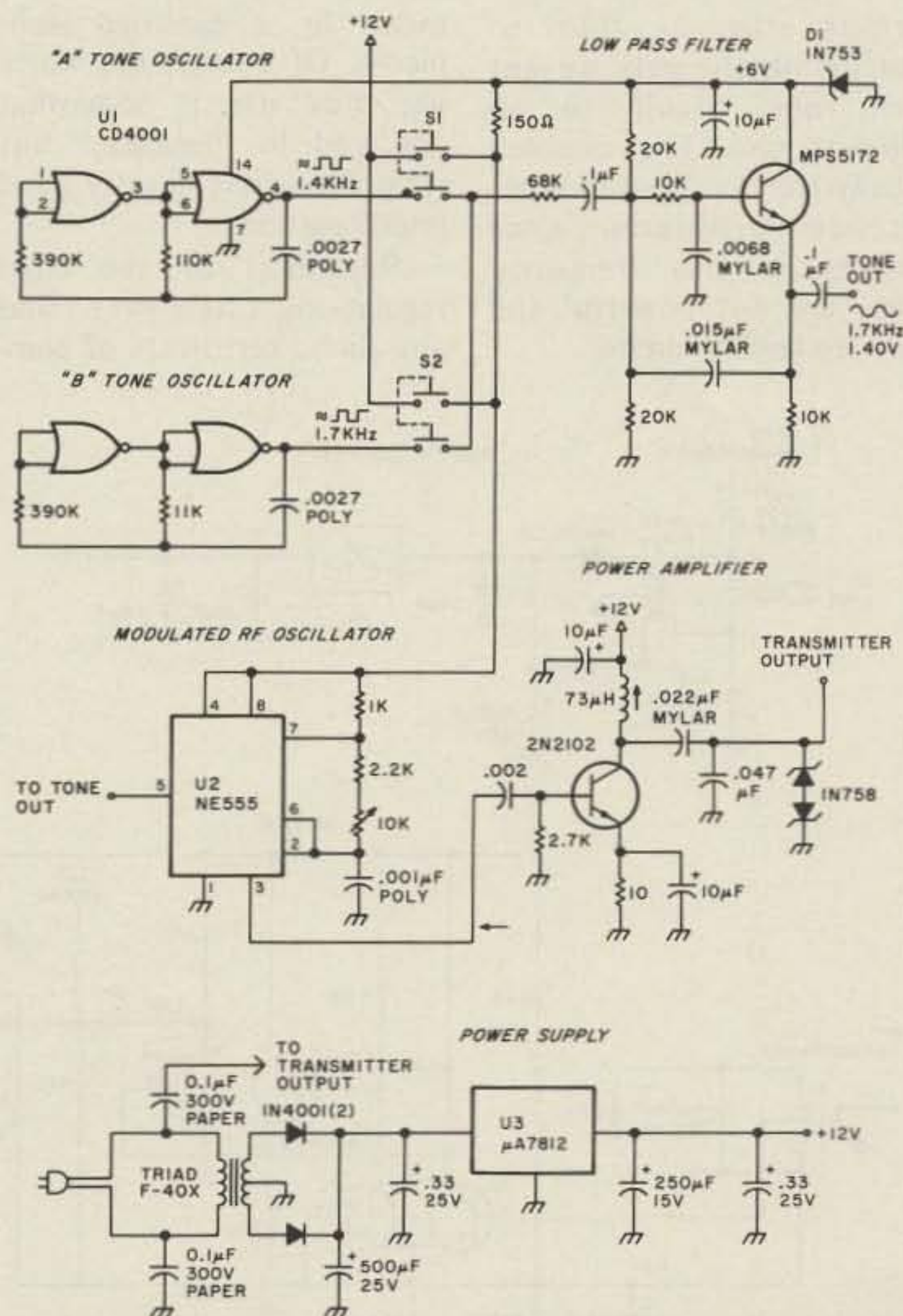

Fig. 2. WW transmitter schematic. Notes: (1) Polarized capacitors are electrolytic or tantalum. (2) Poly means polystyrene. (3) Unspecified capacitors are disc ceramic.

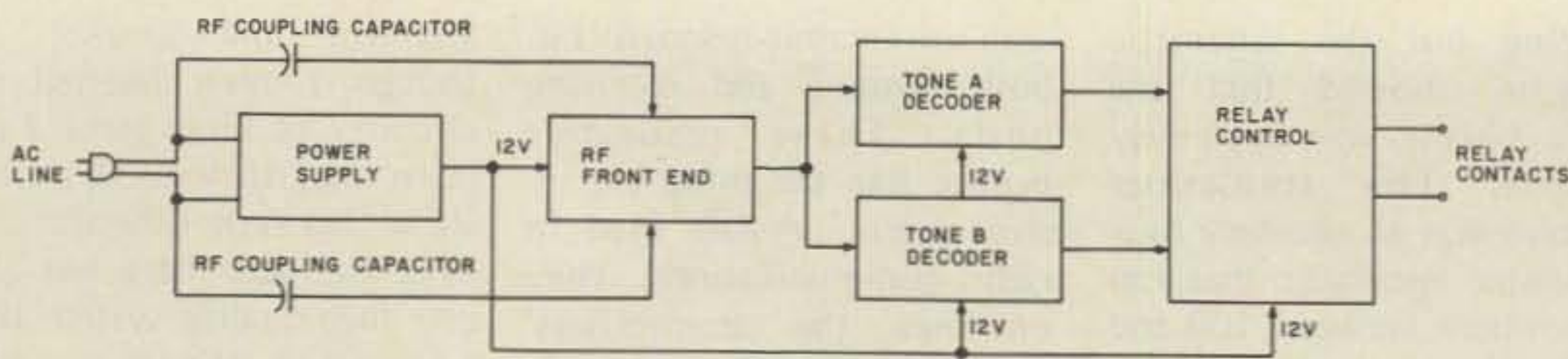

Fig. 3. WW receiver overview.

1 mV for the most sensitive receivers. Simple systems use AM, but FM systems are more reliable and noise-free.

The carrier frequencies in the above range are chosen for several reasons. They are high enough to handle as radio frequencies as far as the transmitters and receivers are concerned, but not so high as to require special circuitry. Very importantly, they are easy to transmit short distances via power line conduction, but are not radiated well because of their long wavelength. Power company pole-mounted transformers attenuate them so that the signals rarely are sent from one circuit to an adjacent one. The receivers usually aren't subject to interference problems, since services in this frequency range are not powerful and they are few in number.

The legality of most WW systems is somewhat hazy. Section 15.4(d) of the FCC rules seems to come the closest in defining such a system as a "restricted radiation device." Then Section 15.7 gives the limits for allowable field strength. Rf level must be below 15 microvolts/meter at a distance of $157,000/F$ (kHz) feet from the apparatus. They likewise require that no interference occur with a licensed service. And, finally, the equipment must bear a certificate of compliance with Part 15 regulations based on measurements by a qualified technician. Of course, the wording they use is somewhat obscured in "legalese," but what I've said is a pretty good interpretation.

Regardless of the cited regulations, I have yet to find any such "certificate of com-

pliance" on any commercially sold equipment I've seen. Whether this is intentional on the FCC's part or just what the story is I'm not sure. At any rate, if you do any experimentation with wired wireless, be sure not to use too much power or do anything else to interfere with a licensed service. Taking these precautions preserves the intent of the FCC regulations and should keep you from attracting their attention.

The Project Begins

In spite of my continuing interest in and occasional use of commercial WW equipment, I'd never really built my own. About five years ago, I did try a few circuits in an AM intercom, but the results were terrible. I couldn't couple enough rf into the power line to overcome the noise generated by fluorescent lights, dimmers, and electric motors. I was never sure whether the problem was insufficient signal or poor receiver design. Perhaps it was a little of both.

Then about two years ago, a friend asked me to help with a problem he had. Basically, he wanted to

control a lamp post at the far end of his driveway, but there were complications. First, there was no power available at the post when the light was off, since the switches were inside the house. Second, he didn't want to run any extra wiring, since it would have to be buried and it is about 200 feet from the house to the lamp post (surgeons don't live on postage-stamp lots).

Because of the no-extra-wire limitation, radio control was an obvious solution, but the distance was rather long for an unlicensed transmitter system. Of course, the lack of available power was a real handicap! I began thinking of a wired wireless transmitter as a possible solution. But this still had two drawbacks. There still was no power to run equipment at the light post, be it wireless or otherwise. More importantly, when the power was off, the transmission path for the rf signal was broken.

Both these limitations, however, were easy to get around. Since the desired control point for the lamp was right at the lamp, a battery-powered WW transmitter could be installed. Nickel-cadmium batteries could be used, connected so that, when power was on to run the lamp, they would be trickle charged. To get the signal around the switch in the house (when off), it was bypassed for rf. Since it was an SCR switch, a series-connected 0.1 uF capacitor and 100-Ohm resistor were connected across its terminals.

The capacitor has low enough reactance at rf to pass the control signal. At 60 Hz, though, the reactance is high enough to limit current flow to about 5 mA. The 100-Ohm resistor protects the SCR from being destroyed by current surges caused by the capacitor.

I built the system, and it worked very well. I seriously doubt though, that many 73 Magazine readers want or need such a control. So what

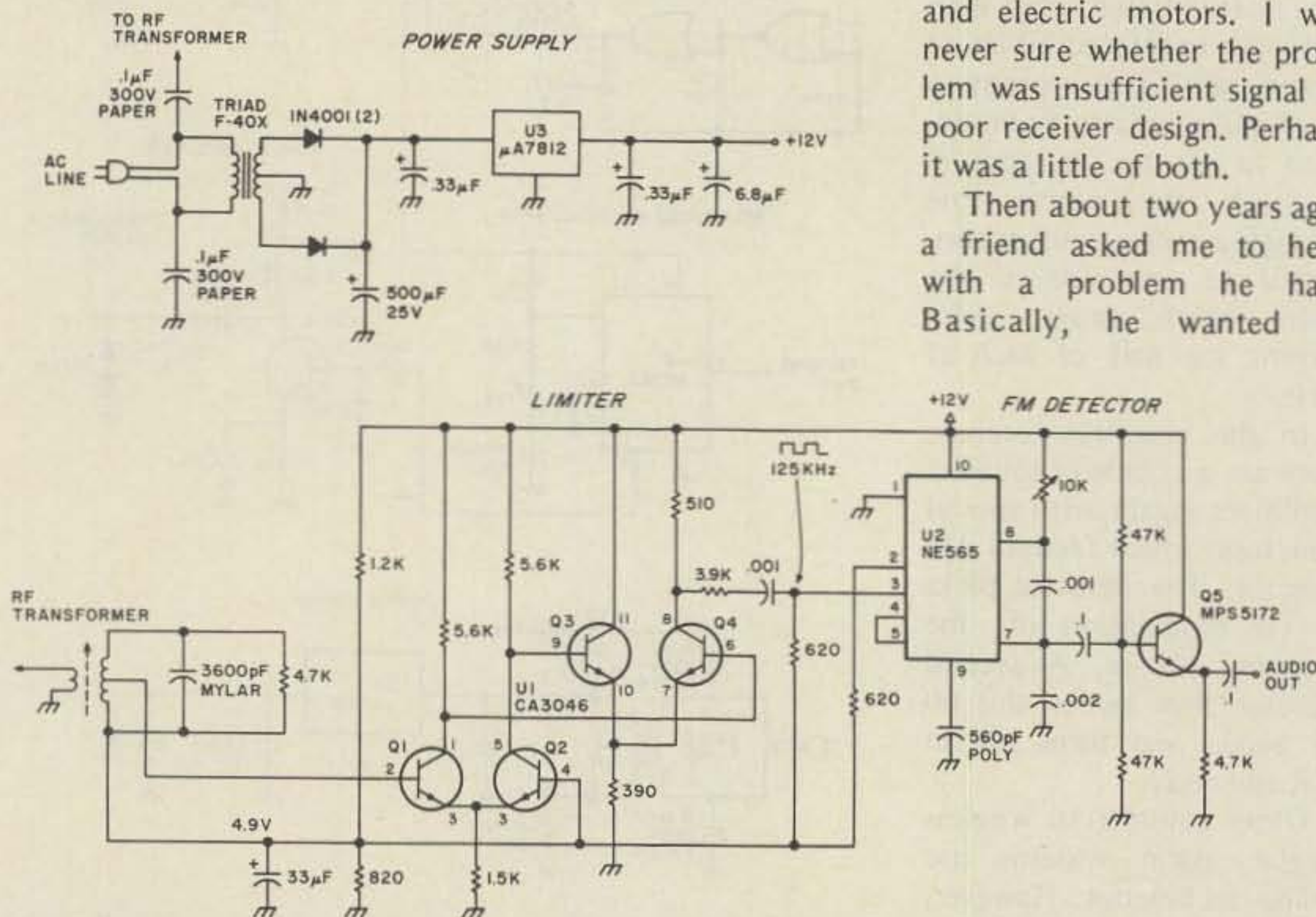

Fig. 4. Rf front end. Notes: See notes (1), (2), and (3) in Fig. 2. (4) Q1, Q2, Q3, and Q4 are part of U1.

I'll describe here is a more general WW control system which need not be dedicated to such restricted usage.

Hardware

Luckily for me, in view of my early WW experiments, I ran across a circuit for a fairly simple transmitter and receiver. National Semiconductor published their AN-146 application note entitled "FM Remote Speaker System." Essentially, the same information also appeared on pages 35 through 40 of *Popular Electronics* in the January, 1976, issue. The article was entitled "A Wireless Audio System for Remote Speakers."

At first, I expected to just copy their transmitter and receiver design with the addition of simple tone generators and detectors for control. So I breadboarded a crude version of each and tested them. They worked fine inside the house no matter how far they were separated. But, when the transmission path included the 200-foot buried run, operation was marginal. Receiver sensitivity couldn't be improved much because of impulse noise, so apparently more transmitter power was required.

For many applications, the National Semiconductor transmitter design is entirely satisfactory, and, if only short-range operation is required, by all means use it. For long runs, however, and where super reliability is needed, the "high-power" design I'll describe is recommended.

I won't belabor all the details of how I finally came up with my version because it would serve little purpose. I'll try, though, to cover the highlights so that you can easily understand how it works. And, with this added information, tailoring the circuits to individual needs is easier, if that's what you want.

Transmitter

The transmitter block dia-

gram is shown in Fig. 1. It features simplicity with enough "guts" to do an effective job. The power supply provides regulated dc to provide isolation from the ac line and stability from varying line voltage. The switches, S1 and S2, serve two purposes. They apply both a tone and dc power to the rf oscillator. When the oscillator is turned on, it applies bias which turns on the power amplifier. The amplifier, in turn, supplies sufficient power to send a signal through the ac line to the receiver.

Fig. 2 is the transmitter schematic diagram. U1 and U2 are CMOS astable multivibrators which are turned on only when one of the control switches is depressed. When S1, for example, is energized, it supplies +12 volts to the zener regulator D1. The switched +6 volts is then used to power both tone oscillators, the low-pass filter, and the modulated oscillator.

At the same time, the square wave output is connected to the transistor low-pass filter. In the filter, harmonics are removed to produce a fairly good sine wave at approximately 1.4 kHz. This tone, in turn, modulates the U2 astable multi. The 555 free runs at 125 kHz and is frequency modulated plus and minus 5 kHz at the tone frequency.

The 125 kHz signal is then applied to the power amplifier. Since it's operated class C, the amplifier produces no output until an rf input is applied. About 200 mW output is produced and is matched to about 30 Ohms by the output tuning network. Various matching impedance levels were tried, but best signal transmission took place when the 30-Ohm design value was used. The two series back-to-back zener diodes provide protection of the output transistor from high-voltage transients on the ac line.

The power supply is a simple half-wave rectifier which feeds a μ A7812 (or

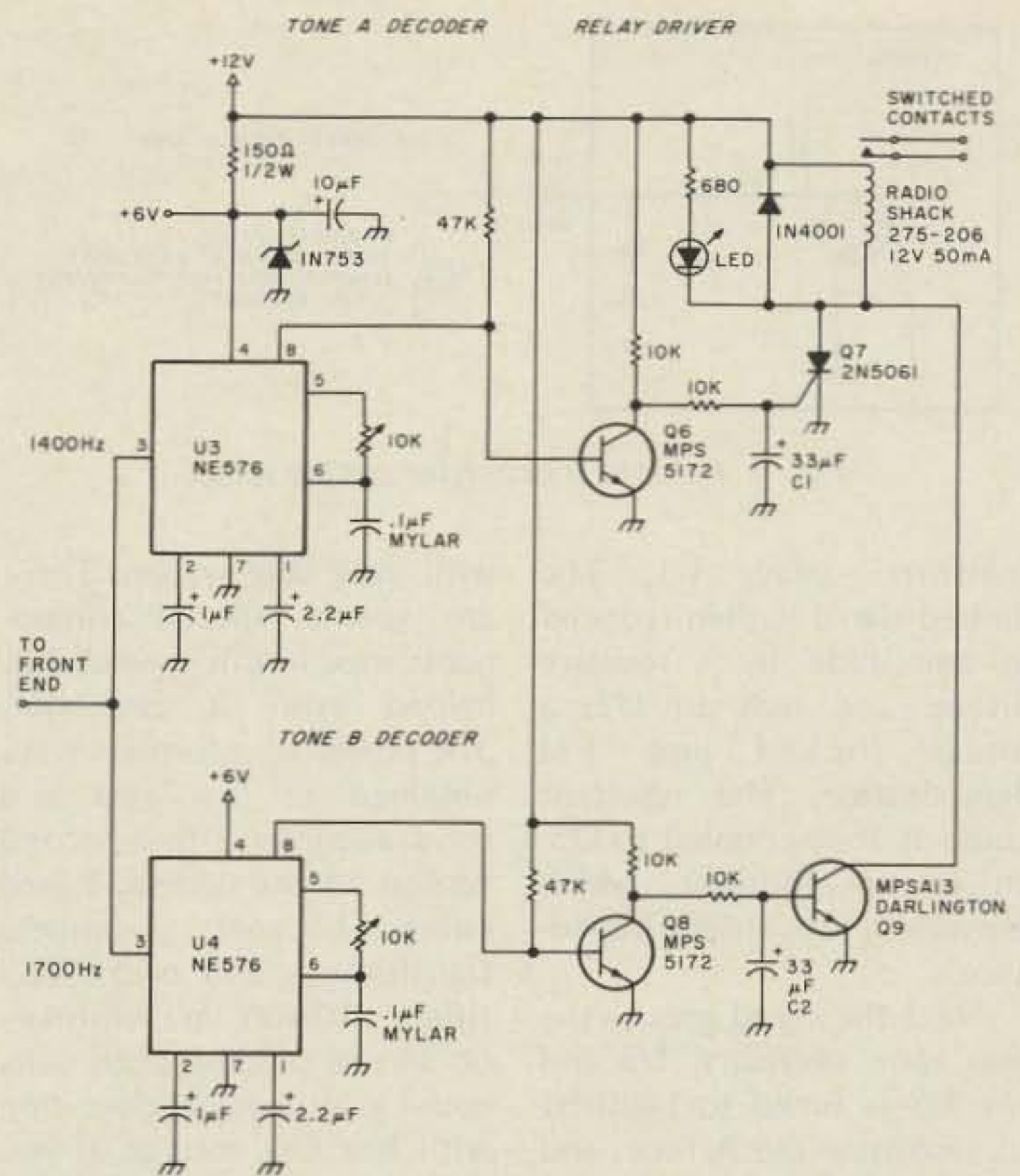

Fig. 5. Tone decoders and relay driver. Notes: See notes (1), (2), and (3) in Fig. 2.

MC7812 or equivalent) three-terminal regulator. Although not necessary except for continuous operation, the regulator is heat sunk for safety's sake. The electrolytic capacitors serve as ripple filters and provide low impedance for correct circuit operation and to keep the regulator from oscillating. The two 0.1 μ F, 300-volt paper dielectric capacitors couple the rf signal onto the power line.

Receiver

The receiver is somewhat more complicated than the transmitter. Fig. 3 shows the receiver functional block diagram. A regulated 12-volt power supply feeds all of the circuitry. The rf front end senses the signal, amplifies it, and demodulates it, providing the tone output. The tone decoders then detect the presence of either tone A or tone B. When tone A is present, the A decoder sends a signal to the relay control circuitry to energize the relay. Then, when tone B is sensed, the relay is turned off.

Fig. 4 shows the schematic diagram for the power supply and rf front end. 16 volts dc is dropped to 12 volts by U3, a simple three-terminal regulator. A small clip-on heat sink was needed to protect U3. The front-end circuit is copied from the National Semiconductor circuit almost intact. Input coupling and selectivity are determined by a single modified i-f can — more about it later. The input signal, removed from off-frequency noise, is amplified and limited in the two-stage differential pair, Q1 through Q4, which is contained in the

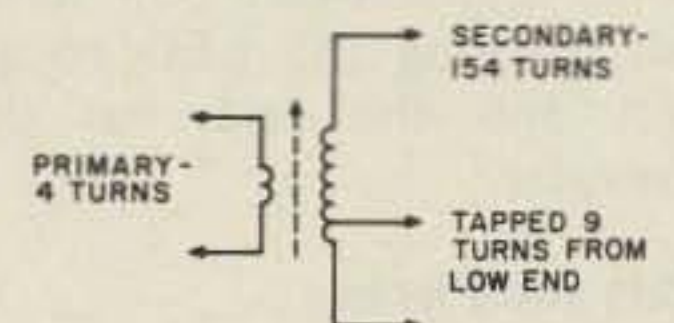

Fig. 6. Construction details for rf transformer. The rf transformer is made from one piece of Radio Shack 273-1383. The original windings were removed and the core rewound with #40 enamel wire, as per the text and this figure.

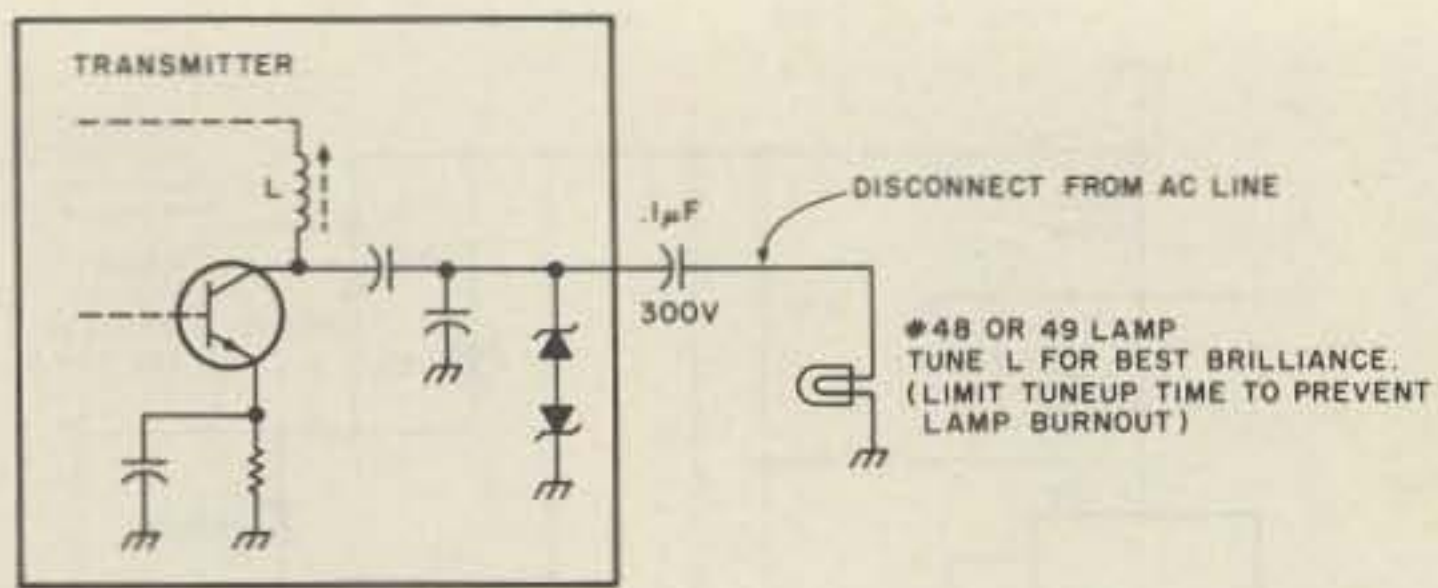

Fig. 7. Remote transmitter tuning setup.

transistor array, U1. The limited signal is then reduced in amplitude by a resistive divider and sent to U2, a phase locked loop FM demodulator. The resultant audio is then coupled to Q5, an emitter follower, which provides a low output impedance.

Next the signal goes to the two tone decoders, U3 and U4. U3 is tuned to 1400 Hz to recognize the A tone, and U4 operates on the 1700 Hz B tone. Presence of the correct tone causes pin 8 of the appropriate decoder to go to ground. If U3 is activated, its output goes low, turning off Q6, whose collector then goes toward 12 volts. When C1 charges sufficiently, SCR Q7 is turned on. Conduction of Q8 turns on the LED to show that an "on" signal has been received. At the same time, the relay is energized, closing its contacts which are used to control an external load. When the A tone disappears, Q7 remains latched on.

Tone B causes U4's output to go low, turning off Q8, which turns on Q9. When on, Q9 shunts current around Q7, turning it off. Then, when tone B disappears, Q9 turns off, causing the LED to go out and the relay to de-energize.

Bits and Pieces

That's most of the system, but a few more comments and suggestions may help you

with your WW system. There are several special components used in this project that helped make it successful. The power transformers were obtained at low cost and serve admirably. In a second version of the system, I used some 15-volt, 1-Ampere transformers and bridge rectifiers. 12-volt transformers or 24-volt center-tapped units could give marginal operation with low line voltage. If you use the lower voltage transformers, just be sure that there is at least a 3-volt dc margin above the 12-volt regulator output, or they will not work.

The transmitter's output coil is rather important. Taking a lead from the National Semiconductor application note, I tried re-winding an i-f can to use here. It worked, but results were poor, due to the high dc resistance of the winding. The coil I used was of unknown origin, and I had to remove turns to make it tune. A J. W. Miller type 23A685RPC coil should work as well.

The receiver's input coil is an i-f can modified as per a modified version of the National Semiconductor application note printed in the *Popular Electronics* article, "A Wireless Audio System for Remote Speakers." Here, both the transmitter and receiver coils were obtained by rewinding miniature transistor radio i-f cans. Fig. 6 shows the required

windings. Although the original article called for Toko transformers, I found that the Radio Shack 273-1383 worked just as well. To perform the modification, first carefully pull the "guts" of the can out the bottom of the shield. Now unscrew the black ferrite cup from the plastic threaded base. Next, cut off the wires to the solder terminals and remove the fixed ceramic capacitor. You will find that the small bobbin containing the windings is held in place only by beeswax. A little heat and careful prying removes it to strip the old wire off and add the new windings. Be careful not to forget which wire is which while you rewind, or you'll have to redo the job as I did (the first time). When soldering the windings onto the base pins, be careful with your iron. Too much heat will destroy the plastic base.

Tune-up of the transmitter is fairly simple. The only frequency adjustment is for the rf output. A frequency counter is recommended. The transmitter output stage is best tuned up by using a no. 48 or 49 pilot lamp as a dummy load. Connect the transmitter output stage as in Fig. 7, and tune the output inductor for maximum brilliance. A few crude tests of rf injected into the line showed this method to be a good compromise between simplicity and maximum signal.

The tone oscillators have no tuning adjustment, since their exact frequencies are not important. To be safe, check the two output frequencies and be sure that they are at least 15 to 20% apart. If they are too close, the receiver's decoders cannot distinguish between them. Change either the 110k or 91k resistors, should any readjustment be needed.

To tune the receiver, a frequency counter and oscilloscope are suggested. First set up a signal source (the matching transmitter is best) to send a weak signal into the receiver. Connect the scope

across the tuned portion of the transformer and tune for maximum signal. To adjust U2, U3, and U4, first short circuit their inputs to ground through a 0.1 uF capacitor, then set their vcos on frequency. Hook up a counter to pin 4 of U2 to read the vco or to pin 5 of U3 and U4 for their oscillators.

In some cases, I found that some low-impedance loads on the power line, particularly high-wattage incandescent light bulbs, caused severe signal attenuation. Usually this doesn't happen, but for long-distance transmission — 200 or 300 feet — lamps close to the transmitter load the signal heavily. To eliminate the difficulty, I placed a choke in series with the offending load. Commercially-available chokes are awfully expensive, but Fig. 8 shows an adequate home brew version.

Parting Comments

A high-performance WW remote control system has been described. Duplication for similar applications should be simple for experienced radio amateurs.

The same ideas can also be adapted for other uses. For example, if long distances aren't involved, the National Semiconductor transmitter circuit can be used with the tone encoders I've described. Or perhaps the remote speaker idea can be duplicated using my power amplifier. In fact, I've been toying with using my remote speaker to monitor my ham receiver from anywhere in the house. Still another possibility is to make a fancy wireless intercom using circuits from both sources.

WW is a very handy transmission technique. I hope that perhaps I've eliminated some of the mystique involved so that other radio amateurs and experimenters can use it for their own purposes. My thanks go to Gary Kirchner WA3YES for the impetus to take on this project. ■

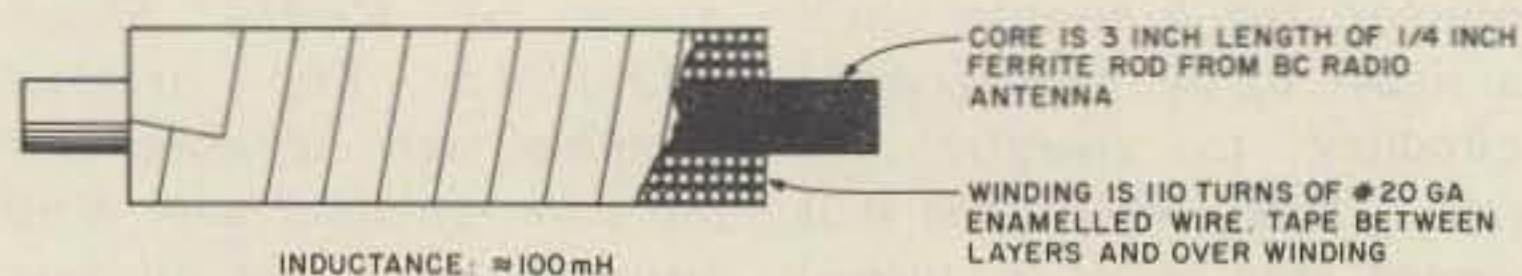

Fig. 8. Rf choke to minimize signal loss in incandescent light.

New!

Better than a pet rock!



Kantronics Freedom VFO

only
\$69.95

With almost 350,000 licensed amateurs on the air, variable frequency operation isn't a luxury, it's a necessity.

If you've tried to operate a rock-bound transmitter on the HF bands today, you know there must be a better way. There is.

The **Kantronics Freedom VFO** will drive the high impedance oscillator tubes of transmitters like the HW-16, DX-60, DX-35 and other "oldie-but-goodies."

The **Freedom VFO** sets you free to roam from 3.650 to 3.750 MHz and 7.000 to 7.200 MHz.

Give your pet rocks to a trusted friend and order a **Freedom VFO** today. Or write us for information and a list of authorized **Kantronics** dealers.

Order now!

KANTRONICS

The Lightweight Champs.

K13

1202 East 23rd St
Lawrence, Kansas 66044

Telephone 913-842-7745

Test with the professionals.

Our Directional RF Wattmeters are the choice of professional RF engineers everywhere. Can discriminate between forward and reflected power in all types of 50 ohm coaxial transmission line. Use plug-in elements for power measurements from 100 milliwatts to 50k watts at frequencies from 2 to 1000 MHz with $\pm 5\%$ accuracy.

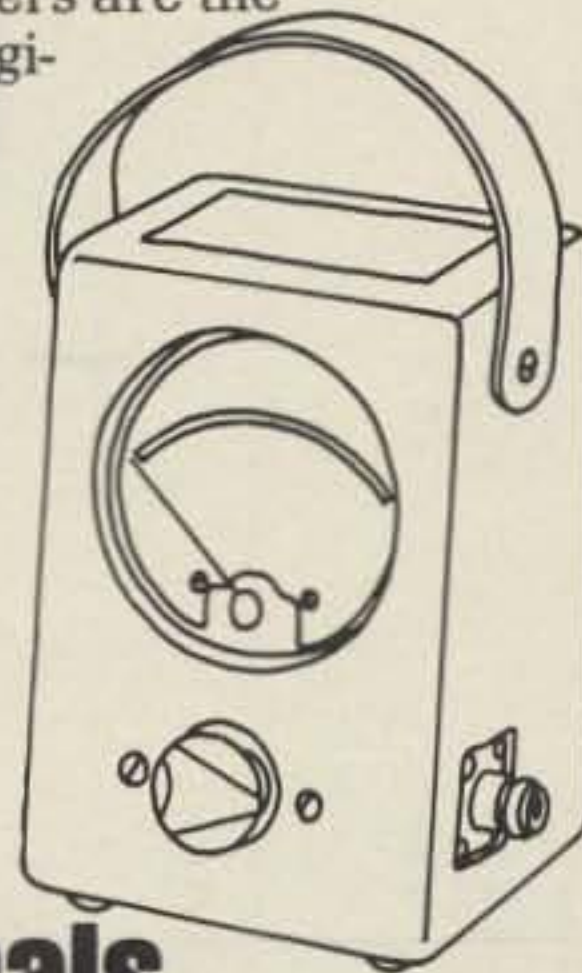

Wattmeters for professionals.

For the name of your local distributor call toll free
800-341-9678

GS

DIELECTRIC COMMUNICATIONS

A UNIT OF GENERAL SIGNAL
RAYMOND, MAINE 04071 • TEL 207-655-4555 • 800-341-9678

D29

30 YEARS...

of experience in supplying top quality antennas to Ham Radio operators at rock bottom prices guarantees high quality and low prices to novice and experienced operator alike.

TWO ELEMENT QUAD with full wavelength driven element and reflector. All metal construction. Gain is equal to that of a three element beam and directivity is exceptional. Assembled weight 25lbs. 10/15/20 quad, totally complete and ready for simple assembly . . . **JUST \$59.95.**

FULL SIZE BEAMS for full size performance. Includes boom, all hardware and gamma match.

12 EL 2M Beam \$56.95

5 EL 10M Beam \$59.95

4 EL 10M Beam \$49.95

3 EL 10M Beam \$45.95

(Truck shipped, not UPS)

5 EL 6M Beam \$49.95

3 EL 15M Beam \$54.95

6 EL 6M Beam \$54.95

4 EL 15M Beam \$59.95

FREIGHT PREPAID on 2, 6, and 10M beams shipped to the 48!

ALL BAND VERTICAL ANTENNAS absolutely complete including loading coil.

V40 vertical antenna for 40, 20, 15, 10 and 6 meter bands. Especially suitable for the novice who operates 40 and 15.

JUST \$25.95

V80 vertical antenna for 80, 40, 20, 15, 10 and 6 meter bands. Used by thousands of novices, technicians and general license hams.

JUST \$27.95

V160 vertical antenna for 160, 80, 40, 20, 15, 10 and 6 meter bands. Same as other vertical antennas, but with larger loading coil.

JUST \$29.95

How to order: Remit total amount with order. We ship verticals, 2, 6, and 10M beams (except 5 EL 10M Beam) prepaid to the 48. Other beams and all quads sent freight collect cheapest way, due to size of package. Check your local truck lines for estimated freight rates. For fast COD service on all prepaid antennas, call (305) 573-2080.

For literature, send self-addressed stamped envelope.

Florida residents add 4% sales tax.

GOTHAM, INC.

2051 N.W. 2nd Avenue
Miami, Florida 33127

G19

**VERTICALS SHIPPED
FREIGHT PREPAID
ANYWHERE IN
THE WORLD!**

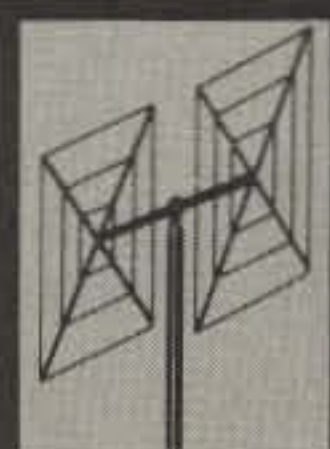
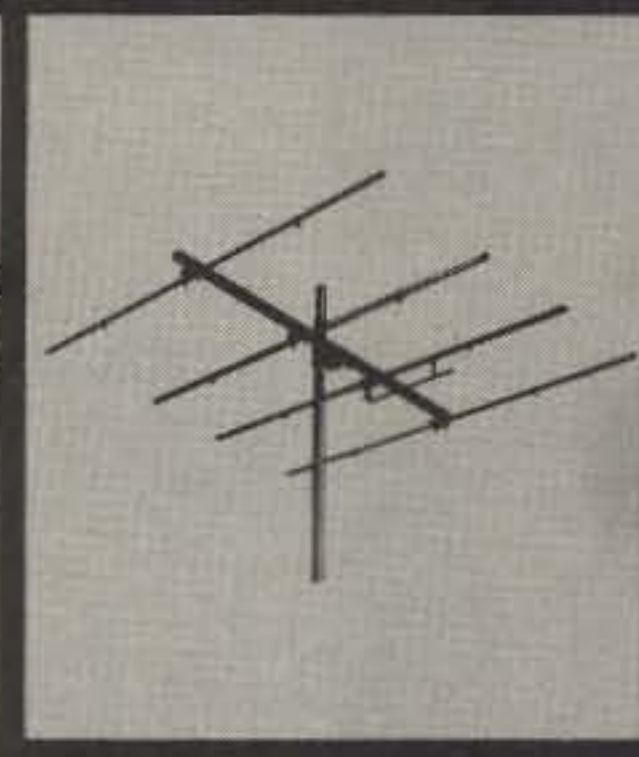

Terry Weatherley G3WDI
 16 Beverley Court
 Carlton Colville
 Lowestoft, Suffolk
 England

Ruddy Good Show!

—2 meters in the Mother Country

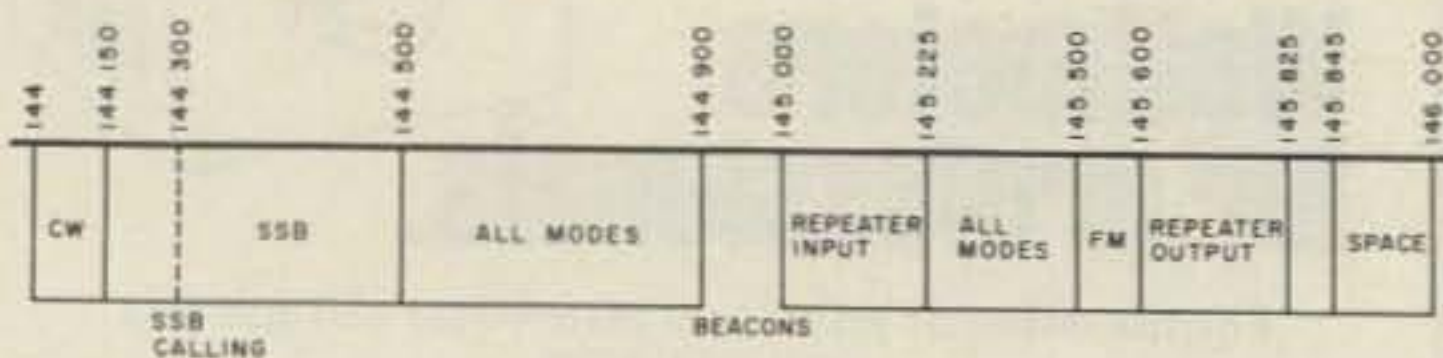
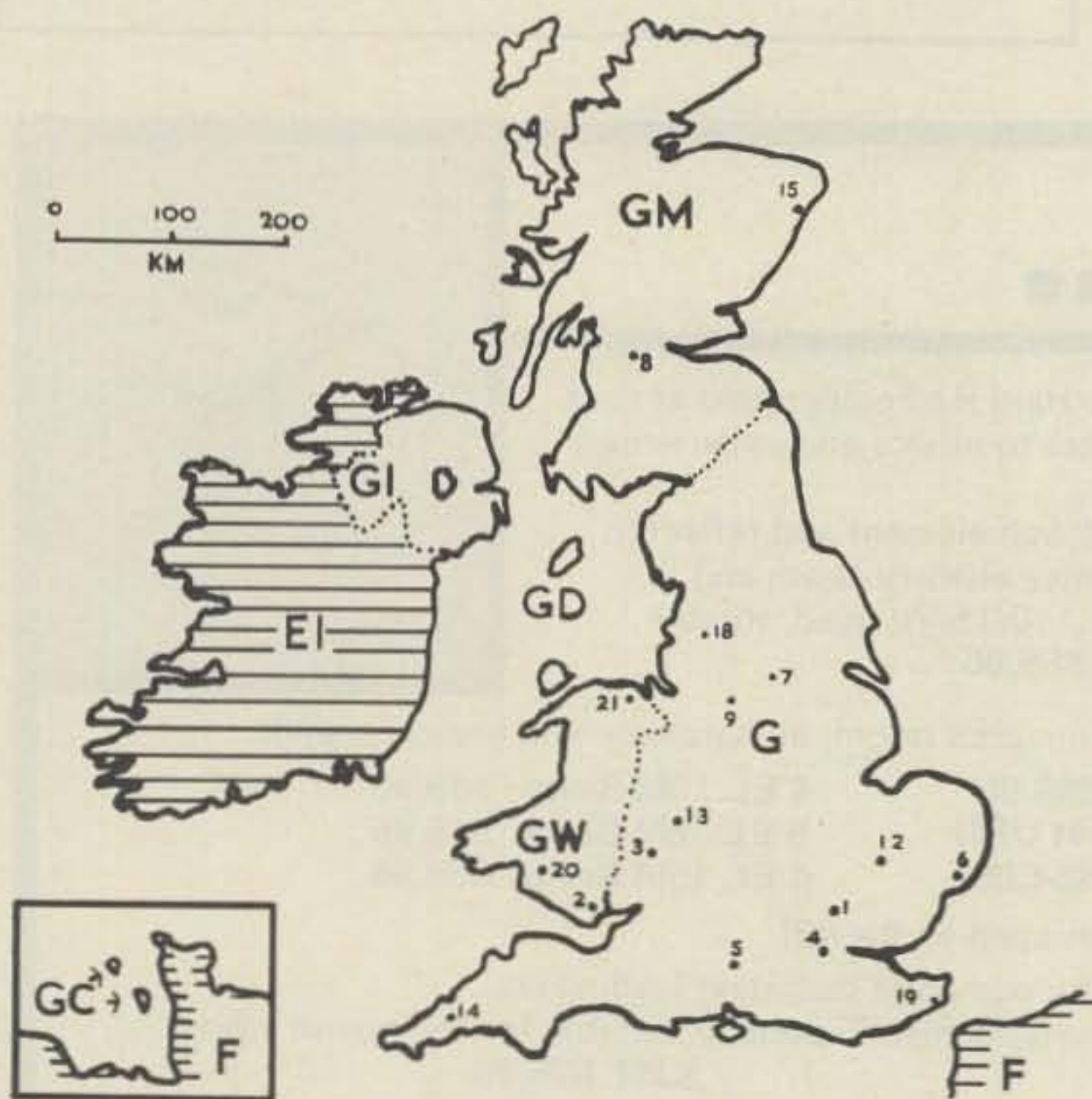

Fig. 1. IARU two meter band plan.



| No. | Call | Ch. | | | |
|-----|-------|-----|----|-------|----------|
| 1 | GB3PI | R6 | 9 | GB3HH | R4 |
| 2 | GB3BC | R6 | 12 | GB3PY | UHF RB12 |
| 3 | GB3MH | R7 | 13 | GB3BM | R5 |
| 4 | GB3LO | R7 | 14 | GB3NC | R5 |
| 5 | GB3SN | R5 | 15 | GB3GN | R7 |
| 6 | GB3PO | R3 | 18 | GB3RF | R7 |
| 7 | GB3NA | R3 | 19 | GB3KR | R4 |
| 8 | GB3CS | R6 | 20 | GB3WW | R7 |
| | | | 21 | GB3MP | R6 |

Fig. 2. U.K. repeaters.

The visitor to the U.K. will find that there are some similarities and some differences between the two meter scene in the U.K. and in the U.S. It is hoped that this article will point to some of these and make the G5--s (reciprocal licenses granted to visitors from abroad are in this series) feel at home on two, even though they are away from home.

The two meter band in the U.K. is from 144 MHz to 146 MHz. Most imported black boxes cover 144 to 148, so this should not be a problem if your rig is crystal-controlled. This article should help you select the right crystals for the trip.

Until about 1973, the two meter band was split up into regional sections, and different parts of the U.K. used different sections. Most worked simplex on AM. You called CQ and listened in your section for a local or in another section for DX. Most equipment was either home brew or converted radio telephone equipment. If you moved, you exchanged your crystal using the crystal exchange scheme organized by the Radio Society of Great Britain.

With the coming of commercial equipment came the International Amateur Radio Union band plan, which was adopted by the U.K. along with others. The regional sections gave place to mode sections, as shown in the band plan (Fig. 1). The repeater scene shows many differences with established U.S. practice.

The growth of repeaters has been very slow and strictly controlled by the licensing authority (the home office). Certain ground rules were laid down quite early on and, by and large, have been adhered to. All repeaters are operated under licenses granted to the Radio Society of Great Britain. The costs involved in building, operating, and maintaining the machines are borne by local groups. All repeaters are open repeaters for all licensed amateurs. The principal purpose of the repeater is to assist mobile stations. All repeaters are vertically polarized for this reason. They are accessed by a 1750 Hz tone burst and will time out after 60 to 120 seconds. Repeater input is 600 kHz lower than the output, and Table 1 lists the frequencies R0 to R9.

The map in Fig. 2 shows the locations and channels of the current repeaters on two in the U.K.

Simplex FM working varies from area to area. In my area (Lowestoft), 145.000 (S0) is used for local working, and this channel is monitored for visitors. In other areas, 145.500 (S20) is monitored. Enquiry to the local club prior to a visit will give local information.

A useful publication covering the U.K. and continental FM scene is the international VHF FM Guide produced by G3UHK and G8AUU. This is an annual publication and costs about two dollars from G3UHK (50 Aldbourne Road, Burnham, Slough SL1 7NJ, England).

There are a number of beacons in the band which serve as useful pointers to band conditions. GB3VHF in Kent on 144.150 is an example. This sends its callsign in CW every 60 seconds. Other beacons are located in other areas.

There is some mobile SSB activity, and 144.3 is the calling frequency. Mobile contacts with the continent from the east coast are not uncommon during good conditions.

Portable working from the tops of cliffs or hills is recommended as an interesting pastime. It certainly gives the feel of being rare DX. DX can indeed be worked. During last summer's very good conditions, I worked, from my home in East Anglia using ten Watts to a six-over-six at ten feet, PA0, ON, F, DK, OE, GW, GM, LA, SM, OZ, and, via sporadic E, IT9 and 9H1.

Locations are given using either the name of the town or the QRA locator system (now called the QTH location system). This system locates a station to within a rectangle of 4.5 x 4.6 km. The system divides Europe into rec-

tangles, each covering 2 degrees of longitude and 1 degree of latitude (see Fig. 3). These large squares are indicated by letters. Each large rectangle is further divided into 80 small rectangles, and these are further divided into nine smaller rectangles (see Fig. 4). A station's position can thus be determined using two letters, two numbers, and a small letter. My QTH is thus AM49a. Squares are

collected over here, and, again, a visitor touring can suddenly become rare DX.

Visitors to the Norfolk Broads can work mobile on the Broads from their hired cruiser (or private yacht). All visitors will be invited to the local club if they call on S0 when in the area.

Much useful information about licensing can be obtained from the RSGB at 35 Doughty Street, London W.C. 1. Enjoy your visit to

| Channel | Input | Output |
|---------|---------|---------|
| R0 | 145.000 | 145.600 |
| R1 | 145.025 | 145.625 |
| R2 | 145.050 | 145.650 |
| R3 | 145.075 | 145.675 |
| R4 | 145.100 | 145.700 |
| R5 | 145.125 | 145.725 |
| R6 | 145.150 | 145.750 |
| R7 | 145.175 | 145.775 |
| R8 | 145.200 | 145.800 |
| R9 | 145.225 | 145.825 |

Table 1. Repeater channels.

the "old country," and I'll see you on two. ■

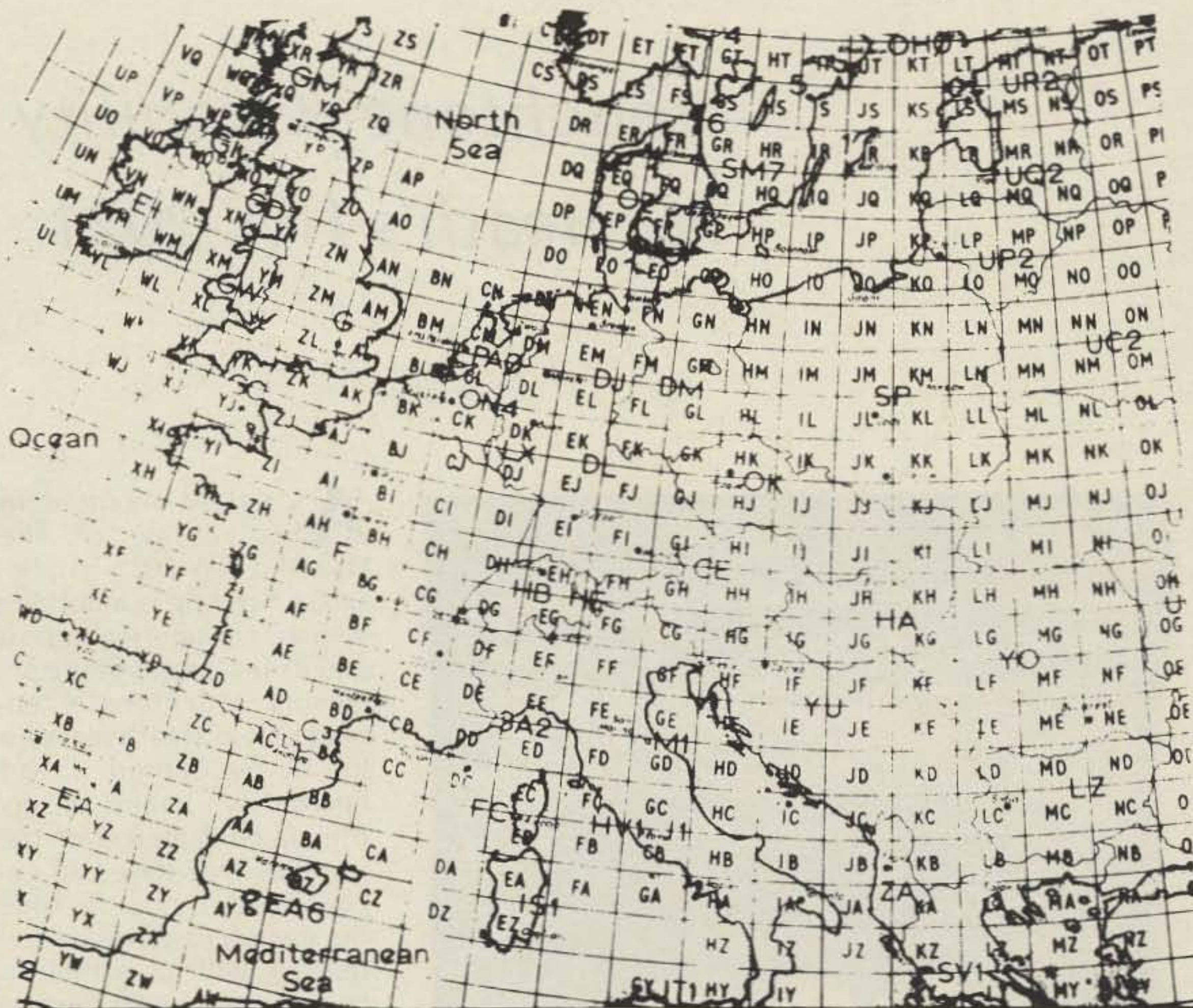

Fig. 3. The QTH location system.

| | | | | | | | | | |
|----|----|----|----|----|----|----|----|----|----|
| 01 | 02 | 03 | 04 | 05 | 06 | 07 | 08 | 09 | 10 |
| 11 | 12 | 13 | 14 | 15 | 16 | 17 | 18 | 19 | 20 |
| 21 | 22 | 23 | 24 | 25 | 26 | 27 | 28 | 29 | 30 |
| 31 | 32 | 33 | 34 | 35 | 36 | 37 | 38 | 39 | 40 |
| 41 | 42 | 43 | 44 | 45 | 46 | 47 | 48 | 49 | 50 |
| 51 | 52 | 53 | 54 | 55 | 56 | 57 | 58 | 59 | 60 |
| 61 | 62 | 63 | 64 | 65 | 66 | 67 | 68 | 69 | 70 |
| 71 | 72 | 73 | 74 | 75 | 76 | 77 | 78 | 79 | 80 |

| | | |
|---|---|---|
| H | A | B |
| G | J | C |
| F | E | D |

Fig. 4. Each large rectangle is divided into 80 smaller rectangles which are then divided into nine more.

Rock Steady

—touchtone™ stability
for Heath's HW-2021

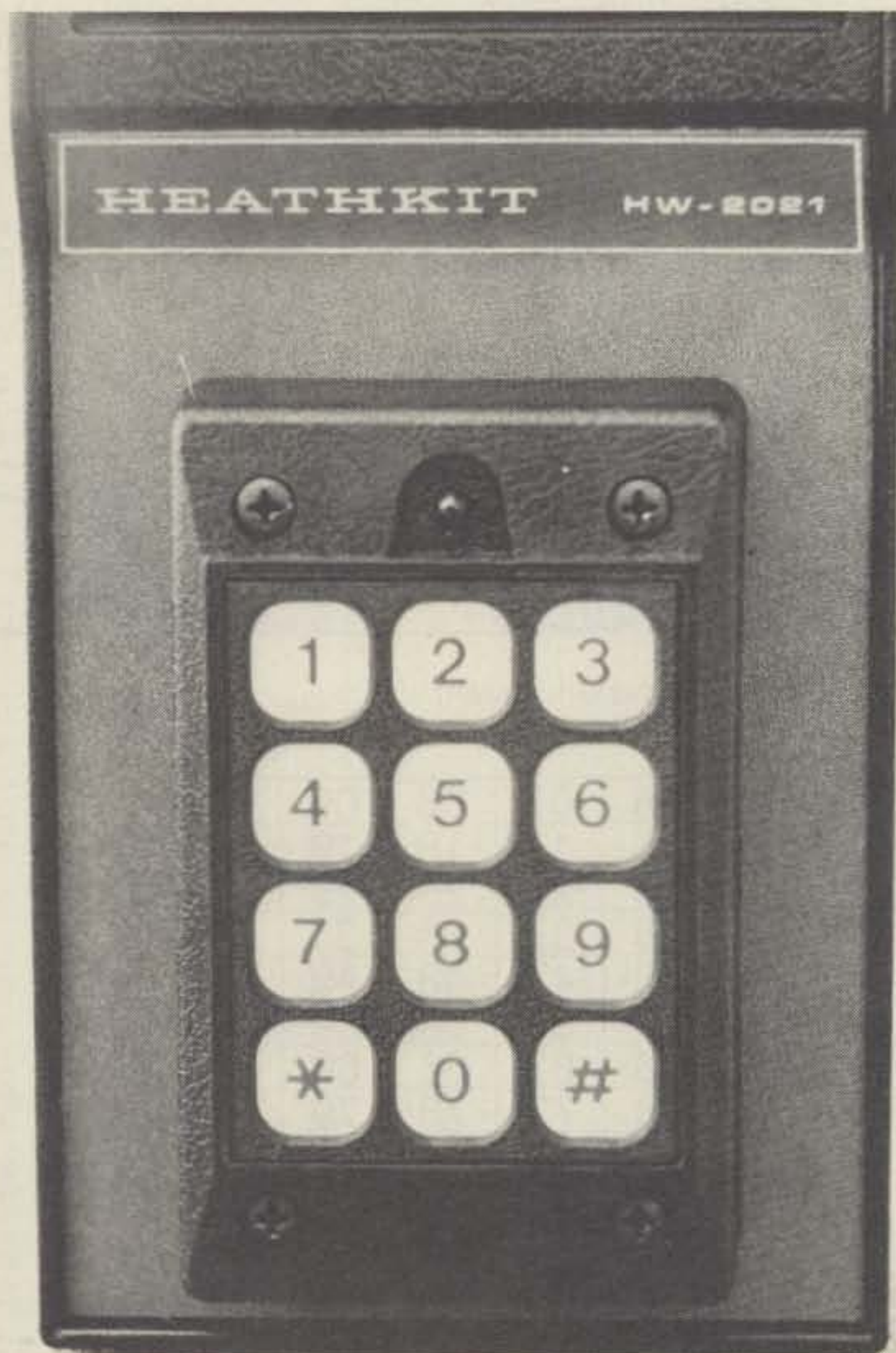

The HWA-2021-3 autopatch encoder modified for crystal frequency control.

As K4JEM reported in his review of the Heathkit HW-2021 handie-talkie,* the rig is a definite winner, considering its cost and its features, but the accessory touchtone™ encoder from Heath leaves a lot to be desired. I had heard from many of my friends on 2 meters of the troubles that they had encountered trying to tune the encoder's tones on frequency, with or without a frequency counter. Several gave up and sent their new rigs to a Heath service shop to be tuned. The rigs that have made it on the air seem to lack reliability in accurate number dialing, and their owners report that the frequency of the tones varies with time and probably temperature changes as well.

Allen found a problem with the values of capacitors supplied with the HWA-2021-3 kit, but, beyond that, it looks to me

like any tone encoder circuit employing NE555 oscillators controlled by resistance-capacitance networks will suffer instabilities due to environmental factors that will make them only marginally suitable for tone encoding. This seems especially true in this handie-talkie application, which one expects to carry outdoors in hot and cold weather, and particularly unnecessary considering the availability of crystal-controlled circuits. Therefore, I expect that there are a number of Heathkit 2021 owners who have installed the encoder accessory but are not happy with it.

I volunteered to build the HW-2021 kit for a fellow ham who had purchased the encoder kit as well. I knew that I didn't care to go through the problems that others had had in getting the encoder to work, nor did I want to build a device for my friend that would be unreliable in the future.

*"Heath HW-2021 Review," S. M. Allen K4JEM, 73 Magazine, August, 1977, p. 160.

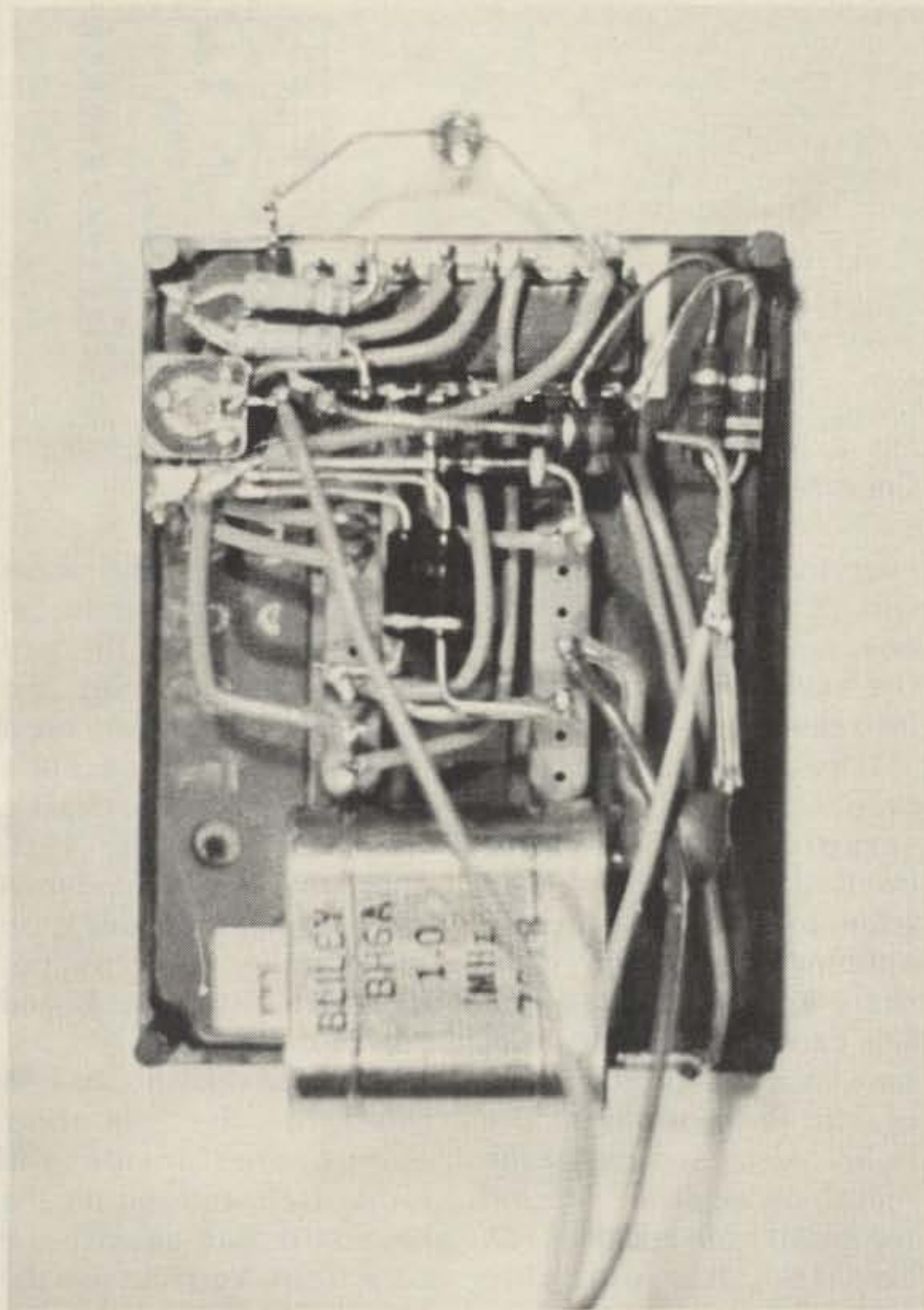

Components mounted and wired on the back of the 12-button keyboard.

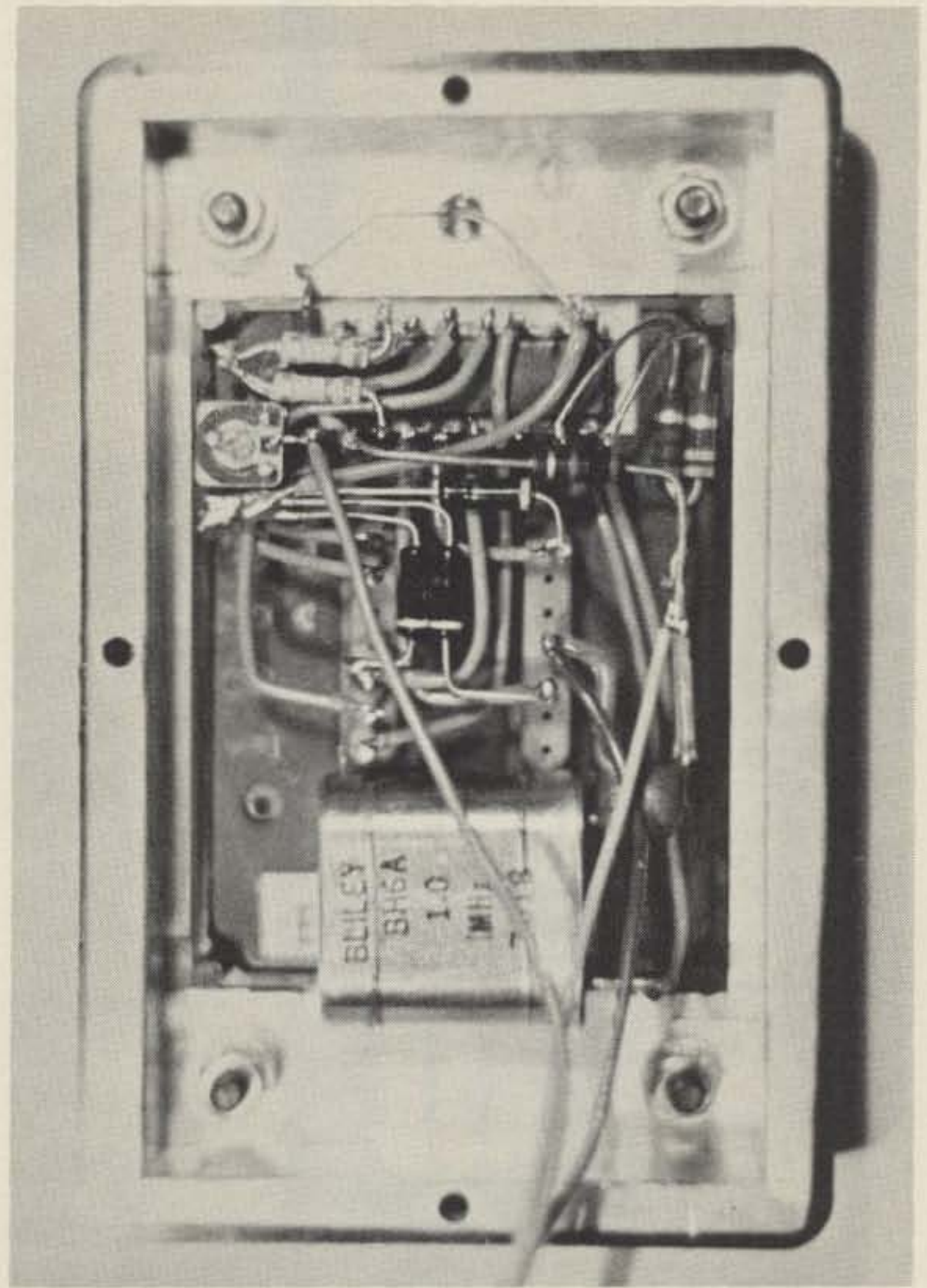

Keyboard is cemented into the plastic case. Metal coating must be removed from inside edge of case for cement to adhere properly.

When the transceiver was finished, I decided to use the HWA-2021-3 enclosure and keyboard, but replace the NE555 circuit with a Motorola MC14410 tone generator. The MC14410 is controlled with a 1000 kHz crystal for more than adequate frequency precision and stability and has enough audio drive for the HT's input circuit.

I wanted to preserve the function of the LED that Heath put on the encoder to let the user know that he is pressing a key (you can't hear the tones) and have a finished product that outwardly appears to be "stock" Heathkit and interfaces with the HT in the same way as the original HWA-2021-3. The modification described is rather extreme, in that one discards the printed circuit board and most of the elec-

tronic components that come in the kit. All you save are the plastic case, keyboard, LED, 10k audio level pot, ribbon cable, screws, and perhaps a resistor or two.

The schematic shows the design I came up with to generate tones and light the LED. The circuit draws no current unless a key is pressed, connects to the HW-2021 with the same

three wires that Heath designed into their kit, and requires only an audio level adjustment. With a good quality crystal, there should be no problems with tone frequency.

The photographs show how the circuit is assembled on the back of the Chomerics keyboard. Lay the keyboard face down and attach the Motorola

chip and crystal with some strong rubber cement. The chip goes at the top, with pins 1 through 8 along the top edge of the keyboard. The crystal (HC6/U size) is cemented at the bottom of the keyboard. Using the up-turned IC legs, the crystal pins, and the pins on the keyboard back as tie points, all components are soldered together using

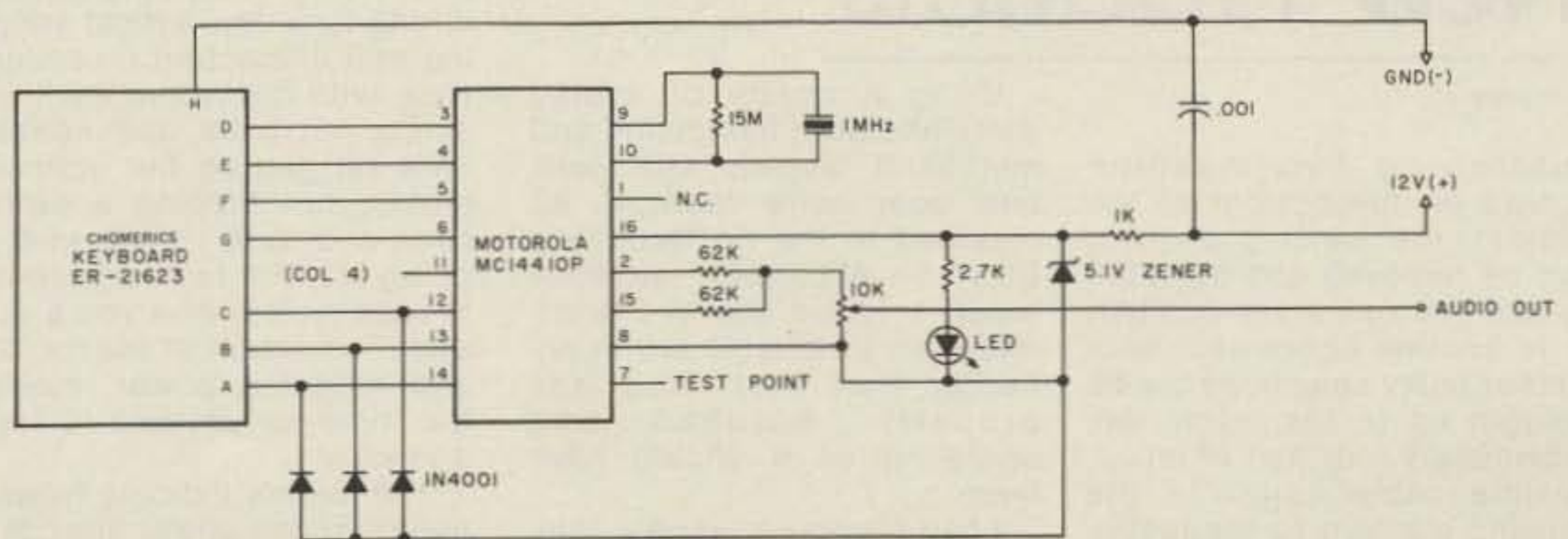
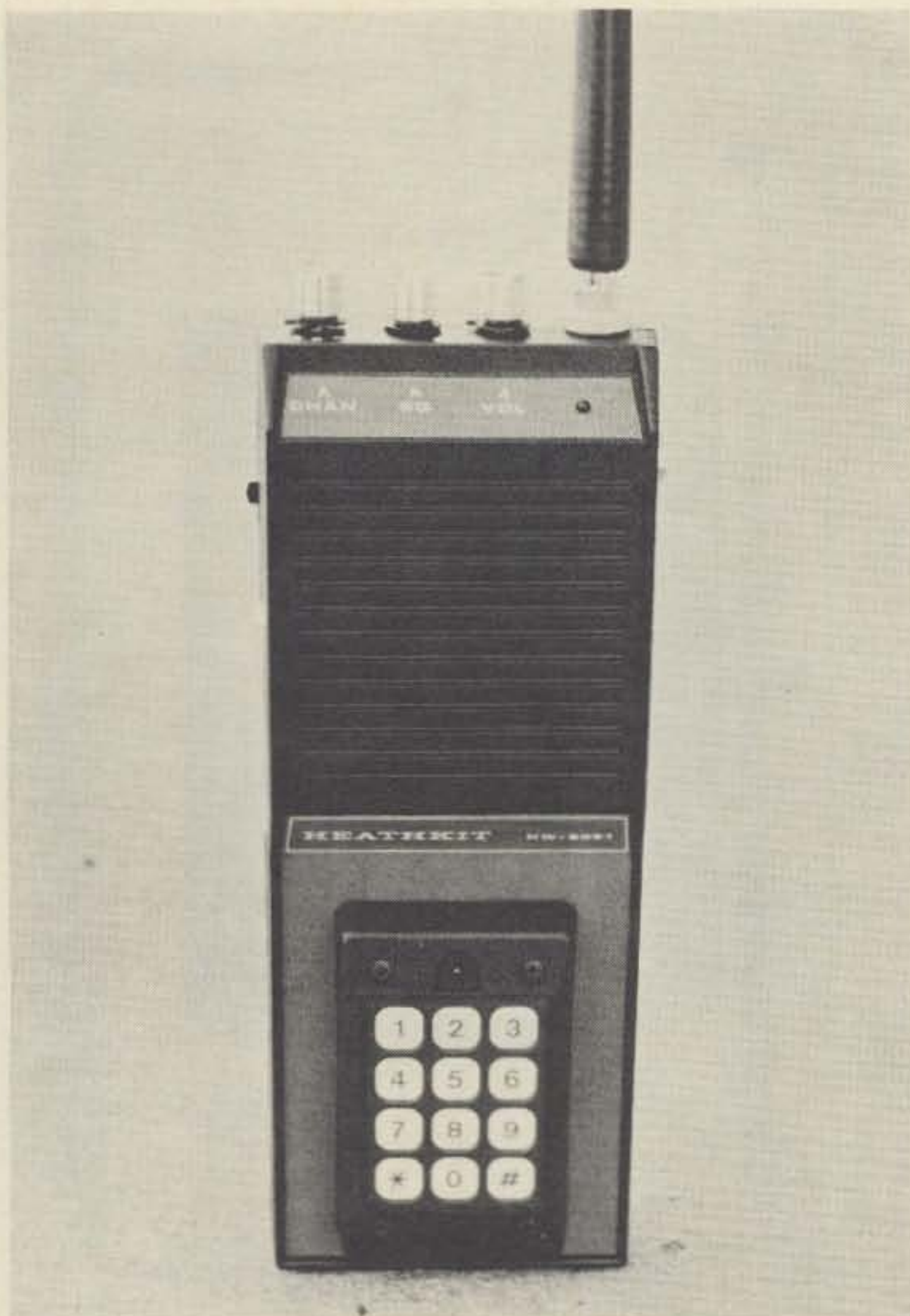

Fig. 1. Schematic and pinouts for modernizing the HWA-2021-3.



Completed HW-2021 with modified encoder pad. The internal improvements are not outwardly visible.

small solid wire. The LED sticks out on its leads and resistor in position for fitting into its hole when the keyboard is mounted in the plastic case. When soldering, be careful not to overheat the keyboard connections, as plastic parts can melt, ruining your keyboard. Solder

quickly, using a low-wattage pencil with a clean tip. When the wiring is completed, attach the 3-wire ribbon and connectors supplied by Heath and connect it to your transceiver. Test the encoder on the air and have another station help you set the audio level to make sure

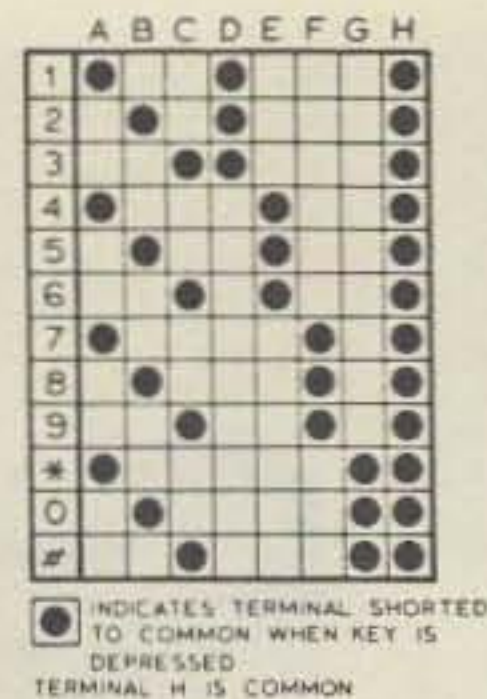
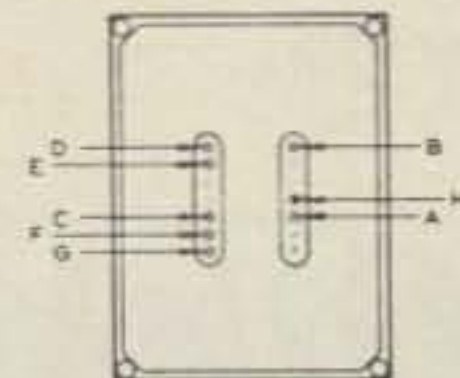

Fig. 2. Terminal connection diagram and code chart for Chomerics ER-21623 keyboard.

everything is working. It will be easier to work on any problem now before the keyboard is cemented into the case.

If everything checks out, prepare the plastic case by scraping the metallic coating from the inside edge of the large square opening. The edge of a sharp knife or a fingernail file can be used, but take care not to remove any plastic and enlarge the hole. Also scrape some metal away from around the small hole for the LED. Locate the machine screws, nuts, and washers that would be used to hold the circuit board to the case in the original kit and mount them in the case. These screws now serve no function except to fill the holes for appearance's sake. Set the keyboard assembly into the case to make sure that everything fits properly, then remove it and coat the keyboard edge with a toluene-base plastic cement. Fit the

keyboard into the case again, checking that the cement evenly fills the gap all around, and set the assembly face down on a nonadhering surface. Put a drop or two of the plastic cement behind the LED, and leave your encoder to dry overnight. Mount it on the handie-talkie as per Heathkit instructions, and you're in business.

It is also possible to find room for the electronic components inside the radio itself and mount the keyboard flat against the case front. You can use the larger size keyboards or a 16-button pad. The fourth column connection from a 16-key pad goes to pin 11 on the chip, and you will need to wire an additional 1N4001 diode to this pin as well. If you haven't purchased the HWA-2021-3 kit but are considering adding touchtone to your rig, I would recommend buying the keyboard and parts and rolling your own for a neat, slim appearance. ■

New Products

from page 35

unscrewing two machine screws on the bottom of the cabinet, the sensing element can be removed and installed behind the operating position or in another convenient spot so that bulky coax need not be brought up to the meter. Approximately four feet of small, flexible cable connects the sensing element to the meter, allowing a wide range of installation positions.

Using a variety of ended wires and both monoband and multiband dipoles with coax and open wire feeders, all matched to the rig through a DenTron MT-2000A antenna tuner, I found the W-2 wattmeter an invaluable aid in ensuring that everything was properly matched and operating as it should have been.

I had previously used a combination swr/relative power meter that required constant

switching back and forth between the forward, reflected, and power output positions during tune-up—a most annoying and distracting procedure. Now, with the W-2 in the line, I simply sit back and concentrate on getting the optimum match, not flipping a switch back and forth to see what is going on. The two large, easy-to-read meters give you a constant indication of the forward and reflected power, making the tune-up process quicker and safer.

The meters indicate forward and reflected power directly in Watts. To convert the reflected power reading into swr, you

simply refer to the easy-to-use swr calculator in the operating manual or the graph on the handy card that can be posted on the wall or some other convenient spot close to the operating position. However, you'll quickly become familiar with the conversion factor and won't even need to check the manual or card to know what the swr is.

The W-2 sensor element has a slide switch to select the forward wattage (200 or 2000) to be measured. The reflected power stays at 200 Watts. The sensing element should be connected

Continued on page 69

This NEW MFJ Versa Tuner II . . .

has SWR and dual range wattmeter, antenna switch, efficient airwound inductor, built in balun. Up to 300 watts RF output. Matches everything from 160 thru 10 Meters: dipoles, inverted vees, random wires, verticals, mobile whips, beams, balance lines, coax lines.



\$79⁹⁵

Antenna matching capacitor. 208 pf. 1000 volt spacing.

Sets power range, 300 and 30 watts. Pull for SWR.

Meter reads SWR and RF watts in 2 ranges.

Efficient airwound induc-tor gives more watts out and less losses.

Transmitter matching capacitor. 208 pf. 1000 volt spacing.

Only MFJ gives you this MFJ-941 Versa Tuner II with all these features at this price:

A SWR and dual range wattmeter (300 and 30 watts full scale) lets you measure RF power output for simplified tuning.

An antenna switch lets you select 2 coax fed antennas, random wire or balance line, and tuner bypass.

A new efficient airwound inductor (12 positions) gives you less losses than a tapped toroid for more watts out.

A 1:4 balun for balance lines. 1000 volt capacitor spacing. Mounting brackets for mobile installations (not shown).

With the NEW MFJ Versa Tuner II you can run your full transceiver power output — up to 300 watts RF power output — and match your

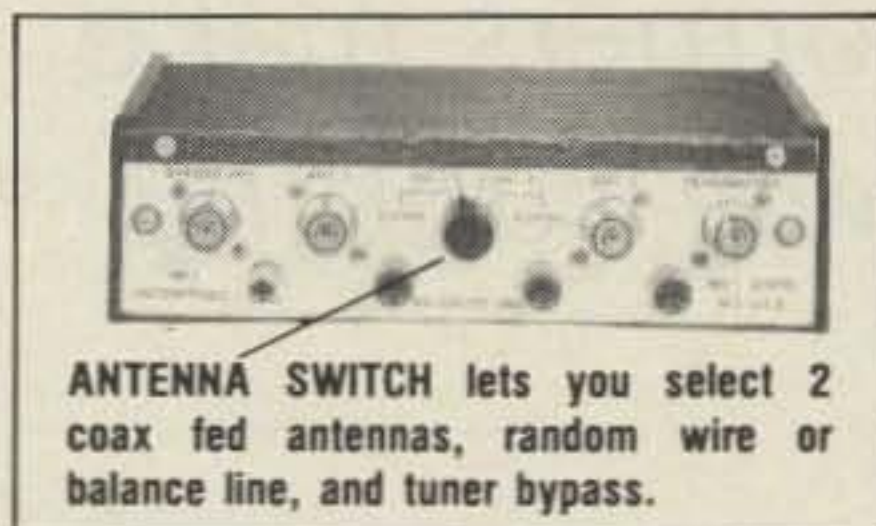

ANTENNA SWITCH lets you select 2 coax fed antennas, random wire or balance line, and tuner bypass.

transmitter to **any** feedline from 160 thru 10 Meters whether you have coax cable, balance line, or random wire.

You can tune out the SWR on your dipole, inverted vee, random wire, vertical, mobile whip, beam, quad, or whatever you have.

You can even operate all bands with just

one existing antenna. No need to put up separate antennas for each band.

Increase the usable bandwidth of your mobile whip by tuning out the SWR **from inside your car.** Works great with all solid state rigs (like the Atlas) and with all tube type rigs.

It travels well, too. Its ultra compact size 8x2x6 inches fit easily in a small corner of your suitcase.

This beautiful little tuner is housed in a deluxe eggshell white Ten-Tec enclosure with walnut grain sides.

SO-239 coax connectors are provided for transmitter input and coax fed antennas. Quality five way binding posts are used for the balance line inputs (2), random wire input (1), and ground (1).



\$59⁹⁵

BRAND NEW

MFJ-901 VERSA TUNER

New efficient air wound coil for more watts out.

Only MFJ uses an efficient air wound inductor (12 positions) in this class of tuners to give you more watts out and less losses than a tapped toroid. Matches everything from 160 thru 10 Meters: dipoles, inverted vees, random wires, verticals, mobile whips, beams, balance lines, coax lines. Up to 200 watts RF output. 1:4 balun for balance lines. Tune out the SWR of your mobile whip **from inside your car.** Works with all rigs. Ultra compact 5x2x6 inches. SO-239 connectors. 5 way binding posts. Ten Tec enclosure.



\$49⁹⁵

BRAND NEW

MFJ-900 ECONO TUNER

Same as MFJ-901 Versa Tuner, but does not have built-in balun for balance lines. Tunes coax lines and random lines.



\$39⁹⁵

MFJ-16010 RANDOM WIRE TUNER

Operate 160 thru 10 Meters. Up to 200 watts RF output. Matches high and low impedances. 12 position inductor. SO-239 connectors. 2x3x4 inches. Matches 25 to 200 ohms at 1.8 MHz.



\$39⁹⁵

BRAND NEW

MFJ-400 8043 ECONO KEYS

MFJ brings you a reliable, full feature economy keyer using the famous CURTIS-8043 keyer-on-a-chip.

Panel Controls: Speed (8 to 50 WPM), pull-to-tune; volume, on-off; 3 conductor, 1/4 inch phone jack for keying output and key paddle input.

Internal weight control lets you adjust dot-dash-space ratio for a distinctive signal to penetrate QRM for solid DX contacts. Sidetone and speaker. Internal tone control.

lambic operation with squeeze key. Dot memory. Instant start. Self completing. Jamproof spacing. Reliable solid state keying: grid block, cathode, solid state transmitters (-300V, 10 ma. max. and +300V, 100 ma. max.).

For Orders **Call toll-free 800-647-8660**

For technical information, order and repair status, and in Mississippi, please call 601-323-5869.

Order any product from MFJ and try it. If not delighted, return within 30 days for a prompt refund (less shipping).

Order today. Money back if not delighted. One year unconditional guarantee. Add \$2.00 shipping/handling.

Order By Mail or Call TOLL FREE 800-647-8660 and Charge It On



MFJ ENTERPRISES

P. O. BOX 494 M52 MISSISSIPPI STATE, MISSISSIPPI 39762

In the Eye of the Beholder

*— ugly transformers make
beautiful power supplies*

Sixty to one hundred dollars or more for a heavy-current power supply tends to cool one's enthusiasm a bit. Winding your own transformer is one way to pare the cost a bit.

The tendency toward on-board regulation suggests that what is needed is a heavy-current unregulated supply with the unregulated input voltage around 7 to 10 V dc for a 5-volt bus. The 7-volt-minimum figure is necessary

because the regulators must have a little more in than they put out. The 7-volt figure also is the loaded dc voltage, which means that the loaded dc will be higher.

Let's assume that you want 5 volts at 10 Amps and 12 volts at 1 Amp. (You may want different voltages or currents, but the process to follow will be the same.)

Power in Watts equals volts multiplied by Amperes. Watts = volts x Amps. I need

$(5 \times 10) + (12 \times 1)$, or 62 Watts, right? Wrong. I need more volts in both instances to allow room for the regula-

tors to work. I use a design voltage of 8 V ac for a 5-volt regulated circuit and 15 V ac for a 12-volt circuit. I have seen articles about projects that used 6.3 V ac for the 5-volt circuit and 12.6 V ac for the 12-volt circuit. I have tried both these values and have not been satisfied with the results. I have used 7 V ac and 14 V ac successfully for 5- and 12-volt regulated circuits, respectively. The power that is not actually used gets turned into heat by the regulators, so some kind of trade-off is required.

If I use a design figure of 8 V ac and 15 V ac for the two supplies, I need $(8 \times 10) + (15 \times 1)$, or 95 Watts. This must be translated into iron. At 60 cycles power line frequency, the amount of power a transformer will handle is directly related to how much iron it contains. So, how much iron do we need?

Over here in the corner of the shop is a vacuum-tube TV set. On the back of the set is a little placard that says: "120 volts alternating current, 60 cycles only; 175 Watts maximum."

Since the power into a transformer is essentially the same as the power out of the transformer, this transformer has iron in it worth 175 Watts. This transformer

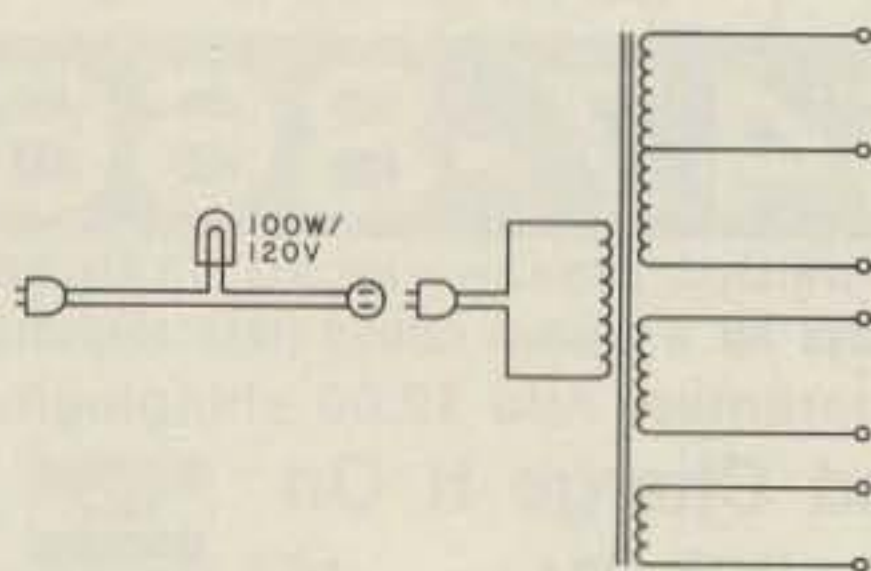

Fig. 1. Initial and final transformer test circuit.

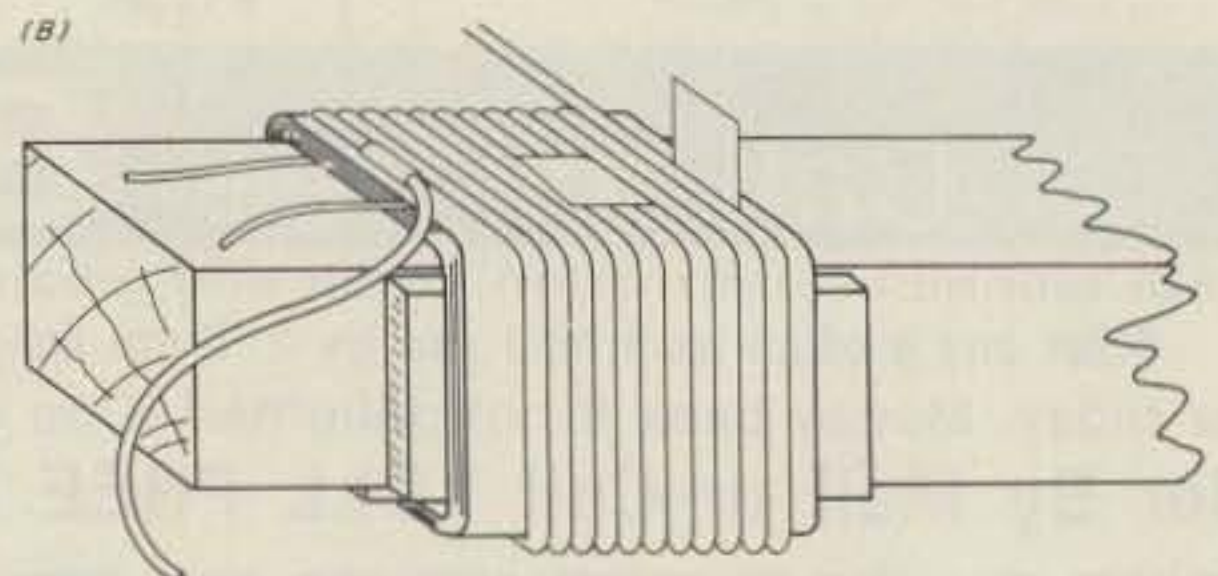
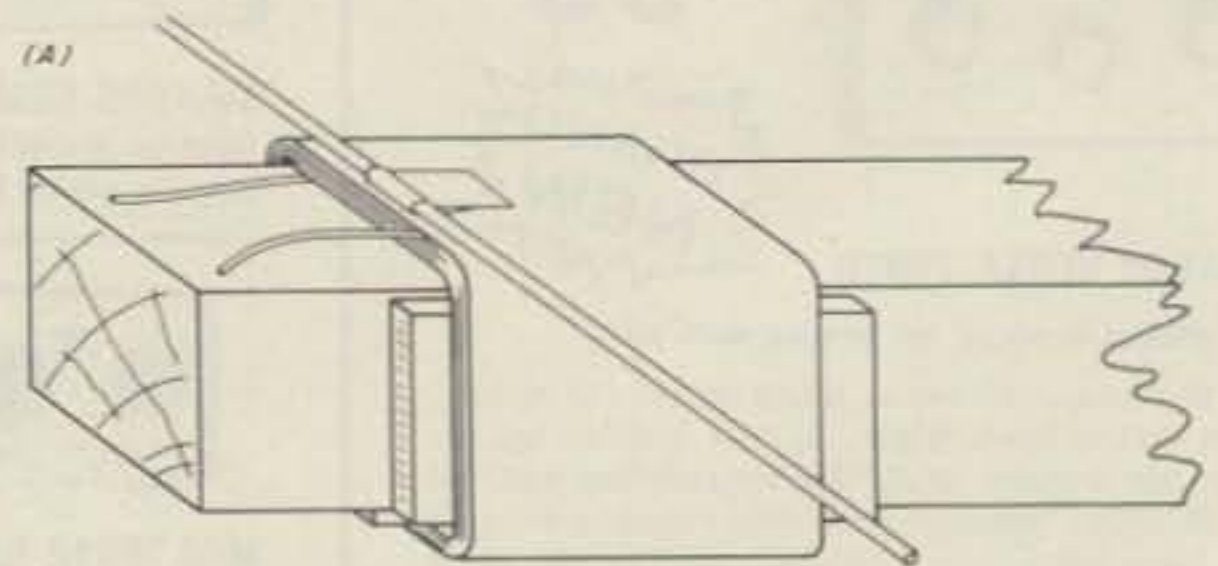

Fig. 2. Starting and finishing windings.

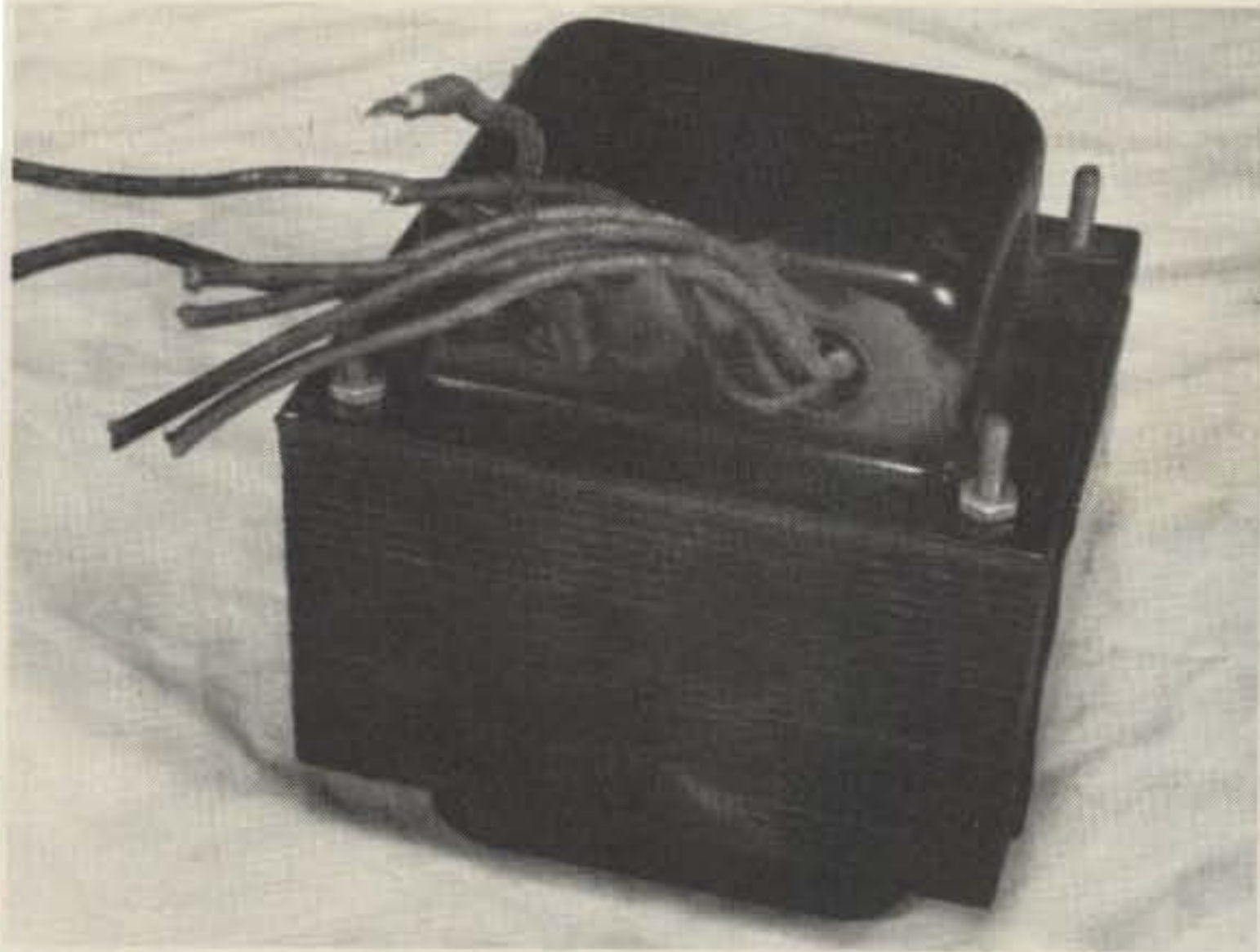

Photo A. The beast.



Photo B. Covers and static shield removed.

would do nicely for the 95-Watt supply I intend to build.

But, you say, the little placard is gone from the back of yours. Or the entire back is missing. Or the transformer has already been removed from the TV set, and there is now no way to determine its original power consumption. Well then, you'll have to do things a little differently.

Here is another transformer lying here on the workbench. It states on the side of it that the secondary is 36 V ac @ 3 Amperes. That multiplies out to 108 Watts. Let's measure the iron in it. To do this, measure the cross-sectional area. This is the iron that is inside the windings. The iron on the outside of the windings doesn't count in the power calculations. I measure 2.5 x 3.5 cm. Multiplying, that gives 8.75 square centimeters. If I divide 108 Watts by 8.75, I get a little over 12 Watts per square centimeter. This transformer would also be suitable for my supply.

And over here is the "beast." It's a TV transformer that has been separated from the TV chassis sometime earlier in its history. The cross-sectional area measures about 4 cm x 7 cm. That's 28 square centimeters. And 28 x 12 is about 336 Watts. Converting the mea-

surements to square inches and using the table in Lew McCoy's article (*QST*, November, 1976), I get 350 Watts. That's close enough for me.

Approximate power in Watts from a 60-cycle transformer equals cross-sectional area (in cm^2) multiplied by 12.

I am going to use this beast, and, as long as I am going to go to the trouble of rewinding it, I will put on two windings for the 12-volt supply and two windings for the 5-volt supply. In the winding area, called the window area, I will put on as many 8 V ac windings as I have room for. I have #18 wire and #14 wire on hand. This is one reason for the multiple windings. Each additional winding will add its current-carrying capacity to other windings with the same number of turns. You can put on one winding that will carry 30 Amperes using #10 (at least) wire, or you can put on 3 windings that will carry at least 10 Amps each. The end result will be the same — 30 Amps of capability. As long as the labor is going to go into rewinding, you might as well take advantage of all the power available in the iron you have selected.

Step One

Step one could have been

the selection of the transformer to be rewound. However, most of you will not have multiple choices in this area. You will have one transformer available and, having determined its power capability, you need to decide which circuit to use. One point before I move on: You can't get 200 Watts from 150 Watts of iron. You can use 350 Watts of iron for 200 Watts output. 350 Watts of iron in a 200-Watt supply is fine business, as there will be lots of room for you to wind your wire in.

Only two choices of circuit are really available. The full-wave bridge circuit, shown in Fig. 3, and the full-wave center-tapped circuit, shown in Fig. 4. In the following short discussion, you will get an insight into why I decided to wind on multiple windings.

The full-wave bridge circuit requires the least number of turns in the rewinding process. If I give my high school students or my adult school students the options of full-wave bridge versus full-wave center-tapped circuits, they invariably opt for the fewer number of turns for the bridge circuit. You will have to evaluate the following trade-offs and make your own decisions.

In the full-wave bridge circuit of Fig. 3, a pair of diodes

is switched across the 8-volt winding during each half of the ac cycle. This means that this pair is in series during this interval. All the current flows through the winding and through each diode in the pair. On the other half of the ac cycle, the remaining pair of diodes in the bridge gets switched in, and all the current then flows through this pair in turn. For a 10-Amp circuit, each diode in the bridge must carry 10 Amps, and the secondary winding must also carry 10 Amps. Since the pair of diodes conducting at this time is in series, each of the two diodes need withstand only half as much inverse voltage. Or each diode need have only half the peak inverse voltage (piv) of the full-wave center-tapped circuit.

In the full-wave center-tapped circuit, each of the diodes must withstand the full piv of the circuit. In either of the two circuit choices, this piv decision for the two circuits is not very important for the 8 V ac winding, because it is hard to find diodes with less than a 25 piv rating.

In the full-wave center-tapped circuit of Fig. 4, only one diode and one half of the secondary winding gets switched into the circuit on each half of the ac cycle. This means that each diode needs to carry only half of the total

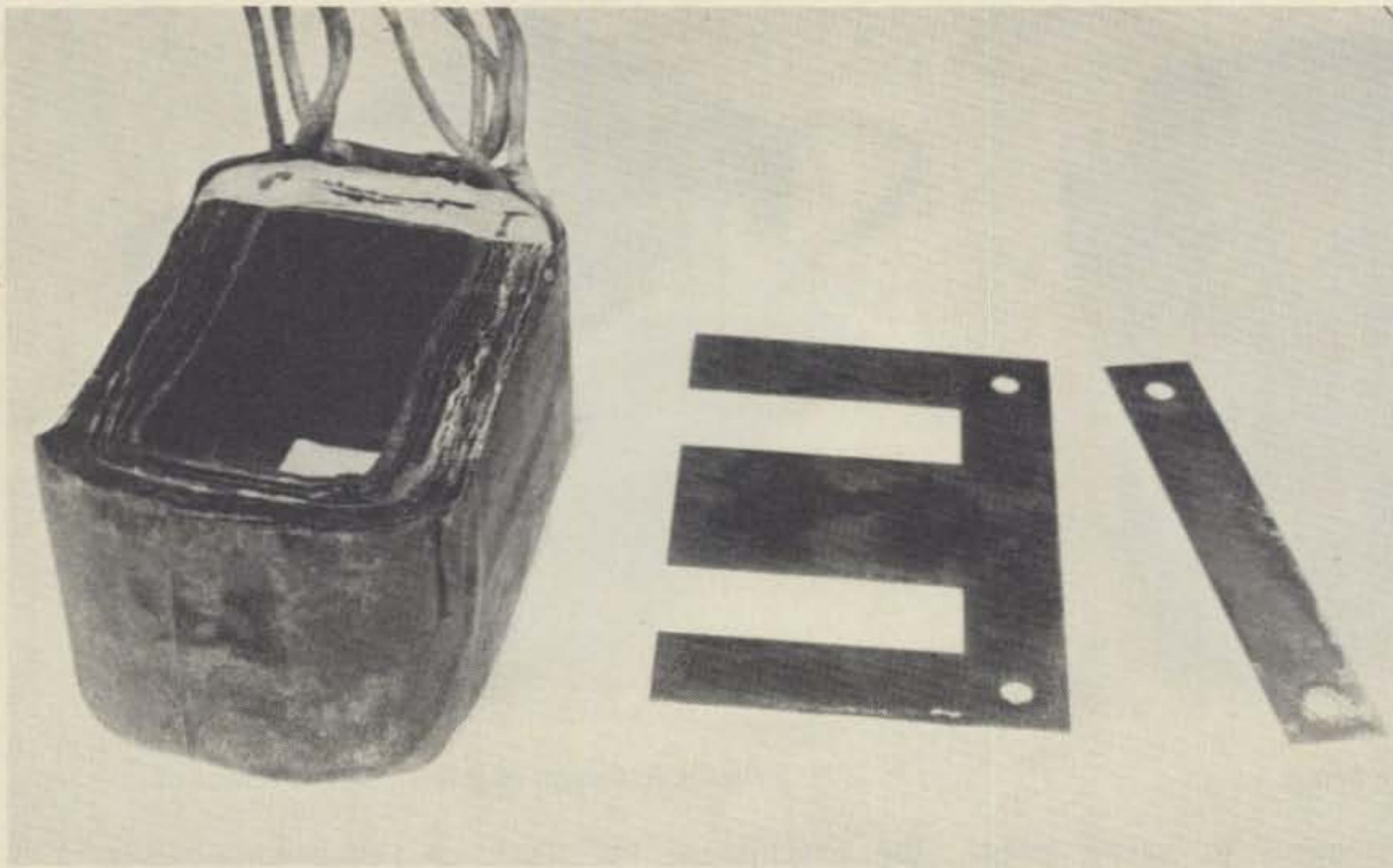

Photo C. Laminations removed.

current, and each half of the secondary winding carries only half of the total current.

What this means is that, for a given wire size and a given current rating of a diode, I can get twice the current from the full-wave center-tapped circuit that I can get from the full-wave bridge circuit. The trade-off is that I must wind on twice as many turns of wire for one circuit as compared with the other.

Now you can see the method in my madness in putting on as many windings as I have room for. I have the

option of changing the circuit configuration and can use either circuit, depending on what I want to do with the rewound transformer.

Step Two

Is the transformer any good? I would like to know if the primary is burned out before I start the rewinding process. I am only going to rewind the secondary(s) and not the primary (I hope). I will whip out a little device that I call an anti-fuse-blower. It consists of a 100-Watt light bulb placed in series with the

primary of the transformer. If the transformer is bad, the light bulb lights up. If the transformer is good, the light bulb either glows very dimly or doesn't light at all. I'll also use the same device later, after rewinding, to make sure that the rewound transformer is okay and doesn't have any surprises built into it. Connect up the transformer to be rewound as shown in Fig. 1, and let it cook for ten minutes or more. If the 100-Watt light bulb lights up to full brilliance, start looking for another transformer.

Step Three

Identify the windings. If the transformer has standard color-code windings, they will be: primary — black wires; high-voltage secondary — red wires; high-voltage winding center tap — red/yellow; 6.3

V ac heater — green; and 5.0 volt heater — yellow. There may be an extra 6.3 V ac winding (for the picture-tube heater), and there might be an extra 5.0-volt winding. If the color code is something other than standard, or the wire colors have badly faded, then your task is a bit more difficult. (And the anti-fuse-blowing light-bulb circuit will be even more advantageous.)

Since you don't know what the primary is, you haven't got it connected up yet. So ring out the wires. The Squawker, presented in the "Kilobaud Classroom" series of articles (*Kilobaud* #10, October, 1977), is very handy for this purpose. Use it, an ohmmeter, or a continuity tester, and find out which wires show continuity. The resistance of the high-voltage winding will be enough to change the pitch of the Squawker. Pair up the wires and tag them. (I usually take a short length of scrap hookup wire of the appropriate color and wrap this in a coil around the wire. Two black coils around two wires would identify the wires that I thought were the primary wires, for example.) Next connect the two wires that you think are the primary of the transformer, and see if the light bulb glows dimly. If it glows brightly, then this pair is not the primary. Try another pair. If the light bulb glows dimly, or not at all, then, using a little caution because 300 to 400 volts bites like crazy, short a pair of wires together. This will turn on the lamp to full

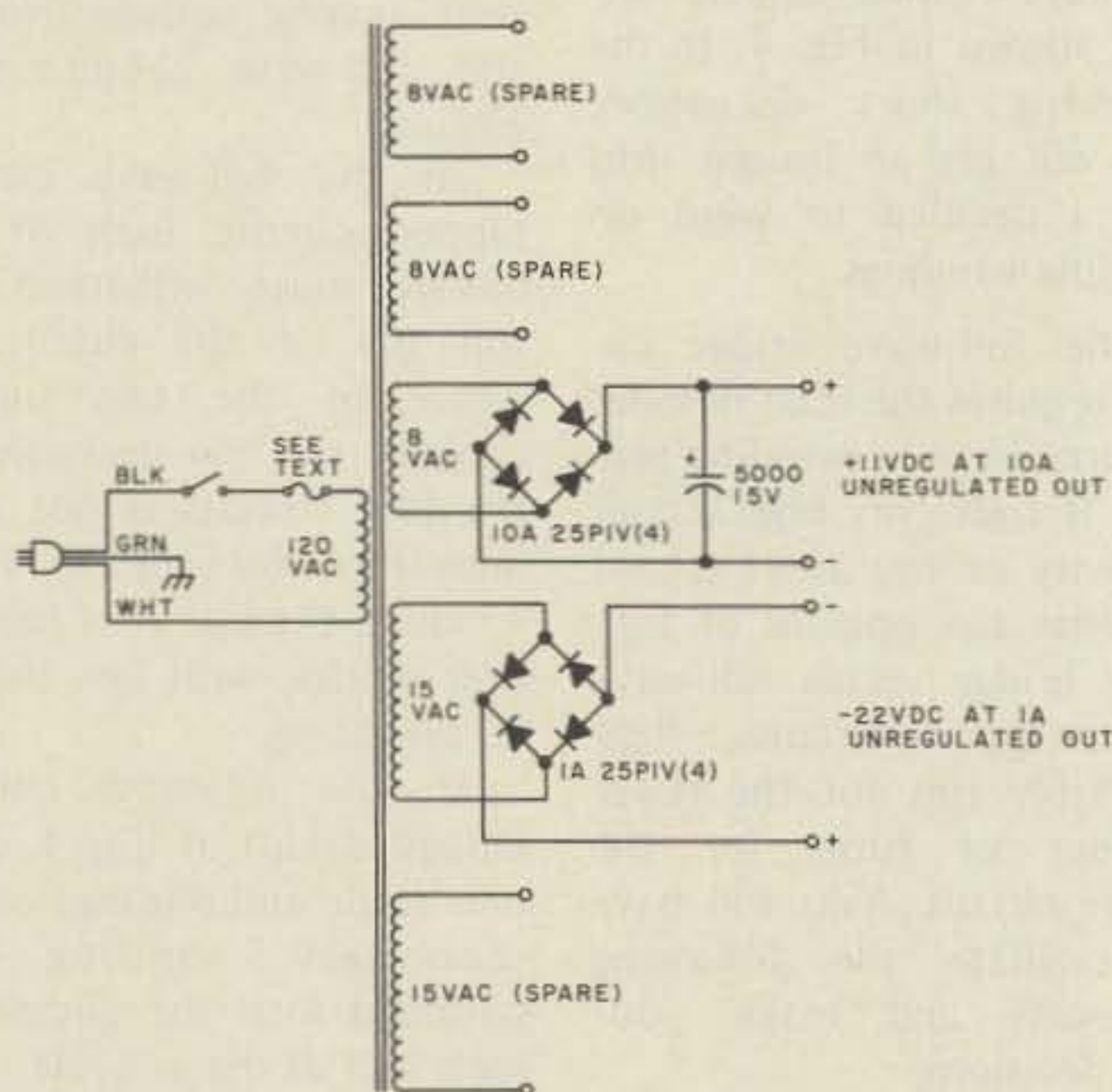

Fig. 3. Full-wave bridge circuit.

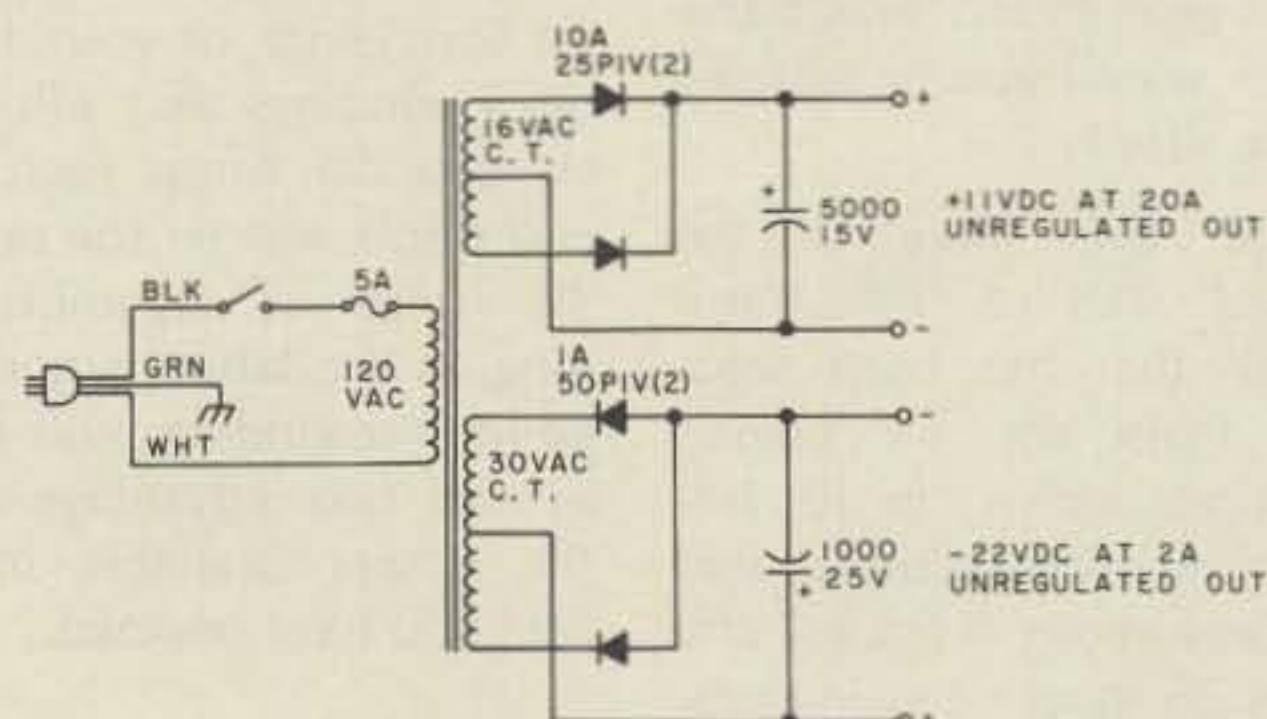

Fig. 4. Full-wave center-tapped circuit.

brilliance. If it doesn't, then you'd better do some checking on your circuit, since you don't have a circuit.

When you think that you have the primary connected to the light bulb and 120 V ac, use a voltmeter to measure the voltages on each identified pair of wires. They may be slightly lower than 5.0 or 6.3 volts because of the lamp in the line, but they'll be close. Watch that high-voltage winding; it's lethal, and we don't want a funeral. The 120 V ac is lethal as well, so use caution. If you don't have a voltmeter, you'll have to find a ham who does, or you'll have to get yourself over to the local high school and use theirs.

Step Four

Disassemble the transformer. Remove any bolts holding the thing together. Store the bolts to put the transformer back together when finished. The iron is glued together with varnish, so, even after the bolts are removed, the transformer will not fall apart. Remove the covers, if any, and store them. Have a small cardboard box handy to put all the pieces in. Use a thin-bladed knife, such as your spouse's paring knife from the kitchen, and force it in between the outermost lamination. Do each side outside the winding first. Then force it down inside the winding. You are trying to break loose the lamination on the outside that is glued to the rest of the laminations with varnish. Run the knife blade all around until you break this outside lamination loose. Now the lamination must be pulled out. Tapping on it with a small hammer and a thin block of wood sometimes works. Perseverance will eventually pay off. Get it out, and try not to butcher it up any more than you have to. After that first lamination is out, you'll have to look carefully at the remaining laminations.

The main laminations are made from E and I sections

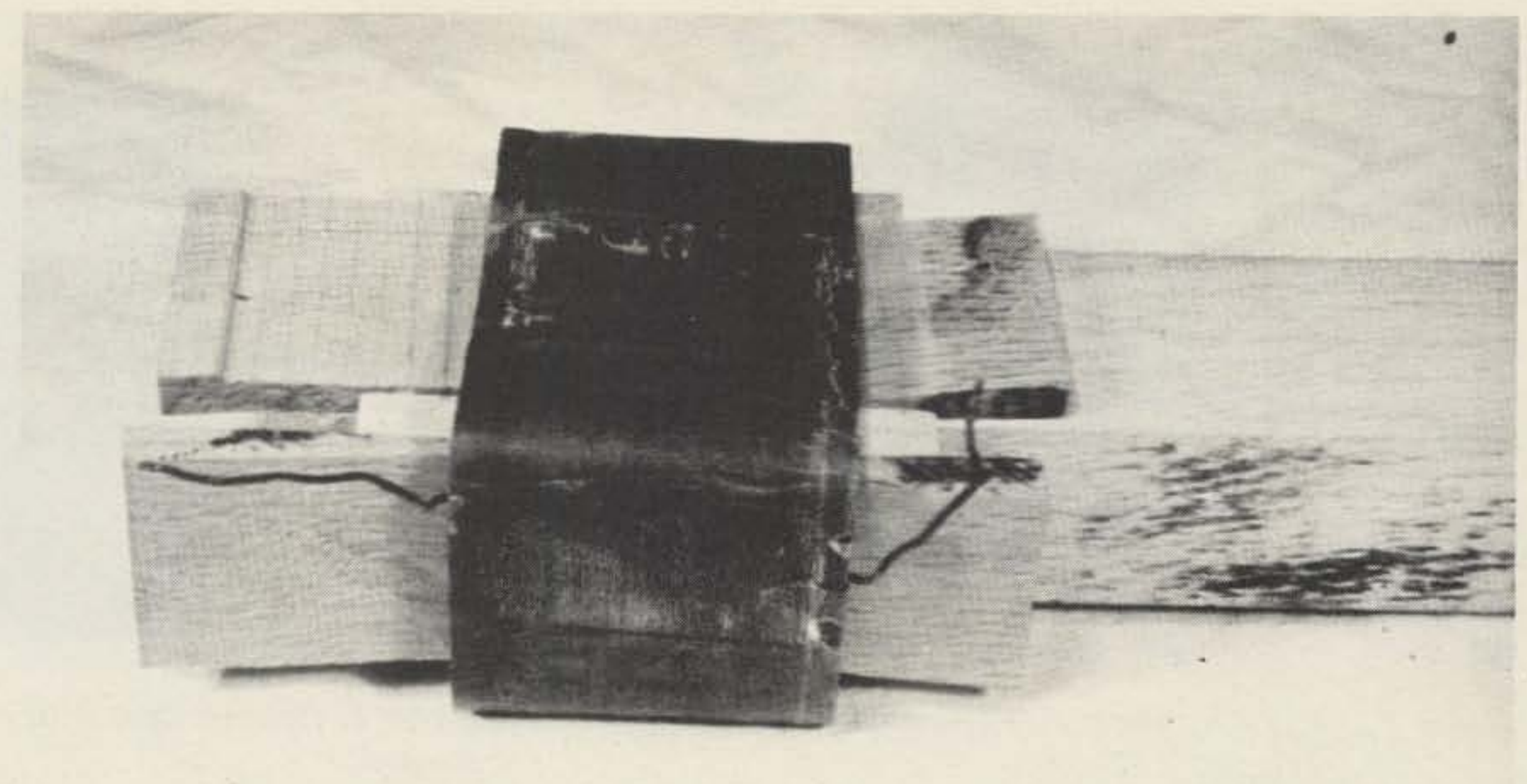

Photo D. Ready for rewinding.

(see Photo C). Sometimes they are singly stacked, sometimes in groups of twos, sometimes in groups of threes. I even pulled a transformer apart once that had all the E laminations in one direction, and all the I's in the other direction. You want to separate each group of E's and I's, and remove them from the stack with the varnish gluing them together. They will be reassembled in the same fashion, so study the transformer to see how it was originally made. After the first several groups of laminations are removed, the remainder tend to come out more easily. Place the laminations in the cardboard box. Some transformers have a copper band that encircles the entire winding and laminations. If you have one, remove it. It usually can be slipped off, but hacksaw it off if necessary.

Step Five

With the iron removed, you are ready for a little surgery. Slit the paper in the area of the windings where the wire exits. Peel off the paper and discard it. Work your way inward until you find the crimps that hold the wires to a fairly thick piece of cardboard. At this point, you might be able to identify wire insulation colors where you could not tell the color be-

fore, especially if the problem was one of fading. If you are lucky, the winding will be in the following order, starting from the innermost and working outward: primary, high-voltage secondary, 6.3-volt winding, and 5.0-volt winding. There are some very practical reasons for this sequence, so it will be by far the most common sequence encountered. Remove the wires from the crimps, and bend them over to one side out of the way. Remove the 5-volt winding, and count the turns. Write the number of turns for the five-volt winding on the side of the box that holds the laminations. Do not trust your memory. Write this number down. I count ten turns on my transformer.

If ten turns produces 5 volts, I now know that the transformer was wound with 2 turns per volt. Since I want 8 V ac for my 5-volt power supply, I will need 16 turns of wire for 8 V ac and 30 turns for the 15 V ac winding. That's why you count the turns for the 5-volt winding. Next remove the 6.3-volt winding. There should be 6 x 2, or 12-13 turns for this winding.

Now cut the wire leadouts (called flyleads) for the high-voltage winding, but *unsolder* the primary wire flyleads. With your knife, cut the wires for the high-voltage sec-

dary, and remove the windings in layers. Work carefully as you approach the primary winding, as you will want to use this winding intact and undamaged. If you should be so unlucky as to have the primary anywhere else but next to the iron core, then the primary will also have to be rewound. 120 volts at 2 turns per volt means 240 turns will have to be wound back on for the primary of the transformer. You may want to disassemble another transformer rather than re-wind the primary.

Step Six

Make a handle for the winding process. Take a rectangular piece of wood slightly smaller than the opening in the core and about 8-10 inches long. Use wooden shims to anchor the handle inside the core firmly. The reason for this is to prevent any distortion of the core during the winding process.

Wrap a piece of scrap wire around the core. Remove it. Measure its length. Multiply this by the number of turns that are to be put on the winding. This gives you the length of wire that you will need for this winding. Since this length will increase for each additional winding added, this step must be repeated after each winding is added. What size wire to use?

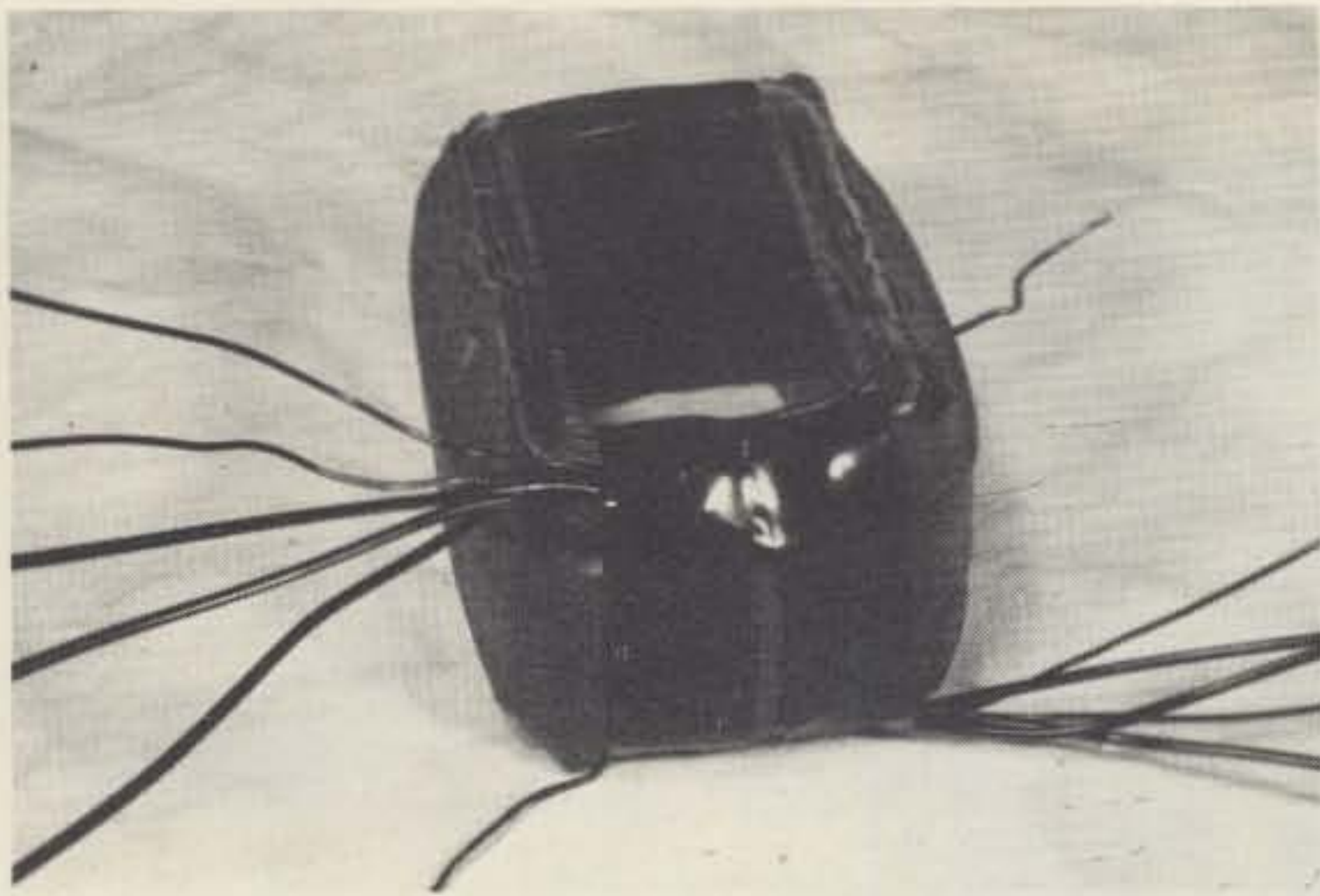

Photo E. Rewound.

The *Radio Amateur's Handbook* has a copper-wire table in the back part of the book. However, no. 12 wire is rated at 20 Amperes, and no. 14 wire is rated at 15 Amperes service for commercial house wiring. Although this is not quite the same as using the wire inside a transformer, it is reasonably close. It can be used as a guide, if you do not have access to a copper-wire table. The wire table suggests #18 wire for 10 Amps and #24 for 1 Amp. If you go 2 wire sizes lower, you will have plenty of safety margin. Use #16 for the 10-Amp winding and #22 for the 1-Amp winding. But I don't have any #16 or any #22. I do have #14 and #18 wire. So I will have about a 200% safety margin.

Since my wire is on a spool, I don't even have to measure it out first. I simply clamp one end of the spool in the vise, after reeling off about 20 feet, and start winding. If I run short, I just unwind a little more to finish up the winding. If you have to go out and buy enough wire, go through the measurement process described earlier, and add a couple feet for safety and flyleads. If you have to buy a 100-foot spool of wire, then don't cut it off first. Just reel off about 20 feet, clamp the other end in a vise, and start winding.

The smaller wire will produce a smoother layer, so it goes on first. The starting of a

winding is shown in Fig. 2(a). The finish of a winding is shown in Fig. 2(b). The start and the finish must be on the same side of the winding, as were the original starts and finishes of the windings that were removed. If this step is not followed, you will never get this brute back together when you're done.

I use 2-inch-wide tape, such as masking tape or "sticky green" tape, between each winding. You can use narrower tape, but it will not produce quite as smooth a layer upon which to wind the next winding. Three-quarter-inch plastic electrical tape can be used by slightly overlapping as you wrap. You should use modern enameled wire, such as Formvar™ or Nyclad™. This stuff has really tough insulation. I simply leave the flyleads long enough to use and solder new flyleads to the primary transformer leads.

Step Seven

Reassemble the laminations. You may find that all the original laminations will not go back in. Put in as many as you can without damaging the rewind core, and let it go at that. There should be only one or two groups of laminations that you can't get back in. I never put back the covers. These are for looks and for protection of the windings. They trap heat inside the transformer. Leaving them off

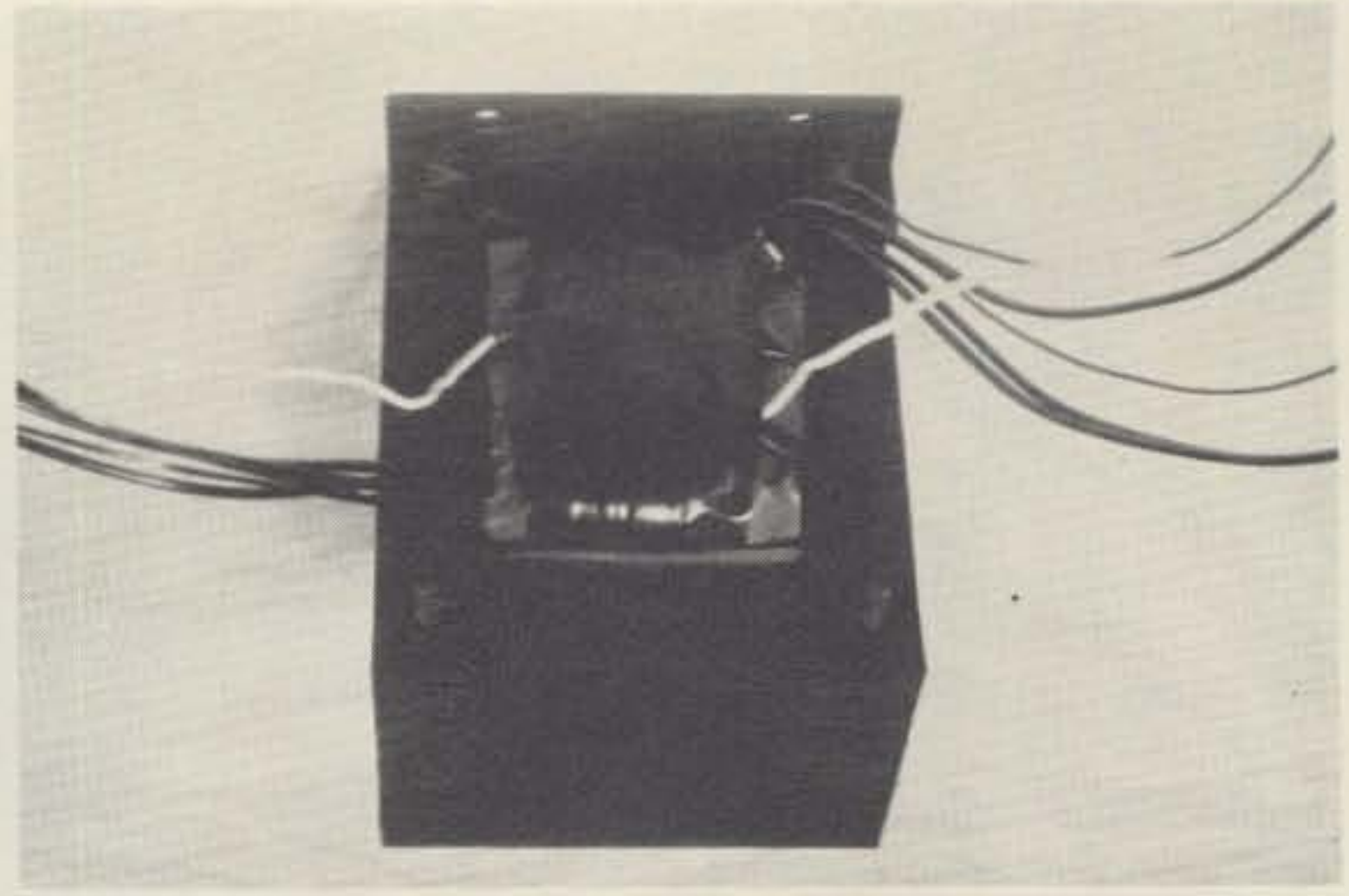

Photo F. Reassembled, with mounting brackets installed, and painted.

makes for a cooler running transformer, especially if you don't get back in all the laminations that came out.

Step Eight

Connect the lamp again in series with the primary of the rewind transformer. It should not light to full brilliance when the primary and lamp circuit are connected to 120 V ac. It should light to full brilliance when any of the secondary windings is shorted. Measure the voltages for the rewind transformer. They should be very close to the calculated values unless somebody miscounted turns when he was rewinding. They may be slightly low, because the lamp is in series with the primary. If all is well, remove the lamp from the primary circuit and connect directly to 120 V ac. I always fuse the primary for this step, because I then go off and leave the thing plugged in for a couple of hours. The transformer laminations after this time should be warm, but not hot enough to be uncomfortable to the hand.

Step Nine

The rewind power transformer must be mounted in some fashion. The simplest way that I know to do this is to use angle brackets. Two pieces of extruded right-angle aluminum are cut to the length of one of the dimensions of the iron. Two holes

are bored that will align with the transformer bolts. The transformer is placed on a wooden surface, and a block of wood is used to tap on and realign the iron laminations. Alternate sides are tapped until all surfaces are satisfactorily plane. The bolts are then inserted, passing through the aluminum brackets, and cinched down. The windings are then masked off, and the laminations and the brackets are given a coat of flat-black spray paint. This completes the transformer.

Step Ten

The current drawn by the primary will be 95 Watts divided by 120 volts, or a little less than 1 Ampere. A 2-Ampere fuse will provide a 100% overload condition before blowing. This is the starting point for the fusing. A filter capacitor appears as a dead short to the diodes in the power supply upon start-up, so the chances of the 2-Amp fuse blowing are pretty good. This fuse will later be increased to as much as 5 Amperes in the finished circuit. If this blows, you can be reasonably certain that there is something else wrong.

The diodes selected for the bridge power supply configuration must each carry the full rated load of 10 Amperes. I plan to use 10-Ampere diodes for this supply, but 25-Ampere diodes would be a better choice, as

they would have a far greater safety margin. I will use the largest filter capacitor for the 5-volt supply that I can find — 100,000 uF, if I can find one I suggest at least 5000 uF for the 5-volt supply and at least 1000 uF for the 12-volt supply.

I expect 8 x 1.41 volts from the 8-volt winding, or approximately 12 V dc. Therefore, the working voltage of this filter capacitor will have to be at least 12 volts, preferably 15 V dc. I expect about 1.5 times 15 volts for the 15-volt winding, so this filter capacitor will need at least a 25 V dc rating.

Figs. 3 and 4 give the unregulated power supply circuits. You may have wire or components on hand which will dictate which of the circuits you will use. Fig. 3 shows the windings that I had room for in the beast that I rewound. The major portion of the labor involved is in taking apart the laminations and in putting them back in. Putting on the windings themselves is actually a small part of the labor.

The piv (also peak reverse voltage or prv) ratings of the diodes should be 25 piv. As mentioned earlier, it is difficult to find diodes with a lesser piv. This piv rating will be satisfactory for both the 8-volt and the 15-volt windings of Fig. 3. Twenty-five piv diodes will be satisfactory for the 16-volt center-tapped windings of Fig. 4, but 50 piv diodes will be required for the 30-volt



Photo G. The beauty. Possible output from regulators: 45 Amps @ 5 V; 10 Amps @ 12 V. Weight — 21 pounds!

center-tapped winding of Fig. 4.

The diodes should be mounted on a heat sink. This is especially true if the diodes are to be operated at anywhere near their rated current capacity. The diodes must be insulated from the heat sink, but they must have thermal conductivity to the heat sink.

Conclusion

The photographs show the stages of beast to beauty. The finished unregulated supply is just under 17 inches long and only as wide as necessary to hold all the components. It was designed to fit into the rear of a cabinet that will take 19-inch panel racks.

The unused space at the right of Photo G, showing the finished supply, can be used for additional filter capaci-

tors, or it can be used to mount the regulator circuits. I haven't decided yet which to do with it.

The aluminum rear apron is a 5/4-inch rack that was cut off to 16-3/4 inches. I used two 4000 uF capacitors in parallel for 8000 uF for the 5-volt unregulated supply. These are paralleled with two strips of scrap double-sided printed circuit board, which makes a handy solderable bus material. Two more 4000 uF capacitors were used for the 12-volt filters.

I found two 6-Ampere bridge rectifier circuits for the 15-volt windings and used them. They can be seen mounted on the panel at the left of the transformer.

I could not find four 10-Ampere diodes or any other heavy-current diodes that

were suitable. I used 4 power transistors. I have been teaching in Kilobaud Classroom that transistors are two diodes mounted back to back, so I decided to see just how four 15-Ampere collector-base junctions would fare used as power diodes. They work fine. The only problem was that the ones I had available were salvaged off printed circuit boards and had very short leads. This presented some difficulties in getting heavy wire connected to the cut-off base leads, but perseverance finally paid off. The transistors were insulated from the heat sink with transistor-mounting kits, and liberal amounts of silicone grease were smeared between panel and transistor case. The entire rear apron is a heat sink. ■

New Products

from page 62

between the output of the transmitter (or amplifier) and the antenna or tuner. Ordinary PL-259 coax connectors will couple correctly with the SO-239 receptacles on the sensing unit.

In addition to selectable 200-/2000-Watt forward power scales, the DenTron W-2 features an operating frequency range of 1.8-30 MHz and meter accuracy of $\pm 5\%$. The

unit measures 7 x 3 1/2 x 6 inches (the removable sensor box is 4 x 2 1/2 x 2 1/2 inches) and weighs 5 lbs. Attractively packaged in a cabinet with black finish that matches the rest of the DenTron product line, the W-2 makes a most practical addition to the shack.

The DenTron W-2 wattmeter is priced at \$99.50. DenTron Radio Co., Inc., 2100 Enterprise Parkway, Twinsburg OH 44087.

Morgan W. Godwin W4WFL
West Peterborough NH

CSC INTRODUCES NEW \$89.95 CALCULATOR-SIZE 50 MHz COUNTER

CSC has introduced their new Mini-Max counter, a surprisingly small, surprisingly inexpensive counter with 50 MHz guaranteed performance.

The Mini-Max counter is in a small (3" x 6" x 1 1/2") calculator-style case. It features a six-digit magnified LED display with 100 Hz resolution. Decimal points after the second and fifth digits act as pilot lights and indicate MHz and kHz points on the display.

The counter display updates ten times per second, permitting easy "speed-read" mode

frequency tuning without the usual one second delay between counter readings.

A UHF FET preamplifier provides very capable weak-signal performance, permitting the Mini-Max to be driven directly from an optional accessory whip antenna. In addition to high sensitivity, this FET front end means a high input impedance (greater than 1 megohm) for minimal loading and a highly linear input.

Using a standard TV color burst crystal for its timebase, the Mini-Max achieves ± 3 ppm timebase accuracy, user-

Continued on page 73

The Full Spectrum of VHF

SCR 1000 - Standard of Comparison
In Repeaters - Now Available with Autopatch!

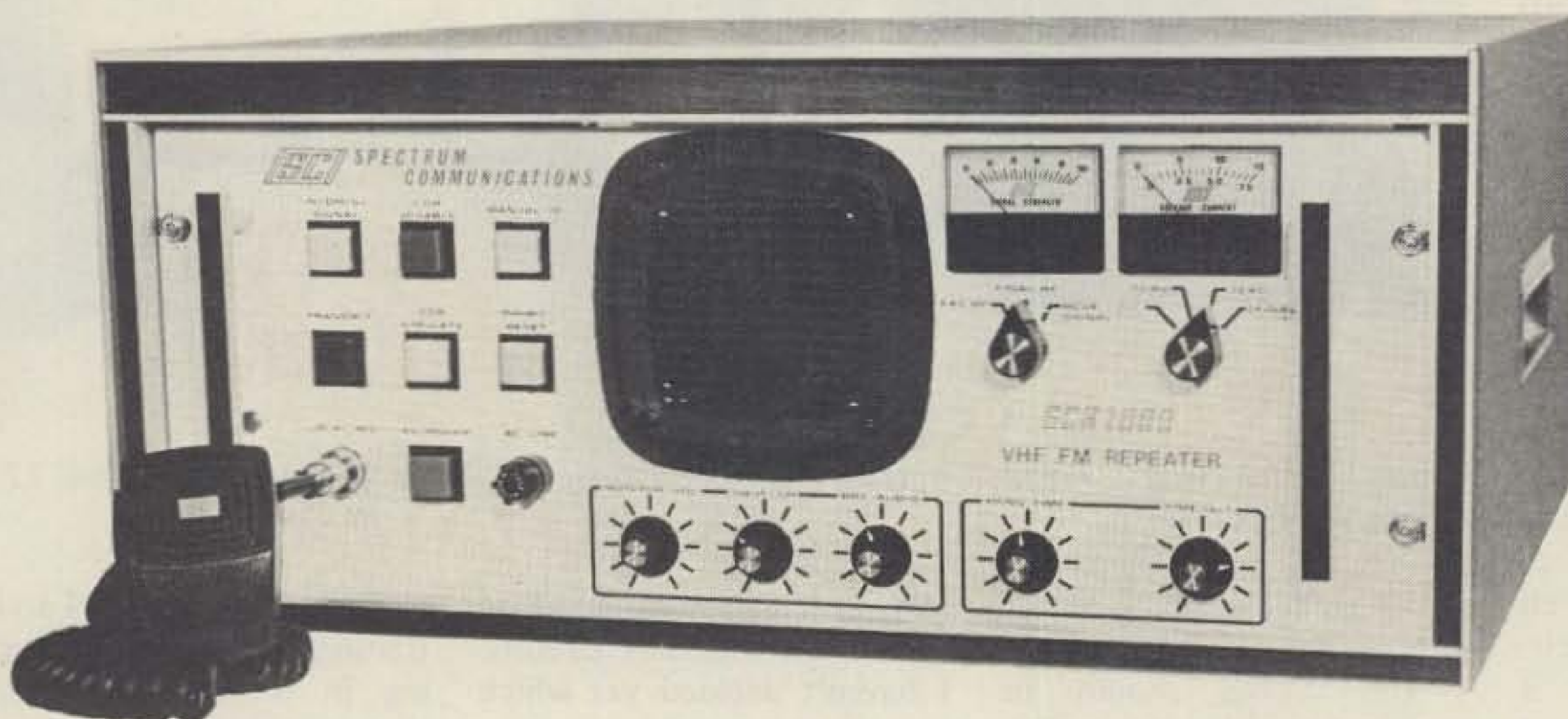

**2M
&
220 MHz!**

Optional Cabinet
\$130.00

180 Day Warranty

The SCR1000/SCAP Combination — A New Dimension in Autopatch Repeater Performance

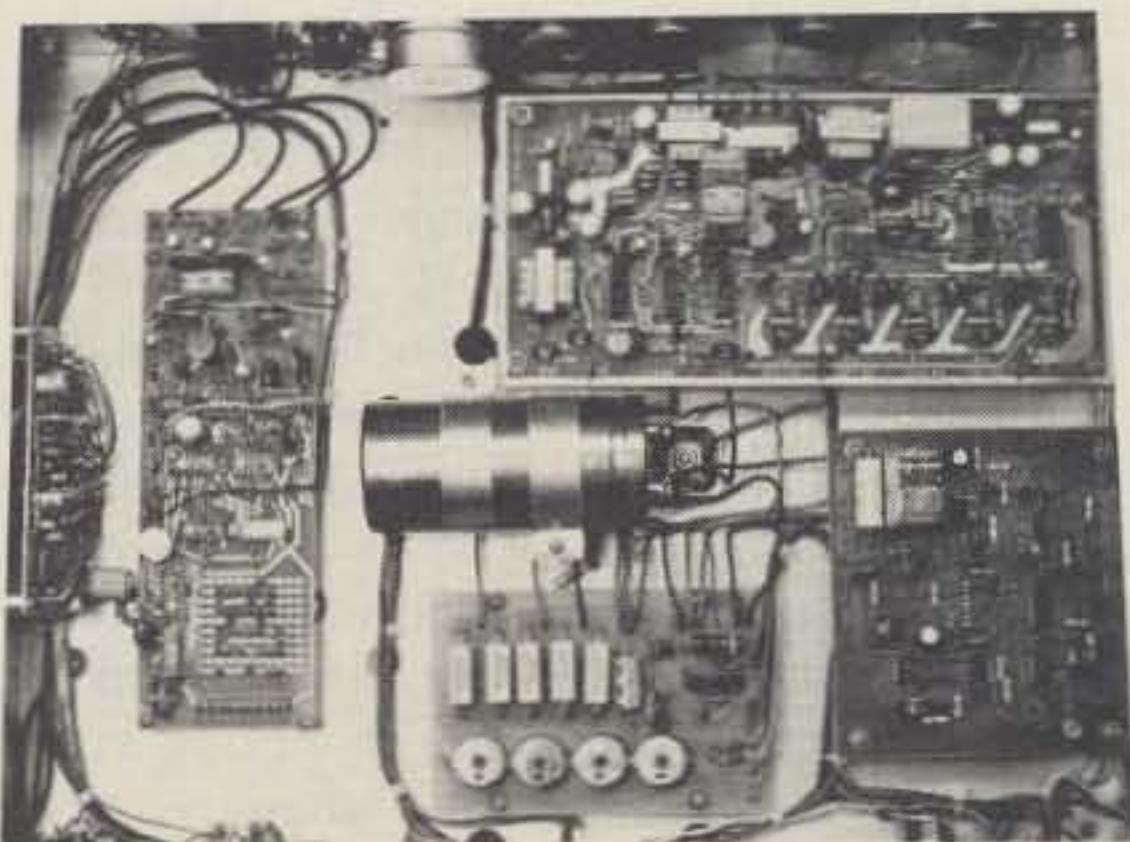

Under chassis view of SCR1000 with Autopatch installed.

Features:

- Normal patch, or secure "reverse" patch
- 3 digit anti-falsing access — single digit disconnect
- 3 digit on-off control of repeater transmitter
- 4 sec. time limit on access

Now Spec Comm has taken the hassle out of putting an autopatch repeater on the air! The SCR1000/SCAP is a fully self-contained 30 watt repeater with built-in autopatch and land line control. You simply plug in the phone line, hook up the duplexer, and you're on the air! The usual months of problems are eliminated! The SCR1000/SCAP has been meticulously engineered to provide the smoothest performing patch together with a positive land line control of the repeater. Just look at all these features:

- Built-in adjustable time-out function — patch shuts down in 30-90 sec. if no carrier is received
- Wide range AGC on audio input and output
- User can mute phone line audio simply by keying his mic button — prevents embarrassing language from being repeated
- Patch access and repeater control — either over the air or over the land line

The SCR 1000/SCAP is a complete Autopatch Repeater — fully assembled, set-up and checked-out in our lab. As with all Spec Comm products, all workmanship and components are of the very highest quality. The price? A very reasonable \$1605.00 complete with FL-6 Receiver Preselector and 8 Pole i-f Crystal Filter (\$2100 w/WP641 Duplexer). Get your order in A.S.A.P.

Call or write today and get the details!



SPECTRUM

1055 W. Germantown Pk.,

FM Repeater Equipment

Quality Speaks For Itself!

See what our customers have to say about the SCR1000

"You have a product that more than meets the specifications you claim . . . In the receiver you have a winner, the intermod is negligible . . . We have many other repeaters both amateur and commercial in the area and as of yet no problem . . . In closing, I would like to thank you for producing a product that does what is expected of it. In this world one seldom gets what he pays for; I feel our group has bought and received our moneys worth."

Jim Todd WA5HTT
Dallas TX

"The receiver is excellent; typically, if a 25-watt mobile can hear the

machine (running 100 watts out of the duplexer), he can get into it. That's pretty good, I must say. Although I'm on a 15-kHz "splinter" between two BIG repeaters, we don't have any adjacent-channel problems with the SCR1000's receiver . . . although the "local" 19/79 group has headaches from their repeater's receiver whenever a mobile operating 146.205, (our freq.), in their area keys up. And their machine is totally "commercial"! Needless to say, the audio quality of the SCR1000 is pretty spectacular. Switching from input to output, even Melissa Manchester can't tell the difference — and neither can I."

S. Katz WB2WIK

- **The SCR1000** — simply the finest repeater available on the amateur market . . . and often compared to "commercial" units selling for 3 times the price! This is a 30Wt. unit, with a very sensitive & selective receiver. Included is a built-in AC Supply, CW IDer, full metering and lighted status indicator/control push-buttons, crystals, local mic, etc. Also provided are jacks for emergency power, remote control, autopatch, etc.
- **A full complement of options are available:** Touchtone™ control, Duplexers, Cable, 'PL', HI/LO Power, Autopatch, Racks, etc. Please Inquire
- **The Spec Comm Repeater System** . . . a sound investment . . . available only by direct factory order. \$1055.00 w/FL-6 and 8 Pole Crystal Fltr. (\$970.00 w/o FL-6.)

SPEC COMM REPEATER BOARDS, SUB-ASSEMBLIES & ACCESSORIES

All equipment assembled & tested. For 2M & 220 MHz.

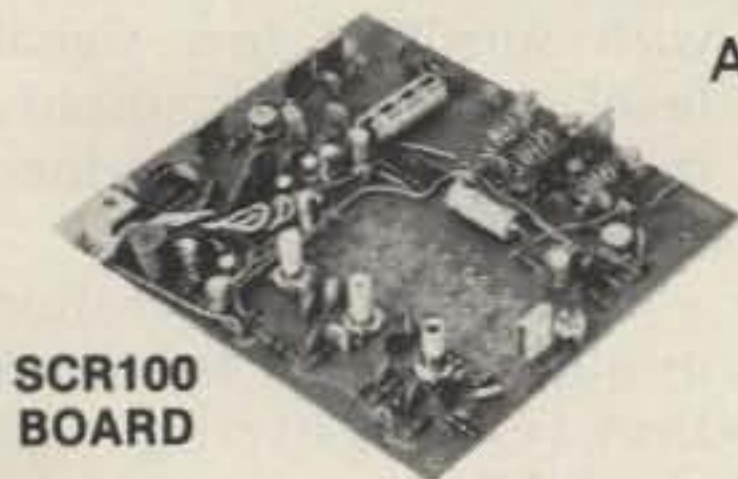

SCR100 BOARD

SCR100 Receiver Board

- Wide dynamic range! Reduces overload, 'desense', and IM.
- Sens. 0.3uV/20dB Qt.
- Sel. -6dB @ ± 6.5 KHz, -90dB @ ± 30KHz, (-110dB w/opt. 8 Pole Fltr.)
- Exc. audio quality! Fast squelch! \$115.00 w/xtal. 8 Pole Fltr. Highly recommended. \$18.95

SCR100 Receiver Assembly

- SCR100 mounted in shielded housing
- Same as used on SCR1000
- Completely asmbld. w/F.T. caps, S0239 conn., AF GAIN POT, etc. \$185.00

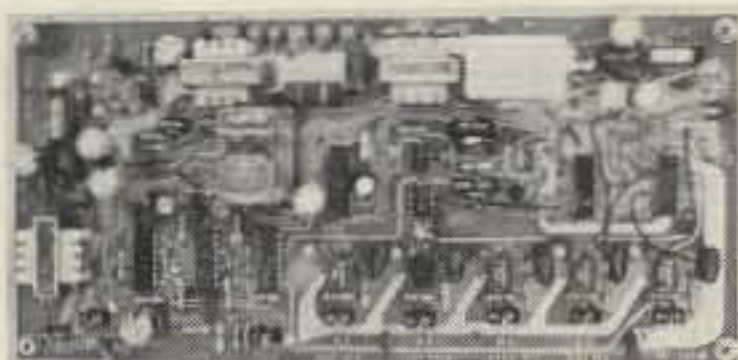

SCAP Autopatch Board

- Provides all basic autopatch functions
- See features on opposite page. \$225.00

RPCM Board

- Used w/SCAP board to provide "Reverse Patch" and land-line control of rptr.
- Includes land line "answering" circuitry. \$79.95

WP641 Duplexer

- Superior Band Pass/Band Reject design
- Provides great rejection of "out-of-band" signals
- Extremely easy to adjust
- -93dB typ. isolation. \$495.00 (fully ckd. out w/SCR1000).

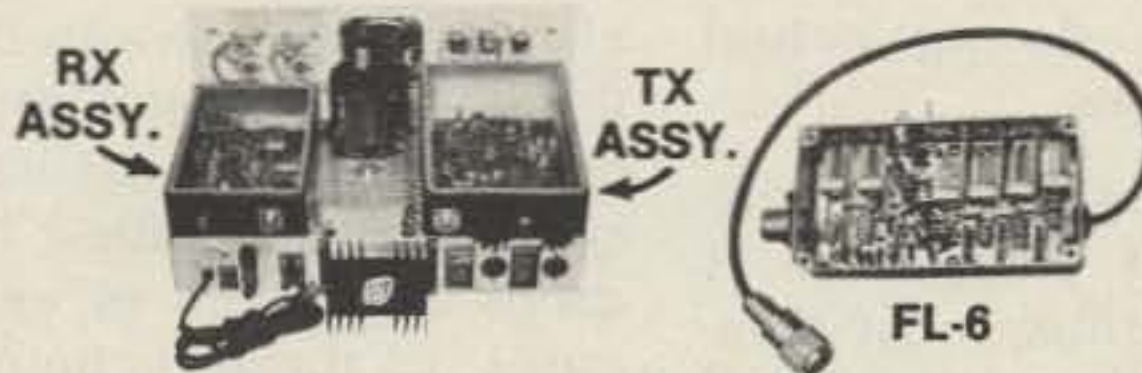

FL-6 Rcvr. Front-End Filter/Preamp

- 6 section filter with preamp.
- Provides tremendous rejection of "out-of-band" signals w/out the usual loss!
- Extremely helpful at sites with many nearby transmitters
- Gain: apx. 12dB
- Selectivity: -20 dB @ ± 2.0 MHz; -60 dB @ ± 6 MHz (typ.)
- \$85.00

TRA-1 Timer Reset Annunciator Board

- Puts out a tone "beep" on rptr. xmtr. apx. 1 sec. after rcvd. signal drops — thus allowing time for breakers
- Resets rptr. time-out timer when tone is emitted
- Adjustable time delay and tone duration
- Used with CTC100 and ID100/250
- \$20.95 (Add \$18.00 for inst. & ck. out in SCR1000)

CTC100 COR/Timer/Control Board

- Complete COR circuitry
- Carrier 'Hang' & T.O. Timers
- Remote xmtr. control
- 100% Solid State CMOS logic
- Many other features \$35.00

ID250 ID & Audio Mixer Board

- Adjustable ID tone, speed, level, timing cycle
- 4 Input AF Mixer & Local Mic amp
- COR input & xmtr. hold
- CMOS logic; PROM memory—250 bits/chan.
- Up to 4 different ID channels!
- Many other features. Programmed \$65.00 (1 chan.)
- Local MIC; \$18.95



SCT 110 BOARD

SCT 110 Xmtr/Exciter Board

- 7 or 10 Wts. Output
- Infinite VSWR proof
- True FM for exc. audio quality
- New Design — specifically for continuous rptr. service
- Very low in "white noise"
- Spurious -70 dB
- With .0005% xtal. \$135.00
- BA-10 30 Wt. Amp board & Heat Sink. 3 sec. LPF & rel. pwr. sensor. \$51.95

SCT110 Transmitter Assembly

- SCT110 mounted in shielded housing
- Same as used on SCR1000
- Completely asmbld. w/F.T. caps, S0239 conn.
- 7 or 10 Wt. unit \$199.95. Add \$62.00 for 30 Wt. unit.



TTC100 TOUCHTONE™ CONTROL BOARD

TTC100 Touchtone™ Control Board

- 3 digit ON, 3 digit OFF control of a single repeater function. Or, 2 functions ON (3 digits each) with 1 digit which turns both OFF.
- Can be used to pull in a relay, trigger logic, etc.
- Typically used for Rptr. ON/OFF, HI/LO Pwr., P.L. ON/OFF, etc.
- Stable, anti-falsing design.
- \$85.00 (\$110.00 inst. & ckd. out in SCR1000.)



COMMUNICATIONS

(Ship./Handl. — \$3.50. PA residents add 6% tax)

Send for Data Sheets!



S8

Norristown, PA 19401 (215) 631-1710

The End of Rf Feedback

—here's how the pros do it

If you've ever had your lip bitten by a "hot" mike or had your finger burned on a metal transmitter cabinet, you know how aggravating rf feedback can be to the amateur setup.

Not all forms of rf feedback, however, are as physically apparent as the previously mentioned situations. The addition of an external speech compressor, a new mike with its coiled cord, or a new high-power linear amplifier, for example, can often cause undesired oscillations and abnormal meter readings in the station transmitter. Two meter rigs and plastic-cased HTs are also quite prone to rf feedback, the latter often being characterized by a low-frequency hum or "motor-boating" effect on the transmitted signal. Rf feedback is particularly annoying, also, to SSTV and RTTY operations, as it tends to disrupt the

transmitted information as well as obliterate in-station monitoring during actual transmissions.

Very little has been written about in-station rf problems; thus, most amateurs usually rely on local advice for suggested cures. Unfortunately, this method has one serious drawback: The variety of opinions acquired usually leaves the troubled amateur totally confused. Suppose, however, that rf feedback problems developed in a 50 kW broadcast station. Such conditions could not be allowed to exist. An immediate solution would be sought! Applying this same reasoning to amateur setups, we see that rf feedback is a dilemma which can be cured.

The following techniques reflect ideas acquired through commercial broadcast experience and knowledge gained

from consulting engineers. Their measure of success in eliminating unwanted rf lies between 95 and 99 percent. Amateurs, naturally, can't afford to invest hundreds of dollars in exotic cures, so these techniques have been slightly "streamlined."

As a preliminary consideration, I will assume your antenna is a coax-fed type (beam, dipole, vertical, etc.) which does not radiate from its feedline. Longwires and windoms, for example, do radiate from their feedlines and are notorious feedback generators. I will also assume your antenna's swr is below 2:1 (a high swr reflects rf energy back into the station equipment), and that the antenna isn't in close proximity and parallel to outdoor power lines (which is also a safety hazard).

HF Station Problems

Most rf feedback problems can usually be linked to insufficient grounding techniques. "Floating grounds" can act as miniature antennas, picking up a small amount of the powerful transmitted signal and returning it to equipment and/or wiring in the shack. Naturally, the returned rf plays havoc

with sensitive low signal level stages which amplify the feedback and produce oscillations.

The prime consideration in eliminating rf feedback involves getting all available energy to the antenna and properly grounding all equipment in the station. Relying on interconnecting cable ground shields and what are assumed to be good grounds invites problems and ground loops. A known, solid ground is the first corrective step.

Begin your ground system (Fig. 1) with two or three long rods spaced approximately one foot apart and driven into the earth near your shack. Connect a heavy wire (No. 6 or 8) or copper strap from the rods to the closest cold water pipe at ground level, and bury this interconnecting wire. Various sizes of grounding strap are available from local electronic supply outlets, or you can remove and use the braid from a length of RG-8/U cable. The cold water pipe should be sandpapered to a shiny finish before the grounding clamp is installed and the completed connection should have a resistance of less than one Ohm.

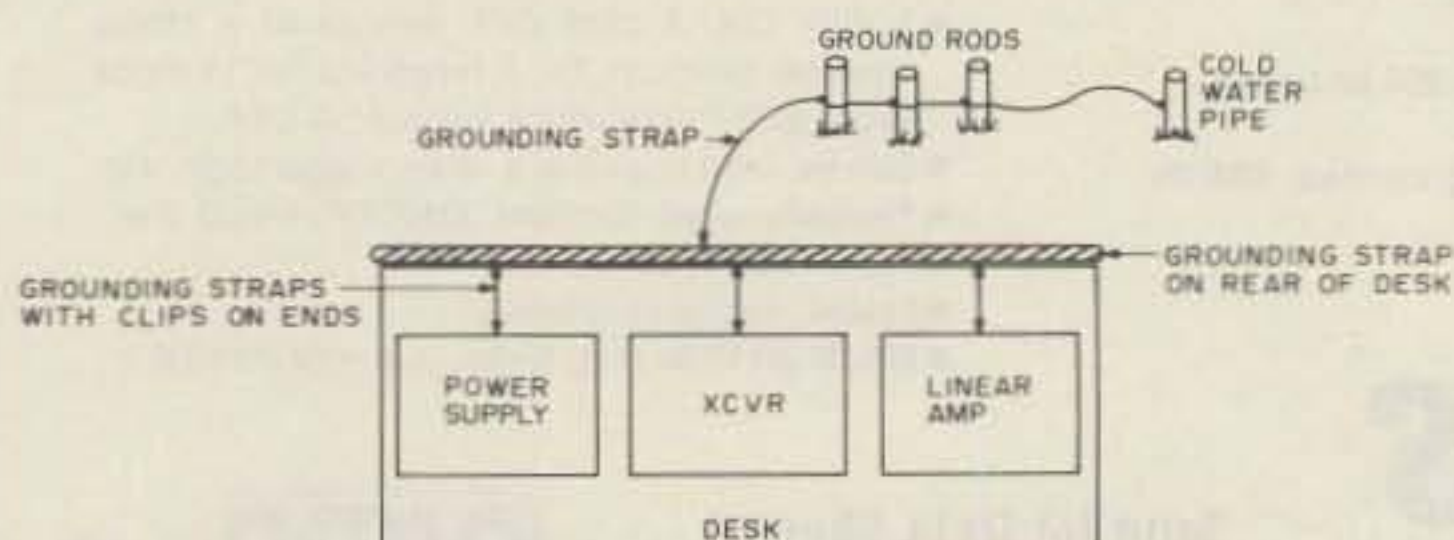

Fig. 1. Layout of grounding strap system.

Next, mount a heavy piece of grounding strap along the back edge of your operating desk and connect it to the outside ground system with heavy wire or cable. Each piece of station equipment should then be connected to the desk's ground bus using the shortest possible length of strap with alligator clips on its ends. Equipment located remote to the operating desk should also be connected to this ground bus via a similarly prepared cable. The previous steps will accomplish two basic purposes: They will eliminate any rf ground loops and provide a very effective ground which should improve your radiated signal. If an rf feedback condition still exists, proceed to the following simple, but effective, steps.

Rf energy often re-enters the station equipment via improperly grounded ac lines or resonant cable lengths. Bypass the ac power cable on each piece of equipment with .01 uF capacitors as shown in Fig. 2. Next, shorten the station's microphone cable to its minimum usable length and double check solder joints in the mike plug(s) for good connections. If you're experiencing feedback in the mike circuit (identified by transmitted squeals and unstable plate meter

readings), the rf filter shown in Fig. 3 can also be installed inside your transmitter at the mike jack. If you use a linear amplifier, shorten the rf cable between your exciter and amplifier to its minimum acceptable length also.

Rf feedback problems which survive the previously described cures will require special detection and correction techniques. Items like an rf "Snif-it" and sensitive neon lamps may be helpful in locating their source(s). Once these sources are semi-localized, you might check with local radio and TV broadcast engineers or consulting engineers for specific elimination techniques. Practically every broadcast station knows a consulting engineer and often these engineers are also hams.

VHF Problems

Although rf feedback isn't a commonly experienced problem in FM gear, it can happen when proper bypassing techniques are not employed. That's why you often find two or three bypass capacitors paralleling power leads and emitter resistors in FM transmitter circuits. Typical values for these capacitors are .01 uF, .001 uF, and 470 pF. Rigs that skimp on these capacitors often experience intermittent feedback problems. These problems

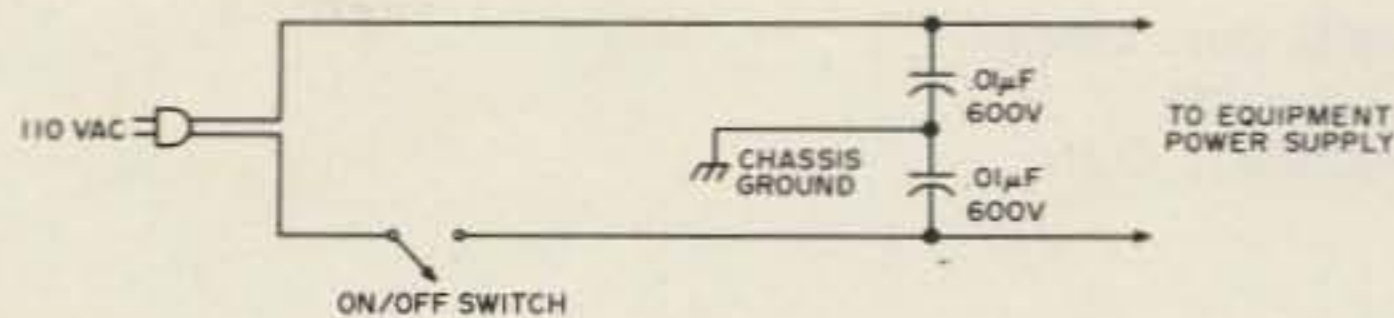

Fig. 2. Ac bypass system for elimination of rf feedback in power lines.

are usually characterized by low-frequency hum and distortion on some, but not all, frequencies. The problems are usually more noticeable at high power levels, also. Plastic-cased HTs are especially prone to rf feedback because the antenna is located near the semi-shielded transmitter, and because lack of space often prohibits effective bypassing techniques. This feedback usually occurs in highly sensitive audio modulation stages. Corrective measures involve adding bypass capacitors to each stage (additional emitter bypass capacitors usually do the trick) and reducing the antenna swr. Power and audio leads which are not bypassed and that run near the HT's top are also rf feedback suspects. Since low-frequency motorboating may also be produced by bad batteries (high internal resistance), this possibility should be checked before

tearing into an HT. Use batteries rather than an ac power supply for this test because the supply's output filter capacitor can decouple stray rf signals. Another effective means of localizing rf feedback with HTs involves switching between an internal and outdoor antenna while noticing its effect on the transmitted signal.

Summary

Each case of rf feedback has its own unique set of circumstances and corrections. Fortunately, many of these cases are easily rectified using straightforward techniques. Difficult feedback cases may require several days of "tinkering" to correct. However, if one diligently and persistently follows a logical process of elimination (of potential rf paths), an acceptable solution can usually be secured in minimum time. Remember, rf feedback can be annihilated! ■

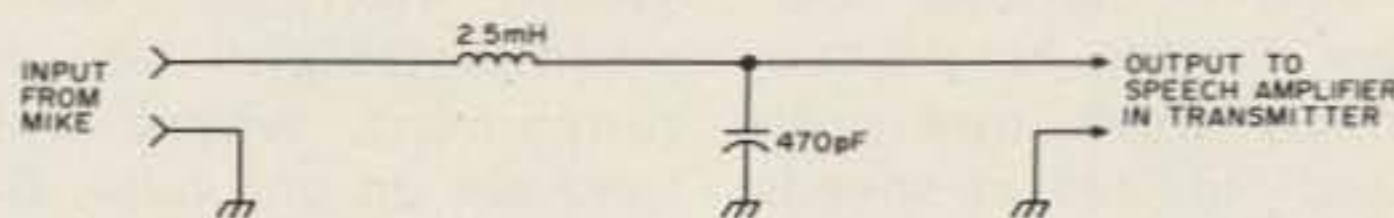

Fig. 3. Rf feedback filter for mike input circuit in transmitter.

New Products

from page 69

trimmable. The digital logic of the Mini-Max is all LS (low power Schottky) series TTL, leading to a low overall current consumption of less than 70 mA.

The suggested resale price for CSC's Mini-Max is \$89.95. A number of optional accessories are also being made available, including an antenna, input cables, a carrying case, ac, and automotive bat-

tery eliminators.

For additional information, contact *Continental Specialties Corporation*, 70 Fulton Terrace, New Haven CT 06509; (203)-624-3103.

TELEX EARPHONES

During my years as an amateur and SWL, I have used many different earphones, new and used, commercial and military surplus, ranging in cost from a couple of dollars to several in the forty to fifty dollar

class. Regardless of origin or value they have—almost without exception—shared a couple of common qualities: the ability to make my ears feel as if someone had injected them with novocaine and that they were about to drop off, and a subsequent roaring headache.

Now, thanks to the folks at Telex, I am wearing phones and actually enjoying the experience. It has been very interesting to be able to switch back and forth between three different Telex models representative of the basic types in their product line and compare them for performance and comfort.

Of the three types, the model HFC-91 is the smallest and lightest, weighing only 1.5 oz. Worn under the chin, the phones fit comfortably in the ears, cushioned by soft foam. A magnetic element feeds the sound through the acoustic tube, introducing a one millisecond delay that enhances intelligibility. The HFC-91s are low impedance (8-20 Ohms) and have a frequency response of 100-3,000 Hz.

If you wish, the driver unit may be detached and snapped onto a nylon earloop for single ear use. During the past few

Continued on page 75

The Heavyweight

— a keyer base
that stays put

Like most hams, I use an electronic keyer for my CW work. It happens to be a Heathkit® HD-10 set up for the high range, so it is pretty awkward to operate at slow speeds. Since I am an active Official Observer, I often have occasion to work newly licensed Novices at speeds well below the 15 wpm minimum my keyer will allow. Since I am also basically uncoordinated below 20 wpm (at least

with a keyer), I like to have a straight key handy for working Novices, but I dislike the clutter produced by having two keys on the table at the same time. The solution, obviously, was to go to a dual paddle/straight key arrangement, where both keys are on one base. But those sexy little units are expensive, the cheapest going for about \$45.00. Not having a handy \$45.00, home brew was clearly my

only choice, and my wife made that very clear.

Since I already had the keyer paddles and a J-38-style straight key, I designed my base around them. If you happen not to have a set of paddles, a good set—without a base—is available from the Ham Radio Center in St. Louis (check 73 Magazine ads). Called the Model HK-2, they are good copies of the famous Brown Brothers' paddles, and they sell for only \$19.95. If you happen to be really concerned about style, you can do as I did and paint your straight key to match the paddles.

I suggest you use lead for the base because it is relatively cheap, easy to melt, and nice and heavy. You can buy the lead from most hardware or sporting goods stores if you like, or you can take the cheap way and finagle a pile of

discarded wheel-balancing weights from your local garage. Fishing weights also work, but they are costly. The wheel weights may be a mite dirty, but melting them down will take care of that. You will need about five or six pounds of lead to make the base, and you can melt it down on your kitchen stove. While a lead-pot is nice to use, any old pan will do. BUT DO NOT PLAN TO USE IT AGAIN TO COOK FOOD. If you use wheel weights, you will have the steel or tin pieces used to attach the weight to the wheel to fish out of the molten brew, or you can use a heavy screening material of some sort to allow only the molten lead to pour through.

The ideal mold, of course, is a metal tray exactly the size you need, but you probably will not have one handy. You can make a

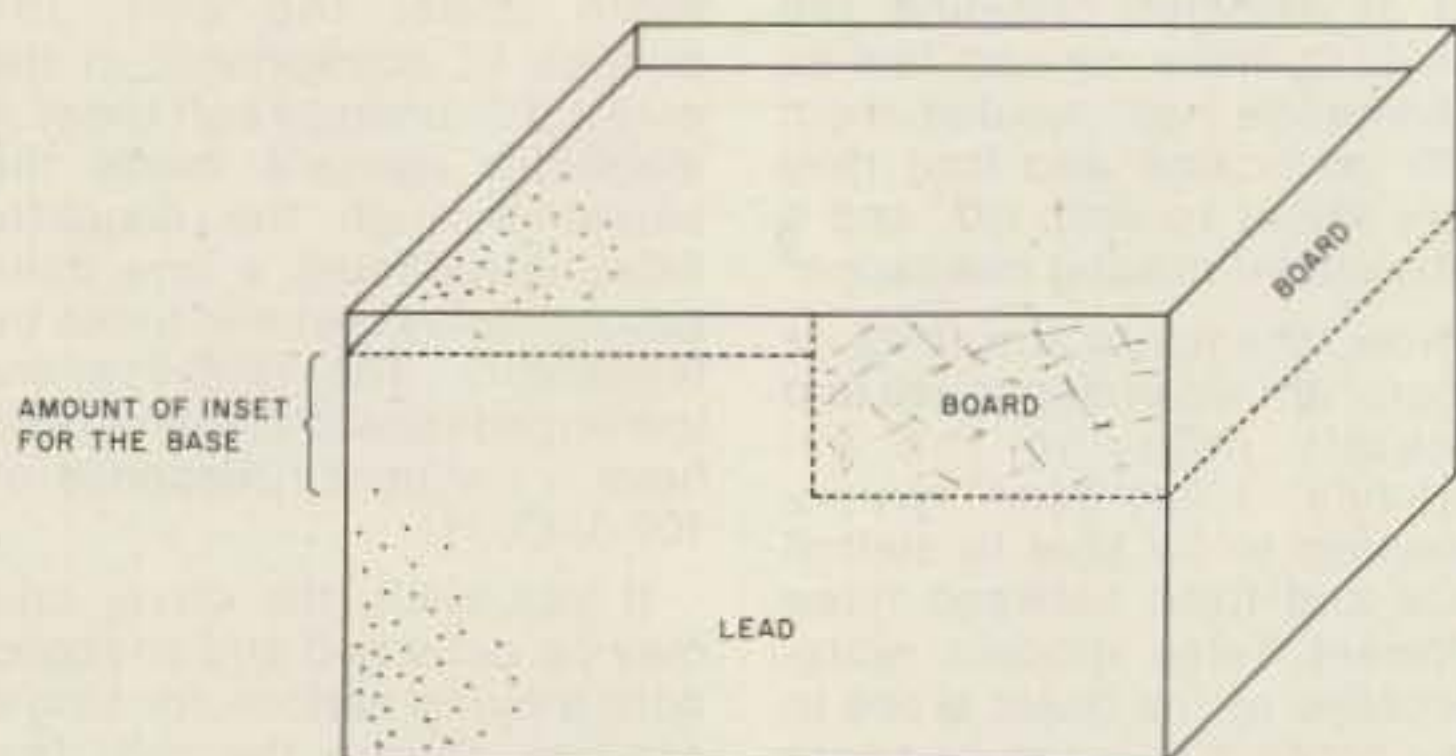

Fig. 1. Using a board to provide the needed base thickness.

good mold, though, by packing mud into a pie or cake pan and shaping it to the proper dimensions. Pour the lead into the mold while the mud is still wet, and it will make it a little easier to clean the dirt off the finished product. I suggest, if you use a standard J-38-style key, that you make one side of the base thinner than the other. The J-38 was designed to be used on a board where the key sits flat on the same level as the telegrapher's forearm, so if you put it on a lead base thick enough to elevate the paddles to the proper level, the straight key will be uncomfortable to use. For that reason, you will need to make part of the base a bit thinner. You can do that in any one of three ways. The first is to beat down one side with a hammer, but since lead is a lot harder than you might imagine, I do not recommend that solution. The

second is to build a small mud floor under half of your mold. If you do that, you will have to pour the lead into the deep side and let it flow onto the mud platform. The lead is very heavy, and you will drill a hole in the mud if you pour the lead directly onto it. The third approach is to place a board over half of the mold as shown in Fig. 1. The lead will flow under the board. It will scorch the board, but it will not ignite it.

You should wind up with a base that weighs about six pounds and that will not—I guarantee—walk around your desk. The dimensions shown in Fig. 2 will accommodate a standard J-38 key (removed from its phenolic base), and a Ham Radio Center set of paddles. A coat of wrinkle-finish black paint and weather stripping for feet makes it an attractive addition to your station. I

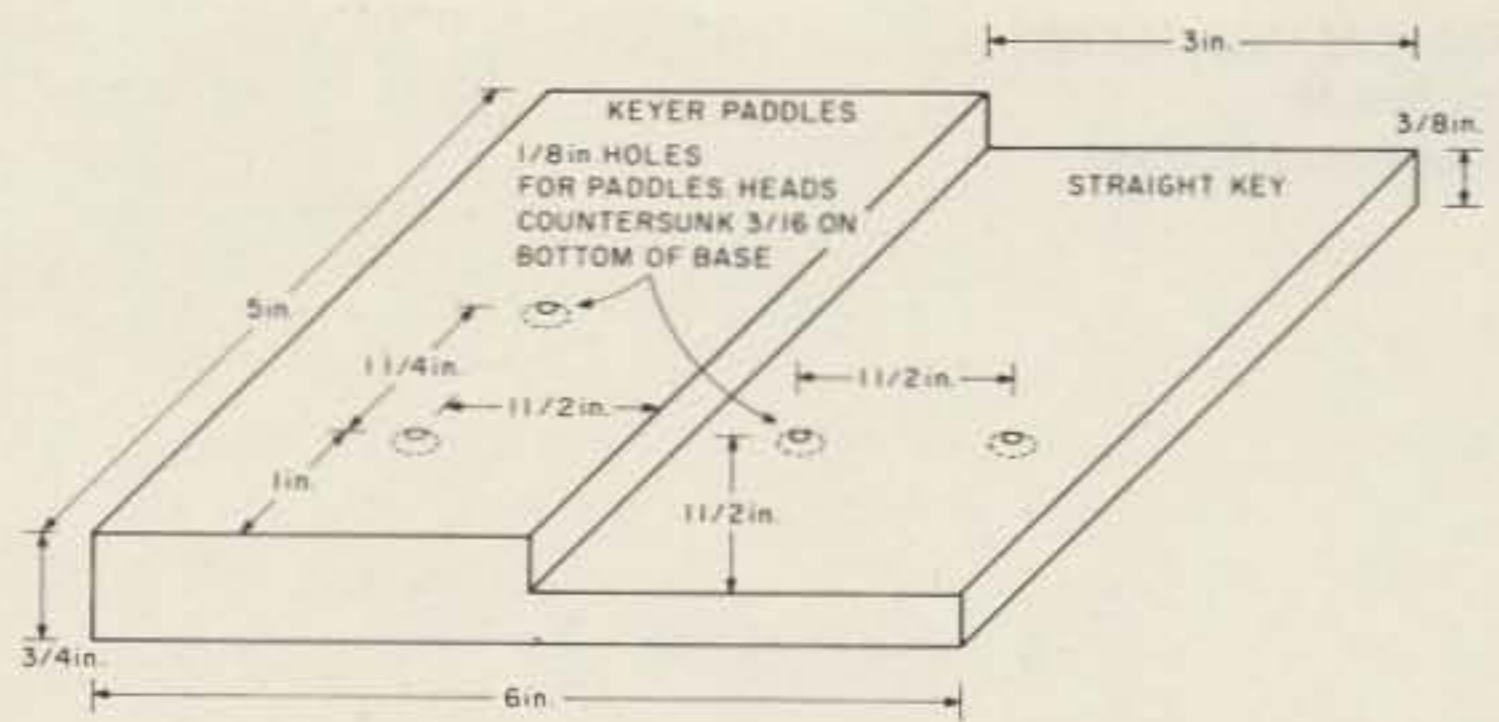

Fig. 2. Lead base dimensions.

glued a terminal strip to the lead using Super Glue, but it would be easy to pour the base with an inset to accommodate a plug of a different sort.

I expected the lead to be a good insulator, but I quickly discovered that it holds true only with very high-grade (read expensive) lead. The common for my paddle is through the lead to the common on the straight key. No wire is needed. Note also that the 1/8-inch bolts used to secure the paddles and key

to the base are countersunk into the bottom of the lead base. If you are left-handed, you may want to reverse the high and low sides to put the paddles in a more comfortable position.

Even if you have to buy every component new, you can have a custom equivalent of the \$45.00 set for less than \$25.00. And if you already have a paddle and straight key, you can add a bit of luxury to your shack for just a few minutes of work. ■

New Products

from page 73

weeks, I have worn the HFC-91s regularly for periods of up to three or four hours at a time without any noticeable discomfort or fatigue and, in fact, I found that I often forgot I had them on.

Weighing only 1.6 oz., Telex's model HTC-2 is similar in appearance to the under-the-chin style phones, but has twin magnetic receivers which are worn over the head. The dual receivers rest on the temples, and the sound is fed into the ears through adjustable tubular sound arms mounted on ball-and-socket joints. This permits the wearer to turn one or both of the sound arms away from the ear, enabling him to converse without removing the phones. Eyeglass wearers who prefer over-the-head phones will find the HTC-2 particularly comfortable, as they apply no pressure to the glass frames. Frequency response is 100-3,000 Hz and impedance is 8-20 Ohms.

Traditionalists will especially like the model C-1320 phones. Full-sized and with

large, comfortable, foam-filled vinyl cushions that reduce external sounds and concentrate the signal at your ear, they can be worn for considerable periods without discomfort or fatigue. In choosing a pair of phones, it's the ears that count. And my ears tell me that they like what they hear and feel when I am using the C-1320s. The phones have a frequency response of 20-20,000 Hz and are low impedance (8-20 Ohms).

Frankly, using the Telex phones has spoiled me, and I've enjoyed every moment of it. Both the HFC-91 and HTC-2 are, in my opinion, just the ticket for the amateur or SWL who demands phones that are very light and comfortable and which can be worn for lengthy periods without becoming bothersome. They are particularly attractive if you carry a rig when you travel, since, with their small size and extremely light weight, you can slip them into a corner of your suitcase or a coat pocket without noticeably adding to your burden. I certainly intend to carry one or both of them with me the next time I head for Europe.

For those willing to give up a few ounces in weight and who like the feel of a more conventional pair of phones, Telex's C-1320s are great. They do a fine job on phone and CW, and knock out a lot of background sounds that are often distracting, particularly when you're trying to pull a really weak signal out of the noise.

All three models have five-foot cords terminated in standard .250-inch diameter phone plugs. List prices are \$8.95 for the HFC-91, \$22.00 for the HTC-2, and \$39.80 for the C-1320. *Telex Communications, Inc., 9600 Aldrich Avenue South, Minneapolis MN 55420.*

Morgan W. Godwin W4WFL
West Peterborough NH

PAINLESS PC FILM PROCESS

If you're like me, many interesting and useful construction projects for the shack never get done simply because of the feeling that it's too much of a bother to prepare the needed printed circuit boards, customized front panels, component placement decals, specialized meter faces, and similar items.

Well, that's no longer a legitimate excuse. Printed Circuit Products Co. has developed a new process for making all of the above mentioned

items and more directly from a magazine page. Called PCP Type-A, it is a "no camera/no chemical" film product that enables the user to produce artwork with the good optical quality and high resolution required to obtain high quality results.

The simple six-step process takes about 15 minutes to complete and, judging by the results of our testing here at 73, you do indeed get high quality work for a minimum of effort—without needing any special tools or developing fixtures. All that is required is for the user to cut the film to the rough size, peel the paper backing from the film, stick the adhesive side of the film to the printed page that you wish to copy, smooth out the air bubbles, and soak the film in water so that you can remove the paper. The film is ready for use when it is dry. Now, using a photoetching process, you can go ahead and produce your PC boards or other items (such as a special meter face or front panel) to give your home brew projects that professional touch.

Current pricing for PCP Type-A is as follows: small pkg. (6 pieces—4" x 6")—\$5.49; medium pkg. (4 pieces—6" x 9")—

Continued on page 77

Sleight of Hand

—getting 12 V from 24-V transformers

Did you ever wonder why your favorite electronic parts catalog often lists 120/24-volt transformers at prices cheaper than 120/12-volt transformers with the same, or lower, amperage ratings? Simple! It all goes back to your high-school economics law of supply and demand. As you are probably aware, most amateur, stereo, and CB equipment intended for mobile use requires 12-14 volts dc. Supply voltages of 24-28 volts dc are usually used for military electronic equipment. Why? Because all recent civilian vehicles have 12-volt dc systems. Most military vehicles use 24-volt dc systems. It follows that in order to use your 12-volt dc amateur, stereo, or CB unit in your house, you need to provide a 12- to 14-volt power supply. Electronic parts suppliers, realizing

that this fact provides a better market for 120/12-14-volt ac transformers, naturally try to get the price for 12-volt transformers as high as the market allows. Wouldn't you do the same if you ran a supply house? Their 120/24-volt ac transformers usually do not move very fast except to someone with surplus military gear or someone building a regulated power supply where higher voltages can be lowered by regulation circuits. However, here we will be talking about providing 12 volts ac to a dc rectifier and filter system where electronic regulation is not employed (but could be, if desired).

Now, do you remember from studying for your ham ticket that the output voltage on the secondary coil of a transformer is equal to the input voltage on the primary coil

multiplied by the turns ratio? Or, in other terms, $N_1/N_2 = V_1/V_2$ where N_1 = primary turns, N_2 = secondary turns, V_1 = primary voltage, and V_2 = secondary voltage. Let's suppose you have a transformer with a 24-volt secondary and a 120-volt primary (Fig. 1). The turns ratio of this transformer would be 5:1.

This means that there are five times as many turns on the primary as on the secondary, and with 120 volts ac applied to the primary, the secondary voltage is $120 \times 1/5$ or 24 volts ac. Now, suppose we applied 60 volts ac to the primary of our transformer (see Fig. 2). The secondary voltage would then be $60 \times 1/5$ or 12 volts ac. Just what we need! But how do we get 60 volts ac easily? Do you remember that voltages across series-connected inductors divide proportionally to the value of the inductance? Suppose we had two transformers of the same kind we have been discussing and series-connected

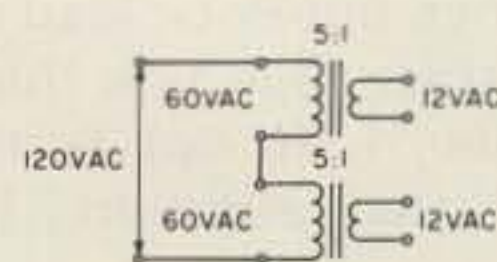

Fig. 3. Series-connected primaries.

the primaries to 120 volts ac (Fig. 3). The primaries of these transformers (which are inductors) have the same value of inductance and the 120 volts ac would divide equally across each transformer primary (60 volts per primary coil). This results in 12 volts ac on each of the secondaries. These can be parallel- or series-connected to give the desired results.

If the secondaries are to be parallel-connected (Fig. 4), an ac voltmeter should be placed across wires A and B to make sure the windings are connected in phase. A reading of 12 volts ac will verify this. A zero or near-zero reading means an out-of-phase connection which can be corrected by reversal of a primary or secondary connection on either transformer. These measure-

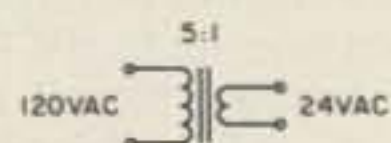

Fig. 1. 5:1 turns ratio with 120 V ac applied.

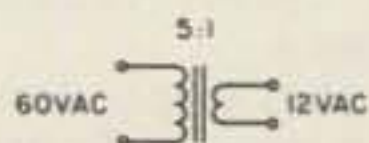

Fig. 2. 5:1 turns ratio with 60 V ac applied.

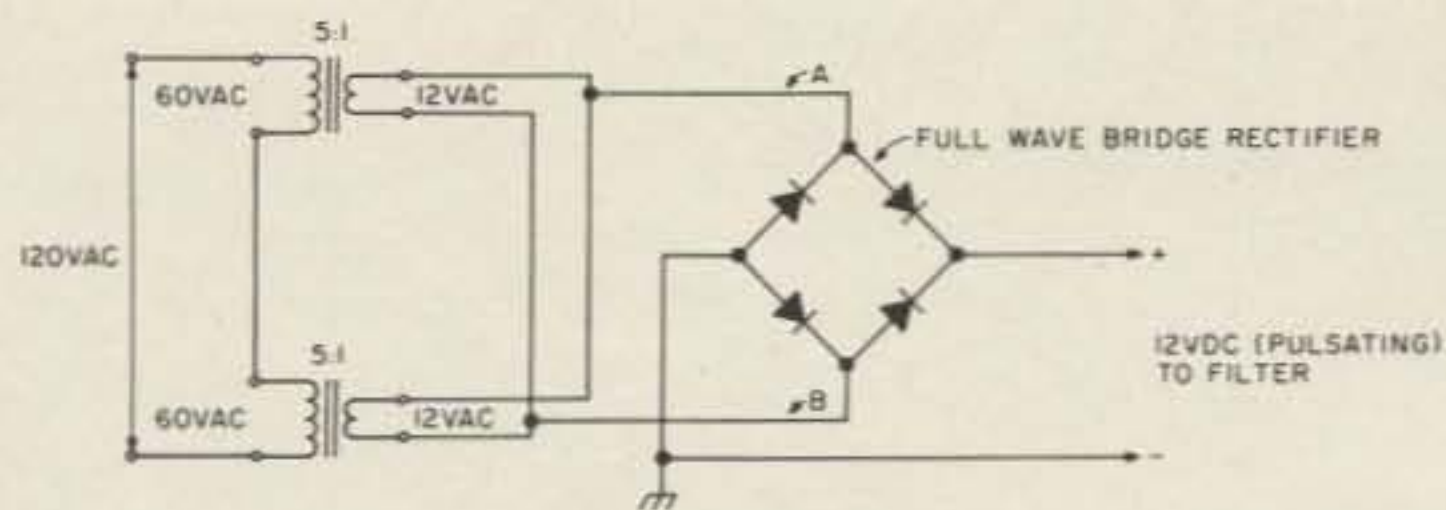

Fig. 4. Parallel-connected secondaries.

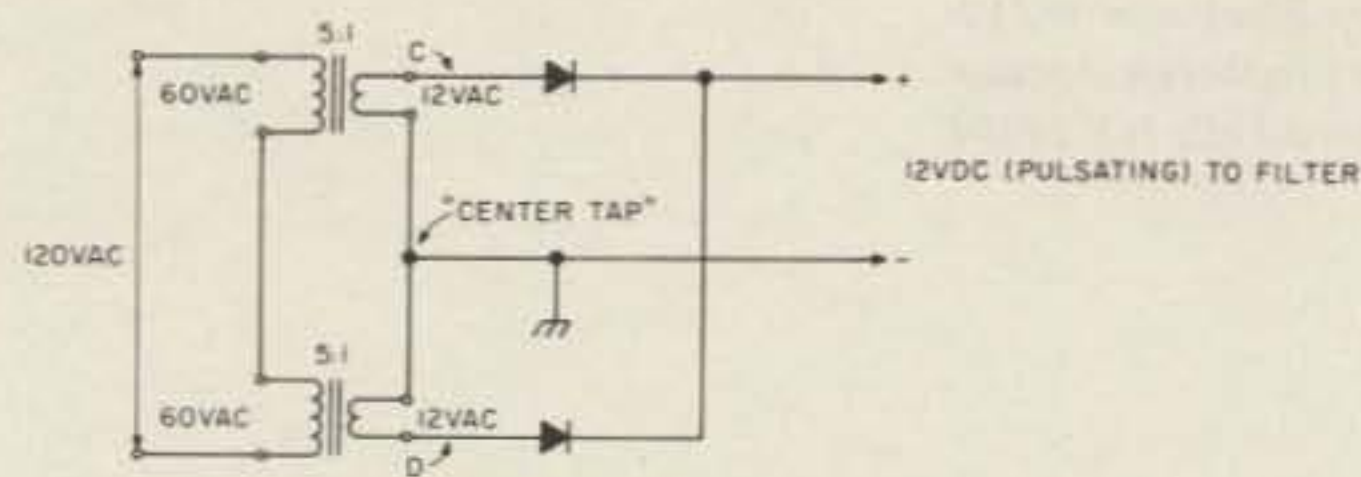

Fig. 5. Series-connected secondaries.

ments should be made quickly since a high current flows during an out-of-phase condition. The output of this arrangement should be fed to a full-wave bridge rectifier system as shown in Fig. 4.

Series-connected secondaries (Fig. 5) can be used in what is known as a full-wave, center-tapped rectifier circuit, since the center-tap is actually the point where the two secondaries are connected together. Here again, the windings must be connected in phase as determined by a 24-volt ac reading across wires C and

D. An out-of-phase condition can be corrected by reversal of any one primary or secondary connection. One advantage of this arrangement is the use of two, rather than four, diodes (or a diode-bridge module) necessary with the parallel secondary connection.

With either of the two transformer combinations, the amount of current that can be drawn will be at least twice the current rating of one single transformer. Since there is twice as much iron, any current available over this amount will most probably

be determined by the primary and secondary wire sizes rather than the magnetic saturation of the transformer iron.

Now you may be wondering, "Could I connect the primaries of three 36-volt or four 48-volt transformers in series to get 12 volts?" Sure, it would work fine, but the weight, bulk, and economic factors would probably catch up with you. It depends on how much room you have and how cheaply you can obtain transformers. Another question might be, "Could I connect a 120/6-volt ac

transformer across my 240-volt ac line to get 12 volts ac?" My answer is: "It would probably work, but don't do it!" The primary insulation may not be able to take 240 volts. If it does short out, the "fireworks factor" would be greater, especially since both sides of the 240-volt line are 120 volts above ground!

You can do many things with transformers if you use some of your "forgotten" radio theory. Don't ever throw a "junk" transformer away just because it has an odd secondary (or primary) voltage. ■

New Products

from page 75

\$6.95; large pkg. (3 pieces—9" x 12")—\$7.95. Write for information and prices on larger sizes and quantities.

PCP Type-A film is available from Printed Circuit Products Co., PO Box 4034, Helena MT 59601.

Morgan W. Godwin W4WFL
West Peterborough NH

NEW SERIES OF MFJ CW/SSB ACTIVE FILTERS

MFJ Enterprises has introduced two new CW and SSB active filters.

The top-of-the-line model is called the MFJ-721 Super Selector CW/SSB Filter. It has a 2-Watt audio amplifier, switchable noise limiting, and an input selector switch for two rigs.

The CW filter is an eight-pole (4 cascaded stages) active filter centered at nominally 750 Hz. It has four selectable bandwidths: 180, 150, 110, 80 Hz. In the 80 Hz position, the response is at least 60 dB down one octave from the center frequency. It drastically reduces noise and provides up to 15 dB improvement in signal-to-noise

ratio.

With a pair of stereo headphones, simulated stereo reception provides the narrow filtered signal to one ear and the unfiltered signal to the other. The ears and brain reject interference but allow off-frequency calls to be heard.

The SSB filter dramatically improves readability by optimizing the audio bandwidth to reduce sideband splatter, remove low and high pitched QRM, remove hiss, remove static crashes, remove background noise, and eliminate 60 and 120 Hz hum.

A self-adjusting automatic peak clipper is provided for SSB. For CW, a valley clipper is also provided. This removes background noise smaller in amplitude than the signal.

It plugs into the phone jack and drives a speaker or phones with 2 Watts of audio. It can also be used as an auxiliary audio power amplifier. The size is 5 x 2 x 6 inches. It requires 9 to 18 V dc; an optional ac adapter is available. The price is \$59.95 (include \$2.00 for shipping and handling).

The MFJ-720 Deluxe Super



The MFJ-721 Super Selector CW/SSB Filter.

CW Filter uses the same eight-pole active filter as in the MFJ-721. The frequency determining components are hand-selected to within one Hz of the nominal 750 Hz center frequency; this gives very steep skirts. The low-Q cascaded design minimizes ringing. A self-adjusting peak noise limiter is built in.

It plugs into the phone jack and drives the speaker or phones with 2 Watts of audio (using an LM-380 audio power IC). The size is 4 x 2 x 6 inches, and it requires 9 to 18 V dc. An optional ac adapter is available. The price is \$44.95 (in-

clude \$2.00 for shipping and handling).

The MFJ-721 Super Selector CW/SSB Filter and the MFJ-720 Deluxe Super CW Filter are both available from MFJ Enterprises, and have a 30-day money-back trial period. If you are not satisfied, you may return it within 30 days for a full refund (less shipping). MFJ also provides a one-year unconditional warranty.

To order, call toll-free (800)-647-8660, or mail the order to MFJ Enterprises, PO Box 494, Mississippi State MS 39726.

CB to 10

—part IX: a pair of Radio Shack rigs

In 1966, I converted a tube-type CB rig to ten meters and put it in my 1950 Desoto. It was fun to operate, but, unfortunately, there were not very many local hams to work. I took the rig out and eventually scrapped it and forgot about ten meter AM.

My interest in ten meters was rekindled at the Amateur Radio Association of the Tonawandas' September, 1976, "Show and Tell" meeting. Bill WB2MAM brought a pair of CB walkie-talkies which he had converted to ten. I got thinking about ten meters again.

In early 1977, Radio Shack sent out a flyer advertising the five-Watt TRC-11 for \$29.95, so I bought one. While in the store, I spotted the TRC-74

100 mW walkie-talkie and decided to try my hand at converting it also. It seemed a natural to take along to hamfests and to use for emergency situations where inexpensive QRP rigs would be needed for QRM-free short-range communications.

The conversions are quick and require a minimum of test equipment. You can get by with an rf probe, a VTVM, and a dummy antenna, but a signal generator capable of ten meter operation is very helpful. An swr bridge could be used in place of the rf probe for the TRC-11 alignment. One word of caution: The adjustable coils and transformers are sealed in place. The larger coils are painted in place and are easily moved, but some of the smaller ad-

justments are sealed with a wax-like substance. If a coil or transformer is wax-sealed above the slug, very carefully remove the wax sealer before making any adjustments. I was lucky—only one coil suffered damage due to my over-torquing on its slug.

Crystals

Both rigs are single-conversion superhets and use the same crystals. Crystals are third-overtone types, and their fundamental frequency in kHz is easily determined, as Fig. 1 illustrates. I ordered my crystals from JAN Crystals and have been pleased with their performance. They cost \$3.75 each, with an additional 25¢ each for postage (air mail) and handling, for a total of \$4.00 per crystal. JAN had advised me that it might take up to a month to deliver them, but the crystals arrived two weeks after I mailed my order.

Converting the TRC-11

Receiver modification is simple. The oscillator starts up easily and has no adjustment. Refer to Fig. 2 for the following adjustment locations. Inject a ten meter AM signal through the antenna connector and

adjust T1 and T2 (the input and output transformers, respectively, for the rf amplifier stage) for maximum output voltage across the speaker voice coil. This completes receiver alignment. My 455 kHz stages were tweaked, and the receiver gain came up a bit. Check yours before proceeding to transmitter alignment. By the way, the TRC-11 has a ceramic filter in the emitter lead of the first i-f transistor.

Transmitter alignment is a bit more complicated. Connect the rig to a dummy antenna, and put the rf probe across the antenna connector. Output may be monitored by inserting an swr bridge between the dummy antenna and the transceiver. Depress the microphone button and adjust T9, the oscillator output coil, until the oscillator starts, as indicated by a very weak output. Adjust T10 for increased output. Similarly, adjust L5 and L6 for maximum output. Go over these adjustments several times, until maximum output is obtained. T9 may need to be adjusted if dc input voltage varies and the rig has no output. Using Heathkit's rf probe and

$$\begin{aligned} \text{Transmit crystal frequency (kHz)} &= \frac{\text{output frequency (kHz)}}{3} \\ \text{Receive crystal frequency (kHz)} &= \frac{\text{output frequency (kHz)} - 455 \text{ kHz}}{3} \\ \text{Example:} & \\ \text{To transmit on 28.805 MHz:} & \\ \text{Transmit crystal frequency (kHz)} &= \frac{28805 \text{ kHz}}{3} = 9601.667 \text{ kHz} \\ \text{To receive 28.805 MHz:} & \\ \text{Receive crystal frequency (kHz)} &= \frac{28805 - 455 \text{ kHz}}{3} = \frac{28350 \text{ kHz}}{3} = 9450.00 \text{ kHz} \end{aligned}$$

Fig. 1. Crystal information. Note: All crystals are 3rd overtone.

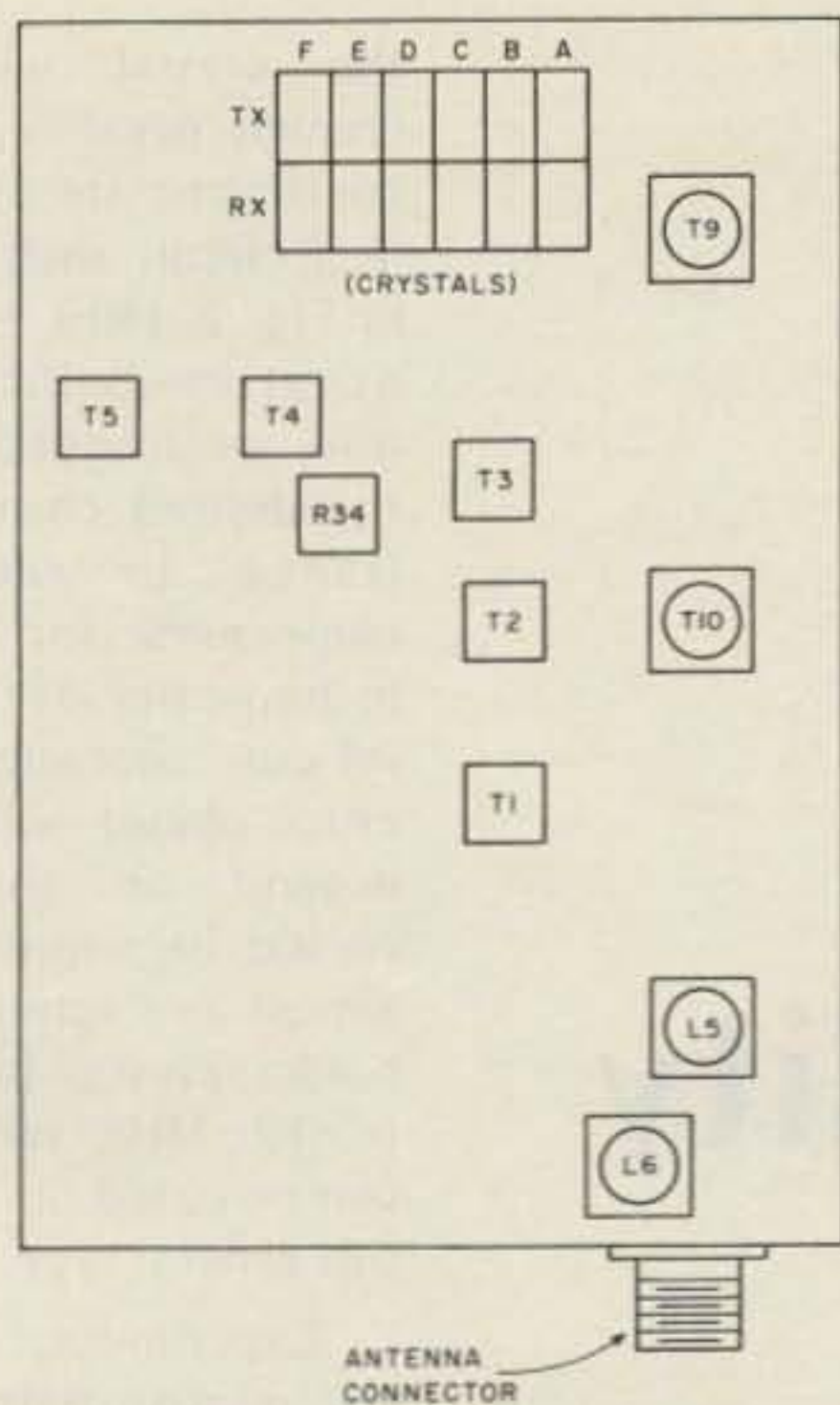

Fig. 2. TRC-11 adjustments layout.

VTVM, I measured one-tenth of a volt less rf output at 28.6 MHz than I originally had at CB channel 9, 27.065 MHz.

TRC-74 Walkie-Talkie Conversion

Refer to Fig. 3 for adjustment locations. The receiver converter stage may not oscillate right away, so adjust the slug of T2 outward until it does. This can be determined by listening for noise through the speaker. It should pick up when the oscillator starts. An alternate method is to inject a ten meter AM signal and adjust T2 until the signal is heard. After oscillations begin, adjust T1, the input rf transformer, for maximum signal strength. This may be measured across the speaker voice coil. At this time, readjust T2 for best signal. Cycle the rig on and off several times to be sure the oscillator will start right off. T2 may be tweaked as necessary. The 455 kHz transformers may be tweaked at this time, if you'd like.

The transmitter is equally simple to get operating on ten. First, extend the

whip antenna full length. Connect the rf probe to TP1, directly adjacent to the TR switch. TP1 is connected to the base of the antenna loading coil, L1. The signal at TP1 may be too weak to measure with an rf probe. A ten meter receiver may be substituted. Depress the T/R switch and adjust T3 for output. After the oscillator is running, adjust L3 and L2 for maximum output. Place the rf probe on the antenna, or continue monitoring with the receiver gain reduced to prevent overloading, and adjust L1 for maximum output. Go through the adjustments several times. T3 may have to be offset slightly to assure oscillator turn-on every time the transmit button is pushed.

Antennas For the TRC-11

In my pickup truck, I use a Hustler mobile antenna with an RM-10 mobile resonator. It gives very fine results. The truck has quite a lot of ignition noise, and the engine must be shut off for best operation. Also, this makes driving a stick-shift vehicle safer.

At home, I use a Radio Shack 21-901 quarter-wave

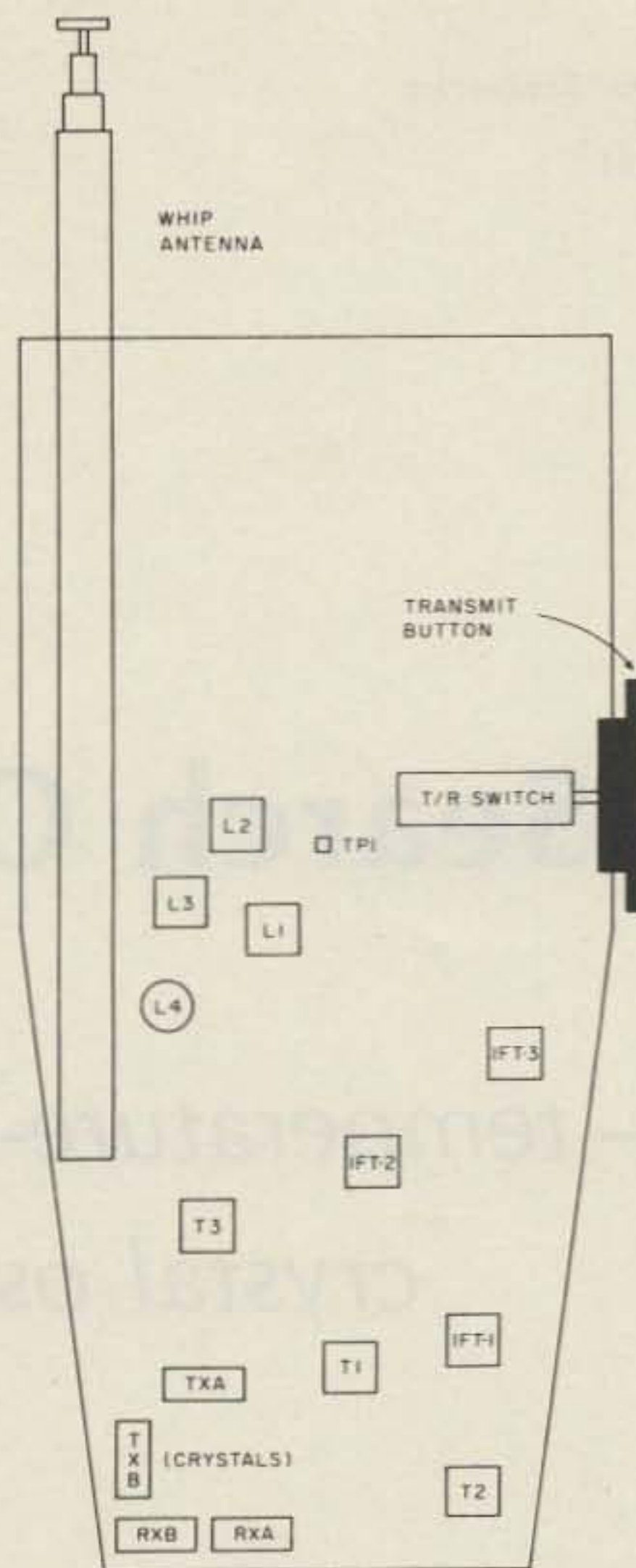

Fig. 3. TRC-74 adjustments layout.

ground-plane antenna mounted three feet above ground. It cost \$16.00 (\$14.95 plus \$1.05 tax). I've pruned five inches off the vertical element and the radials, and the swr, at 28.6 MHz, is about 2 to 1. I'm not trimming it further until western New York's hams decide on final frequencies. At present, I operate on 28.6 and 28.805 MHz with WB2MAM, WB2NFZ, and a few other fellows.

Results

Here in the Falls, I've about a ten-block range between the 100 mW hand-held unit and the mobile 5 Watter. The receiver noise problem in the mobile limits the range. If the truck were suppressed, I feel the range would nearly double.

Between hand-helds in Buffalo, Bill WB2MAM

and I worked about six blocks.

Before I installed the ground plane, I used a hastily-built sloping dipole only 4 feet off the ground and received a 5 x 7 signal report from New Jersey. Reports should become better when the ground plane antenna is up around twenty-five feet.

Comments

Ten meter QRP AM operation is fun and fairly inexpensive. Ten meters offers an alternative to two meters and could very nicely augment it for emergency situations. Range between five-Watt rigs is good, and the band is usually interference-free.

Radio Shack puts out very good service manuals for these rigs. Their stock numbers are 21-139/141 for the TRC-11 and 21-174 for the TRC-74. ■

In Search Of Stability

— temperature-compensated crystal oscillators

the crystal with a high enough negative temperature coefficient are usually found in a circuit such as is shown in Fig. 2. Here, two different negative-coefficient capacitors are blended to produce the desired change in capacitance to counteract or compensate for the decrease in frequency of the "normal" AT-cut characteristics. The exact circuit will, of course, depend on the particular crystal in minute detail, but almost any surplus-type HC-6 holder crystal in the 4 MHz to 12 MHz range may be compensated in a circuit of this general type.

Experimental checking on the relative flatness over the room temperature range can often be verified by cooling the whole circuit down with a blast from a circuit cooler can and then watching the frequency change with a counter. It is, of course, important to have a good reference timebase, better than the oscillator under test for this evaluation. By adding more or less of a particular compensating-coefficient trimmer capacitance, the crystal can be made to remain flat within a few cycles at the 5 MHz region or within 1×10^{-6} over a room temperature variation of 20° to 30° C. A very small NPO trimmer is then used for adjusting the final frequency to the desired value, after determining the effect of adding or subtracting relative ratios between the two compensating capacitors.

It is much easier to experimentally check a particular crystal in this type of circuit than it is to determine the crystal characteristics, particularly for surplus junk box units. Fixed ceramic negative-temperature-co-

Temperature-compensated crystal oscillators (TCXO) are not completely a black art. A typical AT-cut crystal will have a measured temperature-versus-frequency curve as shown in Fig. 1. Inspection of the curve shows that, if you rotate it around the zero-resonant frequency point at about 25° C., the change of frequency can be flattened out over a considerable range. This is precisely what manufacturers do when producing TCXOs. Temperature-compensating capacitors connected in series with

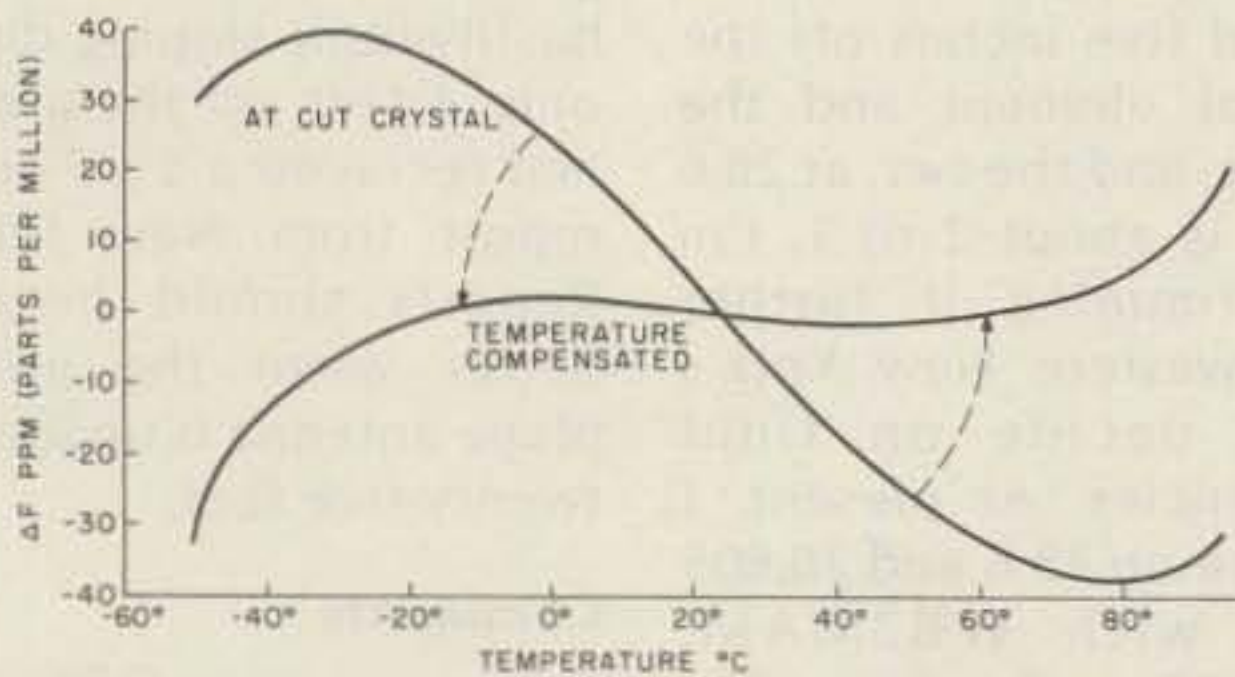

Fig. 1. Generalized temperature-versus-frequency characteristics for AT-cut crystals in the 4 to 12 MHz range.

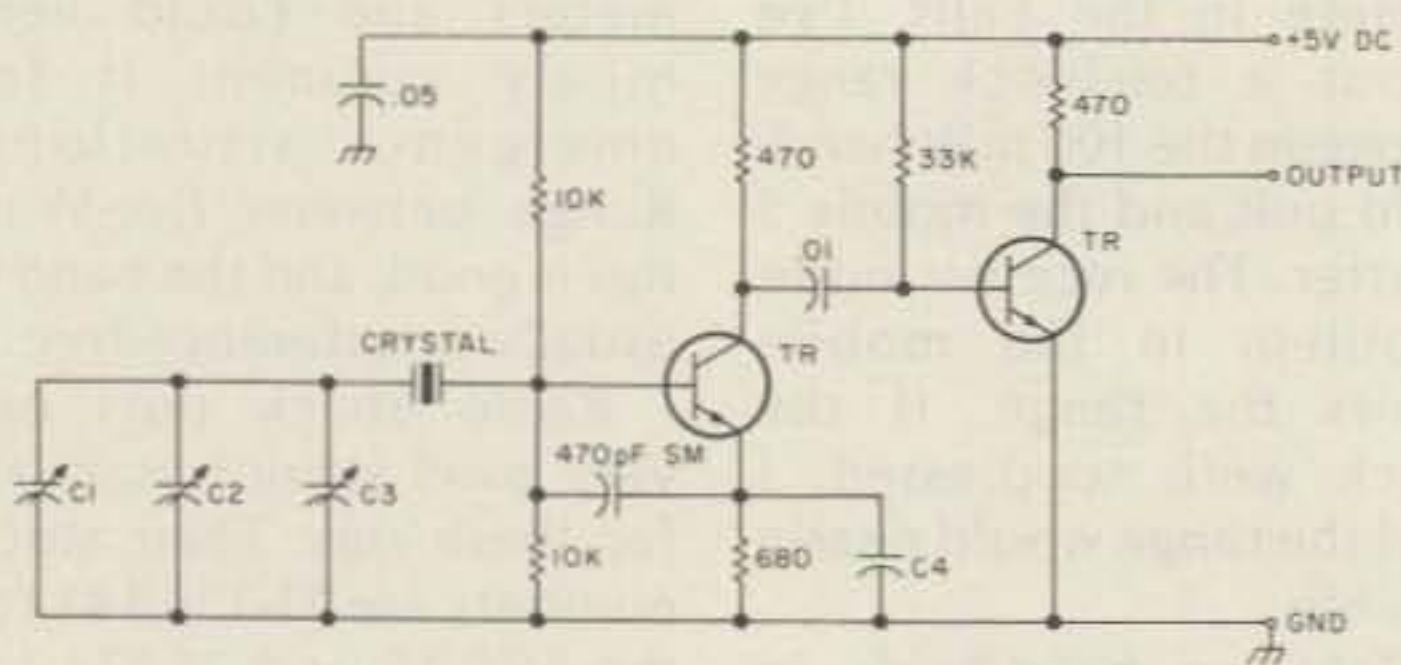

Fig. 2. Temperature-compensated crystal oscillator.

Parts List

For a 5 MHz AT-cut crystal:

- C1 3-8 pF Mouser* 24AA010 NPO (fine frequency trimmer)
- C2 4-24 pF Mouser 24AA012 N-500 (temperature compensating)
- C3 8-48 pF Mouser 24AA014 N-1500 (temperature compensating)
- C4 120 pF silver mica type 5% adjusted for each crystal
- TR NPN silicon HF-type transistor

*Mouser Electronics, 11511 Woodside Avenue, Lakeside CA 92040.

efficient capacitors may often be used after once determining approximately the range with a variable trimmer type. The oscillator is first adjusted for the center frequency by changing the emitter feedback bypass capacitor, C4, for easy starting. If a particular surplus crystal cannot be brought within ± 50 Hz (at a 5 MHz level), chances are that it is not really ground for a zero-resonant point at the marked frequency. It is not possible

to simultaneously compensate and pull the crystal to exact center frequency if it is not already ground close to that point during manufacture with a comparable load capacitance.

A few 4 MHz crystals used in microcomputer clocks can be altered to produce exactly 4.000000 MHz for accurate time-interval measurement, but often they are too far off the desired center frequency. In most computer systems, the exact center frequency is

not particularly important. However, for those who wish to use their microprocessor as a frequency counter or as a time-interval reference at the microsecond level, as in loran-C, a stable and accurate clock is required.

One MHz crystals will work in the circuit of Fig. 2 by changing the C4 feedback bypass to something like 1000 pF instead of 120 pF. However, these crystals will usually not be temperature compensated because lower

frequency crystals are usually DT cut with different characteristics.

Crystals in the range of 4 MHz to 12 MHz have the best characteristics for this type of TCXO use. If a lower frequency is required, a divider is suggested, such as a 4 MHz crystal with a divide-by-4 (7473 or 4027), to produce a 1 MHz output frequency. The 4 MHz oscillator can be compensated, but the output is now the desired lower 1 MHz clock frequency. ■

the indispensable **BIRD43**



THRULINE® WATTMETER

0.45-2300 MHz/0.1-10.000 watts

Still only \$125, most elements \$38.

What more need we say...

Available from **Henry Radio** H3

11240 W. Olympic Blvd., Los Angeles, Calif. 90064 213/477-6701

JBW

Specializes in 220
MHz equipment

Contact JBW for pricing on
the new JBW 220 MHz repeater

CRYSTALS IN STOCK

MIDLAND 13-509
COBRA 200
CLEGG 76
WILSON HAND-HELD

ALL CRYSTALS GUARANTEED

JBW ELECTRONICS ALSO
FEATURES
LUNAR, ESC & MIDLAND
Product Lines

JBW ELECTRONICS, INC.

18618-2 PARTHENIA ST. • NORTHRIDGE, CA 91324
(213) 993-5159

J9



There's a new, eighth OSCAR satellite in orbit, and the AMSAT team helped put it there!

Your help is needed for future satellites. Join AMSAT and support the new, advanced Phase III series of OSCARs, engineered to provide communications over transcontinental distances for hours at a time.

Send \$10 membership dues to AMSAT, P.O. Box 27, Washington, D.C. 20044. Life membership is available for a tax-deductible donation of \$100 or more, payable in quarterly installments if you wish.

Phase III satellite solar cells may be sponsored for \$10 each, and we'll send you a certificate specifying the cells you are sponsoring.

For a tax-deductible contribution of \$1,000 or more, we'll even inscribe your name on a plaque to be placed in orbit aboard the Phase III spacecraft for posterity, and we'll send you a replica honoring your contribution.

Dues and contributions may be charged to VISA or Master Charge. Phone us at (202) 488-8649.

Radio Amateur Satellite Corporation
P.O. BOX 27, WASHINGTON, D.C. 20044

AMSAT



James R. Allison WA4KIL
14 Veraqua Ave.
Coral Gables FL 33134

Robert H. Walker K4FK
400 Tivoli Ave.
Coral Gables FL 33143

On Your Mark!

—RTTY tips for the TS-820

With the skyrocketing popularity of transceivers, there has been a noticeable trend in recent years toward RTTY contacts in which the principals may be 1 kHz or more apart in frequency. Not only does this waste our spectrum, but, if you're transmitting on one frequency and receiving on another, your percentage of replies to calls is decreased.

Your shift can be slightly off, but, if your "mark" frequency coincides with the "mark" frequency of the station you are calling, there is a good chance that he can print you. Move your "mark" a few cycles from the frequency on which he is listening and a signal which is much weaker than yours, but on frequency, will come nicely through his filters. Three guesses which caller will be answered!

I recently acquired a new Kenwood TS-820S. By transceiver standards, it is well equipped for RTTY operation. I noticed, however, that, when I called another station, I very seldom got an answer. When I called CQ, I frequently got answers, but usually I had to turn on the

RIT (receiver incremental tuning) and go looking for them. A quick check revealed that my transmit and receive frequencies were separated by over 150 Hz. That represents quite an error when we are talking about a total shift of 170 Hz!

Empirical experimentation has shown that you can easily get your new TS-820S to transmit and receive RTTY on the same frequency without re-adjusting either the 820 or the converter. If you own the external VFO-820, you can actually "zero beat," after a fashion, and achieve very precise frequency control.

These instructions presuppose that you are transmitting and receiving 170 Hz shift. Not being equipped to transmit 850 Hz shift, we have not attempted to extrapolate our findings to that shift. We also assume that you are using the FSK system built into the 820.

Presetting your RIT before operating RTTY is the key if you operate without the VFO-820. Turn on the crystal calibrator and tune it in with the main tuning knob as though it were a "mark" signal. Now

turn on the RIT and offset it in the + direction until the calibrator signal peaks on your "space" filter. Do not move the main tuning knob once you have peaked up "mark." On our two test units, the white line on the RIT control was just to the right of the red line on the i-f shift control when the i-f shift was centered and the preceding adjustment correctly made.

Leave the RIT as it is now set and normally tune in a RTTY station with the main tuning knob. When you call, you should now be transmitting very close to the frequency on which you are receiving. During the contact, follow any drift with the RIT. Be sure to reset the RIT prior to beginning another contact.

The accuracy of this method is almost completely dependent upon the bandwidth of the filters in your converter. You can obtain a much more precise adjustment if the filters are quite narrow and the converter incorporates a tuning meter to supplement the scope. Even with wide filters, however, this process is accurate enough to materially increase the percentage of returns to

your calls.

Do you have the VFO-820? If so, you're really in good shape! Extremely accurate zero beating is now possible. You must transmit on one vfo and receive on the other. I opt to transmit on the VFO-820 because it is removed from any ambient temperature change within the TS-820S case. Tune in a RTTY signal normally with one of your vfos. Turn the function switch to RMT CALIBRATE and zero beat your other vfo to the first. On our test units, we learned to approach from the low side and stop just short of complete zero beat (a low, almost subliminal growl seems to be the ideal point). With the full load of the transmitter on the power supply, your transmit and receive frequencies will be nearly identical if you stop just short of zero beat.

If possible, practice both of these procedures with a local who is not running transceive. He can tell you how close you are coming to "matching his mark." You'll have no trouble learning to get your TS-820S within just a few cycles of any transmitting station's frequency. ■

HAMTRONICS USED GEAR • TEST EQUIPMENT • SPECIALS

30-DAY GUARANTEE ■ 90-DAY FULL CREDIT TRADE-IN ■ FREE SHIPPING VIA UPS ONLY

Limited quantities. First come, first served. (if weight or size exceeds UPS max., we will ship freight collect)

| | | | | | | | | | |
|---|--|--|--|--|--|--|--|--|---|
| Allied AX-190 Receiver \$159 | TR-22 2 Meter 140 T-4X Transmitter 339 TR-72 2 Meter FM 225 AC-4 AC Supply 95 TR-4-C Transceiver 449 CC-1 Console CPS-1 Supply SC-2 Conv SC-6 Conv 470-25 450 MC SC-1 Calibrator The above all assembled complete pkg. Only \$200 | HT-37 Transmitter 159 HT-40 Transmitter 49 SX-99 Receiver 99 SX-117 Receiver 189 SR-150 Xcvr 259 SR-160 Xcvr 159 SX-146 Receiver 175 HT-44 Transmitter 159 SX-111 Receiver 149 SX-122 Receiver 249 S-36 UHF Receiver 125 | Johnson 1-KW Matchbox/SWR \$195 Courier Linear 139 Ranger I Transmitter 85 Ranger II Transmitter 139 Valiant I Transmitter 129 Invader 2000 Xmitt 495 | Standard SRC-146 HT \$149 826 M Trnscvr 195 SRC-144 395 SRC-851T 250 | Tempo Tempo one Xcvr \$299 AC One Supply 79 FMH 2M H.T. 149 CL-220 Trncur 220 MC 179 FMH 2M w/Talkie 149 | | | | |
| Ameco PV-50 \$ 9 CN-50 29 CN-144 39 TX-62 79 621 VFO 45 | Dycomm 10-0 2 M Ampl \$125 35-0 401N 110 Out 130 470-25 450 MC 120 P-1416 16 Amp Supply 95 | Hammarlund HQ-110 A VHF Receiver \$189 HQ-110C Receiver 119 HQ-110AC Receiver 149 HQ-145X Receiver 169 HQ-170C Receiver 159 HQ-180 Receiver 379 HQ-215 Receiver 259 SP-600 Receiver 179 HX-50 Transmitter 169 | Kenwood T-599 Transmitter \$289 R-599 Receiver 289 TS-520 Tranc 429 QR-666 259 QR-666 Receiver 239 TV 502 Transverter 179 | Swan 700-CX Xcvr \$459 260 Cygnet 289 279 Cygnet 329 500 Xcvr 299 500 CX Xcvr 389 117-XC AC Supply 95 14X DC Module 39 MK II Linear 475 KK VI 6 Meter 550 250 C 6M Xcvr 349 FM 2X2M Xcvr 169 FM-1210A 2M 249 350 Transceiver 269 350C Xcvr 299 600R Receiver 339 600T Transmitter 399 410 VFO 79 | Ten Tec PM-3 Trnsur \$ 49 Argonaut Xcvr 199 KR-40 Keyer 79 RX-10 Receiver 49 S-30 Signalizer 29 Triton II 479 | | | | |
| B&W Waters Nuverfor 2+6 Conv. \$ 75 6100 SSB Xmitter 395 670 SSB Adaptor 39 Co-Dax Keyer 95 | Eico 720 Transmitter \$ 49 722 VFO 39 730 Modulator 39 | Heathkit SB-300 Receiver \$199 SB-301 Receiver 229 HR-10-B Receiver 69 SB-303 Receiver 269 SB-220 Linear Amp 449 SB-102 Trivcvt 379 DX-60B Transmitter 69 HW-32 Transmitter 85 HW-100 Transceiver 249 SB-100 Transceiver 299 SB-401 Transmitter 249 SB-101 Transceiver 349 SB-650 Digital Freq. Display 149 HW-30 Twoer 29 Also Sixer 29 H-10 Monitor 69 VHF-1 Seneca 79 HW-12 Transmitter 75 HP-23 AC Supply 49 HP-23B AC Supply 59 HW-202 2M FM Xcvt 159 SB-620 Spectrum Analyz 120 SB-102 Xcvt 369 SB-610 Scope 95 HA-20 6m Linear 125 SB-634 Console 175 SB-604 Spkr 29.50 SB-644 VFO 129.50 SB-230 Linear 359 SB-104 Transceiver 625 | Knigh T-60 Transmitter \$ 39 r-100 Receiver 59 TR-108 Trancur 2M 79 | Lafayette HA-800 Receiver \$ 89 HP-350 Receiver 149 HE-45 Transceiver 49 | Yaesu FT-401 Xcvt \$499 FRDX 400SD Rec 325 FT 2 Auto 2M FM 249 FT-101B Xcvt 549 FL-2100B Linear 295 FV-101 VFO 79 101E Xcvt Demo 695 | | | | |
| Central Electronics 100V Transmitter 325 MM-2 Scope 69 20-A SSB Adaptor 79 | Eimac AF-67 Transmitter \$ 45 PMR-8 Receiver 79 | Midland 509 H.T. \$149 | Millen 92200 Transmatch \$149 90651-A Grid Dipper 95 | National NC-270 Receiver \$119 NC-300 Receiver 129 NCX-5 Transceiver 279 NCX-5MKII Transcvt 299 NC-303 Receiver 199 AC-500 AC Supply 69 NCX-500 Transceiver 199 NCX-3 Transceiver 169 NC-190 Receiver 149 NC-105 Receiver 69 | Test Equipment Bargains Boonton "Q" Meter \$295 Tektronix 5140 249 Tektronix 545A 950 5 3/54A Plug-in wide band preamp . . 75 Hickok 695 Generator 69 Bendix BC221 Freq Meter 39 Polarad Spectrum Analyzers A84T. . . 1695 Hewlett Packard 400C. 75 Precision E-400 Signal Generator. . . 125 Electro Impulse Spectrum Analyzer . . 395 Dyna/Sciences Model 330 Digital Multimeter 195 Hewlett Packard 4905A Ultra Sonic Detector 550 Hewlett Packard 120A Scope. 250 TS-323/UR Frequency Meter. 175 Hewlett Packard 4910B Open Fault Locator 650 Bird Mod 43 80 General Radio 650A 150 Measurements Mod 80. 195 Nems Clark 1400. 495 Ballantine 300H 175 PACO Scope Mod-S-50 75 Singer FM-10C 3495 Simpson 260 V.O.M. 49.50 | | | | |
| Glegg 22'er FM \$129 66'er 6M Xcvt 115 99'er 6M Xcvt 59 Interceptor BRCUR 275 Ant Pre Amp 22 All Bander 69 HT-146 125 2 Vess 259 FM-27-B Xcvt 325 | Genave GTX22M FM \$165 GTX-200 2M FM 149 | Regency HR-2B 2M FM \$169 HR-220 FM 220 MC 185 AR-2 2M Amplifier 85 HR-25 2M FM 225 HR-6 Meter FM 189 | SBE SB-34 Transceiver \$249 SB-33 Transceiver 189 SB-144 2M FM 175 SBZ-LP Linear 179 | Globe/Galaxy VHF 6+2 Transm Chief Transmitter \$ 39 Galaxy III Xcvt 159 Galaxy V Xcvt 189 Galaxy V Mk II 239 GT-550 Xcvt 279 GT-500A Xcvt 329 AC-400 Supply 79 FM-210 2M FM 95 | Gonset Com II 2M \$ 75 Com II 6M 69 Com IV 2M 129 GC-105 2M 115 G-28 Xcvt 149 G-50 Xcvt 149 | ICOM IC-21 2M FM Xcvt \$299 IC-230 Demo 369 IC-22A 2M FM Xcvt 185 IC-30A 432 MCFM 269 | Drake 2A Receiver \$149 2B Receiver 189 2AQ SPKR QMULT 29 R4 Receiver 289 R4-B Receiver 349 R4-C Receiver 399 MS-4 Speaker 19 2NT Transmitter 125 2NT Transmitter 99 TR-6 695 | Hallicrafters S-108 Receiver \$ 99 SX-101 Receiver 159 HT-32 Transmitter 179 HT-32B Transmitter 269 SX-99 Receiver 79 SX-115 Receiver 349 | Collins 75 A4 Receiver \$395 75S3B Receiver 695 75S1 Receiver 349 KWM-2 Xcvt 595 32S1 Xmitter 349 PM-2 AC Supply 95 516 F2 AC Supply 139 312B5 Console 425 361D2 Mount 29 |



ICOM IC22S

Regular \$299, save \$50; buy an ICOM IC22S for \$299 (no trades) and take a \$50 credit for another purchase.

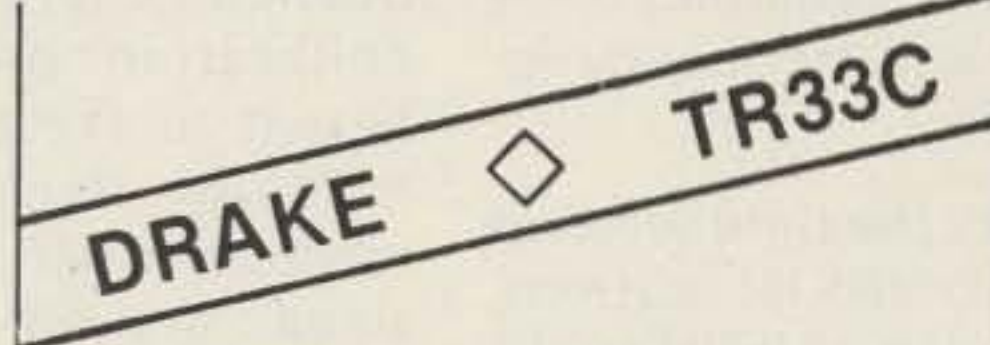

Regular \$229, save \$30; buy a Drake TR33C for \$229 (no trades) and take a \$30 credit for another purchase.



MIDLAND 13-510

Regular \$399, save \$50; buy a Midland 13-510 for \$399 (no trades) and take a \$50 credit for another purchase.



KENWOOD

TS820 \$ 919.00
 TS80S \$1098.00



YAESU

FT101E - 799.00
 FT101EE - 759.00
 FT101EX - 699.00



DRAKE

TR4CW - \$799.00

MAIL & PHONE ORDERS WELCOMED. BANK AMERICARD ACCEPTED. ALL UNITS GUARANTEED

HAMTRONICS

DIVISION OF

Trevoze Electronics

4033 BROWNSVILLE ROAD
 TREVOSE, PA. 19047
 Telephone: Toll Free:
 (215) 357-1400 1 800-523-8998
 (215) 757-5300

A WWW Primer

—become a calibration freak

The international time and frequency community, as it is called, is a very small one generally unknown to the public, yet very important to many of the basic activities of daily life. Radio and TV stations, ship and aircraft navigators, military and government installations, electronics laboratories, and even musical instrument makers all depend on very precise time and/or frequency information.

In the U.S., the National Bureau of Standards (NBS) has provided our primary standards of both time and frequency for more than 50 years—ever since WWV began its service in 1923, first from Washington and later from Greenbelt, Maryland. In 1966, the site was moved to Ft. Collins, Colorado, about 60 miles north of Denver, in order to replace aging equipment, provide better signal coverage nationwide, and be near the NBS frequency standard at Boulder.

Of course, WWV and WWVH are not receivable

in all areas of the world. Many other similar stations, such as JJY (Tokyo), VNG (Lyndhurst, Australia), MSF (Rugby, England), and ZUO (South Africa) provide similar services for their own users. The National Research Council of Canada operates CHU in Ottawa for Canadian users of time and frequency information.

Besides the time services of the two NBS HF stations, WWV and WWVH (Hawaii), standard frequencies are also broadcast and are available to amateurs, who probably account for more than 35% of the listeners and who are more interested in the standard reference marker frequencies. With a general-coverage receiver which can tune the frequencies (2.5, 5, 10, 15, and 20 MHz), a reliable marker frequency is always available for calibration and measurement.

At lower frequencies, such as in the VLF range, it's possible to record the phase differences between

two frequencies; two important broadcasts used are the NBS station WWVB, also in Ft. Collins, and the Ioran-C radio navigation signals. Phase recording is possible because the signal path at VLF is very stable, unlike that at HF. At higher frequencies, there are definite calibration problems inherent in the propagation medium itself. The atmospheric variations of HF signals and the short wavelengths involved prohibit reliable phase comparison.

Actually, WWVB, which broadcasts with 13 kW on 60 kHz in the VLF range, is effectively more accurate than WWV. While frequency tolerance on both is normally kept within a few parts in 1,000 billion, the fact that propagation anomalies at VLF are very minor compared with those at HF allows well-equipped users to maintain calibrations on the order of 1 part in 100 billion. In fact, even WWVH uses WWVB as a cross-check on its own cesium standards and

broadcast signals!

Direct frequency comparison with WWV can be accomplished, practically speaking, to about 1 part in one million. Four methods of calibrating rf and audio sources using WWV are: (1) The relatively simple beat-frequency method; (2) The oscilloscope Lissajous pattern method; (3) The oscilloscope drift pattern method; (4) The sophisticated frequency calibrations by time comparisons technique.

Let's take a look at each method in turn, as well as some special techniques.

The Beat-Frequency Method

Beat-frequency comparison with WWV is a simple technique used by SWLs and hams to calibrate equipment, such as receivers, transmitters, and frequency counters. Typically, a 100 kHz or 1000 kHz calibration signal rich in harmonics is coupled to the receiver along with the

signal from the antenna, mixing a known accurate frequency (such as that of WWV) with the output of the calibrator. The difference frequency of the two rf signals results in an audio output signal known as the beat frequency. This audio frequency decreases to zero when the two frequencies are equal and is known as zero beat.

To calibrate a frequency standard or crystal calibrator with an output frequency lower than that of WWV (normally the case), a harmonic equal to the WWV signal is needed. As an example, if a 100 kHz signal from a calibrator is to be zeroed against the WWV 10 MHz frequency, it must also contain a harmonic 100 times itself. Any calibrator or signal generator used should have a square-wave output that is rich in harmonic content.

In practice, if the beat note is above about 50 Hz, a speaker, headphones, or frequency counter can be used to detect zero beat, while below that frequency, a dc oscilloscope can be hooked up to the receiver's detector output to detect zero beat. An S-meter can also be used, with the beats counted visually as the meter swings through zero beat; this is probably easier to follow very close to zero beat.

To determine whether the calibrator is high or low in frequency, its frequency must be changed to note which way the beat frequency decreases. If increasing the oscillator frequency decreases the beat note, the oscillator frequency is lower than the WWV frequency. The converse is also true.

A similar procedure can be used to set the crystal timebase in a frequency counter by coupling a bit of its output to the station receiver and zeroing it

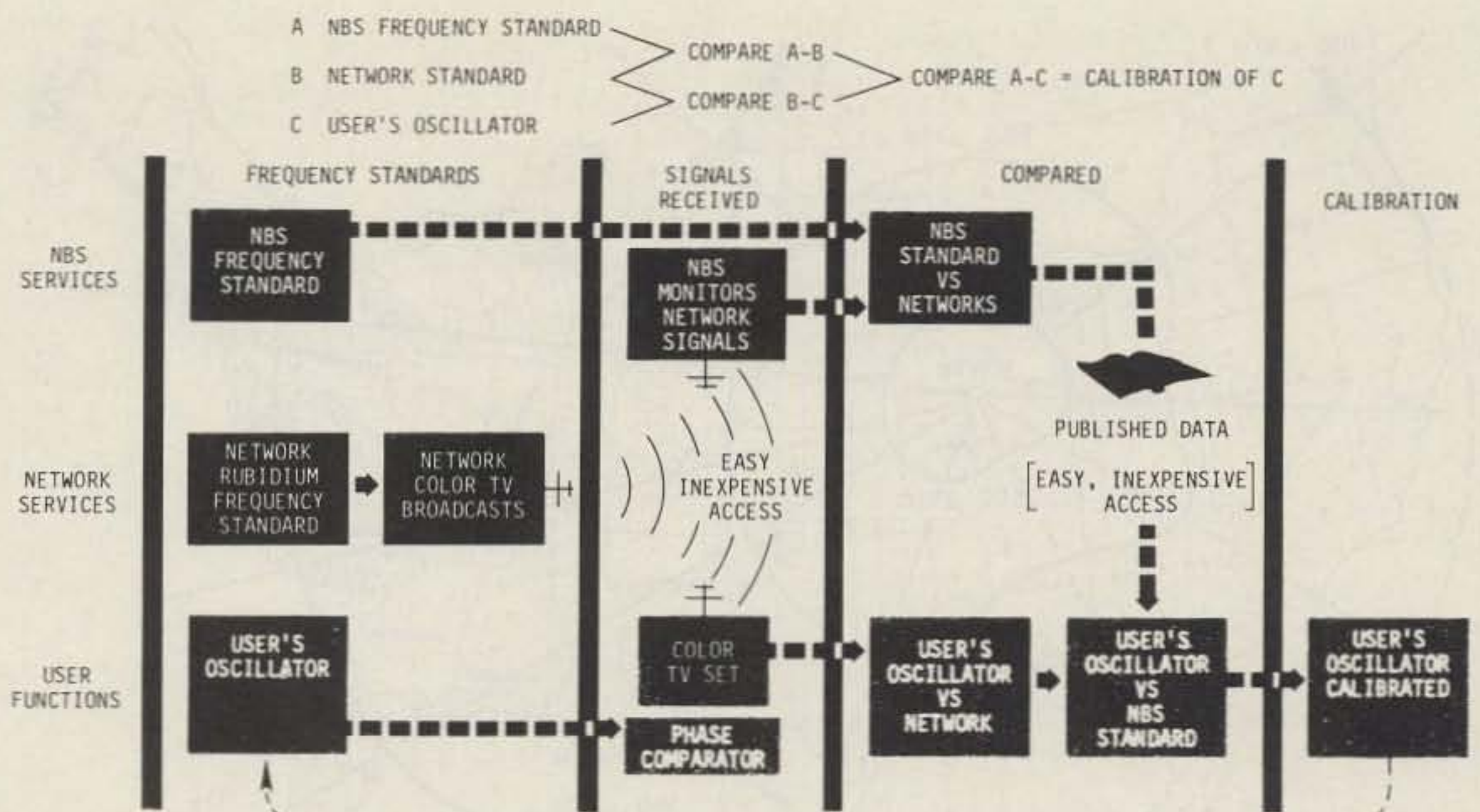

Fig. 1. Frequency calibration using color television signals from NBS Special Publication 432.

against WWV in like fashion. This method is most popular among casual users, such as most hams and SWLs—we use it every time we zero in a crystal calibrator, though we may not give the process much conscious thought or perform the procedure as carefully as we should. However, surprisingly good results can be had if the zero beating is done carefully and, most importantly, if the frequency-determining crystal circuit is temperature-controlled; a crystal calibrator or timebase tends to change frequency with heat. Temperature stability is especially important in frequency counters, where long-term accuracy and stability are necessary if measurements are going to be meaningful.

There are dozens of variations on this method used by hams interested in really precise frequency measurement, which is closely related to the business of frequency calibration. Many of these techniques involve the use of a surplus BC-221 frequency meter in conjunction with a 100 kHz oscillator that has been digitally divided down to provide 1 kHz reference

audio and rf outputs, a frequency counter, and sometimes an oscilloscope. One very simple measurement technique to obtain very respectable accuracy involves using an old but stable tube-type vfo, zero beating it against the signal to be measured and simultaneously feeding the vfo output to the frequency counter for measurement. (Check the discussion of results of the periodic ARRL frequency measuring tests run in QST for a description of the various lash-ups used to provide accuracies of 0.4 parts per million or better—the biggest challenge is in accurately detecting zero beat.)

Following is a discussion of some of the more sophisticated "lab" techniques. Some hams do in fact use them, particularly for audio measurements, but, for the purposes of this article, I will just touch on them lightly. For information on how to use these techniques, consult one of the references mentioned at the conclusion of the article, the *Radio Amateur's Handbook*, or a good electronics engineering text. Most of the techniques, however esoteric, are prac-

tical for use with a good oscilloscope and some patience.

The Oscilloscope Lissajous Pattern Method

WWV signals can be used to calibrate audio oscillators by producing phase patterns on oscilloscopes. The WWV audio signal is applied to the vertical input of the scope, while the oscillator to be calibrated is connected to the horizontal input. The resultant pattern tells the user (1) the frequency ratio between the oscillator setting and the WWV tone and (2) the movement in phase of the oscillator relative to WWV.

You can check the accuracy of the dial setting of the audio oscillator by first picking a dial setting giving a frequency ratio to a WWV audio tone that is an integer and then turning the dial slowly until the pattern becomes stationary. By reading the dial setting, a calibration can be made and the dial then reset to another frequency that is an integer ratio. This procedure also can be applied to fixed frequency sources if they are in correct ratio to the audio

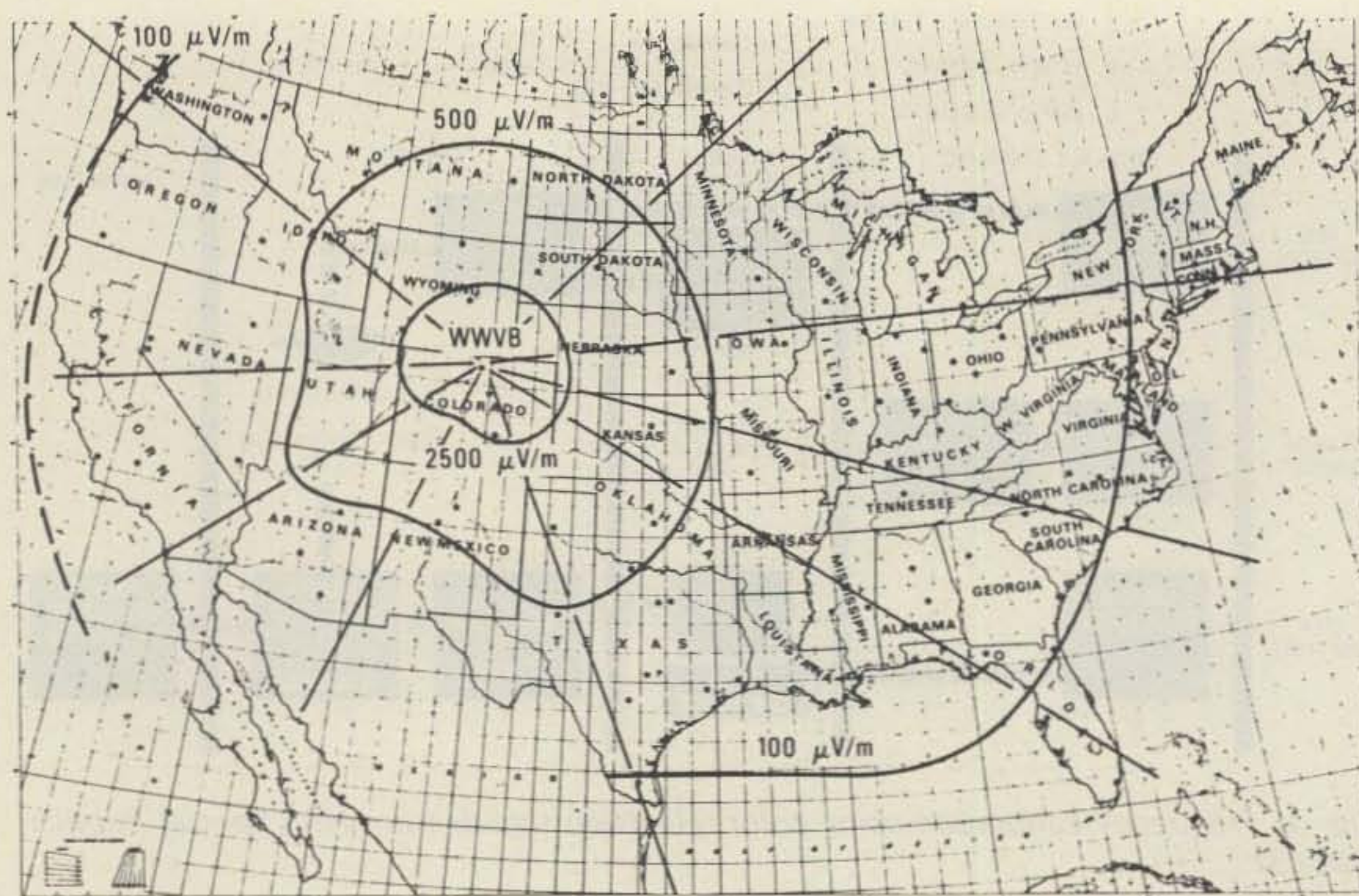

Fig. 2. Field intensity contour map of WWVB at 13 kW erp (from NBS Special Publication 432).

tones on WWV. At this point, the calculations get a bit sticky, so let's skip them and simply mention that, by using this technique, you can calibrate over a 10:1 range in frequency up and down from the 500 and 600 Hz audio tones broadcast by WWV (from 50 Hz to 6 kHz).

Frequency error or "offset" can also be computed using this method. When viewed on the oscilloscope, if the frequencies are exactly equal, the pattern will remain stationary. But if one frequency differs or is offset from the other, the pattern will "rotate." Since one complete rotation of the pattern is equal to one cycle, the number of cycles per unit of time is the offset frequency. Using this information and a little math, you can compute the frequency error of the audio generator. Nice, huh?

Actually, it takes much too long to measure signals with very small offset errors. For the more precise work needed for specialized purposes, a more accurate and faster procedure which measures phase

shifts on an oscilloscope is frequently used. Let's take a look at this technique, with an eye toward the theory rather than the details.

Oscilloscope Drift Pattern Method

This is a very good method of comparing two frequencies, using an oscilloscope with external triggering which is able to detect much smaller audio frequency offsets than the Lissajous method just discussed.

To use this technique, an oscilloscope having a calibrated sweep timebase is used, being externally triggered by the audio source to be measured. The receiver, tuned to WWV, is connected to the scope's vertical input.

With the sweep set at 1 ms/division, the trigger level is set so that a "zero crossover" of the corresponding 500 or 600 Hz WWV audio signal is about midscale on the scope. Then, by visually observing and measuring the phase shift during any given time interval, the frequency offset is determined from the formula: *offset equals*

phase shift divided by time interval.

It turns out that if the zero crossover moves to the right on the scope, the audio frequency is higher than the WWV audio tone, and, if to the left, the signal is lower in frequency.

Obviously, this method is a good one for calibrating audio oscillators and signal generators.

Frequency Comparisons by Time Comparisons of Clocks

This method, aside from its name being a mouthful, is a bit "way out" for the average ham and even most laboratories, but it is an interesting approach and can be highly accurate. Using it, frequency is measured indirectly, overcoming most of the effects of poor signal conditions. By averaging time comparison results, errors caused by propagation conditions can be almost eliminated. But the technique depends on having a very stable frequency standard with a near-zero drift. The offset must be kept nearly constant during the long periods needed to

average the comparison results.

Simply stated, and again skipping the math involved, if a clock controlled by a precision oscillator gains in time with respect to WWV, then the oscillator frequency controlling it is higher than the frequency of the master reference clock at WWV; the converse can also be the case. In any case, the average frequency of an oscillator during the period between two measurements can be calculated and an adjustment made to keep the average frequency constant.

Finally, for those who are interested in accurately setting that new digital clock, you'll be interested in knowing that WWV's time is kept to within a fraction of a microsecond of the internationally agreed-on NBS UTC time scale, while WWVH's accuracy is kept to within 5 microseconds of WWV. For those who wish to play around with timekeeping on this order, sophisticated time synchronization techniques, such as the so-called direct and delayed-trigger methods and the photographic-tick procedure (both of which involve displaying the WWV tick on an oscilloscope), can be used to calculate time to within about 100 microseconds of the time at the station sites. (Propagation and receiver delays prevent being "on the nose.")

While we've talked mostly about WWV, WWVH can be used equally well for most frequency calibration purposes. NBS strives to keep them both synchronized as closely as possible and usually does just that.

Digging a Bit Deeper

Readers interested in more details about frequency measurement (and

timekeeping, too) can peruse NBS Special Publication 432, *NBS Time and Frequency Dissemination Services*, and NBS Technical Note 668, *The Use of National Bureau of Standards High Frequency Broadcasts for Time and Frequency Calibration*, both of which are available from the Superintendent of Documents for a nominal fee. Much of the material in this article was derived from technical data contained in these publications, which go into the business of sophisticated timekeeping and frequency calibration in some detail.

Pub. 432 also gives a fascinating description of the latest in frequency calibration techniques using network television. This new service is exceptionally reliable because the TV networks use rubidium oscillators to produce the 3.58 MHz color subcarrier transmitted along with all color TV programs. If you need to make a calibration, you simply compare the color TV signal with your local oscillator; NBS monitors the network signals and, monthly, publishes the measured differences between the networks and the NBS standard in Boulder in the *NBS Time and Frequency Services Bulletin*. With procedures developed by NBS, you can use this information to compute the difference between your local oscillator and NBS—thus your calibration is traceable to the Boulder standard without depending on WWV reception.

Two methods have been developed for doing this: (1) an inexpensive color-bar comparator method, requiring only a simple circuit connected to a standard color TV set and a stopwatch, and (2) a more complex and expensive digital offset computer method, which provides an

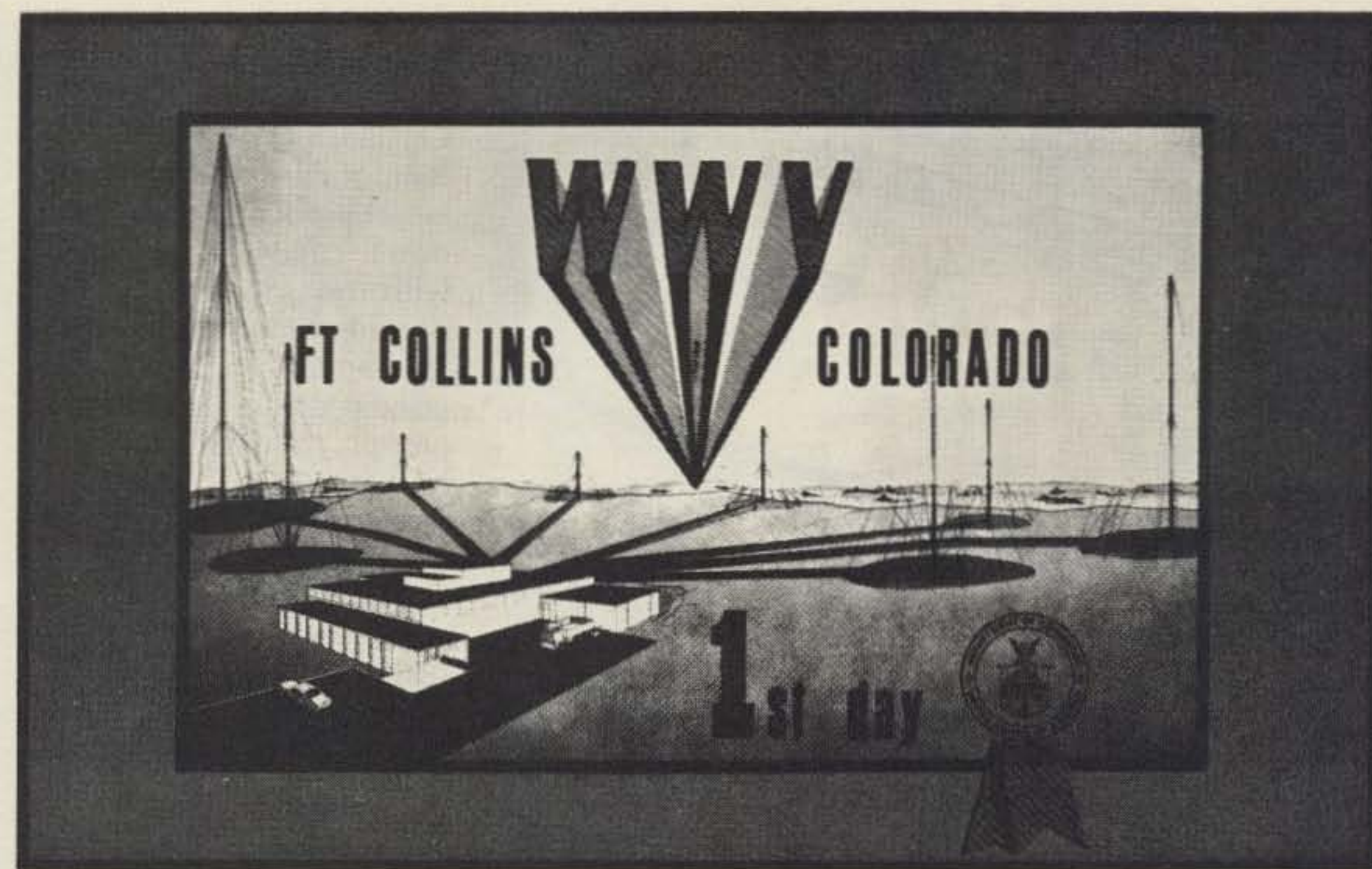

Fig. 3(a). WWV commemorative QSL card. This was issued in commemoration of the station's move to Fort Collins, Colorado, from Greenbelt, Maryland, in December, 1966.

Department of Commerce
 NATIONAL BUREAU OF STANDARDS

RADIO STATION WWV
 FORT COLLINS, COLORADO

| | |
|---------------------------------|--------------------------------|
| 2.5 MHz-40°40'55"N, 105°02'31"W | 15 MHz-40°40'45"N, 105°02'25"W |
| 5 MHz-40°40'42"N, 105°02'25"W | 20 MHz-40°40'53"N, 105°02'29"W |
| 10 MHz-40°40'48"N, 105°02'25"W | 25 MHz-40°40'51"N, 105°02'27"W |

This is to confirm your **first day reception** report of WWV.

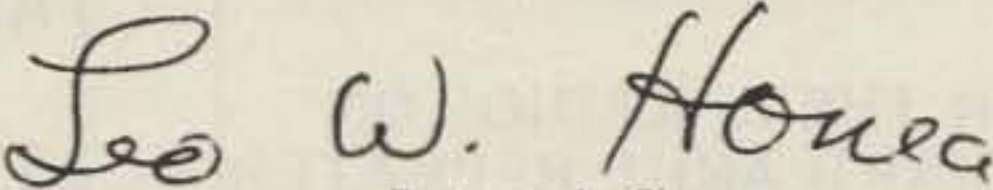
 Engineer-in-Charge

Complete Description of Services of NBS Radio Stations Given in
 Miscellaneous Publication 236 Available from Government Printing Office—15c

Fig. 3(b). Reverse side of commemorative QSL card. Notes: 1) 25 MHz transmissions from WWV have since been curtailed; 2) Special Publication 236 has been replaced by Special Publication 432.

automatic means of calibrating precision crystal or atomic oscillators, involving comparing a signal from the oscillator with the TV color signal and displaying digitally the frequency difference (expressed in parts per 100 billion). This requires a special computer, how-

ever, and is not for casual use, but it can be accurate to one part in 100 billion. NBS can give you more information on these interesting new techniques, including circuit details, if you write to them at Boulder, Colorado 80302. Fig. 1 shows system details. (Time comparisons using TV syn-

chronization pulses are also possible, down to less than one microsecond accuracy.)

Anyone for WWVB?

Earlier, I suggested that WWVB was the "way to go" for really accurate measurements of both time and frequency. Broad-

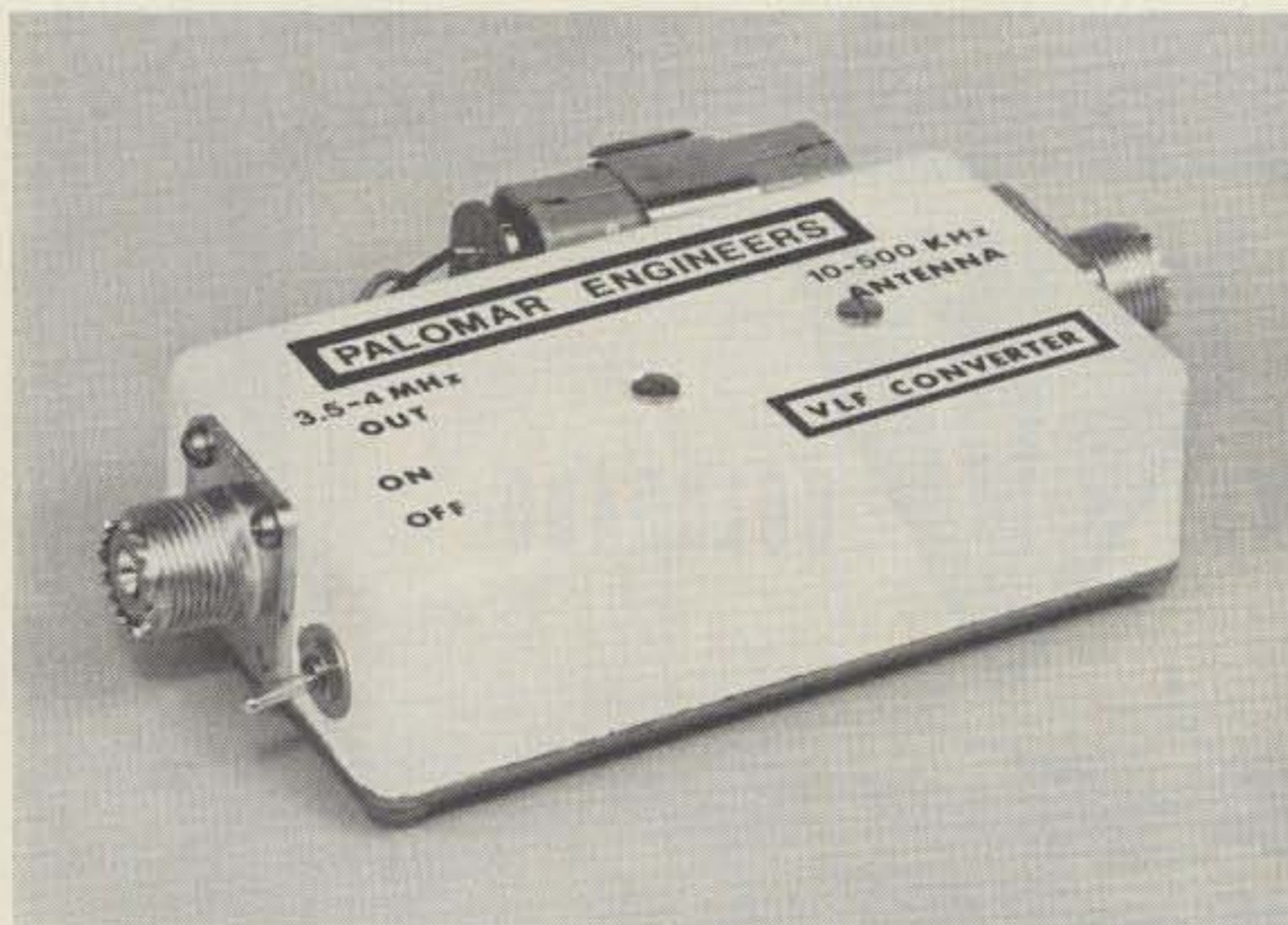

Palomar's new VLF converter can be used to tune WWVB on 60 kHz, as it "translates" the VLF spectrum from 10-500 kHz to the 75/80 meter band. Practically any antenna can be used with this type of converter. The exact length is not important, since any reasonable antenna will be short compared with the long wavelength. Good results can be had from a long horizontal wire (single-wire) or vertical antenna with the lead-in connected to the center pin of the coax antenna connector; a resonant antenna isn't necessary. Loop antennas are also good for VLF.

casting on 60 kHz, it transmits standard time signals, time intervals, and

special UT1 time corrections, much like WWV, but it is practically unaffected

by the propagation anomalies that plague HF stations such as WWV, WWVH, CHU, and JYJ. The problem, of course, is that most general-coverage receivers don't tune 60 kHz. But, with the advent of the experimental band at 160-190 kHz (1750 meters), some good receiver up-converter circuits that allow tuning VLF on an HF receiver or transceiver have been developed and published in the amateur literature. Also, Palomar Engineers (Escondido CA) has come up with a simple but stable crystal-controlled 10-500 kHz up-converter that moves the VLF/LF range tuned up to the 75/80 meter band (3500-4000 kHz).* This kind of converter design carries a plus in that you can also DX

*Actually 3510-4000 kHz, since the converter lower limit is 10 kHz, for a tuning range of 490 kHz.

ship-to-shore communications, the European LF broadcast band, and radio navigation beacons.** And, if WWVB's experimental sister station, WWVL, ever comes back on the air on 20 kHz (it was turned off in 1972), you should be able to receive it also.

WWVB covers most of the U.S. with a fairly good signal. A field intensity contour map is shown in Fig. 2. ■

**There are other standard time and frequency stations operating in the VLF region. These include GBR (Rugby, England) on 16 kHz; JJF2, Chiba, Japan, on 40 kHz; HBR, Pragens, Switzerland, on 75 kHz; and others, though not all these are necessarily loggable in the U.S. The *World Radio and TV Handbook*, distributed in the United States by Gilfer Associates, carries comprehensive listings of these stations.

2 METER CRYSTALS MANY IN STOCK

FOR THESE RADIOS ON
STANDARD ARRL REPEATER
FREQUENCIES

| | |
|--------------------------------|----------------------|
| Clegg HT-146 | Regency HR-212 |
| Drake TR-22 | Regency HR-2B |
| Drake TR-33 (rec only) | Regency HR-312 |
| Drake TR-72 | Regency HR-2MS |
| Genave | S.B.E. |
| Heathkit HW-2021 (rec only) | Sonar 1802-3-4, 3601 |
| Heathkit HW-202 | Standard 146/826 |
| Icom/VHF Eng | Standard Horizon |
| Ken/Wilson | Swan FM 2X |
| Lafayette HA-146 | Tempo FMH |
| Midland 13-505 | Trio/Kenwood |
| Regency HR-2 | Trio/Kenwood TR2200 |
| | Trio/Kenwood TR7200 |

\$3.95 EACH — IN QUANTITIES
OF 10 OR MORE, \$3.50 EACH

Certified check or money order only —
NO CODs

ROLIN DISTRIBUTORS
P.O. Box 436 R15
Dunellen NJ 08812
(201)469-1219

MFJ INTRODUCES A NEW 24 HOUR DIGITAL CLOCK

with HUGE 1-5/8 inch digits that you can keep set to GMT.
Alarm and snooze functions let you use it as an ID Timer.
Assembled, too!



\$29⁹⁵

MFJ Enterprises brings you a new 24 hour digital alarm clock with HUGE 1-5/8 inch orange 7 segment digits that you can see clear across the room.

This one is strictly for your ham shack, one that you can leave set to GMT. No more mental calculations to get GMT.

Use the alarm to remind you of a SKED or with the snooze function as an ID timer to buzz you in 8 minute intervals.

A constantly changing kaleidoscopic pattern indicates continuous operation.

Beige. 2-1/4 x 4-1/8 x 8-3/4 inches. UL listed. Requires 120VAC, 60Hz.

Order from MFJ and try it — no obligation. If not delighted, return it within 30 days for a re-

fund (less shipping). One year limited warranty by MFJ Enterprises.

To order, simply call us toll free 800-647-8660 and charge it on your VISA or Master Charge or mail us a check or money order for \$29.95 plus \$2.00 for shipping and handling.

Don't wait any longer to enjoy the convenience of a "Hams Only" clock. Order today.

MFJ ENTERPRISES

P. O. Box 494
Mississippi State, MS 39762 M52

Call Toll Free 800-647-8660

For order status and repair status and in Mississippi, call 601-323-5869.

SOME DRY INFORMATION ABOUT OUR ALL WEATHER ANTENNAS

Sooner or later almost all ordinary ham antennas are going to become victims of bad weather.

But Shakespeare's brand new line of two meter and HF antennas is anything but ordinary.

We're new to the ham market, but we've been making marine and military antennas for 26 years.

And those 26 years have taught us how to make a ham antenna that'll take just about anything Mother Nature can dish out.

Look at our 5705 omnidirectional VHF base antenna, for example.

Its radiating elements are non-ferrous brass and copper, the finest practical material available for conductivity and corrosion resistance. Surrounding the radiating elements and electrical components is a tough, flexible fiberglass shield. A shield that gives the antenna the strength to withstand winds in excess of 120 miles-per-hour.

The fiberglass keeps out rain, sleet and snow too. So the antenna's radiation pattern won't change, no matter how bad the weather.

Fiberglass protects radiating elements from rain and ice. Therefore no corrosion.

Fiberglass shield protects electrical components from corrosion caused by rain or ice.

Fiberglass gives added strength to the antenna. Prevents breakage in wind and sleet.

Fiberglass prevents radiation patterns from changing in wet weather.

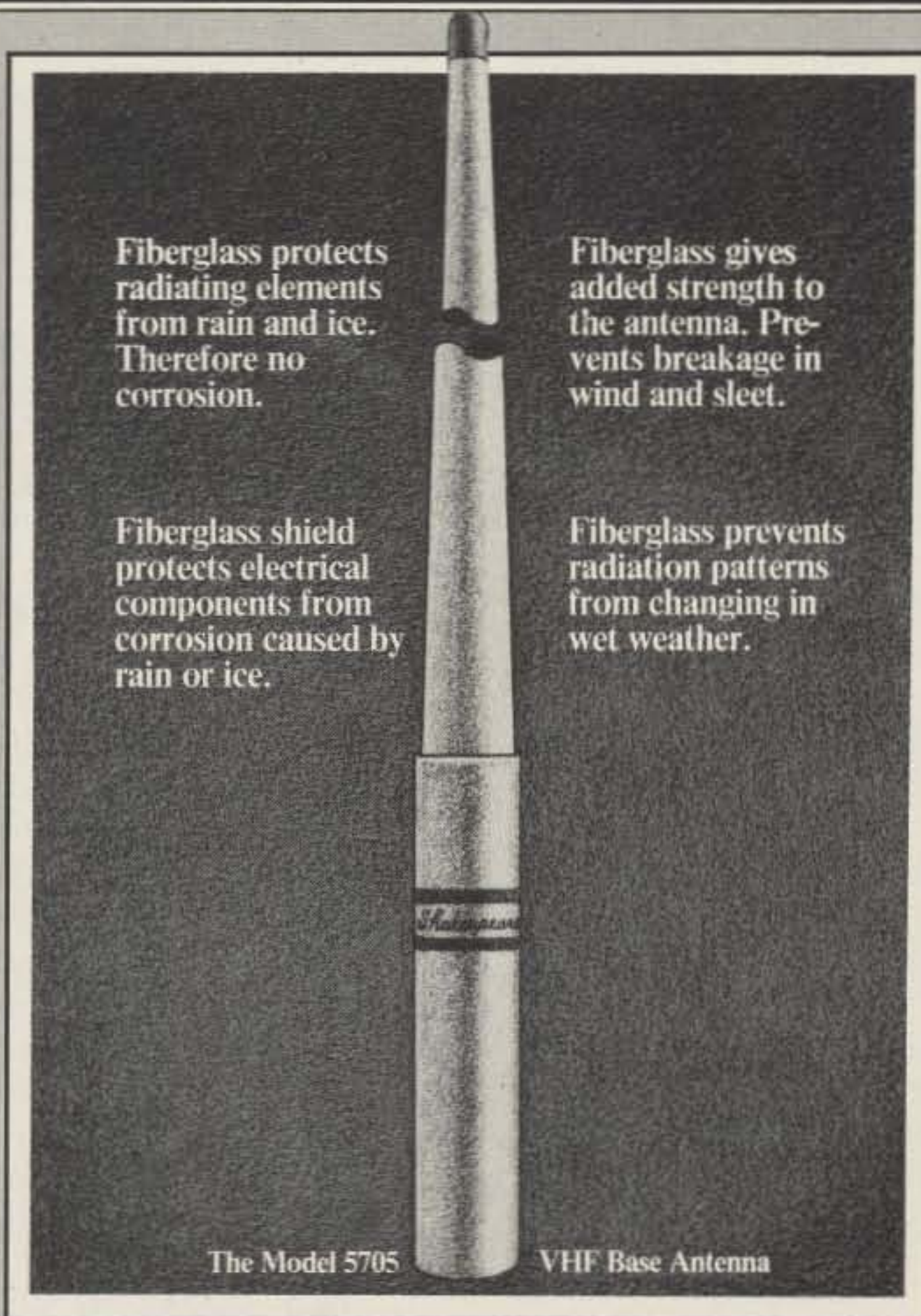

The Model 5705

VHF Base Antenna

And you don't have to worry about radials breaking off, because the 5705 doesn't have any.

But it does have seven vertically polarized and phased 1/2 wave elements, stacked in colinear array and providing an impressive 10 dB gain.

And you can get optional style 5709 reflector that blocks out unwanted coverage and gives you an additional 2 dB gain in the opposite direction.

And here's another important piece of information: the 5705 is pre-tuned at our factory to operate in all environments. So it'll never have to be re-tuned.

Our full ham antenna line is featured in our new catalog: The Complete Works of Shakespeare. And

the catalog is yours. For free.

For additional information just write Shakespeare, Electronics and Fiberglass Division, Department C, Post Office Box 246, Columbia, South Carolina 29202.

Or call National Sales Manager John Hughes, (803) 779-5800 or WA4EAU.

Shakespeare[®]

The Swiss Fork Special

—half-a-beam space saver

The antenna area is generally one where size and performance are directly related. However, sometimes by imaginative physical dimensioning of an antenna, one can obtain performance without an elaborate antenna structure. This is pretty much the case for the HB9 tuning fork antenna. This antenna was described several years ago by HB9RU; a number of them which have been built have given a good account of themselves. It is a compromise antenna, but, nonetheless, it can provide some pretty impressive features:

1. Gain of several dB in the forward direction.
2. A front/back ratio in the order of 10-15 dB.
3. Direct connection of a 52-Ohm coaxial feedline without the need for a balun.
4. A bandwidth of about 250-300 kHz over which the swr stays below 1.5 to 1.
5. Simple construction.

As shown in Fig. 1, the antenna is vertically polarized and is, more or less, half of a regular horizontal 3-element beam turned vertical, although some of the dimensions are slightly different than the norm for

regular 3-element beams. The element length and spacings are as follows:

| | |
|------------------------------------|---------------|
| Driven element: | .31 λ |
| Reflector element: | .29 λ |
| Director element: | .17 λ |
| Spacing, driven element/reflector: | .15 λ |
| Spacing, driven element/director: | .10 λ |

The beam can be built for any band, but is most conveniently built for the 40-10 meter bands. For the 20-10 meter bands, it can be built in such a fashion that it can be broken down easily and used as a portable antenna. It should also be useful for mounting on certain types of flat roofs.

In field usage, it was found that the antenna characteristics, such as swr versus frequency, did not change significantly if the metal boom was elevated at least several feet off the ground. It was claimed for the original design that ground radials were not necessary. But, obviously, when dealing with almost any vertical antenna and especially one which is not full size, good grounding and a proper ground screen

cannot help but improve performance. So, if one were to use the antenna in a fixed location, a good ground screen beneath the antenna is certainly to be recommended. However, for portable operation, one can use the antenna "as is" and obtain performance that would be hard to duplicate by any other form of completely self-contained antenna structure. No support structure is required for the antenna other than some means to get the boom at least several feet off the ground.

The only adjustment necessary is the matching of the transmission line to the driven element. As shown in the original design of Fig. 1, a capacitor was used in series with the driven element and simply adjusted for minimum swr. Since the capacitor is placed at a low impedance, high current point, a receiver-type capacitor will suffice even for several hundred Watts output into the antenna. Care must be taken that the capacitor leads are solidly connected to the

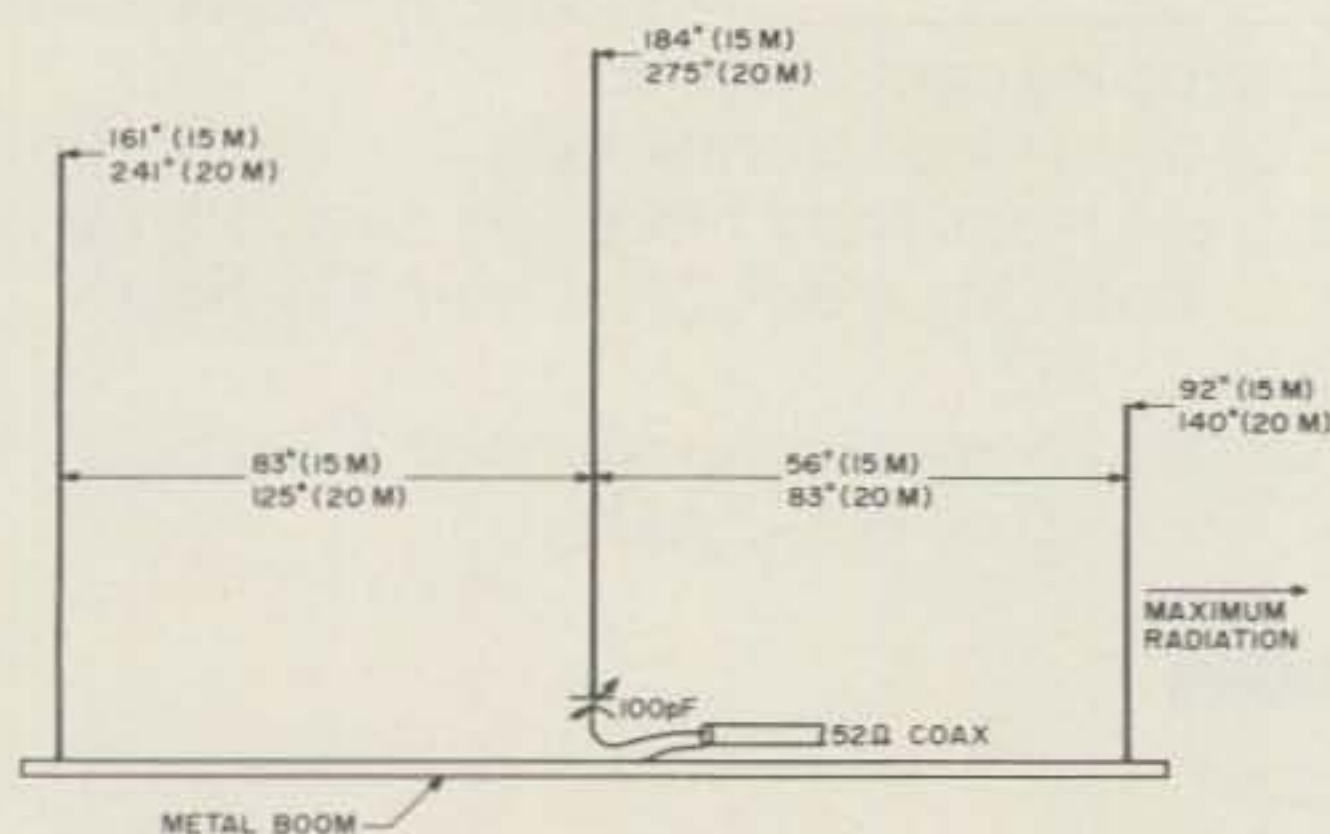

Fig. 1. The vertical "tuning fork" beam, with dimensions for 15 and 20 meters.

boom and to the driven element. This is also true for the connection of the reflector and director elements to the boom. An alternative to the use of the series capacitor method of matching is to use a regular gamma match as found in any antenna manual. If this type of matching method is used, the driven element need only be 0.25λ long instead of the 0.31λ length specified.

There are many methods

that one can use to construct the antenna. One way is by using telescoping aluminum tubing in a manner similar to that used for regular beam construction. By the use of a suitable PVC T-type pipe fitting, one can isolate the driven element from the boom if the series capacitor method of matching is used. The series capacitor need only be enclosed in some protective plastic housing attached to the PVC joint.

For knockdown, portable construction of the antenna, one should consider the use of the old MS series of military surplus mast sections. These are tubular steel, copper-coated mast sections which come in 3-foot lengths and screw into each other. Many amateurs don't know of them, but they represent one of the better bargains (\$.50-\$1 per section) still available for building portable anten-

nas. The mast sections come in a series of different diameter sections which screw together; a vertical element can be self-supporting to 15 feet easily, and higher yet under still wind conditions. Various insulated bases fit the series of mast sections, so it is easy to insulate a driven element from a boom. One source of these mast sections and accessories is Fair Radio, PO Box 1105, Lima OH 45802. ■

NEW
for '78

The FM Deviation Meter Anyone Can Afford



\$189

less batteries and crystals

ECM-5B MK-II fm modulation meter

- Now used by the U.S. Government in over 50 locations
- All new unbreakable A.B.S. cabinet
- 0-6 kHz peak reading linear scale
- Operates 25 MHz to 500 MHz
- Crystal controlled for easy operation
- Audio/Scope output with earphone
- Options: NICAD power PAK \$34.95

Charger \$39.95

Write or call for complete information. Send check or money order for \$189. Shipping prepaid in U.S. Indiana residents add 4% sales tax. Crystals \$7.95 each.

ECM

ECM Corporation
412 N. Weinbach Ave.
Evansville IN 47711
812-476-2121 E1

Sere-Rose & Spencer
Electronics S39

1465 WELLS STATION ROAD
MEMPHIS, TENN. 38108
PH (901) 683-9125—685-8461

Authorized Dealer

DRAKE—ICOM—KENWOOD
REGENCY—TEMPO—DENTRON

CALL OR WRITE
FOR BEST DEAL

1315 BLUFF CITY HWY., BRISTOL, TN. 37620

Rush Electronics Inc.
Quality Electronics Department Store R21



FT-101E

YAESU HF SSB FT-101E
160 thru 10M \$799.00 Retail

COMPLETE LINES
TEMPO
KDK
HYGAIN
DENTRON
CUSHCRAFT
LARSEN

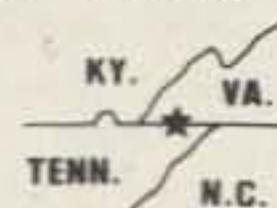

WRITE FOR
SPECIAL PRICES

CALL BOB BROWN WA4HAA
FOR SPECIAL QUOTE
615-764-0831 or 968-5343

HIGH PERFORMANCE CONVERTER AND PRE-AMP FOR OSCAR

UHF Converter



Model
C-432A (408)
\$5995

- Converts 432 or 435 MHz to 29 MHz. (Be sure to specify the input frequency you want)
- 2 tuned RF stages using low noise J-FETS eliminates the need for a separate UHF pre-amp
- Special RCA dual-gate MOSFET mixer gives good conversion gain and minimum cross modulation
- High frequency quartz crystal oscillator and multiplier stages use 1.2 GHz transistors for maximum efficiency
- Conversion gain is more than 20 dB (typically 25 dB) therefore assuring you .1 microvolt sensitivity when used with an average communications receiver
- Just connect a simple turnstile antenna (see Nov. '77 of 73 Magazine) and a 12 volts DC power source (only 30 mA required) and you're ready to receive.

SEE OUR OTHER PRODUCTS IN THE FULL PAGE AD OF THE DECEMBER 1977 ISSUE OR WRITE FOR CATALOG SHEET.

Low Noise • High Gain Pre-Amp For 29 MHz.



Model
201-29
\$2995

- 35 to 40 dB power gain at 29 MHz with a noise figure of only 2.0 dB and a bandwidth of 1 MHz.
- Makes reception of OSCAR possible even with low cost receivers or old receivers with poor sensitivity at 29 MHz.
- Two RF stages using dual-gate MOSFETS
- Manual gain control and provision for AGC
- Requires 12 volts DC at 10 mA.

For immediate shipment of either item call (212) 468-2720 or mail your order with payment plus \$1.00 for air mail to:

VANGUARD LABS
196-23 Jamaica Ave.
Hollis, NY 11423

V1

The End of the Rat's Nest

— a sensible operating console

Most of the amateurs I know are very creative when it comes to designing circuits, but use very little imagination in the designs of their operating benches.

The typical amateur uses a desk or a table for his radios, tacks a coax switch to the wall, places an swr bridge on the receiver, and puts a Cantenna on the floor. Coax, wires, and cables run in seventeen directions, and logbooks, QSL cards, and manuals are stacked in a corner.

A beautiful bench need not be costly, and it can be much more functional than a

tabletop. It should have a compartment to house each piece of equipment plus storage for books, logs, and odds and ends. Ideally, the entire bench should be movable with little effort.

With these parameters in mind, I set out to build an operating bench. Since I have four thumbs on each hand, I decided to modify an existing piece of furniture rather than start from scratch. I found that old breakfronts, storage cabinets, and the like would work nicely. I had an old cabinet/bar piece of furniture which was in excellent shape, and it seemed suitable for the purpose. However, like many

Danish Modern pieces, it had spindly, wobbly legs.

I won't bore you with all of the details of the conversion, but I would suggest you follow some of the steps that I did. These include:

1. Start with Danish Modern furniture, if you can. Then, the finished piece will look more like a custom-made bench than a converted piece of furniture. However, other types of furniture can be used to obtain very desirable results.

2. If the piece has spindly or wobbly legs (mine had thin wrought-iron legs set at an angle), remove the legs. Build a 2" x 4" framework almost

as high as the legs were and attach paneling to the framework.

3. Buy 4 heavy-duty plate swivel casters and screw them to the bottom corners of the 2" x 4" framework.

4. Count the number of items that require 110 V ac. Add two or three to the number and buy enough duplex outlets and boxes to accommodate that many plugs. Decide where those outlets should be situated (on the back of the bench) so that each ac cord takes the most direct route from appliance to outlet. My cords are routed from the equipment through holes in the back panel of the console to the nearest outlets.

Mount the boxes, connect them with conduit, and wire the outlets. I wired some of mine so they are always on (clocks, tape recorder, etc.) and the rest are controlled by a master switch that kills the power to the transceiver, rotor, etc. Shorten all line cords. If you don't want to cut them, wrap them in small bunches and tie the bunches with cable ties.

5. If your piece of furniture doesn't have a drop-down writing surface (mine did) obtain a piece of plywood or formica-covered particle board and hinge it to the front of the furniture at the proper height. The writing surface is kept level, without additional support, through the use of lid support brackets or folding shelf brackets. Both types may be obtained from Craftsman Wood Service Company, 2727 S. Mary St., Chicago, Illinois 60608.

6. If you had to build the 2" x 4" framework, nail or glue some attractive paneling to the front and sides and attach corner moldings for a nice finish.

7. Most radios are too deep to fit in normal furniture. You may have to do as I did and cut away part of the back panel of the furniture. Then bolt pieces of plywood to the shelves below

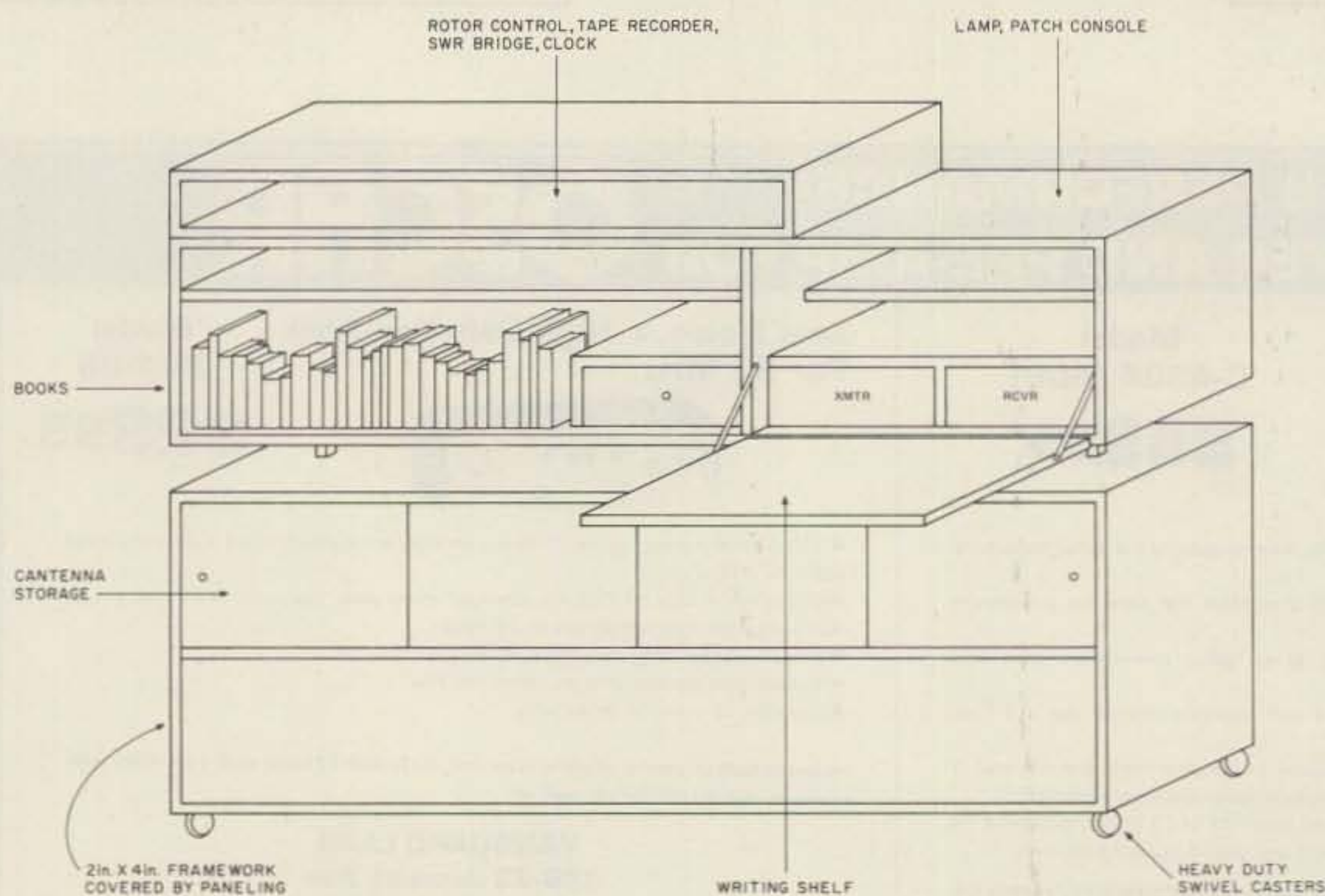
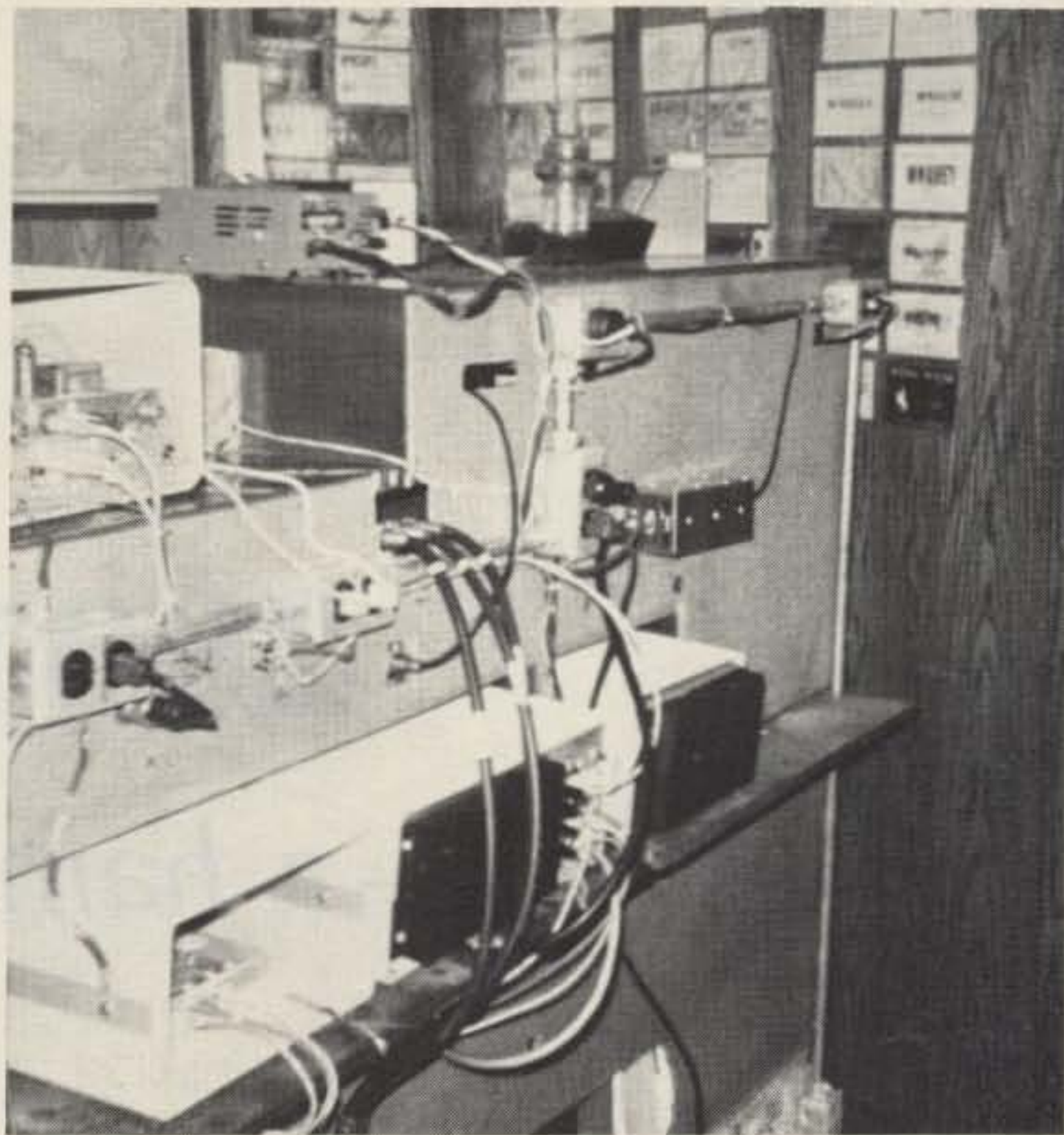

Fig. 1.



the cutouts. Your rigs will extend beyond the back panel but give the appearance of fitting entirely within the cabinet. Naturally, your bench will not fit flush

against the wall once it is modified in this fashion.

8. Use cable ties and staples to keep the wiring behind the console neat. Mount coax switch, filter

switch, etc., on the inside of the back panel.

I have been in dozens of ham shacks but have never seen an operating bench as functional or attractive as

mine. It's ironic that I was going to throw out that old dilapidated bar unit, and the XYL said, "Save it; it may come in handy for something." ■



**Germantown
Amateur
Supply,
Inc.**



G-12

MEMPHIS, TENNESSEE

NO MONKEY BUSINESS!

- (A) Complete Service Facilities
- (B) Good Deals on most Brands
- (C) Shipping within 24 Hours
- (D) All inquiries handled by Active Hams with over 20 years experience in ham radio

CALL TOLL FREE
1-800-238-6168

IN TENNESSEE, CALL 901-452-4276
MONDAY - SATURDAY 8:30-5:30
FOR YOUR SPECIAL.

Write: 3202 Summer Ave., Memphis, Tennessee 38112

Remember Our 45th Anniversary

OPEN HOUSE and TRADE SHOW

Two days—Sept. 15 & 16 1978
Hours: 9 AM to 4:30 PM

OPEN HOUSE AT EVANS

Rt. 3A Bow Junction

TRADE SHOW AT N.H. HWY HOTEL

Exit 14 off I-93—Shuttle Bus Service—
Parking at Hwy Hotel



E33



- Concord: PO Box 893/Concord NH 03301/224-9961
- Nashua: 3 Progress Ave./Nashua NH 03060/882-2761
- Portsmouth: 100 Coakley Rd./Portsmouth NH 03801/431-5570

2001 - 3

—a ham odyssey

It was the day for our weekly mail delivery, and I walked a little faster than usual on the way home from work. The small pile of envelopes was on the table by the door when I came in. Just the usual bills, I thought, as I thumbed through them. But wait a minute; here's a personal letter. Don't get many of those these days. I opened it quickly.

Hotel Winston
Chicago, Illinois
February 2, 1998

Dear Frank:

I ran into Steve Brewster here the other day, and he gave me your address. Guess we haven't seen each other since 1978 or so. Twenty years! Remember the fun we used to have with amateur radio when we were neighbors? I dropped out of it years ago; don't even know if it still exists, what with the limited fuel for home electricity.

I'm arriving in Dallas

two weeks from this coming Sunday and will be there a few days on business. My train from Oklahoma City should get into Dallas about two o'clock in the afternoon. Sure hope we can get together!

Best regards,
Jim Foster

Jim had been a very good friend, and our common interest in ham radio led us to spend many enjoyable Saturday afternoons together working on antennas, conducting experiments, or just shooting the breeze. I looked forward to his visit. Martha was as pleased as I at his coming, and we made plans for him to stay at our house.

His train was three hours late, which wasn't unusual. The icy wind cut into my face as I walked out of the unheated terminal building to meet the train. Jim was one of the first ones off the train. I didn't recognize

him at first; he was much thinner than I remembered him. From the white stubble on his chin, I estimated that he hadn't shaved since Thursday. Then I realized he wouldn't know me with my beard. I gave up shaving and paying for haircuts six years ago; they were luxuries I couldn't afford anymore. I just trim up the edges with scissors now and then.

"Jim!" I called to him when I had worked my way through the crowd to within about ten meters of him. He turned toward my voice, but there was a blank gaze in his eyes as they swept past me, and I knew that I appeared a stranger to him. I waved to him and called again. His eyes darted back to me, stared a moment, frowned, then gave that funny grin of his with his eyes squinting almost shut.

"Frank! Is that you?" His grin widened as we shook hands. "My God, Frank, you look like Santa Claus! I'd never have known you."

We stood there a moment, laughing and slapping each other on the shoulders.

"Come on, Jim," I said, "it's two miles to the feeder train, and we can just make the last run if we walk fast." He picked up his bag, and we started back through the terminal. "You're staying at our house tonight; we've got some canned fish we've been saving for a special occasion, and this is it!"

"Well, that's sure hospitable of you, Frank. It'll be a welcome change from hotel rooms. Thank you!" We didn't need much incentive to walk fast in the cold February wind, so we caught the feeder with several minutes to spare. It being Sunday, we could stand comfortably during the two-hour ride without being crushed between other passengers.

"Tell me about yourself," said Jim. "What are you doing?"

"I'm a research engineer in the micropower elec-

tronics lab at the university, Jim. Used to be you had to have a PhD, or at least a master's degree, to do research there, but credentials aren't so important anymore. Productivity is all anybody cares about. It's only a three-mile walk from my home to the lab, and I enjoy it, except when it's cold or raining, or both. What about you? You seem to be a traveling man."

"Yeah, I'm an energy efficiency inspector for the government. It keeps me on the move constantly. When Janet died, I sold the house and have been practically living out of a suitcase ever since. That's one reason I dropped out of ham radio so long ago. I guess you dropped out, too, when the rationing got tight on home electricity, didn't you? There isn't any ham radio anymore, is there?"

"Oh, sure, Jim! Amateur radio is still legal, but you have to furnish your own power from homemade batteries or generators turned by hand crank or foot pedals, or anything else you can think of, as long as you don't use the public utilities. There are wind-driven generators, if you can find them and are able to pay for them. The farmers with creeks on their land have it made; they dam up the creeks and use water wheels to turn their generators. They have all kinds of power, compared to the rest of us. Trouble is, the generators are all wearing out, and parts are very hard to find. Most people use old alternators from automobiles, and they aren't making those anymore. The reason amateur radio is still around is that hams innovate and contribute to energy technology. But you probably already know about all this, being a government energy inspector."

"Far from it, Frank. I'm

only concerned with the big stuff. Public utilities, what industry there is, that sort of thing. I didn't know the FCC still existed! My job keeps me awfully busy. Most all of my time in hotels and riding trains is taken up with writing my reports. Don't guess I've read a newspaper or listened to a radio in months—maybe years. My ears aren't what they used to be, and those crystal sets they have in some of the hotels don't put enough power into the headphones for me to follow what's being said."

"That's too bad, Jim," I said. "We get a lot of enjoyment from our crystal set. The lack of selectivity is no problem because there aren't many radio stations. If you're lucky, you live within 25 miles of a 250-Watt station. That's the legal power limit for AM broadcasters. They only broadcast at night. News and educational material mostly, but, on Saturday nights, our station plays recordings of the old radio shows from the 1930's and 1940's—drama, comedy, cops and robbers. Young people don't understand much of it, because life was so much different then. I use a Schottky diode in our crystal set. Salvaged it from an old balanced mixer."

"Are you still active in ham radio?" asked Jim.

"I still tinker around with radio at home when I have a little free time. It's almost like when I was a kid in 1940, building galena crystal sets; didn't solder wires together—just scraped the enamel off with a knife and twisted the wires together. Now I twist the wires together because it's aluminum wire. Copper wire and solder just aren't available for ham use. We have a little of each at the lab, but we don't use it very often. There isn't a soldered con-

nection in any of my ham equipment. And aluminum wire isn't what you'd call plentiful; anytime you get hold of a piece of stranded wire, you unwind it to make seven pieces of solid wire. Very few electronic parts are manufactured anymore, and nearly all the components we use are salvaged from old equipment."

"I had no idea things were that bad," said Jim.

"You'd never guess what I'm using to power my rig," I said. Jim's face broke into a curious grin, expecting to hear some wild tale. I smiled and continued. "I've got the back end of an old bicycle frame mounted upside down under the operating table so I can work the pedals with my feet. I've never been able to get an alternator or generator, but I happened to acquire twenty of those little permanent magnet motors they used to make for battery-operated toys. They work as generators when you rotate their shafts. I've got them spaced around the bicycle wheel so the wheel drives them all at the same time; they put out a dc voltage, and I've just connected them in series. The generator shafts turn at about 1000 rpm with a comfortable pedal speed, and each one puts out about 0.7 volts."

Jim began to chuckle. "That sounds like a real contraption," he said. "How much power do you get out of it?"

"Oh, I get more than enough for my transmitter," I replied. "I only run about one Watt output on forty meters."

"One Watt!" exclaimed Jim. "I used to read about the QRP boys back in the old days, but I never figured many of them did much good. Gee, when I sold my rig, I had a kilowatt and a beam on a sixty-foot tower." We looked at each other silent-

ly for a moment when he said that. It hit us how everything had deteriorated as the Earth's oil and gas reserves had been used up. We didn't talk much during the rest of the train ride. Just stared out the window into the darkness of the night, each of us absorbed in our own thoughts.

"This is where we get off, Jim," I said, moving to the door as the train slowed. It was a five-mile walk to my house from the train, and, although it was cold, the wind had calmed. We made small talk on the way. Martha met us at the door, and the smell of fish cooking on the space heater brightened our spirits. After dinner, I took Jim out to the garage to show him my rig.

"Since we don't have cars anymore, Jim, garages make great workshops and ham shacks. All kinds of room." I set the candle on the operating table, pulled up an extra chair for Jim, and then sat down and started pumping the bicycle pedals. When the flashlight bulbs strung above the table brightened, I blew out the candle.

"I'll be darned," said Jim. "Electric lights and everything!"

"Nothing but the finest!" I said with a smile. "My generators furnish lighting as well as power for the ham gear!" I pointed to the circuit mounted on a small piece of wooden board. "That's my transmitter, Jim—two FETs. Just a crystal oscillator and amplifier operated CW. You never hear any phone signals on the bands. This rig draws about 120 milliamps at 14 volts and has about one Watt output. Everybody uses crystal control. No reason not to. There aren't so many of us active anymore. The antenna is a 40 meter half-wave dipole

about 20 meters above the ground, strung between two trees. It's made from short pieces of aluminum wire twisted together, end-to-end. Sometimes the wind blows it down. My transmission line to the antenna is open-wire twinlead with the two wires spaced about five centimeters apart. It's made from short pieces of aluminum wire, too. The spacers are made from short pieces of scrap plastic rods, broken knitting needles, swizzle sticks, you name it. I got a bad blister on my thumb from turning the crank on my hand drill when I drilled all those holes in the ends of the spacers."

"I'm really amazed," Jim said slowly. "Does all this haywire rig really work?"

"Sure does!" I replied proudly. "That's the receiver there on the right. It's a direct-conversion

type—not very efficient. It draws about five milliamps at 14 volts. Last month, I worked two stations, one in St. Louis and one in Phoenix. We don't exchange QSL cards anymore. Postage costs too much. The guy in St. Louis is an electrochemist; he was testing a new kind of organic battery with his three-Watt rig. Put in a good signal here. The one in Phoenix was working with a half-Watt outfit powered by batteries he kept charged with solar cells. No telling where he got those solar cells; they're probably harder to find than any part you can think of." I could see Jim was listening very intently, so I said, "Go ahead and put on the headphones. Tune around the band." He adjusted the phones to his ears slowly and carefully, then leaned forward and turned the receiver's

tuning dial across the band. After a moment, he stopped and listened. He must have picked up a station. In a few minutes, he smiled and removed the headphones.

"Somebody in Kansas City working a guy in Atlanta, but I couldn't hear the Atlanta station. He was only running one Watt, but he had a fairly decent signal. Not strong, but not weak, either. He sent code awfully slow. Must not have been over five words per minute."

"We all send slow, Jim. Remember back in the days of moonbounce how the best technique was slow CW? Well, that goes for any weak signal conditions. It's easier to copy weak signals when code speed is slow, and, if the signal fades temporarily, you don't miss very much."

Jim put the phones down on the table. "Gee, I sure

envy you, Frank. You must have a lot of fun with this. In a way, it must be like ham radio was back in the early days before our time."

"I'm sure it is, Jim. Sometimes I get to philosophizing and think it's some sort of a cycle. Right now we're in a trough, but there may be another crest in the future sometime."

"Maybe so, Frank. Maybe not. From what I've seen tonight, though, I don't think ham radio will ever die out completely. Not as long as there is civilization."

I felt good when he said that. I lit the candle, took my feet off the bicycle pedals and watched the flashlight bulbs grow dim and go out. We got up and went back into the house. Martha was brewing that coffee we had saved, and it smelled great! ■



BRITT'S

2-Way Radio Service B29

2508 North Atlanta Road
Belmont Hills Center
Smyrna,
Georgia 30080
Phone (404) 432-8006

North Georgia's only Authorized Yaesu Dealer

| | |
|----------------|----------------|
| Yaesu | Kenwood |
| Mosley Antenna | Vibroplex keys |
| Cush-Craft | B & W |
| Rohn-Tower | Swan meters |
| C.D.E. Rotors | Hustler |
| Shure | Saxton |
| Wilson | ARRL Books |
| M F J | Call Books |

TPL 2 Meter Amplifiers
Complete service facilities

Call toll free 1-800-241-9961

10 METER C.B.?

SURE!!

With the proliferation of used SSB CB transceivers out there it's a perfect way to go QRP on TEN: Look around your neighborhood and come up with that 23 channel or 40 channel SSB. We make kits for 55 different radios that will put you on the 10 Meter C.W. and Phone Band. Perfect for Oscar work.

- Low cost (from \$10.00).
- Easy to install with all instructions.
- Tune up procedure.
- Alignment for base and mobile. We presently stock kits for most:

| | | |
|---|---|---|
| SBE REALISTIC TRAM COBRA PRESIDENT | BROWNING LAFAYETTE TEABERRY REGENCY PACE | HYGAIN MIDLAND ROYCE COURIER AND MANY MORE |
|---|---|---|

Write or call today for free specification sheets or tell us the make and model of your transceiver and if we don't stock a kit for it, we will make one for you at the same price. For more information write:



AMERICAN CRYSTAL SUPPLY CO.
PO BOX 638
W YARMOUTH, MA 02673
(617) 771-4634

A58

9:30 CST
TO
5:00 CST
MON. thru SAT.

YAESU
The radio.



Is Our Number **1** Line At

Cohoon Amateur Supply C83

1. Full Repair Service
2. Sub-Dealers Welcome
3. Good Prices
4. Ship UPS The Same Day
5. All Used Gear Listed Below
Has A 90 Day Warranty.

USED BUYS

YAESU

| | |
|----------|-------|
| FT-101E | \$599 |
| FT-101EE | \$539 |
| FT-101EX | \$489 |
| FL-21000 | \$359 |
| SP-101B | \$15 |
| FT-301SD | \$459 |
| FT-301S | \$330 |

TEN-TEC

| | |
|------|-------|
| 540 | \$499 |
| 544 | \$539 |
| 2626 | \$99 |
| 509 | \$290 |

DRAKE

| | |
|--------------|-------|
| T4XB | \$299 |
| R4B | \$299 |
| MN-4 | \$89 |
| DC-3 | \$45 |
| TR-4CW/w RIT | \$625 |
| DC-4 | \$79 |
| MS-4 | \$15 |

HEATH

| | |
|---------------|-------|
| SB-104 w/p.s. | \$659 |
| HW101 w/p.s. | \$369 |
| SB-301 | \$180 |

ALSO STOCKING

KENWOOD

TEN-TEC

TEMPO

WILSON

INFO-TECH

KANTRONICS

ATLAS

DENTRON

CUSHCRAFT

KLM

SWAN

TO SERVE YOU BETTER
3 LOCATIONS

Cohoon Amateur Supply

SOUTH

Hwy. 475 Trenton, Kentucky 42286

502-886-4534

Cohoon Amateur Supply

NORTH

Box 4073 Austintown, Ohio 44515

216-538-3424

Cohoon Amateur Supply West Coast Outlet
728 Juniper, VAFB
Lompoc, CA 93437 805-734-4693



YAESU
DEALER

Aug 1978

FREE PROBES FREE PROBES FREE PROBES

NLS MS-215 DUAL TRACE MINISCOPE \$395.00



NLS
1c SALE

LM3A 3 dig 1% DC \$125.
LM3.5A 3 1/2 dig .5% DC \$147.
LM40A 4 dig .1% DC \$190.
LM4A 4 dig .03% DC \$227.

- Rechargeable batteries and charger included
- Measures DC Volts, AC Volts, Ohms and Current
- Automatic polarity, decimal and overload indication
- Rechargeable batteries and charger included
- Measures DC Volts, AC Volts, Ohms and Current
- Automatic polarity, decimal and overload indication
- No zero adjustment and no full-scale ohms adjust
- Battery operated — NiCad batteries; also AC line operation.
- Large LED display for easy reading without interpolation
- Size: 1.9" H x 2.7" W x 4" D
- Parts & labor guaranteed 1 year
- Tilt stand option \$ 3.50
- Leather case \$16.00

Purchase any of the LM series Meters and buy the LEATHER CASE for 1c



NLS
\$289

MS-15 MINISCOPE With Rechargeable Batteries & Charger Unit

- 15 megahertz bandwidth.
- External and internal trigger.
- Time base — .1 microsecond to 0.5 sec. — 21 settings ±3%.
- Battery or line operation.
- Automatic & manual triggering.
- Power consumption — 15 watts.
- Voltage — 100 Volts — 12 settings ±3%.
- Resolution — 1.25"
- Size: 2.7" H x 6.4" W x 7.5" D, 3 pounds.
- 1 year parts & labor guaranteed 1 year.
- Size: 2.7" H x 6.4" W x 7.5" D, 3 pounds.
- Leather carrying case \$24.50
- Leather case \$36.00

MS-215 Dual Trace Version of MS-15 \$395.00

3 LEVEL GOLD WIRE WRAP SOCKETS

| | | | | | |
|--------|-------|-------|---------|---------|-------|
| 1-24 | 25-49 | 50-99 | 100-249 | 250-999 | 1K-5K |
| 9 pin | 41 | 38 | 35 | 31 | 27 |
| 14 pin | 39 | 38 | 36 | 32 | 23 |
| 16 pin | 41 | 42 | 39 | 35 | 30 |
| 18 pin | 63 | 58 | 54 | 47 | 36 |
| 20 pin | 80 | 75 | 70 | 66 | 53 |
| 24 pin | 90 | 85 | 80 | 70 | 57 |
| 24 pin | 90 | 84 | 78 | 68 | 58 |
| 28 pin | 110 | 100 | 90 | 84 | 71 |
| 40 pin | 150 | 140 | 130 | 120 | 89 |

Sockets purchased in multiples of 50 per type may be combined for better prices.

All sockets are GOLD 3 level closed entry. End & side stackable. 2 level, Solder Tail, Low Profile, Tin Sockets and Dip Plugs available. CALL FOR QUOTATION

SALE S-100 BUS EDGE CONNECTORS SALE

S100-WWG 50/100 Cont. .125 ctrs. 3 LEVEL WIRE WRAP .025" sq. posts on 250 spaced rows. GOLD plated.
1-4 5-9 10-24
\$4.00 \$3.75 \$3.50

S100-WWN 50/100 Cont. .125 ctrs. 3 LEVEL WIRE WRAP .025" sq. posts on 250 spaced rows. NASGLO tin-nickel plated.
1-4 5-9 10-24
\$3.50 \$3.25 \$3.00

S100-STG 50/100 Cont. .125 ctrs. DIP SOLDER TAIL on 250 spaced rows for VECTOR and IMASI motherboards. GOLD plated.
1-4 5-9 10-24
\$4.00 \$3.75 \$3.50

S100-STN 50/100 Cont. .125 ctrs. DIP SOLDER TAIL on 250 spaced rows for VECTOR and IMASI motherboards. NASGLO tin-nickel plated.
1-4 5-9 10-24
\$3.50 \$3.25 \$3.00

RG81G 50/100 Cont. .125 ctrs. DIP SOLDER TAIL on .140 spaced rows for ALTAIR motherboards. GOLD plated.
\$5.00

R681-3 50/100 Cont. .125 ctrs. PIERCED SOLDER EYELET tails. GOLD \$7.35

Other Popular Edge Connectors

R644-G 22/44 Cont. .156 ctrs. PIERCED SOLDER EYELET tails. GOLD plated.
1-4 5-9 10-24
\$3.00 \$2.75 \$2.50

R644-3 22/44 Cont. .156 ctrs WIRE WRAP tails. GOLD \$4.71

ATTN: OEM'S and Dealers, many other connectors available call or quotation.

8803 MOTHER BOARD FOR S100 BUS MICRO-COMPUTERS

Price: **\$29.50**

- All includes 12 tantalum capacitors for +5, +12, -12 buses and insulated mounting spacers.
- Wiring side shown. Component side bare epoxy glass with white markings for component locations.
- C10 epoxy glass board with 2 ounce copper, solder plated and .038 dia. for holes for leads.
- Solder mask with solder windows on etched circuits to avoid accidental short circuits.
- Mounts 11 receptacles with 100 contacts (7 rows) on .125 centers with .250 row spacing. Vector part number R681-2; or mounts 10 receptacles plus interconnections to smaller mother board for expansion.
- Includes etched circuits and instructions for option of active, pull-up, or floating terminations.
- Large buses: +5V and GND (10 AMP), ±12V or 19V (7 AMP). Current ratings are per MIL-STD-275 with 10°C rise.
- Fits in Vector-pak enclosures.
- Fits in IMASI 8080 microcomputer as expander board.

Vector Plugboards

8800V Universal Microcomputer/processor plugboard, use with S-100 bus. Complete with heat sink & hardware. 5.3" x 10" x 1/16"

| | | |
|---------|---------|---------|
| 1-4 | 5-9 | 10-24 |
| \$19.95 | \$17.95 | \$15.95 |

8801-1 Same as 8800V except plain, less power buses & heat sink.

| | | |
|---------|---------|---------|
| 1-4 | 5-9 | 10-24 |
| \$14.95 | \$13.46 | \$11.96 |

3677 9.6" x 4.5" \$10.90
3682 9.6" x 4.5" \$10.97
3682-2 6.5" x 4.5" \$9.81
3677-2 6.5" x 4.5" \$9.74

Hi-Density Dual-In-Line Plugboard for Wire Wrap with Power & Grd. Bus Epoxy Glass 1/16" 44 pin con. spaced .156

3690-12 CARD EXTENDER
Card Extender has 100 contacts-50 per side on 125 centers-Attached connector-is compatible with S-100 Bus Systems.....\$25.00
3690 6.5" 22/44 pin .158 ctrs. Extenders.....\$12.00

3662 6.5" x 4.5" \$7.65
3662-2 9.6" x 4.5" \$11.45
P pattern plugboards for IC's Epoxy Glass 1/16" 44 pin con. spaced .156

2708 8K 450 ns EPROM FACTORY PRIME \$10.00 EA. 25 + Call For Price

1/16" Vector BOARD .042 dia holes on 0.1 spacing for IC's

| Phenolic | SIZE | PRICE |
|------------|----------|-------------|
| PART NO. | | 1-9 10-19 |
| 64P44XXXP | 4.5x6.5" | \$1.49 1.34 |
| 169P44XXXP | 4.5x17" | \$3.51 3.16 |

| Epoxy Glass | SIZE | PRICE |
|-------------|----------|-------------|
| PART NO. | | 1-9 10-19 |
| 64P44 | 4.5x6.5" | \$1.70 1.53 |
| 84P44 | 4.5x8.5" | \$2.10 1.89 |
| 169P44 | 4.5x17" | \$4.30 3.87 |
| 169P84 | 8.5x17" | \$7.65 6.89 |

SLIT-N-WRAP P180
Wraps insulated wire on .025" square posts
FOUR TIMES FASTER than regular manual wrap post tools

\$24.50

P160-4T includes charger, wire \$75.00

SLIT-N-WRAP 12" Package WIRE NO. 28 GAGE INSULATED WIRE, 100' SPOOLS
W28-2-A-Pkg. 3. Green W28-2-C-Pkg. 3. Clear W28-2-B-Pkg. 3. Red W28-2-D-Pkg. 3. Blue

14 & 16 PIN GOLD 3 LEVEL WIRE WRAP SOCKETS

14 - G3 100 for \$30.00
16-G3 100 for \$30.00
50 of each for \$32.00

Sockets are End & Side stackable, closed entry

LIQUID CRYSTAL DIGITAL CLOCK-CALENDAR

- For Auto, Home, Office
- Small in size (2x2 1/2 x 1 1/2)
- Push button for seconds release for date.
- Clocks mount anywhere with either 3M double-sided tape or VELCRO, included.
- 2 MODELS AVAILABLE
- LCD-101, portable model runs on self-contained batteries for better than a year
- LCD-102, runs on 12 Volt system and is back-lighted.
- LCD-101 or LCD-102 your choice
- Clear desk stand for

\$34.95.. \$2.00

LEDU MG 10A List \$72. \$44.95 SPECIAL

Perfectly balanced, fluorescent lighting with precision magnifier lens. For prof., techn. & hobbyist. Has the cast protective shade, inst. start 3 diopter lens, 42" reach.

with T8 fluorescent lamp (required) \$49.95
Jumbo Gray or Black Chrome Brown 2 choices please

SC-5 With Rechargeable Batteries & Charger Unit \$89

FM-7 With Rechargeable Batteries & Charger Unit \$195

Features include: • By using the new NLS SC-5 Prescaler, the range of the FM-7 Frequency Meter, which is 10 Hz to 60 MHz, may be extended to 512 MHz (the upper VHF & UHF frequency bands). • The FM-7 utilizes an LED readout, providing 7-digit resolution. • The FM-7 can be calibrated to an accuracy of 0.00001%. • The SC-5 is accurate to one part per million. • Each unit has 30 millivolts sensitivity, is battery powered and has a charger unit included. • Dimensions of each are 1.9" H x 2.7" W x 3.3" D. • The units may be obtained separately or as a "Frequency Duo". • Parts & Labor guaranteed 1 year.

Tilt stand option \$ 3.50
Leather case \$16.00

MICRO-KLIP for .042 dia. holes (all boards on this page)
T42-1 pkg. 100 \$ 1.50
T42-1 pkg. 1000 \$11.00
P-149 hand installing tool \$ 2.83

8" LED ALARM CLOCK
12 hr. LED Alarm Clock uses 3 1/2 digit 8" LED Display with AM/PM indicators and colors. Direct drive, PIN to PIN interface with **\$7998A** I.C. Just add switches, AC Supply, Alarm. Display and I.C. only.

\$7.95 or 2/\$15.00

Price Breakthrough! \$17.50

MA1003 CAR CLOCK

Bright Green Fluorescent Display Crystal Time Base Assembled, just add switches and 12 VDC.

SPECIAL
14CS2 100 for \$14.00
16CS2 100 for \$16.00
14 pin CS2 10 for \$2.00
16 pin CS2 8 for \$2.00

These low cost DIP sockets will accept both standard width plugs and chips. For use with chips, the sockets offer a low profile height of only .125" above the board. These sockets are end stackable.

Vector WRAP POST for .042 dia. holes (all boards on this page)
T-44 pkg. 100 \$ 2.28
T-44 pkg. 1000 \$14.00
A-13 hand installing tool \$ 2.80

24 PIN DIP PLUGS WITH COVERS
3 / \$1.00
40 / \$10.00

PRIORITY ONE ELECTRONICS 49115 West Rosecrans, Hawthorne, CA 90250

Terms: VISA, MC, BAC, check, Money Order, C.O.D., U.S. Funds Only. CA residents add 6% sales tax. Minimum order \$10.00. Orders less than \$75.00 include 10% shipping and handling, excess refunded. Just in case please include your phone no. "Sorry, no over the counter sales"

Send for our latest brochure phone orders welcome (213) 973-4876 OEM and Institutional inquiries invited.

FREE PROBES FREE PROBES FREE PROBES

MICROCOMPUTER MADNESS*



***OR YOUR MONEY BACK!**

(use coupon below and your enjoyment is guaranteed)

24 ARTICLES

Kilobaud has more articles than any other microcomputer magazine. During 1977, for instance, there were 224 articles in Kilobaud—880 pages of articles—a veritable encyclopedia of microcomputing. There will be even more articles in 1978.

FOR THE BEGINNER

Though Kilobaud covers both the technical and programming needs of microcomputers, each article is written to be understandable for the beginner. No other magazine makes it as easy to learn more about microcomputers.

THE BEST PROGRAMS

Only Kilobaud offers programmers both the publication of their programs in the magazine plus a large royalty for the program if it is issued on cassettes. Is it any wonder all of the really good programs are being published in Kilobaud? You'll find the best software... games, diagnostics, teaching, music, business, etc. We're very heavy on programs.

HOBBY OR BUSINESS?

Both businessmen and hobbyists want the same thing: to understand microcomputers... and this is the purpose of Kilobaud. KB also has articles aimed at the businessman to help him know what is available and what it will do.

MONTHLY COLUMNS

Keep up with the latest developments and readers' programs through the letters column. The editorials will keep you up to date on money-making ideas, the progress of the industry and more. The New Products column is particularly useful, including the results of tests of the latest equipment in the Kilobaud microcomputer laboratory—the most complete in the industry.

SUBSCRIBE TO KILOBAUD

Since Kilobaud is the fastest selling microcomputer magazine on the newsstand, it's sometimes hard to find a copy. Why not subscribe today and get the convenience of mail delivery, plus a big cash savings... \$9 over newsstand for a 1-year subscription and a \$36 savings when you subscribe for 3 years. If you are in a hurry, call Toll Free 1-800-258-5473, and enter your subscription right away... we'll bill you later.



Understandable for beginners... Interesting for experts.

Peterborough nh 03458

KILOBAUD

100% GUARANTEE OF EXTREME SATISFACTION!

That's right, if after trying KILOBAUD for 60 days you are willing to cancel your subscription, we'll refund your money begrudgingly! (We work 16 hours a day, seven days a week, to put out the best microcomputer magazine the world has ever seen, jam-packed with great articles and fantastic programs and won't pretend to be happy about being rejected). Your check will be in the next day's mail.

1 year \$15
 3 years \$36
 Bill me
 Payment enclosed

Ms./Mr. _____ (please print)

Address _____

City _____ State _____ Zip _____

For Instant Subscriptions call 1-800-258-5473 or write to KILOBAUD / Peterborough NH 03458.

Please allow 60 days for shipment of your first issue.

The Calculating KIM-1

— calculator versatility
 for any KIM

The programmable calculator system (PCS) provides the hardware and software to convert your basic KIM-1 into a complete programmable scientific calculator. PCS features all basic arithmetic functions, trig functions, logarithms, exponentiation, factorials, powers and roots, two level parentheses, floating decimal, scientific notation with 8-digit mantissa and two-digit

exponent, and six memory registers for storing variables. In addition, PCS allows you to enter, save, and execute programs consisting of lines of calculator language code. The calculator language supports all calculator functions plus branching capability.

Software Operation

The programmable calculator system consists of a

software interpreter that reads input from the KIM-1 key pad. Input can consist of immediately processed requests, such as requests to perform arithmetic calculations (e.g., $1 + 5 =$), requests to display the value of a variable (e.g., $A =$), or program related requests, such as a request to enter a new program or a request to execute a stored program.

Two special techniques are needed to be able to support these functions with the standard KIM-1 key pad and display. First, since you will need to enter 50 unique keystrokes, and the KIM-1 key pad only has 23 keys, a technique of shifting, like upper and lower case on a typewriter, is used. Keys 0-9 alone represent the digits 0-9. Keys A-F alone represent variables named A-F. Keys AD, DA, PC, and GO represent special functions to be described later. The + key is used as a shift key. Entering the shift key and then entering 0-9 or A-F produces one set of special characters (e.g., shift, 3 is the multiply symbol). Entering the shift key twice

and then 0-9 or A-F produces another set of special characters (e.g., shift, shift, 5 is the square root operation). The complete specification for the keys supported is shown in Figs. 2 and 3.

The second special technique allows calculated results and variables, which can be up to 13 digits long, to be displayed on the KIM-1 6-digit output display. This is done by showing the digits like a moving billboard, scanning across the KIM display right to left. After the scan is complete, the last six digits remain lit in the display. A mechanism for repeating the scan is provided if you wish to view the variable again. The speed of the scan can also be varied to suit your needs.

Program Description

The software system consists of the following routines:

- INITIALIZATION — readies the calculator for input.
- INTERPRETER — displays the output buffer and then waits for a line of input to be read. It then examines the line and exits to the proper command handler.
- READLINE — reads one line from the key pad.
- READCHAR — reads one character from the key pad. It converts the character to the correct format for internal processing.
- CALCDRIVER — drives the calculator chip with one line of calculator language code and then reads the results of the execution of the line.
- LINEHANDLER — takes line of calculator language code and prepares it for CALCDRIVER (i.e., replace variables with their actual value). After the line has been executed, LINEHANDLER translates the result so it can be displayed or stored as variable.
- EDITOR — reads lines of calculator language code and stores them as a program.
- GOPROG — takes a stored program and sends each line

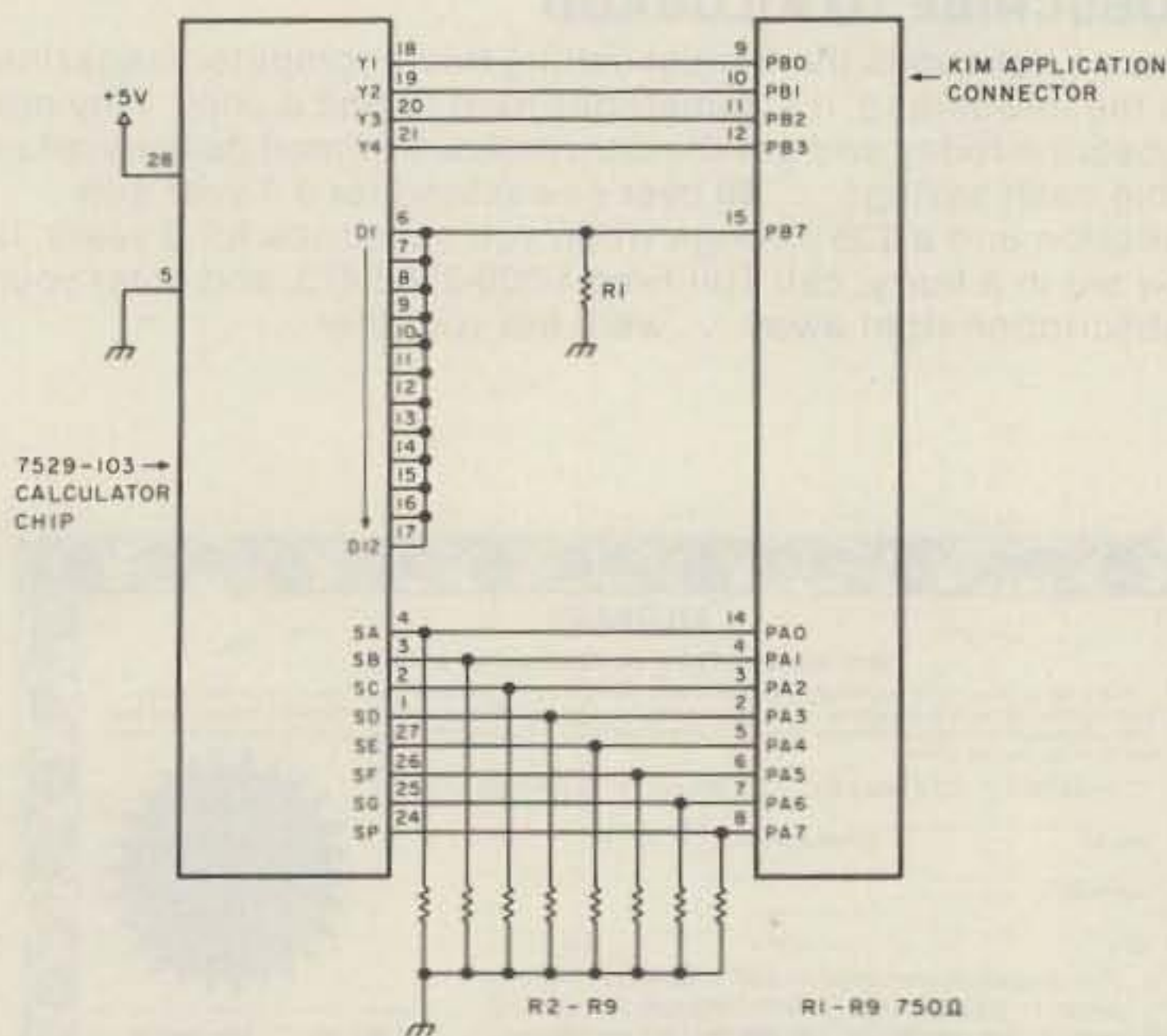

Fig. 1. Interface circuitry.

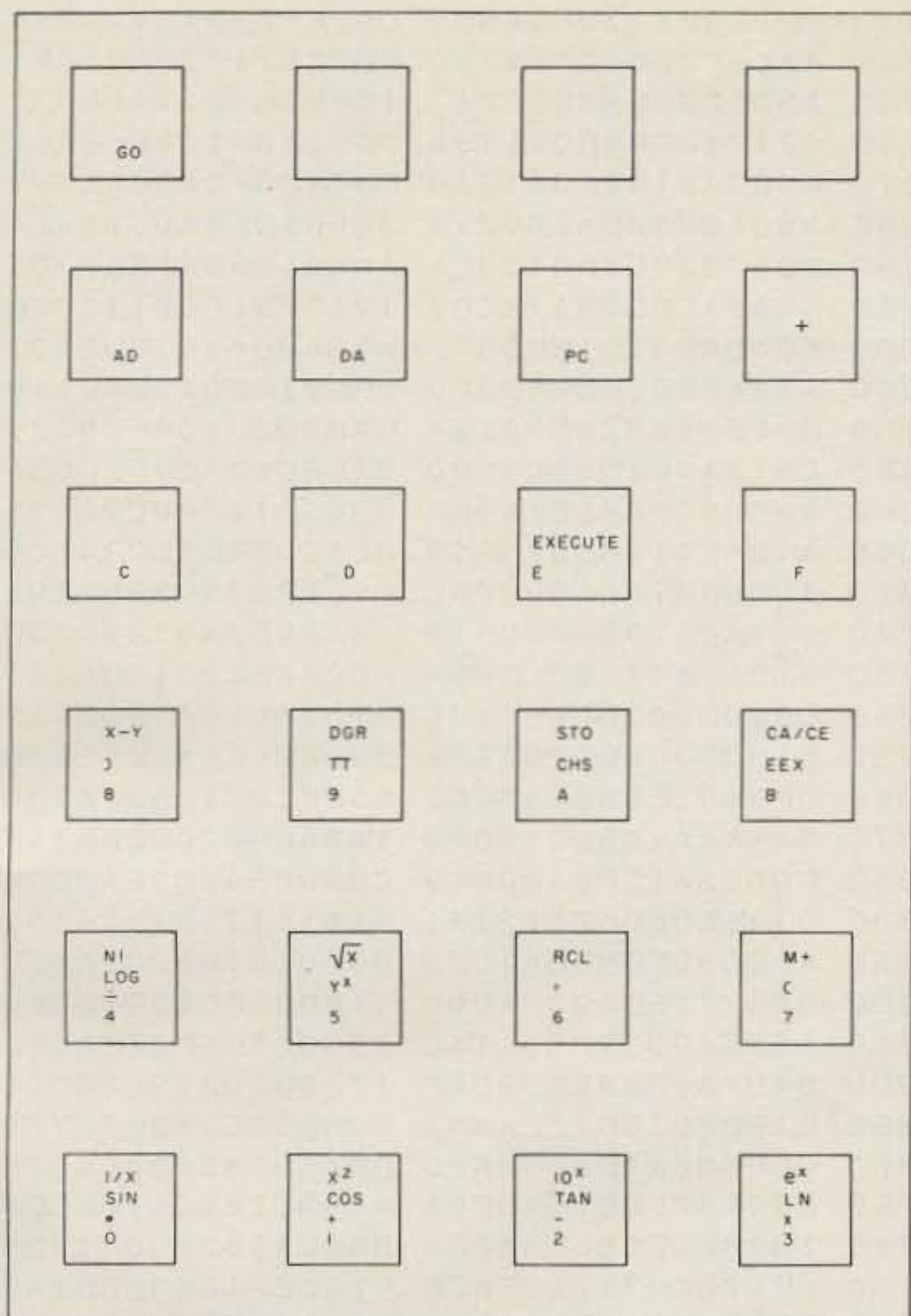

Fig. 2. KIM key pad with PCS functions.

to the LINEHANDLER for execution. After each line, it checks and processes any branch requests.

WRITE/OUTPUT — displays a result or variable.

Hardware Operation

The actual arithmetic operations are performed by an MOS Technology calculator chip 7529-103. The schematic for interfacing this chip to the KIM is shown in Fig. 1. The hardware uses one unusual technique. The 7529-103 is designed to work with a negative 7.5 voltage supply. The chip is connected so that its operating point is shifted to use a positive voltage supply by reversing the ground and V_{dd} connections. To make the chip TTL compatible, the positive voltage level is lowered to 5 volts. This is outside the range recommended by MOS Technology (-6 V to -9.5 V), but most chips should work cor-

rectly.

Keystrokes are sent by KIM to the chip over lines Y1-Y4. Results are sent back to KIM over lines SA-SP. The chip synchronizes all its operations by using the digit strobes (D1-D12). The digit strobes are tied together, and KIM uses these as synchronizing pulses to know the proper time to enter data and read the results.



The entire system . . . at home in the den.

| Key | No shifts | One shift | Two shifts | Three shifts |
|-----|-----------|-----------|------------|-----------------|
| 0 | 0 | . | SIN | 1/X |
| 1 | 1 | + | COS | X ² |
| 2 | 2 | - | TAN | 10 ^X |
| 3 | 3 | x | LN | EX |
| 4 | 4 | ÷ | LOG | N! |
| 5 | 5 | YX | √X | |
| 6 | 6 | = | RCL | |
| 7 | 7 | (| M+ | |
| 8 | 8 |) | X-Y | |
| 9 | 9 | π | DGR | |
| A | A | CHS | STO | |
| B | B | EEX | CA/CE | |
| C | C | | | |
| D | D | | | |
| E | E | EXECUTE | | |
| F | F | | | |
| AD | CHAR | | | |
| | DELETE | | | |
| DA | LINE | | | |
| | DELETE | | | |
| + | SHIFT | | | |
| GO | GO | | | |
| PC | PROGRAM | | | |
| | CREATE | | | |

Fig. 3. Keys with corresponding characters and functions. Note: X² is X squared, 10^X is 10 raised to the X power, EX is E raised to the X power, LN is natural log of X, LOG is log base 10 of X, YX is Y raised to the power X, X-Y is exchange X and Y, and DGR converts back and forth from radians to degrees.

Why did I use a calculator chip to perform the arithmetic operations instead of doing everything in software? I can best explain why by listing the pros and cons of doing it this way and then by indicating which reasons I weighed most heavily in my decision.

Pros for using a calculator chip:

1. All the complicated routines for high-precision arithmetic and scientific functions are coded and debugged in the calculator chip.
2. Those routines don't take

up KIM memory. Therefore, the entire system can fit in the KIM 1K of memory.

3. The routines are in ROM and don't have to be loaded.
4. I could get the chip for less than \$10.
5. The design for the interface of the chip to KIM already existed (see acknowledgements).

Cons for using a calculator chip:

1. It takes longer to perform the arithmetic operations due to the handshaking between KIM and the chip.
2. It uses up I/O lines.

| ADDR | VALUE IN HEX; XX MEANS DON'T CARE | |
|------|-----------------------------------|--------------------|
| 0000 | 4C1001202000F0F8 | A002B1EDC9E2D003 |
| 0010 | 4CCA03C9F4D0034C | A00320B2024C0000 |
| 0020 | EAEAEAA90085D9A0 | 0284F7205300A4F7 |
| 0030 | A5DFC9F3D007A001 | A5D991ED60C9F0D0 |
| 0040 | 0788C6D910E3D0DB | C9F1F0D791EDE6D9 |
| 0050 | C810D6A90085E020 | 8C1E20AF17D0F820 |
| 0060 | AF17F0FB20AF17F0 | F6206A1FC91510E7 |
| 0070 | 85E1A280A00596E7 | 8810FBC910900809 |
| 0080 | F0C9F2F024D01EA6 | E0D004C90A1016C9 |
| 0090 | 00D002A90C0A0A0A | 0A85F6A901CA3003 |
| 00A0 | 0A10FA05F685DF50 | 02E6E0A6E0A0EDCA |
| 00B0 | 300494E710F9C9F2 | F09DA4E1C010B005 |
| 00C0 | B9E71FD003B9CA00 | 85EC600000000092 |
| 00D0 | 9FACB9C6D3000000 | 0000B9B880BDF300 |
| 00E0 | 000000000010780 | 80808080800001XX |
| 00F0 | XXXXXXXXXXXXXXXXXX | XXXXXXXXXXXXXXXXXX |
| 0100 | 8080808080B9F7B8 | B980800000000000 |
| 0110 | A9EA8DAE028DAF02 | 200002A9108DAE02 |
| 0120 | A9FB8DAF02A9208D | 0000A9808D0100A9 |
| 0130 | 178D02004C000000 | 0000000000000000 |
| 0140 | 0000000000000000 | 0000000000000000 |
| 0150 | 0000000000000000 | 0000000000000000 |
| 0160 | 80808080B4B4FF00 | 0000000000000000 |
| 0170 | 0000000000000000 | 0000000000000000 |
| 0180 | 0000000000000000 | 0000000000000000 |
| 0190 | 0000808080808080 | 808080C180808080 |
| 01A0 | 8080808080808080 | C180808080808080 |
| 01B0 | 8080808080C18080 | 8080808080808080 |
| 01C0 | 8080C18080808080 | 80808080808080C1 |
| 01D0 | 8080808080808080 | 80808080C1808080 |
| 01E0 | A9C19D0001E8A90A | 4CD4170000000000 |
| 01F0 | 0000000000000000 | 0000000000000000 |
| 0200 | A90F8D0317A200BD | 640186D6202302A6 |
| 0210 | D6A5D5C9FFD0034C | 8C02E8E0034C0702 |
| 0220 | 20051C85D5A0042C | 021730FBA214CAD0 |
| 0230 | FD2C021730F1A5D5 | C9FFF0344A4A4A4A |
| 0240 | AACAF00C2C021710 | FB2C021730FB10F1 |
| 0250 | A5D5290FAA2C0217 | 10FB8E0217A2002C |
| 0260 | 021730FB8E021788 | D0BD20A102EAEA60 |
| 0270 | A00BA2142C021710 | FBCAD0FDAD001799 |
| 0280 | 86018830EA2C0217 | 30FB10E6A001A20A |
| 0290 | BD8701997A01C8CA | 10F6AD86018D7A01 |
| 02A0 | 60A94C8D05172C07 | 1710FB2C001710FB |
| 02B0 | 6000A001B1ED85D9 | A9B48D64018D6501 |
| 02C0 | A266C8B1EDC6D9F0 | 23C910B01984E1A8 |
| 02D0 | B9C500A820E001EA | EAB902010AF00320 |
| 02E0 | C917A4E1D0DC9D00 | 01E8D0D6C962D004 |
| 02F0 | 9D0001E885DFA9FF | 9D0001200002A271 |
| 0300 | A4DFC010B002B6C5 | 8E1E038E3003A200 |
| 0310 | A000B97A0109809D | 64012075039D7101 |
| 0320 | B97A012980F00BA9 | 08E89D6401A9C29D |
| 0330 | 7101E8C8C00CD0DA | A000AD70010D6F01 |
| 0340 | C980D0038C6E018C | 7101A064A980D900 |
| 0350 | 01D003C8D0F88888 | 888884E4A5DF290E |
| 0360 | 0D8601F003098060 | A5DFC9C1D002A900 |
| 0370 | 4A4A4A4A60C980F0 | 1A86E0A20BDDE71F |
| 0380 | F00CCA10F8A20AC9 | C0F003A209EABD94 |
| 0390 | 03A6E060C1112131 | 415161718191A261 |
| 03A0 | A90085ED85D82020 | 00F01518A001A5ED |
| 03B0 | 85D771ED6902A000 | 91ED85ED86D8D0E6 |
| 03C0 | A6D7A9009D00014C | 0300A5D8F02FA4ED |
| 03D0 | 84D7A90085ED20AF | 1720B2021008A000 |
| 03E0 | B1EDF015D0EEA8A2 | 00BD000188F007C9 |
| 03F0 | 00F006AAD0F38A10 | DBA5D785ED4C0000 |
| 1780 | A005A205B1E4D001 | 6095E788CA10F5D8 |
| 1790 | 189865E685E3A20A | 86E2A9528D071720 |
| 17A0 | AF172C071710F8C6 | E2D0EFA4E3D0D3A9 |
| 17B0 | 7F8D4117A000A209 | B9E70084FC204E1F |
| 17C0 | C8C00690F3203D1F | 60A9B29D0001E8A9 |
| 17D0 | 03EAEAEA85DFB900 | 01C980F0049D0001 |
| 17E0 | E8C8C6DFD0F060 | |

Fig. 4. Hex program listings.

3. Someone has to develop the hardware and software interface to drive the chip.

The factors that led me to use the calculator chip were that I only had 1K of RAM on my KIM, I did not want to code and debug arithmetic

routines, the interface for this chip existed, and I was not concerned about longer execution times.

Calculator Language

The calculator language is built to drive the 7529-103

chip. The complete specifications for the calculator chip and its entry operations come with the chip ("MOS Specification for Single Chip 40 Key Scientific Calculator Array"), so I will not exhaustively repeat them here. The document is worth reading when you implement the system.

Calculator Entry Operations

Range: Inputs and outputs can be positive or negative numbers between $1 \times 10E - 99$ and $9.9999999 \times 10E + 99$ (read the 10E as "ten raised to the power"). The mantissa can be up to 8 digits plus a decimal point with a maximum of 7 digits to the right of the decimal point. Either after or during the entry of the mantissa, the algebraic sign can be changed entering the change sign key (CHS). An exponent is

entered by pressing the enter exponent key (EEX) followed by one or two digits. Either prior to or during the entry of these digits, the sign of the exponent can be changed by pressing the CHS key (e.g., $1.7 = 1.7$, $1.7 \text{ CHS} = -1.7$, $1.7 \text{ EEX } 12 = 1.7 \times 10E +12$, $1.7 \text{ EEX CHS } 4 = 1.7 \times 10E -04$). Results that exceed 8-digit accuracy will automatically be converted to scientific notation.

Mathematical Operations: The operators (+, -, x, ÷, YX) all require two variables as input (e.g., $2 + 3 = 5$). Read YX as Y raised to the X power (e.g., $2 \text{ YX } 3 = 8$). The operators (SIN, COS, TAN, EX, 10X, N!, LOG, LN, X2, 1/X, \sqrt{x}) all require one variable as input and are executed immediately upon entry upon the current



KIM mounted on aluminum chassis box with Lancaster TVT6-L and calculator interface.

operand. Read EX as E raised to the X power, 10X as 10 raised to the X power, and X2 as X squared (e.g., $5 \frac{1}{X} = 0.2$, $7 X^2 = 49$).

Operands may be complex expressions contained within parentheses (e.g., $(1 + 5) \times (2 + 7) = 54$).

You can reverse the order of factors in a two-variable operation by hitting the exchange key (X-Y). For example, $2 \div 3 = .667$, but $2 \div 3 X-Y = 1.5$.

The clear key (CA/CE) clears all data registers except the memory register. The calculator system automatically performs this clear for you before each line entered.

Pressing the store key (STO) stores the last result in the calculator's memory. Recall (RCL) recalls the calculator's memory. Memory add (M+) adds the current data to the memory register. Later you will see that this memory register can be used for branching control for calculator language programs.

In summary, you enter statements just as if you were using an algebraic calculator, entering data left to right as it would appear on a sheet of paper.

Special Keys

0-9: Enter digits 0-9.

A-F: Enter variable names. There are six variables each named by a unique letter, A-F.

GO: The GO key is equivalent to the carriage-return key on a typewriter. It signals the system that the line is completely entered and it is time to process the line. All lines must end with the depression of the GO key (e.g., $2 + 3 = GO$ would result in the display of the answer 5).

After the GO key is pressed, the system will display the result. If there is no result to be displayed, as, for example, while you are entering lines of a program, the system will display the letter G. Pressing GO after a result has just been displayed will redisplay the last output

Formula: $CI = A[(1 + B)^C - 1]$

PC GO
 $(1 + B) YX C = D$ GO
 $A \times (D - 1) = GO$
 GO

1000 = A GO
 .06 = B GO
 1 = C GO
 Shift /E GO

enter program create mode
 enter line 1
 enter line 2
 exit PC mode (Note that you really did enter two successive GOs).
 (Note that D is used as an intermediate variable.)
 set A = 1000 = principle
 set B = 6 percent interest per year
 set C = 1 year (interest compounded yearly)
 execute program

Fig. 5.

message. This is useful if the last output was a result with more than 6 digits, and you wish to see the whole output again scanned across the display.

AD: The AD key will delete the last character entered. It is a backspace-and-erase character. After AD is pressed, the system will display a C (for character deleted). For example, $5 \times 3 = GO$ results in the answer 15; $5 \times 3 AD 5 = GO$ results in the answer 25.

DA: The DA key deletes all characters in the current line (delete all). It resets you back to the start of the current line (e.g., $5 + 2 DA 6 + 3 = GO$ results in the answer 9). After pressing the DA key, the system will display an L for line deleted.

+ : The + key is the shift key. Each successive pressing of the shift key will display another S in the display, so you can keep track of the number of shifts entered. For example, to enter $3 \div 5 = GO$, you would enter $3 +4 5 +6 GO$, where +4 represents divide and +6 represents the equal sign.

PC: The PC (program create) key deletes the previously stored program and allows you to enter lines that will represent a program. Note that PC is a single character line and, like all other lines, is terminated by the GO key.

Entering Lines for Immediate Execution

All basic PCS lines end with an equal sign (=) and then GO (e.g., $1 + 5 = GO$ results in the answer 6; remember that the plus sign was entered as a shift /1).

PCS also supports the

saving of results in any of the six variables, named A, B, C, D, E, and F. To save a result in a variable, end the line with an equal sign, followed by the variable name, followed by GO. Try the following: $1 = A GO$, $2 = B GO$, $A + B = GO$. The system should respond with the answer 3. Remember that the equal sign is entered as shift /6 and the plus as shift /1. Also, note that, as you enter each statement, the system will give you the intermediate result. To display the value of a variable, enter the variable name, an equal sign, and GO (e.g., $B = GO$ will display 2). Try another example with A and B set from above. $(A + B) YX (B \times 3) = GO$. This calculates 3 raised to the 6th power, and the answer should be 729.

Program Creation, Execution, and Branching

PCS allows you to enter a program consisting of one or more lines of calculator

language code. To create a program, enter PC (program create) and GO. The system will display a P after you enter PC and G after you enter GO. Now enter lines just as if you were entering them for immediate execution. Remember that each line ends with a GO. To end program creation, enter two GOs in succession. To execute the program, enter shift /E GO.

For example, to calculate compound interest where: A = principle, B = interest per compounding period, and C = number of compounding periods, enter the program in Fig. 5.

The system will respond with 60.0 as the interest for 1 year. Now try it for 10 years by entering $10 = C GO$ and then shift /E GO. The answer will be 790.8477.

Now for branching: When you write lines of code on your worksheet, number each line of the program starting with 1. These assumed line

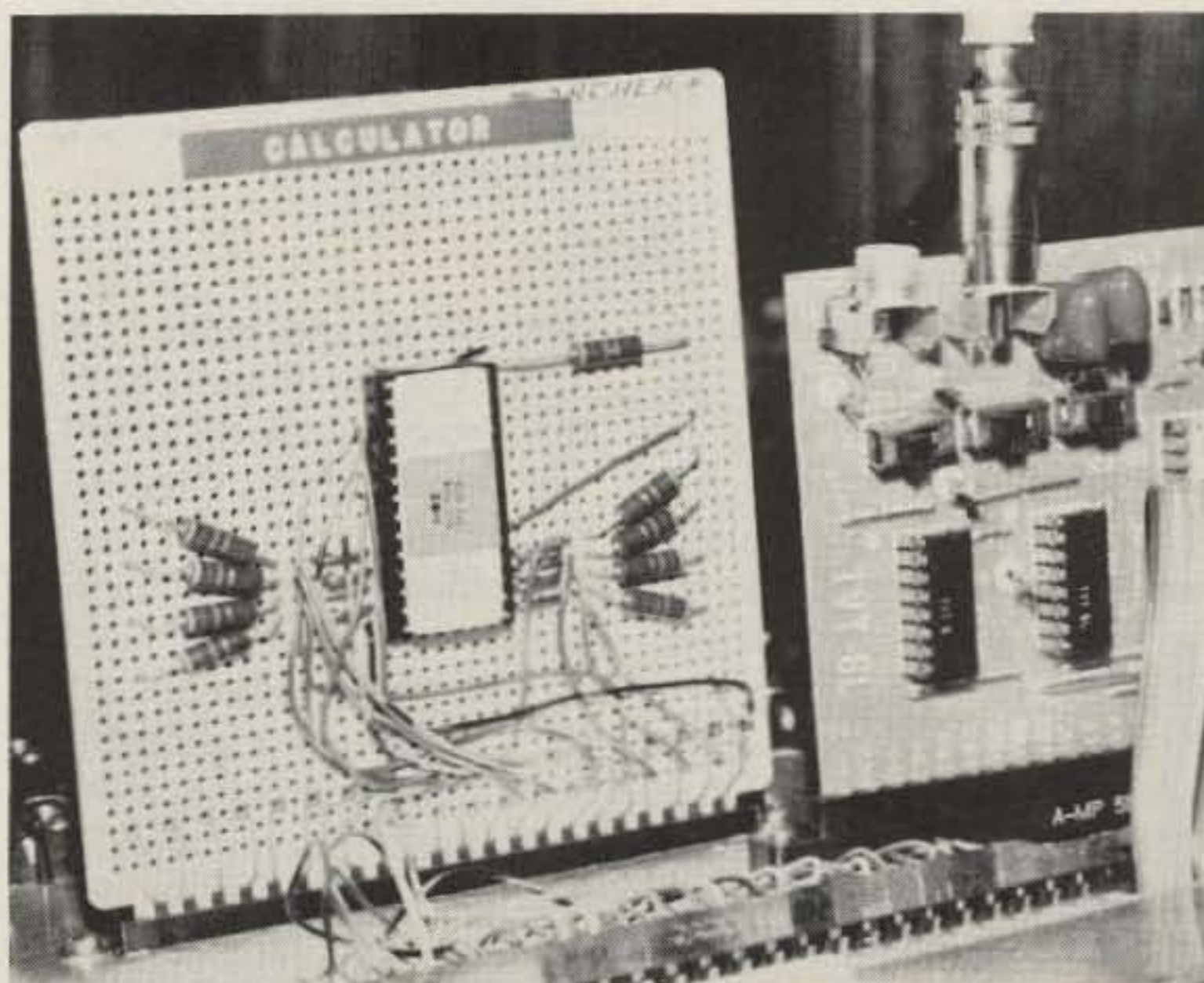

Close-up of calculator interface board.

1. Count to 4
A = loop counter
B = sum

Assumed
line numbers

```

PC  GO
P 1. 3 = A GO
R 2. 0 = B GO
O 3. B + 1 = B GO
G 4. A - 1 = A GO
R 5. A = 3 GO
A 6. B = GO
M

```

Enter program create mode

Line 1 Set loop counter to 3
Line 2 Set sum to zero
Line 3 Add 1 to B
Line 4 Reduce A by 1
Line 5 If A is positive, go to 3
Line 6 Display B

Exit from program create mode
Execute program; system will display
answer B = 4.

We can simplify the branch mechanism by using the calculator's memory as the loop counter. B is still the sum.

```

PC  GO
P 1. 3 = STO = GO
R 2. 0 = B GO
O 3. B + 1 = B GO
G 4. RCL - 1 = STO = 3 GO
R
A
M
GO
Shift / E GO
B = GO

```

Enter program create mode

Line 1 Set loop counter = 3
Line 2 Set sum = 0
Line 3 Add 1 to B
Line 4 Recall memory, subtract 1, save
new value and branch to 3 if positive

Exit program create mode
Execute program; system will display a 4
Display B (equal to 4)

2. Calculate loan payments

A = Amount borrowed
B = Yearly interest
C = Months to repay
Formula: $\text{payment} = \frac{A(B/12)}{1 - [1 + (B/12)]^{-C}}$

```

PC  GO
P 1. B ÷ 12 = D GO
R 2. A × D = E GO
O 3. (D + 1) YX C CHS = F GO
G 4. E ÷ (1 - F) = GO
R
A
M
GO
4000 = A GO
.095 = B GO
30 = C GO
Shift / E GO

```

Enter program create mode

Line 1
Line 2
Line 3
Line 4

Exit
Borrowed \$4000
9.5 percent interest
30 months
Execute program, answer will be
150.31686 (which is your monthly payment)
(Note: D, E, F are used as intermediate variables)

3. Calculate value of investing money periodically

A = Amount invested at the start of each period (period could be a week, month, or year)
B = Interest rate per period
C = Number of periods

```

PC  GO
P 1. C - 1 = STO = GO
R 2. 0 = D GO
O 3. D + A × (1 + B) = D GO
G 4. RCL - 1 = STO = 3 GO
R 5. D = GO
A
M
GO
1000 = A GO
.06 = B GO
1 = C GO
Shift / E GO
5 = C GO
Shift / E GO

```

Enter program create mode

Line 1 Set loop counter
Line 2 Set sum
Line 3 D is value of investment
Line 4 Go through "C" periods
Line 5 Display D

Exit
Invest \$1000 at the start of each year
At 6 percent interest per year, compounded
annually
For one year
Execute, answer is 1060
Now try it for 5 years
Execute, answer is 5675.28

Fig. 6.

numbers will be used as targets for branch instructions. Branching works as follows: 1) enter as a program line any acceptable calculator expression; 2) terminate the expression with an equal sign followed by a line number (e.g., A = 4); 3) when that line is executed, the result is tested, and, if it is positive (zero or greater), the branch will occur, but, if the result is negative, the branch will not occur and the next sequential

line will be executed. In Fig. 5, if A is equal to or greater than zero, a branch to line 4 will occur. If A is less than zero, no branch will occur. Branching to line zero or any nonexistent line will terminate program execution. After the last line of a program is executed, program execution will also be terminated. See Fig. 6 for examples.

Summary of Language Rules

A line consists of:

EXPRESSION = RESULT
GO.

EXPRESSION is any valid calculator expression with or without variable references. = is an equal sign (shift /6).

RESULT is blank — display the result of the expression.

A-F — Set the variables A-F equal to the result of the expression.

Line number — If the result of the expression is positive, branch to the line specified. If the result of the expression is negative, do not branch. Valid line numbers are 1-9. A branch to zero or a nonexistent line terminates the program.

Notes

1. The number of lines in a program is limited by the work space available, which is 93 bytes. Each line requires one byte per character (do not count shifts, since they are not stored) and two bytes for overhead (e.g., A × 3.1 = requires 8 bytes). After a program is stored, any space left over is used for lines that are entered for immediate execution. Exceeding the available workspace will yield unpredictable results.

2. Each line that is executed is first expanded by adding two clear characters and a termination character and by substituting the actual value of variables for their symbolic names A-F. The space to hold the expanded line is 46 bytes, so any one expanded line cannot exceed this value. Since variables can get long (e.g., -1.2345678 10E -95), be careful (e.g., if A is 123.456, the expand line for A + 3.1 = requires 16 bytes).

3. If an F scans across the display, you have overflowed the calculator's range. Try the following: EEX99 × 100 =, and EEX CHS 99 × .001 =.

4. Expect each line to require about 1 second to execute. So, if you have a program that does a lot of looping, it will run for a

while. The display will flash for each line executed to let you know the system is still running.

5. Try entering the numbers 6 and 9 to see what they look like, since the calculator does not use the exact KIM seven-segment display formats for these digits.

6. The chip, MOS 7529-103, with specifications is available from Johnson Computer, PO Box 523, Medina OH 44256.

7. To run the calculator: 1) power on KIM, 2) hit reset, 3) set the interrupt vectors 17FA = 00, 17FB = 1C, 17FC = 00, 17FD = 1C, 17FE = 00, and 17FF = 1C, 4) load the program, and 5) start execution at location zero.

8. If you lose control of an executing program, the best way to regain control is to hit stop, hit reset to reset the stack pointer, store zero in location 0171 to limit the display scan, and restart the program at location zero.

9. In scientific notation, the exponent will be displayed as the last two characters. It will be separated from the mantissa by a blank if the exponent is positive and by a minus sign if the exponent is negative.

10. To vary the speed of the display scan, you can modify location 1797 which is OA. If you make it less, the display will scan faster; if you make it larger, the display will scan slower.

Acknowledgements

The circuit for interfacing the calculator chip to KIM and the CALCDRIVER routine were developed by Eric Rehnke and first appeared in the KIM-1 User Notes, issue 4.

The program that scans the output across the display was developed by Stan Ockers and appeared in the KIM-1 User Notes, issue 1.

I wish to thank Eric for allowing me to incorporate these two routines into the programmable calculator system. ■

The "ULTIMATE"
in CW Reception!

ACTUAL SIZE
3 1/2" WIDE
2 3/8" HIGH
4 3/8" DEEP



COPY ONE®
\$99.95

COPY ONE IS NOT A FILTER! This station accessory is a must for the discriminating amateur who operates CW, whether he is an avid CW op or one who engages in CW for proficiency. The CW signal is **processed** (not filtered) in a manner which allows true **ULTIMATE STATION REJECTION**, a mode which has been previously unavailable. The circuitry* is **totally unique** (patent pending), a must for emergency CW operations. If you haven't had the opportunity to operate a **COPY ONE**, ORDER YOURS TODAY!

COPY ONE CW PROCESSOR SPECIFICATIONS & FEATURES:

- Ultimate station rejection (almost unbelievable but true!)
- Pitch & volume independent of receiver or transceiver
- Full quieting (i.e., no background noise) without squelch
- COPY ONE is not a filter, there is absolutely no ringing or background noise
- Plugs into transceiver or receiver/transmitter combo without modification
- Discriminates signals in 80 to 100 cycle increments
- Full break-in CW operation
- Includes 115 volt AC power supply or may be battery operated
- Built in code practice oscillator
- LED lock-up controls front panel mounted

ORDER YOURS TODAY!
send \$99.95 by check
or money order to:

LOGITRONICS, INC. L11

3135 North Cole Road Boise, Idaho 83704 [208] 377-1562

ok wire wrapping center **ok**

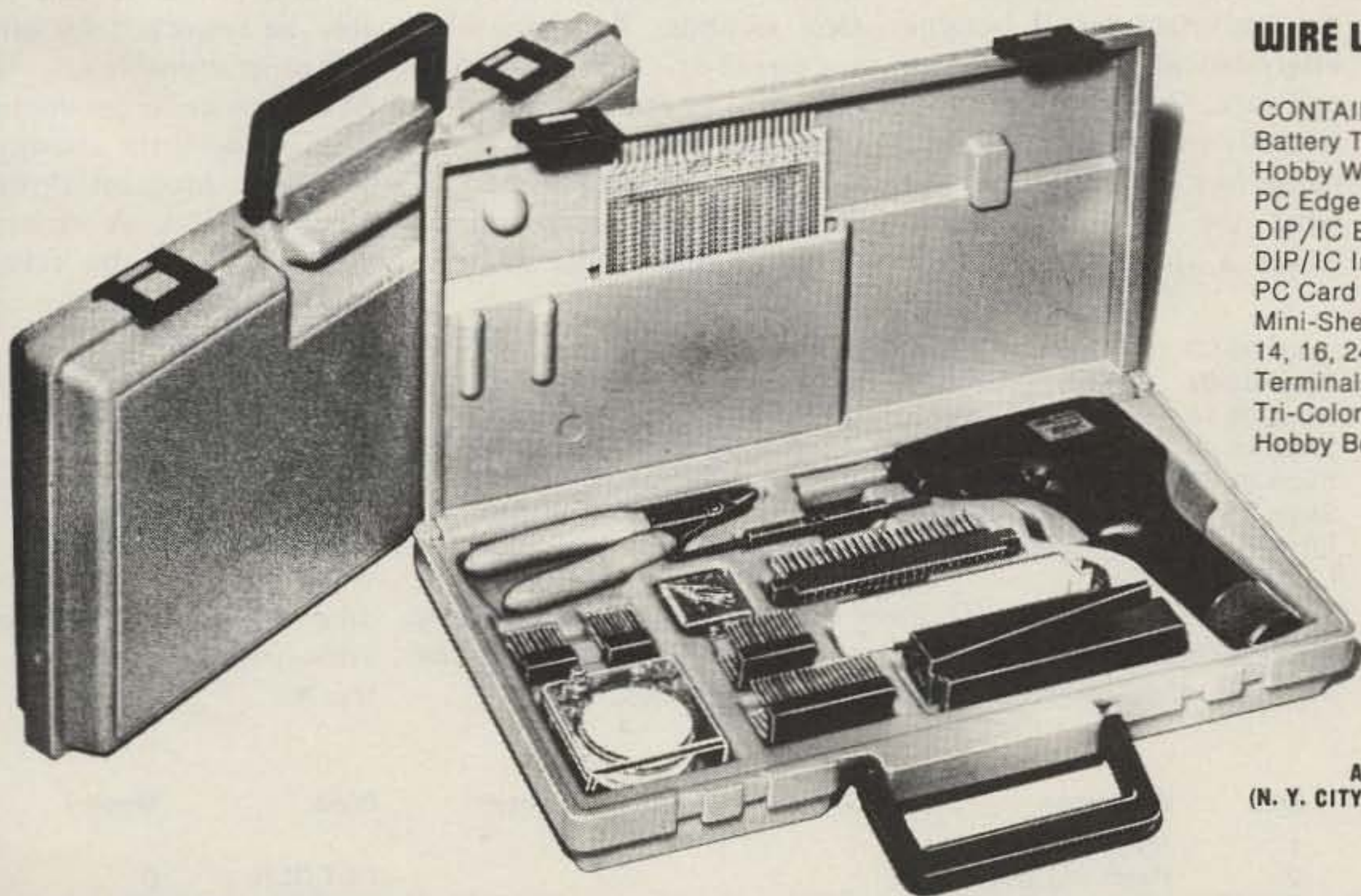

WIRE WRAPPING KIT WK-5

CONTAINS:
Battery Tool BW-630
Hobby Wrap Tool WSU-30 M
PC Edge Connector CON-1
DIP/IC Extractor Tool EX-1
DIP/IC Insertion Tool INS-1416
PC Card Guides & Brackets TRS-2
Mini-Shear with Safety Clip SP-152
14, 16, 24 and 40 DIP Sockets
Terminals WWT-1
Tri-Color Wire Dispenser WD-30-TRI
Hobby Board H-PCB-1

\$74.95

ADD \$1.00 FOR SHIPPING
(N. Y. CITY AND STATE RESIDENTS ADD TAX)

OK MACHINE & TOOL CORPORATION O5

3455 Conner St., Bronx, N.Y. 10475 (212) 994-6600 / Telex 125091

A No-Cost Digital Clock

— use your programmable calculator

If you already own or are contemplating purchasing a programmable calculator, you may want to try a novel

method of using your calculator as a timepiece.

My SR-56 calculator is a versatile piece of hardware, but I have discovered that, much of the time, I use it for simple functions that could be done just as effectively on a less expensive machine. The ability to enter programs that allow the calculator to automatically solve complex equations makes the SR-56 and other calculators like it special. After trying out some of the programs suggested by the manufacturer, I became interested in writing my own software. One item that particularly intrigued me was the pause function. This does just what the name suggests — leaves a short space in the

program. Normally one does not worry about the exact length of the pause, but, just on a whim, I checked mine. It turned out to be about .62 seconds long. To convert this fraction into whole units that made more sense, all I had to do was put three pauses in a row, giving a resulting time of just under three seconds.

Now that the basic time unit was established, it became a simple matter to write an addition program where a new time was displayed every two seconds. By using the t-register (conditional branch), where a number is compared with another number in the memory and a predetermined command is given, it was simple to have

the calculator replace a .6 with a 1 at the minute mark and start over with 1.02 and so forth.

Between using the t-register and the pause function, it is possible to write a 12-hour clock program or even a ten-minute countdown program that could be used by hams as an ID reminder or possibly a dark-room timer.

The accompanying program is meant to serve as a starting point. It can probably be reworked for almost any programmable calculator. As a novice programmer, I have made little attempt to hone the program down to minimum size. A variety of approaches can be taken. I have shown only the one I found most easy to grasp.

If you need super accuracy, then time programming may not be for you. But, if you enjoy writing your own calculator programs and would like to show some unique and useful software to your friends, then give it a try. ■

| Loc | Code | Key |
|-----|------|------------|
| 00 | 59 | *pause |
| 01 | 59 | *pause |
| 02 | 59 | *pause |
| 03 | 74 | - |
| 04 | 92 | . |
| 05 | 00 | 0 |
| 06 | 02 | 2 |
| 07 | 94 | = |
| 08 | 37 | X = T |
| 09 | 01 | 1 |
| 10 | 04 | 4 |
| 11 | 22 | GTO |
| 12 | 00 | 0 |
| 13 | 00 | 0 |
| 14 | 33 | sto |
| 15 | 00 | 0 |
| 16 | 15 | CLR |
| 17 | 32 | $x \leq t$ |
| 18 | 37 | X = T |
| 19 | 03 | 3 |
| 20 | 05 | 5 |
| 21 | 74 | - |
| 22 | 01 | 1 |
| 23 | 94 | = |
| 24 | 32 | $x \leq t$ |
| 25 | 15 | clr |
| 26 | 34 | rcl |
| 27 | 00 | 0 |
| 28 | 74 | - |
| 29 | 92 | . |
| 30 | 04 | 4 |
| 31 | 94 | = |
| 32 | 22 | GTO |
| 33 | 00 | 0 |
| 34 | 00 | 0 |
| 35 | 01 | 1 |
| 36 | 54 | ÷ |
| 37 | 00 | 0 |
| 38 | 94 | = |
| 39 | 41 | R/S |

| Steps | Explanation |
|-------------|---|
| Steps 00-02 | This gives a two-second interval. |
| Steps 03-07 | This subtracts .02 (two seconds) from running total. |
| Steps 08-13 | Running total compared to next lowest minute mark. |
| Steps 14-20 | Running total stored, check made to see if it is 0. |
| Steps 21-25 | T-register decremented to next lowest minute mark. |
| Steps 26-34 | Running total lowered to next minute (.4 subtracted). |
| Steps 35-39 | Flashing display for 00 seconds. |

Table 1. Ten-minute ID timer explanation. When reading display figures, those on the left of the decimal point are the minutes, while those on the right are the seconds.

| Step | Procedure | Enter | Press | Display |
|------|---|-------|------------|--------------|
| 1 | Enter program | | | |
| 2 | Reset and clear | | RST CLR | 0 |
| 3 | Set t-register | 9 | $x \leq t$ | 0 |
| 4 | Enter initial time | 9.6 | | 9.6 |
| 5 | Start clock | | R/S | |
| 6 | Ten-minute mark has been reached (flashing) | | | 9.9999999999 |

Fig. 1. Program listing. Register 0 is time.

Fig. 2. User instructions.

50 144 REPEATERS 220 450 Mhz

THE NEW Hi Pro Mk I

*State-of-the-art, full-feature repeaters that boast broad range temperature and electrical stability for use in an uncontrolled environment

*Low current drain—A plus for emergency 12 volt stand-by battery operation

*The receivers develop maximum usable sensitivity and sideband rejection

*The transmitters develop 15 Watts Minimum of clean rf and a faithful reproduction of the input signal insuring an extremely good sounding repeater

*Includes a high quality dynamic microphone and a detailed instruction manual

5 1/4" x 19" x 13"

OPTIONS

Duplexers

Basic auto patch

Matching cabinet

.0005% High stability crystals



Available Separately:

COR Identifier: All on one board, programmable, fully adjustable, time out (.5-7 min.), hang time (0-1 min.), identifier (1-10 min.), tone, speed, volume, L.E.D. outputs, low current drain CMOS logic, plugs for easy installation and removal plus much more. Completely assembled \$79.95

Basic Repeater: 2 M 130-175 MHz Basic Repeater for 2 meters with all the features of the Hi Pro Mk I less the power supply and front panel controls and accessories \$499.95

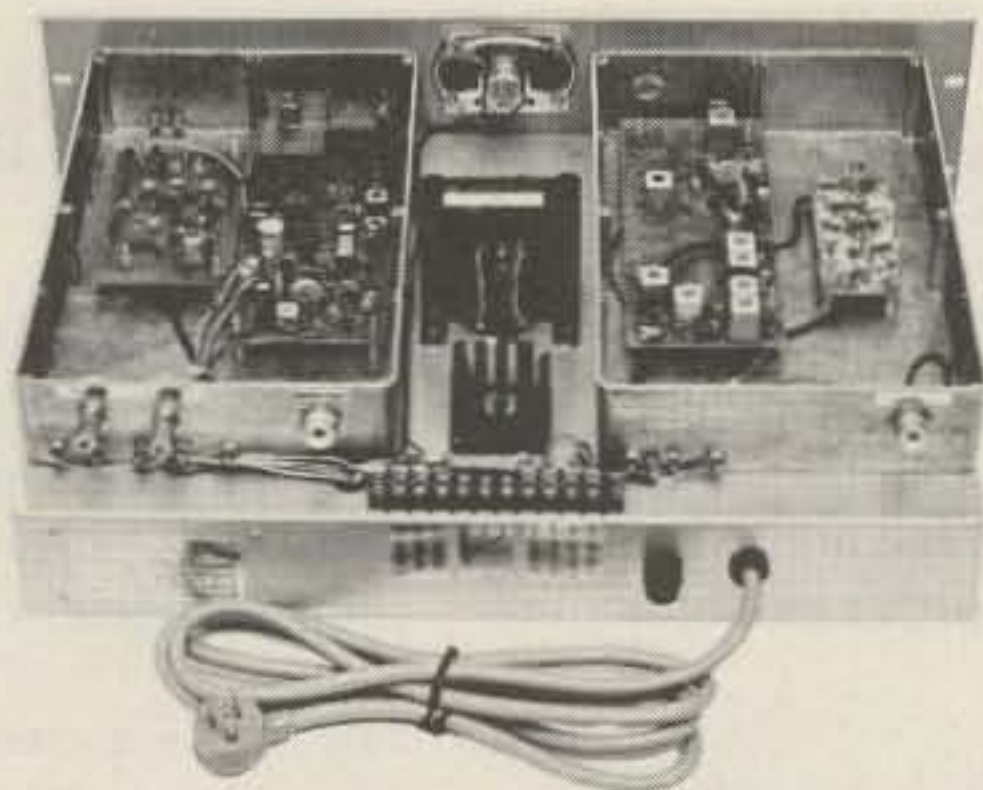

Maggiore Electronic Laboratory

50 MHz \$789.95 450 MHz \$799.95

144 + 220 MHz \$699.95 Plus Shipping PA Res. add 6% tax

845 WESTTOWN RD.

WEST CHESTER, PA. 19380

PHONE 215 436-6051

M36

ok wire wrapping center ok

NEW HOBBY WRAP
MODEL BW 630



Battery
wire
wrapping
tool

\$34.95
COMPLETE WITH BIT
AND SLEEVE

STRIP/WRAP/UNWRAP
TOOL MODEL WSU-30



\$6.95*

RIBBON CABLE
ASSEMBLY

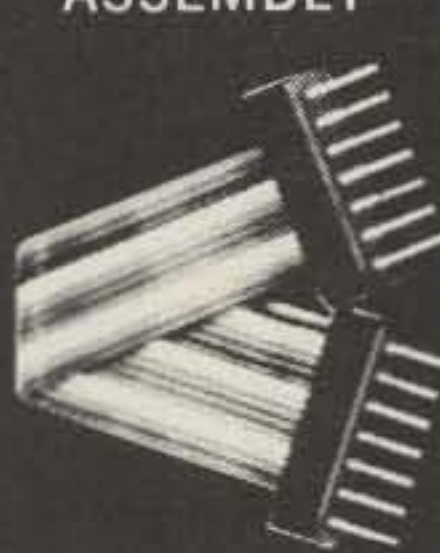

DIP SOCKETS

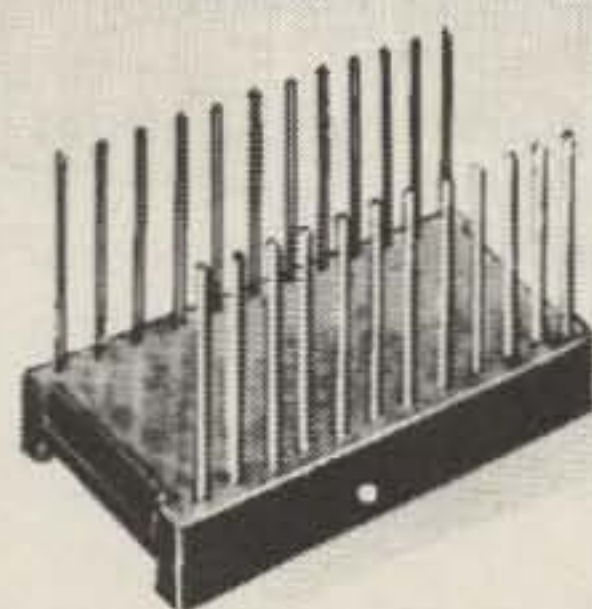

DIP IC INSERTION
TOOL WITH PIN
STRAIGHTENER

MODEL
INS-1416



\$3.49*

WIRE DISPENSER
MODEL
WD-30-B



\$3.95*

PRE-CUT
PRE-STRIPPED WIRE

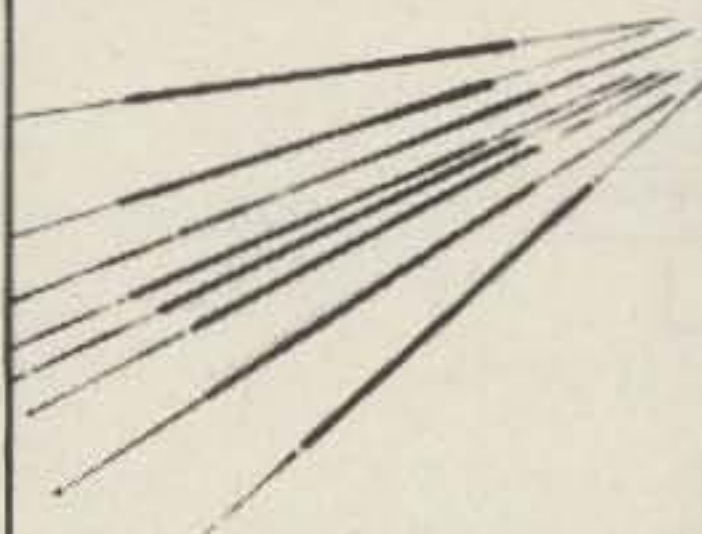

WIRE WRAPPING KIT

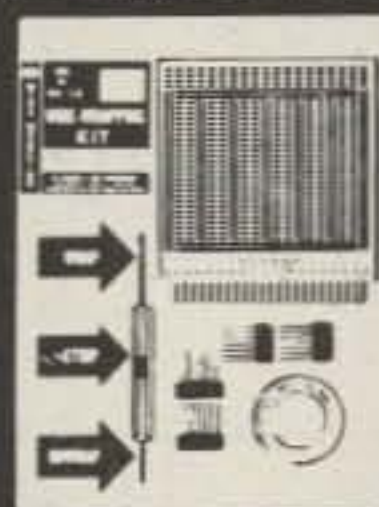

\$15.45*

*MINIMUM ORDER \$25.00, SHIPPING CHARGE \$1.00, N.Y. CITY AND STATE RESIDENTS ADD TAX

OK MACHINE AND TOOL CORPORATION

3455 CONNER STREET, BRONX, NEW YORK, N.Y. 10475 U.S.A.

PHONE (212) 994-6600 TELEX NO. 125091

The BASICs of L-Network Design

— your micro makes it simple

Al Gerbens K7SBK
1038 E. 6th Place
Mesa AZ 85203

An L-network consisting of a single coil and a single capacitor can be used to match a purely resistive line to any complex impedance. Only three L-networks are required to do the job, as explained by Robert Leo W7LR.¹

The three configurations are shown in Fig. 1. Each network is designed to provide impedance matching

between a pure resistance (R) and a complex impedance Z ($R + jX$). Each network, however, will only work for specific combinations of R and Z. The job of normalizing the R and Z values, selecting the correct L-network configuration, and then cranking through the calculations for that configuration is a good job for your micro-computer.

Where to Use an L-Network

Let's say you're constructing a vertical antenna for 40 meters. You will probably need a matching network to go between the 50-Ohm purely resistive coaxial feedline and the complex impedance situa-

tion found at the feedpoint of your new antenna. You can calculate what this impedance should be but rarely is. Practically, you will have to use a noise bridge—or an R-X impedance bridge, if you can beg, borrow, or steal one—in order to determine

the values of the complex impedance.

Program Discussion

Look at the sample run (Fig. 2), and you'll see that both the input and complex impedances are first

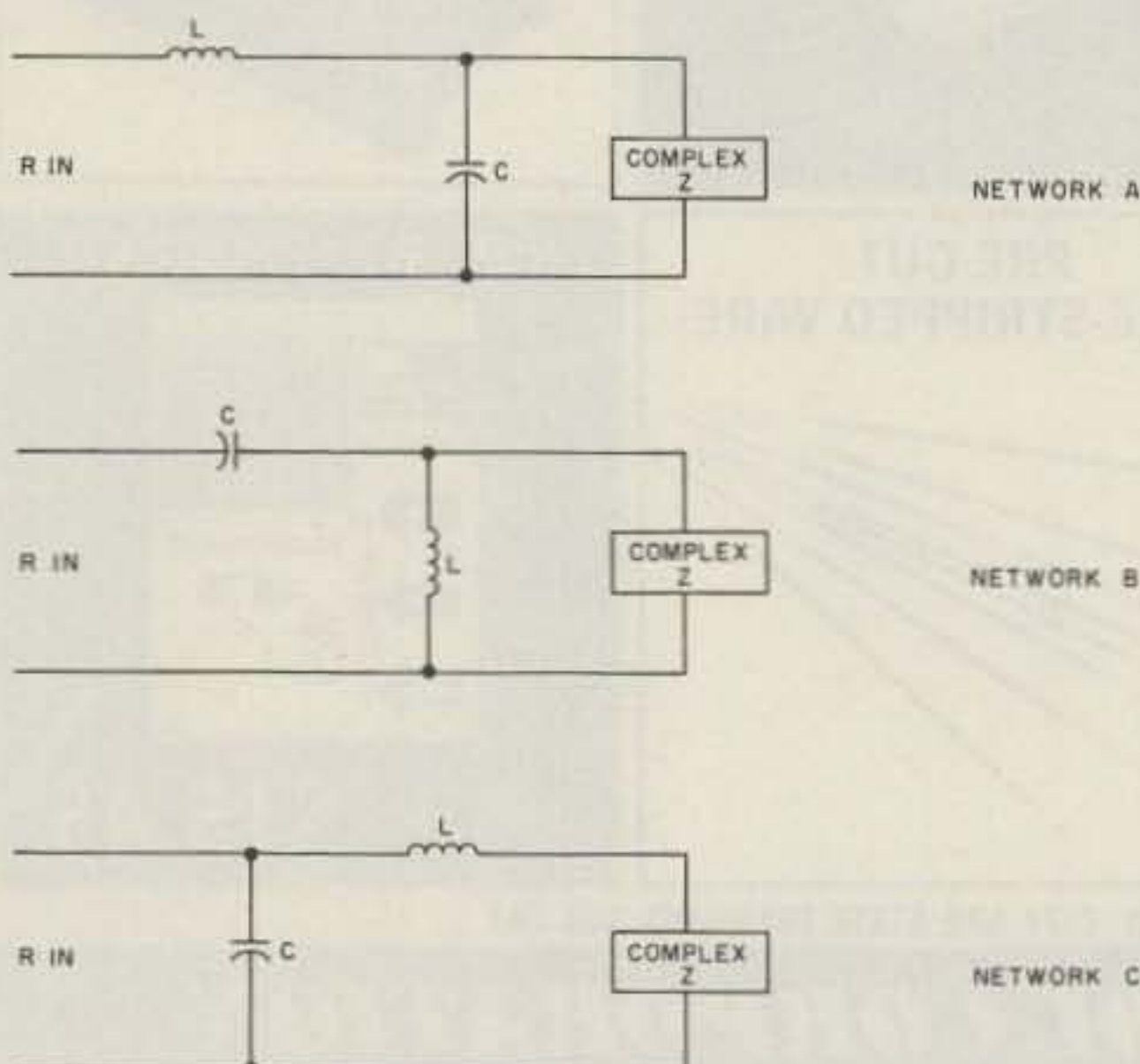

Fig. 1. Three L-network configurations.

RUN

L NETWORK DESIGN

WHAT IS THE INPUT IMPEDANCE TO L NETWORK? 50

ENTER THE COMPLEX IMPEDANCE OF THE LOAD; FIRST THE RESISTIVE COMPONENT AND THEN THE REACTIVE COMPONENT.

RESISTIVE (OHMS) 142

REACTIVE (CAPACITIVE= (-); INDUCTIVE = (+)) 90

NETWORK A USED

CAP. REACTANCE = 84.32Ω

INDUCT. REACTANCE = 86.32Ω

FREQ. IN MHZ? 7.2

CAP. = 262.1 PICOFARADS

CAP. REACTANCE = 84.3Ω

INDUCTANCE = 1.9 MICROHENRIES

INDUCT. REACTANCE = 86.3Ω

INPUT Z = 50

COMPLEX Z = $142 + 90$

WANT TO:

1-ENTER A NEW FREQ.?

2-DESIGN A NEW NETWORK?

3-REVIEW NETWORK A?

4-STOP?

?1

FREQ. IN MHZ? 14.230

CAP. = 132.6 PICOFARADS

CAP. REACTANCE = 84.3Ω

INDUCT. = .9 MICROHENRIES

INDUCT. REACTANCE = 86.3Ω

INPUT Z = 50

COMPLEX Z = $142 + 90$

WANT TO:

1-ENTER A NEW FREQ.?

2-DESIGN A NEW NETWORK?

3-REVIEW NETWORK A?

4-STOP?

?3

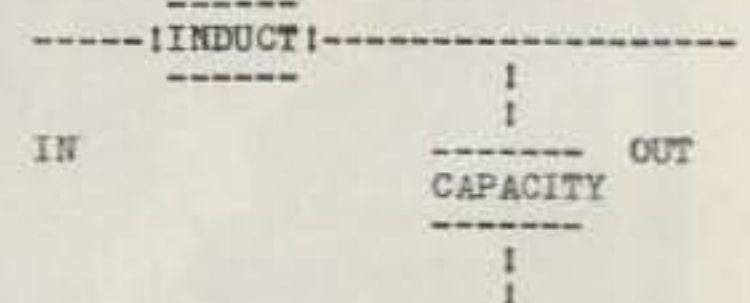

NETWORK A

TO CONTINUE ENTER ANY NUMBER 0

CAP. = 132.6 PICOFARADS

CAP. REACTANCE = 84.3Ω

INDUCT. = .9 MICROHENRIES

INDUCT. REACTANCE = 86.3Ω

INPUT Z = 50

COMPLEX Z = $142 + 90$

WANT TO

1-ENTER A NEW FREQ.?

2-DESIGN A NEW NETWORK?

3-REVIEW NETWORK A?

4-STOP?

?4

READY

Fig. 2. Sample run.

```

LIST
10 FOR X=1TO16:##":NEXT
12 # L NETWORK DESIGN"
14 # - - - - -"
16 FORX=1TO8:##":NEXT
18 FORX=1TO1000:NEXT
20 O$=CHR$(152)
22 INPUT"WHAT IS THE INPUT IMPED
ANCE TO L NETWORK? ",R1
24 #ENTER THE COMPLEX IMPEDANCE
OF"
26 #THE LOAD; FIRST THE RESIST
IVE"
28 #COMPONENT AND THEN THE REAC
TIVE"
30 #COMPONENT."
32 INPUT"RESISTIVE(OHMS) ",R
34 INPUT"REACTIVE (CAPACITIVE=(-
);INDUCTIVE=(+))",X
36 A=X/R1:B=R/R1
38 GOSUB134
40 IF A>.5 THEN 42 ELSE 44
42 IF B>1 THEN 56
44 IF A<0 THEN 46 ELSE 52
46 IF B<1 THEN 48 ELSE 52
48 D=SQRT((A*A)+((B-.5)*(B-.5)))
50 IFD>.5 THEN 56
52 IF A<.5 THEN 54 ELSE 80
54 IF B>1 THEN 68 ELSE 80
56 GOSUB 92
58 C1=(((-2*R1*X)+K)/(2*(R-R1))
60 L1=((R1*X)+(C1*(R-R1)))/R
62 #NETWORK A USED"
64 N$="A"
66 GOTO 102
68 GOSUB 92
70 L1=(2*R1*X)+K
72 C1=(L1*(R-R1)-(R1*X))/R
74 #NETWORK B USED"
76 N$="B"
78 GOTO 102
80 L1=(SQRT(R1*R-R*R))-X
82 S2=(L1+X)*(L1+X)
84 C1=(S2+(R*R))/(L1+X+.0000001)
86 #NETWORK C USED"
88 N$="C"
90 GOTO 102
92 W=4*R1*R1*X*X
94 Y=4*R1*(R-R1)
96 Z=X*X+R*R
98 K=SQRT(W+Y*Z)
100 RETURN
102 #CAP. REACTANCE= ";INT(C1*100)
/100;O$
104 #INDUCT. REACTANCE= ";INT(L1*
100)/100;O$
106 GOSUB 134
108 INPUT"FREQ. IN MHZ.?",F
110 C=1/((C1*2*3.14159*F)
112 L=L1/(2*3.14159*F)
114 C=INT(C*10000000)/10
116 L=INT(L*10)/10
118 #CAP.= ";C;" PICOFARADS"
120 #CAP. REACTANCE= ";INT(C1*10)/10;O$
122 #INDUCT.= ";L;" MICROHENRIES"
124 #INDUCT. REACTANCE= ";INT(L1*10)/10;O$
126 # INPUT Z= ";R1;O$
128 #COMPLEX Z= ";R;" + ";X
130 GOSUB 134
132 GOTO 164
134 #-----"
136 RETURN
138 #-----"
140 #-----I INDUCT I-----"
142 #----- I"
144 #----- I"
146 #IN ----- OUT"
148 #----- CAPACITY"
150 #-----"
152 #----- I"
154 #----- I"
156 #-----"
158 #:#NETWORK A"
160 INPUT"TO CONTINUE ENTER ANY NUMBER",Z
162 GOTO 118
164 #WANT TO:"
166 # 1-ENTER A NEW FREQ.?"
168 # 2-DESIGN A NEW NETWORK?"
170 # 3-REVIEW NETWORK ";N$;" ?"
172 # 4-STOP?"
174 INPUT D
176 IF D=1 THEN 108
178 IF D=2 THEN 22
180 IF D=4 THEN 244
182 FOR X=1 TO 8:##":NEXT
184 IF N$="A" THEN 138
186 IF N$="B" THEN 190
188 IF N$="C" THEN 218
190 # I C I"
192 # I A I"
194 #-----I P I-----"
196 # I I I"
198 # I I I"
200 #-----"
202 # I INDUCT I"
204 #IN -----"
206 # I"
208 # I"
210 #-----"
212 #NETWORK B"
214 INPUT"TO CONTINUE ENTER ANY NUMBER",Z
216 GOTO 118
218 #-----"
220 #-----I INDUCT I-----"
222 # I -----"
224 # I"
226 #-----"
228 #IN CAP OUT"
230 #-----"
232 # I"
234 # I"
236 #-----"
238 #NETWORK C"
240 #:#INPUT"TO CONTINUE ENTER ANY NUMBER",Z
242 GOTO 118
244 END

```

Fig. 3. Program listing.

entered into the computer, which then selects the correct configuration and calculates the values of capacitive and inductive reactance required to perform the match. Next, inputting the frequency in megahertz yields a summary page which now includes specific values for the capacitor (in picofarads) and coil (in microhenries). Select the review option, and your computer

will then print/display a schematic diagram of the correct L-network.

The program is written in D.G.S.S. Maxi-BASIC version 1 and occupies approximately 2.5k of RAM, not counting the interpreter.

Note line 20 in the listing of the program: O\$ = CHR\$(152). This defines the O\$ string as Ohm, a Greek character available on Digital Group systems

because of the MCM6571L character generator ROM which is used. If you are using another system, simply rewrite line 20 to read: O\$ = "ohms".

The program as listed is written for clarity of content and not minimum memory consumption. By introducing a couple of subroutines and combining lines, you can significantly reduce the memory required, if need be.

Conclusion

This program provides an impedance matching capability which is easy to use and belongs in every ham's bag of tricks. ■

References

1. "How to Design L Networks," R. E. Leo W7LR, *Ham Radio Magazine*, Feb., 1974.
2. "Designing Impedance Matching Systems," R. Baird W7CSD, *Ham Radio Magazine*, July, 1973.

SAVE

COMPUTER INTERFACES & PERIPHERALS

SAVE

For free catalog including parts lists and schematics, send a self-addressed stamped envelope.

APPLE II SERIAL I/O
INTERFACE *

Part no. 2

• Baud rates up to 30,000 • Plugs into Apple Peripheral connector • Low-current drain • RS-232 Input and Output. SOFTWARE • Input and Output routine from monitor or BASIC to teletype or other serial printer. • Program for using an Apple II for a video or an intelligent terminal. Also can output in correspondence code to interface with some selectrics. Board only — \$15.00; with parts — \$42.00; assembled and tested — \$62.00.



T.V. TYPEWRITER

Part no. 106

• Stand alone TVT
• 32 char/line, 16 lines, modifications for 64 char/line included • Parallel ASCII (TTL) input • Video output • 1K on board memory • Output for computer controlled cursor • Auto scroll • Non-destructive cursor • Cursor inputs: up, down, left, right, home, EOL, EOS • Scroll up, down • Requires +5 volts at 1.5 amps, and -12 volts at 30 mA • All 7400, TTL chips • Char. gen. 2513 • Upper case only • Board only \$39.00; with parts \$145.00

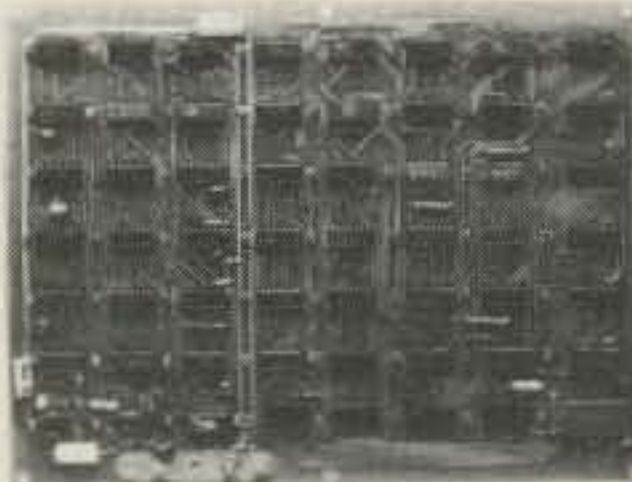
8K STATIC
RAM

Part no. 300

• 8K Altair bus memory • Uses 2102 Static memory chips • Memory protect • Gold contacts • Wait states • On board regulator • S-100 bus compatible • Vector input option • TRI state buffered • Board only \$22.50; with parts \$160.00

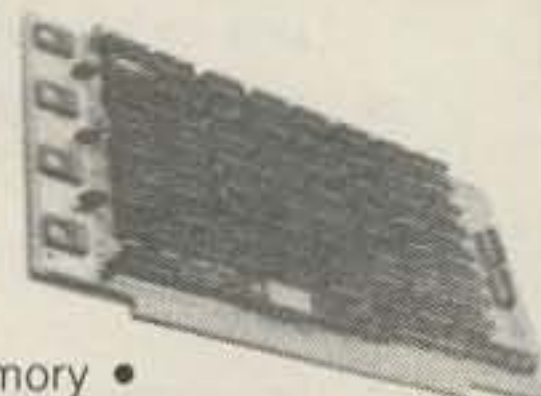

MODEM*

Part no. 109

• Type 103 • Full or half duplex • Works up to 300 baud • Originate or Answer • No coils, only low cost components • TTL input and output-serial • Connect 8 ohm speaker and crystal mic. directly to board • Uses XR FSK demodulator • Requires +5 volts • Board \$7.60; with parts \$27.50



TIDMA*

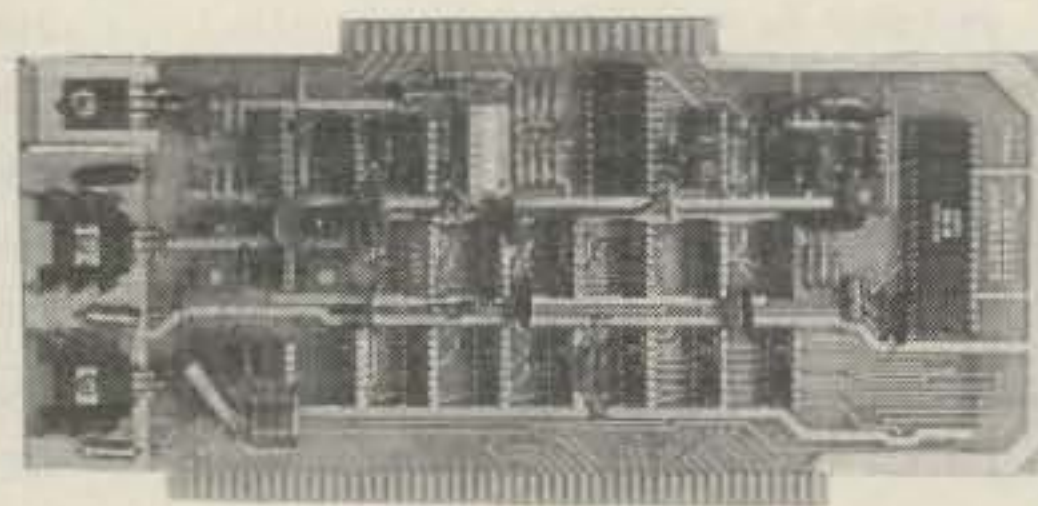

Part no. 112

• Tape Interface Direct Memory Access • Record and play programs without bootstrap loader (no prom) has FSK encoder/decoder for direct connections to low cost recorder at 1200 baud rate, and direct connections for inputs and outputs to a digital recorder at any baud rate. • S-100 bus compatible • Board only \$35.00; with parts \$110.00

DC
POWER SUPPLY*

Part no. 6085

• Board supplies a regulated +5 volts at 3 amps., +12, -12, and -5 volts at 1 amp. • Power required is 8 volts AC at 3 amps., and 24 volts AC C.T. at 1.5 amps. • Board only \$12.50; with parts excluding transformers \$42.50



RF MODULATOR*

Part no. 107

• Converts video to AM modulated RF, Channels 2 or 3. So powerful almost no tuning is required. On board regulated power supply makes this extremely stable. Rated very highly in Doctor Dobbs' Journal. Recommended by Apple. • Power required is 12 volts AC C.T., 0 +5 volts DC • Board \$7.60; with parts \$13.50



TAPE INTERFACE *

Part no. 111

• Play and record Kansas City Standard tapes • Converts a low cost tape recorder to a digital recorder • Works up to 1200 baud • Digital in and out are TTL-serial • Output of board connects to mic. in of recorder • Earphone of recorder connects to input on board • No coils • Requires +5 volts; low power drain • Board \$7.60; with parts \$27.50

UART & BAUD RATE
GENERATOR*

Part no. 101

• Converts serial to parallel and parallel to serial • Low cost on board baud rate generator • Baud rates: 110, 150, 300, 600, 1200, and 2400 • Low power drain +5 volts and -12 volts required • TTL compatible • All characters contain a start bit, 5 to 8 data bits, 1 or 2 stop bits, and either odd or even parity. • All connections go to a 44 pin gold plated edge connector • Board only \$12.00; with parts \$35.00 with connector add \$4.00

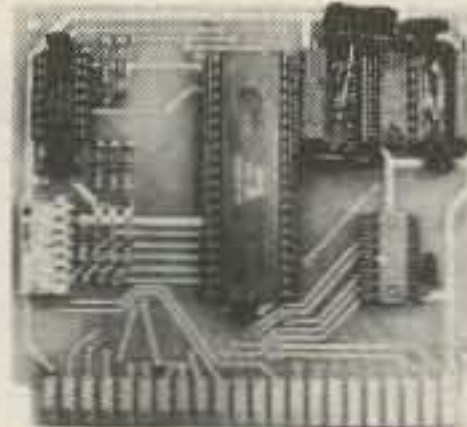
RS 232/TTY
INTERFACE*

Part no. 600

• Converts RS-232 to 20mA current loop, and 20mA current loop to RS-232 • Two separate circuits • Requires +12 and -12 volts • Board only \$4.50, with parts \$7.00

RS 232/TTL
INTERFACE *

Part no. 232

• Converts TTL to RS-232, and converts RS-232 to TTL • Two separate circuits • Requires -12 and +12 volts • All connections go to a 10 pin gold plated edge connector • Board only \$4.50; with parts \$7.00 with connector add \$3.00

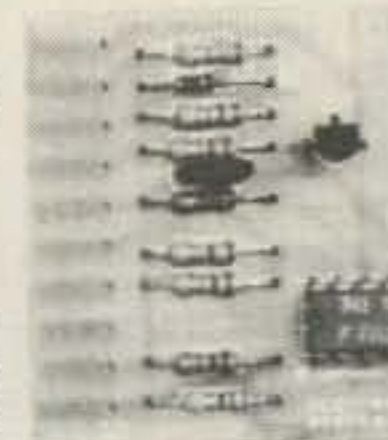

ELECTRONIC SYSTEMS Dept. 73, P.O. Box 21638, San Jose, Calif. USA 95151

E21

To Order:

Mention part number and description. For parts kits add "A" to part number. In USA, shipping paid for orders accompanied by check, money order, or Master Charge, BankAmericard, or VISA number, expiration date and signature. Shipping charges added to C.O.D. orders. California residents add 6.5% for tax. Outside USA add 10% for air mail postage, no C.O.D.'s. Checks and money orders must be payable in US dollars. Parts kits include sockets for all ICs, components, and circuit board. Documentation is included with all products. All items are in stock, and will be shipped the day order is received via first class mail. Prices are in US dollars. No open accounts. To eliminate tariff in Canada boxes are marked "Computer Parts." Dealer inquiries invited. 24 Hour Order Line: (408) 226-4064

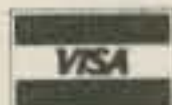

*Designed by John Bell

ROTOR SPECIAL

Wilson WR500.....\$109.95
CDE Ham III.....124.95

ANTENNA SPECIAL

Cuchcraft ATB-34.....\$209.95
Wilson Sys 1.....219.95
Wilson Sys 2.....179.95

HF SPECIAL

Kenwood TS-820S.....\$998.00
Kenwood TS-520S.....679.00
Yaesu FT-101E.....715.00
Yaesu FT-901DM.....1199.00*

*(order now)

2 METER SPECIAL

Tempo VHF/ONE PLUS.....\$349.00
Yaesu FT-227R.....289.95
Wilson WE800.....439.95

Jim WB2JON **Wayne N2WK**

CALL FOR YOUR PRICE TODAY FOR YOUR NEEDS **A51**

Amateur Radio of Rochester

1185 SCOTTSVILLE ROAD - ROCHESTER, NEW YORK 14624 - (716) 235-7540

PCP™ TYPE-A PATENT PENDING

PCP TYPE-A TRANSFER FILM lifts the ink DIRECTLY from printed page!
(NO CHEMICALS or PHOTOGRAPHY required!)

Only additional materials required are: Sensitized boards, developer, & etchant!

SEE POPULAR ELECTRONICS FEB '78 ISSUE!

FINALLY you can make HIGH QUALITY printed circuit boards directly from magazine construction articles! Can also be used to make specialized meter faces, front panel decals, component placement decals & others.

Small Pkg. 6pcs 4x6 \$5.49
Med. Pkg. 4pcs 6x9 \$6.95
Large Pkg. 3pcs 9x12 \$7.95

PCP P26 PRINTED CIRCUIT PRODUCTS CO.
P.O. BOX 4034
MELINA, MT 59601

TELETYPE® MODEL 33 ASR

COMPUTER I/O COMPLETE WITH:

- Tape Punch
- Ready to Go
- Tape Reader
- Line/Local Wired
- Guaranteed 30 Days

\$840.00

INCLUDING PACKING
F.O.B. N.J. FACTORY

COMPLETE COVER READY TO INSTALL \$ 25.00
COPY HOLDER (18003) \$ 14.00
TAPE UNWINDER (12" NEW) \$ 55.00
WIND UP PAPER TAPE WINDER (1") \$ 52.00
ELECTRIC PAPER WINDER (LPM 300 NEW) \$ 50.00
DEC TYPE READER RUNCARD \$ 45.00
ACOUSTIC COUPLER
OMNITEK 501A (NEW) \$180.00
READER POWER PACK (18234) \$ 25.00
EIA RS-232 INTERFACE \$ 55.00
ACOUSTIC COVERS with FAN (NEW) \$75.00

If its for TELETYPE® We Have It.

If you don't see what you need

CALL or WRITE!



TELETYPEWRITER COMMUNICATIONS SPECIALISTS
T13 550 Springfield Avenue • Berkeley Heights, N. J. 07922
(201) 464-5210 • TWX 710 986-3016 • TELEX 13 6479

SUBSIDIARY OF VAN'S W2DLT ELECTRONICS.

REGULATED POWER SUPPLY

- Fully regulated, dual protected, 13.8 volts
- Illuminated on/off switch
- Hammertone metal case

33 Amp (30 Amp continuous)...\$119.95
20 Amp (16 amp. cont.) \$74.95
8 Amp (6 amp. cont.) \$39.95

TIMES CABLE

RG-8U - 100' multiples 18c/ft.
RG-213U - (Non-contaminating jacket)
-100' multiples 22c/ft.
1/2" Aluminum Jacketed hardline - 75 ohm.
1000' rolls only 29c/ft.
PL259 connectors 25/50c ea.
or 100/45c ea. POSTPAID

UNIVERSAL TOWERS

SUPER DISCOUNTS —
S.A.S.E. for brochure and prices!

Send S.A.S.E. for additional information. Include shipping charges with check or money order. (Ohio residents add 4 1/2% sales tax).

JRS ELECTRONICS J8

P.O. Box 1893—Cincinnati, Ohio 45201

AMATEUR TELEVISION ON 439.25 MHz

INTERESTED? ACTIVITY IS
INCREASING EVERYWHERE
YOU CAN GET ACTIVE IN YOUR
AREA WITH OUR PRODUCTS —

**AMIB FSTV CONVERTER
complete \$150.00**
**AX10B FSTV TRANSMITTER
complete \$385.00**

CALL 812-336-4775, OR WRITE US,
FOR COMPLETE DETAILS

**APTRON
LABORATORIES** A6
PO BOX 323
BLOOMINGTON, INDIANA, 47401

Pace-Traps
P15

Box 234
Middlebury CT 06762

ICOM-22S OWNERS!!

Get rid of the CB dial. Go to direct frequency read-out in 30 minutes and minimum cost. PACE-DIAL will do the job. An accurately silk-screened replacement dial and enough dry-transfer numbers to make hundreds of frequency combinations. Tailors the dial to exactly the frequencies you have set-up in your ICOM. Complete dial-kit and full instructions furnished. \$3.25 ppd.



Check or MO to:
Box 234
Middlebury CT 06762
(203) 758-9228

Build Your Own CW Keyboard Keyer



Save Over \$175

QSL for full details

ECM

ECM Corporation,
412 N. Weinbach Ave.,
Evansville, IN 47711
812-476-2121 E1

CIRCUIT BOARDS

- REPEATER CONTROL
- COMPUTER PROJECTS
- SENSITIZED BLANKS
- NEGATIVES/POSITIVES
- PROTO-TYPE BOARDS
- PARTS KIT
- CUSTOM ETCH/DRILL

We can supply many of the items you need to make a p-c board. Send SASE + 25 cents for catalog.

O.C. Stafford S50

Electronic Service and Development
427 S. Benbow Rd.
Greensboro, NC 27401
919-274-9917 DAY/NITE

Hung Up On Autopatch?

—*build this frustration fighter*

Eugene Doren WA6THG
6218 Calle Empinada
San Diego CA 92120

After successfully operating the local autopatch facilities here in the San Diego area, I decided to update and add some convenience features to my touchtone™ machine in the form of an autotimer.

Many times, an automatic time-out feature is incorporated in the patch facilities to limit their operation to a specific period of time. Failure to terminate the patch results in an automatic hang-up, regardless of whether or not you are talking. This is as it should be and prevents long-winded talkers from tying up a very popular operating convenience to the ham community. Being sometimes long-winded, I have had the patch facilities hang me up. After going through this a couple times, I decided that what I needed was my own autotimer to warn

me of this impending disaster. Thus was born the idea for the autore minder autopatch autotimer.

My initial idea was to light an LED and hold it lit for each elapsed minute and then go into a flashing mode for the last 30 seconds. However, this required more circuitry than I could cram into the touchtone box. I decided to simplify the whole operation and use only three LEDs. One would remain on for the first 3½ minutes, with the remaining two going into an alternating flash mode 30 seconds before hang-up by the patch facilities. With this operation, a long-winded talker has thirty seconds to say his good-byes before the bomb falls.

Considerable thought and experimentation went into the final design. I wanted a circuit that would begin timing automatically, rather than one that would have to be manually initiated. Because the autopatch facilities begin the countdown period upon access of the dial tone, the problem of beginning my own timer

circuit was simplified. Depressing any button on the pad will automatically begin the 3½-minute countdown.

With the Western Electric 35N1A pad, battery voltage is automatically applied through the green and green-white pair when any button is depressed. I decided that this could be utilized, as I was already using this switched voltage to turn on a solid state switch across the push-to-talk line in the transmitter. I simply paralleled the new circuit across it.

To keep things simple, uncomplicated, and, most of all, reliable, all transistors used are the common 2N2222A. This is a silicon NPN device with very conservative ratings which is easy to come by and very rugged. On the surplus market, they can be found for as little as 25¢ each. The 555 timer chips are also available for a very reasonable 50¢ each on the surplus market. So the circuit presented can be constructed for very little outlay of cash. Let's take a look and explore how it works.

About the Circuit

The circuit is a very simple one when broken down into its basic components. Neither layout nor parts are critical, with the exception of the timing capacitor used in the 3½-minute portion of the circuit. This capacitor and the associated 8.2-meg resistor form the two basic components used for the timing period. I found, after much trial and error, that electrolytics in this application are not dependable enough due to their higher internal leakage. I used solid tantalum capacitors, although mylar or polycarbonate units would have been better. In addition, a 35-volt unit was selected, even though it is working in a seven-volt circuit. This keeps its leakage problems to an absolute minimum.

Transistor Q1 is used as a switch to discharge C1 through the 1k resistor, R3. Application of battery voltage through the steering diode to the base saturates the transistor and the "switch" is closed. The result is a beautiful short-duration negative pulse which is coupled through

the .001 capacitor to the trigger pin #2 of the 3½-minute timer. This timer is wired in a monostable mode, and, once its timing period has been initiated by a pulse, it ignores all other pulses until its timing period is completed. Simultaneously, as Q1 is being switched on with the application of battery voltage, the SCR is being gated on with the same voltage across the resistor string, R1, R2. This SCR is used as a switch to complete the dc path to the timer chips, IC1 and IC2. Like the old thyatron tube, the SCR, once gated, begins conduction and stays conducting even after its gate voltage is removed. This happens when you lift your finger from the touchtone button. To turn off the SCR and reset the entire circuit, SW1 is momentarily opened. This action is simple and very foolproof. This SCR is a noncritical item, and almost any SCR will work in this application.

Notice that IC1 and IC2 comprise a "stacked" circuit. When IC1 is initially turned on with the trigger pulse from Q1 and C1, its output at pin #3 goes high to full battery voltage less the drop across the SCR, thus turning on LED1. Because IC2 is stacked across pin #3 and battery voltage, it has no voltage potential across it during this period. Therefore, it cannot flash its warning until the first timing period is completed. As C2 reaches 2/3 Vcc, IC1 turns off, and its output at pin #3 goes low. This action switches on voltage to IC2, and it goes into its alternate flashing action.

For ease in setting precisely the required initial timing period of IC1, a 10k pot is used to apply a variable voltage to the reset pin, #5. More voltage on pin #5 results in a longer timing period, and less

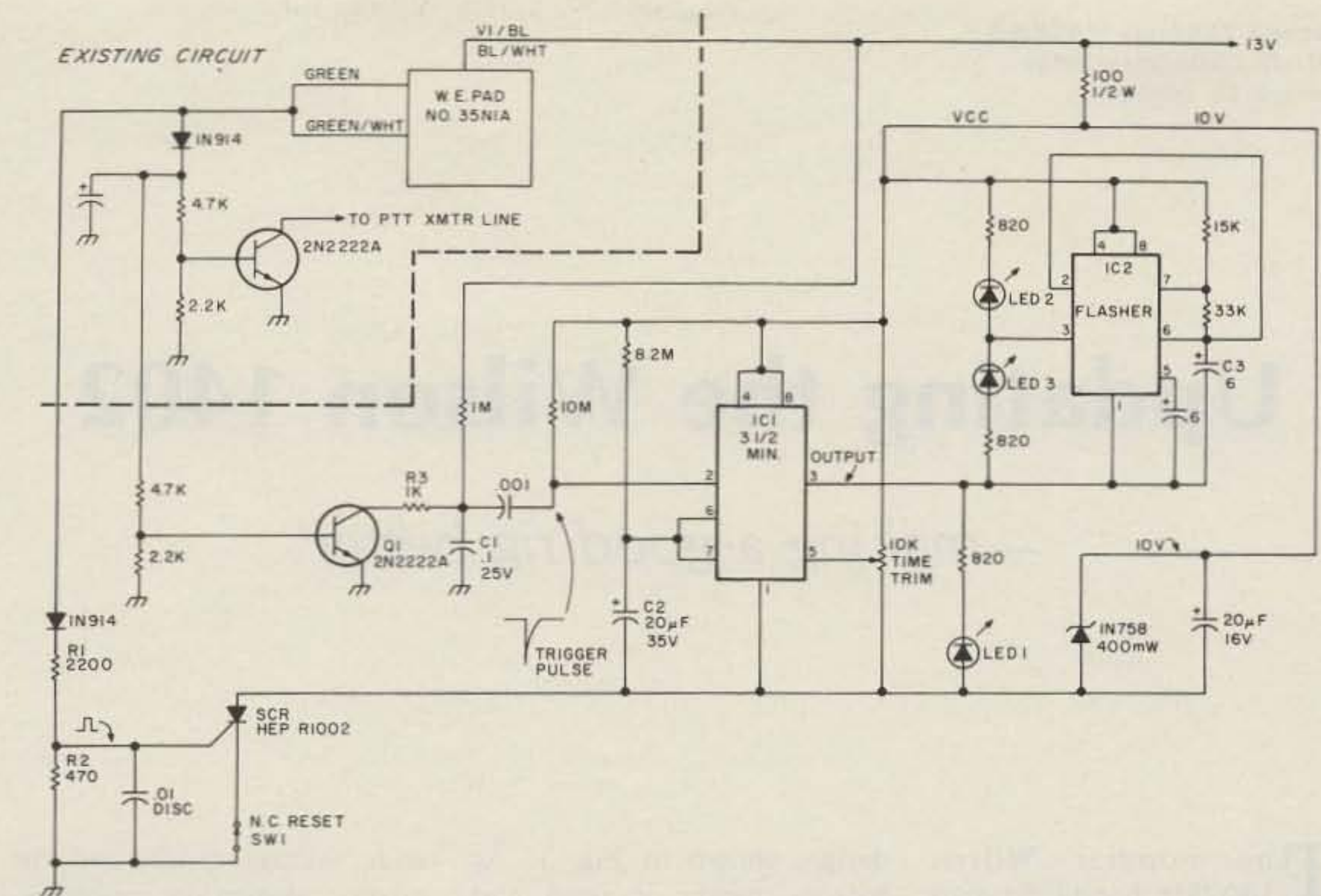

Fig. 1. Autoremind autpatch autotimer. All resistors are ¼ Watt unless noted. IC1-2—LM-555; LEDs—surplus jumbo reds.

voltage shortens the period. With the values shown, the initial timing period of IC1 can be varied from a short twenty seconds or less to as long as four minutes or more, depending upon the accuracy of the capacitor value, C2. I have found that most capacitors are "long" in value, that is, they exhibit more capacitance than their rated values. Because of this, the necessity of the 10k pot arose. Its operation is simple and dependable, and it allows great flexibility in selecting the desired timing period.

There is nothing critical in any values used with IC2. It is wired in an astable configuration with the timing components chosen to give an alternating flash period of about ½ second for each of the two associated LEDs. This flash rate gives a nice busy look and is a real attention-getter. The ten-volt zener diode was added to assist in elimination of spurious automotive transients which were falsely triggering on the timer chips. In addition, it reduced the ap-

plied voltage to C2 and helped to keep the internal leakage problem of this capacitor to a minimum.

Although the spec sheets show only a .01 bypass across pin #5 of the flasher circuit, I found that increasing this value to something around 6 uF eliminated many unexplained actions of the 3½-minute timer chip. Without some good bypassing on this pin, much hash was being generated on the dc line by the flasher circuit.

While browsing through a recent edition of *Popular Science*, I noticed, under the heading "New Products," a telephone timer used to give an indication of when three minutes were up on long-distance calls. Well, friends, if autpatch and touchtone circuits are not your bag, then be my guest and call this circuit "the long-distance telephone timer" (or Fred, if you like). A little imagination could make this same circuit into a dandy 9½-minute station ID timer with 30-second warning by using the values of

8.2 meg and 67 mF in the IC1 circuit. If you should find that IC1 never wants to turn off, put a high impedance voltmeter across C2. You will probably find that this voltage never reaches 2/3 Vcc or around 6½ volts. The problem will most probably boil down to leakage in the timing capacitor, C2. The most troublesome portion of the entire circuit was the development of the necessary trigger pulse used to begin the initial 3½-minute period. Thanks go to Walter Jung and his most helpful booklet, *IC Timer Cookbook*, published by Sams. It's a fascinating bit of reading and recommended to all who want to experiment in the wonderful world of timers.

Try my circuit. It's a fun device. Let your imagination run wild, and perhaps you can come up with another idea for its use. One fellow I know is using the flasher in his car to chase the hamburglars away. Farfetched? Perhaps, but then who is to say what's farfetched if it works? ■

Updating the Wilson 1402

—making a good rig better

The popular Wilson 1402SM hand-held two meter transceiver has gained a reputation as one of the better performing rigs available. However, a common problem seems to appear in 1402s when battery voltage starts dropping much below 12 volts — receive audio distortion.

The problem can be traced to the audio output circuitry

design, shown in Fig. 1. As battery power is used and operating voltage falls below an optimum level, the voltage drop across R45 changes. This results in severe cross-over distortion and, in effect, a reduction in usable battery life. If R45 is replaced by two silicon diodes in series, the voltage drop between the bases of Q19 and Q20 will remain constant over a very

wide voltage range, and the audio distortion vanishes. Unfortunately, this configuration consumes excessive current.

A highly effective compromise circuit is shown in Fig. 2. R45 has been replaced by a low-voltage silicon diode in series with an 82-Ohm, 1/8-Watt resistor. In addition, R43, the collector load of Q19, was replaced with a 120-Ohm resistor. This circuit results in greatly improved audio quality at supply volt-

ages down to 9.5 volts with receiver current drain that is within Wilson specs.

When making the modification, be aware that the exact resistor values marked on your schematic may not match the components in your rig. Tama Denki (manufacturer of the Wilson rig) has apparently changed a few component values without changing the schematic. A small amount of circuit tracing will ensure that you're swapping the right components.

Tama Denki also manufactured the Ken and Pace hand-held transceivers, and it is possible that certain models would demonstrate the same problem. Circuitry changes have been made in the Wilson 1405 which would apparently correct the problem. The audio output circuitry of the 1405 is shown in Fig. 3.

The reverse polarity protection on the 1402 is also of note. As shown in Fig. 4, diode D107 is reverse biased when the proper polarity voltage is applied to the circuit. If polarity should be reversed and a negative voltage applied to point C (external power input jack),

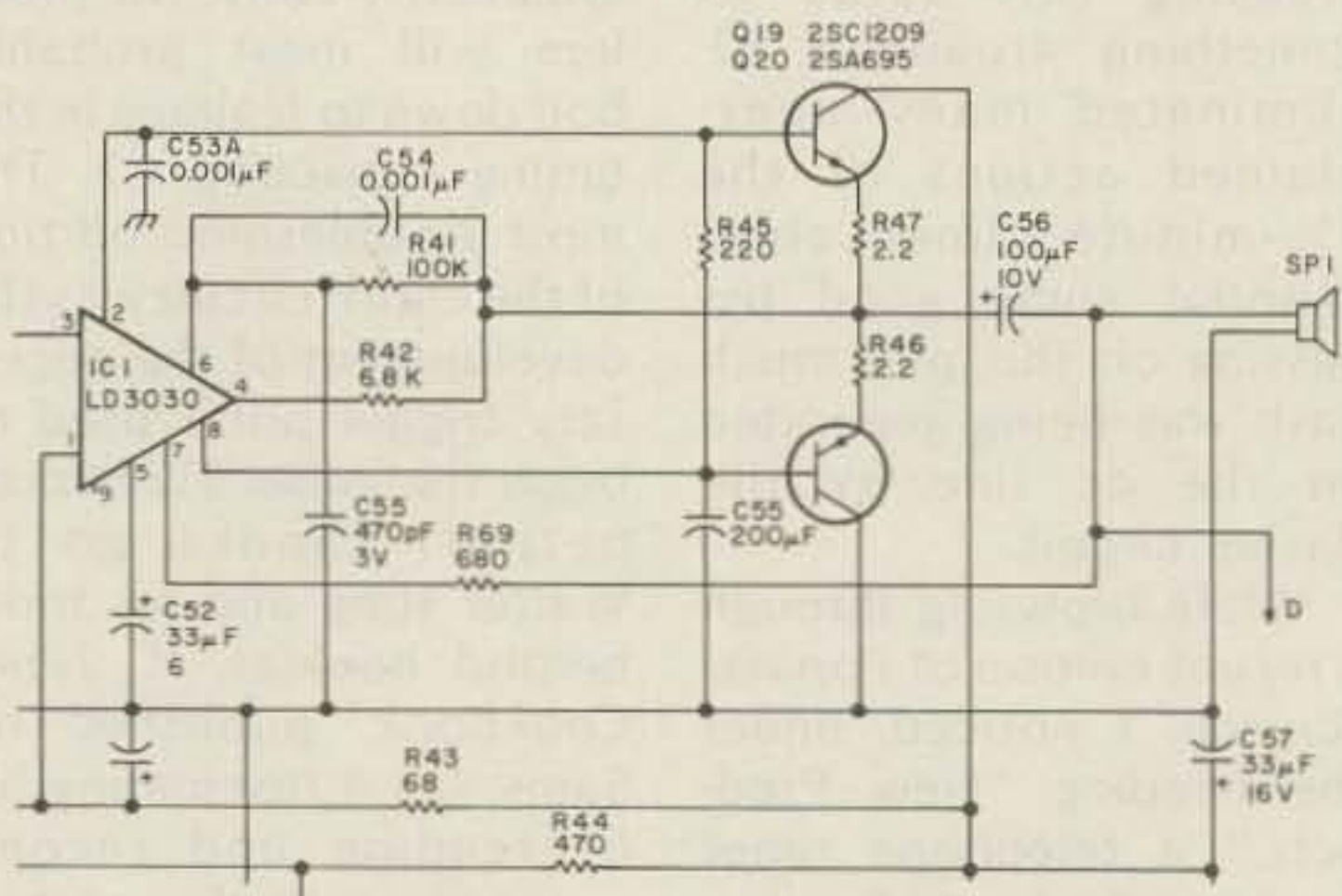

Fig. 1.

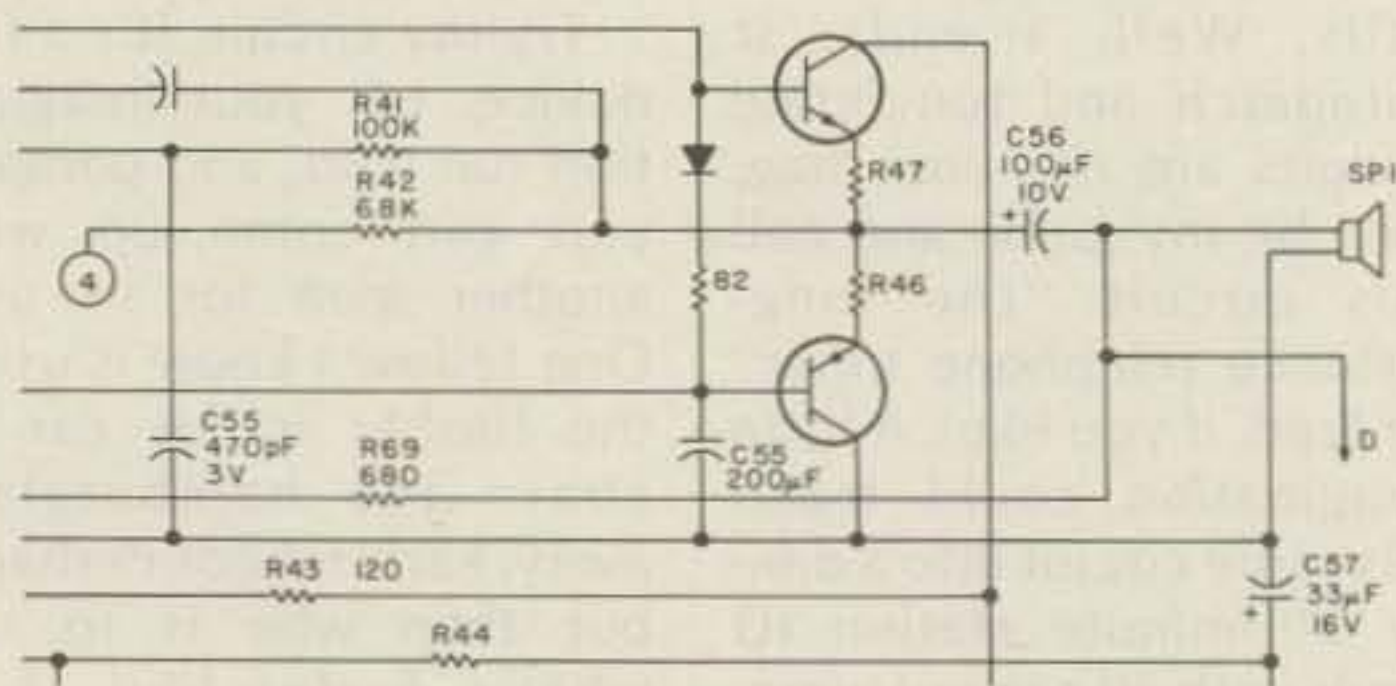

Fig. 2.

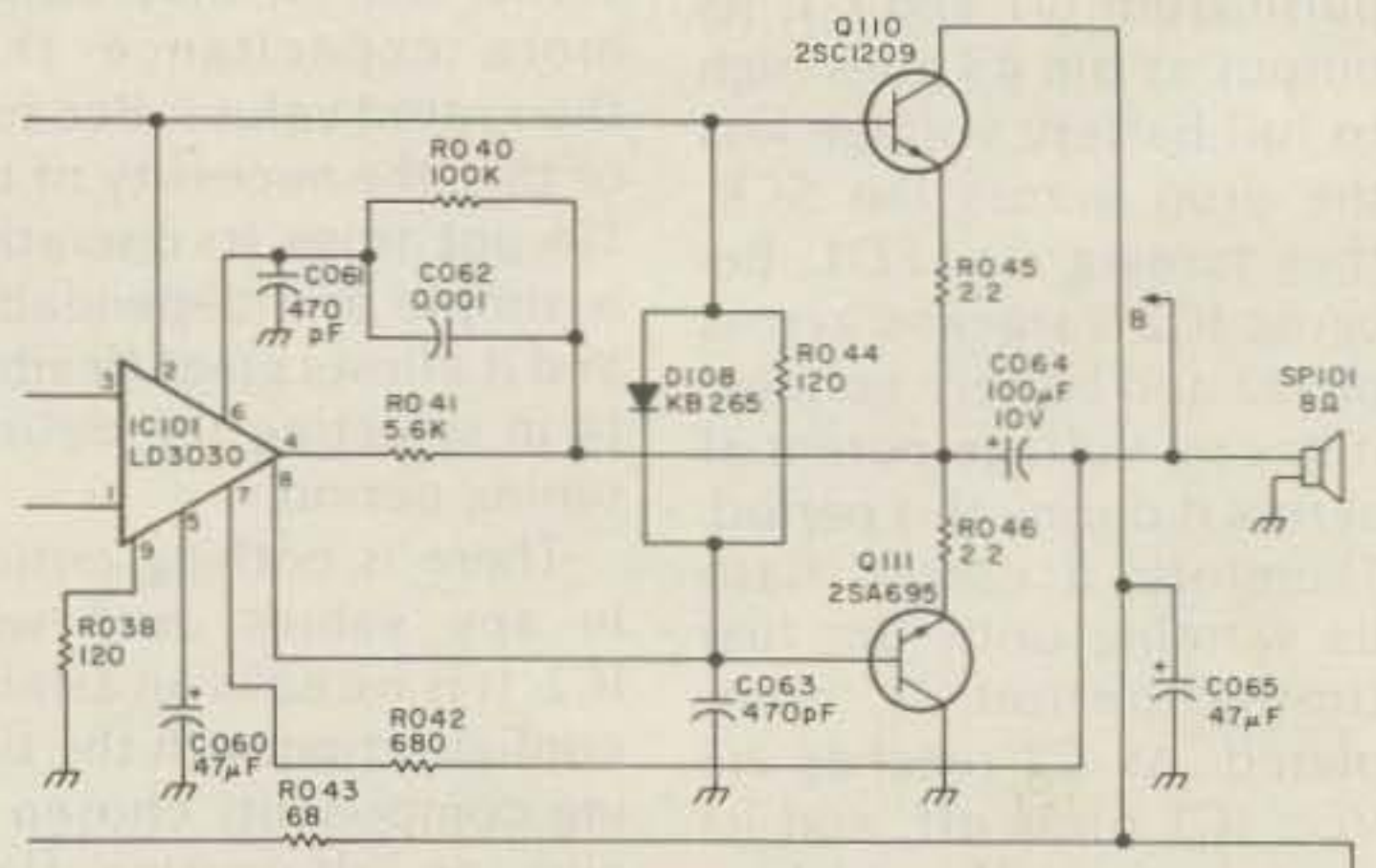

Fig. 3.

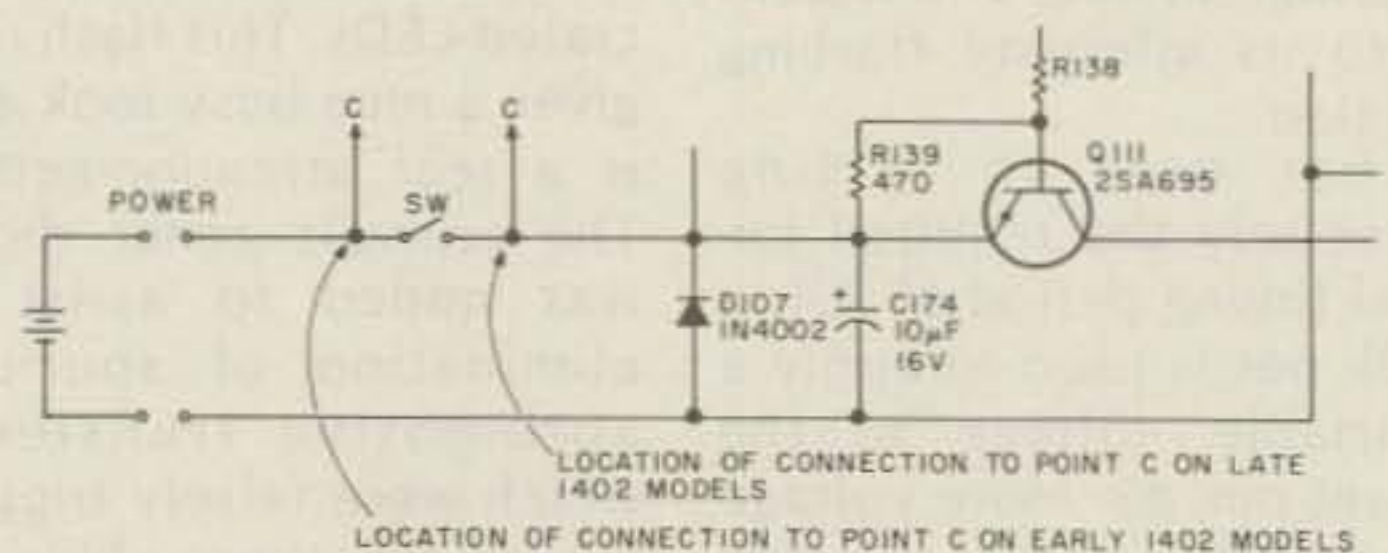

Fig. 4.

the result would not be pleasant! Diode D107 will be forward biased and short circuit the input voltage. D107 will probably open as a result, eliminating all reverse polarity protection!

The solution here is the addition of a fuse in the power input line. About .5 Amps should be about right. Now, if a reverse polarity voltage is encountered, the fuse should blow from the excessive current drawn by D107. Be sure that the fuse is

not a slow-blow type. If the fuse continues to blow with a proper polarity supply voltage, the transmit section is probably in need of peaking or the swr is too high. In either case, transmit current drain is excessive.

On early model 1402s, point C was connected to the battery side of the power switch. Although this may seem logical, it allowed unregulated external power to be applied to the internal nicad batteries while the rig

was left off. This could easily happen in a mobile installation, damaging the nicads. Later models of the 1402 revealed that point C had been moved to the rig side of the power switch. This solution comes with mixed blessings. With this arrangement, the rig is always on, even when the power switch is on "off." In addition, when the rig is switched "on," the nicads may charge at a higher than desirable current (50 mA is recommended by

Gould). A similar arrangement is used on the Wilson 1405, as well.

The simplest and safest way to avoid damaging the nicads is to remove the battery tray when operating mobile. Ideally, the nicads should only be charged on a proper charger. If this procedure is used, point C can be connected to the battery side of the power switch (if not there already), and the rig will truly be off when switched off. ■

W. A. Bohlman K3BPP
101 East St.
Doylestown PA 18901

Quick Check For TT Pads

— test for flea market bargains

All of you, I am sure, have walked around flea markets looking at all of the goodies and have said to yourselves, "That is a reason-

able price for that item, if it works." Let's alleviate that indecision in one area — telephones and, mainly, touch-tone™ pads.

There are two very simple ways of testing a touchtone pad, even when still installed in a telephone. The TT pad requires a dc voltage of 9 to 15 volts to operate. This same line, usually the red of the red-green pair, also contains the audio output of the pad.

color code is reversed inside the phone. ■

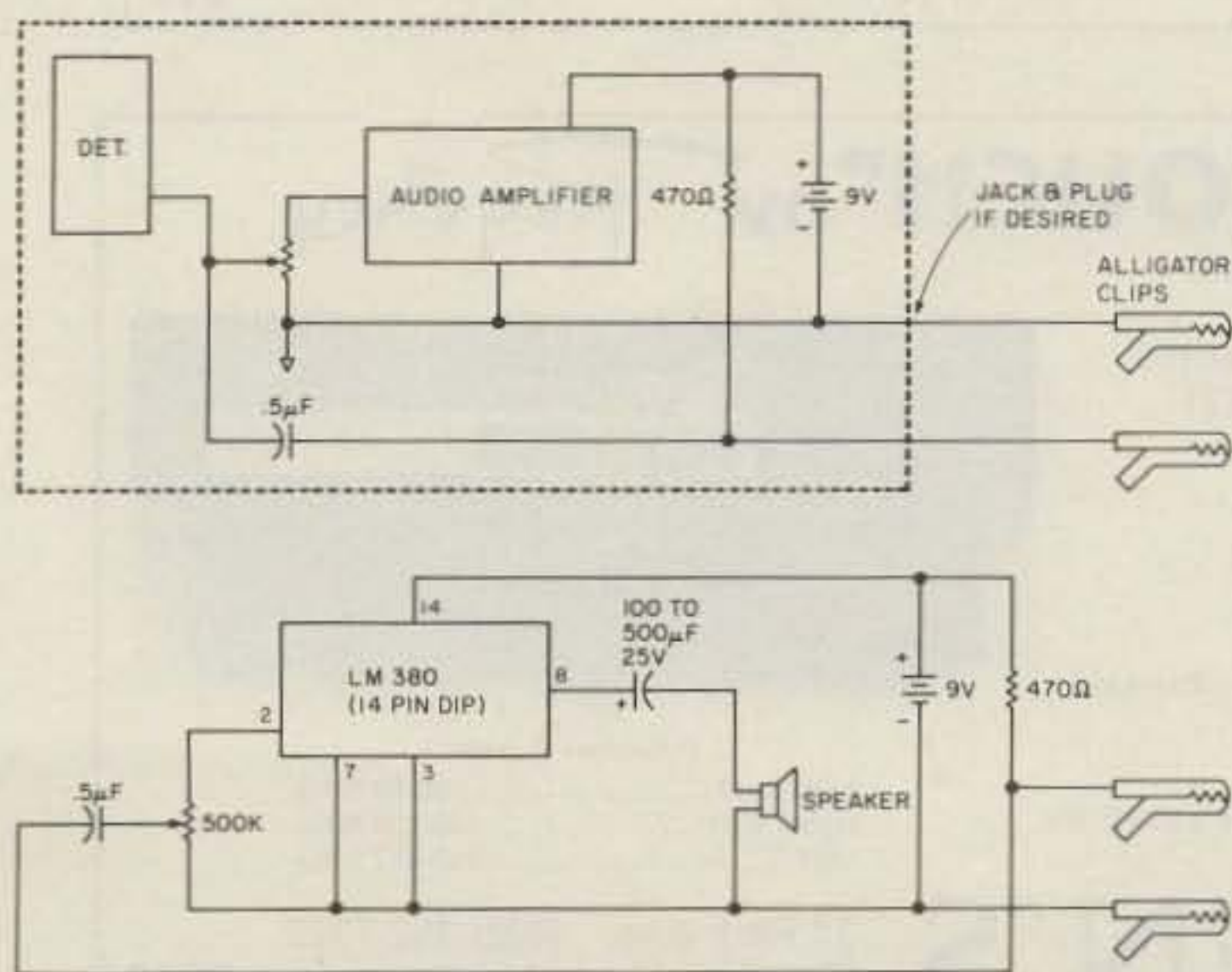

Fig. 1. Alternate solution.

All you have to do to test the pad and the mike of the telephone is to hook 9-15 volts dc through a 470 Ω load resistor to the red wire, connect the green to the other side of the supply, and ac couple through a .5 μF capacitor into an audio amplifier.

A portable transistor radio provides both requirements for testing. There is a 9 V dc supply and an audio amplifier. When testing a phone that looks dead, reverse the leads, because sometimes the

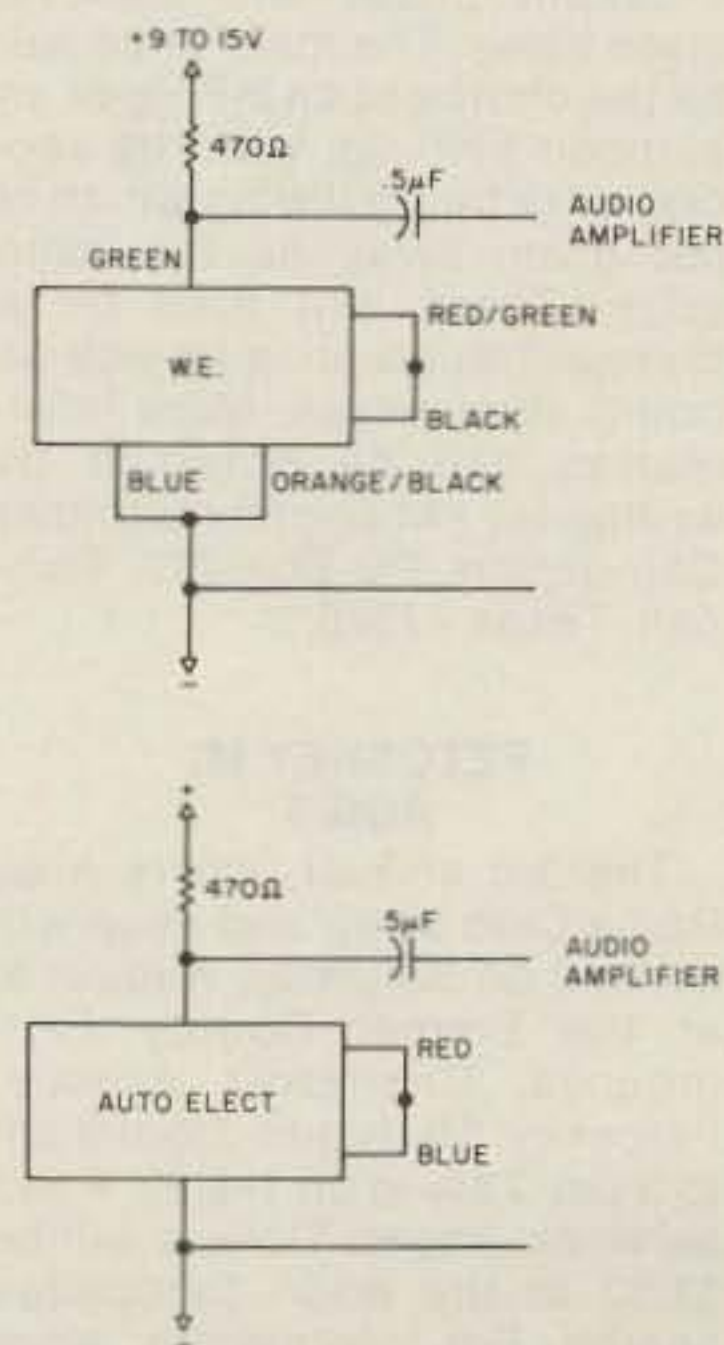

Fig. 2. Typical pad connections.

Social Events

MACKS INN ID AUG 4-6

The 46th Annual WIMU (Wyoming, Idaho, Montana, Utah) Hamfest will be held on August 4, 5, and 6, 1978, at Macks Inn, Idaho, 25 miles south of West Yellowstone, Montana. Talk-in on 146.34/94 and 3935. Advance registration is \$6.00 for adults and \$2.00 for children, before July 25th, 1978. Late/regular registration is \$7.00 and \$2.50. There will be a special prize drawing for preregistration. Please send preregistration to: WIMU Hamfest, 3645 Vaughn Street, Idaho Falls, Idaho 83401; phone (208)-522-9568.

HOUSTON TX AUG 4-6

On August 4, 5, and 6, 1978, the Houston Echo Society will host the annual Texas VHF-FM Society Summer Convention in the Galleria Plaza Hotel, just off interstate loop 610 at Westheimer Rd. While primarily devoted to the VHF-FM spectrum, attractions will also include microprocessors/microcomputers, the annual Texas champion hidden transmitter hunt, OSCAR communications, and much more, covering all phases of amateur radio. There will be forums conducted by both the ARRL and the FCC. A banquet/dance is planned for Saturday night. The featured speaker will be William A. Tynan W3XO, editor of "The World Above 50 MHz" column in QST. Exhibitors will be displaying their wares all day Saturday and Sunday. Several excellent prizes will also be given away. The main prize will be the choice of an HF rig or an allmode VHF rig, with the second prize being the rig which is not given away as the main prize. There will also be a preregistration prize as well as hourly door prizes. More information can be obtained by writing to: FM Society Summer Convention, PO Box 717, Tomball, Texas 77375.

PETOSKEY MI AUG 5

The 3rd annual Straits Area Radio Club swap and shop will be held on Saturday, August 5, at the Emmet County Fairgrounds, Charlevoix Avenue, Petoskey, Michigan, from 9 am to 3 pm. Talk-in on 146.52. Food services, prizes. Tickets will be \$1.50 at the door. Campsites nearby. For information, write to SARC in care of W8IZS, Box 416, Pellston MI 49769.

JACKSONVILLE FL AUG 5-6

The Jacksonville Hamfest Association is happy to announce the 5th annual Jacksonville hamfest which will be held on August 5 and 6, at the Jacksonville Beach Municipal Auditorium. Activities will include the usual swap tables and exhibitors' displays. Featured programs include a DX presentation by the North Florida DX Assn. on that group's recent DXpedition to Haiti at the invitation of the Haitian government. Shortly after the trip, amateur radio was legalized in Haiti after being outlawed for many years. NFDXA also has two CQ Magazine world championships to their credit. A complete seminar on microprocessors will also be featured, along with a "pileup" contest, hidden transmitter hunt, QLF contest, and ARRL meeting. Advanced tickets are now available for \$2.50 per person (\$3 at the door), with swap tables available for \$5 per day. The hamfest site is only one block

from the Atlantic Ocean, and those attending can bring their families for a weekend of fun on the beach. Door prizes and hourly drawings will be conducted. All inquiries should be directed to N4UF, Hamfest Chairman, 911 Rio St. Johns Dr., Jacksonville FL 32211. Phone is 744-9501.

UPPER ST. CLAIR TOWNSHIP PA AUG 6

The 41st annual hamfest of the South Hills Brass Pounders and Modulators will be held on August 6, 1978, from noon to dusk, at St. Clair Beach on Route 19 south, Upper St. Clair Township. There will be a swap and shop, picnic area, and swimming for the family. Mobile check-in on 29.0 MHz and 146.52 simplex. Information and preregistration for \$1.50 (\$2.00 at the door) are available from Bruce Banister, 5954 Leprechaun Dr., Bethel Park PA 15102. Vendors must register.

LEVELLAND TX AUG 6

The 13th annual Northwest Texas Emergency Net Picnic and Swapfest will be held Sunday, August 6, in the city park,

Levelland TX. Registration begins at 8 am. Lunch at 12:30 pm. Bring your own picnic basket. Swapping all day with tables provided. This is a family event and is jointly sponsored by the Hockley County Amateur Radio Club and the Northwest Texas Emergency Net. Talk-in on 146.28/88. A \$2.00 donation will be appreciated but not required.

SALINE MI AUG 6

The Arrow Repeater will sponsor its 3rd Annual Swap and Shop on Sunday, August 6, 1978, at the Saline MI fairgrounds. Indoor and outdoor exhibits, refreshments, and prizes will be featured. Doors open at 8:00 am. Check-in on 146.37/97 and 146.52. Admission is \$1.50 advance; \$2.00 at the door. Display space is \$.50/ft. For more info, advance tickets, or table reservations, write Arrow, Box 1572, Ann Arbor MI 48106.

DUTZOW MO AUG 6

The annual Zero-Beaters Amateur Radio Club Hamfest will be held on Sunday, Aug. 6,

Continued on page 164

THE TRI-BANDER: FINALLY

Built the way a TRI-BANDER should be

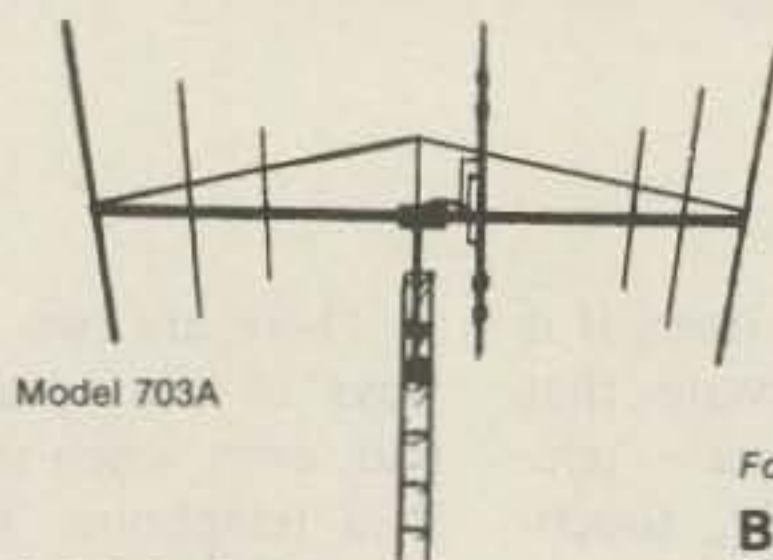

Model 703A

\$289.95

- Rugged
- Seven Elements
- Three Bands (10-15-20)
- Optimum Spacing For:
High Forward Gain
High F:B & F:S Ratios

For Specifications Write To:

BROOKFIELD MANUFACTURING CO.
60-08 Meetinghouse Village
Meriden, CT 06450
(203) 238-0355

B13

"The TOUCH" by Regency

- AUTOMATIC CONTINUOUS SEARCH!
- FIND "SECRET" FREQUENCIES
- SEVERE WEATHER ALERT!
- NEVER BUY CRYSTALS!
- PRIORITY CHANNEL!
- LO, HI, & UHF BANDS!
- SIXTEEN CHANNELS!
- 2 METERS & 450 MHz

\$249 Shipped Prepaid
in USA

Check with order MASTER CHARGE or
VISA — sorry, no COD



Frequency Ranges

LOW VHF 30-50 MHz
HIGH VHF 146-174 MHz
UHF 440-512 MHz

GERKEN'S

37 Park Ave. (603) 352-7329
Keene, New Hampshire 03431

Next time
you light up
a cigarette,
get a look
at your kid's
face

AMERICAN CANCER
SOCIETY

THIS SPACE CONTRIBUTED BY THE PUBLISHER

JAN CRYSTALS
KEEP YOU
ON THE AIR



- CB
- CB standard
- 2 meter
- Scanners
- Amateur Bands
- General Communication
- Industry
- Marine VHF
- Micro processor crystals

easy
to
charge



Send 10¢ for our latest catalog
Write or phone for more details

2400 Crystal Drive
Ft. Myers, Florida 33901
all phones (813) 936-2397

J2

CUSHCRAFT IS THE HF MULTIBAND ANTENNA COMPANY.

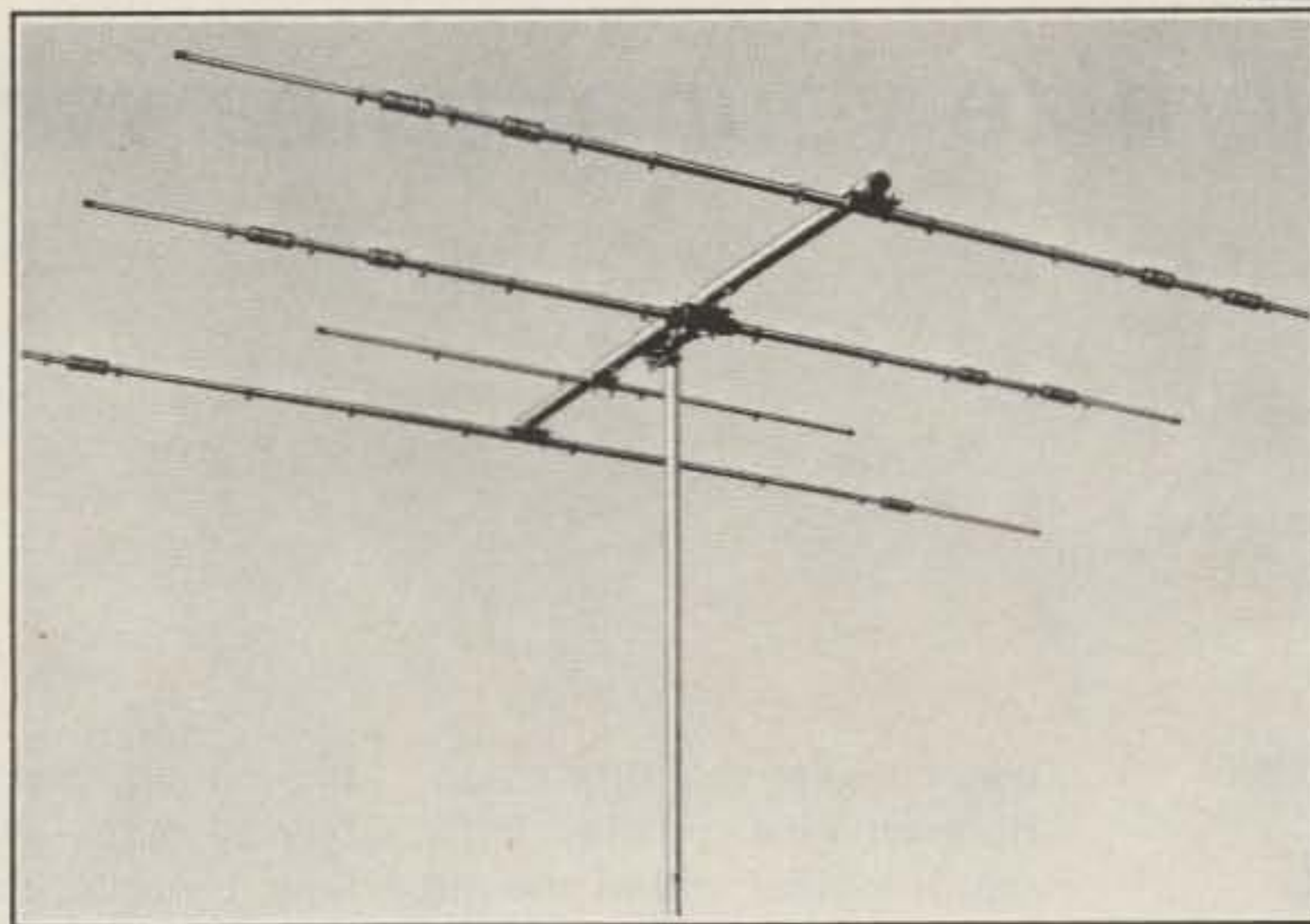

ATB-34, Three Band

Cushcraft manufactures a full range of high-frequency antennas which are performance engineered for the most discriminating amateur. For the amateur who demands top performance in a multiband Yagi beam there's the incomparable ATB-34 three-band beam for broadband, high-gain coverage on 10, 15 and 20 meters.

And for the Amateur with limited antenna space and budget who wants reliable, multiband radio communications there are three Cushcraft multiband verticals to choose from: the three-band ATV-3 for 10, 15 and 20; the four-band ATV-4 for 10, 15, 20 and 40 meters; and the ATV-5 for low VSWR five-band performance from 80 through 10 meters.

Cushcraft high-frequency antennas are quality engineered for top performance; they are often imitated, but never duplicated.

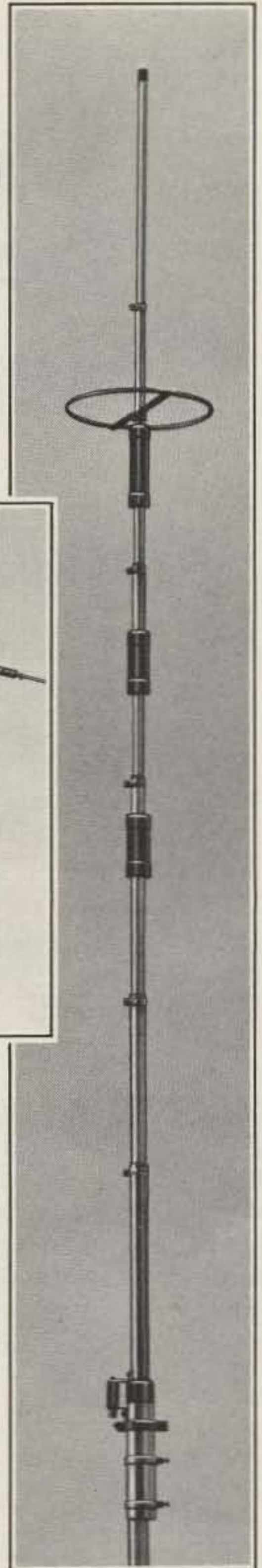

ATV-4, Four Band



UPS SHIPPABLE
cushcraft
CORPORATION

C67

In Stock With Dealers World Wide P.O. Box 4680, Manchester, N. H. 03108

The Op Amp Beam Heading Indicator

—modernize your antenna system

Robert C. Ghormley KØBV
932 S. Comet Ave.
Panama City FL 32401

I saw this linear ohmmeter circuit in the Nov. 11, 1976, issue of *Electronics*, although its theory and operation were treated lightly.¹ My particular application was readout of antenna rotor position using only two wires

connected to the rotor potentiometer (one end plus center tap; the other end of the pot was not connected). The pot resistance between the two wires increased linearly from zero resistance to 1000 Ohms, corresponding to 360° of rotation. Any application where a linear readout of a variable resistance is desired may be filled by this circuit.

If you just want to build

this circuit, are going to go buy all parts, and don't care how it works, use the following: R1 equal to the maximum value of the unknown resistance you're measuring; R2 = 2.2k; V_Z (zener diode voltage) = 3.3 V/400 milliwatts; a 0-1 mA meter; R3 = 2.7k; R4 = 1000 Ohms; a TO-5 can 741 op amp; and a +12 V power supply. Skip toward the end of this article for calibration procedure and cautions. For those who will use junk-box parts, the following will let you roll your own.

A garden-variety 741-type op amp is connected as in Fig. 1. This circuit uses a single power supply, with the op amp's negative supply terminal grounded. The non-inverting (+) input is biased up to a regulated level (any convenient zener up to 5 or 6 volts will function okay). This serves to bias this input and to get the op amp operating "above ground." The inverting (-) input is returned

to ground through a resistor equal in value to the maximum unknown resistance to be measured. The unknown resistance, RX, is connected as a feedback resistor.

The output of the amp feeds a current meter (anything from a 50-microamp to a 1-milliamp movement will work just fine) and a series current-limiting resistor. Note that the negative meter terminal is returned to the reference voltage (the non-inverting input), not to ground. The series variable resistor allows full-scale calibration.

Pick a meter with four major divisions — 0, 25, 50, 75, 100, or something like that. Relabel these S, W, N, E, S, depending on where you wish the antenna to be indexed. To do a neat-looking job, disassemble the meter and erase the existing legend with an ordinary pencil eraser. This takes a little time, but it works (eraser crumbs inside the meter movement are to be avoided). Relabel the scale with dry transfer letters and reassemble.

Any supply voltage from +10 volts to +30 volts, or even slightly higher, will work. Too much will pop the op amp, but they're cheap. The zener should be biased on by R2 so that it draws 3 or 4 milliamps or more (anything above that is just wasted power). C1 and C2 are bypass capacitors (.001 to 0.1 μF disc ceramics will work fine).

In operation, this circuit functions as an inverting amplifier. The gain is $-(RX/R1)$, which varies from zero to minus one as RX varies from zero to R1. The "signal" voltage which is being amplified is the difference between the left-hand side of R1 (ground) and the noninverting input (the zener potential). If this zener voltage were +5.1 volts, for example, the output of the op amp would vary from 5.1 volts, for RX = 0, to 10.2 volts, for RX = R1. The output of the amp is the reference voltage (zener voltage)

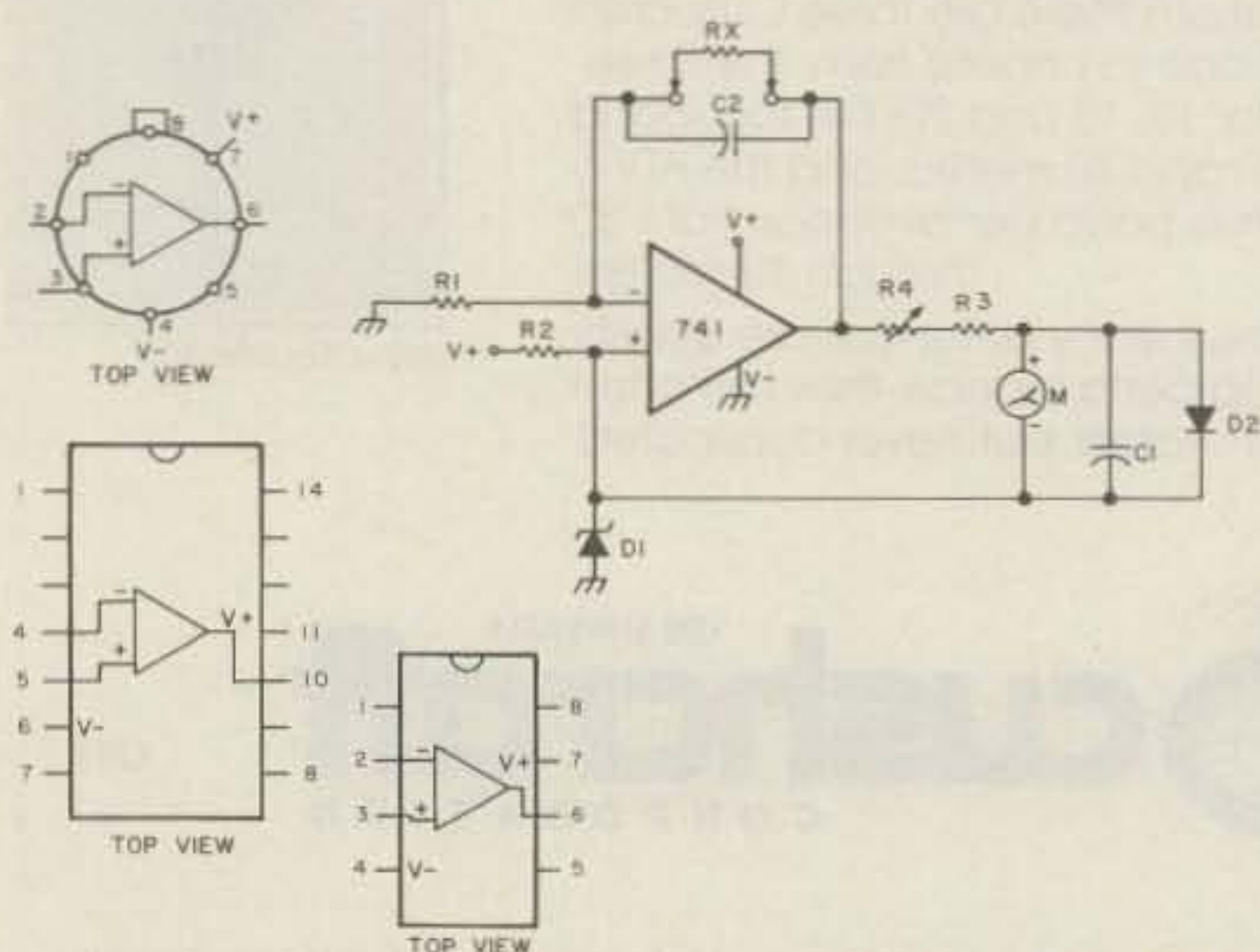

Fig. 1. Linear ohmmeter.

plus the amplified "signal" voltage. If RX is allowed to approach infinity (open terminals), the gain approaches the open-loop op amp gain (a large gain indeed), and the output of the op amp will approach the positive supply voltage, pinning the meter. If this happens often, add the meter protector germanium diode D2 (1N270 or equivalent); it will still pin, but it won't smoke. The series resistors, R3 and R4, are selected to produce a full-scale meter deflection when the op amp output is maximum.

To calibrate, let $RX = 0$ (a short). The meter will show no current (the op amp output voltage will equal the noninverting reference voltage). Now clip in a resistor for RX which is equal to whatever you want the full-scale meter reading to correspond to (1000 Ohms in the case of my TV-type rotor). Adjust R4 to obtain a full-scale meter deflection. Now, just to prove to your-

self that it works, cut RX in half, and note the half-scale reading. Letting RX equal zero (shorted) will produce no meter deflection.

Selection of the zener diode should be made with one eye on the supply voltage. At full-scale meter reading, the output of the op amp will be approximately twice the zener voltage. If a 9 V zener is selected, the maximum op amp output will be 18 V; hence, a power supply voltage of at least 2 or 3 volts above this should be used. A 12 V or 24 V c-t transformer feeding a bridge or full-wave rectifier with a couple hundred microfarads on its output will yield about 18 volts and work just fine. Reference voltage (zener voltage) could then vary from 3 volts up to 6 or 7 volts with no problem. No power supply regulation will be required, unless you're powering something else from the supply and drawing a lot of current.

If the unknown resistance

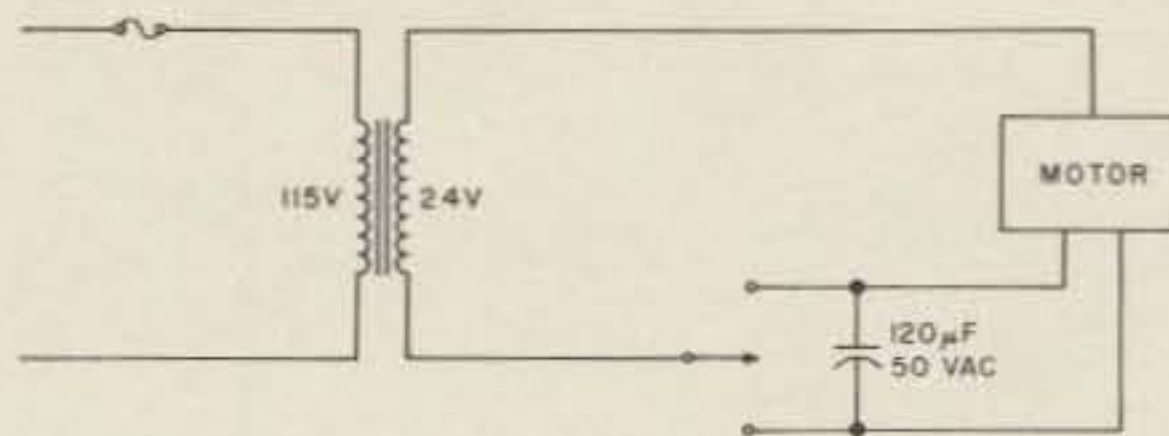

Fig. 2. Rotor motor drive scheme.

is connected to earth ground (or chassis ground) at either end, the circuit will still work if the power supply is completely floated. One end of the pot in my rotor was grounded, so I just floated the negative power supply lead above chassis ground and connected it only to the op amp circuit.

For those who are interested in fabricating the complete control head for a Cornell-Dubilier-type rotor, I offer the following. I have three different rotor types which all use the same driving scheme, shown in Fig. 2. C1 is a 120 μ F/50 V ac rotor replacement capacitor. If this capacitor goes bad, the rotor will turn slowly and erra-

tically, or will refuse to start. Try replacing it before you dismantle the antennas and bring the rotor down! Make sure the switch is a momentary center-off type. Alternatively, you could use a normal toggle switch there with a momentary push-button single-pole switch between it and the transformer. This scheme will not tell you that you have reached the rotor stop, except by the meter indication. If a momentary switch is not used, it would be easy to burn up a rotor motor by leaving power applied. ■

Reference

1. "Direct Reading Ohmmeter," V. Ramprakash, *Electronics*, November, 1976, p. 115.



We have a portable direction finder that REALLY works—on AM, FM, pulsed signals and random noise! Unique left-right DF allows you to take accurate bearings even on short bursts, with no 180° ambiguity. Its 3 dB antenna gain and .06 μ V typical DF sensitivity allow this crystal-controlled unit to hear and positively track a weak signal at very long ranges—while built-in RF gain control with 120 dB range permits DF to within a few feet of the transmitter.

The DF is battery-powered, can be used with accessory antennas, and is 12/24V for use in vehicles or aircraft. This is a factory-built, guaranteed unit—not a kit. It has been successful in locating malicious interference, as well as hidden transmitters in "T-hunts," ELTs, and noise sources in RFI situations.

Prices start at under \$175. Write or call for information on our complete line of portable, airborne, vehicle, and fixed DF systems.

L-TRONICS

5546 Cathedral Oaks Rd.,
Amateur Dept.
Santa Barbara, CA 93111

W6GUX

WD6ESW

L10

PEOPLE BUY BIRD FROM US



Model 43: \$120
CC-1 Leather Case: \$25
Elements: \$36 to \$42

who live in Florida, Georgia and Louisiana.

We have regular Bird customers in Texas, Alaska, Minnesota and dozens of other states as well as Washington. They come to us because they know we have a gigantic stock of Bird and that we ship the same day and that we prepay Bird orders over \$145. Add to this the fact that we are the oldest and largest Amateur store in the Pacific Northwest and you get a glimpse of why we're so popular —

AMATEUR RADIO SUPPLY SEATTLE

A55

6213 13th Ave. So., 98108 (206) 767-3222
Washington Residents: To order, CALL TOLL-FREE 1-800-562-8326.

Super Charger

— keeps nicads up to snuff

Jeremy A. Donimirski WA7YGB
PO Box 66369
Seattle WA 98166

Nickel cadmium (nicad) batteries are enjoying an unprecedented popularity

as a result of the increased use of 2 meter FM by amateurs. Most 2 meter portable

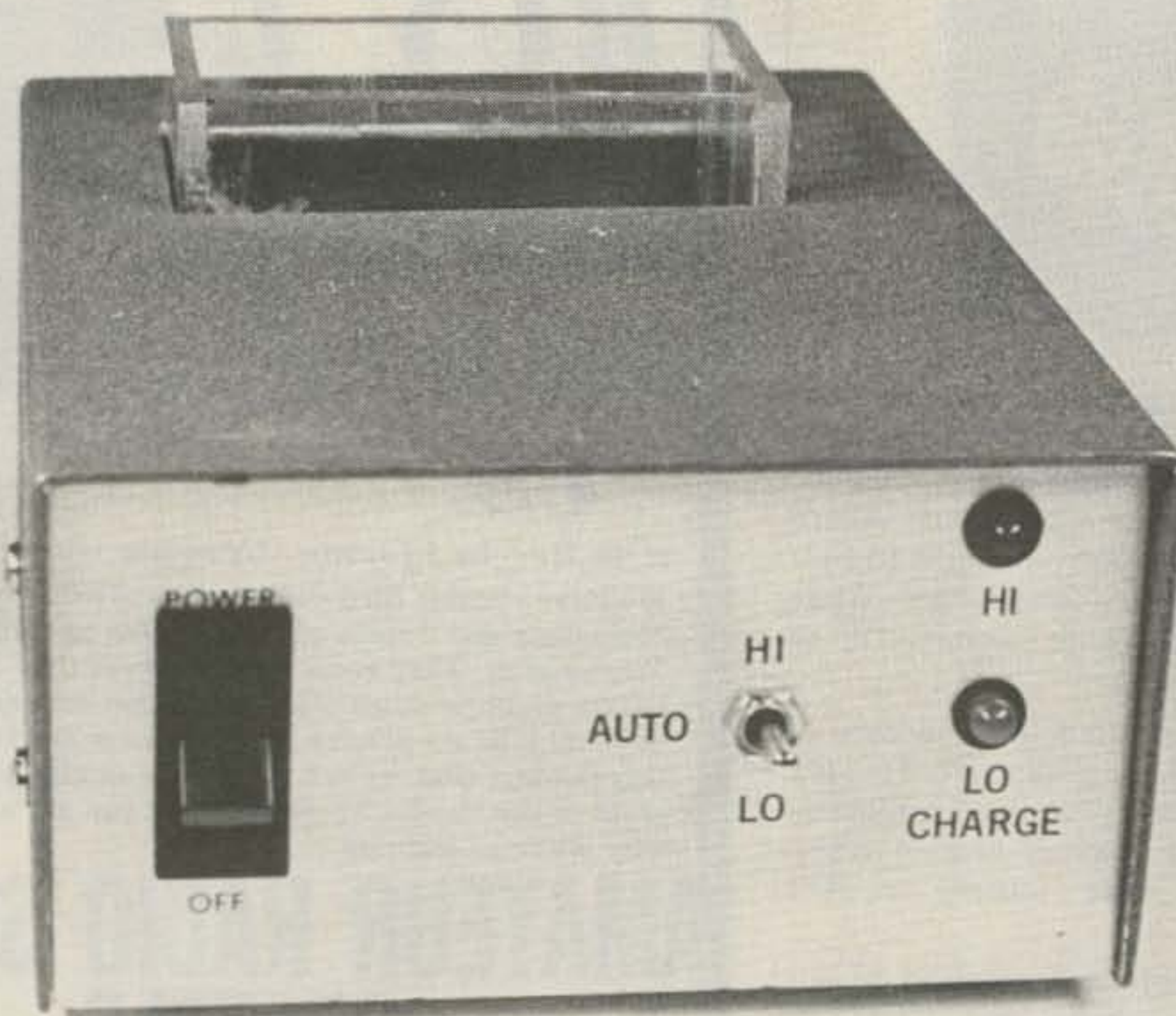

Automatic nicad charger.

radios are nicad equipped.

While nicad batteries offer many advantages to the user, rapid recharge is not one of them. A regular nicad, excluding special types, requires 16 hours of charge time.

Under normal circumstances, the 16-hour recharge is not a problem. But, during periods of increased usage, such as special events, hamventions, or emergencies, the long recharge time can be inconvenient. A fast charge feature would be handy.

This article describes an automatic high/low rate charger which safely reduces the recharge time of a nicad battery by several hours.

Features

The automatic nicad charger features solid state construction, light-emitting diodes (LEDs), and manual override. The working parts of the charger are commonly-available transistors. Only one integrated circuit (a voltage regulator) is used.

Two LEDs indicate the charge rate. One of the two will light only when charge current flows. The charge rate is controlled either by the automatic circuitry or by the manual override switch. This switch may be used to set the charger to the 16-hour rate if speed is unimportant.

The manual override switch may also be used to set the charger to the high rate. The extra current of the high rate will charge a radio battery pack even while the radio is operating.

Readers who are unfamiliar with nicad batteries will benefit from two excellent articles by Pete Stark K2OAW.^{1,2} These two articles describe the care and feeding of nicad batteries in detail.

Construction

The printed circuit board for the automatic nicad charger is divided so that it can be cut into two sections with a band saw and then interconnected with wires.

This configuration may simplify installation of the charger in an existing charger housing.

The PC board may also be left intact, if desired. The mounting location will govern the choice. The larger section of the printed circuit board contains the programmable current generator, while the smaller section contains the automatic circuits.

The charger need not be assembled as an automatic unit. By discarding the automatic circuitry and building only the programmable current generator in Fig. 6, you will have a dual-rate manually-controlled nicad charger.

The prototype automatic nicad charger was built with Plexiglas™ and a discarded power supply chassis. The charger socket was cut to size with a saber saw and then glued together with a cyanoacrylate "Magic Glue." The terminals in the prototype charger are vector clips, but brass rivets or nails may be just as suitable. Ball-point-pen springs are perfect to support the terminals.

Charger Theory

A nicad's worst enemy is heat. Hot places, excessive discharge, or excessive charge all can damage a nicad cell. Excessive charge will not necessarily damage a nicad, however, unless the charge rate causes heating.

When a nicad is depleted of charge, it is permissible to recharge it at a rate greater than normal for several hours without damage. Motorola sells rapid chargers which do exactly that — charge at a high rate until a thermistor, built into the molded battery, senses temperature rise. It then reduces the rate to a safe value. This technique is proven, and, with one variation, is used in the automatic nicad charger.

The automatic nicad charger described in this article samples the voltage across the charging contacts rather than the battery temperature. When a depleted

battery pack is inserted into the automatic charger, the low battery voltage triggers the user-adjustable high charge rate, usually twice the normal rate. The high rate persists until the battery voltage exceeds a predetermined value. The automatic circuitry then lowers the rate to normal.

This method is more convenient than temperature sensing, although perhaps not as precise. Data published by the General Electric Company indicates that nicads do exhibit increasing terminal voltage during charge, especially during a rapid charge. This increase of terminal voltage is rather small per cell, amounting to only a small fraction of a volt. But the change becomes substantial when 8, 10, or more cells are connected in series. The typical amateur battery pack's voltage increase is more than a volt.

Because a nicad's terminal voltage varies with charge rate as well as state of charge, the automatic circuits must incorporate hysteresis in their operation. The high rate-sensing threshold must not coincide with the low rate-sensing threshold. There should be a volt or so of hysteresis between the two. The separated thresholds ensure stability.

To give an example of the instability which would result from no hysteresis, consider a charger whose single threshold voltage is being approached by a battery nearing completion of charge. The high rate is on when the threshold is finally reached. The charger then lowers the charge rate. But the lower charge rate is accompanied by a lower terminal voltage, which the charger interprets as a signal to switch back into high charge. The high charge rate raises the terminal voltage above the threshold and oscillation begins. Hysteresis prevents this, and the automatic nicad charger incorporates a potentiometer to set exactly the amount of

hysteresis desired.

Almost everyone is aware that a nicad should be charged with a constant current. The solid state constant current source used in the automatic nicad charger represents a nearly ideal current generator.

An ideal constant current generator will adjust its voltage as necessary to force its rated current through the load. If necessary, the voltage will be adjusted to infinity. This is both impractical and dangerous.

A reasonable compromise from an ideal generator has been made in the automatic nicad charger. The maximum voltage available to the current generator is the output of an IC voltage regulator. As

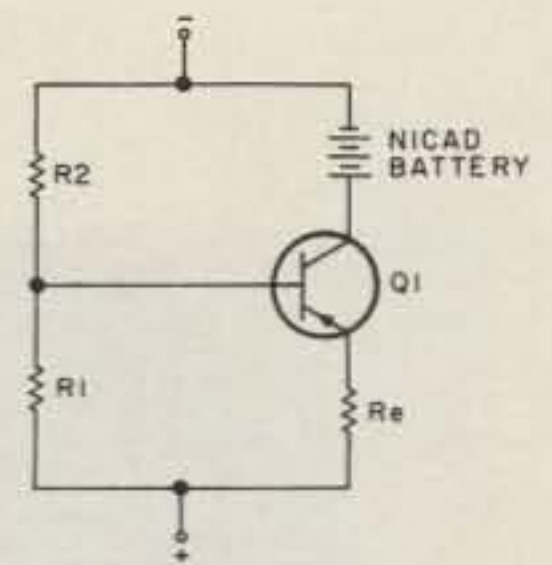

Fig. 1. Class A amplifier serves as a constant current source.

long as the regulator output voltage (about 18 volts) is several volts greater than the battery voltage, the current generator operates normally.

The constant current generator in the automatic nicad charger is based upon a well-established fact — the collector current of a properly biased class A amplifier is

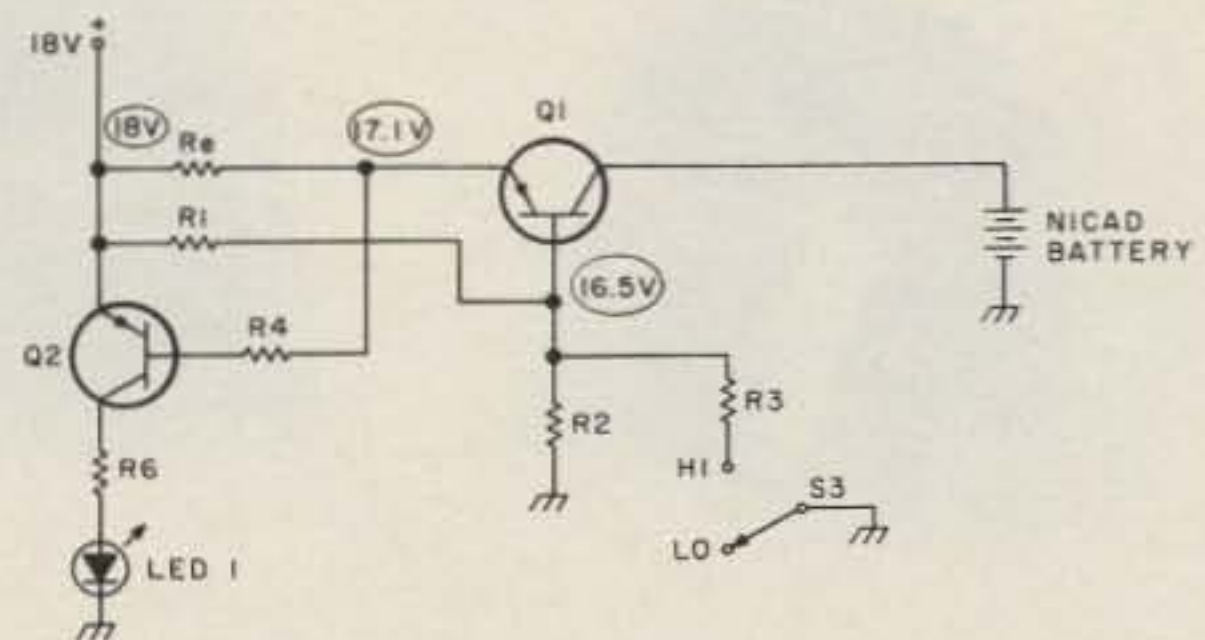

Fig. 2. Basic circuit for dual-rate nicad battery charger.

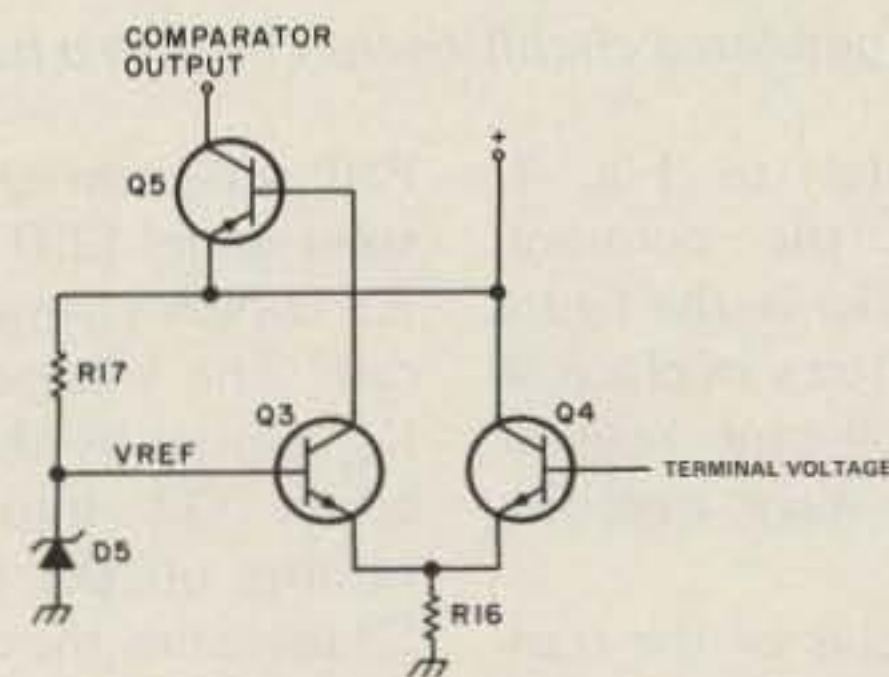

Fig. 3. Basic comparator composed of differential amplifier and peripheral parts.

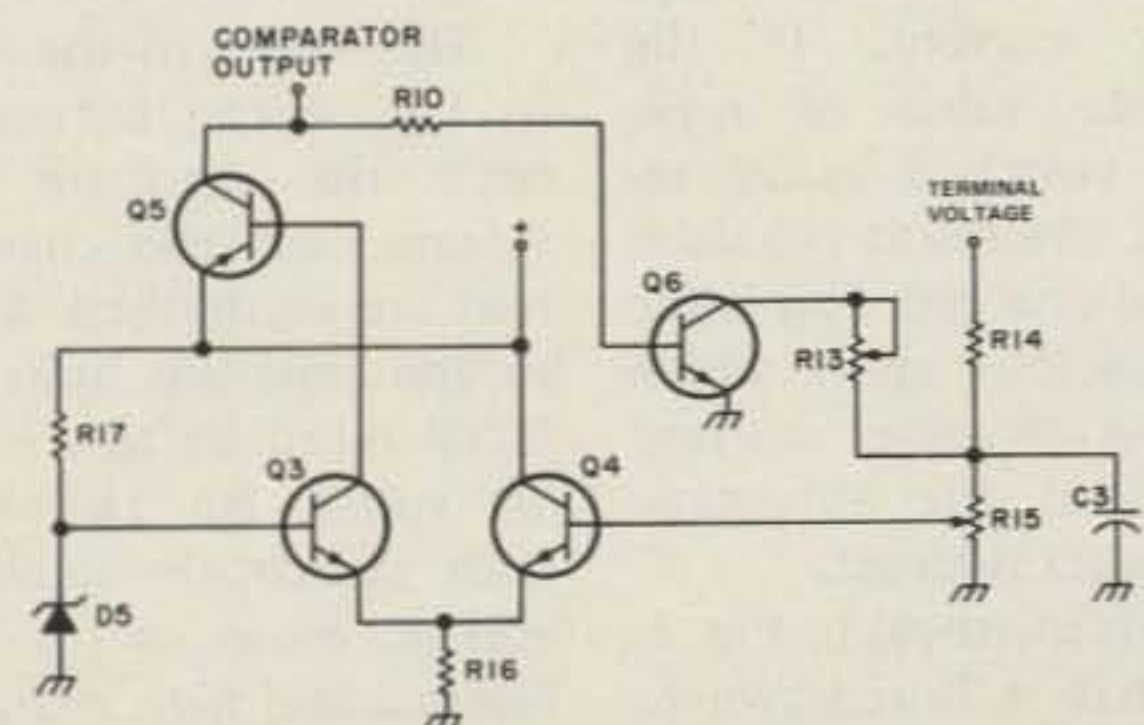
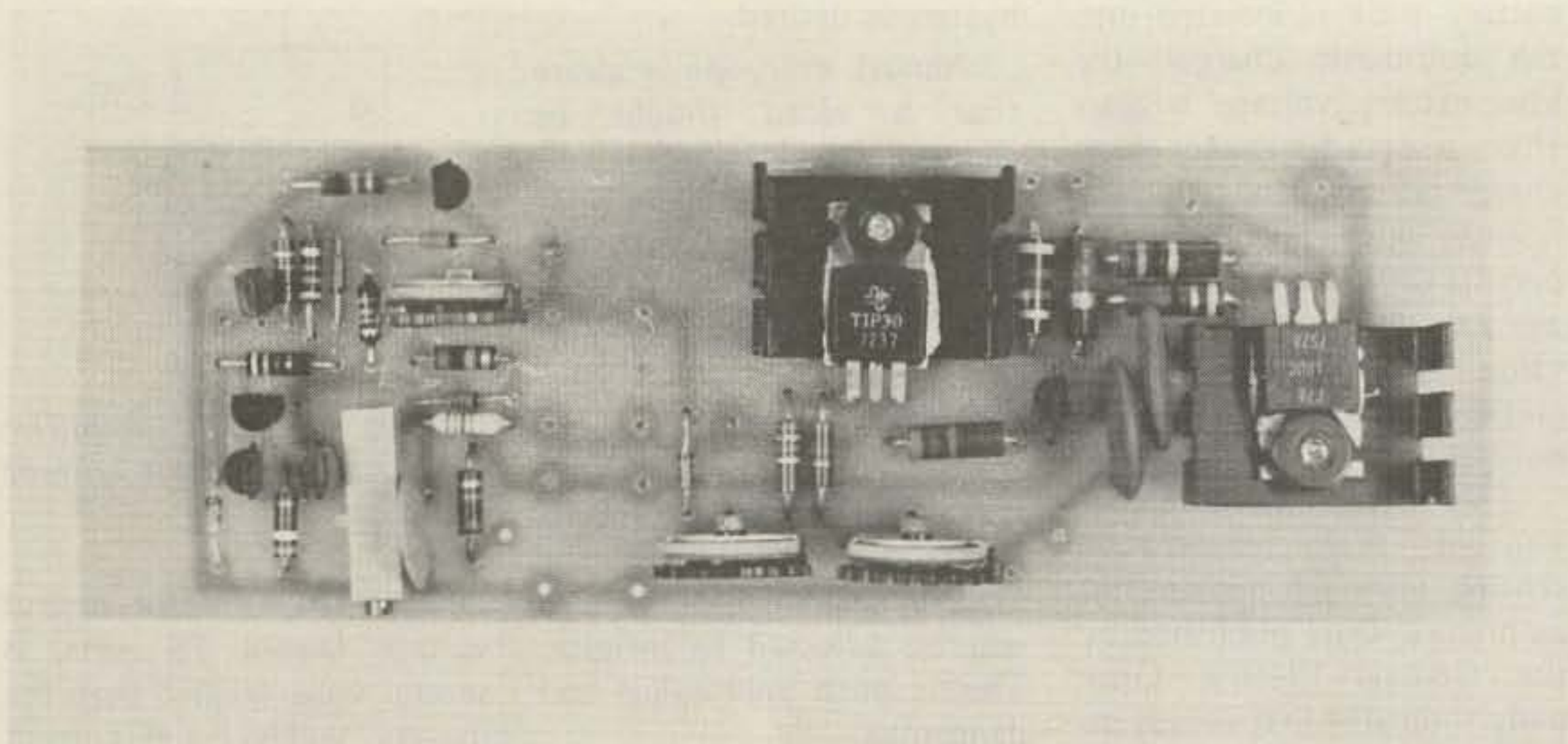
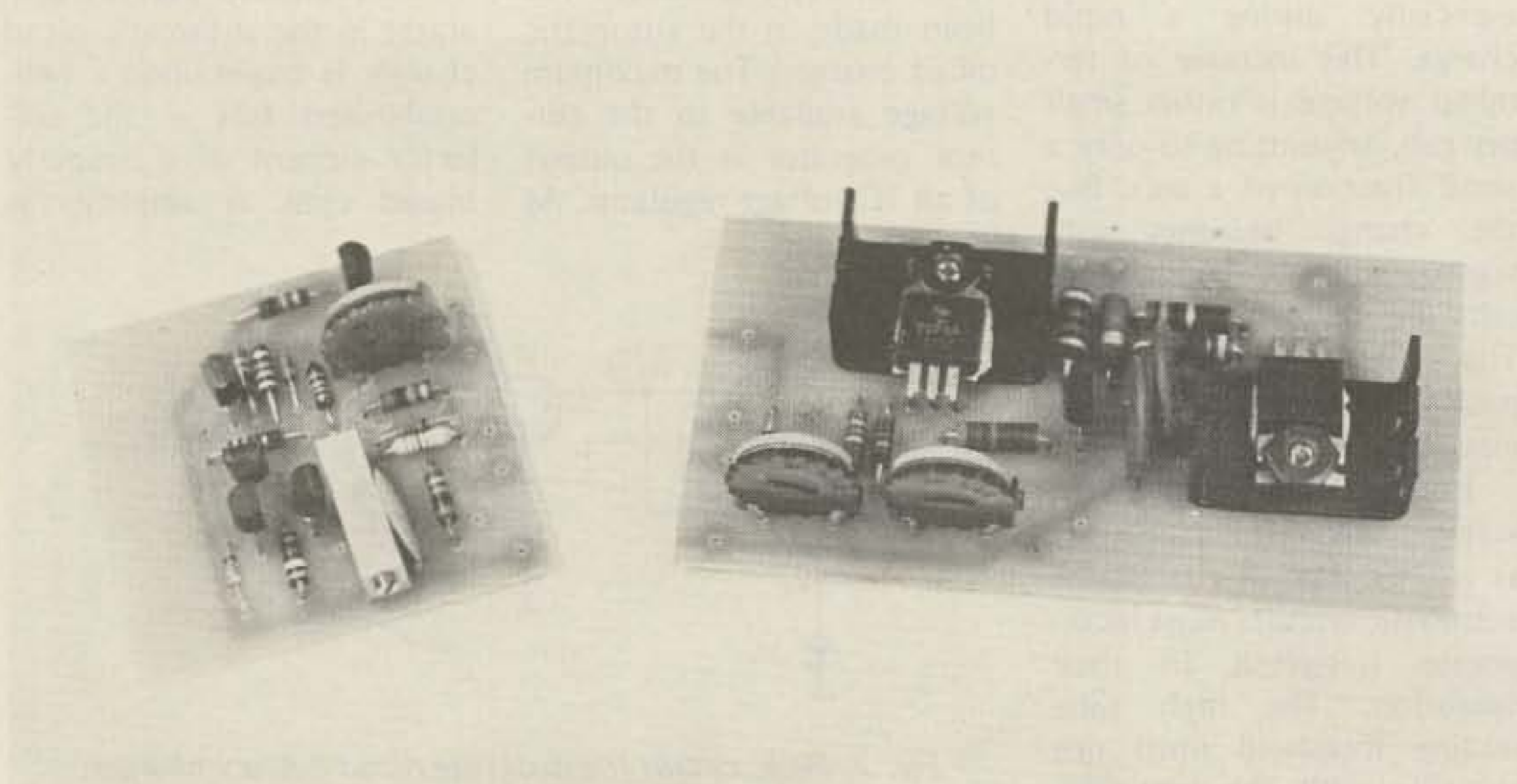

Fig. 4. Basic comparator with hysteresis added by Q6 and controlled by R13.



Completed circuit board.



Completed circuit board cut with a band saw to allow easier mounting.

constant. Refer to Fig. 1. Notice that the common emitter amplifier in the figure has a nicad battery in place of the usual collector resistor and that the stage amplifies no signal.

The base bias of the transistor determines the value of the collector current. Specifically, lowering the value of resistor R2 will raise the collector current. If the appropriate value of resistance is switched across resistor R2, the result is a dual-rate nicad charger. This is the basic principle upon which the programmable current generator of the automatic nicad charger is based.

Fig. 2 is identical to Fig. 1, except that it is redrawn to more closely resemble the complete automatic nicad charger schematic. Included is

PNP transistor Q2, which is a solid state LED switch, and R3, which changes the charge rate. The voltage drop across R_e , caused by charge current, biases Q2 into saturation, turning on the LED. Switch S3 increases the collector current when it connects resistor R3 in parallel with R2.

Resistor Value Calculations

The values of the resistors in Fig. 2 can be computed once the regulator output voltage and the charge current are established. The prototype unit was built for an 8-cell nicad battery (nominal 10 volts). An 18-volt regulator was chosen to allow for voltage drops in the circuit. Normal and high charge rates were chosen to be 50 mA and 100 mA, respectively. A 10-cell nicad battery will

require a higher voltage regulator, such as 24 V.

The value of emitter resistor R_e is determined first. Although it is desirable (for temperature stability) to have a voltage drop of 15% of the supply across R_e , it is not always practical to do so. Power dissipation limitations and available voltage might dictate a compromise. The prototype charger was built with a 5% voltage drop across R_e . Empirical results indicate a 10% change in charge current as a result of transistor heating under load.

To find a resistor value which will have a 5% drop across it at the lowest charge rate, take 5% of 18 volts, which is 0.9 V. In no case should the drop be less than 0.75 volts, the minimum required for the LED switch.

By Ohm's Law, 0.9 V and 50 mA (charge rate) mean a resistor of 18 Ohms, the value of R_e . The value of this resistor may be larger, but never smaller, than the 18 Ohms.

Calculation of the remaining circuit resistors depends upon the base voltage of the transistor. This voltage will always be about 0.6 volts offset from the emitter, if a silicon transistor is used. For the circuit in Fig. 2, the base voltage will be lower than the emitter.

The voltage divider, consisting of R1 and R2, must be designed to divide the 18 volts to the appropriate base voltage. For stability, the current flowing through the divider should be about 10 times the transistor's base current.

A transistor's base current is related to its collector current by its beta specification. If we assume a beta of 40 for the transistor and a collector current of 100 mA, the base current will be 2.5 mA (100/40). The current through the voltage divider should therefore be 25 mA.

Resistor R1 may now be calculated using the 25 mA figure along with the base voltage at the low charge rate. A voltage drop of 1.5 volts (0.9 V + 0.6 V) and a current of 25 mA yield a resistor value of 60 Ohms, a non-standard value. Either 56 or 62 Ohms may be used, since R2 will be a variable resistor which will set the base voltage precisely.

The value of R2 can be calculated from the voltage across it and the current through it. It is about 600 Ohms. A lower value will raise the charge rate. This is done by switching a parallel resistor across R2. In the automatic nicad charger, this can be done either manually or automatically with a voltage comparator.

Comparator Theory

The basic function of the comparator is to compare the battery terminal voltage dur-

ing charge with a known reference, a 5-volt zener diode. If the terminal voltage is above the level of the reference, the output is low. Refer to Fig. 3.

The circuit in Fig. 3 is a differential amplifier composed of two NPN transistors (Q3 and Q4) which share a common emitter resistor. One of the transistors has a PNP transistor base emitter junction in series with its collector. This PNP transistor (Q5) is a switch which changes state according to which NPN transistor is conducting.

When the terminal voltage is lower than the reference, the voltage across the emitter resistor is determined solely by the reference. Specifically, it is one base-emitter drop (0.6 V) lower than the reference. Transistors Q3 and Q5 are both on at this time.

When the terminal voltage is greater than the reference, the voltage across the emitter resistor follows the terminal voltage (less 0.6 volts). Transistor Q4 turns on, and transistors Q3 and Q5 both turn off, due to insufficient bias current.

When the terminal voltage is exactly equal to the reference, the output is indeterminate, neither on nor off. This is an undesirable condition to which commercial comparators are also subject. The high gain of a commercial comparator assures an abrupt transition, minimizing the problem.

The differential amplifier comparator of Fig. 3 exhibits a slow transition as a result of relatively low stage gain. This is not a problem in this application, however, since a volt of hysteresis will be used in the automatic nicad charger.

Fig. 4 is a comparator with hysteresis. The terminal voltage is divided by a series combination of a resistor and a potentiometer. The hysteresis is introduced to the divider by transistor Q6 and resistor R13.

When the terminal voltage is much higher than the

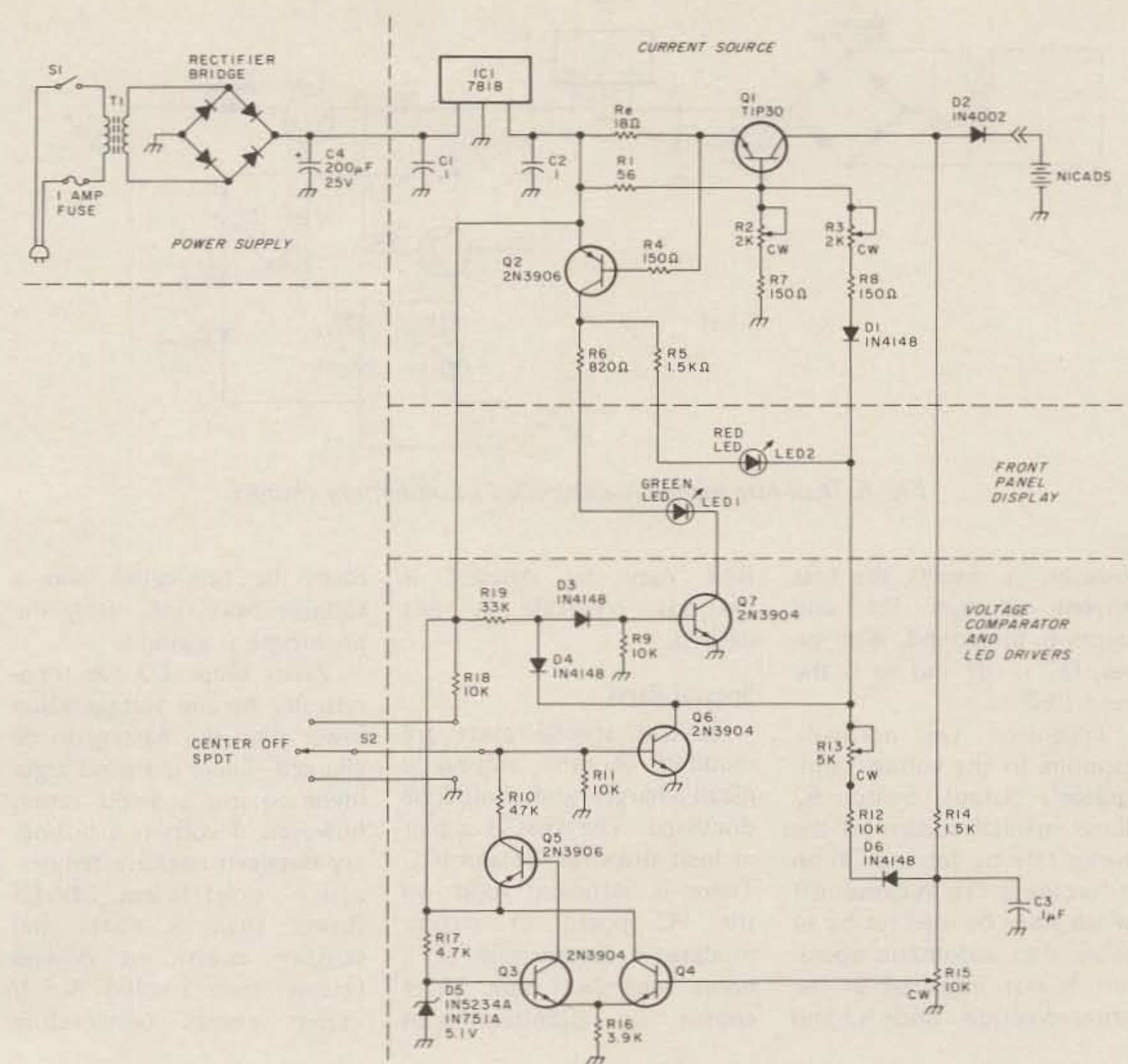

Fig. 5. Automatic nicad battery charger — complete schematic.

threshold level (as it is with no battery connected), Q6 is off and does not affect the voltage at the potentiometer.

Upon reaching the threshold, the decreasing terminal voltage starts the comparator into its slow turn-on transition. Transistor Q6 also turns on at this time, shunting some current away from the potentiometer. This further reduces the voltage across the pot and increases forward bias to Q6. The avalanche action doesn't stop until Q6 is saturated. Because of the path to ground through Q6 and R13, the threshold level is affected.

This deliberately-introduced hysteresis causes a fast "snap action" and a separation of the negative-going (lower) threshold from the positive-going (upper). The terminal voltage required to turn off the comparator is greater than the voltage

which turned it on originally. R13 determines the magnitude of this difference and is used to set the upper threshold. The lower threshold is set solely by potentiometer R15.

Circuit Operation

Refer to Fig. 5, the schematic of the complete automatic nicad charger. IC1 is an 18-volt regulator and requires at least 21 volts at its input. Capacitors C1 and C2 bypass the IC voltage regulator to prevent it from oscillating.

R2 adjusts the low charge rate (50 mA in the prototype), while R3 adjusts the high charge rate (100 mA in the prototype) with the cathode of D1 grounded. Diode D2 prevents the battery from discharging into the charger should S1 be turned off. D1 prevents stray voltages from affecting Q1's operation.

R5 and R6 limit the cur-

rent to the LEDs, as R4 limits the current to Q2. R6 is one half the value of R5, to make up for the lower efficiency of the green LED.

R7, R8, and R12 all perform similar functions. They all maintain a minimum resistance in series with their respective potentiometers, R2, R3, and R13.

Diode D6 prevents voltages from other parts of the circuit from affecting the threshold pot. Capacitor C3 stabilizes the voltage divider. Transistor Q6 controls the charge rate. When it is completely on and charge current is flowing, the red LED illuminates and the charger is in high rate.

Q7 controls the green LED, which indicates the low charge rate. Diode D3 adds a 0.6-volt drop in series with Q7's base, making its turn-on voltage 1.2 volts. Bias for Q7 normally flows through R19 and D3. When Q6 turns on,

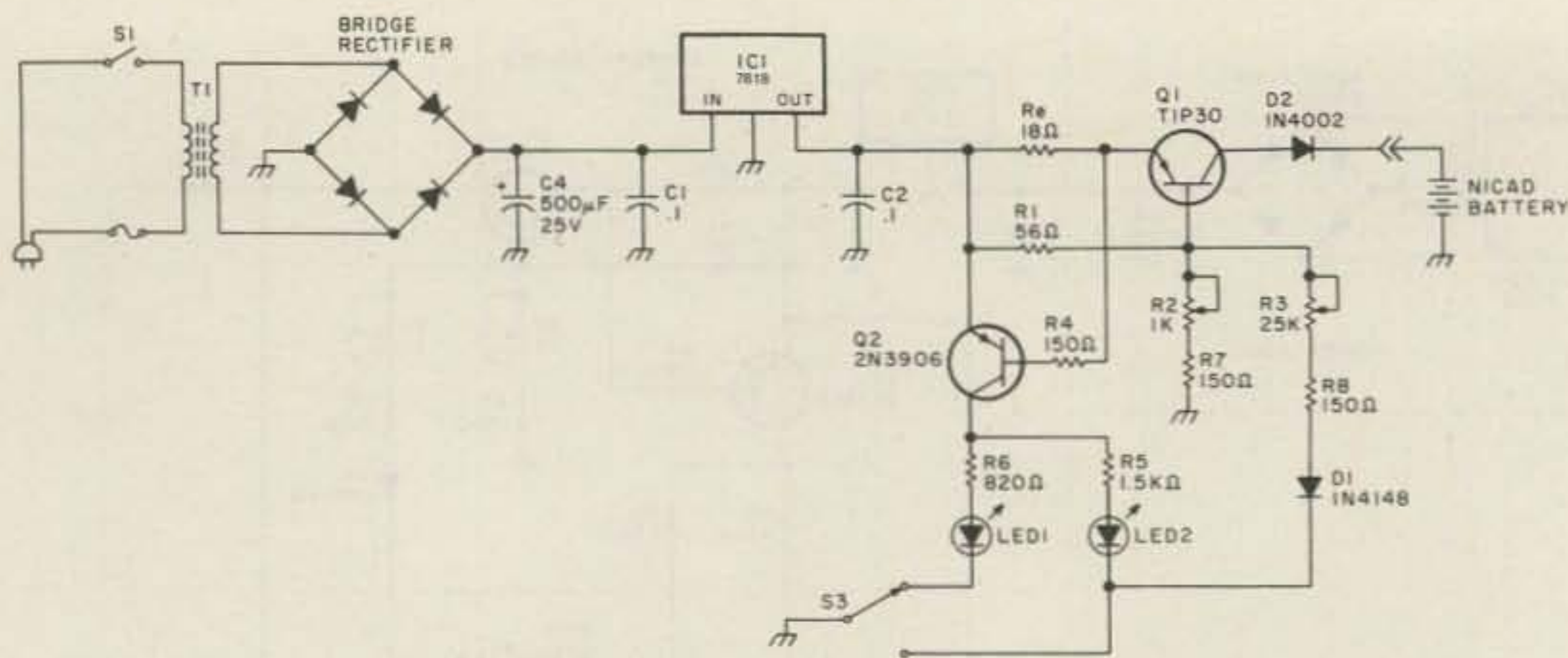

Fig. 6. Dual-rate manually-controlled nicad battery charger.

however, it diverts the bias current through D4 and shunts it to ground. With no bias, Q7 is off and so is the green LED.

Transistor Q6 normally responds to the voltage comparator's output. Switch S2 allows manual control of the charge rate by forcing Q6 on or forcing it off. A center-off switch must be used for S2 to assure that automatic operation is not impaired in the center position. Both S2 and

R18 may be deleted if manual override is not desired.

Special Parts

Several special parts are required for the automatic nicad charger and should be discussed. The first is a pair of heat sinks for Q1 and IC1. There is sufficient room on the PC board to accommodate a commercial or a home brew heat sink. Sheet copper or aluminum can

easily be fabricated into a suitable heat sink, using the prototype as a guide.

Zener diode D5 can theoretically be any voltage value lower than the battery to be charged. There is a good argument to use a 5-volt zener, however. 5 volts is a boundary between negative temperature coefficient diodes (lower than 5 volts) and positive coefficient devices (greater than 5 volts). A 5 V zener resists temperature

effects much like an NPO capacitor. It is an inexpensive way to assure a stable reference.

Threshold-setting potentiometer R15 is a 15-turn precision type, either a Beckman model 89 or a Spectrol model 43. It is often available as surplus from companies such as Poly Paks.⁴ New units may be purchased from James Electronics.³

Resistor R14 may be an ordinary carbon composition type, but better circuit stability will result if a metal film resistor is used. The change of resistance of a carbon composition due to time, temperature, or humidity will affect the threshold voltage. A metal film will assure stability. The film resistor for the prototype was found in an assortment purchased from Radio Shack.

Adjustment

It is preferable to first assemble and test the constant current source and then the comparator. The constant current source is needed to determine the voltage characteristics of the nicad battery to be charged. These characteristics will be used to set the voltage comparator.

Assemble the current source and connect it to a power supply. Only an ammeter is necessary for adjustment. Connect the ammeter between the cathode of D2 (the output) and ground. Turn on the power supply and adjust R2 for the desired low charge rate. Then ground the cathode of D1 with a wire and adjust R3 for the high charge rate. The constant current source may now be used to test the battery.

To properly determine the characteristics of the battery, first discharge it completely (taking care not to reverse any cells). Measure and note the voltage of the battery. Then charge it at the high rate for 5 hours, and again measure and note the battery voltage (while charging). Keep these figures for the

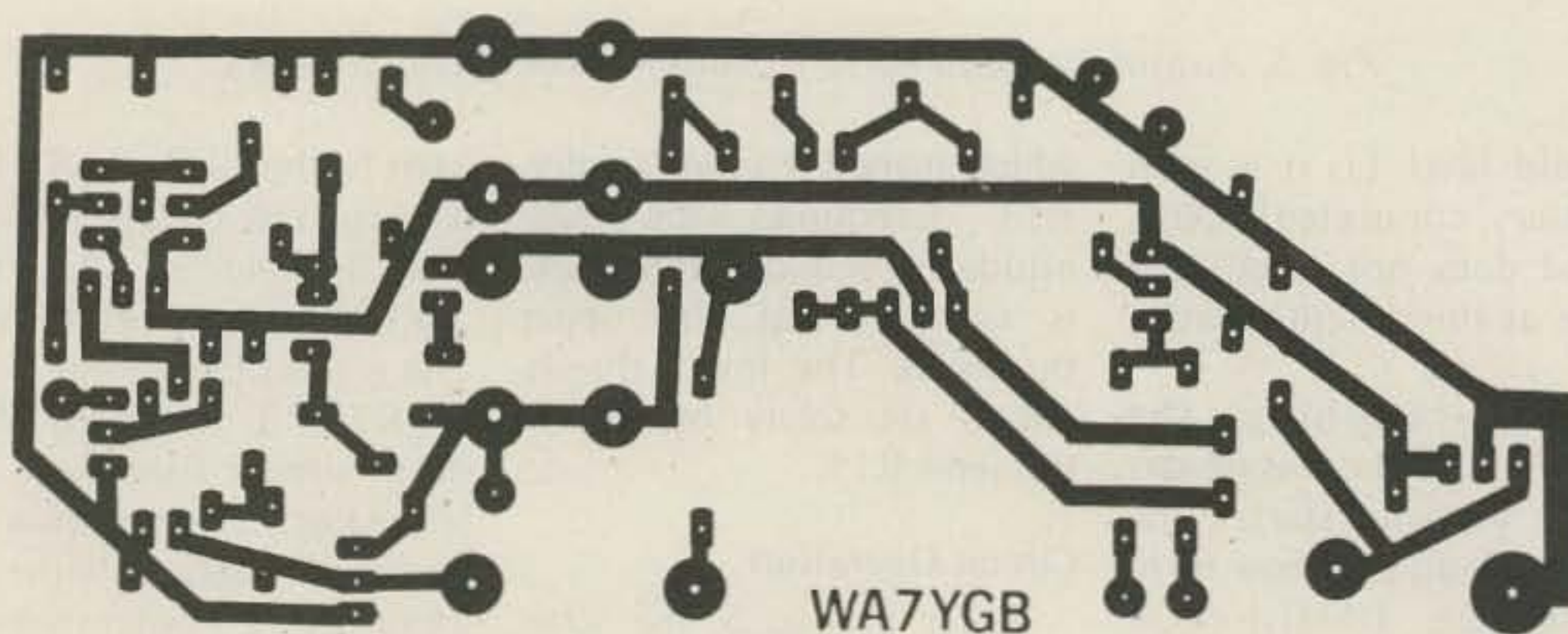

PC board.

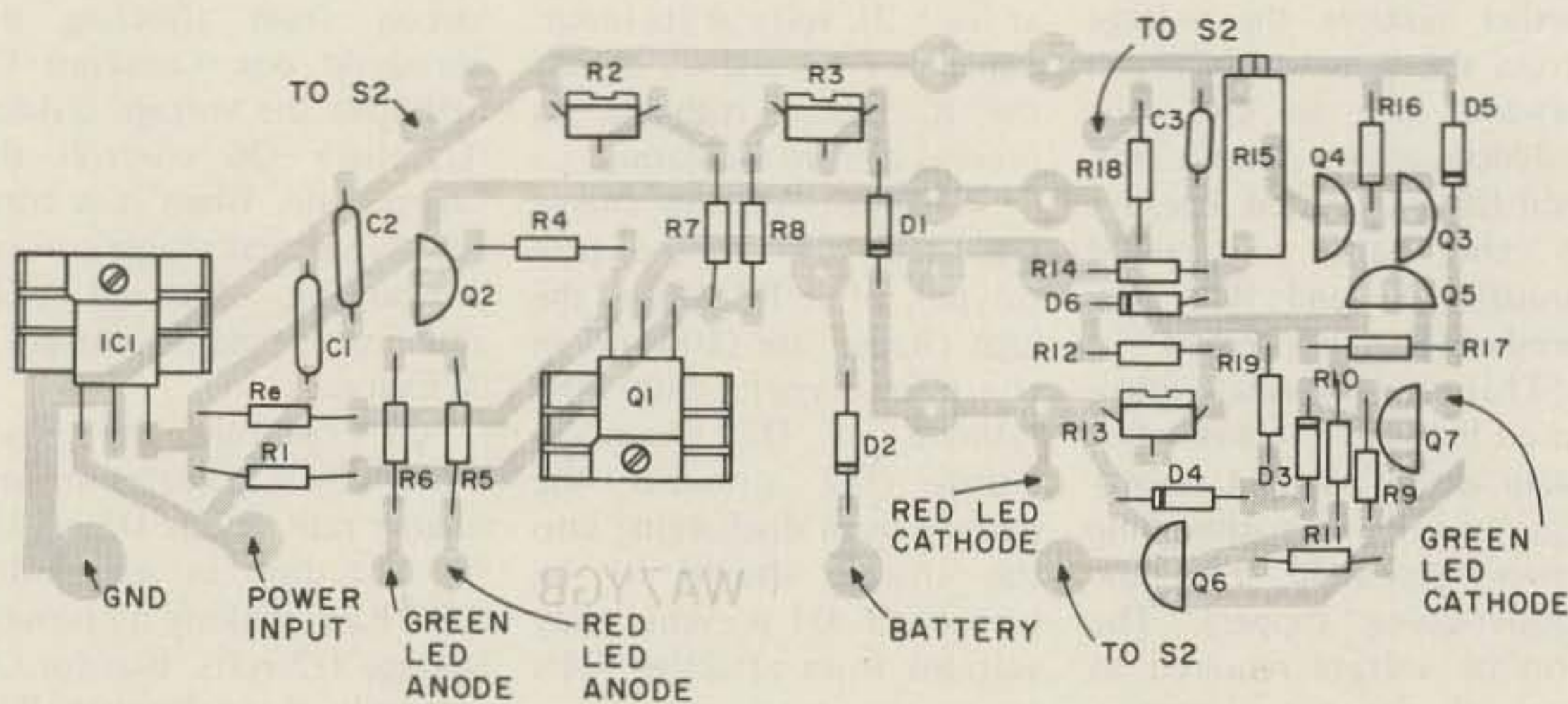

Component layout.

comparator adjustments.

Next assemble the comparator section. Take care to properly locate the various NPN and PNP transistors. Once completed, the comparator may be adjusted. The same power supply used to determine battery characteristics may be used again for the comparator test. A 2-Watt, 500-Ohm wire-wound rheostat will be required to complete adjustments.

Prior to any adjustment efforts, one end of diode D1 must be lifted from the current source portion of the printed circuit board. The 500-Ohm rheostat, which will simulate a battery, should be connected between the output (cathode of D2) and ground. A voltmeter should be connected across the rheostat.

Set R13 to its midpoint prior to proceeding. Then turn on the power supply, adjust the rheostat for maximum voltage, and verify that the green LED (indicating low charge rate) is on. Slowly rotate the rheostat toward minimum voltage and note the voltage value at which the red LED comes on.

Threshold potentiometer R15 will adjust the value at which the red LED turns on. It should be set to a value approximately halfway between the two battery voltages determined previously, or about 1 to 1.5 volts below

the 5-hour charge value. Verify that R15 is correctly set by returning the rheostat to maximum voltage and repeating the test.

It has probably become very evident that the red LED turns off at a different voltage than it turns on. This is the hysteresis mentioned earlier and is the next adjustment.

Measure the voltage (across the rheostat) at which the red LED just turns off. If this happens to be at the

5-hour charge value, there is no need to proceed any further. If not, adjust R13 until it is. Rotate the rheostat several times to minimum and back to maximum to verify that the lower and upper thresholds are correct.

The lower threshold for the prototype battery was set at 10.5 V, while the upper threshold was set at 11.5 V. Respectively, this equals 1.3125 V per cell and 1.4375 V per cell. The upper threshold is the important one. The

lower is set somewhat arbitrarily.

Conclusion

The automatic nicad charger prototype has been operating flawlessly for more than a year. It can always be trusted to initially switch into high charge and then switch into low upon delivery of an adequate amount of charge. A particularly convincing test can be made with a fully charged nicad pack. Upon insertion into the

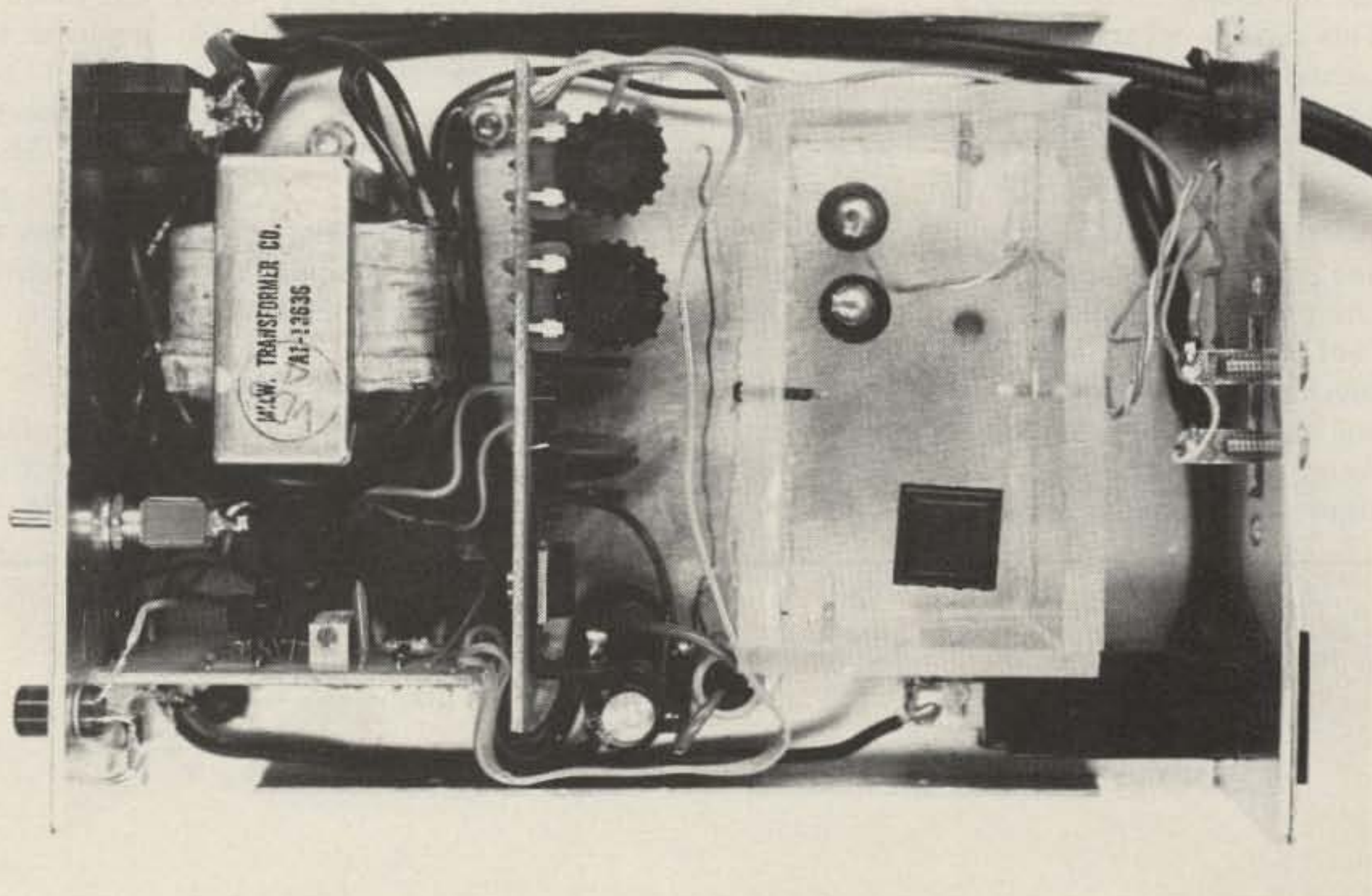

Top view of charger with cover removed.

Parts List

| | | | |
|----------|---|--|---|
| Re | 18 Ohms, ½ Watt (see text) | D5 | 1N5234A or 1N751A 5.1 V zener diode |
| R1 | 56 Ohms, ½ Watt (see text) | D6 | 1N4148 |
| R2, R3 | 2.5k Ohm PC potentiometer (Radio Shack 271-228 or equivalent) | IC1 | 7818 or 7824 depending on the battery (see text) |
| R4 | 150 Ohms, ½ Watt | C1-3 | .1 uF ceramic disc 25 V |
| R5 | 1.5k Ohms, ½ Watt | Q1 | TIP30, 2N6489, or equivalent |
| R6 | 820 Ohms, ½ Watt | Q2 | 2N3906, 2N4403, or equivalent |
| R7, R8 | 150 Ohms, ¼ Watt | Q3, Q4 | 2N3904, 2N4401, or equivalent |
| R9 | 10k Ohms, ¼ Watt | Q5 | 2N3906, 2N4403, or equivalent |
| R10 | 47k Ohms, ¼ Watt | Q6, Q7 | 2N3904, 2N4401, or equivalent |
| R11, R12 | 10k Ohms, ¼ Watt | S1 | SPST switch |
| R13 | 5k Ohm PC potentiometer (Radio Shack 271-217 or equivalent) | S2 | SPDT center-off switch |
| R14 | 1.5k Ohm, ¼ Watt (metal film or other stable type — see text) | LED1 | green light-emitting diode |
| R15 | 10k Ohm precision trimpot (see text) | LED2 | red light-emitting diode |
| R16 | 3.9k Ohms, ¼ Watt | T1 | 24 V transformer (Radio Shack 273-1386 or equivalent) |
| R17 | 4.7k Ohms, ¼ Watt | Bridge | |
| R18 | 10k Ohms, ¼ Watt | Rectifier | (Poly Paks 92CU1346 or equivalent) ⁴ |
| R19 | 33k Ohms, ¼ Watt | C4 | 200 uF 25 V electrolytic |
| D1 | 1N4148 | S3 | SPDT toggle switch (for manual model only) |
| D2 | 1N4002 | Charger housing (home brew or purchased from radio manufacturer) | |
| D3, D4 | 1N4148 | Line cord | |
| | | LED mounting hardware (Ciplite — Tri Tek, Inc.) ⁵ | |
| | | 1 Amp fuse | |

charger, the rate is high, but it slips into low upon sensing the full charge of the battery. This usually occurs within 15 seconds, indicating the viability of the design approach.

It is important to check the battery pack to be charged for shorted cells. If any of the cells are reverse charged, they should be corrected as per K2OAW's suggestions. A shorted cell will confuse the automatic nicad charger and prevent it from switching to low charge.

This may be detrimental to the entire pack.

Since the comparator samples the voltage at the charger terminals, it can be fooled by unexpected voltage drops. Corrosion on the terminals can cause this, as can an unexpected protection diode built into a radio.

If your radio has a built-in diode to prevent inadvertent discharge, its diode voltage drop must be considered when setting the comparator. And the battery terminals

should be kept free of corrosion.

Every effort was made in this article to describe the circuitry in fine detail. I hope that no unclear concepts remain in your mind. However, I will answer any questions you have if they are accompanied by a self-addressed stamped envelope.

Acknowledgement

Many thanks to Dave K7BKX for helping construct the charger socket and for

suggesting the use of vector clips as spring-loaded contacts. ■

References

1. "Making Nicads Behave," K2OAW, 73 Magazine, December, 1974, p. 24.
2. "Zapping Dead Nicads to Life," K2OAW, 73 Magazine, January, 1976, p. 62.
3. James Electronics, 1021 Howard Ave., San Carlos CA 94070.
4. Poly Paks, PO Box 942, South Lynnfield MA 01940.
5. Tri Tek, Inc., 6522 N. 43rd Ave., Glendale AZ 85301.

HW-101 Owners, Check This!

— RIT mod for the good old HW-101

Anton Ruepp HB9BLU
Landstrasse 169
5422 Ob. Ehrendingen
Switzerland

In your Holiday, 1976, issue I found an interesting article titled "Add RIT to your Transceiver." My HW-101 needed that modification, especially since the

CW filter was inserted. I was afraid to take the vfo apart because of the mechanical

work and realignment required. So I had to find an easy way to add RIT to it.

Referring to Fig. 1, C2, R8, D4, and C3 must be installed very close to the tube V 20 on top of the vfo. The connection between C3 and pin 1 of V 20 is a very thin wire inserted into the socket of pin 1.

The other part of the circuit is mounted on a PC board. The switch is on the right, and the potentiometer is on the left side of the S-meter. The LED near the pot indicates RIT "on."

The adjustment is very simple: Set R7 to midrange (S1 off); recalibrate vfo coil (L941). S1 is now on. Adjust the shaft of R6, and tighten the knob so that it's pointing upwards.

This circuit functions well and should be of interest to the many HW-101 owners. ■

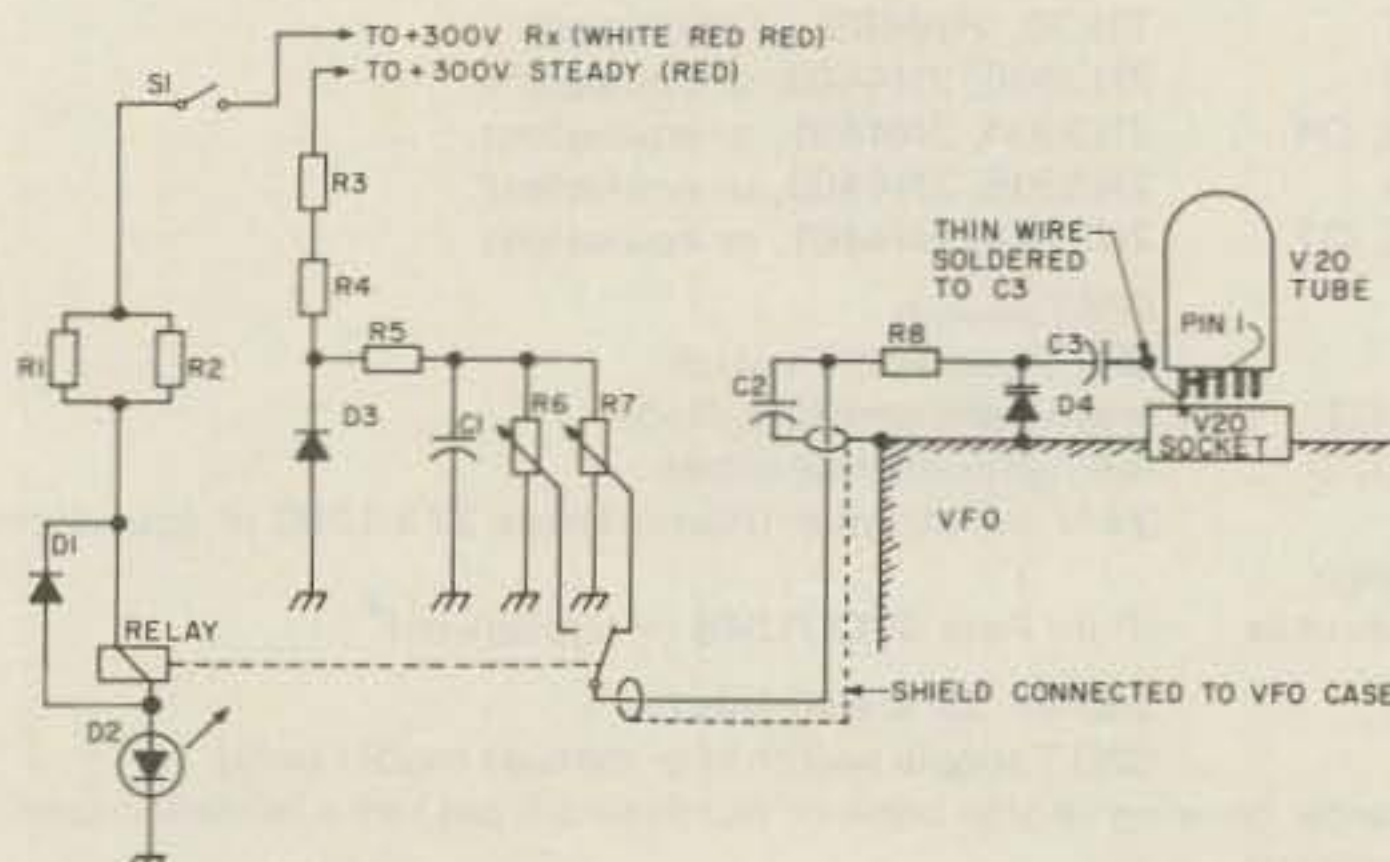

Fig. 1.

Parts List

| | | |
|--------|----------------|--|
| R1, R2 | 47k, 2 W | depends on what type of relay is used (I had a 48 V/12 mA) |
| R3, R4 | 22k, 2 W | |
| R5 | 27k, 1/2 W | Note: If the zener voltage is not too high for D4, forget R5. |
| R6 | 250k lin | potentiometer on front panel |
| R7 | 250k | adjustable resistor |
| R8 | 220k, 1/2 W | |
| C1 | 0.047 mF, 50 V | |
| C2 | 0.01 mF, 50 V | |
| C3 | 10 pF ceramic | |
| D1 | 1N4148 | |
| D2 | red LED | any type capable of handling the relay current, for the front panel (I had a 22 V) |
| D3 | zener 20-27 V | |
| D4 | varactor diode | any 50-15 pF type (sorry, I don't know the American types) |
| Relay | | any convenient type — current should not exceed 15 mA |
| Switch | | any toggle switch capable of handling 300 V dc/50 mA for the front panel |

Clegg is Transceiver Headquarters!

Who was it that said "There's nothing new under the sun?" He was wrong! There now is a generation of truly new concepts in Ham Transceivers. Any one of the rigs shown here has features and performance that never before were available. Regardless of what transceiver you currently own, we contend that replacement with any one of these three will increase your station performance. Each of the three has unique features. The only question is "which best suits your personal operating requirements?" Let us help you decide!



DRAKE TR-7



YAESU FT-901



ICOM IC-701

Drake's "7 SYSTEM" incorporates more innovative technical advances than any product we have seen in many years. Receiver dynamic range exceeds that of all others. If your QTH is in KW alley you'll experience a substantial relief from overload. If you've worried about changes in our bands after the WARC assemblage—the TR-7 can dispell your fears because it accommodates any future possible band relocations and new allocations. The frequency stability of Drake's "full-synthesis" and the large brilliant digital display add to the delight of any TR-7 owner. Space here is inadequate to define the numerous design and operational features of this superb transceiver. Call us for descriptive literature; better yet, drop by and try one in our demonstration room.

You'll discover—as we have—that Drake has created a real winner. One that the others will be hard pressed to equal for years to come. And if you prefer to operate with "separates" the forthcoming R7 Receiver gives you the performance of "twins" plus the convenience of a full performance transceiver for traveling or in the mobile.

YAESU's FT901 system. If you're looking for a transceiver that not only outperforms others on any band from 160 through 10 meters but also has a single matching accessory to conveniently and efficiently cover 6, 2 and 3/4 meter bands, the 901 is it! Even if the VHF and UHF transverter doesn't interest you now, it surely will as OSCAR satellites become the way of life in the next few years. Of all the transceivers we've tested (both on the air and in the lab) none offers the superb control of receiver selectivity offered by YAESU's Variable Selectivity and Notch Filter. And if you work CW, the Tuneable Audio filter will delight you. Nor have we found another Speech Processor system that sounds as good while doing so much for signal punch as that on the 901. Add to this such features as a built in keyer plus both FM and AM detectors. Watch for a gigantic increase in membership in the Fox Tango Club when the gang discovers this great new transceiver.

Watch for YAESU's new matching SCOPE with "panoramic" display and the new synthesized external VFO accessories.

ICOM's IC-701 has to rank very high on our list of best available transceivers. Most of its great features aren't immediately apparent when you first take it out of the box. In fact, after you operate it for a week you'll still be finding new things to like about this all solid state, sophisticated unit. The operating flexibility provided by the dual VFO feature appeals to everyone here at Clegg. It's the first unit that makes no compromise as a fixed station and yet so conveniently mounts in virtually any compact mobile. If you hop from band to band—or chase DX around any single band you'll love its frequency agility and large bright frequency display.

Also available is the matching IC-211 with all mode coverage of 2 meters.

Whatever your needs in Transceivers, Amplifiers, Antennas, Keyers, Station Accessories, etc., call Clegg Toll Free 1-(800)-233-0250; in Pennsylvania call collect—717-299-7221 or write today for our latest catalog!

Clegg Communications Corp. c3
1911 Old Homestead Lane
Greenfield Industrial Park East
Lancaster, PA 17601

Sidetone Is A Must

—improves your fist enormously

Carl Wagar VE3EKR
PO Box 911
Waterloo, Ontario
Canada N2J 4C3

“Skwaaa skwi skwaa
skwik, skwaa skwaa
skwi skwaaaa.” Is that what
you hear when you transmit?
It might be, especially if you

are listening to yourself in
your own receiver.

This is a symptom of a
curse which falls upon each
new ham. Never able to af-

ford a nice new transceiver
with a good sidetone, the
beginner is forced into a
make-do situation. A bor-
rowed receiver-transmitter
combination got me started
in amateur radio. Once I put
up an antenna, everything
went fine until I had to trans-
mit. Then the melodious
tones of the code practice
oscillator (CPO) left my ears
forever.

Twist ... receiver rf gain
down. Click ... antenna re-
lay. Click ... transmitter on
spot. Tap ... key down,
meter moves. Twist ... re-
ceiver rf gain up.
Weeeeeeeeeeeeeeeeeeee. Bfo
adjust ... beeeep beeeep.
Sounds good? Now call that
CQ!

Eventually, the maturing
ham begins looking for a bet-
ter sidetone system. I tried
them all. First there was that
one-transistor circuit with the
wire wrapped around the
transmitter tank coil. When it
sounded more like a flock of
birds than a radio, I switched
to “better” circuits. They had
one that used three transis-
tors and hooked up directly
to the center conductor of the
coax. When that circuit
kept burning up resistors and
made a chirpy bumblebee
sound, I moved on to the
next idea. I finally found two
reed relays and connected
them up so that both relays
would be activated by the
Morse key. One relay would
switch the transmitter, and
the other keyed a 99¢ code
practice oscillator. This
worked fairly well, except
that the relays would stick
and the CPO sounded like it
was worth 29¢.

I finally gave up and trans-
mitted in silence for several
years, even with my newer
but silent transceiver. But a
true ham would never give
up, at least not forever. I
didn't, and I'm going to share
my revelation with you.
While browsing through some
electronic keyer circuits, I
came across the idea: Why
not build an electronic keyer
without the electronic part?

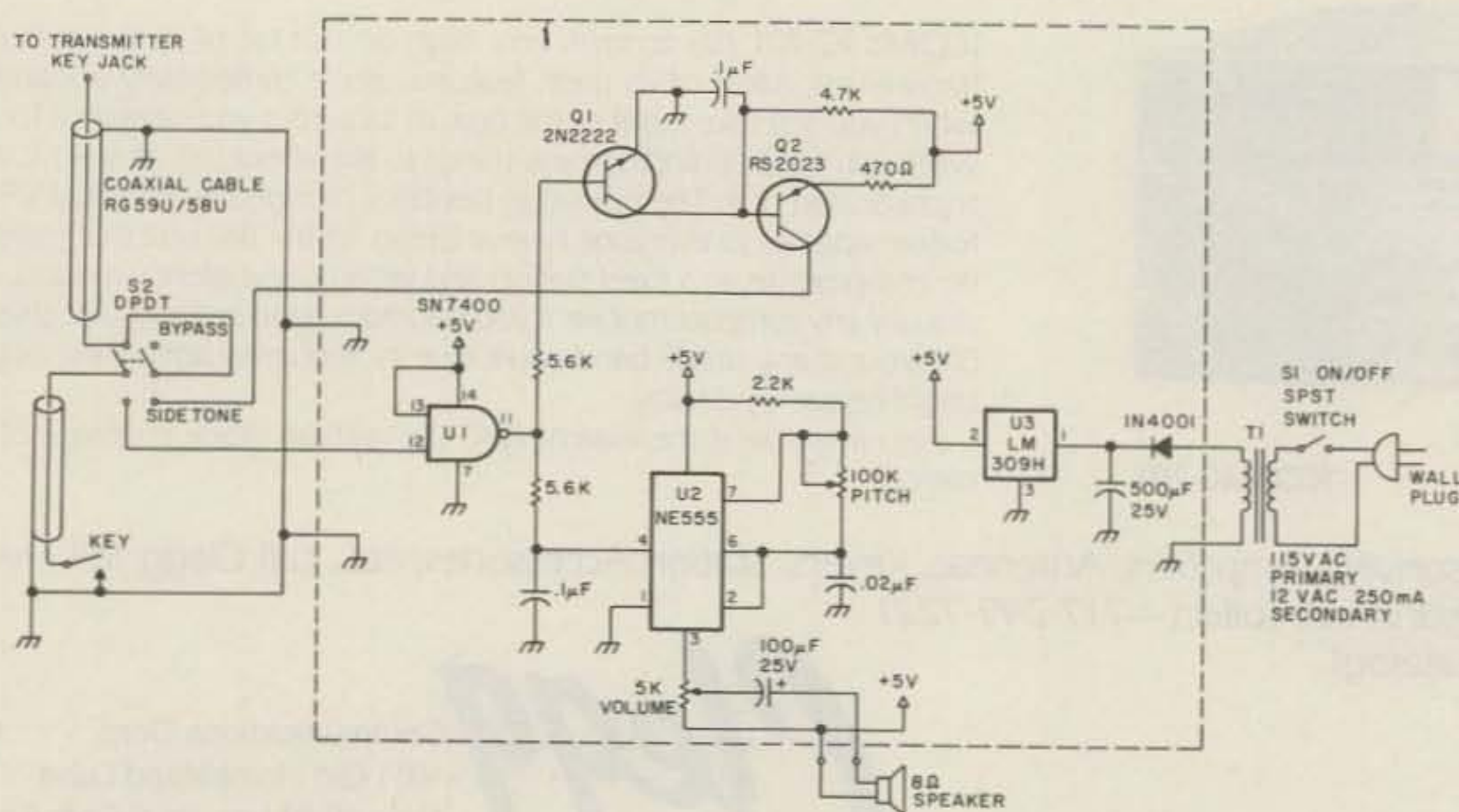

Fig. 1. Schematic diagram.

The electronic keyer is designed to give you properly spaced dits and dahs and is used with a paddle-type key. But remember, it still must key the transmitter and use a sidetone, too. Hmmmm. Here's a two-transistor circuit for keying the rig and a CPO. If I hook them up to the same key, I've got it!

How It Works

I think that this circuit is an ideal project for the new ham. Some of you might be swamped with all the fancy and complex circuits you see in 73. Someday, you say, I'm going to be able to make one of those. Undoubtedly, though, you'll need some practice at building simpler projects in the meantime. I assume that you know what transistors, capacitors, and resistors are. Maybe you haven't used a transistor yet. Well, this project has two of those. Maybe you're curious about those integrated circuits, the little black spider things with shiny legs. Well, there are three of those in this project. Now don't leave yet. How are you ever going to tackle complex things if you don't give this a try?

Look at the schematic diagram shown in Fig. 1. In the top right-hand portion of the diagram, you will see two transistors. Q1 is an NPN-type transistor, and Q2 is a PNP transistor. This is the circuit which keys the transmitter. The base of Q1 is

connected through a 5.6k Ohm resistor to the output of a strange-looking symbol that you may not recognize. This is part of one of the integrated circuits called a NAND gate. If you'll bear with me, I'll explain that in a moment, but, first, all you need to know is that, when you press down on the Morse key, the voltage on the output of that NAND gate goes from zero volts to five volts. This voltage is applied to the base of Q1 and turns on this transistor. This causes current to flow through the 4.7k resistor, into the collector of Q1 and then out of the emitter of Q1 into ground. What this does is lower the voltage on the base of the PNP transistor, Q2, from five volts to near zero volts. This causes Q2 to turn on, which supplies current to the transmitter keying circuit, provided S2 is set on "sidetone." This circuit is designed to key a transmitter which has what is known as grid-block keying. Be sure that your transmitter works this way. Since many of you are most likely using the older, tube-type transmitters, they will likely use either grid-block keying or another type called cathode keying. If your transmitter uses cathode keying, don't give up. You will need to modify your project by using the cathode keying section shown in Fig. 2.

Now I'll get back to that thing called the NAND gate.

Since a lot of circuits you see in 73 Magazine these days use these NAND gates, maybe you should sit down and read this carefully. A NAND gate is just a kind of electronic switch. The term NAND is just a short form for the term NOT AND. If that sounds confusing, keep reading. A NAND gate has three connections besides the two extra power connections of five volts and ground. Of these three connections, two are called inputs, and the other is an output. If you look at the symbol for the NOT AND gate, you will see that one end is round with a little circle on it. The wire connected to that little circle is the output. The other end is square, and the two wires connected to it are inputs.

Everything to do with this gate works on two voltages. Five volts is called a high voltage, and zero volts is called a low voltage. Here's how a NOT AND gate works: The output will usually be high, but, if you connect a high voltage to one input AND the other input, the output will NOT be high. So if both inputs are low, the output will be high. If one input is high and the other is low, then the output will still be high. If the first AND the second inputs are high, then the output will be NOT high or, in other words, low. So, can you see why they named this little NAND gate the way they did?

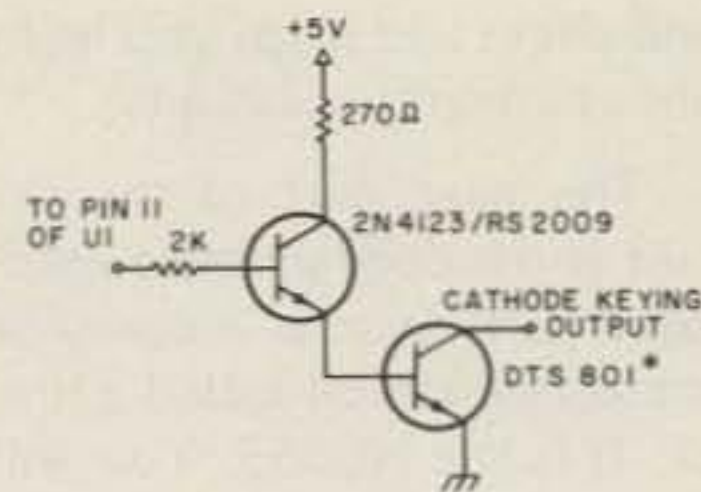
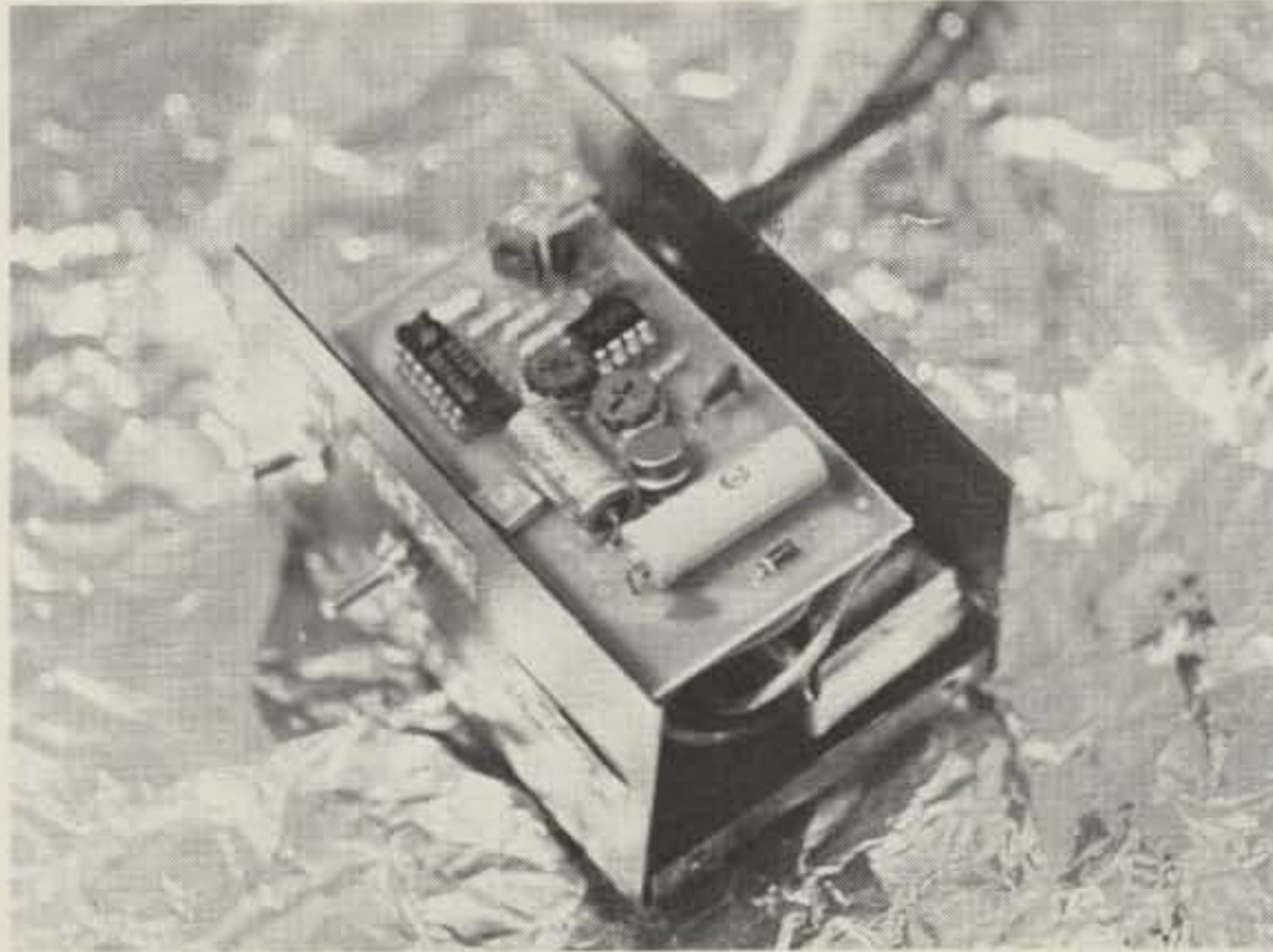

Fig. 2. Cathode-keying circuit. *High-voltage, high-current silicon power transistor or equivalent — ECG-165. It must have V_{ce} greater than plate voltage of final transmit tubes.

In Fig. 1, note that one of the inputs to the NAND gate is connected to five volts, and the other input is connected to the Morse key. There are four of these NAND gates contained in one integrated circuit called the SN7400. This type of integrated circuit is called TTL, for transistor-transistor logic. The peculiar thing about TTL is that, when you leave an input unconnected, it treats it as though it were connected to a high (+5 V) voltage. So here we see that one input is connected to five volts, and, when the key is up, the other input acts as though it were connected to five volts. The result is that the output remains low until you depress the key. This grounds one of the inputs and causes the output to go high. This activates the transistor circuit and keys the transmitter. Key the key, and the transmitter transmits. It works! Using the logic circuit eliminates sparks



and clicks and helps you learn about integrated circuits!

The next part of the circuit is the code practice oscillator part. It uses a complex integrated circuit called a timer. It is the NE555. You will see this component in Fig. 1. It is labeled U2 and has a rectangular shape. Whenever you see a box like this on a schematic diagram, you can be sure that it represents a complex circuit of some sort. You don't need to know

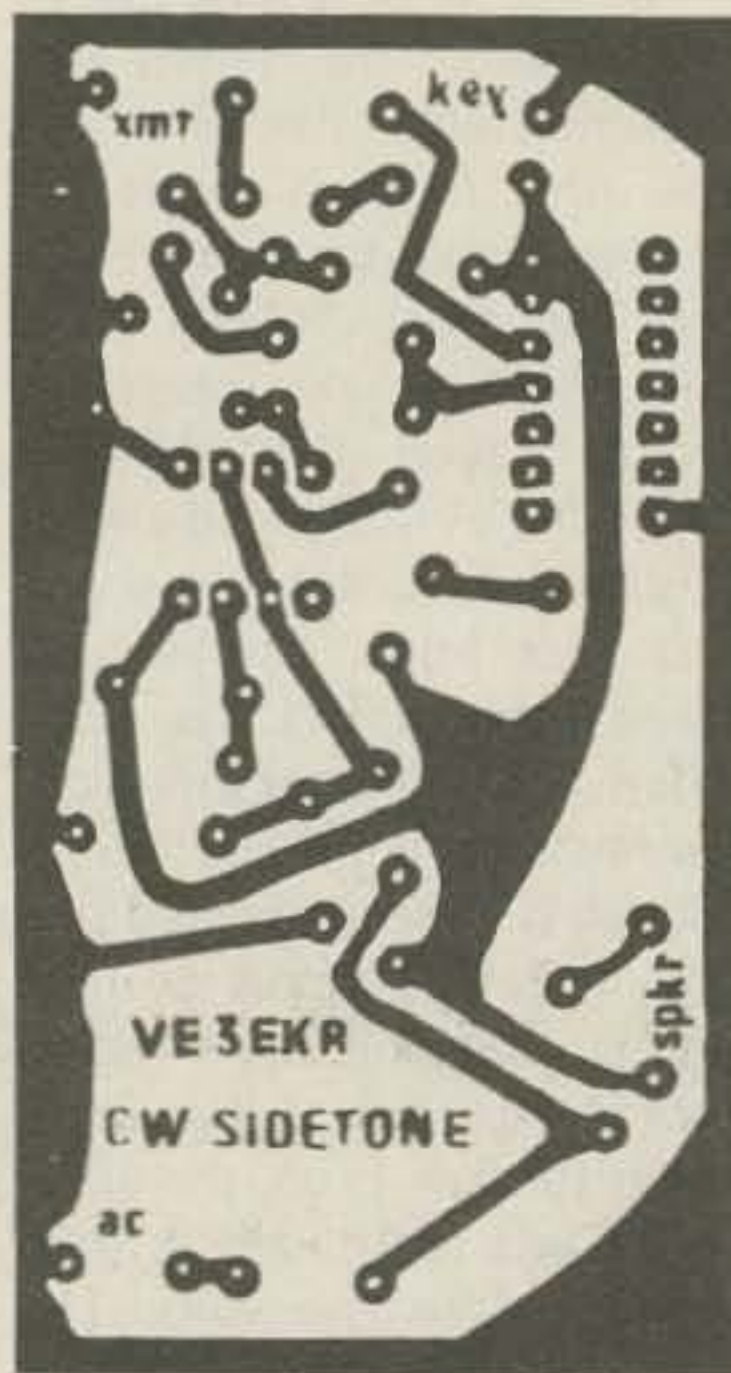

Fig. 3. PC board — full size, copper view.

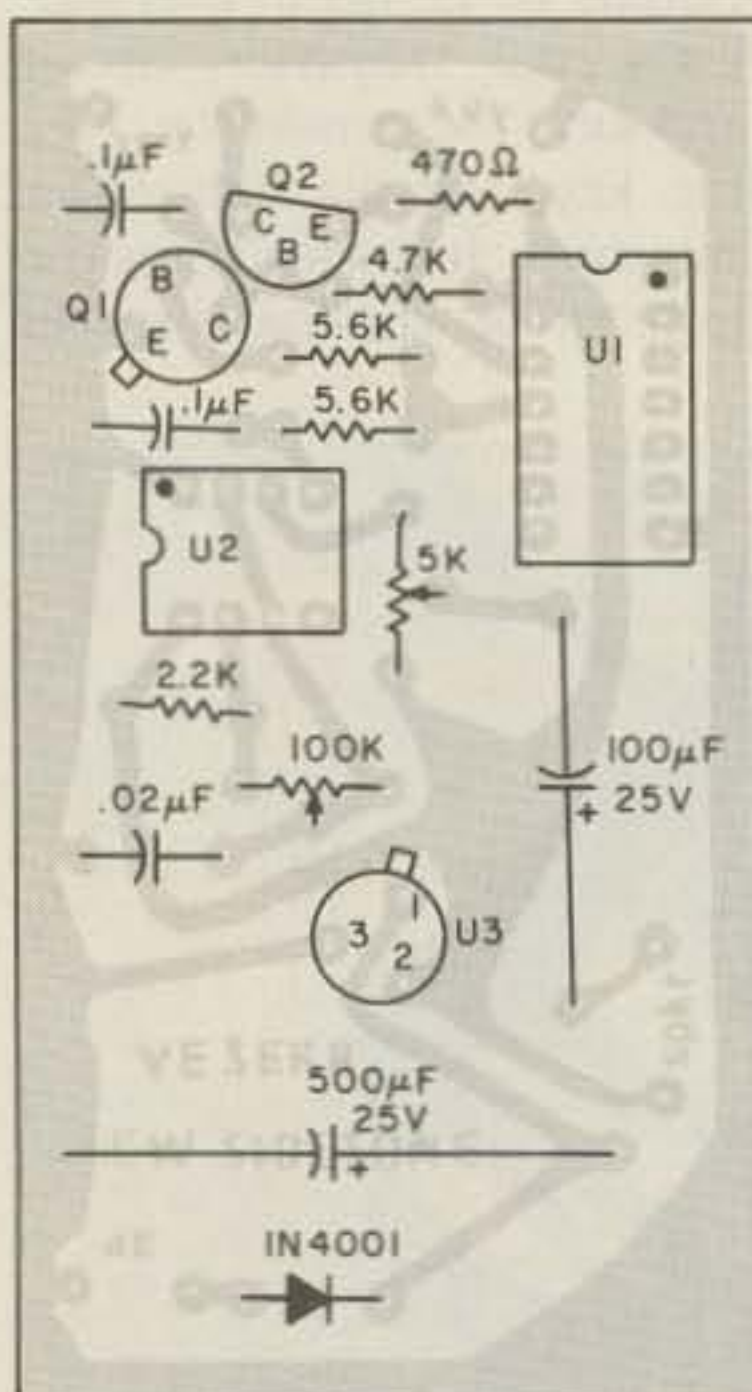

Fig. 4. Parts layout — bottom view.

what's inside an integrated circuit in order to use it. That's the nice thing about ICs (integrated circuits) — you just hook them up and they work.

Connecting a speaker, a volume and tone control, a few resistors, and a few capacitors to this IC gives you a nice sounding, fully adjustable oscillator. When a positive voltage is applied to pin 4 of the 555 circuit through the 5.6k resistor, a tone will be heard in the speaker. When this voltage goes low (the gate output goes low because the key is up), the tone disappears.

Now isn't that neat! Depress the key, and it activates both the transmitter and an audio oscillator at the same time! The only thing left to explain is the power supply that gives us five volts. Using a third integrated circuit gives us five volts, no muss, no fuss. The LM309H integrated circuit voltage regulator has three terminals and looks just like a transistor. Hook one terminal to ground, another to an input voltage from 9 to 30 volts, and you get five volts out the third terminal. You could hook up a nine-volt battery to this, but it might not last very long. I decided to make it so that the circuit could be plugged into the wall.

The power supply section is shown in the bottom right-hand corner of Fig. 1. When S1 is closed, 120 V ac enters the transformer, T1, from the wall outlet. This is transformed down to 12 V ac and is rectified by the 1N4001 diode. We now have pulsating 12 V dc. The ripple is filtered out by the 500 uF capacitor, and 12 V dc is applied to the input of the LM309H. Out of pin 2 of U3 pops +5 V dc, which is then supplied to the circuit.

Everything that is shown inside the dotted box in Fig. 1 can be put on one printed circuit board. Note that S1 turns the sidetone circuit on and that S2 switches between sidetone and bypass. When S2

is set on sidetone, the sidetone circuitry will function if S1 is on. When S2 is in bypass position, this connects the Morse key directly to the transmitter and completely bypasses the sidetone circuit. Note that coaxial cable is used to wire up the key to the sidetone and the sidetone to the transmitter. This eliminates the possibility of rf affecting the sidetone circuitry. So there you have it — a super sidetone circuit!

Construction

Now that I've convinced you that this is a fine little circuit, I've got to convince you to build it. In order to make it easier for you to build, I've designed a printed circuit board layout. Now, I realize that this printed circuit board business may be new to you. If you can get some practice by making this one, though, it'll bring you that much closer to doing some advanced projects. There have been some good articles on making printed circuit boards in *73 Magazine*. It would be well worth the trouble to do some extra reading.

Those of you who already know something about photography will find the printed-circuit-making process fairly simple. The end product is, of course, a PC board. This is a flat, 1/16-inch-thick epoxy fiber board with patterns of thin copper strips on one side. Components are inserted through holes in the board, and the leads are soldered to the copper on the opposite side of the board. The copper strips on the bottom of the board are created through a process known as etching. Originally, a PC board has one side completely covered with a layer of copper. A pattern of etch-resistant material is then applied on top of the copper. This can be done with special pens that have a special ink, or it can be done by applying strips of tape with adhesive backing. The best way is to apply a coating of special light-sensitive plastic and then

photographically remove the plastic from the areas of copper that are to be etched away. In all three methods, the idea is to protect certain areas of copper on the copperclad board from the etching solution into which the board is then placed. The unprotected copper is then etched away, leaving the pattern of copper strips that is required for the circuit.

Most electronic stores sell kits with all of the chemicals and materials that you need to make PC boards photographically. As with any other photographic process you need a negative in order to make the print, which, in this case, will be on the PC board. To make it simple for you to make a PC board, Fig. 3 is a negative of the pattern for the PC board. I have made good PC boards by taking such a pattern from a magazine and making a Xerox® copy of it. Then, in a darkened room, you take the copperclad board and coat it with the light-sensitive coating. Once it is dry, you place the Xerox® negative against the copper surface and sandwich the whole thing between two pieces of glass. Then run outside and expose it to sunlight for several minutes, or buy yourself a sunlamp to expose it. Most photoresists require the ultraviolet light of the sun in order to work. You can then return to your darkroom and place the board in a resist developer solution. This removes the plastic coating from the unexposed parts of the board. Then all that you do is put the board into the etching solution, and ten minutes later you've got a nice PC board! This method is a little crude, but it works fine. Those of you who are photographers may wish to make actual negatives and use Kodalith or some such material for contact printing. Either way, you should endeavor to get a PC board made, as it makes construction much simpler.

Now that you've got a PC board, you will need to get

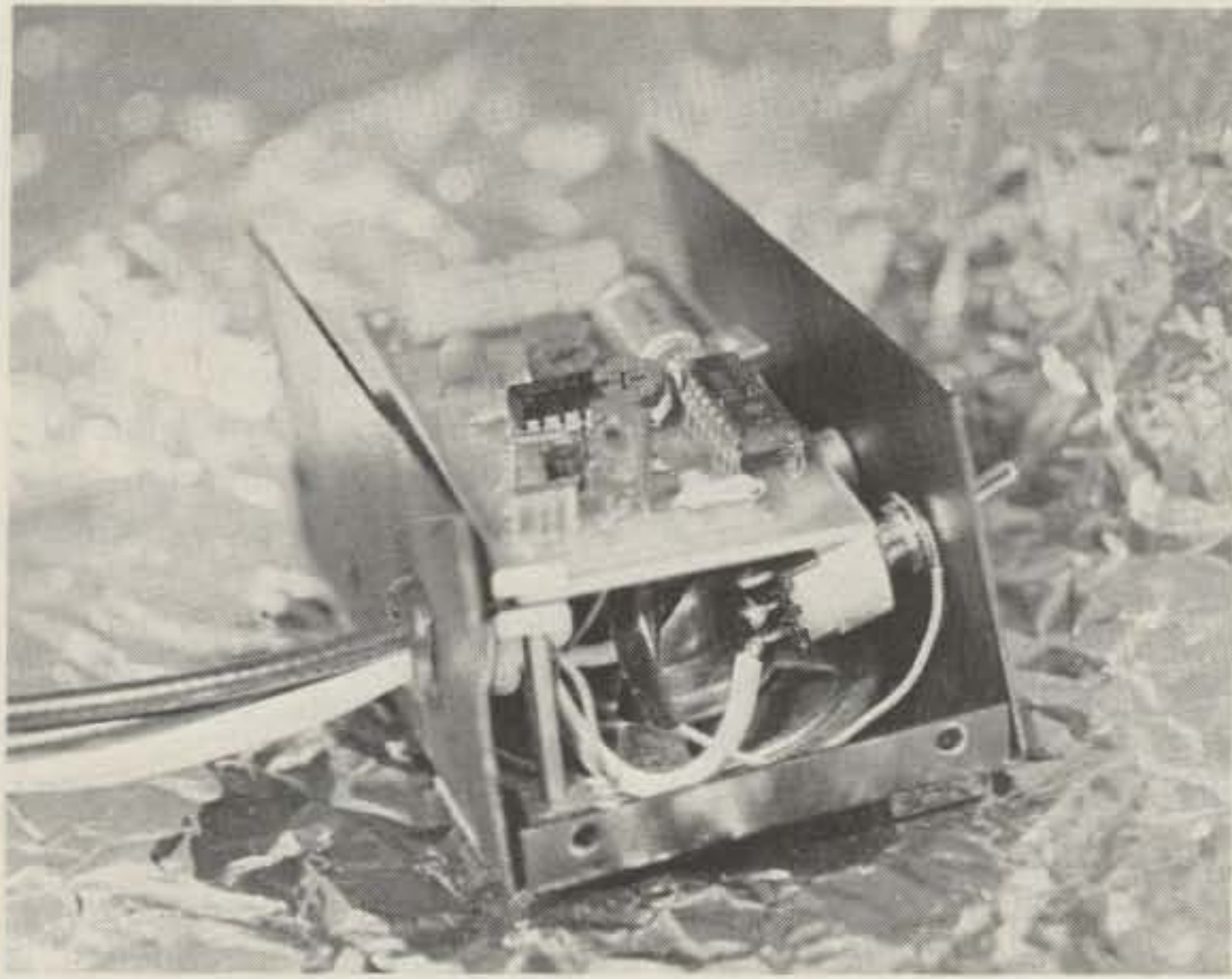

Parts List

- U1 — National SN7400N quad 2-input NAND gate IC or equivalent
- U2 — Signetics NE555 timer IC or equivalent
- U3 — National LM309H IC voltage regulator or equivalent
- Q1 — 2N2222 NPN transistor or any equivalent silicon transistor
- Q2 — RS-2023/MJE350 PNP transistor with $V_{ce} > 50$ V or equivalent
- S1 — SPST toggle switch
- S2 — DPDT toggle switch
- 4.7k $\frac{1}{4}$ W resistor
- 2.2k $\frac{1}{4}$ W resistor
- 470 Ohm $\frac{1}{4}$ W resistor
- two 5.6k $\frac{1}{4}$ W resistors
- 1N4001 50 pv 1 A rectifier
- 100k printed circuit potentiometer
- 5k printed circuit potentiometer
- two .1 uF ceramic disc capacitors
- .02 uF ceramic disc capacitor
- 100 uF 25 V electrolytic capacitor
- 500 uF 25 V electrolytic capacitor
- 115 V ac to 12 V ac filament transformer, 250 mA
- 8-Ohm miniature speaker
- coaxial cable, hookup wire, cabinet, nuts, bolts, etc.

the parts to put onto it. See the parts list. All of these parts are available from the mail-order distributors advertising in *73 Magazine* or from your local electronics store. Q1 can be any good silicon transistor such as the 2N2222. Q2 can be any PNP transistor, but one specification is important. It must be able to withstand the key-up voltage of the transmitter. This means that the specification called V_{ce} must be probably at least 50 V. The 276-2023 available at Radio Shack will do. The Motorola MJE350 has a V_{ce} of 300 V, and I used one of these that I had in the junk box. The integrated circuits, numbered 7400, 555, and LM309H, are fairly common. Make sure that you get the LM309H, as the "H" implies that it is in a small can. If you get an LM309K, it will take up too much room. The volume and tone controls that I used were the printed-circuit-board type that fit onto the board. If you want to be able to adjust these often, you could buy the large cabinet-mounting type, and put them on the cabinet that you install the sidetone in. You could then run wires from the controls to the PC board. The resistors and capacitors as well as the speaker and switches should be easy to obtain.

Once you've got all the parts, it's time to install them on the PC board. First, how-

ever, you've got to drill the holes in the board. If you own a high-speed drill press capable of drilling very small holes, then you're okay. But, if you are like me, you have an old beat-up hand drill. It most likely won't accept bits smaller than 1/16th inch. You could drill the holes with a 1/16th bit, but they would really be too big. Your best bet is to find a hardware store that has the finer drill bits. A #58 drill bit is ideal, and, if they have that, they also probably have a special chuck that will hold these small bits. A shaft extends from this chuck, and it will fit into the chuck of your electric hand drill. If you get one of these little adapters, then you'll be all set. Just drill away until you've done all of the holes.

If you've never done any small-size soldering, then you may need some practice. You need a low-power soldering iron with a small tip and some small-diameter resin core solder. For soldering the two multilegged DIP (dual-inline-package) ICs, you should use integrated circuit sockets or the cheaper molex pins. This way, you can replace the ICs easily and solder the sockets to the PC board without fear of overheating the ICs.

Install the parts according to the parts layout shown in Fig. 4. Push the leads of the capacitors, resistors, and transistors through the proper

holes. Bend and clip the wires on the opposite side, and solder them into place, being careful not to overheat them. Pin diagrams for the transistors and ICs are shown in Fig. 5. Of course, if you are using a substitute transistor, make sure you know the pin diagrams for it. Observe the polarities of the electrolytic capacitors and the diode. The integrated circuits must also plug into their sockets in the proper direction. Pin 1 usually has a dot on the plastic case above it, or there is a notch cut in the end of the IC to indicate positioning. The regulator chip has a little tab sticking out of the side of its can.

Once you have all of the parts installed, look carefully at all of your solder connections. Make sure that there are no cold solder joints or solder "bridges" — shorts between adjacent solder connections. If you want to make sure it works before putting it in a cabinet of your choice, you can do the following: Solder wires to the appropriate points on the board for the speaker, the key, the transmitter, and the transformer. Before connecting the power, unplug the ICs. Plug in the 12 V transformer to the wall, and, if your circuit board passes the smoke test (no smoke), then it is probably safe to plug in the key, the speaker, and the

transmitter, and apply power. With the transmitter on standby position, when the key is depressed, you should get a tone in the speaker. You may have to adjust the tone or volume controls before you can hear anything. If that works, then hook up the transmitter, ground to ground, transistor output to transmitter key input. Take the transmitter off standby position and into transmit mode. Hopefully, it won't transmit until you depress the key. Then you hear the oscillator oscillating and see that the transmitter is transmitting. It works!

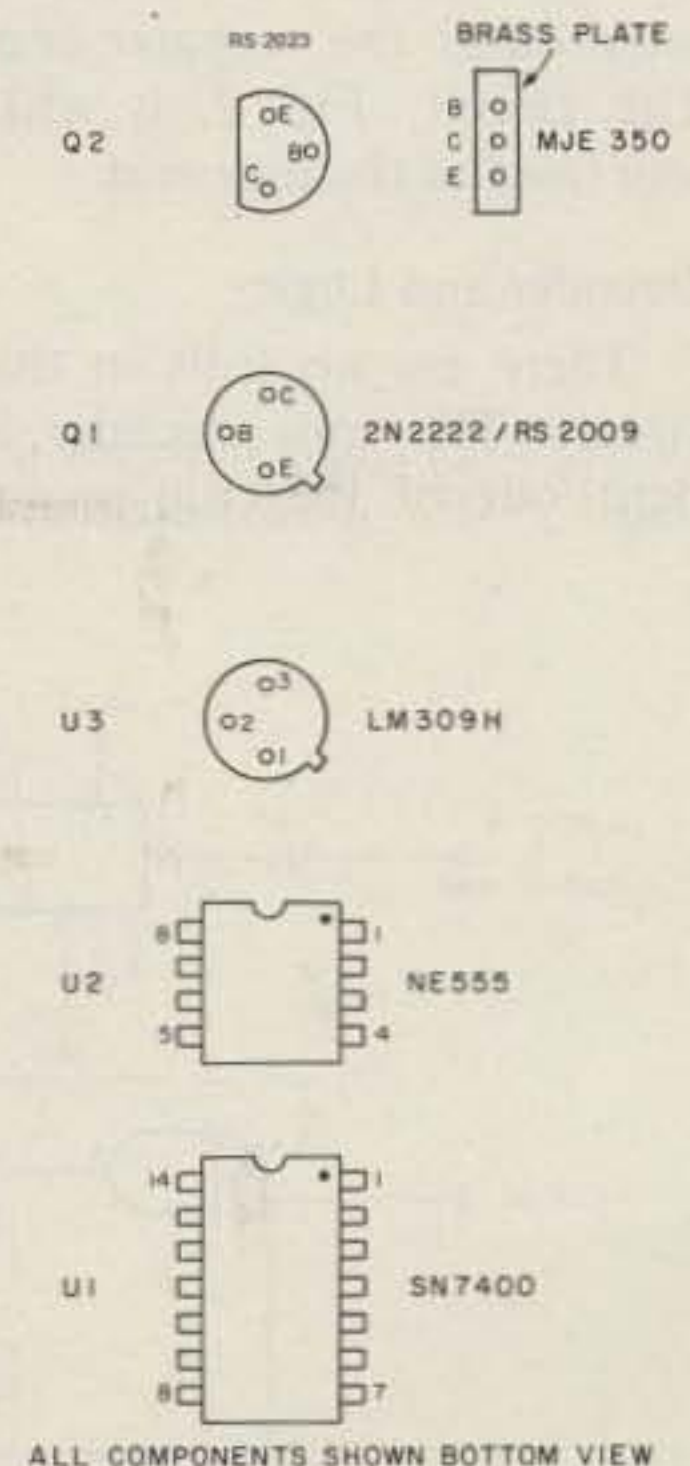

Fig. 5. Pin diagrams.

PROGRAMMABLE CMOS KEYS

AUTEK RESEARCH

CALLS CQ WHILE YOU RELAX!

Also remembers name, QTH, contest exchanges, etc

MODEL MK-1

ONLY \$99.50

- 4 Messages
- Instant record or reprogram
- Designed for Novice, as well as CW "Pro" and Contest OP



An Advanced Programmable Keyer - Yet Priced Lower Than Many Ordinary Keyers

Programmable memory keyers are the biggest advance to come along in years for CW. When you use one, CW truly becomes FUN again! Until the MK-1, quality memory keyers cost \$150 to \$400. But now, anyone can afford a "miniature computer," instead of an ordinary keyer. It's an investment in enjoyable operation for years to come. And an incredible bargain at our breakthrough low price!

ADVANCED "MOS" MEMORY

- Just tap button to start any of four messages.
- You record CQ, contest exchanges, name, QTH, or anything you want in the four messages.
- Record instantly by simply sending the message.
- Play out recording as often as desired.
- Change by simply recording over the old message. No factory programmed extra cost IC's to buy.
- Large 1024 bit total memory stores about 100 characters. Each message holds about 25 characters, depending on character length and pauses, e.g., "CQ CQ DE WSDYD WSDYD CQ TEST K"
- "Combine C/D" switch combines 2 of the 4 messages for extra length of about 50 characters, e.g., "QTH IS LA LA NAME IS BILL BILL RIG HR IS KW ES BEAM ES NEW MEMORY KEYS"
- REPEAT SWITCH repeats message forever until reset. Very useful for longer CQ's, or leave a moderate pause at end of CQ. If no answer, the keyer automatically repeats the CQ until answered. YOU SIT BACK AND WAIT FOR A CALL!
- ADDED CONTEST FEATURES. Instant memory reset with button, or by tapping paddle when playing. Tapping message button restarts message.

PLUS A GREAT AUTOMATIC KEYS

- Dot AND dash memories "forgive" your minor timing mistakes. Most keyers have just a dot memory or none at all. The MK-1 makes sending easier.
- IAMBIC OPERATION. Squeezing dot and dash paddles produces alternate dots and dashes, making it easier to send letters such as C, F, K, Q, R, etc. Most keyers put out only dots, or only dashes when paddles are squeezed, making you work harder.
- FULL CMOS construction. No TTL logic to heat up or draw heavy current. Battery operation if desired. (50 ma @ 9V, 60 ma @ 12 V, typical)
- SELF-COMPLETING characters. Jamproof.
- Extensive RFI protection. 8-50+ WPM.
- Silent transistor output. No clicking relays to fail. (Max. 1300 V., .15 ma. grid blocked rigs, +200 ma. cathode keyed rigs; at key)
- TRIGGERED CLOCK (except when recording) starts instantly at key closure. No confusing wait, or need for you to "keep time," as with many keyers.
- Built-in monitor/speaker. Volume control (panel). Widely adjustable tone (internal trimpot).

To prevent loss of recorded messages when AC power is lost, a 9 V battery may be connected to the rear battery input. No power is drawn from a battery if AC power is on. This makes the MK-1 ideal for field day or expeditions. The MK-1 may be left on continuously in fixed stations, if desired. (Draws less than 1.5 watts AC). The MK-1 may be used with any paddle. A dual lever (squeeze) paddle is recommended to take advantage of iambic operation, but a single lever paddle will also work.

115 VAC or 9-14 VDC. 6x3x5". 2.5 lbs. Handsome light-grey panel with silver lettering. Black steel case. Comes assembled and tested with full instructions.

VISTA power supplies

quality power conversion products for car, boat, home, trailer, truck or recreation vehicle.

deluxe regulated R series convert 120 vac, 60 Hz to 13.8 vdc ± 0.5 vdc

The VISTA series of regulated models is of the highest quality, utilizing the latest in integrated circuit (IC) technology designed for long life and superior performance with hum free, highly regulated stabilized output voltage... the standard of the industry.



models

- VISTA IIR... 2 amps continuous, 4 amps surge auto-reset breaker, UL listed, case size 3"x4"x5 1/2" inches. \$29.95
- VISTA IIR... 3 amps continuous, 5 amps surge auto-reset breaker, UL listed, case size 3"x4"x5 1/2" inches. \$33.95
- VISTA IVR... 4 amps continuous, 6 amps surge current limiting, crowbar over-voltage protected, fused, UL listed features, case size 3"x4"x5 1/2" inches. \$43.95
- VISTA VIR... 6 amps continuous, 8 amps surge current limiting, crowbar over-voltage protected, fused, UL listed features, case size 3"x4"x5 1/2" inches. \$51.95
- VISTA XR... 8 amps continuous, 11 amps surge current limiting, crowbar over-voltage protected, fused, UL listed features, case size 4"x4"x6 1/2" inches. \$79.95
- VISTA XRD... 10 amps continuous, 13 amps surge current limiting, crowbar over-voltage protected, fused, UL listed features, case size 4"x4"x6 1/2" inches. \$94.95
- VISTA XXR... 16 amps continuous, 20 amps surge current limiting, crowbar over-voltage protected, fused, UL listed features, case size 4"x4"x6 1/2" inches. \$103.95
- VISTA XXRD... 20 amps continuous, 26 amps surge current limiting, crowbar over-voltage protected, fused, UL listed features, case size 4"x4"x6 1/2" inches. \$139.95
- VISTA XXXR... 30 amps continuous, 40 amps surge current limiting, crowbar over-voltage protected, fused, UL listed features, case size 4"x4"x6 1/2" inches. \$164.95

*Output 12.5 VDC ± 0.5 VDC

applications

- Home use of low power mobile AM-CB radios, quality car tape players, trickle battery charging.
- Home use of high power mobile AM-CB radios, quality car tape players, trickle battery charging.
- Home use of mobile single side band CB, high power AM-CB and small ham radios, quality car tape players, tape recorders.
- Home use of single side band CB radios, high power car stereo, for the HF perfectionist, low power 2 meter ham radios.
- 10 watts, 2 meter ham, FM-CB, marine and business band radios, low power linear amplifiers.
- 25 watts, 2 meter ham, FM-CB, marine and business band radios, low power linear amplifiers.
- 50 watts, 2 meter ham and FM-CB band radios, linear amplifiers.
- 50 and 75 watts, 2 meter ham band linear amplifiers test bench power supply.
- 100 and 160 watts, 2 meter ham band linear amplifiers, test bench power supply.



KR-400 Azimuth Rotator

Medium duty rotator, supports 400 lbs (181 KG). Ideal for Boomers, HF trib arrays, also limit switches. NOT AVAILABLE

Rotation is 1 min./360°. Accommodates masts 1.5-2.5"D (38-63.5 mm). Supplied with functional direction indicator. 115VAC, 50/60 Hz.

Shipping weight is approx. 18 lbs. (8.16 KG). \$129.95



KR-500 Elevation Rotator

KR-500 provides 180° boom rotation for antennas used OSCAR, EME, etc. NOT AVAILABLE

can be used for... Motor disc brake holds to 1750 inch-pounds (2000 cm-KG). Accommodates booms 1.25-1.625"D (31.75-41.27 mm), masts to 1.5-2.5"D (38-63.5 mm). Weatherproof. Attractive direction indicator.

115VAC, 50/60Hz.

14 lbs. (6.34 KG). \$169.95

The only completely free-standing, telescoping, breakover tower you can buy.

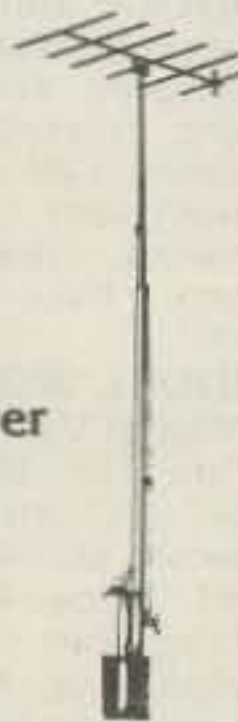

The only completely free-standing, telescoping, breakover tower you can buy.

They telescope. Crank up or down easily to pinpoint best reception.

They breakover. Your feet never have to leave the ground when you pull maintenance - even on our tallest breakover tower.

One-piece price. You get the whole tower, ready to install. No extra charges for base plates, guy wire, etc.

Old-fashioned craftsmanship. Every Tele-Tow'r is cut, assembled, and welded by hand.

Old-fashioned value. Orville Bond found a way to make better towers for less money. Our model 40, which we believe is the most durable, convenient non-breakover 40-footer you can buy, is \$224.21. Our Breakover Model 55, the only tower you can buy that is totally free-standing, telescoping, and a breakover, is just under \$500.

Completely free-standing. No guy wires, no brackets. Yet, by stretching the windload over the entire tower, we've made them stronger than wired or bracketed towers.

| | |
|---|----------|
| 55 Concrete Sleeve | \$32.00 |
| 40 Concrete Sleeve | \$32.50 |
| Model 40 (extends from 23'-40') | \$224.21 |
| Model 55 (extends from 23'-55') | \$410.16 |
| Breakover Model 40 (extends from 23'-40', with breakover at ground level) | \$381.30 |
| Breakover Model 55 (extends from 23'-55', with breakover at ground level) | \$572.65 |

TELE TOWER



Two NEW Rotors from Cornell-Dubilier

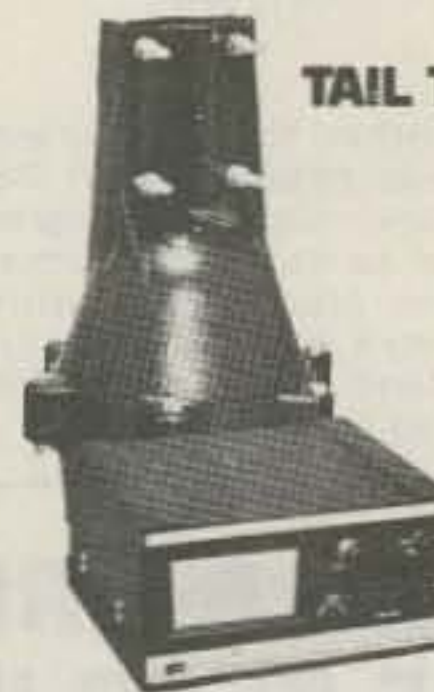

TAIL TWISTER™

- For the New Super Communications Antennas
- New Thickwall Casting
- New Steel Ring Gear
- New Metal Pinion Gear
- New Motor Prebrake
- New Super Wedge Brake
- New L.E.D. Control Box
- Safe 26 Volt Operation

Designed for the newest of the king-size communications antennas, the TAIL TWISTER™ is the ultimate in antenna rotational devices. The TAIL TWISTER™ starts with a deluxe control box featuring snap action controls for brake and directional controls; L.E.D. indicators signal rotation and brake operation, while the illuminated meter provides direction readout. This new control box couples to the newest bell rotor. Using the time tested bell rotor principle, the TAIL TWISTER™ is a brand new design with thickwall castings and six bolt assembly. A brand new motor with prebrake action brings the antenna system to an easy stop, while the massive square front brake wedge locks the assembly in place. A new stainless steel spur gear system provides final drive

HAM III



into a new steel ring gear for total reliability. Triple race, 138 ball bearing assembly carries dead weight and maintains horizontal stability. An optional heavy duty lower mast adaptor is available for lighter loads with mast mounting. Price: \$259.00

The HAM III sets new levels of performance. Snap action switched wedge brake and rotational controls brings pinpoint accuracy to large directional arrays popular in communications. A new motor provides pre-brake action to assist in slowing down rotational mass, and the new thicker wedge brake offers far stronger lock-in phase action. To take full advantage of this new design, the HAM III is designed for in-tower mounting. A new optional heavy duty lower mast adaptor is available when the HAM III is to be mast mounted with smaller arrays. A stainless steel spur gear system multiplies the torque into the dual race 98 ball bearing support assembly assuring years of trouble free performance. Price: \$139.00.

TELEX

PROFESSIONAL HEADPHONES & HEADSETS

BOOM MIC HEADSETS

The ultimate in communications convenience and efficiency select a boom mic headset. Long-time favorite of professional communications, boom mic headsets allow more personal mobility while always keeping the mic properly positioned for fast, precise voice transmission. Boom microphones are completely adjustable to allow perfect positioning. And, boom mic headsets leave both hands free to perform other tasks.

Models are supplied with "close-talking" microphones to limit ambient noise pick-up and provide superior intelligibility. Each model has momentary, inline push-to-talk switch, which can be wired for either push-to-talk relay control or mic circuit interrupt for voice operated stations. The switch may be used as a momentary push-button or it can be locked in the down position. All models have tough, flexible, 20' cords which are striped and lined, ungrounded. Communications gray with black trim.

| MODEL | C-610 | SWL-610 | C-1210 | C-1320 | CM-610 | CM-1210 | CM-1320 | CM-1320S |
|--|----------------|----------------|----------------|----------------|----------------|----------------|----------------|----------------|
| Headphone Sensitivity at 0002 Dynes/cm ² 1W input, 1kHz | 103dB SPL ±5dB | 103dB SPL ±5dB | 103dB SPL ±3dB | 105dB SPL ±5dB | 103dB SPL ±5dB | 103dB SPL ±3dB | 105dB SPL ±5dB | 105dB SPL ±5dB |
| Headphone Impedance | 32-20 ohms | 2000 ohms | 32-20 ohms | 32-20 ohms | 32-20 ohms | 32-20 ohms | 32-20 ohms | 32-20 ohms |
| Microphone Frequency Response | | | | 50-8000 Hz | 50-8000 Hz | 50-8000 Hz | 50-8000 Hz | 50-8000 Hz |
| Microphone Impedance | | | | High | High | High | High | High |
| Microphone Sensitivity below 1 volt/microbar at 1kHz | | | | -51dB ±5dB | -51dB ±5dB | -51dB ±5dB | -51dB ±5dB | -51dB ±5dB |
| Price: | \$9.95 | \$11.65 | \$28.30 | \$37.90 | \$42.80 | \$56.90 | \$68.30 | \$54.50 |



Model C610 (SWL 610) Model C 1320 Model CM 610 Model C 1210



Model CM 1210 Model CM 1320 Model CM 1320S



The NEW KENWOOD TS-820S transceiver

TS-820S now has factory installed digital readout • 160 thru 10 meter coverage • 200 watts PEP • Integral IF shift • Noise blanker • DX & PLL circuitry • DRS dial • IF out, RTTY, XVTR capabilities • Phone patch IN and OUT terminals • RF speech processor. 098.00.

the indispensable BIRD 43 THRU LINE WATTMETER



| Power Range | Frequency Bands (MHz) | | | | |
|-------------|-----------------------|-------|---------|---------|----------|
| | 2-30 | 25-60 | 100-250 | 200-500 | 400-1000 |
| 5 watts | — | 5A | 5C | 5D | 5E |
| 10 watts | — | 10A | 10C | 10D | 10E |
| 25 watts | — | 25A | 25C | 25D | 25E |
| 50 watts | 50H | 50A | 50C | 50D | 50E |
| 100 watts | 100H | 100A | 100C | 100D | 100E |
| 250 watts | 250H | 250A | 250C | 250D | 250E |
| 500 watts | 500H | 500A | 500C | 500D | 500E |
| 1000 watts | 1000H | 1000A | 1000C | 1000D | 1000E |
| 2500 watts | 2500H | — | — | — | — |
| 5000 watts | 5000H | — | — | — | — |

MODEL 43
 Elements (Table 1) 2-30 MHz \$125.00
 Elements (Table 1) 25-1000 MHz 45.00
 Carrying case for Model 43 & 6 elements 38.00
 Carrying case for 12 elements 27.50
 17.00

READ RF WATTS DIRECTLY! (Specify Type N or SO239 connectors) 0.45 – 2300 MHz, 1-10,000 Watts ±5%, low insertion VSWR – 1.05, Unequaled economy and flexibility. Buy only the element(s) covering your present frequency and power needs, add extra ranges later if your requirements expand.

Now you can receive the weak signals with the Ameco PT-2 pre-amplifier!

Model PT-2 is a continuous tuning 6-160 meter Pre-Amp specifically designed for use with a transceiver. The PT-2 combines the features of the well-known PT with new sophisticated control circuitry that permits it to be added to virtually any transceiver with No modification. No serious harm can be without one. Price: \$69.95.



- Improves sensitivity and signal-to-noise ratio.
- Boosts signals up to 26 db.
- For AM or SSB.
- Bypasses itself automatically when the transceiver is transmitting.
- FET amplifier gives superior cross modulation protection.
- Simple to install. • Advanced solid-state circuitry.
- Improves immunity to transceiver front-end overload by use of its built-in attenuator.
- Provides master power control for station equipment.

ALL BAND PREAMPLIFIERS



- 6 THRU 160 METERS
- TWO MODELS AVAILABLE
- RECOMMENDED FOR RECEIVER USE ONLY
- INCLUDES POWER SUPPLY

MODEL PLF employs a dual gate FET providing noise figures of 1.5 to 3.4 db., depending upon the band. The weak signal performance of most receivers as well as image and spurious rejection are greatly improved. Overall gain is in excess of 20 db. Panel contains switching that transfers the antenna directly to the receiver or to the Preamp. Model PLF 117V AC, 60 Hz. Wired & Tested \$44.00

KENWOOD PRICE LIST

| Model | Description | Price |
|---|---|----------|
| IF EQUIPMENT 820 PACESETTER SERIES | | |
| TS-820S | TS-820 Deluxe Transceiver with Digital Display (DG-1) installed, 160-10 meters, IF shift | 1,098.00 |
| TS-820 | Deluxe HF Transceiver 160-10 meters, RF speech processor, IF shift, RF negative feedback | 919.00 |
| DG-1 | Digital Frequency Display for TS-820 | 179.00 |
| VO-820 | Deluxe Remote VFO for 820 Series. Includes its own RIT circuit; frequency reads out on transceiver's digital display | 149.00 |
| SP-820 | Deluxe External Speaker. Includes audio filters for added versatility on receive; 2 audio inputs | 49.00 |
| FW-820 | 500 Hz CW Filter for TS-820 | 49.00 |
| 820 SERIES | | |
| TS-520S | 160-10 HF Transceiver. Digital Display (option) speech processor, RF attenuator, super noise blanker | 739.00 |
| DG-5 | Digital Display for TS-520S. Doubles as a frequency counter, too! Adaptable to TS-520 and 599 series | 189.00 |
| VO-520S | Remote VFO for TS-520S. Built in RIT circuit provides super operating flexibility | 135.00 |
| SP-520 | Matching External Speaker for TS-520S. 8 Ohms. Frequency response 100-5000 Hz | 30.00 |
| FW-520 | 500 Hz CW Filter for TS-520 | 49.00 |
| R-599D Series | | |
| R-599D | 160-10 Solid State Amateur Receiver. 2 and 6 meters (optional). SSB, CW, AM, FM Transceivers/splits with T-599D | 549.00 |
| T-599D | 80-10 Meter Amateur Transmitter. Solid State (except driver and finals). Semi break-in, sidetone, built in power supply | 549.00 |
| SP-599 | External Speaker for 599 Series. 8 Ohms. Frequency response: 100-5000 Hz | 25.00 |
| CC-29A | 2 Meter Converter for R-599D | 35.00 |
| CC-69A | 6 Meter Converter for R-599D | 35.00 |
| FM-599A | FM Filter for R-599D | 45.00 |
| HF MISCELLANEOUS | | |
| R-300 | All Band Communications Receiver. 170 kHz to 30 MHz – 6 bands, AC/DC/Batteries; built in speaker | 249.00 |

| | | |
|--------------------------|--|--------|
| AT-200 | Antenna Tuner. Includes an antenna coupler, SWR meter, power meter, antenna switch, 200W | 149.00 |
| TL-922 | Deluxe 160-10 Linear Amplifier. 2 KW PEP | TBA |
| DK-520 | 2 x 3-500Z tubes, rugged built in power supply | |
| DS-1A | Digital Adaptor Kit (TS-520) | |
| VHF/UHF EQUIPMENT | | |
| TS-600 | DC-DC Converter for TS-820/TS-520S Series | 65.00 |
| TS-600 | 6 Meter All Mode Transceiver. SSB, CW, FM, AM, 10 watts. Built in AC/DC power supplies | 699.00 |
| TS-700S | 2 Meter All Mode Transceiver. SSB, CW, FM, AM, semi break-in, CW sidetone. Digital readout, receiver pre-amp | 729.00 |
| VFO-700S | External VFO for TS-700S. Frequency displays on TS-700S. Special "frequency check" feature | 129.00 |
| SP-70 | 8 Ohms External Speaker Matches TS-600 and TS-700S. Excellent frequency response | 30.00 |
| TR-2200A | 2 Meter Portable Transceiver. FM, 12 channels (6 supplied); NI-CAD batteries, charger are included | 229.00 |
| TR-7400A | 2 Meter Synthesized Transceiver. 25 Watts, 800 channels, 4 MHz, continuous tone-coded squelch (option) | 399.00 |
| TR-7500 | 2 Meter FM Transceiver; digital readout, one knob channel selector system, 10 watts output | 299.00 |
| TR-8300 | 70 CM FM Transceiver. 23 channels (3 supplied). 10 watts, broadband design | 299.00 |
| TV-502S | 2 Meter Transverter, 8 watts; SSB and CW | TBA |
| TV-506 | easily hooks up to 520/820 Series | |
| TV-506 | 6 Meter Transverter, 10 watts; SSB and CW, easily hooks up to 520/820 Series | 249.00 |
| OTHER ACCESSORIES | | |
| HS-4 | KENWOOD Headphone set (8 Ohms) | 16.00 |
| MB-1A | Mobile bracket for TR-2200 A | 13.00 |
| MC-50 | Dynamic Microphone for all KENWOOD stations (Hi/Lo Z) | 39.50 |
| PS-5 | AC Power Supply; 12 VDC @ 3.5 Amps, matches TR-8300; built-in digital clock with timer | 79.00 |
| PS-6 | AC Power Supply; 12 VDC @ 3.5 Amps; matches TR-7500; 8 Ohm speaker included | 79.00 |
| PS-8 | AC Power Supply; 12 VDC @ 8 Amps; matches TR-7400A; well regulated; current limiting | 129.00 |
| VOX-3 | VOX Unit for TS-700A and TS-600 | 25.00 |

TUFTS RADIO CATALOG TUFTS RADIO

ATB-34



4 ELEMENT BEAM

10-15-20 METERS

Cushcraft engineers have incorporated more than 30 years of design experience into the best 3 band HF beam available today. ATB-34 has superb performance with three active elements on each band, the convenience of easy assembly and modest dimensions. Value through heavy duty all aluminum construction and a price complete with 1-1 balun.

SPECIFICATIONS

FORWARD GAIN - EXCELLENT LONGEST ELEMENT - 32' 8"
 F/B RATIO - 30 dB TURNING RADIUS - 18' 9"
 VSWR - 1.5-1 WIND SFC - 5.4 Sq Ft
 POWER WEIGHT - 42 Lbs
 HANDLING - 2000 WATTS PEP WIND SURVIVAL - 90 MPH
 BOOM LENGTH/DIA. - 18' x 2 1/8"

\$259.59

UPS SHIPPABLE complete

ENJOY A NEW WORLD OF DX COMMUNICATIONS WITH ATB-34

VHF - UHF DX-ARRAYS 144, 220, 430 mhz

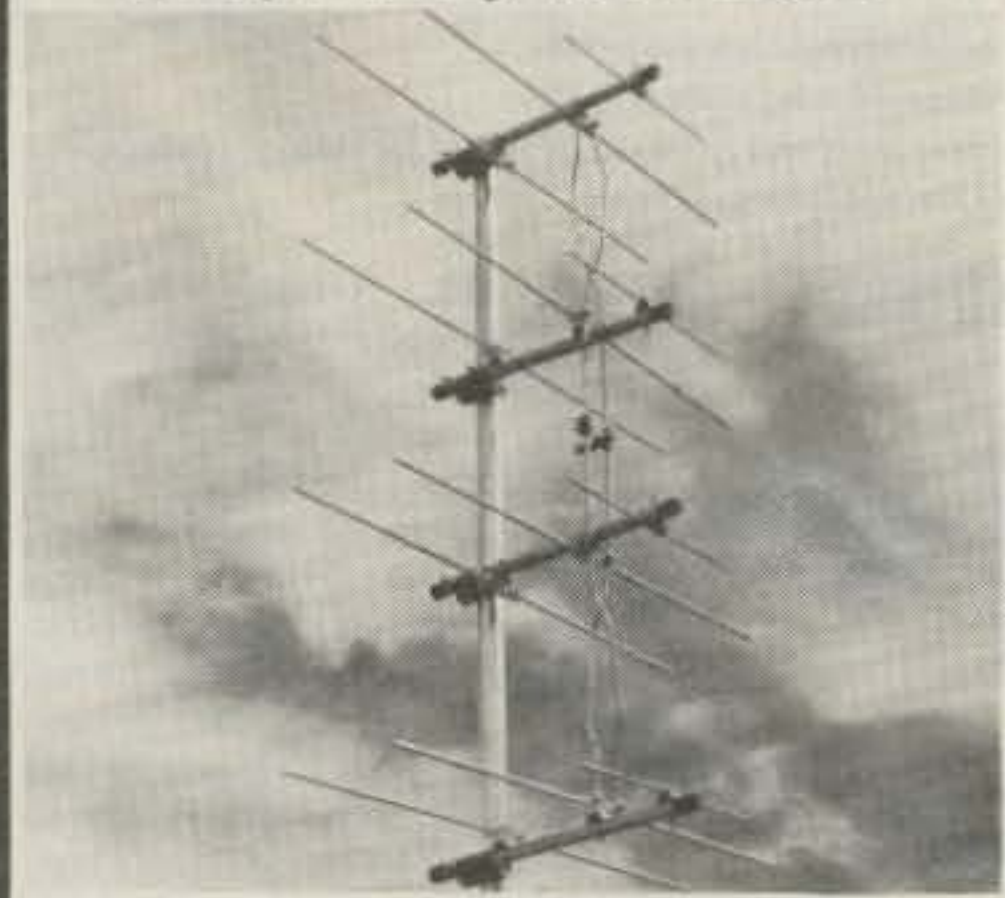

20 ELEMENT DX - ARRAYS

| 20 ELEMENT SPECIFICATIONS | | |
|-----------------------------|-----------|------------------------------|
| Forward Gain ----- | 14.2 db | Impedance ----- 52 ohms |
| F/B Ratio ----- | 20 db | VSWR at Frequency ---- 1 - 1 |
| Fwd. Lobe at 1/2 Pwr. Point | | Bandwidth W/VSWR |
| horizontal ----- | 48" | Less than 2 - 1 ---- 4 mhz |
| vertical ----- | 26" | Power Handling -- 2 KW PEP |
| | 144 Mhz | 220 Mhz |
| Height | 118" | 432 Mhz |
| Width x Depth | 75" x 30" | 78" |
| Turning Radius | 48" | 53" x 20" |
| Maximum Mast Dia. | 1 1/2" | 29" x 11" |
| Net Weight Lbs. | 8 | 32" |
| | | 18" |
| | | 1 1/2" |
| | | 6 |

Vertical support mast not supplied
 2 Meter DX-120 1/4 Meter DX-220 1/4 Meter DX-420
 Am. Net \$47.95 \$42.95 \$36.95

40 ELEMENT DX - ARRAYS

| 40 ELEMENT SPECIFICATIONS | | |
|-----------------------------|------------|------------------------------|
| Forward Gain ----- | 17 db | Impedance ----- 52 ohms |
| F/B Ratio ----- | 20 db | VSWR at Frequency ---- 1 - 1 |
| Fwd. Lobe at 1/2 Pwr. Point | | Bandwidth W/VSWR |
| horizontal ----- | 32" | Less than 2 - 1 ---- 4 mhz |
| vertical ----- | 26" | Power Handling -- 2 KW PEP |
| | 144 Mhz | 220 Mhz |
| Height | 118" | 432 Mhz |
| Width x Depth | 192" x 30" | 78" |
| Turning Radius | 101" | 132" x 20" |
| Maximum Mast Dia. | 2 1/2" | 72" x 11" |
| Net Weight Lbs. | 32 | 65" |
| Wind Rating | 90 mph | 38" |
| Stack Kit No. | DXK-140 | 22 |
| Amateur Net | \$ 65.95 | 90 mph |
| | | 90 mph |
| | | 12 |
| | | 90 mph |
| | | 32 lbs. |
| | | 1 to 1 |
| | | 32 lbs. |

80 ELEMENT DX - ARRAYS

| 80 ELEMENT SPECIFICATIONS | | |
|-----------------------------|------------|------------------------------|
| Forward Gain ----- | 20 db | Impedance ----- 52 ohms |
| F/B Ratio ----- | 20 db | VSWR at Frequency ---- 1 - 1 |
| Fwd. Lobe at 1/2 Pwr. Point | | Bandwidth W/VSWR |
| horizontal ----- | 32" | Less than 2 - 1 ---- 4 mhz |
| vertical ----- | 12" | Power Handling -- 2 KW PEP |
| | 144 Mhz | 220 Mhz |
| Height | 275" | 432 Mhz |
| Width x Depth | 192" x 30" | 182" |
| Turning Radius | 101" | 97" |
| Maximum Mast Dia. | 2 1/2" | 72" x 11" |
| Wind Rating | 90 mph | 65" |
| Net Weight Lbs. | 64 | 38" |
| Stack Kit No. | DXK-180 | 2 1/2" |
| Amateur Net | \$119.95 | 90 mph |
| | | 90 mph |
| | | 24 |
| | | 90 mph |
| | | 22 db |
| | | 1 to 1 |
| | | 35 lbs. |

HF MONOBEAMS 10 15 20 METERS

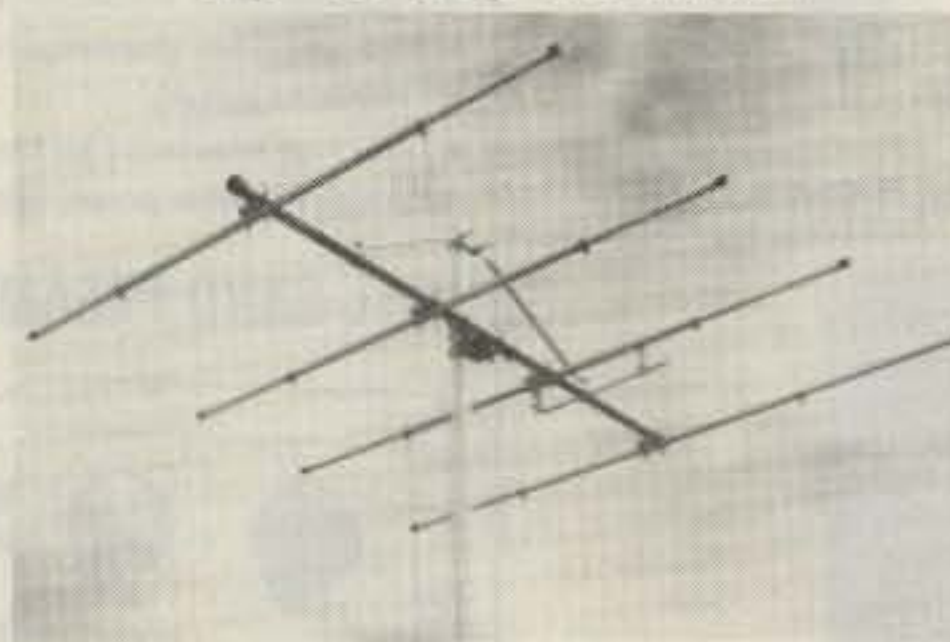

10 METERS

3 ELEMENT BEAM: You can have an outstanding signal using this compact three element beam. It is easily mounted on a lightweight rotator and takes only a limited amount of space. Model No. A28-3—\$79.95
4 ELEMENT BEAM: A real DX'er's beam for the active ham who wants a top signal on 10 meters. Mount on a good ham rotator. Model No. A28-4—\$89.95

| SPECIFICATIONS | A28-3 | A28-4 |
|------------------|--------------|--------------|
| BOOM | 1 1/2" x 10' | 1 5/8" x 18' |
| LONGEST ELEMENT | 17' 6" | 18" |
| ELEMENT DIAMETER | 7/8" - 1/2" | 7/8" - 3/4" |
| TURNING RADIUS | 10" | 14' 3" |
| FORWARD GAIN | 8 db | 10 db |
| FRONT TO BACK | 22 db | 25 db |
| SWR @ FREQUENCY | 1 to 1 | 1 to 1 |
| WEIGHT | 11 lbs. | 21 lbs. |

15 METERS

3 ELEMENT BEAM: A high quality beam which can be mounted on a mast with other antennas. A heavy duty TV rotator will handle it. Model No. A21-3—\$99.95
4 ELEMENT BEAM: For the 15 meter enthusiast this beam will give real DX performance. When mounted on a good ham rotator it will withstand the most adverse weather conditions. Model No. A21-4—\$129.95

| SPECIFICATIONS | A21-3 | A21-4 |
|------------------|--------------|-----------------|
| BOOM | 1 5/8" x 12' | 1 3/4" x 21' 6" |
| LONGEST ELEMENT | 22' 10" | 22' 10" |
| ELEMENT DIAMETER | 7/8" - 3/4" | 7/8" - 3/4" |
| TURNING RADIUS | 13' - 3" | 15' - 8" |
| FORWARD GAIN | 8 db | 10 db |
| FRONT TO BACK | 22 db | 25 db |
| SWR @ FREQUENCY | 1 to 1 | 1 to 1 |
| WEIGHT | 16 lbs. | 32 lbs. |

20 METERS

2 ELEMENT BEAM: Full size beam performance for the active 20 meter ham with limited space and budget. Model No. A14-2—\$119.95
3 ELEMENT BEAM: A real DX'er's beam with full .15 wavelength element spacing. The heavy duty construction gives years of trouble-free service. Model No. A14-3 \$159.95

| SPECIFICATIONS | A14-2 | A14-3 |
|------------------|---------------|-----------------|
| BOOM | 1 5/8" x 10' | 1 5/8" x 20' 6" |
| LONGEST ELEMENT | 35' 10" | 35' 10" |
| ELEMENT DIAMETER | 1 1/8" - 3/4" | 1 1/8" - 3/4" |
| TURNING RADIUS | 18" | 21' |
| FORWARD GAIN | 5 db | 8 db |
| F/B RATIO | 13 db | 22 db |
| SWR @ FREQUENCY | 1 to 1 | 1 to 1 |
| WEIGHT | 20 lbs. | 35 lbs. |



World Radio TV Handbook 1978

A Complete Directory of International Radio and Television
 The most exhaustive and authoritative guide to broadcasting and television stations around the world today. **WORLD RADIO TV HANDBOOK 1978** is an indispensable manual for anyone with a working interest in radio and television. Features:
 • Names and addresses of broadcast companies and stations by country
 • Names and titles of leading officials and personnel
 • Listing by frequency of shortwave stations around the world
 • Program data including frequencies, wavelengths, transmitter power, call signs, times, hours of operation (in each language)
 Plus, a special in-depth editorial section with professional articles, suggestions and tips—much, much more. **WORLD RADIO TV HANDBOOK 1978** is available now for \$11.95.

HF Verticals 10-80 Meters

• efficient top ring • fiberglass trap forms • enameled wire coils • solid aluminum capacitors • no tuning required • full compression clamps • omnidirectional coverage • reinforced base • mast or ground mounting • pre-marked sections • easy assembly • superior quality

3 BAND 20-15 meters/Model ATV-3 \$49.95
4 BAND 4*20*15*10 meters/Model ATV-4 \$89.95
5 BAND 80*40*20*15*10 meters/Model ATV-5 \$109.95



Speak up.

We know all about up. In fact, we're number one from the ground up... when it comes to amateur communications towers. We've been building them for HAMS for more than two decades.
 Whether you're thinking crank-up, guyed or free-standing, check with us first. We're Tri-Ex. Reliable, dependable.
 When we say number one from the ground up, we're talking about towers like Tri-Ex's new "Big W" shown here. It's a free-standing crank-up with a height of 80-ft., providing good DX capability at low cost. Ideal for serious HAMS.

Model W51 (51' Self-supporting)
\$850.00



SST T-1 RANDOM WIRE ANTENNA TUNER

All band operation (160-10 meters) with any random length of wire. 200 watt output power capability — will work with virtually any transceiver. Ideal for portable or home operation. Great for apartments and hotel rooms — simply run a wire inside, out a window, or anyplace available. Toroid inductor for small size: 4-1/4" x 2-3/8" x 3". Built-in neon tune-up indicator. SO-239 connector. Attractive bronze finished enclosure. Only \$29.95

SST T-2 ULTRA TUNER

Tunes out SWR on any coax fed antenna as well as random wires. Works great on all bands (160-10 meters) with any transceiver running up to 200 watts power output. Increases usable bandwidth of any antenna. Tunes out SWR on mobile whips from inside your car.

Uses toroid inductor and specially made capacitors for small size: 5 1/4" x 2 1/4" x 2 1/2". Rugged, yet compact. Attractive bronze finished enclosure. SO-239 coax connectors are used for transmitter input and coax fed antennas. Convenient binding posts are provided for random wire and ground connections. Only \$49.95

SST T-3 IMPEDANCE TRANSFORMER

Matches 52 ohm coax to the lower impedance of a mobile whip or vertical. 12 position switch with taps spread between 3 and 52 ohms. Broadband from 1-30 MHz. Will work with virtually any transceiver — 300 watt output power capability. SO-239 connectors. Toroid inductor for small size: 2-3/4" x 2" x 2-1/4". Attractive bronze finish. Only \$19.95

6 METER BEAMS

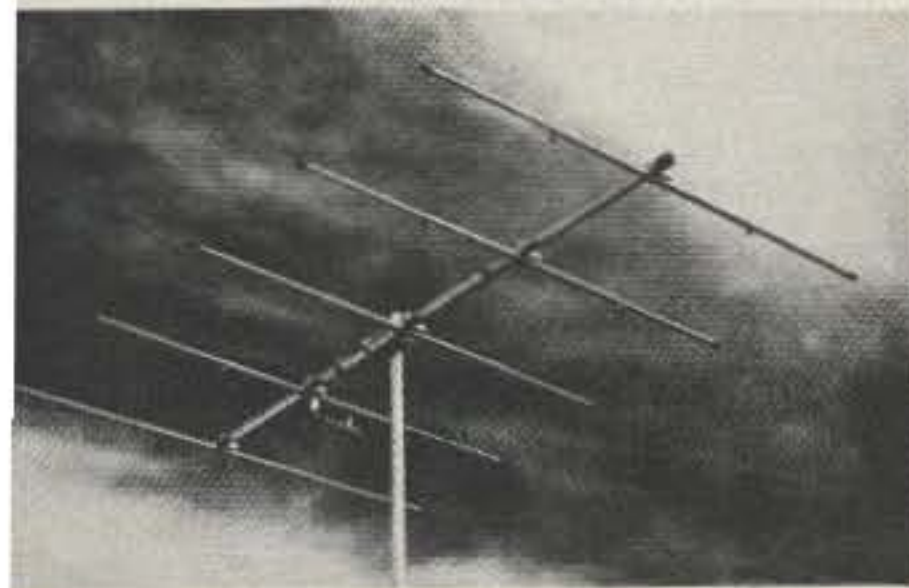

5-6-10 ELEMENTS

Even performance from rugged, full size, 6 meter beams. Element spacings and lengths have been carefully engineered to give the best pattern, high forward gain, good front to back ratio and broad frequency response.

Models are .058 wall and elements are 3/4" - 5/8" .049 wall mess chrome finish aluminum tubing. The 3 and 5 element beams have 1 3/8" - 1 1/4" booms. The 6 and 10 element beams have 1 5/8" - 1 1/2" booms. All brackets are heavy gauge anodized aluminum. Bright finish cad plated bolts are adjustable up to 1 5/8" mast on 3 and 5 element and 2" on 6 and 10 element beams. All models may be mounted for horizontal or vertical polarization.

Features include adjustable length elements, kilowatt Reddi Match and built-in coax fitting for direct 52 ohm feed. These beams are factory marked and supplied with instructions for quick assembly.

| Description | 3 element | 5 element | 6 element | 10 element |
|-------------|-----------|-----------|-----------|------------|
| Model No. | A50-3 | A50-5 | A50-6 | A50-10 |
| Boom Length | 6" | 12" | 20" | 24" |
| Longest El. | 117" | 117" | 117" | 117" |
| Turn Radius | 6" | 7' 6" | 11' | 13' |
| Fwd. Gain | 7.5 dB | 9.5 dB | 11.5 dB | 13 dB |
| F/B Ratio | 20 dB | 24 dB | 26 dB | 28 dB |
| Weight | 7 lbs. | 11 lbs. | 18 lbs. | 25 lbs. |

COAXIAL DUAL STACKING KITS

Double your effective radiated power by stacking 6 meter beams. Cush Craft coaxial stacking kits provide a simple and efficient method for realizing 3 db additional gain while maintaining the superior characteristics of our single beams. The stacking kits are complete with RG-59/U cable and preassembled fittings for direct 52 ohm feed.

| Model No. | For stacking: | Amateur Net |
|-----------|-----------------|-------------|
| 535-SK | A50-3 or A50-5 | \$17.95 |
| 561-SK | A50-6 or A50-10 | \$19.95 |



new RINGO RANGER for FM

4.5 dB* - 6 dB**
Omnidirectional GAIN
BASE STATION ANTENNAS FOR MAXIMUM PERFORMANCE AND VALUE

Cush Craft has created another first by making the world's most popular 2 meter antenna twice as good. The new Ringo Ranger is developed from the basic AR-2 with three half waves in phase and a one eighth wave matching stub. Ringo Ranger gives an extremely low angle of radiation for better signal coverage. It is tunable over a broad frequency range and perfectly matched to 52 ohm coax.

ARX-2, 137-160 MHz, 4 lbs., 112"

ARX-220, 220-225 MHz, 3 lbs., 75"

ARX-450, 435-450 MHz, 3 lbs., 39"

* Reference 1/2 wave dipole.

** Reference 1/4 wave whip used as gain standard by many manufacturers.

Work full quieting into more repeaters and extend the radius of your direct contacts with the new Ringo Ranger.

You can up date your present AR-2 Ringo with the simple addition of this extended kit. The kit includes the phasing network and necessary element extensions. The only modifications required are easy to make saw slits in the top section of your antenna.

ARX-2K CONVERSION KIT

2 METER FM ANTENNAS

A-FM RINGO 3.75 dB Gain (reference 1/4 wave whip). Half wave length antennas with direct dc ground, 52 ohm feed takes PL-259, low angle of radiation with 1-1 SWR. Factory preassembled and ready to install. 6 meter partly preassembled, all but 450 MHz take 1 1/4" mast. There are more Ringos in use than all other FM antennas combined.

| Model Number | AR-2 | AR-25 | AR-6 | AR-220 | AR-450 |
|-------------------|---------|---------|-------|---------|---------|
| Frequency MHz | 135-175 | 135-175 | 50-54 | 220-225 | 440-460 |
| Power-Hdly. Watts | 100 | 500 | 100 | 100 | 250 |
| Wind area sq. ft. | .21' | .21' | .37' | .20' | .10' |

B-4 POLE Up to 9 dB Gain over a 1/2 wave dipole. Overall antenna length 147 MHz - 23' 220 MHz - 15', 435 MHz - 8', pattern 360° - 6 dB gain, 180° - 2 dB gain, 52 ohm feed takes PL-259 connector. Package includes 4 complete dipole assemblies on mounting booms, harness and all hardware. Vertical support mast not supplied.

| | |
|---------|---|
| AFM-4D | 144-150 MHz, 1000 watts, wind area 2.58 sq. ft. |
| AFM-24D | 220-225 MHz, 1000 watts, wind area 1.85 sq. ft. |
| AFM-44D | 435-450 MHz, 1000 watts, wind area 1.13 sq. ft. |

D-POWER PACK The big signal (22 element array) for 2 meter FM, uses two A147-11 yagis with a horizontal mounting boom, coaxial harness and all hardware. Forward gain 16 dB, F/B ratio 24 dB, 1/2 power beamwidth 42°, dimensions 144" x 80" x 40", turn radius 60", weight 15 lbs., 52 ohm feed takes PL-259 fitting.

A147-22 146-148 MHz, 1000 Watts, wind area 2.42 sq. ft.

D-YAGI STACKING KITS VPK includes horizontal mounting boom, harness, hardware and instructions for two vertically polarized yagis gives 3 dB gain over the single antenna.

| | |
|-----------|----------------------------------|
| A14-VPK, | complete 4 element stacking kit |
| A14-SK, | 4 element coax harness only |
| A147-VPK, | complete 11 element stacking kit |
| A147-SK, | 11 element coax harness only |
| A449-SK, | 6 + 11 element coax harness only |

E-4-6-11 ELEMENT YAGIS The standard of comparison in VHF-UHF communications, now cut for FM and vertical polarization. The four and six element models can be tower side mounted. All are rated at 1000 watts with direct 52 ohm feed and PL-259 connectors.

| Model Number | A147-11 | A-147-4 | A449-11 | A449-6 | A210-11 |
|-------------------|-------------|-------------|-------------|-------------|-------------|
| Boom/Longest ele. | 144"/40" | 44"/40" | 60"/13" | 35"/28" | 102"/26" |
| Wght./Turn radius | 6 lbs., 72" | 3 lbs., 44" | 4 lbs., 60" | 3 lbs., 15" | 5 lbs., 51" |
| Gain/F/B ratio dB | 13.2/28 | 9/20 | 13.2/28 | 11/25 | 13.2/28 |
| 1/2 Power beam | 48° | 66° | 48° | 60° | 48° |
| Wind area sq. ft. | 1.21 | .43 | .39 | .30 | .50 |
| Frequency MHz | 146-148 | 146-148 | 440-450 | 440-450 | 220-225 |

F-FM TWIST 12.4 dB Gain: Ten elements horizontal polarization for low end coverage and ten elements vertical polarization for FM coverage. Forward gain 12.4 dB, F/B ratio 22 dB, boom length 130", weight 10 lbs., longest element 40", 52 ohm Reddi Match driven elements take PL-259 connectors, uses two separate feed lines.

A147-20T 145-147 MHz, 1000 watts, wind area 1.42 sq. ft.

HIGH PERFORMANCE VHF YAGIS

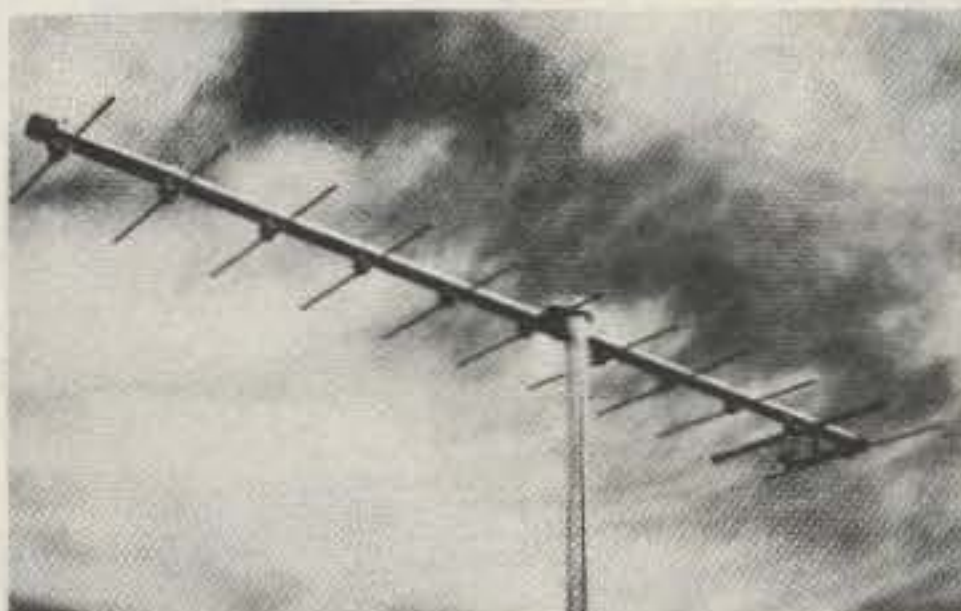

3/4, 1-1/4, 2 METER BEAMS

The standard of comparison in amateur VHF/UHF communications Cush Craft yagis combine all out performance and reliability with optimum size for ease of assembly and mounting at your site.

Lightweight yet rugged, the antennas have 3/16" O. D. solid aluminum elements with 5/16" center sections mounted on heavy duty formed brackets. Booms are 1" and 7/8" O. D. aluminum tubing. Mast mounts of 1/8" formed aluminum have adjustable u-bolts for up to 1-1/2" O. D. masts. They can be mounted for horizontal or vertical polarization. Complete instructions include data on 2 meter FM repeater operation.

New features include a kilowatt Reddi Match for direct 52 ohm coaxial feed with a standard PL-259 fitting. All elements are spaced at .2 wavelength and tapered for improved bandwidth.

| Model No. | A144-7 | A144-11 | A220-11 | A430-11 |
|--------------------------|--------|---------|---------|---------|
| Description | 2m | 2m | 1 1/2m | 1 1/2m |
| Elements | 7 | 11 | 11 | 11 |
| Boom Length | 98" | 144" | 102" | 57" |
| Weight | 4 | 6 | 4 | 3 |
| Fwd. Gain | 11 dB | 13 dB | 13 dB | 13 dB |
| F/B Ratio | 26 dB | 28 dB | 28 dB | 28 dB |
| Fwd. Lobe @ 1/2 pwr. pt. | 46 | 42 | 42 | 42 |
| SWR @ Freq. | 1 to 1 | 1 to 1 | 1 to 1 | 1 to 1 |

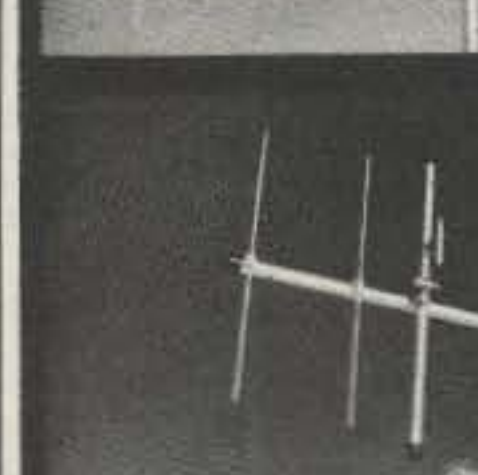
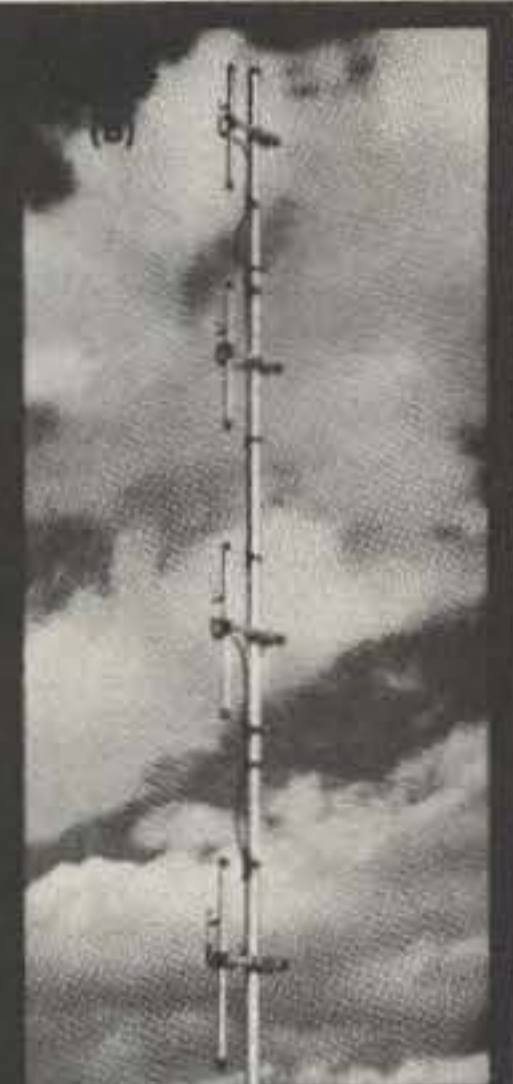

AMATEUR FM ANTENNAS

| | |
|----------|----------|
| A147-4 | \$ 22.95 |
| A147-11 | 34.95 |
| A147-20T | 59.95 |
| A147-22 | 99.95 |
| A220-7 | 23.95 |
| A220-11 | 32.95 |
| A220-22 | 82.95 |
| A449-6 | 23.95 |
| A449-11 | 32.95 |
| AFM-4D | 64.95 |
| AFM-24D | 62.95 |
| AFM-44D | 61.95 |
| AR-2 | 24.95 |
| AR-6 | 36.95 |
| AR-25 | 32.95 |
| AR-220 | 23.95 |
| AR-450 | 23.95 |
| ARX-2 | 36.95 |
| ARX-2K | 14.95 |
| ARX-220 | 36.95 |
| ARX-450 | 36.95 |

AMATEUR FM STACKING KITS

| | |
|----------|----------|
| A14-SK | \$ 17.95 |
| A14-VPK | 26.95 |
| A21-SK | 17.95 |
| A220-VPK | 26.95 |
| A147-SK | 17.95 |
| A147-VPK | 32.95 |
| A449-SK | 17.95 |
| A449-VPK | 26.95 |

BIG WHEEL ANTENNAS

| | |
|-----------|----------|
| ABW-12S | \$ 17.95 |
| ABW-14S | 27.95 |
| ABW-144 | 36.95 |
| BLITZ BUG | |
| LAC-1 | \$ 4.95 |
| LAC-2 | 4.95 |

DX-ARRAYS-20 ELEMENT

| | |
|-----------------|----------|
| DX-120 | \$ 47.95 |
| DX-220 | 42.95 |
| DX-420 | 36.95 |
| DX-ARRAY BALUNS | |
| DX-1BN | \$ 14.95 |
| DX-2BN | 14.95 |
| DX-4BN | 14.95 |
| DX-VPB | 10.95 |

SQUALO ANTENNAS

| | |
|---------|----------|
| ASQ-2 | \$ 19.95 |
| ASQ-6 | 29.95 |
| ASQ-22 | 42.95 |
| ASQ-6SK | 17.95 |
| ASQ-M | 17.95 |

DX-ARRAY-40 ELEMENT

| | |
|---------|----------|
| DXK-140 | \$ 65.95 |
| DXK-240 | 59.95 |
| DXK-440 | 45.95 |

DX-ARRAY-80 ELEMENT

| | |
|---------|----------|
| DXK-180 | \$119.95 |
| SXK-280 | 99.95 |
| DXK-480 | 89.95 |

HF MONOBEAMS

| | |
|-------|----------|
| A14-2 | \$119.95 |
| A14-3 | 159.95 |
| A21-3 | 99.95 |
| A21-4 | 129.95 |
| A28-3 | 79.95 |
| A28-4 | 89.95 |

MULTI BAND HF ANTENNAS

| | |
|--------|----------|
| AFB-1 | \$ 15.95 |
| ATB-34 | 259.95 |
| ATV-3 | 49.95 |
| ATV-4 | 89.95 |
| ATV-5 | 109.95 |

PROLINE VHF BEAMS

| | |
|---------|----------|
| APL-25K | \$ 24.95 |
| APL-65K | 29.95 |
| APL-65 | 159.95 |
| APL-210 | 119.95 |

TWIST ANTENNAS

| | |
|-----------|----------|
| A14T-MB | \$ 17.95 |
| A144-10T | 39.95 |
| A144-20T | 59.95 |
| A144-80QT | 389.95 |
| A432-20T | 54.95 |

VHF/UHF BEAMS

| | |
|---------|----------|
| A50-3 | \$ 36.95 |
| A50-5 | 54.95 |
| A50-6 | 79.95 |
| A50-10 | 109.95 |
| A144-7 | 23.95 |
| A144-11 | 34.95 |
| A430-11 | 27.95 |

VHF/UHF STACKING KITS

| | |
|---------|----------|
| A11-SK | \$ 17.95 |
| A17-SK | 17.95 |
| A41-SK | 17.95 |
| A535-SK | 17.95 |
| A561-SK | 19.95 |
| AQK-144 | 99.95 |
| AQK-444 | 79.95 |

MOBILE ANTENNAS

| | |
|---------|----------|
| AMS-147 | \$ 34.95 |
| ATS-147 | 32.95 |

TUFTS RADIO CATALOG TUFTS RADIO

This NEW MFJ Versa Tuner II . . .



BRAND NEW

- Antenna matching capacitor. 208 pf. 1000 volt spacing.
- Sets power range, 300 and 30 watts. Pull for SWR.
- Meter reads SWR and RF watts in 2 ranges.
- Efficient airwound inductor gives more watts out and less losses.
- Transmitter matching capacitor. 208 pf. 1000 volt spacing.

Only MFJ gives you this MFJ-941 Versa Tuner II with all these features at this price:

A SWR and dual range wattmeter (300 and 30 watts full scale) lets you measure RF power output for simplified tuning.

An antenna switch lets you select 2 coax fed antennas, random wire or balance line, and tuner bypass.

A new efficient airwound inductor (12 positions) gives you less losses than a tapped toroid for more watts out.

A 1:4 balun for balance lines. 1000 volt capacitor spacing. Mounting brackets for mobile installations (not shown).

With the NEW MFJ Versa Tuner II you can run your full transceiver power output — up to 300 watts RF power output — and match your



ANTENNA SWITCH lets you select 2 coax fed antennas, random wire or balance line, and tuner bypass.

transmitter to any feedline from 160 thru 10 Meters whether you have coax cable, balance line, or random wire.

You can tune out the SWR on your dipole, inverted vee, random wire, vertical, mobile whip, beam, quad, or whatever you have.

You can even operate all bands with just

one existing antenna. No need to put up separate antennas for each band.

Increase the usable bandwidth of your mobile whip by tuning out the SWR from inside your car. Works great with all solid state rigs (like the Atlas) and with all tube type rigs.

It travels well, too. Its ultra compact size 5x2x6 inches fits easily in a small corner of your suitcase.

This beautiful little tuner is housed in a deluxe eggshell white Ten-Tec enclosure with walnut grain sides.

50-239 coax connectors are provided for transmitter input and coax fed antennas. Quality five way binding posts are used for the balance line inputs (2), random wire input (1), and ground (1).



\$59⁹⁵

BRAND NEW

MFJ-901 VERSA TUNER

New efficient air wound coil for more watts out.

Only MFJ uses an efficient air wound inductor (12 positions) in this class of tuners to give you more watts out and less losses than a tapped toroid. Matches everything from 160 thru 10 Meters: dipoles, inverted vees, random wires, verticals, mobile whips, beams, balance lines, coax lines. Up to 200 watts RF output. 1:4 balun for balance lines. Tune out the SWR of your mobile whip from inside your car. Works with all rigs. Ultra compact 5x2x6 inches. 50-239 connectors. 5 way binding posts. Ten Tec enclosure.



\$49⁹⁵

BRAND NEW

MFJ-900 ECONO TUNER

Same as MFJ-901 Versa Tuner, but does not have built-in balun for balance lines. Tunes coax lines and random wires.



\$39⁹⁵

MFJ-16010 RANDOM WIRE TUNER

Operate 160 thru 10 Meters. Up to 200 watts RF output. Matches high and low impedances. 12 position inductor. 50-239 connectors. 2x3/4 inches. Matches 25 to 200 ohms at 1.8 MHz.



\$49⁹⁵

BRAND NEW

MFJ-202 RF NOISE BRIDGE

This MFJ RF Noise Bridge lets you adjust your antenna quickly for maximum performance. Measure resonant frequency, radiation resistance and reactance. Exclusive range extender and expanded capacitance range (± 150 pf) gives you much extended measuring range.

Tells resonant frequency and whether to shorten or lengthen your antenna for minimum SWR. Adjust your single or multi-band dipole, inverted vee, beam, vertical, mobile whip or random system for maximum performance. 1 to 100 MHz. 50-239 connectors. 2x3/4 inches. 9 volt battery.

400% MORE RF POWER PLUGS BETWEEN YOUR MICROPHONE AND TRANSMITTER



\$49⁹⁵

LSP-520BX. 30 db dynamic range IC log amp and 3 active filters give clean audio. RF protected. 9 V battery. 3 conductor, 1/4" phone jacks for input and output. 2-3/16 x 3-1/4 x 4 inches.



\$59⁹⁵

LSP-520BX II. Same as LSP-520BX but in a beautiful 2-1/8 x 3-5/8 x 5-9/16 inch Ten-Tec enclosure with uncommitted 4 pin Mic jack, output cable, rotary function switch.



\$29⁹⁵

CWF-2BX Super CW Filter

By far the leader. Over 5000 in use. Razor sharp selectivity. 80 Hz bandwidth, extremely steep skirts. No ringing. Plugs between receiver and phones or connect between audio stage for speaker operation.

• Selectable BW 80, 110, 180 Hz • 60 dB down one octave from center freq. of 750 Hz for 80 Hz BW • Reduces noise 15 dB • 9 V battery • 2-3/16 x 3-1/4 x 4 in.



\$54⁹⁵

CMOS-8043 Electronic Keyer

State of the art design uses CURTIS-8043 Keyer-on-a-chip.

• Built-in Key • Dot memory • Iambic operation with external squeeze key • 8 to 50 WPM • Sidetone and speaker • Speed, volume, tone, weight controls • Ultra reliable solid state keying +300 volts max. • 4 position switch for TUNE, OFF, ON, SIDETONE OFF • Uses 4 penlight cells • 2-3/16 x 3-1/4 x 4 inches



\$17⁹⁵

NEW

CPO-555 Code Oscillator

For the Newcomer to learn the Morse code. For the Old Timer to polish his list. For the Code Instructor to teach his classes.

• Send crisp clear code with plenty of volume for classroom use • Self contained speaker, volume, tone controls, aluminum cabinet • 9 V battery • Top quality U.S. construction • Uses 555 IC timer • 2-3/16 x 3-1/4 x 4 inches



\$29⁹⁵

MFJ-40T QRP Transmitter

Work the world with 5 watts on 40 Meter CW.

• No tuning • Matches 50 ohm load • Clean output with low harmonic content • Power amplifier transistor protected against burnout • Switch selects 3 crystals or VFO input • 12 VDC • 2-3/16 x 3-1/4 x 4 inches

MFJ-40V, Companion VFO \$27.95
MFJ-12DC, IC Regulated Power Supply, 1 amp. 12 VDC \$27.95



\$29⁹⁵

SBF-2BX SSB Filter

Dramatically improves readability.

• Optimizes your audio to reduce sideband splatter, remove low and high pitched QRM, hiss, static crashes, background noise, 60 and 120 Hz hum • Reduces fatigue during contest, DX, and ragchewing • Plugs between phones and receiver or connect between audio stage for speaker operation • Selectable bandwidth IC active audio filter • Uses 9 volt battery • 2-3/16 x 3-1/4 x 4 inches



\$27⁹⁵

MFJ-200BX Frequency Standard

Provides strong, precise markers every 100, 50, or 25 KHz well into VHF region.

• Exclusive circuitry suppresses all unwanted markers • Markers are gated for positive identification CMOS IC's with transistor output • No direct connection necessary • Uses 9 volt battery • Adjustable trimmer for zero beating to WWV • Switch selects 100, 50, 25 KHz or OFF • 2-3/16 x 3-1/4 x 4 inches



\$49⁹⁵

MFJ-1030BX Receiver Preselector

Clearly copy weak unreadable signals (increases signal 3 to 5 "S" units).

• More than 20 dB low noise gain • Separate input and output tuning controls give maximum gain and RF selectivity to significantly reject out-of-band signals and reduce image responses • Dual gate MOS FET for low noise, strong signal handling abilities • Completely stable • Optimized for 10 thru 30 MHz • 9 V battery • 2-1/8 x 3-5/8 x 5-9/16 inches

THE HAM-KEY NOW 5 MODELS

NEW MODEL HK-5 ELECTRONIC KEYS \$69.95



- Iambic circuit for squeeze keying.
- Self completing dots & dashes.
- Dot memory.
- Battery operated with provisions for external power.
- Built-in side-tone monitor.
- Speed, Volume, tone & weight controls.
- Grid-block or direct keying.
- Use with external paddle such as HK-1.



Model HK-1 \$29.95

- Dual lever squeeze paddle.
- Use with HK-5 or any electronic keyer.
- Heavy base with non-slip rubber feet.
- Paddles reversible for wide or close finger spacing.



Model HK-2 \$19.95

- Same as HK-1, less base for those who wish to incorporate in their own Keyer.



Model HK-3 \$16.95

- Deluxe straight key.
- Heavy base, no need to attach to desk.
- Velvet smooth action.

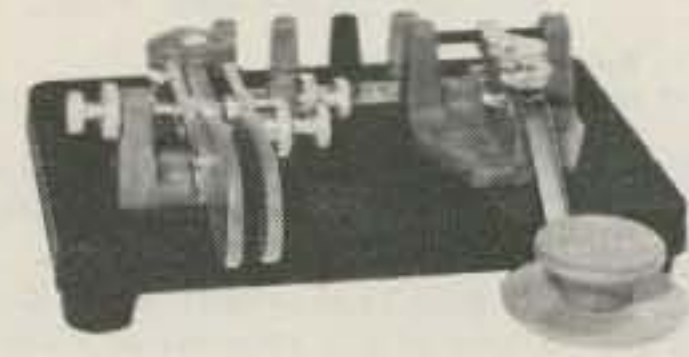

Model HK-4 \$44.95

- Combination on HK-1 & HK-3 on same base.



NEW Jr. Monitor Antenna Tuner

Continuous tuning 1.8-30 MHz
 Forward reading relative output power meter
 300 watt power capability
 Built-in encapsulated balun
 Mobile mounting bracket
 Ceramic Rotary Switch 12-position
 Capacitor spacing 1000 volts
 Tapped toroid inductor
 Antenna inputs:
 a. Coax unbalanced SO239
 b. Random wire
 c. Balanced feedline 75-660 Ohm
 5 1/4" w. x 2 1/4" h. x 6" d.
 All metal black wrinkle finish cabinet
 Weight: 2 1/2 pounds

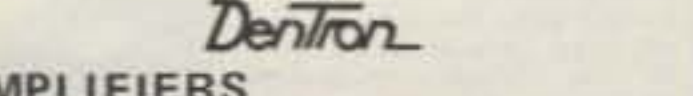

AMPLIFIERS

LA-2500 Amplifier (with Built-Power Supply) \$899.50
 LA-1200 Amplifier 399.50
 C-1200 / AC Power Supply for LA-1200 159.50
 C-1200 / DC Power Supply for LA-1200 199.50

TUNERS

T-3000A Tuner 349.50
 T-2000A Tuner 199.50
 60-10AT Super Tuner 129.50
 Monitor Tuner 79.50

ANTENNAS

60M Mobile Antenna "Mobile on Bander" (160 meters) . 59.50
 enter Feed All Band Doublet antenna 24.50

ACCESSORIES

Big Dummy with coolant . . 29.50
 6-2 Wattmeter 99.50
 160 XV Transverter "Top Bander" 249.50

Read forward and reflected watts at the same time

READ FORWARD AND REFLECTED WATTS AT THE SAME TIME. Tired of constant switching and guesswork? Every serious ham knows he must read both forward and reverse wattage simultaneously for that perfect match. So upgrade with the Dentron W-2 Dual in line Wattmeter. \$99.50.



The MT-5000A
SPECIFICATIONS:
 • Power handling capability in excess of 3 KW PEP
 • Front Panel Antenna Switch with 5 Antenna Inputs plus Tuner bypass position
 • Built-in 50 Ohm - 250 Watt dummy load
 • Dual Wattmeters
 • Compact: 5 1/4" x 14" x 14", 18 pounds
 • Continuous Tuning 160-10 meters
 • 3 Core Heavy-Duty Balun

160 XV MARS Dual Band 279.50
 100 ft. 2kw 300 Transmission Line 19.50
 100 ft. 470 Ohm Ladder Line 12.00
 1 Kilowatt Balun 4:1 Chassis Mt. 27.50
 3 Kilowatt Balun 4:1 Chassis Mt. 29.50



THE MLA-2500 SPECIFICATIONS

- 160 thru 10 meters
- 2000+ watts PEP input on SSB
- 1000 watts DC input on CW, RTTY, or SSTV Continuous Duty
- Variable forced air cooling system
- Self-contained continuous duty power supply
- Two EIMAC 8875 external-anode ceramic/metal triodes operating in grounded grid.
- Covers MARS frequencies without modifications
- Harmonic Suppression better than 50 dB
- Built-in ALC
- Built in RF Wattmeter
- 117V or 234 V AC 50-60 Hz
- Third order distortion down at least 30 dB
- Frequency Range: 1.8 MHz (1.8-2.5) 3.5 MHz (3.4-4.6) 7 MHz (6.0-9.0) 14 MHz (11.0-16.0) 21 MHz (16.0-22.0) 28 MHz (28.0-30.0)
- 40 watts drive for 1 KW DC input
- Rack mounting kit available (standard 19" rack)
- Size: 5 1/4" H x 14" W x 14" D
- Weight: 47 lbs.

Match everything from 160 to 10 with the new 160-10 MAT



NEW: The Monitor Tuner was designed because of overwhelming demand. Hams told us they wanted a 3 kilowatt tuner with a built-in wattmeter, a front panel antenna selector for coax, balanced line and random wire. So we engineered the 160-10m Monitor Tuner. It's a lifetime investment at \$299.50.



Meet the Super Tuner
 MEET THE SUPER TUNER 160-10 AT. The DenTron Super Tuner tunes everything from 160-10 meters. Whether you have balanced line, coax cable, random or long wire, the Super Tuner will match the antenna impedance to your transmitter. All DenTron tuners give you maximum power transfer from your transmitter to your antenna, and isn't that where it really counts?
 1 KW MODEL \$129.50.



Model 333 dummy load wattmeter - Favorite Lightweight Portable-250 WATT RATING - Air Cooled. Ideal field service unit or mobile 2-way radio - CB, marine, business band. Best for 2RP amateur use, CB, with zero to 5 watts full scale low power range.

Frequency Range: DC to 300 MHz
 VSWR: Less than 1.3:1 to 230 MHz
 Power Range: 250 watts intermittent
 Wattmeter Ranges: 0-5, 0-50, 0-125, 0-250
 Connector: SO-239
 Size: 4" x 7" x 8"
 Shipping Weight: 2 lbs.
 Price: \$98.50



High Power - 1000 WATT RATING - Oil Cooled - model 334A dummy load wattmeter. Our most popular combination unit. Handles full amateur power. Meter ranges individually calibrated. Can be panel mounted.

Frequency Range: DC to 300 MHz
 VSWR: Less than 1.3:1 to 230 MHz
 Power Range: 1000 watts CW intermittent. Warning light* signals maximum heat limit.
 Wattmeter Ranges: 0-10, 0-100, 0-300, 0-1000
 Input Connector: SO-239 (hermetically sealed)
 Size: 4 1/2" x 9" x 10 1/2"
 Shipping Weight: 12 lbs.
 Price: \$174.00



Model 374 dummy load wattmeter - Top of the Line - 1500 WATT RATING - Oil Cooled. Our highest power combination unit. Rated to 1500 watts input (intermittent). Meter ranges are individually calibrated for highest accuracy.

Frequency Range: DC to 300 MHz
 VSWR: Less than 1.3:1 to 230 MHz
 Power Range: 1500 watts DC intermittent. Warning light* signals maximum heat limit.
 Wattmeter Ranges: 0-15, 0-50, 0-300, 0-1500
 Input Connector: SO-239 (hermetically sealed)
 Size: 4 1/2" x 9" x 10 1/2"
 Shipping Weight: 12 lbs.
 Price: \$215.00



Wide range attenuator - Model 371-1. Seven rocker switches provide attenuation from 1 dB to 61 dB in 1-dB steps. Switches are marked in dB, 1-2-3-5-10-20-20. Sum of actuated switches (IN position) gives attenuation. With all switches in OUT position, there is NO insertion loss. Attenuator installs in coaxial line using UHF connectors.

Power Capacity: 1/2 watt
 VSWR: 1.3:1 maximum, DC to 225 MHz
 Impedance: 50 ohms
 Accuracy: 1 dB/dB, DC to 60 MHz
 0.1 dB/dB, 20.5 dB, DC to 160 MHz
 0.1 dB/dB, 21.0 dB, DC to 225 MHz
 Size: 8 1/2" x 2 1/2" x 2 1/2"
 Shipping Weight: 1 1/2 lbs.
 Price: \$49.50



Model 331A transistor dip meter - Portable RF single generator, signal monitor, or absorption wavemeter. Lightweight (1 pound, 6 ounces with all coils), battery-powered unit is ideal for field use in testing transceivers, tuning antennas, etc. Can also be used to measure capacity, inductance, circuit Q, and other factors. Indispensable for experimenters, it is easily the most versatile instrument in the shop. Continuous coverage from 2 MHz to 230 MHz in seven ranges.

Frequency Coverage: 2 MHz to 230 MHz in 7 overlapping ranges by plug-in coil assemblies:
 2 MHz-4 MHz, 4 MHz-8MHz, 8 MHz-16 MHz, 16 MHz-32 MHz, 32 MHz-64 MHz, 50 MHz-110 MHz, 110 MHz-230 MHz
 Accuracy: ±3%
 Modulation: 1000 Hz, 25% to 40%
 Power: 9-volt transistor battery, Burgess 2U6 or equivalent
 Size: 7" x 2 1/4" x 2 1/2"
 Shipping Weight: 1 lb., 6 oz.
 Price: \$120.00

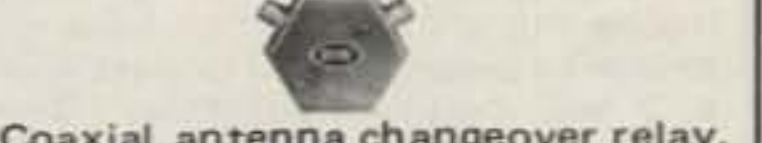

Coaxial antenna changeover relay. Model 377.
 Power Rating: 1000 watts CW (2000 watts SSB)
 VSWR: Less than 1.15:1, DC to 150 MHz
 Power Requirements: 0.015 Ampere, 45 to 130 volts AC
 Connectors: UHF Type SO-239
 Dimensions: 3 1/2" x 1 1/2"
 Shipping Weight: 1 lb.
 Price: \$17.95



Model 359. Increase your transmitter's effective speech power up to four times. This two stage, transistorized Audio Preamp/Limiter can be used with all types of transmitters.
 Input Impedance: 100,000 ohms
 Input Level: 5 millivolts to 20 millivolts
 Voltage Gain: 10 dB
 Output Level: 60 millivolts
 Output Impedance: 50,000 ohms
 Power: 9-volt transistor battery, Burgess 2U6 or equivalent
 Size: 2 1/2" x 3" x 4 1/2"
 Shipping Weight: 6 1/2 oz.
 Connectors: Terminal strip
 Price: \$37.50



Model 372 CLIPREAMP. Get maximum legal modulation without danger of splatter.
 Input Impedance: 100,000 ohms
 Input Levels: 5 millivolts to 20 millivolts
 Voltage Gain: 10 dB
 Output Level: 60 millivolts
 Output Impedance: 50,000 ohms
 Power: 9-volt transistor battery, Burgess 2U6 or equivalent
 Size: 2 1/2" x 3" x 4 1/2"
 Shipping Weight: 7 oz.
 Connectors: Terminal strip
 Price: \$27.50



Universal hybrid coupler II phone patch. Model 3002W and model 3001W. The hybrid circuit provides for effortless VOX operation of the phone patch. A built-in Compreamp speech preamplifier/limiter (in Model 3002W) increases the level of weak phone signals and also prevents overmodulation when the local telephone is used as the station microphone. (The Compreamp also functions as a preamplifier/limiter with the station microphone, if desired.)

Model 300 2W with Compreamp \$125.00
 Model 300 1W without Compreamp \$85.00

Inputs from:
 Line: 600 ohms
 Receiver: 4 ohms
 Microphone: High impedance (50,000 ohms) crystal or dynamic 4 ohms
 Outputs to:
 Transmitter: 50,000 ohms
 Receiver Speaker: 4 ohms
 Tape Recorder: 0.5 megohm
 Size: 6 1/2" x 7 1/2" x 3"
 Shipping Weight: 3 1/2 lbs.
 Power: 9-volt battery, Burgess 2U6 or equivalent
 Connectors: Phone



2-meter mobile AT-200 Antenna Matcher. Use your cars AM/FM antenna for your 2-meter mobile rig. Tunes from the front panel for max. output, min. VSWR (1.2:1 or less for most car antennas). \$24.95



JMR MOBIL-EAR™
Two-way-radio headset with superior fidelity Electret-Capacitor boom microphone and palm-held talk switch.

FOR BROADCAST-QUALITY TRANSMISSION AND RECEPTION FOR BOTH MOBILE UNITS AND BASE STATIONS.

- Boom-mounted electret-capacitor microphone delivers studio-quality, undistorted voice reproduction. Variable gain control lets you adjust for optimum modulation.
- Cushioned earcup lets you monitor in privacy - no speaker blare to disturb others. Blocks out environmental noises, too. Made of unbreakable ABS plastic.
- Headband self-adjusts for comfortable wear over long hours. Spring-flex hinge lets you slip headset on and off with just one hand. Reversible for right or left ear.
- Headset can be hung on standard microphone clip.
- Compact palm-held talk switch lets you keep both hands on the wheel for safer driving. Made of unbreakable ABS plastic.
- Built-in FET transistor amplifier adapts microphone output to any transceiver impedance.
- Compatible with most two-way radios including 40-channel CB units.
- Built-in Velcro pad for easy mounting of the talk switch.
- Made in U.S.A.

SPECIFICATIONS
 Earphone impedance and type: 8 ohms, dynamic
 Microphone type: Electret capacitor
 Microphone frequency response: 200-6000 Hz
 Amplifier type: FET transistor, variable gain
 Amplifier battery: 7-volt Mallory TR-175
 Switching: Relay or electronic

IDEAL FOR EVERY TWO-WAY RADIO COMMUNICATIONS NEED . . .
 CB operators • Amateur radio operators • Police and fire vehicles • Ambulances and emergency vehicles • Taxis and truckers • Marine pleasure and work boats • Construction and demolition crews • Industrial communications • Security patrols • Airport tower and ground crews • Remote broadcast and TV-camera crews • Foresters and fire-watch units •

MIDLAND

13-513 220 MHz FM Tr - 12 vdc. Three pos. selector for 20, 10, 5 watts output. PLL. 1000 frequencies. 220.00 and 225.00 KHz steps with a 5 KHz up. 4 offsets, ± 1.6 MHz. 2 optional.

NOT AVAILABLE

13-500 2m FM Xcv - 12 ch w/16/76, 34/94, mic. & mt.

NOT AVAILABLE

220 MHz FM Xcvr. 10W, 1 ch. w/223.50 MHz, mic. & mt.



The Bencher Ultimate Paddle . . . a dual lever, iambic keyer paddle that will increase your speed, accuracy & operating comfort.

- **ADJUSTABLE CONTACT POINT SPACING** - Precision screw adjustments on each set of contacts make exact settings easy. Contact posts are split and locked by set screws, eliminating the need for locknuts.
- **WIDE RANGE OF TENSION ADJUSTMENT** - Tension on finger knobs is maintained by a long expansion spring. Dual screw adjustments adjust spring tension to match your "fist."
- **SELF ADJUSTING NEEDLE BEARINGS** - Keying shafts pivot in nylon bearings that "float" on machined brass fittings. Spring tension prevents free play and slop; eliminates contact bounce and backlash.
- **SOLID SILVER CONTACT POINTS** - The contact points are solid silver for a lifetime of flawless keying.
- **PRECISION-MACHINED COMPONENTS** - Main frame, contact posts, spring post and bearing ring are all machined from solid brass . . . polished and chrome plated for durability and rich appearance. The Bencher Paddle looks as good as it works!
- **HEAVY STEEL BASE; NON-SKID FEET** - Finished in an attractive black wrinkle finish (chrome plating optional), the base measures 9.5cm x 10.2cm x 1.3cm thick. It weighs 1 kilogram, and with its non-skid rubber feet is as solid as a rock.

Model BY-1 Standard Black Base . . . \$39.95. Model BY-2 Polished Chrome Base . . . \$49.95.

BENCHER, INC.

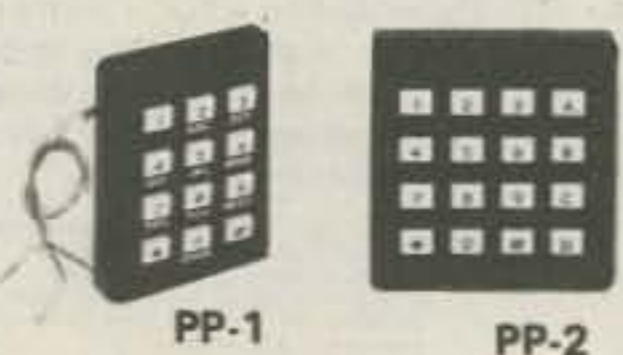

M series is for mounting to surfaces inaccessible from the rear (walls, mobiles, systems interface, panels, test equipment). K series is self-contained with a relay inside the encoder. When keys are pressed contact closer occurs with a 2 sec. delay (adjustable). Contacts are rated at 110 mA @ 28 volts switched, 500 mA carry. PP-2K contains delay exclusion for the fourth column. However, by jumping D-5, 4th column is restored. Unit is operable from 4.5-60 volts at temperatures from 0°-140° F. Output level will drive any transmitter or system. Adjustable output level is controlled with an extremely stable multi-turn trimpot, w/access from the front of the encoder (not behind), saving time for level setting, which amounts to hours when involved w/a system.

PP-1 \$55 (12 keys); PP-1m \$55 (lettering optional add \$1); PP-1K \$66; PP-2 \$58; PP-2m \$58 (lettering optional add \$1); PP-2K \$69; PP-1A \$68 (for standard comm hand-held).

Pipo Communications

MICROWAVE MODULES TEXAS RF

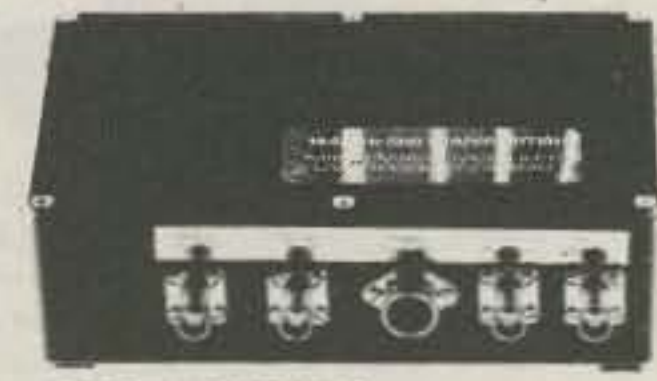

MICROWAVE MODULES HIGH PERFORMANCE UNITS FOR 144, 432 and 1296 MHz

144 MHz MOSFET CONVERTER - MMC144/28
 With dual protected gate Mosfet RF Amplifier and Mixer stage
 Input frequency: 144-146 MHz
 I.F. output frequency: 28-30 MHz
 Typical gain: 30 dB
 Guaranteed maximum noise figure: 2.5 dB
 Typical image rejection: 65 dB
 Crystal oscillator frequency: 116 MHz (leazer controlled)
 Maximum frequency error at 144 MHz: 3 KHz
 Power requirements: 12 volts DC ±25% at 50 mA
 Other I.F. output frequencies available: 12-14, 14-16, 18-20, 24-26 MHz

144 MHz MOSFET CONVERTER - MMC144/28 LO
 Similar to the MMC144/28, this unit features an additional 116 MHz buffer amplifier to provide a local oscillator signal suitable for transverter use.

144 MHz DOUBLE CONVERSION MOSFET CONVERTER - MMC144/2 - MMC144/4
 This unit has been developed to meet the requirement for a converter suitable for use with receivers having better performance at lower frequencies.
 Input frequency: 144-146 MHz
 I.F. output frequencies available: 2.4, 4.6 MHz
 Oscillator frequency: 71 MHz (2.4 MHz IF), 70 MHz (4.6 MHz IF)
 Maximum frequency error at 144 MHz: 3 KHz
 Typical gain: 30 dB
 Guaranteed maximum noise figure: 2.5 dB
 Power requirements: 12 volts DC ±25% at 30 mA

144 MHz DUAL OUTPUT MOSFET PREAMPLIFIER - MMA144
 This two-stage mosfet preamplifier has two separate isolated outputs, for leading two receivers, for example.
 Input frequency: 144-146 MHz
 Typical gain: 18 dB
 Guaranteed maximum noise figure: 2.5 dB
 Bandwidth: 5 MHz at 3 dB, 8 MHz at 10 dB
 Power requirements: 12 volts DC ±25% at 25 mA

432 MHz MOSFET CONVERTER - MMC432/144
 Two RF Amplifiers and a Mosfet Mixer combine high sensitivity and low cross-modulation characteristics.
 Input frequency: 432-434 MHz
 I.F. output frequencies available: 14-16, 18-20, 28-30, 144-146 MHz
 Typical gain: 30 dB
 Guaranteed maximum noise figure: 3.8 dB
 Crystal oscillator frequency: 101 MHz (28-30 MHz IF) (leazer controlled); 96 MHz (144-146 MHz IF)
 Maximum frequency error at 432 MHz: 5 KHz
 Power requirements: 12 volts DC ±25% at 45 mA

1296 MHz CONVERTER - MMC 1296/28 - MMC1296/144
 A hybrid ring mixer with a matched pair of hot-carrier diodes, driving a dual-gate mosfet I.F. amplifier.
 Input frequency: 1296-1298 MHz
 I.F. output frequencies available: 28-30, 144-146 MHz
 Typical gain: 25 dB
 Guaranteed maximum noise figure: 8.5 dB
 Crystal oscillator frequency: 105.666 MHz (28-30 MHz IF) (leazer controlled); 96 MHz (144-146 MHz IF)
 Maximum frequency error at 1296 MHz: 20 kHz
 Power requirements: 12 volts DC ±25% at 50 mA
 Connectors: 50 ohm BNC

TRANSVERTERS:
 MMT 144/28 198.95
 MMT 144/50 198.95
 MMT 432/28S 259.95
 MMT 432/50S 259.95
 MMT 432/144S 298.95

RECEIVING CONVERTERS:
 MMC 144/28 55.95
 MMC 144/28LO 60.95
 MMC 432/28S 65.00
 MMC 432/144 65.00
 MMC 1296/28 71.95
 MMC 1296/144 71.95

VARACTOR TIPLER:
 MMV 1296 81.50

ATTENUATORS:
 MAA 15 16.00

TEE/AX



Patent Pending Model SW-5000

TEE/AX Coax Toggle Switch - \$39.95

- All brass construction
- Teflon insulated
- Captivated internal contacts
- available in UHF, BNC, N, E, all series.
- 52 Ohms
- SPDT, DPDT
- Power 1 KW

TEE/AX, INC.

AMPHENOL BUNKER RAMO

SERIES 31 - BNC CONNECTORS
 Amphenol's BNC connectors are small, lightweight weatherproof connectors with bayonet action for quick disconnect applications.

Shells, coupling rings and male contacts accurately machined from brass. Springs are made beryllium copper. All parts in turn are ASTR plated to give you connectors that can take constant handling, high temperatures and resist abrasion.

- BNC BULKHEAD RECEPTACLE 31-221-385 UG-1094** Mates with any BNC plug. Receptacle can be mounted into panels up to 104" thick. \$1.25
- BNC (M) TO UHF (F) ADAPTER 309-2900-385 UG 255** Adapts any BNC jack to any UHF plug. \$3.63
- DOUBLE MATE ADAPTER 83-877-385** Both coupling rings are free turning. Connects 2 female components. \$2.72
- JACK ADAPTER \$1.95**
- 575-102-385** Adapts 83-1SP-385 to Motorola type auto antenna jack or pin jack.
- PANEL RECEPTACLE 83-1R-385 SO239** Mounts with 4 fasteners in 21/32" diameter hole. \$1.17
- PANEL RECEPTACLE SO239**

BNC(F) TO UHF (M) ADAPTER 31-028-385 UG-273
 Adapts any BNC plug to any UHF jack. \$2.39

PUSH-ON 83-5SP-385 Features an unthreaded, springy shell to push fit on female connectors. \$2.27

LIGHTNING ARRESTOR 575-105-385 Eliminates static build-up from antenna. Protects your valuable equipment against lightning damage. \$4.80

BNC PLUG 31-002-385 UG-88 Commonly used for communications antenna lead cables. For RG 55/U & RG 58/U cables. \$1.59

BNC STRAIGHT ADAPTER 31-219-385 UG-914 1 9/32" long, allows length of cables to be joined. Mates with BNC plugs. \$2.12

BNC PANEL RECEPTACLE 31-003-385 UG-290 Mounts with 4 fasteners in 29/64" diameter hole. \$1.74

83-878-385 SO239SH Mounts in single 21/32" diameter hole. Knurled lock nuts prevent turning. \$1.59

BNC ANGLE ADAPTER 31-009-385 UG-306 Adapts any BNC plug for right angle use. \$4.23

BNC TEE ADAPTER 31-008-385 UG-274 Adapts 2 BNC plugs to 31-003-385 or other female BNC type receptacle. \$4.56

PL-259 . . . 90d UG-175 (Adapter for RG 58U) . . . 25d



Model M-1S

- Nemarc Auto Console Model M-1**
- Universal mount for CB and amateur radios, tape players, AM & FM tuners, & scanners.
 - Sculptured design for "original equipment" look.
 - Low profile for non-slip mounting: 13-1/2" x 10-1/2" x 5-5/8" high.
 - Easy-to-install & remove for theft protection.
 - Tough unbreakable copolymer with rich brown textured finish.
 - Integral cup holder and coin tray.
 - \$19.95
- Auto Console Model M-1S:** Same features as above model PLUS:
- Specially designed 3" x 5" oval speaker for voice communication. Frequency response: 150 Hz-7 KHz, voice coil: 9/16" diameter.
 - \$19.95

Nemarc

If you have a rack for holding spools of wire, you should attach the gadgets explained in this article — or make those you can use for better wire handling.

Spools of five hundred feet of wire should have a 3/4" diameter conduit pipe through the bore to allow them to revolve better.

Smaller spools that have smaller center holes can be strung on 18-gauge wire across the rack. Special 1/4"-diameter holes for this purpose are drilled at each end to hold the wire.

Undamaged empty spools should be saved, reworked for holding wire ends, and painted. They can be used for winding from many short length spools to save space, for spooling up those hardware store hanks, as well as lacing and other cord.

For the convenience of holding wire ends when the metal spools are used, drill and deburr holes at opposite locations on the spool side near the rim. Wooden spools should have a small hole drilled on top of the rim and toward the outside at an angle. When spools cannot be drilled because they are filled with wire, look for a place to hammer a staple on the rim or solder a loop of wire on the outside near the rim and either push the wire through it or tie the end of it to the loop with cord. This will save the expense of using tape which could let loose or create a sticky situation with spaghetti and fine enameled wires.

Wire on the rack tends to unspool too much sometimes, wind around the bore shaft when you're pulling another gauge out, or the wire end springs back out of reach when cut. To solve these inconveniences, first run the conduit through the spool holes, as previously mentioned, to provide even support. The conduit may be used with a steel rod as the main support through the holes on the rack for high-efficiency dispensing. Make

an economy feeder holder by tying twisted cotton cord across the rack below the spools and putting the wire through the twist so the cord will hold it. With this feeder holder cord, you can pull fine wires and lacing cord out to your measuring service.

If the metal spools squeal against the rack or each other upon unspooling wire, try larger diameter painted pie pans between the spools. Drill and deburr a center hole in the pie pans slightly larger than the conduit.

A more professional-looking type is a Lucite™ bracket with the wire pullout holes drilled in it, as shown in Fig. 1. Large holes are 1/2" diameter. For mounting, the hole on the left is used. The other three holes can be used for cable making by using one and pulling the wires through it. The 1/8"-diameter holes are for single wire holding service. The Bakelite™ lid knob on the right can be used for holding bunches of cut-to-length leads bent over it or as a wire-cutter holder while using the bracket guide. This

guide can be painted with Lucite paint.

A hankmaker can be added to the frame by drilling two 1/2" holes vertically in the wire rack frame ten inches apart. In the top hole, put a 3/8" x 6"-long eyebolt by using two hex nuts and two washers. The eye should be vertical. In the lower hole, put a 1/2" x 6"-long bolt that had the hex sawed off. The sawed off place should be filed smooth. Twist one end of the wire on the eyebolt and then wind the wire around both of the posts by hand. When the wire is all wound, pull out some lacing cord from its reel and tie the wire in three separate, evenly spaced places. Now pull the wire hank off the bottom post first.

Another convenient item is the cord line installer made from a Lucite piece, as shown in Fig. 2. Three 1/2"-diameter holes are drilled across it. Add five yards of cotton cord by tying it to one end hole. While holding the Lucite piece (or with it in your pocket), climb the ladder or

tree. When near the place you want, pull up enough cord and throw the Lucite piece over the limb or past the porch roof, for example. Wiggle and feed cord to help the Lucite piece to slide down.

Go down and tie the other end of the cord close to the wire end. Pull the Lucite piece line and slide the antenna en route.

The Lucite cord line installer can be tossed up one story to a roof or lowered to a window or to the ground from the roof or from inside.

Wind up the cord on the Lucite and keep it on a reversed bolt on the wire rack. Use a retaining wing nut. ■

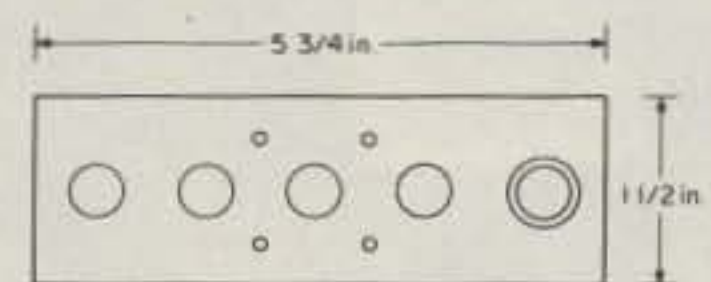

Fig. 1.

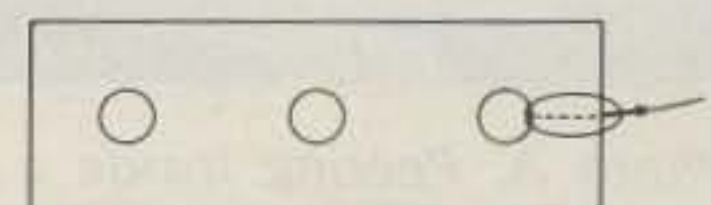

Fig. 2.

Dispense It Right!

— simple tips for wire and cord

Ham Radio Is NOT A Rich Man's Hobby

—another myth exploded

With the advent of Novice privileges for Technicians and the large influx of Novices from the CB ranks, quite a bit of older equipment is being sold at auctions, flea markets, and through used equipment dealers. The demand for a good stable receiver covering 80-10 meters and a moderate-power (90-150 Watt) CW transmitter has risen tremendously. Fortunately, there is a lot of this older equipment—gear built from pre-World War

II to the mid-1960s—still around and available at reasonable prices for beginning hams. This article will explain some tips on obtaining a used transmitter or receiver, what to look for in the way of features and necessities, and how to get one of these older gems working like new or even better than new.

Buying A Rig

You can begin to look for used equipment in a number of places, starting

with the ads in this magazine. But there are advantages to snooping around in the local ham club's newsletter, a radio store's bulletin board, or attending flea markets or auctions. Last is the war surplus market, but I don't see much potential there, since all the equipment is either hopelessly outdated or so difficult to get running that the effort is not worth it. I've fiddled with everything from ARC-5s to TCS transmitters, and, although I learned a good deal about 1940 electronics (and made plenty of mistakes), the rigs are just not practical. Ever try to put a 28-volt relay-keyed MOPA clunker on 15 meter CW? Good luck!

Club bulletins and electronic store bulletin boards are about the best places to look for a good used transmitter or receiver. This way, if you see something you are interested in, you can call up the seller, go over and look at the equipment, and bargain over the price. I have two suggestions if you go this route: First, check out the original ads for the equipment in older ham magazines, if they're

available. Old ads for the gear list its features and specifications; often there's a review of the rig in an issue of that same vintage. Along the same lines, *73 Magazine* for March, 1963, had a whole list of receivers from pre-WW II to 1963, tabulated with pictures and specs. It's still a good guide to older equipment, although the prices listed there are out of date. A second suggestion is to get another, more experienced, ham to go with you. Someone from your local ham club will be glad to come along.

Speaking of prices, how do you know if a rig is a good buy? Look at the commercial ads in recent ham magazines to get an idea of the maximum price you should pay. A good rule of thumb is that a commercial outlet's prices are about 20% higher for used equipment than the price you'd pay for something sold locally. Unless the transmitter or receiver is in perfect, never-been-used condition, never pay what those high-priced ads say it's worth!

So, commercial ham magazine ads are not very good places to get inexpen-

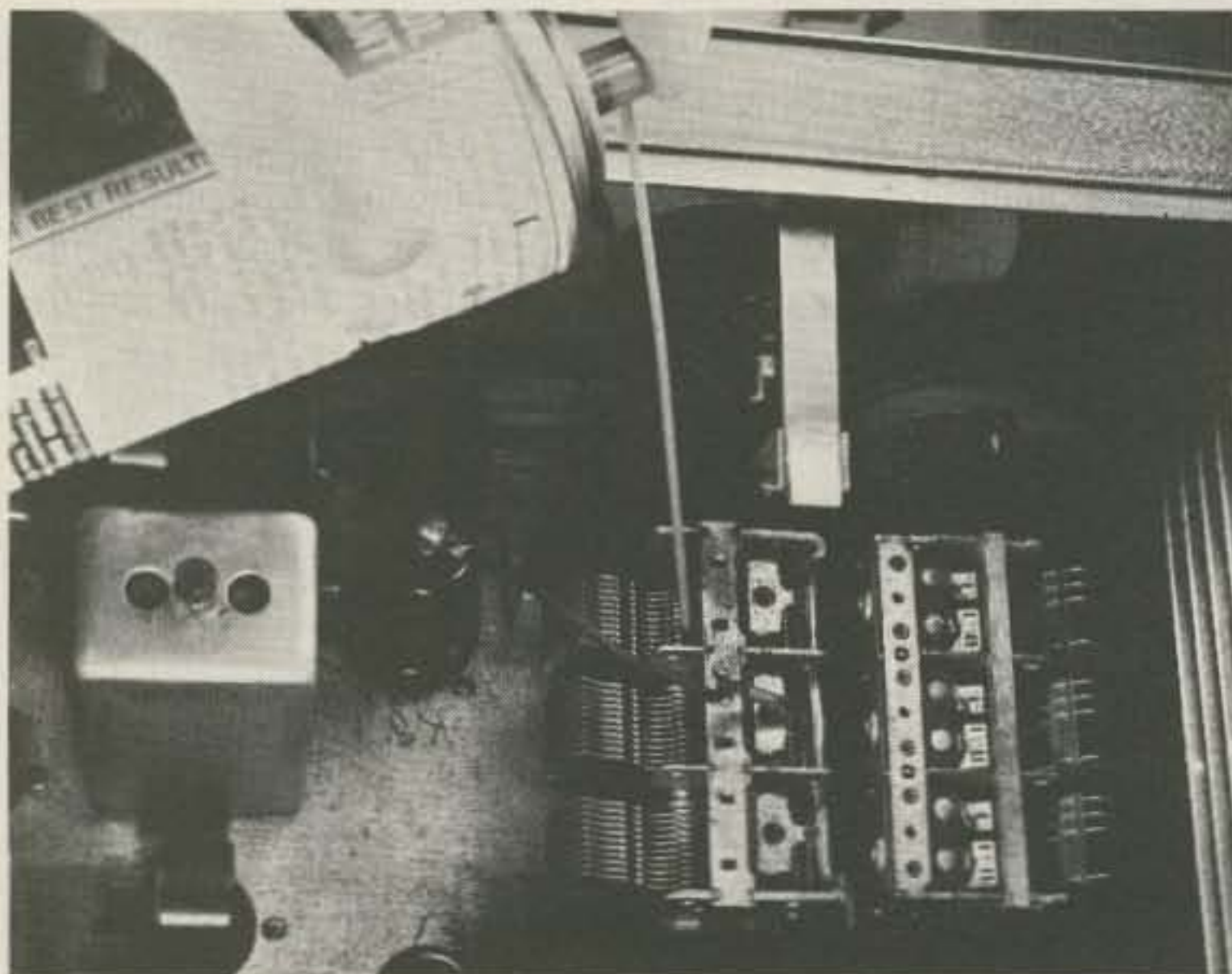

Photo A. Peering inside a 1939-vintage SX-24, note the 3-gang tuning capacitors. Spraying contact cleaner near the bearings reduces scratchiness as the rig is tuned.

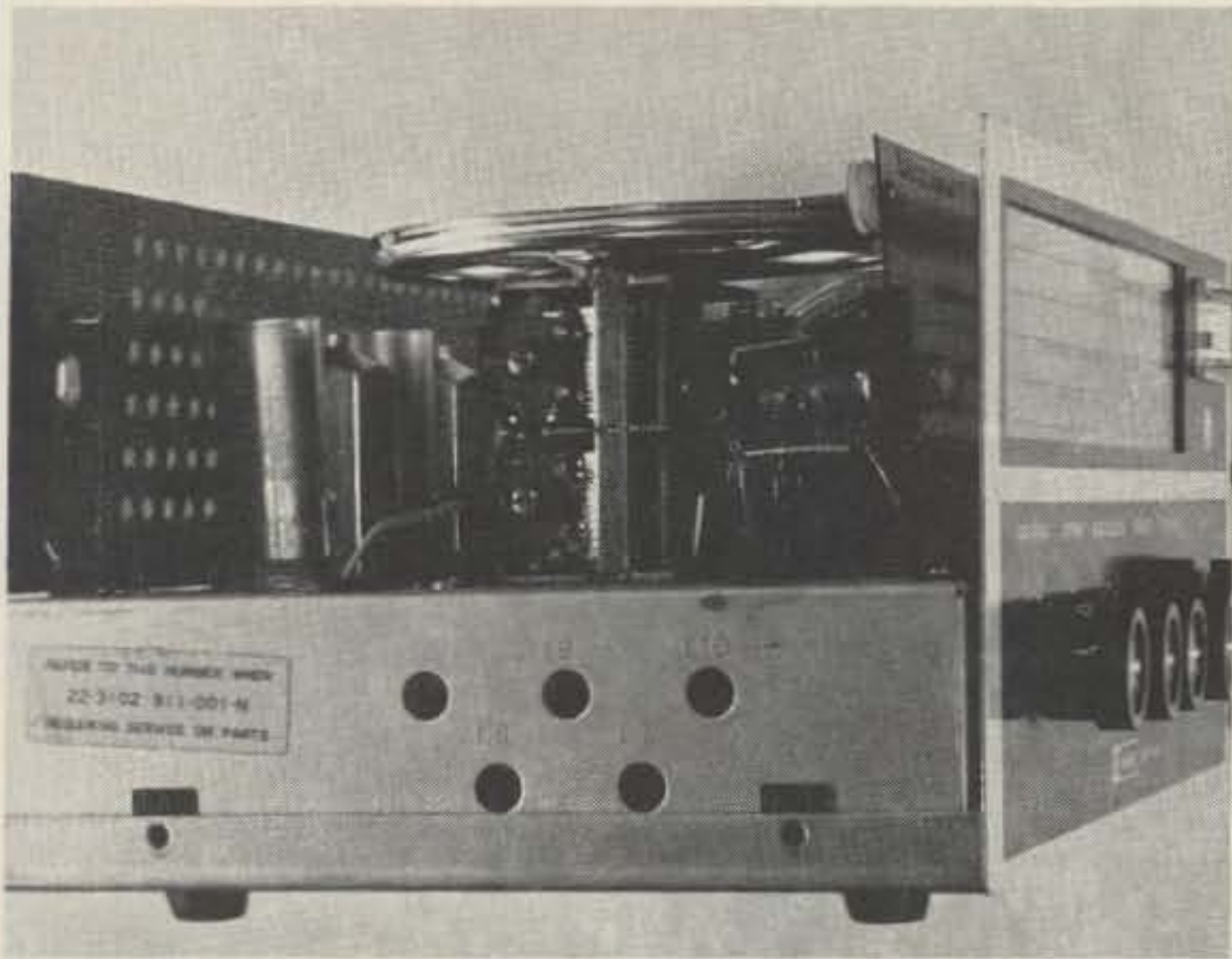

Photo B. Two gangs in a Star Roamer betray its lack of an rf stage.

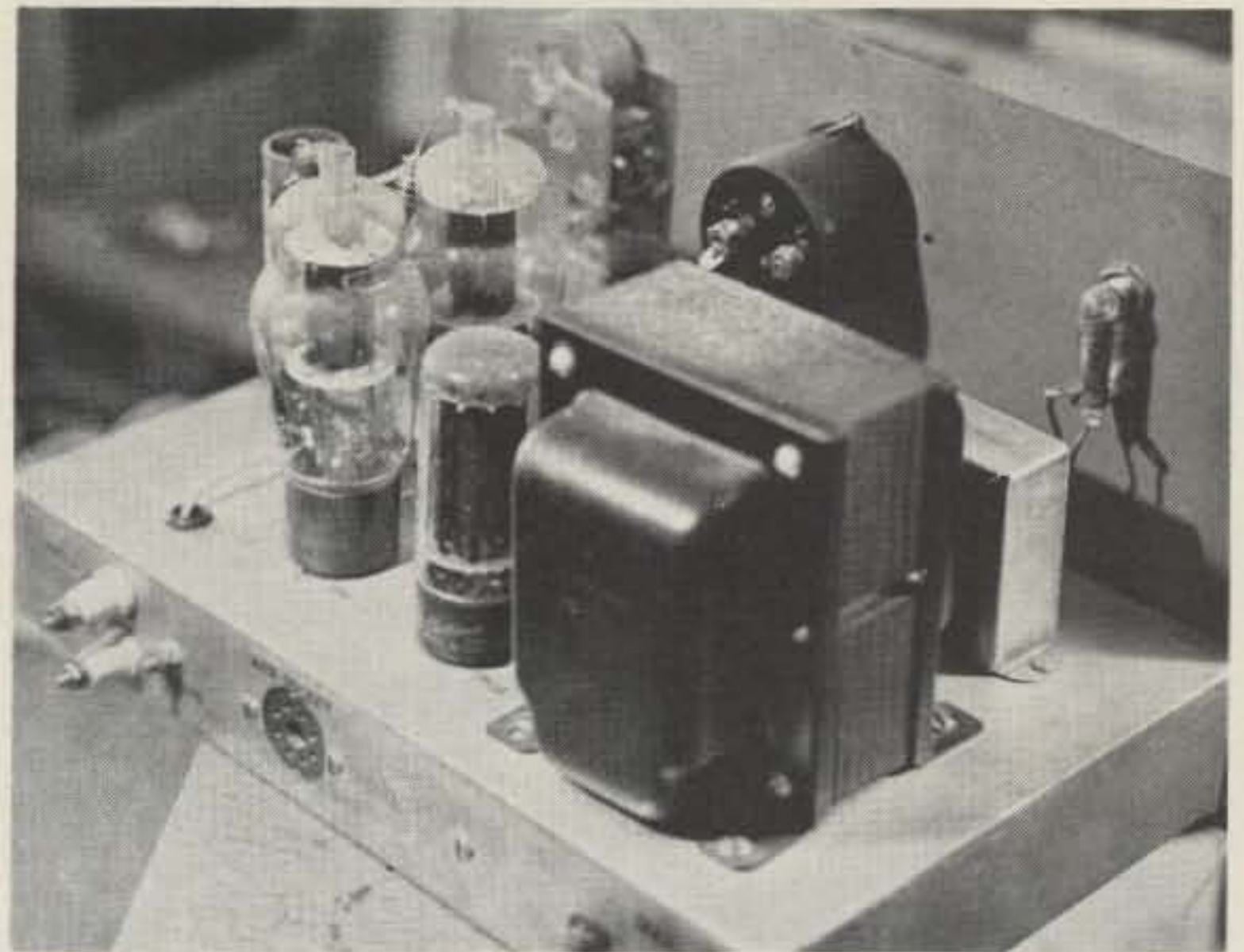

Photo D. These dusty insides are what you'll probably find when you open your purchase.

sive used equipment. Besides the fact that you never see what you're getting, you end up paying for the ad, for handling, and especially for shipping a piece of gear. Much of this older stuff is heavy, and shipping charges can add a considerable amount to the overall price you pay. Need I mention that this is another good reason not to buy "boat anchor" surplus?

What To Look For

If you've been patient enough to get this far, take a little extra time to look over the general appearance of the equipment before you buy it. If the rig

was kit-built, be especially wary of poor craftsmanship; check to see if it has been wired neatly with shiny solder joints and good clean layout. On any piece of equipment, check the feel of the controls. A loose shaft or knob on a gain control or bandswitch is easy to fix, but, if the tuning dial feels rough or sloppy, stay away from it. Unless it's an obvious problem (e.g., the set screw is loose on the knob), tuning mechanisms are a real bear to repair.

Another thing you can try is to pick the rig up and shake it. Does anything sound loose or rattle around? Better make sure

you know what it is (and where it went!) before you buy.

A transmitter should be checked for the following: Does it have its own power supply? What bands does it operate on? Does it use crystal or its own vfo frequency control? Much less important are features like an AM modulator—many of the smaller older transmitters had screen-grid modulators which were pretty inefficient and had poor audio quality. You'll be interested in CW, and AM is hard to find except on 160 meters and 10 meters. Try to get a manual with a schematic. If you

can't find one, try writing Hobby Industries, Box Q864, Council Bluffs, Iowa 51501. They may have one available for your rig.

A receiver is a much more complex and critical component than the relatively simple CW transmitter. A rule of thumb is: Buy the best one you can possibly afford at the time. Nothing is worse than trying to fight the receiver as well as the QRM!

Your receiver choice should be governed by whether or not it has an rf stage first of all. You can see if it does by peering inside the cabinet and



Photo C. Globe Chief transmitter with cleaning materials.



Photo E. Spray the tube and socket contacts and insert/remove the tube to clean mating contact surfaces.

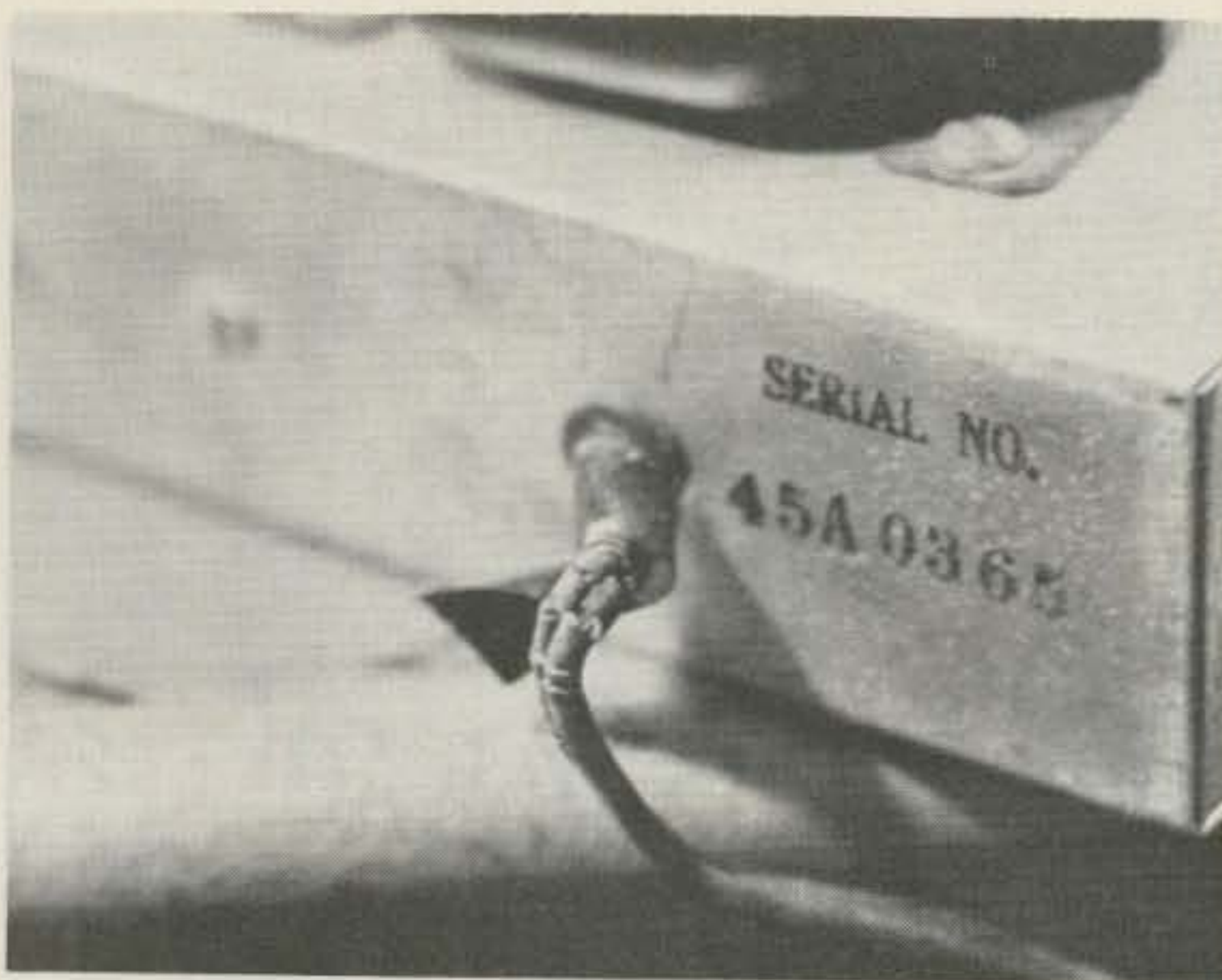

Photo F. Watch out for frayed linecords!

checking how many gangs (sets of plates) the tuning capacitor has. In Photo A, you can see three gangs on the main tuning cap and the bandspread capacitor of an SX-24. This makes one gang each for the rf stage, mixer, and oscillator.

Photo B shows the 2-gang setup of my Knight Kit Star Roamer; it has only a mixer and oscillator and no tuned rf stage. Without the rf amplifier, the receiver will lack sensitivity and be almost useless. Generally, only low-cost receivers lack the rf stage, being mainly intended for casual shortwave broadcast use. So stay away from receivers

like the Star Roamer, the S-38 series, the SW-54, and portable multiband radios. These also lack the stability, bandspread, and selectivity needed for CW communications work.

Speaking of bandspread, does the receiver you're considering have a calibrated bandspread dial for the ham bands (in which case you'll need a crystal calibrator), or is the receiver a ham-band-only affair? Both general coverage and ham-band-only receivers have their advantages. With the latter, you get a better, more stable and generally accurate receiver specifically built for communications.

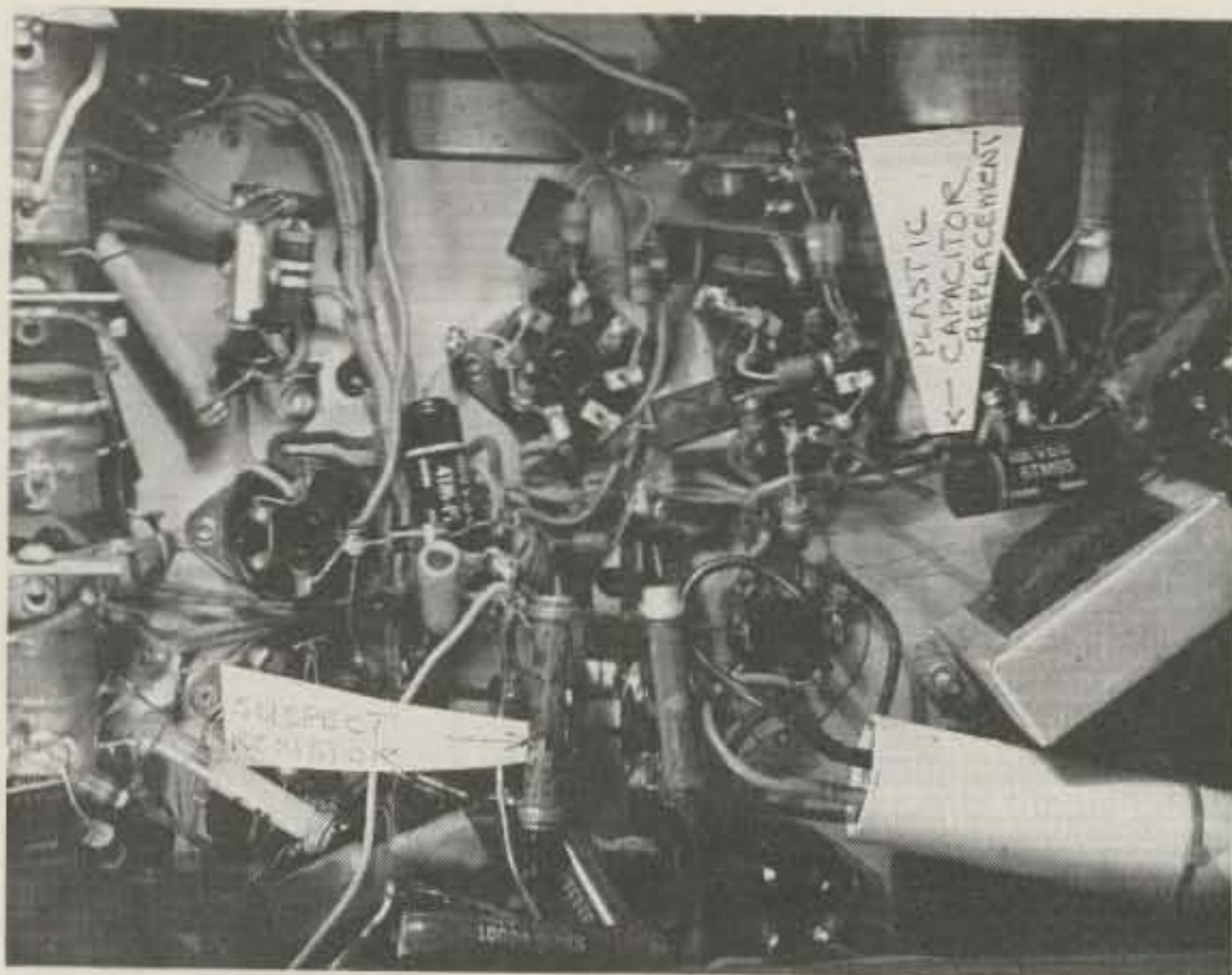

Photo G. Under the chassis of the SX-24, note the replacement filter cap held in place with plastic cable ties.

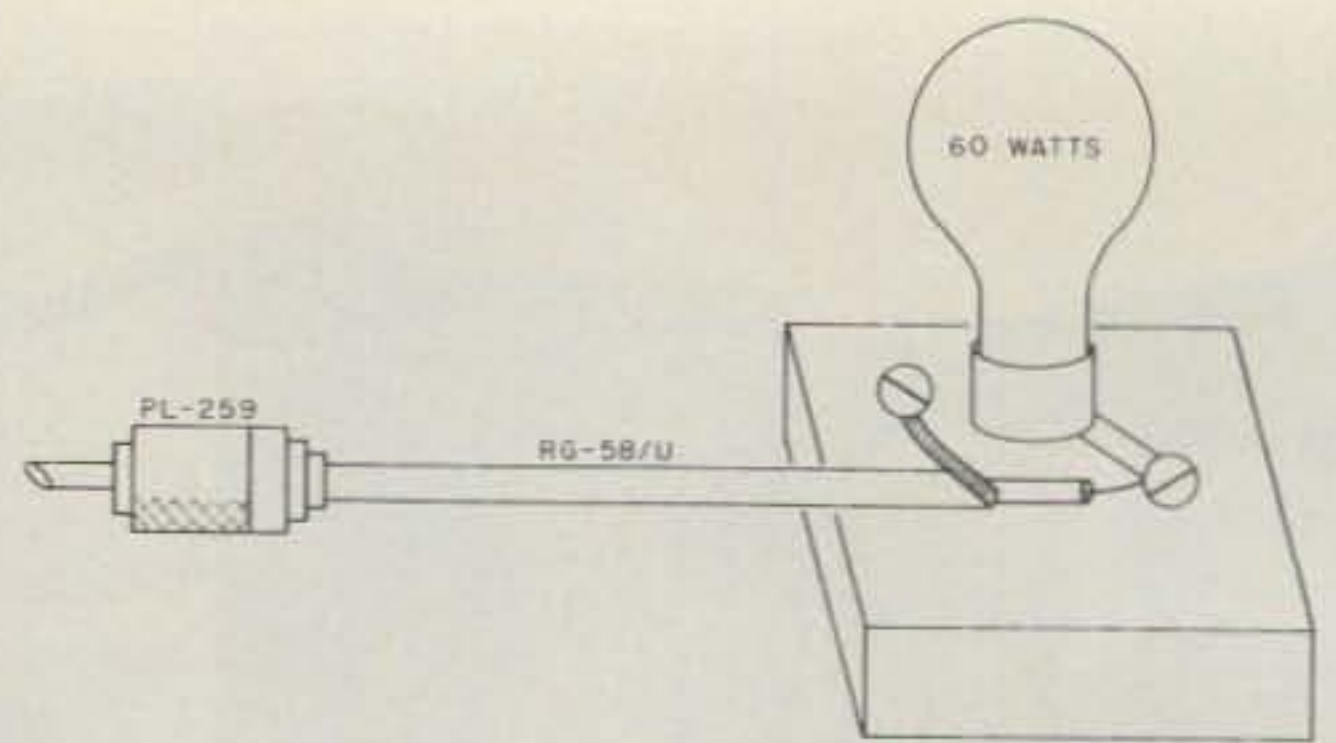

Fig. 1. Simple dummy load/indicator to tune up your transmitter.

Examples are the SX-101, the HQ-170, the SX-111, and others. The general-coverage rig, on the other hand, lets you snoop around bizarre CAP, MARS, military, commercial, and shortwave broadcasts, making things more interesting when hamming gets tiresome. But, I suggest that a first-time buyer invest in a good ham-band-only receiver so that he/she isn't frustrated by the more complicated tuning schemes and somewhat less performance per dollar of a general-coverage rig.

There are all kinds of tricks employed in good receivers to get the needed sharp selectivity—single crystal filters, multiple crystal lattice filters (rare on older rigs), double conversion to a 50 or 85 kHz i-f, mechanical filters, or even multiple stages at 455 kHz. If you can, listen to the receiver you're buying and try out the selectivity scheme. Does it help cut down adjacent signals when properly adjusted? More importantly, is the receiver stable enough to use all the selectivity it's capable of? Give an oldie at least 45 minutes to warm up and settle in to try this.

Receiver manuals, like transmitter manuals, are a necessity. If you can't get one with your purchase, you may find the old Rider's series manuals and schematics at a local library. Try advertising in 73's "Ham Help" and a

local ham newsletter as well.

General Restoration Methods

If you've parted with your money and have excitedly brought your used receiver or transmitter home, you may have noticed a change in its appearance. Did the thing really have all that dust all over it? Was the band-switch always so scratchy? Did the linecord already develop fraying? The receiver sure didn't sound so dead on 15 and 10 meters when you bought it just hours ago!

Take heart. This is part of the fun of buying a used piece of equipment. To get the thing working like new again, you'll need a few simple tools and parts. The first thing to emphasize is that cleanliness is the key to any rig's continued reliable operation. Besides, it makes your purchase much more attractive to look at and operate. More importantly, dust and gunk inside a piece of equipment form low-resistance paths from high-impedance circuits to ground. This can make a considerable difference in a receiver. In a transmitter, dust can cause arcing, particularly in the final tuning caps.

Photo C shows my arsenal of cleaning agents to help remove much of the years' accumulation of grime. On the outside, you can begin by removing all

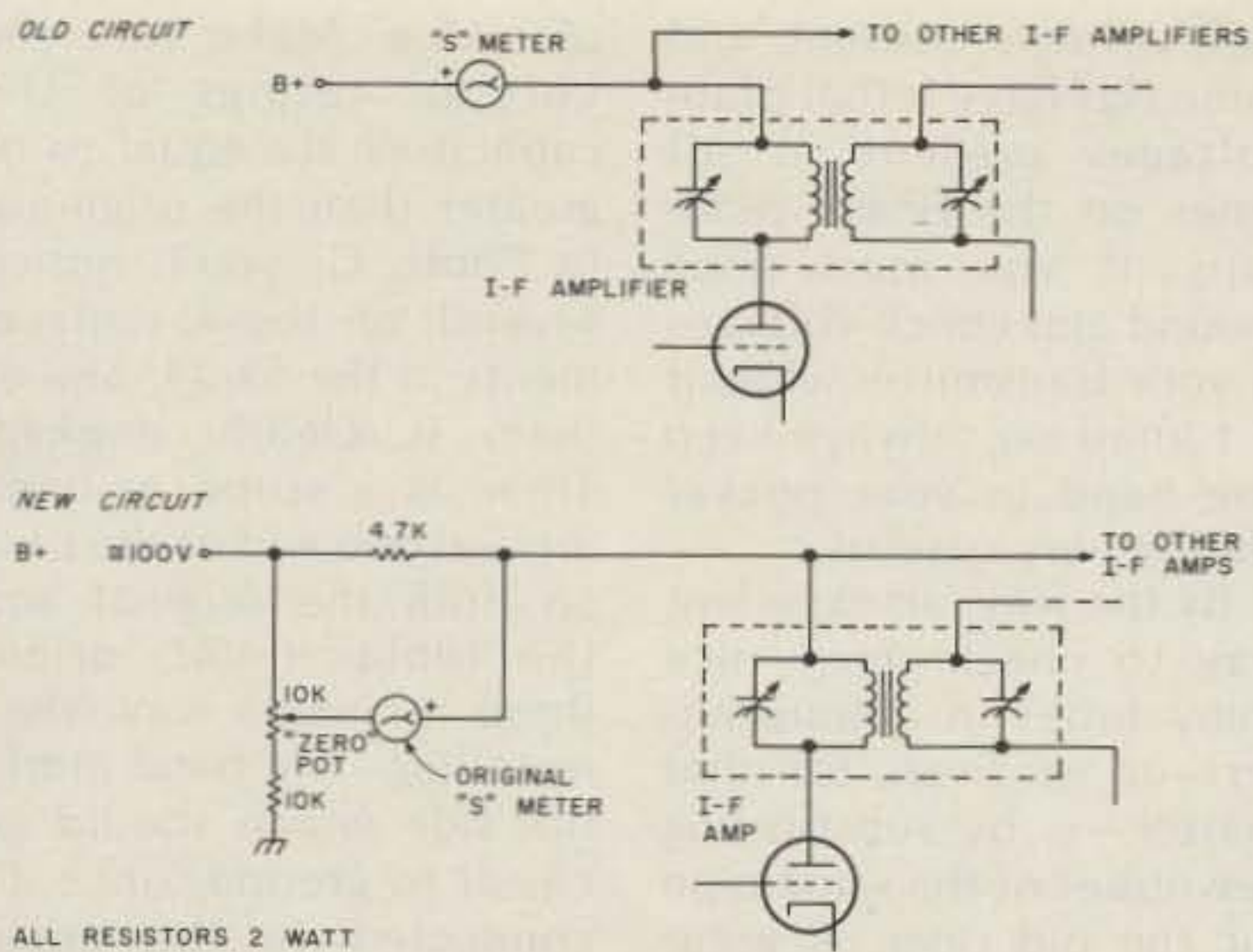

Fig. 2. Improved S-meter circuit for older receivers.

the knobs (make a chart of where the pointers lined up on their shafts). Spray down the front, sides, top, and bottom with a mild detergent cleaner and wipe it down carefully with a paper towel. Be sure to get in the crevices around meter mounts and dial escutcheons. While you're poking around, see if you can take the whole cabinet off the chassis, so you can concentrate on each separately.

Many of these older rigs had wrinkle finishes which are very difficult to clean after dirt has worked into the crevices. The best cure (short of stripping it and repainting the whole darn thing) is to scrub the cabinet with a brush and a bucket of soapy water, hose it off, and then let it sit in the sun to dry. To restore the deep texture of the wrinkle finish, mix four parts of turpentine with one part baby oil and liberally apply this goop all over the painted surfaces. Then wipe off the excess with a clean, dry cloth, and set it out in the sun to heat up and dry off. The turpentine dilutes the oil enough so the panels or cabinet won't feel goeey, but the oil keeps the finish fresh. In addition, you'll find that the panel markings show up bright and shiny after being rubbed with the mixture. If there were a few

spots where the paint was chipped, you can touch up small areas with ordinary matching paint after the dirt is off the cabinet. Let the paint dry, then apply the baby-oil treatment. You'll think you bought a new rig!

Knobs can be cleaned with a toothbrush and soapy water. Don't use harsh detergent on them; I've seen Bakelite knobs become etched by some cleaners. Polish them dry with a soft cloth.

On both transmitters and receivers, several improvements can be made while the chassis is removed from the cabinet. Remove all the tubes and dial lamps (make a chart of what went where), and wipe the chassis down with paper towels dampened with spray cleaner. Clean the dust off each tube and polish with a soft cloth. Dust inhibits a tube's ability to radiate heat and shortens its life (Photo D). Spray the tube and socket with contact cleaner, and, while the two are wet, insert and remove the tube from the socket to clean their mating surfaces.

Inspect your rig's linecord and watch out for conditions like Photo F. Replace this whole cord from the plug to where it connects inside the chassis. Also, check the fuseholder and fuse if

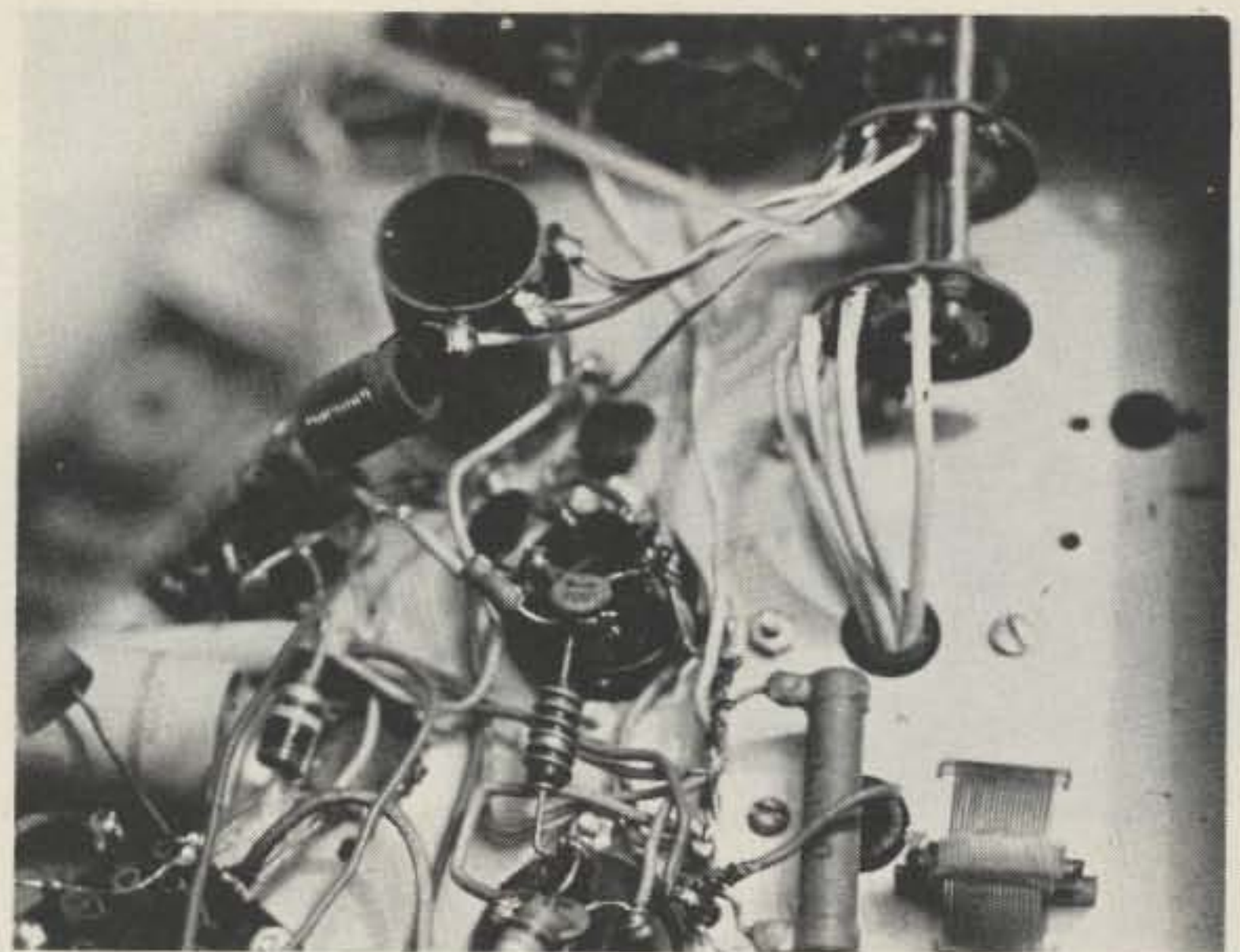

Photo H. Inundate bandswitches with contact cleaner and rotate.

there is one. If it's burned out, be sure to replace it with the same kind and rating and be particularly cautious when looking for faults which may have caused its demise.

Another problem common to old equipment is a bad electrolytic filter capacitor. Sometimes you can pinpoint this problem because the fuse blows only after the rectifier tube warms up and begins to conduct. If you can't find an exact replacement, you can mount a new insulated filter cap under the chassis with plastic cable ties, leaving the old one still in place (but disconnected) so as not to disturb your

receiver's inner aesthetics. An example can be seen in the lower right corner of Photo G.

One very worthwhile thing you can do to improve any older gear's operation is to spray every switch, control, and socket with contact cleaner. Be particularly generous with your squirting around bandswitches, and rotate these many times while wet to work the tarnish off the contacts (Photo H). Shoot the juice inside gain controls and rotate them; a long flexible nozzle tube helps to pinpoint the spray.

Transmitter Fix-Ups

After following the



Photo I. Shiny innards of a clean Globe Chief.

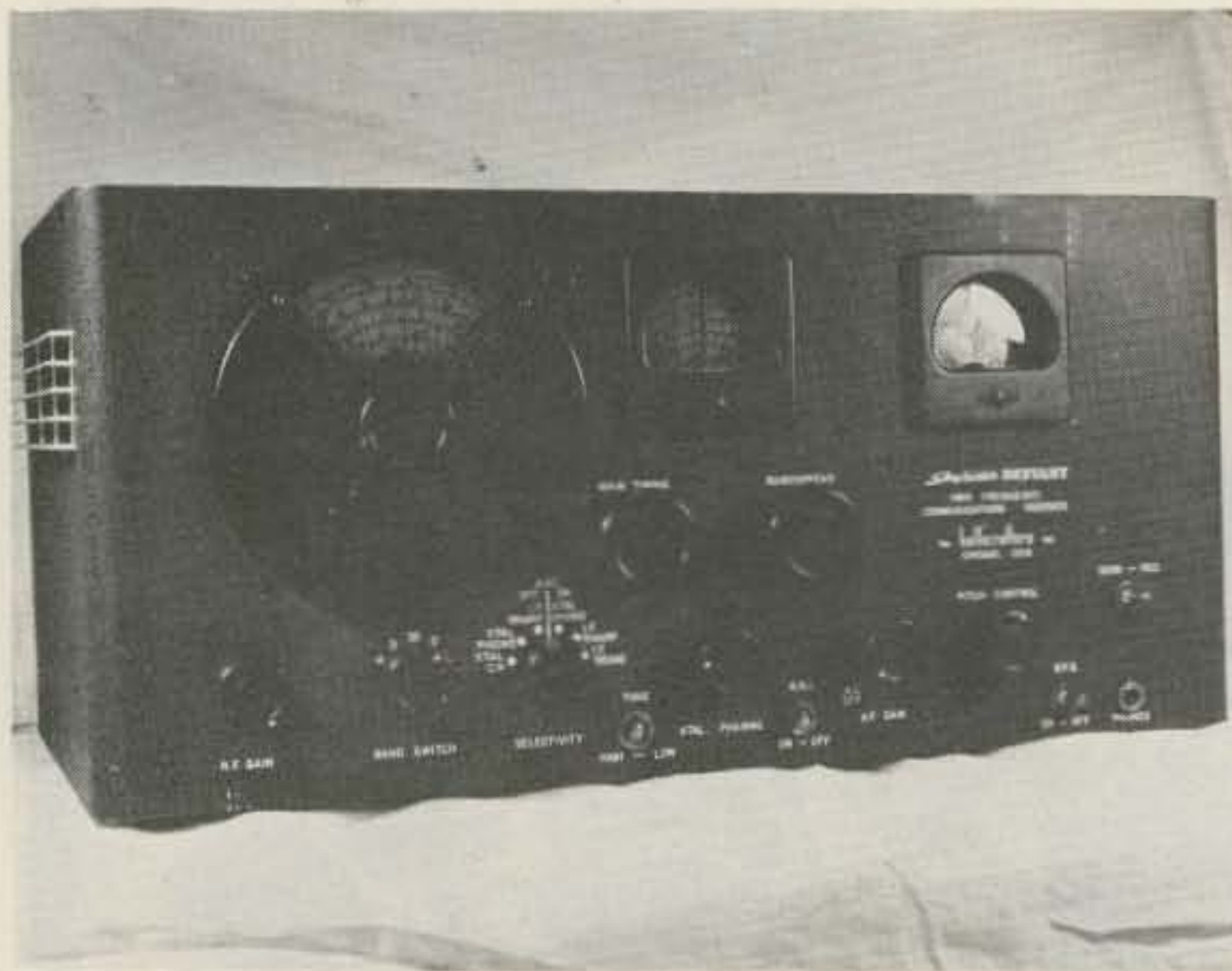

Photo J. A good budget station. Restored SX-24.

above suggestions, your transmitter should look clean inside and out. Be certain to thoroughly clean the final tuning and loading capacitors, as dust will make them arc.

I've seen quite a few suggestions published which say that the only way to test a transmitter is with a mechanically complicated resistor bank and a directional wattmeter. Those things may be nice for VHF or engineering use, but I've learned all I need to know from a simple light bulb. Get yourself a ceramic light socket, attach a piece of RG-58/U cable with connector to match your transmitter, and screw in a 60-Watt light bulb. See Fig.

1. A 75- to 90-Watt input (plate volts times Amps on the finals) should light the thing up to almost full brilliance and makes a dandy dummy load.

This simple device can also serve as a modulation indicator to check if the AM portion of the transmitter is working—i.e., you should get a variation in brilliance when you talk into the mike. And, you'll also have a rough idea of the rig's output power. If it takes 60 Watts of 60 Hz power to light the bulb, it'll take about the same power at rf frequencies.

One warning you should already know about: Even a low-power amateur transmitter has dangerously

high voltages present, and some rigs have lethal plate voltages present at all times on the final's plate caps. If you must poke around and check voltages in your transmitter while it is turned on, always keep one hand in your pocket and be very careful.

By the way, an excellent way to check those nice shiny tubes in a transmitter—or receiver, for that matter—is by substituting new tubes of the same type for the old ones. A great source of good vintage unused tubes (many of them boxed from 40 years ago!) is Fair Radio Sales, Box 1105, Lima, Ohio 45802. Write for their free catalog. If your tube needs aren't listed there, write for a specific bottle, and chances are they'll have it at low cost.

Receiver Notes

After you clean your receiver inside and out and check the tubes, you may find that it isn't quite as perky as you hoped, particularly on frequencies above 10 MHz. The single most effective cure for a weak old receiver is wholesale replacement of the drippy paper-wax bypass capacitors which were generously used in rigs from the 1930s to the 1960s. You may have noticed a yellow gonk deposited on the bottom plate of the cabinet where some of these miserable things have leaked out their innards. Such physical leakages are accompanied by electrical leakage, and the bypass caps begin to seriously affect receiver performance.

Make a list of these caps as they appear in your receiver and go down to a surplus outlet to purchase sealed-in-plastic versions of the same thing. The values aren't critical—a .02 uF unit can easily be substituted for a .022 uF cap or a .05 uF for a .047

uF value. Make sure the voltage ratings of the capacitors are equal to or greater than the originals. In Photo G, you'll notice several of these replacements in the SX-24; one of them is clearly marked. There is a stripe or band around one end of the case on both the original and the replacement; orient these the same way when installing. The band marks the side which should go closer to ground, since it's connected to the outermost foil wrap inside the component. So be careful and do your replacing one at a time, also being sure to locate the cap in the same location as the original. Sometimes they were tied across tube sockets and served a double purpose in shielding inputs from outputs.

You can use ceramic disc capacitors to replace the older tubular models, but I haven't tried it for two reasons: The disc capacitors are generally more expensive than the sealed tubulars (an important factor when you have to replace 18 of the darn things), and they may not be suitable for the shielding purpose mentioned above.

After witnessing Gary WB6WNI's patient replacing of these capacitors in an NC-183, the audio quality went from zero-fi to hi-fi, and the 10 meter performance went from nonexistent to quite acceptable. I've done this same replacement procedure on many other rigs from an SX-71 to an SP-100 and it's worth every bit of your time to do the same. The performance improvement is so remarkable that I'm led to believe that the receivers work better now than when they were new (although I wasn't around when most of them were new).

In pre-WW II receivers, you may find strange-



Photo K. Globe chief ready to go.

looking ceramic tubes with wires on each end, like the ones shown in Photo G. These were pretty miserable excuses for resistors, so, if your receiver is still having problems, you might check to see if their values have changed over the years. If so, replace them with 2-Watt carbon ones.

Troubleshooting for other faulty components is greatly aided by a manual or schematic, but if you can't get one, don't despair. Put one hand in your pocket and probe voltages with a multimeter. A guide to what kinds of readings to expect is found in an old ARRL *Handbook* or a tube manual, since tube base diagrams are given there. You should find low ac filament voltages on the appropriate pins, high dc voltage on the screens and plates, and relatively little or no dc volts on the grids and cathodes. This should help in finding faults without the benefit of a manual.

A mechanical improvement sometimes necessary on an old receiver is a dial restringing job. Use true radio dial string and be 100% certain that you make a diagram of how the string originally went on before you remove the old one. Otherwise, the resultant futile efforts to make the dial pointer and the tuning knob move at one and the same time will drive you nuts.

Most of these old receivers have held their alignment pretty well over the years. If you must tweak, touch up the adjustments, but don't overdo it! Be sure you know which trimmer changes what for which band; they're not necessarily laid out in a logical pattern. Here's one tip for if the receiver is way out of alignment: The local oscillator usually operates 455 kHz

higher in frequency than the dial marking, so listen for it on another well-calibrated receiver and get it aligned first. Then follow through with adjustments to the mixer and rf amplifier, retweaking everything several times for final alignment.

The bfo can be aligned by disconnecting the receiver's antenna and turning the bfo on. Tune its adjustment slug so that the "swish" seems to be centered in the narrowest passband of the receiver (the lowest noise pitch). Any front panel bfo control should be set to midrange for this adjustment.

Some of these older receivers had ridiculous S-meter circuits which glumly responded by measuring the plate current to the i-f amplifiers. I prefer nice, bouncy, generous operation; it can be easily added with a couple of resistors and a potentiometer, as in Fig. 2. Values are shown for the rather low plate voltage of 100 V; you should increase them proportionately to whatever voltage you find in your receiver. Use the original meter, of course, and zero it with the 10k pot. You may have to mess with the values to get the kind of operation you want, and there's nothing critical here.

Station Notes

Now that you've got a good, clean, peak-performing transmitter and receiver (and had fun fixing them up while saving money), you'll need an antenna switch and some way to mute the receiver. Most of these receivers have "mute" terminals on the back panel; when the terminals are shorted, the receiver operates. Get a good Drake or Johnson low-pass filter—the CB types won't take the power and aren't designed for 80-10 meter operation.



Photo L. Baby-oil treatment restores the wrinkle finish of this beautiful old 1937-vintage SP-100.

The FCC requires you to have some kind of frequency standard independent of the means used to control your transmitter's frequency. A 100 kHz crystal calibrator works fine for this and will also give you accurate calibration points to keep your station on frequency.

Many older transmitters will easily load into dipoles or verticals—some have no problems with random wires—so antennas are easy to make. Don't forget that the best station is useless without a good antenna. When you've got the antenna set up, get a

ham friend a couple of miles away to listen to your signal before you really get going. He can check for chirps and harmonics and report back on 10 meters or 2 meters voice if he's got a higher class license.

I hope this article helps you select, clean up, and improve the performance of any older equipment you may be interested in. I've had a great time restoring old machines and using them in my station.

Thanks to Gerry W6NIR, Fred K6YT, Mike G3PPE/VE7, and Dave WA6AWZ for their help and inspiration. ■

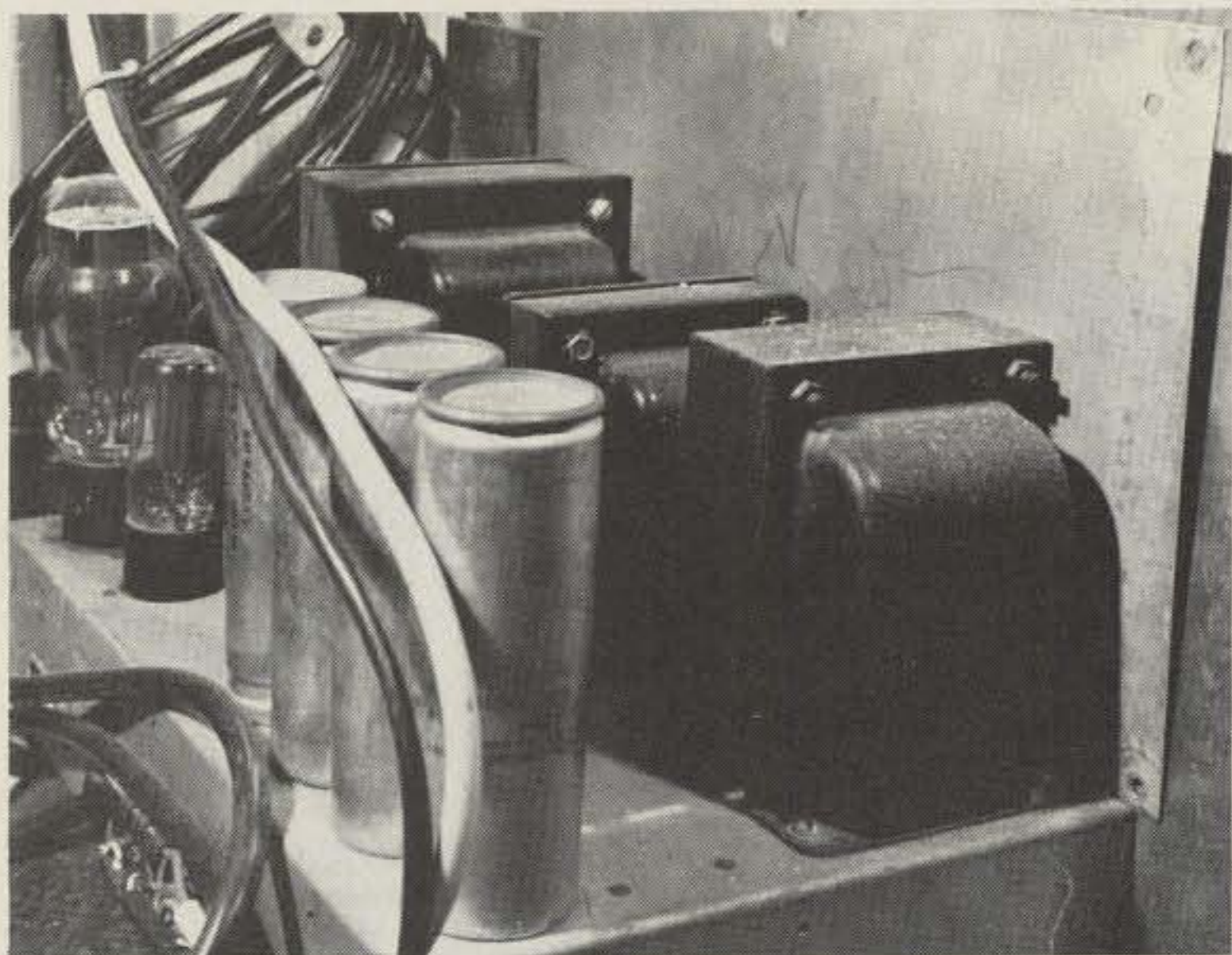
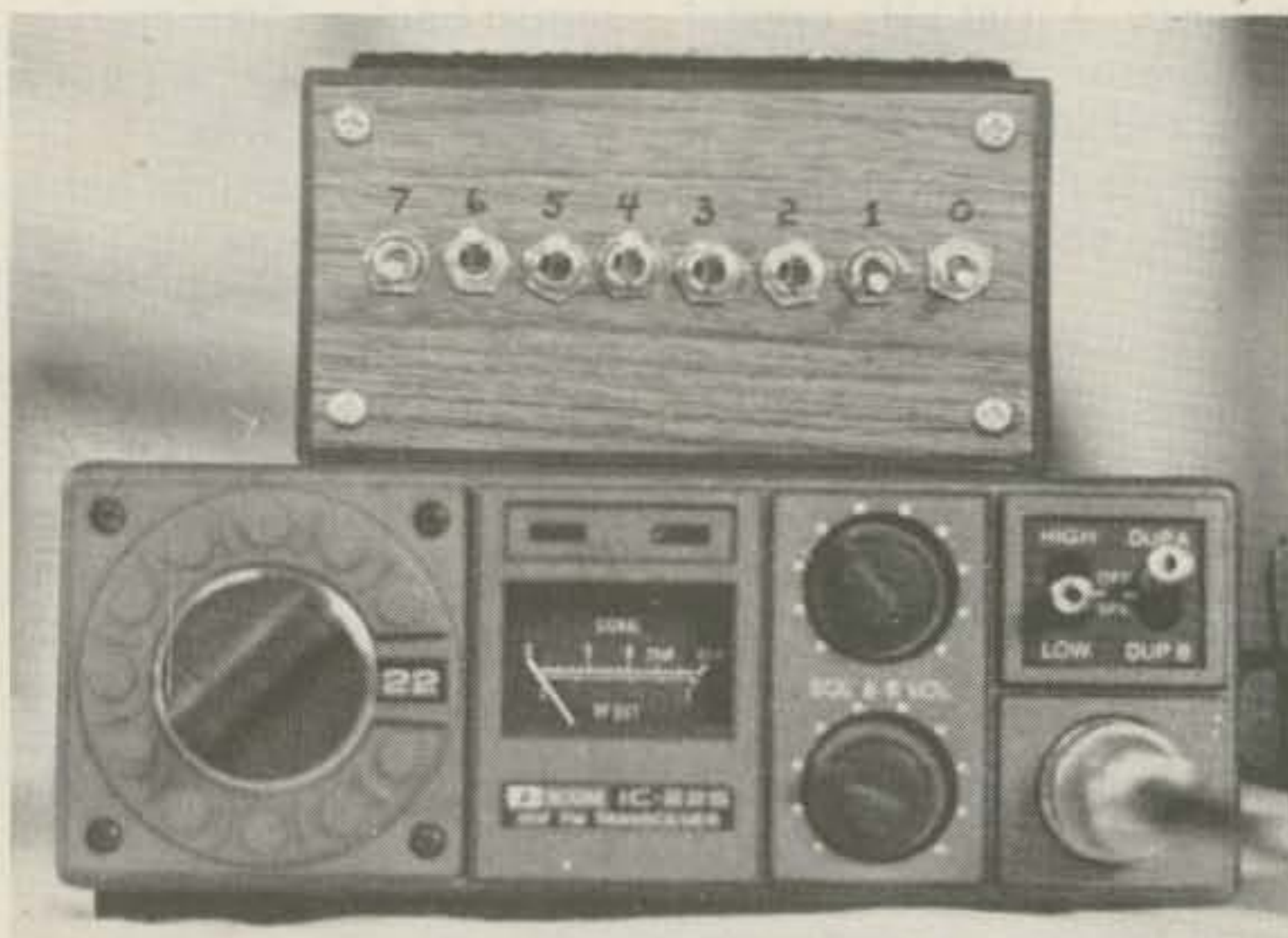

Photo M. Some old receivers like the Hammarlund had separate power supplies. Be sure one is included with your purchase.

The Toggled 22

—simplified programming for your IC-22S



The finished product.

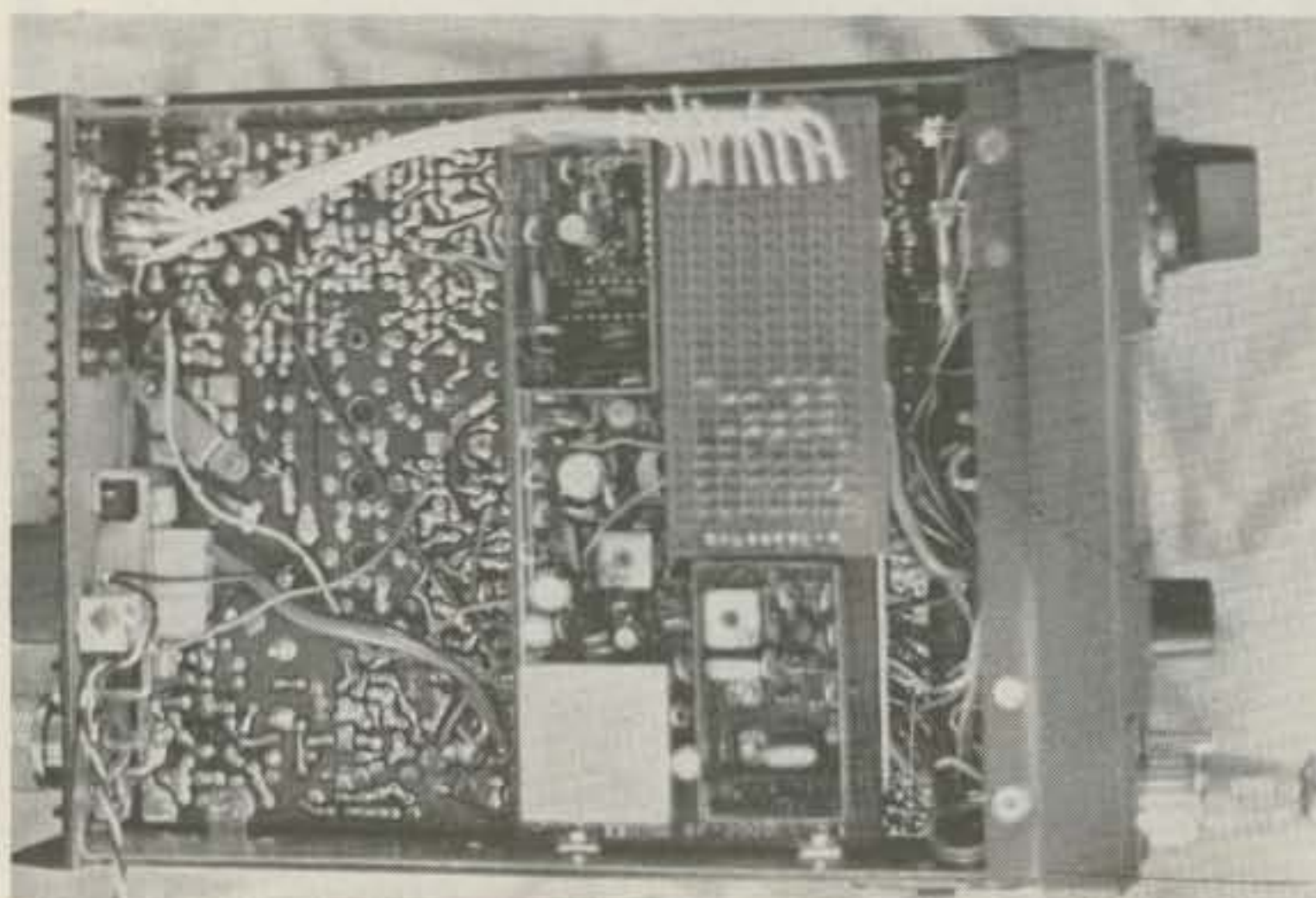

This shows the wiring inside the Icom 22S to connect the programmer.

Since the arrival of the Icom 22S on the market, many people have thought of different ways to rig this fine piece of equipment to cover the entire 146-148 MHz band with the flick of a single switch. I really have no idea how to accomplish this feat with a single switch, but with eight, it's a cinch!

The diode matrix to the Icom 22S is merely a PROM (programmable read only memory). By placing the diodes in the various positions in the diode matrix, you are essentially storing an 8-bit binary word in one of the 22 addressable memories of the PROM. With the use of eight SPST toggle switches, it is possible to put any binary code into the matrix that you wish. This gives you access to the entire band at the touch of a finger. On top of all this, Icom has placed a 9-pin accessory outlet on the rear panel of the unit that will facilitate easy coupling of the programmer to your rig.

Sound too good to be true? Well, there is a catch to it. You must have, along with the programmer, the programmer coding chart provided with the article or the diode placement chart

that comes with the transmitter. The diode placement chart and the addendum provided by Icom have quite a few errors and should be cross-checked. I consider having to carry the programmer coding chart a small inconvenience but worth the effort.

Now let's consider the construction. You need to purchase 8 miniature SPST toggle switches, a small chassis to which the switches can be mounted in a straight line, and some #26 stranded hookup wire. Total cost is about \$12, not including your time spent in construction.

The circuit diagram of Fig. 1 shows how simple the programmer actually is. Mount the eight switches in the chassis all in a horizontal straight line so that they are easy to see and use. Mount 8 diodes in a line on a small piece of perfboard. Solder a 12" piece of hookup wire to the cathode of each diode (banded end). Solder one side of all the switches together to form a common bus. Connect the other side of each switch to the anode of the diodes — one diode for each switch.

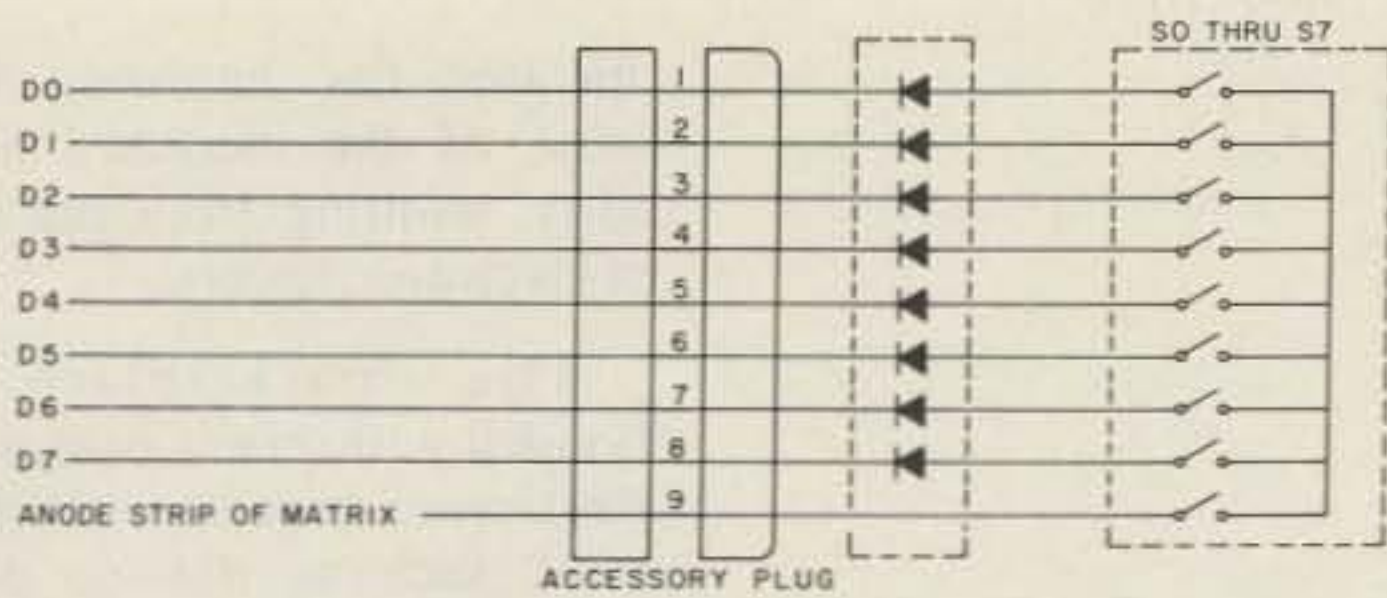

Fig. 1. Circuit diagram for external programmer.

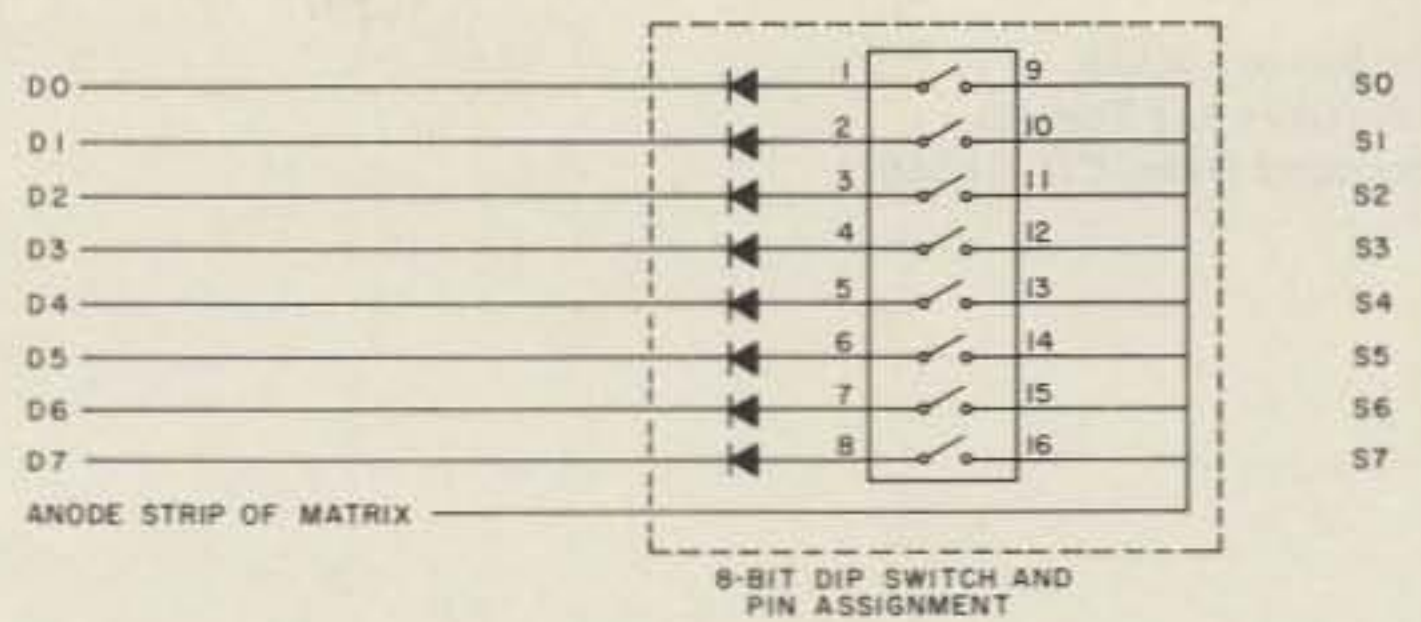

Fig. 2. Circuit diagram for 8-bit DIP switch programmer.

Now connect the common side of the switches to pin #9 of the accessory plug provided by Icom.

We now must define the switches by position. As you are facing the front of the chassis, the switch on the far left is now S7, the next is S6, and so forth. The switch on the far right is S0. Looking at the programmer coding chart, the numbers at the top of the columns correspond to the switch numbers. Where there is a "1" in a switch position, that switch is turned on. When there is a "0", that switch is turned off. Now connect S7 to pin #8 of the accessory plug, S6 to pin #7, and so forth, until you have connected S0 to pin #1. The programmer is finished, but you still have a little work to do.

You must now open the transceiver and wire the diode matrix as follows. First, notice that there is a ground wire connected to pin #8 of the accessory socket. Pins 8 and 1 are connected by a .01 uF capacitor, and there is a wire connected to pin #1. Desolder the ground wire on pin #8 and remove it. Desolder the capacitor from pins 8 and 1 and remove it carefully. Solder one side of the capacitor to the point on the PC board where the ground wire was connected from pin #8. Remove the wire from pin #1, and connect it to the other side of the capacitor. Make sure all connections have been removed from the accessory socket.

Now solder 8 wires of #26 AWG stranded wire (about 6" long) into the holes of chan-

nel 22 where the cathodes of the diodes would normally go. Solder one wire to the anode strip of channel 22. Bundle-tie the wires together and run them in the direction of the accessory socket on the back panel of the transceiver. Connect the wire coming from the anode strip to pin #9. Now connect the wire from diode position D7 to pin #8 of the socket.

Connect the rest of the wires in this manner — D6 to pin 7, and so forth, until D0 is connected to pin #1.

Check your wiring very carefully to see that all wiring is correct. Connect the programmer to your transceiver, and you are ready to use any of the 399 frequency combinations of Icom 22S.

As an added bonus, this design will also apply if you

wish to use an 8-bit DIP switch instead of the toggle switches. The DIP switch can be put on a small perfboard with the diodes and placed inside the transceiver to allow easy programming of any frequency without soldering each time. This would be a good circuit configuration for those of you who have used the accessory plug for an autopatch encoder. ■

| Frequency | Switch code | Frequency | Switch code | Frequency | Switch code |
|-----------|-------------|-----------|-------------|-----------|-------------|
| 146.010 | 01101100 | .655 | 10010111 | .330 | 11000100 |
| .025 | 01101101 | .670 | 10011000 | .345 | 11000101 |
| .040 | 01101110 | .685 | 10011001 | .360 | 11000110 |
| .055 | 01101111 | .700 | 10011010 | .375 | 11000111 |
| .070 | 01110000 | .715 | 10011011 | .390 | 11001000 |
| .085 | 01110001 | .730 | 10011100 | .405 | 11001001 |
| .100 | 01110010 | .745 | 10011101 | .420 | 11001010 |
| .115 | 01110011 | .760 | 10011110 | .435 | 11001011 |
| .130 | 01110100 | .775 | 10011111 | .450 | 11001100 |
| .145 | 01110101 | .790 | 10100000 | .465 | 11001101 |
| .160 | 01110110 | .805 | 10100001 | .480 | 11001110 |
| .175 | 01110111 | .820 | 10100010 | .495 | 11001111 |
| .190 | 01111000 | .835 | 10100011 | .510 | 11010000 |
| .205 | 01111001 | .850 | 10100100 | .525 | 11010001 |
| .220 | 01111010 | .865 | 10100101 | .540 | 11010010 |
| .235 | 01111011 | .880 | 10100110 | .555 | 11010011 |
| .250 | 01111100 | .895 | 10100111 | .570 | 11010100 |
| .265 | 01111101 | .910 | 10101000 | .585 | 11010101 |
| .280 | 01111110 | .925 | 10101001 | .600 | 11010110 |
| .295 | 01111111 | .940 | 10101010 | .615 | 11010111 |
| .310 | 10000000 | .955 | 10101011 | .630 | 11011000 |
| .325 | 10000001 | .970 | 10101100 | .645 | 11011001 |
| .340 | 10000010 | .985 | 10101101 | .660 | 11011010 |
| .355 | 10000011 | 147.000 | 10101110 | .675 | 11011011 |
| .370 | 10000100 | .015 | 10101111 | .690 | 11011100 |
| .385 | 10000101 | .030 | 10110000 | .705 | 11011101 |
| .400 | 10000110 | .045 | 10110001 | .720 | 11011110 |
| .415 | 10000111 | .060 | 10110010 | .735 | 11011111 |
| .430 | 10001000 | .075 | 10110011 | .750 | 11100000 |
| .445 | 10001001 | .090 | 10110100 | .765 | 11100001 |
| .460 | 10001010 | .105 | 10110101 | .780 | 11100010 |
| .475 | 10001011 | .120 | 10110110 | .795 | 11100011 |
| .490 | 10001100 | .135 | 10110111 | .810 | 11100100 |
| .505 | 10001101 | .150 | 10111000 | .825 | 11100101 |
| .520 | 10001110 | .165 | 10111001 | .840 | 11100110 |
| .535 | 10001111 | .180 | 10111010 | .855 | 11100111 |
| .550 | 10010000 | .195 | 10111011 | .870 | 11101000 |
| .565 | 10010001 | .210 | 10111100 | .885 | 11101001 |
| .580 | 10010010 | .225 | 10111101 | .900 | 11101010 |
| .595 | 10010011 | .240 | 10111110 | .915 | 11101011 |
| .610 | 10010100 | .255 | 10111111 | .930 | 11101100 |
| .625 | 10010101 | .270 | 11000000 | .945 | 11101101 |
| .640 | 10010110 | .285 | 11000001 | .960 | 11101110 |
| | | .300 | 11000010 | .975 | 11101111 |
| | | .315 | 11000011 | .990 | 11110000 |

Table 1. Frequency codes for the Icom 22S encoder. Code 1 = switch ON; Code 0 = switch OFF.

Custom-Make Your Key Paddle

—*the iambic Zephyr*

The days of the CW signature are almost gone with the current use of electronic keyers. The personalized penmanship-like characteristics of a CW operator's fist are being replaced by machine-like precision sending with electronic keyers.

The ability to pick out one station in QRM situations by tuning one's ear to a style of fist is becoming obsolete. Narrow bandwidth filters, binaural processing, and CW regenerators are offsetting the old-time ear puckering and fist-signature CW reception

techniques. The electronic keyers are removing the accent from former straight key, sideswiper, and bug operators and are making it easier to copy CW. The "chicken scratch" fist is disappearing, and the code speed copying ability of the average CW

operator has improved because of the increased legibility resulting from the use of electronic keyers.

The marketplace is flooded with many brands of electronic keyers with features such as dot or dash memory, weighting, iambic operation, and built-in side-tones. Some keyers have the paddle mechanism contained in the chassis where the electronics are. Some keyers have a three-wire cable going from the electronic chassis to the paddle mechanism. The latter method has the advantage of allowing more elbow room for the CW operator and eliminating the awkward situation of a bulky keyer chassis occupying valuable tabletop real estate.

There have been many magazine articles on homemade electronic keyers which can be built easily and inexpensively. But coming up with the paddle mechanism has always been left up to the reader. One can buy a paddle mechanism for as little as ten dollars, but can easily pay thirty dollars for a high quality one. It can be expensive to buy a nonplastic, rugged, smooth-operating, adjustable paddle mechanism on a heavy base with rubber feet.

This article describes the modification of a Vibroplex Zephyr semiautomatic key

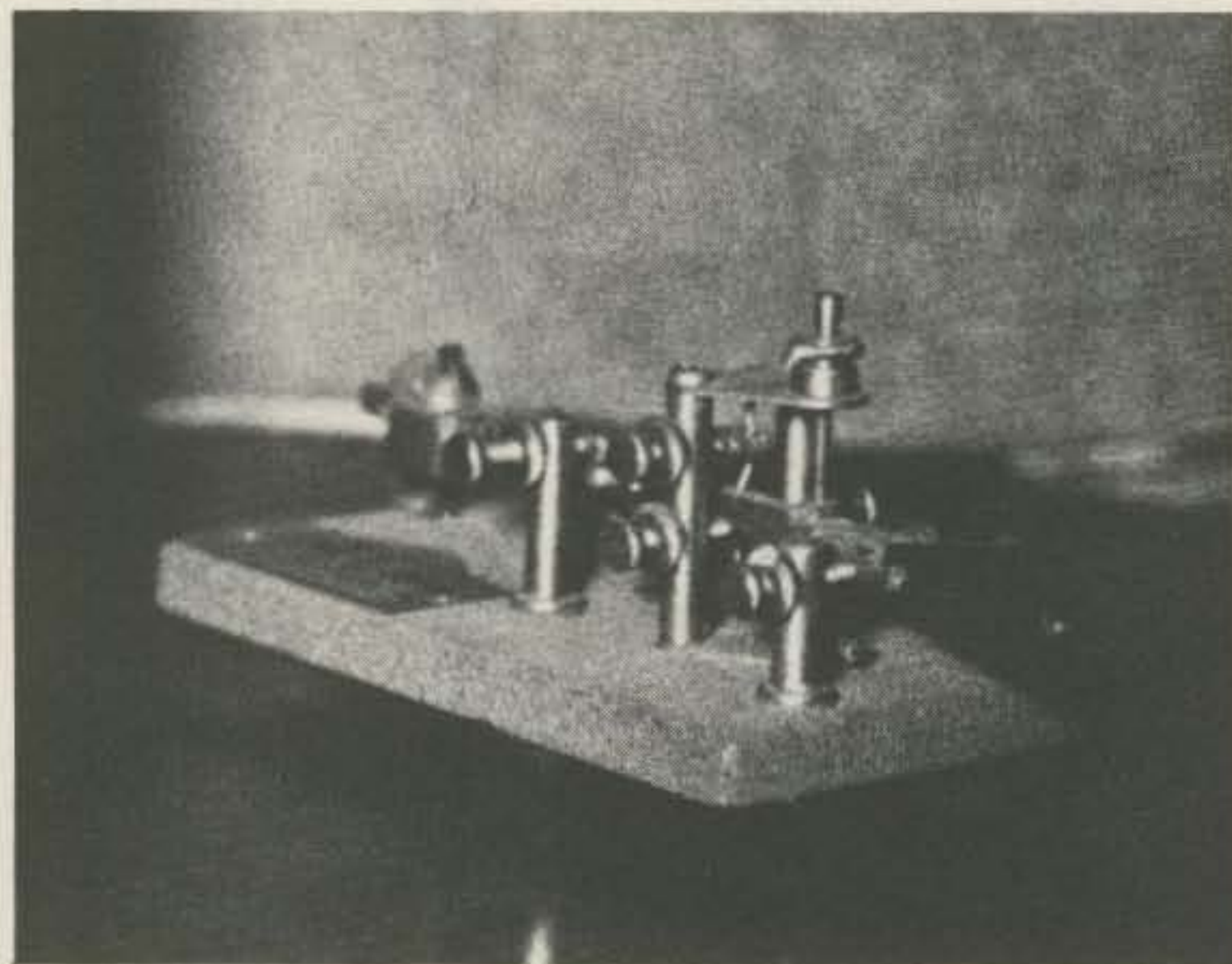

Fig. 1. Before — a Vibroplex Zephyr semiautomatic key.

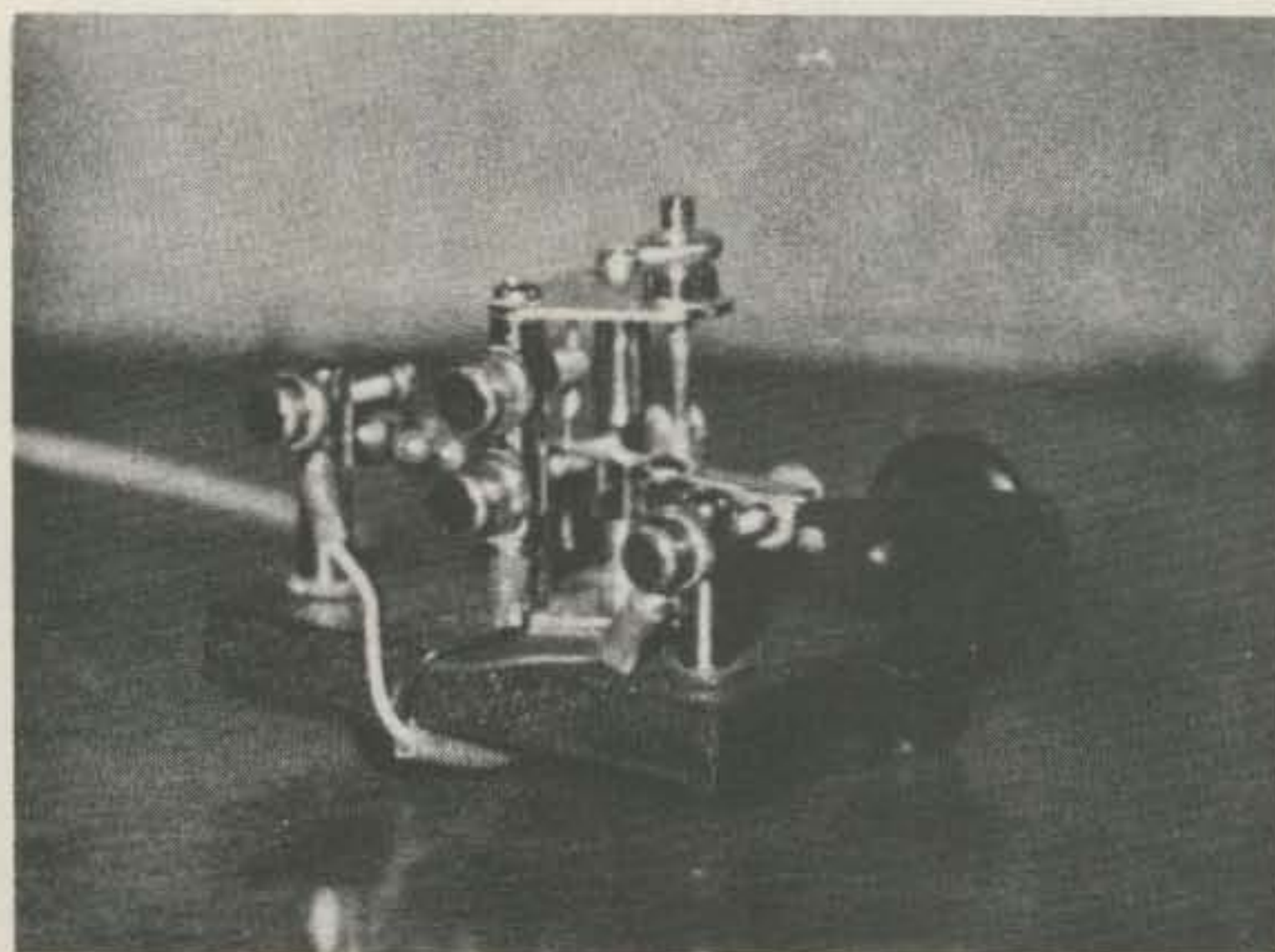

Fig. 2. After — a good-looking electronic keyer paddle mechanism.

(see Fig. 1) to an expensive-looking electronic keyer mechanism (see Fig. 2). It cost me nothing to make this modification, and the end product is quite comparable in looks and performance to the most expensive electronic keyer paddles commercially available.

The only special tools required are a vice, hacksaw, and a file to cut the Zephyr down to size. The Zephyr is disassembled from its base and the chrome parts are re-

stored to their original brilliance with automotive chrome polish. The base is clamped into a vice and hacksawed, using the vice as a straightedge to get a straight and square cut. A file is used to clean up the edges, and the base may be painted with a color to match ham shack gear.

The pendulum is cut down, and the existing hardware is moved around (see Fig. 2) to convert to the electronic keyer paddle con-

figuration. Spade lugs can be used to snap onto the convenient screws on the paddle mechanism for connection to a three-wire system (see Fig. 3). The dot post as well as the dash post must be insulated electrically from the base using the existing hardware.

It took about four hours to modify the Vibroplex Zephyr and would probably take about the same time to modify other kinds of bugs. Visitors to the shack will be impressed with the good

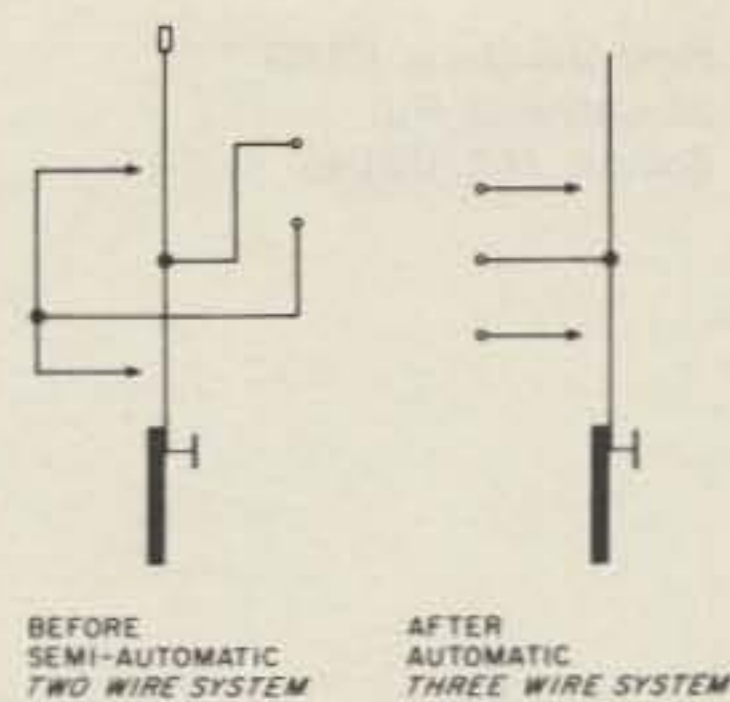

Fig. 3.

looks and low cost of this professional-looking shack accessory. ■

After having several batteries go dead due to the simple fact that I forgot to turn off a battery-powered CW filter after use, I decided to look around for a cheap circuit that would turn the unit off in case I forgot to.

The circuit is a basic NE555 timer circuit with the addition of a reed switch. I was unable to find a relay with a low current consumption, and was able to use the reed switch in its place. The total cost of the entire project was less than \$4.00 using all new parts.

The reed switch shuts all power off after the timing period of the NE555 timer. The timing period may be adjusted by varying the values of R1 and C1. With the values shown, a period of between 9 and 12 minutes is obtained.

The push-button switches are used to reset the timer and pull in the reed switch initially, to provide power for start-up. I used two switches, but a single DPST normally open push-button switch could be used. The only disadvantage of using one switch is that there is no way to shut the unit off before the timing period is up. The switch connected to pin two of the NE555 will shut down operation if pushed before the timing period is up. An SPST switch could be placed in the battery line to provide this feature if so desired.

The reed switch is a General Electric number GE-X7 Experimenter with

between 7,000 and 10,000 turns of number 36 magnet wire wound onto the form supplied with the switch. I placed the form in a variable speed drill to turn the wire onto the form. I didn't count the turns, just filled the form full.

With the CW filter on, the circuit draws 22 mA. This should provide a normal battery life. Whatever is connected to point "A" should not draw more than 250 mA. ■

Sam Miller WB8TXG
4893 Timbercrest Dr.
Canfield OH 44406

Don't Let Your Battery Die

— extend its life
with this simple timer

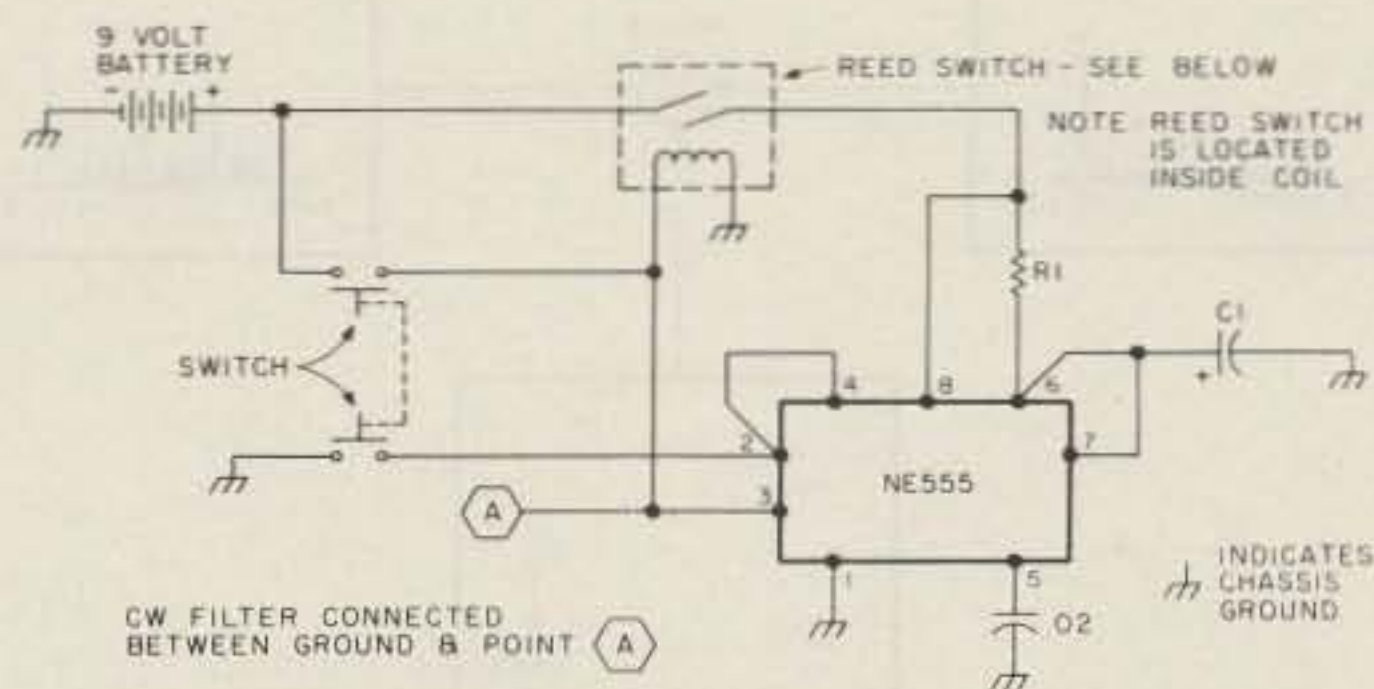

Fig. 1. R1 — 5 meg. C1 — 50 μ F electrolytic. Switch — either 1 n.o. DPST push-button or 2 n.o. SPST push-buttons. Reed switch — #GE-X7 Experimenter line by General Electric with 7,000 to 10,000 turns #36 enamel covered magnet wire around switch form.

New Life For Double Sideband?

—awake, ye pioneers, and get cracking

In the 1930s, when a ham spoke of "radiotelephone," he meant only one mode — good, old-fashioned, full-carrier AM. When hams (or FCC exams) discussed alternate types of modulation, the choice was between grid and plate modulation; FM and SSB were laboratory esoterica for the most part confined to the future.

Since then, most amateurs have learned the folly of full-carrier AM. Single sideband predominates on the low bands, while FM is the workhorse of VHF. Few voice operators have had any experience with another mode that combines the best of FM and SSB with the simplicity of "Ancient Modulation."

What's AM, Anyway?

The popular view of modulation is fraught with misconceptions.¹ Many hams still believe that "amplitude modulation" is accomplished by varying the strength of a "carrier wave" in step with the modulating signal. This is erroneous; by definition, the carrier of an AM signal is not changed by the modulating process and carries no intelligence. In fact, it doesn't carry anything; it just sits there. Audio and rf are mixed in the modulated stage of an AM transmitter, producing sum and difference frequencies which are called sidebands.

The sum and difference products are redundant, and

the full modulating signal can be found in either one of the two sidebands. In SSB transmitters, the carrier and one sideband are removed. This is perfectly sufficient, given the proper reception techniques.

An AM detector, whether a simple diode or an SSB product detector, is nothing but a mixer. The carrier frequency is mixed with the sidebands (one or both), producing difference products which duplicate the original modulating waveform. If the carrier is not transmitted, a beat frequency oscillator (bfo) fills its role within the receiver, mixing with the SSB signal. See Fig. 1.

The nominal signal bandwidth of an SSB signal is that of the modulation. Since the usual voice spectrum is from 300 to 3000 Hz, an SSB signal is 2.7 kHz wide. An AM signal is twice as wide as the maximum modulating fre-

quency, so voice AM uses 6 kHz. This is one of the most important reasons why SSB has supplanted AM on the crowded HF bands.

AM has another big problem — heterodynes. Since AM is just mixing, two nearby carriers can mix and produce audible difference products. CBers are today plagued by heterodynes, as were hams twenty years ago.

Perhaps AM's biggest disadvantage is the energy wasted in the carrier, which must always be twice as powerful as both sidebands together. But it also has one big advantage, which few hams (or anyone else, for that matter) make use of.

Redundancy — FM's Secret Weapon

"Frequency modulation" is often believed to be a process of shifting the carrier's frequency in step with the modulation. This isn't any truer than the carrier-strength theory of AM discussed above. In FM, the carrier sits on a single frequency, but it is surrounded by multiple sidebands, whose phase relationships give the appearance of varying frequency. At one point in the modulating cycle, the upper sidebands will tend to cancel, while the lower sidebands tend to reinforce one another; at the other half of the cycle, the phases switch position. The amplitude of the carrier does vary; a constant amount of power is divided between the carrier and the sidebands.

FM is capable of better noise rejection than AM and has the "capture effect" — a stronger signal will completely obliterate (capture) a weaker signal on the same frequency. While FM's noise resistance is a product of the phase relationships, the rest of its benefits are primarily due to redundancy. The wider the FM signal, the more sidebands; the signal-to-noise ratio rises with bandwidth. Unfortunately, the wider receiver bandwidth needed for

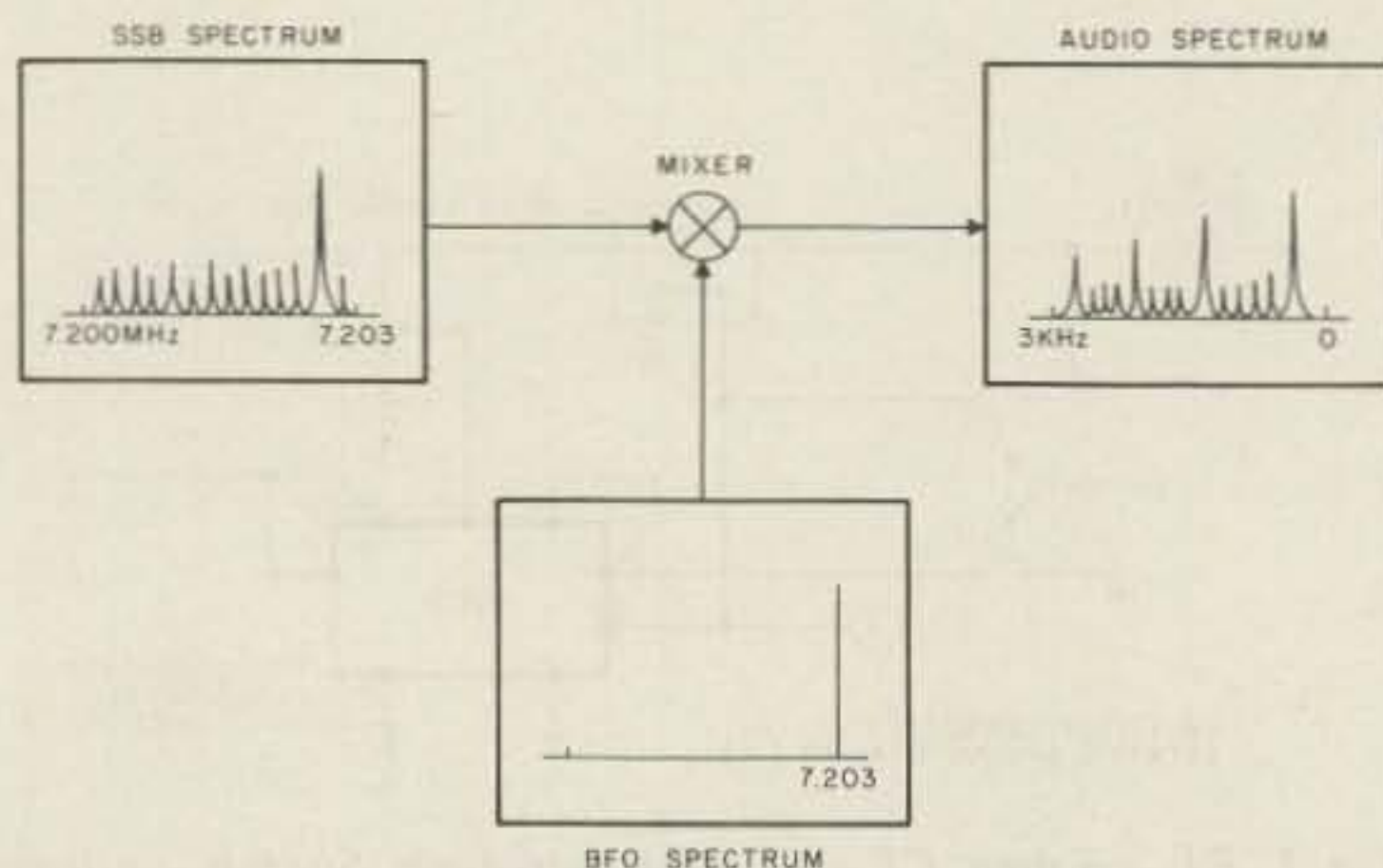

Fig. 1. SSB spectrum is mixed with a carrier in the detector; the output is the difference. In an AM system, the bfo is not needed, since the transmitted carrier is mixed with the sideband(s).

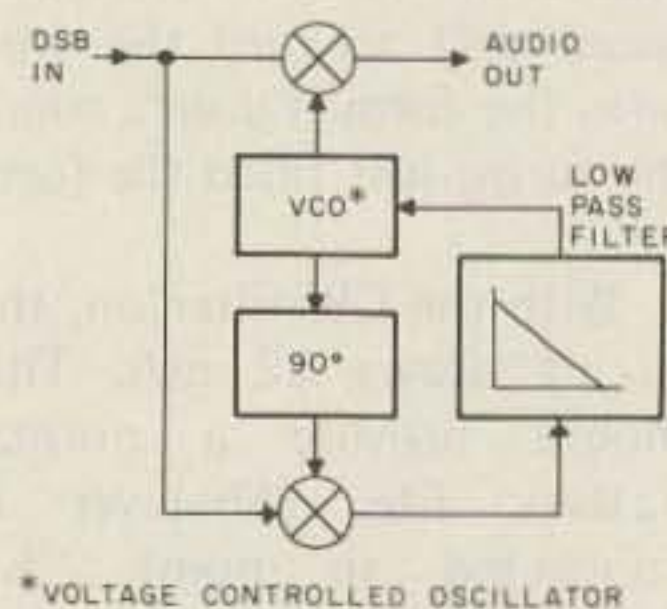

Fig. 2. PLL detector for DSB.

wideband FM admits more noise, so FM requires a stronger signal than SSB to overcome receiver noise.

An FM detector always takes advantage of redundancy. But regular AM has some redundancy, too — two complete sidebands. How can we put this to good use? A diode detector won't suffice, since it mixes all signals indiscriminately. A product detector only works with SSB. To get the most from AM, a synchronous detector is necessary. And a good synchronous detector doesn't require the presence of a carrier between the two sidebands. It enables us to use double sideband, a mode almost forgotten by history.

A Quick History of DSB

Double sideband without carrier (DSB) was developed in the mid-1950s. General Electric developed military communications gear using DSB, but the Collins Radio Company, with its SSB gear, beat GE for the pace-setting military contracts. Some have attributed this to better lobbying on Collins' part, although their equipment certainly can't be slighted for quality. Since then, DSB has been mostly ignored. A few ham DSB transmitters came out around 1960, but they were intended for hams who couldn't afford SSB; the other guy wasn't supposed to notice the "wrong" sideband!

Unlike SSB, DSB cannot be received on an AM/CW receiver. A synchronous detector is necessary. The only way to receive DSB on an SSB receiver is to filter out one sideband. A synchronous detector isn't a simple device. It revolves around a phase locked loop (PLL). How many hams knew about PLLs in 1956? The new PLL chips aren't designed for DSB, but they can be used in DSB receivers. An optimal DSB detector, sometimes called biaural or bisynchronous, requires 20 tubes or so, but it becomes quite manageable with ICs. A single chip could

be built for it, but it hasn't been yet.

Synchronous Detection

The basic difficulty with DSB is that the bfo must be exactly in phase with the carrier used to generate the sidebands. Absolutely perfect stability is necessary, unless phase locking is used. Happily, phase locking isn't tough to achieve. So, by injecting a phase locked bfo into a product detector, DSB can be received. The basic DSB detector in Fig. 2 just keeps the bfo in phase. The result of this is a system that is at least as efficient as SSB and doesn't require any expensive crystal filters.

A true biaural detector makes full use of redundancy. Its operation is basically simple. If a signal isn't simultaneously present in both sidebands, it's spurious, so reject it. This may sound like a nifty trick to pull out of a hat, but it was described in 1956 by John P. Costas W2CRR and, later, in a 1966 73 article — with lots of tubes!

Fig. 3 is a block diagram of the biaural detector. It has two parallel signal paths — the I channel and the Q channel. The incoming DSB signal is fed into two product detectors (balanced mixers). The bfo is fed directly into the I channel. It is shifted 90° (by a resistor and capacitor) before being fed into the Q channel. An adequate 90° phase shift is easy to produce over a narrow range of frequencies (less than an octave at a time), and it requires no adjustments if the detector is used across an entire ham band in a direct-conversion (synchrodyne) receiver.

The I (in-phase) channel will detect everything present in the input, including both the desired DSB signal and any unwanted signals and noise. But the Q (quadrature) channel won't. If you combine a DSB signal with its carrier shifted 90° (in quadrature), you'll get phase modulation, not the original AM.

That's how many FM transmitters work. But, since phase modulation (practically the same as FM) can't be heard on an AM detector, the Q channel will not detect the desired DSB signal. It will hear everything but the desired signal. So a detector just has to shift the Q channel audio 90° (with no great precision; you don't need the expensive shift networks used in phasing-type SSB transmitters) and subtract it from the I channel. The desired signal will remain — free from QRM!

The Q detector has another function. Its output, combined with I in a phase detector (double-balanced mixer), produces a dc control voltage that locks the bfo onto the desired signal. As the oscillator or signal drifts, the signal appears in Q with the right polarity to correct the bfo.

So a DSB transmission-reception system combines the weak-signal performance of SSB (even allowing for the wider bandwidth) with the frequency-correcting ability of FM with automatic frequency control and adds a unique ability to suppress QRM.

Frequency Overlap

If two SSB signals have overlapping passbands, a receiver will hear them both. One will be distorted, but it will still cause interference to the other. But, with properly detected DSB, the phase locked signal will be heard, and the overlapping signal will be attenuated. How ef-

fective this would be on crowded ham bands remains to be seen, since hardly anyone has tested DSB lately, but 10 dB of QRM rejection seems a conservative guess. Signals may overlap without interfering — wouldn't that help in pileups?

On VHF, DSB would prove particularly useful. There's no shortage of band space, and DSB is just as good as SSB for weak-signal DX. Since SSB transmitters for VHF are quite complex, simple "plate modulated" DSB transmitters — AM transmitters with balanced finals — could enable many more hams to enjoy the DX potential of 6, 2, and above.

DSB Transmitters

Short out the crystal filter in a typical SSB transmitter, and it will put out DSB. That's not the easy way to do it, though, unless you have a spare SSB exciter or two. Fig. 4 is a simplified schematic of a DSB final stage. It's quite like an AM final, if you can recall that many years ago, but the carrier is balanced out.

Fig. 5 is a sneaky circuit that uses that most modern of components, the MOSFET. It's just like a plate-modulated AM stage, but it doesn't put out a carrier. A MOSFET has an extremely high-input impedance, like a class A tube amplifier, and it also has a low-output impedance, like a tube. But amplifier tubes are essentially rectifier tubes with one or more control elements. A triode tube is just a diode with a

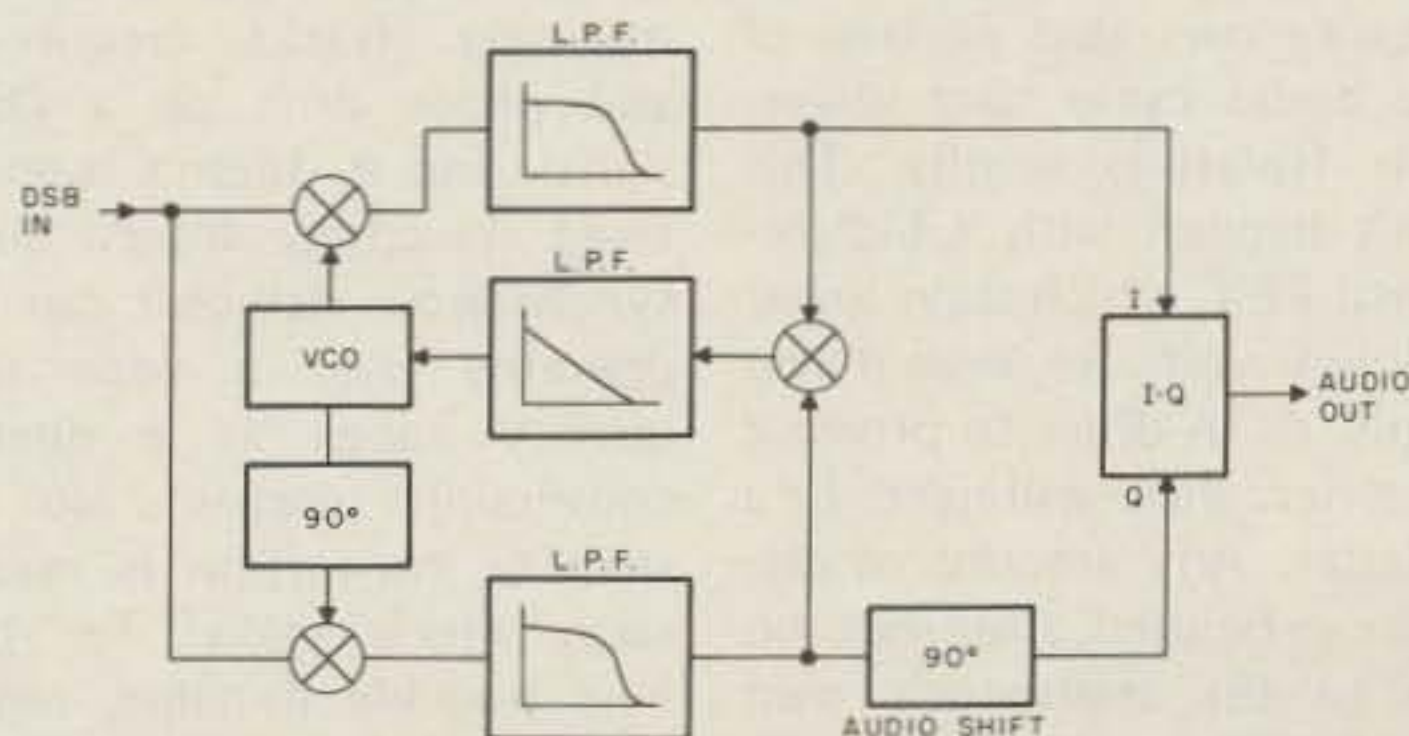

Fig. 3. Biaural detector providing rejection of undesired signals.

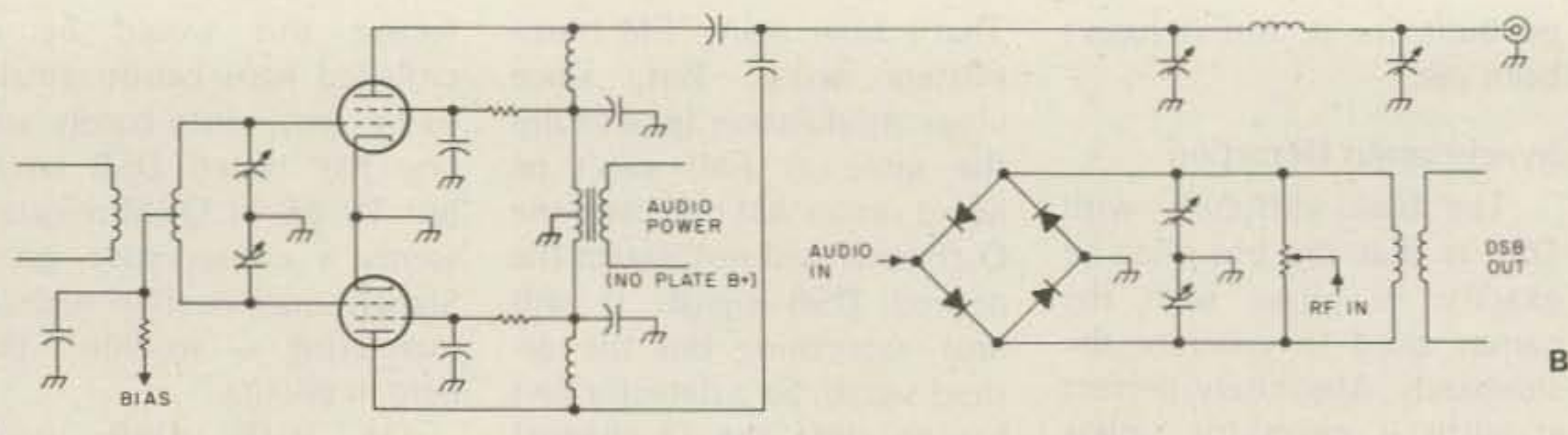

Fig. 4. (a) Balanced modulator using tubes; (b) Ring-type balanced modulator for use in low-power stage of a DSB or SSB transmitter.

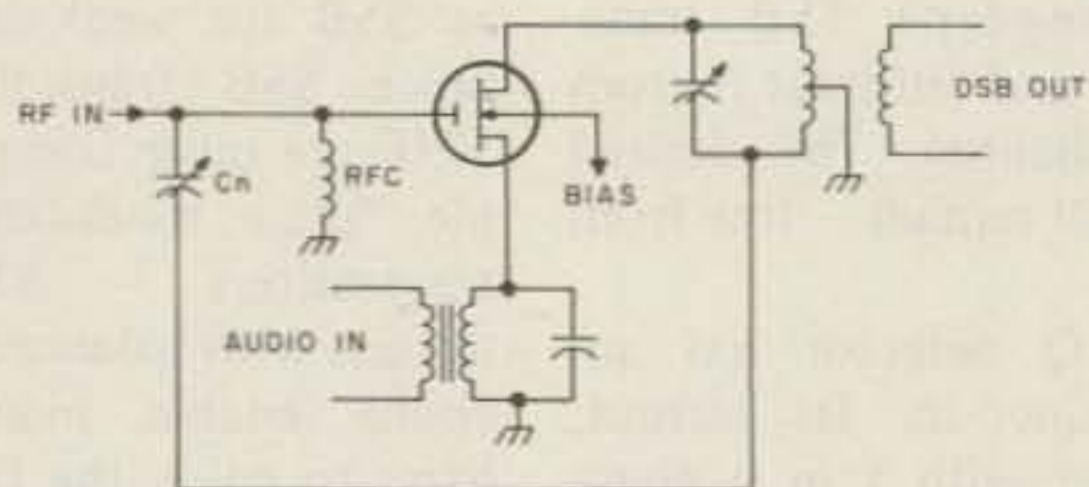

Fig. 5. Single-device balanced modulator. FET must be bidirectional. VMOS power FETs and many others are not; check spec sheets.

grid. FETs, on the other hand, are not diodes. The source and drain (cathode and anode) can be reversed, and current will still flow. Control is by the voltage between the gate and the source.

Notice that this modulated amplifier does not have any source of dc. All power for the stage comes from the audio amplifier. In the absence of audio, there's no output. What could be more balanced than that? By properly neutralizing out the input capacitance of the FET, up to 90 dB of carrier suppression is attainable.

A tube final amplifier turns dc into carrier and generates sidebands from the audio power. If the negative voltage peak of the audio exceeds the dc supply voltage, the tube stops conducting over that portion of the audio cycle and distortion (splatter) results. This can't happen with a bidirectional FET, which stays linear below 0 volts. So, even if you apply dc in order to produce a carrier, there will never be a splatter. Any amount of carrier can be used, from zero on up to the transistor's own limit. But the intelligence-bearing sidebands are not affected. Even the AM boys

should like that kind of splatterproof rig!

Synchrodyne Reception

The cheapest ham receivers today are the direct conversion, synchrodyne or homodyne, units that mix an oscillator with the input signal, detecting either SSB or CW. No i-f is needed. The receiver oscillator doubles as the CW transmitter oscillator in one such rig, the popular Heath HW-7. But, on SSB, the bandpass of the receiver is twice as wide as desired. The 3 kHz below and above the oscillator is heard, but that means you hear undesired signals along with the one you want.

Since DSB makes use of both sides of the carrier frequency, a synchrodyne has the perfect bandpass. A synchronous detector automatically tracks frequency and phase drift on a DSB signal, and it doesn't require fixed selectivity filters. So a synchronous detector can be operated over a wide frequency range as a direct-conversion receiver. No i-f strip or conversion is necessary, which makes for the best possible dynamic range and sensitivity. The cost of the detector is compensated for by the saving in the i-f

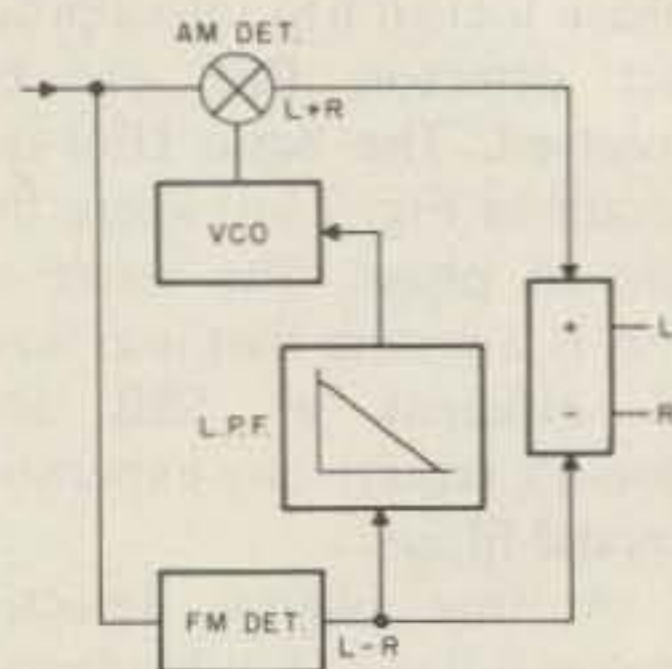

Fig. 6. Simplified AM stereo receiver. Everything but the output network is part of a standard PLL circuit.

stages and filters. Selectivity comes from the low-pass audio filtering in the detector.

AM Stereo

The big money in the radio broadcast game has been shifting to the FM band in recent years. The noisy, low fidelity monophonic sound of AM broadcasting just can't compete with FM where both are available. But AM broadcasters are planning a comeback, thanks to some of the techniques outlined above.

Synchronous detection permits AM receivers to reject heterodynes and much other noise (not, unfortunately, pulses such as ignition noise). Higher fidelity AM is thereby made possible. But, even better, it makes AM stereo practical.

Two rather similar systems have been proposed for AM stereo. Neither is a simple left-on-the-upper, right-on-the-lower sideband system. Instead, the two channels (L+R) that constitute a regular monophonic AM signal are generated using double-sideband techniques with sup-

pressed carrier. The carrier that was used to generate the DSB is then phase modulated with the difference (L-R) audio. An AM stereo receiver then has an AM detector drawing L+R from the sidebands, and an FM detector drawing L-R from the transmitted carrier and its associated sidebands. See Fig. 6.

Two of the systems presently being considered by the FCC differ primarily in that one, proposed by Leonard R. Kahn (an SSB pioneer), has a 90° phase difference in one modulator, whereas the other, proposed by RCA, does not. But that's another story...

An AM stereo receiver doesn't require the sophisticated phase locking circuitry of a DSB receiver, since it has a carrier to phase lock to. Recall that PM doesn't actually change the frequency or phase of the carrier — modulation always consists of adding sidebands. ICs like the 561 PLL detector can be adapted to such a system, while existing mono AM receivers won't even notice the difference. Unfortunately, DSB without carrier can't be received with such inexpensive chips, which are really exalted carrier AM detectors, not synchronized to the sidebands. The chip makers haven't built them, yet.

Too few amateurs understand the virtues of two complete sidebands. While conventional full-carrier AM is terribly inefficient, balancing out the carrier and using a synchronous receiver results in a communications system with weak-signal efficiency at least the equal of SSB, with substantial QRM rejection, automatic drift compensation, and reasonably economical hardware. Amateurs should give more thought to using DSB, especially for long-haul VHF work. ■

Reference

1. Goldstein, F.R., "AM Is Not Dead — It Never Existed at All," 73, May, 1976, p. 110.



Get into "220" Mobile the Easy Way with Midland

Midland has a pair of proven performers, crystal controlled or P.L.L. synthesized . . . both designed to be easy on the pocketbook

To start with, here's Midland's Model 13-509. It's a compact, rugged mobile with capacity for 12 crystal-controlled channels. The "509" transmits with 10-watt or 1-watt output. Its receiver has a dual gate MOS FET front end with hi-Q resonator and ceramic filters. There are SWR and polarity protection circuits, internal DC filtering and electronic switching. With its jack for optional tone burst and discriminator meter, the "509" has even been the basis for many repeaters.

Midland's choice alternative in "220" is P.L.L. synthesized Model 13-513. Here's advanced design with modular construction and digital frequency readout. It's programmed for 500

frequencies between 220 and 225 MHz, with a 5 KHz shift up giving 500 more . . . and 4 offsets are available for repeater use. The receiver has a multiple FET front end with monolithic crystal and ceramic filters. The transmitter switches for 20-watt, 10-watt or 2-watt output. With automatic SWR and polarity protection, internal DC filtering, electronic switching and a jack for tone burst and discriminator meter, the "513" is a very desirable "220" mobile . . . or base.

Pair either of Midland's "220" mobiles with Midland's trunk/roof mount or magnet mount antennas (Models 18-950 and 18-951) for top-notch performance on the band.



For more about Midland "220" Mobile, write: Midland Amateur,
P.O. Box 1903, Kansas City, Missouri 64141

Time And Tide — Digitally

— march to
 a different drummer

The modern equivalent of a Renaissance man would be, I suppose, some character who was equally knowledgeable about professional football, classical ballet, and nuclear physics. Not being quite in that league, but struggling, I try to combine electronics, sailing, and getting along with my wife as the attainments of a modern poor man's Lorenzo de Medici.

Sailing and celestial navigation offer numerous opportunities for the design and use of digital gadgetry. In sailing along the east coast, where shoal waters are a constant hazard, it is often quite important to know whether the tide is out or in. Numerous commercial and government publications tell you, for every day of the sailing season, what time it is high tide at certain principal ports, such as Boston, New Haven, or New York. Other governmental publications tell you when it is high tide at numerous other ports, but only that it is so many hours and/or minutes before or after high tide at the principal ports; e.g., at Stonington, Connecticut, it is two hours and 30 minutes before high tide at Boston.

Hence, the sailor wishing to know what time is high tide at South Clamshell RI must first look up the tidal data for Boston (in EST, while he is on EDST) and then add or subtract the tabular difference. This can get quite confusing, and it would be nice to have a time-keeping device that would tell you the state of the tide at any moment for your own particular harbor or the one you are heading for.

Tide clocks are offered by several suppliers of marine hardware and boat equipment. They are designed to

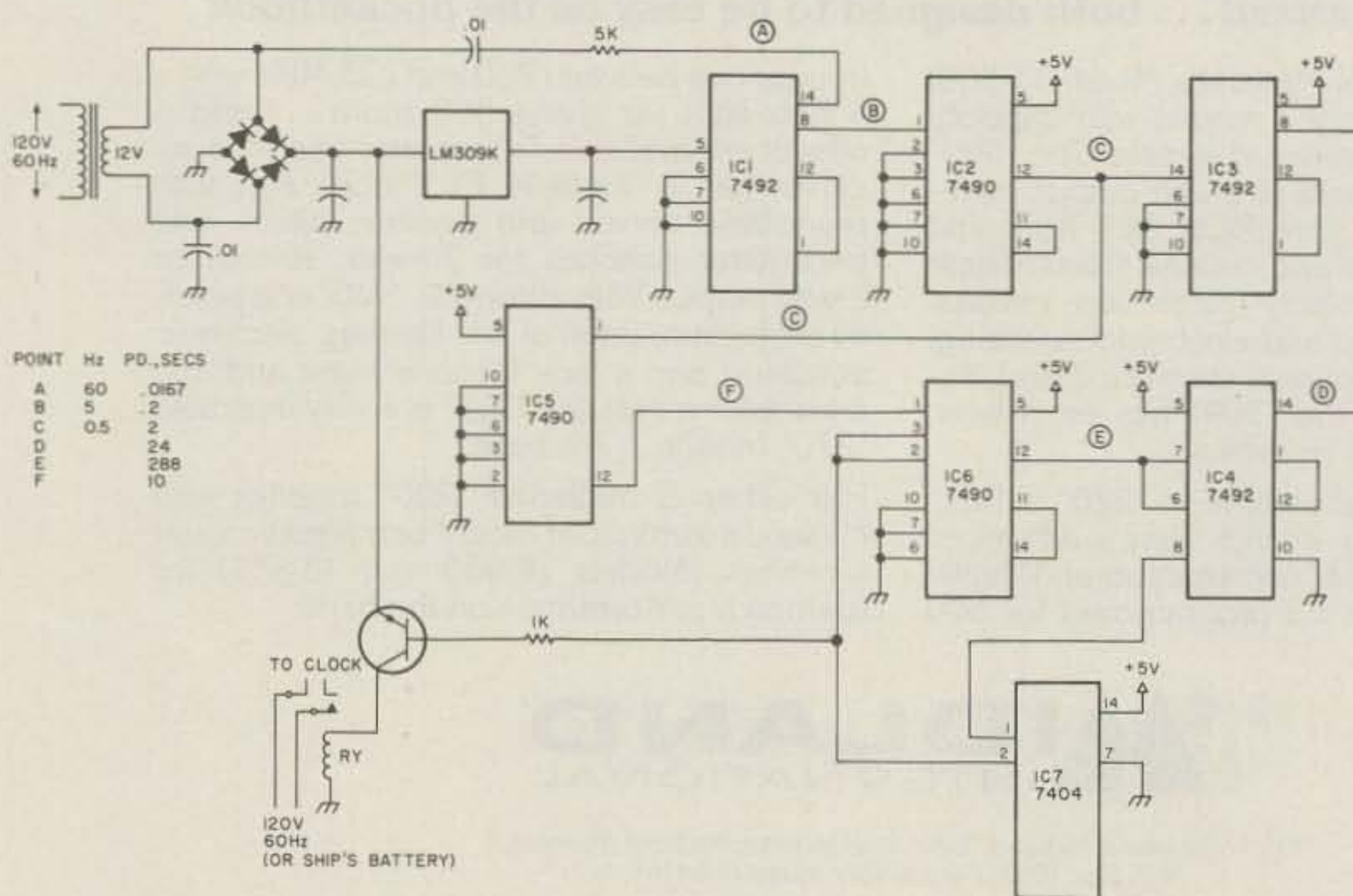

Fig. 1.

run off the power lines, 120 volts, 60 Hertz current, and have only a single hand. It points straight up at high tide and straight down at low tide, with a few gradations in between.

These little goodies usually sell for \$40 and more, and they are useless during the winter or on board an actual boat, where the time reference of the power line is not available.

Electric clocks — the ordinary kind found in most households — can be bought on sale for as little as \$3.00. And battery-operated clocks, suitable for use on a boat, are widely available. But both kinds of clocks are designed to turn the big hand around in exactly 60 minutes. It just so happens that from the first high tide today to the first high tide tomorrow averages out at 24 hours and 50 minutes. The variation from week to week is plus or minus up to 20 minutes or so, but this means little to a sailor; he wants to know whether he is within an hour or two of low tide to escape a grounding. The tidal cycle is set by the moon, and a moon clock would be 50 minutes per day slow by standard time.

I've tried to regulate spring-driven clocks to lose 50 minutes a day (and battery clocks, too) but their regulators don't afford that much variation. So it occurred to me that there might be an application of electronic timing circuitry that would do the job.

A loss of 50 minutes in 24 hours works out to a loss of five seconds every 144 seconds — both nice digital integers. If I could shut off an electric clock for five seconds out of every 144 seconds, I'd have it made. The circuit shown in Fig. 1 will do just that.

A conventional five-volt regulated power supply drives a TTL 7492 frequency divider, which reduces the 60 Hertz power line frequency by a factor of 12 to five Hertz. A 7490 divides this by

10 to give 0.5 Hertz, or a period of two seconds per cycle. Two more 7492s divide by 12 and 12, outputting pulses with a period of 288 seconds, of which 144 seconds will be high and 144 seconds low (a symmetrical square wave).

Meanwhile, a second 7490, fed from the first, divides a 2-second pulse down to a 10-second pulse — again, spending five seconds high and five seconds low. In this application, it isn't the length of the total pulse period that matters, but the lengths of the low and high states.

You want IC4, the 144-second counter (in its low condition), to inhibit the five-second counter. It can do this by putting its low output into one gate of IC7, a hex inverter. The IC7 output is then high, which, when connected to the reset pins 2 and 3 of IC6, holds its output low. This low output is in turn used to keep IC4 counting by grounding its reset pins 6 and 7.

When IC4 has counted up to 144 seconds, its output goes high. Through the inverter, this flips the reset pins of IC6 to low and starts the five-second low period of that counter. Its output remains low, so IC4 keeps on counting in its high state for five seconds. Then IC6 goes high, the high ungrounds reset pins 6 and 7 of IC4, and it goes low again. But the instant it does this, its inverted output ungrounds reset pins 2 and 3 of IC6, disabling it.

IC6, therefore, never actually goes into the high state, except for a few nanoseconds. Its five-second low period is all you ever use.

Fig. 2 shows the states of all the ICs involved in the critical timing cycles. Note that IC6 in effect preempts all but five seconds of IC4's high period by resetting it. But the driving pulse, which is 24 seconds long, from IC3 to IC4 has not been interfered with, so the total pulse length delivered to IC4 by IC3 has been shortened by

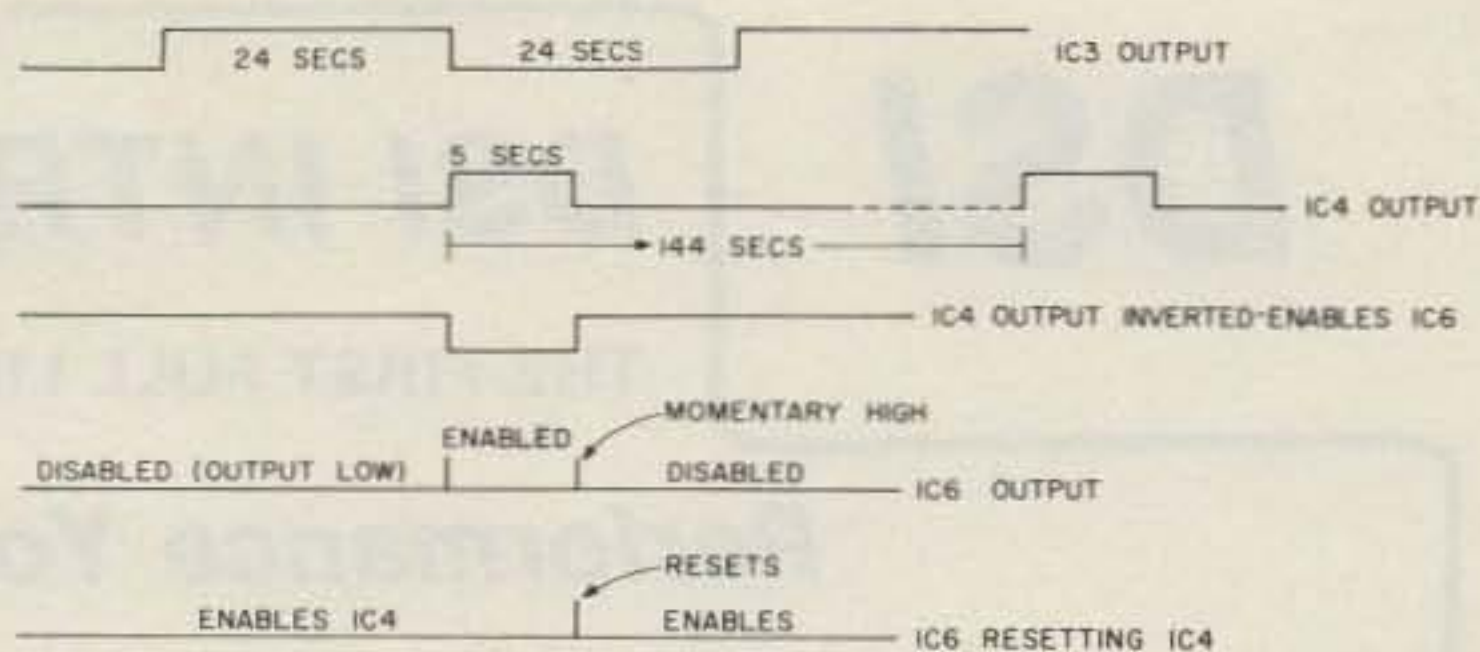

Fig. 2.

five seconds. Hence, the ultimate period of IC4 is 139 seconds off, five seconds on — total, 144 seconds.

Now you have the clock periods all shipshape. How do you turn on and off an ac power line with them?

The roughly four volts dc serving the IC outputs is too weak to kick any relay I know about, so recourse was had to a transistor, switching the higher unregulated voltage available from the power supply — about 15 volts. This is plenty to actuate a 6- or 12-volt relay, rated at 500 or 1000 Ohms, 12 milliamperes. I chose to invert IC4's output through the gate in IC7, to drive the transistor on and turn on the relay and the electric clock during IC4's 139-second low period.

It would have been more elegant to do the ac switching with an SCR, but I had no data on how to arrange that. Maybe some reader can supply a scheme.

This gadget may not help to solve the juvenile delinquency problem, but it was a fascinating exercise in learning how TTL works. I have only one textbook, *The TTL Cookbook* (plus articles in 73.) Indispensable tools were my Heath-Schlumberger counter, which has the uncommon added feature of measuring periods up to 99.999 seconds, and my little Pioneer Products frequency standard, with outputs as slow as 25 Hz. By speeding it up to 1000 Hz, the counter chain can be monitored quickly, instead of waiting 139 seconds for each check. Equally indispensable were my proto board and a stopwatch.

By plugging LEDs into contact sockets on the proto board at the output pins of IC4 and 6, I was able to see just what was going on in each of them.

It may be seen that this technique would lend itself to setting up any other timing cycle that might be desired, such as "on" from noon to 2:00 pm on Thursday or to turn on your Christmas tree lights between December 15 and 30 even though you left for Florida back in November.

Now, what about on a boat with only 12-volt battery power? There are two routes. I first substituted a 555 timer, adjusted to 60 Hz, for the power line source. This is done most easily with a 1 uF tantalum capacitor and a string of PC-style variable resistors, say, 100k and 10k. By juggling the latter, you can get to 59.999 Hz, which is close enough. A neater way is to buy the 60 Hz plug-in kit that is sold with regular digital clock kits. It is CMOS and won't drive TTL reliably without a CD4001 NOR gate (a quad) as a buffer, with the two inputs of the gate in use paralleled, in series with a 2.2k resistor. It can drive one TTL load (see p. 168, *TTL Cookbook*).

Oh, I almost forgot. Set your tide clock at 12:00 when the book says it is high tide, and it will be at 12:00 at high tide forever after, give or take up to 20 minutes. At 6:00 by the clock, it will be low tide; at 3:00 it will be half-way between high and low, with the tide going out; at 9:00, the tide will be half-way in and rising. ■

DSI

DSI INSTRUMENTS INC.

DSI INTRODUCES

THE FIRST FULL LINE OF FREQUENCY COUNTER ACCESSORIES

Performance You Can Count On

DON'T SCRAP THAT OLD FREQUENCY COUNTER

600 MHz PRESCALER ÷ BY 10 WITH BUILT IN PREAMP

- 10 MV @ 150 MHz & 250 MHz
- 50 MV @ 450 MHz
- INCLUDES 115VAC SUPPLY
- OPERATES ON 8-12 VDC
- RUGGED CAST ALUMINUM CASE
- READY TO USE ON ANY COUNTER



69⁹⁵

MODEL PS-600

SUPER PRE-AMP 15 DB PRE-AMPLIFIER 20 MHz TO 800 MHz

- OUTSTANDING AS A PROBE AMPLIFIER
- INCREASE SENSITIVITY OF A COUNTER WITH 100 MV TO 12 MV TYP.
- INCLUDES 115VAC SUPPLY
- OPERATES ON 8.2-13.5 VDC
- RUGGED CAST ALUMINUM CASE



69⁹⁵

MODEL PA-800

RTTY-PL-AUDIO AUDIO SCALER

- x10, x 100 MULTIPLIER
- .01 Hz RESOLUTION WITH 1 SEC GATE TIME
- 20 MV SENSITIVITY 10 Hz TO 10 KHz
- HI Z INPUT 1 MEG OHM
- A MUST FOR PL REEDS, RTTY AND LOW AUDIO WORK WHERE ACCURACY IS MANDATORY



49⁹⁵

MODEL AS-100X

PROTECT YOUR COUNTER T-TAP

160 METERS TO 450 MHz

- POWER LEVELS — 1 WATT TO 250 WATTS
- USE IN LINE WITH TRANSCEIVER
- LOW LOW LOSS
- PROVIDES LEVEL OUTPUT TO COUNTER AT ALL POWER LEVELS
- USE IN LINE WITH DUMMY LOAD OR ANTENNA
- RUGGED CAST ALUMINUM CASE



32⁹⁵

MODEL T-100

ALL UNITS ARE FACTORY ASSEMBLED, TESTED AND CARRY A FULL 1 YEAR WARRANTY.

SEE YOUR LOCAL DEALER

OR

CALL TOLL FREE (800) 854-2049

California Residents add 6% State Sales Tax and Call Collect (714) 565-8402

7914 Ronson Road No. G, San Diego, CA 92111

DSI

D25

DSI INSTRUMENTS INC.

Be the one who's on FREQUENCY!!

With your *DSI Counter*. . . save the shop cost of tweaking xtals. . . know your frequency. . . from 160 meters through 450 MHz. Now *DSI* offers *the most* counter for your dollar. Latest state-of-the-art technology. . . *DSI* advanced LSI design far exceeds outdated TTL. Go with the leader . . . buy a *DSI FREQUENCY* counter and **SAVE TIME & MONEY!!**



MODEL 3500 \$149.95
Includes TCXO ± 1 PPM



MODEL 3600A \$199.95
Includes oven timebase $\pm .5$ PPM

- **MADE IN USA**—Factory assembled—2 Hr. Burn-in Test & Calibration
- Built in 600MHz Prescaler with RF Preamp—Not an add-on
- 7 Large Bright— $\frac{1}{2}$ inch LED Readouts
- Resolution—10Hz Non-Prescaled 100Hz Prescaled, .1 sec Gate
- **ACCURACY** ± 1 PPM \pm one count ± 1 PPM per six months from 65°F to 85°F
- **SENSITIVITY**—50 mVrms 150 to 250MHz 100mV @ 450MHz
- Gate Time Light—Automatic Decimal Point Placement
- Automatic Leading Zero Blanking When No Input Signal is Present
- No RF Connection Required with Supplied Antenna
- **S0239** Connectors Supplied for Direct Probe Input
- AC or DC Operation—115 VAC 50/60 Hz 8.5V to 13.5 VDC @ 300ma
- Comprehensive **Owners Manual** with Complete Schematics
- Size 2 7/8" H x 8" W x 5" Deep

- **MADE IN USA**—Factory Assembled—8 Hr. Burn-in Test & Calibration
- Built in 600MHz Prescaler & RF Preamp—Not an add-on
- 8 Large Bright— $\frac{1}{2}$ inch LED Readouts
- Two Selectable Gate Times—.1 sec. & .1 sec. 100Hz to 600MHz
- **Accuracy** $\pm .5$ PPM \pm one count ± 1 PPM per six months from 50°F to 100°F
- **Sensitivity**—10mVrms 150 to 250MHz 50mV @ 450MHz
- Gate-time & Oven Light—Automatic Decimal Point Placement
- Automatic Leading Zero Blanking—When No Input Signal is present
- No Direct RF Connection Required—With Supplied Antenna
- **S0239** Hz input 50Hz to 75MHz—**S0239** Low \pm 10MHz to 600MHz
- AC or DC Operation 115 VAC 50/60 Hz, 8.5V to 13.5VDC @ 400ma
- 50Hz to 600MHz Sine or Square Wave Input
- **FCC Certifiable**—Designed for the Professional Service Technician
- Resolution 1 Hz Non-Prescaled 10Hz Prescaled @ 1 sec. Gate

PERFORMANCE YOU CAN COUNT ON

1. **PPM OVER TEMPERATURE RANGE** With a spec. of ± 1 PPM over 50°F to 100°F, your worst error over temperature would be ± 145 Hz, when measuring 145 MHz. This is the most important specification for any frequency counter because temperature variation of only a few degrees could have a drastic effect on the accuracy of your counter.
2. **PPM LONG TERM** With a spec. of ± 1 PPM per six months, your additional error would only be 145Hz when measuring 145MHz, six months after calibration.
3. **LAST DIGIT ERROR** All counters have an error in the last digit, if the last digit should read a 5 it could be a 4, 5 or 6. When you have 10 Hz resolution (last digit represents tens of Hz) your additional error will be ± 10 Hz.
4. **TOTAL ERROR** The overall error of a counter is the sum of the error due to temperature variation, last digit error and long term error. A simple ± 1 PPM spec. with no mention of temperature or ageing could conceal a much larger overall inaccuracy. Example: ± 1 PPM at 75°F is ± 145 Hz at 145MHz, but the same counter might be in error 1 KHz or more at only 85°F.

See Your Local Dealer

or

Call Toll Free (800) 854-2049 *DSI Instruments Inc.*

Name _____

Address _____

City _____ State _____ Zip Code _____

Please send more information on your full line of instruments

Check Enclosed C.O.D.

Please charge my: Bank Americard Visa Master Charge AE

Card # _____ Exp. Date _____

Signature _____

California Residents add 6% State Sales Tax and Call Collect (714) 565-8402

• NO EXTRA COSTS •

FREE Shipping anywhere in U.S.A.

.....
: Strongest warranty in the counter field. :
: **ONE YEAR** Parts and Labor :
: Satisfaction Guaranteed. :
.....

Dennis Romack WA60Y1
VP Marketing, DSI

7914 Ronson Road No. G, San Diego, CA 92111

The Sneaky J

—for cliff dwellers and other unfortunates

Hamming is fun, but the simple fact that an increasing number of us live in apartments, condominiums, dormitories, and other urban locations where there are antenna installation restrictions puts a definite crimp in the operating enjoyment of many cliff dwellers. Often it is not possible to install a legal antenna, particularly on the HF bands, and mobiling is the only practical answer. However, in more

cases than one, particularly on VHF, some sort of radiator can be fashioned and installed en route to the midnight raid on the refrigerator.

A particularly easy and inexpensive design that lends itself readily to the problem 2 meter base station installation is the J-style antenna. It was quite popular during the thirties and forties, particularly with police, fire, railroad, and forestry systems,

and, to a lesser extent, with hams, especially on the old five and six meter bands. Even today, business radio installations frequently use the J. It has a number of advantages, particularly with regard to its omnidirectional coverage, vertical radiation pattern (for repeater work on 2), and lack of ground-plane radials. The fact that radials are not needed allows for a "Slim-Jim"-type of installation that is not especially conspicuous, yet is mechanically easier to construct than either ground-plane or coaxial-type verticals.

The J-style antenna is, basically, a variation of the vertical dipole, with the matching device located at the bottom end for adjustment convenience. It may be fed in several ways, such as with balanced feedline (300-600 Ohm), directly with coax, or through a special matching device. Feeding directly with coax is by far the simplest method and will result in a fairly good impedance match approximation that will normally be adequate, producing swrs lower than 1.5:1 at the design frequency.

The essential idea behind the J is that the matching stub should not radiate, but, in real life, it does to a small extent, interfering with radiation from the half-wave portion of the antenna to a

certain degree and effectively raising the radiation angle. However, this technical consideration should not be of real concern for most repeater and local simplex work. The mere simplicity of the antenna, and the fact that it may allow you to get on the air from an otherwise difficult or impossible location, overrides these considerations.

Normally, the J antenna is constructed from parallel lengths of aluminum tubing supported at the bottom where the matching stub is located. However, in this version, designed for attic and other out-of-the-way installations, the antenna is constructed out of a length of high-quality TV-type 300-Ohm twinlead and tacked or stapled at the top to an attic beam or other support. A decent match is obtained to 52-Ohm RG-58/U or RG-8/U coax by means of the built-in quarter-wave matching section made from the lower portion of the twinlead itself.

Fig. 1 shows the simple mechanical construction details. For 146-148 MHz FM work, the antenna can be cut with the half-wave section at 39" and the quarter-wave matching section at 18". These dimensions are a bit long and will have to be cut and pruned slightly to account for proximity to

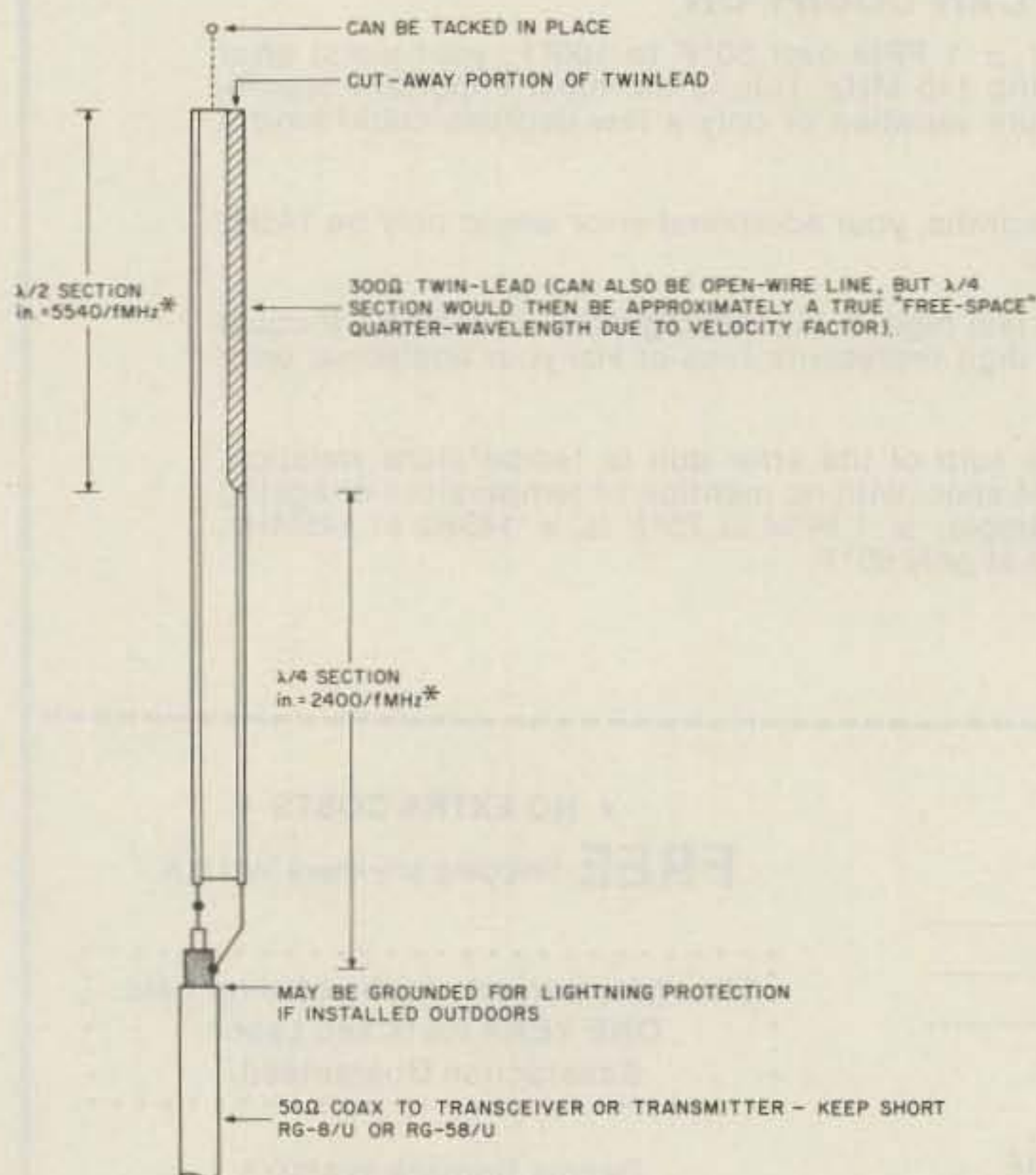

Fig. 1. J antenna. *Formulas are approximate. This should be tuned using an swr bridge for best results. See the text for details. (Drawing not to scale.)

other objects (a real factor, if mounted indoors in an attic), the velocity factor of the twinlead, and so-called "end effects." You can experiment, using a good VHF-type swr bridge, cutting back first the 1/4-wave matching section and then the 1/2-wave section about 1/4" at a time until a good match is obtained. If a low swr (below, say, 1.5:1) cannot be obtained in this manner, try trimming the coaxial cable an inch at a time until the swr as indicated at the transmitter or transceiver is acceptable. This little expediency will not, of course, affect the overall swr at the antenna (where it counts), but will at least allow the antenna to take power properly. If an swr bridge is not available, you can probably go with dimensions of 38" for the 1/2-wave section and 17" for the 1/4-wave matching stub at 147 MHz, at least for starters. Overall length of the antenna will, of course, be the length

of the half-wave and quarter-wave sections combined.

The little J antenna cut for 2 meters will also do reasonably well for occasional VHF aircraft monitoring (108-136 MHz) and VHF/high listening (152-174 MHz). If you want to design it primarily for such work, rather than FMing, try dimensions of 46" and 20" for aircraft; use 35" and 15" for VHF/high monitoring. Should six meters be your cup of tea, try 110" and 48" for pre-pruning starters. Incidentally, the antenna should also give a good account of itself on 1 1/4, but adjustment may be a bit touchy. See Fig. 2 for details. (Dimensions refer to the 1/2-wave and 1/4-wave sections, respectively.)

If the attic of your apartment or condominium isn't accessible or if you don't have one, a bit of individual ingenuity will be required. You might try suspending the unit from an accessible rain gutter or, as a last resort,

taping it to an "outer" indoor wall. In any case, results will be far superior to those possible using a rear-apron mounted rubber ducky or 1/4-wave whip located at the operating console. Just try to keep the antenna as far removed from house wiring and large metal objects as possible. Of course, the J can't be used indoors directly under a metal-sheathed roof. Be sure to use low-loss RG-8/U or its equivalent if a long lead-in run is required.

Finally, the J makes for about the simplest portable antenna possible for those

quick vacation and business trips when something a bit more sophisticated than a rubber ducky is in order. The antenna and feedline form an integral unit and are completely flexible. The whole thing can be simply rolled up and packed along with the transceiver in its box or carrying case. Overall results usually will be much better than a 1/4-wave antenna, yet slightly inferior to the 5/8-wave ground plane.

Try a J for a simple 45-minute construction project one afternoon — you may be surprised by the results! ■

| Band | 1/2-wave section (in.) | 1/4-wave section (in.) |
|--------------------|------------------------|------------------------|
| 6m (51 MHz) | 109 | 47.5 |
| Aircraft (120 MHz) | 46 | 20 |
| 2m (147 MHz) | 38 | 17 |
| VHF/high (160 MHz) | 35 | 15 |
| 1 1/4m (223 MHz) | 25 | 11 |

Fig. 2. Approximate dimensions for the J. For receiving use only; dimensions are not critical. For 6, 2, and 1 1/4m, use slightly longer lengths than those indicated in the table. The antenna is then adjusted for the center of the operating range using an swr bridge or antenna bridge, cutting and pruning as required to get a good match.

WILSON HT's & ANTENNAS
KDK 20 15-R
TRAC—KEYERS
GOLD LINE
TAB BOOKS
ARRL BOOKS
SAXTON WIRE PRODUCTS
LARSEN
CDE—ROTORS
NEW-TRONICS HUSTLER

PRIMO MICS
SHURE MICS
TELEX HEADSETS
COLUMBIA WIRE
WAHL ISOTIP
UNGAR
CUSH CRAFT
ALUMA—TOWERS

KLM
TEN • TEC
SWAN

MOSLEY
ICOM
DENTRON



ICOM Transceiver 2M FM ssb
 IC 211—749.00



540 Triton IV 80-10M Xcvr—699.00
 544 Triton IV Digital—869.00



KLM 160 Power Amplifier—229.95



MT-3000A—349.50



KLM 661—695.00

ZZZ ELECTRONICS INC.

422 ARMOUR CIR N.E.
 ATLANTA, GA 30324
 PHONE • 404 • 876 • 0631

Come by OR Call...
 WILLIAM • WA4SVY
 OR
 CHARLIE • WB4GJU



CUSTOM TRANSFORMERS

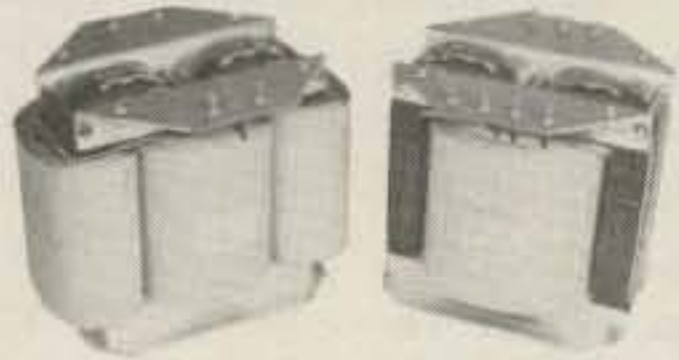

HEAVY DUTY REPLACEMENT TRANSFORMERS*

| | |
|---|----------|
| Collins 30S-1 Plate Transformer | \$165.00 |
| Collins 516F-2 Power Transformer | 95.00 |
| Hunter 2000B Plate Transformer | 125.00 |
| ETO A-77D Plate Transformer | 125.00 |
| Henry 2K Plate Transformer | 140.00 |
| Henry 2K-2 Plate Transformer | 165.00 |
| Henry 2K-2A Plate Transformer | 135.00 |
| Henry 2K-4 Plate Transformer | 165.00 |
| Henry 3K-A Plate Transformer | 165.00 |
| Heath Marauder HX-10 Transformer | 95.00 |
| Gonset GSB-100 Transformer | 95.00 |
| National NCL-2000 Power Transformer | 125.00 |
| Gonset GSB-201 Power Transformer | 135.00 |

SPECIALS

| | |
|---|----------|
| Plate XFMR. 4600 VAC @ 1.5A ICAS 230 VAC 60 Hz primary, Wt. 60 LB | \$195.00 |
| Plate XFMR. 3500 VAC @ 1.0A ICAS 230 VAC 60 Hz primary, Wt. 41 LB | 125.00 |
| Plate XFMR. 3000 VAC @ 0.7A ICAS 115/230 VAC 60 Hz pri, Wt. 27 LB | 95.00 |
| Plate XFMR. 6000 VCT @ 0.8A CCS 115/230 VAC 60 Hz pri, Wt. 41 LB | 135.00 |
| FIL XFMR. 7.5 VCT @ 21A CCS 117 VAC 60 Hz primary Wt. 8 LB | 29.95 |
| FIL Choke bifilar wound 30 AMP RF Filament Choke on 1/2x7 rod | 8.95 |
| DC Filter Choke 8.0 Hy @ 1.5 ADC | 150.00 |
| DC Swinging Choke: 30 Hy @ 0.15A to 5.0 Hy @ 1.0ADC | 100.00 |
| DC Filter Capacitors 100 MFD @4000 VDC | \$75.00 |

*All heavy duty replacement transformers are electrically superior to original equipment(s). All transformers are manufactured to rigid commercial quality specifications and each carries a 24 month guarantee!

Write today for a free quotation on any transformer, Choke, or saturable reactor.

Peter W. Dahl Co.

4007 Fort Blvd. • El Paso, Texas 79930 D6
Telephone (915) 566-5365 or (915) 751-4856

Choosy People LOVE Standard!



C-6500 Solid State, Synthesized Receiver

Covers Broadcast Band From 0.5 to 30 MHz

The C-6500 is capable of receiving AM, CW, USB and LSB. Synthesizer design affords unusual stability and digital dial accuracy. Drift-cancelling 1st mixer injection system provides 30 tunable ranges, covering the entire broadcast band starting at 500 kilohertz through 30 megahertz, from a single 10 MHz crystal oscillator. This ensures the frequency stability necessary for excellent SSB reception. Operates from internal batteries or AC mains.



S18



**Standard
Communications**

Standard Communications Corp. • P.O. Box 92151, Los Angeles, CA 90009

IN
STOCK

\$ 1299⁰⁰



WANT TO TRADE — UP-
GRADE? Call us — for best
quote. Large assortment of
clean used equipment on hand.

50th Year Serving Amateurs

W4WL



W4VOV

FRECK

38-40 Biltmore Ave. F3

Asheville, N C 28801

PHONE: (704) 252-8000

radio &
supply
co., inc.

CLEVELAND

HAMFEST!

COUNTY FAIRGROUNDS
BEREA, OHIO

SATURDAY
SEPT. 9th 1978

8am to 6pm

ADMISSION: \$2.00

CHECK-IN ON 146.52

FOR MORE INFO, WRITE TO:

CLEVELAND HAMFEST ASSOC.
P.O. BOX 27211
CLEVELAND, OHIO 44127

Choosy People LOVE Standard!



Standard Communications offers you a choice of 2 meter handheld radios in either the pocket sized C-118 or the professional sized 146A.

Why Buy The C-118?

- Compact — can be slipped in pocket or purse
- 6 channels but affords 18 channels transmit with unique offset switch which produces transmit offset of ± 600 kHz
- Requires only one crystal for each channel
- BNC antenna connector
- Rubber flex antenna at no additional charge
- LED status lights indicate channel busy and RF output
- 1+ Watts output

Why Buy The 146A?

- More room means larger battery capacity
- Larger case affords greater audio fidelity
- Room for tone options
- Provisions for remote speaker mic
- Full size telescoping antenna is standard feature
- 5 channels
- Meter for RF and signal strength
- 2+ Watts output

Both the C-118 and 146A...

- ... Are ready to operate on 146.94 simplex and 34/94 repeat
- ... Have excellent sensitivity and selectivity characteristics

 **Standard
Communications**

member:



Attn: Advertising Manager
Standard Communications Corp.
P.O. Box 92151
Los Angeles, CA 90009

S18

Gentlemen:

Please send me additional information on

- C-118 2 meter 1 Watt FM Handheld Radio
 146-A 2 Watt VHF Handheld Radio

Name _____

Address _____

City _____ State _____ Zip _____

C

Social Events

from page 116

at the Washington City Park. There is a large area for traders' row; no extra charge to exhibitors for displays. There is a picnic area, refreshments and lunches are available, and there are lots of prizes and activities for the ladies. Ham pilots can fly into our airport. Free transportation will be provided. For more info, write WA0FYA, Dutzow MO 63342.

AMARILLO TX AUG 11-13

The 1978 edition of the Golden Spread Amateur Radio Convention will be held at the Holiday Inn West Motor Hotel, 601 Amarillo Blvd. West, Amarillo, Texas, on Friday evening, Saturday, and Sunday, August 11, 12, and 13, 1978. It is sponsored by the Panhandle Amateur Radio Club of Amarillo. An area has been set aside for amateurs to display their trading and swapping gear. Two Hospitality Hours are slated: one for early arrivals the evening of Aug. 11 and the second for Saturday evening, Aug. 12. Six technical sessions will be held, featuring the very latest in communications expertise. Special activities for the ladies will be available so that there will be something for everyone. Preregistration will be \$4.00 per person; registration at the door will be \$6.00.

MUNCIE IN AUG 12

The Delaware Amateur Radio Association will hold a hamfest from 8:00 am until 5:00 pm on Saturday, August 12, 1978, at Springwater Park, east of Muncie on Country Club Road.

There will be hourly prize drawings from 10:00 am until 4:00 pm, with the grand prize drawing at 4:00 pm. Spaces for the flea market are available at no charge. Tickets are \$1.50 in advance and \$2.00 at the gate. Talk-in on 146.25/.85 and 146.52. Send your check and SASE to PO Box 3021, Muncie IN 47302.

CHARLOTTE VT AUG 12-13

The International Field Days and Hamfest sponsored by the Burlington Amateur Radio Club will be held on August 12-13. Door prizes, raffles, contests, bingo for ladies, a two-day flea market, and much more. Chairman Bob W1DQO suggests early reservations for camping sites on site at Old Lantern, Charlotte VT 05445.

Early bird registration at \$3.00, with gate cost of \$3.50. For other info, please write BARC, PO Box 312, Burlington VT 05402.

WILLOW SPRINGS IL AUG 13

The Hamfesters 44th annual picnic and hamfest will be held on Sunday, August 13, 1978, at Santa Fe Park, 91st and Wolf Road, Willow Springs, Illinois, a southwest suburb of Chicago. There will be exhibits for OMs and XYs and the famous swappers' row. Tickets at the gate will be \$2.00; in advance, \$1.50. For hamfest information or advance tickets, send check or money order (SASE appreciated) to Bob Hayes, 18931 Cedar Ave., Country Club Hills, Illinois 60477.

POMONA CA AUG 13

The Tri-County Amateur Radio Association will hold its annual hamfest on Sunday, August 13, 1978. Several prizes will be awarded including a Midland 220 MHz transceiver. Drawing tickets are 50¢ each. The winner need not be present. The hamfest/picnic will be at Westmont Park, West 9th Street, 1/2 mile west of Highway 71. For tickets or info, write to Box 142, Pomona CA 91769.

LEXINGTON KY AUG 13

The Bluegrass Amateur Radio Club annual hamfest will be held at the National Guard Armory on August 13, starting at 8:00 am. There will be major prizes, forums, refreshments, a paved flea market area, a large indoor exhibit space, and plenty of free parking. Advance tickets are \$2.50; \$3.00 at the door. Flea market space is \$1.00 extra. Talk-in on .16/.76. For more info, contact Paul Heflin WA4PAB, 434 Potomac Dr., Lexington KY 40503, (606)-278-0646.

SAUK RAPIDS MN AUG 13

The St. Cloud Radio Club will hold its annual Ham-Fest on Sunday, August 13, 1978, at the Sauk Rapids Municipal Park. Free camping and overnight parking available at the Lions Park, in Sauk Rapids, 1 mile from the municipal park. Check-in starts at 10:00 am. There will be many door prizes. Pop, coffee, hot dogs, and chili will be available. A ham gear swapfest and sale is planned, so clean out your junk boxes. Talk-in on .34/.94 and 3925 kHz.

For further info, contact Bill Zins WA0OTO, Rt. #4, St. Cloud MN 56301; (612)-253-3428.

CEDARTOWN GA AUG 13

The Cedar Valley Amateur Radio Club of Cedartown, Georgia, will sponsor the Cedar Valley Hamfest, which will be held on August 13, 1978, from 9 am to 4 pm, at the Polk County Fairgrounds located one mile east of Cedartown on US 278. Talk-in frequency will be (WR4AZU) 147.72/.12. Food, drinks and lots of prizes! For more information, please contact Jim T. Schlietett, Pres., W4IMQ, Cedar Valley ARC, PO Box 93, Cedartown GA 30125; telephone: (404)-748-5968.

ROCHESTER MN AUG 18-20

The Central States VHF Society will hold its twelfth annual conference on August 18, 19, and 20, 1978, at the Midway Motor Lodge, Rochester MN. This conference is specifically oriented to operation above 50 MHz. An excellent technical program is planned. A dinner for the conferees and their families, an evening speaker, and prizes are included in the program. For further information, contact the Central States VHF Society, c/o Mr. Mel Larson, 2429 N.W. Viking Court, Rochester MN 55901.

ROCHESTER PA AUG 19

The Beaver Valley Amateur Radio Association's first annual hamfest will be held on Saturday, August 19, from 9 am to 5 pm at Brady's Run Park located 5 miles north of Rochester PA on Route 51. Advance tickets are \$3.00 or three for \$8.00; at the gate, they'll be \$4.00 or three for \$10.00. Seller's fee is \$1.00—bring your own table. There will be a flea market for new and used equipment. Camping spaces, swimming, boating and fishing are available at the park. Refreshments will be available. Prizes: (1st) Kenwood TS-520S, (2nd) Midland 13-500 2 meter FM transceiver, (3rd) DenTron Super Tuner. Talk-in on 25/85; check-in on 52/52. For more information, write Wayne R. Sphar WA3ZMS, Secretary BVARA, 1200 Atlantic Ave., Monaca PA 15061.

NEWBURGH NY AUG 19

The Mt. Beacon Amateur Radio Club will hold its 5th annual hamfest on Saturday, August 19, 9:00 am to 5:00 pm, indoors at Stewart Field, Newburgh NY. This is a rain or shine event with a flea market

and auction. Bring your own table. Talk-in on 37/97 and 52. Plenty of free parking. General admission is \$1.00; sellers, \$2.00; under 12 free. For additional information, contact Ron Perry WA2CGA, Rd 1 Glen Ave., Fishkill NY 12524.

REND LAKE IL AUG 19-20

The Shawnee Amateur Radio Association's (SARA) annual hamfest will be held August 19 and 20 at the North Marcum Access Area on beautiful Rend Lake in southern Illinois. There will be prizes and a large flea market with no charge to vendors. Complete camping and recreational facilities available. Talk-in on 3.925, 146.25/.85, and 146.52. For more information, write or call Gary Wheeler WB9SWG, Box 229 RR #2, Carterville IL 62918, (618)-985-3397, or Nick Koenigstein WB9ELP, 2009 Gray Dr., Carbondale IL 62901, (618)-549-5931.

ABINGDON VA AUG 19-20

The 2nd Annual Bristol Hamfest, sponsored by the Bristol ARC, Inc., will be held on August 19th and 20th at the New Washington County Fair Grounds, Route #11, Abingdon VA 24210. The event will be completely indoors with 45,000 sq. ft. of floor space and ample parking. Admission is \$1.00 and flea market is \$2.00 extra. Food and drinks on premises, with games for the children, and special activities and prizes for the ladies. First prize is a Ten-Tec Triton IV with power supply. Ladies' first prize is a GE food processor. There will be various other prizes. Talk-in 01/61 and 07/67. For further info, send an SASE to Lowry Rouse WD4ECF, 77 Bordwine Road, Bristol VA 24201 or call (703)-669-3086.

WARREN OH AUG 20

The 21st Annual Warren Hamfest will be held at the Trumbull KSU campus, Ohio Route 45 at the Warren outer belt, on Sunday, August 20. This is an ARRL approved event which will be held rain or shine, dawn to dusk. There is a huge lawn for the flea market, with parks, lakes, and family camping nearby. \$2.00 door prize registration.

HAMDEN CT AUG 20

The WELI Amateur Radio Club's second annual flea market and auction will be held on Sunday, August 20 (rain date August 27) from 10:00 am to 4:00 pm at Radio Towers Park, Benham St., Hamden, Connect-

THE CRITIC'S CHOICE

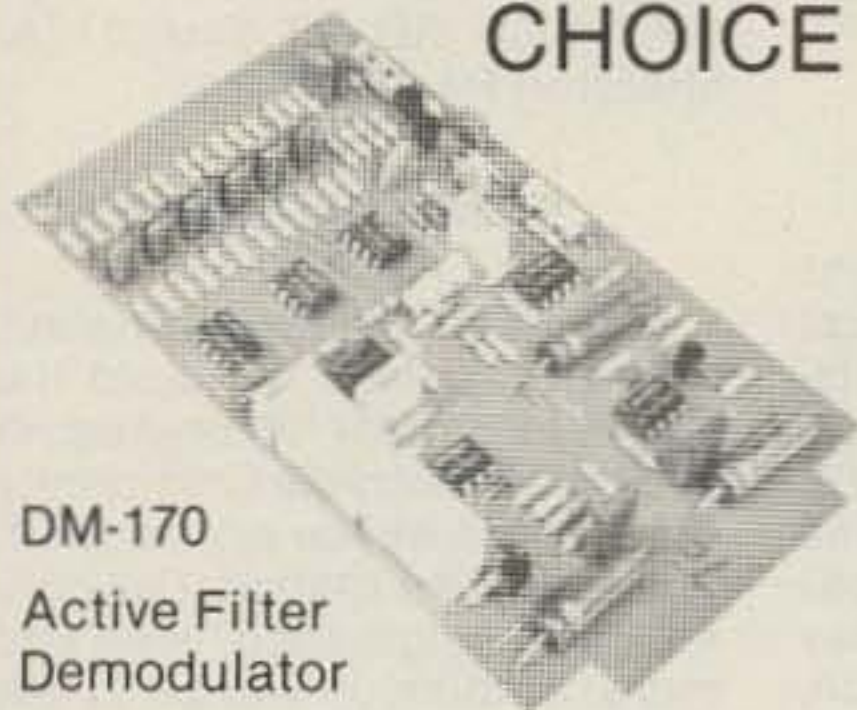

DM-170
Active Filter
Demodulator

Critical buyers are choosing the DM-170 RTTY demodulator to give them more features at lower cost. Write for information and compare. Discover what the critics have. **\$39.95 Kit \$59.95 Wired**

FLESHER CORP.
P.O. Box 976 F5
Topeka, Kansas 66601
(913) 234-0198



CONNECTOR ASSORTMENT

\$25.00 Postpaid **\$23.50** each lots of three

Includes: 5-PL259, 5-SO239, 5-UG175, 5-UG176, 2-PL258, 1-DM, 1-M358, 2-M359, 1-UG255, 1-UG273, 2-PL259PO, 1-1021-20, 1-Lightning Arrestor.

Master Charge & Visa accepted / Send for Free Catalog

COAKIT

P.O. Box 101-A Dumont, N. J. 07628
Circle C21 on Reader Service Card

KEY ELECTRONICS K14

P. O. BOX 3506 SCHENECTADY, N. Y. 12303

GOOD PRICES

Same day service - New Merchandise - No Surplus

Linear ICs

CA3240-Dual CA3140 op amp \$1.95 ea.
CA3189-FM IF System 3.95 ea.

Zener Diodes 1 Watt 10%

| | | | | | |
|--------|--------|---------|--------|--------|---------|
| 1N4735 | 6.2 V | .28 ea. | 1N4743 | 13.0 V | .28 ea. |
| 1N4739 | 9.1 V | .28 ea. | 1N4746 | 18.0 V | .28 ea. |
| 1N4742 | 12.0 V | .28 ea. | 1N4749 | 24.0 V | .28 ea. |

Transistors:

| | | | |
|-----------|------------------|--------|------------------|
| MPS 2222A | .25 ea. 5/\$1.00 | 2N3904 | .25 ea. 5/\$1.00 |
| MPS 2907A | .25 ea. 5/\$1.00 | 2N3906 | .25 ea. 5/\$1.00 |

Send check or money order. N.Y.S. residents add 4% sales tax. \$1.00 shipping and handling charge for orders under \$15.00.

Send .25 for complete list of merchandise.

\$5.00 minimum order.

ALL BAND TRAP ANTENNAS!



ALL 5 BAND OPERATION - ONLY ONE NEAT SMALL ANTENNA. FOR CONGESTED HOUSING AND APARTMENT DWELLERS! LIGHT, NEAT - ALMOST INVISIBLE!

FOR ALL MAKES AMATEUR HF TRANSMITTERS - TRANSRECEIVERS - GUARANTEED FOR 2,000 WATTS PEP POWER. FOR NOVICE AND ALL CLASS AMATEURS!

COMPLETE Ready to put up with 30 ft. Dacron end support cords! Wt. 3 lbs., 1"X5" MOLDED RESONANT TRAPS - just switch your transmitter to desired band for EXCELLENT PERFORMANCE!

NO TUNERS OR BALUNS NEEDED! CAN BE USED IN ATTICS, TOPS OF BUILDINGS. INVERTED Vs IN MINIMUM SPACE. NO CENTER SUPPORT NEEDED, NO HAYWIRE HOUSE APPEARANCE COMPLETELY ASSEMBLED. No tuning - cutting - soldering - measuring - JUST HANG IT, AND USE IT! SWR IS 1.2 AT RESONANCE THOUSANDS IN USE - EASIEST INSTALLATION!

80-40-20-15-10 meter bands---102 ft. with 90 ft. RG58U coax - connector - Model 998BU... \$49.95
40-20-15-10 meter bands---54 ft. with 90 ft. RG58U coax - connector - Model 1001BU... \$48.95
20-15-10 meter bands--- 26ft. with 90 ft. RG58U coax - connector - Model 1007BU... \$47.95

Send only \$5.00 (cash, ck., mo.) and pay postman balance plus COD postage OR SEND FULL PRICE FOR POST PAID DEL. IN USA (Canada is \$5.00 extra) or order by MAIL OR PHONE with BankAmericard VISA - MASTER CHARGE - OR AM EXP. Give number and ex. date. Ph 1-308-236-5333 week days. We ship in 2-3 days. INFLATION? PRICES MAY INCREASE - SAVE - ORDER NOW! INFO. AVAILABLE FROM. WESTERN ELECTRONICS Dept. A7- B Kearney, Nebraska, 68847

NEW! 5-Band Trap Dipole (80 thru 10Meters)



Pre-assembled: Model 370-11

Kit (illustrated): Model 370-12

Power rated 2kW PEP, approx. 110-ft span

Complete with • wire • traps • end insulators • 50 ft RG-8/U, PL-259 connector • heavy duty cast aluminum and steatite center connector.

At your B&W dealer.

4-Band (40 thru 10M), 55 ft model 370-13 also available, pre-assembled only.



Made in Bristol, Pennsylvania, by

Barker & Williamson Inc.

10 Canal Street □ Bristol, PA 19007

... at last ... your shack organized!

A beautiful piece of furniture - your XYL will love it!

\$13995 S-F RADIO DESK Deluxe - Ready to Assemble

Designed with angled rear shelf for your viewing comfort and ease of operation.

FINISHES: Walnut or Teak Stain. Also available in Unfinished Birch, \$124.95.

Additional Information on Request.

Checks, Money Orders, BankAmericard and Master Charge Accepted.

F.O.B. Culver City. (In Calif. Add 6% Sales Tax.) **S33**

S-F AMATEUR RADIO SERVICES

4384 KEYSTONE AVENUE • CULVER CITY, CALIF. 90230 — PHONE (213) 837-4870



Radio equipment not included

Floor Space: 39" Wide 30" Deep

FREQUENCY COUNTERS

FREE

By popular demand we are continuing to offer a Fairchild Clock, Module FCS-8100A (suggested retail \$20) with any purchase of \$99 or more from 73 advertisements.



Previously kitted for Crescomm Inc. by Hal-Tronix

SUMMER SALE

COMPLETE KITS: CONSISTING OF EVERY ESSENTIAL PART NEEDED TO MAKE YOUR COUNTER COMPLETE.
HAL-600A 7-DIGIT COUNTER WITH FREQUENCY RANGE OF ZERO TO 600 MHz. FEATURES TWO INPUTS: ONE FOR LOW FREQUENCY AND ONE FOR HIGH FREQUENCY; AUTOMATIC ZERO SUPPRESSION. TIME BASE IS 1.0 SEC OR .1 SEC GATE WITH OPTIONAL 10 SEC GATE AVAILABLE. ACCURACY $\pm .001\%$. UTILIZES 10-MHz CRYSTAL 5 PPM.

COMPLETE KIT was 149.00 now 129.00

HAL-300A 7-DIGIT COUNTER WITH FREQUENCY RANGE OF ZERO TO 300 MHz. FEATURES TWO INPUTS: ONE FOR LOW FREQUENCY AND ONE FOR HIGH FREQUENCY; AUTOMATIC ZERO SUPPRESSION. TIME BASE IS 1.0 SEC OR .1 SEC GATE WITH OPTIONAL 10 SEC GATE AVAILABLE. ACCURACY $\pm .001\%$. UTILIZES 10-MHz CRYSTAL 5 PPM.

COMPLETE KIT was 124.00 now 109.00

HAL-50A 8-DIGIT COUNTER WITH FREQUENCY RANGE OF ZERO TO 50 MHz OR BETTER. AUTOMATIC DECIMAL POINT, ZERO SUPPRESSION UPON DEMAND. FEATURES TWO INPUTS: ONE FOR LOW FREQUENCY INPUT, AND ONE ON PANEL FOR USE WITH ANY INTERNALLY MOUNTED HAL-TRONIX PRE-SCALER FOR WHICH PROVISIONS HAVE ALREADY BEEN MADE. 1.0 SEC AND .1 SEC TIME GATES. ACCURACY $\pm .001\%$. UTILIZES 10-MHz CRYSTAL 5 PPM.

COMPLETE KIT was 124.00 now 109.00

HAL-TRONIX BASIC COUNTER KITS STILL AVAILABLE

THE FOLLOWING MATERIAL DOES NOT COME WITH THE BASIC KIT: THE CABINET, TRANSFORMER, SWITCHES, COAX FITTINGS, FILTER LENS, FUSE HOLDER, T-03 SOCKET, POWER CORD AND MOUNTING HARDWARE.

| | |
|--|----------|
| HAL-600X (Same Specifications as HAL-600A) | \$124.00 |
| HAL-300X (Same Specifications as HAL-300A) | \$89.00 |
| HAL-50X (Same Specifications as HAL-50A) | \$89.00 |

PRE-SCALER KITS

HAL-0-300PRE (Pre-drilled G10 board and all components) \$19.95

HAL-0-300P/A (Same as above but with preamp) \$24.95

HAL-0-600PRE (Pre-drilled G10 board and all components) \$34.95

HAL 600PA (same as 600PR except with pre-amp) \$39.95

ATTN: RADIO CLUBS

Please feel free to inquire about quantity discounts on any of the HAL-TRONIX kits for your Club projects. Discount schedule ranges from 10% to 25% depending upon how many kits will be required.



"HAL" HAROLD C. NOWLAND
WBZXH

HAL-TRONIX H24

P. O. BOX 1101

SOUTHGATE, MICH. 48195

PHONE (313) 285-1782

SHIPPING INFORMATION:

ORDERS OVER \$15.00 WILL BE SHIPPED POSTPAID EXCEPT ON ITEMS WHERE ADDITIONAL CHARGES ARE REQUESTED. ON ORDERS LESS THAN \$15.00 PLEASE INCLUDE ADDITIONAL \$1.00 FOR HANDLING AND MAILING CHARGES.

SEND SASE FOR FREE FLYER

icut. General admission will be \$.50, and vendor spaces are \$5.00 each. For further information, contact Mike WA1PXM at 934-1063 or Dave WA1ZWB at 467-3258 (area code 203).

HUNTSVILLE AL AUG 20

The North Alabama hamfest will be held on Sunday, August 20, 1978, at The Mall in Huntsville AL. There will be prizes, a large flea market, an ARRL forum, MARS meetings, and ladies activities. A hamfest supper will be held on Saturday night. For more information, write to N.A.H.A., PO Box 423, Huntsville AL 35804.

MARSHALLTOWN IA AUG 20

The Iowa 75 Meter Net will hold its annual potluck picnic and hamfest on Sunday, August 20, 1978, at Riverside Park in Marshalltown, Iowa. After the 12:00 noon meal, there will be a short program with awards and prizes given to attending amateurs. All are welcome.

LAFAYETTE IN AUG 20

The Tippecanoe Amateur Radio Association, Inc., will hold its eighth annual hamfest on Sunday, August 20, 1978, at the Tippecanoe County Fairgrounds, Lafayette, Indiana. From Interstate 65, take the Indiana 25 South exit and stay on Indiana 25 to the fairgrounds. There will be major pre-registration and attendance prizes. To be eligible for pre-registration prizes, tickets must be purchased in advance before August 10, 1978. Plenty of shaded parking with easy access to the flea market. Camping on the grounds, with limited electricity, is available from Friday night through Sunday night. Food and drinks will be available, also. Tickets are \$2.00 each by mail or at the gate, with no extra charge for the flea market setup. Talk-in on 146.13/.73 and 146.94 simplex. To purchase tickets, send an SASE with a check to Bill Bayley WA9ZDI, 1021 Beck Lane, Lafayette IN 47905.

MANSFIELD PA AUG 26

The Tioga County ARC hamfest will be held on Saturday, August 26, starting at 9:00 am at the Tioga Co. Fair Grounds on Rt. 6 between Wellsboro and Mansfield PA. The \$2.00 admission is good for all special programs, and the XYL and children are free. In addition to the usual flea market and displays, a bingo table and other items of interest will be available for the ladies. The

Pennsylvania Grand Canyon is within a short distance. Talk-in on 19/79, 52 simplex, and CB channel 5. For more information, write to Denny Vorhees WA3FWQ, RD #2 Box 117A, Millerton PA 16936.

WENTZVILLE MO AUG 27

The Saint Charles Amateur Radio Club, Inc., will hold the SCARC Hamfest '78 on August 27 at the Wentzville Community Club. There will be prizes, food, and fun—flea market, CW contest, free bingo, food, beer, and more. Admission will be \$1 per car. Talk-in on 34/94 and 07/67. For motel and camping information, prize lists, dealer reservations, and airport pickup, write to SCARC, PO Box 1429, St. Charles MO 63301.

LAPORTE IN AUG 27

The LaPorte County Summer Hamfest, sponsored by the Michigan City and LaPorte Amateur Radio Clubs, is Sunday, August 27, at the LaPorte County Fairgrounds, LaPorte IN. Dealers may set up beginning at 6:00 am and the general public is welcome beginning at 8:00 am. Lots of space indoors and also outdoors on a paved, dust-free midway. Free tables and good food. LaPorte is 50 miles southeast of Chicago on Indiana #2. Talk-in on .01/.61, .37/.97, and .52 simplex. Donation is \$2.00 at the gate. For more information, contact LPARC, PO Box 30, LaPorte IN 46350.

ST. CHARLES IL AUG 27

The Fox River Radio League Hamfest will be held indoors at the Kane Co. Fairgrounds on Sunday, August 27, 1978, at 8:00 am. Activities include commercial sales and exhibits, a used equipment market, door prizes, and a drawing for a Kenwood TS-520S and a Midland 13-500 transceiver. Talk-in on 146.94. Tickets are \$2.00 at the gate and \$1.50 in advance. For further info, contact Don Beridge WB9PAC, 2303 Deerfield Way, Geneva IL 60134.

MORGANTOWN WV SEP 3

The Monongalia Wireless Association will hold its second annual Mon Ham Gala on Sunday, September 3, 1978, at Westover Park, 300 yards off I-79, near Morgantown, West Virginia. The activities begin at 10:00 am and end at 5:00 pm. Talk-in on 16/76. For complete information, contact John Curtis WB8AHH, 817 Willowdale Road, Morgantown WV 26505.

CALL TOLL FREE

1-800-228-4097

Communications Center

443 N 48th Street C58

Lincoln, Nebraska 68504

In Nebraska Call (402)466-8402

1-800-634-6227

Communications Center West

C58

1072 N. Rancho Drive

Las Vegas, Nevada 89106

In Nevada Call (702)647-3114

Antenna Sale!



CUSHCRAFT
ATB-34

MOSLEY CL-36



| HY-GAIN | | Regular | Special |
|----------|------------------------------|-----------|-----------|
| TH6-DXX | Super Thunderbird | \$ 249.95 | \$ 209.95 |
| TH3-MK3 | 3 ele. 10, 15, 20 Mtr. beam | 199.95 | 169.95 |
| Hy-Quad | 2 ele. Quad 10, 15, 20 Mtr. | 219.95 | 189.95 |
| TH3-Jr. | 3 ele. 10, 15, 20 Mtr. beam | 144.50 | 129.95 |
| 18 HT | Hy-Tower 10-80 Mtr. Vertical | 279.95 | 239.95 |
| 14AVQ/WB | 10-40 Mtr. Trap Vertical | 67.00 | 57.00 |
| 18AVT/WB | 10-80 Mtr. Trap Vertical | 97.00 | 84.95 |
| 203 | 3 ele. 2 Mtr. beam | 12.95 | |
| 205 | 5 ele. 2 Mtr. beam | 16.95 | |
| 208 | 8 ele. 2 Mtr. beam | 19.95 | |
| 214 | 14 ele. 2 Mtr. beam | 26.95 | |

| MOSLEY | | Regular | Special |
|------------|-----------------------------|---------|---------|
| Classic 33 | 3 ele. 10, 15, 20 Mtr. beam | 232.50 | 189.95 |
| Classic 36 | 6 ele. 10, 15, 20 Mtr. beam | 310.65 | 249.95 |
| TA-33 | 3 ele. 10, 15, 20 Mtr. beam | 206.50 | 169.95 |
| TA-36 | 6 ele. 10, 15, 20 Mtr. beam | 335.25 | 279.95 |
| TA-33 Jr. | 3 ele. 10, 15, 20 Mtr. beam | 151.85 | 129.95 |
| TA-40KR | 40 Mtr. add on | 92.25 | 74.95 |

| CUSHCRAFT | | Regular | Special |
|-----------|-----------------------------|---------|---------|
| ATB-34 | 4 ele. 10, 15, 20 Mtr. beam | 259.95 | 209.95 |
| ARX-2 | 2 Mtr. Ringo Ranger | 36.95 | 32.95 |
| A147-20T | 2 Mtr. Twist | 59.95 | 52.95 |
| A144-10T | 10 ele. Twist 2 Mtr. | 39.95 | 32.95 |
| A144-20T | 20 ele. Twist 2 Mtr. | 59.95 | 52.95 |

| HUSTLER | | Regular | Special |
|----------|----------------------------|---------|---------|
| 4BTW | 10-40 Mtr. Trap Vertical | 99.95 | 82.95 |
| RM-75 | 75 Meter Resonator | 15.50 | 13.50 |
| RM-75s | 75 Meter Super Resonator | 30.00 | 26.50 |
| G6-144-A | 6 db. 2 Mtr. Base Colinear | 67.55 | 57.95 |

| WILSON | | Regular | Special |
|------------|-----------------------------|---------|---------|
| System One | 5 ele. 10, 15, 20 Mtr. beam | 274.95 | 239.95 |
| System Two | 4 ele. 10, 15, 20 Mtr. beam | 219.95 | 189.95 |

| CDE ROTORS | |
|------------------|----------|
| Ham III | \$125.00 |
| T2X Tail Twister | \$249.00 |
| CD-44 | \$105.00 |

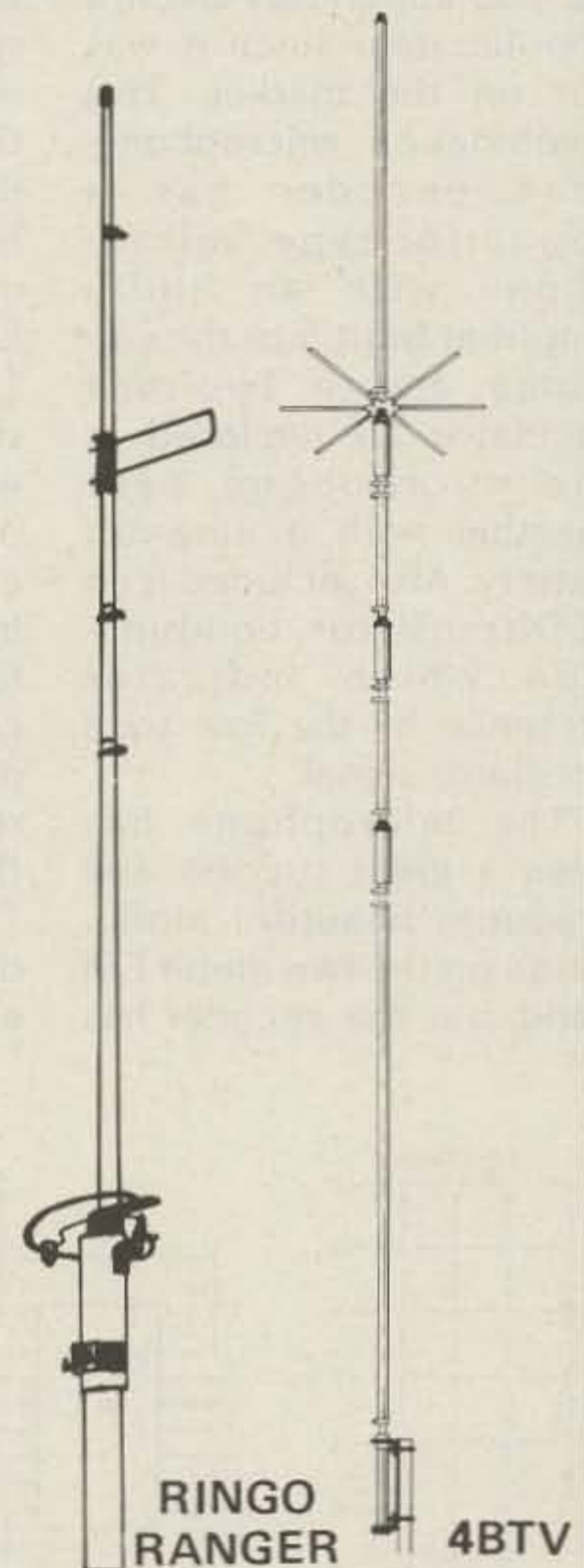

RINGO
RANGER

4BTW



18HT

We carry all major brands of ham radios AT DISCOUNT PRICES

Yaesu — Kenwood — Drake — ICOM — Dentron —
Ten-Tec — Swan — Tempo — Midland — E.T.O. — Wilson

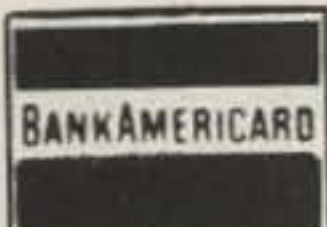

The End of Autopatch Embarrassment

—don't get caught
with your Micoder™ down

The Heath Micoder™ has apparently been a popular item since it was put on the market. This combination microphone/tone encoder has a capacitor-type microphone with an audio amplifier built into the cartridge and a two-tone oscillator all enclosed in the microphone case together with a nine-volt battery. Also included is an LED/transistor combination which indicates presence of the low tone oscillator signal.

The microphone has been a great success and produces beautiful modulation on the two meter FM band, but the encoder has

given some problems. Although I have not specifically pinpointed a reason for unreliability of the encoder, I believe that the use of the 555 IC in a hostile (mobile) environment is the biggest culprit. Even though Heath uses 1-percent precision resistors in the feedback network to obtain the desired output frequency, difficulty has been experienced in obtaining the frequency tolerance necessary to access various repeater autopatches. (See K4JEM's review of the Micoder in the August, 1977, issue of 73 for a more detailed discussion of construction and performance.)

My Micoder was built in conjunction with the Heath HW-2036 synthesized two meter transceiver. Although the Micoder went together without difficulty, the output frequencies were just barely within the tolerance specified by Heath. After installation of the rig in my car (and debugging the 2036), the encoder would act erratically on the two most popular local repeaters. Several times, I got the patch up and couldn't get it back down—a very embarrassing situation, especially when no one was around with an encoder to give an assist. Since I already had one of the Motorola MC14410 2-of-8 tone encoder ICs from some other experiments, I decided to design a PC board and fit it into the microphone case. The circuitry of the MC14410 is very simple and presents no real difficulty getting it into the microphone case with room to spare. I'm somewhat surprised that Heath didn't choose this way to go, considering the simplicity, parts count (13 versus 36), power drain on the battery (1.5 mA versus

12 mA), and the lack of frequency adjustments with the MC14410.

The circuit that I am using is shown in Fig. 1. With the exception of the level control, there are no adjustments. The 1 megahertz crystal was a junk box item and measured 239 Hertz high when used in this circuit. A small trimmer capacitor could be installed across the crystal if desired to put it right on frequency, but I didn't feel it was necessary. The combining resistors off pins 2 and 15 were chosen arbitrarily since plenty of output was available. The 4.7k resistor on the output of the level control was installed to match the microphone circuit. The only minor problem encountered was the power supply of the Heath circuit versus the MC14410 circuit. The 14410 requires a supply voltage in the range of 4 to 6 volts, with 6 volts being the maximum upper limit. I decided that it was desirable to retain use of the 9-volt battery in the mike case to power the audio amplifier in the microphone cartridge, and, therefore, some means of dropping approximately 3.5 volts had to be devised. Since zener diodes in this range were not available to put in series with the battery, I elected to put six 1N914s in series to accomplish the same purpose. These six diodes drop about 3.6 volts under the 1.5 mA load and provide approximately 5.6 volts to the 14410. This arrangement works beautifully, is very inexpensive considering the cost of 1N914s today, and does not waste power (very important in today's energy-conscious world).

The encoder schematic is shown in Fig. 1 together with keyboard connections. Note that the 1N914s are soldered together in a

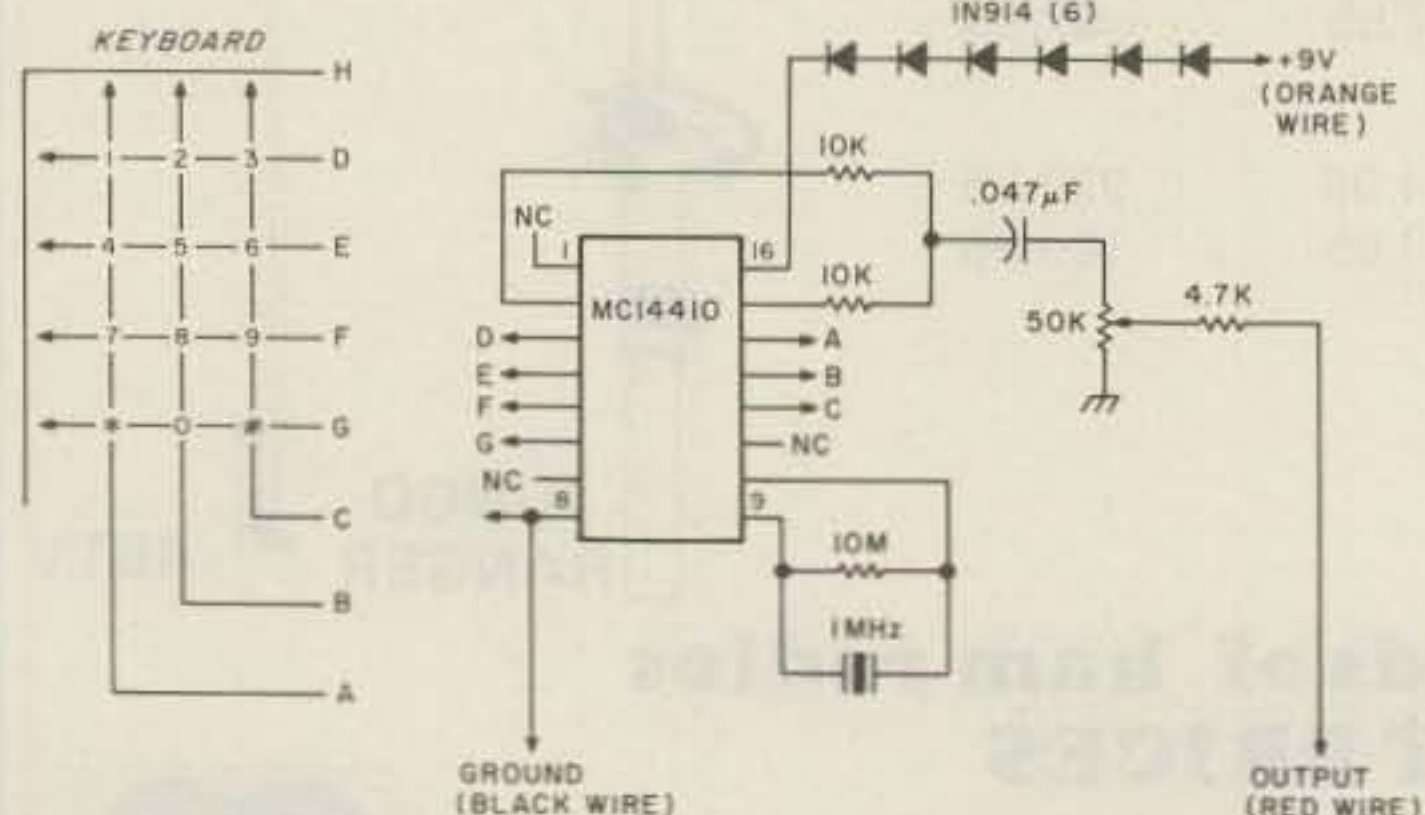

Fig. 1. MC14410 encoder. Notes: (1) All resistors are 1/4 W. (2) 1N914s are soldered in a string and installed on the circuit board. (3) The crystal is in an HC6/U holder.

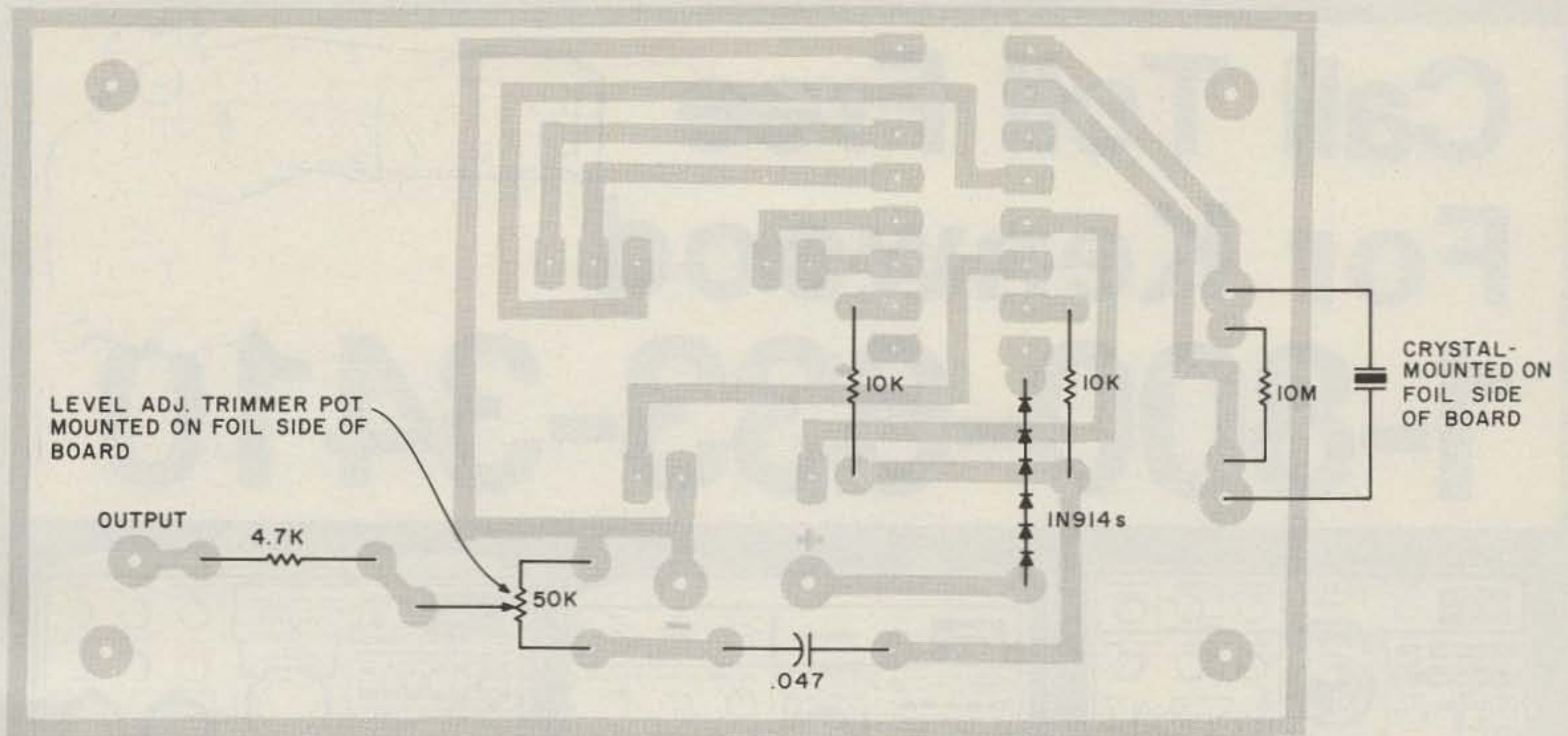

Fig. 2. Component layout.

"string" with very short leads prior to mounting on the PC board. The crystal and output level trimmer are mounted on the foil side of the board. Mounted in this manner, the crystal fits nicely between the mounting posts of the microphone case and the trimmer adjustment is readily accessible. The MC14410 must be soldered directly to the PC board to allow clearance for the

Chomerics keyboard. Likewise, the keyboard pins are soldered to the PC board. Before soldering the keyboard, assemble the PC board and keyboard into the mike case and check the mounting holes for the four retaining screws. If necessary, enlarge the mounting holes in the PC board to ensure proper fit of the keyboard and PC board into the case. The outer foil on the PC board

layout serves no purpose other than a trimming outline for the board. The component layout is shown in Fig. 2, and a PC board layout is shown in Fig. 3. Unused pins (#1, #7, and #11) on the MC14410 may be bent up out of the way or cut off.

After completion, solder the red, black, and orange wires from the mike case to the pad on the PC board and you're ready to give it

a try. Adjust the level pot about midway and try the local autopatch. Either increase or decrease the level adjustment as necessary to obtain the proper deviation. My 2036 requires about 90 mV for reliable operation of the encoder.

My encoder has worked without fail, and I recommend it to anyone having trouble with the Micoder circuitry. ■

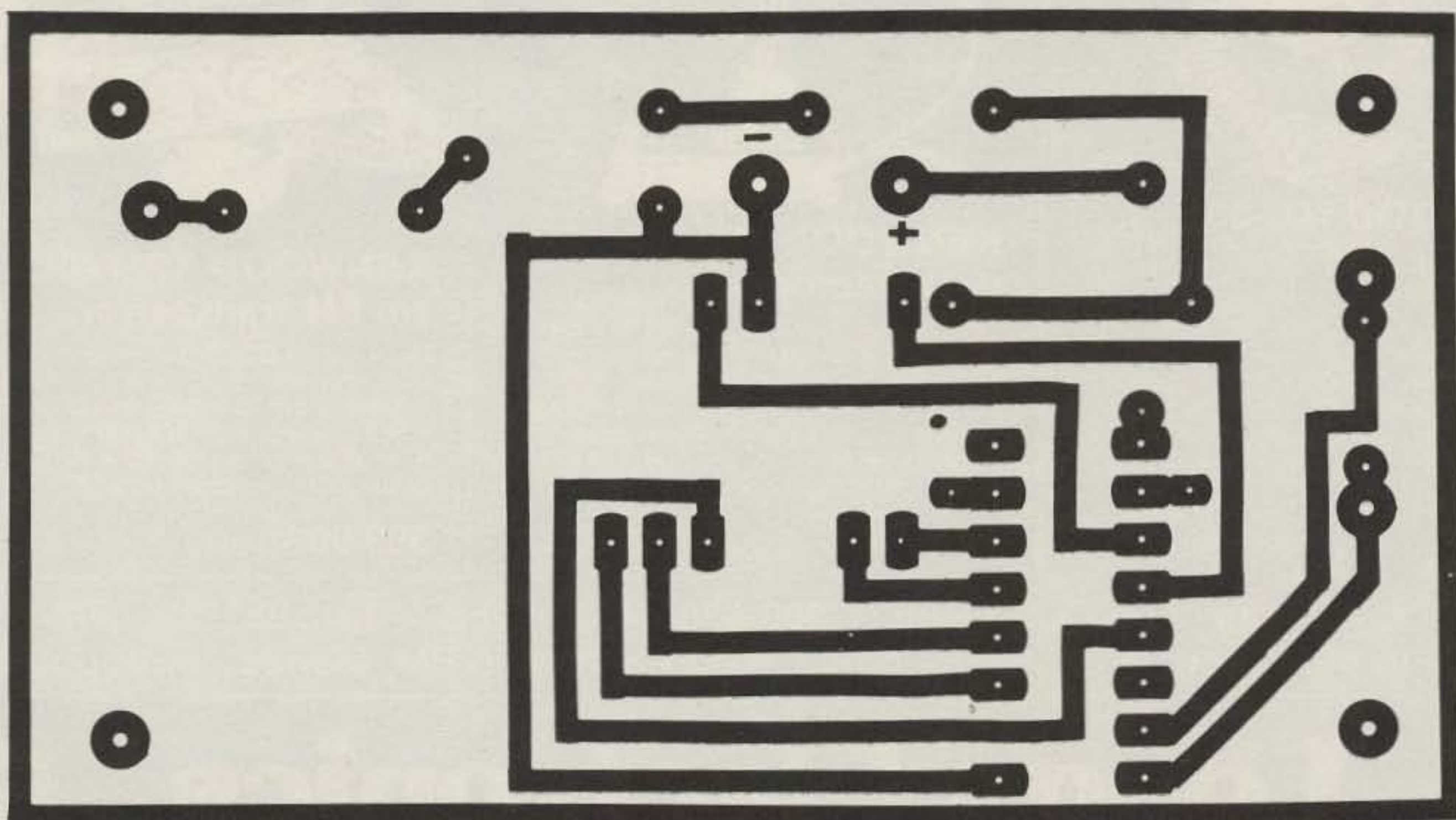
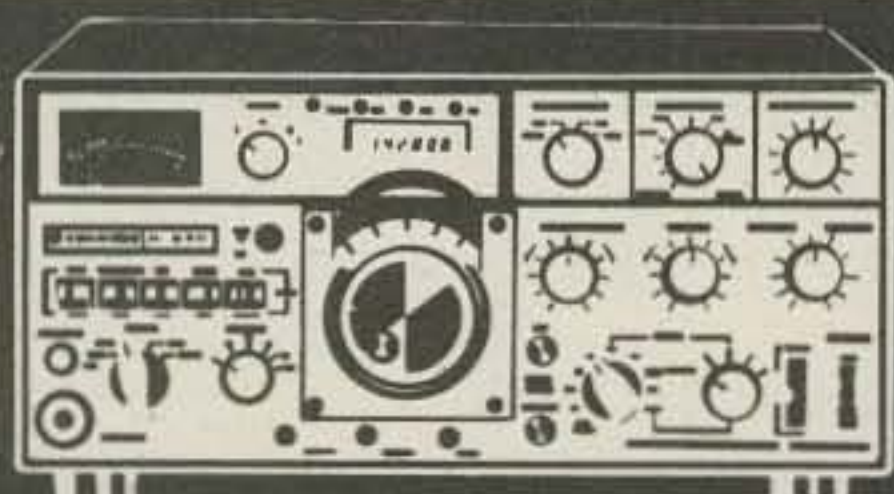
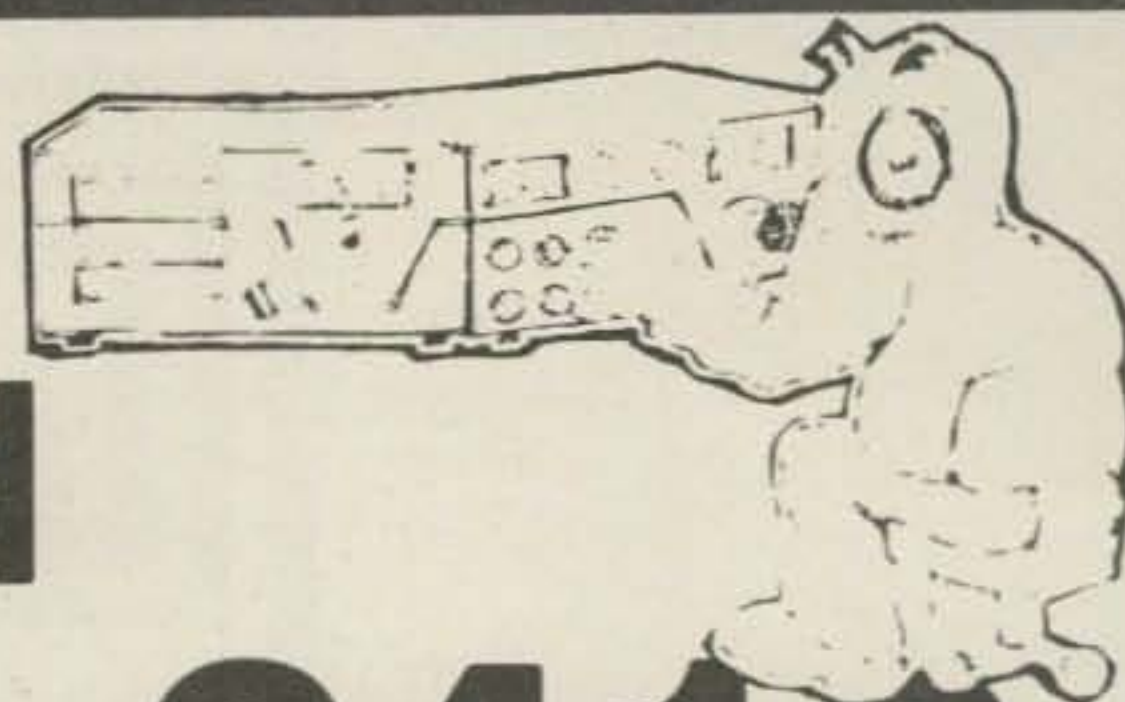

Fig. 3. PC board.

Call Toll Free For Kenwood 1-800-633-3410



The NEW KENWOOD R-820 triple-conversion receiver

The R-820 covers 160 thru 10 meters plus several shortwave broadcast bands. Features: • 8.33 MHz, 455 kHz, & 50 kHz IFs • Digital readout • Notch filter • IF shift • Variable bandwidth tuning • Noise blanker • Stepped RF attenuator • 25 kHz calibrator • RIT switch • Modes: AM, CW, USB, LSB, RTTY • Transceive/separate switch.

1049.00 list price. Call for quote.

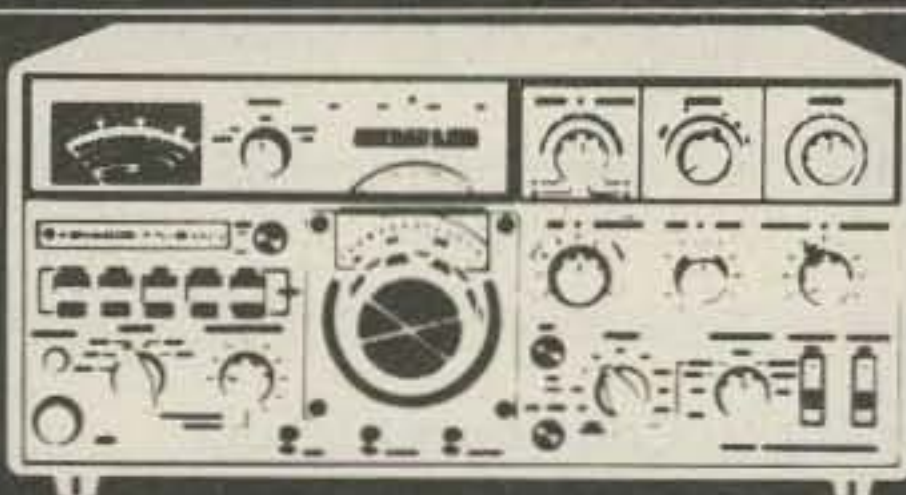

KENWOOD TS-820S transceiver

The NEW Kenwood TS-820S features a factory installed digital frequency readout. • 160 thru 10 meter coverage • Integral IF shift • RF speech processor • VOX • Noise blanker • PLL • Built-in 25 KHz calibrator • CW side tone & semi-break-in • IF OUT, RTTY, & XVTR • Phone patch IN and OUT terminals.

1098.00 list price. Call for quote.

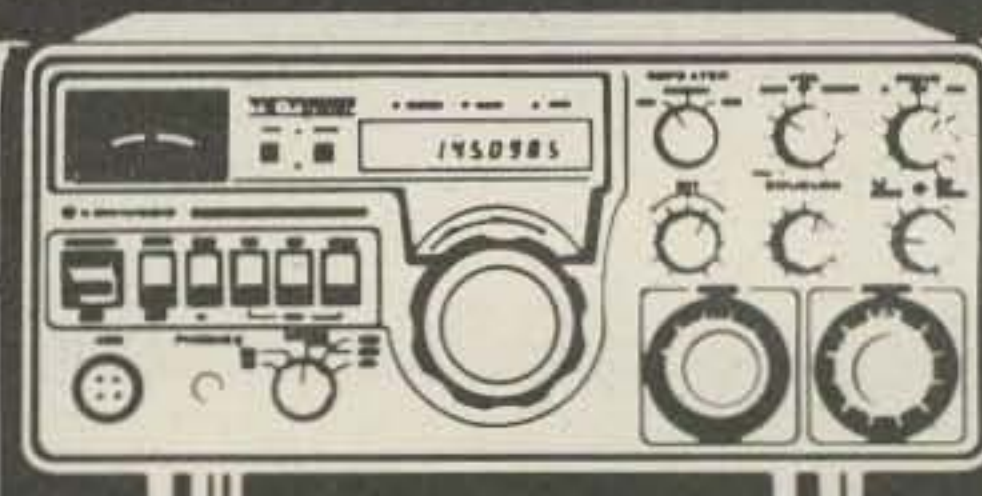

KENWOOD TS-700SP all mode 2m transceiver

Includes SSB, CW, FM, AM, Semi-break-in CW. Features: • Sidetone monitor • Digital frequency readout • Receiver preamp and 600-KHz repeater offset operation within all 2m repeater subbands including the new 144.5-145.5 MHz subband • 10 watts RF output complete with AC & DC power supply.

729.00 list price. Call for quote.



KENWOOD MC-35S dynamic mic

The MC-35S is a 50 K ohms, impedance, dynamic hand held mic. A 2-position switch lets you operate in a quiet mobile or fixed station or select noise cancelling for use in high ambient noise environments. MC-30S: same as MC-35S but 500 ohms, low impedance for TS-7400/7500.

24.95 Call for yours today.

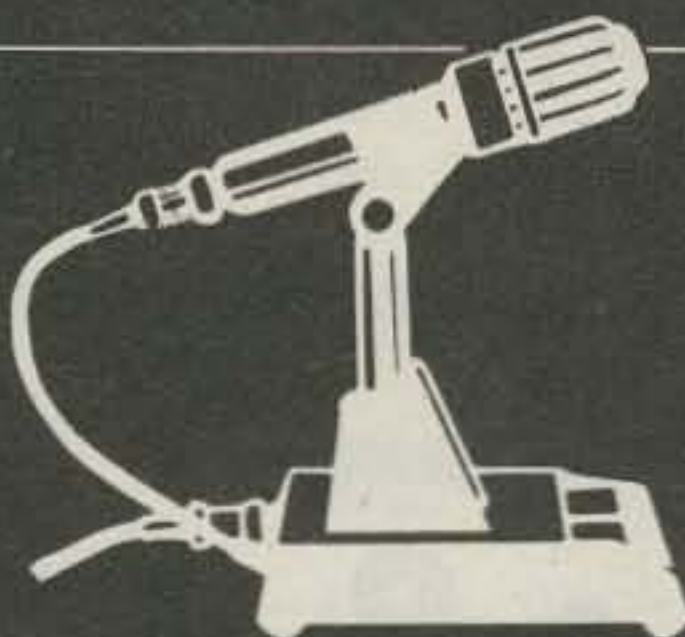

KENWOOD MC-50 desk microphone

The MC-50 dynamic mike has been designed expressly for amateur radio operation. • Complete with PTT & LOCK switches • Easy conversion from HI to LOW impedance • Unidirectional • Mike plug on coil cord for instant hook-up to any Kenwood rig.

39.50 list price. Call for quote.



KENWOOD TR-7400A 5m FM transceiver

Features: • CTCSS provisions, encode and decode • 25 watt output RF • Solid-state final stage • LED readout • PLL gives 800 discrete channels • Repeater offset circuit • PLL unlock protection circuit • MOS FET.

399.00 list price. Call for quote.

Remember, you can call TOLL-FREE: 1-800-633-3410 in U.S.A. or call 1-800-292-8668 in Alabama to place your order. Store hours: 9:00 AM til 5:30 PM, Monday through Friday.



Long's Electronics

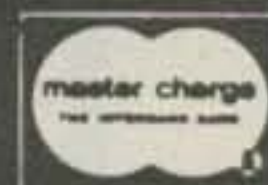

MAIL ORDERS: P.O. BOX 11347 BIRMINGHAM, AL 35202 • STREET ADDRESS: 2808 7TH AVENUE, SOUTH BIRMINGHAM, ALABAMA 35233

Call Toll Free For Drake

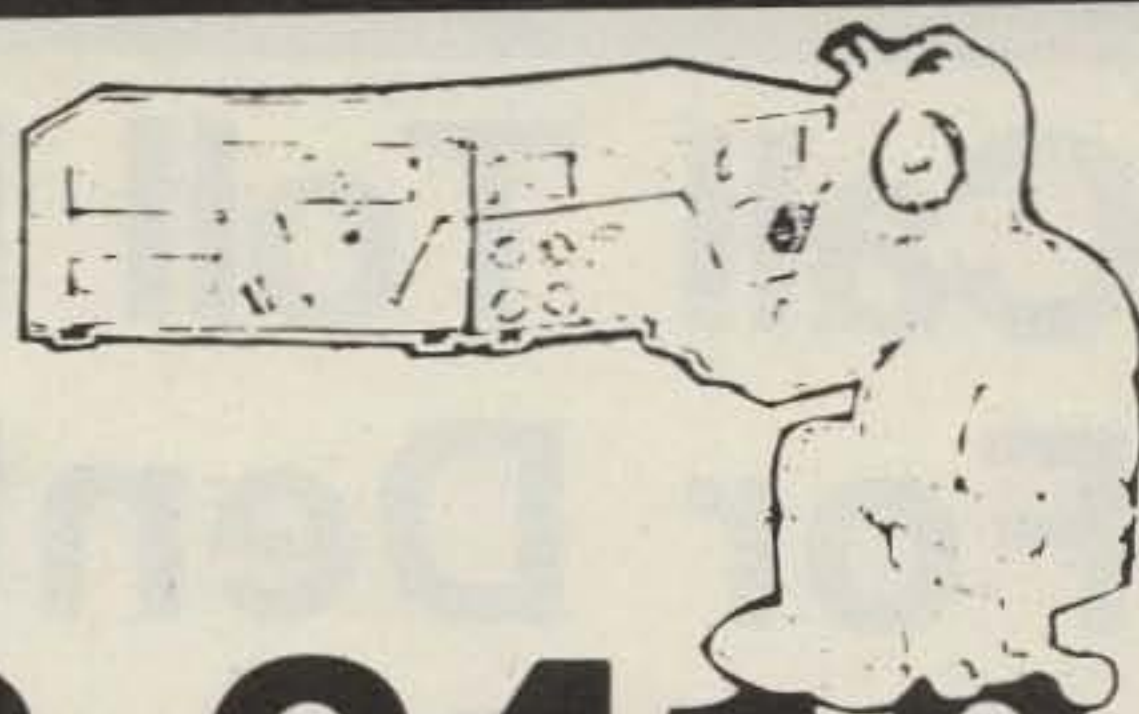

1-800-633-3410

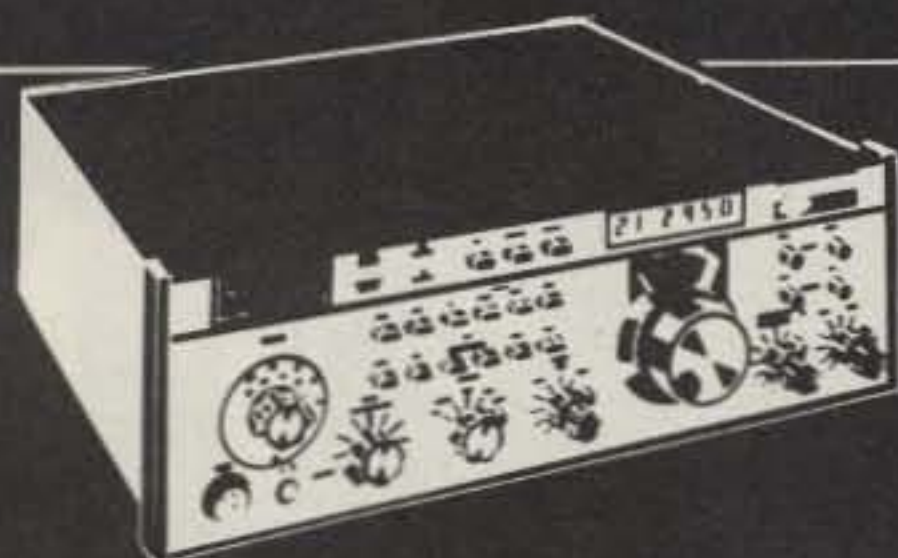

DRAKE TR-7/DR7 HF transceiver

TR-7 is solid-state, continuous coverage and synthesized. TX or RX SSB, CW, RTTY, or AM independently. Noise blanker. Special high power solid-state PA. Internal test facilities: S-meter, RF wattmeter, VSWR bridge, and digital freq. counter reads to 150 MHz for tests. RIT. Power: 250W PEP input. Frequency: 1.5 to 30 MHz.

1072.00 list price. Call for quote.



DRAKE 1525 EM microphone

The auto-patch encoder and microphone are a single unit, fully wired and ready to use • High accuracy IC tone generator, no frequency adjustments • High reliability Digitran* keyboard • Power for tone encoder from transceiver via mic cable • Encoder audio level adjustable from 1mV to 5mV with internal potentiometer • Low output impedance • 4-pin plug.

49.95 Call for yours today.



DRAKE TR-33C 2m transceiver

- 12 channel provision (2 supplied)
- All FET front-end crystal filter for superb intermod. rejection • Ni-Cad cells supplied • Built-in charger • Low power drain circuit on squelched receive • Lighted dial when using external power.

229.00 list price. Call for quote.



DRAKE MN-2000 matching network

- Frequency coverage: 3.5 to 4.0 MHz, 7.0 to 7.3 MHz, 14.0 to 14.35 MHz, 21.0 to 21.45 MHz, 28.0 to 29.7 MHz • Input impedance: 50 ohms resistive • Insertion loss: 0.5 dB or less • Wattmeter accuracy 5% of reading • 1000 watts RF continuous, 2000 W PEP.

250.00 list price. Call for quote.



DRAKE MN-4C matching network

New MN-4C features: 160 thru 10 meters coverage • Matches coax FED, long wire, or balanced line antennas with optional 4:1 balun (24.95) • Handles 250 watts continuous RF output • Built-in RF watt meter/VSWR bridge • Unique "low-pass filter" design provides significant harmonic reduction to fight TVI.

165.00 list price. Call for quote.

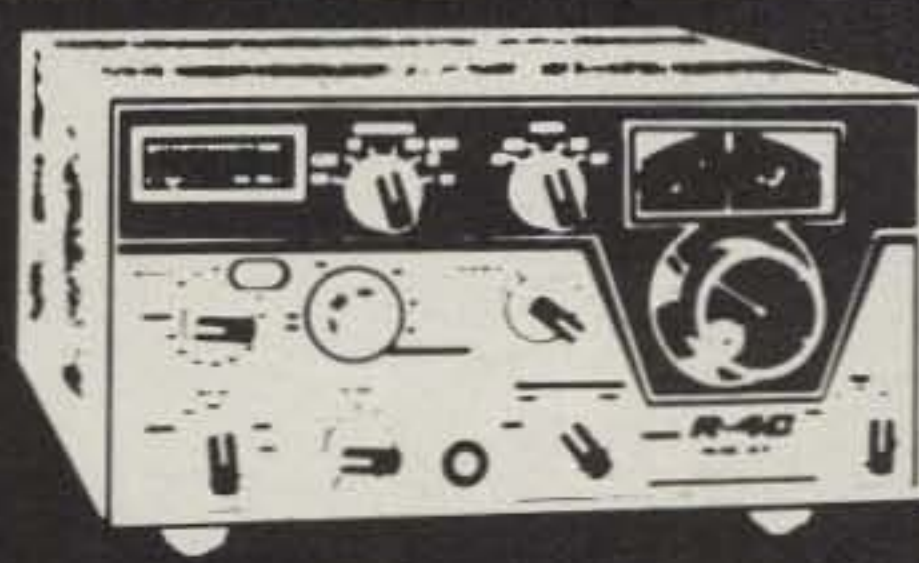

DRAKE R-4C receiver

R-4C has same coverage as the T-4XC, plus any 500 KHz range between 1.5 and 30 MHz • Also use for MARS, WWV, CB, Marine & Shortwave reception • Linear permeability-tuned VFO • 3 AGC release times • Crystal lattice filter in first IF prevents cross-modulation.

699.00 list price. Call for quote.

Remember, you can Call Toll Free: **1-800-633-3410** in the U.S.A. or call **1-800-292-8668** in Alabama for our low price quote. Store hours: 9:00 AM til 5:30 PM, Monday thru Friday.



Long's Electronics



MAIL ORDERS: P.O. BOX 11347 BIRMINGHAM, AL 35202 • STREET ADDRESS: 2808 7TH AVENUE, SOUTH BIRMINGHAM, ALABAMA 35233

Call Toll Free For Dentron 1-800-633-3410

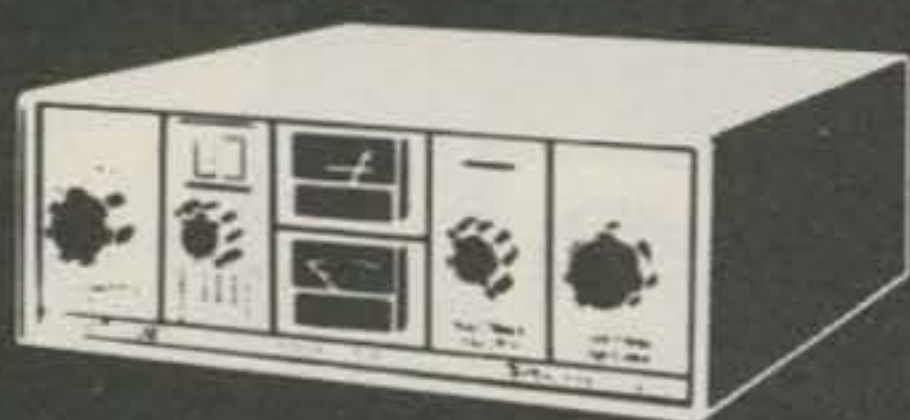
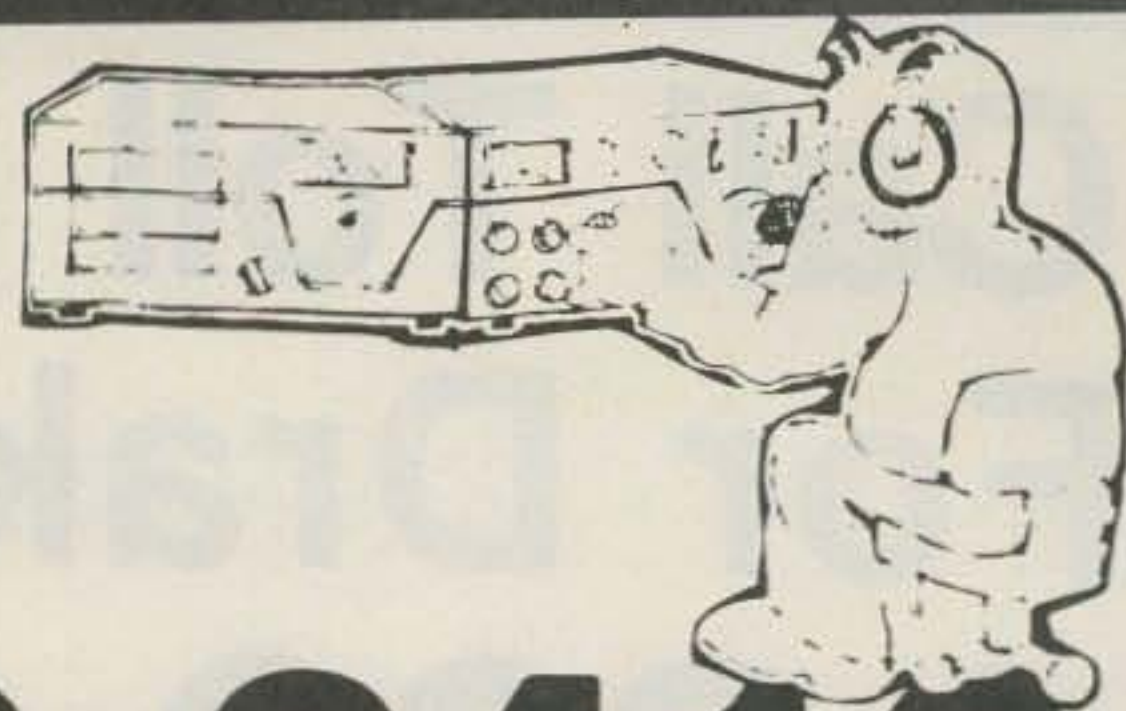

DENTRON MT-3000A antenna tuner

The MT-3000A is Dentron's "ultimate tuner". Tunes 3 coax, random wire and balanced feed system, just select the one. Handles in excess of 3KW PEP

- Built-in 50 ohm - 250W dummy load
- Dual watt meters • 3 core heavy-duty Balun.

349.50 list price. Call for quote.



DENTRON MT-2000A antenna tuner

An economical, full power tuner designed to handle virtually any type of antenna. Features:

- Continuous tuning 1.8 to 30 MHz
- Handles a full 3 KW PEP
- Front panel coax bypass switching
- Built-in 3-core balun
- Front panel grounding switch.

199.50 list price. Call for quote.



DENTRON Big Dummy Load

Tune-up off the air with Dentron's Big Dummy Load. All full power dummy load, it has a flat SWR, full frequency coverage from 1.8 to 300 MHz. A high grade industrial cooling oil is furnished with the unit. Fully assembled and warranted. Help cut out the QRM factor NOW!

29.50 Call for yours today

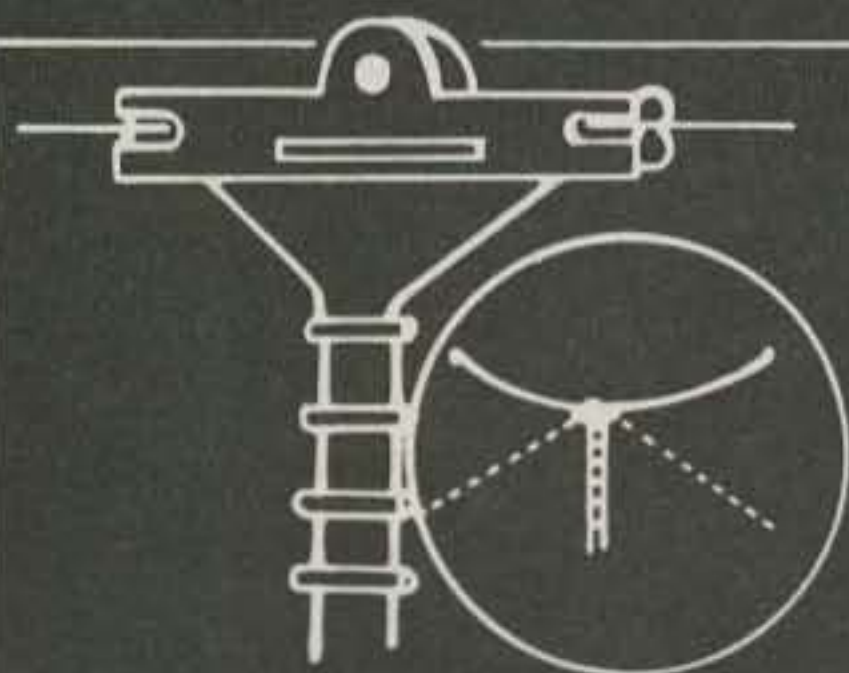

DENTRON All Band Doublet antenna

- Has a total length of 130 feet (14 ga. stranded copper)
- Center fed through 100 ft. of 470 ohm PVC covered balanced transmission line
- Assembly complete
- Tune 10 thru 160 with one antenna
- (Requires antenna tuner).

24.50 Call for yours today.



DENTRON MLA-2500 linear amplifier

- Continuous duty power supply
- 160 thru 10 meter coverage
- 2000+ watts PEP input on SSB
- 1000 watts DC input on CW, RTTY, SSTV
- Two external-anode ceramic/metal triodes operating in grounded grid
- Covers MARS w/o modifications
- 50 ohm input/output impedance
- Built-in RF watt meter.

799.50 list price. Call for quote.

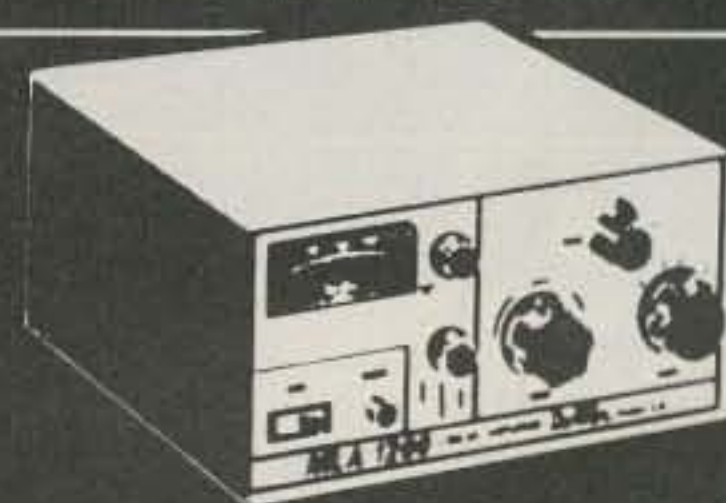

DENTRON MLA-1200 linear amplifier

The MLA-1200 is designed to fill the gap between your barefoot transceiver & a full 2 KW amplifier.

- Single external-anode ceramic metal triode yields 1200 watts PEP on SSB & 1000 W DC on CW
- Most other features same as MLA 2500
- AC power supply is list priced at 159.50
- DC power supply available

399.50 list price. Call for quote.

Remember, you can call TOLL-FREE: 1-800-633-3410 in U.S.A. or call 1-800-292-8668 in Alabama to place your order. Store hours: 9:00 AM til 5:30 PM, Monday through Friday.



Long's Electronics

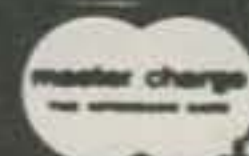

MAIL ORDERS: P.O. BOX 11347 BIRMINGHAM, AL 35202 • STREET ADDRESS: 2808 7TH AVENUE SOUTH BIRMINGHAM, ALABAMA 35233

Call Toll Free For Yaesu



1-800-633-3410

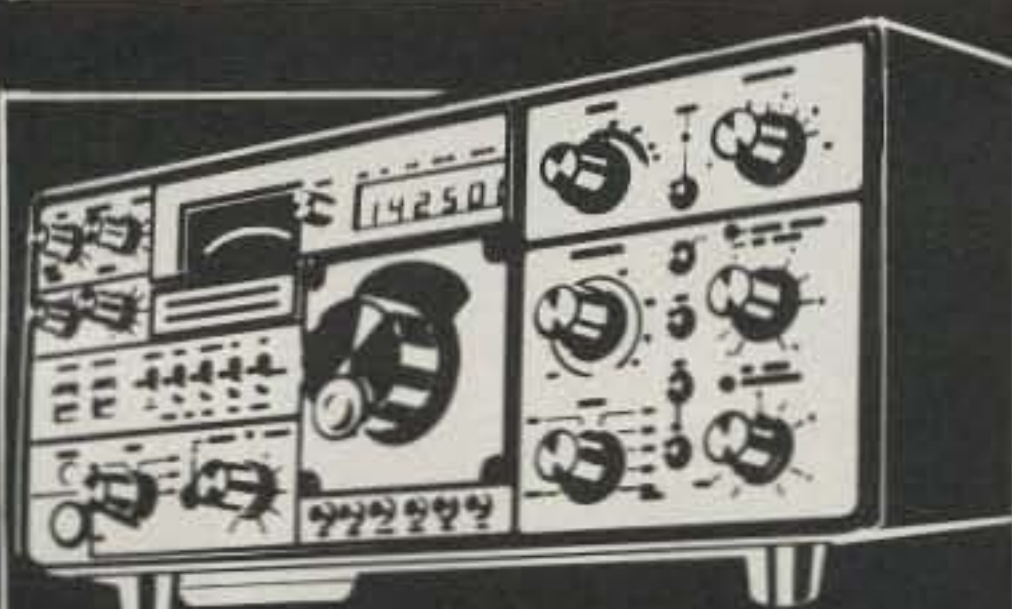

YAESU FT-901DM HF transceiver

Check these: • Reject tuning • Variable IF band width tuning • Audio peak frequency tuning • Digital LED frequency display w/memory for TX & RX, no external VFO required for split frequency operation • Built-in Curtis keyer • Rugged GE 6146B final tubes • 160 thru 10 meter coverage & much more!

1299.00 list price. Call for quote.



YAESU FT-101E transceiver

FT-101E is completely solid-state • Coverage: 160 thru 10 meters • Built-in AC/DC power supplies • Built-in RF speech processor • 260 watts PEP on SSB, 180 watts on CW, 80 watts on AM • Solid-state VFO • VOX • Auto break-in CW sidetone • WWV/JJY reception • Heater switch.

799.00 list price. Call for quote.



YAESU FT-7 HF transceiver

The NEW FT-7 features: • Frequency coverage: 10 thru 80 meters • Sensitivity: 0.5 micro volts for S/N 20 dB • Emissions: LSB, USB, CW • Input power: 20 watts DC • Completely solid-state, single knob tune-up • Xtal calibrator built-in • Semi-break-in with sidetone • Receiver offset tuning • Extremely compact for installation under dashboard.

499.00 list price. Call for quote.

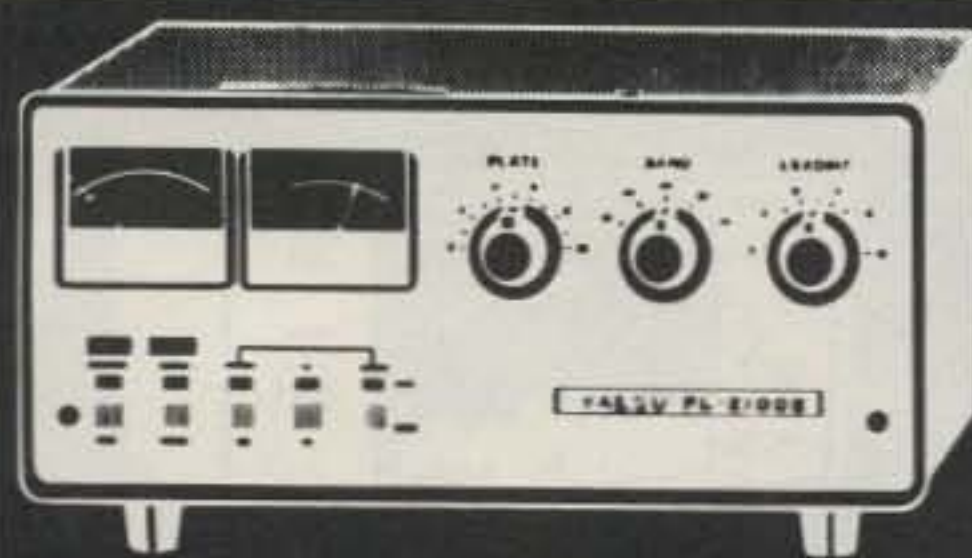

YAESU FL-2100B linear amplifier

The FL-2100B has: • 1200W PEP • Input on 80-10 meters • Easy primary voltage change: 117 to 234 VAC • Dual meters for plate current & voltage • Adjustable SWR meter • Individually tuned input coils on each band • Drive requirement: 30 to 100W.

479.00 list price. Call for quote.



YAESU QTR-24 world clock

Features world time at a glance. Time in any principal city or time zone, can be co-ordinated with local time on a 24 hour basis. The Time Zone Hour Disc automatically retains the correct time. Uses one "C" battery.

30.00 Call for yours today.



YAESU YH-55 Headphone set

Comes equipped with a soft pad for long hours of listening with maximum comfort. Compatible with all Yaesu equipment. 8 ohms impedance.

15.00 Call for yours today.

Remember, you can Call Toll Free: **1-800-633-3410** in the U.S.A. or call **1-800-292-8668** in Alabama for our low price quote. Store hours: 9:00 AM til 5:30 PM, Monday thru Friday.



Long's Electronics



MAIL ORDERS: P.O. BOX 11347 BIRMINGHAM, AL 35202 • STREET ADDRESS: 2808 7TH AVENUE, SOUTH BIRMINGHAM, ALABAMA 35233

Call Toll Free For Swan

1-800-633-3410

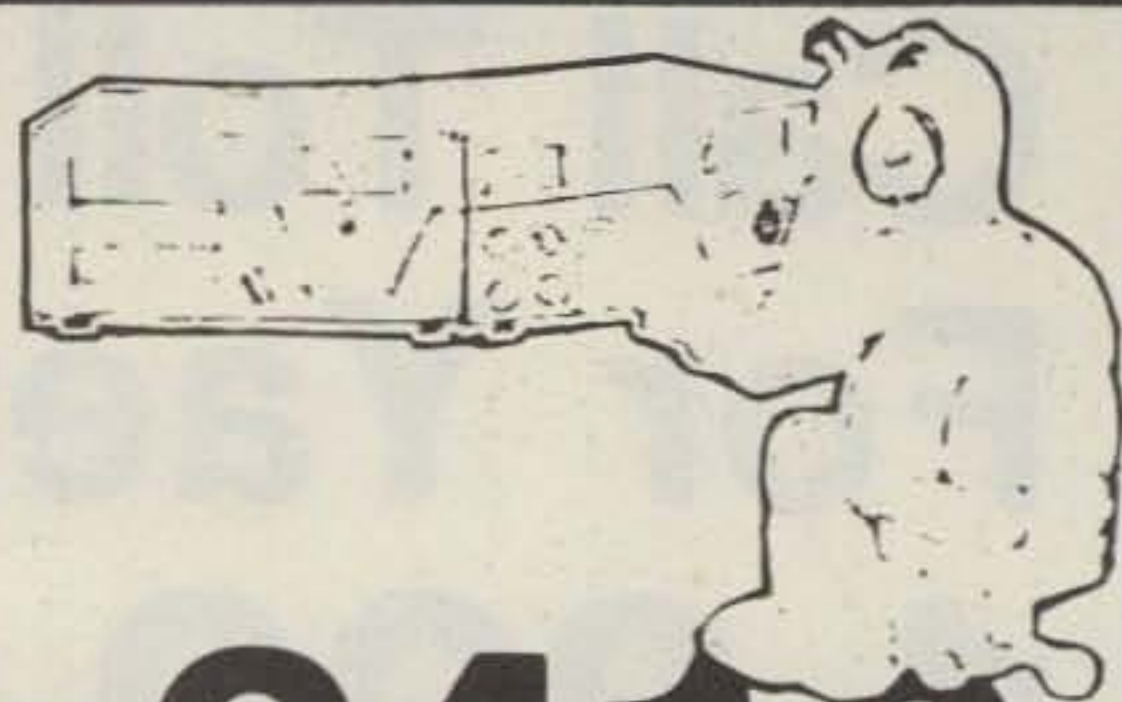

SWAN TB4HA 4 element tri-band beam

All four elements active on all three bands. The heavy duty TB4HA features: • Gain 9dB • Front to back 24-26 dB • Boom length 24' • Longest element 28 ft. 10 in. • Wind surface area 6 sq. ft. • 10-15-20 meters.

259.95 list price. Call for quote.

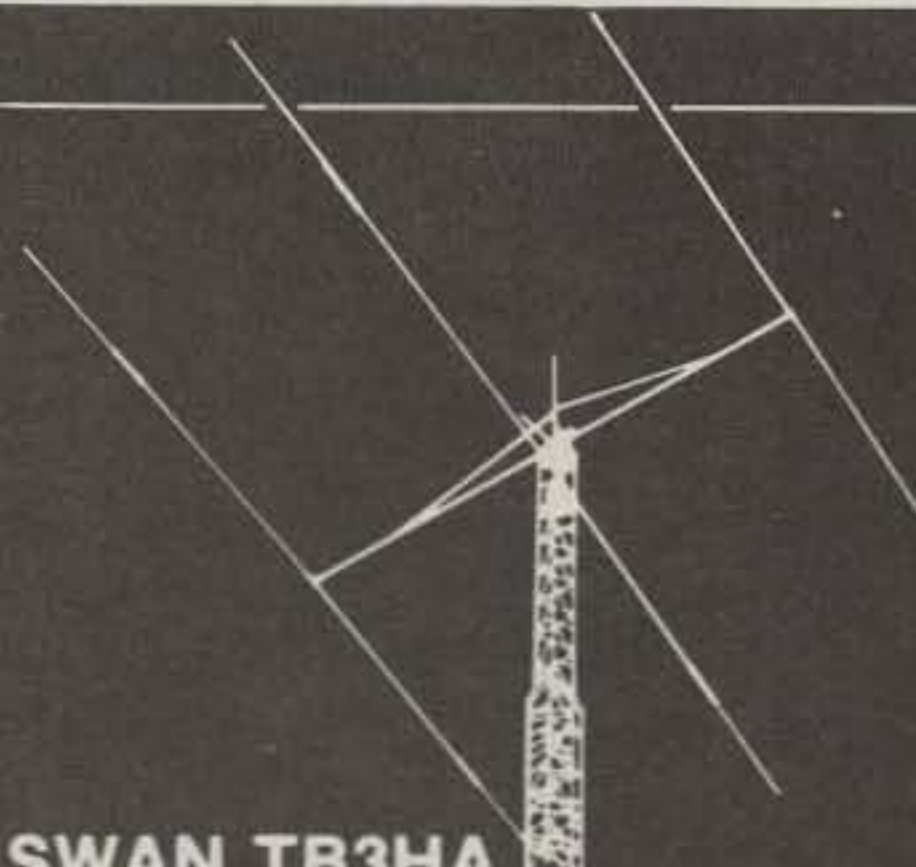

SWAN TB3HA 3 element tri-band beam

The heavy duty TB3HA features: Gain 8dB • Front to back 20-22 dB • Boom length 16' • Longest element 28'2" • Wind surface area 4 sq. ft. • 10-15-20 meters.

199.95 list price. Call for quote.

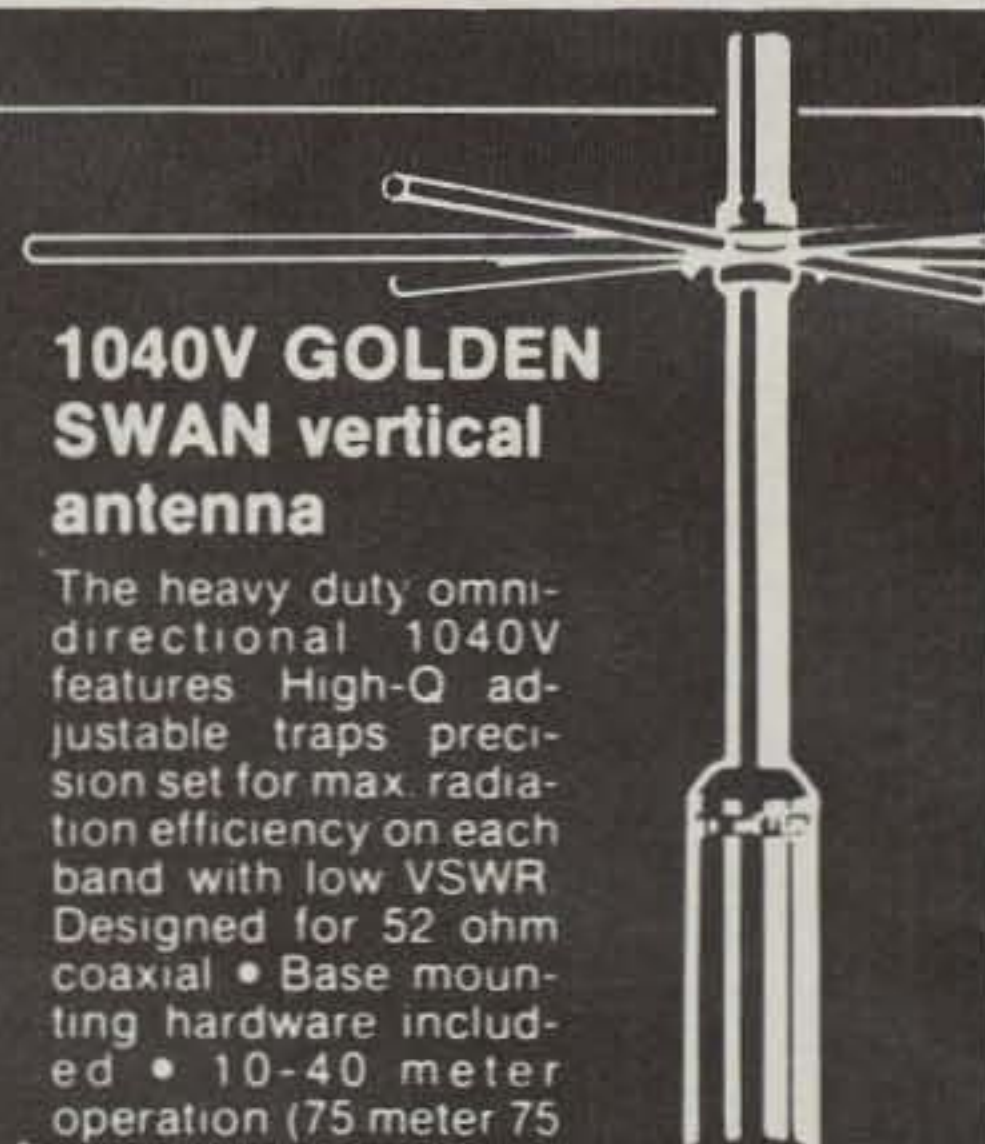

1040V GOLDEN SWAN vertical antenna

The heavy duty omni-directional 1040V features High-Q adjustable traps precision set for max. radiation efficiency on each band with low VSWR. Designed for 52 ohm coaxial • Base mounting hardware included • 10-40 meter operation (75 meter 75 MK resonator optional 39.95)

122.95 list price. Call for quote.



SWAN WM-3000 precision PEAK/RMS wattmeter

Read forward or reflected power with maximum accuracy from 3.5 to 30 MHz • RMS readings available with the flick of a switch • Four scales from 9 to 2000 watts. Requires 117V AC power source.

87.95 Call for yours today



SWAN WMM200 SWR and power meter

Designed for mobile operation and illuminated for night operation • Directional coupler measuring method • Impedance 50 ohms • Power range: 0-20 watts and 200 watts in the second range • VSWR 1:1 - 3:1.

45.95 Call for yours today



SWAN WM200A through-line wattmeter

Reads 20 and 200 watt scales • Includes expanded VSWR scale • Reads PEP or RMS values • Directional Coupler permits reading of forward or reflected power from 50-150 MHz • Requires 117 VAC in peak reading position

87.95 Call for yours today

Remember, you can call TOLL-FREE: **1-800-633-3410** in U.S.A. or call 1-800-292-8668 in Alabama to place your order. Store hours: 9:00 AM til 5:30 PM, Monday through Friday.



Long's Electronics

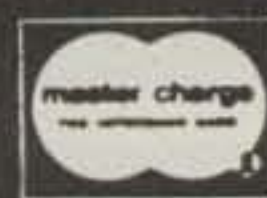

MAIL ORDERS: P.O. BOX 11347 BIRMINGHAM, AL 35202 • STREET ADDRESS: 2808 7TH AVENUE, SOUTH BIRMINGHAM, ALABAMA 35233

Call Toll Free For KLM



1-800-633-3410



KLM PA-15-80BL 2m solid state amplifier

Designed for SSB or FM Broad band, no tuning is required • 15 watts input gives 80 watts output at 8 amps • Reverse polarity and thermal protection.

189.95 list price. Call for quote.



KLM PA-10-160 BL solid state amplifier

Designed for SSB or FM Broad band, no tuning is required • 10 watts input gives 160 watts output at 22 amps • Reverse polarity and thermal protection.

229.95 list price. Call for quote.

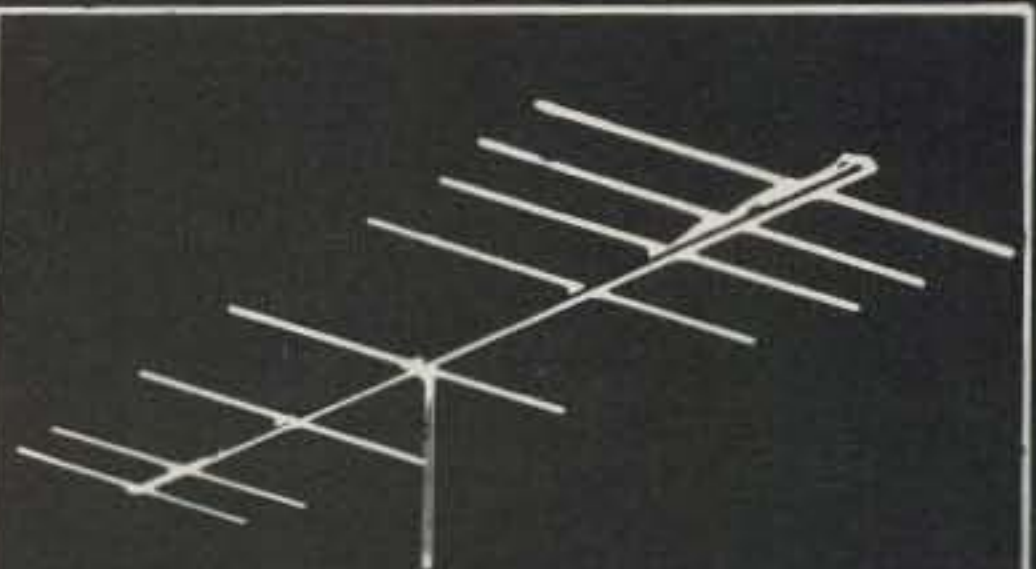

KLM-144-148-8 2m 8 element beam

Features • Gain 12.5 dB • Frequency range 144-148 MHz • VSWR less than 1.2:1 • Boom length 7.25 ft. • Center mounting • Feed impedance 50 ohms balanced • Balun 144-148-50 optional 24.95.

29.95 Call for yours today.

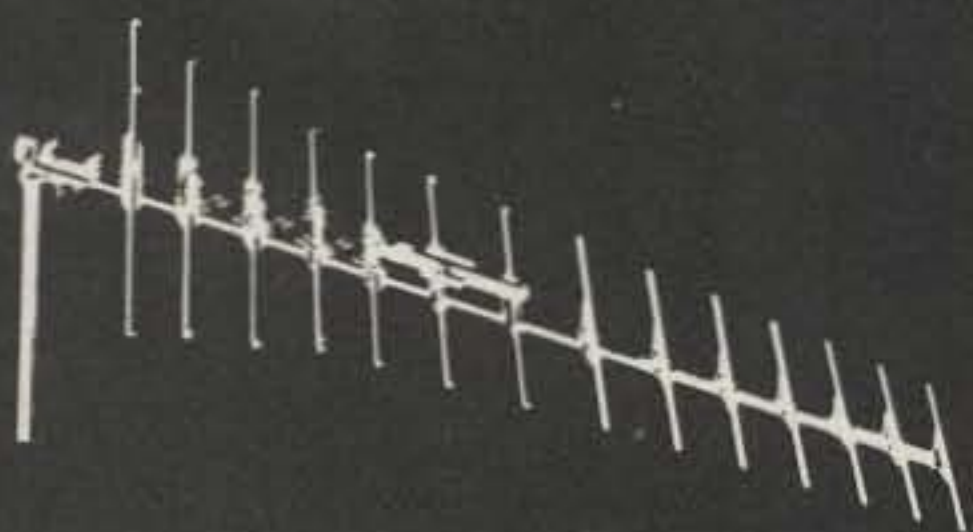

KLM-420-470-14 14 element beam

Features • Gain 13.7 dbi • Frequency range 420-470 MHz • VSWR less than 1.2:1 • Front to back ratio 20dB min. • Boom length 4.75 ft. • Center or end mount • Feed impedance 50 ohms balanced • Balun 420-470-50N optional 24.95.

31.95 Call for yours today.

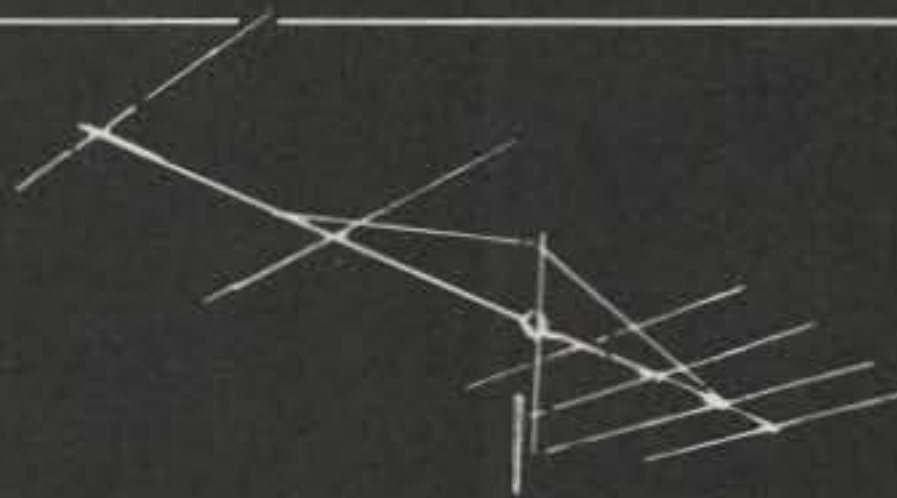

KLM-28-30-6 10 meter 6 element "Big Sticker" antenna

• Gain 11 dB plus or minus 0.3 db • Frequency range 28-30 MHz • Front to back 30dB typical • VSWR less than 1.5:1 • Longest element 18.33' • Boom length 27.52' • Wind area 4 sq. ft. • Feed impedance 200 ohms balanced • KLM-3-60-4:1 Balun optional 24.95.

161.95 list price. Call for quote.

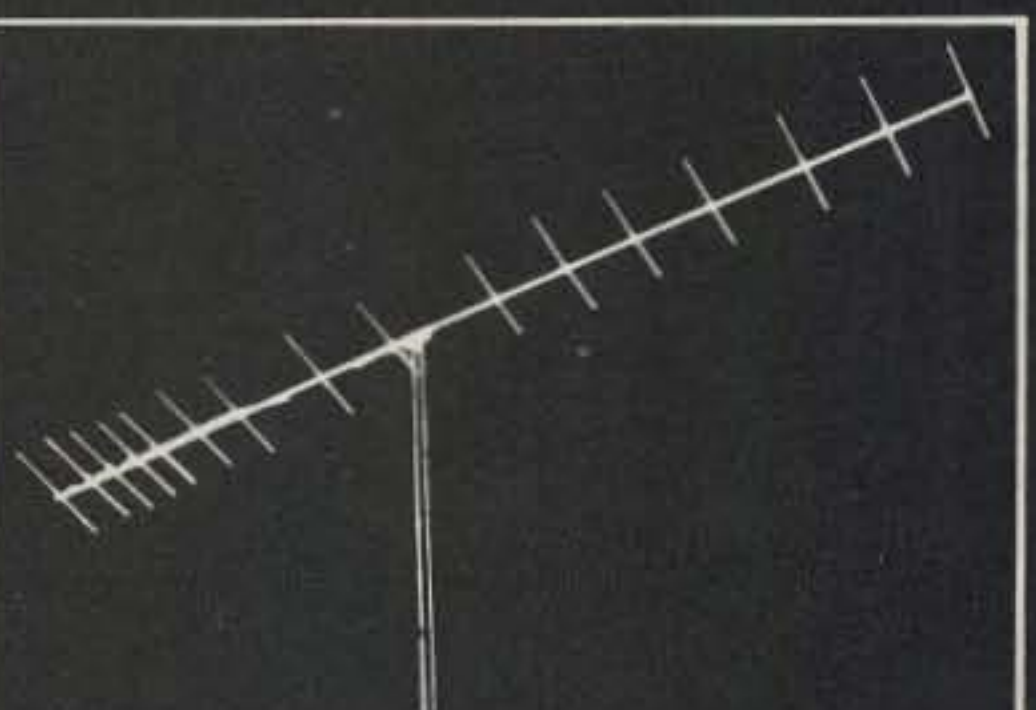

KLM-144-148-4 2m 4 element beam

• Frequency 144-148 MHz • Gain 9 dbi • VSWR less than 1.2:1 • Boom length 2.5' • Center or rear mounting • Feed impedance 200 ohms balanced • Balun 144-148-100 optional 24.95.

22.95 Call for yours today.

Remember, you can Call Toll Free: **1-800-633-3410** in the U.S.A. or call **1-800-292-8668** in Alabama for our low price quote. Store hours: 9:00 AM til 5:30 PM, Monday thru Friday.



Long's Electronics



MAIL ORDERS: P.O. BOX 11347 BIRMINGHAM, AL 35202 • STREET ADDRESS: 2808 7TH AVENUE, SOUTH BIRMINGHAM, ALABAMA 35233

The "Do It All" Digital Clock

— it's even programmable

Fred Blechman K6UGT
23958 Archwood Street
Canoga Park CA 91304

Electronic digital clocks have gone through an interesting evolution in the last 10 years. In the mid-1960s, if you wanted to build a six-digit clock with standard integrated circuits, it took at least 12 ICs and about 70

other discrete parts, plus a lot of wiring — and the parts cost at least \$75! Then just a few years ago, "clock chips" — integrated circuits specifically designed for the task — made it possible to build a simple six-digit clock with only one IC and a small number of other parts, for a total parts cost of less than \$15. It sim-

ply told the time, accurately, to the second. Then, responding to market demand for more varied performance, designs started becoming more sophisticated. Today you can find a number of clock designs with extra features, such as an alarm or a "sleep" switch to turn off a radio after a preset period.

Perhaps the most outstanding example of a digital clock kit offering a large variety of optional features that would be of particular interest to hams and Cbers is the System 5000 Programmable Clock Kit in its "basic" form available from Digital Concepts Corporation, 249 Route 46, Saddle Brook, New Jersey 07662, for \$34.95 plus 5% shipping and handling. This kit, complete to the line cord, solder, and even solder wick, features a bright ½"-high 4-digit fluorescent display with high visibility under high ambient lighting.

With the appropriate switches, you can "program" any or all of the following functions:

- 12- or 24-hour display
- Set hours and minutes independently, either forward or reverse
- Display month and day with a 4-year calendar that only needs correction on February 29 of a leap year
- Display alternate time zone, such as ZULU (GMT),

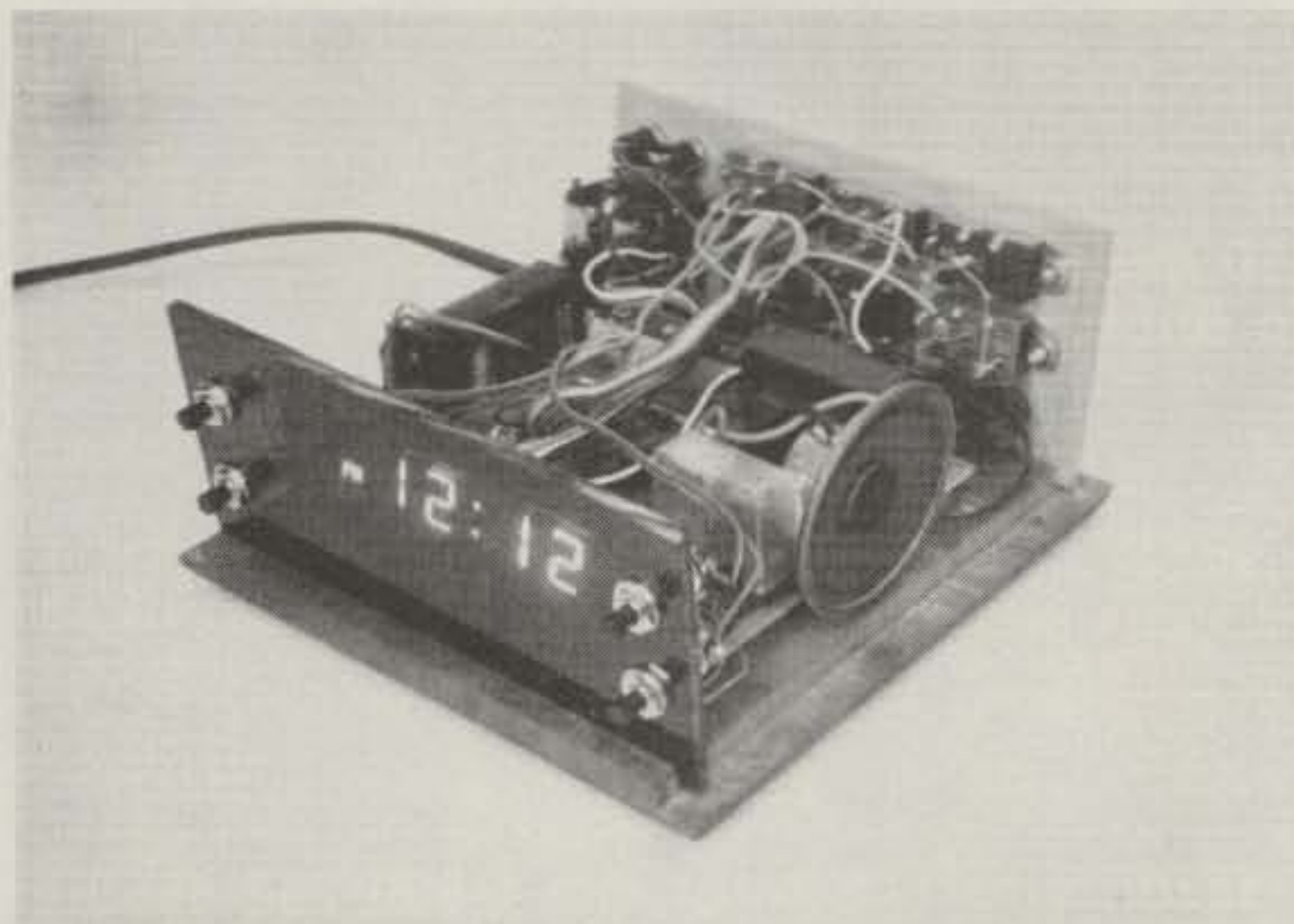

Completed clock with cabinet top removed. Slots in base hold front and rear panels. Forward and reverse time-setting switches are on the front panel; 11 other switches are on the rear panel. The battery on the left side maintains all time registers in memory when power fails. The speaker is used to sound an alarm at either of the two alarm settings.

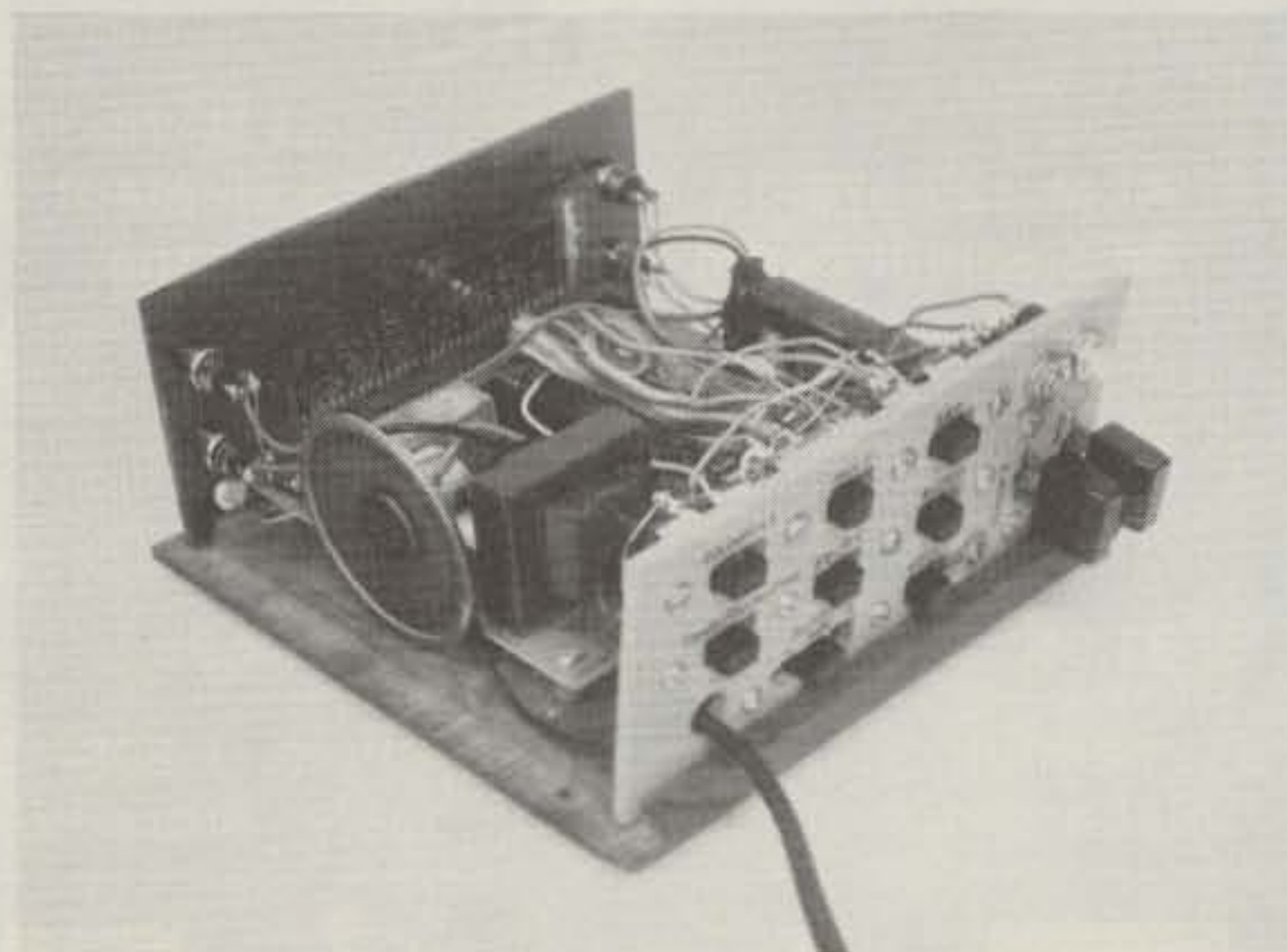

The rear panel contains most of the function switches, with the forward and reverse time-setting switches on the front panel.

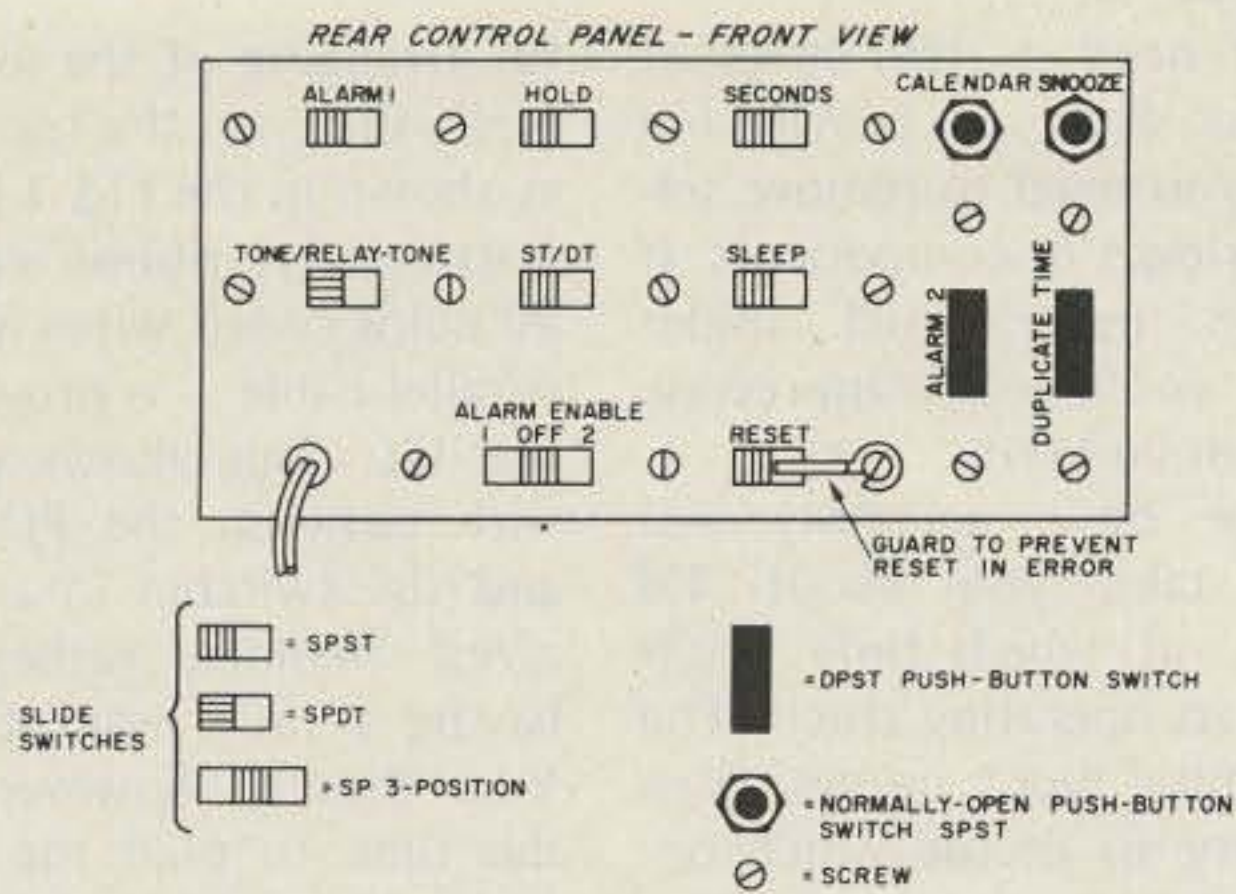

Fig. 1.

on command, while retaining local time in memory

- Activate two alarms independently, each with its own time setting, to trigger a relay or a tone, or a relay followed by a tone eight minutes later
- Reactivate the relay at precise 10-minute intervals after either alarm setting, such as for a reminder to identify with your call letters
- Activate the relay for a preset time up to 59 minutes to power ac or dc external circuits or devices
- Select local Daylight Time or Standard Time without affecting the alternate time-zone setting
- Display seconds on command
- Hold count on command, for precise time setting
- Reset all circuits to "zero" and off

Two switches and a speaker are included in the basic

kit, with eight additional switches available as an option for \$3.75. A relay option kit, which includes a miniature 700-Watt relay and the interface components, costs \$4. An extremely well-made and attractive assembled hand-finished solid walnut cabinet, with a colored plastic faceplate and a textured plastic back panel, sells for \$11. To operate this clock mobile from a 12-volt dc supply, a Quartz Time-Base Kit is \$6.95. A vinyl walnut cabinet, including faceplate and rear panel, is \$5.95.

This clock's "brain" is the 40-pin DCC-7302N integrated circuit. The outputs operating the display are direct drive (eliminating transistor drivers) and nonmultiplexed, so no RFI (radio frequency interference) is generated — particularly important in a ham shack or a car. This IC

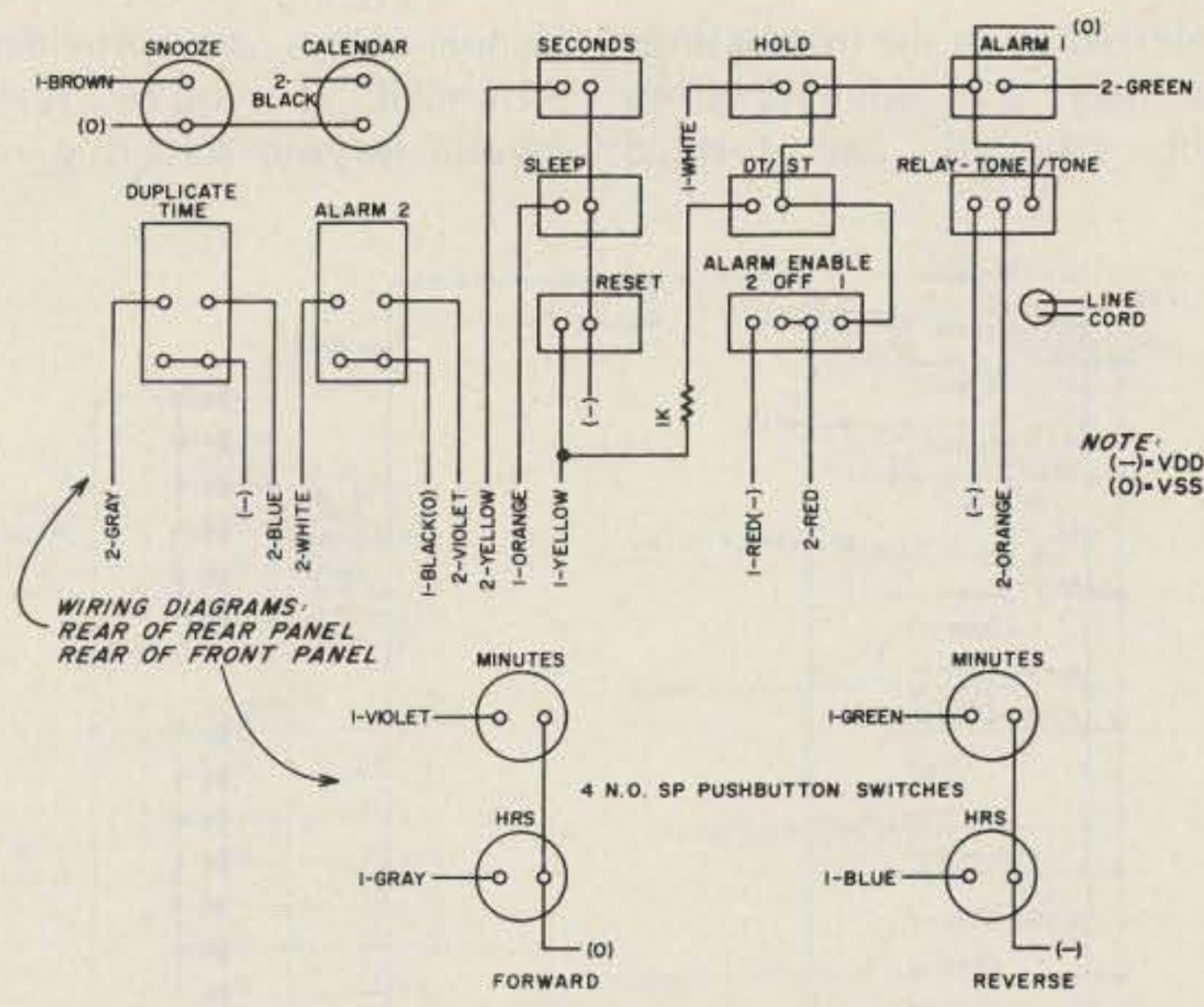

Fig. 2.

has so many possible combinations of features that Digital Concepts includes an 8-page specification sheet showing all the possible options. Also, to aid the builder, separate assembly and programming manuals are provided. Although these manuals are not as detailed as Heathkit manuals, they are far better than most other clock kit distributors provide.

The fluorescent display is a bright blue-green and will shine clearly through most colored filters. A very effective automatic brightness circuit dims the display to match the surrounding light. On most display functions, the colon blinks at a 1 Hz rate, giving life to the display, and allowing the viewer to count off seconds. In the

12-hour format, "pm" is displayed, which means the alarms can be set to repeat every 24 hours, not 12 hours like most clocks. Should the power fail, the entire display will flash on and off when the power returns, to alert you to the incorrect time readout. A 9-volt battery acts as a backup on power failure to retain all time settings in memory until power returns; it does not count during power failure, but freezes the time registers.

Building the clock in its basic form is easy. The instructions, together with a top-quality PC board very clearly silk-screened to show all part locations and optional switch points, make assembly straightforward. Most parts come in identified envelopes



The rectangular cutouts for the switches were cut with a hot knife in the plastic rear panel. A solder lug blocks the reset switch to prevent accidental closure.

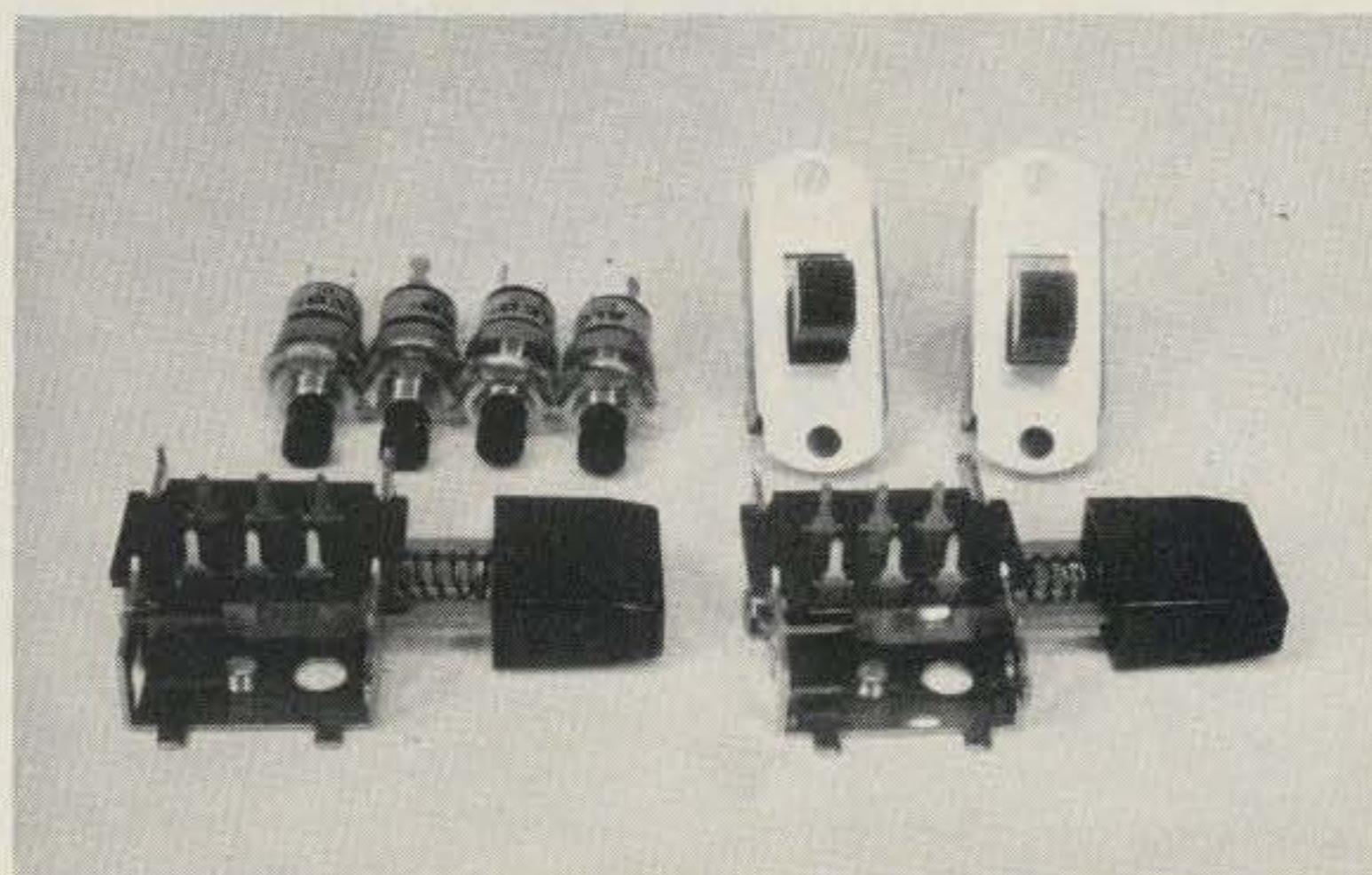

Eight extra switches are available as an option — or use your own switches.

referred to in the instructions as they are required. Even cut, stripped, and formed jumper wires are provided! Although if you're really careful in your soldering you

won't need it, two strips of "solder wick" are provided in case you need to remove solder bridges or components. If you've never used solder wick, you'll really appreciate it when you do!

The basic assembly will only take you about 1½ hours, at which time you'll have an operating clock. The stumbling block comes when you try to decide which options you want to include — there are so many! I decided to use the following: 12-hour display, duplicate time, both alarms, tone and relay plus tone, 10-minute reset on alarms, count inhibit, month-day calendar, one-hour relay countdown, forward and reverse time setting, Standard and Daylight Time selection, seconds display, and reset. This took six SPST normally-open push-button switches, six SPST slide switches, two DPST normally-open push-button switches, and one SP 3-position slide switch. Toggle switches could be used instead of slide switches, at a considerable increase in cost. I put the time-setting switches on the front panel, with the forward-setting switches on the right side (looking from the front) and the reverse-setting switches

ful arranging of the switches to fit them on the rear panel, as shown in the Fig. 1 layout. Fortunately, ribbon cable — 20 color-coded wires in a flat parallel cable — is provided in the kit. This allows you to wire between the PC board and the switches in an organized manner, rather than having a rat's nest of wires. You should, however, take the time to plan the switch wiring by making a wiring diagram, such as Fig. 2, showing wire colors. This will help keep the assembly neat, and it will give you a "road map" for any troubleshooting later on. I divided the ribbon cable into two strips of ten wires each (since the colors repeat every 10 wires) and called them "1" and "2". Therefore, my wire colors on the diagram show a number 1 or 2 before the color to designate the wire strip. The other end of each wire, of course, is connected to the proper point on the PC board. The time-setting switches fit nicely on each side of the display on the front panel, with the forward-setting switches on the right side (looking from the front) and the reverse-setting switches

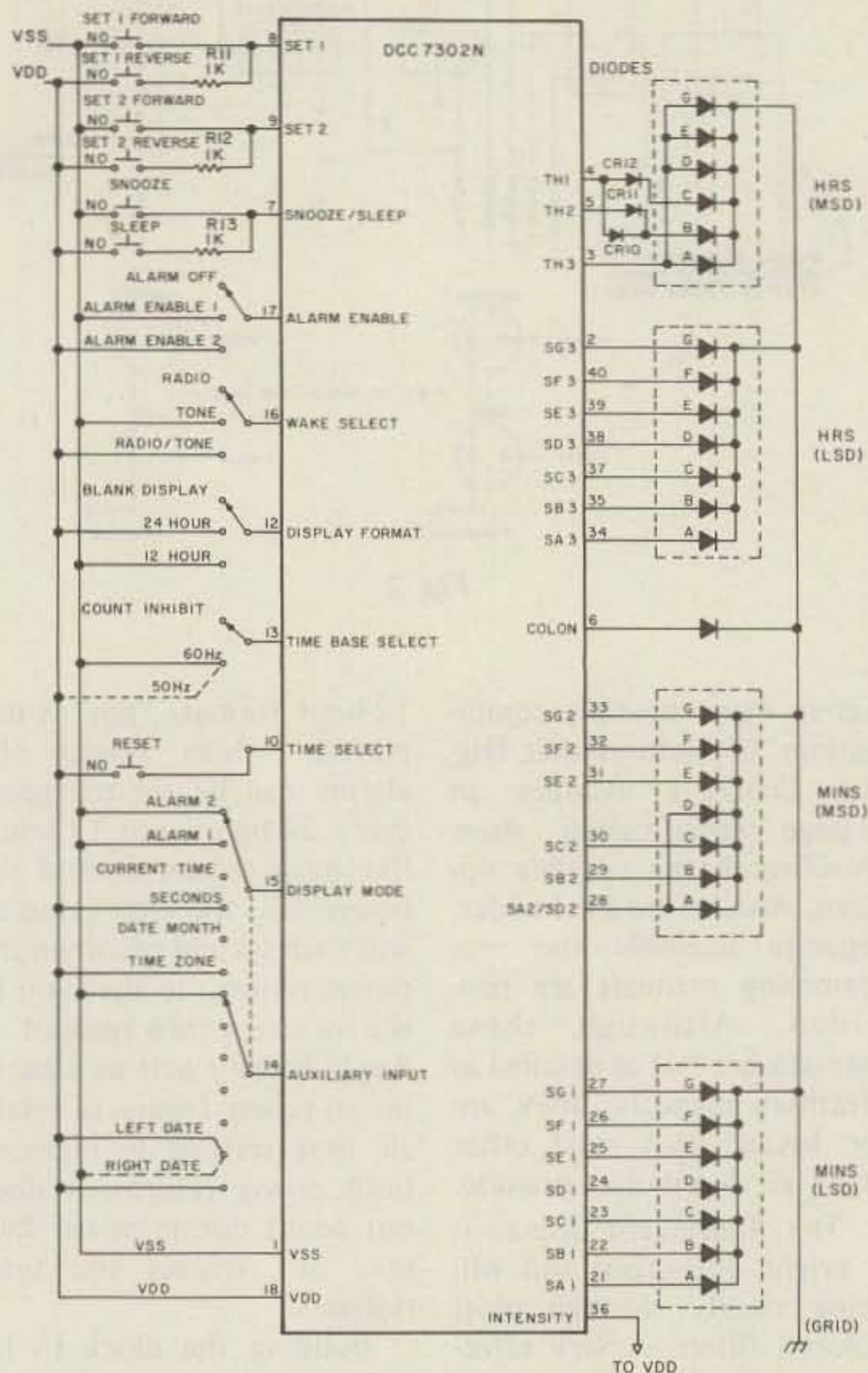
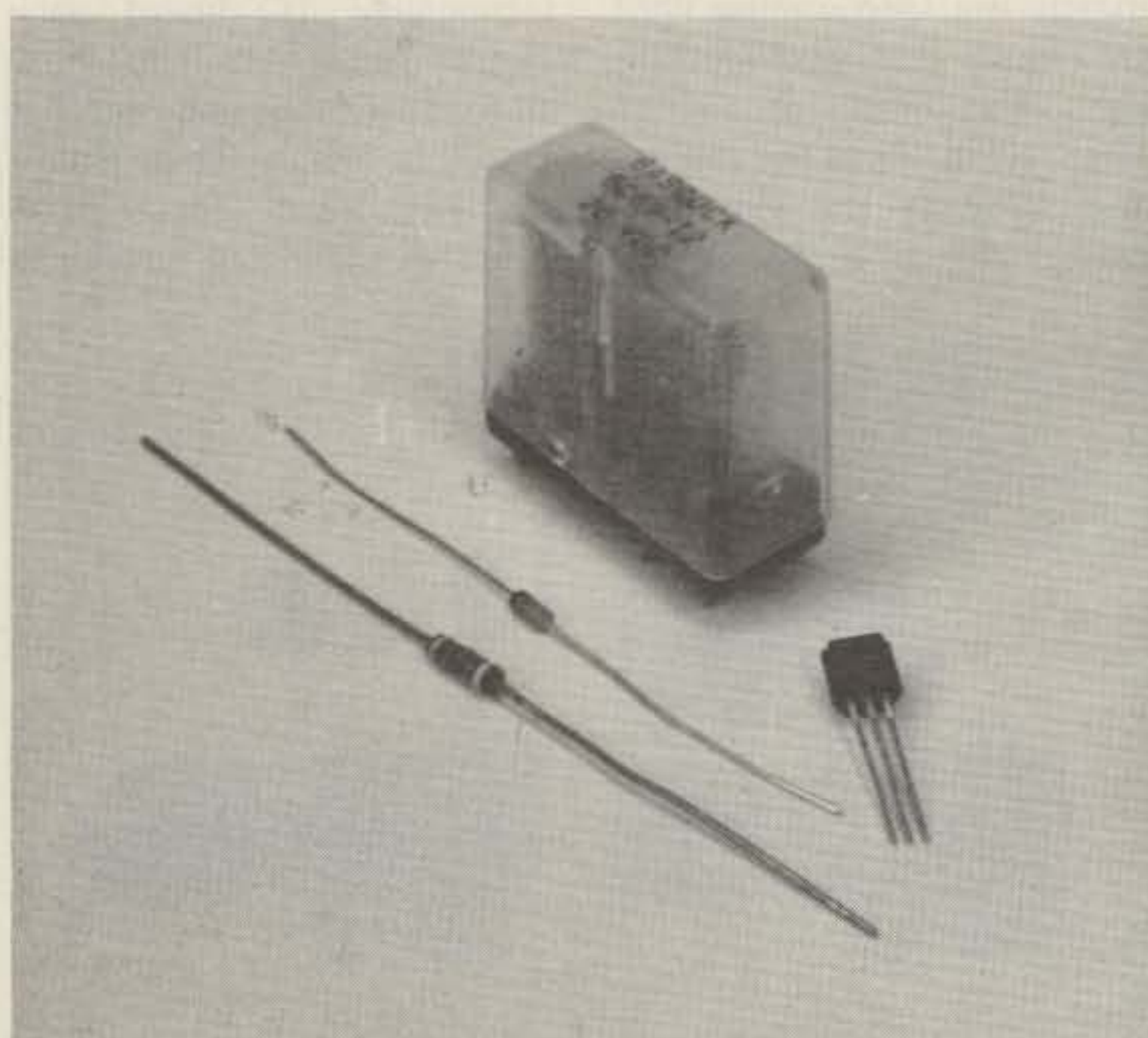
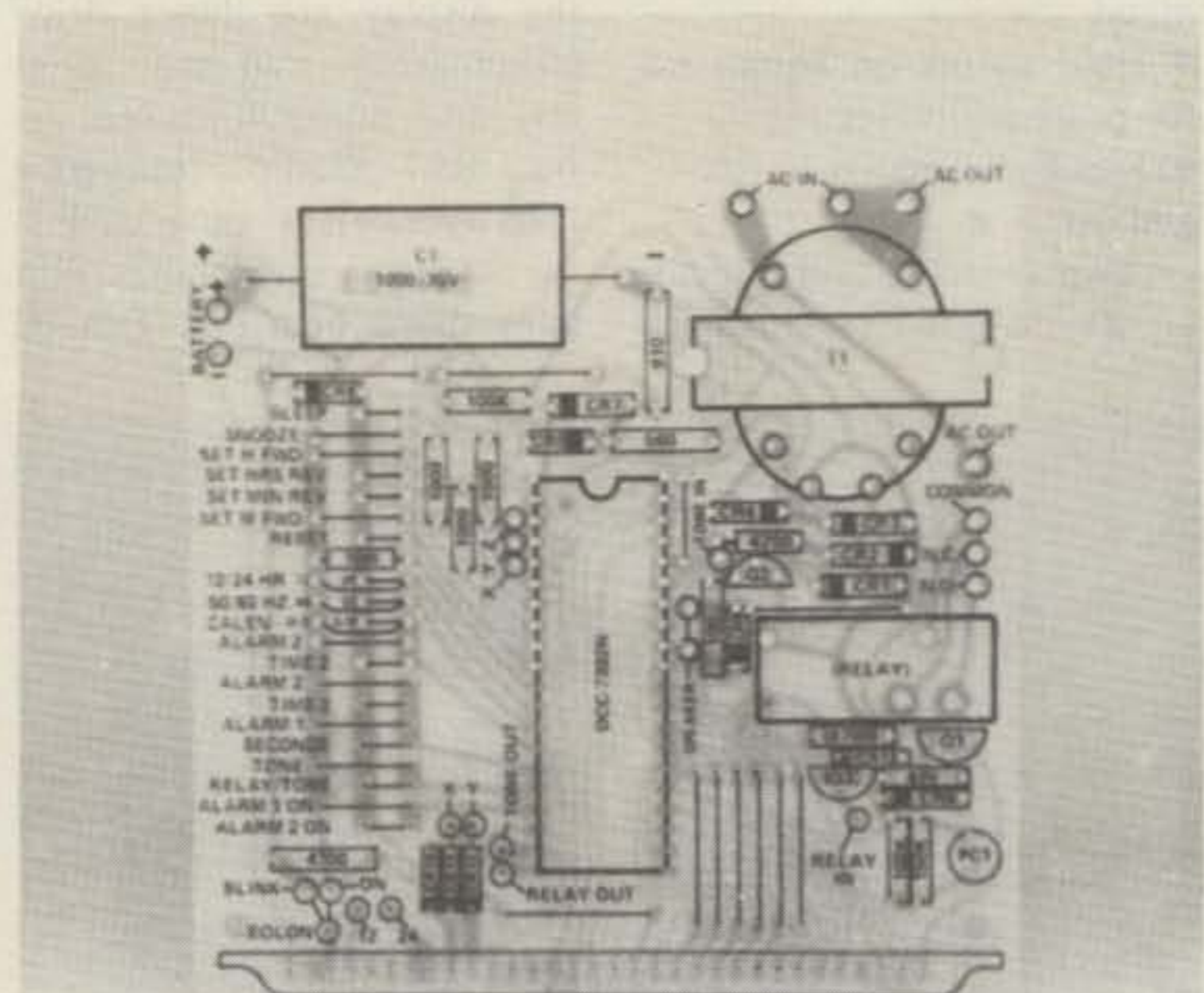

Fig. 3. Generalized circuit.



A miniature 700-Watt relay, a transistor, a resistor, and a diode are available as an optional kit for controlling ac or dc power or signals.



Single-sided PC board holds all components except speaker and switches and is clearly silk-screened on top to show part locations and switching terminals.

on the left.

The relay circuitry is included on the PC board, including jumper points for allowing the normally-open or normally-closed contacts to control either the 117-volt ac line or any external circuit. The relay is activated by either of the alarms or the "sleep" switch. The sleep switch displays countdown time, which can be set forward or backward by the minute-setting switches to any time from 1 to 59 minutes. This counter starts at 10 minutes, and, by leaving the sleep switch closed, it will recycle to 10 minutes after it counts down to 00. This can be used as a 10-minute ID timer for ham or CB use by having a tone or light connected to the normally-open relay terminals. You can also use the "snooze" button to retrigger the alarm automatically every 10 minutes for an hour with alarm 1 or for an unlimited number of 10 minute repeats with alarm 2.

I found several peculiarities in this clock chip when compared to others, and you should be prepared for these operational pitfalls in your checkout and use of this clock. While later models of this kit (built in April, 1977) may cover these things in revisions or reprints of the instructions, most were not covered in my instructions:

1. The alarms cannot be triggered by the time-setting

switches. You must set the alarm in the specified manner and then, to check operation, advance the displayed time to a minute or two before the alarm time. Then let the clock run until the two times coincide, when the relay or the tone, as selected, will operate. To deactivate the relay or tone, press the snooze button or shut off the alarm enable switch. Also, be aware that the alarms will not trigger when seconds are being displayed.

2. The snooze feature resets the alarm for ten minutes. However, this can't be forced by advancing with the minute-setting switch — the

IC must count 10 minutes internally.

3. Don't try to display the calendar with a day-month format. Internal jumpers built into the display provided do not allow this. If you try, you'll get a strange display beyond the ninth of each month.

4. The calendar is programmed in the IC to correctly count the days in each month with February set for 28 days. Therefore, on a leap year, you'll have to advance to February 29 manually. However, since the manual

setting is only used for initial setting and February 29, you'll find that as you cycle through February with the setting switch, February 29 will show up every time. Don't be confused by this. To check proper operation, set the clock to February 28 a minute or two before midnight and let the clock count through midnight. The calendar will come up with March 1, just as it should.

5. With all the switching possibilities, there are "sneak circuits" that short out the power supply. If this is done

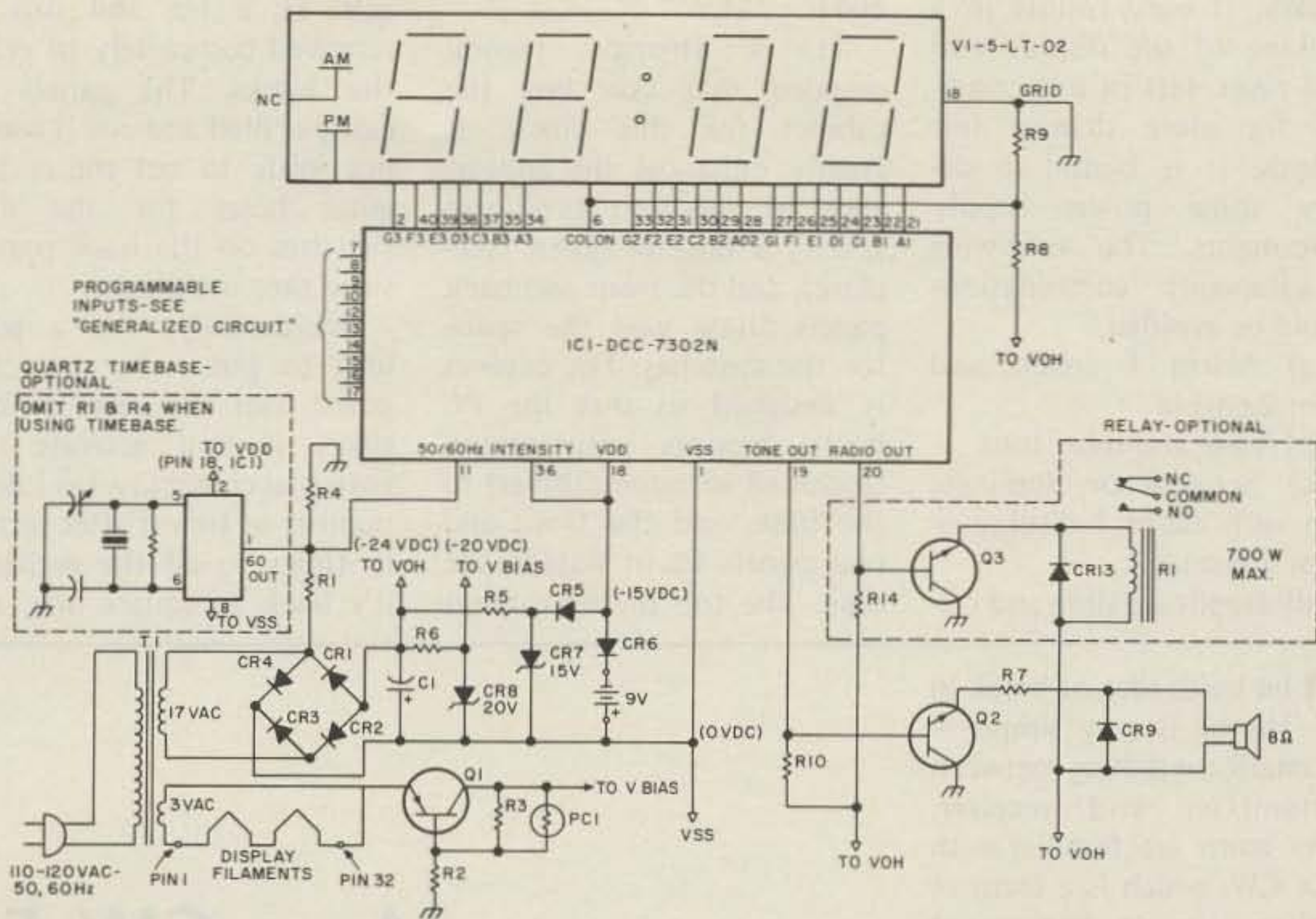
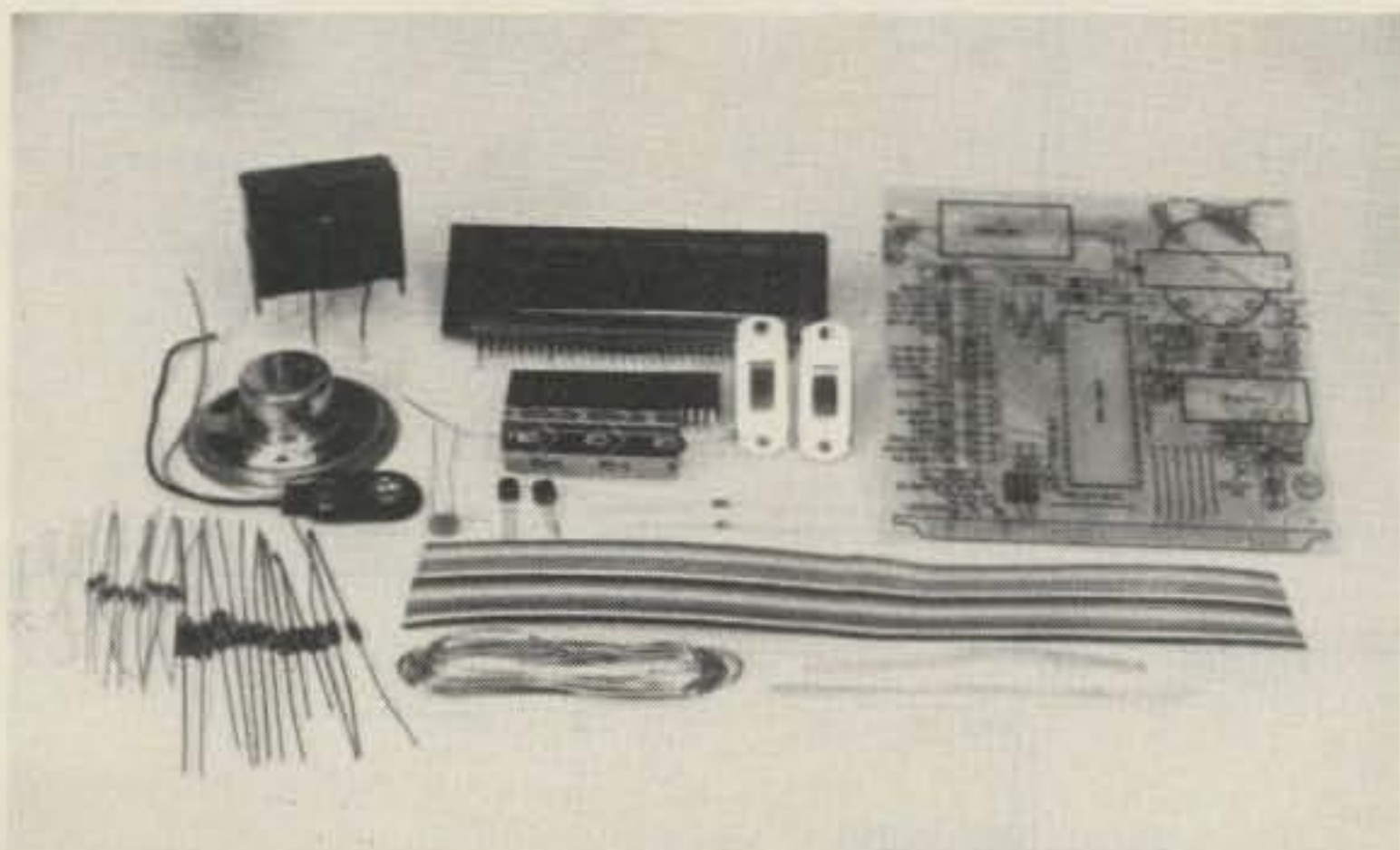

Fig. 4.



The kit is ultracomplete in its basic form, even including ribbon cable, solder, solder-removal wick, and preformed and stripped insulated jumpers.



The optional hand-finished solid walnut cabinet with blue or green faceplate imparts an elegant appearance to this very versatile digital clock.

quickly, it only results in a blanking of the display and total reset; left in this condition for more than a few seconds, it is bound to destroy some power supply components. The following simultaneous combinations should be avoided:

- (a) Alarm 1 enable and alarm 2 enable
- (b) Tone and relay tone
- (c) Seconds or duplicate time with alarm 1 display or alarm 2 display
- (d) Duplicate time and cal-

endar

It is strongly recommended that you buy the cabinet for this clock. It greatly enhances the appearance of the unit (you can specify a blue or green faceplate), and the front and back panels allow you the space for the switches. The cabinet is designed so that the PC board mounts with screws (included with the cabinet) to the base, and the front and rear panels fit in slots in the base. The top of the cabinet

acts as a lid and can be removed completely to get at the works. The panels are easily drilled and cut (I used a hot knife to cut the rectangular holes for the slide switches on the back panel), since they are plastic.

Incidentally, it's a good idea to put some sort of a guard over the reset switch, since, if you activate this switch accidentally (as I did a number of times) after setting in times to all the registers, it's back to square one, and

everything must be reset!

If you want a plain digital electronic clock, there are many kits to choose from. But, if you want one that will tell you the time in London, when to identify your station, help you keep calling schedules, turn on the rig, turn on the coffee pot, keep track of the date for log entries, and even switch instantly between Daylight and Standard Time, then the Series 5000 Programmable Clock Kit is for you! ■

Loran Joly WBØKTH/4
432 Central Avenue
Mora MN 55051

The basic idea of break-in keying is very simple — automatic switching between transmitter and receiver. Many hams are familiar with VOX CW, which is a form of break-in keying because it switches the receiver/transmitter combination back and forth as CW is sent and received. There is, however, a delay in the switching of the receiver. This is not true break-in.

With a true break-in system, reception is possible between each dit or dah of every letter sent. This is an invaluable aid to the traffic handler, for the transmitting station can be interrupted at any moment for a fill.

Block diagrams of the two most popular QSK (break-in) systems are shown in Figs. 1 and 2.

In Fig. 1, a T/R switch is used to block the transmitter rf from going into the receiver.

Fig. 2 shows the connections for a unique break-in system. The antenna system is actually connected and disconnected to the receiver and transmitter by means of a high-speed vacuum relay or a high-current reed relay. Although this system is more expensive to construct, almost all cantankerous idiosyncrasies of earlier T/R systems are eliminated.

My own experimentation has covered both types of break-in systems. Once adjusted properly, both serve the operator very well. A

More CW Fun With Break-In Keying

—how it works

QSO with CW break-in is a totally new experience. As you are sending, you can listen to the QRM that the receiving operator must discriminate against. If both sta-

tions have full break-in, the operator may break and ask questions any time he pleases. Both operators speak up and send as they wish, with no worries about "doubling" on

top of each other.

I have explained the operation and benefit of such a system. If you want to use one, the decision is up to you. ■

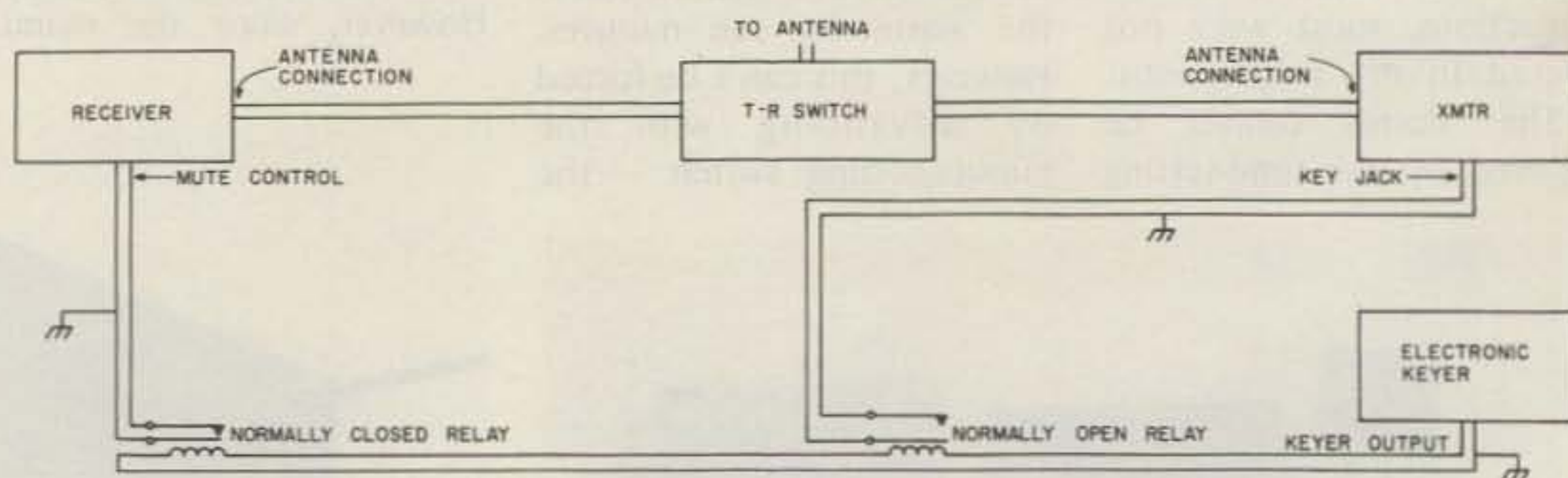

Fig. 1.

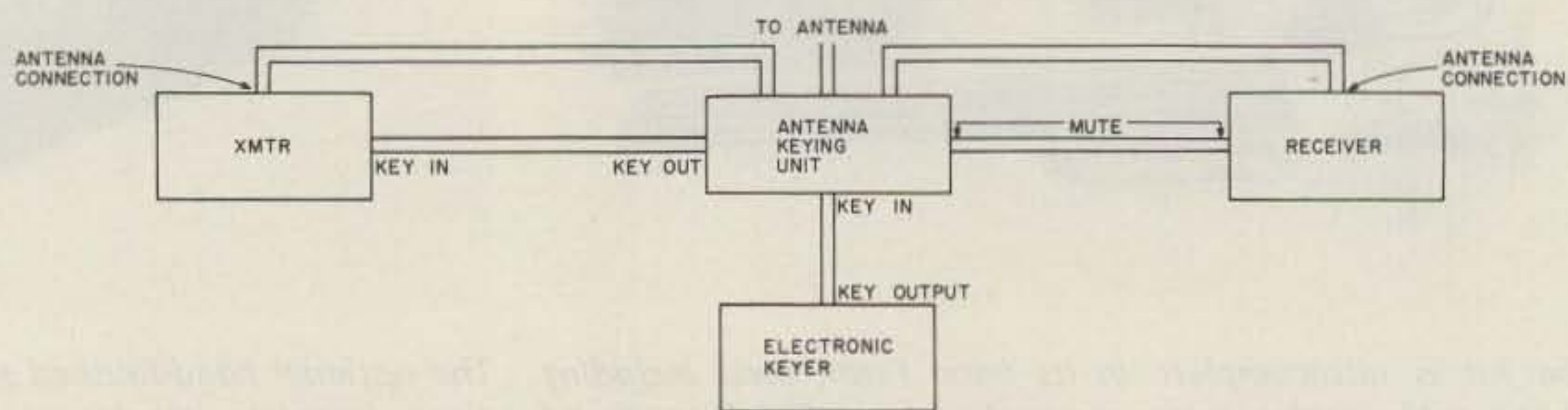
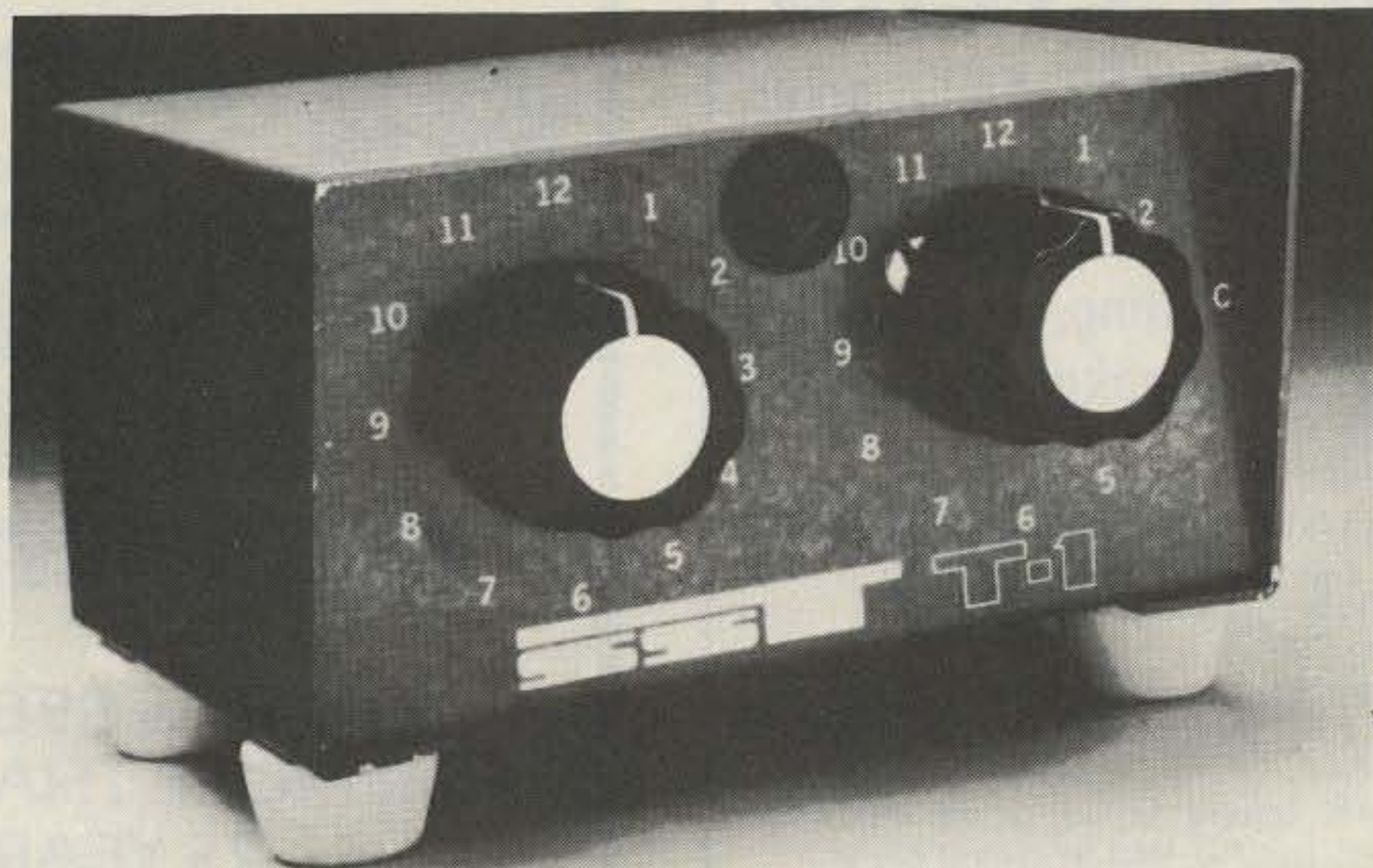

Fig. 2.

SST T-1 RANDOM WIRE ANTENNA TUNER



All band operation (160-10 meters) with any random length of wire. 200 watt output power capability—will work with virtually any transceiver. Ideal for portable or home operation. Great for apartments and hotel rooms—simply run a wire inside, out a window, or anyplace available. Efficient toroid inductor for small size: 4-1/4" x 2-3/8" x 3", and negligible loss. Built-in neon tune-up indicator. SO-239 connector. Attractive bronze finished enclosure.

only **\$29.95**

THE ORIGINAL Random Wire Antenna Tuner. . . in use by amateurs for 6 years.

SST T-2 ULTRA TUNER

Tunes out SWR on any coax fed antenna as well as random wires. Works great on all bands (80-10 meters) with any transceiver running up to 200 watts power output.

Increases usable bandwidth of any antenna. Tunes out SWR on mobile whips from inside your car.

Uses efficient toroid inductor and specially made capacitors for small size: 5-1/4" x 2-1/4" x 2-1/2". Rugged, yet compact. Negligible line loss. Attractive bronze finished enclosure. SO-239 coax connectors are used for transmitter input and coax fed antennas. Convenient binding posts are provided for random wire and ground connections.



only **\$39.95**

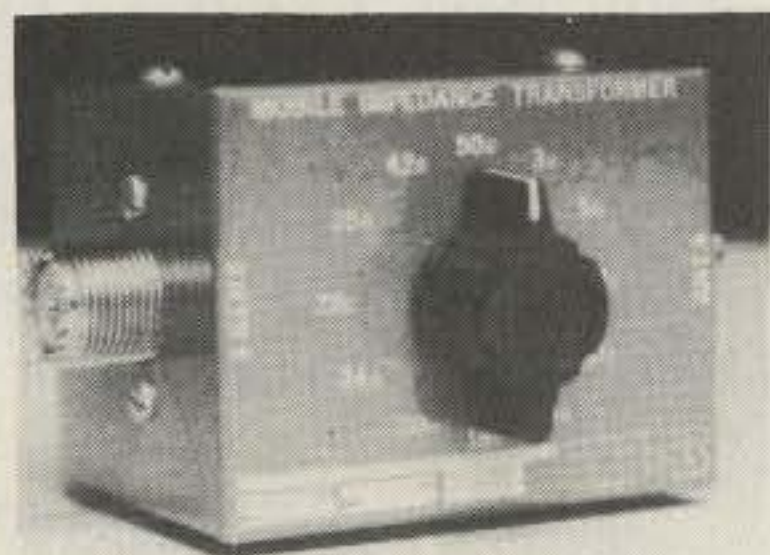

only **\$19.95**

SST T-3

Mobile Impedance Transformer

Matches 52 ohm coax to the lower impedance of a mobile whip or vertical. 12-position switch with taps spread between 3 and 52 ohms. Broadband from 1-30 Mhz. Will work with virtually any transceiver—300 watt output power capability. SO-239 connectors. Toroid inductor for small size: 2-3/4" x 2" x 2-1/4". Attractive bronze finish.

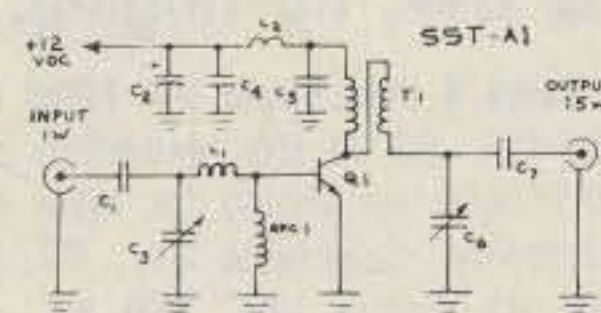
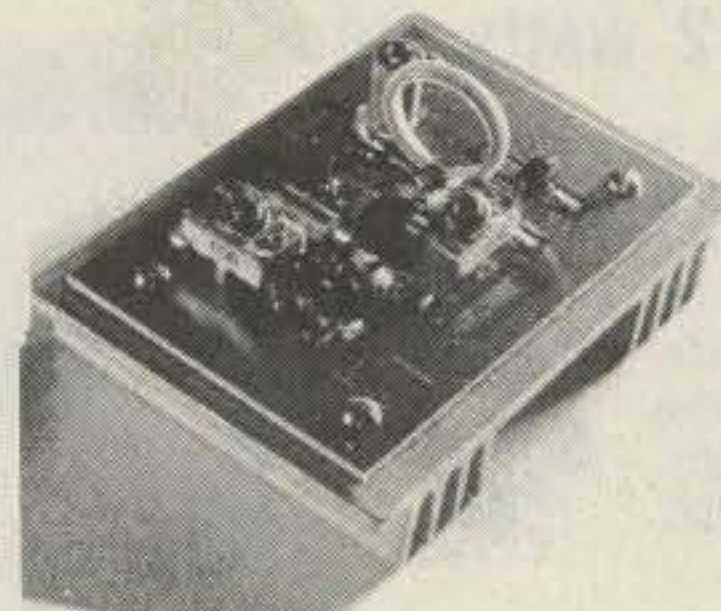

only **\$29.95**

\$49.95 wire and tested

SST A-1 VHF Amplifier Kit

1 watt input gives you 15 watts output across the entire 2 meter band without re-tuning. This easy-to-build kit (approx. 1/2 hr. assembly) includes everything you need for a complete amplifier. All top quality components. Compatible with all 1-3 watt 2-meter transceivers. Short and open protected—not damaged by high SWR.

Kit includes:

- Etched and drilled G-10 epoxy solder plated board.
- Heat sink and mounting hardware. All components—including pre-wound coils.
- Top quality TRW RF power transistor.
- Complete assembly instruction with details on a carrier operated T/R switch.



GUARANTEE



All SST products are guaranteed for 1 year. In addition, they may be returned within 10 days for a full refund (less shipping) if you are not satisfied for any reason. Please add \$2 for shipping and handling. Calif. residents, please add sales tax. COD orders OK by phone.



\$10

ELECTRONICS

P.O. BOX 1 LAWNSDALE, CALIF.
90260 (213) 376-5887

MFJ INTRODUCES NEW SUPER CW/SSB FILTERS

This new MFJ-721 Super Selector CW/SSB Filter gives you 80 Hz BW, steep SSB skirts, noise limiting, 2 watts for speaker plus more.



BRAND NEW \$59⁹⁵

This New MFJ-721 Super Selector CW/SSB Filter gives you a combination of performance and features available only from MFJ: • Razor sharp 80 Hz non-ringing CW filter • Steep skirt SSB filter • Selectable peak and trough noise limiting • Plugs in phone jack • Two watts for speaker • Simulated stereo reception • Inputs for 2 rigs • Speaker and phone jacks • Auxiliary 2 watt amplifier, 20 dB gain.

The CW filter gives you 80 Hz bandwidth and extremely steep skirts with no ringing for razor sharp selectivity. Lets you hear just one CW signal on the crowded Novice bands.

Bandwidth is selectable: bypass, 80, 110, 150, 180 Hz. Response is 60 dB down one octave from center freq. for 80 Hz BW. Center freq. is 750 Hz. Up to 15 dB noise reduction.

8 pole active IC filter. Low Q cascaded stages eliminates ringing. Hand matched components.

The SSB filter dramatically improves readability by optimizing audio bandwidth to reduce

sideband splatter, remove low and high pitched QRM, hiss, static crashes, background noise, and hum.

Makes listening for long periods pleasurable and less fatiguing. Ideal for contest and DX.

IC active filter includes 375 Hz highpass cut-off plus selectable lowpass cutoffs at 2.5, 2.0, 1.5 KHz (36 dB per octave rolloff).

Switchable automatic noise limiter for impulse noise; trough clipper removes background noise.

For Simulated Stereo, the raw signal goes to one ear and the filtered signal to the other. The signal appears in both ears and the QRM in only one. The ears and brain reject QRM yet off-frequency calls can be heard. Requires stereo phones.

Switch selects one of two rigs. OFF position connects speaker to rig. Speaker disables when phones are used. Requires 9 to 18 VDC, 300 ma. 5x2x6 inches. Optional AC adapter is \$7.95. Order yours now.

This New MFJ-720 Deluxe Super CW Filter gives you 80 Hz BW, no ringing, 2 watts out.

Same 8 pole Super CW Filter as in MFJ-721. 80 Hz BW, extremely steep skirts with no ringing for razor sharp selectivity. Selectable BW: 80, 110, 180 Hz. Center freq. 750 Hz. Automatic noise limiter. Plugs in phone jack to drive speaker to 2 watts. 2x4x6 inches. Requires 9-18 VDC, 300 ma.

BRAND NEW

\$44⁹⁵



These MFJ active filters are the most copied in Industry.

MFJ SUPER CW FILTER CWF-2BX



\$29⁹⁵

MFJ SSB FILTER SBF-2BX



\$29⁹⁵

But performance is not copied. Only MFJ hand selects components so the center frequency of each CW stage is within one Hz of each other. CWF-2BX and the SBF-2BX are the same CW and SSB filter as in the MFJ-721 but less speaker amplifier and noise limiter. Plugs in rig to drive phones or connect between audio stage for full speaker operation. Uses 9 V battery. 2x3x4 inches.

For Orders, Call Toll Free

800-647-8660

ORDER TODAY BY MAIL OR CALL TOLL FREE 800-647-8660 AND CHARGE IT ON VISA OR MASTER CHARGE. Order any product from MFJ and try it. If not delighted, return it within 30 days for a prompt refund (less shipping). One year unconditional guarantee. Add \$2.00 shipping/handling. For order/repair status, in Mississippi and outside continental USA, call 601-323-5869.



MFJ ENTERPRISES

P. O. BOX 494 MISSISSIPPI STATE, MISSISSIPPI 39762 M52

Clegg is



**VHF
Head-
quarters**

**AND HAS BEEN
FOR MORE THAN
25 YEARS!**

Regardless of your VHF interest — FM/CW/AM/SSB — Clegg has what you need. The Clegg FM transceivers are judged tops by experienced FM'ers. After 3 years nothing has come along to match the FM-DX. And nothing represents the values of the FM-28, MARK 3 or FM-76.

We also stock all of the high quality MUTLI-MODE VHF Transceivers. Like the ICOM 211 and 245. Like the new YAESU FT-225RD. Or choose between the WILSON HT's or ICOM PORTABLES. We have them both with thousands of crystals.

Planning a 220 Repeater? We have a complete low cost system. Need a new antenna? We stock KLM, WILSON, HUSTLER, MOSLEY, ASP and others.

Whatever your needs for VHF (or HF & UHF) call Clegg Toll Free. ASK FOR OUR LATEST CATALOG!

TOLL FREE
1-(800)-233-0250
In PA call COLLECT
(717) 299-7221

Clegg Communications Corp.

C3

1911 Old Homestead Lane
Greenfield Industrial Park East
Lancaster, PA 17601

"THE PROFESSIONALS"

NEW MODEL CTR-2A • 500 MHz & 1 GHz **COUNTERS**

NEW
Period
Measurement

1 us to
1 sec.



NEW
Built-in
Pre-Amp

10 mv @
150 MHz

The New Model CTR-2A Series Counters are designed and built to the highest standards to fulfill the needs of commercial communications, engineering labs and serious experimenters. With an accuracy of + .00005% (oven option) the CTR-2A can handle the most critical measurements and is about half the cost of other commercial counters.

If you need a reliable counter at an affordable price, the CTR-2A is the answer.

- Built-in Pre-Amp 10 mv @ 150 MHz
- 8 Digit .3" LED Display
- High Stability TCXO Time Base
- Built-in VHF-UHF Prescaler
- Automatic Dp Placement
- TCXO Std. ± 2 ppm
- Period Measurement (Optional)
- Input Diode Protected
- 12V-DC Operation (Optional)
- Oven Controlled Crystal (Optional) ± .5 ppm
- Selectable Gate Times - .1 & 1 sec.

| | |
|-------------------------------|----------|
| 500 MHz Kit CTR-2A-500K | \$249.95 |
| 500 MHz Assembled CTR-2A-500A | 349.95 |
| 1GHz Kit CTR-2A-1000K | 399.95 |
| 1GHz Assembled CTR-2A-1000A | 549.95 |

OPTIONS

| | | | |
|------------------|---------|-----------------------|---------|
| 02) Oven Crystal | \$49.95 | 05) 10 sec. Time Base | \$ 5.00 |
| 03) .43" LED | 10.00 | 06) Period | 15.00 |
| 04) 12 V-DC | 10.00 | 07) Handle | 10.00 |

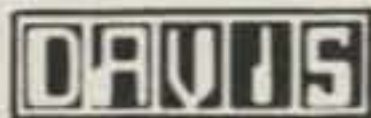

D10

DAVIS ELECTRONICS 636 Sheridan Dr., Tonawanda, N.Y. 14150 716/874-5848



PROBES
Hi-Z
\$15.00
•
Low Pass
\$15.00

Talk is cheap.

Here are some of the actions your company can take to prevent the suffering caused by poor parenting patterns and child abuse.

We want to stop the hurt.

- We are enclosing a tax-deductible donation in the name of our company.
- We want to help. Please call our company and tell us what you're doing to stop the hurt of child abuse in our community.
- We will plan a day for employees' children to visit our place of work to learn what we do and why.

prevent child abuse.
write: Box 2866, Chl., IL 60690
National Committee for Prevention of Child Abuse

Ad Council A Public Service of This Magazine & The Advertising Council

VHF Power Duo!



Max power for the \$
Extends weak signal range
Base or mobile use

What a combination! Westcom's new 2-meter, 90 watt linear amplifier, coupled with Westcom's ruggedized 12 amp. DC power supply. Now, base or mobile, you'll have power for that weak signal work. A natural for the OSCAR uplink. The amplifier, model number 2M 15X90L, is an add-on unit, no internal connections or adjustments required. Operates all modes: SSB; FM; AM; RTTY; and, CW. "microstrip" design provides high stability and optimum performance over wide bandwidth. The tough DC power supply, model number RS-12A, has computer grade components. Looks great with its matched linear amplifier! This "Power Duo" has been specially priced for a limited time, only. Order today, and get both units for **JUST \$198**

Immediate delivery - order today.

W17



ATTENTION KENWOOD & YAESU OWNERS!!!

the W6TOG* RECEIVER MODIFICATION KIT

- INCREASES SELECTIVITY
- IMPROVES SENSITIVITY
- LOWERS INTERNAL NOISE
- COMBATS BLOCKING FROM LOCAL SIGNAL
- IMPROVES NOISE BLANKER OPERATION

| | |
|-------------------|---------|
| TS-520 KIT | \$27.50 |
| TS-520S KIT | 32.50 |
| TS-820 & 820S KIT | 34.50 |
| FT-101 SERIES KIT | 32.50 |
| FR-101 SERIES KIT | 34.50 |

EXPLICIT INSTRUCTIONS MAKE MODIFICATION A CINCH

*WELL KNOWN DXer WITH OVER 300 COUNTRIES CONFIRMED.

Order from
S-F AMATEUR RADIO SERVICES
4384 KEYSTONE AVE., CULVER CITY, CA. 90230 S33
(213) 837-4870

IT'S MAGIC—IT'S "MAGICOM" PROCESSOR MODIFICATION KIT

IMPROVES AUDIO PUNCH • IMPROVES PROCESSED SPEECH QUALITY

Converts **TS-820** speech processor from RF compressor to RF clipper

The "MAGICOM" RF processor module provides up to 6db increase in output with smooth, clean, non-distorted audio and more penetration for those pile-ups. Price \$27.50

ENDORSED BY W6TOG AND BIG GUN DXers WORLD WIDE

SATISFACTION GUARANTEED OR MONEY REFUNDED
All prices postpaid - in Calif. add 6% sales tax - Mastercharge & Visa accepted

Poor Man's Cruise Control

—*better than the commercial jobs*

Is your automobile capable of indicating engine rpm and controlling its own speed on those long trips? The unit described here will do just that and for much less cost than the units going on the market for \$75-100.

When I decided to build this unit, my design goals were as follows:

1. Even though I have a clock face readout tachometer in my Toyota SR-5, I would eventually like to have digital readouts on many of the instruments.

2. Since even good units for speed control already on the market do not really work well over bumpy roads (and this really isn't where you want a speed control), I would forgive the slight errors that might arise under those conditions due to wheel hop and slippage, etc. This allows a given rpm to represent a given speed for any gear you might be in.

3. Due to the fact that I had an article in mind as well as a unit for my car, the speed setting (entry point into automatic control) had

to be either by speed or rpm and not by any phony codes fed in by switch.

4. I drive by tachometer, but many don't. With design goal 3 in mind, I chose the entry point to be by speed, so the driver could watch his speedometer and enter the auto mode where he chose.

5. After pondering item 4, building up the first prototype circuits, and riding around in a friend's van equipped with a speed control for awhile, I could see where entry without multiple switches (my original idea) and a "resume" function to return to auto control at the last speed entered by a "set" switch would both be nice to have. The entry method of the system, Phase 2, was very easy (single switch), and the resume feature fell right in when I got ready to interface the system into the car, as you will see.

6. The electronics of the system must be complete and as much compatible with all automobiles as possible, but I knew I could only present the mechanical parts in general terms, due to the many dif-

ferent types of gas-feed systems on the different cars.

With all this in mind, the system shown here was developed in three phases which I will explain here, because, in doing so, I may help you see how the final system works. Bear in mind, any electronic tachometer is only a low-frequency counter. This is the first phase of the system that I worked on. The input circuit is buffered by a 74121 one-shot to take the "spike" from the ignition coil low side and shape it up into a nice pulse for use by the later TTL circuits. The counter portion is similar to any other counter and can be dealt with as such. The control circuits, however, are quite different to accommodate the very different job the counter will be doing. The clock frequency crystal, F1, is chosen at many times the necessary clock output frequency, F2, for the same reason it is chosen that way in a regular counter. When you go to set or "trim in" the crystal oscillator, by dividing down to the desired F2 frequency, you also divide down any error in setting and

any drift with temperature and time, the same as a bench-type counter does.

This means, also, that you must choose your crystal frequency in a reverse order, working back from the desired gate frequency, F2, and using the formulas in Table 1. This allows the unit to be used with cars having different firing arrangements due to different numbers of cylinders. What you are creating with the clock is a gating "window" that, while open, will count a given number of pulses and allow them to be displayed directly as rpm, even though you are reading the window many more times than once a minute. Obviously, if the readings were taken only once a minute, it would be worthless as a tachometer, much less a speed control.

A couple of features may not be evident if you are not familiar with speed controls. The unit operates off the car battery source (via a regulator) from a line that is on only when the key is in the IGN, or ignition, position. This allows for a failure in the unit, because, in most of the key-lock steering wheel models of today, you want to be able to panic shut down the unit by going to the ACC, or accessory, position and not the off, or wheel-lock, position for safety's sake. Another safety feature is that the system will drop out of the automatic mode the instant the brakes are applied hard enough to bring on the brake lights. I will also show how you can drive this defeat system off the turn signals or another switch to add a deceleration-before-turn automation to your system, but I have not yet done this on my automobile. With this two-diode addition, you revert to manual mode the instant the turn-signal-lever switch closure is sensed. Some may not want this feature, as using your turn signals for lane changing would defeat your automatic speed control. Also, you may wish to in-

clude somewhere in your own mechanical connection a switch of sorts that allows you to press the gas feed to speed up (overriding the auto control) while automatically resuming auto control when you take your foot off the gas. This is very handy for passing another vehicle.

Continuing with the system description, the counter BCD outputs go in three directions. Taking the easiest way first, the BCD lines are fed to wherever you have chosen to mount your tachometer readout devices. As I said, I have a tachometer already, so for me this is just a plug on the control unit that I can plug into the universal readout display. It contains the same things your display will need in the form of a decoder and seven-segment display for each decade of the counter that is monitored. Since only 10s, 100s, and 1000s are monitored in this system, you need only three decoders, but I would use four readouts to avoid confusion. Hardwire the far right, or units, digit to display a constant zero. This way, the display is a direct-read device that you don't have to mentally add a digit to. There are a lot of reasons for deleting the units — the flashing display is distracting, it's not really used or needed, etc. — but an example from my system may be the easiest way to explain my design reasoning. Out on the highway in fifth gear and running at 40 mph, the engine in my car is turning approximately 2000 rpm. This means about 50 rpm/mph. I want you to remember this, because, when you get your system going and have all the mechanical linkages in place, you may find the system has a "hunting" effect you find undesirable. In this case, the 10s latch and comparator can be removed or deleted and the 10s counter used only for the display (for tune-ups, idle set, etc.). If you use only 1000s and 100s in your comparison, and I am assuming an rpm to

1. Determine the number of coil pulses from the coil per revolution of the engine from your car manual.
2. Using 3600 rpm and 4 pulses per revolution as an example, the 36 number must be counted once per "window."
3. (a)
$$\frac{3600 \text{ rev.}}{1 \text{ min.}} \times \frac{4 \text{ pulses}}{\text{rev.}} \times \frac{1 \text{ min.}}{60 \text{ sec.}} = \frac{240 \text{ pulses}}{\text{sec.}}$$

(b)
$$\frac{1 \text{ sec.}}{240 \text{ pulses}} = \frac{4.1666 \dots \times 10^{-3} \text{ sec.}}{1 \text{ pulse}} \times \frac{36 \text{ pulses}}{\text{per window}} = \frac{.15 \text{ sec.}}{\text{window}}$$

(c)
$$\frac{.15 \text{ sec.}}{\text{window}} \times \frac{4 \text{ window periods}}{\text{period of (F)}} = .6 \text{ seconds}$$

(d)
$$\frac{1}{.6 \text{ sec.}} = 1.6666 \dots \text{ cps (x 10 for last clock divider)} = 16.66 \dots \text{ Hz}$$

Input to last clock divider = 16.66 ... Hz.
 If a divider using five 7490s is used, a 1.666 ... MHz crystal is required.
 Just multiply the last 10 F frequency by your divider chain = crystal.

Table 1.

mph ratio like mine, the system will detect and correct for errors of about 100 rpm. This, in my automobile, is about 2 mph, and is as good as most of the units you can buy. Having never torn down one of their units (or owned one), I may use similar design logic, but I doubt that they use the lower cost TTL ICs that you can so readily get ahold of now.

Going now in the tougher direction (only from the amount of circuitry, not complexity), you can follow the BCD lines to the latches. These latches (7475) are often called two-step memories, or simple memories, and this is exactly the function they perform for us. Again using an in-car example, as you speed up away from a stop using the manual gas feed, you eventually come to the steady cruising speed you wish to maintain. The tachometer has been following this by a fluctuation in rpm (as you shift) and a steady rise in rpm to the leveling-off point. When you reach cruising speed, a push on the "set" push-button causes the latches to momentarily accept the rpm (in BCD form) at that time and speed. The one-shot in the "set" push-button line accomplishes two functions. One, it buffers the switch and eliminates the mechanical bounce that most

inexpensive switches have. Two, it opens the memory for new data input for a finite time, because you may try, but you cannot hold an absolutely constant rpm with your foot. That's what speed controls are all about anyway, right? The one-shot allows the data available right at the end of one-shot time to be entered into the latches. Now, the memory will store this "speed" until either a new entry takes place (entry by set button) or the power to the unit is removed.

From the latch ICs, the stored BCD data enters a BCD loop by going to a set of BCD comparators (7485). Several authors, myself included, have explained exactly how these ICs work, so I won't go into detail. For all you analog (linear) fans, just compare their function to a bridge, or make A = B. B, in this case, is the latch data, and A is the BCD I will cover next. Note that the counters never stop counting each time the input control gate is open (enabled). The third direction the BCD takes (of the three mentioned earlier) is to the A input side of the comparators. This is the side that tells the comparator "where am I" in rpm (BCD form) terms. The B side tells the "where should I be." When these are compared at the proper clock rates, the comparator outputs

on one of three lines. The desired line in this case is an A = B condition, where engine rpm equals the desired rpm (and, thus, the desired speed). Another output is A > B, or the engine is under the desired rpm, indicating that the mechanical-accelerate device should come on.

That's really all there is to the electronic part (control unit) of the device, except for some buffering of sorts to get from TTL low levels to a higher power capability and the mechanics themselves. I will now present some ideas on the mechanics. I say "ideas," because, depending on your automobile, some or even all of them may not work.

I can advise, first of all, that, if you are the type of person who is never under the hood of your own car, either obtain competent help at this point, or just enjoy reading this article or building it for some other purpose. The myriad of pollution-control junk and complex wiring under the hood of a 1970s automobile is enough to confuse anyone. The inherently unsafe situation created by an improperly installed or functioning speed control must not be overlooked, either.

On the other hand, if you are reasonably adept at doing your own general automobile

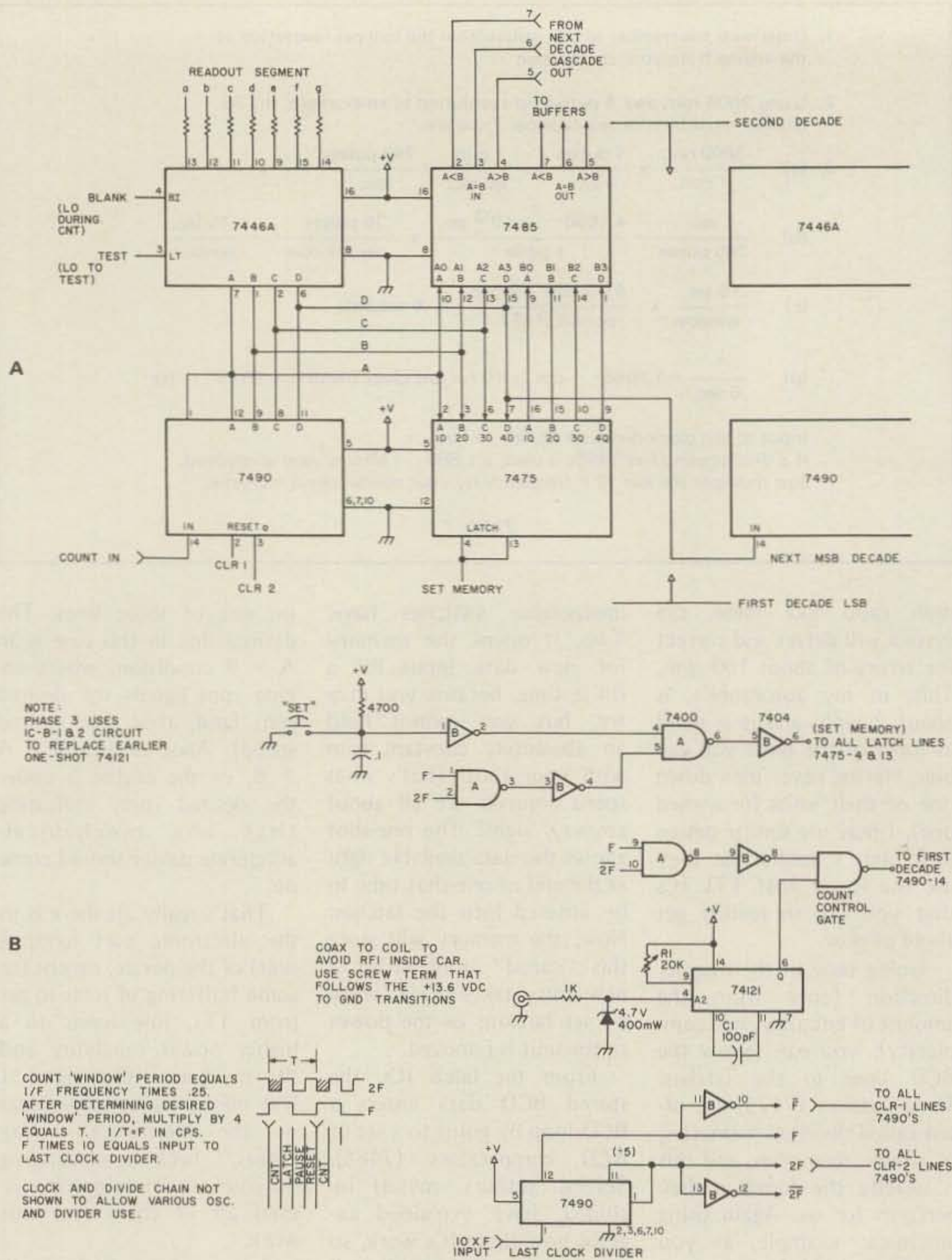

Fig. 1. (a) Counter section. Note: On MSB7485, tie pins 5 and 7 to ground and pin 6 to +V. (b) Clock and control section. +V = +5 V dc regulated ± 2 V.

maintenance, figuring out the how and where of this project should be no problem. That leaves only the sheet metal, brackets, etc., and really no more than the average chassis working tools and experience should get you through that in good fashion. I said before that this is a system, so do build and check it out that way. Small lamps or LEDs on the output control wiring points will let you check out the control package using an audio oscillator as a phony

engine or pulse source. Likewise, grounds applied to the mechanical relays at their input from control unit points should allow you to run up the engine controls (up, down, hold) sitting in your driveway. Note: Don't work in a closed garage and end up failing to realize the fruits of your labors. Also, don't hold the higher engine rpm (1500 rpm and up) too long, as few cars these days cool well enough to handle it unless the car is moving and cramming

air into the radiator slots.

With the system installed and independently checked out, cable up the unit to the mechanics (rotor cable with good insulation and dressed away from any hot engine parts should do the job as well for you as it did me), and go out for a test run. I highly recommend daylight and light traffic on an interstate for this. One, it's where the unit is the most useful. Two, you don't have back bumpers, traffic lights, or un-

expected curves suddenly staring at you if you get carried away with the jollies of having an autopilot and a readout to watch. The only electronic calibration is setting the gate or window time by setting the crystal "on the nose," and this is done on the bench before you install the control unit package. Try to avoid hot or heat-trap areas when installing the control unit, as the unit creates its own heat even using the low-power options of TTL where available, and ICs do have limits on being externally fried, you know. The rest is mechanical adjustment, and I am truly sorry Detroit and the rest of the world have not gotten together on things like fuel flow and feed methods in cars. The mechanical drive, hold, and defeat mechanisms will have to be worked out in each of your own cases.

I can offer here, again, only ideas based on my own system and must let you resolve your own differences. The drive mechanism on my system is an old auto-tune motor from some piece of surplus electronics gear and is plainly marked 28 V dc. But, true to the ham tradition, it worked fine on 13.6 V dc car voltage, so I used it! It bears no name, and I don't remember what form of beast it was removed and saved from, so I am of little help there beyond giving you an idea of things to try. I venture the junk yard wiper motors may also work — but a bit of overkill perhaps — and beware of the holding switch internal in some that returns the motor to wiper-down position regardless of other switch power applied. This motor arrangement then becomes both my speed-up and slow-down control by virtue of it being a dc motor and, therefore, reversible. Since the system must rotate the throttle shaft to a position and then hold it, I first tried a pair of hefty transistors directly driving the motor, one for each direction. By using the system as shown in

Fig. 1, including the LEDs and LED resistors, and coming off the "wrong" lead of the unit to account for the unintentional inversion (buffer on-output device off) caused by this, I was able to constantly drive the motor back and forth over a small range of the 10s rpm resolution I was detecting and using at the time. The system worked (sort of) and was terrifically smooth. So, under the right conditions in your system, you might try it. But, for my part, I smoked a motor in just under a week of off and on driving. I forgot that motors found in these surplus units have no doubt seen much use and some abuse and, also, that they were never intended as continuous-duty devices. One and/or both gave me Murphy's "gotcha." This ended the system Phase 2, the first to really go on the car. The disengage mechanism was nothing more than a removal of the common wire of my

3-wire motor (by relay).

Phase 3 I feel to be a cruder method, but at least it works. Leaving the throttle-return spring in place in both systems, Phase 3 uses the motor to drive the throttle shaft back and forth, the same as Phase 2, but only when correction is demanded. I lowered the duty cycle quite a bit by only using 1000s and 100s and still maintained the roughly 2 mph tolerance mentioned earlier. The only device difference comes in the form of the hold-in device. I had a small solenoid (again 28 V dc) of unknown parentage. I used the solenoid as a brake. My throttle linkage is a cable run to a lever plate on the throttle shaft, like a lot of other cars these days. Gone are the days of the linkage rod and 2-barrel anyone could really work on. There is enough of the bare cable showing on most cars to form a bracket that holds the solenoid and positions it. You want to be

able to form the plate as one half (fixed) of the brake, and the piece moved by the solenoid forms the other half of the brake. This means the throttle cable passes between the two plates (covered with cork like that used to pad ashtrays). When the solenoid is on, it forms a clamp on the throttle cable to hold a fixed position. It's crude, but effective! Remember, this solenoid must in some way be wired to be controlled by the brake light line so that it instantly releases when brakes are applied. In most cars, the 13.6 V dc that lights the brake lights is available at the output of the brake light switch (which is hiding indoors these days, behind the brake pedal). On some cars, this may be a ground with brakes on. The wiring I leave to you, as you will know or check your own options.

This seems awfully light on the mechanics, but maybe someday all cars will be electronic fuel injection (VW

owners, have a ball). The increased efficiency, economy, and just plain smoothness of these injection systems may force this soon, but, in the meantime, the interface must remain a mechanical kludge. I have enough shaft extension to direct motor drive with a coupler, and you may not. Add a hundred or so other variations car to car, and you can see why all my mechanical help is in the form of ideas only.

If you have any troubles on the electronics package, an SASE to me will bring as speedy a reply as you make your question complete. For the mechanics, don't even try me — call a mechanic!

While you wait on parts, discuss it with your mechanic and he can help you a lot, verbally or in the actual doing. Remember, this is a 2-part system, and he doesn't need the electronics package to do his part any more than you need the car to check your package! ■

DEALER DIRECTORY

Fontana CA

We carry the following: ICOM, Midland, Amcom, DenTron, KLM, Swan, Drake, Ten-Tec, Wilson, SST, MFJ, Hy-Gain, Lunar, Nye-Viking, B&W, Redi-kilowatt, Cush Craft, Mosley, Big Signal, Pipo, etc. Full Service Store **Fontana Electronics, 8628 Sierra Ave., Fontana CA 92335, 822-7710.**

Sacramento CA

Largest amateur radio selection in the Sacramento Valley. To serve you, Gary W6NJK, Dennis WB6ISO, Dan WB6RVU and Mike WA6DPN. Mon-Fri 10-6, Sat 10-5. **The Radio Place, 2964 Freepoint Blvd., Sacramento CA 95818, 441-7388.**

Santa Clara CA

Bay area's newest Amateur Radio store. New & used Amateur Radio sales & service. We feature Kenwood, ICOM, Wilson, Yaesu, Atlas, Ten-Tec & many more. **Shaver Radio, 3550 Lochinvar Avenue, Santa Clara CA 95051, 247-4220.**

New Castle DE

Paul WA3QPX, Rob WA3QLS—Serving amateurs in southern New Jersey, Delaware, and Maryland with the largest stock of amateur equipment and accessories in Delaware. **Delaware Amateur Supply, 71 Meadow Road, New Castle DE 19720, 328-7728.**

Bloomington IL

Retail—wholesale distributor for Rohn Towers—antennas by Cush Craft, Antenna Specialists, KLM, Wilson, Hy-Gain. Transceivers by Tempo, Regency, Wilson, Amcom. Also business and marine radios. **Hill Radio, 2503 G.E. Rd., Bloomington IL 61701, 663-2141.**

Terre Haute IN

Your ham headquarters located in the heart of the midwest. **Hoosier Electronics, Inc., 43B Meadows Shopping Center, P.O. Box 2001, Terre Haute IN 47802, 238-1456.**

Wichita KS

Microwave Modules—KLM—KDK—ICOM—Kenwood—Wilson—Standard—ICIR—SWAN—Lunar. We STOCK The Best Communications. **Revcom Electronics, 6247 N. Hydraulic, Wichita KS 67219, 744-1083.**

Dalton MA

Western Massachusetts. Complete 2 meter FM headquarters. Yaesu, KDK, Regency, Larsen, Cush Craft. All kinds of ham gear. **Blue Max Inc., Box 97, Dalton MA 01226, 684-0039.**

Littleton MA

The ham store of N.E. you can rely on. Kenwood, ICOM, Wilson, Yaesu, DenTron, KLM amps, B&W switches & wattmeters, Whistler radar detectors, Bearcat, Regency, antennas by Larsen, Wilson, Hustler, GAM. **TEL-COM Inc. Communications & Electronics, 675 Great Rd. Rt. 119, Littleton MA 01460, 486-3040.**

Syracuse NY

We Deal, We Trade, We Discount, We Please! Yaesu, Kenwood, Drake, ICOM, Ten-Tec, Swan, DenTron, Midland, Cush Craft, KLM, Hy-Gain, etc. Complete 2-way service shop! **Ham-bone Radio (div. Stereo Repair Shop) 3206 Erie Blvd. East, Syracuse NY 13214, 446-2266.**

Syracuse-Rome-Utica NY

Featuring: Yaesu, ICOM, Drake, Atlas, DenTron, Ten-Tec, Swan, Tempo, KLM, Hy-Gain, Mosley, Wilson, Larsen, Midland Southwest Technical Products. You won't be disappointed with equipment/service. **Radio World, Oneida County Airport-Terminal Building, Oriskany NY 13424, 337-2622.**

Souderton PA

Tired of looking at ads ??? Come and try our new and used equipment yourself—personal advice from our staff's 60 years combined ham experience. **Electronic Exchange, 136 N. Main St., Souderton PA 18964, 723-1200.**

Port Angeles WA

Mobile RFI shielding for elimination of ignition and alternator noises. Bonding straps. Components for "do-it-yourself" projects. Plenty of free advice. **Estes Engineering, 930 Marine Drive, Port Angeles WA 98362, 457-0904.**

DEALERS

Your company name and message can contain as many as 25 words for as little as \$150 yearly (prepaid), or \$15 per month (prepaid quarterly). No mention of mail order business or area code permitted. Directory text and payment must reach us 45 days in advance of publication. For example, advertising for the October issue must be in our hands by August 18th. Mail to 73 Magazine, Peterborough NH 03458, ATTN: Aline Coutu.

Tell them you saw their name in **73**

Amateur Radio Supply of Nashville, Inc.

ARSON, INC. Announces The Opening Of

615 South Gallatin Road, Madison, Tennessee 37115 • (615) 868-4956

A40

Authorized dealer for: Kenwood • Yaesu • Drake • Icom •
 • Dentron • Ten-Tec • Wilson • Tempo • Swan • Standard •
 • KLM • Larsen • Cushcraft • B & W • CDE • Newtronics
 (Hustler) • NYE • and others.

These ARSON, INC. policies have satisfied thousands nationwide.

1. Credit cards Welcome (except on "specials")
2. Trades invited.
3. Fast — to your door — delivery via UPS.
4. Large inventory of major lines — most items are in stock NOW!
5. Free Catalog
6. Cost of telephone calls will be deducted from your order.
7. Assurance of fair dealing through our nationwide reputation.
8. We're "burning" to make Hot Deals at A.R.S.O.N., Inc.

NOW - - - - A full line Ham Store with these
 Same Policies in ATLANTA - - ARSON ATLANTA, INC.

TRADE WITH US AND BENEFIT FROM OUR VOLUME BUYING

These are a few of our "HOT" Grand OPENING Specials

YAESU



101E Buy at \$799.00
 Get Free FV101B
 Remote VFO List \$125.00
 Send cashiers check or M.O.
 Shipping will be collect.

The Memorizer



Yaesu FT 227R
 Fully Syn 2M FM
 List \$315.00
 Call for Super Quote

Kenwood



7400A 25 watts
 Fully syn. 2M FM
 List \$399.00
 Call for Super Quote

CDE Ham III



Ham III rotor \$124.00
 Shipping included to Cont. USA
 Ham III rotor plus 100 ft. rotor
 cable \$139.00
 Ham III rotor plus 100 ft. each -
 rotor cable and RG-8U foam
 coax \$162.00
 Send cashiers check or M.O.

We can't advertise most of our special prices - - Call or Write

KENWOOD

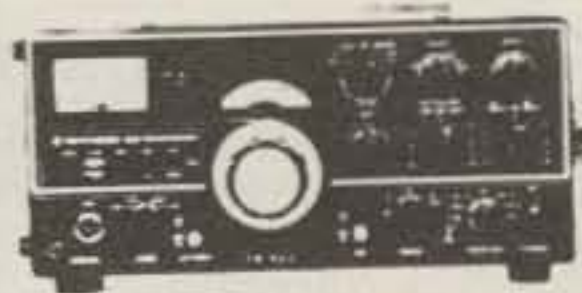

TS 520S List \$739.00
 Buy at \$739.00
 Get Free: 1. CW Filter \$49.00
 2. Ext. Speaker \$30.00
 3. Shipping Included
 Send cashiers check or M.O.

Dentron



Dentron Super Tuner
 List \$129.95
 Buy For \$116.00
 Send cashiers check or M.O.
 Shipping will be collect.

ICOM



IC-211
 4 MEG. MULTI-MODE
 2 METER TRANSCEIVER
 Buy at \$749.00 Get:
 Gift Certificate for \$125.00
 Send cashiers check or M.O.
 Shipping included.

DRAKE



Drake W4 WV4
 List \$79.00 List \$89.00
 Sell \$67.00 Sell \$76.00

WB4DXH • W4LTX • WA4GDX

Amateur Radio Supply of North Atlanta, Inc.

ARSON ATLANTA, INC.

Pinetree Plaza Shopping Center • 5269-6 Buford Highway, Doraville GA 30340 • (405) 455-1771

A56

K4JSR • WA4HUG • WD4LGF

DRAKE'S New STATE OF THE ART RIG IS HERE! !

THE TR-7
List 886.00

DR-7 Dig Readout
List 186.00

PS-7 Power Supply
List 166.00

MS-7 Speaker
List 33.00

Full Line of
Accessories

Call For Yours Now



KENWOOD



TS-820S
Deluxe 160-10M CW; SSB
List \$1098.00



TR-7500
2M 100 Ch. Programable
List \$299.00

DRAKE



R4C Rcvr
160-10M List \$699.00



T-4XC TX
160-10M List \$699.00

YAESU



FT-901 DM
160-10M all Mode HF
List \$1299.00



FRG-7
Broadcast to 30 MHz
List \$315.00

STORE HOURS

Mon. - Fri. 9 AM - 5 PM
Sun. 1 PM - 6 PM

**All Prices Subject to Change
Without Notice.**

MASTER CHARGE
& VISA ACCEPTED

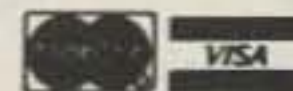

**CALL US and see why if you're not buying from us
We're Losin' and You're Losin'**

ATLANTA (404) 455-1771

NASHVILLE (615) 868-4956

We're "burning" to make "HOT" deals at ARSON ATLANTA, INC.

**THE
PERSONAL
COMMUNICATIONS
FOUNDATION**

Legal research for the amateur
radio and citizens band services.



For information, write: PERSONAL COMMUNICATIONS FOUNDATION
10960 Wilshire Boulevard, Suite 1504
Los Angeles, California 90024
or call: (213) 478-1749

DUPLEXERS



***Patent
Pending**

OUR NEW BANDPASS-
REJECT DUPLEXERS WITH
OUR EXCLUSIVE

BpBr CIRCUIT*

... provides superior perfor-
mance, especially at close
frequency spacing.

Models available for all Ham
bands. Special price for
Amateur Repeater Clubs

CALL OR WRITE FOR DETAILS:

WACOM PRODUCTS, INC.



Box 7307
Waco, Texas 76710
817/776-4444

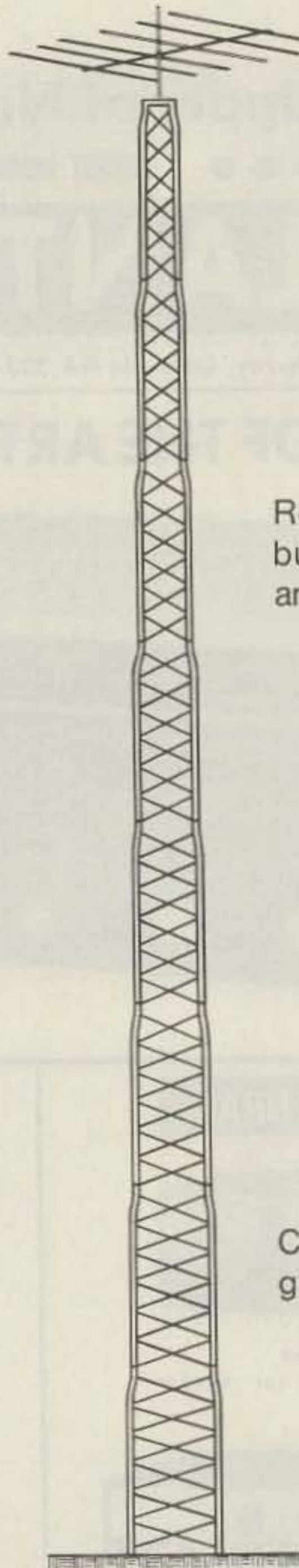

Rohn is the TOWER FORCE when it comes to
building towers — look at the BX Towers
and you'll see why . . .

- HDBX Towers will hold up to 18
sq. ft. antenna capacity.
- Due to design, BX Towers hold
greater antenna loads than
competitive models.
- Can be assembled on the ground and
hinged up or built vertically,
section upon section.
- Shipped nested
- Fabricated in U.S.A.

Check out the ROHN TOWER FORCE, you'll be
glad you did!

Unarco-Rohn

Division of Unarco Industries, Inc.
6718 West Plank Road, P.O. Box 2000
Peoria, Illinois 61656

U2

solid state continuous coverage
**THE
COMM
CENTER**



The Drake TR-7

C75

AREA CODE (301) WASHINGTON 953-9535 - BALTIMORE 792-0600
9624 FT. MEADE RD. LAUREL, MD. 20810

INC.

DREAMING OF A NEW RIG?
YOU'VE COME TO THE RIGHT PLACE!

OVERSTOCK
SALE

THOMAS COMMUNICATIONS

NEWINGTON, CONNECTICUT



"OVER 40 BRANDS IN STOCK"

KENWOOD ★ YAESU ★ KDK ★ DENTRON ★ WILSON ★ MFJ ★ SWAN ★ DRAKE
LARSEN ★ TEMPO ★ BEARCAT ★ B&W ★ ARRL PUBLICATIONS
MOSLEY ★ REGENCY ★ ASTATIC ★ AND MUCH MORE!

★ COMPLETE RADIO SERVICE SHOP ★

—FAST EFFICIENT SERVICE—WE REPAIR ALL BRANDS
—ALL WORK GUARANTEED—AMATEUR EXTRA/FIRST CLASS LICENSES

'YOU SHIP IT—WE FIX IT'

- ★ NEW AND USED Equipment
- ★ TRADES WELCOME
- ★ FREE Catalog
- ★ Same Day U.P.S. Shipping

**TELEPHONE
ORDERS**



THOMAS COMMUNICATIONS T34

95 KITTS LANE, Newington, Connecticut 06111 (203) 666-6225 or 667-3135
OPEN MON.-FRI. 10-6 • THUR. 10-8 • SAT. 10-4

Easy Directions: RT. 91 to RT. 15 South—2 Blocks Past McDonald's (Berlin Turnpike)

YOU ASKED FOR IT-

BOTH MORSE AND RTTY



ST-6000



DS-3000 KSR

The ULTIMATE in coded communications can now be yours with the new DS-3000 KSR TERMINAL (Version 3) and ST-6000 DEMODULATOR. Enjoy the convenience of composing and editing your messages BEFORE transmitting; decode and display CW as well as RTTY signals. Connect the HAL ST-6000 and DS-3000 KSR to your transceiver and antenna and work the world on RTTY and CW.

ST-6000

- 170-425-850 Hz Shift
- Low or High tones
- Crystal tone keyer
- Active band-pass filters
- Autostart and antispacer
- ATC and DTH
- KOS for keyboard break-in
- Scope or meter tuning indicator
- AM or FM limiter modes
- Table or rack mounting
- I/O interface to current loop, RS-232, MIL-188, and CMOS

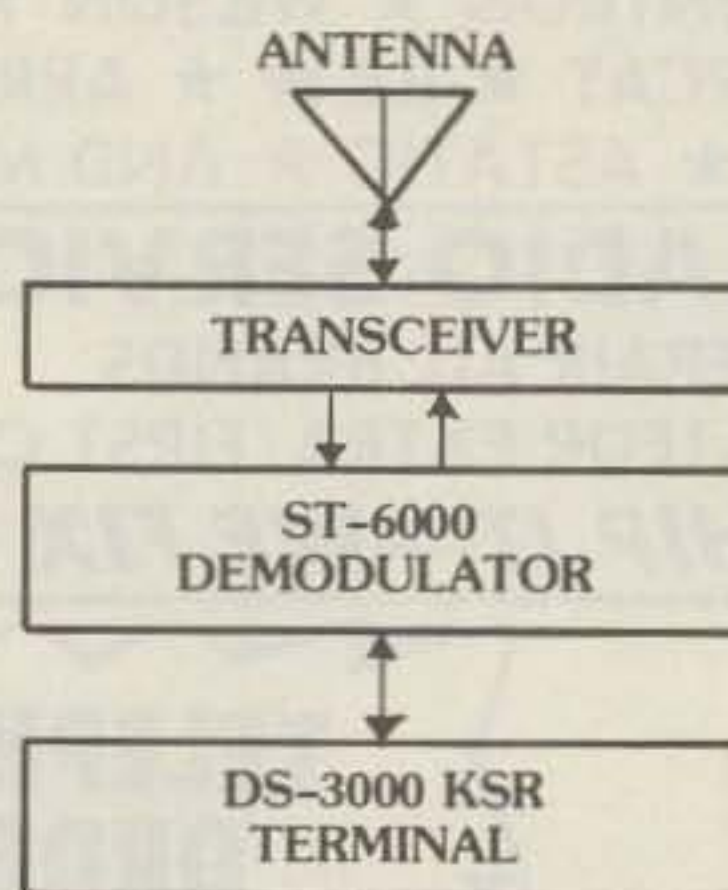

DS-3000 KSR

- MORSE, BAUDOT, and ASCII codes
- Full 72 character lines
- 16 lines of display
- Word wrap-around
- Edit with WORD, LINE, & PAGE modes
- Keyboard programmable HERE IS message
- Up to 175 WPM CW, 5 speeds BAUDOT & ASCII
- 8080A microprocessor controlled
- MORSE also output as ASCII or BAUDOT
- I/O interface to current loop or RS-232
- New streamlined 12 inch display
- On-screen indicators of WORD & PAGE modes

ST-6000M (Meter) \$495.00
 ST-6000S (Scope)..... \$595.00

DS-3000 KSR V3 \$1575.00
 DS-3000 KSR V2 (NO MORSE) . \$1195.00

Write or call us for our new amateur catalog.



HAL COMMUNICATIONS CORP.
 Box 365
 Urbana, Illinois 61801
 217-367-7373

For our European customers see HAL equipment at:
 Richter & Co.; Hannover
 I.E.C. Intereco; Bissone
 Primetek Systems; Handen, Sweden
 Radio Shack of London

Pick a card... any card

CALL TOLL FREE

1-800-228-4097
Communications Center

443 N 48th Street C58
 Lincoln, Nebraska 68504
 In Nebraska Call (402)466-8402

1-800-634-6227
Communications Center West

1072 N. Rancho Drive
 Las Vegas, Nevada 89106
 In Nevada Call (702)647-3114

Sale subject to limited supply

K
♥



YAESU FT-901 DM
 List \$1299
 Price too low to print, call for quote.

♥ **K**

9
♣



Buy a **FT-301** digital for **\$935** and get a power supply & CW filter free!

♣ **6**

J
♦



YAESU FT-101E
 List \$799
 Price too low to print, call for quote.

♦ **J**

J
♣



YAESU FT-7 Mobile
 List \$499
 Call for discount price

♣ **J**

Q
♠



KENWOOD TS-820S
 List \$1099
 Call for low price

♠ **Q**

K
♠



KENWOOD TS-520s
 List \$739
 Our price too low to print, call for it!

♠ **K**

2
♣



KENWOOD TR 7400
 List \$399
 Call for discount price

♣ **2**

K
♦



R4C List \$699
 Your price \$599
T4XC List \$699
 Your price \$599

♦ **K**

10
♦



YAESU FT-227R
 List \$319
 Call for discount price

♦ **10**

RADIO WORLD

CENTRAL NEW YORK'S FASTEST GROWING HAM DEALER



FT 101E



ICOM-211



DENTRON MJA 2500



TEMP-2020

Featuring Yaesu, Icom, Drake, Atlas, Dentron, Ten-Tec, Swan, Regency, Standard, Tempo, KLM, Hy-Gain, Mosley, Larsen, Midland, Wilson, Southwest Technical Products. We service everything we sell! Write or call for quote. YOU WON'T BE DISAPPOINTED.

We are just a few minutes off the NYS Thruway (I-90) Exit 32

RADIO WORLD

ONEIDA COUNTY AIRPORT
TERMINAL BUILDING
ORISKANY, NY 13424

Warren
K21XN

Bob
WA2MSH

315-337-2622

DISCOUNT SCANNERS

The Touch™



\$255.00

Prepaid
USA

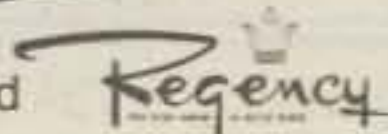

CHECK, M.O., MASTERCHARGE, VISA

BAY-COM B32

196 FRONT STREET
SCITUATE MA 02066
617-545-9700

Other Regency models at similar savings—send for list

...Mass. residents please add 5% tax...

JOYSTICK

Ideal for TV Games, Audio, Computer Games, etc. Features four 100K Center Tapped Pots.

\$3.50 ea. 3/\$10.00



ALCO MEP-10
CERAMIC TERMINAL
STRIP 10 Terminals.
\$.50 ea. - 10/\$4.00



TRIMPOTS
500 ohm
1K-5K-20K-25K 5/75c

TRANSFORMER-117vAC

Primary-12.6 c.t.- 3 Amps. \$3.00

All merchandise 100% guaranteed. Please include postage with your order.

Write for FREE Catalogue. CHICAGOLAND-
Our Store Open Daily at 10:00 A.M.

R.W. ELECTRONICS, INC.

3203 North Western Avenue
Chicago, Illinois 60618

312-248-2480

R18

NEW!

\$36.50

plus \$1.50 s/h
NY res. add tax



Features: CMOS Electronic Keyer

- State-of-the-art CMOS circuitry
- Self completing dots and dashes
- Dot and dash memory
- Iambic keying with any squeeze paddle
- 5-50 WPM
- Speed, volume, tone controls, side tone and speaker
- Low current drain CMOS-battery operation
- Deluxe quarter-inch jacks for keying and output
- Handsome eggshell white base - woodgrain top
- Compact and portable - 1-7/8 x 4-1/4 x 6-1/4
- Grid block keying
- Wired and tested - fully guaranteed - less battery

BRAND NEW!

\$25.95

Plus \$2.00 S/H
NY res. add tax



Features:

- Twin paddle squeeze key
- Extra heavy base—non skid feet
- Adjustable contact spacing
- Touch tension—comfort keying
- Smooth friction free paddle movement
- Handsome crinkle finish base and rich red paddles
- Five way binding posts
- Use with Trac CMOS keyer or any keyer

TRAC-KEY

TRAC

Electronics, Inc.
1106 Rand Bldg.
Buffalo NY 14203

T18

DOVETRON



MPC-1000C

Multipath Correction
In-Band Diversity &
AFSK Tone Keyer

Amateur Net: \$545.00

Standard features include CONTINUOUSLY tuneable Mark and Space channels (1000 Hz to 3200 Hz), Dual Mode (MARK or FSK) Autostart and internal high level neutral loop keyer (20 to 60 ml). Both EIA and MIL FSK outputs are provided for direct interface to microprocessor and video terminal peripherals.



MPC-1000CR

Signal Regeneration &
Speed Conversion

Amateur Net: \$645.00

A front panel switch permits internal TSR-200 Signal Regenerator-Speed converter assembly to electronically "gear-shift" between 60, 67, 75 and 100 WPM. All incoming and outgoing signals are regenerated to less than 0.5% bias distortion. Also available with DIGITAL Autostart (TSR-200D): Amateur Net: \$695.00



MPC-1000R/ TSR-500

Dual UART Regeneration,
Speed Conversion, 200
Char. Memory, Word Cor-
rection & DIGITAL
Autostart

Amateur Net: \$895.00*

The MPC-1000R/TSR-500 provides Preloading and Recirculation of the 200 character FIFO Memory, a keyboard-controlled Word Correction circuit, Variable Character Rate, Tee Dee Inhibit, Blank/LTRS Diddle, a Triple Tone-Pair AFSK Tone Keyer and a Character Recognition/Speed Determination DIGITAL (DAS-100) Autostart mode.

*The MPC-1000R is also available without a TSR assembly and functions as a MPC-1000C with a Triple Tone-Pair AFSK Tone Keyer. This "Basic-R" permits future expansion with a TSR-100, TSR-200, TSR-200D or TSR-500 by simply lifting the lid and plugging in the appropriate TSR assembly: Amateur Net (Basic-R): \$595.00

Your QSL will bring complete specifications, or call: 213-682-3705.

D23



627 FREMONT AVENUE
(P. O. BOX 267)
SOUTH PASADENA, CA. 91030



The LEADER In the Northwest!

ATLAS • ICOM • KENWOOD • YAESU

Come to ABC Communications today for the best solution to your particular communication requirements, whether they be Amateur, Two-way Business Band, VHF Marine or Police Scanner.



DENTRON MLA-2500
\$899.50.



DENTRON MT-3000A
Deluxe Tuner \$349.50.

DENTRON 160-10 AT (not shown)
Super Tuner \$129.50.

Dentron



KENWOOD Transceiver
TS-820S 160 thru 10M \$1098.



KENWOOD Transceiver
TS-520S 160 thru 10M \$739. — (less DG-5)



KENWOOD 2M FM
TR-7400A \$399.

KENWOOD



ATLAS 350-XL Transceiver
160 thru 10M \$1195



ATLAS Transceiver 210X
80 thru 10M \$679.
Atlas Transceiver 215X (not shown)
160 thru 15M \$679.

ATLAS
RADIO INC.



ICOM Transceiver 2M FM
SSB IC 211 \$749.



ICOM Transceiver 2M FM
IC 22S \$299.



ICOM Transceiver 2M FM
IC 245 \$499.

ICOM



YAESU HF SSB
FT-101E, 160 thru 10M \$799.

YAESU



ABC
COMMUNICATIONS

A46



YAESU FT-221R
2 meter FM-SSB \$688.

YAESU

17550 15TH AVE. N.E. • SEATTLE, WASH. 98155 • (206) 364-8300

We also handle Wilson, Cushcraft, Hy-Gain, Antenna Specialists, KLM, etc.
Attention Washington residents: Come on in for excellent service in our complete Communications Repair Shop.

Write or call for SPECIAL tower, rotor, antenna package! Tri-Ex, Rohn, Wilson Towers. Shipping Info: F.O.B. Seattle via UPS, truck, or parcel post.

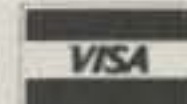
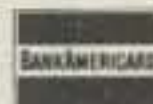

TO PLACE ORDER
CALL TOLL FREE
IN STATE OF WASH.
1-(800) 562-7625
Wash. res. add sales tax

Other locations: (Walk-in customers only) • Bellevue — 12001 N. E. 12th • Everett — 6920 Evergreen Way • Open Mon. thru Sat.

& giant demo & clearance sale

FULL FACTORY WARRANTY!

| WILSON: | SALE PRICE |
|-------------------|------------|
| M-66 (6 E1m 6 M) | \$ 79.95 |
| M-68 (8 E1m 6 M) | 104.95 |
| M-420 (4 E1 20 M) | 141.95 |
| M-155 (5 E1 15 M) | 134.95 |
| WV-1 (40-10 Vert) | 59.95 |
| S Ys-1 Tri-bander | 204.95 |
| S Ys-2 Tri-bander | 164.95 |
| M 420 MTR | 141.95 |
| M 520 | 239.95 |
| M 340 | 554.95 |

| MOSLEY: | SALE PRICE |
|-----------------|------------|
| S-402 2 E1 40 M | 209.95 |
| CL 36 | 233.95 |
| CL 33 | 174.25 |

| QUAD VIKING INSTRUMENTS: | SALE PRICE |
|--------------------------|------------|
| 1322 2 E1 Quad 10-15-20 | 202.95 |
| 1323 3 E1 Quad 10-15-20 | 291.95 |

| INFO TECH: | SALE PRICE |
|------------|------------|
| Mod 300 | 450.00 |
| 100 C | 391.95 |
| 75 A | 287.95 |
| 93 | 212.95 |
| 200 C | 439.95 |
| 150 | 259.95 |
| 75 B | 289.95 |
| 30 C | 289.95 |
| 200 A | 419.95 |
| 10 B | 269.95 |

**(DEALER FOR
DRAKE)... ALSO
WILSON MARK II IN
STOCK!**

WHILE THEY LAST!



**universal
amateur
radio inc**

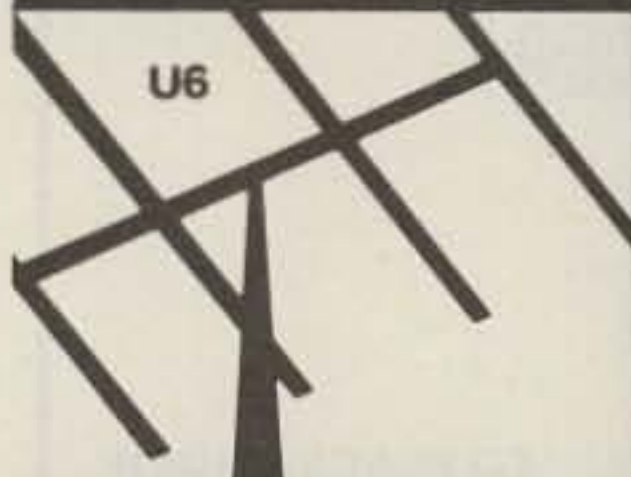

1280 AIDA DRIVE
COLUMBUS, OHIO
(Reynoldsburg) 43068

(614)-866-HAMS

JUST GETTING ON THE AIR? See Adirondack for



- New Equipment
- Used Gear
- Friendly Advice

ADIRONDACK Radio Supply

185-191 West Main Street • P.O. Box 88
Amsterdam, N.Y. 12010 Tel. (518) 842-8350
Just 5 minutes from N.Y. Thruway—Exit 27

Same day shipment. First line parts only. Factory tested. Guaranteed money back. Quality IC's and other components at factory prices.

INTEGRATED CIRCUITS

| | | | | | | | | | | | | | | | | |
|---------|---------|---------|-----------|-----------|-----------|-------|-------|---------|---------|-----------|-----------|-------|-------|---------|---------|----|
| 7408TTL | 74LS28N | 41 | LM340T-15 | 1.10 | LM340T-18 | 1.10 | 7409N | 17 | 74LS20N | 39 | LM340T-24 | 1.10 | 7409N | 17 | 74LS20N | 39 |
| 7409N | 17 | 74LS20N | 39 | LM340T-24 | 1.10 | 7409N | 17 | 74LS20N | 39 | LM340T-24 | 1.10 | 7409N | 17 | 74LS20N | 39 | |
| 7409N | 17 | 74LS20N | 39 | LM340T-24 | 1.10 | 7409N | 17 | 74LS20N | 39 | LM340T-24 | 1.10 | 7409N | 17 | 74LS20N | 39 | |
| 7409N | 17 | 74LS20N | 39 | LM340T-24 | 1.10 | 7409N | 17 | 74LS20N | 39 | LM340T-24 | 1.10 | 7409N | 17 | 74LS20N | 39 | |
| 7409N | 17 | 74LS20N | 39 | LM340T-24 | 1.10 | 7409N | 17 | 74LS20N | 39 | LM340T-24 | 1.10 | 7409N | 17 | 74LS20N | 39 | |

| | | | | | | | |
|---------|------|----------|-------|---------|------|----------|-------|
| CD4511 | 94 | 2112-2 | 3.99 | CD4511 | 94 | 2112-2 | 3.99 |
| CD4515 | 2.50 | 2114 | 8.90 | CD4515 | 2.50 | 2114 | 8.90 |
| CD4516 | 1.10 | MM4110 | 24.95 | CD4516 | 1.10 | MM4110 | 24.95 |
| CD4518 | 1.00 | 25138 | 1.40 | CD4518 | 1.00 | 25138 | 1.40 |
| CD4520 | 1.00 | 21100-1 | 1.40 | CD4520 | 1.00 | 21100-1 | 1.40 |
| CD4527 | 1.51 | MM5282 | 40 | CD4527 | 1.51 | MM5282 | 40 |
| CD4528 | 79 | MM5280 | 3.00 | CD4528 | 79 | MM5280 | 3.00 |
| CD4553 | 5.75 | MM5320 | 9.95 | CD4553 | 5.75 | MM5320 | 9.95 |
| CD4566 | 2.25 | MM5320 | 5.94 | CD4566 | 2.25 | MM5320 | 5.94 |
| CD4583 | 4.50 | PD4110-3 | 4.00 | CD4583 | 4.50 | PD4110-3 | 4.00 |
| CD4585 | 1.10 | PD4110-4 | 3.00 | CD4585 | 1.10 | PD4110-4 | 3.00 |
| CD45100 | 3.00 | PS101 | 13.95 | CD45100 | 3.00 | PS101 | 13.95 |
| CD4007 | 21 | 74C00 | 28 | CD4007 | 21 | 74C00 | 28 |
| CD4008 | 39 | 74C00 | 28 | CD4008 | 39 | 74C00 | 28 |
| CD4009 | 39 | 74C00 | 28 | CD4009 | 39 | 74C00 | 28 |
| CD4010 | 39 | 74C00 | 28 | CD4010 | 39 | 74C00 | 28 |
| CD4011 | 21 | 74C00 | 28 | CD4011 | 21 | 74C00 | 28 |
| CD4012 | 21 | 74C00 | 28 | CD4012 | 21 | 74C00 | 28 |
| CD4013 | 26 | 74C00 | 28 | CD4013 | 26 | 74C00 | 28 |
| CD4014 | 26 | 74C00 | 28 | CD4014 | 26 | 74C00 | 28 |
| CD4015 | 26 | 74C00 | 28 | CD4015 | 26 | 74C00 | 28 |
| CD4016 | 36 | 74C00 | 28 | CD4016 | 36 | 74C00 | 28 |
| CD4017 | 36 | 74C00 | 28 | CD4017 | 36 | 74C00 | 28 |
| CD4018 | 36 | 74C00 | 28 | CD4018 | 36 | 74C00 | 28 |
| CD4019 | 36 | 74C00 | 28 | CD4019 | 36 | 74C00 | 28 |
| CD4020 | 36 | 74C00 | 28 | CD4020 | 36 | 74C00 | 28 |
| CD4021 | 36 | 74C00 | 28 | CD4021 | 36 | 74C00 | 28 |
| CD4022 | 36 | 74C00 | 28 | CD4022 | 36 | 74C00 | 28 |
| CD4023 | 36 | 74C00 | 28 | CD4023 | 36 | 74C00 | 28 |
| CD4024 | 36 | 74C00 | 28 | CD4024 | 36 | 74C00 | 28 |
| CD4025 | 36 | 74C00 | 28 | CD4025 | 36 | 74C00 | 28 |
| CD4026 | 36 | 74C00 | 28 | CD4026 | 36 | 74C00 | 28 |
| CD4027 | 36 | 74C00 | 28 | CD4027 | 36 | 74C00 | 28 |
| CD4028 | 36 | 74C00 | 28 | CD4028 | 36 | 74C00 | 28 |
| CD4029 | 36 | 74C00 | 28 | CD4029 | 36 | 74C00 | 28 |
| CD4030 | 36 | 74C00 | 28 | CD4030 | 36 | 74C00 | 28 |
| CD4031 | 36 | 74C00 | 28 | CD4031 | 36 | 74C00 | 28 |
| CD4032 | 36 | 74C00 | 28 | CD4032 | 36 | 74C00 | 28 |
| CD4033 | 36 | 74C00 | 28 | CD4033 | 36 | 74C00 | 28 |
| CD4034 | 36 | 74C00 | 28 | CD4034 | 36 | 74C00 | 28 |
| CD4035 | 36 | 74C00 | 28 | CD4035 | 36 | 74C00 | 28 |
| CD4036 | 36 | 74C00 | 28 | CD4036 | 36 | 74C00 | 28 |
| CD4037 | 36 | 74C00 | 28 | CD4037 | 36 | 74C00 | 28 |
| CD4038 | 36 | 74C00 | 28 | CD4038 | 36 | 74C00 | 28 |
| CD4039 | 36 | 74C00 | 28 | CD4039 | 36 | 74C00 | 28 |
| CD4040 | 36 | 74C00 | 28 | CD4040 | 36 | 74C00 | 28 |
| CD4041 | 36 | 74C00 | 28 | CD4041 | 36 | 74C00 | 28 |
| CD4042 | 36 | 74C00 | 28 | CD4042 | 36 | 74C00 | 28 |
| CD4043 | 36 | 74C00 | 28 | CD4043 | 36 | 74C00 | 28 |
| CD4044 | 36 | 74C00 | 28 | CD4044 | 36 | 74C00 | 28 |
| CD4045 | 36 | 74C00 | 28 | CD4045 | 36 | 74C00 | 28 |
| CD4046 | 36 | 74C00 | 28 | CD4046 | 36 | 74C00 | 28 |
| CD4047 | 36 | 74C00 | 28 | CD4047 | 36 | 74C00 | 28 |
| CD4048 | 36 | 74C00 | 28 | CD4048 | 36 | 74C00 | 28 |
| CD4049 | 36 | 74C00 | 28 | CD4049 | 36 | 74C00 | 28 |
| CD4050 | 36 | 74C00 | 28 | CD4050 | 36 | 74C00 | 28 |
| CD4051 | 36 | 74C00 | 28 | CD4051 | 36 | 74C00 | 28 |
| CD4052 | 36 | 74C00 | 28 | CD4052 | 36 | 74C00 | 28 |
| CD4053 | 36 | 74C00 | 28 | CD4053 | 36 | 74C00 | 28 |
| CD4054 | 36 | 74C00 | 28 | CD4054 | 36 | 74C00 | 28 |
| CD4055 | 36 | 74C00 | 28 | CD4055 | 36 | 74C00 | 28 |
| CD4056 | 36 | 74C00 | 28 | CD4056 | 36 | 74C00 | 28 |
| CD4057 | 36 | 74C00 | 28 | CD4057 | 36 | 74C00 | 28 |
| CD4058 | 36 | 74C00 | 28 | CD4058 | 36 | 74C00 | 28 |
| CD4059 | 36 | 74C00 | 28 | CD4059 | 36 | 74C00 | 28 |
| CD4060 | 36 | 74C00 | 28 | CD4060 | 36 | 74C00 | 28 |
| CD4061 | 36 | 74C00 | 28 | CD4061 | 36 | 74C00 | 28 |
| CD4062 | 36 | 74C00 | 28 | CD4062 | 36 | 74C00 | 28 |
| CD4063 | 36 | 74C00 | 28 | CD4063 | 36 | 74C00 | 28 |
| CD4064 | 36 | 74C00 | 28 | CD4064 | 36 | 74C00 | 28 |
| CD4065 | 36 | 74C00 | 28 | CD4065 | 36 | 74C00 | 28 |
| CD4066 | 36 | 74C00 | 28 | CD4066 | 36 | 74C00 | 28 |
| CD4067 | 36 | 74C00 | 28 | CD4067 | 36 | 74C00 | 28 |
| CD4068 | 36 | 74C00 | 28 | CD4068 | 36 | 74C00 | 28 |
| CD4069 | 36 | 74C00 | 28 | CD4069 | 36 | 74C00 | 28 |
| CD4070 | 36 | 74C00 | 28 | CD4070 | 36 | 74C00 | 28 |
| CD4071 | 36 | 74C00 | 28 | CD4071 | 36 | 74C00 | 28 |
| CD4072 | 36 | 74C00 | 28 | CD4072 | 36 | 74C00 | 28 |
| CD4073 | 36 | 74C00 | 28 | CD4073 | 36 | 74C00 | 28 |
| CD4074 | 36 | 74C00 | 28 | CD4074 | 36 | 74C00 | 28 |
| CD4075 | 36 | 74C00 | 28 | CD4075 | 36 | 74C00 | 28 |
| CD4076 | 36 | 74C00 | 28 | CD4076 | 36 | 74C00 | 28 |
| CD4077 | 36 | 74C00 | 28 | CD4077 | 36 | 74C00 | 28 |
| CD4078 | 36 | 74C00 | 28 | CD4078 | 36 | 74C00 | 28 |
| CD4079 | 36 | 74C00 | 28 | CD4079 | 36 | 74C00 | 28 |
| CD4080 | 36 | 74C00 | 28 | CD4080 | 36 | 74C00 | 28 |
| CD4081 | 36 | 74C00 | 28 | CD4081 | 36 | 74C00 | 28 |
| CD4082 | 36 | 74C00 | 28 | CD4082 | 36 | 74C00 | 28 |
| CD4083 | 36 | 74C00 | 28 | CD4083 | 36 | 74C00 | 28 |
| CD4084 | 36 | 74C00 | 28 | CD4084 | 36 | 74C00 | 28 |
| CD4085 | 36 | 74C00 | 28 | CD4085 | 36 | 74C00 | 28 |
| CD4086 | 36 | 74C00 | 28 | CD4086 | 36 | 74C00 | 28 |
| CD4087 | 36 | 74C00 | 28 | CD4087 | 36 | 74C00 | 28 |
| CD4088 | 36 | 74C00 | 28 | CD4088 | 36 | 74C00 | 28 |
| CD4089 | 36 | 74C00 | 28 | CD4089 | 36 | 74C00 | 28 |
| CD4090 | 36 | 74C00 | 28 | CD4090 | 36 | 74C00 | 28 |
| CD4091 | 36 | 74C00 | 28 | CD4091 | 36 | 74C00 | 28 |
| CD4092 | 36 | 74C00 | 28 | CD4092 | 36 | 74C00 | 28 |
| CD4093 | 36 | 74C00 | 28 | CD4093 | 36 | 74C00 | 28 |
| CD4094 | 36 | 74C00 | 28 | CD4094 | 36 | 74C00 | 28 |
| CD4095 | 36 | 74C00 | 28 | CD4095 | 36 | 74C00 | 28 |
| CD4096 | 36 | 74C00 | 28 | CD4096 | 36 | 74C00 | 28 |
| CD4097 | 36 | 74C00 | 28 | CD4097 | 36 | 74C00 | 28 |
| CD4098 | 36 | 74C00 | 28 | CD4098 | 36 | 74C00 | 28 |
| CD4099 | 36 | 74C00 | 28 | CD4099 | 36 | 74C00 | 28 |
| CD4100 | 36 | 74C00 | 28 | CD4100 | 36 | 74C00 | 28 |

P.O. Box 4430M Santa Clara, CA 95054
For will call only: (408) 988-1640
2322 Walsh Ave.



| CLOCK MODULES | PRICE | DESCRIPTION | PRICE |
|---------------|-------|-------------|-------|
| MM5282 | 40 | MM5282 | 40 |
| MM5320 | 9.95 | MM5320 | 9.95 |
| MM5320 | 5.94 | MM5320 | 5.94 |
| MM5320 | 4.00 | MM5320 | 4.00 |
| MM5320 | 3.75 | MM5320 | 3.75 |
| MM5320 | 2.95 | MM5320 | |

ADVA



KIT \$11⁹⁵

ASSEMBLED \$17.95
ADD \$1.25 FOR
POSTAGE/HANDLING

VARIABLE POWER SUPPLY

- Continuously Variable from 2V to over 15V
- Short-Circuit Proof
- Typical Regulation of 0.1%
- Electronic Current Limiting at 300mA
- Very Low Output Ripple
- Fiberglass PC Board Mounts All Components
- Assemble in about One Hour
- Makes a Great Bench or Lab Power Supply
- Includes All Components except Case and Meters

OTHER ADVA KITS:

LOGIC PROBE KIT—Use with CMOS, TTL, DTL, RTL, HTL, HINIL and most MOS IC's. Built-in protection against polarity reversal and overvoltage. Draws only a few mA from circuit under test. Dual LED readout. Complete kit includes case and slip leads. **ONLY \$7.95**

FIXED REGULATED POWER SUPPLY KITS—Short-circuit proof, with thermal current limiting. Compact size and typical regulation of 0.5% make these ideal for most electronic projects. Available for: 5V @ 500mA, 6V @ 500mA, 9V @ 500mA, 12V @ 400mA, 15V @ 300mA. Specify voltage when ordering. **\$8.95 ea.**

These easy-to-assemble kits include all components, complete detailed instructions and plated fiberglass PC boards. Power supply kits do not include case or meters. Add \$1.25 per kit for postage and handling.

MAIL NOW! FREE DATA SHEETS supplied with many items from this ad. FREE ON REQUEST—741 Op Amp with every order of \$5 or more—749 Dual Op Amp or two E100 FET's with every order of \$10 or more, postmarked prior to 12/31/77. One free item per order. **ORDER TODAY**—All items subject to prior sale and prices subject to change without notice. All items are new surplus parts—100% functionally tested.

WRITE FOR FREE CATALOG #77 offering over 700 semiconductors carried in stock. Send 13¢ stamp.

TERMS: Send check or money order (U.S. funds) with order. Add 5% postage for U.S., Canada and Mexico. \$1.00 handling charge on orders under \$10. Calif. residents add 6% sales tax. Foreign orders add 10% postage. COD orders—add \$1.00 service charge.

MORE SPECIALS:

RC4195DN ±15V @ 50mA VOLTAGE REGULATOR IC. Very easy to use. Makes a neat Highly Regulated ±15V Supply for OP AMP's, etc. Requires only unregulated DC (18-30V) and 2 bypass capacitors. With Data Sheet and Schematics. 8-pin mDIP **\$1.25**

RC4136 Quad 741 Low-Noise Op Amp mDIP **\$0.95**

LM1304 FM Multiplex Stereo Demodulator DIP **0.99**

LM2111 FM IF Subsystem (IF Amp, Det., Limiter) DIP **0.99**

1N6263 Hot Carrier Diode 0.4V @ 1mA 0.1ns DO-35 **1.00**

ZENERS—Specify Voltage 3.3, 3.9, 4.3, 5.1, 6.8, 8.2 400mW 4/\$1.00
9.1, 10, 12, 15, 16, 18, 20, 22, 24, 27, or 33V (±10%) 1 Watt 3/\$1.00

- MONEY-BACK GUARANTEE
- ALL TESTED AND GUARANTEED

ADVA

ELECTRONICS
BOX 4181 EP, WOODSIDE, CA 94062
Tel. (415) 851-0455

FREE

IC or FET's WITH
\$5 & \$10 ORDERS.†
DATA SHEETS
WITH MANY ITEMS.

| DIODES | TRANSISTORS | TRANSISTORS | TRANSISTORS | LINEAR IC's | | | | | |
|---------------------|-------------|-------------|-------------|-------------|--------|--------------|----------|------------|--------|
| ZENERS & RECTIFIERS | 2N706 | \$0.24 | 2N4001 | 3/51 | 2N5638 | 2/51 | LM340K-5 | \$1.20 | |
| 1N458 to 1N486 | 6/51 | 2N718 | .24 | 2N4002 | \$0.75 | 2N5640 | 2/51 | LM340T-5 | 1.20 |
| 1N483 to 1N486 | 6/51 | 2N720 | .48 | 2N4121 | 3/51 | CP643 | \$4.00 | LM340T-6 | 1.20 |
| 1N490 to 1N494 | 4/51 | 2N818 | 3/51 | 2N4122 | 3/51 | CP650* | \$5.00 | LM340T-12 | 1.20 |
| 1N495 to 1N498 | 4/51 | 2N1613 | \$0.29 | 2N4124 | 5/51 | CP651 | \$4.00 | LM340T-15 | 1.20 |
| 1N499 to 1N502 | 4/51 | 2N1711 | .25 | 2N4248 | 5/51 | E100 | 4/51 | LM340T-24 | 1.20 |
| 1N503 to 1N506 | 4/51 | 2N1880 | .38 | 2N4249 | 5/51 | E101 | 3/51 | LM378M* | .55 |
| 1N507 to 1N510 | 4/51 | 2N1883 | .38 | 2N4250 | 4/51 | E102 | 3/51 | LM377M | 2.50 |
| 1N511 to 1N514 | 15/51 | 2N2219 | .24 | 2N4274 | 5/51 | E175 | 3/51 | LM388M | 1.25 |
| 1N515 to 1N518 | 4/51 | 2N2222 | 6/51 | 2N4302 | \$0.25 | MPF102 to* | 3/51 | NE555V* | 2.51 |
| 1N519 to 1N522 | 4/51 | 2N2222A | 5/51 | 2N4303 | .25 | MPF104 | 3/51 | NE556A | \$0.30 |
| 1N523 to 1N526 | 4/51 | 2N2369 | 5/51 | 2N4338 | 5/51 | MPF112 | 4/51 | LM790CH | .29 |
| 1N527 to 1N530 | 4/51 | 2N2606 to | 5/51 | 2N4300M | 2/51 | MP56515 | 3/51 | LM790CN | .29 |
| 1N531 to 1N534 | 4/51 | 2N2609 | 5/51 | 2N4301 | 5/51 | SE1001 | 4/51 | LM723M | 2/51 |
| 1N535 to 1N538 | 4/51 | 2N2905 | \$0.24 | 2N4352 | \$0.80 | SE1002 | 4/51 | LM723N* | 3/51 |
| 1N539 to 1N542 | 4/51 | 2N2906A | .24 | 2N4416 | 3/51 | SE2001 | 4/51 | LM739M | \$1.00 |
| 1N543 to 1N546 | 4/51 | 2N2907* | 5/51 | 2N4416A | \$0.80 | SE2002 | 4/51 | LM741CN* | 3/51 |
| 1N547 to 1N550 | 4/51 | 2N3553 | \$1.50 | 2N4856 to | 5/51 | SE5001 to | 3/51 | LM741CN* | 4/51 |
| 1N551 to 1N554 | 4/51 | 2N3563 | 6/51 | 2N4881 | 5/51 | SE5003 | 3/51 | LM741CN14 | .34 |
| 1N555 to 1N558 | 4/51 | 2N3964 | 4/51 | 2N4887E | 2/51 | SE5020 | \$3.00 | LM747CN | .65 |
| 1N559 to 1N562 | 4/51 | 2N3965 to | 6/51 | 2N4888E | 2/51 | TIS73 to | 3/51 | 748CJ DIP | .35 |
| 1N563 to 1N566 | 4/51 | 2N3968 | 6/51 | 2N4888 | \$2.50 | TIS75 | 3/51 | 748CJ DIP | 1.00 |
| 1N567 to 1N570 | 4/51 | 2N3970 | 6/51 | 2N4888 | 5/51 | DIGITAL IC's | | 844CP mDIP | 1.00 |
| 1N571 to 1N574 | 4/51 | 2N3972 | 6/51 | 2N4905 | 3/51 | MM5738M | \$2.95 | LM1304N | 1.15 |
| 1N575 to 1N578 | 4/51 | 2N3974 | 6/51 | 2N4905 | 3/51 | SN7400N | .16 | LM1458M* | 3/51 |
| 1N579 to 1N582 | 4/51 | 2N3976 | 6/51 | 2N5008 | 4/51 | SN7410N | .16 | LM2111N | \$1.40 |
| 1N583 to 1N586 | 4/51 | 2N3978 | 6/51 | 2N5125 to | 6/51 | SN7420N | .16 | XR2505CP | 1.55 |
| 1N587 to 1N590 | 4/51 | 2N3980 | 6/51 | 2N5125 | 6/51 | SN7420N | .16 | 2740DE | 1.95 |
| 1N591 to 1N594 | 4/51 | 2N3982 | 6/51 | 2N5138 | 5/51 | SN7440N | .16 | CA3028A | 1.75 |
| 1N595 to 1N598 | 4/51 | 2N3984 | 6/51 | 2N5138 | 5/51 | SN7451N | .16 | CA3046 | .84 |
| 1N599 to 1N602 | 4/51 | 2N3986 | 6/51 | 2N5183 | 3/51 | SN7472N | .38 | LM3075N1 | 1.45 |
| 1N603 to 1N606 | 4/51 | 2N3988 | 6/51 | 2N5187 | 3/51 | SN7475N | .48 | CA3086* | .52 |
| 1N607 to 1N610 | 4/51 | 2N3990 | 6/51 | 2N5199 | 2.50 | SN7476N | .35 | LM3900N | .65 |
| 1N611 to 1N614 | 4/51 | 2N3992 | 6/51 | 2N5210 | 3/51 | SN7480N | .44 | RC4194D | 1.50 |
| 1N615 to 1N618 | 4/51 | 2N3994 | 6/51 | 2N5208 | 2/51 | LINEAR IC's | | RC4194TK* | 2.50 |
| 1N619 to 1N622 | 4/51 | 2N3996 | 6/51 | 2N5207 | 1/50 | LM100H | \$2.50 | RC4195DN* | 1.25 |
| 1N623 to 1N626 | 4/51 | 2N3998 | 6/51 | 2N5432 | 6/51 | LM301AN | .27 | RC4195TK* | 2.25 |
| 1N627 to 1N630 | 4/51 | 2N3999 | 6/51 | 2N5457 | 3/51 | LM307H | .27 | LM4250CN | 2.00 |
| 1N631 to 1N634 | 4/51 | 2N3999 | 6/51 | 2N5458 | 3/51 | LM308N | .88 | RC4558DN | .55 |
| 1N635 to 1N638 | 4/51 | 2N3999 | 6/51 | 2N5484 | 3/51 | LM308K | .94 | N5556V | .95 |
| 1N639 to 1N642 | 4/51 | 2N3999 | 6/51 | 2N5488 | 2/51 | LM311N | .90 | N5559V | .50 |
| 1N643 to 1N646 | 4/51 | 2N3999 | 6/51 | 2N5543 | 2.50 | LM320K-5 | 1.35 | UA7805UC | 1.25 |
| 1N647 to 1N650 | 4/51 | 2N3999 | 6/51 | 2N5544 | 2.50 | LM320K-12 | 1.35 | 8038 DIP* | 3.75 |
| 1N651 to 1N654 | 4/51 | 2N3999 | 6/51 | 2N5561 | 12.00 | LM320K-15 | 1.35 | DM75482 | .88 |
| 1N655 to 1N658 | 4/51 | 2N3999 | 6/51 | | | | | | |

*SUPER SPECIALS:

| | | | | |
|----------|--|--------|--------------------------|--------|
| 1N34 | Germanium Diode | 10/\$1 | FSA2501M Diode Array | 2/51 |
| 1N914 | 100V/10mA Diode | 20/\$1 | MPF102 200MHz RF Amp | 3/51 |
| 1N4001 | 50V/1A Rectifier | 15/51 | 40673 MOSFET RF Amp | \$1.75 |
| 1N4154 | 30V 1N914 | 25/51 | LM324 Quad 741 Op Amp | .94 |
| BR1 | 50V 1/8A Bridge Rec | 4/51 | LM376 Pos Volt Reg mDIP | .55 |
| 2N2222 | NPN Transistor | 6/51 | NE555 Timer mDIP | .38 |
| 2N2907 | PNP Transistor | 6/51 | LM723 2.37V Reg DIP | 3/51 |
| 2N3055 | Power Xistor 10A | \$0.75 | LM741 Comp Op Amp mDIP | 6/51 |
| 2N3904 | NPN Amp/Sw β100 | 6/51 | LM1458 Dual 741 mDIP | 3/51 |
| 2N3906 | PNP Amp/Sw β100 | 6/51 | CA3086 5 Trans Array DIP | .62 |
| CP650 | Power FET 1/2Amp | \$5 | RCA29 Pwr Xistor 1A 30W | .70 |
| RF391 | RF Power Amp Transistor 10-25W @ 3-30MHz TO-3 | \$5.00 | | |
| 555X | Timer 1μs-1hr Different pinout from 555 (w/data) | 3/51 | | |
| RC4194TK | Dual Tracking Regulator ±0.2 to 30V @ 200mA TO-66 | \$2.50 | | |
| RC4195TK | Dual Tracking Regulator ±15V @ 100mA (TO-66) | \$2.25 | | |
| 8038 | Waveform Generator ~100kHz Wave With Circuits & Data | \$3.75 | | |

SPECIALS—THIS MONTH ONLY

| | | | | | |
|---|--|--------|---------|---|------------|
| 1N34A | Germanium Diode 60V 10mA | 10/\$1 | LM308H | Low Bias Current Op Amp-Super 709 | \$0.84 |
| 1N270 | Germanium Diode 80V 200mA | 4/\$1 | LM309K | 5 Volt Regulator | TO-3 .84 |
| 1N914 | Silicon Diode 100V 10mA | 25/\$1 | LM317K | Adjustable Voltage Regulator | 2-37V 3.50 |
| 1N6263 | Hot Carrier Diode (HP2800, etc.) | \$1.00 | LM380N | 2 Watt Audio Power Amplifier | DIP .94 |
| F7 | Power Varactor 1-2W Out @ 432MHz (Specs & Circuits included with F7) | \$2.00 | NE565A | Phase Locked Loop | DIP .94 |
| DIODE GRAB BAG—Mixed zeners, rectifiers, etc. | | 50/\$1 | LM723CN | Precision Voltage Regulator | DIP 3/51 |
| 2N706 | NPN High-Speed Switch 75ns | 4/51 | LM747 | Dual 741 Compensated Op Amp | DIP 2/51 |
| 2N918 | UHF Transistor—Osc/Amp up to 1 GHz | 4/51 | 2102 | 1024-Bit Static RAM (1024 x 1) | DIP \$1.75 |
| 2N2609 | P-Channel FET Amplifier 2500μmhos | \$1.00 | 2740DE | FET-Input Op Amp- like NE 536/μA740 | 1.95 |
| 2N2920 | NPN Dual Transistor 3mV Match β225 | 2.95 | CA3018A | 4-Transistor Array/Darlington | .99 |
| 2N3904 | NPN Amp/Switch β100 40V 200mA | 8/51 | CA3028A | RF/IF Amplifier DC to 120MHz | 1.45 |
| 2N4122 | PNP RF Amplifier & Switch | 3/51 | CA3075E | FM IF Amp/Limiter/Detector | DIP 1.45 |
| 2N4869E | N-Channel Audio FET Super Low-Noise | 2/51 | RC4558 | Dual High Gain Op Amp | mDIP 3/51 |
| 2N4888 | 150 Volt PNP Transistor for Keyer | 2/51 | N5556V | Precision Fast Op Amp | mDIP 2/51 |
| E112 | N-Channel FET VHF RF Amp | 3/51 | N5558V | Dual Hi Gain Op Amp- Comp. | mDIP 3/51 |
| TIS74 | N-Channel FET High-Speed Switch 40Ω | 3/51 | 8038 | Function Generator/VCO with circuits | \$3.75 |
| TO-220 | Mounting Kit-Mica insulator & bushing | 10/\$1 | 8223 | 256-Bit PROM (32 x 8) 50ns | 2.89 |
| | | | LP-10 | LOGIC PROBE kit—TTL, CMOS, etc. Machined case included—1/2 hr. assembly | \$7.85 |

SEND FOR ADVA'S NEW 1978 CATALOG
OVER 700 SEMICONDUCTORS, KITS, CAPACITORS, ETC.—SEND 13¢ STAMP.

ADVA

ELECTRONICS

BOX 4181 EP
WOODSIDE, CA 94062
Tel. (415) 851-0455

LIQUIDATION

Sansui

**Model
QC-04**

**CD-4 FOUR
CHANNEL
QUADRAPHONIC
RECORD
DEMODULATOR!**



12⁹⁵
EACH!
\$9.95 ea. Lots of 3!
\$8.95 ea. Lots of 100!

* Operates on
110/220 vac,
50/60 Hz.

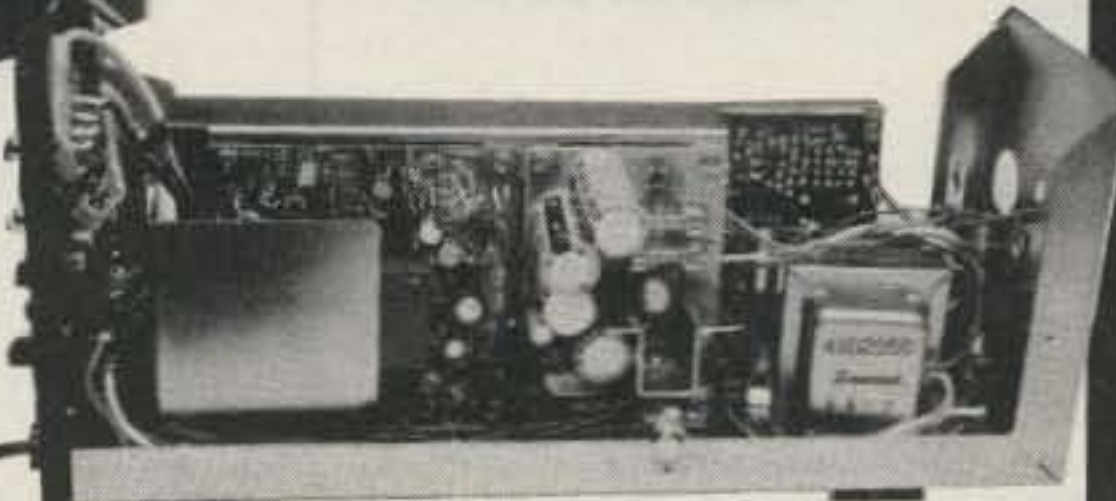

**HUNDREDS OF PARTS!
AN ELECTRONICS GOLD MINE!**

Order ETCO No.
026HP099
(5 lb.)

**1500
IN STOCK!**

A TOP QUALITY SANSUI UNIT!
Model QC-04 is an all-in-one, self-contained assembly designed to accept the output from a CD-4 quad stereo phono cartridge, and demodulate the four channel information to produce four discrete quadrasonic stereo channels, ready to feed into two stereo or one quadrasonic amplifier!
We don't have too much information on this unit, but it's obviously a top-of-the-line unit. It seems to be designed for insertion into an existing stereo amplifier or preamp - three sides are bare as illustrated; the front panel has standard phono inputs and outputs, and the back panel has two interlocking control switches.

A GOLD MINE OF UNIQUE AND VALUABLE PARTS!
In parts alone, the QC-04 is worth many times our low price! Included on the chassis are: a 25 vdc regulated power supply complete with 110 vac power transformer; four low pass filters and two high pass filters of the best quality; integrated circuits, many regular and field-effect transistors, mini trimmer resistors, controls, capacitors, resistors, switches, etc.

CD-4 RECORDS ARE STILL AVAILABLE!
-so you may want to use this unit for its original purpose. They're sold as is, but could probably be made to operate with a minimum of work. Some parts may be missing. A schematic diagram is included with each unit.

SOPHISTICATED CIRCUITRY COULD HAVE MANY USES!
CD-4 Quadrasonic sound is similar in many ways to multiplex stereo. In effect, each channel on the CD-4 recorded is modulated with a high frequency carrier in addition to the audio signal. The carrier is modulated with rear channel information. The QC-04 contains audio and high frequency amplifiers, and two complete multiplex demodulators. There are probably lots of interesting uses for this unit - some of you bright fellows out there are sure to figure them out!

DEALERS WANTED for this and hundreds of other interesting items. Electronics stores, surplus dealers, Distributors, exporters - write on your letterhead for wholesale prices list. You can make money buying from ETCO!

FREE SURPLUS CATALOG! Summer "AA" edition. Many more bargains such as this one! Circle the number shown below on the reader information card.

24 HOUR-A-DAY, 7 DAY-A-WEEK telephone order DESK! Phone in your chargecard orders at low week-end and evening rates! Call 1-518-561-8700.

SURPLUS WANTED - Contact our buying office at 1-514-695-0400 or send list and samples to Plattsburgh address below.

CANADIANS - Ordering from this ad is simple. Please remit in U.S. funds (or add 13% to overall total and remit in Canadian funds). - (Chargex and Mastercharge welcome). We do the paperwork and ship to you direct from the U.S.A. at low American prices. You pay duty and tax to Canadian Customs (Canadian schools are exempt). We have stores in Canada, too! Write for Canadian catalogs. We invite you to visit our Plattsburgh store - just 50 minutes from Montreal on U.S. 87!



E31

ETCO

T.M.

Rush Your Order Today

ETCO ELECTRONICS CORP. U.S.A.
North Country Shopping Center,
Route No. 9, Plattsburgh, N.Y. 12901.

ELECTRONICS LIQUIDATORS OF EXCESS ELECTRONIC INVENTORIES

MERCHANDISE SUBJECT TO PRIOR SALE. Full remittance with each order, please. Money Order, Certified check, BANKAMERICARD, VISA, MASTERCHARGE or CHARGEX. Add 15% for UPS (or postage) and handling (we refund excess). Please try to bring your order total to \$10 or more. Worldwide export orders solicited. Open account to Government agencies, schools, institutions and triple "A" rated industrial & commercial accounts. Special quotes for quantities. N.Y. state residents: add 7% sales tax.

NEW

Frequency Counter

\$89.95 kit



UTILIZES NEW MOS-LSI CIRCUITRY

You've requested it, and now it's here! The CT-50 frequency counter kit has more features than counters selling for twice the price. Measuring frequency is now as easy as pushing a button, the CT-50 will automatically place the decimal point in all modes, giving you quick, reliable readings. Want to use the CT-50 mobile? No problem, it runs equally as well on 12 V dc as it does on 110 V ac. Want super accuracy? The CT-50 uses the popular TV color burst freq. of 3.579545 MHz for time base. Tap off a color TV with our adapter and get ultra accuracy — .001 ppm! The CT-50 offers professional quality at the unheard of price of \$89.95. Order yours today!

- CT-50, 60 MHz counter kit \$ 89.95
- CT-50 WT, 60 MHz counter, wired and tested 159.95
- CT-600, 600 MHz prescaler option for CT-50, add 29.95

SPECIFICATIONS

- Sensitivity: less than 25 mv.
- Frequency range: 5 Hz to 60 MHz, typically 65 MHz
- Gatetime: 1 second, 1/10 second, with automatic decimal point positioning on both direct and prescale
- Display: 8 digit red LED .4" height
- Accuracy: 2.0 ppm, .001 ppm with TV time base!
- Input: BNC, 1 megohm direct, 50 Ohm with prescale option
- Power: 110 V ac 5 Watts or 12 V dc @ 1 Amp
- Size: Approx. 6" x 4" x 2", high quality aluminum case

Color burst adapter for .001 ppm accuracy

- CB-1, kit \$14.95



CLOCK KIT

6 digit 12/24 hour

Want a clock that looks good enough for your living room? Forget the competitor's kludges and try one of ours! Features: jumbo .4" digits, Polaroid lens filter, extruded aluminum case available in 5 colors, quality PC boards and super instructions. All parts are included, no extras to buy. Fully guaranteed. One to two hour assembly time. Colors: silver, gold, black, bronze, blue (specify).

- Clock kit, DC-5 \$22.95
- Alarm clock, DC-8, 12 hr only 24.95
- Mobile clock, DC-7 25.95
- Clock kit with 10 min ID timer, DC-10 ... 25.95
- Assembled and tested clocks available, add \$10.00

CHEAP CLOCK KIT \$8.95

- DC-4 Features:
 - 6 digit .4" LED
 - 12 or 24 format
- Does not include board or transformer
- PC Board \$2.95
- Transformer \$1.49

VIDEO TERMINAL KIT \$149.95

A compact 5 x 10-inch PC card that requires only an ASCII keyboard and a TV set to become a complete interactive terminal for connection to your microprocessor synchronous interface. Its many features are single 5-volt supply, crystal controlled sync and baud rates (up to 9600 baud), 2 pages of 32 characters by 16 lines, read to and from memory, computer and keyboard-operated cursor and page control, parity error display and control, power on initialization, full 64-character ASCII display, block-type see thru cursor. Keyboard/computer control backspaces, forward spaces, line feeds, tab, line feeds, home, returns cursor. Also clears page, clears to end of line, selects page 1 or 2, reads from sr to memory. The card requires 5 volts at approx. 900 ma and outputs standard 75 ohm composite video.

- TH3216 Kit \$149.95
- TH3216, Assembled and Tested 239.95
- VD-1, Video to RF Modulator Kit 6.95

CAR CLOCK KIT \$27.95



- 12/24 Hour 12-Volt AC or DC
- High Accuracy (1 minute/month)
- 6 jumbo .4" LED readouts
- Easy, no-polarity hookup
- Display blanks with ignition
- Case, mounting bracket included
- Super instructions
- Complete Kit, DC-11 \$27.95
- AUTO-DIMMER \$2.50
- Automatically adjusts display brightness according to ambient light level. For DC-11 Car Clock.

MINI-KITS

TONE DECODER KIT

A complete tone decoder on a single PC Board. Features: 400-5000 Hz adjustable frequency range, voltage regulation, 567 IC. Useful for touch-tone decoding, tone burst detection, FSK demod, signaling, and many other uses. Use 7 for 12 button touchtone decoding. Runs on 5 to 12 volts.

- Complete Kit, TD-1 \$4.95

SUPER SLEUTH AMPLIFIER

A super-sensitive amplifier which will pick up a pin drop at 15 feet! Great for monitoring baby's room or as a general purpose test amplifier. Full 2 watts of output, runs on 6 to 12 volts, uses any type of mike. Requires 8-45 ohm speaker.

- Complete Kit, BN-9 \$4.95

FM WIRELESS MIKE KIT

Transmit up to 300' to any FM broadcast radio, uses any type of mike. Runs on 3 to 9 V. Type FM-2 has added super sensitive mike preamp.

- FM-1 \$2.95
- FM-2 \$4.95

COLOR ORGAN/MUSIC LIGHTS

See music come alive! 3 different lights flicker with music or voice. One light for lows, one for the mid-range and one for the highs. Each channel individually adjustable, and drives up to 300 watts. Great for parties, band music, nite clubs and more.

- Complete Kit, ML-1 \$7.95

LED BLINKY KIT

A great attention getter which alternately flashes 2 Jumbo LEDs. Use for name badges, buttons, or warning type panel lights. Runs on 3 to 9 volts.

- Complete Kit \$2.95

POWER SUPPLY KIT

Complete triple regulated power supply provides variable ±15 volts at 200 mA and +5 volts at 1 Amp. 50 mV load regulation good filtering and small size. Kit less transformers. Requires 6-8 V at 1 Amp and 18 to 30 VCT.

- Complete Kit, PS-3LT \$6.95

SIREN KIT

Produces upward and downward wail characteristic of police siren. 5 watts audio output, runs on 3-9 volts, uses 8-45 ohm speaker.

- Complete Kit, SM-3 \$2.95

DECADE COUNTER PARTS

Includes: 7490A, 7475, 7447, LED readout, current limit resistors, and instructions on an easy to build low cost frequency counter.

- Kit of parts, DCU-1 \$3.50

600 MHz PRESCALER



Extend the range of your counter to 600 MHz. Works with all counters. Less than 150 mv sensitivity. Specify ±10 or ±100

- Wired, tested, PS-1B \$59.95
- Kit, PS-1B \$44.95

30 watt 2 meter Power Amp

The famous RE class C power amp now available mail order! Four Watts in for 30 Watts out, 2 in for 15 out, 1 in for 8 out, incredible value, complete with all parts, instructions and details on T-R relay. Case not included.

- Complete Kit, PA-1 \$22.95

CALENDAR ALARM CLOCK

Has every feature one could ever ask for. Kit includes everything except case, build it into wall, station or even car!

- FEATURES:
 - 6 Digits, .5" High LED
 - Calendar shows mo./day
 - True 24 Hour Alarm
 - Battery back up with built in on chip time base
 - 12/24 Hour Format
 - Snooze button
 - 7001 chip does all!
- Complete Kit, less case, DC-9 \$34.95

| DIODES: 1KV,2.5A | | 100V,1A | | 1N914A type | |
|---------------------------------|--------|-------------------------|-------|-----------------------------|--------|
| 5314 Clock | \$2.95 | 555 | \$.50 | 78MG | \$1.49 |
| 74S00 | .35 | 556 | .75 | 309k | .89 |
| 74S112 | .75 | 566 | 1.49 | 309H | .99 |
| 7447 | .79 | 567 | 1.49 | 340K-12 | .99 |
| 7473 | .35 | 1458 | .50 | 7805 | .89 |
| 7475 | .50 | LED DRIVER | | 7812 | .89 |
| 7490A | .55 | 75491 | .50 | 7815 | .89 |
| 74143 | 3.50 | 75492 | .50 | 7818 | .89 |
| DIODES: 1KV,2.5A 5/\$1.00 | | 100V,1A 10/\$1.00 | | 1N914A type 50/\$2.00 | |

LED DISPLAYS

- FND 35975
- FND 510 1.25
- DL 707 1.25
- HP 7730 1.25

Red Polaroid Filter ... 4.25" X 1.125"59

741 OP-AMP SPECIAL

Factory prime mini dip with both Xerox and 741 part numbers

- 10 for \$2.00

SOCKETS

- 14 PIN 5/\$1.00
- 16 PIN 5/\$1.00
- 24 PIN 2/\$1.00
- 40 PIN 3/\$2.00

FERRITE BEADS

- with info and specs 15/\$1.00
- 6 hole Balun Beads 5/\$1.00

ramsey electronics

P.O. Box 4072 Rochester NY 14610

(716) 271-6487

TELEPHONE ORDERS WELCOME



Satisfaction guaranteed or money refunded. COD, add \$1.00. Orders under \$10 add \$.75. NY residents add 7% tax. Add 5% for postage, insurance, and handling. Minimum order \$6.00.

New!

16K E-PROM CARD

IMAGINE HAVING 16K OF SOFTWARE ON LINE AT ALL TIME!

KIT FEATURES:

S-100 (Imsai/Altair) Buss Compatible!

1. Double sided PC board with solder mask and silk screen and gold plated contact fingers.
 2. Selectable wait states.
 3. All address lines & data lines buffered!
 4. All sockets included.
 5. On card regulators.
- KIT INCLUDES ALL PARTS AND SOCKETS (except 2708's). Add \$25. for assembled and tested.

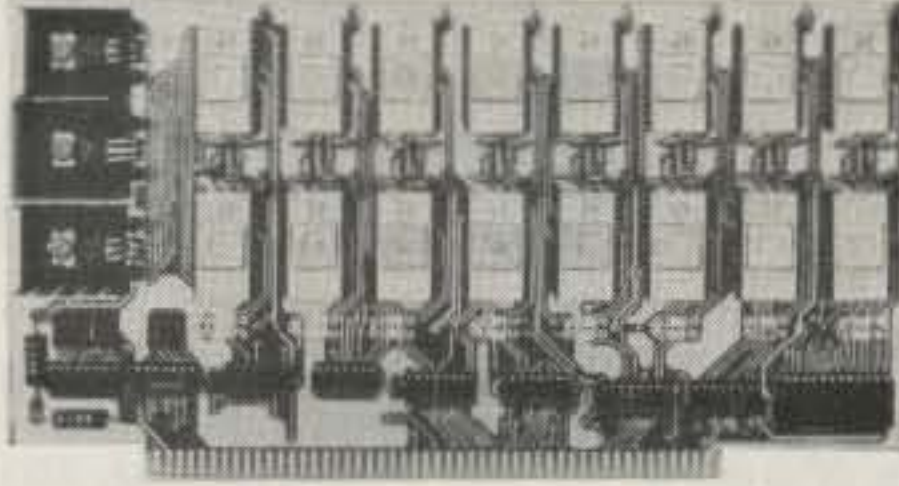

PRICE CUT!

\$57.50 kit

SPECIAL OFFER:

WAS \$69.95

Our 2708's (450NS) are \$12.95 when purchased with above kit.

Fully Static!

ADD \$20 FOR 250NS

8K LOW POWER RAM KIT - \$149.00

S-100 (Imsai/Altair) Buss Compatible!

2 KITS FOR \$279

KIT FEATURES:

1. Doubled sided PC Board with solder mask and silk screen layout. Gold plated contact fingers.
2. All sockets included.
3. Fully buffered on all address and data lines.
4. Phantom is jumper selectable to pin 67.
5. FOUR 7805 regulators are provided on card.

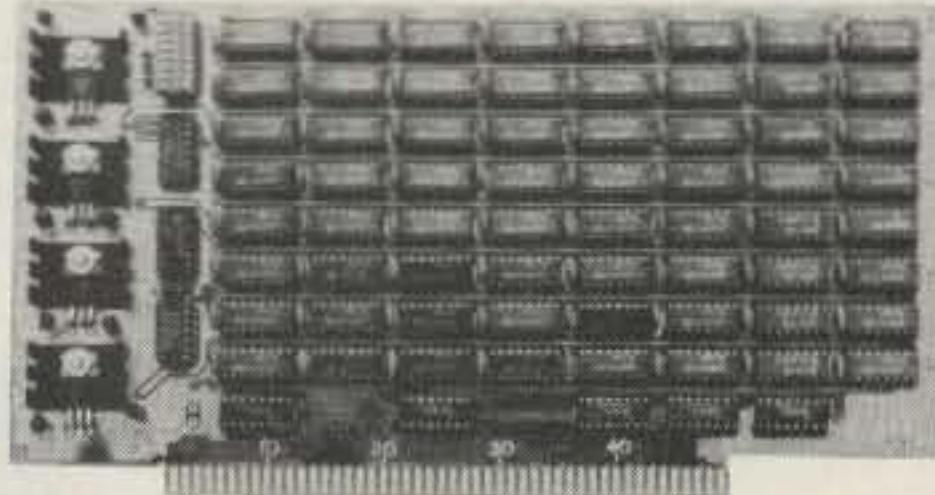

USES 21L02 RAM'S!

Fully Assembled & Burned In \$179.00

Blank PC Board w/ Documentation \$29.95

Low Profile Socket Set 13.50
Support IC's (TTL & Regulators) \$9.75

Bypass CAP's (Disc & Tantalums) \$4.50

MOTOROLA QUAD OP - AMP
MC 3401. PIN FOR PIN SUB.
FOR POPULAR LM 3900.
3 FOR \$1

ALARM CLOCK CHIP
N.S. MM5375AA. Six Digits.
With full Data. **New!**
\$1.95 each

FULL WAVE BRIDGE
4 AMP. 200 PIV.
69¢ 10 FOR \$5.75

NOT ASSOCIATED WITH DIGITAL RESEARCH OF CALIFORNIA, THE SUPPLIERS OF CPM SOFTWARE.

MOTOROLA 7805R VOLTAGE REGULATOR
Same as standard 7805 except 750 MA output.
TO-220. 5VDC output.
44c each or 10 for \$3.95

450 NS! 2708 EPROMS
Now full speed! Prime new units from a major U.S. Mfg. 450 N.S.
Access time. 1K x 8. Equiv. to 4-1702 A's in one package.
\$15.75 ea. 4 FOR \$50.00

COMPUTER MFG. MAKES \$500,000.00 GOOF!

MOTOROLA

4K RAM CHIPS — 99¢ EACH

22 PIN DIP

A major U.S. computer mfg. installed thousands of these 4K Motorola RAM's on the wrong boards and had to remove them. All parts were then tested, and met **FULL SPECS!** If you don't mind a little solder on the leads, then this is the best memory buy in the world. Arranged as 4096 x 1 Bits. 470 NS. The Motorola 6605 is one of the easiest dynamic RAM's to use since it DOES NOT require multiplexed addresses as do most other 4K's such as the 4096 or 4027. A complete memory board design using the 6605 is outlined in the Motorola M6800 Applications Manual starting on page 4-70.

99¢ EACH
(WITH DATA SHEET)

LOOK!

MCM6605

FOR \$6.95 YOU GET AS MUCH STORAGE AS IN 32 - 2102's!

8 FOR \$6.95
4096 BYTES OF RAM!

FULLY GUARANTEED!

SURPLUS BUY OF THE DECADE!!!

4K STATIC RAM'S
2114. The new industry standard. Arranged as 1K x4. Equivalent to 4-21 L02's in 1 package! 18 pin DIP. 2 chips give 1Kx8.
2/\$24. 8/\$85.

OPCOA LED READOUT
SLA-1. Common Anode. .33 inch character size. The original high efficiency LED display. **75c ea.**

4 FOR \$2.50

Z-80 PROGRAMMING MANUAL

By Mostek, The major Z-80 second source. The most detailed explanation ever on the working of the Z-80 CPU CHIPS. At least one full page on each of the 158 Z-80 instructions. A MUST reference manual for any user of the Z-80. 300 pages. Just off the press. **\$12.95**

NATIONAL SEMICONDUCTOR JUMBO CLOCK MODULE

MA1008A BRAND NEW!

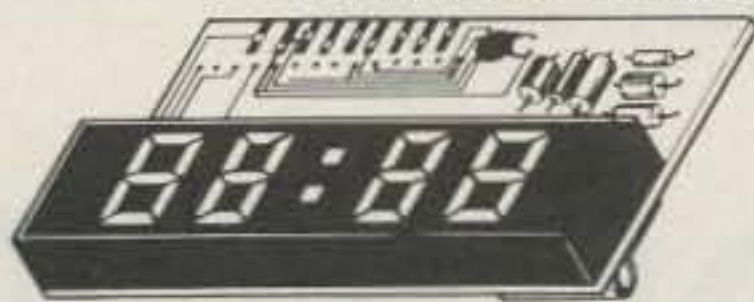

\$6.95

2 FOR \$13

(AC XFMR \$1.95)

COMPARE AT UP TO TWICE OUR PRICE!

MANUFACTURER'S CLOSEOUT!

ASSEMBLED! NOT A KIT!
ZULU VERSION!
We have a limited number of the 24 HR Real time version of this module in stock
#MA1008D — \$9.95

PERFECT FOR USE WITH A TIMEBASE.

Tantalum Capacitors
1 MFD. .35V. By Kemet. Axial Lead. Best Value! **10/\$1.**

New! REAL TIME Computer Clock Chip
N.S. MM5313. Features BOTH 7 segment and BCD outputs. 28 Pin DIP. **\$4.95 with Data**



MICRO-MINI TOGGLE SWITCH

99¢ EACH

SPDT. By RAYTHEON. MADE IN USA! WITH HDWR.

6 FOR \$5

Digital Research Corporation

(OF TEXAS)

P. O. BOX 401247 • GARLAND, TEXAS 75040 • (214) 271-2461

TERMS: Orders under \$15. add 75c. No COD's. We accept VISA, MasterCard and American Express Cards. Money Back Guarantee on all items! Texas Residents add 5% Sales Tax. **WE PAY POSTAGE!**

quantities of quality

SEMICONDUCTORS FOR THE EXPERIMENTER

| | | |
|-------|--------------------------------------|--------|
| LM373 | AM/FM/SSB IF detector (DIP) | \$1.95 |
| LM566 | Square/triangle oscillator (minidip) | \$1.75 |
| LM567 | PLL tone decoder (minidip) | \$1.85 |
| uA706 | DIP audio power amp | \$0.75 |
| FET-1 | Dual NJFET, VHF/UHF amp, package | 3/\$1 |
| FET-2 | NJFET VHF/UHF amp similar to 2N4416 | 3/\$1 |
| G103 | Power transistor (equiv 2N3055) | \$0.75 |

Something Special

RELAY SPECIAL: Beautiful little Electrol reed relays. DPST, N.O., 12V coil; 1" mounting center with 1/10" spaced leads. Now on special at 2/\$1.50

ELECTRIC MOTOR SPECIAL: From time to time we luck out and pick up a True Gizmo. This time, we're offering some of those small DC motors (run on about 1 to 5V DC) you find toys, games, window displays, electric toothbrushes, etc. Now they're on special at 10/\$2.95...how can you go wrong?

TRANSISTOR SPECIAL: NPN, house -numbered TO-92 package replaces 2N3904 and similar. Min Beta 250, goes up to 500; reasonable saturation voltage. Priced at 10/\$1.

SOMETHING TO MAKE LIFE EASY: We carry AP test clips for both 14 pin and 16 pin ICs. Gold plated wiping action; sturdy pins for scope probes; also removes ICs from sockets without damage. **Model TC-14 (14 pin): \$4.50; Model TC-16 (16 pin): \$4.75.** We also carry the A.C.E. 201K breadboarding kit (with 1,032 solderless plug-in tie point capacity) for only \$24.95.

TRIMMER CAPACITORS

| | | |
|-----------|-------------------------|-----------|
| CV2/8P | 2 — 8 pF | 5/\$2.00 |
| CV2.5/11P | 2.5 — 11 pF | 5/\$2.00 |
| CV3/15P | 3 — 15 pF | 4/\$2.00 |
| CV3.5/14P | 3.5 — 14 pF | 4/\$2.00 |
| CV4/12P | 4 — 12 pF | 4/\$2.00 |
| CV5/25P | 5 — 25 pF | 4/\$2.00 |
| CV5/30P | 5 — 30 pF | 4/\$2.00 |
| CV5.5/18P | 5.5 — 18 pF | 4/\$2.00 |
| CV6/30P | 6 — 30 pF | 4/\$2.00 |
| CV7/25P | 7 — 25 pF | 4/\$2.00 |
| CV8/50P | 8 — 50 pF | 3/\$2.00 |
| CV9/35P | 9 — 35 pF | 3/\$2.00 |
| CV9/45P | 9 — 45 pF | 3/\$2.00 |
| CV15/60P | 15 — 60 pF | 3/\$2.00 |
| CV/ASST. | 10 assorted (no choice) | 10/\$2.00 |

RF TRANSISTORS

(All specs for the following taken at 25 degrees C at 2 GHz)

#2NRF1 (\$4.95) 2 GHz power transistor. Pd max 3.5W, Pout minimum 1.0W, Pin 310 mW, efficiency 30%. Similar to RCA 2N5470.

#2NRF2 (\$5.95) 2 GHz power transistor. Pd 8.7W, Pout 2.5W, Pin 300 mW, efficiency 33%. Similar to RCA TA8407.

#2NRF3 (\$6.95) 2 GHz power transistor. Pd 21W, Pout 5.5W, Pin 1.25W, efficiency 33%. Similar to RCA 2N6269.

#2NRF4 (\$7.95) 2 GHz power transistor. Pd 29W, Pout 7.5W, Pin 1.5W, efficiency 33%. Factory selected prime 2N6269.

YES, WE HAVE COMPONENTS . . . not just some components, either, but a truly wide-range selection. From resistors to sophisticated ICs to experimenter and hobbyist items, before you do any shopping check with us . . . you'll be glad you did.

TERMS: Please allow up to 5% for shipping; excess refunded. Add \$1 handling for orders under \$10. Cal res add tax. COD OK with street address for UPS. For VISA®/Mastercharge® orders call our order desk (24 hrs) at (415) 562-0636. Prices good through cover month of magazine.

JUST IN TIME — NATIONAL'S 12V CLOCK! \$16.50 or 3/\$46

The MA1003 clock module is a complete unit . . . just put it in a package and you're on your way. A built-in time base, along with 12V DC operation, make this unit a natural for no-hassle car clock installations. Includes fluorescent readouts (not LEDs) for easy visibility under adverse ambient lighting conditions.

SENTRY CRYSTALS . . . these are series mode, fundamental, wire leads, HC18 package. \$4.95 for any of the following: 4 MHz, 5 MHz, 8 MHz, 9MHz, 10MHz, 12 MHz, 15 MHz, 18 MHz, 20 MHz.

OTHER CRYSTALS: 1.8432 MHz Baud rate generator crystal; HC6 package with wire leads, \$5.95. 500 KHz, series mode, fundamental, wire leads, HC6/U package, \$4.95. 1 MHz, series mode, fundamental, wire leads, HC6/U package, \$5.95. 2 MHz, series mode, fundamental, wire leads, HC6/U package, \$5.90.

CW AUDIO FILTER: Project #17A. Originally designed as a filter for electronic music applications, our manager Reo Pratt (who is also a ham) reports that his unit gives excellent results as a CW filter with variable range and notch width. Kit form only, \$10.50.

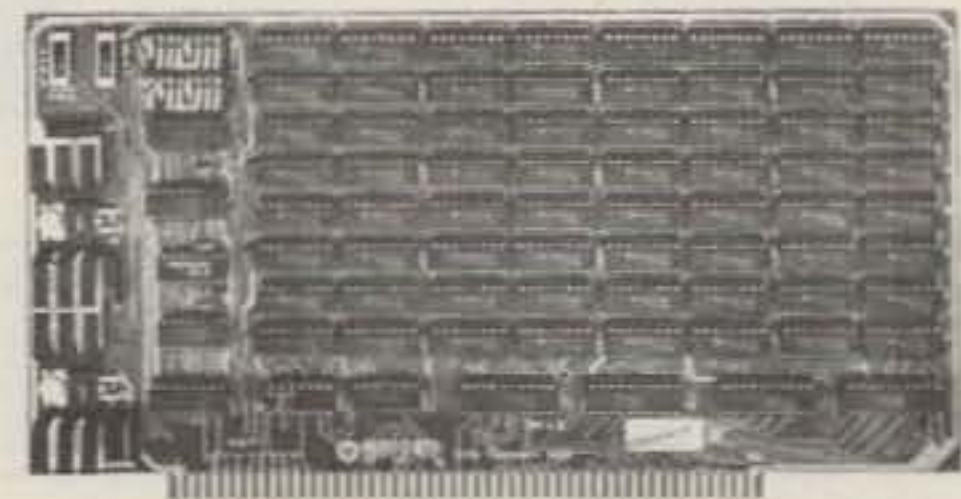

8K x 8 ECONORAM II™ KIT (\$135)

A truly cost-effective package that has drawn raves from both owners and reviewers (see the 1/78 Kilobaud for an example). If you have the space in your motherboard, there's no better way to get 24K of memory than taking advantage of our quantity offer (3 kits for \$375). Add \$20 to single kit price for assembled/tested.

H8 COMPATIBLE ECONORAM VI™ KIT (\$235)

12K x 8 for the H8, with the same features that have made our S-100 boards so popular. Additionally, all sockets and bypass capacitors are already soldered in place so you can get right into the best part of kit building.

UNELECTRONIC SPECIAL: LEATHER DICE CUP, \$2.50

It doesn't blink, flash, or communicate, but it's a beauty for dice players. Limited quantity. This is *not* a joke!

TRS-80 16K CONVERSION KIT

This kit contains 8 uPD416 1 x 16K dynamic memories and instructions on converting your 4K TRS-80 to a 16K machine. You could pay up to \$290 elsewhere, but our kit is only \$190!

GODBOUT

BILL GODBOUT ELECTRONICS
BOX 2355, OAKLAND AIRPORT, CA 94614

G4

7400 TTL

| | | | |
|---------|----|----------|------|
| SN7400N | 16 | SN74160N | 89 |
| SN7401N | 18 | SN74151N | 89 |
| SN7402N | 18 | SN74162N | 1.95 |
| SN7403N | 18 | SN74153N | 89 |
| SN7404N | 18 | SN74163N | 89 |
| SN7405N | 20 | SN74154N | 89 |
| SN7406N | 29 | SN74164N | 89 |
| SN7407N | 29 | SN74155N | 1.25 |
| SN7408N | 20 | SN74165N | 1.25 |
| SN7409N | 20 | SN74166N | 1.25 |
| SN7410N | 18 | SN74167N | 1.95 |
| SN7411N | 25 | SN74170N | 1.59 |
| SN7412N | 25 | SN74171N | 6.00 |
| SN7413N | 40 | SN74172N | 1.25 |
| SN7414N | 70 | SN74173N | 1.25 |
| SN7415N | 25 | SN74174N | 89 |
| SN7416N | 25 | SN74175N | 79 |
| SN7417N | 25 | SN74176N | 79 |
| SN7420N | 20 | SN74177N | 79 |
| SN7421N | 29 | SN74179N | 1.95 |
| SN7422N | 39 | SN74180N | 79 |
| SN7423N | 25 | SN74181N | 1.95 |
| SN7425N | 29 | SN74182N | 79 |
| SN7426N | 25 | SN74184N | 1.95 |
| SN7427N | 39 | SN74185N | 1.95 |
| SN7429N | 25 | SN74186N | 9.95 |
| SN7430N | 20 | SN74187N | 3.95 |
| SN7432N | 25 | SN74190N | 1.25 |
| SN7433N | 25 | SN74191N | 1.25 |
| SN7437N | 25 | SN74192N | 79 |
| SN7438N | 25 | SN74193N | 89 |
| SN7439N | 25 | SN74194N | 79 |
| SN7440N | 20 | SN74195N | 89 |
| SN7441N | 89 | SN74196N | 89 |
| SN7442N | 49 | SN74197N | 89 |
| SN7443N | 75 | SN74198N | 1.49 |
| SN7444N | 75 | SN74199N | 1.49 |
| SN7445A | 75 | SN74200N | 5.99 |
| SN7446A | 75 | SN74201N | 1.79 |
| SN7447A | 89 | SN74202N | 2.25 |
| SN7448A | 79 | SN74203N | 3.95 |
| SN7449N | 20 | SN74204N | 3.95 |
| SN7450N | 20 | SN74205N | 89 |
| SN7451N | 20 | SN74206N | 89 |
| SN7452N | 20 | SN74207N | 89 |
| SN7453N | 20 | SN74208N | 89 |
| SN7454N | 20 | SN74209N | 89 |
| SN7455A | 25 | SN74210N | 89 |
| SN7456N | 20 | SN74211N | 89 |
| SN7457N | 29 | SN74212N | 89 |

BUGBOOK

Continuing Education Series

BUGBOOK I and II by Peter R. Rony, David G. Loran, WB4YJ \$17.00 per set
Sells as a set these two books outline over 90 experiments designed to teach the reader all he will need to know about TTL logic chips to use them in conjunction with microprocessor systems. You'll learn about the basic concepts of digital electronics including gates, flip-flops, latches, buses, decoders, multiplexers, demultiplexers, LED displays, RAM's, ROM's, and much, much more.

BUGBOOK III by Peter R. Rony, David G. Loran, WB4YJ \$5.00
This volume will introduce you to the fabulous UART chip — that all important interface between data terminals, etc., and your microcomputer. It also covers current loops, and the RS 232C interface standard. Particularly recommended for any RTTY enthusiast.

BUGBOOK IV by Peter R. Rony, David G. Loran, WB4YJ, Jonathan A. Thies \$15.00
Here is the book that puts it all together! Besides having much valuable test there are a series of experiments in which the reader completely explores the 8080 chip pin by pin and introduces you to the Mark 80 microcomputer, a unique easily interfaced system. It is recommended that you have the background on the BUGBOOKS I & II before proceeding with BUGBOOK IV.

BUGBOOK V and VI by David G. Loran, Peter R. Rony, Jonathan A. Thies \$19.00 per set
Experiments in digital electronics, 8080A microcomputer programming and 8080A microcomputer interfacing. An integrated approach to self-instructed basic digital electronics, breadboarding and 8080A microcomputer programming. Bugbook V integrates the digital concepts of Bugbook IV into a treatment of 8080A microcomputer programming and interfacing. Detail & laboratory experiments included with each book.

CMOS-M — DESIGNERS PRIMER AND HANDBOOK New expanded version \$8.50
Starts at basic structure of CMOS devices through integration into MSI.

COMPLETE MANUAL FOR DIGITAL CLOCKS by John Weiss and John Brooks \$3.95
Familiarizes technician or hobbyist with basic theories behind digital clocks. Includes trouble shooting guides, basic characteristics of clocks, soldering techniques, clock component data sheets and construction tips.

WIRE-WRAP KIT — WK-2-W

WRAP • STRIP • UNWRAP

- Tool for 30 AWG Wire
- Roll of 50 Ft. White or Blue 30 AWG Wire
- 50 pcs. each 1", 2", 3" & 4" lengths — pre-stripped wire.

\$12.95

WIRE WRAP TOOL WSU-30
WRAP • STRIP • UNWRAP — \$6.95

WIRE WRAP WIRE — 30 AWG
25 ft. min. \$1.25 50 ft. \$1.95 100 ft. \$2.95 1000 ft. \$15.00
SPECIFY COLOR — White - Yellow - Red - Green - Blue - Black

WIRE DISPENSER — WD-30
• 50 ft. roll 30 AWG KYNAR wire wrap wire \$3.95 ea.
• Cuts wire to desired length
• Strips 1" of insulation Specify — Blue-Yellow-White-Red

REPLACEMENT DISPENSER SPOOLS FOR WD 30
Specify blue, yellow, white or red **\$1.98/spool**

XR2206KA \$14.95 **XR2206KB \$19.95**
Function Generator Kit (includes chip, P.C. Board and instructions) **EXAR** Function Generator Kit (includes all components, P.C. Board and instructions)

XR-L555 \$1.50 **XR2242CP \$1.50**
Micro-Power version of the popular 555 Timer and directly interchangeable. Dissipates 1/15th the power and operates down to 2.7 volts. Perfect for battery operation and CMOS circuits.

C/MOS

| | | | |
|--------|------|---------|-------|
| CD4000 | 23 | CD4070 | 55 |
| CD4001 | 23 | CD4071 | 23 |
| CD4002 | 23 | CD4072 | 49 |
| CD4006 | 1.19 | CD4076 | 1.39 |
| CD4007 | 25 | CD4081 | 23 |
| CD4009 | 49 | CD4082 | 23 |
| CD4010 | 49 | CD4093 | 99 |
| CD4011 | 23 | CD4098 | 2.49 |
| CD4012 | 25 | MC14409 | 14.95 |
| CD4013 | 39 | CD4043 | 89 |
| CD4014 | 1.39 | CD4044 | 89 |
| CD4015 | 1.19 | CD4046 | 1.79 |
| CD4016 | 49 | CD4047 | 2.50 |
| CD4017 | 1.19 | CD4048 | 1.35 |
| CD4018 | 99 | CD4049 | 49 |
| CD4019 | 49 | CD4050 | 49 |
| CD4020 | 1.19 | CD4051 | 1.19 |
| CD4021 | 1.39 | CD4052 | 2.95 |
| CD4022 | 1.19 | CD4056 | 9.95 |
| CD4023 | 23 | CD4059 | 9.95 |
| CD4024 | 79 | CD4060 | 1.49 |
| CD4025 | 23 | CD4065 | 79 |
| CD4026 | 2.25 | CD4068 | 39 |
| CD4027 | 69 | CD4069 | 45 |

DISCRETE LEDS

| | | | | | |
|--------|--------|------|-------|--------|------|
| KC209 | Red | 5/51 | KC111 | Red | 5/51 |
| KC209 | Green | 4/51 | KC111 | Green | 4/51 |
| KC209 | Orange | 4/51 | KC111 | Yellow | 4/51 |
| KC209 | Yellow | 4/51 | KC111 | Orange | 4/51 |
| KC22 | Red | 5/51 | KC556 | Red | 5/51 |
| KC22 | Green | 4/51 | KC556 | Green | 4/51 |
| KC22 | Yellow | 4/51 | KC556 | Yellow | 4/51 |
| KC22 | Orange | 4/51 | KC556 | Orange | 4/51 |
| SSL-22 | RT | 4/51 | KC556 | Clear | 7/81 |

DISPLAY LEDS

| | | | | | | | |
|----------|----------------------------|-----|------|-----------|------------------------------|-----|-------|
| MAN 1 | Common Anode-red | 270 | 2.95 | MAN 6660 | Common Cathode-orange | 560 | 99 |
| MAN 2 | 5 x 7 Dot Matrix-red | 300 | 4.95 | MAN 6710 | Common Anode-red-D.D. | 560 | 99 |
| MAN 3 | Common Cathode-red | 125 | 25 | MAN 6730 | Common Anode-red ±1 | 560 | 99 |
| MAN 4 | Common Cathode-red | 187 | 1.95 | MAN 6740 | Common Cathode-red-D.D. | 560 | 99 |
| MAN 52 | Common Anode-green | 300 | 1.25 | MAN 6750 | Common Cathode-red ±1 | 560 | 99 |
| MAN 71 | Common Anode-red | 300 | 1.25 | MAN 6760 | Common Anode-red | 560 | 99 |
| MAN 72 | Common Anode-red | 300 | 99 | MAN 6780 | Common Cathode-red | 560 | 99 |
| MAN 74 | Common Cathode-red | 300 | 1.25 | DL701 | Common Anode-red ±1 | 300 | 99 |
| MAN 81 | Common Anode-yellow | 300 | 99 | DL702 | Common Cathode-red | 300 | 1.25 |
| MAN 82 | Common Anode-yellow | 300 | 99 | DL704 | Common Cathode-red | 300 | 99 |
| MAN 84 | Common Cathode-yellow | 300 | 99 | DL707 | Common Anode-red | 300 | 99 |
| MAN 3620 | Common Anode-orange | 300 | 99 | DL741 | Common Anode-red | 600 | 1.25 |
| MAN 3630 | Common Anode-orange ±1 | 300 | 99 | DL746 | Common Anode-red ±1 | 630 | 1.49 |
| MAN 3640 | Common Cathode-orange | 300 | 99 | DL747 | Common Anode-red | 600 | 1.49 |
| MAN 4610 | Common Anode-orange | 300 | 99 | DL749 | Common Cathode-red ±1 | 630 | 1.49 |
| MAN 4640 | Common Cathode-orange | 400 | 99 | DL750 | Common Cathode-red | 600 | 1.49 |
| MAN 4710 | Common Anode-red ±1 | 400 | 99 | DL738 | Common Cathode-red | 110 | 35 |
| MAN 4730 | Common Anode-red | 400 | 99 | FND707 | Common Cathode | 250 | 69 |
| MAN 4740 | Common Cathode-red | 400 | 99 | FND359 | Common Anode | 350 | 75 |
| MAN 4810 | Common Anode-yellow | 400 | 99 | FND503 | Common Cathode (FND500) | 500 | 99 |
| MAN 6610 | Common Anode-orange-D.D. | 560 | 99 | FND507 | Common Anode (FND510) | 500 | 99 |
| MAN 6630 | Common Anode-orange | 560 | 99 | S082-7300 | 4 x 7 Sgl. Digit-RHDP | 800 | 19.95 |
| MAN 6640 | Common Cathode-orange-D.D. | 560 | 99 | S082-7302 | 4 x 7 Sgl. Digit-LHDP | 800 | 19.95 |
| MAN 6650 | Common Cathode-orange ±1 | 560 | 99 | S082-7304 | Overrange character (±1) | 600 | 15.00 |
| MAN 6660 | Common Anode-orange | 560 | 99 | S082-7340 | 4 x 7 Sgl. Digit-Hexadecimal | 600 | 22.50 |

LINEAR

| | | | |
|------------|------|-----------|-------|
| LM300H | 75 | LM733N | 1.00 |
| LM301H | 35 | LM739N | 1.19 |
| LM301CH | 35 | LM741CH | 35 |
| LM302H | 75 | LM741CN | 35 |
| LM304H | 1.00 | LM747H | 79 |
| LM305H | 60 | LM747N | 79 |
| LM307CN/H | 35 | LM748H | 39 |
| LM308H | 1.00 | LM748N | 39 |
| LM308CN | 1.00 | LM7303N | 99 |
| LM309H | 1.10 | LM7304N | 1.19 |
| LM309CN | 1.25 | LM7305N | 1.40 |
| LM310CN | 1.15 | LM737N | 85 |
| LM311H | 90 | LM737N | 4.00 |
| LM311N | 90 | LM7310N | 2.95 |
| LM317K | 8.50 | LM7351N | 1.65 |
| LM318CN | 1.30 | LM7360CN | 99 |
| LM319N | 1.30 | LM7361N | 1.79 |
| LM320K-5 | 1.35 | LM320N | 1.95 |
| LM320K-5.2 | 1.35 | NE510A | 8.00 |
| LM320K-12 | 1.35 | NE510A | 8.00 |
| LM320K-15 | 1.35 | NE529A | 4.95 |
| LM320K-18 | 1.35 | NE531H | 3.00 |
| LM320K-24 | 1.35 | NE536T | 6.00 |
| LM320K-24 | 1.35 | NE540L | 6.00 |
| LM320T-5 | 1.25 | NE550N | 1.30 |
| LM320T-5.2 | 1.25 | NE555V | 39 |
| LM320T-6 | 1.25 | NE555 | 99 |
| LM320T-12 | 1.25 | NE560B | 5.00 |
| LM320T-15 | 1.25 | NE561B | 5.00 |
| LM320T-18 | 1.25 | NE562B | 5.00 |
| LM320T-24 | 1.25 | NE565H | 1.75 |
| LM323K-5 | 5.95 | NE565N | 1.25 |
| LM324N | 1.80 | NE566CN | 1.75 |
| LM339N | 1.95 | NE567H | 1.25 |
| LM340K-5 | 1.35 | NE567V | 99 |
| LM340K-6 | 1.35 | NE570 | 10.50 |
| LM340K-8 | 1.35 | LM703CN/H | 45 |
| LM340K-12 | 1.35 | LM709H | 29 |
| LM340K-15 | 1.35 | LM709N | 29 |
| LM340K-18 | 1.35 | LM710N | 79 |
| LM340K-24 | 1.35 | LM711N | 39 |
| LM340T-5 | 1.25 | LM723H | 55 |
| LM340T-6 | 1.25 | LM723N | 55 |

IC SOLDERTAIL — LOW PROFILE (TIN) SOCKETS

| | | | | | | | |
|-----------|------|----|----|-----------|------|----|----|
| 8 pin LP | \$17 | 16 | 15 | 24 pin LP | \$37 | 37 | 35 |
| 14 pin LP | 20 | 19 | 18 | 24 pin LP | 38 | 37 | 36 |
| 16 pin LP | 22 | 21 | 20 | 28 pin LP | 45 | 44 | 43 |
| 18 pin LP | 29 | 28 | 27 | 36 pin LP | 60 | 58 | 58 |
| 20 pin LP | 34 | 32 | 30 | 40 pin LP | 63 | 62 | 61 |

SOLDERTAIL STANDARD (TIN)

| | | | | | | | |
|-----------|------|----|----|-----------|------|-----|-----|
| 14 pin ST | \$27 | 25 | 24 | 28 pin ST | \$99 | 90 | 81 |
| 16 pin ST | 30 | 27 | 25 | 36 pin ST | 139 | 126 | 115 |
| 18 pin ST | 35 | 32 | 30 | 40 pin ST | 159 | 145 | 130 |
| 24 pin ST | 49 | 45 | 42 | | | | |

SOLDERTAIL STANDARD (GOLD)

| | | | |
|-----------|------|-----|-----|
| 24 pin SG | \$70 | 83 | 57 |
| 28 pin SG | 110 | 100 | 90 |
| 36 pin SG | 175 | 140 | 126 |
| 40 pin SG | 175 | 159 | 145 |

WIRE WRAP SOCKETS (GOLD) LEVEL #3

| | | | | | | | |
|-----------|------|----|----|-----------|------|-----|-----|
| 8 pin WW | \$40 | 38 | 35 | 22 pin WW | \$95 | 85 | 75 |
| 10 pin WW | 45 | 41 | 37 | 24 pin WW | 105 | 95 | 85 |
| 14 pin WW | 58 | 58 | 57 | 28 pin WW | 140 | 125 | 110 |
| 16 pin WW | 63 | 62 | 61 | 36 pin WW | 159 | 145 | 130 |
| 18 pin WW | 75 | 66 | 62 | 40 pin WW | 175 | 155 | 140 |

RCA LINEAR

| | | | |
|--------|------|--------|------|
| CA3013 | 2.15 | CA3082 | 2.00 |
| CA2023 | 2.56 | CA3083 | 1.60 |
| CA3035 | 2.48 | CA3086 | .85 |
| CA3039 | 1.35 | CA3089 | 3.75 |
| CA3046 | 1.30 | CA3130 | 1.39 |
| CA3059 | 3.25 | CA3140 | 1.25 |
| CA3060 | 3.25 | CA3160 | 1.25 |
| CA3080 | .85 | CA3401 | .49 |
| CA3081 | 2.00 | CA3600 | 3.50 |

CLOCK CHIPS

| | |
|-----------------------------|--------------------------|
| MMS309 | \$ 9.95 |
| MMS311 | 4.95 |
| MMS312 | 4.95 |
| MMS314 | 4.95 |
| MMS316 | 6.95 |
| MMS318 | 9.95 |
| MMS369 | 2.95 |
| MMS581 | 9.95 |
| 7001 | 5.95 |
| 9374 - 7-segment LED driver | common anode LEDs \$.99 |

50 PCS. RESISTOR ASSORTMENTS \$1.75 PER ASST.

| | | | | | | | | | | | | |
|----------|--|---------|---------|---------|---------|---------|---------|---------|---------|---------|--------|---------------------|
| ASST. 1 | 5 ea. | 10 OHM | 12 OHM | 15 OHM | 18 OHM | 22 OHM | 27 OHM | 33 OHM | 39 OHM | 47 OHM | 56 OHM | 1/4 WATT 5% 50 PCS. |
| ASST. 2 | 5 ea. | 180 OHM | 220 OHM | 270 OHM | 330 OHM | 390 OHM | 470 OHM | 560 OHM | 680 OHM | 820 OHM | 1K | 1/4 WATT 5% 50 PCS. |
| ASST. 3 | 5 ea. | 1.2K | 1.5K | 1.8K | 2.2K | 2.7K | 3.3K | 3.9K | 4.7K | 5.6K | 6.8K | 1/4 WATT 5% 50 PCS. |
| ASST. 4 | 5 ea. | 8.2K | 10K | 12K | 15K | 18K | 22K | 27K | 33K | 39K | 47K | 1/4 WATT 5% 50 PCS. |
| ASST. 5 | 5 ea. | 56K | 68K | 82K | 100K | 120K | 150K | 180K | 220K | 270K | 330K | 1/4 WATT 5% 50 PCS. |
| ASST. 6 | 5 ea. | 390K | 470K | 560K | 680K | 820K | 1M | 1.2M | 1.5M | 1.8M | 2.2M | 1/4 WATT 5% 50 PCS. |
| ASST. 7 | 5 ea. | 2.7M | 3.3M | 3.9M | 4.7M | 5.6M | | | | | | 1/4 WATT 5% 50 PCS. |
| ASST. 8R | Includes Resistor Assortments 1-7 (350 PCS.) | | | | | | | | | | | \$9.95 ea. |

74LS00 TTL

| | | | |
|--------|----|---------|----|
| 74LS00 | 23 | 74LS129 | 89 |
| 74LS01 | 23 | 74LS151 | 89 |
| 74LS02 | 23 | 74LS155 | 89 |
| 74LS03 | 23 | 74LS157 | 89 |
| 74LS04 | 29 | 74LS160 | 89 |
| 74LS05 | 29 | 74LS161 | 89 |
| 74LS06 | 29 | 74LS162 | 89 |
| 74LS07 | 29 | 74LS163 | 89 |
| 74LS08 | 29 | 74LS164 | 89 |
| 74LS09 | 29 | 74LS165 | 89 |
| 74LS10 | 29 | 74LS166 | 89 |
| 74LS11 | 29 | 74LS167 | 89 |
| 74LS12 | 29 | 74LS168 | 89 |
| 74LS13 | 29 | 74LS169 | 89 |
| | | | |

| DIODES/ZENERS | | | | SOCKETS/BRIDGES | | | | TRANSISTORS, LEDS, etc. | | | | | |
|---------------|-------|--------------|-----|-----------------|--------------|------|----|-------------------------|-------------------------------|---------------------------|------|--|--|
| 1N914 | 100v | 10mA | .05 | 8-pin | pcb | .20 | ww | .35 | 2N2222 | NPN (2N2222 Plastic .10) | .15 | | |
| 1N4005 | 600v | 1A | .08 | 14-pin | pcb | .20 | ww | .40 | 2N2907 | PNP | .15 | | |
| 1N4007 | 1000v | 1A | .15 | 16-pin | pcb | .20 | ww | .40 | 2N3906 | NPN (Plastic - Unmarked) | .10 | | |
| 1N4148 | 75v | 10mA | .05 | 18-pin | pcb | .25 | ww | .75 | 2N3904 | NPN (Plastic - Unmarked) | .10 | | |
| 1N4733 | 5.1v | 1 W Zener | .25 | 22-pin | pcb | .35 | ww | .95 | 2N3054 | NPN | .35 | | |
| 1N753A | 6.2v | 500 mW Zener | .25 | 24-pin | pcb | .35 | ww | .95 | 2N3055 | NPN 15A 60v | .50 | | |
| 1N758A | 10v | " | .25 | 28-pin | pcb | .45 | ww | 1.25 | T1P125 | PNP Darlington | .35 | | |
| 1N759A | 12v | " | .25 | 40-pin | pcb | .50 | ww | 1.25 | LED Green, Red, Clear, Yellow | | .15 | | |
| 1N5243 | 13v | " | .25 | Molex pins .01 | To-3 Sockets | .25 | | | D.L.747 | 7 seg 5/8" High com-anode | 1.95 | | |
| 1N5244B | 14v | " | .25 | 2 Amp Bridge | 100-prv | .95 | | | MAN72 | 7 seg com-anode (Red) | 1.25 | | |
| 1N5245B | 15v | " | .25 | 25 Amp Bridge | 200-prv | 1.95 | | | MAN3610 | 7 seg com-anode (Orange) | 1.25 | | |
| | | | | | | | | | MAN82A | 7 seg com-anode (Yellow) | 1.25 | | |
| | | | | | | | | | MAN74A | 7 seg com-cathode (Red) | 1.50 | | |
| | | | | | | | | | FND359 | 7 seg com-cathode (Red) | 1.25 | | |

| C MOS | | - T T L - | | | | | | | | | |
|-------|------|-----------|------|-------|------|--------|------|--------|------|---------------|------|
| 4000 | .15 | 7400 | .10 | 7473 | .25 | 74176 | .85 | 74H72 | .35 | 74S133 | .40 |
| 4001 | .15 | 7401 | .15 | 7474 | .30 | 74180 | .55 | 74H101 | .75 | 74S140 | .55 |
| 4002 | .20 | 7402 | .15 | 7475 | .35 | 74181 | 2.25 | 74H103 | .55 | 74S151 | .30 |
| 4004 | 3.95 | 7403 | .15 | 7476 | .40 | 74182 | .75 | 74H106 | .95 | 74S153 | .35 |
| 4006 | .95 | 7404 | .10 | 7480 | .55 | 74190 | 1.25 | | | 74S157 | .75 |
| 4007 | .20 | 7405 | .25 | 7481 | .75 | 74191 | .95 | 74L00 | .25 | 74S158 | .30 |
| 4008 | .75 | 7406 | .25 | 7483 | .75 | 74192 | .75 | 74L02 | .20 | 74S194 | 1.05 |
| 4009 | .35 | 7407 | .55 | 7485 | .55 | 74193 | .85 | 74L03 | .25 | 74S257 (8123) | 1.05 |
| 4010 | .35 | 7408 | .15 | 7486 | .25 | 74194 | .95 | 74L04 | .30 | | |
| 4011 | .20 | 7409 | .15 | 7489 | 1.05 | 74195 | .95 | 74L10 | .20 | 74LS00 | .20 |
| 4012 | .20 | 7410 | .15 | 7490 | .45 | 74196 | .95 | 74L20 | .35 | 74LS01 | .20 |
| 4013 | .40 | 7411 | .25 | 7491 | .70 | 74197 | .95 | 74L30 | .45 | 74LS02 | .20 |
| 4014 | .75 | 7412 | .25 | 7492 | .45 | 74198 | 1.45 | 74L47 | 1.95 | 74LS04 | .20 |
| 4015 | .75 | 7413 | .25 | 7493 | .35 | 74221 | 1.00 | 74L51 | .45 | 74LS05 | .25 |
| 4016 | .35 | 7414 | .75 | 7494 | .75 | 74367 | .75 | 74L55 | .65 | 74LS08 | .25 |
| 4017 | .75 | 7416 | .25 | 7495 | .60 | | | 74L72 | .45 | 74LS09 | .25 |
| 4018 | .75 | 7417 | .40 | 7496 | .80 | 75108A | .35 | 74L73 | .40 | 74LS10 | .25 |
| 4019 | .35 | 7420 | .15 | 74100 | 1.15 | 75491 | .50 | 74L74 | .45 | 74LS11 | .25 |
| 4020 | .85 | 7426 | .25 | 74107 | .25 | 75492 | .50 | 74L75 | .55 | 74LS20 | .20 |
| 4021 | .75 | 7427 | .25 | 74121 | .35 | | | 74L93 | .55 | 74LS21 | .25 |
| 4022 | .75 | 7430 | .15 | 74122 | .55 | | | 74L123 | .85 | 74LS22 | .25 |
| 4023 | .20 | 7432 | .20 | 74123 | .35 | 74H00 | .15 | | | 74LS32 | .25 |
| 4024 | .75 | 7437 | .20 | 74125 | .45 | 74H01 | .20 | 74S00 | .35 | 74LS37 | .25 |
| 4025 | .20 | 7438 | .20 | 74126 | .35 | 74H04 | .20 | 74S02 | .35 | 74LS38 | .35 |
| 4026 | 1.95 | 7440 | .20 | 74132 | .75 | 74H05 | .20 | 74S03 | .25 | 74LS40 | .30 |
| 4027 | .35 | 7441 | 1.15 | 74141 | .90 | 74H08 | .35 | 74S04 | .25 | 74LS42 | .65 |
| 4028 | .75 | 7442 | .45 | 74150 | .85 | 74H10 | .35 | 74S05 | .35 | 74LS51 | .35 |
| 4030 | .35 | 7443 | .45 | 74151 | .65 | 74H11 | .25 | 74S08 | .35 | 74LS74 | .35 |
| 4033 | 1.50 | 7444 | .45 | 74153 | .75 | 74H15 | .45 | 74S10 | .35 | 74LS86 | .35 |
| 4034 | 2.45 | 7445 | .65 | 74154 | .95 | 74H20 | .25 | 74S11 | .35 | 74LS90 | .55 |
| 4035 | .75 | 7446 | .70 | 74156 | .70 | 74H21 | .25 | 74S20 | .25 | 74LS93 | .55 |
| 4040 | .75 | 7447 | .70 | 74157 | .65 | 74H22 | .40 | 74S40 | .20 | 74LS107 | .40 |
| 4041 | .69 | 7448 | .50 | 74161 | .55 | 74H30 | .20 | 74S50 | .20 | 74LS123 | 1.00 |
| 4042 | .65 | 7450 | .25 | 74163 | .85 | 74H40 | .25 | 74S51 | .25 | 74LS151 | .75 |
| 4043 | .50 | 7451 | .25 | 74164 | .60 | 74H50 | .25 | 74S64 | .15 | 74LS153 | .75 |
| 4044 | .65 | 7453 | .20 | 74165 | 1.10 | 74H51 | .25 | 74S74 | .35 | 74LS157 | .75 |
| 4046 | 1.25 | 7454 | .25 | 74166 | 1.25 | 74H52 | .15 | 74S112 | .60 | 74LS164 | 1.00 |
| 4049 | .45 | 7460 | .40 | 74175 | .80 | 74H53J | .25 | 74S114 | .65 | 74LS193 | .95 |
| 4050 | .45 | 7470 | .45 | | | 74H55 | .20 | | | 74LS367 | .75 |
| 4066 | .55 | 7472 | .40 | | | | | | | 74LS368 | .65 |

| | |
|------------|-------|
| 4069/74C04 | .25 |
| 4071 | .25 |
| 4081 | .30 |
| 4082 | .30 |
| MC 14409 | 14.50 |
| MC 14419 | 4.85 |
| 4511 | .95 |
| 74C151 | 1.90 |

| LINEARS, REGULATORS, etc. | | | |
|---------------------------|------|-------------------|------|
| MCT2 | .95 | LM320T5 | 1.65 |
| 8038 | 3.95 | LM320T12 | 1.65 |
| LM201 | .75 | LM320T15 | 1.65 |
| LM301 | .45 | LM324N | 1.25 |
| LM308 (Mini) | .95 | LM339 | .75 |
| LM309H | .65 | 7805 (340T5) | .95 |
| LM309K (340K-5) | .85 | LM340T12 | .95 |
| LM310 | .85 | LM340T15 | .95 |
| LM311D (Mini) | .75 | LM340T18 | .95 |
| LM318 (Mini) | 1.75 | LM340T24 | .95 |
| LM320K5(7905) | 1.65 | LM340K12 | 1.25 |
| LM320K12 | 1.65 | LM340K15 | 1.25 |
| | | LM340K18 | 1.25 |
| | | LM340K24 | 1.25 |
| | | 78L05 | .75 |
| | | 78L12 | .75 |
| | | 78L15 | .75 |
| | | 78M05 | .75 |
| | | LM373 | 2.95 |
| | | LM380 (8-14 PIN) | .95 |
| | | LM709 (8, 14 PIN) | .25 |
| | | LM711 | .45 |
| | | LM723 | .40 |
| | | LM725N | 2.50 |
| | | LM739 | 1.50 |
| | | LM741 (8-14) | .25 |
| | | LM747 | 1.10 |
| | | LM1307 | 1.25 |
| | | LM1458 | .65 |
| | | LM3900 | .50 |
| | | LM75451 | .65 |
| | | NE555 | .35 |
| | | NE556 | .85 |
| | | NE565 | .95 |
| | | NE566 | 1.25 |
| | | NE567 | .95 |

| 9000 SERIES | | | |
|-------------|-----|-------|------|
| 9301 | .85 | 95H03 | 1.10 |
| 9309 | .35 | 9601 | .20 |
| 9322 | .65 | 9602 | .45 |

| MICRO'S, RAMS, CPU'S, E-PROMS | | | |
|-------------------------------|------|---------|-------|
| 74S188 | 3.00 | 8214 | 8.95 |
| 1702A | 4.50 | 8224 | 3.25 |
| MM5314 | 3.00 | 8228 | 6.00 |
| MM5316 | 3.50 | 8251 | 8.50 |
| 2102-1 | 1.45 | 8255 | 10.50 |
| 2102L-1 | 1.75 | 8T13 | 1.50 |
| 2114 | 9.50 | 8T23 | 1.50 |
| TR1602B | 3.95 | 8T24 | 2.00 |
| TMS 4044- | 9.95 | 8T97 | 1.00 |
| | | 2107B-4 | 4.95 |
| 8080 | 8.95 | 2708 | 9.50 |
| 8212 | 2.95 | Z80 PIO | 8.50 |

INTEGRATED CIRCUITS UNLIMITED 19

7889 Clairemont Mesa Boulevard, San Diego, California 92111
(714) 278-4394 (Calif. Res.)

All orders shipped prepaid No minimum
Open accounts invited COD orders accepted

Discounts available at OEM Quantities California Residents add 6% Sales Tax

All IC's Prime/Guaranteed. All orders shipped same day received.

| | | |
|--|--------------------------|--------|
| | SPECIAL DISCOUNTS | |
| | Total Order | Deduct |
| | \$35 - \$99 | 10% |
| | \$100 - \$300 | 15% |
| | \$301 - \$1000 | 20% |

24 Hour Toll Free Phone 1-800-854-2211 American Express / BankAmericard / Visa / MasterCard



POLY PAKS' 1¢ REBELLION

WE'RE FIGHTING BACK INFLATION WITH THIS EXCLUSIVE 1¢ SALE

RIBBON CABLE!
Order by Cat. #A3939
and Conductors

| Cond. | 4-ft. | 8-ft. | 1¢ Sale |
|-------|-------|-------|---------|
| 26 | 1.98 | 3.96 | 1.99 |
| 34 | 1.98 | 3.96 | 1.99 |
| 40 | 1.98 | 3.96 | 1.99 |

BUY 1 AT SALE
PRICE, GET 2ND
FOR 1¢ MORE!!!

PENNIES FOR YOUR MEMORIES!

| Type | Description | Sale | 1¢ Sale! | Order by Cat. No. |
|-------|--------------------|------|----------|-------------------|
| 1103 | 1K Dynamic RAM | 1.29 | 1.30 | |
| 5202 | 2K Prom | 2.95 | 2.96 | 8A3459 & |
| 5262 | 2K x 1 Dynamic RAM | .99 | 1.00 | |
| 1702A | 256 x 8 EPROM | 4.95 | 4.96 | Type No. |

Parts & Semi One Centers

| Quan. | Description (Order by Cat. No. in parenthesis) | Sale | 1¢ SALE |
|-------------------|--|------|----------------|
| 1-40 | CHANNEL CB SELECTOR, w/knob, for PLL circuits (#BA5045) | 1.00 | 2 for 1.01 |
| 1-23 | CHANNEL CB SELECTOR, w/knob, for PLL & xtal (#BA5044) | 1.00 | 2 for 1.01 |
| 10-IC | "DICE", microscopical circuits, teaches theory (#BA5065) | 1.19 | 20 for 1.20 |
| 1-6" | HI-FI SPEAKER, full range, for car-at-home (#BA5294) | 4.95 | 2 for 4.96 |
| 1-LED | WATCH GUTS, men's, how good? We don't know (#BA5267) | 1.95 | 2 for 1.96 |
| 1-UHF | TUNER, solid state, standard type (#BA2927) | 1.00 | 2 for 1.01 |
| 10-SLIDE | SWITCHES, asst pop styles (#BAU1495) | 1.00 | 20 for 1.01 |
| 4-TANTALUM | CAPACITORS, 6.8 uF 35V, dipped (#BA5281) | 1.00 | 8 for 1.01 |
| 5 | PANCAKE PHOTOCELLS, 600 to 15K ohms (#BA2939) | 1.00 | 10 for 1.01 |
| 1 | 100KHZ MARKER CRYSTALS, approx for marker gen. (#BA3896) | 1.95 | 2 for 1.96 |
| 1 | MOTHERBOARD EDGE CONNECTOR, 106 pins, .125" (#BA3987) | 3.50 | 2 for 3.51 |
| 1 | 48-PIN EDGE CONNECTOR, .156" spacing (4R3963) | 1.95 | 2 for 1.96 |
| 1 | METER, 50uA, 1 1/2" square, 0-20db (#BA3705) | 1.19 | 2 for 1.20 |
| 1 | SPST RELAY, norm. open 12-24 VDC, 1250 ohms, dip style (#BA5175) | 1.00 | 2 for 1.01 |
| 1 | VEEDER ROOT COUNTER, 000-999, resettable, panel mt. (#BA5081) | 1.49 | 2 for 1.50 |
| 2 | DUAL GATE MOSFET, sim. to 3N200, 3N187, for RF & Mixer (#BA5101) | 1.00 | 4 for 1.01 |
| 2 | LCD THERMAL INDICATORS, 88-108°F, 7x1", flexible (#BA5195) | 1.00 | 4 for 1.01 |
| 1 | JOYSTICK, four 100K pots, with knob (#BA3808A) | 4.95 | 2 for 4.96 |
| 1 | ECCO THUMBWHEEL SWITCH, BCD, 0-7 (#BA2870A) | 1.49 | 2 for 1.50 |
| 15 | "POP" OPTICAL LENSES, plano-convex, 1" dia, plastic (#BA5043) | 1.19 | 30 for 1.96 |
| 1 | PLESSEY TV SIDEBAND FILTER, for chan. 3 or 4 (#BA3975) | 1.95 | 2 for 1.96 |
| 30-FL | WIRE WRAP WIRE, 30 gage, for ICs, terminals (#BA3803) | 1.00 | 60-ft for 1.01 |
| 2.9V | NI-CAD CHARGER PAK, plug-in, 1.25MA, 1.25 VAC pri (#BA4098) | 1.49 | 2 for 1.50 |
| 20-DATA | ENTRY PUSH-SWITCHES, spst, norm open, for keyboards (#BA5279) | 2.00 | 40 for 2.01 |
| 75-SN7400 | TTL ICs, untested 50%+ yield, pop types (#BA2415) | 2.00 | 150 for 2.01 |
| 100-MINI | DIP ICs, linear, untested 50%+ yield, pop types (#BA3245) | 2.00 | 200 for 2.01 |
| 75-LINEAR | OP AMPS, untested 50%+ yield, amps-dips-minidips (#BA2416) | 2.00 | 150 for 2.01 |
| 100-TTLs & LINEAR | MIXED, with 7400s, 50%+ yield (#BA2431) | 2.00 | 200 for 2.01 |
| 1 | JOYSTICK, two 10K pots, for computers, TV games (#BA5037) | 2.95 | 2 for 2.96 |
| 1 | 8-TRACK TAPE HEAD, with plug'n' cord (#BA3468) | 2.50 | 2 for 2.51 |
| 150 | PREFORMED DISC CAPACITORS, marked values, asst'd (#BA2605) | 2.00 | 300 for 2.01 |
| 150 | TRIMMER CAPACITORS, mica compression, piston, asst'd (#BA3714) | 2.00 | 120 for 2.01 |
| 60 | YELLOW JACKET MYLAR CAPACITORS, marked, pop values (#BA3476) | 2.00 | 150 for 2.01 |
| 150 | GLASS ZENERS, 400 MW, untested, better than 50% yield (#BA2740) | 2.00 | 300 for 2.01 |
| 75 | CARBON FILM RESISTORS, 1/4 watt, 5 & 10%, marked, asst'd (#BA3534) | 2.00 | 150 for 2.01 |
| 250 | UNMARKED CAPACITORS, polystyrene, molded, pop values (#BA3805) | 2.00 | 500 for 2.01 |
| 300 | SILICON SIGNAL DIODES, micro, glass, zeners too! 50% yield (#BA2628) | 2.00 | 600 for 2.01 |
| 8 | IC SOCKETS, 14, 18 pin, solder tail (#BA3621) | 2.00 | 16 for 2.01 |
| 100 | 1N4148/914 SWITCHING DIODES, 50%+ yield, Untested! (#BA2418) | 2.00 | 200 for 2.01 |
| 30 | PC TRIM POTENTIOMETERS, thumbwheel, screwdriver asst'l (#BA3345) | 2.00 | 60 for 2.01 |
| 15 | SLIDE VOLUME CONTROLS, asst'd values, duals, singles (#BA3057) | 2.00 | 30 for 2.01 |
| 75 | 4" CABLE TIES, plastic, like "Ty-wrap" (#BA5218) | 2.00 | 150 for 2.01 |
| 10 | CALCULATOR KEYBOARDS, 20 keys and more (#BA3524) | 2.00 | 20 for 2.01 |
| 10 | CRYSTALS, may include CB, Ham & more (#BA3250) | 2.00 | 20 for 2.01 |
| 100 | TERMINAL STRIPS, from 2 lugs up (#BA3136) | 2.00 | 200 for 2.01 |
| 30 | NE-2NEON LAMPS, all 100% good (#BA2613) | 2.00 | 60 for 2.01 |
| 40-R | SHIELDED CABLE, 1 cond, miles, phonos. (#BA3577) | 2.00 | 80-ft for 2.01 |
| 50 | TRANSISTOR ELECTRODS, asst'd values, styles (#BA2747) | 2.00 | 100 for 2.01 |
| 3 | SOUND TRIGGERS, sound triggers scr w/amp (#BA3625) | 2.00 | 6 for 2.01 |
| 10 | CB CRYSTALS, for phase lock loop, HAM, HC/1B (#BA5050) | 2.00 | 20 for 2.01 |
| 100 | DISC CAPACITORS, long leads, marked, asst'd (#BA2598) | 2.00 | 200 for 2.01 |
| 10 | VOLTAGE REGULATORS, hobby LM320, 340, TO-3 (#BA3330) | 2.00 | 20 for 2.01 |
| 30 | PANEL SWITCHES, slides, rotaries, mod, etc (#BA3268) | 2.00 | 60 for 2.01 |
| 200 | RESISTOR SPECIAL, 1/4 to 1W, carbon, metal (#BA3054) | 2.00 | 400 for 2.01 |
| 200 | HALF WATTERS, resistors, carbon, metal (#BA3046) | 2.00 | 400 for 2.01 |
| 100 | NATIONAL IC BONANZA, linears, 7400s ROMS (#BA2860) | 2.00 | 200 for 2.01 |
| 15 | LM340T VOLTAGE REGULATORS, 5 to 24V, TO-220 (#BA2635) | 2.00 | 30 for 2.01 |
| 100 | TWO WATTERS, resistors, carbon-metal marked (#BA2735) | 2.00 | 200 for 2.01 |
| 100 | POLYSTYRENE CAPS, asst'd values, voltage, hi-Q (#BA2729) | 2.00 | 200 for 2.01 |
| 50 | THERMISTORS, resistors that change with temp (#BA4089) | 2.00 | 100 for 2.01 |
| 20 | BRIDGES, untested, 2, 4, 6, 10, amp, full wave (#BA4022) | 2.00 | 40 for 2.01 |
| 25 | LAMP N'SOCKET SETS, micro, 1.5V, T2 (#BA3957) | 2.00 | 50 for 2.01 |
| 15 | MIXED READOUTS, hobby, untested, .127, .3, .5, etc. (#BA3619) | 2.00 | 30 for 2.01 |
| 150 | QUARTER WATTERS, resistors, metal film, marked (#BA3413) | 2.00 | 300 for 2.01 |
| 100 | PLASTIC TRANSISTORS, untested, TO-92 (#BA2604) | 2.00 | 200 for 2.01 |
| 200 | PREFORMED RESISTORS, 1/4, 1/2, 1W, marked, asst'd (#BA2608) | 2.00 | 400 for 2.01 |
| 200 | PRECISION RESISTORS, 1/4, 1/2, 1W, 1%, 2% marked (#BA2428) | 2.00 | 400 for 2.01 |
| 60 | DIPPED MYLARS, shiny finish, asst'd values (#BA2597) | 2.00 | 120 for 2.01 |
| 30 | VOLUME CONTROLS, audio, linear, asst'd values (#BA2421) | 2.00 | 60 for 2.01 |
| 30 | CLOCK CHIPS, National, hobby & untested, alarm (#BA5089) | 2.00 | 60 for 2.01 |
| 30 | MM5262 2K RAMS, hobby, untested (#BA3940) | 2.00 | 60 for 2.01 |
| 10 | PUSH SWITCHES, push-to-break, spst, alarms (#BA5289) | 2.00 | 20 for 2.01 |
| 25 | CD4000 SERIES CMOS, untested, 50% useable yield (#BA5284) | 2.00 | 50 for 2.01 |
| 1 | CHARACTER GENERATOR, 5 x 7 Mostek MK 2002P (#BA3898) | 4.95 | 2 for 4.96 |

POP-AMPS AT "CENT-CIBLE" PRICES

Case code: T=TO-220 Power Tab; V=Mini dip; K=TO-3; H=TO-5; N=DIP.

| Type No. | Each | 2 for | Type No. | Each | 2 for | Type | Each | 2 for |
|-----------|------|-------|-----------|------|-------|---------|------|-------|
| LM300H | .79 | .80 | LM340T-6 | 1.49 | 1.50 | LM703N | .59 | .60 |
| LM300N | .49 | .50 | LM340T-8 | 1.49 | 1.50 | LM704H | .19 | .20 |
| LM301V | .45 | .46 | LM340T-12 | 1.49 | 1.50 | LM709N | .19 | .20 |
| LM301H | .45 | .46 | LM340T-15 | 1.49 | 1.50 | LM709N | .49 | .50 |
| LM307V | .45 | .46 | LM340T-18 | 1.49 | 1.50 | LM733N | .79 | .80 |
| LM308V | .29 | .30 | LM340T-24 | 1.49 | 1.50 | LM741V | .25 | .26 |
| LM308H | .69 | .70 | LM350N | .49 | .50 | LM741H | .30 | .31 |
| LM309K | 1.49 | 1.50 | LM370N | 1.99 | 2.00 | LM747H | .59 | .60 |
| LM311V | .29 | .30 | LM376V | .29 | .30 | LM1304 | 1.49 | 1.50 |
| LM311H | 1.49 | 1.50 | LM377N | 2.25 | 2.26 | LM1310 | 1.79 | 1.80 |
| LM318V | .99 | 1.00 | LM380N | 1.39 | 1.40 | LM1312 | 2.49 | 2.50 |
| LM320H-5 | .99 | 1.00 | LM381N | 1.99 | 2.00 | LM1414V | .19 | .20 |
| LM320H-12 | .99 | 1.00 | LM386N | 1.49 | 1.50 | LM1458V | .39 | .40 |
| LM320H-15 | .99 | 1.00 | LM531H | 1.49 | 1.50 | LM1800N | .79 | .80 |
| LM320T-6 | 1.49 | 1.50 | LM532N | .25 | .26 | LM3028H | .65 | .66 |
| LM322N | 1.19 | 1.20 | LM532H | .25 | .26 | LM3900N | .49 | .50 |
| LM324N | 1.79 | 1.80 | NE540H | 5.95 | 5.96 | LM3909V | 1.25 | 1.26 |
| LM339N | 1.79 | 1.80 | LM555V | .75 | .76 | LM4250 | 1.20 | 1.21 |
| LM340K-5 | 1.49 | 1.50 | LM556N | 1.79 | 1.80 | LM75451 | .69 | .70 |
| LM340K-6 | 1.49 | 1.50 | LM558H | .39 | .40 | LM75453 | .69 | .70 |
| LM340K-8 | 1.49 | 1.50 | LM558H | .39 | .40 | LM75491 | .80 | .81 |
| LM340K-12 | 1.49 | 1.50 | LM561N | 1.00 | 1.01 | LM75492 | .80 | .81 |
| LM340K-15 | 1.49 | 1.50 | LM565H | 1.00 | 1.01 | LM75494 | .60 | .61 |
| LM340K-18 | 1.49 | 1.50 | LM566 | 2.49 | 2.50 | PA263 | 1.50 | 1.51 |
| LM340K-24 | 1.49 | 1.50 | LM567 | 2.39 | 2.40 | DM8864N | 1.29 | 1.30 |
| LM340T-5 | 1.49 | 1.50 | | | | | | |

1N4000 Epoxy Rectifiers

| Cat. No. | Type | Volts | Sale | 1¢ SALE! | Type No. |
|----------|--------|-------|---------------|---------------|----------|
| 8A2377 | 1N4001 | 50 | 10 for \$.75 | 20 for \$.76 | |
| 8A2378 | 1N4002 | 100 | 10 for .85 | 20 for .86 | |
| 8A2379 | 1N4003 | 200 | 10 for .95 | 20 for .96 | |
| 8A2380 | 1N4004 | 400 | 10 for 1.19 | 20 for 1.20 | Amp! |
| 8A2381 | 1N4005 | 600 | 10 for 1.39 | 20 for 1.40 | Mini |
| 8A2382 | 1N4006 | 800 | 10 for 1.49 | 20 for 1.50 | ature! |
| 8A2383 | 1N4007 | 1000 | 10 for 1.59 | 20 for 1.60 | |

25 AMP BRIDGE RECTIFIERS

Order No. 8A2273 & voltage

| V | Each | 1¢ SALE |
|-----|--------|--------------|
| 50 | \$1.95 | 2 for \$1.96 |
| 100 | 1.49 | 2 for 1.50 |
| 200 | 1.69 | 2 for 1.70 |
| 400 | 1.99 | 2 for 2.00 |
| 600 | 2.25 | 2 for 2.26 |
| 800 | 2.50 | 2 for 2.51 |

BULLET RECTIFIERS!

Order by Cat. No. 8A60884 and voltage

1.5 AMP

| | | |
|------|---------------|---------------|
| 50V | 10 for \$.59 | 20 for \$.60 |
| 100V | 10 for .69 | 20 for .70 |
| 200V | 10 for .79 | 20 for .80 |
| 400V | 10 for .89 | 20 for .90 |

TOGGLE SWITCHES!

3 Amps, 125 VAC contacts, with chrome handles, complete with mounting hardware.

| Cat. No. | Type | Sale | 1¢ Sale! |
|----------|-------|--------|----------|
| 8A4036 | SPDT | \$1.29 | \$1.30 |
| 8A5085 | SPNT* | 1.39 | 1.40 |

MICRO MINI



LYTIC KLINIC

Order No. 8A3269 and value

| UF | V | Style | Sale | Electrolytic capacitors |
|-----|----|-------|---------------|-------------------------|
| 10 | 15 | P.C. | 10 for \$1.00 | 20 for \$1.01 |
| 50 | 15 | P.C. | 8 for 1.00 | 16 for 1.01 |
| 150 | 25 | P.C. | 8 for 1.00 | 16 for 1.01 |
| 50 | 25 | P.C. | 6 for 1.00 | 12 for 1.01 |
| 20 | 15 | Axial | 10 for 1.00 | 20 for 1.01 |
| 20 | 15 | P.C. | 10 for 1.00 | 20 for 1.01 |

6 AMP CARTWHEEL RECTIFIERS

Cat. 8A3584

| V. | Each | 1¢ SALE |
|------|--------|--------------|
| 50 | \$.36 | 2 for \$.37 |
| 100 | .45 | 2 for .46 |
| 200 | .61 | 2 for .62 |
| 400 | .79 | 2 for .80 |
| 600 | .90 | 2 for .91 |
| 800 | 1.19 | 2 for 1.20 |
| 1000 | 1.39 | 2 for 1.40 |

10 AMP - POWER TABS!

#BA1448 - TRIACS
#BA1590 - QUADRACS

| PRV | Sale | 2 for |
|-----|-------|-------|
| 50 | \$.55 | \$.56 |
| 100 | .69 | .70 |
| 200 | .88 | .89 |

LEDS!

YOUR CHOICE 5 for \$1.00
1¢ SALE 10 for \$1.01

Order by Cat. No.
8A2135 JUMBO RED LED
8A2137 MICRO RED LED
8A2790 JUMBO RED CLEAR LED

ZENERS!

Order by Cat. No. 8A5210A & voltage & wattage

| 1 Watt | Sale | 1¢ SALE |
|--------|--------------|---------------|
| 7.5V | 5 for \$1.10 | 10 for \$1.01 |
| 8.2V | 5 for 1.10 | 10 for 1.01 |
| 9.1V | 5 for 1.10 | 10 for 1.01 |
| 11.0V | 5 for 1.10 | 10 for 1.01 |
| 12.0V | 5 for 1.10 | 10 for 1.01 |
| 15.0V | 5 for 1.10 | 10 for 1.01 |

Order by Cat. No. 8A5210B

| 3 WATTS | Sale | 1¢ SALE |
|---------|--------------|--------------|
| 3.3V | 3 for \$1.60 | 6 for \$1.01 |
| 6.0V | 3 for 1.60 | 6 for 1.01 |
| 6.2V | 3 for 1.60 | 6 for 1.01 |
| 8.2V | 3 for 1.60 | 6 for 1.01 |
| 15.0V | 3 for 1.60 | 6 for 1.01 |
| 18.0V | 3 for 1.60 | 6 for 1.01 |
| 24.0V | 3 for 1.60 | 6 for 1.01 |
| 30.0V | 3 for 1.60 | 6 for 1.01 |

22 OP AMP & TTL IC FACTORY "DUMP-IN"

V=Minidip
N=Dip
H=TO-5

7 for \$1.00
14 for \$1.01

| | |
|---------|-----------------------|
| LM308V | HI FET Input Op Amp |
| LM311V | Hi Perf volt comp |
| LM709H | Op Amp |
| LM1800N | FM Stereo w/PLL Demod |
| LM3900N | Quad Matched Op Amp |
| LM558V | Dual 741 |

| | |
|--------|-----------------------------------|
| SN7401 | Quad 2 input NAND, O.C. |
| SN7403 | Quad 2 input NOR, O.C. |
| SN7406 | Hex inverter, buffer, driver |
| SN7410 | Triple 3 input NAND |
| SN7420 | Dual 4 input NAND |
| SN7440 | Dual 4 input buffer |
| SN7450 | Expan 2-wide, 2-in AND-OR-INV |
| SN7451 | Dual 2-wide, 2-3-input AND-OR-INV |
| SN7453 | 4-wide, 2-in, AND/OR invert |
| SN7455 | 2-wide, 4-in, AND/OR invert |
| SN7464 | 4-2-3-imp, AND/OR invert |
| SN7470 | |

ASSOCIATED RADIO

AMERICA'S #1 Real Amateur Radio Store



OUR
32ND
YEAR

Actual current photos of some of our reconditioned equipment.

We have hundreds of reconditioned items. Save big with confidence. Reconditioned units carry a guarantee.

We trade - USED on NEW or USED on USED

We sell - ALL major brands NEW & USED

We buy - Many types of amateur equipment.

ASSOCIATED RADIO

8012 CONSER BOX 4327
OVERLAND PARK, KANSAS 66204

913-381-5900



CALL US WITH YOUR REQUIREMENTS

NOTE:

WE ALSO SELL MUCH OF OUR TRADE-IN EQUIPMENT BEFORE WE RECONDITION IT. THIS WE SELL AT GREATLY REDUCED PRICE. REAL BARGAINS FOR THE EXPERIENCED HAM. SEND \$1.00 AND YOUR NAME - CALL LETTERS AND ADDRESS TO US AND WE'LL SEND YOU NOT ONLY OUR REGULAR CATALOG BUT A CURRENT LIST OF UNSERVICED BARGAINS.

A50

(Cut on dotted line and keep next to your radio equipment)

(Cut on dotted line and keep next to your radio equipment)

DIAL DIRECT

DIAL FREE!

NO CHARGE TO CALLING PARTY

1-800-325-3636

The ONLY NUMBER you'll ever need!

*** FOR THE FAMOUS HAM-KEY™ AND HAM-KEYER™**
We make squeeze-paddle and straight-key models... all for use with our brand-new, improved electronic keyer.

*** FOR NEW OR USED AMATEUR RADIO GEAR**... we're specialists and carry in stock most of the famous-brand lines. Or, we will talk trade.

*** FOR FAST, DOOR-STEP DELIVERY**... give us a call. You'll be amazed; for we guarantee we'll ship your equipment the same day. Plus, most shipments are **PRE-PAID**.

*** TO SAVE MONEY**... join thousands of our satisfied customers who buy from us as easily as from their local supplier. So, remember your call is **Toll Free**.



TM Trade-Mark

HAM RADIO CENTER

8340-42 Olive Blvd. P.O. Box 28271 St. Louis, MO 63132 H2



7294 N.W. 54 STREET
MIAMI, FLORIDA 33166

SURPLUS ELECTRONICS CORP. S43

PHONE: (305) 887-8228

TWX: 810-848-6085

WHOLESALE - RETAIL

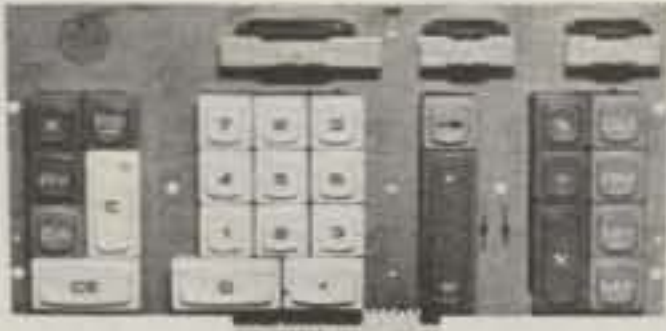
| | | | |
|--|--|--|---|
| <p>RADIO TRANSMITTER Type T-20/ARC-5 5.3 to 7 MC or 4-5.3 MC Brand new—Never used— Tubes alone are worth the price \$24.95 only 30 left less cover</p> | <p>— NORTH ELECTRIC TRANSFORMER — 2470—9024 117 V 50/60 Hz—Multiple windings will produce: + 24 V dc—50 Amp + 12 V dc—100 Amp - 12 V dc—50 Amp Other voltages can be obtained, complete with specification sheets—Limited Qty. \$49.95 \$49.95</p> | | <p>KESTER #44—SOLDER 63/37 Alloy .032 diameter. —5lb. Spools Only— \$6.00 per lb.</p> <hr/> <p>12 Vdc SIRENS Very Loud \$8.95</p> |
| <p>SURPRISE PACKAGE Resistors, Caps, Semis, Pots, Relays, etc. We guarantee it to be \$25.00 worth of material. Every package is different. \$5.00</p> | <p>TEXAS INSTRUMENT KEYBOARD  Has 3 slide switches—28 different keys— keypads re- movable by removing 4 screws. \$1.95 ea., 5 for \$8.00 10 for \$13.95</p> | | <p>CERAMIC PRECISION CAPS-ERIE 47 pF—100 V 220 pF—100 V \$.10 ea. 470 pF—100 V 500 pF—100 V 15 for \$1.00 560 pF—100 V 1000 pF—100 V 50 for \$3.25 2000 pF—100 V</p> |
| <p>White Porcelain Egg Insulator 1 1/2" x 1" 50¢ ea 3 for \$1.25</p> | <p>SIGNAL DIODE 1N4148 \$ 5.00 per hundred \$25.00 per thousand or, 15 for \$1.00</p> | <p>POWER MATCH CONVERTER Pearce-Simpson —Max Loads 30 Watts converts: for positive 6 to 12 Vdc } or negative 6 to 18 Vdc } ground systems 12 to 24 Vdc } 3 1/2" x 3 1/2" x 2" \$7.95</p> | <p>STANCOR TRANSFORMER #P-8180B—117 V in— 25.2 V ct at 1 Amp \$3.00 ea., 2 for \$5.00 3 for \$6.50</p> |
| <p>Neon Panel Light 110 Vac Amber, w/ built in resistor & wire leads—3 for \$1.50</p> | <p>WIRE WOUND RESISTORS .1 Ohm—5 W .10 Ohm—10 W @ 15¢ each</p> | | <p>MUFFIN FANS 3 Blades, 110 Vac, 4 3/4" sq. Removed from equipment— Excellent condition—\$4.95</p> <hr/> <p>"New" Muffin Fans 3 Blades-110 Vac, 4 3/4" sq. \$9.95</p> |
| <p>PANEL METERS 2 1/4" x 2 1/4" also 2 1/4" x 3" 10-0-10 dc Amps } \$4.00 ea 0-20 dc Volts } 25-0-25 dc Volts } 2 for 0-25 dc Volts } \$7.00 0-50 ac Volts } -Shunt Required-</p> | <p>New Dry Nickel-Cadmium Battery 2 1/4" x 2 3/4" x 8 3/4" General Electric 12.0 Volts dc @ 4.0 Amp hrs. \$19.95 while they last.</p> | | <p>TRIMMER CAPS Small enough to fit in your watch— 3.5 to 20 pF 5 to 30 pF 7 to 40 pF \$.75 ea., 2 for \$1.25 5 for \$3.00</p> |
| <p>POWER SUPPLY 110 AC to 12 VDC 550 mA 23 Watts 3 1/2" w x 4" h x 6 1/2" d \$9.95</p> | <p>HOOK-UP WIRE Size 20 or 22— various colors— no color selection solid \$6.00/1000' \$10.00/2000'</p> | <p>POLYFOAM COAX—50R Equal to RG174 \$4.95/100' Low Loss Polyfoam Coax Cable</p> | <p>JOY STICK For TV games and hi fi with four, 100K pots 2 3/4" X 2 3/4" X 1" with 1" handle—\$3.95</p> |
| <p>Heavy Duty Instrument Case Grey vinyl over wood—inside also lined w/ vinyl & foam padding. Flip- top w/ handle and keylock w/ key. inside dem. 4 1/2" D x 8 1/4" W x 10" H \$25.00 value—\$9.95</p> | <p>E2000 Memory 52 x 52 200 WD 12 DG \$4.95</p> | | <p>New Boxer Fans 5 Blades 110V ac 4 3/4"—\$11.95</p> |
| <p>Varo Bridge Rectifier 10 amps. 220 Vdc—\$1.50</p> | | | |

SPECIALS—SPECIALS—SPECIALS—SPECIALS—SPECIALS—SPECIALS—SPECIALS—SPECIALS

| | | | | | | |
|--|--|---|---|---|---|--|
| <p>Computer Grade Caps 1000 mf—50 V 10,000 mf—20 V 8200 mf—25 V 30,000 mf—15 V 21,000 mf—25 V \$2.50 ea.</p> | <p>CTS DIP Switches 8 position \$1.25 ea., 2 for \$2.00</p> | <p>Trimmer Cap Arco/Elmenco PC-402 2 to 20 pF \$.60 ea. 5 for \$2.50, 15 for \$5.00</p> | <p>MASSA Ultrasonic Transducer 37 or 40 kHz \$1.50 ea. 2 for \$2.50, 5 for \$5.00</p> | <p>Relay—P & B 4 PDT—110 Vdc 6050 Ohm coil 10 Amp contacts \$1.50 ea., 2 for \$2.75, 3 for \$3.25</p> | <p>Bourns Trimpot #200L—1—201M 200 Ohm \$1.50 ea., 2 for \$2.50, 5 for \$6.75</p>  | <p>Stancor Transformer #P-8650 Step down/Isolation 117Vpai-12V6.5Amp. w/cord & receptacle \$5.95</p> |
|--|--|---|---|---|---|--|

TERMS: All material guaranteed • If for any reason you are not satisfied, our products may be returned within 10 days for a full refund (less shipping). Please add \$3 for shipping and handling on all orders. Additional 5% charge for shipping any item over 5 lbs. COD's accepted for orders totaling \$50.00 or more. All orders shipped UPS unless otherwise specified. Florida residents please add 4% sales tax. Minimum order \$15.00.

EQUIPMENT / COMPONENTS / WIRE & CABLE / ACCESSORIES

GET YOUR NEW RADIO AMATEUR CALLBOOKS

The **U.S. Callbook** has over 350,000 W & K listings. It lists calls, license classes, names and addresses plus the many valuable back-up charts and references you come to expect from the **Callbook**.

\$14.95
PLUS SHIPPING

Specialize in DX? Then you're looking for the **Foreign Callbook** with over 280,000 calls, names and addresses of radio amateurs outside the USA plus many valuable, additional features of interest to the DX'r.

\$13.95
PLUS SHIPPING

See your favorite electronics dealer or write direct for free catalog to the publisher.

**RADIO AMATEUR
callbook INC.**
Dept. B 925 Sherwood Drive
Lake Bluff, Ill. 60044

R1

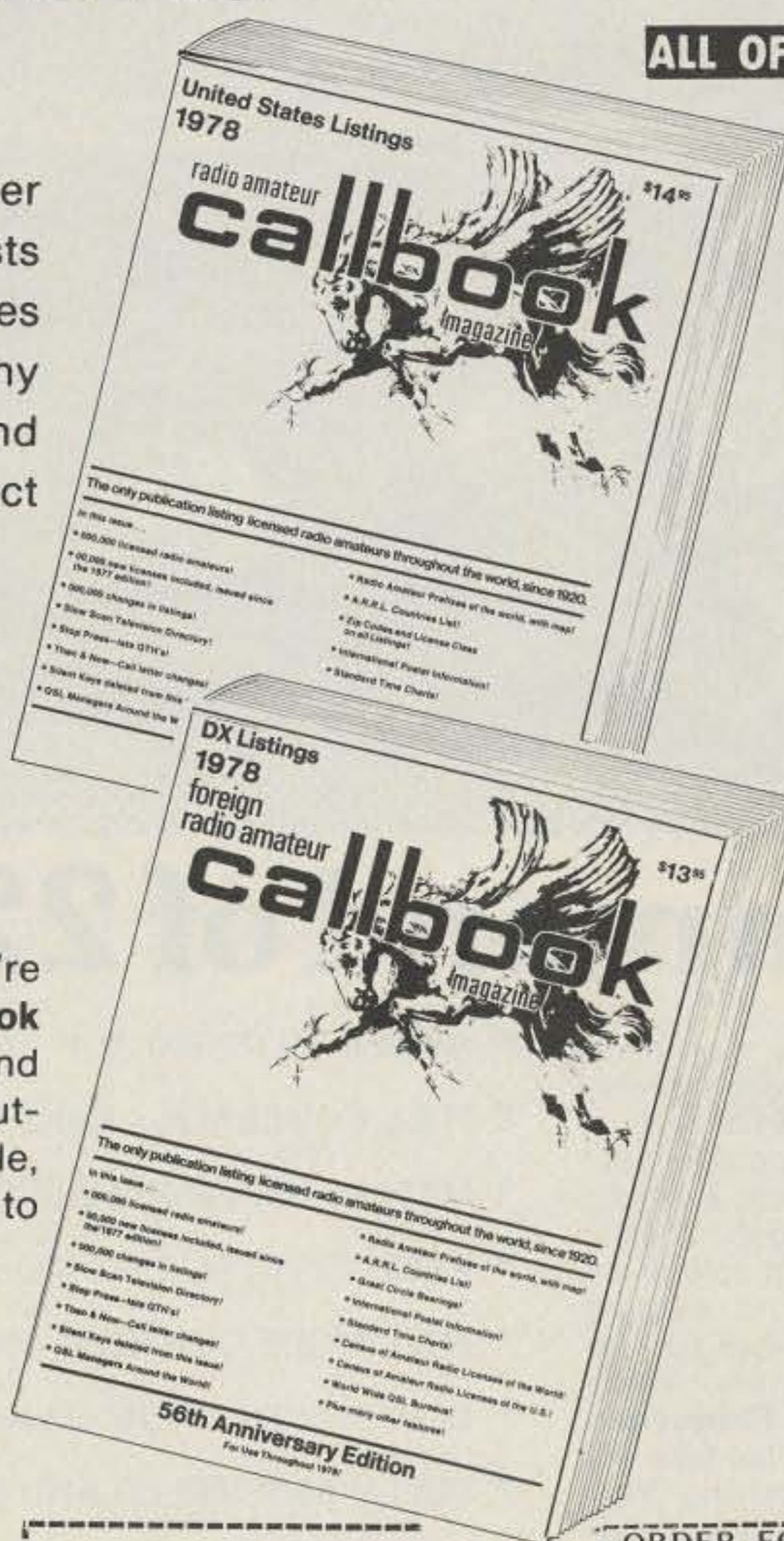

ALL OF THESE EXTRA FEATURES INCLUDED

- International Radio Amateur Prefixes!
- Radio Amateur Prefixes by Countries!
- A.R.R.L. Phonetic Alphabet!
- Great Circle Bearings and Charts!
- International "Q" and "Z" Signals!
- World Standard Time Charts!
- International Postal Information!
- World Prefix Map!
- F.C.C. Examination Points!
- Where to Buy!
- Telegraphers' Abbreviations!
- DX Operating Code!
- A.R.R.L. Countries List!
- At Your Service — Amateur Radio Dealers!
- QSL Managers Around the World!
- World Wide QSL Bureaus!
- Census of Radio Amateurs of the World!
- Telegraph Codes!
- AMSAT — Oscar Users Directory!
- Slow Scan Television Directory!
- Reciprocal Licenses!
- Hawaii Included!
- Many Other Features!

*Respected worldwide as
the only complete authority
for radio amateur
QSL and QTH information.*

Save \$1.50 order both send \$30.40

ORDER FORM

| Item | Price Each | Shipping | Total Price |
|---|------------|----------|-------------|
| <input type="checkbox"/> U. S. CALLBOOK | \$14.95 | \$1.50 | \$16.45 |
| <input type="checkbox"/> FOREIGN CALLBOOK | \$13.95 | \$1.50 | \$15.45 |

Illinois residents only add 5% sales tax _____

Name _____ Total _____

Address _____

City _____

State _____ Zip _____ Total Enclosed _____

Charge: BankAmericard Master Charge Interbank # _____
Credit card # _____ Expiration date _____

Signature _____

NEW!

Synthacoder 509



Ask about Group Purchases

ONLY
\$129⁹⁵
postpaid

Take Command of 220 MHz!

The Synthacoder 509 represents the first of a totally new generation of frequency synthesizers, based on the latest advances in CMOS-LSI techniques. "Matrix Modules", which contain programming diodes, make adding new channels a cinch. Simply snip the leads on the diodes not needed, plug it in, and you are **On The Air!** Our unique interface design allows you to use your existing crystal positions even though the synthesizer has been installed. The Synthacoder is also easily adapted for **Scanning** and **External Frequency Control**. To sum it up—We are sure that you will find the new Synthacoder 509 **Everything You Want** in a 220 MHz synthesizer—And at a **Price Comparable to Crystals!**

- ★ SIMPLE TO INTERFACE - Three wires and no holes!
- ★ FULL COVERAGE - 220-225 MHz in 20 KHz steps
- ★ MATRIX PROGRAMMABLE - No more crystals
- ★ EXCLUSIVE "MATRIX MODULES" - Program in seconds
- ★ FULL MODE CONTROL - Simplex, Repeater, Reverse
- ★ LOW POWER CMOS - Draws only 60 ma
- ★ FULLY ASSEMBLED AND CALIBRATED - Not a kit
- ★ FITS MIDLAND, COBRA, and CLEGG 220 MHz transceivers

Engineering Specialties

P.O. BOX 2233
1247 COMMERCIAL AVENUE
OXNARD, CA 93030
(805) 486-0817

738

- I'LL BITE! Please send more info.
 I'M HOOKED! Please RUSH my Synthacoder.

YES, I would like to purchase a Synthacoder for my 220 radio. Enclosed please find my \$129.95 (Price includes postage and handling). California residents add 6% sales tax.

\$ _____ enclosed. Check Money Order
Please charge my Master Charge BankAmericard
Credit card # _____
Interbank # _____
Expiration date _____
Signature _____



Name _____ Call _____
Address _____
City _____ State _____ Zip _____



\$95 Stand Alone Video Terminal

αΒΓδєθλμνπΣφψωΩοιζζ°±÷%[]|←→↑↓
 !"#%&'()*+,-./012456789:;<=>?
 @ABCDEFGHIJKLMNPOQRSTUVWXYZ[\]^_
 `abcdefghijklmnopqrstuvwxyz{|}~

SCT-100 FEATURES:

- 64 X 16 line format with 128 displayable characters
- Serial ASCII or BAUDOT with multiple Baud rates
- \$187 Assembled or \$157 Kit (Partial Kit \$95)
- Full cursor control with scrolling and paging
- On board power supply
- Many additional features

Call or write today. MC/VISA accepted

XITEX CORP. P.O. Box #20887

Dallas, Texas, 75220 ● Phone (214) 386-3859
 Overseas orders and dealer inquiries welcome

ALUMA TOWERS

A47

VERO BEACH, FLORIDA 32960

MFG'S OF ALUMINUM TOWERS

- ★ TELESCOPING (Crank Up)
- ★ WALL MOUNTED
- ★ TILT-OVER
- ★ GUYED MODELS (to 100 Ft.)

Excellent for Ham Communications.

HIGH QUALITY — LOW PRICES

MADE IN LONG-LASTING NO-RUST ALUMINUM!

McCLARAN SALES TAKES IN ANYTHING ON TRADE FOR NEW ALUMA TOWERS.

NEED: Scanners, CB, 2 Meter, Marine, Antiques, Coins, Ham Gear.

We accept Master Charge & Visa Cards

FOR SALES & TRADES CONTACT
R.D. McCLARAN SALES

430 Franklyn at Beach
 Indialantic, Florida 32903
 (305) 723-4793

electronic calculators

| LIST | HAM NET | TEXAS INSTRUMENTS ELECTRONIC CALCULATORS |
|----------|----------|--|
| \$299.95 | \$269.95 | T.I.-59, 960 STEP PROGRAMMABLE SCIENTIFIC |
| 124.95 | 112.45 | T.I.-58, 480 STEP PROGRAMMABLE SCIENTIFIC |
| 79.95 | 71.95 | T.I.-57, 150 STEP PROGRAMMABLE SCIENTIFIC |
| 59.95 | 53.95 | T.I.-55, 32 STEP PROGRAMMABLE SCIENTIFIC |
| 59.95 | 53.95 | T.I. PROGRAMMER, CONVERTS DECIMAL/OCTAL/HEX |
| 79.95 | 71.95 | T.I. MBA, SUPER PREPROGRAMMED FINANCIAL |
| LIST | HAM NET | HEWLETT-PACKARD ELECTRONIC CALCULATORS |
| \$750.00 | \$675.00 | H.P.-97, 224 STEP PROG SCIENTIFIC PRINT/VISUAL |
| 450.00 | 405.00 | H.P.-67, 224 STEP PROG SCIENTIFIC |
| 345.00 | 310.50 | H.P.-19C, 98 STEP PROG SCIENTIFIC PRINT/VISUAL |
| 195.00 | 175.50 | H.P.-29C, 98 STEP PROG SCIENTIFIC |
| 160.00 | 144.00 | H.P.-25C, 49 STEP PROG SCIENTIFIC |
| 325.00 | 292.50 | H.P.-91, PREPROGRAMMED SCIENTIFIC PRINT/VISUAL |
| 100.00 | 90.00 | H.P.-33E 49 STEP PROG SCIENTIFIC |
| 80.00 | 72.00 | H.P.-32E PREPROGRAMMED SCIENTIFIC WITH STAT |
| 60.00 | 54.00 | H.P.-31E PREPROGRAMMED SCIENTIFIC |
| 495.00 | 445.50 | H.P.-92, PREPROGRAMMED FINANCIAL PRINT/VISUAL |
| 120.00 | 108.00 | H.P.-38, 8 STEP PROGRAMMABLE SUPER FINANCIAL |
| 75.00 | 67.50 | H.P.-37, PREPROGRAMMED FINANCIAL |

WE STOCK ALL HEWLETT-PACKARD AND T.I. CALCULATOR SOFTWARE AND ACCESSORIES

SEND ME THE CALCULATOR(S) INDICATED BELOW, COMPLETE WITH INCLUDED ACCESSORIES, INSTRUCTIONS, AND MANUFACTURERS WARRANTY. I UNDERSTAND THAT IF I AM NOT COMPLETELY SATISFIED, I MAY RETURN IT WITHIN 10 DAYS FOR A COMPLETE REFUND (LESS SHIPPING).

MODEL(S) _____ QUANTITY _____ AMOUNT ENCLOSED \$ _____

WE HONOR _____ VISA _____ MASTERCHARGE _____ MONEY ORDERS _____ COD

ADD \$2.00 FOR POSTAGE AND HANDLING. PLEASE ALLOW 10 DAYS FROM DATE OF RECEIPT OF ORDER FOR DELIVERY. TEXAS RESIDENTS ADD 5% SALES TAX.

CARD NUMBER _____ EXPIRATION DATE _____

FULL NAME _____ CALL _____

STREET _____ CITY _____ STATE _____ ZIP _____

MORE LITERATURE MODEL(S) _____

*****DEALER INQUIRIES INVITED*****

Hartwells H26
Office World, Inc.

MAIL TO: 6810 LARKWOOD
 HOUSTON, TEX 77074
 ATTN: STEVE, WA5OEN
 PHONE: A.C. (713) 777-2673

NEW ADDITIONS



● **A GUIDE TO HAM RADIO**—BK7321—by Larry Kahaner WB2NEL. What's Amateur Radio all about? You can learn the basics of this fascinating hobby with this excellent beginner's guide. It answers the most frequently asked questions in an easy-going manner, and it shows the best way to go about getting an FCC license. A Guide to Ham Radio is an ideal introduction to a hobby enjoyed by people around the world. \$4.95.*

● **VOLUME IV—IC TEST EQUIPMENT**—LB7362—it's easy and fun to build your own test equipment with ICs! Here in this fourth volume of the 73 TEST EQUIPMENT LIBRARY are 42 home construction projects for building test equipment to work with your ham station and in servicing digital equipment. Counters, scalars, frequency standards, synthesizers, logic probes... **JUST ABOUT EVERYTHING** you need and can build with ICs. \$4.95.*

**SPECIAL:
PRE-PUBLICATION OFFER**
(orders will be filled on
a first-in, first-out basis)

● **HOW TO BUILD A MICROCOMPUTER—AND REALLY UNDERSTAND IT**—BK7325—by Sam Creason. The electronics hobbyist who wants to build his own microcomputer system now has a practical "How-To" guidebook. Sam Creason's book is a combination technical manual and programming guide that takes the hobbyist step by step through the design, construction, testing, and debugging of a complete microcomputer system. This book is must reading for anyone desiring a true understanding of small computer systems. \$9.95.*



● **SSB... THE MISUNDERSTOOD MODE**—BK7351—by James B. Wilson. Single Sideband Transmission... thousands of us use it every day, yet, it remains one of the least understood facets of amateur radio. J. B. Wilson presents several methods of sideband generation, amply illustrated with charts and schematics, which will enable the ambitious reader to construct his own sideband generator. A must for the technically-serious ham. \$5.50.*

● **PROPAGATION WIZARD'S HANDBOOK**—BK7302—by J. H. Nelson. When sunspots riddled the worldwide communications networks of the 1940's, John Henry Nelson looked to the planets for an answer. The result was a theory of propagation forecasting based upon interplanetary alignment that made the author the most reliable forecaster in America today. The book provides an enlightened look at communications past, present, and future, as well as teaching the art of propagation forecasting. 6.95.*

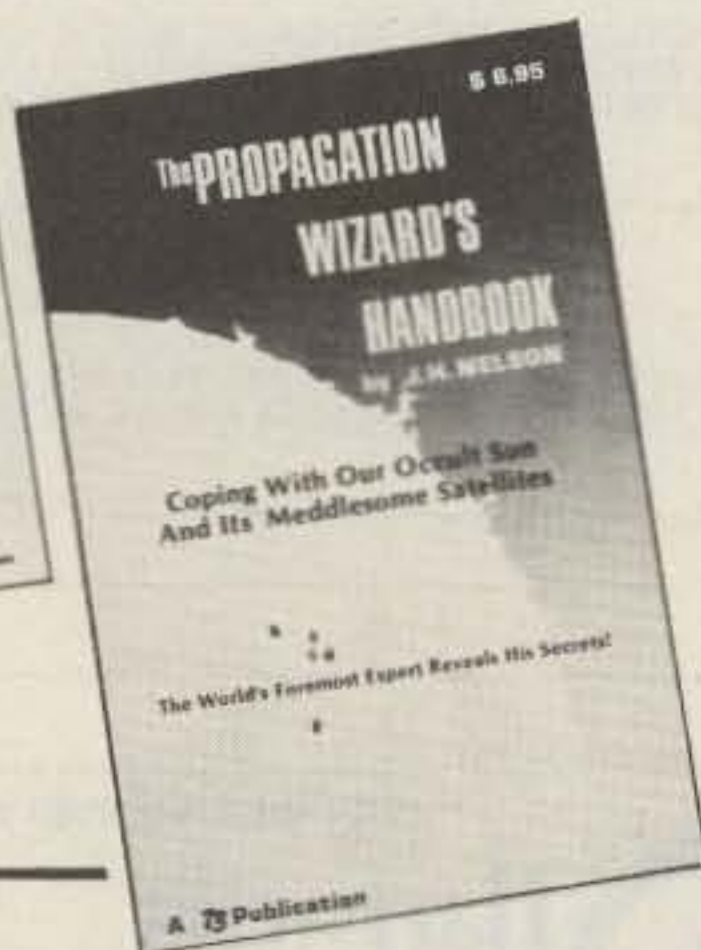

Use the order card in the back of this magazine or itemize your order on a separate piece of paper and mail to:
73 Radio Bookshop • Peterborough NH 03458. Be sure to include check or detailed credit card information.

* Add \$1.00 handling charge for orders under \$10.00. Note: Prices subject to change on books not published by 73 Magazine.

FOR TOLL FREE ORDERING CALL 1-800-258-5473

Radio Bookshop

LICENSE STUDY GUIDES & TAPES

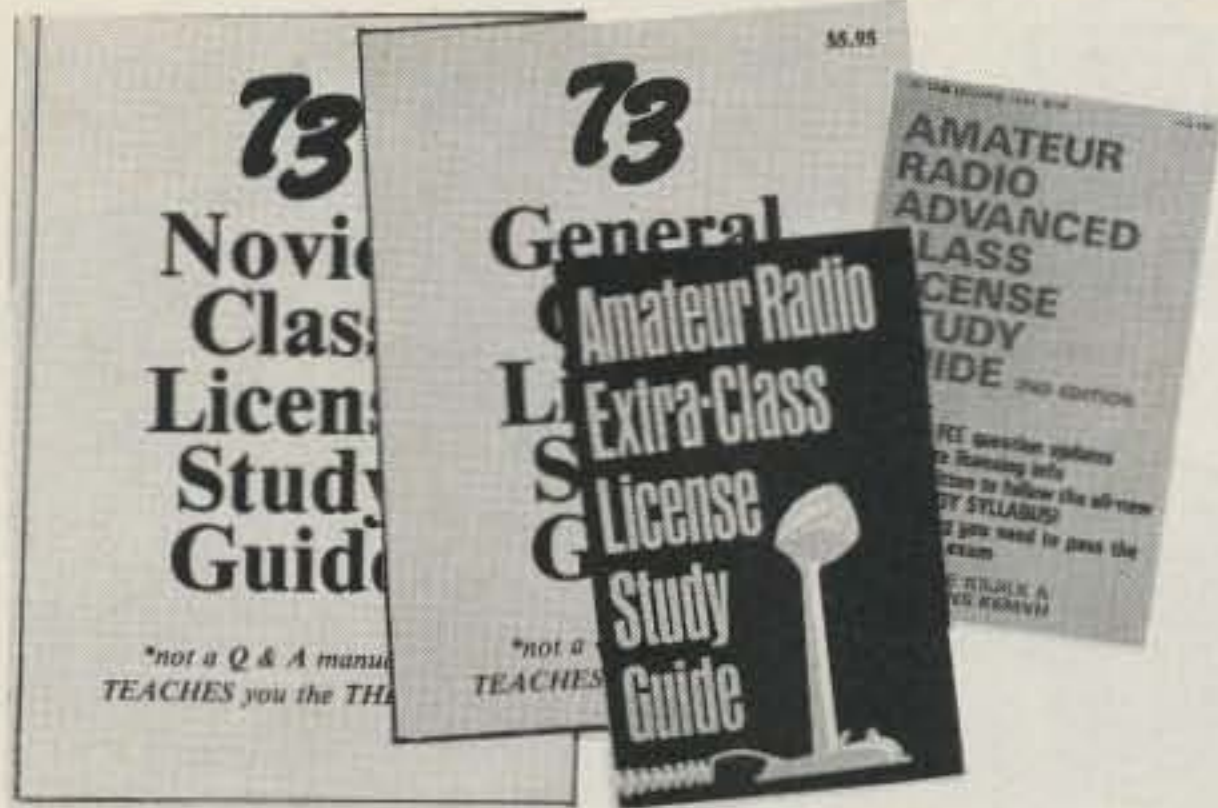

● **NOVICE STUDY GUIDE—SG7357**—Here is a completely new study guide and reference book for the potential ham. This is not a question/answer memorization course. Electronic and radio fundamentals are presented and explained in an easy-to-understand fashion, preparing the beginner for the Novice exam. Includes the latest FCC amateur regulations, as well as application forms. Easily the best path into the exciting world of ham radio! \$4.95.*

● **GENERAL CLASS STUDY GUIDE—SG7358**—A complete theory course for the prospective General or Technician. This reference explains transistor, amplifier, and general radio theory, while preparing the Novice for the "big" ticket. After getting your ticket, you'll use this guide again and again as an electronic reference source. Not a question/answer guide that becomes dated when the FCC updates the amateur exams. \$5.95.*

● **ADVANCED CLASS STUDY GUIDE—SG1081**—Ready to upgrade your license? To prevent retaking the FCC theory exam, you need the 73 Advanced theory guide. SSB, antenna theory, transmitters, and electronics measuring techniques are covered in detail in this easy-to-follow study guide. Special modes and techniques, such as RTTY, are also treated. An engineering degree is not necessary to master Advanced theory—try this book before visiting the examiner's office! \$5.95.*

● **EXTRA CLASS LICENSE STUDY GUIDE—SG1080**—Before going for your 1 × 2 call, it pays to be a master of the Extra class electronic theory. This study guide is the logical extension of the 73 theory course. All the theory necessary to pass the exam is presented. Antennas, transmission lines, swr are discussed, as well as noise, propagation, and specialized communication techniques. This book is not a classroom lecture or memorization guide, but rather a logical presentation of the material that must be understood before attempting the Extra exam. Save yourself a return trip to the FCC and try the 73 method first! \$5.95.*

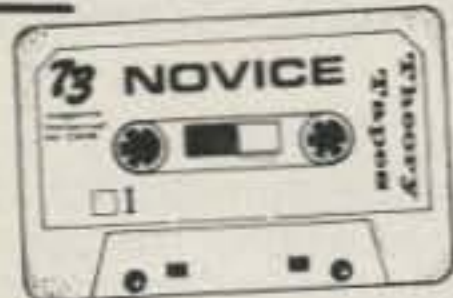

NOVICE THEORY TAPES Startling Learning Breakthrough

● **NOVICE THEORY TAPES—CT7300**—Startling Learning Breakthrough. You'll be astounded at how really simple the theory is when you hear it explained on these tapes. Three tapes of theory and one of questions and answers from the latest Novice exams give you the edge you need to breeze through your exam. 73 is interested in helping get more amateurs, so we're giving you the complete set of our tapes for the incredibly low price of **ONLY \$15.95.***

Scientists have proven that you learn faster by listening than by reading because you can play a cassette tape over and over in your spare time—even while you're driving! You get more and more info each time you hear it.

You can't progress without solid fundamentals. These four hour-long tapes give you all the basics you'll need to pass the Novice exam easily. You'll have an understanding of the basics which will be invaluable to you for the rest of your life! Can you afford to take your Novice exam without first listening to these tapes? Set of 4—\$15.95.*



SSTV

● **SLOW SCAN TELEVISION TAPE—CT7350**—Prize-winning programs from the 73 SSTV contest. Excellent for Demo! \$5.95.*

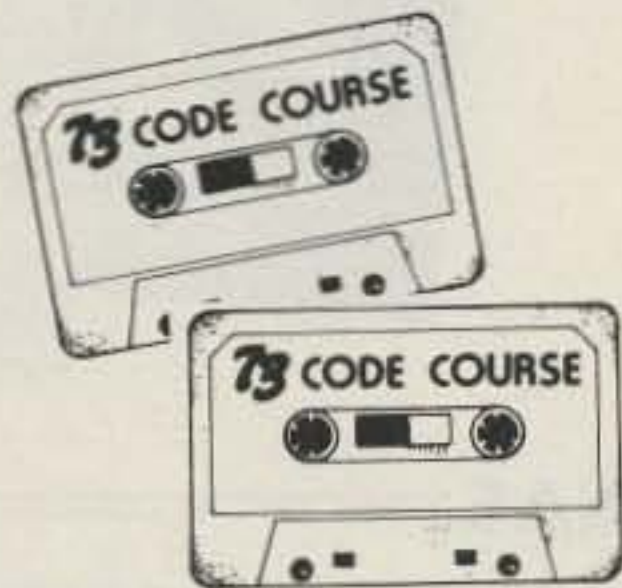

Any Four Tapes For \$15.95!
\$4.95 Each!*

"GENESIS"

5 WPM—CT7305—This is the beginning tape for people who do not know the code at all. It takes them through the 26 letters, 10 numbers and necessary punctuation, complete with practice every step of the way using the newest blitz teaching techniques. It is almost miraculous! In one hour many people—including kids of ten—are able to master the code. The ease of learning gives confidence to beginners who might otherwise drop out.

"THE STICKLER"

6+ WPM—CT7306—This is the practice tape for the Novice and Technician licenses. It is made up of one solid hour of

73 CODE SYSTEM TAPES

code, sent at the official FCC standard (no other tape we've heard uses these standards, so many people flunk the code when they are suddenly—under pressure—faced with characters sent at 13 wpm and spaced for 5 wpm). This tape is not memorizable, unlike the zany 5 wpm tape, since the code groups are entirely random characters sent in groups of five.

"THE CANADIAN"

10+ WPM—CT7310—73 hasn't forgotten the Canadian hams—our 10 WPM tape prepares you to breeze through your country's licensing exams. Like the other code groups, the tape is not memorizable and, once mastered, provides a margin of safety in the actual text situation.

"BACK BREAKER"

13+ WPM—CT7313—Code groups again, at a brisk 13 per so you will be at ease when you sit down in front of the steely-eyed government inspector and he starts sending you plain language at only 13 per. You need this extra margin to overcome the panic which is universal in the test situations. When you've spent your money and time to take the test, you'll thank heavens you had this back-breaking tape.

"COURAGEOUS"

20+ WPM—CT7320—Code is what gets you when you go for the Extra class license. It is so embarrassing to panic out just because you didn't prepare yourself with this tape. Though this is only one word faster, the code groups are so difficult that you'll almost fall asleep copying the FCC stuff by comparison. Users report that they can't believe how easy 20 per really is with this fantastic one hour tape.

"OUTRAGEOUS"

25+ WPM—CT7325—This is the tape for that small group of overachieving hams who wouldn't be content to simply satisfy the code requirements of the Extra Class license. It's the toughest tape we've got and we keep a permanent file of hams who have mastered it. Let us know when you're up to speed and we'll inscribe your name in 73's CW "Hall of Fame."



Use the order card in the back of this magazine or itemize your order on a separate piece of paper and mail to:
73 Radio Bookshop • Peterborough NH 03458. Be sure to include check or detailed credit card information.

* Add \$1.00 handling charge for orders under \$10.00. Note: Prices subject to change on books not published by 73 Magazine.

FOR TOLL FREE ORDERING CALL 1-800-258-5473

Radio Bookshop

73 TECHNICAL LIBRARY

● **BEHIND THE DIAL**—BK7307—By Bob Grove. Get more fun out of shortwave listening with this interesting guide to receivers, antennas, frequencies and interference. \$4.95.*

● **THE CHALLENGE OF 160**—BK7309—is the newest book in the 73 technical library, dedicated to 160 meter operating. Si Dunn provides all necessary information to get started on this unique band. The all-important antenna and ground systems are described in detail. The introduction contains interesting photos of Stew Perry's (the King of 160) shack. This reference is a must for new and experienced "Top Band" operators. Price: \$4.95.*

● **IC OP-AMP COOKBOOK**—BK1028—by Walter G. Jung. Covers not only the basic theory of the IC op amp in great detail, but also includes over 250 practical circuit applications, liberally illustrated. 592 pages, 5½ x 8½, softbound. \$12.95.*

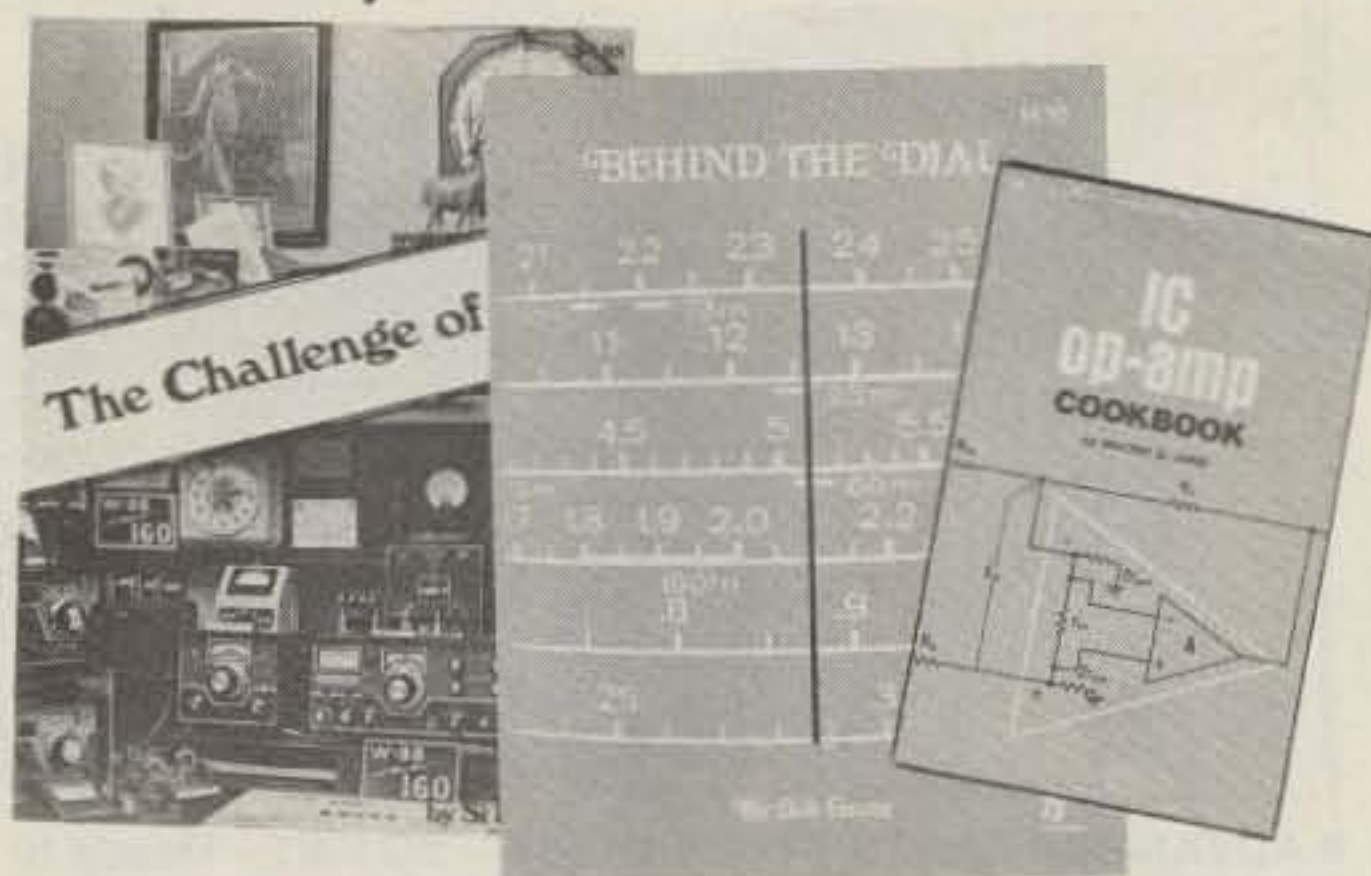

● **INTRODUCTION TO RTTY**—BK7380—A beginner's guide to radioteletype including teletypewriter fundamentals, signals, distortion and RTTY art. You can be a RTTY artist! A 73 publication. \$2.00.*

● **THE NEW RTTY HANDBOOK**—BK7347—is a new edition and the only up-to-date RTTY book available. The state of the art has been changing radically and has made all previous RTTY books obsolete. It has the latest circuits, great for the newcomer and expert alike. \$5.95.*

● **PROPAGATION WIZARD'S HANDBOOK**—BK7302—by J. H. Nelson. When sunspots riddled the worldwide communications networks of the 1940's, John Henry Nelson looked to the planets for an answer. The result was a theory of propagation forecasting based upon interplanetary alignment that made the author the most reliable forecaster in America today. The book provides an enlightened look at communications past, present, and future, as well as teaching the art of propagation forecasting. \$6.95.*



● **SSB ... THE MISUNDERSTOOD MODE**—BK7351—by James B. Wilson. Single Sideband Transmission ... thousands of us use it every day, yet it remains one of the least understood facets of amateur radio. J. B. Wilson presents several methods of sideband generation, amply illustrated with charts and schematics, which will enable the ambitious reader to construct his own sideband generator. A must for the technically-serious ham. \$5.50.*

● **SSTV HANDBOOK**—BK7354(hardcover), BK7355(softcover)—This excellent book tells all about it, from its history and basics to the present state-of-the-art techniques. Contains chapters on circuits, monitors, cameras, color SSTV, test equipment and much more. Hardbound \$7.00, softbound \$5.00.*

● **WEATHER SATELLITE HANDBOOK**—BK7370—Simple equipment and methods for getting good pictures from the weather satellite. Antennas, receivers, monitors, facsimile you can build, tracking, automatic control (you don't even have to be home). Dr. Taggart WB8DQT. \$4.95.*



ANTENNAS

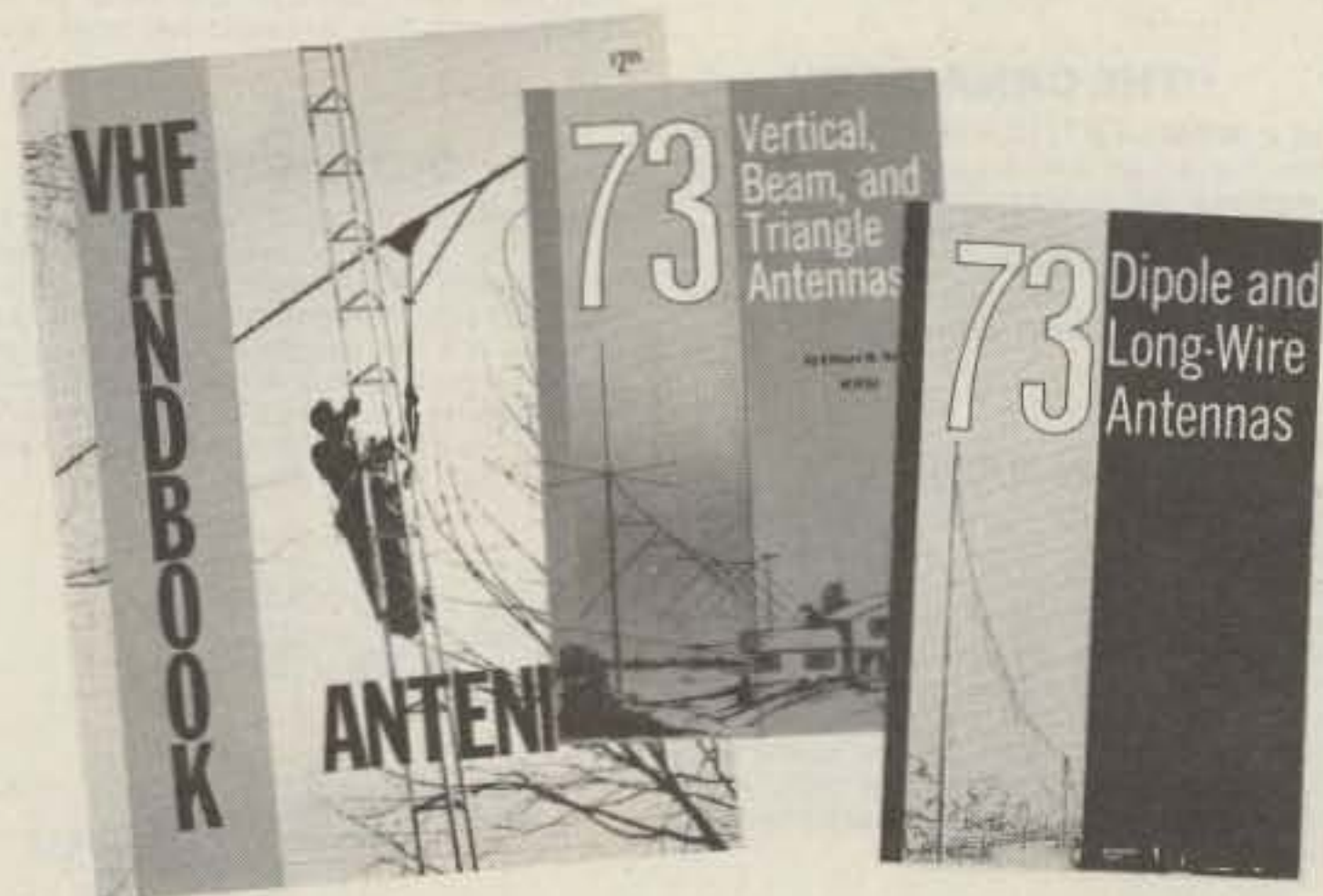

● **73 DIPOLE AND LONG-WIRE ANTENNAS**—BK1016—by Edward M. Noll W3FQJ. This is the first collection of virtually every type of wire antenna used by amateurs. Includes dimensions, configurations, and detailed construction data for 73 different antenna types. Appendices describe the construction of noise bridges, line tuners, and data on measuring resonant frequency, velocity factor, and swr. \$5.50.*

● **73 VERTICAL, BEAM AND TRIANGLE ANTENNAS**—BK1069—by Edward M. Noll W3FQJ. Describes 73 different antennas for amateurs. Each design is the result of the author's own experiments covering the construction of noise bridges and antenna line tuners, as well as methods for measuring resonant frequency, velocity factor, and standing-wave ratios. 160 pages. \$5.50.*

● **VHF ANTENNA HANDBOOK**—BK7368—The NEW VHF Antenna Handbook details the theory, design and construction of hundreds of different VHF and UHF antennas ... A practical book written for the average amateur who takes joy in building, not full of complex formulas for the design engineer. Packed with fabulous antenna projects you can build. \$4.95.*

Use the order card in the back of this magazine or itemize your order on a separate piece of paper and mail to:
73 Radio Bookshop • Peterborough NH 03458. Be sure to include check or detailed credit card information.

* Add \$1.00 handling charge for orders under \$10.00. Note: Prices subject to change on books not published by 73 Magazine.

FOR TOLL FREE ORDERING CALL 1-800-258-5473

Radio Bookshop

BEGINNER'S • INTRODUCTORY

● **THE STORY OF COMPUTERS**—BK1056—by Donald D. Spencer, is to computer books what *Dick and Jane* is to novels . . . elementary, gives the non-computerist a fair idea of what the hobbyist is talking about when he speaks computer lingo. Attempts to explain to a spouse, child or any un-electronics-minded friend what computers are and can do. \$4.95.*

● **HOBBY COMPUTERS ARE HERE!**—BK7322—If you want to come up to speed on how computers work . . . hardware and software . . . this is an excellent book. It starts with the fundamentals and explains the circuits and the basics of programming, along with a couple of TVT construction projects, ASCII-Baudot, etc. This book has the highest recommendations as a teaching aid for newcomers. \$4.95.*

● **THE NEW HOBBY COMPUTERS**—BK7340—This book takes it from where "Hobby Computers Are Here!" leaves off, with chapters on Large Scale Integration, how to choose a microprocessor chip, an introduction to programming, low cost I/O for a computer, computer arithmetic, checking memory boards, a Baudot monitor/editor system, an audible logic probe for finding those tough problems, a ham's computer, a computer QSO machine . . . and much, much more! \$4.95.*

● **HOME COMPUTERS: 2nd QUESTIONS & ANSWERS** by Rich Didday. Two books aimed exclusively at the novice computer hobbyist/home computer user. Written in a rather unusual style which has a beginner asking questions which are answered by a person with a substantial background in computers and personal computing. The questions are just the kind beginners come up with . . . and the answers are presented in easy-to-understand terms (usually with a diagram to illustrate the point). Both the hardware and software aspects of home computing are covered from A to Z. An index in both books makes them ideal as reference material for anyone. Volume I: Hardware—BK1023—\$7.95*; Volume II: Software—BK1024—\$6.95.*

● **MICROCOMPUTER PRIMER**—BK1035—by M. Waite and M. Pardee. Describes basic computer theory, explains numbering systems, and introduces the reader to the world of programming. Describes the world of microcomputing in "real world" terminology. \$7.95.*

● **A STEP BY STEP INTRODUCTION TO 8080 MICROPROCESSOR SYSTEMS**—BK1054—by D. L. Cohn & J. L. Melsa. The step-by-step presentation does not require any computer or electronics background, so anyone who is interested can follow it. However, the book is not only intended for beginners. Engineers and technicians who are familiar with electronics will find the software descriptions valuable in updating their skills. Computer professionals will find the detailed treatment of the 8080 architecture and instructions set useful. \$7.95.*

● **HOW TO BUY & USE MINICOMPUTERS AND MICROCOMPUTERS**—BK1025—by Wm. Barden, Jr. This book discusses these smaller brethren of computers and shows how the reader can become a part of the revolution—how he can own and use a functioning computer system in his home to do a variety of practical or recreational tasks. \$9.95.*

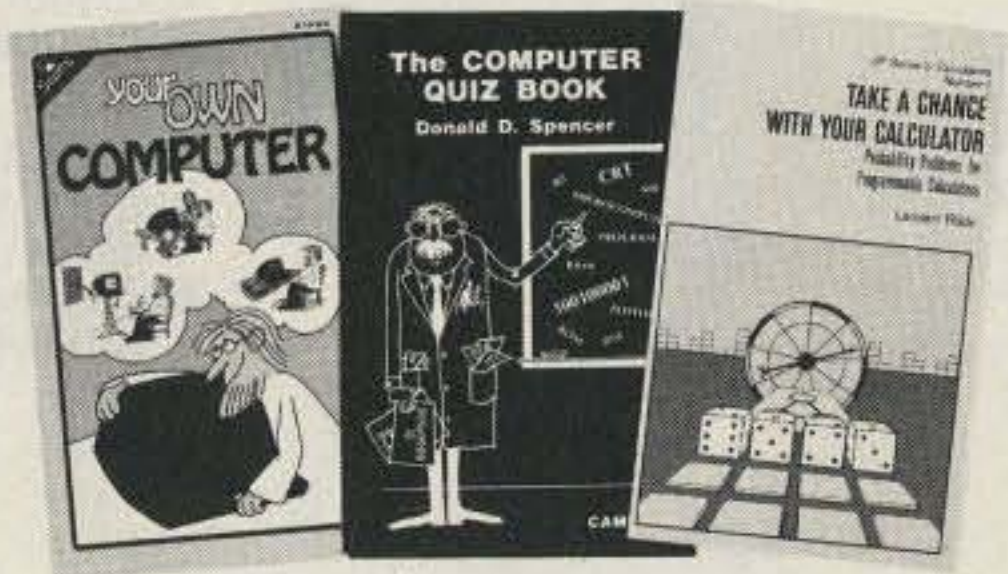
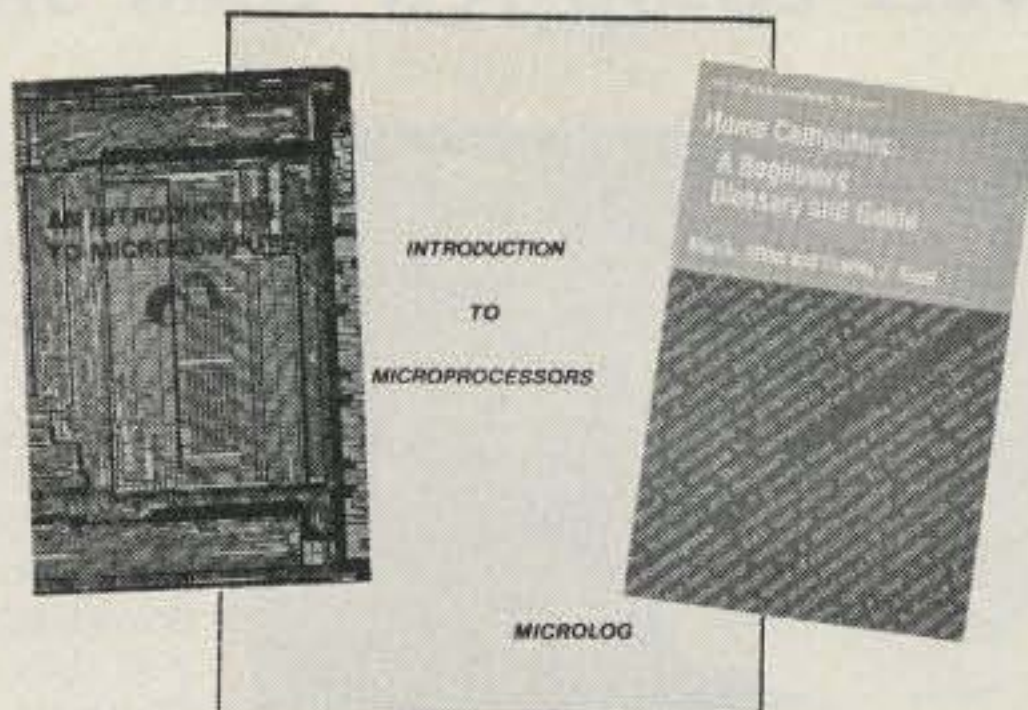
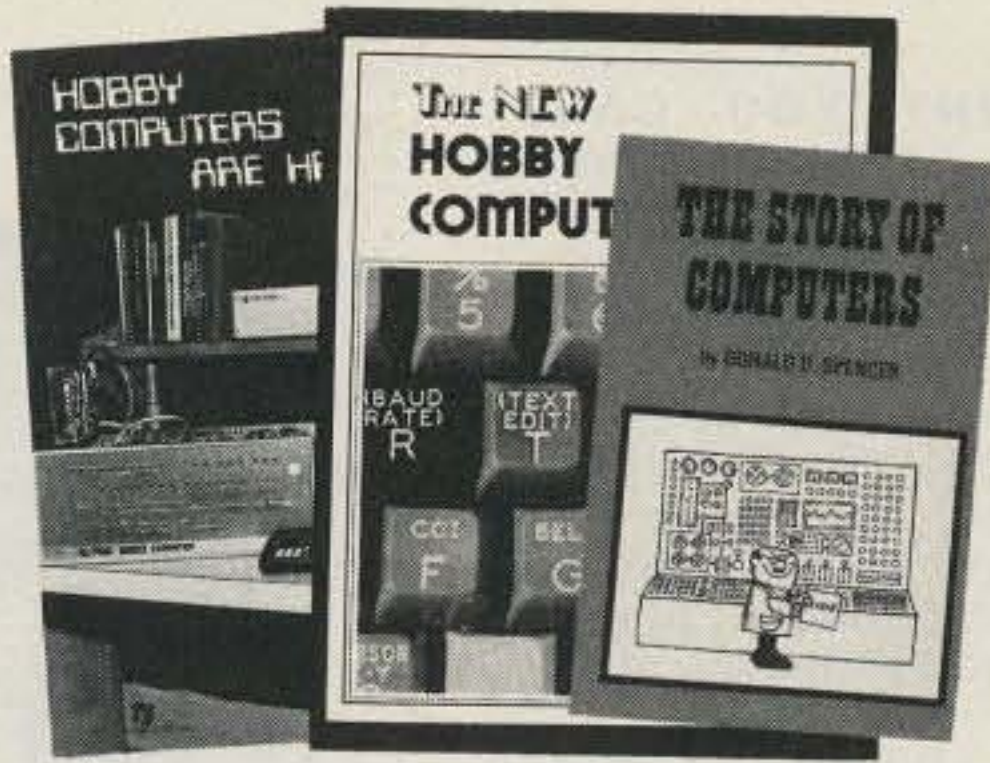

● **MICROPROCESSORS FROM CHIPS TO SYSTEMS**—BK1036—by Rodney Zaks, is a complete and detailed introduction to microprocessors and microcomputer systems. No preliminary knowledge of computers or microprocessors is required to read this book, although a basic engineering knowledge is naturally an advantage. Intended for all wishing to understand the concepts, techniques and components of microprocessors in a short time. \$9.95.*

● **INTRODUCTION TO MICROPROCESSORS**—BK1032—by Charles Rockwell of MICROLOG, is an ideal reference for the individual desiring to understand the hardware aspects of microprocessor systems. Describes the hardware details of computer devices in terms the beginner can understand, instead of treating the micro chip as a "black box." Specific systems are not described and programming is only briefly discussed. \$17.50 US and Canada, \$20 elsewhere.*

● **AN INTRODUCTION TO MICROCOMPUTERS, VOLS. 1 AND 2**, by Adam Osborne Associates, are references dealing with microcomputer architecture in general and specifically with details about most of the common chips. These books are not software-oriented, but are invaluable for the hobbyist who is into building his own interfaces and processors. Volume I is dedicated to general hardware theory related to micros, and Volume II discusses the practical details of each micro chip. (Detailed review in Kilobaud #2) Volume I—BK1030—\$7.50*; Volume II—BK1031—\$12.50.*

● **HOME COMPUTERS: A BEGINNER'S GLOSSARY AND GUIDE**—BK1022—This book is intended as a quick reference source for beginners. Included is a general introduction to microcomputers, a simple application & sample system, the history of microcomputers & their uses, and an introduction to some actual equipment. A chapter on number systems includes a number conversion chart, binary arithmetic from conversions to divisions, and a discussion of octal and hexadecimal numbers. A good background to read technical literature and computer equipment specifications. \$6.95.*

● **YOUR OWN COMPUTER**—BK1072—by M. Waite and M. Pardee. The personal computer has been touted as the next consumer product, but most individuals still wonder why. Much technical material has been written, but there is little material for the average individual without an extensive background in electronics. This book removes the stigma of complexity that surrounds the computer and has succeeded in providing a simple, easy-to-understand guide to these units. \$1.95.*

● **TAKE A CHANCE WITH YOUR CALCULATOR**—BK1002—Lennart Rade wrote this book to help you to discover the world of probability with your programmable calculator. You will need NO previous experience either in probability theory or in programming to learn both from this book. \$8.95.*

● **THE COMPUTER QUIZ BOOK**—BK1112—by Donald D. Spencer, is written for readers who would like to test themselves on basic computer concepts. It may be used effectively by anyone interested in checking his knowledge of computer concepts. \$5.95.*

Use the order card in the back of this magazine or itemize your order on a separate piece of paper and mail to:
73 Radio Bookshop • Peterborough NH 03458. Be sure to include check or detailed credit card information.

* Add \$1.00 handling charge for orders under \$10.00. Note: Prices subject to change on books not published by 73 Magazine.

FOR TOLL FREE ORDERING CALL 1-800-258-5473

RADIO BOOKSHOP

TEST EQUIPMENT

● **RF AND DIGITAL TEST EQUIPMENT YOU CAN BUILD**—BK1044—Rf burst, function, square wave generators, variable length pulse generators—100 kHz marker, i-f and rf sweep generators, audio osc, af/rf signal injector, 146 MHz synthesizer, digital readouts for counters, several counters, prescaler, microwave meter, etc. 252 pages. \$5.95.*

● **VOL. I COMPONENT TESTERS**—LB7359—...how to build transistor testers (8), diode testers (3), IC testers (3), voltmeters and VTVMs (9), ohmmeters (8 different kinds), inductance (3), capacity (9), Q measurement, crystal checking (6), temperature (2), aural meters for the blind (3) and all sorts of miscellaneous data on meters... using them, making them more versatile, making standards. Invaluable book. \$4.95.*

● **VOL. II AUDIO FREQUENCY TESTERS**—LB7360—...jam packed with all kinds of audio frequency test equipment. If you're into SSB, RTTY, SSTV, etc., this book is a must for you... a good book for hi-fi addicts and experimenters, too! \$4.95.*

● **VOL. III RADIO FREQUENCY TESTERS**—LB7361—Radio frequency waves, the common denominator of Amateur Radio. Such items as SWR, antenna impedance, line impedance, rf output and field strength; detailed instructions on testing these items includes sections on signal generators, crystal calibrators, grid dip oscillators, noise generators, dummy loads and much more. \$4.95.*

● **VOL. IV IC TEST EQUIPMENT**—LB7362—Become a troubleshooting wizard. All you need to know about pulse, audio and sync generators, frequency counters, digital component testers, logic probes and more! Plus a cumulative index for all four volumes of the 73 Test Equipment Library. \$4.95.*



THE WELL-EQUIPPED HAM SHACK

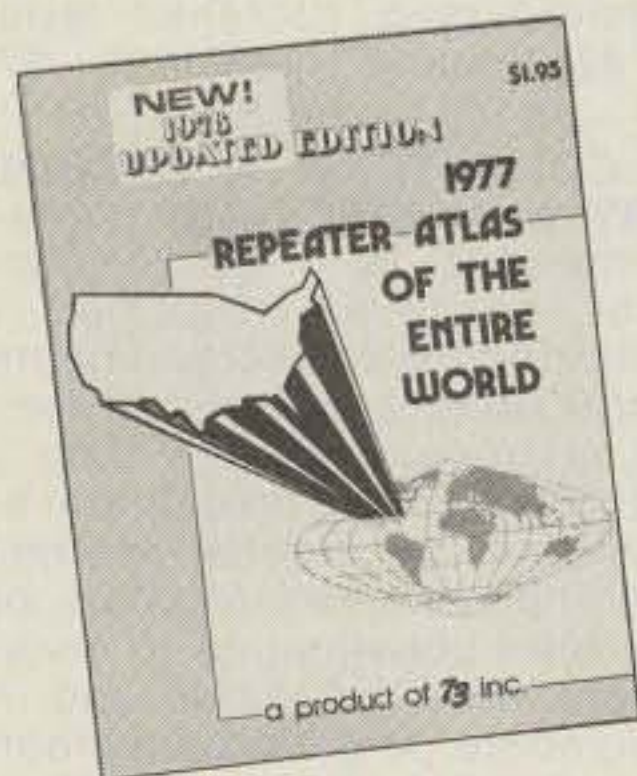

● **NEW REPEATER ATLAS OF THE ENTIRE WORLD**—BK7345—150% as big as any list ever available—nearly 900 more repeaters listed. New improved maps show the locations by frequency of every repeater in the States. Only \$1.95.*

● **QSL CARDS**—73 turns out a fantastic series of QSL cards at about half the cost of having them done elsewhere because they are run as a fill-in between printing books and other items in the 73 Print Shop. 250 Style W—QW0250—for \$8.95*; 500 Style W—QW0500—for \$13.95*; 250 Style X—QX0250—for \$8.95*; 500 Style X—QX0500—for \$13.95*; 250 Style Y—QY0250—for \$8.95*; 500 Style Y—QY0500—for \$13.95.*

● **73 MAGAZINE BINDERS**—Preserve and protect your collection for your lifetime! There's no excuse for lost issues when you have these handsome red binders with gold lettering. Order 1—BN1001—for \$6.50*; 2 or more—BN1002—for \$6.00 each.*



Style X



Style W



Style Y

● **BACK ISSUES**—Complete your collection—many are prime collectibles now, classics in the field! A full collection is an invaluable compendium of radio and electronics knowledge! \$2.00 each*, or 5 for \$5.00.*

● **LIBRARY SHELF BOXES**—These sturdy white, corrugated, dirt-resistant boxes each hold a full year of 73 or Kilobaud. With your order, request self-sticking labels for any of the following: 73, Kilobaud, CQ, QST, Ham Radio, Personal Computing, Radio Electronics, Interface Age, and Byte. Order 1—BX1000—for \$2.00*; order 2-7—BX1001—for \$1.50 each*; order 8 or more—BX1002—for \$1.25 each*.



Use the order card in the back of this magazine or itemize your order on a separate piece of paper and mail to:
73 Radio Bookshop • Peterborough NH 03458. Be sure to include check or detailed credit card information.

* Add \$1.00 handling charge for orders under \$10.00. Note: Prices subject to change on books not published by 73 Magazine.

FOR TOLL FREE ORDERING CALL 1-800-258-5473

Radio Bookshop

SOFTWARE • PROGRAMMING

● **DISCOVERING BASIC—A PROBLEM SOLVING APPROACH**—BK1017—by Robert E. Smith, deals with progressively more complex problems which allow the reader to discover the vocabulary of BASIC language as he develops skill and confidence in putting it to work. Clear and concise explanations. Problems used cover a wide range of interests—insurance, geometry, puzzles, economics, etc. \$6.85.*

● **BASIC NEW 2ND EDITION**—BK1081—by Bob Albrecht. Self-teaching guide to the computer language you will need to know for use with your microcomputer. This is one of the easiest ways to learn computer programming. \$4.95.*

● **A QUICK LOOK AT BASIC**—BK1043—by Donald D. Spencer. A perfect reference for the beginning programmer. Assumes that the reader has no previous programming experience and is a self-teaching guide for the individual desiring to learn the fundamentals of BASIC. \$4.95.*

● **MY COMPUTER LIKES ME... WHEN I SPEAK IN BASIC**—BK1039—by Bob Albrecht. An introduction to BASIC... simple enough for kids. If you want to teach BASIC to anyone quickly, this is the way to go. \$2.00.*

● **FUN WITH COMPUTERS AND BASIC**—BK1021—by Donald D. Spencer, contains an easy-to-understand explanation of the BASIC Programming Language and is intended for persons who have had no previous exposure to computer programming. Over half the book is devoted to problems using games, puzzles, and mathematical recreations. A superior book for self-teaching and learning computer programming. \$6.95.*

● **SIXTY CHALLENGING PROBLEMS WITH BASIC SOLUTIONS**—BK1073—by Donald Spencer, provides the serious student of BASIC programming with interesting problems and solutions. No knowledge of math above algebra required. Includes a number of game programs, as well as programs for financial interest, conversions and numeric manipulations. \$6.95.*

● **THE SECRET GUIDE TO COMPUTERS** Parts 1, 2, and 3 by Russ Walter. **Part One** describes computers in general, and after reading for ten minutes you will be writing simple BASIC programs! **Part Two** discusses computer applications. It's one thing to master the syntax of the language such as BASIC and another to solve problems using the new tool. **Part Three** describes programming languages. Ever heard of APL and QLISP? BASIC is not the only language used to program computers. 7th Edition. Part I—BK1050—\$2.75*; Part II—BK1051—\$2.50*; Part III—BK1052—\$3.50.*

● **SOME COMMON BASIC PROGRAMS**—BK1053—published by Adam Osborne & Associates, Inc. Perfect for non-technical computerists requiring ready-to-use programs. Business programs, plus miscellaneous programs. Invaluable for the user who is not an experienced programmer. All will operate in the stand-alone mode. \$8.50 paperback.*

● **ADVANCED BASIC APPLICATIONS AND PROBLEMS**—BK1000—by James Coan is for those who want to extend their expertise with BASIC. Offers advanced techniques and applications. \$7.95.*



● **SCIENTIFIC RESEARCH INSTRUMENTS' BASIC SOFTWARE LIBRARY** is a complete do-it-yourself kit. Written in everybody's BASIC immediately executable in ANY computer with 4K, no other peripherals needed. **Volume I** contains business and recreational programs and is 300 pages. **Volume II** is 260 pages and contains math, engineering, statistics and plotting programs. **Volume III** contains money managing, advanced business programs such as billing, A/R, inventory, payroll, etc. **Volume IV** contains general purpose programs like loans, rates, retirement, plus games: Poker, Enterprise (take charge while Capt. Kirk is away), Football and more! **Volume V** is filled with experimenter's programs including games, pictures and misc. problems like "logic." Volume I—LB1002—& Volume II—LB1003—\$24.95* each; Volume III—LB1004—\$39.95*; Volume IV—LB1005—& Volume V—LB1006—\$9.95* each; Volume VI—LB1007—\$49.95*; Volume VII—LB1008—\$39.95.*

● **MICROPROCESSOR PROGRAMMING FOR COMPUTER HOBBYISTS**—BK1038—by Neill Graham is for the hobbyist interested in intermediate and advanced techniques of programming and data structuring. Written to take up where the computer manufacturers' instruction manuals and the introductory programming language texts leave off. \$8.95.*

● **8080 PROGRAMMING FOR LOGIC DESIGN**—BK1078—Ideal reference for an in-depth understanding of the 8080 processor. Application-oriented and the 8080 is discussed in light of replacing conventional, hard-wired logic. Practical design considerations are provided for the implementation of an 8080-base control system. \$8.50.*

● **8080 SOFTWARE GOURMET GUIDE AND COOKBOOK**—BK1102—If you have been spending too much time developing simple routines for your 8080, try this new book by Scelbi Computing and Robert Findley. Describes sorting, searching, and many other routines for the 8080 user. \$9.95.*

● **6800 PROGRAMMING FOR LOGIC DESIGN**—BK1077—Oriented toward the industrial user, this book describes the process by which conventional logic can be replaced by a 6800 microprocessor. Provides practical information that allows an experimenter to design a complete micro control system from the "ground up." \$8.50.*

● **6800 SOFTWARE GOURMET GUIDE & COOKBOOK**—BK1075—If you have been spending too much time developing routines for your 6800 microprocessor, try the new book by Scelbi Computing and Robert Findley. Describes sorting, searching, and many other routines for the 6800 user. \$10.95.*

● **FORTRAN PROGRAMMING**—BK1019—by Donald Spencer. FORTRAN was designed for complex numeric calculations and possesses extended I/O capability. It is easily learned, as it is an English-like computer language. \$7.95.*

● **FORTRAN WORKBOOK**—BK1020—by Donald Spencer. Provides practical examples and problems to solve. Flowcharting is also discussed. Almost all micros support BASIC—it won't be long before FORTRAN is commonplace. \$4.95.*

Use the order card in the back of this magazine or itemize your order on a separate piece of paper and mail to:
73 Radio Bookshop • Peterborough NH 03458. Be sure to include check or detailed credit card information.

* Add \$1.00 handling charge for orders under \$10.00. Note: Prices subject to change on books not published by 73 Magazine.

FOR TOLL FREE ORDERING CALL 1-800-258-5473

Radio Bookshop

SOFTWARE PROGRAMMING... continued

● **PAYROLL WITH COST ACCOUNTING—IN BASIC**—BK1001—by L. Poole & M. Borchers, includes program listings with remarks, descriptions, discussions of the principle behind each program, file layouts, and a complete user's manual with step-by-step instructions, flowcharts, and simple reports and CRT displays. Payroll and cost accounting features include separate payrolls for up to 10 companies, time-tested interactive data entry, easy correction of data entry errors, job costing (labor distribution), check printing with full deduction and pay detail, and 16 different printed reports, including W-2 and 941. \$12.50.*

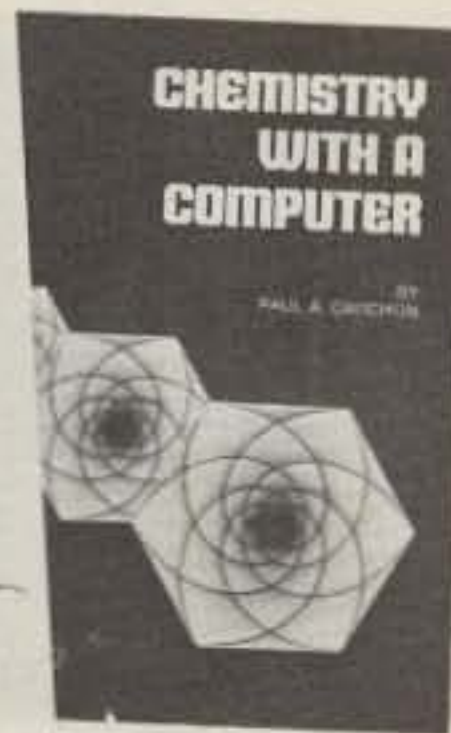

● **HOW TO PROGRAM MICROCOMPUTERS**—BK1027—by Wm. Barden, Jr. Here is a guide to assembly language programming of the Intel 8080, Motorola MC6800, and MOS Technology MCS6502 microprocessors. It is written especially for beginning programmers with hobbyist microcomputers based on one of these three chips. The topics covered range from data manipulations at the bit level up to data handling of tables and lists, and from simple adds and subtracts up to floating-point operations. \$8.95.*

● **CHEMISTRY WITH A COMPUTER**—BK1010—by Paul A. Cauchon, contains a collection of tutorial, simulation and problem-generation computer programs. Usable with almost any chemistry course in the high school or college level. \$9.95.*

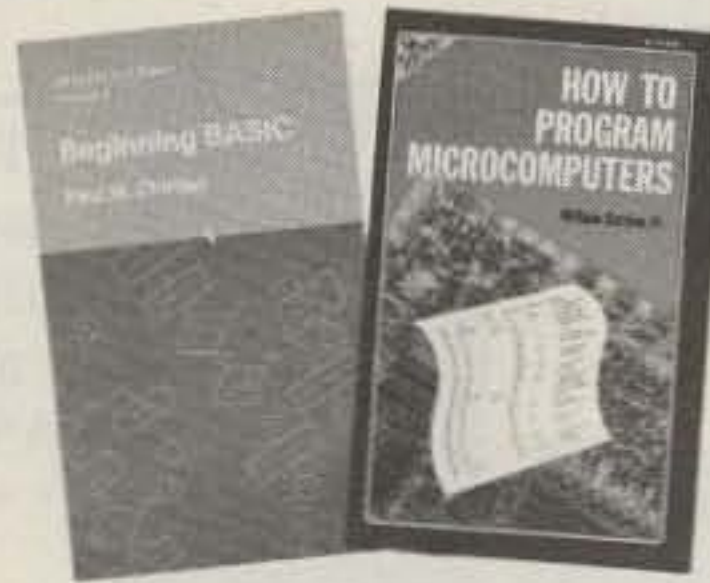

● **BEGINNING BASIC**—BK1007—by Dr. Paul Chirlian, provides a really basic BASIC that covers all the topics in simple, easy-to-understand language. Nothing is left out, everything is presented in clear, step-by-step fashion. This book will make a good BASIC programmer of any reader. \$9.95.*

HARDWARE

● **MICROPROCESSOR INTERFACING TECHNIQUES**—BK1037—by Austin Lesea & Rodney Zaks will teach you how to interconnect a complete system and interface it to all the usual peripherals. It covers hardware and software skills and techniques, including the use and design of model buses such as the IEEE 488 or \$100. \$9.95.*



● **TTL COOKBOOK**—BK1063—by Donald Lancaster. Explains what TTL is, how it works, and how to use it. Discusses practical applications, such as a digital counter and display system, events counter, electronic stopwatch, digital voltmeter, and a digital tachometer. \$8.95.*

● **CMOS COOKBOOK**—BK1011—by Don Lancaster. Details the application of CMOS, the low power logic family suitable for most applications presently dominated by TTL. Required reading for every serious digital experimenter! \$9.95.*

● **TVT COOKBOOK**—BK1064—by Don Lancaster, describes the use of a standard television receiver as a microprocessor CRT terminal. Explains and describes character generation, cursor control and interface information in typical, easy-to-understand Lancaster style. \$9.95.*

● **BUILD-IT BOOK OF DIGITAL ELECTRONIC TIMEPIECES**—BK1008—by Robert Haviland is a data-packed guide to building every timekeeping device you can imagine: rugged shipboard clocks, second-splitting digital IC chronometers, decorator digital IC chronometers, decorator digital clocks, a precision timer, a frequency-period meter, a tide and moon clock, an automatic alarm setter, etc. Including full-size printed circuit board layouts. \$6.95.*

● **THE "COMPULATOR" BOOK—BUILDING SUPER CALCULATORS & MINI COMPUTER HARDWARE WITH CALCULATOR CHIPS**—BK1012—by R. P. Haviland, provides ideas, design info and printed circuit boards for calculator chip projects. Tie it in with a Teletype to create a virtually infinite memory system. \$7.95.*



73

TEST EQUIPMENT LIBRARY

● **VOLUME I COMPONENT TESTERS**—LB7359—Build your own test equipment and save a bundle (and have a lot of fun). Volume I of the 73 Test Equipment Library shows you how to build and use transistor testers (8 of 'em), three diode testers, 3 IC testers, 9 voltmeters and VTVMs, 8 ohmmeters, 3 inductance meters, and a raft of other gadgets for checking temperature, crystals, Q, etc. \$4.95.*

● **VOLUME II AUDIO FREQUENCY TESTERS**—LB7360—If you're into audio such as digital cassette recording, RTTY, Baudot vs. ASCII, SSTV, SSB, Touchtone or even hi-fi, you'll want to have this book full of home-built test equipment projects. \$4.95.*

● **VOLUME III RADIO FREQUENCY TESTERS**—LB7361—This is of more interest to hams and CBers: test equipment you can build for checking out transmitters and receivers, signal generators, noise generators, crystal calibrators, GDOs, dummy loads. \$4.95.*

● **VOLUME IV IC TEST EQUIPMENT**—LB7362—Become a troubleshooting wizard. All you need to know about pulse, audio and sync generators, frequency counters, digital component testers, logic probes and more! Plus a cumulative index for all four volumes of the 73 Test Equipment Library. \$4.95.*

● **LSI-11 REFERENCE CARD**—CC 2011—A must for Heath H11 users. Contains listings of all instructions by mnemonic and opcode, console ODT commands, trap and interrupt vector locations and more. From Digital Equipment Corporation. \$1.00.*

Use the order card in the back of this magazine or itemize your order on a separate piece of paper and mail to:
73 Radio Bookshop • Peterborough NH 03458. Be sure to include check or detailed credit card information.

* Add \$1.00 handling charge for orders under \$10.00. Note: Prices subject to change on books not published by 73 Magazine.

FOR TOLL FREE ORDERING CALL 1-800-258-5473

10 thru 80 the easy way!!!

"BIG SIGNAL" W2AU BALUN *
"OLD RELIABLE" W2VS ANTENNA COILS *

ANTENNA KIT

These two old friends* get together with 120 feet of high quality #14-7 strand copper antenna wire and a pair of "END-SULATORS" end insulators to create a superior 80 through 10 meter, 108 foot long, full power (1,000 watts/2,000 watts P.E.P.) antenna. Instructions included.
Price \$48.25 plus \$1.00 handling charge.
In Calif. add 6% sales tax. Mastercharge & Visa accepted.

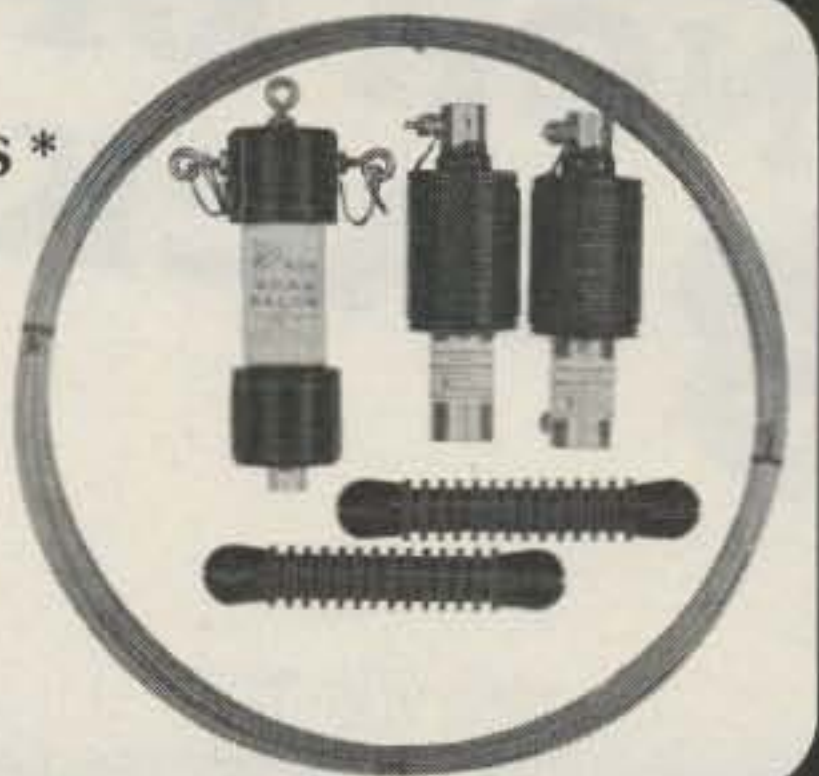

Order from: S-F AMATEUR RADIO SERVICES
4384 KEYSTONE AVE., CULVER CITY CALIFORNIA 90230 Ph. (213) 837-4870

Iron Powder and Ferrite TOROIDAL CORES

Wide selection - Large stock
Fast, one-day service
Technical data with each order
Write for free Tech-Data-Flyer

AMIDON
Associates

12033 Otsego Street, North Hollywood, Calif. 91607

In Germany: Elektronkladen, Wilhelm - Mellies Str. 88
4930 Detmold 18, West Germany. A26



**To get overseas trade leads like this,
you could open offices in 127 countries.**

Or use our computer.



The U.S. Commerce Department's computer-operated Trade Opportunities Program (TOP) can supply you with immediate, continuing, specific leads tailored to your sales objectives for any of 127 countries. So if you can't be all over the world at one time, we've got the answer. To learn more, write Secretary of Commerce, U.S. Department of Commerce, BIC-9C, Washington, D.C. 20230.

**Ad
Council**

A Public Service of This Magazine & The Advertising Council

Pace-Traps
P15

Box 234
Middlebury CT 06762

ICOM-22S OWNERS!!

Get rid of the CB dial. Go to direct frequency read-out in 30 minutes and minimum cost. PACE-DIAL will do the job. An accurately silk-screened replacement dial and enough dry-transfer numbers to make hundreds of frequency combinations. Tailors the dial to exactly the frequencies you have set-up in your ICOM. Complete dial-kit and full instructions furnished. \$3.25 ppd.



Check or MO to:
Box 234
Middlebury CT 06762
(203) 758-9228

MORE GOODIES FROM ISLAND

An unusual combination of ruggedness, compactness, and bandwidth is offered by these monoband heliwhip antennas. For 10, 15 & 20, all models use 6' tapered element halves.

WHIP Our hi-Z winding minimizes ground return losses for mobile service. \$18.

VEE 2 whip inverted V. Featherweight, efficient radiator goes way up there easily. Use with a kite or balloon for super DX. Direct 50Ω feed. 2 lb. \$35.

BEAM 4 whips: 2 el., driven & reflector. Cuts QRM, covers the band like a big antenna, but weighs only 4 lb. 10 dB i/b, 6' boom, 12' el., direct 50Ω feed \$75.

MINI LP 8 whips: 4 el. Log periodic cell. Featured in June '78 73. Big signal from an 8 lb. antenna. 10' boom 12' el. \$175

2 week refund privilege on all antennas.

Island Antennas
Block Island, RI 02807
Custom antennas our specialty.

Trans Com T35 Tone Signaling Equipment

Featuring the TG-1B Sub-Audible Tone Encoder
Compatible with P.L., CG and other systems

Features:

- Low sine wave distortion of less than 1.5% THD
- Plug in tone element
- Excellent Temperature & frequency stability
- Low current draw using CMOS IC's
- Immunity to RF

Two year warranty

Priced at \$27.95
wired and tested
with tone element



Also Available

DTMF encoder, from \$29.95, DTMF Decoders, and two tone sequential tone encoders and decoders.

Order from or for further information contact

Trans Com

P.O. Box 120, Addison, Illinois 60101 312-653-6724

BAG-A-BUNCH OF 73 BACK ISSUES!*



**Your Choice/Our Choice Special
\$1 per Issue
(Minimum order 5 issues, your choice)
OR 25 Issues Our Choice—\$10.00**

- Vintage (1960 thru 1965) Mid-years (1966 thru 1971)
 Nearly new (1972 thru 1977) pre-1978 issues

- | | | |
|----------------------------------|----------------------------------|-------------------------------------|
| <input type="checkbox"/> JUNE 63 | <input type="checkbox"/> MAY 70 | <input type="checkbox"/> NOV 73 |
| <input type="checkbox"/> AUG 63 | <input type="checkbox"/> JUNE 70 | <input type="checkbox"/> DEC 73 |
| <input type="checkbox"/> OCT 63 | <input type="checkbox"/> DEC 70 | <input type="checkbox"/> FEB 74 |
| <input type="checkbox"/> FEB 64 | <input type="checkbox"/> JAN 71 | <input type="checkbox"/> APR 74 |
| <input type="checkbox"/> JULY 67 | <input type="checkbox"/> FEB 71 | <input type="checkbox"/> MAY 74 |
| <input type="checkbox"/> OCT 67 | <input type="checkbox"/> MAR 71 | <input type="checkbox"/> JULY 74 |
| <input type="checkbox"/> JUNE 68 | <input type="checkbox"/> MAY 71 | <input type="checkbox"/> AUG 74 |
| <input type="checkbox"/> JULY 68 | <input type="checkbox"/> JUNE 71 | <input type="checkbox"/> SEPT 74 |
| <input type="checkbox"/> SEPT 68 | <input type="checkbox"/> JULY 71 | <input type="checkbox"/> OCT 74 |
| <input type="checkbox"/> JAN 69 | <input type="checkbox"/> AUG 71 | <input type="checkbox"/> NOV 74 |
| <input type="checkbox"/> FEB 69 | <input type="checkbox"/> SEPT 71 | <input type="checkbox"/> DEC 74 |
| <input type="checkbox"/> MAR 69 | <input type="checkbox"/> OCT 71 | <input type="checkbox"/> FEB 75 |
| <input type="checkbox"/> APR 69 | <input type="checkbox"/> NOV 71 | <input type="checkbox"/> APR 75 |
| <input type="checkbox"/> MAY 69 | <input type="checkbox"/> AUG 72 | <input type="checkbox"/> AUG 75 |
| <input type="checkbox"/> JUNE 69 | <input type="checkbox"/> SEPT 72 | <input type="checkbox"/> SEPT 75 |
| <input type="checkbox"/> JULY 69 | <input type="checkbox"/> OCT 72 | <input type="checkbox"/> OCT 75 |
| <input type="checkbox"/> AUG 69 | <input type="checkbox"/> NOV 72 | <input type="checkbox"/> NOV/DEC 75 |
| <input type="checkbox"/> SEPT 69 | <input type="checkbox"/> DEC 72 | <input type="checkbox"/> FEB 76 |
| <input type="checkbox"/> OCT 69 | <input type="checkbox"/> JAN 73 | <input type="checkbox"/> MAY 76 |
| <input type="checkbox"/> NOV 69 | <input type="checkbox"/> APR 73 | <input type="checkbox"/> JUNE 76 |
| <input type="checkbox"/> DEC 69 | <input type="checkbox"/> JUNE 73 | <input type="checkbox"/> JULY 76 |
| <input type="checkbox"/> JAN 70 | <input type="checkbox"/> AUG 73 | <input type="checkbox"/> SEPT 76 |
| <input type="checkbox"/> FEB 70 | <input type="checkbox"/> SEPT 73 | <input type="checkbox"/> OCT 76 |
| <input type="checkbox"/> MAR 70 | <input type="checkbox"/> OCT 73 | <input type="checkbox"/> NOV 76 |
| <input type="checkbox"/> APR 70 | | <input type="checkbox"/> DEC 76 |
| | | <input type="checkbox"/> HOLIDAY 76 |

73 Magazine Back Issue Classics (All 1977 issues are still available!)
 \$5.00* - 5 Issues (indicate your choice at left)
 \$10.00* - 25 issues - our choice

\$ _____ Enclosed. Cash Check Money order
 American Express BankAmericard/VISA Master Charge
 Credit Card # _____ Expiration date _____
 Signature _____

Vintage Mid-years Nearly new
 Name _____
 Address _____
 City _____ State _____ Zip _____

73 magazine
 Peterborough NH
 03458

*Add \$1.00 shipping and handling charge.

IS HARD COPY STORAGE A PROBLEM?



73, as thick as it is, is more like a floppy when it comes to standing on the bookshelf. Try the 73 Library Shelf Boxes, . . . sturdy corrugated white dirt resistant cardboard boxes which will keep them from flopping around. We have self-sticking labels for the boxes, too, not only for 73, but also for *Kilobaud* . . . and for *CQ*, *QST*, *Ham Radio*, *Personal Computing*, *Radio Electronics*, *Interface Age*, and *Byte*. Ask for whatever stickers you want with your box order. They hold a full year of 73 . . . or *Kilobaud*. Your magazine library is your prime reference, keep it handy and keep it neat with these strong library shelf boxes . . . One box is \$2.00, 2 boxes are \$3.00 and eight boxes are \$10.00. Be sure to specify which labels we should send. Have your credit card handy and call our toll-free order number 800-258-5473, or use the order card in the back of the magazine and mail to:

73 magazine
PETERBOROUGH NH 03458

Hot Item!!

**WEATHER
SATELLITE
HANDBOOK
\$4.95**

*Weather Satellite Antenna Systems,
Receivers, How To Find & Track
Satellites . . .*

**WEATHER
SATELLITE
HANDBOOK**



A complete satellite ground station can be built for less than the cost of a good television set! And you don't have to be a mechanical or electrical genius, either. This text is fully illustrated and you will find information on simple equipment, methods for producing good pictures from the weather satellite, antennas, receivers, monitors, tracking & automatic control.

73 magazine
PETERBOROUGH NH 03458

PROPAGATION

by
J. H. Nelson

EASTERN UNITED STATES TO:

| | GMT: | 00 | 02 | 04 | 06 | 08 | 10 | 12 | 14 | 16 | 18 | 20 | 22 |
|--------------|------|----|-----|----|----|----|----|----|----|-----|-----|-----|-----|
| ALASKA | 14 | 14 | 7 | 7 | 7 | 7 | 7 | 7A | 14 | 14 | 14 | 14 | |
| ARGENTINA | 14 | 14 | 7A | 7 | 7 | 7 | 14 | 14 | 14 | 14A | 21 | 21 | |
| AUSTRALIA | 14 | 14 | 14B | 7B | 7B | 7 | 7 | 7 | 7 | 7 | 14 | 14 | |
| CANAL ZONE | 14A | 14 | 7 | 7 | 7 | 7 | 14 | 14 | 14 | 14 | 14 | 14A | |
| ENGLAND | 7A | 7 | 7 | 7 | 7 | 7 | 14 | 14 | 14 | 14 | 14A | 14 | |
| HAWAII | 14 | 14 | 14B | 7 | 7 | 7 | 7 | 7B | 14 | 14 | 14 | 14 | |
| INDIA | 14B | 7B | 7B | 7B | 7B | 7B | 14 | 14 | 14 | 14 | 14 | 14B | |
| JAPAN | 14 | 14 | 7B | 7 | 7 | 7 | 7 | 7 | 7A | 14 | 14 | 14 | |
| MEXICO | 14 | 14 | 7 | 7 | 7 | 7 | 7 | 14 | 14 | 14 | 14 | 14 | |
| PHILIPPINES | 14 | 14 | 7B | 7B | 7B | 7B | 7B | 7 | 7A | 14 | 14 | 14 | |
| PUERTO RICO | 14 | 7A | 7 | 7 | 7 | 7 | 7A | 14 | 14 | 14 | 14 | 14 | |
| SOUTH AFRICA | 7 | 7 | 3A | 7 | 7B | 14 | 14 | 14 | 14 | 14 | 14 | 14 | 14B |
| U. S. S. R. | 7 | 7 | 7 | 7 | 7 | 7 | 14 | 14 | 14 | 14 | 14 | 14 | 14B |
| WEST COAST | 14 | 14 | 7A | 7 | 7 | 7 | 7 | 14 | 14 | 14 | 14 | 14A | |

CENTRAL UNITED STATES TO:

| | | | | | | | | | | | | | |
|--------------|-----|-----|----|-----|----|----|----|----|----|----|-----|-----|-----|
| ALASKA | 14 | 14 | 7A | 7 | 7 | 7 | 7 | 7 | 7A | 14 | 14 | 14 | |
| ARGENTINA | 14 | 14 | 14 | 7A | 7 | 7 | 7A | 14 | 14 | 14 | 14A | 21 | |
| AUSTRALIA | 14 | 14 | 14 | 14B | 7B | 7 | 7 | 7 | 7 | 7 | 14 | 14 | |
| CANAL ZONE | 14A | 14 | 14 | 7 | 7 | 7 | 7 | 14 | 14 | 14 | 14 | 14A | |
| ENGLAND | 7 | 7 | 7 | 7 | 7 | 7 | 7A | 14 | 14 | 14 | 14 | 14 | |
| HAWAII | 14 | 14 | 14 | 14B | 7 | 7 | 7 | 7 | 14 | 14 | 14 | 14 | |
| INDIA | 14B | 14B | 7B | 7B | 7B | 7B | 7B | 7B | 14 | 14 | 14 | 14 | |
| JAPAN | 14 | 14 | 14 | 7 | 7 | 7 | 7 | 7 | 7A | 14 | 14 | 14 | |
| MEXICO | 14 | 14 | 7 | 7 | 7 | 7 | 7 | 7 | 7A | 14 | 14 | 14 | |
| PHILIPPINES | 14 | 14 | 14 | 7B | 7B | 7B | 7B | 7 | 7A | 14 | 14 | 14 | |
| PUERTO RICO | 14 | 14 | 7A | 7 | 7 | 7 | 7A | 14 | 14 | 14 | 14 | 14 | |
| SOUTH AFRICA | 7 | 7 | 3A | 7 | 7B | 7B | 14 | 14 | 14 | 14 | 14 | 14 | 14B |
| U. S. S. R. | 7 | 7 | 7 | 7 | 7 | 7 | 7 | 14 | 14 | 14 | 14 | 14 | 14B |

WESTERN UNITED STATES TO:

| | | | | | | | | | | | | | |
|--------------|-----|----|----|----|----|----|----|----|----|----|----|-----|-----|
| ALASKA | 14 | 14 | 14 | 7 | 7 | 7 | 7 | 7 | 7 | 7 | 7A | 14 | |
| ARGENTINA | 14 | 14 | 14 | 7A | 7 | 7 | 7 | 14 | 14 | 14 | 14 | 21 | |
| AUSTRALIA | 21 | 21 | 21 | 14 | 14 | 7A | 7 | 7 | 7 | 7 | 14 | 14 | |
| CANAL ZONE | 14A | 14 | 14 | 7 | 7 | 7 | 7 | 14 | 14 | 14 | 14 | 14 | |
| ENGLAND | 7 | 7 | 7 | 7 | 7 | 7 | 7 | 7 | 14 | 14 | 14 | 14 | |
| HAWAII | 14A | 21 | 21 | 14 | 7 | 7 | 7 | 7 | 14 | 14 | 14 | 14 | |
| INDIA | 14 | 14 | 14 | 7B | 7B | 7B | 7B | 7B | 14 | 14 | 14 | 14 | |
| JAPAN | 14 | 14 | 14 | 14 | 7 | 7 | 7 | 7 | 7 | 7A | 14 | 14 | |
| MEXICO | 14 | 14 | 14 | 7 | 7 | 7 | 7 | 14 | 14 | 14 | 14 | 14 | |
| PHILIPPINES | 14 | 14 | 14 | 14 | 7B | 7B | 7B | 7 | 7A | 14 | 14 | 14 | |
| PUERTO RICO | 14 | 14 | 7A | 7 | 7 | 7 | 7 | 14 | 14 | 14 | 14 | 14 | |
| SOUTH AFRICA | 7 | 7 | 3A | 7 | 7B | 7B | 7B | 14 | 14 | 14 | 14 | 14 | 14B |
| U. S. S. R. | 7 | 7 | 7 | 7 | 7 | 7 | 7 | 7A | 14 | 14 | 14 | 14 | 14B |
| EAST COAST | 14 | 14 | 7A | 7 | 7 | 7 | 7 | 14 | 14 | 14 | 14 | 14A | |

A = Next higher frequency may also be useful
B = Difficult circuit this period
F = Fair
G = Good
P = Poor

august

| sun | mon | tue | wed | thu | fri | sat |
|----------------|----------------|----------------|----------------|----------------|----------------|----------------|
| ● ○ ○ ○ | | 1 G | 2 G | 3 G | 4 G | 5 G |
| 6 F | 7 F | 8 F | 9 G | 10 G | 11 G | 12 G |
| 13 G | 14 G | 15 G | 16 P | 17 F | 18 G | 19 G |
| 20 G | 21 F | 22 G | 23 G | 24 F | 25 P | 26 P |
| 27 P | 28 F | 29 G | 30 G | 31 F | | |

MOVING?

Let us know 8 weeks in advance so that you won't miss a single issue of 73 Magazine.

Attach old label where indicated and print new address in space provided. Also include your mailing label whenever you write concerning your subscription. It helps us serve you promptly. Write to:



- Address change only
- Extend subscription
- Enter new subscription
- 1 year \$15.00
- Payment enclosed (1 extra BONUS issue)
- Bill me later

If you have no label handy, print OLD address here.

AFFIX LABEL

Name _____ Call _____

Address _____

City _____ State _____ Zip _____

print NEW address here:

Name _____ Call _____

Address _____

City _____ State _____ Zip _____

TICKETS TO COMPETENCE!

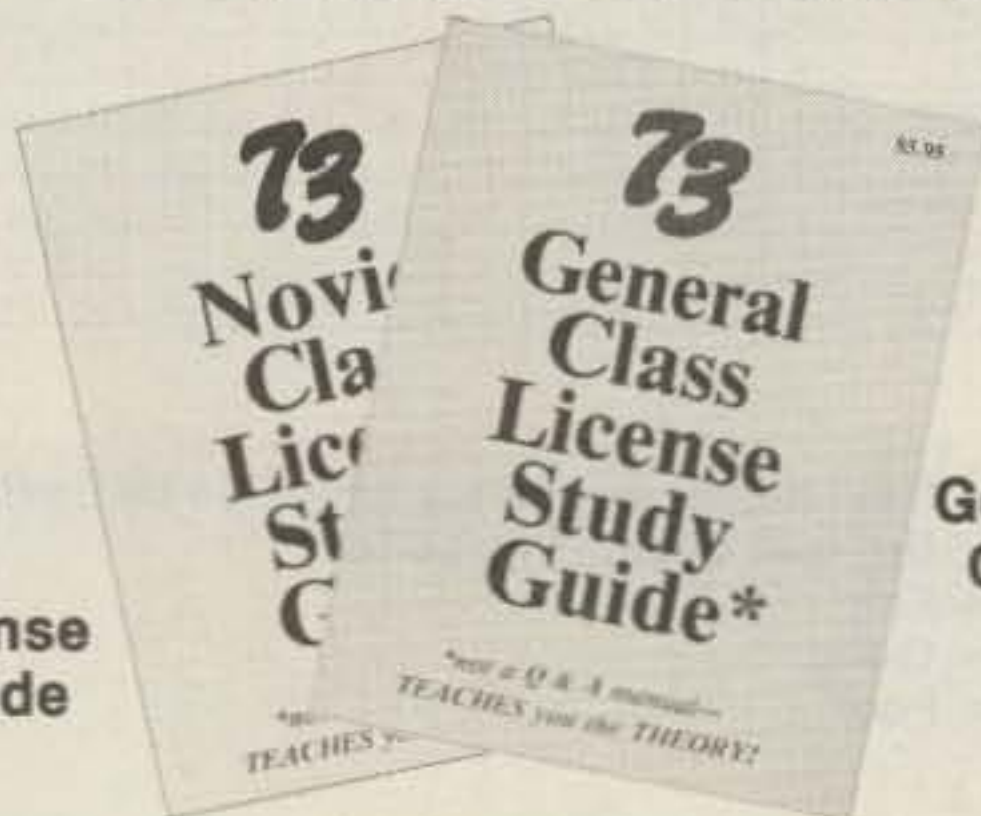

Novice Class License Guide

General Class License Guide

Novice Guide — This excellent reference will launch you into the exciting world of ham radio! Covers radio and electronic fundamentals, preparing you to pass the Novice exam; also includes the latest FCC amateur regulations and application forms. \$4.95

General Guide — If you're looking ahead to your General or Technician exam, or are already licensed, this excellent reference work is a must for you! Covers completely transistor, amplifier, and general radio theory; you'll use it again and again! \$5.95.

73 Magazine • Peterborough NH 03458

73 magazine

ADVERTISER index

- A48 ABC Communications 195
- A1 Adirondack Radio Supply 196
- A24 Adva Electronics 198
- A57 Alliance Manufacturing Company 47
- A47 Aluma Tower Company 215
- A51 Amateur Radio of Rochester 111
- A55 Amateur Radio Supply 119
- A40 Amateur Radio Supply of Nashville, Inc. 188, 189
- A56 Amateur Radio Supply of North Atlanta, Inc. 188, 189
- A58 American Crystal Supply 96
- A26 Amidon Associates 223
- A6 Apron Laboratories 111
- A50 Associated Radio 210
- B33 Barker & Williamson 185
- B32 Bay-Com 194
- B29 Britt's 2-Way Radio 96
- B13 Brookfield Manufacturing Company 116
- B8 Bullet Electronics 202
- C3 Clegg 127, 182
- C84 Cleveland Hamfest 162
- C21 Coakitt 185
- C83 Cohoon Amateur Supply 97
- C75 Comm Center, Laurel 190
- C58 Communications Center, NE 167, 193
- C6 Communications Specialists 20, 21
- C87 Crushcraft 117
- D6 Peter W. Dahl Company 162
- D10 Davis Electronics 183
- D15 DenTron 11
- D29 Dielectric 57
- D20 Digital Research Corporation 204, 205
- D23 Dovetron 194
- D25 DSI Instruments 158, 159
- E1 ECM Corporation 91, 111
- E19 Edgcom 32, 33
- E21 Electronic Systems 110
- E12 Engineering Specialties 214
- E31 ETCO Electronics 199
- E33 Evans Radio 93
- F5 Flesher Corporation 165
- F3 Freck Radio & Supply 162
- G12 Gerken's, Inc. Sales & Service 116
- G4 Germantown Amateur Supply 93
- G19 Godbout Electronics 206
- Gotham, Inc. 57
- H42 HAL Communications 192
- H2 Ham-Tronix 186
- H2 Ham Radio Center 211
- H16 Hamtronics, NY 201
- H8 Hamtronics, PA 83
- H26 Hartwell's Office World 215
- H3 Henry Radio Ctr. 81
- H25 Hobby World Electronics 197
- I1 ICOM 7
- I9 Integrated Circuits 208
- I19 Island Antennas 223
- J1 Jameco Electronics 207
- J2 Jan Crystals 117
- J9 J&W Electronics, Inc. 81
- J8 JRS Electronics 111
- K13 Kantronics 57
- K14 Kenwood CIV, 5
- L11 Key Electronics 165
- L1 Logitronics 105
- L9 Long's Electronics 170-175
- L10 L-Tronics 119
- M35 Madison Electronics 47
- M36 Magglore Electronic Labs 107
- M52 MFJ Enterprises 63, 88, 182
- M48 Microtronics 111
- M41 Midland International 155
- N2 New England ARRL 50
- N2 New-Tronics 15
- O5 OK Machine & Tool 105, 107
- O3 Optoelectronics 203
- P15 Pace-Traps 111, 223
- P30 Palomar Electronics 25
- P1 Palomar Engineers 36
- P2 Poly Paks 209
- P26 Printed Circuit Products 111
- P21 Priority One 98
- Q3 Quest Electronics 196
- R1 Radio Amateur Callbook, Inc. 213
- R Radio World 194
- R8 Ramsay Electronics 200
- R15 Rolin Distributors 88
- R21 Rush Electronics 91
- R18 R.W. Electronics, Inc. 194
- S39 Sere-Rose & Spencer 91
- S33 S-F Amateur Radio Services 165, 183, 223
- S58 Shakespeare 89
- S57 Siliconix, Inc. 37
- S8 Spectrum Communications 70, 71
- S10 SST Electronics 181
- S50 O.C. Stafford Electronics 111
- S18 Standard Communications 162, 163
- S38 Stuart Electronics 36
- S43 Surplus Electronics 212
- T13 Teletypewriter Communications Specialists 111
- T33 Telex Communications, Inc. 43
- Ten-Tec 49
- T34 Thomas Communications 191
- T18 Trac Electronics 194
- T35 Trans Com 223
- T3 Tuff's Radio Electronics 133-140
- U2 Unarco-Rohn 190
- U6 Universal Amateur Radio Service, Inc. 196
- V1 Vanguard Labs 91
- V5 VHF Engineering 43
- W15 Wacom 190
- W17 Westcom Engineering 183
- W18 Western Electronics 165
- W2 Wilson Electronics 3
- X1 Xitex 215
- X1 Yaesu Electronics Corp. CIII, 16, 19
- Z1 ZZZ Electronics, Inc. 181

From 73... 98, 187, 216-222, 224-225

*Reader Service inquiries not honored.

BOOKS etc.

| CATALOG # | MERCHANDISE | PRICE |
|-----------|---------------------------------|---------|
| BK1082 | 1001 PRACTICAL ELECT. CIRCUITS | \$ 9.95 |
| BK7398 | 108 QUESTIONS & ANSWERS | \$ 1.95 |
| BK1073 | 60 PROBLEMS W/BASIC SOLUTIONS | \$ 6.95 |
| BK1077 | 6800 PROG FOR LOGIC DESIGN | \$ 7.50 |
| BK1075 | 6800 SOFTWARE GOURMET GUIDE | \$10.95 |
| BK1016 | 73 DIPOLE & LONG WIRE ANTENNAS | \$ 5.50 |
| BK1078 | 8080 PROG FOR LOGIC DESIGN | \$ 7.50 |
| BK1102 | 8080 SOFTWARE GOURMET GUIDE | \$ 9.95 |
| BK1000 | ADVANCED BASIC | \$ 7.95 |
| BK1081 | BASIC 2ND EDITION | \$ 4.95 |
| BK1074 | BASIC COMPUTER GAMES | \$ 7.50 |
| LB1092 | BASIC SOFTWARE LIBRARY VOL 1 | \$24.95 |
| LB1003 | BASIC SOFTWARE LIBRARY VOL 2 | \$24.95 |
| LB1004 | BASIC SOFTWARE LIBRARY VOL 3 | \$39.95 |
| LB1005 | BASIC SOFTWARE LIBRARY VOL 4 | \$ 9.95 |
| LB1006 | BASIC SOFTWARE LIBRARY VOL 5 | \$ 9.95 |
| LB1007 | BASIC SOFTWARE LIBRARY VOL 6 | \$48.95 |
| LB1008 | BASIC SOFTWARE LIBRARY VOL 7 | \$39.95 |
| BK1007 | BEGINNING BASIC | \$ 9.95 |
| BK7307 | BEHIND THE DIAL | \$ 4.95 |
| BN1001 | BINDER—73—1 | \$ 6.50 |
| BN1002 | BINDER—73—2&UP | \$ 8.00 |
| BN1011 | BINDER—KB—1 | \$ 6.50 |
| BN1012 | BINDER—KB—2&UP | \$ 6.00 |
| BK1008 | BUILD-IT BOOK OF DIG ELEC TMPC | \$ 6.95 |
| BK7309 | CHALLENGE OF 160 | \$ 4.95 |
| BK1010 | CHEMISTRY WITH A COMPUTER | \$ 9.95 |
| BK1011 | CMOS COOKBOOK | \$ 9.95 |
| CT7305 | CODE TAPE—5 WPM | \$ 4.95 |
| CT7306 | CODE TAPE—6 WPM | \$ 4.95 |
| CT7310 | CODE TAPE—10 WPM | \$ 4.95 |
| CT7313 | CODE TAPE—13 WPM | \$ 4.95 |
| CT7320 | CODE TAPE—20 WPM | \$ 4.95 |
| CT7325 | CODE TAPE—25 WPM | \$ 4.95 |
| CT7399 | CODE TAPE—LEARN MORSE CODE | \$ 4.95 |
| CT7394 | CODE TAPES—(ANY FOUR OF ABOVE) | \$15.95 |
| NC7301 | COMPLETE NOVICE STUDY KIT | \$25.00 |
| BK1012 | COMPULATOR BOOK | \$ 7.95 |
| BK1013 | COMPULATOR DICTIONARY | \$ 5.95 |
| BK1014 | COMPUTER PROGRAMMING HANDBOOK | \$ 9.95 |
| BK1112 | COMPUTER QUIZ BOOK | \$ 5.95 |
| TS7303 | COMPUTERMANIAC T-SHIRT—LARGE | \$ 5.50 |
| TS7302 | COMPUTERMANIAC T-SHIRT—MED. | \$ 5.50 |
| TS7301 | COMPUTERMANIAC T-SHIRT—SMALL | \$ 5.50 |
| TS7304 | COMPUTERMANIAC T-SHIRT—XL | \$ 5.50 |
| BK1017 | DISCOVERING BASIC | \$ 6.85 |
| BK1018 | FASCINATING WORLD OF RADIO COM | \$ 3.95 |
| BK1046 | FIRST BOOK OF COMPUTER GAMES | \$14.95 |
| BK1019 | FORTAN PROGRAMMING | \$ 7.95 |
| BK1020 | FORTAN WORKBOOK | \$ 4.95 |
| BK1021 | FUN WITH COMPUTERS AND BASIC | \$ 6.95 |
| BK7321 | GUIDE TO HAM RADIO | \$ 4.95 |
| BK7322 | HOBBY COMPUTERS ARE HERE | \$ 4.95 |
| BK1023 | HOME COMPUTERS Q + A VOL 1 | \$ 7.95 |
| BK1024 | HOME COMPUTERS Q + A VOL 2 | \$ 6.95 |
| BK1022 | HOME COMPUTERS—GLOSSARY/GUIDE | \$ 6.95 |
| BK7325 | HOW TO BUILD A MICROCOMPUTER | \$ 9.95 |
| BK1025 | HOW TO BUY & USE MINIS/MICROS | \$ 9.95 |
| BK7326 | HOW TO MAKE BETTER QSLs | \$ 2.50 |
| BK1027 | HOW TO PROGRAM MICROCOMPUTERS | \$ 8.95 |
| BK1028 | IC OP AMP COOKBOOK | \$12.95 |
| BK1029 | IC TIMER COOKBOOK | \$ 9.95 |
| BK1131 | INSTANT BASIC | \$ 6.00 |
| BK1130 | INTRO TO MICROCOMPUTERS VOL 0 | \$ 7.50 |
| BK1030 | INTRO TO MICROCOMPUTERS VOL 1 | \$ 7.50 |
| BK1031 | INTRO TO MICROCOMPUTERS VOL 2 | \$12.50 |
| BK1032 | INTRO TO MICROPROCESSORS | \$17.50 |
| BK7380 | INTRO TO RTTY | \$ 2.00 |
| CC2011 | LSI-11 REFERENCE CARD | \$ 1.00 |
| MP7303 | MAP OF US WITH CALL AREAS | \$ 1.00 |
| MP7302 | MAP OF WORLD WITH DX PREFIXES | \$ 2.00 |
| BK1033 | MASTER BOOK OF HAM RADIO CIRC. | \$ 8.95 |
| BK1037 | MICRO INTERFACING TECHNIQUES | \$ 9.95 |
| BK1038 | MICRO PROG. FOR HOBBYISTS | \$ 8.95 |
| BK1034 | MICROCOMPUTER DICTIONARY | \$15.95 |
| BK1035 | MICROCOMPUTER PRIMER | \$ 7.95 |
| BK1137 | MICROPROCESSOR LEXICON | \$ 2.95 |
| BK1036 | MICROS FROM CHIPS TO SYSTEMS | \$ 9.95 |
| BK1039 | MY COMPUTER LIKES ME | \$ 2.00 |
| BK7340 | NEW HOBBY COMPUTERS | \$ 4.95 |
| CT7300 | NOVICE THEORY TAPES | \$15.95 |
| BK1001 | PAYROLL AND COST ACCOUNTING | \$12.50 |
| BK1041 | PERIODICAL GUIDE—1976 | \$ 3.00 |
| BK1042 | PERIODICAL GUIDE JAN—JUN 1977 | \$ 3.00 |
| BK1190 | PRACTICAL TEST INSTRUMENTS | \$ 4.95 |
| BK1140 | PROGRAMMING IN PASCAL | \$ 6.95 |
| QW0250 | QSL CARDS—STYLE W—250 | \$ 8.95 |
| QW0500 | QSL CARDS—STYLE W—500 | \$13.95 |
| QX0250 | QSL CARDS—STYLE X—250 | \$ 8.95 |
| QX0500 | QSL CARDS—STYLE X—500 | \$13.95 |
| OY0250 | QSL CARDS—STYLE Y—250 | \$ 8.95 |
| OY0500 | QSL CARDS—STYLE Y—500 | \$13.95 |
| BK1043 | QUICK LOOK AT BASIC | \$ 4.95 |
| BK7345 | REPEATER ATLAS | \$ 1.95 |
| BK1044 | RF DIGITAL TEST EQUIPMENT | \$ 5.95 |
| BK1046 | RTL COOKBOOK | \$ 5.50 |
| BK7347 | RTTY HANDBOOK | \$ 5.95 |
| BK1050 | SECRET GUIDE TO COMPUTERS V 1 | \$ 2.75 |
| BK1051 | SECRET GUIDE TO COMPUTERS V 2 | \$ 2.50 |
| BK1052 | SECRET GUIDE TO COMPUTERS V 3 | \$ 3.50 |
| BX1000 | SHELF BOX—1 | \$ 2.00 |
| BX1001 | SHELF BOX—2 | \$ 1.50 |
| BX1002 | SHELF BOX—3 UP | \$ 1.25 |
| BK7350 | SIMPLIFIED MATH | \$ 0.50 |
| BK1053 | SOME COMMON BASIC PROGRAMS | \$ 8.50 |
| BK7351 | SSB-THE MISUNDERSTOOD MODE | \$ 5.50 |
| BK7354 | SSTV HANDBOOK (HARDCOVER) | \$ 7.00 |
| BK7355 | SSTV HANDBOOK (SOFTCOVER) | \$ 5.00 |
| CT7350 | SSTV TAPE | \$ 5.95 |
| BK1054 | STEP BY STEP INTRO TO 8080 | \$ 7.95 |
| SG1081 | STUDY GUIDE—ADVANCED CLASS | \$ 5.95 |
| SG1080 | STUDY GUIDE—EXTRA CLASS | \$ 5.95 |
| SG7358 | STUDY GUIDE—GENERAL CLASS | \$ 5.95 |
| SG7357 | STUDY GUIDE—NOVICE CLASS | \$ 4.95 |
| BK1002 | TAKE A CHANCE W/YOUR CALCULATOR | \$ 8.95 |
| LB7359 | TEST EQUIP LIB V1—COMP TESTERS | \$ 4.95 |
| LB7360 | TEST EQUIP LIB V2—AUDIO TESTERS | \$ 4.95 |
| LB7361 | TEST EQUIP LIB V3—RADIO EQUIP | \$ 4.95 |
| LB7362 | TEST EQUIP LIB V4—IC TEST EQUIP | \$ 4.95 |
| BK1056 | THE STORY OF COMPUTERS | \$ 4.95 |
| BK1063 | TTL COOKBOOK | \$ 8.95 |
| BK1064 | TVT COOKBOOK | \$ 9.95 |
| CC1065 | TYCHON'S 8080 HEX CODE CARD | \$ 3.00 |
| CC1066 | TYCHON'S 8080 OCTAL CODE CARD | \$ 3.00 |
| BK1067 | UNDERGROUND BUYING GUIDE | \$ 5.95 |
| BK1079 | UNDERSTANDING MICROCOMPUTERS | \$ 8.30 |
| BK1069 | VERTICAL BEAM & TRIANGLE ANTNS | \$ 5.50 |
| BK7368 | VHF ANTENNA HANDBOOK | \$ 4.95 |
| BK7370 | WEATHER SATELLITE HANDBOOK | \$ 4.95 |
| BK1071 | WHAT TO DO AFTER YOU HIT RETURN | \$ 8.00 |
| WW7300 | WORK THE WORLD PACKAGE | \$ 5.95 |
| BK1172 | YOUR HOME COMPUTER | \$ 6.00 |
| BK1072 | YOUR OWN COMPUTER | \$ 1.95 |

FT-225RD 2 METER TRANSCEIVER DIGITAL READOUT

ALL MODE: SSB, CW, AM, FM
SOLID STATE
PLUG IN MODULE



NEW ON 2 FROM YAESU

A compact versatile transceiver for the dedicated two-meter DXer, the built-in memory and twenty-five watt output puts the FT-225RD far ahead. See it at your dealers today, or write for our 1978 full line catalog.

SPECIFICATIONS:

General

Frequency Range: 144-145 MHz, 145-146 MHz, 146-147 MHz, 147-148 MHz

Frequency Readout: Digital readout to 100 Hz, analog display resolution better than 1 KHz.

Modes of Operation: LSB, USB, CW, AM, FM

Frequency Stability: Within 100 Hz during any 30 minute period after warmup. Not more than 20 Hz with 10% line voltage variation.

Intermediate Frequencies: 1st IF=10.7 MHz; 2nd IF=455 KHz.

Antenna Impedance: 50 ohms unbalanced

Repeater Split: 600 KHz installed, any split up to 1 MHz with optional crystal.

Power Requirements: AC 100/110/117/200/234 Volts

DC 13.8 Volts, negative ground

Power Consumption: AC Receive 30 VA

Transmit 160 VA at full output

DC Receive 1.2 Amps Transmit 6.5 Amps

Size: 280mm (W) x 125mm (H) x 315mm (D)

Weight: Approximately 9 kg

Receiver

Sensitivity: SSB/CW 0.3 μ V for 10dB S/N

FM 0.35 μ V for 20dB QS

AM 1.0 μ V for 10dB S/N

Selectivity: SSB/CW/AM 2.3 KHz at 6dB down

4.1 KHz at 60dB down

FM 12 KHz at 6dB down 28 KHz at 60dB down

Image Response: Better than -60dB

Spurious Response: Better than 1 μ V at antenna

Price And Specifications Subject To
Change Without Notice Or Obligation



YAESU
The radio.

YAESU ELECTRONICS CORP., 15954 Downey Ave., Paramount, CA 90723 (213) 633-4007
YAESU ELECTRONICS CORP., Eastern Service Ctr., 613 Redna Ter., Cincinnati, OH 45215



TS-820S

AMATEUR RADIO OPERATORS UNIVERSALLY RESPECT THE TS-820S FOR ITS SUPERB QUALITY, PROVEN THROUGH THOUSANDS OF HOURS OF OPERATING TIME UNDER ALL ENVIRONMENTAL CONDITIONS. THE TS-820S, WHICH COVERS 160 THROUGH ALL OF 10 METERS, HAS EVERY FEATURE ANY AMATEUR COULD DESIRE, INCLUDING THE FAMOUS IF SHIFT, RF SPEECH PROCESSOR AND NOISE BLANKER.

R-820

THE ULTIMATE IN RECEIVER DESIGN! MORE FEATURES THAN EVER BEFORE AVAILABLE IN A HAM-BAND RECEIVER. THE R-820 IS A TRIPLE-CONVERSION RECEIVER, COVERING ALL AMATEUR BANDS FROM 160 THROUGH 10 METERS, AS WELL AS SEVERAL SHORTWAVE BROADCAST BANDS. IT FEATURES DIGITAL AS WELL AS ANALOG FREQUENCY READOUTS, NOTCH FILTER, IF SHIFT, VARIABLE BANDWIDTH TUNING, SHARP IF FILTERS, NOISE BLANKER, STEPPED RF ATTENUATOR, 25 kHz CALIBRATOR, AND MANY OTHER FEATURES, PROVIDING MORE OPERATING CONVENIENCES THAN ANY OTHER HAM-BAND RECEIVER.

