

73 Magazine

for Radio Amateurs

- 32 **You Can Watch Those Secret TV Channels**
—a complete MDS receiving system
..... **K0JB, K0FQA**
- 44 **Simple Dual-Voltage Supply**
—power for many projects. **W4VGZ**
- 46 **Bargain Zener Classifier**
—Novice project. **WD8AAM**
- 48 **What the Hell is a Decibel?**
—1/10 of a bel, of course. **WA5EBB**
- 50 **Frosting for the FT-901DM**
—simple improvements for Yaesu's superb performer. **K4TWJ**
- 52 **Mods for the Mark**
—desirable extras for your Wilson HT
..... **K9EID**
- 56 **The History of Ham Radio**
—part IX. **W9CI**
- 60 **Add-On Keyboard for Your Keyer**
—the "a la carte" design. **K4BZD**
- 64 **Little Extras for the Century 21**
—easy add-ons. **KN4JJG**
- 68 **The Many-Talented 723**
—how can regulated supplies get much simpler? **WB0SKX**
- 72 **One-Chip Tone Decoding**
—how simple can it get? **WB0VGI**
- 78  **Computerize That Mailing List**
—club secretaries, this is for you
..... **WB5UTJ/N5AUX**
- 90 **More Power to You**
—12-V supply has current limiting, over-voltage protection, the works
..... **K9MLD**
- 94 **Hit the Panic Button!**
—a kill-switch system protects you and your ham shack. **AA6C**
- 96 **A Powerful Plus For Your TR-2200A**
—improved supply/charger is a first-rate addition. **W6RON**
- 100 **Build a Wide-Range Rf Resistance Bridge**
—with a multitude of uses. **K4KI**
- 106 **Try the Potted J**
—a 2m antenna impervious to the elements. **Staff**
- 108 **Testing the DSI 3600A Frequency Counter**
—as much accuracy as you'll ever need
..... **WA6ITF**
- 116 **The Tri-Polarized VHC Antenna**
—should be a killer for VHF. **K8UR**
- 120 **The One-Note Pipe Organ**
—CW never sounded sweeter
..... **WB7CMZ**
- 124 **A Better Heathkit "Cantenna"**
—improved metering circuit for an old standby **W5ZG**
- 126 **The 80 Meter Coax L**
—compact design really works
..... **AA4AG/DA1KV**



the praise is pouring in



*Shown with accessory touch tone pad

Top view

We have never enjoyed such an overwhelming response to a new product. Letters of praise for Tempo's S-1 are coming in daily. Words such as great, fabulous, and fantastic are common. In a few short months the S-1 has taken the Amateur world by storm. In addition to its unique features and its versatility, it has now proven itself to be an extremely rugged and dependable unit...qualities unmatched at any price, but unheard of at the S-1's low price.

This amazing pocket sized radio represents a major breakthrough in 2-meter communications. Other units that are larger, heavier and are similarly priced can offer only 6 channels. The S-1's price includes the battery pack, charger, and a telescoping antenna. But, far more important is its *proven* performance record as a fully synthesized 800 channel hand held transceiver.

The optional touch tone pad adds greatly to its convenience and the addition of a Tempo solid solid state amplifier adds tremendously to its power.

The Tempo line also features a fine line of extremely compact UHF and VHF pocket receivers. They're low priced, dependable, and available with CTCSS and 2-tone decoders. The Tempo FMT-2 & FMT-42 (UHF) provides excellent mobile communications and features a remote control head for hide-away mounting.

The Tempo FMH-42 (UHF) and the *NEW* FMH-12 and FMH-15 (VHF) micro hand held transceivers provide 6 channel capability, dependability plus many worthwhile features at a low price. FCC type accepted models also available. Please call or write for complete information. Also available from Tempo dealers throughout the U.S. and abroad.

The proven
TEMPO S-1
does it all...
portable...mobile
...base station
and gives you
800 channels
in one of the
smallest hand helds

SPECIFICATIONS

Frequency Coverage: 144 to 148 MHz
Channel Spacing: Receive every 5 kHz, transmit Simplex or ± 600 kHz
Power Requirements: 9.6 VDC
Current Drain: 17 ma-standby
500 ma-transmit
Batteries: 8 cell ni-cad pack included
Antenna Impedance: 50 ohms
Dimensions: 40 mm x 62 mm x 165 mm (1.6" x 2.5" x 6.5")
RF Output: Better than 1.5 watts
Sensitivity: Better than 5 microvolts

Price... \$349.00 With touch tone pad... \$399.00

SUPPLIED ACCESSORIES

Telescoping whip antenna, ni-cad battery pack, charger.

OPTIONAL ACCESSORIES

Touch tone pad: \$55 • Tone burst generator: \$29.95 • CTCSS sub-audible tone control: \$29.95 • Rubber flex antenna: \$8 • Leather holster: \$16 • Cigarette lighter plug mobile charging unit: \$6 • Matching 30 watt output 13.8 VDC power amplifier (S30): \$89 • Matching 80 watt output power amplifier (S80): \$169

TEMPO VHF & UHF SOLID STATE POWER AMPLIFIERS

Boost your signal... give it the range and clarity of a high powered base station. VHF (135 to 175 MHz)

Drive Power	Output	Model No.	Price
2W	130W	130A02	\$209
10W	130W	130A10	\$189
30W	130W	130A30	\$199
2W	80W	80A02	\$169
10W	80W	80A10	\$149
30W	80W	80A30	\$159
2W	50W	50A02	\$129
2W	30W	30A02	\$ 89

UHF (400 to 512 MHz) models, lower power and FCC type accepted models also available.

NEW TOLL FREE ORDER NUMBER: (800) 421-6631

For all states except California.
Calif. residents please call collect on our regular numbers.

11240 W. Olympic Blvd., Los Angeles, Calif. 90064 213/477-6701
931 N. Euclid, Anaheim, Calif. 92801 714/772-9200
Butler, Missouri 64730 816/679-3127



Henry Radio

Prices subject to change without notice

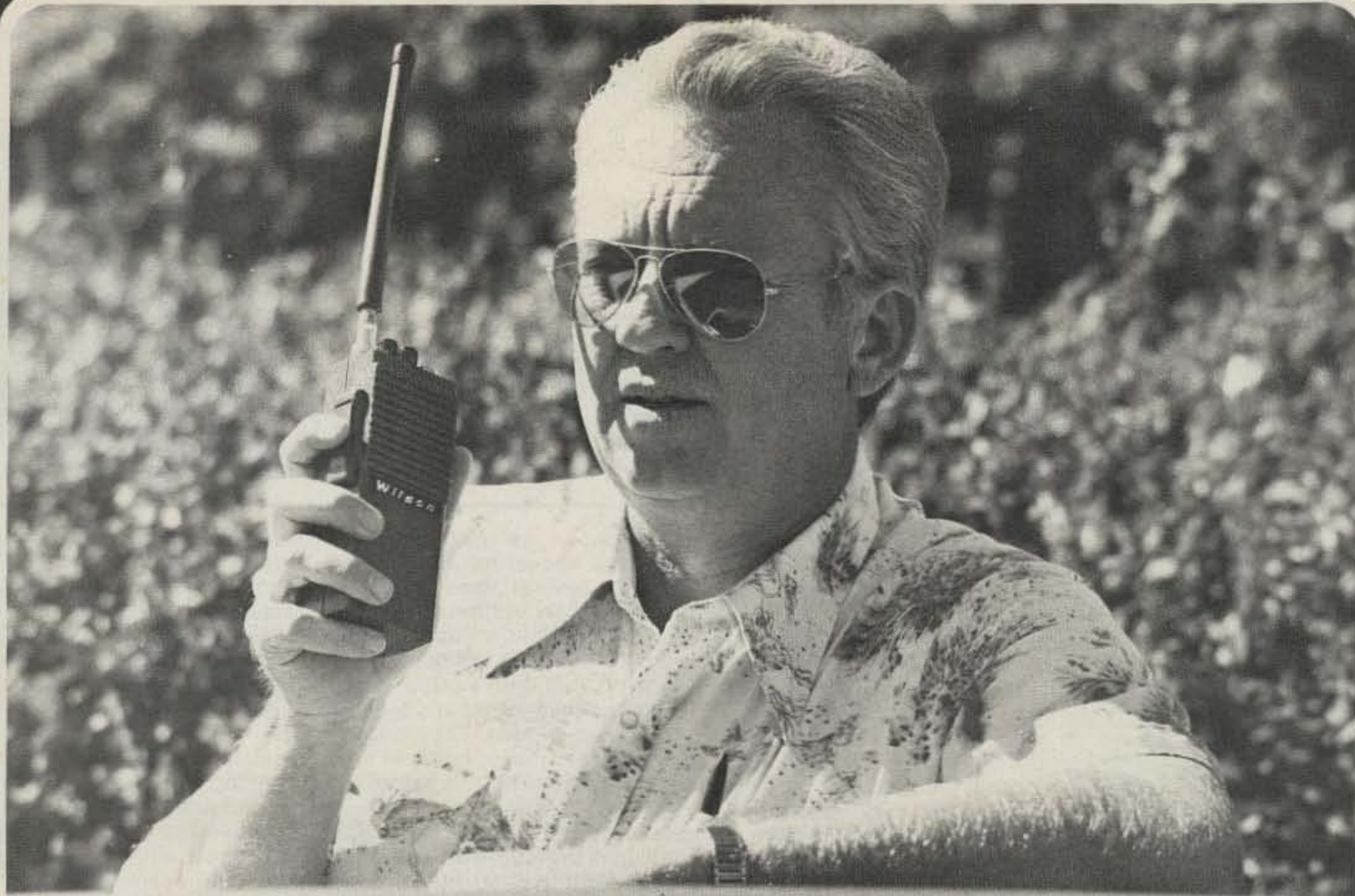

Wilson...

has your needs well in hand.

Today's Amateur demands rugged, rapid and accurate communications between Hams in the know. That's why they choose the Wilson Mark Series of hand-held radios. With specifications like these . . . why not choose the most popular radio available?

The Mark radios offer: • 144-148 MHz range • 6 Channel operation • Individual trimmers on TX and RX xtals • Rugged Lexan® outer case • Current drain: RX, 15 mA, TX, Mark II, 500 mA, Mark IV, 900 mA • A power saving Hi/Lo Switch • 12 KHz ceramic filter and 10.7 monolithic filter included • 10.7 MHz and 455 KHz IF • Spurious and harmonics, more than 50 dB below quieting • Uses special rechargeable Ni-Cad battery pack • LED battery condition indicator • Rubber duck and one pair Xtals 52/52 included • Weight: 19 oz. including batteries • Size: 6" x 1.770" x 2.440".

Advantages such as solid state circuitry, rugged Lexan® case, removable rear panel (enabling easy access to battery compartment) and compact mini-size enhance the Mark Series portable radio's versatility. In addition, a full line of accessories is available to satisfy almost any of your requirements.

Options available, include Touch Tone Pad, Leather

Case, Chargers for Desk Top, Travel or Automobile, Speaker Mike, and large capacity, small size Batteries.

For more details and/or the name of your nearest dealer, contact: Consumer Products Division, Wilson Electronics Incorporated, 4288 S. Polaris Ave., P. O. Box 19000, Las Vegas, NV 89119. Phone 702-739-1931, Telex 684-522.



Wilson Electronics Incorporated

A Subsidiary of Regency Electronics, Inc.

✓ W2

Prices and specifications subject to change without notice.

Staff

EDITOR/PUBLISHER
Wayne Green W2NSD/1

EXECUTIVE VICE PRESIDENT
Sherry Smythe

ASSISTANT PUBLISHER
Jeffrey D. DeTray WB8BTH/1

ADMINISTRATIVE ASSISTANT
Dotty Gibson

MANAGING EDITOR
John C. Burnett

ASSISTANT MANAGING EDITOR
Susan G. Philbrick

NEWS EDITOR
Gene Smarte WB6TOV/1

EDITORIAL ASSISTANTS
Elisabeth Blackmore
Richard Phenix

BOOK PUBLICATIONS
Jim Perry

PRODUCTION MANAGER
Lynn Panciera-Fraser

ART DEPARTMENT
Cathleen Callahan
Bob Drew
James H. Gray II
Bruce Hedin
Chip Jackson
Dion Owens
Noel R. Self WB1ARP
Robin M. Sloan
John W. White

PRINTING
Gary Steinbach

PHOTOGRAPHY
Bill Heydolph
Tedd Cluff

TYPESETTING
Barbara J. Latti
Sara Bedell
David Dawe
Holly J. Walsh

BOOKKEEPER
Knud E. M. Keller KV4GG/1

CIRCULATION
Pauline Johnstone

DATA ENTRY
Cathy DeSilva
Margaret Sheldon

DIRECTOR OF MARKETING AND CIRCULATION
Robert R. LaPointe

ASSISTANT CIRCULATION MANAGER
Mary Beth Stanek

BULK SALES MANAGER
Judy Waterman

SHIPPING
Ethan Perry, Mgr.
Bill Barry

RECEPTIONIST
Beth Smith

ASSOCIATES
Robert Baker WB2GFE
E. H. Barnett WB0IX
Schley Cox WB9LHO
Tom DiBiase WB8KZD
Terry Fox WB4JFI
W. Sanger Green
Dave Ingram K4TWJ
Larry Kahaner WB2NEL
Joe Kasser G3ZCZ
Bill Pasternak WA6ITF
John Schultz W4FA
Waller Scott K8DIZ
Peter Stark K2OAW
Chuck Stuart N5KC
Bill Turner WA0ABI

COMPUTER PROGRAMMING
Richard J. Dykema

CUSTOMER SERVICE
Florence Goldman

ADVERTISING
Aline Coutu, Mgr.
Bill York
Kevin Rushako
Nancy Ciampa
Marcia Stone
Gaye Halberg
Lori Mugford
Rita Rivard

W2NSD/1 NEVER SAY DIE

editorial by Wayne Green



DXING AGAIN

It's been a long time since I've been on twenty meters seriously seeking out DX. I got heavily into this back in the mid-60s. Then I got into FM and repeaters... and there really is only so much time a week I can spend on hamming. Next came enthusiasm for slow scan... another incredible user of hamming time... and also a lot of fun. Then I got into OSCAR, and boy, does that take a lot of time and work... and is also immensely rewarding with fun.

A couple of years ago, I decided it was time to poke into the newly developing sunspot cycle and get some DXing done. I had a Tech working at the magazine at the time and I wanted him to refurbish our beam... which resulted in his totally destroying both the beam and the tower. It sure was exciting when it crashed down!

Anxious to get going, I started dickering for a new tower. Several tower firms responded favorably to my offer to swap some ad space for a new tower. One firm was super hot on this and wanted me to put up their newest and biggest crank-up system. They weren't able to get things going in time for the job to be done before the 1977-78 ice age settled in up here, so we planned on setting it all up in the spring of 1978. Then they kept putting me off with vague promises and delays for an entire year. I finally gave up on them and got a tower almost immediately from Rohn... bless 'em. This one arrived the day before the ground froze solid for the winter.

The tower is now up and working, complete with a Wilson tribander antenna. I finally got a rig hooked up to it the other day and found out something which I hadn't realized... most of the modern-day rigs don't put out enough soup to drive my old Henry 2K amplifier to anywhere near full output. I had that trouble years ago with my Central Electronics

200-V exciter. It takes about 300 Watts or so to hit the 2K hard enough to push it to 1,000 Watts average output.

Even with only about 400 to 500 Watts registering on the Bird Wattmeter, I found the new station to work extremely well. There is an initial psychological handicap when I am not running a full gallon... I know I am up against 5-kW and 10-kW competitors in the pileups and I don't go in with the confidence I might otherwise have.

My first call was to FM7WE on Martinique, which used to be relatively rare. Guy came back the first try and gave me a nice report. The distance wasn't amazing, but my ability to shoulder my way through a medium pileup was impressive. No sooner was I finished talking with Guy than I tuned up a few kHz and heard VP8RX in the Falkland Islands trying to con-



Howard Furst W6PHA runs Global Importing and sells keyers and a lot of other interesting gadgets. Seen here with his junior op, Howard also is a lawyer practicing before the FCC... and an old friend.

SCENE AT DAYTON



Who is this mysterious and handsome stranger? Could it be The Long Ranger? Superham? Or might it even be legendary Larson E. Rapp W1OU? Dayton was agog.



Marv Druskoff of Yaesu created quite a stir at the Dayton Hamvention with his prototype synthesized rig. He had it chained to his belt to make sure that there was no way to mislay the unit. Programmable.

TS-180S SERIES



TL-922A



SM-220



For the ultimate in quality and performance

Specifications for Model TS-180S

TS-180S with DFC*

All solid-state, this innovative 160-10 meter SSB/CW/FSK transceiver with DFC (*Digital Frequency Control) includes four memories which can be digitally tuned up or down in 20-Hz steps, slow or fast, by means of memory-shift paddle switches. The original stored frequency can be recalled, and the newly tuned memory frequency can also be stored. The memories are usable in transmit, receive, and transceive modes. It's like having four remote VFO's, but with even more flexibility. Separate VFO and memory RIT controls are provided. The solid-state final requires no dipping or loading, and runs up to 200 watts PEP input. It covers 50 kHz above and below each band (100 kHz with the tunable memories) and is adaptable for three new bands (to be considered at WARC). The built-in microprocessor-controlled digital display shows the actual VFO frequency, or the fixed-channel frequency, or the remote VFO frequency (if the optional VFO-180 is used), and it also shows the RIT frequencies. When a frequency is stored in the "M1" memory, the digital display can be switched to indicate the stored frequency and the difference between the stored and VFO frequencies simultaneously. Other features include IF SHIFT, selectable CW receive bandwidths, tunable noise blanker, RF AGC, and improved RF speech processors. Optional accessories, besides the VFO-180 remote VFO, include the DF-180 Digital Frequency Control; SP-180 external speaker; YK-88SSB SSB filter; YK-88CW CW filter; AT-180 antenna tuner/SWR and power meter/antenna switch; PS-30 base station power supply (turns on and off remotely with TS-180S power switch); MC-50 base station microphone, and HS-4 head phones.

	Model TS-180S
Frequency Range:	160m 1.80-2.00MHz 80m 3.50-4.00MHz 40m 7.00-7.30MHz 20m 14.00-14.35MHz 15m 21.00-21.45MHz 10m 28.00-29.70MHz WWV 10.00-10.50MHz (receive only)
Modes	SSB (LSB and USB)/CW/FSK
Power Requirements:	R: 13.8 VDC, 1.8 A T: 13.8 VDC, 20. A
Final Power Input:	160-15m 200 W PEP (SSB) 160 W DC (CW) 100 W DC (FSK) 10m 160 W PEP (SSB) 140 W DC (CW) 100 W DC (FSK)
Audio Input Impedance:	500Ω-50kΩ
RF Output Impedance:	50Ω
Frequency Stability:	Within 100Hz during any 30-min. period after warmup. Within ±1kHz during first hr. after 1 min. warmup.
Carrier Suppression:	Better than 40dB
Sideband Suppression:	Better than 60dB
Spurious Radiation:	Better than 50dB
Harmonic Radiation:	Better than 40dB
Audio Frequency Response:	400-2600Hz, within -6dB
Receiver Sensitivity:	0.25μV at 10dB S/N
Image Ratio:	Better than 60dB
IF Rejection:	Better than 80dB
Receiver Selectivity:	SSB, CW Wide: 2.4kHz (-6dB) 4.2kHz (-60dB) *CW Narrow, FSK: 0.5kHz (-6dB) 1.8kHz (-60dB) *(CW Filter Option)
Audio Output Impedance:	4-16Ω
Audio Output:	2W (4Ω)
Dimensions:	13-1/2 (343)W x 5-11/14 (147)H x 14-3/10 (363)D in. (mm) (inc. heat sink, knobs, etc.)
Weight:	11.5 kg (25.35 lbs.)

TL-922A

Linear amplifier for 160-15 meters runs maximum legal power with 80 watts or more drive. RF input power is 2000 watts PEP on SSB and 1000 watts DC on CW and RTTY. Features include variable threshold level ALC, turn-off delay circuit for blower, and hefty construction.

SM-220

Station monitor combines a wideband (10 MHz) oscilloscope and built-in two-tone generator to monitor all transmitted and received waveforms. It also shows a trapezoid pattern for checking linearity. Pan-display option allows observing number of signals in ±20 or ±100 kHz band segments.

See your Authorized Kenwood Dealer for complete information.



TRIO-KENWOOD COMMUNICATIONS INC.
1111 WEST WALNUT / COMPTON, CA 90220

Swan's Success Story:

100MX Power House

The Field-Proven Rig the Whole World's Talking About.

235 Watt PEP
and CW on
ALL Bands

Price? You won't
believe it! Just ask
your dealer.

All solid state quality American
construction, with epoxy glass
boards to withstand the
rugged mobile environment.



Look to Swan for Quality Accessories . . . and Service



SWAN
ELECTRONICS

A member of the Cubic Corporation family of companies

305 Airport Road
Oceanside, CA 92054
714-757-7525

A Knob with a new twist "VRS"TM

Swan Astro 150 Exclusive Microprocessor Control w/memory gives you over 100,000 fully synthesized frequencies, and more!

- VRS — Variable Rate Scanning, a dramatic new technique for unprecedented tuning ease and accuracy
- POWER — 235 watts PEP and CW on all bands for that DX punch
- Advanced microcomputer technology developed and manufactured in the U.S.A.
- Price? See your authorized SWAN dealer for a pleasant surprise!



Dual Meter
Reads PEP output in watts and receive "S" units.

Full Break-in CW
(or semi, switch selected)

Wide Frequency Coverage

- 10M — 28.0-30.0 MHz
 - 15M — 20.8-23.0 MHz
 - 20M — 13.8-16.0 MHz
 - 40M — 6.0-8.3 MHz
 - 80M — 3.0-4.5 MHz
 - 160M — 1.8-2.4 MHz*
- *in lieu of 10M band on Model Astro 151

Mike Tuning
For accurate 100 Hz steps or fixed rate scan.

PSU-5
Power Supply
with Speaker



THE MOST ADVANCED HF SSB TRANSCEIVER AVAILABLE.

FULLY SOLID-STATE **SWAN ASTRO 150**

SWAN
ELECTRONICS

A member of the Cubic Corporation family of companies.

305 Airport Road / Oceanside, CA 92054 / 714-757-7525

Chuck Stuart N5KC
5115 Menefee Drive
Dallas TX 75227

Hard as it is for us to believe, 10 months have passed since this column first appeared in these pages. At that time we had high hopes and a lot of ideas as to what would make an interesting DX column.

Most of those hopes have been realized, and from the mail we receive, many of you find our efforts worth reading each month. Credit goes to all of you who have written or called with information, suggestions, and comments. Without a constant flow of news, rumors, gossip, and facts, there would be no column. Thanks to all of you and keep those cards and letters coming, folks.

SLIM

Many of you have written in wondering just who is this Slim character we keep mentioning. Slim was invented by Hugh Cassidy WA6AUD, editor of the weekly *West Coast DX Bulletin*, as a personalization for pirate, phoney, etc. Any illegal operator is called Slim.

It began in 1968 when a station showed up signing 8X8A, giving his QTH as Cray Island and his name as Slim. Cray Island was supposed to be a newly-formed volcanic island just south of Iceland that would definitely count as a new one. Although most everyone was taken in, it soon became apparent that this was just another pirate operation when Slim's designated QSL manager denied any knowledge of the operation.

From that time on, any illegal operation has been said to be the work of Slim. Slim has operated around the world since first appearing in 1968. You've probably worked him sometime yourself, for Slim is everywhere.

HEARD ON THE BAND

The OE6XG/A group ran off some 13,800 contacts from Abu Ail despite generator problems. QSL to WA3HUP with SASE, etc. Financial contributions to help offset the several thousand dollars spent by each member of the group would be appreciated.

3B8CF, 3B8CD, and 3B8DA all hold licenses for 3B6, Agalega, and visit the island regularly to maintain the radar and weather-monitoring equipment.

While we're in the area, 5R8AN has been active Mondays and Thursdays from 1900Z

on 14345 kHz. QSL to K4IE.

VK9NI on Norfolk Island runs a daily sked to Europe on 28585 kHz from 0900Z to 1100Z. He listens for stateside Sundays on 28900 kHz after his 0001Z sked with W6EDN. QSL to PO Box 290, Norfolk Island, via Australia.

KA1IW plans to keep the following schedule until his August 15 departure from Ogasawara Island: 3797 kHz from 1200Z to 1300Z, 7064 kHz from 1130Z to 1200Z, 14285 kHz from 1000Z to 1130Z, 21365 kHz from 2330Z to 0100Z, and 28550 kHz from 2300Z to 2330Z. QSL to K8DYZ.

You CW fans can find HS1ABD most days near 14030 kHz from 1400Z and around 3515 kHz from 0300Z. QSL to K3EST.

If you are confused by the UK8 callsigns, the following list should help to ease your pain. UH8 is UK8B/E/H/Y. UJ8 is UK8J/R/S. UI8 is UK8A/C/D/F/I/L/O/T/Z. UM8 is UK8M/N/P/Q. Now look back through your log to see how many new ones you worked without knowing it.

KC6AT in the Western Carolines is active regularly around 14285 kHz from 0800Z. QSL to Box 490, Koror, Palau, WCI 96940. SASE, please.

KV4AA's record of 48,100 QSOs in a single year will go into the *Guinness Book of World Records* unless someone can prove a higher total. If you can, contact Frank Anzalone W1WY.

Although you might be getting a late start, a prize of a holiday for two to the Isle of Capri will be awarded to the amateur making the most contacts with Naples, Italy, from now to December 31, 1979. Logs must reach Box 336, I80100 Naples, Italy, by January 31, 1980.

N4XX offers a free copy of the *Shortwave Propagation Handbook* to anyone helping him obtain a valid QSL for 10-meter contacts with 5A1TG (December, 1957) and/or 5A4TT (January, 1958).

Business Week magazine of May 7th had a very interesting article on WARC 79. They note that some of the lesser-developed countries are already on record as planning to demand and get everything in sight. They draw a parallel to one of the ITU conferences a few years back when some totally land-locked countries demanded and got maritime frequencies. The results of WARC 79 will have a strong effect on amateur radio for years to come.

The Jersey ARC club station, GJ3DVC, operated by GJ4HSW,

can usually be found on 21300 kHz Fridays from 1800Z and on Sundays from 0930Z around 14270 kHz.

5T5CJ looks for stateside daily during the week on 28525 kHz from 2100Z to 2200Z. He also seeks stateside contacts via OSCAR 8. QSL to W4BAA.

OH2BH is mounting a massive effort to activate Mt. Athos this summer. A whole new generation of DXers has come into being since this rare spot was last heard.

The following Americans are active with the peace-keeping forces in the Sinai: Rich WD4SCJ/SU, Ed K5AON/SU, Ken WB5BXQ/SU, Ed W5PYW/SU, and WA7JRL/SU. They have 10,000 QSLs printed and waiting to be filled out at ESY-SFM, PO Box 21, FPO NY 09527. SASE, please.

Congratulations to the first officers of the newly-formed South Florida DX Association: Joe Picior WB4OSN, President, Norm Alexander W4QQN, VP, Rob Robinson W2SR, Secretary, and Vic Dubois N4TO, Treasurer.

The QSLs for the K4YT/5R8 operation are not being accepted for DXCC credit, unauthorized operation being the reason given.

The Caribbean Net on 14175 kHz at 1100Z is a good place to snag some of the more rare types in that area. A recent roll call was answered by VP2A, VP2D, VP2K, VP2L, J3, J6, 6Y5, 9Y4, HI8, VP2M, VP2S, 8R1, C6, HK, HC, HS, 9M2, CO, 9M6, 9V1, VS5, YJ8, DU, YB, VR1, VR6, H44, 3D2, VK9, ZL, UA, JD1, 4S7, BV2, T2, FB8Z, A51, KX6, and KA1. Actually, some are rather far removed from the Caribbean area, but you get the idea.

A9ZEX was a special call used at the Middle East Communications Faire. QSL to the A9 Bureau.

The March Norfolk Island operation by HB9AAA netted some 5500 QSOs covering 112 countries. Cards were mailed in April.

The Bangalore Radio Club in India meets most days on 7090 kHz at 0730Z.

We have reported in the past on the advantages of enclosing IRCs, mint stamps, dollar bills, etc., when requesting QSLs direct from overseas QSL routes. We also made a point of suggesting that it is usually best to follow the directions of the DX station himself. Now along comes PY1APS with a new request concerning his recent PY0APS operation from Fernando de Noronha. Gerson says to skip the IRCs, stamps, etc., and send computer programs instead. Seems he has a new Radio Shack TRS-80 micro-computer with 16K Level II BASIC and he needs programs

to use with his new computer. If you have any programs you want to share, you can send them to Gerson Rissin, PO Box 12178 Copacabana, 20000 Rio de Janeiro, RJ, Brasil.

XT2AW is a new operator in the Voltaic Republic. His name is Harold and you can QSL to Box 2332, Ouagadougou, Voltaic Republic.

The newly-formed Bangladesh Amateur Radio Club is in need of service manuals for Hallicrafters SBT-20 crystal-controlled transceivers. If you can supply information on these units, contact K1ZZ at ARRL Headquarters.

Bob Geary 5Z4NH, a DX Profile of a few months back, has left Kenya after 13 years and is returning stateside.

Congratulations to new Radio Club of America members Jim Fisk W1HR, John Knight W6YY, and Bill Vette K6TXR.

One of the side benefits of the recent 1S1DX operation from Spratley Island was the 16,000 plus QSOs the group handed out from VS5, Brunei, and some 3,000 from VS6, Hong Kong. The main Brunei operation by N2OO was from VS5MS's QTH. Gear used was a FT-901DM barefoot and a TH6DXX at 65 feet. Even with all the problems that developed, some of the group are planning another trip to Brunei. The following list should help to locate the correct QSL route for the station you worked. VS5AR and VS5M to N4GG. VS5SW to K4SMX. 1S1DX, VS5ZR, and VS5JB to VK2BJL. VS5OO, VS5MS, VS5KV, and VS6AK to N2OO. Be sure to enclose the usual SAE or SASE. The group is still in debt for the trip and, should you be so inclined, support can be directed to the South Jersey DX Assn., 33 Shore Drive, Manahakin NJ 08050.

There is apparently a new low-power AM license class in Russia, having a code-free exam and aimed at the younger set. The class is identifiable by the EZ prefix. While in Russia, we might mention that the looked-for 160-meter authorization came through in March. Maximum power is ten Watts in the 1850 kHz to 1950 kHz band. Subbands are 1850 to 1875 for CW, 1875 to 1900 for CW and SSB, and 1900 to 1950 for CW/SSB/AM.

If you are among the many thirsting for a Dodecanese contact, check 21345 kHz on the weekends after 1330Z. SV5JH hangs out in that area, or so the story goes. QSL to DJ9ZB.

LU3ZY in the South Sandwich group has been quite regular on both 40 and 15 CW.

Continued on page 172

MESSAGE MEMORY KEYS

"BRAND NEW"



Model # TE201

\$69.95

Features:

- Advanced CMOS message memory
- Two (50 char. each) message storage
- Repeat function
- Records at any speed—plays back at any speed
- Longer message capacity
- Example: send CQ CQ CQ DX de WB2YJM WB2YJM K—then play second message on contact—de WB2YJM QSL NY NY 579 579 Paul Paul K
- Use for daily QSOs or contests

PLUS:

- State-of-the-art CMOS keyer
- Self completing dots and dashes
- Both dot and dash memory
- Iambic keying with any squeeze paddle
- 5-50 wpm
- Speed, volume, tone, tune and weight controls
- Sidetone and speaker
- Low current drain CMOS battery operation—portable
- Deluxe quarter-inch jacks for keying and output
- Keys grid block and solid state rigs
- WIRE AND TESTED FULLY GUARANTEED—LESS BATTERY

"BRAND NEW"



Model # TE144

59.95

- State-of-the-art CMOS circuitry
- Self completing dots and dashes
- Both dot and dash memory
- IAMBIC keying with any squeeze paddle
- 5-50 wpm
- Speed, weight, tone, volume tune controls & sidetone and speaker

- Semi-automatic "bug" operation & straight keying—rear panel switch
- Low current drain CMOS battery operation—portable
- Deluxe quarter inch jacks for keying and output
- Keys grid block and solid state rigs
- Wired and tested—fully guaranteed—less battery



TRAC - KEY

FEATURES:

- Twin paddle squeeze key
- Extra heavy base—non-skid feet
- Adjustable contact spacing
- Touch tension—comfort keying
- Smooth friction free paddle movement
- Handsome crinkle finish base and rich red paddles
- Five way binding posts
- Use with Trac CMOS keyer or any keyer

\$25.95

plus \$2.00 s/h
NY res. add tax

AT YOUR DEALER OR SEND CHECK OR MONEY ORDER.

TRAC ELECTRONICS, INC
1106 RAND BLDG. T18
BUFFALO NY 14203

VLF Converter



- New device opens up the world of Very Low Frequency radio.
- Gives reception of the 1750 meter band at 160-190 KHz where transmitters of one watt power can be operated without FCC license.
- Also covers the navigation radiobeacon band, standard frequency broadcasts, ship-to-shore communications, and the European low frequency broadcast band.

The converter moves all these signals to the 80 meter amateur band where they can be tuned in on an ordinary shortwave receiver.

The converter is simple to use and has no tuning adjustments. Tuning of VLF singles is done entirely by the receiver which picks up 10 KHz signals at 3510 KHz, 100 KHz signals at 3600 KHz, 500 KHz signals at 4000 KHz.

The VLF converter has crystal control for accurate frequency conversion, a low noise rf amplifier for high sensitivity, and a multipole filter to cut broadcast and 80 meter interference.

All this performance is packed into a small 3" x 1½" x 6" die cast aluminum case with UHF (SO-239) connectors.

The unique Palomar Engineers circuit eliminates the complex bandswitching and tuning adjustments usually found in VLF converters. Free descriptive brochure sent on request.

Order direct. VLF Converter \$55.00 postpaid in U.S. and Canada. California residents add sales tax.

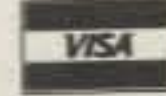

Explore the interesting world of VLF. Order your converter today! Send check or money order to:

Palomar Engineers

Box 455, Escondido, CA. 92025 • Phone: [714] 747-3343

Looking West

Bill Pasternak WA6ITF
24854-C Newhall Ave.
Newhall CA 91321

Something great happened recently in San Diego, California—score one for amateur radio! San Diego amateurs have won a major victory in the realm of tower height ordinances. This is bound to have a lasting effect on communities throughout this state and elsewhere. Exactly what happened, you ask? Jim Allen W6OGC of La Mesa, California, sent us this report.

WHO SAYS YOU CAN'T WIN AT CITY HALL?

"Have you heard about the new zoning code restricting ham towers to 50 feet in the county?" asked K6NA as I walked into the local radio store one Saturday late last December.

"What!!!?" was my incredulous response. Thus did I learn that the Board of Supervisors of San Diego County had, in enacting a complete revision of the County Zoning Ordinance, slipped in a "zinger" which had escaped the notice of local hams. It was to become effective on January 1, 1979, only a matter of days away.

Obviously, something had to be done. Glenn suggested I contact Sybil W6GIC, who was a delegate to the San Diego County Amateur Radio Council (SANDARC), which had begun to react. I contacted Sybil and learned that while SANDARC was hosting 7,000 visitors to the ARRL National Convention, the county had been in the process of enacting this new ordinance. Sybil suggested I contact Larry N6LY, a SANDARC officer who had been assigned the job of writing a letter protesting this ordinance to the local Department of Land Use and Environmental Regulation. She also suggested contact with our SCM, W6INI. Larry was able to give me the text of the height limitation section and a summary of the letter to LUER. He also gave me the name of the LUER employee to contact. Sybil had gone over to their office and gotten the name.

Not being technically well-trained, I have many times been the grateful recipient of help on technical problems from more technically-oriented fellow hams. Now it seemed like here was a problem that I, as a lawyer, might be able to help with. So, I offered to help in any way I could. The response to this offer of help was immediate, enthusiastic, and affirmative.

As best I could determine, the ordinance had completely escaped the attention of local amateurs in the pre-enactment consideration. The staff had not thought to seek out amateurs, and amateurs were oblivious to the revision which was only 2 sections less than one page long in a completely rewritten zoning ordinance over an inch thick.

When I spoke to the staff at LUER, I learned that the reason 50 feet was chosen was that it was a nice round number that seemed high enough to accommodate us. I promptly disabused them of that idea!

The new zoning ordinance established "height designations" for each zone which permitted building heights of between 15 and 60 feet, depending upon the area. Exceptions to the maximum height were available for, among other things, "Transmitting antennas no more than 50 feet in height used by licensed amateur (ham) radio operators." Amateur antennas in excess of 50 feet would be allowed provided a minor use permit could be obtained. A minor use permit required payment of a \$200 fee, a hearing upon notice, and an environmental impact review, which, we learned, cost \$250.00 and up. A more dismal prospect could scarcely be imagined.

To us, it was clear that this ordinance had been proposed and considered by people who had no idea of the disastrous impact of this type of regulation on our activities. Consequently, our first thrust was to educate.

I prepared a brief draft report explaining what amateur radio is, what we do, and how and why we do it. I also explained elementary antenna and propagation practice. The draft was reviewed by W6GIC, W6INI, N6LY, and K6NA. Many helpful ideas were considered and incorporated. In this process, K6NA and I spent many hours changing, editing, thinking out loud, arguing the merits and demerits, and banging the thing into shape. Glenn is an individual who is not only thoroughly familiar with just about every aspect of ham radio (including "hands on" experience with large, tall antennas), but also brings a good measure of practical common sense to bear on the task at hand. It is due to his creative and practical ideas that the report was brief, readable, and informative. The report included, as exhibits, FCC Regulations, Subpart A, Section 97.1, Chapter 1 of the 1979 *Amateur Radio Handbook*,

copies of QST articles dealing with emergency communications, and a representative set of plans and drawings for a well-known free-standing tower.

Armed with this, I made an appointment to see the staff member at LUER. He was at once receptive and discouraging. After listening for about 45 minutes, he said he would be happy to review the report, but felt that the prospect of LUER recommending an amendment was none too bright. A few weeks later, I heard that the Director of LUER had decided not to recommend an amendment.

Initial research had led me to the conclusion that a court challenge was out of the question. This impression was confirmed by Howard W6US, a fellow lawyer of vast experience. This was not so much a legal problem as it was a political problem.

At the January SANDARC meeting, I reported on my activities and conclusions. I had no political experience, but it seemed to me that the Board of Supervisors had to be shown that (1) this was a serious problem, (2) our reasons and proposals for an amendment were reasonable and in the public interest, and (3) our views would have considerable voter support. One way to show support would be a petition signed by county residents.

The delegates directed me to prepare a suitable petition which would be circulated throughout all member clubs. Each club member would be supplied with petition forms and asked to obtain as many signatures as possible. I immediately prepared the petition and delivered it to W6GIC, who had accepted the responsibility of getting it distributed to the SANDARC member clubs, who would print up as many as necessary for its members' needs. All petitions would be returned to me or to the delegate representing the particular club in time to be taken to the SANDARC meeting in late March.

The word was passed on local repeaters and ARES nets. Within a very short time, practically every active ham in San Diego was alerted to the situation. Announcements were made at club meetings and published in club newsletters.

Pretty soon, I could not listen for very long on the local repeaters without hearing some discussion of the county ordinance. I had hundreds of QSOs with local hams offering suggestions, asking for details, requesting more petition forms, or offering to help. Petitions were distributed to local ham equipment outlets. They were available at the swap meet, were

mailed out with club newsletters, and were distributed at meetings. Some hams filled up the ones they had and asked for more.

While all this was going on, LUER changed its mind. I learned that LUER would recommend an amendment to 75 feet to the County Planning Commission, which would consider it and make a recommendation to the Board of Supervisors. While 75 feet was not what we had in mind, it was at least an opportunity to get our foot in the door, so to speak, and sell our position. The hearing was set up for March 25 at 9 am, the morning after the SANDARC meeting at which petitions were to be returned.

Along with the idea of the petition, it seemed important to have as many hams as possible attend the hearing. A large turnout supporting our position would be persuasive. Again the word was passed on local repeaters and ARES nets. Everyone who could possibly take the time to come to the hearing was urged to go.

Prior to the hearing, I had sought the advice of John K6KOI, another local attorney with experience in land use and regulation matters. He and one of his partners met me for lunch and were able to make many extremely valuable suggestions as to how to best present our position to the Planning Commission. I sprang for lunch, and it was one of the best investments I've ever made. They were intimately familiar with the Planning Commission and what kinds of arguments would be most persuasive.

At the March SANDARC meeting, the delegates passed a motion commissioning me as their spokesman. A fairly impressive stack of petitions was delivered.

The next morning, about a dozen hams and I appeared at the hearing. I gave a presentation, much shorter than planned, since the Chairman refused to allow more than 5 minutes or so, in spite of the rules which allow each speaker 3 minutes, each of whom can cede his time to a spokesman, not to exceed a total of 15 minutes.

Paul WA6GDC spoke at the hearing to relate an incident which had occurred the previous evening. Paul is active in "Happy Flyers," an organization of ham-pilots. An ELT had gone off in the mountains east of San Diego. No one on the ground had heard it. It was reported by a jet plane passing over at 30,000 feet. Search and rescue teams had been dispatched and were then combing

Continued on page 136

New OMNI/SERIES B Filters The Crowd

The new OMNI/SERIES B makes today's bands seem less crowded. By offering a new i-f selection that provides up to 16 poles of filtering for superior selectivity. And a new Notch Filter to remove QRM. No other amateur transceiver we know of out-performs it.

NEW I-F RESPONSE SELECTION. OMNI comes equipped with an excellent 8-pole 2.4 kHz crystal ladder i-f filter which is highly satisfactory in normal conditions. But when the going gets rough, the new OMNI/SERIES B, with optional filters installed, provides two additional special purpose i-f responses.

The 1.8 kHz crystal ladder filter transforms an unreadable SSB signal in heavy QRM into one that gets the message through. The 0.5 kHz 8-pole filter provides extremely steep and deep skirts to the CW passband window which effectively blocks out even the very strong adjacent signals.

Both of these filters can be front-panel switched in series with the standard filter to provide up to 16 poles of filtering for near-ultimate selectivity. In addition, the standard CW active audio filters have three bandwidths (450, 300, and 150 Hz) to give even further attenuation to adjacent signals. In effect, OMNI/SERIES B has six selectivity curves—three for SSB and three for CW. That's true state-of-the-art selectivity.

NEW NOTCH FILTER. A variable frequency notch filter in OMNI/SERIES B is placed inside the AGC loop to eliminate interfering carriers and CW signals without affecting received signals. Attenuation is more than 8 "S" units (over 50 db) for any frequency between 0.2 kHz and 3.5 kHz.

OMNI/SERIES B RETAINS ALL THE FEATURES THAT MADE IT FAMOUS.

All solid-state; 160-10 meters plus convertible 10 MHz and AUX band positions; Broadband design for band changing without tuneup, without danger;

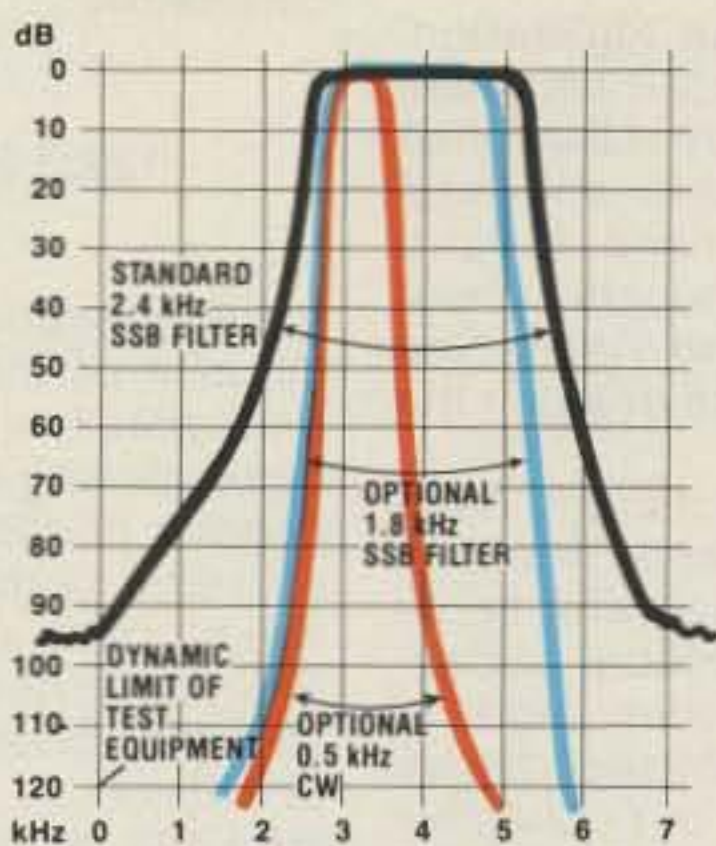

OMNI/SERIES B I-F RESPONSES WITH STANDARD AND OPTIONAL FILTERS.

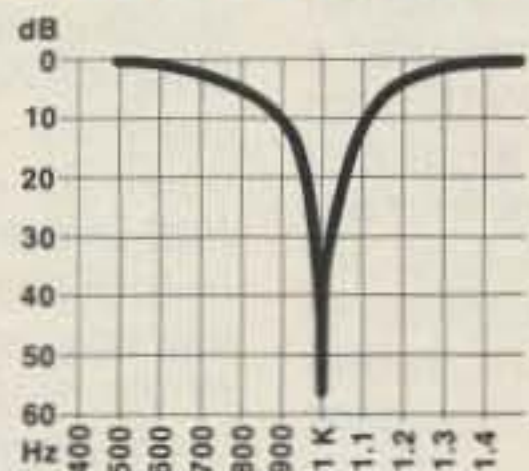

NOTCH FILTER PERFORMANCE ADJUSTED TO 1 kHz POINT.

TEN-TEC, INC.
SEVIERVILLE, TENNESSEE 37862
EXPORT: 5715 LINCOLN AVE., CHICAGO, ILL. 60646

Choice of readouts —OMNI-A for analog dial or OMNI-D for digital dial; Built-in VOX and PTT facilities; Selectable Break-in, instant or delayed receiver muting; Dual-Range Receiver Offset Tuning, ± 5 kHz or ± 0.5 kHz; Wide Overload Capabilities, dynamic range typically exceeds 90 dB and a PIN diode switched 18 dB attenuator is also included; Phone Patch Interface Jacks; Adjustable ALC; Adjustable Sidetone; Exceptional Sensitivity; 200 Watts input to final with full warranty on final transistors for first year, pro-rata for 5 years; 100% Duty Cycle for RTTY, SSTV or sustained hard usage; 12 VDC Circuitry for mobile use, external supplies for 117/220 VAC operation; Front Panel Microphone and Key Jacks; Built-in 25 kHz Calibrator in analog dial model; Zero-Beat Switch; "S"/SWR Meter; Dual Speakers; Plug-In Circuit Boards; Functional Styling, black textured vinyl over aluminum "clamshell" case, complementary nonreflective warm dark metal front panel; Complete Shielding; Easier-to-use size: 5 $\frac{3}{4}$ "h x 14 $\frac{1}{4}$ "w x 14"d; Full Options: Model 645 Keyer \$85; Model 243 Remote VFO \$139; Model 252MO matching AC power supply \$139; Model 248 Noise Blanker \$49; Model 217 500 Hz 8-pole Crystal Ladder CW Filter \$55; Model 218 1.8 kHz 8-pole Crystal Ladder SSB Filter \$55;

OMNI owners note: Your OMNI can be converted to a SERIES B model at the factory for just \$50 (plus \$5 for packing and shipping). The notch filter replaces your present squelch control and provision is made for the two additional optional filters; a partial panel with new nomenclature is provided. Contact us for details.

Model 545 Series B OMNI-A \$949
Model 546 Series B OMNI-D \$1119

Experience the uncrowded world of OMNI/SERIES B. See your TEN-TEC dealer or write for full details.



LETTERS

PLANNING

The ARRL's new Long-Range Planning Committee is seeking to obtain input and ideas from amateurs throughout the country. As the committee's first chairman, I have prepared the attached "open letter" to US amateurs to solicit (via the amateur radio press) their assistance with the work of the committee. I'm hoping that you would be willing to include it in an early issue of 73.

Victor C. Clark W4KFC
Clifton VA

Dear Fellow Radio Amateur:

For more than sixty years, amateur radio in the United States has grown like Topsy, carried along on the wave of a galloping technology, without a great deal of thought being given to its long-range future. Having established during this initial half-century an impressive record of technical innovation and a growing repertoire of services to society, we have not done too badly.

But where are we going from here, and what will be our "basis and purpose" in the years ahead? Some express concern, for example, that the character of amateur radio in this country has been moving away from the technical aspects of yesteryear—the designing, constructing, and subsequent testing of home-built equipment. If, in fact, our technically-oriented justification for spectrum occupancy is declining, there is little evidence that the impact of such a trend upon our long-range future is being given a great deal of thought. Most of us recognize that amateur radio is changing and will continue to change, for our activities are closely linked not only to a rapidly changing technological field, but also to a dynamic society that confronts us with new obstacles, challenges, and opportunities for providing useful public service.

With a steadily increasing number of new amateurs, the spectre of more government intervention, and pressures on our frequencies and erstwhile freedoms (via WARC, changes in licensing regulations, revision of the Communications Act of 1934, the growing rash of

restrictive antenna legislation, RFI problems, etc.), it becomes increasingly apparent that *all* of us—ARRL members and non-members alike—need to give much serious thought about where the Amateur Radio Service is or should be going in the decade ahead.

Long-range planning is hardly an exact science, but it is possible to anticipate some problems, to perceive certain distant opportunities, and to develop appropriate recommendations. If we put our collective heads together, perhaps we can do something to establish positive courses, rather than simply drifting and reacting to external events. But it will require a substantial amount of effort on a continuing basis by a number of concerned amateurs who are willing to assess the past for the guidance it may provide in planning for the future, rather than merely criticizing past decisions or failures.

As a method of providing a focus for a long-range planning effort, the ARRL's Directors at their January board meeting created a Long-Range Planning Committee (LRPC), set aside initial funding for its operation, and gave it the responsibility of "...reviewing and making recommendations to the Board concerning the programs which the League is and should be providing to its members and to the Amateur Radio Service..."

At its initial meeting in February, the members of the LRPC—Dick Baldwin W1RU, Hazard Reeves K2GL, Charles Dorian W3JPT, Vic Clark W4KFC, Larry Price W4RA, Jay Holladay W6EJJ, and Herbert Hoover III W6ZH (with ARRL President Harry Dannals W2HD, ex-officio)—agreed upon a number of criteria governing its activities: No facet of the ARRL's operation was exempt from scrutiny and/or recommendations; the general welfare of the entire Amateur Radio Service was to be served, not just parts of it; and a subject as complex and far-reaching as the future of amateur radio and the ARRL could not be thoroughly appraised without the input of many different people... ARRL members or not.

Therefore, if you have some thoughts, comments, and/or recommendations about the future of the Amateur Radio Ser-

vice and/or the ARRL in general, or some very specific portions thereof, please let the LRPC have the benefit of your thinking. A letter or card sent to me at the address given below, marked for the attention of the LRPC, will be acknowledged, and I will make sure that your comments are made available to each of the members of the committee.

Vic Clark W4KFC
Chairman, LRPC
12927 Popes Head Road
Clifton VA 22024

It is interesting to see a leading director of the ARRL admit in print that the material we have been reading in QST about the League providing guidance for amateur radio has been hogwash. Here is the admission that there has not been much thought given to long-range problems... which anyone who has been keeping up with events knows all too well.

Next Vic tries to put over that old saw about amateurs not building any more. I'm sick and tired of hearing that from the League... it is a lie and a put-down for amateurs. The fact is that more amateurs than ever before are building and designing equipment. The percentage of the magazine ads for parts is proof positive of this. Just compare the parts advertised today with the meager parts ads of the 1930s, back when hams were really hams. Utter rot. In those days the construction projects filled two very small magazines... we print more projects in a couple of issues than you could find in a year in the olden and golden days of ham construction.

Sure we're having problems with the FCC and with WARC. We are living in a much more political world than we were forty years ago and we are stuck with a sixty-year-old organization which is still somewhere back in the '30s politically. You deal with the FCC in a political manner, not with dockets and testimony or even with lawsuits. It is time the ARRL learned this and started dealing realistically with the world of the '80s. Remember that the FCC got backed down once and once only in recent years, and that was over the repeater rules. I organized that project completely and ran it with the ARRL refusing to cooperate, saying it wouldn't work. It did work... and nothing else has.

The ARRL has funded almost identical efforts before. The directors set aside \$100,000 to be used to help preserve amateur radio. Instead, it was used as a slush fund for vacations and other nonsense. There never has been an accounting of the expenses put to this fund

... and there never will be. So here we go again.

However, despite my cynicism, take Vic at his word and give him the input he wants. Let's see if anything happens this time... and perhaps we can find out what they ever did with the \$100,000 they set aside and kept replenishing for preserving amateur radio.—Wayne.

INTRUDER WATCH

Wells R. Chapin W8GI
507 Franklin
Kingsley MI 49649

Dear OM:

Your article, "Where Have All the kHz Gone?", in the June, 1977, issue of 73 made me realize that mine was not the only voice crying in the wilderness. Reminds me of Clair Foster and Boyd Phelps too many years ago.

Now for the record: I've been licensed since 1936 and an ARRL member almost that long. My QSTs go back to 1934. I view with alarm the "increased expenses" of this non-profit organization that requires all too frequent raises in dues. I view with alarm the high pay of the top management people in Newington and their all-expenses-paid junkets to overseas conferences, along with wives or secretaries. I view with alarm the loss of dedicated staff along with the "necessary" building addition.

I wonder about all those fine "services" provided to the membership. (My own attempt, once, to utilize their "Technical Information Service" was a disaster.) I wonder about their vaunted "Intruder Watch," which you mention.

Let me tell you about their "Intruder Watch." Two years ago, I was home recovering from an operation, so I scanned all the HF bands during the day to see what was going on, just as I did in 1938 when I was also home for reasons of health. The comparison in daytime ham activity between 1938 and 1977 was astonishing—the HF bands are less crowded now! It made me wonder about the great "band crowding" claimed by the ARRL.

But, getting back to the "Intruder Watch," I discovered during the day very strong Russian language AM nets, sometimes two or three, on frequencies around 3550 and 3650 kHz in our 80-meter CW band. These obviously were the foreign fishing boats right off the coast of Long Island, and they could be seen. This was before the 200-mile law went into effect.

Continued on page 132

**HAVE YOU
SEEN THE
VIBROPLEX[®]**

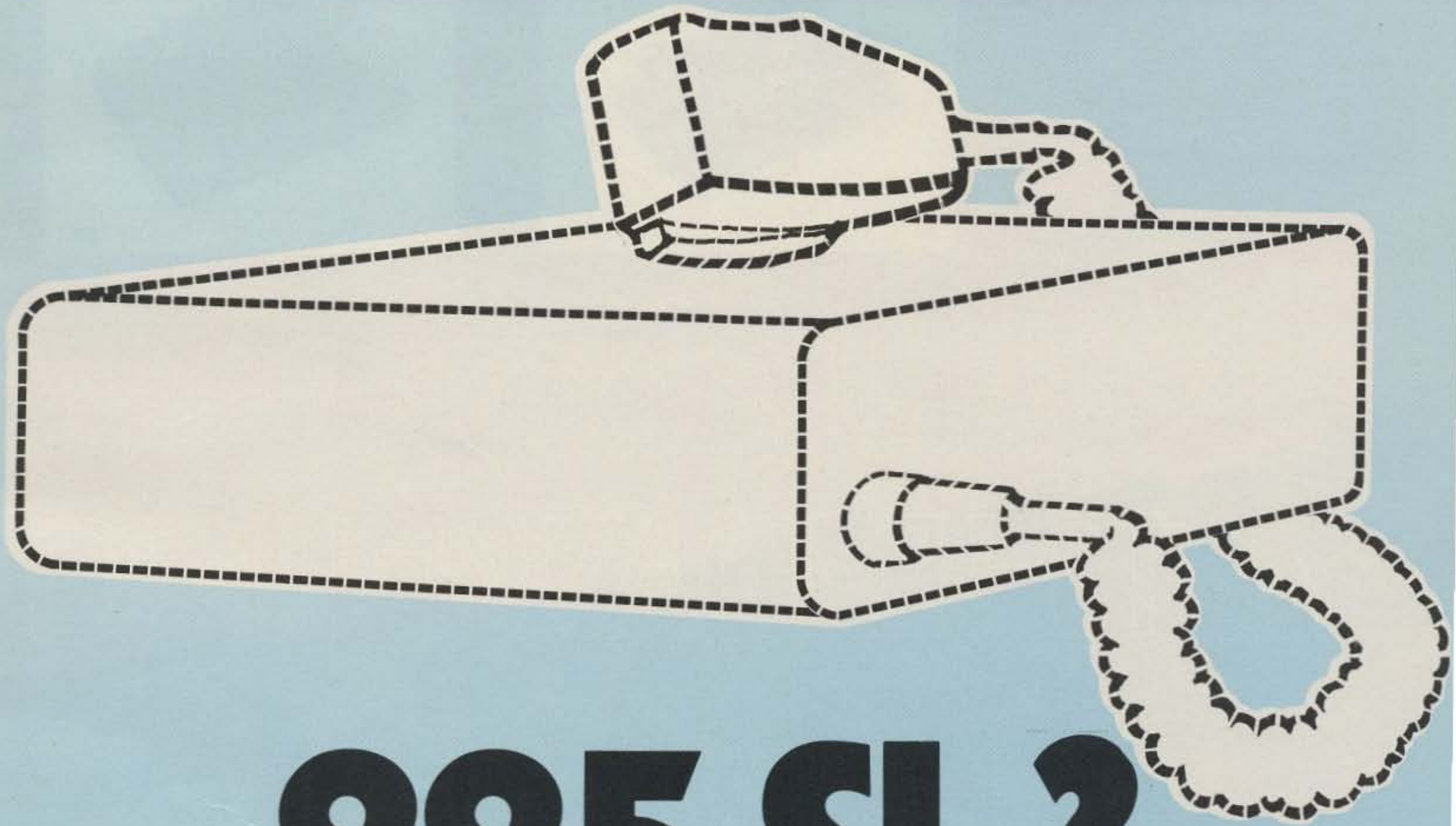

225 SL?

You can see it by writing: The Vibroplex Company, Inc.
476 Fore St., P.O. Box 7230, Portland, Maine 04112.

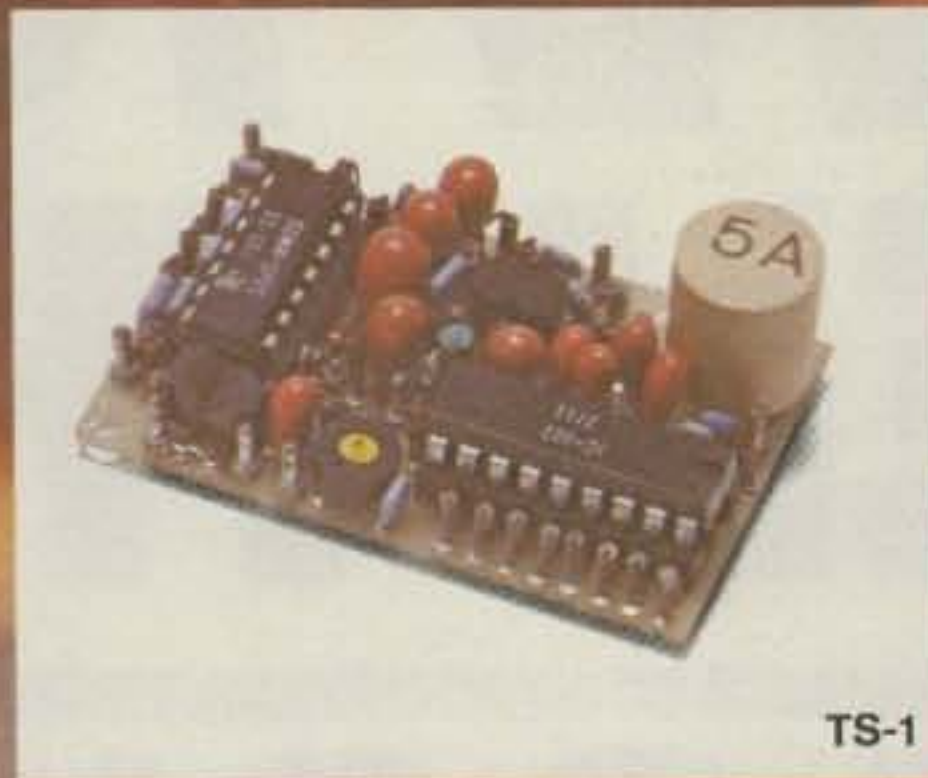

TS-1

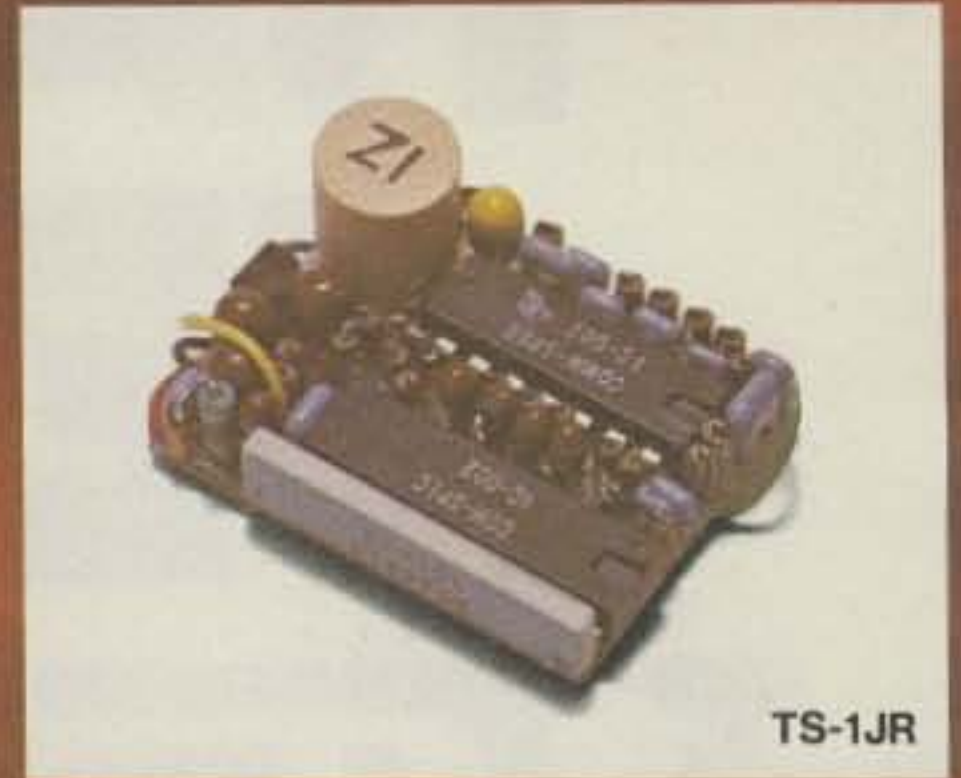

TS-1JR



PE-2



SD-1

THE DAWNING

The age of tone control has come to Amateur Radio. What better way to utilize our ever diminishing resource of frequency spectrum? Sub-audible tone control allows several repeaters to share the same channel with minimal geographic separation. It allows protection from intermod and interference for repeaters, remote base stations, and autopatches. It even allows silent monitoring of our crowded simplex channels.

We make the most reliable and complete line of tone products available. All are totally immune to RF, use plug-in, field replaceable, frequency determining elements for low cost and the most accurate and stable frequency control possible. Our impeccable 1 day delivery is unmatched in the industry and you are protected by a full 1 year warranty when our products are returned to the factory for repair. Isn't it time for you to get into the New Age of tone control?



ME-3



TE-8



TE-12

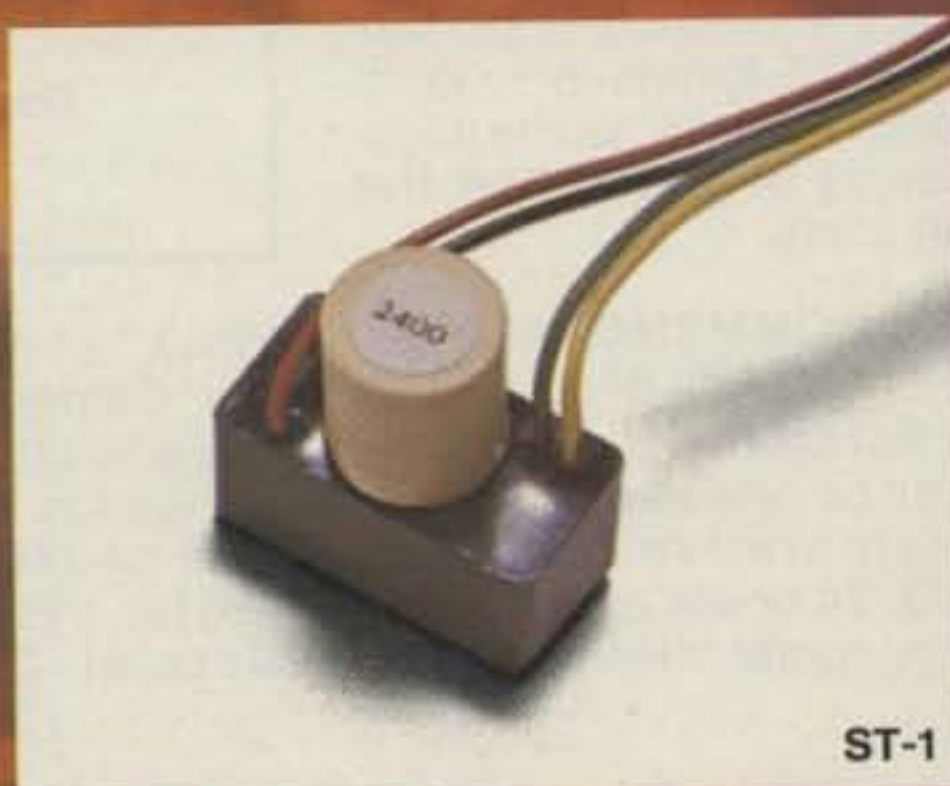

ST-1

OF A NEW AGE.

TS-1 Sub-Audible Encoder-Decoder • Microminiature in size, 1.25" x 2.0" x .65" • Encodes and decodes simultaneously • \$59.95 complete with K-1 element.

TS-1JR Sub-Audible Encoder-Decoder • Microminiature version of the TS-1 measuring just 1.0" x 1.25" x .65", for hand-held units • \$79.95 complete with K-1 element.

ME-3 Sub-Audible Encoder • Microminiature in size, measures .45" x 1.1" x .6" • Instant start-up • \$29.95 complete with K-1 element.

TE-8 Eight-Tone Sub-Audible Encoder • Measures 2.6" x 2.0" x .7" • Frequency selection made by either a pull to ground or to supply • \$69.95 with 8 K-1 elements.

PE-2 Two-Tone Sequential Encoder for paging • Two call unit • Measures 1.25" x 2.0" x .65" • \$49.95 with 2K-2 elements.

SD-1 Two-Tone Sequential Decoder • Frequency range is 268.5-2109.4 Hz • Measures 1.2" x 1.67" x .65" • Momentary output for horn relay, latched output for call light and receiver muting built-in • \$59.95 with 2 K-2 elements.

TE-12 Twelve-Tone Sub-Audible or Burst-Tone Encoder • Frequency range is 67.0-263.0 Hz sub-audible or 1650-4200 Hz burst-tone • Measures 4.25" x 2.5" x 1.5" • \$79.95 with 12 K-1 elements.

ST-1 Burst-Tone Encoder • Measures .95" x .5" x .5" plus K-1 measurements • Frequency range is 1650-4200 Hz • \$29.95 with K-1 element.

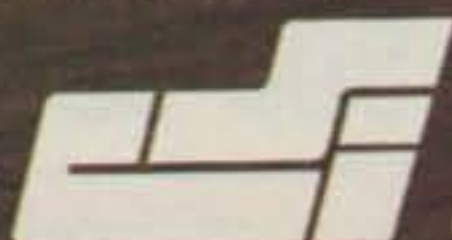

**COMMUNICATIONS
SPECIALISTS**

426 W. Taft Ave., Orange, CA 92667
(714) 998-3021

Contests

Robert Baker WB2GFE
15 Windsor Dr.
Atco NJ 08004

DAFG 10 METER CONTEST

Contest Period:
1200 to 1600 GMT
August 4, 1979

Note: This contest started in May, 1979, but information was received too late for entry in the contest calendar. This is therefore the second and final part of the test.

EXCHANGE:

RST, QSO number, name, QTH.

FREQUENCIES:

28075 to 28175 MHz, RTTY only!

SCORING:

Each station may be worked once. Each complete two-way RTTY contact counts as one point. The multiplier is determined by the number of countries worked. The European Country List (WAE) and the latest ARRL Country List will be used. In addition, each different prefix will be considered as a multiplier, too. The final score will be a total of the multipliers multiplied by the total of QSO points.

CLASSIFICATIONS:

Class A—up to 100 Watts output; Class B—above 100 Watts output; Class C—SWL.

LOGS AND ENTRIES:

Logs must contain name, call, and complete address of participant, class, call of station worked, complete exchange sent and received, country, final score, and time in GMT. Logs without final score will be considered check logs. SWLs—for points, multiply and score same as above. The same station may be reported a maximum of 5 times. Instead of exchange received, report call of station worked. Your log should be in the hands of the manager no later than 30 days after closing the test. Address entries to: Klaus K. Zielski DF7FB, PO Box 1147, D-6455 Erlensee 1, West Germany. Awards to the highest-scoring SWL and first five in each class.

BARC COMMEMORATIVE STATION

The Bancroft Amateur Radio Club will be operating a special commemorative station, XJ3TBC, 24 hours a day during the centennial "Homecoming

Week" of August 11 to 18 from the Centennial Headquarters. CW and phone operation on all HF bands except 160 meters, VHF on 146.52 simplex, and repeater VE3TBF on 147.24/84. Special QSLs for working

XJ3TBC on receipt of your log information. A certificate award is available for working XJ3TBC on any three different bands on receipt of your log in-

Continued on page 141

Calendar

Aug 4
Aug 4-5
Aug 25-26
Sept 8*
Sept 8-9
Sept 9*
Sept 11-12
Sept 15-16
Sept 15-17
Sept 22-23
Sept 29-30
Sept 30-Oct 1
Oct 13-14
Oct 20-21
Nov 3-4
Nov 10-11

Nov 11
Nov 17-18
Nov 24*
Nov 25*
Dec 1-2
Dec 1-3

Dec 8-9

DAFG 10 Meter Contest
ARRL UHF Contest
All Asian DX contest—CW
DAFG Short Contest—VHF
ARRL VHF QSO Party
DAFG Short Contest—SW
Kentucky QSO Party
Scandinavian Activity—CW
Washington State QSO Party
Scandinavian Activity—Phone
Delta QSO Party
Fall Classic Radio Exchange
ARRL CD Party—CW
ARRL CD Party—Phone
ARRL Sweepstakes—CW
CQ-WE Contest
IPA Contest
OK DX Contest
ARRL Sweepstakes—Phone
DAFG Short Contest—SW
DAFG Short Contest—VHF
ARRL 160 Meter Contest
Connecticut QSO Party
North Carolina QSO Party
ARRL 10 Meter Contest

* = described in June issue

HAM RADIO CENTER

for the famous HAM-KEY* and KEYER!

*TM trade-mark



Model HK-3M

With anti-tip bracket even a heavy-handed key pounder cannot tip. All the features of the HK-3.

\$19⁹⁵

- Deluxe straight key
- Heavy base — no need to attach to desk
- Navy type knob

CC-3 shielded cable w/plug for HK-3M \$3.95



Model HK-1

• Dual-lever squeeze paddle
\$29⁹⁵
CC-1 shielded cable w/plug for HK-1 \$4.49



Model HK-2

• Same as HK-1, less base for incorporation in own keyer
\$19⁹⁵



Model HK-5A Electronic Keyer

- New Cabinet Colored-Keyed to match most modern radio equipment
- Iambic Circuit for squeeze keying
- Self-completing dots and dashes
- Curtis 8044 I.C. Keyer Chip

\$69⁹⁵

NEW! Model AT-B Anti-Tip Bracket

Converts any HK-3 to HK-3M

\$2⁹⁹
Prepaid



Model HK-4

• Combination of HK-1 and HK-3

\$44⁹⁵

CC-1/3 shielded cable w/plugs for HK-4 \$7.95

Order today direct or from your favorite dealer • Add \$2.00 shipping & handling per unit (USA) Same day shipment . . .

HAM RADIO CENTER



JUST DIAL
8340 OLIVE BLVD.
P.O. BOX 28271

1-800-325-3636

TOLL FREE
ST. LOUIS, MO.
63132



ICOM squeezes optimum performance into even the tightest spaces.

Detachable control head of the IC-280, remotely mountable 2 meter mobile transceiver



ICOM Performance comes in full feature, multi-mode fixed station transceivers and also in the diminutive IC-280, designed to fit the most cramped modern vehicle. This heavily endowed performer is microprocessor controlled with the most sophisticated program of any of the ICOM radios. Small size means big performance with ICOM.



IC-280 control head mounted in Datsun 280Z.

Touchtone capacity for the IC-280 is provided by the optional TT1215 which plugs into the 280's mic socket with no modification to mic or radio (no battery).

A 25 watt output module is available on special order from ICOM East or ICOM West. (Optional at extra cost; installation extra.)

The totally detachable small front section of the IC-280 houses the microprocessor for frequency control and memory. The IC-280's control head can store three frequencies of your choice which are selected by a four position front panel switch; and these frequencies are retained for as long as power is applied to the radio's memory pin... even when the front panel switch is turned off or power from the ignition is interrupted. And when power is completely removed from the IC-280 the ± 600 KHz splits are still maintained!

Frequency coverage of the IC-280 is in excess of the 2 meter band and its performance can easily accommodate the 144-145 (20 KHz/step) band plan. The main section uses the latest innovations in large signal handling FET front ends to provide excellent intermodulation character and good sensitivity at the same time. The IF filters are crystal monolithics in the first IF and ceramic in the second, providing narrow band capacity for today and tomorrow's crowded conditions. The IC-280 will be providing ICOM Performance for years to come.

ICOM Performance: Nobody Does It Better.

All ICOM radios significantly exceed FCC regulations limiting spurious emissions. Specifications subject to change without notice.

HF/VHF/UHF AMATEUR AND MARINE COMMUNICATION EQUIPMENT



ICOM

ICOM EAST, INC.

ICOM CANADA
7087 Victoria Drive
Vancouver B.C. V5P 3Y9

ICOM INFORMATION SERVICE
3331 Towerwood Dr., Suite 304
Dallas, Texas 75234

Please send me a full-color ICOM Product Line Catalog and a list of Authorized ICOM Dealers.

NAME _____ CALL _____

ADDRESS _____

CITY _____ STATE _____ ZIP _____

You may send a machine copy of this form.

RTTY Loop

Marc I. Leavey, M.D. WA3AJR
4006 Winlee Road
Randallstown MD 21133

How did that Gershwin tune go? "Summertime, and the RTTY is easy"? Well, the season is upon us, and it's time to see what the mailperson brings.

Al Baketel K7ZMO of Kennewick, Washington, sends along his RTTY transmitting program, which he combined with the receiving program published in last year's RTTY Loop. Al has submitted it to the LFD-400 User's Group for owners of 6800 systems and Percom disks, and I am sure that users of compatible systems will appreciate his efforts.

Victor Johnson, in Minneapolis, Minnesota, writes requesting a similar RTTY program written for the H-8, the Heathkit 8080-based system. While there have been several RTTY programs published in the various ham magazines, I have yet to find one written specifically for the H-8. I do not know if the architecture of this machine would prevent using programs written for other 8080-based systems, but I invite any readers with information on such a program to drop me a line and let me know. Victor also asks one of the most common questions of newcomers to the Green Key set: "Where can I get equipment?" I would urge you all to check the ads in 73 carefully and make contact at your local ham club or clubs. Frequently you may be able to find a machine locally which would normally go unsold; let someone know you are in the market.

Another RTTY neophyte (or is it neo-RTTY-phyte?) is Jerry Strauss KB6BP (ex-WB6QIN), of Yorba Linda, California. Jerry followed a rather interesting course in his entry into RTTY. He notes that as an active ham for 15 years, he had always wanted to get into RTTY, but the thoughts of "all those gears, printers, etc." was totally foreign and somewhat frightening to him. So, when Radio Shack came out with the TRS-80 and a RTTY adapter was developed and marketed by Microtronics, he decided to kill the proverbial two birds and get into RTTY and have a computer, too. He states that the system worked well, but that there were some problems. The most troublesome one he noted was the leakage of TRS-80 square waves into his receiver, particularly on twenty meters. So, Jerry followed the path most of us travelled in the other direction

and bought a Model 28 and a HAL ST-5000. Now happy on RTTY, he is looking forward to the purchase of punched tape equipment soon. He also has thought about installing a spark gap, I suppose. Seriously, Jerry's letter raises an important point that needs to be emphasized more and more these days. You *don't* need all the super-modern gizmos with video displays, memories, and ASCII to enjoy RTTY. Whether you are using the lowliest thirty-year-old printer covered two inches deep in grease and dust or a \$10,000 computer system with triple buffers and direct memory speed inversion, once that signal goes out on the air, it is the same 60-wpm Baudot code. We can all talk to one another. That's what makes it so much fun!

Jim Dollinger WB9QPY echoes that sentiment in another letter. While Jim is using all the "standards," Model 19, etc., he is also interested in video terminals and such. He would like to see more about UARTs, and we hope to have more about these interesting devices in the future. Jim also asks for tips to convert a TV set to a video display. The "source authority" (as they used to say on *Jeopardy*) for that information would probably be Don Lancaster's book, the *TVT Cookbook*, available most anywhere from Sams and now "second-sourced" by Radio Shack. Another description can be found in the July, 1977, issue of *Kilobaud Microcomputing*, page 30. Grant Runyan writes of "The Great TV to CRT Monitor Conversion," and that may be just what you're looking for.

Whew! With all this talk of sophisticated RTTY equipment and state-of-the-art techniques, we sometimes lose sight of the simple puzzles that confront the neo-RTTY-phyte (I like that word!). R.E. Ferguson, from Wolf Point, Montana, writes: "I have a Model 15 TTY. The line feed double spaces. Can this be changed to single line spacing?"

Well, R.E., the Model 15 was set up to provide either single or double line feeds. The double setting is commonly used in commercial press, where double-spaced copy is easier to read on the air or to edit for publication. I will admit that it has a tendency to waste paper when used on the ham bands and is less than desirable when someone is sending you a picture.

Fig. 1 is a diagram of the left side of the Model 15 platen as

you face the machine. The Model 19 is the same, of course. The winged lever protruding out of the side is called, would you believe, the single-double line-feed lever. When the lever is up, the machine will line feed once upon receipt of a "line feed." When the lever is down, two line feeds are issued. I suspect your machine is set in the "down" double-line-feed position.

In case you have to adjust this mechanism, you may wish to operate the motor by hand, with "line feed" coded in to assess the way the pawl latches a toothed wheel to produce the line-feed action. This pawl is called the detent lever, and where it hinges is termed the "detent-lever eccentric screw." This screw, when rotated, changes where the pawl hits the ratchet that turns the platen. If, after checking the position of the "single-double line-feed lever," the machine is still double line feeding, you may need to turn the eccentric. Note, if you do, that there are two positions of the detent-lever eccentric screw which will provide correct adjustment. You should use the position which applies the least tension to the detent-lever spring and be sure that the detent roller rests in the bottom of a notch on the detent ratchet. To sum up, as with all adjustments to TTY machines: Good luck, don't force anything, and if you are not sure what you are doing, ask for help.

Quite a few responses have been received to the question about commercial RTTY frequencies. In general, a few points have come up. Commercial RTTY stations, if using Baudot code, are rarely following ham conventions. That means they frequently use strange shifts, like 425 Hz, speeds, like 67 wpm, and transmit "upside down," with high shift. Nonetheless, they are copyable if you know where to look and have equipment which can copy.

The shift problem can usually be obviated by "straddle tuning," with autostart and the like turned off. Most all converters

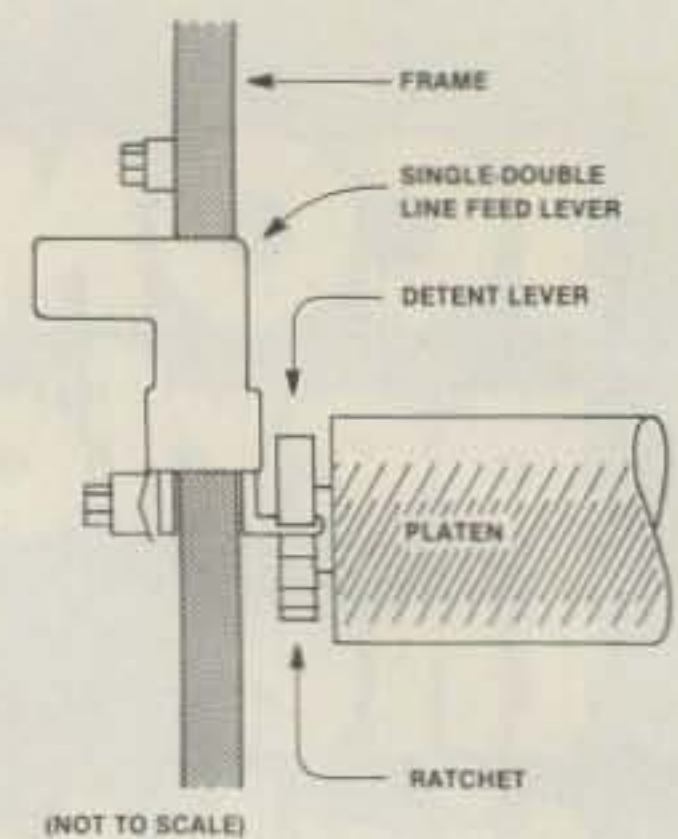

Fig. 1. Single-double line feed on the Model 15/19.

can invert an upside-down signal. The speed problem is a little tackier, but a Model 15 will copy 67 wpm with adjustment of the range control, usually. Those of you with Model 28 systems or computers should have no problems.

As far as where to look, there is really all kinds of advice. The September, 1977, issue of 73 carried an article on page 52, "RTTY SWLing," by Webb Linz-mayer, which presented several long lists of signals copied that year in New Jersey. Bob Melville K3WRV passes along the guidance to look around three and seven MHz, where he finds quite a few interesting signals.

Bill Mauldin, of Boca Raton, Florida, passes along the information that the Voice of America operates on 14638 kHz, 100 wpm, with full-time news, in English and Spanish. Weather information is all over the place; one might try 10950 kHz, 16440 kHz, 8110 kHz, 8130 kHz, and 18765 kHz. All of these are also 100 wpm, 850-Hz shift. The weather transmissions use the "weather" code, which uses different symbols to represent cloud cover, etc. We will cover interpretation of some of these codes in a future column.

So scout around and let me know what you find. If I hear it, too, so much the better! I will try to pass along any good information to you all, the links in the RTTY Loop.

Ham Help

I am in need of a manual or schematic for a Hallicrafters general coverage receiver, model S-38D. I will be happy to pay any postage or duplicating costs.

William P. Smith K3LF
RD#2,
Cold Spring Creamery Rd.
Doylestown PA 18901

Can anyone help me find a manual and schematic for an

Allied AX-190 receiver? I would appreciate any help.

Mike Marmer KB8GH
2749 Symphony Way
Dayton OH 45449

I would like to get in touch with hams who are former members of the Civilian Conservation Corp (C.C.C.).

Joseph Schwartz K2VGV

Super Terminals with Hidden Features

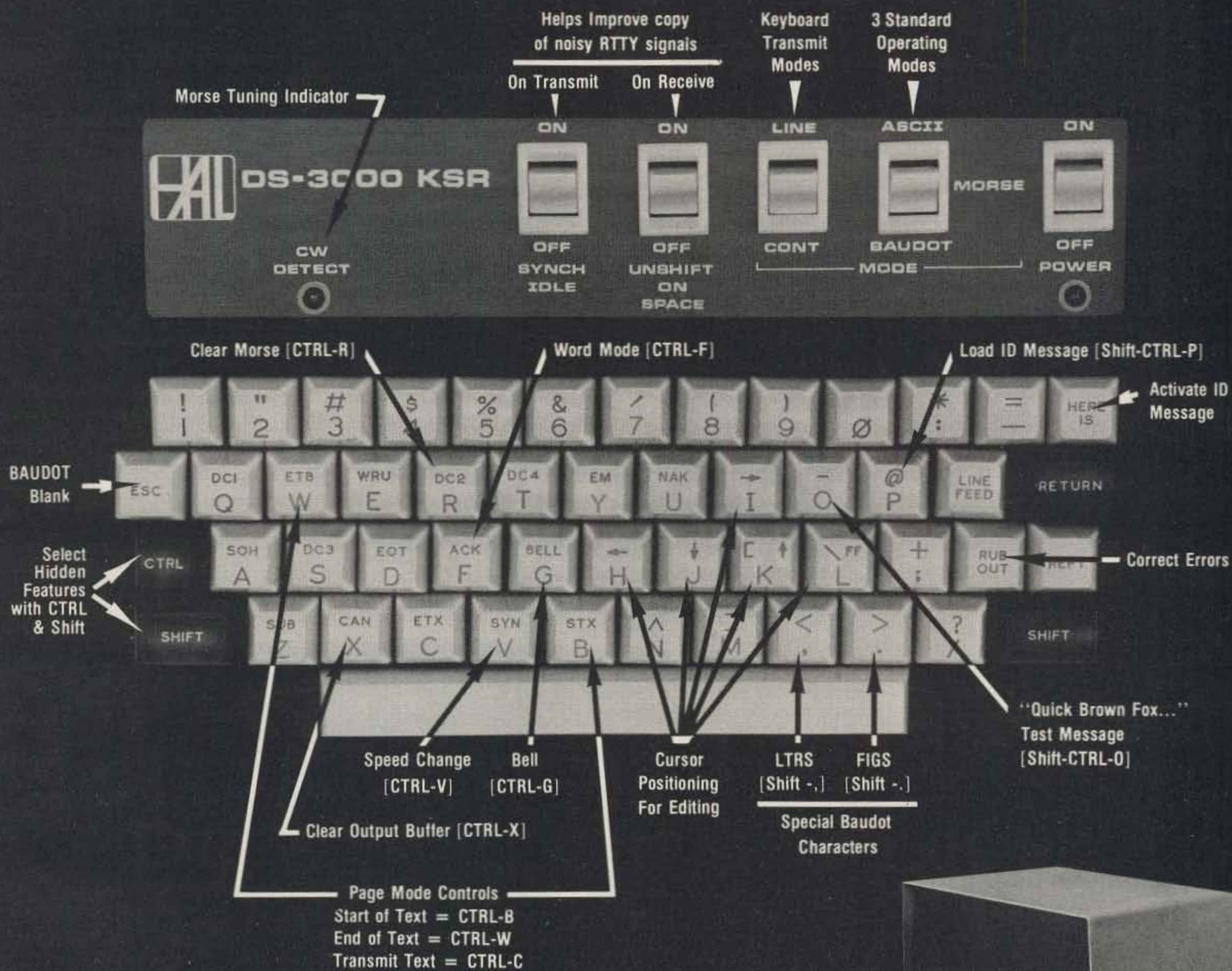

For super operator convenience, Our keyboard works in MORSE, BAUDOT, and ASCII codes and controls the terminal, too. You can edit a message, program the HERE IS message, send the "QUICK BROWN FOX..." test message, change speeds, and change the terminal modes, all from the keyboard itself. In fact, the KOS (Keyboard Operated Switch) feature even turns the transmitter on and off from the keyboard. The DS-3000 KSR also features full-length 72 character lines (16 lines per screen), 5 speeds of BAUDOT and ASCII RTTY and Morse code from 1 to 175 wpm (Version 3), and word wrap-around to prevent splitting of words at the end of a line. When combined with the HAL ST-6000 Demodulator, you have the ULTIMATE in RTTY equipment.



DS-3000 KSR Version 3 (MORSE, BAUDOT, ASCII) \$1575.00
 DS-3000 KSR Version 2 (BAUDOT & ASCII only) \$1195.00

Write for our latest catalog & RTTY guide.



HAL COMMUNICATIONS CORP.
 Box 365
 Urbana, Illinois 61801
 217-367-7373

H40



For our Overseas customers:
 see HAL equipment at:
 Richter & Co.; Hannover
 I.E.C. Interrelco; Bissone
 Vicom Imports; Auburn, Vic., Australia

New Products

TEMPO INTRODUCES NEW K6FZ MINIATURE TRIBANDER ANTENNA

Henry Radio has announced the full availability of a new miniature K6FZ 20/15/10 meter tribander antenna under its Tempo brand name. Measuring only 8 feet square, the new antenna is based upon a full half-wave-long constant-current loop design using capacitive phase shifters in the outer arms to achieve front-to-back ratios on the order of 15 dB. Gain over a full-size dipole is 1 dB.

The new Tempo tribander is constructed mainly of exceptionally strong and lightweight fiberglass antenna rods made by Monogram Industries. A copper conductor is positioned centrally in each rod. The basic antenna is the 20 meter loop (onto which the smaller 15 and 10 meter loops can be mounted optionally). Elements screw or snap together in a matter of minutes to simplify assembly or disassembly, a feature of particular interest to field day and DXpedition enthusiasts. The overall weight of the tribander is 14 pounds, and the antenna can be rotated, if desired, by any inexpensive TV rotor.

In addition to its more than adequate front-to-back ratio and gain, considering its small size, the bandwidth on 20, 15, and 10 is exceptionally wide.

The 20 meter resonant frequency is set by rotating a knob in the boom to any desired spot. On 10 and 15 meters, the user can select operation on either phone or CW. The power rating is a full kilowatt. One common 50-Ohm feed is used for all three loops, and swr is adjustable to 1:1 on 20. It is almost as low on the other two bands.

Looking like a TV antenna to laymen and angry neighbors, the new Tempo tribander can be the answer to the amateur "shut-in." Where rooftop mounting is not possible, the antenna can be hung in an attic, in a tree, or just about anyplace and still put out a creditable signal. For further information, contact *Henry Radio, 11240 W. Olympic Blvd., Los Angeles CA 90064; (213)-477-6701*. Reader Service number H3.

DIP NICKEL CADMIUM BATTERIES ANNOUNCED BY PANASONIC

Two models of DIP (dual-in-line) nickel cadmium batteries for easy mounting on printed circuit boards are now available from the Electronic Components Division of Panasonic Company. Designated as "MEMORY MOUNT™" nickel cadmium, the new batteries are available in two voltage ratings—2.4 and 3.6 V dc—with the capacities of 110 mAh. The rectan-



Panasonic's new DIP nickel cadmium battery.

gular DIP package offers pins that have standard PC-board spacing.

To prevent accidental battery discharge during the widely-used wave soldering of PC boards, the new DIP batteries are available in the discharged state. Once they have been soldered into the PC board, they can be charged to the desired capacity.

The new DIP batteries offer

standard high-performance characteristics of Panasonic nickel cadmium rechargeable batteries. These include good capacity retention, 500 or more charge-discharge cycle capability, and high degree of cell uniformity.

These new batteries will be available after July. For further information, contact *Panasonic Company, Electronic Components Division, One Panasonic*



New Tempo miniature tribander.

Target in
on the world
with
The Engineered Choice.
CDE
Antenna
Rotor Systems

CDE's new antenna rotor brochure.

Way, Secaucus NJ 07094; (201)-348-7136. Reader Service number P31.

NEW BROCHURE DESCRIBES COMPLETE LINE OF CDE ANTENNA ROTOR SYSTEMS

Cornell-Dubilier Electric Corporation has released a new eight-page color brochure presenting their complete line of antenna rotor systems. Each of the six rotor systems is illustrated and described.

They include: the Tailtwister™, designed for king-sized antenna arrays of up to a 30 sq. ft. wind load area; the new Ham IV™, the latest version of the world-famous Ham series; the new CD 45, incorporating professional features at a popular price; the BIG TALK™, with IC control that lets you pre-program locations most commonly used; the AR 40, a deluxe unit with solid-state accuracy and silent operation; and the AR22XL, a popular system with automatic control. Included in the CDE Antenna Rotor Systems brochure is a breakaway photograph of the time-tested Bell rotor.

For further information, contact Leonard Sabal, Cornell-Dubilier Electric Corporation, subsidiary of Federal Pacific Electric Company, 150 Avenue L, Newark NJ 07101; (201)-589-7500. Reader Service number C143.

SENCORE INTRODUCES NEW IN-OR-OUT-OF-CIRCUIT POCKET CRICKET TRANSISTOR TESTER

Sencore has recently introduced a new pocket-sized transistor tester to meet the increasing need of solid-state field service. Battery-operated, and weighing only 14 oz., the

Pocket Cricket is totally prepared to check virtually all transistors and FETs on the market, in or out of circuit. No setup book or transistor data is needed at all to check transistor gain and leakage between all transistor elements. This patented new device has the unique capability of automatically connecting the test leads for test, regardless of how they are connected to the transistor. For test lead identification, a 12-position switch is rotated through all positions until the Cricket "chirps." The chirping noise notifies the user that the leads are connected correctly and the switch control points to the test lead connections. Gain is simply read as good or bad on the meter scale for fast field operation.

The TF54 Pocket Cricket also identifies the component being tested as a transistor or FET during the test, should the user not be able to identify a replacement transistor. The company claims 99.9 percent testing reliability.

New features, not found on small transistor testers made by Sencore, include solid action bat handle switches, a D'Arsonval meter movement for more accurate leakage measurements on critical transistors, and an automatic off circuit that turns the instrument off after 10 minutes of use (to save batteries). The instrument can be ac-operated on the bench with an optional PA208 power adapter. Other accessories include a three-pronged touchtone probe (part no. 39G85) for easy connection to a printed circuit board and a highly durable leatherette carrying case (part no. CC217).

For further information, con-



Optoelectronics' new PDT-590 digital thermometer.

tact Sencore, Inc., 3200 Sencore Drive, Sioux Falls SC 57107; (605)-339-0100. Reader Service number S102.

PRECISION DIGITAL THERMOMETER

Optoelectronics' new precision Celsius/Fahrenheit digital thermometer has .1° resolution and two sensors (switch-selectable). The PDT-590 has a -50° C to +150° C (-60 to +200° F) temperature range with better than ±.7° accuracy. Two laser-trimmed temperature-to-current transducers can be remoted over hundreds of feet of two-conductor cable without noise pickup. The switch-selectable Fahrenheit or Celsius temperature is displayed on four .43-inch high-intensity LEDs. The PDT-590 is enclosed in an attractive heavy-duty bronze aluminum case and is provided with a 115 V wall plug trans-

former for ac operation. Optional internal nicad batteries provide several hours of portable operation. Size: 1 3/4" H x 4 1/4" W x 5 1/4" D; weight: 14 ounces. For further information, contact Optoelectronics, Inc., 5821 N.E. 14th Avenue, Ft. Lauderdale FL 33334; (305)-771-2050/1. Reader Service number O3.

VHF FM RECEIVER KITS FROM HAMTRONICS

Hamtronics, Inc., has just announced an exciting new series of VHF FM receiver kits. The model R75 is the fourth generation receiver by Hamtronics, and it incorporates all the design features of the previous designs—plus some new ones. The chief feature of the R75 series is a wide range of selectivity options. Four models, with different crystal filters, provide the optimum selectivity for each type of service, ranging from



Sencore's Pocket Cricket.

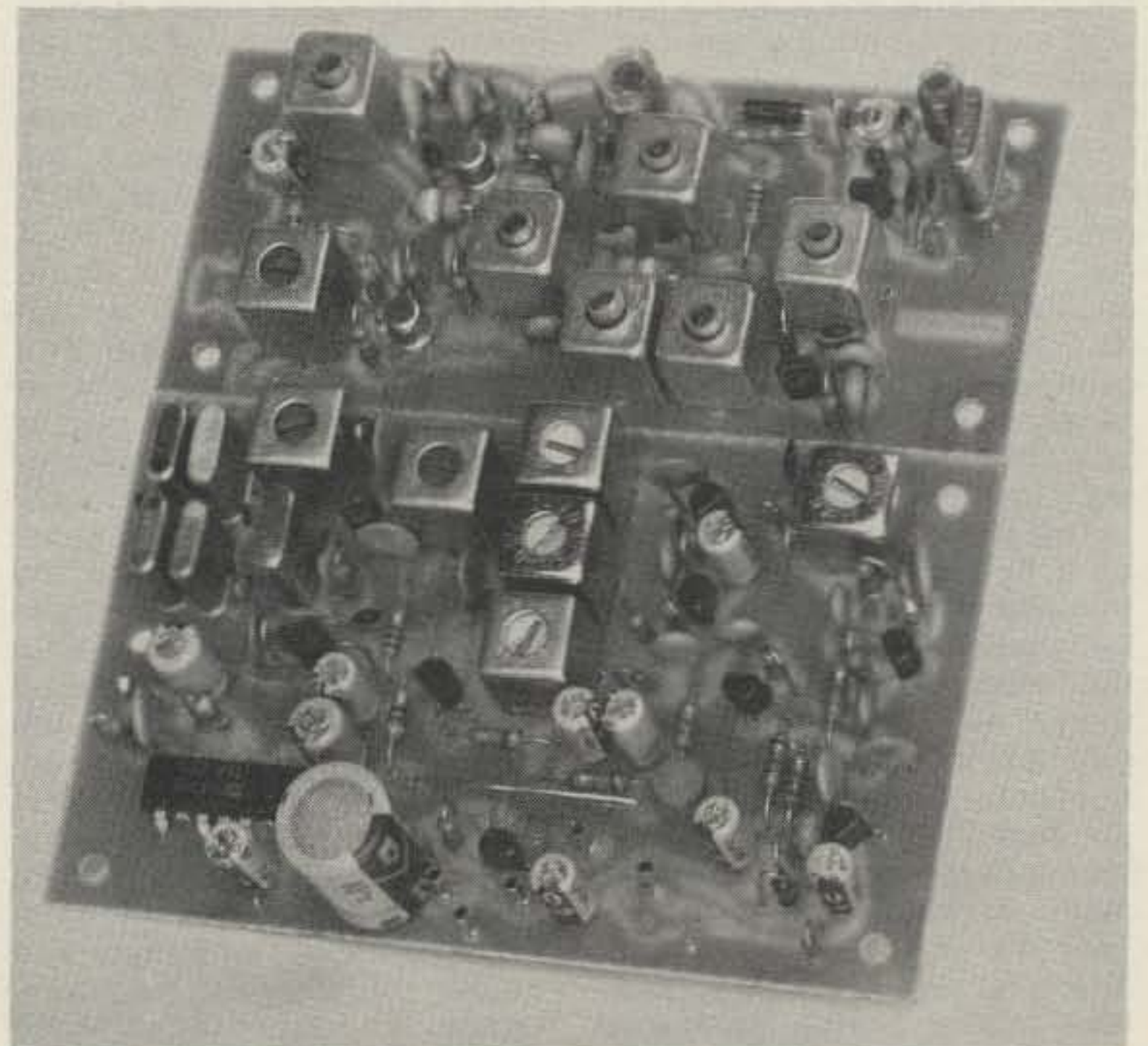

A Hamtronics VHF FM receiver board.

± 30 kHz at -60 dB for weather satellite reception to ± 15 kHz at -100 dB for demanding split-channel repeater service. Other features include increased sensitivity, smaller size, and easy construction. The 4- x 4 $\frac{1}{4}$ -inch receiver consists of two PC boards, allowing for mounting flexibility. Kits are available for the 10m, 6m, 2m, and 220-MHz ham bands. They can also be used on adjacent commercial and weather satellite frequencies.

For more information, contact Hamtronics, Inc., 65F Moul Rd., Hilton NY 14468; (716)-392-9430. Reader Service number H16.

A LOOK AT THE SIGNAL ENHANCER II

In the fifties and sixties, the best way to improve receiver selectivity at low cost was to add one of the outboard devices popular then, such as a Q-multiplier (which worked on the set's i-f stages) or a war surplus radio range filter (which was inserted in the set's headphone lead). Both methods left a lot to be desired.

It seems that suddenly hams have discovered that the easiest—and in some ways, most cost-effective—way of improving receiver selectivity is to add an outboard audio filter. The popularity of these so-called "active" filters has not been lost on manufacturers either—perhaps a dozen make these handy accessories, including Kantronics, Datong, Electronic Research Corporation of Virginia, Dynamic Electronics, Palomar Engineers, Waneco Radio, Autek Research, and MFJ Enterprises.

MFJ has come up with several good designs, each one better than the one preceding it, with each mod adding new convenience features. Their latest "maxi-filter" is the Signal Enhancer II, a very attractive dual tunable design intended to remove interference from SSB, AM, CW, and RTTY signals. The ads for the new filter stressed its flexibility and improvements over earlier models, so I arranged with the hams at MFJ to put one of the new filters to work in my ham shack.

The Model 752 filter arrived on a Friday afternoon, and by that evening I had digested the installation instructions. From the instructions, I learned that the 10" x 2" x 6" cream-and-walnut cabinet contains not one, but two, independent filters. The main filter is a two-section, four-pole variable filter with four major functions: peak, notch, lowpass, and highpass modes. There is also a second "auxiliary" filter having peak and notch functions only. (The idea of having two filters is to allow



MFJ's Signal Enhancer II.

you to peak or "enhance" the desired signal while at the same time you remove or "notch out" QRM.) The four-page instruction manual and the catalogue that was included in the shipping package told the facts: The main and auxiliary filters allow selectivity down to 40 Hz bandwidth, variable over the frequency range of 300 to 3000 Hz, and the notch depth goes all the way down to 70 dB. Six front-panel controls allow function selection (bypass, on, and SSB or CW noise limiter), main filter operating mode (peak, notch, lowpass, or highpass), and main filter selectivity and frequency adjustment. There are also two controls for the auxiliary filter, which can be operated simultaneously with the main one. The auxiliary selectivity control has a push-in, push-out feature so that either the peak or notch function can be selected with a gentle push on the control knob.

The filter came complete with a 110-volt power supply; it's of the "external power adapter" types commonly used with portable radios and small tape recorders. The filter will also run directly from any 9-18-volt source of filtered dc. The audio from the rig is connected to the filter input by means of RCA-type phono plugs; the MFJ-752 can accommodate two inputs which are selected by a rear-panel slide switch, allowing you to connect two rigs to the filter. A standard ($\frac{1}{4}$ ") phone jack is used to hook up your regular station speaker; the speaker line is disabled whenever headphones are inserted into the headphone jack on the rear panel. I should point out that this jack is of the 2-circuit (stereo) type; it's best used with stereo headphones to take advantage of the so-called "simulated stereo" feature. (When you use stereo phones, unfiltered audio directly from the receiver is fed to one earphone; the other ear gets "processed" or filtered audio. Mono headphones can be used if the stereo feature isn't wanted.

More on this later.)

The power switch is the main control. When power is off, the filter is cut out of the circuit and audio is routed directly to the speaker or headphones. In the "on" position, the filter is in business, without the noise limiter feature. Going to NL/SSB or NL/CW, noise limiters are cut in that are designed to limit impulse noise peaks and remove background noise.

Having owned the Autek QF-1 and QF-1A filters, both excellent units, I found tuning and adjustment a bit more complicated using the Signal Enhancer II—possibly because there are more knobs to turn! Once I got the hang of it, though, I found that it did a good job on both CW and SSB in slicing through QRM and QRN. On CW, I could zero-in on the desired signal in the peak mode and almost completely eliminate other signals by carefully adjusting the selectivity and frequency controls. I found that the lowpass mode was "super" for CW work; signals could be boosted even more so than in the peak mode, and this mode gave more audio output to boot. (Because circuit gain rises in the lowpass mode, you have to watch the input audio level to prevent overdriving the filter with consequent distortion.)

I also prefer using the lowpass mode on SSB, although peak and notch can also be used depending on QRM conditions. If heterodyne QRM is the major problem, you can run in the notch mode, adjusting the frequency control to null out the offending signal. You can run in any main filter mode and cut in the auxiliary filter in either the notch or peak modes. For instance, you can, when working SSB, operate the main filter in the peak mode, adjusting the frequency and bandwidth controls for best audio response, and then—using the auxiliary filter— notch out any annoying heterodyne. On CW, you can kick in both the primary and auxiliary filters to yield very

"tight" selectivity with little ringing, or you can peak with the main filter and notch out another signal with the auxiliary filter. The possibilities are almost endless and are really limited only by your imagination and dexterity!

I found the noise limiter circuits very useful, even though my transceiver (a Tempo 2020) has a built-in noise blanker. The limiters were especially helpful when used in conjunction with my Yaesu FRG-7, whose ANL (automatic noise limiter) works only on AM signals. The limiters did, however, cut down on the filter's audio output (particularly noticeable when using a speaker rather than headphones), and the CW limiter had to be used judiciously (as it could be overloaded and start to "chop" the desired signals if the receiver's audio gain were run too high). The trick is to set the audio or rf gain on your rig at the right level so that the signal is passed but the noise is blocked.

A tinkerer, I also tried the MFJ filter with my KLM-2700 multi-mode 2-meter transceiver and with a JC Penney 6237 AM CB base station set. The filter worked surprisingly well with the KLM rig, especially on SSB and CW where there is no provision to install optional, sharper i-f filters. On FM, there was no noticeable selectivity improvement, although the filter's controls could be adjusted to modify and enhance the set's audio response. When using the MFJ unit with the Penney CB transceiver, a very noticeable improvement in selectivity was obtained, and it was easy to null out AM carrier heterodynes. The noise filter was effective with both units (even on FM), despite the fact that the KLM rig has a built-in noise blanker and the Penney CB set is equipped with an adjustable noise limiter.

The "simulated stereo" feature took some getting used to, but has its place, particularly on CW. The idea is to have "raw" receiver audio fed to one ear and filtered or "processed" audio fed to the other. This unique feature allows you to copy off-frequency stations in one ear while you simultaneously hear "single-signal" audio in the other; the brain hears all the signals, but the processed signal stands out from the pack. I found that working in the simulated stereo mode cuts down fatigue as well. The kind of phones with individual volume controls on each ear work best, since you can easily strike a balance between processed and unprocessed audio levels.

A couple of cautions are in

Continued on page 130

This NEW MFJ Versa Tuner II . . .

has SWR and dual range wattmeter, antenna switch, efficient airwound inductor, built in balun. Up to 300 watts RF output. Matches everything from 160 thru 10 Meters: dipoles, inverted vees, random wires, verticals, mobile whips, beams, balance lines, coax lines.



BRAND NEW

\$79⁹⁵

Antenna matching capacitor. 208 pf. 1000 volt spacing.

Sets power range, 300 and 30 watts. Pull for SWR.

Meter reads SWR and RF watts in 2 ranges.

Efficient airwound inductor gives more watts out and less losses.

Transmitter matching capacitor. 208 pf. 1000 volt spacing.

Only MFJ gives you this MFJ-941 Versa Tuner II with all these features at this price:

A SWR and dual range wattmeter (300 and 30 watts full scale) lets you measure RF power output for simplified tuning.

An antenna switch lets you select 2 coax fed antennas, random wire or balance line, and tuner bypass.

A new efficient airwound inductor (12 positions) gives you less losses than a tapped toroid for more watts out.

A 1:4 balun for balance lines. 1000 volt capacitor spacing. Mounting brackets for mobile installations (not shown).

With the NEW MFJ Versa Tuner II you can run your full transceiver power output — up to 300 watts RF power output — and match your

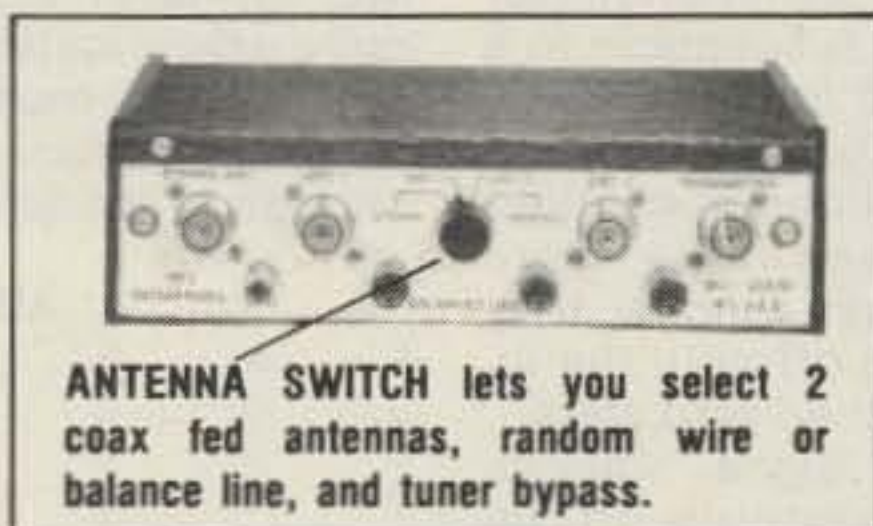

ANTENNA SWITCH lets you select 2 coax fed antennas, random wire or balance line, and tuner bypass.

transmitter to any feedline from 160 thru 10 Meters whether you have coax cable, balance line, or random wire.

You can tune out the SWR on your dipole, inverted vee, random wire, vertical, mobile whip, beam, quad, or whatever you have.

You can even operate all bands with just

one existing antenna. No need to put up separate antennas for each band.

Increase the usable bandwidth of your mobile whip by tuning out the SWR from inside your car. Works great with all solid state rigs (like the Atlas) and with all tube type rigs.

It travels well, too. Its ultra compact size 8x2x6 inches fit easily in a small corner of your suitcase.

This beautiful little tuner is housed in a deluxe eggshell white Ten-Tec enclosure with walnut grain sides.

S0-239 coax connectors are provided for transmitter input and coax fed antennas. Quality five way binding posts are used for the balance line inputs (2), random wire input (1), and ground (1).



\$59⁹⁵

BRAND NEW

MFJ-901 VERSA TUNER

New efficient air wound coil for more watts out.

Only MFJ uses an efficient air wound inductor (12 positions) in this class of tuners to give you more watts out and less losses than a tapped toroid. Matches everything from 160 thru 10 Meters: dipoles, inverted vees, random wires, verticals, mobile whips, beams, balance lines, coax lines. Up to 200 watts RF output. 1:4 balun for balance lines. Tune out the SWR of your mobile whip from inside your car. Works with all rigs. Ultra compact 5x2x6 inches. S0-239 connectors. 5 way binding posts. Ten Tec enclosure.



\$49⁹⁵

BRAND NEW

MFJ-900 ECONO TUNER

Same as MFJ-901 Versa Tuner, but does not have built-in balun for balance lines. Tunes coax lines and random lines.



\$39⁹⁵

MFJ-16010 RANDOM WIRE TUNER

Operate 160 thru 10 Meters. Up to 200 watts RF output. Matches high and low impedances. 12 position inductor. S0-239 connectors. 2x3x4 inches. Matches 25 to 200 ohms at 1.8 MHz.



\$39⁹⁵

BRAND NEW

MFJ-400 8043 ECONO KEYS

MFJ brings you a reliable, full feature economy keyer using the famous CURTIS-8043 keyer-on-a-chip.

Panel Controls: Speed (8 to 50 WPM), pull-to-tune; volume, on-off; 3 conductor, 1/4 inch phone jack for keying output and key paddle input.

Internal weight control lets you adjust dot-dash-space ratio for a distinctive signal to penetrate QRM for solid DX contacts. Sidetone and speaker. Internal tone control.

Lambic operation with squeeze key. Dot memory. Instant start. Self completing. Jamproof spacing. Reliable solid state keying: gnd block, cathode, solid state transmitters (-300V, 10 ma. max. and +300V, 100 ma. max.).

For Orders **Call toll-free 800-647-8660**

For technical information, order and repair status, and in Mississippi, please call 601-323-5869.

Order any product from MFJ and try it. If not delighted, return within 30 days for a prompt refund (less shipping).

Order today. Money back if not delighted. One year unconditional guarantee. Add \$2.00 shipping/handling.

Order By Mail or Call TOLL FREE 800-647-8660 and Charge It On

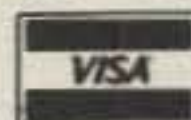

MFJ ENTERPRISES

P. O. BOX 494 M52
MISSISSIPPI STATE, MISSISSIPPI 39762

Microcomputer Interfacing

David G. Larsen
Peter R. Rony
Jonathan A. Titus
Christopher A. Titus

In many analog-to-digital converter applications, it is too expensive to dedicate one A/D converter to each sensor. An alternate approach is to share one A/D converter among several sensors. This is called *multiplexing*, since many signal sources share a common transmission path to a single receiving device, in this case, the A/D converter.

A multiplexer may be a rotary switch having multiple taps or positions (Fig. 1), a small-signal reed relay available in a dual in-line package (DIP) the size of a 14-pin or 16-pin integrated-circuit device, a semiconductor switching device based upon *complementary-metal-oxide semiconductor (CMOS) or metal-oxide field-effect transistor (MOSFET) technology*, or a complex communication device used by the telephone companies. Some of the advantages of semiconductor switches that make them practical for multiplexers are: 1) small size, i.e., housed in a standard dual in-line package; 2) directly compatible with TTL signals; 3) built-in on-board digital decoders for channel select; 4) positive and negative signal inputs, i.e., bipolar operation; 5) high speed switching; 6) long

life, i.e., no mechanical wear; 7) low contact resistance, less than 100 Ω ; and 8) high off-state resistance, 100⁸ Ω typical.

Semiconductor switches are not ideal devices, and they too have some limitations or constraints that must be considered prior to their use in multiplexer circuits. Almost all such switches require two power supplies, typically +15 V and -15 V. Signal inputs cannot exceed these potentials without damaging the device. Most of the semiconductor switching devices, particularly the CMOS and MOSFET devices, are easily damaged by static electrical discharges, such as those produced by synthetic fabrics, rugs, etc. Newer designs incorporate static protection devices within the multiplexing integrated circuit device. Early semiconductor switches were susceptible to a problem called *latchup*, which caused them to act as though they were silicon-controlled rectifiers. Once they were turned on to pass a signal, they refused to turn off until the input signal reached zero volts.

A variety of signal sources can provide outputs to be multiplexed. These outputs can include low-level thermocouple signals, high-level pressure transducer outputs, dc and ac outputs, and high and low frequency outputs. These types of signals may all be multiplexed

GLOSSARY	
Bandwidth	The ability of the multiplexer to pass a signal at a particular frequency once it is turned on. The bandwidth is the -3 dB point and is equivalent to the <i>small-signal bandwidth</i> associated with sample-and-hold devices.
Crosstalk	A measure of the amount of a signal input to an "off" channel that appears at the output of the multiplexer superimposed upon the signal passed through the "on" channel. This is a direct function of the frequency of the signals, since the semiconductor switches are capacitively coupled within the integrated circuit chip. The higher the frequency, the greater the crosstalk. This phenomenon is similar to the <i>feedthrough</i> problem associated with sample-and-hold devices.
Settling time	The time necessary for the multiplexer's output to be within a certain error percentage of the input signal once the channel is <i>selected</i> , or turned "on." This time may be specified either as the switching time of the semiconductor switch plus the analog output settling time, or as the analog output settling time alone.
Switching transients	Transient voltage spikes that appear at a multiplexer's output when the multiplexer is switched from one channel to another and one of the switches is turned off. Such spikes may cause inaccurate measurements if the output is sampled, digitized, or integrated during this time.
Throughput rate	A measure of the fastest channel-to-channel switch rate that may be used if the rated accuracy, generally 0.01%, is to be achieved.

successfully, although some pre-multiplexer and post-multiplexer signal conditioning may be required. As an example, low-level signals may require amplification before they are input to a multiplexer, since transient signals may be large enough to cause significant er-

rors in the low-level multiplexer output. If necessary, the resulting amplified and multiplexed signal may be attenuated after being multiplexed. Alternatively, a post-multiplexer filter could be used to remove un-

Continued on page 136

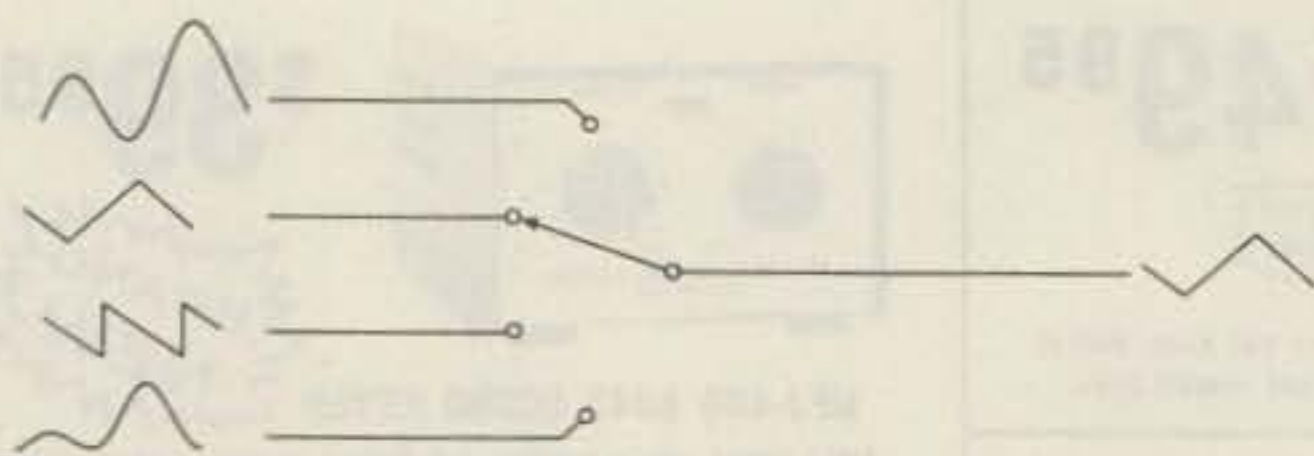

Fig. 1. Simple rotary switch multiplexer showing four possible inputs.

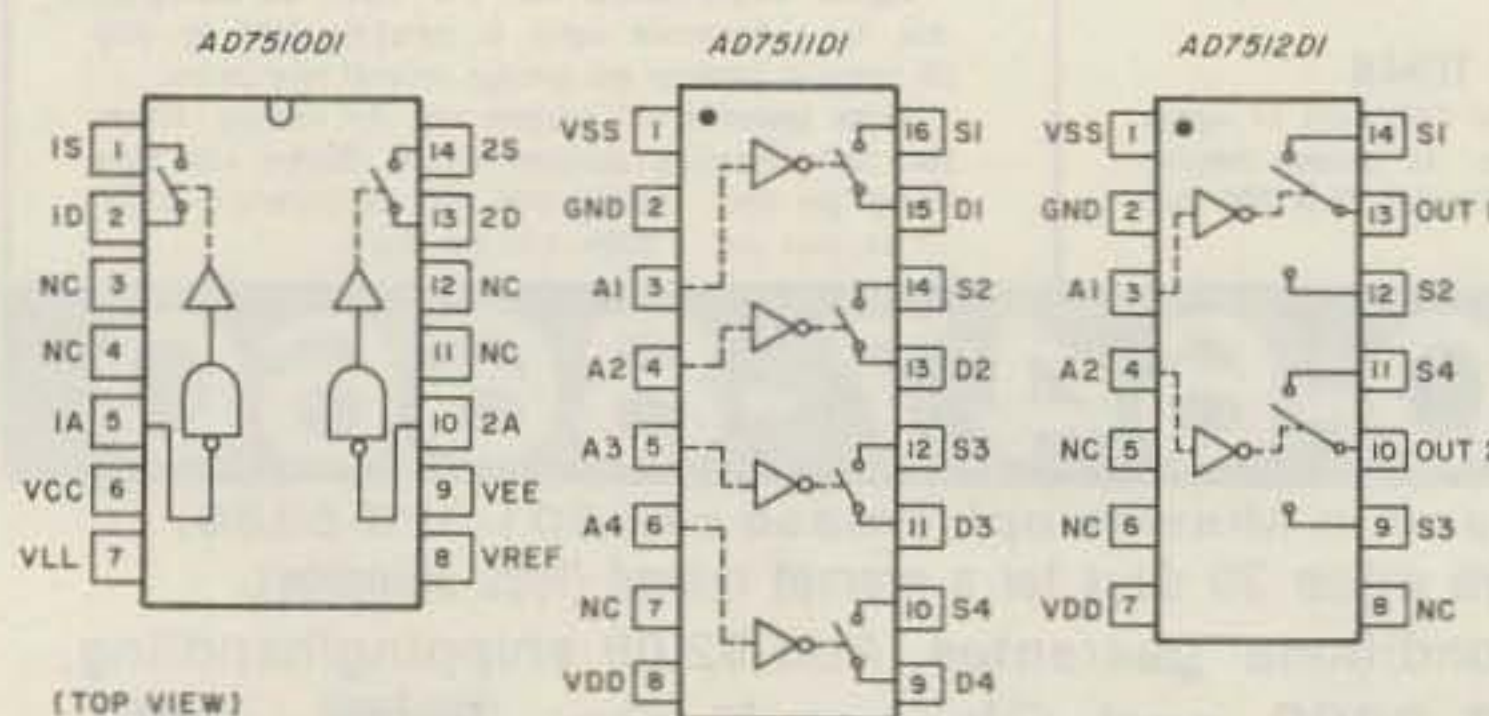

Fig. 2. Pin configurations of typical multiplexers that do not have decoding logic.

AD7506						AD7507				
A ₃	A ₂	A ₁	A ₀	EN	"ON"	A ₂	A ₁	A ₀	EN	"ON"
0	0	0	0	1	1	0	0	0	1	1 & 9
0	0	0	1	1	2	0	0	1	1	2 & 10
0	0	1	0	1	3	0	1	0	1	3 & 11
0	0	1	1	1	4	0	1	1	1	4 & 12
0	1	0	0	1	5	1	0	0	1	5 & 13
0	1	0	1	1	6	1	0	1	1	6 & 14
0	1	1	0	1	7	1	1	0	1	7 & 15
0	1	1	1	1	8	1	1	1	1	8 & 16
1	0	0	0	1	9	X	X	X	0	None
1	0	0	1	1	10					
1	0	1	0	1	11					
1	0	1	1	1	12					
1	1	0	0	1	13					
1	1	0	1	1	14					
1	1	1	0	1	15					
1	1	1	1	1	16					
X	X	X	X	0	None					

Truth Tables

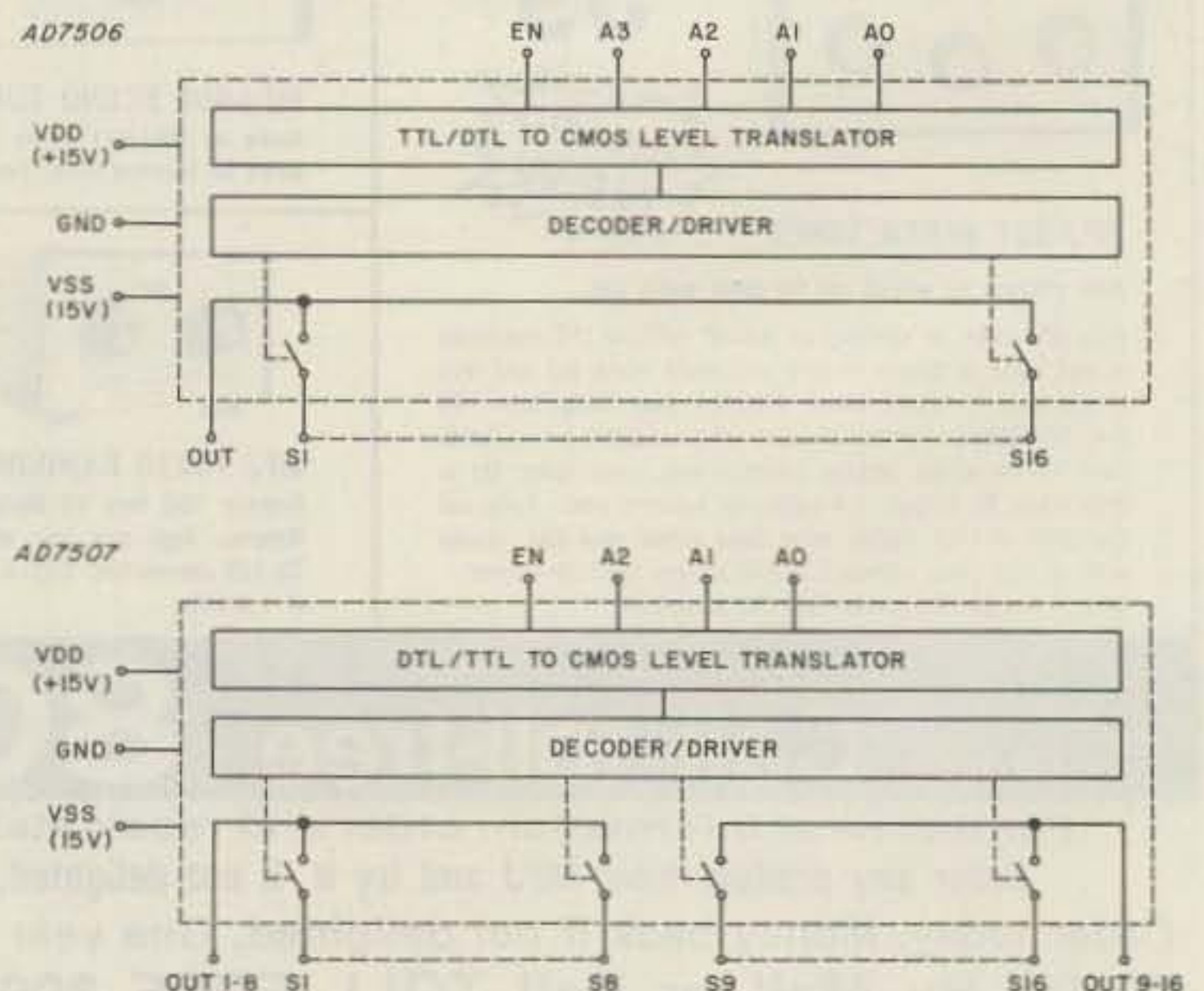

Fig. 3. Block diagrams of typical multiplexers with on-chip decoders.

The Scanning Memorizers



FT-127RA
(220 MHz)

FT-227RB
(144 MHz)

FT-627RA
(50 MHz)

The FT-127RA, FT-227RB and FT-627RA, FM transceivers, allow scanning and expanded memory coverage for the demanding VHF FM operator. All feature up/down scanning capability with control from the microphone; the scanner will also search for a busy or clear channel. Four memory channels are available — two for simplex, three for repeater channels, one for a split of up to 4 MHz. Other performance features are similar to those of the renowned FT-227R.

OPTIONAL EQUIPMENT

Keyboard Microphone: YM-22 for FT-127RA and FT-627RA
(YM-22 standard feature with FT-227RB)
Squelch Unit • FP-4 AC Power Supply

CPU-2500R/K 2M FM Transceiver with Central Processing Unit

The age of computers has entered the amateur scene with the announcement of the CPU-2500R/K 2-meter FM transceiver. Controlled by a 4-bit central processing unit (CPU), the CPU-2500R/K contains a scanner, 4 memory channels, manual or automatic tone burst, an optional sub-audible tone squelch, and 25 watts output.

The keyboard microphone allows two-tone input for autopatch or control purposes, as well as remote programming of dial or memory frequencies.

Automatic ± 600 kHz repeater split, or program a split up to 4 MHz using the memory. Keyboard microphone allows remote programming of odd splits.

CPU scanner will search for a busy or clear channel, upon your command.

Four memory channels for simplex or repeater use, plus another memory channel for a split of up to 4 MHz.



879

YAESU ^{Y1}
The radio.



YAESU ELECTRONICS CORP., 15954 Downey Ave., Paramount, CA 90723 • (213) 633-4007
YAESU ELECTRONICS Eastern Service Ctr., 9812 Princeton-Glendale Rd., Cincinnati OH 45246

Awards

Bill Gosney WB7BFK
4471 40th N.E.
Whidbey Island
Oak Harbor WA 98277

Welcome to 73's new "Awards" column. To offer some variety, both domestic and DX-type achievements will be outlined here. Naturally, I must ask our readers to submit additional award news and information as it becomes available. I would like to encourage you to check with your local radio club to see if they might have an award they sponsor which would be of interest to our readers. Ask them to submit a copy of their award program rules along with a sample copy of the award certificate.

Just the other day I received a cheerful note from Tom Owens K7RI, president of the Western Washington DX Club. Tom, along with awards chairman Morris Shepard W7LVI, provided me with the latest up-to-date information about the Washington Totem Award, sponsored by their DX organization.

The Washington Totem Award was initiated in 1973 by the Western Washington DX Club, thus becoming the first major W7 award available to the amateur community. It used as its motif the colorful totem pole, symbolic of the Indian culture of the Pacific Northwest.

The first award was issued to 9X5NA; to date, 133 awards have been issued to 61 DX countries. To qualify:

1. Applicants must submit proof of QSOs with 100 different Washington stations. Twenty (20) of these must be confirmed contacts with different Western Washington DX Club members. DX stations need only confirm twenty-five (25) Washington sta-

tions including ten (10) WWDXC members.

2. General certification rules apply. Submission of QSL cards is not required. Cards may be checked and certified by an officer of any recognized club or society. DX stations may submit log data in lieu of QSL card confirmation.

3. To be valid, all contacts must have been made January 1, 1973 or later.

4. Certified lists submitted must be in alphabetical order, with date and time in GMT.

5. The Washington Totem Award is free to all stations outside of the United States. US stations must include an application fee of \$1.00. If QSL cards are sent to WWDXC for checking, sufficient postage for their safe return must be included with the application and confirmation list.

6. Special endorsements will be issued for specific band or mode accomplishments if all supporting information is included with the application.

7. The WWDXC will furnish a current membership listing upon request (and SASE). Mail all inquiries to: Awards Manager, WWDXC, Inc., PO Box 224, Mercer Island WA 98040, USA.

I might hint to our readers wishing to seek this award that members of the Western Washington DX Club sponsor three DX Nets daily. To be part of the "W7PHO Family Hour," tune to 14.225 MHz at 1400 and 2300 GMT and to 21.320 MHz at 0000 GMT daily.

While on the subject of domestic awards, particularly those from Washington State, I cannot go without mentioning the awards program sponsored by the Boeing Employees' Ama-

teur Radio Society, more commonly referred to as the BEARS. The BEARS offer quite an array of incentives for parchment pursuers. Let's take a closer look at each one individually:

WORKED FIVE BEARS AWARD

This award is offered for those stations confirming contact with at least five (5) members of the Boeing Employees' Amateur Radio Socie-

ty. There are no band, mode, or time restrictions. General certification rules apply.

WORKED THREE BEAR CUBS AWARD

Issued specifically to any station confirming contact with at least three (3) Novice members of the Boeing Employees' Amateur Radio Society. There are no

Continued on page 139

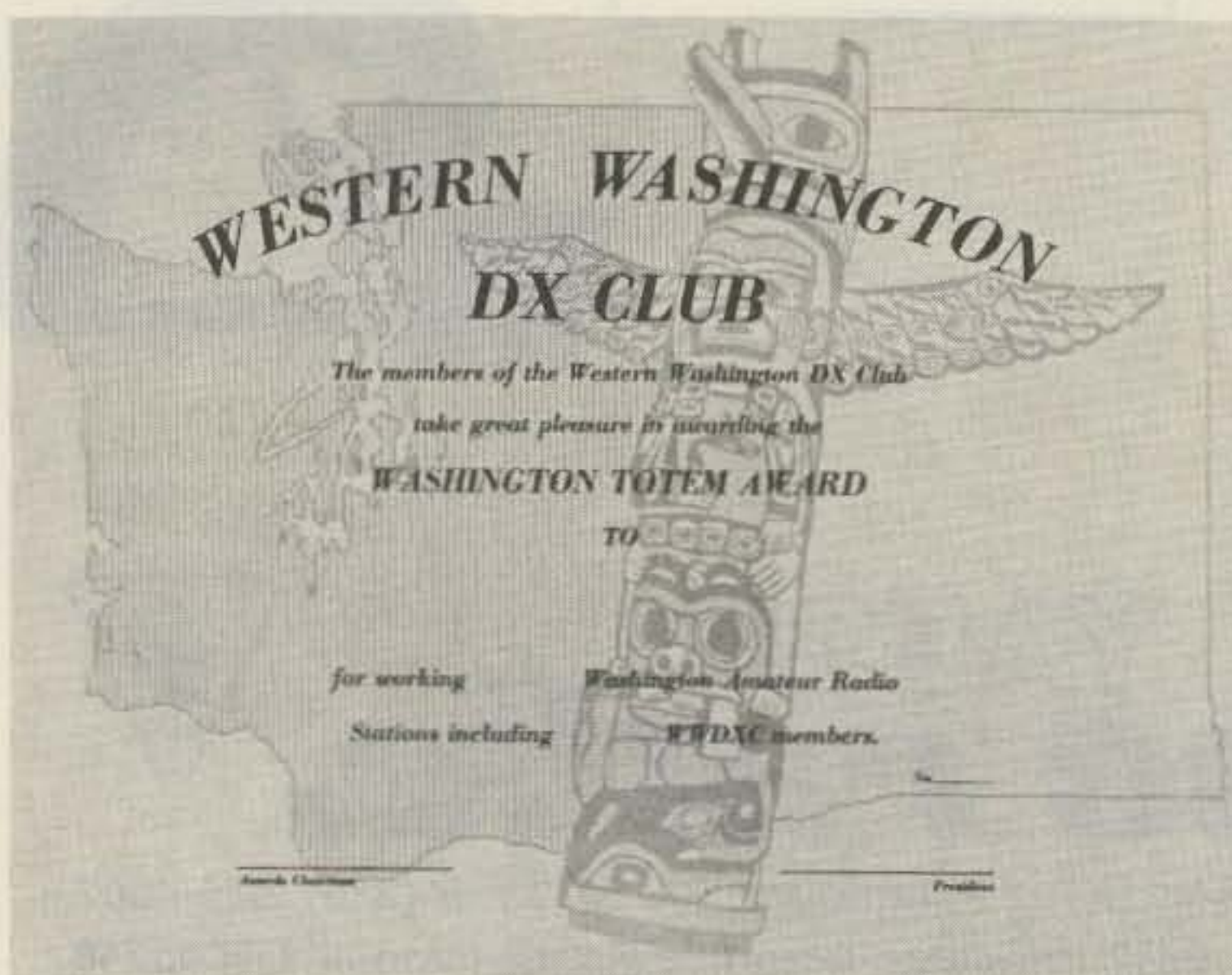

Ham Radio Center has a Branch Store on the corner.

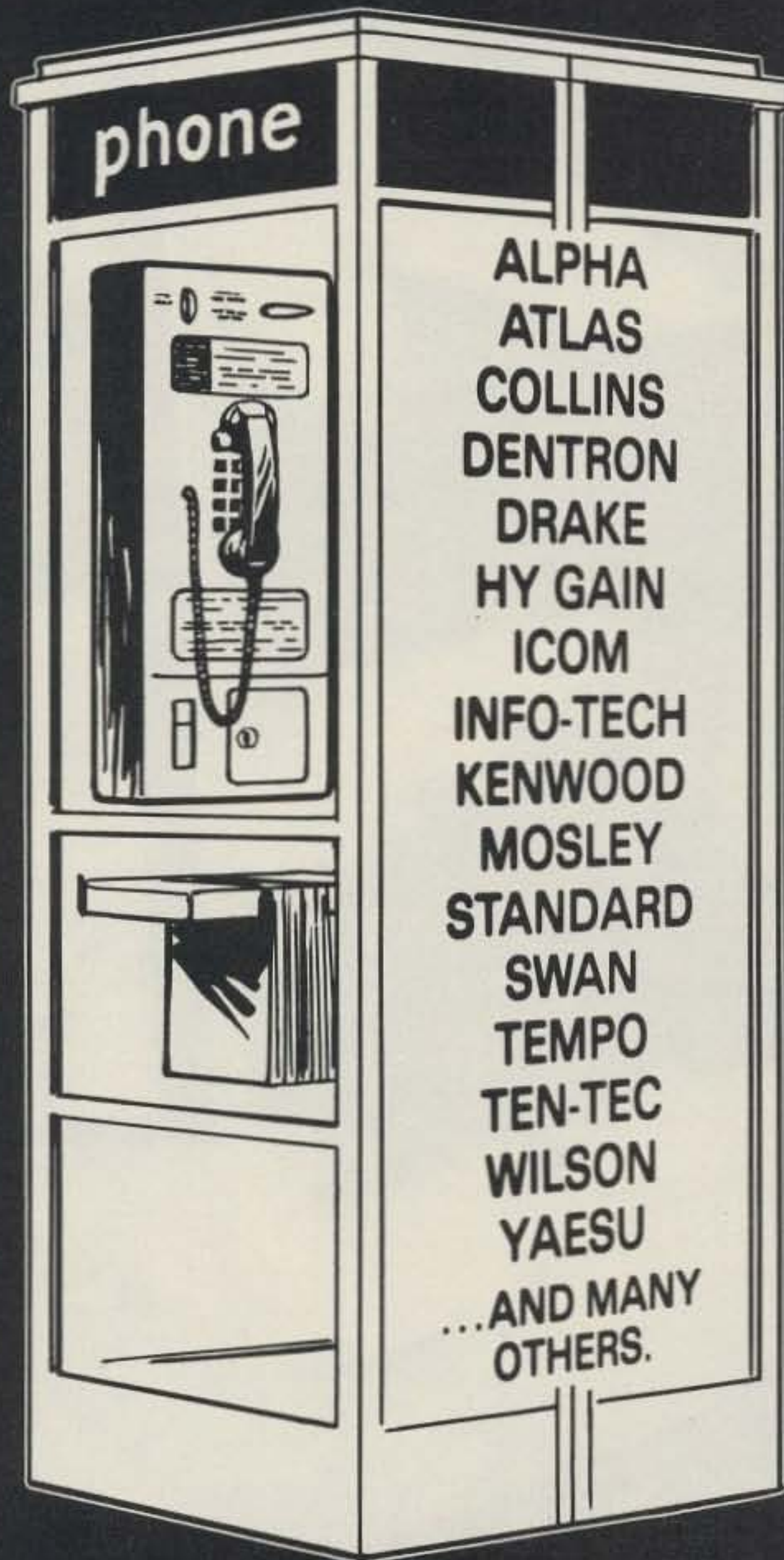

**CALL
TOLL
FREE**

**BEST
PRICE**

**FAST
DELIVERY**

NEW!
HAM-KEY*

*TM trade-mark



Model
HK-3M

With anti-tip bracket even a heavy-handed key pounder cannot tip. All the features of the HK-3.

- Deluxe straight key
- Navy type knob
- Heavy base

\$19⁹⁵

Add \$2.00 shipping & handling per unit (USA)

1-800-325-3636

HAM RADIO CENTER

8340-42 Olive Blvd • PO Box 28271 • St. Louis, MO 63132



Introducing
the new
SCR 4000

FEATURES
450 Watts Power
21 Amps Current
1000 WPM
Full
Sensitivity
1000 WPM
Full
Sensitivity

Super Deluxe
30M Hz
FM Repeater!

8.5 Mc 209 MHz IF Crystal Filter for excellent audio
100% Channel & Image Rejection
Front Panel Receiver Discriminator & Deviation
Meter Functions
Built-in Ultra-High-Stability Transmitter Crystal
Oscillator/Even Unit... the ultimate in fre-
quency stability over wide temp. ranges
plus... all of the many other well known
features found in the SCR 1000 VHF No.
1 model

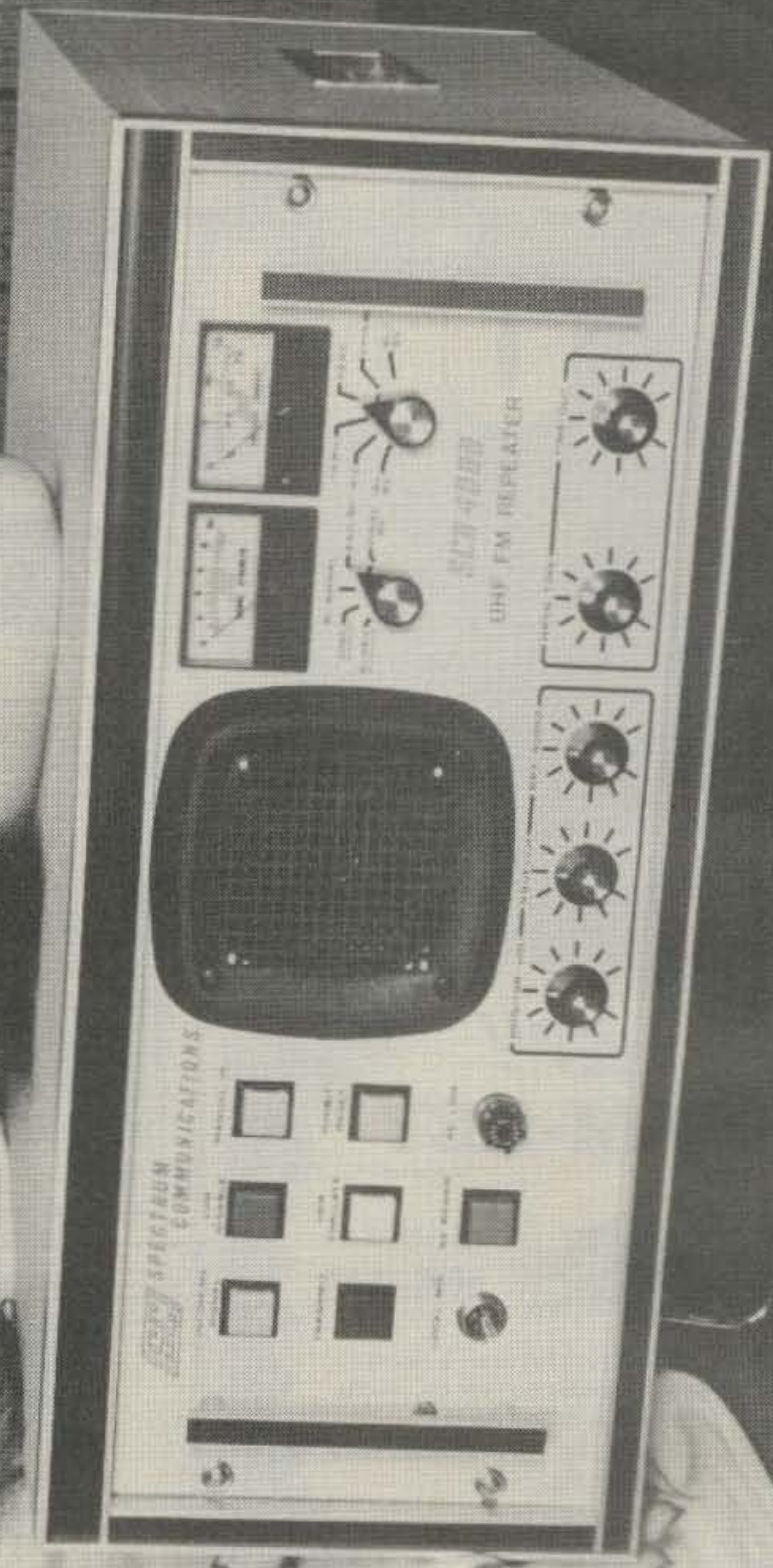

Spec Comm is proud to announce the great customer demand for a repeater such as this for many months, and our engineers have put in hundreds of man-hours to develop a unit which incorporates all of the features requested by our customers over the last 2½ years.

The SCR4000 includes completely new transmitter and receiver boards, which were designed from the ground up specifically for this new repeater. The rest of the unit is basically the same as our tried and proven SCR1000 VHF Repeater which has an excellent reputation for performance and reliability throughout the world!

Of course, as with other Spec Comm products, only the latest state-of-the-art designs and the very finest quality components and workmanship are used throughout. Also, you'll be happy to hear one of the most amazing things about the SCR4000—its price! About ½ that of repeaters sold by "the big two names" in 2 way radio... And their older design units don't even offer many of the excellent convenient features which are standard on the SCR4000!

The SCR4000 is sold factory direct only, or through authorized Foreign Sales Reps. Since there has been a tremendous demand for the SCR4000, we suggest that you get your order in as soon as possible!

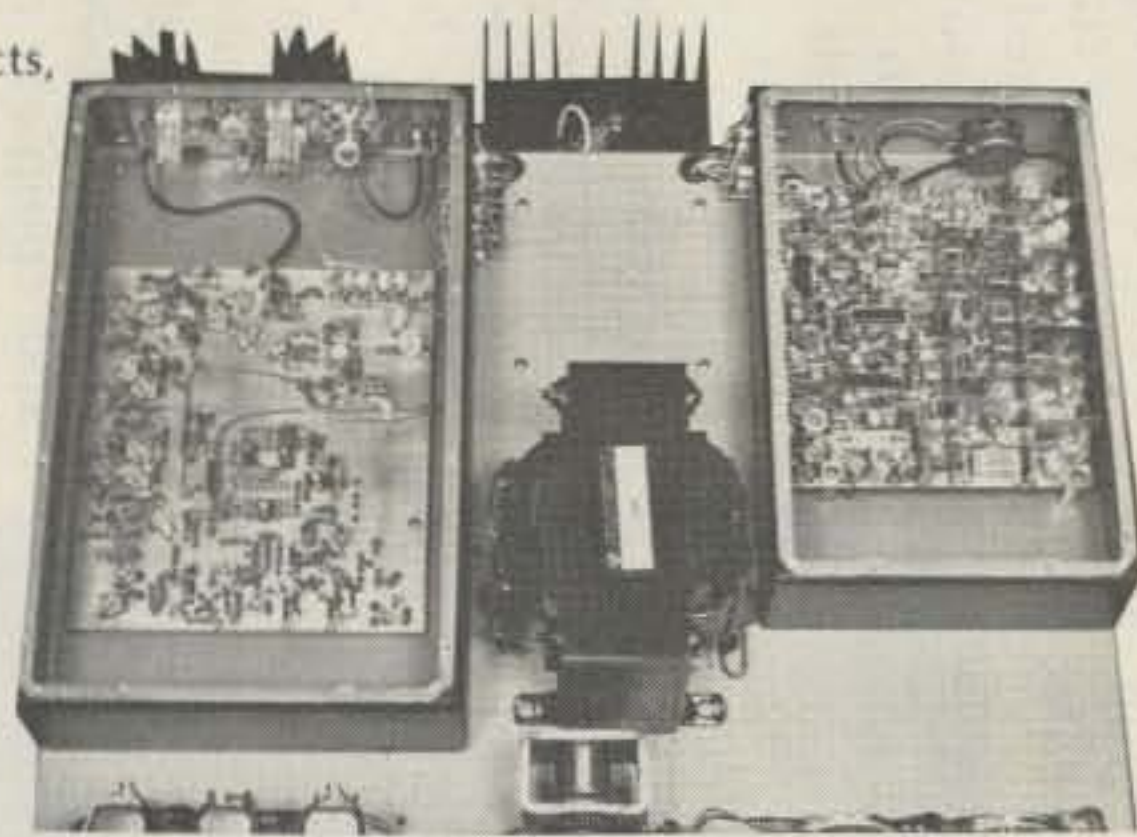

Transmitter **SCR 4000** Receiver

SCR 4000 Specifications

RF Output: 30 Watts typ. Infinite VSWR proof
Sensitivity: 0.35 uV/12 dB SINAD typ.
Selectivity: -6dB @ ±6.5 kHz; -100 dB @ ±30 kHz.

FEATURES

- Full Metering of critical levels. (Voltages, currents, Rel. RF out, RX Sig. strength, etc.)
- Front Panel Controls for timers & AF levels.
- Lighted push-buttons for control/test functions & status indicators.
- State-of-the-Art CMOS control logic & timers—No Relay problems!
- Built-in AC Supply w/instant btry.

switchover to emergency pwr. (+ Trickle Chgr.)

- Supplied with ± .0005% International Precision Xtals & local mic.
- Built-in CW IDer—Low current draw, 250 bit PROM Memory! Adjustable speed, pitch, time, etc.
- Jacks Provided for Remote Control, Auto-Patch, DC out, AF in/out, COR Switch, etc.
- True FM—for Rpt. Audio so good, "It sounds like direct!"

OPTIONS

- Full Autopatch, with or without reverse patch, and "Landline" or Radio Remote Control of the Repeater. (0/1 Inhibit Available).
- Radio and/or Landline TouchTone

Remote Control of such repeater functions as Patch Inhibit/Reset; Switch ID Tracks; Repeater ON/OFF; PL ON/OFF, etc.

- "PL"-CTCSS
- Up to 4 different IDs; Automatic switching to "Emergency Power ID" when on battery pwr.
- "Kerchunker Killer"—5 sec. Rptr. Xmtr. turn-on timer.
- Timeout—Timer Reset Tone Annunciator

Along with a complete line of Repeater System Accessories... such as: The Finest Duplexers, Cavities, Cabinets from 7" to 7', Antennas, "Hardline," Cables, etc.

new ID1000 Automatic Base Station CW Identifier



For Commercial & Amateur Applications

- Automatically IDs your Station (Base or Repeater) per FCC requirements every 5-30 min. (adjustable).
- Meets all FCC requirements for Parts 89, 91, 93, 95, 97 & other applications.
- Convenient Front Panel Controls for AC Power; Trigger Mode; (Automatic/COR, Continuous, or Disable); Manual ID; Local Monitor Spkr. Volume.
- Front Panel Status Indicator Lights for AC Power; ID in progress; DC Power operation.
- Built-in AC Power Supply
- 12VDC Battery Input w/auto-switchover to "Emergency Power."
- Optional "Emergency Power ID."
- Adjustable CW Tone Pitch, Speed & Level.
- Provision for up to 4 different ID channels!
- Plug-in IC Memory Chip!
- Two Inhibit Inputs.
- Std. 19" Rack Mount.

new

COMMERCIAL MOBILE & BASE TRANSCEIVERS

Spec Comm "Professional Communications Line"

- 136-174 MHz & 220-240 MHz (450 soon)
- 6 channels
- 0.35 uV Rcvr.
- 6 or 8 Pole Crystal Ftr
- Beautiful Audio—RX & TX
- Very Reasonable Price!



SC 250 25 wt. Mobile unit

- "Super Rugged" Housing



SC 300 25-30 wt. Base station

- Very attractive woodgrain housing
- Built-in AC Power Supply
- Front Panel Status Indicator Lights
- Optional Rcvr. Scanning Function Available



SPECTRUM COMMUNICATIONS

Write or call for Data Sheets, prices, etc. ● Export orders—Contact our International Dept.

1055 W. Germantown Pk., Dept. S7 ● Norristown PA 19401 ● (215) 631-1710

You Can Watch Those Secret TV Channels

— a complete MDS receiving system

Good-bye, commercials!

Jim Barber K0JB
Rt. 1, 22518-97th Ave. North
Rogers MN 55374

Jevon Lieberg K0FQA
Rt. 1, 12285 Genereux Place
Rogers MN 55374

Did you know that there are two secret TV channels? Nobody advertises them, and you can't even buy a TV set that has these channels.

How long have you been complaining about all the commercials while watching your favorite program

or a late night movie? Well, here is the answer to your prayers—*these channels don't even have commercials!*

The programming on these channels consists of movies (P-, PG-, and R-rated), nightclub acts, and sporting events. They

are allocated to Multipoint Distribution Service (MDS). The existence of these channels was written up in 73 last November.¹

If you have heard of MDS via other amateurs, friends, or magazine articles, your curiosity has probably urged you to be on the lookout for a receive system you could build yourself. If this is true, read on!

The MDS Receive System

In this article we will give complete construction details on how to build a cheap and simple MDS receive system. This system will include the antenna, mixer, local oscillator, i-f amplifier, power supply, and complete mechanical layout.

The frequencies of the two microwave MDS video channels are 2154.75 MHz for channel 1 and 2160.75 MHz for channel 2. The audio is 4.5 MHz below the video. For more detailed information about microwave TV, read *A Vidiot's Guide to Microwave TV* by Paul Shuch.²

Locating the MDS Transmitter

If you have seen or

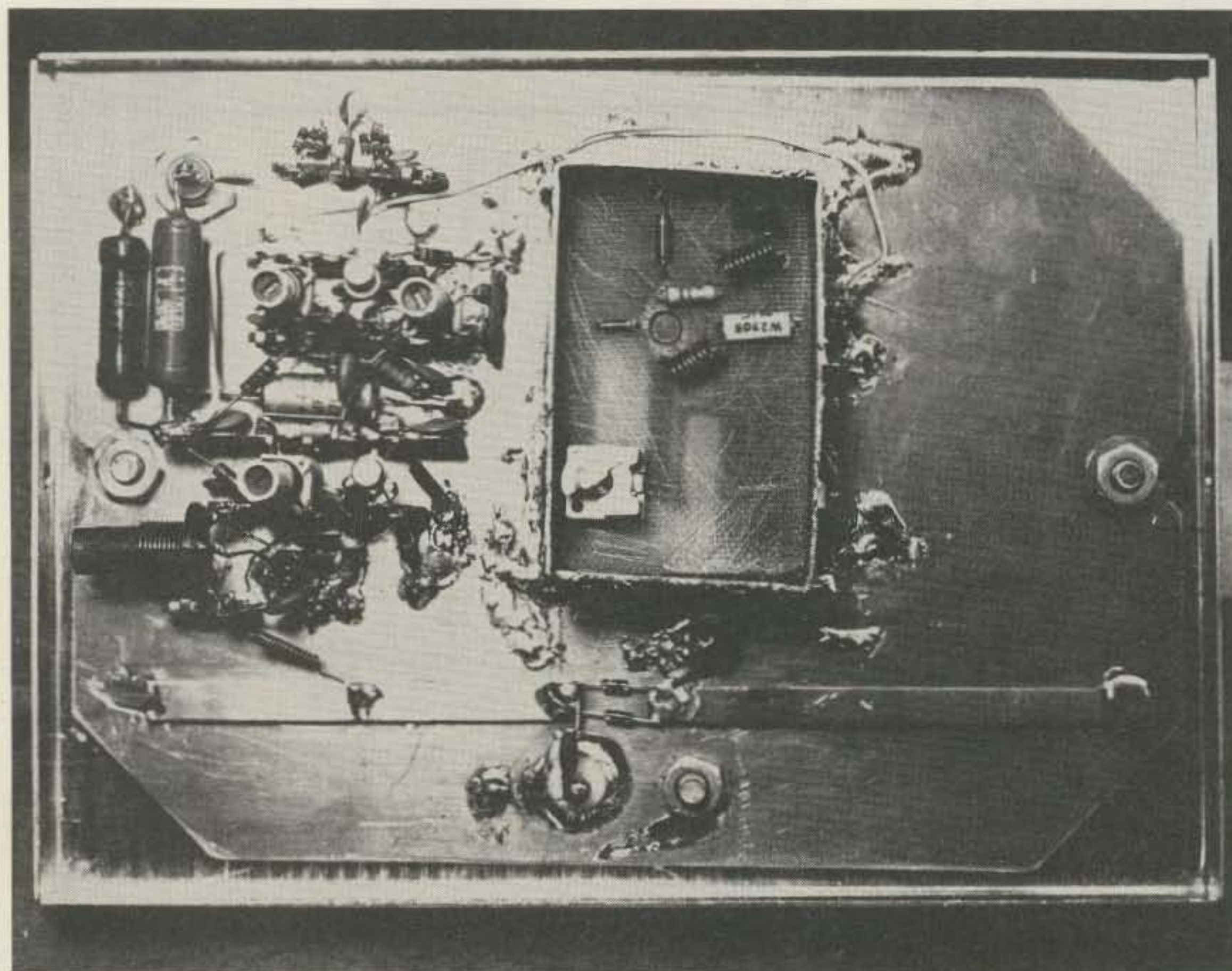

Photo A. This is a close-up of the downconverter showing i-f amplifier, mixer, and the local oscillator in its brass box with the cover removed. The piece of angle aluminum used to mount the box to the mast can also be seen.

heard of small dish antennas located on apartment buildings or hotels, this indicates that there is an active MDS channel nearby.

There are several ways to locate the source of the MDS signal in your area. If your city has an FCC office, they will have a list of all allocated frequencies and the locations of the transmitters. This list is on microfiche and is public information. Stations are listed by their frequency, so look up both MDS channels. The location will be given by latitude and longitude; with a good map, you will be able to pinpoint it.

Another way is to note the direction of several receiving antennas on buildings and use triangulation to find the transmitter. If you can find out the name of the company offering MDS service locally, just call and ask them. One thing is certain—it will be located on one of the highest structures around. After all, their objective is to be line-of-sight to as large an area as possible.

Checking the Receive Path

After finding the source of the MDS signal, you must confirm your location as being suitable for good reception. As you know, microwave signals generally travel only in a straight line, and obstructions such as trees and buildings severely attenuate the signal strength. As a rule of thumb, if you can see the building or tower where the MDS transmitting antenna is located, no matter how distant, then you have a very good location.

If you are line-of-sight, you will not gain much by increasing the height of the antenna. In other words, don't put your antenna at the top of your fifty-foot tower if you can see the location of the signal

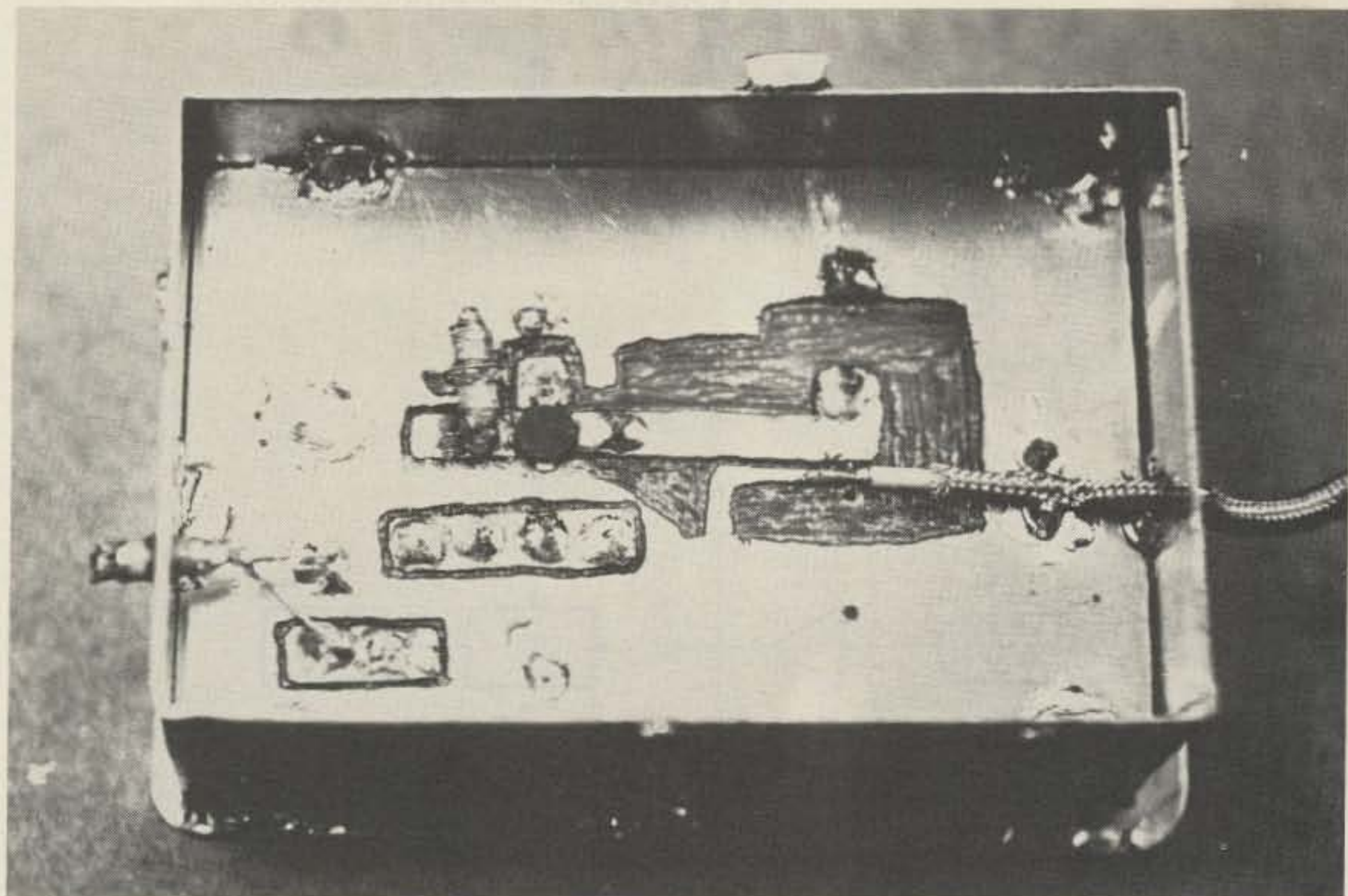

Photo B. This picture shows a close-up of the foil side of homemade printed circuit board used for the local oscillator. Note the modified feedthrough capacitor used for a base bypass capacitor. A 270-pF disc with very short leads also can be used.

source from your living-room window. Some obstructions can be tolerated if not too severe, and the signal loss can be made up through the use of preamplifiers and/or a larger antenna.

Circuit Description: Mixer

The mixer is the secret to a good microwave downconverter. It normally contains most of the critical parts and generally is the most difficult to construct. I think we can speak from experience on this subject, having built the interdigital converter by WA2CQH,³ the high-performance balanced mixer for 2304 MHz by WA2ZZF,⁴ and the solid-state 2304-MHz converter by K2JNG, WA2LTM, and WA2VTR.⁵ Then, along came the October, 1978, *Ham Radio* magazine, with Jim Dietrich and his twin-diode mixer article.⁶

This mixer is so simple that you find it hard to feel that you have earned the quality of the signal that comes out of it. The mixer consists of two half-wave lines mounted above a ground plane. The first

half wave is grounded on one end, and the other end has a pair of back-to-back diodes connecting it to the second half-wave line. This second line is open on its far end, and the i-f output is taken from the center of it.

The rf input is at the diode end of the second half-wave line, and the local oscillator input is at the diode end of the first half-wave line. (See Fig. 1 for detail.) The input circuit at the rf port is a high-

pass filter to keep the i-f energy from getting out of the rf port. This filter also keeps the antenna input at dc ground. The output circuit at the i-f port is a low-pass filter to keep the LO out of the i-f. For a more detailed description of the mixer, read Jim Dietrich's article.⁶

The diodes used in the original article were MA4882. We were unable to get these locally, so we used Hewlett-Packard 5082-2835. This is a very

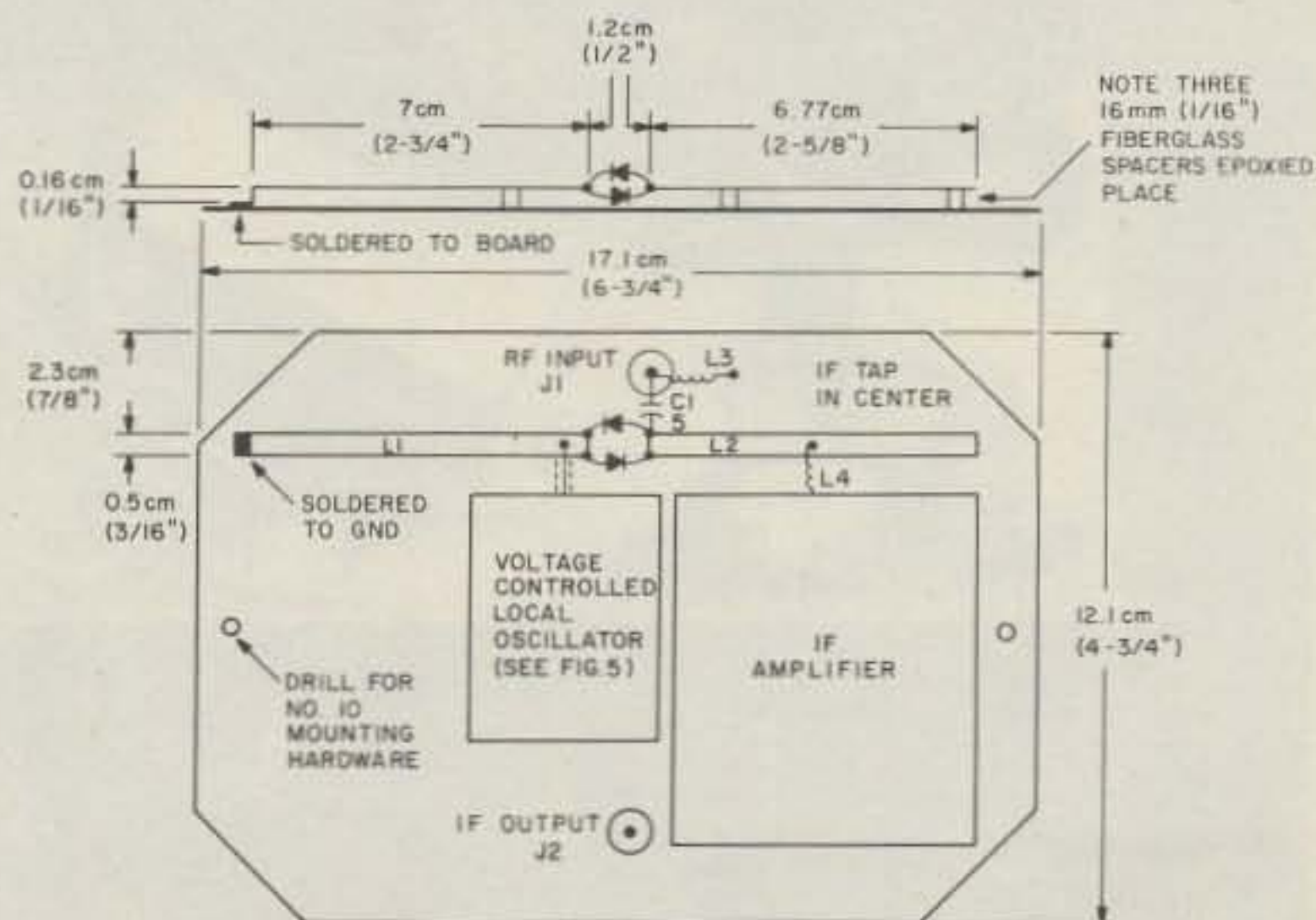
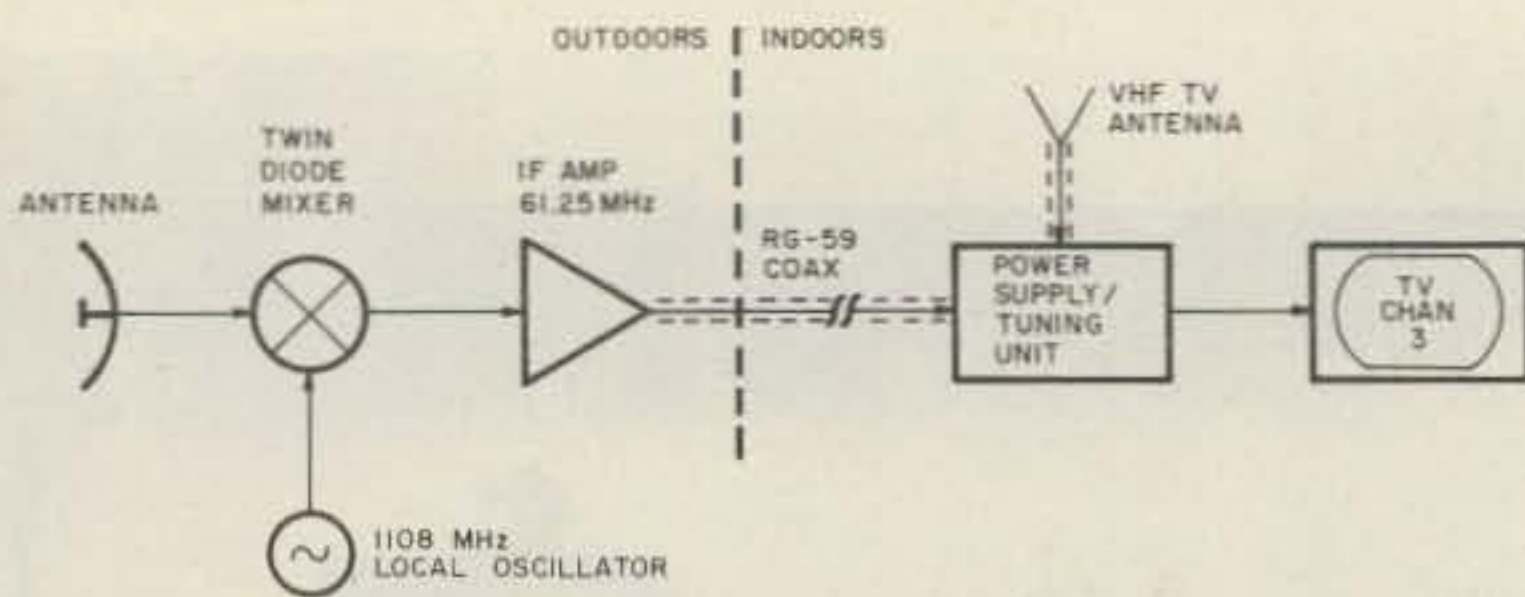
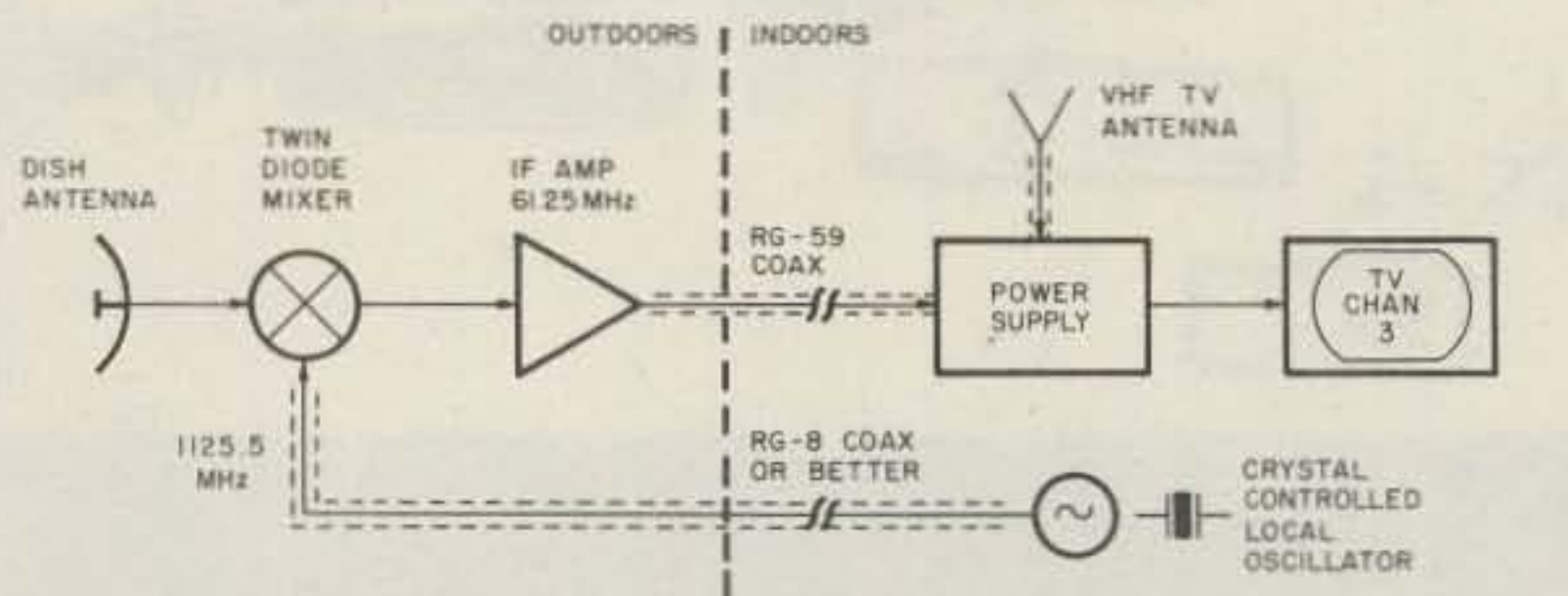

Fig. 1. General layout of the downconverter and construction details of the twin-diode mixer. J1 is a type N or BNC. J2 is an F61 TV-type connector.



A. 2154.75 MHz MDS SIGNAL



B. 2312.25 GHz AMATEUR TV SIGNAL

Fig. 2. (a) Block diagram of MDS receive system as described in this article. (b) Block diagram using alternate crystal-controlled local oscillator. Frequencies shown are correct to convert down to standard VHF TV channel 3 (video).

fine inexpensive diode for microwave mixers, but H-P does not give a noise figure rating for it. Any good Schottky diode can be in this circuit, but if you want to know its noise figure rating, you will have to pay more. The 2835 is about

\$1.10, and the prices go up from there. A good compromise, possibly, is H-P's 5082-2817. It has a 6-dB noise figure at 2 GHz and costs only \$1.85.

Block Diagram

The block diagram

shown in Fig. 2(a) is representative of the MDS receive system as described in this construction article. This system consists of a mixer, voltage-controlled local oscillator, and i-f amplifier located at the antenna, and the com-

bination power supply/tuning unit, located at the TV set. The RG-59/U feedline then performs the dual purpose of carrying the i-f signal down the line to the TV and carrying the power supply/tuning voltage up the line to the converter.

This results in a nice, cheap, and efficient system requiring no expensive feedline and connectors and a minimum of critical circuits. No special test gear is required for tune-up.

The block diagram shown in Fig. 2(b) is one of many configuration alternatives possible and is shown mainly to provoke some thought about other uses for the basic system. An example of another use would be for fast-scan amateur television where the usual DX signal would be much weaker than an MDS signal, and the guesswork of tuning is eliminated through the use of a crystal-controlled local oscillator.

Circuit Description: The Local Oscillator

Building a satisfactory local oscillator is the next hurdle one must overcome in the construction of a microwave converter. You will be thankful to know that the twin-diode mixer helps us here, too, because this mixer requires an LO running at only half the frequency needed for other mixers.

In this system we have done away with all the drudgery of those crystal-controlled oscillator/multiplier chains also and settled on a nice simple free-running oscillator.^{8,9} This oscillator has a tuning range of about 900-1300 MHz and a power output capability of several milliwatts. You might ask, "Is that possible? Won't it drift?" The answer to both questions is "yes." Not only is it possible, but it's also very simple.

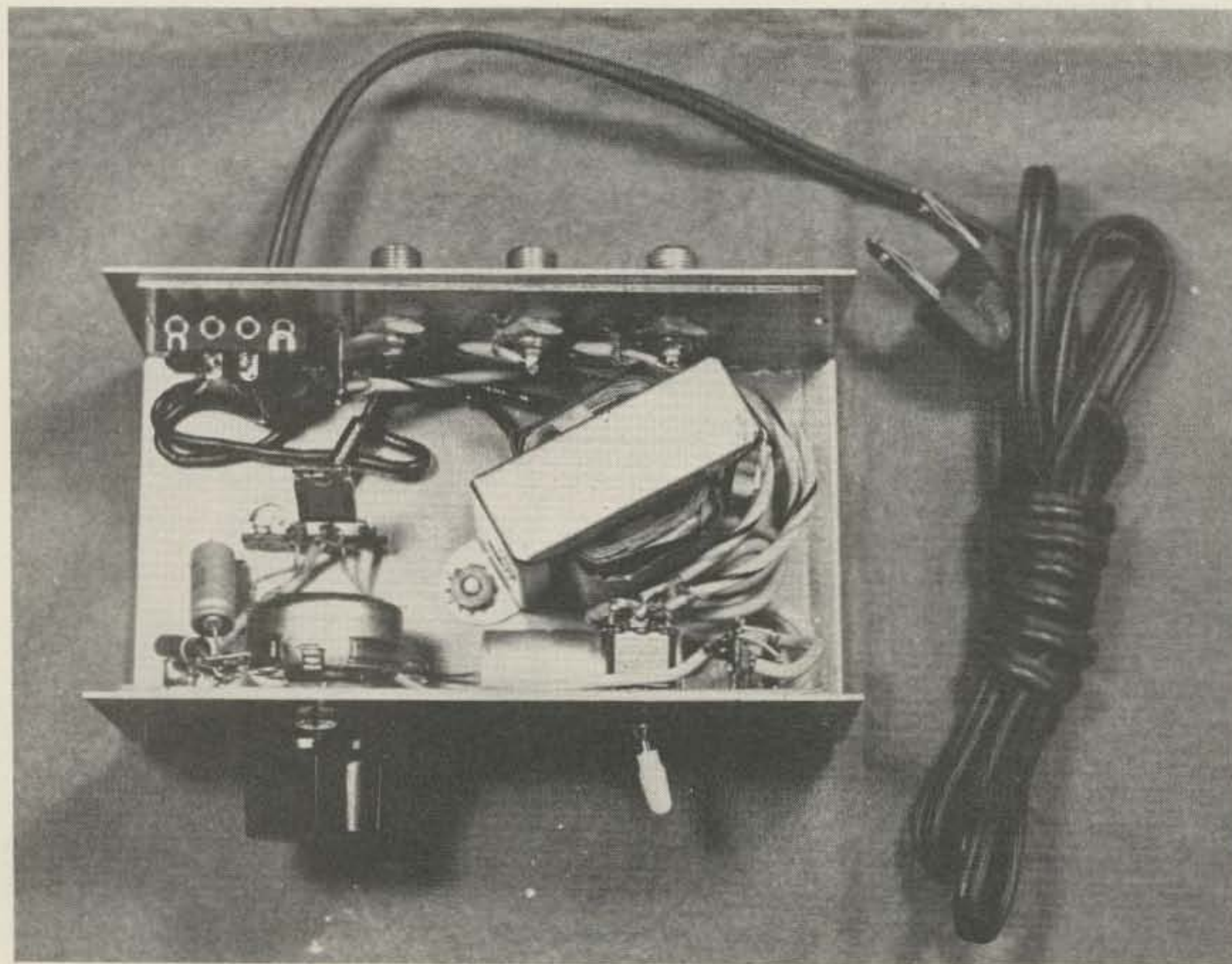

Photo C. This is a top view of the power supply/tuning unit.

The oscillator consists of a printed circuit board with an etched inductor, a Motorola MRF901 transistor, and about six other parts. This is about as simple as it could be. As far as drift goes, we have found that it is at a very slow rate, completely due to changes in outside temperature.

A TV set is a very broad receiver and will tolerate considerable drift. Since this LO is a voltage-controlled oscillator and can be remotely tuned from the control box, frequency adjustments can be made at any time. If this type of stability is not satisfactory for you, you may wish to build a crystal-controlled LO. We might suggest the one used on the interdigital converter³ with a doubler from a Paul Shuch article.¹⁰ Possibly another consideration along this line would be the Paul Wade article in *Ham Radio*, October, 1978.¹¹ Although these alternatives would double the size of the converter, it may be worth it—particularly if you plan to distribute the signal to a number of TV sets. This is because, when tuning the converter for one TV set, the others are affected. This may be necessary once your neighbor finds out what you are watching.

Circuit Description: I-f Amplifier

The i-f amplifier is a two-stage amplifier using dual-gate MOSFETs. The function of the i-f amplifier is to boost the signal from the mixer and also provide enough power to drive the RG-59/U coax line to the control box and TV set. This amplifier has been used to drive up to 600 feet of RG-59/U cable with enough signal at the far end to still have a good picture. Although the center frequency is 63 MHz (channel 3), the amplifier is broad enough to cover channels 2 through 4. The output of



Photo D. This photo shows a complete MDS receive system. The tripod, mast, and U-clamps are standard TV items. All connectors and the box containing the downconverter should be weatherproofed.

the amplifier goes into a 75-Ohm, 3-dB pad. This pad gives the amplifier a constant impedance to look into, and, along with the ferrite beads on gate two of both of the MOSFETs, helps make this amplifier very stable.

Circuit Description: Power Supply/Tuning Unit

The power supply used in the MDS receive system performs two separate functions. First, it supplies the operating voltage for the i-f amplifier and local

oscillator, and second, because it is adjustable and the local oscillator is frequency-sensitive to voltage, it provides tuning control for the downconverter.

The 24-volt ac transformer, diode bridge, and filter capacitor provide about 34 volts dc to the 12-volt regulator. The regulator is made adjustable by the addition of the fixed resistor, R1, and the variable resistor, R2. With the values shown in Fig. 4, the voltage is adjustable

from 12 to 17 volts.

Rf choke RFC1 isolates the rf from the supply, and the dc is carried via the feedline to the downconverter. DPDT switch S1 performs the dual function of switching the TV between the VHF antenna and the MDS downconverter and properly terminating the unused lead with a 75 Ω resistor.

It may seem that the current capacity of the power supply far exceeds the requirements of the downconverter, and it does. The

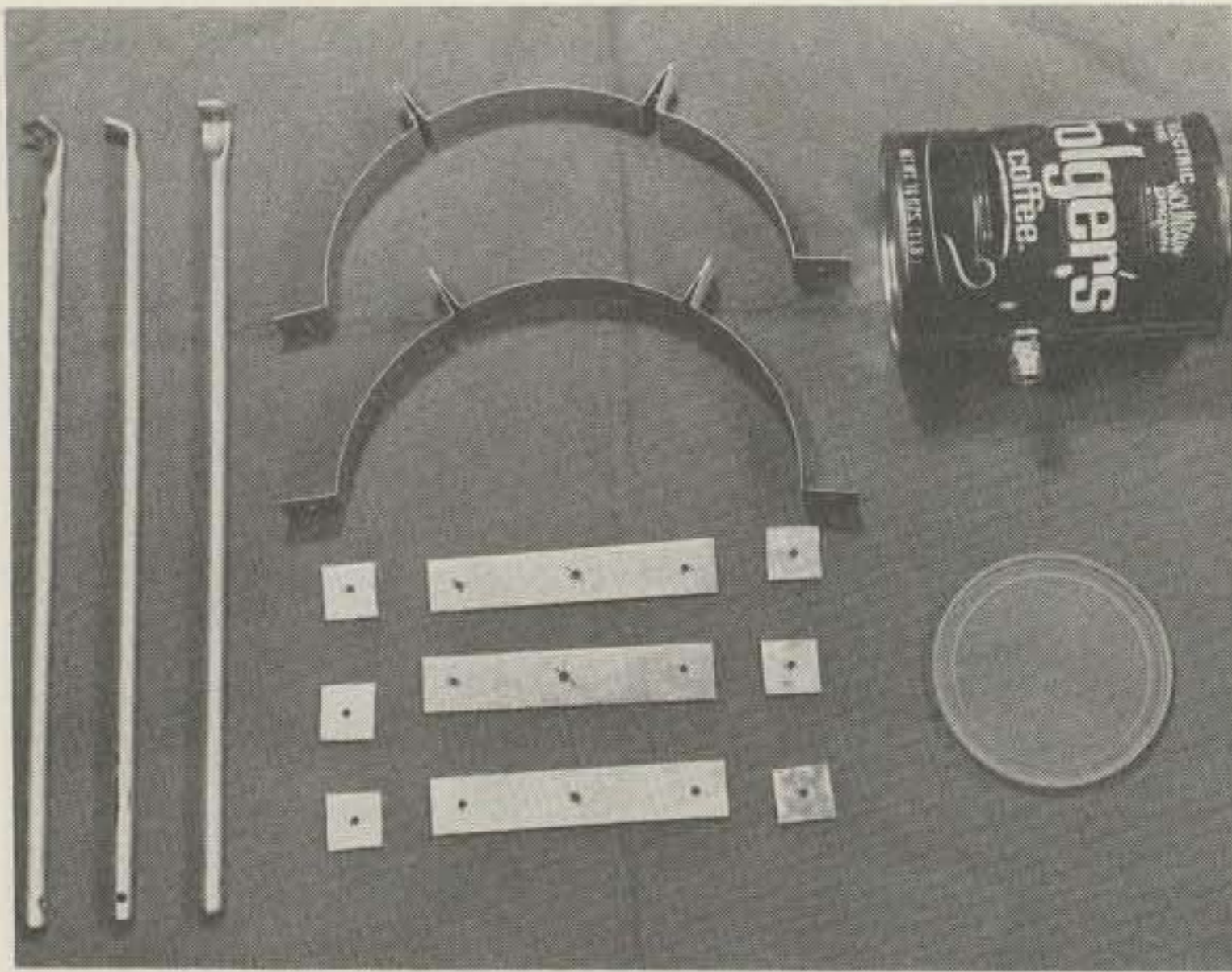

Photo E. This photograph shows the feedhorn before it was painted. Also shown are the supporting legs, straps, ties, and square washers used to mount the feedhorn in front of the reflector. The plastic cover that comes with the coffee can is used as a radome.

overkill is for two reasons. First, there is generally no difference in the cost of the larger parts, so you may as well use them and have the added capacity. Second, the relatively stiff supply provides a very well-regulated voltage to the downconverter regardless of any power line changes.

Circuit Description: Antenna

The antenna is con-

structed from a child's 25-inch snow saucer and a one-pound coffee can.

The saucer is not a true parabola, but it is close enough to give 15+ dB of gain at 2 GHz.¹² It was chosen for its light aluminum construction and availability. The saucer used is manufactured by Mirro Aluminum Co., Manitowoc WI 54220; the model number is T3589. Another source is Sears. They have what looks like

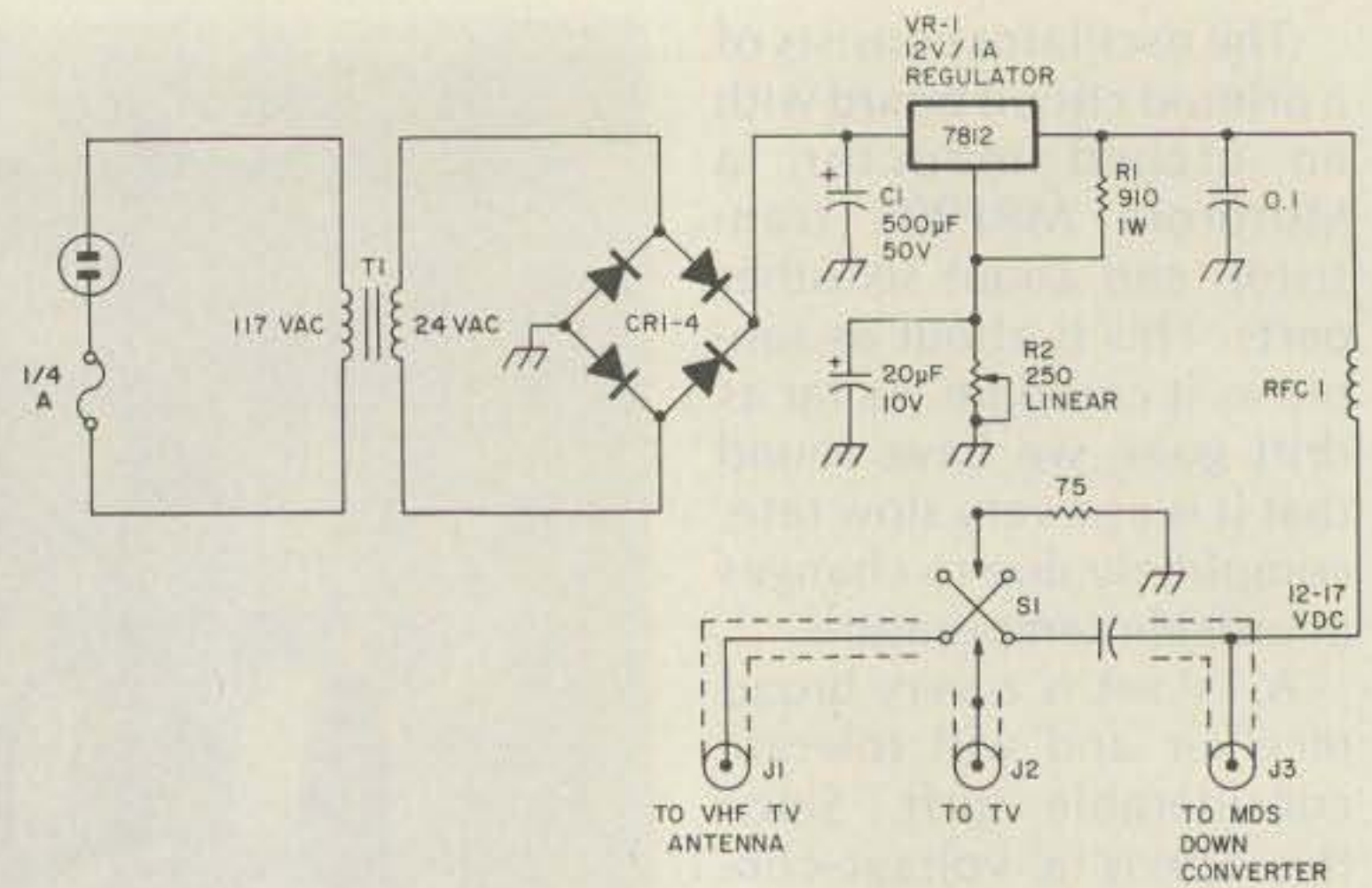

Fig. 4. Schematic diagram of the MDS downconverter power supply/tuning unit. T1 is 300 mA to 1 Amp at 24 Vac maximum. CR1-4 are 50 piv, 1 Amp, such as 1N4001. C1 is 500 uF or more. RFC1 is about 7 uH, such as Ohmite Z50 or Miller RFC-50. The three chassis-mount coaxial connectors, J1-3, are TV-type F61. S1 is a subminiature DPDT wired so that the unused cable input is terminated with a 75-Ohm resistor. A power switch seemed unnecessary, but don't forget the fuse.

the same saucer in their toy catalog, and the catalog number is 79N85063L.

The one-pound coffee can is also readily available and makes an excellent feedhorn. This horn was described in the May, 1976, *Ham Radio* by WA9HUV.¹³ This antenna has been compared with a commercial two-foot dish with a dipole and splash-plate-type feed. It was considerably better, but no at-

tempt was made to measure how much better. When the same feedhorn was put on the commercial dish, it became the better antenna. So, if you already have a dish antenna and don't plan to use the saucer, we still recommend using this feedhorn. To find the focal length of surplus microwave antennas, see *Ham Radio*, March, 1974,⁷ or the *RSCB VHF-UHF Manual*.¹⁴

Downconverter Construction

The downconverter is housed in an LMB 572, 12.7-cm (5-inch) by 17.7-cm (7-inch) by 5.1 cm (2-inch) aluminum box. The first step in construction is to cut a piece of .16-cm (1/16-inch) double-clad printed circuit board to the dimensions shown in Fig. 1. Cut off the corners and drill the holes to accommodate the coaxial connectors and mounting hardware. Also, drill corresponding holes in the cover of the LMB box at this time. Temporarily mount the board in the cover and, placing the cover on the box, check for clearance between the box and the

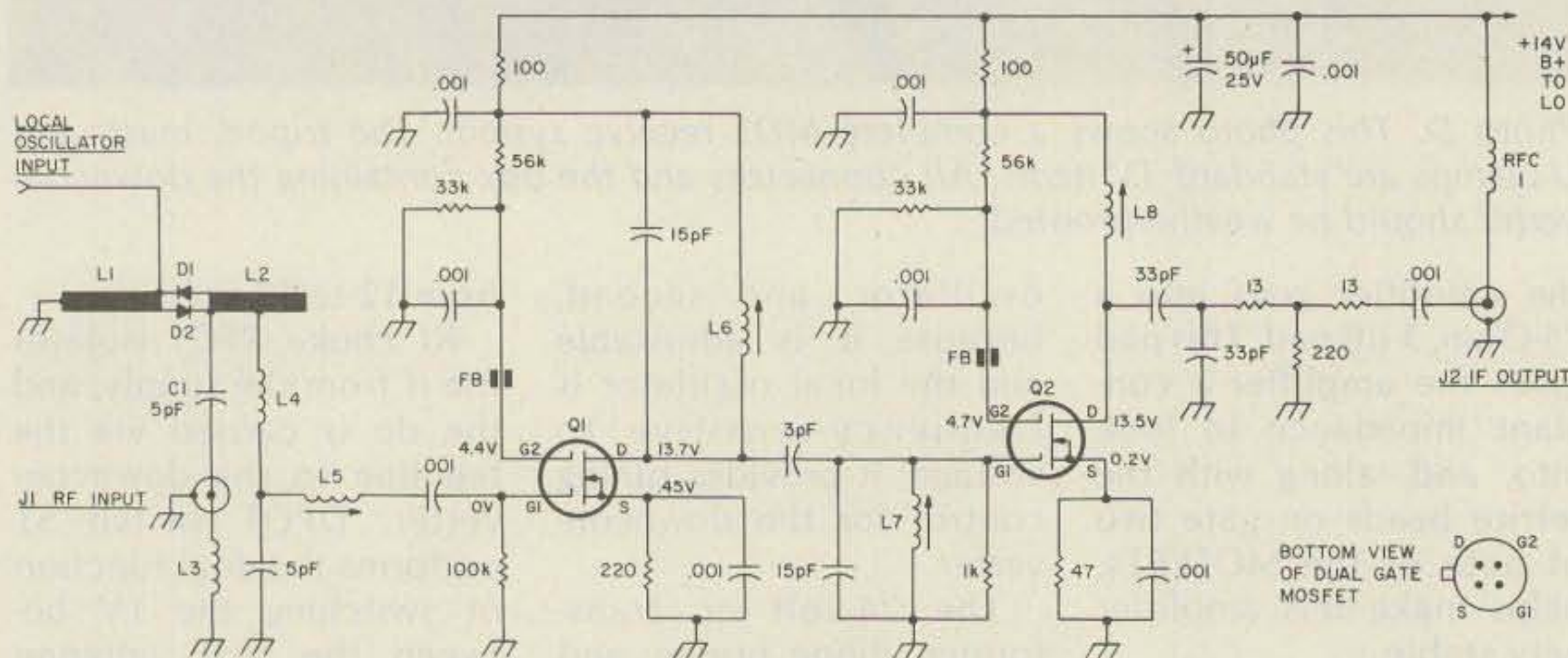

Fig. 3. Schematic diagram of i-f amplifier and mixer sections of the MDS downconverter. D1 and D2 are H-P 5082-2835, or the best microwave mixer diodes you can afford. Q1 and Q2 are Toshiba 3SK35 dual-gate MOSFETs; others, such as RCA 40673, work well. RFC1 is Ohmite Z50 or Miller RFC-50 (see power supply RFC1). L1 and L2 are shown in detail in Fig. 1. L3: 4 turns #28 AWG .3-cm (1/8-inch) diameter. L4: 15 turns #32 AWG .16-cm (1/16-inch) diameter (.085 uH). L5: 11 turns #22 AWG .56-cm (7/32-inch) diameter slug-tuned plastic form (.8-1.8 uH). L6-L8: 7 turns #22 AWG .56-cm (7/32-inch) diameter slug-tuned plastic form (.2-.6 uH). J1 is a type N or BNC chassis connector. J2 is a TV-type F61 chassis connector. Voltages shown were measured with a 10-megohm input VTVM.

board.

Remove the board from the cover and begin building the twin-diode mixer. Cut the two copper or brass lines as shown in Fig. 1 and attach to the board by soldering the end shown as grounded, and using epoxy cement and three small .16-cm (1/16-inch) fiberglass spacers as shown. Scraps of PC board are used for the spacers. You may have to rough up the copper a bit with emery paper in order to get the epoxy to stick well.

Next, wire the i-f amplifier and complete the wiring of the mixer as shown in the schematic in Fig. 3. Use short, direct wiring, using the copperclad board for all ground connections. The unit shown in Photo A uses point-to-point wiring, using Bakelite™ terminal strips. This seems to work well, and no trouble has been encountered. Don't forget the ferrite beads on gate 2 of the two MOSFETs, and keep L5-8 as far apart from each other as possible.

The local oscillator shown in Photo B is built on a homemade printed circuit board. The board is a 4-cm (1½-inch) by 6-cm (2¼-inch) piece of .16-cm (1/16-inch) G10 single-sided circuit board. A Dremel Moto-tool® with a small carbide tipped burr was used to grind away the unwanted copper plating. Fig. 5(a) shows the circuit board layout and dimensions. The circuit is not really critical, but the board layout should be followed as closely as possible for best results.

Bypass capacitor C2 is a modified 270-pF feedthrough type. Both ends are snipped off as short as possible, then one end is soldered to the base of Q1 and the mounting ring is soldered to ground. Tuning capacitor C1, shown in Photo A, is a Johnson type U 189-502-5 1.3-6.7 pF air-

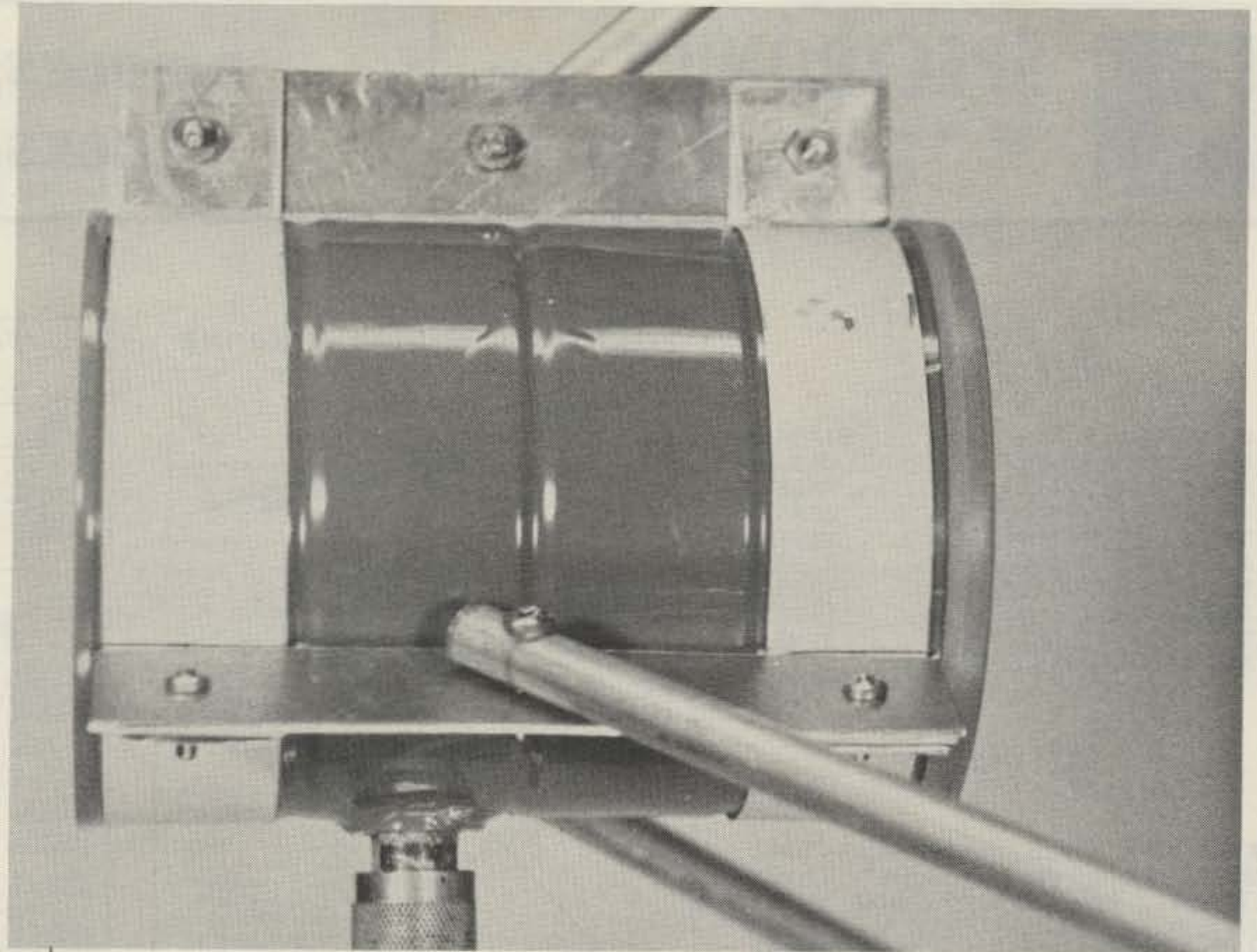

Photo F. Here is a close-up of the completed feedhorn and supporting hardware. Note the plastic radome cover is in place.

variable. Later, it was found that a small tubular type such as a Centralab 829-3 .5-3 pF worked better. Using a tuning capacitor with an NPO temperature coefficient and metal film resistors reduces frequency drift due to temperature changes. Wire the remainder of the local oscillator as shown in Fig. 5(b).

The local oscillator is mounted in a small box fashioned from a strip of brass 3.2 cm (1¼ inch) wide and about 20.2 cm (8 inches) long. The board is suspended in the center of the box by soldering the edges of the circuit board to the center of the inside walls of the box. Holes for the B+ feedthrough capacitor, C3, and rf output coaxial cable are drilled, then the box is placed near the mixer as shown in Fig. 1 and temporarily tack-soldered in place. Make a cover for the box by cutting a 4.5-cm (1¾-inch) by 6.5-cm (2½-inch) piece of printed circuit board or thin brass. Drill a hole in it

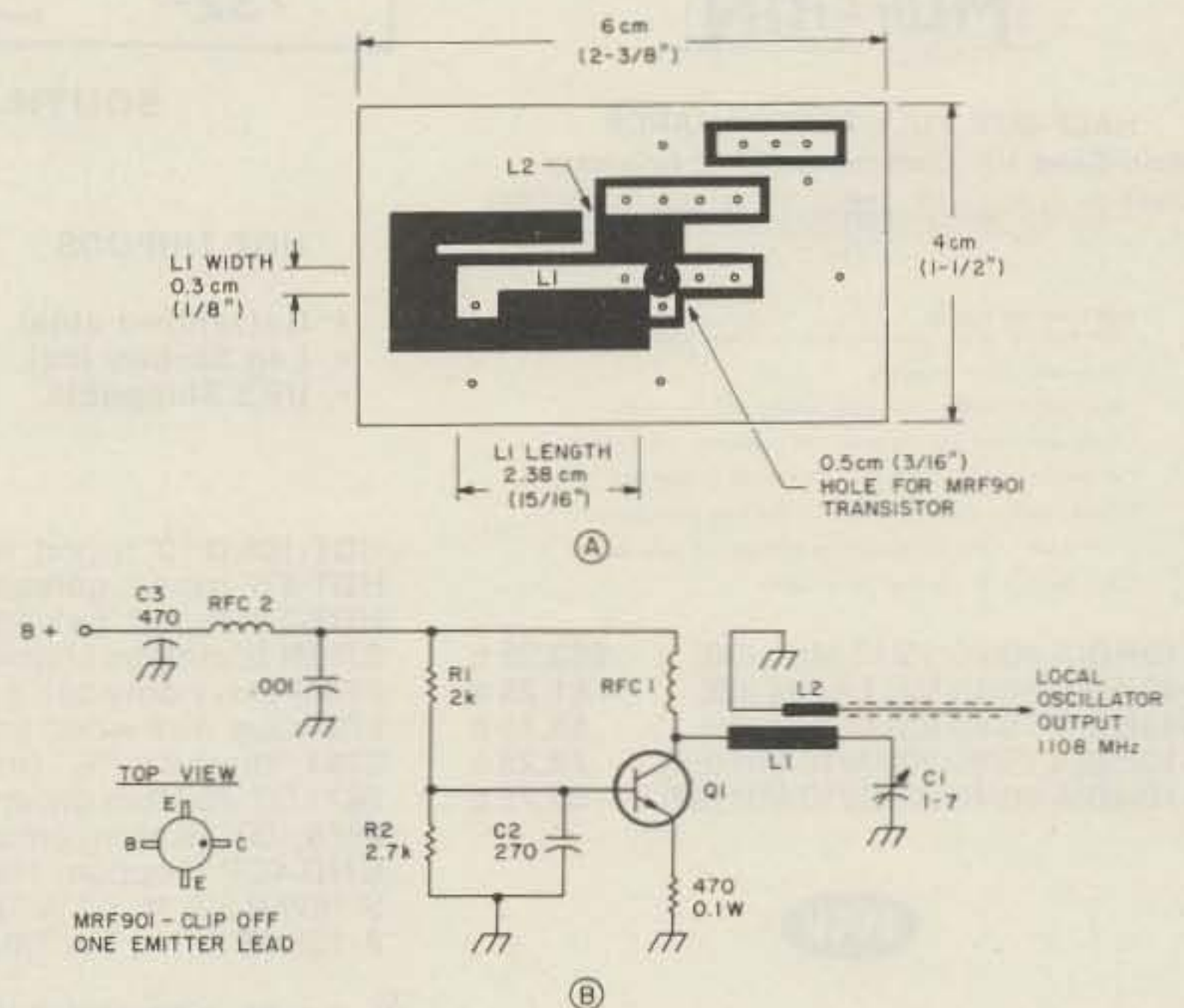

Fig. 5. (a) Bottom-view layout of local-oscillator circuit board. The shaded area indicates the area etched away. Use single-sided G10 epoxy circuit board. (b) Schematic diagram of local oscillator. Q1 is Motorola MRF901. RFC1, 2 is 13.5-cm (5¼-inch) #26 AWG close-wound, using a piece of #14 AWG as a mandrel. C1 is a 1-7-pF Johnson-type U (see text). R1 and R2 are ¼-W metal film-type resistors. C2 is a modified 270-pF feedthrough (see text) or other small low-inductance capacitor. This capacitor is soldered to the foil side of the circuit board to ensure short lead lengths. L1 and L2 are PC board inductors. Keep L2 as narrow and as close to L1 as possible. See Fig. 5(a).



SPECTRONICS, INC.

1009 Garfield St., Oak Park, Illinois • 60304

(312) 848-6777

DIPOLES, ROTORS, ACCESSORIES

At Warehouse-To-You Savings

KLM

- KLM 144-148-11 2 meter beam..... \$47.95 c
- KLM 144-148-14 2 meter beam..... 65.95 c
- KLM 144-148-16 2 meter beam..... 72.95 d
- KLM 219-226-7 220 MHz beam..... 28.95 b
- KLM 219-226-9 220 MHz beam..... 29.95 b
- KLM 219-226-11 220 MHz beam..... 32.95 c
- KLM 219-226-14 220 MHz beam..... 49.95 d
- KLM 420-470-6 UHF beam 19.95 b
- KLM 420-470-14-UHF beam 31.95 c
- STANDARD BALUNS for abv beams. 24.95 b

Larsen

- LM150K 2M 3db, mob ant w/cable .. \$31.95 c
- NM0150 2M adapt ant TAD/TAE mt .. 27.10 b
- NLA150K 3/8" hole, 3db mob w/cable 33.75 c
- LMQ-K 1/4 wave w/cable 136-512 MHz . 9.55 b
- LM220K 220 MHz, 3db mob w/cable . 32.00 c
- LM440K UHF 5db mob w/cable..... 30.00 c
- MMLM150 2M Mag mt 3db gain ant.. 40.75 d
- PQ 1/4 wave port and w/PL259 conn... 5.25 a

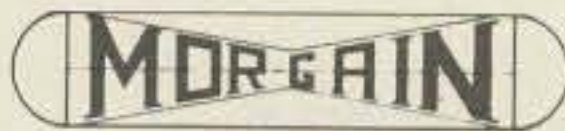

HALF-SIZE FULL PERFORMANCE Multi-Band HF Communications Antennas

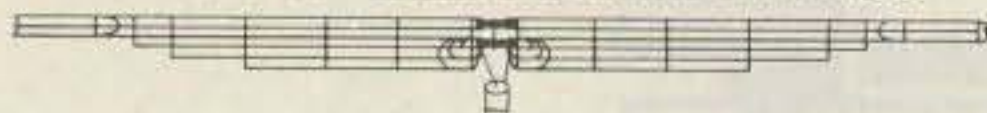

- MOR-GAIN HD Dipoles.....
- * One half the length of conventional half-wave dipoles
- * Multi-band, Multi-frequency
- * Maximum efficiency - no traps, loading coils, or stubs
- * Fully assembled and pre-tuned - no measuring, no cutting
- * All weather rated - 1 KW AM, 2.5 KW CW or PEP SSB
- * Proven performance - more than 10,000 have been delivered
- * Permit use of the full capabilities of today's 5-band xcvrs.
- * One feedline for operation on all bands

- 40-10HD/A 40/20/15/10 Mtrs (36) \$63.25 c
- 80-40HD/A 80/40 Mtr bands (69) 61.25 c
- 75-40HD/A 75/40 Mtr bands (66) 58.75 c
- 75-10HD/A 75/40/20/15/10 Mtr (66).... 78.25 c
- 80-10HD/A 80/40/20/15/10 Mtr (69).... 80.25 c



MODEL
595
\$21⁵⁰

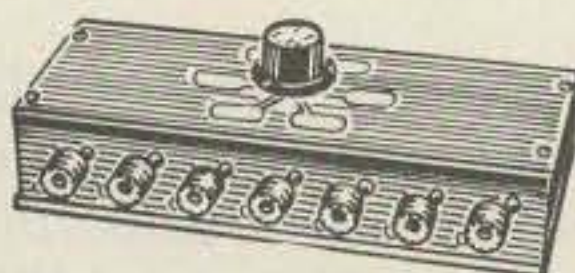

Our most popular switch. 6 position, grounds all except selected output circuit. Can be mounted on wall, on desk, or almost anywhere. Good to 150MHz. Wt. 2 lbs.

- 375 6 position, axial lead, gnd..... \$19.75 a
- 376 5 pos, PROTAX, gnd pos 19.75 a
- 550A 5 pos, Radial, no gnding 17.50 a
- 550A2 2 pos, Radial, economy sw ... 14.95 a
- 590 5 pos, axial, panel mtg..... 18.50 a
- 590G same as above w/gnd unused . 18.50 a
- 592 2 pos axial, panel mtg 17.25 a

"SLINKY" Dipole Antenna

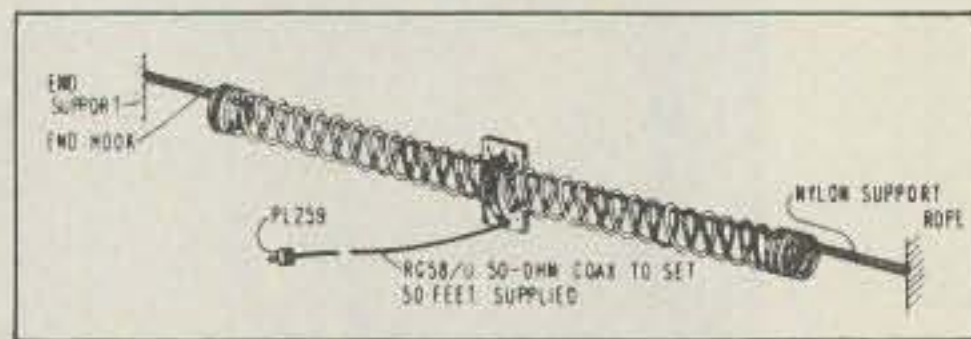

A lot of performance in a little space, on 80/75, 40 and 20 meters. Only one setting needed for full band coverage—low VSWR throughout. Can be set at any length from 24-40' on 80/75 meters, 12-35' on 40, 6-18' on 20. Band change takes less than a minute. Handles 1000 watts CW, 2000 PEP on SSB. With 50' RG-58/U coax \$43.95

NEW! B&W PORTABLE WHIP ANTENNA



Quick Mounting
\$32⁵⁰

Simple, dependable whip is designed especially for apartment dwellers and renters who cannot install a permanent antenna. Tunes the 2, 6, 10, 15, 20 and 40-meter Amateur bands. Offers VSWR of 1:1:1 when properly adjusted to operating frequency. Ideal for use as a portable emergency antenna, too. Amounts to almost any horizontal support with a simple clamp bracket.

Weights less than 2 pounds including five base-loading coils (not used for 6 & 2 meters), coax line and counterpoise Whip is 22 1/2" long disassembled, extends to 57". Mount is 14" long. Power rating, 360 watts SSB or CW. Model 370-10 \$32.50

SOUTH RIVER

HDT TRIPODS

- Galvanized steel.
- Lag Screws incl.
- UPS Shippable.

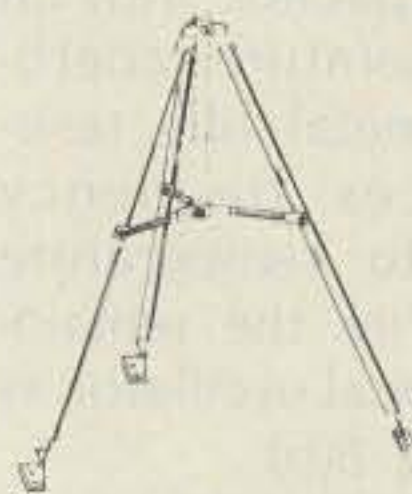

- HDT-10KD 10' tripod, hvy duty \$49.95 g
- HDT-5' 5' tripod, galvanized..... 24.95 f
- HDT-3' 3' tripod, galvanized 15.95 c
- ST-SN Stainless chimney mt (pair) .. 17.50 c
- PFM71 Hvy duty self sup roof mt 8.95 c
- 2791 Guy wire wood screw hooks (3) .. 1.54 a
- 2751 "thread x 7/8" turnbuckle (3) 3.46 b
- 2871 50' #8 alum ground wire..... 4.35 b
- 2876 100' #8 alum ground wire..... 8.19 c
- GND-4CP 4' copper plated grd rod... 3.39 c
- S-1625P 2 1/2 ft. x 1 1/4" mast 3.95 c
- A-125-5P 5 ft. x 1 1/4" alum mast..... 11.50 c

WHEN ORDERING FROM SPECTRONICS, REMEMBER:

ALL PRICES are subject to change without notice. When any item carries a special sale price lower than shown in the catalog, you will automatically receive a refund if you overpaid with your order.

C.O.D. ORDERS require payment to be made by cash, certified check, or money order only. We will gladly quote you the exact amount that the deliveryman will ask for.

SHIPPING CHARGES must be added to your order. Please refer to the chart on the order blank page and add to your total.

ALL ORDERS sent F.O.B. Oak Park, Illinois.

Famous "W2AU" Balun

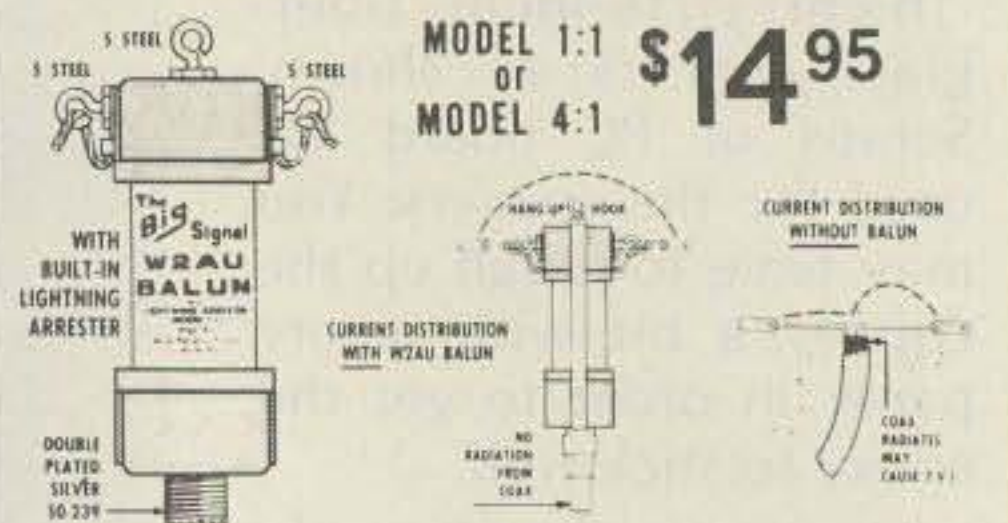

- MODEL 1:1 \$14⁹⁵
 - OR
 - MODEL 4:1
- HANDLES FULL 2 KW PEP AND THEN SOME. Broad-Banded 3 to 40 Mc.
 - HELPS TVI PROBLEMS By Reducing Coax Line Radiation
 - NOW ALL STAINLESS STEEL HARDWARE. SO239 Double Silver Plated
 - IMPROVES F/B RATIO By Reducing Coax Line Pick-Up
 - REPLACES CENTER INSULATOR. Withstands Antenna Pull of Over 600 Lbs.
 - BUILT-IN LIGHTNING ARRESTER. Helps Protect Balun — Could Also Save Your Valuable Gear
 - BUILT-IN HANG-UP HOOK. Ideal For Inverted Vees, Multi-Band Antennas, Dipoles, Beam and Quads
- NOW BEING USED BY ALL BRANCHES OF THE U.S. ARMED FORCES, FAA, RCA, CIA, CANADIAN DEFENSE DEPT. PLUS THOUSANDS OF HAMS THE WORLD OVER
- Comes in 2 models. 1:1 matches 50 or 75 ohm unbalanced (coax line) to 50 or 75 ohm balanced load. 4:1 model matches 50 or 75 ohm unbalanced (coax line) to 200 or 300 ohm balanced load.
- Model 1:1.....\$14.95 Model 4:1.....\$14.95

DIPOLE HEADQUARTERS

- 8U FOAM, hi dens braid 50 ft..... \$11.95 c
- 8U FOAM, hi dens braid 100 ft..... 22.00 e
- RG58A/U stranded center 50 ft 6.95 c
- RG58A/U stranded center 100 ft..... 9.95 d
- RG58 3 ft w/PL259 each end..... 3.35 b
- RG58 5 ft w/PL259 each end..... 4.39 b
- RG58 50 ft w/PL259 each end..... 9.95 c

COPPER WIRE

- #14 stranded, 100 ft spool..... 5.95 c
- #14 solidcopper enameled 100'..... 5.95 c

INSULATORS

- Egg Ins, porcelain per pair99 a
- DOG BONE, porcelain set of 3 1.25 a
- HY GAIN #155 center insulator..... 5.95 b
- HY GAIN Cycloc end ins per pair.... 3.95 b
- MOSLEY dipole center insulator 5.75 a

CONNECTORS

- PL259 UHF male, 2 per pkg 1.59 a
- SO239 UHF female chassis mt69 a
- UG175 Adapts RG58 to PL259, pkg 2... .59 a
- UG176 Adapts RG59 to PL259, pkg 2... .59 a
- PL258 UHF double female99 a
- DM-SP UHF double male 1.69 a
- M359 90 deg UHF elbow conn 2.10 a
- UG88U BNC male for RG58 1.49 a
- 1094 BNC female 1.10 a
- M358 UHF "T" connector..... 2.95 a
- UG255 UHF female to BNC male 3.49 a
- UG273 BNC female to UHF male 2.45 a

ESTIMATED WEIGHT CODING

After the price of each item you will find a letter, i.e., 19.95 a. To make it easier to figure shipping costs, these letters indicate the approximate weight of the item as follows:

- a. Less than 1 lb. f. 20-30 lbs.
- b. 1-3 lbs. d. 7-10 lbs. g. 30-40 lbs.
- c. 4-6 lbs. e. 10-20 lbs. h. 40-50 lbs.

★ will be sent truck collect.

HF & VHF BEAMS and VERTICALS

At Warehouse-To-You Savings



SPECTRONICS, INC.

1009 Garfield St., Oak Park, Illinois • 60304

✓S81

(312) 848-6777

the antenna
specialists



2 MTR DUCKIES

- Model HM-4. Has 5/16"-32 thread. Fits Motorola HT's. ICOM IC215 and Standard 146A \$7.00
- Model HM-5. Same as above, but with PL-259 connector \$7.00
- Model HM-226. Same, with TNC connector for Wilson 1405 \$18.50
- Model HM-227. Same, but with BNC connector termination \$12.00
- Model HM-228. With F connector for Wilson 1402 & Tempo \$11.50

HM-4

HM-5

- HM180 2mtr, 3db trunk lip ant. \$33.50 b
- HM179 2mtr, 3db hole mount ant. 29.00 b
- HM20 2mtr, 3db for marine use. 39.00 b
- HM176 440MHz 5db trunk lip ant. 33.00 b
- HM175 440MHz 5db hole mount ant. 29.00 b
- HM224 220MHz 4db trunk lip ant. 33.50 b

NEW! ASP-694 1/4-Wave Magnetic Antenna

Low profile magnetic antenna with cable and connector. Tunable 108-512 MHz. Can be converted to gain antenna later. Wt.: 3 lbs.

Model ASP-694 \$21.00



- AR2 2meter Ringo base ant. \$24.95 b
- ARX2 2mtr Ringo Ranger base ant. 39.95 c
- AR220 220MHz Ringo base ant. 24.95 b
- ARX220 220MHz Ringo Ranger. 39.95 c
- AR450 UHF Ringo base ant. 24.95 b
- ARX450 UHF Ringo Ranger base ant. 39.95 c
- AR6 6 meter Ringo base ant. 36.95 c
- ARX2K Adapts 2M Ringo to Ranger. 16.95 b
- A147-4 4 ele 2M FM beam ant. 24.95 b
- A147-11 11 ele 2M FM beam. 36.95 c
- A147-20T 10 ele 2M vert/horz twist. 62.95 d
- A144-7 7 ele 2M CW/SSB beam. 26.95 c
- A144-11 11 ele 2M CW/SSB beam. 36.95 d
- A144-10T 10 ele Twist OSCAR ant. 42.95 c
- A144-20T 20 ele Twist OSCAR ant. 62.95 d
- A220-7 7 ele 220MHz beam. 26.95 c
- A220-11 11 ele 220MHz beam. 34.95 c
- A449-6 6 ele UHF FM beam. 24.95 c
- A449-11 11 ele UHF beam. 34.95 c
- A432-11 11el 432MHz SSB/CW beam. 34.95 c
- AFM4D 144-148MHz Four Pole. 69.95 c
- AFM24D 220MHz Four Pole. 64.95 c
- AFM44D 435-450MHz Four Pole. 64.95 c
- ASQ-2 2M Squalo horiz ant. 19.95 b
- LAC-1 Coax lightning arrester. 4.95 a
- LAC2- Coax lightning arrester. 4.95 a
- ATB34 ★ 4 ele 20-10mtr beam. 219.95 ★
- ATV3 20-10mtr trap vertical. 49.95 e
- ATV4 40-10mtr trap vertical. 69.95 e
- ATV5 80-10mtr trap vertical. 89.95 e
- A50-3 3 element 6 meter beam. 39.95 d
- A50-5 5 element 6 meter beam. 59.95 e
- A28-3 ★ 3 element 10 meter beam. 69.95 ★
- A432-20T 432MHz 20 ele twist. 59.95 d

2M BASE ANT. PACKAGE



Here's what you get:

- Cushcraft AR2 Ringo South River.
- PFM71 Roof mount.
- A125-5P 5' alum mast.
- Lag bolts.
- 50' 8U foam coax.
- PL259 coax conn.

\$59⁹⁵

Wt. 16 lbs.

FINCO

The most rugged 6 & 2 meter beams we've seen yet!!

- A 2-10 10 ele, 2M beam \$44.95 d
- A 2-5 5 ele, 2M beam, 9.5db gain. 27.95 c
- A 2-2 10 ele, 2M dual polarization. 46.50 e
- A62 6&2M antenna on one boom 74.95 e
- A6-5 5 element 6M beam, 11db 46.50 e
- A6-3 3 ele 6M beam, 7db gain 30.00 d
- A 1 1/4 220MHz 10 ele, 13.8db 32.95 d

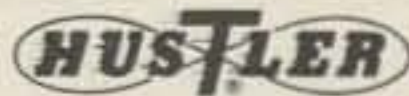

\$9⁹⁵ "BUCK-BUSTER" SF-2 ANTENNA

Fits all Hustler deluxe mobile mounts. 3/8"x24 base. 5/8" wave two meters, 3.4 db gain. SWR at resonance: adj. to 1.5:1 or better. Bandwidth: 6 MHz, 2:1 or better SWR, 100 watts max.

\$79⁹⁵ NEW 4-BTV VERTICAL

One setting covers 10, 15, 20, 40M. Space restricted or unlimited, you get top signal reports, consistent contacts and complete coverage. Add 5th band with a 75M resonator. Use one feedline, any length. Requires no switching or matching devices. 15 lbs.

SF-2

4-BTV

- MO1 Mobile mast \$22.95 c
- MO2 Mobile mast 22.95 c
- RM10 10 Meter resonator 6.95 b
- RM15 15 meter resonator 7.95 b
- RM20 20 Meter resonator 8.95 b
- RM40 40 Meter resonator 14.95 b
- RM75 75 Meter resonator 16.95 b
- RM80 80 Meter resonator 17.95 b
- RM10S 10M resonator 2KW PEP 11.95 b
- RM15S 15M resonator 2KW PEP 12.95 b
- RM20S 20M resonator 2KW PEP 13.95 b
- RM40S 40M resonator 2KW PEP 16.95 b
- RM75S 75M resonator 2KW PEP 31.95 b
- RM80S 80M resonator 2KW PEP 31.95 b
- CG144 5.2db 2mtr ant 3/8 x 24 stud 26.95 b
- CGT144 Same but trunk lip mount. 42.95 c
- SF2 3db 2mtr ant 3/8 x 24 stud 9.95 b
- SF220 3db 220MHz ant 3/8 x 24 stud. 11.95 b
- 4BTV 40-10mtr vertical 79.95 e
- G6-144 2mtr base ant 6db. 79.95 d
- BM1 Bumper mount 3/8 x 24 thread. 15.95 d
- RSS2 Mobile resonator spring 5.95 a
- QD1 Quick disconnect 3/8 x 24 16.95 a

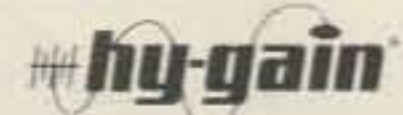

VERTICAL ANTENNAS

Model 14AVQ/WB

- 40 thru 10 meters.
- Wide band performance
- New Hy-Q traps

Self-supporting, automatic band switching vertical antenna. Omni-directional performance. Favorable L/C ratio. High Q. True 1/4 wave resonance on all bands. Low angle radiation pattern. Taper swagged seamless aluminum construction. 12" double-grip mast bracket. Full circumference compression clamps at tubing joints. Weight: 8.2 lbs.

Model 14AVQ/WB \$57.00

Model 18AVT/WB

- Automatic band switching
- Completely Self-Supporting
- Omni-Directional Performance

Three beefed-up Hy-Q traps permit automatic switching. 5 band capability. Favorable L/C ratio. Top loading coil. Across the band performance with one furnished setting for each band (10 thru 40). True 1/4 wave resonance on all bands. SWR of 2:1 or less at band edges. Low angle radiation pattern. Extra heavy duty tapered swagged seamless aluminum tubing with full circumference, corrosion resistant compression clamps at tubing joints. Antenna can be mounted without guide wires. 25' high. Weight: 10.7 lbs.

Model 18 AVT/WB \$79.95

- BN86 Ferrite balun for 80-10mtrs. \$15.95 a
- 155 Center insulator for doublet. 5.95 a
- 156 End insul. for doublet (pair) 3.95 a
- 18HT ★ HyTower 80-10M vertical. 239.95 ★
- 18V Economy 80 tru 10M vertical. 24.95 c
- 12AVQ 20-10mtr trap vertical. 39.95 c
- 14AVQ 40-10mtr trap vertical. 57.00 d
- 18AVT/WB 80-10mtr trap vertical. 79.95 d
- 2BDQ Trap doublet for 80 & 40mtr. 39.95 d
- 5BDQ Trap doublet for 80-10mtrs. 69.95 e
- TH3 MkIII ★ 3 ele 20-10 tribander. 179.95 ★
- TH6DXX ★ 6 ele 20-10M tribander. 239.95 ★
- TH3 Jr 3 ele tribander (750W PEP) .. 129.95 e
- HY QUAD ★ 2 ele quad 20-10 mtrs. 189.95 ★
- 103BA 3 element 10Mtr beam. 54.95 e
- 153BA ★ 3 element 15mtr beam. 79.95
- 204BA ★ 4 element 20mtr beam. 179.95 ★
- 402BA ★ 2 element 40 mtr beam. 169.95 ★
- 64B ★ 4 element 6 meter beam. 39.95
- 270 6db fiberglass 2M antenna. 39.95 e
- 203 3 element 2 meter yagi. 15.95 b
- 205 5 element 2 meter yagi. 17.95 c
- 208 8 element 2 meter yagi. 25.95 c
- 214 14 element 2 meter yagi. 31.95 d



- TA33 ★ 3 el triband beam 2KW PEP. \$189.95
- TA33Jr ★ 3ele triband 1KW PEP. 149.95 ★
- TA36 ★ 6ele triband 2KW PEP. 269.95 ★
- CL33 ★ 3 ele Classic. 209.95 ★
- CL36 ★ 6 ele Classic. 269.95 ★
- TA40KR 40mtr adpt for TA33/36. 92.95 e
- MPK3 2KW conv kit for TA33Jr. 67.65 e

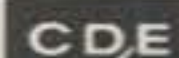

- HAM IV Rotor with control box. \$149.95 f
- T2X Tailtwister xtra hvy dty. 219.95 f
- CD45 Medium duty rotor. 119.95 f
- AR22XL Light duty rotor. 59.95 e
- Mast adaptor for Ham II/T2X. 29.95 d
- South Center meter kit. 3.00 a

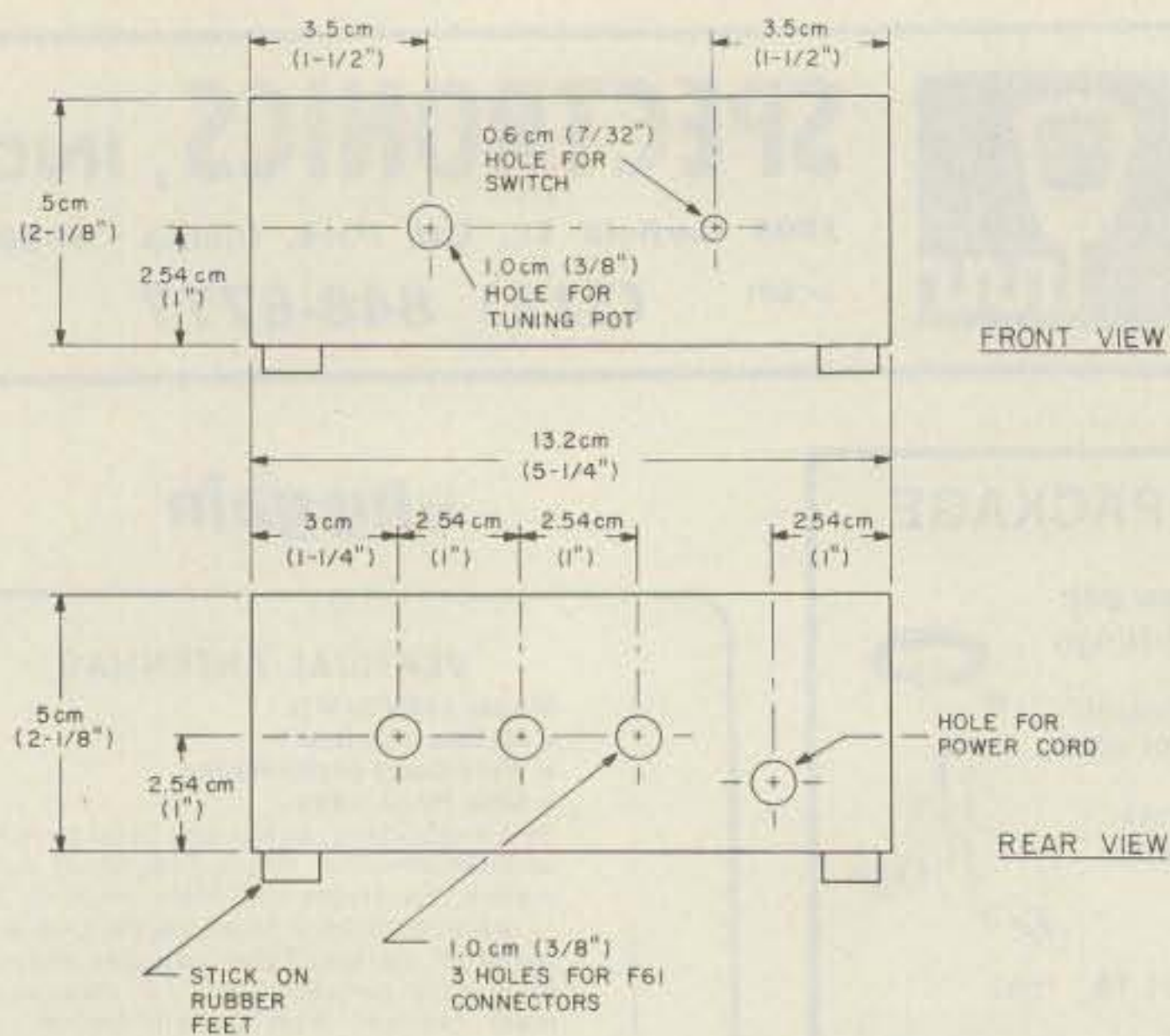

Fig. 6. Front and rear panel layout of the power supply/tuning unit chassis.

to permit access to tuning capacitor C1, and tack-solder the cover in place. Permanent attachment is not done until checkout and tune-up are complete.

Power Supply

The combination power supply/tuning unit is built into a 13.3-cm (5 1/4-inch) by 7.6-cm (3-inch) by 5.4-cm (2-1/8-inch) aluminum box. An LMB Tite-Fit chassis #780 works well. The box is

drilled to accept mounting of the controls and type F61 coaxial connectors. The function switch is a DPDT subminiature, requiring a .6-cm (7/32-inch) hole. Holes for the coaxial connectors, the tuning pot, and the ac line grommet are 1-cm (3/8-inch). See Fig. 6.

The unit shown in Photo C was lined with double-clad printed circuit board. This was done in order to

accommodate soldering to ground conveniently. This is a personal construction preference and certainly is not required. At this time, before the hardware is attached, the two-piece box may be covered with contact paper or painted as the builder desires. Small rubber stick-on-type feet are then attached.

Point-to-point wiring using Bakelite terminal strips was used in the unit shown. Follow the schematic in Fig. 4 and no trouble should be encountered.

Antenna Construction

The antenna design is shown in Figs. 7 through 10 and Photos D, E, and F. For the reflector bracket, you will need two 79-cm (30-inch) pieces of 1.27-cm (1/2-inch) aluminum tubing. Bend both ends of the pieces of tubing 90° to make the two U-shaped brackets as shown in Fig. 7. Use an electrician's 1/2-inch EMT conduit bender for this job, bending very slowly, and you will end up with a nice kinkless bend. Now, flatten about 1.9 cm (3/4

inches) of each end of the two U-brackets in a vise and drill a .5-cm (3/16-inch) hole in the center of each of the flattened areas. Bend these flattened ends back at an angle that matches the contour of the outside edge of the back of the reflector.

Next, cut a 14-cm (5 1/2-inch) by 16.5-cm (6 1/2-inch), by .3-cm (1/8-inch) thick piece of aluminum plate. Drill a .5-cm (3/16-inch) hole in each corner and the four .64-cm (1/4-inch) holes for the TV U-clamps. Center this plate on the two U-brackets and mark and drill four .5-cm (3/16-inch) holes in the U-brackets, matching the corner holes in the plate. Attach the plate to the brackets using four #10 bolts, nuts, and lock washers. See Fig. 7.

Now, hold the bracket against the back of the reflector, mark, and drill four .5-cm (3/16-inch) holes in the reflector, matching the holes in the flattened ends of the U-bracket. Attach the bracket to the reflector using four #10 bolts, flat washers, lock washers, and nuts.

The feedhorn is made from a one-pound coffee can measuring 10.2 cm (4 inches) in diameter by 13.7 cm (5-3/8 inches) in length. Drill a 1.3-cm (1/2-inch) hole 5.1 cm (2 inches) from the bottom of the can. Prepare a flange-mount type N or BNC connector (remembering that this is a microwave antenna, and SO-239/PL-259 connectors will not work) by soldering a 2.9-cm (1-1/8-inch) by .5-cm (3/16-inch) piece of copper or brass tubing to the center pin. Solder this connector into the hole previously drilled in the can. Soldering the connector to the can is recommended for both electrical and mechanical integrity. (See Fig. 9.)

Before mounting the feedhorn to the reflector, it

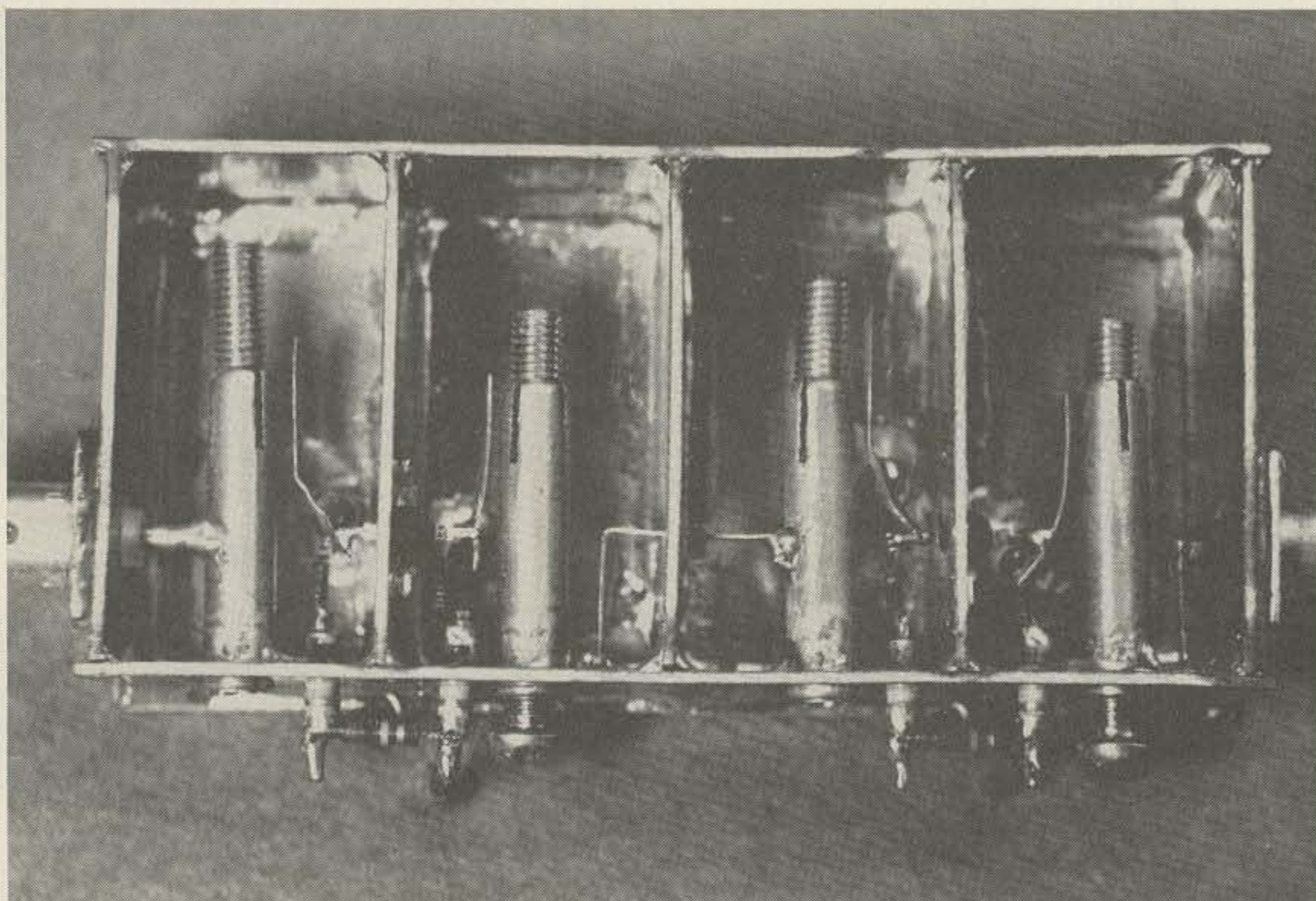

Photo C. Here is a top view of a dual version of the WA9HUV 2304-MHz preamp. This preamp covers the MDS band with no modifications. Note the L-shaped coupling link passing through the center partition.

should be given a thorough paint job inside and out. Don't paint the rf connector, the dipole, or the plastic cover. A good quality, anti-corrosion exterior metal paint should be used.

The feedhorn is held over the focal point with a three-legged support. The legs are made from three pieces of 1-cm (3/8-inch) diameter aluminum tubing 38 cm (15 inches) long. One end of each leg is flattened 1.3 cm (1/2 inch) back, and a .3-cm (1/8-inch) hole is drilled in the center of each flattened area. Drill a .3-cm (1/8-inch) hole in each of the legs 1.27 cm (1/2 inch) from the opposite end and 90° around from the first hole. Bend the flattened ends back to about a 45° angle. See Fig. 8.

In order to attach the supporting legs to the feedhorn, two straps are made of thin aluminum flashing material. Two strips, 2.5 cm (1 inch) wide by 46 cm (18 inches) long are bent and drilled, as shown in Fig. 8. These straps are wrapped around the can and tied together, using three 12.7-cm (5-inch) by 2.5-cm (1-inch) pieces of .16-cm (1/16-inch) aluminum sheet. Six 2.5-cm (1-inch) square pieces of the same material are used as washers, and #8 hardware is used to hold it all together. The supporting legs are then bolted between the reflector and the strap ties, using #8 hardware. See Fig. 10.

All of the hardware used in this antenna should be of the plated type to assure long life; you wouldn't want the thing to fall apart while you're watching something good on the tube.

The open end of the can faces the reflector, and, for proper focus, should end up 28 cm (11 inches) from the surface of the reflector.

All of the dimensions used here are correct for

the 63.5-cm (25 inch) aluminum saucer sled. Some adjustments may have to be made if a different reflector is used.

Care should be taken in choosing a mount for the antenna. The reflector presents a surface area of over .3 square meters (3 1/2 square feet) to the wind. A 61-cm (2-foot) roof tripod fitted with a 3.2-cm (1 1/4-inch) mast should be able to withstand all but the strongest winds. Mount the antenna as low as possible above the tripod, and make sure all bolts and clamps are secure. If possible, mount the antenna in a wind-sheltered location that still has a line-of-sight view of the MDS transmitting antenna.

Final Assembly and Tune-Up

Attach the antenna and downconverter to the mast and set in a tripod as shown in Photo D. Connect a short piece of good coax between the feedhorn and the downconverter. We

have found that Berk-tek brand ultra-flex RG-8X coax fitted with BNC connectors works well for this purpose. The remainder of the cabling uses RG-59/U coaxial cable and TV-type F connectors.

The system can be tuned up with little or no test gear. If you are lucky enough to have a signal generator that covers 2.15 GHz, by all means use it. But, if you are like the rest of us, you will have to get by without it.

The tune-up steps will be to first check out the power supply, tune the oscillator, and peak up the i-f amplifier. This tune-up requires a location that is line-of-sight to the MDS transmitter, easy access to the downconverter and antenna assembly, and a TV set.

Don't attempt tuning up the downconverter on your roof or tower. Play it safe!!

Ensure that the power supply is operating properly by measuring the output voltage. It should be

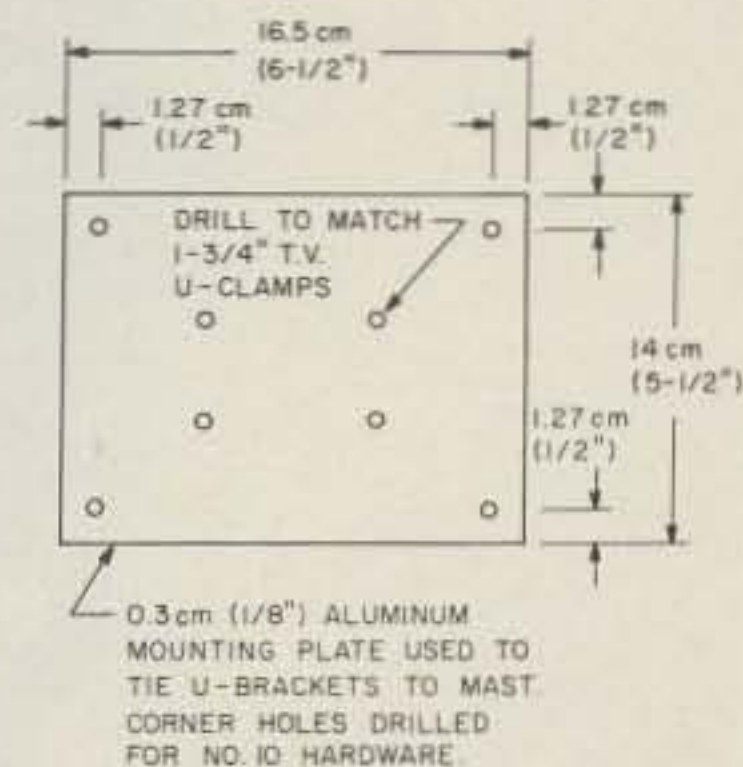
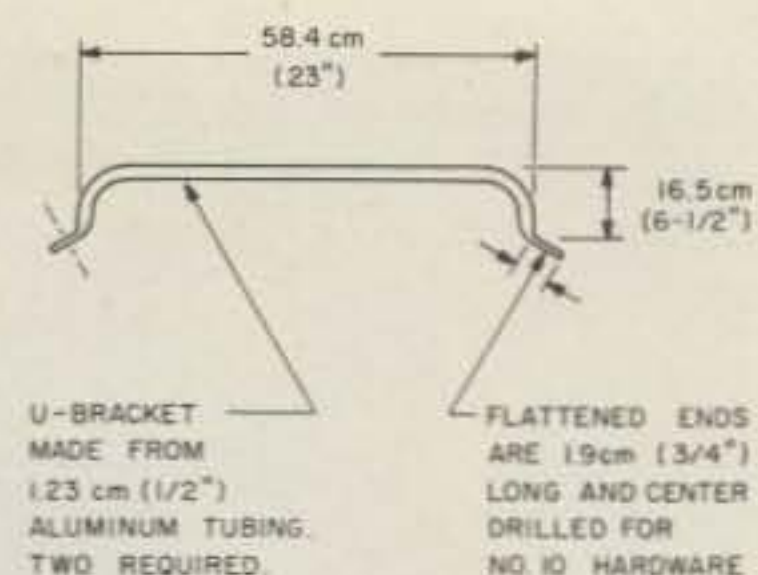

Fig. 7. Construction details of the U-brackets and mounting plate.

adjustable from 12 to 17 volts by varying the tuning pot, R2. This check should be done before applying power to the downconverter.

I-f Amplifier Tuning

Tuning the i-f amplifier is

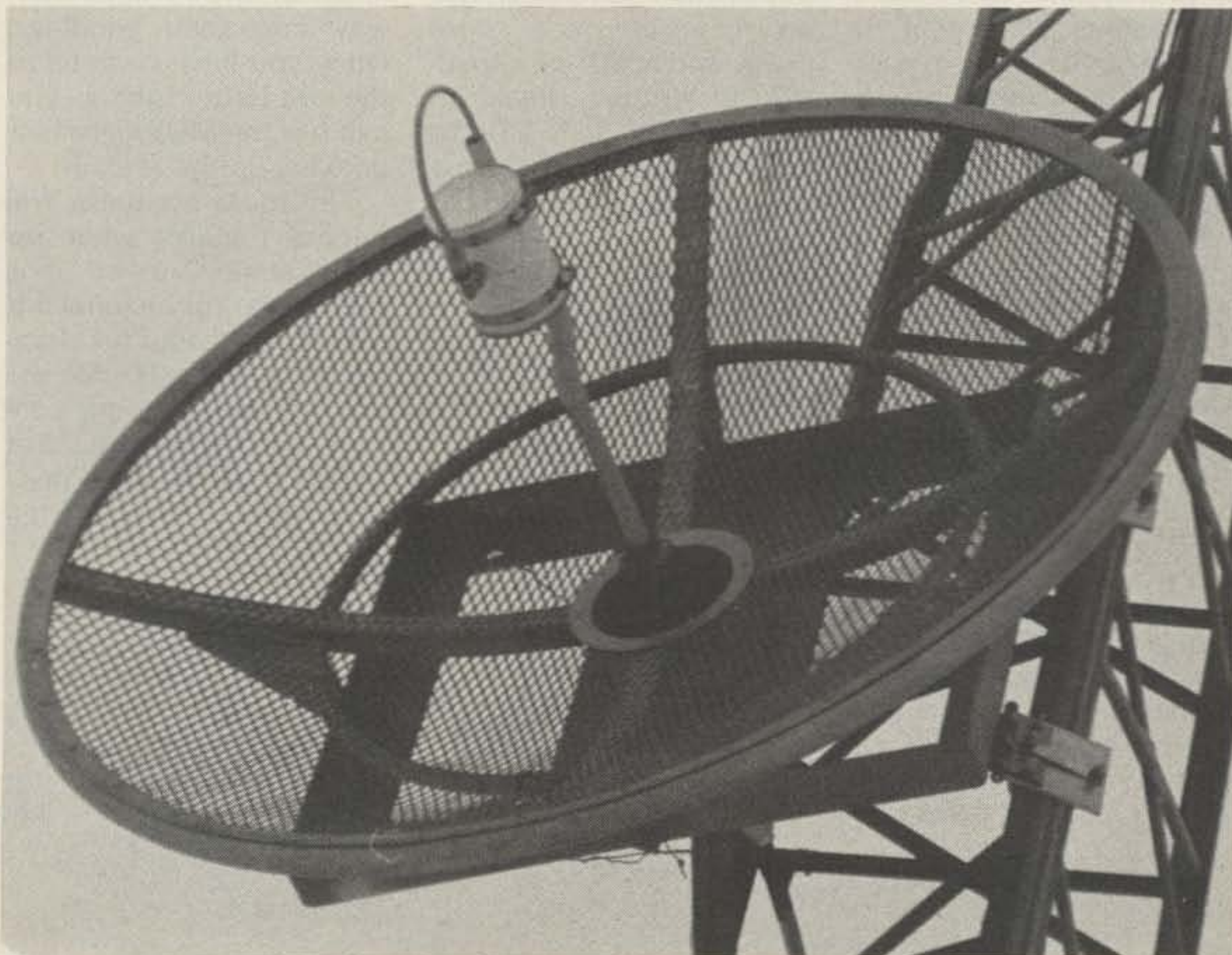

Photo H. This is a 122-cm (4-foot) commercial dish using a WA9HUV coffee can feedhorn. This antenna is used for MDS reception in a marginal signal location.



Photo 1. This is a 74-cm (29-inch) commercial reflector using a WA9HUV coffee can feedhorn. Located 4.5 meters (15 feet) high, this antenna pulls in snowfree color MDS TV signals over a distance of 32 kilometers (20 miles).

quite simple. First, you must choose which TV channel you will be using in your system. This should be channel 2, 3, or 4. It should not be in use in your area. Inject a signal into L5 from a signal generator or a grid-dip meter. The signal frequency should be 57

MHz for channel 2, 63 MHz for channel 3, or 69 MHz for channel 4. On the output of the i-f amplifier, use an rf probe or a series diode and a .001- μ F capacitor to ground. Peak all coils (L5, L6, L7, L8) for maximum voltage across the .001- μ F capacitor.

If you do not have a signal source at the i-f frequency, then set the slugs in all of the i-f coils halfway into their windings. Once you have completed the oscillator tuning, you can use the MDS signal for peaking up the i-f coils.

The local oscillator frequency required when using channel 2 as an i-f is 1105 MHz, for channel 3 it is 1108 MHz, and for channel 4 it's 1111 MHz. Set the power supply tuning control to midrange. Set switch S1 to the MDS position. Using an insulated

tuning wand, adjust C1 to the proper frequency. If you have a frequency counter or spectrum analyzer that covers the LO frequency, use them. We have found, however, that using an off-the-air signal and adjusting for a good TV picture is the fastest and most sure way to accomplish this.

While tuning C1, you will probably see all sorts of strange patterns on your TV screen along with two or more settings that produce a standard TV picture. The tuning range of the LO is enough so that both the signal that we want and its image can be tuned in. Tune C1 to the higher of the two, which is the setting when the plates of C1 are the least meshed. The tuning control in the power supply can now be used for fine tuning. In the event that C1 shows no effect, you can test the oscillator for activity by using the signal sniffer shown in Fig. 11.

Preamps

There undoubtedly will be some locations that will have marginal signals. If, after having built the system, you find that your signal is snowy, you may wish to improve it with a preamp. There have been several good articles about 2304 preamps in the ham publications in recent years. The one that appears easiest to build is in the July, 1974, *Ham Radio*, by WA9HUV.¹⁵

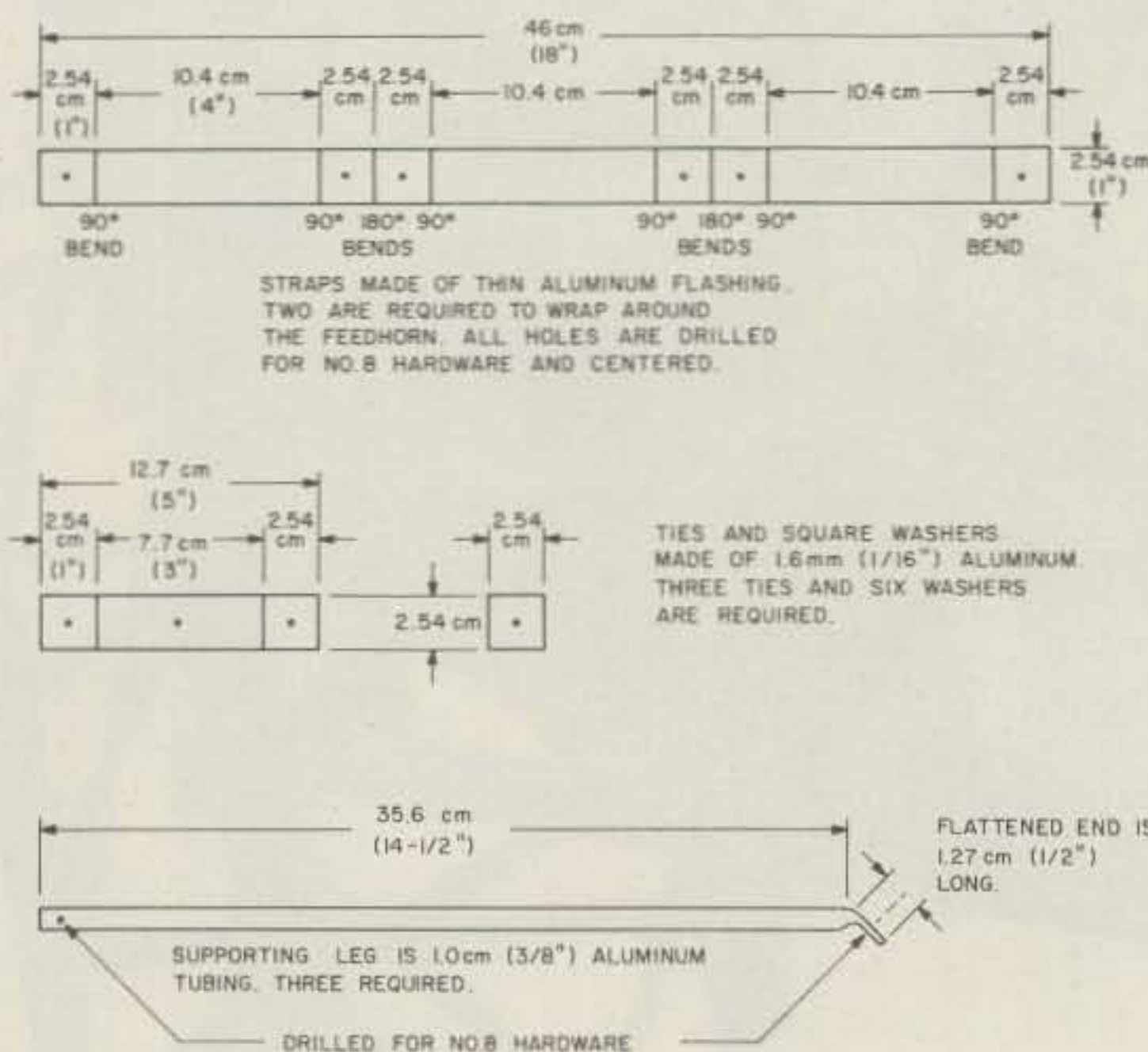

Fig. 8. Construction details of the feedhorn mounting straps, strap ties, and support legs.

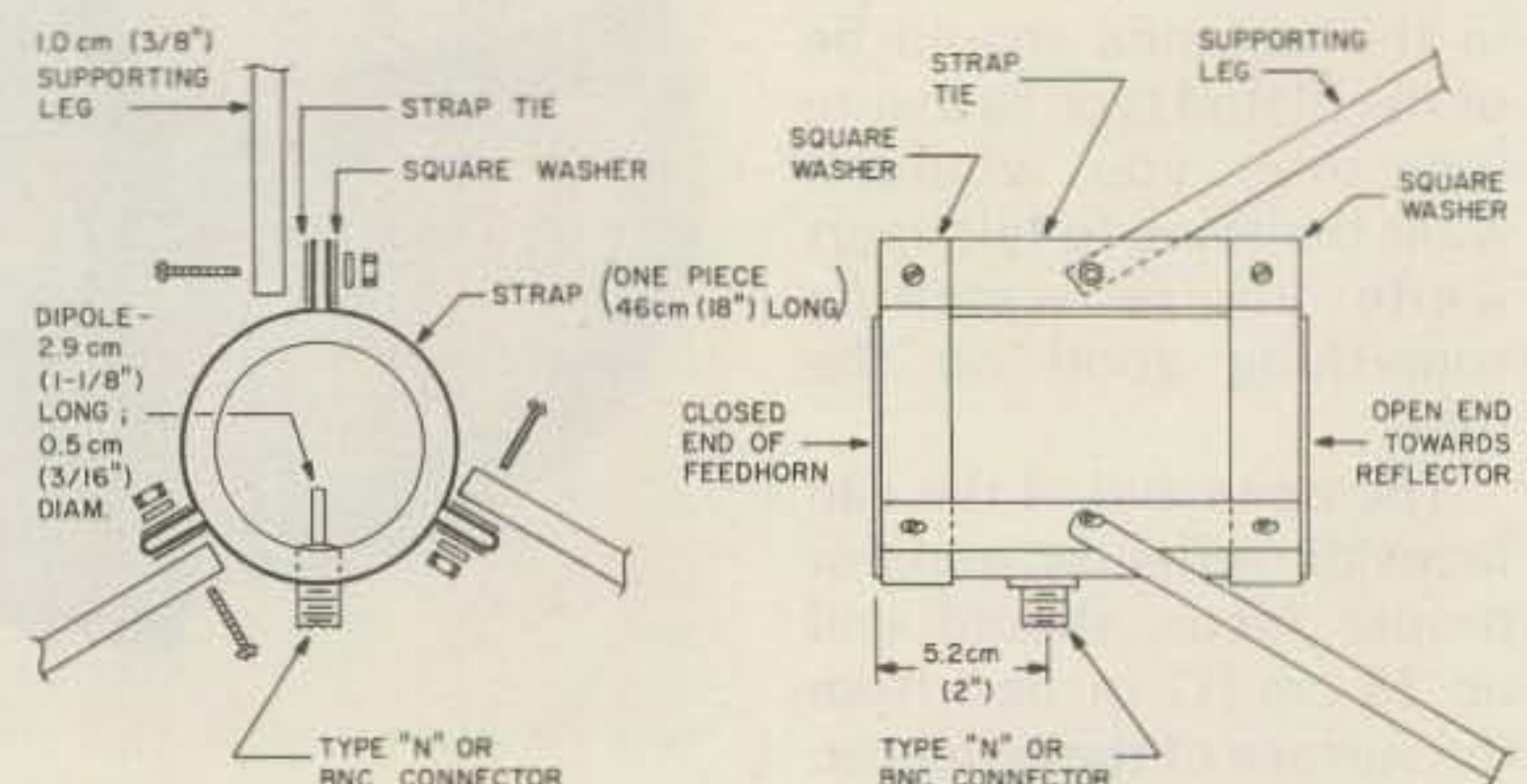

Fig. 9. Feedhorn mounting details.

You will find that most of the transistors the article recommends run from \$17.50 to \$70.00 each. As you can see, this could get expensive, especially if you need two or three preamps in series for more gain. What we have done is change the transistor to a MRF901, which costs \$1.44. This device has less than a 3-dB noise figure at 2 GHz, but only about 6 dB of gain. Now, 6 dB of gain when you have a snowy picture does not help much. For a location that is marginal, we have built two of these preamps in the same box. That gives about 12 dB of gain and also eliminates the need for two connectors. At this frequency, too many connectors in the line can add a lot of loss and is expensive. I am sure it would be possible to build more stages into one box if needed, but we have not yet tried this. We have had up to three of these double preamps together with short cables. This worked well and gave a lot of gain.

We built most of our preamps using double-sided printed circuit board. This is faster and much easier than brass. Be sure to solder together intersecting edges on the inside where possible. At this frequency, a good rf-tight box is desirable. WA9HUV's article gives two possible circuits depending on what kind of transistor is used. When using a MRF901, use the circuit on page 8 of the article, which is labeled

Fig. 1. We show the method of coupling two stages together in Photo G here.

The preamp should be mounted as close to the feedhorn as possible, and it also will need to be enclosed in a weatherproof box. Power tapped from the downconverter can be used to power as many preamps as are found to be necessary.

Conclusion

In this article we have shown you details for building a cheap and easily-reproducible MDS receive system. Most of the circuits and ideas have been gleaned from previous construction articles and manufacturers' applications notes, so no originality is claimed. Although the system as described performs very well, if you find that you can make any significant improvements to the systems, we certainly would be interested in hearing of them.

Since the original design of the system, printed circuit boards have been laid out and are now being made. These boards, along with some of the harder-to-find components and complete antennas, are available from the authors. Send an SASE for details. ■

Acknowledgements

We would like to thank John Fox W0LER and Ernie Simon W9JCE for the help and encouragement they gave in completing this project.

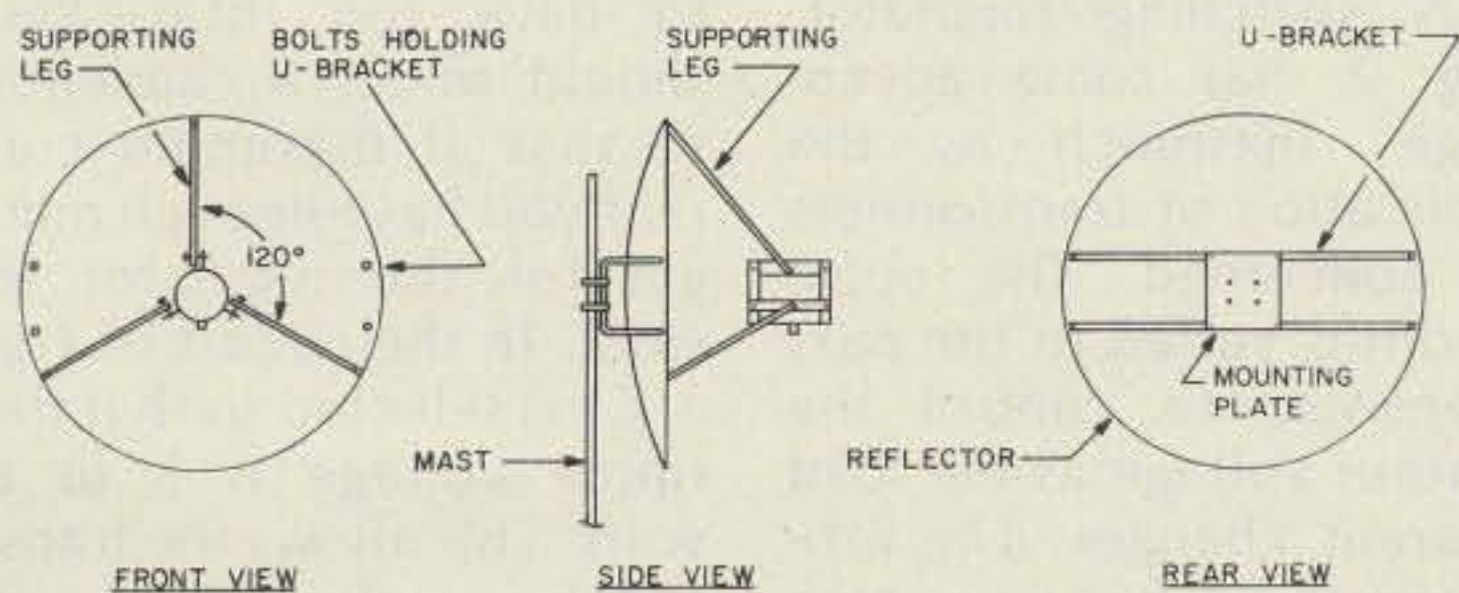

Fig. 10. Final construction of saucer sled antenna. The open end of the feedhorn should end up 28 cm (11 inches) from the surface of the reflector for proper focus.



Photo J. Here are snow saucers before modifications. Shown are the steel 69-cm (27-inch) model made by Flexible Flyer and the 64-cm (25-inch) aluminum Sno Coaster made by Mirro. Remove the handles before using as a reflector.

References

1. "MDS: What Is It?", James Edwards, 73, November, 1978.
2. *A Vidiot's Guide to Microwave TV*, H. Paul Shuch, Chief Engineer, Micro Comm, 14908 Sandy Lane, San Jose CA 95124. (Send Paul an SASE and \$1.00.)
3. "Interdigital Converters for 1296 and 2304 MHz," R. E. Fisher WA2CQH, QST, January, 1974.
4. "High-Performance Balanced Mixer for 2304 MHz," Paul Wade WA2ZZF, Ham Radio, October, 1975.
5. "Solid-State 2304-MHz Converter," Walter Stanton K2JNG; Douglas Moser WA2LTM; Dolph Vilardi WA2VTR, Ham Radio, March, 1972.
6. "Twin-Diode Mixer," Jim Dietrich WA0RDX, Ham Radio, October, 1978.
7. "Finding the Focal Length of Surplus Microwave Dish Antennas," John Franke WA4WDL, Ham Radio, March, 1974.
8. "1220 MHz—Use It or Lose It!", Bill Hoisington K1CLL, 73, March, 1978.
9. "Down Converter Receives Satellite Video," Percy Rouse, Jr., Microwaves, November, 1978.
10. "Improved Grounding for the 1296-MHz Microstrip Filter," H. Paul Shuch N6TX, Ham Radio, August, 1978.
11. "Clean Local Oscillator Chain for 1296," Paul Wade WA2ZZF, Ham Radio, October, 1978.

12. "A Twelve-Foot Stressed Parabolic Dish," Dick Knadle K2RIW, QST, August, 1972.
13. "Cylindrical Feed Horn for Parabolic Reflectors," Norman Foot WA9HUV, Ham Radio, May, 1976.
14. *RSGB VHF-UHF Manual*, Third Edition, D. S. Evans G3RPE, G. R. Jessop G6JP.
15. "Narrow-Band Solid-State 2304-MHz Preamplifiers," Norman Foot WA9HUV, Ham Radio, July, 1974.
16. "Parabolic Reflector Gain," Walter Pfiester, Jr. W2TQK, Ham Radio, July, 1975.

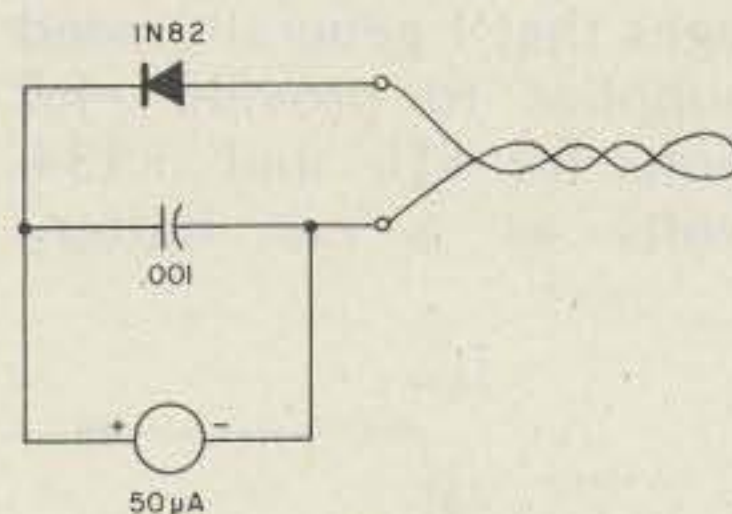

Fig. 11. A piece of test equipment called a signal sniffer. It can be used to tell if the oscillator is working. The meter movement should be a good quality 50- μ A movement. The diode is a 1N82 or other high-frequency diode, and the pickup loop is about twelve inches of #22 hookup wire twisted together with a one-inch loop at the end. This sniffer works to 2 GHz or more.

Simple Dual-Voltage Supply

— power for many projects

A welcome addition to any shack.

E. E. Buffington W4VGZ
2736 Woodbury Drive
Burlington NC 27215

Why doesn't someone tell parts distributors and transformer manufacturers that *nobody* designs tube circuits anymore, let alone *builds* them. Catalog pages are full of filament transformers and they are being bought because nothing else is available. Manufacturers seem to be rushing to resupply this so-called great demand.

There are two dc voltages that I generally need supplies to provide: +5 volts for TTL and +13.6 volts as a car battery

eliminator. A 12.6 V ac filament transformer will not work well for these dc voltages. Those of you who have tried were frustrated, I'm sure, by the attempt.

Take the +5-volt supply, for instance. Okay, full-wave rectification with the c-t grounded will yield a peak dc on the filter capacitor of $(6.3 \times 1.414) - 0.5 = 8.4$ volts. Now, an LM309K needs +7 volts to regulate (a 2-volt regulator margin). This means that the maximum ripple is 1.4 volts. Let's say you need 1 Amp from this supply and you chose a 1- or 2-Amp transformer. Now, to get the ripple to less than 1.4 volts, you start to pile on the capacitance and the

full-load ripple comes down. Then as you add more capacitance, the ripple goes up! What is going on here? As you add more capacitance, the phase angle over which you draw current decreases. This means that you are not continuously drawing 1 Amp from the transformer, but, instead, you are drawing many Amps over a short time to yield a continuous load current of 1 Amp. Transformer core saturation and winding resistance drops are causing the problem. The truth is that this transformer will not work except for small currents. The +13.6-volt supply using a bridge rectifier will yield the same picture—not enough margin for the regulator to operate. The next highest filament transformer is 24 volts—too much voltage and too much power to be thrown away via the heat sink.

A switching regulator, Fig. 2, has some advantages inasmuch as the utilization of transformers is concerned. The pulse width is varied to the pass transistor to control the output voltage as the load current changes. The efficiency can be very high with this configuration. The disadvantages are formidable. Switching tran-

sients clutter up the spectrum so that much shielding and filtering is necessary. Transient load changes may generate output voltage variations amounting to ± 20 percent or more. As you might gather, I don't recommend this circuit for the ham shack.

What we *really* need in a transformer is 18 V c-t. This voltage is perfect for both the +5-volt and +13.6-volt supplies. Few distributors stock them so you really have to look around. Fig. 1 shows a couple of ways to connect filament transformers to furnish the required voltage.

Fig. 3 shows a really great supply that uses easy-to-get parts. I have included the Radio Shack part numbers for your convenience.

Now, a word about the filter capacitor. It is as important not to have too much capacitance as it is to have too little. You should select a capacitor so that at maximum current you have enough margin for the regulator to work. In the circuit of Fig. 3, C1 is selected so that the ripple voltage is 5 or 6 volts. This allows the transformer to furnish the 3 Amperes of output current over a much wider phase angle. I have used the for-

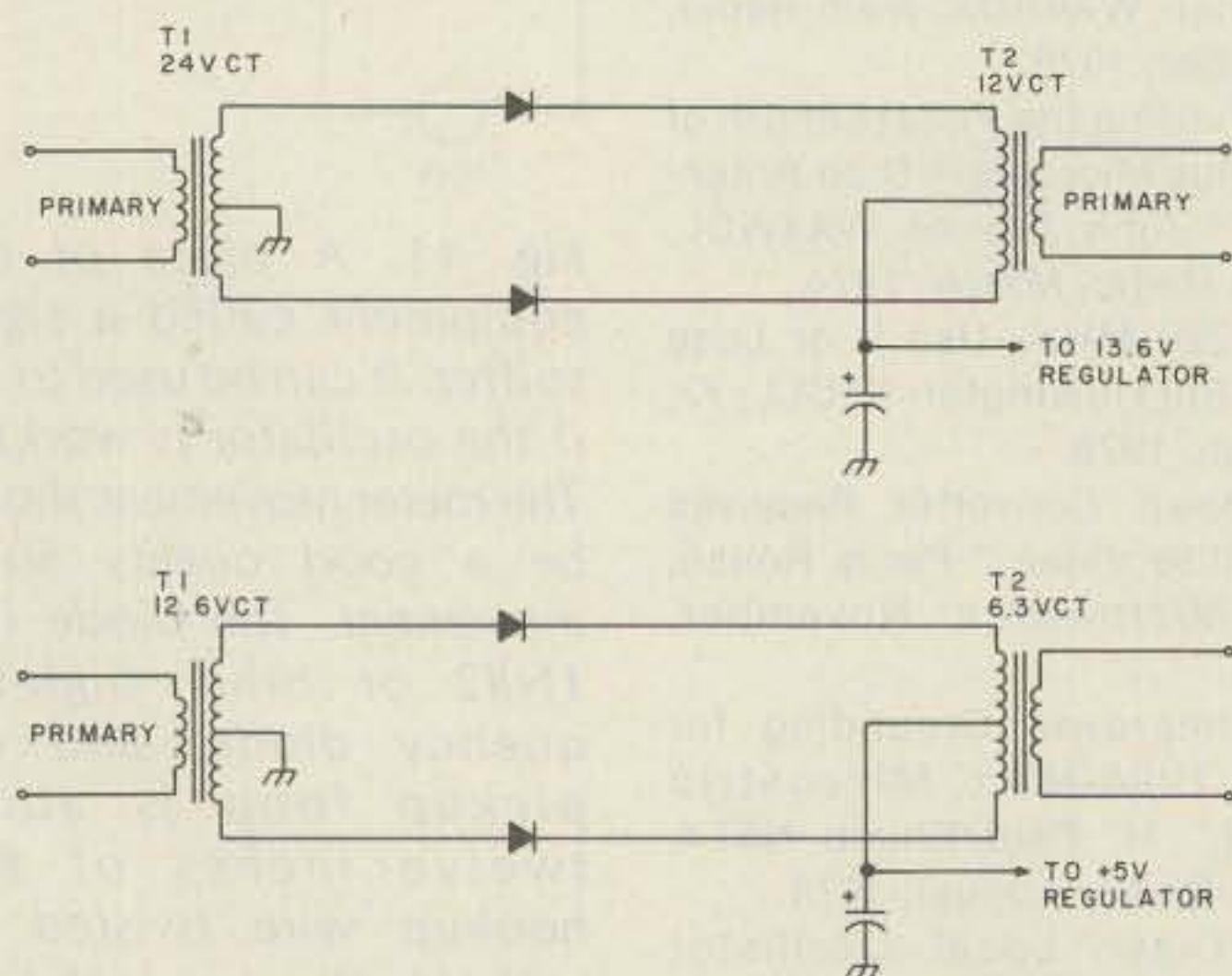

Fig. 1. Filament transformers connected to yield the required input voltages to the regulator.

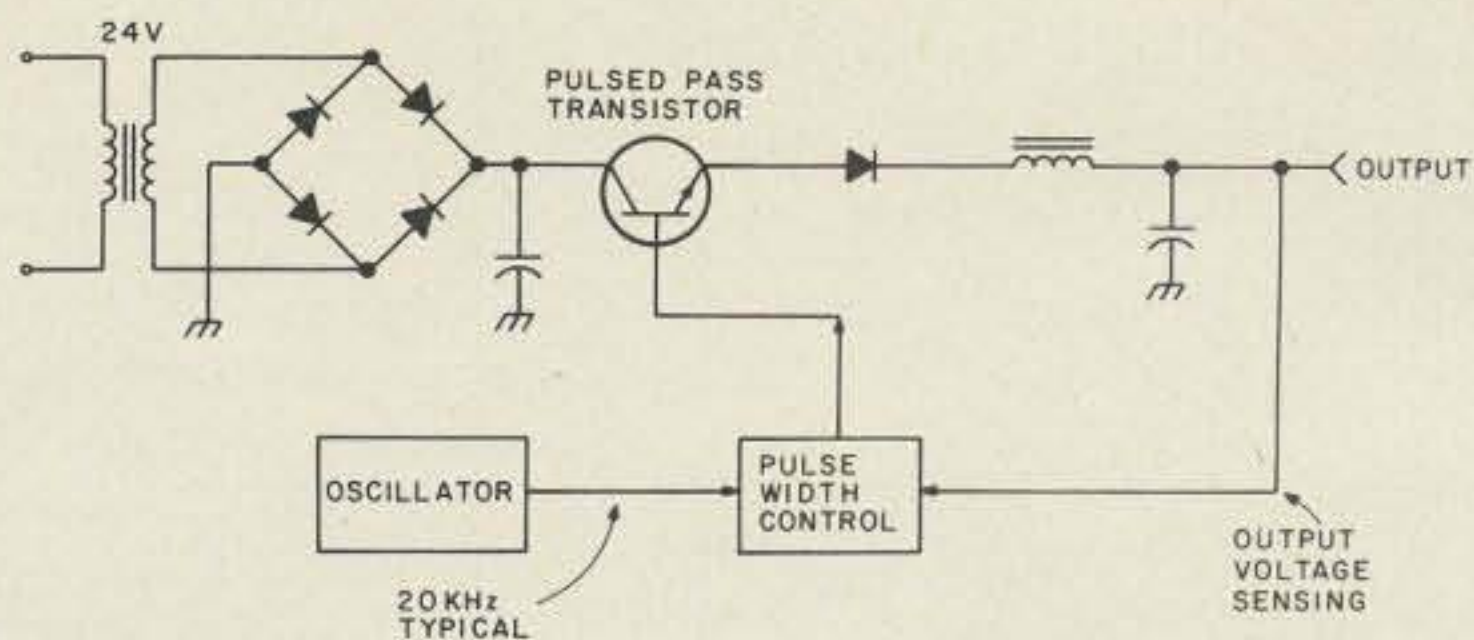
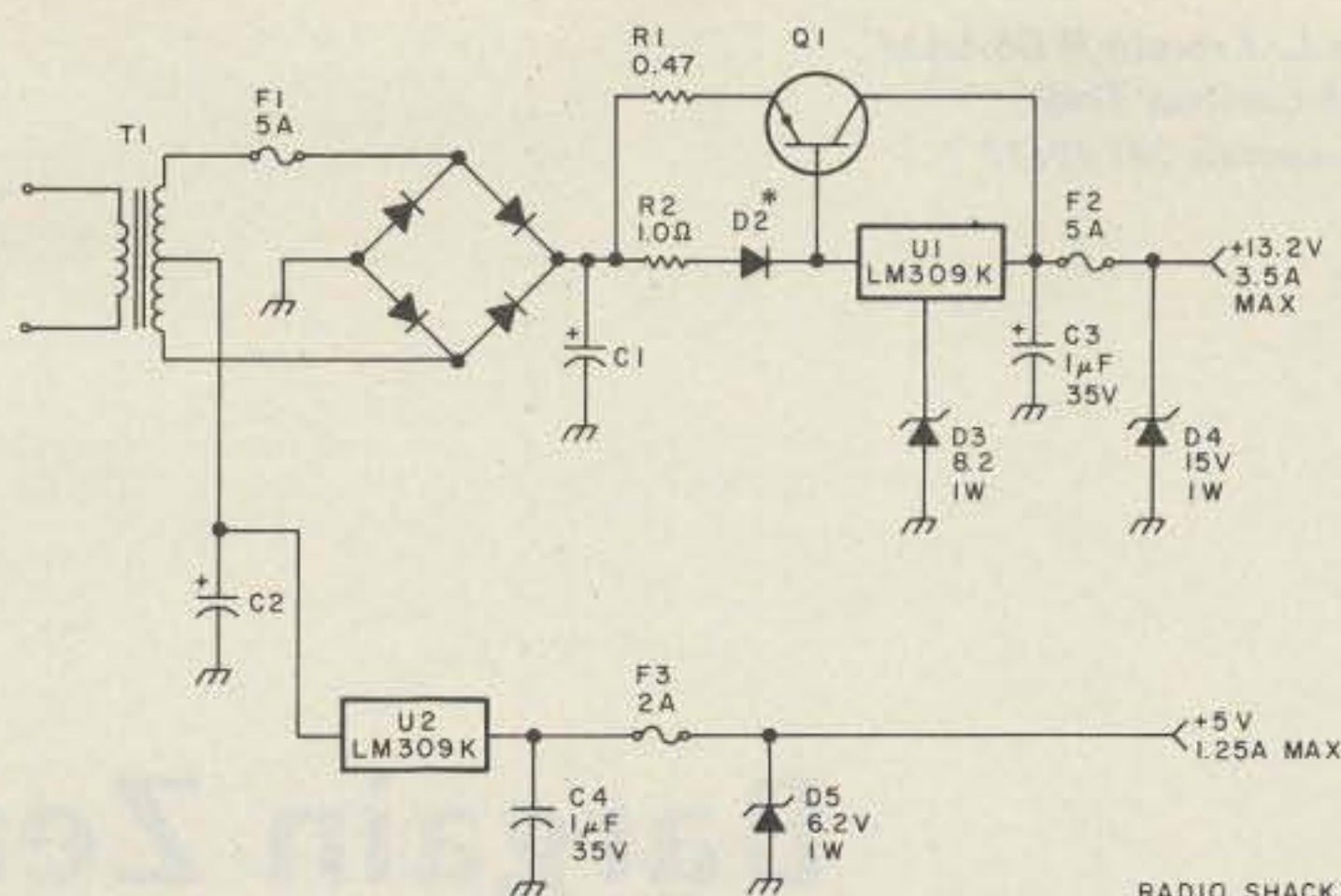

Fig. 2. Switching regulator showing basic functional blocks.

mula $E = I/120C$ with good results. E is the peak-to-peak ripple voltage, I , the dc current in Amperes, and C , the filter capacitor in farads. This formula is not exact but should be quite close for most applications.

Resistors $R1$ and $R2$ in the circuit of Fig. 3 cause the current to divide between the regulator and the pass transistor. For three Amperes at the load, two will flow through the pass transistor and one through the LM309K. If you use a germanium pass

transistor, you can omit $D2$, as $D2$ compensates for the base-to-emitter junction voltage drop of the pass transistor. Zener diodes $D4$ and $D5$ form an overvoltage protection that will blow the output fuse in case of a regulator failure. If you don't put in this protection, you'll be sorry! An insulating washer is needed for $U1$ as the case is above ground by the drop across $D3$. The case of $U2$ can be bolted to ground. Use a common heat sink having a thermal resistance to ambient of



PART	DESCRIPTION	RADIO SHACK NUMBER
T1	18VCT 4A	273-1514
D1	BRIDGE 6A	276-1180
R1	0.47Ω 5W	271-130
R2	1.0Ω 10W	271-131
C1	5000μF 35V	272-1022
C2	2200μF 35V	272-1020
D2	50V 3A	276-1141
C3, C4	1μF 35V	272-1406
U1, U2	LM309K	
Q1	PNP, 5A OR	RS 2006 (GE) RS 2043 (SIL)

Fig. 3. Power supply using easy-to-find parts.

less than one degree per Watt. The addition of panel meters to monitor the current would be a nice improvement. The fuses would not be expected to blow as the power supply is protected against short-circuiting

and overload. Of course, you can't load both regulators to their full capacity at the same time, as this would overload the transformer.

This power supply should be a welcome addition to any ham shack. ■

THE BIG SIGNAL
UNADILLA U9
"W2AU" Baluns

Still Only \$14.95

DEMANDED BY PROFESSIONALS WORLD-WIDE OVER 12 YEARS

• The Original Lightning Arrest
• 650# Strength
• Stainless Hardware
• Sealed
• GUARANTEED

ASSISTANCE? Call: HUGH GUNNISON, WA2ZOT
Toll-Free 800-448-1666
[NYS Collect 315-437-3953]



FOR HIGHEST ANTENNA EFFICIENCY

1:1 OR 4:1
2,000 W
PEP

FULL-POWER, QUALITY HAM ANTENNA PARTS AT YOUR DEALER

- BALUNS · TRAPS · INSULATORS
- QUAD PARTS · ANTENNA KITS
- BOOM/MAST MOUNTS · WIRE
- CABLE · CONNECTORS

WRITE FOR FULL CATALOG [Enclose 30c Stamps]

ICROWAVE FILTER COMPANY, INC. UNADILLA/REYCO DIVISION [Dept. 73]
6743 KINNE STREET, EAST SYRACUSE, NEW YORK 13057

DEALERS WANTED - OVER 300 WORLD-WIDE

NEW! 5-Band Trap Dipole (80 thru 10Meters)



Pre-assembled: Model 370-11

Power rated 2kW PEP, approx. 110-ft span

Complete with • wire • traps • end insulators • 50 ft RG-8/U, PL-259 connector • heavy duty cast aluminum and steatite center connector.

At your B23 4-Band (40 thru 10M), B&W dealer. 55 ft model 370-13 also available, pre-assembled only.



Made in Bristol, Pennsylvania, by
Barker & Williamson Inc.
10 Canal Street □ Bristol, PA 19007



CENTRAL NEW YORK'S FASTEST GROWING HAM DEALER



DRAKE TR7-DR7



YAESU FT225RD



YAESU CPU-2500RK



ICOM IC-701



YAESU FT-901DM

Featuring Yaesu, Icom, Drake, Atlas, Ten-Tec, Swan, Dentron, Pace, Palomar, Alda, Midland, Wilson, KDK, MFJ, Microwave Module, Standard, Tempo, Astron, KLM, Hy-Gain, Mosley, Larsen, Cushcraft, Hustler, Mini Products, Universal and Tristao Towers. We service everything we sell! Write or call for quote. You Won't be Disappointed. We are just a few minutes off the NYS Thruway (I-90) Exit 32

CALL TOLL-FREE ONEIDA COUNTY AIRPORT TERMINAL BUILDING
1-800-448-7914
NY STATE RESIDENTS CALL 315-337-2622 or 315-337-0203

Bob Warren
WA2MSH K2IXN

Bargain Zener Classifier

— Novice project

Enjoy.

Some time ago, I was building a low-voltage power supply which used a zener diode to regulate the base current of the regula-

tor power transistor and found I didn't have the proper zener in my junk box. Checking my local parts store, I found that a

single zener of the voltage I needed was about twice as expensive as a package of 20 miscellaneous zeners I had seen at my local

Radio Shack store. As always, my frugal nature suggested I get the most for my money, so I built a simple circuit, which I am going to pass along, that enabled me to check the zener voltage of each diode.

Simplicity

The circuit is as simple as they come. Follow Fig. 1 and the photographs and you should have no problem building a useful gadget which comes in very handy almost 90% of the time you build a new project. Looking at the schematic, you'll notice the power transformer is very important as it isolates the circuit from the ac line for safety. Next, the diode rectifies the ac into pulsating dc. The following 120k resistor drops the voltage to the potentiometer. The electrolytic capacitor smoothes out the dc ripple to provide a dc voltage of about 30 volts to the alligator clips. (It's the next thing to an instant project.)

Using the Tester

Place the cathode (the

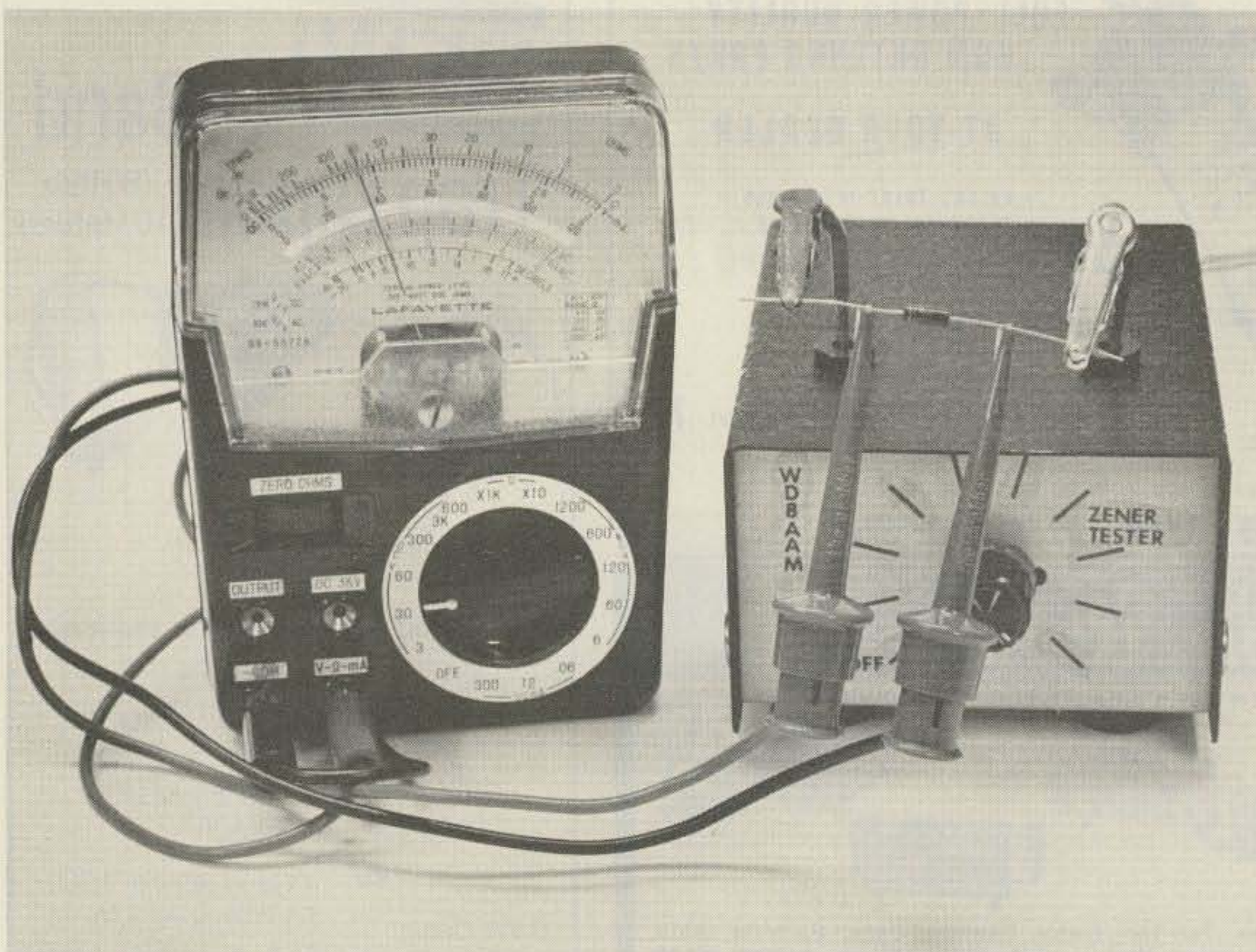

Unit with a zener diode being tested and showing proper hookup to the VOM. Note that the VOM is indicating 8.6 volts even though the tester voltage output is 28 volts. Don't forget to set the VOM to measure dc voltage. It doesn't show up very well in the photo, but I used red wire for the plus alligator clip and black for the negative. These wires were then inserted into 2 phone tip jacks on the top of the case.

end with the band) of the zener that you wish to classify in the plus voltage alligator clip, connect the VOM, as shown in the photograph, run the voltage up until the VOM needle stops, and that's the zener regulating, or breakdown, voltage. If you connect the zener backwards in the circuit, you should get very little, if any, indication on the VOM meter because the diode is conducting and presents a short circuit to the tester. This circuit passes very little current through the zener under test, so you shouldn't have any problems with zener burnouts.

If, after classifying all your diodes, you still don't

have the correct value, try putting two or three of them in series. When I built my power supply, I needed a 12-volt to 13-volt zener. I put an 8.2-volt and a 4.3-volt zener together in series to obtain 12.5 volts and, because of this, I could also tap at the junction of the zeners to obtain a regulated 8.2 volts.

You'll find that regular diodes and transistors have a zener action as well. Although voltage values will be random and current capabilities small, they can often be used in place of a regular zener diode. When the transistor is bad anyway, it beats throwing it away.

You'll notice all parts

have a wide tolerance, so you can use any of the old

parts you may have in your junk box. Enjoy yourself. ■

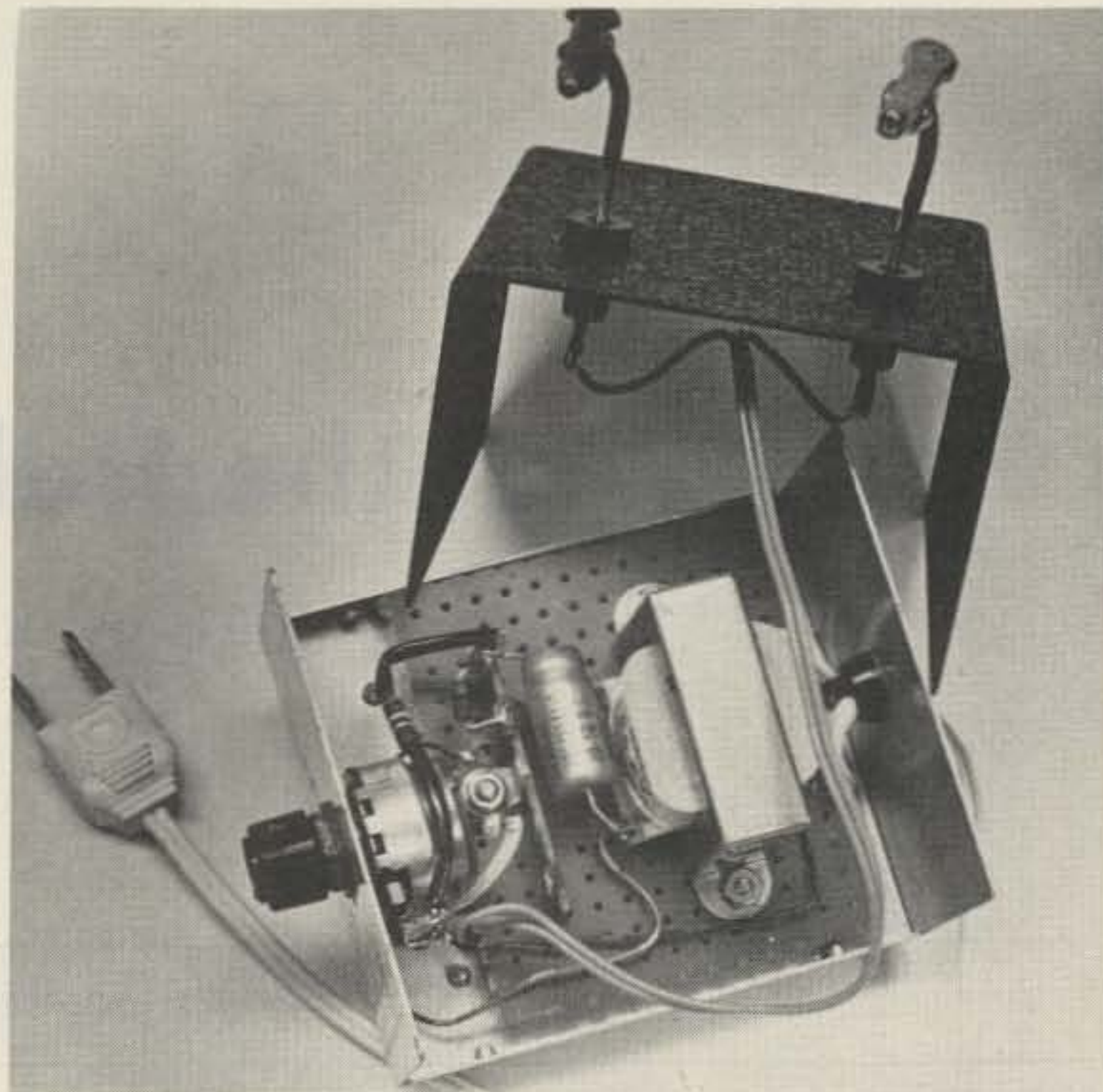

Interior view. All the parts came from my junk box with the exception of the case and power transformer which are Radio Shack stock items. A small piece of perfboard was used to mount the parts, and spacers were used to lift the perfboard off the metal chassis.

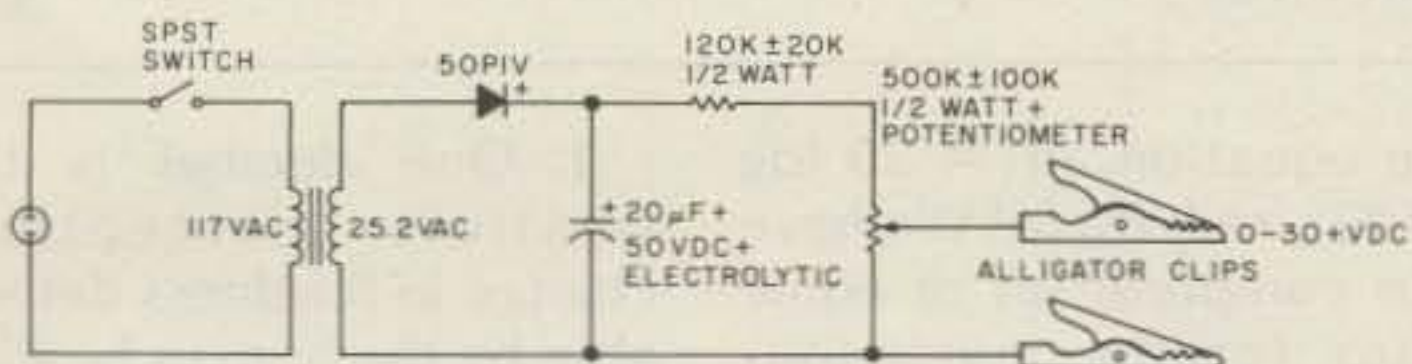
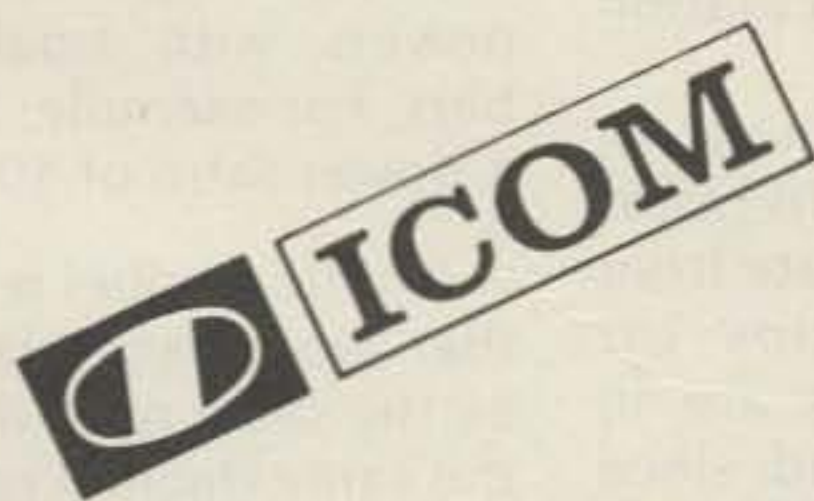

Fig. 1. Zener tester.

KENWOOD

DENTRON



CALL NOW FOR
SPECIAL PRICES



ORDER TOLL FREE!

G.I.S.M.O. 800-845-6183

IN S.C. DIAL 803/366-7157



**2305 CHERRY ROAD
ROCK HILL, S.C. 29730**

73,

**THE
GISMO
GANG**

803-366-7157 EXIT 66-B OFF I-77

YAESU

ALPHA

What the Hell is a Decibel?

— 1/10 of a bel, of course

Rationalizing the ratio.

I have always had a difficult time dealing with decibels. It is important to remember what a decibel is and what it isn't. First, the decibel (dB) is, itself, not a measure of anything. It is not a unit like a volt or an Ampere. Hams often have a problem with this. It is not a measure of the loudness of anything, nor is it the measure of the power in any signal.

The decibel is a ratio—that's all. It is ten times the base 10 logarithm of the ratio of two power levels.

So a decibel only has meaning with reference to some other power. For example, 100 Watts bears the same ratio to 10 Watts as 10 Watts bears to 1 Watt. The ratio in each case is 10 to 1. Any two power levels having the ratio of 10 to 1 would have the same number of dBs relating them.

The basic unit is the bel. The bel is defined as: $n = \log (P1/P2)$, where P1 and P2 are the two power levels being compared and the base 10 logarithm is used.

The decibel is 1/10 of a bel, so there are 10 dB per bel, and: $m = 10 \log (P1/P2)$. You already know the equations for power: $P = IE$, $P = E^2/R$, and $P = I^2R$, where I and E are the current through and the voltage across the resistance, R.

Now, with a little fancy footwork and algebraic substitution, we can come up with the following: $m = 10 \log (E1^2/R1)/(E2^2/R2)$, which can be further reduced to: $m = 10 \log (E1^2/E2^2)$, if and only if $R1 = R2$. Further reduction yields: $m = 20 \log (E1/E2)$.

Using a similar process, we can derive the follow-

ing equation: $m = 20 \log (I1/I2)$, and, tra-la! We have our complete set of equations for the mysterious decibel. The important thing to remember is that for the two equations involving voltage and current, the resistance that the voltage is across or that the current flows through must be identical for the two values to be compared. Otherwise the calculation is invalid.

Don't try to think in terms of a set of dB ratios for power as separate from a set of dB ratios for voltage. All ratios are in terms of power, and, since you already know that the power goes as the voltage (or the current) squared, you can deal with either quantity.

Table 1 lists working voltage (also current) and power ratios for various dB ratios. Note that the voltage-ratio numbers are simply the square roots of the power-ratio numbers.

The decibel is used for any one of three reasons depending upon which reference book you believe. I've added a fourth reason.

1. One decibel is the smallest perceptible change in loudness detectable by the human hearing system. The human ear is a logarithmic device and the decibel is a logarithmic number, so there is a better correspondence between the perceived loudness ratio and the decibel.

2. The decibel is used to express large ratios of powers with small numbers. For example, 30 dB is a power ratio of 1000.

3. The decibel is used so that any change in power by the same ratio will have the same decibel ratio. For example, a change from 1 to 2 Watts is a 3 dB change, as is a change of from 1000 to 2000 Watts. The effect on communications of these changes in levels will be the same.

4. The decibel is used to confuse radio amateurs.

OK, where are these dastardly decibels foisted on an unsuspecting amateur radio operator? Probably the most common use of the decibel in amateur radio is in relation to your receiver S-meter. The

Voltage (Current) Ratio	Power Ratio	dB
.32	.1	-10
.45	.2	-7
.50	.25	-6
.71	.50	-3
.89	.79	-1
1.00	1.00	0
1.12	1.26	1
1.41	2.00	3
2.00	4.00	6
2.24	5.00	7
3.16	10.00	10
4.47	20.00	13
7.07	50.00	17
10.00	100.00	20
14.14	200.00	23
22.36	500.00	27
31.62	1000.00	30

Table 1.

S-meter is usually calibrated in S-units from zero through nine and then in dB above S-9. S-9 is supposed to correspond to a signal level at the receiver antenna terminals of 50 microvolts (although it rarely does). Each S-unit corresponds to 6 dB, so S-8 is 50 microvolts minus 6 dB. Refer to Table 1 or do the following calculation: $-6 = 20 \log(E1/50 \mu V)$, $E1 = (50 \times 10^{-6}) 10^{-6/20}$.

This reveals that the signal level at the antenna terminals is now 25 microvolts. The calculation above is valid because the antenna input impedance of the receiver does not change. The denominator of the ratio is always the reference amplitude. So, every S-unit down corresponds to about one-half of the voltage at the antenna terminals of the S-unit above it.

Likewise, if the meter reads 10 dB above S-9, the voltage at the antenna terminals is 10 dB higher than 50 microvolts. $10 = 20 \log(E1/50 \mu V)$; $E1 = (50 \times 10^{-6}) 10^{10/20}$.

This corresponds to a received signal of 158.1 microvolts. The unfortunate fact is that most receivers don't have S-meter readings which are significant in any absolute sense—about all you can tell is which signal is stronger at your QTH.

Another common use of the decibel is in the measurement of antenna gain. The important thing to note here is what kind of antenna is used as a reference. Remember that the decibel is only a ratio and that the goodness of an antenna as measured in decibels is only a goodness relative to some other type of antenna. The two most common reference antennas are the isotropic antenna and the dipole antenna. The isotropic antenna is a theoretical model of an

antenna which radiates equally well in all directions. Dipoles are, of course, real antennas that have a radiation pattern which is not everywhere identical.

When talking about the gain of an antenna, we are talking about the increased power radiated in its direction of maximum radiation compared to the power radiated in the direction of maximum radiation for the reference antenna. Obviously no additional power is "generated" by the antenna. What the antenna does is tend to concentrate the available power in one direction at the expense of all other directions.

If the gain of an antenna is given in dB over isotropic and you want to know the gain of the antenna relative to a dipole, subtract 2.1 dB from the figure. Similarly, if you have the gain of an antenna over a dipole and you want to know the gain of the antenna over an isotropic antenna, add 2.1 dB. This follows from the fact that the gain of a dipole antenna over an isotropic antenna is 2.1 dB.

It is important to know that decibels can be added or subtracted as the gain of the system is increased or decreased. For example, say your transmitter puts out 1 Watt and that an amplifier boosts it to 10 Watts—that's a gain of 10 dB. Now, suppose you have another amplifier that boosts the signal to 500 Watts—that's 17 dB additional. So the total gain of the amplifiers is $10 \text{ dB} + 17 \text{ dB} = 27 \text{ dB}$.

Now, suppose you have an antenna with a gain of 12 dB over isotropic and you trade it in for an antenna with a gain of 18 dB over isotropic. You've bought yourself $18 \text{ dB} - 12 \text{ dB} = 6 \text{ dB}$ gain.

Another antenna-related use of decibels relates to

coaxial feed cable. You may be surprised to learn that the loss in RG-58/U coax is 6 dB per 100 feet at 150 MHz, and the loss in RG-8/U coax is less than 2.5 dB per 100 feet at 150 MHz. This means that if you're using a 10-Watt transmitter through 100 feet of RG-58/U, and you're operating on 150 MHz (out of the band), the power delivered to the antenna will be 2.5 Watts. The same setup with RG-8/U coax will deliver 5.6 Watts to the antenna—this is 3.5 dB better performance. So, as you can see, those dBs can sneak up on you.

Perhaps the most common use of the decibel is in the measurement of sound levels. I have heard, on occasion, people refer to a sound-pressure-level meter (SPL meter) as a "dB meter." There is no such thing. The SPL meter indicates the sound pressure

relative to a reference acoustic pressure of .0002 microbars. So, 100 dB SPL is, in fact, 20 microbars of acoustic pressure. (Acoustic pressure is analogous to electrical voltage.)

It can be useful to practice some calculations using decibels. A good working knowledge of the use of the decibel can keep you from feeling left out the next time someone brags about his antenna with 10 dB gain. ■

References

The ARRL Antenna Book, Newington, Connecticut, The American Radio Relay League, 1968, pp. 44, 85.

Doug DeMaw, "What Does My S-Meter Tell Me?", *QST*, June, 1977, pp. 40-42.

The Radio Amateur's Handbook, Newington, Connecticut, The American Radio Relay League, 1977, pp. 40-41.

Ken Schnell, "Antenna Gain Facts—don't be misled," 73, August, 1977, p. 55.



**Germtown
Amateur
Supply,
Inc.**

MEMPHIS, TENNESSEE

NO MONKEY BUSINESS!

- (A) Complete Service Facilities
- (B) Good Deals on most Brands
- (C) Shipping within 24 Hours
- (D) All inquiries handled by Active Hams with over 20 years experience in ham radio

CALL TOLL FREE
1-800-238-6168

IN TENNESSEE, CALL 901-452-4276
MONDAY - SATURDAY 8:30-5:30
FOR YOUR SPECIAL.

Write: 3202 Summer Ave., Memphis, Tennessee 38112

Frosting for the FT-901DM

— simple improvements for Yaesu's superb performer

Dave Ingram K4TWJ
 Eastwood Village, #1201 South
 Rte. 11, Box 499
 Birmingham AL 35210

One of the hottest and most exciting rigs presently on the amateur market is Yaesu's FT-901DM transceiver. The outstanding performance of this "no compromise" unit is rivaled only by the enthusiasm, interest, and technical prowess of its stateside representatives and distributors.

Before delving into the collection of 901 modifications I've gathered via

several sources, I must emphasize that this unit is a star performer as it stands, and you can expect long-term enjoyment regardless of your decision whether or not to try any of these options. I'm complimenting the rig, not discrediting it in any way.

Speech Compressor

The FT-901DM's speech compressor does a superb job, but its response is tailored for high-pitched Japanese voices rather than the lower-pitched American voices.

If you would like to see the speech compressor become a real tiger, change

C218 on PB1703 from a 100 pF to a .01-uF mylar™ or paper capacitor. PB1703, the ALC/speech compressor board, is located third from the rear on the rig's left side. C218 is located on PB1703's bottom center, and its solder connections are almost directly beneath the clear plastic-insulated jumper on the circuitry side of this board. This modification extends the compressor's low frequency range and allows it to operate more efficiently.

While discussing audio response of the 901, I might also suggest that amateurs searching for a quality mike try the Shure 526 (less transistor preamp) with the 901. I've tried a bundle of mikes with mine, and this one performed head-and-shoulders above all others.

ALC

If you would like smoother ALC action (or if you've been concerned about meter readings in the green part of the ALC scale), this simple modification will ease your mind

and produce very good results. Remove the 901's bottom cover and locate the socket for board PB1703. Connect a 68k, ¼-Watt resistor between the ground and pin 16 of this socket, then bypass the resistor with a 2.2-uF tantalum capacitor.

This is a good time to tweak dot-dash ratios on the Curtis Keyer, if desired. The keyer's PC board is also located on the 901's bottom side.

Low 40-Meter Output

If your 901 produces an output of less than the usual 100 to 120 Watts on 40 meters, try this simple procedure. Add a .01-uF 500-volt disc capacitor from C22 to ground. C22 is a feedthrough capacitor located in the power supply.

Flickering LEDs

The memory LED in some 901s (located above the digital frequency readout exhibits a very slight flicker when the unit is originally turned on and a frequency isn't loaded in

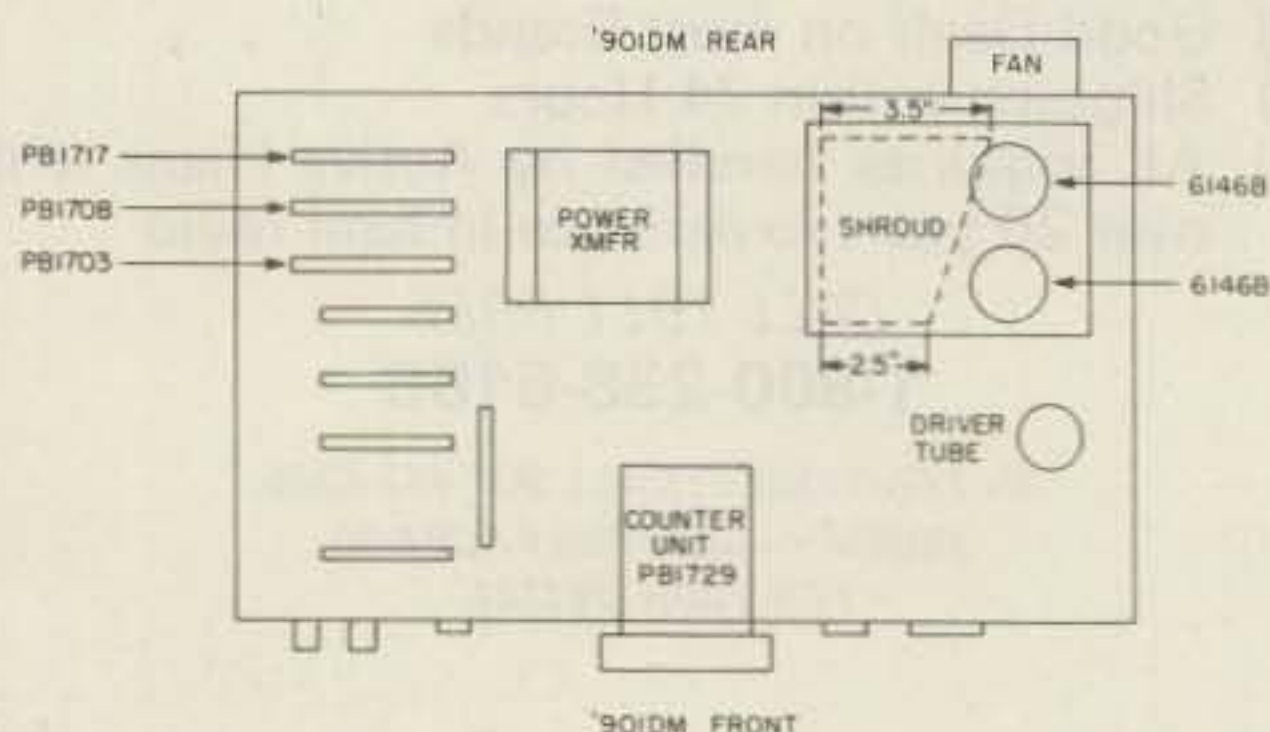

Fig. 1. Placement of 6146B cooling shroud and printed boards, as described in the text.

memory. There are two simple solutions to this situation: 1) Simply tap the memory button and load a frequency into memory, or 2) change C61 on the memory board from .33 uF to 4.7 uF. A tantalum capacitor is suggested.

Fan Noise

Since I'm accustomed to the total silence of Rotron Whisper fans, I found the Yaesu fan a mite loud for my sensitive ears. A close inspection of the fan revealed a slightly off-center armature. This situation was visible when holding the fan proper up to the light and looking through its rotating armature to assure symmetrical alignment. I found the most accurate way to adjust this fan involved carefully applying 110 volts to the removed fan and slowly positioning its armature for minimum noise. If you prefer an absolute death-quiet fan, Rotron's small Boxer fan can be substituted here. The fan in my 901 may have been one in a hundred, so use your own discretion with this modification. Fortunately, this fan unplugs and unbolts from the outside of the 901's rear, so you need not open the rig for this modification.

Cooling Shroud For 6146B Finals

While the Japanese are very proficient in electronic technology, they seem somewhat limited on air ducting and cooling techniques. Erskine Jackson W4CEC solved this problem quite easily. He cut a triangular sheet of aluminum 2.5 inches by 3.5 inches and installed it above the final amplifier compartment as shown in Fig. 1. This shroud prevents "short circuit" air being pulled from atop the tube compartment and alternatively pulls it across the 6146Bs from the compart-

ment's sides. This superb technique also has been used with Kenwood gear.

6146 Finals

A problem has been noted with the GE-brand 6146Bs installed in many 901DMs. The screen grid would fall against the plate and apply +900 volts to the +210-volt screenline. Yaesu recently switched to Toshiba 6146Bs and this problem has been eliminated. If your 901 has GE finals, you would be wise to make this switch also. Pursuing this situation a step further, Yaesu has developed a modification to protect the 210-volt supply from this problem. Here's the information:

Install a diode as shown in Fig. 2. This is included in lots 006 and higher, with lot 007 using a new etch pattern that includes this modification.

Modification: (1) Remove the bottom cover on the FT-901; (2) attach a soldering post to the chassis with a tapping screw as illustrated; (3) solder a 10D10 diode to the post—*note the diode polarity*; (4) remove the yellow wire from the printed circuit board (PB-1715A) and solder it to the diode installed in step 3; (5) connect the other end of the diode to the printed board where the yellow wire was removed; and (6) replace the bottom cover.

Reducing Excess Baggage

Most of the 901's heat is generated in its left back corner. This heat comes from the bleeders on top of PB1717 and from the choke and components on PB1708. Since several capacitors and resistors are physically located above the choke on PB1708, they may become hot and change value and eventually fail. Realizing this problem, Yaesu suggests R13 (47k, 1/2-Watt) and R03 (470 Ohms, 1 Watt) on

PB1708 be changed to the same resistance in 2-Watt resistors. Further investigation of this particular circuit revealed that its only function is as part of a filter section for a 160-volt line going to the 901's rear accessory jack. Since W4CEC and I have no immediate plans to use this jack, we disconnected our circuits by pulling one end of diode D03 loose from the board. We also removed our black plastic "board cover" to permit air flow. The results have been quite gratifying, and our 901s now run quite cool, even when used for long periods of time.

Counter Protection

It has been found that capacitor C2954 on the counter unit (PB1729) was installed backwards in early 901DMs, and this may lead to failure in various segments of the digital display. You can quickly check this in your unit in the following manner. Locate the counter unit behind the digital display and pry up its snap-on cover. C2954 is a small, blue capacitor on the unit's left side. Its markings should face the rig's rear (toward the power transformer). If the capacitor's markings face the rig's front, simply remove and reverse it.

You'll gain a wealth of knowledge on 901 construction when investigating this modification. The enclosed PLL unit (PB1709)

and the rf unit (PB1702) must be removed before the counter unit and digital display can be slid back and removed. All screws on these units stay intact when freed, thus eliminating the lost-screws-or-spacers dilemma. You'll also notice that the plug-in digital displays are readily available, inexpensive units.

Conclusion

The modular construction of Yaesu's 901 makes servicing a relatively simple task. Few rigs offer this capability. That fact, coupled with the large number of technically-oriented amateurs owning 901s, has resulted in the modifications presented in this article. It's logical to assume that additional modifications or improvements on this rig will continue the collection presented here. This leads me to believe that the original "Fox Tango Club" may soon reach its greatest days. The FT-901DM is the most outstanding rig I've ever owned or operated.

I would like to thank Bernie Tower W6RNW of Yaesu and Don Langston WB4JYV of Long's Electronics for their support and assistance with information concerning the FT-901DM. A special thanks to Erskine Jackson W4CEC for his ideas, suggestions, and assistance as we modified our 901s. Thanks also to my XYL, Sandy WB4OEE, for typing this article. ■

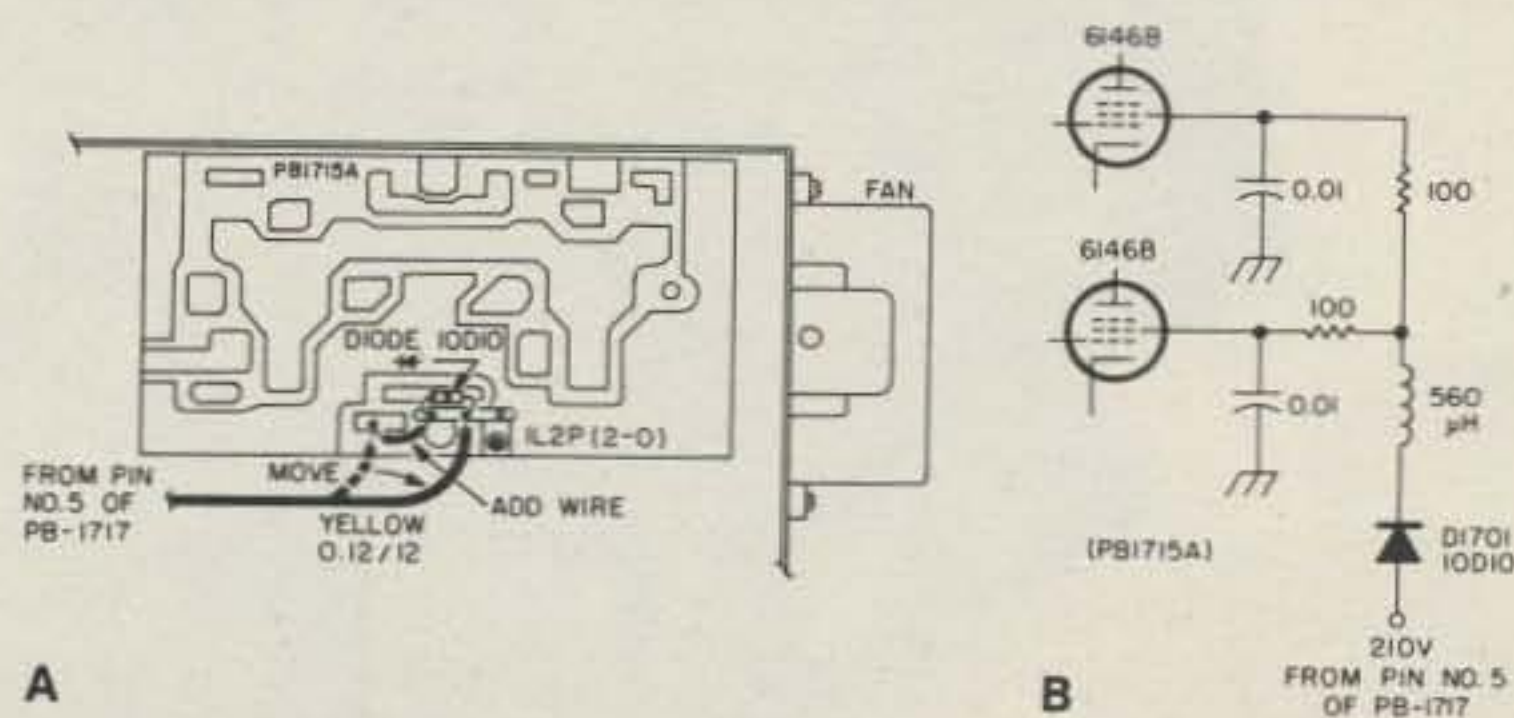

Fig. 2. (a) Illustration for screen-to-plate short protection described in the text. (b) Schematic for this modification.

Mods for the Mark

— desirable extras for your Wilson HT

*Bob Heil K9EID
#2 Heil Industrial Blvd.
Marissa IL 62257*

Many of the new Wilson Mark II handheld units are showing up on the many repeater systems. The HT is really a

neat little package, but, as usual, it can be improved upon with a little ingenuity and time.

Battery-Level Indicator

The one thing that the Mark II really needs is a method for monitoring your battery level. Two systems can be used. The simplest is a new LED by

Hewlett-Packard which has a comparator circuit built into a tiny LED. All you need is one resistor and a diode in series with it to set the threshold at your charged-battery voltage. Simply connect to the PTT line. Each time you transmit, the small LED will light. If it doesn't, your battery voltage has fallen off

and caused the comparator not to turn on and light the LED. If you want, you can connect this comparator LED to the battery through the extra switch contacts on the squelch that Wilson provides for tone squelch additions. This new voltage-sensing LED is available from H-P as part #5082-4732.

S-Meter/Battery Level

I figured that since Wilson was nice enough to leave at least two square inches of circuit board space in the bottom of the Mark II for their optional tone squelch board, I would take advantage of this and build an S-meter circuit for receive and a battery-level indicator for transmit.

The meter used was purchased from Hy-Gain. It is the same one they used in their #3086 HT. It mounts in the bottom of the Wilson on that same little plastic end piece that houses the battery-charging contacts. This works out so that you



don't have to cut any holes in the main case. A touch of epoxy cement holds the little meter in place. Be sure to recess it a little so the HT will sit level in the charger.

The S-meter circuitry is very simple. Just about any NPN transistor can be used as an amplifier to drive the meter. A part of the output of the second i-f amplifier is detected with D1 and fed into the meter amplifier.

The battery-level indicator circuit is simply one diode connected to the junction of two resistors to form a voltage divider off the PTT line. This allows the meter to function only during transmit. You also could connect the level meter circuit directly to the battery through that spare switch contact on the squelch control that was originally planned for a tone squelch circuit. Using this method, one can check the battery level at any time, not just during transmit. Personally, I prefer using the meter to monitor during my transmit periods since that is when the current drain is the heaviest.

Easy Construction

For the purists, a printed circuit board could be laid out, but with such a simple and small circuit, vector-board can be used quite effectively. The board measures 2-1/4" x 7/8". Mount the parts, solder all connections, and leave about 5" of all wires so easy connections can be made to the main Wilson PC board. The only problem you may have is in making certain you observe the diode polarities. The rest is very straightforward, and it should all go together quickly and easily.

An easy method to secure the board is to use some small, 1/8"-wide tape along the sides of the board, and simply tape it in place. Works out great!



Only 4 Connections

The circuit board uses only four connections to the main circuit board of the Wilson: B+, ground, PTT line, and the receiver limiter. Extra sensitivity can be achieved in the S-meter circuit by adjusting R1. For transmitter hunts or weak signal hunting, you may want to play with the resistor.

Cut the four wires to their necessary lengths, trim, and solder in place. Your S-meter/battery-level indicator is ready for action!

External Headphone Jack

There may be times when you desire to use your Mark II with a small earplug so as not to disturb anyone else; install a micro-jack in that bottom plate so that the speaker line is disconnected when the earplug is plugged in.

Improving the Transmit Audio

Being in the professional audio business, I tend to be a bit "picky" about the audio we, as amateur radio operators, hear. After comparing the Mark II transmit audio to many other hand-held units, it became apparent that improvement

was necessary. The improvements are also very simple to achieve.

New Mic Cartridge

First and easiest is to replace the Mark II micro-

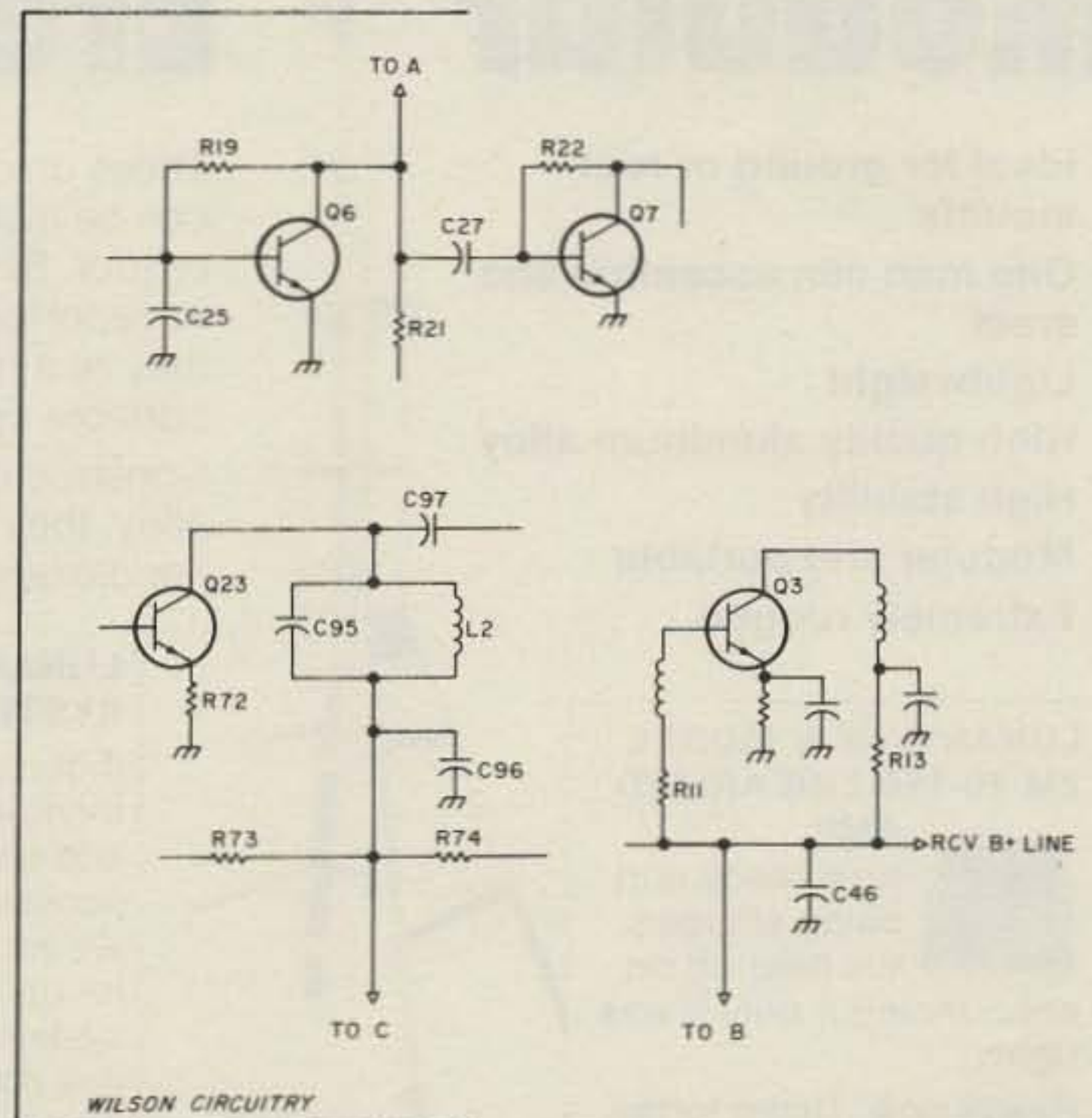
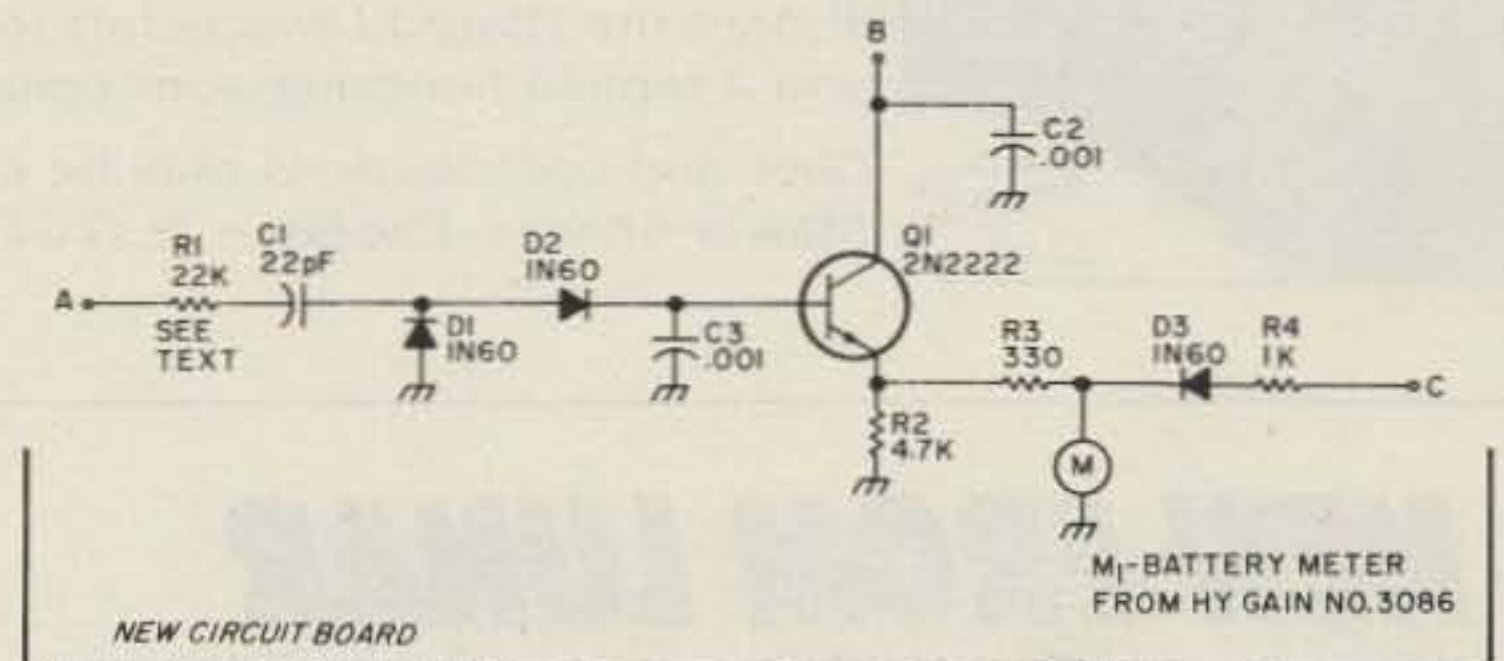

Fig. 1. Mods for the Mark. Pick-off points A, B, C are easily located by referring to p. 18, "Circuit Board Overlay," of the operating and service manual.

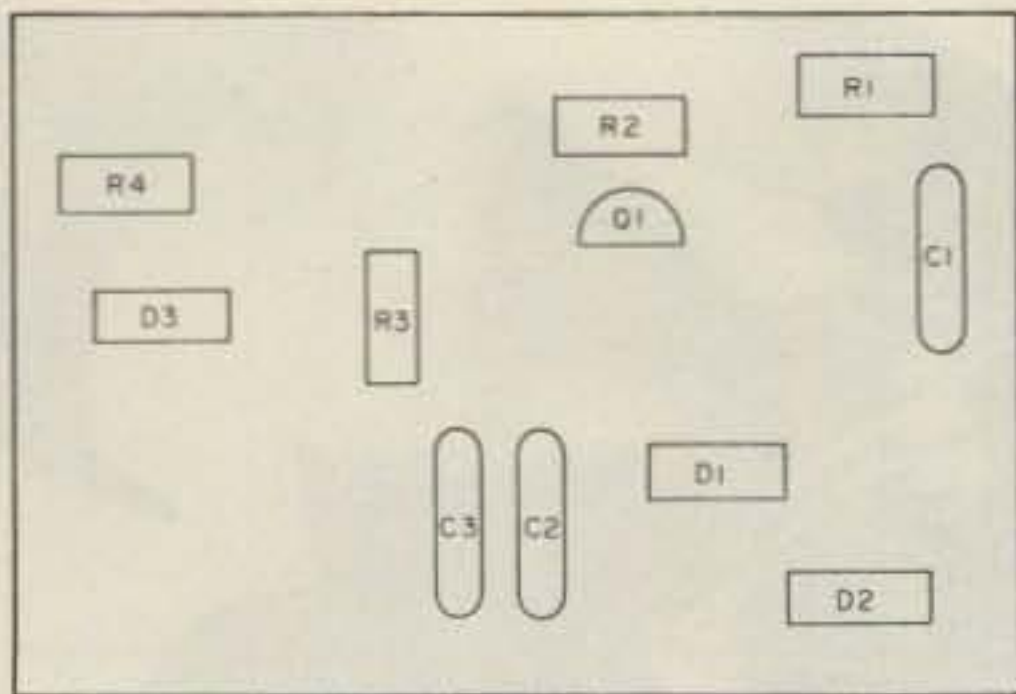
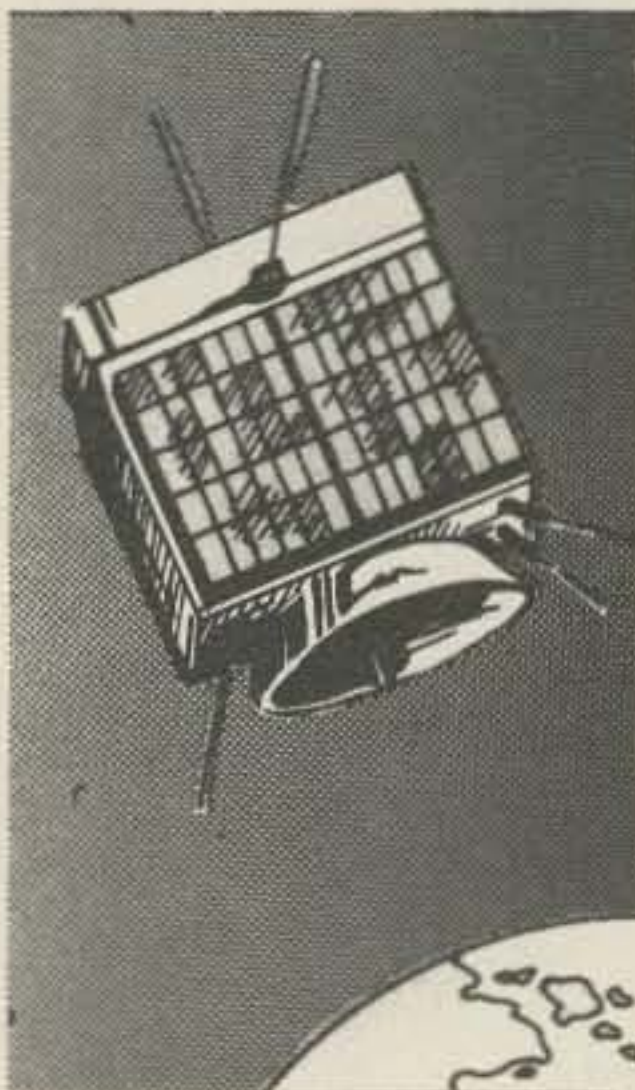

Fig. 2. PC card layout for Mark II. Complete kit with all components, PC board, and wire harness, but without meter (available from Hy-Gain) is \$8.00 from Melco, P.O. Box 26, Marissa IL 62257.

phone with a Knowles BA1501 (Knowles Electronics, 3100 N. Mannheim, Franklin Park, Illinois 60131). This really helped the audio response as noted on an audio analyzer. A few component changes also are in order to achieve better audio. Change R78 from 3.3k to 1.5k, C111 from 0.1 to .47, and C118 from 0.15 to .47.

Try this audio mod and I

can guarantee that your friends will think you are on a full-sized mobile transmitter! We might also point out to Mark II owners that by simply changing the driver transistor, Q24, to an MRF 515, you will have a Mark IV. Use care when tuning the collector coils of Q24 so that no parasitics are present in the output. The change is easy and will give you about 4 Watts out. ■



There's a new, eighth OSCAR satellite in orbit, and the AMSAT team helped put it there!

Your help is needed for future satellites. Join AMSAT and support the new, advanced Phase III series of OSCARs, engineered to provide communications over transcontinental distances for hours at a time.

Send \$10 membership dues to AMSAT, P.O. Box 27, Washington, D.C. 20044. Life membership is available for a tax-deductible donation of \$100 or more, payable in quarterly installments if you wish.

Phase III satellite solar cells may be sponsored for \$10 each, and we'll send you a certificate specifying the cells you are sponsoring.

For a tax-deductible contribution of \$1,000 or more, we'll even inscribe your name on a plaque to be placed in orbit aboard the Phase III spacecraft for posterity, and we'll send you a replica honoring your contribution.

Dues and contributions may be charged to VISA or Master Charge. Phone us at (202) 488-8649.

Radio Amateur Satellite Corporation
P.O. BOX 27, WASHINGTON, D.C. 20044
AMSAT
AMSAT MEMBER

NEW FROM LUNAR

Modular Erectable Towers

- Ideal for ground or roof mounts
- One man can assemble and erect
- Lightweight
- High quality aluminum alloy
- High stability
- Modular and portable
- Extremely rugged

LUNAR'S NEW MODEL 2M 10-150 LINEARIZED AMP



Now ready and being shipped. We held off on announcing it until it was right...

Ready now. Order today from your Lunar dealer.

These unique antenna towers can be installed on the ground or roof. Since they're easily transported and site erected, they're a natural for field and portable operations.

Constructed of sturdy aluminum alloy, they're sturdy enough to handle large size HF beams and

EME arrays as well. Also available with optional stainless steel hardware for harsh environments.

Base is approximately 60" high and weighs 28 pounds. Tower sections are 72" high and weigh 21 pounds.

LUNAR'S TRANSVERTER SYSTEMS

Individual modules and other accessories are available



for up and down converter systems. Can be connected in any combination your system dictates. Write for complete list of modules and accessories.

Louis Anclaux
WB 6NMT



L17

LUNAR
electronics

2785 KURTZ STREET • SUITE 10
SAN DIEGO, CA 92110 • (714) 299-9740
TELEX 181747

A Breakthrough In Technology!

THE YAESU FT-207R

MICROPROCESSOR CONTROLLED SYNTHESIZED HANDIE

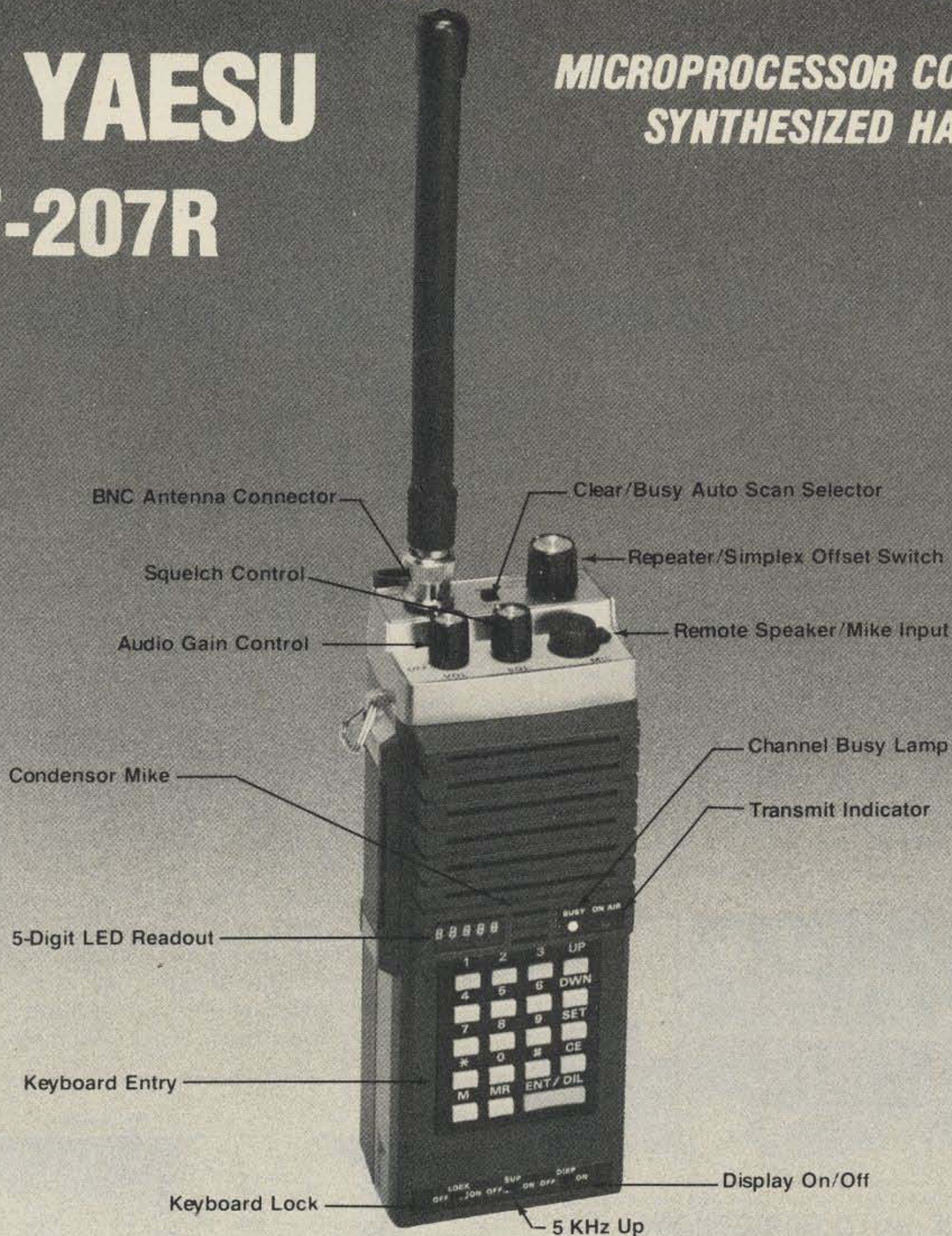

***The Yaesu FT-207R Synthesized Handie
has all the features you could want in a very compact package***

- 144-148 MHz Range
- 10 KHz Steps
- 3 Watts Output
- 4 Memories plus Programmable Offset
- Priority Channel
- Memory and Band Auto Scan
- Optional Equipment:
 - Keyboard Encoded Frequency Entry
 - 2 Tone (Touchtone®) Input from Keyboard
 - Keyboard Lock guards against accidental frequency change
 - Odd Splits Can Be Programmed from Keyboard
 - Automatic Battery Saver Feature for LED Display
 - Rubber Flex Antenna

Tone Squelch, Speaker/Mike, Nicads, Battery Charger



Price And Specifications Subject To
Change Without Notice Or Obligation

YAESU **The radio.**



679X

YAESU ELECTRONICS CORP., 15954 Downey Ave., Paramount, CA 90723 ● (213) 633-4007

YAESU ELECTRONICS Eastern Service Ctr., 9812 Princeton-Glendale Rd., Cincinnati, OH 45246

The History of Ham Radio

— part IX

Reprinted from QCC News, a publication of the Chicago Area Chapter of the QCWA.

In the early 1920s, in order to be truly portable a radio receiver had to be

fairly light in weight, have a degree of efficiency, and be designed so that it could be moved about with ease. It was dependent, above all, on some type of portable antenna. *Reliable operation and portability were the basic criteria.* The antenna was of the loop

type, of modest dimensions, and foldable. Dry "A" cells were the only source of sufficient current required for the filaments of the vacuum tubes. The plate supply depended on "B" batteries. The batteries contributed the major weight. The older UV 200 and UV 201 tubes were replaced by UV 199 and the WD11 tubes which did not require as much filament current, thus lengthening the operating life.

Using a loop for recep-

tion posed somewhat of a problem. The loops used had distinct directional characteristics. A loop had variation coverage as much as five to one forward compared to the sides. During the summer months, general activity among radio amateurs was not only down, but rather drab and unenthusiastic. QRN and static prevailed with regularity, and activity was carried on the assigned wavelength of 200 meters (plus or minus).



Left—Mr. Grebe Tuning up His Auto Radio Phone Set. Top Center—Mr. Grebe Radiophoning En Route. Bottom Center—Complete View of Auto Showing Antenna Construction. Right—Rear View of Auto Showing Method Employed to Support Masts.

THE AUTO RADIOPHONE

By A. H. GREBE
Expert Radio Contractor

THE present stage of radio telephone development has placed this form of communication on such a highly practical plane that its rapid adoption for many useful purposes is only a matter of a very little time.

On aircraft it is now considered indispensable and because of the extreme simplicity of operation it will be used in many places on land over spaces which cannot be economically spanned by wires.

Having experimented considerably with vacuum tube radio telephones during the past few years, and being impressed by the adaptability of this type of radio communication to small antennas, the writer desired to make some tests with a radio telephone equipment installed in a motor car.

At first it was decided to use a flat loop as the radiating member, but this was abandoned in favor of a four-wire flat top antenna, used in conjunction with the frame and body of the car as a counterpiece. It was found best to depend on efficient radi-

ation of the transmitted energy and sufficiently amplified incoming signals, than to sacrifice radiated energy in favor of the advantages of the loop for receiving.

The antenna system was constructed along portable lines, the supporting masts being fitted with socket joints for assembly and attachment to the car frame. It was not so as the entire antenna system was slung under the running board on hooks provided for this purpose. The antenna wire was the same as used on aircraft and the non-kinking characteristics of braided wire made it more suitable than other kinds.

The transmitter consisted of a panel and cabinet assembly which included the vacuum tube mounting, choke coils, oscillating circuits and modulating system. Meters were

provided for indicating the filament current, modulator and oscillator tube space currents and the radiated energy. The oscillating circuit was so arranged as to be controlled by means of a tickler coupling, and the dial for indicating the position of this coil was provided on the panel. Filament current was obtained from a storage battery located back of the seat, and this battery supplied the current for operating a small dynamotor, as well as the vacuum tubes in the receiver. The microphone transmitter was mounted on a convenient handle and arranged with a plug which was inserted thru the front of the panel. Another plug and jack was provided for connecting a hand telegraph key for buzzer modulation. A switch control on the panel



Above—Radio Telephone Generator Panel of Latest Design. To Right—Complete Receiver and Transmitter Combined.

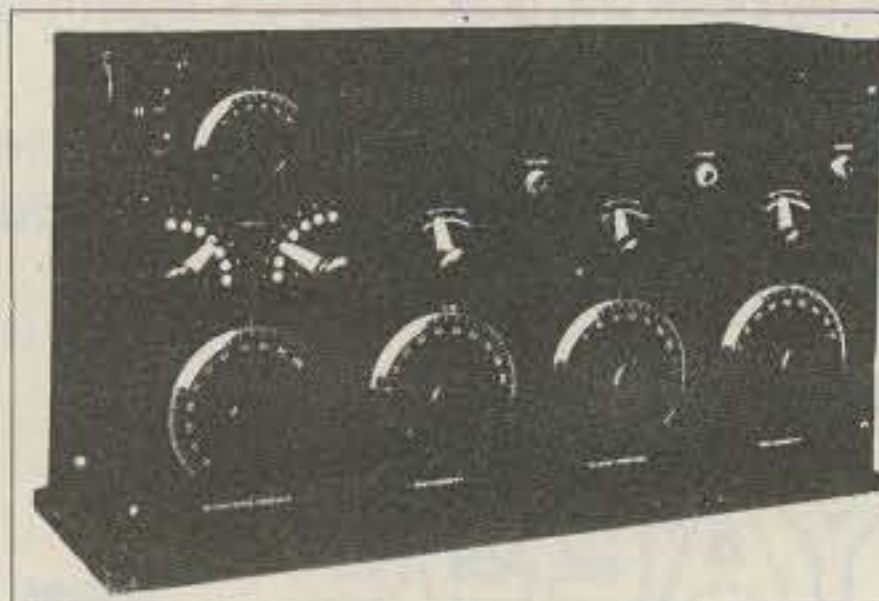

Fig. 1.

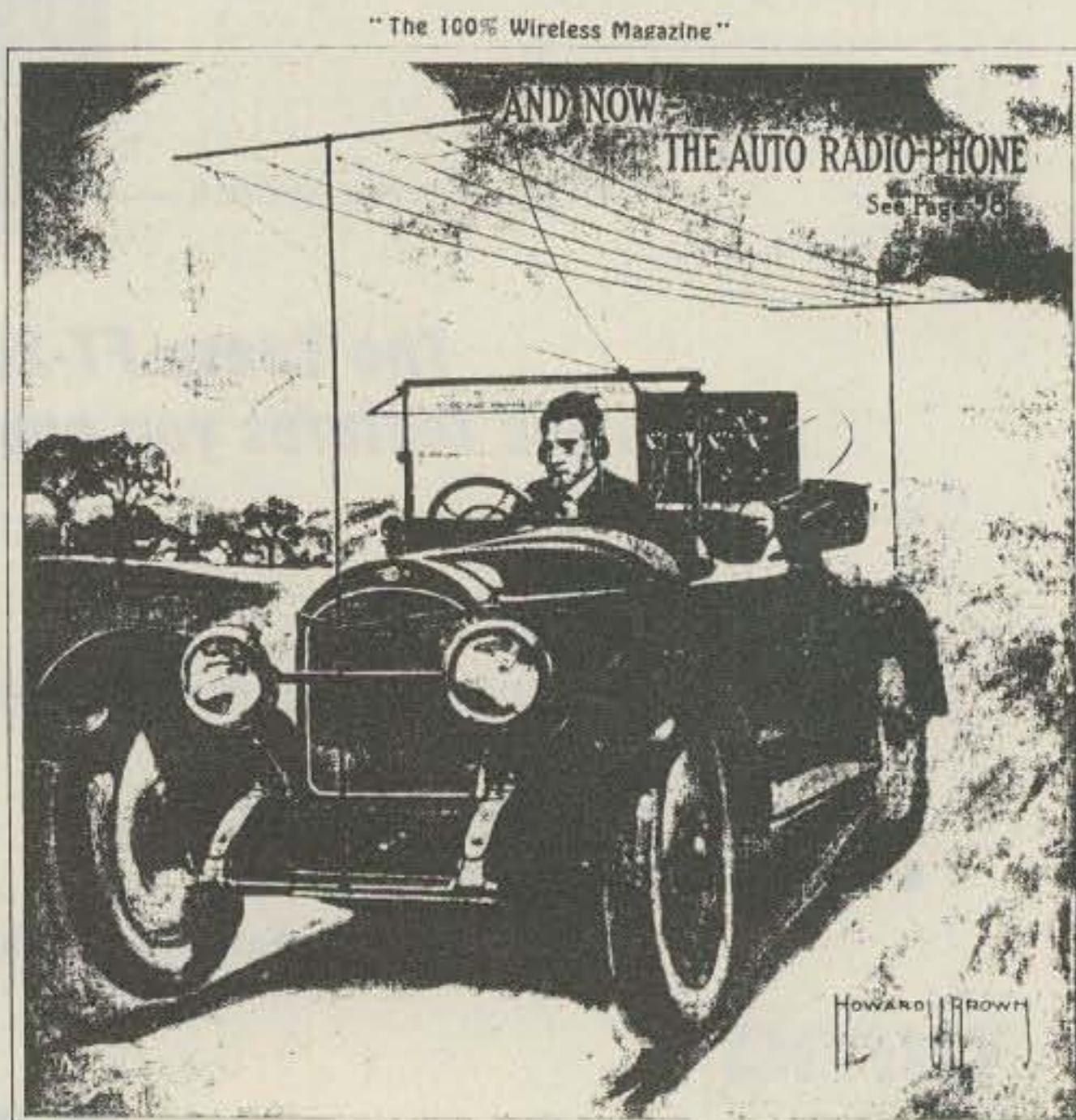

Fig. 2.

The broadcast listeners had the evening hours with little or no amateur QRM to contend with. The agreed upon hours of silence were regularly observed by the amateurs. Summer activity was usually looked upon as putting a damper on most ham transmitting. It was a time to take inventory of equipment, to rebuild and update for the coming winter season.

Whenever radio amateurs were involved in a project, ingenuity prevailed. A. H. Grebe, the well-known inventor and manufacturer of the CR line of receivers known and used by most amateurs during the twenties, went portable in a big way by giving the loop advocates an eyeful. He preferred to stay with the usual design—flat top, multiwire model—in spite of the limited cruising mobility (Fig. 2).

The aerial with auto-body-counterpoise configuration was preferred over a loop to avoid specific directivity. When ready to dismantle the outfit, what did Mr. Grebe devise? The entire overhead system was slung under the running board (cars had large running boards in them days) on hooks provided for that purpose. Instead of using dry cells, a storage battery was available for the heavy drain required for the tubes.

Fig. 3 illustrates what was available for radio entertainment while visiting the famous boardwalk at Asbury Park, NJ: the Roller Chair Special. The apparatus consisted of a radio chair so compact that three persons could sit comfortably side by side in the seat. A loop of the flat type was connected to the detector-amplifier held in the laps of the travelers. No coils were used, all tuning being accomplished solely with the variable

condenser. Signals from stations over 200 miles distant were heard. Such sets were effective for wavelengths of 300 to 500 meters, and good results were often had at wavelengths up to 800 meters.

A more practical and somewhat more compact, all-around enclosed model of portability consisted of a receiver using a popular circuit known as a Grimes "Inverse Duplex" (Figs. 4, 5), having four tubes of the WD11 type. The set had a wavelength tuning capability of 200 to 3500 meters. The particular instrument shown in Fig. 4 was transported to the Philippine Islands in 1924 and served a lumbermill owner for years. It traveled by motorboat and other sundry conveyances over the broad island and mainland areas, giving the owner contact capability with his home base. The receiver was used in connection with a kW spark transmitter.

Legislation Problems Unsolved

The very rapid expansion of radio broadcasting during 1922/1923, together with the great demand for receivers and the need for some semblance of interference control, pressured legislators in Congress to come up with an urgent solution. The folks back home demanded action.

As a result of the first radio conference, held in Washington in the spring of 1922, Congressman White of Maine introduced a bill, known as the White Bill, HR 11964. For almost a year thereafter the bill was periodically under discussion, often under review, but constantly in the minds of the radio amateur.

On January 2, 1923, almost a year after the White Bill was introduced, the ARRL President, Hiram Percy Maxim, went to

Washington for a hearing on the bill. He was instrumental in bringing to bear on the legislation the opinions and recommendations of the amateur fraternity. It was the ARRL up in front, promoting action and showing great interest in bringing about an equitable solution to the problems confronting listeners, the broadcasters, the commercial operators, and the thousands of amateurs. But speaking in behalf of radio amateurs in particular, it was Mr. Maxim's foremost objective to ensure that amateur radio would continue to have its rightful place.

The White Bill contemplated legislation to broaden the wave band for broadcasting so that the service could grow, expand, and perform in an orderly fashion, an action that was required so that Secretary of Commerce Hoover could be given authority to properly regulate radio in the United States. The bill was carefully analyzed, several

recommendations and amendments were proposed, and suggestions were offered in an attempt to bring the listener and the radio amateur into accord. It was hoped that commercial interests would not be the dominating influence in this free and open domain, the ether.

However, in the End, What Happened?

The White Bill, HR 11964, passed the House on January 31, 1923, went to the Senate, and there was referred to the Committee on Interstate Commerce. Because of considerable outside opposition to various provisions, the bill languished and finally remained to die with the expiration of the 67th Congress on March 4, 1923.

Sensing trouble, and knowing the general attitude taken by many interests in the bill, White introduced a new bill on January 11th, with certain modifications proposed. It included provisions somewhat more palatable to the



W. Harold Warren and Guests Receiving Signals from Stations 200 Miles Distant in a Radio Roller Chair on the Asbury Park Boardwalk

Fig. 3.

objectors. The new bill was introduced as the White-Kellogg Bill. It also died in the face of considerable opposition. This virtually ended the hopes of all concerned to patch up the old 1912 radio law and bring order out of a simmering and ongoing chaotic situation.

On March 20, 1923, Secretary Hoover called his Radio Telephone Conference members to review the situation, hoping that a solution could be found to administratively cope with a defiant muddle. It was paramount that a way be found to open up more wavelength channels for broadcasting. The second National Radio Conference thus came to order.

In the meantime, amateurs, again caught in the middle but constantly cooperative, commanding the staunch support of the

Secretary, had devised a so-called "Rochester Plan." The plan specified that in communities where QRM would be considerable and above normal in volume, quiet hours would be observed between 7 and 10:30 in the evening in all zones throughout the country, especially in the more heavily populated areas. At the conclusion of this second conference and after months of deliberation, a schedule evolved and was recommended. (See Table 1.)

Amateur Activities on the Rise

Amateurs were beginning to discover, through their constant experimenting, that wavelengths below 200 meters had possibilities not to be denied. The vacuum tube and the associated cir-

cuitry developed led the experimentally-minded amateur into unexplored fields. He discovered that by using vacuum tubes instead of spark gaps he was able consistently to span distances with ease and much less power on his assigned wavelengths. Dropping down below 200 meters had tremendous possibilities. All of the early tests engaged in between individuals in various parts of the country were usually planned in advance and followed a schedule. Practically no one was listening below 200 meters. Nobody had a receiver at this stage of radio progress, nor the capability, to tune down much below 200 meters. With no signals on the air except by prearrangements between individual operators, there was only static to be heard. The ether was just an empty void below

200 meters and was generally avoided.

As the amateur slowly ventured into the lower unexplored regions, he faced one common question, namely, "Will the efficiency of the tubes I have available decrease as the wavelengths become shorter?" He knew that the larger tubes were still quite inefficient in design and the circuitry lacking in development. Many amateurs could not be convinced that "below 200 meters" was a fertile field in which to risk expensive "bottles." This area also was unsuited to the tuners used, and besides . . . the antenna he was using was too long, and nobody could be heard with whom to communicate. The League at Hartford had a great deal of convincing to do and a great many illusive misgivings to overcome among



Fig. 4.



Fig. 5.

the majority of hams. Most amateurs were unwilling to let down their old multi-element aerials, disconnect the ammeter from the antenna lead, or trust the plain Hartley transmitter circuit. There was still an amount of extraordinary experimenting ahead.

Wavelength Vs. Frequency

Another major stumbling block in the way of progress was evident. This was the fact that nobody knew or was seriously concerned about how to make wavelength measurements. Up to this time, very little reference had been made to the term *frequency*, nor much attention paid to conversion from wavelength to frequency. Conversation among radio men held rather tenuously to *meters*. Not until the League convinced the radio division of the Bureau of Standards that by trans-

Below 130 meters
130 meters
130-143 meters
143 meters
143-150 meters
150-200 meters
200-222 meters
222-231 meters
231-286 meters
286-288 meters
288-300 meters
300 meters
300-450 meters
450 meters
450-545 meters
545-674 meters
674 meters
674-800 meters
800 meters

Available for special licensing. Government, CW, exclusive.
Available for special licensing. Government, CW, exclusive.
Available for special licensing. Amateur, CW, ICA, phone, spark, exclusive.
Special amateur, technical & training schools, CW, exclusive.
Aircraft, CW, ICW, phone, nonexclusive.
Class B broadcasting, phone, nonexclusive. Reserved.
Class A broadcasting, phone, exclusive.
Marine, CW, ICW, spark, nonexclusive.
Class A broadcasting, phone, exclusive.
Marine, CW, ICW, spark, exclusive.
Class A broadcasting, phone, exclusive.
Marine & aircraft, CW, ICW, spark, exclusive.
Government, CW, nonexclusive.
Marine & aircraft, CW, ICW, spark, exclusive.
Radio compass, CW, ICW, spark, exclusive.

Table 1. Schedule evolved from the 2nd National Radio Conference. Class A and B broadcasting stations were assigned a wave band of 10,000 cycles, none closer together than 20 kilocycles in frequency. Within each area zone there would be ten stations separated by 50 kilocycles.

mitting measured frequencies over their Washington station, WWV, for amateurs to copy and adjust circuits to conform to, would the ice be broken. So, from this time on, the wavemeter gradually became the most important

laboratory instrument in the ham shack. Schedules were now arranged to have transmissions from WWV appear periodically, set for eleven pm, EST, on specified wavelengths and frequencies. They provided calibration settings for all

home-built wavemeters, permitting the receiving tuners to be modified or rebuilt or redesigned for receiving the higher frequencies. A new and important era in amateur radio was now set in motion with vigor. ■

New 2 Meter Avanti Mobile Antenna

Mounts on glass — no holes!

- Receives and transmits through glass.
- Superior performance equivalent to 5/8 wave.
- Superior radiation full Omni-Directional.

It's easy to install — No holes to drill, no magnet to scratch the paint, no clamps. Uses an especially developed epoxy adhesive that secures antenna to window like a 1/4" bolt. The capacity coupling box is simply attached with a special adhesive tape to inside of window. Worried about crimping or corroding coaxial cables? It's all inside and out of sight.

Models also available for 220 MHz and 432 MHz.

AH 151.3G SPECIFICATIONS

Gain	Equivalent to 5/8 wave
2 meter V.S.W.R. Band Width	Better than 1.5:1
Maximum power	150 watts
Nominal Impedance	50 Ohms
Chrome plated casting. Stainless Steel hardware. Swivel whip holder	
Height	33"
Performance and Mechanical Patents Pending	

Buy one from your nearest AVANTI dealer. If your dealer does not have one in stock, have him call the following toll free number and we will ship him one within 24 hours:

(800) 323-9429

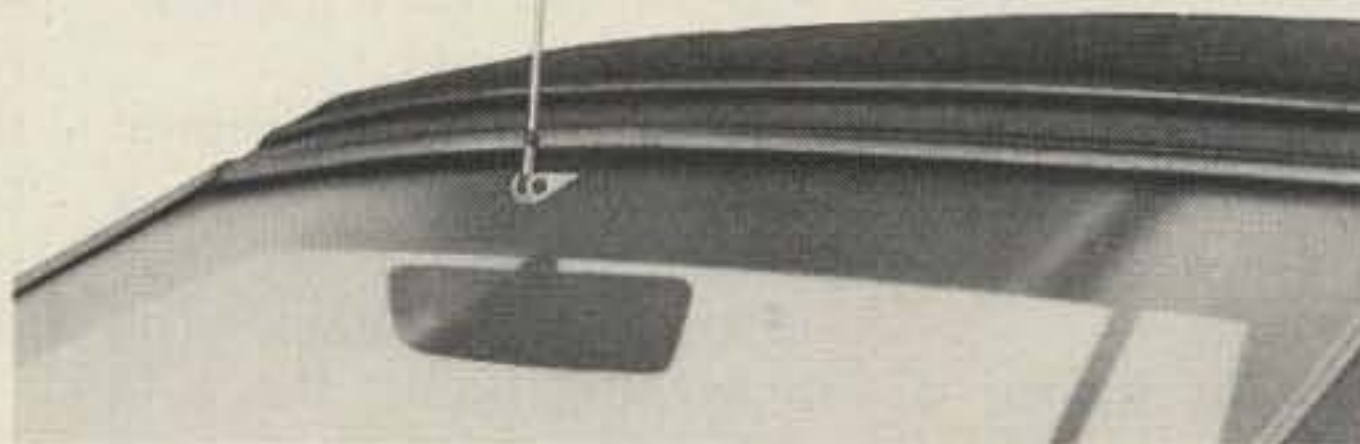
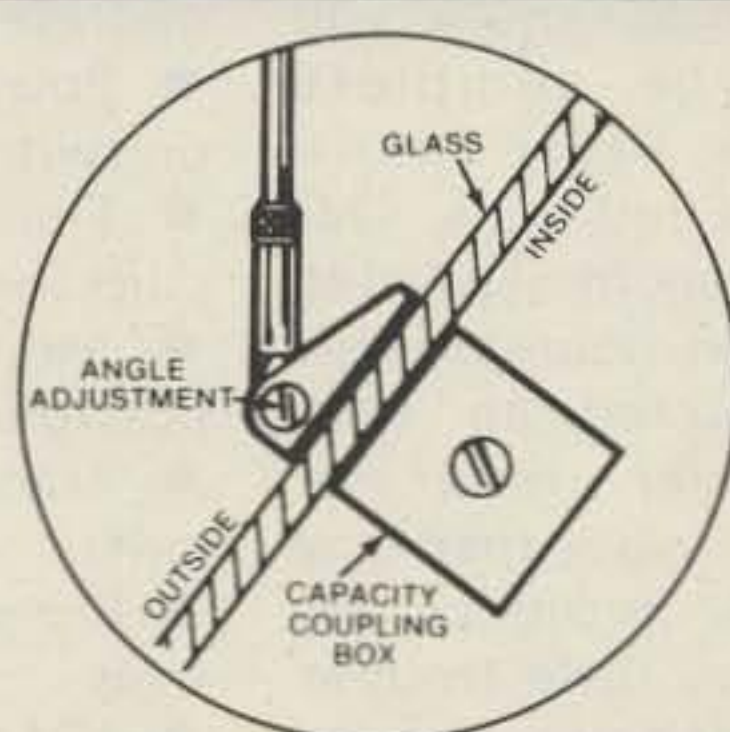

See Avanti's other new amateur mobile and base antennas. Write for new catalog today.

Send 50¢ for handling and postage.

✓ A93

avanti antennas

Avanti Research and Development, Inc.,
 340 Stewart Ave., Addison, IL 60101
 © 1979 In Canada: Lenbrook Ind., Scarborough, Ontario M1H 1H5

Add-On Keyboard for Your Keyer

— the "a la carte" design

Easier than you think.

*Edward J. Faber K4BZD
554 Sulgrave Drive
Columbia SC 29210*

If you have an electronic keyer in your shack, you can go the complete keyboard route more easily than you think. This project is recommended to all who have home brewed or constructed an electronic keyer. However, even if it is your first time for an IC project, you should have little trouble. The cost of this project can be negligible if you can find an old keyboard and a handful of diodes. Only three ICs are required to get you started.

Your existing keyer is used as a functional part of the Morse keyboard... a la carte (you can make one your way without a lot of fuss). Your keyer should be of a semiconductor design, preferably containing a +5-volt supply. If your keyer uses 12AT7s, please read on; it may still be easy to get rid of the bug! Chances are your keyer already has many of the

circuits required to make the a la carte design work. If your keyer has any of the below listed features or functions, that part of your Morse keyboard is ready to operate.

- Power supply with off/on switch
- Timing and weight circuits for dot/dash elements
- Monitor, volume, and possible tone controls
- Transmitter keying circuits
- Operator test-tune controls
- ROM or PROM message readout options

To build this additional hardware would cost you a buck-two-eighty, so why bother to do it again?! The nice thing about the a la carte design is that your keyer remains usable at any instant you desire to cease sending via the keyboard. In most cases, no modification or changes are required within your keyer, although getting into it may be desirable to achieve the simplest interface to the keyboard circuits.

So what does it take to

order up one a la carte keyboard? Take a look at the menu in the parts list. Items 1 through 5 you'll need for the main course. Item 6 is the dessert and, therefore, optional, depending upon your application and keyboard design.

How to Get Rid of the Bug

In this design, I used a diode matrix to establish the Morse coding elements (dots and dashes—forget about the spaces; your keyer takes care of that). In Fig. 1, the diodes forming the dot elements connect to a "dot" 8-bit shift register (U2), and the dash diodes connect to the "dash" shift register (U1). Examples of the diode arrangement to form the letters Q, S, and T are provided. The diodes may be wired all on one assembly to simplify wiring. The 8-bit shift registers store the "dot" and "dash" characterization for each letter in the order sent. There is no requirement to characterize the elemental spaces because this function re-

sides in the logic of your keyer.

When a keyboard switch is depressed, a logic zero (\approx 0V) appears on the output (pin 9) of U1 or U2. If the character being sent begins with a dash, pin 9 of U1 goes low. If the character begins with a dot, pin 9 of U2 goes low. The transition from a high to a low causes one of the terminals on your keyer to see a ground; thus it (the keyer) begins to do its thing, and it sends a beautiful dot or dash.

If the shift registers were not clocked, a second dash or dot would follow the first just as if you were holding down the key on your keyer. If both of the shift register outputs are high, the keyer again does its thing by doing nothing. When your keyer is idle, the a la carte keyboard assumes you have completed sending a letter, and it awaits the suggestion that you desire to send another letter. The letter-space oscillator (U3) controls this timing (Fig. 2). It sends a pulse (C) to the

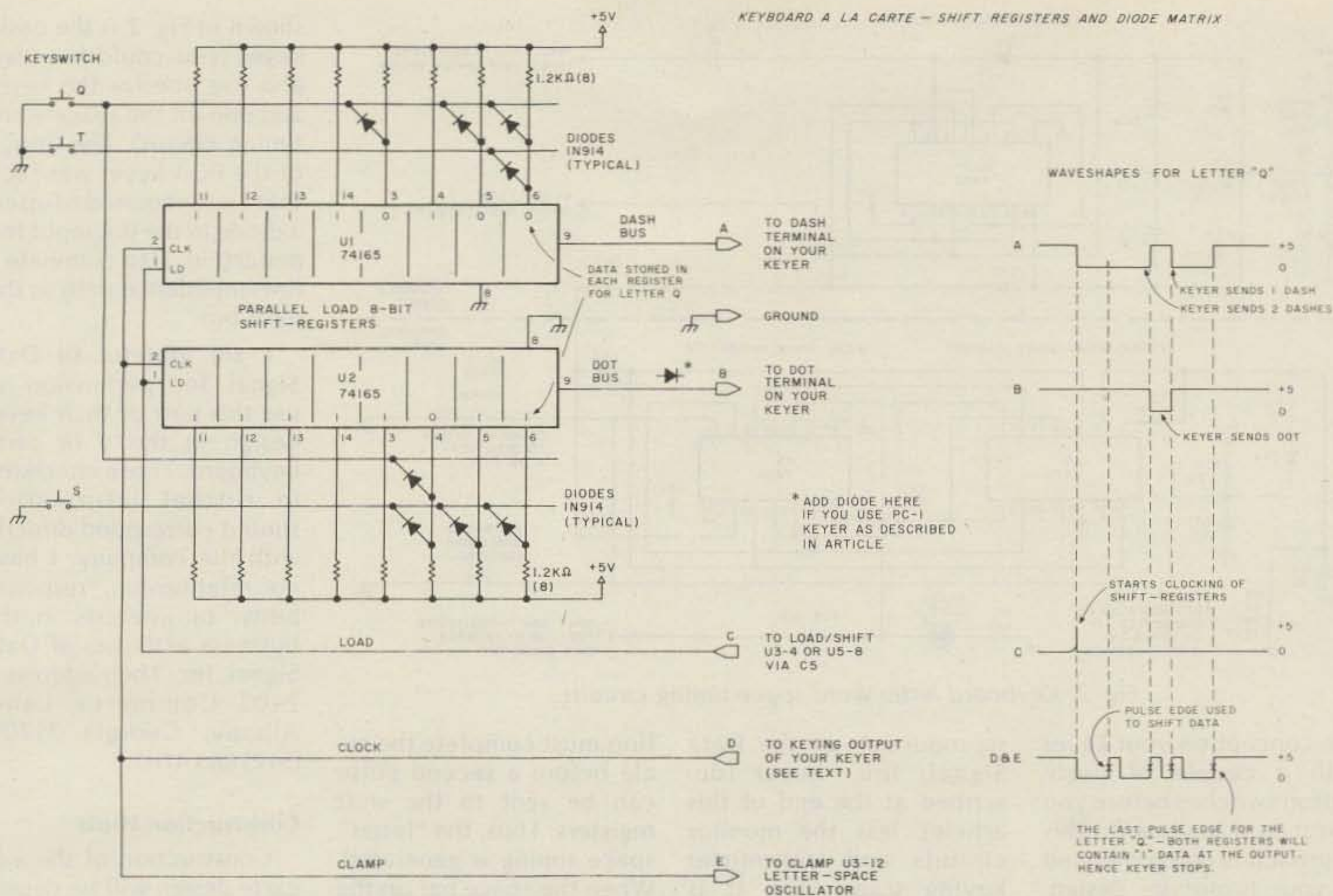

Fig. 1. Keyboard a la carte—shift registers and diode matrix.

shift register's load/shift input (pin 1) so that you can load in the next character from the diode matrix. If this pulse arrives at the shift registers when a key is being depressed, the next dot or dash instantly is on its way to the proper input of your keyer. Fig. 1 shows logically how the letter "Q" is loaded into the registers.

When your keyer is sending the letter, an output signal similar to the waveform shown in Fig. 1 (D and E) is routed to the shift registers (pin 2). This is a true representation of the Morse code as sent to your transmitter. It serves as a clock to advance the data stored in each of the eight locations in the shift registers. The 74165 clocks on the positive-going pulse at the end of each dot or dash element formed in your keyer. With the generation of the letter "Q", the data is shifted four times after

the initial start by the letter-space oscillator. The clock signal must be of the phase shown in the diagram or your keyer will send extraneous signals. In my keyer, a signal was acquired at the base of one of the transmitter keying transistors and routed through a 7400 logic gate to invert the signal to the desired phase. Check around your keyer; you'll find an appropriate location. The signal should measure about +5 volts when off, and near 0 volts when a dot or dash is present. There are all kinds of ways to capture this output. You can even use one of your transmitter keying outputs with an appropriate interface to give you the proper clocking signal. Here's your chance to apply some of your own talents to the design.

The Main Menu

If you just connect U1, U2, and U3, the diode matrix, and the keyswitch,

as shown in the diagrams, you will have a very versatile system. The variable resistor network provides a full range of adjustments to control the speed or timing of the letter-space oscillator. R2 and perhaps R5 should be mounted as operating controls. The other variables may be fixed or trimmed one time to achieve the adjustment ranges desired. With these controls and those on your keyer, you can establish a keyboard fist of your very own style.

My keyboard performed with spectacular success. Speed was controllable from 4 to 50 wpm. The shift registers provided one full letter of memory. No problems with keybounce, transmitter RFI, EMI, or other intermittent operation occurred. Besides all the letters and numbers, the shift registers can store up to eight code elements, so you can send \overline{AR} , \overline{AS} ,

\overline{BT} , \overline{SK} , $\overline{?}$, $\overline{/}$, \overline{CQ} , error, and any other procedural signals you can invent. However, remember that the registers will not store space data.

Several additional features were added to my keyboard to aid in the operating pleasures of the device. One is a "test" switch to effectively short the "V" keyswitch to ground. This permits the continuous execution of "Vs" for adjustment purposes. An LED was also added on the control panel to give a visual indication that the keyboard is active and ready to load the next character. Timing this light when sending Vs will give a good indication of sending speed on the keyboard. The LED is connected at U3, pin 6 in the simple version and at U5, pin 8 in the optional space-bar version.

The keyboard should work with just about any keyer. You can test the en-

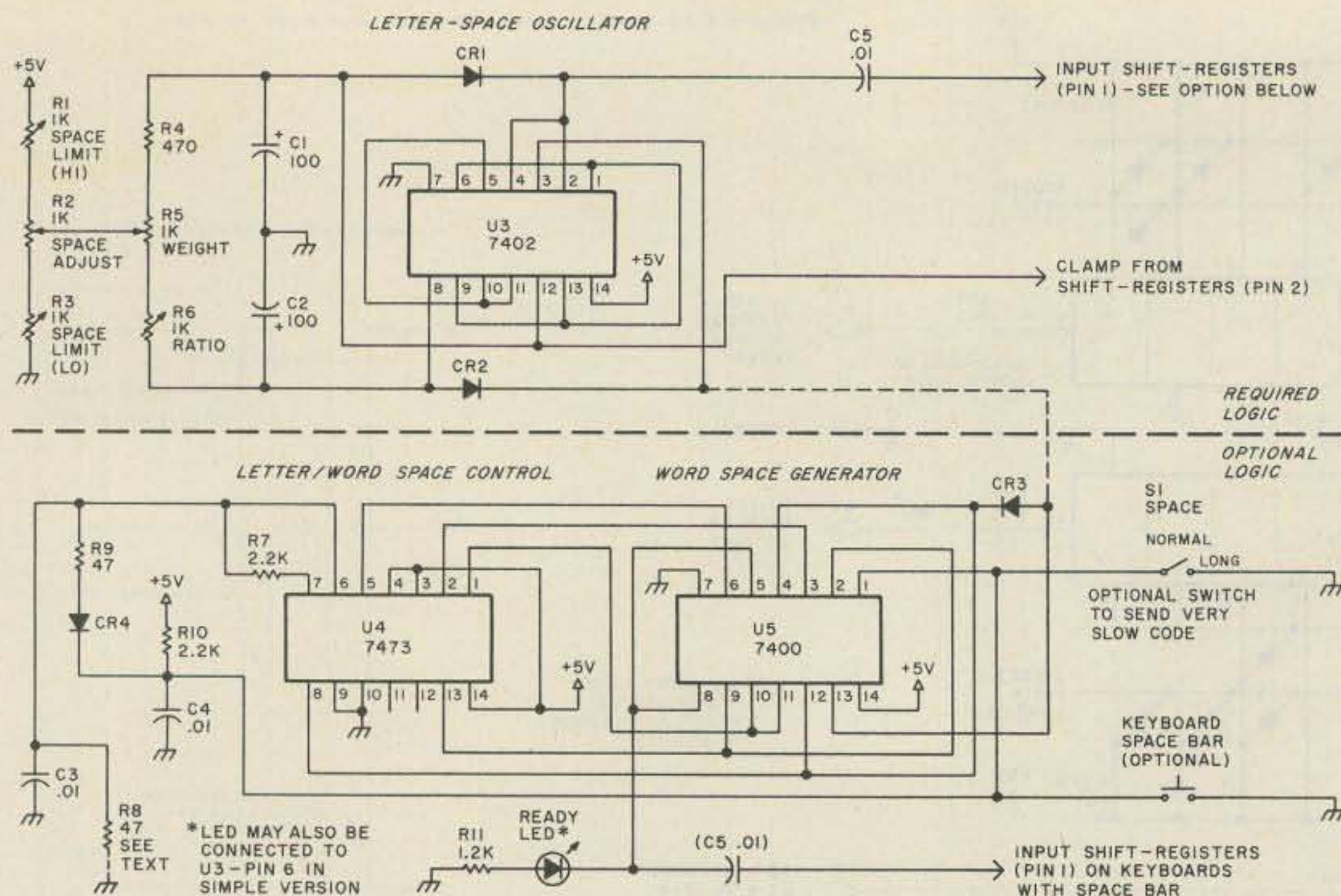

Fig. 2. Keyboard letter/word space-timing circuits.

tire concept on your keyer with a couple of push-button switches before you invest in a keyboard. This approach is recommended in your prototype design. Regardless, I see no complication in going keyboard a la carte with popular keyer designs such as the Accukeyer and the more recent micro-to-keyer concepts. The only test equipment used during many hours of experimenting was a multimeter and several LEDs. No ICs or other parts failed for any reason whatsoever.

Here's the Dessert

If the keyboard you have selected to use contains a space bar, you can add an optional circuit, shown in Fig. 2. It consists of a 7400 gate and a 7473 flip-flop. For most parts, it is a

reproduction of the Data Signal, Inc., keyer (described at the end of this article) less the monitor circuits and transmitter keying transistors. It is shown here with permission of Data Signal, Inc.

The circuit sends controlled letter-space and word-space pulses which activate the shift registers at the start of the next letter or next word being keyed from the keyboard switches. When R8 is grounded (this is a dot input for the circuit when it is used as a keyer), the space oscillator, U3, starts to run. This sets U4. Also, when U3 starts its cycle, a 1 is placed on U5, pin 8, and a positive pulse is sent to the shift registers to permit loading of data from the diode matrix. Once this occurs, the oscillator and flip-

flop must complete the cycle before a second pulse can be sent to the shift registers. Thus, the "letter" space timing is generated. When the space bar on the keyboard is depressed, R10 is grounded (the dash input to the keyer circuit) and flip-flop U4 extends the rest period to the full word-space timing as determined by the variable adjustments at the oscillator. A convenient letter/word spacing switch fixes the spacing at its maximum set length. The addition of this switch is useful if the keyboard is to be operated at very low speeds for teaching purposes or when operating on the Novice band.

The Author's Keyer

For my design, I used a Data Signal, Inc., PC-1 keyer. It was constructed from a kit which cost about \$16.00. The kit consisted of four ICs, transistors, diodes, pots, capacitors, speaker, PC board, and wire. The keyer was mounted in a small utility box with a simple power supply. The entire kit could be incorporated into the keyboard package without difficulty. The circuit

shown in Fig. 2 is the basic keyer (you could buy two and use one for the keyer and one for the space-word timing circuit). The design of the PC-1 keyer was such that I was required to insert a diode in the dot input terminal (Fig. 1) to eliminate a low-impedance path to the dash bus.

I am grateful to Data Signal for permission to use this part of their keyer design in the a la carte keyboard. Those interested in further information should correspond directly with the company. I have no relationship, responsibility, or interests in the business activities of Data Signal, Inc. Their address is 2403 Commerce Lane, Albany, Georgia 31707, (912)-883-4703.

Construction Hints

Construction of the a la carte design will be dependent upon the keyboard you are able to use. Remember, you may use push-button switches to fabricate a keyboard design if the cost of a purchased unit is out of the question. Regardless, switch contacts should be normally open if you follow these schematics. The diode matrix can be mounted on a block of wood about one-half an inch thick by 3½ to 4 inches wide and 7 or 8 inches long. In my keyboard, the block was sized to fit under the keyswitches. The diodes are inserted into predrilled holes in the board such that the body of the diode is hidden from view and the diode leads extend out through each side of the board. The proper polarity of the diode must be observed when inserted (see Fig. 3). Also, remember that pin 6 of U2 and U3 is the first-in, first-out data line for each chip. Reversing the order of the data lines will result in operational failure.

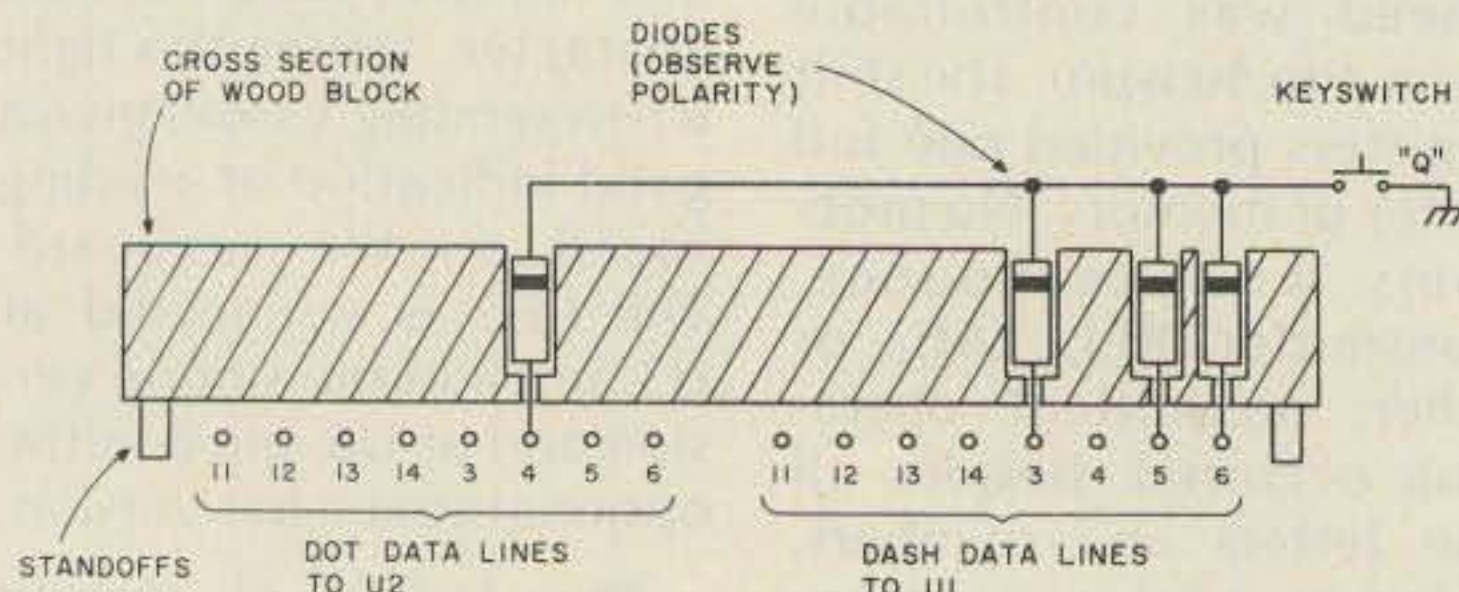

Fig. 3. Diode matrix assembly (wiring for the letter "Q" shown).

The matrix board also contains the sixteen pull-up resistors. They are connected to the sixteen data lines at one end of the board. The other resistor leads are all common to the +5-volt source. A layout for the diode matrix should be started by preparing a template on graph paper. Mark the hole pattern for each diode so that they can be connected between each of the 16 data lines according to the code elements of each character. Locate the holes for the pull-up resistors at one end of the board. Wrap a piece of tape around the bit you intend to use to drill out the diode holes so that the bit will stop before going all the way through the board. Another piece of tape should be wrapped around a needle or bit of the appropriate size of the wire leads of the diodes. Use the needle to extend the hole for the diode

leads to pass completely through. In this case, the tape helps to center the needle in the existing diode hole.

Small crimp-on contacts of an unknown variety were used to provide a mating interface between the wires of the matrix and the wiring coming from the keyswitches and logic. The leads, however, could be soldered if consideration in the layout is made for disassembly and repair. The matrix board was mounted on four stand-offs, as shown in the diagram, to insulate it from the keyboard housing.

The ICs can be mounted on just about any old vec-

torboard. I used sockets, but they were not necessary. Figs. 1 and 2 are arranged to show a wiring configuration for the ICs. The true schematic representation is not shown in detail to make the drawings more useful in the assembly of the project. Refer to appropriate data books for schematic details. The control panel design, again, is a function of the keyboard used, and the control options selected from the text.

Bypassing and filtering of the power source is desirable at several places to ensure reliable performance. Recommendations here are a function of the

power source used and the effectiveness of the ground system and, therefore, are left to the builder to determine. In the cabling between the keyboard and your keyer, use shielded wire if possible. These lines should be kept as short as possible. The use of connectors and plugs might be more appropriate than terminal strips to help prevent false triggering from rf in the radio shack.

One final warning about the operating effects of your new keyboard... Your SSB friends will wonder what happened to you. You'll be a born-again CW man, this time without the bug. ■

Parts List

Item	Qty.	Description	Approx. Cost
1.	1	Keyer, yours—if you don't have one, see text	---
2.	1	Keyboard (45 or more keys, microswitches will work)	don't pay over \$19
3.	2	Dot/dash shift register ICs (74165)	\$1.25
4.	1	Dot/dash matrix, you'll need about 200 signal diodes	\$4.00
5.	1	Letter/space oscillator—7402 IC, plus misc. parts	\$3.00
6.	1	Word/space generator—7400 and 7473 ICs	\$1.00

ASCII MORSE RTTY

MONITOR \$139.
(12" B&W)

COMPLETE KEYBOARD TERMINAL \$350. Kit 295.
(Less Monitor)



SCT-100 STAND ALONE VIDEO BOARD

- Partial Kit \$95.
- Full Kit \$157.
- Assembled & Tested \$187.

COMPUTER

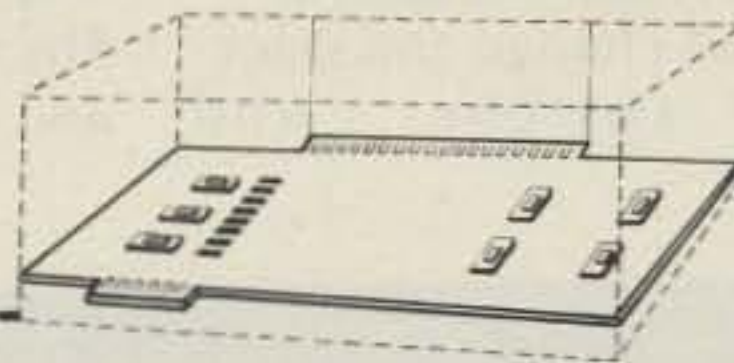

RS232 (in/out)

SERIAL LOOP

Features

- ASCII & BAUDOT
- Auto Sync. 1-150 WPM
- Microcomputer Interface

TRANSCEIVER



TERMINAL UNIT

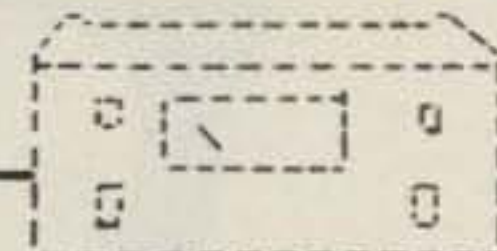

RTTY (TX/RX)

MRS-100



MORSE (TX/RX)

- Partial Kit \$95.
- Full Kit \$225.

- Assembled & Tested \$295.

KEYER OPTIONAL

XITEX CORP.

9861 Chartwell Drive
Dallas, Texas 75243 (214) 349-2490

MC / VISA ORDER BY PHONE X3

Little Extras for the Century 21

— easy add-ons

Make a good rig a little better.

Bob Borum KN4JJG
5708 Orient Rd.
Tampa FL 33610

Recently, I bought a Ten-Tec Century 21 80-10 meter CW-only transceiver. I used it for a couple of weeks just as it came from the box, and all in all I was very happy with the ease of operation and the fine signal reports I was receiving. But, being the typical ham, I thought I

would change things a bit.

Little Things

The first things that bothered me were the prop-up feet and the size of the control knobs. If you have small fingers the knobs are okay, but they got lost in my big fingers. Digging through my junk box, I came up with a matched pair of knobs for the band-change and selectivity switches, and

another pair for the rf and af controls. The ease of operation greatly increased. As for the feet, I had a couple of 1¼-inch feet left over from another project.

Bigger Things

Everything was all right for about a week, and then the sidetone began to get to me. It sounded like a frog was living in the radio. The note was about 350 Hz and my ear is tuned to

around 700 Hz, so out came the schematic and off came the bottom cover. R1, a 68k ½-W resistor (47k in my unit) on board the 80356, controls the frequency of the sidetone. If this resistor is decreased in value, the tone increases in frequency. I paralleled another 47k resistor with R1 and the tone was just about right. So I removed R1 and installed a wire to one of the solder pads and a 22k ½-W resistor to the other. I found a space on the rear panel to mount a 25k linear pot in series with the wire from the other solder pad. Now I have variable sidetone.

As long as I had the board out and the bottom off, I looked around for solder whiskers, cold solder joints, etc. I noticed that the selectivity switch had several unused connections, and, sure enough, the selectivity switch had other positions available by turning the switch to the left from the 2.5 position. This made me think that if 500-Hz selectivity is good, wouldn't 200-Hz be better? The present active filter circuit in the Century is a good one, so I just dupli-

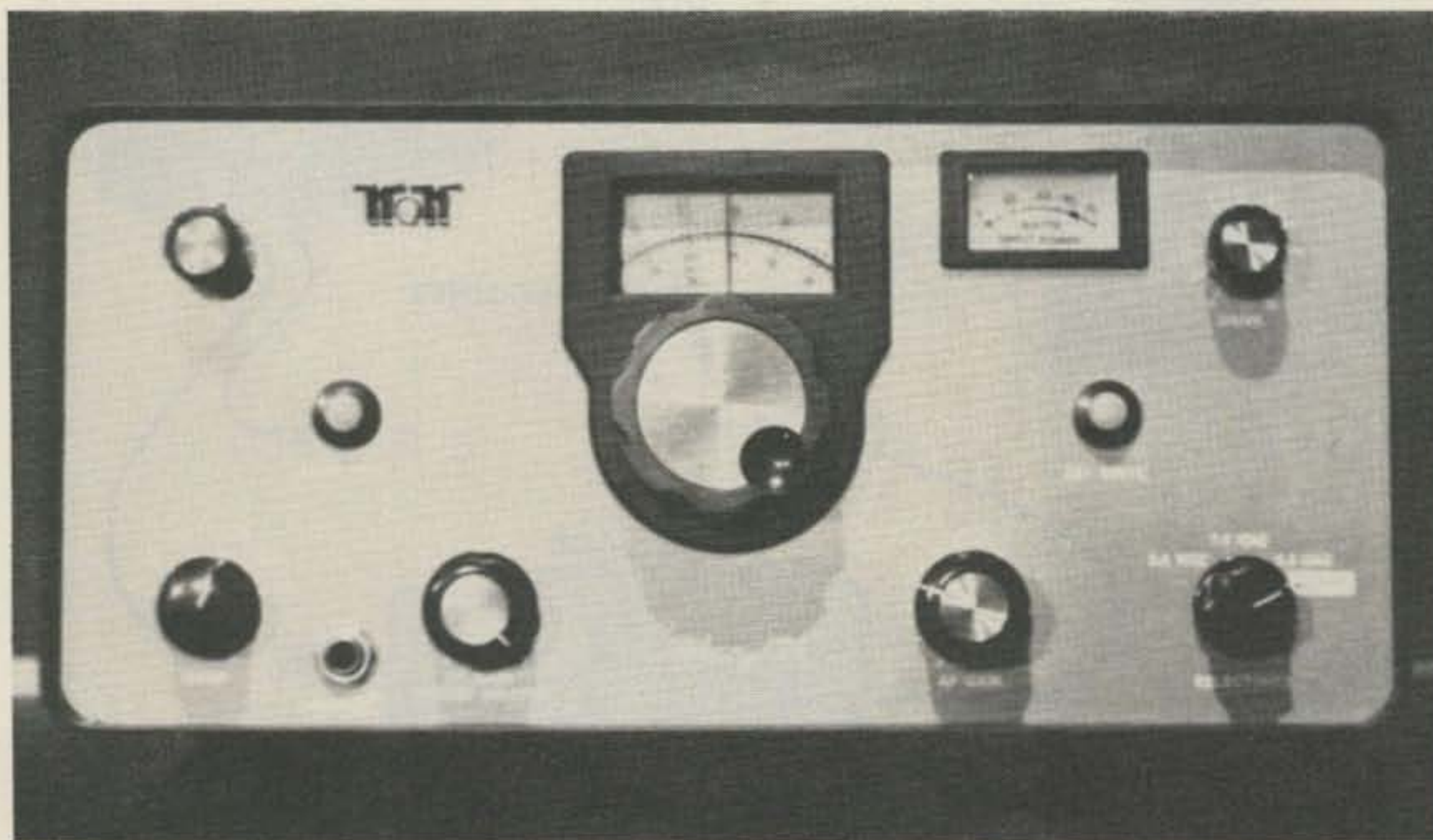

The new, larger knobs installed, with the selectivity switch in the .2-kHz position.

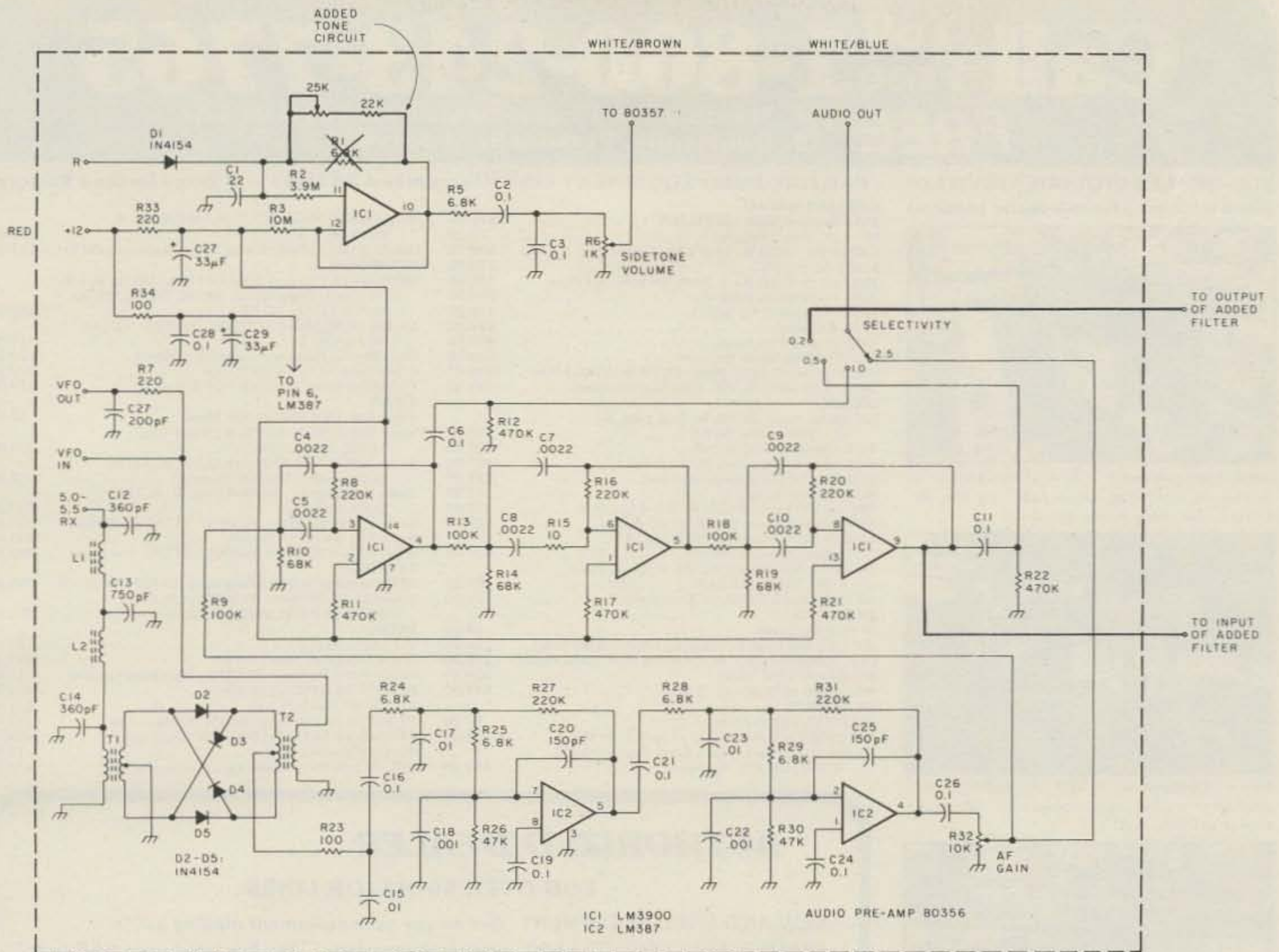

Fig. 1. 80356 audio preamp.

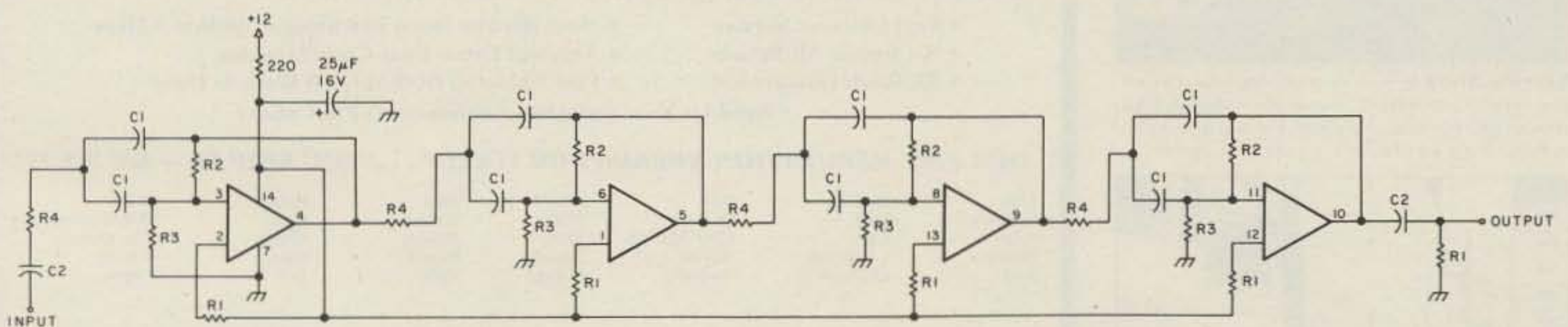
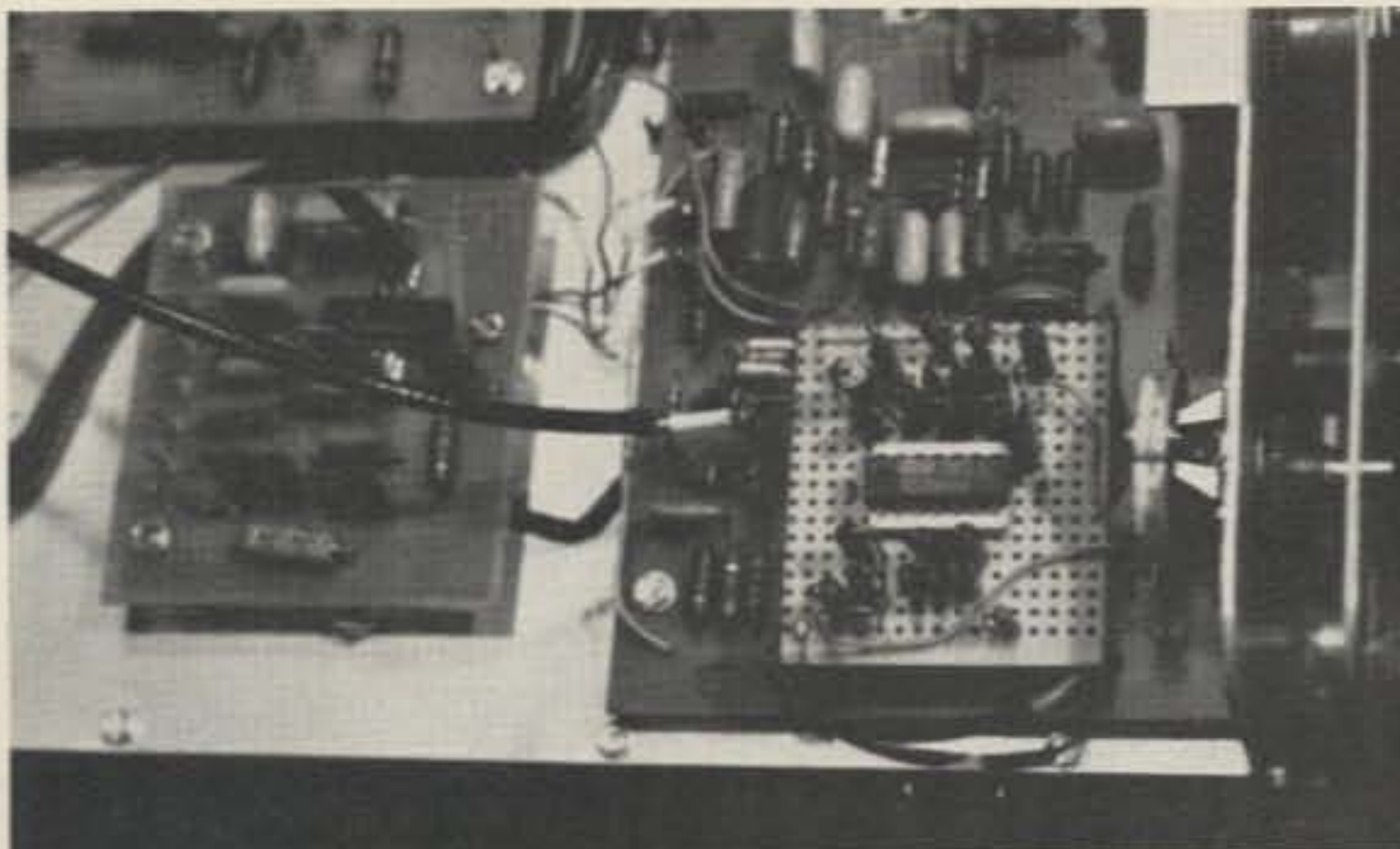
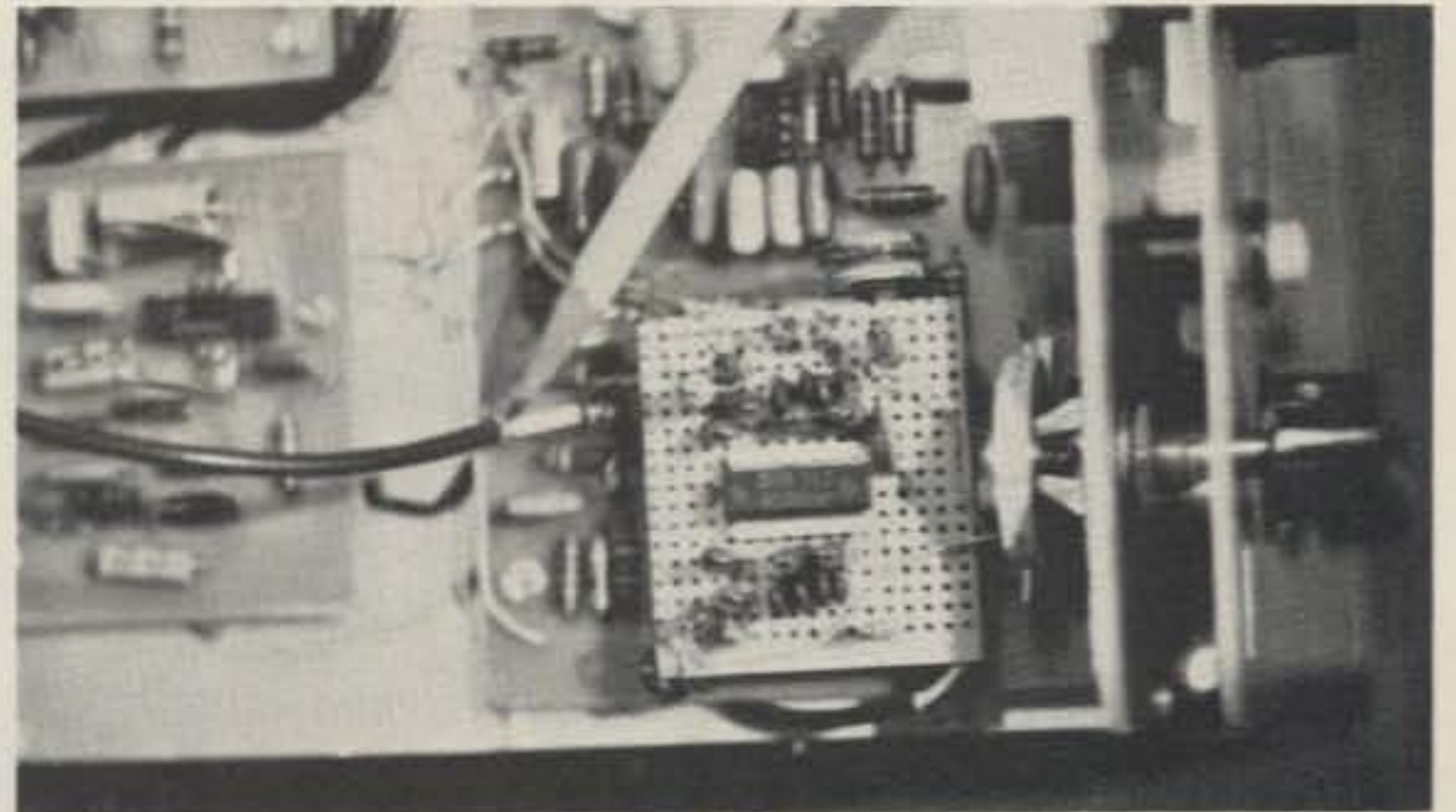

Fig. 2. Audio active filter. R1—470k. R2—220k. R3—68k. R4—100k. C1—2200pF. C2—.1µF. IC—LM3900.



Added CW filter mounted behind selectivity switch.



Pencil points to the wire going to the sidetone control—also shown is the added filter on vectorboard.

Call Toll Free 1-800-243-7765

FREE • Monthly Used Equipment / New Specials List
• Courteous, Personalized Service

SUB-DEALER INQUIRIES INVITED!
(Send letterhead for sub-dealer package)



New Equipment — All new equipment on display is operating for actual "on the air" QSO's. We really know our gear!



Used Equipment — We recondition and guarantee all our used equipment. We make sure it satisfies you!



Service Shop — You've probably heard of our fine service reputation — using Cushman CE4B signal generators, Hewlett Packard oscilloscopes, Bird wattmeters — we fix it right!



Inventory Warehouse — Our large volume assures you the best prices!

PARTIAL USED EQUIPMENT LIST (Guaranteed 30 Days — 7 Days Refund Policy)

COLLINS RADIO		KENWOOD	
75S3 Receiver With CW FILTER	479.00	SB101 10-80 Meter XCVR W/HP23B AC & HP13 DC P.S.	449.00
MP-1 DC Power Supply	75.00	HW 16,80,40,15 Meter CWXCVRW/Kantronics VFO	159.00
KWM2 SN-10454 W/516F2 Tranceiver (Exc. Cond.)	699.00	TR7200A 23 Channel 2 meter FM XCVR W/Bracket, DC Cord, Xtals-52/52, 94/94, 28/88, 40/00, 34/94, 16/76, 10/70	189.00
516F2 AC Supply	149.00	TS-520 10-80 Meter XCVR W/DK-520 - Adapter Kit For DG-5	519.00
75A4 10-80 Meter Recv. W/3 Mechanical Filters	319.00	DG-5 Digital Display/Frequency Counter	219.00
75S1 10-80 Meter Receiver	299.00	R-300 General Coverage RCVR	219.00
32S-1 W/516F-2 AC Supply	479.00	TS-700S 2 Meter All Mode XCVR-Digital	529.00
312B-4 Console	189.00	SWAN	
30L2 10-80 Meter Amp.	495.00	Swan WM-1500 PWR/SWR Meter	50.00
75S-3B 10-80 Meter Receiver	649.00	Swan 250 6 Meter XCVR W/Noise Blkr, 117XC Supp./Spkr.	329.00
KWM-2 (round) 10-80 Meter XCVR W/516F-2 P.S.	1099.00	Swan 700CX - 10-80 Meter XCVR W/117XC Supp./Spkr., Vox, DC Supply	612.00
390A-.5-32 MHZ RCVR - Excellent Condition	549.00	Swan 260 Cygnet - 10-80 XCVR W/AC/DC Supp. built in	289.00
DRAKE		Swan 350 10-80 Meter XCVR W/117XC AC Supply	329.00
2-C 10-80 Meter RCVR W/Xtal Calb & 2C-Q Multiplier/SPKR	218.00	Swan 240 W/117XC Supply	149.00
TR-6 6 Meter XCVR W/NB	579.00	Swan 500 10-80 Meter XCVR W/117 AC Pwr Supp.	395.00
T-4X 10-160 Meter Xmt W/AC-4 P.S.	419.00	TEN TEC	
SSR-1 General Coverage Receiver	219.00	505"Argonaut" W/250 8Amp Supp. 10-80 Meter XCVR	265.00
AC-10 Power Supply	37.95	Triton 11 10-80 Meter XCVR W/CW Filter 200 Watt P.E.P. input - Solid State	399.00
R4C 10-160 Meter RCVR W/MS-4 Speaker	459.00	YAESU	
T4XC 10-160 Meter XMTR W/AC-4 P.S.	529.00	YO-100 — Scope	149.00
TR-6W/NB 6 Meter XCVR W/AC-4 Supp/Shure 444 Mike	679.00	FLDX 400 10-80 Meter XMTR	299.00
TR-33C 2 Meter Port. XCVR W/Case, Mike, Cord, Nicads, 12 Xtals	189.00	FRDX 400 2-80 Meter RCVR W/Matching Speaker	319.00
2B 10-80 Meter RCVR W/Xtals Calb.	179.00	FT-401B 10-80 Meter XCVR	485.00
DENTRON		FT-7 10-80 Meter XCVR	375.00
Jr. Monitor Tuner	49.00	FT-101EX 10-160 Meter XCVR W/Mike, Fan	525.00
WP-1A 2 KW Peak Reading Wattmeter (Like New)	125.00	FT-101B 10-160 Meter XCVR W/DC Supply	489.00
GLA-1000 1KW Amp. W/10 Meter Mod. (New Finals)	275.00	SP-401P Phone Patch	19.00
MT-3000A 3 KW Tuner	259.00	FRG-7 .5-30 MHZ - General Coverage RCVR	250.00
MLA-2500 10-80 Meter - 2 KW	629.00		
HEATHKIT			
SM210 Volt OHM Meter	80.00		
HW-2036 2 Meter XCVR W/Touch Tone Mike	249.00		
SB104 10-80 Meter Solid State Digital XCVR W/HP1144 P.S. Speaker	599.00		

AUTHORIZED DEALER . . .

FOR OVER 50 MAJOR LINES .

NEW AND USED EQUIPMENT "Get on our used equipment mailing list."
TRADES WELCOME "The best allowances anywhere" "We buy good used SSB gear"
OUR EVERYDAY LOW PRICES "remain the same for cash or trade-ins!"
SAME DAY U.P.S. SHIPPING "Just a phone call away"
COMPLETE RADIO SERVICE SHOP "Mail Order Repair Service"

- Fast Efficient Service
- We Repair All Brands
- All Work Guaranteed
- Most Repairs Done and Shipped Within 7 Days
- Amateur Extra / First Class Licenses
- Free Shipping Both Ways If Work Is Done
- Send Us Your Defective Equipment U.P.S Collect

OUR FINE REPUTATION SPEAKS FOR ITSELF . . . "YOU SHIP IT — WE FIX IT"

Alda	B & W	DSI	ICOM	MFJ	Robot	TRAC
Alliance	CDE	Drake	KDK	Microlog	Rohn	VHF Engineering
Atlas	CES	ETO ALPHA	KLM	Mosley	Shure	Vibroplex
Benchner	Cushcraft	Hustler	Larsen	Murch	Swan	Wilson
Bird	Dentron	Hy-Gain	Mirage	PIPO	Ten Tec	Yaesu

"We can match most any other quote!"

THOMAS COMMUNICATIONS

95 Kitts Lane, Newington, Conn. 06111
"Near ARRL Headquarters"

Connecticut Residents Call: 203-667-0811
OPEN MON.-FRI. 10-6 • THURS. 10-8 P.M. • SAT. 10-4
EASY DIRECTIONS: Rt. 15 South — 2 blocks past McDonald's (Berlin Turnpike)

Call or Write for your super quote today!



WE EXPORT (Sub-Dealers wanted in foreign countries)

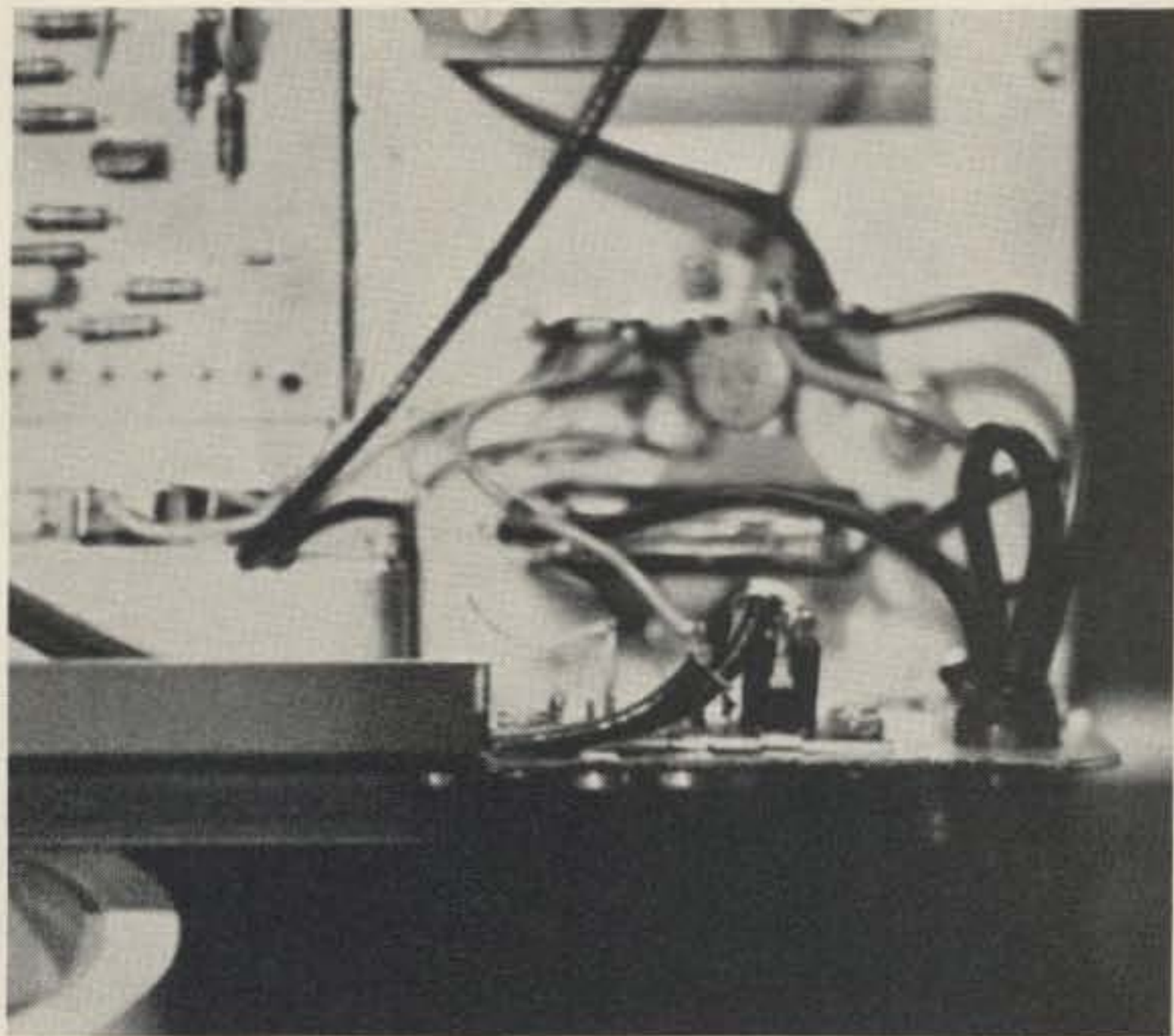

Bottom view of placement of auxiliary speaker jack.

cated it by using all 4 of the amps in the LM3900 chip. Construction is straightforward, using a small square of vectorboard. I used a wire-wrap 14-pin IC socket, and it really simplified construction. With Super Glue™, I mounted 2 fiber standoffs to the 80356 board to mount the new active filter on after construction. I Super Glued the vectorboard to these standoffs.

The selectivity knob is the setscrew type, so by moving the connections on the board the knob can be rotated so the dial still reads correctly. A small Dymo™ label slightly to

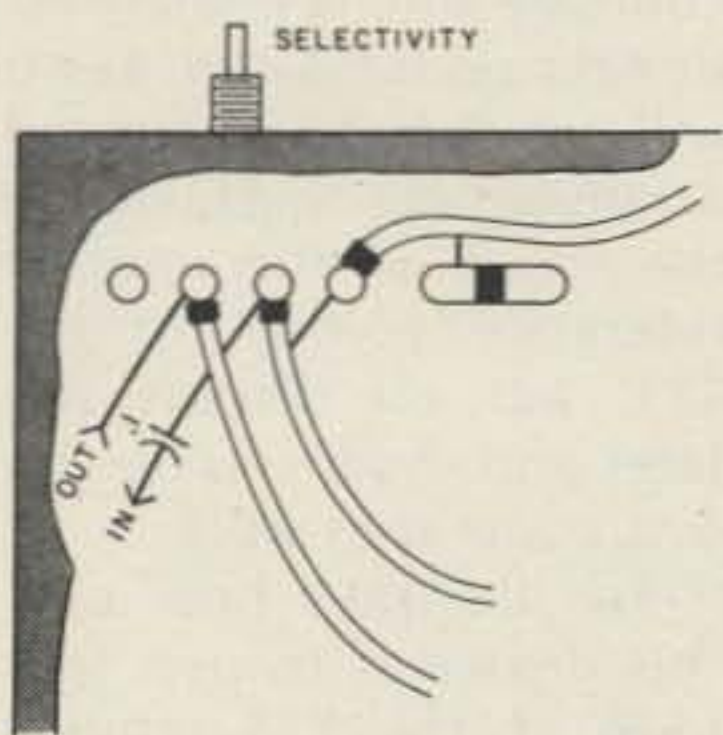

Fig. 3. Bottom view of 80356 audio preamp board. Cut foil as indicated by heavy black areas. Add jumpers as indicated by heavy black lines. In/out indicates wiring to added filter.

the right and down a bit from the .5 position is the .2 position. This modification is very simple, works well, and can be removed to have the circuit made normal, with no indications that it was ever done. Now, talk about single signal selectivity! The signals just leap out at you when the tone of the signal is tuned to 750 Hz.

Last but not least, I installed an external speaker jack on the back in place of one of the 12-V accessory phono jacks. I used a miniature phone jack of the shunting type. If an external speaker is plugged in, the internal speaker is cut off. Care should be taken so that the other 12-V accessory jack is not shorted to the phone jack you install. I will be glad to answer any letters concerned with these modifications if there is an SASE enclosed. Let's see... amplified agc would be nice, maybe a vernier control for the offset tuning, and SSB shouldn't be too hard. Well, that will come later; I'll enjoy what I have for awhile.

All parts for these modifications can be bought at Radio Shack for around \$15.00. ■



Mounting of the sidetone control and the auxiliary speaker jack.

State of the art TECHNICAL EXCELLENCE in RTTY



The FSK-1000 Demodulator

If you demand the finest, no compromise technology, you need the FSK-1000 demodulator. Can't be outcopied because its design, computer grade parts, and modern technology offer landline copy over radio circuits.

Stops QRM with selectable 55 or 100 Hz. filters and two tone limiterless operation

Decision level correction improves selective fading

Uses either 170 volt, 60 Ma. or RS-232 loops

Video operation available. Interfaces microcomputers. We can install your Xitex SCT-100 board inside, too

Continuously adjustable shift from 100 to 1000 Hz.

Write for details. Visa and Master Charge accepted.

Being introduced now at

\$397.00

FOB Columbus, Ohio

\$449.00 August 1, 1979

IRL

700 Taylor Road
Columbus, Ohio 43230
(614) 864-2464

The Many-Talented 723

— how can regulated supplies get much simpler?

Design your own voltage regulator.

Whenever you need a regulated power supply for the test bench or for that special IC project you're working on, consider the 723 integrated voltage regulator. This handy little device is inexpensive (priced around 70¢), simple to use, and offers a lot of capability in a small package. With it, you can build a quality regulated power supply using very

few parts. Read on and I'll show you how easy it is to custom design your own regulator around the 723 to suit your particular application.

Before we begin, let's look at a few characteristics of the device itself. The 723 operates with a rectified and filtered input voltage in the range of 9.5 volts to 40 volts. The output voltage is adjustable from 2 volts to 37 volts with .01% line and load regulation.

In case the terms "line regulation" and "load regulation" are unfamiliar to you, line regulation is the percentage change in the regulator output voltage for a change in the input voltage; load regulation is the percentage change in the regulator output voltage for a change in the regulator output current. Ripple regulation, which is defined as the ratio of the peak-to-peak input-ripple

voltage to the peak-to-peak output-ripple voltage, is typically 45 dB.

As you can see, the regulation characteristics of the 723 are excellent. Note, however, that the 723 has two disadvantages that we must deal with. The first of these is that this IC can provide a maximum output current of only 150 mA. This limitation can be overcome by adding a single external pass transistor, as we will see later. The second disadvantage pertains to the value of the internal reference voltage of the 723, but I'll discuss this later and show you how to overcome it as well.

To illustrate how easy this device is to use, let's look at the 723 internal structure and then design a few regulator circuits with it. Fig. 1 shows the essential functions of a typical series voltage regulator. The reference voltage element provides a known stable voltage which is

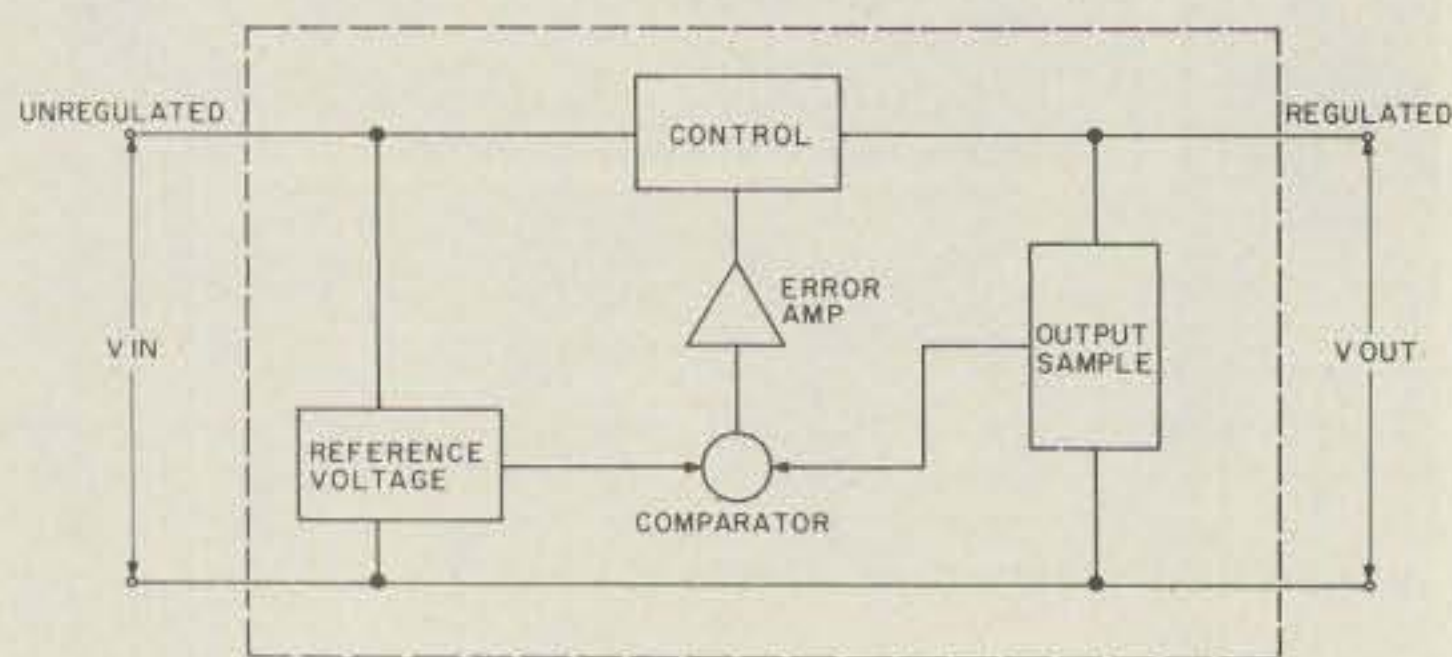

Fig. 1. Functional block diagram of a series voltage regulator.

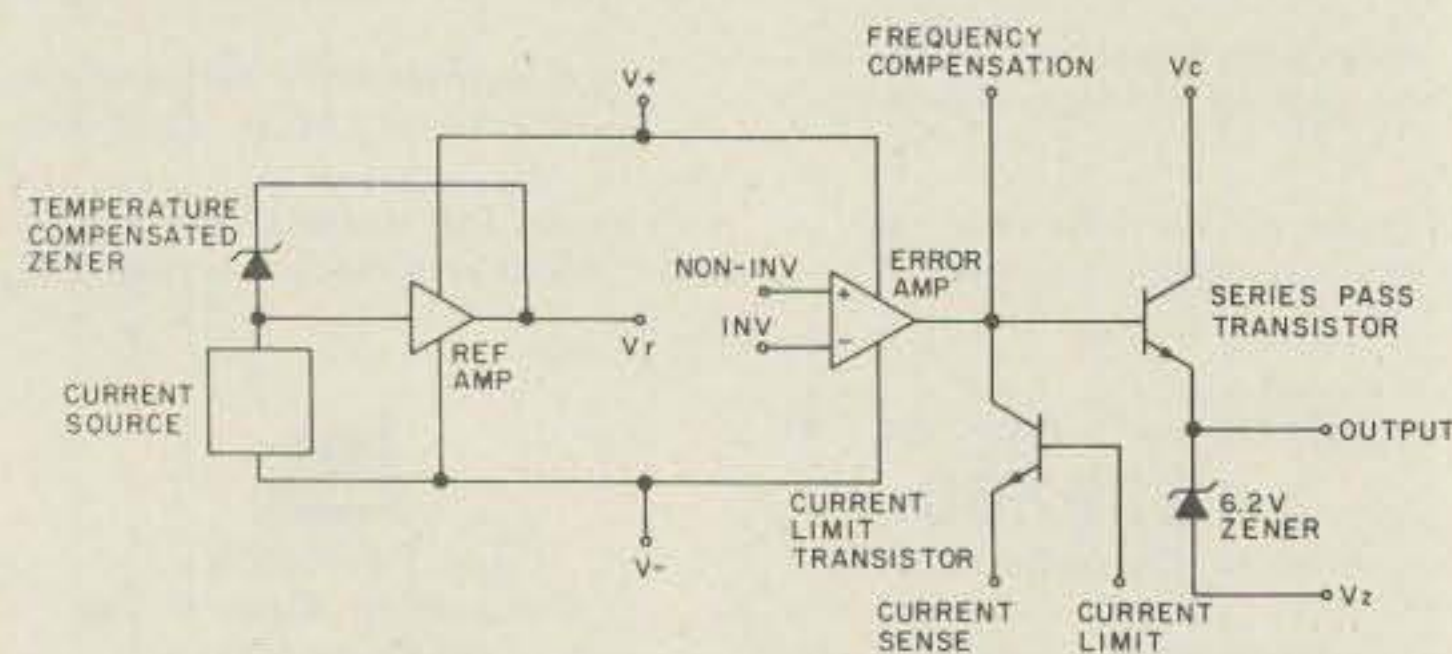

Fig. 2. Internal 723 functional block diagram.

compared with a sample of the regulated output voltage at the comparator. The comparator subtracts the sampled output voltage from the reference voltage. This difference voltage (or error voltage) is then amplified by the error amplifier to provide drive for the control element. The control element behaves similarly to a valve in a water line in that it conducts more or less to adjust its resistance, and hence its voltage drop, to yield the proper output voltage across the load.

Now compare the internal features of the 723 (Fig. 2) with the regulator block diagram (Fig. 1). The 723 contains all the necessary regulator components except the output sampling element. The reference amplifier, current source, and zener diode comprise a stable temperature-compensated voltage source. Other internal functions include an error amplifier, a series pass transistor (the control element), an adjustable current limiter, and a 6.2-volt zener diode. The input of the error amplifier functions as a comparator by taking the difference between the voltages applied to the inverting and noninverting inputs. Note that the current limiter and the 6.2-volt zener diode are features

that are not essential to the operation of the regulator. However, the current limiter is extremely useful for setting the maximum (short circuit) current output from the regulator, and the 6.2-volt zener diode can be used in floating or negative voltage regulator applications. One caution should be noted here—the 6.2-volt zener diode is only accessible in the 14-pin dual-in-line package. The flat pack and the 10-lead metal can packages do not have enough pins to accommodate all the internal functions of the 723, so the Vz output is not accessible. The pin outputs for the various packages are shown in Fig. 3.

High-Voltage Regulator (7.1 volts to 37 volts)

A typical 723 regulator circuit is shown in Fig. 4. In this figure, the temperature-compensated zener, the reference amplifier, and the current source are represented by an equivalent independent voltage source (a battery) to simplify the diagram. Vr may vary somewhat from device to device (6.6 volts to 7.5 volts), although it is typically 7.1 volts. The value of Vr establishes the lowest possible output voltage obtained from this circuit.

R1 and R2 form a volt-

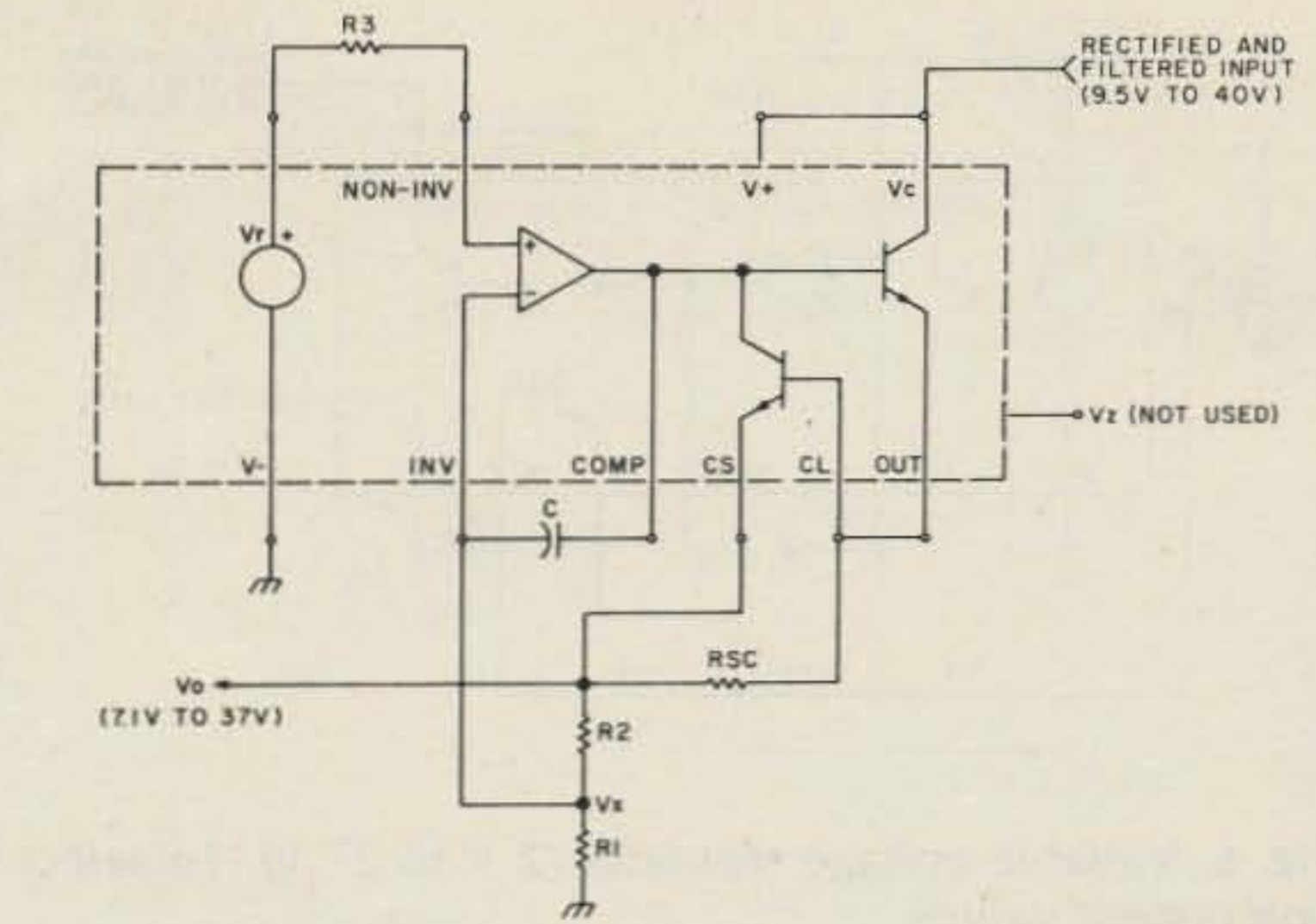

Fig. 4. High-voltage regulator (7.1 V to 37 V). To select component values:

1. Choose V_o
2. Measure V_r (or assume $V_r = 7.1$ V)
3. $R_1 = V_r/I_b$ (I_b is between 0.1 mA and 5 mA)
4. $R_2 = (V_o - V_r)/I_b$
5. $R_3 = R_1R_2/(R_1 + R_2)$
6. $R_{sc} = 0.65/I_{sc}$ ($I_{sc} = \text{max. output current limit}$)
7. $C = 100$ pF to 500 pF

age divider network from which the output sample (V_x) is taken. Therefore $V_x = V_oR_1/(R_1 + R_2)$. If V_x is greater than V_r , the error voltage (which is $V_r - V_x$) will be negative and the output of the error amplifier will decrease, causing the series pass transistor to conduct less. This, in turn, causes V_o to decrease until V_x is equal to V_r . At this point, the error voltage is essentially zero and the output volt-

age (V_o) remains steady at a value equal to $V_r(R_1 + R_2)/R_1$. Should the output voltage begin to decrease, V_x will begin to decrease proportionally. As V_x attempts to drop lower than V_r , the error voltage becomes positive, causing the output of the error amplifier to increase. The pass transistor then conducts harder, which causes V_o to increase until $V_x = V_r$ once again. As before, $V_o = V_r(R_1 + R_2)/R_1$.

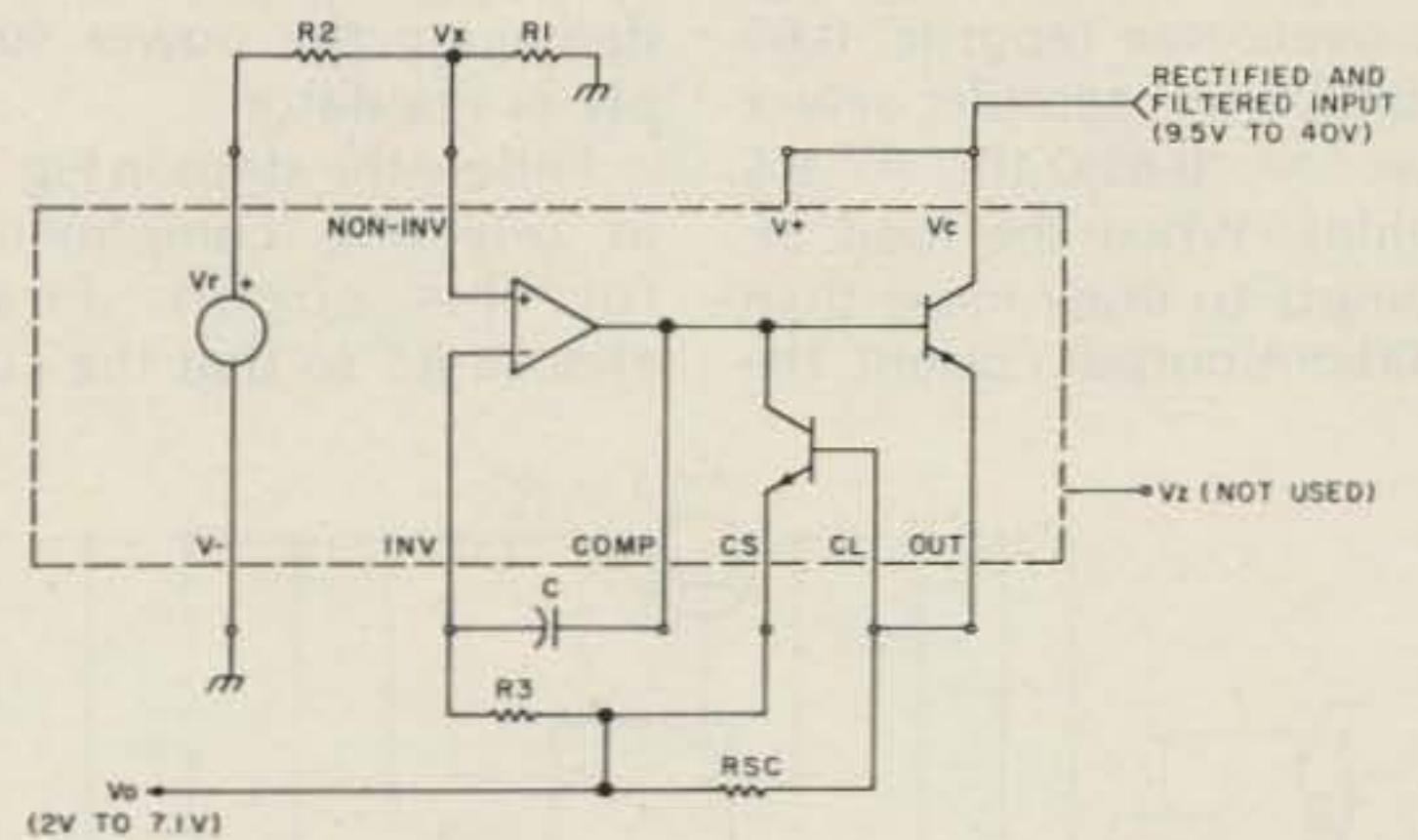

Fig. 5. Low-voltage regulator (2 V to 7.1 V). To select component values:

1. Choose V_o
2. Measure V_r (or assume $V_r = 7.1$ V)
3. $R_1 = V_r/I_b$ (I_b is between 0.1 mA and 5 mA)
4. $R_2 = R_1(V_r - V_o)/V_o$
5. $R_3 = R_1R_2/(R_1 + R_2)$
6. $R_{sc} = 0.65/I_{sc}$ ($I_{sc} = \text{max. output current limit}$)
7. $C = 100$ pF to 500 pF

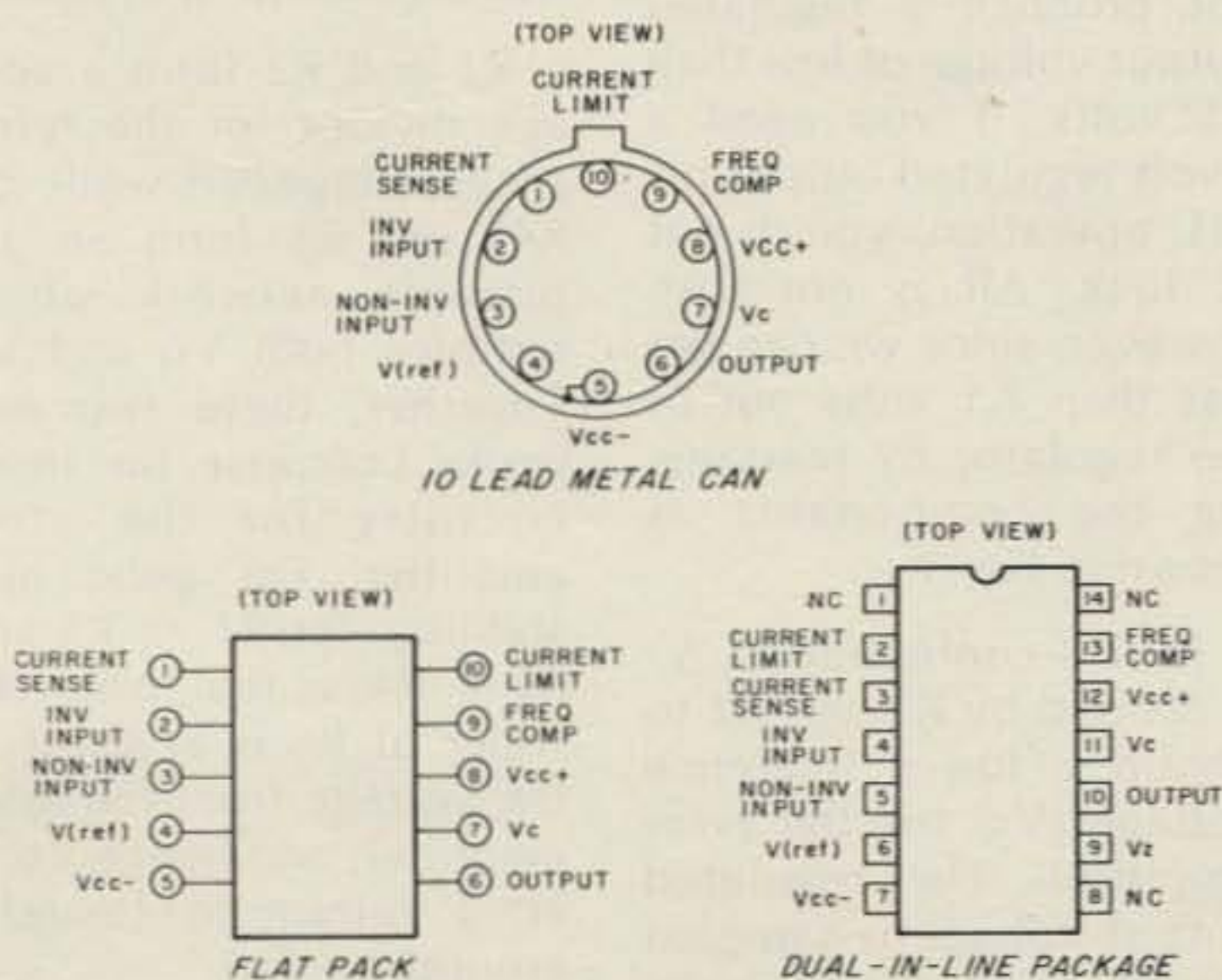

Fig. 3. 723 IC pin outputs.

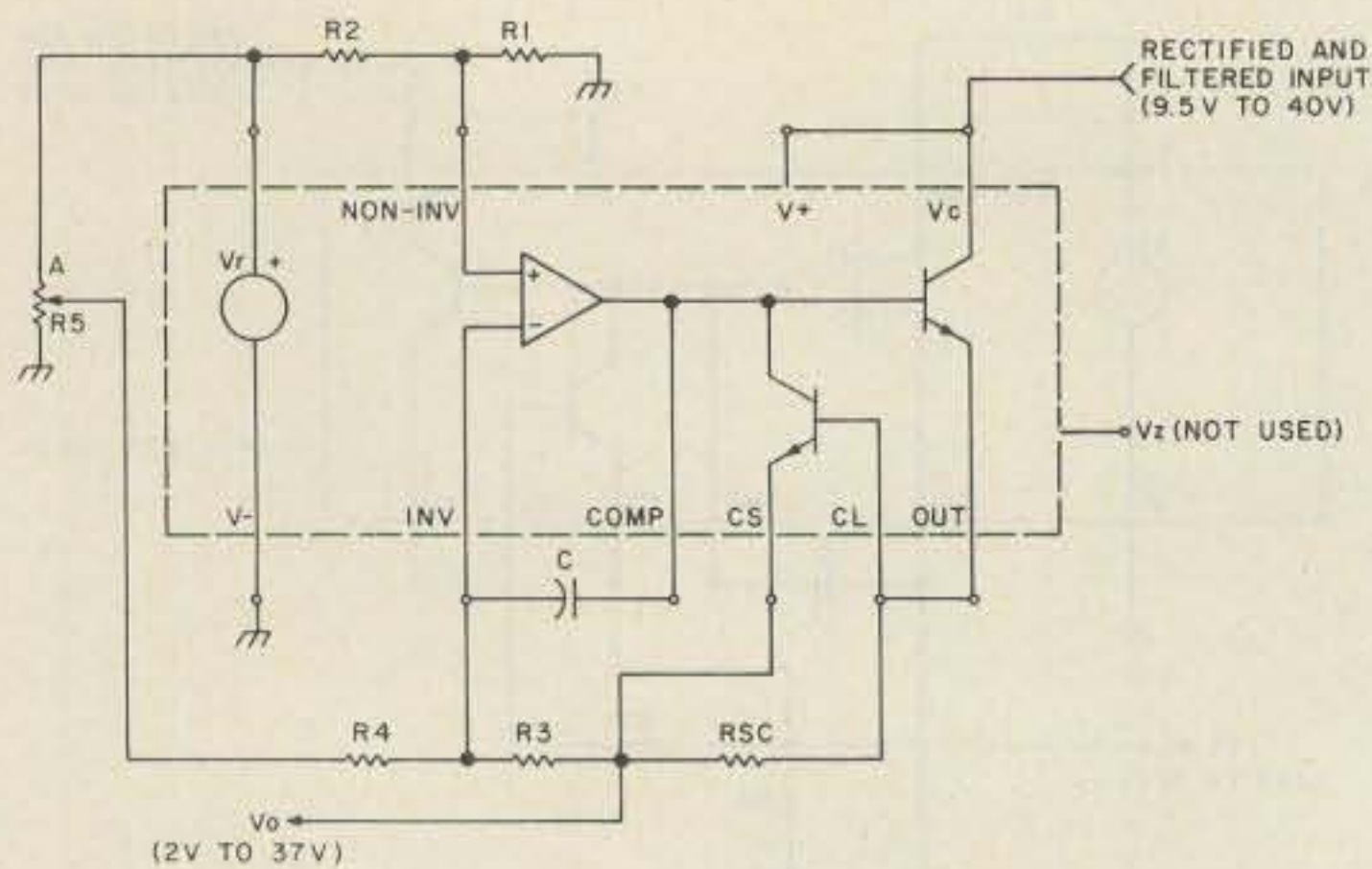

Fig. 6. Variable voltage regulator (2 V to 27 V). To select component values:

1. Choose V_o (here, V_o is the max. output voltage)
2. Measure V_r (or assume $V_r = 7.1$ V)
3. $R_5 = V_r/I_b$ (I_b is between 0.1 mA and 5 mA)
4. $R_1 = V_r V_o / I_b (V_r + V_o)$ (I_b is between 0.1 mA and 5 mA)
5. $R_2 = R_1 (V_r / V_o)$
6. $R_1 = R_3$
7. $R_2 = R_4$
8. $R_{5C} = 0.65 / I_{sc}$ (I_{sc} = max. output current limit)
9. $C = 100$ pF to 500 pF

R_{5C} is a series current-limiting resistor which is selected to limit the maximum current the load can draw (I_{sc}). Since this resistor is connected between the base and emitter of the current-limiting transistor, the load current through R_{5C} forward biases this transistor. Note, however, that the current-limiting transistor does not conduct until its base-emitter junction potential is overcome (approx. 0.65 volts). For example, select $R_{5C} = 0.65 / 0.10 = 6.5$ Ohms. When the load attempts to draw more than 100-mA output current, the

current limiter conducts and robs the series pass transistor of drive current from the error amplifier. The result is that the output voltage begins to drop off to restrict the current to the limit set by R_{5C} . R_{5C} is often selected so that the current capability of the regulator and power supply components is not exceeded. Therefore, you can short the output leads of the power supply without damaging the power supply or regulator.

Follow the steps in Fig. 4 in selecting components for this circuit. First, choose R_1 so that the cur-

rent drawn by the voltage-divider network (R_1 and R_2) is between 0.1 mA and 5 mA, and let's call this current I_b . Suppose we let $I_b = 1$ mA; then $R_1 = V_x / I_b$. But note that we previously stated that regulator action tends to maintain $V_x = V_r$, so $R_1 = V_r / I_b = 7.1 / .001 = 7100$ Ohms. Next, the selection of R_2 is dependent upon the output voltage you want; $R_2 = (V_o - V_r) / I_b$. Finally, R_3 is chosen to balance the impedances seen by the input of the error amp. This improves error amp stability and accuracy. Therefore, R_3 should be equal to the parallel combination of R_1 and R_2 . If you want to keep the parts count to an absolute minimum, then just connect V_r to the noninverting input of the error amp and leave R_3 out altogether. In most applications, you'll never notice a difference. The capacitor (C) in most 723 regulator applications should be 100 pF to 500 pF. This capacitor prevents the error amplifier from oscillating.

Low-Voltage Regulator (2 volts to 7.1 volts)

The circuit of Fig. 4 has one primary disadvantage in that the lowest output voltage obtainable from the regulator is limited by V_r . Therefore, this circuit cannot produce a regulated output voltage of less than 7.1 volts. If you need a 5-volt regulated output for TTL operation, you're out of luck. All is not lost, however, since we can get less than 7.1 volts out of the regulator by rearranging the components as shown in Fig. 5.

In this configuration, V_r is divided by R_1 and R_2 to obtain a lower reference voltage (V_x) for the error amplifier. The regulated output voltage is sampled via R_3 at the inverting input of the error amplifier.

Regulator action is similar to that previously described. In this case, the error amplifier adjusts the conduction of the pass transistor until $V_o = V_x$. First select R_1 for a voltage divider bias current (I_b) of from 0.1 mA to 5 mA as before, ($R_1 = V_o / I_b$). R_{5C} functions as previously described.

Variable-Voltage Regulator (2 volts to 37 volts)

The regulator circuits in Figs. 4 and 5 have fixed output voltages. Both of these regulators could be made variable by replacing R_1 or R_2 with a potentiometer, but we still have the disadvantages previously mentioned in that the output of the circuit in Fig. 4 is limited to an output voltage range of 7.1 volts to 37 volts, and the regulator of Fig. 5 is limited to an output voltage range of 2 volts to 7.1 volts. This is a particular disadvantage when working with differing logic families because TTL circuits require 5 volts, while transistor and MOS circuitry require higher voltages. Therefore, if you're building a variable power supply for your test bench, it is desirable for the supply to be variable over the entire range of the 723, if possible. The regulator configuration in Fig. 6 will do this quite nicely.

R_1 and R_2 form a voltage divider for the reference voltage (V_r), while R_3 , R_4 , and R_5 form an adjustable network which samples both V_o and V_r . Together, these two networks comprise the input circuitry for the error amplifier. For good bias stability, let $R_1 = R_3$ and $R_2 = R_4$, so that, when the wiper of R_5 is at point A, the voltage from the error amplifier, and hence V_o , is at a minimum (usually around 2 volts).

Now let's determine the

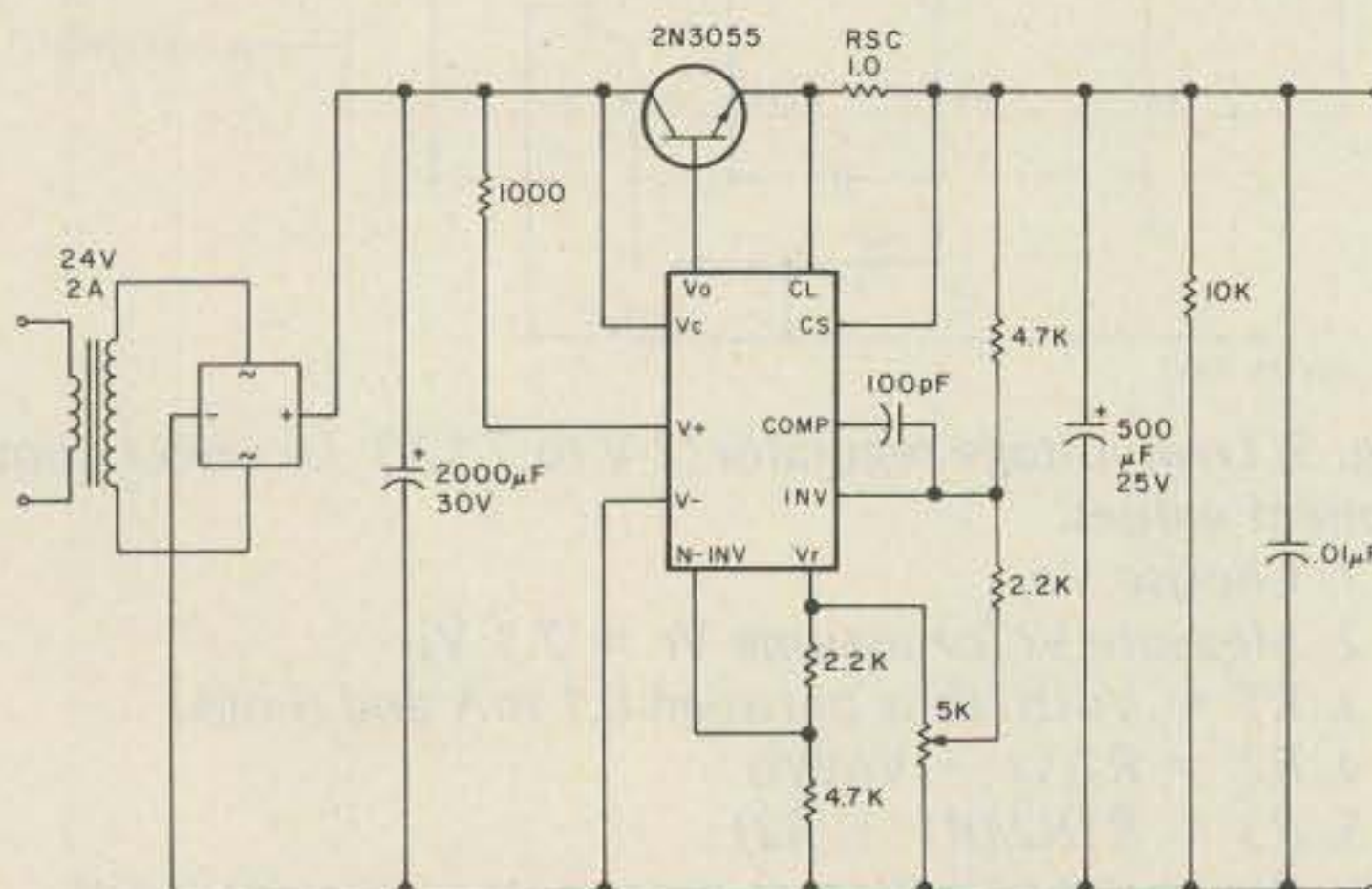

Fig. 7. Variable regulated power supply.

component values for this circuit. We can begin by choosing R5 so that the current drawn from Vr is less than 5 mA (Vr is normally capable of supplying 15 mA max.). Once R5 is determined, choose R1 + R2 so that this combination draws from 0.1 mA to 5 mA from Vr. Continue with the steps outlined in Fig. 6 to complete the circuit.

Since the internal series pass transistor is only

capable of 150 mA, you may want to consider an external pass transistor. Almost any good NPN power transistor capable of dissipating sufficient power for your current requirements will be suitable. An external pass transistor can be employed in the circuits of Fig. 4, Fig. 5, or Fig. 6 by connecting it just as shown in Fig. 7. The internal pass transistor now becomes a driver for

the external series pass transistor.

The circuit I use for various IC projects is shown in Fig. 7. The components for this circuit were chosen from the formulas given in Fig. 6. This regulated power supply provides a variable output of approximately 2 volts to 15 volts. Rsc was selected so that the maximum output current is approximately 1.2 Amps.

So there you have it! Now it's your turn, so give it a try. Just follow the steps given in each figure to build a regulated power supply to your own specifications. Since the selection of the bias current (Ib) is not critical, the component values selected can vary over a rather wide range so that you have plenty of flexibility in using parts you may already have on hand. ■

GET THE BEST QUOTE

Antennas
By
TAYLOR



TET U.S.A.



TEN-TEC



570 Century 21 70w CW Xcvt	\$299.00
574 Century 21/Digital	399.00
670 Keyer	29.00
276 Calibrator	29.00
274 Century Digital Mod Kit	90.00
247 Antenna Tuner	69.00
277 Antenna Tuner/SWR Bridge	85.00



509 Argonaut 80-10m 5w Xcvt	349.00
206 A Crystal calibrator	29.00
208 External CW filter	29.00
210 AC power supply	34.00
210/E 110/220 vac ps	39.00
215P Microphone w/plug	29.50
405 80-10m 50w linear	149.00
251M AC ps for 405 & 509	95.00
251M/E 110/220 vac ps	102.00



540 80-10m 200w Xcvt	699.00
544 As above, w/Digital readout	869.00
252M 18A 110 vac power supply	119.00
262M As above, w/VOX	145.00
252M/E 18A 110/230v supply	126.00
262M/E As above, w/VOX	152.00
207 Ammeter	14.00
240 160m converter	110.00
241 Xtal oscillator	35.00
242 External VFO	179.00
244 Digital display	197.00
245 150 Hz CW filter	25.00
249 Noise blanker	29.00
Ten meter Xtal	each 5.00
1102 Snap up legs	pair 1.00



470 (for Century 21)	KR-50
ELECTRONIC KEYS & PADDLES	
KR1A Dual paddle assembly	\$ 35.00
KR2A Single paddle assembly	17.00
KR3A Single paddle keyer, DC	29.50
KR20A Dual paddle keyer, AC/DC	69.50
KR50 Dual paddle Ultramatic, AC/DC	110.00

LUNAR
electronics

LUNAR
LINEARIZED
AMPS



**AMATEUR RADIO
LINEARIZED AMPLIFIERS**

**28-432 LOW NOISE FIGURE
RECEIVING PREAMPLIFIERS**

BRODIE ELECTRONICS COMPANY

✓ B47

2537 Edgewood Drive
Moore, Oklahoma 73160
405-794-0406

RADIO EQUIPMENT DOESN'T GROW ON TREES

*But the C & A ELECTRONICS Warehouse Sale
Will Make You Think It Does!*

AEA
ALDA
ANTENNA SPECIALISTS
ARRL
ATLAS
ASTRON
ASTATIC
AMERICAN ELECTRONICS
ALEXANDER MFG.
BIRD ELECTRONICS
BEARCAT
BK PRODUCTS
CRAIG
CUSHCRAFT

COMMUNICATIONS SPECIALISTS
DVE
DSI INSTRUMENTS
DRAKE
DYCOMM
GOLDLINE
HY-GAIN
HUSTLER
ICOM
INTERNATIONAL CRYSTALS
KDK
KLM ELECTRONICS
KENWOOD
KRIKET

LUNAR
LARSEN
MAXRAD
MIRAGE
MIDLAND
MOTOROLA
NON-LINEAR SYSTEMS
PACE
PIPO
POWER INC.
ROYCE
REGENCY
RUSSELL
REDCO COUNTERS

STANDARD
SANYO
SHAKESPHERE
TPL
TRIEX
TAYLOR
TRISTAO
TRINETICS
VHF ENGINEERING
WILSON
WESTCOM
YAESU

Call **213-834-5868**

FOR YOUR BEST VALUES ON THESE FINE LINES

**Be Sure To Check Our
SUPER SAVER**

Cash & Carry Specials



✓ C88
CGA Electronic Enterprises

Distributors of Commercial and Amateur Radio Equipment

22010 S. Wilmington Ave., Suite 105
Carson, CA 90745

One-Chip Tone Decoding

— how simple can it get?

The MK5102N.

Mostek Corporation of Dallas, Texas, has produced the latest in microcomputer control of phone systems. The MK5102N integrated tone receiver chip became available in engineering prototype models in January, 1978, and will revolutionize the use of tones to control remote equipment and improve the interface of phone and radio systems. The chip accepts the high- and low-group tones from the standard DTMF (touchtone™) pads, and provides outputs of either a 4-bit binary code or a

dual 2-bit row/column code.

I'll begin with a short introduction to the tone system. The phone companies introduced the 8 standard tones for dialing their touchtone™ phones in 1963. Previously, the dialing was performed by interrupting the 20 milliamps (mA) of direct current. The current was interrupted at 10 Hz with a switch on the dial as it spun back to its spring-loaded position. Dialing the number 5, for example, would give 5 pulses. This has the disadvantage of requiring ex-

cessive amounts of power (using enough voltage to drive the 20 mA through miles of phone line), and it introduced bothersome clicking into the phones of other users whose phones were connected through the same bundle of wires to the central switching exchange. The tone system was developed to help overcome these problems. The eight tones fall in the audio frequency spectrum from 697 Hz to 1633 Hz. They have been carefully chosen to not be harmonically related to one another, and are spaced approximately 10% apart. This spacing allows for some margin of error so that one tone is not mistaken for another.

The phone company requires that the tones be within 1.5% of their center frequency to be properly decoded. This requires that the tone transmitter be well controlled in all conditions of temperature, humidity, and power supply voltage. I'll bet that some of you have heard a tone generator fail in the cold

winter weather because it failed to meet the $\pm 1.5\%$ tolerance. Another of the phone company's requirements is that the two tones can have no more than a two dB difference in amplitude. This means that the two voltage amplitudes must be in a ratio of less than 1.6 to 1. For example, if the low-group tone is 1.0 volts root mean squared (rms), the high-group tone must be less than 1.6 volts rms, but greater than .625 volts rms. The actual amplitudes of the signals are normally measured on a 600-Ohm impedance standard audio line, where 1 milliwatt (mW) of power across the line is designated 0 dBm. The specification for tones on the phone lines is that the nominal levels be -4 to -6 dBm, with the low-group minimum of -10 dBm, and a high-group minimum of -8 dBm. The maximum level of the two combined tones is $+2$ dBm. These levels will not be important for the decoder chip, but will enter into the discussion when we regenerate

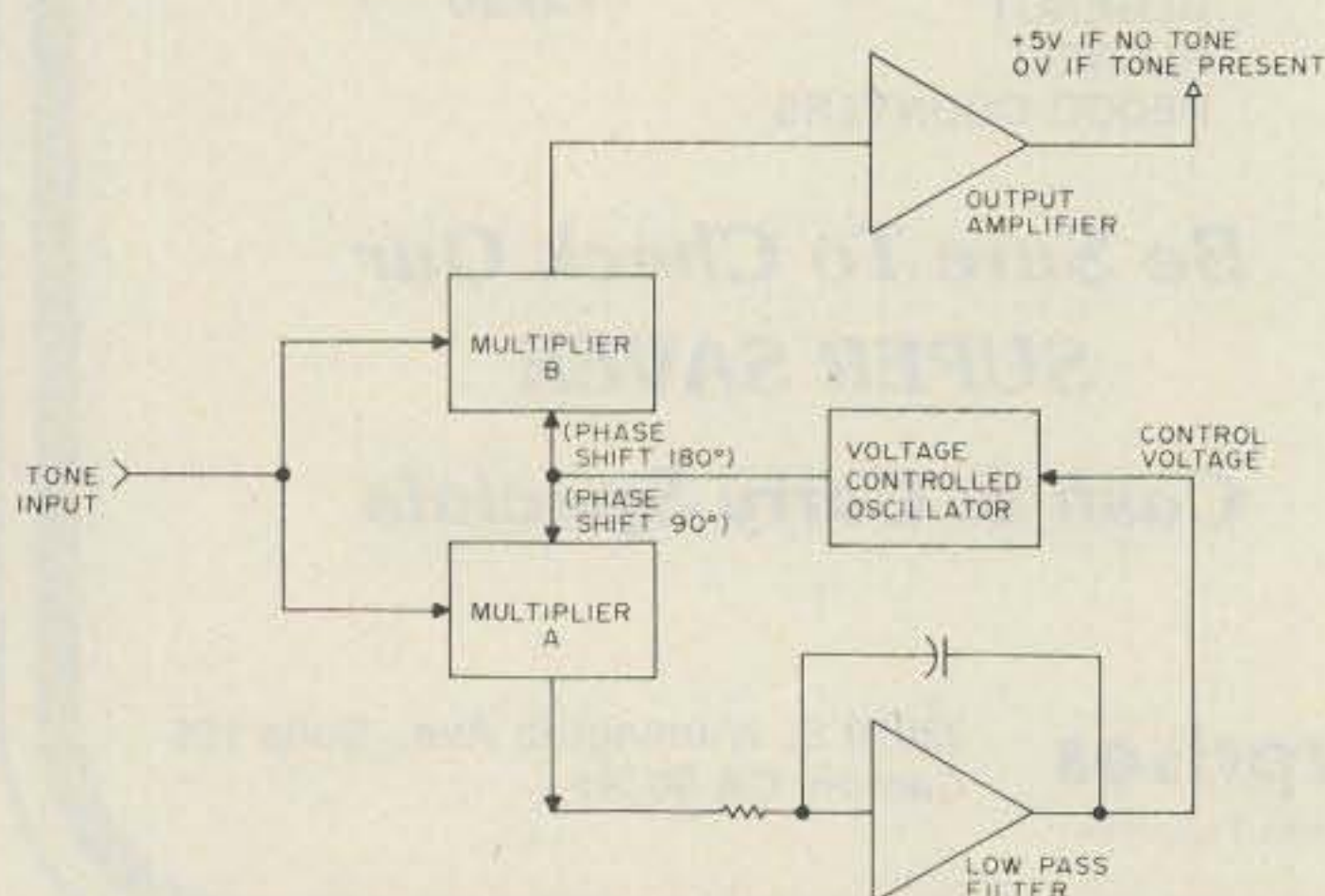

Fig. 1. NE567 block diagram.

the tones to be placed on the phone line. Also, the phone company specifies that the tones should have a minimum duration of 50 milliseconds (ms), with at least 45 ms between digits.

When Mostek set out to perform the decoding with a digital chip, they faced stiff competition. Most of the decoding today is done with a circuit like the NE567, phase-locked-loop, tone-decoder chip. The chip has a voltage-controlled oscillator (vco), which will phase-lock onto tone frequencies within a small range of its free-running frequency. When the loop locks onto the incoming tone, it multiplies the incoming sine wave by the vco's output in two different multipliers. One multiplier (A in Fig. 1) output is fed through a low-pass filter to the control voltage of the vco. Any error between the vco and the incoming tone sine wave will change the dc voltage on the control input to the vco. This changes the vco's frequency to match that of the incoming tone. This locks the vco 90° out of phase from the incoming sine wave. The other multiplier (B) receives the vco output an additional 90° out of phase from the first multiplier. This will produce a large negative dc voltage at the second multiplier's output. Multiplying two sine waves 180° out of phase will produce a negative dc component. The second multiplier's output is filtered and fed to the output pin of the 567. This pin will go from +5 volts to ground when it locks onto the incoming tone.

The phase-locked-loop decoding scheme requires that many resistors and capacitors keep their values in all environmental conditions. Each decoder (one is used for each of the eight tones) has one resistor and one capacitor which must

be stable to keep the center frequency of the decoder accurate. This is the major disadvantage of the phase-locked-loop technique of decoding.

The MK5102N integrated-tone receiver uses a different scheme to decode the tones. After the high- and low-group frequencies are separated to their respective input pins on the chip, the zero crossings are counted in a specified time period. A number of these counts are taken and averaged over a longer time period. If the number of crossings matches that of a valid tone in both inputs, the digit's code is put onto the output latches (memory flip-flops that will not change after the tone has been removed). At the same time, the strobe pin (pin 4) goes high to signify that a valid tone is present. When the tone is removed, the strobe returns to a logical low, but the data pins (pins 7 through 10) will not change until the next tone is entered. Thus, one can use the strobe line to provide the interrupt to the microprocessor to stop whatever is in progress and pay attention to the receiver.

Instead of 16 frequency-determining elements of the phase-locked-loop system, the MK5102N uses an inexpensive, 3.579545 MHz, color-burst oscillator crystal as a frequency reference. The crystal is connected directly to the input and output pins of the oscillator (pins 2 and 3), with no additional components. This is an in-

Low group (Hz)	High group (Hz)			
	1209	1336	1477	1633
697	1	2	3	A
770	4	5	6	B
852	7	8	9	C
941	*	0	#	D

Table 1.

expensive temperature-stable crystal, which can be easily obtained and needs no fine tuning. Tests of the frequency-detection bandwidth of the receiver resulted in reliable detection of the tones $\pm 3\%$ of their center frequencies. This is one of the disadvantages of the receiver chip in that the detection width cannot be adjusted as it can for the 567 tone decoder. However, the receiver chip will decode well within the phone company's frequency tolerance, and thus should work well on all properly adjusted phone pads. The chip responded to tones within the 40 ms specified by Mostek, and required 35 ms between tones to successfully detect the se-

quential dialing of the same digit (such as hitting two 5s in sequence).

The real trick to operating the receiver is the pre-filtering of the audio tones before they are injected into the integrated circuit. The standard tones consist of two groups. Each digit activates one frequency of the low group and one frequency of the high group, allowing for 16 possible combinations. Table 1 shows the digits and their frequency pairs.

The filter must separate the low-group tones to the low-group input (pin 11), and the high-group tones to the high-group input (pin 12). The tones are separated by low-pass filters separating the low group, and high-pass filters separ-

Digit	4-bit binary ($V_C = 5V$ dc)				Dual 2-bit row/column ($V_C = 0$)			
	D8	D4	D2	D1	D8	D4	D2	D1
1	0	0	0	1	0	1	0	1
2	0	0	1	0	0	1	1	0
3	0	0	1	1	0	1	1	1
4	0	1	0	0	1	0	0	1
5	0	1	0	1	1	0	1	0
6	0	1	1	0	1	0	1	1
7	0	1	1	1	1	1	0	1
8	1	0	0	0	1	1	1	0
9	1	0	0	1	1	1	1	1
0	1	0	1	0	0	0	1	0
*	1	0	1	1	0	0	0	1
#	1	1	0	0	0	0	1	1
A	1	1	0	1	0	1	0	0
B	1	1	1	0	1	0	0	0
C	1	1	1	1	1	1	0	0
D	0	0	0	0	0	0	0	0

Table 2. Because of the unfortunate definition of the 0, *, and #, the above code does not match the standard hexadecimal code.

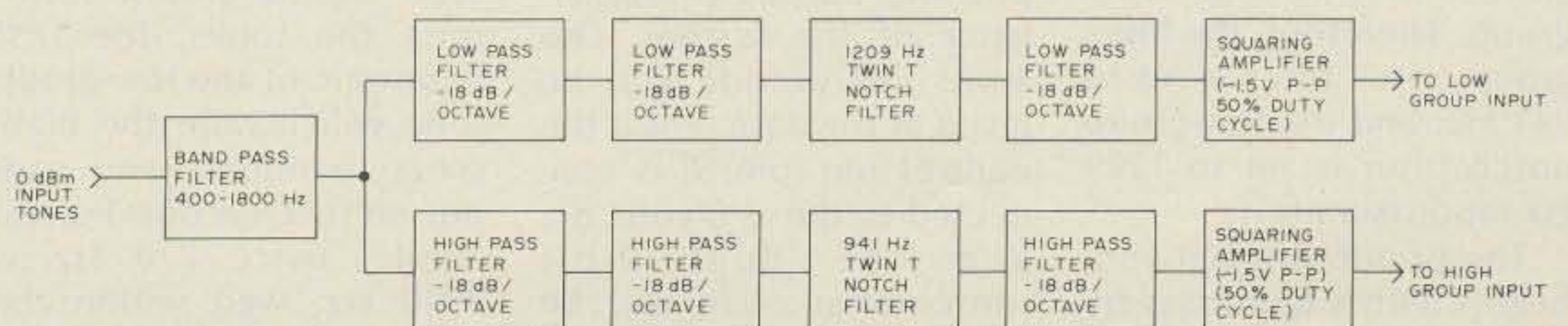

Fig. 2. Prefilter block diagram.

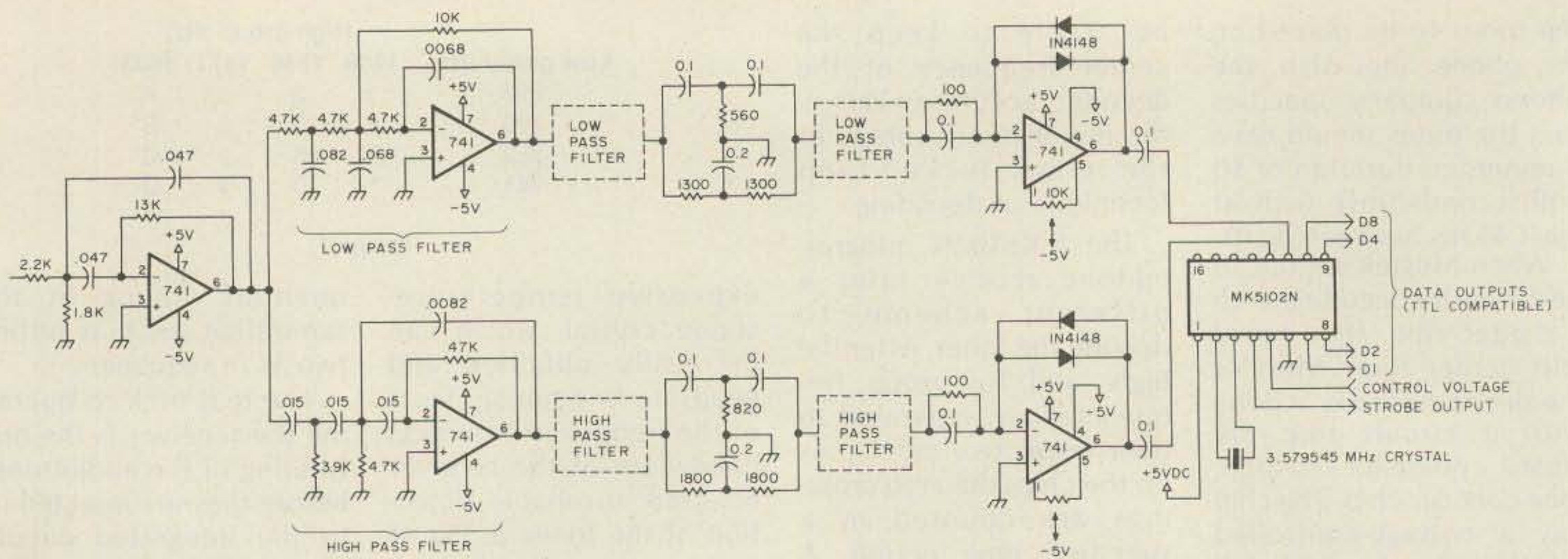

Fig. 3. System schematic.

ating the high group. The filters must separate the tones (which are input at approximately equal amplitudes, remember) by at least 33 dB (38 dB in the first-run engineering prototype chips). 33 dB is a voltage ratio of 45 to 1. Roughly, if the high tone is 1 volt rms, the low tone on the high input must be less than 20 millivolts rms. The prefilter block diagram is shown in Fig. 2.

The major filtering is done using active audio filters in a crossover filter. The crossover point was chosen at 1075 Hz, midway between the two groups. Each filter is a Butterworth filter with a roll-off of -18 dB per octave, and a 3-dB point at 1075 Hz. To sharpen the band edge, and also to help isolate the closest tones, the high-group high-pass filter string includes a twin-T notch filter between the second and third operational amplifiers. Similarly, the low-group low-pass filters include a notch filter in the same location. The notches are set to the closest tone of the other group. Therefore, the high-group notch filter is set to 941 Hz, and the low-group notch filter is set to 1209 Hz (approximately).

The prefiltering network begins with a bandpass filter with its gain down 3 dB at 400 Hz and 1800 Hz to

eliminate noise and distortion products. The input is designed to take standard 0-dBm (across 600 Ohms) tones from the source. The gain of the input amplifier can be adjusted to meet these input levels, or the input bandpass filter can be redesigned to take other levels from the source. Lab tests of the filters shown in Fig. 3 showed successful decoding for tones from $-\frac{1}{2}$ dBm to +3 dBm. The output of each filter string is put through a squaring amp which should be adjusted for 50% duty cycle of the square wave into the receiver chip. The chip also includes two onboard operational amplifiers which were not used in this design. Production models of the onboard amplifiers should make them useful in the prefiltering network.

Fig. 3 is the complete schematic of the receiver system from audio input to digital output. All component values should be $\pm 5\%$, and care should be taken to use high quality operational amplifiers. In Table 2, I have given the input and output characteristics of the system. The 4-bit binary code will be given at the data pins if the control pin (pin 5) is connected to the +5 volts dc, and the dual 2-bit row/column code will be given if the control pin is left unconnected. If the

control pin is grounded, the output data pins will go to a high impedance state. This allows connection of many devices to a common data bus. If the other devices are in a high impedance state on their outputs, only the activated chip (i.e., raising the control pin voltage to +5 volts) will put data on the bus. This allows the same four wires to be connected to all the devices and saves a lot of wiring.

The design here uses ± 5 -volt dc power-supply voltages to be compatible with the repeater here at the University of Minnesota, WR0AQU. The 5102 will operate with a positive supply voltage of 4.5 to 5.5 volts dc. Use of higher supply voltages for the operational amplifiers may be desirable to prevent flat-topping of the tones by overdriving the amplifiers. This can occur if the tones come into the system at an especially high amplitude. This brings up one of the severest limitations of the receiver chip. If the audio system which delivers the tone to the prefilter distorts the tones, the first harmonic of the low-group tone will invade the high-group bandpass and cannot be filtered out. For example, twice 770 Hz is 1540 Hz, well within the high-group bandpass. Care must be taken that no clip-

ping of the audio occurs, and that the audio system response from 500 Hz to 1700 Hz be reasonably flat. This will assure that the two tones arrive at the input to the prefilter at the same amplitude with little distortion.

The specification sheet gives a requirement of 12-dB signal-to-noise ratio, which I assume means that the noise must be at least 12 dB below the valid tones. To test this, a third sine wave was introduced, together with a valid tone at 0 dBm. The decoding became marginal with the third tone above -10 dBm. This easily meets the specifications of the 12-dB signal-to-noise ratio.

As a further test, I hooked the system to the speaker audio of an Icom 22A and monitored the output of a popular local repeater (WR0ALU, 16/76) for a day. This repeater is very active and frequently used for autopatches. False detections were very infrequent (2 per day), and the dialed tones were decoded with good reliability. The number of false detections may seem excessive, but you must remember that chances are slim that the access code will be detected (1 in 8 per day for a single-digit access code), and that I was monitoring the audio after it had passed through the

TIMETRAC

By Comus

the microcomputer-controlled
appointment clock

NEW
First Time Offer

— NOT A KIT —
Regular Price \$79.95
Introductory Offer by
HAL-TRONIX
only \$69.95



FEATURES:

- Sleek modern styling to complement any home or office decor.
- Tells the time.
- Tells the date and year.
- Up-timer to 60 minutes, 59 seconds with pause.
- Alarm to ring at the same time everyday.
- Daily appointment sets appointments for the next 23 hours, 59 minutes.
- Future appointments up to one year.
- Dimmer switch for display.
- Memory will hold up to 30 appointments.
- Lithium power cell to retain memory during power outage.
- Appointments entered out of chronological order will be stored in chronological order.
- Colon flashes once each second.
- A.M./P.M. indicator.
- Plugs into any wall outlet.
- Easy to read vacuum fluorescent display.
- Extremely accurate quartz crystal clock.

EFFICIENT. REMARKABLE.

TimeTrac sold and distributed by HAL-TRONIX. Dealers welcome.

Send 15¢ stamp or S.A.S.E. for information and flyer on other HAL-TRONIX products. To order by phone: 1-313-285-1782.



"HAL" HAROLD C. NOWLAND
WBZXH

HAL-TRONIX ✓ H24
P.O. Box 1101
Southgate, MI 48195

SHIPPING
INFORMATION:

ORDERS OVER \$15.00 WILL BE SHIPPED POSTPAID EXCEPT ON ITEMS WHERE ADDITIONAL CHARGES ARE REQUESTED. ON ORDERS LESS THAN \$15.00 PLEASE INCLUDE ADDITIONAL \$1.00 FOR HANDLING AND MAILING CHARGES.

Look to us...

For all of your
Station Requirements

Transceivers, Receivers,
Amplifiers, Antennas,
Towers, Rotors, Tuners
and Accessories.

CHOOSE FROM THESE WELL KNOWN
BRANDS—

the antenna specialists co.

  CONSOLIDATED
CDE 

METRON 

TEN-TEC  

AND MANY MORE . . .

Whether you need a 2
meter mobile antenna
or a complete HF Sta-
tion — we have it in
stock.

HF ● VHF ● UHF

Call or write
for our free
catalog.

Cleqq Communications Corp.
1911 Olde Homestead Lane
Greenfield Industrial Park East
Lancaster, PA 17601
(717) 299-7221

✓ C3

repeater's transmitter and my receiver, essentially doubling the distortion of the tones. Tones sent simplex (i.e., not through a repeater) were decoded with excellent reliability (no observed errors).

I find the possibility of further computer control of the repeater exciting. The 16-digit DTMF code allows direct entry of hexadecimal code into a microcomputer system.

The 16-tone pads are available for the stations which desire special control functions not on the 12-digit pad (which does not include the A, B, C, or D digits). We can use any phone booth on the street to call the repeater and issue control commands to the system. This is especially valuable when the receiver is faulty and will not respond to VHF signals.

The next challenge will

be to complete the phone interface and the tone dialing system. Mostek has already marketed the 5086 tone-dialer chip, which will be used to regenerate the tones to meet the phone company's requirements. Circuitry and description of this system will follow in another article. I hope that you find the challenge of this technology interesting, and will join us in the world of the microprocessor.

I would like to thank Mr. Joe Jarrett of Mostek, Inc., for his help in getting this system running. ■

References

1. *Audio Handbook*, Dennis Bohn, ed., National Semiconductor, Inc. (filters).
2. *The Radio Amateur's Handbook*, ARRL, Newington CT (tones and phone company specifications).
3. *Electronics*, June 7, 1971, pp. 86-89 (active bandpass filters).

U6

universal amateur radio inc

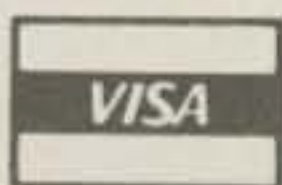

1280 AIDA DRIVE
COLUMBUS, OHIO
(Reynoldsburg) 43068

(614)-866-HAMS

INVENTORY REDUCTION AND CLEARANCE SALE!

SWAN ANTENNAS: TB4H, 4 ele. TRIBAND BEAM - \$199.95; 4010-40 thru 10M Vertical -\$54.95; 75 MK - 75M add-on Kit for the Swan 1040V -\$24.96; 75AK - 75M add-on Kit for the Swan 4010V. - \$29.00; **KIRK QUADS:** Model 1322-2 Element Triband - \$189.95; Model 1323-3-Element Triband - \$284.95; **WILSON ANTENNAS:** -M68 6M - 8 Element Beam -\$89.00; M66 - 6M - 6 Element Beam \$67.00; M106 - 10M 6 Element Beam - \$98.00; **WILSON (GUYED) 46 ft. Telescoping Tower GT46** -\$159.00; CRF10 Base and raising fixture for GT46 - \$64.00; **HEIGHTS TELESCOPING TOWER -CUA 40** - 12 sq. ft. with hinged base -\$759.95; Info. Tech Model 100 TRI-MODE CONVERTER - \$334.95; Info. Tech Model 300 TRI-MODE Keyboard - \$399.95; **YAESU Ft. 7B Transceiver** - \$589.95; Panasonic Short Wave Receivers in stock: **LIMITED SUPPLY.** All items subject to prior sale!

Code Made Easy.

To really master code, get Pickering Code Master instruction tapes. They're easy to use, easy to learn, complete and reliable. But don't just take our word for it, ask any ham. Or order a set and see for yourself.

CM-1 Novice. A complete course with 5, 7 and 9 WPM code group practice.

CM-1½ General. No instruction, just practice. ½ hr. at 11 WPM, 1 hr. at 14 WPM and ½ hr. at 17 WPM. Tape includes coded groups and straight text.

CM-2 Extra Class. Mostly straight text, some groups. 1 hr. at 20 WPM, ½ hr. at 25 and 30 WPM.

All courses are two hours long and come with key sheets for checking problem areas.

To order, send your check, money order, Master Charge or Visa number (along with card expiration date) to Codemaster. Specify number and quantity of tapes desired. Tapes are \$7.95 each, two for \$14, and three for \$19. Also specify 7" reel or cassette. We'll send your tapes post paid by fourth class mail. First class, Canada and Mexico orders, add \$1 per reel, 50¢ per cassette. To order by phone, call (401) 683-0575.

R.I. residents, add 6% sales tax.

P44

Pickering
Codemaster Co.,
P.O. Box 396 D,
Portsmouth, R.I.
02871



Pickering Codemaster. Your key to code.

Newest, Low Cost
INLINE RF WATTMETER

USES NO EXTERNAL DELICATE SLUGS
COVERS 20 MHz THRU 1000 MHz

TELEWAVE MODEL 44

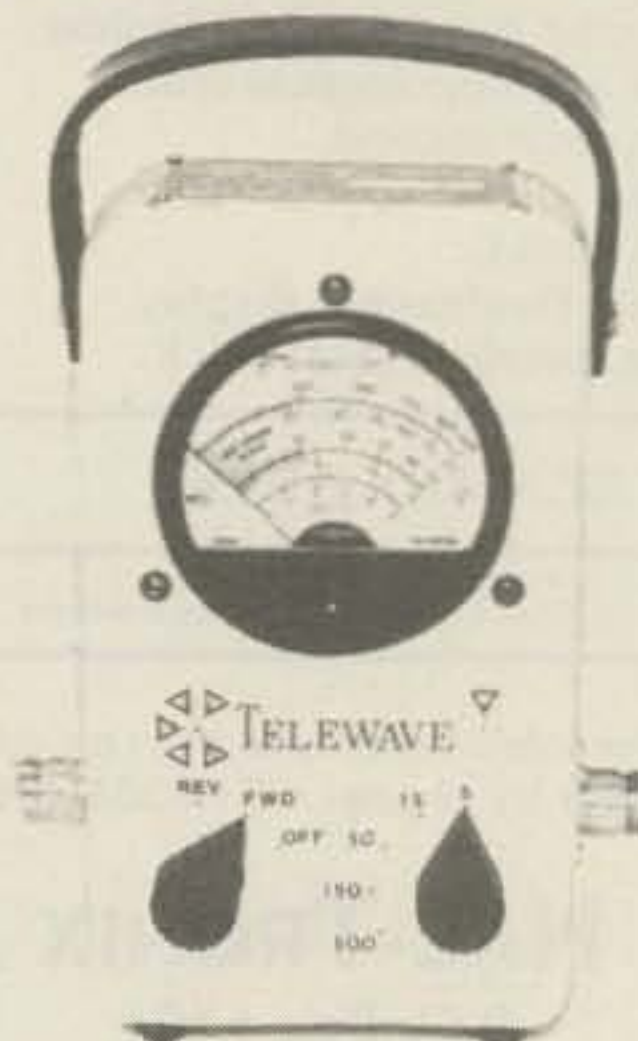

No Band Switching
20 MHz — 1 GHz

0 to 500 Watts
In 5 Ranges

Forward And
Reflected Power

Rugged Die-Cast
Metal Case

"N" Connectors
UHF on Special Order

VSWR Conversion
Chart on Rear

Shipped From Our Stock • Just \$295 Complete

All M.O. & Cert. Check orders shipped next day Calif. Res. Add 6% Tax

ROSS DISTRIBUTING CORP. • (213) 919-3446

P.O. BOX 5003 • COVINA, CA 91723 R35

EG-73-7/8-79

New MFJ 3 & 1.5 KW Versa Tuners

Run up to 3 KW or 1.5 KW PEP and match everything from 1.8 thru 30 MHz: coax, balanced line, random wire. Built-in balun.

3 KW VERSA TUNER IV's

1.5 KW VERSA TUNER III's



NEW MFJ KW VERSA TUNERS HAVE THESE FEATURES IN COMMON

These 6 new MFJ KW Versa Tuners let you run up to 3 KW or 1.5 KW PEP (depending on the model) and match any feedline continuously from 1.8 to 30 MHz: coax, balanced line or random wire. Gives maximum power transfer. Harmonic attenuation reduces TVI, out of band emissions.

All metal, low profile cabinet gives RFI protection, rigid construction, sleek styling. Black. Rich anodized aluminum front panel. 5x14x14 inches.

Flip down stand tilts tuner for easy viewing.

Efficient, encapsulated 4:1 ferrite balun. 250 pf, 6000 volt capacitors. 18 position dual inductor, 17 amp, 3000 V ceramic rotary switch (3 KW version). 12 position inductor, ceramic rotary switch (1.5 KW version). 2% meters. SO-239 coax connectors, ceramic feedthru for random wire and balanced line. One year limited warranty. Made in U.S.A.

3 KW VERSA TUNER IV's

1 MFJ-984 3 KW VERSA TUNER IV

\$299⁹⁵ *EXCLUSIVE RF AMMETER insures maximum power to antenna at minimum SWR. Built-in dummy load.*

This is MFJ's best 3 KW Versa Tuner IV. The MFJ-984 Deluxe 3 KW Versa Tuner IV gives you a combination of quality, performance, and features that others can't touch at this price.

An exclusive 10 amp RF ammeter insures maximum power to antenna at minimum SWR. A separate meter gives SWR, forward, reflected power in 2 ranges (2000 and 200 watts).

Versatile antenna switch lets you select 2 coax lines thru tuner and 1 thru or direct, or random wire, balanced line or dummy load.

A 200 watt 50 ohm dummy load lets you tune your exciter off air for peak performance. Efficient, encapsulated 4:1 ferrite balun.

2 MFJ-981 3 KW VERSA TUNER IV

\$199⁹⁵ *Accurate meter gives SWR, forward and reflected power in 2 ranges: 2000 and 200 watts. 4:1 ferrite balun.*

The MFJ-981 3 KW Versa Tuner IV is one of MFJ's most popular Versa Tuners. An accurate meter gives you SWR, forward and reflected power in 2 ranges: 2000 and 200 watts. Encapsulated 4:1 ferrite balun.

3 MFJ-982 3 KW VERSA TUNER IV

\$199⁹⁵ *Antenna switch lets you select 1 coax thru tuner and 2 coax thru tuner or direct, or random wire and balanced line.*

The MFJ-982 3 KW Versa Tuner IV gives you a versatile 7 position antenna switch that lets you select 1 coax thru tuner and 2 coax thru tuner or direct, or random wire and balanced line. Encapsulated 4:1 balun.

If you already have a SWR/wattmeter, the MFJ-982 is for you.

4 MFJ-980 3 KW VERSA TUNER IV

\$169⁹⁵ *Heavy duty encapsulated 4:1 ferrite balun for balanced lines.*

The MFJ-980 is MFJ's lowest priced 3 KW Versa Tuner IV but has the same matching capabilities as the other 3 KW Versa Tuner IV's.

Features an efficient, encapsulated 4:1 ferrite balun for balanced lines.

1.5 KW VERSA TUNER III's

5 MFJ-962 1.5 KW VERSA TUNER III

\$169⁹⁵ *SWR, dual range forward and reflected power meter, 6 position antenna switch, encapsulated 4:1 ferrite balun.*

The MFJ-962 1.5 KW Versa Tuner III is an exceptional value.

An accurate meter gives SWR, forward and reflected power in 2 ranges (2000 and 200 watts).

A versatile six position antenna switch lets you select 2 coax lines thru tuner or direct, or random wire and balanced line. Encapsulated 4:1 balun.

Black front panel has reverse lettering.

6 MFJ-961 1.5 KW Versa Tuner III

\$149⁹⁵ *6 position antenna switch lets you select 2 coax lines thru tuner or direct, or random wire and balanced line.*

The MFJ-961 1.5 KW Versa Tuner III gives you a versatile six position antenna switch. It lets you select 2 coax lines thru tuner or direct, or random wire and balanced line. Encapsulated 4:1 ferrite balun.

If you already have a SWR/wattmeter, the MFJ-961 is for you.

Black front panel has reverse lettering.

FOR YOUR NEAREST DEALER OR FOR ORDERS

CALL TOLL-FREE **800-647-1800**

Why not visit your dealer today? Compare these 3 KW and 1.5 KW Versa Tuners to other tuners. You'll be convinced that its value, quality and features make it a truly outstanding value. If no dealer is available, order direct from MFJ and try it. If not delighted, return it within 30 days for a prompt refund (less shipping). Charge VISA, MC. Or mail check, money order plus \$10 shipping/handling.

For technical information, order/repair status, in Mississippi, outside continental USA, call 601-323-5869.

Order By Mail or Call TOLL FREE 800-647-1800 and Charge It On

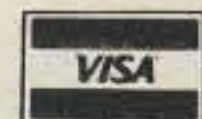

MFJ ENTERPRISES, INC.

P. O. BOX 494 ✓ M52

MISSISSIPPI STATE, MISSISSIPPI 39762

Computerize That Mailing List

— club secretaries, this is for you

Most amateur radio clubs produce some type of newsletter or bulletin on a more or less regular basis. These are usually generated by the efforts of a few members who have the desire, time, and other necessary resources to produce, reproduce, and distribute the

club rag. Although some clubs simply hand out copies at each regular meeting, most of the larger, well-organized clubs maintain a complete and detailed membership list and mail their newsletter to all members on record a few days prior to the monthly meeting.

Many of these clubs utilize the services of someone who has access to a computer system to keep their records and to print membership lists and even mailing labels each month. (Anyone who has had the dubious honor of addressing club bulletins by hand (month after month) can

readily appreciate the convenience of using preprinted, peel-off, stick-on address labels.)

This article presupposes that your club has one or more people who either have their own microprocessor system or have access to a commercial system where time can be

Membership File Maintenance program.

DEFINED SIZE: 8192 BYTES 8 SECTORS DISC: 0 SECTOR: 7863
PROGRAM SIZE: 4674 BYTES 19 PAGES

0010 REM "ARCMF" ARCMF FILE MAINTENANCE

```
0020 CLEAR
0040 IOLIST N1$,N2$,A1$,A2$,A3$,Z1$,P1$,C2$,C1$,D1$,D2$,D3$
0050 DIM N1$(16),N2$(16),A1$(32),A2$(16),A3$(2),Z1$(5),P1$(10),C2$(1),C1$(8),D1
0050:$(16),D2$(16),D3$(12),C9$(8),P9$(3),S9$(5),K$(8)
0060 DIM S$(32,""),F$(32,"")
0100 OPEN (1)"KCCMF"
1000 PRINT 'CS', 'SB',@(26,0),"ARCMF FILE MAINTENANCE",@(70,0),DAY
1010 PRINT @(1,2),"1. CALL SIGN:",@(31,2),"2. CLASS:",@(1,4),"3. LAST NAME:",@(1,6
1010:),"4. FIRST NAME:",@(1,8),"5. ADDRESS:",@(1,10),"6. CITY:",@(1,12),"7. STATE/Z
1010:IP:",@(1,14),"9. TELEPHONE:",@(0,16),"11. DATA CODES:",@(0,18),"12. OTHER DAT
1010:A:",@(0,20),"13. RACES DATA:", 'SF'
1500 PRINT 'CF'
1510 CLEAR
1550 DIM N1$(16),N2$(16),A1$(32),A2$(16),A3$(2),Z1$(5),P1$(10),C2$(1),C1$(8),D1
1550:$(16),D2$(16),D3$(12),C9$(8),P9$(3),S9$(5),K$(8)
1560 DIM S$(32,""),F$(32,"")
```

2000 REM -----CALL SIGN-----

```
2005 PRINT 'SF',@(15,2),F$(1,8),S$(1,5)
2010 INPUT @(15,2),C1$
2015 IF (C1$="END") OR (CTL=4) THEN GOTO 9090
2020 LET L=LEN(C1$)
2025 IF (L>8) THEN GOTO 8010
2030 IF (L>1) THEN GOTO 2050
2035 LET S=1
2040 LET C2$=""
2045 GOTO 2300
```

2049 REM -----BUILD KEY-----

```
2050 LET N=1
2051 SETERR 2070
2052 LET A=NUM(C1$(N,1))
2053 RESET
2060 GOTO 2090
2070 SETERR 2110
2071 LET P9$(N,1)=C1$(N,1)
2075 LET N=N+1
2080 IF (N>L) THEN GOTO 8010
2085 GOTO 2051
2090 LET S9$(1,(L-N))=C1$(N+1),(L-N)
2095 LET K$=S9$(1,(L-N))+C1$(N,1)+P9$(1,(N-1))+S$(1,(8-L))
2100 PRINT @(50,2), 'SB', "KEY:",K$, 'SF'
2105 GOTO 4000
2110 RESET
2120 LET N=LEN(C1$)
2125 IF (N<8) THEN LET K$=C1$+S$(1,8-N)
2130 IF (N>7) THEN LET K$(1,8)=C1$(1,8)
2140 GOTO 4000
```

2200 REM -----CLASS-----

```
2205 RESET
2209 PRINT @(39,2),S$(1,5), 'RB'
2210 INPUT @(40,2),C2$
2220 IF LEN(C2$)>1 THEN GOTO 2200
2230 IF C2$="N" OR C2$="T" OR C2$="G" OR C2$="A" OR C2$="E" OR C2$="B" OR C2$="
2230:X" OR C2$=" " OR C2$="?" THEN GOTO 2280
2240 GOTO 8020
2280 PRINT @(40,2),C2$
2290 IF (S=2) THEN GOTO 6000
```

2300 REM -----LAST NAME-----

```
2301 SETERR 2310
2310 PRINT @(15,4),F$(1,16)
2320 INPUT @(15,4),N1$
2321 IF (LEN(N1$)<3) THEN GOTO 1000
2330 IF (LEN(N1$)<17) THEN GOTO 2370
2340 GOSUB 8030
2360 GOTO 2300
2370 IF (S=2) THEN GOTO 6000
```

2400 REM -----FIRST NAME-----

```
2401 SETERR 2410
2410 PRINT @(15,6),F$(1,16)
2420 INPUT @(15,6),N2$
2421 IF (LEN(N2$)<2) THEN GOTO 2410
2430 IF LEN(A3$)<2 THEN LET A3$="TX"
2432 IF (LEN(N2$)<17) THEN GOTO 2435
2433 GOSUB 8030
2434 GOTO 2400
2435 SETERR 8040
2440 IF (S<1) THEN GOTO 2499
2445 LET N=LEN(N1$)
2450 LET M=LEN(N2$)
2455 IF (N<4) THEN LET N1$=N1$+S$(1,4-N)
2460 IF (M<4) THEN LET N2$=N2$+S$(1,4-N)
2470 LET K$=N1$(1,4)+N2$(1,4)
2480 PRINT @(50,2), "KEY:",K$
2499 IF (S=2) THEN GOTO 6000
```

2500 REM -----ADDRESS-----

```
2510 PRINT @(15,8),F$,
2520 INPUT @(15,8),A1$
2521 IF (LEN(A1$)<5) THEN GOTO 2510
2530 IF (LEN(A1$)<33) THEN GOTO 2570
2550 GOSUB 8040
2560 GOTO 2510
2570 IF (S=2) THEN GOTO 6000
```

2600 REM -----CITY-----

```
2610 PRINT @(15,10),F$(1,16)
2620 INPUT @(15,10),A2$
2621 IF (LEN(A2$)<5) THEN GOTO 2610
2640 IF (LEN(A2$)<17) THEN GOTO 2690
2650 GOSUB 8040
2670 GOTO 2610
2690 IF (S=2) THEN GOTO 2800
```

2700 REM -----STATE-----

```
2710 PRINT @(15,12),F$(1,2), " (2-LETTER CODE)", 'RB'
2720 INPUT @(15,12),A3$
2740 IF LEN(A3$)<2 THEN LET A3$="TX"
2790 IF (S=2) THEN GOTO 2860
```

2800 REM -----ZIP CODE-----

```
2810 PRINT @(15,12),A3$, " ",F$(1,5), " (ZIP CODE)", 'RB'
2820 INPUT @(18,12),Z1$
2825 SETERR 2810
2830 LET N=NUM(Z1$)
2840 IF (N<1) OR (N>99999) THEN GOTO 2810
2860 PRINT @(15,12),A3$,S$(1,2),Z1$,S$(1,20)
2890 IF (S=2) THEN GOTO 6000
```

had for little or nothing. Frankly, I doubt that there are many companies with their own computer system which wouldn't give a little free computer time to such a worthwhile and public service-oriented organization as an amateur radio club. I am talking about an amount of time on the order of ten to twenty minutes a month, depending upon the size of the club, the speed of the typist, and the kind of system used. Most companies should be happy to provide this kind of computer time in return for the goodwill and possible publicity.

Printer paper would be insignificant since most computer operators and programmers waste more paper in one day than your club would use each month. About the only ex-

pense that would have to come from the club coffer would be the special mailing labels with gummed backs. These will cost somewhere between \$40 and \$60 for 20,000 labels, depending upon the kind used and the particular supplier. That's enough to last a club with 300 members more than five years.

The primary goal of this article is to provide the necessary programs for anyone wishing to establish and maintain an amateur radio club membership file on any computer system that supports the BASIC programming language. The ham radio club membership system presented here consists of three programs. The first provides for the data entry and file maintenance functions necessary to add,

change, and delete members' records. The second program prints a membership list, and the third program produces the mailing labels for the club bulletin.

Another goal of this article is to spark your imagination with a few examples of what else can be done for the club and its members by using spinoffs from the original membership list and mailing label programs. For example, suppose your club is located in a rather large metropolitan area and many of the club members would like to share rides with each other going to the club meetings (or car-pool to work or to sidewalk sales, hamfests, and so on). Since all the address information is in the computer, why not have the computer print a special list of all the members in a

particular sequence, such as by city? Even better, how about printing the list in zip-code order? Since zip codes are smaller divisions of cities and towns, a zip-code-sequenced list would show all of the hams who lived in the same part of town grouped together in the list.

Another interesting and useful way to print the membership list is by license classification. This would show all Novices, Technicians, Generals, and so on, grouped together by their respective classifications. This could be a valuable tool for the officers of the club in planning classes or special events, and could even save money in postage fees (something to consider carefully lately) if a special newsletter needed to be mailed only to those in a

2900 REM -----AREA CODE-----

```
2910 PRINT @(15,14),F$(1,3), " (AREA CODE)", 'RB',
2915 SETERR 8090
2920 INPUT @(15,14),P$(1,3)
2925 SETERR 8090
2930 LET N=NUM(P$(1,3))
2940 IF (N<100) OR (N>999) THEN GOTO 8090
```

3000 REM -----PHONE NUMBER-----

```
3005 RESET
3010 PRINT @(14,14), "(", P$(1,3), ")", " F$(1,7), " ", 'RB',
3020 INPUT @(20,14), P$(4,7)
3030 PRINT @(14,14), "(", P$(1,3), ")", " P$(4,3), "-", P$(7,4),
3090 IF (S=2) THEN GOTO 6000
3095 LET D1$=" R"
3096 GOTO 6000
```

3100 REM -----CLUB CODES-----

```
3101 LET D1$=""
3110 PRINT @(15,16),F$(1,16),
3120 INPUT @(15,16),D1$
3130 IF (LEN(D1$)<17) THEN GOTO 3190
3140 GOSUB 8030
3150 GOTO 3110
3190 IF (S=2) THEN GOTO 6000
```

3200 REM -----OTHER DATA-----

```
3201 LET D2$=""
3210 PRINT @(15,18),F$(1,16),
3220 INPUT @(15,18),D2$
3230 IF (LEN(D2$)<17) THEN GOTO 3290
3240 GOSUB 8030
3250 GOTO 3210
3290 IF (S=2) THEN GOTO 6000
```

3300 REM -----RACES DATA-----

```
3301 LET D3$=""
3310 PRINT @(15,20),F$(1,12),
3320 INPUT @(15,20),D3$
3330 IF (LEN(D3$)<13) THEN GOTO 6000
3340 GOSUB 8030
3350 GOTO 3310
```

4000 REM -----READ ARCHF RECORD-----

```
4001 RESET
4002 PRINT @(0,3), 'CL',
4005 IF (S=4) THEN GOTO 5000
4008 LET S=0
4009 PRINT @(15,2), C1$, S$(1,5)
4010 READ (1, KEY=K$(1,8), DOM=2200) IOL=0040
```

4020 REM -----OLD RECORD-----

```
4030 LET S=2
4040 LET C9$=C1$
```

5000 REM -----DISPLAY DATA-----

```
5005 RESET
5020 PRINT 'CF', @(15,2), C1$, @(41,2), C2$, @(15,4), N1$, @(15,6), N2$, @(15,8), A1$, @(1
5020 5,10), A2$, @(15,12), A3$, @(19,12), Z1$, @(14,14), "(", P$(1,3), ")", " P$(4,3), "-"
5020 " P$(7,4), @(15,16), D1$, @(15,18), D2$, @(15,20), D3$,
5050 IF (S=4) THEN PRINT @(11,3), "NEW CALL SIGN", 'RB',
```

6000 REM -----REQUEST ?-----

```
6005 SETERR 6010
```

```
6010 INPUT @(15,22), "ENTER # TO CHANGE, OR CR TO CONTINUE.", 'RB', R$
6020 IF (R$="END") OR (CTL=4) THEN GOTO 7000
6030 IF (R$="D") OR (R$="DELETE") OR (CTL=3) THEN GOTO 7800
6035 IF (LEN(R$)>2) THEN GOTO 6100
6040 LET F=NUM(R$)
6050 LET S=2
6060 ON F GOTO 7000, 7100, 2200, 2300, 2400, 2500, 2600, 2700, 2800, 2900, 2900, 3100, 3200
6060 , 3300, 6010
```

7000 REM -----WRITE RECORD-----

```
7010 WRITE (1, KEY=K$) IOL=0040
7020 LET S=0
7030 GOTO 1500
```

7100 REM -----CALL SIGN CHANGE-----

```
7110 PRINT @(0,22), 'CL',
7120 INPUT @(15,22), "CHANGE CALL SIGN (YES/NO) ? ", R$
7130 IF (R$="YES") THEN GOTO 7200
7140 GOTO 5000
7200 LET S=4
7210 GOTO 7830
```

7800 REM -----DELETE RECORD-----

```
7810 PRINT @(15,22), 'CL', 'RB', "DELETE ", C9$, " ? ",
7811 INPUT @(33,22), R$
7820 IF (R$<>"YES") THEN GOTO 5000
```

```
7830 REMOVE (1, KEY=K$)
```

```
7840 GOTO 1500
```

8000 REM -----ERROR ROUTINES-----

```
8001 PRINT @(13,3), 'RB', "NON-LICENSED MEMBER ? ",
8002 INPUT @(35,3), R$
8003 IF R$="Y" THEN GOTO 4000
8005 PRINT @(0,3), 'CL',
8006 RESET
8011 PRINT @(15,2), " I N V A L I D ", 'RB',
8012 WAIT 3
8013 GOTO 1500
8021 PRINT @(31,3), "MUST BE N, T, Q, A, E, OR ?", 'RB',
8022 WAIT 3
8023 PRINT @(0,3), 'CL',
8025 GOTO 2200
8031 PRINT @(35,11), "TOO LONG", 'RB',
8032 WAIT 2
8033 PRINT @(0,11), 'CL',
8035 RETURN
```

8040 REM -----NAME TOO SHORT FOR KEY-----

```
8041 IF (LEN(N1$)<4) THEN LET N1$=N1$+S$(1,4-LEN(N1$))
8042 IF (LEN(N2$)<4) THEN LET N2$=N2$+S$(1,4-LEN(N2$))
8043 GOTO 2440
8091 PRINT @(15,15), "MUST HAVE AREA CODE", 'RB',
8092 WAIT 3
8093 PRINT @(0,15), 'CL',
8094 GOTO 2900
9000 CLEAR
9090 CLOSE (1)
9997 PRINT 'CS', "CLEAR ..."
```

```
9998 REM "ARCHFM" ... ARCHF FILE MAINTENANCE
```

```
9999 END
```

NUMBER OF STATEMENTS: 215

END

DEFINED SIZE 2560 BYTES 10 SECTORS DISC 0 SECTOR 6283
PROGRAM SIZE 2445 BYTES 10 PAGES

```
0010 REM "KCCMFL". KCC MEMBERSHIP FILE LIST
0020 CLEAR
0040 IOLIST N1$,N2$,A1$,A2$,A3$,Z1$,P1$,C2$,C1$,D1$,D2$,D3$
0050 DIM N1$(16),N2$(16),A1$(32),A2$(16),A3$(2),Z1$(5),P1$(10),C2$(1),C1$(8),D1$
0060 DIM S$(32,""),F$(32,"-")
0100 OPEN (1)"KCCMF"
0105 OPEN (5)"LP"
0200 LET S=0
0201 LET P=1
0300 PRINT "CS", "SB",@(26,0),"KCCMF FILE LISTING",@(70,0),DAY, "SF"
0310 PRINT @(10,10), "RB", "CREATING SORT FILE"
0500 ERASE "ZASORT"
0501 SORT "ZASORT",23,500,0,6293
0502 OPEN (2)"ZASORT"
0510 PRINT @(0,10), "CL", "RB"
2000 PRINT (5)'FF', 'EP', "FORT WORTH KILOCYCLE CLUB ROSTER",@(38),DAY,@(60), "PAGE
2000 ",P
2001 LET P=P+1
2005 PRINT (5)@(2), "CALL",@(7), "CLASS",@(14), "LASTNAME",@(28), "FIRSTNAME",@(48),
2005 "ADDRESS",@(78), "CITY, STATE, ZIP CODE",@(103), "TELEPHONE",@(116), "AFFILIAT
2005 ION"
2006 PRINT (5)@(0), "-----",@(45), "-----
2006 -----",@(78), "-----",@(101), "-----
2006 ---",@(115), "-----"
2020 LET L=0
2030 IF (S=2)GOTO6100

4000 REM
4001 LET C1$=""
4002 LET K1$=KEY(1,END=6000)
4010 READ (1,KEY=K1$)IOL=40
4015 PRINT @(10,3),C1$
4020 LET Z1$=Z1$+"00000"
4030 LET Z1$=Z1$(1,5)
4040 LET A4$=A1$+" "
4050 LET A4$=A4$(1,10)
4060 LET K2$=Z1$+A4$+K1$
4100 WRITE (2,KEY=K2$)
4500 IF (C2$="A")A=A+1
4510 IF (D1$(13,1)="C")B=B+1
4520 IF (C2$="E")E=E+1
4530 IF (C2$="G")G=G+1
4540 IF (C2$="N")N=N+1
4550 IF (C2$="T")T=T+1
4560 IF (D1$(13,1)="F")F=F+1
4570 IF (D1$(13,1)="L")L=L+1
4580 IF (C2$="?")O=O+1
```

```
4590 IF ((C2$="")AND(D1$(13,1)@="C"))O=O+1
4600 REM
4605 IF (C2$=" ")GOTO4001
4610 SETERR 4660
4620 LET X=NUM(C1$(2,1))
4630 RESET
4640 LET C1$=(" "+C1$(1,2)+" "+C1$(3))
4650 GOTO 5020
4660 LET C1$=(C1$(1,3)+" "+C1$(4))

5000 REM
5020 PRINT (5)@(0),C1$,@(9),C2$, " ",N1$,@(28),N2$,@(45),A1$,@(78),A2$,@(91),A3$
5020 ,@(94),Z1$, " (",P1$(1,3),")",P1$(4,3),"-",P1$(7,4), " ",D1$(1,13)
5030 PRINT (5)""
5035 LET L=L+2
5040 IF (L<50)GOTO4001
5050 GOTO 2000

6000 REM
6010 CLOSE (1)
6020 OPEN (1)"KCCMF"
6030 LET S=2
6100 READ (1,END=9000)IOL=40
6101 IF (C2$@=" ")GOTO6100
6102 PRINT @(10,3), "CL",N1$
6120 PRINT (5)@(2),C1$,@(9),C2$, " ",N1$,@(28),N2$,@(45),A1$,@(78),A2$,@(91),A3$,
6120 ,@(94),Z1$, " (",P1$(1,3),")",P1$(4,3),"-",P1$(7,4), " ",D1$(1,13)
6130 PRINT (5)""
6135 LET L=L+2
6140 IF (L<50)GOTO6100
6150 GOTO 2000

9000 REM
9100 PRINT (5)'LF', 'LF', 'EP', "STATISTICS: "
9110 PRINT (5)'LF', 'E', " EXTRAS: ",A, " ADVANCED, ",G, " GENERALS, ",T, " TECHNICIANS
9110 , ",N, " NOVICES, ",U, " UNLICENSED MEMBERS "
9200 PRINT (5)'LF', 'M', " LIFE MEMBER, ",F, " FAMILY MEMBERS, ",B, " ASSOCIATE MEMBER
9200 S (CLUBS, ETC. ) "
9209 IF (Q<1)GOTO9250
9210 PRINT (5)'LF', 'Q', " UNKNOWN LICENSE CLASS "
9250 PRINT (5)'LF', 'EP', (E+A+G+T+N+B+U+Q), " TOTAL MEMBERS: "
9400 PRINT (5)'LF', 'EP', "QRT"
9410 PRINT (5)'FF', 'FF'
9901 CLOSE (1)
9902 CLOSE (2)
9905 CLOSE (5)
9997 LET S=4
9998 RUN "KCCMLP"
9999 END
```

NUMBER OF STATEMENTS: 83

Membership File List program.

particular group.

Other interesting, if less practical, ways of listing the members of a radio club include listings by first name (ever wonder how many Eds or Jims there are in your group?), by telephone number, or even in order of street address. Anything that is put into the computer record can be used as the "key" for any sorting sequence desired. But enough of that. Let's get back to the main subject.

The programs behind the mailing labels and membership list are very straightforward. The main idea is to provide the user with a fast and easy method of entering the necessary information into the computer. I have seen many systems that do not place much importance on that word "easy." All I can say is, if it's not easy to use, it's not going to get used.

File Maintenance Program

The first program is called the File Maintenance program. As previously mentioned, this program allows the operator to

enter new members into the computer and to change any information already on file. It also allows the operator to delete members who don't pay their dues.

As with the other programs to be described, it is designed for use on an interactive computer system with a video display terminal (VDT). Punched-tape systems, as everyone knows, are now obsolete. Obviously, most 8-bit microprocessors fit in the interactive category, so don't think that you have to use a big time-sharing system. All you need is a computer (CPU), VDT, printer, and a disk storage device with enough capacity to hold all your data.

The File Maintenance program writes all membership data on the data storage disk. This information includes the usual: name, address, city, state, zip code, telephone number, and each member's callsign and license class. There also are three additional data items included in each member's record on the system described

here. These may be used to record membership status or affiliations with other clubs or organizations (RACES, ARES, etc.). There is enough room for office telephone numbers or special remarks regarding type of equipment and operating capabilities. This part of the system is entirely open for whatever use your club might want for it.

One character position, for example, can indicate whether a member is "active," "inactive," "sponsor," "complimentary," "family member," or "life" member. By using, say, twelve character positions in the first "extra data" field, each member can be identified with twelve different groups in addition to the primary club. Obviously, this makes it possible for more than one club in an area to be supported by the same computer system using the same data file and programs.

Another type of information the club might wish to maintain could be the emergency capabilities of the members—subject, of course, to the consent of

each member. (You gotta be careful what you put into the machine, lest it permit some unscrupulous use.)

Since the membership list is usually made available to the members, some of the "extra" data need not be printed on anything except the master listings used by officers of the club. Each club is different, and each one must choose whatever features are deemed most useful and desirable for its own purposes.

The File Maintenance program uses a direct-access disk file with the callsign used as the "key" to each record. The File Maintenance part of the operating system software automatically keeps each record in its proper sequence as each new record is added to the file. The callsign was chosen as the KEY simply because hams invariably use it for identification and each callsign is unique. A random-access data file must have a unique KEY for each record in the same file.

For those members who

BATTERY-WRAP

WIRE WRAPPING TOOL
MODEL **BW-2630**

- POSITIVE INDEXING
- ANTI-OVERWRAPPING
- BITS AVAILABLE FOR AWG 26, 28 & 30
- BATTERY OPERATED
- LIGHT WEIGHT

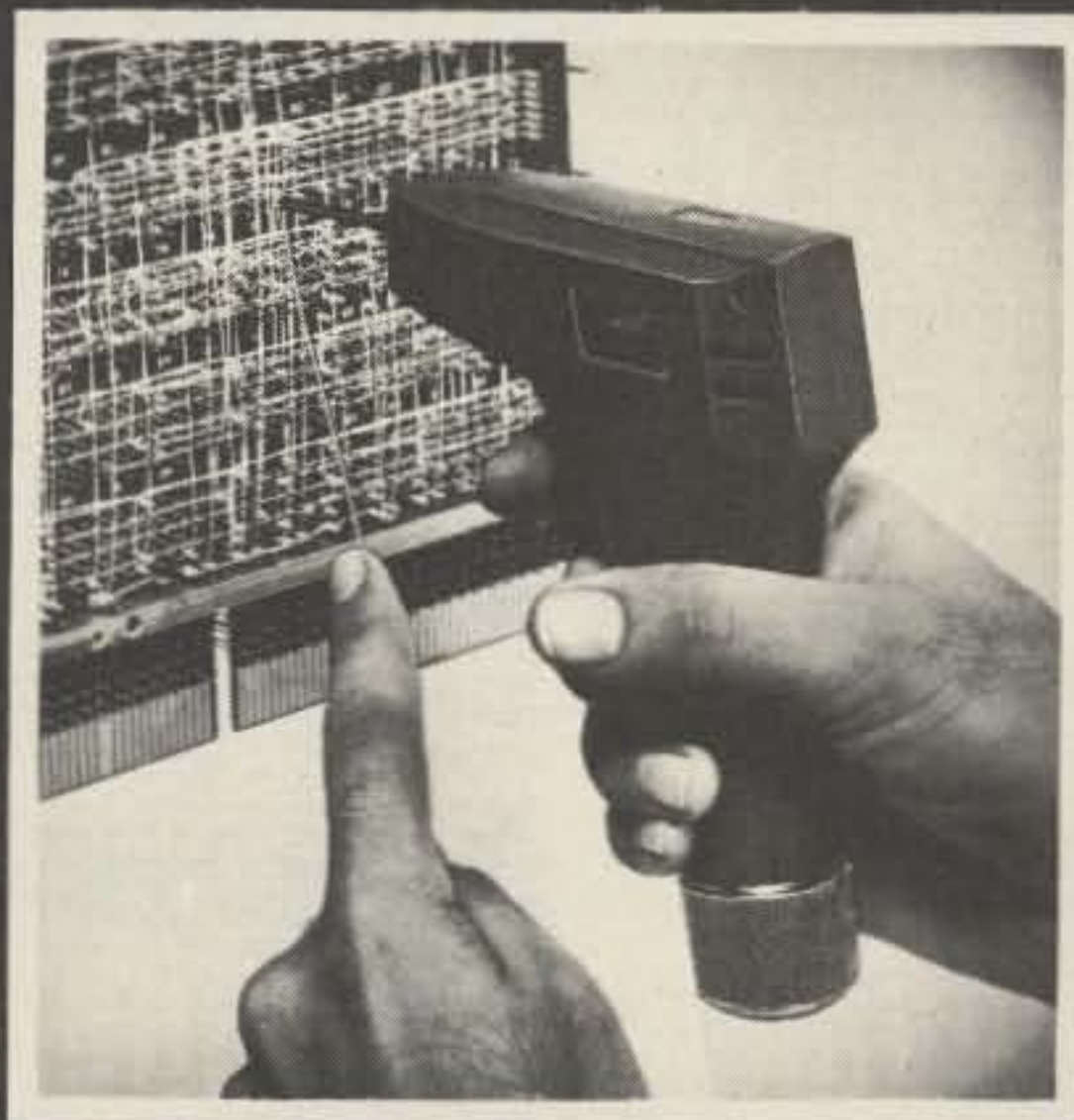

\$19⁸⁵*

BATTERIES AND BIT NOT INCLUDED

U.S.A.
FOREIGN
PATENTS
PENDING



OK MACHINE & TOOL CORPORATION
3455 CONNER ST., BRONX, N.Y. 10475 U.S.A.
TELEX 125091

BW-2630	BATTERY-WRAP TOOL	\$19.85
BT-30	BIT FOR AWG 30	\$ 3.95
BT-2828	BIT FOR AWG 26 & 28	\$ 7.95
RB-20	TWO NI-CAD BATTERIES	\$10.75

*MINIMUM ORDER \$25.00, SHIPPING CHARGE \$2.00, N.Y. CITY AND STATE RESIDENTS ADD TAX

DEALER DIRECTORY

Tell them you saw
their name in 73

Fontana CA

We carry the following: ICOM, Midland, Amcom, DenTron, KLM, Swan, Drake, Ten-Tec, Wilson, SST, MFJ, Hy-Gain, Lunar, Nye-Viking, B&W, Redi-kilowatt, CushCraft, Mosley, Big Signal, Pipo, etc. Full Service Store **Fontana Electronics**, 8628 Sierra Ave., Fontana CA 92335, 822-7710.

Santa Clara CA

Bay area's newest Amateur Radio store. New & used Amateur Radio sales & service. We feature Kenwood, ICOM, Wilson, Yaesu, Atlas, Ten-Tec & many more. **Shaver Radio**, 3550 Lochinvar Avenue, Santa Clara CA 95051, 247-4220.

Denver CO

Experimenter's paradise! Electronic and mechanical components for computer people, audio people, hams, robot builders, experimenters. Open six days a week. **Gateway Electronics Corp.**, 2839 W. 44th Ave., Denver CO 80211, 458-5444.

Columbus GA

KENWOOD—YAESU—DRAKE

The world's most fantastic amateur showroom! You gotta see it to believe it! **Radio Wholesale**, 2012 Auburn Avenue, Columbus GA 31906, 561-7000.

Preston ID

Ross WB7BYZ, has the Largest Stock of Amateur Gear in the Intermountain West and the Best Prices. Call me for all your ham needs. **Ross Distributing**, 78 So. State, Preston ID 83263, 852-0830.

Terre Haute IN

Your ham headquarters located in the heart of the midwest. **Hoosier Electronics, Inc.**, 43B Meadows Shopping Center, P.O. Box 2001, Terre Haute IN 47802, 238-1456.

Littleton MA

The ham store of N.E. you can rely on. Kenwood, ICOM, Wilson, Yaesu, DenTron, KLM amps, B&W switches & wattmeters, Whistler radar detectors, Bearcat, Regency, antennas by Larsen, Wilson, Hustler, GAM. **TEL-COM Inc. Communications & Electronics**, 675 Great Rd., Rt. 119, Littleton MA 01460, 486-3040.

Laurel MD

We stock Drake, Icom, Ten-Tec, Swan, Tempo, Dentron, DSI, KDK, Wilson, Midland and others. Call toll free 800-638-4486. **The Comm Center, Inc.**, Laurel Plaza, Rte. 198, Laurel MD 20810.

St. Louis MO

Experimenter's paradise! Electronic and mechanical components for computer people, audio people, hams, robot builders, experimenters. Open six days a week. **Gateway Electronics Corp.**, 8123-25 Page Blvd., St. Louis MO 63130, 427-6116.

Camden NJ

X-Band (& other frequencies) Microwave Components & Equipment. Laboratory Grade Test Instruments, Power Supplies, 1000's in stock at all times, BUY & SELL all popular makes—HP, GR, FXR, ESI, Sorensen, Singer, etc. **Lectronic Research Labs**, 1423 Ferry Ave., Camden NJ 08104, 541-4200.

North Arlington NJ

Collins, General Radio, Tektronix, Hewlett Packard. Radio sales/service. Cash or trade for tubes or gear. **Ted W2KUW, DCO, INC.**, 10 Schuyler Avenue, No. Arlington NJ 07032 998-4246.

Syracuse—Central NY

We deal, we trade, we discount, we please! Yaesu, Ten-Tec, Cushcraft, Drake, Dentron, KLM, Midland, B&W, ICOM, Hygain, Swan, Amcom, Telco, Mirage, DSI etc. Complete 2-way service shop! **Ham-Bone Radio (Div. Stereo Repair Shop)** 3206 Erie Blvd. East, Syracuse NY 13214, 446-2266.

Syracuse-Rome-Utica NY

Featuring: Yaesu, ICOM, Drake, Atlas, DenTron, Ten-Tec, Swan, Tempo, KLM, Hy-Gain, Mosley, Wilson, Larsen, Midland Southwest Technical Products. You won't be disappointed with equipment/service. **Radio World, Oneida County Airport-Terminal Building**, Oriskany NY 13424, 337-2622.

Scranton PA

ICOM, Bird, CushCraft, VHF Engineering, Antenna Specialists, Barker & Williamson, CDE Rotators, Ham-Keys, Belden, W2AU/W2VS, Shure, Regency, CES Touch-Tone pads, Radio Amateur Callbooks. **LaRue Electronics**, 1112 Grandview St., Scranton PA 18509, 343-2124.

Houston TX

Experimenter's paradise! Electronic and mechanical components for computer people, audio people, hams, robot builders, experimenters. Open six days a week. **Gateway Electronics Inc.**, 8932 Clarkcrest, Houston TX 77063, 978-6575.

Port Angeles WA

Mobile RFI shielding for elimination of ignition and alternator noises, Bonding straps. Components for "do-it-yourself" projects. Plenty of free advice. **Estes Engineering**, 930 Marine Drive, Port Angeles WA 98362, 457-0904.

DEALERS

Your company name and message can contain up to 25 words for as little as \$150 yearly (prepaid), or \$15 per month (prepaid quarterly). No mention of mail-order business or area code permitted. Directory text and payment must reach us 45 days in advance of publication. For example, advertising for the October issue must be in our hands by August 15th. Mail to 73 Magazine, Peterborough NH 03458. ATTN: Aline Coutu.

DEFINED SIZE: 2560 BYTES 10 SECTORS DISC 0 SECTOR 6273
 PROGRAM SIZE: 2410 BYTES 10 PAGES

```
0010 REM "KCCMLP", KCC MAILING LABELS
0020 CLEAR
0040 IOLIST N1$,N2$,A1$,A2$,A3$,Z1$,P1$,C2$,C1$,D1$,D2$,D3$
0041 IOLIST N3$,N4$,W2$,X2$,Y2$,Z2$,P1$,C2$,C3$,D1$,D2$,D3$
0042 IOLIST N5$,N6$,W3$,X3$,Y3$,Z3$,P1$,C2$,C4$,D1$,D2$,D3$
0043 IOLIST N7$,N8$,W4$,X4$,Y4$,Z4$,P1$,C2$,C5$,D1$,D2$,D3$
0050 DIM N1$(16),N2$(16),A1$(32),A2$(16),A3$(2),Z1$(5),P1$(10),C2$(11),C1$(8),D1$
0050 (16),D2$(16),D3$(16),K$(8),N3$(16),N4$(16),N5$(16),N6$(16),N7$(16),N8$(16),
0050 W2$(32),W3$(32),W4$(32),X2$(16),X3$(16),X4$(16),Y2$(2),Y3$(2),Y4$(2),Z2$(5),
0050 Z3$(5),Z4$(5),C3$(8),C4$(8),C5$(8),F$(30,"#")
0101 OPEN (1)"KCCMF"
0102 OPEN (2)"ZASORT"
0105 OPEN (5)"LP"
1000 PRINT "CS", "SB", @(26,0), "KCCMF FILE LISTING", @(70,0), DAY, "SF"
```

```
2000 REM -----FORMS-ALIGNMENT-----
2005 FOR X=1T03
2010 FOR Y=1T04
2100 PRINT (5)F$, @(33), F$, @(67), F$, @(101), F$
2105 NEXT Y
2110 PRINT (5)""
2120 PRINT (5)""
2200 NEXT X
3000 PRINT "RB", "LF", "ARE FORMS PRINTING OK ? (Y/CR) : ",
3010 INPUT C1$
3020 IF (C1$="Y")GOTO2000
```

```
4000 REM -----READ KCC RECORD-----
4010 LET K$=KEY(2,END=9000)
4011 READ (2)
4012 READ (1,KEY=K$(16,8))IOL=40
4013 IF (A1$=W4$)GOTO4010
4014 LET N=N+1
4015 IF (D1$(13,1)="C")GOTO6110
4020 LET K$=KEY(2,END=7041)
4021 READ (2)
4022 READ (1,KEY=K$(16,8))IOL=41
4023 IF (W2$=A1$)GOTO4020
4024 LET N=N+1
4025 IF (D1$(13,1)="C")GOTO6120
4030 LET K$=KEY(2,END=7042)
4031 READ (2)
4032 READ (1,KEY=K$(16,8))IOL=42
4033 IF (W3$=W2$)GOTO4030
4034 LET N=N+1
4035 IF (D1$(13,1)="C")GOTO6130
4040 LET K$=KEY(2,END=7043)
```

```
4041 READ (2)
4042 READ (1,KEY=K$(16,8))IOL=43
4043 IF (W4$=W3$)GOTO4040
4044 LET N=N+1
4045 IF (D1$(13,1)="C")GOTO6140
5010 PRINT (5)C1$, @(33), C3$, @(67), C4$, @(101), C5$
5015 IF (LEN(N8$)<15)GOTO5020
5016 LET N8$=N8$(1,14)
5020 PRINT (5)N2$, " ", N1$, @(33), N4$, " ", N3$, @(67), N6$, " ", N5$, @(101), N8$, " ", N7$
5025 IF (LEN(W4$)<31)GOTO5030
5026 PRINT (5)A1$, @(33), W2$, @(67), W3$, @(101), W4$(1,31)
5027 GOTO 5040
5030 PRINT (5)A1$, @(33), W2$, @(67), W3$, @(101), W4$
5040 PRINT (5)A2$, @(21), A3$, " ", Z1$, @(33), X2$, @(55), Y2$, " ", Z2$, @(67), X3$, @(89),
5040 Y3$, " ", Z3$, @(101), X4$, @(123), Y4$, " ", Z4$
5050 PRINT (5)""
5060 PRINT (5)""
5999 GOTO 4000
6110 LET N9$=N1$
6111 LET N1$=N2$
6112 LET N2$=N3$
6113 GOTO 4020
6120 LET N9$=N3$
6121 LET N3$=N4$
6122 LET N4$=N5$
6123 GOTO 4030
6130 LET N9$=N5$
6131 LET N5$=N6$
6132 LET N6$=N7$
6133 GOTO 4040
6140 LET N9$=N7$
6141 LET N7$=N8$
6142 LET N8$=N9$
6143 GOTO 5000
7041 LET N3$="", N4$="", W2$="", X2$="", Y2$="", Z2$="", C3$=""
7042 LET N5$="", N6$="", W3$="", X3$="", Y3$="", Z3$="", C4$=""
7043 LET N7$="", N8$="", W4$="", X4$="", Y4$="", Z4$="", C5$=""
7044 GOTO 5000

9000 REM
9010 PRINT (5)'EP',N, " LABELS PRINTED ", DAY, @(35),N, " LABELS PRINTED ", DAY, @(70)
9010 :N, " LABELS PRINTED ", DAY
9020 PRINT (5)N, " LABELS PRINTED ", DAY, @(35),N, " LABELS PRINTED ", @(70),N, " LABE
9020 :LS PRINTED ", DAY
9810 BEGIN
9820 LET S=4
9888 RUN "HAM"
9999 END
```

NUMBER OF STATEMENTS: 86

Mailing Label program.

do not yet have their callsigns, the program simply uses the first four characters of their last name plus the first four characters of their first name for the actual KEY for those members.

By the way, much consideration was given to exactly which method should be used to "sort" the callsigns. One of the best known listings of callsigns is, of course, the *Callbook*. The sorting technique used for the *Callbook* is to take the call area number as the primary "sort field," followed by the suffix, and finally, the prefix. Actually, the *Callbook* uses a rather arbitrary and non-alphabetical sequence for the prefix in order to get the calls to come out by "age" of license. Now, with old 1 x 2 and 1 x 3 callsigns being reissued to recent upgrades, however, this method is becoming less meaningful and justified. Anyway, for sorting such a large national listing, I think almost everyone would agree that this technique is okay. I have found, however, that for smaller lists, a modified

version works much better.

Since the members of any one club are usually local residents, their callsigns generally will all have the same area number. It doesn't make much sense, therefore, to separate a local listing by call area the way we would a national listing. With this system, each callsign entered is rearranged by the File Maintenance program so that the suffix comes first, followed by the prefix and the call area number. (No provision was made here to take care of foreign callsigns, by the way.) Thus, the actual KEYS in the data records are not exactly the actual callsigns but rather a special arrangement of callsigns which allows the computer to store the records in the sequence we want.

Some advantage was taken, when writing these programs, of the extensions to the BASIC language on our own system. Other systems which do not support these features can be used with only a few minor modifications, however, due to the general compatibility of BASIC

from one machine to another.

Once a callsign has been entered, the File Maintenance program reads the disk file immediately to see if that callsign had been entered previously. If so, the information is displayed on the VDT. The user is asked what data, if any, should be changed. Thus, the program "assumes" that since the member is already on file, the operator must want to look at or change something in that member's record. If, on the other hand, that callsign is not already on file, the program proceeds by prompting the user to enter the next data item (the license classification). Each separate data item is entered in turn until all items have been filled in. At this point, the program asks if any corrections need to be made before continuing. If there are no errors on the screen, the user simply indicates "no"; the program writes that record on the disk and then asks for another callsign.

Club members who do

not yet have callsigns are handled as follows: When the program requests the next callsign, the VDT operator simply presses the "CR/ENTER" key without entering any characters at all in the callsign field. The program then skips over the callsign and license classification fields and goes directly to the last name field.

The operator enters the last name of that member, then the first name, just as usual. As soon as the program has received both the last and first names, it combines the first four letters of the last name with the first four of the first name and uses this "string" of characters as the KEY for that member's data record in the disk file.

In any one club, there probably won't be more than one person with these same eight characters, taken the same way, who also don't have callsigns. Hence, these members can be assigned a unique KEY that not only gets them on file, but also even ensures that they will be listed alphabetically later, as we shall see.



ENTER A WHOLE NEW WORLD with KILOBAUD MICROCOMPUTING

... and get your first issue FREE!

Hardly a day passes without the computer having some effect on millions around the world. The world of microcomputing is changing every day, and there's one way you can keep up to speed in this dynamic field: Subscribe to Kilobaud **MICROCOMPUTING**. **MICROCOMPUTING** magazine is the forerunner in small business and home computing, loaded with articles on the most popular microcomputers available: the TRS-80, Apple, PET, Heathkit, Imsai and Altair, to name a few. In addition, the articles cover a whole range of subjects, from business applications to educational uses, from product reviews to the latest in software.

As a special limited offer to new subscribers, we'll send you your first issue absolutely free! You'll receive 13 issues for the price of 12. And we're offering you a year's subscription at half the newsstand price . . . only \$15 (it's \$30 a year on the newsstand), and the only difference between a subscriber copy and a copy of **MICROCOMPUTING** on the newsstand is \$1.25. Send in the card today and we'll deliver your first copy in 4-6 weeks.

ENTER A WHOLE NEW WORLD WITH KILOBAUD MICROCOMPUTING And Get Your First Issue Free!

- Send me my first issue of **MICROCOMPUTING** free and start my subscription into the new world of **MICROCOMPUTING**.
- One year (12 issues) at half the cover price—\$15.
- I prefer the additional savings of 3 years (36 issues) for \$45. I understand that I'll still receive my first issue free.
- Payment Enclosed Bill Me Later
- Bill my Master Charge Visa

Card # _____ Exp. Date _____
 Signature _____
 Name _____
 Address _____
 City _____ State _____ Zip _____

Offer good in U.S.A. and possessions only. Canadian subscriptions add \$2.00 per year. All foreign, one year only—\$23 payable in U.S. currency only.

MICROCOMPUTING Subscription Department • P.O. Box 997 • Farmingdale NY 11737 198SA

ENTER A WHOLE NEW WORLD WITH KILOBAUD MICROCOMPUTING And Get Your First Issue Free!

- Send me my first issue of **MICROCOMPUTING** free and start my subscription into the new world of **MICROCOMPUTING**.
- One year (12 issues) at half the cover price—\$15.
- I prefer the additional savings of 3 years (36 issues) for \$45. I understand that I'll still receive my first issue free.
- Payment Enclosed Bill Me Later
- Bill my Master Charge Visa

Card # _____ Exp. Date _____
 Signature _____
 Name _____
 Address _____
 City _____ State _____ Zip _____

Offer good in U.S.A. and possessions only. Canadian subscriptions add \$2.00 per year. All foreign, one year only—\$23 payable in U.S. currency only.

MICROCOMPUTING Subscription Department • P.O. Box 997 • Farmingdale NY 11737 198SB

There is some amount of "editing" performed on each data item entered. This is done merely to help ensure the validity of the data entered into the computer. For example, an address is usually more than three or four characters long. Any attempt to enter an address shorter than that will be considered a mistake. In case the user attempts to skip the address, the program will ignore such a silly thing and, instead, will repeat the request for a realistic address. If a member's address is temporarily not available, the missing data should be "flagged" by entering a long string of asterisks (or any other special character). That should attract the attention of anyone proofreading the list later, and they can collect the missing information. Similarly, the only valid license classes are N, T, G, A, and E. In addition to these five letters, the program also allows the operator to enter a "B" to indicate a club station or sponsor or a "?" to indicate that the class of the licensee is unknown.

Periodically, the Fort Worth Kilocycle Club runs a special program which changes all "?" to "N". This always gets an immediate response from those members who have failed to notify the KC Club of their actual license class.

Other items worth verifying include the state, zip code, and telephone number. Again, if this information is unavailable at the time, the operator should fill in these fields with something to catch the eye of the proofreader. The KC Club uses a string of 9s for missing zip codes and all 0s for missing telephone numbers.

When all items have been entered, the File Maintenance program writes the new (or modified) member's record on

the disk and requests another callsign. If a member is to be deleted, the user keys in that member's callsign, the program displays the information on that member on the display screen, and requests the user to "ENTER ITEM# TO CHANGE, OR 'CR' TO CONTINUE:". The operator then enters the word "DELETE." The program will respond with the question, "DELETE WB5UTJ?" This gives the user one last chance to verify that this member is to be deleted. If the user enters the word "YES," the program will remove that record from the data file. Any other response will abort the delete request and the program will ask for another callsign.

For those members without callsigns, the user may either enter that special string of characters (first four characters of the last name plus the first four characters of the first name) in the callsign field or skip the callsign and enter the last and first names in the usual manner to display or delete members.

During data entry, if a mistake is made on any line, the user always has a chance to correct the error before going to the next line by backspacing to the mistake and retyping the data. If an error is not caught in time, the program gives you one last chance to correct any line, after all lines have been entered and before the data is written on the disk. (Entering the letter "X" in the class field indicates to the program that you want to reenter a mistyped callsign.) And, finally, entering END in the callsign field terminates the File Maintenance program.

I might mention here, for the curious, the purpose of the two different types of input statements used in the File Maintenance pro-

gram. The READ statement and the READRECORD statement both get information input from the device specified (or implied), such as the disk or the VDT. The READ statement looks for "null entry" (CR) as the indication that the operator has entered a complete data item. The READRECORD statement is used whenever an entry of a specific length is expected, such as in the license class (one character only) or the state code, zip, code or telephone number. This statement also has the ability to verify that certain letters or characters have been entered. If the data entered via the READRECORD statement does not match the allowable response, the program automatically generates an error condition and the same statement (in this instance) is executed again and again until the operator enters a valid response.

The READRECORD statement also saves a few keystrokes by not requiring the user to hit the CR key after entering the appropriate number of characters for that input. While this feature may not save much time in this particular application, it is a good idea to use it wherever it would be appropriate for good programming practice. When large volumes of data are considered, this type of statement does indeed save a significant amount of time as well as reduces the probability of error.

Again, if these features are not available on your system, the program can easily be changed to accomplish the same purpose by simply using READ statements throughout, followed by the desired editing statements. By reducing the chances of the user entering bad data, the overall efficiency of the system can be in-

creased greatly.

Membership List Program

The second program is simple and almost self-explanatory. It reads the membership file sequentially and prints the information that was recorded by the File Maintenance program. Since the callsigns were used as the KEYS to the data records, and since the system we use allows us to read direct-access files without specifying the actual KEYS, the members come out automatically in alphanumeric order by callsign. Those members without callsigns also come out in the proper order.

For readability, a space is inserted between the prefix/area and the suffix of each callsign. This makes it even easier to scan the list looking for a particular suffix or callsign.

The Membership List program prints the licensed members first, then prints those members without calls. This is done by the simple expediency of reading the file twice, passing over those members without callsigns on the first pass and skipping the others on the second pass. Although not the most efficient method according to professional programming standards, it is the easiest. Remembering how the unlicensed members were KEYed, you can see how they happen to come out in alphabetical order.

At the end of the job, the Membership List program prints a summary of the club's membership showing the total number of members broken down by license class. Thus, the club can see at a glance just how many Novices, Techs, Generals, Advanceds, and Extras they have. The summary information also includes totals for all family members, life members, sponsors, unlicensed members, and courtesy mem-

bers.

Mailing Label Program

The mailing labels are printed using a modified version of the Membership List program. The Fort Worth Kilocycle Club uses standard gummed-back labels arranged four-across on continuous form stock. This program reads four records at a time and then prints these four callsigns, names, and mailing addresses, four labels at a time.

The Mailing Label program first prints a few test lines for alignment, then, when the operator has adjusted the printer for correct alignment, begins printing the labels. This program arranges the call-sign back into the correct format and even puts the first names in front of the last names before printing, for a more natural appearance. Clubs, sponsors, and other such "affiliated" members are printed last names first since they are usually entered differently than the others.

In order to save postage costs, the KC Club wanted to send only one bulletin to any household where more than one member lives. To accommodate this, the Mailing Label program was changed slightly to "sort" all records by zip code and address before printing the labels. Actually, as the Membership List program prints its own list, it also creates a new and separate file consisting of keys only. These keys are made up of the zip code plus the address of each member. When the Mailing Label program runs, it reads this special "sort" file sequentially to get the records, one at a time, in the proper order.

To eliminate duplicate mailings to the same address, the Mailing Label program simply skips any record having an address identical to the last one

printed.

And Much, Much More

In addition to the regular membership list and mailing labels, the KC Club is getting some of the other benefits mentioned earlier. Once every year, the KC Club receives a copy of three separate listings. One is the usual roster with all members listed by callsign. One is an alphabetical listing of all the members by last name. And the third listing is in order of zip code for all those who might want to carpool or just want to know how many other hams there are in their neighborhood.

Recently, this particular listing turned out to be quite useful during a local emergency. On a Sunday afternoon, the elderly grandmother of a young lady ham radio operator walked away from the nursing home where she was a resident. The granddaughter and her husband (also a ham) requested the assistance of other area hams on the Fort Worth 34/94 two-meter repeater.

As usual, hams were both quick and numerous in response. Mobile operators thoroughly searched every area where possible sightings of the elderly grandmother were reported. The search continued day and night for five days.

When Jean Price WA5JCQ, the secretary-treasurer of the Fort Worth Kilocycle Club, heard of the situation, she realized that the many areas being reported as possible search areas might be covered much more quickly by hams who actually lived in those areas. And since she had that zip-code-sequenced list, complete with callsigns and telephone numbers of all the KC Club members, she volunteered to call all those members who lived in or near the areas where people reported seeing the missing

lady.

Unfortunately, the woman had died the same day she left the nursing home, after walking less than a mile. At least one search party had covered a large area on foot and by helicopter not more than a mile away from where her body lay in the tall grass.

Although this search ended tragically, we all learned some valuable lessons during the ordeal. Perhaps one of the most useful lessons was the fact that we could use a computer listing of amateur radio operators, sorted by zip code, to reduce the time and effort required in search and rescue operations. Perhaps the same type of listing could be used in other situations as well.

Some of the extra information maintained on the KC Club's records includes which members have RDF

capabilities. By "pressing a button" (or two), other programs not shown here can be run to give an up-to-date listing of all those members equipped to track down a jammer or bootlegger. This list goes to the local "SWAT" team commanders for use in coordinating RDF drills and, occasionally, the real thing. Fort Worth, Dallas, and the surrounding cities have some of the cleanest two-meter repeaters in the country. This fact may be due primarily to the nature of Texans, but credit must go to the well-equipped and well-organized T-hunters in the "metroplex," who have excellent track records.

These are only a few of the extra goodies (bells and whistles) available when a computer is used for the benefit of amateur radio. Future applications are endless. ■

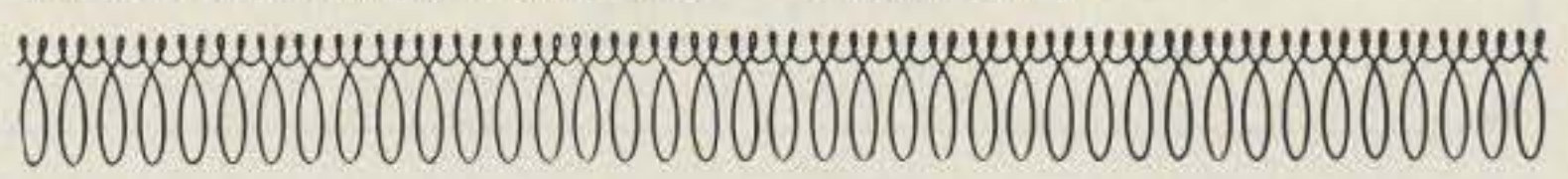

CUSTOM TRANSFORMERS



HEAVY-DUTY REPLACEMENT TRANSFORMERS

BTILK-2000 Plate	\$135	HEATH HA-10 Plate	\$115
COLLINS 30S-1 Power	\$215	HEATH HX-10 Power	\$95
COLLINS KWS-1 Plate	\$135	HEATH SB-220 Plate	\$125
COLLINS 516F-2 Power	\$95	HENRY 2K Plate	\$150
DENTRON 160-10L Power	\$125	HENRY 2K-2 Power	\$155
DRAKE L4B Plate	\$165	HENRY 2K-4 Power	\$165
GONSET GSB-100 Power	\$95	HENRY 3K-A Plate	\$165
GONSET GSB-201 Power	\$135	HENRY 3K-A DC Choke	\$85
H-CRAFTERS HT-32 Power	\$95	EFJ T-BOLT Plate	\$125
H-CRAFTERS HT-37 Power	\$95	EFJ 500 Modulation	\$95
HEATH DX-100 LV Power	\$95	EFJ 500 DC Choke	\$75
HEATH DX-100 Modl	\$95	NATL NCL-2000 Plate	\$125

OFF-THE-SHELF SPECIALS

PLATE XFMR:	3000 VAC @ 3.0A CCS 230 PRI-120LB	\$450
PLATE XFMR:	2400 VAC @ 1.5A ICAS 220/240 PRI-4 1LB	\$150
PLATE XFMR:	3000 VAC @ 1.5A CCS 230 PRI-60LB	\$195
PLATE XFMR:	3000 VAC @ 0.7A ICAS 115/230 PRI-27LB	\$115
PLATE XFMR:	3500 VAC @ 1.0A ICAS 115/230 PRI-4 1LB	\$150
PLATE XFMR:	4000/4600 VAC @ 1.5A ICAS 230 PRI-60LB	\$195
PLATE XFMR:	6000 VCT @ 0.8A CCS 115/230 PRI-4 1LB	\$150
FILMT XFMR:	5.0 VCT @ 30A 117 PRI-9.5LB	\$30
FILMT XFMR:	7.5 VCT @ 21A 117 PRI-9.5LB	\$30
FILMT XFMR:	7.5 VCT @ 55A 115/230 PRI-14.6LB	\$65
FILMT XFMR:	7.5 VCT @ 75A 115/230 PRI-20.2LB	\$95
FIL CHOKE:	30 AMP Bifilar Wound on 1/2"x7" rod	\$9
DC CHOKE:	8.0 Henries @ 1.5 AMP DC 4 1LB	\$150
SWG CHOKE:	5-30 Henries @ 1.0 AMP DC 23LB	\$100

ALL TRANSFORMERS & CHOKES GUARANTEED FOR 24 MONTHS

Many others also available. Write for free list or quote on any custom transformer, choke, or saturable reactor.

Peter W. Dahl Co.

4007 Fort Blvd. • El Paso, Texas 79930
Telephone (915) 566-5365



Kantronics' Field Day ^{T.M.}

Morse/radioteletype reader & speed display

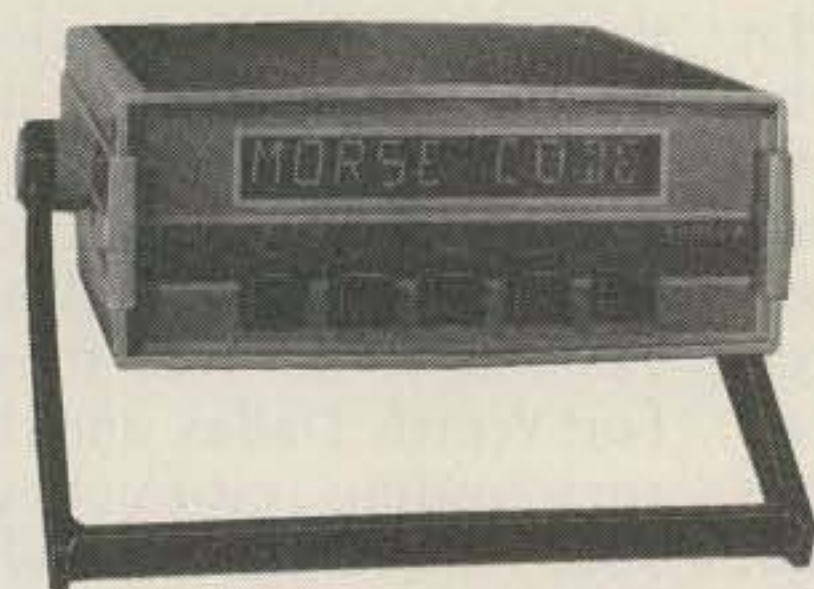

only
\$449.95

Kantronics' Field Day morse code/teletype reader reads code signals right off the air. Its powerful microcomputer system picks out signals, computes their speed and even reads sloppy copy up to 80 words per minute.

The **Field Day** is simple to use. You plug it into your station receiver just as you would a set of headphones. Code and teletype conversations are converted from dots and dashes to standard alphanumeric text. The text advances from right to left across ten big 1/2 inch displays.

The **Field Day** displays incoming or outgoing code speed for you at the touch of a button, right on the front panel. The **Field Day** is enclosed in a compact, lightweight package including speaker. HWD 3.44" by 8.50" by 9.25". The **Field Day** has the features that make it a truly great code reader. Write us for a complete **Kantronics** authorized dealer list.

✓K13

KANTRONICS

The Lightweight Champs.

1202 East 23rd Street
Lawrence, Kansas 66044

Phone: 913-842-7745

We accept Visa, Master Charge, check and money orders.

KIM™ BUS IS A WINNER!

AIM™, VIM™, (SYM)™, KIM™ OWNERS (and any other KIM™ bus users) buy the best 8K board available anywhere:

GRAND OPENING SPECIAL—HDE 8K RAM—\$169! 3 for \$465.00!

100 hour burn in—low power—commercial/industrial quality 90 day parts and labor warranty (reg. \$195.00!)

KIM-1 Computer \$179.00

KIM-4 Motherboards \$119.00

Also—turn your KIM™ (or relative) into the best 6502 development system available at any price. Expand with HDE's full size floppy system with DOS/Editor/Assembler! If you thought the ARESCO was powerful, try this one out. Completely compatible with existing ARESCO source files. Powerful editor/DOS command structure—new 2 pass assembler. Industrial/commercial grade components with 90 day warranty. KIM bus compatible interface card—power supply for 4 drives single drive—\$1995.00; dual drive \$2750.00 (45 day del.)

✓P43

Add 5% for shipping. VISA/Master Charge. Free shipping on prepaid cashier's check orders.

PLAINSMAN MICRO SYSTEMS, Div. 5C Corporation:
P. O. Box 1712 Auburn AL 36830 (205) 745-7735

Dealers for OSI, COMMODORE, COMPUCOLOR, ALTOS



CONNECTOR ASSORTMENT

\$25.00 **\$23.50** each

Postpaid lots of three

Includes: 5-PL259, 5-SO239, 5-UG175, 5-UG176, 2-PL258, 1-DM, 1-M358, 2-M359, 1-UG255, 1-UG273, 2-PL259PO, 1-1021-20, 1-Lightning Arrestor.

Master Charge & Visa accepted / Send for Free Catalog

COAKIT ✓C21

P.O. Box 101-A Dumont, N. J. 07628

Circle C21 on Reader Service Card

BI-DIRECTIONAL CASSETTE RECORDERS ★ SPECIAL BARGAIN SALE ★

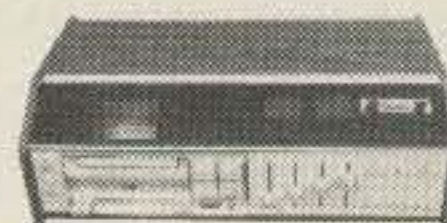

Every now and then we run into something unusual in our shopping for equipment. In this case it was a particularly good buy on Sonex cassette recorders. We needed a bunch of recorders for code tape duplication ... but in order to buy at a low price we had to take about 50 more than we needed. *You benefit.* These cassette recorders record and play both directions without stopping. You might expect to pay from \$250 up for a recorder like this ... we'll pass them along at our cost ... after all, we're not in the recorder business. While they last, get these recorders for \$75 each. One to a customer, please ... don't be greedy. You can call up the Radio Bookshop and place your order with a charge card: 603-924-3873.

73 MAGAZINE, PETERBOROUGH, NEW HAMPSHIRE 03458

The only thing we can't disguise is the professional quality of **as** amateur antennas.

Amateur Radio spoken here!

FREE decal just for fun!

Name _____

Address _____

City _____ State _____ Zip _____

✓A62



the antenna specialists co.

© "Stripes of Quality"
a member of The Allen Group Inc.
12435 Euclid Ave. Cleveland, Ohio 44106
Export: 2200 Shames Drive, Westbury, L.I., New York 11590
Canada: A. C. Simmonds & Sons, Ltd.

Instant Software™ New Releases

More Programs per Package! More Programs to choose from!

More fun for your computing dollar than any other brand of ready-to-use software!

Check out this batch of New Releases:

TRS-80* Level II

FINANCIAL ASSISTANT Compute the figures for a wide variety of business needs. Included are:

- **Depreciation**—This program lets you figure depreciation on equipment in five different ways.
 - **Loan Amortization Schedule**—Merely enter a few essential factors, and your TRS-80 will display a complete breakdown of all costs and schedules of payment for any loan.
 - **Financier**—This program performs thirteen common financial calculations. Easily handles calculations on investments, depreciation, and loans.
 - **1% Forecasting**—Use this simple program to forecast sales, expenses, or any other historical data series.
- All you need is a TRS-80 Level II 16K. **Order No. 0072R \$7.95**

TRS-80 UTILITY 1 Ever wonder how some programmers give their programs that professional look? Instant Software has the answer with the TRS-80 Utility 1 package. Included are:

- **RENUM**—Now you can easily renumber any Level II program to make room for modification, or to clean up the listing.
- **DUPLIK**—This program will let you duplicate any BASIC, assembler, or machine-language program, verify the data, merge two or more programs into one data block, and even copy Level I programs on a Level II machine. For TRS-80 Level II 16K. **Order No. 0081R \$7.95.**

TRS-80 UTILITY 2 Let Instant Software change the drudgery of editing your programs into a quick, easy job. Included in this package are:

- **CFETCH**—Search through any Level II program tape and get the file names for all the programs. You can also merge BASIC programs, with consecutive line numbers, into one program.
 - **CWRITE**—Combine subroutines, that work in different memory locations into one program. This works with BASIC or machine-language programs and gives you a general checksum.
- This package is just the thing for your TRS-80 Level II 16K. **Order No. 0076R \$7.95**

TEACHER Now you can have the benefits of computer-assisted instruction right in your own home. The programs allow you to input any number of questions and answers. Using this data, the computer will prepare several types of tests, quiz students, provide up to three "hints" per question—even offer graphic rewards for younger children, all at the user's discretion. Perfect for parents, teachers, or anyone faced with learning a lot of material in the shortest possible time. Furnished with blank data cassette. Teacher requires a 16K Level II TRS-80. **Order No. 0065R \$9.95.**

DOODLES AND DISPLAYS II Wait until your children get a hold of this package:

- **Doodle Pad**—Draw pictures and save them on cassette tapes.
 - **Symmetrics**—An electric kaleidoscope that change's from black to white and back again. It's almost hypnotic!
 - **Drawing**—like Doodle Pad, but for the serious artist. Over 40 user commands!
 - **Random Pattern Display**—The computer does the drawing, but those with itchy fingers can tamper.
 - **Math Curves**—Bring those Geometry lessons to life. Six different geometrical curves on the screen of your TRS-80.
 - **Rug Patterns**—Yes, it does design rug patterns and, with a choice of user or computer control, it can do a whole lot more.
- For the Level II 16K TRS-80. **Order No. 0042R \$7.95.**

HOUSEHOLD ACCOUNTANT Let your TRS-80 help you out with many of your daily household calculations. Save time and money with these fine programs:

- **Budget and Expense Analysis**—You can change budgeting into a more pleasant job with this program. With nine sections for income and expenses and the option for one- and three-month review or year totals, you can see where your money is going.
 - **Life Insurance Cost Comparison**—Compare the cost of various life insurance policies. Find out the difference in price between term and whole life. This program can store and display up to six different results.
 - **Datebook**—Record all those important dates in your life for fast, easy access. The program has all major holidays already included.
- All you need is TRS-80 Level II 16K. **Order No. 0069R \$7.95**

MODEL ROCKET ANALYZER AND PRE-FLIGHT CHECK Let your TRS-80 help you enjoy the fast-growing hobby of model rocketry. The complementary programs included are:

- **Model Rocket Flight History Prediction**—This program will compute the flight characteristics for almost any model rocket. Engine and body tube data included covers Estes, Centuri, Flight Systems, A.V.I. Astroport, C.M.R., and Kopter products.
- **Weather Forecaster**—Before you launch your rocket, get an up-to-the-minute weather forecast. Just enter your location, elevation, average temperatures for January and July, and barometric pressure. You'll be the short-range weather forecaster for your local area. For a successful launch, you'll need TRS-80 Level II 16K. **Order No. 0024R \$7.95**

PET**

DIGITAL CLOCK Don't let your PET sit idle when you are not programming, put it to work with these two unique and useful programs:

- **Digital Clock**—Turn you PET into an extremely accurate time-piece that you can use to display local time, time in distant zones, and as a split time clock for up to nine different sporting events.
- **Moving Sign**—Let the world know what's on your mind. This program turns your PET into a flashing graphic display that will put your message across. **Order No. 0083P \$7.95.**

TURF AND TARGET Whether on the field or in the air, you'll have fun with Turf and Target package. Included are:

- **Quarterback**—You're the quarterback as you try to get the pigskin over the goal line. You can pass, punt, hand off, and see the results of your play using the PET's superb graphics.
- **Soccer II**—Play the fast-action game of soccer with four playing options. The computer can play itself, play a single player, two players with computer assistance, and two players without help.
- **Shoot**—You're the hunter as you try to shoot the bird out of the air. The PET will keep score.
- **Target**—Use the numeric keypad to shoot your puck into the home position as fast as you can. To run and score all you'll need is a PET with 8K. **Order No. 0097P \$7.95**

ARCADE I This package combines an exciting outdoors sport with one of America's most popular indoor sports:

- **Kite Fight**—It's a national sport in India. After you and a friend have spent several hours maneuvering your kites across the screen of your PET, you'll know why!
 - **Pinball**—By far the finest use of the PET's exceptional graphics capabilities we've ever seen, and a heck of a lot of fun to play to boot.
- Requires an 8K PET. **Order No. 0074R \$7.95.**

ARCADE II One challenging memory game and two fast-paced action games make this one package the whole family will enjoy for some time to come. Package includes:

- **UFO**—Catch the elusive UFO before it hits the ground!
 - **Hit**—Better than a skeet shoot. The target remains stationary, but you're moving all over the place.
 - **Blockade**—A two-player game that combines strategy and fast reflexes.
- Requires 8K PET. **Order No. 0045P \$7.95.**

Apple***

MATH TUTOR I Parents, teachers, students, now you can turn your Apple computer into a mathematics tutor. Your children or students can begin to enjoy their math lessons with these programs:

- **Hanging**—Perfect your skill with decimal numbers while you try to cheat the hangman.
- **Spellbinder**—Cast spells against a competing magician as you practice working with fractions.
- **Whole Space**—While you exercise your skill at using whole numbers, your ship attacks the enemy planet and destroys alien spacecraft.

All programs have varying levels of difficulty. All you need is Applesoft II with your Apple II 24K. **Order No. 0073A \$7.95**

INSTANT SOFTWARE \$7.95

Designed for use on
APPLE*
20K

Math Tutor II

- Robot Duel
- Car Jump
- Sub Attack

* A trademark of Apple Computer Inc. **Requires Applesoft II**

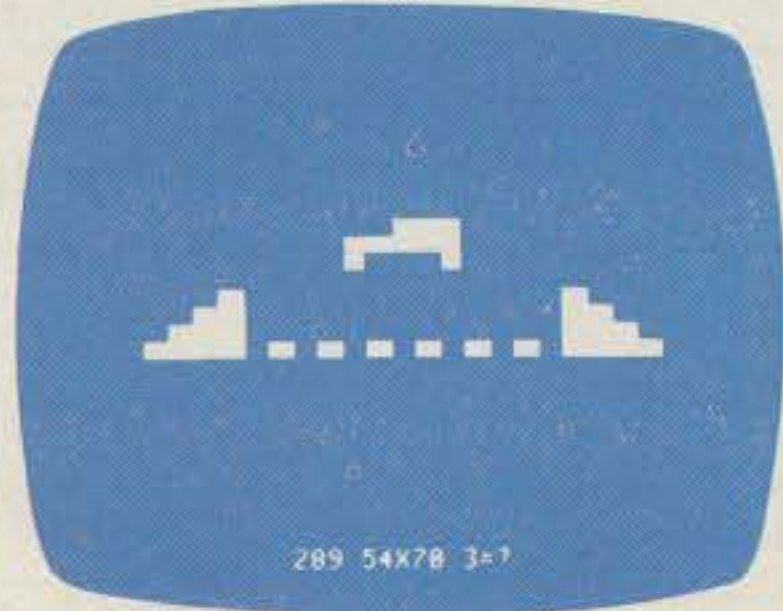

0098A Instant Software Inc. Peterborough NH 03458 USA. See reverse for program information.

MATH TUTOR II Your Apple computer can go beyond game playing and become a mathematics tutor for your children. Using the technique of immediate positive reinforcement, you can make math fun with:

- **Car Jump**—Reinforce the concept of calculating area while having fun making your car jump over the ramps.
 - **Robot Duel**—Practice figuring volumes of various containers while your robot fights against the computer's mechanical man.
 - **Sub Attack**—Take the mystery out of working with percentages as your submarine sneaks into the harbor and destroys the enemy fleet.
- All you need is Applesoft II with your Apple II and 20K. **Order No. 0098A \$7.95.**

*A trademark of Tandy Corporation

**A trademark of Commodore Business Machines Inc.

***A trademark of Apple Computer Inc.

A few good reasons why you should buy

Instant Software™

The Selection

With over 300 programs now available for business, home, education, science, and just plain fun, you'll be able to do more with your computer than you ever dreamed possible — and we add more programs to our line every day.

The Content

It takes a talented team of computer professionals, over 800 associate editors, and the best equipped microlab in the world to weed through the mountain of submitted software and bring you programming that is always topical, up-to-date, and error free.

The Price

Compare for yourself. Instant Software's high-volume sales bring you more programs for your computing dollar than any other brand.

The Cassette

Top-quality, premium-cased cassettes provide easy loading and long life.

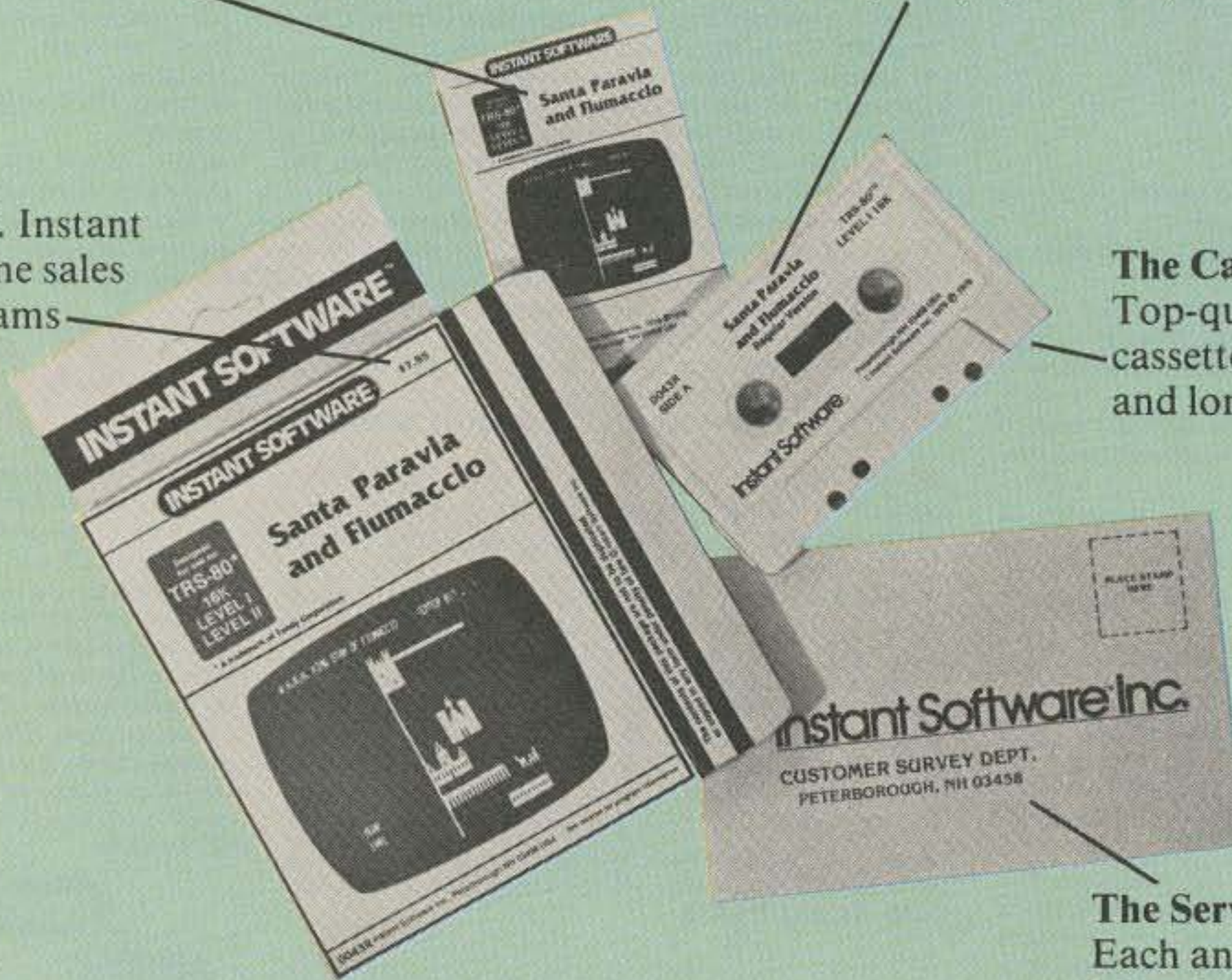

The Service

Each and every program is backed by our guarantee.

Display package shown above only available when purchased through dealers.

To receive our free catalog, write: INSTANT SOFTWARE, DEPT. ISF4, Peterborough, N.H. 03458

Ask for Instant Software at a computer store near you.

Alabama

The Computer Shack
913 Shadyview Lane, Adamsville
Computerland of Huntsville
3020 University Dr. Huntsville

California

Byte Shop of Mt. View
1063 West El Camino Real, Mt. View
Byte Shop of Sacramento
6041 Greenback Ln. Citrus Heights
Capital Computer Systems
3396 El Camino Ave. Sacramento
Computer Components of South Bay
15818 Hawthorne Blvd. Lawndale
Computer Components Inc.
6791 Westminster Ave. Westminster
Computerland
16720 S. Hawthorne, Lawndale
Computerland of San Francisco
117 Fremont St. San Francisco
Computerland of W. LA
6840 La Cienga Blvd. Englewood
I.C.E. House Inc.
398 North E. St. San Bernardino
Microsun Computer Center
2989 North Main St. Walnut Creek
Opamp/Technical Books
1033 N. Sycamore Ave. Los Angeles
Radio Shack
8250 Mira Mesa Blvd. San Diego

Silver Spur Elect. Comm.
13552 Central Ave. Chino

The Computer Store
820 Broadway, Santa Monica

Colorado

Byte Shop
3464 S. Acoma St. Englewood

Connecticut

Bridgeport Computers Inc.
3876 Main St. Bridgeport

Florida

AMF Electronics
11146 N. 30th St. Tampa
Interstate Marketing
Fort Lauderdale
Sound Ideas
2201-C N.W. 13th Gainesville

Georgia

Atlanta Computer Mart
Atlanta

Hawaii

Radio Shack
1712 S. King St. Honolulu

Louisiana

Computer Shoppe Inc.
3225 Danny Park Suite 222,
Metairie

Massachusetts

Computer Packages Unlimited
99 Reservoir St. Holden

The Computer Store
120 Cambridge St. Burlington

Tufts Radio & Electronics
206 Mystic Ave. Medford

Michigan

Computerland of Grand Rapids
2927 28th St. S.E. Kentwood

Computerland of Southfield
29673 Northwestern Hwy. Southfield

Computer Mart
560 W. 14 Mile Rd. Clawson

Hobby House
1035 W. Territorial Rd. Battle Creek

Nebraska

Omaha Computer Store
4540 S. 84th St. Omaha

New Mexico

South West Computer Center
121 Wyatt Drive, Suite 7, Las Cruces

New York

Aristo Craft
314 Fifth Ave. NYC

Computer Corner
200 Hamilton Ave. White Plains

Computer Factory
485 Lexington Ave. NYC

Key Electronics
Schenectady

Ohio

Astro Video Electronics
504 E. Main St. Lancaster

Computer Store of Toledo
18 Hillwyck Dr. Toledo

21st Century Shop
16 Convention Way, Cincinnati

Oregon

Computerland of Portland
12021 SW Main St. Tigard

Pennsylvania

Artco Elect.
302 Wyoming Ave. Kingston

Personal Computer Corp.
Frazer Mall, Lancaster Ave. Frazer

Tennessee

Computerlab
671 S. Menden Hall Rd. Memphis

Texas

Computercraft Inc.
3211 Fondren, Houston

Interactive Computers
7620 Dashwood Rd. Houston

K.A. Elect.
1220 Majesty Dr. Dallas

Radio Shack
1117 Conway, Mission

Ram Micro Systems
6353 Camp Bowie Blvd. Ft. Worth

Virginia

Home Computer Center
2927 Virginia Beach Blvd. Virginia Beach

Washington

Personal Computers
S 104 Freva, Spokane

Ye Old Computer Shop
1301 G. Washington, Richland

Wisconsin

Byte Shop Of Milwaukee
6019 West Layton Ave. Greenfield

Canada

Compumart
Station J. Ottawa, Ontario

Computer Mart. Ltd.
1055 Yonge St. Suite 208 Toronto

Micro Shack of W. Canada
333 Park Street, Regina, Sask.

Orthon Holdings Ltd.
12411 Stony Plain Road
Edmonton, Alberta

England

LP Enterprises
313 Kingston Road, Ilford, Essex

France

Sivea S.A.
20 Rue de Leningrad, Paris

Food for Thought

Someday, every child will benefit from computer-assisted instruction.

Why not give your child the head start he deserves?

For the Apple*

Math Tutor I

The Math Tutor I package is designed to help younger children learn the concepts of mathematics. It uses the technique of positive, immediate reinforcement. When the child enters a correct answer, he or she is rewarded with the opportunity to move a spaceship, cast a magic spell, or rescue a man from a most unfortunate fate. By using this method of positive reinforcement, children will learn to associate mathematics with pleasant experiences, as opposed to the stark reality of numbers that has driven so many pupils to an early dislike of math. The program also provides the opportunity for parents to indulge in a unique learning experience with their children, while introducing them to the exciting world of microcomputing. Teachers can also use the program in a classroom setting to provide that extra incentive. Math Tutor I contains the following programs:

Hanging

A variation of the traditional game of Hangman. In Hanging, students must spare the graphic character's "life" by correctly answering the questions posed by the computer.

Spellbinder

The student is cast as a magician competing against another magician that's controlled by the computer. He must answer the questions about fractions correctly in order to cast magic clouds, fireballs, and other spells at his rival.

Whole Space

Students are given the opportunity to lead an attack on an evil planet. Every time a correct answer is given to a math problem posed by the computer, he can move his ship closer to his goal. Every wrong answer gives the enemy an opportunity to fire back.

Order No. 0073A \$7.95

Note: the Hanging and Spellbinder programs require Applesoft II BASIC. The Whole Space program can run in integer BASIC.

Math Tutor II

Math Tutor II is designed to complement the Math Tutor I package and introduces students to more advanced mathematical principles. Again, it uses the technique of positive reinforcement by offering rewards for correct answers—a principle long recognized as effective in helping students develop healthy attitudes towards study. To keep pace with individual pupil's development, all of the programs in this package may be used with any one of four levels of difficulty. Package includes:

Car Jump

Make the car jump over the buses. Every time your student correctly calculates the areas of various geometric planes the number of buses in the line is increased by one.

Robot Duel

Each time a student correctly answers a question involving volumes of geometric solids, he's allowed one shot at the computer "robot." For every incorrect answer, his shield power drops, and the enemy robot is given the opportunity to shoot back.

Sub Attack

Students get to practice using percentages as they maneuver their sub into the harbor. A correct answer lets them fire their torpedoes at the enemy fleet.

Order No. 0098A \$7.95

Note: All programs in this package require Applesoft II BASIC.

*Apple and Applesoft II are trademarks of Apple Computer Inc.
**TRS-80 is a registered trademark of Tandy Corp.

For the TRS-80**

Teacher

This practical program allows you to input any number of questions and answers from the fields of science, languages, history—you name it. Using this data, the computer will prepare several types of tests, quiz students—providing up to three hints per question—even offer graphic rewards for younger children, all at the user's discretion. True or False tests may also be given.

Included with the Teacher package is a separate program, Teacher Data transfer, that allows several tests to be recorded sequentially on one cassette, thereby permitting the administration of whole lessons without the inconvenience of loading individual cassettes. Teacher is effective, practical, easy to use—perfect for teachers, parents, businessmen or anyone faced with learning a lot of material in the shortest possible time. Furnished with blank data cassette.

Order No. 0065R \$9.95

If your local Instant Software dealer doesn't have the program you're looking for, order your software direct: Just use the order blank provided below or call Toll-Free 1-800-258-5473.

Name _____
 Address _____
 City _____
 State _____ Zip _____
 Check Money order
 VISA AMEX Master Charge
 Card No. _____
 Expiration Date _____
 Signed _____ Date _____

Order your Instant Software today!

Quantity	Order No.	Unit Cost	Total Cost
Shipping and Handling			\$1.00
Total Order			

Instant Software Inc. Dept. 73-ISF4
 Peterborough, N.H. 03458 USA

As with all Instant Software programs, Math Tutor I & II and Teacher are sold complete with detailed instructions that take even the novice, step by step, from loading and running the program, through suggestions for use and care of cassettes.

Check our list of dealers on the next page for the store nearest you.

Instant Software™ Inc.

Peterborough, N.H. 03458

603-924-7296

DEALER INQUIRIES INVITED

More Power to You

— 12-V supply has current limiting, overvoltage protection, the works

With all of the solid-state transmitters, receivers, and transceivers on the market, power supplies to provide the proper voltage and current are sometimes complicated. There has been a need for a simple power supply de-

sign that provides over-current and overvoltage protection. Good components and design considerations are important if you are to have a reliable power unit.

The design which I will describe will allow you to

adjust it to fit your needs. Most of the parts used are available from your junk box or local parts store. The hardest item to locate at a reasonable cost is a transformer. The voltage requirements for a good 13.5-V dc supply are a minimum of 36 V ac, center-tapped, or a single 18-V ac winding (see Fig. 1). For a 13.5-V dc regulator to perform, we have an upper voltage-sag limitation of 18

to 18.5 V dc under a maximum load. What we are asking the regulator to do is to maintain regulation at 13.5 V dc with a difference voltage of 4 to 5 V dc (13.5 V dc regulated + 5 V dc = 18.5 V dc unregulated). Keep in mind that this is the minimum voltage needed to maintain regulation. If you choose a transformer that yields a higher voltage difference (regulated to unregulated), the product of this difference voltage and load current, in power (heat), must be dissipated in the regulator, which we will discuss later.

If you have a solid-state rig you wish to power, check the manufacturer's specifications for current consumption. Choose a transformer which will handle that load current with a voltage level sufficient enough to maintain the unregulated supply requirements we discussed earlier.

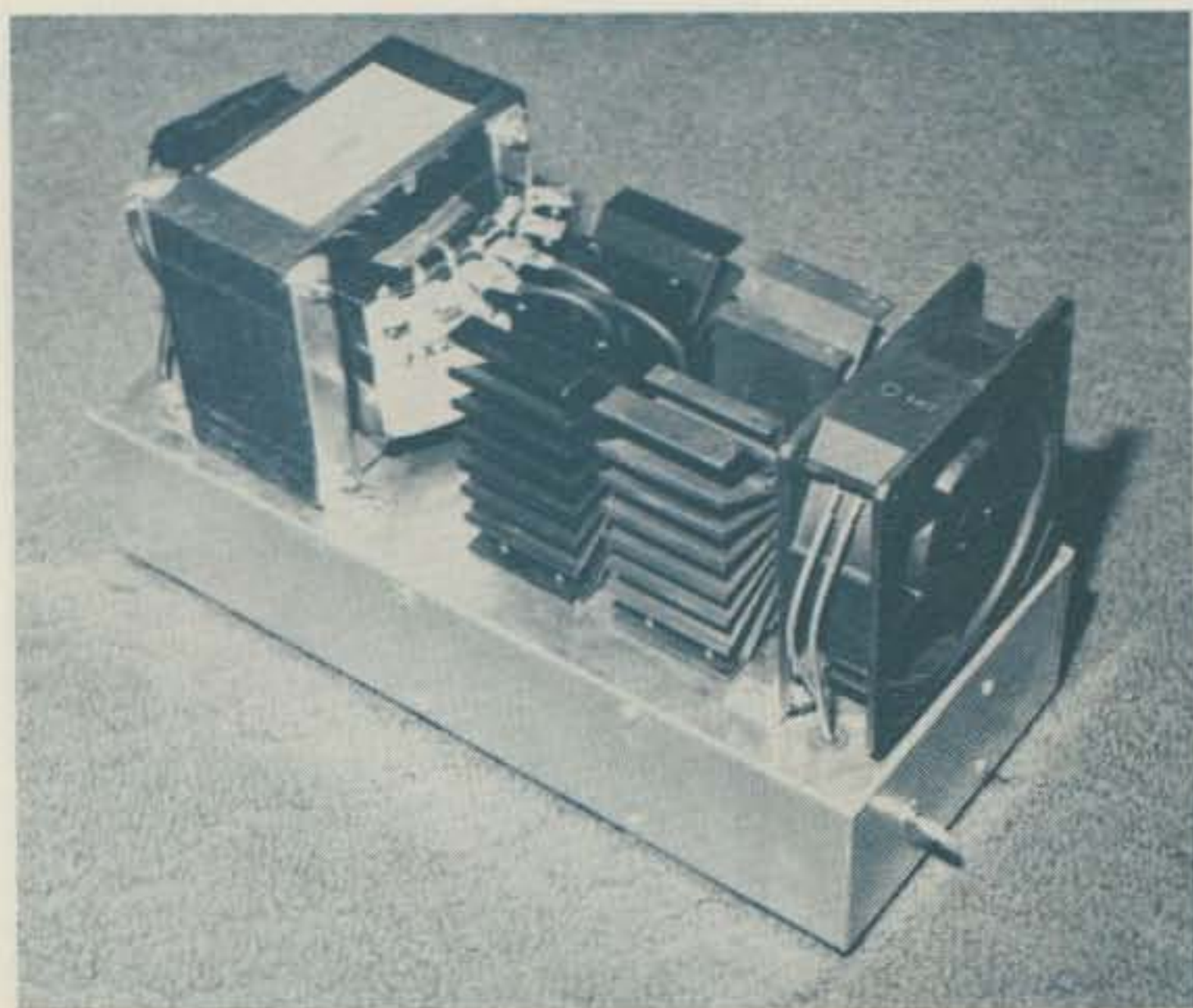

Top view of completed supply.

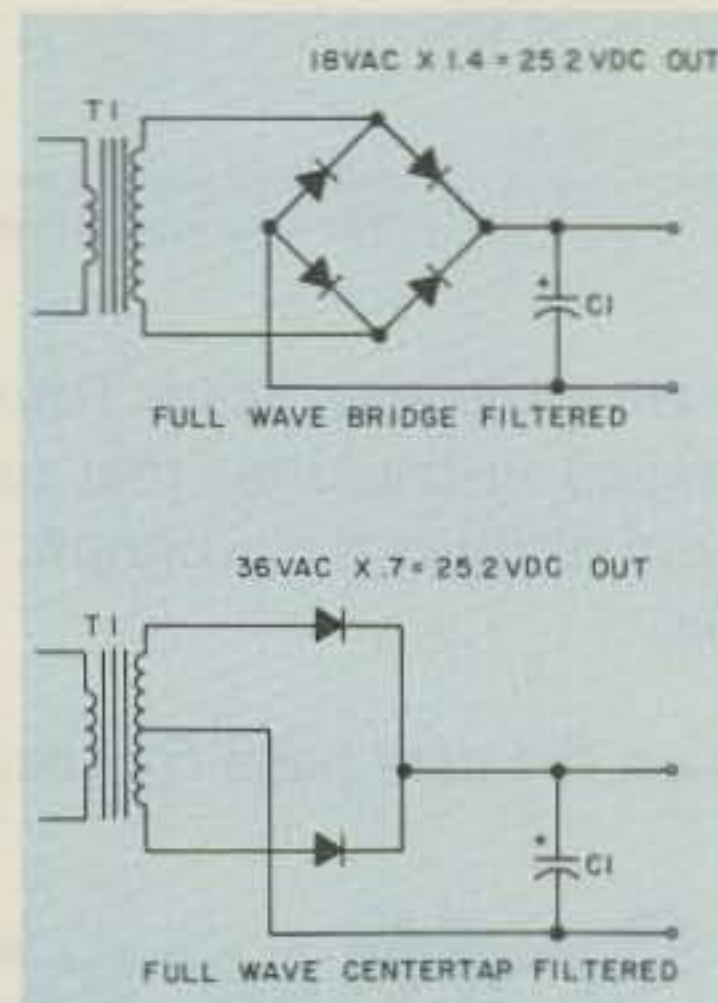

Fig. 1.

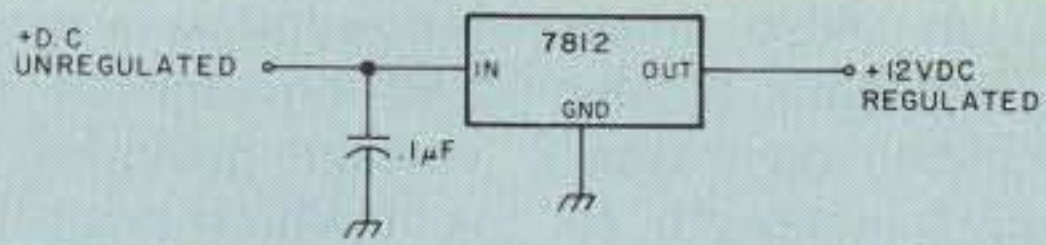

Fig. 2.

Select a diode assembly which will handle the I_{dc} output. My requirement was a maximum of 20 Amps to power a repeater and amplifier. My diode assembly will therefore have to handle 20 Amps. Each diode used will have a voltage drop of approximately 1 volt across it, and, at 20 Amps, $P = I \times E$, or 20 Amps \times 1 volt = 20 Watts. Heat-sink these devices well to dissipate this energy.

The filter capacitor may be gauged by a simple rule of thumb. For every Amp (I_{dc}) delivered, a minimum of 3000 μF of capacitance is required. You can have ripple in your supply and never notice it at the output of the regulator as long as the maximum ripple component never drops below the minimum unregulated voltage of 18 to 18.5 V dc. This capacitor value is arrived at mathematically, but, for simplicity, let's stick to the rule of thumb.

Now let's get to work on the heart of the supply. The key part of our regulated supply is a simple 3-lead positive regulator, an MC7812 that you can get at Radio Shack. This device will handle a maximum of 1 Amp alone, and has designed-in current limiting and short-circuit protection. See Fig. 2.

There are many manufacturers of this device who use prefixes other than MC, but 7812 is the device number. 78 is the design series and 12 is the regulated output voltage. You are about to ask a question! If I want 13.5 V dc, what am I doing with a 12-V dc fixed regulator? It is very simple. To increase the voltage of the regulator, we add one diode in series with the ground lead for every .6-V dc increase desired. See Fig. 3. These regulators vary slightly in regard to their actual regulated output voltage, but the additional diodes will allow us to select the actual voltage needed.

In Figs. 2 and 3, I have used a .1- μF capacitor. This capacitor is needed to stabilize the regulator from ground loops. Attach this capacitor as close to the regulator chip as possible.

As I mentioned earlier, this 3-lead regulator is capable of 1-Amp maximum output current. To achieve a higher current capability, we add a pass transistor. This device will give the current gain needed in the design. The pass transistor, or transistors, must handle the total output current of the supply. For this 20-Amp supply, I selected two 15-Amp PNP power transistors to do the

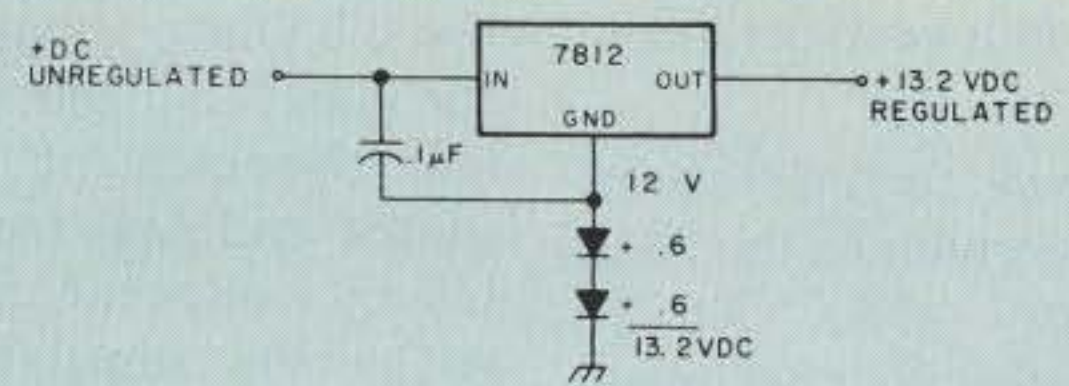

Fig. 3.

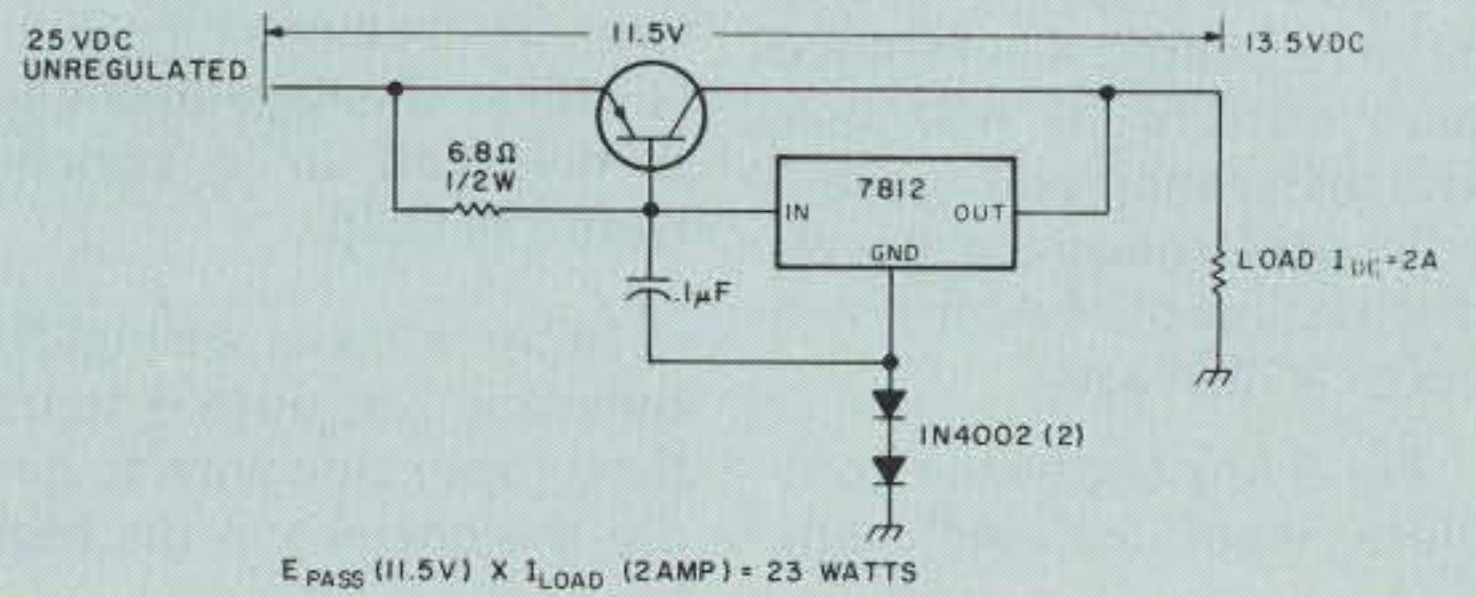

Fig. 4.

job. One 20-Amp device would do it, but for a heat-dissipation safety factor, I used two.

Let's stop for a moment now and talk about the difference voltage I mentioned earlier. If we have an unregulated dc supply voltage of 25 V dc and a regulated output of 13.5 V dc, the difference voltage will be 11.5 volts. The product of the difference voltage and the load current will be the power dissipated, in Watts, by the pass transistor. For example, 11.5 volts \times 2 Amps (load current) = 23 Watts of heat in the transistor. See Fig. 4.

My supply circuit requirement was 20 Amps. Now, 20 Amps \times 11.5 volts is 230 Watts! That is a lot of power! The transformer is going to help in this dissipation, though. Fortunately, the unregulated voltage will sag, and we have selected a trans-

former that will only deliver 18.5 volts unregulated at 20 Amps. The difference between 13.5 volts regulated and the unregulated 18.5 volts is 5 volts. So, a 5-volt difference \times 20 Amps = 100 Watts, which is a big difference! Using two pass transistors, we can dissipate 50 Watts in each device. With 50 Watts of heat to get rid of, you must use a good heat sink to pass this power into the air effectively. We must keep the junction temperature of the transistor below its maximum rating to keep from destroying the device. In this 20-Amp design, I used a 120-CFM muffin fan and two heat sinks that would handle 80 Watts using natural convection. By using forced air instead of natural convection, I could mount the heat sinks in any position. For natural convection, position the heat

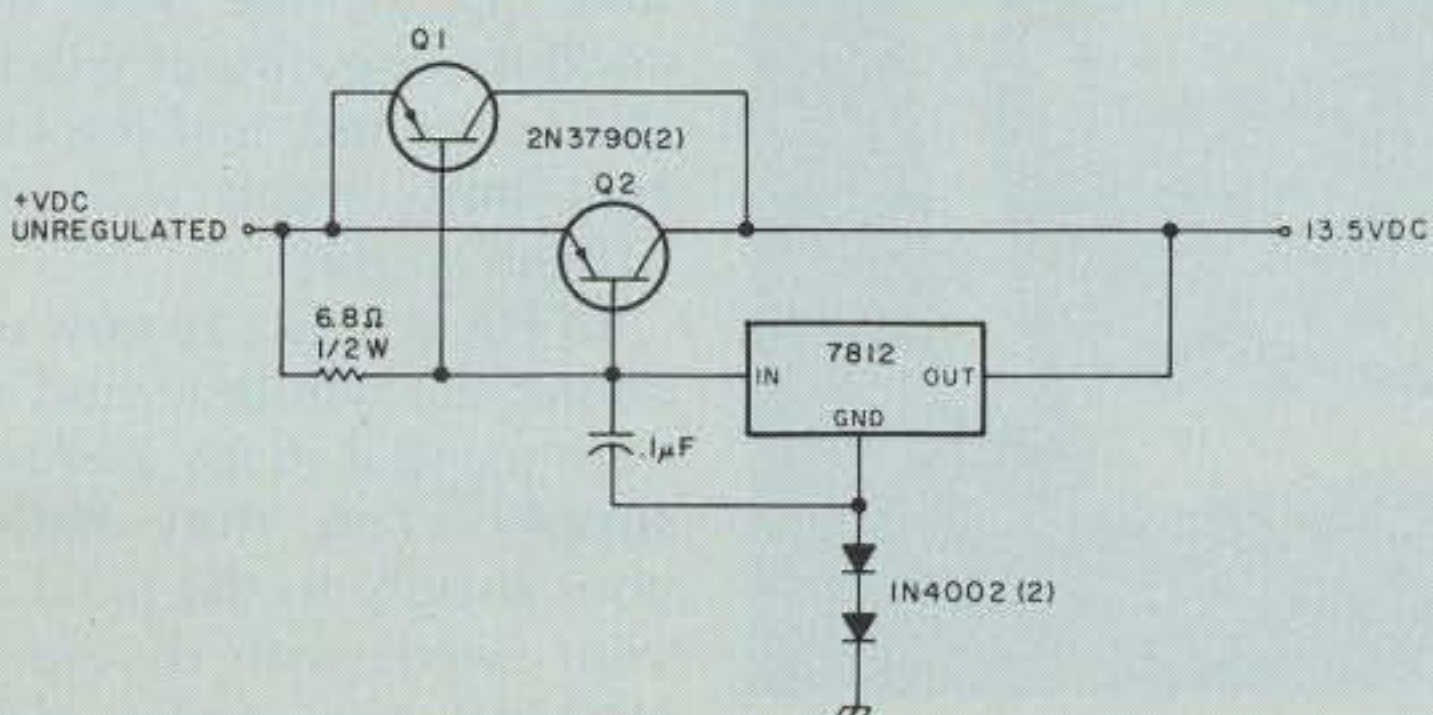

Fig. 5.

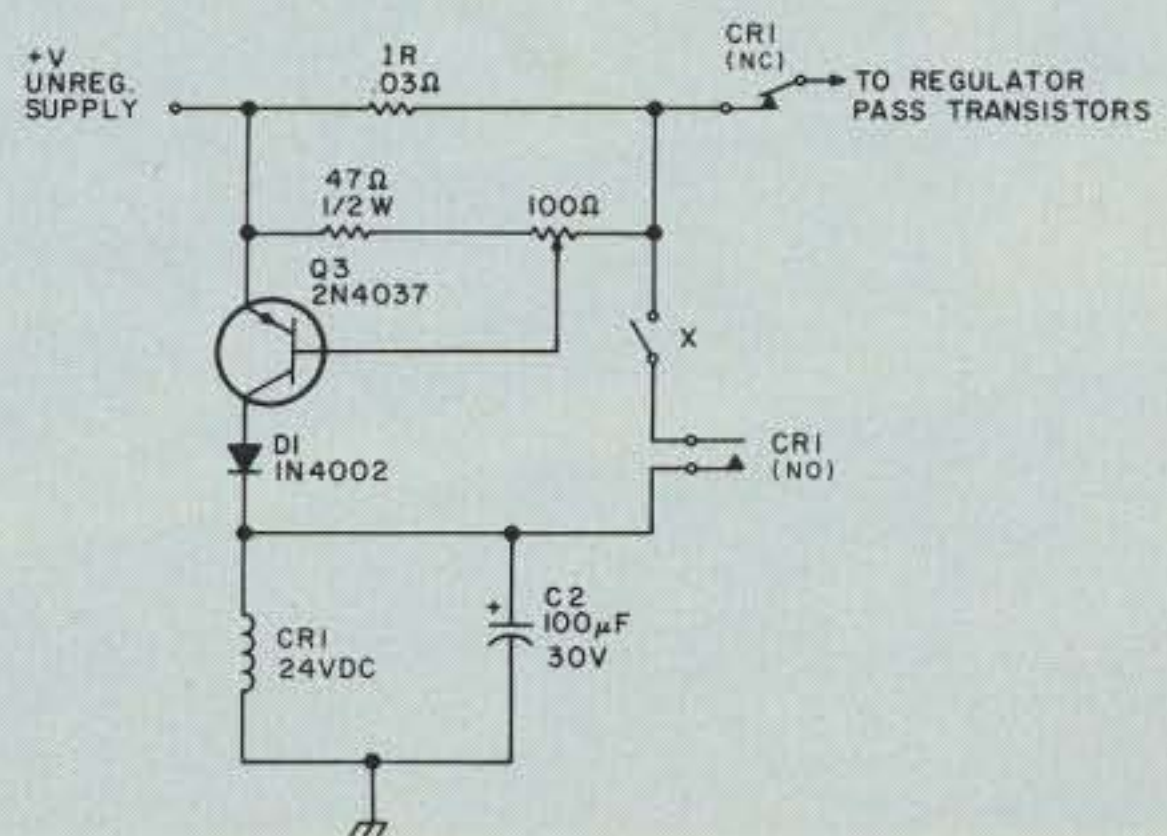

Fig. 6. Current limiter.

sink fins in a vertical direction.

Heat-sink considerations should be given to the 7812 regulator, also. At 20 Amps, and a maximum beta per transistor of approximately 50, we will have to handle a combined base current of 400 mA. The difference voltage of 5 volts will require a power dissipation of $.4 \text{ Amps} \times 5 \text{ volts} = 2 \text{ Watts}$.

Fig. 5 illustrates the complete regulator, including

the 6.8-Ohm, $\frac{1}{2}$ -Watt resistor which is used to establish the bias of the regulator and pass transistors. Using collector feedback with this regulator chip proves to be very effective and stable. The supply will even be free of rf instability unless the regulator chip is involved in a concentrated rf field.

In the area of wiring, the only point of note is to use the proper size wire to handle the current in the high-

current areas. Also, keep the two wire leads to the emitters of the pass transistors equal in length to allow balanced emitter current.

We have discussed the regulator; now let's examine a current limiter. See Fig. 6. This current limiter operates instantaneously and it will only reset after the power is turned off and the supply bleeds down, or a reset push-button, normally closed, is added at point X. C2 should be sized to allow a delayed dropout, so relay CR1 does not buzz when it reaches the current limit. Resistor "IR" is selected so that the current-limit relay will trip at 20 Amps and higher, depending on the setting of the 100-Ohm pot. To operate, a .6-V dc drop

is needed between the base and emitter of Q3. This voltage provides bias current which permits collector current to flow which, in turn, energizes CR1. CR1 must handle the total current of the supply even if it means paralleling contacts. To select resistor IR, use $.6 \text{ V}/20 \text{ A} = .03 \text{ Ohms}$. This "resistor" turned out to be a coil of 14-gauge nichrome wire. By adjusting the 100-Ohm pot, we may now select a slightly higher current limit. If your supply is smaller, use $.6 \text{ V}/\text{your current} = \text{IR}$. For example, $.6 \text{ V}/5 \text{ A} = .12 \text{ Ohms}$. This resistor will drop some voltage, so rate the power carefully: $P = .6 \times 5 = 3 \text{ Watts}$, and remember the voltage drop. This .6 volts may not seem like much, but the minimum unregulated voltage is 18 V dc.

The last control circuit to design is called a "crowbar" circuit. Its intent is to protect your gear from overvoltage due to a regulator failure. See Fig. 7. In this circuit, we will select an overvoltage of approximately 15 volts. This is done by adjusting control R1 until the lamp just lights, and then backing the control off slightly until the lamp does not light. Remember, to turn off the lamp you must reset the SCR by momentarily disconnecting the lamp or turning off the supply. After this calibration, remove the lamp and connect the anode of the SCR directly to the output of the supply. If, during use, an overvoltage condition occurs, the SCR will conduct, the output will be short-circuited, and the current-limit circuit will turn off the supply.

In Fig. 8, you can now examine the whole circuit as I am using it in my 20-Amp supply. You may tailor your supply to the level of your needs with the information we have discussed. ■

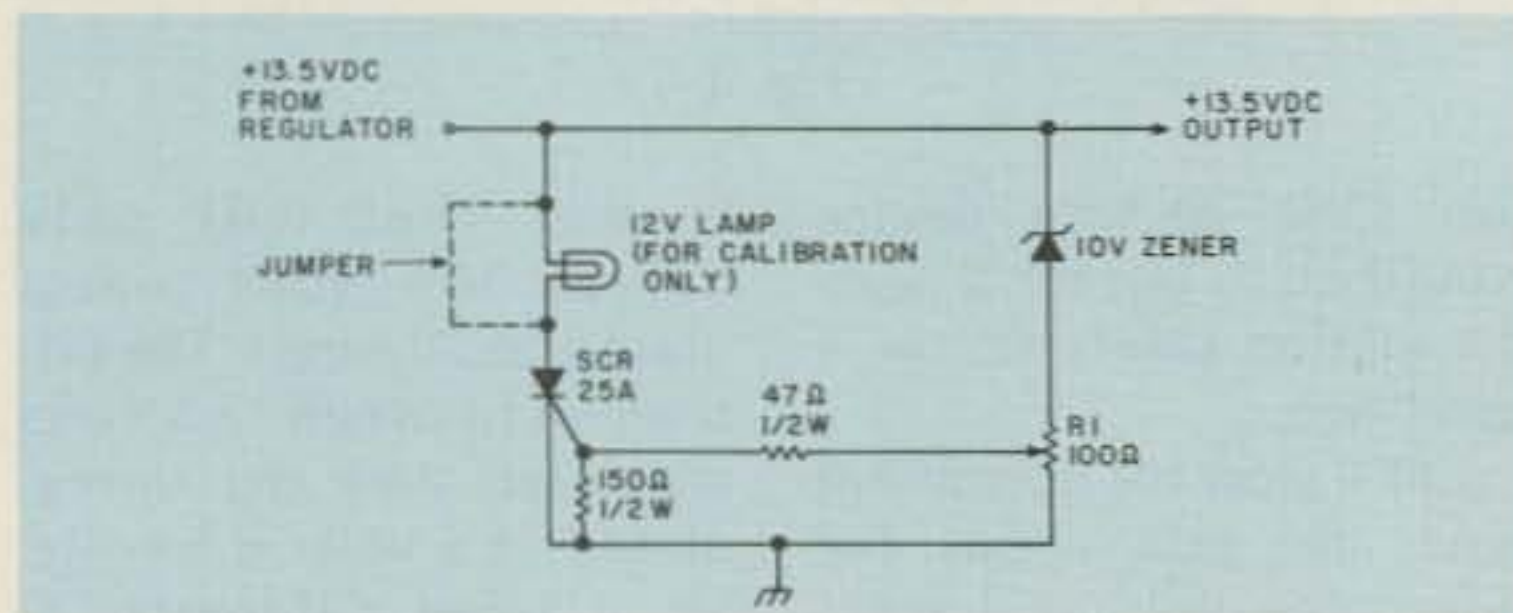

Fig. 7. Crowbar circuit.

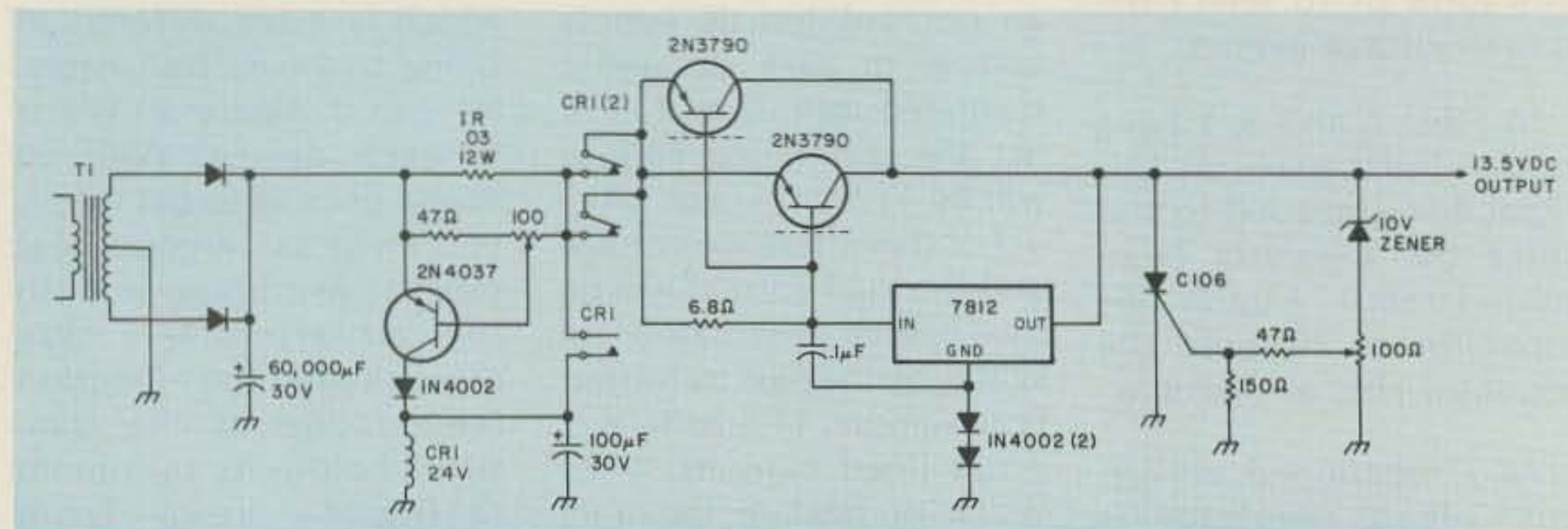
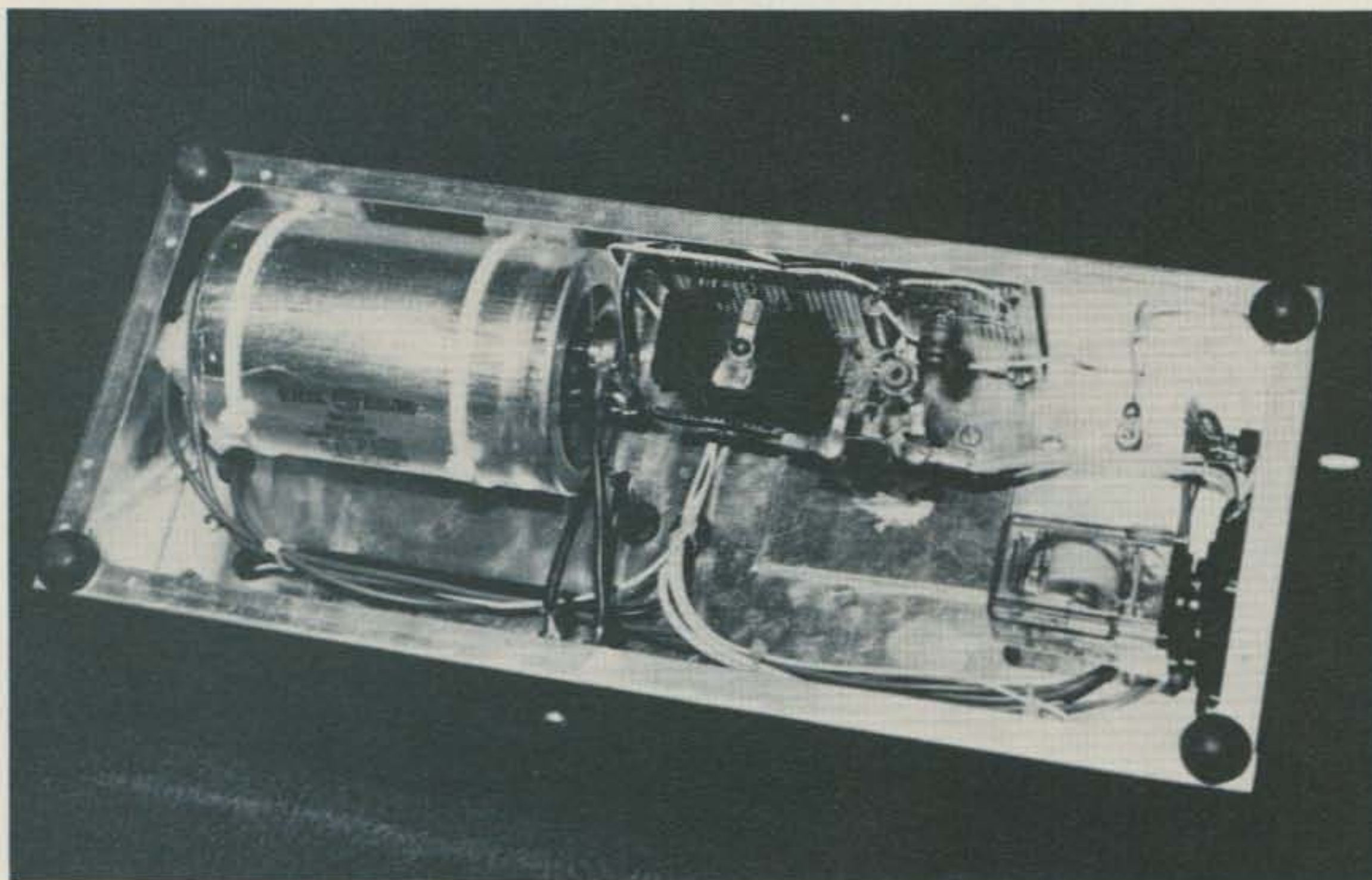

Fig. 8. Complete power supply schematic diagram.



Bottom view of completed supply.

NEW FROM DSI!

50 Hz — 500 MHz 8 DIGITS

1 Meg INPUT — 1 Hz RESOLUTION — 1 PPM TCXO

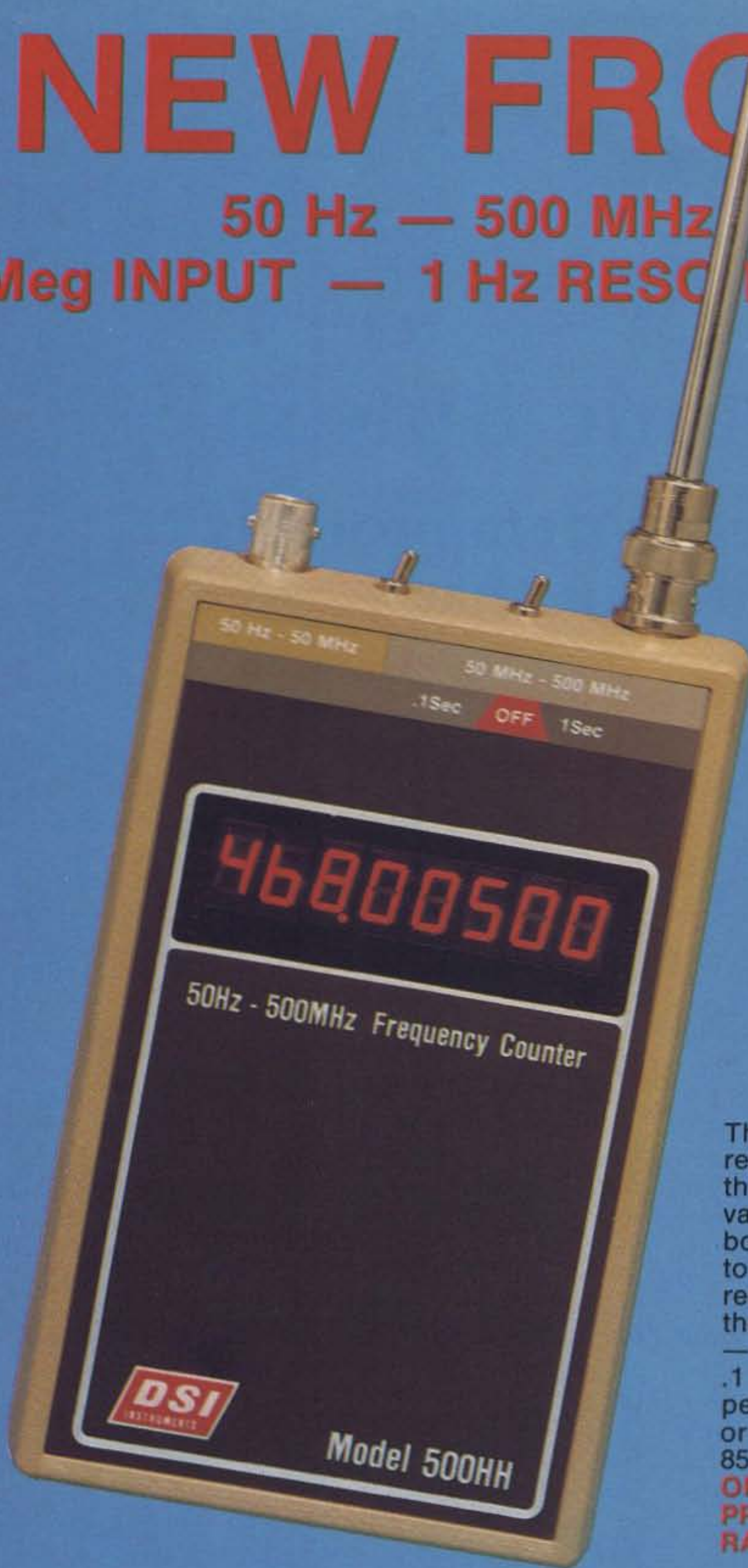

- AC—DC Operation
- BNC Inputs 1 Meg Direct 50 Ohms Prescaled
- 8 Large .4" LED Readouts
- Auto Decimal Point & Zero Blanking
- 1 Year Limited Warranty Parts & Labor
- 100% Factory Assembled in U.S.A.

\$149⁹⁵

MODEL 500 HH
50 Hz — 500 MHz
Without Battery Capability

MODEL 100 HH
50 Hz — 100 MHz

\$99⁹⁵

Without Battery Capability

SAVE \$5⁰⁰

With Battery Capability

MODEL 500 HH . . \$169.95

MODEL 100 HH . . \$119.95

Includes AC-9 Battery Eliminator

The 100 HH and 500 HH hand held frequency counters represent a significant new advancement, utilizing the latest LSI design . . . and because it's a DSI innovation, you know it obsoletes any competitive makes, both in price and performance. No longer do you have to sacrifice accuracy, ultra small readouts and poor resolution to get a calculator size instrument. Both the 100 HH and 500 HH have eight .4 inch LED digits — 1 Hz resolution — direct in only 1 sec. or 10 Hz in .1 sec. — 1 PPM TCXO time base. These counters are perfect for all applications be it mobile, hilltop, marine or bench work. **CALL TODAY TOLL FREE: (800—854-2049) Cal. Res. CALL (800—542-6253) TO ORDER OR RECEIVE MORE INFORMATION ON DSI'S FULL PRODUCT LINE OF FREQUENCY COUNTERS RANGING FROM 10 Hz TO 1.3 GHz.**

FREQUENCY COUNTER CONSUMER DATA COMPARISON CHART

MANUFACTURER	MODEL	SUG'STD. LIST PRICE	FREQUENCY RANGE	TYPE OF TIME BASE	ACCURACY OVER TEMPERATURE		SENSITIVITY			DIGITS		PRE-SCALE INPUT RESOLUTION	
					17° - 40°C	0° - 40°C	100 Hz - 25 MHz	50 MHz - 250 MHz	250 MHz - 450 MHz	No.	SIZE IN INCHES	.1 SEC	1 SEC
DSI INSTRUMENTS	100 HH	\$ 99.95	50Hz-100MHz	TCXO	1 PPM	2 PPM	25 MV	NA	NA	8	.4	100 Hz	10 Hz
DSI INSTRUMENTS	500 HH	\$149.95	50Hz-550MHz	TCXO	1 PPM	2 PPM	25 MV	20 MV	30 MV	8	.4	100 Hz	10 Hz
CSC†	MAX-550	\$149.95	1kHz-550MHz	Non-Compensated	3 PPM @ 25°C	8 PPM	500 MV*	250 MV	250 MV	6	.1	NA	1 kHz
OPTOELECTRONICS	OPT-7000	\$139.95	10Hz-600MHz	TCXO	1.8 PPM	3.2 PPM	NS	NS	NS	7	.4	1 kHz	100 Hz

* 1 kHz - 50 MHz † Continental Specialties Corp.

The specifications and prices included in the above chart are as published in manufacturer's literature and advertisements appearing in early 1979. DSI INSTRUMENTS only assumes responsibility for their own specifications.

100 HH...\$ 99.95 W/Battery Pack...\$119.95
500 HH...\$149.95 W/Battery Pack...\$169.95

Prices and/or specifications subject to change without notice or obligation.

These prices include factory installed rechargeable NiCad battery packs.

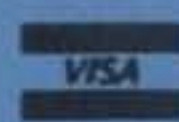

DSI INSTRUMENTS, INC.
7924 Ronson Road, Dept. G
San Diego, California 92111

T-500 Ant. \$ 7.95
AC-9 Battery Eliminator \$ 7.95

TERMS: MC - VISA - AE - Check - M.O. - COD in U.S. Funds. Please add 10% to a maximum of \$10.00 for shipping, handling and insurance. Orders outside of USA & Canada, please add \$20.00 addition to cover air shipment. California residents add 6% Sales Tax.

Hit the Panic Button!

— a kill-switch system protects you and your shack

What would you do if you were operating away and noticed a wisp of smoke coming out of your new linear amplifier? Or if you were working on some gear and felt a whole lot of electrons running between your fingertips and your toes? Or if you were going on vacation and wanted to make sure your station wouldn't be operated in your absence?

You'd want to kill the power (I hope!), and in at least the first two cases, you'd want it off *fast*. And it might be even nicer if this could be done easily by somebody else, such as one of the kids—or even the dog—if you got into trouble and couldn't kill

the power yourself. Aside from these situations, there are times when it is merely convenient to know that all your shack power is off.

A properly-engineered kill-switch system thus has a number of advantages, and if you have not yet installed this basic safety/convenience feature, you might consider it. In most cases it is a simple thing to do, it is economical, and whether or not you ever plan on using it, just getting it in place is guaranteed to give you a good feeling. At the very least, your station will have a new touch of class.

The basic circuit for a kill switch is shown in Fig. 1. It consists of three parts:

a contactor (relay) in series with the main power line, one or more kill switches, and a reset switch. This last is nice if you ever wish to restore power once it has been killed. The circuit also shows a transformer, the purpose of which will be explained shortly.

The contactor is the heart of the system. It should have high-current-capacity contacts at least equal to the trip point of the circuit breaker feeding the shack, and preferably twice that. The reason is that the contacts will carry all the current your shack is using, and if it is necessary to kill power at a time of high-current draw, you will want the contact to open cleanly without arcing. Good reliable contactors (UL listed) are available from your friendly local electrical distributor.

The contactor should have a low-voltage coil; 24 V ac is a readily-available standard. This is so you won't have any unnecessary high voltage running around the shack to the kill switches. The transformer secondary voltage should match the contactor coil voltage; 24-volt bell transformers

are readily available at low cost. You also can use 12 V ac, which is a standard and readily available, but the current draw by the contactor coil will be about twice as much and it will tend to get warm. Whatever you use, the contactor should be rated for continuous duty, both in the coil and in the contacts.

The kill switches are normally-closed push-button switches, and they should be located so they are easy to get to and easy to operate. I prefer industrial-grade actuators with big red push-buttons (3" or so in diameter) so they can be hit easily with an entire hand—literally, "panic buttons." On my own service benches, kill switches are located so they also can be hit easily just by moving a knee. If you use more than one kill switch, they're just wired in series, as shown in Fig. 1. Industrial-grade switches are highly recommended because what is most important is reliability. It would be mortifying, to say the least, to smash one in panic and then discover it didn't work because you broke it!

The reset switch is a

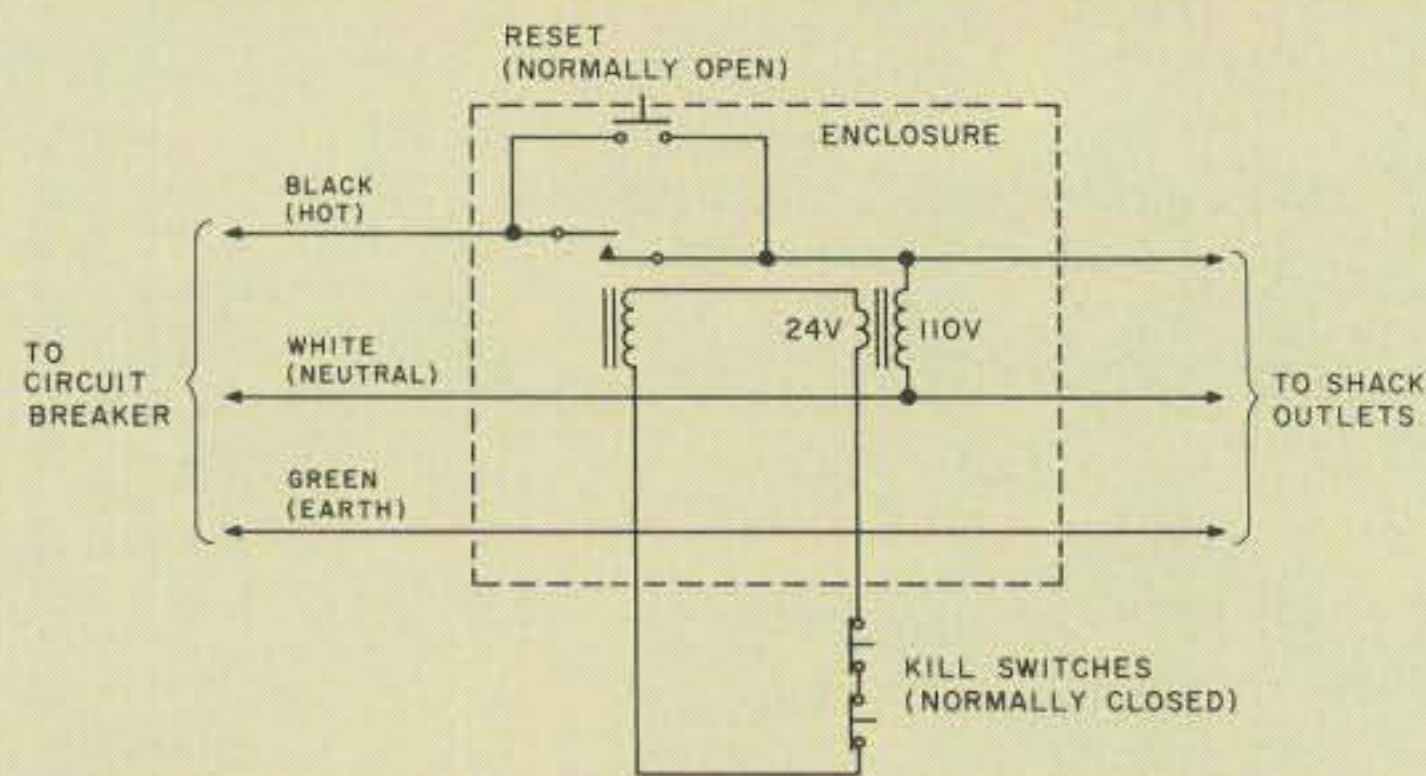

Fig. 1. Schematic for the kill-switch system. Only the hot wire may be interrupted—the neutral and earth wires must not be broken. Check with local authorities to verify respective wire colors in your locality.

A Powerful Plus For Your TR-2200A

— improved supply/charger is a first-rate addition

Two versions available.

After using my new Kenwood TR-2200A for a few days, I discovered that its standard battery power and charging setup was rather inconvenient for a heavy usage cycle. It was not possible to listen or transmit while charging the batteries, and I found that, invariably, the batteries were always near complete discharge whenever I had an important use for the transceiver.

I am sure other hams who monitor 2 meters ex-

tensively have run into this same problem of running down the batteries on receive, with no power to spare for a needed transmission. The charging cycle naturally takes about 16 hours, which uses up 8 hours of daytime activity as well as 8 hours at night. The net result is at most 8 daily hours of operation, provided the batteries stay charged that long.

The Solution

To help myself out of this frustrating situation, I

developed the circuit shown in Fig. 1. It consists of a regulated 12.6-V-dc source rated at 1 Ampere, a battery-charging source, and an automatic charger shutoff circuit. The 12.6-V supply is used to continuously power the TR-2200A for receive and transmit. During operation on the 12.6-V supply, the batteries also can be simultaneously charged by the flick of a switch (SW3). The charger source provides a current of roughly 45 mA (.1C) into a nominal battery voltage of 13 volts, which is the same current provided by the Kenwood charging unit. As an additional feature to avoid that nagging mental question, "Are my batteries charged yet?", I added a voltage sensing circuit that automatically terminates the battery charging when the battery voltage reaches a predetermined level. The charging shutdown voltage is adjustable and set by the trimpot, R4. Battery charging and automatic charging shutdown can be used regardless of whether the

TR-2200A is switched on or off. Three LED indicators constantly monitor the regulated dc output and the charging circuit. LED L3 glows when the batteries are up to the voltage set by R4, indicating that charging has been completed.

Circuit Operation

The transformer, T1, in conjunction with D1-4 and C1-2, provides a raw dc source of approximately 17 volts. C1 and C2 have a total capacitance of 16,000 μ F to assure minimal ripple and droop in the 17 volts when large amounts of current are being drawn from IC1. Remember that the TR-2200A draws about .7 of an Amp during transmit in the high power mode. The raw 17-volt source is used to power both the IC regulator and the charge circuit. IC1 provides a stable 12-V supply, and diode D5 acts as a booster to give a total regulated output of 12.6 V. C3 and C4 are high-frequency bypass capacitors and are necessary to ensure stability in

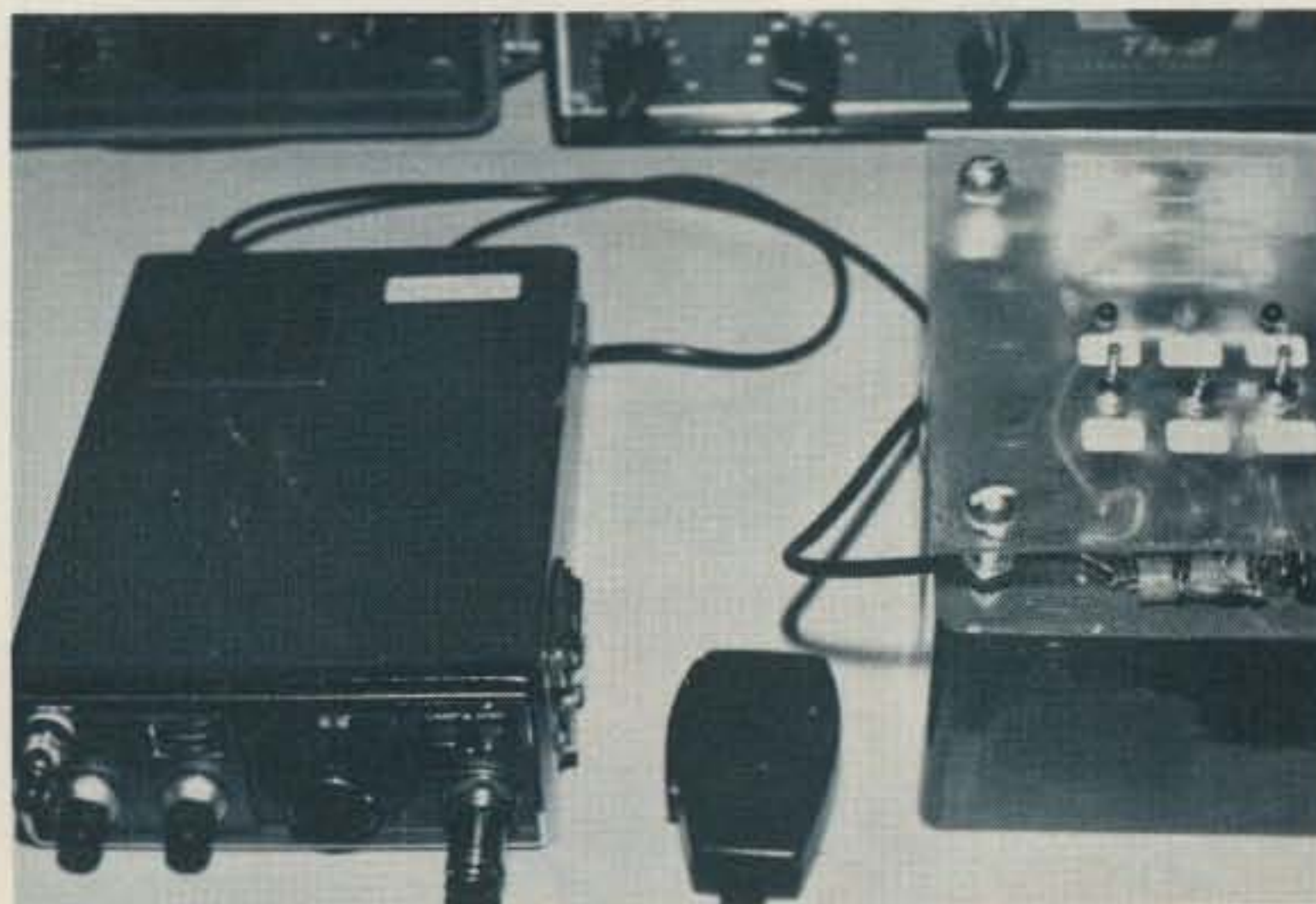

Photo A.

normally-open push-button switch, but can be any other type of switch as well. It needn't be especially reliable or easy to get to, but it should not be located far from the contactor because it will have high voltage (110 V ac) on it. Like the kill switches, the reset switch need have no great current-carrying capacity.

The contactor should be mounted in an enclosure, UL-approved, of course, near where the power line first enters the shack. The transformer and reset switch can be mounted near the enclosure, or on it, using knockouts, depending on the enclosure you get. The whole thing can be placed inside a locked box, if desired, to prevent unauthorized access to the reset button. The 24-volt line (or whatever low-voltage line you have selected) just runs out of

the box/enclosure. Very simple.

When wiring up the contactor, a few safety precautions are in order. First, make sure power is off at the circuit breaker, and verify that it is off by means of a portable lamp or circuit-tester inside the shack at the point you plan to cut into the power line. Secondly, make sure you insert the contacts into the hot side of the power line, not the cold or "neutral" side. In most localities, the black wire is the hot and the white wire is the neutral. You never, ever, want to put a switch or any other kind of interruption into the neutral.

If you find a green wire also, don't cut it! It is the earth wire, and if it gets broken, you may have all kinds of problems in all sorts of places where you don't want them when you don't want them. (You may

even find your trusty soldering iron is frying you as well as the solder, for instance. Not much fun.) If you have any doubts about the color coding, check with your local power company or a local electrical contractor. Note: In some communities it may be required that a licensed electrician actually make the connection for you and/or that the result be inspected by the local building inspector.

Once the contactor is wired up, just run the low-voltage line through the kill switches and you're in business. Now, and only now, you can turn shack power back on at the circuit breaker. The shack will still be dead, however, because the contactor contacts are open and thus there can be no voltage on the coil to energize it. Pressing the reset button applies 110 volts to the

transformer, which supplies the low voltage to the contactor coil (through the kill switches), energizing the contactor and closing the contacts. The contactor will remain energized when the reset button is released because the transformer—like all the other equipment in the shack—is now getting its primary power through the contacts.

And there you are! With luck, you've got a nice new convenience for the shack. With somewhat less luck, you've got a simple system that'll keep you from having no luck at all. Just one final point: Teach the family how to kill power if they ever need to. If you ever need assistance, smashing one of the prominent red buttons should be the first thing they do, and such a time is definitely not the time to explain the system to them. ■



The LEADER In the Northwest!

ATLAS • ICOM • KENWOOD • YAESU



Kenwood 7600
2m FM Transceiver



Kenwood 7625
2m FM Transceiver



ICOM-IC280



ABC
COMMUNICATIONS ✓ A46



Yaesu FT101ZD

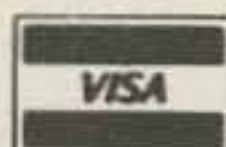

17550 15th Ave. N.E. • Seattle WA 98155 • (206) 364-8300



Other locations: (Walk-in customers only) • Bellevue—12001 N.E. 12th • Everett—4610 Evergreen Way • Open Mon. thru Sat.

the 7812 regulator. Fuse F2 and zener D6 act as a crowbar circuit to open up the dc source to the TR-2200A, should the voltage rise above 15 V. This could happen, for example, if IC1 shorted and provided 17 volts to its output terminal. F2 and D6 protect the TR-2200A from exceeding its maximum input voltage of 15.8 V, since D6 will draw enough current to blow F2 at elevated voltages. At a normal output level of 12.6 volts, D6 does not conduct enough current to affect the circuit.

The battery-charging current is provided by R2 in series with the 17-volt source. When SW3 is switched on, current flows through R2, SW3, and the normally-closed contacts of K1 to the battery in the TR-2200A. Note that the battery pack is disconnected from the rest of the TR-2200A circuits when the power cable is plugged into the back of the transceiver. This allows simultaneous but independent operation of the rig and charging of the batteries.

The automatic charging shutdown is provided by the differential amplifier (Q1, Q2, Q3) and the relay, K1. If switch SW3 is turned on when the nicad battery voltage is less than the voltage set at the base of Q2, then Q3 and K1 are held off and the contacts of K1 remain closed. When the battery voltage rises during charging to within about 10 mV of the "set-point" voltage at Q2, Q3 will conduct enough to turn on K1 and open the charging circuit. The shutdown has a positive latch since opening the contacts of K1 causes the voltage at the base of Q1 to be pulled up to 17 volts by R2, which guarantees that K1 will remain energized. While K1 is being driven, indicator L3 will glow, showing that the battery charge cycle is complete. R5, R4,

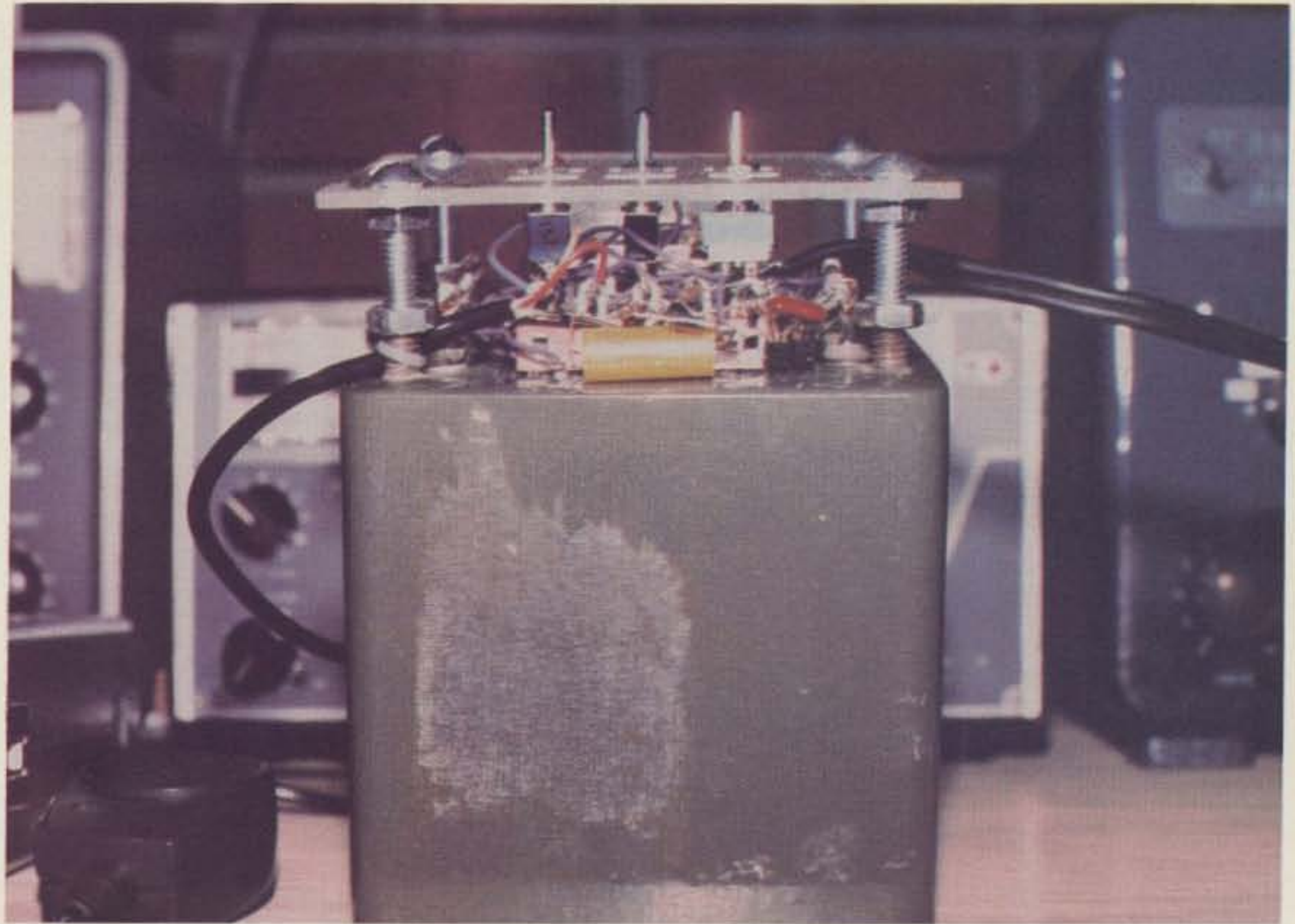

Photo B.

D7, and C5 form a reference set-point voltage for the differential amplifier. R8 is a protection resistor to prevent high current burnout of the batteries should Q1 and Q2 develop shorts. D8 prevents L2 from glowing when SW3 is in the off position. Without D8, L2 can glow due to breakdown current flowing in the reverse biased base-emitter junction of Q1.

Switch SW2 defeats the automatic charge circuit by shorting the contacts of K1. Note that in this manual charge mode, indicator L3 still glows whenever charging is complete and the battery voltage is up to the set-point level. SW2 also has another important practical function. When the TR-2200A is used for transmitting, the auto shutdown circuit tends to get falsely triggered when the battery is close to the final set-point voltage. This is due mostly to the sagging of the 17-volt supply during transmit, which changes the voltage at the base of Q2. Although I managed to

eliminate this problem electronically, the additional transistors, etc., that were required could not compete with the simplicity or the cost of the single toggle switch, SW2. In addition, the manual mode seemed to be a worthwhile feature for certain charging situations.

Construction Details

I used a free-form chassis-less technique to build up the dc supply/charger circuit. This was mostly due to a lack of a chassis in my junk box, but it was also due to an unwillingness to complicate a simple project with a lot of sheet metal work. The circuit will work with just about any construction technique, so you can use epoxy PC boards and painted cabinets if that makes you feel more comfortable.

There are a few construction items that deserve special attention. The regulator package will dissipate about 3.5 Watts under full transmit load and thus needs to be mounted on a heat sink.

The thermal resistance of the heat sink should be less than 20° C/Watt. I used a small piece of scrap aluminum (2" × 3") bent into an L shape, which runs fairly cool under all conditions. The builder can experiment with any heat sink materials he has available to keep the regulator temperature down.

It should be noted that the mounting tab of the 7812 regulator is not at ground potential and will have to be insulated if a metal chassis is used. Also, bypass capacitors C3 and C4 should be mounted very close to the 7812.

Photo A shows a picture of the completed supply unit with the TR-2200A. The power transformer provides a mounting base for all components, including a Plexiglas™ panel for the toggle switches and LEDs. Nearly all of the circuit was built up on two terminal strips which were epoxied along with the heat sink and fuse holder to the top of the transformer case. Cable ties were used to mount the 8,000-uF electrolytics to

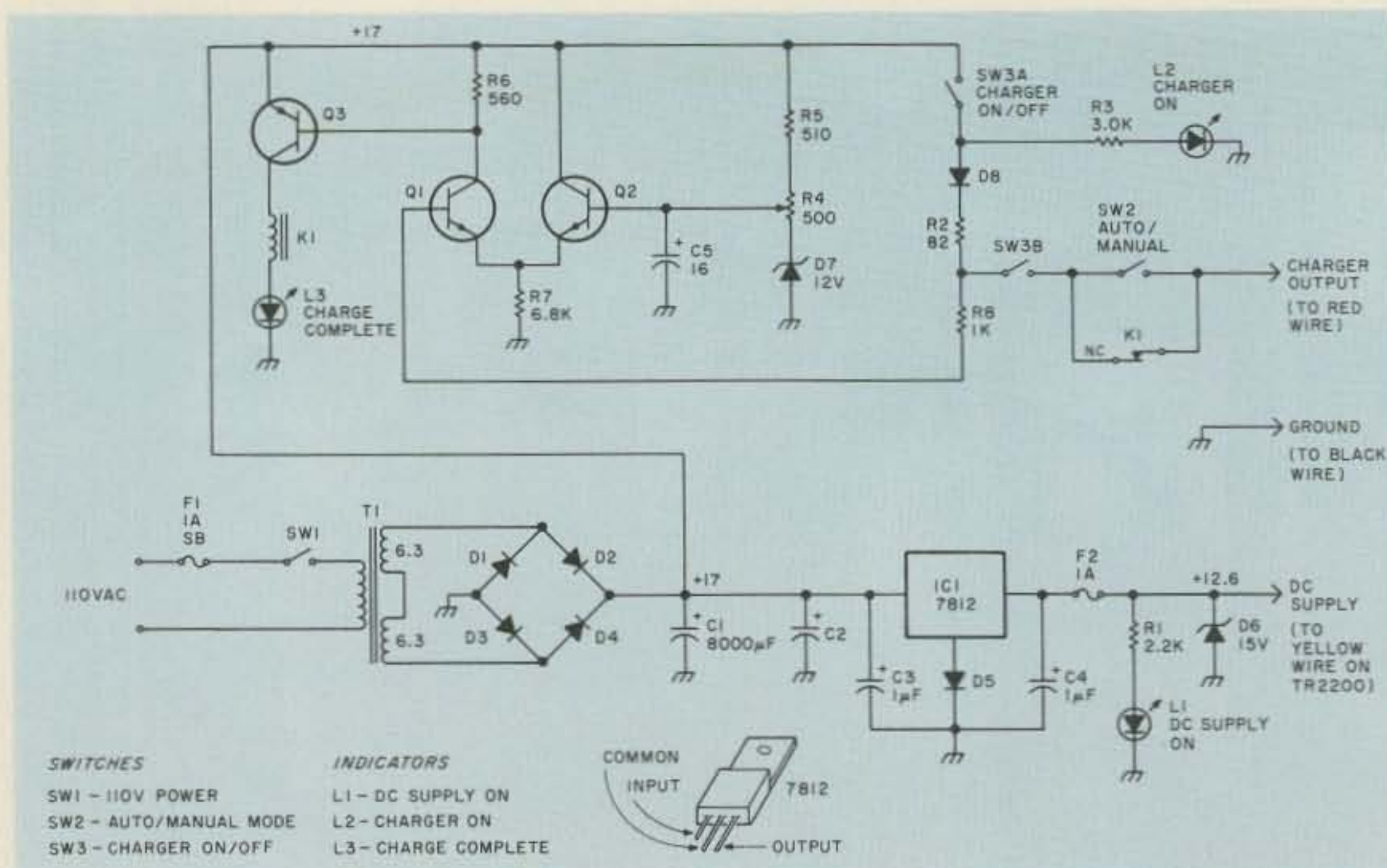

Fig. 1.

the back of the transformer. Hardware that mated with the mounting studs of the transformer was used to support the Plexiglas switch panel. The components in the differential amplifier were "space wired" to simplify construction.

About the Parts

The parts to build this unit are fairly noncritical and should be available at

a low cost from your neighborhood surplus dealer. I managed to build up my supply from junk box components.

There are three parts items that deserve discussion. Relay K1 must be operable at a coil voltage between 5 and 12 volts and a current of <10 mA. This is due to the 17-volt supply used and the current available from Q3. My relay was a reed type and had a coil

resistance of 3k. The builder should be able to find a surplus relay that will do the job. Remember, however, that normally-closed contacts are used in the circuit, so an SPST type will not work.

The transformer secondaries should be rated at more than 1 Ampere to ensure low IR drops in the windings. The total drop in ac voltage with a 1 Amp load on the secondary should be less than .5 V below the nominal to assure a stable 17-volt supply. A surplus filament transformer rated at 3 Amps should be adequate, but experimentation here by the builder is definitely encouraged.

The values of C1 and C2 are fairly arbitrary and can be changed by a factor of two with little performance change. If you buy these items, try to get all the capacitance in one unit to simplify construction.

Adjustments

R4 is the only adjustment in the supply. To adjust it, put an accurate (high-impedance-type) voltmeter from the base of Q2 to ground. Set the voltage for 14.0 volts so that the charger will shut

down when the individual cell voltage in the TR-2200A battery pack is 1.40 volts (there are 10 batteries in the pack). According to the GE Handbook,¹ the cell voltage will increase above 1.40 volts at the beginning of an overcharge condition, and the 14.0-volt setting I have suggested above is based on this information. An alternate way to adjust R4 is to allow discharged batteries to charge for 16 hours and then to adjust R4 until the charge complete lamp just comes on. Some experimentation may be necessary to get the best voltage threshold for your rig.

A Low-Cost Alternative

If you are interested in building this dc supply/charger but do not want or cannot afford all of its features, a stripped-down version is easily derived from the complete unit. Just eliminate all components except those with an * on the parts list. This basic unit will still provide a dc supply and simultaneous charging, but does not incorporate any safety or convenience features.

Regardless of which version you decide to build, I am sure you will find this supply to be a valuable accessory to your TR-2200A. For those of you with other kinds of battery-operated rigs, I am sure they could be configured like the TR-2200A to make use of this circuit.

As far as I have been able to learn, a supply of this type is not now commercially available, and I would enjoy working with any enterprising group that would like to manufacture the unit. ■

Reference

1. Joseph Grant, editor, *Nickel-Cadmium Battery Applications Engineering Handbook*, General Electric Co., 1975, page 4-38.

Parts List

*T1	Filament transformer 12.6 V ac @ 3 Amps
*IC1	7812 fixed voltage regulator: 12 Volts
Q1, Q2	2N3904 NPN transistor
Q3	2N3906 PNP transistor
*D1, D2, D3, D4	Silicon diode 100 piv @ 1 Amp
*D5	1N914
D6	Zener diode 15-volt, 400 mW
D7	Zener diode 12-volt, 400 mW
D8	1N914
*C1, C2	8000 uF, 20 V
*C3, C4	1 uF tantalum 35 V
C5	16 uF, 20 V
R1	2.2k ¼ W 5%
*R2	82 ½ W 5%
R3	3.0k ¼ W 5%
R4	500-Ohm trimpot
R5	510 ¼ W 5%
R6	560 ¼ W 5%
R7	6.8k ¼ W 5%
R8	1.0k ¼ W 5%
K1	Relay, SPDT, dc coil 5- to 12-volt @ 5 mA
F1	Fuse 1 Amp delay type
F2	Fuse 1 Amp
*SW1	SPST toggle switch
SW2	SPST toggle switch
*SW3	DPST toggle switch
L1, L2, L3	LED lamps, choose your own colors

QRZ? QRZ? QRZ?

NEVER AGAIN!!! Extend your range and improve weak signal area performance with the **Vhf engineering Blue Line Amplifiers.**

Attractive, blue anodized finish.

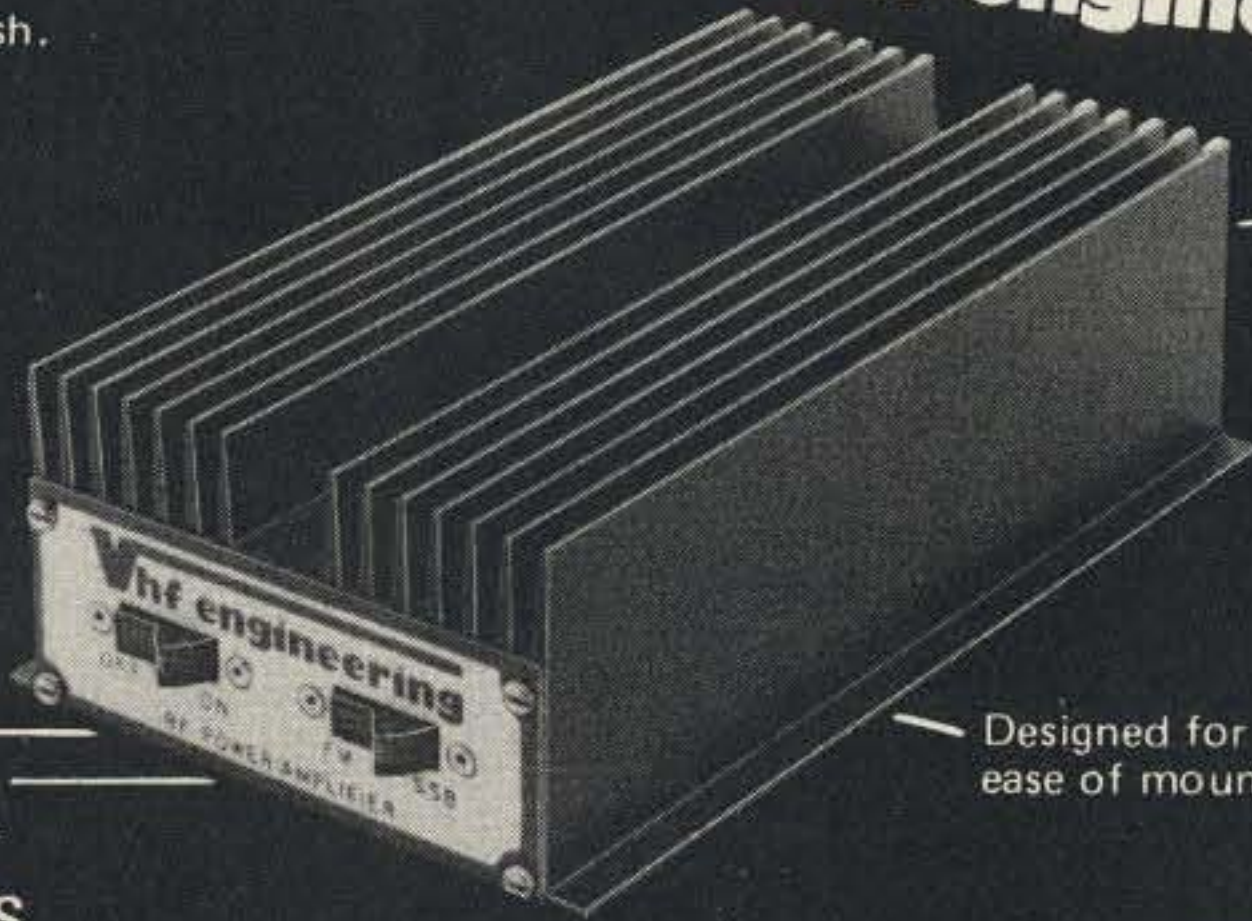

Full heatsink area mounted on top for additional cooling

Rugged, one piece aluminum extrusion.

Power switch and mode switch on front panel.

Designed for ease of mounting.

FEATURES

- High efficiency means low current drain.
- Broad band design (no tuning).
- Direct 12 volt DC operation.
- Indicator lamps for On/Off and FM/SSB.
- Relay switching (allows you to put amplifier in or out of circuit at the flip of a switch).
- Insertion loss of less than 1 dB.
- 90 day limited warranty on parts and labor.

Model	Band	Power Input	Power Output
BLC 10/70	144 MHz	10 W	70 W
BLC 2/70	144 MHz	2 W	70 W
BLC 10/150	144 MHz	10 W	150 W
BLC 30/150	144 MHz	30 W	150 W
BLD 2/60	220 MHz	2 W	60 W
BLD 10/60	220 MHz	10 W	60 W
BLD 10/120	220 MHz	10 W	120 W
BLE 10/40	420 MHz	10 W	40 W
BLE 2/40	420 MHz	2 W	40 W
BLE 10/80	420 MHz	10 W	80 W

AVAILABLE ONLY AT THESE AUTHORIZED DEALERS

CALIFORNIA

C & A Electronic Enterprises, Carson, CA 90745, Ph. 213-834-5868
 Tele-Com Electronics, San Jose CA 95124, Ph. 408-377-4479
 Westcom, San Marcos, CA 92069, Ph. 714-744-0700
 Zackit Corporation, Vallejo, CA 94590, Ph 707-644-6676

COLORADO

A.E.S. Communications, Wes-Com, Colorado Springs, CO 80909,
 Ph. 303-475-7050

CONNECTICUT

Thomas Communications, Newington, CT 06111, Ph. 203-667-0811

FLORIDA

Amateur Electronic Supply, Orlando, FL 32803, Ph. 305-894-3238
 N & G Distributing, Miami, FL 33126, Ph. 305-592-9685
 VHF/JAX, Orange Park, FL 32073, Ph. 904-264-7176

GEORGIA

Repeaters Unlimited, Div. of Creative Electronics, Marietta, GA 30065,
 Ph. 404-971-2122

ILLINOIS

Klaus Radio, Peoria, IL 61614, Ph. 309-691-4840
 Spectronics, Oak Park, IL 60304, Ph. 312-848-6777

IOWA

Bob Smith Electronics, Fort Dodge, IA 50501, Ph. 515-576-3886

MASSACHUSETTS

Tufts Radio Electronics, Medford, MA 02155, Ph. 617-395-8280

MICHIGAN

Harry Crofts Electronics, Northville, MI 48167, Ph. 313-349-0176
 The Ham Shack, Kentwood, MI 49508, Ph. 616-531-1976

MINNESOTA

PAL Electronics, Minneapolis, MN 55412, Ph. 612-521-4662

MISSOURI

Alpha Electronic Labs, Columbia, MO 65201, Ph. 314-449-1362

NEBRASKA

Communications Center, Lincoln, NE 68504, Ph. 402-466-3733

NEVADA

Communications Center West, Las Vegas, NV 89106, Ph. 702-647-3114

NEW JERSEY

C. H. Electronics, Inc., Clifton, NJ 07011, Ph. 201-478-9700

NEW YORK

Barry Electronics, New York, NY 10012, Ph. 212-925-7000
 Com-Tech Electronics, Rensselaer, NY 12144, Ph. 518-477-8461
 Delmar Electronics, W. Babylon, LI, NY 11704, Ph. 516-420-1234
 VHF Communications, Jamestown, NY 14701, Ph. 716-664-6345

OHIO

Universal Amateur Radio, Reynoldsburg, (Columbus) Ohio 43068
 Ph. 614-866-4267

OKLAHOMA

Derrick Electronics, Broken Arrow, OK 74012, Ph. 918-251-9923

PENNSYLVANIA

LaRue Electronics, Scranton, PA 18509, Ph. 717-343-2124

SOUTH DAKOTA

Burghardt Amateur Center, Watertown, SD 57201, Ph. 605-886-7314

TEXAS

AGL Electronics, Dallas, TX 75234, Ph. 214-241-6414
 Madison Electronics Supply, Houston, TX 77002, Ph. 713-658-0268

VIRGINIA

Radio Communications, Roanoke, VA 24016, Ph. 703-342-8513

WASHINGTON

A-B-C Communications, Seattle, WA 98155, Ph. 206-364-8300

WISCONSIN

Amateur Electronic Supply, Milwaukee, WI 53216, Ph. 414-442-4200

CANADA

Bytown Marine Ltd., Ottawa, Ontario, Can. K2H 7V1, Ph. 613-820-6910
 Traeger Distributors, Richmond, BC, Can. V6X 2A7, Ph. 604-278-1541

Build a Wide-Range Rf Resistance Bridge

— with a multitude of uses

Putting theory into practice.

*William Vissers K4KI
1245 S. Orlando Ave.
Cocoa Beach FL 32931*

Excellent articles on rf resistance bridges have appeared in various publications, particularly one by Jerry Sevick in the Nov., 1975, issue of *QST*. However, my own analysis showed that a wide-range bridge would have many applications rather than the few for a bridge designed to measure a small range of resistance for a specific purpose.

The bridge I designed is simple, and easy to build, use, and calibrate. Its direct reading feature eliminates the need for an auxiliary chart or graph that can easily get lost or damaged. The versatility of the bridge makes it a worthwhile addition to any amateur station. The

basic theory presented will outline how wide range is easily obtained, and the detailed description of its different uses will prove its value.

The Basic Bridge

Fig. 1 shows the wide-range bridge principle explained by a simple numerical example. The two legs of the bridge, R_A and R_B , are made up of a single variable 100-Ohm two-Watt linear potentiometer. R_C is a half-Watt 50-Ohm carbon resistance. R_X symbolizes the unknown resistance we wish to measure. E is a voltage source, and I is the meter I will measure our null with when the bridge is in balance.

Without going into a lot of bridge theory and proofs that can be found in any textbook, all we need to know is the basic bridge equation for a balanced condition, which is: $R_X/R_B = 50/R_A$. Solving for R_X ,

we find that $R_X = (R_B)(50)/R_A$. Now, as I've already said that R_A and R_B are nothing more than a 100-Ohm potentiometer, let us set the potentiometer near one end of its travel so that R_A is equal to ten Ohms. Then R_B will be equal to 100 - 10, or 90 Ohms.

Now, if we set the potentiometer near the end of its travel so that R_A is equal to 90 Ohms, we find that R_B will be equal to 10 Ohms. And, solving for R_X , we now find that $R_X = (50)(10)/90 = 5.56$ Ohms. These calculations show that a wide-range bridge design can be achieved quite easily.

I know that already some of you will be saying, "Why don't you run the potentiometer to zero for both calculations just shown and come up with a bridge with a range of from zero to infinity?" That is a

very good thought, but we do run into some practical limitations. We would find that our bridge sensitivity would have dropped to zero, for one thing. And secondly, as there is no such thing as zero resistance when the potentiometer is at the end of its travel, our actual bridge range is somewhat less than zero to infinity. But with a small transistor amplifier we can easily increase the basic bridge sensitivity. And this increased sensitivity also allows our exciting voltage to be anything from an ordinary rf signal generator, to a grid-dip meter, to a simple low-powered variable-frequency oscillator. If a grid-dip meter is used, a single turn coupling coil attached to the bridge input jack will provide plenty of excitation voltage. In my own case, I use a Heathkit® Model LG-1 signal generator with a maximum output

of a tenth of a volt. This is adequate for proper operation of the bridge. So, if care is taken in our calibration, we can come up with a wide-range bridge sufficiently accurate for all amateur usage.

The Actual Bridge Circuit

The basic bridge circuit just described is used in the final circuit of Fig. 2. As in all rf circuitry, every effort should be made to keep the internal bridge leads as short as possible to avoid excessive lead inductance and capacity to ground. The input and output coax jacks are about an inch and a half apart on the chassis. This allowed very short leads to be used.

A pair of binding posts, A and B, are in parallel with the output jack J2 so that calibration resistors and wire-connected leads can be easily connected without having to use clip leads or other methods of connection. The 1N34 diode detector rectifies the nulling voltage and feeds it to the transistor amplifier through a 4.7k resistor, along with a couple of .01-uF bypass condensers. The transistor amplifier circuit was about the simplest one I know; it is a standard differential amplifier.

The transistors used were a couple of surplus PNP 2N396As donated by my buddy K4YS. Any standard general-purpose transistor will work as well, although it may be necessary to use another value of resistance for R4 of Fig. 2. In my own case, I temporarily used a variable 25k resistor for R4 and adjusted its value until the amplifier gave the gain and stability I desired. Then the variable resistance was measured with an ohmmeter, and a fixed value used in its place. It's a quick and easy way to optimize a circuit. The vari-

able 10k potentiometer R2 used for balancing the meter current to zero during the initial null was an available 2-Watt potentiometer, although a small trimpot can be used if desired. R3 is a 2-Watt potentiometer-type variable resistance used as a sensitivity control that limits the current through the 50-uA microammeter when setting for initial null. Switch S1 turns the transistor amplifier "on" or "off". Switch S2 allows the transistor amplifier to be used for other purposes, as will be described later on. The entire bridge is self-contained in a 7" x 5" x 2" chassis. A coat of gray enamel paint gives it a professional look. I have found that painting the chassis before final assembly and baking it in the kitchen oven for about fifteen minutes at 250 degrees Fahrenheit produces a hard, smooth finish.

Calibration

The simplest way to make the bridge direct-reading, which avoids the use of separate calibration curves, is to paste a piece of white cardboard directly on the chassis under the 100-Ohm potentiometer knob. This allows actual values to be inked in when the calibration is made. Fig. 3 is a theoretical

calibration sheet illustrating the method just described. Theoretical values were shown, as every individual calibration will vary somewhat depending upon the linearity of the 100-Ohm potentiometer and the actual values of the resistance of the potentiometer at the ends of its travel.

I had mentioned earlier that this resistance will not be zero, and its actual value does affect the calibration points obtained. However, I did find that in my case there was close agreement between theoretical and actual values within the range of 10 to 400 Ohms. In any event, the actual values obtained during calibration will allow you to read well beyond the values just mentioned. Naturally, reproducible accuracy will not be as great at the extreme ends as at the middle of the resistance range. As in all instruments, the calibration is only as good as the standards used.

The calibration standards used were ordinary 5% tolerance small fixed carbon resistors. The calibration technique is very simple. Connect the calibration resistance selected across binding posts A and B. Set the balance control to about the midway position, and

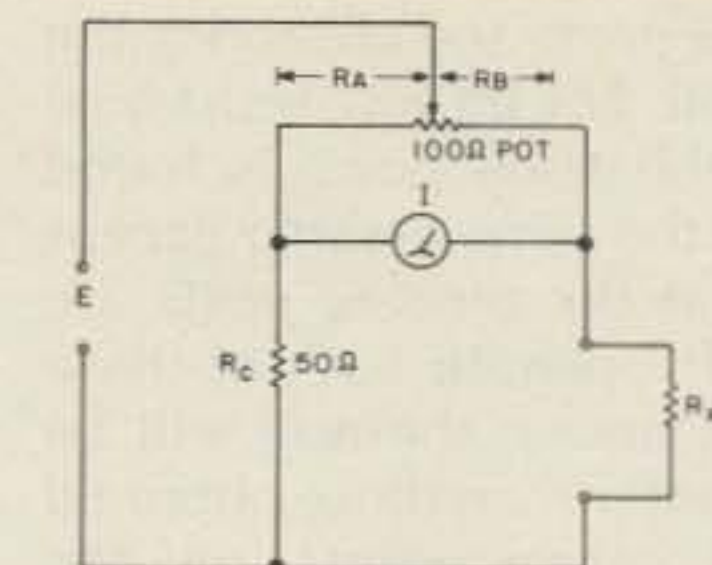
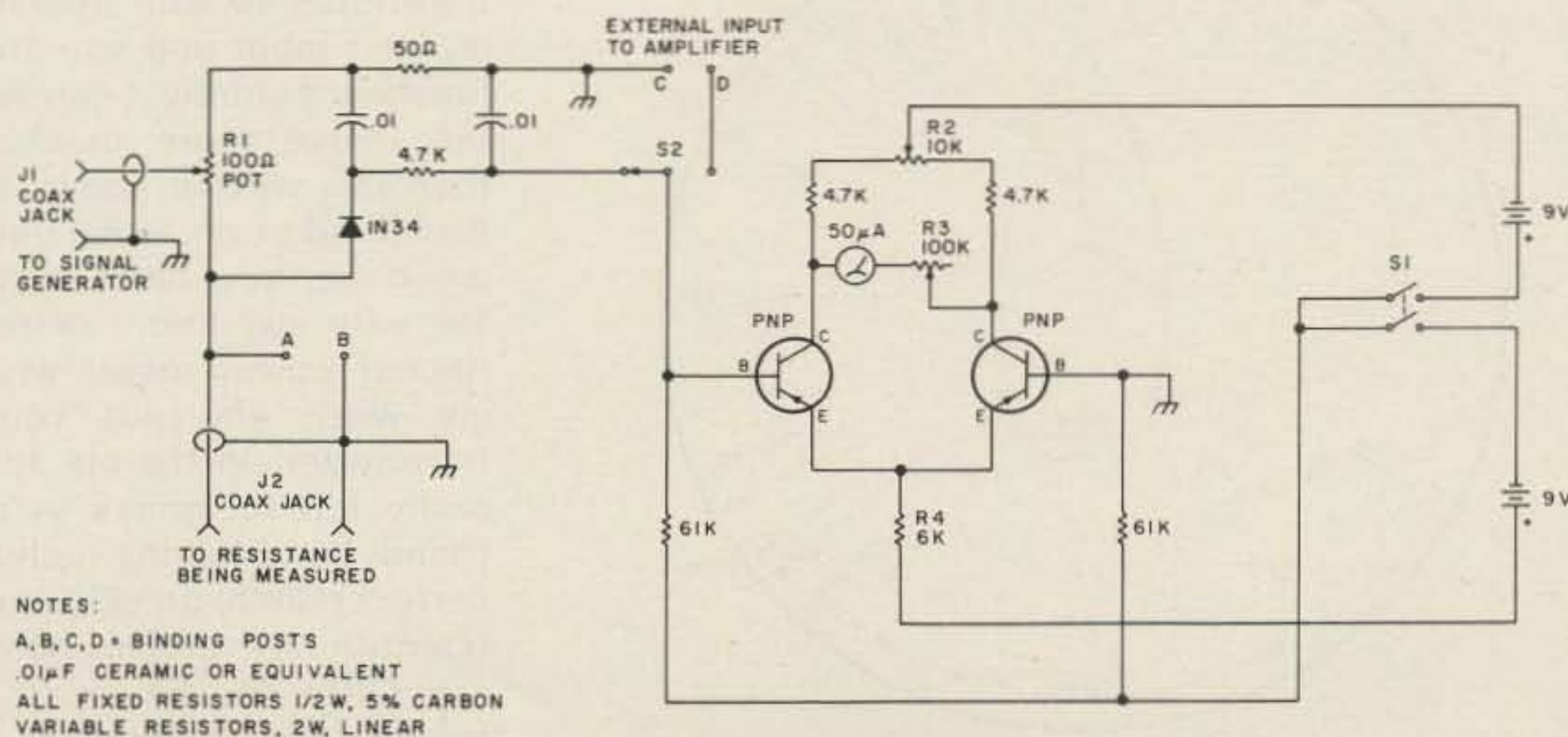

Fig. 1. Basic wide-range bridge.

set the sensitivity control to minimum sensitivity (maximum resistance). Turn the power switch to the "on" position. Now adjust the balance control until the meter reads zero. Apply an rf voltage from the signal generator to J1, the input jack. The signal generator frequency I used was 3.75 MHz, although the frequency is not important since the basic bridge is not frequency-sensitive. The meter will read some current. Adjust the 100-Ohm bridge potentiometer until a null is obtained. Now the sensitivity control can be increased to maximum sensitivity, and the output of the signal generator can be increased as desired. The bridge potentiometer is now rotated until the best null is obtained. The dial scale can now be marked for the calibration resistance value. As many calibration points as desired can be obtained in this way. The zero resistance point can be obtained by shorting the bind-



NOTES:
A, B, C, D = BINDING POSTS
.01μF CERAMIC OR EQUIVALENT
ALL FIXED RESISTORS 1/2W, 5% CARBON
VARIABLE RESISTORS, 2W, LINEAR

Fig. 2. Wide-range rf bridge.

ing posts and observing the null. The infinite resistance calibration point is found in the same manner except that the binding posts are left open. In both of these instances, the null will be poorer than those obtained at other points on the scale.

Actual Uses of the Bridge

Although the bridge is normally used to measure rf resistance, its wide range allows it to establish other measurements where the actual resistance values are of secondary importance. Therefore, I am going to include those items which make the bridge so useful under these circumstances. These secondary uses are of great value, not only for obtaining specific data, but also in tying many theoretical concepts we read about to simple observations that we are now equipped to make. In almost all rf measurements, the circuit being checked is frequency-sensitive so that at resonance the circuit becomes a pure resistance. Knowledge of the resonant frequency is read from the signal generator. The resistance value read from the bridge will provide sufficient information for almost any problem that the amateur may want to

solve.

Antenna resistance at resonance:

Connect your antenna coax line to J2 and apply rf voltage from the signal generator. Establish a first approximate null by rotating the 100-Ohm potentiometer knob on the bridge. Then vary the frequency of the signal generator until the null is more pronounced. The final nulling consists of adjusting both the frequency of the signal generator and the variable control on the bridge. This is necessary to obtain the best null. At the lowest null obtained, the resistance will be the antenna system resistance, and the frequency will be its resonant frequency. I was careful to say antenna system, as this is defined as your antenna with the normal coax feedline attached. If for some reason you want to know the actual antenna resistance, then your feedline will have to be an electrical half wavelength long. The reasons for this are covered more fully in transmission line theory, and are considered a bit too much for the scope of this article. But, as we shall see shortly, our bridge will easily measure an electrical half or quarter wavelength of coax line if this in-

formation is needed.

Tuning your matching unit:

This bridge is a wonderful device to allow you to load your transmitter to exactly 50 Ohms without even putting a test signal on the air. You no longer have the worry of inadvertently loading up into a high swr condition and possibly damaging your final. At the same time, you can't create any unnecessary QRM on our already crowded bands. And once you've done this for any frequencies, just note the dial settings of your transmitter and matching unit, and you can quickly put your transmitter on and be assured that you will be perfectly matched. First off, load up your transmitter at the desired frequency into a dummy load. (Normally, this is 50 Ohms.) Then connect J2 to the input of your matching unit, and connect the output of your matching unit to your antenna system. Select the frequency you just tuned up your transmitter to on your signal generator. Then set the variable 100-Ohm potentiometer on your bridge to 50 Ohms on the calibrated scale. Turn up your bridge, and adjust your matching unit until the best null is obtained. Presto! You are now completely tuned up. You don't have to touch your transmitter tuning or loading at all. Just reconnect your transmitter to your matching unit input and you are finished. Actually, I can do the above more quickly than I've written about it. And in addition, when you are done, you can't even see your swr meter or reflected power meter wiggle when you put your transmitter on the air. It's really fun to amaze your friends by obtaining such a perfect match, quickly and scientifically, and without any QRM on the air. It's tuning up your station in a really engineering fashion.

How good is your matching unit?

From the preceding step it is easy to go a bit further and establish the resistive matching limits of your tuning unit. It's a quick method of comparing one kind of a unit against another. I'm sure we all agree that to define the limits of a matching unit as "being able to load into a random wire" is not a very exact technical description. This is particularly true since random could mean anything from a couple of feet to a couple of wavelengths. I've found in my own case that my bridge has allowed me to design a wide-range matching unit, and quickly establish which variables are important to obtain the wide range I desired for my specific antenna needs.

All you do is see what the resistance limits are that your matching will load into and still retain 50 Ohms at the input jack. The technique is very easy. You can use your 5% calibrating resistors for this purpose. Just connect a resistance to your matching unit output and jack J2 of the bridge to the matching unit input. Set the bridge resistance knob to read 50 Ohms on the scale. Now adjust your matching unit until you can achieve a bridge null at the frequency of operation you have selected on the signal generator. In this way you can quickly determine the upper and lower resistance loading limits of your matching unit. If the resistances you select are too high or too low, you will not be able to obtain a satisfactory null on the bridge. My home-built matching unit matches from about 10 to 200 Ohms without any difficulty. Generally speaking, the wider the resistance range, the wider the range of the matching unit for varying impedances. And you'll be

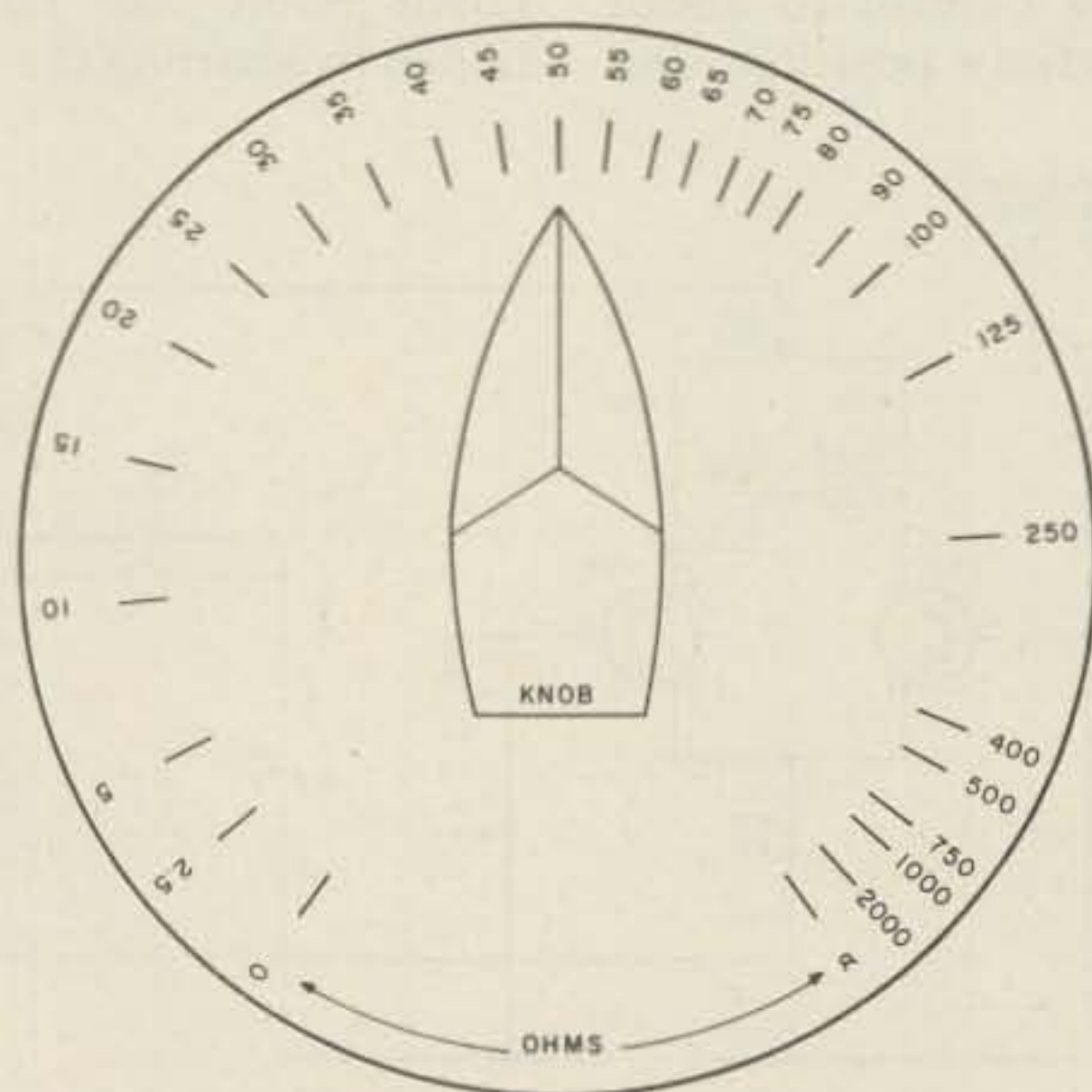

Fig. 3. Direct-reading bridge scale.

CALL TOLL FREE
1-800-228-4097



Hy-Gain 3806
 2-Meter Hand-Held Amateur Transceiver

SPECIALLY PRICED ONLY \$119.⁹⁵

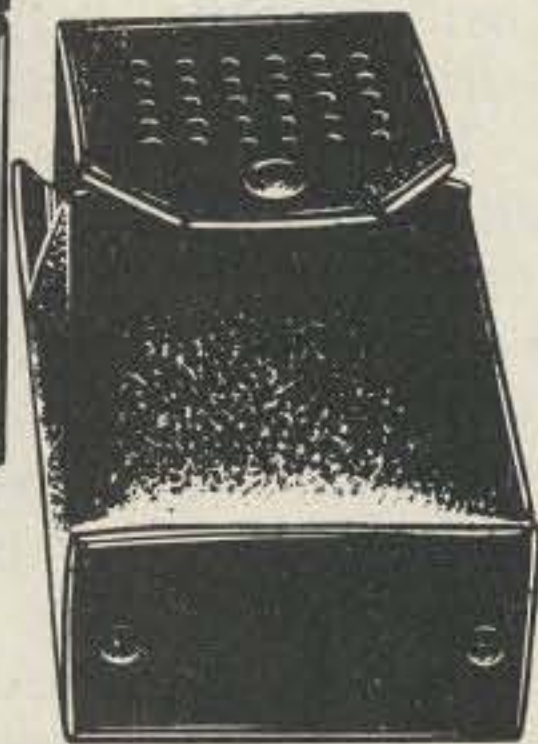

- Low cost, 6-channel hand-held provides superb voice transmission over short to medium distances
- Sharply tuned on-frequency selectivity in the RF amplifier stages plus FET's in the 1st and 2nd mixers for virtual immunity to out-of-band signals intermodulation distortion and cross-modulation
- Separate microphone and speaker elements for enhanced audio
- Internally adjustable mic preamp—a Hy-Gain exclusive
- Specially gasketed case seals out water, dirt and corrosive salt air
- Watertight, high-impact ABS plastic case—ribbed for non-slip grip
- Top-mounted controls for instant access

Accessories:

Model No.	Description	Price
3807	Nicad Battery Pack	\$31.95
1104	Touch Tone Pad	\$44.95
1106	AC Battery Charger	\$ 9.95
1107	Cigarette Lighter Adaptor Cord	\$ 9.95
1108	Antenna Adaptor Cord	\$ 9.95
1110	Carrying Case (Leather)	\$17.85
1111	Carrying Case (Vinyl)	\$ 9.95
269	Rubber Duck Antenna	\$ 5.95
	Crystal Certificates	\$ 3.95

PLEASE ENCLOSE \$2.50 FOR SHIPPING AND HANDLING PER UNIT

CALL TOLL FREE
1-800-228-4097

for Quality Ham Radio Products at Discount Prices

YAESU
 KENWOOD
 DRAKE
 ICOM
 STANDARD
 EDGE COM
 KDK
 PANASONIC

DENTRON
 HY-GAIN
 MOSLEY
 CUSHCRAFT
 WILSON
 HUSTLER
 LARSEN
 BENCHER
 ROBOT

TAYLOR
 SWAN
 TEMPO
 TEN-TEC
 MIDLAND
 CDE
 AUTEK
 MIRAGE
 AEA

E.T.O. ALPHA
 VHF ENGINEERING
 BERK-TEK CABLE
 CONSOLIDATED TOWER
 SAY
 SHURE
 TELEX
 ROBOT-SSTV
 BENCHER

Our Mail Order Hours (CST)

M-F 8 am to 12 Midnight
 Saturday 8 am to 6 pm
 Sunday 12 Noon to 8 am

Call and Talk to

Don	WBØYEZ	Ken	WDØEMR
Denny	WØQR	Eli	KAØCEJ
Bill	WBØYHJ	John	WBØMTS
Joe	WAØWRI	Blaine	WBØQLH
Jim	KAØCRK	Bob	WBØRQZ



C58

Communications Center

443 N. 48th, Lincoln, Nebraska 68504

In Nebraska Call (402) 466-8402



surprised to find the different ranges obtained by different kinds of matching units. It's an education in itself.

Resonant frequency of tuned circuits:

The ease with which the bridge can determine the resonant frequency of a totally enclosed tuned circuit is quite amazing. And it will even tell you whether or not it is a series-tuned circuit or a parallel-tuned circuit. All you need is two leads from the circuit being tested. Connect the leads to output binding posts A and B. We know that if a circuit is a series one, its electrical resistance will be low. So, just to obtain the best null, vary the signal generator frequency and the 100-Ohm control at the low resistance end of the scale. At the best null obtained, the signal generator frequency will be the resonant frequency of the tuned circuit. The resistance reading will be its equivalent series resistance.

The parallel circuit is measured in the same way, except that the bridge potentiometer is at the high end of the scale. The resistance value measured will be the equivalent parallel resistance of the tuned circuit. And, as before, the signal generator will indicate the resonant frequency of the tuned circuit. I mentioned that the tuned circuit could be completely enclosed. This bridge can measure resonant frequencies where it would be impossible to inductively couple in a grid-dip meter to make a similar measurement.

Measurement of velocity factor of coax cable:

The technique of measuring the velocity factor of coaxial cable is simple when it is realized that an electrical quarter wavelength of line (or odd numbered multiples there-

of) open at the far end acts like a series-tuned circuit at the near, or measured, end. Just connect your piece of coax cable to J2 and null the bridge at the low resistance end of the scale, at the same time varying the signal generator frequency for the lowest frequency for the best null obtainable. The equation for velocity factor in this case is: Velocity factor = (length in feet)(F_{MHz})/246 for a quarter-wave section of line. And now, as an experiment, if you triple your signal frequency, your line will again null the bridge. It is now acting as a three-quarter-wavelength line. In this way, it is very easy to demonstrate basic transmission line theory.

The same principle is used in determining the electrical half of a line open at the far end. This condition is equivalent to a parallel-tuned circuit. Just adjust your bridge null at the high resistance end of its scale, and at the same time adjust your signal generator for the lowest frequency that will give you the best null. The velocity factor can be checked and the formula will be velocity factor = (length in feet)(F_{MHz})/492 for a half-wave section of line. You can also use this method for setting up for a half-wave section of line if desired.

Characteristic impedance of coax cable:

The characteristic impedance of a coax cable can easily be determined with the rf bridge. All you do is connect one end of the cable to J2 and connect a selected resistor across the other end of the cable. The selection of this resistance is such that when the signal generator frequency is varied there is no change in the bridge reading. At that point, the resistance selected is equal to the characteristic im-

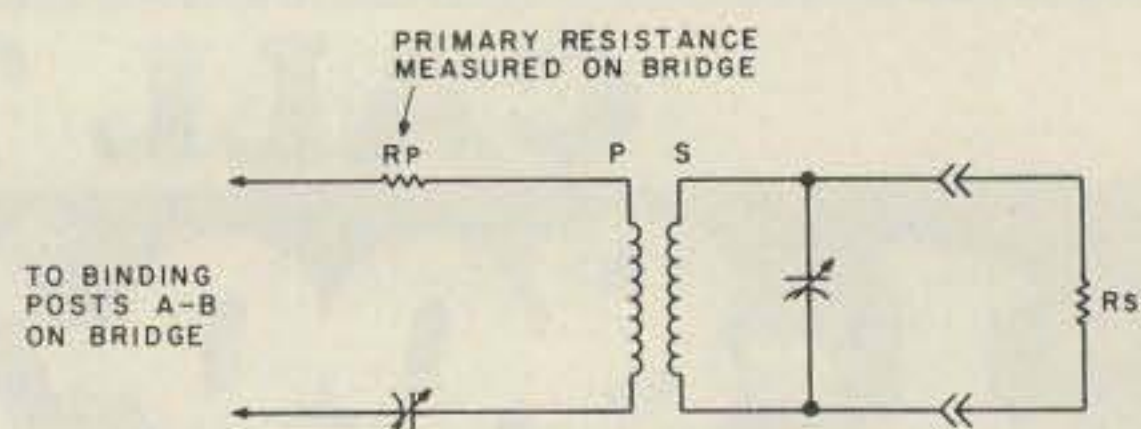

Fig. 4. The effect of secondary resistance being reflected in primary circuit.

pedance of the coaxial cable. It is an easy matter to try several different values of resistance to terminate the cable, so that a variation of signal generator frequency will show no change in the meter reading. The null can now be obtained, and the resistance reading will be the characteristic impedance of the cable. The value read will be equal to the terminating resistance at the end of the line. This illustrates the basic principle that a properly terminated line presents a constant pure resistance to a varying input frequency.

Reflected resistance of tuned coupled circuits:

Although it is possible to wade through a great deal of circuit theory to prove that resistance can be reflected from one circuit to another, this easily performed experiment will show it in a manner in which, if once performed, it will never be forgotten. An actual experiment is such a wonderful way of firming up any theoretical proof in anyone's mind. The principle of reflected resistance can be demonstrated as shown in Fig. 4, where a parallel-tuned circuit is inductively coupled to a series circuit. Loading down the secondary with a resistance generates a reflected resistance in the primary whose value can be determined by measuring the change of resistance with the bridge. Close-coupling effects can also be demonstrated by observing the re-tuning necessary to reestablish resonance when the secondary is coupled into the

primary. This item described is an easy way to demonstrate rather complex principles, particularly when teaching basics to students studying for an amateur license.

The transistor amplifier:

In addition to the many uses just described, I found that the addition of an SPDT switch, S2, and a couple of binding posts, C and D, would allow me to use the transistor amplifier for other duties in my amateur station. One valuable use is as a field-strength-meter amplifier. My regular simple field-strength meter diode circuit is now far more sensitive, which allows me to make my field-strength measurements further away from the antenna and avoid close-field effects. This makes my field-strength measurements more accurate and meaningful. A second use is as a small experimental capacity bridge, which I built using the same principles as the bridge previously described.

Conclusion

The development of this bridge and an investigation into its many uses has been one of the most interesting projects I've done since becoming an amateur more than fifty years ago. Undoubtedly, many more uses will be found for it, which will further enhance its value in your station. And if you are like me, you'll find that actually building something and using it is a wonderful way to impress theory on your mind. There is no better way of learning than by actually doing. ■

Amateur Radio Supply of Nashville, Inc.

615 South Gallatin Road - Madison, Tennessee 37115

CALL A.R.S.O.N. NOW!

615 868-4956

for the Best DEALS

Sure, we take trades on new equipment! Call or write.

We're Burning to Make "Hot" Deals!!

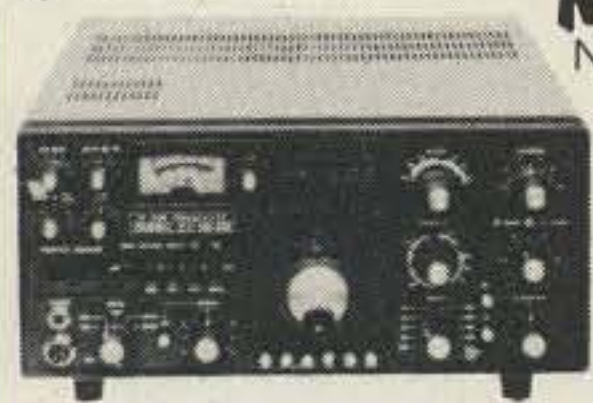
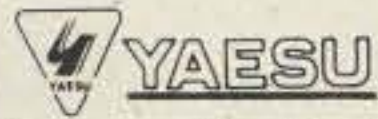

NEW!
NOW IN STOCK!
FT101ZD

Digital 160M-10M
Deluxe Features

Check the others
then get our price!

**YAESU
FT 901 DM**

Call for
yours
today!

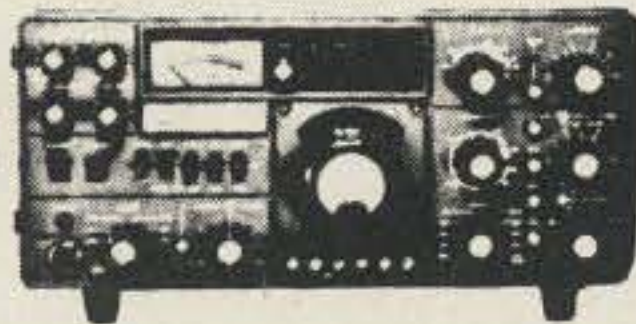

NEW! YAESU FT207R

Synthesized Handi-Talkie.
2 Watts
In Stock Now!!

CALL NOW FOR OUR PRICE!

We stock the complete YAESU line!

Dentron



**Dentron
GLA 1000**

1 KW DC INPUT!
1200 W. PEP!

LOW PRICES!

**NEW!
Dentron
HF 200A**

Fixed or Mobile!
200 WATTS
P.E.P.

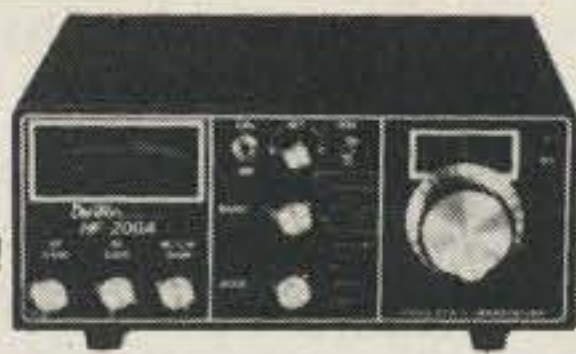

We have the New Dentron AF-1A Audio Processor, Dentron Antenna Tuners, Antennas and SWR Meters.

•CLIPPERTON L •MLA 2500 B
•DTR 2000L

CHECK OUR LOW PRICES!

**DAIWA
J. W. Miller**



Call or write for SUPER LOW prices!

USED EQUIPMENT? OUR STOCK TURNS FAST. WRITE OR CALL YOUR SPECIFIC NEEDS.



**NEW!
TS 180S**

All Solid State
with Digital
Frequency
Control. 200W
P.E.P. Memory.



Best Price Anywhere!



NEW!

TS 120S

ALL SOLID STATE
HF TRANSCEIVER
PLUS A FULL LINE OF ACCESSORIES!



NEW!

TR 7600

TR 7625

10 or 25 Watt FM 2 meter xcvr synthesized with memory. Get our best price!

IN STOCK! Ask about the RM 76 Micro Processor for the 7600/7625.

We stock the full KENWOOD line and provide warranty and after-warranty service. **BUY WITH CONFIDENCE!**



**B108 2M AMP • MP1 HF SWR MTR
MP2 VHF SWR MTR**

WE'VE GOT 'EM IN STOCK!
Call or write for prices!

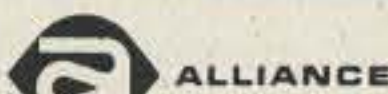

Rotor Special ALLIANCE HD-73

SPECIAL OFFER!!

\$105.00 Including
Shipping in U.S.A.

HD-73 with 100 feet
rotor cable \$120.00

HD73 with 100 feet rotor cable and 100 feet R8BU \$150.00
Cashiers check or M.O. please.



CDE ROTOR SPECIALS

The NEW HAM IV Rotor
Shipping included

HAM IV Rotor \$147.00

HAM IV Rotor with 100 ft.
rotor cable \$162.00

HAM IV Rotor plus 100 ft each -
rotor cable and first grade R8BU \$185.00
Send cashiers check or M.O. please.



MFJ ENTERPRISES, INC.

... TUNERS - FILTERS - CLOCKS
WE GOT 'EM - CHECK US FIRST!

CLOSEOUT SPECIALS! SEND S.A.S.E.
FOR OUR PINK SHEET SPECIALS!

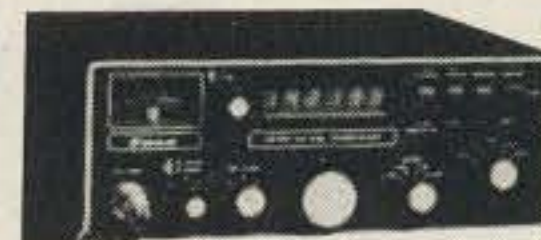

NEW!

**SWAN
ELECTRONICS**

ASTRO 150

HF SSB Transceiver featuring "VRS"
Fully Synthesized 235 Watts PEP & CW.
See the Swan ads and Call us or write for
BEST PRICES ANYWHERE!

**SWAN 100 MX
P.S. and ANT.
TUNER.**

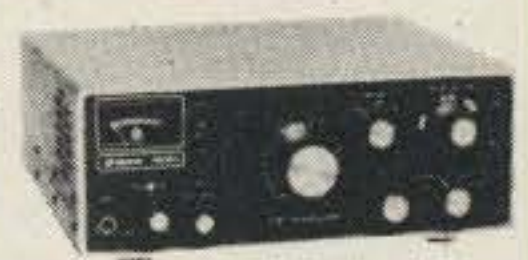

Call or write for quote - ideal for home
QTH or mobile!

TEN-TEC **OMNI**

D&A

UNBEATABLE
PRICES

Full TEN-TEC
Line in stock!



**DSI Counter
Semi-kit**

Get On Frequency!



WRITE OR CALL FOR SPECIAL PRICE!

DATONG

We have in stock the amazing Datong FL-1 active audio filter. Also now have the ASP, Automatic speech processor ... plus the Code tutor ... Fantastic additions to your station. Call or write for information and prices.

ICOM

ICOM - 701, 211, 215, 280, 30A
All in stock!!! Compare our PRICES!

ROBOT

SSTV - ROBOT

PUT YOURSELF
IN THE PICTURE!

Get in on the latest in
Ham Radio!

CALL OR WRITE NOW FOR PRICES!

avanti antennas

The fantastic new
Avanti 2 meter
Mobile
Antenna—
mounts on your
car window
glass! 3 DB gain.
Neat and compact
installation—
GET OUR LOW PRICE NOW!!!

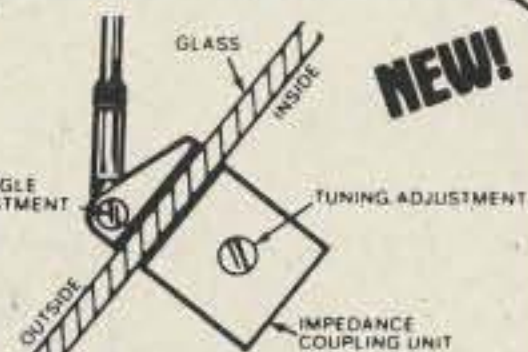

Fast UPS Delivery. Place your order then
STAND BACK! We ship your order the same
day we get it. Best prices and quick handling
of your order.

SUMMER STORE HOURS - Monday thru Friday - 9 AM - 5 PM ✓ A40

Amateur Radio Supply of Nashville, Inc.

Try the Potted J

— a 2m antenna impervious to the elements

Structural integrity and simple construction.

Some antenna is better than no antenna at all. In many circumstances where adverse weather conditions are encountered, a primary consideration should be to have an antenna that will function dependably even though it might not provide the last dB of gain. This article describes such an antenna designed primarily for 2 meter repeater usage. The antenna has only a modest amount of gain over a simple ground-plane antenna.

But, it has far better structural integrity. The materials used to construct the antenna might vary a bit depending on what is available locally, but the design permits construction by anyone using only simple hand tools.

The antenna form is a commonly used variation of the old-fashioned J antenna shown in Fig. 1(a). The variation, as shown in Fig. 1(b), simply uses a closed metal cylinder for the lower $\frac{1}{4}\lambda$ section in-

stead of the open-style construction of the original J antenna. This type of construction has a number of advantages, such as easy mounting on any type of mast, relatively inconspicuous appearance, and an all-metal, dc grounded structure. Since the antenna's central element and the metal cylinder are electrically shorted at the base of the antenna, that point will be a low impedance point. At the other end of the $\frac{1}{4}\lambda$ cylinder, there will be a high impedance point. The latter is the only point where consideration has to be given to proper insulation between the metal elements of the antenna.

The mechanical dimensions of the antenna are given in Fig. 2(a). Depending on the materials available locally, the diameters of the cylinder and the radiating element can vary a bit from those shown. But, the lengths should be

closely maintained and dimensioned using the formulas shown in Fig. 1(a) for the particular segment of the 2 meter band of interest. The mechanical construction can vary a bit from that shown as long as the dimensions are maintained, the central element is securely grounded to the bottom of the $\frac{1}{4}\lambda$ cylinder, and the coaxial feedline is connected properly.

In the method of construction shown, the end of the central element is flattened out at the bottom and bent and bolted to the bottom side of the $\frac{1}{4}\lambda$ cylinder. Additionally, a small piece of the same material as the central element is flattened out and used as a brace to the other bottom side of the cylinder. The coaxial cable shield is connected via a ground lug to the inside of the cylinder and the inner conductor is either soldered or connected to the central element

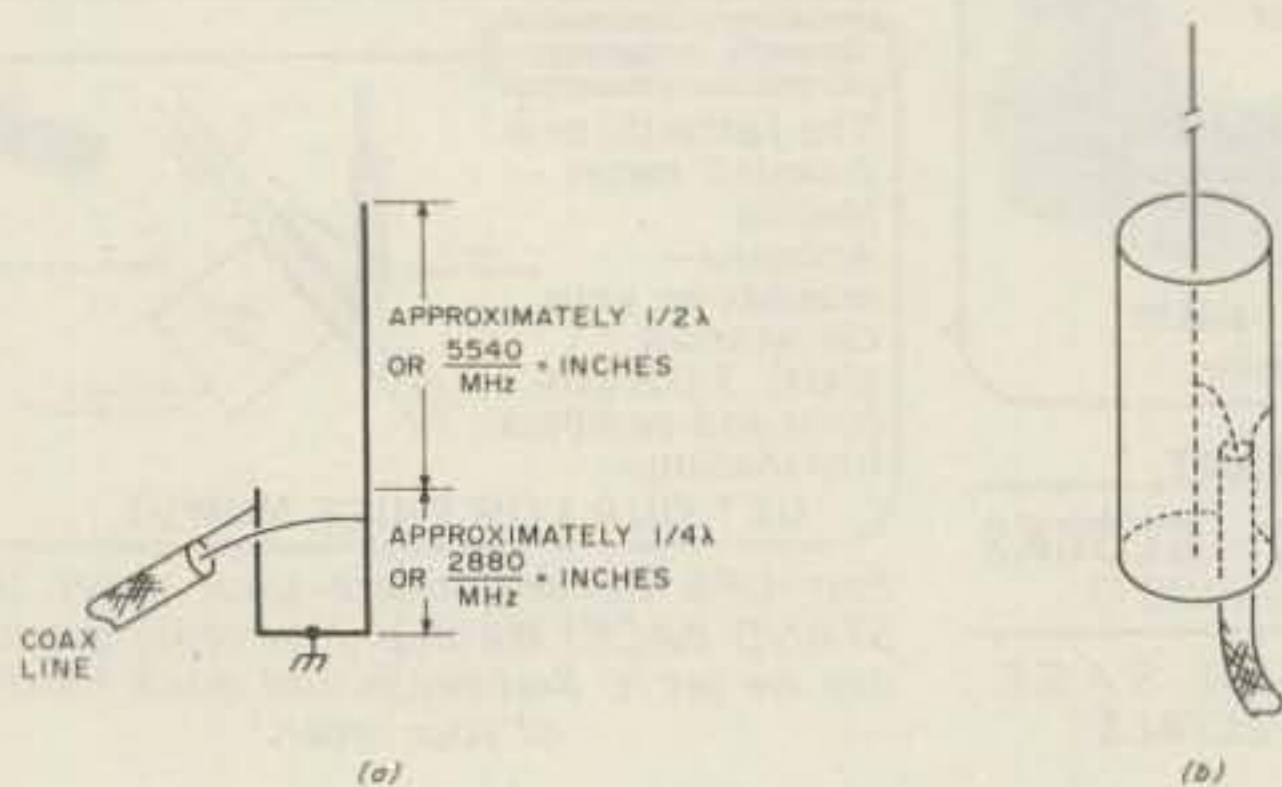

Fig. 1. Basic J antenna (a) and variation where lower $\frac{1}{4}\lambda$ section is in the form of a cylinder (b).

at the point indicated via a ground lug. The connection to the central element can be made before that element is inserted in the cylinder. The connection of the cable shield must be made after insertion. This requires a bit of dexterity working in the narrow cylinder, but with good lighting and patience it can be done. One handy way to help things along is to temporarily glue the nut for the bolt holding the ground lug on a thin piece of wood. Once the nut is started on the bolt, the wood piece can be broken away.

Before the final assembly step, check the electrical performance of the antenna for swr. It should check out with a very low swr if proper dimensions have been maintained. If one wants to optimize the swr, the feedpoint on the central element can be varied slightly up or down. Usually this can be done without having to change the connection point for the ground shield of the coaxial feedline. This does mean going through the procedure of having to take out and reinsert the central element, but it is not at all that tedious after one does it once or twice. During this test, the central element can be held centered in the upper end of the cylinder by a PVC reducer fitting as shown in Fig. 2(b). These reducer fittings can be found wherever PVC piping fittings are available and one can be found which will fit exactly over a pipe having a 1 1/4" outside diameter.

The final and most important step in assembly is to fill the cylinder in completely with an insulating compound. This will give the antenna its final mechanical rigidity and, more importantly, completely exclude moisture leakage or condensation in the cylinder. Many potting or seal-

ing compounds can be used as long as they contain no form of metal filler. The plastic resin body fillers sold in automotive stores, with or without fiberglass reinforcement, are readily available. However, to make the filler flow readily in the cylinder, the filler should be heated so that it is fairly liquid. Don't use an open flame to make the filler liquid, but rather insert the container (a tin can will do) containing the filler into a bath of very hot water. Temporarily plug the top end of the PVC fitting where the central element protrudes and, with the cylinder initially held at an angle, pour in the filler from the coaxial cable end.

The use of a coaxial connector on the antenna was deliberately avoided. Simple coaxial connectors, when used in a harsh outdoor environment, will almost always eventually become the source of a problem. This is the same reason why screw-in elements, etc., are avoided. Of course, this all means that the antenna becomes a throw-away unit in case something should really damage it. But, the cost of materials involved to build another antenna is relatively low. As long as it does last, one can use the antenna with the confidence that none of the electrical or mechanical connections inside the antenna are likely to become corroded.

The 1/4λ cylinder need not be insulated from a metal mast as long as it is fastened to the mast at the bottom of the cylinder with the usual metal U-type mast clamps.

One can add parasitic or phased elements around the basic antenna if it is desired to obtain some directivity. Parasitic elements, of course, require no cable connection to the main element, but then one has to go through

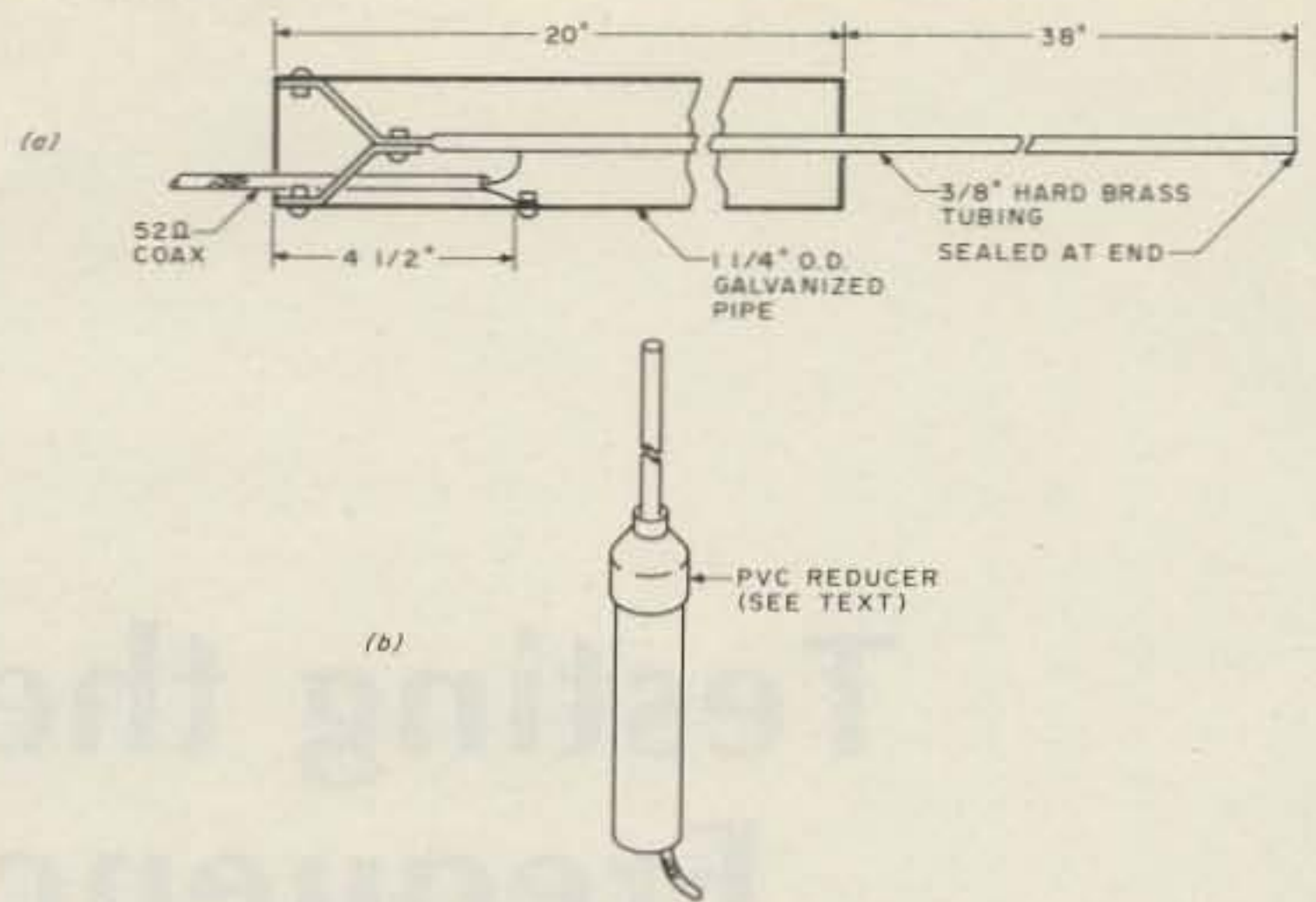



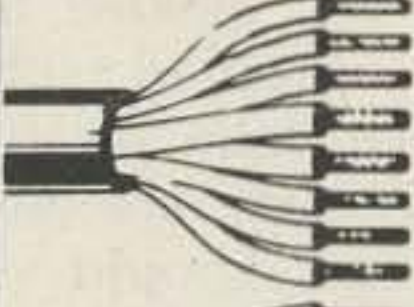
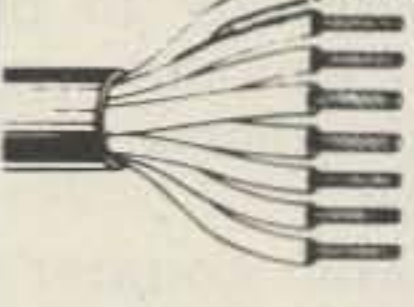

Fig. 2. (a) A cross-sectional view of the antenna giving dimensions centered in the 2 meter band. (b) A PVC pipe reducer used to insulate and center the vertical radiator at the top of the 1/4λ cylinder.

a careful process of seeing that the feedpoint of the main element is altered to compensate for the presence of the parasitic element. In spite of the increased cable cost, etc., if one really wants to keep the weather-ruggedness for a directive antenna in-

stallation paramount, it would be better to have two spaced antennas of the type described with separate feedlines. Then, the necessary phasing, matching, and switching can be done from the protected environment inside the shack. ■

BELDEN

Part Number	MHz	db/100 ft.	db/100 m
 9888 42¢/ft	50	1.2	3.9
	100	1.8	5.9
	200	2.6	8.5
	300	3.3	10.8
	400	3.8	12.5
 8214 26¢/ft.	50	1.2	3.9
	100	1.8	5.9
	200	2.6	8.5
	300	3.3	10.8
	400	3.8	12.5
 8237 23¢/ft	100	2.0	6.6
	200	3.0	9.8
	400	4.7	15.4
	900	7.8	25.6
 8267 27¢/ft	100	2.0	6.6
	200	3.0	9.8
	400	4.7	15.4
	900	7.8	25.6
 8448 17¢/ft	No. of Cond. — 8 AWG (in mm) — 6-22, (7x30), [1.76]; 2-18, (16x30), [1.19]		
 9405 28¢/ft	No. of Cond. — 8 AWG (in mm) — 2-16, (26x30), [1.52]; 6-18, (16x30), [1.17]		

MADISON M35
ELECTRONICS SUPPLY, INC.
 1508 MCKINNEY • HOUSTON, TEXAS 77002
 713/658-0268
 MASTERCHARGE • VISA

Testing the DSI 3600A Frequency Counter

— as much accuracy as you'll ever need

Score another one for DSI!

*Bill Pasternak WA6ITF
Associate Editor*

"Measures frequencies to 600 MHz; includes oven-compensated crystal timebase; includes built-in 600 MHz prescaler... not an ad-on; resolution to 1 Hz direct and 10 Hz prescaled; sensitivity 10 mV rms @ 146 and 220 MHz to 50 mV rms @ 450 MHz; accuracy .5 PPM over temperature; automatic decimal point placement; 8 large bright .5-inch digits and more!"... Yes, these are nice claims for any piece of equipment, and, when you realize that this counter costs only \$199.95, it all seems even sweeter. Ah, but there is always a "but." In this case, the "but" was, "but will it work the way DSI claims under actual amateur shack conditions?" The answer is a

large-sized "yes," so, if you are interested in a frequency counter of your very own, read on.

When DSI says that the counter comes complete and ready to operate, they are not fooling. Packed along with the 3600A, in the neat little white shipping carton, one will find a 110-V ac to 12-V dc power converter, a telescoping whip antenna, and one of the finest instruction manuals I have seen in a long time. The book not only contains the "how to's" of using the 3600A, but also has detailed schematics that take up two full pages and are very easy to read. Should you find it necessary to perform service on this instrument, such schematics are a true asset.

The basic counter is housed in a scratch-resistant, highly durable black plastic case. Plastic, you say... why plastic? Light weight and portability are but two of the reasons and

I'll bet there are many others. The fact is that the 3600A is so light in weight that it feels like you are carrying a portable transistor radio without the batteries. DSI claims that there are virtually no spurious emissions from the case, and I corroborated that using my old standby Millen gdo as an absorption wavemeter. Nothing could be detected on the Millen from the BC band through the highest frequency of the gdo. Score one for DSI.

The front of the counter is a transparent dark red panel which has high light transfer properties, and about the only place you may have problems reading the .5"-LEDs is in direct bright sunlight. Along with the 8-digit display for frequency readout there are two other LEDs. One indicates gating time, while the other monitors the cycling of the crystal oven. The base frequency oscillator is temperature-compensated

using the time-proven crystal oven technique, and I suspect that it's this oven that accounts for the remarkable long-term stability of the unit. Score another one for DSI.

There is but one control on the counter, and that is its "gating switch," which selects one of two timebases in either the direct or prescaled ranges. The rear of the unit has three connectors. A mini phone jack serves as power input, and two SO-239 UHF connectors are used for both rf inputs. To use the counters, one need only plug the power converter into the unit, connect either an input probe or the telescoping antenna, set range/gating, and read frequency.

DSI includes a warning in their manual that reads in bold black letters, "Warning—do not transmit directly into counter." Actually, the counter seems so sensitive that, in most cases, the whip sup-

plied by DSI is more than sufficient.

To check a frequency counter, one needs a source of signals to read, as well as something to compare against. Well, what can the "average" amateur use as a standard of comparison? In my case, I happened to have tweaked my Clegg FM-76 220 MHz radio earlier in the week on a multi-kilobuck counting device. Since it had only been a few days, I figured that it was close enough for "amateur work." The 3600A showed that the FM-76 was within 50 to 100 Hz on each of its 11 crystallized-up transmit positions. In my book, that was enough proof of the accuracy claim—far more than is necessary for most amateur applications. "Real nice," I thought to myself.

Over the next week, I tried the counter under a number of different conditions. In each case, I was all but amazed by the extreme sensitivity of the unit. One experiment I tried was placing the 3600A atop the Sylvania color TV set in the living room and keying my FMH in the den some sixteen feet away. The display lit up to read 146.52053. Not bad for a 1.5-Watt handheld and a rubber duck to a counter with a whip as an input probe. This "sensitivity feature" was real handy when I decided to reset the transmitter in my trunk-mount Motorola. I simply made up a cable with a mini phone plug on one end and a cigar lighter plug on the other, shoved the 3600A on the rear deck of the Torino to shield it from direct sunlight and tweaked the T-power with ease. No extension cords were needed. The car powered both the radio and the counter.

DSI claims a 600-MHz top end for the 3600A. I can't tell you about that, but it

does work to specs in the 440-MHz range as checked using a Motorola HT-220 belonging to a good friend who owns one of those "secret" California remotes. Again, the test was from the den to the living room, whip to whip. I also checked the lower limits of the 3600A by using an Audiovox CB radio and my Globe Scout/Hallicrafters HA-5 combo. I'll tell you one thing—that HA-5 is one stable vfo, even when multiplied to six and 10 meters. I always suspected this to be the case, but having a counter really proved this once and for all. Again, these were the same kind of tests you might use a counter for.

In all, I tried the counter from the 80 meter amateur band up to 450 MHz which were the limits of the test if available to me. In each case, the 3600A lived up to the claims made for it by DSI in their advertisements. What more is there? If something proves to be as it's claimed, it's very nice to be able to recommend it to others. The DSI 3600A counter is such an instrument.

More information on the complete line of DSI instruments can be had by writing DSI, 7914 Ronson



Road #G, San Diego CA 92111. Or, if, after reading this, you are in a hurry to order one, you can call DSI at (800)-854-2049. In California, call (714)-565-8402 collect. Oh yes, lest we forget, DSI gives a warranty of one full year on parts

and labor. DSI also pays the return postage. This guarantee is personally backed by DSI's marketing vice president Dennis Romack WA6OYI. I know Dennis and he is the one guy who means every word he says. ■

NEW!! THE SPACE CASE®

...What better way to give your circuit designs a professional look. House them in top quality enclosures...

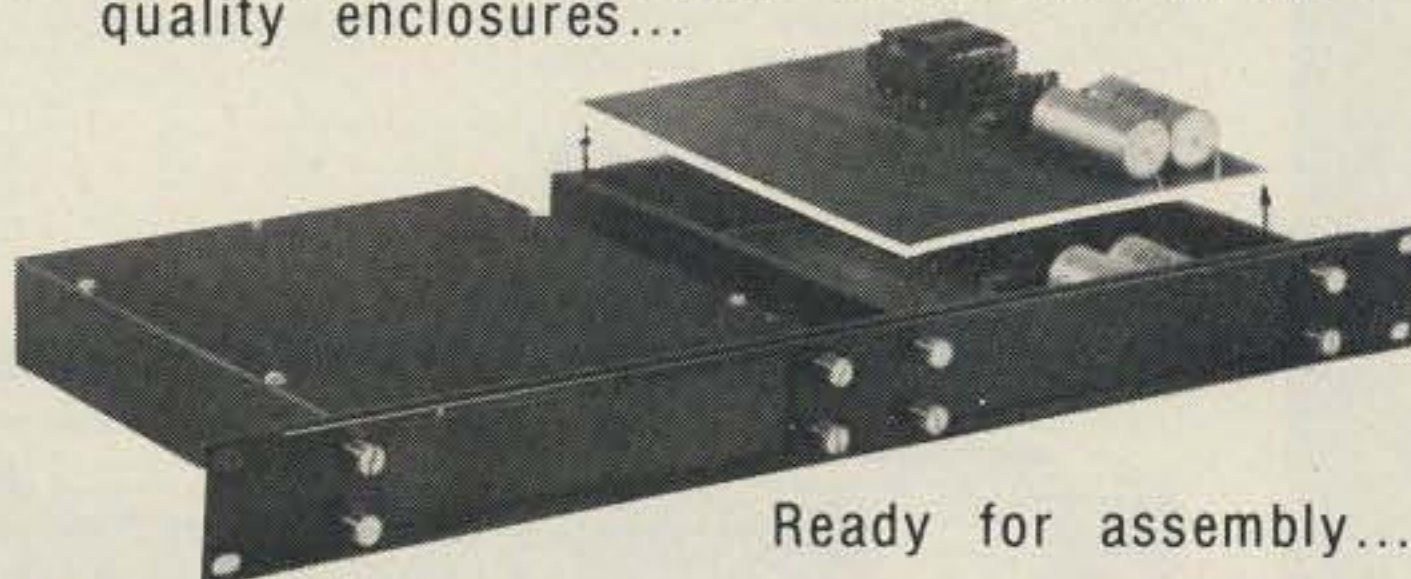

Ready for assembly...

THE SPACE CASE®

- C-1 1½" x 7" x 8" \$24.50
- C-3 3" x 7" x 8" \$29.50

• 6061-T6 Black Anodized Aluminum • ¼" Sides, ½" Front and Rear, 18 Gauge Top and Bottom Panels • Circuit Card Guides • Pre-Drilled For Ease of Assembly • All Necessary Hardware

RACK PANELS

- P-1 1¾" x 19" \$12.50
- P-3 3½" x 19" \$14.50

• Fits Any Standard Size Rack

PROTO-TYPE BOARDS

- B-5 5V (Complete) \$40.50
- B-12 ± 12V (Complete) \$45.00
- B-B Bare Board \$25.00
- T-5 5V Transformer \$12.00
- T-12 ± 12V Transformer \$12.00

• Powerbuses Accepts Up To 25, 14 Pinpacks • Provisions Made For Either 5V at 800 ma. or ± 12V at 230 ma. By Simple Transformer Change • Complete With All Parts.

✓ \$100

SCOTT MANUFACTURING

CALL OR WRITE FOR FREE LITERATURE
(216) 494-6050

P.O. BOX 2304 NORTH CANTON, OHIO 44720

1-800-633-3410 TODAY!

CALL LONG'S TOLL FREE

LONG'S HAM BUYERS GUIDE



Prices in this catalog subject to change without notice. Prices good only while supply lasts.

ORDER NOW!

DRAKE TR/DR7 general coverage digital R/O transceiver

Covers 160 thru 10 meters, reception from 1.5-30 MHz continuous, 0-30 MHz with optional Aux-7, modes: USB, LSB, CW, RTTY, AM, true passband tuning, RIT, built-in RF wattmeter/VSWR bridge, SSB 250W PEP, CW 250W, AM 80W. Power supply required for AC operation. PS-7 120/240V power supply available.

1395.00 List. Call for quote.

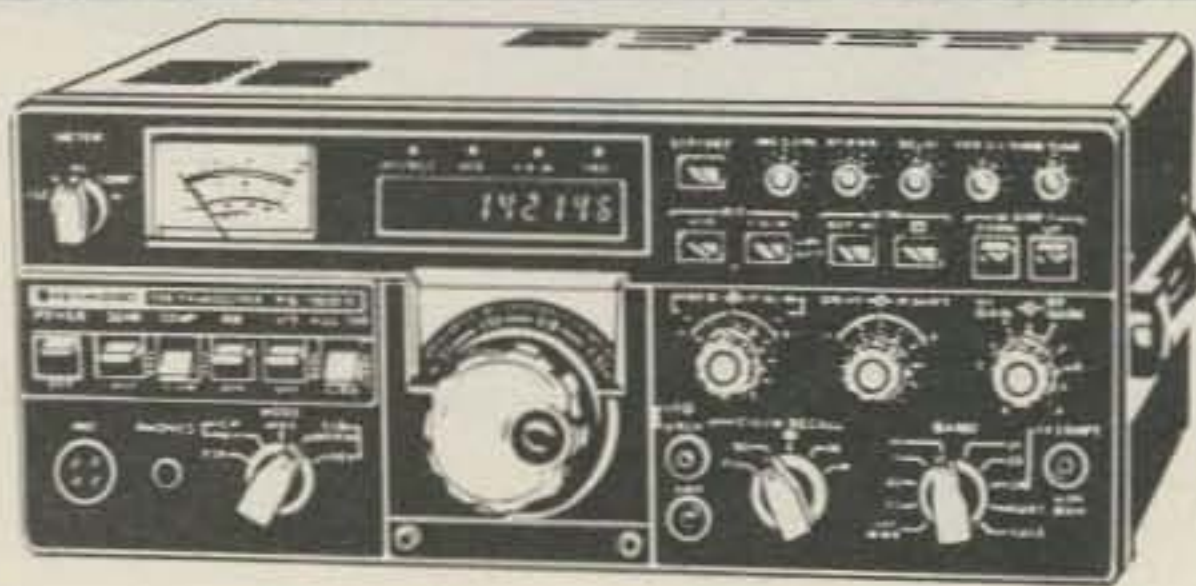
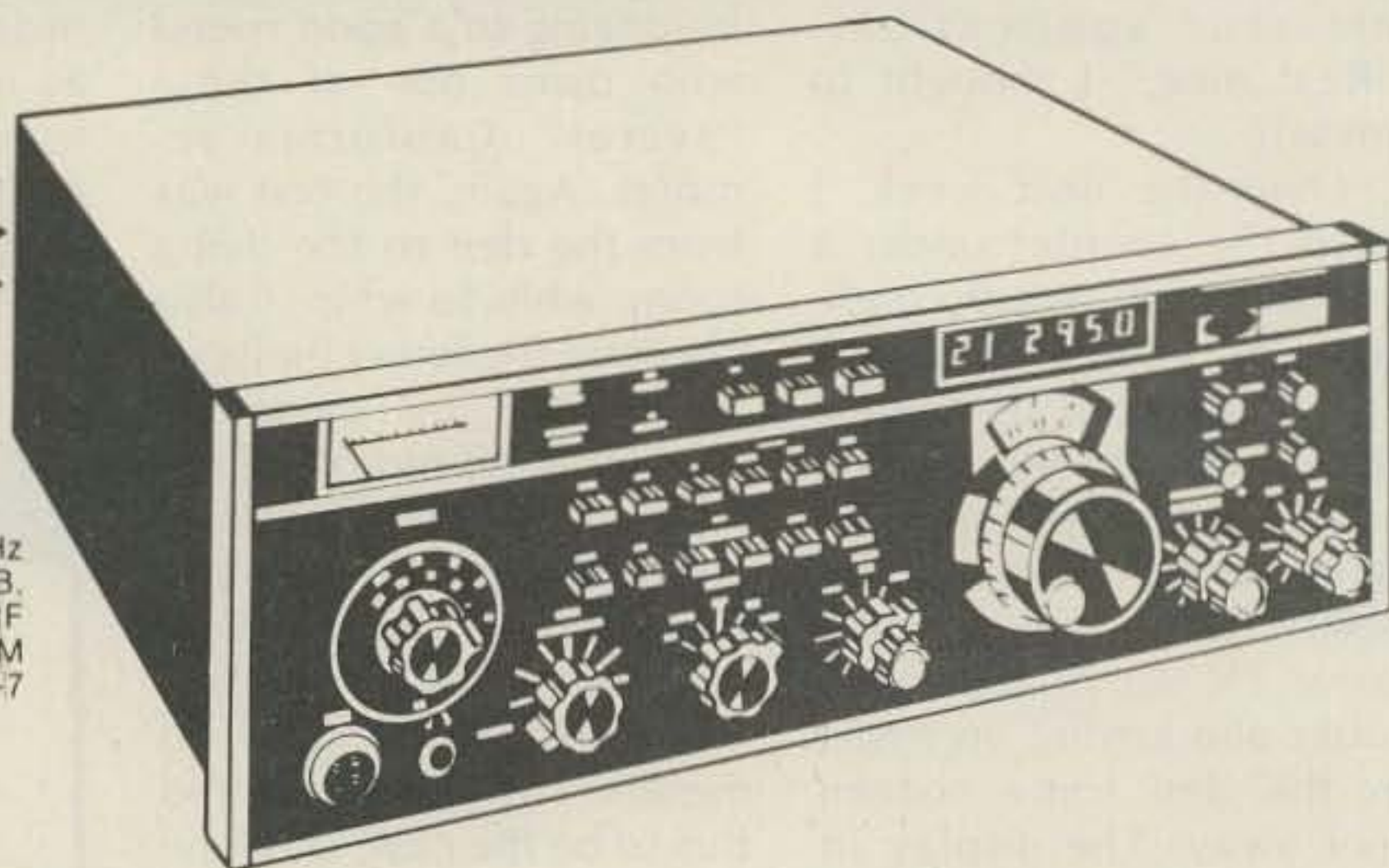

KENWOOD TS-180S HF transceiver

With Digital Frequency control with 4 memories & manual scanning, all solid state, 200W PEP SSB/160W DC, 160-10 meters, WWV, adaptable to 3 proposed bands, microprocessor, IF shift, noise blanker, RF AGC, Dual RIT (VFO & memory/fix), SSB, CW, & FSK, 13.8 VDC operation.

1149.95 List. Call for quote.

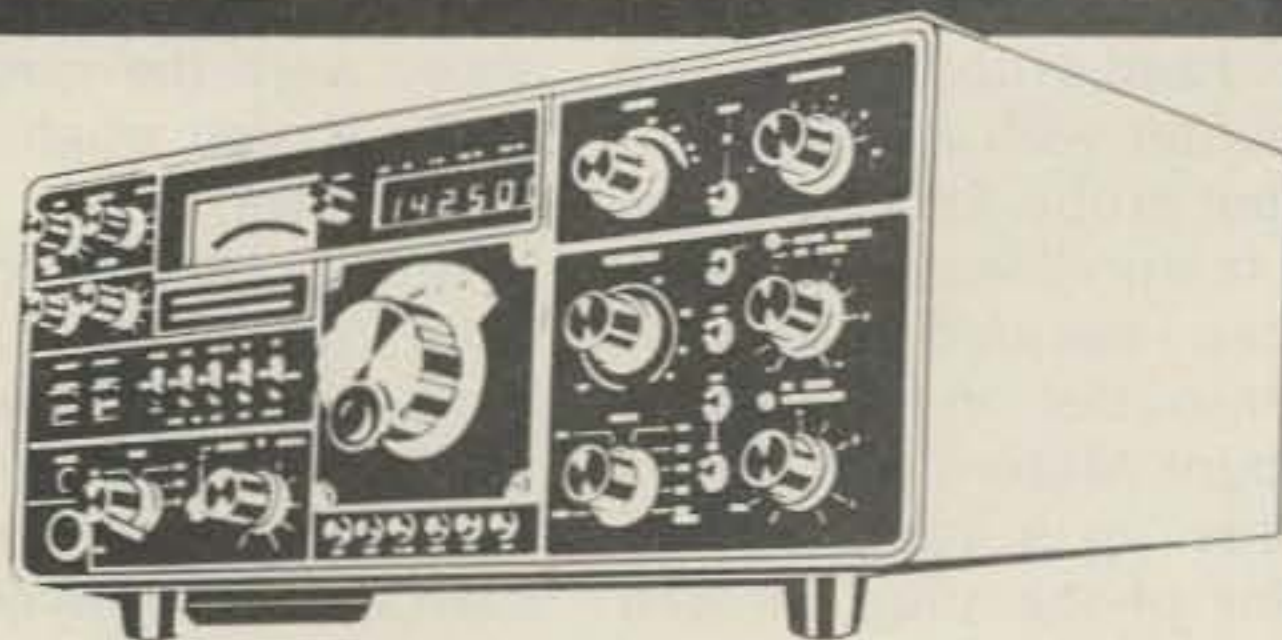

YAESU FT-901DM HF transceiver

An all mode HF total communications system. Freq. coverage: 160 thru 10 meters, 200W PEP, RF speech processor, built-in VFO, reject tuning, variable IF band width tuning, LED freq. display with memory, built-in Curtis Keyer, 6146 final tubes, AC/DC power supply built-in audio peak freq. tuning.

1459.00 List. Call for quote.



Long's Electronics



CALL LONG'S TODAY!

1-800-633-3410 TOLL FREE



KENWOOD PS-30 power supply

Designed to match the TS-120S, this unit supplies regulated 13.8 VDC at 15 A continuous, 20A intermittent load with complete ease and safety due to the use of generous heat sinks and an automatic reset electronic overload trip.

139.00 Call for quote.

200 WATTS PEP

KENWOOD TS-120S All solid state HF SSB transceiver

No tune up needed on this extremely small unit with miniaturized circuits and solid state construction. It has built-in digital display, cooling fan, IF shift, built-in protection for the final transistor, VOX, noise blanker, 25 KHz marker. The freq. range is 80 to 10 meters and WWV, modes: SSB and CW, power requirements: receive - 0.7A 13.8 VDC, transmit - 18A 13.8 VDC. Size: 3 1/2" H x 9 1/4" W x 13 1/2" L. Weight 11.7 lbs.



699.95

List. Call for quote.

KENWOOD TS-120S ACCESSORIES

KENWOOD SP-120 speaker

A good-looking compact speaker matching the styling of the TS-120S that is designed for home station use. Provides clear reproduction of the TS-120S high quality audio.

39.00 Call today

KENWOOD YK-88C CW Crystal filter

A 500 cycle for use with the TS-120S.

59.95 Call today



KENWOOD TR-7625 25W transceiver

The unit has memory channel with simplex or repeater operation \pm 600 KHz transmitter offset, mode switch for switching the transmit freq. up or down, full 4 MHz coverage on 2m (144.00-147.995), 800 channels, 5 KHz offset switch, MHz selector switch, digital freq. display, unlock indicator for transceiver protection.

425.00 List. Call for quote.

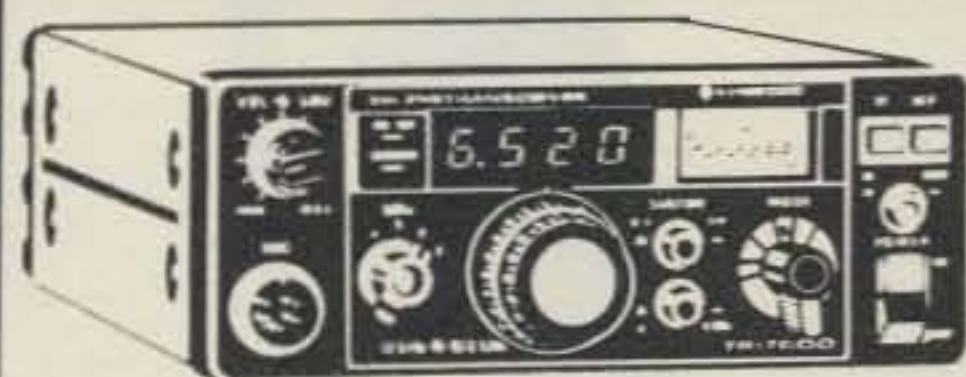

KENWOOD TR-7600 2m FM transceiver The radio that remembers

Full 4 MHz coverage (144-148), 800 channels, 10 W RF output/1 W low, memory channel with repeater or simplex offset, 13.8 VDC at 3 amps continuous.

375.00 List. Call for quote.



KENWOOD VFO-120

This unit allows the operator to work split frequencies, find a clear frequency while holding the original one. It has new features as the T-F set switch which prevents mis-operation in double split frequency operation and aids in quick setting of transmit frequencies.

159.95 List. Call for quote.



KENWOOD SP-820 speaker

It has built-in selectable tone filters to attenuate high or low frequency response inputs. Also 2 channel selectable headphone outputs switchable through the tone filters. Impedance 8 ohms

65.00 Call today.

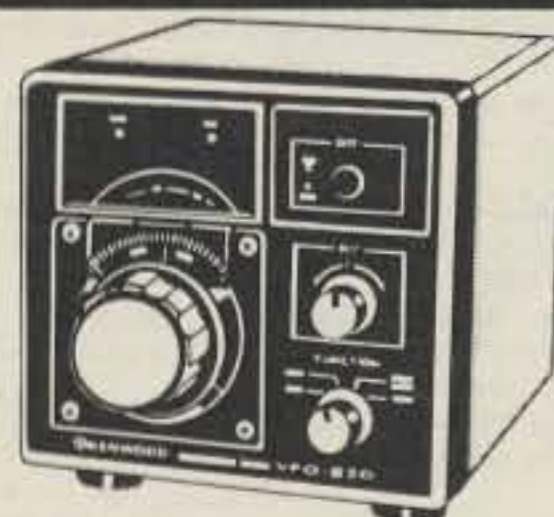

KENWOOD VFO-820

Comes equipped with a DRS dial like the TS-820S series for excellent linearity, stability, and ease of frequency reading. Digital display of the main unit indicates the frequency of the VFO.

175.00 Call for quote.



KENWOOD R-300 all band communications receiver

Listen to foreign broadcasts or ham operators from around the world! It has a 3-way power supply (AC/batteries/external DC). In case of an AC power failure, it automatically switches to DC so is ideal for emergency use. The receiver frequencies (180 KHz to 30 MHz) are all covered by 6 bands. There is a 500 KHz marker on the receiver.

279.00 List. Call for quote.

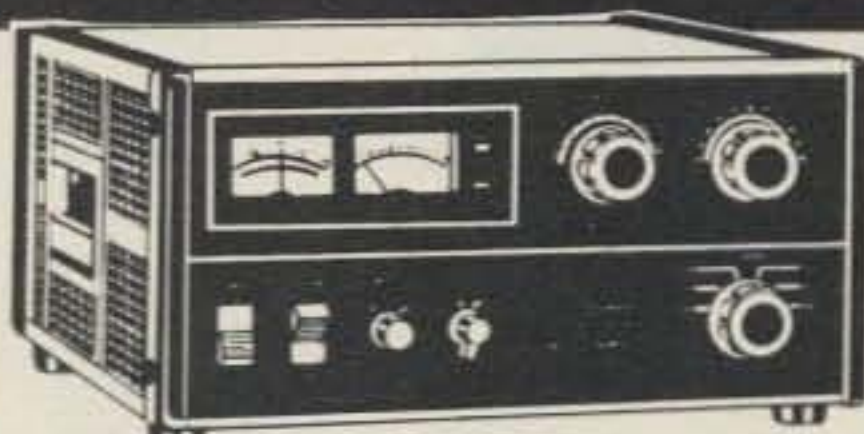

KENWOOD TL-922A 2000W linear amplifier

Features: 2 3-500Z final tubes, time delay fan circuit, frequency range: 160 thru 15 meters, drive power: 80W or more for full output, RF input power: SSB 2000W PEP, CW & RTTY: 1000W DC, power requirements: 120/220/240 VAC 50/60 Hz.

1199.00 List. Call for quote.

DON'T WAIT!



KENWOOD MC-45 touch tone mic

The touch tone circuit provides PTT with only 1/2 second hang time. It is an omnidirectional, dynamic mic with 500 ohm impedance, very good frequency response, and adjustable tone output level. Power requirement: 8 VDC, 20 mA. Complete with connector and coiled cord. Compatible with the TR-7600 and TR-7625 with no modification.

49.95 Call today.

VISA

Long's Electronics



& MAPS CALL TOLL

FOR YOUR BOOKS, TAPES



ARRL Publications

ARRL Radio Amateur's Handbook Newly revised & jam-packed with everything from basics to latest developments. I.N. 10081 9.75

ARRL Radio Amateur's License Manual The most up to date compilation of rules & regulations. Covers from Novice to Extra Class. I.N. 10012 4.00



ARRL Antenna Handbook Complete instructions for building antennas of all types. I.N. 10026 5.00

ARRL World Map I.N. 10099 3.50

LCF Calculator Slide rule type calculator to compute resonant frequency, etc. A great aid! I.N. 10062 3.00

Electronic Data Book All you need to know about Filter design, RF circuit data, antennas and feeding info & more. I.N. 10027 4.00

Learning to Work With Integrated Circuits Build a digital voltmeter/freq. counter while learning about IC's. I.N. 10060 2.00

Single Sideband for the Radio Amateur Covers theory and practical how-to-built ideas. I.N. 10017 3.00

FM and Repeaters for the Radio Amateur Learn all about FM and repeaters from this handy book. I.N. 10014 5.00

Solid State Design for the Radio Amateur. Packed with information for practical use of solid state devices. I.N. 10061 7.00

Solid State Basics Pure solid state information and practical basics for today's ham. I.N. 10037 5.00

Specialized Communication Techniques for the Radio Amateur Covers ATV, SSTV, FAX, RTTY, satellite communications and more. I.N. 10028. 3.00

ARRL Radiogram Message Pads I.N. 10007 75 ea.

ARRL Special Operating Kit Consists of ARRL Ham Radio Guide, full color U.S. area call map, ARRL log book, 70 ARRL radiograms. I.N. 10063 6.50

ARRL Ham Radio Operating Guide Brush up on good operating practices with this ready reference source. I.N. 10025 4.00

Satellite Communications A package of maps and articles explaining amateur satellites. Includes Getting to Know OSCAR. I.N. 10064. 4.75

80 meter DXing Handbook. Contains 4 sections on propagation, antennas, station equipment, and operating practices. It's filled with solid practical experience. I.N. 26307 4.50

The Amateur Radio Vertical Antenna Handbook. The first book for amateurs solely about vertical antennas. It is full of information. I.N. 26316 5.00

The Challenge of 160 The unique operating characteristics are explained and there are tips on building simple equipment. I.N. 26312 4.95

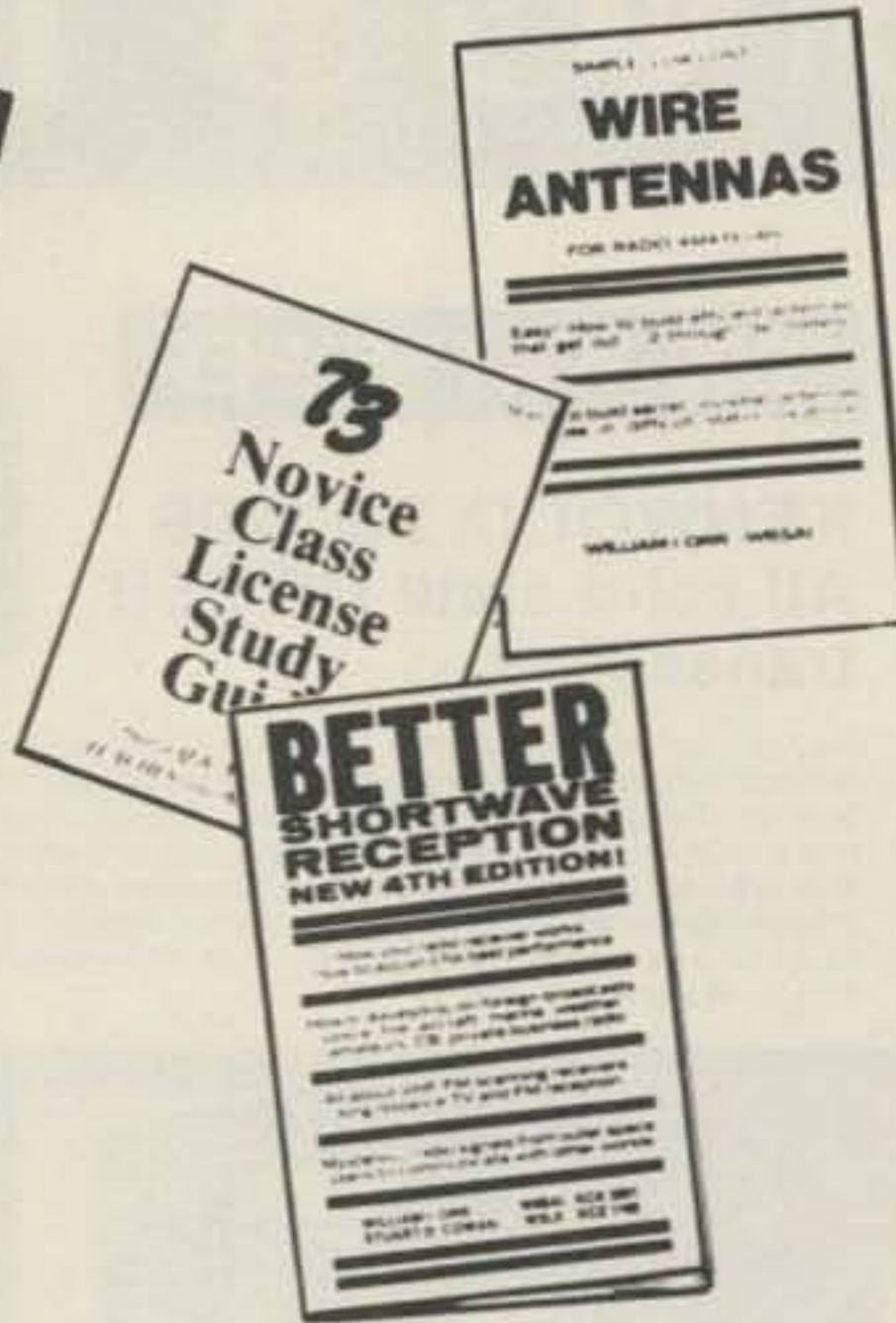

Hints and Kinks New ideas written by hams themselves. This is full of practical ideas and tips that they have used successfully. I.N. 10029 4.00

Radio Frequency Interference A new book to help everyone understand RFI. It covers all from good neighbor relations to simple technical cures for RFI. Helps identify and solve problems. I.N. 10083 3.00



ARRL Code Kit Upgrade your Novice or Tech. License with these 2 60 min. cassettes with speeds of 5, 7 1/2, 10, & 13 wpm. Instruction book included. I.N. 10046 8.00

ARRL Log Books spiral bound books
Large I.N. 10015 1.75
Small I.N. 1002075

Tune in the World with Ham Radio Learn all about amateur radio with a text and a morse code cassette. For the beginner studying for the Novice exam. I.N. 10031 7.00

Understanding Amateur Radio A must guide for the newcomer. It explains in simple language elementary principles of electronics & tells how to build low cost equipment. I.N. 10016 5.00

Radio Publications, Inc.

Beam Antennas Handbook by Wm. Orr, W6SA1 I.N. 26200 4.95

Wire Antennas by Wm. Orr, W6SA1 I.N. 10058 4.95

All About Cubical Quad by Wm. Orr, W6SA1 I.N. 26201 4.75

The Truth About CB Antennas by Wm. Orr, W6SA1 I.N. 26202 5.95

EIMAC's Care and Feeding of Power Grid Tubes I.N. 26205 4.95

The Antenna Handbook I.N. 26207 6.95

VHF Handbook by Wm. Orr, W6SA1 I.N. 26203 5.95

Better Short Wave Reception by Wm. Orr, W6SA1 I.N. 26204 4.95



Ameco Books

Communicate with the World with Ham Radio NP-1 I.N. 24825 6.95

Ameco 7-01 Question and Answer Guide for the Novice Exam 1.00

Question & Answer for Advanced Class Exam 16-1 I.N. 24809 1.50

Question & Answer for Extra Class Exam 17-1 I.N. 24801 1.50

Radio Amateur Theory Course 102-01 I.N. 24812 4.95

Radio Electronics Made Simple I.N. 24800 2.50

Logbook I.N. 24807 1.50

Commercial Radio Operator Theory Course 15-01 I.N. 24808 6.95

Commercial Q&A License Guide Ele. 4 10-01 I.N. 24805 1.95

Commercial Q&A License Guide Ele. 3 9-01. I.N. 24804 2.95

Commercial Q&A License Guide Ele. 1, 2, & 9. 8-01. I.N. 24803 1.50



Other Great Books

Collins Radio Co. SSB Amateur Single Sideband I.N. 10092 4.95

73 Magazine VHF Antenna Handbook I.N. 26303 4.95

73 Magazine Novice Class Study Guide. I.N. 26300 4.95

73 Magazine General Class Study Guide I.N. 26301 4.95

The Beverage Antenna Handbook. I.N. 0000 5.00

K3CHP DX QSL Guide I.N. 26313 3.95

Amateur TV in a Nutshell I.N. 26322 5.00

How to Make Better QSL's. I.N. 26304 4.95

The Complete Handbook of Slow Scan TV. I.N. 30518 9.95

Remember, you can Call Toll Free: 1-800-633-3410 in the U.S.A. or call 1-800-292-8668 in Alabama for our low price quote. Store hours: 9:00 AM til 5:30 PM, Monday thru Friday.

VISA

Long's Electronics

master charge

MAIL ORDERS: P.O. BOX 11347 BIRMINGHAM, AL 35202 • STREET ADDRESS: 2808 7TH AVENUE SOUTH BIRMINGHAM, ALABAMA 3523

FREE 1-800-633-3410 OR

ORDER BY MAIL TODAY

Tab Books

- Novice Class Study Guide I.N. 30517 5.95
- General Class Study Guide I.N. 30519 7.95
- Advanced Class Study Guide I.N. 30522 5.95
- Extra Class Study Guide I.N. 26302 5.95
- A Beginners Guide to Microprocessors I.N. 30502 5.95
- 57 Programs and Games in Basic I.N. 30501 7.95
- The "Compulator" Book I.N. 30509 7.95
- Ham Radio Incentive Licensing Guide I.N. 30503 4.95
- Programming Microprocessors I.N. 30508 6.95



- Third Class FCC License Study Guide I.N. 30514 6.95
- First Class FCC License Study Guide I.N. 30542 7.95
- Electronics Data Handbook I.N. 30549 5.95
- Impedance I.N. 30520 5.95
- Basic Digital Electronics I.N. 30527 4.95
- Basic Electronic Problems Solved I.N. 30545 4.95
- Tower's International FET Selector I.N. 30500 6.95
- Second Class FCC Encyclopedia I.N. 30535 7.95
- How to Use AF and RF Signal Generators I.N. 30512 5.95
- Electronics Unraveled I.N. 30531 5.95
- Master Transistor/IC Substitution Handbook I.N. 30510 7.95
- RF and Digital Test Equipment You Can Build I.N. 30521 5.95
- Commercial FCC License Handbook I.N. 30542 7.95
- IC Projects for the Amateur and Experimenter I.N. 30543 5.94
- How to Read Electronic Circuit Diagrams I.N. 30546 6.95



- Getting the Most Out of Your Electronic Calculator I.N. 30528 4.95
- How to Install Everything Electronic I.N. 30552 7.95
- The 2 Meter FM Repeater Circuit Handbook I.N. 30537 6.95
- Modern Applications of Linear IC's I.N. 30530 9.95
- Mobile Radio Handbook I.N. 30534 4.95
- Basic Electricity and Beginning Electronics I.N. 30536 5.95
- Practical Solid State DC Power Supplies I.N. 30515 6.95
- Electronic Conversions, Symbols, and Formulas I.N. 30524 5.95
- Tower's International Transistor Selector I.N. 30507 6.95
- Electronic Test Equipment and How to Use It I.N. 30526 4.95



- Master Handbook of 1001 Practical Electronic Circuits I.N. 30523 9.95
- Master Handbook of Ham Radio Circuits I.N. 30506 8.95
- Complete Short Wave Listeners handbook I.N. 30532 6.95
- Master OP-AMP Applications Handbook I.N. 30505 9.95
- C.E.T. License Handbook I.N. 30513 8.95
- Effective Trouble Shooting with EVM and Scope I.N. 30525 5.95
- Handbook of Electronic Tables I.N. 30548 4.95
- Homebrew HF/VHF Antenna Handbook I.N. 30504 5.95
- How to Be a Ham I.N. 30533 3.95



Radio Amateur Callbook

- Map Library A complete set of maps, prefix world map, great circle chart, map of N. America, and world atlas. I.N. 10005 3.75
- Callbook binders
 - U.S. callbook red I.N. 10054 6.00
 - DX callbook blue I.N. 10055 6.00
 - DX Callbooks I.N. 10001 14.95
 - U.S. Callbooks I.N. 10000 15.95
 - Prefix map of North America I.N. 10004 1.25
 - Zone prefix map of the World I.N. 10022 1.25
 - Great circle chart of the World I.N. 10003 1.25

RSGB Books

- Oscar - Amateur Radio Satellites The comprehensive book on amateur satellites illustrated with pictures and charts I.N. 10059 8.50
- VHF-UHF Manual If you have any interest above 30 MHz, then get this book. It covers everything in this field I.N. 26208 13.95



TRAINING PACKAGES TAPES

Crack the code and ace your exam by studying the new way with our selection of cassettes. Just drop them into a cassette player and study anywhere easily and quickly. You'll have great results.

73 cassettes
Novice Theory Tapes prepare you for the FCC novice exam. Clearly presented material can be reviewed many times I.N. 26306 15.95

- Code Tapes**
- 5 word per min. Blitz Tape I.N. 26308 4.95
 - 6 word per min. Blitz Tape I.N. 26309 4.95
 - 13 word per min. Blitz Tape I.N. 26310 4.95
 - 20 word per min. Blitz Tape I.N. 26311 4.95



Te co Code Practice Tape are guaranteed for life.

- Novice tape I.N. 31461 3.95
- 5 wpm tape I.N. 31450 3.95
- 7 1/2 wpm tape I.N. 31451 3.95
- 10 wpm tape I.N. 31452 3.95
- 13 wpm tape I.N. 31460 3.95
- 15 wpm tape I.N. 31454 3.95
- 17 wpm tape I.N. 31455 3.95
- 20 wpm tape I.N. 31456 3.95
- 22 wpm tape I.N. 31457 3.95
- 25/30 wpm tape I.N. 31458 3.95
- 35/40 wpm tape I.N. 31459 3.95

Ameco Code Tapes

- Junior Code Course #100-T Covers start to 8 wpm I.N. 24819 4.95
- Advanced Code Course #103-T From 8' to 18 wpm I.N. 24821 4.95
- Senior Code Course #101-T Double length covering the Junior and Advanced Courses start to 18 wpm I.N. 24820 8.95
- Extra Class Code Course #104-T Covers from 13 wpm to 22 wpm includes FCC type exam I.N. 24822 4.95
- General Class QSO tapes #105-OT 12, 13, 14, & 15 wpm I.N. 24827 4.95
- Extra Class QSO tape #106OT 19, 20, 21, & 22 wpm I.N. 24826 4.95

Katronics

QSO Code Tapes Covers 7, 10, 13, & 15 wpm Be ready for the new FCC exams! I.N. 28906 4.95

Remember, you can Call Toll Free: 1-800-633-3410 in the U.S.A. or call 1-800-292-8668 in Alabama for our low price quote. Store hours: 9:00 AM til 5:30 PM, Monday thru Friday.

VISA

Long's Electronics

master charge

MAIL ORDERS: P.O. BOX 11347 BIRMINGHAM, AL 35202 • STREET ADDRESS: 2808 7TH AVENUE SOUTH BIRMINGHAM, ALABAMA 35233

1-800-633-3410 TODAY!

CALL LONG'S TOLL FREE



MFJ-962 Versa Tuner III

1.5 KW PEP, will match everything from 1.8 thru 30 MHz, coax, balanced line, random wire, built-in balun, SWR, dual range forward and reflected power meter and flexible 6 position switch.

159.95 List. Call for quote.



MFJ-752 dual tunable SSB/CW filter

Now you can zero in SSB/CW signals and notch out the interfering signal at the same time. The primary filter lets you peak, notch, lowpass, or highpass signals. Works with any rig, switchable noise limiter, power requirements 110 VAC or 9-18 VDC.

79.95 Call today.

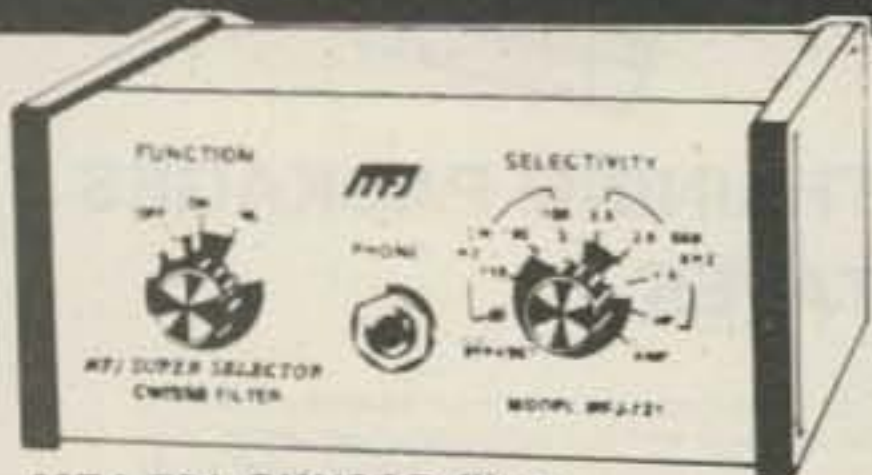

MFJ-721 CW/SSB filter

Featuring: selectable bandwidth, 8 pole active filter, switchable automatic noise limiter, plugs into phone jack, 2 watts for speaker, simulated stereo reception, inputs for 2 rigs, speaker and phone jacks, aux. 2W amplifier, 20 dB gain, 80 Hz bandwidth, requires 9-18 VDC, 300 ma. max.

59.95 Call today.



MFJ-8044 IC deluxe keyer

Sends iambic, automatic, semi-automatic, or manual Dot and dash memories, totally RF proof, solid state keying, front panel controls, weight control, tone control, function switch, 3 conductor "X" phone jack for key, phono jacks for keying outputs. Squeeze key optional.

69.95 Call today.



MFJ-941B Versa Tuner II

Features: SWR and dual range wattmeter, antenna switch, built-in balun, 300W RF output. Matches everything from 1.8 thru 30 MHz, uses 1 antenna, increases the usable bandwidth, has SO-239 connectors.

79.95 Call today.

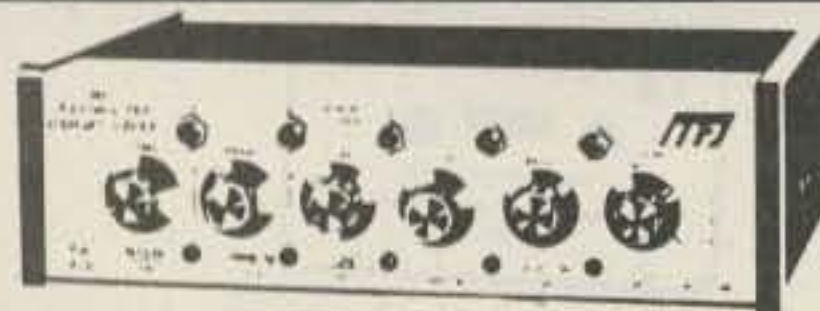

MFJ-484 Grandmaster memory keyer

Featuring: speed control, 4 LEDs to show memory in use, record and playback, iambic operation, dot-dash memories, repeat messages with pauses, built-in memory saver, weight control, tone control, tune function, solid state keying, uses 110 VAC or 12-15 VDC. Automatically switches to external batteries when AC power is lost.

139.95 List. Call for quote.



MFJ-901 Versa tuner

Featuring: efficient 12 position air inductor for more watts out! 200 watts RF, 1.4 balun built-in and has SO-239 connectors.

49.95 Call today.

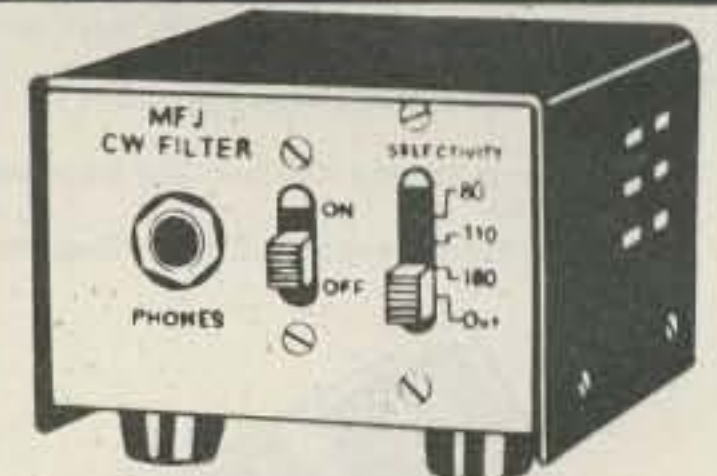

MFJ CWF-2BX super CW filter

This unit features an 8 pole filter, an 80 Hz bandwidth, a selectable bandwidth, center frequency 750 Hz. Requires 9 volt battery 2" x 3" x 4". Compact, light weight unit.

29.95 Call today.

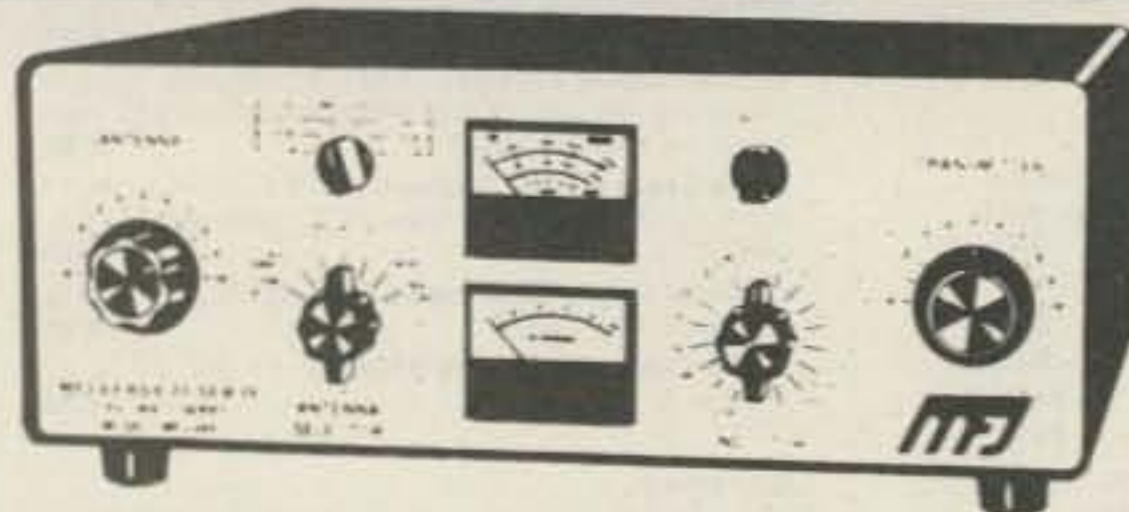

MFJ-984 Deluxe Versa Tuner IV

The ultimate antenna tuner. Now you can match anything, from 1.8 to 30 MHz; coax, balanced line and random wire. This tuner has 3 KW PEP, SWR, forward-reflected watt-meter, RF ammeter, dummy load, antenna switch, and built-in balun.

299.95 List. Call for quote.



MFJ-981 Versa Tuner IV

3 KW PEP, matches everything from 1.8 thru 30 MHz, coax, balanced lines, and random wires. It has a built-in balun, SWR, dual range forward and reflected power meter.

199.95 List. Call for quote.

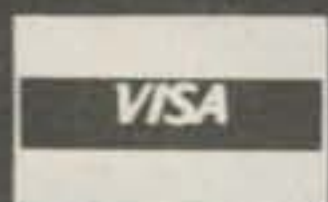

Long's Electronics



MAIL ORDERS: P.O. BOX 11347 BIRMINGHAM, AL 35202 • STREET ADDRESS: 2808 7TH AVENUE SOUTH BIRMINGHAM, ALABAMA 35233

CALL LONG'S TODAY!

1-800-633-3410 TOLL FREE

BENCHER BY-1 iambic paddle

The Ultimate iambic paddle. Features solid silver contact points, full range adjustment, non-skid feet and heavy steel black textured base.

39.95 Call today.



B&W 595 coax switch

Features: 6 outputs, a power rating of 2 KW PEP, VSWR of less than 1.2:1 up to 150 MHz, grounds all unused antennas.

21.50 Call today.



B&W 593 3 position coax switch

This switch features: 3 outputs, a power rating of 2 KW PEP, VSWR of less than 1.2:1 up to 150 MHz, & grounds all unused antennas.

17.50 Call today.



NYE VIKING "Master Key" 114-330-001

The "master key" is the first major improvement in telegraph key design in 50 years! Contact assembly is isolated from base, greatly reducing shock hazard. Heavy die-cast body eliminates "walking". Gold-plated silver contacts. Complete with Navy knob and two conductor cords with 1/4" key plug.

19.50 Call today.

BENCHER BY-2 iambic paddle

The BY-2 has all the features of the BY-1 but comes with chrome base.

49.95 Call today.



LARSEN LM-150 antenna

The famous 49" quadruple plated stainless steel rod with high efficiency, 1/2 wave length, 3 dB gain, freq. range 144-174 MHz. Comes with Allen wrench and cutting chart. LM-Q 1/4 wave antenna also available 2.65.

23.85 Call today.



Larsen Antennas



Mount your antenna one of 4 ways!

LM-TLM	trunk lid mount	14.60
LM-MM	magnetic mount	14.60
LM-GC	gutter clamp	14.60
LM-K	roof top mount	6.95

All units come with 17' RG A/U coax cable. Call today.

DENTRON Big Dummy load



Now you can tune-up off the air with the Big Dummy! A full power dummy load, it has a flat SWR, full frequency coverage from 1.8 to 300 MHz and a high grade of industrial cooling oil furnished with the unit. Fully assembled. Cut out the QRM factor now!

29.50 Call today!



YAESU QTR-24 world clock

A great addition to your ham shack! Now you can tell world time at a glance. It is battery powered and automatically retains the correct time.

35.00 Call today!

CALL NOW!

HY-GAIN HB-MAG 287 Hy-bander foldover antenna

A magnetic mount antenna with the unique fold over for mounting on hatchback cars. 1/2 wave, ratchet foldover adjusts through a 180 degree arc and hold its position at speed up to 120 mph. Less than 1.4:1 VSWR, 144-148 MHz, power rated to 150W, 3 dB gain, DC grounded.

19.95 Call today!

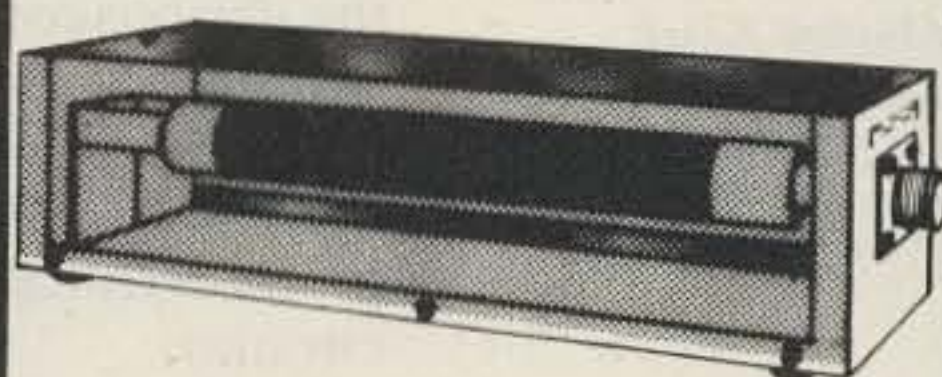

DRAKE Dummy loads

DL-1000 air cooled dummy load. Power rating 1000 watts. SWR: 1.5:1 max., 0-30 MHz, SO-239 connectors. Expanded rating limitation when used with the FA-7 cooling fan. Also available: DL-300 dummy load 19.95.

39.95 Call today.

TELEX CM-1320 headset

"Top of the line" with a boom microphone-ceramic, high impedance. The choice of DX-peditors.

75.25 Call today.



TELEX CM-1320S headset

The CM-1320S has all the fine features of the CM-1320 but with single ear piece. Order yours today.

59.95 Call today.



ORDER TODAY!

DRAKE TVI filters

TV-3300-LP low pass filter Attenuation: better than 80 dB above 41 MHz, 2000W PEP, SO-239 connectors **26.60**

TV-5200-LP low pass filter with 200W on 6 meters, 1000W below 30 MHz SO-239 connectors **26.60**

TV-300-HP high pass filter Attenuation: 40 dB at 52 MHz and lower. For use with 300 ohm twin lead **10.60**

TV-42-LP low pass filter with 4 sections, 43.2 MC cut-off and high attenuation in all TV channels for transmitters operating at 30 MHz and lower. Rated at 100W input. **14.60**

Call today.

ORDER NOW!

SHURE 444 desk mic

Has PTT switch, adjustable head. Freq. 300 to 3000 Hz. Omnidirectional with controlled magnetic mic element for SSB, High impedance: 50K ohms.

64.50 Call for quote.



Long's Electronics



The Tri-Polarized VHC Antenna

— should be a killer for VHF

Vertical, horizontal, circular.

D. Mitchell K8UR
13356 Wabash
Milan MI 48160

This article is about an easy way to achieve the various modes of polarization from a single antenna system, the VHC antenna. VHC—V for vertical, H for horizontal, and C for circular.

The attempts of antennas in amateur use to achieve the different modes were either expensive (multiple arrays and multiple dollars) or exclusive to a particular mode. This ultimately re-

sulted in the purchase of many identical antennas to hang off the tower for vertical, horizontal, or a combination of the two to achieve circular polarization.

The antenna I am about to describe is a single antenna to be used for all modes of polarization—vertical, horizontal, and circular. All of these polarizations are becoming more common due to the amateurs' diverse interests: VHF-FM, SSB, and OSCAR. Why use one array for FM, another for SSB, and another yet for OSCAR when on the VHF bands?

The VHC antenna idea came to mind while I was operating on 80 meters, actually. I often found it advisable to use a particular mode of polarization for DX work there which was dependent upon conditions on a particular night or even the particular part of the opening. Vertical

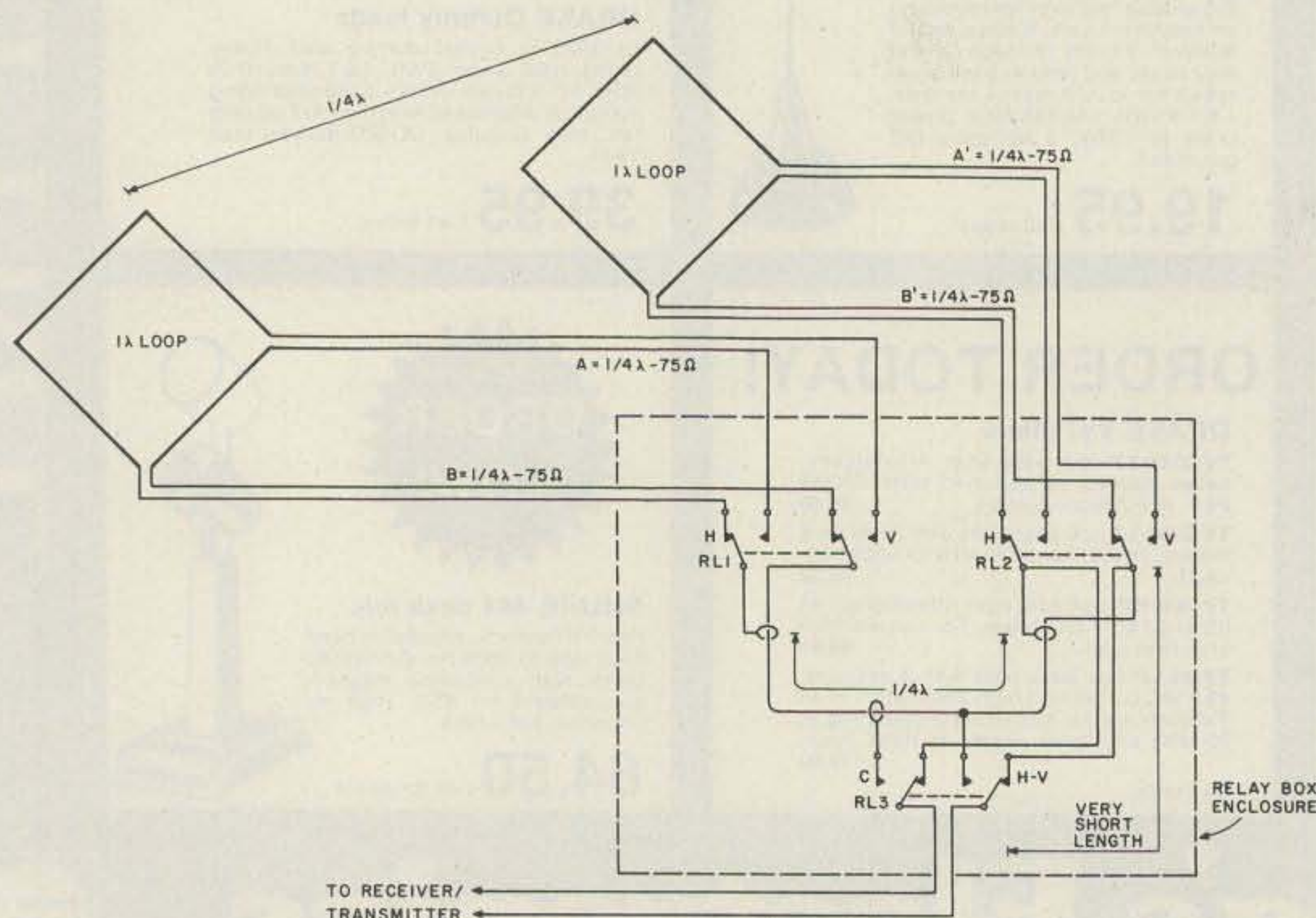

Fig. 1. VHC antenna.

A Breakthrough In Technology!

MICROPROCESSOR CONTROLLED SYNTHESIZED HANDIE

FT-207R



144-148 MHz Range
3 Watts Output

Memory and
Band Auto Scan

Automatic Battery Saver
Feature for LED Display

Priority Channel

Rubber Flex Antenna

BNC Antenna
Connector

Clear/Busy Auto
Scan Selector

Repeater/Simplex
Offset Switch

Squelch Control

Audio Gain
Control

Remote
Speaker/Mike
Input

Condensor Mike

Channel
Busy Lamp

Transmit
Indicator

5-Digit LED
Readout

Keyboard Encoded
Frequency Entry

Keyboard Lock
guards against
accidental frequency
change

Display
On/Off

5 KHz Up

- Optional Equipment:
Tone Squelch, Speaker/Mike, Nicads, Battery Charger

*The Yaesu FT-207R Synthesized Handie
has all the features you could want in a very compact package*

✓ T44

TOWER ELECTRONICS

24001 Alicia Pky., Mission Viejo, CA 92691
(714) 768-8900

"The Southwest's full-line Yaesu Distributor"

Go with the Leader!

The Clegg FM-28 is the
value leader in 2 meter
FM Transceivers.

**CHECK THE FEATURES AND YOU'LL KNOW
WHY.**

- ✓ Fully synthesized
- ✓ 144-148 MHz Coverage
- ✓ 25 Watt Transmitter (1w low power)
- ✓ Provisions for non-standard offsets
- ✓ One Year Warranty
- ✓ 800 Channel Scanner Option available
- ✓ Only \$295.00 (\$395.00 with scanner option) complete with microphone, mobile mount, etc.



CLEGG FM-28
(Shown with scanner option)

Order yours today and ...
Go with the leader.

Clegg Communications Corp.

1911 Olde Homestead Lane
Greenfield Industrial Park East
Lancaster, PA 17601
(717) 299-7221

*Scanner kit available to
modify earlier model
FM-28's. Call or write for
detailed brochure.

✓ C3

For once in your life...live.

A sleek graceful sailing vessel glides across the sometimes green, sometimes blue Caribbean. The cargo: you. And an intimate group of lively, fun-loving shipmates.

Uniform of the day: Shorts and tee shirts. Or your bikini if you want. And bare feet.

Mission: A leisurely cruise to remote islands with names like Martinique, Grenada, Antigua—those are the ones you've heard of. Before the cruise ends, you'll



know the names of many more. You'll know intimately the enchanting different mood of each...and its own beauty and charm.



Life aboard your big sailing yacht is informal. Relaxed. Romantic.

There's good food. And 'grog'. And a few pleasant comforts... but any resemblance to a plush pretentious resort hotel is accidental.

Spend 6 days exploring paradise.

Spend six nights watching the moon rise and getting to know interesting people. It could be the most meaningful experience of your life...and it's easily the best vacation you've had.



A cruise is forming now. Your share from \$290. Write Cap'n Mike for your free adventure booklet in full color.

Come on and live.



Windjammer Cruises.

✓ W10

Name _____

Address _____

City _____ State _____ Zip _____

Phone _____

P.O. Box 122, Dept. 622 Miami Beach, FL 33139

polarization proved superior on some occasions, while horizontal polarization would prove better on others.

While the problems encountered on 80 meters may not be thought of in the same light for the VHF frequencies, it is still useful insight, as the VHC antenna did first come from thinking of 80 meter antennas.

The difference between the 80 meter and VHF philosophy is that, on 80, it is not the actual polarization that is important, but the angle of transmitted or received radiation. It is often found that a low angle of radiation on 80 makes for a good DX antenna, but there are times when a horizontal antenna outperforms the low-angle vertical antennas that are often used. The many variations in antenna height and radiation angles of antennas, mixed with the ionosphere height, distance to the DX station, and his antenna system, are too complex for the human mind, and I will not attempt to share my ignorance of the matter with you. But I will tell you of an antenna to try.

The 80 meter version of the VHC antenna appears in Fig. 1. The basic premise is that by feeding the loop antenna at the bottom or top, horizontal polarization results. By feeding the loop at either side, vertical polarization results. And, as stated earlier, I feel it is not the polarization that counts here, but rather the lower angle of radiation achieved by the vertical polarization.

The orientation of the full-wave loop can be either square or diamond or circular. The version that is in use at K8UR is of the diamond variety so that only one support is required.

The idea of the 1/4-wave sections marked A and B is as follows. When feeding A, B (being an open-ended 1/4 wavelength) appears shorted at the antenna connection and does not come into play. When feeding B, the 1/4 wavelength of A does not come into play. Both elements are identical and the only thing that must be emphasized is that when either A or B length is left unconnected directly to the feedline, neither side of the coax center conductor or shield should be attached to the switchbox in any way. DPDT relays are highly recommended so that the builder does not have problems with the end of the 1/4-wave sections of A and B not appearing as a short at the antenna end.

The switchbox containing the DPDT relays should have the SO-239s insulated from the container and tower, if mounted on one. Regular 4-lead rotor cable is used at K8UR to supply the switching voltages to the relays.

A logical way to switch the correct combination of antenna elements into play is shown in Fig. 2. The switching matrix uses diodes large enough for the relays chosen. The diodes can be mounted on the back of the relay voltage select switch that most likely will be in the power supply for the relays, convenient to the operating position.

All lengths of coax used are 1/4-wavelength, with the exception being the length between RL1 and RL2, where it is actually two 1/8-wave pieces intersecting at RL3 and connected to RL3. When installing the loops, care must be taken to keep the center conductors of A and A' going to the same side of their loops, respectively. The same is true for B and B'. If you follow Fig. 1 carefully, you should come out OK. The length of coax from

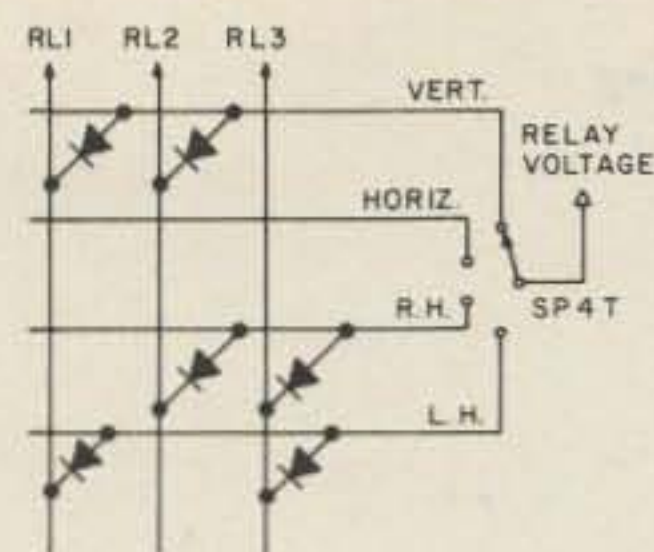

	RL1	RL2	RL3
Vertical polarization	On	On	Off
Horizontal polarization	Off	Off	Off
Right-hand circular	Off	On	On
Left-hand circular	On	Off	On

Fig. 2. Relays.

the antenna relay box to the transmitter is of any length.

The ability to switch instantly from vertical to horizontal or circular has taken the guesswork out of which antenna or polarization is best at any particular moment. The antenna used on 80 meters does not include the circular feature, but it is worth the effort with vertical and horizontal modes alone.

Two meters should be the ideal frequency for the VHC antenna, with SSB using horizontal, FM using vertical, and OSCAR using circular. The addition of parasitic directors and reflectors also has possibilities for the VHC. For the 80 meter band, where two elements alone are already large, it can be easily made to reverse directions by feeding RL1 first instead of RL2, as shown in Fig. 1. ■

TELREX "Tri-Band" — \$415.00

ELECTRICAL

Gain in DB reference 1/2 wave dipole
Front to back ratio
V/S/W/R at resonant point
Maximum Power Input
Nominal Input Impedance
Beamwidth to 1/2 power Input
Frequency range
Side Nulls

TB5EM

8.5 dbd
28 db
1.3/1
4 KWP
52 ohm
60° 3 bands
10, 15, 20
35 db

MECHANICAL

Number of Elements
Alum. Boom: Dia. & Lgth. approx.
Turning Radius approx.
Wind Load at 100 mph (approx.)
Wind Area
Longest Element
Net Weight (approx.)
Shipping weight (domestic pack)
Length of shipping carton

Five
2.2.5"x18 ft.
20 ft.
210 lbs.
7 sq. ft.
36 ft.
49 lbs.
60 lbs.
13 ft.

MADISON ELECTRONICS SUPPLY, INC.

1508 McKINNEY • HOUSTON, TEXAS 77002
713/658-0268

W5GJ, W5MBB, K5AAD, N5JJ, AG5K, W5VVM, W5EGP, WA5TGU, WB5AYF, K5BGB.

MASTERCHARGE • VISA

DLA!

The One-Note Pipe Organ

— CW never sounded sweeter

The latest from Rathole 857.

It is springtime. Today is the sixth of May, 1978. It is snowing outside and it is Saturday. So, why am I pushing typewriter keys instead of pushing a straight key down and pulling it back up? Because the spring winds blew all day yesterday, and besides wrecking the chicken house and blowing down branches and trees, it also blew down my entire antenna farm and broke up all the wooden slabs and

scraps that held all those wires up in the air.

Mr. Hawkins runs a sawmill just a couple of miles down the road and he lets me have all the slabs and scraps I want. I have burned many tons of them in my heater, besides building the woodshed, the chicken house, and the antenna supports. But, it's snowing, and I don't really want to go scrounge slabs in a snowstorm. So, that's why I'm writing about

radio instead of doing radio.

A few days ago, I noticed an ad for a special speaker for CW. It shapes the tones or muffles the off frequencies or something like that—there is even a graph full of decibels to show what it does. Aha! A really new idea. There is "something new under the sun." Nobody ever thought of this before. Maybe I'll buy one of these instead of an active audio filter.

Browsing in my pile of old radio magazines... (Don't get the idea I got all these magazines by subscription. I just recently got my ticket and more recently began to subscribe to 73. I got most of them at hamfests and from the Lockheed Radio Club for 20¢ apiece.²)

Well, well. Lookie here! Here's something along the same line, and twenty-six years earlier! (QST, Sept.,

'52, p. 66.) The half page of text gives two versions of a sort of one-note pipe organ, attributed to the R.S.G.B.³

I have a Tech ticket (WB7CMZ) but my house is behind a hill and under the power lines, so I cannot key up the "local" repeater (fifty miles away). All I really have is a sort of five-year Novice license. (These days, I could've gotten that⁴ anyway, without losing a day's wages and traveling five hundred miles to get it, but that was the best I could do this past winter.) "See Double You" is all I get to do. My antique Hallicrafters SX-28 is not really selective enough to suit me. The device interested me, so I built my own version of it. Here's how (dimensions are not critical, and there are probably 347 different ways to build this gadget successfully):

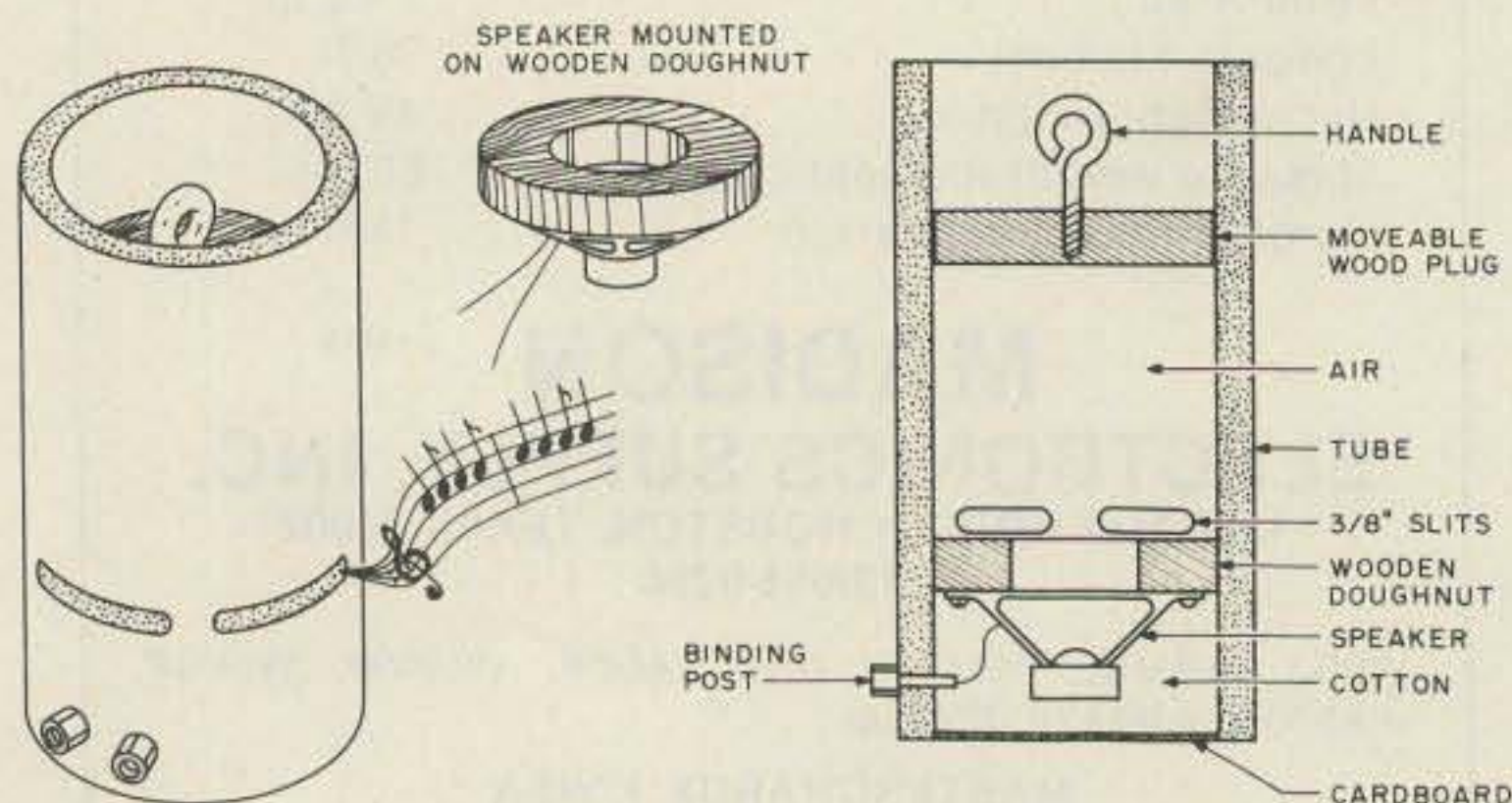

Fig. 1. Diagram and drawings of "One-Note Organ."

CALL TOLL FREE

1-800-228-4097
Communications Center

443 N 48th Street
 Lincoln, Nebraska 68504
 In Nebraska Call (402)466-8402

✓ C58

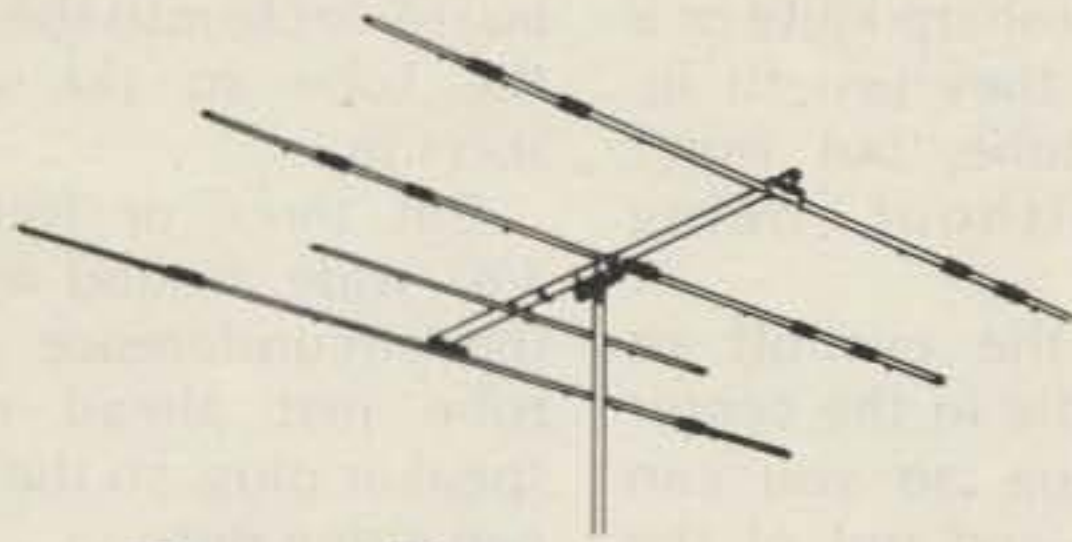

Antenna Sale!

HY-GAIN

		Regular	Special			Regular	Special
TH6DXX	Super Thunderbird	\$299.95	\$239.95	18HT	Hy-Tower 80-10M vertical	299.95	239.95
TH3MK3	3 el. 10-15-20M beam	229.95	179.95	18AVT/WB	80-10M Trap vertical	99.95	79.95
TH3JR	3 el. 10-15-20M beam	149.95	129.95	14AVQ/WB	40-10M Trap vertical	69.95	57.00
Hy-Quad	2 el. 10-15-20M Quad	229.95	179.95	12AVQ	20-10M Trap Vertical	39.95	32.95
205BA	5 el. "Long John" 20M beam	289.95	229.95	14RMQ	Roof Mounting kit (verticals)	33.95	29.95
155BA	5 el. "Long John" 15M beam	169.95	139.95	5BDQ	80-10M Trap doublet	89.95	69.95
105BA	5 el. "Long John" 10M beam	119.95	99.95	2BDQ	80-40M Trap doublet	49.95	39.95
204BA	4 el. 20M beam	219.95	179.95	66B	6 el. 6M beam	119.95	99.95
204MK5	5 el. conversion kit	99.95	79.95	203	3 el. 2M beam	15.95	
153BA	3 el. 15M beam	79.95	69.95	205	5 el. 2M beam	17.95	
103BA	3 el. 10M beam	54.95	44.95	208	8 el. 2M beam	25.95	
402BA	2 el. 40M beam	209.95	169.95	214	14 el. 2M beam	31.95	
BN-86	Balun for beam antennas	15.95	15.95	LA-1	Deluxe lightning arrestor	59.95	49.95
TH2MK3	2 el. 10-15-20M beam	149.95	119.95				

MOSLEY

		Regular	Special
Classic 33	3 el. 10, 15, 20 Mtr. beam	304.75	209.95
Classic 36	6 el. 10, 15, 20 Mtr. beam	392.75	269.95
TA-33	3 el. 10, 15, 20 Mtr. beam	264.00	189.95
TA-36	6 el. 10, 15, 20 Mtr. beam	392.75	269.95
TA-33 Jr.	3 el. 10, 15, 20 Mtr. beam	197.00	149.95
TA-40KR	40 Mtr. Add On	119.95	89.95

CUSHCRAFT

ATB-34	4 ele. 10, 15, 20 Mtr. beam	289.95	219.95	A147-11	11 ele. 146-148 Mhz. beam	36.95	30.95
ATV-4	10, 15, 20, 40 Mtr. Vertical	89.95	69.95	A147-22	22 ele. Power Pack	109.95	89.95
ATV-5	10, 15, 20, 40, 80 Mtr. Vertical	109.95	89.95	A144-10T	2 Mtr. "Twist" 10 ele.	42.95	34.95
ARX-2	2 Mtr. Ringo Ranger	39.95	32.95	A144-20T	2 Mtr. "Twist" 20 ele.	62.95	52.95
AR-6	6 Mtr. Ringo	36.95	32.95	A147-20T	2 Mtr. beam	62.95	52.95
ARX-220	220 Mhz. Ringo Ranger	39.95	32.95	A430-11	432 Mhz. 11 ele. beam	34.95	29.95
ARX-450	435 Mhz. Ringo Ranger	39.95	32.95	A432-20T	430-436 Mhz. Beam	59.95	49.95
A144-11	11 ele. 144-146 Mhz. beam	36.95	30.95				

HUSTLER

3-TBA	3 ele; 10, 15, 20 Mtr. beam	259.95	189.95
4-BTV	10-40 Mtr. Vertical	99.95	79.95
5-BTV	10-80 Mtr. Vertical	134.95	99.95
RM-75	75 Meter Resonator	16.95	14.50
RM-75S	75 Meter Super Resonator	31.95	27.50
G6-144B	2 Mtr. Base Colinear	79.95	59.95
G7-144	2 Mtr. Base Colinear	119.95	89.95

WILSON

System One	5 ele. 10, 15, 20, Mtr. Beam	\$299.95	\$239.95
System Two	4 ele. 10, 15, 20 Mtr. Beam	249.95	199.95
System Three	3 ele. 10, 15, 20 Mtr. Beam	199.95	159.95
WV-1	10-40 Mtr. Vertical	79.95	69.95

TAYLOR

HQ 1040AV	10-40 Mtr. Trap vertical	59.95	49.95
-----------	--------------------------	-------	-------

ROTORS

HamIII \$125.00 T2X Tailtwister \$199.95 Alliance HD 73 \$109.95

Call for prices on rotor cable, Coax, Towers, and Accessories. All prices do not include shipping.

We carry all major brands of ham radios AT DISCOUNT PRICES

Yaesu — Kenwood — Drake — ICOM — Dentron —
 Ten-Tec — Swan — Tempo — Midland — E.T.O. — Wilson



First, cut two round plugs of wood a little bigger than the inside of the mailing tube. Trim them with a very sharp knife or a rasp until they just fit inside the tube, but won't move without being pushed.

Mount the eyebolt or other handle in the center of one plug, so you can slide it in and out of the tube. You may tune the "organ" by changing the length of the resonant column of air.

Make a two-inch hole in the middle of the other plug and mount the speaker on it. Now is a good time to solder the wires onto your speaker. It will be very inconvenient later. This is the voice of experience. Glue this assembly three inches into one end of the tube. See Fig. 1. Mount the binding posts in the tube wall and solder the wires in place. Fill up the space behind the

speaker with the cotton. Don't stuff it in so tight that the speaker cone cannot vibrate. Glue the cardboard circle into the end of the tube so the cotton stays in.

Cut three or four slits 3/8" wide around most of the circumference of the tube just ahead of the speaker plug, so the sound can come out.

Slather plenty of glue on all the cut edges of the cardboard to reinforce it.

Push the movable plug into the open end of the tube. Hook the binding posts up to your receiver speaker terminals with flexible wire. Adjust the movable plug to resonate the speaker to the CW note you like best, or to the note your receiver produces loudest, and enjoy a purer cleaner note, with less buzz, hum, pop, grind, and QRM. And you did it almost for free, in one evening.⁵ ■

Parts List

Wooden fruit-lug end (or equivalent)
4"-diameter cardboard mailing tube (or equivalent)
3" speaker (or equivalent)—one that will fit inside the mailing tube
Handful of cotton (or equivalent)
4" circle of corrugated cardboard (or equivalent)
2 binding posts—optional
Hookup wire
Eye-bolt, screw-eye, or other finger handle

References

1. Ecclesiastes 1:9 and 10.
2. 2814 Empire Avenue, Burbank CA 91514.
3. Radio Society of Great Britain.
4. Recent FCC change makes Novice license renewable.
5. Unless you used epoxy glue. It hardens overnight.

Other Notes

1. If you don't happen to have a mailing tube, I suppose you could use plastic or metal pipe, tin cans, or a square wooden tube.

2. If you don't have a speaker that fits inside your tube, put the speaker in a separate box 3/8" away from the tube. If you're a sharp tinkerer, you can think of a way to make do with what you have.

3. If you don't like the looks of it when you get finished, it will work just as well painted, wallpapered, or with a lampshade.

4. I took a picture of this thing, but it just looks like two feet of mailing tube with slits and binding posts. (You can cut it shorter if you don't like low notes.)

5. If you pull out the plug entirely, the whole thing turns back into just a funny-looking speaker for listening to SSB or AM.

6. If you don't have binding posts, send me a quarter and an SASE to Glenn's Trading Post, Rathole 857, Poverty Flat, Eagar AZ 85925. I'll send you a pair you'll like.

ALL-MODE VHF amplifiers

FOR BASE STATION & REPEATER USE

MODEL: V350

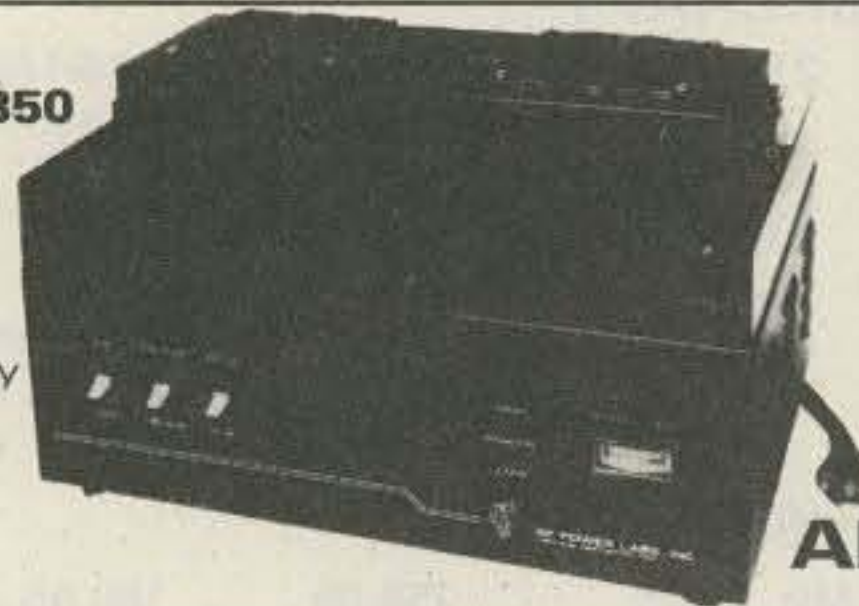

- ☆ Built-in 115/230 VAC Supply
- ☆ AM-FM-CW-SSB-RTTY
- ☆ 60dB Harmonics
- ☆ 60dB Spurious
- ☆ Heavy Duty Design

MODEL: V180

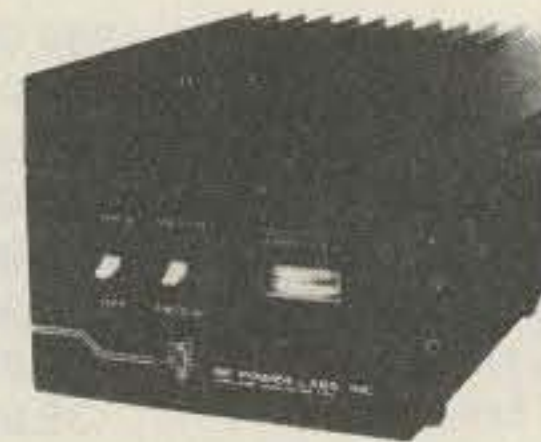

- ☆ Illuminated Panel Meter
- ☆ Automatic T/R Switching
- ☆ VSWR Protected
- ☆ +13V/3A Accessory Socket
- ☆ U.S. Manufactured

All Solid-State!

MODEL	FREQUENCY	INPUT	OUTPUT	SIZE WxDxH	WEIGHT	FAN KIT REQUIRED	PRICE
**V76	50-52MHz	8-15W	100-120W	216x330x178mm	11.7 kg (26 lbs)	No	\$339.00
**V360	50-52MHz	5-10W	400-450W	432x330x178mm	23.4 kg (52 lbs)	Yes	\$895.00
V70	144-148MHz	10-15W	75-90W	216x330x178mm	11.7 kg (26 lbs)	No	\$315.00
V71	144-148MHz	1-3W	75-90W	216x330x178mm	11.7 kg (26 lbs)	No	\$349.00
V180	144-148MHz	5-15W	170-200W	216x330x178mm	13.5 kg (30 lbs)	CW & FM	\$539.00
V350	144-148MHz	10-20W	350-400W	432x330x178mm	23.4 kg (52 lbs)	Yes	\$895.00
V130B	220-225MHz	10-15W	70-85W	216x330x178mm	11.7 kg (26 lbs)	No	\$329.00
V135B	220-225MHz	25-35W	140-160W	216x330x178mm	11.7 kg (26 lbs)	CW & FM	\$469.00
F110		Fan Kit, 115VAC		135x135x50mm	1 kg (2.2 lbs)	—	\$ 33.00
F220		Fan Kit, 230VAC		135x135x50mm	1 kg (2.2 lbs)	—	\$ 33.00
*F135		Fan Kit, 115VAC		381x140x89mm	3.2 kg (7 lbs)	—	\$ 59.00
*F235		Fan Kit, 230VAC		381x140x89mm	3.2 kg (7 lbs)	—	\$ 59.00
RM-1		19 Inch Rack Adaptor		483x3x178mm	1 kg (2.2 lbs)	—	\$ 25.00
*RM-2		19 Inch Rack Adaptor		197x32x28mm	.5 kg (1.1 lbs)	—	\$ 12.00

*Used with the V360 & V350 Amplifiers / **For Export Only / Other Frequencies Available on Request

Dealer Inquiries Invited

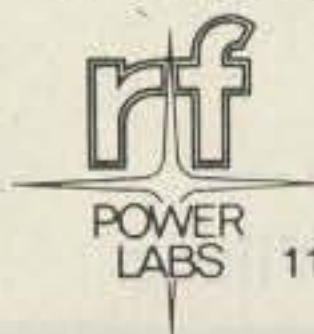

RF POWER LABS, INC.

✓R27



11013-118th Place N.E. • Kirkland, Washington 98033 Telephone: (206) 822-1251 • TELEX No. 32-1042

- Special Saturday night activities
- Swap shop inside and out
- ARRL talks and topics
- Forums and meetings
- Commercial exhibits
- Hourly prizes
- Major awards

Now in its 14th year
September 7, 8 and 9, 1979

MELBOURNE HAMFEST

Meet us at the air-conditioned Melbourne auditorium. Hamfest headquarters at the Ramada Inn, US1. Talk-in on 25/85. Tickets are \$3.50 per person.

For full information contact:
Platinum Coast Amateur Radio Society
PO Box 1004
Melbourne FL 32901

1-805-485-0942

VINEYARD AMATEUR RADIO

We sell Ten-Tec, Alda, SST, Wilson, Lunar, Mirage, and many others for less.



★ INTRODUCING ★

The RM-101 and TS-820 rcvr mod kit

Improves overload, crossmod, and sensitivity (noise fig.)

BEST OF ALL, the kit sells for \$14.95 (half of the cost of other kits)

Drop us a card or call for our low prices

VAR Vineyard Amateur Radio
4407 Vineyard Rd. 
✓ V75 Oxnard, CA 93030 

SCANNERS * SCANNERS * SCANNERS

YOU'VE SEEN THE REST, NOW BUY THE BEST

HAM SCAN-2

Kenwood 7400A, KDK 2015R, KDK 2016A, Pace Comm II, Midland 13-510, HW-2036, others

- Features one channel of memory, without need of resetting dials to zeros as required by others.
- Unit mounts totally inside of rig, no external boxes.
- Scanning rate 200 kHz nom, not 50 kHz, with a 3 second pause on all active channels before resuming scan.
- Mike-mounted switch provides 3 functions: scan start/stop, remote frequency incrementing, and transmit interlocking when in active scan mode.
- Totally assembled and tested \$59.95 \$1.50 shp.

Order HAM SCAN-2 and please specify type of rig

Technical Clinic

P.O. BOX 636
STERLING HTS. MI 48078 ✓ T64
Phone Orders Call: (313) 286-4836

ALL BAND TRAP ANTENNAS!



PRE-TUNED - COMPLETELY ASSEMBLED - ONLY ONE NEAT SMALL ANTENNA FOR UP TO 6 BANDS! EXCELLENT FOR CONGESTED HOUSING AREAS - APARTMENTS LIGHT - STRONG - ALMOST INVISIBLE!

FOR ALL MAKES & MODELS OF AMATEUR TRANSCEIVERS - TRANSMITTERS - GUARANTEED FOR 2000 WATTS SSB 1000 WATTS CW. FOR NOVICE AND ALL CLASS AMATEURS!

COMPLETE AS SHOWN with 90 ft. RG58U-52 ohm feedline, and PL259 connector, insulators, 30 ft. 300 lb. test dacron end supports, center connector with built in lightning arrester and static discharge - molded, sealed, weatherproof, resonant traps 1"X6" - you just switch to band desired for excellent worldwide operation - transmitting and receiving! WT. LESS THAN 5 LBS.

160-80-40-20-15-10 bands 2 trap-- with 90 ft. RG58U - connector - Model 777BU . . . \$59.95
80-40-20-15-10 bands 2 trap --- 102 ft. with 90 ft. RG58U - connector - Model 998BU . . . \$54.95
40-20-15-10 bands 2 trap --- 54ft. with 90 ft. RG58U coax - connector - Model 1001BU . . . \$53.95
20-15-10 bands 2 trap --- 26 ft. with 90 ft. RG58U coax - connector - Model 1007BU . . . \$52.95

SEND FULL PRICE FOR POST PAID INSURED DEL. IN USA. (Canada is \$5.00 extra for postage - clerical - customs - etc.) or order using VISA Bank Americard - MASTER CHARGE - AMER. EXPRESS. Give number and ex. date. Ph 1-308-236-5333 9AM - 6PM week days. We ship in 2-3 days. PRICES MAY INCREASE SO - ORDER NOW AND SAVE! All antennas guaranteed for 1 year. Money back trial! Made in USA. FREE INFO. AVAILABLE ONLY FROM.

WESTERN ELECTRONICS

Dept. A7-8

Kearney, Nebraska, 68847

DOVETRON



MPC-1000C

Multipath Correction
In-Band Diversity &
AFSK Tone Keyer

Amateur Net: \$545.00

Standard features include CONTINUOUSLY tuneable Mark and Space channels (1000 Hz to 3200 Hz), Dual Mode (MARK or FSK) Autostart and internal high level neutral loop keyer (20 to 60 ml). Both EIA and MIL FSK outputs are provided for direct interface to microprocessor and video terminal peripherals.



MPC-1000CR

Signal Regeneration &
Speed Conversion

Amateur Net: \$645.00

A front panel switch permits internal TSR-200 Signal Regenerator-Speed converter assembly to electronically "gear-shift" between 60, 67, 75 and 100 WPM. All incoming and outgoing signals are regenerated to less than 0.5% bias distortion. Also available with DIGITAL Autostart (TSR-200D): Amateur Net: \$695.00

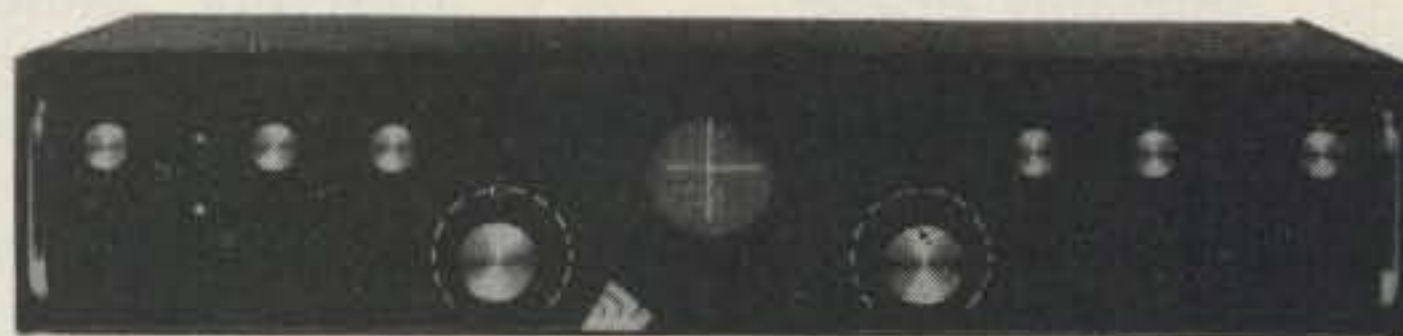

MPC-1000R/ TSR-500

Dual UART Regeneration,
Speed Conversion, 200
Char. Memory, Word Cor-
rection & DIGITAL
Autostart

Amateur Net: \$895.00*

The MPC-1000R/TSR-500 provides Preloading and Recirculation of the 200 character FIFO Memory, a keyboard-controlled Word Correction circuit, Variable Character Rate, Tee Dee Inhibit, Blank/LTRS Diddle, a Triple Tone-Pair AFSK Tone Keyer and a Character Recognition/Speed Determination DIGITAL (DAS-100) Autostart mode.

*The MPC-1000R is also available without a TSR assembly and functions as a MPC-1000C with a Triple Tone-Pair AFSK Tone Keyer. This "Basic-R" permits future expansion with a TSR-100, TSR-200, TSR-200D or TSR-500 by simply lifting the lid and plugging in the appropriate TSR assembly: Amateur Net (Basic-R): \$595.00

Your QSL will bring complete specifications, or call: 213-682-3705.

✓ D23

DOVETRON

627 FREMONT AVENUE
(P. O. BOX 267)
SOUTH PASADENA, CA. 91030

A Better Heathkit "Cantenna"

— improved metering circuit for an old standby

Update your dummy load.

The Heathkit® "Cantenna" dummy load, Model HN-31, consists of a fifty-Ohm dummy load resistor, R1, immersed in oil, and an indicating circuit consisting of resistors R2 and R3, capacitor C1, and diode D1. Fig. 1 shows the schematic diagram.

The indicating circuit provides for connection of a direct current meter to the jack marked DC OUT. This arrangement provides

a means of indicating relative power.

With the circuit shown in Fig. 1, an amount of power at 3.5 MHz applied to the dummy load will produce a certain meter deflection. If the same amount of power is applied to the dummy load at 29.7 MHz, the meter deflection will be considerably greater.

By modifying the indicator circuit to that

shown in Fig. 2, the indicating meter can be made to read the same value for a given amount of power whether it be at 3.5 MHz, 29.7 MHz, or at any frequency between these values.

When this has been accomplished, the indicating meter may be calibrated in Watts and will provide satisfactory indication of transmitter output power at any frequency between 3.5 MHz and 29.7 MHz.

The basic difference between the indicator circuits shown in Fig. 1 and Fig. 2 is that the circuit shown in Fig. 2 incorporates a frequency-compensating network.

In my case, an indicating meter that would read

200 Watts full scale was desired.

The first operation was to modify the circuit shown in Fig. 1 to that shown in Fig. 2. Note that in Fig. 2 the value of resistor R3 has been changed from 1000 Ohms to 2500 Ohms. It will be noted that Fig. 2 includes the additional components noted in Table 1.

All of these additional components are installed within the small metal box which is attached to the pail lid of the Heathkit® "Cantenna."

The indicating meter employed had a 200-microampere full-scale movement with an internal resistance of twelve hundred Ohms. This meter was di-

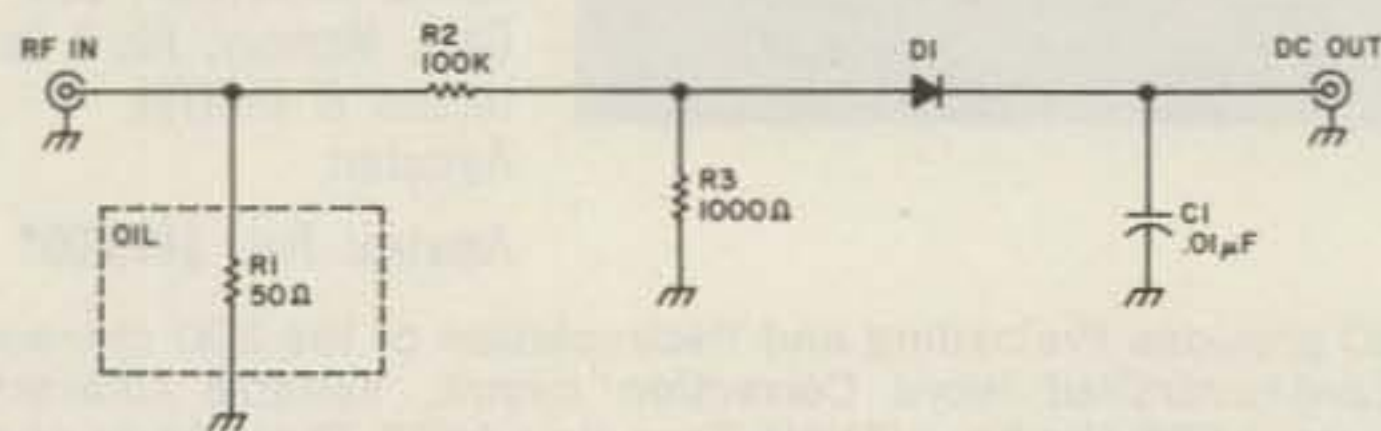

Fig. 1. Schematic of the Heathkit® "Cantenna."

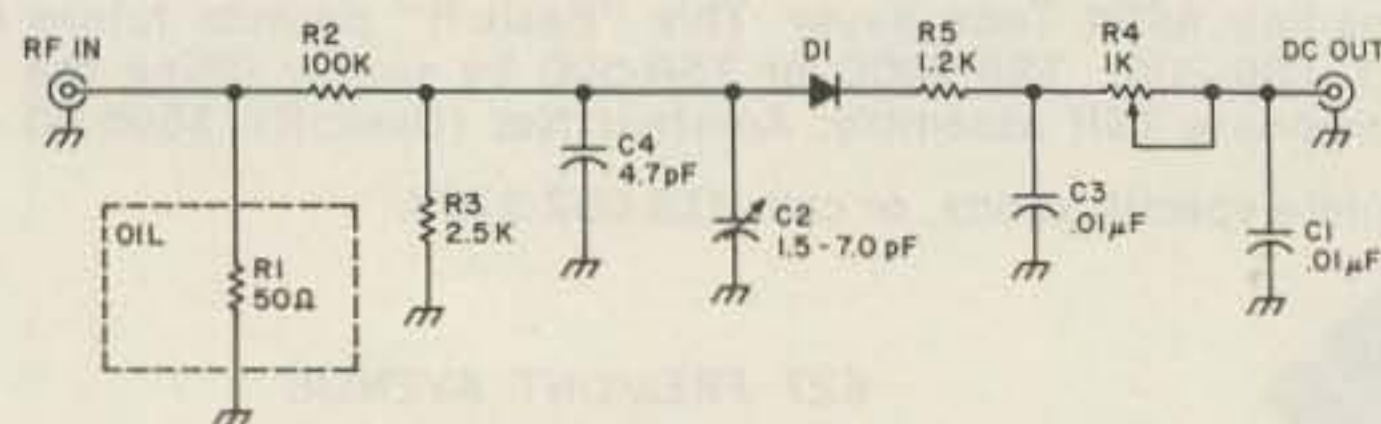

Fig. 2. Modified schematic of the Heathkit® "Cantenna."

C2	1.5-7.0-pF glass, piston-type variable capacitor
C3	.01-uF disk ceramic capacitor
R4	1000-Ohm miniature micro-potentiometer, Bourns trimpot 120-14-E1000
R5	1200-Ohm, 1/4-Watt resistor, 10% tolerance
C4	4.7-pF disk ceramic capacitor

Table 1. The additional components included in Fig. 2.

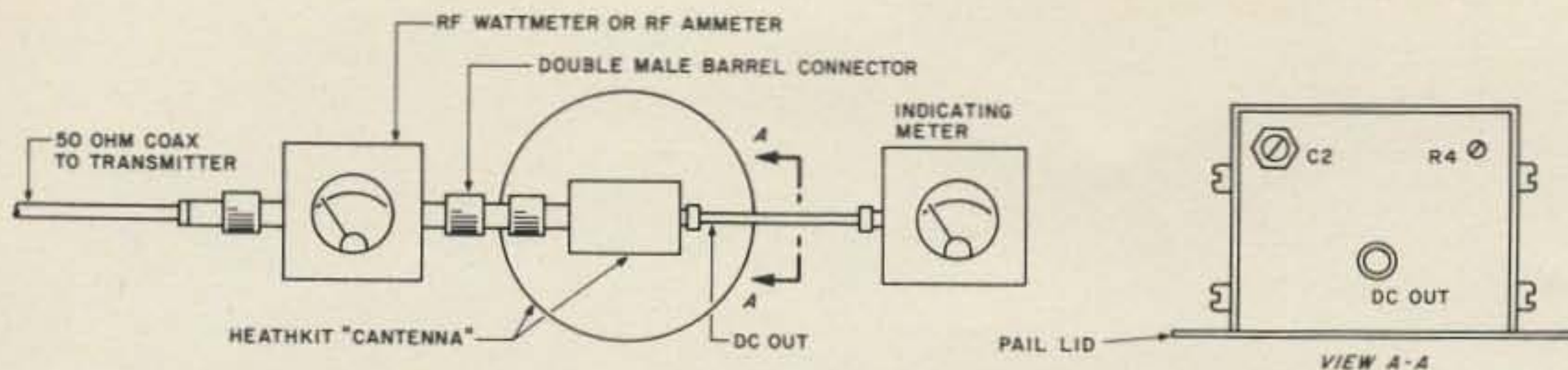

Fig. 3. Setup for frequency-compensation adjustment.

rectly connected to the DC OUT jack of the Heathkit® dummy load.

An indicator that will show the amount of power applied to the dummy load is necessary for proper adjustment of the frequency-compensating network. Either an ammeter or a wattmeter of known accuracy may be employed. The setup for frequency adjustment for proper compensation is shown in Fig. 3.

The adjustment procedure is as follows:

1. Set C2 at minimum capacity and set R4 at maximum resistance.

2. Set the transmitter on 3.5 MHz. Gradually increase the power level until the ammeter reads two Amperes or the wattmeter reads 200 Watts. Decrease the resistance of R4 until the indicating meter reads full scale.

3. Set the transmitter on 29.7 MHz. Gradually increase the power level until the ammeter reads two Amperes or the wattmeter reads 200 Watts. Note that the indicating meter will read full scale before the ammeter reads two Amperes or the wattmeter reads 200 Watts. Reduce the reading of the indicat-

ing meter by increasing the capacity of C2 until the indicating meter reads full scale when either the ammeter reads two Amperes or the wattmeter reads 200 Watts.

4. Repeat steps 2 and 3 in sequence until the indicating meter reads full scale when the ammeter reads two Amperes or the wattmeter reads 200 Watts, whether the applied frequency is 3.5 MHz or 29.7 MHz.

If a wattmeter was employed in the adjustment setup, the indicating meter may be directly calibrated from the wattmeter read-

Ammeter Reading, Amperes	Indicating Meter, Watts
.4472	10
.6325	20
.7746	30
.8944	40
1.0000	50
1.0955	60
1.1832	70
1.2649	80
1.3416	90
1.4142	100
1.4832	110
1.5492	120
1.6125	130
1.6733	140
1.7320	150
1.7889	160
1.8439	170
1.8974	180
1.9494	190
2.0000	200

Table 2.

ings.

If an ammeter was employed in the adjustment setup, the Watts corresponding to the ammeter reading are shown in Table 2, and the indicating meter may be calibrated from this data. ■

The Personal Antenna

...Custom created with Hustler components.

Make your choice of Hustler components. Aluminum and chrome plated brass mast with bumper mounting or stainless steel 180° adjustable ball fender/deck mount. Standard 500 watt PEP resonators or Super 2 KW PEP resonators with large "Hi-Q" computer designed inductor and stainless steel tip rod. Optional quick disconnect stainless steel resonator spring. Quality manufactured 50 ohm coax. You want top performance. That's why you should customize with the MO/RM series antennas and components from Hustler, the name recognized for personal quality in antennas!

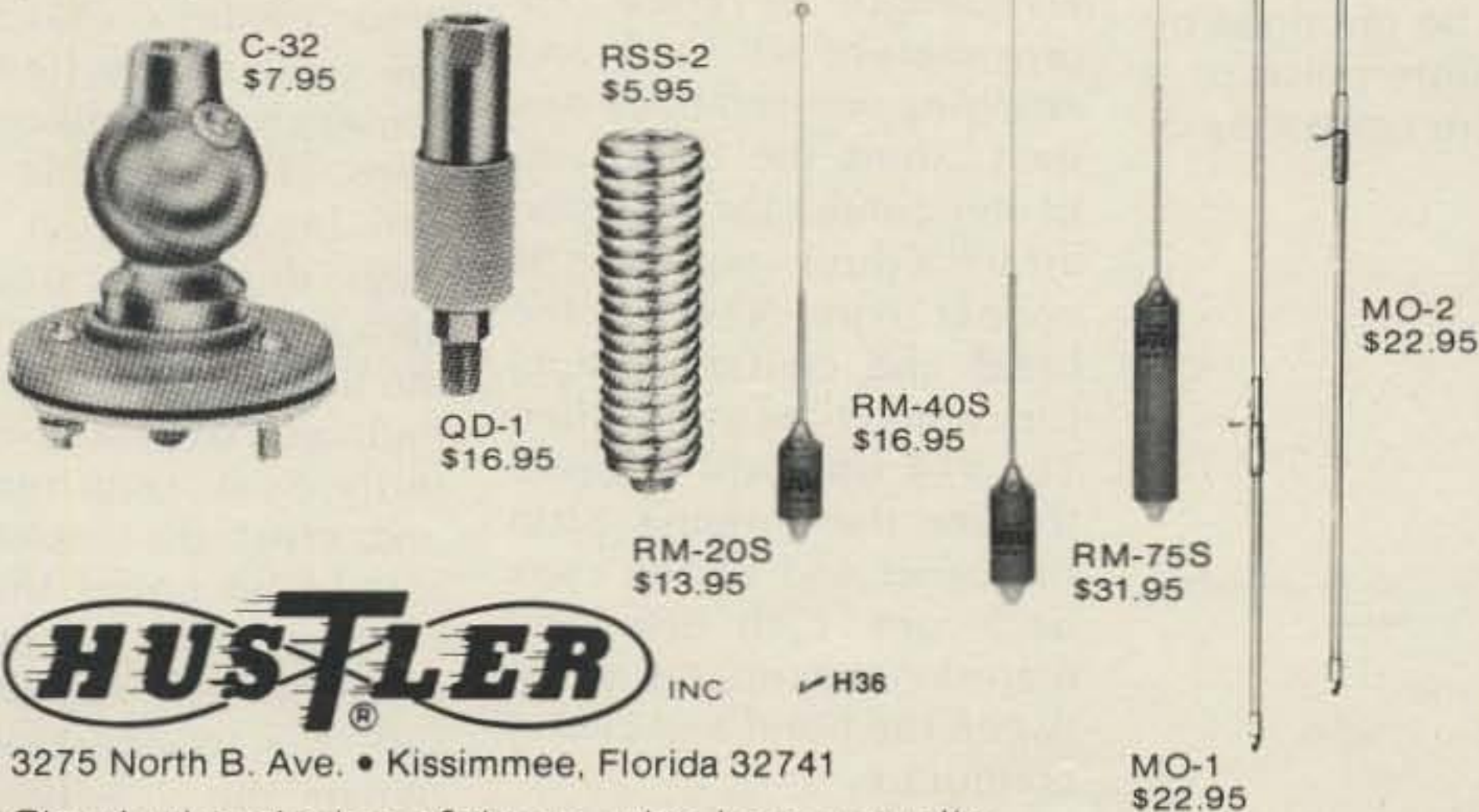

3275 North B. Ave. • Kissimmee, Florida 32741

Clearly the choice of those who know quality.

HUSTLER DEALERS

Amateur Electronic Supply
 621 Commonwealth Ave.
 Orlando, FL 32803
 305-894-3238

Delaware Amateur Supply
 71 Meadow Road
 New Castle, DE 19720
 302-328-7728

Evans Radio, Inc.
 Route 3-A Bow Junction
 Concord, NH 03301
 603-224-9961

Sunrise Amateur Radio
 1351 State Road 84
 Ft. Lauderdale, FL 33315
 305-761-7676

Union Electronic Distributors
 16012 South Cottage Grove
 South Holland, IL 60473
 312-723-1500

Western Radio
 1415 India St.
 San Diego, CA 92101
 714-239-0361

The 80 Meter Coax L

— compact design really works

There have been many articles written about do-it-yourself antennas for just about every purpose imaginable—multi-band, longwires, verticals, big ones, small ones, and on and on, but all of these antenna articles have this in common: You must have certain hardware items available and some electronics expertise to put them together. The antenna I am about to describe to you is simple, small (for cramped spaces), and very efficient. The best part about this antenna is the fact that all you need to build it is some solder, a soldering iron, #14 copper wire, some common hand tools, and a roll of coaxial cable.

I am not an electronics engineer by any stretch of the imagination and I don't fully understand how this antenna works, but I can honestly say that it does

work and works very well. I am presently in West Germany with the US Air Force, and I have worked stations all along the east coast and in central USA, and, of course, all around Europe. I received consistent 5/6 and 5/7 reports from all contacts.

Construction and initial testing were conducted while I was stationed in Oklahoma, knowing that when I arrived in Germany, with its narrow, crowded streets and houses touching each other, I would not be able to put up a full-sized 80 meter dipole. This antenna is basically a quarter-wave shorted stub of RG-58 (or other common coax) fed out of phase against earth ground with the outer braid of the coax acting as the radiating portion of the antenna. Better results can be obtained by using a counterpoise or a radial system consisting of

one or more radials laid along the ground. If a matchbox is available, this antenna, as described, will work well on 80 and 40 meters without pruning the antenna. It also can be used on other bands by making the length of the coax $\frac{1}{4}$ wavelength for the band desired. If no matchbox is available, quite a bit of cut-and-try work is required. However, when you reach optimum resonance using this method, the antenna will show an swr of about 1:1 across the entire 80 meter band from 3500 to 4000 kHz.

Well, so much for the background history and specifications, and on to the construction and ways to get it in the air.

Construction is started by simply cutting a quarter wavelength of coax (approximately 63 feet) and stripping one end back one inch. Short the braid and center conductor together, attach a three-foot piece of copper wire (#14) to the braid and center conductor connection, and solder. The #14 wire will be used to tune the antenna. Strip the other end of the coax back one inch also and maintain the separation between the braid and center conductor.

When you reach this point, it is time to prepare

the feedline. The length of the feedline is not critical and can be made to meet individual requirements. Strip the feedline (opposite the transmitter connector) back one inch and maintain the separation between the center conductor and braid.

Now it's time to connect the feedline to the antenna. This is achieved by connecting the braid of the feedline to the center conductor of the antenna and the center conductor of the feedline to the braid of the antenna. Next, drive a ground rod into good old Mother Earth and attach 1 or 2 radials ($\frac{1}{4}$ wavelength of #14 copper wire each) to the ground rod, leaving the remaining portion of each radial stretched out across the ground. Now, connect the feedline braid and antenna center conductor to the grounding system and solder and tape all connections. The antenna itself can be erected in many ways, depending on available space, as depicted in the illustrations. Select the method that best suits your individual requirements and erect the antenna. It should be noted that the vertical and horizontal distances are not critical, but the connection between the feedline and antenna always should be kept at ground level. After

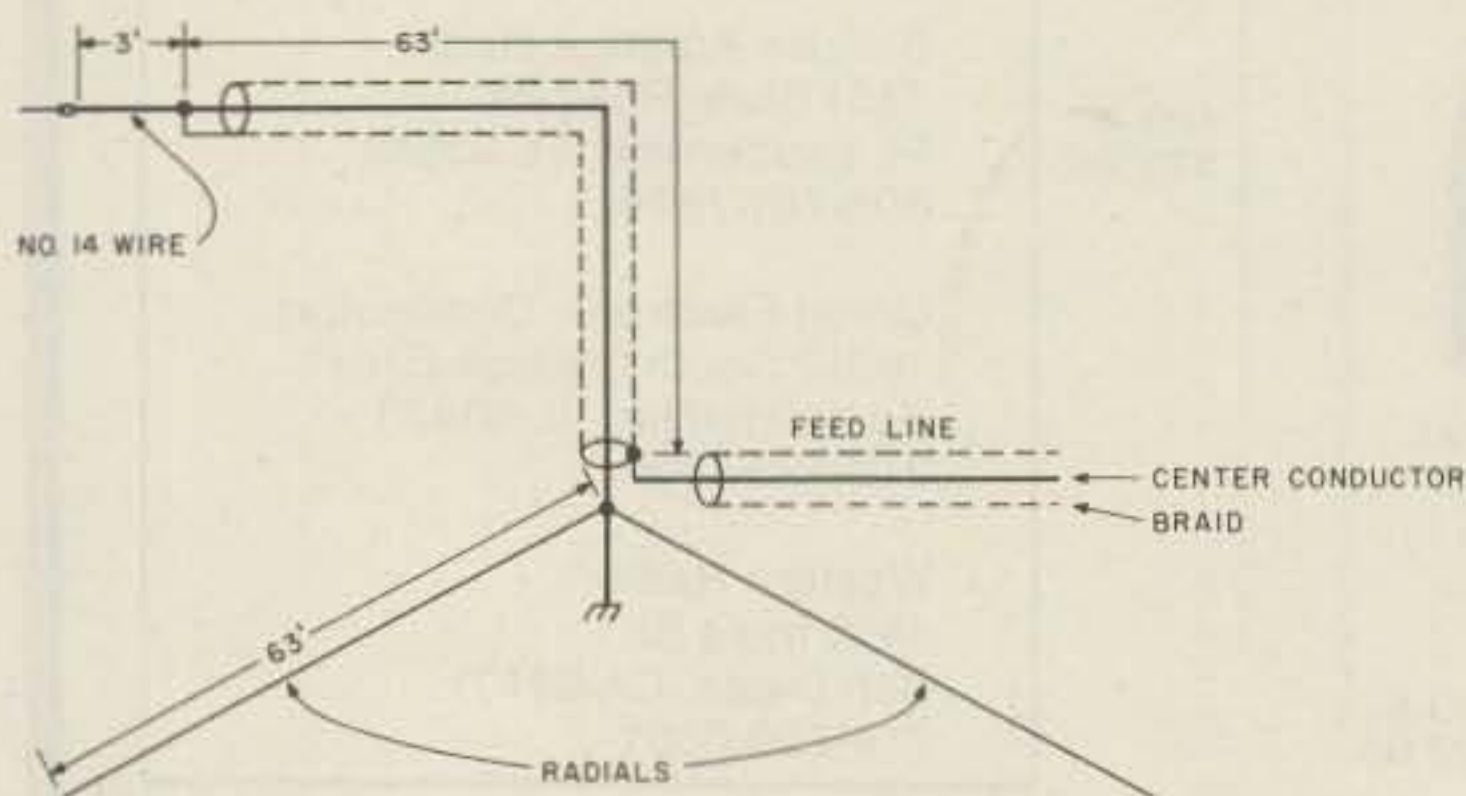

Fig. 1. The 80 meter coax inverted L.

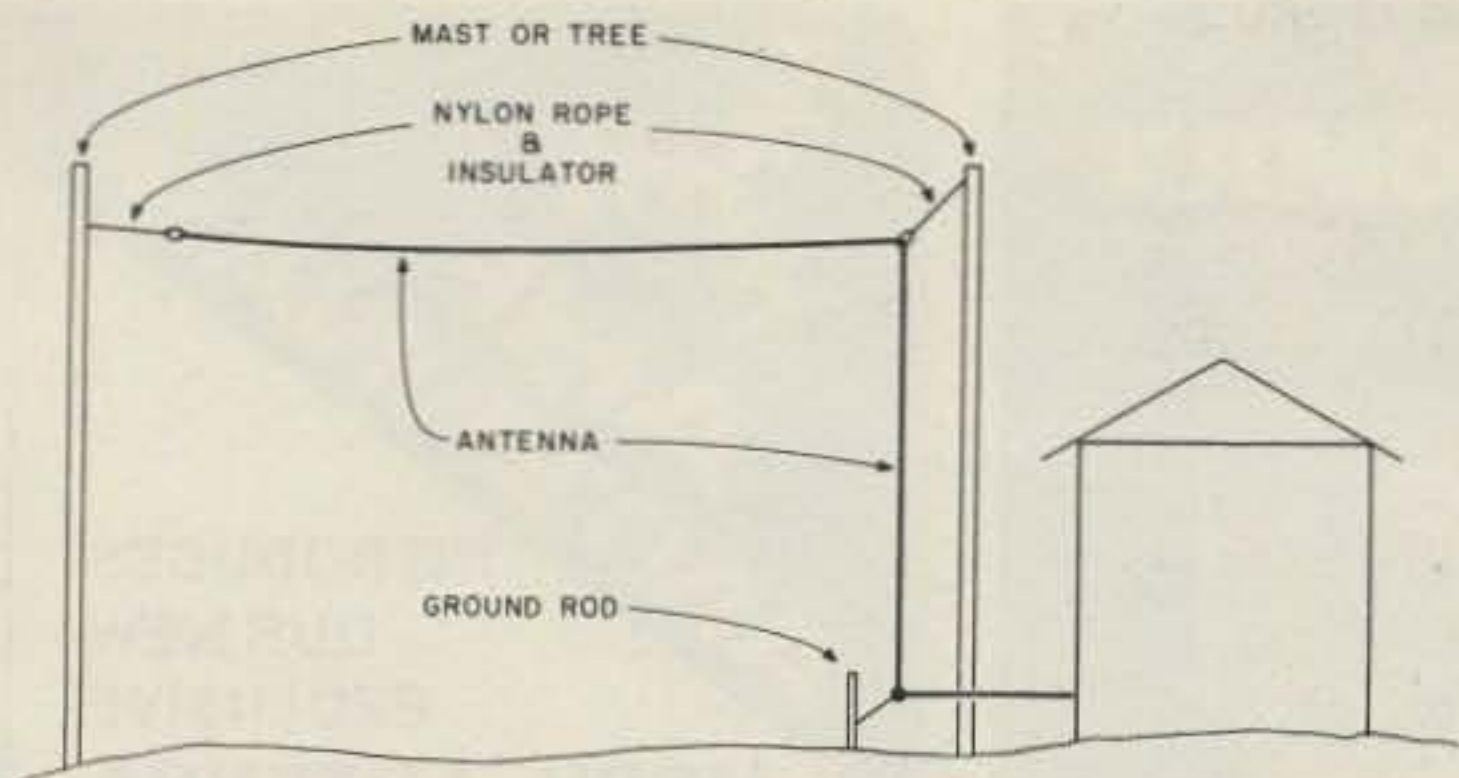

Fig. 2. Hanging method A—inverted L. This method requires only 33' of yard space. The antenna is raised to a vertical height of 30', using a tree or mast to secure the antenna to, and then out horizontally a distance of 33'. This method also provides vertical and horizontal polarization.

the antenna has been erected, connect the feed-line to the transmitter through the swr bridge.

Start out testing the antenna with low power and remain on low power throughout the testing and tuning stage. You may start with an swr as high as 2.5:1, but don't despair. This is when the tuning starts.

Tuning is accomplished by trimming the #14 wire at the end of the antenna. Cut a 6-inch piece of the #14 wire from the end of the antenna and then check the swr again. If the swr has dropped, but not enough, cut off another 6-inch piece of wire, check the swr again, and repeat this process until the swr is

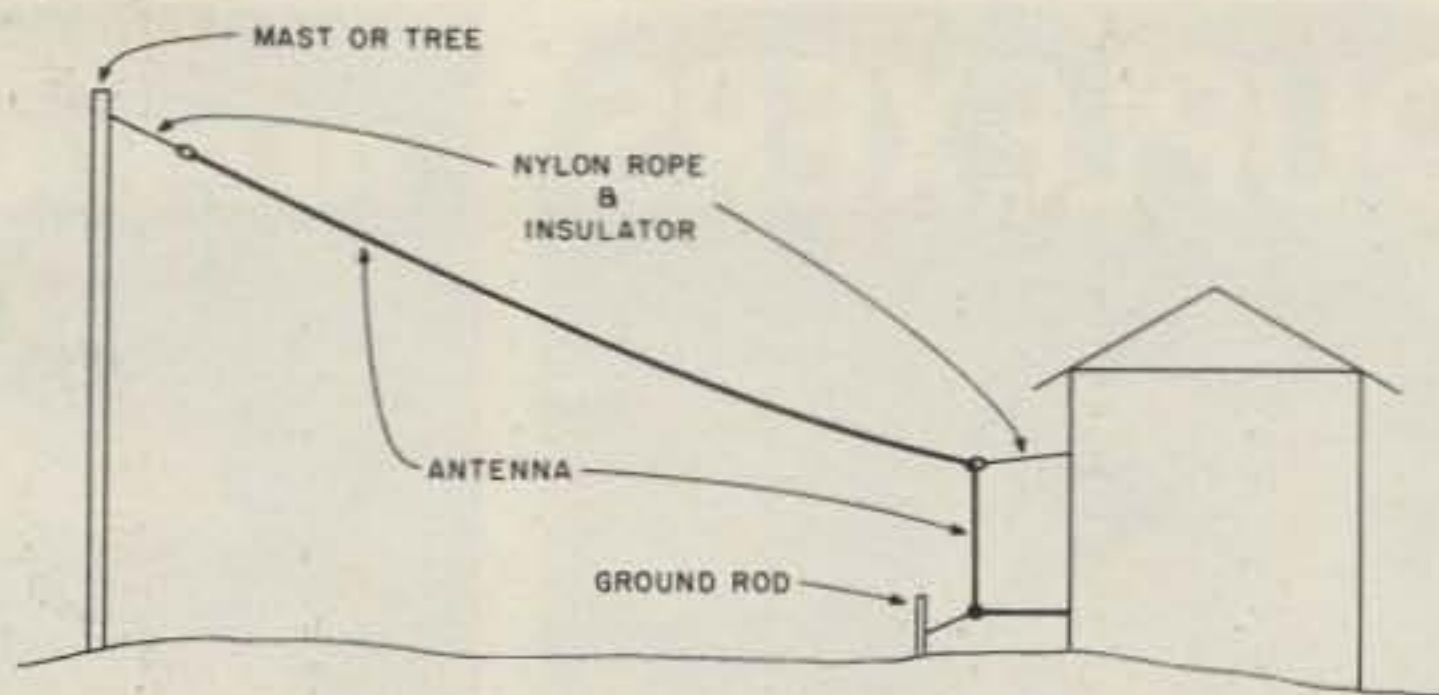

Fig. 3. Hanging method B—sloper. This method requires about 60' of yard space, but can be used if a tree or mast near the house cannot be utilized.

satisfactory. If you continue to trim the #14 wire to a point where there is no more wire to trim and the swr is still too high, you must start cutting off 6-inch pieces of the antenna itself. Be sure that the braid and center conductor of the antenna are reconnected each time this is done, before the swr check is made. If, on the other hand, the swr went up after the first piece of wire was cut off, you must add #14 wire to the end of

the antenna in 6-inch pieces until the swr is satisfactory. A lot of time could be saved in this process if a friend could cut and prune the antenna while you remain in the shack to conduct the swr checks, shouting instructions to him.

As I said before, this antenna is very simple, small, and efficient, and an excellent one especially for the Novice because of the low cost and ease of construction. ■

BARRY ELECTRONICS CORP.

Mon-Wed.	9:00-5:30
Thurs.	9:00-7:30
Fri.	9:00-6:30
Sat.	10:00-3:00

512 Broadway
New York, N.Y.
10012

✓ B47

CALL FOR BEST OFFERS
212-925-7000

The largest and oldest ham radio store in New York.

We stock all popular brands—
YAESU, DRAKE, TEMPO, SWAN, ICOM,
DENTRON, KDK, ATLAS, KANTRONICS,
HY-GAIN, MOSLEY, TRI-EX TOWERS,
CDR ROTORS, ALDA, AUTEK

YAESU
FT-101 ZD

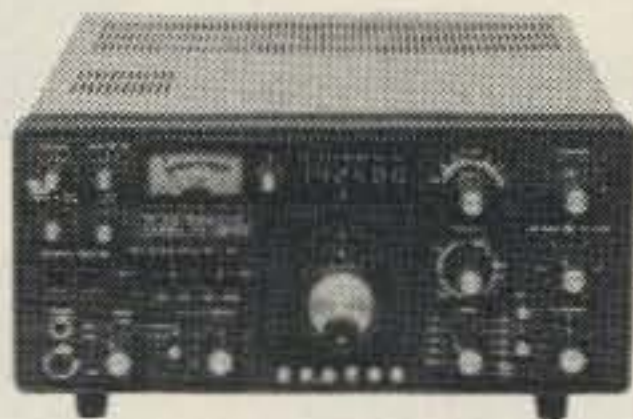

- Complete repair lab on premises
- Tubes and parts in stock
- Export inquiries expedited
- Spanish spoken

VIBROPLEX®

Vibroplex® has built for those who use electronic keyers, the finest keying mechanism available.

the
Vibro-Keyer
"deluxe"
\$65⁰⁰



"THE OLDEST NAME
IN AMATEUR RADIO"

- Adjustable jeweled bearings.
- Tension and contact spacing fully adjustable.
- Large, solid, coin silver contact points.
- 2½ lb. chrome plated steel base rests on non-skid feet.
- Top parts designed from our world famous Vibroplex® "Original."
- Lifetime guarantee against manufacturing defects.
- Registered serial number.
- Vibroplex® quality through-out.

"Standard" model with wrinkle finished cast iron base available for \$49.50.

Available at your dealers or through the factory. Send check, money order, or use your VISA or Master Charge. We pay all shipping charges except on orders outside the continental U.S.

See your dealer or write for literature on all our world famous line to:

The Vibroplex Company, Inc. ✓ V24
P.O. Box 7230 476 Fore St. Portland, Maine 04112
Or call: (207) 775-7710

DUPLEXERS



US PATENT
4080601

✓ W15

OUR NEW BANDPASS-REJECT DUPLEXERS WITH OUR EXCLUSIVE

BpBr CIRCUIT*

... provides superior performance, especially at close frequency spacing.

Models available for all Ham bands. Special price for Amateur Repeater Clubs

CALL OR WRITE FOR DETAILS:

WACOM PRODUCTS, INC.



Box 7307
Waco, Texas 76710
817/776-4444

YOU CAN'T BUY
ALPHA/VOMAX
PERFORMANCE IN ANY OTHER
SPEECH PROCESSOR



ALPHA/VOMAX can boost the "talk power" of your rig up to ten times (10 dB) or more under tough conditions.

VOMAX SBP-4's *split band processing* is the only technique more effective than rf clipping. Because harmonic and intermodulation distortion is uniquely low, intelligibility is superb and your voice sounds natural.

SET IT AND FORGET IT — Silky smooth AGC absorbs changes in mike output up to 40 dB, virtually insuring optimum clipping and a clean, crisp signal at all times. And VOMAX installs easily in the mike line to any rig.

You can pay more, but you can't match ALPHA/VOMAX performance or convenience. Contact your dealer or ETO for details on ALPHA linears and ALPHA/VOMAX.



EHRHORN TECHNOLOGICAL
OPERATIONS, INC.
P.O. BOX 708, CANON CITY, CO 81212
(303) 275-1613

AHF ANTENNAS

INTRODUCES
OUR NEW
EXCLUSIVE

MOBIL ANTENNA

- ★ GREATER FIELD STRENGTH
- ★ GREATER TUNING RANGE
- ★ ALL NON-CORROSIVE PARTS
- ★ ALL THREADS U.S. STANDARD 3/8 x 24
- ★ MADE ENTIRELY OF QUALITY MATERIALS

OUR FINEST KIT only **\$85.00**
Radiator, Mast, 10 Meter Adaptor, and
1 ea. 75, 40, 20 and 15 Meter Coils
(Parts may be purchased separately)

Common 2 - 4 - 6 and 8 MHz MARINE
frequency coils also available

2 to 30 MHz Custom Frequency
Coils, made to order

✓ A92 Contact your favorite dealer or
Write for brochure

AHF / ANTENNAS

2814 S. Baywater Ave.
San Pedro Ca. 90731
Phone (213) 831-5444
Dealerships available

QUASAR VIDEO TAPE RECORDER SALE!

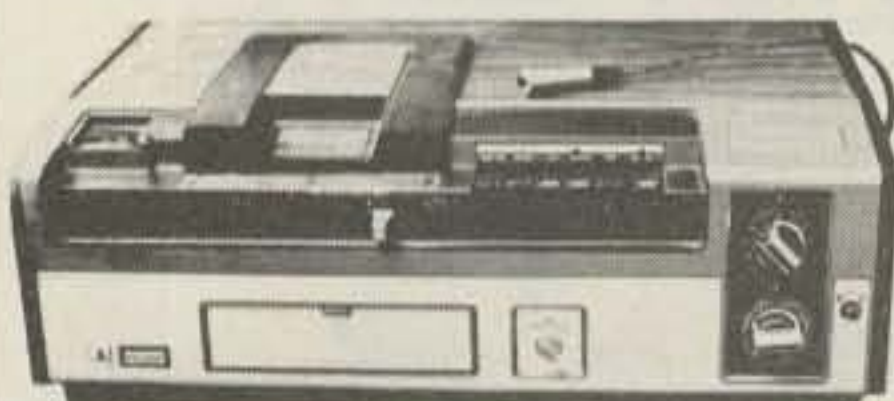

- ★ Records to two hours, color or black & white
 - ★ Records off the air—record one program while watching another
 - ★ Camera input to make your own tapes
 - ★ Can be used with optional timer while you are out
 - ★ Pause control for editing
 - ★ Limited supply—these \$1,000 VTRs were demonstrators & come with new warrantee... \$499
- \$100 worth of new blank tape will be included at no extra charge!

Send for our new catalog!
\$3 Shipping charge per order • NO C.O.D.s!

Bill: MC Visa Amex

Credit card # _____

Exp. date _____

Signature _____

Name _____

Address _____

City _____ State _____ Zip _____



209 S. Mystic Ave
Medford MA 02155
1(800) 225-4428
(617) 395-8280

RECOGNIZE THESE?

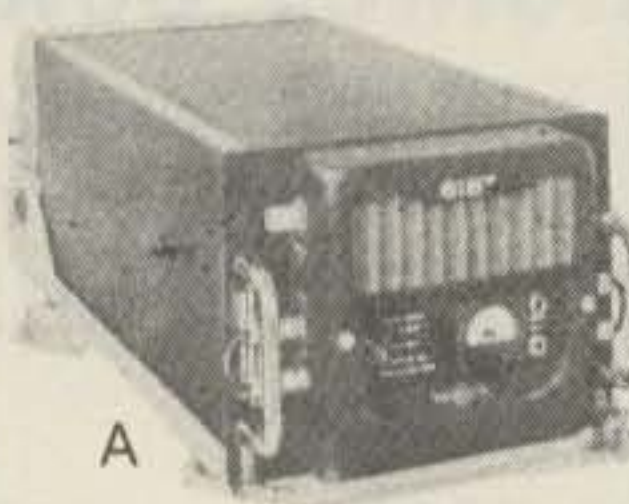

A

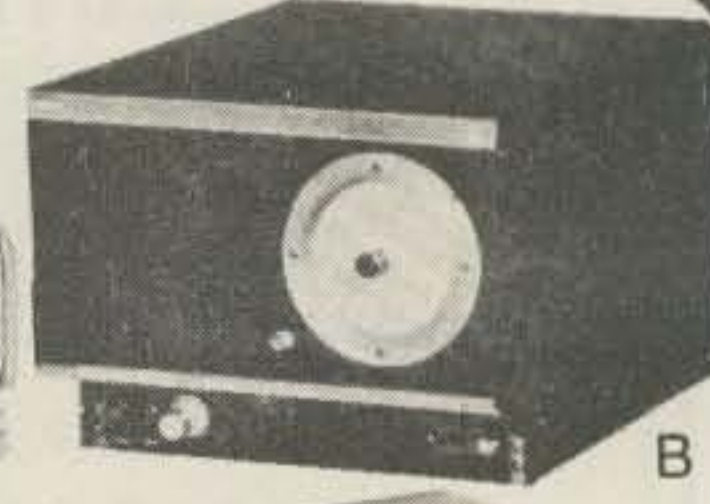

B

TOP CASH PAID FOR THESE ITEMS

ALSO WANT ANY OTHER
COLLINS AVOINIC EQUIP-
MENT, MODULES, OR PARTS.
ALSO NAVY AND GROUND
EQUIPMENT.

IF IT'S MILITARY, WE ARE
INTERESTED.

FIND OUT WHAT YOUR EQUIPMENT
IS WORTH.

Absolutely no obligation, call collect
NOW for information and prices.
WHO KNOWS? YOU MIGHT BE SIT-
TING ON A "GOLD MINE".
CALL COLLECT TODAY AND FIND
OUT.

SPACE ELECTRONIC CO.

DIV. OF MILITARY ELECTRONIC CORP.
35 Ruta Court, S. Hackensack
N.J. 07606, (201) 440-8787

✓ V57

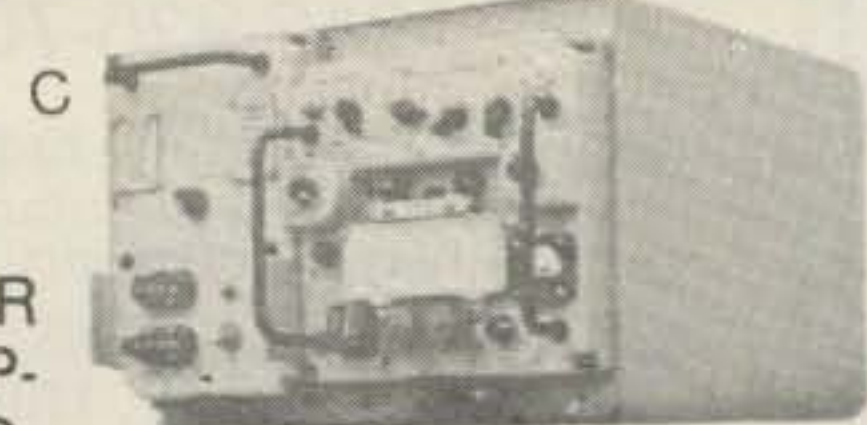

C

URGENTLY NEEDED
AN/SRC-21 or AN/SRC-20
or parts from same.

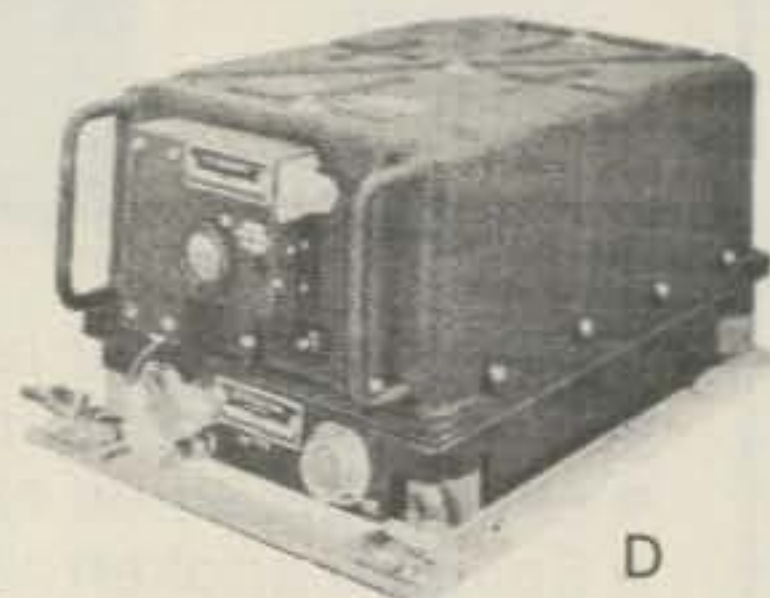

D

A-618T or ARC-94 or ARC-102.
B-490T or CU-1658 or CU-1669.
C-URC-9A or RT-581 and PP-2702.
D-ARC-51



Para-graphics is proud to announce its' new portfolio of QSL's. The portfolio contains our complete line of QSL Cards... not small reproductions, but actual size, FULL COLOR prints. Included in the portfolio are twelve brand new, FULL COLOR cards.

Send \$1.00 today, for your QSL portfolio. The \$1.00 is redeemable with your first order of QSL's.

para-graphics ✓ P20

exclusive QSL's for the Ham Radio Operator...

P.O. Box 268, Whitehall, PA 18052
A Division of AA Printing Service, Inc.
801 Third Street, Whitehall, PA 18052

BRAND NEW!



You've never seen an antenna book quite like this:

- How to build practical beams, quads and wire antennas.
- Computer-generated beam headings to every known country in the world.
- Charts and tables to eliminate tricky calculations.
- Practical ideas for the newcomer.
- Complete bibliography of magazine articles on antennas.
- Tips on how to keep your antenna up. And much, much more.

New format, big diagrams, easy-to-read text. And it's completely brand new! Durable vinyl cover. \$9.95. Order now!

I enclose \$10.95 for **Practical Antennas for the Radio Amateur. (BK1015)** (\$9.95 for book, plus \$1.00 handling)

Enclosed: Check Money Order
 Master Charge Visa

Card # _____

Interbank # _____ Exp. date _____

Signature _____

Name _____

Address _____

City _____

State _____ Zip _____

73 Magazine Radio Bookshop
Pine St. • Peterborough NH 03458

8/73

NOTE TO 73 Subscribers

From time to time 73 Magazine makes its subscriber lists available to carefully-screened companies and organizations whose products, services or information may be of interest to you. In every case, we must approve all organizations wishing to mail to our subscribers. In every case they receive a list of names and addresses only—no other information we may have is divulged. Each organization may use the list only once and agrees never to make any personal or telephone solicitations from it.

The overwhelming majority of our subscribers appreciate this controlled use of our mailing lists—it helps them shop conveniently by mail for products and services they need, often at substantial savings. A few people prefer their names not be used. It is to them we address this message.

If you do *not* wish to be a part of this service, please complete the form below... your name will not be used in this manner for any reason.

(If you asked us in the past to remove your name from our lists, there is no need to repeat the request.) Please allow about six weeks for your request to take effect.

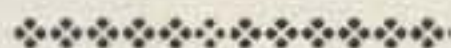

I wish to have my name removed from the list of subscribers receiving mail other than the regular subscription to 73 Magazine.



Mr. _____
Mrs. _____
Ms. _____
Please Print

Address _____
City _____ State _____ Zip _____

Mail this form with your mailing label from the latest issue (or fill out the information as it appears on the label) to:

73 Magazine
Subscription Services Dept.
P.O. Box 931
Farmingdale NY 11737

OSCAR Orbits

Courtesy of AMSAT

The listed data tells you the time and place that OSCAR 7 and OSCAR 8 cross the equator in an ascending orbit for the first time each day. To calculate successive OSCAR 7 orbits, make a list of the first orbit number and the next twelve orbits for that day. List the time of the first orbit. Each successive orbit is 115 minutes later (two hours less five minutes). The chart gives the longitude of the day's first ascending (northbound) equatorial crossing. Add 29° for each succeeding orbit. When OSCAR is ascending on the other side of the world from you, it will descend over you. To find the equatorial descending longitude, subtract 166° from the ascending longitude. To find the time OSCAR 7 passes the North Pole, add 29 minutes to the time it passes the equator. You should be able to hear OSCAR 7 when it is within 45 degrees of you. The easiest way to determine if OSCAR is above the horizon (and thus within range) at your location is to take a globe and draw a circle with a radius of 2450 miles (4000 kilometers) from your QTH. If OSCAR passes above that circle, you should be able to hear it. If it passes right overhead, you should hear it for about 24 minutes total. OSCAR 7 will pass an imaginary line drawn from San Francisco to Norfolk about 12 minutes after passing the equator. Add about a minute for each 200 miles that you live north of this line. If OSCAR passes 15° east or west of you, add another minute; at 30°, three minutes; at 45°, ten minutes. Mode A: 145.85-.95 MHz uplink, 29.4-29.5 MHz downlink, beacon at 29.502 MHz. Mode B: 432.125-.175 MHz uplink, 145.975-.925 MHz downlink, beacon at 145.972 MHz.

OSCAR 8 calculations are similar to those for OSCAR 7, with some important exceptions. Instead of making 13 orbits each day, OSCAR 8 makes 14 orbits during each 24-hour period. The orbital period of OSCAR 8 is therefore somewhat shorter: 103 minutes.

To calculate successive OSCAR 8 orbits, make a list of the first orbit number (from the OSCAR 8 chart) and the next thirteen orbits for that day. List the time of the first orbit. Each successive orbit is then 103 minutes later. The chart gives the longitude of the day's first ascending equatorial crossing. Add 26° for each succeeding orbit. To find the time OSCAR 8 passes the North Pole, add 26 minutes to the time it crosses the equator. OSCAR 8 will cross the imaginary San Francisco-to-Norfolk line about 11 minutes after crossing the equator. Mode A: 145.85-.95 MHz uplink, 29.4-29.50 MHz downlink, beacon at 29.40 MHz. Mode J: 145.90-146.00 MHz uplink, 435.20-435.10 MHz downlink, beacon on 435.090 MHz.

OSCAR 7 Orbital Information				OSCAR 8 Orbital Information			
Orbit	Date (Aug)	Time (GMT)	Longitude of Eq. Crossing °W	Orbit	Date (Aug)	Time (GMT)	Longitude of Eq. Crossing °W
21540X	1	0135:11	88.3	7161X	1	0142:37	71.1
21552	2	0034:31	73.1	7174Abn	2	0004:33	46.6
21565	3	0128:48	86.7	7188Abn	3	0009:43	47.9
21577	4	0028:08	71.6	7202Jbn	4	0014:53	49.2
21590	5	0122:25	85.2	7216Jbn	5	0020:03	50.5
21602qrp	6	0021:46	70.0	7230Abn	6	0025:13	51.8
21615	7	0116:03	83.6	7244Abn	7	0030:23	53.1
21627X	8	0015:23	68.4	7258X	8	0035:32	54.4
21640	9	0109:40	82.0	7272Abn	9	0040:42	55.7
21652	10	0009:00	66.9	7286Abn	10	0045:52	57.0
21665	11	0103:17	80.5	7300Jbn	11	0051:02	58.3
21677	12	0002:37	65.3	7314Jbn	12	0056:12	59.6
21690qrp	13	0056:54	78.9	7328Abn	13	0101:22	61.0
21703	14	0151:11	92.5	7342Abn	14	0106:31	62.3
21715X	15	0050:31	77.4	7356X	15	0111:41	63.6
21728	16	0144:48	91.0	7370Abn	16	0116:51	64.9
21740	17	0044:09	75.8	7384Abn	17	0122:01	66.2
21753	18	0138:26	89.4	7398Jbn	18	0127:11	67.5
21765	19	0037:46	74.2	7412Jbn	19	0132:20	68.8
21778qrp	20	0132:03	87.8	7426Abn	20	0137:30	70.1
21790	21	0031:23	72.7	7440Abn	21	0142:40	71.4
21803X	22	0125:40	86.3	7453X	22	0004:36	46.9
21815	23	0025:00	71.1	7467Abn	23	0009:45	48.2
21828	24	0119:17	84.7	7481Abn	24	0014:55	49.5
21840	25	0018:37	69.6	7495Jbn	25	0020:05	50.8
21853	26	0112:54	83.2	7509Jbn	26	0025:14	52.1
21865qrp	27	0012:15	68.0	7523Abn	27	0030:24	53.4
21878	28	0106:32	81.6	7537Abn	28	0035:34	54.8
21890X	29	0005:52	66.5	7551X	29	0040:43	56.1
21903	30	0100:09	80.0	7565Abn	30	0045:53	57.4
21916	31	0154:26	93.6	7579Abn	31	0051:02	58.7

New Products

from page 24

order: (1) With too-high selectivity set in, the filter may "ring," so go easy and only use the degree of selectivity you need. Also, remember that it's hard to tune your receiver with 40-Hz bandwidth set in! (2) The auxiliary filter is wired in series with the main filter, so you have to remember to set it at minimum settings when it's not in use. (3) The filter can't completely overcome poor receiver i-f selectivity or overloading on strong signals. You may be able to minimize overload problems by turning off the agc and riding the rf gain control on your set.

All things considered, the filter is undoubtedly a good buy and has a number of very convenient features built in; I enjoyed reviewing and using it. Nevertheless, a few minor improvements could be made: (1) The power adapter furnished with my unit didn't enable the filter to develop quite enough audio. The instructions say that a full 18 volts at 300 mA is required for full two-Watt audio output. A huskier adapter would be useful. (2) The headphone jack could be transferred to the front panel, and a multiple-position speaker/phones selector switch added. (3) An "on-off" LED panel indicator would be a

nice feature, as it's easy to forget to turn the filter off when not in use. (4) A schematic diagram, along with alignment instructions, should be provided for the day when maintenance may be required. (5) There is an audible click heard in the speaker whenever the unit is switched on and off. It's not loud enough to be objectionable, however.

At about \$80 at this writing, the MFJ-752 filter packs in a lot of features at a modest price; for \$20 less, the Model 751 is available (similar to the 752 but without the auxiliary filter, highpass function, bypass feature, and connections for a second receiver). I found the Signal Enhancer II to be a very competitive, seven-IC design that should be a handy accessory and worthwhile investment for the old-timer and beginner alike. For further information, contact MFJ Enterprises, Inc., PO Box 494, Mississippi State MS 39762; (800)-647-1800. Reader Service number M52.

Karl T. Thurber, Jr. WB8FXJ
Ft. Walton Beach FL

AVANTI'S NEW MOBILE ANTENNA

Avanti Research and Development, Inc., has come up with a new concept in VHF mobile antennas, an antenna that mounts on glass in minutes

without tools. No ground plane is required, and there are no holes to drill.

A low-profile, one-inch stainless steel mount holds the whip to the window by a new aerospace adhesive discovery that is 50 inch pounds stronger than a 1/4" x 20 metal bolt. It can be easily removed, though, according to instructions, and is guaranteed by Avanti to hold securely under even abnormal weather conditions and excessive vehicular vibrations.

There are no external electrical connections to corrode, as the coax cable and capacitor box are mounted inside the vehicle. The new AH 151.36 antenna has tested 1 dB stronger than conventional 5/8-wave trunk-mount antennas, according to the manufacturer. It is also claimed to have a more uniform omni pattern than "ground"-plane-type antennas.

Because this unique 1/2-wave design is mounted higher than a trunk-mounted 5/8-wave antenna, it offers a higher effective

radiation point well above the roof of the vehicle for maximum performance in all applications. The capacitive coupler forms a highly tuned circuit between the antenna and the radio to assure maximum performance throughout the 2 meter band.

Its full half-wave design is said to provide a radiation pattern that is not directionally influenced by mounting location as are conventional 1/4-wave and 5/8-wave mobile antennas. Typical mounting of 1/4-wave and 5/8-wave ground-plane mobile antennas frequently blocks radiation patterns.

The stainless steel whip and hardware connect to a chrome-plated casting. The tough ABS capacitive coupling box houses a fine-tuning coil connected to the radio by a pre-assembled coaxial cable assembly. For further information, contact Avanti Research and Development, Inc., 340 Stewart Avenue, Addison IL 60101; (312)-628-9350. Reader Service number A93.

Ham Help

I have a Motorola UHF rig, model U44BBT-1000A which I plan to convert to 440 FM. I would like help in obtaining all schematics and information possible on the radio and its

conversion. I also need wiring diagrams or schematics for the control head, which is missing.

Bob Lombardi WB4EHS
22246 SW 64 Way
Boca Raton FL 33433



73 MAGAZINE:

INNOVATION IN AMATEUR RADIO

For over 18 years, 73 Magazine has been the innovator in amateur radio. 73 led the way in developing the use of solid-state circuitry, and was the first to promote such things as SSTV, radioteletype, computer applications for radio communications, and single sideband.

Radio electronics has changed as 73 has changed. Ever notice how other magazines published in the field of radio electronics are just like the ones before them? Same old subjects in every issue, same predictable views, same old editorials . . . try to find it in 73 . . . you won't. In one issue you might find building projects and information on antennas, moonbouncing and mountain-topping; in the next issue you might read about computers, radioteletype, or traffic handling.

FREE TRIAL COPY

Mail the order form today and we'll send you your first copy at absolutely no obligation . . . that's right, if you're not completely satisfied after you've read your first issue, just write "Cancel" on your invoice and send it back to us . . . the first issue is yours to keep—on us! In addition, we'll guarantee every issue of your subscription . . . if you're not satisfied with your first—or your eleventh—issue, we'll refund your money on all remaining issues. Mail the order form today and get your new subscription started for \$15 . . . half the price you'd pay on the newsstand.

Free Trial Subscription 73 Magazine: The Innovator in Amateur Radio

Please send me my trial copy of 73 at no obligation. I understand that you'll start my subscription and bill me later . . . if I'm not completely satisfied I'll mark the invoice "cancel" and mail it back within 10 days.

One year—\$15 Three years—\$45

I prefer to pay now.

Bill me Payment enclosed

Bill my: Master Charge Visa

Card# _____ Exp. date _____

Signature _____

Name _____
(please print or type)

Address _____

City _____ State _____ Zip _____

Offer good to new subscribers only. Canadian subscriptions add \$2 per year. All foreign subscriptions one year only, \$26 payable in US currency.

Please allow 60 days for shipment of first issue. 198B

73 Magazine • Subscription Dept. Box 931 • Farmingdale NY 11737

Free Trial Subscription 73 Magazine: The Innovator in Amateur Radio

Please send me my trial copy of 73 at no obligation. I understand that you'll start my subscription and bill me later . . . if I'm not completely satisfied I'll mark the invoice "cancel" and mail it back within 10 days.

One year—\$15 Three years—\$45

I prefer to pay now.

Bill me Payment enclosed

Bill my: Master Charge Visa

Card# _____ Exp. date _____

Signature _____

Name _____
(please print or type)

Address _____

City _____ State _____ Zip _____

Offer good to new subscribers only. Canadian subscriptions add \$2 per year. All foreign subscriptions one year only, \$26 payable in US currency.

Please allow 60 days for shipment of first issue. 198C

73 Magazine • Subscription Dept. Box 931 • Farmingdale NY 11737

ou goons don't ever proof
lousy manuscripts from bat
burhans' rock to...
you...
I insist that you print ev
tell Ma Bell that she shou

LETTERS

from page 14

I recorded, on a standard tape cassette, much of their operation. I even caught one net when they switched to high-speed CW. The cassette, along with a detailed log, was sent to the ARRL "Intruder Watch." After a couple of months, with no reply, I sent a letter directly to Dick Baldwin asking if they had received the cassette. Again, no reply. Finally, after a few more months, I asked Harry Dannals to check on this. His verbal report was that they had received it, but apparently lost track of the cassette—they didn't know where it was! So much for "Intruder Watch."

Yes, 40 meters disturbs me, too, like 160 meters disturbs me. Yes, I know, the ARRL is the only "game in town." With all the money they have (our money), why can't they represent us *properly* in Washington and in Geneva? It is no wonder that not all hams are members of the ARRL.

An interesting sidelight: Many Long Island (this is Dannals country) hams, staunch defenders of the ARRL and loud detractors of Wayne Green, do not subscribe to 73 and don't read his editorials elsewhere! Guess who tells the radio clubs in the Hudson Division that Wayne is "lying"?

Thanks again for telling it like it is.

Byron H. Kretzman W2JTP
Huntington NY

DOUBLING

In the midst of the confusion generated here in JA/KA land by the FCC's new "system" of assigning amateur callsigns, a dim ray of hope came to me the other day. I'd like your opinion and the opinions of your readers on this.

What about doubling the number in the present KA callsigns in Japan? Instead of KA2RF, why not KA22RF? Instead of KA6OJ, why not KA66OJ? I'm not sure if the authorities here would go along with the idea, but it seems worth a try to me.

As I understand the system here, the FCC doesn't have to agree with such a change. They *don't* make our present callsign assignments.

Would such a change only cause more confusion? Would it make the KAs in Japan a unique, recognizable group again? Has anybody got a better idea? Let's hear from some of the former KAs who have operated from Japan. Let's hear from some of the new KAs in the States!

Ralph H. Fellows II
KA2RF/WB5FTV
Box 2785

APO San Francisco CA 96328

GFI'S

I enjoyed your June, 1979, issue of 73 Magazine. Your article on page 138, "Protect Yourself with a GFI," is very true and something all of us should be aware of. I notice, however, that the price schedule on page 140 for the components and what it would take to build this apparatus does conflict quite a bit with available ready-made kits. For example, Hubbell Electric Company has a portable model GRP-115 available which has been on the market for some time. This unit sells complete for \$53.60. Likewise, Slater Electric Company has a ground-fault interrupter (\$30.60) with the entire component layout built into a receptacle which can be placed in a normal-sized 18-cubic-inch box. The two devices I am mentioning have a reset and test button already built into the receptacle, and, of course, do not need a 6 x 9 box with handles to enclose same.

Such devices have been required in any new construction since January 1, 1975. In other words, thousands and thousands have been produced and installed with very few problems. This could very well be the basis for a future article for your magazine.

Carroll T. Overton, Jr. WD4FZG
Goldsboro NC

CODE FOREVER

I have listened to your voice so much on the 73 Novice code study tape that I feel like I know you. I hope to finish up the Novice test next week and take the General in the next 30 days or so. Please let me thank you for the outstanding study material.

The letter from Jack McCord KA4EXD published in the May, 1979, issue of 73 was most interesting—made me stop and think a little. Here I am at age 42 working on a Novice ham license, looking forward to all of the possible new contacts and friends out there, and wondering why someone of Mr. McCord's radio experience and background would even think thoughts like that, much less write them!

I have sat by the radio for many years just listening, and now I sincerely have to search my soul to try and find just why I never realized what a truly wonderful hobby media amateur radio is. I could kick myself for never taking the trouble to sit down and learn the code that bonds all radio amateurs into a group that is like no other. I hope the code requirement is there always.

During the past few weeks, my understanding of the radio service, the amateur who does the talking or communicating, and the fraternity that this relationship and association really is has been increased with each dah and dit that has entered my mind. And believe me, it hasn't been easy. That has probably made it even more worthwhile!

Certainly ham radio has the rag chewers, the QSL collectors, the weather askers, and the guys who do all of the other things that Mr. McCord wrote about. It is a hobby, not a profession, and it is to be enjoyed. With all of the many hams out there, somewhere there is a person who enjoys the same thing you do. This is the reward of ham radio—trying to find this person—and making many, many contacts and friends along the way. I am really looking forward to it! I am just sorry I waited so long to get started.

Since Mr. McCord is a locomotive engineer, maybe his feelings have something to do with going down the same old tracks, in the same old trains, pulling the same old cars, never looking at the different people he is passing on his ride through life. The day will come when he will realize that he is wrong, and if not, I feel sorry for him.

Again, thanks very much for your excellent publication and study materials. Although I purchased the ARRL package, too, I found your material and tapes much more valuable with regard to the tests. I am planning to press on for the General, Advanced, and Extra as my knowledge and understanding increase. I will be using your materials to get me there.

I am a Captain with National Airlines, flying the Boeing 727 on routes all over the country. Should you ever fly National,

please check "up front" to see if I am there. I would enjoy talking with you.

William D. Mauldin
Boca Raton FL

THE WOODPECKER

I wanted to write you about the letter in May's 73 Magazine concerning the Russian "woodpecker." I tried the recommended procedure from the shack at the store, and it worked. It may have been coincidence, but soon after I began to send dits in time with the clicks, the interference stopped. Even if it was coincidence (both times), it made me feel better! I hope it is really working, for that damn noise has helped me lose more DX than just about anything. The gentlemen from the West Coast DX Association are to be applauded. Now the Russians are probably hot on UFO chasing, with the recent glitches in their little radar. Brilliant!

One other thing, Wayne. Don't be too hard on those people who are loyal fans of yours. I understand your position on wanting people to agree with you with their brains and not their guts, but you are a public figure—in the public eye. To many, you are bigger than life whether you like it or not. Their gut reactions begin in their brains, for their brains filter your words down to the level of emotion. This is basic human nature, and this is an emotional subject, unfortunately. I think you'd be surprised at how many friends you have that never speak up for themselves; they like to hear you speak for them. I think they would come through in a pinch, however, and their group should be cultivated. You have the rare talent of being controversial combined with the ability to make friends. Well, I don't want to get too far into this, for I don't want you to think I'm a sentimental clod. Just know that you have friends who are behind you.

Steve Baumrucker WD4MKQ
Chapel Hill NC

Thanks for the most kind letter. If you get any more data on the woodpecker, please pass it along!—Wayne.

VLF

I have just had the pleasure of reading Mr. Ralph W. Burhans' article on VLF reception, and would like to inform readers that they can obtain more information from the manual *Naval Shore Electronics Criteria, VLF, LF, and MF Communications Systems*, Navelex No. 0101,113 (Federal Stock No. 008-059-

SPLIT SCREEN SPLIT SCREEN

TRANSCIVE MODE

Type and Edit Your Text Even While Receiving

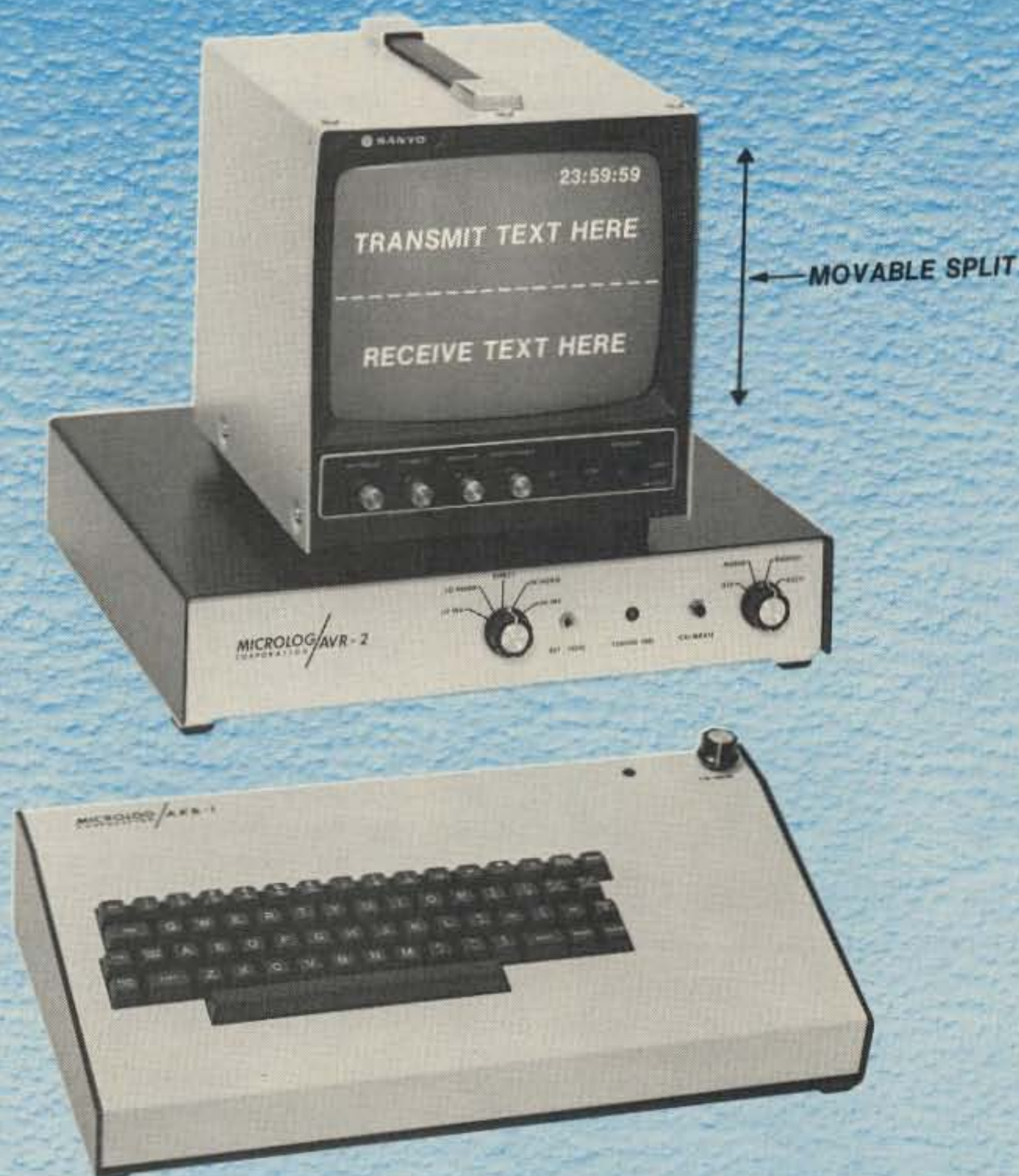

Pace Setting Features:

- Mode and Speed Readout • 24 Hour Clock • Normal and Zoom Display
- Normal or Inverted Video • Computer Trainer • "Brag Tape"
- Digital or Analog Selection of Morse Speed • Automatic T/R Switch
- Expanded Text Buffer to 1950 Characters • Automatic CW Identification
- Up to Ten Message Memories

Complete CW/Baudot/ASCII Split Screen System from \$999 with your T.V.
(Includes AKB-1 Keyboard and AVR-2 Decoder.)

Direct hookup to your transceiver - nothing else to buy.

Upgrade your existing MICROLOG system with our Split Screen field mod kit only \$99.

One year warranty on all products. Add \$4.00 shipping per item. MD residents add 5% sales tax.

Prices Subject to Change



MICROLOG
CORPORATION

4 Professional Drive - Suite 119
Gaithersburg, Maryland 20760
Telephone (301) 948-5307

00015-2, \$3.50), available from the Superintendent of Documents, US Government Printing Office, Washington DC 20402.

Harry A. Weber
Chicago IL

IARL

Please count me in as a charter member of the new International Amateur Radio Lobby. I'll join as soon as you call for members! Whatever happens during WARC '79, we all need to be more prepared the next time around. The organization you outlined in the April, 1979, issue of 73 looks as close to ideal as possible. I hope you can get it all together by the end of the year.

In answer to your questions, ten dollars a year is more than fair. With the ARRL asking eighteen dollars a year, you could probably justify twelve to fifteen dollars a year.

Contests have a definite place in amateur radio—how about the special mode con-

tests, i.e., computer CW, RTTY, SSTV, satellite, etc.? Your mentioned contest ideas are very good.

The "IARL" should be separate from *73 Magazine*. I say that because I hate to be forced into anything—the choice should be left to the individual. A package price for the two would be welcomed, I'm sure.

The officers of the organization should be elected by the rank and file members and they should hold a two-year term.

In summary, I think we need a strong lobby voice in Washington, and I have full faith that you can get the job done. Go to it!

Randall L. Rife KA4BAX
Clearwater FL

CANAM COUNCIL

The Canam (Canadian, American) Repeater Council was formed in 1973 on the initiative of the Brandon Amateur Radio Club.

The Council is made up of

representatives from amateur radio clubs from Manitoba and North Dakota. It usually gets together twice a year and meets on the air in between. It was our opinion that some group should be formed to suggest frequencies for the use of repeaters on both sides of the border so they would not interfere with each other.

It was hoped that groups planning repeaters would contact the Council before they picked their frequencies to see that it was not likely to interfere with some other group.

We would like to see every club in Manitoba and North Dakota have a representative on the Council.

For further information, please contact: Bill Graham VE4QG, 16 Frontenac Crescent, Shilo, Manitoba, Canada R0K 2A0, or Ken Larsen K0PVG, R.R. #1, Devils Lake ND 58301.

Dave Snydal VE4XN
Secretary-Treasurer
Brandon Amateur Radio Club
Brandon, Manitoba

NO MORE NET

The Novice 15m WAS Net has been discontinued and a 40m version started. Check-in on 7.135 at 0800 UTC on Saturdays. KA8AKL is net control.

Rick Todd KA8AKL
Newbury OH

ARMED OVER?

The April issue of 73 contains comments by Wayne regarding the \$100,000 fiasco by the ARRL last year. This is old, old news.

The fiasco was disclosed at the Pacific Division Convention at Reno last August as explanation for the large number of *Handbooks* donated for use as door prizes. I was the recipient of one.

I know Wayne laughs all the way to the bank with his ARRL "disclosures." We look to him to amuse us with new stories, not those that are warmed over.

Vince Salemme
Livermore CA

W2NSD/1 NEVER SAY DIE

editorial by Wayne Green

from page 7

BENEFITS

During the much-too-brief planning sessions for the linear amplifier testimony, I tried hard to convince the ham manufacturers and Bob Booth to think along these lines, but there was no way to convince them. They knew that the Commission was dead wrong and they were determined to tell them that. The Commissioners did not want to hear this news, so it went in one ear and out the other.

If we want a Communicator Class license, we can have it. First, we have to find out what the problems are which are holding it up with the Commission... and there is no difficulty in getting this information. Next, we have to come up with some good solutions to these problems... solutions which will make it beneficial for the FCC to do what we want. If we provide enough benefits to the FCC and don't give them additional problems, we'll get everything we want. It's as simple as that. This is the way I organized the hearing in 1973—and it worked perfectly. It can work again.

The key to any sales pitch, whether it be for subscriptions to a magazine, to advertisers, to sell a product, or to convince the FCC to act the way we want, lies in the simple concept of emphasizing the benefits and having a ready and simple answer to any objections. For instance, when our ad department talks with advertisers, we point out that our readers are spending an average of \$500 each per year on ham gear according to our latest poll. If you work that out, it comes to roughly \$3.75 million per month... and that comes to about \$37.50 in return for every dollar spent in the magazine for advertising. That's one hell of an ad return, and it perhaps explains why 73 has more ads than any other ham magazine. Most advertisers are primarily interested in the bottom line... not in a bunch of talk about circulation (which can include thousands of libraries... which don't buy products).

With the drop in newcomers to amateur radio, it might be prudent for both the industry and the clubs to think seriously in terms of getting some action

on a Communicator Class license... there are certainly a bunch of advantages for hams. We've seen what the sparse use of 220 MHz has done to us... first with CB trying to poach it and then with the maritime interests sneaking around in back of us and grabbing it via the WARC route. We desperately need new hams, and I think we've seen that the traditional way of getting them has not been working.

WARC

There has been nothing much new on the WARC front... still no reason for optimism. But once that is past... if we are reasonably intact... we will have to get started on a program of growth and modernization. I've written before on our need for a three-pronged approach to the situation... with a lobby in Washington to work on getting the rules we need through the FCC expeditiously... a national lobby to get news of amateur radio into the media and encourage the growth of the hobby... and an international lobby to get amateur radio into every one of the emerging nations and make them supportive of amateur radio at future international conferences.

Let me say this clearly: If the ARRL doesn't shape up and accept the responsibilities outlined above... I will do it. I prefer to do more fun things and develop computer software sales... perhaps DXpedition a bit, etc. From here on it is up to you... either you get the

League to stop wasting your money or else I'll get something going to do the job they should be doing. Note that, ARRL directors.

If I do get something working along this line, it is going to cost a lot more than \$18 per year and you are going to enthusiastically support it. But then, I will get the job done and not come up with an emerdement of obfuscation about why nothing happened.

APRIL WINNER

Philip S. Rand W1DBM ran away with April's \$100 bonus check for his article "An 8-Element, All-Driven Vertical Beam." Remember, you can vote for your favorite article by using your Reader Service card ballot at the back of the magazine.

BRITISH HAMFEST

The RSGB was kind enough to arrange their yearly hamfest during my short visit to England in May, bless their hearts. My main purpose for the trip was to set up distribution of Instant Software in the UK and other European countries, but you can be sure that I didn't miss visiting the yearly hamfest.

It was quite a way from the center of town. Sherry and I found it at the end of an Underground line... plus a bus trip... at the Alexandra Palace... a large building. My ego got a boost right away when I was recognized by some local 73 readers. That's fun.

I snapped a few pictures so

you could get an idea of the size of the hamfest. It was mostly involved with the selling of equip-

ment and parts. They had dozens of booths selling zillions of radio parts.



This is a wide-angle view showing the center part of the exhibits floor. There is an antenna booth at the lower right and an enormous pile of used test equipment (much of it laboratory) in the center.



On each side of the main hall was a smaller section, again filled with booths selling used equipment and parts. It was perhaps 70% giant flea market in US terms.



The RSGB group was actively pushing 73 . . . see tee-shirt proof.



This is the front of the palace. The exhibits hall ran the entire length of the building! You had to go way around to the side of the building to get in.



Most of the ham gear was pretty much what we have. It comes from Japan, just like ours.



This view may help give you an idea of the size of the place. This shows just the exhibits in the left-hand side of the main hall.



In case you think I wasn't there . . . that's me talking crystals with QuartSLab.

Microcomputer Interfacing

from page 26

wanted noise generated by the switching transients.

Analog switches may be used in almost any circuit that requires a voltage switch. Typical applications for analog switches include their use in D/A converters, programmable gain amplifiers, filters, and integrators. Our main interest in these switching devices centers around their use in analog multiplexers used to switch multiple signal inputs to a common point for amplification and digitization. The two types of switching devices that we shall consider are those without decoders and those with decoders.

Some analog switches, such as the Texas Instruments TL182C and the Analog Devices 7510, 7511, and 7512 devices, have control inputs for each individual switch. Pin configurations for these chips are shown in Fig. 2. This type of analog switch requires a separate logic signal to actuate each switch. These switches find

use in applications where more than one switch is to be actuated at one time, or where individual switch control is needed.

Switches employed for analog signal multiplexing are generally more useful when they are equipped with built-in, or on-chip, decoder circuits. Such decoder circuits typically accept parallel binary TTL input and then actuate the correct switch that corresponds to the binary code applied. The binary code can only represent a single binary value at one time, so only one switch at a time is actuated. Block diagrams and truth tables for the Analog Devices 7506 and 7507 analog multiplexers are shown in Fig. 3.

When using analog multiplexers with on-chip decoders, it is still the user's responsibility to provide the correct code of the channel required. Many decoder chips also contain an enable input that permits multiplexer schemes to be expanded to include a larger number of selectable channels.

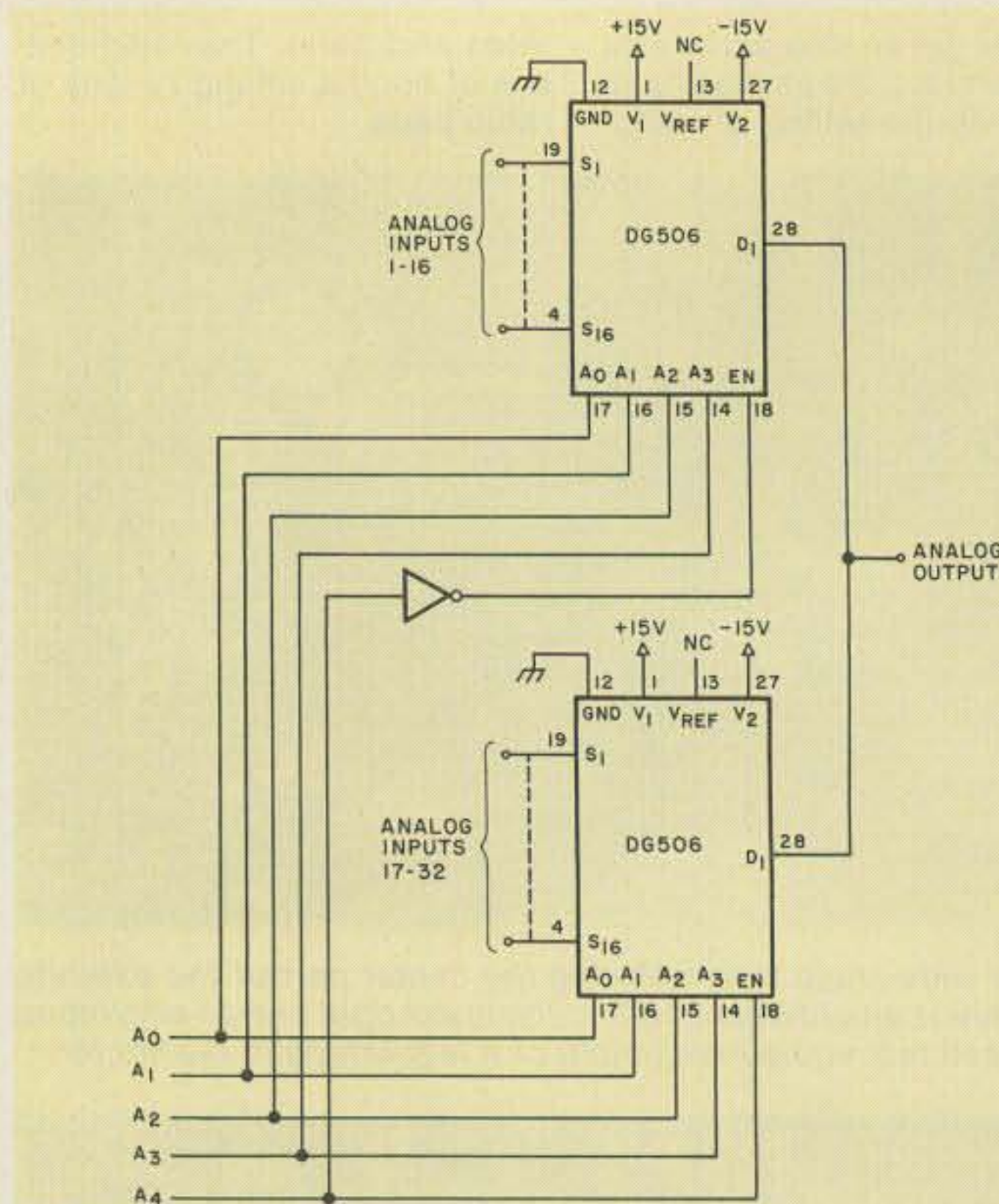

Fig. 4. Block diagram of a 32-channel analog multiplexer using 16-channel multiplexer chips.

A typical example is the 32-channel multiplexer circuit shown in Fig. 4. In this example, a Siliconix DG506 multiplexer is used. Note the use of the enable input at pin 18. This input allows us to switch be-

tween the two multiplexers by enabling one while disabling the other. With the aid of such an enable input and additional decoder circuits, such a multiplexer scheme can be expanded almost indefinitely.

Looking West

from page 12

the area. Paul said that with higher antennas, their distress beacon would have been more likely to be heard and rescue could have begun more quickly. It was very effective, since it emphasized in a direct way the sometimes life or death situations which occur and the value of our activities in dealing with them.

The Planning Commission voted to recommend to the Board an amendment excepting amateur antennas up to 100 feet in height from the minor use permit requirement. This was encouraging, but not entirely satisfactory. The Commission reasoned that a 100-foot threshold would exempt nearly all installations.

I did not mention the petitions to the Planning Commission. The Planning Commission is composed of citizens appointed by the Board of Supervisors. Petitions, it seemed to me, are most impressive to elected officials who run for office and who can be expected to be more sensitive to public

opinion.

We were encouraged by the Planning Commission action. After all, for our purposes, 100 feet is more than twice as good as 50 feet. Since the Planning Commission action was unanimous and also supported, if somewhat belatedly, by the LUER staff, I was confident that the Board would approve at least 100 feet.

The Board of Supervisors hearing was set for April 29. An intensive effort was made to get a large turnout, since we felt that our turnout of a dozen or so at the Planning Commission hearing was definitely a helpful factor in obtaining the 100-foot recommendation.

About 30 hams appeared at the Board hearing on April 29. We found ourselves near the end of a long agenda. Arrangements had been made, as we had done at the Planning Commission hearing, to announce on the Otay repeater what time we would be heard so that all of us would be spared the ordeal of sitting there all day waiting. As it turned out, we sat there until after 4 pm when the Board

realized that they would not get to us. The hearing was continued to May 16, with a promise that we would be heard early on.

We had decided, on the theory that there's no harm in asking, to take the approach that, while we definitely favored an amendment, we would be most in favor of a total exemption, being limited only by FCC rules which allow up to 200 feet in most areas.

We redoubled our efforts to obtain a large turnout, with hams even taking a day off from work to attend. Paul WA6GDC, a most talented artist, had come up with the great idea of inviting local hams to the "county's largest antenna-raising party, at their (Board of Supervisors) place." Paul drew this up and got it circulated and published in several newsletters and posted in all the local ham equipment outlets. This was another terrific example of the extraordinary creativity and willingness to work that many hams displayed.

Our efforts were rewarded by the appearance of about 60 hams at the hearing on May 16. This accounted for about 90% of the total attendance at the hearing, at which several other items were to be considered besides ours.

I had arranged for Bob WA6QQQ, who is a radio engineer and consultant to the broadcast and TV industry with top-notch credentials, to give a short technical presentation. He worked up a number of good points, but the Board indicated they didn't really want to hear the technical side of it. I thought this was a real shame, since he had done a lot of work preparing. His input was very valuable in helping me prepare my remarks, and so his effort was by no means lost, even though he didn't give his presentation.

Don WB6DPO, President of the El Cajon Amateur Radio Club, gave a brief but effective statement on behalf of that club's membership. The club's newsletter editor, Charlie WD6GVR, brought out, in a very impressive way, by asking a question, that the cost of a minor use permit was at least \$450—with no refund if denied. Jim Smith W6VCE gave a short talk emphasizing the value of our emergency services to the Weather Bureau, among others. His remarks drew brief applause.

Supervisor Lucille Moore's late husband was a ham, and she had a very good idea of what we were talking about. Supervisor Roger Hedgecock

surprised many of us by indicating that he felt local government would do well to avoid regulating amateur radio in a manner inconsistent with FCC rules, which, he said, "cover every detail."

Mrs. Moore initially moved acceptance of 100 feet. The vote was a 2 to 2 tie. After further discussion among the Board and several questions about FCC rules to the staff and to me, Mrs. Moore moved acceptance of an exemption of 200 feet. This time the vote was unanimously in favor. Sustained applause and cheering greeted the vote. We had won!

How had it happened? Primarily, I think, we learned that if we "circle the wagons" and all pull together, and if we prepare ourselves to sell our program in a positive, reasonable manner, our chances of success are considerably improved. Ham radio has an excellent record in most places and can be sold. By the way, it seems to me extremely important to preserve and guard this excellent record from being sullied by unfortunate and imprudent conduct.

In our case, three factors seem to account for the success of this effort. First, we had a fairly large turnout at the hearing. We would have been more secure had we had a large turnout at each hearing, but not everyone can arrange his affairs to attend. Hams have to work, travel, etc., just like anyone else. But it was definitely important that the Supervisors could look out into the audience and see that, if nothing else, their action was going to be witnessed by a roomful of voters who were concerned enough to come out and participate, who would probably remember this come the next election, and who were probably interested enough to tell their buddies how they were treated.

Second, the petition had a very important positive effect on the Supervisors. We didn't tell them how many signatures were gathered. I gave the petition to the Clerk of the Board without fanfare at the first hearing, which was continued. The Supervisors had the exact number of signatures at the time of the final hearing. They had had a count made by their staff, and when I mentioned the petition, they indicated that they had definitely reacted to it.

Third, we tried to present our arguments in a positive, rational way. This was in contrast to a group which appeared on another matter prior to ours. The thrust of their argument was negative. They eventually berated the Supervisors for passing such "stupid laws and for being such stupid jerks" who couldn't see the justice of the change the group sought. Needless to say, this was very poorly received. They went home empty-handed.

We tried to structure our presentation to emphasize the public interest, balancing the competing diverse interests in aesthetics versus the importance of reliable public service communications. The function of the Board, and any deliberative law-making body, is to balance these competing values, and this seemed to strike a responsive chord.

Special credit for this affair goes to SANDARC delegates and officers, SCM, W6INI, W6GIC, W6SLF, N6LY, W6QR, K6NA, W6US, K6KOI, WA6GDC, W6PDA, WB6DPO, WD6GVR, W6VCE, WA6QQQ, WA6HJJ, the officers of the several radio clubs in the county, and countless hams who pitched in and helped in many ways.

Who says you can't win at City Hall? We did!

There you have the story from someone who was a part of it.

Looking West wishes to add its congratulations for the fine teamwork shown by the San Diego amateur community in stopping this ordinance from becoming a disaster for the Amateur Radio Service. Special thanks to Sybil Albright W6GIC for sending along Jim Allen's fine story.

TWO METERS AND THE GREAT BALLOON RACE

About ten years ago, the famed Fifth Dimension vocal group had a million-plus-selling record titled "Up, Up, and Away!" It was a dream song; it told of sailing freely through the air, free of the earthly bonds that shackle mankind to his oh-so-hum-drum existence. It was a song that any dreamer could relate to. It has stayed with me ever since...

There are balloons of one's dreams and then there are the real kind, the ones filled with helium or just hot air (no pun intended) that do indeed lift man from his earthly bonds. The fact is that ballooning is a very big hobby with many today and interest in it grows with each passing year. It was because of this interest that, in the year 1906, an expatriate US publisher named James Gordon Bennett lent his name in sponsorship to what came to be known as the Gordon Bennett International Cup Race. With the exception of the World War I years, the race continued uninterrupted until 1938. Poland won that one. However, then World War II intervened and a cloud of silence fell upon the event from 1939 to 1979.

Things might have stayed this way if not for the intervention of Dr. Tom Heinsheimer. Dr. Heinsheimer is not a ham; he is an aerospace scientist with a sincere love of ballooning, according to Nate Brightman K6OSC, who supplied much of

the input for this story. It was because of the unyielding devotion of Dr. Heinsheimer that the year 1979 saw the revival of this event. Herein lies an amateur radio story to capture the imagination of any ham.

The "New Gordon Bennett Race" took a path from Long Beach, California, eastward to the "Duke City" of Albuquerque, New Mexico. It was expected that any balloon completing the race would be airborne for a minimum of 72 to 96 hours. Nobody could really be sure, since gas-filled balloons do not perform in the exact same manner as do other aircraft. You really can't steer a balloon. You can make it go up, you can make it come down, and that's about it. Once airborne, you are strictly at the mercy of Mother Nature herself. You go where the prevailing winds take you and the final outcome is anyone's guess. On the weekend of May 27th, some 18 gas-filled balloons took to the "wild blue yonder," scattered hither and yon as the winds carried them, in hopes of being the first to set down in the "Duke City."

Organizing a race such as this really presents quite a logistics problem, as you can well imagine. How do you keep track of eighteen free-flying balloons that might go anywhere? Enter amateur radio and an organization known as the Associated Radio Amateurs of Long Beach. Since the race was to begin in the parking lot for the *Queen Mary*, now permanently docked in Long Beach, California, harbor, using the newly-restored "wireless room" aboard the *Queen Mary* as a control point seemed to be the logical first step. The FAA must have thought this was a good idea since they declared the "wireless room" a temporary control tower for the duration of the race. The balloons



Thirty-five members of the Associated Radio Amateurs of Long Beach took part in communications handling for the Gordon Bennett International Balloon Race. The ARALB boasts a membership of 225. Photos by Nate Brightman K6OSC.



Ron Boan AK6Y, member of the ARALB, who set up the net with Arizona and New Mexico hams, is shown acting as net control. A minimum of 32 hams maintained a vigil on the net until released by Ron. Nate Brightman K6OSC, Projects Chairman for the ARALB, was Director of Communications for the balloon race.



After nightfall, Howard Brightman K6OSD followed his field operation with a night of monitoring phone calls from the balloon chase crews and the news media. Logging the most number of continuous hours, he slept with the phones and totaled 81 hours of operation. Behind Howard, a member of a chase crew club records reported balloon position. All field HT operators wore green ribbons on their right shoulders for easy identification.



As balloonist Ernest Iselin HB9BJ (one of two hams racing) looks up at his balloon, Howard Brightman K6OSD uses an HT to report progress to the command center in the Queen Mary wireless room. The other ham racing, pilot of the Japanese balloon, was Saburo Ichiyoshi JR1IH.

were ordered to carry portable battery-powered VHF aircraft transceivers; however, there was no way to recharge batteries should they fail. Another sure-fire method to keep track of the balloonists was needed.

Since each balloon would have a chase car following it, it was decided that each car would be supplied with an amateur transceiver and a licensed amateur to operate it. To ensure ongoing communications, a two-meter interlink stretching from Los Angeles to Albuquerque by way of Kingman, Arizona, was established so that those serving as communicators would never be out of contact with the command center aboard the *Queen Mary*. Operators with hand-helds were also solicited and dispersed as lookouts from some of our "natural towers" that abound in the southwest. Under the guidance of the Associated Amateurs of Long Beach, a complete communications network was set up and checked out prior to the race. During the event, it performed flawlessly.

As the balloons took to the air, things reached a fever pitch on 146.52 and remained that way for close to three days. Even though .52 is a heavily used simplex channel around Los Angeles, virtually the entire amateur community stayed clear of the channel for the duration of the event, thus permitting an uninterrupted flow of information among those amateurs involved in the tracking operation. As an added measure of protection, a group known as the "Happy Flyers" was on standby alert should their services be needed. Operating under the direction of Squadron 5 Commander Lee Osborne WA6FSP, the Happy Flyers, who are a group of

amateur radio operator pilots who normally involve themselves in search and rescue missions of downed aircraft, would take to the air to locate any balloon that might be lost from ground-level visual contact. Being amateurs themselves, the Happy Flyers could converse directly with both the command center and the ground units, thus eliminating the need for crossband relays. Luckily, nothing in the way of a true emergency occurred; however, for the first few hours of the race, an aircraft piloted by Commander Osborne was in the air to oversee things.

None of the balloons reached Albuquerque. One well-known balloon, the *Double Eagle II*, reached Las Vegas and under the rules was declared the winner. Others did not even get that far. Another US entry named the *Rosie O'Grady* touched down a few short hours later in the parking lot of the Jet Propulsion Laboratory in Pasadena, California, thus taking about five hours to make the trip from Long Beach that can be driven in 40 minutes. However, to balloonists, time has no relevance whatsoever; it's the freedom that counts. "To dance across a silver sky . . . to fly . . . free as a bird." To follow a dream—that's the real meaning. A US entry won this year's Gordon Bennett Race and next year the US will again host the event. Already the Associated Amateurs of Long Beach are planning for it. They did an excellent job this year and they intend to make next year even better.

220: THE WAR TO SAVE IT CONTINUES

The May 25th edition of *HR Report* contained a front-page statement that has angered

many Southern California amateurs. It is *HR Report's* claim that the "Fight to Save 220" campaign initiated by the 220-SMA of Southern California and taken up nationally by other groups is actually hurting the growth of 220. The story states that the current campaign is making people adopt a wait-and-see attitude and that this has stifled growth of the spectrum.

Rationale for this closing statement comes from *HR's* belief that surface facts concerning the future of this spectrum point to the US position as being one of "bargaining" with 220 as nothing but another pawn in an overall chess game, that in the end, 220 will be safe and therefore this campaign is really not necessary. If only we could be sure that such was the case. However, the bureaucracy has sold amateur radio down the tubes so many times that in this case amateurs are totally convinced that their only defense is a strong offense, that once and for all it is time to put a stop to the "woodpecker effect" that has over the years eroded our spectrum. Every 220 operator I talk with, and that is a goodly number each week, is convinced that this is a fight to the death, that this is the one singular battle that will determine the destiny of all amateur spectrum. If inroads of any type are permitted to take place on 220, then no band is safe. Will 450 be next? Two meters or 20 meters perhaps? Regardless of what *HR Report*, the ARRL, or anyone else says, the battle will continue until such time as one side or the other has fallen. The objective is to once and for all make it clear that amateurs will not permit even the slightest bit of spectrum theft and will not tolerate further threats to 220 or any spectrum now assigned to the amateur service from any

quarter.

220 operators from all over the nation have jumped onto the "Save 220" bandwagon, but, as of yet, only one magazine. Neither *QST* nor the ARRL proper has been heard from and everyone else seems to be waiting in the wings for something to happen. The 220 people I have spoken with have made it clear that with or without the blessing of the Newington hierarchy, they will continue. They never expected any real ARRL support from the outset and could care less if it does come. Even ARMA, which has a vested financial interest in this spectrum, has yet to come forth and say yea or nay. In the end, this has become a fight of the "people" against the "establishment," and the only support they have asked has been from one another. By far, the people of 220 are far more "together" than any other group I have ever had the opportunity to witness. Other amateur special interest groups can really take a lesson in strategy planning from them. They have, in effect, placed everything on the line in fighting to protect their spectrum and no veiled promises or threats will dissuade them. They could care less what the establishment thinks. They're out for only one goal—to win!

Along these lines, it was recognized that one of the most important aspects of any campaign is the ability to readily communicate. However, channeled relay operation does not readily lend itself to this without complex intertie systems. In seeking an alternative to this, 220-SMA Advisor Ray Von Neumann K6PUW and Henry Lachmiller WB6JLG hit upon a simple solution. Just as UHF remote bases have established 146.46 MHz as the National Remote Base Intertie Channel, why not have a similar gather-

ing spot for 220-MHz systems? Consultation between the 220-SMA and Tasma led to the establishment of 145.56 MHz as the "Regional 220 Intertie Channel" with recommendations from both groups that it be adopted nationally and be included in the overall national 2-meter bandplan. The concept here is to keep the people of 220 MHz in contact with one another without the need of synthesized radios or special equipment. Rather, each system provides a downlink to the common meeting ground of 145.56 MHz and conversation is automatic. In the few short weeks since the

channel was announced, a goodly number of systems have initiated such operation and each week finds new ones. Ray has reported that Arizona may soon initiate a similar operation on 145.56 and hopes that it will eventually become a national 220-MHz intertie whereby information can be sent all over the place by relay from district to district. The ability to continually communicate is very important, more so now than ever before. VHF propagation tends to limit our communication ability. The 220 downlink concept is a step toward remedying this.

"AND THEN THERE IS 14.285 MHZ" DEPARTMENT

Another frequency to keep your ears on is 14.285 MHz on 20 meters. It seems to have become a very popular lowband intertie channel for VHF and UHF remote downlink HF operation and LW is getting quite a few reports of such operations. Actually there is no particular reason that 14.285 was chosen by the remote people. The story is simply that the first remote to install a 20-meter downlink radio just set it there and everyone else seems to have taken the same route. There is no way to know how many re-

motes downlink to 14.285; however, the number is growing rapidly. While it's doubtful that many systems will go to the trouble of installing a 20-meter SSB radio and antenna at their site, the fact is that a number have and users report it to be one heck of a way to operate HF while eating dinner at the local diner or driving home on a crowded freeway. A number of remotes are reported to have all-band/all-mode HF capability which includes remotely tunable receivers and remotely rotatable beam antennas. Squelch tales and "PL" on 20 meters? What next!?

Awards

from page 28

band, mode, or time restrictions. General certification rules apply.

ZONE 3 AWARD

This award is offered in four (4) levels of operating achievement:

1. Basic Zone 3 Award. This award is issued to those stations submitting written evidence of having worked an amateur in each state and Canadian province in Zone 3. These geographical limits would include Arizona, Oregon, California, Nevada, Utah, Washington, and the province of British Columbia. Contacts may be made in any amateur band and mode and must have been made on or after January 1, 1946.

2. Master Zone 3 Award. Applicant must follow the same rules as stated for the Basic Award with the exception that all contacts must be made with a station located in the capital city of each state and province in Zone 3.

3. Special Zone 3 Award. This special award recognition requires the applicant to work five (5) Zone 3 stations whose last call letters spell the word BEARS. All other rules for the Basic Zone 3 Award apply.

4. Extra Zone 3 Award. This award combines the difficulty of both the Master and Special Award and undoubtedly becomes the most sought-after in the Zone 3 program. To qualify, contacts must be made with stations located in capital cities of Zone 3 states and provinces. In addition, the last letters of their calls must spell the word BEARS.

All awards offered by the BEARS are available free of charge. Applicants must make a self-prepared list of required contacts, including the city and state of each amateur contact claimed, the date of each QSO,

the band, and the mode. This list must be verified by at least two (2) amateurs, Technicians or above, an officer of an active radio club, or a notary public. In each case, the applicant must have written confirmations on hand for each contact claimed. Submit your award application to: The Boeing Employees' Amateur Radio Society, Willis Propst K7RS, 18415 38th Avenue, South Seattle WA 98188.

Representing the Finnish Amateur Radio League, Inc., our good friend Mervi Huotari, award manager for SRAL, writes to inform us about the beautiful OH series of awards being offered by this dedicated organization in northern Europe.

Mervi indicates that all applications must be forwarded to the attention of the SRAL Award Manager, PO Box 306, Helsinki 10, Finland, and suggests that QSL cards not be sent. Instead, Mervi states that all claimed contacts should be verified locally by two licensed amateurs, a club official, or a notary public.

To be valid, all contacts qualifying for the OH-series awards must have been made since June 10, 1947. The OH awards consist of the following:

OHA

1. Applicants in Denmark, Norway, and Sweden need contact with at least 50 different OH stations, including 8 OH call areas on one band, plus 8 different OH call areas together on other band(s).

2. Other European applicants need contact with at least 20 different OH stations, including at least 7 OH call areas. The maximum number of contacts per band is 15, so at least two different bands must be used.

3. Non-European applicants need contact with 15 different OH stations, including at least 5

OH call areas on any band or combination of bands. Contacts made on 3.5 MHz will count for two contact points each.

4. CW, phone, or mixed mode contacts count. The minimum acceptable reports are 338 RS(T). Contacts with Finnish maritime mobile stations do not count.

5. The award fee is 5 IRCs, to be sent with each application.

6. The OH8 stations with suffixes ND, NJ, NS, NV, NX, OA, OB, OC, OG, OI, ON, OP, OQ, OR, OU, OX, OZ, PA, PB, PD, PF, PL, PM, and PQ are counted as OH9 stations if contacted before June 1, 1954.

OHA-100

The applicant must have worked at least 100 different OH stations, including all 10 call areas on one band plus (again) all 10 OH call areas on another (one) band. The 100 stations must all be different, but in order to meet the call area requirement, the same station may be worked on different bands; in this case, the total number of contacts will be over 100. All authorized bands may be used, as well as CW, phone, or both.

The application list must be in district and alphabetical order (only call signs and dates), giving separate declaration of

the required 2 x 10 call areas/bands.

See also paragraphs 4, 5, and 6 of OHA rules above.

OHA-300

The applicant must have worked and confirmed at least 300 different OH stations, including all 10 OH call areas separately on each of three bands, i.e., 3 x 10 OH districts. The 300 OH stations must be all different, but in order to meet the call-area/band requirement, the same OH station may be worked on different bands. In this case, the number of QSOs will exceed 300. All bands, CW, and/or phone may be used.

The application list must be in district and alphabetical order (only call signs and dates), giving separate declaration of the required 3 x 10 districts/bands.

See also paragraphs 4, 5, and 6 of the OHA rules.

OHA-500

This award will be available to any foreign applicant for confirmed contact with 500 different OH stations, regardless of time, mode, or band used. For OH applicants, only contacts made since February 1, 1967, will count.

A list of the 500 OH QSL cards on hand must be submitted to the awards manager. As with all OH-series awards,



this list must be verified by at least two amateurs, a club official, or a notary public. The award manager reserves the right to call for any QSL to be submitted in support of any claim. This list must be written in alphabetical order by call-sign, and no other details are necessary.

The OHA-500 is given to qualified applicants free of charge, compliments of SRAL.

From down under, the boys at the Wireless Institute of Australia were kind enough to forward the March, 1979, issue of their publication, *Amateur Radio Journal*. In that edition, WIA columnists presented the entire portfolio of WIA-sponsored achievement awards. We will review the well-known Worked All VK Call Areas Award (WAVKCA):

WAVKCA

Objects:

1. This award is offered by the WIA as tangible evidence of the proficiency of overseas amateurs in making contacts with the various call areas of the Commonwealth of Australia.

2. The award may be claimed by any amateur in the world who is a member of an affiliated society of the IARU, but no Australian amateur will be eligible.

Requirements:

1. A handsome certificate will be awarded to any applicant who makes contacts with Australian amateur stations in the

areas shown in Table 1. A total of 22 contacts must be made.

Operation:

1. Contacts between overseas stations and Australian stations must have been made on or after January 1, 1946.

2. Contacts may be made using any authorized frequency band or type of emission permitted to Australian amateurs, but crossband contacts will not be allowed.

3. No contacts made with ship or aircraft stations in Australian territories will be eligible, but land-mobile or portable stations may be contacted provided the location at the time of contact is shown on the confirmation.

Verifications:

1. The applicant must submit proof in the form of QSL cards or another form of written evidence confirming two-way contacts have been made. Such verification must show the date and time of contact, call of the station worked, type of emission and frequency used, signal reports, and location (portable or land-mobile stations only) of the stations contacted.

2. If the applicant is a member of a society which has a reciprocal agreement with WIA to verify claimed contacts for its members, submit your QSLs to that society, being sure to enclose sufficient postage fees for their safe return.

Application:

1. Applicants should submit

their certified list of contacts and/or list of contacts with QSL cards to the Federal Awards Manager, WIA, Postbox 150, Toorak, Victoria 3142, Australia. There is no fee for the award—it's compliments of WIA!

Join me next month as we span the globe in search of operating incentives such as those which appeared this

issue. Should you learn of any operating awards in the meantime, why not share them with our many readers throughout the world? I'd be pleased to hear from those who read this column and would appreciate your comments both pro and con, any suggestions you might have, and most certainly any award input you might care to submit.

Territory	Call Area	QSLs required
Australian Antarctica		
Heard Island	VK0	1
Macquarie Island		
Australian Capital Territory	VK1	1
Lord Howe Island		
State of New South Wales	VK2	3
State of Victoria	VK3	3
State of Queensland		
Thursday Island	VK4	3
Willis Island		
State of South Australia	VK5	3
State of Western Australia	VK6	3
Flinders Island		
King Island	VK7	3
State of Tasmania		
Northern Territory	VK8	1
Admiralty Islands		
Bougainville Island		
Christmas Island		
Cocos Islands		
Nauru	VK9	1
New Guinea		
New Ireland		
Norfolk Island		
Papua Territory		

Table 1. In areas above where more than one confirmation is required, contacts may be made with any or all of the territories grouped together. VK9: Where a territory is no longer under Australian jurisdiction, contacts up to the date of independence will be accepted.

Review

AMATEUR TELEVISION IN A NUTSHELL

Sooner or later every ham gets the urge to try something new and different. For some this means a better rig. The more adventuresome types may want to try a new mode. Fast-scan television is one such opportunity. Activity starts at 432 MHz and is even found in the microwave bands. Until recently, there has been no universally good source of information for the beginner. This void is partially filled by the book, *Amateur Television in a Nutshell: Everything you need to know to build or operate your own ham TV station*.

The book was first published in early 1978 by Henry Ruh WB9WWM, the publisher of *A-5 Magazine*. Despite its 8½" x 11" cover size, there are only 60 pages of text, making it truly a "nutshell" of information; price is \$5.00. The contents include a short theory section followed by chapters on receiver, transmitter, and antenna construction projects. A listing of ATV

operators, several charts, and a few pages of advertisements comprise the rest of the book.

Since the world of video is new to most prospective ATVers, the author gives a rather detailed explanation of the TV signal and describes how a camera works. Once the basics are mastered, it is time to think about gear. Ruh lists specific recommendations about the individual units an ATV station will need. The prices are sure to have changed, but the model and manufacturer information is likely to be useful for a few more years.

Although the easiest way to get involved in ATV is by purchasing ready-made equipment, many hams find that the long-term attraction of fast-scan operation is home-brewing. The projects discussed in the book are lifted from the pages of *A-5 Magazine*. They are written in a cookbook fashion with little attention given to the mysteries of UHF construction. Despite the frequent occur-

rence of pictorial aids, a number of the photographs and diagrams are of questionable value because of blurry or crude reproduction.

Prospective ATVers are likely to ask, "What can I do with my station once it is built?" *Amateur Television in a Nutshell* lacks any good answer. For amateurs new to UHF and video, the best source of information and help is probably an

experienced ham, preferably living nearby. *Amateur Television in a Nutshell* is not a replacement for practical knowledge, nor is it likely to be a timeless reference of the subject. If you have a genuine interest in the subject but don't know how to get started, do yourself a favor and buy a copy of *Amateur Television in a Nutshell*.

Tim Daniel N8RK
c/o 73 Magazine

Ham Help

I have a Hallicrafters receiver, model S-40A, and I need alignment instructions and identification of the trimmer capacitors. I also have an Elmac Model A54H portable transmitter for which I need instructions for aligning the vfo and identification of the trimmer capacitors. I will be glad to pay a reasonable charge for copies and postage.

Benford Rhodes W4RKW
126 Elizabeth St.
Jacksonville NC 28540

I am doing experimental work in radio spectrum efficiency. I am in urgent need of a spectrum

analyzer, which I cannot afford. I need an inexpensive method to adapt a B&K 10-MHz, dual-beam, triggered-sweep oscilloscope for my needs. I am especially interested in the region of 100 kHz ± 5 kHz.

Roy Hickman, Sr.
PO Box 572
Wauchula FL 33873

I need a schematic and/or manual for a Viking 122 vfo. I will pay for photocopying and shipping.

John Pape KA2FJA
72 Stelfox St.
Demarest NJ 07627

Contests

from page 18

formation plus 2 IRCs or one dollar. DX stations will qualify

by working XJ3TBC on 2 different bands. Each day an appropriate prize will be given to the lucky Canadian or US amateur working XJ3TBC closest to a preselected time. Amateurs visiting the station are invited

to and will receive a commemorative memento of their participation.

SARTG WORLDWIDE RTTY CONTEST

Contest Periods:
0000 to 0800 GMT
Saturday, August 18
1600 to 2400 GMT
Saturday, August 18
0800 to 1600 GMT
Sunday, August 19

The contest is sponsored by the Scandinavian Amateur Radio Teletype Group. Use all bands 80 through 10 meters on RTTY only. Operating classes include single-op, multi-operator/single-transmitter, and SWLs. The same station may be worked once on each band for QSO and multiplier credits. Only two-way RTTY QSOs will count.

EXCHANGE:

RST and QSO number.

POINTS:

QSO with your own country is 5 points, with other country in the same continent is 10 points, with other continent is 15 points. In USA, Canada, and Australia, each call area will be considered as a separate country. Use the DXCC list and each district in the three countries listed above for multipliers. Note: A contact with a station which would count as a multiplier must be found in at least 5 logs, or contest logs from the multiplier station must be received in order to be valid. Final score is the sum of QSO points times the sum of multipliers. SWLs use the same rules for

Continued on page 172

Results

1979 US SSTV CONTEST RESULTS

Once again, the annual SSTV Contest was a joyous success and all contestants reported having the times of their lives during this informal event. As you will recall, this US-sponsored SSTV contest is held during the second full weekend of each March.

The overall 1979 SSTV Contest winner was Roland Soucie N6WQ of Costa Mesa, California. As you can see in the contest tally, Roland's victory was practically a landslide—and he followed the correct (shorter contest times) rules which were published in *73 Magazine*. Roland also took the awards for most countries worked and the most continents worked. Since John WB9OGS and Roland N6WQ tied for most states/provinces, both SSTVers will receive awards for their accomplishments.

Brooks W1JKF and Dave K4TWJ wish to thank everyone who participated in the SSTV Contest for making this event a tremendous success. We tried to expand this year's contest into a jointly-sponsored event which was announced in all the amateur magazines. Unfortunately, *CQ* published incorrect contest times while *QST* mentioned the contest somewhere in the back of an issue, under QCWA happenings or the like. I never found that announcement!

On-the-air contest monitoring which Brooks and I did indicated an extremely congenial spirit of competition and courtesy among all SSTVers. Many operators would actually wait in turn for QSOs to avoid possibly QRMing others.

Several SSTVers have recommended changes for next year's contest. These recommendations were acquired during the contest, via the Saturday SSTV Net, and via mail. The prime consideration involved making this contest an international affair. Before this plan can be adopted as a unanimous effort, we need opinions (and assistance!) from all SSTVers. If the contest is to be truly international, then prime time should also be available to our friends around the world. What operating schedules would you deem necessary? How should an awards and publicity program be implemented? Please contact W1JKF and K4TWJ with your opinion... soon! The Saturday SSTV Net is usually this activity's planning table. See you then?

Dave Ingram K4TWJ
Brooks Kendall W1JKF

	Total Credit	QSOs	States Provinces	Countries	Continents	Name
N6WQ	231	123	33	10	5	Roland
WB9OGS	159	86	33	5	3	John
WA3APB	159	69	25	9	4	Bill
WB0RYP	150	74	27	6	3	Carl
AF0K	146	75	26	6	3	Mel
W1WS	132	60	22	7	3	Connie
WD4DCW	129	54	19	2	1	Stan
W3CJI	129	52	22	8	3	Brownie
W2GND	121	51	25	6	3	Harry
W6WDL	111	74	27	5	1	Bob
W9ET	108	45	18	6	3	Jerry
K4FJK	101	52	24	3	2	Jerry
WB9UTM	100	48	27	4	1	Bob
K8EMI	96	36	20	5	3	Ed
XE1HT	76	32	14	3	3	Juanita
WA0LLQ	74	31	23	3	1	Jay
PA0DXY	66	20	11	4	3	Kees
K0TW	51	22	14	2	1	Tom
SWL				RYT	Netherlands	J.A. Vande

1979 SSTV CONTEST COMMENTS

"The SSTVers are a great bunch of hams who should be commended for their sportsmanship and courtesy during the contest."—K4FJK.

"Rig acted up once, but I gave it the old gravity test from 3 inches off the table and it straightened right up."—WA0LLQ.

"Great contest, but it needs a magazine sponsor."—W2GND.

"And one that can get information right and illustrate an interest in SSTV, like *73* continuously does. Right, Wayne?"—K4TWJ.

"Although I couldn't stay in the whole time, it was loads of fun."—K8EMI.

"Great—can't wait until next time."—WB0RYP.

"In our Dutch magazine, *Electron*, contest rules were not clear."—PA0DXY.

"Disappointing was working 2 DX stations in the same country."

"Mixed emotions was working 2 mobile SSB contacts and sending them video before finding out they did not operate SSTV. My average was five contacts an hour."—AF0K.

Results

RESULTS OF THE SCANDINAVIAN AMATEUR RADIO TELEPRINTER GROUP (SARTG) 8TH WORLDWIDE RTTY CONTEST, 1978

WORLD TOP SCORES Single-Operator Top Five Class A

I3FUE	298,540
IT9ZWS	247,845
K3KD	241,825
F9XY	240,800
HB9AVK	233,225

Multi-Operator Top Five Class B

I5MYL	244,925
DL0TS	183,150
LZ2KRR	182,250
I1COB	153,655
G3UUP	152,800

Shortwave Listeners Class C

F. Rossi	218,550
OK1-11857	209,700
B. Niendorf	206,640
G8CDW	72,600
K. Wustner	70,265

Corrections

After my article appeared in the April, 1979, issue of 73 ("The Heath/Kenwood Connection"), I found a small refinement which could be added to the project. Its total cost is small and it should take only a few minutes to install.

I realized that one could use some method of instantly bypassing the remote vfo aside from using the function switch on the remote vfo. For example, in case of some unexpected failure in which the remote vfo and its function switch are inoperative, it would be nice to immediately go to the rig's vfo. I have not had any such failure as yet, but anything can happen in

electronics.

A side benefit was found when it was discovered that *both* vfos (internal and remote) could be used at the same time. This is very nice when one wants to find a clear spot to move to while still in contact. Also, one could monitor a sked or calling frequency while tuning around.

The only parts needed are a lamp, a resistor, and a switch. The lamp I used is a Radio Shack 12-volt/25-mA lamp with red lens and mounting clip. Since I felt it was a little too bright, I put a 47-Ohm, 1/4-Watt resistor in series to prolong the bulb's life. (See Fig. 6.)

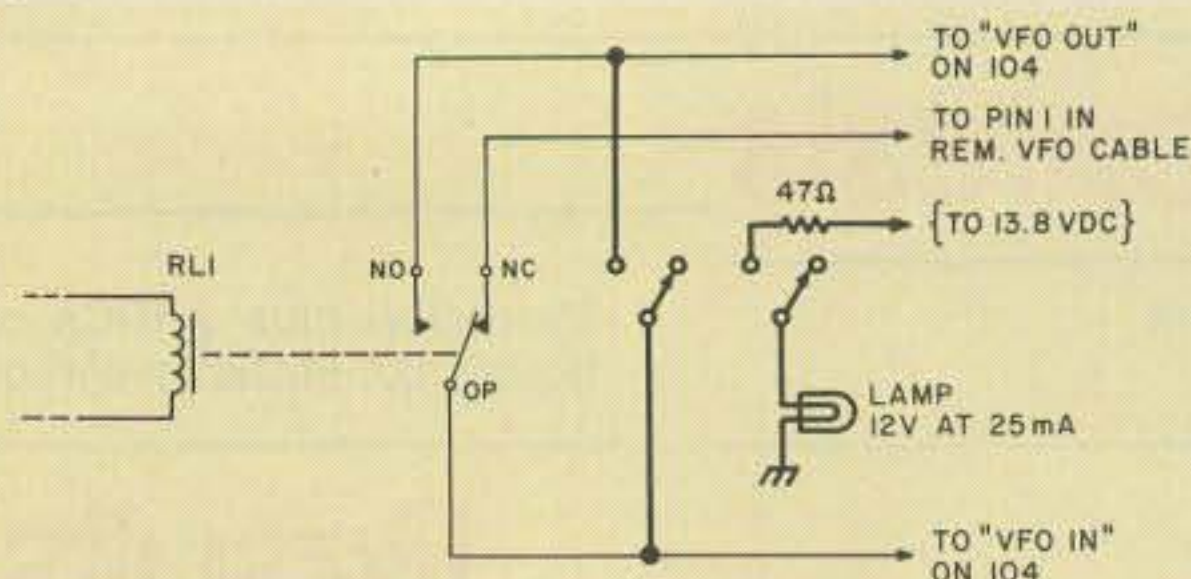

Revised Fig. 6, "The Heath/Kenwood Connection."

Why install a red lamp? It's okay to *listen* on two frequencies at the same time but not to *transmit* on two frequencies at the same time. In fact, I considered using a push-button switch which would then allow multi-frequency operation *only* whenever one makes the conscious effort of pressing the switch. I recommend giving serious thought to this alter-

native. If a toggle switch is installed, the bright red lamp may prevent giving an SSB CQ with the other vfo on the CW segment of the band!

The addition meant placing the interface box up front where it's more accessible and visible but I feel it's worth it.

Robert B. Lunsford, Jr. WB5QGI
Killeen TX

Social Events

Listings in this column are provided free of charge on a space-available basis. The following information should be included in every announcement: sponsor, event, date, time, place, city, state, admission charge (if any), features, talk-in frequencies, and the name of whom to contact for further information. Announcements must be received two months prior to the month in which the event takes place.

IRVING TX AUG 3-5

Encounter '79, the Texas VHF-FM Society's 1979 Summer Convention, will be held August 3-5, 1979, at the Villa Inn, Irving, Texas. Activities include a transmitter hunt, flea market, FCC exams, manufacturers' exhibits, hospitality room, and several programs and forums. Talk-in on 146.52 and repeaters in the area. Registration at the door is \$6.00. For further information, people may write to Encounter '79, PO Box 3608, Arlington TX 76010.

FLAGSTAFF AZ AUG 3-5

The Amateur Radio Council of Arizona will hold its annual Ft. Tuthill Hamfest on August 3-5, 1979, at Flagstaff, Arizona. Prizes include TS-520 transceivers, a microwave oven, a Whson Mark II HT, a Wilson System III triband antenna, and more. Featured will be a western barbecue, tech sessions, and exhibits. Camping facilities are also available. For further details or information, write Ft. Tuthill Hamfest, c/o

8520 E. Edwards Ave., Scottsdale AZ 85253.

LITTLE ROCK AR AUG 4-5

The Central Arkansas Radio Emergency Net (CAREN) Amateur Radio Club will hold its second annual Ham-a-Rama on Saturday and Sunday, August 4-5, 1979, at the Arkansas State Fairgrounds, Little Rock, Arkansas. There will be two main prizes given, as well as door prizes. Featured will be forums, dealers' exhibits, a Saturday night party, and a large flea market. Talk-in on 146.34/94. For details, send an SASE to Morris Middleton AD5M, 19 Elmerst Drive, Little Rock AR 72209.

JACKSONVILLE FL AUG 4-5

The Jacksonville Hamfest Association is pleased to announce the 1979 Jacksonville Hamfest and ARRL North Florida Section Convention to be held on August 4-5, 1979, at the Jacksonville Beach Municipal Auditorium, Jacksonville, Florida. The location is just one block from the beach, where U.S. 90 meets the sea.

Advanced registrations are available at \$3.00 per person from R. J. Cutting W2KGI/4, 303 10th St., Atlantic Beach, Florida 32233. Price at the door will be \$3.50.

A large indoor swap area will be featured, with advance table reservations available for \$5.00 per table per day from Robbie Roberts KH6FMD/W4, 10557 Atlantic Blvd., #31, Jacksonville, Florida 32211. Information on

exhibitors' booths and space are available from the same address.

Other features and programs include statewide organization meetings on such topics as traffic nets and MARS, a microprocessor seminar, a solar power demonstration, a DX "pileup" contest, a hidden transmitter hunt, an OSCAR forum, ARRL forums, emergency preparedness programs, DX and contest presentations, antenna and technical seminars, and much more.

More general information may be obtained from JHA, 911 Rio St. Johns Dr., Jacksonville FL 32211.

LEVELLAND TX AUG 5

The Hockley County Amateur Radio Club and the Northwest Texas Emergency Net will sponsor their 14th annual picnic and swapfest on Sunday, August 5, 1979, at the City Park, Levelland, Texas. A \$2.00 registration is requested but not required. Registration begins at 8:00 am and lunch will begin at 12:30 pm with a bring-your-own-picnic-basket lunch. There will be swapping all day with tables provided. Talk-in on 146.28/88.

GLENN MI AUG 5

The Black River Amateur Radio Club will sponsor its 26th annual VHF Picnic and Swap 'n Shop on Sunday, August 5, 1979, at the Allegan County Park, Glenn, Michigan. Take Interstate 196 north of South Haven, Michigan, to the Glenn Exit. Door prizes will be awarded. Bring the family and a picnic basket (no lunch will be provided on the grounds) to enjoy the beach and playground. Talk-in on 147.90/30 and

146.52. For information, contact Ed Alderman WB8BNN, RR#2, Box 98AA, Bangor MI 49013, or phone (616)-427-8830.

ANGOLA IN AUG 5

The Steuben County Radio Amateurs will hold their annual F.M. Picnic and Hamfest on Sunday, August 5, 1979, at Crooked Lake, Angola, Indiana. There will be prizes, picnic-style barbecued chicken, inside tables for exhibitors and vendors, and overnight camping (fee charged by county park). Talk-in on 146.52 and 147.81/.21. Admission is \$2.00.

SALEM OH AUG 5

The second annual Salem Area Hamfest will be held on August 5, 1979, from 9:00 am to 3:00 pm at the Kent State Salem campus, Salem, Ohio. Tickets are \$1.50 in advance and \$2.00 at the door. Inside tables are \$5.00 with space for your own table at \$2.00. Flea market space is \$1.00. There will be air-conditioning, a wheelchair ramp, free parking, refreshments, and prizes, consisting of an Atlas RX-110, TX-110, and a PS-110. Talk-in on 146.52. For details, write Harry Milhoan WA8FBS, 1128 West State, Salem OH 44460.

REND LAKE IL AUG 5

The Shawnee Amateur Radio Association Hamfest will be held on August 5, 1979, at Rend Lake in southern Illinois. Complete camping and recreational facilities will be available, so plan to spend the weekend at the lake and attend the hamfest on Sunday. Family activities are planned. Hourly door prizes will be awarded. There will be no charge to vendors. For informa-

tion, contact WB9ELP or WB9SWG.

**PITTSBURGH PA
AUG 5**

The South Hills Brass Pounders and Modulators will hold its 42nd annual Pittsburgh Hamfest on August 5, 1979, from noon until dusk at the Allegheny County Community College south campus on Rte. 885, 2 miles south of the Allegheny County Airport and approximately 15 miles southeast of Pittsburgh, Pennsylvania. Advance registration is \$1.50; \$2.00 at the door. There will be a large indoor air-conditioned area for vendors and the flea market, and a large paved surface for the outdoor flea market. There will also be prizes and food. Talk-in on 146.13/.73 and .52/.52. For information and pre-registration, write Bruce Banister, 5954 Leprechaun Dr., Bethel Park PA 15102.

**MT SINAI LI NY
AUG 5**

The Radio Central Amateur Radio Club will hold its "Ham-Central" on Sunday, August 5, 1979 (rain date is August 12, 1979), at the Mt. Sinai Elementary School, Rte. 25A, Mt. Sinai, Long Island, New York. Admission for sellers is \$3.00 per tailgate space and \$1.50 for buyers, with XYL and children under 12 free. Monies are to be used for Radio Central and the St. Charles Hospital Repeater. Doors will open at 7:00 am for sellers and 9:00 for others. They will close at 4:00 pm. Featured will be antenna advice with Art and Madeline Greenberg, a Novice table, great food, a CW contest, an ARRL table, a special event of a fly-in by the Suffolk County Police Dept. helicopter, and a Radio Central Club table. Talk-in on 146.52 WA2UEC and 144.71/145.31 K2VL. For information, call Joan Longtin at (516)-924-8438 or Robin Goodman at (516)-744-6260, or write Radio Central, "Ham-Central," PO Box 680, Miller Place NY 11764.

**AMARILLO TX
AUG 10-12**

The Panhandle Amateur Radio Club will hold its sixth annual Golden Spread Hamfest and Convention on Friday, Saturday, and Sunday, August 10-12, 1979, at The Inn of Amarillo, 601 Amarillo Blvd. West, Amarillo, Texas. The format consists of two full days of exhibits and trading, six technical sessions, programs for the ladies, valuable door prizes, Army and Navy MARS meetings, ARES meeting, an ARRL forum, and plenty of free parking. Displays may be set up any time after 1:00 pm on Friday, August 10th, at a fee of \$20.00

per table. For information, write Hamfest, PO Box 10221, Amarillo TX 79106, or phone Jay Ledbetter WB5UBM at (806)-376-6042 (nights and weekends) or Chuck Passmore WB5BRC at (806)-372-1631.

**MUNCIE IN
AUG 11**

The Delaware Amateur Radio Association will hold its 2nd annual hamfest on Saturday,

August 11, 1979, starting at 7:00 am, at Springwater Park, County Roads 300 E. and 100 N., Muncie, Indiana. Tickets are \$1.50 in advance and \$2.00 at the gate. Reserved table space is \$1.00 per table with no extra charge for outside space. There will be hourly drawings from 9:00 am until 3:00 pm, with the grand prize of a Tempo SYNCOM S1 being drawn at 3:00 pm. Second prize will be a HAM III rotor.

Talk-in on 146.25/.85 and 146.52/.52. For information or tickets, send money and an SASE to DARA, PO Box 3021, Muncie IN 47302.

**WOODBIDGE NJ
AUG 11**

The DeVry Tech Amateur Radio Club will hold its third annual flea market on Saturday,

Continued on page 160

FLESHER CORP.

RTTY made easy !

**TR-128
NEW
FROM
FLESHER**



***RTTY REGENERATIVE
BAUD RATE CONVERTER**
TTL compatible connections for direct hook-up to the TU-170, also adaptable to other units.

- ~ Five standard baud rates
- ~ Stable crystal-controlled oscillator
- ~ 128 Character storage capacity with storage status meter to show buffer fill
- ~ Continuously variable character rate

Wired \$239.95 Kit \$169.95



Flesher products . . . the critics choice!

FLESHER CORP.

P.O. Box 976 Topeka, Ks. 66601 913/234-0198
Add \$3.00 for postage and handling.



**TU-170
TERMINAL
UNIT**

Connect to your receiver speaker, transmitter microphone jack, and teletype machine and you're on the air. Ideal for HF and VHF auto start operation.

- ~ Autostat with threshold control and solid state relay
- ~ Stable audio frequency shift oscillator produces phase coherent sine wave tones
- ~ TTL compatible inputs and outputs for auxiliary equipment
- ~ High level output for scope tuning

WIRED \$234.95 KIT \$159.95

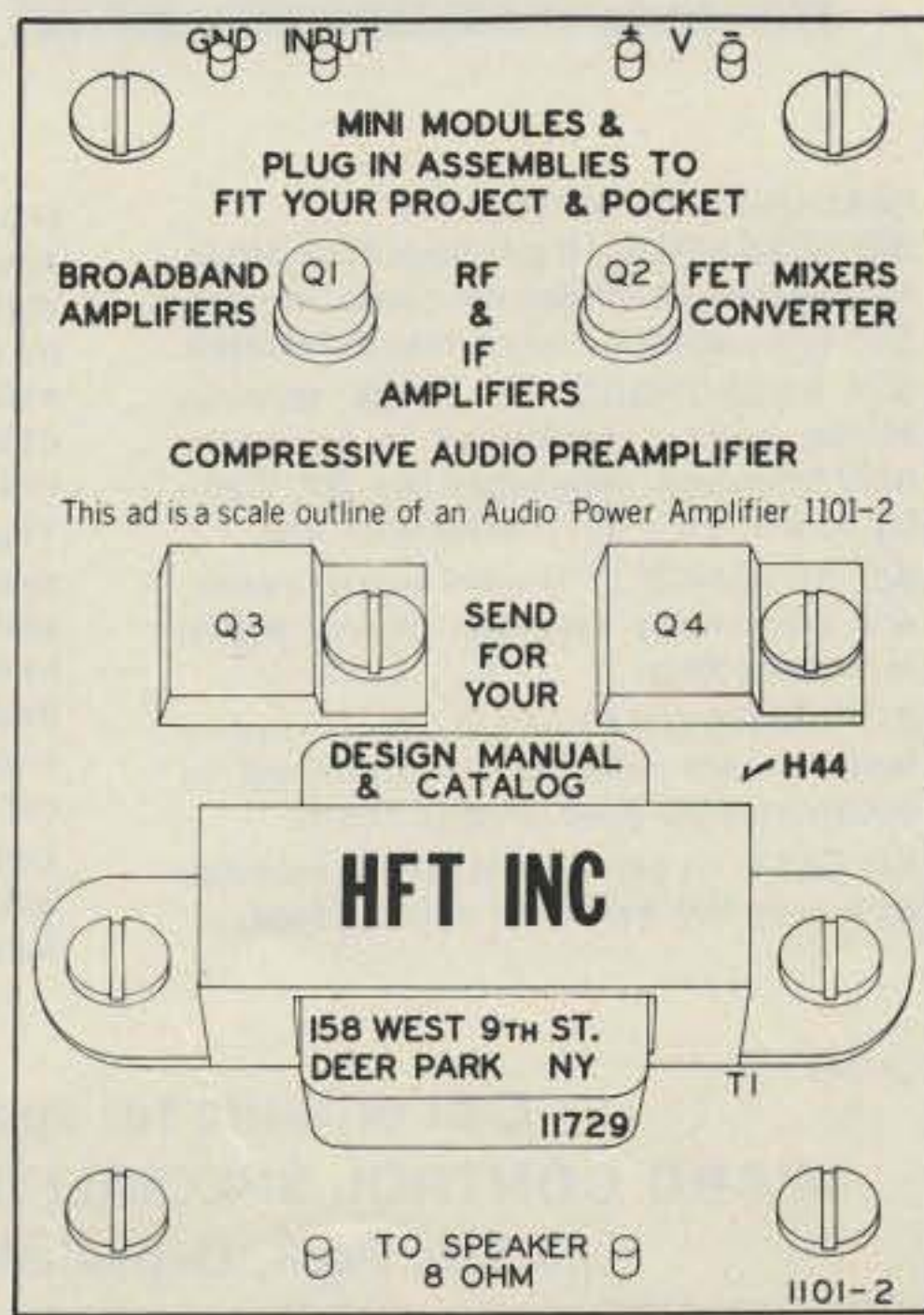
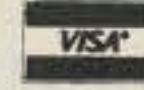



Bearcat® 250

Only \$269.00 plus \$5.00 U.P.S. shipping.
Quantity discounts available!

Order toll free (800) 521-4414
or (313) 994-4444. Circle C5 on reader's service card for a free catalog or write us at Box 1002, Ann Arbor, Michigan 48106

**COMMUNICATIONS
ELECTRONICS™**

FREE!
RADIO AMATEURS
WORLD ATLAS
 with purchase of famous
CALLBOOK
MAP LIBRARY!

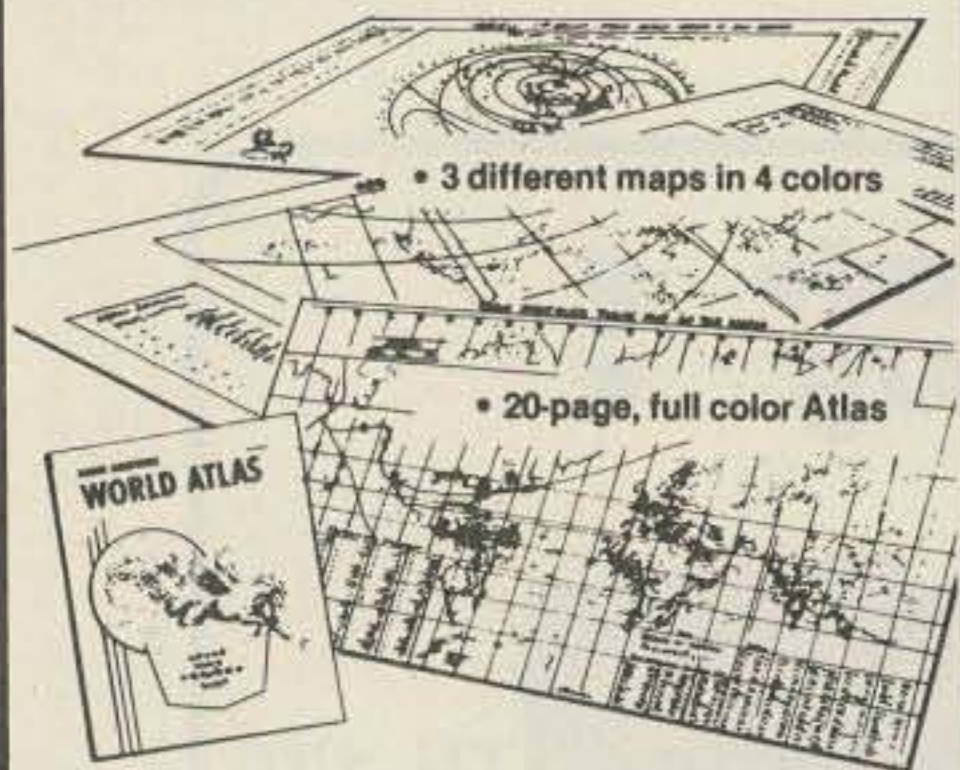

Here's an offer you can't refuse! You receive three, information-packed, Amateur Callbook maps, folded, plus the World Atlas for only \$3.75 plus \$1.50 shipping and handling. If purchased separately, total value of map/atlas offer would be \$6.25, plus shipping. You save \$2.50 and get these invaluable radio amateur aids!

- 1. Prefix Map of the World, folded.**
 World-wide prefixes. Shows 40-zone map on one side, 90-zone map on the other. Size 40" x 28"
- 2. Map of North America, folded.**
 Includes Central America and Caribbean to the Equator. Shows call areas, zone boundaries, prefixes, etc. Size 30" x 25"
- 3. Great Circle Chart of World, folded**
 Centered on 40°N, 100° W. Shows cities, latitude, longitude, great circle bearings and more! Size 30" x 25"

Plus special FREE bonus!

The Callbook's own **Radio Amateur World Atlas**, **FREE** with the purchase of the 3 maps. Contains eleven full color maps of the world, looking at things from the radio amateurs point of view.

Callbook Map Library	\$3.75
Shipping	\$1.50
Total	\$5.25



Special Limited Offer!
Amateur Radio
Emblem Patch
 only \$2.50 prepaid

Pegasus on blue field, red lettering. 3" wide x 3" high. Great on jackets and caps. Sorry, no call letters.

ORDER TODAY!

Order from your favorite electronics dealer or direct from the publisher. All direct orders add \$1.50 for shipping. Illinois residents add 5% Sales Tax.

RADIO AMATEUR
callbook INC.
 Dept. B
 925 Sherwood Drive
 Lake Bluff, Ill 60044

SCANNERS:

KDK 2015R, KDK 2016A

MIDLAND 13-510, 13-513, CLEGG FM-28

YAESU FT227, ICOM IC22S, KENWOOD TR7400A

- AED continues to expand its line of quality scanners. All of the above scanners are custom designed for their respective rigs.
- All scanners install completely inside the rig. No obtrusive external connections.
- All are easy to assemble and come complete with a detailed instruction manual.
- Scanned frequency displayed on digital readout (except IC22S).
- In the scanner OFF mode the rig operates normally. In the scanner ON mode the scanner locks on an occupied frequency, pauses for a preset time (about 5 secs.) and then resumes scanning.
- This gives you the ability to eavesdrop all over the band without lifting a finger. When you hear something interesting, you flip the switch to the LOCK mode and the rig is ready to transmit.

AED SCANNER SPECIFICATIONS

	KDK 2015R	KDK 2016A	KENWOOD TR7400A	YAESU FT227R	MIDLAND 13-510 13-513	CLEGG FM-28	ICOM IC22S
SCAN RATE	Adjustable 100kHz/sec-1mHz/sec		50kHz/sec	200kHz/sec	100kHz/sec	100kHz/sec	100kHz/sec
SWEEP WIDTH	144-148 or only the mHz segment you select on mHz switch	142-149.995	complete band or mHz you want	adjustable eg. 146-148 144-146 146-147	scans the mHz seg. selected by the mHz switch	same as Midland	145.35-147.99
SCAN CONTROLS	2 mini toggle switches mounted on rig. LOCK switch may be mounted on mic.		2 mini toggle switches mounted on rig.	1 mini toggle switch mounted on mic or rig.	2 mini toggle switches mounted on rig.	same as Midland	1 mini toggle switch mounted on mic or rig.
PRICE FOR KIT	\$39.95		\$39.95	\$34.95	\$39.95	\$39.95	\$34.95
PRICE PRE-ASSEMBLED	\$59.95		\$59.95	\$54.95	\$59.95	\$59.95	\$54.95

Add \$1.50 for postage & handling

DEALER INQUIRIES INVITED

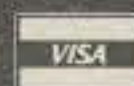

AED ELECTRONICS

750 LUCERNE RD., SUITE 120
 MONTREAL, QUEBEC, CANADA H3R 2H6
 TEL. 514-737-7293

END OF SUMMER SPECIAL
 \$5.00 off kit, \$10.00 off assembled rigs.
 (prices as shown)
 Sale ends August 31st



✓ A60

THE SMART CHOICE IN

REPEATER CONTROL

Now with three exciting new features:

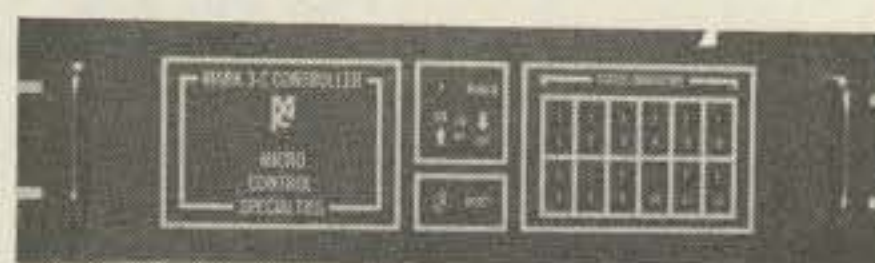

- Long Distance Calling
- Autodialing
- Remotely selectable timeout limits

IMAGINE A CONTROLLER —

SO VERSATILE It provides four different classes of output functions in addition to autopatch and reverse autopatch.

SO RESPONSIVE It sends thirteen Morse coded messages to keep you fully informed. Messages like BZ if you try to access a busy autopatch line.

SO ADVANCED It uses microprocessor technology and non-falsing digital tone decoding.

SO PERSONALIZED that many features are custom programmed to accommodate your unique needs.

SO EASY it can be installed in minutes with only five essential connections.

NOW imagine automatic dialing of emergency telephone numbers, long distance autopatch calling under control op supervision, plus remotely commandable timeout limits to match various operating conditions and you've just imagined the MARK 3C.

The MARK 3C is a complete control system with all audio and logic circuitry, status display, and power supply in one handsome cabinet. Its third generation design can replace racks of hardwired equipment while giving vastly expanded capability.

Get the field-proven power that only a MARK 3C can give at \$995. (100% factory assembled and tested)

✓ M69

Call or Write for specifications

MICRO CONTROL SPECIALITIES (617) 372-3442
 23 Elm Park, Groveland, Ma. 01834

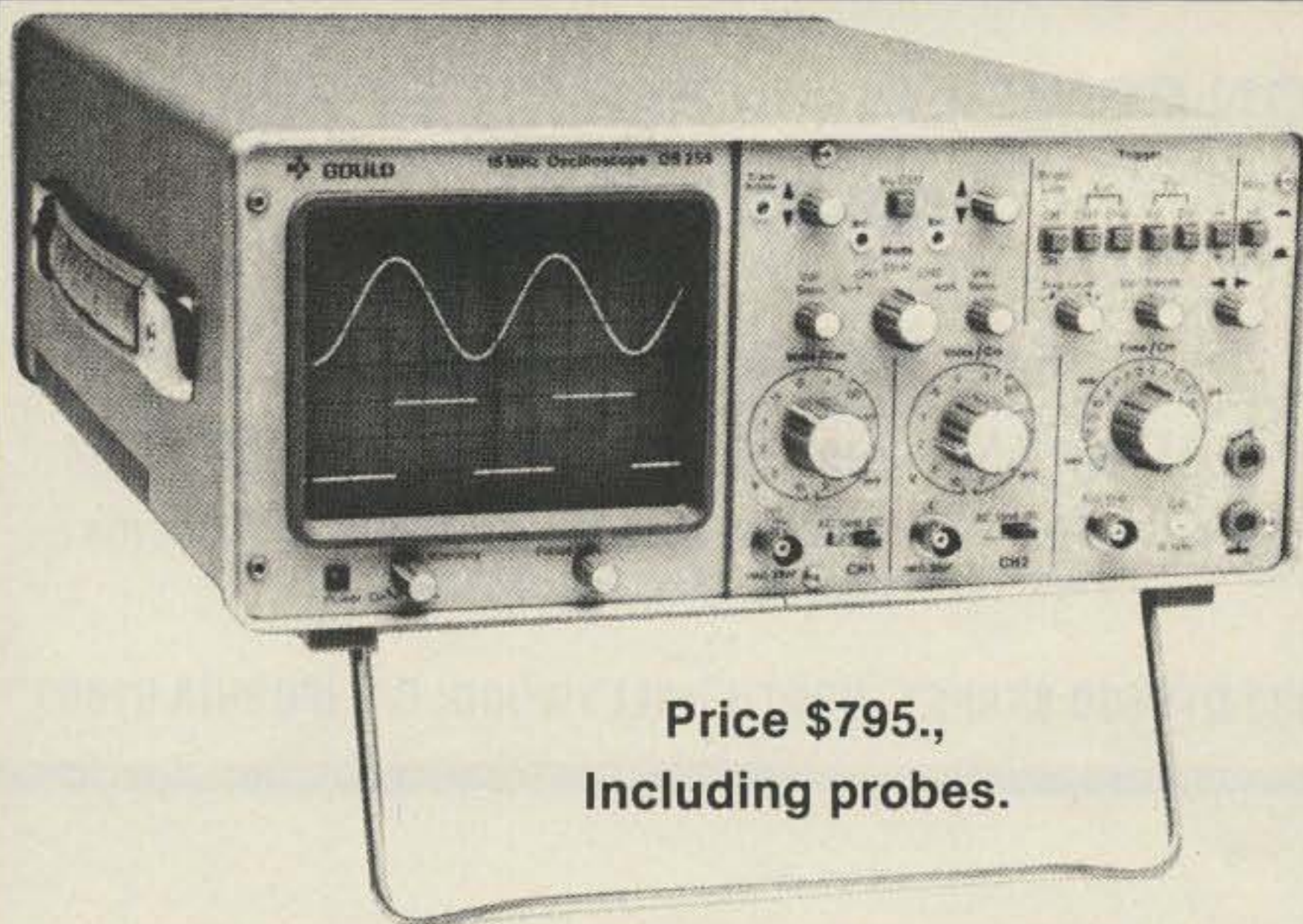

Price \$795.,
Including probes.

**Looking for reliability?
Look to the professionals
from Gould.**

R. LESLIE Electronic L24
Laboratories

3054 Scott Boulevard · Santa Clara Ca. 95050 (408) 727-1782



Directional RF wattmeters from Dielectric

The new 1000-A
Wattmeter from
Dielectric accepts
plug-in elements
that permit RF
measurements from

100 mW to 5000 watts full-scale and from 2 MHz to 1
GHz. The large 4½" meter face is easy to read and has ± 5%
full scale accuracy and great resolution.

The 1000-A is available in a convenient all-purpose kit that
includes a SNIFFER adjustable RF signal sampler, spare UHF
connector and patch cable. All contained in a durable
carrying case.

RF Instruments for Professionals

For the name of your local distributor, call Toll Free 800-341-9678.

A limited number of distributor locations are currently available; inquiries welcomed.

GS DIELECTRIC COMMUNICATIONS D29
A UNIT OF GENERAL SIGNAL
RAYMOND, MAINE 04071 • TEL. 207-655-4555 • 800-341-9678

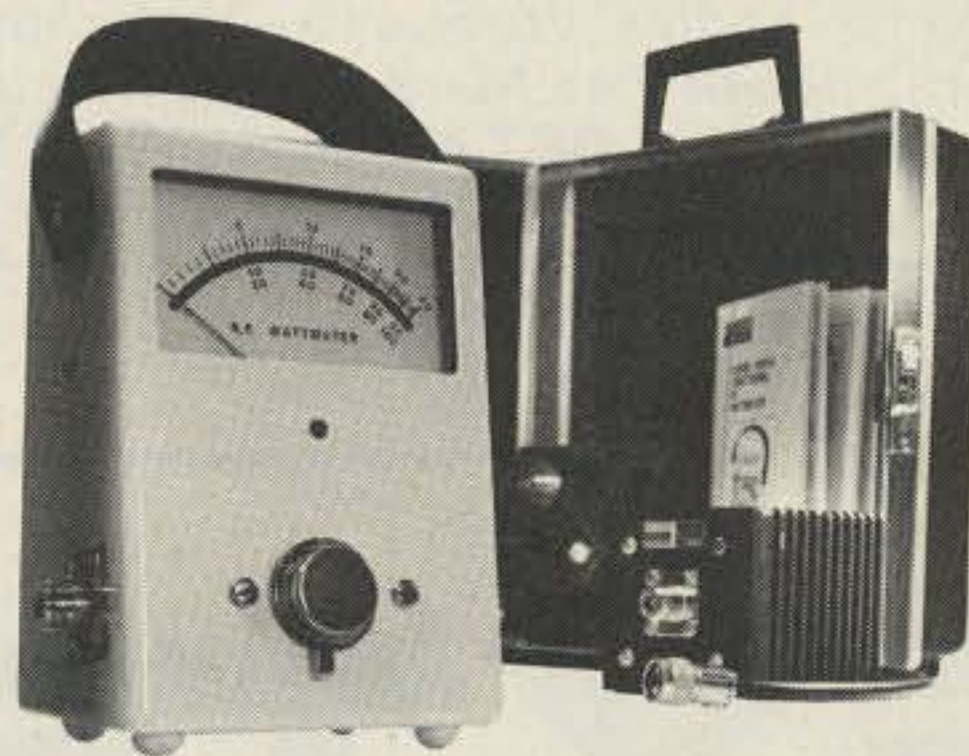

**COMPLETELY
FREE-STANDING,
TELESCOPING TOWERS.**



PUT IT RIGHT WHERE YOU WANT IT.
With one hand, raise the tower from 21' to
as high as 55'. Find exactly the right re-
ceiving level from CB, Ham or TV. When
you want to adjust your antenna, install a
new one, or pull maintenance, crank it
down again. No more climbing up in the
sky to repair or replace antennas. With the
exception of our breakover models, this is
the most convenient tower you can buy.

**BREAKOVERS—THE ULTIMATE IN CON-
VENIENCE**—Our breakovers not only
telescope, they lie down for you. One man
can crank it down, then lay it down, so
your feet never have to leave the ground,
even on our tallest towers.

TOTALLY FREE-STANDING. No guy
wires, no brackets. Our towers are de-
signed to withstand 60 mile winds, with 50
pounds rotor and antenna with a vertical
area of 6 square feet.

TOWER CONSTRUCTION. We make it out
of the finest materials available. Our steel
is thicker and heavier, our cables are
thicker and stronger—our towers them-
selves are two or three times heavier than
comparable towers on the market. Weight
runs about 165 pounds for our 40' towers
350 pounds for 55'. Several design innova-
tions are used to make Tele-Tow'r the
strongest, most reliable tower.

ONE-PIECE PRICE. When you buy one of
these towers you get the whole tower
ready to install. No accessory charges, no
extra costs for guy wire, base plates, etc.
And even our complete one-piece price is
considerably lower than any comparable
tower on the market.

Concrete sleeves available for Model 40s
and Model 55s. By using sleeves you can
move tower to another location and all
you leave is the sleeve in concrete.

40' MODELS

Model 40 (extends 21' to 40')

Breakover Model 40

(extends from 23' to 40' with breakover at ground
level)

55' MODELS

Model 55 (extends from 21' to 55')

Breakover Model 55

(Extends from 23' to 55' with breakover at ground
level)

TELE-TOW'R MFG. CO., INC.

P.O. Box 3412 • Enid, Oklahoma 73701
405-233-4412

T52

3 YEARS WARRANTY!

EXACT Replacements for
SYLVANIA
ECG Transistor-Diodes-ICs



ECG#	ECG#	ECG#	ECG#	ECG#	ECG#
100	.94	163	5.95	220	1.72
101	.98	164	5.75	221	1.90
102	.96	165	6.95	222	1.99
102A	.98	171	1.37	223	2.79
103	1.05	172A	.72	224	5.06
103A	1.11	175	1.62	225	4.34
104	1.06	176	2.06	226	1.67
105	2.27	177	.49	228	1.38
106	.80	179	5.69	229	1.06
107	.79	180	5.88	230	3.60
108	.89	181	4.65	231	3.96
121	2.15	182	3.35	232	.70
123	.69	183	3.63	233	.74
123A	.79	184	1.37	234	.72
124	1.53	185	1.70	235	2.45
126	1.16	186A	1.46	236	5.75
127	4.60	187A	1.46	237	5.07
128	1.37	188	1.59	238	7.95
129	1.56	189	1.59	239	3.02
130	1.95	190	1.85	241	1.71
131	1.98	191	2.07	242	1.90
132	1.01	192	.98	276	8.72
133	1.14	193	1.04	278	2.36
152	1.43	194	.82	279	5.85
153	1.85	195A	2.67	280	5.06
154	1.85	196	1.98	281	6.35
155	2.02	197	1.89	282	4.24
157	1.43	198	1.89	283	6.32
158	1.08	199	.59	284	7.35
159	.86	210	1.37	285	7.99
160	1.43	211	1.56	286	5.75
161	.98	218	3.08	287	.69
162	5.75	219	4.36	288	.74
					.88
					.98
					1.99
					2.26
					1.08
					1.14
					2.02
					1.13
					1.13
					2.02
					2.02
					2.80
					2.80
					2.57
					7.65
					3.27
					7.65
					2.13
					1.13
					1.00
					7.85
					2.01
					2.74
					24.20
					20.60
					1.11
					26.00
					7.65
					1.80
					3.53
					3.53
					27.50
					.96

- R-U-S-H, All Orders Shipped Same Day Received
- FREE Freight on all prepaid orders
- EXCLUSIVE 3 YEAR CONDITIONAL WARRANTY!
- NO Min. Order-Quantity Discounts Available
- Exact ICs & Diodes In Stock
- Longer Hours Mon-Sat 9a-10p, Sun 1-7p
- Call or write today—to place your order (518)-465-3367

Communications & T.V. Unlimited
Dept 73, 17 Washington St., Rensselaer, N.Y. 12144
DISTRIBUTOR INQUIRIES INVITED
T.V.-C.B.-AMATEUR RADIO-STEREO-MONITORS-
ELECTRONIC PARTS ✓C105

FAST SCAN ATV

ALL YOU NEED IN ONE BOX



Show the shack, home movies, computer games, etc. Connect to the ant. terminals of any TV set, add a good 450 antenna, a camera, and you are there...

- 10 Watts peak RF output. Specify 434.0 or 439.25 MHz
- Subcarrier sound with plenty of mic gain for distance pick-up.
- 8 MHz bandwidth, high resolution necessary for computer alphanumeric and color.
- Tuneable converter covers 420 to 450. (Covers CH 2, 3)
- Contains AC to 12VDC regulated 3 AMP power supply.
- Only \$399.00 direct mail. Check, Money Order, VISA. Send S.A.S.E. for catalog of ATV Modules and PC Boards.



HITACHI HV-62U TV CAMERA \$239 ppd.
• Better than 500 line resolution. 7 watts on 117VAC.
• Small 4x25/8x8 inches. Can run on 12vdc @ 230ma.
• 10,000:1 automatic light compensation. Lens included.
Send SASE for catalog of ATV and UHF products VISA or MC orders call (213) 447-4565.

P.C. ELECTRONICS

Maryann 2522 PAXSON Tom
WB6YSS ARCADIA, CA 91006 W6ORG

✓P41

IRON POWDER and FERRITE PRODUCTS

AMIDON
Associates ✓A26

Fast, Reliable Service Since 1963

Small Orders Welcome Free 'Tech-Data' Flyer

Toroidal Cores, Shielding Beads, Shielded Coil Forms
Ferrite Rods, Pot Cores, Baluns, Etc.

12033 OTSEGO STREET, NORTH HOLLYWOOD, CALIFORNIA 91607

8th ANNUAL

HAM-O-RAMA '79

SEPT. 14th—6 PM-9 PM SEPT. 15th—7 AM-5PM

Advance TICKETS \$3.00—Outdoor Flea Market \$1.00
Indoor FLEA \$5.00 additional 9:30 PM Friday join our FLING
ERIE COUNTY FAIRGROUNDS, HAMBURG, N.Y.

Speakers—Ladies' Programs—Major manufacturers—R.V. Hookups—
Indoor/Outdoor Flea Markets—Talk-In on 52 & 31/91—off N.Y.S. 1-90
at Exit 57 **DETAILS:** HAM-O-RAMA Committee, WB2OIF
93A. Altruria St., Buffalo NY 14220 **PHONE** (716) 824-1752

EXTEND YOUR RANGE...

With the **RPT-1B Repeater**. Backed by Standard Communications' years of experience in producing quality repeaters for the commercial and amateur market, this superior 10 watt VHF repeater operates on a single pair of channels in the 143-149 MHz range. It contains separate transmitter and receiver assemblies for the re-transmission of signals and a COR/TIMER for control of the switching/timing/monitoring functions of the system. In addition, an optional private channel unit may be installed as an accessory. It may be operated in either a repeat or duplex mode. Priced under \$850 from your dealer.

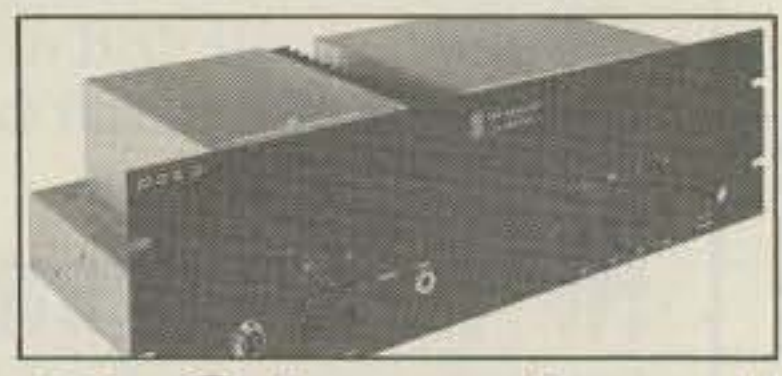

Write today for a FREE Catalog Sheet or see your nearest Standard Communications Dealer.

Standard Communications ✓S18

P.O. Box 92151, Los Angeles, California 90009

RSME HOLD SLOW TIME SCAN ALL DELT ENTR

Available for Kenwood TR 7400, Midland 13-510, Yaesu 227R, or KDK FM-144

At your Ham Radio Dealer or Call or Write ✓C115

CES COMMUNICATIONS ELECTRONICS SPECIALTIES, inc.

399 W. Fairbanks Ave., Winter Park, Fla. 32789
305/645-0474

TODAY'S MOST VERSATILE SCANNER

Scan a few channels or all 800 - for example - you can program CES Model 800 to scan Repeater and Simplex Channels or all 2 Meter Bands - Other features include: Instantaneous Addition or Deletion of Channels • Scan Resume delay assures hearing return calls • Resume and Hold provides complete control of scanning action • Hold Control activated by mic's P.T.T. switch • Scan entire band in 5 KHz steps and retain programmed memory • Selectable automatic scan resume after 10 secs. on channel. Slow Scan of memory to locate specific channels.

JAN CRYSTALS

JAN CRYSTALS KEEP YOU ON THE AIR

- CB
- CB standard
- 2 meter
- Scanners
- Amateur Bands
- General Communication
- Industry
- Marine VHF
- Micro processor crystals

Send 10¢ for our latest catalog. Write or phone for more details.

Jan Crystals
2400 Crystal Drive
Ft. Myers, Florida 33907
all phones (813) 936-2397

✓ J2

easy to charge



... at last ...

your shack organized!

A beautiful piece of furniture — your XYL will love it!

\$149.95 S-F RADIO DESK

Deluxe - Ready to Assemble

Designed with angled rear shelf for your viewing comfort and ease of operation.

FINISHES: Walnut or Teak Stain.
Also available in Unfinished Birch, \$134.95

Additional Information on Request.
Checks, Money Orders, BankAmericard and Master Charge Accepted.

F.O.B. Culver City. (In Calif. Add 6% Sales Tax.) ✓ S33

S-F AMATEUR RADIO SERVICES

4384 KEYSTONE AVENUE • CULVER CITY, CALIF. 90230 — PHONE (213) 837-4870



Radio equipment not included

Floor Space: 39" Wide 30" Deep

ALL BAND TRAP VERTICAL ANTENNAS!

FULL 1 4th WAVE - All Bands! Automatic Selection with proven HI-Q Traps. 3 Models-ALL self supporting - Ground or roof mount. HEAVY Double wall seamless Aluminum lower section - HI IMPACT POLY Low Loss Plastic Cover OVER-ALL. NO WOBBLY, LUMPY TRAPS - NO UNSIGHTLY CLAMPS needed - Same size all the way up - 1 1/4" - Traps hidden inside. You can use it in a 1 ft. sq. Backyard! Neighbors will never know this is a HI-Power ALL Direction DX Antenna. FOR APARTMENTS, ROW HOUSES, MOBILE HOMES - CONDOS etc. where minimum space and neat appearance is MANDATORY! Instant "Drive In" ground mount (included). Use with or without radials (included) (All angle roof mount - Extra) COMPLETELY PRETUNED - NO ADJUSTMENTS NEEDED EVER! NO TUNER NEEDED Over All Bands (except 80 meter - 400 KC) SWR 1-1 to 2-1 at Band edges, Std, SO239 connector - 50 ohm for any length RG58U - RG8U feedline. Matches ALL MAKES TRANSRECEIVERS. 2000 Watt PEP. Shipped in 5 ft. Box - PREPAID IN USA. Assembles in 3 min. using only screwdriver. WEATHERPROOF!

No.-AVT80-10 5 Band 24'9" \$79.95
No.- AVT40-10 4 Band 18'9" \$69.95
No.- AVT20-10 3 Band 12'6" \$59.95

SEND FULL PRICE FOR PP DEL IN USA (Canada is \$5.00 extra for postage, clerical, Customs etc.) or order using VISA (BankAmericard) or MASTER CHARGE or AMER EXP. Give Number and Ex. date. Ph 1-308-236-5333 9AM-6PM weekdays. We ship in 2-3 days. Prices will increase Sept 1, so order NOW AND SAVE. All Antennas Guaranteed for 1 year - 10 day money back trial. Made in USA. Free Inf. Available from

WESTERN ELECTRONICS
Dept. A7 -8 Kearney Ne, 68847



TRS-80 OWNERS

Send-Receive RTTY & CW

- Auto. send & receive: RTTY & CW.
- Complete hardware & software.
- Connects to TRS-80 User Port & key/headphone jacks.
- 10 message memories - 255 char. ea.
- Keyboard buffer-allows typing ahead.
- Uses built-in PLL or external TU.
- Morse trainer-random 5 letter words.
- Includes hardware, cassette & manual.
- Requires Level II Basic & 16K RAM.

■ PET version available, 69.95 kit / 99.95 wired

Write or call for detailed brochure

\$99. kit
\$129. wired

MACROTRONICS, inc.
FORMERLY MICROTRONICS ✓ M48

P.O. Box 747 (S) Keyes, CA 95328 (209) 634-8888 / 667-2888 California residents add 6% tax



CB TO 10 METER

10 METER CONVERSION KITS FOR CB RADIOS AM and SSB

- Kits for over 300 Models of CB Radios
- Low Cost from \$10.00
Easy to Install with All Instructions
Tune-Up Procedure Alignment
- KITS FOR MOST POPULAR UNITS
Over 5,000 Satisfied Customers
- Write or Call Today for FREE list of kits. If we don't stock it—we'll make a kit for you.

AMERICAN CRYSTAL SUPPLY COMPANY

PO Box 638
W Yarmouth, MA 02673
(617) 771-4634 ✓ A58

NEW ELECTRONIC PARTS

Brand name, first line components. Stocked in depth. 24 hour delivery. Low prices and money back guarantee on all products we carry.

STAMP BRINGS CATALOG

SPECIALS KEYBOARD ENCLOSURES

SIX SIZES	W	D	H	PRICE
14"	8.3"	3"		\$15.20
17"	8.3"	3"		18.35
20"	8.3"	3"		19.25
14"	11.3"	3"		16.50
17"	11.3"	3"		18.80
20"	11.3"	3"		20.75

Blue base, specify white or black top.

MAGNA-LITE JR
ONLY
\$5.79



IDEAL FOR:
• Project Microcircuit Reading
• Electronics — Design, Production & Inspection
• Industrial — Engineers, Technicians, Draftsmen
• Laboratory & Research

RTTY

UT4 SPEED CVTR BOARD
KIT \$109.95
BOARD ALONE \$18.95
AUTO CW ID KIT \$37.90

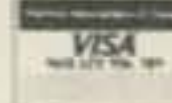

SHIPPING
INCLUDED
IN PRICE

Daytapro Electronics, Inc.

Formerly NuData Electronics ✓ D35
3029 N. WILSHIRE LN., ARLINGTON HTS. ILL. 60004
PHONE 312-870 0555

NOW from BETTS

Hypersil power transformer
Pri has 4 115 for 230 or 440;
Sec 803 @ 735 ma.—Use 2
xfmrs bridged for 1500 VDC
Price pre-paid USA \$39.95

Jennings vacuum variables
UCS-500 @ 7.5KV \$165.
UCSXF-1000 @ 10KV \$255.
UCSXF-1200 @ 10KV \$275.

Filter choke, swinging
3-15 hy @ .6-.06 amp res 112
1KV ins. 5x6x7 29 lbs.
Ship pre-paid USA \$39.95

Oil filter capacitor
10 mfd @ 2KV 3x4x5 5 lbs
Ship pre-paid USA \$15.95

Send check with orders

J.S. BETTS COMPANY

P.O. Box 426 Fairburn, GA 30213
Phone (404)-964-3764

Radio Shack DEALER

MICRO MANAGEMENT SYSTEMS



Up To 15% Discount
on
TRS-80's
BUSINESS SOFTWARE

MICRO-COMPUTER SPECIALIST
LARRY OWENS
COMPUTER CENTER

MINI MALL—DOWNTOWN SHOPPING CENTER
CAIRO, GEORGIA 31728
✓ M95 912-377-7120

JUST GETTING ON THE AIR?

See Adirondack for



- New Equipment
- Used Gear
- Friendly Advice

ADIRONDACK Radio Supply

185-191 West Main Street • P.O. Box 88
Amsterdam, N.Y. 12010 Tel. (518) 842-8350
Just 5 minutes from N.Y. Thruway—Exit 27

✓ A1

Key Electronics

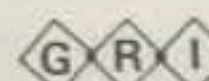

Full ASCII Professional Keyboard Kit, Model 756

Model 756 Keyboard Kit \$64.95
Model 701 Plastic Enclosure \$14.95
Model 702 Steel Enclosure \$29.95

INTEGRATED CIRCUITS:

SN76477N Complex Sound Gen. \$2.95 2 \$5.50
CA3140 Op Amp 6
CA3240 Dual Op Amp \$1.10
uA555 Timer 4

SOCKETS:

8 pin Low profile 15 8/\$1.00
14 pin Low profile 19 6/\$1.00
16 pin Low profile 22 5/\$1.00
Transistor Socket 12 10/\$1.00

FREE: CA3140 with orders of \$5.00 or more.
Please include \$1.00 for postage and handling.

N.Y.S. Residents Add 4% Sales Tax
Send to: Key Electronics
P.O. Box 3506
Schenectady, NY 12303 ✓ M

50 144 REPEATERS 220 450 Mhz

Hi Pro Mk I



OPTIONS

Duplexers
Basic auto patch
Matching cabinet
.0005% High stability crystals

50 MHz \$789.95 450 MHz 799.95
144 + 220 MHz \$699.95

PA Res. add 6% tax
PLUS SHIPPING

Now with courtesy
beep and beacon
capability

Available Separately:

COR Identifier: All on one board, programmable, Fully adjustable, time out (.5-7 min.), hang time (0-1 min.), identifier (1-10 min.), tone, speed, volume, L.E.D. outputs, low current drain CMOS logic, plugs for easy installation and removal plus much more. \$79.95

Basic Repeater \$499.95

2M 130-175 MHz Basic Repeater for 2 meters with all the features of the Hi Pro Mk I less the power supply and front panel controls and accessories.

Maggiore Electronic Laboratory

845 WESTTOWN RD. ✓ M36
WEST CHESTER, PA. 19380 PHONE 215 436-6051

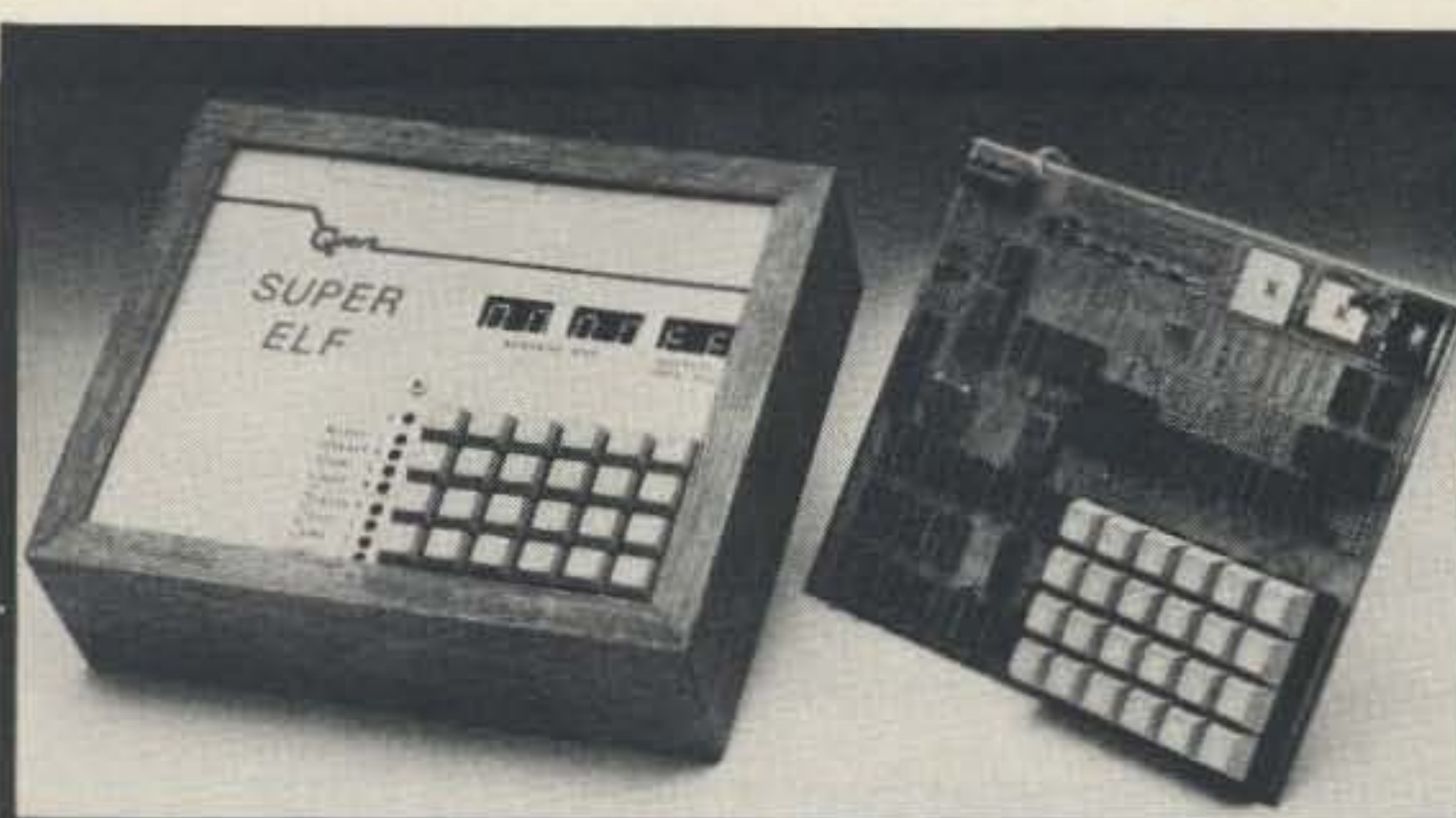

RCA Cosmac Super Elf Computer \$106.95

Compare features before you decide to buy any other computer. There is no other computer on the market today that has all the desirable benefits of the Super Elf for so little money. The Super Elf is a small single board computer that does many big things. It is an excellent computer for training and for learning programming with its machine language and yet it is easily expanded with additional memory, Tiny Basic, ASCII Keyboards, video character generation, etc.

The Super Elf includes a ROM monitor for program loading, editing and execution with SINGLE STEP for program debugging which is not included in others at the same price. With SINGLE STEP you can see the microprocessor chip operating with the unique Quest address and data bus displays before, during and after executing instructions. Also, CPU mode and instruction cycle are decoded and displayed on 8 LED indicators.

An RCA 1861 video graphics chip allows you to connect to your own TV with an inexpensive video modulator to do graphics and games. There is a speaker system included for writing your own music or using many music programs already written. The speaker amplifier may also be used to drive relays for control purposes.

A 24 key HEX keyboard includes 16 HEX keys plus load, reset, run, wait, input, memory protect, monitor select and single step. Large, on

board displays provide output and optional high and low address. There is a 44 pin standard connector for PC cards and a 50 pin connector for the Quest Super Expansion Board. Power supply and sockets for all IC's are included in the price plus a detailed 127 pg. instruction manual which now includes over 40 pgs. of software info. including a series of lessons to help get you started and a music program and graphics target game.

Remember, other computers only offer Super Elf features at additional cost or not at all. Compare before you buy. Super Elf Kit \$106.95, High address option \$8.95, Low address option \$9.95. Custom Cabinet with drilled and labeled plexiglass front panel \$24.95. Expansion Cabinet with room for 4 S-100 boards \$41.00. NiCad Battery Memory Saver Kit \$6.95. All kits and options also come completely assembled and tested.

Questdata, a 12 page monthly software publication for 1802 computer users is available by subscription for \$12.00 per year.

Attention Elf Owners

New products in hardware and software coming soon.

Tiny Basic cassette \$10.00, on ROM \$38.00, original Elf kit board \$14.95.

Super Expansion Board with

This is truly an astounding value! This board has been designed to allow you to decide how you want it optioned. The Super Expansion Board comes with 4K of low power RAM fully addressable anywhere in 64K with built-in memory protect and a cassette interface. Provisions have been made for all other options on the same board and it fits neatly into the hardwood cabinet alongside the Super Elf. The board includes slots for up to 6K of EPROM (2708, 2758, 2716 or TI 2716) and is fully socketed. EPROM can be used for the monitor and Tiny Basic or other purposes.

A 1K Super ROM Monitor \$19.95 is available as an on board option in 2708 EPROM which has been preprogrammed with a program loader/editor and error checking multi file cassette read/write software, (relocatable cassette file) another exclusive from Quest. It includes register save and readout, block move capability and video graphics driver with blinking cursor. Break points can be used with the register save feature to isolate program bugs quickly, then follow with single step. The Super Monitor is written with subroutines allowing users to take advantage of monitor functions simply by calling them up.

Cassette Interface \$89.95

Improvements and revisions are easily done with the monitor. If you have the Super Expansion Board and Super Monitor the interface is up and running at the push of a button.

Other on board options include Parallel Input and Output Ports with full handshake. They allow easy connection of an ASCII keyboard to the input port. RS 232 and 20 ma Current Loop for teletype or other device are on board and if you need more memory there are two S-100 slots for static RAM or video boards. A Godbout 8K RAM board is available for \$135.00. Also a 1K Super Monitor version 2 with video driver for full capability display with Tiny Basic and a video interface board. Parallel I/O Ports \$9.85, RS 232 \$4.50, TTY 20 ma I/F \$1.95, S-100 \$4.50. A 50 pin connector set with ribbon cable is available at \$12.50 for easy connection between the Super Elf and the Super Expansion Board.

The Power Supply Kit for the Super Expansion Board is a 5 amp supply with multiple positive and negative voltages \$29.95. Add \$4.00 for shipping. Prepunched frame \$7.50. Case \$10.00. Add \$1.50 for shipping.

Auto Clock Kit \$17.95

DC clock with 4-50" displays. Uses National MA-1012 module with alarm option. Includes light dimmer, crystal timebase PC boards. Fully regulated, comp. instructs. Add \$3.95 for beautiful dark gray case. Best value anywhere.

RCA Cosmac VIP Kit \$229.00

Video computer with games and graphics. Fully assem. and test. \$249.00 All VIP options avail. week deliv.

Not a Cheap Clock Kit \$14.95

Includes everything except case. 2-PC boards. 6-50" LED Displays. 5314 clock chip, transformer, all components and full instructions. Orange displays also avail. Same kit w/.80" displays. Red only. \$21.95 Case \$11.75

60 Hz Crystal Time Base Kit \$4.40

Converts digital clocks from AC line frequency to crystal time base. Outstanding accuracy. Kit includes: PC board, IC, crystal, resistors, capacitors and trimmer.

Digital Temp. Meter Kit \$39.95

Indoor and outdoor. Switches back and forth. Beautiful. 50" LED readouts. Nothing like it available. Needs no additional parts for complete, full operation. Will measure -100° to +200°F, tenths of a degree, air or liquid. Beautiful woodgrain case w/bezel \$11.75

NiCad Battery Fixer/Charger Kit \$7.25

Opens shorted cells that won't hold a charge and then charges them up, all in one kit w/full parts and instructions.

PROM Eraser Will erase 25 PROMs in 15 minutes. Ultraviolet, assembled \$34.50

Rockwell AIM 65 Computer

6502 based single board with full ASCII keyboard and 20 column thermal printer, 20 char. alphanumeric display, ROM monitor, fully expandable. \$375.00. 4K version \$450.00. 4K Assembler \$85.00, 8K Basic Interpreter \$100.00. Power supply assem. in case \$60.00. AIM 65 in thin briefcase with power supply \$485.00.

Same day shipment. First line parts only. Factory tested. Guaranteed money back. Quality IC's and other components at factory prices.

INTEGRATED CIRCUITS

7400TL					
7400N	.17	LM379M	5.00		
7402N	.17	LM380N	1.00		
7404N	.19	LM381	1.60	CD4585	1.10
7409N	.23	LM382	1.60	CD40182	3.00
7410N	.17	LM703H	.40	74C00	.28
7414N	.63	LM709H	.28	74C04	.33
7420N	.17	LM723H	.67	74C10	.28
7422N	1.35	LM733N	.57	74C14	2.10
7430N	.20	LM741CH	.35	74C20	.28
7442N	.50	LM741N	.25	74C20	.28
7445N	.69	LM747H	.62	74C30	.28
7447N	.60	LM748N	.35	74C48	1.95
7448N	.69	LM1303N	.82	74C74	.75
7450N	.17	LM1304	1.10	74C75	1.40
7474N	.29	LM1305	1.27	74C90	1.15
7475N	.49	LM1307	2.00	74C154	3.00
7485N	.88	LM1310	2.75	74C160	1.44
7485N	2.00	LM1458	.47	74C160	1.44
7490N	.43	LM1800	1.75	74C175	1.35
7492N	.43	LM1812	7.50	74C192	1.65
7493N	.43	LM1889	3.00	74C221	2.00
7495N	.59	LM2111	1.75	74C905	3.00
74100N	.90	LM2902	1.50	74C906	1.75
74107N	.28	LM2909N	.80	74C914	1.95
74121N	.34	LM3905	1.75	74C922	5.50
74123N	.59	LM3909N	.81	74C923	5.50
74125N	.39	MC14549V	.30	74C925	6.95
74145N	.89	NE550N	.85	74C926	6.95
74150N	.95	NE555V	.43	74C927	6.95
74151N	.89	NE556A	.79		
74154N	1.00	NE558A	1.00	0905	.95
74157N	.89	NE566V	1.50	0906	.95
74161N	.87	NE567V	1.20	0907	.95
74162N	.87	NE570B	5.00	0908	.95
74153N	.87	NE571B	5.00	0909	1.25
74174N	.96	78L05	.60	0910	4.50
74175N	.90	78L08	.60	0911	3.00
74190N	1.15	78L05	.70	0912	3.00
74192N	.87	78M05	.85	0913	3.10
74193N	.85	75108	1.75	0914	3.50
74221N	1.55	75491CN	.50	0915	3.20
74298N	1.85	75492CN	.55	0916	3.60
74355N	.95	75494CN	.89	0917	2.75
74368N	.95			0918	1.69
74367N	.95			0919	2.75
				0920	1.69
				0921	2.90
				0922	2.90
				0923	2.90
				0924	2.90
				0925	2.90
				0926	2.90
				0927	2.90
				0928	2.90
				0929	2.90
				0930	2.90
				0931	2.90
				0932	2.90
				0933	2.90
				0934	2.90
				0935	2.90
				0936	2.90
				0937	2.90
				0938	2.90
				0939	2.90
				0940	2.90
				0941	2.90
				0942	2.90
				0943	2.90
				0944	2.90
				0945	2.90
				0946	2.90
				0947	2.90
				0948	2.90
				0949	2.90
				0950	2.90
				0951	2.90
				0952	2.90
				0953	2.90
				0954	2.90
				0955	2.90
				0956	2.90
				0957	2.90
				0958	2.90
				0959	2.90
				0960	2.90
				0961	2.90
				0962	2.90
				0963	2.90
				0964	2.90
				0965	2.90
				0966	2.90
				0967	2.90
				0968	2.90
				0969	2.90
				0970	2.90
				0971	2.90
				0972	2.90
				0973	2.90
				0974	2.90
				0975	2.90
				0976	2.90
				0977	2.90
				0978	2.90
				0979	2.90
				0980	2.90
				0981	2.90
				0982	2.90
				0983	2.90
				0984	2.90
				0985	2.90
				0986	2.90
				0987	2.90
				0988	2.90
				0989	2.90
				0990	2.90
				0991	2.90
				0992	2.90
				0993	2.90
				0994	2.90
				0995	2.90
				0996	2.90
				0997	2.90
				0998	2.90
				0999	2.90
				1000	2.90

P.O. Box 4430M Santa Clara, CA 95054

For will call only: (408) 988-1640

2322 Walsh Ave.



CLOCK MODULES Complete alarm clocks ready to hook up with transformer and switches. Very compact with .50" and .84" digits.

MA1002A, C or E .50" 2.95
102P3 Transformer 8.95
MA1010A, C or E .84" 11.95
102P2 Transformer 2.25

Special transformer and six switches when purchased w/module 2.95
MA1003 car module .2" great Rear. display 15.95

RESISTORS 1/4 watt 5%
 10 per type .03 1000 per type .012
 25 per type .025 350 per type pack
 100 per type .015 5 per type 6.75

KEYBOARDS
 56 key ASCII keyboard kit \$67.50
 Fully assembled 77.50
 53 key ASCII keyboard kit 90.00
 Fully assembled 70.00 Enclosure 14.95

LEDS
 Red T018 .15
 Green, Yellow T018 .20
 Jumbo Red .20
 Green, Orange, Yellow Jumbo .25
 Oligite LED Mounting Clips 8S1.25 (specify red, amber, green, yellow, clear)

CONTINENTAL SPECIALTIES in stock
 Complete line of breadboard test equip.
MAX-100 8 digit Freq. Cr. \$128.95

OK WIRE WRAP TOOLS in stock
Portable Multimeter \$18.00

DIGITAL THERMOMETER \$48.50
 Self. oper. General purpose or medical
 32"-230°F. Disposable probe cover
 ±.2% accuracy. Comp. Assy. in
 compact case. Switches from F to C.

COMPUTER BOARD KITS
 8K RAM Board Kit \$135.00
 4K EPROM Kit 114.95
 I/O Board Kit 44.50
 Extender Board w/connector 12.50
 16K EPROM Board kit w/ PROMS 74.50
 North Star Floppy Disk Kit \$65.00
 Additional Drive Kit 415.00

SPECIAL PRODUCTS
 MMS865 Stopwatch Timer 9.00
 PC board 7.50
 Switches Mem. Pushbutton 2.7
 3 pos. slide .25
 Encoder HD0165-5 6.95

3 Digit Universal Counter Board Kit
 Operates 5-18 Volt DC to 5 MHz
 typ. 125' LED display 10.50
 Voice actuated switch .50

Paratronix 100A Logic Analyzer Kit \$235.00
 Model 10 Trigger \$229.00
 Expander Kit \$369.00
 Model 150 Bus \$369.00
 Sinclair 3 1/2 Digit Multimeter \$59.95
 Clock Calendar Kit \$23.95

TRANSFORMERS
 8V 300 ma 3.25
 12 Volt 300 ma transformer 1.25
 12-0V CT 600 ma 3.75
 12V 250 ma wall plug 2.95
 12V CT 250 ma wall plug 3.50
 24V CT 400 ma 3.95
 10V 1.2 amp wall plug 4.85
 12V 6 amp 12.95

KEYBOARD ENCODERS
 AYS-2376 \$12.50
 AYS-3800 17.95
 74C922 5.50
 74C923 5.50
 HD0165-5 6.95

IC Test Clips
 1 18
 Red .55 47
 Black .55 47

Keyer 8043 14.50
 comp. w/spec./sock.

TRANSISTORS
 2N1893 .40
 2N2222A .18
 2N2369 .30
 2N2904A .20
 2N2907A .25
 2N3053 .25
 2N3638 .25
 2N3643 .25
 2N3904 .18
 2N3906 .18
 2N4400 .29
 2N4401 .75
 2N4402 .20
 5050 .25V 2.50
 5800 .40V 3.00
 6100 .40V 3.00
 7300 .50V 3.00
 80V 2.50
 8000 .55V 2.50
 10000 .20V 2.50
 12000 .30V 3.50
 RS232 Complete Set 6.50
 35000 .25V 5.00
 DE9P 1.50 55000
 DE9S 1.95 82000
 DA15P 2.10 60000
 DA15S 3.10 76000
 120000 10V 6.00

COMPUTER GRADE CAPS
 1600 mfd 200V 4.50
 2000 mfd 45V 2.50
 3000 mfd 50V 2.50
 5000 mfd 25V 2.50
 5800 mfd 40V 3.00
 6100 mfd 40V 3.00
 7300 mfd 50V 3.00
 80V 2.50
 8000 mfd 55V 2.50
 10000 mfd 20V 2.50
 12000 mfd 30V 3.50
 RS232 Complete Set 6.50
 35000 mfd 25V 5.00
 DE9P 1.50 55000
 DE9S 1.95 82000
 DA15P 2.10 60000
 DA15S 3.10 76000
 120000 10V 6.00

Multi-volt Computer Power Supply

8v 5 amp, ±18v .5 amp, 5v 1.5 amp, -5v .5 amp, 12v .5 amp, -12 option. ±5v, ±12v are regulated. Kit \$29.95. Kit with punched frame \$37.45. Woodgrain case \$10.00.

Video Modulator Kit \$8.95

Convert your TV set into a high quality monitor without affecting normal usage. Complete kit with full instructions.

2.5 MHz Frequency Counter Kit

Complete kit less case \$37.50

PASS FCC EXAMS



The Original FCC Tests-Answers Exam manual that prepares you at home for FCC First & Second class Radiotelephone licenses. You get the complete set of 15 newly revised multiple-choice examinations—covering all areas tested on the actual FCC exam. Also included—helpful study tips, short cuts, and "Self-Study Ability Test." These updated FCC Tests-Answers take the mystery out of preparing for current FCC exams. Practical proven Material. \$9.95 postpaid. Unconditional Moneyback Guarantee.

COMMAND PRODUCTIONS

RADIO ENGINEERING DIVISION ✓ C106
P.O. BOX 26348-F SAN FRANCISCO, CA 94126
Please rush me Tests-Answers for FCC First and Second Class Commercial License. My \$9.95 is enclosed.

Name _____
Address _____
City _____ State _____ Zip _____

FAST SCAN 420-450 MHz
an **ATV FIRST** . . . from **APTRON**
our **NEW -**
Model 1570B

ATV REPEATER

a **COMMERCIAL QUALITY** system
providing for **COLOR** operation
with **AURAL SUBCARRIER** sound
plus many more features

a complete, single package unit
ready to put on the air . . . also
complete antenna available . . .

Call us at 1-812-336-4775, or
write us for details and pricing.

APTRON LABORATORIES ✓ A6
PO Box 323 Bloomington IN 47401

NOW! NOW! NOW! NOW! NOW!

The ultimate answer for eliminating the damaging effects of antenna weight on your rotor . . . it's the

"UDM THRUSTOR"



- Fits any taper tower or can be used with flat top.
- Accepts 1 1/4" mast pipe
- All steel construction.
- Utilizing precision ground & hardened ball-type thrust bearing.
- Comes ready to install.
- Eliminates the damaging effect on your rotor.
- Shipped prepaid UPS (U.S.A.)
- Check, cash, money order, Visa, MasterCard. \$49.95 complete.
- Also available for 2" mast pipe for \$59.95

UDM ENTERPRISES ✓ U10
P.O. Box 2037, Sandusky, Ohio 44870

HAMTRONICS, INC.

WHERE THE HAM IS KING

FOR OVER 30 YEARS ✓ H8

Let Us Fill Your



Specific Needs From

OUR \$2,000,000.00 AMATEUR GEAR INVENTORY

ALL THE FAMOUS NAMES—TRANSCEIVERS—AMPLIFIERS—ANTENNAS—TOWERS

Give us a try before you buy • Call Jim Titus

a Division of TREVOSE ELECTRONICS, INC/ 4033 Brownsville Road, Trevoese, PA 19047

FREE UPS SHIPPING ON PREPAID ORDERS



215-357-1400

ALL NEW

Real-State-of-the-Art

TWO NEW AC•DC•BATTERY PORTABLE COUNTERS

OPTO-8000 .1A 10Hz to 600 MHz — FREQUENCY COUNTER

- Precision TCXO time base 0.1 PPM Stability 17-40°C
- Super Sensitivity with preamps in both HI-Z & 50 Ohm inputs <10mV to 50MHz, 25 mV @ 150 MHz <50mV to 600MHz
- Auto Decimal Point • Aluminum Case • Socketed IC's
- Three position attenuator: X1, X10, X100 (avoids false counting)

- #OPTO-8000.1A Factory Assembled \$329.95
- #OPTO-8000.1AK Kit Form \$279.95
- #NI-CAD-80 NI-CAD Battery Pack \$ 19.95

OPTO-7000 10 Hz to 600 MHz MINIATURE COUNTER

- XTAL (TCXO) Time Base ±.08PPM/°C
- Aluminum Case • HI-Z & 50 Ohm inputs
- 1 Sec. & 1/10 Sec. Gate times • Auto Dec. Pt.
- Built-in Prescaler and Preamps Standard

- #OPTO-7000 Factory Assembled - 1 Year-Guar . . \$139.95
- #OPTO-7000K Kit Form 99.95
- #AC-70 AC Power Pack 4.95
- #NI-CAD-70 NI-CAD Battery Pack 19.95
- #TCXO-70 Precision TCXO Time Base <0.1PPM, 17-40°C 79.95

ACCESSORIES

PROBES:

- #P-100 50 Ohm, 1X \$13.95
- #P-101 Lo-Pass 16.95
- #P-102 H1-Z, 2X 16.95
- #AP-8015 UHF Counter Preamp 20 MHz to 600 MHz 15-50 DB Gain (Not Shown) . . \$49.95/Kit \$39.95

#D-450 Antenna

- Rubber Duck RF Pick-up 450 MHz . . \$12.50
- #D-146 Same as above 146.5MHz \$12.50
- #RA-BNC Right-Angle BNC Adapter for above Antenna 2.95

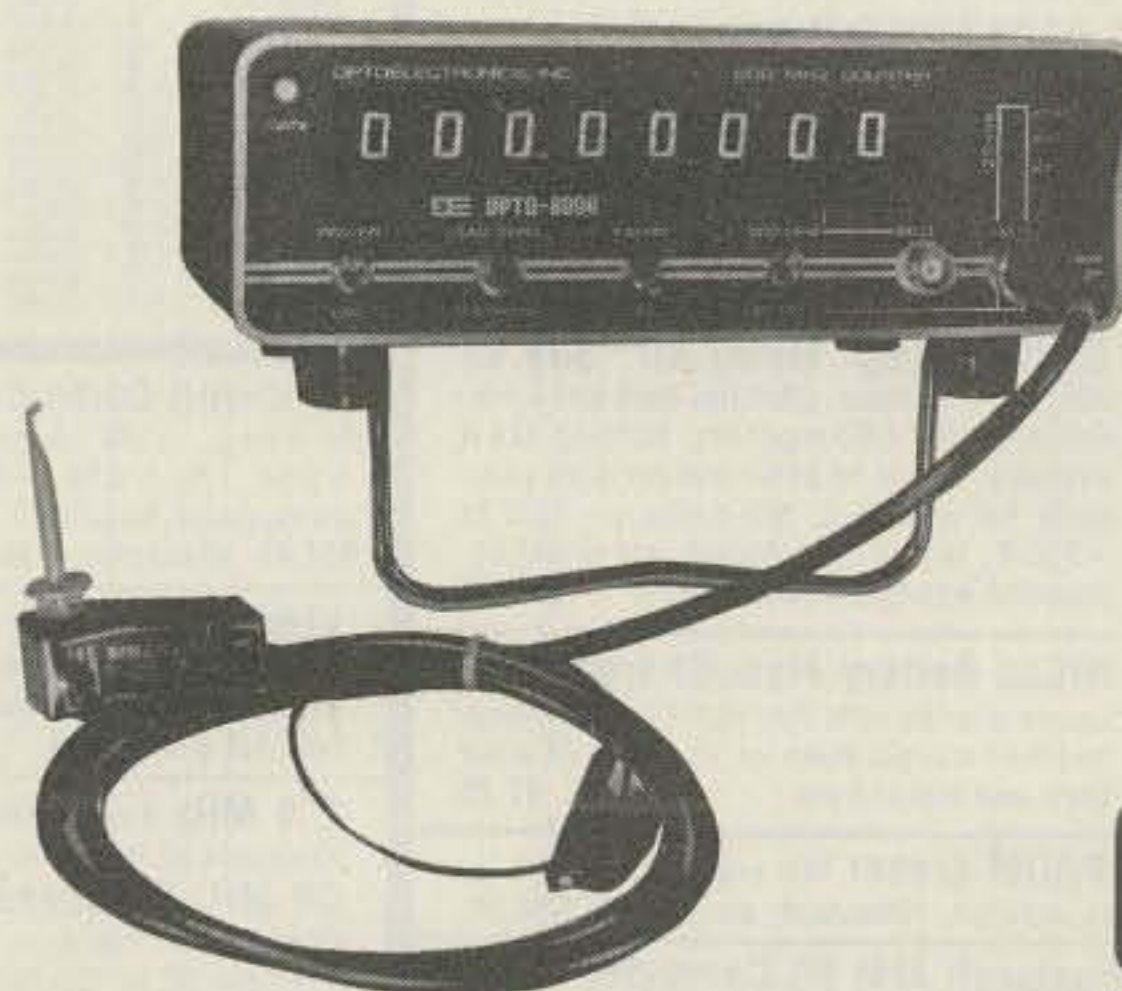

ORDER FACTORY DIRECT — PHONE OR MAIL

TERMS: Orders to U.S. and Canada, add 5% to maximum of \$10.00 per order for shipping, handling and insurance. To all other countries, add 10% of total order. Florida residents add 4% state tax. C.O.D. fee: \$1.00. Personal checks must clear before merchandise is shipped.

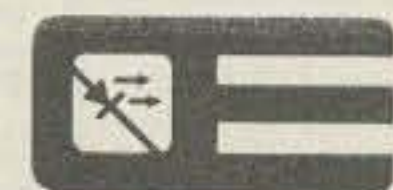

OPTOELECTRONICS, INC. ✓ O3

5821 NE 14 Avenue
Ft. Lauderdale, FL 33334
Phones: (305) 771-2050 771-2051

Phone orders accepted

Atlas, Bencher, Bird, Bomar, B&W, CDE, CES, CSC, Cushcraft, Daiwa, Datong, DGM, Drake, ETO, F9FT, Finco, Ham Key, Henry Hustler, Hygain,

☆☆☆☆☆☆☆☆ PALOMAR ENGINEERS ☆☆☆☆☆

R-X NOISE BRIDGE \$49.95



- Learn the truth about your antenna.
- Find its resonant frequency.
- Find R and X off-resonance.
- Broadband 1-100 MHz.
- Simple to use. — Self contained.

VLF CONVERTER \$55.00



- New device opens up the world of VLF radio.
- Converts VLF to 80 meters. For use with any shortwave receiver covering 3.5-4 MHz.
- Advanced design for simple operation, high performance.
- Gives reception of the 1750 meter band.
- Also covers navigation radiobeacons, WWVB, ship-to-shore, and LF broadcast band.

LOOP ANTENNA
Loop Amplifier \$67.50
Plug-in loops \$47.50 ea.

- Plug-in loops available for:
1600-5000 KHz (160/80 meter amateur bands)
550-1600 KHz (Broadcast Band)
150-550 KHz (VLF, 1750 meter band)
40-150 KHz (WWVB, Loran)
10-40 KHz (Omega)
- Nulls out interference



ALL BANDS PREAMPLIFIER \$89.50



- Tunes 1.8 to 54 MHz. Covers ALL amateur bands 160 to 6 meters. ALL shortwave broadcast bands.
- For receivers AND transceivers.
- Up to 20 db gain.
- Peps up that tired receiver.
- Reduces image and spurious response.

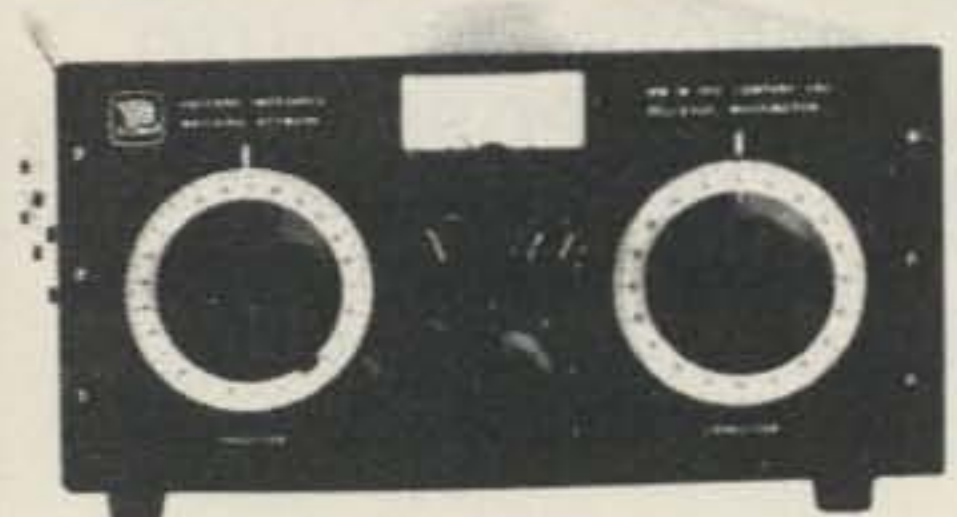

Model MB II \$295
(with Balun) \$325

MB II provides:
* Constant SWR monitoring * Precision tuning of final amp. * Harmonic suppression.
* Receiver input impedance-matching. * Maximum power transfer to antenna. * Continuous frequency coverage 1.6 to 30 MHz. * Precision tuning of any wire 1/2 wavelength or longer, with SWR of 1:1.

MB II features:
* Finest quality, made-in-USA components. * Large, precision, easy-to-read dials with 360 readout. * Optional 3000 watt Balun for twin lead antennas.

BIRD
Electronic Corporation

\$94 VHF model 4362 (140-180 MHz)
\$94 HF model 4360 (18-30 MHz)

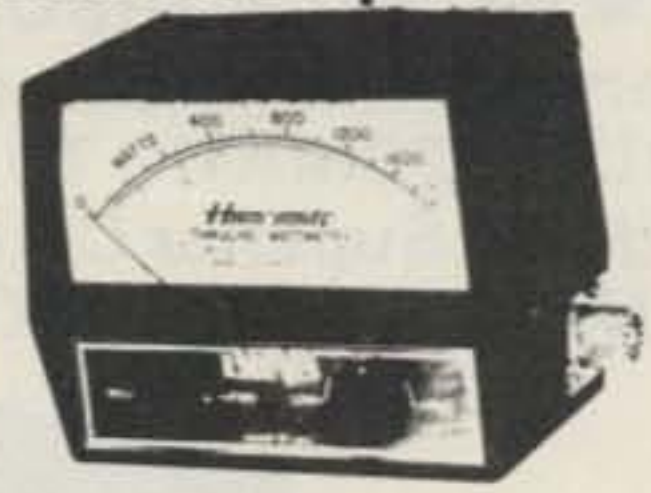

The 4360, 4362 HAM-MATE Directional Wattmeters are insertion type instruments for measuring forward or reflected power in 50-ohm coaxial transmission lines. They are direct descendants of the model 43 THRULINE® Wattmeter — the professional standard of the industry — and will accurately measure RF power flow under any load condition. Each wattmeter is made up of a precisely machined section of 50-ohm line, a rotatable sensing element and meter calibrated in watts, all mounted in a high-impact plastic housing. It is this type of solid construction and the directional THRULINE coupling circuit, without toroids, that account for the superiority of the HAM-MATE Wattmeters.

the indispensable
BIRD 43
THRULINE
WATTMETER



Power Range	Frequency Bands (MHz)				
	2-30	25-60	100-250	200-500	600-1000
5 watts	—	5A	5C	5D	5E
10 watts	—	10A	10C	10D	10E
25 watts	—	25A	25C	25D	25E
50 watts	50H	50A	50C	50D	50E
100 watts	100H	100A	100C	100D	100E
250 watts	250H	250A	250C	250D	250E
500 watts	500H	500A	500C	500D	500E
1000 watts	1000H	1000A	1000C	1000D	1000E
2500 watts	2500H	—	—	—	—
5000 watts	5000H	—	—	—	—

MODEL 43
Elements (Table 1) 2-30 MHz \$125.00
Elements (Table 1) 25-1000 MHz 45.00
Carrying case for Model 43 & 6 elements 38.00
Carrying case for 12 elements 27.50
Carrying case for 12 elements 17.00

READ RF WATTS DIRECTLY! (Specify Type N or SO239 connectors) 0.45 – 2300 MHz, 1-10,000 Watts ±5%, low insertion VSWR — 1.05. Unequaled economy and flexibility. Buy only the element(s) covering your present frequency and power needs, add extra ranges later if your requirements expand.



5-BAND TRAP DIPOLE
(80 thru 10 Meters)

Barker & Williamson

Power rated 2k WPEP, approx. 110 ft. span

Complete with: wire, traps, end insulators, 50 ft. RG-8/U, PL-259 connector, heavy-duty cast aluminum and steatite center connector. 4-Band (40 thru 10M) 55 ft.



Pre-assembled:
Model 370-11
— \$59.95

Kit (illustrated):
Model 370-12 — \$49.95



BOMAR Crystal Company
TWO METERS

CRYSTALS IN STOCK Motorola HT 220 Crystals In Stock!
Standard • Icom • Heathkit • Ken • Clegg • Regency • Wilson • VHF Eng • Drake • And Others! Lifetime Guarantee! Now only \$9/pair.

Hy-Gain REEL TAPE PORTABLE DIPOLE
for 10 thru 80 Meters Model 18TD

The most portable high performance dipole ever...

The Model 18TD is unquestionably the most foolproof high performance portable doublet antenna system ever developed. It has proven invaluable in providing reliable communications in vital military and commercial applications throughout the world. Two stainless steel tapes, calibrated in meters, extend from either side of the main housing up to a total distance of 132 feet for 3.5 mc operation. 25 ft. lengths of polypropylene rope attached to each tape permits installation to poles, trees, buildings... whatever is available for forming a doublet antenna system. Integrated in the high impact housing is a frequency to length conversion chart calibrated to meter measurements on the tapes... makes installation foolproof. Feeds with 52 ohm coax. Delivers outstanding performance as a portable or permanent installation. Measures 10x5 1/2 x 2 inches retracted. Wt., 4.1 lbs. Order No. 228 Price: \$94.95



BANDPASS-REJECT DUPLEXER
DPLA-144 FOR 144-174 MHz

Also available for 54, 220, 450 MHz.

THESE BAND PASS BAND REJECT CIRCUIT... DUPLEXERS include the use of an exclusive circuit developed by VHF SWG which provides superior suppression of spurious signals... When used with a high Q line, the Band Pass Band Reject Circuit provides frequency response curves with bandpass cavity characteristics at the frequency to be passed and band-reject cavity characteristics at the frequency to be attenuated. Performance characteristics improve as the frequency deviation is increased. Frequency stability of the Band Pass Band Reject Circuit duplexer is excellent — an important factor at close frequency spacing. Each model will handle transmitter power up to 250 watts and all models are supplied with complete cable harness and mounting frame.



\$409.95

Name _____ Call _____
Address _____
City _____ State _____ Zip _____
Order: _____
 Check Enclosed Visa Master Charge Send for Free Catalog
PRICES SUBJECT TO CHANGE WITHOUT NOTICE
Card no. _____ Card exp. date _____
Signature _____



Radio Electronics
OPEN DAILY 9-9
SATURDAY 9-6

206 Mystic Avenue, Box 73, Medford, Mass. 02155, 1-800-225-4428, (Mass. residents: 1-617-395-8280)

NEW!

NEW!

NEW!



FM2016A

All Solid State-CMOS PL digital synthesized - No Crystals to Buy! 5KHz steps - 144-149 MHz-HUGE 3/8" LED digital readout PLUS MARS-CAP and MULTIPLE OFFSET BUILT IN.

- 5 MHz Band Coverage - 1000 Channels (instead of the usual 2 MHz to 4 MHz-400 to 800 Channels)
- 4 CHANNEL RAM IC MEMORY WITH SCANNING AND AUTO TRANSMIT
- MULTIPLE FREQUENCY OFFSETS
- ELECTRONIC AUTO TUNING - TRANSMIT AND RECEIVE
- INTERNAL MULTIPURPOSE TONE OSCILLATOR
- RIT
- RF ATT
- DISCRIMINATOR METER - 16 Watts Output-Superior Receiver Sensitivity and Selectivity - 15 POLE FILTER, MONOLITHIC CRYSTAL FILTER AND AUTOMATIC TUNED RECEIVER FRONT END, COMPARE!
- Superb Engineering and Superior Commercial Avionics Grade Quality and Construction Second to None at ANY PRICE.

SUMMER SPECIAL

\$329⁰⁰

ALSO - NEW FM 6016A FOR 6 METERS



FM-1* Microphone with Built-in Touch Tone Pad

WHY BUY LESS? THE FM-1 HAS IT ALL!

- New! Auto key up
- Snap-Action Keyboard
- Adj. level and tone balance
- Use with any transceiver
- Only 3 1/4" x 2" \$39.95

Regulated AC/PS Model FMPS-4R . . . \$39.95

SHOWN WITH OPTIONAL μP-800 MICRO-PROGRAMMER* \$99.⁰⁰

- **FREQUENCY RANGE:** Receive and Transmit: 144.00 to 148.995 MHz, 5 KHz steps (1000 channels) + MARS-CAP and MULTIPLE OFFSET BUILT IN.
- **HUGE 3/8" LED DIGITAL READOUT.**
- **4 CHANNEL RAM SCANNER WITH IC MEMORY AND AUTO TRANSMIT:** Program any 4 frequencies and reprogram at any time using the front panel controls—search for occupied (closed) channel or vacant (open) channels. Internal Ni-Cad included to retain memory (no diode matrix to wire or change).
- **MULTIPLE FREQUENCY OFFSETS: NO CRYSTALS TO BUY - EVER -** Any offset any split! "Odd Ball" splits accomplished by digital programming. Never any need for crystals!
- **INTERNAL MULTIPURPOSE TONE OSCILLATOR BUILT IN:** Sine Wave 1750 Hz tone burst for "whistle on operation" and sub-audible tone operation. Internal 2 position switch for automatic and manual operation, tone burst or sub audible tone. PL - adjustable 60-203 Hz (100 Hz Pre-Set).
- **AIRCRAFT TYPE FREQUENCY SELECTOR:** Large and small coaxially mounted knobs select 100KHz and 10KHz steps respectively. Switches click-stopped with a home position facilitate frequency changing without need to view LED's while driving and provides the sightless amateur with full Frequency Selection as standard equipment.
- **FULL AUTOMATIC TUNING OF RECEIVER FRONT END AND TRANSMITTER CIRCUITS:** DC output of PLL fed to varactor diodes in all front end RF tuned circuits provides full sensitivity and optimum intermodulation rejection over the entire band. APC(AUTO POWER CONTROL) - Keeps RF output constant from band edge to band edge. NO OTHER AMATEUR UNIT AT ANY PRICE has these features which are found in only the most sophisticated the expensive aircraft and commercial transceivers.

- **TRUE FM:** Not phase modulation - for superb emphasized hi-fi audio quality second to none.
- **RIT CONTROL:** Used to improve clarity when contacting stations with off frequency carrier.
- **MONITOR LAMPS:** 2 LED's on front panel indicate (1) incoming signal-channel busy, and (2) Transmit.
- **FULLY REGULATED INTEGRAL POWER SUPPLY:** Operating voltage for all 9v circuits independently regulated. Massive Commercial Hash Filter.
- **MODULAR COMMERCIAL GRADE CONSTRUCTION:** 3 Unitized modules eliminate stray coupling and facilitate ease of maintenance.
- **ACCESSORY SOCKET:** Fully wired for touch tone, phone patch, and other accessories. Internal switch connects receiver output to internal speaker when connector is not in use.
- **MULTI-PURPOSE METER:** Triple Function Meter Provides Discriminator Meter, "S" Reading on receive and Power Out on Transmit.
- **RECEIVE:** Better than .25uv sensitivity, 15 POLE FILTER as well as monolithic crystal filter and AUTOMATIC TUNED LC circuits provide superior skirt selectivity - COMPARE!
- **HIGH/LOW POWER OUTPUT:** 16 watts and 1 watt, switch selected. Low power may be adjusted anywhere between 1 and 16 watts. Fully protected - short or open SWR.
- **RF ATT:** Live right next to King Kong Repeater and can't operate? With the 2016A You Can - Just flick the RF ATT switch. Only the 2016A has this feature.
- **OTHER FEATURES:** Dynamic Microphone, built in speaker, mobile mounting bracket, external 5 pin accessory jack, speaker jack, and much, much more. Size 2 1/2 x 7 x 7 1/2. All cords, plugs, fuses, microphone hanger, etc. included. Weight 5 lbs.

Manufactured by one of the world's most distinguished Avionics manufacturers, Kyokuto Denshi Kaisha, Ltd. First in the world with an all solid state 2 meter FM transceiver.

A21

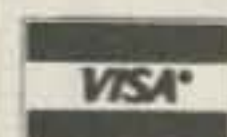
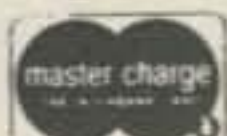

AMATEUR-WHOLESALE ELECTRONICS

8817 S.W. 129th Terrace, Miami, Florida 33176

Telephone (305) 233-3631 • Telex: 80-3356

U.S. DISTRIBUTOR DEALER INQUIRIES INVITED

ORDER NOW TOLL-FREE

Credit card holders may use

our toll-free ordering number

Ask for operator 701

(800) 824-7888

In California (800) 852-7777

Alaska and Hawaii (800) 824-7919

Regional Sales & Service Centers:

East: Sanford Communications, Inc. Colonia, N.J. (201) 574-3003

Northeast: Buzzards Bay Electronics Buzzards Bay, Mass. (617) 759-3376

West: The Radio Place Sacramento, Cal. (916) 441-7388

Northwest: Action Supply, Inc. Boise, Idaho (208) 344-5084

Midwest: Universal Service Columbus, Ohio (614) 866-4267

South: Electronic Communications Highland Springs, Virginia (804) 737-5100

800

800

COMPARE AT ANY PRICE!
JP-800 MICRO-PROGRAMMER
 FOR KDK 2016A AND 2015R



- 800 CHANNEL PROGRAMMABLE MEMORY WITH SCAN. RETAINS MEMORY WHEN OFF ... **AND** ...
- FULL BAND RANDOM SCAN - UP OR DOWN
- SINGLE STEP SCAN FEATURE IN ANY MODE.
- MEMORY SLOW SCAN
- HOLD AND TRANSMIT AT ANY TIME.
- AUTOMATIC RESUME
- EASY INSTALLATION

\$99⁰⁰

ACCESSORIES FOR KDK:
 FM2016A AND FM2015R

- JP 800 - Micro Programmer 99.00
- FMPS-4R Regulated AC Power Supply ... 39.95
- FMMC-1 Touch Tone Microphone 39.95
- FMAT-1 1/4 Wave Portable Antenna
 For Motel, Hotel, or Apt. 7.95
- Extra DC Power Cord & Plug 4.00
- Extra Mounting Bracket 6.00



SUPERB!
NEW ICOM
IC-701S
H.F. XCEIVER

Please Call or Write for Special Package Price

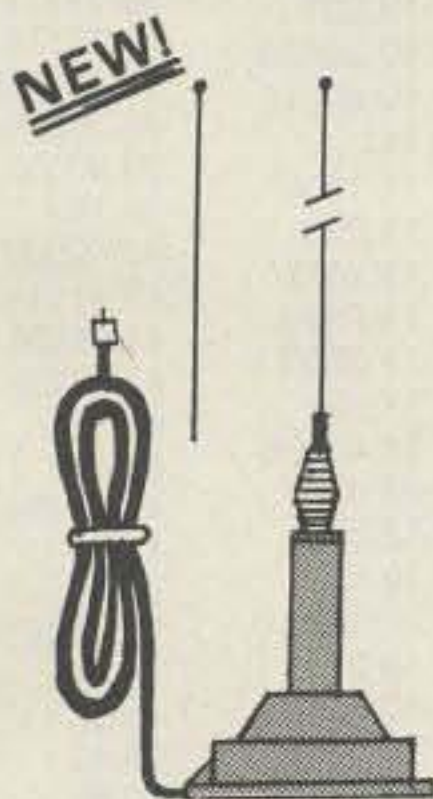

KDK MAX II
TWIN ANTENNA

- SUPER 80 LB. 100 M.P.H. BLACK MAGNETIC MOUNT
- 5/8 WAVE FOR MAX II SIGNAL **AND**
- 1/4 WAVE FOR CLOSE-IN AND RESTRICTED HEIGHT AREAS
- INSTANT CHANGE-OVER
- SUPERIOR PERFORMANCE
- STAINLESS STEEL SPRING AND WHIP, CHROME ON BRASS BASE - COMPARE!
- COMPLETE WITH 17' COAX AND CONNECTOR

\$29⁹⁵

COMPARE!! Nothing Else Does!

NEW CDE HAM IV
ROTATORS

Reg. \$189.95

Our Price \$149⁰⁰

NEW!
TOWER
MASTER
 40 foot Self-Supporting
 Crank-up
 Mast



Regular
\$345

COMPLETE
 With Hinged
 Mounting Plate
 And House Bracket

Our Price
\$310

\$19 Shipping
 Anywhere USA

SIGMA RF-2000 SWR & POWER METER



Cal PWR Scales 200W-2000W Freq. Range 3.5-150 MHz. Please do not confuse the RF2000 with similar appearing lower priced units. RF2000 is an individually calibrated professional quality instrument. Unequaled at many times the price. Size 7" (w) x 2-1/3" (d).

Shipping Anywhere **\$35**
 in USA \$1.00

SST T-4
ULTRA TUNER DELUXE



ULTRA TUNER DELUXE Matches any antenna—coax fed or random wire on all bands (160-10 meters). Tune out the SWR on your antenna for more efficient operation of any rig. Home, mobile, portable—only 9"x2 1/4"x5" • 300 watt RF output capability • **SWR meter** with 2-color scale • **Antenna Switch** selects between two coax fed antennas, random wire, or tuner bypass • Efficient **Airwound inductor** • 208 pf. 1000V. Capacitors • Attractive bronze finished enclosure.

only \$64.95

SST T-2 ULTRA TUNER

Tunes out SWR on any antenna—coax fed or random wire (160-10 meters). Any rig—up to 200 watts RF output. Rugged, yet compact: 5 1/4" x 2 1/4" x 2 1/4".



only \$37.95

SST T-3 MOBILE
IMPEDANCE
TRANSFORMER

Matches 52 ohm coax to the lower impedance of a mobile whip. Taps between 3 and 50 ohms. 3-30 MHz. 300 watts output. 2 3/4" x 2" x 2 1/4".



only \$19.95

SST T-1 RANDOM WIRE
ANTENNA TUNER

All bands (160-10 m.) with any wire • 200W output • Any transceiver • Home or portable • Neon tune-up indicator.



only \$29.95

SST DL-1 K4RLJ DUMMY LOAD. 1000W PEP 1.5:1 1-225 MHz. Scaled. 3-1/8" x 4-3/8".

only \$17.95

SST CL-1 24 HR. CLOCK. Giant red LED numerals. Month and day also at push of button. Beautiful for your desk. 110VAC.

only \$22.95

SSTB-1 BALUN for balanced lines. 300W.

only \$5.00

Call (213) 376-5887 to order C.O.D., VISA, or Master Charge.

To Order:

Send a check or money order—or use your M.C. or VISA. Add 83 shipping and handling. Calif. residents, add sales tax.

Guarantee: All SST products are unconditionally guaranteed for 1 year. In addition, they may be returned within 10 days for a full refund (less shipping) if you are not satisfied for any reason.

AMATEUR-WHOLESALE ELECTRONICS

8817 S.W. 129 Terr.
 Miami, Fla. 33176
 Tel: (305) 233-3631

ORDER NOW TOLL-FREE
 Credit card holders may use our toll-free ordering number. Ask for operator 701
(800) 824-7888
 In California (800) 852-7777
 Alaska and Hawaii (800) 824-7919



SST
ELECTRONICS ✓S10
 P.O. BOX 1 LAWNSDALE, CALIF.
 90260 (213) 376-5887

MURATA CERAMIC FILTERS		TYCO		ALL CRYSTALS \$4.95						
Model SFD-455D 455 kHz \$3.00		10.7 MHz Monolithic Crystal Filter \$5.95		31.5 KC	2.2395 MC	2.854 MC	3.4045 MC	6.753 MC	21.99965	20.1 MC
Model SFB-455D 455 kHz \$2.00				37.35	2.24075	2.854285	3.4115	6.7562	22.	
				49.710	2.241	2.865	3.4325	6.7605	23.25	
				70	2.246	2.868	3.4535	6.7712	23.575	
				81.9	2.2475	2.8725	3.4675	6.77625	25.47667	
				96	2.2925	2.876875	3.4815	6.880000	25.9	
				225	2.2975	2.887	3.5	6.910	25.99961	
				250	2.320	2.889	3.579545	6.940	26.66667	
				285.714	2.326	2.894	3.64	7.0057	26.8965	
				576	2.32625	2.910	3.7735	7.15	26.9	
				720	2.32885	2.920	3.80	7.35	26.958	
				1.0000 MC	2.3525	2.925450	3.805	7.390	27.77778	
				1.2288	2.35256	2.92545	3.803	7.423	27.9	
				1.3047	2.368	2.931	3.901	7.443	28.728	
				1.4	2.374	2.94375	3.908	7.473	28.88889	
				1.455	2.375	2.945	3.9168	7.5	28.9	
				1.689600	2.38725	2.94675	4.0000	7.81	28.93888	
				1.7	2.395	2.952	4.011	8.00764	29.896	
				1.76375	2.396875	2.966	4.126666	8.00824	29.9	
				1.77125	2.42	2.973	4.26	8.075	30.0000	
				1.773125	2.4375	2.980	4.3	8.12	30.9	
				1.78675	2.44275	2.981	4.57	8.15571	31.0000	
				1.80224	2.4495	2.98325	4.6895	8.364	31.11111	
				1.81875	2.45	2.987	4.6965	8.820	31.66667	
				1.845125	2.4585	2.9989	4.7	8.8285	31.9	
				1.84375	2.46125	3.001	4.7175	8.837	32.0000	
				1.845625	2.482	3.0235	4.7245	8.8455	32.22222	
				1.84575	2.486	3.045	4.7315	8.854	32.9	
				1.846	2.5	3.049	4.765	8.8625	33.0000	
				1.8425	2.51375	3.053	4.89	8.871	33.33333	
				1.84975	2.56	3.062	5.0000	8.879500	33.9	
				1.8575	2.581	3.067	5.13125	8.888	34.0000	
				1.908125	2.604	3.074	5.139585	8.905	34.4444	
				1.925	2.6245	3.1125	5.147917	8.9305	34.44444	
				1.927	2.618	3.126	5.164583	8.939	35.0000	
				1.932	2.62825	3.137	5.348400	8.956	35.25000	
				1.982	2.633125	3.13975	5.426636	9.0265	35.55555	
				1.985	2.639	3.1435	5.436636	9.65	36.0000	
				1.9942	2.63575	3.144	5.456	9.65	36.21750	
				1.995975	2.64325	3.145	5.4675	9.7	36.66667	
				1.964750	2.646	3.151	5.4990	9.75	37.00000	
				2.0000	2.647	3.1545	5.5065	9.8	37.2175	
				2.0285	2.650750	3.158	5.515	9.85	37.385	
				2.05975	2.6545	3.1585	5.5215	9.9	37.460	
				2.126175	2.65825	3.1615	5.544	9.95	37.77777	
				2.12795	2.660	3.1625	5.5515	9.999	38.00000	
				2.1315	2.662	3.166	5.559	10.0000	38.33333	
				2.133275	2.66575	3.16975	5.5665	10.021	38.77777	
				2.13505	2.6695	3.177	5.574	10.20833	38.77778	
				2.136825	2.677	3.181	5.5815	10.80375	38.88888	
				2.1425	2.68075	3.1825	5.589	11.	38.88889	
				2.144625	2.681	3.18475	5.604	11.1805	39.00000	
				2.14675	2.6845	3.1885	5.619	11.228	39.160	
				2.148875	2.68825	3.2035	5.6115	11.2375	40.00000	
				2.151	2.69575	3.20725	5.6265	11.2995	41.11111	
				2.153125	2.7	3.2105	5.6415	11.3565	41.66666	
				2.15375	2.702	3.2165	5.6715	11.535	43.33333	
				2.155	2.704	3.2175	5.675	11.69626	45.	
				2.15525	2.71075	3.2315	5.680	12.49	47.48	
				2.157375	2.715	3.23275	5.695	12.99	49.84166	
				2.1595	2.716	3.2365	5.7	13.09	49.95	
				2.16375	2.723	3.23775	5.7105	13.102	53.45	
				2.165875	2.730	3.23775	5.733333	13.2155	54.95 MC	
				2.170125	2.7315	3.2385	5.8968	13.2455	55.45	
				2.17225	2.73225	3.238875	6.110	13.2745	57.45	
				2.174375	2.732625	3.23925	6.155	13.2845	59.45	
				2.1765	2.733	3.24	6.210	13.2845	60.45	
				2.17925	2.737	3.24025	6.321458	13.2945	61.95	
				2.18475	2.73975	3.2405	6.380833	13.3045	63.80833	
				2.18575	2.742125	3.241	6.424583	13.3145	66.66667	
				2.194125	2.7425	3.2425	6.425	13.3245	72.855	
				2.207063	2.744	3.244	6.427083	13.3345	75.185	
				2.208313	2.7445	3.244	6.427083	13.3445	76.66667	
				2.209563	2.74475	3.24975	6.45	13.3545	82.75	
				2.210812	2.746875	3.4975	6.47	14.315	83.	
				2.210813	2.751	3.2515	6.4711	15.016	84.	
				2.212063	2.754	3.255	6.510	15.036	85.833330	
				2.214562	2.75525	3.256125	6.537	17.2800	90.833	
				2.214563	2.762375	3.256125	6.567	17.8710	93.1346	
				2.215625	2.7735	3.258625	6.582	17.9065	93.535	
				2.217938	2.776625	3.261	6.612	17.9165	93.9353	
				2.21975	2.78	3.261125	6.6645	17.9265	94.3	
				2.222125	2.814	3.268625	6.673	17.9265	95.	
				2.22325	2.817	3.271125	6.693	17.9365	95.35	
				2.22675	2.8225	3.273625	6.723	17.9465	106.850	
				2.22875	2.835	3.276125	6.7305	17.9665	123.5	
				2.23725	2.85	3.3	6.738	17.975	146.64	
						3.3345	6.75125	17.9735	147.09	
								19.100	165.5	

HEWLETT PACKARD UHF, VHF, AND MICROWAVE SIGNAL GENERATORS AND SWEEPERS, AND OTHER EQUIPMENT	
MODEL 434A Calorimetric power meter \$450.00	MODEL 416A Ratio meter \$125.00
MODEL 400DR Vacuum tube voltmeter \$79.95	MODEL 616B/A 1.8 to 4.2 GHz only \$399.00
MODEL 606A 50 kHz to 65 MHz .1mV to 3V into 50 ohms \$1,000.00	MODEL 683C 2 to 4 GHz ONLY \$299.00
	MODEL 612A 450 to 1230 MHz .1uv to .5uv into 50 ohms ONLY \$499.99
	MODEL TS510/U HP608D 10 MHz to 420 MHz .1V to .5V \$399.95

WISPER FANS			
This fan is super quiet, efficient cooling where low acoustical disturbance is a must. Size 4.68" x 4.68" x 1.50", Impedance protected, 50/60 Hz 120 volts AC ONLY \$9.95 or 2/\$18.00			

TRW BROADBAND AMPLIFIER MODEL CA615B			
Frequency response 40 to 300 MHZ			
Gain	300 MHZ 16dB MIN. 17.5dB MAX.		
	50 MHZ 0 to -1dB from 300 MHZ		
Voltage	24 volts DC at 220ma MAX		
	ONLY \$14.95		

circuit board drill bits			
Size	Price	Size	Price
35	\$2.15	58	\$1.85
42	\$2.15	59	\$1.85
47	\$2.15	60	\$1.85
49	\$2.15	61	\$1.85
50	\$2.15	62	\$1.85
51	\$2.15	63	\$1.85
52	\$2.15	64	\$1.85
53	\$1.85	65	\$1.85
54	\$1.85	66	\$1.90
55	\$1.85	1.25 mm	\$1.85
56	\$1.85	1.45 mm	\$1.85
57	\$1.85	3.20 mm	\$3.58

INTEGRATED CIRCUITS			
MC1303L	\$ 2.00	MC1460R	\$ 5.40
MC1461R	6.90	MC1463R	5.15
MC1469G	2.05	MC1469R	3.55
MC1550G	1.50	MC1560G	10.20
MC1560R	12.40	MC1563R	10.00
MC1568G	5.31	MC1568L	5.00
MC1569R	8.15	MC1590G	6.50
MC4024P	3.82	MC6800P	9.95
MC6820P	6.95	MC68B21P	12.00
2513	6.95	4116-200NS	10.37
8080A	3.95	TMS4060	6.95
2708TI	8.95	TMS4024	13.90
2716TI	29.95	1702A	4.95

Prices are subject to change. Some items are in limited quantity.

Polorad Model 1206
1.95 to 4.20 GHz
signal source
\$400.00
Model 1107 3.8 to 8.20
GHz signal generator
\$550.00

Alfred Model 632D
Sweep signal generator
2-4 GHz \$339.00

FETS		
3N128		\$1.00
40673		1.39
MPF102		.45
MPF121		1.00
MPF131		1.00

SPECIALS!		
IN831		\$8.00
IN5711		2.00
IN5712		4.00

TUNNEL DIODES	
TYPE	PRICE
TD261A	\$10.00
TD266A	10.00
1N2930	7.65
1N2939	7.65
1N4395	5.40

E.F. Johnson tube socket #122-0275-001
for 3-400Z, 3-500Z, 4-125A, 4-250A, 4-400A
\$29.95/pair

Magic Lantren Model ATCR3
2350 MHz down converter and power supply with Bogner antenna
\$299.95
(limited quantity available — may be back ordered)

RF TRANSISTORS

TYPE	PRICE	2N5184	2.00	MM1552	50.00
2N1561	\$15.00	2N5216	47.50	MM1553	56.50
2N1562	15.00	2N5583	4.43	MM1601	5.50
2N1692	15.00	2N5589	4.60	MM1602/2N5842	7.50
2N1693	15.00	2N5590	6.30	MM1607	8.65
2N2857JAN	2.45	2N5591	10.35	MM1661	15.00
2N2876	12.35	2N5637	20.70	MM1669	17.50
2N2880	25.00	2N5641	4.90	MM1943	3.00
2N2927	7.00	2N5643	14.38	MM2605	3.00
2N2947	17.25	2N5645	11.00	MM2608	5.00
2N2948	15.50	2N5764	27.00	MM8006	2.15
2N2949	3.90	2N5842	8.65	MMCM918	1.00
2N2950	5.00	2N5862	50.00	MMT72	.61
2N3287	4.30	2N5913	3.25	MMT74	.94
2N3294	1.15	2N5922	10.00	MMT2857	1.43
2N3301	.75	2N5942	46.00	MMT3960A	6.25
2N3302	1.05	2N5943	1.75	MRF304	43.45
2N3304	1.48	2N5944	7.50	MRF502	.49
2N3307	10.50	2N5945	10.90	MRF504	6.95
2N3309	3.90	2N5946	13.20	MRF509	4.90
2N3375/MM3375	7.00	2N6080	5.45	MRF511	8.60
2N3553	1.45	2N6081	8.60	MRF901	3.00
2N3818	6.00	2N6082	9.90	MRF5177	20.70
2N3866	1.09	2N6083	11.80	MRF8004	1.44
2N3866JAN	2.70	2N6084	13.20	PT3539B	3.00
2N3866JANTX	4.43	2N6094	5.75	PT4186B	3.00
2N3924	3.20	2N6096	19.35	PT4571A	1.50
2N3925	6.00	2N6097	28.00	PT4612	5.00
2N3927	11.50	2N6136	18.70	PT4628	5.00
2N3950	26.25	2N6166	36.80	PT4640	5.00
2N4072	1.70	2N6265	75.00	PT8659	10.72
2N4135	2.00	2N6266	100.00	PT9784	24.30
2N4427	1.09	2N6439	43.45	PT9790	41.70
2N4429	7.50	BFR90	3.00	PT9847	26.40
2N4430	20.00	HEP76/S3014	4.95	SD1043	5.00
2N4957	3.50	HEPS3002	11.30	SD1116	3.00
2N4958	2.80	HEPS3003	29.88	SD1118	5.00
2N4959	2.12	HEPS3005	9.95	SD1119	3.00
2N4976	19.00	HEPS3006	19.90	TA7993	75.00
2N5090	6.90	HEPS3007	24.95	TA7994	100.00
2N5108	3.90	HEPS3010	11.34	40281	10.90
2N5109	1.55	HEPS5026	2.56	40282	11.90
2N5160	3.34	MM1500	32.20	40290	2.48
2N5179	.49	MM1550	10.00		

MHZ ELECTRONIC KITS:

kit #1

Motorola MC14410CP CMOS Tone Generator

CMOS Tone Generator uses 1MHZ crystal to produce standard dual frequency dialing signal. Directly compatible with 12 key Chomeric Touch Tone Pads. Kit includes the following:

- 1 Motorola MC14410CP Chip
- 1 PC Board

And all other parts for assembly with 1 MHz crystal

NOW ONLY \$15.70
\$20.65

Kit #2

Fairchild 95H90DC Prescaler 350MHZ.

95H90DC Prescaler divides by 10 to 350 MHZ. This kit will take any 35MHZ Counter to 350 MHZ. Kit includes the following:

- 1 Fairchild 95H90DC Chip
- 1 2N5179 Transistor
- 2 UG-88/U BNC Connectors
- 1 PC Board

And all other parts for assembly.

NOW ONLY \$19.95

FAIRCHILD VHF AND UHF PRESCALER CHIPS

95H90DC	350MHZ Prescaler Divide by 10/11	\$ 9.50
95H91DC	350MHZ Prescaler Divide by 5/6	8.95
11C90DC	650MHZ Prescaler Divide by 10/11	16.50
11C91DC	650MHZ Prescaler Divide by 5/6	15.95
11C83DC	1GHZ Divide by 248/256 Prescaler	29.90
11C70DC	600MHZ Flip/Flop with reset	12.30
11C58DC	ECL VCM	4.53
11C44DC	Phase Frequency Detector (MC4044P/L)	3.82
11C24DC	Dual TTL VCM (MC4024P/L)	3.82
11C06DC	UHF Prescaler 750MHZ D Type Flip/Flop	12.30
11C05DC	1GHZ Counter Divide by 4	74.35
11C01FC	High Speed Dual 5-4 Input NO/NOR Gate	15.40

CRYSTAL FILTERS: Tyco 001-19880 same as 2194F

10.7MHZ Narrow Band Crystal Filter
3 db bandwidth 15khz minimum 20 db bandwidth 60khz minimum 40 db bandwidth 150khz minimum. Ultimate 50 db: Insertion loss 1.0db Max. Ripple 1.0db Max. Ct. 0 + - 5pf. Rt. 3600 Ohms.

NOW ONLY \$5.95

TUBES

2E26	\$5.00	4CX1500B	\$285.00
3-500Z	90.00	4X150A	37.00
3-1000Z	225.00	4X150G	70.00
3B28	5.00	100TH	144.00
4.65A	54.50	572B	33.60
4-125A	68.75	811A	12.95
4-250A	80.00	5894	39.00
4-400A	81.50	6146A	5.25
4-1000A	255.00	6146B	6.25
5-500A	145.00	6360	7.95
4CX250B	38.50	6907	35.00
4CX250F	53.50	6939	9.95
4CX250G	53.50	7360	10.60
4CX250K	72.00	8072	45.00
4CX250R	48.00	8295A/PL172	328.00
4CX350A	60.00	856OAS	50.00
4CX1000A	289.00	8950	5.95

SONALERT Model SL628P
6-28 volts DC
3-14 ma
\$5.95

1 MHz TCXO Crystal Oscillator
TTL output
3.3 volts DC
\$19.95

TERMS:
All CHECKS and MONEY ORDERS ARE IN US FUNDS!
ALL ORDERS SENT FIRST CLASS OR UPS
Please include \$1.50 Minimum for postage.
ALL PRICES ARE IN US DOLLARS.
ALL PARTS PRIME/GUARANTEED

MHz^{MS}
electronics

(602) 242-3037

**2111 W. Camelback
Phoenix, Arizona 85015**

BANK AMERICARD/VISA/MASTERCHARGE

Your Number:
(or equivalent)

Exp. Date

Your Signature:

FREQUENCY COUNTER KIT

Outstanding Performance

Incredible Price **\$89⁹⁵**

CT-50



The CT-50 is a versatile and precision frequency counter which will measure frequencies to 60 MHz and up to 600 MHz with the CT-600 option. Large Scale Integration, CMOS circuitry and solid state display technology have enabled this counter to match performance found in units selling for over three times as much. Low power consumption (typically 300-400 ma) makes the CT-50 ideal for portable battery operation. Features of the CT-50 include large 3 digit LED display, RF shielded all metal case, easy pushbutton operation, automatic decimal point, fully socketed IC chips and input protection to 50 volts to insure against accidental burnout or overload. And, the best feature of all is the easy assembly. Clear, step by step instructions guide you to a finished unit you can rely on.

Order your today!

CT-50, 60 MHz counter kit
 CT-50WT, 60 MHz counter, wired and tested
 CT-600, 600 MHz scaler option, add

\$89.95
 159.95
 29.95

CB-1 Color TV calibrator-stabilizer
 DP-1, DC probe, general purpose probe
 HP-1 High impedance probe, non-loading

\$14.95
 12.95
 15.95

SPECIFICATIONS:

Frequency range: 6 Hz to 65 MHz, 600 MHz with CT-600
 Resolution: 10 Hz @ 0.1 sec gate, 1 Hz @ 1 sec gate
 Readout: 8 digit, 0.4" high LED, direct readout in MHz
 Accuracy: adjustable to 0.5 ppm
 Stability: 2.0 ppm over 10° to 40° C, temperature compensated
 Input: BNC, 1 megohm, 20 pf direct, 50 ohm with CT-600
 Overload: 50VAC maximum, all modes
 Sensitivity: less than 25 mv to 65 MHz, 50-150 mv to 600 MHz
 Power: 110 VAC 5 Watts or 12 VDC @ 400 ma
 Size: 6" x 4" x 2", high quality aluminum case, 2 lbs
 ICS: 13 units, all socketed

CAR CLOCK

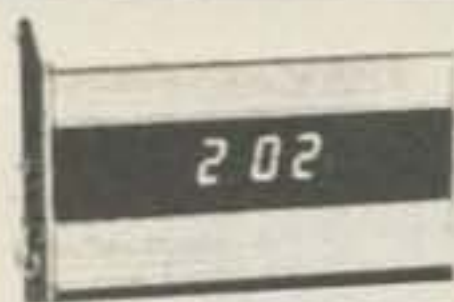

The UN-KIT, only 5 solder connections

Here's a super looking, rugged and accurate auto clock, which is a snap to build and install. Clock movement is completely assembled—you only solder 3 wires and 2 switches, takes about 15 minutes! Display is bright green with automatic brightness control photocell—assures you of a highly readable display, day or night. Comes in a satin finish anodized aluminum case which can be attached 5 different ways using 2 sided tape. Choice of silver, black or gold case (specify).

DC-3 kit, 12 hour format \$22.95
 DC-3 wired and tested \$29.95
 110V AC adapter \$5.95

Under dash car clock



12/24 hour clock in a beautiful plastic case features: 6 jumbo RED LEDs, high accuracy (1min/mo.), easy 3 wire hookup, display blanks with ignition, and super instructions. Optional dimmer automatically adjusts display to ambient light level.
 DC-11 clock with mtg. bracket \$27.95
 DM-1 dimmer adapter 2.50

PRESCALER



Extend the range of your counter to 600 MHz. Works with any counter. Includes 2 transistor pre-amp to give super sens, typically 20 mv at 150 MHz. Specify +10 or +100 ratio.
 PS-1B, 600 MHz pre-scaler \$59.95
 PS-1BK, 600 MHz pre-scaler kit 49.95

OP-AMP SPECIAL

741 mini dip 12/\$2.00
 B1-FET mini dip, 741 type 10/\$2.00

VIDEO TERMINAL

A completely self-contained, stand alone video terminal card. Requires only an ASCII keyboard and TV set to become a complete terminal unit. Two units available, common features are: single 5V supply, XTAL controlled sync and baud rates (to 9600), complete computer and keyboard control of cursor. Parity error control and display. Accepts and generates serial ASCII plus parallel keyboard input. The 3216 is 32 char. by 16 lines, 2 pages with memory dump feature. The 6416 is 64 char. by 16 lines, with scrolling, upper and lower case (optional) and has RS-232 and 20ma loop interfaces on board. Kits include sockets and complete documentation.

RE 3216, terminal card \$149.95
 RE 6416, terminal card 189.95
 Lower Case option, 6416 only 13.95
 Power Supply Kit 14.95
 Video/RF Modulator, VD-1 6.95
 Assembled, tested units, add 60.00

CALENDAR ALARM CLOCK

The clock that's got it all: 6-5" LEDs, 12/24 hour, snooze, 24 hour alarm, 4 year calendar, battery backup, and lots more. The super 7001 chip is used. Size: 5x4x2 inches.
 Complete kit, less case (not available) \$34.95
 DC-9

30 Watt 2 mtr PWR AMP

Simple Class C power amp features 8 times power gain, 1 W in for 8 out, 2 in for 15 out, 4 W in for 30 out. Max. output of 35 W, incredible value, complete with all parts, less case and T-R relay.
 PA-1, 30 W pwr amp kit \$22.95
 TR-1, RF sensed T-R relay kit 6.95

FM MINI MIKE KIT



A super high performance FM wireless mike kit! Transmits a stable signal up to 300 yards with exceptional audio quality by means of its built in electret mike. Kit includes case, mike, on-off switch, antenna, battery and super instructions. This is the finest unit available.

FM-3 kit \$12.95
 FM-3 wired and tested 16.95

CLOCK KITS



our Best Seller
 your Best Deal

Try your hand at building the finest looking clock on the market. Its satin finish anodized aluminum case looks great anywhere, while six .4" LED digits provide a highly readable display. This is a complete kit, no extras needed, and it only takes 1-2 hours to assemble. Your choice of case colors: silver, gold, bronze, black, blue (specify).
 Clock kit, 12/24 hour, DC-5 \$22.95
 Clock with 10 min. ID timer, 12/24 hour, DC-10 27.95
 Alarm clock, 12 hour only, DC-8 24.95
 12V DC car clock, DC-7 27.95
 For wired and tested clocks add \$10.00 to kit price

Ramsey's famous MINI-KITS

FM WIRELESS MIKE KIT

Transmits up to 300' to any FM broadcast radio, uses any type of mike. Runs on 3 to 9V. Type FM-2 has added sensitive mike preamp stage.
 FM-1 kit \$2.95 FM-2 kit \$4.95



VIDEO MODULATOR KIT

Converts any TV to video monitor. Super stable, tunable over ch. 4-6. Runs on 5-15V, accepts std. video signal. Best unit on the market!
 Complete kit, VD-1 \$6.95

TONE DECODER

A complete tone decoder on a single PC board. Features: 400-5000 Hz adjustable range via 20 turn pot, voltage regulation, 567 IC. Useful for touch-tone decoding, tone burst detection, FSK, etc. Can also be used as a stable tone encoder. Runs on 5 to 12 volts.
 Complete kit, TD-1 \$5.95



SUPER SLEUTH

A super sensitive amplifier which will pick up a pin drop at 15 feet! Great for monitoring baby's room or as general purpose amplifier. Full 2 W rms output, runs on 6 to 15 volts, uses 8-45 ohm speaker.
 Complete kit, BN-9 \$5.95



POWER SUPPLY KIT

Complete triple regulated power supply provides variable 6 to 18 volts at 200 ma and +5V at 1 Amp. Excellent load regulation, good filtering and small size. Less transformers, requires 6.3V @ 1 A and 24 VCT.
 Complete kit, PS-3LT \$6.95



COLOR ORGAN/MUSIC LIGHTS

See music come alive! 3 different lights flicker with music. One light for lows, one for the mid-range and one for the highs. Each channel individually adjustable, and drives up to 300W. Great for parties, band music, nite clubs and more.
 Complete kit, ML-1 \$7.95

LED Blinky KIT

A great attention getter which alternately flashes 2 jumbo LEDs. Use for name badges, buttons, warning panel lights, anything! Runs on 3 to 15 volts.
 Complete kit, BL-1 \$2.95

WHISPER LIGHT KIT

An interesting kit, small mike picks up sounds and converts them to light. The louder the sound the brighter the light. Completely self-contained, includes mike, runs on 110VAC, controls up to 300 watts.
 Complete kit, WL-1 \$6.95

SIREN KIT

Produces upward and downward wail characteristic of a police siren. 5W peak audio output, runs on 3-15 volts, uses 3-45 ohm speaker.
 Complete kit, SM-3 \$2.95

Hard to find PARTS

LINEAR ICs	REGULATORS
301 \$.35	78MG \$1.25
324 1.50	723 .50
380 1.25	309K .85
380-8 .75	7805 .85
555 .45	78L05 .25
556 .85	7905 1.25
566 1.15	7812 .85
567 1.25	7912 1.25
1458 .50	7815 .85
3900 .50	TTL ICs
CMOS ICs	74500 .35
4011 .20	7447 .65
4013 .35	7475 .50
4046 1.85	7490 .50
4049 .40	74196TI 1.35
4518 1.25	SPECIAL ICs
5369 1.75	11C90 13.50
TRANSISTORS	10116 1.25
2N3904 type 10 1.00	4511 2.00
2N3906 type 10 1.00	5314 2.95
NPN 30W Pwr 3 1.00	5375AB 2.95
PNP 30W Pwr 3 1.00	7001 6.50
2N3055 .60	4059 + N 9.00
UJT 2N2646 type 3 2.00	7208 17.95
FET MPF102 type 3 2.00	LEDs
UHF 2N5179 type 3 2.00	Jumbo red 8 1.00
MRF-238 RF 11.95	Jumbo green 6 1.00
SOCKETS	Jumbo yellow 6 1.00
8 pin 10 2.00	Mini red 8 1.00
14 pin 10 2.00	Micro red 8 1.00
16 pin 10 2.00	BiPolar .75
24 pin 4 2.00	FERRITE BEADS
28 pin 4 2.00	With info, specs 15 1.00
40 pin 3 2.00	6 hole balun 5 1.00

ramsey electronics

BOX 4072, ROCHESTER, N.Y. 14610

PHONE ORDERS CALL (716) 271-6487

Thanks to Debbie, Tom and Dallas Gang for a great time.



TERMS: Satisfaction guaranteed or money refunded. COD add \$1.50. Minimum order, \$6.00. Orders under \$10.00, add \$.75. Add 5% for postage, insurance, handling. Overseas, add 15%. NY residents, add 7% tax.

These Low Cost SSB TRANSMITTING CONVERTERS

Let you use inexpensive recycled 10 or 11 meter SSB exciters on VHF!

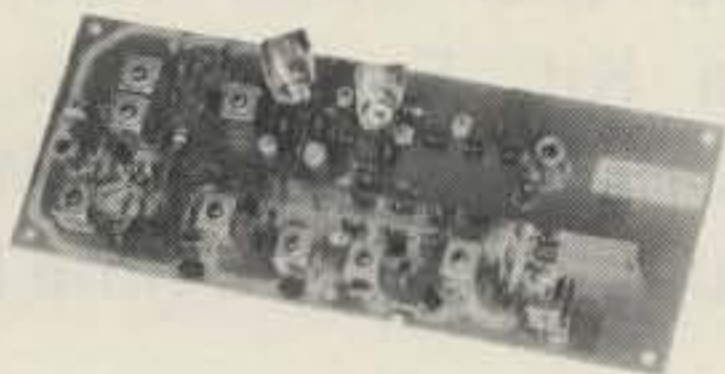

- Linear Converter for SSB, CW, FM, etc.
- A fraction of the price of other units
- 2W p.e.p. output with 1 mW drive
- Use low power tap on exciter or attenuator pad
- Easy to align with built-in test points
- Link with VHF RX converter for transceive

KIT ONLY \$69.95

MODEL	INPUT (MHz)	OUTPUT (MHz)
XV2-1	28-30	50-52
XV2-2	28-30	220-222
XV2-3	28-30 (26-28)	222-224 (220-222)
XV2-4	28-30	144-146
XV2-5	28-30	145-147
XV2-6	26-28	144-146
XV2-7	144-146	50-52
XV2-8	144-146	220-222

FAMOUS HAMTRONICS PREAMPS

Let you hear the weak ones too!
Great for OSCAR, SSB, FM, ATV. Over 14,000 in use throughout the world on all types of receivers.

P9 Kit \$12.95
P14 Wired \$24.95
Specify band when ordering

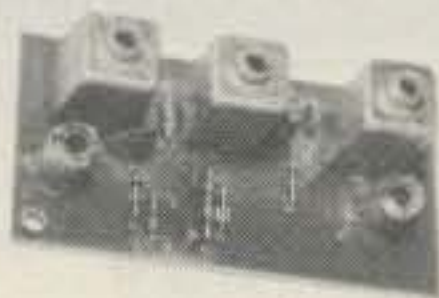

- Deluxe vhf model for applications where space permits • 1 1/2" x 3" • Models available to cover any 4 MHz band in the 26 to 230 MHz range • 12 Vdc • 2 stages • Ideal for OSCAR • 20 dB gain

P8 Kit \$10.95
Specify band when ordering

- Miniature vhf model for tight spaces—size only 1/2 x 2 3/4
- Models available to cover any 4 MHz band in the range 20 to 230 MHz • 20 db gain • 12 Vdc

P15 Kit \$18.95
P35 Wired \$34.95



- Covers any 6 MHz band in UHF range of 380 to 520 MHz • 20 dB gain • 2 stages • 12 Vdc

Easy to Build FET RECEIVING CONVERTERS

Let you receive OSCAR and other exciting VHF and UHF signals on your present HF or 2M receiver

VHF KIT STILL ONLY \$34.95



MODEL	RF RANGE	OUTPUT RANGE
C28	28-32 MHz	144-146
C50	50-52	28-30
C50-2	50-52	144-146
C144	144-146	28-30
C145	145-147	28-30
C146	146-148	28-30
C146	144-146	26-28
C220	220-222	28-30
C220-2	220-222	144-146
C110	Any 2 MHz of Aircraft Band	26-28 or 28-30
C110-ELT	121.5 (121.6)	CB Chan 9 (17)



UHF KIT ONLY \$34.95

MODEL	RF RANGE	OUTPUT RANGE
C432-2	432-434	28-30
C432-5	435-437	28-30
C432-4	432-436	144-146
C432-7	427.25	61.25
C432-9	439.25	61.25

Professional Quality VHF/UHF FM/CW EXCITERS

- Fully shielded designs
- Double tuned circuits for spurious suppression
- Easy to align with built-in test aids

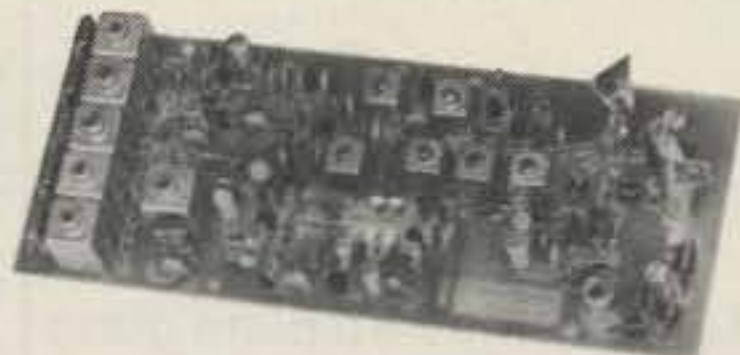

T50-50	6-chan, 6M, 2W Kit	\$49.95
T50-150	6-chan, 2M, 2W Kit	\$49.95
T50-220	6-chan, 220 MHz, 1 1/2W Kit	\$49.95
T40/T20	11-chan, 450 MHz, 200mW Kit	\$49.95

See our Complete Line of VHF & UHF Linear PA's

- Use as linear or class C PA
- For use with SSB Xmtg Converters, FM Exciters, etc.

LPA 2-15	VHF PA, 2W in/15-20W out. Solid-state t/r switching. Kit only	\$59.95
LPA 2-45	VHF PA, 2W in/40-45W out. Can also be used with 8-10W drive. Kit price	\$109.95
LPA 4-10	UHF PA, 200-500mW in/6-10W out. Kit price only	\$79.95

New R75 One Channel VHF FM RECEIVER

Offers Unprecedented Range of Selectivity Options!

- New generation
- More sensitive
- More selective
- Uses crystal filters
- Smaller
- Easy to align

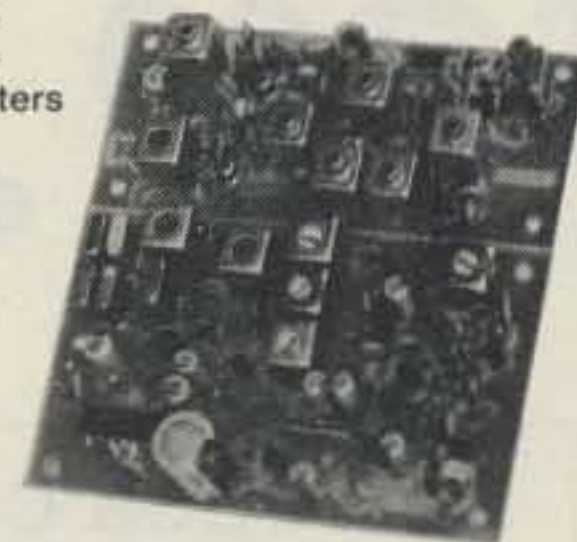

R75A	Kit for monitor or weather satellite service. -60dB at ± 30 KHz.	\$69.95
R75B	Kit for normal nbfm service. -60dB at ±17KHz, -80dB at ± 25 KHz.	\$74.95
R75C	Kit for repeater service. -60dB at ± 14 KHz, -80dB at ± 22 KHz.	\$84.95
R75D	Kit for split channel operation. Uses 8 pole crystal filter! -60dB at ± 9 KHz, -100dB at ± 15 KHz...	\$99.95

Specify band: 10M, 6M, 2M, or 220 MHz. May also be used on adjacent commercial bands. Use 2M version for 137MHz WX satellite.

HAMTRONICS SIX CHANNEL VHF & UHF FM RECEIVERS

In use by the hundreds throughout the world. Unlimited applications.

- Commercial grade design
- Easy to build & align
- 70 or 100dB selectivity options
- Low system cost
- Compartmentized shielding

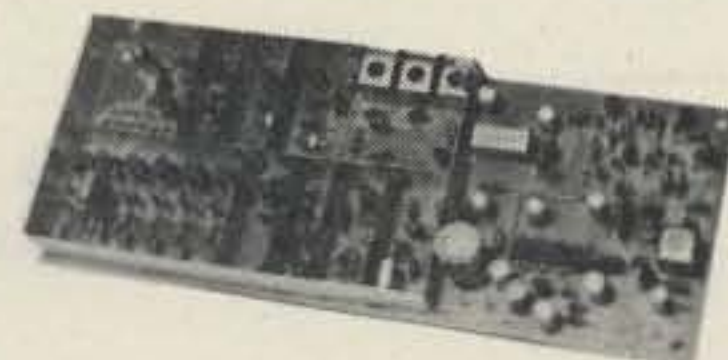

R70 VHF Receiver kit for 10M, 6M, 2M, 220 MHz or adjacent commercial bands \$74.95
Optional xtal filter for 100dB adjacent channel... \$10.00



R90 UHF Receiver kit for any 2MHz segment of 380 to 520 MHz band..... \$89.95

IT'S EASY TO ORDER!

- Write or phone 716-392-9430 (Electronic answering service evenings & weekends)
- Use Credit Card, UPS COD, Check, Money Order
- Add \$2.00 shipping & handling per order

Call or Write to Get **FREE 1979 CATALOG** With Complete Details

(Send 4 IRC's for overseas mailing)

hamtronics, inc.

65A MOUL RD · HILTON, NY 14468

DEALER INQUIRIES INVITED

NATIONAL SEMICONDUCTOR

NEW!

CAR CLOCK MODULE - #MA6008

\$6⁹⁹ each

Originally used by HYGAIN to indicate time and channel on an expensive C.B. Mini size, self contained module. Not a Kit. Four digits plus flashing indicator for seconds. Includes MM5369 and 3.58 MHZ crystal for super accurate time base. With hookup data.

**INCLUDES CRYSTAL TIMEBASE!
WORKS ON 12 VDC!**

**MFGR'S CLOSEOUT
LIMITED QTY.**

NATIONAL SEMICONDUCTOR

MILITARY TIME FORMAT!

JUMBO CLOCK MODULE

**MA1008D
BRAND NEW!**

ASSEMBLED,
NOT A KIT!

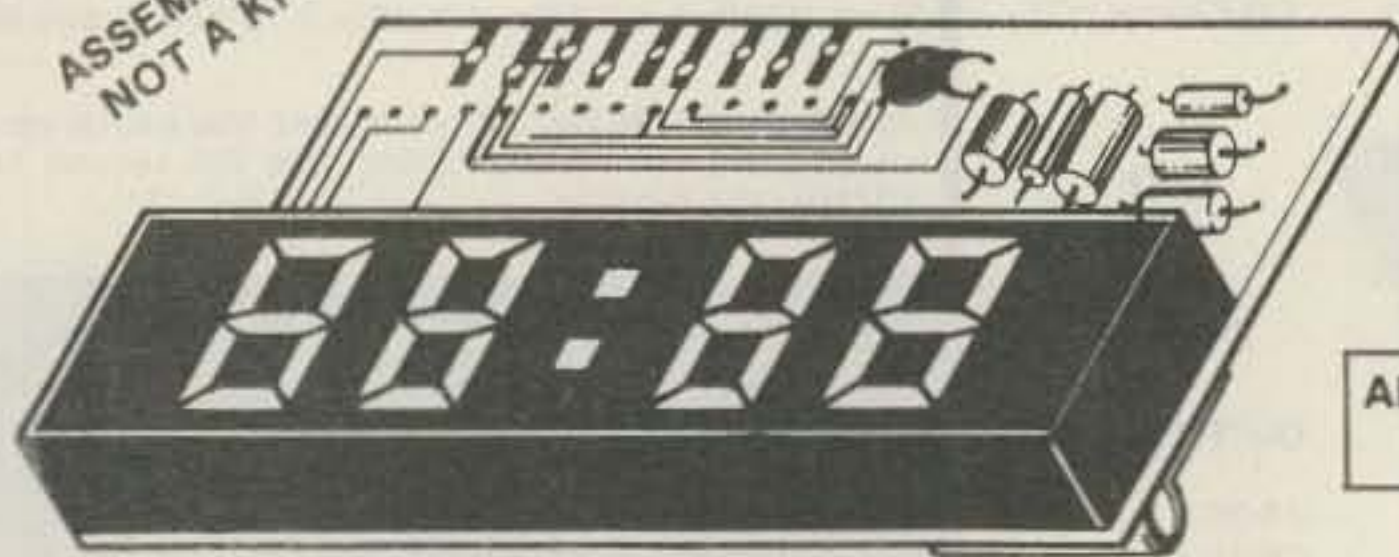

\$4⁹⁵
REG. \$9.95

ADD \$1.95 FOR
AC XFMR

FEATURES:

- ★ FOUR JUMBO 1/2 INCH LED DISPLAYS
- ★ 24 HR REAL TIME FORMAT
- ★ 24 HR ALARM SIGNAL OUTPUT
- ★ 50 OR 60 Hz OPERATION
- ★ LED BRIGHTNESS CONTROL
- ★ POWER FAILURE INDICATOR
- ★ SLEEP & SNOOZE TIMERS
- ★ DIRECT LED DRIVE (LOW RFI)
- ★ COMES WITH FULL DATA

**COMPARE AT UP TO TWICE
OUR PRICE!**

MANUFACTURER'S CLOSEOUT!

ZULU

50% OFF SALE!

PERFECT FOR USE
WITH A TIMEBASE.

TEMPERATURE CONTROLLED HEATING PLATE

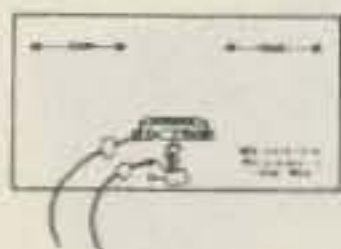

\$2.99

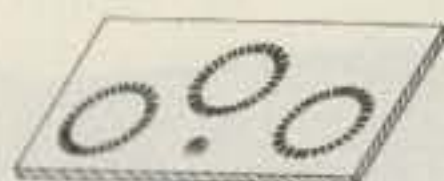

5 1/2 x 10 1/2 In. 120 VAC, 120 WATTS. Made of 1/4 In. tempered plate glass with Ni-Chrome heating element laminated to back. Element size is 4 1/4 x 9 1/4 Inches. Double protected by TIKLIXON Thermostat and two thermal fuses. Each also has neon ready light.

Besides the obvious use as a bun warmer, food warmer, coffee warmer, glue warmer, etc., our tests show this plate to be an excellent warmer for ferric chloride solution used in etching PC Boards by hobbyists. Typically increases etching efficiency by 300% over room temperature. Non-Submersible.

NATIONAL SEMICONDUCTOR

"COLOSSUS JR." JUMBO CLOCK MODULE

**MA1013
BRAND NEW!**

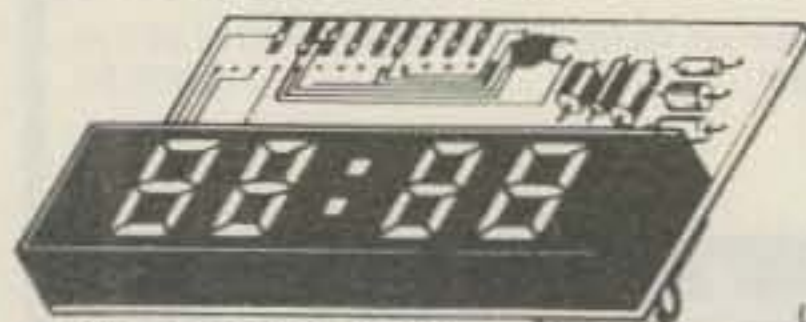

\$8.50

2 FOR
\$15

(AC XFMR \$1.95)

ASSEMBLED! NOT A KIT!

MANUFACTURER'S CLOSEOUT!

PERFECT FOR USE
WITH A TIMEBASE.

- Bright 4 digit 0.7" LED Display
- Complete-Add only Transformer and Switches
- 24 Hour Alarm Signal Output
- 12 Hour Real Time Format
- 50 or 60 Hz Operation
- Power Failure Indication
- LED Brightness Control
- Sleep and Snooze Timers
- Alarm "on" and PM Indicators
- Direct Drive - No RFI
- Direct Replacement for MA1012
- Comes with Full Data



MICRO-MINI TOGGLE SWITCH

99¢
EACH

SPDT. By RAYTHEON.
MADE IN USA! WITH HDWR.

6 FOR \$5

60 Hz CRYSTAL TIME BASE

\$4.95 (Complete Kit)

Uses MM5369 CMOS divider IC with high accuracy 3.579545 MHZ Crystal. Use with all MOS Clock Chips or Modules. Draws only 1.5 MA. All parts, data and PC Board included. 100 Hz. same as above, except \$5.95.

SILICON POWER SOLAR CELLS

2 Inch Dia. Approx. .5 VDC at 500 MA. in sunlight. Factory new units, not rejects as sold by others. Series for higher voltage, parallel for higher current. Converts solar energy directly to electricity. **LIMITED QUANTITY. \$5⁹⁹ ea**

FAIRCHILD PNP

"SUPER TRANSISTOR"
2N4402. TO-92 Plastic. Silicon PNP Driver. High Current. VCEO-40 HFE-50 to 150 at 150 MA. FT-150 MHZ. A super "BEEFED-UP" Version of the 2N3906.

8 FOR \$1.19

JUMBO IC ASSORTMENT

All new not rejects. BIG computer mfg. Surplus. Some standard marked, many house numbered. TTL, DTL, LINEAR. All prime. 1st line.

50 for \$1.59 500 for \$12.95

TOSHIBA POWER AUDIO AMP

5.8 WATTS RMS Typical Output. 50 to 30,000 HZ ± 3 DB. For CB's, tape decks, PA's, etc. Works off of a single supply voltage from 10.5 to 18 VDC. 10 Pin plastic DIP with special built in heat sink tab. Perfect for use on 12VDC. **\$3⁹⁹ each**
With Data.

Digital Research: Parts

(OF TEXAS)

P.O. BOX 401247 • GARLAND, TEXAS 75041 • (214) 271-2461

TERMS: Add 50¢ postage, we pay balance. Orders under \$50 add 75¢ handling. No C.O.D. We accept Visa, MasterCard and American Express cards. Tex. Res. add 5% Tax. Foreign orders (except Canada) add 20% P&H. 90 Day Money Back Guarantee on all items.

16K EPROM CARD-S 100 BUSS

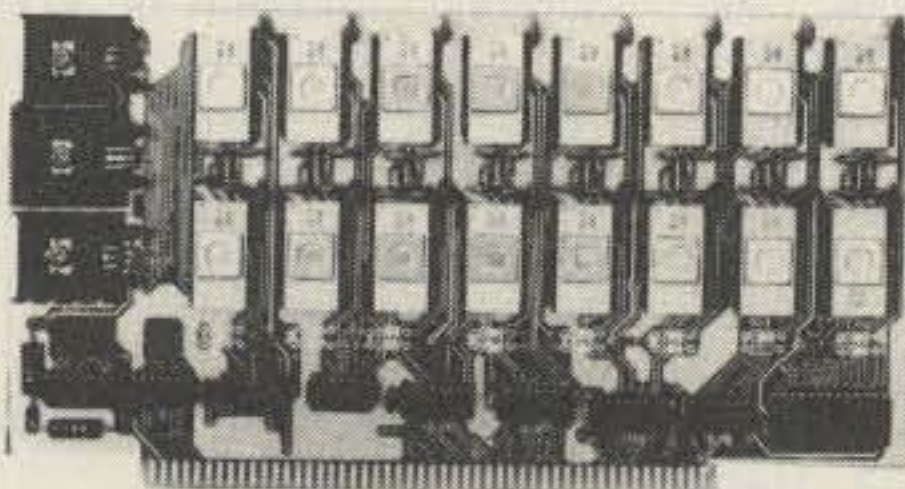

\$59.95
KIT

OUR
BEST
SELLING
KIT!

USES 2708's!

Thousands of personal and business systems around the world use this board with complete satisfaction. Puts 16K of software on line at **ALL TIMES!** Kit features a top quality soldermasked and silk-screened PC board and first run parts and sockets. All parts (except 2708's) are included. Any number of EPROM locations may be disabled to avoid any memory conflicts. Fully buffered and has WAIT STATE capabilities.

OUR 450NS 2708'S
ARE \$8.95 EA. WITH
PURCHASE OF KIT

ASSEMBLED
AND FULLY TESTED
ADD \$25

8K LOW POWER RAM KIT-S 100 BUSS 250 NS SALE!

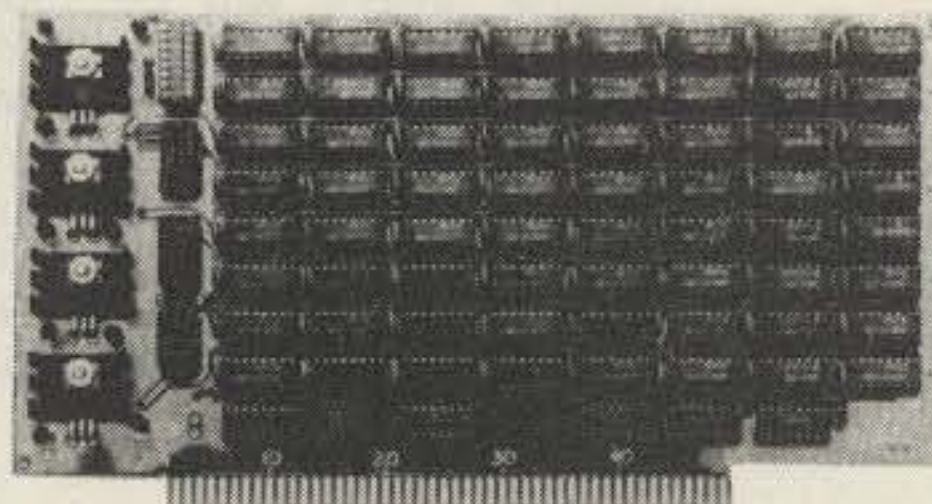

ADD \$5
FOR
250NS!

\$129 KIT

(450 NS RAMS!)

Thousands of computer systems rely on this rugged, work horse, RAM board. Designed for error-free, NO HASSLE, systems use.

KIT FEATURES:

1. Doubled sided PC Board with solder mask and silk screen layout. Gold plated contact fingers.
2. All sockets included.
3. Fully buffered on all address and data lines.
4. Phantom is jumper selectable to pin 67.
5. FOUR 7805 regulators are provided on card.

Blank PC Board w/Documentation
\$29.95

Low Profile Socket Set...**13.50**
Support IC's (TTL & Regulators)
\$9.75

Bypass CAP's (Disc & Tantalums)
\$4.50

ASSEMBLED AND FULLY
BURNED IN ADD \$30

16K STATIC RAM KIT-S 100 BUSS

\$295 KIT

FULLY
STATIC, AT
DYNAMIC PRICES

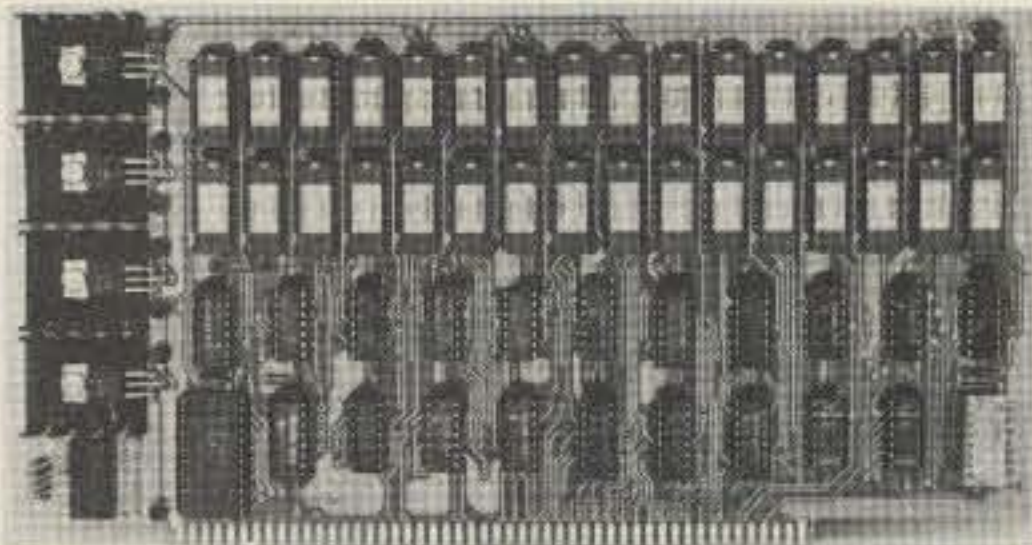

WHY THE 2114 RAM CHIP?

We feel the 2114 will be the next industry standard RAM chip (like the 2102 was). This means price, availability, and quality will all be good! Next, the 2114 is FULLY STATIC! We feel this is the **ONLY** way to go on the S-100 Buss! We've all heard the HORROR stories about some Dynamic Ram Boards having trouble with DMA and FLOPPY DISC DRIVES. Who needs these kinds of problems? And finally, even among other 4K Static RAM's the 2114 stands out! Not all 4K static Rams are created equal! Some of the other 4K's have clocked chip enable lines and various timing windows just as critical as Dynamic RAM's. Some of our competitor's 16K boards use these "tricky" devices. But not us! The 2114 is the **ONLY** logical choice for a trouble-free, straightforward design.

KIT FEATURES:

1. Addressable as four separate 4K Blocks.
2. ON BOARD BANK SELECT circuitry. (Cromemco Standard!). Allows up to 512K on line!
3. Uses 2114 (450NS) 4K Static Rams.
4. ON BOARD SELECTABLE WAIT STATES.
5. Double sided PC Board, with solder mask and silk screened layout. Gold plated contact fingers.
6. All address and data lines fully buffered.
7. Kit includes ALL parts and sockets.
8. PHANTOM is jumpered to PIN 67.
9. LOW POWER: under 2 amps TYPICAL from the +8 Volt Buss.
10. Blank PC Board can be populated as any multiple of 4K.

BLANK PC BOARD W/DATA—\$33

LOW PROFILE SOCKET SET—\$12
SUPPORT IC'S & CAPS—\$19.95

ASSEMBLED & TESTED—ADD \$30
2114 RAM'S—8 FOR \$69.95

16K STATIC RAM SS-50 BUSS

\$295 KIT

FULLY STATIC
AT DYNAMIC PRICES

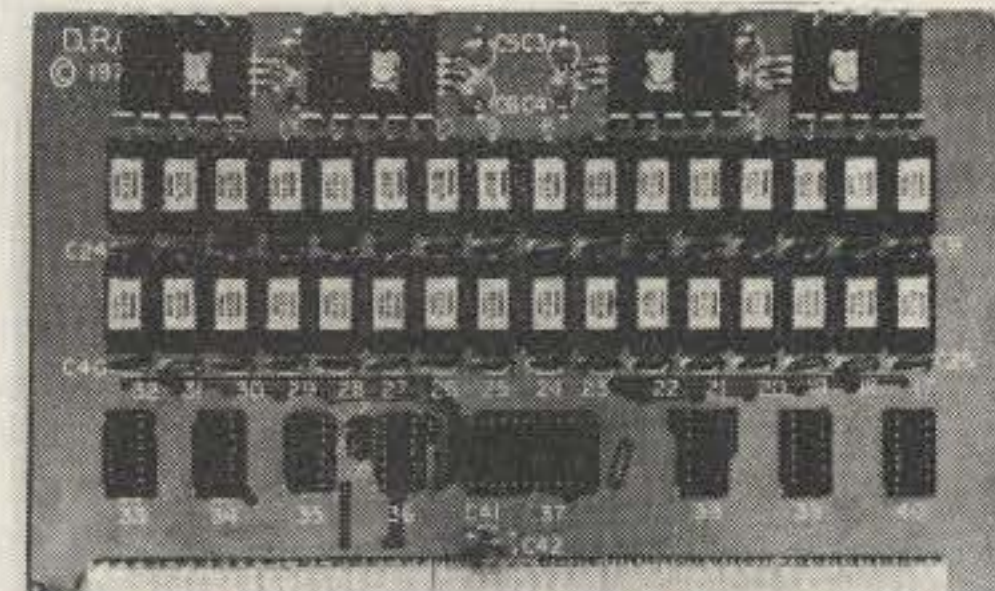

KIT FEATURES:

1. Addressable on 16K Boundaries
2. Uses 2114 Static Ram
3. Runs at Full Speed
4. Double sided PC Board. Solder mask and silk screened layout. Gold fingers.
5. All Parts and Sockets included
6. Low Power: Under 2 Amps Typical

FOR SWTPC
6800 BUSS!

BLANK PC BOARD—\$33

SUPPORT IC'S AND CAPS—\$19.95

COMPLETE SOCKET SET—\$12

TM990 BUSS PROTOTYPE & WIREWRAP BOARD

For use with the Texas Instrument Series of 16 Bit Microcomputer Modules. Fully buss compatible. An inexpensive and quick way to expand the capacity of your TI computer. Made of G-10 Epoxy PC material. Gold plated contact fingers all plated through holes. High density, up to over 100 DIP's. Fully documented. **\$70** each (OEM Discounts Available)

450 NS! 2708 EPROMS

Now full speed! Prime new units from a major U.S. Mfg. 450 N.S. Access time. 1K x 8. Equiv. to 4-1702 A's in one package.

~~\$15.75 ea.~~

\$9.95

~~4 For \$50.00~~

PRICE CUT

ANNOUNCEMENT:

To better serve our customers we are splitting Digital Research Corp of Texas into two operating sections: Parts and Computers. We feel this change will allow us to offer you lower prices, better service, and many more new products. Continue to order parts, clock modules, etc. from D.R.P. P.O. Box 401247 Garland, TX 75040. To order computer parts and computer kits order from Digital Research: Computers P.O. Box 401565 Garland, TX 75040.

Z-80 PROGRAMMING MANUAL

By MOSTEK, or ZILOG. The most detailed explanation ever on the working of the Z-80 CPU CHIPS. At least one full page on each of the 158 Z-80 instructions. A MUST reference manual for any user of the Z-80. 300 pages. Just off the press.

\$12.95

NOT ASSOCIATED WITH
DIGITAL RESEARCH
OF CALIFORNIA,
THE SUPPLIERS OF
CPM SOFTWARE.

16K DYNAMIC RAM CHIP

16K X 1 Bits. 16 Pin Package. Same as Mostek 4116-4. 250 NS access. 410 NS cycle time. Our best price yet for this state of the art RAM. 32K and 64K RAM boards using this chip are readily available. These are new, fully guaranteed devices by a major mfg. **VERY LIMITED STOCK!**

8 FOR \$79.50

Digital Research: Computers
(OF TEXAS)

P.O. Box 401565 • GARLAND, TEXAS 75040 • (214) 271-2461

TERMS: Add 50¢ postage, we pay balance. Orders under \$15 add 75¢ handling. No C.O.D. We accept Visa, MasterCard, and American Express cards. Tex. Res. add 5% Tax. Foreign orders (except Canada add 20% P & H. 90 Day Money Back Guarantee on all items.

Social Events

from page 143

August 11, 1979, in the rear parking lot at DeVry Technical Institute, 479 Green St., between Rte. 1 and Rte. 9, Woodbridge, New Jersey. Space is \$2.00, admission is free.

CHARLOTTE VT AUG 11-12

The Burlington Amateur Radio Club will hold its International Field Days on August 11-12, 1979, at the Old Lantern, Charlotte, Vermont. The outdoor flea market will be held on both Saturday and Sunday. Special features will include bingo and a model air show, plus many prizes. Camping will be available by reservation only; there will be no early birds. Admission is \$3.00 both at the gate and in advance. For further information, write BARC, Box 312, Burlington VT 05402.

LEXINGTON KY AUG 12

The Bluegrass Amateur Radio Club will host its annual ARRL Central Kentucky Bluegrass Hamfest on August 12, 1979, starting at 8:00 am at the Fasig-Tipton Sales Paddock, Newtown Pike, Lexington, Kentucky. Featured will be grand prizes, hourly door prizes, forums, indoor exhibits, distributors, and a paved outside flea market. Admission is \$2.50 advance and \$3.00 at the door, which includes parking. Food service will be available. Talk-in on 146.16/.76. For details, write Bluegrass Hamfest, Attn: Edward Bono WA4ONE, 2077 Dogwood Drive, Lexington KY 40504.

WILLOW SPRINGS IL AUG 12

The Hamfesters Radio Club, Inc., will hold its 45th annual picnic and hamfest on Sunday, August 12, 1979, at Santa Fe Park, 91st and Wolf Rd., Willow Springs, Illinois, a suburb southwest of Chicago. This event will feature the famous swapper's row. Tickets are \$2.00 at the gate or \$1.50 in advance. For hamfest information and advance tickets, send check or money order (SASE appreciated) to Box 42792, Chicago IL 60642.

CEDARTOWN GA AUG 12

The Cedar Valley Amateur Radio Club will hold its annual Cedar Valley Hamfest on August 12, 1979, from 8:00 am to 4:00 pm at the Polk County Fairgrounds, on US 278, two

miles east of Cedartown, Georgia. There will be food, drinks, and prizes. Talk-in on 147.72/.12 (WR4AZU). For more information, please contact Jim T. Schliestett W4IMQ, Secretary, Cedar Valley ARC, PO Box 93, Cedartown GA 30125, or phone (404)-748-5968.

RIPLEY WV AUG 12

A hamfest and flea market will be held on August 12, 1979, at Cedar Lakes Park, Ripley, West Virginia. Forums include Bob Halprin K1XA of the ARRL Communications Department. For advance flyer and general information, write Bob Morris WA8CTO, 628 Church Street South, Ripley WV 25271.

OKLAHOMA CITY OK AUG 14-16

The "Private Satellite Seminar," sponsored by Bob Cooper, Jr., Editor-in-Chief of *CATJ Magazine* and host of the *Satellite Magazine* television program, will be held on August 14-16, 1979, at an educational institution in Oklahoma City, Oklahoma. Highlights will include a two-part seminar on the TD-2 conversion and a two-part seminar on the "Howard Terminal" (complete plans included in registration packet). Numerous manufacturers will be on hand to demonstrate their equipment and to investigate the "private TVRO market." Registration fee for the three-day event is \$125. For full information, contact SPTS '79 at (405)-947-4717, or write SPTS '79, Suite 106, 4209 NW 23rd, Oklahoma City OK 73107.

OAKLAND NJ AUG 18

The 550 Amateur Radio Club and Oakland Repeater, Inc., will hold its annual flea market on August 18, 1979, at the American Legion Hall, Oak Street, Oakland, New Jersey. Indoor tables are \$5.00, and tailgating is \$3.00. There is no admission fee for buyers. Refreshments will be available on the premises. Talk-in on 147.49/146.49 or 146.52. For information, call Bud Hauser WA2JUO at (201)-797-8471 or (201)-791-0589 for advance reservations and information.

TACOMA WA AUG 18-19

The Radio Club of Tacoma (W7DK) will hold its annual Hamfair on Saturday and Sunday, August 18-19, 1979, starting at 9:00 am both days, at Camp Murray, about 10 miles

south of Tacoma, Washington, on I-5. Featured will be prizes, seminars, contests, commercial exhibits, a food bar, a flea market, and a Saturday night banquet. Camping and trailer facilities will be available. Talk-in on .96/.36. For more information, contact Dave Ransier WB7SDB, 10315 63rd Ave. Ct. East, Puyallup WA 98371, or phone (206)-845-7800.

DECATUR AL AUG 18-19

The North Alabama Ham Association will hold its annual hamfest on August 18-19, 1979, at the Calhoun Community College gym in Decatur, Alabama. Examinations will be administered by the FCC, door prizes will be given, and tickets may be purchased for other equipment drawings. Camping is available at nearby Point Mallard. Talk-in on 146.40/147.00, 146.34/.94, or .52/.52. For more information, write to the North Alabama Ham Association, Box 9, Decatur AL 35602.

PETOSKEY MI AUG 18-19

The Straits Area Radio Club will hold its Swap 'n Shop and hamfest on August 18-19, 1979, at Petoskey Middle School, State and Howard Streets, across from the Catholic church and post office, Petoskey, Michigan. There will be a donation of \$2.00 at the door. Table space is also \$2.00. Refreshments will be available. There will be a swap and shop on Saturday from 9:00 am to 4:00 pm and on Sunday from 9:00 am to 12:00 pm. Prizes, a ladies' program, and seminars at 11:00 am and 2:00 pm on Saturday will be featured. A banquet at the Holiday Inn on Saturday at 7:00 pm will have Mellish Reef DXpeditioner Bob Walsh WA8MOA as guest speaker. Banquet tickets are \$7.50 and are limited to 200, sold in advance only. For full information and lodging, send an SASE to Bill Moss WA8AXF, 715 Harvey Street, Petoskey MI 49770, or phone (616)-347-4734.

ABINGDON VA AUG 18-19

The 3rd annual Bristol Hamfest will be held on Saturday, August 18, from 9:00 am to 5:00 pm, and on Sunday, August 19, 1979, from 9:00 am to 4:00 pm at the New Washington County Fairgrounds (behind the Rex shopping center), Rte. 11, Abingdon, Virginia. This will be an all-indoor event. Admission is \$1.00 with an additional \$2.00 for flea market space (bring your own tables). Additional prize tickets may also be purchased. Featured will be ladies' activities, children's games, and catered food. Prizes include

a Ten-Tec Triton IV, with power supply, an electric toaster oven, and a Yaesu FT-202R hand-held, with accessories, plus various other smaller prizes. The main prize drawing will be held on Sunday afternoon at 3:00 pm. Talk-in on .01/.61 and .07/.67. For further information, please send an SASE to Lowry Rouse WD4ECF, 77 Bordwine Road, Bristol VA 24201, or phone (703)-669-3086.

MONTGOMERYVILLE PA AUG 19

The Mid-Atlantic Amateur Radio Club will hold its annual J.B.M. Hamfest on August 19, 1979, from 9:00 am to 4:00 pm at the Budco 309 Twin Drive-In Theater at the end of 309 Expressway and Rt. 63, Montgomeryville, Pennsylvania. Doors will open at 8:00 am for setup. Admission is \$2.50 with \$1.00 additional for tailgating. Non-hams in the party are free. Food and beverage service will be available. Door prizes and a raffle for a major piece of equipment will enliven the festivities. Talk-in on 147.45, 146.52, and on the club repeater, WB3JOE, 147.66/.06. For further information, contact Gene Hoenig WB3FTJ, 717 Amherst Circle, Newtown Square PA 19073, or call (215)-221-3666 during business hours or (215)-353-3281 evenings or weekends.

WARREN OH AUG 19

The Warren Amateur Radio Association, Inc., will hold its 22nd annual Warren Hamfest on Sunday, August 19, 1979, at the Kent State University Trumbull Campus, Warren, Ohio, located at the intersection of Ohio Rte. 5 bypass and Ohio Rte. 45. Registration is \$2.00 each, or 3 for \$5.00, with children under 12 admitted free. There will be a giant flea market on the campus grounds, with the flea market opening at 6:00 am at \$1.00 per space. Many dealer displays will be inside an air-conditioned building. Main prizes include a Ten-Tec 546, a Wilson System I, a Wilson Mark II, an Atlas transceiver, and many more. The main prize drawing will be at 4:00 pm. Winners need not be present. Mobile check-in on WR8ACX 146.97.

LAFAYETTE IN AUG 19

The Tippecanoe Amateur Radio Association, Inc., will hold its Lafayette, Indiana, Hamfest on Sunday, August 19, 1979, at the Tippecanoe County 4-H Fairgrounds, on Indiana Highway #25, Lafayette, Indiana. Gates will open at 6:00 am. Advance tickets are available by

Continued on page 168

BULLET ELECTRONICS

P.O. BOX 401244E
GARLAND, TX 75040
(214) 278-3553

WE APOLOGIZE!

* Phone orders accepted on credit card orders

JUST WHEN IT LOOKED LIKE ALL THE HOOPLA ABOUT OUR LOW COST HIGH CURRENT REGULATED PS-14 POWER SUPPLY KIT WAS FADING AWAY AND OUR COMPETITORS COULD BREATHE A LITTLE EASIER, WE GO AND DO SOMETHING LIKE THIS!

PS-15 POWER SUPPLY KIT 12V 30 AMPS

SPECS:

CONTINUOUS CURRENT REGULATION	30 AMPS
RIPPLE	200 MV LOAD AND LINE
CURRENT LIMIT	LESS THAN 300MV @ 30A
VOLTAGE OUTPUT	ADJUSTABLE FOLDBACK TYPE
SAFETY FEATURES	ADJUSTABLE 11.5 TO 14 VDC
	SHORT CIRCUIT PROTECTION; THERMAL SHUTDOWN; RF BY-PASSED

YOU GET:

- HUGE 40 AMP TRANSFORMER
- 3 LARGE HEATSINKS
- DRILLED & PLATED PC BOARD
- LARGE COMPUTER GRADE CAP
- ALL ELECTRONIC PARTS
- FUSES, FUSEHOLDERS, LINE CORD WIRE, MICA INSULATORS
- COMPLETE STEP-BY-STEP INSTRUCTIONS
- COMPLETE WARRANTY AND REPAIR SERVICE
- WE PAY SHIPPING!

PRICE DOES NOT INCLUDE CHASSIS, METERS OR JACKS

PS-14 Power Supply Kit.

Same features as above but 20 AMP max current. SHIPPING PAID. **45.00**

Regulator Card &

Components: **14.95**

59.95

*Canadian Orders add \$10.00 for Shipping and Insurance.

OVP-2 OVERVOLTAGE PROTECTOR

Protect your expensive gear from overvoltage from transients or power supply malfunctions. Use with any fused power supply. Compatible with PS-14 or PS-15. Adjustable 10-20 VDC

MATCHED METER SET

A quality pair of American Made 3 1/2" rectangular panel meters. 5% Accuracy. Modern styling.

SET 0-15VDC, 0-30ADC **12.95 set**

SPECIAL PACKAGE:

PS-15; OVP-2 AND METERS

75.00

SHIPPING PAID

SE-01 SOUND EFFECTS KIT

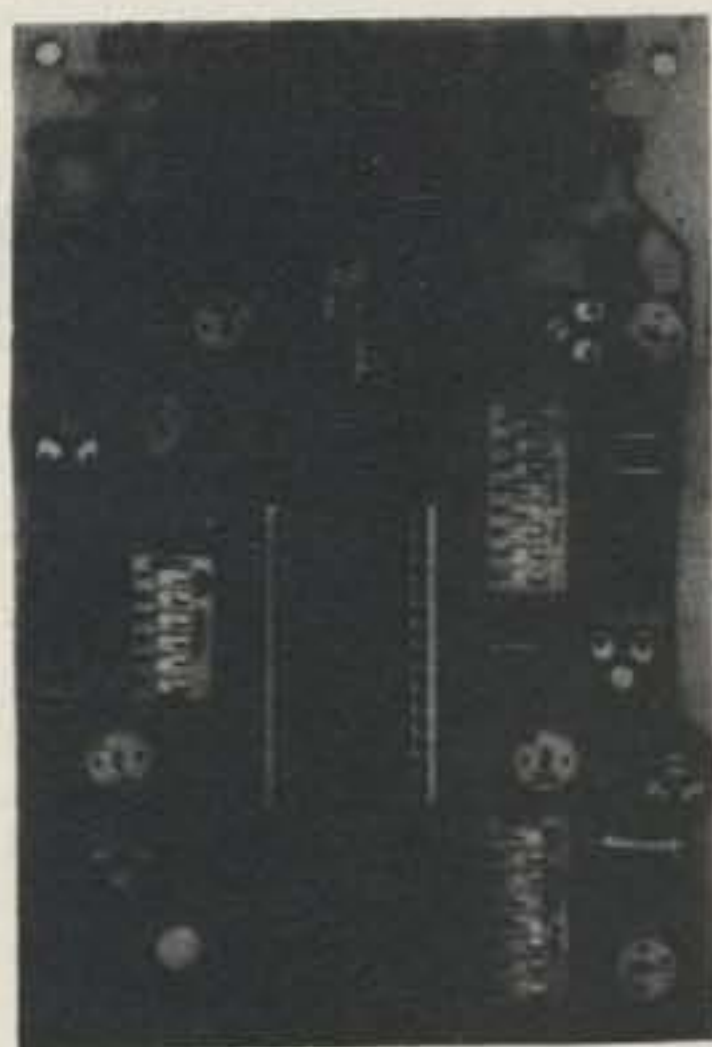

- ALL PARTS
- COMPLETE INSTRUCTIONS
- QUALITY PLATED & DRILLED BOARD
- IC SPECS INCLUDED
- RUNS ON ONE 9-VOLT BATTERY
- SMALL 3 1/2" x 5"
- **\$16.95** LESS SPEAKER & BATTERY
- 76477 CHIP IS INCLUDED. EXTRA CHIPS \$2.95 EACH

7 WATT AUDIO AMP KIT

SMALL, SINGLE HYBRID IC AND COMPONENTS FIT ON A 2" x 3" PC BOARD (INCLUDED). RUNS ON 12 VDC. GREAT FOR ANY PROJECT THAT NEEDS AN INEXPENSIVE AMP. LESS THAN 3% THD @ 5 WATTS. COMPATIBLE WITH SE-01 SOUND KIT. **\$5.95**

6 DIGIT AUTO/VAN CLOCK

- LARGE 1/2" CHARACTERS (LED)
- QUARTZ XTAL TIMEBASE
- ALARM & SNOOZE OPTIONS
- NOISE FILTERING
- EASY TO ASSEMBLE
- 4 1/2" x 3" x 1 1/2"
- DRILLED & PLATED PC BOARDS

COMPLETE KIT 12 VDC **\$16.95**

ULTRASONIC RELAY KIT

INVISIBLE BEAM WORKS LIKE A PHOTO ELECTRIC EYE. USE UP TO 25 FT. APART. COMPLETE KIT. ALL PARTS & PC BOARDS. **\$21.50**

LED'S

JUMBO GREEN	4/.89
JUMBO RED	5/.89
MEDIUM RED (1/8")	.15
MEDIUM GRN OR YELLOW	.16

- NO COD'S
- SEND CHECK, M.O., M.C. OR VISA
- ADD 5% FOR SHIPPING
- CATALOG FREE UPON REQUEST
- ORDERS UNDER \$10 ADD 75c
- TEX. RESIDENTS ADD 5% SALES TAX
- FOREIGN ADD 10%

OTHERS WILL SELL YOU THE CHIP, BUT ONLY BULLET CAN FURNISH YOU A COMPLETE KIT OF ALL THE PARTS YOU NEED TO PUT THE T.I. 76477 SOUND CHIP THROUGH ITS PAGES! WE INCLUDE SPECS AND PROGRAMMING CHARTS. YOU WILL BE AMAZED AT THE THOUSANDS OF SOUND EFFECTS YOU CAN PRODUCE WITH OUR KIT! MAKE PHASOR GUN, STEAM TRAIN, GUNSHOT AND OTHER SOUNDS. BOARD HAS AUXILIARY PULSE GENERATOR, COMPARATOR AND MULTIPLEX OSC FOR EVEN MORE VERSATILITY.

it's SUMMER SPECIAL time...

Special prices are good from July 15 to August 31. Quantities are limited - order now and save!

MA1003 CLOCK MODULE ~~\$16.50~~

\$13.20

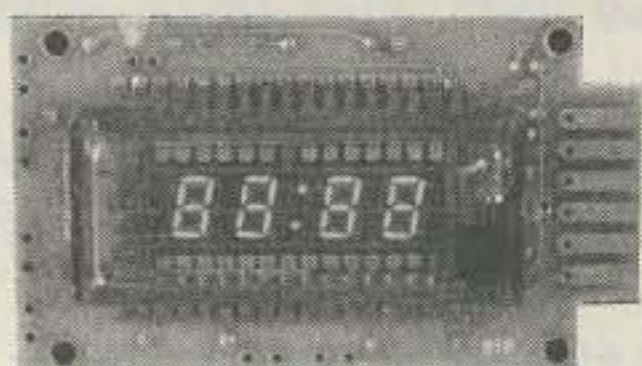

20% off our very best clock module. Internal crystal timebase accurate to .01%, fluorescent readouts, full documentation (with automotive applications), simple assembly (just add 2 time set switches and 12V DC), and much more. Matching case with mounting hardware and optical filter: \$5.95. **Hurry - clock prices may never be this low again.**

16K MEMORY EXPANSION CHIP SET ~~\$109~~ \$87.20

20% off one of our all-time best sellers. For Radio Shack-80, Exidy Sorcerer, Apple computers. Compare with similar kits: 250 ns access time, low power parts, DIP shunts included, 1 year limited warranty, and easy-to-follow instructions that make memory expansion a snap.

12V 8A POWER SUPPLY KIT ~~\$44.50~~

\$40.05

10% off our ever-popular hefty power supply. Handles 8A continuous, 12A with a 50% duty cycle. Features foldback current limiting, crowbar overvoltage protection, RF suppression, much more. For transceivers, portable & automotive tape and TV equipment, disc drives, etc. Easy to assemble - except for transformer, diodes and filter caps, all parts mount on heavy-duty circuit board. Does not include case.

CRYSTALS AT 10% OFF!

XT500K	500 KHz, series mode, fundamental, wire leads, HC6/U package . . . \$4.95 \$4.45
XT1M	1 MHz, otherwise same as above . . . \$5.95 \$5.35
XT1.84320	1.84320 MHz, otherwise same as above . . . \$5.95 \$5.35
XT2M	2 MHz, otherwise same as above . . . \$5.95 \$5.35
XT3.58M	3.58 MHz (colorburst), otherwise same as above . . . \$2.25 \$2.02
XT4M	4 MHz, series mode, fundamental, HC18 package . . . \$4.95 \$4.45
XT4.5315M	4.5315 MHz, otherwise same as above . . . \$4.95 \$4.45
XT5M	5 MHz, otherwise same as above . . . \$4.95 \$4.45
XT8M	8 MHz, otherwise same as above . . . \$4.95 \$4.45
XT9M	9 MHz, otherwise same as above . . . \$4.95 \$4.45
XT10M	10 MHz, otherwise same as above . . . \$4.95 \$4.45
XT12M	12 MHz, otherwise same as above . . . \$4.95 \$4.45
XT15M	15 MHz, otherwise same as above . . . \$4.95 \$4.45
XT18M	18 MHz, otherwise same as above . . . \$4.95 \$4.45
XT20M	20 MHz, otherwise same as above . . . \$4.95 \$4.45

BIPOLAR, REGULATED, VIRTUALLY BLOW-OUT PROOF, 1/4 AMP PER SIDE POWER SUPPLY KIT: ONLY \$15!

Sorry this isn't on special, but we just can't pare the price down any further. These power supplies are great for fixed voltage applications; specify project #13, and choose from ±5V, ±6V, ±8V, ±9V, ±12V, or ±15V. Compact, simple assembly; does not include case.

10% OFF ON RF POWER TRANSISTORS FOR HAMS!

2NRF-1	2 GHz RF power transistor. Pd max (@ 25 degrees C) 3.5W, Pout min @ 2 GHz 1.0W, Pin 310 mW, efficiency @ 2 GHz 30%, round shape, similar to RCA 2N5470. \$4.95 \$4.45
2NRF-2	2 GHz RF power transistor. Pd 8.7W, Pout 2.5W, Pin 300 mW, efficiency 33%, cross shape, similar to RCA TA8407. \$5.95 \$5.35
2NRF-3	2 GHz RF power transistor. Pd 21W, Pout 5.5W, Pin 1.25W, efficiency 33%, cross shape. Similar to RCA 2N6269. \$6.95 \$6.25
2NRF-4	2 GHz RF power transistor. Pd 29W, Pout 7.5W, Pin 1.5W, efficiency 33%, cross shape. Factory selected, prime 2N6269. \$7.95 \$7.15

MEMORY CHIP SPECIAL

Now you can play with memory without playing havoc with your budget: try our 21L02 special, and get ten 1K static RAMs for only \$9.90 (that's less than 1¢ per byte!) These are low power units, suitable for use with any 2 MHz computer system, and are new, prime, high quality parts.

TERMS: Add \$1 handling to orders under \$15. Allow up to 5% shipping, more for power supplies (excess refunded). Give street address for UPS delivery. VISA®/Mastercharge® call our 24 hour order desk at (415) 562-0636. CODs OK with street address. Cal. res. add sales tax. **Thanks for your business!**

GODBOUT

BILL GODBOUT ELECTRONICS
BOX 2355, OAKLAND AIRPORT, CA 94614

FREE FLYER: Whether you're a computer user, electronic musician, experimenter, or mad scientist, we have bargains for you . . . and they're all listed in our flyer (including lots of specials that are too provocative to put in family magazines such as this). Send us your name and address; add 41¢ in stamps for 1st class delivery.

Transistor Checker

— Completely Assembled —
— Battery Operated —



The ASI Transistor Checker is capable of checking a wide range of transistor types, either "in circuit" or out of circuit. To operate, simply plug the transistor to be checked into the front panel socket, or connect it with the alligator clip test leads provided. The unit safely and automatically identifies low, medium and high-power PNP and NPN transistors. Size: 3 1/4" x 5 1/4" x 2" "C" cell battery not included.

Trans-Check \$29.95 ea.

Custom Cables & Jumpers



DB 25 Series Cables

Part No.	Cable Length	Connectors	Price
DB25P-4-P	4 Ft.	2-DP25P	\$15.95 ea.
DB25P-4-S	4 Ft.	1-DP25P/1-25S	\$16.95 ea.
DB25S-4-S	4 ft.	2-DP25S	\$17.95 ea.

Dip Jumpers

DJ14-1	1 ft.	1-14 Pin	\$1.59 ea.
DJ16-1	1 ft.	1-16 Pin	1.79 ea.
DJ24-1	1 ft.	1-24 Pin	2.79 ea.
DJ14-1-14	1 ft.	2-14 Pin	2.79 ea.
DJ16-1-16	1 ft.	2-16 Pin	3.19 ea.
DJ24-1-24	1 ft.	2-24 Pin	4.95 ea.

For Custom Cables & Jumpers, See JAMECO 1979 Catalog for Pricing

CONNECTORS

25 Pin-D Subminiature

DB25P (as pictured)	PLUG (Meets RS232)	\$2.95
DB25S	SOCKET (Meets RS232)	\$3.50
DB51226-1	Cable Cover for DB25P or DB25S	\$1.75

PRINTED CIRCUIT EDGE-CARD

156 Spacing-Tri-Double Row-Out — Bifurcated Contacts — Fits .054 to .070 P.C. Cards

15/30	PINS (Solder Eyelet)	\$1.95
18/36	PINS (Solder Eyelet)	\$2.49
22/44	PINS (Solder Eyelet)	\$2.95
50/100 (.100 Spacing)	PINS (Wire Wrap)	\$6.95
50/100 (.125 Spacing)	PINS (Wire Wrap)	R681-1 \$6.95

4-Digit Clock Kit

- Bright .357" ht. red display
- Sequential flashing colon
- 12 or 24 hour operation
- Extruded aluminum case (black)
- Pressure switches for hours, minutes & hold functions
- Includes all components, case and wall transformer
- Size: 3 1/4 x 1 1/4 x 1 1/4

JE730 \$14.95

Jumbo 6-Digit Clock Kit

- Four .630" ht. and two .300" ht. common anode displays
- Uses MM5314 clock chip
- Switches for hours, minutes and hold functions
- Hours easily viewable to 30 feet
- Simulated walnut case
- 115VAC operation
- 12 or 24 hour operation
- Includes all components, case and wall transformer
- Size: 6 1/4 x 3 1/4 x 1 1/4

JE747 \$29.95

JE701

6-Digit Clock Kit \$19.95

REMOTE CONTROL TRANSMITTER & RECEIVER



- CAN BE USED AS REMOTE CONTROL FOR TV
- USE IT FOR YOUR OWN GARAGE DOOR OPENER
- TRANSMITS BETWEEN 3000 AND 4000 KHz
- FOUR-DIGIT DISPLAY FOR REMOTE CONTROL APPLICATIONS
- TRANSMITTER USES A 1.5V BATTERY
- SCHEMATIC INCLUDED

\$19.95

Digital Stopwatch Kit

- Use Intersil 7206 Chip
- Plated thru double-sided P.C. Board
- LED display (red)
- Times to 99 min. 59.99 sec. with auto reset
- Quartz crystal controlled
- Three stopwatches in one: single event, split (cumulative) & taylor (sequential timing)
- Uses 3 penlite batteries
- Size: 4.5" x 2.15" x .90"

JE900 \$39.95

MICROPROCESSOR COMPONENTS

8080/8080A SUPPORT DEVICES		MICROPROCESSOR MANUALS	
8080A	CPU	\$ 9.95	
8212	8-Bit Input/Output	3.25	M-Z80 User Manual \$7.50
8214	Priority Interrupt Control	5.95	M-COP1802 User Manual 7.50
8216	Bi-Directional Bus Driver	3.49	M-2850 User Manual 5.00
8224	Clock Generator/Driver	3.95	
8226	Bus Driver	3.49	
8228	System Controller/Bus Driver	5.95	
8238	System Controller	5.95	
8251	Prog. Comm. I/O (USART)	7.95	
8253	Prog. Interval Timer	14.95	
8255	Prog. Periph. I/O (PPI)	9.95	
8257	Prog. DMA Control	19.95	
8259	Prog. Interrupt Control	19.95	
8080/8080A SUPPORT DEVICES		ROM'S	
MC6800	MPU	\$14.95	
MC6802CP	MPU with Clock and Ram	24.95	
MC6810AHP	128KB Static Ram	5.95	2513(2140) Character Generator(upper case) \$9.95
MC6821	Periph. Inter. Adapt (MC6820)	7.49	2513(3021) Character Generator(lower case) 9.95
MC6828	Priority Interrupt Controller	12.95	2516 Character Generator 10.95
MC6830LR	1024KB Bit ROM (MC68A30-8)	14.95	MMS230N 2048-Bit Read Only Memory 1.95
MC6850	Asynchronous Comm. Adapter	7.95	
MC6852	Synchronous Serial Data Adapt.	9.95	
MC6865	0-600 bps Digital MODEM	12.95	
MC6862	2400 bps Modulator	14.95	
MC6880A	Quad 3-State Bus. Trans. (MC68725)	2.25	
MICROPROCESSOR CHIPS—MISCELLANEOUS		RAM'S	
Z80(780C)	CPU	\$19.95	1101 256X1 Static \$1.49
Z80A(780-1)	CPU	24.95	1103 1024X1 Dynamic .99
COP1802	CPU	19.95	2101(8101) 256X4 Static 3.95
2650	MPU	19.95	2102 1024X1 Static 1.75
8502	CPU	11.95	21102 1024X1 Static 1.95
8035	8-Bit MPU w/clock, RAM, I/O lines	11.95	2111(8111) 256X4 Static 3.95
P8085	CPU	19.95	2112 256X4 Static 4.95
TMS9900JL	16-Bit MPU w/hardware, multiply & divide	49.95	2114 1024X4 Static 450ns 9.95
			2114L 1024X4 Static 450ns low power 10.95
			2114-3 1024X4 Static 300ns 10.95
			2114L-3 1024X4 Static 300ns low power 11.95
			5101 256X4 Static 7.95
			5280/2107 4096X1 Dynamic 4.95
			7489 16X4 Static 1.75
			74S200 256X1 Static Tristate 4.95
			83421 256X1 Static 2.95
			UPD414 4K Dynamic 16 pin 4.95
			(MK4027) 16K Dynamic 16 pin 9.95
			(MK4116) 4K Static 14.95
			TMS4044- 4K Static 14.95
			45N1 1024X4 Static 14.95
			TMS4045 16,384X1 Dynamic 9.95
			2117 16,384X1 Dynamic 4/1.00
			PROM'S
			1702A 2048 FAMOS \$5.95
			2716INTEL 16K* EPROM 59.95
			TMS2516 16K* EPROM 49.95
			(2716) *Requires single +5V power supply
			TMS2532 4KXB EPROM 89.95
			2708 8K EPROM 10.95
			2716 T.1 16K** EPROM 29.95
			**Requires 3 voltages, -5V, +5V, +12V
			5203 2048 FAMOS 14.95
			6301;3(7811) 1024 Tristate Bipolar 3.49
			6330-1(7802) 256 Open C Bipolar 2.95
			82523 32X8 Open Collector 3.95
			825115 4096 Bipolar 19.95
			825123 32X8 Tristate 3.95
			74186 512 TTL Open Collector 9.95
			74188 256 TTL Open Collector 3.95
			74S267 1024 Static 2.95
			UART'S
			A-Y-5-1013 30K BAUD 5.95

CSC CONTINENTAL SPECIALTIES

Proto Board 203



PB 203 \$75.00

Proto Board 203A



PB 203A \$124.95

Model Number	L x W x H (Inches)	Price
PB-6	6.0 x 4.5 x 1.4	\$15.95
PB-100	6.0 x 4.5 x 1.4	\$19.95
PB-101	6.0 x 4.5 x 1.4	\$22.95

Model Number	L x W x H (Inches)	Price
PB-102	7.0 x 4.5 x 1.4	\$26.95
PB-103	9.0 x 6.0 x 1.4	\$44.95
PB-104	9.8 x 8.0 x 1.4	\$54.95

THE SINCLAIR PDM35



PDM35: Digital Multimeter . . . \$59.95
(completely assembled)
PDM-AC: 117V AC Adapter . . . 6.95
PDM-DC: Deluxe padded carrying case. . . 6.95

100 MHz 8-Digit Counter



MAX-100 \$134.95

ACCESSORIES FOR MAX 100:
Mobile Charger Eliminator use power from car battery Model 100 — CLA \$3.95
Charger/Eliminator use 110 V AC Model 100 — CAI \$8.95

REGULATED POWER SUPPLY

JE200 5V-1 AMP POWER SUPPLY



JE200 \$14.95

JE205 ADAPTER BOARD

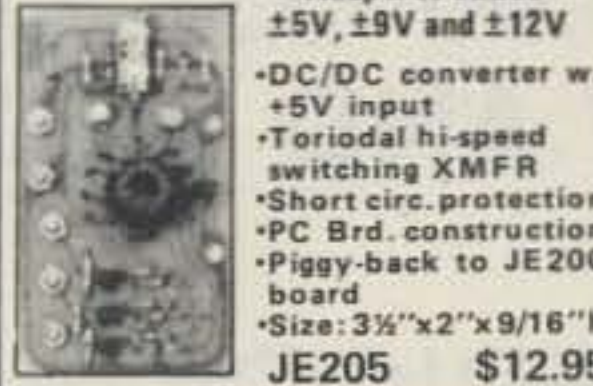

JE205 \$12.95

\$10.00 Min. Order — U.S. Funds Only
Calif. Residents Add 6% Sales Tax
Postage — Add 5% plus \$1 Insurance (if desired)
Spec Sheets — 25¢
1979 Catalog Available — Send 41¢ stamp

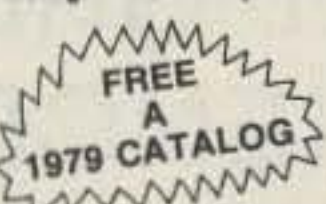

Jameco ELECTRONICS

MAIL ORDER ELECTRONICS — WORLDWIDE
1021 HOWARD AVENUE, SAN CARLOS, CA 94070
ADVERTISED PRICES GOOD THRU AUGUST

PHONE ORDERS WELCOME
(415) 592-8097

The Incredible

"Pennywhistle 103"

\$139.95 Kit Only



The Pennywhistle 103 is capable of recording data to and from audio tape without critical speed requirements for the recorder and it is able to communicate directly with another modern and terminal for telephone "hamming" and communications. In addition, it is free of critical adjustments and is built with non-precision, readily available parts.

Data Transmission Method	Frequency-Shift Keying, full-duplex (half-duplex selectable)
Maximum Data Rate	300 Baud
Data Format	Asynchronous Serial (return to mark level required between each character)
Receive Channel Frequencies	2025 Hz for space, 2225 Hz for mark
Transmit Channel Frequencies	Switch selectable: Low (normal) — 1070 space, 1270 mark, High — 025 space, 2225 mark
Receive Sensitivity	-46 dbm acoustically coupled
Transmit Level	-15 dbm nominal, Adjustable from -6 dbm to -20 dbm
Receive Frequency Tolerance	Frequency reference automatically adjusts to allow for operation between 1800 Hz and 2400 Hz
Digital Data Interface	EIA RS-232C or 20 mA current loop (receiver is optoisolated and non-polar)
Power Requirements	120 VAC, single phase, 10 Watts
Physical	All components mount on a single 5" by 9" printed circuit board. All components included.

Requires a VOM, Audio Oscillator, Frequency Counter and/or Oscilloscope to align.

TRS-80 16K Conversion Kit

Expand your 4K TRS-80 System to 16K. Kit comes complete with:

- * 8 each UPD416-1 (16K Dynamic Rams) 250NS
- * Documentation for conversion

TRS-16K \$75.00

COMPUTER CASSETTES

- 6 EACH 15 MINUTE HIGH QUALITY C-15 CASSETTES
- PLASTIC CASE INCLUDED
- 12 CASSETTE CAPACITY
- ADDITIONAL CASSETTES AVAILABLE #C-15-\$2.95 ea

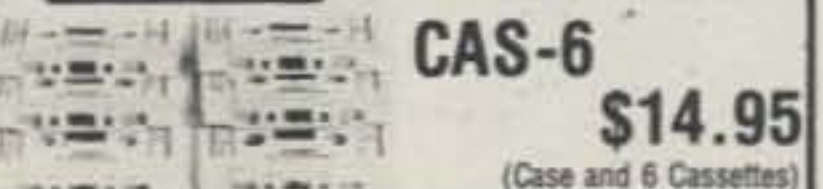

CAS-6 \$14.95
(Case and 6 Cassettes)

SUP 'R' MOD II

UHF Channel 33 TV Interface Unit Kit

- Wide Band B/W or Color System
- ★ Converts TV to Video Display for home computers, CCTV camera, Apple II, works with Cromeco Dazzler, SOL-20, IRS-80, Challenger, etc.
- MOD II is pretuned to Channel 33 (UHF).
- ★ Includes coaxial cable and antenna transformer.

MOD II \$29.95 Kit

Function Generator Kit

- Provides 3 basic waveforms: sine, triangle & square wave
- Frequency range from 1 Hz to 100K Hz
- Output amplitude from 0-volts to over 6 volts (peak to peak)
- Uses a 12V supply or a ±6V split supply
- Incl. chip, P.C. board, components and instructions.

JE2206B \$19.95

IDEAL FOR TRS 80

CASSETTE CONTROLLER

- "Plug/Jack interface to any computer system requiring remote control of cassette functions"
- The CC100 controls cassette motor functions, monitors tape location with its internal speaker and requires no power. Eliminates the plugging and unplugging of cables during computer loading operation from cassette.



#CC-100 \$29.50

63-Key Unencoded Keyboard



This is a 63-key, terminal keyboard newly manufactured by a large computer manufacturer. It is unencoded with SPST keys, unattached to any kind of PC board. A very solid molded plastic 13 x 4" base suits most application. **IN STOCK \$29.95/each**

Hexadecimal Unencoded Keypad

19-key pad includes 1-10 keys, ABCDEF and 2 optional keys and a shift key. **\$10.95/each**

ASSOCIATED RADIO

913-381-5900

8012 CONSER BOX 4327

OVERLAND PARK, KANSAS 66204



CALL US WITH YOUR REQUIREMENTS
AMERICA'S NO. 1 Real Amateur Radio Store



**(Associated Wants to TRADE - BUY - SELL
GOT YOUR BEST DEAL? THEN CALL US AT
913-381-5900 - NO TRADE? ASK FOR EXT. 12)**

**NOTE: SEND \$1.00 FOR OUR CURRENT CATALOG
OF NEW AND RECONDITIONED EQUIPMENT.**

*** ALSO WE PERIODICALLY PUBLISH A LIST OF
UNSERVICED EQUIPMENT AT GREAT SAVINGS.
A BONANZA FOR THE EXPERIENCED OPERATOR.
TO OBTAIN THE NEXT UNSERVICED BARGAIN LIST,
SEND A SELF ADDRESSED STAMPED ENVELOPE.**

Poly Paks'®

ECONOMY MINDED INFLATION FIGHTING



SALE

\$9.99
Cat. No. 92CU5653
DIAL DESK TELEPHONE
Guaranteed Satisfaction

\$9.95 **GEL/SEL ENERGY PAKS**
Portable Power at Poly Paks Prices! Brand New, 4V @ 2.6 Amp. Hr. Gel Cell storage battery. Units consist of gelled electrolyte, enclosed in hermetically sealed plastic, for years of dependable service. Compact, (only 3-1/2" x 2-3/8" x 1-5/16" in size). Stack 'em to produce 8V, 12V, 24V... or increase the amperage up and away. Use 'em for Burglar Alarms, Intrusion Detectors, Ham, Mobile, or Solar Storage Applications. Cat. No. 92CU5788

\$39.95
Cat. No. 92CU4007
STEREO AM-FM-MPX TUNER/AMPLIFIER
Slide volume, bass, treble, balance controls!
2 & 4 speaker systems!

12VDC 10 AMP POWER SUPPLY
\$49.95
Wired
Regulated

HY GAIN LED CLOCK KIT*
Panel or case design • 3 PC set
*Kit consists of a 3 pc set, transformer, function switches-on-a-board, and a National MA1012-12A digital clock module with all parts and IC chip mounted on a 3" x 1 3/8" G-10 pc board. The RED filtered module measures 3" x 3/4" x 3/16". The PC board-module is mounted in a bakelite frame 3 7/8" x 1 3/4" x 1/8" with 2 holes for easy panel mounting. (3 1/2" on centers).
Cat. No. 92CU5663

\$14.88
Cat. No. 92CU5545
PARALLEL ENTRY DIGITAL PRINTER
These unique printers feature precision Swiss construction. 18 key columns are divided into 16 for numerals, and 2 for alphabetical and trig figures, and mathematical functions. Each wheel is 12 position. Utilizes 2.75" wide adding machine tape, and dual color ribbon. Printing technique: parallel pressure printing, multiple copies. Print Rate: 3 lines per second. Operating voltage: 22 to 28 VDC. Comes in original packing w/roll of tape. Size: 6-1/2" x 3-1/8" x 5-3/8". Wt. 7 lbs. Cat. No. 92CU5545

Converts 115VAC to 12VDC at 10 Amps fully regulated! Supplies up to 16 Amp surge. Dual transistor regulation with Motorola 2N3055 and 2N3773 for maximum dependability. Less than 100mv ripple, regulation better than 5%. Extra large heat sink for ULTRA COOL operation. Front panel on/off switch, fuse, and indicator lamp for fingertip control. 8 1/2" x 6 1/2" x 4 high. Wt. 9 lbs. Cat. No. 92CU5541

Only \$9.95
40 channel CB ONE ARM BANDIT BY hy-gain
Single-Handed Operation Leaves "One For The Road"
All Controls Contained in The Mike
Now, take one hand command of all 40 ch's with the One Arm Bandit, the set with the works in the mike. All the controls you used to fumble for on the desk, are planted in the Palm of Your Hand. OFF/ON, VOLUME, SQUELCH, CHANNEL SELECTOR, and DISPLAY, as well as the SPEAKER itself are all conveniently located where your fingers do the talking. Cat. No. 92CU5886

\$8.88
Cat. No. 3921
HANDY COMPUTER MULTITESTER
• 1000 ohms per volt
1% precision, movements diode protected against burnout. Measures DC volts 0-15-150-1000; AC volts 0-15-150-1000; DC current 0-150ma; resistance X1000. Sensitivity 1000 ohms/volt AC-DC. Uses penlite cell, not included. Size 2 3/8" x 3 1/2" x 1 3/8". Wt. 5 ozs. Cat. No. 3921

"CRIMP-ON" PL-259 COAX PLUG 4 for \$1.29
Cat. No. 92CU5696
Quick, Easy plier crimping. No Soldering! Strip insulation-squeeze. Mates to SO-239. For RG58/U - 59/U.

40 CHANNEL CB BOARD
Only \$9.99
Poly Paks buys up factory close-out from Hy gain... so you gain! Boards have Heatinked 9 Watt Amp Chip, RF and Mod. Transistors, and National Semi-MM series PLL. May be used for 10 meter conversion (see 6 month series "CB to 10" in 73 Mag.) The parts alone make it an offer you can't refuse. Cat. No. 92CU5680

Only \$12.50
HIGH POWER 300 CFM BLOWER
Imagine a 300 CFM blower worth \$33.00 at a special purchase for economy savings. Powerful! dynamically balanced. Motor specs 115vac 2.2 Amps. Housing: Wheel 5 1/4" diameter, 2 1/8" deep; housing diameter 7 1/4" x 3 1/4" deep; FLANGE 4 1/4" square; INLET 3 5/16" x 2 1/8". All black steel construction. 14" long, 115vac wires with lugs. Use for home, shop and industry. Wt. 12 lbs. Removed from equipment. Cat. No. 92CU5165

MINI LECTROS

MFD.	VOLTS	LEADS	SALE
25	15	Axial	.14
25	25	Axial	.17
50	15	Axial	.17
50	25	Axial	.19
50	100	Axial	.21
100	15	Axial	.23
100	50	Axial	.35
220	25	P.C.	.32
300	25	P.C.	.33
500	15	P.C.	.33
500	25	P.C.	.36
1000	15	P.C.	.55
1000	25	Axial	.59

Order by Cat. No. 92CU5718 and Value

1N4000 Epoxy Rectifiers

Cat. No.	Type	Volts	Sale
2377	1N4001	50	10 for \$.75
2378	1N4002	100	10 for .85
2379	1N4003	200	10 for .95
2380	1N4004	400	10 for 1.19
2381	1N4005	600	10 for 1.39
2382	1N4006	800	10 for 1.49
2383	1N4007	1000	10 for 1.59

\$2.95 Ea
3 ELEMENT 120 VAC HOTPLATE
This Top Quality, Multi-Purpose Hotplate features, Built-In Thermostat, Neon "Red" AC Indicator Lamp, and 1/8" Textured Glass Surface for even heat distribution. Generates up to 150°C. 120 watts! Use for photographic applications, laboratory work, aquarium heater, plants, etc. Size: 10-3/8" x 5-3/8" x 1/8". Wt. 1 lb. 2 oz. Cat. No. 92CU5723

"SKINNY-TRIMS" POTENTIOMETERS
3/8" square! Single turn style Screw-driver adjust. 20% tolerance, 0.5 Watt ratings, cermet construction. PC leads. ORDER BY CAT. NO. AND VALUE

6 for \$2.49	Type-63 SINGLE TURN FLAT
10	100 1K 5K 25K 200K
20	200 2K 10K 50K 500K
50	500 2.5K 20K 100K 1 Meg

Cat. No. 92CU3866

2000 DEGREE SOLAR FURNACE Only \$5.95
Giant Fresnel Flat Magnifying Lense
It's different! It's unusual! Magnifies like a lens, yet it's flat! A series of small concentric grooves extend from the center to the edge of the lens, acting like a giant prism! Each groove bends the light waves that hit it, acting like a conventional convex lens. Lightweight, inexpensive, and extremely short focal length of 12". Harness the sun's energy with the fresnel lens and a simple wooden frame! Focus the sun on any flammable object and watch it burst into flames within seconds! Size 11" square, 3/32" thick. Optically perfect. Wt. 1 lb. Cat. No. 92CU5338

\$2.98
Cat. No. 92CU3375
ULTRASONIC TRANSDUCER
Perfect for dozens of projects, including remote control, alarms, etc. Sends and receives! 1" diameter, 3/4" deep, with standard RCA type phono jack. Wt. 2 oz.

Only \$2.50
Cat. No. 92CU5720
"TIE-PIN" CONDENSER MIKE
It's a little giant in sound quality. Metal encased, and omnidirectional. Frequency response 20-20,000 Hz. Less tie pin or lapel clip. 600 ohm impedance, 1.5 VDC. Cat. No. 92CU5720

LED WATCH GUTS
\$1.49
3 for \$3 (Men's)
Cat. No. 92CU51158

HOW TO ORDER
When ordering, always use catalog number, type no., the name of the magazine you are ordering from and the month

Order by Cat. No. LEADS: Your Choice 20 for \$2.49

1788	MICRO TOPHAT RED
1942	MED YELLOW STUBBY
1802	MICRO SINGLE PIN RED
2135	JUMBO RED
2138	JUMBO GREEN
2137	MICRO RED
2790	JUMBO RED CLEAR

"BEEM-O-LIGHT" LASER DIODES
Rated @ 5-9 Watts. Wavelength: 904 nm. **\$5.99**
Cat. No. 92CU3508

"INCHER" READOUT
\$1 each
To be exact 0.8" of an inch. COMMON CATHODE, direct replacement for Litronics 747. Left decimal. 5V @ 8 mils per segment. Red. Cat. No. 92CU3327

DIP SWITCHES

Cat. No.	Switches	Sale
3668	2	.77
3669	3	.88
3021	4	.99
3670	5	1.19
5164	8	1.95
3672	10	2.50

Order by Cat. No.

POLY PAKS®
COD'S MAY BE PHONED!
P.O. BOX 942-A8
SO. LYNNFIELD, MA 01940
Terms: Add Postage
Phone: (617) 245-3828
Retail: 16-18 Del Carmine St.
MINIMUM ORDER: \$8 Wakefield, MA
Rated: Net 30

7294 N.W. 54 STREET
MIAMI, FLORIDA 33166

SURPLUS ELECTRONICS CORP. ✓ S43

PHONE: (305) 887-8228

TWX: 810-848-6085

WHOLESALE - RETAIL

<p>PL259's/SO 239's Quality American Made 10/\$5.00 100/\$35.00 50/\$20.00 1000/\$300.00</p>	<p>CB SPECIAL Brand new printed circuit board assembly. Used in all HyGain 40 channel CB transceivers. Fits many other manufacturers' units also. Squelch pot/volume control/channel selector switch not included. 1- 9—7.50 ea. Board 10-49—6.50 ea. Dimensions 50-99—6.00 ea. 6" x 6 1/2" 100-up—5.50 ea</p>		<p>IC SOCKETS Cambion Gold Plated Wire Wrap 14 pin .35 ea 10/\$3.00 16 pin .38 ea 10/\$3.30</p>
<p>E. F. Johnson NICAD 12.0 V. 1.2 AH @ 10 hr rate 4 1/2" x 1 7/8" x 1 3/4" \$1495ea.</p>	<p>NEW Hy-Gain Remote 40ch CB Less Case, Speaker & Control Mic (as is) \$14.95 ea</p>		<p>SIGNAL DIODE IN 4148 \$5.00 PER 100 25.00 PER 1000 OR 15 FOR \$1.00</p>
<p>E F Johnson External Battery Charger Model 239-0206-001 Output 14.5 V dc @ 50 mA. \$3.50 ea.</p>	<p>ASTATIC T-UG8-D104 PREAMP Desktop microphone w/crystal element 3 Pin Plug \$35 ea.</p>		<p>MODEM CABLE 50' cable contains 13 # 22 ga. wire DB-25p with DB-51226-1 cover on one end \$6.50 ea 10/\$50.00</p>
<p>E. F. Johnson S Meter Edge Meter 250 UA. Fits in 5/8" x 1-3/8" hole. MTG holes on each end 1-1/4" behind panel. Black scale 0-5 bottom 1-20 top \$1.25 ea. 5/\$5.00</p>	<p>NEW E.F. Johnson Power Mic/Less Cord Desk Top Style \$19.95 ea</p>		<p>EFJ CRYSTAL OVENS 6V/12V 75° \$5.00 ea.</p>
<p>Edge meter same as above with silver scale and reads SWR 1-10 \$1.25ea 5/\$5.00</p>	<p>New 40 CH CB Boards 1-9 \$10.50 ea 10-49 \$9.50 ea w/40 ch SW 50-99 \$9.00 ea 100-up \$8.50 ea</p>	<p>SOLDER LUG TYPE CAPS 50 UF @ 350V 1" D x 3" L 50 UF @ 450V 1" D x 2 1/2" L 50 UF @ 450V 1" D x 3" L 60¢ EA 5 FOR \$2.50</p>	<p>MOTOROLA SRF 574 house marked 9W 175 MHz Amp. \$5.00 ea.</p>
<p>E. F. Johnson Signal Strength Meter 200 UA 2 1/2" x 2 1/2" Sq. mounts in 1 3/4" hole 1" behind panel. Scale: 1-30 db top 0-5 bottom. \$4.95ea 5/\$20.00</p>	<p>Serviceman Special New Hy-Gain 40ch CB Less Case, Speaker & Knobs (as is) \$14.95 ea</p>		<p>100 ASSORTED DISC CAPS (FULL LEADS) 20 EA OF 5 DIFFERENT VALUES \$2.00 PER PACK</p>
<p>PANEL METERS \$4.00 ea 2 for \$7.00 25-0-25 dc Volts } 2 1/4" x 3" 0-25 dc Volts } 2 1/4" x 2 1/4" 0-50 ac Volts } -Shunt Required-</p>	<p>MINI TOGGLE SW C&H SPDT \$1.00 ea 6/\$5.00</p>	<p>2 SIDED .062 Copper Clad Board 9 1/4" x 10 1/4" \$2.00ea 3/\$5.00 Sony RK64A 2 conductor mini phono plug w/patch cord 3'6" long \$2.00ea POLYFOAM COAX—50 OHM Equal to RG174 \$4.95/100' Low Loss Polyfoam Coax Cable</p>	<p>RECEIVER FRONT ENDS Made by EFJ 132-174 MHz \$12.00 ea.</p>
<p>CMOS RCA CD 4012 AE Dual 4 in Nand Gate 6/\$1.00 100/\$10.00 50/\$6.00 1000/\$80.00</p>	<p>12 Vdc RELAY SPST Open Frame 5 Amp Contacts Mfg-Magnecraft \$1.50 ea 4/\$5.00</p>	<p>STANCOR TRANSFORMERS STEP-DOWN AUTO (3) COND LINE CORD W/RECPT GSD 200 (230V In/115V Out @ 200 Va) \$12.00 ea GSD 400 (230 In/115 V Out @ 400 Va) \$14.50 ea</p>	<p>TRIMMER CAPS Small enough to fit in your watch— 3.5 to 20 pF 5 to 30 pF \$.75 ea., 2 for \$1.25 5 for \$3.00</p>
<p>C & K SWITCHES PART # MOVEMENT 7101 ON/NONE/ON SPST 7103 ON/OFF/ON SPST 7107 ON/NONE/ON SPST 7108 ON/NONE/(ON) SPST 7201 ON/NONE/ON DPDT \$1.00 EA 6 FOR \$5.00 6 TV GAMES ON (1) CHIP Gen Instr AY-3-8500-1 28 Pin Plastic Case EVERYDAY LOW PRICE \$7.50 ea</p>	<p>12 Vdc RELAY SPST 35 Amp Contacts Open Frame Rugged, great for mobile use \$4.50 ea 5/\$20.00</p>	<p>CRYSTAL FILTERS 10.7 3/Lead Can Type \$3.00 ea.</p>	<p>CAPS 2200 UF @ 16V Radial Leads .25 ea. 10/\$2.00</p>
<p>Coax Connectors UG-273/U BNC-F/UHF-M 2.50 UG-255/U BNC-M/UHF-F 3.00 UG-146A/U N-M/UHF-F 4.50 UG-83B/U N-F/UHF-M 4.50 UG-175 RG-58 Adapt. .20 UG-176 RG-59 Adapt. .20</p>	<p>CERAMIC IF FILTERS EFC L455K \$3.50 ea.</p>		<p>White Porcelain Egg Insulator 1 1/2" x 1" 50¢ ea. 3 for \$1.25</p>
<p>GOLD PLATED CARD EDGE CONNECTORS</p>			
<p>Double Row/Wire Wrap .100 25 pins \$3.49 ea 10/\$30.00 30 pins \$3.96 ea 10/\$32.00 50 pins \$5.43 ea 10/\$45.00</p>	<p>Double Row/Solder Eyelet .156 6 pins \$1.10 ea 10/\$9.00 15 pins \$1.55 ea 10/\$12.50 22 pins \$2.08 ea 10/\$17.00 43 pins \$3.66 ea 10/\$30.00</p>	<p>22 pins/Double Row/Dipped Solder .156 \$2.08 ea 10/\$17.00 22 pins/Double Row/Wire Wrap .156 \$2.44 ea 10/\$19.00</p>	

TERMS: All material guaranteed • If for any reason you are not satisfied, our products may be returned within 10 days for a full refund (less shipping). Please add \$3 for shipping and handling on all orders. Additional 5% charge for shipping any item over 5 lbs. COD's accepted for orders totaling \$50.00 or more. All orders shipped UPS unless otherwise specified. Florida residents please add 4% sales tax. Minimum order \$15.00.

EQUIPMENT / COMPONENTS / WIRE & CABLE / ACCESSORIES

SEMICONDUCTORS SURPLUS

✓S63

2822 North 32nd Street/Unit -1 Phoenix, Arizona 85008 (602) 956-9423

We accept checks, MasterCard, and Visa

Prices subject to change without notice

R.F. CONNECTORS

UG-1095A/U	\$3.99
UG-58/U	3.29
UG-30C/U	3.00
UG-27C/U	3.50
PL-259	.50
SO-239	.43
UG-175	.36
PL-258	2.99
UG-106	.69
UG-177	.69
UG-274/U	3.27
UG-447/U	1.50
UG-492	3.69
UG-306/U	3.00
UG-646/U	3.29
UG-260B/U	1.59
UG-1094/U	.90
UG-701/U	3.00
UG-212C/U	3.00

TUBES

3-500Z	\$90.00
572B/T160L	34.00
6146	5.09
6146A	5.99
6-46W	7.95
811A	12.95
811	9.95
4CX250B	36.95
4CX250R	39.95
6KD6	4.99
6LF6	4.99
6LQ6/6JE6	6.25
8950	6.65
2E26	6.00
3B28	5.00
4X150A	15.00
6360/A	7.95
6939	5.95
7289/2C39	4.95
8072	45.00
4-400A	90.00
8877	300.00
PL172	250.00
4-1000A	160.00
4-250A	35.00

FERRITE BEADS

12/\$.89 or
100/\$4.00

1N914/1N4148

30/\$1.00 or
120/\$3.00

R.F. TRANSISTORS

2N2857	\$1.80
2N2857JAN	2.45
2N2947	17.00
2N3375	7.00
2N3553	1.80
2N3818	6.00
2N3866	1.09
2N3866JAN	2.70
2N2866JANTX	4.43
2N3925	6.00
2N3948	2.00
2N3950	26.25
2N3960	4.70
2N4072	1.70
2N4427	1.09
2N4877	2.57
2N4957	3.50
2N5108	3.90
2N5109	1.55
2N5179	.59
2N5589	4.60
2N5583	5.00
2N5590	6.30
2N5591	10.35
2N6080	5.45
2N6081	8.80
2N6082	10.75
2N6083	12.00
2N6084	13.20
2N6095	10.35
2N6097	19.35
MRF502	.69
MRF8004	.75
SS2548	.75
40280	3.50
40281	10.90
40282	11.90

TRIMMERS 5-80pf

45¢ each or 10/3.50
or 100/25.00

CHOKE (U252) 2.5mh

150ma 30MHz
2/\$1.00

TRIMMER CAPS

small enough to
fit in your watch
3.5-11pf 75¢ each
or 10/\$6.00

PISTON CAPS 1.2-10pf

75¢ each or 10/\$5.50

F.E.T.'s

MPF4391	\$.75 or 10/ 6.50
MPF112	.69 or 10/ 5.50
MPF102	.43 or 10/ 3.50
40673	1.39 or 10/10.00
3N128	1.35 or 10/10.00
2N5248	.60 or 10/ 4.50
MPF131	.60 or 10/ 5.00
2N4303	.45 or 10/ 3.50
2N3958	2.95 each
MFE2000	.90 or 10/ 8.00
MFE2001	.99 or 10/ 8.00
MFE2008	4.20 or 10/36.00
MFE2009	4.80 or 10/39.00
MFE3002	3.35 each
MMF-5	5.00 each
MFE120	1.00 or 10/ 8.50
2N3436	2.25 each
2N4416	1.00 each
MFE131	1.05 each

MICROWAVE DIODES

1N21D	\$ 1.40
1N21C	1.05
1N21WE	2.00
1N23B	1.05
1N23C	1.05
1N23CR	2.00
1N23E	2.00
1N23F	4.10
1N23WE	2.10
1N25	3.03
1N121WE	4.00
1N286	5.00
1N416E	5.00
1N446	8.00
1N3655A	4.00
1N5153	15.00
1N5711	1.20

ADDITIONAL R.F. TRANSISTORS

40894	\$ 2.50
MRF454/568BLYCF	17.10

BRIDGES 24 AMPS

500PIV \$2.99 each

LM566V VCO/FUNCTION GENERATOR

\$.99 each

LM340T-5 & LM340T

-12 \$1.49 each

VACUUM

CAPACITORS

Amperex Model CVC
10/1k-5KV405A 10 pf to 1000
pf @5000 volts \$59.95

MC4024P &

MC4044P \$3.25 each

HEP 170 2.5 Amps

1000PIV 10/\$2.00 or 100/\$14.50

POTTER & BRUMFIELD 12VDC RELAYS

SPDT 25 Amps \$5.95
2PDT 3 Amps \$1.99

KILOVAC H-8/54

VACUUM RELAY

26 volt coil \$29.95 each

E. F. JOHNSON TUBE

SOCKETS for 3-400Z and
3-5000Z tubes \$29.95 per pair

TOROIDAL CORES

T-37-6 6/1.00
25/4.00, 50/6.00
100/10.00

4CX250B/R SOCKETS AND CHIMNEYS NEW

\$14.95 per set (1 socket, 1
chimney)

B&W COILS

1206T \$3.99
2006T \$7.99

FAIRCHILD REGULATOR 78H05KC

\$6.99 each

TUBES

6146B \$6.50

MINIMUM ORDER \$5.00

Minimum Shipping \$1. Insurance 35¢
per \$100. COD charges 85¢ to street ad-
dress only! We prefer street address as
we ship UPS and P.O. Box #'s take up to
50% longer to deliver. We accept VISA
or MasterCard. Please list complete
card number and expiration date. Allow
10% extra for shipping of heavy items.
We reserve the right to change prices
without notice. All items listed are sub-
ject to prior sale. Some items listed are
in small quantities.

Social Events

from page 160

mail at \$2.00 per ticket. Send payment and an SASE by the 10th of August to Carl Vinyard KB9DV, 10012 SR 26 East, Lafayette IN 47905. Tickets are also available at the gate. Pre-registration prize will be a Wilson Mark IV handie-talkie and charger; the grand prize is a Yaesu FT-227RA 2m mobile transceiver. Many other additional prizes will be awarded. There will be a flea market, forums, and refreshments available, plus camping on the grounds with limited hookups available Friday through Sunday nights only. A camping fee, in addition to a hamfest ticket, is required. Talk-in on 146.13/.73 and 146.52.

WRIGHTSTOWN NJ AUG 19

The West Jersey Radio Amateurs, Inc., will hold its hamfest on August 19, 1979, from 10:00 am to 5:00 pm at McGuire Air Force Base, Wrightstown, New Jersey. Admission is \$2.00 at the door and \$1.50 in advance, with XYLS and children free. There will be an additional \$2.00 admission for tailgate or table space (bring your own table). Featured will be refreshments, door prizes, and activities. Talk-in on 146.52 and 147.75/.15. Advance tickets may be purchased from club members or by sending an SASE to Sam Shontz WB2GEX, 107 Spruce Lane, Rte. 16, Mt. Holly NJ 08060. For information, call Larry Cohen WA2TRJ, at (609)-871-5852 or Mary Lou Shontz WB2QIU at (609)-267-3063.

BEAR DE AUG 19

The fourth annual New Delmarva Hamfest will be held on Sunday, August 19, 1979, at Gloryland Park, Bear, Delaware. Donations will be \$2.00 in advance, and \$2.50 at the gate. Tables are available at \$3.00 each. Tailgating will be \$2.00 per space. There will be many prizes, and food and drinks will be available. Talk-in on .52/.52 and .13/.73. For tickets or information, send an SASE to Stephen Momot K3HBP, 14 Balsam Rd., Wilmington DE 19804. Make checks payable to Delmarva Hamfest, Inc.

HAMDEN CT AUG 25

The WELI Amateur Radio Club will hold its 3rd annual flea market on August 25, 1979, at Radio Towers Park, Benham St.,

Hamden, Connecticut. Rain date will be September 1, 1979. Admission is \$.50 with kids under 12 free. Dealer's fee is \$5.00 at the gate and \$4.00 for pre-registration. Food will be available. For information or pre-registration, write WELI Amateur Radio Club, PO Box 85, New Haven CT 06513.

MANSFIELD PA AUG 25

The Tioga County Amateur Radio Club will hold its third annual hamfest on August 25, 1979, from 9:00 am to 5:00 pm at the Tioga County Fairgrounds, East of Mansfield, Pennsylvania, on Rte. 660, 1/2 mile off US Rte. 6. Admission is \$1.00 per person, with children under 16 admitted free. Featured will be an open-air and under-cover flea market, dealers and traders, technical forums, ARRL news, FCC information, a slow scan demonstration by Fred WB2NAC, ladies' and harmonics' activities, a craft show, and RC models. There will be a raffle and door prize every hour. Bring your picnic lunch or visit the snack bar. Talk-in on 146.19/.79 WA3DPV/RPT, .52/.52, and CB channel 5. For information, contact Wells Farr WB3CUF, 101 Sherwood Street, Mansfield PA 16933, or Don Kimble AE3Z, Box 109, 210 Maple Street, Knoxville PA 16928.

ST. CHARLES IL AUG 26

The Fox River Radio League will hold its hamfest on Sunday, August 26, 1979, at the Kane Co. Fairgrounds Exhibition Hall, St. Charles, Illinois. Tickets are \$1.50 in advance and \$2.00 at the gate. For information, contact Martin Schwamberger WB9TNQ, 1051 Northfield Drive, Aurora IL 60505.

LA PORTE IN AUG 26

The annual La Porte County Hamfest will be held, rain or shine, on Sunday, August 26, 1979, at the County Fairgrounds, on Highway 2, west of La Porte, Indiana. There will be an outdoor paved flea market area and also plenty of indoor display spaces available at \$1.00 each. There will be overnight trailer hookups for early birds. Advance tickets are \$2.00 each. Send an SASE to PO Box 30, La Porte IN 46350.

WENTZVILLE MO AUG 26

The St. Charles Amateur Radio Club, Inc., will hold Hamfest '79 on August 26, 1979,

at the Wentzville Community Club, Wentzville, Missouri. Featured will be a flea market, a CW contest, free bingo, and many more activities for XYLS and harmonics. Admission is \$1.00 per car. Talk-in on .34/.94 and .07/.67. For motel and camping information, prize lists, and dealer reservations, write SCARC, PO Box 1429, St. Charles MO 63301.

MARYSVILLE OH AUG 26

The Union County Amateur Radio Club will hold its "Hamfest '79" (rain or shine) on Sunday, August 26, 1979, at the Union County Fairgrounds, Marysville, Ohio. Take Rte. 33 north from Columbus, exit at the second Marysville exit, and follow the signs to the Marysville Fairgrounds. Admission is \$1.50 advance and \$2.00 at the door. There will be food available on the grounds and

free overnight camping on Saturday. There will also be a large flea market with no charge to the seller, only a gate pass will be needed. Inside tables will be available for dealers. Featured will be an ARRL forum, an AREC meeting, a MARS meeting, and more. Talk-in on 146.52 or 146.99/.39. For information or dealer space, write Chuck Simpson, 19726 Del Co. Line Rd., Marysville OH 43040, or phone (614)-666-2721.

WATERLOO IA AUG 26

The Iowa 75-Meter Net Picnic will be held Sunday, August 26, 1979, at Hickory Hills Park, south of Waterloo, Iowa. The event will begin in the morning with a potluck meal at noon and a brief program in the afternoon with prizes, etc. For further information, write Lovelle J. Pedersen WB0JFF, 2327 W. Reinbeck, Hudson IA 50643.

Ham Help

I am blind and have been bedridden with spinal arthritis for nine years. All this time I have spent living in hospitals, from which I am writing to you now. I hope your readers can help me.

I would like some friends out there beyond my four walls to help me get a two-meter set, a handie-talkie, or perhaps a mobile, though I don't drive a car. I need some Morse code tapes, although I do know some characters already. I need to learn the radio theory on tape cassettes, also.

I became more interested in ham radio when I found myself in a county hospital and confined to bed without a phone in my room. On my Sony radio receiver, on 147 MHz, I accidentally picked up some hams, and I discovered that they were on repeaters and I could pick them up from fifty miles away in the San Fernando Valley. I heard other blind ham operators on the repeaters, also. And I wish I could talk to some of them. Some are very humorous and intelligent; others argue, but it's all interesting. I heard one or two young ladies, also. I know Phil, Scott "KMO," and Bob "HMC," but I can't talk to them. Darn it!

What is this synthesizer and simplex they talk about? I think it's pretty good for my indoor Sony radio to pick them up in this concrete and steel building, though I am six stories up in Torrance.

I need live visitors and those who will read for me since I am

blind. My hospital desk phone is (213)-533-2783 (though I unhappily will go back to a nursing home). Please call and write me, hams, readers, and pen pals.

Dick Jastrow
Room 6, West Floor
Harbor General Hospital
1000 West Carson Street
Torrance CA 90509

First of all, I'd like to thank everyone who helped me out with information on the Knight-kit R-100A receiver. I really appreciated it.

Next, I wonder if anyone could furnish me with a schematic for a Hallicrafters model CRX-102 VHF receiver. It's a transistorized receiver that covers 144 to 174 MHz. The chassis number is SN 1312449. Also, can anyone get me a schematic for an EICO 720 CW transmitter? Thanks.

John Vercellino WB9OVV
4636 Pershing
Downers Grove IL 60515

I would like to get in contact with a ham in the Santa Fe NM area, who could help me obtain my General ticket. I also am in desperate need of a manual, schematic, and alignment info for the following equipment: Hammarlund HQ-110 receiver, Motorola HT-220 hand-held transceiver, and a General Electric Royal Executive FM transceiver. Any help will be greatly appreciated. I will be more than happy to pay for copying costs and postage.

Mark A. Arnold
Rt. 1, Box 210X, Space 130
Santa Fe NM 87501

DIODES/ZENERS			
QTY.			
1N914	100v	10mA	.05
1N4005	600v	1A	.08
1N4007	1000v	1A	.15
1N4148	75v	10mA	.05
1N4733	5.1v	1 W Zener	.25
1N4749	24v	1W	.25
1N753A	6.2v	500 mW Zener	.25
1N758A	10v	"	.25
1N759A	12v	"	.25
1N5243	13v	"	.25
1N5244B	14v	"	.25
1N5245B	15v	"	.25
1N5349	12v	3W	.25

SOCKETS/BRIDGES			
QTY.			
8-pin	pcb	.16 ww	.35
14-pin	pcb	.20 ww	.40
16-pin	pcb	.25 ww	.45
18-pin	pcb	.30 ww	.95
20-pin	pcb	.35 ww	1.05
22-pin	pcb	.40 ww	1.15
24-pin	pcb	.45 ww	1.25
28-pin	pcb	.50 ww	1.35
40-pin	pcb	.55 ww	1.45
Molex pins	.01 To-3 Sockets		.35
2 Amp Bridge	100-prv		.95
25 Amp Bridge	200-prv		1.50

TRANSISTORS, LEDES, etc.			
QTY.			
2N2222M	(2N2222 Plastic .10)		.15
2N2222A			.19
2N2907A	PNP		.19
2N3906	PNP (Plastic)		.19
2N3904	NPN (Plastic)		.19
2N3054	NPN		.55
2N3055	NPN 15A 60v		.60
T1P125	PNP Darlington		1.95
LED Green,	Red, Clear, Yellow		.19
D.L.747	7 seg 5/8" High com-anode		1.95
MAN72	7 seg com-anode (Red)		1.25
MAN3610	7 seg com-anode (Orange)		1.25
MAN82A	7 seg com-anode (Yellow)		1.25
MAN74	7 seg com-cathode (Red)		1.50
FND359	7 seg com-cathode (Red)		1.25

9000 SERIES			
QTY.		QTY.	
9301	.85	9322	.65
9309	.50	9601	.30
		9602	.45

C MOS							
QTY.		QTY.		QTY.		QTY.	
4000	.15	4017	.75	4034	2.45	4069/74C04	.45
4001	.20	4018	.75	4035	.75	4071	.25
4002	.25	4019	.35	4037	1.80	4081	.30
4004	3.95	4020	.85	4040	.75	4082	.30
4006	.95	4021	.75	4041	.69	4507	.95
4007	.25	4022	.75	4042	.65	4511	.95
4008	.75	4023	.25	4043	.50	4512	1.50
4009	.35	4024	.75	4044	.65	4515	2.95
4010	.35	4025	.25	4046	1.25	4519	.85
4011	.30	4026	1.95	4047	2.50	4522	1.10
4012	.25	4027	.35	4048	1.25	4526	.95
4013	.40	4028	.75	4049	.65	4528	1.10
4014	.75	4029	1.15	4050	.45	4529	.95
4015	.75	4030	.30	4052	.75	MC14409	14.50
4016	.35	4033	1.50	4053	.95	MC14419	4.85
				4066	.75	74C151	2.50

MICRO's, RAMS, CPU's, E-PROMS	
QTY.	
8T13	2.50
8T23	2.50
8T24	3.00
8T97	1.75
74S188	3.00
1488	1.25
1489	1.25
1702A	4.50
AM 9050	4.00
ICM 7207	6.95
ICM 7208	13.95
MPS 6520	10.00
MM 5314	4.00
MM 5316	4.50
MM 5387	3.50
MM 5369	2.95
TR 1602B	3.95
UPD 414	4.95
Z 80 A	22.50
Z 80	17.50
Z 80 P10	10.50
2102	1.45
2102L	1.75
2107B-4	4.95
2114	9.50
2513	6.25
2708	11.50
2716 D.S.	34.00
2716 (5v)	69.00
2758 (5v)	26.95
3242	10.50
4116	11.50
6800	13.95
6850	7.95
8080	7.50
8085	22.50
8212	2.75
8214	4.95
8216	3.50
8224	4.25
8228	6.00
8251	7.50
8253	18.50
8255	8.50
TMS 4044	9.95

- T T L -							
QTY.		QTY.		QTY.		QTY.	
7400	.20	7492	.45	74H20	.25	74LS76	.70
7401	.20	7493	.35	74H21	.25	74LS86	.95
7402	.20	7494	.75	74H22	.40	74LS90	.85
7403	.20	7495	.60	74H30	.30	74LS93	.85
7404	.20	7496	.80	74H40	.35	74LS96	2.00
7405	.35	74100	1.15	74H50	.30	74LS107	.90
7406	.25	74107	.35	74H51	.30	74LS109	1.50
7407	.55	74121	.35	74H52	.20	74LS123	1.95
7408	.20	74122	.55	74H53	.25	74LS138	2.00
7409	.25	74123	.55	74H55	.25	74LS151	.95
7410	.20	74125	.45	74H72	.35	74LS153	1.15
7411	.25	74126	.45	74H74	.35	74LS157	1.15
7412	.25	74132	.75	74H101	.95	74LS160	1.15
7413	.45	74141	.90	74H103	.55	74LS164	2.90
7414	.75	74150	.85	74H106	1.15	74LS193	2.00
7416	.25	74151	.95	74L00	.30	74LS195	1.15
7417	.40	74153	.95	74L02	.30	74LS244	2.90
7420	.25	74154	1.15	74L03	.35	74LS259	1.50
7426	.25	74156	.70	74L04	.40	74LS298	1.50
7427	.25	74157	.65	74L10	.30	74LS367	1.95
7430	.20	74161/9316	.75	74L20	.45	74LS368	1.25
7432	.30	74163	.85	74L30	.55	74LS373	2.50
7437	.20	74164	.75	74L47	1.95	74S00	.45
7438	.30	74165	1.10	74L51	.65	74S02	.45
7440	.20	74166	1.75	74L55	.85	74S03	.35
7441	1.15	74175	.90	74L72	.65	74S04	.35
7442	.55	74176	.95	74L73	.70	74S05	.45
7443	.45	74177	1.10	74L74	.75	74S08	.45
7444	.45	74180	.95	74L75	1.05	74S10	.45
7445	.75	74181	2.25	74L85	2.00	74S11	.45
7446	.70	74182	.75	74L93	.75	74S20	.35
7447	.70	74190	1.25	74L123	1.95	74S22	.55
7448	.50	74191	1.25	74LS00	.40	74S40	.30
7450	.25	74192	.75	74LS01	.40	74S50	.30
7451	.25	74193	.85	74LS02	.45	74S51	.35
7453	.20	74194	.95	74LS03	.45	74S64	.15
7454	.25	74195	.95	74LS04	.45	74S74	.70
7460	.40	74196	.95	74LS05	.45	74S112	.60
7470	.45	74197	.95	74LS08	.45	74S114	.85
7472	.40	74198	1.45	74LS09	.45	74S133	.85
7473	.25	74221	1.50	74LS10	.45	74S140	.75
7474	.30	74298	1.50	74LS11	.45	74S151	.95
7475	.35	74367	1.35	74LS20	.45	74S153	.95
7476	.40	75491	.65	74LS21	.45	74S157	.98
7480	.75	75492	.65	74LS22	.45	74S158	.80
7481	.85	74H00	.20	74LS32	.50	74S194	1.50
7482	.95	74H01	.30	74LS37	.45	74S196	2.00
7483	.95	74H04	.30	74LS38	.65	74S257 (8123)	2.50
7485	.75	74H05	.25	74LS40	.70	8131	2.75
7486	.55	74H08	.35	74LS42	.95		
7489	1.05	74H10	.35	74LS51	.75		
7490	.55	74H11	.25	74LS74	.95		
7491	.70	74H15	.45	74LS75	1.20		

I ² L, LINEARS, REGULATORS, ETC.							
QTY.		QTY.		QTY.		QTY.	
MCT2	.95	LM320K24	1.65	LM373	3.95		
8038	3.95	LM320T5	1.65	LM377	3.95		
LM201	.75	LM320T12	1.65	78L05	.75		
LM301	.45	LM320T15	1.65	78L12	.75		
LM308	.65	LM323K	5.95	78L15	.75		
LM309H	.85	LM324	1.25	78M05	.75		
LM309 (340K-5)	1.50	LM339	.75	LM380 (8-14 Pin)	1.19		
LM310	.85	7805 (340T5)	1.15	LM709 (8-14 Pin)	.45		
LM311 (8-14 Pin)	.75	LM340T12	.95	LM711	.45		
LM318	1.50	LM340T15	.95	LM723	.40		
LM320H6	.79	LM340T18	.95	LM725	2.50		
LM320H15	.79	LM340T24	.95	LM739	1.50		
LM320H24	.79	LM340K12	1.25	LM741 (8-14)	.45		
7905 (LM320K5)	1.65	LM340K15	1.25	LM747	1.10		
LM320K12	1.65	LM340K18	1.25	LM1307	1.75		
LM320K15	1.65	LM340K24	1.25	LM1458	.65		

LM3900	.95
LM75451	.65
NE555	.45
NE556	.85
NE565	1.15
NE566	1.25
NE567	.95
TA7205	6.95
76477	2.95
95H90	9.95

INTEGRATED CIRCUITS UNLIMITED

7889 Clairemont Mesa Blvd., San Diego, California 92111
 Out of State 1-800-854-2211 Cable Address: ICUSD Telex: 697-827
 (714) 278-4394 California Residents 1-800-542-6239

NAME _____

STREET ADDRESS _____

CITY _____ STATE _____ ZIP _____

PHONE _____ CHARGE CARD # _____ AE Visa BA MC _____ EXP. DATE _____

C.O.D. _____ WILL CALL _____ UPS _____ POST _____ NET 10th OF THE MONTH _____ PO # _____

ALL ORDERS SHIPPED PREPAID - NO MINIMUM - COD ORDERS ACCEPTED - ALL ORDERS SHIPPED SAME DAY
 OPEN ACCOUNTS INVITED - California Residents add 6% Sales Tax. PRICES SUBJECT TO CHANGE WITHOUT NOTICE.
 24 Hour Phone Service - We accept American Express / Visa / BankAmericard / Master Charge

SPECIAL DISCOUNTS	
Total Order	Deduct
\$35-\$99	10%
\$100-\$300	15%
\$301-\$1000	20%

VARIABLE POWER SUPPLY KIT \$11⁹⁵

- Continuously Variable from 2V to over 15V
- Short-Circuit Proof
- Typical Regulation of 0.1%
- Electronic Current Limiting at 300mA
- Very Low Output Ripple
- Fiberglass PC Board Mounts All Components
- Assemble in about One Hour
- Makes a Great Bench or Lab Power Supply
- Includes All Components except Case and Meters

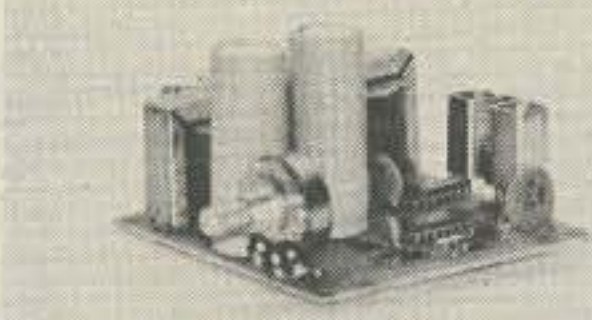

ADD \$1.25 FOR POSTAGE/HANDLING

SPECIALS - THIS MONTH ONLY

1N34A	Germanium Diode 50V 10mA	10/\$1	LM308H	Low Bias Current Op Amp-Super 709	\$0.84
1N270	Germanium Diode 80V 200mA	4/\$1	LM309K	5 Volt Regulator TO-3	.84
1N914	Silicon Diode 100V 10mA	25/\$1	LM317K	Adjustable Voltage Regulator 2-37V	3.50
1N6263	Hot Carrier Diode (HP2800, etc.)	\$1.00	LM380N	2 Watt Audio Power Amplifier DIP	.94
F7	Power Varactor 1-2W Out @ 432MHz (Specs & Circuits included with F7)	\$2.00	NE565A	Phase Locked Loop DIP	.94
DIODE GRAB BAG-Mixed zeners, rectifiers, etc.		50/\$1	LM723CN	Precision Voltage Regulator DIP	3/\$1
2N706	NPN High-Speed Switch 75ns	4/\$1	LM747	Dual 741 Compensated Op Amp DIP	2/\$1
2N918	UHF Transistor-Osc/Amp up to 1 GHz	4/\$1	2102	1024-Bit Static RAM (1024 x 1) DIP	\$1.75
2N2609	P-Channel FET Amplifier 2500μmhos	\$1.00	2740DE	FET Input Op Amp-like NE 536, μA740	1.95
2N2920	NPN Dual Transistor 3mV Match β225	2.95	CA3018A	4-Transistor Array/Darlington	.99
2N3904	NPN Amp/Switch 100 40V 200mA	8/\$1	CA3028A	RF/IF Amplifier DC to 120MHz	1.45
2N4122	PNP RF Amplifier & Switch	3/\$1	CA3075E	FM IF Amp/Limiter/Detector DIP	1.45
2N4869E	N-Channel Audio FET Super Low-Noise	2/\$1	RC4558	Dual High Gain Op Amp mDIP	3/\$1
2N4888	150 Volt PNP Transistor for Keyer	2/\$1	N5558V	Precision Fast Op Amp mDIP	2/\$1
E112	N-Channel FET VHF RF Amp	3/\$1	N5558V	Dual Hi Gain Op Amp-Comp. mDIP	3/\$1
T1S74	N-Channel FET High-Speed Switch 40ns	3/\$1	8038	Function Generator/VCO with circuits	\$3.75

SEND FOR ADVA'S NEW 1979 CATALOG
NEARLY 1000 SEMICONDUCTORS, KITS, CAPACITORS, ETC.-SEND 25¢ STAMP.

OTHER ADVA KITS:

LOGIC PROBE KIT-Use with CMOS, TTL, DTL, RTL, HTL, HINIL and most MOS IC's. Built-in protection against polarity reversal and overvoltage. Draws only a few mA from circuit under test. Dual LED readout. Complete kit includes case and clip leads. **ONLY \$7.85**

FIXED REGULATED POWER SUPPLY KITS-Short-circuit proof with thermal current limiting. Compact size and typical regulation of 0.5% make these ideal for most electronic projects. Available for 5V @ 500mA, 6V @ 500mA, 9V @ 500mA, 12V @ 400mA, 15V @ 300mA. Specify voltage when ordering. **\$8.95 ea.**

These easy-to-assemble kits include all components, complete detailed instructions and plated fiberglass PC boards. Power supply kits do not include case or meters. Add \$1.25 per kit for postage and handling.

MAIL NOW! FREE DATA SHEETS supplied with many items from this ad. **FREE ON REQUEST**-741 Op Amp with every order of \$5 or more-749 Dual Op Amp or two E100 FET's with every order of \$10 or more, postmarked prior to 12/31/78. One free item per order. **ORDER TODAY**-All items subject to prior sale and prices subject to change without notice. All items are new surplus parts-100% functionally tested.

WRITE FOR FREE CATALOG #79 offering over 700 semiconductors carried in stock. Send 25¢ stamp.

TERMS: Send check or money order (U.S. funds) with order. Add 5% postage for U.S., Canada and Mexico. \$1.00 handling charge on orders under \$10. Calif. residents add 8% sales tax. Foreign orders add 10% postage. COD orders-add \$1.00 service charge.

MORE SPECIALS:

RC4195DN ±15V @ 50mA VOLTAGE REGULATOR IC. Very easy to use. Makes a neat Highly Regulated ±15V Supply for OP AMP's, etc. Requires only unregulated DC (18-30V) and 2 bypass capacitors. With Data Sheet and Schematics. 8-pin mDIP	\$1.25
RC4136 Quad 741 Low-Noise Op Amp mDIP	\$0.95
LM1304 FM Multiplex Stereo Demodulator DIP	0.99
LM2111 FM IF Subsystem (IF Amp, Det., Limiter) DIP	0.99
1N6263 Hot Carrier Diode 0.4V @ 1mA 0.1ns DO-35	1.00
ZENERS-Specify Voltage 3.3, 3.9, 4.3, 5.1, 6.8, 8.2, 9.1, 10, 12, 15, 16, 18, 20, 22, 24, 27, or 33V (±10%)	400mW 4/\$1.00 1 Watt 3/\$1.00

- MONEY-BACK GUARANTEE
- ALL TESTED AND GUARANTEED

ADVA ELECTRONICS
BOX 4181 GB, WOODSIDE, CA 94062
Tel. (415) 328-1500

FREE

IC or FET's WITH
\$5 & \$10 ORDERS.1
DATA SHEETS
WITH MANY ITEMS.

DIODES	TRANSISTORS	TRANSISTORS	TRANSISTORS	LINEAR IC's
ZENERS & RECTIFIERS	2N706 \$0.24	2N4091 3/\$1	2N5638 2/\$1	LM340K-5 \$1.20
1N456 to 1N458 6/\$1	2N718 .24	2N4092 \$0.75	2N5640 2/\$1	LM340T-6 1.20
1N483 6/\$1	2N720 .48	2N4121 3/\$1	CP643 \$4.00	LM340T-12 1.20
1N486 6/\$1	2N718 3/\$1	2N4122 3/\$1	CP650* \$5.00	LM340T-15 1.20
1N746 to 1N759 15/\$1	2N1613 \$0.20	2N4124 5/\$1	CP651 \$4.00	LM340T-24 1.20
1N914* 15/\$1	2N1711 .29	2N4248 5/\$1	E100 4/\$1	LM376N* .55
1N974 4/\$1	2N1890 .38	2N4249 5/\$1	E101 3/\$1	LM377N 2.60
1N3064 6/\$1	2N1893 .38	2N4250 4/\$1	E102 3/\$1	LM380N 1.28
1N3090 6/\$1	2N2219 .24	2N4274 5/\$1	E175 3/\$1	NE555V* 2/\$1
1N4001* 12/\$1	2N2222 6/\$1	2N4302 \$0.29	MPF102 to*	NE556V \$0.90
1N4002 12/\$1	2N2222A 5/\$1	2N4303 .29	MPF112 4/\$1	LM709CN .28
1N4003 12/\$1	2N2369 5/\$1	2N4338 .29	MPF112 4/\$1	LM709CN .28
1N4004 12/\$1	2N2606 to \$2	2N4381 \$1	SE1001 4/\$1	LM723N* 2/\$1
1N4005 10/\$1	2N2905 \$0.24	2N4392 \$0.90	SE1002 4/\$1	LM723N* 3/\$1
1N4006 10/\$1	2N2906 .24	2N4416 2/\$1	SE2001 4/\$1	LM723N \$1.00
1N4007 10/\$1	2N2907* 5/\$1	2N4416A \$0.80	SE2002 4/\$1	LM741CN 3/\$1
1N4008 10/\$1	2N3553 \$1.50	2N4856 to \$1	SE5001 to 3/\$1	LM741CN 4/\$1
1N4009 10/\$1	2N3563 6/\$1	2N4861 \$1	SE5003 3/\$1	LM741CN14 .34
1N4010 10/\$1	2N3564 4/\$1	2N487E 2/\$1	SE5020 \$3.00	LM747CN .85
1N4148 15/\$1	2N3565 to 6/\$1	2N4888E 2/\$1	T1S73 to 3/\$1	748CJ DIP .35
1N4154* 25/\$1	2N3568 6/\$1	2N4881 \$2.50	T1S75 3/\$1	749CJ DIP 1.00
1N4370 to 2/\$1	2N3638 6/\$1	2N4888 \$1	DIGITAL IC's	
1N4372 2/\$1	2N3638A 5/\$1	2N4865 3/\$1	MM5738N \$2.95	LM130AN 1.15
1N4454 15/\$1	2N3641 5/\$1	2N5087 4/\$1	SN7400N .16	LM1458N* 3/\$1
1N4728 to 3/\$1	2N3642 5/\$1	2N5088 4/\$1	SN7410N .16	LM2111N \$1.40
1N5231 to 4/\$1	2N3643 6/\$1	2N5126 to 6/\$1	SN7420N .16	XR2580CP 1.55
1N5236 4/\$1	2N3644 4/\$1	2N5135 6/\$1	SN7422N .16	2740DE 1.95
	2N3646 4/\$1	2N5138 5/\$1	SN7440N .16	CA3028A 1.75
	2N3688 to 3/\$1	2N5139 5/\$1	SN7451N .18	CA3046 .84
	2N3690 3/\$1	2N5163 3/\$1	SN7473N .36	LM3075M1 1.45
	2N3691 to 4/\$1	2N5197 \$5.00	SN7475N .48	CA3086* .62
	2N3694 4/\$1	2N5199 2.50	SN7476N .35	LM3900N .55
	1N5144 \$2	2N3821 \$0.80	2N5210 3/\$1	RC4194D 1.50
	D5 144MHz \$5	2N3822 .70	2N5308 2/\$1	RC4194TK* 2.50
	F7 432MHz \$2	2N3823 .40	2N5397 \$1.50	LM100H \$7.50
	MV830 to \$1	2N3866 .75	2N5432 1.90	LM301AN .27
	MV832 6/\$1	2N3903 to* 6/\$1	2N5457 1.90	LM307H .27
	MV1620 to \$1	2N3906 6/\$1	2N5458 \$0.38	LM308N .88
	MV1634 6/\$1	2N3919 \$5.00	2N5484 3/\$1	LM309K .94
	MV1866 to \$2	2N3922 5.00	2N5486 2/\$1	LM3111N .90
	MV1872 6/\$1	2N3954 3.20	2N5543 \$3.00	LM320K-5 1.35
	MV2201 to \$1	2N3958 1.15	2N5544 2.50	LM320K-12 1.35
		2N3970 1.00	2N5561 12.00	LM320K-15 1.35
				OM75492 3.75

*SUPER SPECIALS:

1N34 Germanium Diode	10/\$1	FSA2501M Diode Array	2/\$1
1N914 100V/10mA Diode	20/\$1	MPF102 200MHz RF Amp	3/\$1
1N4001 50V/1A Rectifier	15/\$1	40673 MOSFET RF Amp	\$1.75
1N4154 30V 1N914	25/\$1	LM324 Quad 741 Op Amp	.94
BR1 50V 1/2A Bridge Rec	4/\$1	LM376 Pos Volt Reg mDIP	.55
2N2222 NPN Transistor	6/\$1	NE555 Timer mDIP	.38
2N2907 PNP Transistor	6/\$1	LM723 2-37V Reg DIP	3/\$1
2N3055 Power Xistor 10A	\$0.75	LM741 Comp Op Amp mDIP	6/\$1
2N3904 NPN Amp/Sw β100	6/\$1	LM1458 Dual 741 mDIP	3/\$1
2N3906 PNP Amp/Sw β100	6/\$1	CA3086 5 Trans Array DIP	.62
CP650 Power FET 1/2Amp	\$5	RCA29 Pwr Xistor 1A 30W	.70
RF391 RF Power Amp Transistor 10-25W @ 3-30MHz TO-3	\$5.00		
555X Timer 1μs-1hr Different pinout from 555 (w/data)	3/\$1		
RC4194TK Dual Tracking Regulator ±0.2 to 30V @ 200mA TO-66	\$2.50		
RC4195TK Dual Tracking Regulator ±15V @ 100mA (TO-66)	\$2.25		
8038 Waveform Generator ~∇∇∇ Wave With Circuits & Data	\$3.75		

NEW SPECIALS

LM318CN	High Speed Op Amp 50V/μs mDIP	\$0.94
LM318D	High Speed Op Amp 50V/μs DIP	.90
LM339N	Quad Comparator Single or Dual Supply	.79
LM380N-8	1/2W Audio Power Amplifier 8-22V	.90
NE567V	Tone Decoder (PLL) 0.01Hz to 500kHz	.99
XR567CP	Tone Decoder (PLL) 0.01Hz to 500 kHz	.99
LM723CN	Precision Voltage Regulator 2-37V DIP	3/\$1
LM747CN	Dual 741 Compensated Op Amp	2/\$1
SAD1024	Dual 512 Stage (1024) Audio Delay Line "Bucket Brigade" Appl. Data included	\$18.95
XR2206CP	Function Generator with applic. data	4.40
XR2242CP	Long-Range Precision Timer μs to days	1.50
1 YEAR TIMER Kit-2 XR2242's and Applic. Note		3.00
LM2901N	Quad Comparator +5V or 2 to 36VDC	\$1.20
CA3018A	4-Transistor Array/Darlington	.99
CA3028A	RF/IF Amplifier DC to 120MHz	1.25
RC4558	Dual High Gain Op Amp mDIP	3/\$1
SPACER Kit - 4 ea of 5 assorted size spacers		\$1.00
±15 VOLT Regulated Power Supply Kit-Easy assembly, 5mV regulation, 100mA, fully protected. Includes all components and hardware, no PCB or case-Add \$1.50 for shipping		\$13.95

1N270	Germanium Diode 80V 200mA	4/\$1
1N823	Temp Comp Reference 6.2V±5% ±.005%/°C	\$0.60
1N914	Silicon Diode 100V 10mA	25/\$1
1N3044	100V Zener 1W-Better than an OB3	.75
1N3045	110V Zener 1W-Better than an OB2/OC3	.75
1N3071	200V 100mA Switching Diode 40ns	.30
2N2915	NPN Dual Transistor 3mV Match β100	\$1.95
2N3819M	N-Channel RF FET 100MHz Amp	.35
2N4020	PNP Dual Transistor 5mV Match β250	5.00
2N4445	N-Channel FET 5Ω Switch	3.50
2N5394E	Ultra-Low Noise J-FET Audio Amp	\$1.25
2N5912	Dual J-FET RF Dif Amp to 800MHz	2.90
2N6028	Programmable Unijunction Transistor	.45
2N6449	300 Volt N-Channel J-FET Amp/Sw	2.00
CP640	Broadband FET RF Amp 140dB Dyn Range	\$4.50
E304	N-Channel RF FET 3.8dB NF @ 400MHz	.50
MPSA12	NPN Darlington Transistor β20,000	.75
T1S88	N-Channel FET 400MHz RF Amp	.60
RESISTOR Kit-150 pcs 1/4W, 20 most common values, individually packaged, 5 to 20 pcs each		\$4.95
PC BOARD Mounting Kit-8 ea spacer, screw, nut and washer-32 pcs total.		\$1.00

SEND FOR ADVA'S NEW 1979 CATALOG
NEARLY 1000 SEMICONDUCTORS, KITS, CAPACITORS, ETC.-SEND 25¢ STAMP.

ADVA ELECTRONICS

BOX 4181 GB
WOODSIDE, CA 94062
Tel.(415) 328-1500

MOTOROLA 4 MHZ XTAL OSCIL-LATOR 14 pin dip pkg., 5 VDC in, 4 MHz out. TTL compatible. **\$5.95 ea.**

NATIONAL SEMICONDUCTOR - 6 DIGIT CLOCK MODULE A 12-hr. clock featuring alarm and snooze alarm function. Comes complete with everything. All you add is a power cord and switches. Each module utilizes discreet components and is ready for you to mount in your enclosure. Display is 6 each seven segments, .33 inches high, clockchip is MM5375. Can easily be mounted in either of our instrument clock case kits. **\$14.95.**

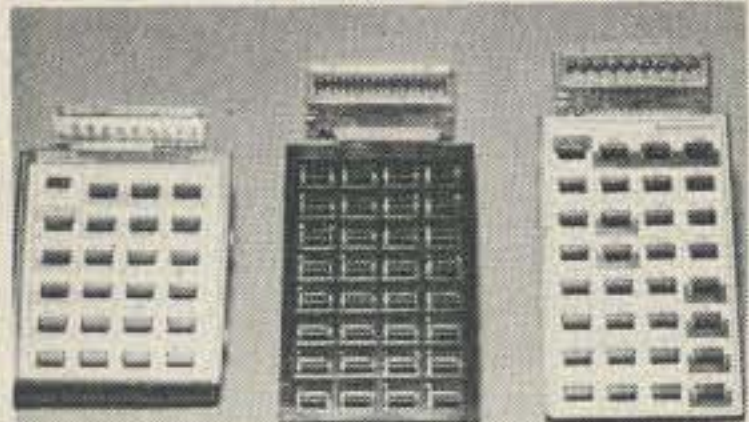

CALCULATOR GUTS

Experimenter's delight. Each keyboard includes a monolithic calculator chip and display. These are rejects. It might be something simple to repair or it could be very nasty. At this price, who cares! 9 volt. **\$1.50 ea. 3/\$3.00.**

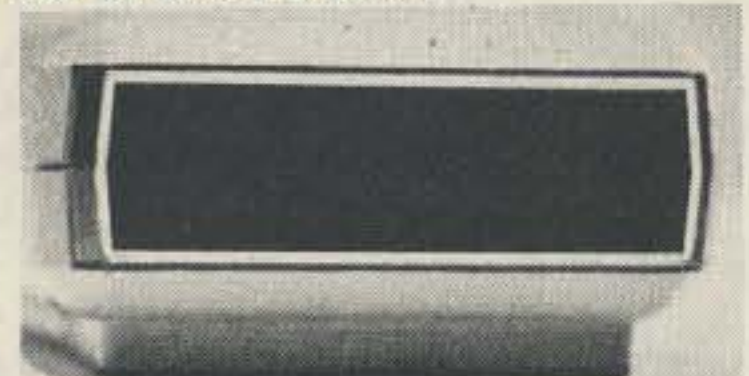

INSTRUMENT CLOCK CASE KIT

A real jewel for those small projects. Hinged top door allows you to hide your control area. O.D. 4 1/2" x 4" x 1 3/4". **\$1.99 each.**

DB-25 FEMALE CONNECTOR

A unique assembly originally adapting the RS232 Type Connector to flat cable. **\$1.50 each or 2/\$2.50.**



INSTRUMENT/CLOCK CASE KIT

Perfect for your opto projects. Solid aluminum construction with real walnut sides. O.D. 5-3/8" by 5-3/8" by 2". **\$6.95 ea.**

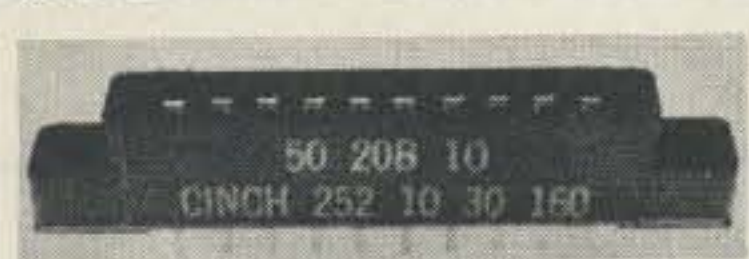

EDGE CARD CONNECTOR

Cinch Jones 10/20 Pins. .156 Spacing PC Mount. .85 Burndy 22/44 Pins. .156 spacing PC Mount, **\$1.40 each.**

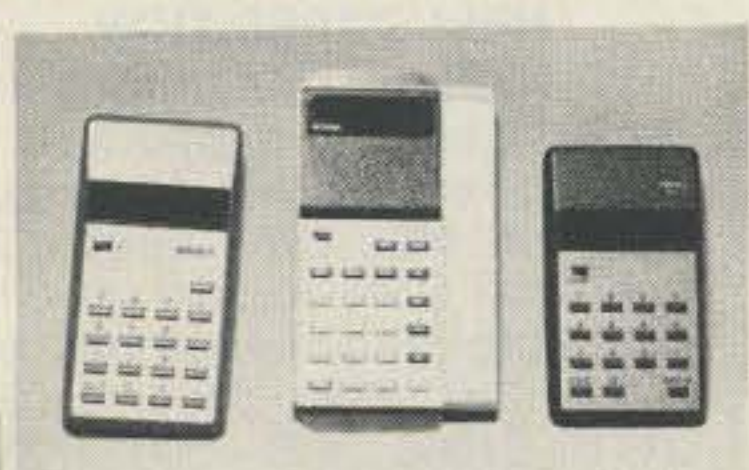

DEFECTIVE CALCULATORS

Well, some are and some are not. We can't afford the time to test them. **\$2.50 ea.** Batteries not included. **2/\$4.00.**

M-M Electronic Sales

A division of **united products Corporation**

Corp. Hdqts., 2300 1st Ave—Seattle, Wash. 98121

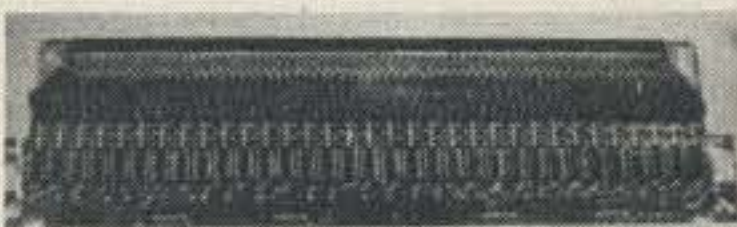

LINE PRINTER HAMMER DRIVER BOARD

Each board contains approx. 130 each #MJE800 (Silicon Darlington NPN hfe 750, 1.5A). About \$130.00 worth, over 100 1N4001 diodes, plus support chips. The whole package is yours for only **\$14.95.**

HURRY, WE DON'T EXPECT THESE TO LAST VERY LONG!

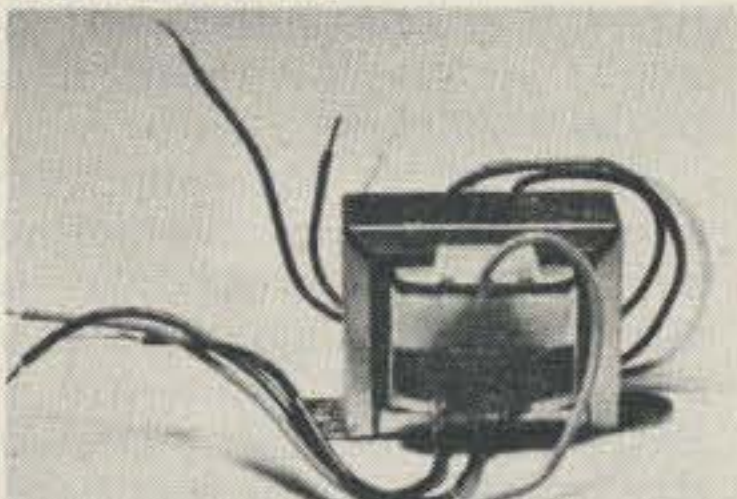

TRANSFORMER Pri. 110 VAC Sec. 11.2 and 5 VCT @ .1 amp. **\$.95 ea.**

MINIATURE D.P.D.T. [PUSH BUT TON] momentary, rated 6A/125 VAC, microswitch part #8N2021. **Only \$1.54.**

CLOCK DISPLAY

National Semi. 6 Digit Multiplexed Display; .33" Characters (Common Cathode). **A REAL BUY AT JUST \$1.00.**

EDGE METER 100-0-100 ua 1/2" by 11/16". Compare with other meters costing \$6.00. **Only \$2.00 ea.** Why pay more?

DIODE SALE 1N4148

100/\$1.95 TAPE/REEL
1000/\$14.95

DIODES

TYPE	VOLTS	WATTS	PRICE
1N4001	50	1A	15/\$1.00
1N4002	100	1A	15/\$1.00
1N4003	200	1A	12/\$1.00
1N4004	400	1A	12/\$1.00
1N4005	600	1A	10/\$1.00
1N4006	800	1A	10/\$1.00
1N4007	1000	1A	6/\$1.00
1N5400	50	3A	5/\$1.00
1N5401	100	3A	5/\$1.00
1N5402	200	3A	5/\$1.25
1N5403	300	3A	4/\$1.25
1N5404	400	3A	4/\$1.25
1N5405	500	3A	4/\$1.49
1N5406	600	3A	4/\$1.49
1N5407	800	3A	3/\$1.49
1N5408	1000	3A	2/\$.99
1N4148	75	10M	20/\$1.00

1/4 WATT 5% DEPOSITED CARBON FILM RESISTOR ASSORTMENTS

ASST. A	10 ea 1 OHM 1.5 OHM 2 OHM 2.7 OHM 3 OHM 3.6 OHM 4.7 OHM 5.6 OHM 6.8 OHM 8.2 OHM	100 pcs \$2.40
ASST. B	10 ea 10 OHM 12 OHM 15 OHM 18 OHM 22 OHM 27 OHM 33 OHM 39 OHM 47 OHM 56 OHM	100 pcs \$2.40
ASST. C	10 ea 68 OHM 82 OHM 100 OHM 120 OHM 150 OHM 180 OHM 220 OHM 270 OHM 330 OHM 390 OHM	100 pcs \$2.40
ASST. D	10 ea 470 OHM 560 OHM 680 OHM 820 OHM 1K 1.2K 1.5K 1.8K 2.2K 2.7K	100 pcs \$2.40
ASST. E	10 ea 3.3K 3.9K 4.7K 5.6K 6.8K 8.2K 10K 12K 15K 18K	100 pcs \$2.40
ASST. F	10 ea 22K 27K 33K 39K 47K 56K 68K 82K 100K 120K	100 pcs \$2.40
ASST. G	10 ea 150K 180K 220K 270K 330K 390K 470K 560K 680K 820K	100 pcs \$2.40
ASST. H	10 ea 1M 1.2M 1.5M 1.8M 2.2M 2.7M 3.3M 3.9M 4.7M 5.6M	100 pcs \$2.40
ASST. A-H	INCLUDES ALL RESISTOR ASSORTMENTS (800 pcs)	\$14.95 ea

SOLID DIPPED TANTALUM CAPACITORS

	1-99	100 PLUS
.1 X 35 VOLT	.23	.19
.15	.35	.23
.22	.35	.23
.33	.35	.23
.47	.35	.23
.68	.35	.23
1.0	.35	.25
1.5	.35	.29
2.2	.35	.31
3.3	.35	.36
4.7	.35	.38
6.8	.35	.50
10.0	.35	.60
15.0	.35	.79
22.0	.35	1.39
33.0	.35	2.08
47.0	.35	2.65

VALUES AND QUANT. MAY BE ASSORTED TO ATTAIN QUANT. PRICING

NYLON TIE WRAPS

3"	65000	10/\$.30
4"	65002	10/ .50
5.3"	65003	10/ .59
6.9"	65004	10/ .69
10.8"	65005	10/ 1.59
13.0"	65006	10/ 2.69
14.4"	65055	10/ 2.96
SCREW MOUNT		
13.6"	65054	10/ 4.29
7.4"	65052	10/ .98
5.8"	65051	10/ .89
4.4"	65050	10/ .75

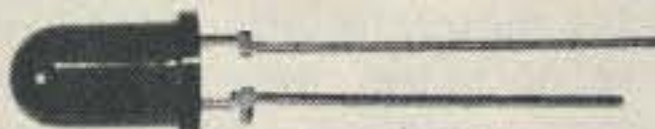

GALLIUM PHOSPHIDE L.E.D.'s

Provide greater light out-put, brighter colors, greater uniformity and less current drain than regular L.E.D.'s

.110 DIAMETER		
P/N 724H	Red Diffused	4/\$1.00
724G	Green Diffused	4/ 1.19
724Y	Yellow Diffused	4/ 1.49
724O	Orange Diffused	4/ 1.49
.220 DIAMETER		
714H	Red Diffused	5/\$1.19
714G	Green Diffused	4/ 1.49
714Y	Yellow Diffused	4/ 1.59
714O	Orange Diffused	4/ 1.59
.220 DIAMETER (low dome)		
704R	Red Diffused	4/\$1.59
704G	Green Diffused	4/ 1.65
704Y	Yellow Diffused	4/ 1.84
704O	Orange Diffused	4/ 1.84
101R-g	Dual (Red and Green)	2/5.00
		\$2.85

MOUNTING HARDWARE
.220 Diameter #7aMH 12/\$1.44

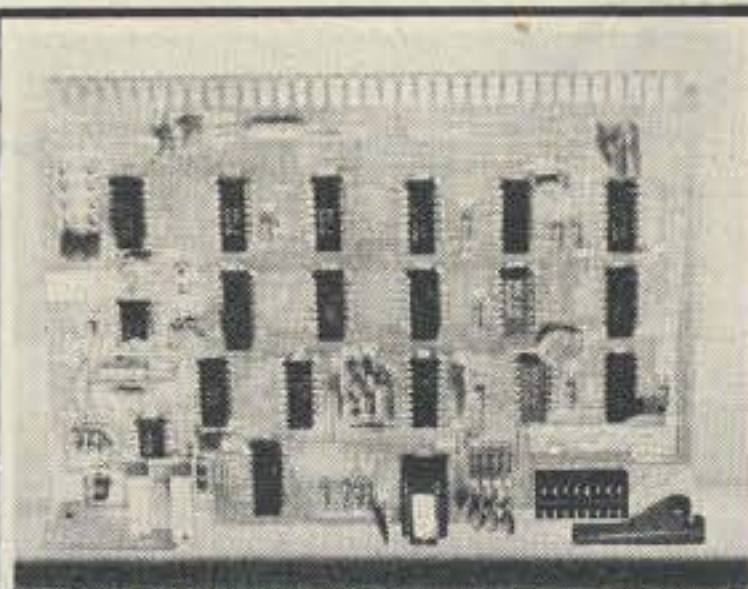

PARTS BOARDS A great way to buy parts on a budget. We guarantee your money's worth. **ONLY \$1.00 ea.**

ROTRON WHISPER FAN #WR2H1

3 Blade 4" Diameter 75CFM 115VAC. NET \$17.00 YOUR PRICE **\$9.95** Wait now, these are not pull-outs or something like that, these are new!

CLAIREX PHOTO CELLS

These have a real USEFUL range to them. Any project involving control from ambient light levels will utilize this photo cell. Light resistance 1K. Fast response. .156 Diameter. **\$.75 each or 2/\$1.00.**

NOVUS CALCULATOR #824R

Rechargeable Ni-Cad calculator WITH MEMORY, EX, CS AND % KEY. **\$4.95 ea.** (owners manual and charger are not included)

PLASTIC PARTS BOX A nice little hinged-top box for storing all your small parts. O.d. 6 3/4" by 3 3/4" by 2". **\$.75 ea. 10/\$5.00.**



REPEAT OF A SELL-OUT

A complete 12 hour digital clock. Some are manufacture line rejects, some are returns, and some are just scratched. Features: hours, minutes, alarm, snooze alarm. Parts value alone would equal \$20.00, you pay only **\$6.00 ea.**

HOT DEALS

75493N (quad seg. driver)	55
SN7428N	25
1000uf 25VDC P-C	25
2000uf 25VDC AXIAL	50
18 ga. LINE CORD 6'	25
2N2222A	4/1.00
2N3054	75
2N3055 (TO-3)	99
MEMOREX 1" VIDEO TAPE 1/2 HOUR (with case)	4.95
SIEMENS MAGNETIC SENSOR	1.99
43/43 GOLD EDGE CONN. .156	4.95
P/B MIN. 12VDC RELAY D.P.D.T.	1.99

FREE BY POPULAR DEMAND

With min. purchase of \$50.00, you will receive free, a 5 function National Semiconductor L.C.D. mens watch. With min. purchase of \$100.00 you will receive free, our L.C.D. car clock. (watch and clock advertised in Dec. issue of 73 Mag.)

For Master Charge/Visa Orders Use Our

TOLL FREE HOT LINE: 1-800-426-0634

for areas outside Washington (incl. Alaska & Hawaii)

O.E.M.'s WELCOME



Terms: All orders shipped promptly. Minimum order \$5.00. Telephone orders accepted. All orders shipped UPS or PP. Add 5% extra for shipping & handling. Washington state residents add additional 5.4% sales tax. Master Charge & Visa cards accepted. Money orders & your personal or company check are welcome. Funds made payable in U.S. currency only. No C.O.D. orders. Your satisfaction is guaranteed on all merchandise purchased. All merchandise subject to prior sale. Open account to govt. agencies & publicly funded schools.

Store Hours M-F 9-6 • SAT 9-5

DX

from page 10

Watch 7007 and 21035 kHz from 2330Z.

6O1FG returned to Italy from Somalia on April 2 with far fewer contacts than were hoped for. The political situation is still not settled enough for good DXing. He would have liked to have spent more time operating, but conditions just were not favorable.

W2TDQ runs a twice weekly sked with SV9JI on Crete. Watch 14288 kHz on Tuesdays and Fridays from 2100Z.

JA7JT/JD1 left Ogasawara and set up shop on Marcus Island. He plans to stay through August when he will return to Ogasawara. QSL to JH7BRG.

N4WX kept the faith and finally came up with a ZD9BM QSL for a 1970 contact.

Jacky F6BBJ advises that he still has logs for his previous activity from St. Brandon VQ8CFB, Chagos VQ9SM, and Agalega 3B6CF, and can supply QSLs on request.

Before his untimely death last year, ZE7JX provided many stations with a new one on 160 meters. Steve Reichlyn AA4V has obtained those logs and QSL requests should be directed to Steve at Box 9096, Columbia SC 29290.

OZ8AE was active from Macquarie Island signing VK0JC just at the end of 1978. QSLs can be directed to OZ6MI but don't expect any return until OZ8AE makes it back to Denmark later this year.

In lieu of other routes, T2 stations can generally be QSLed via Weather Station, Funafuti, Tuvalu, Central Pacific.

For any of you adventure-some types looking around for somewhere new to vacation, W9KNI reports the following areas have been silent since at least January 1, 1975: BY, CE0X, VK0H, VU2L, XZ, YA, ZA, 3C0, 3X, and 7O. There have been rumors of 3X, YA, and 7O, but these have not been authenticated. Take your pick. Any one is guaranteed to draw a crowd.

P29JS checked into the possibility of obtaining Andaman operating permission while on a short trip to India. It seems licensing requirements have been relaxed somewhat, but he is still waiting for official word.

Ex-EP2VH, Vern Hardy, is back in Florida, but his logs covering two and a half years of activity in Iran, were confiscated. Vern is not sure if he will ever get them back.

The DXCC workload at the ARRL has increased tremendously with the large jump in the number of licensed amateurs in the last couple of years. The result will probably be, among other things, limiting submissions of new countries to only twice a year.

HC5EE passes along word that HC5RG was killed in a plane crash April 30th while searching for another downed aircraft.

CR9AJ is returning to Portugal where he will be signing CT1ADP. Torres has provided most of the CR9 activity the past couple of years and will be missed. His new address is PO Box 2676, Lisbon, 1100, Portugal.

S2BTF still shows regularly on the weekends on 14225 kHz after 1200Z.

Although the original intent was for DL8DC to handle the QSL chores for TY9ER, plans were changed and cards should be routed through W2TK. This decision was made so that some of the more obnoxious entries could be edited from the log. If your card came back marked "not in log," maybe a little self-examination of your DX operating habits is in order.

A51PN has been showing most Tuesday/Wednesday/Friday mornings after 1145Z on a 14265/14195 kHz split frequency operation. Listen on the long path and QSL direct.

KX6PP has been showing around 0830Z on 14252 kHz. QSL to 1406 34th Street West, Birmingham AL 35218, with the usual SASE.

ZD7HH needs Maine, Vermont, and Wyoming to complete his WAS. Look for him on 21291 kHz from 2100Z. QSL to W4FRU.

ZS2MI has been showing around 14240 most weekdays at 0630Z in a list-type operation. Look for WA2JUQ making the list. QSL to WA2IZN, 225 Route 17, Upper Saddle Brook NJ 07458.

Ex-EP2IA has returned to England where he now signs G3SXW. Roger has shipped his EP logs and a stack of blank cards to W4YE for processing. Any QSL requests should be directed there.

Someone at the FCC monitoring station in Anchorage apparently got hold of an outdated list of banned countries and issued pink slips to several rather startled DXers for contacts with HS stations in Thailand. The notices stated that contact with amateur stations in Thailand was forbidden and gave the offenders ten

days to reply. A quick check with local FCC offices and the ARRL showed no change in HS status, much to the relief of the "guilty" parties. We wonder if the DXCC Desk would accept those pink slips in lieu of a QSL for HS credit.

Although the recent YV0AA activity should have slowed the Aves Island demand for awhile, it appears that there is a permanent population of scientific types on Aves and not one, but two, permanent amateur stations. It seems that YV5HAM and YV5HQE are both located on Aves Island and are used for handling traffic back to Venezuela. They do not sign with the standard YV0 prefix because they do not want to attract the unwanted attention of the DX types. If you habla espanol, you might listen for them daily below 14200 kHz.

With rumors abounding that a Swedish group had permission to operate in Albania, the sudden appearance of a station signing ZA5T and giving SM2DMU as his QSL manager, gave many the hope that finally here was a true-blue Tiranian. Unfortunately, it turned out to be Tirana Slim. Someday...

UK1PAA has been showing from Franz Joseph Land on a very limited operating schedule. The station is crystal-controlled on 14030 kHz and the time to listen is around 1400Z. Some reports also have him on fifteen meters around the same time on 21015. He seldom stays around for long, but he will apparently be there for some time.

Jacky F6BBJ, one of the operators on the Clipperton Island effort as well as several other expeditions, is planning a 3B6 St. Brandon operation in September. Jacky is a top operator and always manages to run up a large QSO total wherever he goes.

The KP4AM/D logs for the

Desecheo operation arrived at the Northern California DX Foundation for QSL processing in late May. Although there were some 20,000 entries in the logs, all cards were in the mails before the end of June. If you haven't received yours as yet, it might be time to try again. The ARRL DXCC Desk announced they would begin accepting Desecheo QSLs September 1st... only for contacts made March 1, 1979, or later. That should clear up any questions concerning the earlier W0DX/D operation.

That TH8JM operation from the Central African Empire in May was apparently sans official permission, so there is some question concerning ARRL acceptance.

In response to our DX riddle in which three DXCC countries share the same prefix but are located within different continental boundaries, Charles Martin AB4I and John Reasoner WA4QMQ came up with VK0—Heard, VK0—Macquarie, and VK0—Australian Antarctic. Nice going, guys, but these are not the ones I had in mind. See what else you can come up with.

To improve our coverage of specific areas of DX interest, we are looking for a few reporters who would have time to send in a page or two each month covering happenings on their favorite band/mode of DXing. We need more information on OSCAR, SSTV, CW, Novice bands, 160 meters, VHF/UHF, channelized 10-meter AM, etc.

If you specialize in any of these areas and would like to have a monthly byline here in this column, write and let me know what your specialty is and we will try to assemble a top staff of super reporters.

That's all this month. Work a new one.

Thanks as always to the *West Coast DX Bulletin*, *LIDXA Bulletin*, and *Worldradio News*.

Contests

from page 141

scoring, but based on stations and messages copied.

ENTRIES:

Logs must be received by October 10 and must contain: band, date, time in GMT, call-sign, exchanges, points, and multipliers. Use a separate sheet for each band and enclose a summary sheet showing the scoring, classification, call-sign, name, and address, and in the case of multi-operator stations, the names and call-signs of all operators involved. Send logs to: SARTG,

Contest & Award Manager, C. J. Jensen OZ2CJ, Meisnersgade 5, 8900 Randers, Denmark.

HELL DXPEDITION

W8TQE, the Adrian Amateur Radio Club, will give you a chance to work Hell, Michigan, between 1600 GMT August 25 and 1600 GMT August 26. The operating frequencies will be: CW—3710, 3565, 7110, 14065, 21110, 21065; SSB—3900, 7235, 14285, 21360, 28625. A colorful QSL certificate can be obtained by accompanying your QSL with a legal-size SASE and mailing it to: W8TQE, PO Box 111, Adrian MI 49221.

RADIO BOOKSHOP

LICENSE STUDY GUIDES & TAPES

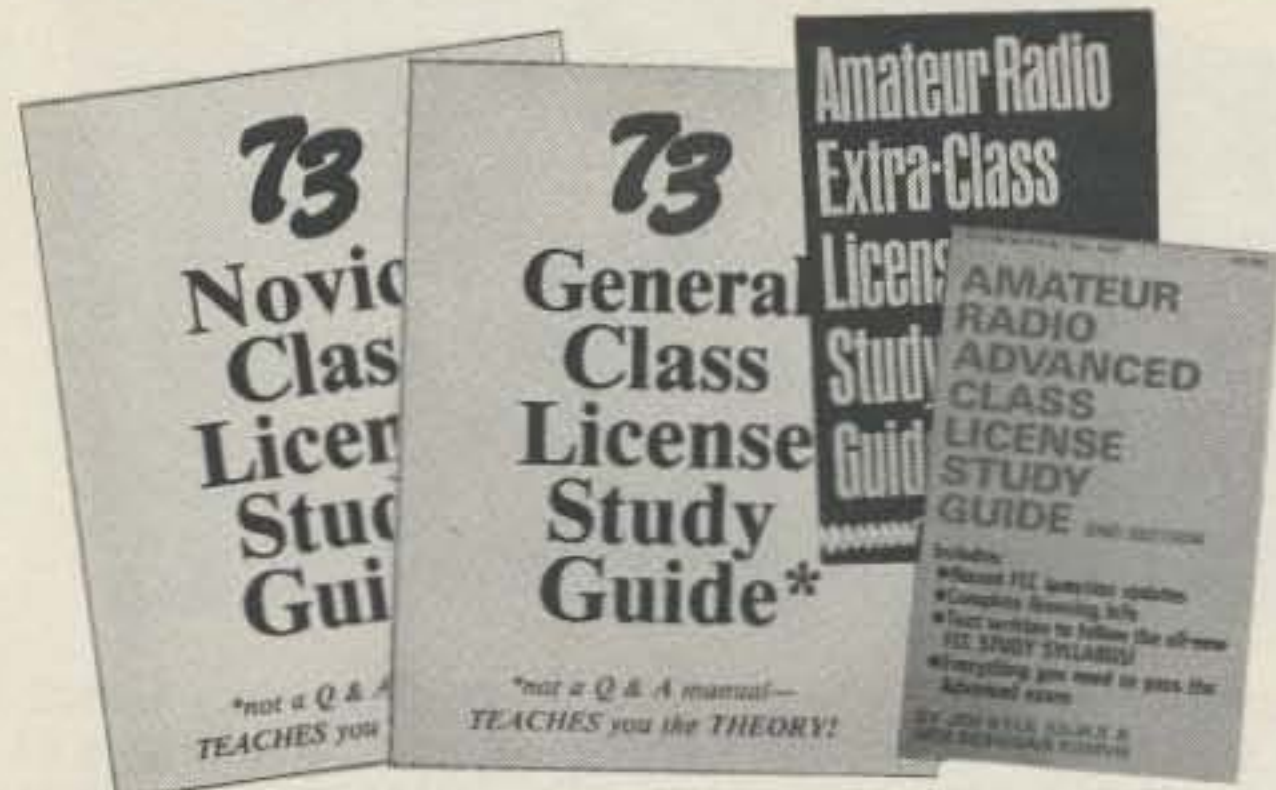

● **NOVICE STUDY GUIDE—SG7357**—Here is a completely new study guide and reference book for the potential ham. This is not a question/answer memorization course. Electronic and radio fundamentals are presented and explained in an easy-to-understand fashion, preparing the beginner for the Novice exam. Includes the latest FCC amateur regulations, as well as application forms. Easily the best path into the exciting world of ham radio! \$4.95.*

● **GENERAL CLASS STUDY GUIDE—SG7358**—A complete theory course for the prospective General or Technician. This reference explains transistor, amplifier, and general radio theory, while preparing the Novice for the "big" ticket. After getting your ticket, you'll use this guide again and again as an electronic reference source. Not a question/answer guide that becomes dated when the FCC updates the amateur exams. \$5.95.*

● **ADVANCED CLASS STUDY GUIDE—SG1081**—Ready to upgrade your license? To prevent retaking the FCC theory exam, you need the 73 Advanced theory guide. SSB, antenna theory, transmitters, and electronics measuring techniques are covered in detail in this easy-to-follow study guide. Special modes and techniques, such as RTTY, are also treated. An engineering degree is not necessary to master Advanced theory—try this book before visiting the examiner's office! \$5.95.*

● **EXTRA CLASS LICENSE STUDY GUIDE—SG1080**—Before going for your 1 × 2 call, it pays to be a master of the Extra class electronic theory. This study guide is the logical extension of the 73 theory course. All the theory necessary to pass the exam is presented. Antennas, transmission lines, swr are discussed, as well as noise, propagation, and specialized communication techniques. This book is not a classroom lecture or memorization guide, but rather a logical presentation of the material that must be understood before attempting the Extra exam. Save yourself a return trip to the FCC and try the 73 method first! \$5.95.*



NOVICE THEORY TAPES Startling Learning Breakthrough



● **NOVICE THEORY TAPES—CT7300**—Startling Learning Breakthrough. You'll be astounded at how really simple the theory is when you hear it explained on these tapes. Three tapes of theory and one of questions and answers from the latest Novice exams give you the edge you need to breeze through your exam. 73 is interested in helping get more amateurs, so we're giving you the complete set of our tapes for the incredibly low price of **ONLY \$15.95.***

Scientists have proven that you learn faster by listening than by reading because you can play a cassette tape over and over in your spare time—even while you're driving! You get more and more info each time you hear it.

You can't progress without solid fundamentals. These four hour-long tapes give you all the basics you'll need to pass the Novice exam easily. You'll have an understanding of the basics which will be invaluable to you for the rest of your life! Can you afford to take your Novice exam without first listening to these tapes? Set of 4—\$15.95.*



SSTV

● **SLOW SCAN TELEVISION TAPE—CT7350**—Prize-winning programs from the 73 SSTV contest. Excellent for Demo! \$5.95.*

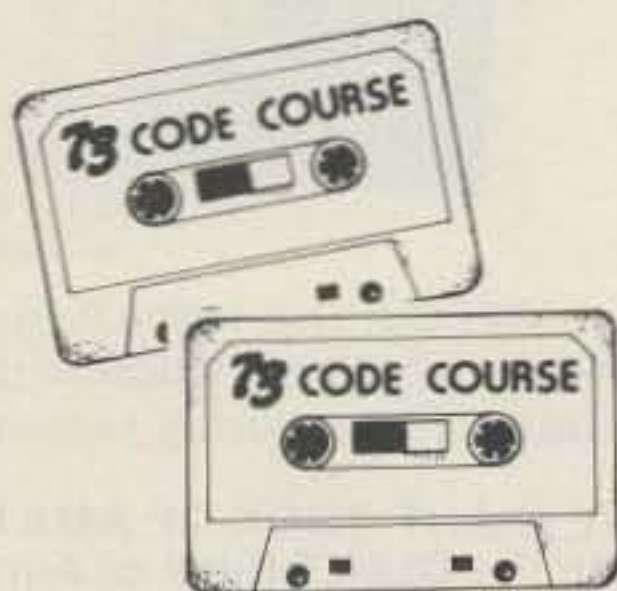

73 CODE SYSTEM TAPES

Any Four Tapes For \$15.95! *
\$4.95 Each! *

"GENESIS"

5 WPM—CT7305—This is the beginning tape for people who do not know the code at all. It takes them through the 26 letters, 10 numbers and necessary punctuation, complete with practice every step of the way using the newest blitz teaching techniques. It is almost miraculous! In one hour many people—including kids of ten—are able to master the code. The ease of learning gives confidence to beginners who might otherwise drop out.

"THE STICKLER"

6+ WPM—CT7306—This is the practice tape for the Novice and Technician licenses. It is made up of one solid hour of

code, sent at the official FCC standard (no other tape we've heard uses these standards, so many people flunk the code when they are suddenly—under pressure—faced with characters sent at 13 wpm and spaced for 5 wpm). This tape is not memorizable, unlike the zany 5 wpm tape, since the code groups are entirely random characters sent in groups of five.

"THE CANADIAN"

10+ WPM—CT7310—73 hasn't forgotten the Canadian hams—our 10 WPM tape prepares you to breeze through your country's licensing exams. Like the other code groups, the tape is not memorizable and, once mastered, provides a margin of safety in the actual text situation.

"BACK BREAKER"

13+ WPM—CT7313—Code groups again, at a brisk 13 per so you will be at ease when you sit down in front of the steely-eyed government inspector and he starts sending you plain language at only 13 per. You need this extra margin to overcome the panic which is universal in the test situations. When you've spent your money and time to take the test, you'll thank heavens you had this back-breaking tape.

"COURAGEOUS"

20+ WPM—CT7320—Code is what gets you when you go for the Extra class license. It is so embarrassing to panic out just because you didn't prepare yourself with this tape. Though this is only one word faster, the code groups are so difficult that you'll almost fall asleep copying the FCC stuff by comparison. Users report that they can't believe how easy 20 per really is with this fantastic one hour tape.

"OUTRAGEOUS"

25+ WPM—CT7325—This is the tape for that small group of overachieving hams who wouldn't be content to simply satisfy the code requirements of the Extra Class license. It's the toughest tape we've got and we keep a permanent file of hams who have mastered it. Let us know when you're up to speed and we'll inscribe your name in 73's CW "Hall of Fame."



Use the order card in the back of this magazine or itemize your order on a separate piece of paper and mail to:
73 Radio Bookshop • Peterborough NH 03458. Be sure to include check or detailed credit card information.
*Add \$1.00 handling charge. Note: Prices subject to change on books not published by 73 Magazine.

FOR CUSTOMER SERVICE CALL (603) 924-7298

RADIO BOOKSHOP

73 TECHNICAL LIBRARY

● **BEHIND THE DIAL**—BK7307—By Bob Grove. Get more fun out of shortwave listening with this interesting guide to receivers, antennas, frequencies and interference. \$4.95.*

● **THE CHALLENGE OF 160**—BK7309—is the newest book in the 73 technical library, dedicated to 160 meter operating. Si Dunn provides all necessary information to get started on this unique band. The all-important antenna and ground systems are described in detail. The introduction contains interesting photos of Stew Perry's (the King of 160) shack. This reference is a must for new and experienced "Top Band" operators. Price: \$4.95.*

● **IC OP-AMP COOKBOOK**—BK1028—by Walter G. Jung. Covers not only the basic theory of the IC op amp in great detail, but also includes over 250 practical circuit applications, liberally illustrated. 592 pages, 5½ × 8½, softbound. \$12.95.*

● **THE POWER SUPPLY HANDBOOK**—BK7305—Need a power supply for a gadget you're building? In the **POWER SUPPLY HANDBOOK** there are dozens ready-to-build, plus detailed steps for designing your own. There are circuits and parts lists for all kinds of supplies, ranging from simple DC types to highly stable regulated versions. If you need a circuit to convert a DC voltage to a higher or lower voltage, turn DC into AC, or AC to DC—then this is the book you need. With more than 400 pages, you should be able to find just the circuit you need. Without a doubt one of the best power supply source books available, compiled by the editors of 73. \$7.95.*



● **INTRODUCTION TO RTTY**—BK7380—A beginner's guide to radioteletype including teletypewriter fundamentals, signals, distortion and RTTY art. You can be a RTTY artist! A 73 publication. \$2.00.*

● **THE NEW RTTY HANDBOOK**—BK7347—is a new edition and the only up-to-date RTTY book available. The state of the art has been changing radically and has made all previous RTTY books obsolete. It has the latest circuits, great for the newcomer and expert alike. \$5.95.*

● **PROPAGATION WIZARD'S HANDBOOK**—BK7302—by J. H. Nelson. When sunspots riddled the worldwide communications networks of the 1940's, John Henry Nelson looked to the planets for an answer. The result was a theory of propagation forecasting based upon interplanetary alignment that made the author the most reliable forecaster in America today. The book provides an enlightened look at communications past, present, and future, as well as teaching the art of propagation forecasting. \$6.95.*



● **SSB... THE MISUNDERSTOOD MODE**—BK7351—by James B. Wilson. Single Sideband Transmission... thousands of us use it every day, yet it remains one of the least understood facets of amateur radio. J. B. Wilson presents several methods of sideband generation, amply illustrated with charts and schematics, which will enable the ambitious reader to construct his own sideband generator. A must for the technically-serious ham. \$5.50.*

● **SSTV HANDBOOK**—BK7354(hardcover), BK7355(softcover)—This excellent book tells all about it, from its history and basics to the present state-of-the-art techniques. Contains chapters on circuits, monitors, cameras, color SSTV, test equipment and much more. Hardbound \$7.00, softbound \$5.00.*

● **WEATHER SATELLITE HANDBOOK**—BK7370—Simple equipment and methods for getting good pictures from the weather satellite. Antennas, receivers, monitors, facsimile you can build, tracking, automatic control (you don't even have to be home). Dr. Taggart WB8DQT. \$4.95.*

● **73 DIPOLE AND LONG-WIRE ANTENNAS**—BK1016—by Edward M. Noll W3FQJ. This is the first collection of virtually every type of wire antenna used by amateurs. Includes dimensions, configurations, and detailed construction data for 73 different antenna types. Appendices describe the construction of noise bridges, line tuners, and data on measuring resonant frequency, velocity factor, and swr. \$5.50.*



● **THE GIANT BOOK OF AMATEUR RADIO ANTENNAS**—BK7304—With the **GIANT Book of Amateur Radio Antennas** by your side, antennas will become the least of your worries. Over 450 pages of design ideas, theory and reference data make this book live up to its title. The 7 chapters cover everything from basic antenna theory through designs for DIY accessories, as well as dozens of antenna designs. Whether planning to build or buy, design or admire, test or enjoy a ham antenna—this is the book for you. From the editors of 73; published by Tab Books. \$12.95 Hardback.*

● **73 VERTICAL, BEAM AND TRIANGLE ANTENNAS**—BK1069—by Edward M. Noll W3FQJ. Describes 73 different antennas for amateurs. Each design is the result of the author's own experiments covering the construction of noise bridges and antenna line tuners, as well as methods for measuring resonant frequency, velocity factor, and standing-wave ratios. 160 pages. \$5.50.*

● **VHF ANTENNA HANDBOOK**—BK7368—The **NEW VHF Antenna Handbook** details the theory, design and construction of hundreds of different VHF and UHF antennas... A practical book written for the average amateur who takes joy in building, not full of complex formulas for the design engineer. Packed with fabulous antenna projects you can build. \$4.95.*



Use the order card in the back of this magazine or itemize your order on a separate piece of paper and mail to:
73 Radio Bookshop • Peterborough NH 03458. Be sure to include check or detailed credit card information.
*Add \$1.00 handling charge. Note: Prices subject to change on books not published by 73 Magazine.

FOR TOLL FREE ORDERING CALL 1-800-258-5473

Radio Bookshop

TEST EQUIPMENT

● **RF AND DIGITAL TEST EQUIPMENT YOU CAN BUILD**—BK1044—Rf burst, function, square wave generators, variable length pulse generators—100 kHz marker, i-f and rf sweep generators, audio osc, af/rf signal injector, 146 MHz synthesizer, digital readouts for counters, several counters, prescaler, microwave meter, etc. 252 pages. \$5.95.*

● **VOL. I COMPONENT TESTERS**—LB7359—... how to build transistor testers (8), diode testers (3), IC testers (3), voltmeters and VTVMs (9), ohmmeters (8 different kinds), inductance (3), capacity (9), Q measurement, crystal checking (6), temperature (2), aural meters for the blind (3) and all sorts of miscellaneous data on meters... using them, making them more versatile, making standards. Invaluable book. \$4.95.*

● **VOL. II AUDIO FREQUENCY TESTERS**—LB7360—... jam packed with all kinds of audio frequency test equipment. If you're into SSB, RTTY, SSTV, etc., this book is a must for you... a good book for hi-fi addicts and experimenters, too! \$4.95.*

● **VOL. III RADIO FREQUENCY TESTERS**—LB7361—Radio frequency waves, the common denominator of Amateur Radio. Such items as SWR, antenna impedance, line impedance, rf output and field strength; detailed instructions on testing these items includes sections on signal generators, crystal calibrators, grid dip oscillators, noise generators, dummy loads and much more. \$4.95.*

● **VOL. IV IC TEST EQUIPMENT**—LB7362—Become a troubleshooting wizard! In this fourth volume of the 73 TEST EQUIPMENT LIBRARY are 42 home construction projects for building test equipment to work with your ham station and in servicing digital equipment. Plus a cumulative index for all four volumes of the 73 TEST EQUIPMENT LIBRARY. \$4.95.*



THE WELL-EQUIPPED HAM SHACK

● **73 MAGAZINE BINDERS**—Preserve and protect your collection for your lifetime! There's no excuse for lost issues when you have these handsome red binders with gold lettering. Order 1—BN1001—for \$6.50*; 2 or more—BN1002—for \$6.00 each.* (specify 1978 or 1979 binders)

● **QSL CARDS**—73 turns out a fantastic series of QSL cards at about half the cost of having them done elsewhere because they are run as a fill-in between printing books and other items in the 73 Print Shop. 250 Style W—QW0250—for \$8.95*; 500 Style W—QW0500—for \$13.95*; 250 Style X—QX0250—for \$8.95*; 500 Style X—QX0500—for \$13.95*; 250 Style Y—QY0250—for \$8.95*; 500 Style Y—QY0500—for \$13.95.*



● **HOW TO BUILD A MICROCOMPUTER—AND REALLY UNDERSTAND IT**—BK7325—by Sam Creason. The electronics hobbyist who wants to build his own microcomputer system now has a practical "How-To" guidebook. Sam Creason's book is a combination technical manual and programming guide that takes the hobbyist step-by-step through the design, construction, testing and debugging of a complete microcomputer system. \$9.95.*

● **1979 WORLD REPEATER ATLAS**—BK7346—With a new easy-to-use format, the 1979 World Repeater Atlas is the largest ever published by 73. More than 230 pages of repeaters, listed by both location and frequency, together with over 50 location maps—make this the best repeater atlas ever! Nearly 2000 separate repeater locations are shown on the maps, with greater accuracy than ever before. \$4.95.*

● **BACK ISSUES**—Complete your collection; many are prime collectables now, classics in the field! A full collection is an invaluable compendium of radio and electronics knowledge!



Style X

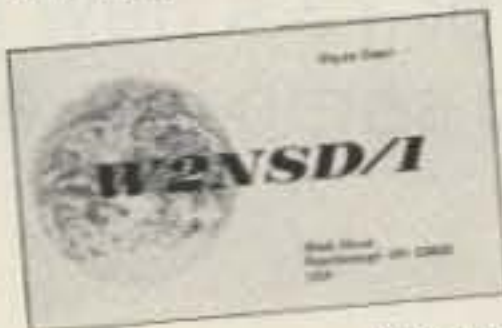

Style W

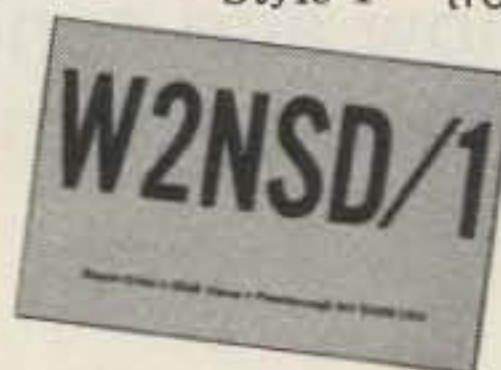

Style Y

Single back issue—ST0000—\$3.00*;
25 our choice—ST2500—\$12.00*;
25 your choice—ST2501—\$25.00*;
5 your choice—ST0500—\$8.50*;
10 your choice—ST1000—\$14.00.*

● **OWNER REPAIR OF AMATEUR RADIO EQUIPMENT**—BK7310—Frank Glass shares over 40 years of operating, servicing, and design experience in this book. There are several books and numerous articles available on the subject of repairs to electronic equipment. The information within these books ranges from the elementary to the highly technical written for the top engineers in the field. But this book stands out from the rest in that it is written in narrative style aimed at conveying the concept of electronic servicing. A written discussion of how components work and how they are combined to provide communication equipment is used to help the reader understand the concepts required to service station equipment. \$7.95.*

● **A GUIDE TO HAM RADIO**—BK7321—by Larry Kahaner WB2NEL. What's Amateur Radio all about? You can learn the basics of this fascinating hobby with this excellent beginner's guide. It answers the most frequently asked questions in an easy-going manner, and it shows the best way to go about getting an FCC license. A Guide to Ham Radio is an ideal introduction to a hobby enjoyed by people around the world. \$4.95.*

● **LIBRARY SHELF BOXES**—These sturdy white, corrugated, dirt-resistant boxes each hold a full year of 73 or Kilobaud Microcomputing. With your order, request self-sticking labels for any of the following: 73, Kilobaud Microcomputing, CQ, QST, Ham Radio, Personal Computing, Radio Electronics, Interface Age, and Byte. Order 1—BX1000—for \$2.00*; order 2-7—BX2002—for \$1.50 each*; order 8 or more—BX1002—for \$1.25 each*.

Use the order card in the back of this magazine or itemize your order on a separate piece of paper and mail to:
73 Radio Bookshop • Peterborough NH 03458. Be sure to include check or detailed credit card information.
* Add \$1.00 handling charge. Note: Prices subject to change on books not published by 73 Magazine.

FOR CUSTOMER SERVICE CALL (603) 924-7298

**22,650
pages.**



**That's the size of the world's
most comprehensive guide to
the subject of ham radio:
18 years of 73 Magazine.**

The back issues of 73 are a gold mine of interesting articles. Unlike the other magazines, which fill their pages with activity reports, there's little to go stale in 73. You'll find pioneering articles on SSTV, FM, repeaters, ICs, and computers. Even the editorials are fun as Wayne Green's dire predictions, like the debacle of incentive licensing, have come to pass.

Clip the coupon below and send for 73's new back issue catalogue. Treat yourself (or a friendly ham) to some fun, and a fantastic bargain to boot.

YES! Rush me 73's FREE Back Issue Catalogue!

Name _____

Address _____

City _____ State _____ Zip _____

73 **magazine**
PETERBOROUGH NH 03458

ALL NEW 1979 REPEATER ATLAS OF THE WORLD



The all new 1979 Repeater Atlas is now available as a result of the cooperation of hundreds of individuals, repeater groups, and coordinators. This is the largest atlas available anywhere. It includes 234 pages, 50 location maps, over 4,500 stations, and 9,000 entries, in a new, easy-to-use format indexed by location and frequency. Call Toll Free (800) 258-5473; have your credit card handy and order your 1979 Repeater Atlas (BK 7346) today. \$4.95

73 magazine

Peterborough NH 03458

MOVING?

Let us know 8 weeks in advance so that you won't miss a single issue of 73 Magazine. Attach old label where indicated and print new address in space provided. Also include your mailing label whenever you write concerning your subscription. It helps us serve you promptly. Write to:

73 magazine

Subscription Department
P.O. Box 931
Farmingdale NY 11737

- | | |
|---|---|
| <input type="checkbox"/> Address change only | <input type="checkbox"/> Payment enclosed |
| <input type="checkbox"/> Extend subscription | (1 extra BONUS issue) |
| <input type="checkbox"/> Enter new subscription | <input type="checkbox"/> Bill me later |
| <input type="checkbox"/> 1 year \$18.00 | |

If you have no label handy, print OLD address here.

Name _____ Call _____

Address _____

City _____ State _____ Zip _____

print NEW address here:

Name _____ Call _____

Address _____

City _____ State _____ Zip _____

AFFIX LABEL

S8-79

PROPAGATION

by
J. H. Nelson

EASTERN UNITED STATES TO:

GMT: 00 02 04 06 08 10 12 14 16 18 20 22

ALASKA	14	14	7A	7	7	7	7	7A	14	14	14	14
ARGENTINA	21	14A	14	7A	7	7	14	21	21	21A	21A	21
AUSTRALIA	21A	14A	14	7B	7B	7	7	7	7	14	14	21
CANAL ZONE	21	14	14	7	7	7	14	14	14	21	21A	21A
ENGLAND	14	14	7	7	7A	14	14	21	21	14	14	14
HAWAII	21	14	14	7B	7	7	7	14B	14	14	21	21
INDIA	14	14	7B	7B	7B	7B	7A	14	14	14	14	14
JAPAN	14	14	14	7B	7B	7B	7B	7A	14B	14	14	14A
MEXICO	21	14	14	7	7	7	7	14	14	14	21	21
PHILIPPINES	14	14	14B	7B	7B	7B	7B	14B	14	14	14	14
PUERTO RICO	14	14	7	7	7	7	7A	14	14	14	14	14
SOUTH AFRICA	7B	7	7	7	7B	14	14	21	21A	21A	14	14
U. S. S. R.	7	7	7	7	7	7B	14	14	14	14A	14A	14
WEST COAST	21	14A	14	7	7	7	7	14	14	14	21	21

CENTRAL UNITED STATES TO:

ALASKA	14	14	14	7A	7	7	7	7	14	14	14	14
ARGENTINA	21	21	14	7A	7	7	14	14	21	21	21A	21A
AUSTRALIA	21A	21	14	14	7	7	7	7	7	14	14	21
CANAL ZONE	21A	21	14	7	7	7	7	14	14	21	21	21A
ENGLAND	14	7	7	7	7	7	14	14	14	14	21	14
HAWAII	21	21	14A	14	7	7	7	7	14	14	21	21
INDIA	14	14	14	7B	7B	7B	7B	7A	14	14	14	14
JAPAN	14A	14	14	7A	7B	7B	7B	7A	14B	14	14	14
MEXICO	14	14	7	7	7	7	7	7A	14	14	14	14
PHILIPPINES	14	14	14	14B	7B	7B	7B	14B	14	14	14	14
PUERTO RICO	21	14	7A	7	7	7	14	14	14	14	21	21
SOUTH AFRICA	7B	7	7	7	7B	7B	14	14	14	21	21	14
U. S. S. R.	7	7	7	7	7	7	7A	14	14	14	14A	14

WESTERN UNITED STATES TO:

ALASKA	14	14	14	7A	7	7	7	7	14	14	14	14
ARGENTINA	21	21	14	14	7	7	7	14	21	21	21A	21A
AUSTRALIA	21A	21A	21A	14	14	14	7	7	7	14	14	21
CANAL ZONE	21A	21	14	7	7	7	7	14	14	21	21	21
ENGLAND	14	7	7	7	7	7	7	14	14	14	14A	14
HAWAII	21A	21A	21	14	14	7	7	7	14	14	21	21
INDIA	14	14	14	14	7B	7B	7B	7B	14	14	14	14
JAPAN	14A	14A	14	14	7	7	7	7A	14	14	14	14
MEXICO	14A	14	14	7	7	7	7	14	14	14	14A	21
PHILIPPINES	14A	14A	14	14	14	7B	7B	7	14	14	14	14
PUERTO RICO	21	14A	14	7	7	7	7	14	14	14A	21	21
SOUTH AFRICA	7B	7	7	7	7B	7B	7B	14	14	14	21	14
U. S. S. R.	7B	7	7	7	7	7	7B	14	14	14	14	14
EAST COAST	21	14A	14	7	7	7	7	14	14	14	21	21

- A = Next higher frequency may also be useful
- B = Difficult circuit this period
- F = Fair
- G = Good
- P = Poor
- SF = Chance of solar flares

august

sun	mon	tue	wed	thu	fri	sat
			1	2	3	4
			G	G	G	G
5	6	7	8	9	10	11
G	G	G	G	G	G	F
12	13	14	15	16	17	18
F	F/SF	F/SF	F/SF	F/SF	P/SF	P/SF
19	20	21	22	23	24	25
F	G	G	G	F	F/SF	F/SF
26	27	28	29	30	31	
F	F	G	G	G	G	

READER SERVICE

A46 ABC Communications..... 95	* Ehrhorn Technological Opera- tions, Inc..... 128	* Palomar Engineers..... 11	V75 Vineyard Amateur Radio..... 123
A1 Adirondack Radio Supply..... 148	F5 Flesher Corporation..... 143	P31 Panasonic..... 22	W15 Wacom..... 128
A24 Adva Electronics..... 170	G12 Germantown Amateur Supply..... 49	P20 para-graphics..... 129	W18 Western Electronics.... 123,147
A60 AED Electronics..... 144	G22 G.I.S.M.O..... 47	P41 P. C. Electronics..... 146	W2 Wilson Electronics..... 3
A92 AHF Antennas..... 128	G4 Godbout Electronics..... 162	P44 Pickering Codemaster Co..... 76	W10 Windjammer..... 118
A57 Alliance Manufacturing Co..... 7	* HAL Communications..... 21	* Plainsman Micro Systems..... 86	X3 Xitex Corp..... 63
A40 Amateur Radio Supply of Nashville, Inc..... 105	H24 Hal-Tronix..... 75	P2 Poly Paks..... 165	Y1 Yaesu Electronics Corp..... CIII,27,55
A21 Amateur-Wholesale Elect..... 152,153	* Ham-O-Rama '79..... 146	Q3 Quest Electronics..... 149	From 73..... 86,129,173-178
A58 American Crystal..... 148	H2 Ham Radio Center..... 18,29	R1 Radio Amateur Callbook, Inc..... 144	
A26 Amidon Associates..... 146	H16 Hamtronics, NY..... 23,157	* Radio World..... 45	
* Amsat..... 54	H8 Hamtronics, PA..... 150	R8 Ramsey Electronics..... 156	
A62 Antenna Specialists..... 86	H3 Henry Radio..... CII, 22	R27 RF Power Labs, Inc..... 122	
A6 Apron Laboratories..... 150	H44 HFT, Inc..... 143	R35 Ross Distributing Corp..... 76	
* Associated Radio..... 164	H36 Hustler..... 125	S100 Scott Manufacturing..... 109	
A93 Avanti R & D..... 59,130	* ICOM..... 19	S63 Semiconductors Surplus..... 167	
B23 Barker-Williamson..... 45	I32 Instant Software..... 87-89	S102 Sencore..... 23	
B54 Barry Electronics..... 127	I9 Integrated Circuits, Unltd..... 169	S33 S-F Amateur Radio Services..... 147	
B49 J. S. Betts Co..... 148	I27 IRL..... 67	S7 Space Electronics..... 128	
B42 Brodie Electronics Co..... 71	J1 Jameco Electronics..... 163	S81 Spectronics, Inc..... 38,39	
B8 Bullet Electronics..... 161	J2 Jan Crystals..... 147	S8 Spectrum Commun..... 30,31	
C88 C & A Elec. Enterprises..... 71	K13 Kantronics..... 86	S10 SST Electronics..... 153	
C3 Clegg..... 75,117	* Kenwood..... CIV,5	S18 Standard Communications..... 146	
C21 Coakit..... 86	K14 Key Electronics..... 148	S43 Surplus Electronics..... 166	
C106 Command Productions..... 150	* Kilobaud..... 83	S44 Swan Electronics..... 8,9	
C58 Communications Center NE..... 103,121	L24 R. Leslie Electronics Lab..... 145	T64 Technical Clinic..... 123	
C5 Communications Elec..... 143	L9 Long's Electronics..... 110-115	T52 Tele-Tow'r Mfg. Co., Inc..... 145	
C115 Communications Electronics Specialties..... 147	L17 Lunar Electronics..... 54	* Ten-Tec..... 13	
C6 Communications Spec..... 16,17	M48 Macrotronics, Inc..... 147	T34 Thomas Communications..... 66	
C105 Communications & TV Unltd..... 146	M35 Madison Elec. Sup..... 107,119	T48 Tower Electronics Corp..... 117	
C143 Cornell-Dubillier..... 23	M36 Maggore Electronic Lab..... 148	T18 Trac Electronics, Inc..... 11	
D6 Peter W. Dahl Company..... 85	* Melbourne Florida Hamfest..... 123	T3 Tufts Radio Elec..... 128,151	
D35 Daytapro Electronics, Inc..... 148	M52 MFJ Enterprises..... 24,25,77	U10 UDM Enterprises..... 150	
D29 Dielectric Communications..... 145	M8 MHZ Electronics..... 154,155	U9 Unadilla/Reyco Division..... 45	
D20 Digital Research Corp..... 158,159	M69 Micro Control Specialties..... 144	U8 United Products..... 171	
D23 Dovetron..... 123	M55 Microlog Corp..... 133	U6 Universal Amateur Radio, Inc..... 76	
D25 DSI Instruments..... 93	M95 Micro Management Systems..... 148	V5 VHF Engineering..... 99	
	O5 OK Machine & Tool..... 81	V24 Vibroplex..... 15,127	
	O3 Optoelectronics, Inc..... 23,150		

*Reader Service inquiries not honored.
Please contact advertiser directly.

BOOKS, ETC.

BK1016 73 DIPOLE & LONG WIRE ANTENNAS..... \$ 5.50	BK1015 PRACTICAL ANTENNAS FOR THE RADIO AMATEUR..... \$ 9.95
ST0000 73 BACK ISSUE..... \$ 3.00	BK7302 PROPAGATION WIZARD'S HANDBOOK..... \$ 6.95
ST2500 73 BACK ISSUES—25 OUR CHOICE..... \$10.00	QW0250 QSL CARDS—STYLE W—250..... \$ 8.95
ST0500 73 BACK ISSUES—5 YOUR CHOICE..... \$ 7.00	QW0500 QSL CARDS—STYLE W—500..... \$13.95
ST1000 73 BACK ISSUES—10 YOUR CHOICE..... \$12.00	QX0250 QSL CARDS—STYLE X—250..... \$ 8.95
ST2501 73 BACK ISSUES—25 YOUR CHOICE..... \$20.00	QX0500 QSL CARDS—STYLE X—500..... \$13.95
BK7307 BEHIND THE DIAL..... \$ 4.95	QY0250 QSL CARDS—STYLE Y—250..... \$ 8.95
BN1001 BINDER—73—1..... \$ 6.50	QY0500 QSL CARDS—STYLE Y—500..... \$13.95
BN1002 BINDER—73—2 AND UP..... \$ 6.00	BK7346 1979 WORLD REPEATER ATLAS..... \$ 4.95
BK7309 CHALLENGE OF 160..... \$ 4.95	BK1044 RF DIGITAL TEST EQUIPMENT..... \$ 5.95
CT7305 CODE TAPE—5 WPM..... \$ 4.95	BK7347 RTTY HANDBOOK..... \$ 5.95
CT7306 CODE TAPE—6 + WPM..... \$ 4.95	BX1000 SHELF BOX—1..... \$ 2.00
CT7310 CODE TAPE—10 + WPM..... \$ 4.95	BX1001 SHELF BOXES—2..... \$1.50 each
CT7313 CODE TAPE—13 + WPM..... \$ 4.95	BX1002 SHELF BOXES—8 AND UP..... \$1.25 each
CT7320 CODE TAPE—20 + WPM..... \$ 4.95	BK7351 SSB THE MISUNDERSTOOD MODE..... \$ 5.50
CT7325 CODE TAPE—25 + WPM..... \$ 4.95	BK7354 SSTV HANDBOOK (HARDCOVER)..... \$ 7.00
CT7394 CODE TAPES (ANY FOUR ABOVE)..... \$15.95	BK7355 SSTV HANDBOOK (SOFTCOVER)..... \$ 5.00
BK7321 GUIDE TO HAM RADIO..... \$ 4.95	CT7350 SSTV TAPE..... \$ 5.95
BK7325 HOW TO BUILD A MICROCOMPUTER & REALLY UNDERSTAND IT..... \$ 9.95	SG1081 STUDY GUIDE—ADVANCED CLASS..... \$ 5.95
BK7304 GIANT BOOK OF AMATEUR RADIO ANTENNAS..... \$12.95	SG1080 STUDY GUIDE—EXTRA CLASS..... \$ 5.95
BK1028 IC OP AMP COOKBOOK..... \$12.95	SG7358 STUDY GUIDE—GENERAL CLASS..... \$ 5.95
BK7380 INTRO TO RTTY..... \$ 2.00	SG7357 STUDY GUIDE—NOVICE CLASS..... \$ 4.95
CT7300 NOVICE THEORY TAPES..... \$15.95	LB7359 TEST EQUIP LIB V1—COMP TESTERS..... \$ 4.95
BK7310 OWNER REPAIR OF AMATEUR RADIO EQUIPMENT..... \$ 7.95	LB7360 TEST EQUIP LIB V2—AUDIO TESTERS..... \$ 4.95
BK7305 POWER SUPPLY HANDBOOK..... \$ 7.95	LB7361 TEST EQUIP LIB V3—RADIO EQUIP..... \$ 4.95
	LB7362 TEST EQUIP LIB V4—IC TEST EQUIP..... \$ 4.95
	BK1069 VERTICAL BEAM & TRIANGLE ANTNS..... \$ 5.50
	BK7368 VHF ANTENNA HANDBOOK..... \$ 4.95
	BK7370 WEATHER SATELLITE HANDBOOK..... \$ 4.95

A Breakthrough In Technology!

THE YAESU FT-207R

MICROPROCESSOR CONTROLLED SYNTHESIZED HANDIE



***The Yaesu FT-207R Synthesized Handie
has all the features you could want in a very compact package***

- 144-148 MHz Range
- 10 KHz Steps
- 3 Watts Output
- 4 Memories plus Programmable Offset
- Priority Channel
- Memory and Band Auto Scan
- Optional Equipment:
 - Tone Squelch, Speaker/Mike, Nicads, Battery Charger
- Keyboard Encoded Frequency Entry
- 2 Tone (Touchtone®) Input from Keyboard
- Keyboard Lock guards against accidental frequency change
- Odd Splits Can Be Programmed from Keyboard
- Automatic Battery Saver Feature for LED Display
- Rubber Flex Antenna



Price And Specifications Subject To
Change Without Notice Or Obligation

YAESU **The radio.**



679X

YAESU ELECTRONICS CORP., 15954 Downey Ave., Paramount, CA 90723 ● (213) 633-4007
YAESU ELECTRONICS Eastern Service Ctr., 9812 Princeton-Glendale Rd., Cincinnati, OH 45246

TS-520SE



"Cents-ability" in a quality HF Rig!

The TS-520SE is an economical new version of the TS-520S...the world's most popular 160-10 meter Amateur transceiver. Now anyone can easily afford a high quality HF transceiver, providing 200 watts PEP input on SSB and 160 watts DC on CW!

The TS-520SE is a high-quality 160-10 meter SSB/CW transceiver intended for ham-shack use. The following changes were made to produce the new "SE" model:

- Replaced the heater switch with a CW WIDE/NARROW bandwidth switch, for use with the optional CW-520 500-Hz CW filter. A big improvement for the CW operator!
- Removed DC converter terminals. Now it operates strictly on 120 VAC and is not intended for mobile use.
- Removed transverter terminals. Now it is strictly a 160-10 meter SSB/CW transceiver. (DG-5 Digital Display is optional).

Ask your Authorized Kenwood Dealer about the amazing TS-520SE...and its surprisingly affordable price!

 **KENWOOD**
...pacesetter in amateur radio

TRIO-KENWOOD COMMUNICATIONS INC.
1111 WEST WALNUT/COMPTON, CA 90220