

73 Magazine

for Radio Amateurs

- 30 **Good-Bye to Autopatch Hassles**
—low-cost remedies to common problems..... **WB2LEI/4**
- 34 **Baudot-ASCII Converter Follow-Up**
—add a FIFO buffer for typing ease
..... **VE4YD, VE4CM**
- 38 **CB to 10**
—part XXII: more talk power for the TRC-11..... **N4APN**
- 40 **The L With It**
—an alternative to the variable inductor..... **K4KI**
- 44 **Future Rig and Rigamarole**
—are you ready for faster-than-light propagation?..... **W6HDM**
- 48 **Gone But Not Forgotten**
—supermods for the HW-2021
..... **AD5X**
- 54 **The History of Ham Radio**
—part XI..... **W9CI**
- 58 **CB to 10**
—part XXIII: the Sears Roadtalker 40
..... **W6SZS**
- 62 **Neat Readout for the 2036**
—displays frequency on S-meter face
..... **K3GRX**
- 66 **Modernize That Boat Anchor!**
—older tube rigs are more fun when you give them the solid state treatment
..... **AD5X**

- 70 **Ham Shack Numerology**
—a gentle introduction to electronic math..... **W6HDM**
- 74 **COMPULOG: A Multi-Purpose Record Keeper**
—whither the paper logbook?
..... **WA1ZSE**
- 78 **Computer System I/O Interface**
—handles RS232, 20-mA loop, and KC Standard conversions
..... **VE3CAF**
- 80 **Number Fun on your Micro**
—explore mathematical curiosities with your TRS-80..... **W3KBM**
- 82 **Baudot Message Formatter**
—in BASIC..... **W6RLL**
- 88 **Lab-Quality Hi I Supply**
—part I..... **McClellan**
- 96 **A Do-It-Yourself Speech Compandor**
—let's experiment!..... **W6TNS/7**
- 107 **Morse Converter for Frequency Displays**
—another breakthrough for blind hams..... **WA6AXE/KH6**
- 116 **On the Trail of the Hamburglar**
—retrieving ripped-off radios... **W0EX**



NOW... YOU SAVE THREE WAYS AT HENRY RADIO

1. CALL FOR OUR LOW, LOW CASH OR CREDIT CARD PRICES ON ALL MAJOR EQUIPMENT.

2. TAKE ADVANTAGE OF OUR FANTASTIC MONTHLY SPECIALS ON SELECTED FINE EQUIPMENT.

TEMPO
FMH-2
2 METER HANDHELD

TEMPO
S-1

SYNTHESIZED VHF
HAND HELD
TRANSCEIVER

DRAKE
TR-7

H.F. TRANSCEIVER

KENWOOD
TS-520SE

H.F. TRANSCEIVER

SWAN
ASTRO 150

H.F. TRANSCEIVER

ICOM
IC-701

H.F. TRANSCEIVER

SWAN
100-MX

H.F. TRANSCEIVER

KENWOOD
R-1000

COMMUNICATIONS RECEIVER

KENWOOD
TS-700SP

2 METER TRANSCEIVER

DRAKE
UV-3

VHF/UHF TRANSCEIVER 6 METER

ICOM
IC-551D

6 METER TRANSCEIVER

KENWOOD
TS-180S

H.F. TRANSCEIVER

YAESU
FT-101ZD

H.F. TRANSCEIVER

YAESU
FT-901DM

H.F. TRANSCEIVER

3. ENJOY THE WORLD FAMOUS HENRY RADIO SERVICE. NO ONE ELSE CAN OFFER YOU THE BACKGROUND OF EXPERIENCE AND THE VALUE OF RESPONSIBLE MARKETING LIKE HENRY RADIO.

Henry Radio also offers a broad line of commercial and FCC type accepted amplifiers covering the range of 3 MHz to 500 MHz. Henry amplifiers are in use all around the world. Commercial and export inquiries are invited.

Tempo solid state amplifiers are available at Tempo dealers throughout the U.S.



NEW TOLL FREE ORDER NUMBER: (800) 421-8631

For all states except California.
Calif. residents please call collect on our regular numbers.

11240 W. Olympic Blvd., Los Angeles, Calif. 90064 213/477-6701
931 N. Euclid, Anaheim, Calif. 92801 714/772-9200
Butler, Missouri 64730 816/679-3127

Henry Radio

FACTORY DIRECT SALE!!

Wilson Electronics

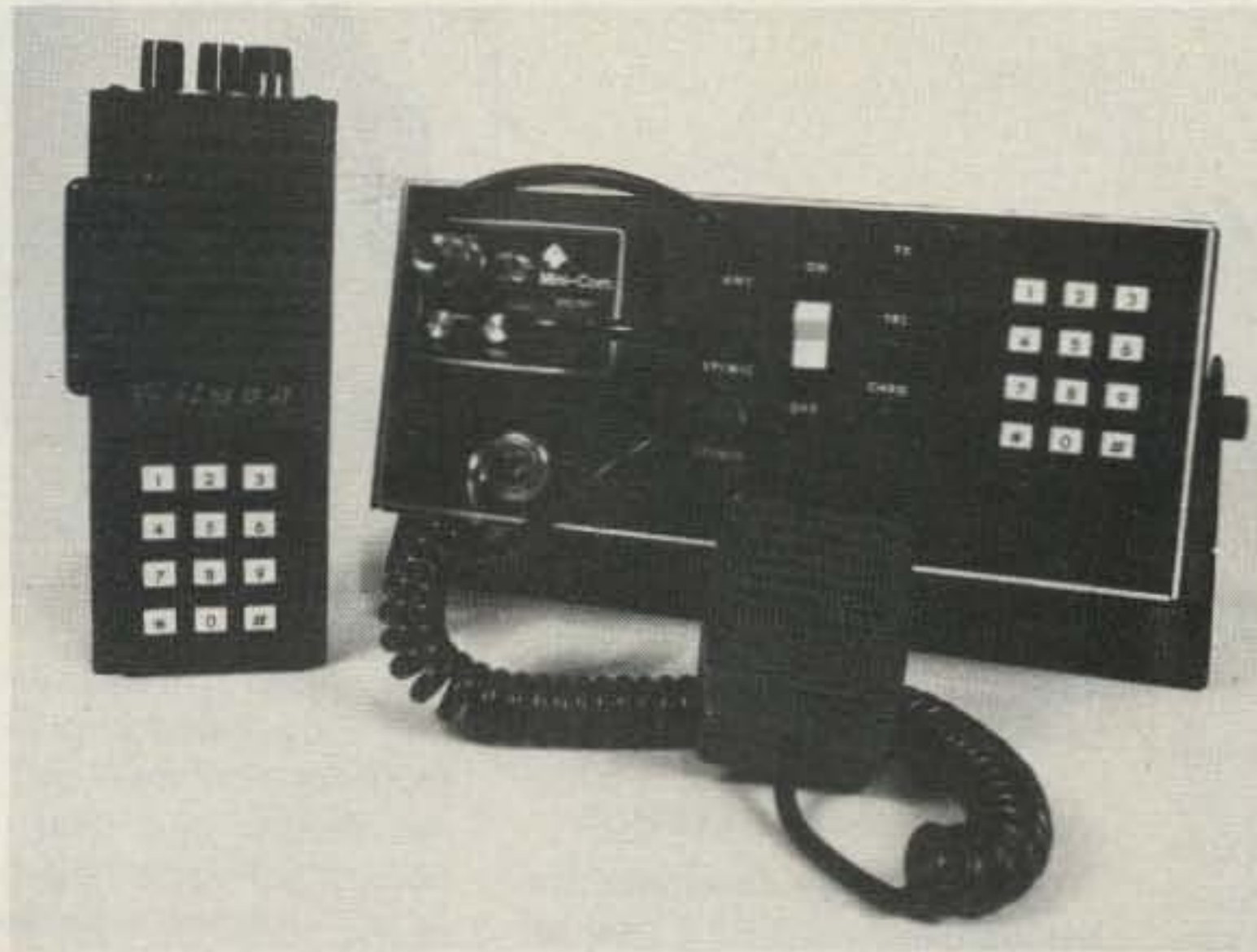

MARK II
Save \$105.90

MARK IV
Save \$112.90

- At greatly reduced prices.
- Mark II and IV accessories.
- Introducing the new Mobile Amplifier Charger.
- Battery and Five free Xtal pairs of your choice with radio.

Mobile Amplifier Charger and Amplifier Specifications

| | | POWER (Watts) | | | AMP* 13.8 Vdc |
|-----------|--------------------------|---------------|-------------|--------------|------------------|
| | | Useable | In (Typ) | Out (Typ) | |
| WMH 440TT | Mobile Amplifier Charger | 1-6 | 4 | 40 | 5.0 |
| WMH 480TT | Mobile Amplifier Charger | 1-6 | 4 | 85 | 15.6 |
| WA 440 | Broad Band Amplifier | 1-6 | 4 | 40 | 4.8 |
| WA 480 | Broad Band Amplifier | 1-6 | 4 | 85 | 15.5 |
| WA 2080 | Broad Band Amplifier | 10-25 | 20 | 90 | 11.0 |

MOBILE AMPLIFIER FEATURES

- 5-watt audio amplifier for external speaker.
- Automatic fast/trickle charge.
- Front panel Touch-Tone® Pad which allows generation of DTMF tones.
- Over and under mounting bracket for under dash, floor mounting or base station use.
- A Key-locking feature for security.
- Mobile antenna connect.

(Detach Here)

MODEL NUMBER

| MODEL NUMBER | | SALE PRICE |
|------------------------------------|--|------------|
| <input type="checkbox"/> MARK II | 1 and 2.5 Watt 2m HH | \$189.00 |
| <input type="checkbox"/> MARK IV | 1 and 4 Watt 2m HH Radios (Includes battery and 52/52 plus 5 Xtal pairs of your choice) | 212.00 |
| <input type="checkbox"/> BC-2 | Desk Battery Charger | 31.00 |
| <input type="checkbox"/> BP-4 | Extra Battery Pack | 19.00 |
| <input type="checkbox"/> LC-3 | Leather Case | 15.00 |
| <input type="checkbox"/> LC-3P | Leather Case for Touch-Tone® Pad | 15.00 |
| <input type="checkbox"/> TTP | Touch-Tone® Pad (Factory Installed) | 48.50 |
| <input type="checkbox"/> MC-12 | Mobile Charger Only | 135.00 |
| <input type="checkbox"/> WMH 440 | 40W Mobile Amplifier Charger | 199.00 |
| <input type="checkbox"/> WMH 480 | 80W Mobile Amplifier Charger | 271.00 |
| <input type="checkbox"/> WMH 440TT | 40W Mobile Amplifier Charger with Touch-Tone® Pad | 240.00 |
| <input type="checkbox"/> WMH 480TT | 80W Mobile Amplifier Charger with Touch-Tone® Pad | 309.00 |
| <input type="checkbox"/> WA 440 | 40W No Tuning Amplifier for Portable Radios | 108.00 |
| <input type="checkbox"/> WA 480 | 80W No Tuning Amplifier for Portable Radio | 181.00 |
| <input type="checkbox"/> WA 2080 | 80W No Tuning Amplifier for Mobile Units | 147.00 |

TO: **Wilson Electronics**
4288 South Polaris Avenue
Las Vegas, Nevada 89103

✓81



Ship me all indicated on above chart.

Enclosed is \$ _____

Check Money Order MC VISA

Card Number _____ Expiration Date _____

Xtals 52/52 / / / / /

Name _____ Address _____

City _____ State _____ Zip _____

Signature _____

Shipping Prepaid — Nevada Residents Add 3 1/4% Sales Tax

Info

Manuscripts

Contributions in the form of manuscripts with drawings and/or photographs are welcome and will be considered for possible publication. We can assume no responsibility for loss or damage to any material. Please enclose a stamped, self-addressed envelope with each submission. Payment for the use of any unsolicited material will be made upon acceptance. All contributions should be directed to the 73 editorial offices. "How to Write for 73" guidelines are available upon request.

Editorial Offices:

Pine Street
Peterborough NH 03458
Phone: 603-924-3873, 924-3874

Advertising Offices:

Pine Street
Peterborough NH 03458
Phone: 603-924-7138, 924-7139

Circulation Offices:

Pine Street
Peterborough NH 03458
Phone: 603-924-7296

Subscription Rates

In the United States and Possessions:

One Year (12 issues) \$18.00
Two Years (24 issues) \$30.00
Three Years (36 issues) \$45.00
Lifetime subscription \$240.00

Elsewhere:

Canada—add \$2.00 per year unless paid with U.S. currency.

All other foreign—one year only—\$26.00 payable in U.S. currency through a U.S. bank. (Surface mail).

To subscribe, renew or change an address:

Write to 73 Magazine, Subscription Department, PO Box 931, Farmingdale NY 11737. For renewals and changes of address, include the address label from your most recent issue of 73. For gift subscriptions, include your name and address as well as those of gift recipients. Postmaster: Send form #3579 to 73 Magazine, Subscription Services, P.O. Box 931, Farmingdale NY 11737.

Subscription problem or question:

Write to 73 Magazine, Subscription Department, PO Box 931, Farmingdale NY 11737. Please include an address label.

73 Magazine (ISSN 0098-9010) is published monthly by 73, Inc., 80 Pine Street, Peterborough NH 03458. Second class postage is paid at Peterborough NH 03458 and at additional mailing offices. Copyright (c) 1980 by 73, Inc. All rights reserved. No part of this publication may be reprinted or otherwise reproduced without written permission from the publisher. Microfilm Edition—University Microfilm, Ann Arbor MI 48106.

W2NSD/1 NEVER SAY DIE

editorial by Wayne Green



ST. LOUIS

The May hamfest/computerfest in St. Louis has been recognized by the League and this year will be a combination Midwest/Central Division ARRL Convention. Not bad when you remember that this show was boycotted last year by the League.

With Dynamic Dannals for a speaker, I would be eclipsed anyway, so it is best that I keep to my work at home and see how the show fares this year as an ARRL convention.

Between starting a new magazine this spring, working on plans for a software plant in Ireland, getting ready to promote two new modes of ham communications, laying plans for getting amateur radio into a bunch of Third World countries, and a few other things like that, I can ill afford to take time to visit hamfests, much as I enjoy them.

Amateur radio has been in the doldrums for a year now and there is a need for some ideas to get it going again. The number of new hams has been drying up . . . old-timers have been getting fed up with the garbage on the bands, repeaters are getting killed by crazies, sales of equipment are way down, and many dealers are folding up . . . things are a mess. I have some ideas on tackling this mess . . . including the FCC, which has been laying bummers on us one after the other for a couple of years. I was going to present a comprehensive plan for getting things going at St. Louis, but instead I'll hold it for release in 73 later on. Some of the plan has to do with the two new modes of ham communications which I will have discussed with the industry at

Aspen in January, but which will be kept secret for a while.

COPING WITH PSYCHOS

California has developed the kerchunking nerd to a new art form, the compleat psychotic repeater jammer. This has developed into a cult around Los Angeles and has driven the straight groups bananas.

My advice, which seems to be a drug on the market, is to find out whether the straights are smarter than the fruitcakes. If the FC group is winning, then they obviously have the brains on their side.

One approach is to turn helplessly to the FCC for assistance. The odds are very high that they will react poorly to this, being government employees and thus not accustomed to having to deal with actual work . . . other than handling reams of forms. Remember that the amateur radio "service" is reputed to be self-policing. My suggestion is to take this seriously and get set up to do this policing. I favor taking measures as strong as are required to get the needed results . . . the Psycho Posse, if you will.

In my experience, physical force seldom accomplishes anything beneficial. It is difficult to get a group together to brainstorm a problem when all you want to do is go out and break some SOB's neck. But what you want to do is put psychological pressure on, not break arms or cut coax. Look on such an occasion as a blessing, an opportunity for you to try to outsmart a nerd . . . if you are up to it.

The chances are very good that you will be able to enlist the help of the nerd's neighbors, too, for it is unlikely that some-

one who is so inconsiderate of his fellow hams is going to be more considerate of people who live around him. You may be able to get some help from his fellow workers, who are probably also suffering in their own way. It is very unlikely that someone who is making a career out of being a lousy ham is going to be a pillar of his community in any other way.

I would like to come up with more concrete suggestions, but most of the ideas which are coming to mind are far too fiendish. Get together in a group and brainstorm it. Not only will the exercise of the brains be fun, but you'll be surprised at the devilish ideas you'll come up with. All you want to do is make life as interesting for the bastard as he has for you . . . right?

Of course, you can always just give up, turn off your two-meter receiver, and move to other ham activities. This will immediately solve your problems. I presume you've already considered this course of action and found it wanting. Perhaps you take a perverse delight in getting mad at the buggers who screw up the repeater? Well, enter into the spirit of it and see if you can, in turn, make life frustrating and aggravating for them.

If you continue to shirk your responsibility as an amateur to participate in the self-policing action we are mandated to provide and you insist on trying to get the FCC to do your dirty work, be prepared for the FCC to react in some way that you don't expect and for the end result to be most unpleasant. Can you think of a single time when someone has petitioned the FCC for rule changes that the

High quality...top performance!



Maximum convenience with optimum features

TS-180S

The TS-180S is Kenwood's top-of-the-line all solid-state HF SSB/CW/FSK transceiver. New circuit-design technology has been incorporated throughout the transceiver, resulting in optimum receiver and transmitter performance, as well as advanced operating features that every DXer, contest operator, and all Amateurs would desire for maximum efficiency and flexibility.

TS-180S FEATURES:

- Digital Frequency Control (DFC), including four memories and manual scanning. Memories are usable in transmit and/or receive modes. Memory-shift paddle switches allow any of the memory frequencies to be tuned in 20-Hz steps up or down, slow or fast, with recall of the original stored frequency. It's almost like having four remote VFOs!
- All solid-state... including the final. No dipping or loading. Just dial up the frequency, peak the drive, and operate!
- High power... 200 W PEP/160 W DC input on

160-15 meters, and 160 W PEP/140 W DC on 10 meters (entire band provided). Also covers more than 50 kHz (100 kHz with DFC) above and below each band (MARS, etc.), and receives WWV on 10 MHz.

- Adaptable to all three new bands.
- Improved dynamic range.
- Dual SSB filter (optional), with very steep shape factor to reduce out-of-passband noise on receive and to improve operation of RF speech processor on transmit.
- Single-conversion system with highly advanced PLL circuit, using only one crystal with improved stability and spurious characteristics.
- Built-in microprocessor-controlled large digital display. Shows actual VFO frequency and difference between VFO and "M1" memory frequency. Blinking decimal points indicate "out of band." Monoscale dial, too.
- IF shift... Kenwood's famous passband tuning that reduces QRM.
- Selectable wide and narrow CW bandwidth on receive (500-Hz CW filter is optional).
- Automatic selection of upper and lower sideband (SSB NORM/SSB REV switch).
- Tunable noise blanker (adjustable noise-sampling frequency).

- RF AGC ("RGC"), which activates automatically to prevent overload from strong, local signals.
- AGC (selectable fast/slow/off).
- Dual RIT (VFO and memory/fix).
- Three operating modes... SSB, CW, and FSK.
- Improved RF speech processor.
- 13.8 VDC operation.
- Also available is the TS-180S without DFC, which still shows VFO frequency and difference between VFO and "hold" frequencies on the digital display.
- Full line of matching accessories, including PS-30 base-station power supply, SP-180 external speaker with selectable audio filters, VFO-180 remote VFO, AT-180 antenna tuner/SWR and power meter, DF-180 digital frequency control, YK-88 CW filter, and YK-88 SSB filter.

All of these advanced features can be yours... and at an attractive price! Visit your local Authorized Kenwood Dealer and inquire about the exciting TS-180S with DFC!

NOTE: Price, specifications subject to change without notice and obligation.

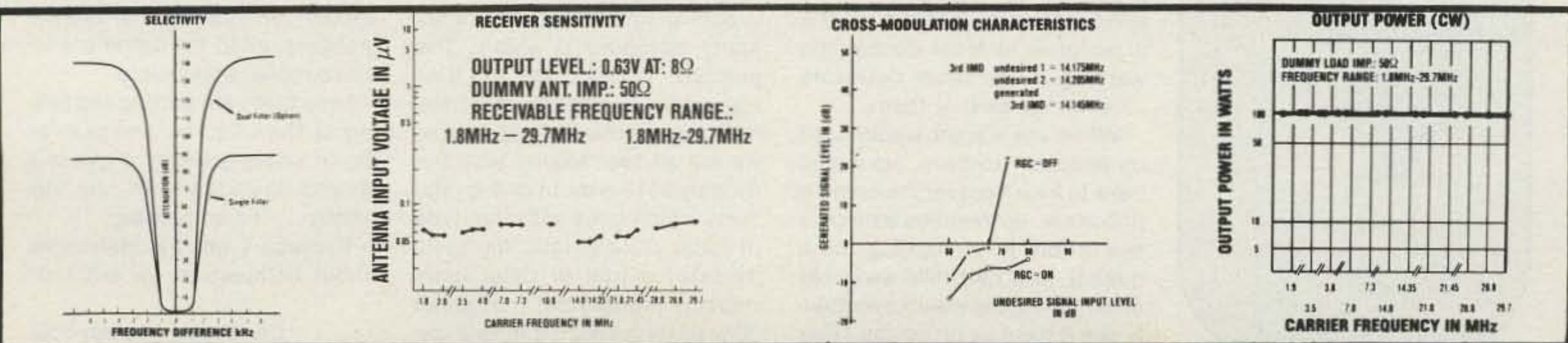

Staff

EDITOR/PUBLISHER
Wayne Green W2NSD/1

EXECUTIVE VICE PRESIDENT
Sherry Smythe

CORPORATE CONTROLLER
Alan Thulander

ASSISTANT PUBLISHER
Jeffrey DeTray WB8BTH

ADMINISTRATIVE ASSISTANT
Dotty Gibson

MANAGING EDITOR
John Burnett

ASSISTANT MANAGING EDITOR
Susan Philbrick

NEWS EDITOR
Gene Smarte WB6TOV/1

EDITORIAL ASSISTANTS
Nancy Noyd
Richard Phenix

PRODUCTION MANAGER
Noel Self WB1ARP

ASSISTANT PRODUCTION MANAGER
Robin Sloan

ART DEPARTMENT
Steve Baldwin
Bob Drew
Bruce Hedin
Kenneth Jackson
Michael Murphy
Dion Owens
Nancy Salmon
Patrice Scribner
John White

BOOK PUBLICATIONS
Jim Perry

BOOK PRODUCTION
Emily Gibbs
Chris Brown N1AUI

PHOTOGRAPHY
Bill Heydolph
Tedd Cluff
Terrie Anderson

TYPESETTING
Barbara Latti
Sara Bedell
Sandie Gunseth

ACCOUNTING MANAGER
Knud Keller KV4GG/1

DATA ENTRY
Cathy DeSilva

CIRCULATION MANAGER
Debra Boudrieau

ASSISTANT CIRCULATION MANAGER
Barbara Block

CIRCULATION
Pauline Johnstone

BULK SALES MANAGER
Ginnie Boudrieau

SHIPPING
Mark Dendy
Bill Barry
Bryan Hastings KA1DXZ

RECEPTIONIST
Doni Jarvis

ASSOCIATES
Robert Baker WB2GFE
Sanger Green
Dave Ingram K4TWJ
Larry Kahaner WB2NEL
Joe Kasser G3ZCZ
Bill Pasternak WA6ITF
John Schultz W4FA
Peter Stark K2OAW

ADVERTISING
Aline Coutu, Mgr.
Kevin Rushalko
Nancy Ciampa
Marcia Stone
Louise Holdsworth
Jerry Merrifield
Lori Mugford
Rita Rivard
Hal Stephens

result has been other than complete neglect or a disastrous proposal which overkills the problem beyond belief? This is not going to change.

Some hams have been unhappy over the FCC refusing to react at faster than their usual glacial pace (for which I give thanks) and have gone on to get their congressmen to put pressure on the FCC. This will, I predict, result in even more awful end results. The FCC is almost immobile, but when really pushed (as by a congressman), it moves in a direction which cannot be predicted. Leave it alone.

NEW RADAR DETECTORS

When I heard that every participant in the coast-to-coast Cannonball Rally, which is a race rather than a rally, had used the Cincinnati Microwave "Escort" radar detector, I suspected something was afoot. None of the radar detectors which have been on the market for some time has been spectacularly sensitive and some have been incredibly insensitive. So, even at the high ticket price of \$300, it seemed prudent to check this new entry out in comparison with the best the field had to offer heretofore.

The 73 van, fitted out as a traveling office and radio test lab, bristles with from four to six radar detectors, giving us a good idea of the sensitivity, degree of falsing, relative merit, etc., of most of the popular makes of detectors. The Escort, ordered back last summer and subject to a five-month delivery wait, finally arrived and was put on the test line in the van.

There is no shortage of effective radar detector tests in New Hampshire, where virtually every state police car and most town police are equipped with moving radar. It quickly became apparent that the Escort, the first of a new type of detector using the superheterodyne principle, is a breakthrough in microwave receivers. We found that it often gave at least double the warning of the other detectors . . . even the best of them.

When the Escort would light up and start to beep, we would have to look hard for the coming police car. Sometimes we would see it off in a parking lot a quarter to a half mile away. At other times, we would eventually see it pass us going the other

way. The unit has an S-meter on it, so you can see about how strong the radar signals are and react appropriately.

Many of the standard detectors scare the hell out of you by suddenly beeping away for no good reason. Some take off when you go under a bridge; some sound when you are near a radio station tower or a CBer. Others just chirp for no apparent reason at all. These false reports detract from the value of the detector. The Escort is subject to false alarms, too, but it is perhaps unfair to use the term "false" since what it is detecting is the signals from security systems which are sharing the police radar channel. You often get these signals when you drive by warehouses and stores where alarm protection is used. These are seldom in areas where one would expect to encounter police radar, so this falsing has not been particularly annoying.

The other detector manufacturers have recognized the power of the Escort and most of them are bringing out their own version of this superhet circuit . . . and at about the same \$300 price tag. Whistler has announced the Q-1000, promising quick deliveries. The Fox people now have the SuperFox, with 3-4 weeks delivery quoted. Fuzzbuster, which faked some people out with the claim that an earlier model was a superhet, has now announced for real their new superhet.

Of the non-superhet detectors, we found the Fuzzbuster and Bearfinder to both be good, with the Fox and Long Ranger being just a bit better most of the time. Our worst experiences were with the Whistler and Centurion, which seemed to wake up to the police at about the time a policeman's foot would be put on the van running board.

Why all this fuss over radar? Considering that the van can hardly go over 55 mph going down a steep hill with the wind in back of it, the likelihood of actually speeding is slight. The problem is this: Up in New Hampshire, where most of the radar is the moving radar type, we are all too familiar with the roughly 30% error in giving citations which goes with this type of radar. That's right; the testimony in a trial of radar units recently brought out that about 30% of the speeding tickets giv-

en with this type of radar are given in error. This means that the motorist needs every possible warning that a disaster is imminent in the area so that he can be super careful. When the detector sounds off, you first make sure that your speed is well below the allowed speed, then you quickly make a check of the traffic around you (both the cars going your direction or the other way), you look for trucks which might give large targets on the radar and which might be interpreted by the police as being your car by accident, and you watch most carefully for the police car.

We have mountains in New Hampshire and it is all too common to coast down a long hill in neutral as a way to conserve gas. To use the brakes would be to obviously waste fuel. So where do the police lie in wait? You know it . . . at the bottom of long hills. I remember a little trap the police in Whitefield (NH) had set up a few years back. At the foot of a particularly steep and long hill coming into town, they had a few feet marked with a not too obvious sign and a speed limit of 5 mph. That cost me \$25 in a speeding fine one day . . . \$10 fine and \$15 court costs. Oh, I was speeding . . . they clocked me at 15 mph through the area.

The radar detectors are also handy when we are working with the ham 10-GHz equipment. With them we can find out if the 10-GHz stuff is working, which all too frequently it isn't. That equipment spends more time on the test bench than in service.

"220 CB IS DEAD . . ."

In case you run into a ham with a conveniently short memory, it was not very long ago that we were exposed to a bunch of BS about who saved the amateur 220 band. No, it wasn't me, though I did my little part . . . as did a lot of other people. I bring this up because there are some hints that we are about to suffer another emerdement of credit-grabbing, all to the detriment of those really responsible.

I see that I am getting top billing as the villain of amateur radio in some quarters. I guess I should be happy with any top billing . . . it's *something*.

Perhaps I am too defensive about enthusiasm for amateur

Continued on page 152

(616) 982-3296

WA8ZV0



Heathkit® service is at the other end

Heathkit Service Techs know their stuff and you can count on them for answers on any Heathkit HAM gear. Most problems can be solved right over the phone. Those that require hands-on service can be brought to one of the 55 Heathkit Electronic Centers throughout the U.S. or sent in to the Heath factory. Either way, you'll find reliable, experienced people who know what they're doing. And that's a very good reason to consider Heath when you're considering amateur radio gear.



Free catalog

For all the newest in Heathkit Amateur Radio, send for the latest, free Heathkit Catalog. It's loaded with nearly 400 exciting kits for your home, work or pleasure. Send for

yours today or pick one up at your Heathkit Electronic Center.

Heathkit®

303

Heath Company, Dept. 011-634, Benton Harbor, MI 49022
Heathkit Electronic Centers (Units of Veritechnology Electronics Corporation)
are located in major cities throughout the U.S.
See your white pages.

AM-402

Propagation forecasts are some DXers' staples and others' after-dinner tea. All the monthly magazines have a propagation column and each has its uses. They are all prepared using the 56-day forecast method, due to the constraints of publishing. Forecasts found in the various DX bulletins and on the W1AW on-the-air propagation bulletins are based on 28-day recurrence of solar phenomena with some last-minute updating as necessary. One DXer who deserves recognition for the service he provides is Ted Cohen N4XX, who regularly supplies propagation forecasts to bulletin editors and others. Ted's up-to-the-minute forecasts prove to be more accurate than, say, the local weather forecaster who has thousands of dollars of equipment at his disposal.

The value of propagation forecasts in these sunspot-rich times is debatable. Those who are looking for the exquisite long-path openings on 15 and 10 meters may find the forecasts of use, although long-path propagation is vastly more difficult to predict than short path. Today's bands can generally be counted on to provide the necessary paths to what one is trying to work; the determining factor is availability of a station to work. At least that's better than during the sunspot doldrums, where both Sol and the operator at the other end often seem to be working to the DXer's detriment. During December, the N4XX forecasts, which are always labeled Above Normal, High Normal, Normal, Low Normal, and Below Normal (or combinations thereof), totalled 9 Above, 14 High, 3 Low, and 5 combinations. No days were relegated Below Normal status.

Those who noted somewhat less than sterling radio conditions in January and February, compared to autumn, are advised that worry is *not* in order. Typically, spring and fall provide more excitement than the dead of Northern Hemisphere winter, when propagation settles down and fireworks abate. Look for increasing delicious openings, especially on 20 and 15 long path, around the end of March. Meanwhile, enjoy the 40- and

80-meter bands, and 160 if you have it, during their winter peaks.

Any country you need is a rare one . . . anything you have is run of the mill. One year ago, Art Westneat W1AM ran his last list of "Most Needed" countries in the *West Coast DX Bulletin*. Seventy-five strong, the list read like the blank spaces on the countries list of most operating positions around the world. Dennis Sullivan K6YCM took that list, subtracted the countries which have been available in the past year, and came up with a final tally of the twenty-five countries craved most. Now, take a copy of this to your local travel agent and get out the checkbook!

25 places to visit in 1980:

1. BY China
2. VS9 Kamarans
3. XZ Burma
4. ZA Albania
5. VK0 Heard Island
6. VU7 Laccadives
7. 7O PRD of Yemen
8. FB8W Crozet (on now)
9. XU Cambodia
10. 3Y Bouvet (on briefly in '79)
11. VU7 Andamans
12. 3X Guinea
13. 6O Somalia
14. FR7 Glorioso
15. CE0 San Felix
16. YA Afghanistan
17. XV5 Vietnam
18. 9U5 Burundi
19. 4W Yemen
20. FR7 Juan de Nova
21. S9 Sao Thomé
22. HK0 Malpelo
23. 5A Libya
24. 7Q Malawi
25. 5X5 Uganda

Now, if anyone out there needs just 25 countries and they match with our list, we'd like to hear from you. Some sort of prize would be in order. Your editor, who is holding at about 290 after 20 years of on-again, off-again DXing, has ten of the 25, but the other 15 are enticing. Admittedly, we worked most of the ten in the early 70s and haven't heard them since.

The list is interesting from several points of view. Ten of the 25 are islands. Nine are in Asia, twelve in Africa, two in South America, and one each in Oceania (Heard) and Europe (Albania). Several have essen-

tially zero population, including Crozet, Bouvet, Juan de Nova, Glorioso, San Felix, and Malpelo. The Kamarans have only about 2,000 souls and the Andamans and Laccadives combined have less than 100,000. Of course, the most populous country on Earth tops the list.

What seems to set these 25 countries apart is a commentary on world affairs: They are all either so down and out technologically that radio is simply out of the question or else they have closed their doors to outsiders, even outsiders from their "mother country." They are all hard to get to, to get into, and probably impossible to get into with radios. The Bahamas, they ain't.

WARC is over, finally, and amateurs will probably be getting three new HF bands over the next five years or so. The implications are tremendous: 10 MHz will take much of the long-distance load off 20 meters during years of low sunspot activity, 18 MHz will be the premier DX band much of the time, and 24 MHz will give much of the fascination of 10 meters while not being quite so dependent on the solar flux. However, most radios in use around the world will not be able to receive and transmit on these bands with the simple addition of a crystal or two, so extensive use of the new spots will depend on how much the manufacturers gear up for them in the next few years.

What the new bands will do is increase enthusiasm among amateurs who have run out of accomplishments to shoot for on our present bands. There will be a #1 DXCC to be made on each band, and the scramble will be on. Some of the five-band awards will undoubtedly be expanded to eight-banders and the rush for contacts and QSLs will commence. Along with the Phase Three OSCAR satellites upcoming, these new HF bands will make the 1980s a banner decade for DXing.

AROUND THE BANDS IN DECEMBER

Possibly the high point was an operation from the Central African Republic, TL0BQ, by KA1BQ, KA1BOH, and I8MPO. Their week-long SSB-only operation pretty much put the demand for this one to bed, except for those on the CW Honor Roll, however, who were stymied in attempts to get a Morse con-

tact. Plans for an operation from the Congo by this group were thwarted. QSLs for TL0BQ go to Giampaolo Nucciotti I8KDB, V. Fracanzano 31, 80127 Napoli, Italy.

SM3RL fired up from the Maldiv Islands as 8Q7AM, working mostly CW. SM3ITL is a semi-permanent resident of the islands now and uses the call 8Q7AL. Cards for either of these go to SM3CXS.

W6QL and W6KG continued their travels in the Caribbean. Following operation from Grenada as J3ABV, they opened up on St. Vincent as VP2SAX; 9,000 contacts included 141 countries and CQ CW and ARRL 160-Meter Contests. K1XA and K1TO operated from St. Vincent as VP2SX during the CQ CW Contest, also, causing some confusion. QSL VP2SAX to YASME and VP2SX to AB1U.

TN8AJ returned to the bands in late December and his operations became more professional daily. Another Novice operator testing the DX waters from Africa is TZ4AQS, who first appeared in November, 1979. He is Jan Wilholt and his home call-sign in Holland is PE0AQS. His QSL manager, ON6BC, assisted on frequency for a few weeks, but Jan soon took the bull by the horns and began working split frequency pileups with aplomb. He is found mainly on Saturdays and Sundays on 15 and 20 meters, using a Kenwood receiver and transmitter with dipoles. He is expected to be in the Mali Republic for two years, where he is an electrician for a Dutch company building roads.

Marion Island's ZS2MI showed on 20 meters in December; the best time to find him is 05-0600 UTC around 14240. The present operator departs in April.

Mike Smedal, formerly EP2LI, now signs A7XD from Qatar. Considerable effort resulted in his equipment finally getting out of Iran in the autumn and A7XD is now found several times a week on 20 meters. His QSL manager is WA4PYF.

Four Norwegians began operating from Svalbard in December, expecting to stay until June. Calls and QSL routes are: JW1SO/LA4DM, JW7FD/LA5NM, JW5IJ/LA5NM, and JW8FG/LA8FG. Their quad loops produce a booming signal

Continued on page 137

When quality counts

Do not be fooled by the low prices, these brand new lab quality frequency counters have important advantages over instruments costing much more. The models 7010 and 8010 are not old counters repackaged but 100% new designs using the latest LSI state-of-the-art circuitry. With only 4 IC's, our new 7010 offers a host of features including 10 Hz to 600 MHz operation, 9 digit display, 3 gate times and more. This outperforms units using 10-15 IC's at several times the size and power consumption. The older designs using many more parts increase the possibility of failure and complexity of troubleshooting. Look closely at our impressive specifications and note you can buy these lab quality counters for similar or less money than hobby quality units with TV xtal time bases and plastic cases!

Both the new 7010 and 8010 have new amplifier circuits with amazingly flat frequency response and improved dynamic range. Sensitivity is excellent and charted below for all frequencies covered by the instruments.

Both counters use a modern, no warm up, 10 MHz TCXO [temperature compensated xtal oscillator] time base with external clock capability - no economical 3.579545 MHz TV xtal.

Quality metal cases with machine screws and heavy guage black anodized aluminum provide RF shielding, light weight and are rugged and attractive - not economical plastic.

For improved resolution there are 3 gate times on the 7010 and 8 gate times on the 8010 with rapid display update. For example, the 10 second gate time on either model will update the continuous display every 10.2 seconds. Some competitive counters offering a 10 second gate time may require 20 seconds between display updates.

The 7010 and 8010 carry a 100% parts and labor guarantee for a full year. No "limited" guarantee here! Fast service when you need it too, 90% of all serviced instruments are on the way back to the user within two business days.

We have earned a reputation for state-of-the-art designs, quality products, fast service and honest advertising. All of our products are manufactured and shipped from our modern 13,000 square foot facility in Ft. Lauderdale, Florida.

When quality counts...count on Optoelectronics.



MODEL 7010 600 MHz

MODEL 8010 1 GHz

- 100% U.S.A. FACTORY ASSEMBLED
- 100% PARTS & LABOR YEAR GUARANTEE
- CERTIFIED NBS TRACEABLE CALIBRATION
- EXTERNAL CLOCK INPUT
- DISPLAY HOLD FUNCTION
- 9 RED LED DIGITS, .4" HIGH
- .1 Hz RESOLUTION
- 0.1 PPM 10 MHz TCXO TIME BASE
- LAB/PORTABLE-AC ADAPTER INCLUDED
- 1 MEGOHM & 50 OHM INPUTS
- STATE-OF-THE-ART LSI DESIGNS
- COMPREHENSIVE USER MANUAL PROVIDED

• COMPACT SIZES—7010- 1-3/4" Hx4-1/4" Wx5-1/4" D 8010- 3" Hx7-1/2" Wx6-1/2" D

| MODEL | \$ PRICE | RANGE 10Hz to | LED DIGITS | SENSITIVITY | | | HI-Z INPUT 10Hz - 60 MHz | GATE TIMES | RESOLUTION | | | TCXO TIME BASE | | EXT CLOCK INPUT | NI-CAD BATT PACK |
|-----------------|------------------|---------------|------------|-------------|--------------------------|---------------------|--------------------------|-------------------|------------|--------|------------------|------------------|--------|---------------------|---------------------|
| | | | | 25-250 MHz | 50 OHM INPUT 250-450 MHz | 450 MHz-1GHz | | | 12 MHz | 60 MHz | MAX. FREQ. | 20-40 °C | FREQ. | | |
| 7010 *7010.1 | 145.00 225.00 | 600 MHz | 9 | 5-20 mV | 10-30 mV | 20-40 mV to 600 MHz | 1-10 mV | {3} .1, 1, 10 SEC | .1Hz | 1 Hz | 10 Hz 600 MHz | 1 PPM 0.1 PPM | 10 MHz | YES OPTION \$25. | YES OPTION \$15. |
| 8010 *8010.1 | 325.00 405.00 | 1 GHz | 9 | 1-10 mV | 5-20 mV | 10-25 mV | 1-10 mV | {8} .01-20 SEC | .1 Hz | 1 Hz | 10 Hz 1 GHz | 1 PPM 0.1 PPM | 10 MHz | YES STD | YES OPTION \$39. |

* Has precision 0.1 PPM TCXO time base.

MODEL 7010

#7010 600 MHz Counter - 1 PPM TCXO \$145.00
#7010.1 600 MHz Counter - 0.1 PPM TCXO \$225.00

OPTIONS

#Ni-Cad-701 Ni-Cad Battery Pack & charging circuitry
Installs inside unit \$ 15.00
#EC-70 External Clock Input, 10 MHz \$ 25.00
#CC-70 Carry Case, Padded Black Vinyl \$ 8.95

MODEL 8010

#8010 1 GHz Counter - 1 PPM TCXO \$325.00
#8010.1 1 GHz Counter - 0.1 PPM TCXO \$405.00
#8010.1-13 1.3 GHz Counter - 0.1 PPM TCXO \$495.00

OPTIONS

#Ni-Cad-801 Ni-Cad Battery Pack & charging circuitry
Installs inside unit \$ 39.00
#CC-80 Carry Case, Padded Black Vinyl \$ 9.95

ACCESSORIES

#TA-100 Telescope Ant with Right Angle BNC \$ 9.95
#P-100 Probe, 50 ohm, 1x \$13.95
#P-101 Probe, Lo-Pass, Audio Usage \$16.95
#P-102 Probe, Hi-Z, General Purpose \$16.95



ORDER FACTORY DIRECT • CALL TOLL FREE



Optoelectronics inc

5821 N.E. 14th Avenue, Fort Lauderdale, Florida 33334

1-800-327-5912

FROM FLORIDA (305) 771-2051/2

TERMS: Orders to U.S. and Canada, add 5% for shipping, handling and insurance to a maximum of \$10.00. All other orders add 10%.

Contests

Robert Baker WB2GFE
15 Windsor Dr.
Atco NJ 08004

VIRGINIA QSO PARTY
Starts: 1800 GMT Saturday,
March 8
Ends: 0200 GMT Monday,
March 10

This party is sponsored by the Sterling Park Amateur Radio Club. The same station may be worked on each band and mode; VA stations may work other VA stations. The Central Virginia Contest Club plans to put a number of rare VA counties on the air during the contest.

EXCHANGE:

QSO number, RS(T), and VA county or state, province, country.

FREQUENCIES:

Phone — 3930, 7230, 14285, 21375, 28575.

CW — 60 kHz from low end of each band and Novices' bands.

Check phone bands on even hours GMT.

SCORING:

One point per QSO. VA stations multiply total QSO points by sum of states, provinces, countries, and VA counties worked. Others use number of VA counties for their multiplier (98 max.).

AWARDS:

Certificates to high scorer in each state, province, country, and each VA county; to high score Novice in state and out of state; and special certificate to the top out-of-state score.

ENTRIES:

A summary sheet and a check sheet are requested. Only QSOs on 160 through 10 meters will be counted. Logs must be received by April 15th and mailed to: Virginia QSO Party, PO Box 599, Sterling VA 22170. Those desiring a copy of the results are requested to provide an SASE.

EUROPE AND AFRICA GIANT RTTY FLASH

Contest Periods:

1400 to 2400 GMT March 9

0800 to 1800 GMT March 10

Sponsored by the IATG, this is the 12th annual RTTY Flash Contest as part of a new promotional program for RTTY. The basic purpose of this contest is to increase interest in RTTY, and, even more, to increase interest in intercontinental contacts rather than just international contacts. Remember, this contest is valid towards the final standings of the Continent World Championship. The contest is open to RTTY SWLs with the same scoring rules. Use all

amateur bands from 80 to 10 meters on 2-way RTTY only. Each station may be contacted only once on any band; additional contacts may be made with the same station if a different band is used. The DXCC list will be used for country status except that the VE/VO, W/K, VK, PY, LU, JA, and UA09 call areas will be considered as separate countries.

EXCHANGE/MESSAGES:

The message will consist of RST, QSO number, and continent.

SCORING:

Each completed exchange counts 1 point on 80/40 meters, 2 points on 20 meters, 8 points on 15 meters, and 12 points on 10 meters. No points or multipliers for any contacts with one's own country. Multipliers are given for countries and continents. A multiplier is given for each country worked on 20/15/10 meters. No multipliers for 80 and 40 meters. A separate multiplier may be claimed for the same country if a different band is used, up to a maximum of 3 times. Only countries which appear in at least 5 other logs will be valid as multipliers. One's own country is not a valid multiplier. The continents are valid as multipliers, and for contacts with Europe and Africa, both the sender and the receiver will each receive 100 points as a multiplier. 50 points will be assigned for each of the remaining continents contacted. An additional 100 points will be given for each contact with Europe and Africa on 10 or 15 meters. Final score is then: total QSO points x total number of countries x total continent points + total points for Europe and Africa stations worked. Example: 600 QSO points x 10 countries worked x 100 continent points = 600,000 plus 20 Europe and Africa stations worked on 10 or 15 meters, giving a great total of 602,000 points.

PROMOTIONAL PERIODS:

Two promotional periods are included in the contest as follows: Saturday, March 9, from 1700 to 1800 GMT, and Sunday, March 10, from 1000 to 1100 GMT. Stations operating from North America, South America, Australia, Oceania, or Asia who contact Europe and/or Africa during these hours will *double* their points for these periods.

ENTRIES & AWARDS:

Prizes include grand prizes

(as usual, reserved for the four first place winners). Consolation prizes along with medals and certificates will also be awarded. Use one log for each band. Logs must contain: date/time in GMT, callsign, RST and QSO number, continents sent and received, country and continent multipliers, points, and final score. In order to qualify, all logs must be received no later than April 15th and be sent to: Prof. Franco Fanti, Via A. Dallolio n 19, 40139 Bologna, Italy.

RTTYers entering logs in the Giant Contest who have not participated in previous contests will receive an additional bonus of 5% of their final score.

Usual disqualification rules apply. Logs with compiling errors which exceed 10% of the final score will also be excluded from the final standing and will serve only as check logs.

DARC "CORONA" 10-METER RTTY CONTEST

Contest periods will be held
from 1100 to 1700 GMT

on the following dates:

March 15, May 10,

September 27, November 15

The DARC eV invites radio amateurs worldwide to participate in the annual contest which is held to increase RTTY activity on the 10-meter band. There will be four tests within the year with each test scored separately. Use the recommended portions of the 10-meter band.

EXCHANGE:

RST, QSO number, and name.

SCORING:

Each station can be contacted only once. Each completed 2-way RTTY QSO is worth 1 point. Multipliers include the WAE and DXCC lists and each district in W/K, VE/VO, and VK. Also count each different prefix as a multiplier. Final score is total number of QSOs times total multiplier. European country list: G31, CT1, CT2, DL, DM, EA, EA6, EI, F, FC, G, GC Gurnsey, GC Jersey, GD, GI, GM, GM Shetland, GW, HA, HB9, HB0, HV, I, IS, IT, JW, JW Baer, JX, LA, LX, LZ, M1, OE, OH, OH0, OJ0, OK, ON, OY, OZ, PA, SM, SP, SV, SV Crete, SV Rhodes, SV Athos, TA1, TF, UA13456, UA2, UA Franz Josef Land, UB5, UC2, UO5, UN1, UP2, UQ2, UR2, YO, YU, ZA, ZB2, 3A, 4U, 9H1.

Calendar

| | |
|------------|---|
| Mar 1-2 | ARRL DX Competition — Phone |
| Mar 8-9 | QCWA QSO Party — Phone |
| Mar 8-10 | Virginia QSO Party |
| Mar 9-10 | Europe and Africa RTTY Giant Flash |
| Mar 15 | DARC Corona 10-Meter RTTY Contest |
| Mar 22-23 | Tennessee QSO Party |
| Mar 22-24 | BARTG Sprint RTTY Contest |
| Mar 29-30 | YL International SSBers QSO Party — CW |
| Mar 29-31 | Wisconsin QSO Party |
| Apr 5-7 | QRP ARC International QSO Party |
| Apr 19-20 | YL International SSBers QSO Party — Phone |
| Apr 26-27 | Helvetia Contest |
| May 10 | DARC Corona 10-Meter RTTY Contest |
| May 17-18 | Florida QSO Party |
| June 28-29 | ARRL Field Day |
| Aug 9-10 | European DX Contest — CW |
| Sept 13-14 | European DX Contest — Phone |
| Sept 13-15 | Washington State QSO Party |
| Sept 14 | North American Sprint |
| Sept 27 | DARC Corona 10-Meter RTTY Contest |
| Oct 4-5 | California QSO Party |
| Nov 8-9 | European DX Contest — RTTY |
| Nov 9 | International OK DX Contest |
| Nov 15 | DARC Corona 10-Meter RTTY Contest |

Continued on page 126

EITHER WAY YOU GO...2 OR 6!



**GO WITH QUALITY.
GO WITH ICOM.
GO WITH THE BEST.**

The IC-251A is the newest addition to ICOM's all mode transceiver line. Like the matching IC-551, the IC-251A has dual digital VFO's, three memories, scanning (even SSB), and many other features you only get from ICOM.

Both units include the no backlash, no delay light chopper, similar to the IC-701, as a standard feature at no cost. Coupled to the microprocessor, this provides split frequency operation as well as completely variable offsets.

Check the specs, and you'll agree, either way you go, ICOM is simply the best.

SPECIFICATIONS

Listed below are some of the

IC-551 specifications. IC-251A's specs are identical except where noted (in bold).

Frequency Coverage: 50~54MHz
(143.8~148.19MHz)

RF Output Power:

SSB 10W PEP
(1~10W adjustable) (10W)

CW 10W
(1~10W adjustable) (10W)

AM 4W
(0~4W adjustable) (—)

FM* 10
(1~10W adjustable) (1~10W)

Sensitivity: SSB/CW/AM

Less than 0.5 μ V for 10dB S+N/N

FM* More than 30dB
S+N+D/N+D at 1 μ V

Squelch Sensitivity: SSB/CW/AM

1 μ V
FM* 0.4 μ V (0.4 μ V)

Selectivity: SSB/CW/AM

More than \pm 1.1KHz at -6dB (1.2)
Less than \pm 2.2KHz at -6dB (2.4)
(When Pass Band Tuning Unit is installed: less than 1KHz at -6dB)

FM* More than \pm 7.5KHz at -6dB
Less than \pm 15KHz at -60dB

Dimensions: 111mm (H)

\times 241mm (W) \times 311mm (D)

Weight: 6.1kg (5kg)

Spurious Response Rejection Ratio:

More than 60dB

HF/VHF/UHF AMATEUR AND MARINE COMMUNICATION EQUIPMENT



ICOM

ICOM AMERICA, INCORPORATED

Sales Service Centers located at:

2112 116th Avenue NE
Bellevue, WA 98004
Phone (206) 454-8155

3331 Towerwood Dr., Suite 307
Dallas, TX 75234
Phone (214) 620-2780

ICOM INFORMATION SERVICE

2112 116th Ave., N.E.
Bellevue, WA 98004

Please send me: IC-551 specifications sheet; IC-251A specifications sheet; List of Authorized ICOM Dealers.

NAME _____ CALL _____

ADDRESS _____

CITY _____ STATE _____ ZIP _____

You may send a machine copy of this form

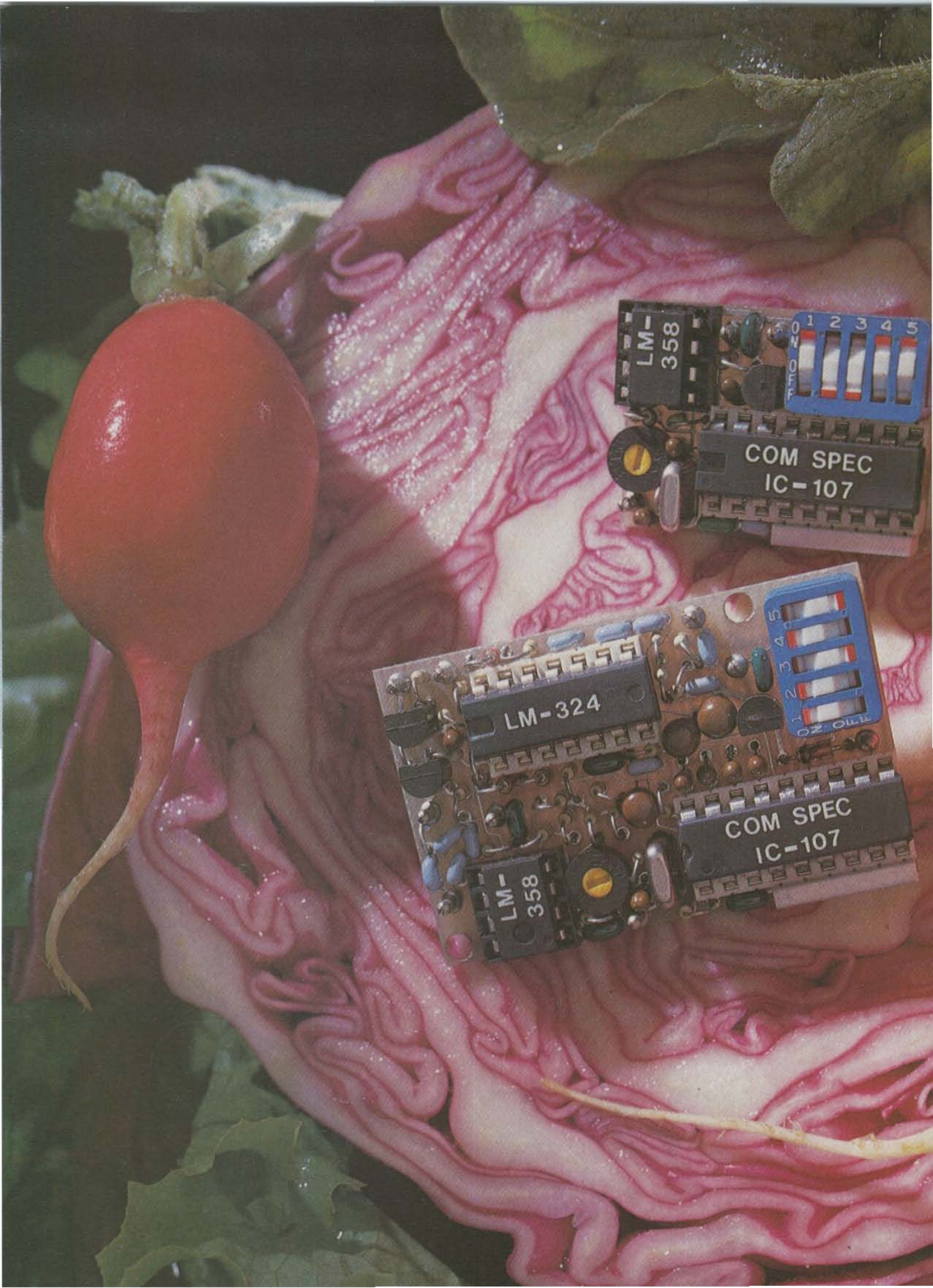

LM-358

1 2 3 4 5
TTL OUT

COM SPEC
IC-107

LM-324

1 2 3 4 5
TTL OUT

COM SPEC
IC-107

LM-358

A fresh idea!

Our new crop of tone equipment is the freshest thing growing in the encoder/decoder field today. All tones are instantly programmable by setting a dip switch; no counter is required. Frequency accuracy is an astonishing $\pm .1$ Hz over all temperature extremes. Multiple tone frequency operation is a snap since the dip switch may be removed. Our SS-32 encode only model is programmed for all 32 CTCSS tones or all test tones, touch-tones and burst-tones.

And, of course, there's no need to mention our 1 day delivery and 1 year warranty.



TS-32 Encoder-Decoder

- Size: 1.25" x 2.0" x .40"
- High-pass tone filter included that may be muted
- Meets all new RS-220-A specifications
- Available in all 32 EIA standard CTCSS tones

SS-32 Encoder

- Size: .9" x 1.3" x .40"
- Available with either Group A or Group B tones

Frequencies Available:

| Group A | | | |
|---------|----------|----------|----------|
| 67.0 XZ | 91.5 ZZ | 118.8 2B | 156.7 5A |
| 71.9 XA | 94.8 ZA | 123.0 3Z | 162.2 5B |
| 74.4 WA | 97.4 ZB | 127.3 3A | 167.9 6Z |
| 77.0 XB | 100.0 1Z | 131.8 3B | 173.8 6A |
| 79.7 SP | 103.5 1A | 136.5 4Z | 179.9 6B |
| 82.5 YZ | 107.2 1B | 141.3 4A | 186.2 7Z |
| 85.4 YA | 110.9 2Z | 146.2 4B | 192.8 7A |
| 88.5 YB | 114.8 2A | 151.4 5Z | 203.5 M1 |

- Frequency accuracy, $\pm .1$ Hz maximum - 40°C to + 85°C
- Frequencies to 250 Hz available on special order
- Continuous tone

| Group B | | |
|-------------|--------------|---------------------|
| TEST-TONES: | TOUCH-TONES: | BURST-TONES: |
| 600 | 697 1209 | 1600 1850 2150 2400 |
| 1000 | 770 1336 | 1650 1900 2200 2450 |
| 1500 | 852 1477 | 1700 1950 2250 2500 |
| 2175 | 941 1633 | 1750 2000 2300 2550 |
| 2805 | | 1800 2100 2350 |

- Frequency accuracy, ± 1 Hz maximum - 40°C to + 85°C
- Tone length approximately 300 ms. May be lengthened, shortened or eliminated by changing value of resistor

Wired and tested: TS-32 \$59.95, SS-32 \$29.95

 **COMMUNICATIONS SPECIALISTS** ✓ 15

426 West Taft Avenue, Orange, California 92667
(800) 854-0547 / California: (714) 998-3021

Even WEAK SIGNALS print clearly with a HAL

ST-6000 Demodulator \$659.00



Demodulator.

ST-5000 Demodulator \$239.00



Pulling in weak or distorted signals with a HAL Demodulator is no problem. Even if the band is crowded.

With high-gain, wide-bandwidth limiters and extremely linear active detector circuits, both the ST-6000 and ST-5000 Demodulators convert RTTY tones into strong, readable signals that display bright and clear.

Tones necessary for transmitting RTTY are conveniently generated and receive filters and transmit tones are accurately set and matched to assure on-the-money transceive operation.

**HAL Communications and
amateur radio serving
the 1980 Winter Olympics
through W.O.R.A.N.
(Winter Olympics Radio
Amateur Network)**

**Both the ST-6000 & ST-5000
offer these features:**

- Internal Loop Supply • Internal AFSK Generator with CW ID Tone • Internal Tuning Indicator • Autostart Motor Control • Line/Local Loop Control • TTY Machine Compatibility • RS-232 type DATA Interface • "High" or "Low" Tones • 120/240, 50/60 Hz Power • Normal/Reverse Switch • 170 and 850 Shift • Active Discriminator • Metal Cabinets for RF Shielding.

Special Features of the ST-6000:

- Mark-Hold • Antispace • Automatic Threshold Control (ATC) • Decision Threshold Hysteresis (DTH) • Keyboard Operated Switch (KOS) • MIL-188 and CMOS Data Interface • Optional Oscilloscope Tuning Indicator • Crystal Controlled AFSK Tones • Active Input Bandpass Filter • Pre-Limiter AGC • Three Shifts (170 - 425 - 850)

Write or give us a call. We'll be glad to send you our new RTTY catalog.



HAL COMMUNICATIONS CORP.
Box 365
Urbana, Illinois 61801
217-367-7373

For our European customers, contact: Richter & Co. D3000
Hannover 1 • I.E.C. Interelco, 6816 Bissone/Lugano • Radio
Shack Ltd., London NW6 3AY • Erik Torpdahl Telecom, DK 3660
Stenlose Denmark

ou moons don't ever prove
lousy manuscripts from bat
burh of rock on
you li, cord y co art in
I insist that you print ev
tell Ma Bell that she shou

AD INFINITUM

I have just returned from a very interesting amateur radio club meeting. Don Miller, the ARRL director, just gave the first post-WARC speech by a League official.

Miller is normally a pretty staid individual... but this speech was colorful, slanderous, and full of good ol' American intrigue. It appears that he was spouting the League line (i.e., Dick Baldwin's), which is designed to thrill hams about how clever the ARRL is.

I have summarized the high points of this speech.

1. When Dick Baldwin left a world conference 15 years ago, he decided the hams would go after three new bands in 1979.

2. The ARRL top brass realized that an international organization was needed, so they started the IARU and put an impressionable Canadian in charge. It is supported "under the table by the League." Its purpose is to push for development of amateur radio in Third World countries.

3. To spread their influence, the League hired Bruce Johnson, because of his skills as a linguist. For several years he engaged in nonstop travel promoting amateur radio.

4. As an example of the ARRL's effectiveness, Miller cited an incident in Nicaragua, where Somoza (a ham?) appointed a pro-ham radio delegate to WARC just days before being deposed.

5. The money lost by the League (in 15 of the past 16 years) equals the money spent on WARC. This is "more than \$500,000." To promote ham radio at WARC, the ARRL sponsored three cocktail parties.

6. It costs \$1,000 per day to keep a person in Geneva. The League had between 10 and 15 representatives there for the entire conference.

7. Wayne Green had nothing to do with the success at WARC... his efforts were intended to

destroy ham radio... he is probably the lowest ham in America tonight... he will say that the League's victory is only luck.

8. The League managed to get a ham on almost all of the sub-committees of the frequency allocation committee.

9. The official U.S. delegation was "very poor"; the ARRL is responsible for saving all of America's frequencies.

10. The Chinese originally wanted to use 28 MHz for land mobile. To solve this problem, the League officials took some of the Chinese delegation members to lunch and poured several bottles of champagne down them, then convinced them to retract their anti-ham stance.

11. Wayne Green is the "world's greatest magazine salesman... but he is not interested in the future of ham radio..."

12. By creating a typographical error in the final draft of a proposal that would have taken 40 meters away from the hams, the League was able to prevent the issue from reaching a vote before the end of the conference.

13. The FCC is run by a CBer.

14. The new 10-MHz band is Dick Baldwin's creation.

15. The Canadians were "bastards"; they voted against the American position. They wanted part of the 75-meter band to use for a broadcast station. The official Canadian reason was to improve communications to the Yukon... the real reason according to Newington is to beam a signal at Louisiana to convince them to secede when Quebec does!

16. "The Japs" don't want amateur radio (they voted against the U.S.) and we shouldn't buy their gear. Because of this, the League will revoke Okino Torishima's DXCC status. The only reason it got approval in the first place was an attempt to be friends with the JARL before WARC!

17. The presence of imported

two-meter gear has caused it to be used by Latin American countries for commercial use (illegal according to international law)... this is another reason not to buy it.

Don is more realistic when you talk to him individually. The speech covered a number of other incidents about WARC. It sounded like the League had all the answers for the world, and that outside of the U.S. and Europe, everyone is a "cannibal or chink." Basically the ugly American approach. Needless to say, this version of ham radio had Dick Baldwin being the man responsible for saving amateur radio from Wayne Green and the cannibals.

At the end of his sermon (which included no less than a dozen pleas to join the ARRL), Miller said the future of ham radio lies in home-brewing... not traffic handling, CW, or DX... and that is hardly the standard ARRL line.

Miller promises to give the Board of Directors no peace until a lobbyist is installed in Washington. He claims it is being stonewalled because of cost... about \$100K a year. Apparently the League is running on money saved up during World War II.

Someone asked Don about NBVM. He says the League support was all Baldwin's idea. Dick's lack of technical background caused him to be suckered by Tom Lott. The directors went along with the NBVM scheme as a "shot in the dark" proposal to boost the League. Miller, who has a PhD in Electrical Engineering, says that the system will work fine in the lab, but that's about all it will do. He said that we won't be hearing about NBVM anymore.

This was the first time I have heard such a rampant attack on Wayne Green or so many stories about how conniving the ARRL is. I don't think Miller really has any grudges; I think they are coming from Newington.

All in all, it was an interesting evening. Somehow I now have a greater appreciation of where your editorials are coming from.

Name and address withheld by request

Hmmm. There do appear to be a few minor inaccuracies in the Miller talk which might be noted. I'll tackle them by the numbers,

since, if history repeats itself, clubs may be hearing much the same talk from most directors.

1. I think the ITU conference in reference here was in 1971, nine years ago, not 15, the one where the League represented us at Geneva and lost every microwave satellite frequency above 500 MHz for us... and about 90% of those below 500 MHz. It was a total loss of over 138,000 MHz and it changed the future of amateur radio totally. The three new bands first came up when Prose Walker got to be the Chief of the Amateur Division of the FCC. I visited him at the time and he explained how he had looked over the short-wave allocations and had found three small bands which might eventually be vacated by commercial interests as they shifted to satellites and cables. Baldwin may have decided to go after them, but it was Prose Walker who came up with the idea and proposed it to the FCC.

2. Ask any old-time ARRL member when the IARU started. It's been around for a long time... certainly way before Baldwin ever thought of working for the League. The poor support of the IARU, while insisting upon maintaining control, has long been a bitter pill for the European amateur societies. Miller is right that Baldwin did put an impressionable Canadian in charge. Members of the Amateur Radio Manufacturer's Association heard from Mr. Eaton and drew their unfavorable opinion of him and IARU. I think I reported on that sometime back, including the double-talk from Baldwin at the same meeting. Someday my tapes of these meetings may be valuable historical documents... for it is all there on tape.

3. According to Eaton, only countries where there were member societies of the IARU were visited in Africa... and then it was on a lower level. I think all members of the League would like to see a full report on the countries visited by Johnson and the investment involved. I can recall no time in history where the League ever permitted members to have any detailed information on money spent toward "saving our frequencies."

5. Being, essentially, a non-drinker, perhaps I am not a good one to comment on the cocktail

Continued on page 148

A SWAN FOR EVERY NEED

Talk State of the art, Versatility, or Economy — SWAN'S famous "world's best" Engineering team has designed a complete line of Transceivers to suit your need.

Take a look at the three hottest new SSB Transceivers this year. They're all made in America and they're all from Swan. Whatever your dreams—from a compact fully synthesized mobile to a full-blown base station with dual PTO's—one of these will bring them to reality today. They're all solid state, all 235 Watts PEP and CW on all frequencies, and most of all they're affordable.

Most Advanced HF Transceiver in the World—ASTRO 150

HF SSB Transceiver featuring "VRS" a knob with a new twist, and over 100,000 fully microprocessor-controlled frequencies on present or envisioned "ham" bands.

High Power — Full 235 Watts PEP & CW, all bands Truly Synthesized in accurate 100Hz steps Full CW Break-In with narrow XTAL Filter Standby Memory — ALL BANDS True PEP

output meter Model 150 — 80 thru 10 meters Model 151 — 160 thru 15 Meters

ASTRO 102 BX



100 MX



Most Versatile HF 160M-10M Transceiver in the World—ASTRO 102 BX

Dual PTO's, 235 Watts PEP & CW on all frequencies, IF Passband tuning, with LED position indicators and full break-in.

All solid state Modern design and styling Tunable notch filter 4 Function Meter Speech Processor VOX Adjustable AGC Decay 2 Position CW Wave Shaping 16 Pole IF Filter Crystal CW Filter PLL Synthesized Band Selection

Economy with top SWAN quality and mobility—100MX

235 Watts PEP & CW on all frequencies. The field-proven Rig the whole world's talking about.

All solid-state Modern design and styling VOX Noise Blanker Semi-CW Break-in RIT ± 1.5 KHz 25 KHz Calibrator, built-in CW side tone with adjustable pitch and level Internal speaker Jack for external counter



ASTRO 150



A division of Cubic Communications, Inc.

305 Airport Rd. • Oceanside, Ca. 92054
(714) 757-7525

Look to Swan for Quality Accessories . . . and Service

70

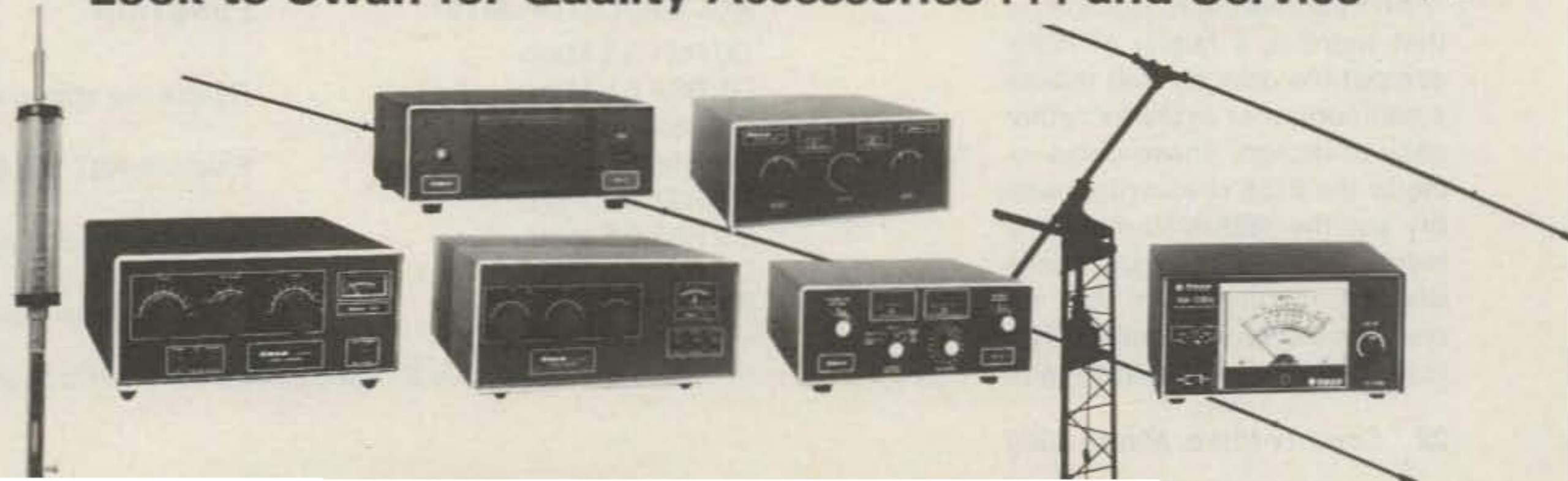

Microcomputer Interfacing

Christopher A. Titus
David G. Larsen WB4HYJ
Peter R. Rony
Jonathan A. Titus

Our past columns have concentrated upon the 8080 central processing unit (CPU), and our interfacing and software examples have all been developed for 8080-based computer systems. A new processor, the 8085, is now available with all of the capabilities of the 8080, but with a few additional features that make it worthwhile.

One of the main features of the 8085 is that it is software-compatible with the machine codes for the 8080. Thus, a 303 is a jump (JMP) instruction in both systems. The 8085 has two additional instructions that will be discussed later. Basic 8080 systems generally include a clock generator and a status latch circuit for external control of the 8080. These functions are now provided for, within the 8085. A simple RC network or a crystal may be used directly with the 8085 for the generation of the clock pulses needed by the system. Many of the control signals that are needed by external devices are now generated in the 8085 chip, further reducing the amount of external logic that is required.

There is a price to pay for this, though. The 8085 uses one set of eight lines to transmit both data and address information. In some systems, it may be necessary to latch the address bits (A7-A0) so that they are readily available for use in the system. An Address Latch Enable signal (ALE) is output by the 8085 to control such a latch circuit. You may recall that this type of bus multiplexing was also done in the 8008, the first general-purpose eight-bit microprocessor chip.

Another feature of the 8085 is that there is a family of 8085-compatible devices that makes small computer systems rather easy to design. These chips include the 8155 read/write memory and the 8355/8755 read only memory devices. Since these devices require both the address and data information that is multiplexed on a single eight-

line bus, they are set up to internally demultiplex the necessary data. The ALE signal is distributed to all of the 8085-compatible devices to control these internal functions. A typical latch circuit that will demultiplex the address and data is shown in Fig. 1.

The 8085 provides the high address bits (A15-A8) on eight output pins. These signals have no other purpose and they are not multiplexed. They are equivalent to the A15-A8 lines in an 8080-based computer. Some of the other 8085 inputs and outputs such as interrupt (INTR), interrupt acknowledge (INTA), RESET, HOLD, Hold acknowledge (HLDA), and READY operate as they do in 8080 systems. There are also two new outputs from an 8085: CLOCK OUT, a TTL-compatible clock signal of one-half the system clock frequency and RESET OUT, a signal that may be used to reset other system components. The RESET OUT signal is

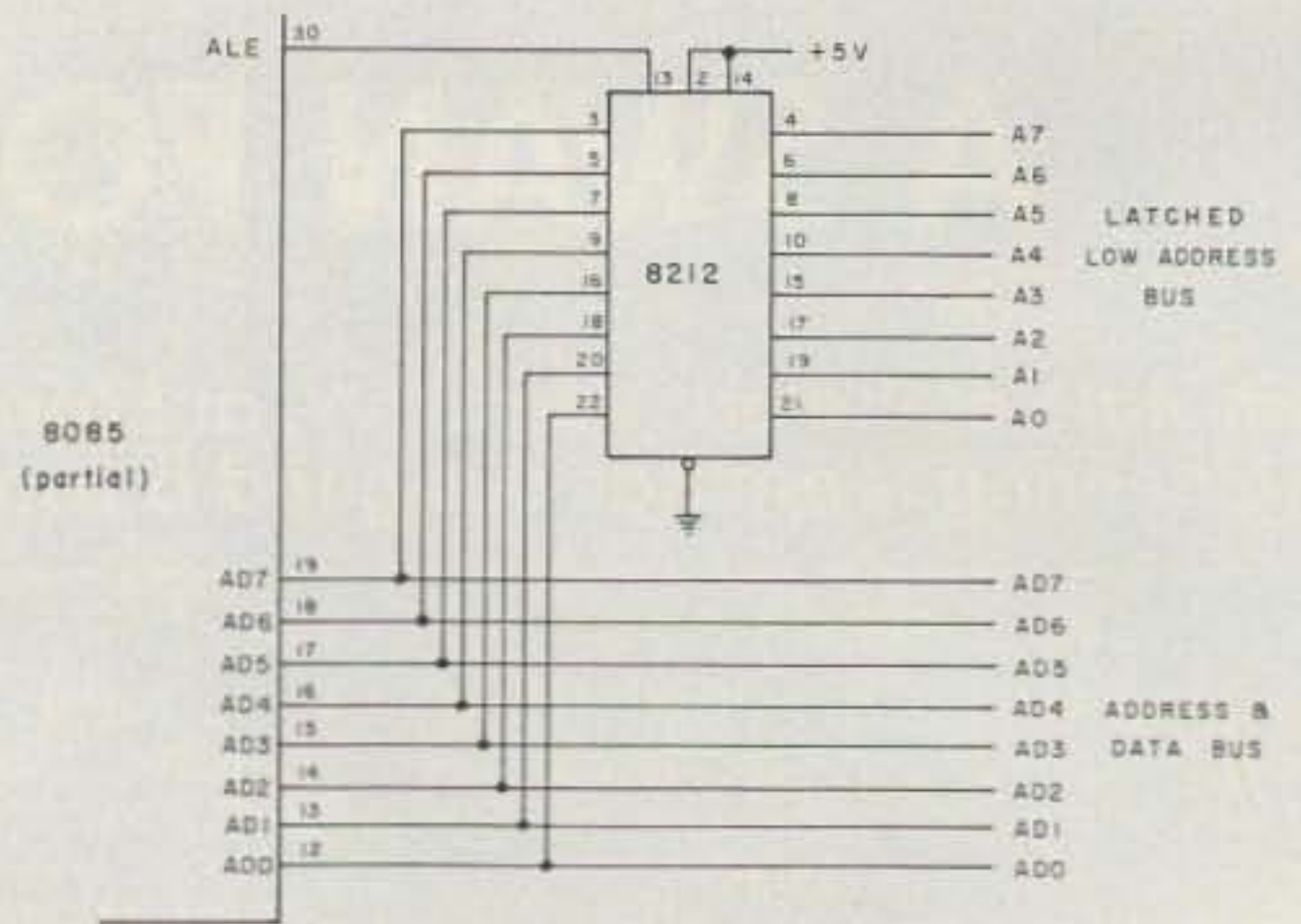

Fig. 1. Use of a latch to demultiplex the 8085's low address bits.

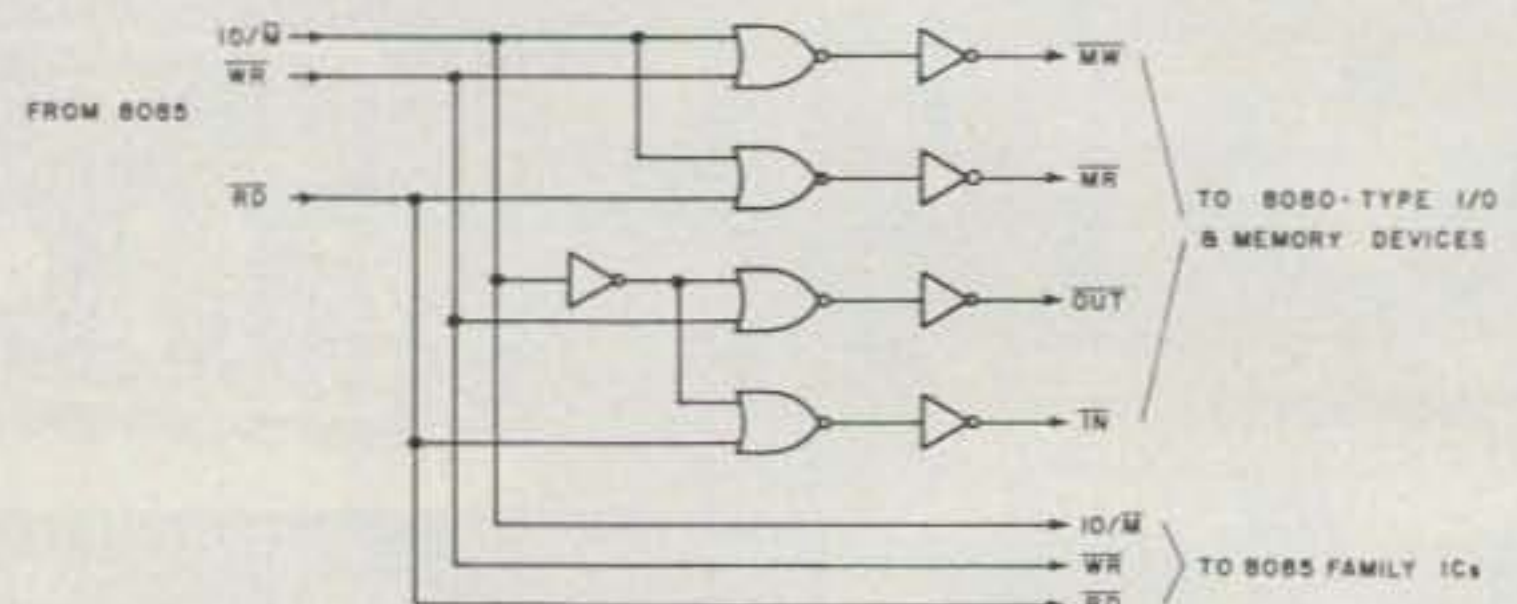

Fig. 2. Necessary gating to generate 8080-compatible control signals in an 8085 system.

derived from the reset input to the 8085.

The 8085 uses three control signals to manage the flow of

data to and from memories and the CPU and to and from I/O

Continued on page 149

| NAME | RESTART ADDRESS | CHARACTERISTICS |
|---------|-----------------|---|
| TRAP | 000 044 | Highest priority of all interrupts. Non-maskable, always "on." Both edge and level sensitive. |
| RST 5.5 | 000 054 | Maskable, logic 1 sensitive |
| RST 6.5 | 000 064 | Maskable, logic 1 sensitive |
| RST 7.5 | 000 074 | Maskable, positive edge sensitive |

Table 1. Internal 8085 Interrupts.

SIM, Set Interrupt Mask 060

FUNCTION

Mask Bits for RST inputs on 8085 Chip*

0 = Enable

1 = Disable

Must be a logic 1 to allow masks to be changed
Logic 1 clears an RST 7.5 interrupt request*

Logic 1 loads SOD data to SOD pin (pin 4)

* All masks are disabled by an external reset

RIM, Read Interrupt Mask 040

FUNCTION

Reads the status of the current masks

Enables RST 5.5, 6.5, and 7.5

Reads any pending interrupt requests

Reads data in from SID input

Table 2. The SIM and RIM Instructions.

ACCUMULATOR BITS

D0 RST 5.5 Mask

D1 RST 6.5 Mask

D2 RST 7.5 Mask

D3 Mask Enable

D4 Reset RST 7.5

D5 Not used

D6 SOD Enable

D7 SOD Bit

ACCUMULATOR BITS

D0 RST 5.5 Mask

D1 RST 6.5 Mask

D2 RST 7.5 Mask

D3 Interrupt Enable

D4 RST 5.5 Input

D5 RST 6.5 Input

D6 RST 7.5 Input

D7 SID Bit

219 WAYS TO INCREASE YOUR AMATEUR RADIO & ELECTRONICS KNOW-HOW!

SEND NO MONEY! We'll Invoice you on 10-DAY FREE TRIAL. ALL BOOKS 100% GUARANTEED. You must be satisfied or return the books and we'll cancel the invoice.



1152—Antenna Data Reference Manual—incl. dimension tables. Literally 100's of ready-to-build transmitting/receiving antenna designs for hams. Shows you how to homebrew and customize your own antennas. Included are half-wave dipoles, inverted vees, verticals, Yagis, deltas, quads, and limited space and hidden antennas, etc. 266 p., 229 il. only \$7.95.

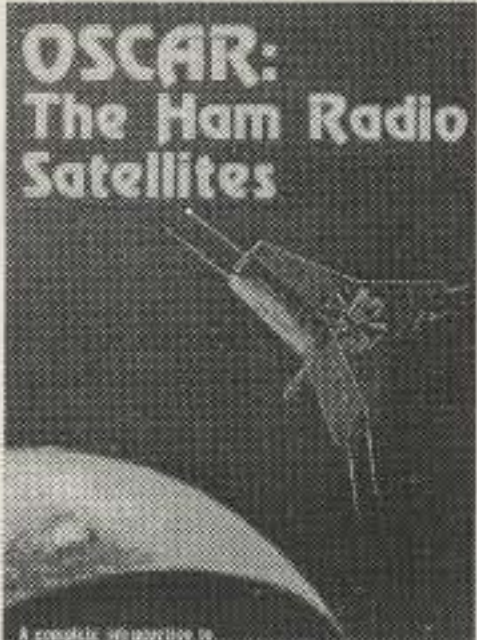

1120—OSCAR: The Ham Radio Satellites. A complete intro to ham communications via satellite! Includes all the details you need to start your own amateur earth station. You learn the ins and outs of every type of OSCAR satellite and its equipment, and you get full data on how to set up your own earth station, antennas, and tracking aids. 140 p., 91 il. only \$4.95.

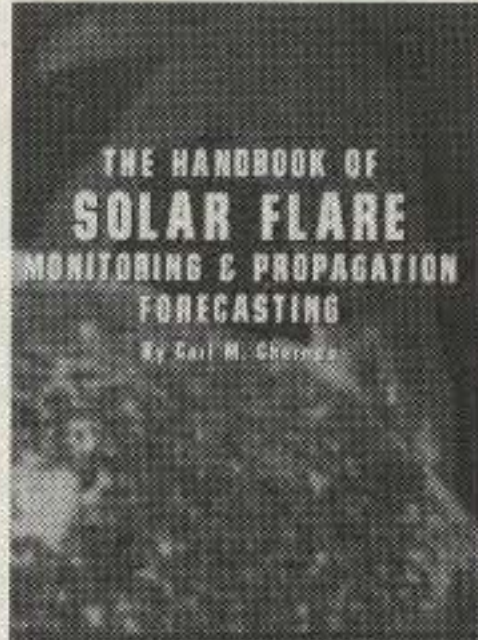

1005—Solar Flare Monitoring & Propagation Forecasting Handbook. A detailed, step-by-step guide to designing, building, setting up, and operating your own solar flare detection station, for as little as \$100, and to monitoring and studying solar flares. Shows how to maintain gear, solve VLF problems and interpret chart readouts. 196 p., 92 il. only \$6.95.



859—The Complete Handbook of Slow-Scan TV. How to set up and operate a slow-scan TV amateur station—all the theory, the practice, the procedures, the equipment, and the latest innovations including digital scan conversion. Tells you how SSTV works, how to build your own equipment, boost power, and about program production. 304 p., 169 il. only \$9.95.



802—The Giant Book of Amateur Radio Antennas. Complete build-it and installation data for over 50 tested ham antennas. Whether you're into mobile operations, DX, VHF, UHF, etc., there's something in this huge 462-page volume that will fit your needs. It's for all modes, goodie, and some are souped-up versions of the tried and true—but they're all useful. 400 p., 255 il. only \$8.95.



801—Master Handbook of Ham Radio Circuits. A rich collection of over 100 practical circuits. Contains some of the most ingenious ham radio circuits around—all have been built and tested by hams—some are brand new, some are oldies but fit your needs. It's for all modes, goodie, and some are souped-up versions of the tried and true—but they're all useful. 400 p., 301 il. only \$8.95.

COMPUTERS, MICROPROCESSORS & ROBOTICS

- 1169—GIANT Handbook of Computer Projects 504 p., 217 il. \$9.95
- 1160—1001 Things to do With Your Personal Computer 336 p. \$7.95
- 1201—Complete Microcomputer Systems Hdbk. 322 p., 125 il. \$9.95
- 1050—Most Popular Subroutines in BASIC 182 p., 349 il. \$5.95
- 1045—Programmer's Guide to LISP 210 p., 133 il. \$5.95
- 1241—How To Build Your Own Self-Programming Robot 238 p. \$7.95
- 1062—The A to Z Book of Computer Games 308 p., 73 il. \$7.95
- 1111—Design, Build, Prog. Your Own Working Computer System \$8.95
- 1053—Microprocessor Cookbook 266 p., 124 il. \$5.95
- 1141—How To Build Your Own Working Robot Pet 238 p., 86 il. \$7.95
- 1107—Computerist's Handy Manual 64 p., 39 il. \$2.95
- 1069—Computerist's Handy Databook/Dictionary 96 p., 42 il. \$3.95
- 1071—The Complete Handbook of Robotics 364 p., 137 il. \$7.95
- 1085—24 Tested, Ready-To-Run Game Programs in BASIC 252 p. \$6.95
- 1070—Digital Interfacing with an Analog World 406 p., 277 il. \$8.95
- 1088—Illustrated Dict. of Microcomputer Terminology 322 p., 150 il. \$7.95
- 1076—Artificial Intelligence 252 p., 118 il. \$7.95
- 841—Build Your Own Working Robot 238 p., 117 il. \$5.95
- 1099—How To Build Your Own Working 16-Bit Microcomputer 80p. \$3.95
- 1095—Programs in BASIC for Elec. Eng., Techs., & Exp. 140 p. \$4.95
- 1077—Hdbk. of Remote Control & Automation Techs. 294 p., 250 il. \$7.95
- 1055—The BASIC Cookbook 140 p., 49 il. \$4.95
- 1015—Beginner's Gde. to Computers & Microprocessors 308 p. \$6.95
- 1000—57 Practical Programs & Games in BASIC 210 p., 64 il. \$7.95
- 995—Beginner's Guide to Microprocessors 182 p., 106 il. \$5.95
- 985—Programming Microprocessors 208 p., 102 il. \$6.95
- 676—Simplified Computer Programming—Including RPG 240 p. \$6.95
- 971—Miniprocessors: from Calculators to Computers 196 p. \$5.95
- 874—Master Handbook of Digital Logic Applic's. 392 p., 287 il. \$7.95
- 952—M/processor Programming for Computer Hobbyists 387 p. \$8.95
- 955—Modern Digital Communications 308 p., 122 il. \$6.95
- 853—Piloting/Navigation With the Pocket Calculator; 406 p., 338 il. \$8.95
- 975—The "Computer" Book—Build Super Calculators & Mini-computer Hdwe. with Calculator Chips 322 p., 227 il. \$7.95
- 752—Computer Programming Handbook 518 p., 114 il. \$9.95
- 554—Computer Technician's Handbook 480 p., 428 il. \$10.95
- 824—Advanced Applications for Pocket Calculators 304 p., 275 il. \$5.95
- 538—Computer Circuits & How They Work 192 p., 109 il. \$5.95
- 574—Beginner's Guide to Computer Programming 480 p., 364 il. \$9.95
- 785—Microprocessor/Microprogramming Hdbk. 294 p., 176 il. \$6.95
- 709—Modern Guide to Digital Logic 294 p., 222 il. \$7.95
- 724—Get the Most Out of Electronic Calculators 204 p., 28 il. \$4.95
- 548—Beginner's Guide to Computer Logic 192 p., 175 il. \$5.95
- 538—Computer Circuits & How They Work 192 p., 109 il. \$5.95

HAM RADIO, COMMUNICATIONS, & TELEPHONES

- 1194—How to Repair Amateur Radio Equipment 448 p., 385 il. \$9.95
- 665—Mobile Radio Handbook 192 p., 175 il. \$4.95
- 1097—All About Telephones 192 p., 140 il. \$4.95
- 1052—Radar Detector Handy Manual 80 p., 63 il. \$2.25
- 1054—Antenna Construction Hdbk. for Ham, CB & SWL 238 p. \$5.95
- 997—The Handbook of Telephones & Accessories 432 p., 215 il. \$9.95
- 963—Home-Brew HF/VHF Antenna Handbook 210 p., 143 il. \$5.95
- 685—The Complete Shortwave Listener's Handbook 288 p., 101 il. \$6.95
- 683—Pictorial Guide to CB Radio Install./Repair 256 p., 304 il. \$5.95
- 673—How to Be A Ham—Incls. Latest FCC Rules 192 p., 25 il. \$3.95
- 950—Ill Dict. of Broadcast—CATV—Telecomms 420 p., 104 il. \$8.95
- 735—The Complete FM 2-Way Radio Handbook 294 p., 111 il. \$6.95
- 954—Practical CB Radio Troubleshooting & Repair 406 p., 169 il. \$7.95
- 597—RTTY Handbook 320 p., 230 il. \$6.95
- 722—Amateur FM Conversion & Const. Projects 276 p., 187 il. \$5.95
- 678—Modern Communications Switching Systems 276 p., 171 il. \$17.95
- 621—The 2-Meter FM Repeater Circuits Handbook 312 p., 194 il. \$6.95

SEMICONDUCTORS, TUBES & TRANSISTORS

- 1216—Towers' International OpAmp Linear-IC Selector 190 p. \$7.95
- 1016—Towers' International FET Selector 140 p., 97 il. \$4.95
- 1010—Towers' Inter. Transistor Selector 200 p., 179 il. 7" x 10" \$6.95
- 856—Master OP-AMP Applications Handbook 476 p., 320 il. \$9.95
- 960—IC Function Locator 224 p., 28 il. \$5.95
- 984—CMOS Databook 280 p., 270 il. \$6.95
- 870—Master Tube Substitution Handbook 322 p., 576 il. \$4.95
- 717—Transistor Theory for Technicians & Engrs. 224 p., 116 il. \$5.95
- 938—Linear IC Applications Handbook 280 p., 183 il. \$6.95
- 470—Transistor Circuit Guidebook 224 p., 118 il. \$5.95
- 794—Microelectronics 266 p., 228 il. \$5.95
- 708—Modern Applications of Linear IC's 276 p., 301 il. \$9.95
- 570—Popular Tube/Transistor Substitution Guide 256 p. \$3.95

ELECTRONIC MUSIC

- 743—Electronic Music Circuit Guidebook 252 p., 180 il. \$6.95
- 843—Sourcebook of Electronic Organ Circuits 168 p., 101 il. \$4.95
- 718—Electronic Music Production 156 p., 79 il. \$3.95
- 546—Electronic Musical Instruments 192 p., 121 il. \$5.95
- 832—Electronic Musical Instr. Manual 210 p., 7" x 10" 385 il. \$6.95
- 503—Servicing Electronic Organs 196 p., 8 1/2" x 11" 145 il. \$9.95

CIRCUITS BOOKS, HOBBY ELECTRONICS & PROJECTS

- 1199—The Master IC Cookbook 476 p., 707 il. \$9.95
- 1137—First Book of Electronic Projects 64 p., 55 il. \$3.50
- 1184—Master Guide to Electronic Circuits 616 p., 302 il. \$12.95
- 1168—How to Repair Clocks 182 p., 90 il. \$5.95
- 1123—The Laser Experimenter's Handbook 210 p., 187 il. \$6.95
- 1118—Making & Using Electricity From the Sun 144 p. \$5.95
- 881—666 Science Tricks & Experiments 406 p., 386 il. \$7.95
- 1142—84 Practical IC Projects You Can Build 140 p., 113 il. \$4.95
- 805—99 Test Equipment Projects You Can Build 378 p., 337 il. \$7.95
- 804—Master Hdbk. of 1001 MORE Practical Electronic Circ. \$12.95
- 1105—How To Cast Small Metal & Rubber Parts 144 p., 132 il. \$5.95
- 1101—How To Design & Build Your Own Custom TV Games 546 p. \$9.95
- 806—The Power Supply Handbook 420 p., 292 il. \$7.95
- 1108—Lasers, The Light Fantastic 294 p., 158 il. \$6.95
- 1079—How to Build & Use Low-Cost Hydrophones 140 p., 98 il. \$4.95
- 1113—Understanding Electronics 182 p., 265 il. \$4.95
- 800—Master Hdbk. of 1001 Practical Electronic Circuits 602 p. \$12.95
- 1060—303 Dynamic Electronic Circuits 308 p., 303 il. \$6.95
- 1023—Beginner's Guide to Designing/Bldg Transistor Radios. \$4.95
- 965—Modern Transistor Radios 64 p., 112 il. \$2.50
- 958—Beginner's Guide to Making Electr. Gadgets 140 p., 113 il. \$4.95
- 921—The ABC Book of Hi-Fi/Audio Projects 168 p., 131 il. \$4.95
- 909—How to Build Metal/Treasure Locators 140 p., 60 il. \$3.95
- 935—Build-It Book of Optoelectronic Projects 238 p., 175 il. \$5.95
- 964—Modern Crystal Radios (Make and Use Series) 64 p., 101 il. \$2.50
- 637—Fun with Electronics 140 p., 50 il. \$3.95
- 836—Optoelectronics Guidebook-with Projects 196 p., 115 il. \$5.95
- 905—Build-It Book of Digital Electronic Timepieces 294 p., 209 il. \$6.95
- 926—Model Railroad Electronics 308 p., 218 il. \$5.95
- 912—88 Practical Op Amp Circuits You Can Build 140 p., 120 il. \$4.95
- 868—Cber's Handybook of Simple Hobby Projects 168 p., 114 il. \$3.95
- 887—106 Easy Electr. Projects-beyond the transistor 224 p. \$5.95
- 790—21 Simple Transistor Radios You Can Build 140 p., 122 il. \$3.95
- 861—Display Electronics 252 p., 195 il. \$5.95
- 771—Integrated Circuits Guidebook 196 p., 119 il. \$5.95
- 706—Indexed Guide to Modern Electronic Circuits 216 p., 92 il. \$4.95
- 787—OP AMP Circuit Design & Applications 280 p., 239 il. \$6.95
- 796—MOSFET Circuits Guidebook-with 100 Projects 322 p., 196 il. \$5.95
- 714—Radio Astronomy for the Amateur 252 p., 88 il. \$5.95
- 571—Radio Electronics Hobby Projects 192 p., 214 il. \$6.95
- 591—Solid State Projects for the Experimenter 224 p., 228 il. \$4.95
- 780—111 Digital & Linear IC Projects 210 p., 244 il. \$5.95
- 699—Solid State Circuits Guidebook 252 p., 227 il. \$5.95
- 629—Handbook of IC Circuit Projects 224 p., 136 il. \$5.95
- 487—64 Hobby Projects for Home & Car 192 p., 195 il. \$4.95
- 537—125 One-Transistor Projects 192 p., 125 il. \$4.95
- 83—Fun with Electricity 128 p., 94 il. \$3.95
- 647—Stereo/Quad Hi-Fi Principles & Projects 192 p., 100 il. \$4.95
- 464—Electronic Hobbyist's IC Project Handbook 154 p., 86 il. \$4.95
- 613—New IC FET Principles & Projects 154 p., 60 il. \$4.95
- 462—104 Easy Transistor Projects You Can Build 224 p., 105 il. \$7.95
- 590—Practical Solid-State Principles & Projects 176 p., 127 il. \$3.95
- 568—IC Projects for Amateur & Experimenter 192 p., 252 il. \$5.95
- 542—Transistor Projects for Hobbyists & Students 192 p., 153 il. \$4.95
- 70—Electronic Puzzles & Games 128 p., 75 il. \$3.95
- 112—Learn Electronics by Building 208 p., 214 il. \$4.95
- 470—Transistor Circuit Guidebook 224 p., 118 il. \$5.95

ELECTRONIC TEST EQUIPMENT

- 1177—Practical T shgt. with Modern Test Instruments 304 p., 288 il. \$7.95
- 1162—Practical T shgt. with Modern Scopes 288 p., 267 il. \$7.95
- 132—How to Test Almost Everything Electronic 160 p., 144 il. \$3.95
- 730—Effective Troubleshooting with EVM/Scope 238 p., 185 il. \$5.95
- 1012—How To Design/Build Electr. Instrumentation 420 p., 210 il. \$9.95
- 792—Build-It Book of Miniature Test & Msmt. Instr. 238 p., 151 il. \$4.95
- 422—Working with the Oscilloscope 104 p., 183 il. 7" x 9 1/4" \$4.95
- 672—Understanding & Using the VOM & EVM 192 p., 187 il. \$5.95
- 927—How to Use AF & RF Signal Generators 238 p., 162 il. \$5.95
- 702—Electronic Measurements Simplified 240 p., 217 il. \$4.95
- 723—Electronic Test Equipment—& How To Use It 204 p., 174 il. \$4.95
- 729—RF & Digital Test Equipment You Can Build 252 p., 217 il. \$5.95
- 877—Under. & Using Modern Signal Generators 294 p., 120 il. \$6.95
- 664—Understanding & Using the Oscilloscope 272 p., 170 il. \$5.95
- 577—How to Use Color TV Test Instruments 256 p., 230 il. \$5.95
- 131—Test Instruments for Electronics 192 p., 155 il. \$4.95
- 680—How to T shoot & Repair Electr. Test Eqpt. 252 p., 143 il. \$6.95
- 777—Under./Using Modern Electr./Swing./Test Equipment 252 p. \$5.95
- 483—99 Ways to Use Your Oscilloscope 192 p., 327 il. \$5.95
- 485—How to Use Test Instr. in Electronics Servicing 256 p., 234 il. \$4.95

MODEL RADIO CONTROL

- 1174—Model Radio Control 252 p., 237 il. \$6.95
- 1093—Radio Control Handbook-4th Edition 420 p., 315 il. \$9.95
- 1135—Radio Control Manual—Sys., Circuits, Const.—3rd Ed. \$5.95
- 825—Flying Model Airplanes/Helicopters by RC 192 p., 147 il. \$5.95
- 747—RC Modeler's Handbook of Gliders & Sailplanes 196 p., 143 il. \$4.95
- 812—Radio Control for Models 350 p., 417 il. \$6.95
- 693—Model Sail & Power Boating by Remote Control 192 p., 125 il. \$4.95
- 122—Advanced Radio Control 192 p., 181 il. \$4.95

FCC LICENSE STUDY GUIDES

- 1073—Amateur Rad. Lic. Sty. Gde. for Nov. Tech & Gen. Class \$6.95
- 1092—First Class Commercial FCC Lic. Study Guide 392 p., 205 il. \$7.95
- 582—Commercial FCC License Handbook 444 p., 150 il. \$8.95
- 652—2nd Class FCC Encyclopedia Study Guide 602 p., 600 il. \$7.95
- 893—Third Class FCC License Study Guide 322 p., 88 il. \$6.95
- 873—Ham Radio Novice Class License Study Guide 224 p., 57 il. \$5.95
- 851—Ham Radio General Class License Study Guide 448 p. \$7.95
- 827—Ham Radio Advanced Class License Study Guide 252 p. \$6.95
- 543—Ham Radio Extra-Class License Study Guide 224 p., 162 il. \$5.95
- 989—Ham Radio Incentive Licensing Guide 154 p., 34 il. \$4.95

BASIC & GENERAL ELECTRONICS TECHNOLOGY

- 1066—Illustrated Dictionary of Electronics 882 p., 472 il. \$14.95
- 510—How to Read Electronic Circuit Diagrams 192 p., 140 il. \$6.95
- 588—Basic Electronics Course 384 p., 275 il. \$9.95
- 882—Transistor Ignition Systems 252 p., 162 il. \$5.95
- 749—Auto Electronics Simplified 256 p., 202 il. \$5.95
- 748—The Complete Auto Electric Handbook 210 p., 139 il. \$5.95
- 691—Practical Solid-State DC Power Supplies 196 p., 151 il. \$6.95
- 628—Basic Electricity & Beginning Electronics 252 p., 191 il. \$6.95
- 830—Introduction to Medical Electronics 320 p., 126 il. \$7.95
- 655—Modern Electronics Math 686 p., 424 il. \$11.95
- 728—Basic Digital Electronics 210 p., 117 il. \$4.95
- 691—Electronics Unraveled 228 p., 96 il. \$5.95
- 828—Switching Regulators & Power Supplies 252 p., 128 il. \$6.95
- 583—Industrial Electronics: Principles & Practice 416 p., 380 il. \$8.95
- 930—Servicing Medical & Bioelectronic Equipment 350 p., 165 il. \$8.95
- 601—Basic Color Television Course 420 p., over 300 il. \$9.95
- 104—Basic Radio Course 224 p., 128 il. \$5.95
- 638—Marine Electronics Handbook 192 p., 106 il. \$4.95
- 528—Pulse & Switching Circuits 256 p., 184 il. \$5.95
- 585—Digital Electronics: Principles & Practice 292 p., 191 il. \$5.95
- 105—Basic TV Course 224 p., 128 il. \$5.95
- 111—Basic Transistor Course 224 p., 179 il. \$7.95
- 791—Mathematics Unraveled—A New Commonsense Approach \$6.95

BROADCASTING & ELECTRONICS ENGINEERING

- 1133—The Active Filter Handbook 280 p., 251 il. \$6.95
- 1132—Hdbk. of Electrical Noise: Measurement and Technology \$6.95
- 1038—Electronic Designer's Handbook-3rd Edition 350 p., 278 il. \$9.95
- 1087—How to Repair Briggs & Stratton Engines 182 p., 135 il. \$4.95
- 1035—Instrumentation & Control Sys. Eng. Hdbk. 434 p., 184 il. \$19.95
- 929—Solid-State Motor Controls 322 p., 162 il. \$8.95
- 742—Prof. Electrical/Electr. Engr's License Study Guide 476 p. \$7.95
- 750—Electronic Conversions, Symbols & Formulas 224 p., 46 il. \$5.95
- 829—Impedance 196 p., 90 il. \$5.95
- 774—Digital/Logic Electronics Hdbk. 308 p., 226 il. \$6.95
- 118—Electronics Data Handbook 256 p., 149 il. \$5.95
- 811—Complete Hdbk. of Videocassette Recorders 280 p., 160 il. \$5.95
- 852—B-cast Engr. & Maintenance Hdbk. 532 p., 235 il. \$19.95
- 815—Design/Maintain. CATV/Small TV Studio 288 p., 100 il. \$12.95
- 768—Cablecasting Production Handbook 210 p., 44 il. \$12.95
- 1009—CCTV Installation, Maintenance & Repair 294 p., 208 il. \$8.95
- 733—Directional Broadcast Antennas 210 p., 60 il. \$12.95
- 833—Complete Broadcast Antenna Handbook 448 p., 310 il. \$17.95
- 523—Guide to Radio-TV B-cast Engineering Pract. 288 p., 140 il. \$12.95

10-DAY FREE TRIAL—NO RISK COUPON

TAB BOOKS, Blue Ridge Summit, Pa. 17214

Please send me the books indicated below:

- I enclose \$_____ Send postpaid.
- Invoice me on 10-day trial (plus shipping)

Book # _____ Book # _____ Book # _____ Book # _____

Name _____ Phone _____

Company _____

Address _____

City _____ State _____ Zip _____

Pa. add 6% Sales tax. All orders outside USA \$T-380 must add 15% shipping and be prepaid.

Tomorrow's Technology—Here Today!

THE YAESU FT-207R

The "horse-and-buggy" days of crystal-controlled handies are gone! Yaesu's engineers have harnessed the power of the microprocessor, bringing you 800 channels, digital display, memory, and scanning from a hand-held package. Only with Yaesu can you get these big performance features in such a compact package.

- 4 bit CPU chip for frequency control.
- Keyboard entry of all frequencies
- Digital frequency display.
- 800 channels across 144-148 MHz.
- Up/Down manual scan, or auto scan for busy/clear channels. 10 kHz scanning steps.
- Five channels of memory
- Priority channel with search-back feature.
- Keyboard lock to prevent accidental frequency change.
- Memory backup
- ± 600 kHz or odd repeater splits.
- Display ON/OFF switch for battery conservation.
- Equipped with rubber flex antenna, wallmount battery charger, earphone, shoulder strap, and belt clip.
- Switchable RF output 2.5 watts (minimum) or 200 mW
- Earphone for private listening
- 2 Tone (Touchtone[®]) Input from Keyboard
- Highly reliable LED frequency display (works in cold temperatures and does not fade with age)



SPECIFICATIONS:

GENERAL

Frequency coverage: 144-148 MHz
 Number of channels: 800
 Emission type: F3
 Batteries: NiCd battery pack
 Voltage requirement: 10.8 VDC
 $\pm 10\%$, maximum
 Current consumption:
 Receive: 35 mA squelched (150 mA unsquelched with maximum audio)
 Transmit: 800 mA (full power)
 Case dimensions: 68 x 181 x 54 mm (HWD)
 Weight (with batteries): 680 grams

RECEIVER

Circuit type: Double conversion superheterodyne intermediate frequencies.
 1st IF = 10.7 MHz
 2nd IF = 455 kHz
 Sensitivity: 0.32 μ V for 20 dB quieting
 Selectivity: ± 7.5 kHz at 60 dB down
 Audio Output: 200 mW at 10% THD

Price And Specifications Subject To Change Without Notice Or Obligation

Hi-Low Power Switch (Bottom of Case)

TRANSMITTER

Power Output: 2.5 watts minimum /200mW
 Deviation: ± 5 kHz
 Spurious radiation: -60 dB or better
 Microphone: Condenser type (2000 ohms)

OPTIONS

LC-C7 Leather Carrying Case
 YM-24 Remote Speaker/Microphone
 Tone Squelch Unit
 NB-P9 Battery Pack
 NC-2 Quick Charger

YAESU
The radio.



180

YAESU ELECTRONICS CORP., 6851 Waltham Way, Paramount, CA 90723 • (213) 633-4007

YAESU ELECTRONICS Eastern Service Ctr., 9812 Princeton-Glendale Rd., Cincinnati, OH 45246

Leaky Lines

Dave Mann K2AGZ
3 Daniel Lane
Kinnelon NJ 07405

*A tap-tapping, but unlike Poe's
bird,
He needs no "midnight dreary"
to be heard,
Nor chamber door on which to
rap,
He's heard across the whole
darned map.
On ev'ry band, from dusk to
dawn,
The gross intruder carries on.
I'd love to swat that lousy
gremlin,
But who can get into the Krem-
lin?*

This small piece of doggerel, rude and rotten though it may be, points up a problem that has been plaguing us for lo, these many moons. There have been all sorts of overtures made to the Soviets to try to persuade them to take this intruder off the bands, but to no avail. We don't even really know what type of device this Russian "woodpecker" may be, but we have a notion that it is some sort of a scanner. What purpose can it serve? Surely there are more important communications for the Russians to snoop into... matters that relate to politics and international affairs. What can possibly interest them, for example, in monitoring the 8Z4 expedition as they did for hours on end? Up and down the DX bands they slide, inflicting the spectrum with their unwelcome presence.

They zero in on any frequency occupied by anyone who may be trying to work DX. If it is the Russians' intention to irritate, then they are doing a remarkably good job of it. But I cannot quite grasp the logic behind the tactic. Of what earthly use is this constant jamming of amateur radio?

They might well contemplate this: that the common belief is that this device of theirs serves no other purpose than making mischief through annoyance... that this may make it difficult for us to take them seriously in all other respects. The guy who thought up the "woodpecker" must be related to that other clown who claimed that the Russians invented "beisbol." The woodpecker is a childish idiocy

that will win nothing but contempt and scorn for the Soviets.

Some politician recently had the effrontery to suggest that far too much electric power is being wasted through amateur radio and that the energy consumed would be much better utilized in the heating of homes and the running of factories.

I've got a hot news flash: If he really wants to accomplish something worthwhile, he should figure out some way to store all the hot air that is generated by politicians, and then perhaps we wouldn't need to use any other source of energy at all!

Word is out that Donny Osmond, of the Donny and Marie Show, has gotten a Novice ticket and has joined the amateur fraternity. We wish him well, together with all other newcomers to our ranks. 73 once published an article which listed all the celebrities who hold ham licenses, and perhaps it might be a good idea to upgrade that piece, for many, like Donny, have become licensed since, and some old-timers have become inactive, while quite a few have gone on to join that Old Brass Pounder in the sky.

One guy that nobody ever hears anymore is Arthur Godfrey K4LIB. The trouble was that every time he came on the air, hundreds who recognized his distinctive voice would break in and the poor guy couldn't have an uninterrupted QSO. The same thing always happened to the redoubtable Jean Shepherd K2ORS, who had a veritable army of fans who wouldn't let him come on the air without constant breaking.

Speaking of Jean Shepherd, I must tell you about a brainstorm of his.

Years ago, a group of us used to hold nightly rag chews on 20 meters. These used to run well into the wee small hours of the morning. Jean and I, together with Dave Sohmer W2DJE, Jim Meyle K2PXX, Jack Powers W2JIA, Fred Arakelian W2MQI, and several others, would congregate on about 14.260 (old-timers will recall that in those days, about 1963 or so, we were still operating under the so-

called "gentlemen's agreement," reserving the lowest end of the phone portion for AM users). Discussions were generally frivolous, covering the broadest possible spectrum of subject matter. Rarely did we get involved in anything serious... it was all fun and games.

One night, Jean began talking about the culture and growing of beards (it was just about the time that the hippie movement was surfacing, and guys were showing up all over the place with hirsute facial adornments). He announced that the net, which he called "The Bearded Network," was having its annual drive for new members and that anyone monitoring could join simply by writing in and requesting membership... no initiation fee or membership dues.

I don't know what possessed him... it was strictly spontaneous and unexpected. The rest of us picked up his cue at once, and from that time on, each night's session would begin with a discussion relating to beards... famous historical figures who had worn them, such as Abe Lincoln, Robert E. Lee, H. W. Longfellow, Walt Whitman, the Smith Brothers, the Twelve Apostles, and so forth. Jean announced that we had a kit available which would speed up the growth process for young men, and Dave offered a bottled remedy for "beard lice." Jack raised the question of sleeping with the beard under the sheets while sleeping, or outside of them. We observed Roberts' Rules of Order... all very proper, just like a Madison Avenue corporate board meeting.

All this nonsense took place night after night throughout the long winter. All sorts of mail ar-

rived in response... none of which was answered, of course. Whenever anyone broke in to complain about not having received his membership card, he would be advised that there was a six-week delay due to the unprecedented response.

So it went on and on, and we must have developed a listening audience of several hundreds. God knows what this meant in terms of absenteeism in schools and on the job, for the sessions never broke up before at least 4 am.

Sooner or later it was bound to happen. During the Washington's Birthday Sale down at Harrison Radio, Dave Sohmer was browsing around, looking for bargains. He was wearing his QCWA pin, as all good members of that organization do, thus exposing his callsign to view. All at once a young fellow in naval uniform accosted him. "What are you trying to pull?" he thundered. "Why, you're nothing but a phony. You don't even wear a beard! No wonder I never got that membership card," he added. "Someone ought to knock hell out of you." Fortunately, this guy was all mouth and no action... he walked away in a towering rage. Dave told me that at the moment he thought the fellow was about to tear him apart.

"The Bearded Network" finally petered out. But it had been fun while it lasted.

Somehow, you don't hear this sort of thing anymore. People seem so all-fired serious on the bands nowadays. There's no room for humor and high spirits anymore. If that's called progress, I'll cheerfully take hemlock! Relief is just a swallow away!

Ham Help

I need to obtain both the construction and operation manuals for an Eico 722 vfo kit. Also, I need an operating manual for a Hallicrafters HT-40 transmitter. I will pay copying costs or copy myself.

Bill Danielson
3428 South Court
Palo Alto CA 94306

I badly need a schematic and alignment instructions for a Na-

tional NC-300 receiver. I will pay to have a copy made.

Bob Amos
607 North Madden
Shamrock TX 79079

I would like to start a net on 80 or 40 meters to experiment with the active-participation, role-playing game, Traveller.

David Martin
1605 Singletree Lane
Bowling Green KY 42101

New Products

RADIO SHACK PLUG 'N POWER WIRELESS REMOTE CONTROL SYSTEM

The new Radio Shack Plug 'n Power Wireless Remote Control System provides instant plug-in remote control of from one to 16 lights, appliances, or other ac-operated devices with no wiring or installation required.

The compact 4 3/4" x 3 1/2" x 3 1/2" remote control center is simply plugged into any ac outlet in your home, office, or business. The lamp or appliance, such as a TV, stereo, coffeepot, or security system, is plugged into a switch module which then plugs into an ac outlet.

Each lamp dimmer switch module will control any incandescent lamp rated up to 30 Watts, turning it on, dim, bright, or off. Appliance switch modules will control appliances rated up to 15 Amps or incandescent lamps up to 500 Watts.

An easily installed switch module is also available to replace wall switches for control of incandescent lights up to 500 Watts. Its functions include on and off by remote or local control, and bright and dim by remote control.

Sixteen "house code" settings on the control center and switch modules are said to permit the use of several systems in the same area without interaction, or to control up to 256 individual circuits. Any number of switches may be operated on a single circuit as well. The remote control center has but-

tons for "all-on" and "all-off" that can be used in case of an emergency.

The Radio Shack Plug 'n Power Remote Control System is available from participating Radio Shack stores and dealers. *Radio Shack, 1300 One Tandy Center, Fort Worth TX 76102.*

NEW 2 KW ANTENNA TUNER KIT IS UNVEILED BY HEATH COMPANY

A new 2 kW antenna tuner in kit form has been introduced by Heath Company, world's largest manufacturer of electronic kits. Featuring a built-in balun, the Heathkit SA-2040 antenna tuner can be used with any type of balanced or unbalanced feedline. It tunes continuously between 3.5 MHz and 30 MHz.

Incorporated in the SA-2040's design is a continuously variable inductor said to give an infinite number of impedance settings for precise antenna matching. Inductor settings are indicated by a counter on the front panel. By noting settings on the erasable front panel, the operator can return quickly to a specific frequency, especially helpful for net operations or contesting.

This antenna tuner features silver-plated straps and roller contact assembly for minimal rf loss at high frequencies. Its large ceramic feedthrough insulators are designed to withstand high voltage rf. The tuner is capable of handling up to 2000 Watts PEP on sideband

and 100 Watts on CW.

The SA-2040 kit includes a detailed Heathkit instruction manual and can be built in two evenings. Upon completion, the antenna tuner can be personalized with the operator's own callsign using stick-on numerals and letters included with the kit. The unit is housed in a black and gray metal cabinet measuring 5-5/8" H x 14-13/16" W x 13-15/16" D.

The SA-2040 antenna tuner, and nearly 400 other electronic kits you build yourself, can be seen at Heathkit Electronic Centers or in the latest Heathkit Catalog. A free copy may be obtained by writing *Heath Company, Department 350-110, Benton Harbor MI 49022.* Reader Service number 303.

CLUTTERFREE MODULAR CONSOLES

In the frantic world of electronics merchandising, manufacturers and users of equipment often overlook the obvious—like what to set it on! Even the most diligent reader will fail to find more than a tiny handful of furniture manufacturers in the hundreds of equipment ads which support the pages of a major hobby magazine like 73.

Fortunately, at least one capable woodworker recognized the importance of rugged quality, professional appearance, and reasonable cost: Clutterfree Modular Consoles, a division of Cloverleaf Products.

I was privileged recently to have the opportunity to assemble one of Clutterfree's excellent equipment consoles and was very impressed with what I had

when I finished.

While it would be possible to manufacture a cabinet made from solid hardwood, it is far more economical to use thick particle board with a natural-looking finish. This is the philosophy behind manufacturing these equipment desks. The finish laminate is made from decorative Plyocite®, a highly-resistant covering which offers protections from solvents, stains, cleaners, and even burns.

The Clutterfree is available in a number of options. As shipped, a face board is provided for custom cutout to receive the components of the ham station. While the customer may wish to exercise the care required to make a good fit, he may send measurements to the factory before shipment and skilled craftsmen will make the cutouts for him at a slight additional cost.

Once fitted, the sloping front panel provides comfortable access to the operating controls of your equipment. Or, as shown in the photograph, the optional front panel may be omitted entirely and the equipment set in place. This is especially handy for those of us who can never make up our minds as to what equipment we are planning to keep and what we are going to swap at the next hamfest!

Tabletop room is quite spacious: nearly five feet wide by 2 1/2 feet deep. Cabinet room in the pedestals is voluminous, too. Plenty of space for books, logs, QSL cards, spare components, and whatever else might be needed at the operating position. A drawer model is



Plug 'n Power Remote Control System from Radio Shack.



Model SA-2040 antenna tuner from Heath.

now available at additional cost, making the console a beautiful piece of office furniture as well.

Height of the tabletop will accommodate a wide range of users' knees and permit leg-crossing, too!

The upper shelf is quite rigid when securely locked down by the mounting screws; a vertical divider doubles as a center brace. This shelf is a logical place to put a clock, lamp, speaker or any other light appliance or paraphernalia.

Because of the substantial weight of the hefty console, it is a good idea to examine carefully the component packages upon arrival from the shipper. The finished wood is well packaged, but shippers have a tendency to find the weak spots! In our particular case, a tell-tale hole showed that a talented fork-lift operator took careful aim before skewering our console! Our replacement met the same fate and was refused upon delivery. Needless to say, we are now using a different shipper! It's heartbreaking to see a fine piece of carefully-made furniture become a battleground for war games.

Your console will consist of three packages. Final assembly is easy. The two pedestals are fully assembled already. After they are spaced appropriately apart, you simply set the tabletop in place, insert the screws provided, and tighten up. The upper shelf is also a snap to complete; members are already slotted for a sure fit. Average assembly time is less than an hour. When the job is finished, you will be proud of your product. It is handsome, modern, durable, practically designed, and reasonably priced.

Clutterfree Modular Consoles are \$169.95 and are available from *Cloverleaf Products, PO Box 5103, Tacoma WA 98405*. Reader Service number 476.

Robert B. Grove
Brasstown NC

CHECKING OUT THE MACROTRONICS M650 RTTY INTERFACE UNIT

If you're a ham and own a home microcomputer, you'll want to read up on a way to get on the air on RTTY and CW using your computer. The Macrotronics M650 interface unit is designed to convert the PET™ computer to a first-class RTTY and CW terminal.

Radioteletype (RTTY) is a rapidly-growing form of amateur radio communications, especially in its most advanced "digitized" form. Electronics has taken RTTY out of the woods, so to speak, by enabling compact, state-of-the-art electronic terminal equipment having few if any moving parts that replace bulky and noisy mechanical teleprinters.

One can easily get on RTTY today by three means: (1) buying surplus mechanical teleprinter equipment—the classic method; (2) buying or building a "dedicated" RTTY system, examples being the type of gear sold by HAL Communications and Microlog; or (3) building or purchasing a home computer interface unit.

I chose to go the third route for reasons of economy and simplicity, having already purchased a PET, and being unwilling to devote \$600-700 or more to a single-purpose dedicated RTTY system. I was immediately attracted by the Macrotronics ads for the PET and Radio Shack TRS-80 interface adapters that began to appear in the ham magazines last spring. I was sold on the PET M650 interface as a way of almost instantly getting on the air on RTTY.

My "instant" conversion to RTTY dragged out to nearly six months due to production problems encountered in gearing up the interface units for sale. What finally arrived was surely worth the wait—a very professionally wired-and-tested "black box" complete with debugged software and an extensive instruction manual. All that was necessary was to add my own AFSK (audio frequency shift keying) unit and connecting cables for it, required to modulate the transceiver's SSB input to produce the FSK tones by which RTTY is transmitted over the air. Let's look at some of the features of the M650.

RTTY Features and Capabilities

The system produces a three-level split screen display on the PET's video monitor. The transmit buffer is displayed on the top 6 lines of the display and the receive buffer is presented on the bottom 12 lines. The middle 2 lines display "real-time" characters as they are being transmitted over the air. With this buffered system, you can type ahead into the transmit



Clutterfree Modular Console from Cloverleaf Products.

buffer while you are receiving an incoming message, which allows you to have full editing and correction control over what you compose. When it's your turn to transmit, you enter the send mode (by depressing a particular key on the computer's keyboard); the transmit buffer will begin to send what's stored in it. You can continue to type ahead into the transmit buffer, which will be displayed at the top of the screen. Instant replay of received messages is also possible, so that you can send a received message back to the originating station. Incoming messages can be saved on the computer's built-in cassette recorder and played back at a later time—an excellent feature

for traffic handlers.

The M650 RTTY system works with 110-baud ASCII coding or standard teleprinter Baudot code at speeds of 60, 67, 75, or 100 words per minute (wpm). Received signals may be *inverted* from the keyboard, useful in deciphering stations sending upside down (mark and space tones reversed). The unit also has provisions for sending the FCC-required CW identification (ID) in Morse code at the end of each transmission, then automatically transferring to the receive mode. The ID message is keyboard programmable. In addition, there are eight message memories available,

Continued on page 144

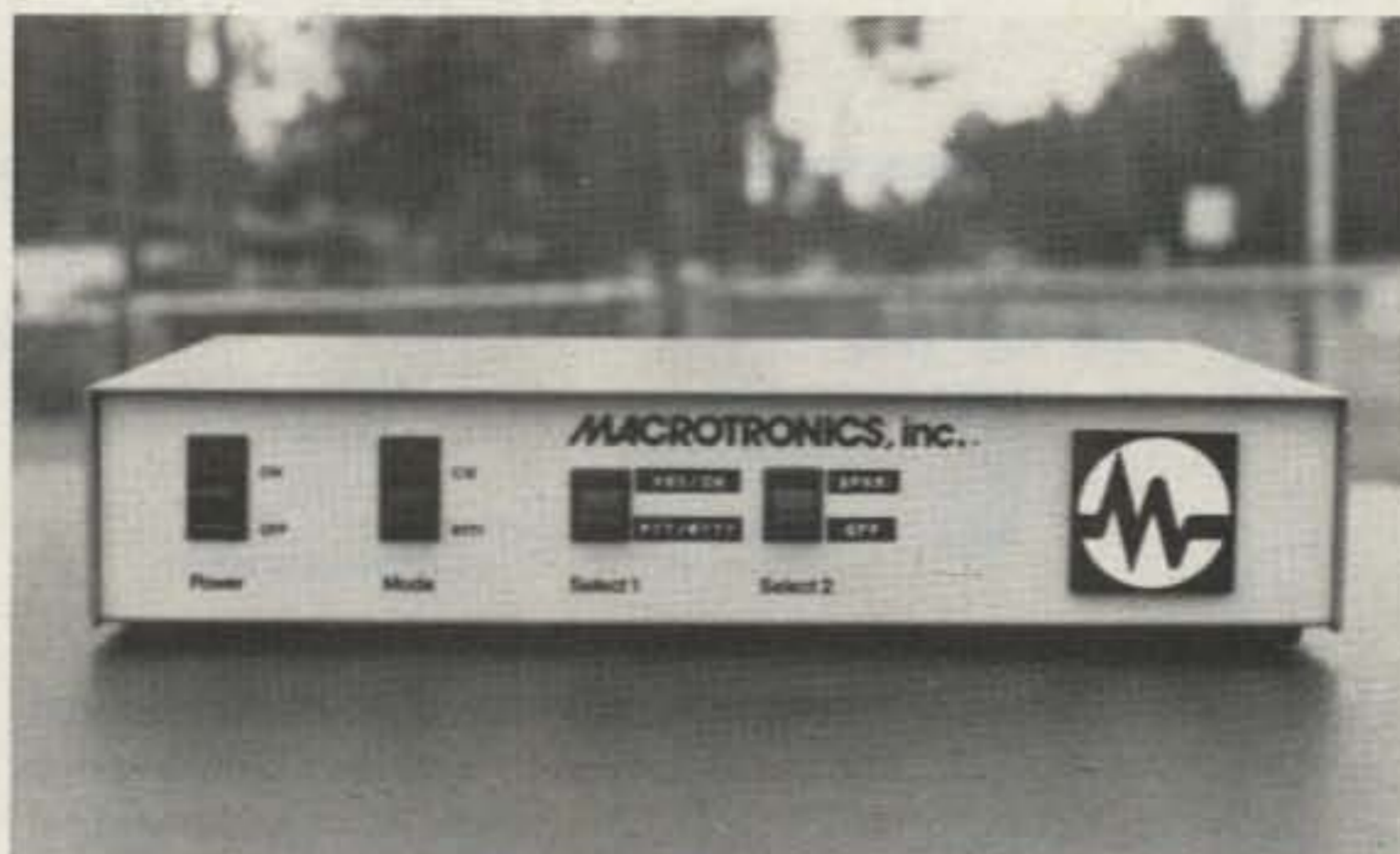

Macrotronics' M650 computer interface is sold wired and tested for \$210. "Select 1" and "Select 2" switches are for future accessory installation and are temporarily in use by the reviewer for transmitter switching functions.

ANSWER: TUFTS RADIO ELECTRONICS. Send for our fabulous radio catalog today.

Tempo, Ten-Tec, Texas RF, Tonna Antennas, TPL, Tri-EX, Van Gorden, Vibroplex, Vidaire, Vista, VHF Engineering, VOMAX, Wilson, YAESU?

KENWOOD



TR7600 VHF XCVR
BLC 10/70 VHF Power Amplifier

TR7600: 2m FM XCVR. 10 watts, LED readout, 144-147.995. Fully synthesized, any repeater offset possible, memory channel.

\$375.00
149.95

TOTAL REGULAR PRICE **\$524.95**
SALE PRICE **\$424.95**

SAVE \$100.00

Vhf engineering

Unarco-Rohn

COMPLETE 25G TOWER PACKAGES

50' Guyed Tower: Includes top section, 4 regular sections, base plate, rotor plate, 50' guy wire, 2 guy assemblies with torque bars, 3 concrete guy anchors and other miscellaneous hardware.



TOTAL REGULAR PRICE **\$594.02**
SALE PRICE **464.02**

SAVE \$130.00

50' Bracketed Tower: Includes top section, 4 regular sections, base plate, rotor plate and universal house bracket.

TOTAL REGULAR PRICE **\$366.15**
SALE PRICE **266.15**

SAVE \$100.00

BECKMAN



...Beckman Multimeters keep going.

If you've ever been troubled by a faulty multimeter — or had one that wasn't quite up to the tougher jobs — your troubles are over

TECH 300 — \$100
TECH 310 — \$130

Choice of Models
The TECH 310 has all above features, 7 functions, 29 ranges, plus 0.25% Vdc accuracy.
The TECH 300 has a 0.5% Vdc accuracy and all the above features, but without Insta-Ohms™ continuity function or the 10 amp current ranges

Complete Multimeter Capability
DC volts: 100µV to 1500V
AC volts: 100µV to 1000V rms
Resistance: 0.1Ω to 20MΩ
DC current: 100nA to 10A (TECH 310)
100nA to 2A (TECH 300)
AC current: 100nA to 10A (TECH 310)
100nA to 2A (TECH 300)
Diode/Semiconductor test function
Continuity Function (TECH 310)

TEN-TEC



574



570

TUFTS NOVICE EXCLUSIVE

Purchase your Century 21 (570 or 574) from us and have up to one year to apply the full purchase price towards a model 540, 544, 545, or 546 when you upgrade your station.

NOVICE SPECIAL

TEMPO

KLM

YAESU

Syncom S1 with TTP:
From Tempo — the world's first synthesized 800 channel handheld transceiver. Includes battery pack, charger, telescoping antenna — and 800 channels!

FT207R:
From YAESU — 2m FM XCVR. Handheld completely synthesized, digital readout, keyboard access, 2 watts, 4 memories and much more.

KLM PA2-25B Power Amplifier: 2 watts in, 25 watts out.

PACKAGE 1

| | |
|-----------------------------|-----------------|
| Tempo S1 w/TTP | \$339.00 |
| KLM PA2-25B Power Amplifier | 92.95 |
| Total Regular Price | \$431.95 |
| SALE PRICE | \$396.95 |
| SAVE \$35.00 | |

PACKAGE 2

| | |
|--------------------------------|-----------------|
| FT207R Synthesized 2m handheld | \$399.00 |
| KLM PA2-25B Power Amplifier | 92.95 |
| Total Regular Price | \$491.95 |
| SALE PRICE | \$441.95 |
| SAVE \$50.00 | |

KENWOOD

...pacesetter in amateur radio



TS520SE

TS520SE: 160-10 meters, 200 watts P.E.P., speech processor, noise blanker, excellent sensitivity and minimum cross-mod.

5BTV

| | |
|----------------------------|-----------------|
| TS520SE | \$629.95 |
| Hustler 5BTV Vertical | 139.95 |
| TOTAL REGULAR PRICE | \$769.90 |
| SALE PRICE | \$649.90 |
| SAVE \$120.00 | |

or

| | |
|----------------------------|-----------------|
| TS520SE | \$629.95 |
| ATB34 Cushcraft TriBander | 289.95 |
| TOTAL REGULAR PRICE | \$919.90 |
| SALE PRICE | \$769.90 |
| SAVE \$150.00 | |

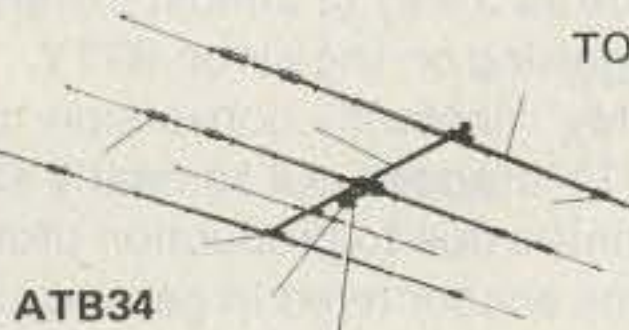

ATB34





KENWOOD



MBII TUNER:
3kW, 160-10 meters.



TL922A: 2kW P.E.P., 160-15 meters, 3-500Z tubes.



Model 43



| | |
|----------------------------|------------------|
| TL922A: | \$1199.00 |
| MBII Tuner | 295.00 |
| Total Regular Price | \$1494.00 |
| Sale Price | \$1294.00 |
| SAVE \$200.00 | |

| | |
|--|------------------|
| TL922A: Bird Model 43 with 2500H element and carrying case | 201.00 |
| Total Regular Price | \$1400.00 |
| Sale Price | \$1200.00 |
| SAVE \$200.00 | |

CALL AND CHECK OUR GREAT DEALS ON ALL YOUR AMATEUR RADIO NEEDS.
DIAL: (617) 395-8280

Stock items shipped within 24 hours. Prices subject to change. Limited quantity on some items.

Palomar, Pipo Communications, Regency, Robot, Rohn, Sharp, Slinky, SST, Stinger, Swan, Teletower, Telex,

QUESTION: Who has Advanced Electronics, Alpha, AMECO, Amphenol, Antenna Specialists, Astatic,

☆☆☆☆☆☆☆☆☆☆ **PALOMAR ENGINEERS** ☆☆☆☆☆☆☆☆☆

R-X NOISE BRIDGE \$55.00



- Learn the truth about your antenna.
- Find its resonant frequency.
- Find R and X off-resonance.
- Broadband 1-100 MHz.
- Simple to use. — Self contained.

VLF CONVERTER \$59.95



- New device opens up the world of VLF radio.
- Converts VLF to 80 meters. For use with any shortwave receiver covering 3.5-4 MHz.
- Advanced design for simple operation, high performance.
- Gives reception of the 1750 meter band.
- Also covers navigation radiobeacons, WWVB, ship-to-shore, and LF broadcast band.

LOOP ANTENNA

Loop Amplifier \$67.50
Plug-in loops \$47.50 ea.

- Plug-in loops available for:
1600-5000 KHz (160/80 meter amateur bands)
550-1600 KHz (Broadcast Band)
150-550 KHz (VLF, 1750 meter band)
40-150 KHz (WWVB, Loran)
10-40 KHz (Omega)
- Nulls out interference



ALL BANDS PREAMPLIFIER \$89.50



- Tunes 1.8 to 54 MHz. Covers ALL amateur bands 160 to 6 meters. ALL shortwave broadcast bands.
- For receivers AND transceivers.
- Up to 20 db gain.
- Peps up that tired receiver.
- Reduces image and spurious response.



Model MB II \$295
(with Balun) \$325

MB II provides:

- * Constant SWR monitoring
- * Precision tuning of final amp
- * Harmonic suppression
- * Receiver input impedance-matching
- * Maximum power transfer to antenna
- * Continuous frequency coverage 1.6 to 30 MHz
- * Precision tuning of any wire 1/2 wavelength or longer, with SWR of 1:1

MB II features:

- * Finest quality, made-in-USA components
- * Large precision, easy-to-read dials with 360 readout
- * Optional 3000 watt Balun for twin lead antennas

BIRD Electronic Corporation

\$94 VHF model 4362 (140-180 MHz)
\$94 HF model 4360 (18-30 MHz)



The 4360, 4362 HAM-MATE Directional Wattmeters are insertion type instruments for measuring forward or reflected power in 50-ohm coaxial transmission lines. They are direct descendants of the model 43 THRULINE® Wattmeter — the professional standard of the industry—and will accurately measure RF power flow under any load condition. Each wattmeter is made up of a precisely machined section of 50-ohm line, a rotatable sensing element and meter calibrated in watts, all mounted in a high-impact plastic housing. It is this type of solid construction and the directional THRULINE coupling circuit, without toroids, that account for the superiority of the HAM-MATE Wattmeters.

the indispensable **BIRD 43** THRULINE WATTMETER



| Power Range | Frequency Bands (MHz) | | | | |
|-------------|-----------------------|--------|---------|----------|----------|
| | 2-30 | 25-100 | 100-250 | 250-1000 | 400-1000 |
| 5 watts | 5A | 5E | 5D | 5F | 5G |
| 10 watts | 10A | 10E | 10D | 10F | 10G |
| 25 watts | 25A | 25E | 25D | 25F | 25G |
| 50 watts | 50H | 50A | 50E | 50D | 50F |
| 100 watts | 100H | 100A | 100E | 100D | 100F |
| 250 watts | 250H | 250A | 250E | 250D | 250F |
| 500 watts | 500H | 500A | 500E | 500D | 500F |
| 1000 watts | 1000H | 1000A | 1000E | 1000D | 1000F |
| 2500 watts | 2500H | 2500A | 2500E | 2500D | 2500F |
| 5000 watts | 5000H | | | | |

MODEL 43
Elements (Table 1) 2-30 MHz \$130.00
Elements (Table 1) 25-1000 MHz 45.00
Carrying case for Model 43 & 6 elements 38.00
Carrying case for 12 elements 27.50
Carrying case for 12 elements 17.00

READ RF WATTS DIRECTLY! (Specify Type N or SO239 connectors) 0.45 — 2300 MHz, 1-10,000 Watts ±5%, low insertion VSWR — 1.05. Unequalled economy and flexibility. Buy only the element(s) covering your present frequency and power needs, add extra ranges later if your requirements expand.



5-BAND TRAP DIPOLE (80 thru 10 Meters)

Barker & Williamson

Power rated 2k WPEP, approx. 110 ft. span

Complete with: wire, traps, and insulators, 50 ft. RG-8/U, PL-259 connector, heavy-duty cast aluminum and steatite center connector.



Pre-assembled:
Model 370-11 — \$64.95

Kit (illustrated):
Model 370-12 — \$54.95



TWO-METER CRYSTAL SALE

Limited to existing stock.

Standard • Icom • Heathkit • Ken • Clegg • Regency • Wilson • VHF Eng • Drake • And Others!

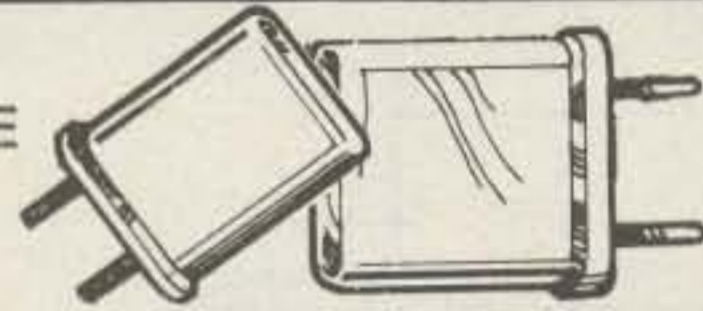

Hy-Gain REEL TAPE PORTABLE DIPOLE for 10 thru 80 Meters Model 18TD

The most portable high performance dipole ever...

The Model 18TD is unquestionably the most foolproof high performance portable doublet antenna system ever developed. It has proven invaluable in providing reliable communications in vital military and commercial applications throughout the world. Two stainless steel tapes, calibrated in meters, extend from either side of the main housing up to a total distance of 132 feet for 3.5 mc operation. 25 ft. lengths of polypropylene rope attached to each tape permits installation to poles, trees, buildings... whatever is available for forming a doublet antenna system. Integrated in the high impact housing is a frequency to length conversion chart calibrated to meter measurements on the tapes... makes installation foolproof. Feeds with 52 ohm coax. Delivers outstanding performance as a portable or permanent installation. Measures 10x5 1/2x2 inches retracted. Wt. 4.1 lbs. Order No. 228 Price: \$94.95



hy-gain

BANDPASS-REJECT DUPLEXER DPLA-144 FOR 144-174 MHz

Also available for 54, 220, 450 MHz.

THESE BAND PASS BAND REJECT CIRCUIT DUPLXERS utilize the use of an exclusive circuit developed for VHF and UHF which provides superior suppression of spurious signals and noise between and adjacent to the duplex frequency. When used with a high Q filter, the Band Pass Band Reject Circuit provides frequency response curves with bandwidths equal to those of the duplexer to be used and bandwidths equal to those of the duplexer to be used. Performance characteristics improve as the frequency of operation is increased. Frequency stability of the Band Pass Band Reject Circuit Duplexer is excellent... an important factor in most frequency spacing. Each model will handle transmitter power up to 200-watts and all models are supplied with complete cable harness and mounting frame.

\$479



WACOM

Name _____ Call _____
Address _____
City _____ State _____ Zip _____
Order: _____
 Check Enclosed Visa Master Charge Send for Free Catalog
PRICES SUBJECT TO CHANGE WITHOUT NOTICE
Card no. _____ Card exp. date _____
Signature _____

TUFTS

Radio Electronics
OPEN DAILY 9-9
SATURDAY 9-5

206 Mystic Avenue, Medford, Mass. 02155, Tel: 1-617-395-8280

JMR, KLM, Kenwood, Larsen, MFJ, Microwave Filter, Morgain, Mosley, Newtronics, NPC, Nye Viking,

Atlas, Bencher, Bird, Bomar, B&W, CDE, CES, CSC, Cushcraft, Daiwa, Datong, DGM, Drake, ETO, F9FT, Finco, Ham Key, Henry Hustler, Hygain,

Good-Bye to Autopatch Hassles

— low-cost remedies to common problems

Quite often when a repeater group starts to install an autopatch unit on its repeater, it encounters a few problems. These include coming up

with a practical way to monitor and log the patches and how to get everyone's tones set to the right level. While most of the other problems associated with autopatch can be solved through proper education of the users, those two problems have simple solutions with a minimum investment in equipment.

adaptable for this operation. For our particular system at WR2ABS, in Binghamton, we use a \$30 model obtained from Radio Shack. It has an automatic volume level circuit, is ac or dc powered, and has a jack from which we can control the machine's starting and stopping. We use 120-minute cassettes. Each cassette is good for around 30 calls per side. We use about 45 cassettes for a year of logging. A careful watch of bargain stores such as Olsen Electronics, in Akron, Ohio, can yield some excellent prices on voice-quality cassettes. We purchased ours as needed in just big enough lot sizes to qualify for discounts, as we didn't know how many tapes we would eventually need.

The vast majority of patches use some means of tape-recording the calls for the logging requirements. The big professional machines with the 10½" reels and 1-7/8 ips speed may be great for time-between-tape changes, but they fall a bit short when one wants to review the tapes without shutting the system down. Those machines are a bit costly without insisting on two of them.

A more practical device is the lowly cassette recorder. These are cheap, readily available, and most

A lot of groups are under the impression that the recorder must be at the repeater site. This is probably one of the poorest choices

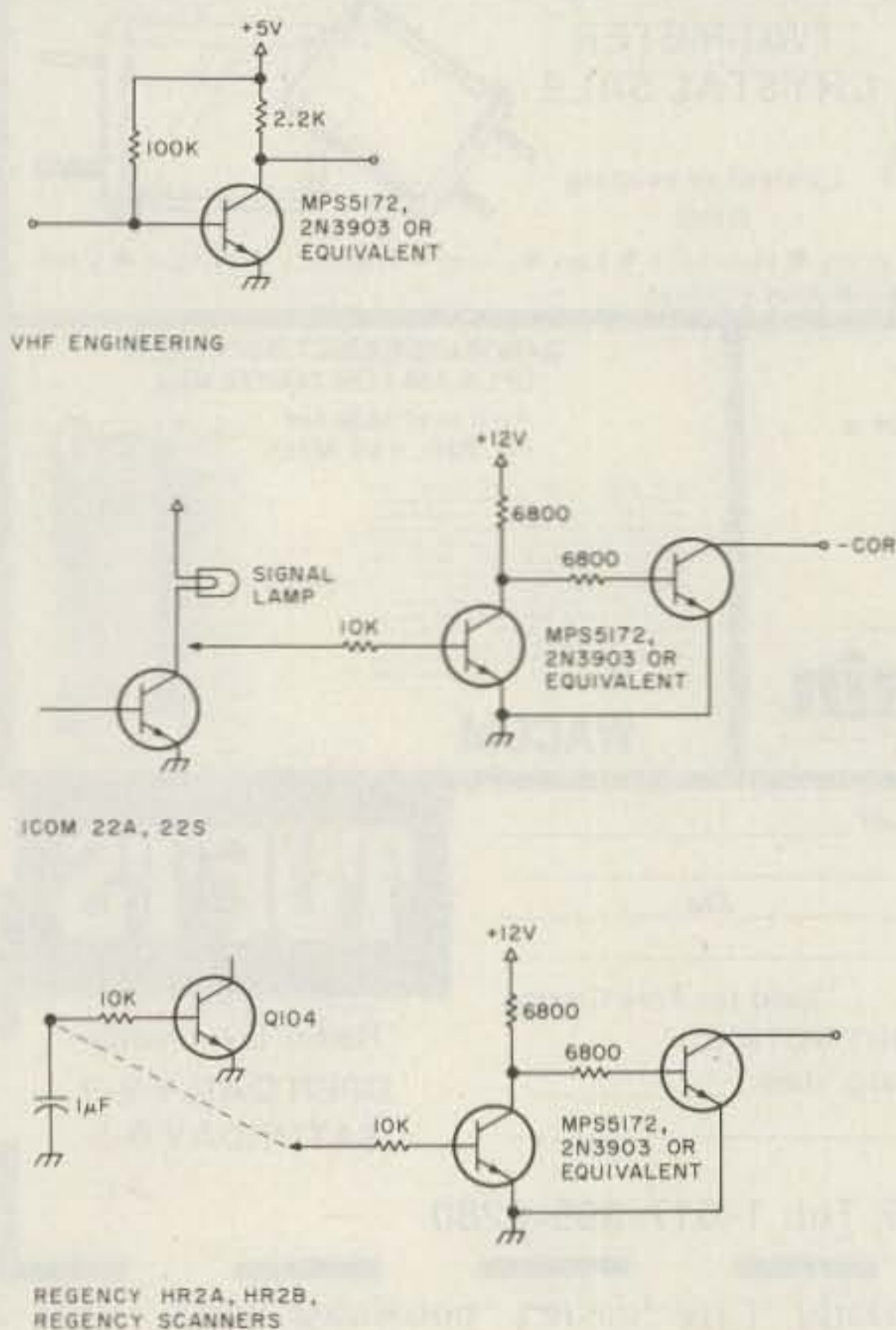

Fig. 1.

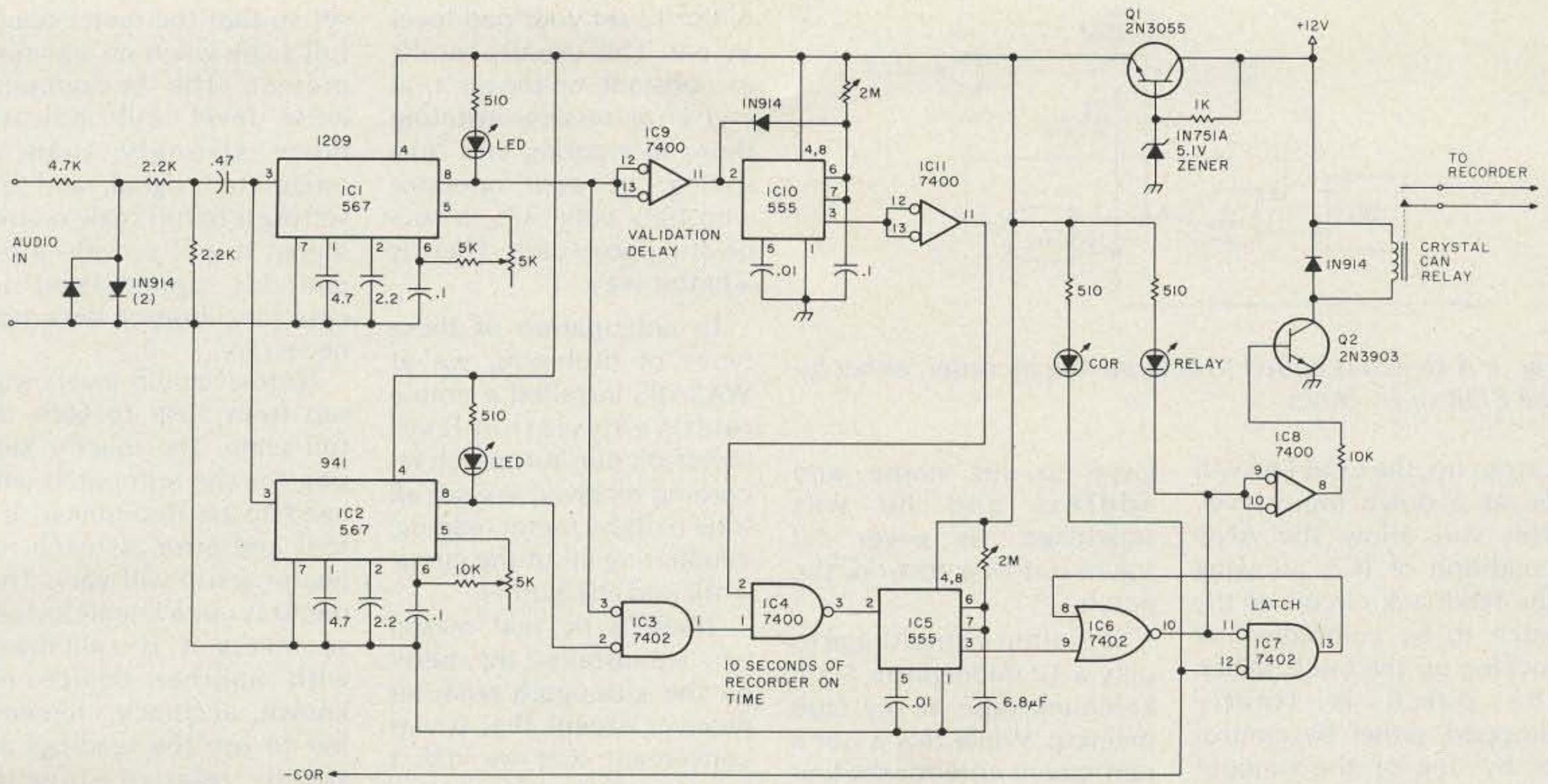

Fig. 2. Tape-recorder control.

for the location of the recorder. The best place is in someone's house—preferably the house of someone who is home often. By teaming up the recorder with a receiver capable of receiving the repeater full quieting, the combination can be housed anywhere. And by placing the combination in a residence, you eliminate worries about electricity, accessibility, temperature variation, and supervision. The lucky custodian need only glance at the recorder periodically to ensure an adequate supply of tape, or flip over the cartridge, or put in a new one. As this occurs only every few days, it is no great hardship on anyone.

The receiver chosen for this task need not be fancy or super-sensitive. A little scrounging often can turn up an old scanner, or someone's old fire monitor, or even an old out-of-service rig. We ended up using the receiver designated as our lockout receiver for those days when it was required.

The only modification to the receiver is to install a COR circuit. All other attachments are made to

the existing circuitry of the receiver. Fig. 1 illustrates a number of COR circuits that can be adapted to almost any receiver having a squelch circuit. The main idea is to connect to that point in the squelch circuit that drives the audio gate. A parallel circuit is added so that when the gate is opened by the presence of a carrier, a logic down level appears at the COR terminal of the added circuit.

The next step is to construct a circuit that activates the tape recorder in the same manner as the one that activates the patch. Since most patches use the * up, # down access, this is the circuit that will be described. In those areas where nerds abound, forcing one to go to a multi-digit access, one must then substitute the same access circuit used for the patch and substitute it in the circuit to be described below. The basic philosophy involved is that the tape recorder is to activate when the patch comes up and go down when the patch goes down.

Please look at Fig. 2. The AUDIO IN terminals are

connected across the speaker terminals of the monitor receiver. The 5k-ohm input impedance will not load the speaker circuit at all. If the audio level is too loud, the two diodes will start conducting and limit the audio level into the phase locked loops, ICs 1 and 2. R1 is adjusted by placing a frequency counter on pin 5 of IC1. Adjust R1 until the counter reads approximately 1180 Hz. This phase locked loop is to be set to trip when it sees 1209 Hz. Setting the loop about 30 cycles low seems to allow faster lock-up, especially in the presence of another tone. This method is not supported in the literature, but it works.

By the same method, set R2 so that the counter on pin 5 of IC2 reads 910 Hz. This will allow IC2 to respond to a 941 Hz tone. Thus, when a * is sent, both phase locked loops will activate, satisfying the AND condition of IC3. Since the phase locked loops react very quickly, voice peaks can trip this circuit. IC10 is used to generate a one-second delay which is ANDed with the output of the two

phase locked loops. The result is that not only must both tones be present, but they must be present for the length of the time delay. This will prevent random voice signals from tripping the recorder.

ICs 9 and 11 serve only to provide the proper polarity in and out of the delay circuit. IC5 is a variable delay that will apply a set pulse to the latch circuit made up of ICs 6 and 7. The latch being set will activate the tape recorder. The latch is a "set over reset" type, or the latch will remain set independent of the reset pulse as long as the set line is active. The delay circuit of IC5 is used to keep the recorder on for about 10 seconds. This allows the recorder to pick up attempts to access the patch and will keep the recorder on long enough to allow it to come up to speed. The reset to the latch is the COR line from the circuit described previously.

The idea behind this is that while the patch is active, the repeater carrier is up continuously during both sides of the conversation. With the repeater

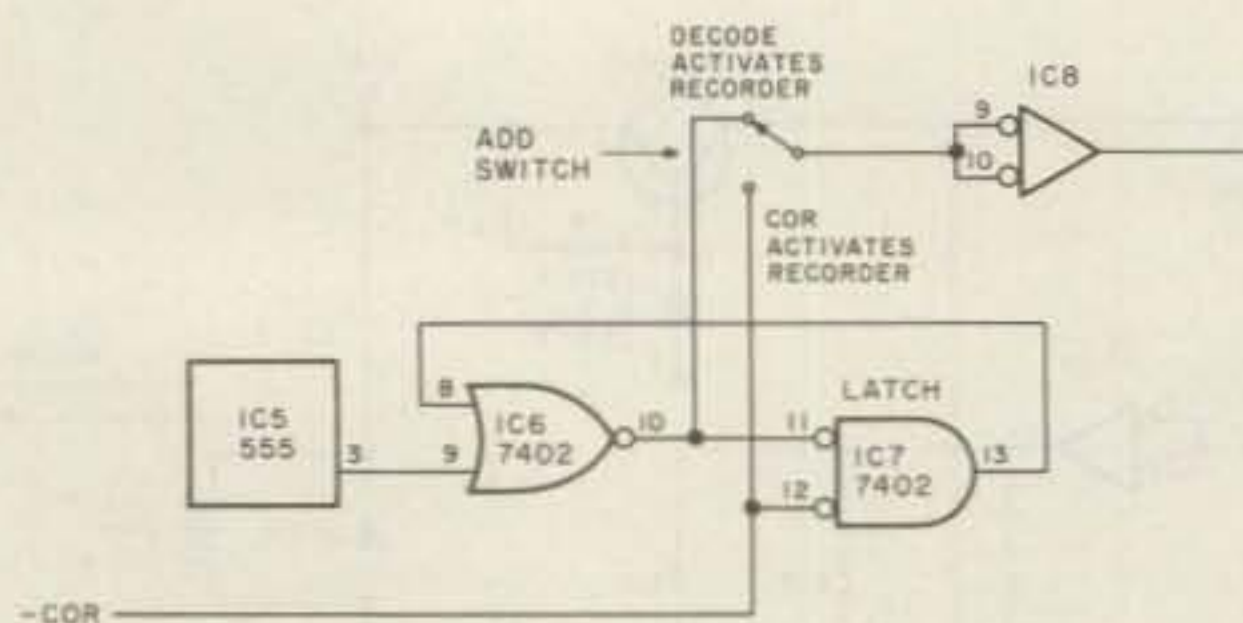

Fig. 3. A switch is added to activate the recorder, either by the COR or by tones.

carrier up, the COR line will be at a down logic level. This will allow the AND condition of IC7, allowing the feedback circuit of the latch to be complete and locking up the latch. When the patch is finally dropped, either by control or by one of the timeout functions, the repeater carrier will drop and the COR line will go up, resetting the latch and turning off the recorder. The latch is coupled to the tape recorder by means of IC8, Q2, and the relay. The relay contacts are wired to the remote control jack of the tape recorder. Q1 serves as a voltage regulator to generate 5 volts for the logic circuitry.

One modification to this circuit is shown in Fig. 3. With the addition of one switch, the tape recorder can be activated by the autopatch access tones or it can be set to turn on each time the COR is activated. There may be those times when it is desirable to record everything on the repeater, not just the patch. For example, it is extremely useful to record an emergency exercise. A full scenario is recorded in time sequence for later examination and critiquing. We managed to locate and remove from the air waves a "Good Buddy" type whose "hot" radio had some neat push-buttons that dialed a telephone. By recording the struggles of this poor sap and decoding the phone number he was trying to dial, a reverse phone book

gave us his name and address and he was squelched. He never did figure out how to work the patch.

It is often instructional to play a 12 midnight to 6 am kerchunk tape at the club meeting. While this is not a permanent cure for the kerchunk problem, it does prove that the number of kerchunks between midnight and 6 am is exceeded only by the number of furlongs between here and Venus.

One source of irritation can be eliminated by setting everyone's touch-tone™ pads to the proper level. Every 2m FM rig has a limiting circuit in the modulation chain that is used to prevent over-deviating. This circuit usually consists of a couple of diodes, and they tend to clip modulation peaks. It's this clipping action that puts the kibosh on many perfect dialing records. The clipping action generates harmonics that fall within the audio passband of the tone decoder. It seems that Ma Bell's decoders get hyper if there are any signals louder than 20 dB less than the level of the tones. This means that if there are any extraneous signals present along with the tones, the decoder may refuse to recognize the tones. Since most people cannot even tell that any distortion exists on the tone signals, let alone what the relative level between the high tone and low tone is, it is absolutely ludicrous to at-

tempt to set your pad level by ear. This usually results in constant on-the-air trial and error testing, irritating those monitoring and frustrating the poor operator who bats only .375 in successful phone calls. There is a better way.

In anticipation of these types of problems, we at WR2ABS installed a simple relative-deviation-level meter on our autopatch recording receiver. We set all tone pads by meter reading, eliminating all of the guesswork and the bother.

There is no real reason why we installed the meter on the autopatch recorder receiver except that it was convenient and we didn't have another receiver lying around. The two sets of circuitry are not related to each other and may be installed on two separate receivers at two totally separate locations.

As this meter circuit, shown in Fig. 4, is purely a relative indicator of deviation, the correct settings must be determined by trial and error. But, once found, the meter can be declared "the golden standard" and can be used to set everyone's tone pads consistently. The input of the meter circuit is connected to the output of the discriminator circuit. The easiest point is usually on the hot side of the volume control. The meter circuit must be connected before the squelch gate and before the volume control. We want neither the squelch control nor the volume control position to affect the meter calibration in any way. The discriminator output is fed to an operational amplifier through a 15k pot which serves as a gain control. The amplified audio is rectified by the full-wave bridge, the peak output of which is applied to the meter. The meter will respond to peak deviation of either polarity. To calibrate, the 15k pot is

set so that the meter reads full scale when no signal is present. The background noise level will indicate more strongly than a modulated signal, and by setting it to full scale on the meter, it will provide a repeatable upper level in case recalibration becomes necessary.

Normal audio levels will run from 50% to 60% of full scale. The specific setting for the autopatch will need to be determined by trial and error, as each repeater setup will vary. The meter is not a linear device, so unless it is calibrated with another device of known accuracy, remember to use the readings as strictly relative—repeatable, but relative.

The touchtone signal consists of two sine-wave audio tones. The low group representing the rows are 647, 770, 852, and 941 Hz, respectively. The high group representing the columns are 1209, 1336, and 1477 Hz, respectively. Ideally, the proper tone consists of a high tone and a low tone and nothing else, including such things as harmonics from clipping, voices, noise from less than full-quieting signals, and music. Any other noise must be at least 20 dB lower in amplitude than the tones or the Ma Bell decoders will hiccup. The two tones must add in a linear manner. So, if one tone is louder than another, it may show the same peak amplitude as one with totally different individual amplitudes but with the same sum amplitude. For this reason, it is important to set the pads up by looking at the individual tones, as Ma Bell also is fussy as to their relative amplitude. The low tone should be equal to, or less than, the high tone, but no more than 4 dB lower. Determining this condition by ear is impossible, as is sensing the distortion levels. For a greater insight,

check the excellent article, "Inside Ma Bell," by Spenser Whipple, Jr., in the May, 1975, issue of 73 Magazine, page 61.

To produce a single tone with most pads, push the two adjacent buttons in any row or column to produce the tone for that row or column. Example: Pushing the 2 and the 5 together will produce the 1336-Hz tone, and pushing the 4 and the 5 together will produce a 770-Hz tone. These two tones just happen to be near the middle of the tone range and therefore serve well for test purposes.

To calibrate your system, find someone who has a pad with the low tone slightly less than the high tone and who can adjust the pad volume quite easily. By experimentation, set the pad to the point where it just will access the phone system without misdialing. Take careful note of the meter levels of the 5 tone, as well as of the window. Repeat this test, and this time set the pad just below the point where misdialing occurs on the high amplitude side. Again, take careful note of the readings of the same items as before. This will represent the high level of the window. Pads should be set so that the single-tone levels fall within the center of the window. In our situation, the tones are set to read about 40% of full scale, with the dual-tone reading about 60% of full scale. This will vary with every setup. It is interesting to note that most problems involve tones that are too loud, including the much more subtle problem (one that the Golden Ear boys can't spot) where the low tone is much louder than the high tone.

By setting everyone's tones in the window, misdialing is practically eliminated, and on-the-air trial and error testing is

gone. There will always be the HT boys attempting access to the patch from 50 miles out, since they hear the 200 Watts erp of the repeater full quieting and they can't figure out why 1.5 Watts into a rubber ducky (.5 Watts erp) won't make it back. Education is futile at that point.

One more problem area is with surplus Western Electric and ITT pads. One of the reasons they may be surplus is that the tones are off frequency. Another is that one out of the three or four tones won't fall within specifications. You must be within $\pm 1.5\%$ in frequency. The frequency can be adjusted with the cores on the rear of the pad. If one of the three or four tones does not fall within specifications, dump the pad, as it is unfixable and not worth the grief. For those pads that will not generate single tones, adjust them with the 5 tone by bringing the level from "too low" up to the proper level for a dual tone. This keeps it out of clipping. Occasionally, you will find a rig with the clipping level too low. The operator will be suffering from misdialing and low deviation—he will be bassy. He must crank up the clipping level (often referred to as deviation-limiting) until he is as loud as everyone else and back his mike gain down so that only 10% of his peaks will hit clipping. Then he can set his pad level.

The uniform setting of pads and the easing of the recording of logging information will take most of the burden out of running an autopatch. This leaves out the frustration and makes for a less formal and stiff operation. We also publish a series of rules which is sent to everyone new who pops up on the air. It is part of our Welcome Package, which contains a sheet about the repeater, a sheet

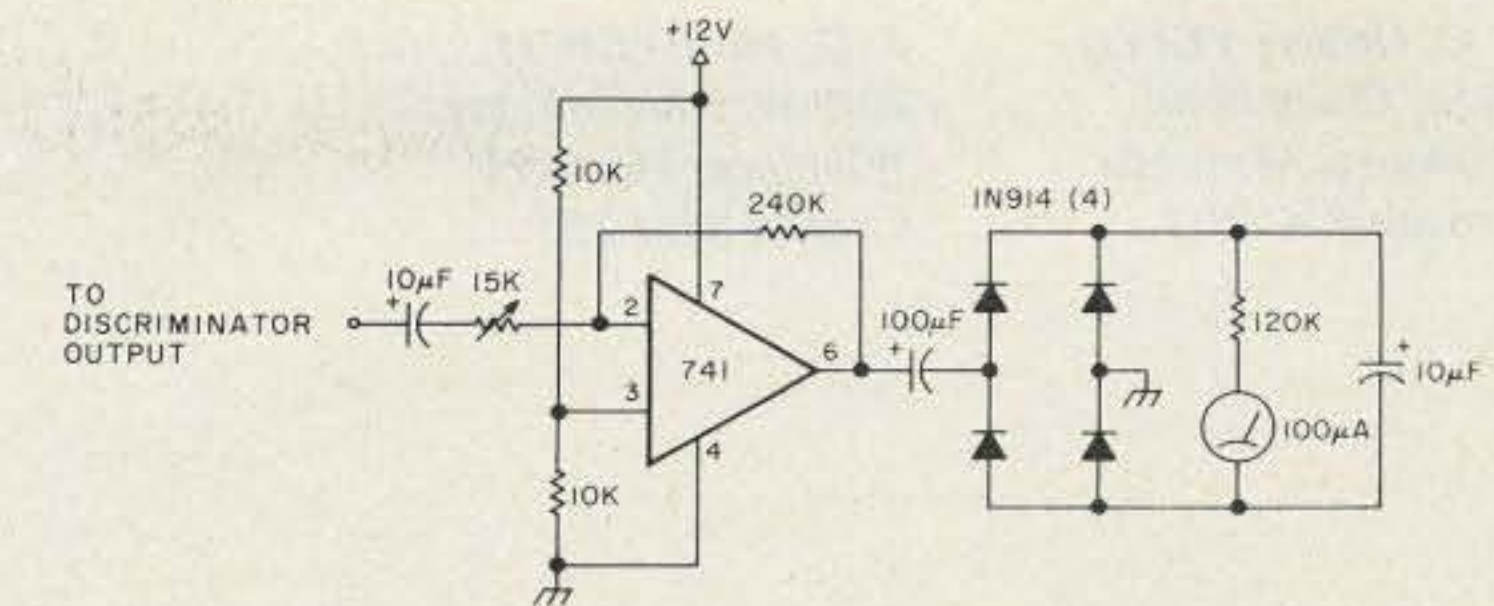

Fig. 4. Deviation-detector circuit.

on the club, one on the patch, a list of members, a repeater directory of the state, and a sheet of emergency phone numbers suitable for hanging from the sun visor. A sincere welcome, coupled with instant education, has proven to be one of the major factors leading to the lack of autopatch problems.

With a wide-open patch that has been up for two years and has averaged 180 calls a month, we have never had an incident that would cause us to install safeguards. The unrestricted and informal attitude has never prompted challenges. This is not to say that we have not had our share of testers of the grey areas of the rules, but a friendly off-line discussion of the rules and their interpretation, using 73, QST, HR Reports, and other publications as visible references as to how the FCC is viewing different matters, has usually solved any differences.

Obviously, in the larger urban areas where there lie greater nerd concentrations, reason is not always an effective tool. I can only offer sympathy to those areas, as the answers to their problems defy solution. But to the group just contemplating autopatch, fear not; usually there are not 1000 nerds waiting in the woodwork just anticipating the day they can bolix things up. Give your group a chance; most of our foreboding "what ifs" never came to pass. If everyone knows everyone else, as do

those in most smaller communities, friendly informality works well. If there are factions, cliques, rivals, etc., this attitude may not work, but it is futile to sit and generalize—each group is best qualified to evaluate its individual problems.

The elusive point that should not be avoided by beating around the bush is that autopatch is a tremendous convenience as well as a public service. The expressions on the faces of one of our local chiefs of police and the reporter standing next to him were enjoyable to watch when an HT was pulled out of a pocket and used to dial up the chief's phone. The patch has been used to call the State Police so often to report accidents that all of the dispatchers are using "over" and other familiar techniques. If you want to start a near-riot at a CB coffee break, whip out the ol' HT, tickle the keyboard nonchalantly, and watch the eyes bug out on the first ring. That alone is worth 5 guys at the next Novice class. Autopatch is the major factor that increased our club membership from about 130 to 240. It's worth the trouble.

I hope that this article has taken some of the mystique out of the subject of autopatch and will lead some groups reluctant to install a patch to think more kindly about it. Who knows, you might save someone's life by your ability to report some emergency directly and immediately. ■

J. C. Delaive VE4YD
76 St. Claire Blvd.
Winnipeg, Manitoba
Canada R2C 0V2

J. G. Mills VE4CM
1019 Weatherdon Ave.
Winnipeg, Manitoba
Canada R3M 2B5

Baudot-ASCII Converter Follow-Up

— add a FIFO buffer for typing ease

The 5885 code converter¹ was conceived in response to the increased availability of Model 33 and 35 Teletype™ machines in Canada. With the converter you can use an ASCII-coded TTY machine to communicate in

Baudot code in the amateur bands.

Because of the response to the 5885 converter, we decided to refine the system by adding a buffer, regulating the output rate, and providing better control for the tape reader.

The 5885 converter can be used as is, but there is one disadvantage. When typing, the operator has to keep in mind the automatic insertion of shift characters and has to type slowly and evenly to avoid loss of a character. The buffer will eliminate this. A person can type as fast as he can without having to worry about the insertion of shift characters. Also, the output rate of the buffer can be controlled so that a regular stream of characters goes on the air while you type in spurts. This way, it gives you time to think what to say next, while the buffer is still pumping out data. For those who have heard a UT-4 in operation, this unit works in a similar fashion.

It was decided the buffer should have the following features: one-line buffering, power-on reset, preload, reader control, buffer-contents indicator, and variable output speed with buffer full override.

Controls

Four controls have been brought out to the front: reset, preload, output rate,

and fast runout.

The reset clears the counters and FIFOs and initializes all the flip-flops. It is used primarily if you have something in the buffer and it is no longer valid, or a number of mistakes have been made.

The preload is used to type a string of characters into the buffer and hold it until you are ready to send it out. You can start typing while the other party is still transmitting to you. Then, when you turn off the preload switch, your characters will begin to flow out of the buffer.

The output rate is set by the output-rate potentiometer. With the values indicated in the parts list, the rate can be varied from 2 char/sec to full speed. It should be set for your average typing speed. That means that the override should hardly ever start up, nor should it be set so fast that the buffer-empty LED is on most of the time.

The fast runout is used when you are finished typing but have a large number of characters in the buffer and want to give it

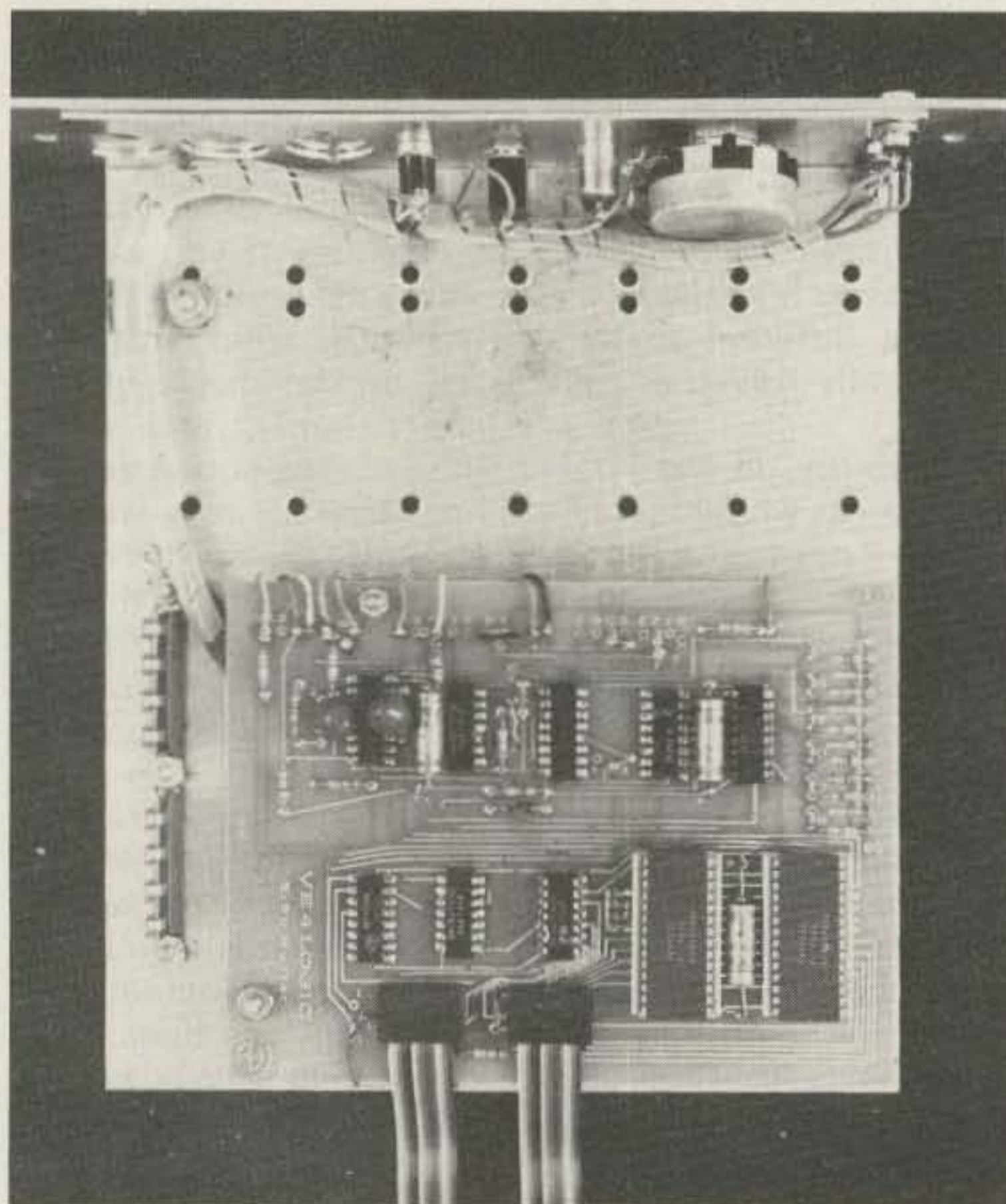

Photo A.

to the other party. When this control is pushed, the buffer will empty at full speed. The buffer-empty LED will come on when it is finished.

Character Storage

The buffer consists of a pair of 33512 Fairchild 40-x 9-bit FIFOs, giving a full line of buffering—actually, 79 Baudot characters—unless there are several shift characters, which will make it less. The FIFO is an “elastic” memory between subsystems. It will take the data and expel it at greatly different rates. The data exits in the exact same order as it was entered, without any external control.^{2,3}

Power-On Reset

When the buffer is turned on initially, the control logic in the FIFOs will have their preferred turn-on condition, and it can happen that the indication is that valid data is available. To make sure this does not happen, NOR gate 4C is used as a delay.

When power is applied, the voltage on pins 8 and 9 of U4C is low and will start rising to +5 volts. After a short while, the voltage will be enough so that it equals a logic high and the output will go low. This clears the counters and the UARTs. The inverter signal is used to reset the FIFOs and set the reader-control flip-flop. The input can be brought out to the front panel also, in case manual reset is needed.

Data Flow

The data is strobed into the FIFO by the signal CS (Character Strobe) coming from U4B pin 6 on the converter board. At the same time, it increments the counter.

When one or more characters have been shifted into the buffer, the OR (Output Ready) output goes high indicating the

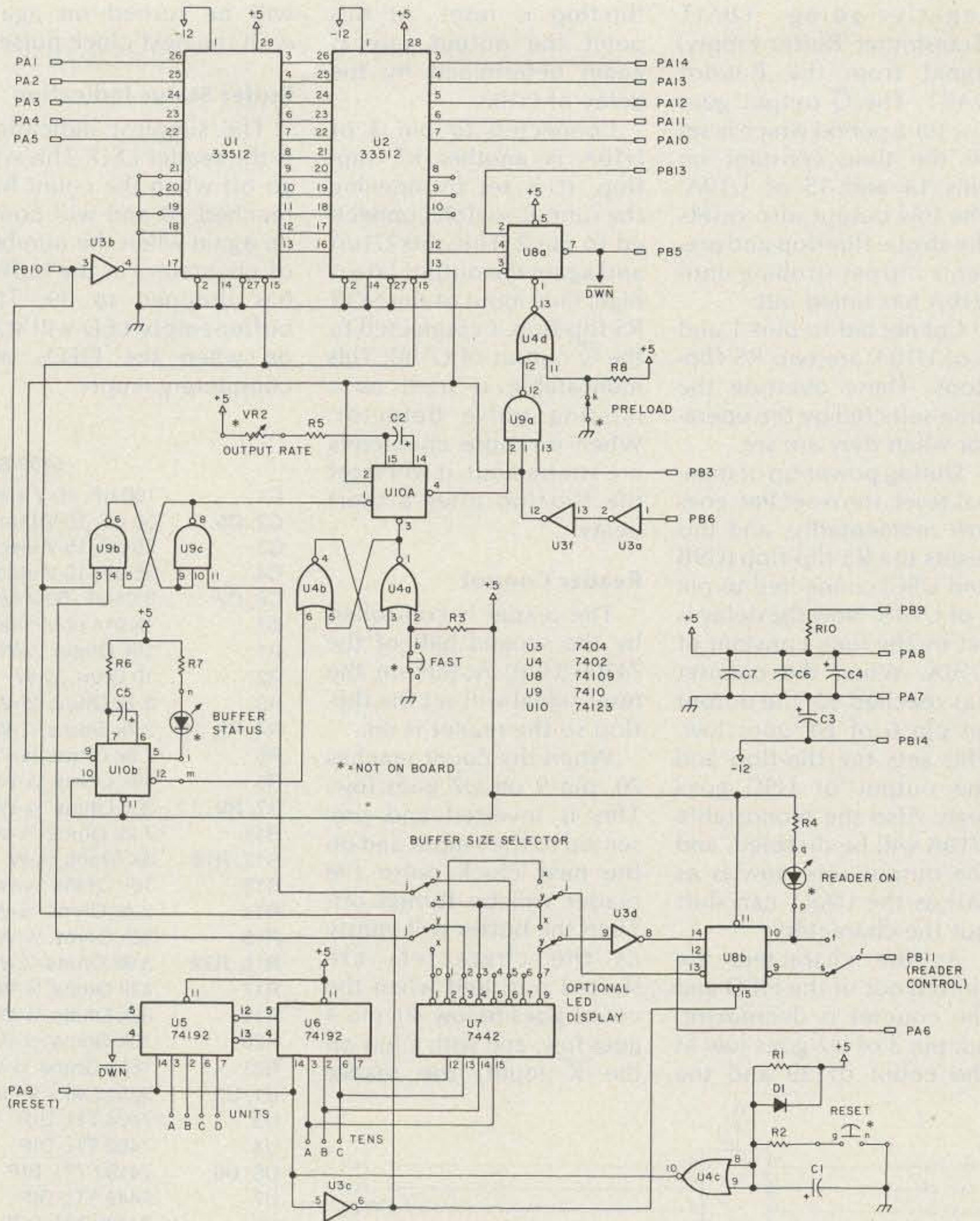

Fig. 1. 5150 buffer. (Design by John Delaive VE4YD and Gary Mills VE4CM; board by Bert Franz VE4BF; design box and drawings by Fritz H. Hellmuth VE4XD.)

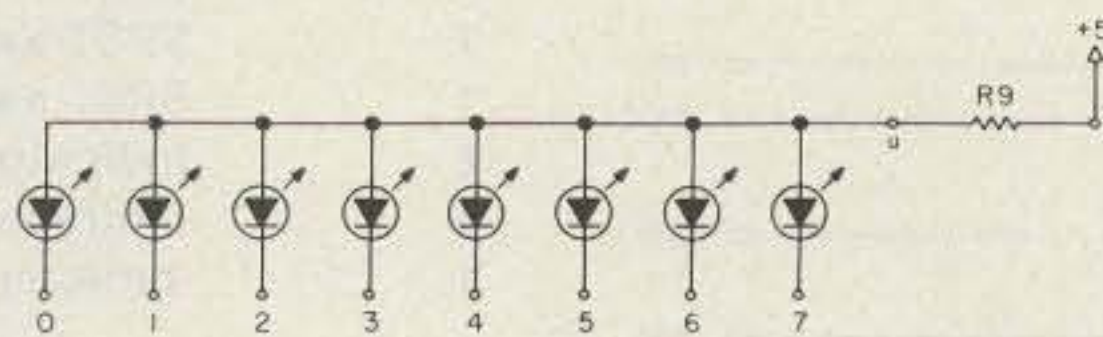

Fig. 2. LED display.

buffer has valid data on its output.

The OR signal is presented to the J input of the output strobe flip-flop, U8A. When its reset input is high, the \bar{Q} output will go low for one clock period. When this happens, the data on the output of the FIFO is

strobed into the Baudot output UART and, at the same time, the counter is decremented.

Variable Output Rate

The 74123A monostable is used to set the output rate of characters from the FIFO. It is triggered on the

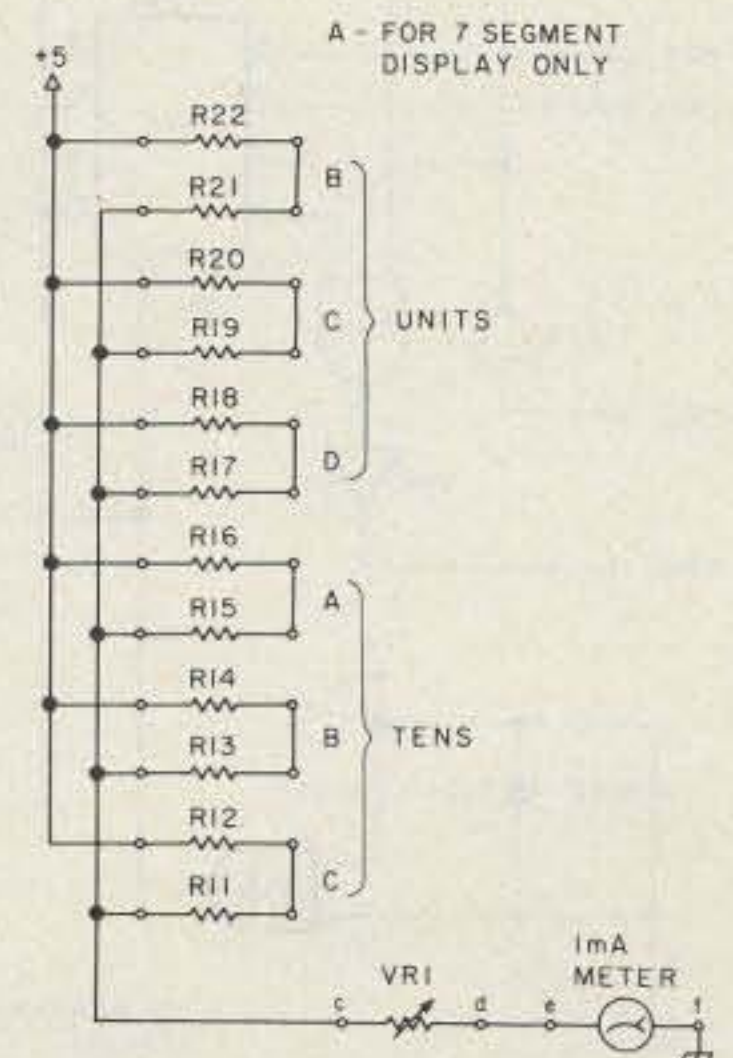

Fig. 3. Analog display.

negative-going TBMT (Transmitter Buffer Empty) signal from the Baudot UART. The \bar{Q} output goes low for a period which is set by the time constant on pins 14 and 15 of U10A. The low output also resets the strobe flip-flop and prevents it from strobing until U10A has timed out.

Connected to pins 1 and 3 of U10A are two RS flip-flops. These override the time selected by the operator when they are set.

During power-up or manual reset, the reset line goes low momentarily, and this resets the RS flip-flop (U9B and U9C) connected to pin 1 of U10A. Now the delay is set by the time constant of U10A. When the counter has reached 60, the output on pin 6 of U7 goes low. This sets the flip-flop and the output of U9C goes high. Also the monostable U10A will be disabled, and the output rate now is as fast as the UART can shift out the characters.

As the characters are shifted out of the FIFO and the counter is decremented, pin 3 of U7 goes low at the count of 29 and the

flip-flop is reset. At this point the output rate is again determined by the delay of U10A.

Connected to pin 3 of U10A is another RS flip-flop. It is set by opening the runout switch connected to pin 2. This sets U10A and again the output rate is high. One input of the NOR RS flip-flop is connected to the \bar{Q} output of U10B. This monostable is used as a missing pulse detector. When no more characters are strobed out, it will reset the flip-flop after a short delay.

Reader Control

The reader is controlled by the second half of the 74109 (U8B). At turn-on, the reset signal will set the flip-flop so the reader is on.

When the count reaches 70, pin 9 on U7 goes low. This is inverted and presented to the J input and on the next clock pulse the reader will be turned off. Then the buffer will empty as the characters are shifted out, and when the count goes below 40, pin 4 goes low, and with a low on the \bar{K} input, the reader

will be turned on again with the next clock pulse.

Buffer Status Indication

The simplest indication is the reader LED. This will go off when the count has reached 70 and will come on again when the number of characters in the buffer has dropped to 39. The buffer-empty LED will stay on when the FIFOs are completely empty.

There are provisions for three alternatives for buffer status indication. The first one consists of 8 LED indicators (Fig. 2). With no contents in the buffer, no. 1 is lit; when the count reaches 10, no. 2 lights, etc. With only one LED on at a time, the anodes may be connected together and go via a 390-Ohm resistor to +5 volts. The second method involves a meter indication

5150 Buffer Parts List

| | |
|------------|--|
| C1 | 100-uF, 10-V electrol. cap. |
| C2, C5 | 50-uF, 10-V tant. cap. |
| C3 | 25-uF, 15-V electrol. cap. |
| C4 | 25-uF, 10-V electrol. cap. |
| C6, C7 | 0.01-uF, 50-V cer. disc. |
| D1 | 1N914 or similar diode |
| R1 | 10k Ohms 1/4-W |
| R2 | 10 Ohm, 1/4-W |
| R3 | 2.7k Ohms 1/4-W |
| R4, R8, 10 | 2.7k Ohms 1/4-W |
| R5 | 7.5k Ohms 1/4-W |
| R6 | 30k Ohms 1/4-W |
| R7, R9 | 330 Ohms 1/4-W |
| R11 | 7.2k Ohms 1/4-W |
| R12, R18 | 3k Ohms 1/4-W |
| R13 | 16k Ohms 1/4-W |
| R14 | 2.4k Ohms 1/4-W |
| R15 | 33k Ohms 1/4-W |
| R16, R22 | 3.9k Ohms 1/4-W |
| R17 | 43k Ohms 1/4-W |
| R19 | 82k Ohms 1/4-W |
| R20 | 10k Ohms 1/4-W |
| R21 | 180k Ohms 1/4-W |
| U1, U2 | 33512 40 x 9 FIFO Fairchild |
| U3 | 7404 TTL DIP |
| U4 | 7402 TTL DIP |
| U5, U6 | 74192 TTL DIP |
| U7 | 7442 TTL DIP |
| U8 | 74109 TTL DIP |
| U9 | 7410 TTL DIP |
| U10 | 74123 TTL DIP |
| VR 1 | 2k Ohms, 1/2-W PC board trimmer |
| VR 2 | 50k Ohms, potentiometer—output rate |
| 1 | SPST switch, toggle—preload |
| 1 | SPST switch, NC push-button—fast |
| 1 | SPST switch, NC push-button—reset |
| 2 | Indicator LEDs, 10-15 mA |
| 8 | Indicator LEDs, 10-15 mA, for optional LED display |
| 1 | 1-mA meter for optional analog display |

Simple Buffer Parts List

| | |
|------------|--|
| C101, C102 | 100-uF, 10-V electrol. cap. |
| C103 | 5-uF, 10-V electrol. cap. |
| C104 | 0.01, 50-V cer. cap. |
| R101 | 2.7k Ohm, 1/4-W resistor |
| R102 | 10k Ohm, 1/4-W resistor |
| R103 | 1k Ohm, 1/4-W resistor |
| R104 | 15 to 25k Ohm, 1/4-W resistor (see text) |
| R105 | 470 Ohm, 1/4-W resistor |
| U11, U12 | CD 40105B 16 x 4 FIFO Motorola |
| U13 | 7400 TTL DIP |
| U14 | 7404 TTL DIP |
| U15 | 74109 TTL DIP |
| U16 | 555 timer |

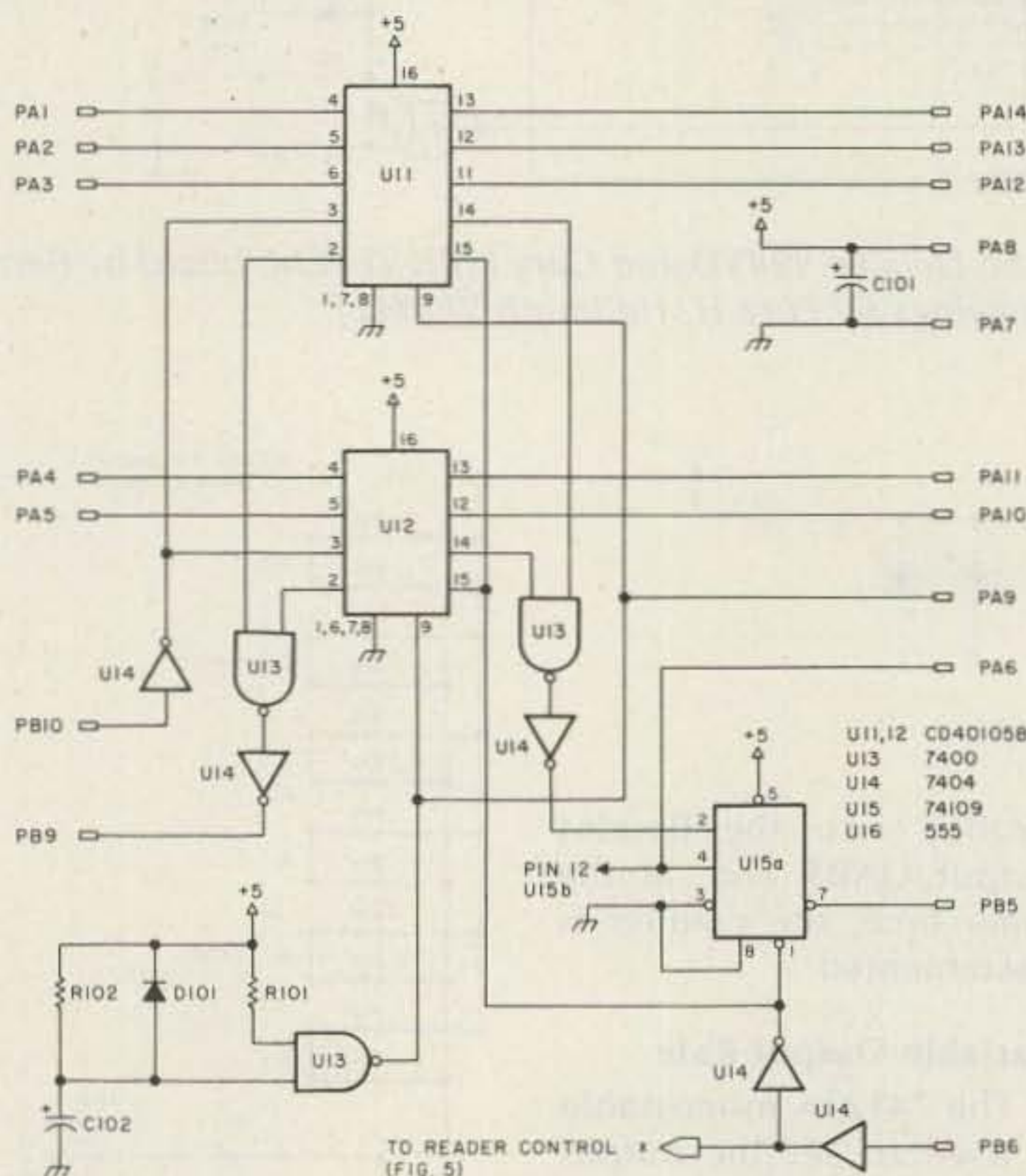

Fig. 4. Alternate buffer.

and is a digital-to-analog conversion (Fig. 3). There are six sets of resistors used in the conversion. This is not for accuracy but to smooth out the variations in the meter indication. The values shown are for a 0- to 1-mA meter. The 2k-Ohm variable resistor is for calibration. The range is wide enough to set the scale at 80% or 100% full scale for a count of 80.

It also is possible to display the actual count of characters in the buffer with a pair of 7-segment displays. This method is not incorporated on the board, but the connections are made available. For this system, two decoders, two drivers, and two displays are needed.

Simple Version

For those who do not need a complicated circuit but just some buffering to take care of the up- and

down-shifts, Fig. 4 shows how to do it. It uses two inexpensive 16- x 4-bit-wide FIFOs. Another nice feature of these is that only a single supply is needed, which can be from 3 to 18 volts. Also, no modifications have to be made to the converter board.

Operation of this circuit is similar where applicable to the main circuit. If a tape reader is available, see Fig. 5—a reader control circuit. It uses a 555

timer which is controlled by the TBMT output of the UART. This is set by R104 to shift in between 5 and 10 characters before it stops and then waits for the buffer to empty.

There might be a slight hesitation in printing when the buffer is empty and before the reader starts up again, but this can be noticed only at 100 wpm.

Construction

A board was designed

for the buffer⁴ and a number of units have been built and are in use now. No board was made up for the simple version; since the circuit is quite simple, it can be constructed on Vero-board.

Power supply requirement for the converter-FIFO combination is +5 volts at 750 mA and -12 volts at 150 mA. ■

References

1. J. G. Mills VE4CM, "Baudot to ASCII Converter," *73 Magazine*, September, 1977, pps. 80 to 85.
2. George Landers, "FIFO First In First Out," Fairchild Semiconductors.
3. Doug Farrar, "Understanding the FIFO," AN-332, Fairchild Semiconductors.
4. 5150 double-sided PC board with plated-through holes and two 6-inch connecting cables can be obtained from VE4 Logic, PO Box 77, Dugald, Manitoba, Canada, R0E 0K0, at a cost of US \$19.50, prepaid USA and Canada.

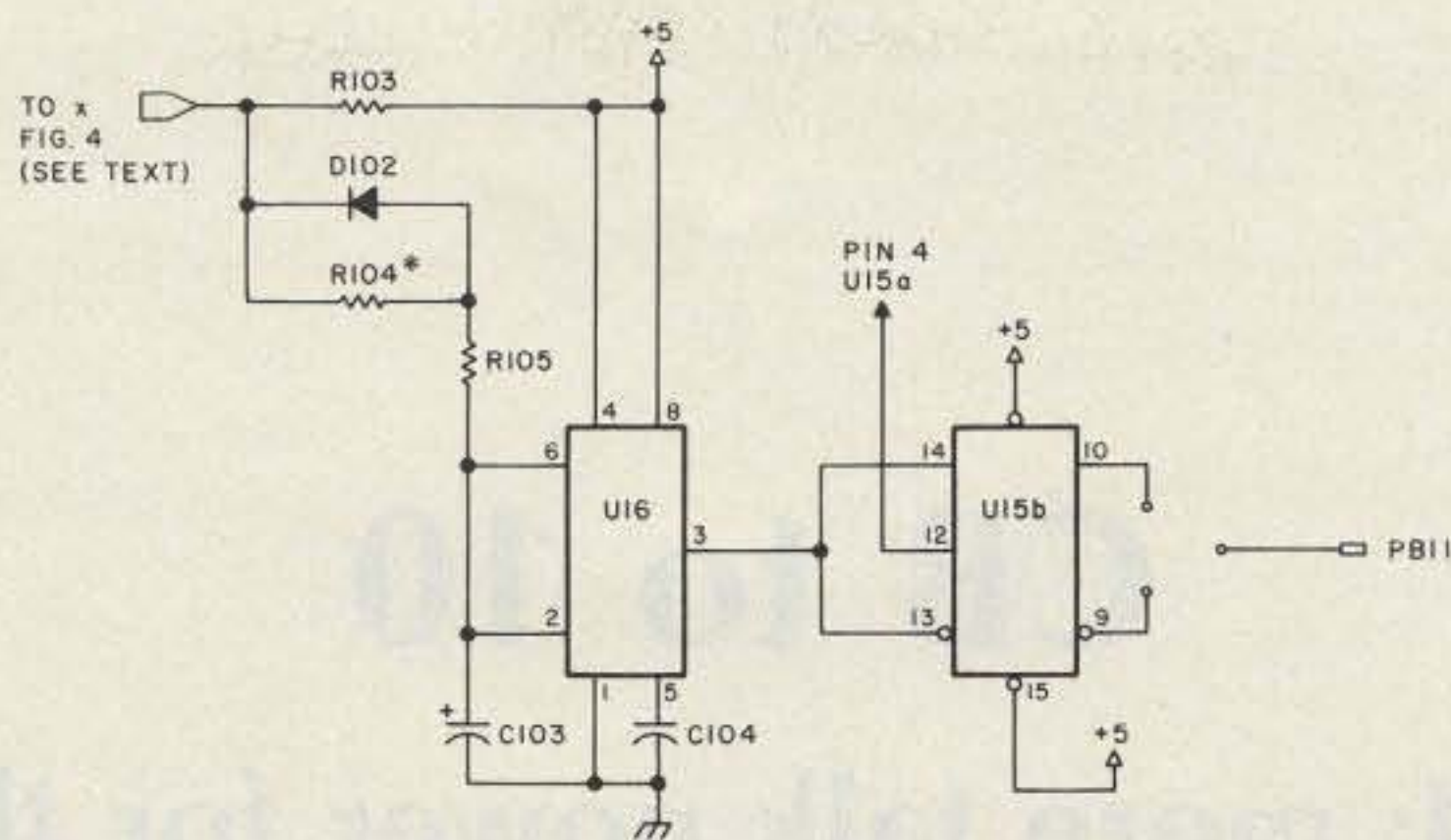

Fig. 5. Tape reader control.

NEW!

HAL

PS-1.0 GHZ

PA-19

WIDEBAND PREAMPLIFIER

- 1.00 GHZ pre-scaler ÷ by 1000
- Broadband operation 10HZ to 1.25 GHZ
- High sensitivity
- Standard T2L or ECL power supply
- Dual mode operation—VHF/UHF
- Independent VHF and UHF inputs
- Divide by 1000 so it can be used with any counter having seven digits or more.
- Circuit uses only four chips.
- Fully assembled and tested.

- 2 to 200 MHz band width (-3db points)
- 19 db gain
- 50 ohms input & output impedance
- Tiny PC Board size (7/8" x 1-5/8")
- Absolutely no tuning required
- Extremely stable
- Draws only 20MA at 12 v dc
- Great way to increase sensitivity of receivers, counter, etc.
- Fully assembled and tested
- Instructions provided, full warranty.



"HAL" HAROLD C. NOWLAND
WBZXH

\$79.95

HAL-TRONIX

P.O. Box 1101

Southgate, MI 48195

(313) 285-1782



31



\$8.95

SHIPPING INFORMATION ORDERS OVER \$15.00 WILL BE SHIPPED POSTPAID EXCEPT ON ITEMS WHERE ADDITIONAL CHARGES ARE REQUESTED. ON ORDERS LESS THAN \$15.00 PLEASE INCLUDE ADDITIONAL \$1.00 FOR HANDLING AND MAILING CHARGES. SEND SASE FOR FREE FLYER.

CB to 10

— part XXII: more talk power for the TRC-11

Christopher Veal N4APN
Rt. 4, Box 259
Louisville TN 37777

If you are one of the many hams who purchased a Radio Shack TRC-11 CB unit, this article will tell you how to increase its modulation considerably. Another ham and I bought a pair of TRC-11s when Radio Shack was selling them out at half price. The TRC-11 is a 6-channel, 5-Watt, 12-volt transceiver.

After replacing the crystals with 10 meter crystals, the receiver was realigned with a signal generator. The transmitter was then adjusted for maximum output. Our units had about 4-1/2 Watts output and worked fine over short distances, but the modulation was very weak even when yelling into the microphone. On a meter, the maximum modulation was 80% and the average was a small 40%.

After inspecting the schematic, it was decided that the microphone amplifier gain (also the audio amplifier gain) could be increased by bypassing R40 on Q8 or R44 on Q9. A 100-uF, 15-V electrolytic was tried, but it oscillated on Q9. On Q8, things looked good. The capacitor is simply paralleled with R40 (see the schematic with the radio). Now the maximum modulation was still 80%, but the average was now

70%. Any electrolytic capacitor 50 to 150 uF and above 15 volts should work.

A few of these radios are being used on the Civil Air Patrol frequency of 26.620 and I am sure this modification would benefit these operators. Look for us on 28.9 and 29.0 MHz AM.

Thanks to Wayne W4TZZ for technical assistance and to Ed KB4GH who helped with on-the-air testing. ■



Lunar's new 2M 4-40P Linearized Amplifier makes your hand-held synthesized transceiver a GIANT!

1 to 4 WATTS IN— 10 to 40 WATTS OUT.

- Can be used with any 1-5 watt radio.
- Linearized so it's compatible with SSB.
- Has pre-amp for receiver portion to increase power and clarity of incoming signals.
- Amp and pre-amp functions independently controllable.
- Remote control capability.
- Regulated voltage output as required by the FT 207R and TR2400 to conserve battery pack.
- Turns your 1-4 watt transceiver into a higher powered base or mobile station.
- Made with the quality and care that has made Lunar the leader in linearized amps.

2785 Kurtz Street, Suite 10, San Diego, CA 92110
Telephone 714 299-9740
Telex 181747

Louis N. Anciaux
WB6NMT



new

SCR 4000

The Super-Deluxe 450MHz Repeater!

Features

- 30-40W. Output
- Low Noise/Wide Dynamic Range 8 Pole Fitr. Front End for Excellent Sensitivity & Rejection of IM's & Spurious Responses.
- Sensitivity: 0.3 μ V Typ./12 dB SINAD.
- 8 Pole First IF Crystal Filter + 4 Pole Ceramic 2nd IF Fitr. for Super Selectivity.
- Receiver Discriminator & Deviation Meter Functions!
- Ultra-High Stability Transmitter Crystal Oscillator/Oven.
- Plus—All of the Many Other Features Found in the SCR1000 VHF Repeater—Full Metering, Lighted Status Indicators/Control Push-buttons, Btry. Pwr. Input, AC Pwr. Supply, CW IDer, etc., etc.!



180 Day Warranty!

Shown in optional cabinet

Spec Comm is proud to announce the new SCR4000 UHF FM Repeater! This unit incorporates all of the many desirable repeater control, test and operating features which have been requested by our customers over the past 2½ years. The SCR4000 includes completely new transmitter and receiver boards which were specifically designed for this new repeater. The rest of the unit is basically the same as our tried and proven SCR1000 VHF Repeater which has an excellent reputation for performance and reliability throughout the world!

Of course, the SCR1000 VHF unit is still available in 2 Mtr. and 220 MHz versions along with a complete line of options and accessories for all of our repeaters . . . such as: Full Autopatch/Reverse Patch/Land-Line Control; Touch-Tone Control of various repeater functions; "PL"-CTCSS; "Emergency Pwr. I.D."; various Courtesy Tone and Timer units, etc. PLUS—the finest Duplexers, Cabinets, Antennas, Cables, etc.

The SCR4000 and SCR1000 are sold factory direct only or through Foreign Sales Reps—at prices which are only about ½ that of the "big two" names in 2-way radio! Get your order in A.S.A.P.!

Spec-Comm Repeater Boards & Sub-Assemblies

2M 220 MHz 450 MHz!

- FL-6 Preselector, Rcvr. Front-End Filter/Preamp. Exc. rejection of strong "out of band" sigs. -60dB @ \pm 6 MHz.
- SCR100 Receiver Board w/xtal & 8 Pole IF Filter.
- SCR450 UHF Receiver Bd. New Design, as above.
- SCR100/450 Receiver Assembly. Rcvr. Bd. mounted in shielded housing.
- SCT110 Xmtr./Exciter Bd. 7 or 10 Wt. bd. w/xtal. BA-10 30 Wt. Amp. bd. & Ht. Sink.
- SCT410 NEW 10W, UHF Transmitter Bd.
- SCT110/450 Transmitter Assembly. Xmtr. Bd. mounted in shielded housing. 7 or 30 Wt. Unit.
- CTC100 COR/Timer/Control Bd
- ID250 CW ID/AF Mixer Bd. Programmed.
- SCAP Autopatch Bd.
- RPCM "Reverse Patch" & Control Bd.
- IH10 0/1 Inhibit Bd. (For SCAP)
- TTC100 Touch Tone Control Bd. 3 or 2 digit control, 1 or 2 functions.
- TRA-1 Timer Reset Annunciator Bd.
- TMR-1 Timer Bd.
- OS-18 TX Xtal Osc./oven. w/xtal

new COMMERCIAL MOBILE & BASE TRANSCEIVERS

Spec Comm "Professional Communications Line"

- 136-174 MHz & 220-240 MHz (450 soon)
- 6 channels
- 0.35 μ V Rcvr
- 6 or 8 Pole Crystal Fitr.
- Beautiful Audio—RX & TX
- Very Reasonable Price!



PCL 250 25 wt. Mobile unit
● "Super Rugged" Housing



PCL 300 25-30 wt. Base station
● Built-in AC Power Supply
● Front Panel Status Indicator Lights
● Optional Rcvr. Scanning Function Available



SPECTRUM COMMUNICATIONS

Write or call for Data Sheets, prices, etc. ● Export orders—Contact our International Dept.

1055 W. Germantown Pk., Dept. S3 ● Norristown PA 19401 ● (215) 631-1710

The L With It

— an alternative to the variable inductor

William Vissers K4KI
1245 S. Orlando Ave.
Cocoa Beach FL 32931

A friend of mine who had decided to build

himself a transmatch recently called me on the phone. He acted as if he had just discovered inflation. "Do you know how much they are asking for a rotary inductor?"

Well, after he told me that he just couldn't afford that kind of money, especially after he had figured in the cost of the turns counter, he said, "The L with it!"

Believe it or not, that's what gave me the idea. Yes: "The L with it." A little thinking about basic theory, and I came up with an idea that shows that the rotary inductor can easily be replaced with a small fixed inductor in series with a variable condenser. I've tried it in several different applications, and it worked perfectly every time.

The theory used is merely a simple application of some of those equations I memorized to pass my FCC exam and thought I'd never use again. So, we'll not only learn to save money, we can renew an acquaintance with basic circuitry calculations. There also is an extra bonus that I'll keep as a surprise until later in this article.

Circuit Theory

Let's start right in and say we want a 0-to-12-microhenry variable inductor for use at 3.75 MHz, which is the middle of the 80-meter band. Although I've started with a fixed frequency, we'll see later on that the technique to be described will work for all bands and all frequencies.

It's easy to calculate the maximum inductive reactance. It is nothing more than $X_L = (2)(\pi)(F)(L)$, where π is equal to 3.14, F is in MHz, and L is in microhenrys. Then, $X_L = (2)(3.14)(3.75)(12) = 283$ Ohms.

Now let's say that we rummaged in our junk box and found a variable condenser with a capacity of 250 picofarads. The reactance of this condenser at 3.75 MHz is $X_C = 1,000,000 / (2)(\pi)(F)(C)$, where C is given in picofarads. Thus, $X_C = 1,000,000 / (2)(3.14)(3.75)(250) = 170$ Ohms.

Now all we have to do is to draw the simple circuit shown in Fig. 1, where we take our variable con-

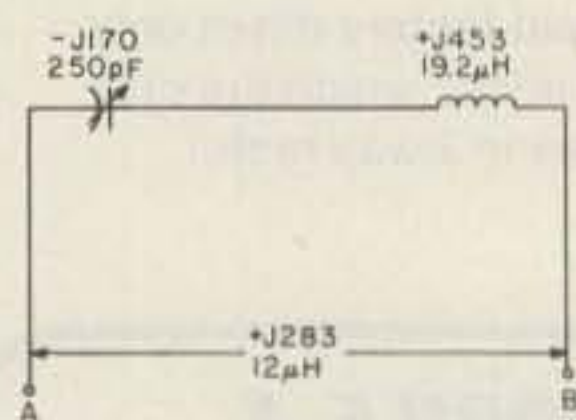

Fig. 1.

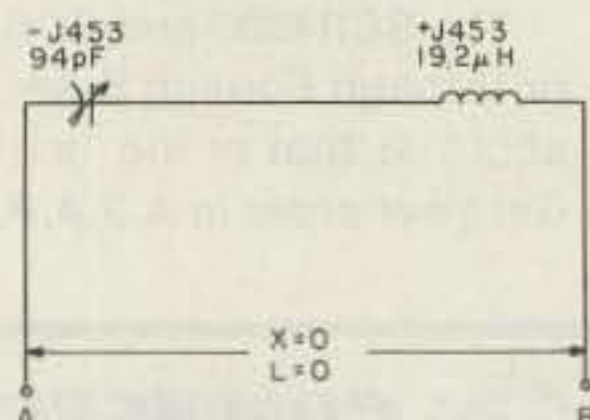

Fig. 2.

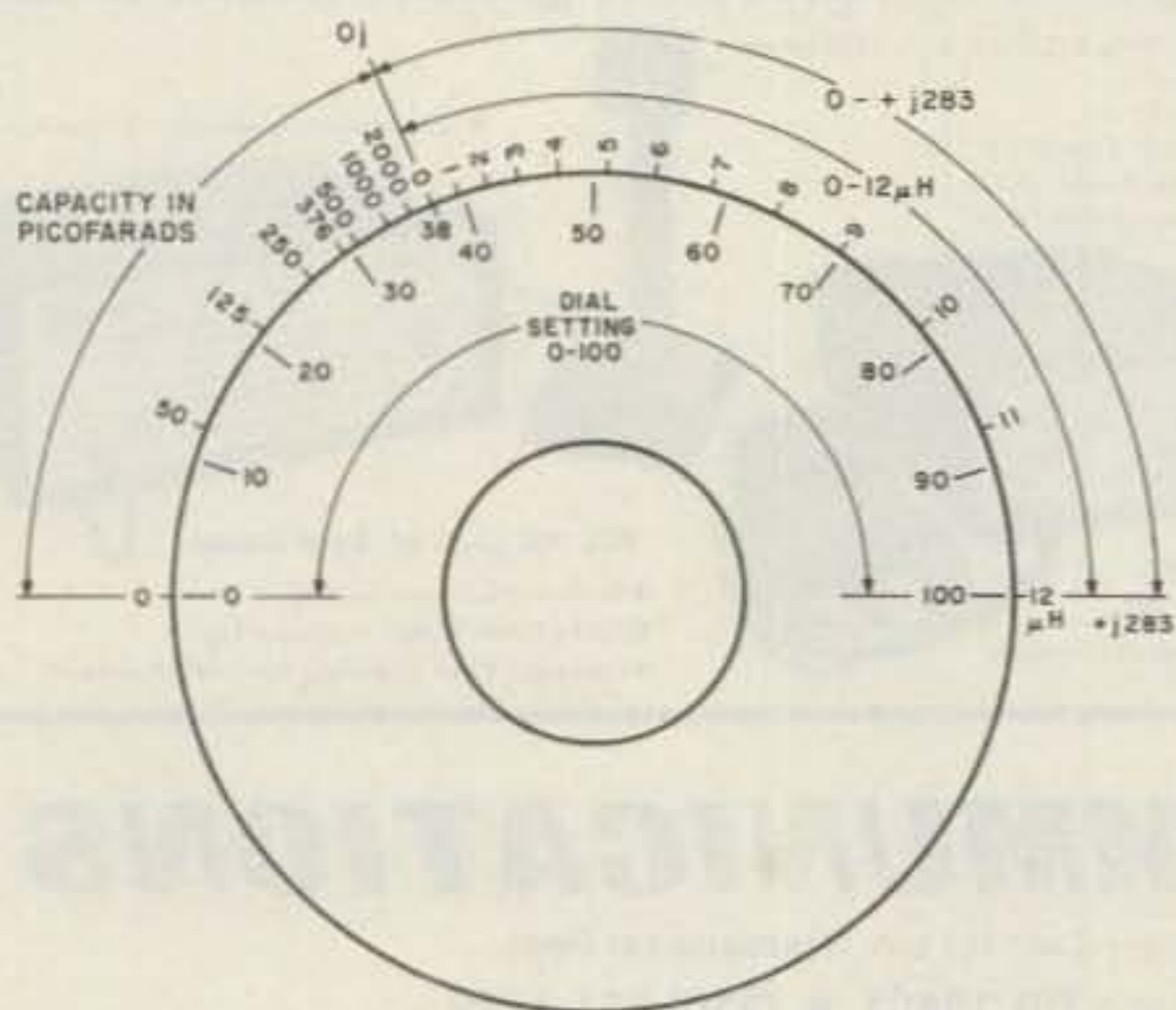

Fig. 3. For 19.2-uH fixed inductance, 3.75 MHz.

denser and place it in series with an unknown value of fixed inductance.

Using the commonly-accepted nomenclature, that capacitive reactance is $-j$ and inductive reactance is $+j$, all we do now is to put in the numbers we have already calculated. The value of reactance for the condenser is $-j 170$, and the value of reactance for the variable inductor we want to obtain is $+j 283$ Ohms. We shall put in the value of $+j 283$ Ohms between terminals A and B. From basic circuit theory, we see that the value of fixed inductive reactance required is $X_L = +j 283 - (-j 170) = +j 453$ Ohms.

Calculating the value of the fixed inductance in microhenrys, we find it to be $L = X_L / (2)(\pi)(F) = 453 / (2)(3.14)(3.75) = 19.2$ microhenrys. This value of inductance is also shown in Fig. 1.

It is now necessary to find the value of capacity that will give a net value of zero reactance at A-B. All we do is to reduce the capacitance value until its reactance is equal to the reactance of the fixed inductance, which we have calculated to be 453 Ohms. The capacity value is found by solving for C. $C = 1,000,000 / (2)(3.14)(3.75)(453) = 94$ picofarads.

As the reactance between terminals A-B is zero Ohms, then the inductive reactance and the inductance will also be zero. So, we have developed a method to obtain an equivalent variable inductance of from 0 to 12 microhenrys. The circuit and results of the calculations are shown in Fig. 2.

Generally, most variable condensers in amateur usage are linear with respect to dial setting. If we assume that we are using a dial with graduations from 0 to 100, it is easy to find the dial setting cor-

responding to 94 picofarads. The dial setting is $(94)(100) / 250 = 38$. The dial is shown in Fig. 3, where the values of inductance and their corresponding dial settings also are shown.

The Big Bonus

Now that we have seen how easy it is to obtain a variable inductive reactance equivalent to a variable rotary inductance of 0 to 12 microhenrys, let's look a bit further into circuit theory.

If we decrease the value of capacitance of the variable condenser below 94 picofarads, our net reactance will be capacitive between points A-B. As a numerical example, assume that the condenser is set to 30 on the dial. The capacity at this dial setting will be $(30)(250) / 100 = 75$ picofarads. Calculating the capacitive reactance of 75 picofarads, we find that $X_C = 1,000,000 / (2)(3.14)(3.75)(75) = -j 566$ Ohms.

Representing this value in Fig. 4, it is seen that the equivalent reactance between points A-B is $+j 453 - j 566 = -j 113$ Ohms.

Calculating the equivalent capacity between points A-B it is found that $C = 1,000,000 / (2)(3.14)(3.75)(113) = 376$ picofarads.

The variable condenser that we have in the circuit has a maximum value of only 250 picofarads. Yet, in our circuit of Fig. 4, it is seen that with a setting of only 75 picofarads we actually end up with an equivalent capacity of 376 picofarads across A-B. It seems almost like magic! But it isn't magic. It's only using a bit of simple math—and it really works!

Using the same method of calculation, it's easy to show the equivalent capacity for various dial settings between 0 and 38. This is shown in Fig. 3 for convenience, and a closer look at

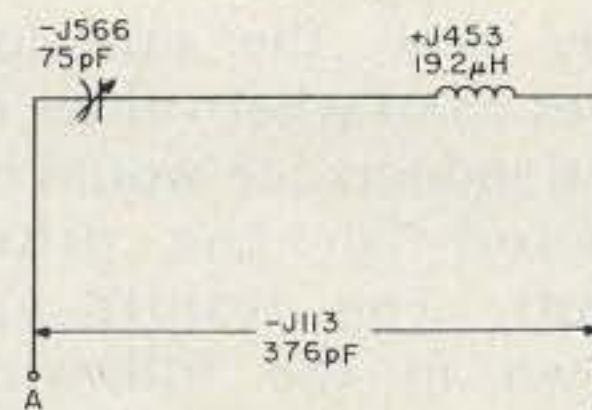

Fig. 4.

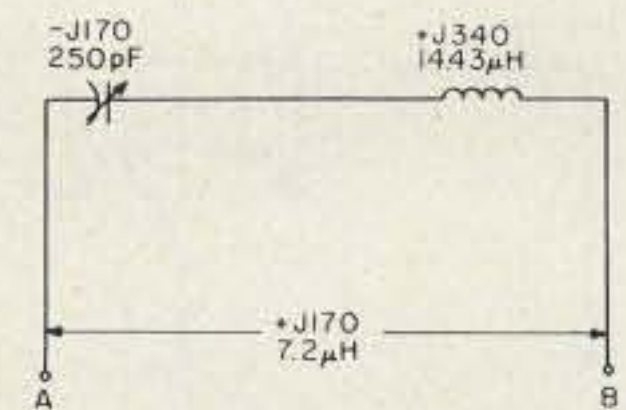

Fig. 5.

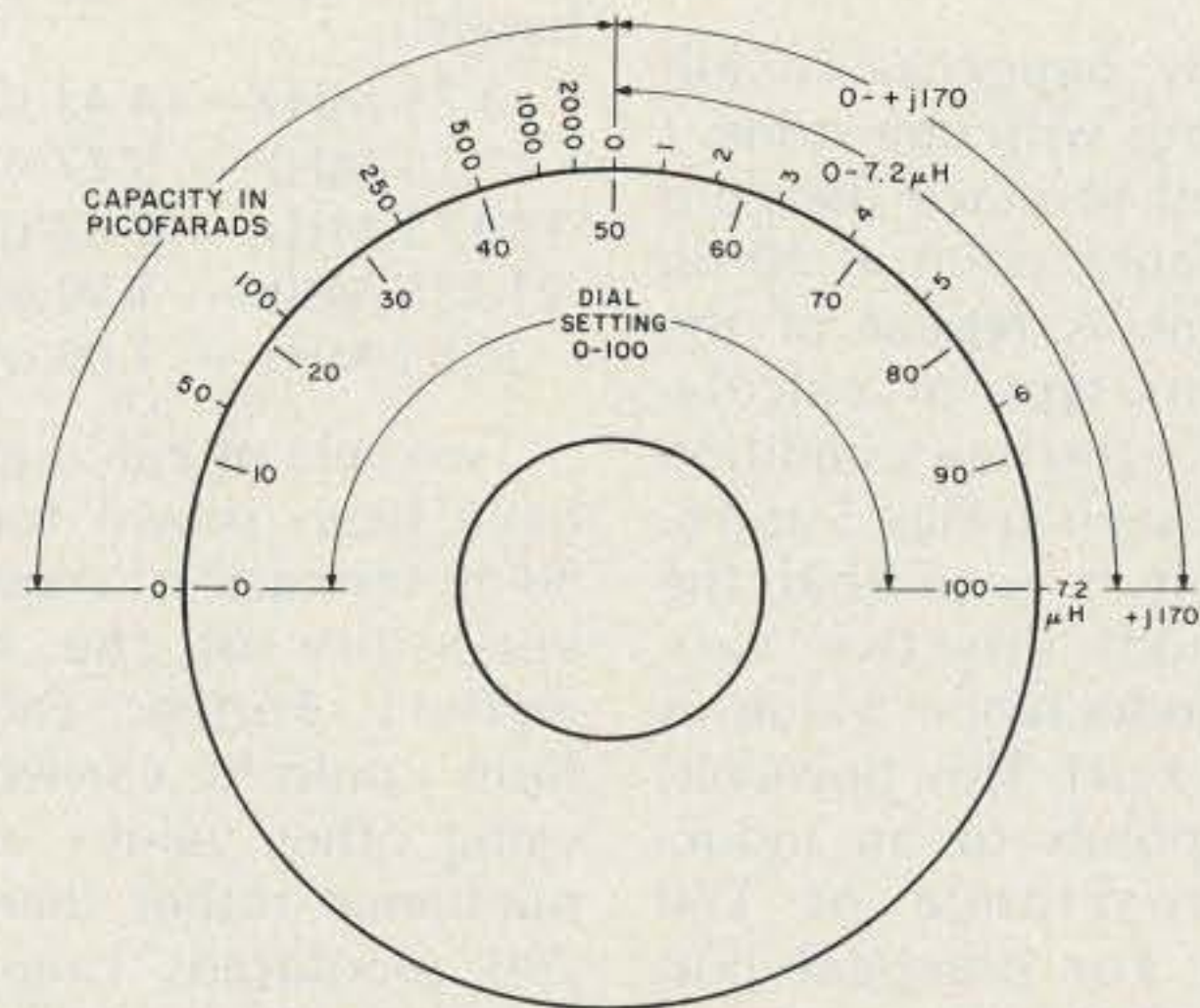

Fig. 6. For 14.43-uH fixed inductance, 3.75 MHz.

Fig. 3 shows a remarkable feature. With a single variable condenser, it is easy to obtain both an equivalent variable inductor of 0-12 microhenrys, and an equivalent variable condenser of between 0 and a couple of thousand picofarads. And it's all done with a 250-picofarad variable condenser and a small fixed inductance!

General

By this time, a number of questions will have arisen. The most obvious one is, what is the equivalent variable inductance maximum at the band ends of 3.5 and 4.0 MHz? Naturally, the equivalent inductance will vary somewhat with frequency, but, because the ratio of bandwidth to center frequency numerically is only $4.0 - 3.5 / 3.75 = .133$, our equivalent inductance variation also will be close to that figure. In addition, the zero inductance dial setting will vary slightly. These small variations are really of no consequence, however, because for operational purposes we are interested in

an easily-controllable reactance variation. We are not particularly interested in what the actual inductance or capacity is for any dial setting as we vary the frequency over our band limits. The actual calculated values for Fig. 3, for the fixed inductance of 19.2 uH, are: (1) for 3.5 MHz, an equivalent inductance of 11 microhenrys and a zero inductance dial setting of 43; (2) for 3.75 MHz, the two values are 12 and 38, and (3) for 4.0 MHz, they are 12.9 and 33.

Because the ratio of bandwidth to center band frequency is greatest for the 80-meter band, the variations will be relatively smaller for the other bands from 10 through 40 meters.

A second question that merits examination, is how accurate the value of the fixed inductance has to be. (The figure of 19.2 uH was carried out to three places so that anyone repeating my calculations would have an easy reference check.) The best way to answer this question is to vary the value of the fixed inductance and see what

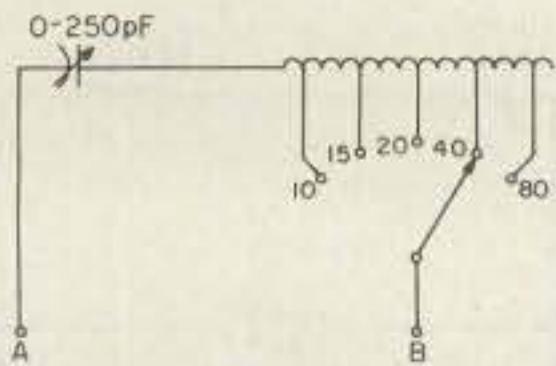

Fig. 7. Variable reactance unit.

actually happens. To kill two birds with one stone, I decided to place the zero inductance point at 50 on the dial. A repeat of the previous type of calculations for this new condition can be seen in Figs. 5 and 6. Here, it is seen that the maximum effective variable inductance value is only 7.2 μH . This, however, corresponds to an inductive reactance of 170 Ohms. For practical purposes, that amount is large enough for general amateur usage. Another thing noted in Fig. 6 is that this spreads out the capacitive part of the dial from 0 to 50 on the dial at 3.75 MHz.

By now, the question arises as to what values of fixed inductance would be needed for the other bands. The results are shown in the following table for a desired variable maximum inductive reactance of 170 Ohms for all bands:

| | |
|-------------|---------------------|
| 3.75 MHz— | 14.43 μH |
| 7.15 MHz— | 5.77 μH |
| 14.175 MHz— | 2.42 μH |
| 21.225 MHz— | 1.50 μH |
| 28.85 MHz— | 1.06 μH |

Two sets of calculations have been shown for the 80-meter case to show the versatility of the basic method. Further calculations could be carried out using other values of capacitance rather than the 250 picofarads originally selected. The only thing we would find would be differing ranges for the maximum variable inductance and different zero inductance locations on the dial. The basic method and cal-

culations stay the same.

The problem of having a different fixed inductance for each band is easily solved by the common method of using a single tapped coil as shown in Fig. 7. Coil dimensions and turns have not been shown, as the size of the variable condenser used, the variable inductive range desired, and variations in coil sizes used by different amateurs will vary. My own personal experience has shown that the amount of inductance required for the fixed inductance is very easily determined experimentally. The advantage of doing it experimentally is that you can then determine the optimum operating performance for the reactance range required for your own needs.

One last thing that should be mentioned is that the zero inductance dial setting will become less as the operating frequency is raised. In the extreme case, at the frequency for the last-shown table of fixed inductances, at a frequency of 28.85, the dial setting will be 11.5. The only operational problem this might pose is that the change in capacitive reactance between 0 and 11.5 will be fairly rapid. In my own experience, however, this has not proved bothersome. This crowding can be easily eliminated by using a smaller size of variable condenser and calculating the fixed inductance size to give you the variable inductive reactance range you desire. For example, for 28.85 MHz, the use of a 50-picofarad variable condenser and a fixed inductance of 1.55 microhenrys will give the equivalent variable inductive reactance maximum of 170 Ohms that we had used previously. The zero point will be moved to 39 on the dial. This example was shown to illustrate the versatility

and trade-offs that are possible using this method as described.

Uses

The first use that suggested itself to me was to build a truly versatile matching unit. An L tuner, using the circuit of Fig. 7 for each leg, performed extremely well. Its ability to allow each leg to have either a capacitive or an inductive reactance gave it an almost universal range. As a matter of interest, it was used to tune up a short 80-meter inductively-loaded vertical antenna that was resonant at the low end of the band, and we all know how sharp those verticals are. Well, this tuner allowed me to obtain a 1:1 SWR anywhere in the band with no problem. The friend of mine who owned this antenna was a bit flabbergasted! My own present 80-meter open-wire dipole tunes up perfectly now on all bands.

Other uses will suggest themselves. I'm already breadboarding up an impedance bridge that shows great promise. The fact that this method allows the obtaining of both a variable capacitive reactance and a variable inductive reactance on a single dial will undoubtedly be found useful for many applications.

As in all multiband rf circuitry, efforts should be made to keep all distributed capacities as low as possible to avoid internal resonances.

The demonstrations I've already given of the technique described have aroused a great deal of interest among my friends, and I'll be glad to answer any questions you may have. Just send along a self-addressed stamped envelope.

Now you, too, along with me, can say, if you don't have a variable inductance, "The L with it!" ■

Computer RTTY Demodulator

FSK-1000
\$449.00

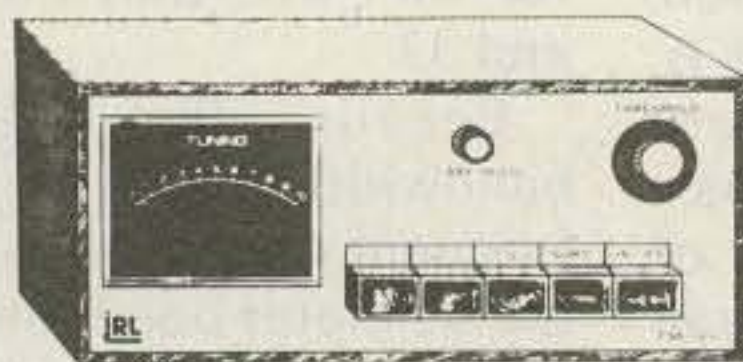
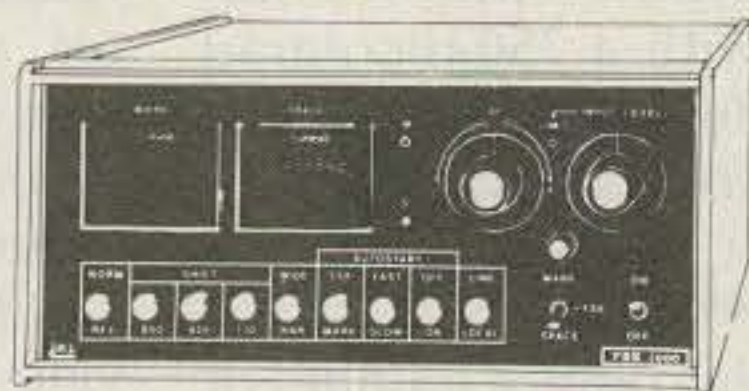

FSK-500
\$197.00

✓ 37

iRL will now ship your FSK-1000 within 48 hours on Visa or MC. No need to wait for months to enjoy the finest RTTY demodulator. For those with the TRS-80 or other microcomputer, iRL has the FSK-500: the quality demodulator with no hassel interface and the low price tag. TRS-80 software is \$46.00 or \$20.00 with above units.

Call or write for full details or see our ad in the December, 1979 issue of 73 Magazine.

iRL
T.M.

700 TAYLOR ROAD
COLUMBUS,
OHIO 43230

84.95

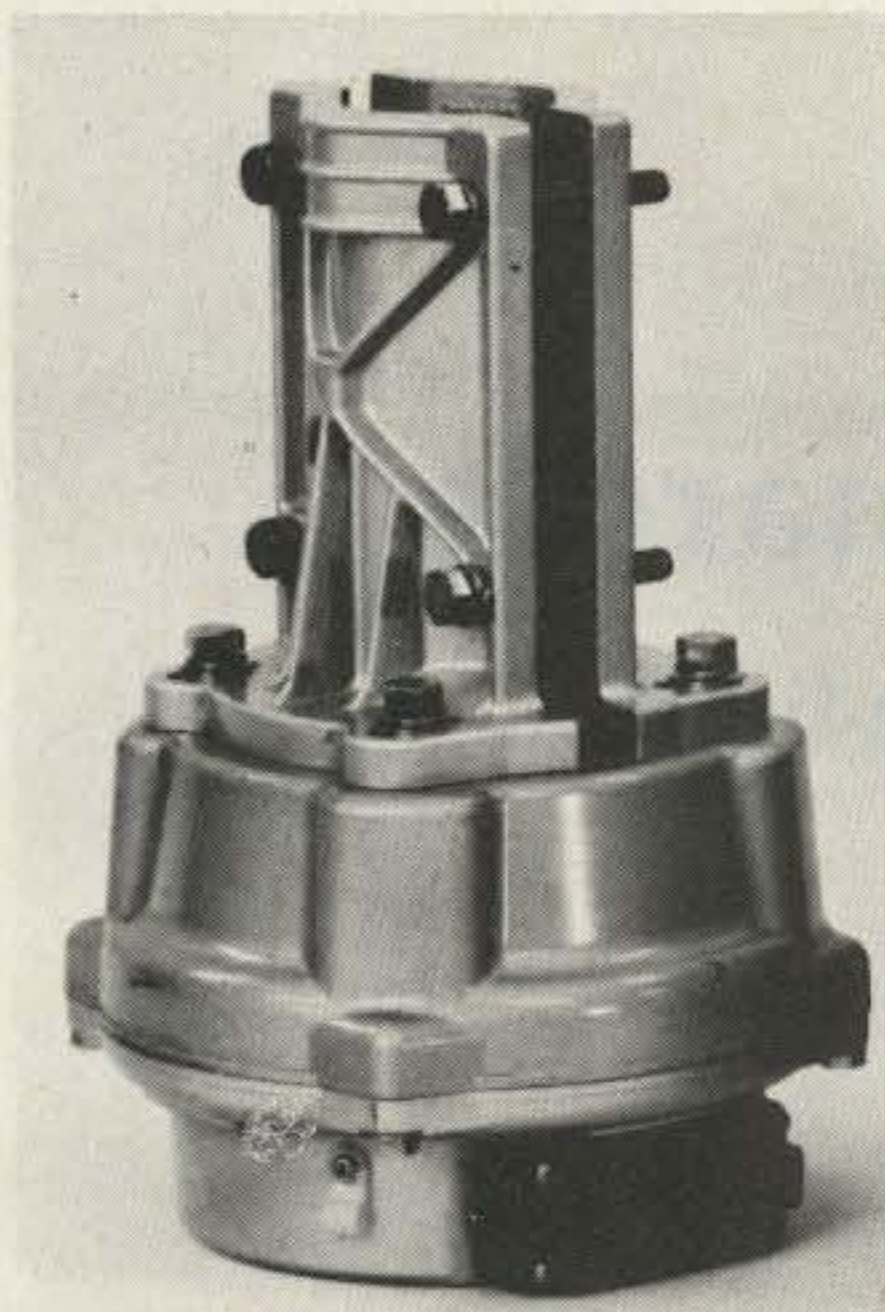

| MODEL | KR-2000 | KR-600 | KR-400 |
|----------------------------|-----------|-----------|-----------|
| Height | 13 5/8" | 10 5/8" | 10 5/8" |
| Width | 8 7/8" | 7 1/8" | 7 1/8" |
| Weight | 19.8 lbs. | 10.1 lbs. | 9.9 lbs. |
| Vertical Load | 550 Lbs. | 440 lbs. | 440 lb. |
| Wind Load Ft. ² | 32 1/2 | 16 1/2 | 7 1/2 |
| Suggested Retail | \$ 399.95 | \$ 202.95 | \$ 116.95 |
| TET Price | \$ 289.95 | \$ 139.95 | \$ 84.95 |

CONTROLLER FEATURES :

Large commercial quality meter with Solid State regulated supply in the control circuit provides accurate direction indication

KR-400

EASY-ALIGNING MAST CLAMPS :

Our new mast guage (Patent Pending) eliminates any alignment problems. An antenna mast of 1 1/2" - 2 1/2" in diameter can be accomodated.

SPECIFICALLY
DESIGNED FOR
OSCAR MOON
BOUNCE
180 DEGREES
ELEVATION

KR-500

149.95



Call Toll FREE

1-800-654-3231

TET U.S.A., INC.

425 Highland Parkway, Norman, Oklahoma 73069
Oklahoma Residents Call (405) 360-6410



Future Rig and Rigamarole

— are you ready for faster-than-light propagation?

In buoyant spirits the other evening, I devoted my efforts to the noble task of extracting a couple of extra functions from one of the dedicated ICs in my all-silicon rig. Dedication notwithstanding, the sophisticated chip made several futile attempts to comply with my desires, then bit the dust without the glowing anode, hot smell, or audible stress signals which have reliably guided my experimental endeavors throughout all these many years of hamming. Well, so be it! Never had I been one to remain idle very long when aflame

with the passion to experiment.

I quickly transferred my creative urges to some experiments in high technology I had long intended to perform. Gathering together a couple of servicemen's signal generators, my ancient-vintage oscilloscope, and a handful of junk box components, I was off to the races.

Soon I was observing endless variety in the display of all manner of geometric patterns. These danced across the 'scope screen in almost hypnotic gyrations, and my main

task was to hold some of them sufficiently steady for evaluation. Call such activities merely electronic doodling if you wish, OM, but please be assured that I was never one to use the meager time allotted to us in frivolous fashion. Indeed, the phosphor's green glow harmonized appropriately with the greenbacks I envisaged some large firm would fork over for exclusive rights to a rapid method for generating artistic designs for neckties, wallpaper, and for improving the esthetics of the environment in general. (In lieu of your initial reaction, OM, I trust a more considered judgment will recognize the goal-motivated nature of this research project.)

One thing leading to another, it happened that I accidentally, or synergistically, injected into a diode circuit a signal of several kHz together with one of several tens-of-kHz, whereupon I monitored a fairly nice amplitude-modulated waveform. However, because of the inadequacies of the 'scope sync system, and surely because of the haywire aspect of my lash-

up, I couldn't quite stop the display. The modulation drifted slowly from left to right across the screen and the carrier cycles contained therein drifted in the same direction, but at a livelier rate. This provided the illusion that the carrier cycles were "walking through" the modulation envelope (see Fig. 1). If, OM, you now agree that one thing is going to lead to another, your intuition is right on the beam!

As if in a trance, I felt this fascinating display eradicate my fantasies of millions of polyester shirts bearing frozen Lissajous patterns at a penny royalty for each. Rather, I began to think of my pattern generator as a tutorial aid to *technical instruction* courses! Here, for example, was an excellent depiction of the concepts of group-velocity and phase-velocity in the propagation of radio waves; even though the carrier waves were zipping along at their own merry pace (phase-velocity), they did not determine the rate at which the information in the modulation envelope was trans-

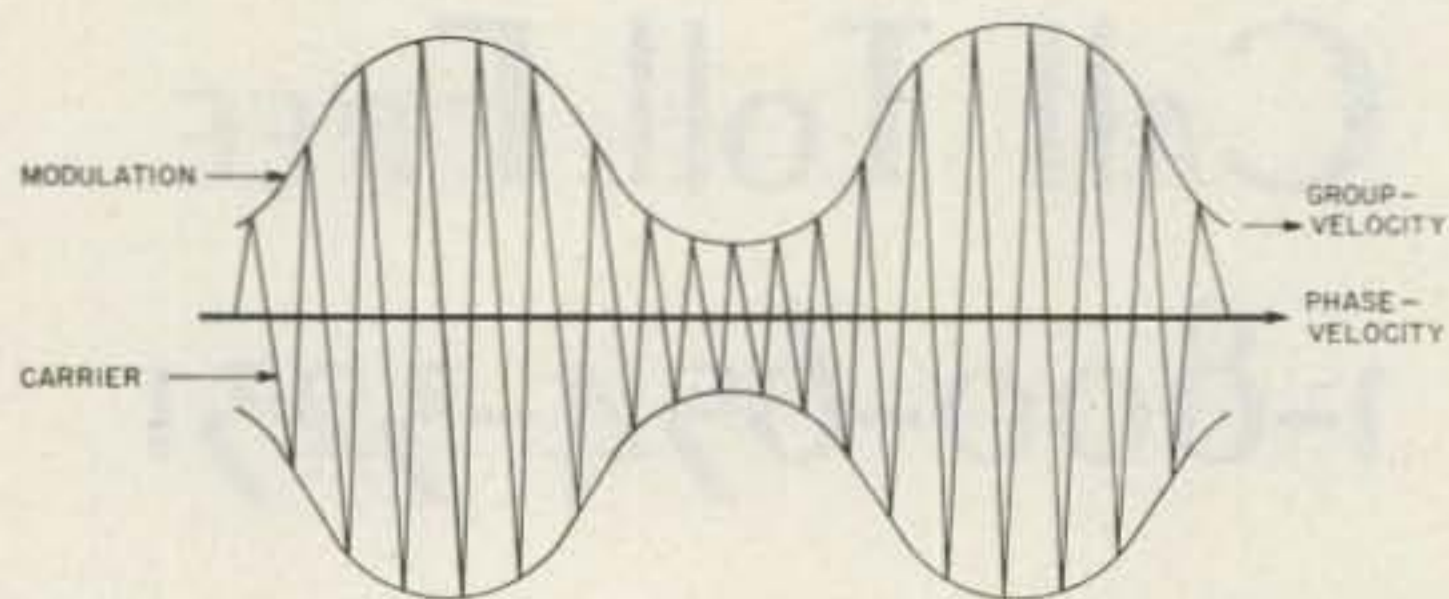

Fig. 1. The unexpected scope display—a good graphic simulation of group- and phase-velocity. When the phase-velocity of the carrier cycles exceeds the speed of radiation in free space, the carrier will "walk through" the modulation envelope. The modulating information, therefore, can progress only at the slower group-velocity. (In free space, the phase- and group-velocities are the same.)

ferred "from transmitter to receiver," i.e., from the left to the right side of the oscilloscope screen.

This phenomenon is particularly interesting because phase-velocity can exceed the value of c , the speed of light in free space! And Einstein's postulates are not violated, we are told, inasmuch as phase-velocity in excess of c cannot carry matter, energy, or information with it. In a sense, phase-velocity is a mathematical abstraction; it is not directly detectable by any device or circuit. It is a tantalizing notion, however, that a school of thought proclaims the possibility that matter and information can have super- c speeds. If so, its speculations allow for speeds from c to infinity, but not at c . We are reminded of supersonic aircraft—once having penetrated the sonic barrier, their speeds are no longer limited by the speed of sound.

In another sense, this faster-than-light entity, phase-velocity, serves various mundane purposes. Whenever light travels from one medium to another, we find that its action is precisely described by considering not one, but two, speed components—group- and phase-velocity. More relevant to the antics of hams, DX communication by means of skip is a case in point. In Fig. 2, we see a long-distance QSO that obviously is based neither on ground waves nor on line-of-sight. Rather, the radio waves enter the ionosphere, are refracted therein, and return to a distant QTH. Refraction is but another term for bending—why is the path of the waves bent? The ionosphere is a transmission medium containing free electrons of increasing density as the radio waves enter it. An

energy interaction occurs, and the top portion of the wave fronts is speeded up relative to the lower portions. You can think of the differential in your car if you like, OM; the turning or bending of the wave path is the logical result. The top of the wave fronts traverses the ionosphere at a phase-velocity greater than c , but merely "walks through" the modulation envelope. So our audio modulation gains no time in getting to the receiving site, no matter how long the radio waves spend in the ionosphere. Thus is the axiom complied with that information can be conveyed only at group-velocity, which can attain c but often is somewhat less.

Adding a few more points of info to your recall, OM, radio waves do propagate at speed c in free space; both group-velocity and phase-velocity are then equal to c . Under other circumstances, such as when the rf is being conveyed from your rig to the antenna, the group-velocity in the transmission line may be only around 60% of c . In air, the group-velocity is very slightly less than c . In general, group- and phase-velocities have inverse relationships—a group-velocity below c tends to be accompanied by a phase-velocity above c .

Admittedly, OM, all this business about radio-wave propagation and modulation-transit time came up in a roundabout way. If I continue to pursue it in its pedagogic details, nothing greater will be accomplished than a cure for a few cases of insomnia. Instead, I cordially invite you to direct your attention to some rather strange events which just happen to relate to much that has been hitherto discussed. And I promise not to bore you with further allusions to

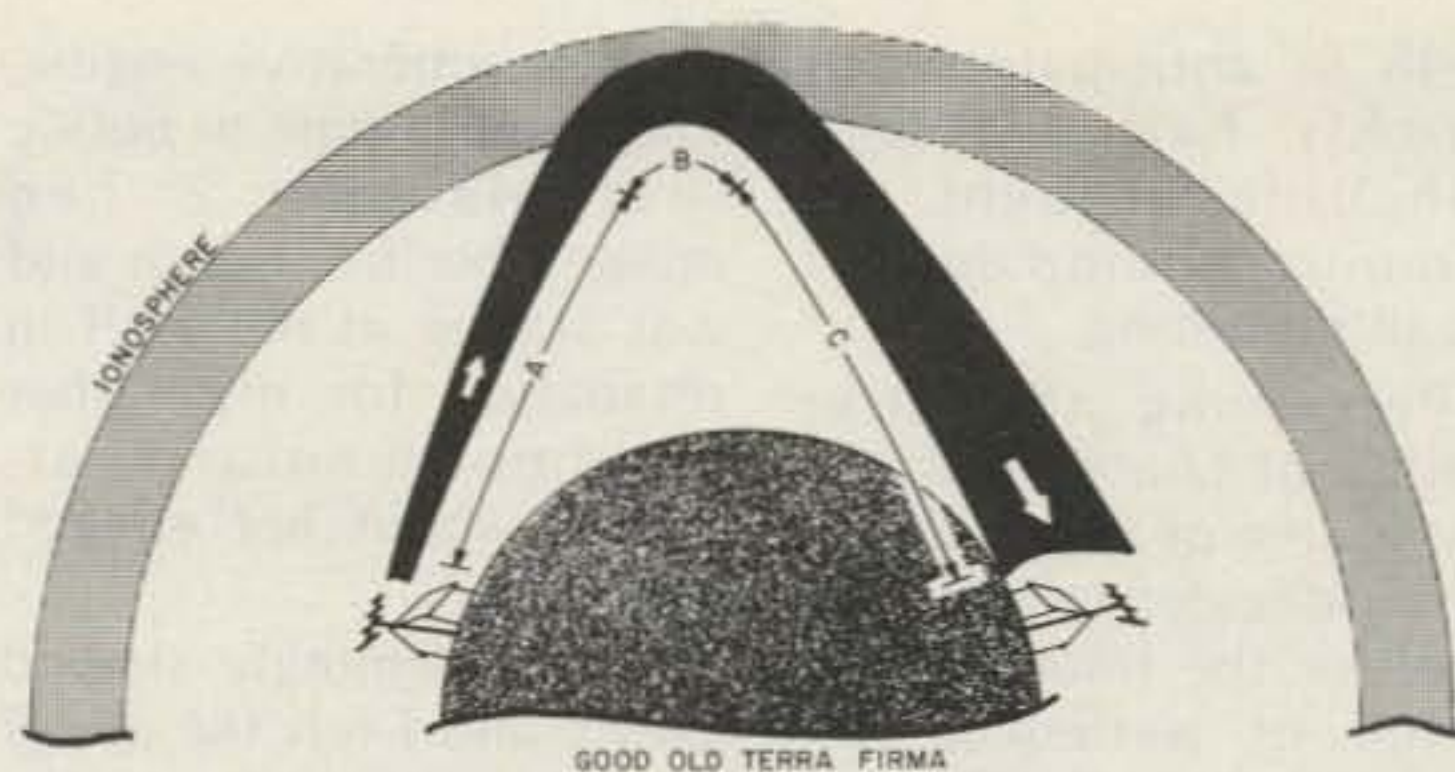

Fig. 2. DX via skip involves wave speeds greater than the speed of light in free space. (A) The speed of propagation does not exceed c , the speed of light in free space. (B) Top portions of wave fronts exceed c , thereby causing bending of the propagation path. (C) Once out of the ionosphere, the situation is again as in Region A.

my oscillographic teaching aid. Despite its money-making potential, its challenge to the imagination pales into insignificance alongside the electronic marvel you are about to encounter.

My relevant and, I hope, believable experience commenced a couple of months ago while driving on one of those long, straight, and scenery-less roads connecting a series of small towns. To relieve the boredom, I had fired up the mobile rig and was busy rag chewing on 40-meter SSB with a ham in the big city several hundred miles due south. For a time, all went well. Our mutually S8 signals were unencumbered by either QRM or QRN, but, with the passage of time and miles, I began to notice a diminution of his signal strength. Then, within a period of, say, ten minutes, it rapidly became impossible to copy him; the QSO was abruptly and inadvertently terminated.

Now you might contend that there need be nothing out of the ordinary in such an occurrence. OM, you just may be as right as apple pie, but allow me to cite the following strange phenomena which accompanied this fade-out.

- The increased distance between us during those

ten minutes was, percentagewise, trivial.

- It all happened between two and three o'clock in the afternoon, so there was no dawn or dusk transition.

- All the time his signal was becoming weaker, mine was reported to be getting progressively stronger. In fact, his last discernible comment was, "Hey, OM, it sounds like you are right smack on top of me now!"

- Other frequencies scanned on 40 meters were dead, as were also the 20- and 80-meter bands.

- The car radio delivered a lot of noise, but responded to no broadcast stations.

While my befuddled mind was trying to resolve this very eerie package of propagation anomalies, the first traffic light in thirty miles abruptly shattered the continuity of my thoughts. And it was as red as the grid of an overdriven linear. Obeying its command, I came to a stop and made ready to greet the green light with the usual great leap forward. But this beacon of the highways was in no hurry to accommodate my impulses. Indeed, it exhibited a downright sadistic behavior, obviously enjoying its prolonged red glare while I fidgeted and gnashed my teeth, to say nothing of my nearly mashing a few gear

teeth in anticipatory but quickly halted starts. "Shoulda brought my camping equipment," I recall muttering.

Perceiving the utter futility of contention with my source of annoyance, I wisely decided to relax and practice the time-honored virtue of patience. Observing the countryside around me, my attention was attracted to a small bungalow-like place of business slightly recessed off the road and about fifty yards ahead. Adjoining it was a parking lot with several late-model, luxury-type cars. (Compared to mine, this might include almost anything, OM.) I found myself pondering the nature of the wares or services sold so far away from a business community. Surely, OM, you can fathom the uninhibited conjectures that came into my mind! "What a snazzy ham shack and antenna farm I could make out of that combo!" I fantasized.

But this was no ham shack, for large signs on the gabled roof clearly delineated the operations therein performed. This was the abode of one Madame Z, who purported to possess inordinate insight into the past, present, and future—for a fee. A small sign conveyed the additional information that the stated fee was payable in *this* time domain, the present.

"What a bunch of balderdash, baloney, and blarney!" I declared to imaginary seekers of ultimate wisdom. At the next moment, I dug out in response to the long-awaited green light. But this is where the karma of my life (or, perhaps, a past existence) asserted itself, for if there was one thing the ancient buggy did not take kindly to, it was acceleration. Amidst the coughing, wheezing, and misfiring of

the uncooperative engine, I had ample time to notice that Madame Z had opened her front door and was staring at me as if in retaliation for my rather uncomplimentary attitudes about her alleged faculties.

Time seemingly slowed down, and I felt the pangs of remorse best known to reprimanded schoolboys. (Practical-minded readers certainly have the right to attribute the slowdown to the Edsel.) Time distortion or whatever, OM, I clearly saw that this pert young seeress was a mini-skirted eyeful—quite the converse of the stereotyped witch we may tend to associate with this profession. Being basically an open-minded sort, I found myself acknowledging the vast strides modern science has made in parapsychology. Indeed, had I not been on the way to a business appointment in the upcoming town, I would have stopped by for an objective discussion of psychokinesis, ESP, and other occult manifestations such as the attraction between oppositely-polarized entities. Suffice it to say, OM, I don't think the "other" traveling salesman ever beheld such a farmer's daughter as this!

Inasmuch as my perverse clunker refused to break down or run out of gas in this vicinity, I finally arrived at my destination—not, however, without the observation that the bands became mysteriously alive again, once Madame Z's facilities were out of sight.

Well, OM, far be it from my intent to bore you with the details of my business activities at the thriving metropolis of Hicksville—pop. 549. Nor shall I indulge in naïveté by pretending that you have not jumped the gun on my unraveling tale. Obviously, I

was destined to visit Madame Z on my return trip. Let us just say that I was overwhelmingly intrigued with the halo of rf shielding surrounding her "ham shack." And so it was—I parked the flivver on her "antenna farm," jumped out, and proceeded up the several steps leading to her door.

There was no need to knock, for the door magically opened, revealing the very shapely shape of the madame! I found myself being more than cordially escorted to a chair alongside a small table. I couldn't still the strange feeling that my entry at that very instant was *expected*—or was it planned? In any event, I assured her that I had no problems whatsoever in either the fecundary or the fiduciary domains. The whole atmosphere was dreamlike, OM, and Madame Z chose to ignore my prevarications. We seated ourselves on opposite sides of the table. On the one hand, I felt trapped. On the other hand, I felt enraptured with the pulchritude of this very delightful oracle!

"I feel that you are a person with much technological insight, and that you are immersed in a fascinating hobby having to do with an applied science," cooed the seeress.

I reflected on her probable observation of the transmitting whip on the flivver, to say nothing of my call letters written all over the place.

"You must learn to relax your hostilities," she admonished, much to my embarrassment. "Are you an amateur operator?" came the inevitable question.

I nodded in affirmation. I also thought that she should be telling me, rather than asking me things, if she expected our tête-à-tête QSO to culminate in enhancement of her mate-

rial well-being in this present existence. But all vestiges of suspicion, opposition, and unease speedily evaporated as a consequence of her next deduction. That she was endowed with a truly uncanny insight into the occult I could no longer doubt.

"Radio amateurs are greatly esteemed by the psychically sensitive. None in this incarnation possesses a more positive mix of the ultimate virtues. These include intelligence, achievement-oriented behavior, self-policing morality, impulsion for high adventure, and wisdom beyond attainment in our systems of formal education."

Silently, but graciously, I accepted her eerie deduction of facts well known to hams anywhere and everywhere, but not always recognized by those outside the realm.

In addition to revealing these truths about hams in general, Madame Z unraveled a lot of nice things about this particular ham—things that were buried even beyond my own conscious knowledge. But, OM, what really will be of interest to you is not what she said, but what happened then and there, right before my own two eyes. For while the seance was proceeding, a giant crystal ball materialized a couple of inches above the table. For sure, OM, there was nothing on the table when we initially sat down!

So I found myself beholding this levitated sphere. It was about two feet in diameter, and was slowly rotating about an unseen axis inclined about 45 degrees with respect to the table top. Because my sensual acuity had been strangely awakened to a degree unimaginable in everyday life, I perceived a heck of a lot more than the

globular entity, which I have only superficially described, OM. For this was no mere fortune-telling gadget. Rather, it was an intricate, highly complex system of silicon circuits—a huge IC chip, if you will!

Arranged in various planes were quivering PN junctions suggestive of the organs of a living creature. The innermost structure was composed of a junction concentric with the ball itself; this junction was being bombarded by the emanations of a cluster of radioactive atoms at the very center of the ball. This, OM, was the power supply for the entire system. You see, OM, I was being accorded a preview of the ham transmitter of the future!

The boundary between the outer surface of this sphere and the air was pinkishly aglow. I noted that the glowing aura appeared to rotate counter-directional to the "transmitter." In any event, here was the only visual evidence of power transfer to distant reaches of the universe. In other words, the outer shell was, among other things, the radiating element (charmingly referred to in primitive phases of the radio art as the "antenna"—named after the feeler organ of insects). Also, the outer shell, because of its piezoelectric property, constituted the microphone of this FB xmtr. OM, if you are still with me, please remember that I am normally a guy who is mighty quick to question the veracity of things that can't be duplicated, weighed, and measured in the scientific lab. But, maybe I wasn't my normal self during this peer into the future; maybe, too, Madame Z wasn't exactly what you would call scientific.

Whilst contemplating

this unbelievable spectacle, I received an ESP message from Madame Z directing me to say something. Obliging, I responded with, "Hello, test, one, two, three, four, hello, test!" As I spoke, the envelope of ionized air surrounding the crystal rig varied in intensity and color. Surmising that the deep purplish hue was indicative of over-modulation, I repeated in a more subdued voice level. Then, from what I can describe only as a fourth-dimensional locus in the time-space continuum, came the retort:

"That's much better, W6HDM—always glad to contact minor planets in inconspicuous galaxies; it beefs up my cosmic DX record!"

Now, OM, please don't partake of this with a tongue-in-cheek attitude, for that is not the way I am relating it. I am telling it like it is, or rather, *will be!*

Allow me to explain things a bit. That pink plasma engulfing the spherical rig was caused by super-duper high-frequency rf entering the ether (grudgingly "rediscovered" in the 1980s). Propagation is near instantaneous at phase-velocity. As you know, OM, radio emissions of our era had been doomed to propagational speeds at the mere speed of light because they radiated at group-velocity. Phase-velocity beautifully solves the DX problem for the celestial domain, for it can so greatly exceed the speed of light that many constellations and island universes may be incorporated in near-delayless communications links. Moreover, OM, one may re-establish contacts with long-bygone fists who spend eternity QSOing between galaxies on freqs which make X-rays look like dc—a sort of happy hunting ground for those

hams who abided by FCC rules during their brief earthly incarnation!

I can well anticipate your question, OM, as to how the modulating information could be propagated at phase-velocity—was it not pointed out somewhat earlier that this is a scientific no-no? The answer is at once simple and complex. It is simple because this futuristic rig imparts the modulation to the very medium in which the rf develops its high phase-velocity—that is, to the aura of ionized air. Complexity then enters the picture—at least from your viewpoint of the '70s, OM, because receiving methods for super-c radiation were then unknown. Those of you who have investigated ESP are acquainted with the proposition that such communication appears to be instantaneous. Trouble is, OM,

there was no way to prove it in your time.

Because this exposé concerns itself with the rig of the future, further detailing of detection techniques must await the outcome of my next seance. Suffice it to say, OM, no receiver other than the human mind is needed for detection of such super-c message-bearing radiation.

Lest credulity be stretched too far, OM, I now will bring this tale to its well-deserved finale. As you undoubtedly have deducted, I wound up dating Madame Z, who is quite sincere in her conviction that a knight on a white horse is all the more a prospect if his hoss sports a transmitting whip. And that's about it, OM, except that my fantasy about a rural ham shack and antenna farm just might materialize one of these fine days! ■

MODEL TR70A

ATV RECEIVING CONVERTER, 420-450 MHz



- TUNABLE—vernier tuned, 420 to 450 MHz
- HIGH PERFORMANCE—low noise RF preamp., mosfet mixer, mosfet IF amp. [Ch2 or 3 out]
- SELF-CONTAINED—including power supply
- 1 YEAR WARRANTY
- PRICE: \$ 88.00 [includes shipping. Add \$ 1.15 for COD shipment]

To order, or receive detailed information, write us or call us at 1-812-336-4775

**APTRON
LABORATORIES** ✓8
PO BOX 373, BLOOMINGTON, INDIANA, 47402

Gone But Not Forgotten

— supermods for the HW-2021

Phil Salas AD5X
707 Auburn Drive
Richardson TX 75081

The Heathkit® HW-2021 two-meter walkie-talkie didn't stay on the market very long, yet it was

quite a bargain when you consider the accessories that came standard with it. The nicad pack, flex antenna, and charger would add \$50 to \$75 to the basic price of any other walkie-talkie, not to mention the money saved by having to

buy only one crystal per channel instead of the usual two.

What other features would you like this unit to have? How about easily-added external charging for mobile and fixed operation? Or a BNC antenna connector, mating BNC flex antenna with an inexpensive magnetic mount? And, of course, +600-kHz

transmit offset and an external handset? Read on and see how to convert this unit into a *Super HW-2021*.

First, consider external charging. I was interested in assisting the rig from the car battery while operating mobile. This external charging is easily accomplished through the two unused pins on the present power connector. First disassemble the charger plug and solder a red and black wire to the inner two pins. Next, cut the charger cable and install a 4-pin moxex™ connector on the new 4-conductor cable. Install a mating moxex connector on the cord at-

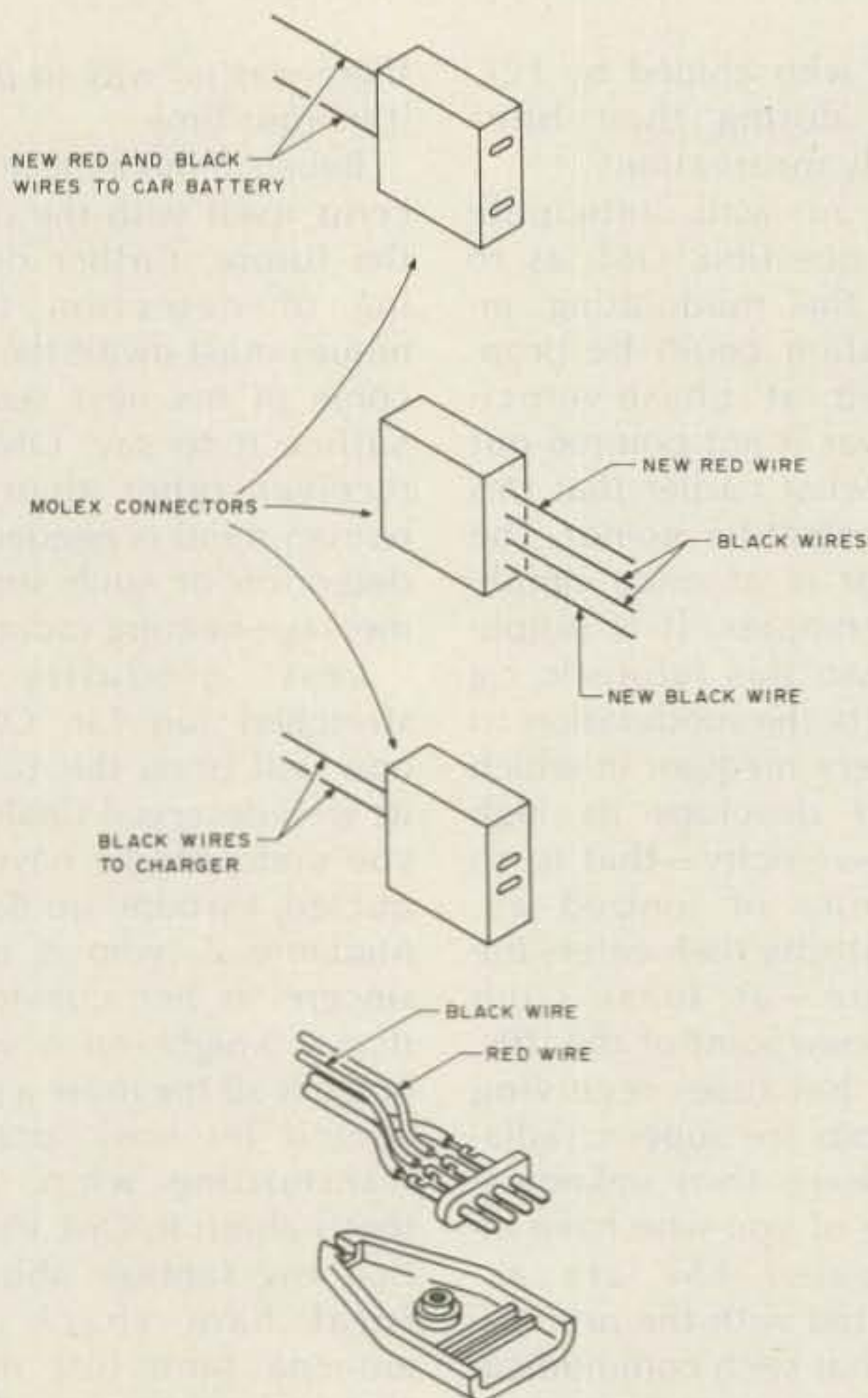

Fig. 1. Power cable wiring details.

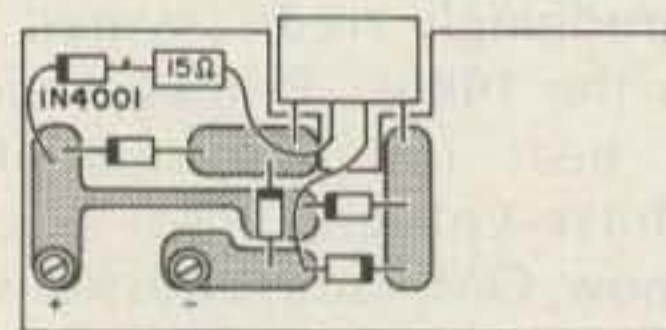

Fig. 2. Battery connector PC board modifications.

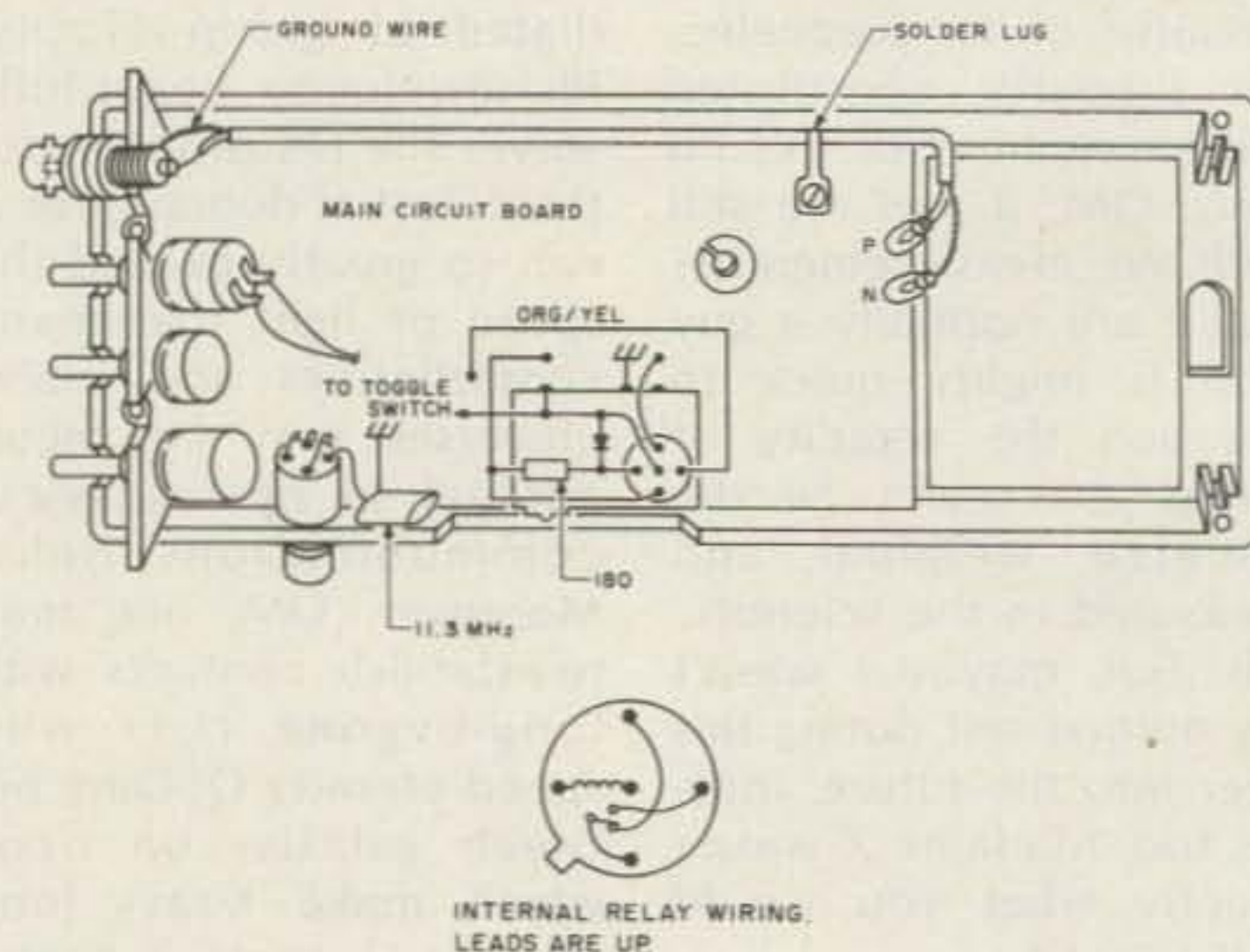

Fig. 3.

tached to the black wires on the new 4-conductor cable. Make up a second power cord of red and black wires and install a mating mox connector on this so that the pins on this connector mate with the pins attached to the red and black wires on the new 4-conductor cable. You now have the option of easily snapping on either the charger or the cable attached to your car battery. Fig. 1 gives the cable wiring details.

Now that you have external power and ground coming into the unit, you need to do something with it. Refer to Fig. 2. On the battery-connector PC board, connect a 1N4001 diode in series with a 15-Ohm resistor from the positive battery connector to the input pin corresponding to the external positive supply. The anode of the 1N4001 should be towards the external power pin. The resistor limits the battery-charging current to a safe rate. Finally, connect a piece of insulated wire from the external power ground pin to the negative battery clip.

A BNC antenna jack would be more convenient for mobile operation and would also help clean up the wiring mess of the present external antenna jack. To do this, remove the rubber ducky and external antenna connectors. With a thin-bladed pocketknife, cut out an additional 1/8 inch (approximately) of the bottom edge of the hole that the rubber ducky antenna connector was mounted in. Thread the BNC retaining nut on the BNC jack and solder a ground wire to the shell of the BNC jack near the center conductor pin. Refer to Fig. 3. The BNC jack can now be mounted in the hole and the nut tightened sufficiently to hold the jack snug while

epoxy is poured around it for a permanent bond. After the epoxy has set up, route the antenna coax from the BNC jack to the antenna pins on the PC board, as illustrated. Note the solder lug added under the PC board mounting screw to help keep the antenna coax fixed. Solder the cable shield to the ground pins on both ends of the board and also to the ground wire on the BNC jack.

The rubber ducky antenna can be modified easily to take a BNC plug. First, mount the antenna base-side-up in a vise and, preferably using a drill press, carefully drill a small hole in the center of the base. Sand off the plating around the hole and insert a piece of #22 wire (size not critical) into it. Solder this connection. Now, clip the wire to 0.6 inches and solder the BNC plug pin to it *after* putting a small piece of insulation around the wire. Take a 1/4-inch rubber grommet and trim off one of the lips. Place this grommet over the antenna base and check to see that the antenna and pin fit into the BNC sleeve easily. Refer to Fig. 4. Now add a small amount of epoxy to the insulated wire between the pin and antenna base and assemble the antenna to the BNC plug. Stand the antenna vertically and weight it as shown in Fig. 5. Apply epoxy to the BNC sleeve/antenna-base interface and allow it to set up. This completes the BNC connector modification.

One local repeater requires the +600-kHz offset, three other repeaters are on the standard -600-kHz offset, and 146.52 MHz is a popular simplex frequency for long mobile-to-mobile rag chewing on the way home from work. Others have recently described methods of adding the +600-kHz

offset to this rig.^{1,2} I'll contribute my modification so as to give another choice in the matter.

All of the switching is performed with a SP3T miniature rotary switch available either from RCL Electronics, Inc., Manchester NH 03103 (type SW-281-1), or from Daven Division, Thomas A. Edison, Inc., McGraw Edison Co., Manchester NH 03103 (type 18-KB-3-C500M). This switch fits perfectly into the hole left by the removed SPDT slide switch. However, before this switch can be added, R89 must be replaced with another 1000-Ohm, 1/4-Watt resistor—only with longer leads—so that the resistor can be laid flat on the PC board. This allows the necessary room for the switch. Also, sleeving must be added to the three bare wires which went to the old switch in order to keep from shorting any of them out against the new switch. Refer to Fig. 3 for the switch wiring details.

The +600-kHz offset crystal is an 11.3-MHz HC-18 type which I ordered from Jan Crystals. Wrap this crystal with a layer of

tape and position it horizontally between the PTT switch and the rotary switch. One lead is soldered to the circuit board ground and the other is soldered to the rotary switch, as shown in Fig. 3. Next, exchange the simplex (10.7-MHz) and -600-kHz offset (10.3-MHz) crystals. A small knob for 1/8-inch shafts can now be added to the rotary switch. You will now be able to switch between -600-kHz, simplex, and +600-kHz transmit combinations.

Since I like to operate mobile quite a bit, I wanted an external handset, as it is inconvenient to have to hold the HW-2021 all the time. Any surplus handset will do fine as long as it has a PTT switch. I found mine through Fair Radio Sales. First, though, you need to mount a mi-

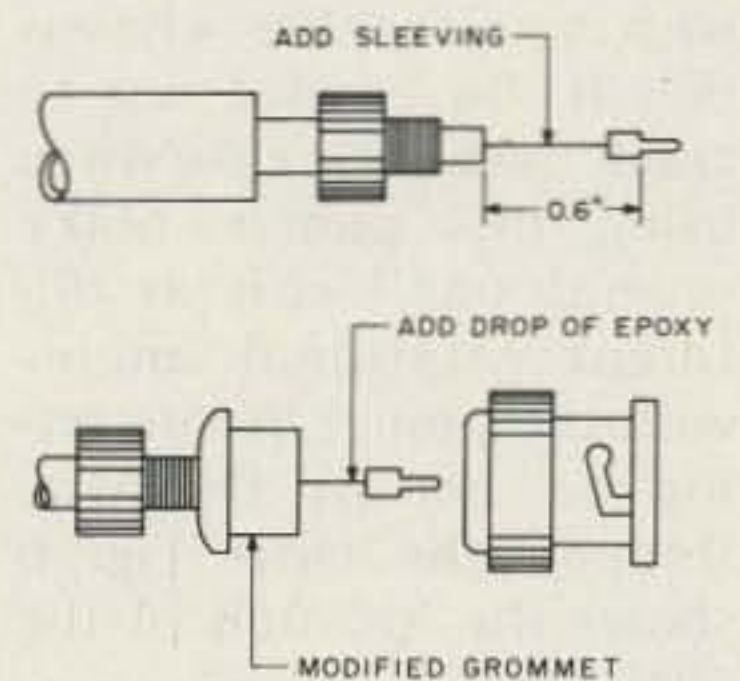

Fig. 4.

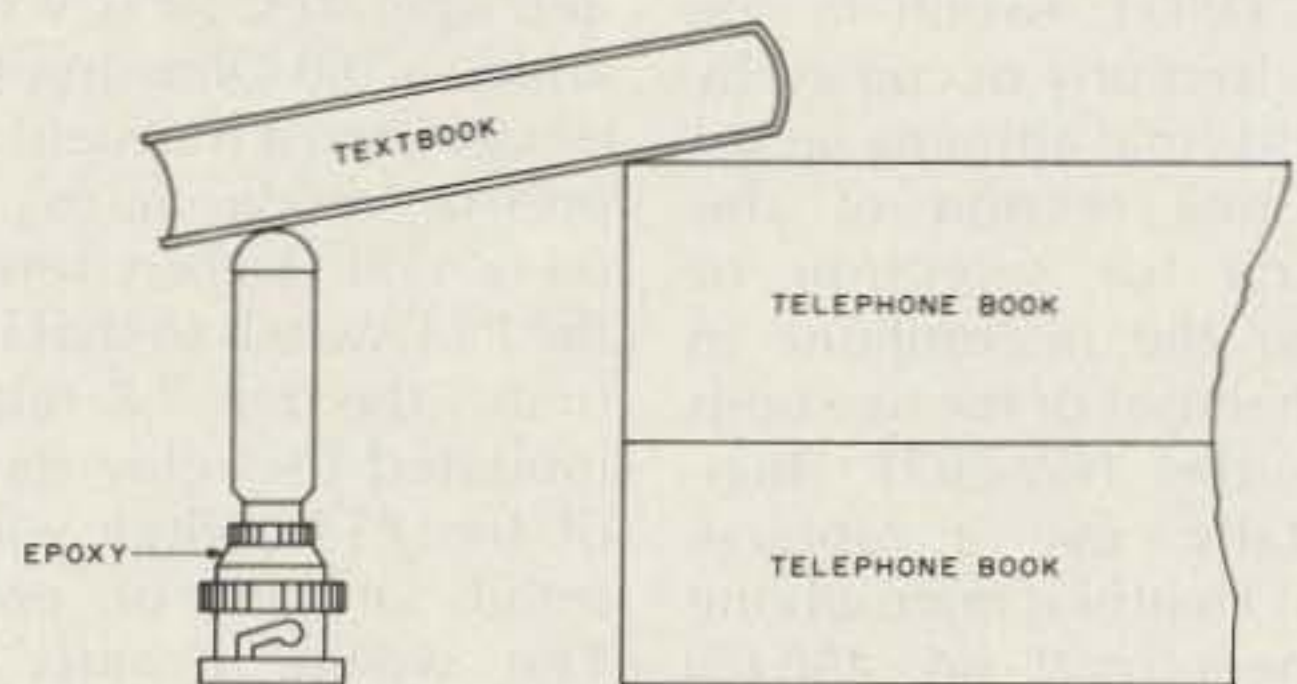

Fig. 5.

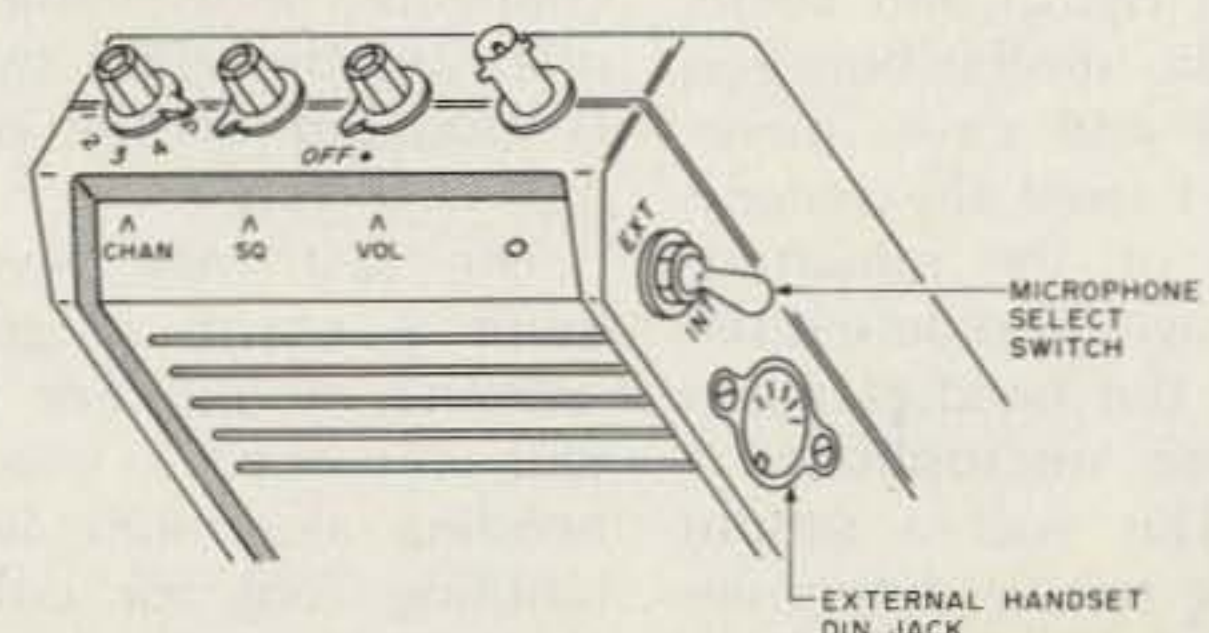

Fig. 6.

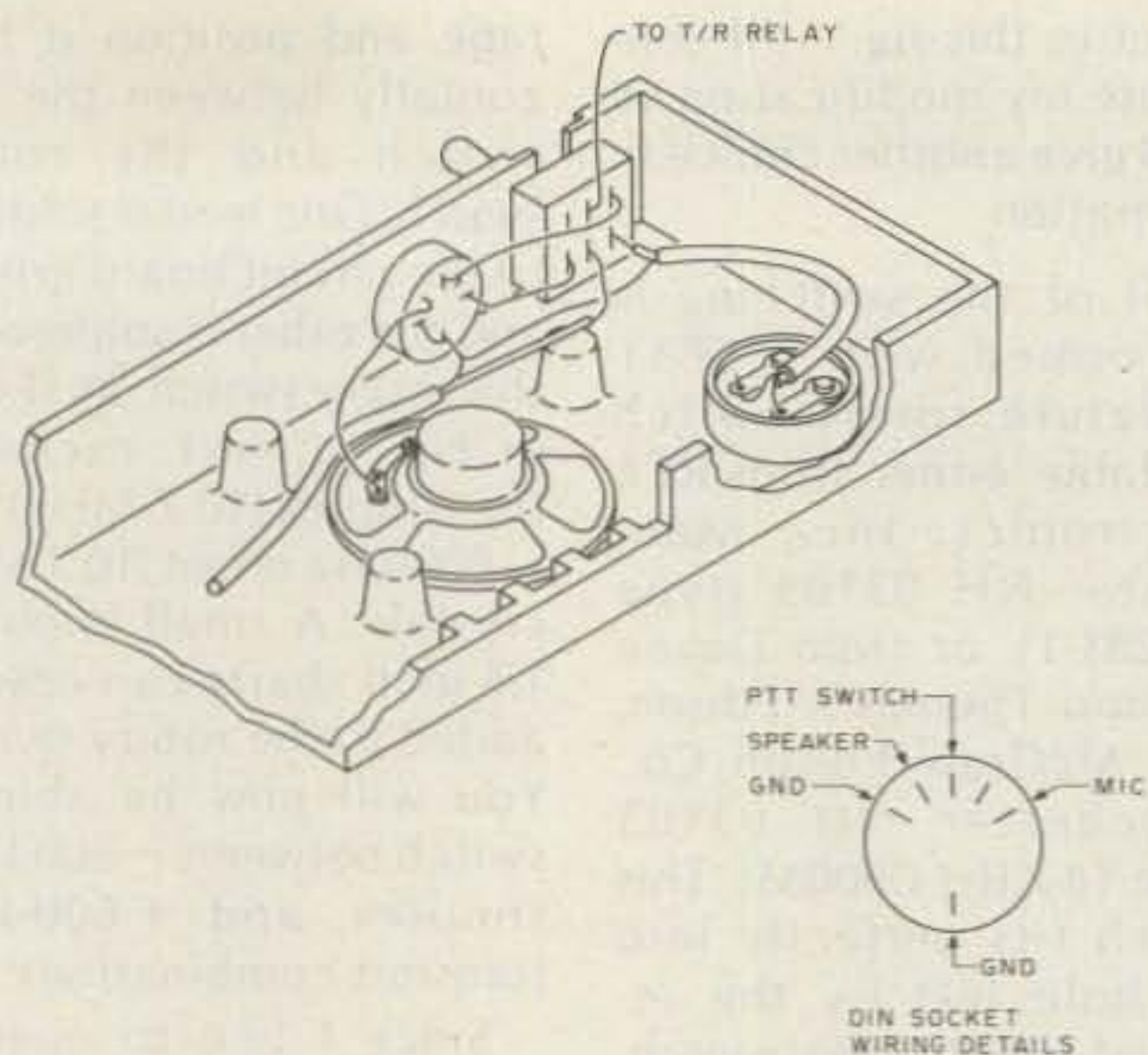

Fig. 7.

crophone jack on the HW-2021. I used the regular CB-type DIN plug and jack sold by Radio Shack for about one dollar each. The DIN jack requires a 5/8-inch mounting hole which can be made with a Greenlee chassis punch. Be careful not to crack the plastic case when using this punch. Make several small cuts at different rotational angles with the punch before trying to go all the way through the case. Fig. 6 shows the location of the DIN jack.

I also mounted a miniature DPDT switch in the hole formerly occupied by the external antenna jack. I use one section of this switch for selection of either the microphone in the handset or the one built into the HW-2021. Incidentally, use a replacement Heathkit microphone element (part no. 480-69) for the handset microphone. It costs \$6.00 through Heath and keeps the audio similar between handset and case microphone. I used the second section of the miniature toggle switch to defeat the PTT in the handset when the case microphone is used. This was a simple way for me to determine that the handset microphone was selected

without having to look at the switch. The handset speaker was simply tied in parallel with the HW-2021 speaker. You may want to add a dropping resistor depending on the handset speaker used. The DIN socket and DPDT switch wiring details are shown in Fig. 7.

In order to use the external handset, you will need to use a relay to perform the T-R switching function instead of the present PTT switch. I used a miniature SPDT relay made by Tele-dyne (type J411-6WL). This is a TO-5 case-style relay and operates off 6 V dc. I added a 180-Ohm dropping resistor and a transient suppressor diode across the relay coil. I then rewired the PTT switch so that it actuates the new T-R relay. I mounted the relay on top of the PTT switch with a small amount of epoxy. The wiring details are shown in Fig. 3. Note that the handset PTT wire is connected between the T-R relay and the DPDT switch is mounted on the other half of the case.

The last task was to build a cheap magnetic antenna mount. For this, you will need a vise for bending aluminum and a nibbling tool for cutting the magnet mounting holes. Refer to Fig. 8. First

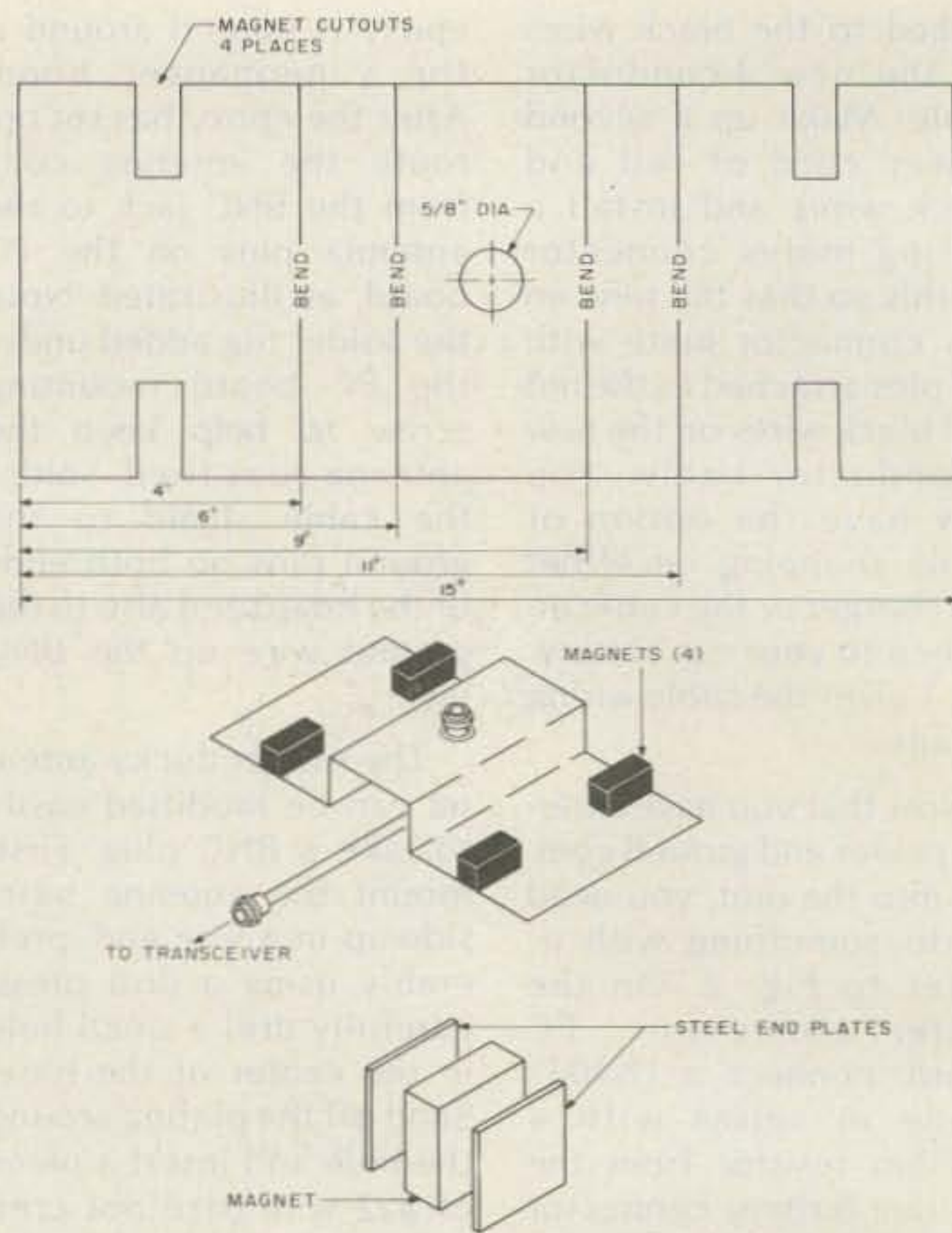

Fig. 8.

drill a 5/8-inch hole in the center of the aluminum sheet. This hole will be used for either a BNC bulk-head feedthrough connector or a regular BNC jack if you are willing to solder the coax to the antenna mount. The magnets are rectangular types available from Radio Shack and cost 15¢ each. You will need to cut out two 1/16-to-1/8-inch steel plates with approximately the same outside dimensions as the large flat sides of the magnets for each of the magnets. Place one plate on each side of a magnet and observe how well the magnet will now stick to any steel surface when mounted vertically.

After bending the sheet aluminum as shown, cut out slots for the four magnets so as to completely clear the magnets. Next, find a flat steel surface, put a sheet of newspaper over it, and place the aluminum mount over it—weighted so as to keep it flat. Place the magnets and end plates in the slots provided for

and make sure that they stick firmly to the steel surface under the newspaper. Now apply epoxy liberally to the aluminum mounting plate/magnet interface points. When the epoxy cures, you will have a magnetic mobile mount that will stay on your car to at least 75 mph. For the antenna itself, I simply use the rubber flex antenna from the HW-2021. It is more than adequate for most mobile-to-repeater usage and always ensures that you will have your flex antenna with you.

The Heathkit HW-2021 has all the room necessary to add all of the desirable functions you could want in this hand-held rig. In addition, a mobile magnetic antenna mount has also been described which can be used with any other hand-held rig. ■

References

1. "Improving your HW-2021," *73 Magazine*, March, 1978, p. 130.
2. "Improving Heath's HT," *73 Magazine*, October, 1978, p. 54.

NEW! MFJ INTRODUCES THE GRANDMASTER MEMORY KEYERS

At \$139.95 this MFJ-484 GRANDMASTER memory keyer gives you more features per dollar than any other memory keyer available — and Here's Why . . .

WEIGHT CONTROL TO PENETRATE QRM. PULL TO COMBINE MEMORIES A AND B FOR 1, 2, OR 3 FIFTY CHARACTER MESSAGES.

MESSAGE BUTTONS SELECT DESIRED 25 CHARACTER MESSAGES.

RESETS MEMORY IN USE TO BEGINNING.

SPEED CONTROL, 8 TO 50 WPM. PULL TO RECORD.

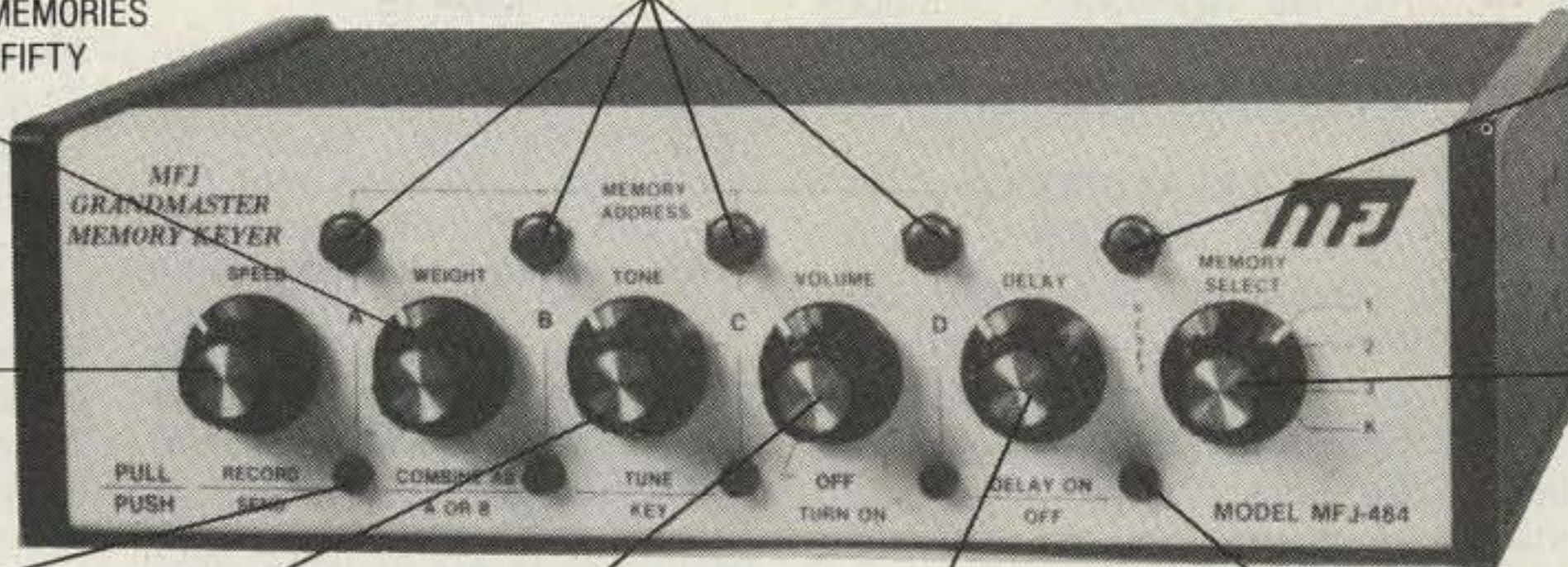

MEMORY SELECT: POSITIONS 1, 2, 3 ARE EACH SPLIT INTO MEMORY SECTIONS A, B, C, D (UP TO TWELVE 25 CHARACTER MESSAGES). SWITCH COMBINES A AND B. POSITION K GIVES YOU 100, 75, 50, OR 25 CHARACTERS BY PRESSING BUTTONS A, B, C, OR D.

LEDs (4) SHOW WHICH MEMORY IS IN USE AND WHEN IT ENDS.

TONE CONTROL. PULL TO TUNE.

VOLUME CONTROL. POWER ON-OFF.

DELAY REPEAT CONTROL (0 TO 2 MINUTES). PULL FOR AUTO REPEAT.

LED INDICATES DELAY REPEAT MODE.

NOW YOU CAN CALL CQ, SEND YOUR QTH, NAME, ETC., ALL AUTOMATICALLY.

And only MFJ offers you the MFJ-484 Grandmaster memory keyer with this much flexibility at this price.

Up to twelve 25 character messages plus a 100, 75, 50, or 25 character message (4096 bits total).

A switch combines 25 character messages for up to three 50 character messages.

To record, pull out the speed control, touch a message button and send. To playback, push in the speed control, select your message and touch the button. That's all there is to it!

You can repeat any message continuously and even leave a pause between repeats (up to 2 minutes). Example: Call CQ. Pause. Listen. If no answer, it repeats CQ again. To answer simply start sending. LED indicates Delay Repeat Mode.

Instantly insert or make changes in any playing message by simply sending. Continue by touching another button.

Memory resets to beginning with button, or by tapping paddle when playing. Touching message button restarts message.

LEDs show which 25 character memory is in use and when it ends.

Built-in memory saver. Uses 9 volt battery, no drain when power is on. Saves messages in memory when power loss occurs or when transporting keyer. Ultra compact, 8x2x6 inches. All IC's in sockets.

PLUS A MFJ DELUXE FULL FEATURE KEYS. Iambic operation with squeeze key. Dot-dash insertion.

Dot-dash memories, self-completing dots and dashes, jamproof spacing, instant start (except when recording).

All controls are on front panel: speed, weight, tone, volume. Smooth linear speed

control. 8 to 50 WPM.

Weight control lets you adjust dot-dash-space ratio; makes your signal distinctive to penetrate QRM.

Tone control. Room filling volume. Speaker.

Tune function keys transmitter for tuning. Ultra reliable solid state keying: grid block, cathode, solid state transmitters (-300 V, 10 ma. max., +300 V, 100 ma. max.). CMOS ICs, MOS memories. Use 12 to 15 VDC or 110 VAC with optional AC adapter, \$7.95.

Automatically switches to external batteries when AC power is lost.

OPTIONAL BENCHER IAMBIC PADDLE for all memory keyers. Dot and dash paddles have fully adjustable tension and spacing for the exact "feel" you like. Heavy base with non-slip rubber feet eliminates "walking". \$39.95 plus \$3.00 for shipping and handling.



THIS MFJ-482 FEATURES FOUR 25 OR A 50 AND TWO 25 CHARACTER MESSAGES.

- Speed, volume, weight, tone controls
- Combine memory switch
- Repeat, tune functions
- Built-in memory saver

\$99⁹⁵



Similar to MFJ-484 but with 1024 bits of memory, less delay repeat, single memory operating LED. Weight and tone controls adjustable from rear panel. 6x2x6 inches. 110 VAC or 12 to 15 VDC.

THIS MFJ-481 GIVES YOU TWO 50 CHARACTER MESSAGES.

- Speed, volume, tone controls
- Repeat function
- Tune function
- Built-in memory saver

\$79⁹⁵



Similar to MFJ-482 but with two 50 character messages, less weight controls. Internal tone control. Volume control is adjustable from rear panel. 5x2x6 inches. 110 VAC or 12 to 15 VDC.

For Orders Call toll-free 800-647-1800

Order any product from MFJ and try it. If not delighted, return within 30 days for a prompt refund (less shipping).

Order today. Money back if not delighted. One year unconditional guarantee. Add \$3.00 shipping/handling.

For technical information, order/repair status, in Mississippi, outside continental USA, call 601-323-5869.

Order By Mail or Call TOLL FREE 800-647-1800 and Charge It on



MFJ ENTERPRISES, INC.

P. O. BOX 494 ✓47

MISSISSIPPI STATE, MISSISSIPPI 39762

Social Events

Listings in this column are provided free of charge on a space-available basis. The following information should be included in every announcement: sponsor, event, date, time, place, city, state, admission charge (if any), features, talk-in frequencies, and the name of whom to contact for further information. Announcements must be received two months prior to the month in which the event takes place.

BLACKSBURG VA MARCH

Virginia Polytechnic Institute and State University Department of Chemistry will hold three short courses in March, 1980, at the Virginia Tech campus, Blacksburg, Virginia. The first workshop, entitled Digital Electronics for Instrumentation and Automation, will be held on March 10-11, 1980. The second workshop, entitled 8080-8085-Z80 Microcomputer Interfacing, Design, and Software, will be held on March 12-14, 1980. The third workshop, entitled TRS-80 Interfacing and Programming for Instrumentation and Control, will be held on March 17-18, 1980. These programs will be directed by Dr. Jonathan A. Titus, Dr. Paul Field, Dr. Christopher Titus, and Mr. David G. Larsen. These are hands-on workshops with the participants having the opportunity to retain the equipment. For more information, contact Dr. Linda Leffel, CEC, Virginia Tech, Blacksburg VA 24061, or phone (703)-961-5241.

CHRISTIANA DE MAR 2

The Delaware Valley Amateur Radio Society will hold its Winter Fest and Computer Show on March 2, 1980, from 10:00 am to 4:30 pm at Christiana Memorial Hall, Rte. 273 and Old Baltimore Pike, Christiana, Delaware. Events include a transmitter hunt (Freedom Foundation Fox Hunters Sanction Number 80-1) and a frost-bite tailgate section. Tables, food, and free parking will be available. Dealer inquiries are invited. Talk-in on 146.52, 223.36/224.96, and 146.355/955. For information and advance tickets, write to DVARS, PO Box 426, New Castle DE 19720.

MANCHESTER NH MAR 8

The Interstate Repeater Club will hold its annual Auctionfest

on Saturday, March 8, 1980, at the Sheraton Wayfarer Convention Center in Manchester, New Hampshire. Door prizes and refreshments will be part of the fun. Activities start with equipment check-in and review beginning at 7:00 am and the auction starting at 10:00 am. Admission is 50 cents for adults; children under 15 are free. Talk-in on 146.25/85 and 146.52. For more information, send an SASE to IRC Auctionfest, PO Box 94, Nashua NH 03061, or phone Gary Delong KA1BCA at (603)-434-5872.

LAFAYETTE LA MAR 8-9

The Acadiana Amateur Radio Association, Inc., will hold the 20th annual Lafayette Hamfest/Banquet at the Scott Lions Club Building, Lafayette LA. Exit south from I-10, go 6/10 miles, and turn right on Lion Road. Doors open at noon on Saturday and at 9:00 am on Sunday. There will be commercial displays on both days. The flea market is on Sunday only; \$2 per table. There will be ladies' activities on both days, with a ladies' tour leaving at 9:00 am Sunday. There will be hourly prizes and much more. The annual banquet is at 7:30 pm on Saturday (Cajun happy hour is 6:30 to 7:30 pm). Banquet tickets are \$10 per person, limited to first 200 reservations. There is no admission fee. Talk in on 147.81/21 or 146.22/82. For further information or to make your banquet reservations, write AARA, PO Box 51174, Lafayette LA 70505, or call (318)-367-3901.

COLUMBUS GA MAR 8-9

The Columbus Amateur Radio Club will hold its hamfest March 8th and 9th at the Columbus Municipal Auditorium, US Routes 27 and 280. Free admission. Prize tickets are \$1.00 each; table rental is \$5.00 per day. Free outside flea market. Campers may stay free on grounds overnight. Friday night setup available. Plenty of free parking. Advance tickets: N4ATI, 263 Logan Ave., Ft. Benning GA 31905. Table rentals: K4RHU, 2701 Peabody Ave., Columbus GA 31904; phone: (404)-322-7001.

STERLING IL MAR 9

The Sterling-Rock Falls Ama-

teur Radio Society will hold its 20th annual hamfest on Sunday, March 9, 1980, at the Sterling High School field house, 1608 4th Ave., Sterling, Illinois. Advance tickets are \$1.50; door tickets are \$2.00. Over \$2,000 worth of prizes will be given away. A large indoor flea market will be restricted to radio and electronic items only. There will be plenty of free parking, lots of bargains, and plenty of good food. Talk-in on .25/.85 (WR9AER). For tickets, write Don Van Sant WA9PBS, 1104 5th Avenue, Rock Falls IL 61071.

MIDLAND TX MAR 15

The Midland Amateur Radio Club will hold its annual swapfest on Saturday, March 15, 1980, from 12:00 noon until 7:00 pm, and on Sunday, March 16, 1980, starting at 8:00 am, at the Midland County Exhibit Building east of Midland, Texas, on Highway 80. There will be door prizes. Pre-registration is \$4.50 or \$5.00 at the door. Talk-in on 146.16/146.76. For more information or to pre-register, write the Midland Amateur Radio Club, Box 4401, Midland TX 79701.

MARSHALL MI MAR 15

The Southern Michigan Amateur Radio Society, the Calhoun County Repeater Association, and the Amateurs of the Marshall Schools will hold their 19th annual "Michigan Crossroads" Hamfest on Saturday, March 15, 1980, at Marshall High School, Marshall, Michigan. Doors will open at 7:00 am for exhibitors and at 8:00 am for the general public. Admission is \$2.00 at the door and \$1.50 in advance. There will be free parking, unloading help, and food service available, plus door prizes. Talk-in is on 146.52 and 146.07/67. Table space is \$.50 per foot. Featured will be forums, displays, and special programs for the ladies. For information and table reservations, contact SMARS, PO Box 934, Battle Creek MI 49016.

WINCHESTER IN MAR 15-16

The Randolph Amateur Radio Association will hold its 1st annual hamfest on March 15-16, 1980, from 8:00 am to 8:00 pm, both days, at the National Guard Armory, 700 Western Ave., Winchester, Indiana. Featured will be door prizes, food and drink, and a program of speakers for both days. The cost per table, or an equivalent space, is \$3.00. Tickets are \$2.50 at the door or \$1.50 in advance. Talk-in on 147.90/147.30, 223.30/224.90, and 146.52.

JEFFERSON WI MAR 16

The Tri County ARC hamfest will be held on March 16, 1980, at the Jefferson County Fair Grounds, Jefferson, Wisconsin. Advance tickets are \$1.50. Reserve tables are \$2.00 in advance and a 6-ft. space \$1.00. Send an SASE to Glenn Eisenbrandt WA9VYL, 711 East St., Fort Atkinson WI 53538.

HAZEL PARK MI MAR 22

The Catalpa Amateur Radio Society will honor Dusty Dunn W8CQ on the celebration of his 60th year as a ham on Saturday, March 22, 1980 (Dusty's birthday), at the Stephenson Club, Hazel Park MI. The cost of the banquet is \$12.50 per person. A cash bar opens at 6:30 pm and dinner begins at 7:30 pm. Reservations must be made by March 12, 1980. Talk-in on 146.55 simplex. For tickets, make checks payable to Charles Master W8OU, Box 294, Clawson MI 48017, or call (313)-646-3367.

VERO BEACH FL MAR 22-23

The Treasure Coast Hamfest will be held on March 22 and 23, 1980, at the Vero Beach Community Center. Prizes, drawings, QCWA luncheon. Admission will be \$3 per family in advance or \$3.50 at the door. Talk-in on 146.13/73, 146.04/64, and 222.34/223.94. For information, write PO Box 3088, Vero Beach FL 32960.

FORT WALTON BEACH FL MAR 22-23

The Playground Amateur Radio Club will hold its 10th anniversary swapfest on Saturday and Sunday, March 22-23, 1980, from 8:00 am to 4:00 pm each day, at the Okaloosa County Shrine Fairgrounds, Fort Walton Beach, Florida.

WAUKEGAN IL MAR 23

The Libertyville and Mundelein Amateur Radio Society (LAMARS) will hold its annual hamfest on March 23, 1980, at the J-M Club, 708 Greenwood Ave., Waukegan IL. Doors will open at 7:00 am. Large indoor facility. Plenty of food and drink. 7-ft. tables available at \$4.00 each. Great prizes and goodies. Tickets will be \$2.00 at the door or \$1.50 in advance. Write for tickets or tables (include SASE) to: LAMARS, PO Box 751, Libertyville IL 60048.

Continued on page 152

ECONOMICAL RTTY

Flesher Corp offers a selection of compact, economical RTTY equipment and accessories unequalled in quality or function for the price. Flesher units

are designed with minimum space requirements in mind, too. Call or write today for our free 1980 catalog of affordable kits, wired units and accessories.



FLESHER CORP

✓23

P.O. Box 976 • Topeka, Kansas 66601 • 913 • 234 • 0198

ALDELCO ELECTRONICS COMPANY

| RF DEVICES | | |
|---------------------|--------|--------------------------|
| 2N5913 1.7W 175 MHz | \$1.70 | 2N6080 4W 175 MHz 5.40 |
| 2N3866 1W 400 MHz | 1.25 | 2N6081 15W 175 MHz 8.45 |
| 2N5589 3W 175 MHz | 4.75 | 2N6082 25W 175 MHz 10.95 |
| 2N5590 10W 175 MHz | 7.80 | 2N6083 30W 175 MHz 11.75 |
| 2N5591 25W 175 MHz | 10.95 | 2N6084 40W 175 MHz 13.30 |

OVERVOLTAGE PROTECTION OV-12 Provides protection from runaway Power Supply Voltage. Triggers @ 16V 25 Amp rated, 1 piece moulded unit for 12 Volt DC fused Power Supply \$8.95 OV-5 for 5 Volt PS triggers at 7V \$9.95

ACCUKEYER KIT. Similar to Handbook version. Includes PC Board, IC's, Sockets & all parts. Includes sidetone on board, lmbic operation dot dash memory. Only \$21.95

NEW MEMORY KIT. 1056 bit memory expandable to 4224 bits. 1 2102 supplied. Additional chips \$1.25 each. Led indicator. Adaptable to other keyers. Uses 5VDC. Only \$21.95

Dual digital 12 or 24 HOUR CLOCK KIT. NOW WITH A NEW WALNUT WOOD GRAIN CABINET Model ALD 5-W Six Big 0.5 Displays Only \$52.95 12 or 24 Hour Operation — Each Clock controlled separately Freeze Feature for Time Set — Easy assembly for clock and Cabinet

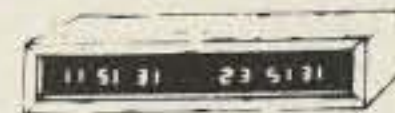

5 Pin Din Accessory Cord and Plug. Fits KDK 60 HZ Crystal time Base Kit \$4.95

ALARM CLOCK KIT Six 0.5 LED Display Readouts Elapsed Time indicator 12 Hour Format with 24 Hour Alarm Snooze feature AM/PM indicator. Power supply power failure indicator. 12 or 24 Hour Clock Kit 0.5 Display LED's Wood Grain Cabinet \$19.95 Only \$21.95 \$4.95

TUNABLE AMATEUR TV CONVERTER Receive Fast Scan ATV in the 420 MHz Band with any TV Set. Low noise high gain Amplifier stage with Varactor Tuned input and output. Built-in 110 VAC Supply Two Tone Walnut & Beige Cabinet measuring 1-7/8" x 4-1/4" x 4-1/8" Factory Wired & Tested 2 Year Guaranty Only \$59.95

| Lunch Counter Kit (boards & front panel only) | | \$14.50 |
|---|---------|----------------------------|
| 11C90 Prescaler | \$19.95 | 1 MHz crystal \$ 7.95 |
| 74C925 Multiplex | \$15.95 | 10-60 PF trimmer \$.60 |
| F9368 Drivers (2) | \$15.95 | 704 displays, each \$ 1.25 |
| Resistor Kit | \$ 1.75 | Capacitor Kit \$ 6.00 |

Add 6% for Shipping. Min. Order \$10.00. Out of USA send Certified Check or Money Order. Include Postage.

ALDELCO

2789 A Milburn Avenue, Baldwin, NY 11510
(516) 378-4555

✓300 Send 1st class stamp for our catalog

SCANNER S:

KDK 2015R, KDK 2016A

MIDLAND 13-510, 13-513, CLEGG FM-28

YAESU FT227R, ICOM IC22S,

KENWOOD TR7400A, TR7600, & TR7625

- AED continues to expand its line of quality scanners. All of the above scanners are custom designed for their respective rigs.
- All scanners install completely inside the rig. No obtrusive external connections.
- All are easy to assemble and come complete with a detailed instruction manual.
- Scanned frequency displayed on digital readout (except IC22S).
- In the scanner OFF mode the rig operates normally. In the scanner ON mode the scanner locks on an occupied frequency, pauses for a preset time (about 5 secs.) and then resumes scanning.
- This gives you the ability to eavesdrop all over the band without lifting a finger. When you hear something interesting, you flip the switch to the LOCK mode and the rig is ready to transmit.

AED SCANNER SPECIFICATIONS

| | KDK 2015R | KDK 2016A | KENWOOD TR7600 TR7625 | KENWOOD TR7400A | YAESU FT227R | MIDLAND 13-510 13-513 | CLEGG FM-28 | ICOM IC22S |
|---------------------|--|-------------|--|--|---|---|-----------------|---|
| SCAN RATE | Adjustable 100kHz/sec-1MHz/sec | | 50kHz/sec | 200kHz/sec | 100kHz/sec | 100kHz/sec | 100kHz/sec | 100kHz/sec |
| SWEEP WIDTH | 144-148 or only the MHz segment you select on MHz switch | 142-149.995 | complete band or MHz you want | complete band or MHz you want | adjustable eg. 146-148 144-146 146-147 | scans the MHz seg. selected by the MHz switch | same as Midland | 145.35-147.99 |
| SCAN CONTROLS | 2 mini toggle switches mounted on rig — LOCK switch may be mounted on mic. | | 2 mini toggle switches mounted on rig. | 2 mini toggle switches mounted on rig. | 1 mini toggle switch mounted on mic or rig. | 2 mini toggle switches mounted on rig. | same as Midland | 1 mini toggle switch mounted on mic or rig. |
| PRICE FOR KIT | \$39.95 | | | | | | | |
| PRICE PRE-ASSEMBLED | \$59.95 | | | | | | | |

DEALER INQUIRIES INVITED



AED ELECTRONICS

750 LUCERNE RD., SUITE 120
MONTREAL, QUEBEC, CANADA H3R 2H6
TEL. 514-737-7293

Add \$1.50 for postage & handling

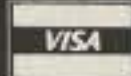

QUASAR VIDEO TAPE RECORDER SALE!

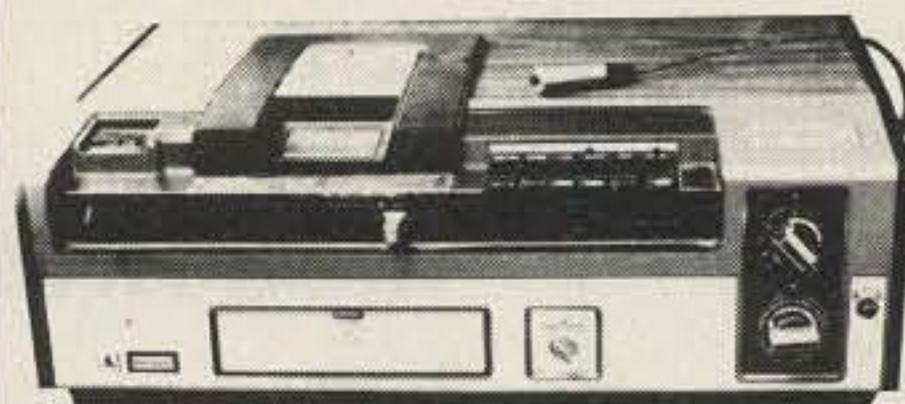

- ★ Records to two hours, color or black & white
 - ★ Records off the air—record one program while watching another
 - ★ Camera input to make your own tapes
 - ★ Can be used with optional timer while you are out
 - ★ Pause control for editing
 - ★ Limited supply—these \$1,000 VTRs were demonstrators & come with new warranty . . . \$499
- \$100 worth of new blank tape will be included at no extra charge!

Send for our new catalog!
\$3 Shipping charge per order • NO C.O.D.s!

Bill: MC Visa

Credit card # _____

Exp. date _____

Signature _____

Name _____

Address _____

City _____ State _____ Zip _____



206 Mystic Ave.
Medford MA 02155
(617) 395-8280

✓77

The History of Ham Radio

— part XI

Reprinted from QCC News, a publication of the Chicago Area Chapter of the QCWA.

The post-WWI years from 1920 to 1927 found the mushrooming radio industry still in its infancy, but struggling to find a foothold—very much in need of direction. It was a new technology still in

relative obscurity awaiting a Midas touch!

Radio did not have a definite pattern by which to gauge its destiny. From the very beginning it was partially inundated with revolutionary inventions and new developments, many of a questionable nature. There existed no guidelines to follow in this new field.

The introduction of numerous bills in Congress to update the 1912 Wireless Act merely aggravated the situation. The end of hostilities, the conversion from a war to a peace climate, resulted in the creation of many new companies, large and small, seeking to take advantage of this developing, growing industry. Here existed a "made-to-order" opportunity for questionable financial interests to inundate a lucrative market with investment stock schemes. An unwary public remained confused, except for the wide-awake radio amateur, to whom these conflicts meant very little. His interests were directed toward testing all the new gadgets flooding the radio market and experimenting

with the numerous circuit arrangements that were perpetually introduced through dealer folders and pamphlets. In general, this game of wireless had him spending many hours at the Morse key, exchanging messages via the established relay routes and frequently exchanging radio signals with neighboring and foreign countries.

Outstanding researchers and inventors, personalities of the stature of Major Howard Armstrong, for one, and men on the technical staff of the ARRL—John Reinartz and S. Kruse, among others—introduced circuit designs under such names as "regenerative," "heterodyne," "neutrodyne," "super-heterodyne," and "reflex," all of which provided the amateur with endless hours of experimental activity.

The 1923 Challenge Across the Atlantic

During the winter of 1922, our radio amateur had succeeded in spanning the Atlantic Ocean with his wireless signal operative on 200 meters, but only in one direction—from the

ARMSTRONG'S NEW SUPER-REGENERATIVE RECEIVER

The Circuit and Complete
Working Directions

Second Edition
Enlarged and Elaborated—With New Data

PRICE
TWENTY
FIVE
CENTS

25c.

Published by

THE E. I. COMPANY
233 FULTON ST., NEW YORK CITY

Copyright by E. I. Co., 1922

United States to the British Isles. He did not have to be encouraged to tackle the two-way spanning. Active steps were taken by the ARRL to accomplish this feat, this time giving all amateur radio stations an opportunity to participate in the effort. The results which the experimenter was having with the wavelengths below 200 meters, going down to 150 and even down to 100 meters, provided renewed activity and a desire for some real DX. All the planning and the cooperation soon produced astonishing results.

On November 17, 1923, there was a headline banner across the amateur radio horizon. For the first time in history, the Atlantic Ocean was bridged by amateur radio in two-way contact with an exchange of messages. Distance records were quickly attained via two-way phone contacts with stations in Hawaii and Alaska, Japan and Australia, and the American continent. This was a year of jubilation.

The Language Problem

With the crossing of the Atlantic and the contacts now possible with foreign countries, there arose a request on the part of many to solve, in some way, the language problem for better exchange of messages. The question was how to do it. There was immediately suggested an International Language, an IL, for short, to facilitate common understanding. At the beginning, such a proposal was regarded as indispensable. A well-established Esperanto system of word and sentence construction was in use in many countries and was extensively used at conventions and other gatherings with considerable success. Esperanto was considered to be valuable as a rapid means of common understanding.

However, the use of the synthetic language proved too "burdensome" and "uncommon" to the majority of amateurs and, through neglect, was soon forgotten.

Solving the Call Letter Identity Problem

The early assignment of call letters among United States amateurs was simple: The district number was followed by either two or three letters of the alphabet. But, as Canadian and foreign stations with similar and often identical call letters were contacted, confusion arose unless an additional first character was added. To correct this problem, the ARRL initially suggested that the United States amateur simply use "de" and the Canadians the letter "v" before giving their call. This soon proved inadequate and gave way to an assigned alphabetical letter as follows to which all agreed and used.

- A—Australia
- C—Canada
- F—France
- S—Spain
- U—United States
- G—Great Britain
- I—Italy
- M—Mexico
- R—Argentina
- Z—New Zealand
- N—Netherlands
- O—South Africa
- P—Portugal
- C—Cuba

These letters, however, did not conform to those assigned by the countries' respective governments. This plan was first adopted as of December 15, 1922. Additional letters were required from time to time and assignments were made by the ARRL Operating Department. Several two-letter prefixes were needed toward the termination of this method of call-letter designation, i.e., FN—Finland and CH—Chile. The letters were used for a time by all amateurs except in

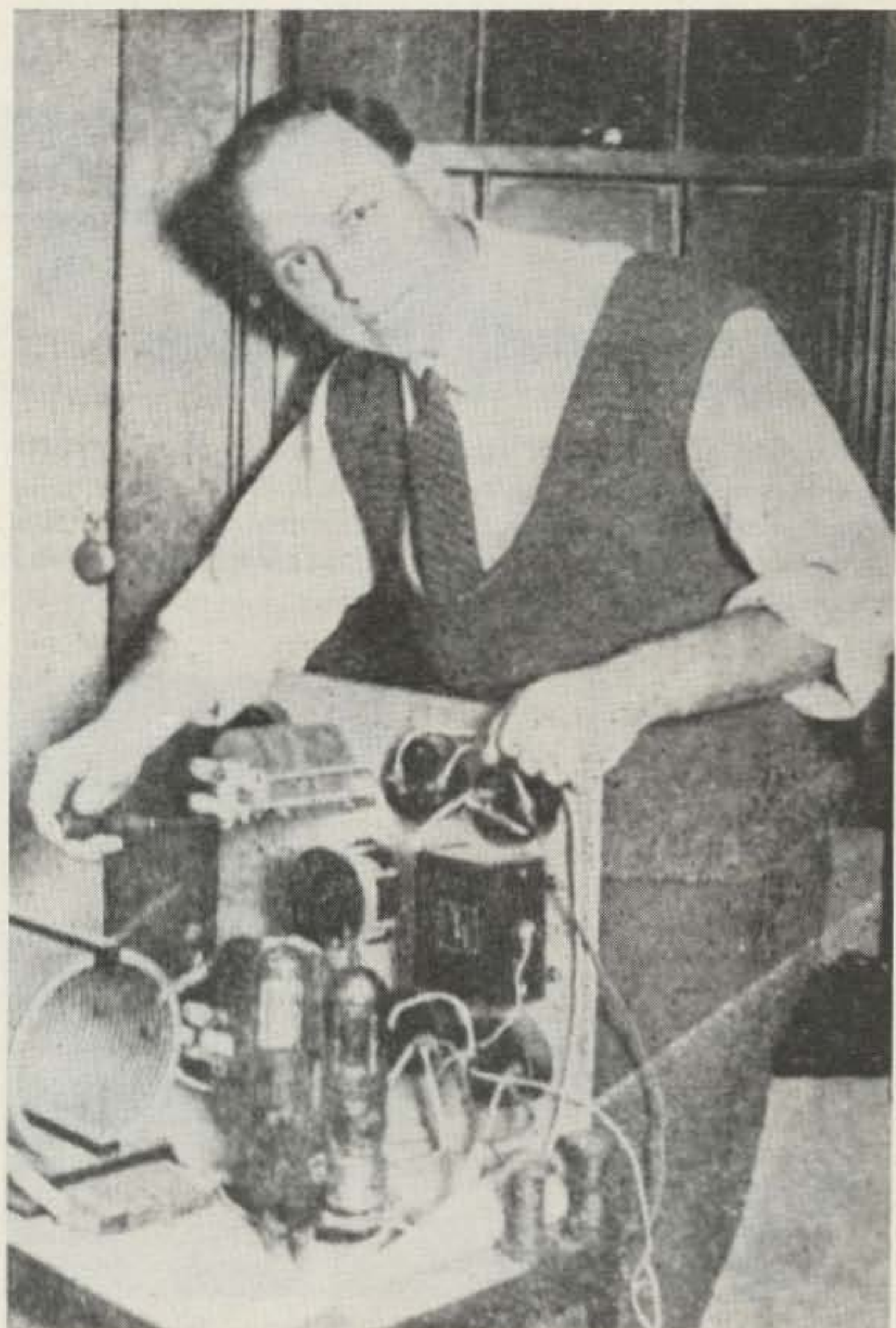

John L. Reinartz and the set at 1QP-1XAM.

Britain, where such permission was not granted.

Worldwide Amateur Radio — A Reality In Fact

As more and more international amateur radio contacts were consistently and regularly logged, serious consideration was given toward an international radio amateur organization, eventually to be affiliated with the American Radio Relay League. In the making was a relay circling the globe, thus involving amateurs worldwide linking all continents! This was the ultimate challenging thought for amateur radio. No sooner was this idea proposed than the ARRL board of directors commissioned its president, Hiram Maxim, to call together all interested foreign ama-

teurs for an early meeting. The United States and Canadian amateurs, with years of experience and with an established organization nearing 20,000 members, were expected to provide leadership and guidance toward making an international amateur radio relay league a challenging asset for world communication.

So, on March 12, 1924, in Paris, France, the amateur representatives of nine different countries—France, Great Britain, Belgium, Switzerland, Italy, Spain, Luxembourg, Canada, Denmark (absent), and the United States—sat down together, deliberated for several days, and formulated the beginning of the *International Amateur Radio Union*. Appointed at the meeting was a tem-

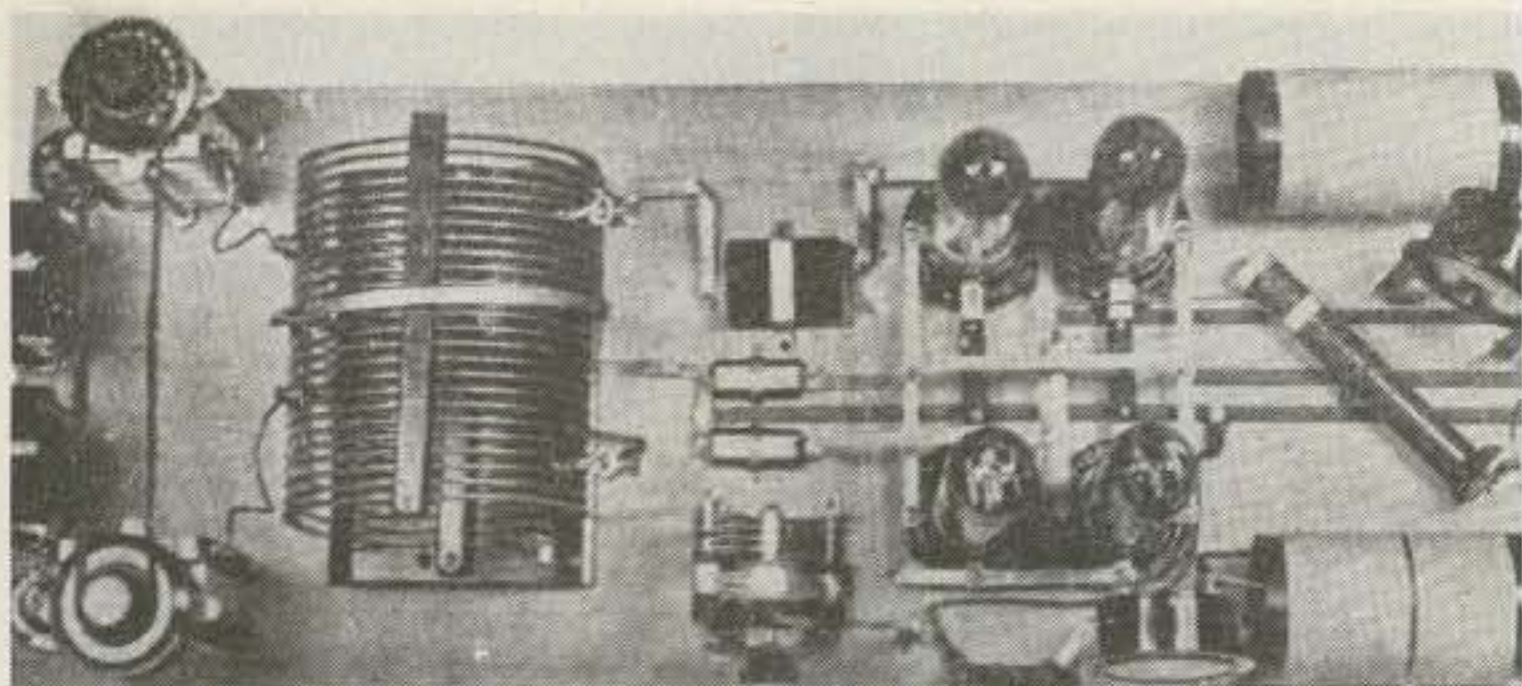

The transmitter at 1MO-1BHW which, under the call 1MO and on a wavelength of 110 meters, was the first American amateur station to connect with a European amateur. This set was built in accordance with the scheme outlined by John L. Reinartz of 1QP-1XAM.



1MO and his "hay-wire" receiver with which he worked F6AB.

porary Committee of Organization to select and approve a permanent name, a constitution, and operating procedures. During Easter, 1925, the IARU was officially declared a permanent organization, with Hiram Maxim as its first president.

The Wavelength Breakthrough for Amateur Radio

For a number of years, and especially during 1923, desire and hope were on the minds of the amateurs for expanded operation on the lower wavelengths. Many experiments conducted in trials and contacts proved convincingly that the higher frequencies could be depended on to provide consistent DX. Again through the efforts of the ARRL, the Department of Commerce, during

the summer of 1924, issued the following letter directed to all supervisors of radio:

*Department of Commerce
Bureau of Navigation
Washington*

July 24, 1924

*All Supervisors of Radio
Sirs:*

Effective this date you are authorized to issue general and restricted amateur radio station licenses to permit the use of any one or all of the following bands of short wavelengths: 75 to 80 meters, 40 to 42 meters, 20 to 22 meters, 4 to 5 meters, in addition to the band 150 to 200 meters, provided application is made by the owner of the station, which station must be prepared to use the wavelength, or wavelengths, requested.

The use of continuous

wave telegraphy only will be permitted on wavelengths other than 150 to 200 meters, and the antenna circuit must not be directly coupled to the transmitting circuit.

Silent hours will not be required of amateurs while using the wavelengths within the above bands below 80 meters except where the transmitting station is so situated as to produce objectionable interference with other services.

Hereafter, special amateur stations will not use wavelengths above 200 meters. They may be authorized to use the bands of wavelengths from 105 to 110 meters in addition to the wavelengths within the bands authorized for general and restricted amateur use, where the special amateurs are engaged in conducting tests with government or commercial stations.

General, restricted, and special amateur stations will be permitted to use the entire band of wavelengths from 150 to 200 meters employing pure CW, spark, and modulated forms of transmission.

It should be made clear to the amateurs that the authority granted above is necessarily tentative because of the rapid development taking place in radio communication, and the bands of wavelengths authorized may be changed whenever in the opinion of the Secretary of Commerce such change is necessary.

With the assignment of the five new wave bands, amateurs enthusiastically entered a new radio communications era. Regular licenses had to be modified by district supervisors. No longer was the amateur confined to the selection of one or maybe two frequencies as specified on his former license permit. From now on, the operator had greater flexibility in

choosing desired operating frequencies.

Amateurs were requested by the department to make immediate use of these broadened privileges so that the bureau could gather vital information and determine practical usage in this spectrum. The new bands were made available on an "until further notice" basis. To assist in reducing broadcast listener interference, specific types of carrier modulation and types of power supplies at the transmitter were prohibited, i.e., spark, phone, and ICW modulation were declared out. The "silent hours," stipulated at lower wavelengths, were cancelled for the higher frequencies. The 150- to 200-meter band was opened up for any and all uses.

These newly assigned wave bands materially broadened the operating range for the amateurs. They had been clamoring for ether space and were anxious to readjust their experimental circuits and antennas for a go at these higher frequencies. A calibrated wavemeter became vital. Still required by all radio amateurs was an operator's as well as a station license. A code speed requirement of 10 words per minute prevailed.

The 1924 White Bill, HR 7357 — and Others

On February 28, 1924, Congressman White, Chairman of the Subcommittee on Radio, introduced a new bill to abrogate the old Wireless Act of 1912, declaring that the original law had outgrown its usefulness.

The White bill was aimed at vesting all administrative powers pertaining to radio in the hands of the Secretary of Commerce. He was to classify all radio stations as to wavelength, licensing, hours of operation, type of equipment,

and power. In short, the Secretary would have complete jurisdiction over all radio activities and facilities. As the general hearings on the bill proceeded, it became evident that the radio amateur, especially the ARRL, would be negative about the overall stipulations in the bill. They felt that such broad discretionary powers in the hands of one individual would be too dangerous. Other interested parties at the hearing expressed similar negative views on the bill.

By May, 1924, the structure of the White bill, as it had initially been presented, had gone through a series of changes and maneuvers. Provisions were combined with a similar bill, the Howell bill, S 2930; it was considerably modified again, but in the end remained the White HR 7357 document, as an

acceptable paper in line for ultimate passage. In its final form, it incorporated appeals against unfavorable decisions in the issuance of licenses and other activities. Throughout the hearings, amateurs received favorable consideration.

At this stage in time, however, the conditions surrounding all radio communication in the United States required extensive exploration and far more research and legislation. Secretary of Commerce Hoover stated that eventually radio broadcasting would of necessity have to be considered within the field of public service and divorced from private enterprise altogether. Hoover proposed sending a bill to Congress outlining his views. The evidence was clear—a National Radio Conference was in the offing. ■

Order Your Collins KWM-380

NOW!
and receive **FREE**
ONE of the following

(+ old pricing, deposit only required)

- 1) Noise Blanker — \$195.00
- 2) 2 Filters, your choice — \$96.00 ea.
- 3) Blower Kit — \$195.00



Get on with the Best!



MADISON

Electronics Supply, Inc. ✓45

1508 McKinney • Houston, Texas 77002 • (713) 658-0268

the direct connection

AVANTI • ASTRON • ALLIANCE • ATLAS • ALPHA • BIRD • CUSHCRAFT • COLLINS • CDE • DRAKE • DENTRON • HY-GAIN • HUSTLER • ICOM • KLM • KENWOOD • MOSLEY • MICRO-LOG • MOR-GAIN • MIRAGE • MFJ • PALOMAR ENG. • SWAN • TEN-TEC • TAYLOR • TRI-EX • TELE-TOW'R • UNIVERSAL • UNARCO-ROHN ... ALL THESE AND MORE

MIDCOM ELECTRONICS, INC.
2506 S. BRENTWOOD BOULEVARD
ST. LOUIS, MISSOURI 63144



1-800-325-3609

MO. RESIDENTS CALL COLLECT 314-961-9990

CB to 10

— part XXIII: the Sears Roadtalker 40

Affecting all things, change brings us into the future, where a venerable old name like Sears, Roebuck and Co. is simplified to Sears, and where

Photo by Daniel B. Smith, Jr. K6PRK

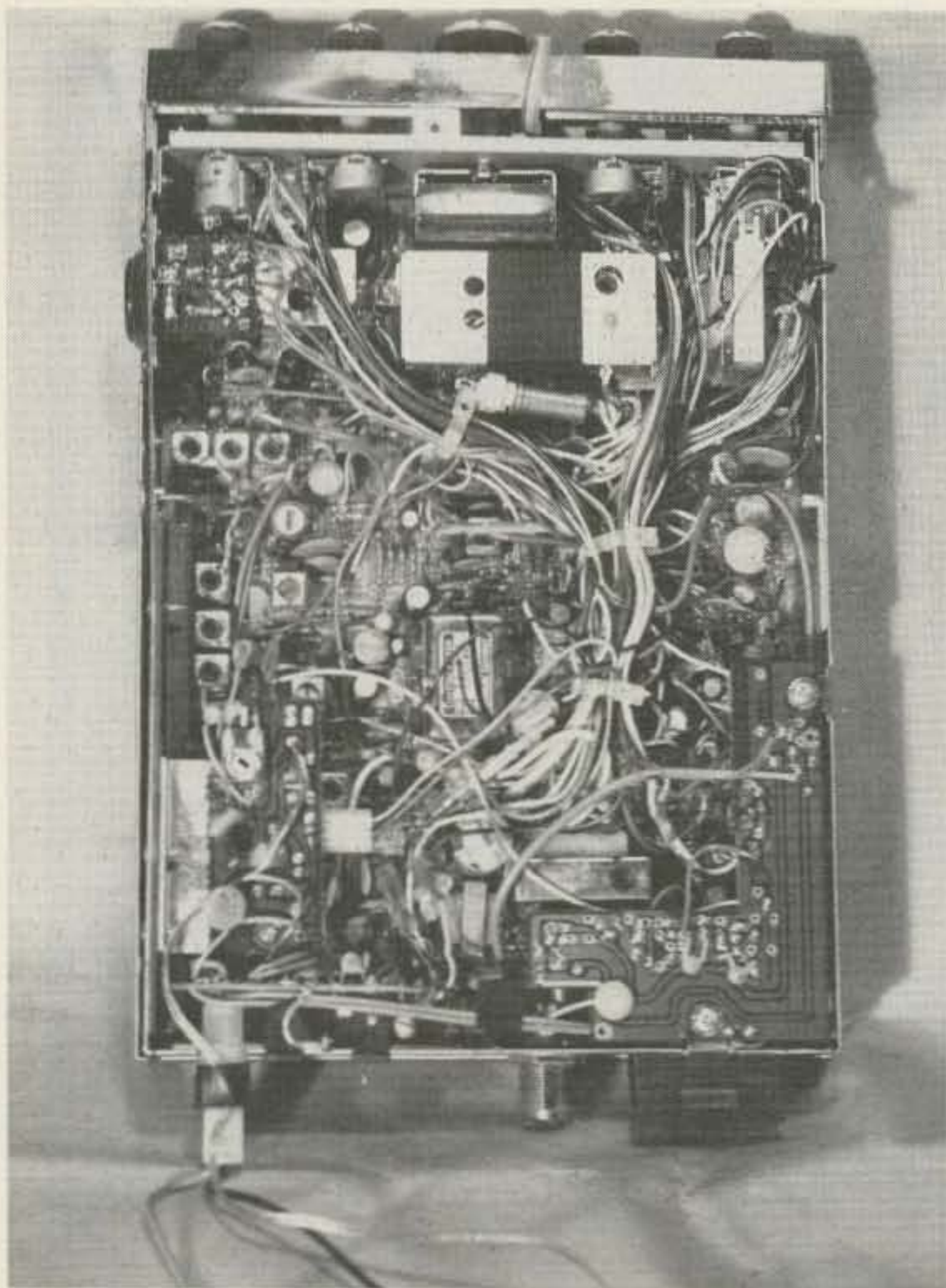

Fig. 1. Bottom view of the Sears Roadtalker 40 showing component layout.

amateur radio sports new terminology such as micro-processor, phase locked loop, etc. The ham bands have changed their make-up in the past 25 years. The AM heterodyne alleys of 20 and 40 meters now ring with the cacophony of sideband and automatic computerized CW IDers. Even the 10-meter band (the one revered by most hams because of its uncongested spectrum, leisurely operating pace, and surprisingly low-power DX capabilities) now bustles with new activity: incessant DX beacons, fully-quieted FM signals passing through intercontinental repeaters, the doppler shift of CW tones as satellites whiz by, and the chatter of channelized QRP rigs rising in a crescendo as sunspot activity moves steadily toward peak 21 and beyond.

When Sears and Roebuck together were a household name in the early fifties (and before), operating on the 10-meter band was a lot simpler. A ham in those days could afford to build his own rigs, or he could modify, for his needs, a wide variety of

WWII surplus hardware. Working all over Europe in one morning with 50-Watts AM was, as remembered 25 years later, quite a surprise, as well as a very rewarding experience.

Recently, several surprises and rewarding experiences accompanied my modification and use of a 40-channel phase-locked loop CB transceiver purchased from that venerable old company, Sears. In an age where building from scratch is cost-prohibitive, the Sears Roadtalker 40, model 3826, AM-SSB rig was purchased new and sight-unseen for under \$80.00 during a recent sale. Upon opening the box, the manual and accompanying schematic were immediately perused for the electrical details of conversion. Also, the bottom cover was removed to examine the physical problems concerned with the change-over—see Fig. 1.

The "doghouse" containing the reference oscillator is in the upper center of the chassis. This oscillator is the key to the conversion. The articles listed in the References are excel-

lent in their statement and solution to the conversion problem. Fortunately, the Sears rig has an almost identical PLL circuit to the rig in Reference 1.

Fig. 2 shows the Sears model 3826 block diagram; the key to the conversion is the vcxo, Q701. The vcxo's third harmonic is mixed with the vco (Q707) frequency in Q703, is filtered by LPF1, and is fed into the PLL controller. For channel 1, this frequency is 1.28 MHz. In this PLL, the vco will automatically seek the correct frequency to achieve a 1.28 MHz difference with the vcxo reference oscillator.

In order to move the rig's operation into the 10-meter band, the X701 frequency has to be increased. For example, to move the CB channel 1 operating frequency from 26.965 to 28.510, the vco has to be increased by 1.545 MHz. To achieve this, the X701 frequency should be increased from 12.320 to 12.835 MHz. This increase of .515 Hz is one third the vco frequency increase required. The reason for only the 1/3 increase is that the 3rd harmonic is mixed with the vco.

So much for theory; now let's discuss the actual conversion details. A 13-MHz HC-18/U-style crystal was purchased at a local surplus parts house to get the rig tuned to the 10-meter band. With this crystal, channel 1 is 29.005 MHz. It was decided to tune the receiver and transmitter to channel 1 while hoping that the tuned circuitry was broadbanded enough to cover 40 channels above, as well as below, 29.005 MHz. As it turns out, this was a good choice of a tune-up frequency. The crystal and socket (shown in Fig. 1) are taped to the outside of the metal doghouse because of its

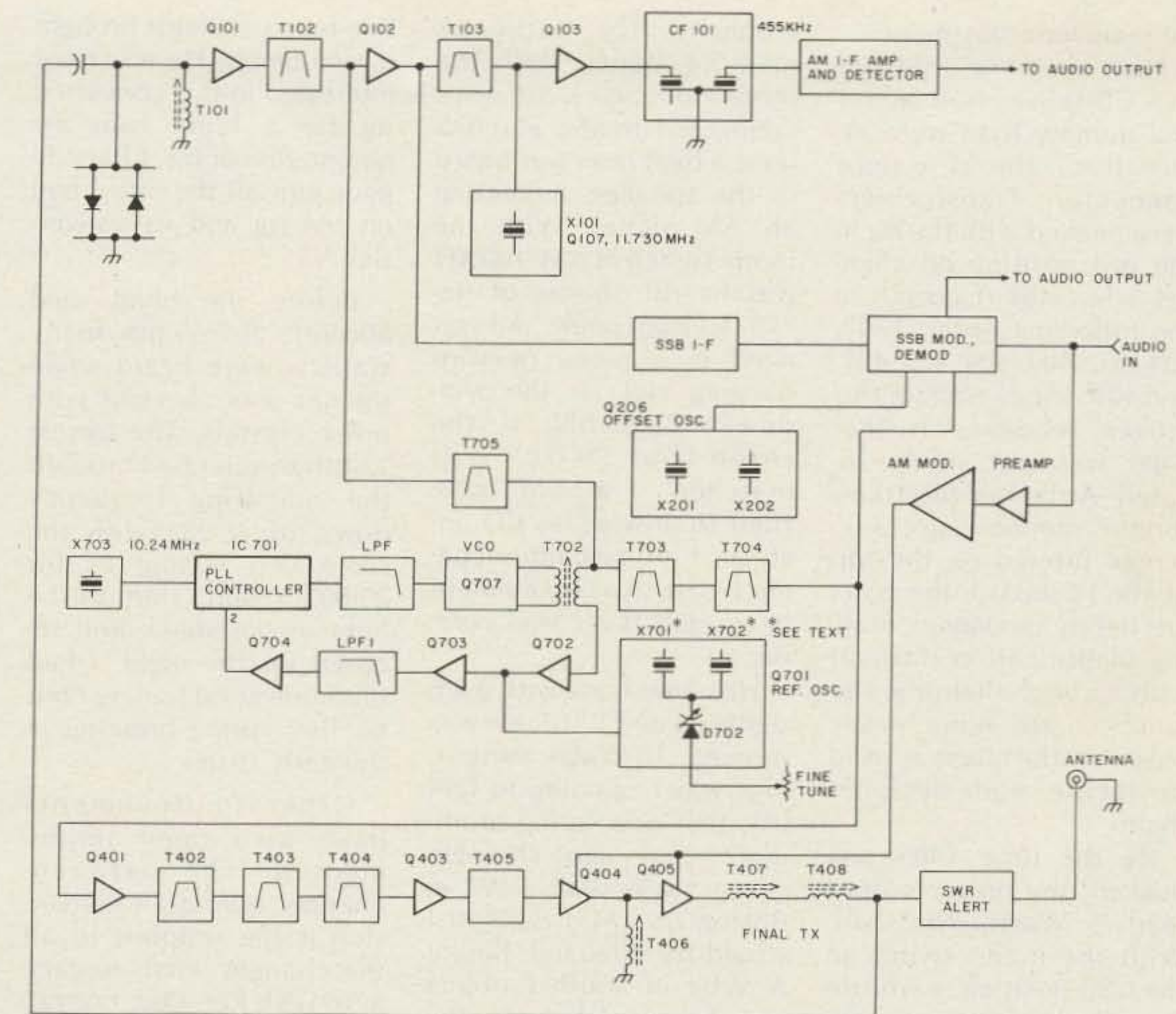

Fig. 2. Sears Roadtalker 40, model 3826, simplified functional block diagram.

large size. The crystal socket allowed easy crystal changes to check the bandwidth of operation for a single vco-tuned circuit setting.

In order to unsolder the 12.320 crystal, the bottom of the doghouse has to be unsoldered from the sides. A solder wick was used with a 45-Watt soldering iron to remove the solder bonds. It was easier to unsolder the circuit board ends of the three doghouse posts to gain easy access to the bottom cover than to unscrew the three doghouse flange attachment screws. These soft metal screws were cemented in place and I stripped the Phillips head slots while attempting to remove them.

After the crystal and socket were added, the doghouse was set in place and one post was soldered to the PC board. The doghouse assembly was pressed into the bottom

cover. Since it was a tight fit, no sides-to-bottom solder bonding was applied. This would facilitate easy removal for future performance improvements which require changes to this reference oscillator circuit. These changes will be discussed later.

The next step was to remove the sealing wax from the top of all the transformer tuning slugs. This was accomplished easily by scraping the wax out with the chisel end of a small jeweler's screwdriver. All transformer slugs shown in Fig. 2, except T103 and T406, were cleaned. T701, the tank-circuit inductor (located in the small PC-board-mounted metal enclosure to the left of the reference oscillator doghouse—see Fig. 1), had the most sealing wax applied to the top of the transformer. With the vco cover removed, it was discovered that the circuit-

ry inside was completely covered with sealing wax, probably to prevent parts movement during vibration.

After securing a suitable alignment tool for the small square hole in the slugs, the moment of truth had arrived. It was time to tune up on 10 meters. With the channel selector set on channel 1, a three-foot piece of antenna wire attached to the antenna jack center conductor, and 12-V dc power applied, the T702 slug was turned slowly clockwise. In about a half turn, a sideband signal was heard signing a W9 call. Pin 2 on IC701 was checked with a Heathkit® frequency counter. A stable 1.28-MHz frequency readout was observed. Next, T102 was turned clockwise, and in less than one turn, the level of the noise was peaked. T705 and T102 were easily noise-peaked in less than one turn. That's it

for receiver adjustment.

Next, an inline, inexpensive CB power/vswr meter and dummy load were attached to the rf output connector. Transformers were peaked with the rig in the AM position on channel 1 for max rf output in the following order: T703, 704, 402, 403, 404, 408, 407, and 405. The reason for this broken sequence is that T405 was not easily located. Although the transformer numbers are silk-screen printed on the top of the PC board, the parts are tightly packaged, making identification difficult without bright lighting. The numbers are more easily read if a flashlight is used to locate and decipher them.

By the time T405 was peaked, the power output read 5 Watts. Not bad. With the mode switch in the USB position, a whistle was directed into the mi-

crophone. The wattmeter read 7.5 Watts. With the three-foot piece of wire connected to the antenna jack, a beat note was heard in the speaker, indicating an AM signal. With the mode switch in AM, JH7XJJ was heard! Shades of the "48" sunspot peak: "All you need is a piece of wire hanging out of the window!" Probably, if the three-foot wire was matched, I would have tried to answer his CQ; instead, I not-so-calmly connected up to a two-element beam. DX fever was coming on.

He came back with a 5/6 signal on an FT-101. He was running 15-Watts output. This was beginning to feel like that one spring morning 25 years ago! The next contact was with a W1 in Boston on AM. I thought I would try sideband. Bingo! A WB4 in South Carolina was heard. Adjusting the

fine-tune oscillator brought him in nicely. He was most interested in this converted rig for a blind ham acquaintance of his. I happily gave him all the info I had on the rig and its conversion.

Before the band died abruptly at 7:45 pm, many stations were heard while the set was checked with other crystals. The lowest 12-MHz rock I had brought the operating frequency down to 28.255 with the same vco setting as for 29.005. When I shut off the light in the shack and secured for the night, I had the same good feeling I felt on that spring morning in the early fifties.

Other improvements have also been implemented. The between-channel operation conversion is the simplest of all the changes. First, replace X702 (LSB Ref. Osc. crystal) with a crystal identical with the X701 that was previously replaced. X702 can be netted 5 kHz away from X701 with CT702. Next, power will be applied to D220 through R236 when the mode switch is in the LSB position. This diode will keep the USB-AM offset crystal, X201, switched on for all modes. The LSB position becomes a second set of USB frequencies placed between those set by X701 in the USB-AM position. The total frequency change by the fine tune will be approximately 5 kHz. Cut the green wire coming out of the plug on the left side of the mode selector switch about one inch from the plug. (This switch can be seen in Fig. 1 to the right of the reference oscillator doghouse.) Strip a quarter-inch of the plug end of the green wire and connect it to the orange wire terminal next to it inside the plug.

The next change to implement is fine-tune tracking on transmit. Remove

R702 and short out R711, which connects the bottom end of the fine-tune control, RV701, to ground. Disconnect the red wire from the top end of the fine-tune control. Connect the top end of this control to a regulated voltage source that is always present for all operational modes such as regulator bus BB. This bus can be found in many places on the circuit board.

The extra set of wires coming out of the transceiver to the bottom left of Fig. 1 is the 12-volt control for a relay that switches in an 80-Watt, solid-state linear on transmit. It should be mentioned that American Crystal Supply Co. has a conversion kit which expands the number of channels.

When the band is open, CW signals are heard very low in the background. This occurs because the image rejection is not quite as good as with your TS-520 or FT-101 rigs. This background activity is much less objectionable than noise. With the ranks of QRP rig owners growing, one only has to mention during the QSO that he/she is running QRP and you will be surprised at the W1 or W2 breaking in to ask details of your rig.

For the price, the satisfaction of successfully completing your own conversion, sharing your conversion details with others, and regularly discovering a DX station on one or more of your 40 channels and working him stirs the imagination and brings back the pleasure of hamming with an excellent low-cost rig. This, to me, is well worth it in this age of one grand ham rigs. ■

References

1. Welsh, "CB to 10—Part XII: Convert a Kraco PLL Rig," *73 Magazine*, October, 1978, pp. 254-255.
2. Cann, "CB to 10—Part XVI: A CW Conversion," *73 Magazine*, January, 1979, pp. 56-57.

★ YOU ASKED FOR IT ★

A COMPLETE REPEATER STARRING THE MARK 3C SUPERCONTROLLER

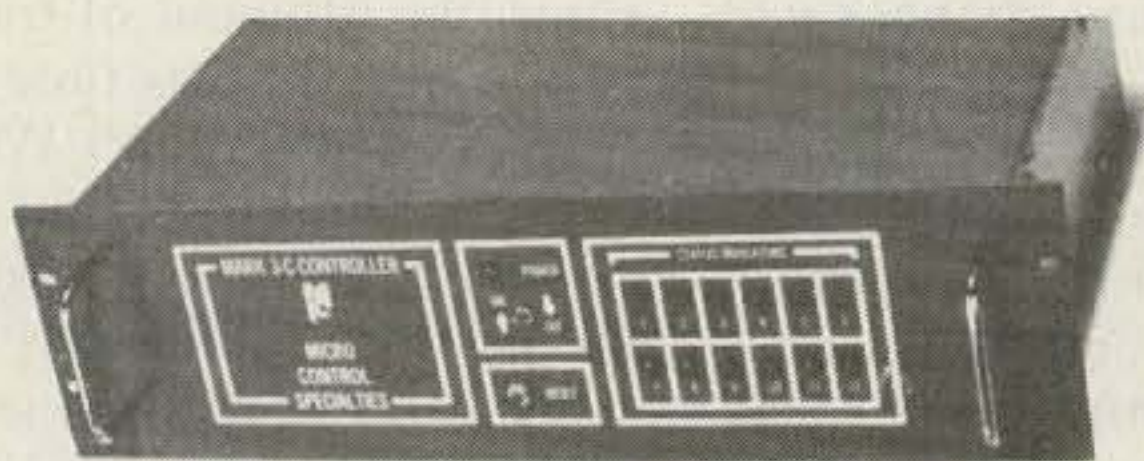

ALL the unique features which make Mark 3C the acclaimed leader in repeater control —

- Autopatch
- Reverse patch
- Autodial
- 40 Functions
- 13 Morse messages
- Custom tail messages
- Digital tone decoding
- Microprocessor control

MARK 3-C CONTROLLER \$995.

AND NOW, even the repeater is built in —

- Receiver sens. 0.25 UV
- Super crisp audio
- Transmitter output 2W

PLUS options —

- Power amplifiers (pick your level)
- Sub-audible tone
- Control receivers

MARK 3CR REPEATER

144-220 \$1495. Introductory price.

Call or write for specifications

MICRO CONTROL SPECIALITIES (617) 372-3442
23 Elm Park, Groveland, Ma. 01834

✓ 49

SOMETHING DIFFERENT

The FT-107 Series with "DMS"*

"It's A Cut Above The Rest"

* **OPTIONAL DIGITAL MEMORY SHIFT ("DMS")**
12 discrete memories. Stores individual frequencies or use as 12 full coverage VFOs (500 kHz each)

- Solid State
- 240 watts DC SSB/CW
- 160-10 meters, WWV
(2 auxiliary band positions are available for future expansion)
- RF Speech Processor
- SSB, CW, AM, FSK
- Built-in SWR Meter
- Excellent Dynamic Range
- Audio Peak/Notch Filter
- Variable Bandwidth
- Full Line of Accessories



The FT-107 has been created as a result of a blending of technologies — computer, solid state and RF design. By careful utilization of these disciplines and the experience gained from our FT-301 series, YAESU has achieved an HF transceiver which offers unique features (e. g. "Digital Memory Shift"), efficient operation and a level of performance that has been previously unattainable.

(Receiver Section) FT-107 TRANSCEIVER SPECIFICATIONS (Transmitter Section)

Sensitivity: 0.25 uV for 10dB S/N, CW/SSB, FSK
1.0 uV for 10dB S/N, AM

Image Rejection: 60dB except 10 meters (50dB)

IF Rejection: 70dB

Selectivity: SSB 2.4 kHz at -6dB, 4.0 kHz at -60dB.
CW 0.6 kHz at -6dB, 1.2 kHz at -60dB.
AM 6 kHz at -6dB, 12 kHz at -60dB
Variable IF Bandwidth

20dB RF Attenuator

Peak/Notch Audio Filter

Audio Output: 3 watts (4-16 ohms)

Accessories: FV-107 VFO (standard not synthesized)
FTV-107 VHF (UHF Transverter)
FC-107 Antenna Tuner
SP-107 Matching Speaker
FP-107 AC Power Supply

Power Input: 240 watts DC SSB/CW
80 watts DC AM/FSK

Opposite Sideband Suppression: Better than 50dB

Spurious Radiation: -50dB.

Transmitter Bandwidth 350-2700 hz (-6dB)

Transmitter: 3rd IMD -31dB neg feedback 6dB

Transmitter Stability: 30 hz after 10 min. warmup
less than 100 hz after 30 min.

Antenna Input Impedance: 50 ohms

Microphone Impedance: 500 ohms

Power Required: 13.5V DC at 20 amps
100/110/117/200/220/234V AC at 650 VA

YAESU ⁸³ 

The radio.

Price And Specifications Subject To
Change Without Notice Or Obligation

1179R

YAESU ELECTRONICS CORP., 6851 Walthall Way, Paramount, CA 90723 • (213) 633-4007
YAESU ELECTRONICS Eastern Service Ctr., 9812 Princeton-Glendale Rd., Cincinnati, OH 45246

Neat Readout for the 2036

— displays frequency on S-meter face

Breathes there a ham with soul so dead, who never to himself has said, "Now that I have a brand new rig, How can I modify this thingamajig?"

One of the few problems many owners of the popular Heathkit HW-2036 experience is not knowing what frequency the rig is tuned to when in a dark car. Many operators have replaced the S-meter with a digital readout. Not wanting to eliminate the meter (it impresses CBers), and not liking the hang-on type displays many have used, I went looking for a good spot on the cabinet to mount a display. Yecch! There wasn't any! Then, in my infinite wisdom, I realized that the back face of

the signal meter is translucent and that was the answer. With an LED readout mounted in back of the meter, the display shines through the meter face, superimposed on the meter scale.

Construction Details

I made this circuit on two printed circuit boards, one for the driver circuit and one for the display. The driver board mounts behind the speaker, and the LED-readout board mounts against the meter. An independent three-terminal 5-volt regulator is mounted to this chassis.

Driver circuit board: The driver board contains only the three 7447 integrated circuits and the current-limiting resistors. It is made

long and narrow to fit behind the speaker. Mine wound up being about 1-1/4 inches by 3 inches. The foil pattern for the driver board is shown in Fig. 2. Pins 1, 2, 6, and 7 of each IC will connect to the thumb switches on the HW-2036. Pins 9 through 15 connect to the resistors.

Construction hint: One way to drill those zillion little holes in the circuit board is to get a hunk of IC perfboard (Radio Shack #276-1394). Tape this to your PC board and use the perfboard as a drilling guide. Just drop the drill bit into the hole and let'er spin. You'll have a perfectly spaced set of holes for mounting your integrated circuits and resistors. After all the holes are drilled using the perfboard template,

draw your foil pattern using a resist pen.

Now that you have all those stupid holes drilled, solder in the three 7447 integrated circuits. To save space, I soldered directly to the chips, but low-profile sockets could be used. Of course, you will make sure that the integrated circuit is not inserted backwards, since the resulting smoke is hazardous to the chip's health. The next step is to solder in the seven resistors for each driver. On the driver for the middle digit, an extra resistor is used at pin 16 (5-V supply) for the decimal point.

One more job on this board before we put it aside. Connect one end of a flat multi-conductor cable to pins 1, 2, 6, and 7 on each of the three chips. Cut them long enough to connect to the thumb switches later. Exact size can be determined at installation time. Connect one end of another multi-conductor cable, about 7 inches long, to the free end of the 22 resistors and to the 5-volt connection. These will be connected later to the readout board. Add a couple of pigtailed for a ground and for the 5-volt power supply. Now put the board aside where the wife, kids, cats and dogs can't get at it.



Photo A. Complete installation of frequency display superimposed on S-meter.

Readout board: Now we have to build something to connect all those wires to. This board has only three LED chips and the interconnecting cable. The readout board is 3/4" x 1-1/4", just big enough to hold the chips. Referring to Fig. 3, drill another mess of holes (that's the hardest part of this project) for mounting the LED chips and connections. Notice there are four rows of holes for each LED. The outer rows are for the LED pins and the inner rows for the cable connections. When the LED is mounted on the board, there is a nice gap between the LED and board. Our wires from the driver board will go between the LED and board, through this gap.

After locating the driver board you hid from the family, connect the free end of the dangling cable to the inner set of holes on the readout board. Just follow the schematic, Fig. 1, carefully, for pin numbers. Don't goof, since we will be covering these wires with the LED chips. Remember the decimal point connection on the middle LED digit and the 5-volt connection between the boards. Make sure there is no bare wire showing on the component side of the board which could contact a pin on the LED.

Now, mount the LEDs into the outside set of holes, spanning the wires. There is

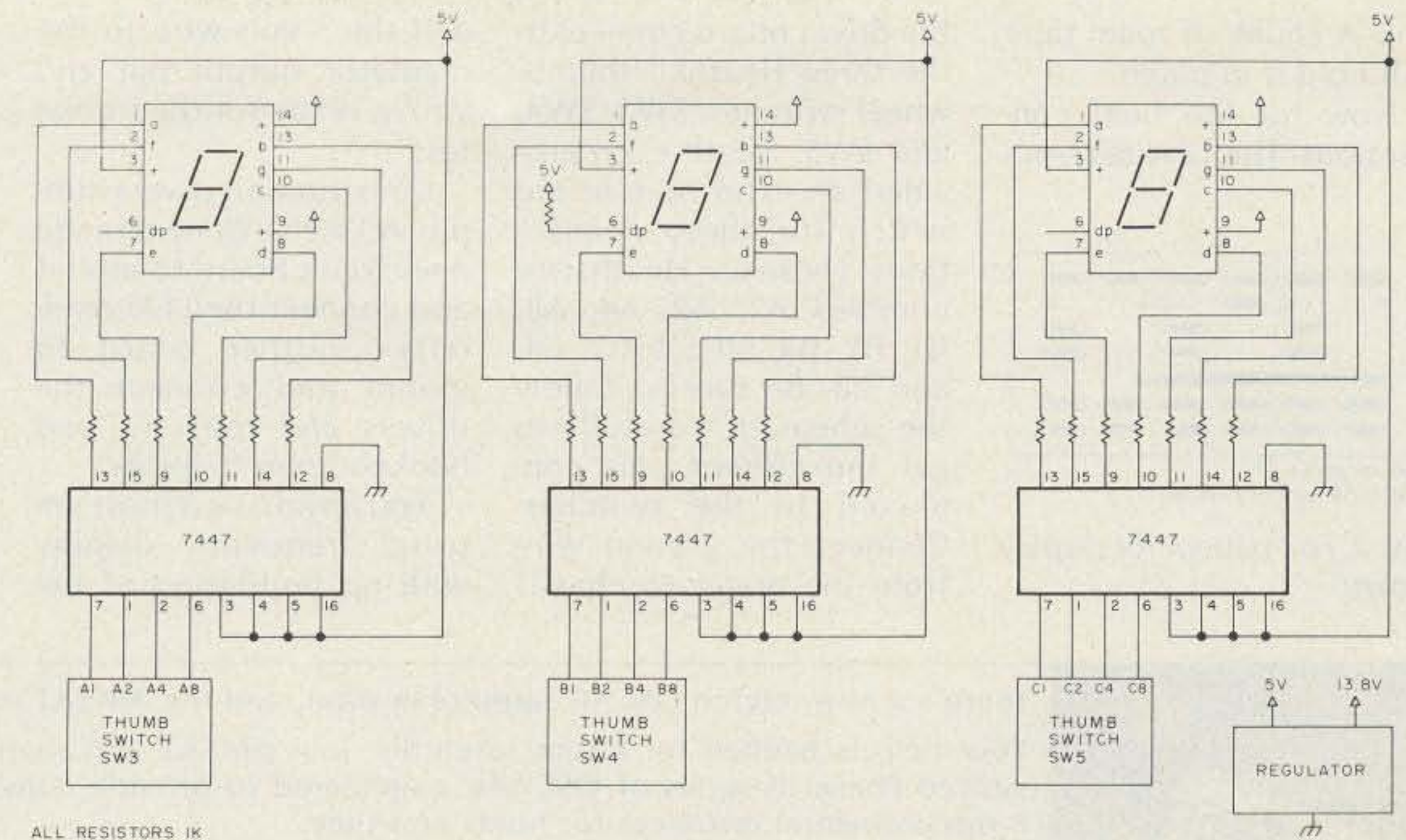

Fig. 1. Schematic of driver and readout.

not enough room here to use IC sockets. Bend the pins against the foil to save room. Photo B shows the completed readout board with attached cable. At this point you have two boards connected by a multi-conductor cable. Plunk this assembly back in the hiding place.

Power Supply

This part is as easy as getting a CB license. To avoid overworking the built-in power supply, I mounted the three-terminal regulator on the Heath Z-shaped chassis near the mike cable clamp. (I used a mike connector and moved it to the right side of the front panel, but this is not necessary.) Run a wire between the input terminal of

the regulator and the 13.8-volt supply, and that's done.

Installation

It's time to dig out the circuit boards from their hiding place one last time and wrap up the project. Depending on how ambitious you are, you can make a mounting bracket for the

driver board, or if you're as lazy as I am, just wrap the board with tape and slide it alongside the speaker, between the magnet and chassis. Stick a hunk of tape to the foil of the readout board to insulate it, and thread the readout board and cable over to the meter. Wedge it between the meter and vco

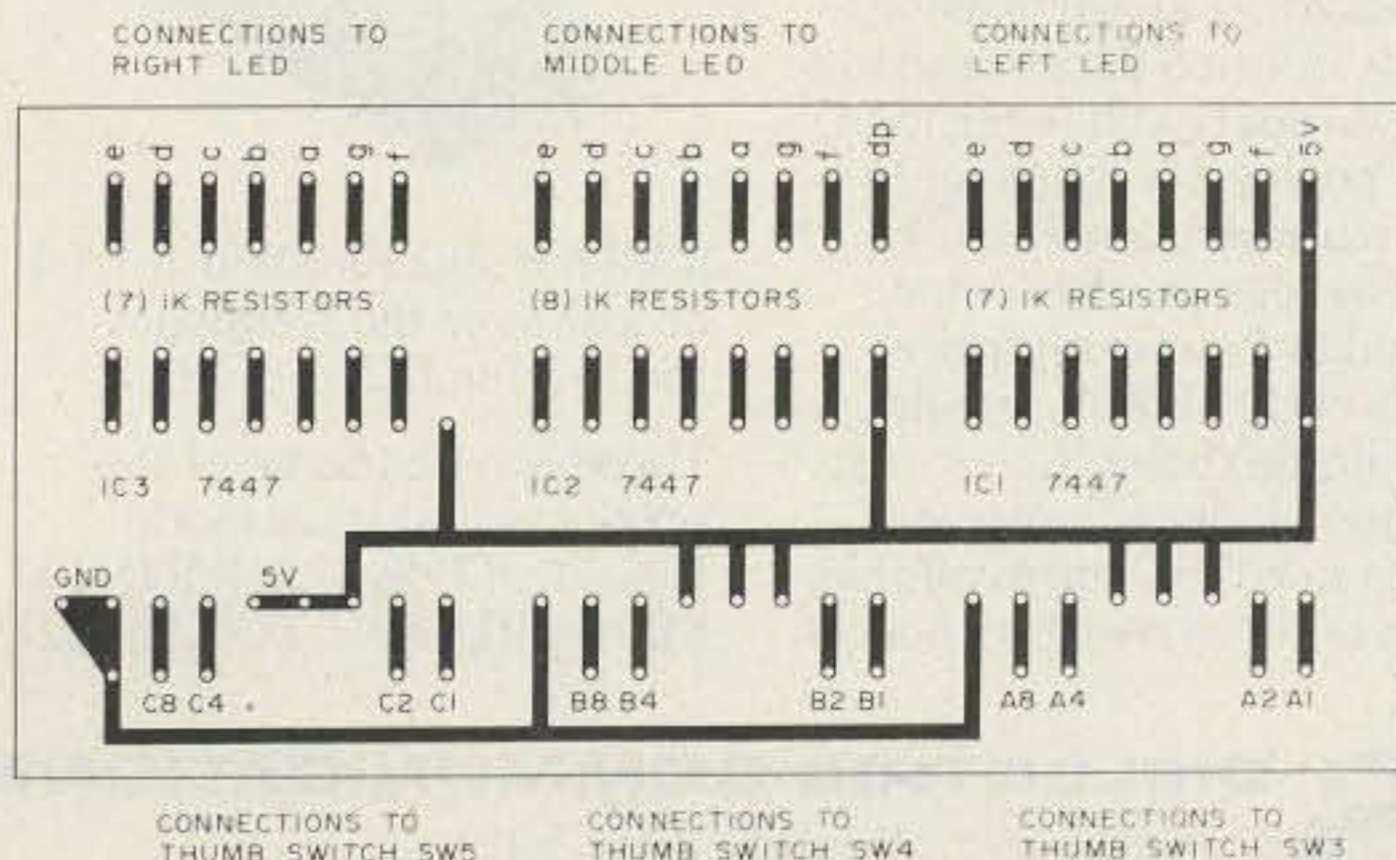

Fig. 2. Foil pattern for driver board.

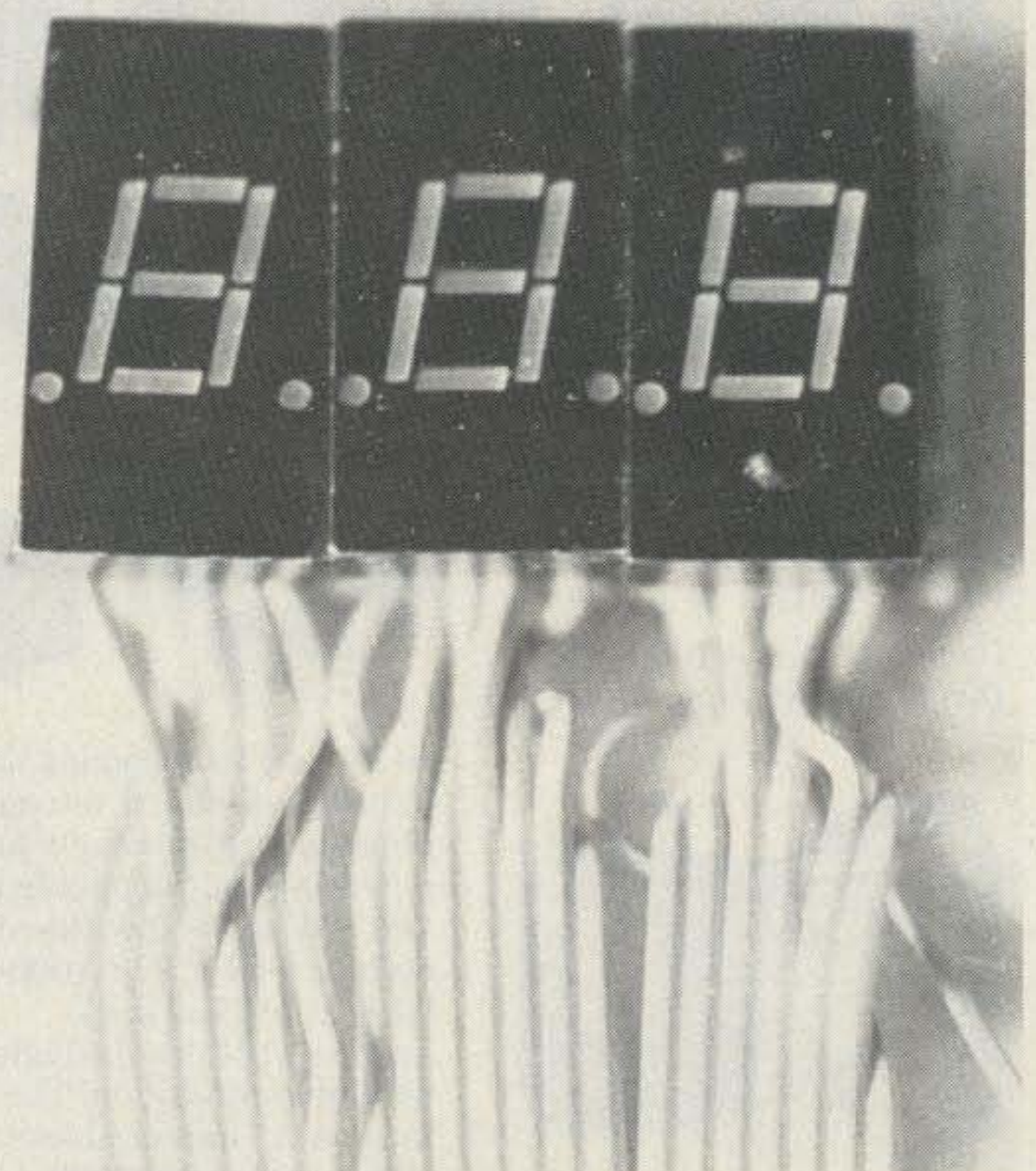
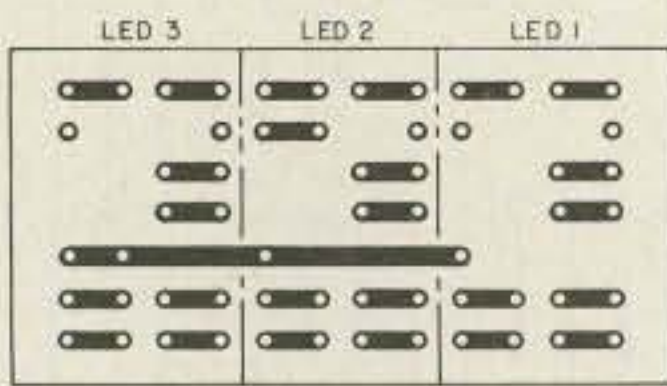

Photo B. Complete display board with connecting cable.

box. A chunk of foam tape will hold it in place.

Now for the final connections. The 12 wires from



NO PIN AT 4,5,12
NOTE PIN 6 CONNECTION ON LED 2

Fig. 3. Foil pattern for display board.

the driver board connect to the three Heathkit thumb-wheel switches, SW3, SW4, and SW5. Heath even provided an extra hole in the switch for these connections. These are Heath wire numbers A1, A2, A4, A8, B1, B2, B4, B8, C1, C2, C4, and C8. Be sure to follow the schematic carefully to get the correct pins connected to the switches. Connect the ground wire from the driver to chassis

and the 5-volt wire to the regulator output pin and you're ready for the smoke test.

Construction is very simple. All we've done is made one circuit board to mount and connect the LED read-outs, another board to mount and connect the drivers and resistors, and hooked them together.

You now have a most unusual frequency display with no mutilation of the

cabinet, no sacrifice of functions, and no messy hang-ons. And I'll bet you're the only kid on the block who has one! ■

Parts List

- (22) 1k resistors, 1/4-W
- (3) 7447 driver/decoder integrated circuits (Radio Shack #276-1805)
- (3) .3" common-anode LED (Radio Shack #276-053)
- (1) 5-V, 3-terminal regulator (Radio Shack #276-1770)



There's a new, eighth OSCAR satellite in orbit, and the AMSAT team helped put it there! Your help is needed for future satellites. Join AMSAT and support the new, advanced Phase III series of OSCARs, engineered to provide communications over transcontinental distances for hours at a time.

Send \$10 membership dues to AMSAT, P.O. Box 27, Washington, D.C. 20044. Life membership is available for a tax-deductible donation of \$100 or more, payable in quarterly installments if you wish.

Phase III satellite solar cells may be sponsored for \$10 each, and we'll send you a certificate specifying the cells you are sponsoring.

For a tax-deductible contribution of \$1,000 or more, we'll even inscribe your name on a plaque to be placed in orbit aboard the Phase III spacecraft for posterity, and we'll send you a replica honoring your contribution.

Dues and contributions may be charged to VISA or Master Charge. Phone us at (202) 488-8649.

Radio Amateur Satellite Corporation
P.O. BOX 27, WASHINGTON, D.C. 20044
AMSAT
AMSAT MEMBER

DIELECTRIC'S RF MEASUREMENT EQUIPMENT

Dielectric — the leader in RF measurement equipment offers a variety of RF products for the communications industry.

Dielectric's new 1000-A RF Directional Wattmeter, well



on its way to becoming the industry standard, accepts plug-in range elements for power measurements from 100 mW to 5000 watts at 2 MHz to 1 GHz. The 1000-A, with $\pm 5\%$ full scale accuracy, offers the highest available resolution. The large $4\frac{1}{2}$ " mirrored-scale meter makes the 1000-A the

easiest to read of any wattmeter on the market.

Terminating Load Resistors range from a 5 W dry load to a 50 KW heat-exchanger load. Low power dry loads up to 150 watts are available as well as high power water-cooled or heat-exchanger loads up to 50 KW. In addition, liquid dielectric/air convection loads with a power range to 10 KW are available. Each of these resistors boasts

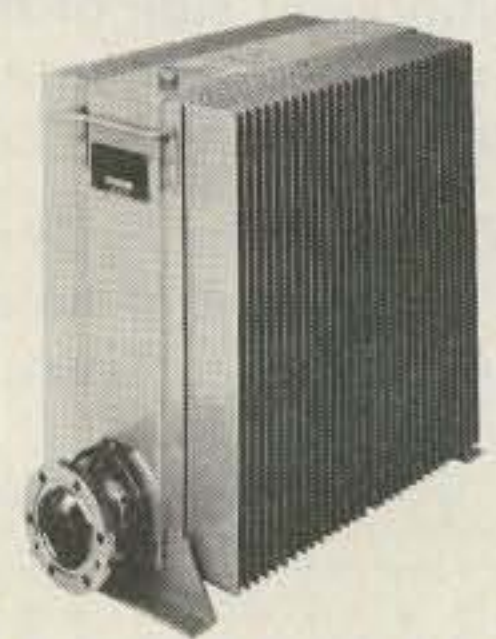

a VSWR specification of 1.1:1 or less over the frequency range from DC to 1 GHz.

These are just some of the products that have made Dielectric THE LEADER IN RF MEASUREMENT EQUIPMENT.

GS DIELECTRIC COMMUNICATIONS
A UNIT OF GENERAL SIGNAL
RAYMOND, MAINE 04071 • TEL. 207-655-4555 • 800-341-9678

8340-42 Olive Blvd. • P.O. Box 28271 • St. Louis, MO 63132

HAM RADIO CENTER

BEST PRICE — FAST DELIVERY

FOR

1-800-325-3636



32

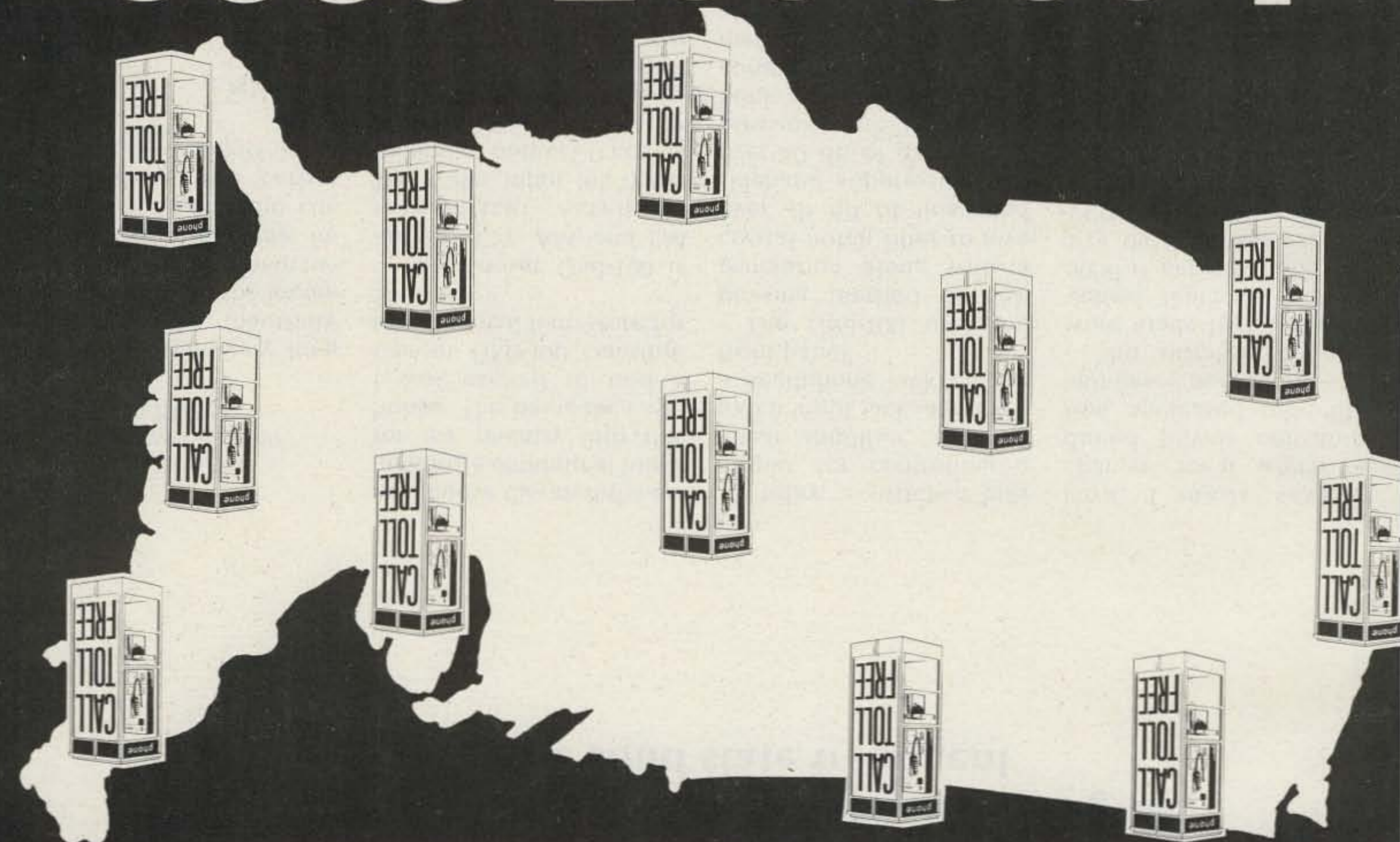

**HAM RADIO CENTER
HAS BRANCH STORES
ALL OVER THE COUNTRY**

Modernize That Boat Anchor!

— older tube rigs are more fun when you give them the solid state treatment

Phil Salas AD5X
1700 Stockton Trail
Plano TX 75023

After a relatively long period of inactivity due primarily to the inconveniences of apartment living, I again became involved with ham radio. Unfortunately, the rather traumatic payments for a

new house dictated the expenditure of minimal funds for my re-entry into this hobby. This being the case, I was excited to find a Gonset GSB-100 transmitter at a local ham store for \$80.

The Gonset GSB-100 is an SSB, CW, AM, and PM transmitter rated at 100 Watts input (65 Watts minimum output). It covers 80, 40, 20, 15, and one MHz of 10 meters. The vfo is extremely stable (250-Hz drift maximum over a two-hour period from a cold start). The transmitter has built-in VOX and anti-VOX, receiver audio inputs and outputs, 117-V ac output for a

TR relay, a switched bias output for controlling a linear amplifier, a phone patch input jack, and even a headphone jack on the front panel.

The GSB-100 uses the phasing method of SSB generation along with a crystal notch filter to give over 40 dB of unwanted sideband suppression and over 60 dB of carrier suppression. The instruction book is well written and a complete transmitter alignment can be performed in about an hour with an oscilloscope and a VTVM with an rf probe. After checking out the transmitter for proper opera-

tion, I made several changes to it which reduced power consumption, increased tube life, and eased operation.

The simplest changes were made first. These involved replacing V8, the 9006 rf detector tube, and V14, the 6AL5 VOX and anti-VOX detector tube, with silicon diodes. Almost any type of diode can be used as long as it has a reverse breakdown voltage of 50 volts or more. I used type 1N4454 high-speed switching diodes. For the 9006 rf detector tube, solder a diode between pins 7 (cathode) and 1 (anode). For the 6AL5, diodes must

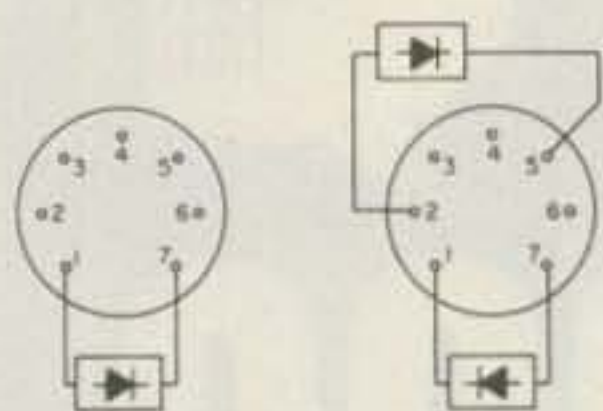

Fig. 1. V8 socket (9006), left, and V14 socket (6AL5).

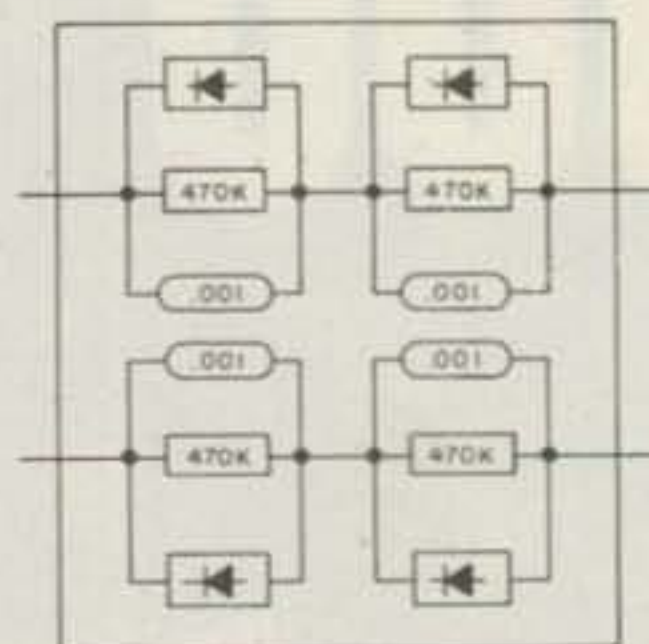

Fig. 2. Rectifier board.

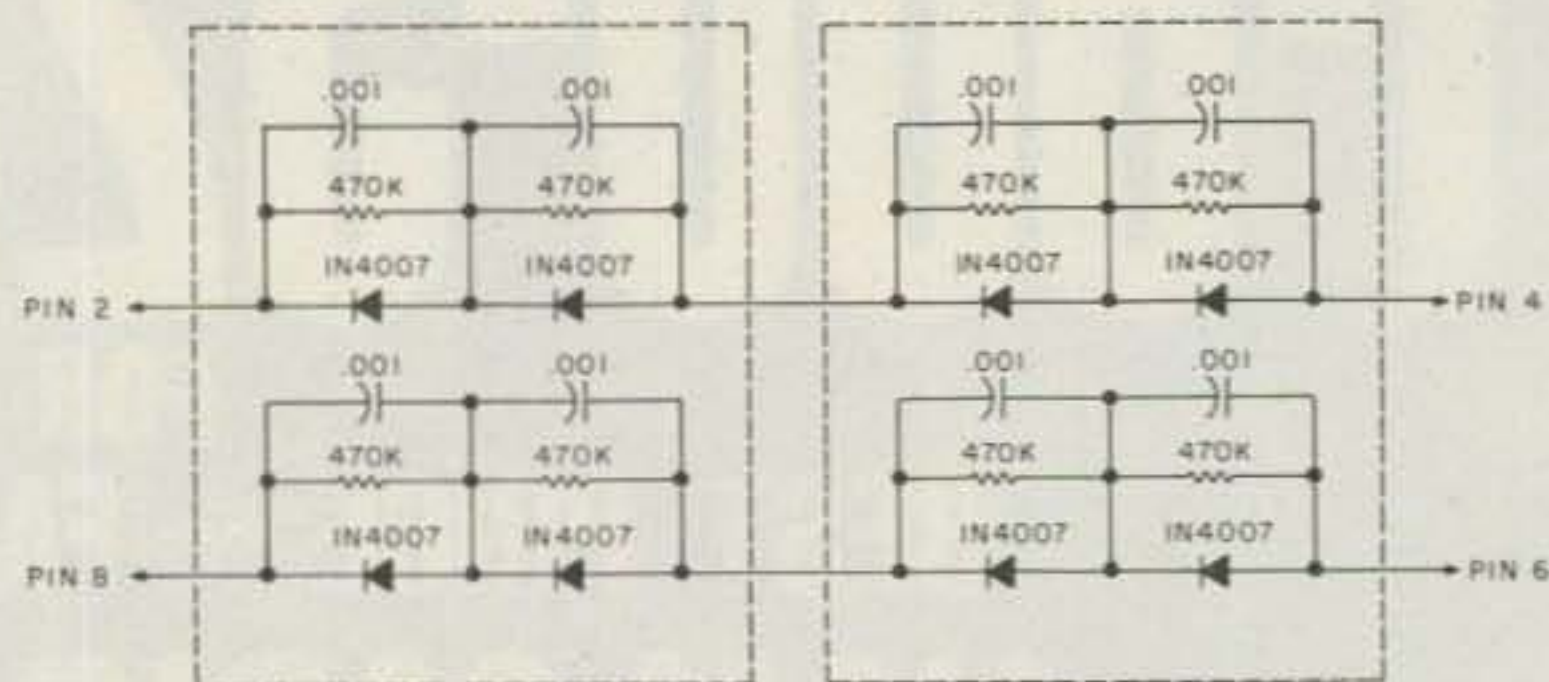
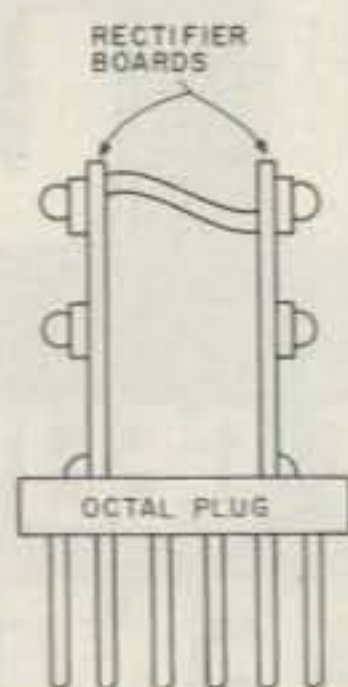

Fig. 3. Rectifier assembly and schematic.

Call 1-203-667-0811

ORDER YOURS TODAY!

NEW EQUIPMENT SPECIALS

| | | | |
|---|---|--|--|
| AZDEN PCS-2000 2 Meter Xcvr. \$339 | SWAN 600R Rcvr. \$399 350 Xcvr. w/117XC P.S./Spkr. 349 250 6 Meter Xcvr. w/117XC, P.S./Spkr. 289 | R-4B Rcvr. 349 R-4A Rcvr. 279 T-4X Xmtr. 329 T-4XB Xmtr. 369 T-4XC Xmtr. 429 AC-4 89 MS-4 19 TR-33C 2 meter port. 169 TR-22 2 meter port. 129 | HW-104 Xcvr. w/P.S., Spkr., CW Filter, N.B., Mike 549 SB-634 Console 169 |
| ATLAS RX110 Rcvr. 169 RX110S Rcvr. 199 PS110H P.S. 68 MM-110 Mobile Mnt. 27 215X w/N.B. 499 | TEMPO Tempo One Xcvr. w/AC One 399 | DENTRON HF200A Xcvr. w/HF-ACS P.S., Mike 519 Super Tuner Plus 99 W-2 Wattmeter 49 | ICOM IC-22S 2 Meter Xcvr. 189 IC-22S 2 Meter Xcvr. w/ 5/8 Wave Ant. 209 IC-215 w/BC-20 159 IC-3PA D.C. Supply 49 IC-245 2 Meter Xcvr. 299 |
| ALLIANCE HD-73 Rotor 119 | TEN TEC Triton II Xcvr. w/252 P.S., CW Filter 475 Triton IV Xcvr. w/CW Filter 519 540 Xcvr. w/252G P.S. 569 244 Digital Display 139 | ELECTRONIC RESEARCH CORP. SL-55 Tunable Audio Filter 49 | JOHNSON 275 Watt Matchbox w/SWR Meter 119 |
| ALDA 103 Xcvr. w/N.B., Xtal Cal., Mike, Bracket, PS 115, P.S. 399 | YAESU FT-301SD Xcvr. w/CW Filter, Processor 499 FT-301D Xcvr. w/FP-301, P.S., & Spkr. 679 FT-901D Xcvr. "Demo" w/warr. 999 FT-901DE Xcvr. w/FM option "Demo" w/warr. 1065 FT-901DM Xcvr. w/CW & AM Filters 1049 FR-101S Rcvr. w/6 meter conv., FM, Xtals 499 FT-227R 2 meter Xcvr. 249 | HAMMARLUND HW-170 Rcvr. 169 | KENWOOD TS-600 6 Meter Xcvr. 529 R-820 Deluxe Rcvr. 759 TS-820S Xcvr. 799 QR-666 General Cov. Rcvr. 199 |
| BIRD Model 43 - Call for Price | USED EQUIPMENT | HALLICRAFTERS SX-101A Rcvr. 179 SX-115 Rcvr. 259 FPM-300 Xcvr. 349 | MILLENNIUM 92201 Transmatch w/SWR Meter 99 |
| CDE CDE-44 Rotor 89 | ATLAS 210X (Special Edition) w/N.B. 429 215X w/DMK 399 200PS Power Supply 69 | HENRY 100 AL10 Amp. w/PS 1220B Supply & Cabinet 229 | MIRAGE BI08 2 Meter Amp. w/Rcvr. Preamp. 129 |
| CUSHCRAFT ATB-34 199 ARX-2 31 ATV-5 89 A147-11 32 A50-5 54.95 | COLLINS 75S-3B Receiver 649 75S-3 Receiver 450 KWM-2 (round) Xcvr. 1099 KWM-2A Xcvr. 749 516F-2 Power Supply 149 LC-1-32S Processor 69 LC-1-KWM Processor 69 516E-1 DC Supply 69 | HEATHKIT SB-303 Rcvr. 259 | NATIONAL NCX-5 Xcvr. w/P.S. & Spkr. 359 |
| DENTRON Dial for discounts | CLEGG Zeus 331 6 & 2 meter Xmtr. 50 FM-27B 2 meter Xcvr. 169 | | REGENCY HR-6 6 Meter Xcvr. 109 HR-2 2 Meter Xcvr. 99 |
| ICOM New low prices! | C.T.G. Magnum Six Processor 59 | | |
| KLM 15-160 BL 2 Meter Amp. 229 | COMTRONIX FM-80 10 meter "FM" Xcvr. 149 | | |
| KENWOOD Now in Stock! Call for Prices | DRAKE 2B Rcvr. 189 | | |
| ROBOT Model 400 649 | | | |
| SWAN TB-3HA Tribander 169 10-40V 10-40 meter vertical 95 | | | |
| TEN-TEC KR-20A Keyer 49.95 KR-50 Keyer 89.95 | | | |
| YAESU FT-7B Xcvr. 589 FT-127RA 220 Mhz Xcvr. 399 YC-221 Display 99 CPU2500R/K Xcvr. 419 | | | |

We Sell and Service the Following New and Used Equipment:

| | | |
|------------|-----------|-------------------|
| Alda | DSI | Mirage |
| Alliance | ETO Alpha | Mosley |
| Ameco | Ham Key | Murch |
| ARRL | Hustler | PIPO |
| Atlas | Hy-Gain | Robot |
| Bencher | ICOM | Rohn |
| Bird | JW Miller | Saxton Wire |
| B & W | KDK | Shure |
| Callbook | KLM | SST Electronics |
| CDE | Larsen | Swan |
| CES | MFJ | Telex |
| Covercraft | Microlog | Ten Tec |
| Cushcraft | | TET Antennas |
| Dentron | | Trac |
| Drake | | Unadilla |
| | | VHF Engineering |
| | | Vibroplex |
| | | Wilson |
| | | Wilson Commercial |
| | | Yaesu |

KENWOOD

WE TAKE PHONE ORDERS OR SHIP C.O.D.

Call
or Write
for your
super quote
today!



WE EXPORT
(Sub-Dealers
wanted in
foreign countries)

THOMAS COMMUNICATIONS

95 Kitts Lane, Newington, Conn. 06111
"Near ARRL Headquarters"

Connecticut Residents Call: 203-667-0811
OPEN MON-FRI 10-6 • THURS 10-8 P.M. • SAT 10-4
EASY DIRECTIONS: Rt. 15 South — 2 blocks past McDonald's (Berlin Turnpike)

SUB-DEALER INQUIRIES INVITED! (Send letterhead for complete package)

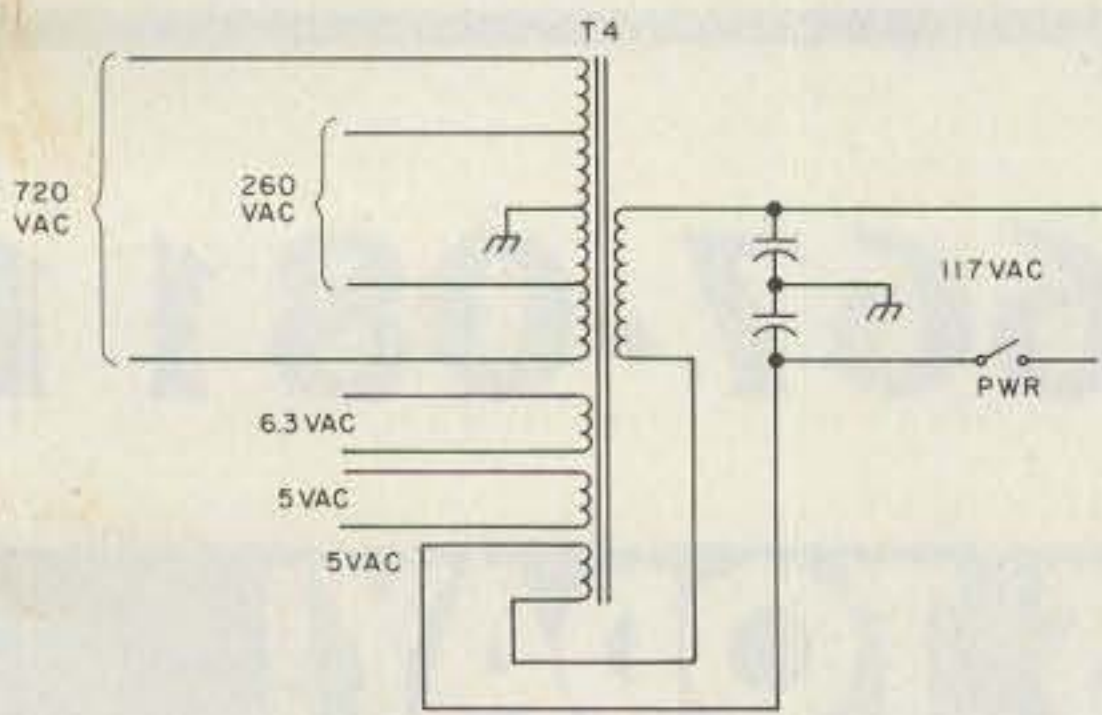

Fig. 4.

be soldered between pins 5 (cathode) and 2 (anode) and between pins 1 (cathode) and 7 (anode). Refer to Fig. 1.

The two 5U4 rectifier tubes, power transformer, and 6DQ5 final amplifier tube are all located in a small corner of the transmitter chassis resulting in quite a bit of heat being generated at this point. Replacing the 5U4s with solid state rectifiers would lower this generated heat significantly, but the decreased voltage drop of the solid state rectifiers could cause problems if not properly addressed. In this case, I found that the 5U4s have about a 100-volt drop.

I started with V15, the high-voltage rectifier. The high-voltage supply uses a choke input filter. A solid state rectifier was built on an octal tube plug. The details are shown in Figs. 2 and 3. The transformer high-voltage secondary is rated at 720 V ac rms. In order to keep from exceeding the diode breakdown voltage, the diode stack must be rated at the peak-to-peak transformer voltage of $2.8 \times 720 = 2016$ volts. Three 1N4007s (1000 V piv) would be sufficient. I used four so as to have two identical rectifier boards.

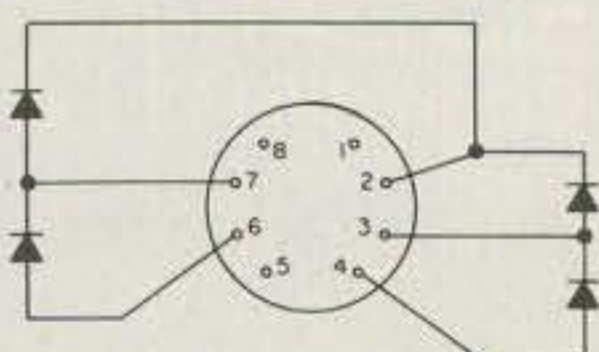

Fig. 5. V16 socket.

Equalizing resistors (470k, ¼-Watt) and transient protection capacitors (0.001 uF, 1000 V) were also used. The 5-volt filament winding was disconnected and pins 2 and 8 of the tube socket were connected together with #18 bus wire.

After plugging in the solid state rectifier and applying power, I found that the high-voltage dc was now 710 volts instead of the original 610 volts. I connected up the newly freed-up 5-volt filament winding in series with the 117-V ac power transformer primary phased so as to oppose the input voltage. See Fig. 4. I suggest that when you do this, tack the wires together for the first try since Murphy's Law decrees that you will first phase the voltages to add. When this had been properly done (two tries were necessary), the high-voltage dc was found to have dropped to 670 volts. I left it at this, and now load the transmitter to 150 mA instead of the original 160

mA so as to keep the final plate power input approximately the same as it was originally. A second benefit of this change was to slightly decrease the filament voltages on all of the tubes, which should lead to increased tube lifetime. The filament voltages had been running slightly high due to the fact that the transmitter was designed for 115-V ac nominal input and the line voltage here in Plano, Texas, is between 120 and 125 V ac.

The low-voltage supply was attacked next. This utilizes a capacitive input filter to give a nominal 275-V dc key-down voltage. I soldered two 1N4007 diodes in series for each leg of the full-wave rectifier directly on the tube socket of V16. See Fig. 5. Power was applied, and a quick check of the dc voltage showed that it had risen to 360 V dc (no 5U4 rectifier drop)! Going to a choke input filter reduced this to 250 V dc (a reduction of $\sqrt{2}$, as was expected). This is slightly less than the original 275 volts. This voltage is not critical, however, and proper operation of the transmitter was still evident. The choke input filter was made by tying both sections of C15, the dual 40-uF filter capacitor, in parallel and connecting choke CH2 between the rectifier output and C15. See Fig. 6. This completes



Fig. 6. Capacitive input (original), left, and choke input (modified), right.

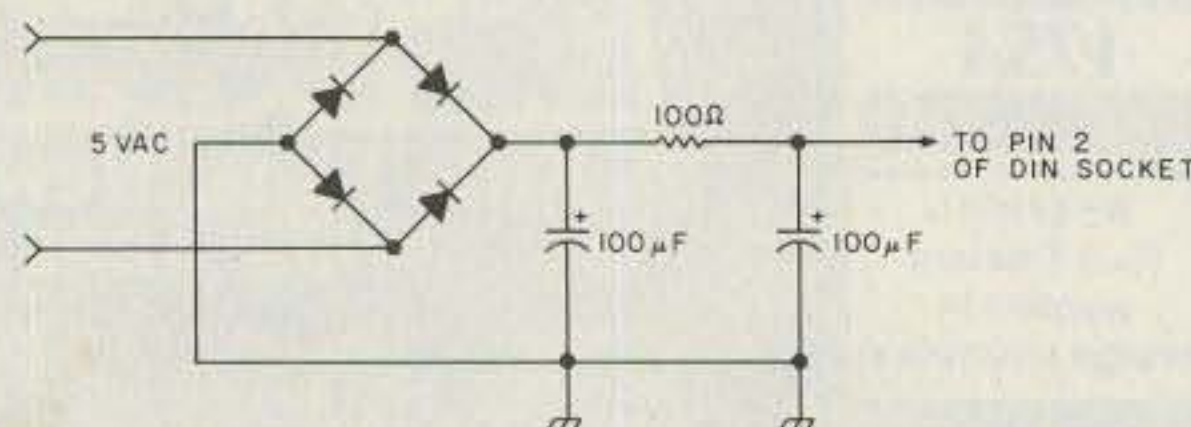

Fig. 7. Power mike dc supply.

the power supply changes. I next made some changes so that I could use an inexpensive CB-type microphone with the transmitter.

The GSB-100 requires a high-level output microphone for proper audio drive. Instead of using a crystal or ceramic microphone, I purchased a Radio Shack CB-type power mike which periodically goes on sale for \$12. This microphone comes equipped with the DIN-style plug. I purchased a DIN receptacle and replaced the original single-conductor mike jack with it. This requires the use of a 5/8-inch Greenlee hole punch. Push-to-talk was next added to the GSB-100 by simply routing a wire from pin 3 on the DIN socket (grounded on transmit) to pin 7 of V13, the control grid of the relay driver tube.

The final transmitter modification was the addition of a dc power supply for the power mike. After purchasing the power mike for what I considered an excellent price, I found that it required a \$3.50 battery for power. I used the second 5-volt filament winding with a bridge rectifier to obtain the microphone voltage. This is shown in Fig. 7. In addition, the PTT switch on the power mike must be wired so as always to provide power to the microphone amplifier. See Fig. 8.

This article details a few of the things that can be done to used ham equipment to improve it. In this case, I wound up with an excellent SSB/CW transmitter with PTT and VOX and a power consumption 35 Watts less than that of the original transmitter. ■

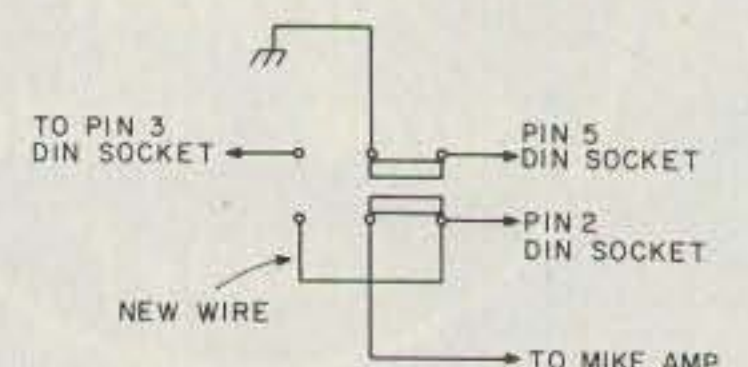
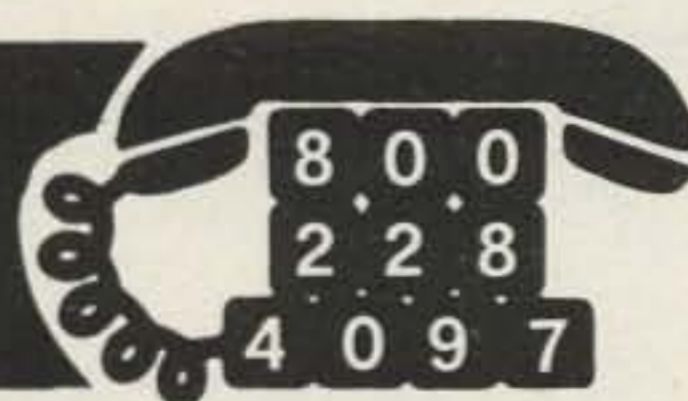

Fig. 8. PTT wiring.

CALL TOLL FREE
1-800-228-4097



SPRING CLEANING SPECIALS



Telex Model 88
 Headset only \$49.95



NEW Kenwood R-1000
 Receiver
 List \$499.95
 Call for discount price

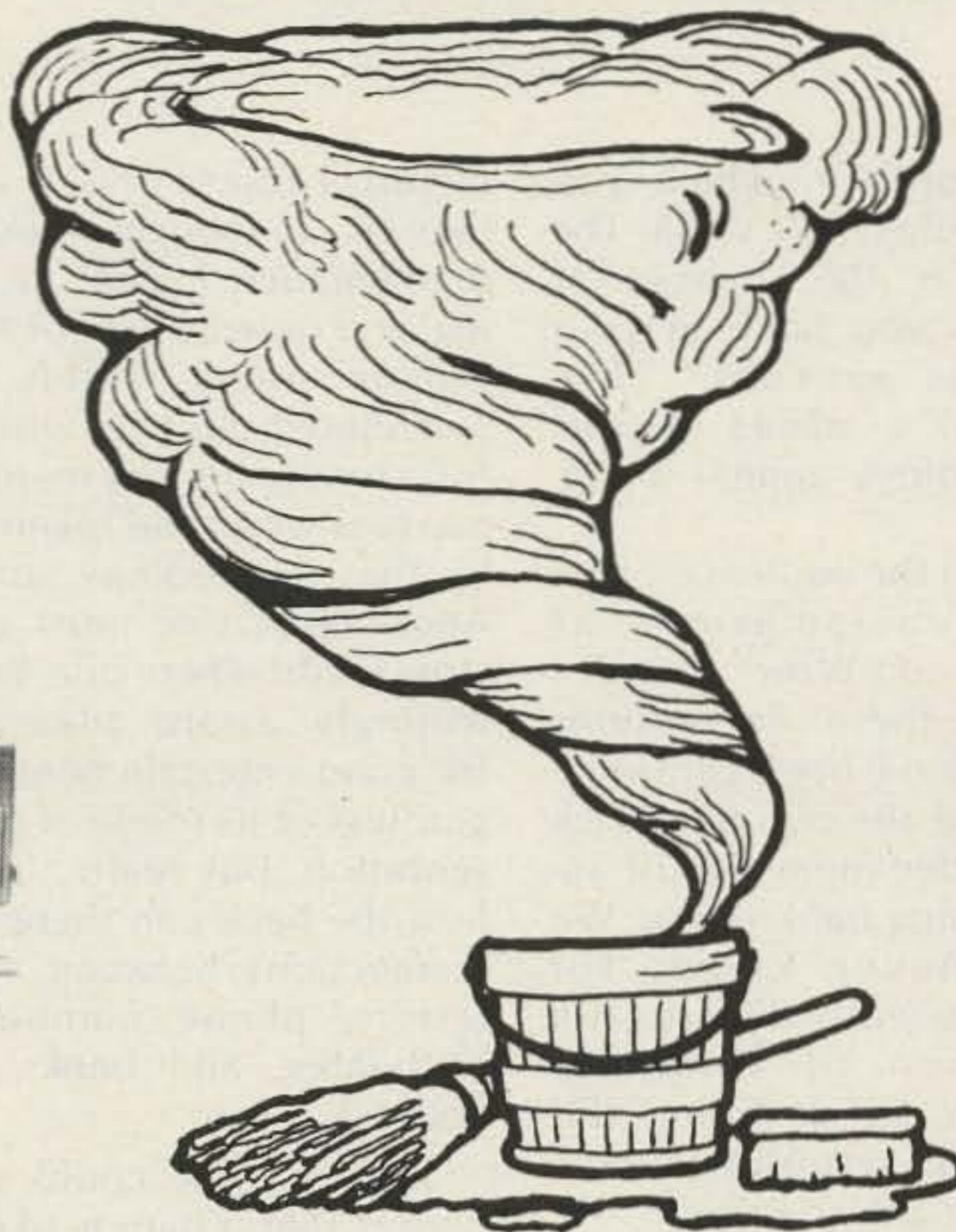

Dentron GLA-1000
 Amplifier
 Only \$299.95



Panasonic RF-4900
 General Coverage Receiver
 List \$549.95
 Ours - \$399.95

SPRING CLEANING SUPER SAVERS

| | | REGULAR | CLEAN OUT |
|------------------|---------------------------|-----------|-----------|
| Yaesu CPU-2500RK | FM Mobile | \$ 585.00 | \$ 399.00 |
| Yaesu FT-227RB | 2 Mtr. Mobile | 425.00 | 339.95 |
| Yaesu FT-225RD | 2 Mtr. Base | 895.00 | 669.95 |
| Yaesu FT-625RD | 6 Mtr. Base | 895.00 | 669.95 |
| Yaesu FT-901DM | H.F. Transceiver | 1459.00 | 1199.95 |
| Yaesu FRG-7000 | General Coverage Receiver | 655.00 | 519.95 |
| Midland 13-1510A | 2 Meter Mobile | 439.95 | 329.95 |
| Drake MN-4C | Antenna Tuner | 165.00 | 119.95 |
| Swan MKII | 2KW Linear Amp. | 995.00 | 799.00 |
| Avanti AH151.3 | Thru the Glass Antenna | 34.95 | 29.95 |
| Tempo S-1 | Synthesized hand held | 299.95 | 269.95 |
| Bencher BY-1 | Paddle | 39.95 | 36.95 |
| Drake TR7/DR7 | H.F. Transceiver | 1395.00 | 1219.95 |
| CDE Ham 4 | Rotor | 199.95 | 149.95 |
| CDE Tailtwister | Rotor | 299.95 | 199.95 |
| Alliance HD-73 | Rotor | 154.95 | 109.95 |
| Hygain 3750 | H.F. Transceiver | 1995.00 | CALL |
| Kenwood TS-520SE | H.F. Transceiver | 629.95 | CALL |
| Kenwood TS-120S | H.F. Transceiver | 699.95 | CALL |
| Kenwood TS-180S | H.F. Transceiver | 1149.95 | CALL |
| Kenwood TR-7600 | 2 Mtr. Mobile | 375.00 | CALL |

Antenna Sale!

| | | Regular | Special |
|----------|-------------------------------|----------|----------|
| HY-GAIN | | | |
| TH6DXX | Super Thunderbird | \$329.95 | \$259.95 |
| TH3MK3 | 3 el. 10-15-20M beam | 222.95 | 179.95 |
| TH3JR | 3 el. 10-15-20M beam | 169.95 | 139.95 |
| Hy-Quad | 2 el. 10-15-20M Quad | 274.95 | 219.95 |
| 205BA | 5 el. "Long John" 20M beam | 329.95 | 259.95 |
| 155BA | 5 el. "Long John" 15M beam | 199.95 | 159.95 |
| 105BA | 5 el. "Long John" 10M beam | 129.95 | 109.95 |
| 204BA | 4 el. 20M beam | 249.95 | 199.95 |
| 204MK5 | 5 el. conversion kit | 99.95 | 79.95 |
| 153BA | 3 el. 15M beam | 89.95 | 79.95 |
| 103BA | 3 el. 10M beam | 74.95 | 59.95 |
| 402BA | 2 el. 40M beam | 239.95 | 189.95 |
| BN-86 | Balun for beam antennas | 15.95 | 15.95 |
| TH2MK3 | 2 el. 10-15-20M beam | 149.95 | 119.95 |
| 18HT | Hy-Tower 80-10M vertical | \$359.95 | \$289.95 |
| 18AVT/WB | 80-10M Trap vertical | 105.95 | 84.95 |
| 14AVO/WB | 40-10M Trap vertical | 69.95 | 57.00 |
| 12AVO | 20-10M Trap Vertical | 42.95 | 34.95 |
| 14RMQ | Roof Mounting kit (verticals) | 33.95 | 29.95 |
| 5BDO | 80-10M Trap doublet | 109.95 | 89.95 |
| 2BDO | 80-40M Trap doublet | 59.95 | 49.95 |
| 66B | 6 el. 6M beam | 119.95 | 99.95 |
| 203 | 3 el. 2M beam | 15.95 | |
| 205 | 5 el. 2M beam | 21.95 | |
| 208 | 8 el. 2M beam | 29.95 | |
| 214 | 14 el. 2M beam | 34.95 | |
| LA-1 | Deluxe lightning arrester | 59.95 | 49.95 |
| THSDX | | 269.95 | 209.95 |

Call for discounts on Cushcraft, Mosley, Hustler

We Export



Communications Center

443 N. 48th, Lincoln, Nebraska 68504

In Nebraska Call (402)466-8402



Ham Shack Numerology

— a gentle introduction to electronic math

A recent, and initially boring, session at the local radio club was magically sparked by one of those master-of-ceremony types blessed with the ability to yank the proverbial rabbit out of the right hat at the right time. In this instance, the blessed one inspired a zesty interest by asserting he could use numerology to determine any individual's bank account!

His spiel followed such lines as these: "First, figure the numerical sum of your station call letters (A=1, B=2, C=3, etc.). Next, multiply this sum by the total you get from adding up the digits in your telephone number. Finally, divide this product by the number corresponding to

the month in which you were born (1-12). Voilà! The result is the number of dollars you have in your savings account." The author's ideas about numerology appear in Fig. 1.

From the audience came such exclamations as Hmm! and Wow! For all I knew, these expressions could have been confirmations of the numbers trick or sudden memories of approaching bankruptcy. We will never know, for nobody was willing to risk invasion of financial privacy by declaring this PhD of pseudo-science either right or wrong.

A few days later, while endeavoring to coax performance from a newly-designed but uncooperative

circuit, I found myself immersed in thoughts about mathematics, logical thinking, and rational uses of the human mind. Surely, I speculated, no ham with a full complement of mental marbles would be taken in by that numerology stuff. Admittedly, one must bestow credit where due and willingly award plaudits for good entertainment regardless of its mode of presentation. But really, OM, how the heck can there be connections between call letters, phone numbers, birthdates, and bank accounts?

The best one could say here is that a ham is likely to have a low bank account. And by the same token, it is not improbable that he lags behind in his telephone payments. It might even be philosophically argued that all entities and all events in the universe are interrelated. Certainly, those seeking short-cuts to knowledge are not in short supply. They never tire of formulating cause and effect relationships, sans consultation with Ma Nature. Ever present in our midst are those claiming correlation of stock market prices with the height of women's skirts. We strongly suspect that P. T. Barnum rests in peace. . .

In contrast to such devotees of fuzzy facts, our average ham is a

mathematician par excellence! For example, suppose that a designer, using academically-rigorous methods, specifies a five-Watt resistor where three Watts of dissipation are encountered. Our ham, however, is likely to come up with a ten-Watt unit. Admittedly, his achievement may result from the smouldering embers of his initially-selected ½-Watt resistor. Yet, despite the unconcealed unorthodoxy of his procedures, we can rest assured that his ultimate circuit implementations violate no laws of nature—appearances to the contrary notwithstanding!

Having now debunked the irrational and paid homage to the technological integrity of ham engineering practices, it will prove both interesting and instructive to investigate some bona-fide "tricks" with certain numbers. Perhaps you may come to share the author's conviction that the elusive line of demarcation between false and true can be exceedingly thin; "... could you but find it—to the treasure house. And peradventure to The Master, too!"

Let us first consider our auld acquaintance (who should not be forgot), pi. The ratio of a circle's circumference to its diameter, pi is notorious for its

'Omar Khayyam.

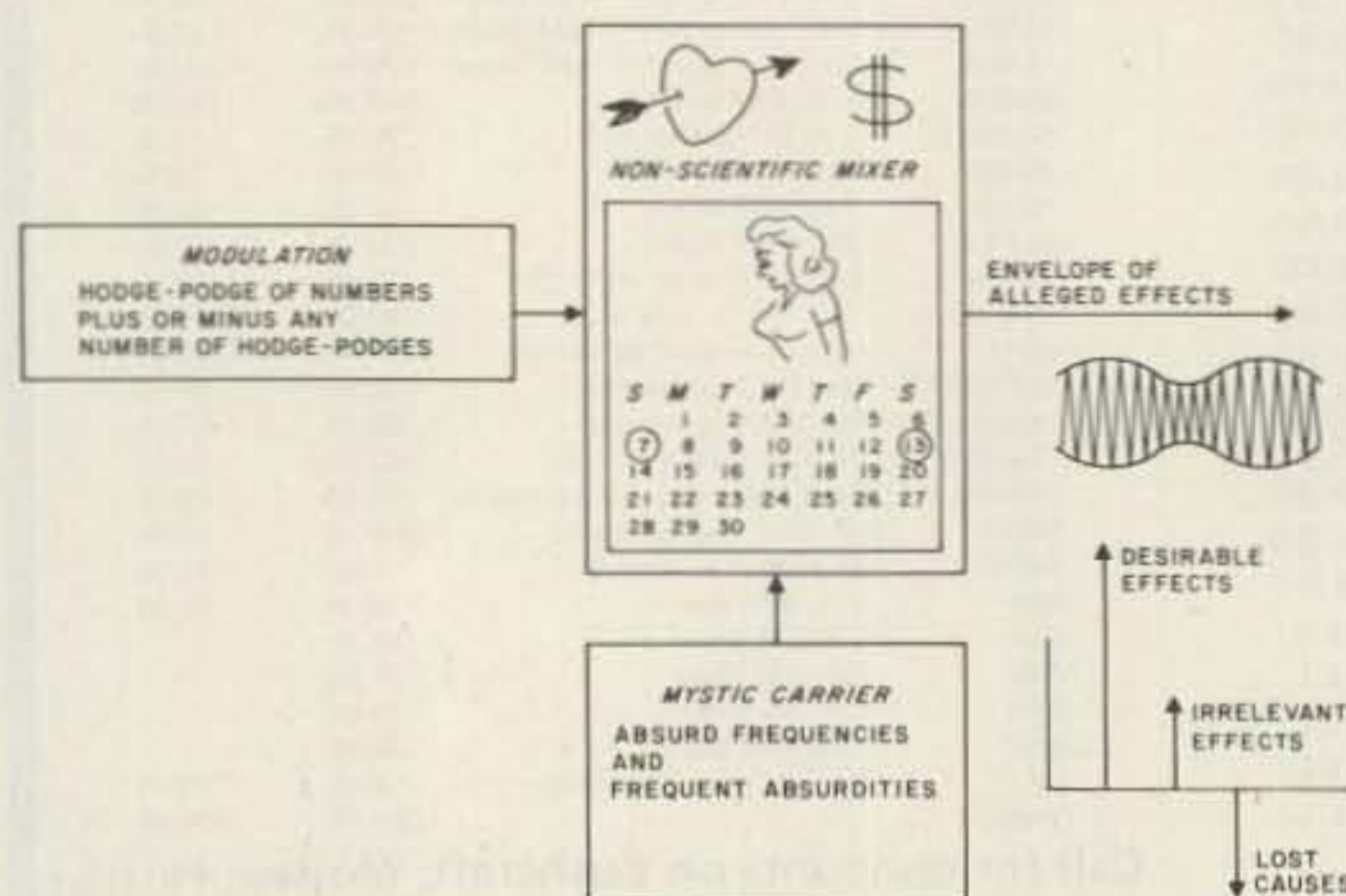

Fig. 1. Block diagram and output spectrum of numerology process. Notwithstanding conceptions of the lay public, the ham's addiction to this domain of the soothsayer's art is minimal. Except for the computation of output power, modulation index, and bandedge frequencies, numerical manipulation is rarely violated.

appearance in equations apparently far removed from the geometry of a circle. Be that as it may, one would like to think that, because of the simplicity and symmetry of circles, pi would turn out to be a nice integral number, or, at least, one that comes out "even."

For ham calculations, we are accustomed to using the value 3.14 for pi. If you consult a handbook of math tables, you can find that pi to ten places is 3.1415926536. But even this is an approximation, in the sense that the last place has been "rounded off." In fact, pi has been calculated to at least twenty thousand places in the digital computer, and that twenty-thousandth place must still be rounded off! To make matters worse, no one has been able to discern any rhyme or reason to these endless decimal places. Suppose, OM, that you were making the initial discovery of pi by using a compass and ruler. Would you readily accept that the relationship between such elemental dimensions could be so wild? Or, would you blame your measuring instruments for pi's persistent remainder?

Although we would not fault the mathematicians for labeling pi an "irrational" number, in what follows we shall see that the endless numbers cannot be construed as a random fallout, as though the digits had been recklessly cast from a giant pepper shaker.

Surprisingly, pi can be calculated by merely performing simple arithmetical operations indicated by a sequence or series of numbers. And, each decimal place so calculated is accurate, except, of course, the last one, because this is rounded off. Such a number series is depicted in Fig. 2. Why should the sum of these

alternate positive and negative fractions produce pi accurate to any number of dozens, hundreds, or even thousands of decimal places? As may be suspected, there are academically-acceptable answers. Whether these answers completely resolve one's natural amazement over the situation is a question on another level of consciousness. Although number series are old hat to the mathematically-versed, many have long forgotten their own gasps of astonishment when first introduced to them. Actually, we have merely scratched the surface—it will be rewarding to inspect other manifestations of such "scientific numerology."

Another constant that asserts itself whenever we use mathematics to indicate the connection between cause and effect or between states of being is epsilon, or ϵ . This strange number, as with pi, never comes out even regardless of the number of decimal places calculated. Epsilon to ten places is 2.7182818285. Although epsilon is not simply related to a geometric figure, as is pi, there is nothing arbitrary or artificial about its value. Indeed, it is entrenched in virtually everything going on in the universe. This is because this old universe of ours is dynamic rather than static; it turns out that epsilon likes to get involved in anything that changes. Included are such measurables as temperature, radioactivity, pressure, biological aging, energy in electric and magnetic fields, and even bank interest and population growth. Again, intuition would suggest that such a universal number should be a nice simple one. But, again, nature, with her majestic overview of these processes, has thought otherwise.

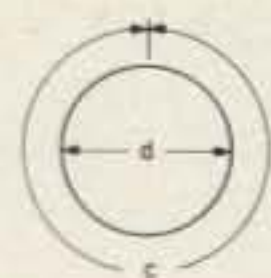

$$\pi = c/d = 3.1415926536\dots$$

$$\pi = 4 \left(1/1 - 1/3 + 1/5 - 1/7 + 1/9 \text{ etc.} \right)$$

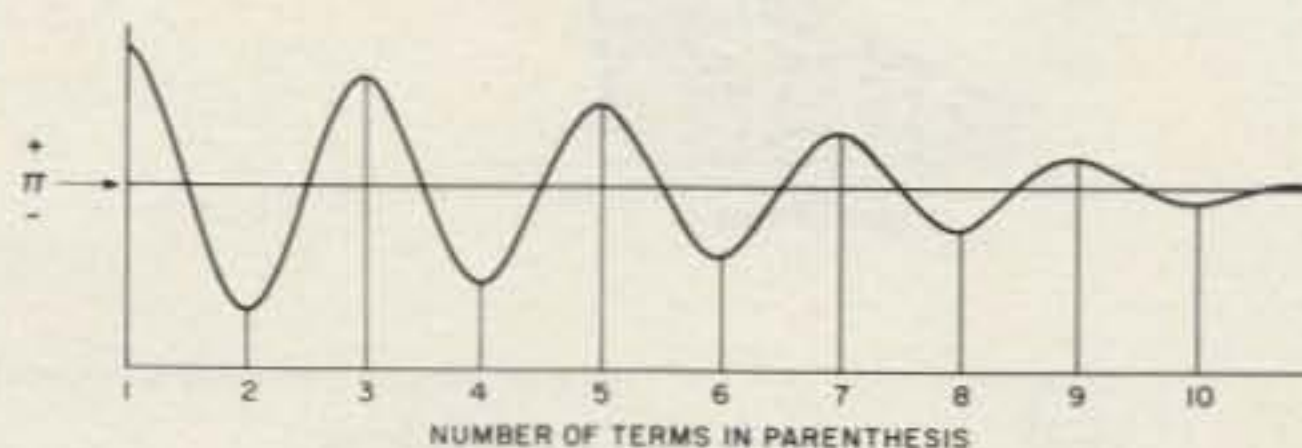

Fig. 2. Pi and the simple number series for computing its value to any degree of accuracy. The curve shows that greater and greater accuracy is approached as more terms are used.

Just the same, epsilon is unique, for it, too, can be expressed as a simple number series. Now, don't invest magical qualities in these number series—they cannot be used to produce just any string of numbers. It is truly amazing that epsilon can also be calculated to any number of decimal places by carrying out the easy arithmetical operations of a certain number series!

Epsilon is most intimately associated with any process that undergoes so-called organic growth or decay. The word "organic" stems from the fact that biological species tend to modify their populations in a manner readily stipulated by some exponential power of epsilon. For example, the bugs depicted in Fig. 3(a) are reproducing in such a way that their number at any given time can be calculated by a simple "growth" equation involving epsilon. We may say that these critters are expanding straightforwardly according to $N_t = N_0 e^{xt}$, where N_t is the number of bugs present at any time, and N_0 is the number of bugs originally present.

Assuming an Adam-Eve situation, we might start with just a pair of ambitious bugs. Then, N_0 would equal 2. The value of x describes the effective birthrate of these bugs and determines how fast the

population curve rises with passing time. Finally, t represents the time elapsing from the fall from grace of the original buglet duo. Generally, x and t have to be derived from measurement or observation. It may well be that x can be gleaned from a biological handbook covering the antics of various types of bugs. In any event, once we deduce x and t , we find ourselves able to predict the consequences of one particular entomological romance. (Such a relationship is very close to electronics, as evidenced by the inevitable appearance of "bugs" in breadboarded circuits!)

Another, and perhaps more mundane, manifestation of epsilon is shown in Fig. 3(b). Suppose you have not nearly been pauperized by inflation and manage to start a savings account with one thousand dollars. Assume that while this account draws simple interest, you patiently await the great day when your money has doubled to two thousand bucks. You propose to remove it at that time in order to buy an improved version of a two thousand dollar rig you had set your heart on when you deposited the kilobuck. (We know full well that the rig will cost four thou by then, but that is not the point.) When, at

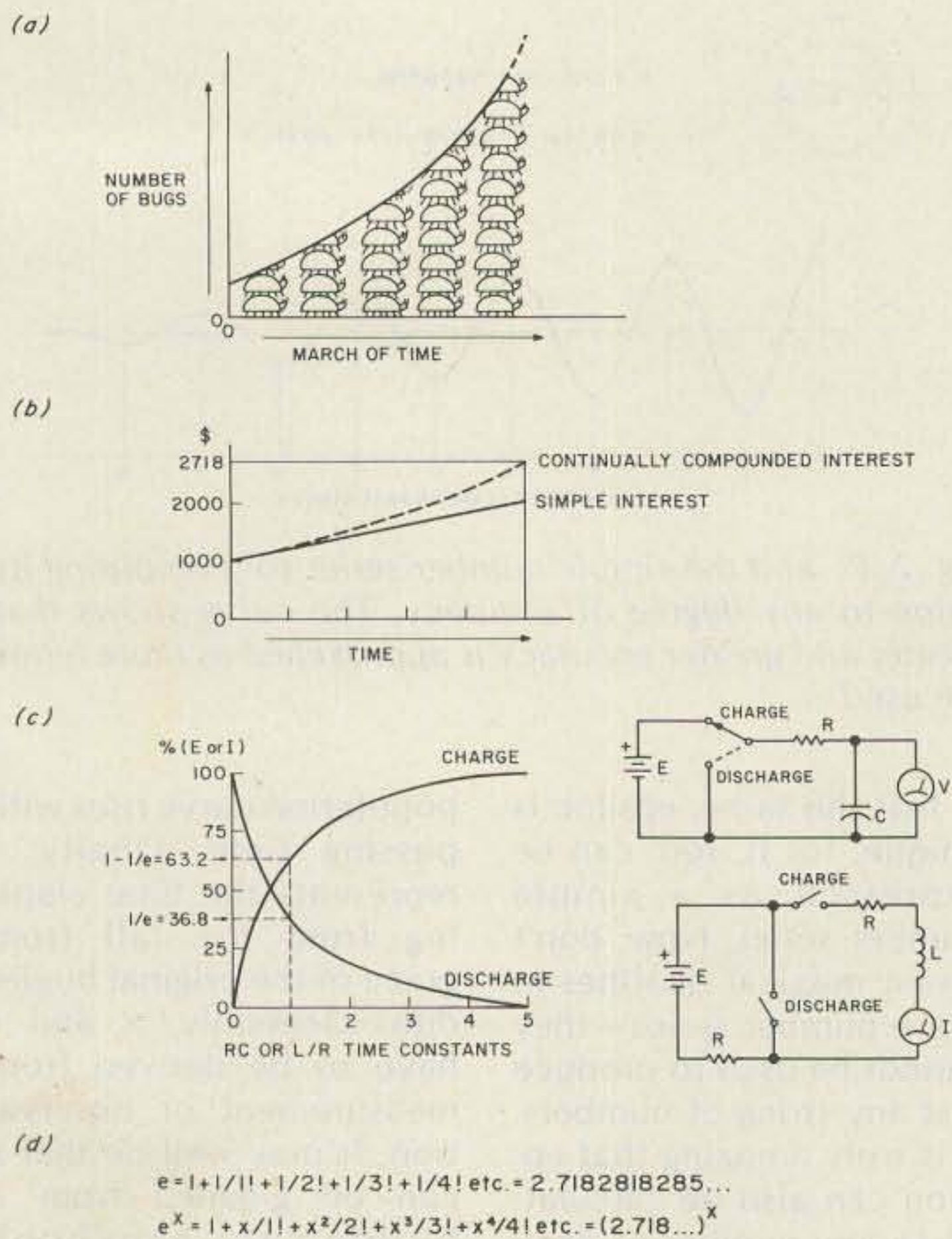

Fig. 3. Situations providing insights into the nature of epsilon. (a) Population growth of bugs whose main occupation is begetting buglets. (b) "Population growth" of dollars in two kinds of accounts. (c) "Population growth" and "decline" of electronics in RC and RL circuits. (d) Simple number sequences for determination of "population parameter," epsilon, or epsilon raised to an exponent x. Note: r is a small resistance—much smaller than R—and protects the dc source from short-circuit current.

long last, you withdraw your \$2,000, the following situation will be true: Had your money been earning compounding interest at the same percentage rate, you would now be withdrawing \$2,718.28! Welcome, epsilon!

OM, if you do not immediately grasp the significance of such growth, you stand in company with multitudes, for the population "explosion" on this planet likewise fails to dent the progenitors thereof.

For our ham shack mentalities, the nature of epsilon is, perhaps, displayed more meaningfully by the charge and discharge curves shown in Fig. 3(c). This "universal" graph depicts voltage and cur-

rent variation in simple RC and RL circuits. The discharge curve can represent the voltage depletion across a charged capacitor which has been connected across a resistance, R.

With no mathematics at all, we know that this voltage starts at value E, the voltage of the dc charging source, and ultimately decays to zero. Note that time is shown in terms of RC time constants, rather than in ordinary "clock" units. The unit of time called the time constant is the product of capacitance (in farads) and resistance (in Ohms). Thus, the actual clock time corresponding to a time constant depends upon R and C and, of course, can vary widely according to these circuit

values. Finally, the actual equation of the discharge curve for capacitor voltage, V, is $V = Ee^{-t/RC}$. Now, OM, all this has been cited just for the sake of review. Actually, we can get the "feel" for epsilon without even knowing the values of E, R, or C. Nor do we even have to be aware of the equation for V!

It happens beautifully that at the lapse of one time constant—regardless of what actual clock time that corresponds to—the voltage across the capacitor will have discharged to 36.8% of its initial value, E. Now, this might appear to be just some isolated fact worth memorizing, perhaps, and not really essential to everyday electronics life. But, the fact that the reciprocal of epsilon is also 0.368, or 36.8%, cannot be dismissed by the alert mind as a stray coincidence. For it is true that in all instances of the discharge of capacitor voltage by means of a resistance, $1/e$ of the initial capacitor voltage coincides with the lapse of one time constant!

An analogous situation prevails for the discharge of current in an LR circuit. That is, one time constant after a charged inductor has been switched from a dc source to a resistance, the circuit current is $1/e$ or 36.8% of its initial value. In such circuits, one time constant is the time in seconds corresponding to L/R , where L is the inductance in henrys and R represents the resistance in Ohms.

Incidentally, the author's October, 1975, CQ article, "Alice in Basic Land," explains why such combinations as Ohms and farads or Ohms and henrys obligingly enable themselves to be expressed in nice, convenient time units called seconds. All too many texts gloss over the justification for calling RC and L/R "time constants."

For the moment, however, it is interesting to contemplate that bugs, bucks, and electrons can have their "population" changes described with the aid of epsilon!

The charge curve of Fig. 3(c) can represent the growth of capacitor voltage after an initially-discharged capacitor has been connected through a resistance to a voltage source, E. In such a case, we find that 63.2% of voltage E will be developed across the capacitor at the instant corresponding to one RC time constant. This percentage is equal to $1 - 1/e$. Similarly, the current in an LR circuit will attain 63.2% of its ultimate (Ohm's Law) value at the instant defined by one L/R time constant.

To say the least, a salient feature of epsilon is its assertiveness. Although all of the curves illustrated in Figs. 3(a), (b), and (c) involve e, a more encompassing statement would be that growth or decay functions involve e^x . (Actually, e is merely a special instance involving e^x , in which the value of x is one.) It is gratifying to see in Fig. 3(d) that both e and e^x can be determined for any number of decimal places by means of simple number sequences. Incidentally, the exclamation mark, !, signifies the factorial process. Thus, 1! is factorial one, or one times one = 1. Factorial two, or 2!, is one times two, or 2. And, 3! represents one times two times three, or 6, etc. Even if this is brand new to you, OM, surely a mystique resides in the fact that an endless series of accurate decimal places is forthcoming from a very simple process.

Enough growth and decay situations have been cited to drive home the importance of epsilon. Suffice it to say that epsilon makes its appearance any

time the rate of change of a quantity is continually proportional to the amount of the quantity. Described in another way, epsilon tells us that the law of compound interest is at work.

At this stage, the awesome properties of certain numerical arrangements have been adequately displayed. The author, however, cannot resist mention of one more very interesting aspect of this logical, yet eerie, game of digits. Specifically, it is only natural to ponder the possibility of pi and epsilon making a mutual appearance in some kind of relationship. Inasmuch as both are deeply rooted in the architecture and dynamics of nature's universe, we strongly suspect they may not have spent these untold billions of years in a state of independent aloofness!

Consider the equation,

$\text{Sinh } x = 1/2(e^x - 1/e^x)$. Whether or not it is felt that we are encroaching on the area of higher mathematics depends, of course, upon how much math was fired at us during our academic tribulations. Suffice it to say, however, that you will become quite familiar with expressions of this type if you ever succumb to the desire to calculate the happenings on transmission lines rather than to infer them from swr meter readings. Fortunately, you would not necessarily have to acquire expertise status, for such quantities as Sinh, the hyperbolic sine, and friend epsilon raised to the x power can be gotten from readily-available tables.

Or, better still, a few appropriate button-pressings on your pocket calculator will save much stress on the brain. Here's something to keep in mind,

though: Although "x" represents an angle, it must be stipulated in radians rather than in degrees. This should be no cause for consternation, for it is just a matter of dealing in, say, quarts rather than pints. It happens that one radian is equal to 59.296 degrees. The nice thing about radian measure is that there are 2 pi radians in a full circle. And, even better, angular displacements commonly encountered in electrical work such as 45, 60, 90, or 180 degrees correspond to simple fractions of pi, such as pi/8, pi/6, pi/4, and pi/2, respectively. Suppose now that we substitute pi/6 wherever x appears in this strange equation. Let's see what happens:

$\text{Pi}/6 = 3.141592654/6 = 0.5235987756$. OK, let's write down the value of epsilon raised to this power. Now we find that $e^x =$

1.688091795. The reciprocal of this number is 0.5923858472. Performing the indicated subtraction, we have 0.592384847 subtracted from 1.688091795 = 1.095706948; and one-half of this is 0.547853474, which is, indeed, the hyperbolic sine of 60 degrees, or pi/6 radians! As you have probably inferred, the identity between the left- and right-hand members of the equation will check out for any angle—that is, any value of x. If your head is swimming, let it be reiterated that what we have done, OM, is to show evidence of the mutual appearance of pi and epsilon in one relationship.

Please be advised that any reaction to all this will be tolerated, except "so what!" In any event, 'tis QRT time, OM, so in the spirit of ham shack numerics, vy best 73s 'til next time. ■

Microlog AKB-1 memory keyboard. . .



. . . famous for its smooth and reliable operation, now with special option packages tailored to suit your needs:

AKB-1 Memory Keyboard for CW \$299

AKB-1 with RTTY, AFSK Generator and T/R Relay (Save \$51) \$449

Add 2000 character expanded memory and brag tape (Save \$151) \$599

Limited time offer.

4 Professional Drive, Suite 119,
Gaithersburg, MD 20760,
301-948-5307

51

MICROLOG
CORPORATION

Innovators in Digital Communication



Radio World

CENTRAL NEW YORK'S FASTEST GROWING HAM DEALER



Featuring Yaesu, Icom, Drake, Ten-Tec, Swan, DenTron, Midland, KDK, MFJ, Microwave Module, Tempo, Astron, KLM, Hy-Gain, Mosley, Larsen, Cushcraft, Hustler, Mini Products, Bird, DSI, Mirage, Vibroplex, Bencher, Info-Tech, Universal Towers, Callbook, ARRL, Astatic, Shure. *We service everything we sell!* Write or call for quote. **You Won't be Disappointed.**
We are just a few minutes off the NYS Thruway (I-90) Exit 32

Warren K2IXN **ONEIDA COUNTY AIRPORT TERMINAL BUILDING** **Bob WA2MSH**
ORISKANY, NEW YORK 13424
Call Toll Free: 1-800-448-7914 New York State Residents Call: 315-337-2622 or 315-337-0203

Microcraft's New Morse-A-Word

- Eight character moving display.
- Built-in code practice oscillator.
- Excellent for learning Morse Code. ✓50
- Complete — no CRT or expensive extras needed.
- Decodes audio CW signals from your receiver's speaker and displays letters, numbers, punctuation and special Morse characters as the code is received.



MORSE-A-WORD Kit with 4 character readout MAWK-4 \$149.95
MORSE-A-WORD Kit with 8 character readout MAWK-8 \$169.95
MORSE-A-WORD wired & tested with 8 character readout . . . MAWF \$249.95

Send check or money order. Use your VISA or Master Charge. Add \$3.50 shipping and handling for continental U.S. Wisconsin residents add 4% State Sales Tax.

Microcraft Corporation Telephone: (414) 241-8144
P. O. Box 513G, Thiensville, Wisconsin 53092

COMPULOG: A Multi-Purpose Record Keeper

—whither the paper logbook?

Douglas C. Allen WA1ZSE
32 Lebanon St.
Hanover NH 03755

Access to a time-share computer system, coupled with an interest in ham-oriented applications

for microcomputers, recently prompted me to investigate the possibility of developing a program for computerizing a ham log. Aside from being able to simply log my QSOs, an additional program option which I felt would be worthwhile in such a ven-

ture included the ability to search through my QSO file for a particular log entry, thereby verifying, at the touch of a few keys and with a fraction of the time it would take to manually scan the log, whether or not I had logged a previous QSO with the station in question. I also thought that an option for contest logging would be nice. In the latter, all I would have to do would be to input the call in question, and, if it were already logged, the computer would say so. If not logged, the computer would automatically enter that call, along with additional contest logging information, into the contest file. The speed of computerized contest logging would save valuable operating time by preventing duplicate contest entries and eliminating the need for using dupe sheets. The program COMPULOG, discussed in the following text, is the end result of this effort.

Program Logic

The flowchart on Fig. 1 provides a synoptic view of the program logic formulating the basis for COMPULOG.

Calling up COMPULOG

results in the user being given three program options. LOG ENTRY (option 1) is the center point of the program since it allows for the terminal input of a QSO log entry. Once the entry is made (format to be discussed later), it is placed into HAMLOG, the data storage file for all log entries. When the user-specified number of log entries has been made, LOG ENTRY recycles back to user option.

SEARCH (option 2) provides for the ability to scan the entire HAMLOG file at computer speed in response to a request (input as the station's call letters) to determine if a previous QSO has been carried out with the station in question. If it has been, the complete log entry is returned to the user. It should also be noted that if a logged contact has multiple listings (i.e., at different times) in HAMLOG, all of those entries are returned as well. Hence, the last as well as the first entries are instantly available. If the contact has not been previously logged in HAMLOG, then the user receives the message "STATION HAS NOT BEEN LOGGED." As

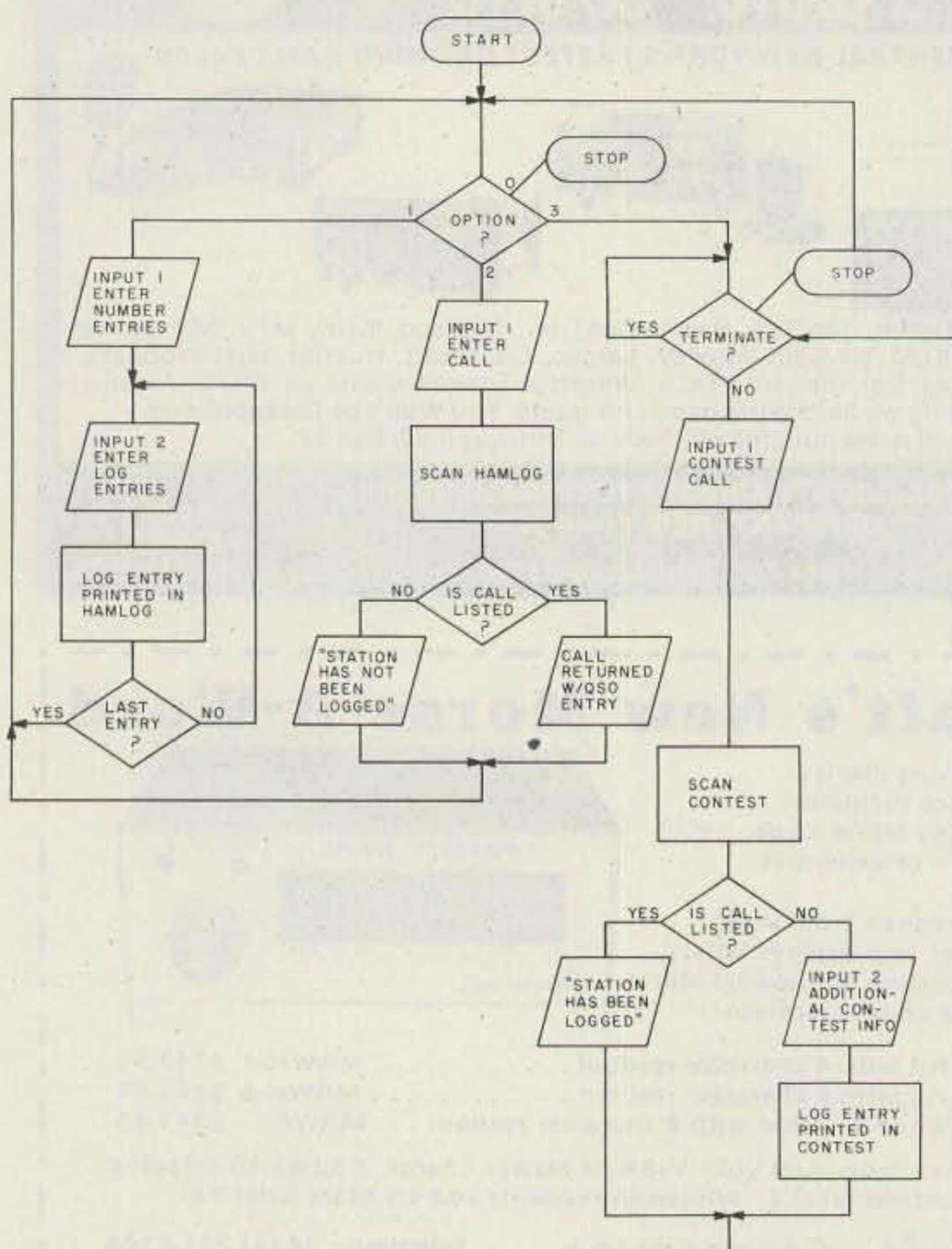

Fig. 1. Flowchart for COMPULOG.

with LOG ENTRY, upon completion of the SEARCH option (in this case one scan of the entire log), program control is returned to the user.

CONTEST LOG (option 3) combines elements of LOG ENTRY and SEARCH, though in a more streamlined manner. User selection of this option results in a request for input, again in the form of call letters. Once an entry has been made, the computer will then search through CONTEST, the data storage file for this option, for any duplications. If the call has already been logged, the message "STATION HAS BEEN LOGGED" is returned. If the call has not been logged, the call letters are returned and are followed by "...?", indicating that the contact is a new one and that additional logging information (according to contest format, e.g., signal reports, section nos., etc.) is required for completion and insertion into CONTEST. When this has been accomplished, the computer is then ready to accept another entry. Unlike LOG ENTRY and SEARCH, where return to user control is automatic, typing in the command STOP is necessary in the first request for input in order to return to user option control.

At any point in the entire program where the user is asked for an option number, typing 0 will cause COMPULOG to terminate.

Program Structure

The listing of COMPULOG in Fig. 2 shows a simple and relatively straightforward program that should require only minor alterations to make it compatible with most presently available mini-computer systems using various forms of BASIC. The program is divided into

three main sections, and, since each section runs independently of the others, the need for subprogramming is eliminated. Program control is directed by the IF THEN statements of lines 190-220 in response to the user-selected option of line 180. Data files HAMLOG and CONTEST are terminal-format files (versus random-access files) and must be assigned file numbers, saved and empty, before initiating COMPULOG for the first time.

The applicability of terminal-format files in COMPULOG is ideal. A terminal-format file is a collection of lines, composed of numbers and/or string characters, which may vary widely in length. File entries can be typed in directly from the terminal. These files will provide for the initial storage of data which will be used as input to the program as well as storage of the data in listable form for output from the program (e.g., listing the contest log or QSO file). Lines 330-340 are all that are necessary for storing data in the appropriate file (in this case, HAMLOG). Since HAMLOG and CONTEST are defined at the very beginning of COMPULOG, further references to them at any point in the program can be made via their assigned file numbers.

Line 280 is the log entry format statement. While the type of information and the order in which it is entered into HAMLOG is largely subjective, the insertion of the call as the first entry in each string, followed by a minimum of 2 spaces, is critical to proper program operation. The reason is as follows: The search functions of options 2 and 3 are set up so that as the computer scans the data files, it reads only the first 6 spaces (cf., e.g., line 460) of each string en-

```

100 FILE #1:'HAMLOG'
110 FILE #2:'CONTEST'
120
130 PRINT 'COMPULOG OPTIONS: LOG ENTRY (1), SEARCH (2)'
140 PRINT 'CONTEST LOG (3), PROGRAM TERMINATION (0)'
150 PRINT
160 PRINT 'OPTION':
170
180 INPUT A
190 IF A=1 THEN 260
200 IF A=2 THEN 410
210 IF A=3 THEN 640
220 IF A=0 THEN 900
230
240 REM OPTION 1 - LOG ENTRIES
250
260 PRINT 'LOG ENTRY FORMAT:'
270 PRINT
280 PRINT 'CALL(+2X) NAME QTH QSO-DATE MODE/FREQ RST REMARKS'
290 PRINT
300 PRINT 'NO OF ENTRIES':
310 INPUT N
320 FOR I=1 TO N
330   LINPUT A$
340   PRINT #1:A$
350 NEXT I
360 PRINT
370 GO TO 160
380
390 REM OPTION 2 - LOG SEARCH
400
410 PRINT 'CALL':
420 LINPUT A$
430 PRINT
440 RESET #1
450 LINPUT #1:B$
460 LET X$=SEG$(B$, 1, 6)
470 IF X$=A$ THEN 490
480 GO TO 540
490 IF END#1 THEN 580
500 GO TO 450
510 LINPUT #1:B$
520 LET X$=SEG$(B$, 1, 6)
530 IF X$=A$ THEN 560
540 PRINT B$
550 PRINT
560 IF END#1 THEN 160
570 GO TO 510
580 PRINT 'STATION HAS NOT BEEN LOGGED'
590 PRINT
600 GO TO 160
610
620 REM OPTION 3 - CONTEST LOG
630
640 PRINT 'ENTER NAME OF CONTEST, DATE, OPERATOR(S)':
650 PRINT
660 LINPUT C$
670 PRINT #2:C$
680 PRINT
690 PRINT 'ENTER CONTEST LOGGING FORMAT':
700 PRINT
710 LINPUT D$
720 PRINT #2:'CONTEST LOGGING FORMAT:':D$
730 PRINT
740 PRINT 'CONTEST LOG NOW OPEN'
750 PRINT
760 LINPUT A$
770 IF A$='STOP' THEN 160
780 RESET #2
790 LINPUT #2:B$
800 LET X$=SEG$(B$, 1, 6)
810 IF X$=A$ THEN 870
820 IF MORE#2 THEN 790
830 PRINT A$;'...':
840 LINPUT A1$
850 PRINT #2:A$;' *;A1$
860 GO TO 760
870 PRINT 'STATION HAS BEEN LOGGED'
880 GO TO 760
890
900 END

```

Fig. 2. Listing of COMPULOG.

try and compares the contents of these spaces with the terminal-input entry. The first 6 spaces will accommodate the 2 x 3 calls such as WA1ZSE. Six spaces is also the minimum number necessary to allow for the duplication of call letters in 2 x 3 calls up to but not including the last letter (e.g., WA1ZSE, WA1ZSR). More importantly, however, in those cases where 1 x 2 or 1 x 3 calls are present, the 2 spaces following these entries will

effectively be blank spaces so that all the computer "sees" is the 1 x 2 or 1 x 3 call. If the 6-space format is not adhered to, a scan for a 1 x 2 or 1 x 3 call will produce the "STATION HAS NOT BEEN LOGGED" message, since the computer will read the correct call plus the first letter(s) of the next bit of log information occupying spaces 5 and/or 6. Due to the 6-space maximum of the call entry format, portable and interim suffixes cannot

```

*RUN
COMPULOG OPTIONS: LOG ENTRY (1), SEARCH (2)
CONTEST LOG (3), PROGRAM TERMINATION (0)

OPTION? 1
LOG ENTRY FORMAT:

CALL(+2X) NAME QTH QSO-DATE MODE/FREQ RST REMARKS

NO OF ENTRIES? 1
? WA1ZSE DOUG W. LEBANON, N.H. 3-3-78 A1/21.4 579 QRP 5 WATTS

OPTION? 2
CALL? WA1ZSR

STATION HAS NOT BEEN LOGGED

OPTION? 2
CALL? WA1ZSE

WA1ZSE DOUG W. LEBANON, N.H. 3-3-78 A1/21.4 579 QRP 5 WATTS

OPTION? 3
ENTER NAME OF CONTEST, DATE, OPERATOR(S)

? 44TH ARRL INTERNAT'L DX COMPETITION CW MODE WA1ZSE, OP

ENTER CONTEST LOGGING FORMAT

? CALL FREQ DATE/TIME EXCHANGE:SENT/RCVD

CONTEST LOG NOW OPEN

? F6??
F6??...? 21 3-??-78/1620 UTC 579 NH/589-100
? G4??
G4??...? 14 3-??-78/1623 599 /599-200
? OZ5??
OZ5??...? 28 3-??-78/1625 599 /579-070
? G4??
STATION HAS BEEN LOGGED
? STOP
OPTION? 0

*OLD CONTEST
*LIST

44TH ARRL INTERNAT'L DX COMPETITION CW MODE WA1ZSE, OP
CONTEST LOGGING FORMAT:CALL FREQ DATE/TIME EXCHANGE:SENT/RCVD
F6?? 21 3-??-78/1620 UTC 579 NH/589-100
G4?? 14 3-??-78/1623 599 /599-200
OZ5?? 28 3-??-78/1625 599 /579-070

```

Fig. 3. Sample run of COMPULOG, using all three options and including a listing of CONTEST after completion run. The format used in CONTEST LOG serves only as an illustration. Under actual contest conditions, a different format may be necessary to speed up the logging process.

be accommodated by COMPULOG. However, such information could be included under "Remarks."

Each log entry of my HAMLOG file is entered as a single string. LINPUT (versus INPUT) statements are used in HAMLOG and elsewhere throughout the rest of the program only to allow for the inclusion of such special characters as quotation marks, slant bars (e.g., mode/freq), and commas (as would separate city and state).

Lines 410-600 constitute the SEARCH option which instructs the computer to carry out a string-by-string search of HAMLOG to determine whether or not a call has been previously logged. However, the programming statements are set up to assume that the

call is not listed, as would more often be the case. Lines 450-500 form the first loop of this option, which tells the computer to scan a string; if the computer does not find call letters matching the call in question, the message "STATION HAS NOT BEEN LOGGED" is returned (line 580). If, during a string scan, the computer matches the input call with an entry stored in HAMLOG, the SEARCH option enters the second loop (lines 510-570), where the log entry is printed and the scan continued to locate and print any duplicate listings described earlier. In either loop, once an entire scan has been completed, the SEARCH option terminates.

Note the use of RESET

statements in lines 440 and 670. When working with terminal-format files, it is helpful to think of these files as having pointers or markers which serve as an indicator of the position in a file from which the next input (i.e., from data file to program) will be taken or, as in the case of LOG ENTRY, the position at which the next information printed to the file will begin. When HAMLOG and CONTEST are first opened, the file marker is at the beginning of the file. After each request for input by COMPULOG, the file marker is positioned just after the information input of the next string entry where information may or may not be taken. In case of a print operation (e.g., entering log entries in HAMLOG), the marker is positioned at the end of the file. If you were to subsequently ask for program input from HAMLOG, the computer would attempt to read past the last entry in the file, resulting in the termination of the program. The RESET command at the beginning of SEARCH and CONTEST LOG ensures that the pointer will always be repositioned at the beginning of the respective file following a log entry or at the end of a scan through either file.

The program statements comprising CONTEST LOG are pretty much self-explanatory in view of the preceding discussion. Lines 640-670 serve a two-fold purpose. First, they act as the first-string entry in CONTEST and the point at which the file marker is initially located. (This series of statements was not part of the original program, with the result that the first attempt to input a contest call produced an error message. The message originated from the search function, which could not

find a last entry because the file was initially empty.) Second, they provide a means of identifying the output if, at the end of the contest, it is desirable to LIST it.

Using COMPULOG

While the size of my log reflects only a year or two of sporadic activity, there are ham friends of mine who index their activity by log book volume numbers. Time and an expanding log would excuse most of us from the kind of mental recall you would have to have if, on hearing or initiating a QSO, you were to suddenly wonder if that fellow on the other end was someone you should know or perhaps once worked. Unless you index your log(s) for quick retrieval of information or organize your QSOs via a number of clever schemes designed to accomplish the same, chances are you are not going to obtain the information you seek very readily. Using a computer to do your logging and subsequently your searching would provide you with a way to get this information in a fraction of the usual time.

When speaking in terms of the time element involved in retrieving the stored data, it should be obvious to potential users of this program that the efficiency of using a computer to log and search your QSOs will depend largely upon the data access time for whatever mode of data storage is used. While this may not present an objectionable time lag when using SEARCH, contest logging may present problems, since speed in logging is an essential element in keeping the contacts flowing. Depending upon the accessibility of your data, the use of this program in contests might then be ques-

tionable in terms of its efficiency. The time-share system I use gives me the ability to obtain data from my file(s) within fractions of a second after hitting the RETURN key. Such speed is beyond the capabilities for most of today's microsystems using tape or floppy discs as the storage medium.

The potential of using COMPULOG in contest logging intrigues me nonetheless, and I am hoping to use it in one of the forthcoming contests. I would appreciate hearing from those of you who decide to give it a try as well. On the surface, I can see a much smoother flow of exchanges, more contacts logged per unit of time, and less time wasted in logging duplicates or in using dupe sheets to prevent them. Furthermore, the submission of computer printouts from a contest, if

properly identified and formatted, should be acceptable to the contest's sponsors.

Permutations of this logging program are limited only by the imagination. As examples, some users may wish to alter the input/output format; include program options for listing log entries according to date, mode, call area, or a whole host of other variables; create additional files and/or program options for net control operations; log SSTV, OSCAR, and VHF activity; or use specialty files for keeping track of certificate hunts.

I do not foresee the day when everyone will throw away the time-honored system of the written log for the sake of a computer, but, for those fortunate enough to have the capability, computerized logging has its possibilities and its pleasures. ■

**choose your terms . . .
choose your savings!!**

Send me one year of 80 Microcomputing for just \$15. (I save over 37%.)

I prefer 2 years for \$24. (I save 50%.)

I prefer 3 years for \$36. (I save 50% off the newsstand price.)

80 MICROCOMPUTING

The magazine for today's biggest selling computer.

- New subscription Renewal
 Payment enclosed \$ _____ Bill me
 Visa Master Charge Am Express

Card # _____ Exp. date _____

Signature _____

Name _____

Street _____

City _____ State _____ Zip _____

Canada: same as US rates, in US funds.
 Other foreign: \$20 one year only, US funds.

303B6

80 Microcomputing • POB 981 • Farmingdale NY 11737

DEALER DIRECTORY

Fontana CA

We carry the following: ICOM, Midland, Amcom, DenTron, KLM, Swan, Drake, Ten-Tec, Wilson, SST, MFJ, Hy-Gain, Lunar, Nye-Viking, B&W, Redi-kilowatt, CushCraft, Mosley, Big Signal, Pipo, etc. Full Service Store Fontana Electronics, 8628 Sierra Ave., Fontana CA 92335, 822-7710.

San Jose CA

Bay area's newest Amateur Radio store. New & used Amateur Radio sales & service. We feature Kenwood, ICOM, KDK, Yaesu, Ten-Tec, VHF Engineering & many more. Shaver Radio, Inc., 1378 So. Bascom Ave., San Jose CA 95128, 998-1103.

Denver CO

Experimenter's paradise! Electronic and mechanical components for computer people, audio people, hams, robot builders, experimenters. Open six days a week. Gateway Electronics Corp., 2839 W. 44th Ave., Denver CO 80211, 458-5444.

New Castle DE

ICOM, Ten-Tec, Swan, KDK, NDI, Tempo, Wilson; Authorized dealer: 1 mile off I-95. No sales tax. Delaware Amateur Supply, 71 Meadow Road, New Castle DE 19720, 328-7728.

Columbus GA

KENWOOD—YAESU—DRAKE
 The world's most fantastic amateur showroom! You gotta see it to believe it! Radio Wholesale, 2012 Auburn Avenue, Columbus GA 31906, 561-7000.

Preston ID

Ross WB7BYZ, has the Largest Stock of Amateur Gear in the Intermountain West and the Best Prices. Call me for all your ham needs. Ross Distributing, 78 So. State, Preston ID 83263, 852-0830.

Terre Haute IN

Your ham headquarters located in the heart of the midwest. Hoosier Electronics, Inc., 43B Meadows Shopping Center, P.O. Box 2001, Terre Haute IN 47802, 238-1456.

Littleton MA

The ham store of N.E. you can rely on. Kenwood, ICOM, Wilson, Yaesu, DenTron, KLM amps, B&W switches & wattmeters, Whistler radar detectors, Bearcat, Regency, antennas by Larsen, Wislon, Hustler, GAM. TEL-COM Inc. Communications & Electronics, 675 Great Rd., Rt. 119, Littleton MA 01460, 486-3040.

Laurel MD

Kenwood, Drake, ICOM, Ten-Tec, Swan, DenTron, Tempo and many ham accessories. Also computers by Apple and Exidy. Call toll free 1-800-638-4486. The Comm Center, Inc., Laurel Plaza—Rt. 198, Laurel MD 20810.

St. Louis MO

Experimenter's paradise! Electronic and mechanical components for computer people, audio people, hams, robot builders, experimenters. Open six days a week. Gateway Electronics Corp., 8123-25 Page Blvd., St. Louis MO 63130, 427-6116.

Camden NJ

X-band (& other frequencies) Microwave Components & Equipment. Laboratory Grade Test Instruments, Power Supplies, 1000's in stock at all times, BUY & SELL all popular makes—HP, GR, FXR, ESI, Sorensen, Singer, etc. Lectronic Research Labs, 1423 Ferry Ave., Camden NJ 08104, 541-4200.

Syracuse—Central NY

We deal, we trade, we discount, we please! Yaesu, Ten-Tec, Cushcraft, Drake, DenTron, KLM, Midland, B&W, ICOM, Hygain, Swan, Amcom, Telco, Mirage, DSI etc. Complete 2-way service shop! Ham-Bone Radio (Div. Stereo Repair Shop) 3206 Erie Blvd. East, Syracuse NY 13214, 446-2266.

Syracuse—Rome—Utica NY

Featuring: Yaesu, ICOM, Drake, Atlas, DenTron, Ten-Tec, Swan, Tempo, KLM, Hy-Gain, Mosley, Wilson, Larsen, Midland Southwest Technical Products. You won't be disappointed with equipment/service. Radio World, Oneida County Airport-Terminal Building, Oriskany NY 13424, 337-2622.

Phila. PA/Camden NJ

Waveguide & coaxial microwave components & equipment. Laboratory grade test instruments, power supplies. Buy, sell & trade all popular makes, HP, GR, FXR, ESI, Sorensen, Singer, etc. Lectronic Research Labs., 1423 Ferry Ave., Camden NJ 08104, 541-4200.

Scranton PA

ICOM, Bird, CushCraft, VHF Engineering, Antenna Specialists, Barker & Williamson CDE Rotators, Ham-Keys, Belden, W2AU/W2VS, Shure, Regency, CES Touch-Tone pads, Radio Amateur Callbooks. LaRue Electronics, 1112 Grandview St., Scranton PA 18509, 343-2124.

Houston TX

Experimenter's paradise! Electronic and mechanical components for computer people, audio people, hams, robot builders, experimenters. Open six days a week. Gateway Electronics Inc., 8932 Clarkcrest, Houston TX 77063, 978-6575.

San Antonio TX

Complete 2 way service shop. Call Dee, W5FSP. Selling Antenna Specialists, Avanti, Azden, Bird, Hy-gain, Standard communications, Genave, Henry, CushCraft, Hustler, ICOM, KDK, MFJ, Nye, Shure, Swan, Tempo, Ten-Tec and others. Appliance & Equipment Co., Inc., 2317 Vance Jackson Road, San Antonio TX 78213, 734-7793.

Davenport WA

Preassembled all band antennas 160m/10m. Trap models start at \$36.50, no trap models start at \$54.50. Complete ham radio repair and parts. Electronic Communications Service Co., Rt. 1-78K, Davenport WA 99122, 725-6822.

Port Angeles WA

Mobile RFI shielding for elimination of ignition and alternator noises. Bonding straps. Components for "do-it-yourself" projects. Plenty of free advice. Estes Engineering, 930 Marine Drive, Port Angeles WA 98362, 457-0904.

DEALERS

Your company name and message can contain up to 25 words for as little as \$150 yearly (prepaid), or \$15 per month (prepaid quarterly). No mention of mail-order business or area code permitted. Directory text and payment must reach us 45 days in advance of publication. For example, advertising for the April issue must be in our hands by February 15th. Mail to 73 Magazine, Peterborough NH 03458. ATTN: Aline Coutu.

73

Computer System I/O Interface

— handles RS232, 20-mA loop, and KC Standard conversions

The interface design shown in the drawings is for a microcomputer employing RS232 I/O and user I/O combinations of RS232, TTY, and audio cassette. Minor circuit changes would easily provide various I/O combinations to suit individual needs.

The central feature of the interface is the audio cassette FSK modem. The modem utilizes an Exar XR2206 function generator modulator and an Exar

XR2211 phase-locked tone-demodulator. The modem is designed to operate up to 1200 baud using a 1200-Hz to 2500-Hz frequency shift (Kansas City). Repeated read/writes at 1200 baud of a 12K byte program have been without error.

The ICs can be purchased for approximately \$15 and the other electronic components usually can be found in a well-equipped hobby workshop. The complete circuit was

built on a Radio Shack 4" × 4½" PC board and was installed in a small metal cabinet. The total cost for the I/O interface was less than \$35.

Fig. 2 shows how user inputs produce RS232 which becomes the input to the computer. A TTY keyboard current loop of 20 mA will key the IL-74 photocoupler to produce a T²L signal as well as turn on an LED indicator. The RS232 input

also is converted to a T²L signal by a section of the XR1489A line driver. These two T²L signals are switch selectable so that only one of these signals is connected to one input side of the 74367 tri-state buffer. The T²L output of the XR2211 is connected to the other input side of the tri-state buffer. When a tone is detected by the XR2211 demodulator, the carrier logic of the demodulator will automatically switch the tri-state buffer to receive FSK from the cassette player and the switch-selectable inputs will be made inactive. The XR2211 data line remains logic 1 (marking) with no tone, and remains logic 1 upon tone detection as long as the tone is marking, i.e., 1200 Hz. Breaks in the RS232 to the computer will not occur when the cassette player is put in the play-back position; thus, data reads from the cassette will not have start glitches. The T²L output of the tri-state buffer drives an XR1488 T²L-to-RS232 line driver to produce the re-

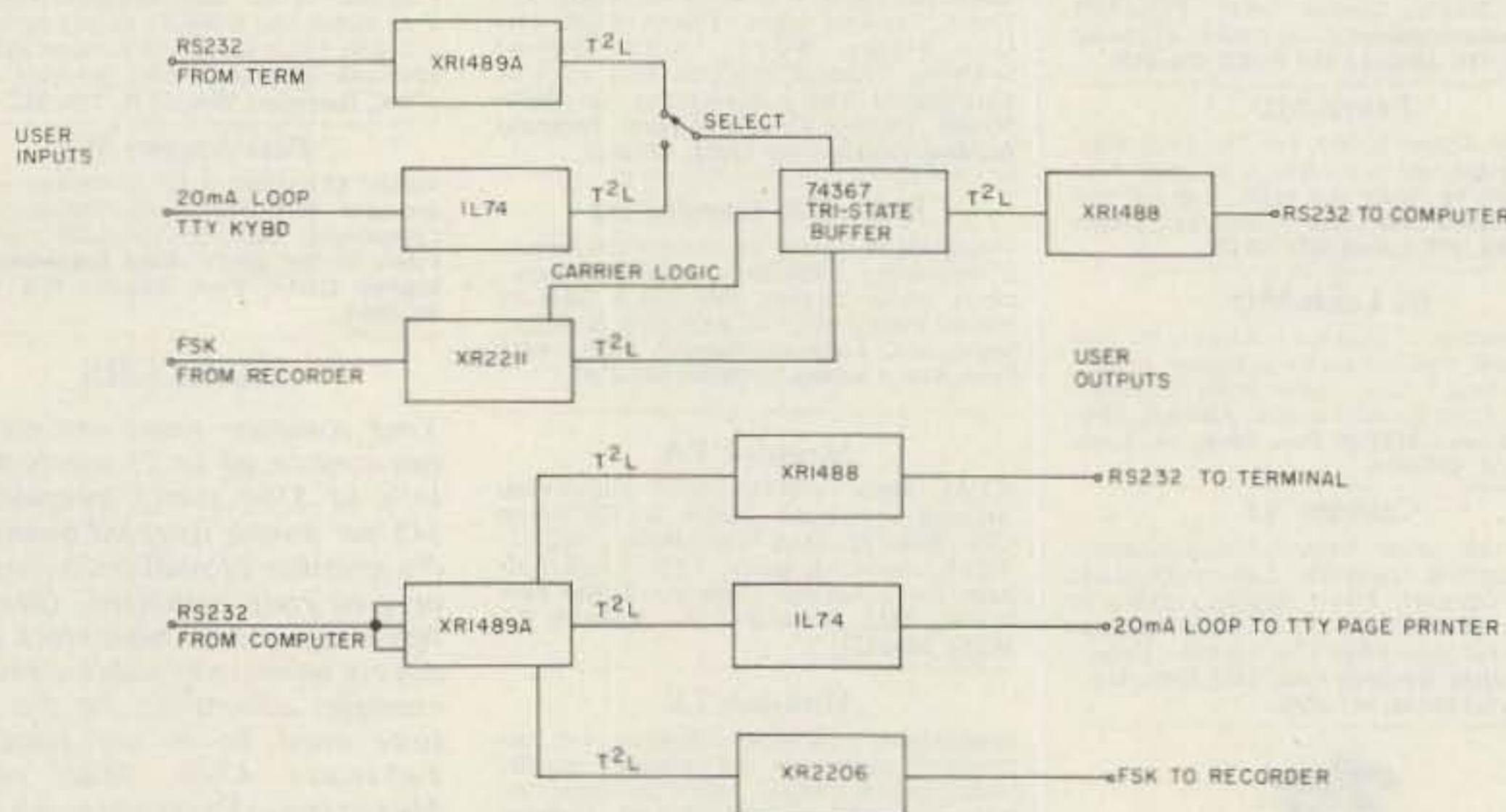

Fig. 1. Block diagram of I/O interface.

Number Fun on your Micro

— explore mathematical curiosities with your TRS-80

Allan S. Joffe W3KBM
1005 Twining Road
Dresher PA 19025

Occasionally, as you sit before your electronic salted peanut (mine being a TRS-80), little phrases and nuggets from outer space float through the cerebral nooks and crannies. On one such occasion, the phrases were "division by subtraction" and "multiplication by addition." Since no momentous things were transpiring on the two meter receiver making up the background sounds, I set out to revisit these two concepts.

Program listing 1 is what I came up with as an an-

swer to division by what might be better termed "successive subtraction." It really turned out to be a chance of renewing acquaintances with the (hopefully) proper use of some of the conditional types of statements available on the TRS-80.

Program listing 2 might just make journalistic history, not for the fact that it is divided into parts, but for the fact that neither part really works. Before you sniff the page in an attempt to see what I might be high on, what is offered here is a chance for the less-than-expert programmers among us to try to get them to work. Two different starting points are shown, and each of them,

as they stand, has very real but opposite problems. If you decide to tackle these program ideas on a dull day, just remember that your final effort has to handle positive and negative numbers in any mix. You will also find it easy to come up with a solution which handles integers, but fractions or decimal parts will be another story.

Let's shift gears for a bit and roll through the "Valley of the Primes." Prime numbers have always held a fascination for math-

ematical types down through the ages, and this same high interest seems to bite every computer buff at one time or another.

As you know, a prime number is an integer which may only be divided by itself and the number 1. All prime numbers are odd numbers by definition, since any even number is a sure bet to be divided by some factor or other. The only exception to this rule is the number 2.

The next interesting fact about primes is that their

```
5 CLS
10 INPUT "DIVIDEND"; X
15 J = 0
20 INPUT "DIVISOR"; N
25 X = X - N
30 J = J + 1
35 IF X/N < 0 GOTO 45
37 IF X/N > 0 GOTO 25
40 IF X < N PRINT J";X/N: STOP
45 IF X/N < 0 THEN J = J + (X/N)
50 PRINT J : STOP
```

Program listing 1. This illustrates the process of division by successive subtraction. If you try a large division such as 1000/1, please be sure to have a good book handy as the computer tiptoes through the loop.

```
A
5 CLS
10 INPUT "MULTIPLIER"; B
20 INPUT "MULTIPLICAND"; J
30 FOR N = 1 TO B
40 X = X + J
50 NEXT N
60 PRINT X
```

```
B
5 CLS
10 INPUT "MULTIPLIER"; B
20 INPUT "MULTIPLICAND"; J
30 N = N + B
40 C = C + 1
50 IF C = J PRINT N: STOP
60 GOTO 30
```

Program listing 2. (a) This is the easiest listing to whip into possible working shape. In its present imperfect form, it has troubles, including not being able to accept values of B less than 1. (b) This is a toughie. Be in a good mood if you tackle it. It has the same assortment of problems as listing (a) in slightly different places. For instance, as it stands, it will not accept values of J which are less than 1.

reciprocals are endless repeating decimals. Some of these reciprocals have interesting characteristics in that the point of repetition is at exactly $n-1$ decimal places (where n is the value of the prime). As an example, $1/7 = .142857142857\dots$. Notice the repeating quality of the decimal string—the repeat taking place after the $n-1$, or 6th, decimal place has been generated.

An example of a prime which does not follow this pattern is 13. $1/13$ generates the pattern $.076923076923\dots$, which shows a double repeat within the $n-1$ framework. The number 19 shows a pattern like that of 7, and repeats after the $n-1$, or 18th, decimal place.

If you are reasonably alert, that statement should ring a small bell, and that bell is what I am leading up to. As you know, even using the

(TRS-80) DEFDBL statement does not allow for more than seventeen decimal places. So how can I get the eighteen places as needed in taking the reciprocal of 19?

Program listing 3 is the little gem which will allow your TRS-80 to spit out decimal places until the cows come home. It is very possible (if you have a great deal of patience) to take the reciprocal of the prime number 499. You can probably watch the decimal places fly by and, after $n-1$ of them, or 498 decimal places, you will then see that 499 is in the same repetitive category as the number 7. Naturally, if you choose to take the reciprocal of some common number such as 2, you will just see $.500000000000\dots$, and the zeroes will spill out all night, or until you call it quits.

While program listings 1 and 3 may be more fun and

```

5 DEFDBL Y
10 INPUT X,Y
20 IF X > Y THEN 50
30 X = X * 10
50 A = INT(X/Y)
60 R = ((X/Y) - A) * Y
70 PRINT A ;
80 X = R
90 GOTO 20

```

(If you want to check primes for their pattern of repetition, you may add the following lines.)

```

15 J = 1
75 J = J + 1
77 IF J = 2 * Y - 1 THEN STOP

```

Program listing 3. These inserted lines will stop the calculations after two complete repetitions have gone through the program. This will allow you to view the type of repetition pattern which the particular prime reciprocal under investigation follows.

instantly applicable to something which you have had in mind but were just too busy to try, don't ignore the learning possibilities in those imperfect listings in Program listing 2. The name of the game in learning to program is practice. Predigested or

cookbook programs are very necessary to avoid constantly reinventing the wheel, but the sooner and more often that you tread the backwaters of programming practice, the sooner you, and not the computer, will be the boss. ■

NEW!



PRB-1 DIGITAL LOGIC PROBE

Compatible with DTL, TTL, CMOS, MOS and Microprocessors using a 4 to 15V power supply. Thresholds automatically programmed. Automatic resetting memory. No adjustment required. Visual indication of logic levels, using LED's to show high, low, bad level or open circuit logic and pulses. Highly sophisticated, shirt pocket portable (protective tip cap and removable coil cord).

- DC to > 50 MHZ
- 10 Nsec. pulse response
- 120 K Ω impedance
- Automatic pulse stretching to 50 Msec.
- Automatic resetting memory
- Open circuit detection
- Automatic threshold resetting
- Compatible with all logic families 4-15 VDC
- Range extended to 15-25 VDC with optional PA-1 adapter
- Supply O.V.P. to ± 70 VDC
- No switches/no calibration

\$36⁹⁵*

* ADD \$2.00 FOR SHIPPING (N. Y. CITY AND STATE RESIDENTS ADD TAX)

OK MACHINE & TOOL CORPORATION 54

3455 Conner St., Bronx, N.Y. 10475 (212) 994-6600 / Telex 125091

Baudot Message Formatter

— in BASIC

If you have ever programmed a PROM with a Baudot message for a RTTY station, you are well aware that the procedure for formatting the message is long and tedious. The manual approach, with repeated trial and error code table searches and trial "fittings," often leads to programming errors and short tempers.

Here is a BASIC program designed to make Baudot message formatting a quick and simple task.

The program is written in Microsoft™ extended BASIC, but can easily be adapted to any BASIC having string-variable capability.

An address offset capability is provided which allows joining message seg-

ments to form a message of unlimited length. The offset feature is also very useful when moving message segments about in the program field.

Special ASCII characters are provided on input to allow representation of

non-printing Baudot characters.

The program output is tabular and consists of the PROM address (relocatable), character to be programmed, octal value of the character, and the 5-bit binary pattern to be programmed.

Lines 10-160 print the instructions. Lines 170-230 input the message to be programmed and set up the output table. The remainder of the program consists of an incremental data table search, an output data "filter," and a print command.

The program checks for valid Baudot characters and flags any ASCII non-equivalence.

For those of you who dislike typing programs with lengthy data tables, a paper tape of the program is available from the author. ■

```

10 FOR I=1 TO 4:PRINT:NEXT I
20 PRINT "BAUDOT PROM FORMATTER"
30 PRINT "J.W. YOUNG ... W6RLL"
40 PRINT "MARCH 1979"
50 PRINT:PRINT
60 PRINT "ON INPUT MAKE THE FOLLOWING ASCII FOR BAUDOT SUBSTITUTIONS:"
70 PRINT:PRINT
80 PRINT TAB(20); "BAUDOT          ASCII"
90 PRINT TAB(20); "-----":PRINT
100 PRINT TAB(20); "CR              *"
110 PRINT TAB(20); "LF              +"
120 PRINT TAB(20); "LETTERS        <"
130 PRINT TAB(20); "FIGURES        >"
140 PRINT TAB(20); "BLANK          %"
150 PRINT TAB(20); "BELL           ="
160 E$=" ... NO BAUDOT EQUIVALENT FOR "
170 PRINT:PRINT:PRINT "INPUT MESSAGE":PRINT
180 LINE INPUT A$
190 PRINT:PRINT
200 INPUT "DESIRED ADDRESS OFFSET";O:PRINT:PRINT:O=INT(O)
210 PRINT:PRINT:PRINT "ADDRESS", "CHARACTER", "OCTAL", "B4-B0"
220 PRINT "-----", "-----", "-----", "-----"
230 PRINT:PRINT
240 FOR I=1 TO LEN(A$):T$=MID$(A$,I,1)
250 IF T$=CHR$(34) THEN PRINT (I-1)+O,T$,"021","10001":GOTO 380
260 RESTORE
270 FOR J=1 TO 200
280 READ B$
290 IF B$="ERROR" THEN PRINT B$+E$+T$:PRINT:PRINT:PRINT:END
300 IF B$=>T$ THEN NEXT J
310 IF B$="*" THEN B$="CR":GOTO 370
320 IF B$="+" THEN B$="LF":GOTO 370
330 IF B$="%" THEN B$="BLANK":GOTO 370
340 IF B$="<" THEN B$="LETTERS":GOTO 370
350 IF B$="=" THEN B$="BELL":GOTO 370
360 IF B$=">" THEN B$="FIGURES"
370 PRINT (I-1)+O,,:PRINT B$,:READ B$:PRINT B$,:READ B$:PRINT B$
380 NEXT I
390 PRINT:PRINT
400 DATA 0,003,00011,8,031,11001,C,016,01110,D,011,01001,E,001,00001
410 DATA 0,015,01101,G,032,11010,H,024,10100,I,006,00110,J,013,01011
420 DATA 0,017,01111,L,022,10010,M,034,11100,N,014,01100,O,030,11000
430 DATA 0,026,10110,Q,027,10111,R,012,01010,S,005,00101,T,020,10000
440 DATA 0,007,00111,V,036,11110,W,023,10011,X,035,11101,Y,025,10101
450 DATA 0,021,10001," ",004,00100,* ,010,01000,+ ,002,00010
460 DATA 0,000,00000,>,033,11011,<,037,11111,=,005,00101,
470 DATA 0,003,00011,?,031,11001,":",016,01110,$,011,01001,3,001,00001
480 DATA 0,015,01101,&,032,11010,#,024,10100,8,006,00110,' ,013,01011
490 DATA 0,017,01111,) ,022,10010,.,034,11100," ,014,01100,9,030,11000
500 DATA 0,026,10110,1,027,10111,4,012,01010,5,020,10000
510 DATA 0,007,00111,"; ",036,11110,2,023,10011,/,035,11101,6,025,10101
520 DATA ERROR

```

Table 1. Program listing.

ON INPUT MAKE THE FOLLOWING ASCII FOR BAUDOT SUBSTITUTIONS:

| BAUDOT | ASCII |
|---------|-------|
| ----- | ----- |
| CR | * |
| LF | + |
| LETTERS | < |
| FIGURES | > |
| BLANK | % |
| BELL | = |

INPUT MESSAGE

+<<THIS IS JOE W>6<RLL NNNN+<<

DESIRED ADDRESS OFFSET

0

| ADDRESS | CHARACTER | OCTAL | B4-B0 |
|---------|-----------|-------|-------|
| ----- | ----- | ----- | ----- |
| 0 | CR | 010 | 01000 |
| 1 | LF | 002 | 00010 |
| 2 | LETTERS | 037 | 11111 |
| 3 | LETTERS | 037 | 11111 |
| 4 | T | 020 | 10000 |
| 5 | H | 024 | 10100 |
| 6 | I | 006 | 00110 |
| 7 | S | 005 | 00101 |
| 8 | | 004 | 00100 |
| 9 | I | 006 | 00110 |
| 10 | S | 005 | 00101 |
| 11 | | 004 | 00100 |
| 12 | J | 013 | 01011 |
| 13 | O | 030 | 11000 |
| 14 | E | 001 | 00001 |
| 15 | | 004 | 00100 |
| 16 | W | 023 | 10011 |
| 17 | FIGURES | 033 | 11011 |
| 18 | 6 | 025 | 10101 |
| 19 | LETTERS | 037 | 11111 |
| 20 | R | 012 | 01010 |
| 21 | L | 022 | 10010 |
| 22 | L | 022 | 10010 |
| 23 | | 004 | 00100 |
| 24 | N | 014 | 01100 |
| 25 | N | 014 | 01100 |
| 26 | N | 014 | 01100 |
| 27 | N | 014 | 01100 |
| 28 | CR | 010 | 01000 |
| 29 | LF | 002 | 00010 |
| 30 | LETTERS | 037 | 11111 |
| 31 | LETTERS | 037 | 11111 |

Table 2. Sample run.

ITEM NO.
WK-7

CMOS SAFE

IC INSERTION/EXTRACTION KIT

✓ 54

- KIT INCLUDES**
- MOS-1416 14-16 CMOS SAFE INSERTER
 - EX-1 14-16 EXTRACTOR
 - MOS-2428 24-28 CMOS SAFE INSERTER
 - EX-2 24-40 CMOS SAFE EXTRACTOR
 - MOS-40 36-40 CMOS SAFE INSERTER



OK MACHINE & TOOL CORPORATION
3455 CONNER ST., BRONX, N.Y. 10475 U.S.A.
PHONE (212) 994-6600 TELEX NO. 125091



PRINTED IN U.S.A.

PATENT PENDING

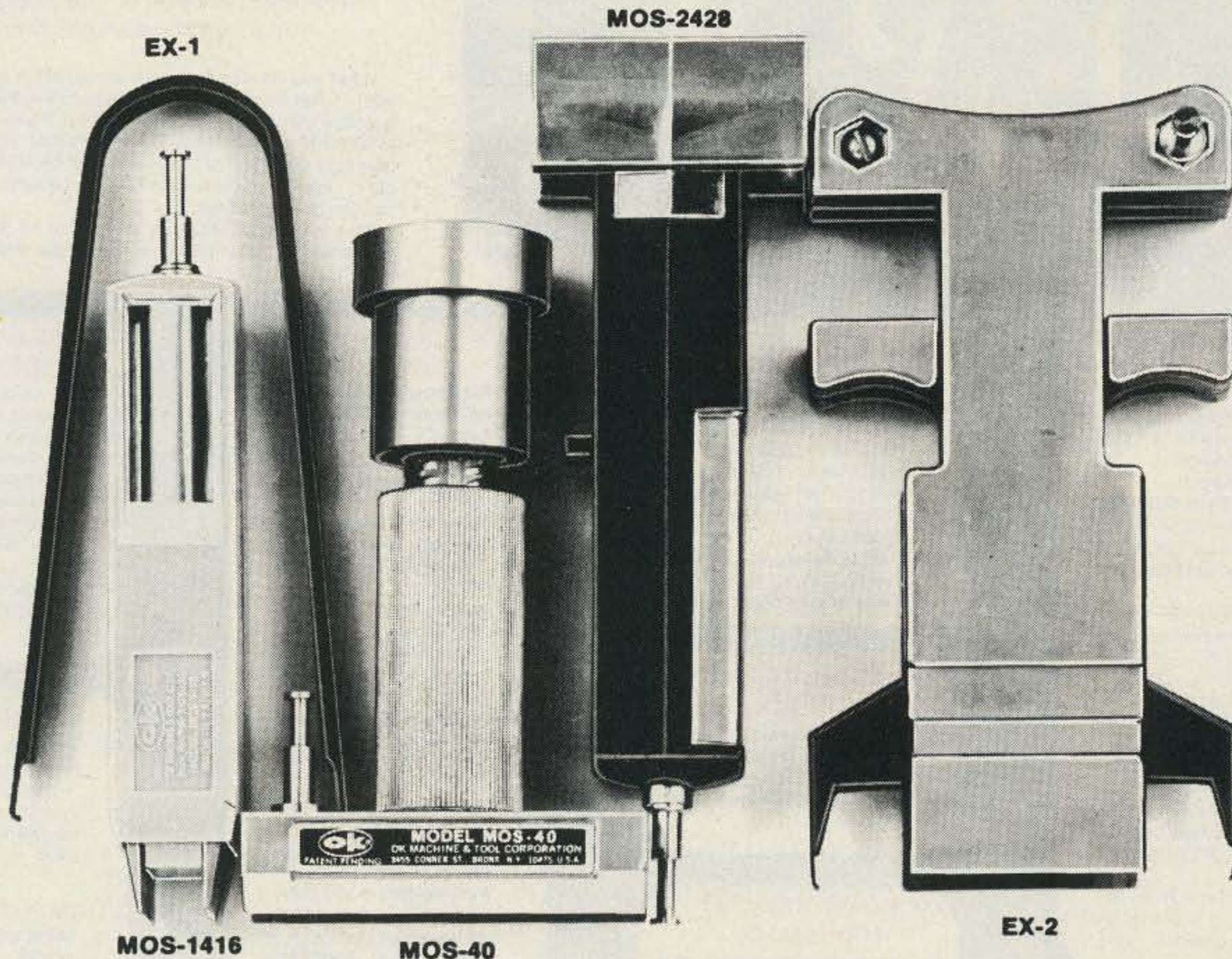

| | | |
|------|------------------------------------|---------|
| WK-7 | COMPLETE IC INSERTER/EXTRACTOR KIT | \$29.95 |
|------|------------------------------------|---------|

INDIVIDUAL COMPONENTS

| | | |
|----------|------------------------------------|---------|
| MOS-1416 | 14-16 PIN MOS CMOS SAFE INSERTER | \$ 7.95 |
| MOS-2428 | 24-28 PIN MOS CMOS SAFE INSERTER | \$ 7.95 |
| MOS-40 | 36-40 PIN MOS CMOS SAFE INSERTER | \$ 7.95 |
| EX-1 | 14-16 PIN EXTRACTOR TOOL | \$ 1.49 |
| EX-2 | 24-40 PIN CMOS SAFE EXTRACTOR TOOL | \$ 7.95 |

MINIMUM BILLING \$25.00. ADD SHIPPING CHARGE \$2.00. NEW YORK RESIDENTS ADD APPLICABLE TAX.

OK MACHINE & TOOL CORPORATION 3455 CONNER ST., BRONX, N.Y. 10475 (212) 994-6600/TELEX 125091

MOM'S 20% OFF

Inventory Clearance SALE

MAIL ORDER MICROS
 Dept M73 • PO Box 427 • Marlboro NH 03455
 Phone: (603) 924-3041

IMSAI HARDWARE

- 1 IMSAI 8800 Mainframe S-100—Excellent condition. #D0087-\$839.
- 1 IMSAI 80/15 S-100 Development System—Partially assembled, needs a CPU card, excellent condition. #S0088-\$525 as is. **SPECIAL PRICE.**
- 1 IMSAI 80/15 S-100 Development System—Kit, mainframe cover missing, needs a CPU card, excellent condition. #S0089-\$500 as is. **SPECIAL PRICE.**
- 2 IMSAI 4K RAM card—S-100, good condition. #D0055-\$89.60

IMSAI SERIAL I/O CARDS

- 1 IMSAI Serial I/O card 2-2—Two serial ports, full RS-232 control, S-100, good condition. #D0090-\$188.
- 5 IMSAI Serial I/O card 2-2 (kit)—Two serial ports, full RS-232 control, S-100, new. #D0091-\$124.
- 2 IMSAI Serial I/O card 2-1 (kit)—One serial port, full control RS-232 control, S-100, new. #D0092-\$100.

IMSAI PARALLEL I/O CARDS

- 1 IMSAI Parallel I/O card 4-4—Four parallel ports, S-100, excellent condition. #D0093-\$186.
- 1 IMSAI Parallel I/O card 4-1 (kit)—One parallel port, S-100, new. #D0094-\$74.40.

IMSAI SOFTWARE

- 2 IMSAI IMDOS V2.02 on 8" Disk for S-100—No documentation, but this is apparently IMSAI's version of CP/M for S-100 systems with an IMSAI Disk Controller. #D0056-\$96 each.
- 2 IMSAI BASIC 9A—This BASIC is for an S-100 system with a TARBELL cassette interface. #D0057-\$22.
- 1 TARBELL Cassette Interface (kit)—Kansas City Interface, Tarbell Phase encoding, S-100, new. #D0064-\$96.

PHONE INTERFACE

- 6 Novation Modem #3102A—Connects to any phone, originate only, good condition. #S021-\$165 each. **SPECIAL PRICE.**
- 2 Novation Modem #31—Connects to any phone, originate only, good condition. #S022-\$200 each. **SPECIAL PRICE.**
- 1 Novation Modem #43—Connects to any phone, originate only, good condition. #S023-\$165. **SPECIAL PRICE.**

VECTOR GRAPHIC S-100

- 3 Vector Graphic ROM/RAM card—12K empty ROM sockets, 1K RAM, excellent condition. #D0078-\$119.60.
- 5 Vector Graphic Analog Interface—Allows hobbyist to interface analog experiments, S-100, new. #D0079-\$79.20.
- 1 Vector Graphic Analog Interface (kit)—As above, S-100, new. #D0080-\$55.60.

TDL ZAPPLE

- 2 TDL Z-80 8K BASIC—This is for a Z-80 system with a ZAPPLE Monitor. #D0071-\$30.
- 1 TDL ZAPPLE 2K Monitor—Nice monitor to start a system with. #D0072-\$16.
- 3 TDL ZAP 1K Monitor—Simple monitor. #D0073-\$12.

TDL HARDWARE

- 2 TDL ZPU Z-80 CPU—S-100 CPU with adjustable clock 0-4 MHz, good condition. #D0062-\$159.
- 1 TDL Systems Monitor Board—Contains system software including monitor, S-100, good condition. #D0063-\$140.

HONEYWELL

- 15 Honeywell ASR-33 Communications Consoles with TTY, paper tape reader and punch. Used, working when removed from service. Shipped freight collect or you pick up. Weight 300 lbs. \$395. Order #P006.

TDL TEXT PROCESSOR

- 2 TDL Text Output Processor—Text processor. #D0074-\$16.
- 1 TDL Text editor—Nice editor. #D0075-\$12.
- 1 TDL Memory Test—Simple utility. #D0076-\$4.

TDL SOFTWARE-DISK

- 1 TDL FDOS & SuperBASIC on 8" Disk—This requires an ICOM Disk Controller and at least 20K of memory, plus a ZAPPLE Monitor in an S-100 Cabinet (Altair, IMSAI, etc.). #D0065-\$137.
- 1 TDL System Software on 5 1/4" disk—This set of system software requires a North Star Disk Controller, a TDL Systems Monitor Board I, and consists of 12K BASIC, Relocator/Linking Loader, Z-80 Editor, and Text Processor. #D0066-\$183.
- 1 TDL System Software on 5 1/4" disk—This is the same as above, but does not require the Systems Monitor Board I. #D0067-\$200.
- 1 TDL System Software on 5 1/4" disk—Again, as above, but requires a HELIOS Disk Controller and the TDL Systems Monitor Board II (not I). #D0068-\$183.

TDL SOFTWARE-CASSETTE

- 1 TDL BASIC V2.1 on cassette—Disk version. #D0069-\$12.
- 1 TDL System Pack—This is the same as the Disk Pack. #D0070-\$136.

MOUNTAIN HARDWARE

- 7 Mountain Hardware AC Controller—Remote AC outlet control, S-100, new. #D040-\$100 each.
- 4 Mountain Hardware remote outlet—Remote module for above, two channels, new. #D041-\$72 each.

HEURISTICS SPEECH LAB

- 1 Heuristics Speech Lab—S-100, used, fair condition. #S042-\$100 as is. **SPECIAL PRICE.**
- 4 Heuristics Speech Labs—S-100, new. #D043-\$151 each.

SHUGART MINIDISK DRIVES

- 1 Shugart MiniDisk Drives—No cabinet, good condition. #S036-\$320. **SPECIAL PRICE.**
- 4 Shugart MiniDisk Drives—No cabinet, good condition. #S037-\$300 each. **SPECIAL PRICE.**
- 4 Power Supplies for above—good condition. #S038-\$30 each. **SPECIAL PRICE.**

Prices include 20% discount. **SPECIAL PRICE** includes more than 20% discount.

Quantities are limited, immediate refund if ordered item is no longer available. Please read terms below.

TERMS: FOB Marlboro, NH USA. Limited stock; everything guaranteed as described; you pay postage on returns. PRINT orders clearly. Minimum order \$10 plus \$2.50 shipping and handling charge in USA only. **DOUBLE THAT ELSEWHERE.** Orders over \$50 add 5% for shipping in USA; 10% elsewhere (we will refund excess). Orders shipped UPS or insured mail only. Send US funds by check or money order. For credit card purchases, add 4%, list AE, MC or VISA, number, and expiration date. Mail to MOM'S, Department M73, PO Box 427, Marlboro NH 03455.

Condition of Inventory:
 New = original container
 Excellent = new, but not in original container
 Good = tested or used in store

| Qty | Catalog # | Description | Unit Price | Total |
|-----|-----------|-------------|------------|-------|
| | | | | |
| | | | | |
| | | | | |
| | | | | |
| | | | | |
| | | | | |
| | | | | |
| | | | | |
| | | | | |
| | | | | |

Enclosed \$ _____

Bill: AE MC VISA

Card no. _____

Name _____

Address _____

City _____

Ship: UPS

Insured mail Signature _____

MOM'S
 MAIL ORDER MICROS
 Dept M73 • PO Box 427 • Marlboro NH 03455
 Phone: (603) 924-3041

Shipping & Handling _____

Credit Card (+4%) _____

Total _____

Exp Date _____

State _____ Zip _____

DSI CONTINUES TO DO IT

Best Price to Quality Features Ratio

FACTORY WIRED 500 MHz or 1 GHz • 8 Digits 1 PPM • TCXO

109⁹⁵

5500 WIRED

50 Hz to 512 MHz

5510 WIRED

139⁹⁵ 50 Hz to 1 GHz



10 MHz OVEN TIME BASE 500 MHz or 1.2 GHz

169⁹⁵

5600 KIT

50 Hz to 512 MHz

199⁹⁵

5612 KIT

50 Hz to 1.2 GHz



TRUE RMS — 3 1/2 Digits — DMM — .1% Basic Accuracy

169⁹⁵

LC 5000

FACTORY
WIRED



1GHz For Only \$139.95

Compare these features and you will buy *DSI*

5500/ 5510 STANDARD FEATURES

- 5510 - 50 Hz to 1GHz
- 5500 - 50Hz to 512MHz
- Made in U.S.A.
- 8 Digits not 6 or 7
- 1PPM TCXO not 1.5PPM or 10PPM
- Resolution 1Hz @ 50MHz not 10Hz

With the introduction of the 5510 *DSI* has filled a long standing void in the frequency counter market place. You now have the choice of selecting a 512 MHz model 5500 for around a \$100 or for only \$30.00 more you can buy an 8 digit 1GHz counter model 5510. With this 1GHz capability the new world of 960 MHz is immediately available to you. Both the 5500 and 5510 are available with a rechargeable battery pack which includes the AC adapter and battery charger for one low price. Whether you select the 5500 or the 5510 you will receive the best price to quality features ratio in the industry, no wonder *DSI* has become one of the world's largest manufacturers of high quality frequency counter instrumentation.

9 DIGITS 1.2 GHz FOR ONLY \$199.95

- 5612 - 50Hz to 1.2GHz
- 5600 - 50Hz to 512MHz
- External 10MHz inputs & outputs
- 10MHz 2PPM 10°-40° C Preportional oven
- 9 large 1/2 inch LED Readouts
- .1Hz Resolution to 50MHz

Why buy a 5600A or 5612 kit? Because 95% of the assembly is completed by *DSI* and you are only one hour away from solving all those difficult bench problems, from setting the frequency of an audio signal to within 1/10 of a Hz, to checking the frequency of a 960 MHz mobile radio. Whether you are servicing a VTR, trouble shooting a PLL circuit, the 5600A/5612 is the right counter with accuracy that will meet any FCC land mobile, broadcast, or telecommunications requirements. On the bench or in the field the 5600A/5612 will do the job you need. The 5600/5612 includes a self contained battery holder providing instant portability of *DSI* offers a 10 hour rechargeable battery pack option. In addition *DSI* offers an audio multiplier which allows you to resolve a 1/1000 of a Hz. The 5600A/5612 is perfect for communications, TV servicing, industrial testing or meeting your QSO on the correct frequency every time.

LARGE LCD READOUTS-PRECISION LASER TRIMMED RESISTOR NETWORKS

- AC TRUE RMS to 1000v — 200mv, 2v, 20v, 200v, 1000v
- DC VOLTAGE to 1000v — 200mv, 2v, 20v, 200v, 1000v
- DC CURRENT to 2 amps — 200ma, 2ma, 20ma, 200ma, 2a
- RESISTANCE to 20 megohms — 200, 2k, 20k, 2 meg, 20 meg
- AUTOMATIC POLARITY INDICATOR

FOR INFORMATION — DEALER LOCATION — ORDERS — OEM
 CALL 800-854-2049 CALIFORNIA RESIDENTS CALL 800-542-6253

| Model | Price | Frequency Range Typ | Accuracy Over Temperature | Sensitivity Typ | | | Number of Readouts | Power Requirements | Size H W D |
|-------------|----------|---------------------|---|-----------------|-------------|--------------|--------------------|---|----------------------|
| | | | | @ 100Hz-25MHz | @ 50-250MHz | @ 250-450MHz | | | |
| 5600A-Kit | \$169.95 | 50Hz-550MHz | Proportional Oven .2 PPM 10° - 40° C | 5-10mv | 5-10mv | 5-50mv | 9 | *115 VAC or 8.2-14.5 VDC | 3 1/4" x 9 1/2" x 9" |
| 5600A-Wired | \$199.95 | | | 5-10mv | 5-10mv | 5-50mv | | | |
| 5612Kit | \$199.95 | 50Hz-1.2 GHz | Proportional Oven .2 PPM 10° - 40° C | 5-10mv | 5-10mv | 5-50mv | 9 | *115 VAC or 8.2-14.5 VDC | 3 1/4" x 9 1/2" x 9" |
| 5612 Wired | \$239.95 | | | 5-10mv | 5-10mv | 5-50mv | | | |
| 5500 Wired | \$109.95 | 50Hz-512MHz | TCXO 1 PPM 17° - 40° C | 10-25mv | 10-15mv | 15-50mv | 8 | 115 VAC or 8.2-14.5 VDC or NICAD PAK. | 1 1/2" x 5" x 5 1/2" |
| 5510 Wired | \$139.95 | 50Hz-1GHz | | 10-25mv | 10-15mv | 15-50mv | | | |

Factory wired units carry 1 year limited warranty kits carry a 90 day limited warranty.
 Prices and/or specifications subject to change without notice or obligation.

*With AC-9 Adapter

Prices effective
Feb. 1, 1980

- 5510 Wired 139.95
- 5500 Wired 109.95
- 5510/BAC Wired 164.95
- 5500/BAC Wired 134.95
- T600 BNC ANT (all models) 7.95
- AC-9 AC Adapter(all models) 7.95
- LC 5000 169.95

INTERNAL BAT. ONLY AC-9 NOT REQUIRED.



DSI INSTRUMENTS, INC.

9550 Chesapeake Drive
 San Diego, California 92123
 (714) 565-8402

TERMS: MC — VISA — AE — CHECK — M.O. — COD
 in U.S. Funds. Please add 10% to a maximum of \$10.00
 for shipping, handling and insurance. Orders outside
 of USA & Canada, please add \$20.00 additional to
 cover air shipment. California residents add 6% Sales Tax

- 5612 Kit 199.95
- 5612 Wired 239.95
- 5600A Kit 169.95
- 5600A Wired 199.95
- BA56 Rechargeable
- 10 Hr. Bat. Pack 29.95
- AM-56 Audio Multiplier
- .001 Hz Resolution 34.95

Lab-Quality Hi I Supply

— part I

There is nothing as handy or as necessary as a good power supply on your test bench. Yet, because good power supplies cost so much, few of us can really afford to buy one. I think it is time to do something about that, and thus, here-described, is a laboratory-quality power

supply capable of serving probably all of your needs.

The Hi I power supply has all of the features of the best laboratory supplies. You get an adjustable, fully-regulated output of 0- to 15-volts dc. The regulation is excellent—typically ensuring less than a 10-mV drop over the volt-

age range. The dc output is well filtered, too, with negligible ripple over the voltage/current ranges. And this supply will cause minimum interference to sensitive communications equipment, since simple noise-filtering has been included in the design.

There is adjustable cur-

rent-limiting built in, and you can adjust for the maximum current delivered to the load—an important feature that can save equipment if a short is present. Included in this unit is provision for external sensing; this feature, found in the best high-current supplies, compensates for long power leads, insuring that the load gets full power at all times. This is a vital feature and will be discussed in more detail, but for now it's enough to say that it's necessary with heavy loads. You get a laboratory power supply with easy adjustment of voltage and current plus an optional digital display of each value and, to top it off, you can draw up to 20 Amperes. Needless to say, if you have been wanting to build a top-quality power supply, this might be your best bet!

Construction of this type of project is not especially hard, but it is best tackled by someone who is well-versed in soldering techniques and in the ability to follow a schematic. This just makes the project easier and increases your

Photos by Roger Wilcox

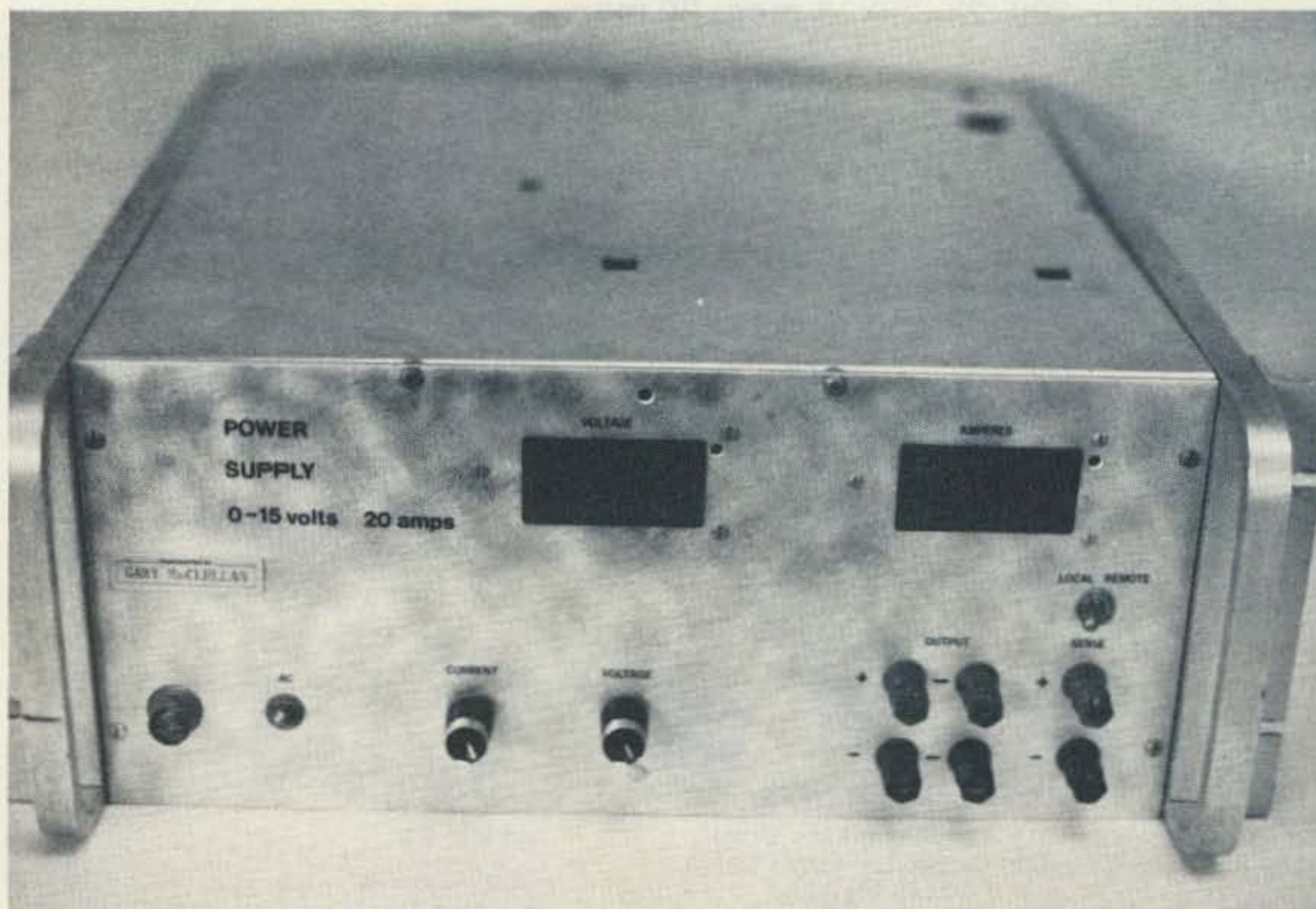

Photo A.

chances of success the first time the unit is powered. Like most heavy-duty power supplies, this one is big. The circuitry is arranged on a pair of heat sinks and on a plug-in PC card. Aside from a filter capacitor and power transformer mounted on the bottom of the case, the few other components mount on the front panel. Construction is fairly easy, and the most time will be spent wiring together the previously-mentioned components. The bulk of this project is on a single PC card which is easily built. In short, everything possible has been done to make this project easy to build.

Most of the components in this project are easy to get through surplus dealers listed in the back of this magazine. Feel free to raid your junk box for any parts not readily available. Most of the parts you will be hunting up will be power transistors and resistors. They are common in surplus. There are two potentially tough components to obtain: the power transformer and rectifiers. Since 30-Amp power transformers and 40-Amp rectifiers aren't especially common, even in surplus, special attention has been paid to locating these parts and in describing workable substitutes. The prototype cost around \$65, using new and surplus parts, but this is a mere fraction of what commercial units cost (about \$400).

One thing that may have entered your mind as you read this article is, "why a 20-Amp capacity?" The answer is simple. If you do any work on high-current logic such as TTL memories, or work on communications equipment, you need a high-current capacity. This is especially true in the communications field where transmitter power is rising and

more is required of the power supply. Besides, using a messy storage battery to power communications equipment is definitely outdated. This supply has the power capacity for both simple low-power circuitry and those heavy-duty jobs, so you won't be stuck with using storage batteries as many people are.

Circuit Data

The Hi I power supply is based on a classic series-pass type of voltage-regulator circuit. It uses a total of three ICs and eight power transistors for up to 20 Amps of output. One of the ICs is a constant-voltage reference which provides a voltage to an error op amp. The error-op amp compares the reference voltage to the output voltage of the power supply and adjusts the power transistors so that the two voltages are the same. This process is continuous, and keeps the output voltage constant regardless of load on the power supply.

A rather simplified idea of how the power supply works is shown in Fig. 1(a). (In these diagrams, unnecessary parts such as resistors have been left out to give you a clearer picture of what's going on.) The heart of this power supply is IC2, a 741-style dual op amp. It serves as an error amplifier, and the job of voltage regulation starts here. Its job is rather simple in that it strives to keep the dc levels on both inputs equal at all times. Let's look at another important part—IC1. This is a three-terminal voltage regulator, and it puts out 10 stable volts. This voltage is divided through pot R33, which serves as the front panel voltage-adjust control. The voltage off the pot drives one op amp input of the error amplifier. Next, the output voltage

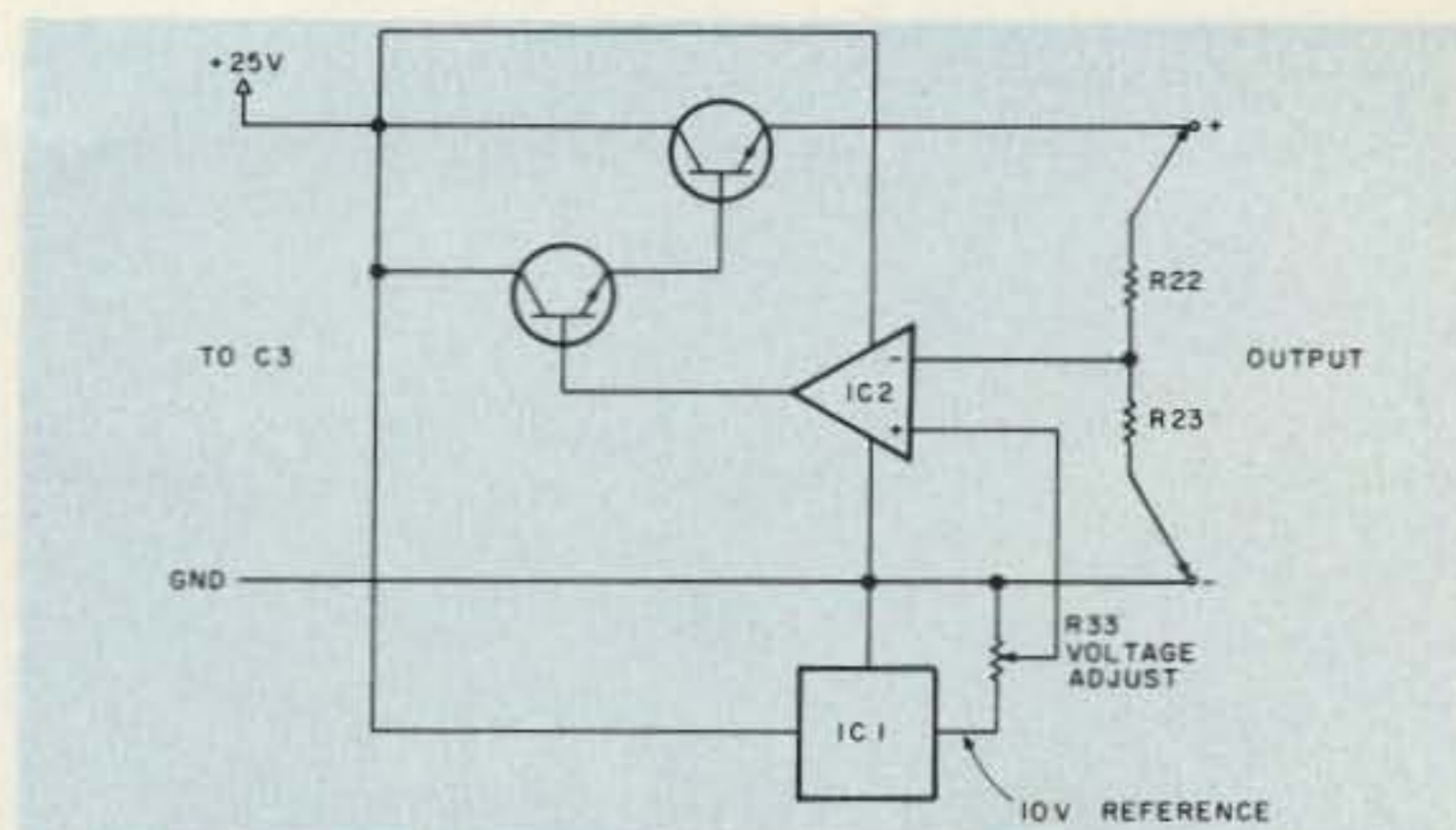

Fig. 1(a). Basic voltage regulation circuit.

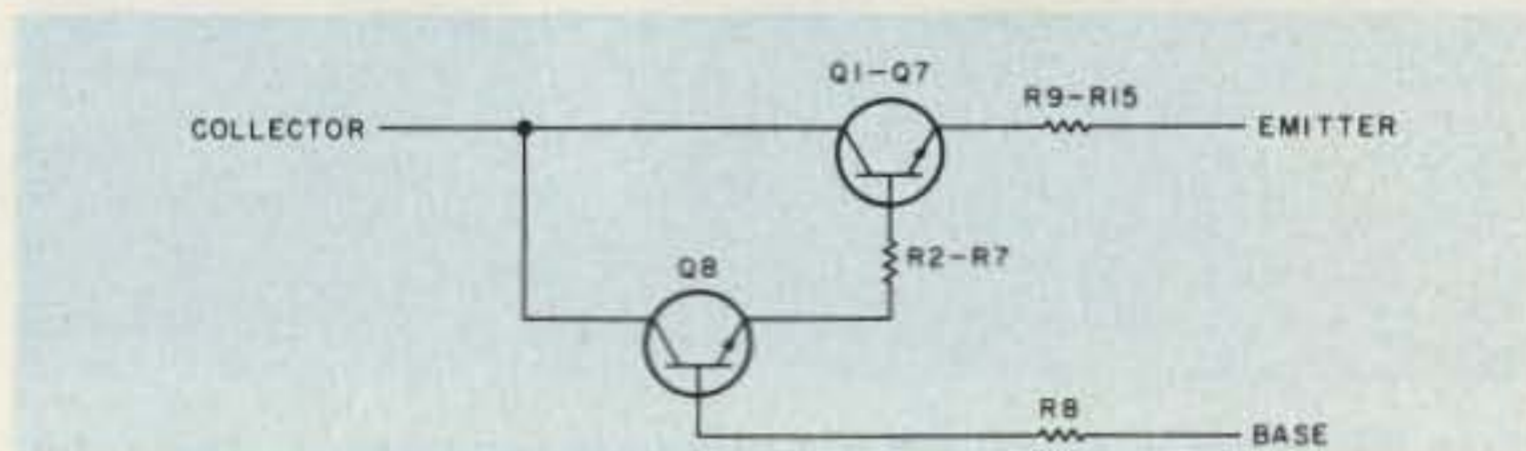

Fig. 1(b). Basic Darlington transistor.

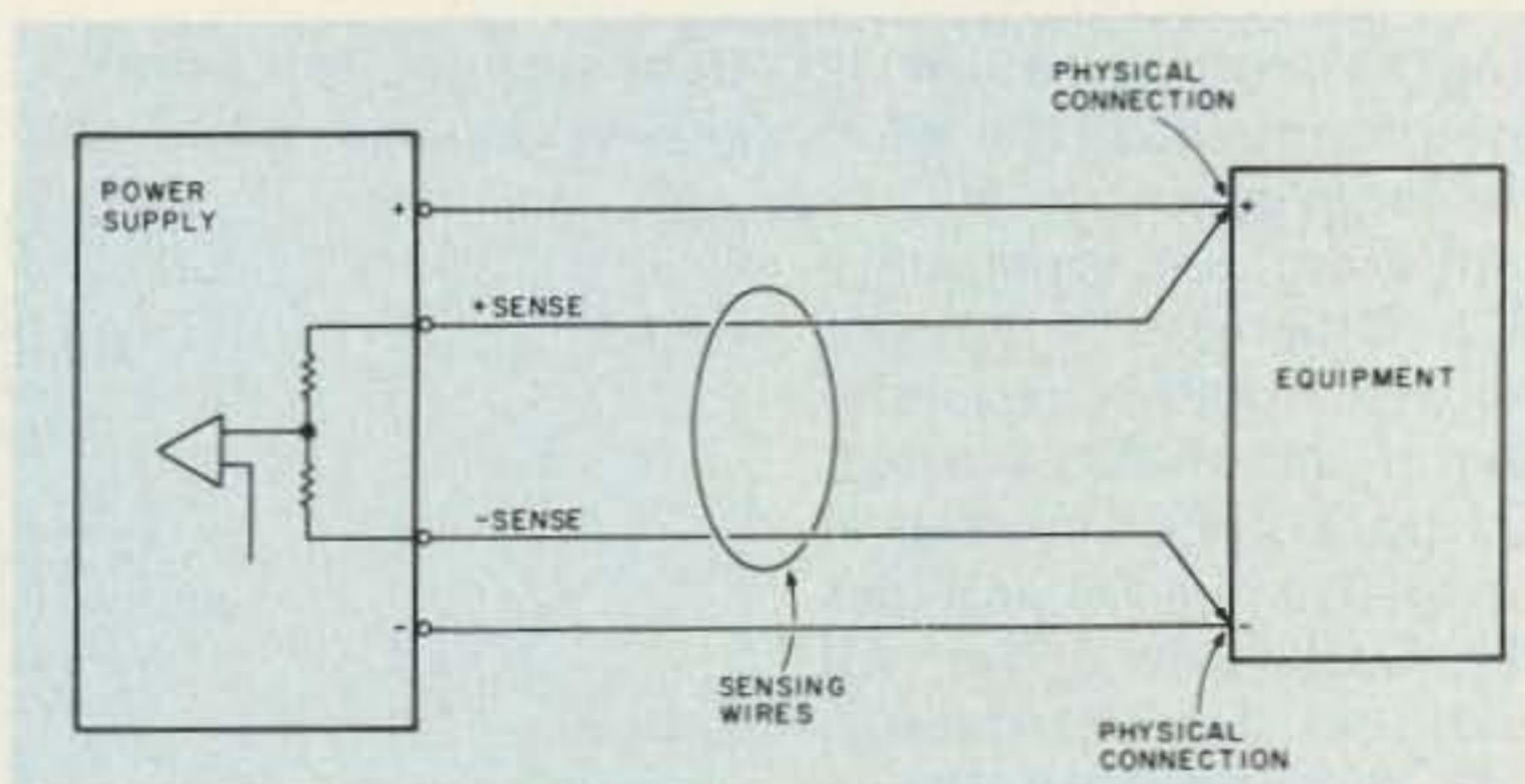

Fig. 2. Hookup for external sensing.

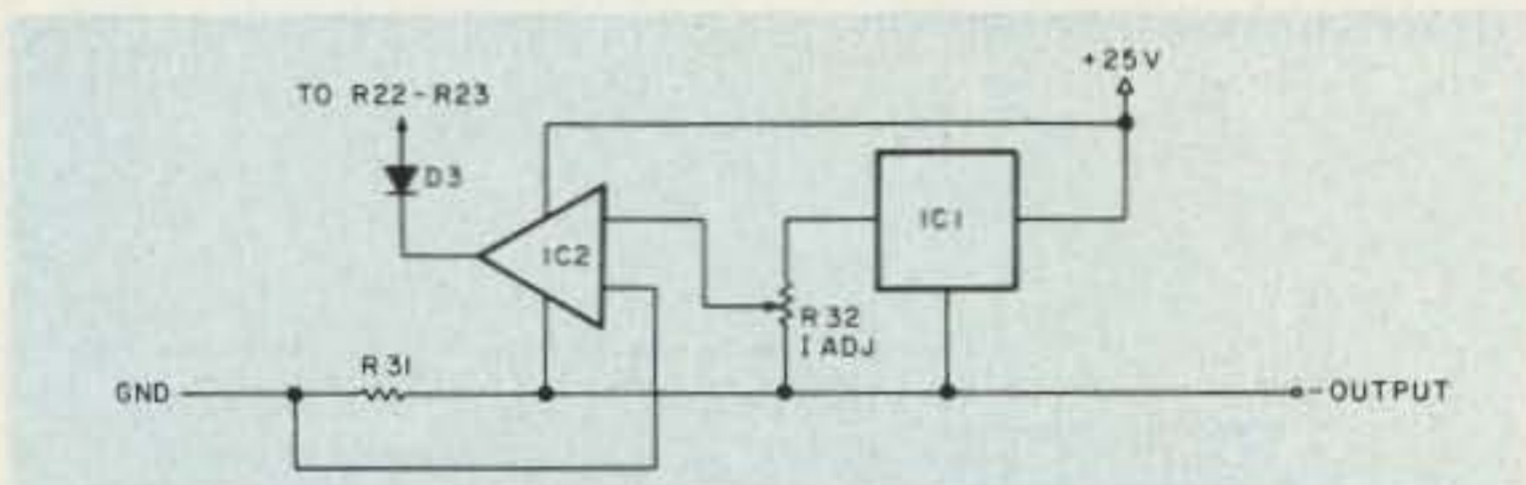

Fig. 3. Basic current-limiting circuit.

from the panel output jacks is scaled down by resistors R22 and R23. As a result, an output of 0 to 15 volts on the jacks appears as 0 to 10 volts at the resistor junction. This scaled voltage is connected to the other op amp input, and the error amp, IC2, compares the inputs. If, say, the scaled-voltage input is low compared to the reference input, the op amp will drive the power transistors harder, raising the supply voltage until the two error amp inputs are

equal. If, suppose, the scaled input to the op amp is higher than the reference input, the reverse will happen—the transistors will receive less current and the output voltage will fall.

One important area that hasn't been discussed concerns the power transistors. There are eight silicon, 150-Watt NPN devices wired as a big Darlington transistor. This is done since 20-Amp Darlington transistors are hard to get, and 8 discrete transistors tend to be cheap in surplus. A Dar-

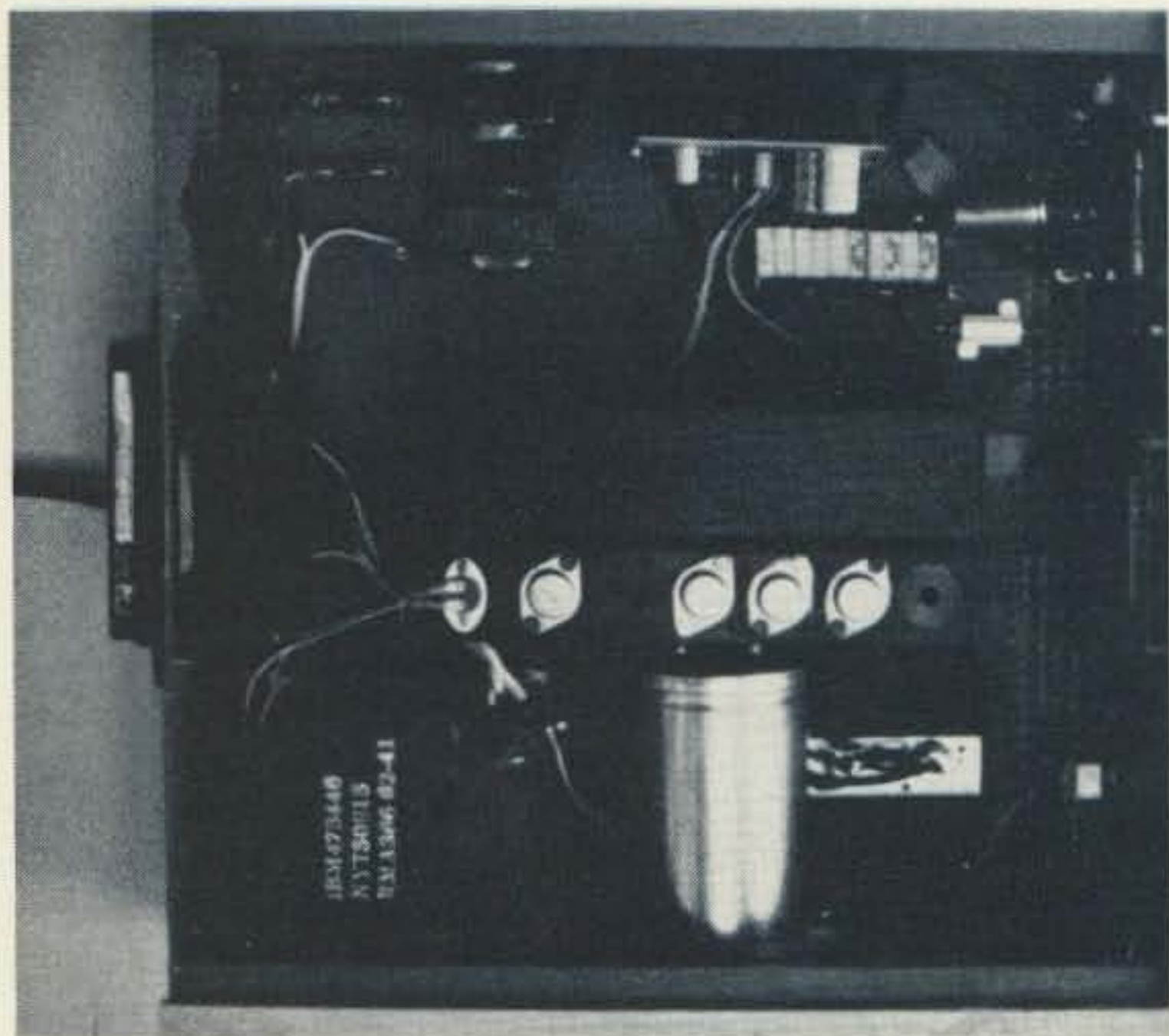

Photo B. This is a top view of the power supply, showing the location of the principal parts.

lington configuration is used to minimize the need for large amounts of current from the error amp, IC2. Otherwise, a current booster would be required. In this unit, the Q1 through Q7 transistors are wired in parallel, while Q8 provides the Darlington driver. All those resistors, R2 through R15, are necessary to prevent "current hogging," a condition whereby one

transistor runs hot from excessive current while one

near it runs cold from insufficient current. These resistors help to ensure longer life from the power transistors; they are shown more fully on the schematic.

While on the subject of voltage regulation, the connections for sensing and the reason for external sensing must be discussed. When you deal with high currents you invariably find that various voltage drops prevent you from getting the same voltage at your equipment as at the power supply. This voltage drop results from resistance in the connectors and cable, and increasing the current levels aggravates this problem. The solution is twofold. First, the wire size in the cable

should be large enough to handle the load current—and it should be kept as short as possible. This part of the solution can help tremendously, but external sensing can ensure that the load receives the proper voltage. To provide this, the ends of resistors R22 and R23 are brought out to binding posts on the front panel. Each post is connected *directly* to the power terminals of the load or equipment. This is shown in Fig. 2. The important thing to remember is that these wires are connected *physically* to the equipment's power terminals. Thus, the power supply will automatically adjust for the correct voltage at the equipment and ignore voltage drops in the cable and connectors.

The current-limiting circuitry is formed by the second section of op amp IC2, voltage-reference IC1, and R31. In operation, IC1, a 10-volt regulator, supplies 10 volts to resistor R27 and pot R32. The voltage is

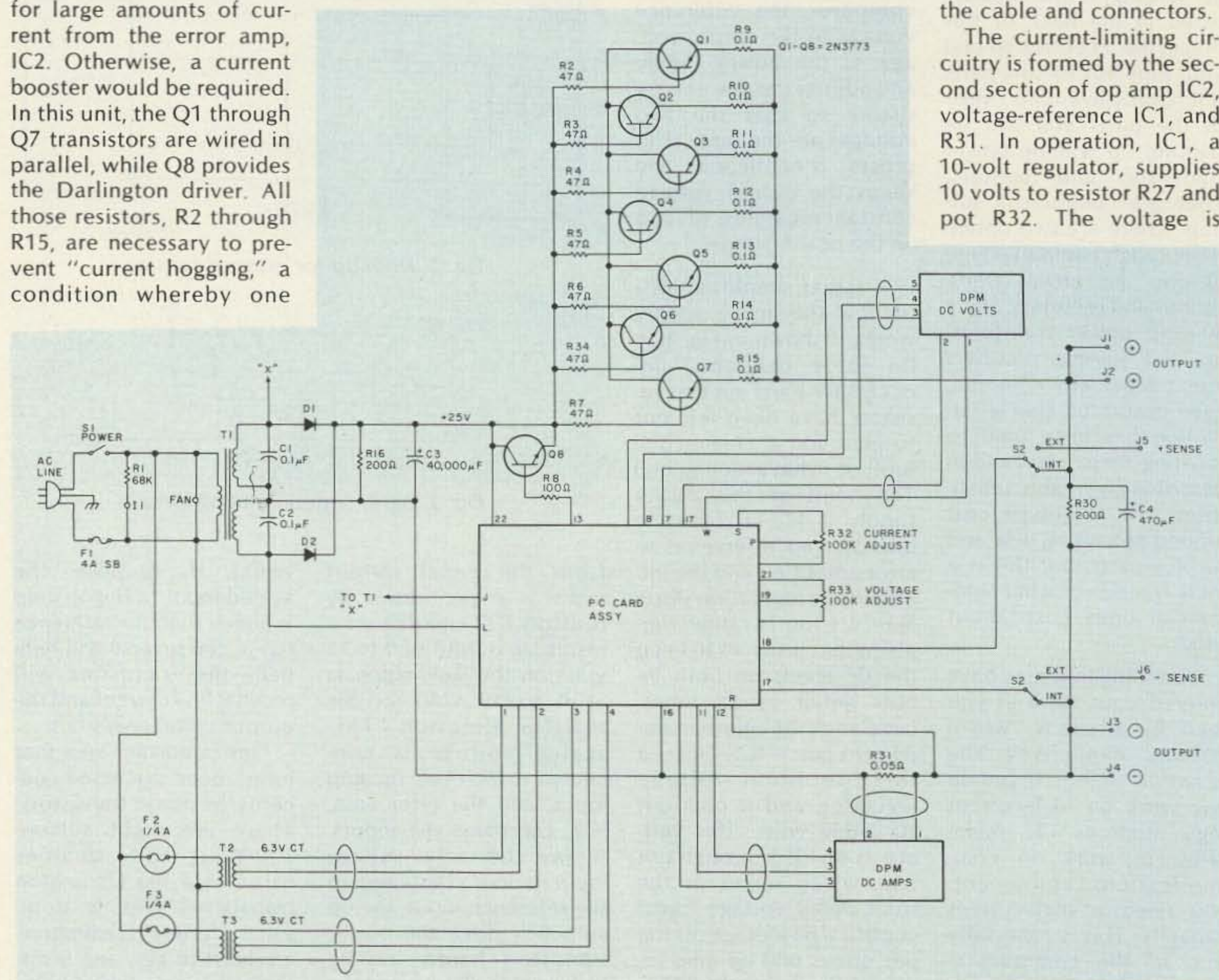

Fig. 4. Schematic—20-Amp power supply.

divided down to about 1.1 volts, which appears across the pot. This is shown generally in Fig. 3 and in the schematic. The pot is labeled Current Adjust and its output drives an op amp input. This voltage determines the trip point of the current-limiting circuitry and is vital to the operation of the circuitry. Next, a voltage drop occurs across R31, a big 0.05-Ohm resistor. This behemoth is made of 20 1-Ohm resistors, so "big" isn't an understatement! Current drawn from the power supply must pass through this resistor, and Ohm's Law tells us that 1.0 volt equals a 20-Amp current draw. Voltage is tapped from this resistor, and it drives the other input of IC2. In operation, the current-adjust pot, R32, is set for the desired current. With no load on the power supply, the op amp output is about 24 volts and diode D3 won't conduct. So, the power supply operates normally. As the current consumption of the load rises, it may produce enough voltage drop across R31 to equal the voltage from pot R32. The op amp, which is wired as a comparator, senses when the two input voltages are the same and the output swings from 24 volts to a low value which is determined by the setting of R32. When the output of the op amp goes low, it takes the voltage control line going to the other section of the dual-section IC with it, causing a reduction in the output voltage as if the voltage control pot had been turned.

That just about does it for the power-supply circuit theory, but let's finish by looking at a few miscellaneous circuit details. On the schematic, the line voltage is changed to about 25 volts by transformer T1. This voltage is rectified by D1 and D2, two

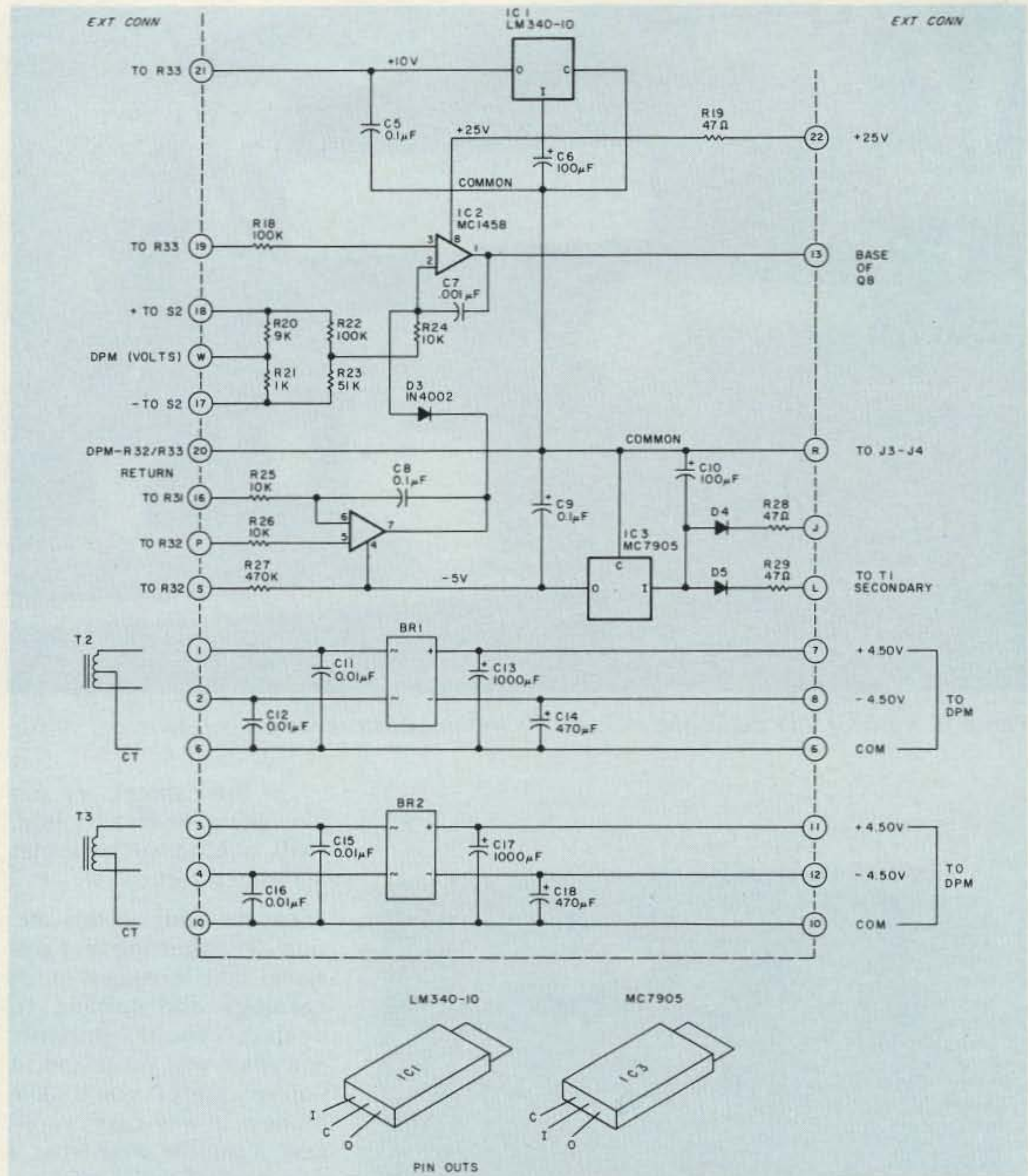

Fig. 5. PC card arrangement.

40-Amp silicon rectifiers on a separate heat sink. Filtering is done by C3, a 40,000-uF unit. Also, ac voltage is tapped off T1, rectified by D4/D5, filtered by C10, and regulated to minus 5 volts by IC3. This voltage drives op amp IC2, assuring full regulation of the output voltage down to zero volts. It also is mandatory for enabling the current-limiting circuit to work. Noise is kept to a minimum by capacitors C1/C2, and stabilization of the power supply is done with capacitors C7 and C8. Full display of the output voltages and currents is done with two home-made

digital panel meters (DPMs), and power-supply support circuitry is included. This is the job of T2/T3 on the chassis, and BR1/BR2 plus related parts on the PC card. The DPM construction will be discussed in part II of this article. If preferred, conventional analog meters may sub for the DPMs.

Locating the Parts

Although I made every possible attempt to use readily-available parts, some will cause problems. Luckily, there are ways to solve them. Most of the parts, and particularly all parts mounted on the PC

card, are easy to get from such suppliers as Digi-Key and others. The eight power transistors are seen in surplus, too, and as this was written, California Digital plus others have them. As you shop or scrounge for parts, just remember one thing: Your power supply is as good as what you put in it, so watch what you buy.

You may have problems finding parts such as T1, C3, and the cabinet. Good sources for T1 include old IBM 12-volt, 20-Amp computer supplies that turn up in surplus. Try Fair Radio, Meshna, or B & F Enterprises. As this is written,

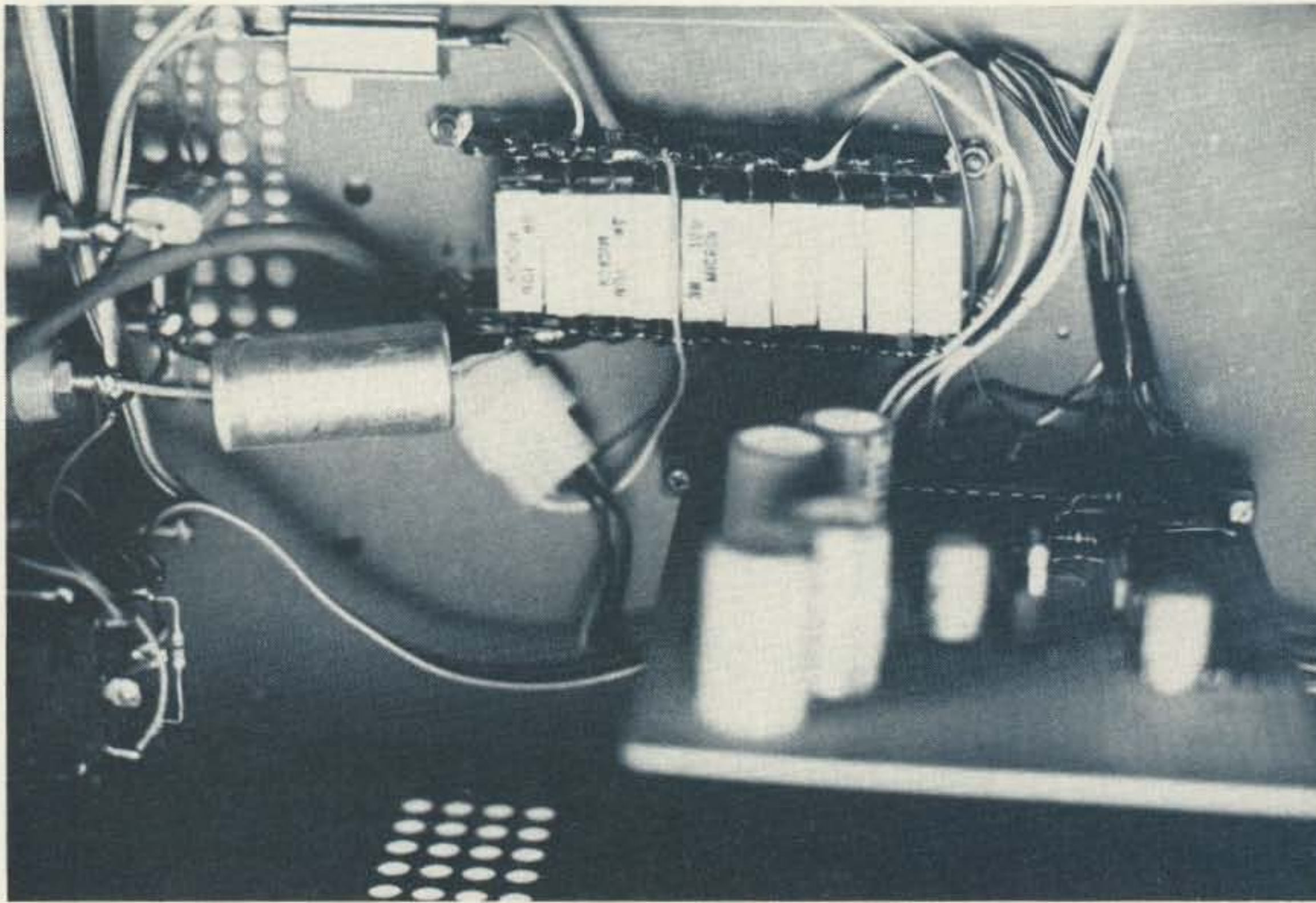

Photo C. Resistor R31 detail shows here: 20 1-Ohm resistors are on two terminal strips.

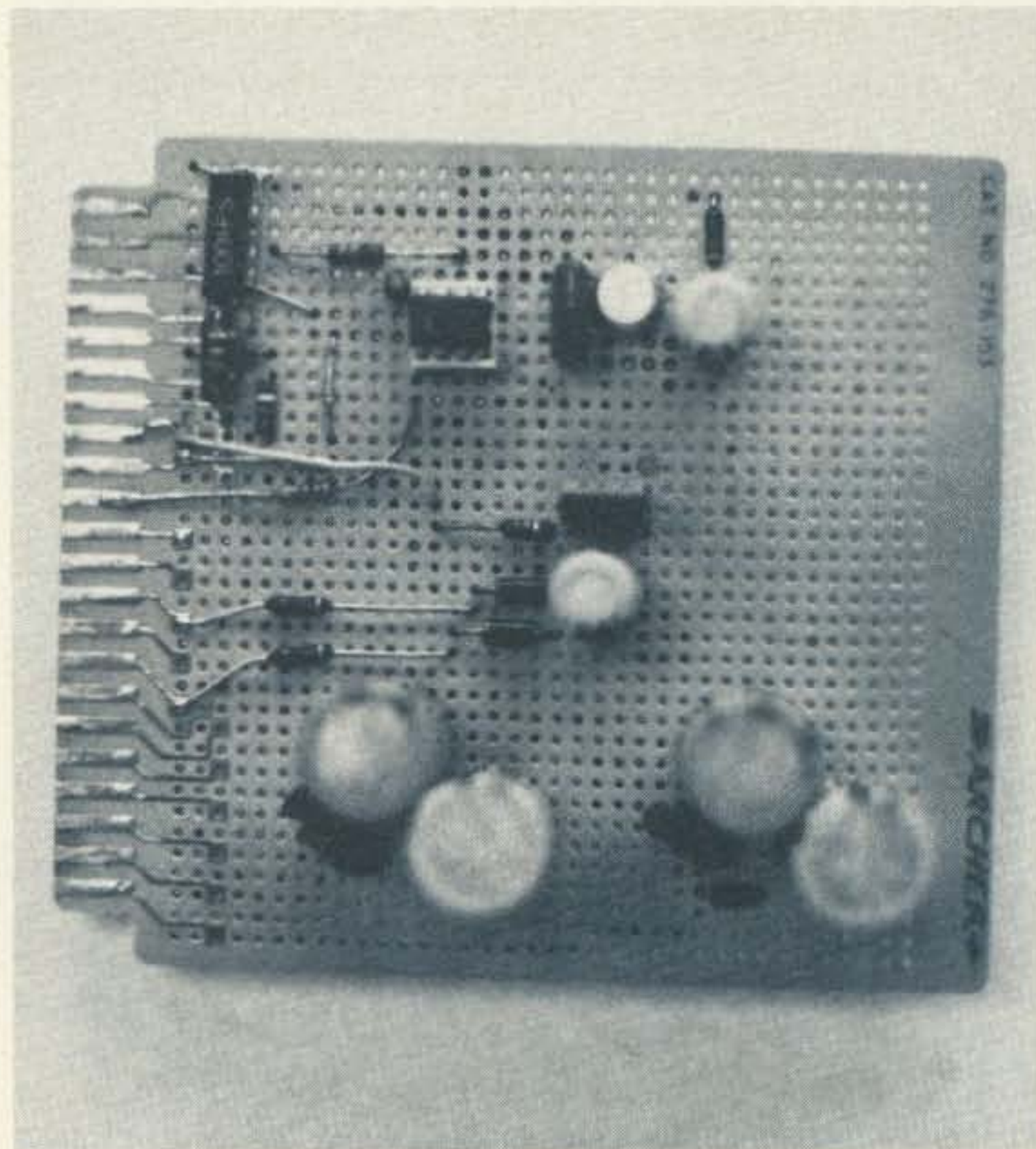

Photo D. Here is a top view of the PC card, showing the location of parts.

Poly Paks has been offering a 6-volt, 12-Amp transformer. You could use three of these, and then replace diodes D1/D2 with a 25-Amp bridge rectifier to get the proper voltages, albeit at reduced current. Or perhaps you could buy

one new from Signal Transformer. Look around!

C3 is a big computer-grade unit that shows up often in surplus; try the stores mentioned earlier. You might have to parallel several units—say, four 10k-uF units, to get results.

For the cabinet, try surplus again, or else try Bud, LMB, or other such cabinet manufacturers.

Let me sum up this section by suggesting that you spend time looking through catalogs and talking to dealers. You'll probably get what you want and, if you're careful, you'll save money. In any case, you'll save a bundle over what a commercial unit costs!

Construction

Construction of this power supply is fairly easy if you know what you are doing and take your time. This project is built in three parts: PC card, heat sinks, and cabinet. It is suggested that you build one at a time, check for errors, and then proceed on to the next.

The first step is to assemble the PC card. Pick up the card from your local Radio Shack, plus the parts, and you are ready to start. First, use steel wool (such as in a soap pad) to clean the fingers on each side of the card. Shine them up. Then dab a little solder flux over the fingers and tin each

neatly with solder. Clean off the excess flux with a good flux remover like Callectro[®] developer (Catalog no. 22-234), which works better for this job than some substances intended for this use, and it costs a fraction of what commercial flux remover costs. This one step of tinning the fingers will stop intermittents, which plague this type of PC board.

Next, slip the edge connector over the fingers, and refer to the numbers/letters stamped on it as you wire up the fingers. The rest of the construction can be guided well by the schematic and photo.

Wiring is not too critical, but keep the leads of C7 and C8 short, and mount C6 and C9 close to IC2's socket. You won't need any heat sinks on IC1 and IC3, so don't make provisions for any. If you prefer to use lower-cost analog meters on your version, omit C11 thru C18, BR1, and BR2. These components form power supplies for the DPMs we used. Resistors R20 and R21 form a 10:1 voltage divider, and may be 1% units. Other values may be used, such as 9.09k and 1.1k for the set, if desired. It would be a good idea to select these resistor values with a 5½-digit ohmmeter, but resistor error can be "tuned out" with the DPM calibration later on. If you use analog meters, omit R21 and select R20 to give your meter a 0-15 range. After you are done with the wiring, install IC2 and check for shorts and bad solder connections.

The second step is to build the heat sink assemblies. In the prototype, two heat sinks were used, one for D1/D2 and the other for the transistors. If desired, a single large sink may be used for these parts. Start by selecting a 6" square, finned heat sink for the

diodes. Drill holes for the diodes to fit, then mount them with diode mounting kits (mica washers, insulator, and hardware). Wire the two cathode lugs together and connect an 8" piece of no. 12 hookup wire to them. Then attach an 8" piece of no. 12 wire to each anode lead of the diodes. That finishes the diode heat-sink assembly.

Next, select a suitable heat sink for 8 power transistors. Mine is finned, black, and measures 6" high by 10" wide by 5" deep. A suitable heat sink found in surplus would be one of those used on computer supplies or high-powered amplifiers. Drill the 8 transistor mounting holes, and then mount transistors Q1 through Q8. Use transistor mounting kits with sockets and insulators. Put generous amounts of silicone grease under the insulator and case of each transistor, and then secure tightly with the hardware. Check for shorts to ground with your ohmmeter. Now comes the task of wiring up the transistors. The method used is rather important, so pay attention as to how you do the job.

Mount a 4-lug terminal strip at each end of the heat sink, on the terminal side. Cut a piece of no. 12 bus wire the length of the sink. Pass the wire through one terminal of each strip, and run it the length of the heat sink to the other terminal strip. Then run another no. 12 wire through the other set of terminals. Do not use the strip grounds! These bus wires form the collector and emitter leads of a super-Darlington transistor. Then take a length of no. 18 bus wire and tie a collector of any transistor to the big bus. Solder with a good, secure connection. Repeat this with the other transistors.

Next, install the seven

emitter resistors, R9 through R15, from the emitter terminal of each transistor to the other big bus. Note that there is no such resistor (0.1 Ohm) on the emitter of Q1. Next, install resistors R2 through R6 to the base leads of Q1 through Q7. Tie the free ends of these resistors together, and connect all of them to the emitter of Q8. Solder the 100-Ohm, 1-Watt resistor, R8, to the base lead of this transistor. Connect the free end of the resistor to an unused lug on one of the terminal strips. Finish up by labeling the bus connections on the ter-

minal strips, and by checking for poor solder joints. By assembling your transistors in this manner, you will minimize undesired voltage drop. The effort is worth it!

The last step is to drill the case and wire in the assemblies you built. When laying out the components, it is desirable to position the transformer, rectifier, and filter cap so they are as close as possible. This minimizes voltage drops. The heaviest current loop in the supply occurs between the transformer, rectifier, and filter, so keep those wires short. You were

told to put 8" wires on the rectifiers because it was felt that this was the maximum length you should have. In practice, arrange things so you must shorten these wires. As far as the rest of the arrangement goes, use good construction practices. For best results, the wires around T1, C3, both heat sink assemblies, and the output jacks should be kept short.

After the holes are drilled, you might want to assemble the front panel first. All the pots and switches are mounted and interconnected with the PC module with multi-conduc-

Parts List

C1, C2, C5, C9—0.1-uF, 50-volt disc capacitors
 C3—40,000-uF, 30-volt computer-grade electrolytic capacitor
 C4—470-uF, 25-volt electrolytic capacitor
 C6, C10—100-uF, 25-volt, PC-mount electrolytic capacitors
 C7—0.001-uF mylar[®] capacitor, 25 volt or up
 C8—0.1-uF, 50-volt mylar capacitor
 C11, C12, C15, C16—0.01-uF, 25-volt disc capacitors
 C13, C17—1000-uF, 6.3-volt, PC-mount electrolytic capacitors
 C14, C18—470-uF, 6.3-volt, PC-mount electrolytic capacitors
 D1, D2—40-Amp, 50-piv diodes (Motorola 1N1183A or International Rectifier 40HFR5, or similar)
 D3, D4, D5—1-Amp, 50-piv diodes, 1N4002 or similar
 BR1, BR2—1-Amp, 50-piv bridge rectifiers
 FAN—Surplus box fan, 115 volts, 60 Hz
 F1—4-Amp, 3AG slow-blow fuse and chassis holder
 F2, F3—¼-Amp, 3AG standard fuse and chassis holders
 I1—Type NE-51H neon lamp in holder
 J1, J2—Heavy-duty red binding posts—5 way
 J3, J4—Heavy-duty black binding posts—5 way
 J5—Red 5-way binding post
 J6—Black 5-way binding post
 IC1—National LM-340-10 regulator, 10 volts
 IC2—Motorola MC-1458 dual-op amp IC
 IC3—Motorola MC-7905 regulator, minus 5 volts
 Q1, Q8—2N3773 power transistors on heat sink

(All resistors 5% film unless noted)

R1—68k, ¼-Watt resistor
 R2-R7, R34—47-Ohm, ½-Watt resistors
 R8—100-Ohm, ½-Watt resistor
 R9-R15—0.1-Ohm, 7-Watt wire-wound power resistors
 R16, R30—200-Ohm, 5-Watt resistors
 R17—Not used.
 R18, R22—100k, ¼-Watt resistors
 R19, R28, R29—47-Ohm, ¼-Watt resistors
 R20—9k Ohm, 0.1% resistor (May be selected 5% film resistors—see text.)
 R21—1k Ohm, 0.1% resistor, as above
 R23—51k Ohm, ¼-Watt resistor
 R24, R25, R26—10k Ohm, ¼-Watt resistors
 R27—470k Ohm, ¼-Watt resistors
 R31—0.05-Ohm resistor, 100 Watts. (Use 20 1-Ohm, 5-Watt resistors in parallel.)
 R32, R33—100k Ohm, 10-turn pots from surplus (Beckman model 7276-R100K)
 S1—10-Amp, SPST toggle switch
 S2—DPDT toggle switch (Current rating not critical.)
 T1—35-volt center-tapped, 30-Amp power transformer
 T2, T3—6.3-volt c-t, 600-mA filament transformers
 Misc: Large cabinet for finished unit, Radio Shack model 276-154 PC card, 22-pin dual-edge connector, no. 12 wire, hookup wire, hardware, etc.

Suppliers Listing

Although we have found many other suppliers of parts for the power supplies, we have found these dealers to be a good sample of typical parts sources.

| | |
|--|---|
| B & F Enterprises 119 Foster St. Peabody MA 01906 | Transformers, big resistors, big capacitors, pots and miscellaneous |
| Fair Radio Sales P.O. Box 1105 1016 E. Eureka St. Lima OH 45802 | Transformers, big capacitors, and resistors, cabinet, etc. |
| John Meshna Surplus P.O. Box 62 E. Lynn MA 01904 | Transformers, capacitors, resistors, miscellaneous |
| Digi-Key Corp. P.O. Box 677 Hiway 32 South Thief River Falls MN 56701 | ICs, small resistors, capacitors, hardware |
| Signal Transformer 500 Bayview Ave. Inwood NY 11696 | Transformer T1 (Their model 24-25 looks promising.) |
| California Digital P.O. Box 3097K Torrance CA 90503 | Filter capacitors, power transistors, miscellaneous |

tor ribbon cable. This makes a nice, neat layout. The power switch wiring around S1 is wired separately with no. 18 stranded wire. You don't want a 60-Hz signal in the cable! Also use more no. 18 wire around the rest of the ac line wiring. You may not want to mount the DPMs until you see part II of this article; space limitations here prevent construction details on these playing card-sized units. But, in all likelihood, you will be busy with what I have presented so far, and by the time you reach this point, part II will be out. Of course, you may prefer to cut costs and use analog panel meters, and that is fine.

One thing before we leave the front panel: Be sure the leads from S2 go *directly* to the output jacks. These are the sensing leads.

Next, you can turn to the rear panel and install the fan and power cord. Then turn to the bottom of the box and install T1, C3, the heat sinks, and the PC card connector. Leave the connector loose since you will be connecting wires to it. A terminal strip mounted next to the power cord is a handy addition you can

make, since you will be connecting many wires to it. Wire up the ac line wiring first, then turn to wiring up D1/D2. Connect C3, being sure to use terminal lugs, and remember to keep the leads short. Then connect a short wire from C3 to the collector of the heat sink Darlington transistors. Do this at the *fan end* of the heat sink. Install the minus lead from C3 to output terminals J3/J4. Then finish up the heavy wiring by running a short no. 12 wire from the emitter terminal on the power transistor heat sink to the positive terminals, J1/J2. It might be better if you connect the wire to the emitter terminal on the side opposite the terminal you made the collector connection, but this is a matter of convenience. Finish up the balance of the wiring, which will be mostly to the edge connector. Check it over when you are done, for shorts and errors. With that you are all set to proceed to "Checkout."

Checkout

Now, except for a few checks, you are all set to fire up your power supply and see if it works. Remove the PC card and connect a

voltmeter to the output terminals. Apply power to the supply and read the meter. It should read zero, or close to it. If not, check the transistor heat sink for a shorted or reversed transistor. Then, when this is taken care of, measure the voltage across C3. It should be around 20-27 volts dc. If not, check out the parts before it and repair. Switch off the supply, and wait a few minutes for C3 to discharge. Insert the PC card and set the sense switch, S2, to internal. Apply power to the supply, and you should find you can adjust the output voltage smoothly from zero to about 15 volts with the voltage-adjust pot. Connect a load such as a 1-Ohm, 100-Watt resistor, and you should find there is no change of the output voltage at the output terminals over the output range. The current-adjust pot will cause the output voltage to fall or "fold back" to a lower level; advancing this pot will cause the output voltage to rise to the correct value. So, if you find you suddenly lose regulation, this is why. The adjustment pot's range is typically from 180 mA to a little over 20

Amps. This concludes the checkout of your power supply. If you have any problems, check the wiring on the PC card and the solder joints you made with the high-current wiring.

Operation

Operation of this power supply is a snap. Turn it on, set the voltage, and connect the load. Or, if you prefer, advance the voltage while the load is connected. The current-adjust pot is adjusted until the output voltage starts to drop, then increased slightly. This way, a short in the load will trip the current-limiting circuitry and shut down the power supply.

We have found the power supply to be great for running VHF communications gear since the regulated source of power tends to increase the transmitter's power output. This supply also has come in handy for other heavy-duty tasks such as emergency battery charging (saved a tow charge!) and powering entertainment radios that were sick. Yet it also powers CMOS circuitry. For me, this power supply rapidly became indispensable.

For heavy loads above 10 Amps, it often will help to connect leads to the external sensing jacks and run them directly to the power terminals on the equipment. This ensures that the voltage will be regulated directly at the equipment terminals, and often transmitter power output will be greater. But when you use external sensing, be extra-careful to connect the sensing wiring well. If one of the wires comes off, this supply will put out a full, unregulated dc voltage, and that may be harmful to your rig! This situation is true with all such supplies, so be careful. ■

The engineering
breakthrough by

DRAKE

brings an entirely new state of the art
to worldwide radio communications...

solid state

TR7

synthesized hf
transceiving system

continuous coverage

0-30 MHz

continuous coverage reception — no gaps —
no range crystals required

160-10 Meters

Amateur Band transmission, including
capability for MARS, Embassy, Government,
and future band expansions



- ★ Sophisticated System Concept
- ★ Innovative Design Features
- ★ Straightforward Simplified Operation
- ★ State of the art performance now a pleasure

7 Line Accessories

- RV7 Remote VFO • PS7 120/240V Ac Supply • Aux7 Range Program Board
- MS7 Matching Speaker • NB7 Noise Blanker • FA7 Fan • SL300 Cw Filter, 300 Hz • SL500 Cw Filter, 500 Hz
- SL1800 Ssb/RTTY Filter, 1.8 kHz • SL6000 A-m Filter, 6.0 kHz • MMK7 Mobile Mounting Kit • TR7 Service Kit/Extender Board Set • TR7 Service/Schematic Book.

- Broadband, 100% Solid State Design.
- Exclusive Synthesized/PTO Frequency Control — 1 kHz dial, 100 Hz digital readout. 500 kHz range pushbuttons.
- Continuous, Wide Range Frequency Coverage — 1.5 thru 30 MHz (zero thru 30 MHz with optional Aux7).
- State of the Art "Up-Conversion" Receiver Design — with high level double balanced mixer.
- True Full-Passband Tuning improves reception in heavy QRM.
- Unique Independent Receive Selectivity — Optional front panel pushbutton-selected filters.
- Effective Noise Blanker — true impulse-type performance.
- Special High Power Solid State Power Amplifier — diagonal heat sink allows internal mounting. Continuous duty on SSTV/RTTY with optional fan.
- TR7 Internal Test Facilities — "S" meter and built-in rf Wattmeter/VSWR Bridge.
- Receiver Incremental Tuning (RIT)

Specifications and prices subject to change without notice or obligation.

R. L. DRAKE COMPANY



540 Richard St., Miamisburg, Ohio 45342
Phone: (513) 866-2421 • Telex: 288-017

✓ 19

For a FREE Drake Full Line Catalog contact your favorite Drake Dealer.

A Do-It-Yourself Speech Compressor

—let's experiment!

Donald L. Stoner W6TNS/7
John Hancock Building
Mercer Island WA 98040

One of the most popular words in ham radio jargon these days is *compondoring*. It is rare to pick up an amateur radio publication and not find some mention of this "new" technique. Since you will be hearing a lot more about speech compandoring in the future, you should know what it is, how it works, and if it is applicable in your station. I should add

that the bulk of my compandor experience has been with SSB equipment. However, the application to be described should be equally effective with AM or FM gear.

What is compandoring? The word is a contraction of compressor and expander. The compressor is associated with the transmitter and the expander is used in the receiver. Actually, there are two forms of speech compandoring, frequency and amplitude. These are separate and distinct techniques which can be used together

or separately. This article confines itself to amplitude compandor techniques which you can incorporate in your gear.

Frequency Compandoring

At the moment, this technique is rather complex and, therefore, relatively expensive. It involves compressing the frequency spectrum at the transmitter, then reassembling it to its original form at the receiver. The main advantage is the reduction in occupied bandwidth. With reasonably good band conditions, the improvement in signal-to-noise ratio is only modest. However, in the presence of heavy QRM, the ability to "get through" is significantly enhanced by narrowing the required bandwidth.

Amplitude Compandoring

Thanks to Signetics Corp., amplitude compandoring is relatively inexpensive and is applicable to any ham rig, either existing or on the drawing board. It involves amplitude compression of the transmitted signal and expansion to its original form at the receiving end of the circuit. The material which follows covers this technique and should be of interest to all experiment-minded

amateurs.

The VBC System

The voice bandwidth compression (VBC) system, invented by Dr. Richard Harris and Tom Lott, involves both frequency and amplitude compandoring. The frequency technique involves interleaving the vowel and consonant sounds (which never occur in human speech at the same time). Since the sounds are at different ends of the voice spectrum, combining them by means of filters permits reducing the occupied bandwidth of the transmitted signal by approximately half. The VBC system (NBVM) has been described extensively in *QST*, the *Handbook*, and 73 (January, 1980). Refer to these if you are interested in this technique.

Enter The Chip

A significant part of the benefit obtained in the VBC system is due to amplitude compandoring of the speech. Naturally, this does not reduce the spectrum required, but it certainly does improve the "talk power" of a compandored radio. Actually, amplitude compandoring has been used for many years by the telephone company to improve signal-to-noise ratios on

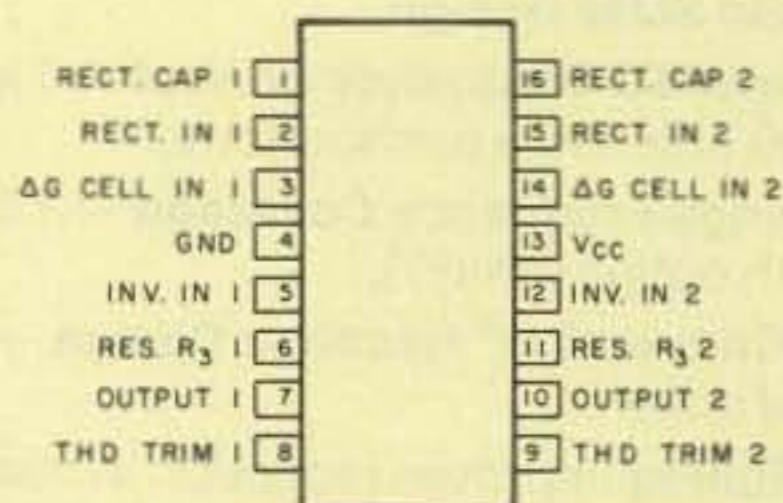

Fig. 1. Pinout for the NE570/571 package. Note symmetry of the two identical sections.

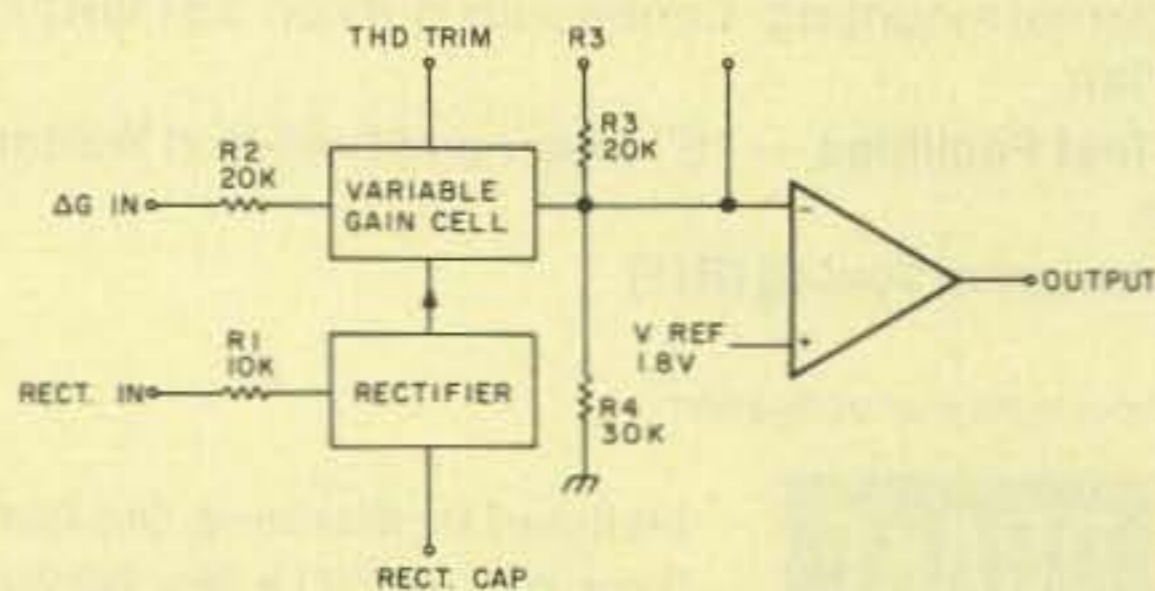

Fig. 2. The basic "building blocks" of the 570/571. They can be connected as either a compressor or expander.

their voice circuits. Until the advent of integrated circuits, it required many vacuum-tube stages to efficiently compress and/or expand telephone conversations without distortion. Each active communications circuit required a separate compandor.

Earlier, I mentioned Signetics. Some time ago, they introduced a semiconductor device (the NE571) which packed all those tubes into an inexpensive IC. The chip features processing circuits that can be configured either as a compressor or an expander. The pinout of the NE571 is shown in Fig. 1.

It is an easy device to work with since the connections to the innards are duplicated for the two sections (the chip contains two identical channels) on each side of the package. There are three principal sections in each channel, an operational amplifier, a variable gain cell, and a full-wave rectifier (see Fig. 2).

If the three blocks are connected together as shown in Fig. 3, the channel will act as a compressor. It works in the following manner. The audio output is applied to the rectifier and variable gain cell. As the output level increases, the voltage from the rectifier also increases. This, in turn, increases the signal through the variable gain cell. Thus, more degenerative feedback is applied to the op-amp input and its gain drops. In practice, a two-unit increase in input results in only a one-unit increase in the output. The incoming signal is thereby effectively compressed. When the peaks are significantly compressed and the lower energy (and amplitude) peaks are less compressed, the peak-to-average ratio of the voice is decreased. The net effect is for the transmitter to sound louder at the other end of

the voice circuit.

What makes the NE571 such a spectacular device is that compression occurs logarithmically over the entire dynamic range. Since there is no clipping or limiting point, the waveform is essentially unmodified and, therefore, undistorted. Signetics claims less than 2% distortion (1% for the NE570) which is virtually inaudible in a communications circuit. Even this small amount of distortion can be trimmed out in hi-fi applications by using the "THD TRIM" connection (pins 8 and 9). Because of its low distortion, the compressor can be left in the circuit at all times, unless you wish to switch it in and out to demonstrate its effectiveness.

While the compression application for the NE571 is impressive, it is the expander configuration that is exciting. Although the NE571 has been available for some time, everyone has overlooked its usefulness in ham radio applications. The incorrect assumption has been made that, to be

useful, the compandored radio must be communicating with another compandored radio to derive any benefit from the NE571. This is definitely not the case.

Obviously, the compressor action will provide more talk power no matter what radio is receiving a signal from any transmitter. When the expander is installed in a radio, it will produce up to a 16-dB improvement in the signal-to-noise ratio of the received signal whether the transmitter is an Atlas, Swan, Yaesu, Kenwood, or any other rig, for that matter.

The same three building blocks that were used in the compressor can be re-configured as an expander. The block diagram is shown in Fig. 4. In this case, the variable gain cell is in series with the incoming audio and the op-amp input. The incoming audio is also applied to the full-wave rectifier. When the input audio increases, the gain of the variable cell also increases. This, in turn, passes more signal to the op amp. Thus,

every unit of increase in the input results in a two-unit increase in the output. As before, in the compressor configuration, the action is logarithmic over a 110-dB dynamic range.

How does expanding the audio increase the signal-to-noise ratio, you ask? It's a little harder to explain than compression, a technique amateurs have been familiar with for years. However, bear with me and see what happens in an actual situation.

Let's say you have an expander (which can be switched in and out of the circuit) connected to your receiver. Let's tune in a station and adjust the volume for a comfortable listening level with the expander switched out of the circuit. All set? Now switch in the expander. What happens? The volume gets a lot louder since we stretched (or expanded) the audio out to a higher amplitude. What do you do now? You reach over and turn the volume down to once again establish a comfortable listening level. But, what



The Stoner PRO-10 operates between 28.0 and 29.5 MHz. It is the first ham transceiver to feature amplitude-compandored speech.

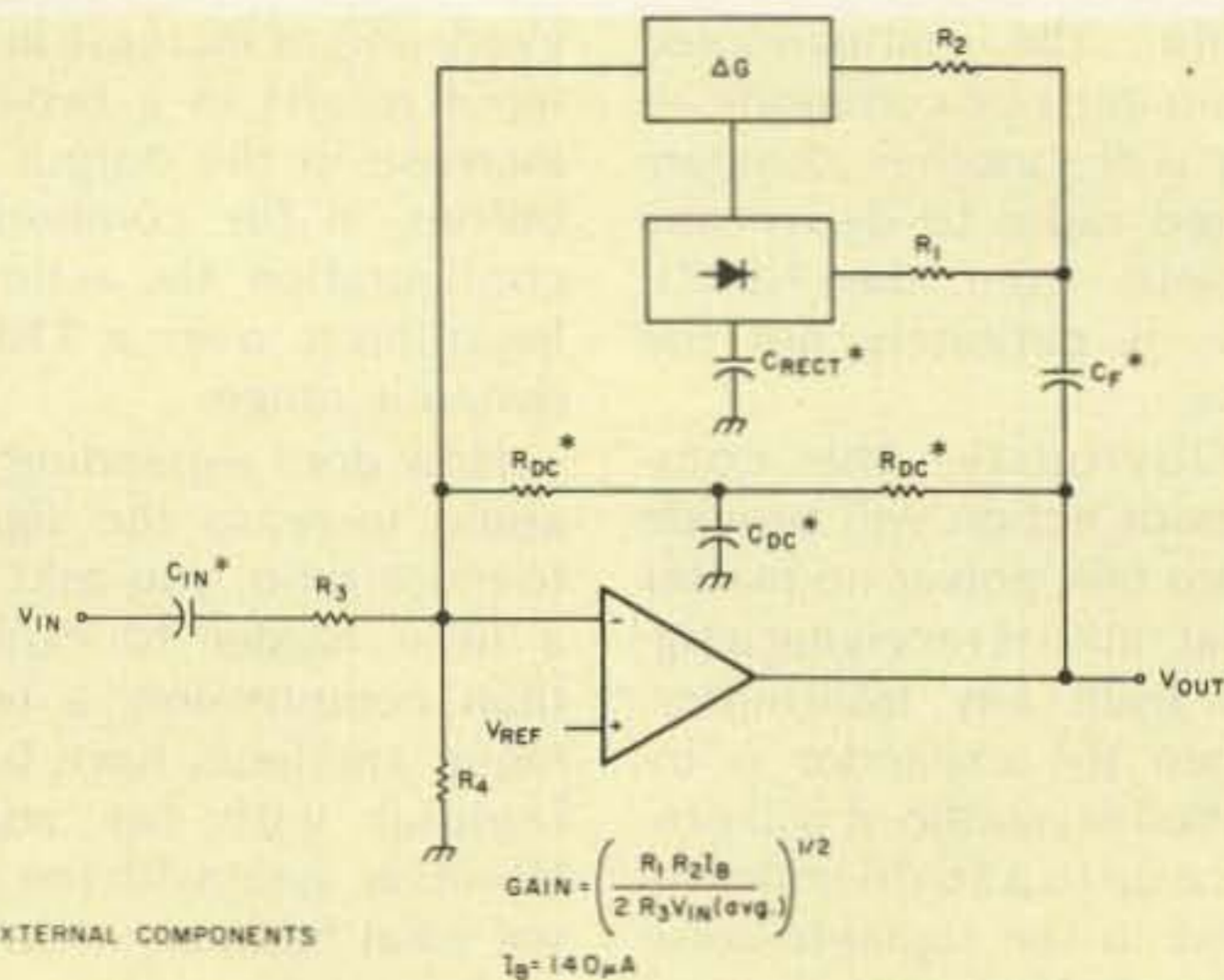

Fig. 3. The basic configuration to assemble the "blocks" as a compressor.

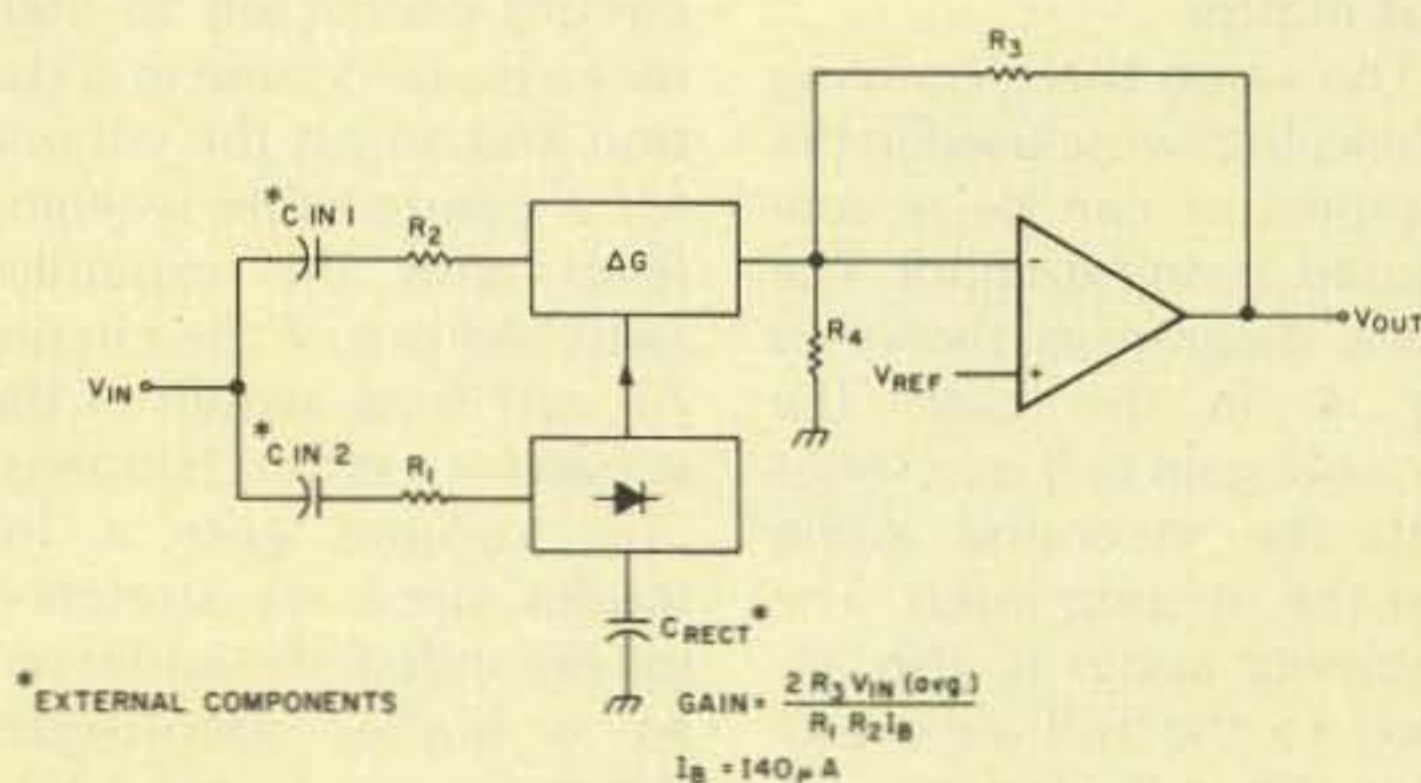

Fig. 4. The basic configuration to assemble the "blocks" as an expander.

happens between words or when the station quits talking? The background noise is reduced by the amount that you turned the volume down! Since the volume of the incoming station is the same, and the background noise is reduced, the signal-to-noise ratio is improved. The expansion occurs logarithmically, and no audible distortion is added to the incoming signal.

A Home-Brew Compressor

The first commercial

application of the NE571 in an amateur radio transceiver is the PRO-10 shown in the photograph. The PRO-10 incorporates a unique PLL synthesizer and vfo combination with 100-Watts output over the range of 28.0 to 29.5 MHz.

The circuit of the NE571 compressor (as used in the PRO-10) is shown in Figs. 5 and 6. It should be relatively easy to add this circuit to an existing solid-state SSB transceiver.

The compressor portion

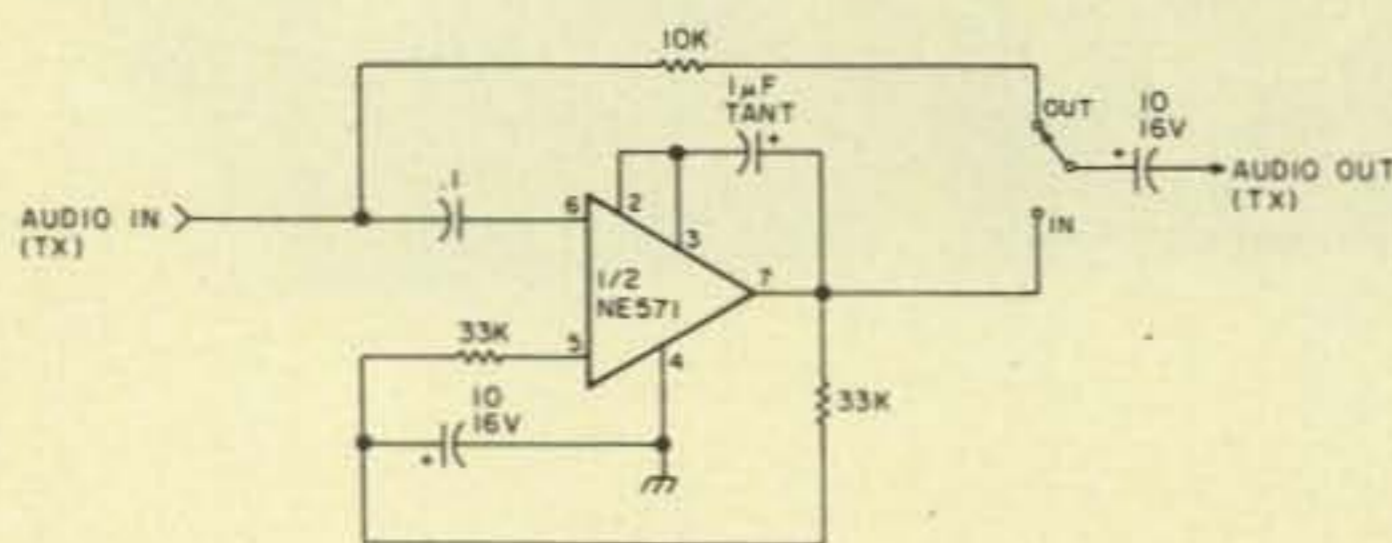

Fig. 5. Schematic diagram of the compressor circuit incorporated in the PRO-10.

is shown in Fig. 5. Note that if you use only this half of the chip, it will be necessary to connect pin 13 (B+) and the components associated with pin 1. The audio input connects to pin 6. Since the NE571 has a high input impedance, a small disc capacitor is used to block dc. A dynamic microphone will not provide sufficient drive. A stage of preamplification with approximately 20 dB of gain will be required ahead of the NE571. The capacitor between pins 2-3 and 7 couples audio into the full-wave rectifier and variable gain cell. The 1-megohm resistor from B+ to pin 1 (see Fig. 6) provides tracking bias for the diode rectifier. The 1-μF tantalum capacitor establishes the decay time of the compressor action.

To incorporate the circuit in an existing circuit, break the connection between the microphone preamplifier and the stage the preamplifier drives. Insert the circuitry shown in Fig. 5. Before putting it on the air, check the waveform at pin 7. There should be no sign of clipping with loud speech into the microphone. If clipping is observed, it means there is too much gain ahead of the compressor. With the proper drive level, there should be 1-2 volts of signal at pin 7. Since the output amplitude of the NE571 is quite high, it will be necessary to reduce the drive to the following circuitry. The 10k potentiometer should be adjusted so that with a loud voice the maximum drive level is approximately the same whether the compressor is switched in or out of the circuit.

PRO-10 Expander

The expander portion of the NE571 is going to be a bit more tricky to interface with your equipment and have the level correct. The circuitry of the expander-half of the NE571 is shown

in Fig. 6. Note that if this circuit is used by itself, pin 4 in Fig. 5 will have to be grounded.

The audio from the detector will probably require one stage of amplification before applying it to the inputs of the NE571. Pin 14 is the variable gain cell and pin 15 is the rectifier input. The detected audio is applied to both of these inputs. The 33k resistor determines the operating point of the expander. For example, with the 33k value shown, the circuit will have -4-dB gain with 0-dBM input. Values between 22k and 56k will produce 0-dB gain with values between 0- and -10-dBM input, respectively.

The 10k resistor, connected to the OUT connection on the switch, bypasses audio around the compressor when the NE571 is switched out of the circuit. Since the impedance the expander "sees" is not known, the value must be empirically adjusted by the constructor. The value is correct when a strong incoming station appears to have the same speaker volume when the expander is switched in or out of the circuit.

Using the expander is not a panacea. For example, if a signal is in the noise, the expander cannot help. If the audio peaks are no higher than the noise, then, obviously, the noise and audio will be expanded equally. Conceivably, if the signal were lower than the noise, it could make reception worse when the expander was switched in. I've never heard this happen, however. Most of the time the expander will make an improvement which varies from the noticeable to the spectacular.

For example, a 1-micro-volt signal produces a 15-dB signal-to-noise ratio in the PRO-10. When the expander is switched on, the S/N ratio increases to

INNOVATION IN AMATEUR RADIO

73

For over 18 years, 73 Magazine has been the innovator in amateur radio. 73 led the way to developing the use of solid-state circuitry, and was the first to promote such things as SSTV, radioteletype, computer applications for radio communications, and single sideband.

Radio electronics has changed as 73 has changed. Ever notice how other magazines published in the field of radio electronics are just like the ones before them? Same old subjects in every issue, same predictable views, same old editorials . . . try to find it in 73 . . . you won't. In one issue you might find building projects and information on antennas, moonbouncing and mountaintopping; in the next issue you might read about computers, radioteletype, or traffic handling.

FREE TRIAL COPY

Write today and we'll send you your first copy with absolutely no obligation . . . that's right, if you're not completely satisfied after you've read your first issue, just write "CANCEL" on your invoice and send it back to us . . . the first issue is yours to keep — on us! In addition, we'll guarantee every issue of your subscription . . . if you're not satisfied with your first — or your eleventh — issue, we'll refund your money on all remaining issues. Call in your order today and get your new subscription started for \$15 . . . half the price you'd pay on the newsstand. Have your credit card handy and call us toll-free at (800) 258-5473.

**or . . .
use
this
coupon
and
subscribe
today . . .**

Please send me my trial copy of 73 at no obligation. I understand that you'll start my subscription and bill me later . . . if I'm not completely satisfied I'll mark the invoice "CANCEL" and mail it back within 10 days.

One year—\$15

Three years—\$45

Bill me

Payment Enclosed

Bill my: Visa

Master Charge

Card # _____ Exp. date _____

Signature _____

Name _____

Address _____

City/State/Zip _____

Canada: \$15 in US funds. Other foreign \$26 one year only, in US funds.

303B6

TOLEDO MOBILE RADIO ASSOCIATION

FREE AUCTION STARTS AT 10 A.M. • PRIZES



PROUDLY PRESENTS ITS



25TH ANNUAL
AUCTION AND HAMFEST

MARCH 23, 1980

AT THE
LUCAS COUNTY
REC. CENTER
MAUMEE, OHIO

FOR INFORMATION WRITE

T.M.R.A. INC. PO BOX 24, TEMPERANCE, MI. 48182

TICKETS ARE 2⁵ IN ADVANCE AND 3⁵ AT THE DOOR

8 A.M. TO 5 P.M. • AMPLE FREE PARKING

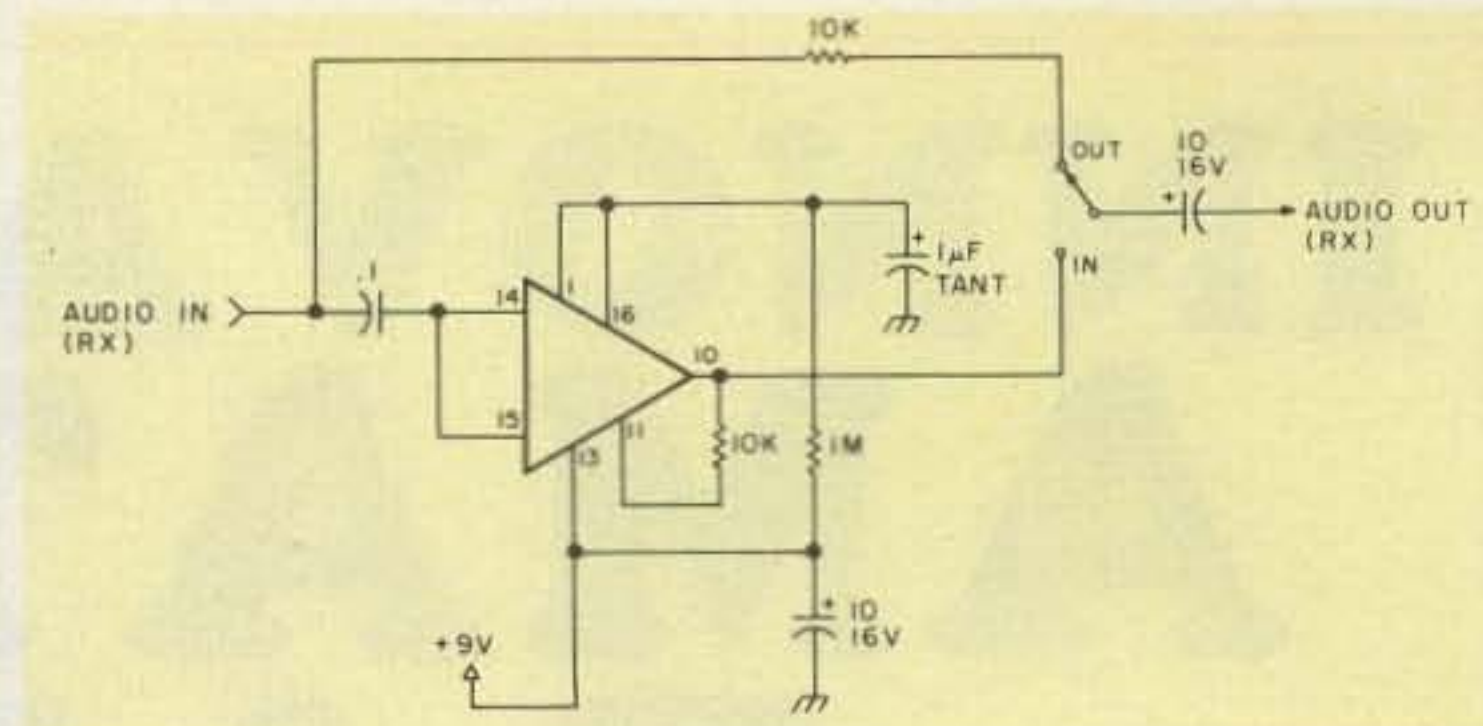

Fig. 6. Schematic diagram of the expander circuit incorporated in the PRO-10.

about 25 dB. A signal strong enough to actuate the avc produces a S/N ratio well in excess of 30 dB with the expander in the circuit.

While this article has emphasized an HF SSB application for the NE571, it should be equally useful in FM and other applications. For example, it could be used in low-speed data circuits, such as transferring programs off cassette tape recorders. With a properly designed circuit, it will

stretch the pulses to increase their amplitude with respect to the noise. That's called increasing the signal-to-noise ratio.

I would like to thank Tom Lott of VBC, Inc., for "planting the seed" on the usefulness of the NE571, and also to thank Fred Cleveland of the same company for his technical assistance. Special thanks and gratitude are due Signetics, who provided invaluable help with the NE571. ■

Heavy Favorite

Hustler's 5-BTV™ five band vertical antenna.

Made heavier for better performance and quality. Heavier optimum Q traps assure accurate and permanent resonance for greater bandwidth. Heavier solid one-inch fiberglass trap forms give optimum electrical and mechanical stability.

One setting provides total band coverage from 10 through 40 meters with SWR of 1.6:1 or better at band edges, and up to 100 kHz on 75/80 meters.

Easy to assemble and install. Features high strength heat treated seamless aluminum construction throughout, plus heavy duty stainless steel hardware. Feed with any length 50 ohm coax.

For the BIG difference in performance, it's the Hustler 5-BTV antenna.

HUSTLER INC. 305

3275 North B. Ave. • Kissimmee, Florida 32741
Clearly the choice of those who know quality.

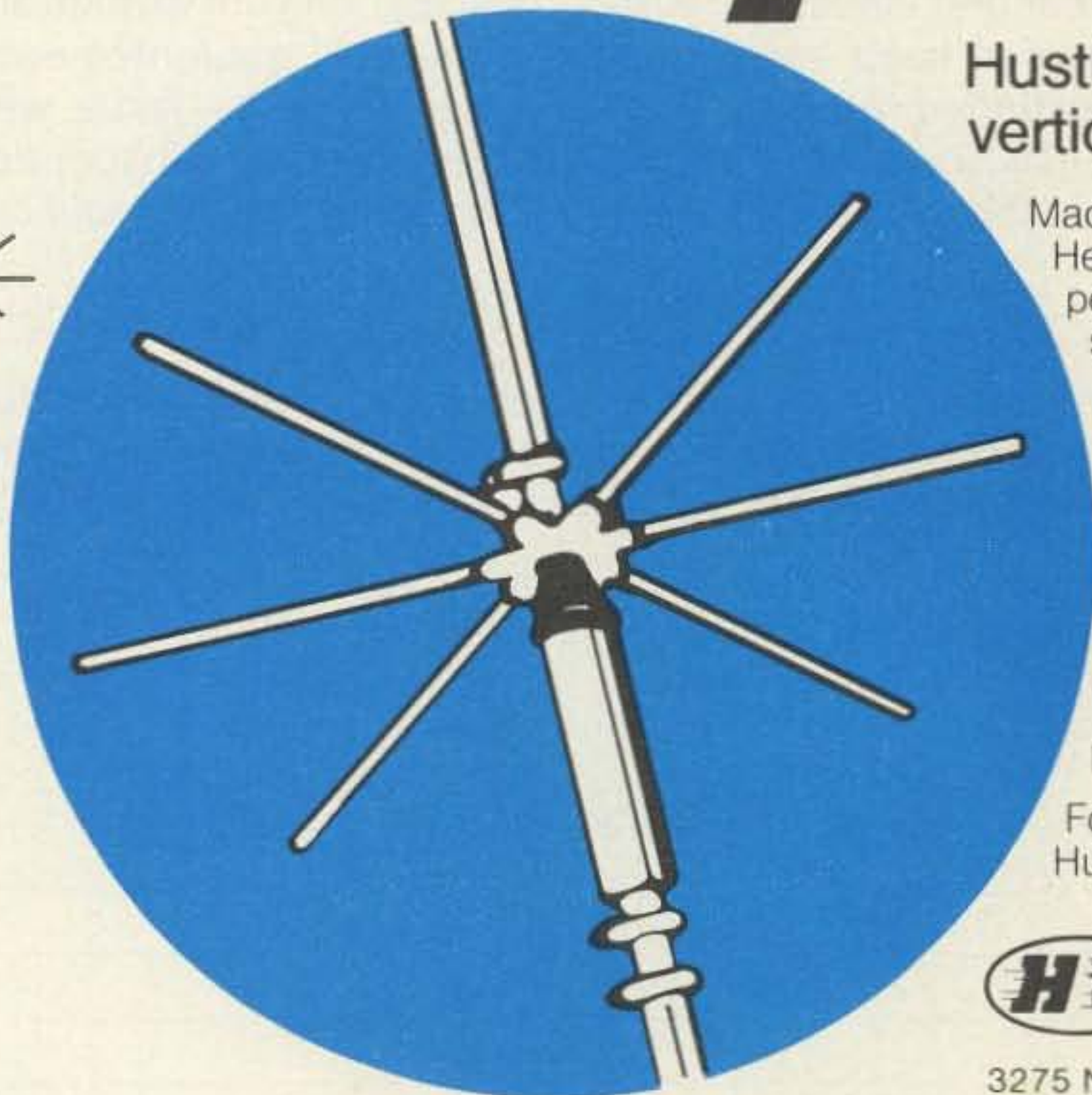

ATR-6800

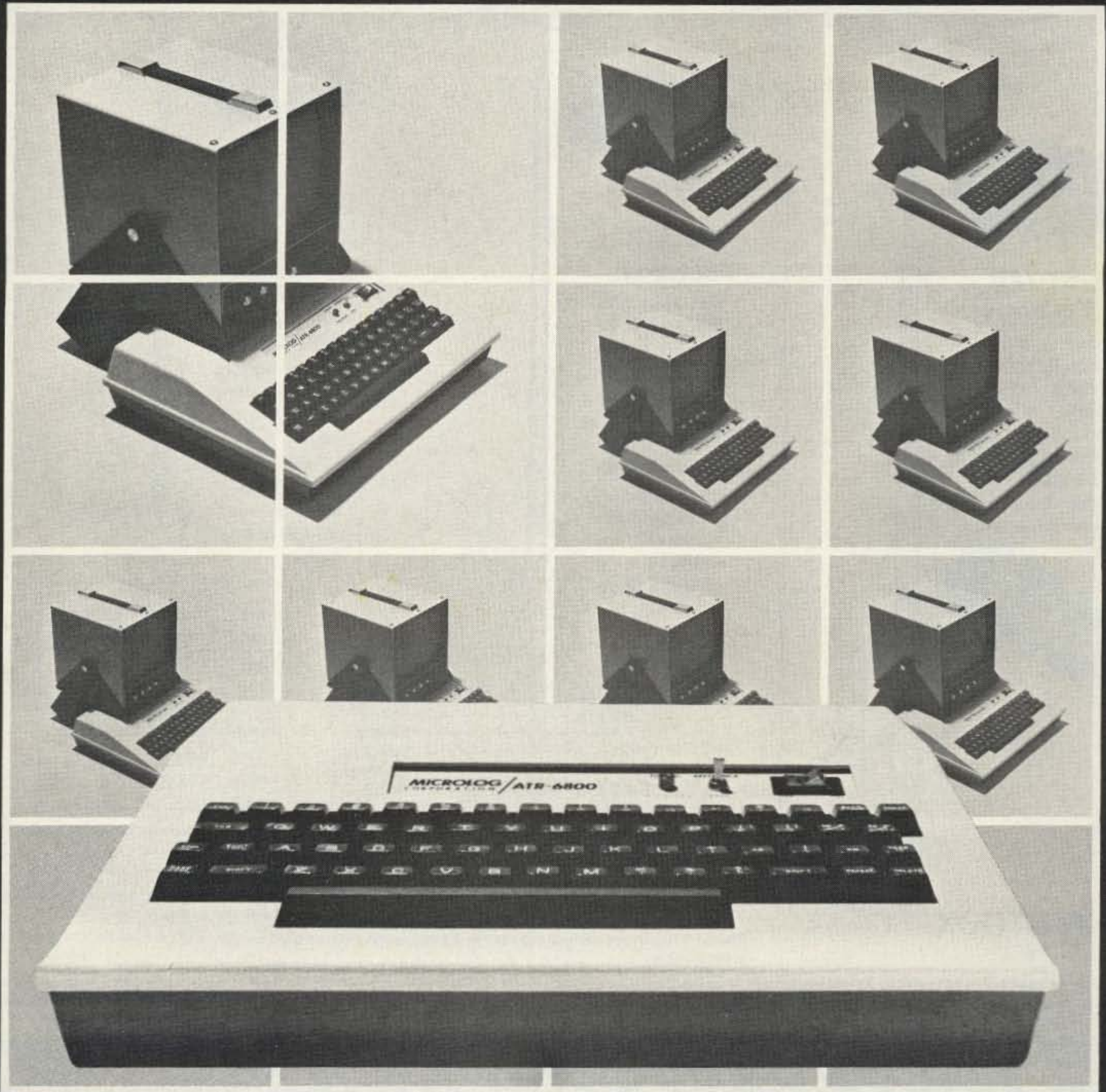

Truly a new dimension in digital communications, the ATR-6800 is more than a superb CW and RTTY machine. It includes a user programmable microprocessor designed to fully automate your station.

Your ATR-6800 is ready to run in a "real world" environment. A shielded metal box and extensive RFI filtering allow side by side operation with your kilowatt, and there is no need for extra attachments or cumbersome program loading.

Direct connection to your transceiver provides total capability on CW and all Baudot and ASCII speeds, both present and future.

For additional performance specs, just use your imagination . . . ATR-6800 with 9" monitor amateur net. \$1,995.

Ask your dealer for a full demo, or drop by. MICROLOG CORPORATION, 4 Professional Drive, Suite 119, Gaithersburg, MD. 20760. telephone (301)-948-5307.

MICROLOG ✓ 51

INNOVATORS IN DIGITAL COMMUNICATIONS

WILSON SYSTEMS TOWERS

— IN STOCK —



FACTORY DIRECT
\$949⁹⁵

ST-77B

Features:

Max. Height: 77'
Min. Height: 24'
Weight: 700 lbs.
Winch: 1500 lbs.
Cable: 6400 lbs.
Requires FB-77B or RB-77B
Totally Freestanding with Bases below

FACTORY DIRECT
\$549⁹⁵

MT-61B

Features:

Max. Height: 61'
Min. Height: 23'
Weight: 450 lbs.
Winch: 1200 lbs.
Cable: 4200 lbs.
No Guys required when mounting against house.
For completely freestanding installation, use RB-61B or FB-61B below.

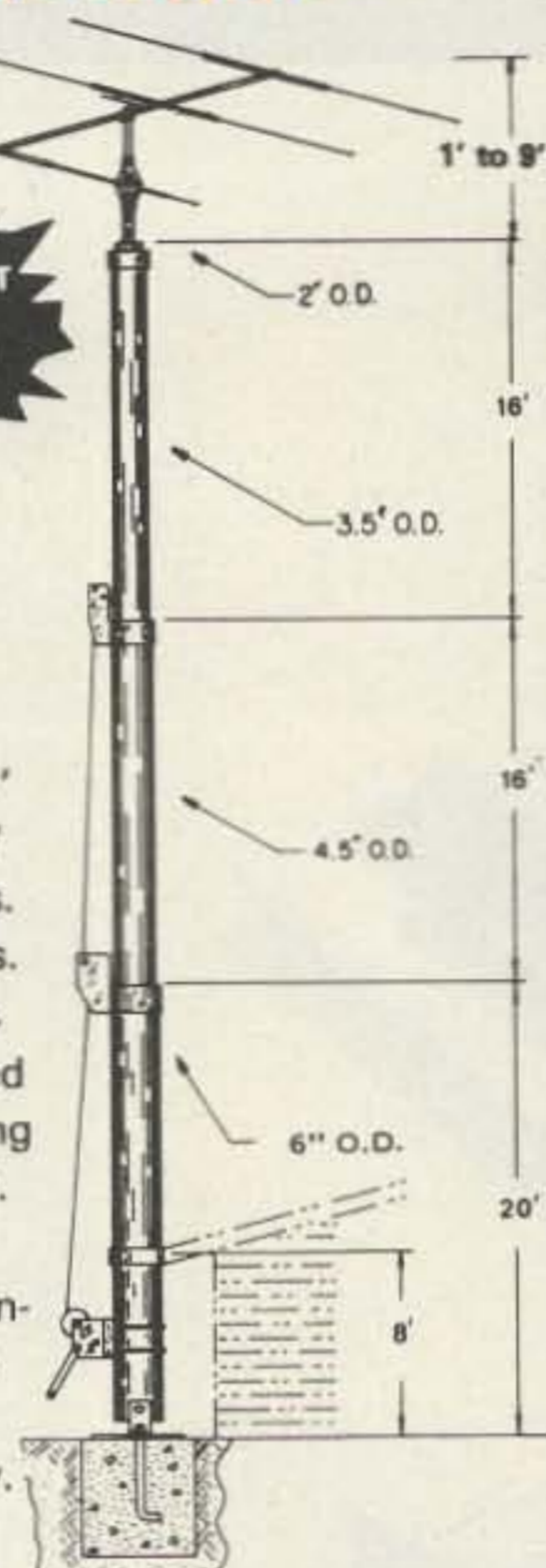

FACTORY DIRECT
\$314⁹⁵

TT-45B

Features:

Max Height: 45'
Min. Height: 22'
Weight: 250 lbs.
Winch: 1200 lbs.
Cable: 4200 lbs.
No Guys required when mounting against eve of house.
For completely freestanding installation, use RG-45B or FB-45B below.



| BASE CHART | | |
|------------|-----------------|--------|
| TOWER | WIDTH | DEPTH |
| TT-45B | 12" x 12" | 30" |
| FB-45B | 30" x 30" | 4 1/2' |
| RB-45B | 30" x 30" | 4 1/2' |
| MT-61B | 18" x 18" | 4' |
| FB-61B | 3' x 3' | 5 1/2' |
| ST-77B | See Below | Bases |
| FB-77B | 3 1/2' x 3 1/2' | 6' |
| RB-77B | 3 1/2' x 3 1/2' | 6' |

| WIND LOADING | | | |
|--------------|--------|---------|-------------------------------------|
| Tower | Height | Sq. Ft. | Square Footage Based on 50 MPH Wind |
| ST-77B | 69 | 18 | |
| | 77 | 12 | |
| MT-61B | 53 | 18 | |
| | 61 | 12 | |
| TT-45B | 37 | 18 | |
| | 45 | 12 | |

Wilson Systems uses a new high strength carbon steel tube manufactured especially for Wilson Systems. It is 25% stronger than conventional pipe or tubing. The tubing size used is: 2" & 3 1/2"-.095; 4 1/2" & 6"-.125, 8"-.134. All tubing is hot dip galvanized. Top section is 2" O.D. for proper rotor and antenna mounting.

The TT-45B and MT-61B come complete with house bracket and hinged base plate for against-house mounting. For totally freestanding installation, use either of the tilt-over bases shown below.

The ST-77B can not be mounted against the house and must be used with the tilt-over base FB-77B or RB-77B shown below.

All three towers above are able to handle large arrays of up to 20 sq. ft. at 80 mph WHEN GUYED with one set of 4-point Guys at the top of the 3 1/2" section. Guying Kits are available at the following prices: GK-45B — \$59.95; GK-61B — \$79.95; GK-77B — \$99.95. When using the Guy System with RB Series Rotating Base, an additional thrust bearing at the top is required. The WTB-1 is available for \$49.95.

IN STOCK

TILT-OVER BASES FOR TOWERS

FIXED BASE

The FB Series was designed to provide an economical method of moving the tower away from the house. It will support the tower in a completely free-standing vertical position, while also having the capabilities of tilting the tower over to provide an easy access to the antenna. The rotor mounts at the top of the tower in the conventional manner, and will not rotate the complete tower.

- FB-45B... 112 lbs... \$154.95
- FB-61B... 169 lbs... \$214.95
- FB-77B... 250 lbs... \$299.95



ROTATING BASE

The RB Series was designed for the Amateur who wants the added convenience of being able to work on the rotor on the ground position. This series of bases will give that ease plus rotate the complete tower and antenna system by the use of a heavy duty thrust bearing at the base of the tower mounting position, while still being able to tilt the tower over when desiring to make changes on the antenna system.

- RB-45B... 144 lbs... \$219.95
- RB-61B... 229 lbs... \$299.95
- RB-77B... 300 lbs... \$449.95

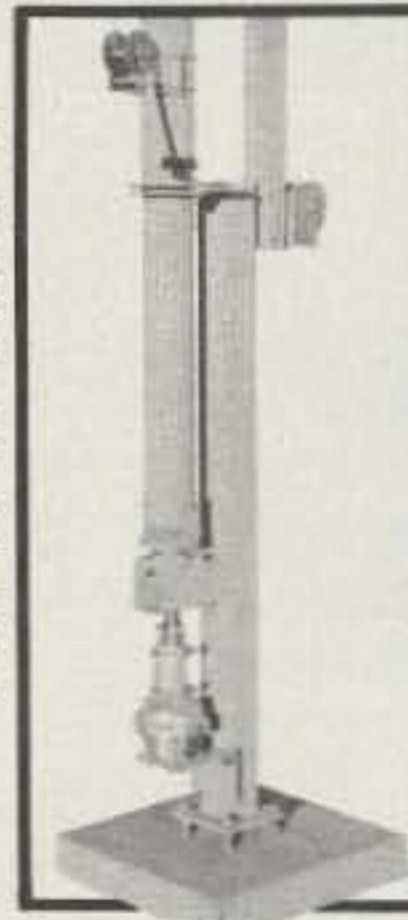

Tilting the tower over is a one-man task with the Wilson bases. (Shown above is the RB-61B. Rotor is not included.)

ORDER
FACTORY DIRECT
1-800-634-6898

W S I WILSON SYSTEMS, INC.

4286 S. Polaris Ave., Las Vegas, Nevada 89103

WILSON SYSTEMS, INC. presents the SYSTEM 36

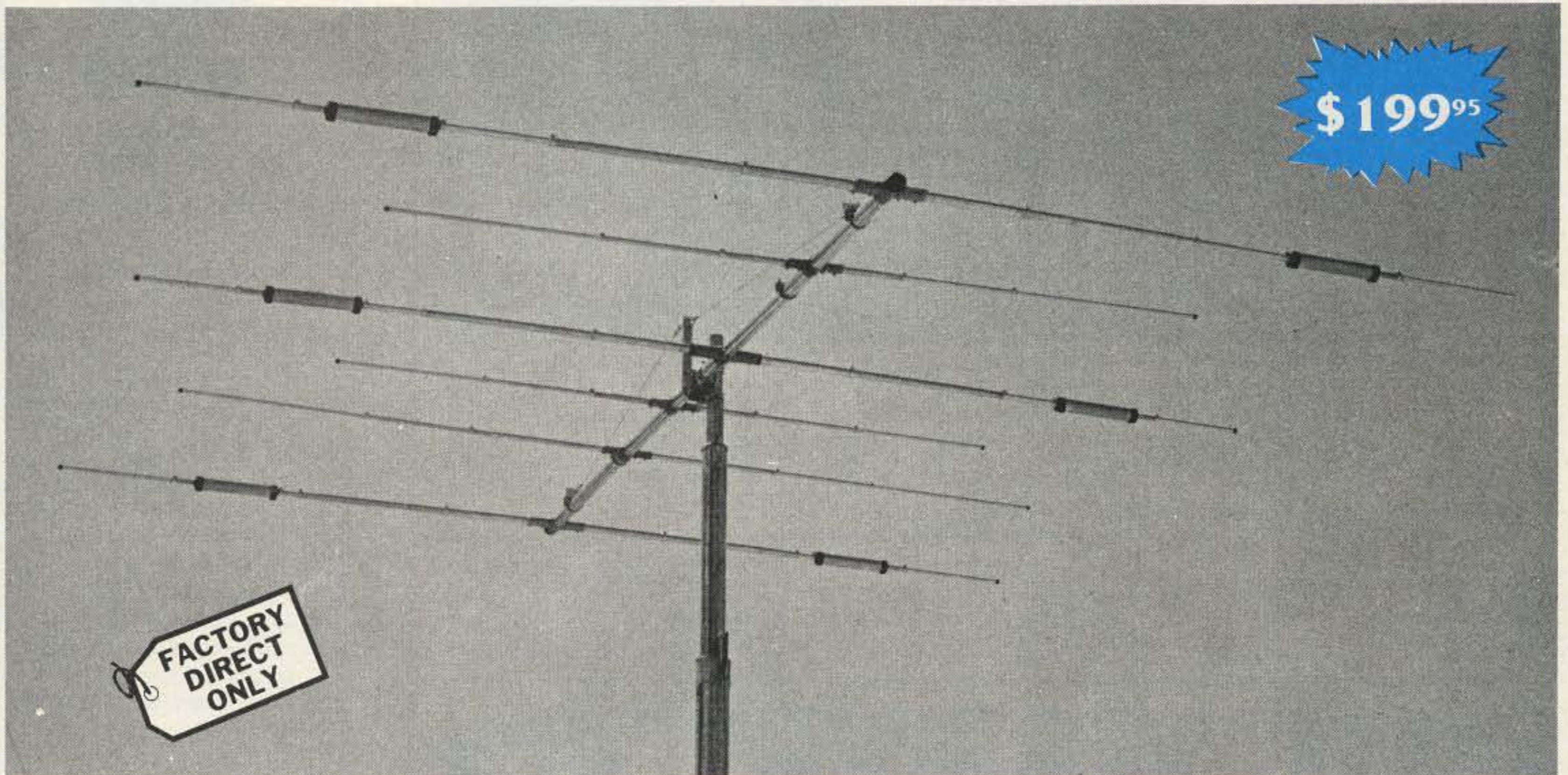

A trap loaded antenna that performs like a monobander! That's the characteristic of this six element three band beam. Through the use of wide spacing and interlacing of elements, the following is possible: three active elements on 20, three active elements on 15, and four active elements on 10 meters. No need to run separate coax feed lines for each band,

as the bandswitching is automatically made via the High-Q Wilson traps. Designed to handle the maximum legal power, the traps are capped at each end to provide a weather-proof seal against rain and dust. The special High-Q traps are the strongest available in the industry today.

SPECIFICATIONS

Band MHz 14-21-28
 Maximum power input . . . Legal limit
 Gain (dBd) Up to 9 dB
 VSWR @ resonance . . . 1.3:1
 Impedance 50 Ω
 F/B ratio 20 dB or better

Boom (O.D. x Length) . . 2" x 24'2 1/2"
 No. of elements 6
 Longest element 28'2 1/2"
 Turning radius 18'6"
 Maximum mast diameter. 2"
 Surface area 8.6 sq. ft.

Wind loading @ 80 mph . . 215 lbs.
 Maximum wind survival . . 100 mph
 Feed method Coaxial Balun
 Assembled weight (approx. 53 lbs.
 Shipping weight (approx.) . 62 lbs.

Compare the SY-36 with others . . .

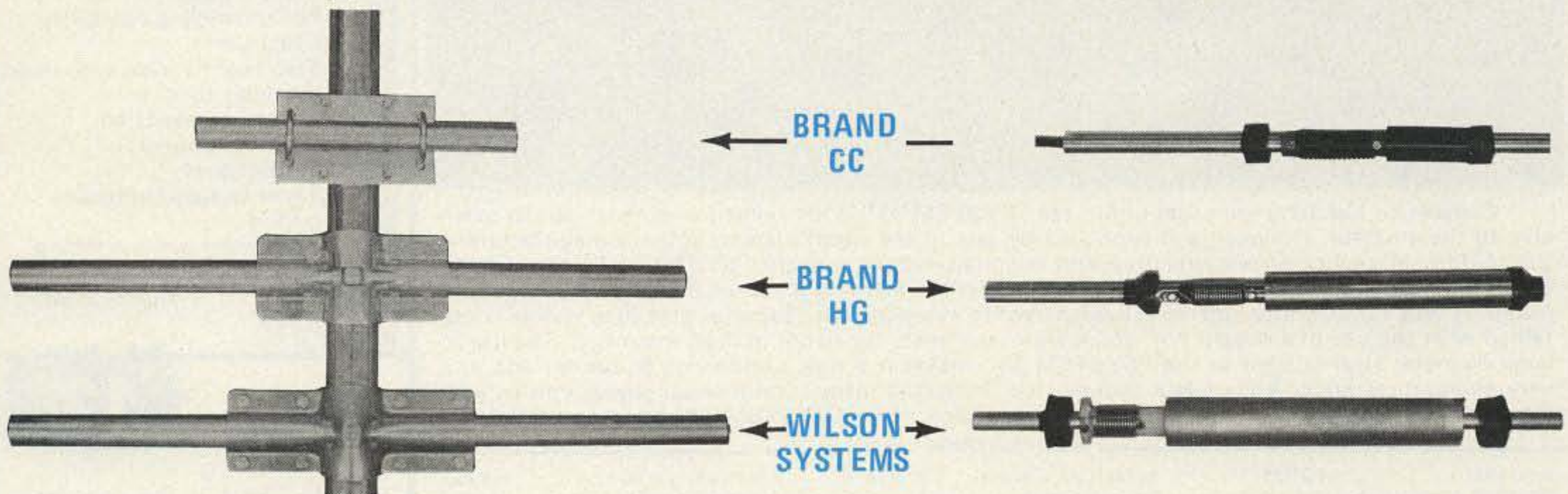

Compare the size and strength of the boom to element clamps. See who offers the largest and heaviest duty. Which would you prefer?

Wilson Systems traps offer a larger diameter trap coil and a larger outside housing, giving excellent Q and power capabilities.

**CALL
 FACTORY DIRECT
 1-800-634-6898**

**W S I WILSON
 SYSTEMS, INC.**

4286 S. Polaris Ave., Las Vegas, Nevada 89103

Prices and specifications subject to change without notice.

WILSON SYSTEMS INC. MULTI-BAND ANTENNAS

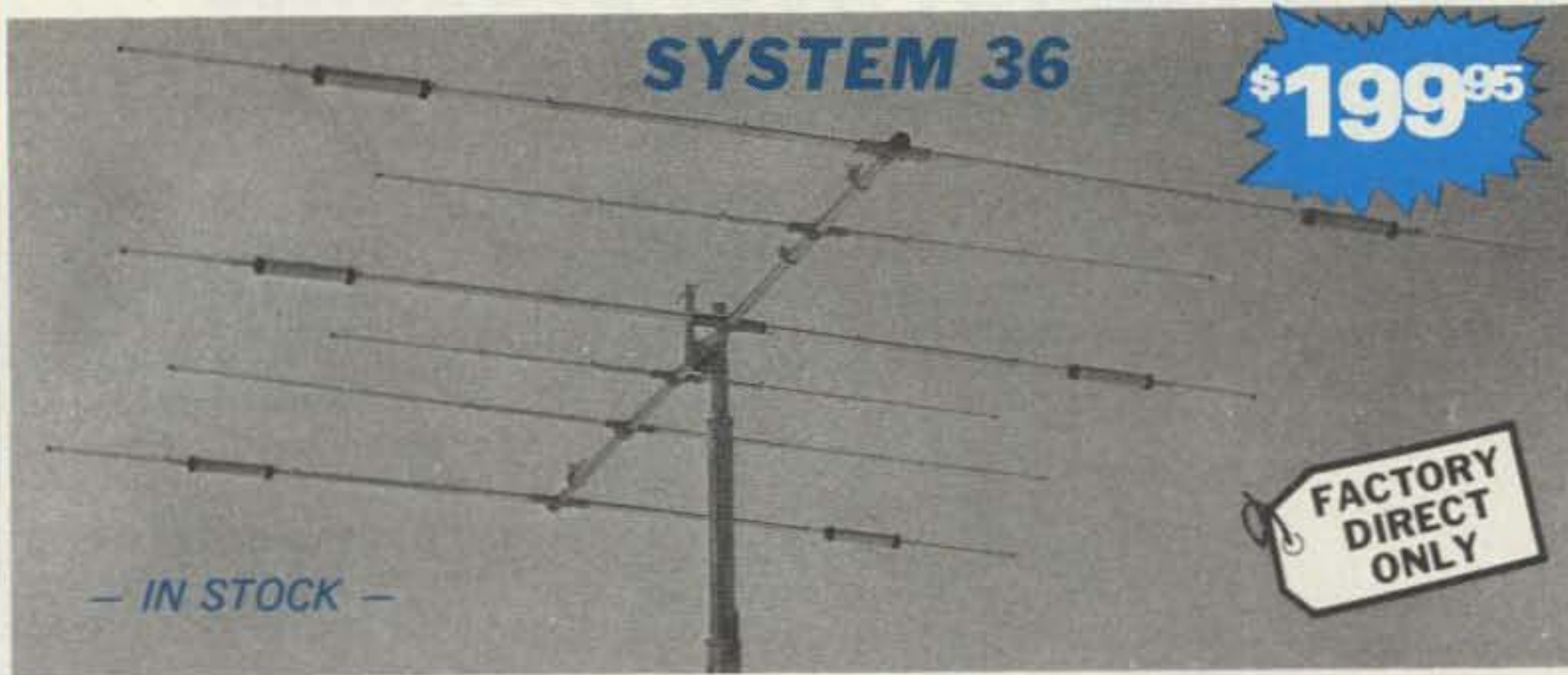

A trap loaded antenna that performs like a monobander! That's the characteristic of this six element three band beam. Through the use of wide spacing and interlacing of elements, the following is possible: three active elements on 20, three active elements on 15 and four active elements on 10 meters. No need to run separate coax feed lines for each band, as the bandswitching is automatically made via the High-Q Wilson traps. Designed to handle the maximum legal power, the traps are capped at each end to provide a weather-proof seal against rain and dust. The special High-Q traps are the strongest available in the industry today.

SPECIFICATIONS

| | | | | | |
|-------------------------------|-----------------|---------------------------------|-----------------|-------------------------------------|---------------|
| Band MHz | 14-21-28 | Boom (O.D. x Length) | 2" x 24' 2 1/2" | Wind Loading @ 80 mph | 215 lbs. |
| Maximum power input | Legal Limit | No. of Elements | 6 | Maximum wind survival | 100 mph |
| Gain (dBd) | Up to 9 dB | Longest Element | 28' 2 1/2" | Feed method | Coaxial Balun |
| VSWR @ resonance | 1.3:1 | Turning Radius | 18' 6" | Matching Method | Beta |
| Impedance | 50 ohm | Maximum mast diameter | 2" | Assembled weight (approx) | 53 lbs. |
| F/B Ratio | 20 dB or better | Surface area | 8.6 sq. ft. | Shipping weight (approx) | 62 lbs. |



Now you can have the capabilities of 40-meter operation on the System 36 and System 33. Using the same type high quality traps, the 40-meter addition will offer 200HKZ of bandwidth at less than 2:1 SWR. The new 33-6 MK will fit your present SY36 or SY33, and using the same single feed line.

SPECIFICATIONS

| | | | | | |
|-------------------------------|-----------------|---------------------------------|-------------|--|----------|
| Band MHz | 14-21-28 | Boom (O.D. x length) | 2" x 14' 4" | Wind loading at 80 mph | 114 lbs. |
| Maximum power input | Legal Limit | No. of elements | 3 | Assembled weight (approx) | 37 lbs. |
| Gain (dbd) | Up to 8 dB | Longest element | 27' 4" | Shipping weight (approx) | 42 lbs. |
| VSWR at resonance | 1.3:1 | Turning radius | 15' 9" | Direct 52 ohm feed — no balun required | |
| Impedance | 50 ohms | Maximum mast diameter | 2" O.D. | Maximum wind survival | 100 mph |
| F/B Ratio | 20 dB or better | Surface area | 5.7 sq. ft. | | |

Capable of handling the Legal Limit, the "SYSTEM 33" is the finest compact tri-bander available to the amateur. Designed and produced by one of the world's largest antenna manufacturers, the traditional quality of workmanship and materials excels with the "SYSTEM 33". New boom-to-element mount consists of two 1/8" thick formed aluminum plates that will provide more clamping and holding strength to prevent element misalignment. Superior clamping power is obtained with the use of a rugged 1/4" thick aluminum plate for boom to mast mounting. The use of large diameter High-Q traps in the "SYSTEM 33" makes it a high performing tri-bander and at a very economical price. A complete step-by-step illustrated instruction manual guides you to easy assembly and the lightweight antenna makes installation of the "SYSTEM 33" quick and simple.

W S I WILSON SYSTEMS, INC.

4286 S. Polaris Ave., Las Vegas, Nevada 89103

Prices and specifications subject to change without notice.

ORDER FACTORY DIRECT 1-800-634-6898



WV-1A

4 BAND TRAP VERTICAL (10 - 40 METERS)

No bandswitching necessary with this vertical. An excellent low cost DX antenna with an electrical quarter wavelength on each band and low angle radiation. Advanced design provides low SWR and exceptionally flat response across the full width of each band.

Featured is the Wilson large diameter High-Q traps which will maintain resonant points with varying temperatures and humidity.

Easily assembled, the WV-1A is supplied with a base mount bracket to attach to vent pipe or to a mast driven in the ground.

Note: Radials are required for peak operation. (See GR-1 below)

SPECIFICATIONS

- 19' total height
- Self supporting — no guys required
- Weight — 14 lbs.
- Input impedance: 50 Ω
- Powerhandling capability: Legal Limit
- Two High-Q traps with large diameter coils
- Low angle radiation
- Omnidirectional performance
- Taper swaged aluminum tubing
- Automatic bandswitching
- Mast bracket furnished
- SWR: 1.1:1 or less on all bands



GR-1

The GR-1 is the complete ground radial kit for the WV-1A. It consists of: 150' of 7/14 stranded copper wire and heavy duty egg insulators, instructions. The GR-1 will increase the efficiency of the GR-1 by providing the correct counterpoise.

TO: ALL AMATEURS
FROM: WILSON SYSTEMS, INC.

I would like to take this opportunity to thank you for your support during the last six months. The response was much greater than anticipated and as a result, we fell behind in our shipping. We now have shipping under control and increased production, all of which contribute to the in-stock situation of almost all the products that we offer. Your kindness and patience at that time was appreciated by everyone at Wilson Systems.

With each product that we manufacture, we include a "Product Evaluation Sheet." This enables us to understand what you like and dislike about our products and services. We appreciate the ideas and comments that you have returned to us on these sheets and have instituted some of the changes suggested. So please continue to send them in.

I'm sure you've noticed the way prices have been creeping (and in some cases leaping) upward. We don't like to raise the prices any more than you like to see them go up, but have you seen the price of steel or aluminum lately?

Not all the price increases are directly related to increased materials costs. Sometimes it is the result of an upgrade to a better product. That is the case with the towers. I am very enthusiastic about the new "B" model towers. Did you take a look at the new specifications? Notice the features that have been changed: thickness of tubing, type of tubing used, and the wind loading. The wind load capability has increased dramatically. Oh yes, they've increased in price—but so has the quality! And did you notice the new tower? That's a 77', freestanding, rotatable tower that will safely handle 12 sq. ft. of antenna at 77' (or 18 sq. ft. at 72') in a 50 mph wind. All of this for less than \$1,400, including the rotating base!

I would also like to mention that this month we are announcing a new antenna product. We are offering you an adapter kit for the SY-36 and SY-33 to add 40-meter operation. This kit, the 33-6 MK, will add 200kc of 40-meter operation to your tribander. It will work only with the SY-33 and SY-36.

We look forward to serving you with almost all products now in stock.

Yours truly,
JIM WILSON
Wilson Systems, Inc.

P.S. Remember, most items are now in stock and ready for shipment.

WILSON SYSTEMS, INC. — 4286 S. Polaris
Las Vegas, NV 89103 — (702) 739-7401

**FACTORY DIRECT
ORDER BLANK**

Toll-Free Order Number
1-800-634-6898

WILSON SYSTEMS ANTENNAS

WILSON SYSTEMS TOWERS

| Qty | Model | Description | Shipping | Price | Qty. | Model | Description | Shipping | Price |
|-----|---------|---|----------|---------|------|--------|--|----------|--------|
| | SY36 | 6 Ele. Tribander for 10, 15, 20 Mtrs. | UPS | 199.95 | | TT-45B | Freestanding 45' Tubular Tower | TRUCK | 314.95 |
| | SY33 | 3 Ele. Tribander for 10, 15, 20 Mtrs. | UPS | 149.95 | | RB-45B | Rotating Base for TT-45B w/tilt over feature | TRUCK | 219.95 |
| | 33-6 MK | 40 Mtr. Mod Kit for SY33 & SY36 | UPS | 49.95 | | FB-45B | Fixed Base for TT-45B w/tilt over feature | TRUCK | 154.95 |
| | WV-1A | Trap Vertical for 10, 15, 20, 40 Mtrs. | UPS | 49.95 | | MT-61B | Freestanding 61' Tubular Tower | TRUCK | 549.95 |
| | GR-1 | Ground Radials for WV-1A | UPS | 12.95 | | RB-61B | Rotating Base for MT-61B w/tilt over feature | TRUCK | 299.95 |
| | M-520A | 5 Elements on 20 Mtrs. | TRUCK | 229.95 | | FB-61B | Fixed Base for MT-61B w/tilt over feature | TRUCK | 214.95 |
| | M-420A | 4 Elements on 20 Mtrs. | UPS | 159.95 | | ST-77B | Freestanding 77' Tubular Tower | TRUCK | 949.95 |
| | M-515A | 5 Elements on 15 Mtrs. | UPS | 129.95 | | RB-77B | Rotating Base for ST-77B w/tilt over feature | TRUCK | 449.95 |
| | M-415A | 4 Elements on 15 Mtrs. | UPS | 84.95 | | FB-77B | Fixed Base for ST-77B w/tilt over feature | TRUCK | 299.95 |
| | M-510A | 5 Elements on 10 Mtrs. | UPS | 84.95 | | GK-45B | Guying Kit for TT-45B | UPS | 59.95 |
| | M-410A | 4 Elements on 10 Mtrs. | UPS | 69.95 | | GK-61B | Guying Kit for MT-61B | UPS | 79.95 |
| | | ACCESSORIES | | | | GK-77B | Guying Kit for ST-77B | UPS | 99.95 |
| | HD-73 | Alliance Heavy Duty Rotor | UPS | 109.95 | | WTB-1 | Thrust Bearing for Top of Tower | UPS | 49.95 |
| | RC-8C | B/C Rotor Cable | UPS | .12/ft. | | | | | |
| | RG-8U | RG-8U Foam-Ultra Flexible Coaxial Cable. 38 strand center conductor, 11 guage | UPS | .21/ft. | | | | | |

NOTE:

On Coaxial and Rotor Cable, minimum order is 100' and 50' multiples.
Prices and specifications subject to change without notice.
Ninety (90) Day Limited Warranty — All Products FOB Las Vegas, Nevada

Prices Effective March 1-31, 1980 Nevada Residents add 3 1/2 % Sales Tax
Ship C.O.D. Check enclosed Charge to VISA MasterCard

Card No. _____ Expires _____
Bank No. _____ Signature _____
Name _____ Phone _____
Street _____
City _____ State _____ Zip _____

Prices and specifications subject to change without notice.

R-X Noise Bridge



- Learn the truth about your antenna.
- Find its resonant frequency.
- Adjust it to your operating frequency quickly and easily.

If there is one place in your station where you cannot risk uncertain results it is in your antenna.

The Palomar Engineers R-X Noise Bridge tells you if your antenna is resonant or not and, if it is not, whether it is too long or too short. All this in one measurement reading. And it works just as well with ham-band-only receivers as with general coverage equipment because it gives perfect null readings even when the antenna is not resonant. It gives resistance and reactance readings on dipoles, inverted Vees, quads, beams, multiband trap dipoles and verticals. No station is complete without this up-to-date instrument.

Why work in the dark? Your SWR meter or your resistance noise bridge tells only half the story. Get the instrument that really works, the Palomar Engineers R-X Noise Bridge. Use it to check your antennas from 1 to 100 MHz. And use it in your shack to adjust resonant frequencies of both series and parallel tuned circuits. Works better than a dip meter and costs a lot less. Send for our free brochure.



The price is \$55.00 in the U.S. and Canada. Add \$3.00 shipping/handling. California residents add sales tax.

Fully guaranteed by the originator of the R-X Noise Bridge.

ORDER YOURS NOW!

Palomar Engineers

Box 455, Escondido, CA. 92025

Phone: [714] 747-3343

DELUXE MESSAGE MEMORY KEYS

"BRAND NEW"
\$89.95



Features: Model TE-284

- State-of-the-Art CMOS Circuitry
- Three choices of Message Storage
 - A. Two (50 character each) message storage
 - B. Four (25 character each) message storage
 - C. One 50 character and two 25 character message storage
- Records at any speed-plays at any speed
- Memory operating LED
- Use for daily QSO or contests

PLUS:

- Self-completing dots and dashes
- Both dot and dash memory
- Iambic Keying with any squeeze paddle
- 5-50 w.p.m.
- Speed, volume, tone, tune and weight controls
- Sidetone and speaker
- Low current drain CMOS battery operation-portable
- Deluxe quarter-inch jacks for keying and output
- Keys grid block and solid state rigs
- WIRED AND TESTED FULLY GUARANTEED—LESS BATTERY

MESSAGE MEMORY KEYS



Features:

- Advanced CMOS message memory
- Two (50 char. each) message storage
- Repeat function
- Records at any speed—plays back at any speed
- Longer message capacity
- Example: send CQ CQ CQ DX de WB2YJM WB2YJM K—then play second message on contact—de WB2YJM QSL NY NY 579 579 Paul Paul K
- Use for daily QSOs or contests

Model # TE201

\$69.95

PLUS:

- State-of-the-art CMOS keyer
- Self completing dots and dashes
- Both dot and dash memory
- Iambic keying with any squeeze paddle
- 5-50 wpm
- Speed, volume, tone, tune and weight controls
- Sidetone and speaker
- Low current drain CMOS battery operation—portable
- Deluxe quarter-inch jacks for keying and output
- Keys grid block and solid state rigs
- WIRED AND TESTED FULLY GUARANTEED—LESS BATTERY

"BRAND NEW"

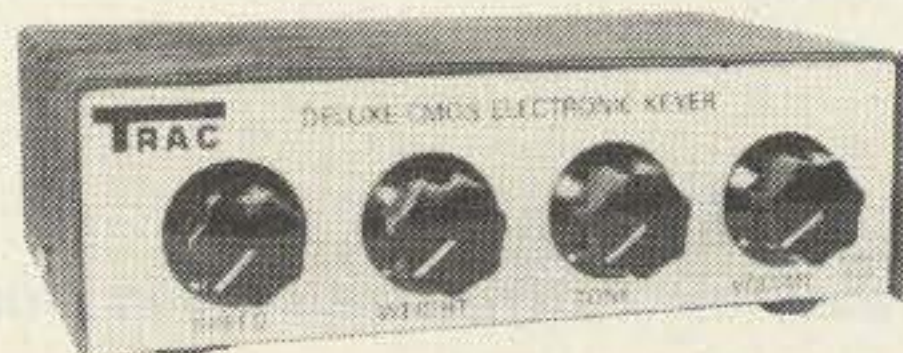

Model # TE144
59.95

Features: Deluxe CMOS Electronic Keyer

- State-of-the-art CMOS circuitry
- Self completing dots and dashes
- Both dot and dash memory
- IAMBIC keying with any squeeze paddle 5-50 wpm
- Speed, weight, tone, volume tune controls & sidetone and speaker
- Semi-automatic "bug" operation & straight keying—rear panel switch
- Low current drain CMOS battery operation—portable
- Deluxe quarter inch jacks for keying and output
- Keys grid block and solid state rigs
- Wired and tested—fully guaranteed—less battery



Model # TE133

\$49.95

Features CMOS ELECTRONIC KEYS

- State-of-the-art-CMOS circuitry
- Self completing dots and dashes
- Dot and dash memory
- Iambic keying with any squeeze paddle
- 5-50 WPM
- Speed, volume, tone, weight & tune controls, sidetone and speaker
- Low current drain CMOS battery operation
- Deluxe quarter inch jacks for keying and output
- Handsome eggshell white base—woodgrain top
- Compact and portable 1-7/8 x 4-1/4 x 6-1/4
- Grid block & solid state keying
- Wired and rested—fully guaranteed less battery

MODEL TE122—same as TE133 less wgt, tune, solid state keying \$36.50

AT YOUR DEALER OR SEND CHECK OR MONEY ORDER.

(plus \$2.00 s/h NY res. add tax)

TRAC

ELECTRONICS, INC
1106 RAND BLDG.
BUFFALO NY 14203

✓76

Morse Converter for Frequency Displays

— another breakthrough for blind hams

The following article describes a digital converter which was designed and built by WA6AXE/3 for

the visually-handicapped person. The device converts the binary-coded decimal (BCD) output which drives

the 7-segment LED frequency display of the DRAKE TR-7 into Morse code audio output.

After completing my last project ("Morse Converter for DMMs"*), it was time to begin work on a new converter which would be of benefit to more hams. The DMM-to-Morse code converter's usage by the visually-handicapped person is limited to those blind hams who want the challenge of using a piece of test equipment normally used only by the sighted person. However, this new digital converter can be used by any blind ham whose rig has a digital frequency display!

My blind friend, W6LZV, had just purchased the Drake TR-7; therefore, it was selected for use in the design of the new digital converter.

One area of concern to many blind amateurs has been their inability to discern the exact frequency on which they were operating. This surely does not have to be a problem any longer. Since digital frequency



Photo A. The Digital Frequency Display-to-Morse Code Converter (DFD-MCC). The name DIGICON (Digital Converter) was given to my project by W6LZV.

*73 Magazine, September, 1979.

display can provide an extremely accurate frequency readout, this new converter, in conjunction with a digital frequency display, can be a most valuable asset to any blind amateur radio operator.

Since the converter was designed to be an integral part of a blind ham's station, it is right at home with W6LZV. It is functioning perfectly!

Though the Drake TR-7 was used in the design of the project, the concept of the project itself can relate to any rig having a digital frequency readout.

For simplicity in this article, I will hereafter refer to the Digital Frequency Display-to-Morse Code Converter as the DFD-MCC.

Beginning the Project

Starting the project was quite frustrating. I began research on it back in September, 1978. At that time, no schematic of a Drake DR-7 board was available. I had thought about looking at the DR-7 board in a friend's TR-7, and trying to draw the schematic from scratch, but this would have been entirely too time consuming. Then I had a brainstorm; I called Ron Wysong K8AY, the Director of Engineering at Drake. After telling him about the design concept, I asked if there was a way I could obtain a copy of at least the DR-7 schematic. Thanks to Ron, I had the schematic four days later, and thereafter things really started rolling.

Design Objectives

The main objective was to provide the blind user with the Morse code (audio output) equivalent of each of the six digits making up the TR-7's frequency display. This was done because of the TR-7's general coverage possibilities. If a "ham bands only" type of transceiver were to be used,

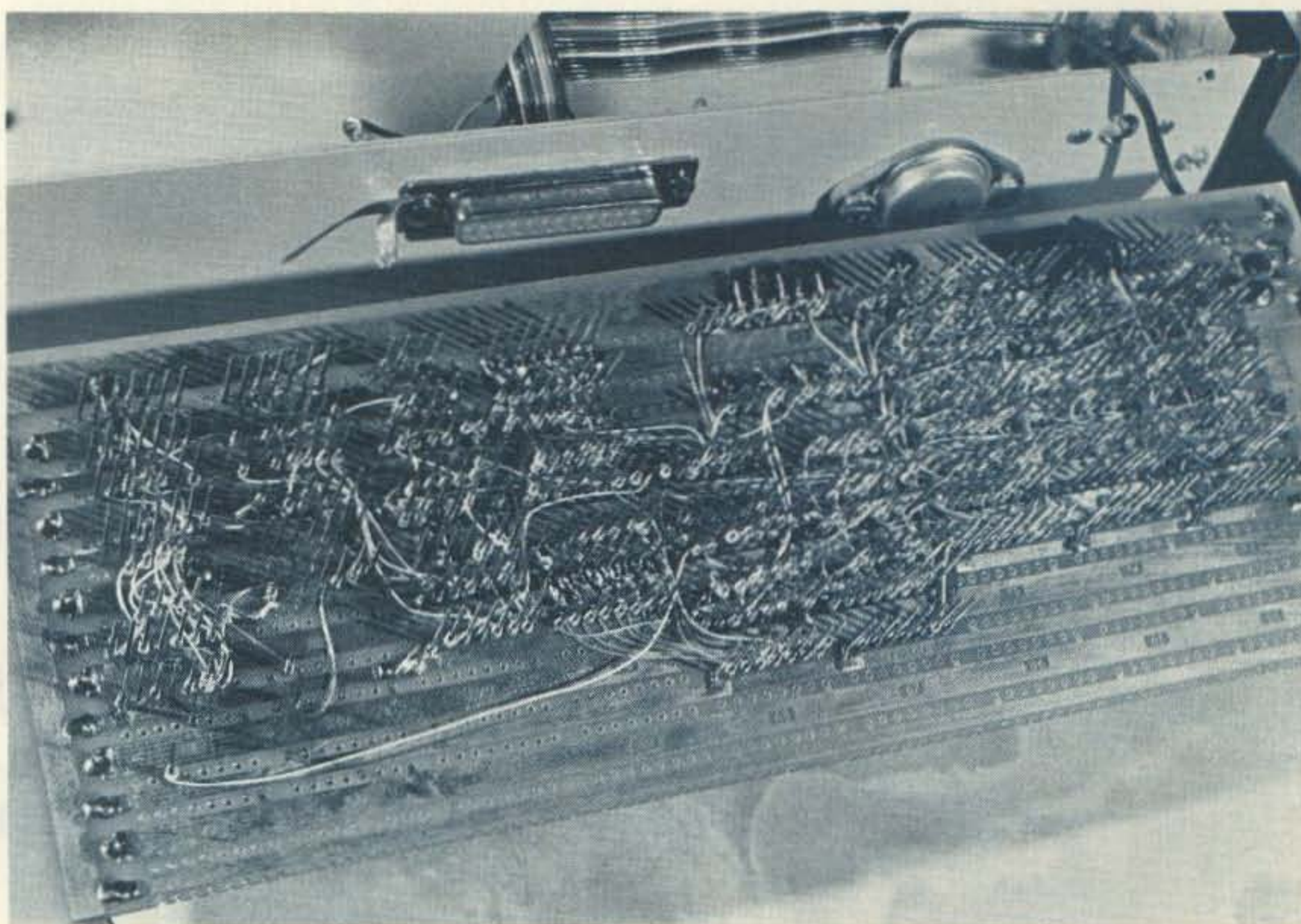

Photo B. This photograph details the appearance of the wire-wrapping technique. The wire-wrapping was done with #30 KYNAR wire and the WSU-30M wire-wrapping tool.

the first two digits (10s of MHz and 1s of MHz) could be deleted.

Another prime objective was to keep the amount of external controls (switches and pushbuttons) down to a

minimum, and to keep the overall external layout as simple as possible.

By providing the DR-7 board (optional digital frequency readout board inside of the TR-7) with an ex-

ternal input, it can be used as a frequency counter. Therefore, one extra benefit realized from using the Drake TR-7 in this project is a frequency counter-to-Morse code converter!

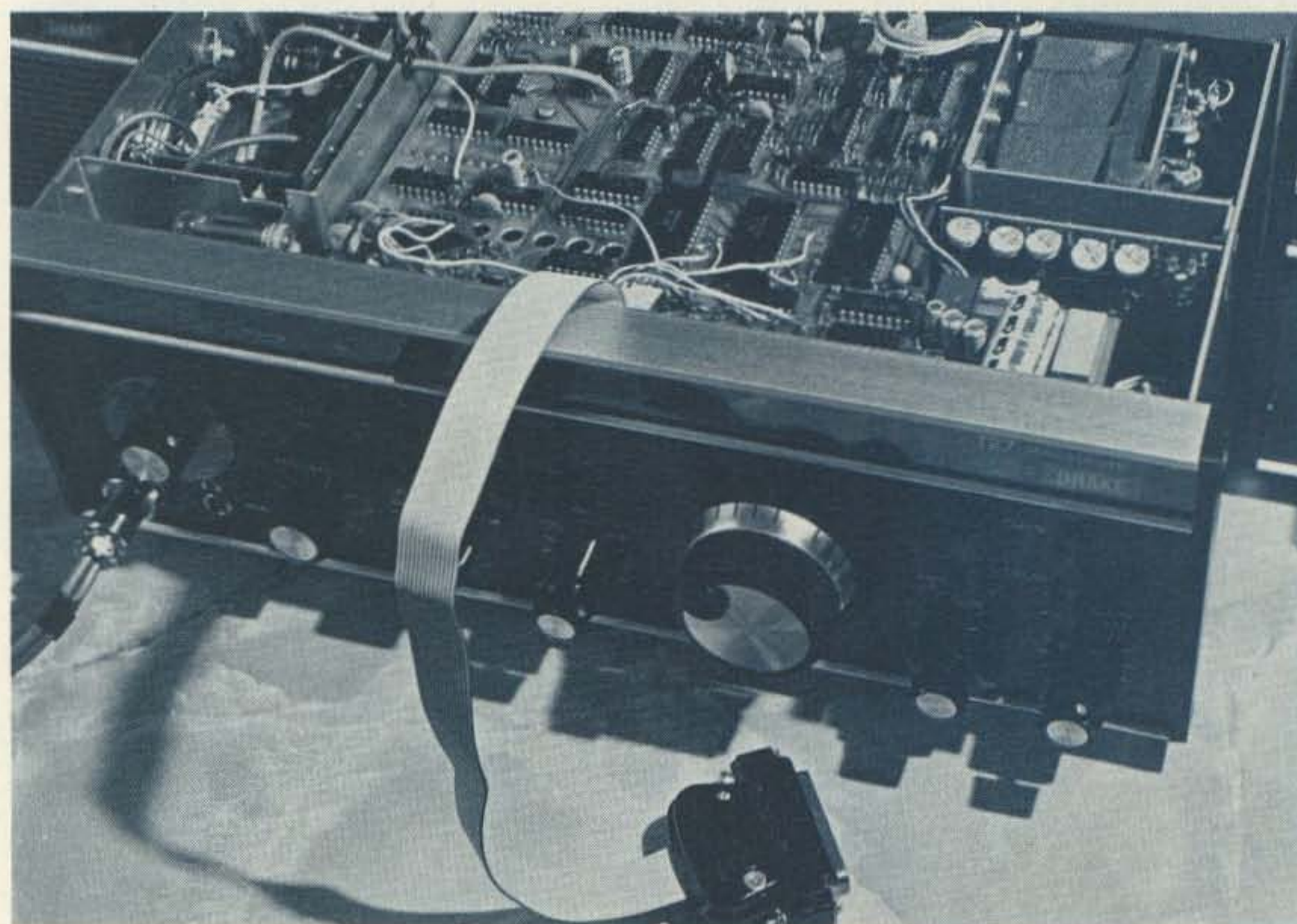

Photo C. This shows the 14-conductor ribbon-wire cable as it enters the Drake TR-7. The black plug connector is used to connect the DR-7 board's output with the DFD-MCC's input.

New 2 Meter Avanti Mobile Antenna

Mounts on glass — no holes!

- **Receives and transmits through glass.**
- **Superior performance equivalent to 5/8 wave.**
- **Superior radiation full Omni-Directional.**

It's easy to install — No holes to drill, no magnet to scratch the paint, no clamps. Uses an especially developed epoxy adhesive that secures antenna to window like a 1/4" bolt. The capacity coupling box is simply attached with a special adhesive tape to inside of window. Worried about crimping or corroding coaxial cables? It's all inside and out of sight.

AH 151.3G SPECIFICATIONS

| | |
|---|------------------------|
| Gain | Equivalent to 5/8 wave |
| 2 meter V.S.W.R. Band Width | Better than 1.5:1 |
| Maximum power | 150 |
| Nominal Impedance | 50 Ohms |
| Chrome plated casting, Stainless Steel hardware, Swivel whip holder | Height 33" |
| Performance and Mechanical Patents Pending | |

Buy one from your nearest AVANTI dealer. If your dealer does not have one in stock, have him call the following toll free number and we will ship him one within 24 hours:

(800) 323-9429

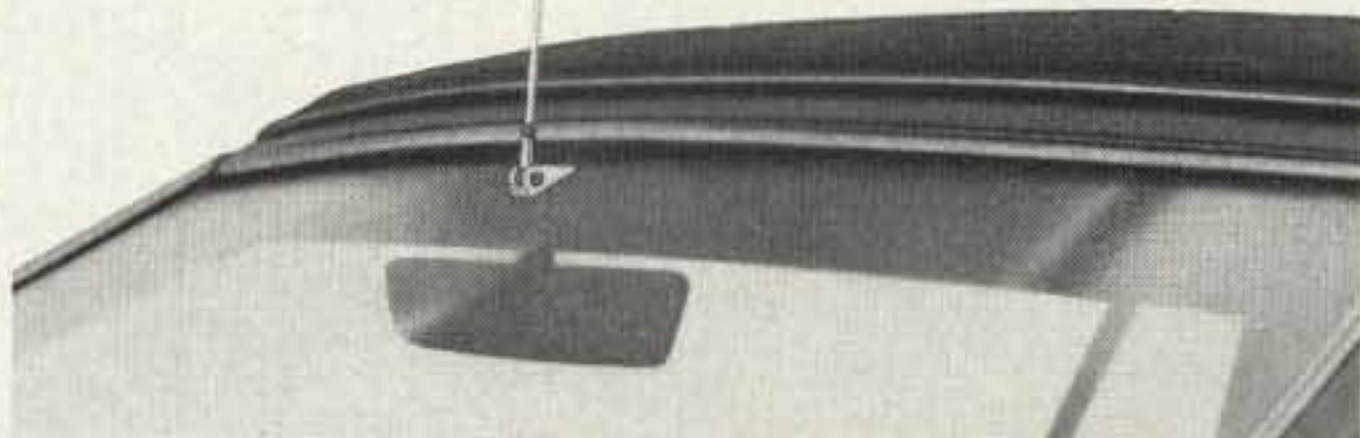
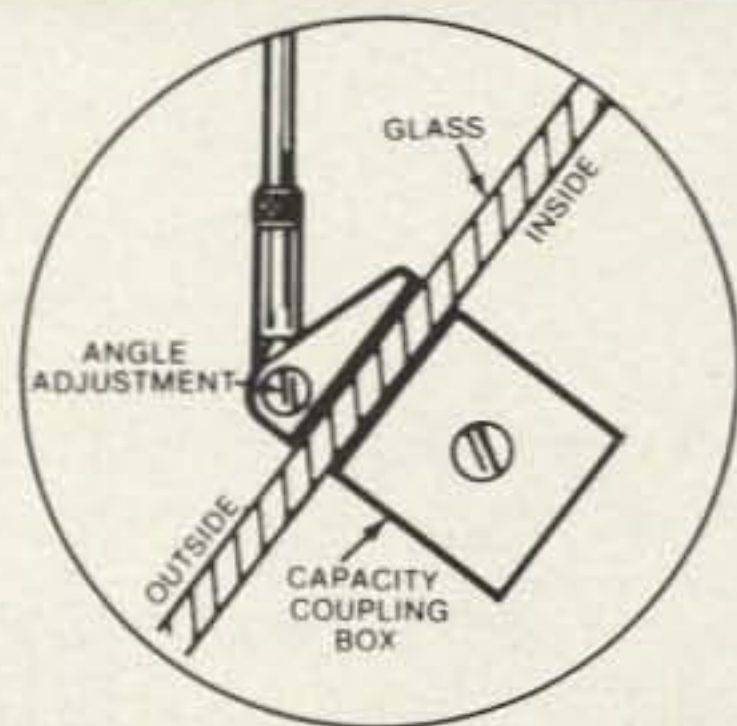

See Avanti's other new amateur mobile and base antennas. Write for new catalog today.

Send 50¢ for handling and postage.

✓ 10

avanti antennas

Avanti Research and Development, Inc.,
340 Stewart Ave., Addison, IL 60101
1979 In Canada: Lenbrook Ind., Scarborough, Ontario M1H 1H5

X-RATED

**OUTPERFORMS
ALL commercially
available tribanders
AND many monoband
systems, too!**

KLM's KT-34X

20, 15, & 10M — FOR THE MATURE HAM ONLY

KT-34 UPGRADE KITS AVAILABLE

WRITE FOR COMPLETE DETAILS OR
SEE YOUR LOCAL KLM DEALER

KLM 17025 LAUREL RD., MORGAN HILL, CA 95037, (408) 779-7363 ✓ 40

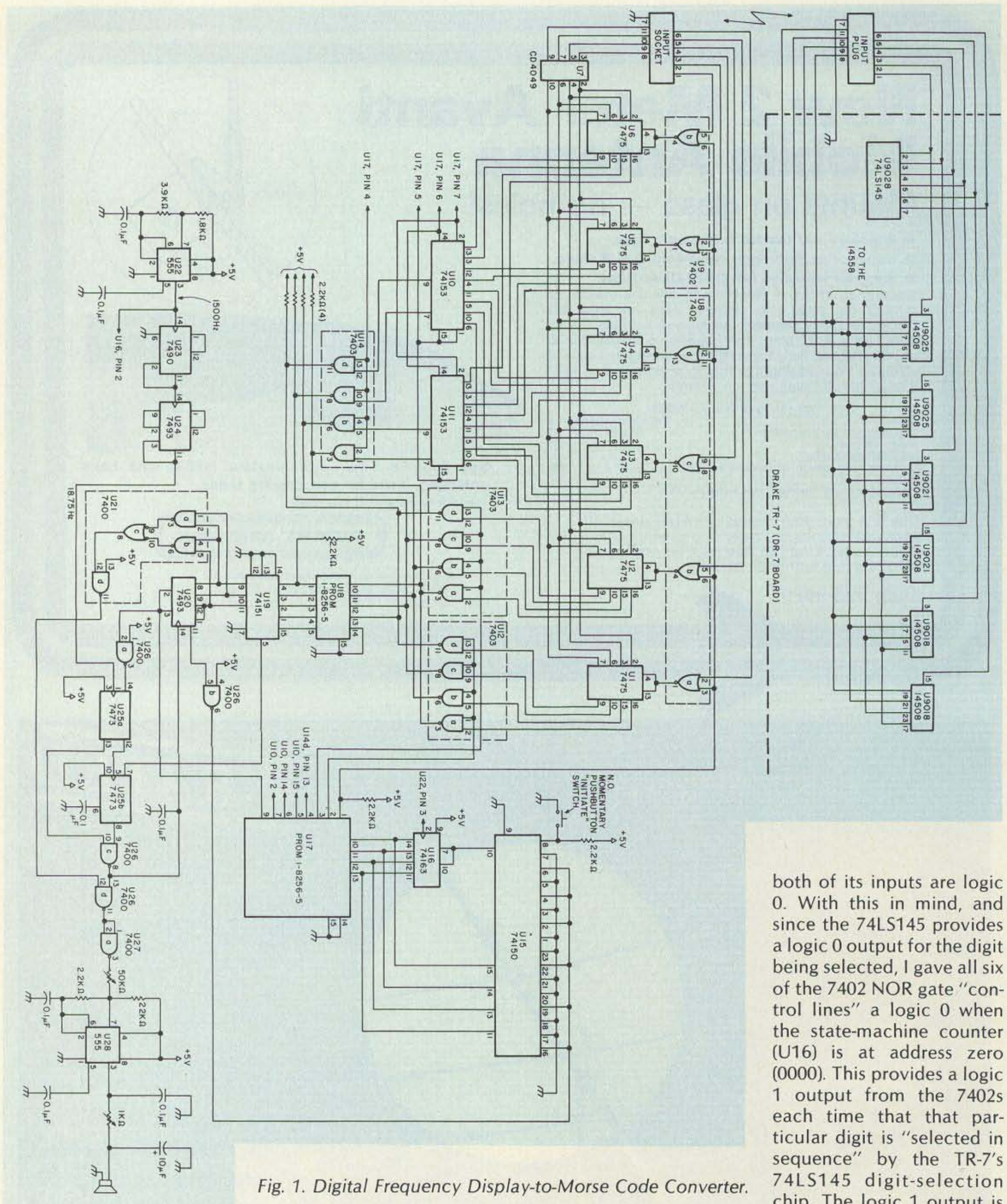

Fig. 1. Digital Frequency Display-to-Morse Code Converter.

TR-7 Digital Display (MUX)

See Fig. 1. The TR-7 multiplexed display components which drive the DFD-MCC are: U9018, U9021, and U9025—14508 dual 4-bit latches used for the binary-coded decimal (BCD), and

U9028—a 74LS145 BCD-to-decimal decoder/driver used for the digit selection.

DFD-MCC (DEMUX)

To accomplish the demultiplexing of the TR-7's multiplexed frequen-

cy display, I used six 7475 quad latches (U1-U6), and two 7402 quad 2-input NOR gate chips (U8 and U9).

Demux Logic

A NOR gate provides a logic 1 output only when

both of its inputs are logic 0. With this in mind, and since the 74LS145 provides a logic 0 output for the digit being selected, I gave all six of the 7402 NOR gate "control lines" a logic 0 when the state-machine counter (U16) is at address zero (0000). This provides a logic 1 output from the 7402s each time that that particular digit is "selected in sequence" by the TR-7's 74LS145 digit-selection chip. The logic 1 output is then driven to the 7475 quad latch enable inputs (pins 4 and 13). This ENABLES the 7475s to "follow" any changes that occur in the digital frequency display while the converter is waiting for the "next instruction"—the initiate

command. Once the initiate command is set (grounding pin 8 of U15, 74150), a logic 1 is sent to the NOR gate control lines. This action drives the NOR gate outputs to logic 0, thereby **DISABLING** the 7475 latches and "locking-in" each one of the six digits.

Digit Sequencing

Now that the six digits are demultiplexed and stored in the 7475 quad latches, we need to send each one of them, in proper sequence, to the BCD-to-Morse converter ROM (U18). The contents of U1 through U6 are: 10s of MHz, 1s of MHz, 100s of kHz, 10s of kHz, 1s of kHz, and 100s of Hz, respectively. Proper sequencing through the six digits is accomplished by the network of IC chips U10-U14.

The state-machine controller ROM (U17) provides all logic necessary for enabling, disabling, and addressing the five IC chips which make up the digit-sequencing network.

U10 and U11, 74153 dual 1-of-4 data selectors, are used to select/sequence digits three through six. U12, U13, and U14, 7403 quad 2-input NAND gates with "open collectors," comprise a **WIRED-NOR** bus system used for sending all six digits, one at a time, to the BCD-to-Morse converter ROM on one set of four lines.

The following paragraphs will detail the events taking place during each "state" of the state-machine controller ROM (with regard to the digit-sequencing process).

During states 0001 and 0010, the 1st digit (10s of MHz) is being addressed and sent. The 1st digit (stored in U1) enters the bus system via U12. To permit only the 1st digit onto the bus system, we provide a logic 1 (pin 2 of U17) to the

"enable output lines" of only U12. The other two 7403 chips (U13 and U14) are provided with a logic 0, thereby disabling their output. At this point, the BCD information at the inputs of U13 and U14 have no effect on the bus system.

During states 0011 and 0100, the 2nd digit (1s of MHz) is being addressed and sent. Chips U12 and U14 get a logic 0 on their enable output lines. U13 is the only 7403 receiving the logic 1 (from pin 3 to U17) for enabling its output to enter onto the bus system.

During states 0101 and 0110, the 3rd digit (100s of kHz) is being addressed and sent. Beginning with this digit, the 74153s, U10 and U11, come into play. Both of the 74153's chip outputs are enabled, as are the enable output control lines of U14 (from pin 4 of U17). Chips U12 and U13 are now disabled, and will remain disabled through state 1111. The binary address, 00, necessary to push out the 3rd digit from the 74153s, is provided to pins 2 and 14 (from the state-

| State | Read Enable U10/11, 74153 (B) U10/11, 74153 (A) U10/11, Chip Enable U14 Output Enable U13 Output Enable U12 Output Enable Digit "lock-up" | Remarks |
|-------|--|---------------------------------|
| 0000 | 1 0 0 1 0 0 0 0 | Wait for next instruction |
| 0001 | 1 0 0 1 0 0 1 1 | Address 1st digit (10s of MHz) |
| 0010 | 0 0 0 1 0 0 1 1 | Send 1st digit (10s of MHz) |
| 0011 | 1 0 0 1 0 1 0 1 | Address 2nd digit (1s of MHz) |
| 0100 | 0 0 0 1 0 1 0 1 | Send 2nd digit (1s of MHz) |
| 0101 | 1 0 0 0 1 0 0 1 | Address 3rd digit (100s of kHz) |
| 0110 | 0 0 0 0 1 0 0 1 | Send 3rd digit (100s of kHz) |
| 0111 | 1 0 1 1 0 0 0 1 | Clear BCD-to-Morse converter |
| 1000 | 1 0 1 0 1 0 0 1 | Address 4th digit (10s of kHz) |
| 1001 | 0 0 1 0 1 0 0 1 | Send 4th digit (10s of kHz) |
| 1010 | 1 1 0 1 0 0 0 1 | Clear BCD-to-Morse converter |
| 1011 | 1 1 0 0 1 0 0 1 | Address 5th digit (1s of kHz) |
| 1100 | 0 1 0 0 1 0 0 1 | Send 5th digit (1s of kHz) |
| 1101 | 1 1 1 1 0 0 0 1 | Clear BCD-to-Morse converter |
| 1110 | 1 1 1 0 1 0 0 1 | Address 6th digit (100s of Hz) |
| 1111 | 0 1 1 0 1 0 0 1 | Send 6th digit (100s of Hz) |

Fig. 2. Control ROM contents and program.

| Digit | ROM Address | ROM Contents |
|-------|-------------|--------------|
| 0 | 0000 | 11111 |
| 1 | 0001 | 11110 |
| 2 | 0010 | 11100 |
| 3 | 0011 | 11000 |
| 4 | 0100 | 10000 |
| 5 | 0101 | 00000 |
| 6 | 0110 | 00001 |
| 7 | 0111 | 00011 |
| 8 | 1000 | 00111 |
| 9 | 1001 | 01111 |
| blank | 1111 | 11111 |

Fig. 3. Code conversion ROM contents.

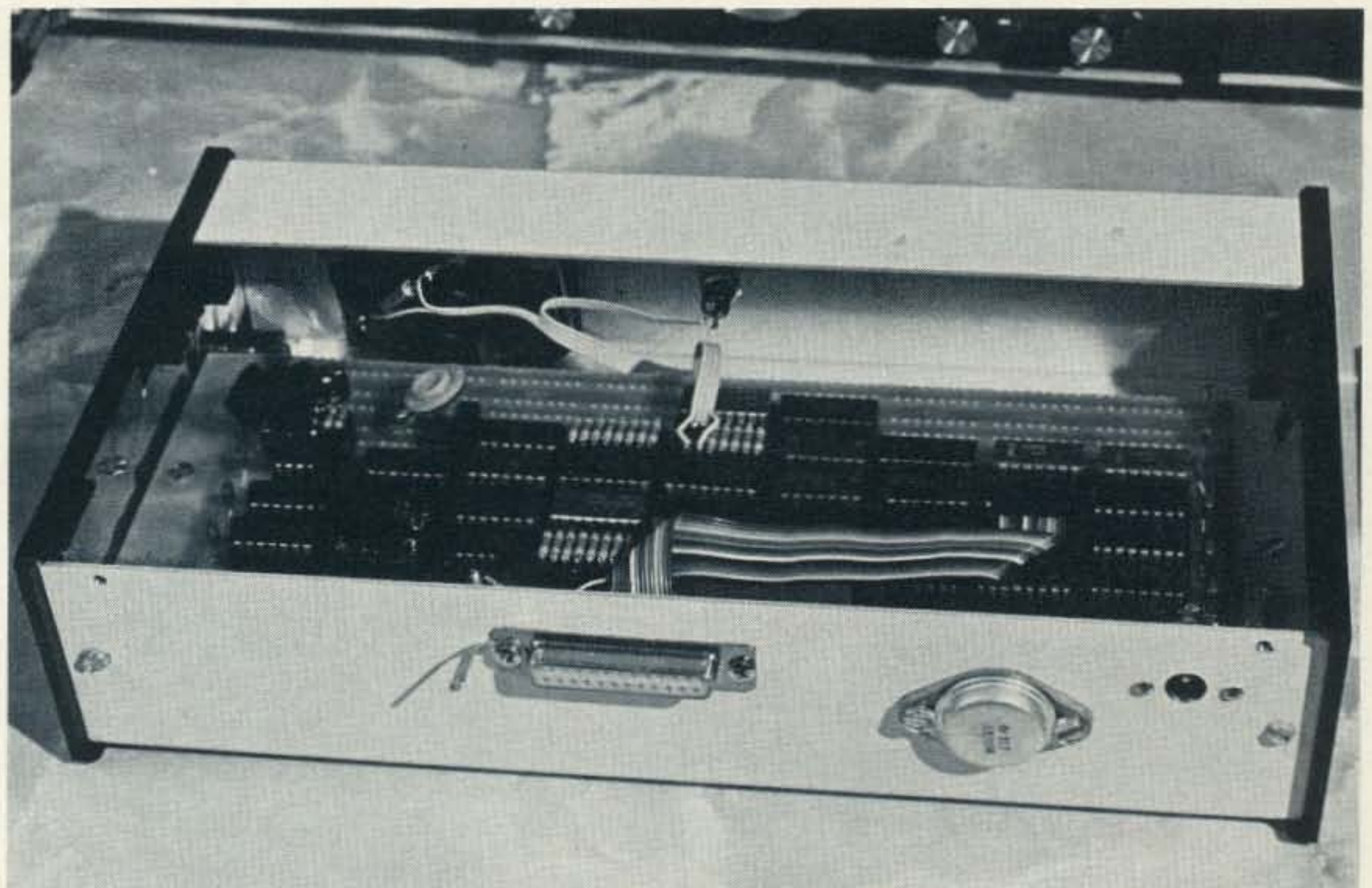

Photo D. Here is a "back" view of the DFD-MCC. The LM309K 5-V regulator is located on the right-hand side. The input socket is located in the center of the back apron. The unregulated dc input connector is located on the right side of the LM309K.

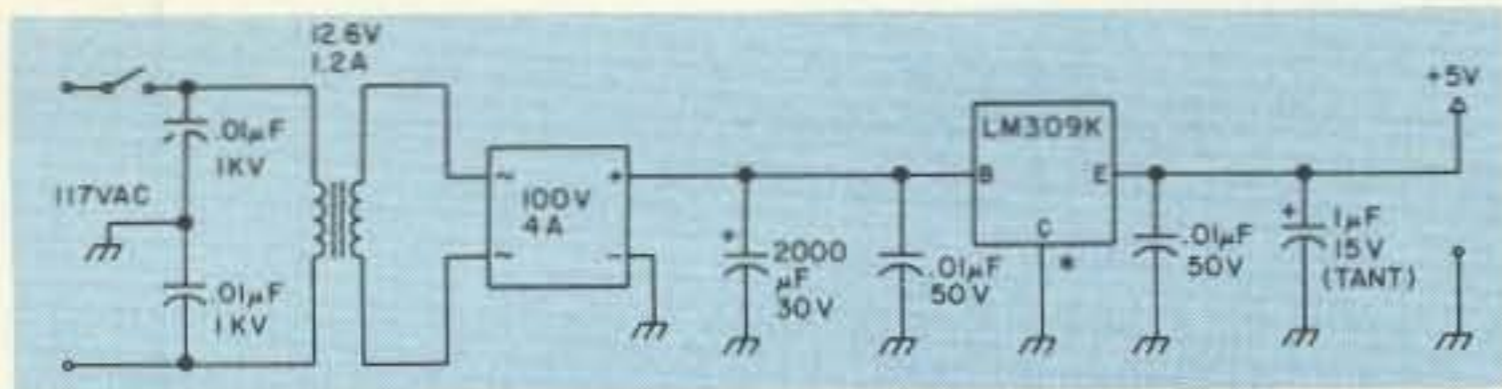

Fig. 4. 117-V ac input power supply for the DFD-MCC. (The main cabinet's back apron is used as the heatsink for the LM309K.)

machine controller ROM, U17).

During state 0111, "clearing the BCD-to-Morse converter," all chips which receive logic from U18 are disabled.

During states 1000 and 1001, the 4th digit (10s of kHz) is being addressed and sent. As with the 3rd digit, the necessary binary address, now 01, is provided to the 74153s. Again, the output 7403 (U14) and both of the 74153s are enabled.

During state 1010, "clearing the BCD-to-Morse converter," all chips which receive logic from U18 are again disabled.

During states 1011 and 1100, the 5th digit (1s of kHz) is being addressed and sent. The binary address, 10, is sent to the 74153s. U14 and both of the 74153s are enabled. U12 and U13 remain disabled.

During state 1101, all chips receiving logic from

U18 are again disabled. During state 1110 and 1111, the 6th digit (100s of Hz) is being addressed and sent. The binary address, 11, is delivered to both 74153s. U14 and both of the 74153s are enabled. Chips U12 and U13 remain disabled.

Once the 6th digit is sent, the state-counter reverts to address 0000 where the logic outputs from the state-machine controller ROM tell all chips to "wait for the next instruction".

The control ROM (U17) program, which has just been narratively described, along with the exact contents of this ROM, is shown in Fig. 2.

TR-7-to-DFD-MCC Interface

At this point, it is time to mention what has happened to the binary-coded decimal (BCD) which was generated by the TR-7's 14508 chips. The BCD leaving the 14508s is in the form

of "positive" logic. Since I had already planned on using positive logic BCD as the input to the BCD-to-Morse converter ROM (U18), the use of a CD4049, and a 7403 bus system provided the necessary inversions to permit BCD to enter U18. The actual flow is as follows: BCD from the TR-7 enters the "interface" CD4049, CMOS-to-TTL buffer (inverting) chip. As it leaves the CD4049, it is in an inverted form (BCD), and enters the 7475 quad latches. Leaving the 7475 latches, and entering the 7403 NAND gates, which comprise the WIRED-NOR bus system, the information remains in the BCD form. But, as it leaves the 7403 NAND gates and enters onto the bus system, it is once again inverted back to BCD. Therefore, we now have positive logic BCD entering U18 from the bus system.

BCD-to-Morse Converter ROM

The output of the WIRED-NOR bus system is connected to the ADDRESS lines of the BCD-to-Morse converter ROM (U18), a Harris PROM 1-8256-5 code-conversion ROM. This "field-programmable"

ROM converts BCD to an intermediate code in which 0 represents a dit and 1, a dah. The contents of the code-conversion ROM are shown in Fig. 3. Note that the ROM will convert a "blanked" first digit into a Morse code zero. With this in mind, the blind user of the DFD-MCC can account for all six digits, whether or not the first is blanked (actually a zero, but it is suppressed to the sighted person) or is a valid digit (1 through 9).

I chose the Harris PROM 1-8256-5 due to its local availability. This chip can be replaced by any of the 32×8 type of PROMS: 8223, 82S23, 74188, 74S188, etc. Programming of the 8223 and 82S23 has been discussed in previous editions of *73 Magazine*, and will not be discussed in this article.

The State-Machine Controller Network

This network is composed of chips U15, a 74150 16-to-1 data selector, U16, a 74163 4-bit synchronous counter, and U17, a PROM 1-8256-5 32×8 ROM. U15 is the input multiplexer, acting like a single pole, 16-throw logic switch. U16 is the "state" counter whose binary outputs determine the current state. U17 is the "state-machine" ROM. Its address lines are connected to the state counter's output line.

Once again, there are various types of 32×8 (256-bit) PROMS available for use as the state-machine ROM (U17).

Other Information

The power supply. The power supply used for the DFD-MCC is shown in Fig. 4.

Changing CW speeds. The speed of the CW output is determined by the frequency of the square wave entering pin 1 of the 7473 (U25). The output speed in wpm is equal to 1.2 times this frequency. My

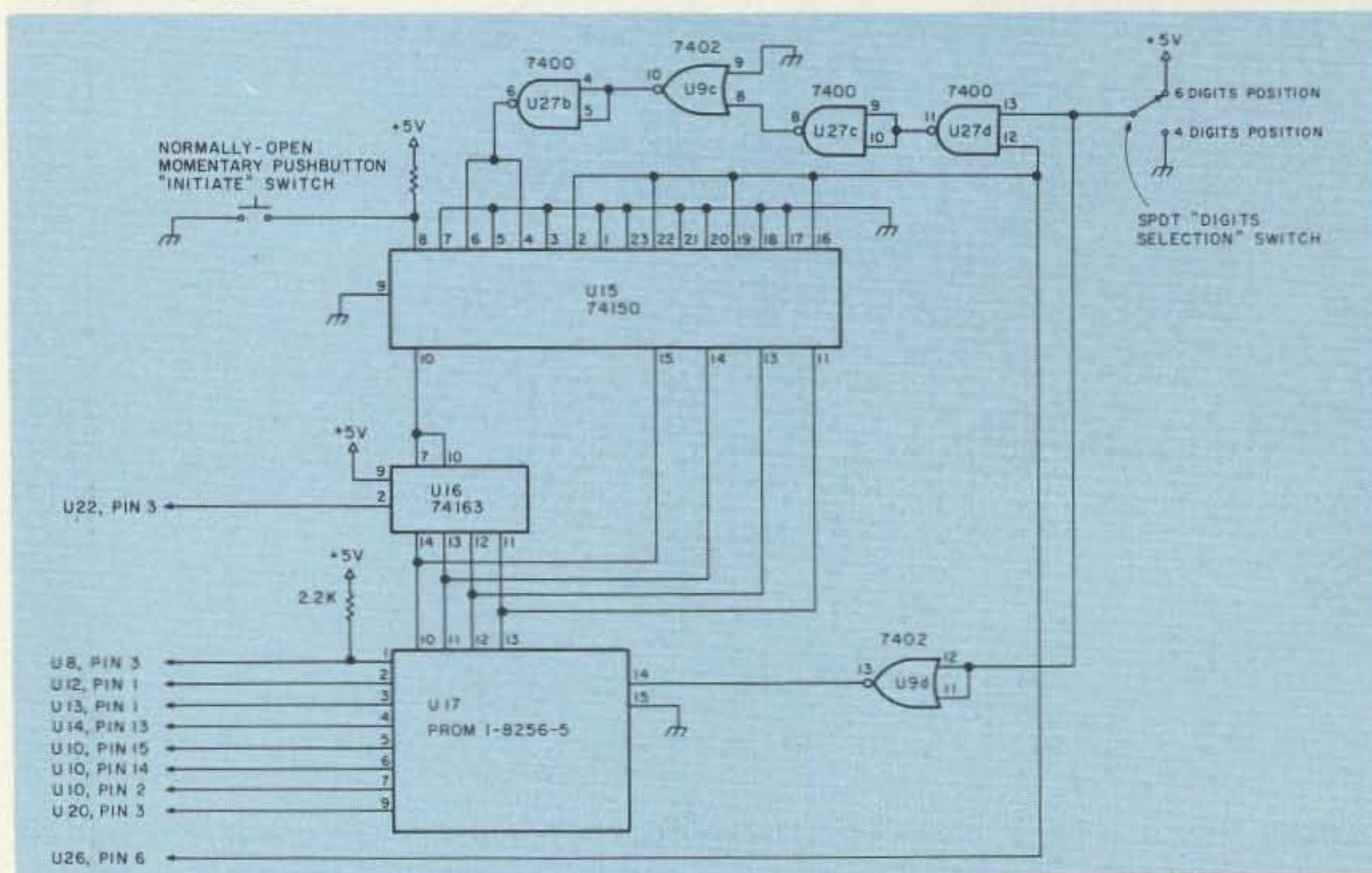

Fig. 5. Optional 4- or 6-digit selection.

converter is currently set at about 22 wpm. The best way to alter the CW speed is to change the division ratio of U24.

The master clock. The master clock is a NE555P timer IC wired as an astable multivibrator with a free-running frequency of about 1500 Hz. This frequency is further divided by 7490 and 7493 counters (U23 and U24) to about 18.5 Hz, for use in the BCD-to-Morse converter.

Construction notes. I used the Ten-Tec cabinets due to their beauty and simplicity of design (Photo A). Since the current design is a "prototype," I used the wire-wrapping technique (Photo B). This gave me the complete versatility in construction that I wanted. I used a 14-conductor ribbon-wire cable to interconnect the TR-7 and the DFD-MCC (Photo C). The LM309K, 5-V regulator, was mounted on the back apron of the cabinet so that maximum heat dissipation would be obtained (Photo D). Most of the discrete components were placed on DIP plugs (component holders/carriers) because they make it easier to change parts (modular fashion) and also enhance the beauty and simplicity of the layout. (See Photo E).

Wanting to keep the amount of switches and other controlling devices down to a minimum, the only controls which are placed on the front panels are the on-off switch on the power supply, and the normally-open momentary pushbutton switch on the main cabinet. This simplicity in design minimizes the number of external controls which have to be dealt with by the blind user.

Connections to the DR-7 board were made by "hard-wiring" the 11-conductor ribbon-wire cable (14-conductor cable with 3 wires not used) directly to the ap-

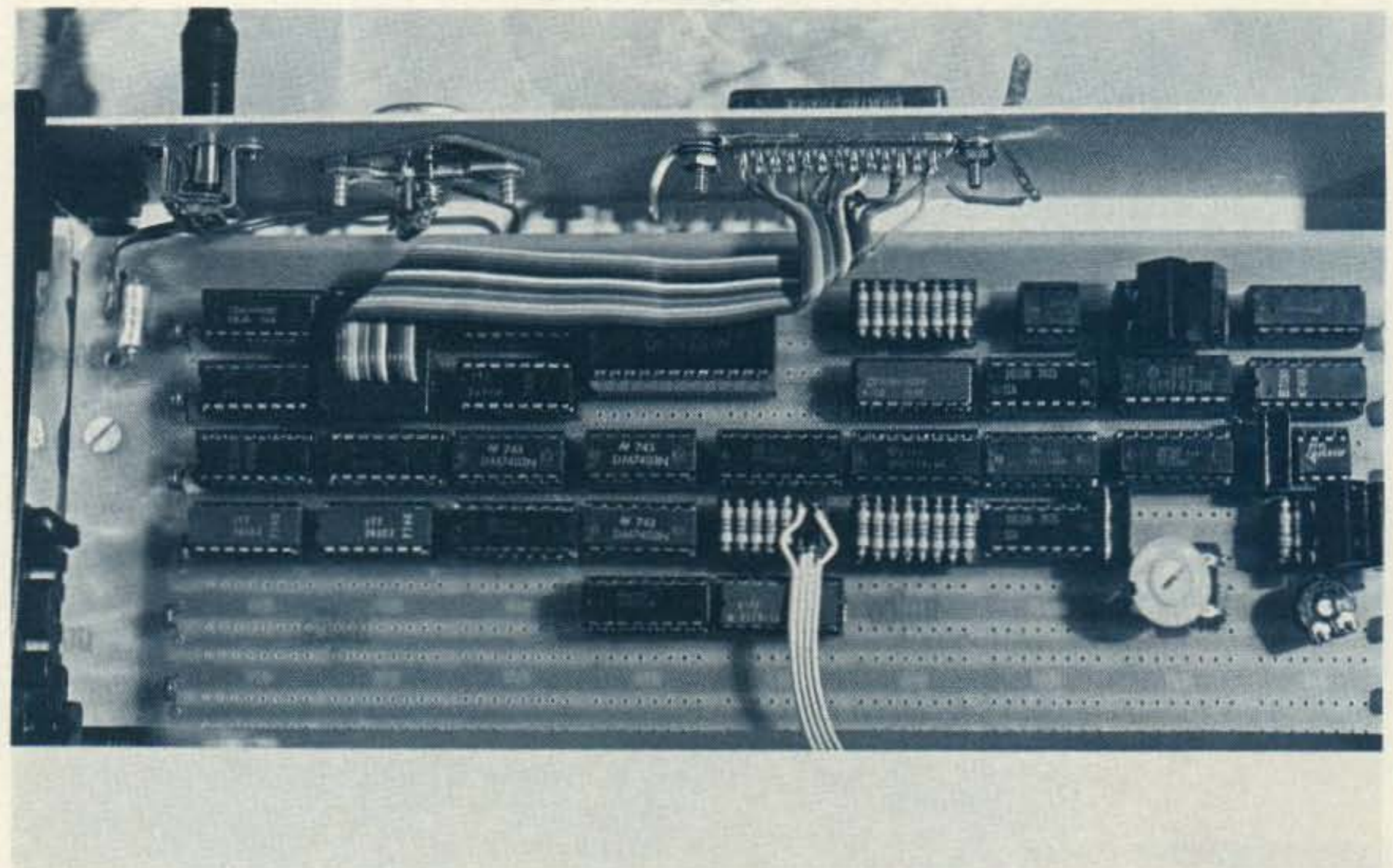

Photo E. This photo details the usage of DIP plugs for holding the discrete components. Note the "modular fashion" which simplifies the overall layout.

propriate junctions (See Photo F).

Since we are dealing with 28 IC chips, twelve 0.01- μ F, 50-V disc "despiking" capacitors were used. Also, a 10- μ F, 20-V tantalum capacitor was used at the point where the +5-V line enters onto the PC board.

The 50-Ohm potentiometer, located inside the main cabinet, is used as a pitch control. The 1-Ohm potentiometer, also located inside the main cabinet, is used as the output volume control.

Though Fig. 1 shows only one 2.2k-Ohm "pull-up" resistor (pin 1 of U17 and U18), pull-up resistors (2.2k-Ohm) should be used on all outputs of both U17 and U18.

The approximate "new" component cost for this digital converter is \$90.00 (including the cabinets and wire-wrap type PC board).

"After Installation" Notes

During the installation phase of this project, several interfacing matters became apparent. The interconnecting cables between the DFD-MCC and the transceiver's digital-display PC board should be kept as

| State | Read Enable U10/11, 74153 (B) | U10/11, 74153 (A) | U10/11, Chip Enable | U14 Output Enable | U13 Output Enable | U12 Output Enable | Digit "lock-up" | Remarks |
|-------|----------------------------------|-------------------|---------------------|-------------------|-------------------|-------------------|-----------------|---------------------------------|
| 00000 | 1 | 0 | 0 | 1 | 0 | 0 | 0 | Wait for next instruction |
| 00001 | 1 | 0 | 0 | 1 | 0 | 0 | 1 | Address 1st digit (10s of MHz) |
| 00010 | 0 | 0 | 0 | 1 | 0 | 0 | 1 | Send 1st digit (10s of MHz) |
| 00011 | 1 | 0 | 0 | 1 | 0 | 1 | 0 | Address 2nd digit (1s of MHz) |
| 00100 | 0 | 0 | 0 | 1 | 0 | 1 | 0 | Send 2nd digit (1s of MHz) |
| 00101 | 1 | 0 | 0 | 0 | 1 | 0 | 0 | Address 3rd digit (100s of kHz) |
| 00110 | 0 | 0 | 0 | 0 | 1 | 0 | 0 | Send 3rd digit (100s of kHz) |
| 00111 | 1 | 0 | 1 | 1 | 0 | 0 | 0 | Clear BCD-to-Morse converter |
| 01000 | 1 | 0 | 1 | 0 | 1 | 0 | 0 | Address 4th digit (10s of kHz) |
| 01001 | 0 | 0 | 1 | 0 | 1 | 0 | 0 | Send 4th digit (10s of kHz) |
| 01010 | 1 | 1 | 0 | 1 | 0 | 0 | 0 | Clear BCD-to-Morse converter |
| 01011 | 1 | 1 | 0 | 0 | 1 | 0 | 0 | Address 5th digit (1s of kHz) |
| 01100 | 0 | 1 | 0 | 0 | 1 | 0 | 0 | Send 5th digit (1s of kHz) |
| 01101 | 1 | 1 | 1 | 1 | 0 | 0 | 0 | Clear BCD-to-Morse converter |
| 01110 | 1 | 1 | 1 | 0 | 1 | 0 | 0 | Address 6th digit (100s of Hz) |
| 01111 | 0 | 1 | 1 | 0 | 1 | 0 | 0 | Send 6th digit (100s of Hz) |
| 10000 | 1 | 0 | 0 | 1 | 0 | 0 | 0 | Wait for next instruction |
| 10001 | 1 | 0 | 0 | 1 | 0 | 0 | 0 | Continue to next instruction |
| 10010 | 1 | 0 | 0 | 1 | 0 | 0 | 0 | Continue to next instruction |
| 10011 | 1 | 0 | 0 | 1 | 0 | 0 | 0 | Continue to next instruction |
| 10100 | 1 | 0 | 0 | 1 | 0 | 0 | 0 | Continue to next instruction |
| 10101 | 1 | 0 | 0 | 0 | 1 | 0 | 0 | Address 3rd digit (100s of kHz) |
| 10110 | 0 | 0 | 0 | 0 | 1 | 0 | 0 | Send 3rd digit (100s of kHz) |
| 10111 | 1 | 0 | 1 | 1 | 0 | 0 | 0 | Clear BCD-to-Morse converter |
| 11000 | 1 | 0 | 1 | 0 | 1 | 0 | 0 | Address 4th digit (10s of kHz) |
| 11001 | 0 | 0 | 1 | 0 | 1 | 0 | 0 | Send 4th digit (10s of kHz) |
| 11010 | 1 | 1 | 0 | 1 | 0 | 0 | 0 | Clear BCD-to-Morse converter |
| 11011 | 1 | 1 | 0 | 0 | 1 | 0 | 0 | Address 5th digit (1s of kHz) |
| 11100 | 0 | 1 | 0 | 0 | 1 | 0 | 0 | Send 5th digit (1s of kHz) |
| 11101 | 1 | 1 | 1 | 1 | 0 | 0 | 0 | Clear BCD-to-Morse converter |
| 11110 | 1 | 1 | 1 | 0 | 1 | 0 | 0 | Address 6th digit (100s of Hz) |
| 11111 | 0 | 1 | 1 | 0 | 1 | 0 | 0 | Send 6th digit (100s of Hz) |

Fig. 6. Control ROM (U17) contents and program for the optional 4- to 6-digit selection.

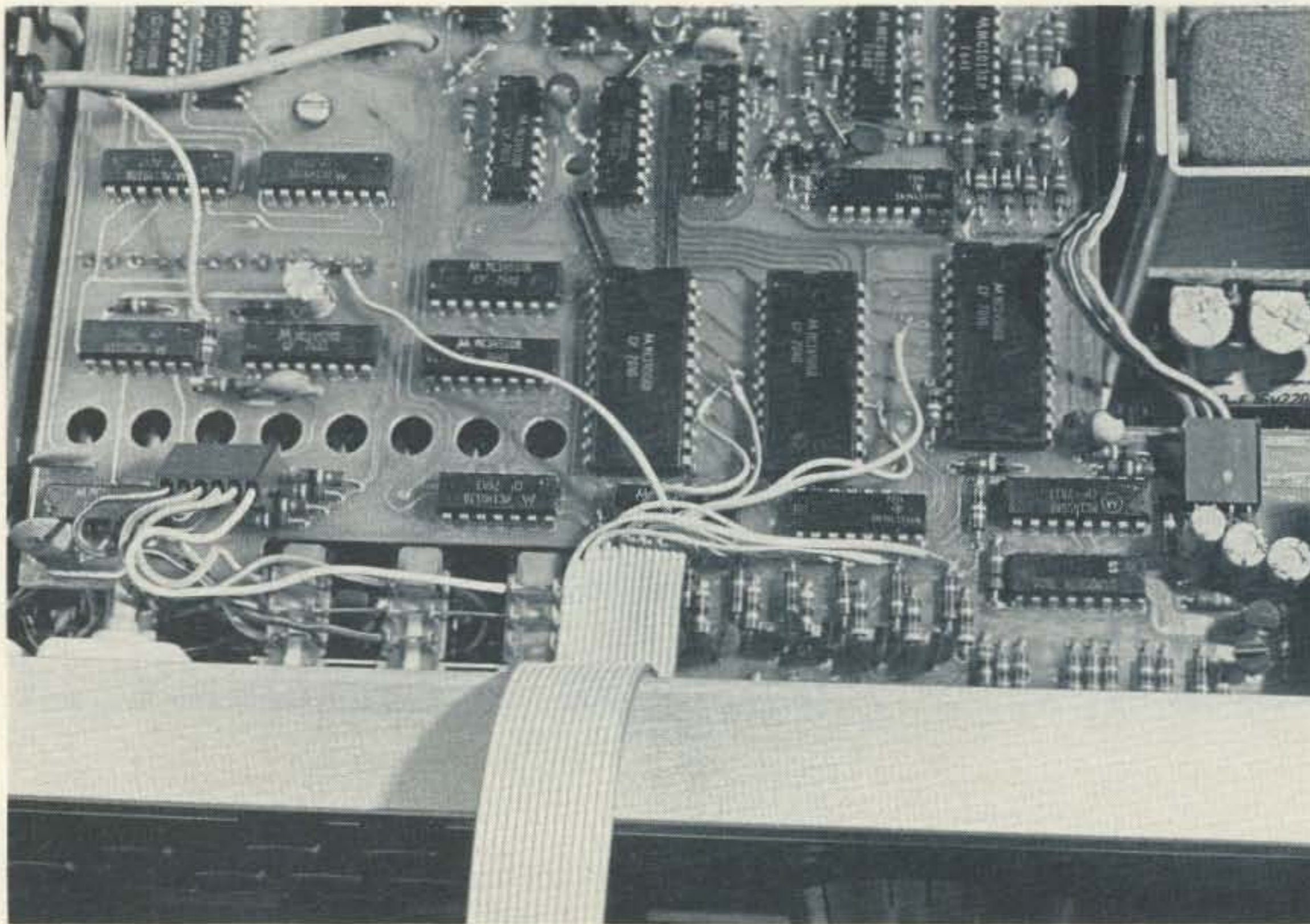

Photo F. Details of the hard-wiring technique used on the DR-7 board can be seen here.

short as possible and should be shielded.

When soldering around

CMOS-type IC chips, always use a 3-wire grounded soldering iron/gun.

If the builder uses a connector between the DFD-MCC inputs and the transceiver outputs (display board), the DFD-MCC power supply must be turned off prior to disconnecting or connecting or the 7402 and CD4049 IC chips can be damaged.

One final glitch which we had to overcome was the sporadic transmission of an erroneous 3rd digit. It was noted that the erroneously-sent digit was always a duplicate of the 1st digit. After looking at the 74LS145 output lines, we saw that there was a very slight feedthrough spike on the 3rd digit's firing line. Instead of dealing with the spike on the transceiver's display PC board, I dropped 0.001- μ F bypass disc capacitors onto the 7475 (3rd-digit) output lines. This solved the problem and maintained all discrete components inside the main DFD-MCC cabinet.

Option — 4- or 6-Digit Selection

Though my converter was designed to provide the user with the contents of all

six digits making up the digital frequency display, Fig. 5 shows the additional use of U9C, U9D, U27B, U27C, and U27D. With these NAND and NOR gates, we now have the option of giving the blind user only 4 digits or the full 6 digits. This option was made by using existing unused gates from U9 and U27. If the builder decides to include this option, the schematic in Fig. 1 should be altered as shown in Fig. 5. Also, U17 (PROM 1-8256-5) should be "blown" as shown in Fig. 6. U17 in this optional version uses all 32 states of the PROM.

The 4-digit option provides the user with the contents of the 100s of kHz, 10s of kHz, 1s of kHz, and 100s of Hz.

Acknowledgements

My sincere thanks to WB3EVS for his technical assistance, to WB5FIX for the use of his TR-7 in the initial stages of the project, to K8AY for his assistance in obtaining the DR-7 schematic, and to WA6DLI for the superb photographs.

Future Projects

Plans are currently underway for a "universal" type of digital converter for the visually handicapped. This universal converter would hook up to any rig, with or without a digital frequency display.

On the extravagant, yet still very practical side, I have plans for making a "talking" frequency display.

I will be glad to correspond about the DFD-MCC or any other digital converter. An SASE would be appreciated. ■

References

1. Robert J. Souza WA1MXV, "The Morse Clock—timely repeater ID," *73 Magazine*, July, 1977, p. 54.
2. Don Lancaster, *TTL Cookbook*, 1974, Howard W. Sams & Co., Inc.



**Germantown
Amateur
Supply,
Inc.**

MEMPHIS, TENNESSEE

NO MONKEY BUSINESS!

- (A) Complete Service Facilities
- (B) Good Deals on most Brands
- (C) Shipping within 24 Hours
- (D) All inquiries handled by Active Hams with over 20 years experience in ham radio

CALL TOLL FREE
1-800-238-6168

IN TENNESSEE, CALL 901-452-4276
MONDAY - SATURDAY 8:30-5:30
FOR YOUR SPECIAL.

Write: 3202 Summer Ave., Memphis, Tennessee 38112

SIGNALCRAFTER INTRODUCES

The Most Advanced Automatic Computing RF Measuring Instrument in Amateur Radio!



MODEL 30

This new Signalcrafters SWR/Power Meter is in a class by itself. Signalcrafters custom-designed integrated circuits compute SWR automatically, thus eliminating need for "set" or "sensitivity" controls. The built-in analog computer operates over the power range of only one watt to several kilowatts with unparalleled accuracy. Our auto-ranging feature automatically selects the proper range of 0 to 20, 0 to 200, or 0 to 2,000 watts according to the RF level detected on the transmission line and indicates the proper range on one of three front panel LED's. The operator can assume manual control of this feature by selecting one of the three basic ranges on the front panel switches. Two large taut-band meters indicate forward power and SWR. Complete hands-off operation! The amateur may also choose between either average or peak RF power. Self-indicating push buttons allow selection of any of three antennas or a dummy load when used with external 12-volt coaxial relays or our Model 50 Antenna Relay/Dummy Load. The 1.5 to 30 mhz coupler is plug-in mounted on the rear apron and can be unplugged and remote-mounted for convenience. The attractive, heavy-duty, low profile metal cabinet complements the latest transceiver designs. DC output receptacles supply analog voltages that track the meter readings. These outputs can be used to control many different accessories, such as analog to digital converters, remote meters, control and alarm devices, as well as the Signalcrafters Model 40 Audio-Tuner for the blind amateur. Operates from 110 volt 60 hz AC. Width: 8½" (216 mm), Height: 4½" (108 mm), Depth: 6" (152 mm).....\$225.00

® SIGNALCRAFTERS, INC. ✓ 66

5460 Buena Vista Drive
Shawnee Mission, Kansas 66205
913/262-6565; Telex: 42-4171

All Signalcrafters products are designed, engineered and produced in the U.S.A.
Prices include shipping to all U.S.A. — VISA and Master Charge accepted.
Kansas residents please add 3½ percent.

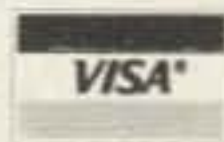

On the Trail of the Hamburglar

— retrieving ripped-off radios

The recent newspaper article read, "The county auditor collected \$3,641.65 from the sale of 563 items the Sheriff's Department had recovered as unidentified stolen property. The money will go into the county's general revenue fund. Guns, bicycles, and radio equipment were the

most popular items during the six-hour-long auction."

Once your ham rig has been stolen, what are your chances of getting it back? Probably better than you think, and certainly better than the newspaper article suggests, provided you have helped your cause by doing a little preventive

work of your own.

Much has been said on the subject of marking your possessions with identifying numbers to aid in their recovery should they be stolen. Here we will have a brief look into the systems used by law enforcement agencies across the country to detect and identify sto-

len property by using these identifying numbers. Police evidence rooms everywhere are crowded with recovered stolen property. Much of it will never be returned to the rightful owners simply because it cannot be identified.

In early 1967, the FBI placed in service a system designed to help counteract the growing crime rate. Known as the National Crime Information Center, but more commonly by its initials, NCIC, it is an advanced computerized information storage system with instant retrieval capability. Through the use of very sophisticated equipment located in Washington, D.C., NCIC stores vast amounts of data pertaining to crimes and wanted criminals. Most of this is beyond the scope of this article. We are interested in the part of this system known as the "Stolen Property File."

To be effective, such a system must be universally and immediately accessible. Each and every police department in the country, no matter how small, must have the means of making computer entries and inquiries. The means by which this is accomplished is a nationwide computer



Photo A. The author making an NCIC inquiry through the IBM video terminal at his dispatching console.

system using high-speed data transmission to all parts of the country by way of high-quality telephone lines.

Each state operates its own in-state computer system with interfaces to NCIC and the National Law Enforcement Telecommunications System, NLETS, by which the routine message traffic of the police trade is handled and by which direct computer-to-computer inquiries are made. Headquartered in Phoenix, Arizona, where the control and switching computer is located, NLETS handles computerized communications among the fifty states.

While details of local computer systems vary widely from state to state, most have numerous terminals, each of which may rapidly transmit and receive from any other terminal in any state. Nearly every police department of substantial size operates at least one terminal, and larger departments handle computer traffic for smaller agencies which cannot justify the cost of maintaining a terminal because of their low volume of traffic. Usually terminals are located at dispatch consoles, making it possible for officers in the field to obtain data very quickly from almost anywhere in the nation. Using his computer terminal, a dispatcher can obtain fully-automated information on drivers' licenses and automobile registrations both from his own state's motor vehicle bureau and from that of any other state. He also has full access to the FBI's NCIC files. Response times to these inquiries normally are very short. Where video display terminals are used, the reply to an officer's inquiry can normally be read right back to him with only a short pause. Within the state of Missouri, there are presently about two hundred ter-

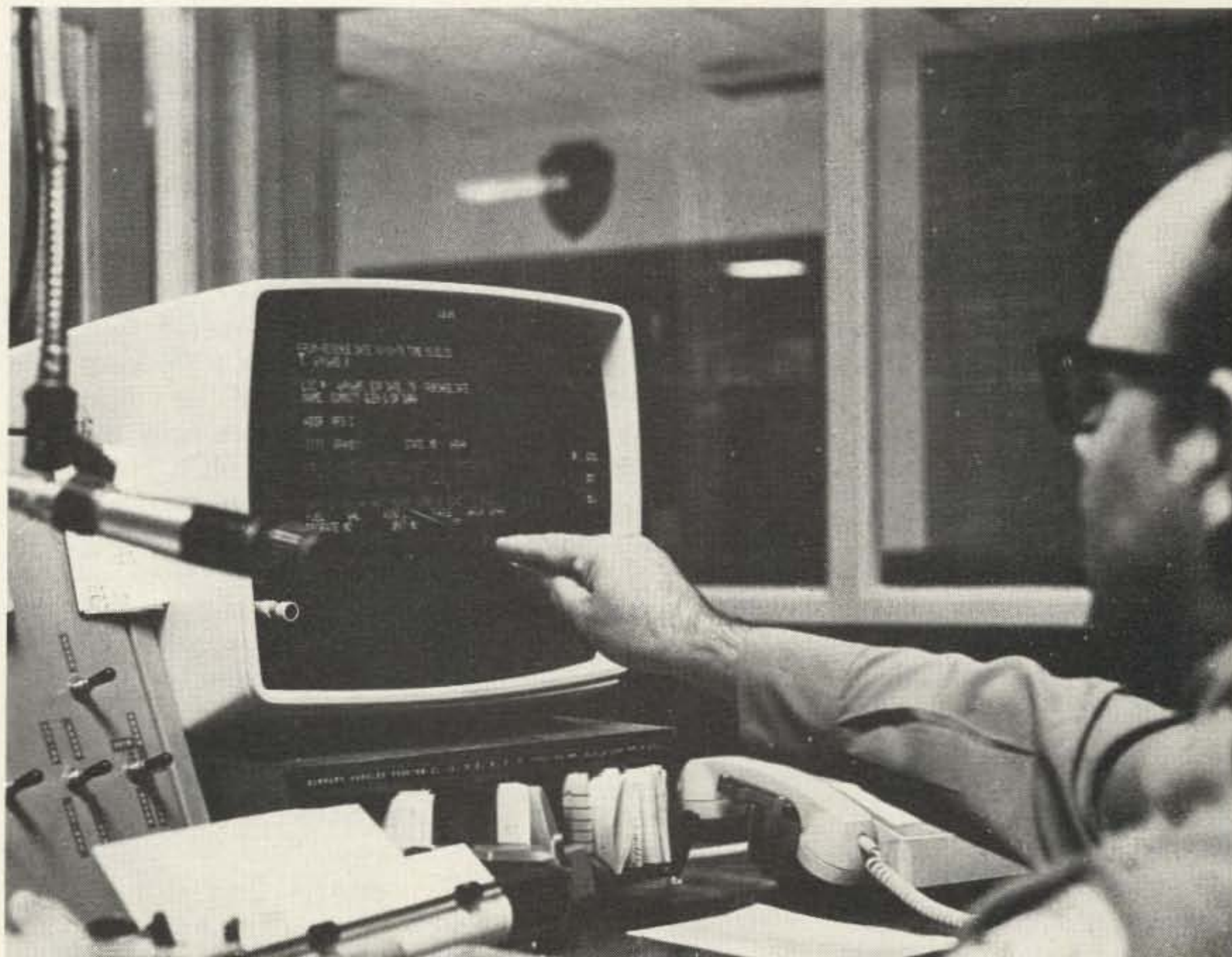

Photo B. The author checks a response to an inquiry.

minals active on this system, known there as MULES, the Missouri Uniform Law Enforcement System. (See Fig. 1.) Any reference to Missouri's widely-known reputation for raising prime quality, real live mules is surely coincidental.

When the NCIC program was first begun, such in-state computer facilities did not exist. They were developed to replace the radiotelegraph and wire teletype nets formerly used for police communications and also are used extensively for various statistical functions and record-keeping within the individual states.

How can we use this vast computer network to aid in the recovery of stolen property? Four things are necessary for the system to function properly:

1. The article stolen must have been marked with at least one clearly identifiable, unique number in such a way that it cannot easily be removed.

2. The theft must be reported to the police agency with jurisdiction along with all descriptive data, including identifying numbers.

3. The police agency must initiate an entry into the NCIC Stolen Property File.

4. The stolen article must then, at some later time, become the object of a computer inquiry into the Stolen Property File. That is to

say, it must become the object of some police officer's attention so that he will request that such a check be made.

Further examination of these criteria is necessary. Most equipment is marked at the factory with a serial number. The problem lies in the way the serial number is attached to the equipment. Usually the number is stamped on a small tag

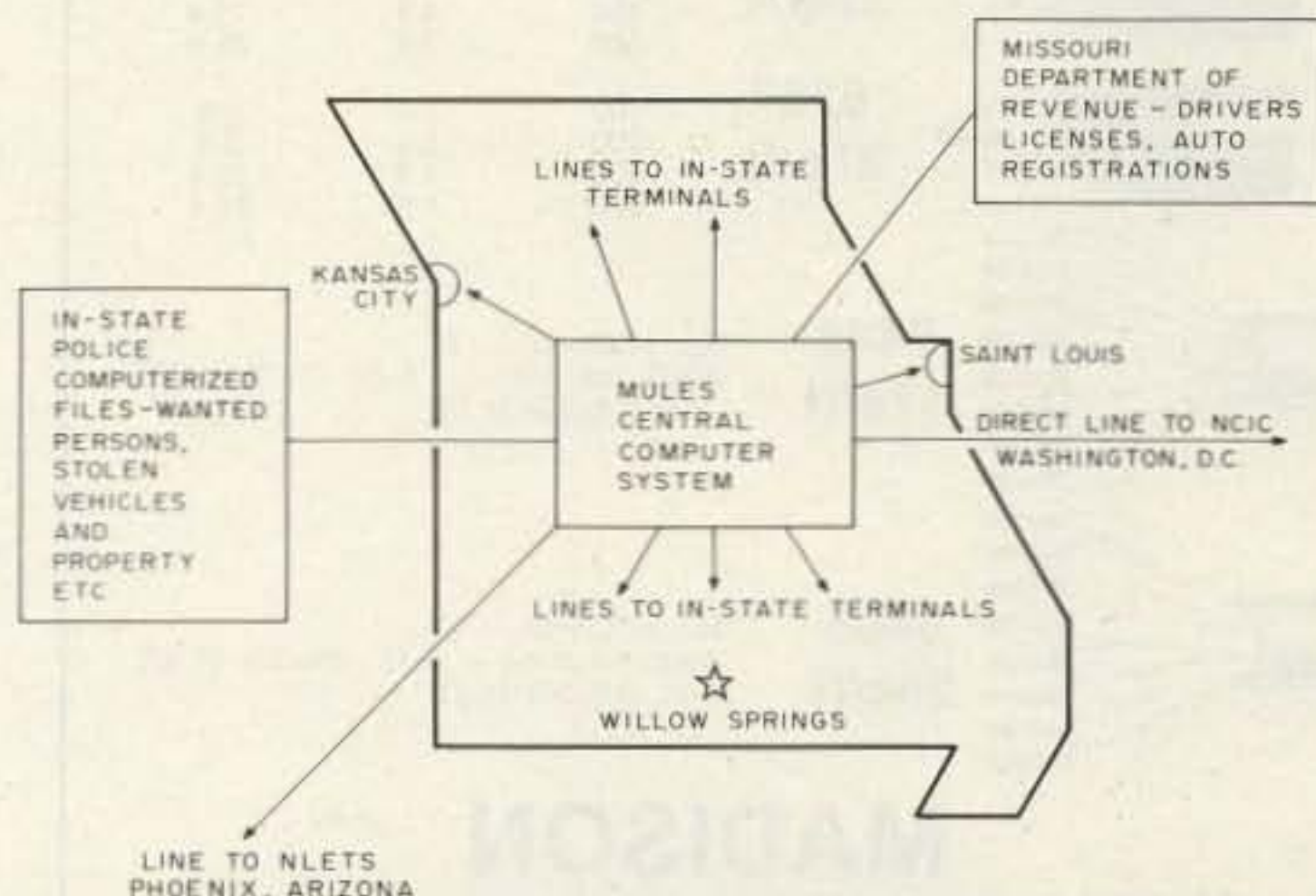

Fig. 1. MULES—The Missouri Uniform Law Enforcement System. Details vary from state to state, but police agencies nationwide have the same capability to utilize the NLETS message system and the NCIC files.

made of foil or light aluminum, and sometimes even paper, which is attached to the equipment in a variety of mediocre ways. The glue, screws, or pop rivets used require little imagination from a thief bent on removing the serial number. Once removed, there is almost no way to match the gear with the missing serial number. We are left with the necessity of adding to the equipment valid identifying numbers which are difficult to remove and which are easily traced back to the owner.

Remember, the same nationwide computer system that allows access to NCIC files also allows an immediate check of drivers' licenses by number from any state through NLETS. When a driver's license number is applied to the equipment, along with the two-letter state identifier (MO for Missouri), complete name and address in-

formation of the owner is immediately available to the inquiring policeman. It must be emphasized that the state identifier is absolutely required since it is nearly impossible to check all fifty states to see which one issued a driver's license bearing that number. These two-letter codes are the same as those used by the US Postal Service and are standard nationwide.

The best procedure is to engrave the unit's serial number, your driver's license number with state ID code, and your social security number on each piece of gear. Some uniform system should be used; for example:

SER. 698571
SOC. 487-46-5177
MO DL C016575694711288

There is another advantage to having your driver's license and social security numbers on each piece of gear. Any time an inquiry is

made on either of those numbers, the response will include all items bearing that number which are reported stolen, while the serial number would draw a response showing only the one piece of gear bearing that number. If the theft included several items of equipment from your ham station and the culprit was caught with only a single item, the NCIC computer would immediately notify the officer that not only was the piece of gear in question stolen, but also that there were other pieces of gear taken. This can be of considerable importance since a thief wouldn't be likely to confess voluntarily that he has the remainder of your ham station stashed away at his home.

Numbers other than the unit's original serial number are known to NCIC as "Owner Applied Numbers" and are entered into the computer in such a way that they can be queried independently of the serial number. An inquiry on either number will produce an identical response.

Obviously, the theft must be reported to the police and an investigation must be made before the numbers you have engraved can be listed with NCIC. Only a bona fide police agency, with prior authorization from the FBI, can generate these computer transactions. If you don't have the information available, of course NCIC cannot be of service. This fact points to another benefit of using your driver's license and social security numbers. Even if you don't remember the serial number, or lose it, the item still can be listed with NCIC since your driver's license and social security numbers will nearly always be available.

The numbers should be applied to the gear using the most durable method available and should be

placed in a conspicuous place on the gear. It is good to place the numbers both inside and outside the equipment cabinet. The sight of an area on the gear where a number obviously has been removed will always arouse suspicion and lead an officer to check further. If the number appears again inside the cabinet, it almost certainly will be found and checked.

The means are available to reduce losses due to theft considerably. It should be equally clear that this system cannot function effectively without the cooperation and assistance of each of us. This system is used extensively for all types of articles, and all the information contained in this article pertains to all of your personal property as well as your radio gear. Enormous amounts of money and effort have been expended to devise and perfect this system. Only those in the computer field can fully appreciate the effort and many years of time which were required to standardize the many states on a common computer data base.

For those who wonder just how active the NCIC system is, the FBI offers the following information. As of May 1, 1978, there were over six and one-half million active records on file in the following categories: 139,821 persons wanted for felony crimes, 901,235 stolen and felony-related vehicles, 1,238,807 stolen guns, 14,572 stolen boats, 331,379 lost or stolen license plates, and 906,266 other articles of stolen property, including ham radio gear. No individual wants to see his equipment become one of these statistics, but should it happen to you, be ready to assist by having made the right preparations. ■

BELDEN

| | Part Number | MHz | db/100 ft. | db/100 m |
|--|----------------|---|------------|----------|
| | 9888 | 50 | 1.2 | 3.9 |
| | 42¢/ft | 100 | 1.8 | 5.9 |
| | | 200 | 2.6 | 8.5 |
| | | 300 | 3.3 | 10.8 |
| | | 400 | 3.8 | 12.5 |
| | 8214 | 50 | 1.2 | 3.9 |
| | 26¢/ft. | 100 | 1.8 | 5.9 |
| | | 200 | 2.6 | 8.5 |
| | | 300 | 3.3 | 10.8 |
| | | 400 | 3.8 | 12.5 |
| | 8237 | 100 | 2.0 | 6.6 |
| | 23¢/ft | 200 | 3.0 | 9.8 |
| | | 400 | 4.7 | 15.4 |
| | | 900 | 7.8 | 25.6 |
| | 8267 | 100 | 2.0 | 6.6 |
| | 27¢/ft | 200 | 3.0 | 9.8 |
| | | 400 | 4.7 | 15.4 |
| | | 900 | 7.8 | 25.6 |
| | 8448 | No. of Cond. — 8 | | |
| | 17¢/ft | AWG (in mm) — 6-22, (7x30), [1.76]; 2-18, (16x30), [1.19] | | |
| | 9405 | No. of Cond. — 8 | | |
| | 28¢/ft | AWG (in mm) — 2-16, (26x30), [1.52]; 6-18, (16x30), [1.17] | | |

MADISON ✓45

ELECTRONICS SUPPLY, INC.

1508 McKINNEY • HOUSTON, TEXAS 77002

713/658-0268

MASTERCARD • VISA

AZDEN ★ NEW! ★ AZDEN ★ NEW! ★ AZDEN ★ NEW! ★ AZDEN

AZDEN®

REVOLUTIONIZES THE STATE OF THE ART AWE AND AZDEN. INTRODUCE THE BRILLIANT NEW PCS-2000 MICROCOMPUTER CONTROLLED

NEW!



2 METER FM TRANSCEIVER

NOT \$550.00
**SPRING
SALE**

NOW AVAILABLE!!

PCS-2800 10-meter FM transceiver 28-30 MHz with all features of PCS 2000. 10 watts output, selectable simplex or + 100 KHz offset.

Introductory Price \$299⁰⁰

\$299⁰⁰
REG. \$369.00



**COMPARE THESE FEATURES
WITH ANY UNIT AT ANY PRICE**

- **FREQUENCY RANGE:** Receive and transmit: 144.00 to 147.995 MHz, 5Khz steps + MARS-CAP* and MULTIPLE OFFSET BUILT IN.
- **ALL SOLID STATE-CMOS PL DIGITAL SYNTHESIZED.**
- **SIZE:** UNBELIEVABLE! ONLY 6¾" x 2¾" x 9¾". COMPARE!
- **MICROCOMPUTER CONTROLLED:** All scanning and frequency-control functions are performed by microcomputer.
- **DETACHABLE HEAD:** The control head may be separated from the radio for use in limited spaces and for security purposes.
- **SIX-CHANNEL MEMORY:** Each memory is re-programmable. Memory is retained even when the unit is turned off.
- **MEMORY SCAN:** The six channels may be scanned in either the "busy" or "vacant" modes for quick, easy location of an occupied or unoccupied frequency.
- **FULL-BAND SCAN:** All channels may be scanned in either "busy" or "vacant" mode. This is especially useful for locating repeater frequencies in an unfamiliar area.
- **INSTANT MEMORY-1 RECALL:** By pressing a button on the microphone or front panel, memory channel 1 may be recalled for immediate use.
- **MIC-CONTROLLED VOLUME AND SQUELCH:** Volume and squelch can be adjusted from the microphone for convenience in mobile operation.

- **ACCESSORY OFFSET:** Provides three additional offset values: +0.4 MHz, +1 MHz and +1.6 MHz. Other offsets may also be obtained.
- **25 WATTS OUTPUT:** Also 5 watts low power for short-distance communication.
- **DIGITAL S/RF METER:** LEDS indicate signal strength and power output. No more mechanical meter movements to fall apart!
- **LARGE ½-INCH LED DISPLAY:** Easy-to-read frequency display minimizes "eyes-off-the-road" time.
- **PUSHBUTTON FREQUENCY CONTROL FROM MIC OR FRONT PANEL:** Any frequency may be selected by pressing a microphone or front-panel switch.
- **SUPERIOR RECEIVER SENSITIVITY:** 0.28 uV for 20-dB quieting. The squelch sensitivity is superb, requiring less than 0.1 uV to open. The receiver audio circuits are designed and built to exacting specifications, resulting in unsurpassed received-signal intelligibility.
- **TRUE FM, NOT PHASE MODULATION:** Transmitted audio quality is optimized by the same high standard of design and construction as is found in the receiver. The microphone amplifier and compression circuits offer intelligibility second to none.
- **OTHER FEATURES:** Dynamic Microphone, built in speaker, mobile mounting bracket, external remote speaker jack (head and radio) and much, much more. All cords, plugs, fuses, microphone hanger, etc. included. Weight-6 lbs.
- **ACCESSORIES:** 15' REMOTE CABLE... \$29.95. *MARS-CAP KIT... TBA. PCS-6R A/C POWER SUPPLY... \$49.95. TOUCHTONE MIC. KIT... \$39.95.



AMATEUR-WHOLESALE ELECTRONICS

8817 S.W. 129th Terrace, Miami, Florida 33176

Telephone (305) 233-3631 • Telex: 80-3356

U.S. DISTRIBUTOR DEALER INQUIRIES INVITED

ORDER NOW TOLL-FREE

Credit card holders may use our toll-free ordering number

Ask for operator 701
(800) 824-7888

In California (800) 852-7777
Alaska and Hawaii (800) 824-7919



New from Longs . . . Kenwood R-1000 compact communications receiver

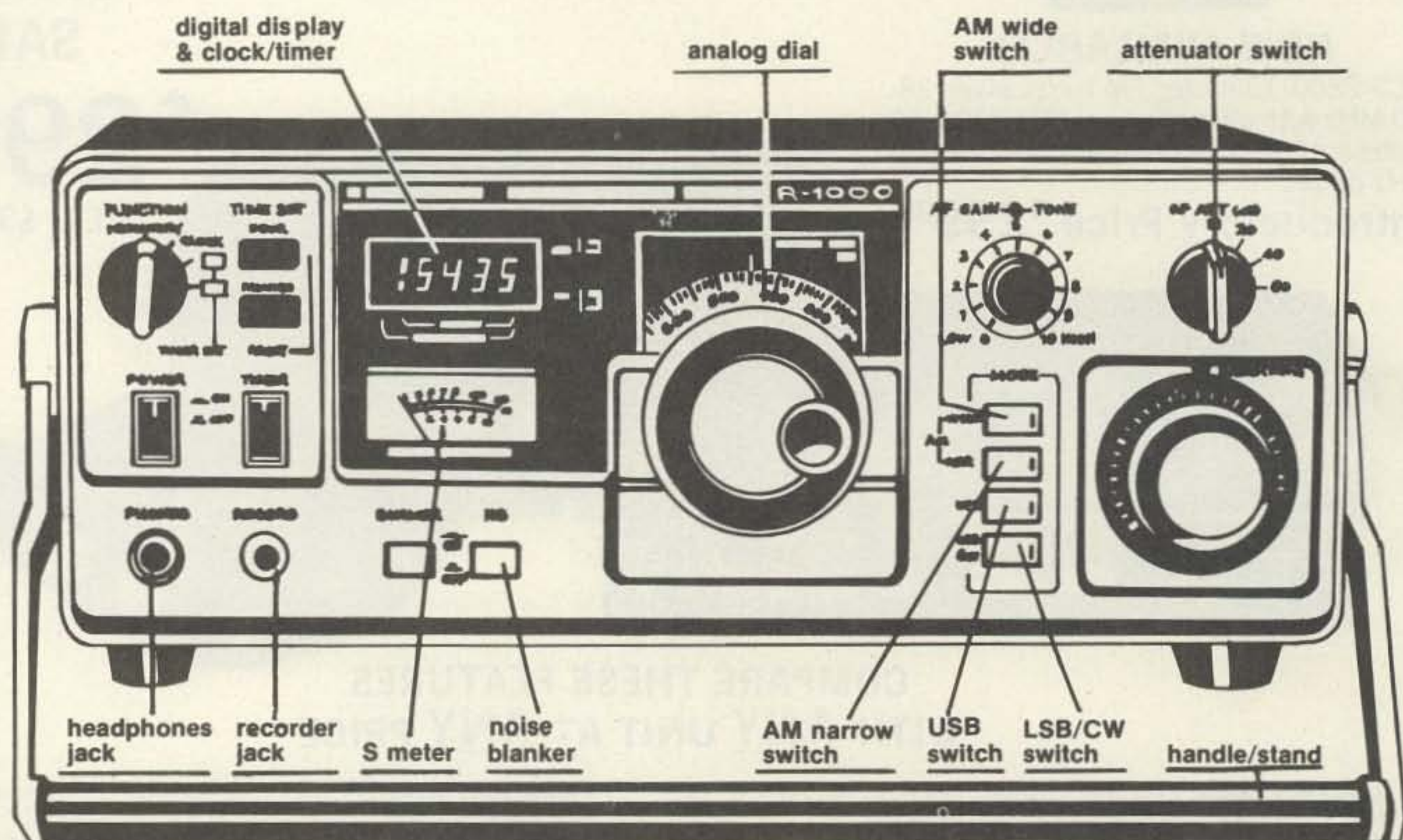

The new, compact (12 $\frac{1}{4}$ "W x 4 $\frac{1}{2}$ "H x 8-9/16"D) R-1000 is a high class general coverage receiver covering 30 bands from 200 KHz to 30 MHz. It features: PLL synthesizer, digital display readout (1 KHz step) and analog dial calibrated at 10 KHz intervals from 0 to 1,000 KHz. The 12 hr. quartz digital clock with timer can be set to go on or off at any time. A stepped RF attenuator provides 20, 40, and 60 dB attenuation to protect the unit from damage by high input power signals. Also features: 3 stage IF filter, tone control, built-in noise blanker, dimmer switch, recording terminal, selectable AC power voltage (100, 120, 220 or 240 VAC), wire antenna terminals and UHF connector (SO-239 for coax cable), large 10 cm built-in speaker, external speaker jack, 2 position antenna selector switch, accessory terminals for timer and muting circuit. Has calibrated S meter, AF gain control, 4 mode switches. Selects LSB/CW, USB, narrow AM or wide AM.

Sensitivity (S + N/N 10 dB or more): SSB 200 KHz - 2 MHz: 5 micro V, AM 50 micro V. SSB 2 MHz - 30 MHz 0.5 micro V, AM 5 micro V. Frequency stability: ± 2 KHz Max. from 1-60 min. after power on, + 300 Hz max. in every subsequent 30 min. Selectivity: AM (wide) 12 KHz at -6dB, 25 KHz at -50dB. AM (narrow) 6 KHz at -6dB, 18 KHz at -50dB. SSB/CW 2.7 KHz at -6dB, 5 KHz at -60dB.

499.00

List Price. Call for Quote.

Long's



Use your Master Charge or BankAmericard/VISA when you order.

Ham Radio Department Store

MAIL ORDERS: P.O. BOX 11347 BIRMINGHAM, AL 35202 • STREET ADDRESS: 2808 7TH AVENUE SOUTH BIRMINGHAM, ALABAMA 35233

KENWOOD TR-2400 synthesized 2 meter hand-held transceiver

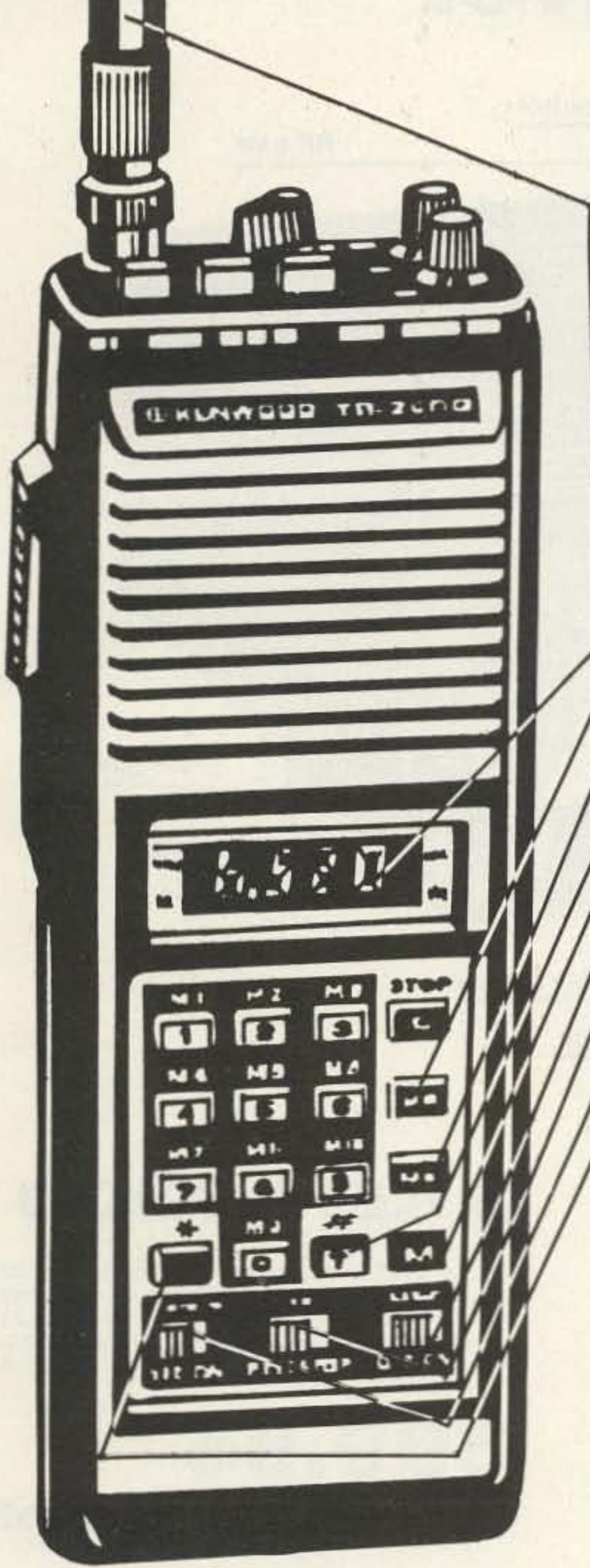

- rubberflex antenna
- LCD digital readout
- memory scan
- memory recall
- memory scan up
- memory write
- lamp off/on
- push to talk lock
- frequency lock
- memory scan down

The TR-2400 features LCD digital readout, 10 memories, automatic memory scanning, and up/down manual scanning for busy or open channels. It has mode switch for standard repeater ± 600 KHz, offset, simplex, and non-standard repeater splits. A reverse momentary switch allows operator to receive on the input of a repeater or to determine if the repeater is "upside down". The large LCD digital readout has virtually no current drain and is readable in direct sunlight and in the dark with the lamp switch. Also features built-in touch tone generator with 16 button keyboard, and keyboard selection of 5-KHz channels from 144.000 to 147.995 MHz. Operates on MARS repeaters within 143.900 to 148.495 MHz by using memory 10 for transmit offset frequency. Two lock switches prevent accidental frequency change and accidental transmission. 1.5 watts RF output. Includes flexible rubberized antenna with BNC connector, NiCad battery pack and AC wall charger.

395.00
List Price. Call for Quote.

Optional accessories available

- LH-1 leather case. 34.95
- ST-1 base stand for quick charge and fixed station operation (includes SO-239 coax connector for external antenna and a 4 pin mic plug for an external mic). 84.95
- BC-5 DC (automobile) quick charger. 39.95

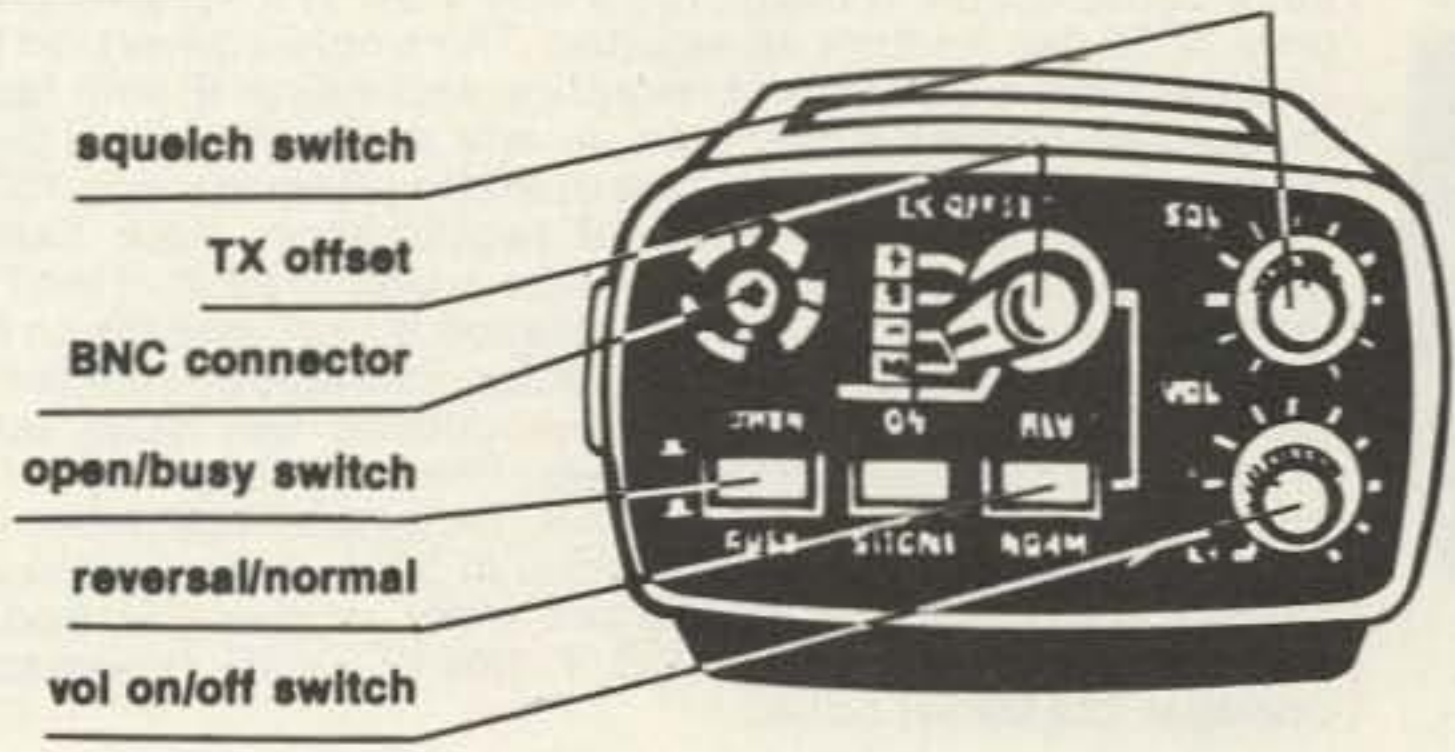

Call Toll Free **1-800-633-3410**

IN ALABAMA CALL 1-800-292-8668 9 AM TIL 5:30 PM CST, MONDAY THRU FRIDAY

Kenwood TS-120S compact all solid state HF SSB transceiver

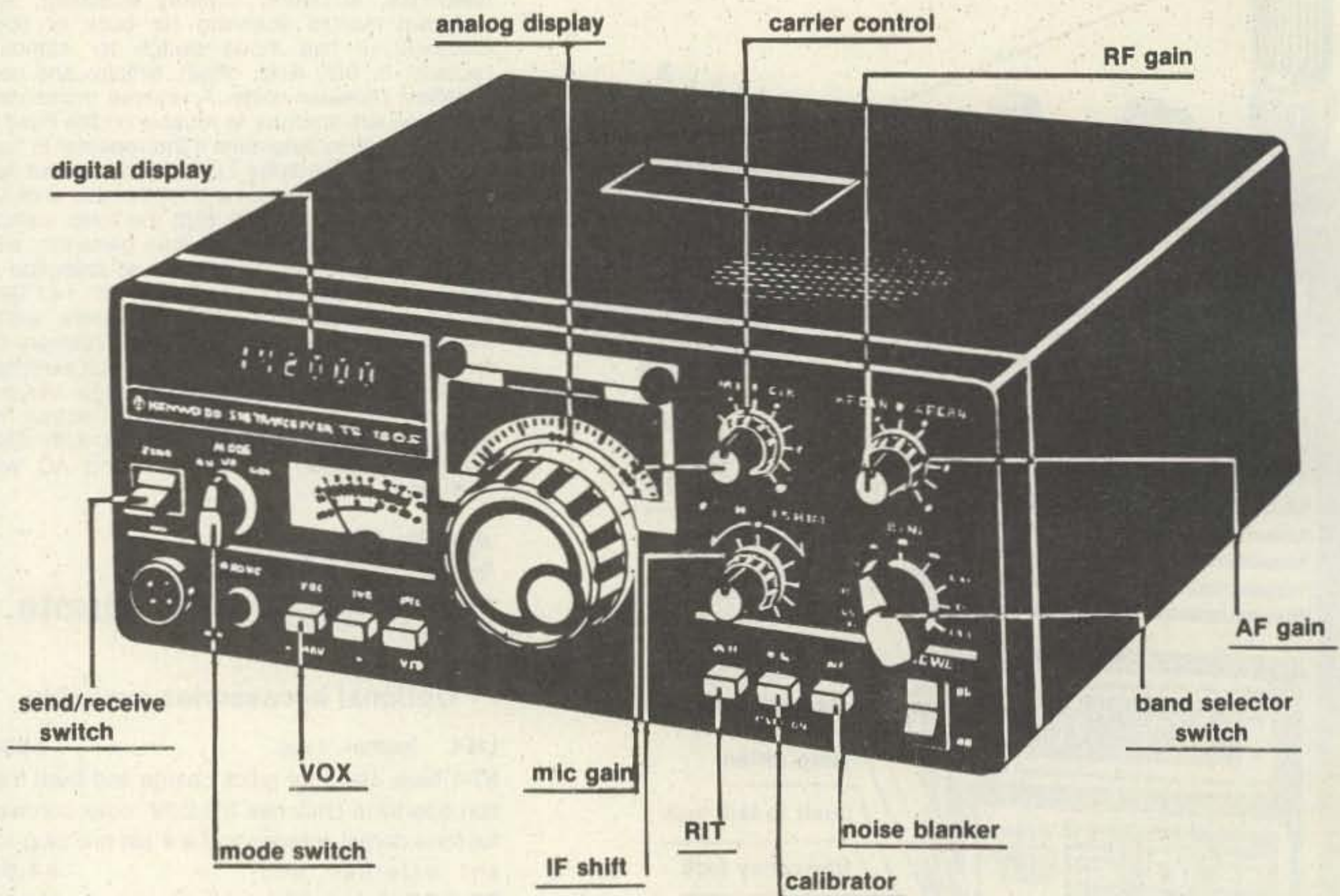

The TS-120S is incredibly small due to miniaturized circuits and all solid state construction. It measures 9½"W x 3¾"H x 11-9/16"D and weighs only 12.32 lbs. No tune up required. The single-conversion PLL system improves transmission and reception and makes IF shift operation and mono-dial indication available on any mode. A built-in 6-digit digital frequency display indicates the operating frequency to 100 Hz on any band and in any mode without recalibration. Four fixed channels available. One crystal element can be added to each of the 7, 14, 21, and 28-MHz bands. Fixed-channel operation is also possible on the 3.5-MHz band by changing an inside connector. Features 200 watts PEP, IF shift, final transistor protection, built-in cooling fan, VOX, built-in noise blanker, and built-in 25 KHz marker. The front-panel meter functions as an "S" meter on receive and as an IC meter and ALC meter on transmit. Any impedance mic, from 500 ohms to 50 K, may be used with the TS-120S. It covers 80 to 10 meters and WWV, modes: SSB and CW. Power requirements: R: 0.7A 13.8 VDC, T: 18A 13.8 VDC. Power supply PS-30 optional 139.00 list price.

 **KENWOOD**

Frequency stability: Within 100 Hz during any 30 min. period after warmup. Within ± 1 KHz during the first hr. after 1 min. warm up. Sensitivity: 0.25 micro V at 10 dB S/N. Selectivity: SSB 2.4 KHz (-6dB) 4.2 KHz (-60dB), CW 0.5 KHz (-6dB) 1.8 KHz (-60dB).

699.95

List Price. Call for Quote.

Long's



Use your Master Charge or BankAmericard/VISA when you order.

Ham Radio Department Store

MAIL ORDERS: P.O. BOX 11347 BIRMINGHAM, AL 35202 • STREET ADDRESS: 2808 7TH AVENUE SOUTH BIRMINGHAM, ALABAMA 35233

A full 2KW PEP amplifier at a price you can afford — The DENTRON Clipperton L linear amplifier! *Dentron*

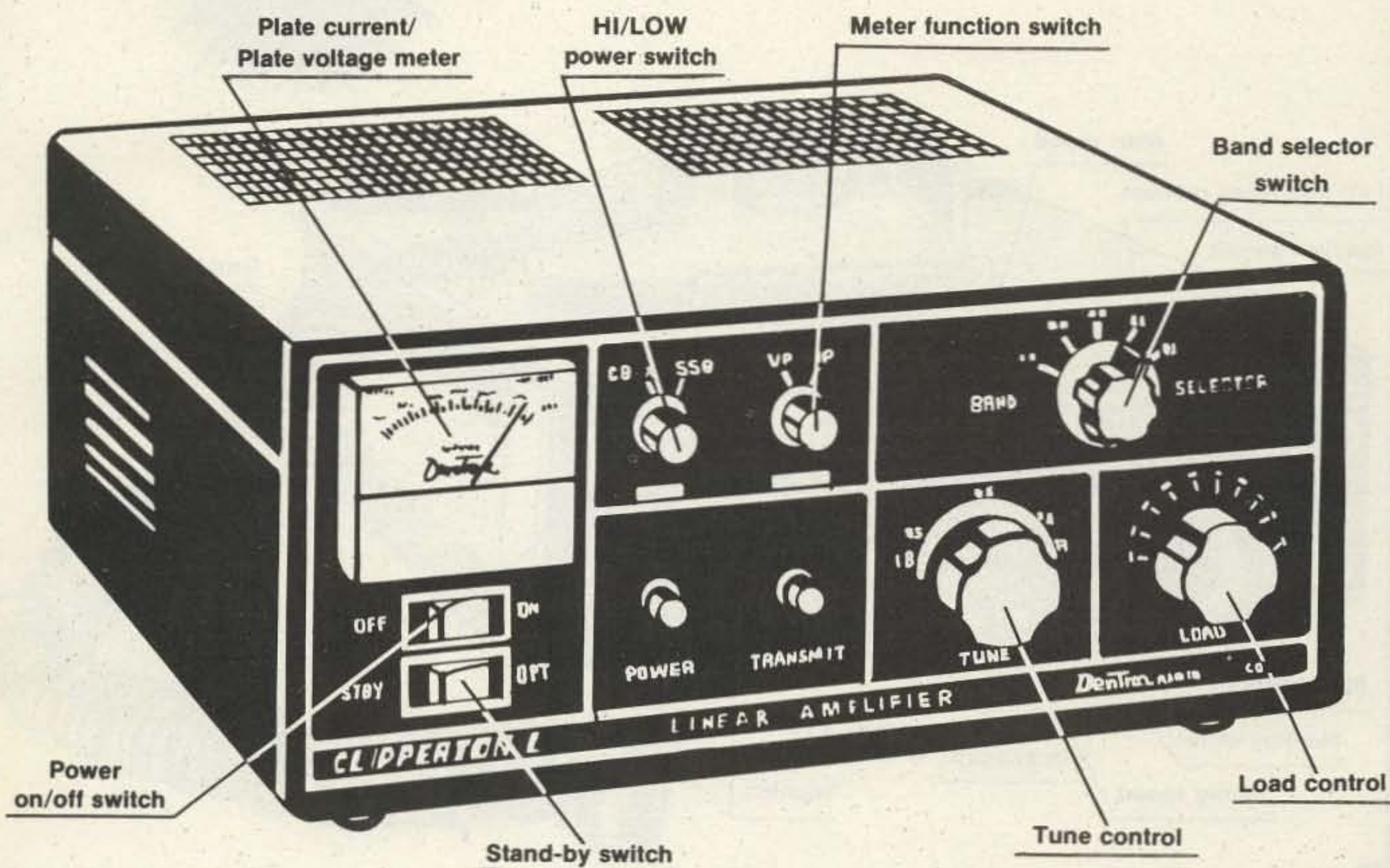

The Clipperton L linear amplifier covers 160-15 meters and most MARS frequencies. It delivers 2000 watts PEP input on SSB and 1000 watts DC input on CW, RTTY, or SSTV; all continuous duty. There are four 572B triodes operating in grounded grid, hi/lo power switching and linear bypass from the front panel, a large illuminated meter for monitoring plate current and plate voltage, a built-in continuous duty power supply-2500 volt idle SSB — 1800 volt idle CW approximately with rear panel selection of 117 volts or 234 volts primary transformer taps and adjustable ALC. The Clipperton L also features forced air cooling for longer tube life, harmonic suppression that meets or exceeds FCC requirements, 50 ohm impedance unbalanced at better than 1.5 to 1 VSWR and 50 ohm output impedance. Size: 6"H x 14½"W x 14½"D. Weight: 42 lbs.

CALL NOW!

699.50

List Price. Call for Quote.

Call Toll Free **1-800-633-3410**

IN ALABAMA CALL 1-800-292-8668 9 AM TIL 5:30 PM CST, MONDAY THRU FRIDAY

Power to the mobile operators! ICOM IC-255A

25 watt 2 meter FM transceiver!

CALL NOW!

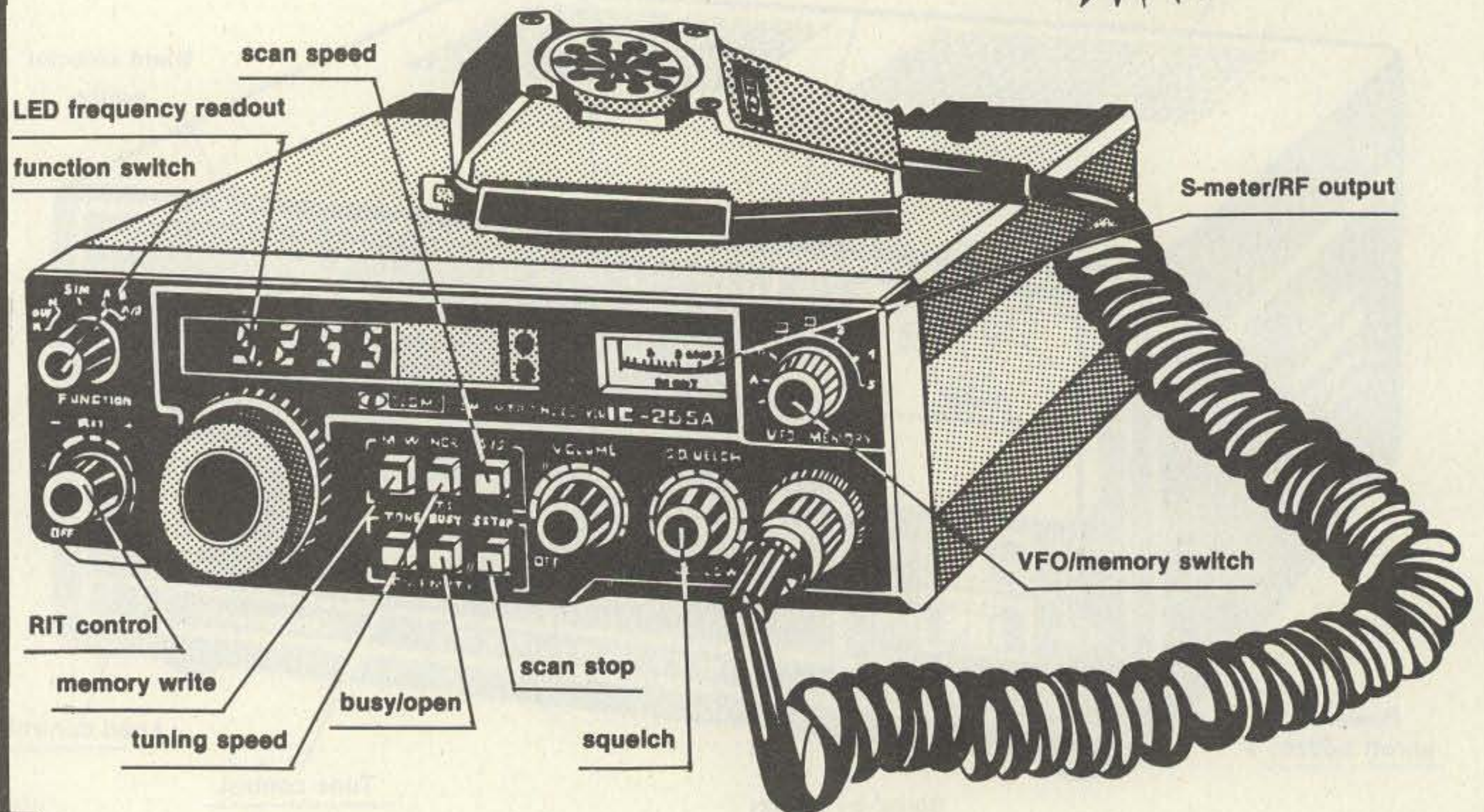

The microprocessor controlled IC-255A is a compact unit which packs more big, multifeature flexibility than any other Icom mobile to date. This one offers a 5 channel memory with adjustable scanning speed, and auto-stop. The 5 channels can be written from any inband frequencies, and the scan function can be programmed to scan all 5 or only 2 memories, stopping on any signal. Program scan allows any portion of the band to be scanned. It covers 143.800 to 148.195 MHz and features dual VFO for standard or programmable splits, 2 speed tuning (5 or 15 KHz), monolithic crystal, and ceramic IF filters. Helical cavity filters provide excellent intermodulation distortion characteristics. 25 watts or 1 watt selectable power output. Operating modes: simplex or duplex with ± 600 KHz or any inband frequency split programmable.

Frequency stability: ± 1.5 KHz or less.
Power requirements: 13.8VDC at 5.5A TX.
Power output 25W high, 1W low.

389.00
List Price. Call for Quote.

Long's



Use your Master Charge or BankAmericard/VISA when you order.

Ham Radio Department Store

MAIL ORDERS: P.O. BOX 11347 BIRMINGHAM, AL 35202 • STREET ADDRESS: 2808 7TH AVENUE SOUTH BIRMINGHAM, ALABAMA 35233

ICOM IC-551 compact 50 MHz all mode transceiver

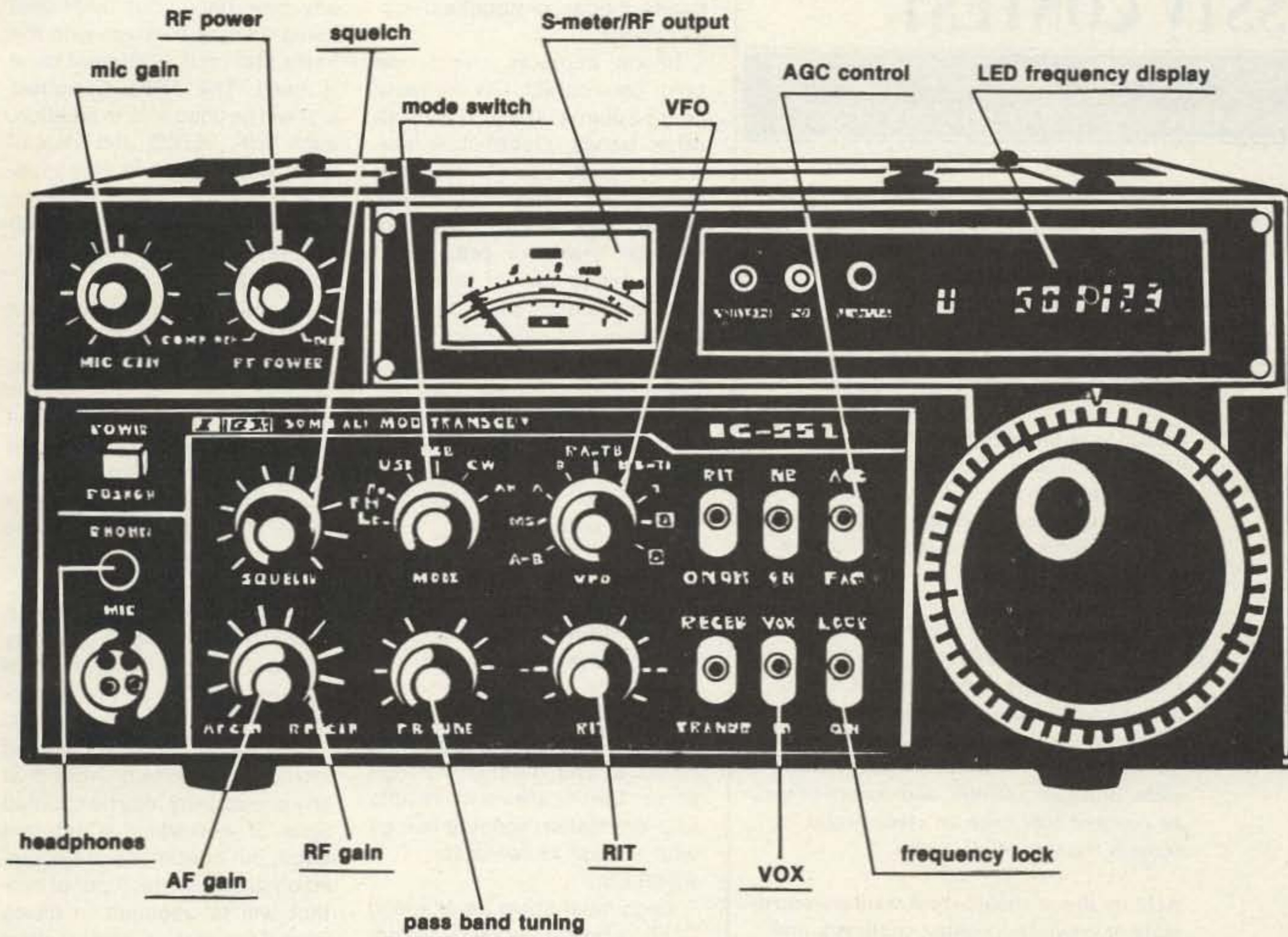

Icom's IC-551 is an all mode 6 meter unit in a compact, easy to use instrument which uses a built-in microprocessor for frequency control and scanning. The no backlash, no delay dual VFO light chopper system is included as a standard feature and provides split frequency operation as well as completely variable offsets. It covers 50.000 MHz to 53.999.9 MHz and features a 6 digit frequency readout, 2 digital VFO's, built-in AC/DC power supply, variable output from 1 to 10 watts, dial lock switch for mobile use, noise blanker, variable scan speed, and 3 memories. It can scan memories and scan the entire 6 meter band or any selected segment of the band. Modes:SSB, CW, AM, FM (optional). FF speech processor and variable bandpass module optional. VOX unit available. Power output: SSB 10W PEP (1-10W adjustable), CW 10W (1-10W adjustable), AM 4W (1-4 adjustable),FM 10W (1-10W adjustable).



Sensitivity: SSB, CW, AM less than 0.5 microvolts for 10 dB S+N/N FM. More than 30 dB S+N+D/N+D at 1 microvolt. Less than 0.6 microvolts for 20 dB noise quieting.

449.00

List Price.Call for Quote.

Call Toll Free **1-800-633-3410**

IN ALABAMA CALL 1-800-292-8668 9 AM TIL 5:30 PM CST, MONDAY THRU FRIDAY

Contests

from page 14

TENNESSEE QSO PARTY

Operating Periods:
2100 GMT Saturday,

March 22 to 0500 GMT Sunday,
March 23 and 1400 to 2200 GMT
Sunday, March 23

Sponsored by the Tennessee
Council of ARCs. Repeater con-

1980 INTERNATIONAL SSTV CONTEST

Saturday, March 8, 1500 to 2300 GMT
Sunday, March 9, 1500 to 2300 GMT

| | |
|--------------------|--|
| SPONSOR | 73 Magazine, Peterborough NH 03458 USA |
| OBJECT | To exchange SSTV pictures with as many stations in as many parts of the world as possible during the contest periods. |
| FREQUENCIES | All amateur frequencies between 3.5 and 29.7 MHz where SSTV is permitted. |
| EXCHANGE | Exchange of pictures must include callsign, RST report, and consecutive contact number starting with 001. FCC rules require a verbal exchange of callsigns for US stations. Do not include the contact number in the verbal exchange. |
| CREDITS | One (1) point for each station worked. A station may be worked once on each band for credit. One (1) point for each US state or Canadian province worked. Five (5) points for each country worked. Five (5) points for each continent worked. Each state, province, country, and continent may be counted only once for credit. Total score is the sum of all credits. |
| ENTRIES | Activity sheets should show station worked, state or province, country, continent, and band (80, 40, 20, 15, 10). Summary sheets should show number of stations worked, number of states and provinces worked, number of countries worked, number of continents worked, and total score. Entries become the property of the contest committee. Excessive discrepancies in a contest entry may cause disqualification. Contest entries must be postmarked no later than April 30, 1980. The decisions of the contest committee are final. |
| AWARDS | The top scorer will receive a certificate and a one year subscription to 73 Magazine. Certificates will also be awarded to the station working the most countries and to the station working the most continents. |

Send all entries to:

R. Brooks Kendall W1JKF or David Ingram K4TWJ
10 Stocker St. Eastwood Village, #1201 South
Saugus MA 01906 Rte. 11, Box 499
Birmingham AL 35210

tacts are not allowed. Mobiles compete against mobiles, portables against portables. Single transmitter entries only. No county line operation for multiple contacts. Portable stations must set up per field day rules. No list operation permitted.

EXCHANGE:

Tennessee stations give RS(T) and county. Others give RS(T) and state, province, district, or country. The same station may be worked on different bands, modes, or counties.

SCORING:

Phone contacts count one point per contact; CW contacts count 2 points on 80 or 1½ on all other bands. Out-of-state stations take QSO points times the number of different counties worked for the final score. Tennessee stations take QSO points times sum of following: different states plus different Tennessee counties plus different VE/VO districts. Bonus points of 200 for each county outside of home county with minimum of 10 QSOs in each. Power bonus of 1.5 multiplier for all stations operating at 200 Watts dc or less.

FREQUENCIES:

Phone—3980, 7280, 14280, 21380, 28580.

CW—50 kHz from bottom; Novices within their bands.

AWARDS:

Plaque to Tennessee top scorer, Tennessee mobile and portable, and out-of-state high score. Certificates with results to every station sending in logs with at least 15 contacts.

ENTRIES:

Logs must show date/time in GMT, station worked, band, mode, exchange, and score. Use separate log sheets for each band with over 50 contacts. Must submit cross check sheet similar to ARRL check sheet CD77 if worked over 200 QSOs. Logs must be legible to avoid disqualification. Mailing deadline is May 1st. Include a business-size addressed envelope with your log and send to: Dave Goggio, 1419 Favell, Memphis TN 38116.

BARTG SPRING RTTY CONTEST

Starts: 0200 GMT
Saturday, March 22
Ends: 0200 GMT
Monday, March 24

The total contest period is 48 hours, but not more than 30 hours of operation is permitted.

Time spent listening counts as operating time. The 18 hour non-operating period can be taken at any time during the contest, but off periods may not be less than 3 hours at a time. Times on the air must be summarized on the summary sheet. There will be separate categories for single operators, multi-operator stations, and SWLs. Use all amateur bands from 80 to 10 meters on RTTY only. Stations may not be contacted more than once on any one band, but additional contacts may be made with the same station if a different band is used. The ARRL Countries List will be used and, in addition, each W/K, VE/VO, and VK call area will be counted as a separate country. Note, however, that W/K, VE/VO, and VK count only once for QCA purposes.

EXCHANGE:

Messages exchanged will consist of: time (in GMT), consisting of a full four-figure group (the use of the expression "same" or "same as yours" will not be acceptable), RST, and message number. The number must consist of a three-figure group starting with 001 for the first contact made.

SCORING:

All 2-way RTTY contacts with stations within own country count 2 points, outside own country count 10 points. All stations will receive a bonus of 200 points for each country worked including their own. Note that any one country may be counted again if worked on a different band, but continents are counted once only. Note: Proof of contact will be required in cases where the station worked does not appear in any other contest log received or the station worked does not send in a check log. The final score is the sum of: QSO points times the total of countries worked plus the total country points times 200 times the number of continents worked. For example: 302 exchange points x 10 countries = 3020, 10 countries x 200 x 3 continents = 6000; final score = 9020.

ENTRIES AND AWARDS:

Use a separate sheet for each band and indicate all times on the air in the logs. Logs must contain: date/time in GMT, callsign of station worked, RST and message number sent/received, time received, and points

Continued on page 130

LARUE ELECTRONICS CUSHCRAFT ANTENNA HEADQUARTERS

CUSHCRAFT ANTENNAS: 2-METER: A32-19, A144-11, A147-4, A147-11, A147-20T, A147-22, AFM-4D, AR-2, ARX-2, AMS-147, ATS-147, 214B, 214FB, A11-SK, A14-SK, A14-VPK, A22-SK, A32-SK, A147-VPK, ARX-2K AND 228-VPK. 6-METER: A50-3, A50-5, A50-6, A50-10, A535-SK AND AR-6. 220-MHZ.: A220-7, A220-11, AFM-24D, AMS-220, ARX-220 AND ATS-220. 450-MHZ.: A430-11, A449-11, AFM-44D AND ARX-450. OSCAR: A14T-MB, A144-10T, A144-20T AND A432-20T. HF: 10-3CD, 10-4CD, 15-3CD, 15-4CD, 20-3CD, A28-3, ATB-34, ATV-3, ATV-4 AND ATV-5. BLITZ BUGS: LAC-1 AND LAC-2. ICOM TRANSCEIVERS: IC-22S, IC-202S, IC-215, IC-251A, IC-255A, IC-260A, IC-280, IC-402, IC-502, IC-551, IC-551D AND IC-701AC. ICOM ACCESSORIES ALSO IN STOCK. BIRD MODEL 43 AND 4431 WATTMETERS, TABLE-1 ELEMENTS AND CC-1/EC-1 CARRYING CASES. ANTENNA SPECIALISTS 2-METER AND 450-MHZ. MOBILE AND FIXED STATION ANTENNAS. CDE ROTATORS: T2X TAILTWISTER \$199.00, HAM-IV \$149.00, CD-45 \$109.00 AND AR-22-XL \$59.00. BELDEN COAX AND ROTOR CABLE. W2AU/W2VS ANTENNA PRODUCTS. BARKER & WILLIAMSON COAX SWITCHES AND DIPOLE KITS. VHF ENGINEERING 2-METER BLUE LINE AMPLIFIERS, POWER SUPPLIES AND MANY OTHER KITS AND W/T UNITS AVAILABLE. HAM-KEYS: HK-1 \$29.95, HK-2 \$19.95, HK-3M \$19.95, HK-4 \$44.95 AND HK-5A ELECTRONIC KEYS \$69.95. CES 230A MICROPAD \$44.95 AND 235 MICRODIALER \$69.95. THE NEW AVANTI "ON-GLASS" 2-METER, 220-MHZ. AND 450-MHZ. ANTENNAS IN STOCK. NEW ITEM: THE ELECTRONICS MODEL PA 1-10 [1-WATT IN, 10-WATTS OUT] 2-METER FM RF AMPLIFIER, GREAT FOR HANDIE-TALKIES AND PORTABLES, \$69.95. SHURE 444 MICROPHONES \$39.00. AMPHENOL RF AND MICROPHONE CONNECTORS. 1980 RADIO AMATEUR CALLBOOKS: U.S. \$16.95, FOREIGN \$15.95. ARRL PUBLICATIONS. AMECO BOOKS AND CODE TAPES. ALL PRICES QUOTED IN THIS AD WILL INCLUDE UPS/INSURANCE CHARGES. 73, L. GENE LARUE K3HAM. ✓ 41

LaRue Electronics, 1112 GRANDVIEW STREET, SCRANTON, PA. 18509 - Ph. [717]343-2124

JAN CRYSTALS

JAN CRYSTALS KEEP YOU ON THE AIR

- CB
- CB standard
- 2 meter
- Scanners
- Amateur Bands
- General Communication
- Industry
- Marine VHF
- Micro processor crystals

Send 10¢ for our latest catalog.
Write or phone for more details.

Jan Crystals
2400 Crystal Drive
Ft. Myers, Florida 33907
all phones (813) 936-2397



easy to charge

✓ 39

Now from J. W. Miller

DAIWA CORPORATION

Communications Essentials

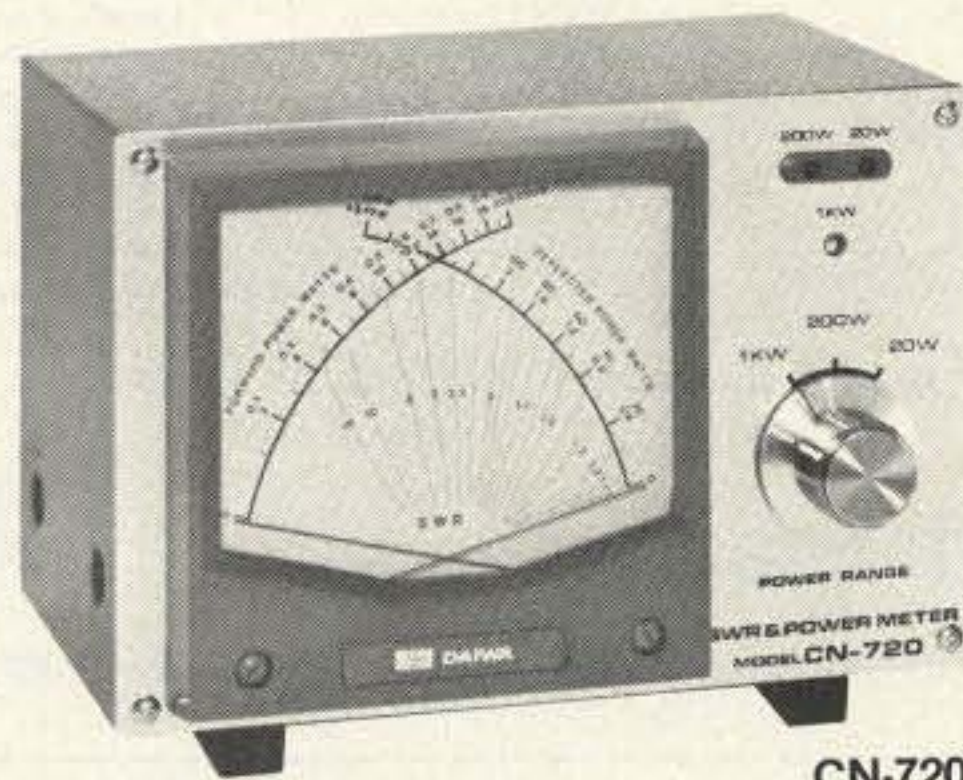

CN-720

SWR & Power Meters Models CN-720 and CN-620

Simultaneous direct reading SWR,
Forward Power and Reflected Power.

Frequency Range: 1.8—150 MHz
SWR Detection Sensitivity: 5 Watts min.
Power: 3 Ranges (Forward, 20/200/1000 Watts)
(Reflected, 4/40/200 Watts)

Tolerance: ± 10% full scale
Input/output Impedance: 50 Ohms
Connectors: SO-239
Dimensions: 180 x 120 x 130 mm;
7 x 4.75 x 5 in.
165 x 75 x 97 mm;
6.5 x 3 x 4 in.

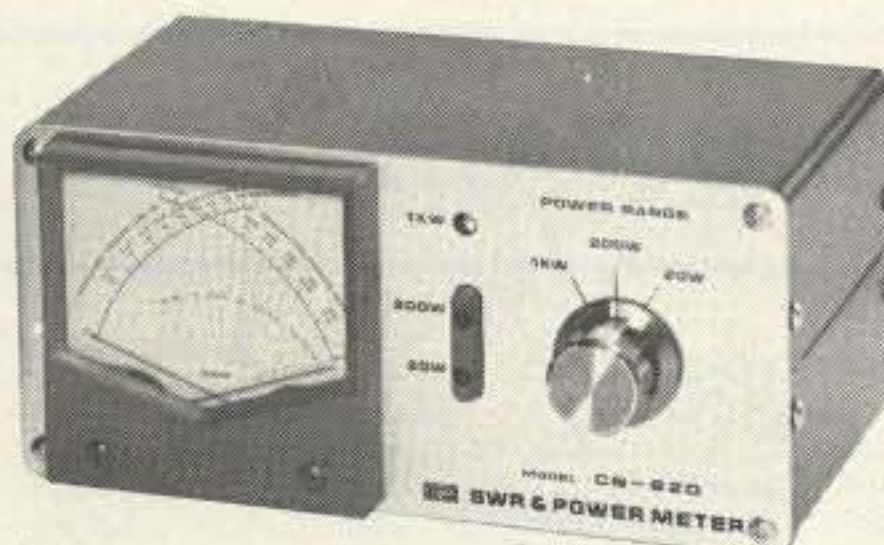

CN-620

SWR & Power Meter Model CN-630

Simultaneous direct reading SWR,
Forward Power and Reflected Power.

Frequency Range: 140—450 MHz
SWR Detection Sensitivity: 5 Watts min.
Power: 2 Ranges (Forward, 20/200 Watts)
(Reflected, 4/40 Watts)

Tolerance: ± 10% full scale
Input/output Impedance: 50 Ohms
Connectors: SO-239
Dimensions: 180 x 85 x 120 mm;
7.12 x 3.37 x 4.75 in.



CN-630

Exclusive USA agent for these units;
inquiries invited.

Write for literature.



J. W. Miller Division BELL INDUSTRIES

19070 REYES AVE. ■ P.O. BOX 5825
COMPTON, CALIFORNIA 90224

✓ 308

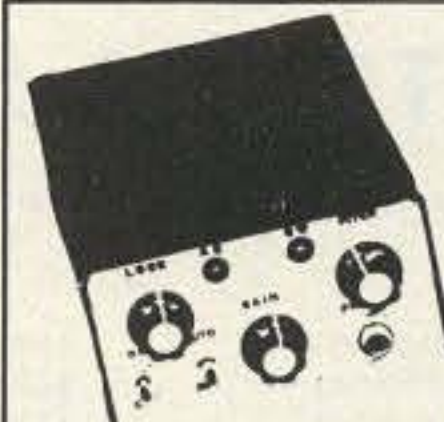

NOW - THE NEW

AMCODER

IT'S EVEN BETTER!!!

4" x 2 3/8" x 6"

- Still only 40hz wide. Single signal - no QRM/QRN reception. Immune to impulse (ignition) noise.
- Still tape quality audio with TTL compatible signal for computer interface applications. No noise appears in the AMCODER output.
- NOT A FILTER!! Its CW regeneration.
- NOW - dig into the noise for the weak ones without front end overload with our new AGC module. No locking on noise.
- No mods to your gear. Just plug into phone jack. Speaker or phone outputs with bypass switching when not in use. No external power required.
- 26DB dynamic range (5 to 6S unit fade margin) with AGC module when properly adjusted.
- Constant level input to the AMCODER regardless of receiver audio level with either S-1 or 30 over 9 signals. (Works on phone signal levels too) with the AGC module.
- Still reduced operator fatigue, variable frequency acquisition, 400-1400hz and variable frequency output tone (and smoother).
- Still variable output level for station speaker or head phones.

Complete kit (Less AGC option)
(Cabinet included) \$79.95
AGC Module (only FWT) for
older AMCODERS 29.95
AGC Module (Only FWT) for
new AMCODERS 29.95
New AMCODER Factory wired & tested 94.95
With AGC Module installed 119.95
Foreign - Add \$20.00 - all in U.S. Funds.
Ship your old AMCODER to AMC for updating and
installation of AGC module - we pay for return
shipping 32.50

VISA & Mastercharge Accepted
Maryland residents - add 5% Sales Tax.
Write for brochure or check reader info card.

AMC ENGINEERING
P.O. Box 427
Jessup, Md. 20794

✓ 6

Phone: 301-799-7741

ALL-MODE VHF amplifiers

FOR BASE STATION & REPEATER USE

MODEL: V350



MODEL: V180

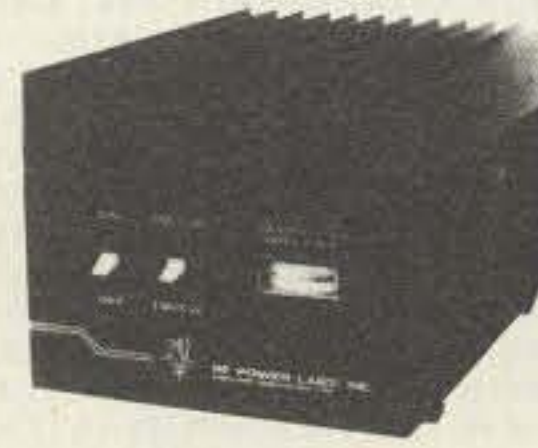

- ☆ Built-in 115/230 VAC Supply
- ☆ AM-FM-CW-SSB-RTTY
- ☆ 60dB Harmonics
- ☆ 60dB Spurious
- ☆ Heavy Duty Design

- ☆ Illuminated Panel Meter
- ☆ Automatic T/R Switching
- ☆ VSWR Protected
- ☆ + 13V/3A Accessory Socket
- ☆ U.S. Manufactured

All Solid-State!

| MODEL | FREQUENCY | INPUT | OUTPUT | SIZE WxDxH | WEIGHT | FAN KIT REQUIRED | PRICE |
|-------|------------|----------------------|----------|---------------|------------------|---------------------|----------|
| V76 | 50-54MHz | 8-15W | 100-120W | 216x330x178mm | 11.7 kg (26 lbs) | No | \$339.00 |
| V360 | 50-54MHz | 2-10W | 400-450W | 432x330x178mm | 23.4 kg (52 lbs) | Yes | \$895.00 |
| V70 | 144-148MHz | 10-15W | 75-90W | 216x330x178mm | 11.7 kg (26 lbs) | No | \$315.00 |
| V71 | 144-148MHz | 1-3W | 75-90W | 216x330x178mm | 11.7 kg (26 lbs) | No | \$349.00 |
| V180 | 144-148MHz | 5-15W | 170-200W | 216x330x178mm | 13.5 kg (30 lbs) | CW & FM | \$539.00 |
| V350 | 144-148MHz | 10-20W | 350-400W | 432x330x178mm | 23.4 kg (52 lbs) | Yes | \$895.00 |
| V130B | 220-225MHz | 10-15W | 70-85W | 216x330x178mm | 11.7 kg (26 lbs) | No | \$329.00 |
| V135B | 220-225MHz | 25-35W | 140-160W | 216x330x178mm | 11.7 kg (26 lbs) | CW & FM | \$469.00 |
| F110 | | Fan Kit, 115VAC | | 135x135x50mm | 1 kg (2.2 lbs) | - | \$ 33.00 |
| F220 | | Fan Kit, 230VAC | | 135x135x50mm | 1 kg (2.2 lbs) | - | \$ 33.00 |
| *F135 | | Fan Kit, 115VAC | | 381x140x89mm | 3.2 kg (7 lbs) | - | \$ 59.00 |
| *F235 | | Fan Kit, 230VAC | | 381x140x89mm | 3.2 kg (7 lbs) | - | \$ 59.00 |
| RM-1 | | 19 Inch Rack Adaptor | | 483x3x178mm | 1 kg (2.2 lbs) | - | \$ 25.00 |
| *RM-2 | | 19 Inch Rack Adaptor | | 197x32x28mm | .5 kg (1.1 lbs) | - | \$ 12.00 |

*Used with the V360 & V350 Amplifiers

Other Frequencies Available on Request

Dealer Inquiries Invited

Meeting all applicable FCC Requirements.



RF POWER LABS, INC.

63



11013-118th Place N.E. • Kirkland, Washington 98033 Telephone: (206) 822-1251 • TELEX No. 32-1042

ANTENNA SYSTEMS/TOWER HARDWARE

HY-GAIN ANTENNAS

| | | |
|----------|------------------------------|-------|
| TH5DX | New 5-Element Triband Beam | \$195 |
| TH6DXX | 6-Element Triband Beam | \$225 |
| TH3MK3 | 3-Element Triband Beam | \$165 |
| TH3JR | 3-Element Triband Beam | \$119 |
| TH2MK3 | 2-Element Triband Beam | \$109 |
| HY-QUAD | 2-Element Triband Quad | \$199 |
| 402BA | 2-Element 40-mtr Beam | \$175 |
| 205BA | 5-Element 20-mtr "Long John" | \$225 |
| 155BA | 5-Element 15-mtr "Long John" | \$145 |
| 105BA | 5-Element 10-mtr "Long John" | \$94 |
| 204BA | 4-Element 20-mtr Beam | \$175 |
| 153BA | 3-Element 15-mtr Beam | \$64 |
| 103BA | 3-Element 10-mtr Beam | \$54 |
| DB1015A | 3-Element 10/15-mtr Beam | \$115 |
| 64B | 4-Element 6-mtr Beam | \$42 |
| 66B | 6-Element 6-mtr Beam | \$89 |
| 18HT | Hy-Tower 80-10 mtr. Vertical | \$249 |
| 18AVT/WR | 80-10 mtr Trap Vertical | \$75 |
| 14AVQ/WB | 40-10 mtr Trap Vertical | \$55 |
| 208 | 8-Element 2-mtr Beam | \$24 |
| 214 | 14-Element 2-mtr Beam | \$29 |
| 28DQ | 80/40 mtr Trap Dipole | \$49 |
| 58DQ | 80-10 mtr Trap Dipole | \$85 |
| BN86 | 80-10 mtr KW Balun | \$14 |

KLM ANTENNAS

| | | |
|--------------|-------------------------|-------|
| KT34A | 4-El Tribander | \$299 |
| KT34XA | New 6-El Tribander | \$449 |
| 160V | 160-mtr Vertical | \$89 |
| 7.0-7.3-4A | 4-El 40-mtr Beam | \$589 |
| 7.2-1 | 40-mtr Dipole | \$139 |
| 10-30-7A-LP | 7-El 10-30 MHz Beam | \$599 |
| 13.9-14.4-6A | 6-El 20-mtr Beam | \$629 |
| 21.0-21.5-6A | 6-El 15-mtr Beam | \$379 |
| 28-30-6A | 6-El 10-mtr Beam | \$199 |
| 50-52-11 | 11-El 6-mtr Beam | \$169 |
| 144-148-13LB | 13-El 2-mtr Long Boomer | \$69 |
| 219-226-14 | 14-El 220 MHz Beam | \$49 |
| 432-16LB | 16-El 432 MHz Beam | \$59 |
| 3-60-1:1 | 1:1 4-KW PEP Balun | \$24 |
| 3-60-4:1 | 4:1 4-KW PEP Balun | \$24 |

CUSHCRAFT ANTENNAS

| | | |
|-----------|---------------------------------|-------|
| ATB-34 | 4-Element Triband Beam | \$209 |
| ATV-4 | 40-10 mtr Trap Vertical | \$78 |
| ATV-5 | 80-10 mtr Trap Vertical | \$85 |
| 15-4CD | New 4-Element 15-mtr Beam | \$89 |
| 10-4CD | New 4-Element 10-mtr Beam | \$67 |
| A50-5 | 5-Element 6-mtr Beam | \$55 |
| A617B | New 6-Element 6-mtr Beam | \$149 |
| ARX-2 | 2-mtr "Ringo Ranger" | \$30 |
| A-3219 | 19-Element 2-mtr "Boomer" | \$66 |
| A-214B | 14-Element 2-mtr "Boomer" | \$53 |
| A-214FB | 14-Element 2-mtr FM "Boomer" | \$53 |
| A-228FB | 28-Element 2-mtr FM Power Pack | \$165 |
| A-147-11 | 11-Element 2-mtr FM Beam | \$30 |
| A-147-22 | 22-Element 2-mtr FM Power Pack | \$90 |
| DX120 | 20-Element 2-mtr Collinear | \$45 |
| ARX-450 | 450 MHz "Ringo Ranger" | \$30 |
| A-144-10T | 10-Element 2-mtr "Oscar" ant. | \$37 |
| A-144-20T | 20-Element 2-mtr "Oscar" ant. | \$53 |
| A-432-20T | 20-Element 432 MHz "Oscar" ant. | \$49 |
| LAC-1 | "Blitz-Bug" Male/Female | \$5 |
| LAC-2 | "Blitz Bug" Female/Female | \$5 |

ANTENNA ROTORS

| | | |
|------------------------------------|---------------------------|----------|
| Alliance HD-73 | Rated for 10.7 sq. ft. | \$99 |
| Alliance U-100 | Ideal for Elevation Rotor | \$39 |
| CDE CD-45 | Rated for 9 sq. ft. | \$115 |
| CDE HAMIV | Rated for 15 sq. ft. | \$149 |
| CDE Tailltwister | Rated for 30 sq. ft. | \$209 |
| 8 Conductor Rotor Cable | | \$15/ft. |
| Heavy Duty 8 Conductor Rotor Cable | | \$36/ft. |

ROHN TOWERS

| | | | |
|-------------|---------------------------------------|-------------|--------------|
| 20G \$29.50 | 25G \$38.50 | 45G \$67.50 | 55G \$104.50 |
| HDBX48 | Free-standing 48-ft. tower (18 sq.ft) | | \$305 |
| HBX56 | Free-standing 56-ft. tower (10 sq.ft) | | \$335 |
| FK2548 | 48-ft 25G Foldover tower | | \$599 |
| FK2558 | 58-ft 25G Foldover tower | | \$666 |
| FK2568 | 68-ft 25G Foldover tower | | \$729 |
| FK4548 | 48-ft 45G Foldover tower | | \$839 |
| FK4558 | 58-ft 45G Foldover tower | | \$929 |
| FK4568 | 68-ft 45G Foldover tower | | \$999 |

(Freight paid on all foldover towers. Prices 10% higher west of Rocky Mountain states.)

GALVANIZED STEEL TOWER HARDWARE

| | | |
|--|---------------|---------------|
| 3/16" EHS (3990 lb rating) | \$9.50/100 ft | \$90/1000 ft. |
| 1/4" EHS (6000 lb rating) | \$12/100 ft | \$111/1000 ft |
| 5/32" - 7 x 7 Aircraft cable (2700lb) | | \$8/100 ft |
| 3/16 CCM cable clamps (3/16" or 5/32" cable) | | \$0.30 |
| 1/4 CCM cable clamps (1/4" cable) | | \$0.40 |
| 1/4 TH Thimble (fits all sizes) | | \$0.25 |
| 3/8 EE (3/8" Eye and eye turnbuckle) | | \$5.50 |
| 3/8 EJ (3/8" Eye and jaw turnbuckle) | | \$6.00 |
| 1/2 EE (1/2" Eye and eye turnbuckle) | | \$7.50 |
| 1/2 EJ (1/2" Eye and jaw turnbuckle) | | \$8.00 |
| 3/16" Preformed guy deadend | | \$1.45 |
| 1/4" Preformed guy deadend | | \$1.65 |
| 6"-dia. 4-ft long earth screw anchor | | \$10.50 |
| 2"-dia 10-ft long heavy duty mast | | \$35.00 |
| 500D Guy insulator (5/32" or 3/16" cable) | | \$0.85 |
| 502 Guy insulator (1/4" cable) | | \$1.80 |

COAXIAL CABLE AND CONNECTORS

| | |
|------------------------------------|---------|
| RG-213/U (Mil-spec RG-8/u) | \$29/ft |
| RG-8X new 1/4" diam. low loss foam | \$15/ft |
| 1/2" 50-ohm Polyjacketed Hardline | \$65/ft |
| Male Hardline Connector (PL-259) | \$8.00 |
| Female Hardline Connector (SO-239) | \$9.00 |
| Male Hardline Connector (Type N) | \$10.00 |
| Female Hardline Connector (Type N) | \$10.00 |

HY-GAIN TOWER MASTER AND TELE-TOWER CRANK-UPS

Direct factory shipment to save freight expenses. Call for our competitive quote on these towers. We can ship tower bases from stock to allow you to complete foundation work while tower is being prepared for shipment.

For a quote on your antenna system needs, call today!

TEXAS TOWERS

1309 Summit Ave. Plano, Texas 75074
 9 a.m. - 6 p.m. Mon-Fri, 9 a.m. - 1 p.m. Sat

TELEPHONE: (214) 423-2376

A Texas Communications Products Company (TEXCOM)

"spring specials"

| | |
|--|----------|
| Cushcraft "boomer" | \$ 69.95 |
| OMNI-J 2 Meter Antenna | 39.95 |
| Tonna F9FT Antennas 144/16 el. | 59.95 |
| Klitzing VHF-UHF Amplifiers | |
| 2M 10W in - 100W Out | 179.95 |
| 432 10W in - 50W Out | 189.95 |
| Bird 43 and slugs, UPS paid in USA ... | stock |
| Microwave Modules, less 15% off list stock | |
| Telrex TB5EM, in stock | 415.00 |
| New Telrex TB5ES, 2 KW pep version | 315.00 |
| New Palomar Engr. Trans. Preamp | 89.50 |
| Bencher Paddles — \$39.95 Chrome ... | 49.95 |
| Vibroplex paddles in stock, plus bugs, | |
| write for prices. | |
| ETO 76 Amplifiers | stock |
| Lunar 6M-2M-220 In Line Preamps ... | 49.95 |
| Janel QSA-5 | 41.95 |
| HAM-X Tailtwister Rotor | 189.95 |
| HAM-4 Rotor | 139.95 |
| Cetron 572B | 29.50 |
| New HDI HC-1400 144/148MHZ, 25 watt, | |
| Synthesized 2 meter transceiver . | 349.00 |
| Remote digital readout | 49.95 |
| Motorola HEP170 | 0.29 |
| Mallory 2.5A/1000PIV epoxy diode ... | 0.19 |
| Aerovox 1000PF/500V Feed thru cap ... | 1.95 |
| Technical Books: Ameco, ARRL, Sams, Tab, | |
| Rider, Radio Pub., Callbook, Cowan, | |
| WRTVH, etc. | Call |
| NEW Belden 9405 (2#16)(6#18) 8 wire rotor | |
| cable, heavy duty for long runs | 0.32/ft |
| 8448 8 wire rotor cable | 0.20/ft |
| 9888 double shield RG8 Foam | 0.46/ft |
| 8214 RG8 Foam | 0.26/ft |
| 8237 RG8 Regular | 0.23/ft |
| 8267 RG213 | 0.30 |
| Amphenol Silver Plate PL259 (831SP) ... | 0.69 |
| Belden 14 ga. stranded antenna wire | |
| #8000 | 0.06/ft |
| Times 1/2" Foam Hardline \$0.65/ft. — | |
| Connectors, ea. | 15.00 |
| Berktek RG8X, 52 ohm, KW, per ft. | 0.16 |
| Robot "Slow Scan" Now in Stock | Call |
| Alliance HD73 Rotor | 109.95 |
| Teletow'r-self support- | |
| 55 ft/w breakover | 549.00 |
| 40 ft/w breakover | 399.00 |
| Telrex antennas? In Stock! Monobanders? | |
| You bet! | |

Looking for antique parts?
Write specific need to W5GJ.

THIS MONTH'S SPECIALS:

Icom IC701, AC, MIC — \$1,195.00
 NEW ICOM IC255A, 2M — \$349.00
 Dentron GLA 1000 Amp. \$319.00
 Dentron Clipperton L — \$499.00
 (Limited Qty.)
 New Price \$599.00 after current
 supply runs out.
 Kenwood TS700SP \$599.00;
 TR7625 \$399.00;
 TR7600 \$299.00; RM76 \$99.95.
 Limited Qtys.

MASTERCARD • VISA

All prices fob Houston except where indicated.
 Prices subject to change without notice, all items
 guaranteed. Some items subject prior sale. Send
 letterhead for Dealer price list. Texas residents add
 6% tax. Please add postage estimate \$1.00
 minimum.

MADISON
ELECTRONICS SUPPLY, INC.
 1508 McKINNEY
 HOUSTON, TEXAS 77002
 713/658-0268

When it comes to AMATEUR RADIO QSL's ...



it's the
ONLY BOOK!
US or DX Listings

1980 callbooks NOW READY!

Here they are! The latest editions. World-famous Radio Amateur Callbooks, the most respected and complete listing of radio amateurs. Lists calls, license classes, address information. Loaded with special features such as call changes, prefixes of the world, standard time charts, world-wide QSL bureaus and more. The new 1980 Radio Amateur Callbooks are available now. The U.S. Edition features over 400,000 listings, over 120,000 changes from last year. The Foreign Edition, over 315,000 listings, over 90,000 call changes. Place your order now.

| | Each | Shipping | Total |
|---|---------|----------|---------|
| <input type="checkbox"/> US Callbook | \$16.95 | \$1.75 | \$18.70 |
| <input type="checkbox"/> Foreign Callbook | \$15.95 | \$1.75 | \$17.70 |

Order both books at the same time for \$34.65, includes shipping.

Order from your favorite electronics dealer or direct from the publisher. All direct orders add \$1.75 for shipping. Illinois residents add 5% Sales Tax.



SPECIAL LIMITED OFFER!
Amateur Radio
Emblem Patch
only \$2.50 postpaid

Pegasus on blue field, red lettering. 3" wide x 3" high. Great on jackets and caps. Sorry, no call letters.

ORDER TODAY!

✓61
 RADIO AMATEUR
callbook INC.
 925 Sherwood Drive
 Lake Bluff, IL 60044

What does it really cost to get on RTTY?

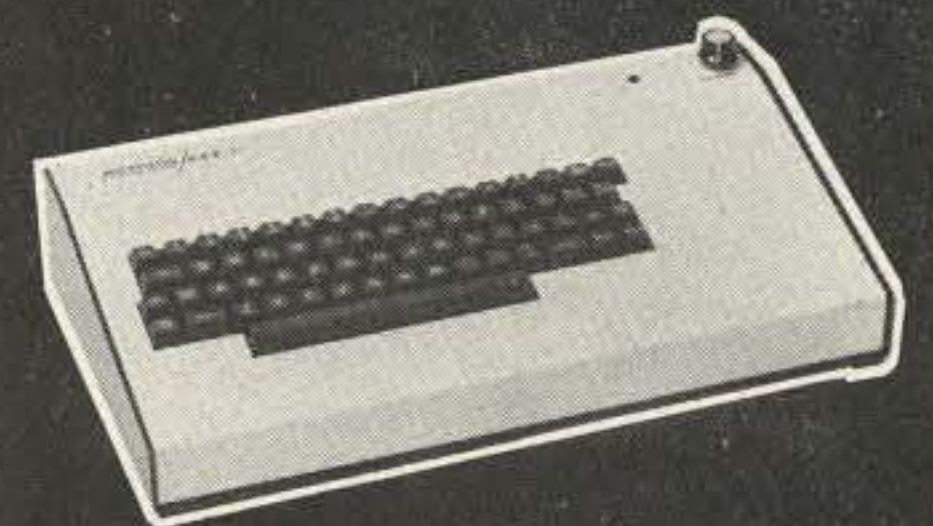

*No Economy models,
no extras*

... its all there. The Microlog "Split Screen Package" will get you on silent RTTY and CW with any rig, any mode; and with features you will find most desirable. \$999 for complete AKB-1 keyboard and AVR-2 decoder using your TV (\$1099 with 9" monitor shown). Compare on quality, features and price; we're sure you'll stay with MICROLOG. 4 Professional Drive, Suite 119, Gaithersburg, Maryland 20760, 301-948-5307.

✓51
MICROLOG
 CORPORATION

Innovators in Digital Communication

Looking West

from page 8

have their spirits lifted. I know that when I go through some of the cards here, my spirits are lifted and I sometimes have a tear in my eye reading the cards. It's so heartwarming to see the expression of support from the people for the hostages, and hopefully we can resolve this crisis very, very soon. Thank you once again, ham radio operators."

THE BIG NEW YEAR'S DAY INTERLINK DEPT.

We opened this month's column with a story about the WB6BJM/R repeater and its public service work. Our closing story also involves some open operation of this normally private repeater, and what also appears to be becoming an annual event of this group. I speak of the New Year's Day interlink between WB6BJM/R and any other system that has interest in

the project. This year, it was a four-way with the K4VYN repeater in Tysons Corner VA and two Ohio machines: WR8ADP in Dayton and WR8ACB in Cincinnati.

I could not hang around for the entire event, but what I did hear and see was well worth my time. Again, Joe had opened his private repeater to any and all who happened by the channel during the five hours of on and off festivities. Within a short time, hundreds of operators in all cities involved in the hookup had a chance to converse with one another. To say the operation ran as smooth as silk would

be an understatement. It was simply beautiful and definitely a tribute to all involved.

Joe has told me that he is interested in expanding the linking concept. If you happen to have an autopatch-equipped repeater handy and would like to get involved in this project in the future, you might drop a letter to Joe Olivera WB6BJM, Pipo Communications, PO Box 3435, Hollywood CA 90028. Whether you take an active part in it or just listen, it's one heck of a way to start a new year... or celebrate any holiday for that matter.

Contests

from page 126

claimed. Note: Logs from SWLs must contain both the full report sent and received by the station logged. Incomplete loggings are not eligible for scoring. The summary sheet should show the full scoring, the times on the air, and, in the case of multi-operator stations, the names and call signs of all operators involved with the operation of the station. Summary sheets and logs are available from the Contest Manager; please include 2 IRCs to cover postage (or large SASE in United Kingdom). All logs must be received by May 31st in order to qualify. Send your contest or check logs to: Ted Double G8CDW, 89 Linden Gardens, Enfield, Middlesex, England EN1 4DX. The judges' decision will be final and no correspondence can be entered into in respect to incorrect or late entries; all logs will remain the property of the BARTG. Certificates will be awarded to the leading stations in each of the three classes, the top station in each continent, and each W/K, VE/VO, and VK call area.

If a contestant manages to contact 25 or more different countries on 2-way RTTY during the contest, a claim may be made for the Quarter Century Award (QCA) issued by BARTG and for which a charge of \$3.00 US or 15 IRCs is made. Make your claim at the same time as you send in your log. Holders of existing QCA awards will automatically have any new countries added to their records.

However, in view of the high volume of work which the Contest Manager will have to deal with, it will not be possible to prepare and send out new awards or update existing awards until the final results of the contest have been evaluated and dispatched.

Similarly, if any contestant manages to contact stations on 2-way RTTY within each of the 6 continents and the BARTG Contest Manager has received a contest or check log from each of the 6 operators concerned, a claim may be made for the WAC award issued by the *RTTY Journal*. The necessary information will be sent on to the *Journal*, who will issue the WAC award free of charge.

WISCONSIN QSO PARTY

Starts: 2100 GMT March 29

Ends: 0300 GMT March 31

The maximum operating time is 24 hours; any station may be worked only once (on any band). General call is "CQ WIS." Repeater QSOs are not allowed.

EXCHANGE:

RS(T) and Wisconsin county or state.

FREQUENCIES:

Phone—3990, 7290, 14290, 21390, 28590.

CW—60 kHz up from band edge; 20 kHz up from bottom of Novice bands.

SCORING:

Phone contacts count one point each; CW contacts count two points each. Multiply QSO points times total Wisconsin counties (maximum 72) or by state and county total for

Wisconsin stations.

AWARDS & ENTRIES:

Awards to the highest score per state and the highest club score. Logs must show date, band, mode, time (GMT), call, report, and score. Logs must be legible or will be classified as check logs. Logs containing more than 100 contacts must also be submitted with ARRL or similar "dupe" sheet. All entries must be postmarked before May 1st. Send results to: Wisconsin QSO Party, c/o West Allis RAC, PO Box 1072, Milwaukee WI 53201.

YL INTERNATIONAL SSBERS QSO PARTY

CW

Starts: 0001 GMT March 29

Ends: 2359 GMT March 30

Phone

Starts: 0001 GMT April 19

Ends: 2359 GMT April 20

Two 6-hour rest periods are required during each contest period (CW/phone). All bands will be used and the same station may be contacted on different bands for contact points, but not for country multipliers. The country multiplier is used only one time. Two meters may be used, but no repeater contacts are allowed.

Any member desiring to enter the DX/WK team category should immediately send a request to: Lyle F. Shaw, 52340 Tallyho Drive, South Bend IN 46635. For record purposes, requests should be made in writing. In the week preceding the QSO Party, members wishing a partner may request one through system controls on the SSBers daily systems. No team assignments will be made after the party begins. A DX/WK team consists of a DX and WK member of ISSB. The team score is

the sum of both partners. Score to be determined when both logs are received. When only one log is received, credit will be given as single operator.

YL/OM teams are self-evident in their operation and need not file as with DX/WK teams. Each YL/OM team consists of one YL member and one OM member who are related: husband/wife, father/daughter, mother/son, or brother/sister. Operation must be from same QTH, using same rig with his/her own call. Non-members must operate in single-operator category.

EXCHANGE:

Name, RS(T), SSBers number, country, state, partner's call (if available); if non-member, send "no number," QTH.

FREQUENCIES:

CW—3665, 7070, 14070, 21070, 28070.

Phone—3925, 7290, 14333, 21373, 28673.

Please note: Listen for DX on 3765 and 7090. Listen for VK on 3690 on 75-meter phone, as their top frequency is 3700. It is requested that stations spread out to relieve the congestion on 14333. Please use frequencies from 14280 to 14345, remembering the nets on 14313 and 14336. Also, DX stations use frequencies 14160 to 14190 for contacts between DX.

SCORING:

On CW: Score 6 points for each member contacted on any continent. All CW contacts must be made outside the American phone band. Non-member contacts count one for each contact.

On phone: Score 3 points for each member contacted on any

Continued on page 136

MFJ SPEECH PROCESSOR

Punch thru QRM with up to 400% more RF power



\$59⁹⁵

MFJ Super Logarithmic Speech Processor plugs between your microphone and transmitter to give you up to 400% more RF power.

IC logarithmic amplifier strengthens weak valleys, reduces peaks of speech. Active filter concentrates power, gives clean audio for maximum punch. RF filtered. 9 V battery.

Two models. LSP-520BX II (pictured) \$59.95, 4x2x6 inches, deluxe cabinet. LSP-520 BX (not shown) \$49.95, standard MFJ cabinet, 2x3x4 inches. One year unconditional guarantee.

Try it. If not delighted, return within 30 days for refund (less shipping). **Order today.** Call toll free 800-647-1800. Charge VISA, MC or mail check, money order. \$3.00 shipping. ✓47

CALL TOLL FREE . . . 800-647-1800

For technical information, order/repair status, in Miss., outside continental USA, call 601-323-5869.

MFJ ENTERPRISES, INC.

BOX 494, MISSISSIPPI STATE, MS 39762

AUXILIARY POWER for Emergency or Portable Operation

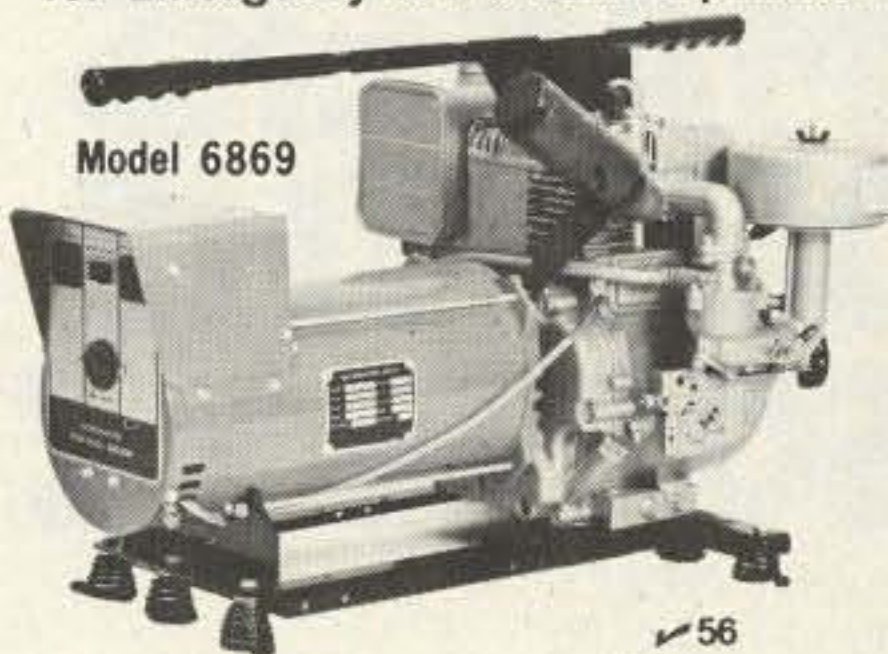

Light wt. Portable Alternator. Stand-by power for Ham Equipment, household needs during power outages or operation in remote areas. Operates lighting, refrigerators, heating systems or other appliances including freq. sensitive loads such as TV sets, induction motors and fluorescent lights. Solid-State voltage regulation. 3750W rating; 25% surge capacity. 120/240V at 31.3/15.6A. 8 HP/3600 RPM B&S engine. Alternator draws just enough engine output to meet load resulting in up to 25% fuel savings. Low interference. Advanced design. Drip-proof construction protects windings from rain and dirt assuring long life. One year warranty by manufacturer. 30"L x 18"W x 19"H. 128 lbs. Shipped via Truck

PREPAID (No extra charges) . . \$725.00

Electric Start 121.00

Battery Charging 12.00

Spark Arrest Muffler 23.00

Models available with 1350 to 7000 watt ratings. Write for our quote and additional information.

Mastercharge or VISA accepted

OUTDOOR OUTFITTERS

705 Elm Ct. Waukesha, WI 53186
Ph. 1-414-542-7772 • Ken, N9KS - Mgr.

GILFER'S "BEST SELLER" SHORTWAVE BOOKS

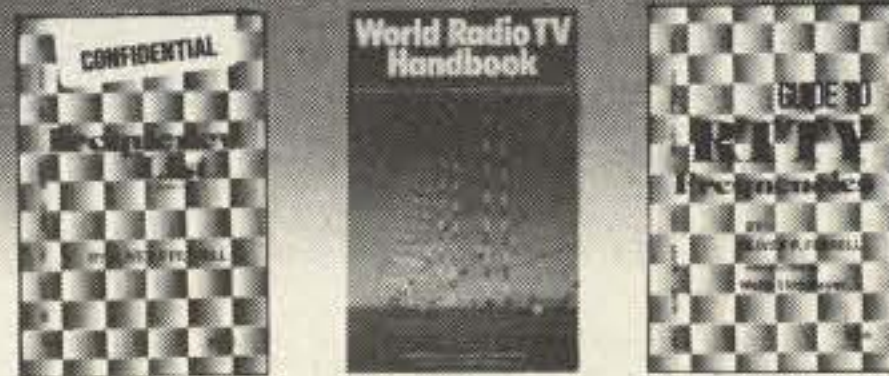

Latest Edition

CONFIDENTIAL FREQUENCY LIST Identifies 5,000 non-broadcast short-wave stations (telephone, coast, military, spy, etc.) from 4-26 MHz. \$6.95 ppd.

Just Released 34th Edition

WORLD RADIO TV HANDBOOK "Bible" of the SWL—comprehensive list of all shortwave broadcasters with all details—plus special articles. \$14.95 ppd.

Just Released

GUIDE TO RTTY FREQUENCIES First time ever—details on 3,500 radio teletype stations with info on how to ID special codes & languages. \$8.95 ppd.

Save \$4.90 — All 3 for \$25.95

FREE SHORTWAVE CATALOG

• Receivers • Antennas • Preselectors
• Accessories • Books • Forms • Logs ✓26

GILFER SHORTWAVE

Dept. 733, Box 239, Park Ridge NJ 07656

DIGITAL MODERNIZATION KIT



\$96.45

Plus \$3.50 ship. & handling
U.S. and Canada - Wash. residents
include sales tax.

THE DMK IS A COMPLETELY WIRED AND TESTED DIGITAL READOUT UNIT, that translates the LMO frequency to a frequency referenced from the HET and BFO oscillators. The DMK has independent calibration for each band. The last two digits are programmed and controlled by the Mode Switch, to correct for the difference in the USB/LSB LMO shift frequency. Both the Counter Clock and the Translation Oscillator are Crystal Controlled. The accuracy of the DMK is determined by the accuracy of your calibration source (Receiver Crystal Calibrator and etc). Installation instructions and mounting hardware is available for the following units:

SB-102 USE DMK-102
SB-300 USE DMK-300
SB-303 USE DMK-303

SB-401 USE DMK-401
HW-101 USE DMK-101
HW-100 USE DMK-100

All DMK's are electronically identical, only the installation instructions and mounting hardware may be different, therefore the DMK will work in units other than those listed above.

Easy step-by-step installation instructions. We will install for \$23.45.

TECHNICAL INFORMATION & PHONE ORDERS:
AL STAGGS, P.E. 1-206-829-0056
Time 0900 - 0200 Local Time

PHONE ORDERS ONLY:
1-206-588-5804
Time 0800-2300 Local Time

PROTRONICS, INC. ✓59

MASTER CHARGE

BOX 778
BUCKLEY, WA 98321

VISA

FAST SCAN ATV

WHY GET ON FAST SCAN ATV?

- You can send broadcast quality video of home movies, video tapes, computer games, etc, at a cost that is less than slocan.
- Really improves public service communications for parades, RACES, CAP searches, weather watch, etc.
- DX is about the same as 2 meter simplex — 15 to 100 miles.

ALL IN ONE BOX



TC-1 Transmitter/Conv
Plug in camera, ant, mic and you are on the air \$399 ppd



HITACHI HV-62 TV CAMERA
High performance closed circuit camera just right for atv. with lens \$239 ppd

PUT YOUR OWN SYSTEM TOGETHER



TVC-1B CONVERTER tunes 420 mhz down to ch 2 or 3 . . \$49.50 ppd
TXA5 EXCITER \$69 ppd
PA5 10 WATT LINEAR . . \$79 ppd
FMA5 Audio Subcarrier . \$24.50 ppd

"SEE US IN DAYTON"

SEND FOR OUR CATALOG, WE HAVE IT ALL
Modules for the builder, complete units for the operator, antennas, color cameras, repeaters, preamps, linears, video ider and clock, and more. 19 years in ATV.

Call 213-447-4565 ✓57



Maryann
WB6YSS

P.C. ELECTRONICS

2522 PAXSON
ARCADIA, CA 91006

Tom
W6ORG



WHY ARE ANTENNA MAKERS ANGRY ABOUT THE NEW AEA ISOPOLE™?

Introductory Price:
Isopole 144—\$49.95
Isopole 220—\$44.95



For the first time, ham operators are finding out just how poorly designed most vertical, omnidirectional VHF antennas really are.

AEA university level research has proven that most antennas now being offered create unwanted coupling of RF currents onto the antenna support structure and coaxial feedline shield from the transceiver.

Proper design and decoupling on the new AEA ISOPOLE™ virtually eliminates the RF spillover problem and can help you achieve the maximum attainable gain for the size of the antenna—equivalent to doubling your power in all directions on the horizon relative to an ideal half-wave dipole, or 6 db gain over a typical one quarter wavelength groundplane antenna. The most popular 2 meter omnidirectional "gain" antennas are unable to achieve the gain figures for an ideal half-wave dipole, resulting from poor feedline decoupling.

Plus! The new AEA ISOPOLE™:

- requires no tuning. ✓2
- is easy to assemble.
- covers a bandwidth nearly double the two meter ham band.

- has less than 2:1 SWR over the entire 2 meter band.
- has a beam pattern independent of feedline length.
- requires no ground plane.
- features completely weather protected RF connections.
- is designed for maximum legal power.
- mounts easily on a standard TV mast. (TV mast NOT supplied by AEA)

Prove it to yourself.

Let us send you a design for a simple tester you can use to see just how much RF spillover is coming off your own equipment.

The design is included in a copy of our free booklet: **FACTS ABOUT PROPER VHF VERTICAL ANTENNA DESIGN**. To get your copy, or information about ordering an AEA ISOPOLE™, write or call Advanced Electronic Applications, Inc., P.O. Box 2160, Lynnwood, Washington 98036. Call 206/775-7373.



AEA

Brings you the breakthrough!

Completely Free Standing Towers

TELE TOW'R

PAT. NO.

4,151,534

40' MODEL

Model 40 (extends from 21' to 40')

List \$259.10

55' MODEL

Model 55 (extends from 21' to 55')

List \$473.97

Breakover Model

40 (extends from 23' to 40' with breakover at ground level)

List \$440.62

Breakover Model

55 (extends from 23' to 55' with breakover at ground level)

List \$661.75

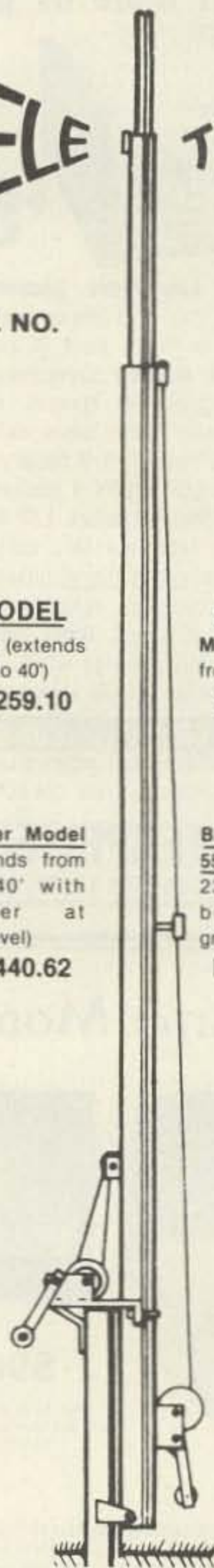

All steel constructed.

Concrete sleeve available for all models.

✓72

TELE-TOW'R MFG. CO., INC.
P.O. Box 3412 • Enid, OK 73701
405-233-4412

**Signalcrafters Presents
The Most Advanced
Automatic Computing
Power Meters
In Amateur Radio!**



MODELS 31 and 32*

Our portable Models 31 and 32 feature the same state-of-the-art technology that is incorporated in their Big Brother, the Model 30. Never again will you have to bother with SWR "calibrate" controls and switches! Signalcrafters' custom integrated circuit makes power and SWR measurement a "hands-off" operation by automatically computing SWR. The result is unparalleled accuracy and ease of operation.

FEATURES:

- **CUSTOM IC**—Computes SWR from the level sensed on the transmission line independent of the power level. This analog computer operates over a range of only one watt to the full scale of the meter with unequalled accuracy.
- **RUGGED TAUT-BAND METERS**—Provide accuracy and readability that must be seen to be appreciated.
- **HEAVY DUTY CABINETS**—Handsome heavy duty metal cabinets complement virtually every transceiver on the market today.
- **TWO MODES—PEAK OR AVERAGE**—The amateur may choose between either peak or average power readings.
- **POWER REQUIREMENTS**—Due to the advanced low current design, battery life is truly outstanding, making this meter a natural for portable or field day operation. Uses standard 9 volt battery or 120V AC with optional AC adaptor.

ATTRACTIVE AFFORDABLE PRICING

- *Model 31A (0 to 200w)
31B (0 to 20w)
.....only **\$149.00**
- Model 32A (0 to 200w, 0 to 2000w)
32B (0 to 20w,
0 to 200w)
.....only **\$169.00**

SIGNALCRAFTERS, INC.®
5460 BUENA VISTA DRIVE
SHAWNEE MISSION, KANSAS 66205
913/262-6565; TELEX 42-4171

All Signalcrafters products are designed, engineered, and produced in the U.S.A. Prices include shipping to all U.S.A. VISA and Master Charge accepted. Kansas Residents please add 3 1/2 percent.

**Our smart machine
reads sloppy copy.**

**New! Includes 24-hour UTC clock,
110 and 300 baud ASCII, & tuning eye!**



**Kantronics
Field Day®**

\$449.95

If someone tells you they offer the same features we do, check them out with the list below. Kantronics offers the finest in state-of-the-art technology through over 35 dealerships in the United States, Canada and West Germany.

- Morse copying ability
- 3 to 80 WPM Morse range
- Computer programs for improving sloppy Morse
- Radioteletype copying ability - 60, 67, 75 and 100 WPM Baudot
- ASCII radioteletype ability - 110 and 300 WPM baud
- Copies any shift of RTTY
- 24-hour UTC clock available in any mode
- Entire unit contained in one package
- Automatic code-speed tracking
- Full 10-character, large size display
- Displays code speed
- Tuning eye for faster tuning
- Full year limited warranty
- Internal speaker
- Requires no TV set for use
- Advanced demodulator circuits
- Internal 200 Hz bandwidth filter
- All letters, numbers and punctuation plus 8 special Morse characters and 5 special RTTY characters
- 15-day trial period.

Send for our free brochure that explains the Field Day system of Morse and RTTY decoding. Or you can order from one of our dealers or our factory today. Our number is below, give us a call.

Special SWL model - \$464.95

Free

Code
Reading
Made
Simple

Okay, tell me more.

Name _____
Address _____
City _____ State _____
Zip _____

Kantronics
1202 E. 23rd Street (913) 842-7745
Lawrence, Kansas 66044



For your TRS-80
send & receive
CW/RTTY



FEATURES

- Auto Send & Receive RTTY & CW
- Connects to TRS-80 User Port & Key/head phone jacks
- 10 message memories 255 char. ea.
- Uses builtin PLL or external TU

- Includes hardware, cassette & manual
 - Morse tutorial-10 lessons-corrects mistakes Simplest, fastest way to learn the code
 - Morse practice-random 5 letter words
 - Auto numbering contest keyer
 - Interactive graphics custom PIX
 - Autotransmitter control PTT
 - Requires Level II Basic & 16K RAM
 - CM80 In cabinet as illustrated \$279
 - M80 As above minus cabinet \$149
 - M800 Adds advanced RTTY features to M80 \$99
- PET, APPLE, SORCERER versions available

Write or call for complete catalog



MACROTRONICS, inc. [®] ✓44

1125 N. Golden State Blvd. / Suite G
Turlock, CA 95380 (S)
(209) 667-2888 / 634-8888



We are experiencing telephone difficulties,
please keep trying.

California residents add 6% tax

2-METER MOBILE

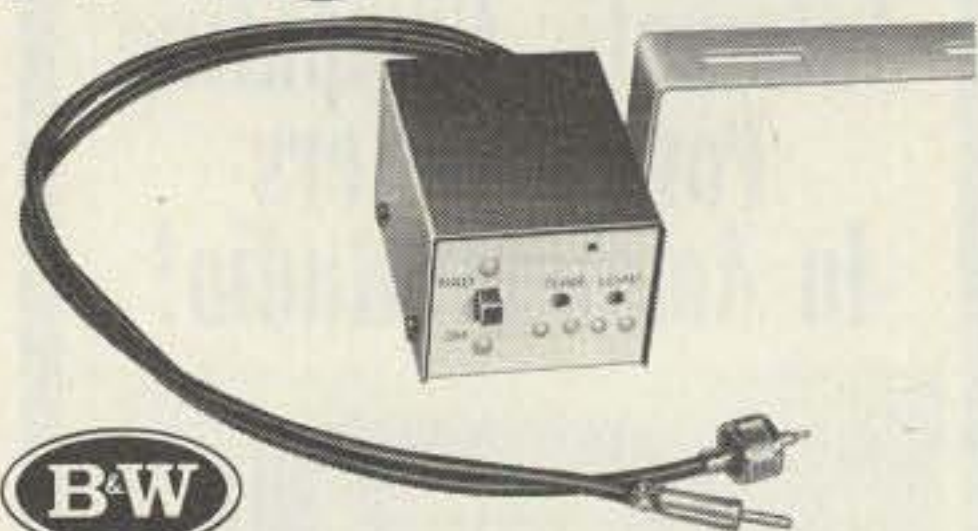

B&W

AT-200 Antenna Matcher

Use your car's AM/FM antenna for your 2-meter mobile rig.—Eliminate the two-antenna tip-off to thieves, without the nuisance of hideaways.

Save the cost of a 2-meter mobile antenna.

AT-200 tunes from the front panel for maximum output, minimum VSWR (1.2:1 or less for most car antennas).

at your B&W dealer. ✓11

Made in the U.S.A. by **B&W**

Barker & Williamson, Inc.

10 Canal Street, Bristol, PA 19007

NEW MFJ SOLID STATE 24 HOUR DIGITAL CLOCK

Eliminate converting to GMT. Pleasant **BLUE** easy-on-eyes display. Bright .6 inch digits. **ID timer**. Alarm, snooze, lock functions. Power out, alarm on indicators. Assembled.



Pleasant Blue Display
is easy-on-eyes.
Bright .6 inch digits.
Built-in ID timer.

\$29⁹⁵

The MFJ-101 is a new all solid state 24 hour digital clock. Just set it to GMT and forget about converting to GMT.

Pleasant blue .6 inch digits (like TS-820S) are easy-on-eyes and bright enough to see clear across your room.

ID timer alerts you every 9 minutes after you tap ID/doze button.

Set alarm to remind you of SKED or simply to wake you up in morning. Has alarm on indicator.

Fast/slow set buttons make setting time and alarm simple.

Lock function prevents missetting time/alarm. Digits flash if power is interrupted. Rugged black plastic case. Brush aluminum front/top panel.

UL approved. 110 VAC. 50/60 HZ switch for USA, Europe, Japan and other countries. Use

220/240 VAC with optional AC adapter. 6x2x3 in.

Order from MFJ and try it — no obligation. If not delighted, return it within 30 days for refund (less shipping). One year limited warranty by MFJ.

Order today. Call toll free 800-647-1800. Charge VISA, MC or mail check, money order for \$29.95 plus \$3.00 shipping/handling for MFJ-101.

Don't wait any longer to enjoy the convenience of reading GMT time directly.

CALL TOLL FREE ... 800-647-1800

Call 601-323-5869 for technical information, order/repair status. Also call 601-323-5869 outside continental USA and in Mississippi. ✓47

MFJ ENTERPRISES, INC.

BOX 494, MISSISSIPPI STATE, MS 39762

The QSL Organizer™ Holds 240 QSL's



FREE ALBUM with every 40 pages.

Tired of cluttering up your walls, stuffing QSL's in drawers and boxes? A great new way to organize, preserve and display your QSL cards is in clear vinyl pocket pages. Each specially designed, crystal clear heavy duty page, holds 6 cards (back to back). The roomy 4" x 6" pockets even hold those extra large Japanese QSL's. With every 40 pages (minimum) ordered, you'll receive a handsome 9" x 14" sturdy 3-ring album, fully padded, in durable 'Brown-Hide' vinyl.

As gifts for friends, as valuable club prizes, or as a treat for yourself - the QSL Organizer is a must, for every radio shack. Try it for 30 days. If you're not delighted, return it for full refund.

| | |
|--|----------------------------|
| 1 FREE Album and 40 pages at .47 ea. plus \$1.95 shipping. Total \$20.75 | Pages, pkgs of 40 only |
| 2 FREE Albums and 80 pages at .45 ea. plus \$3.45 shipping. Total \$39.45 | CA residents add 6% tax |

Send Check, Money Order, Mastercharge, Visa to:

MIL INDUSTRIES Dept 3 ✓307

P. O. Box #44457 Panorama City, CA 91402

- ★ Technical Forums
- ★ ARRL and FCC Forums
- ★ GIANT 3-Day Flea Market
- ★ New Products and Exhibits
- ★ Grand Banquet
- ★ Women's Activities
- ★ Special Group Meetings
- ★ Hundreds of Prizes
- ★ CW Proficiency Tests
- ★ Amateur of Year Award
- ★ Special Achievement Awards
- ★ Expanded Exhibits and Parking

DAYTON HAMVENTION '80

April 25, 26, 27, 1980

Hara Arena and Exhibition Center Dayton, Ohio

Meet your amateur radio friends from all over the world at the internationally famous Dayton HAMVENTION.

Banquet speaker Saturday evening will be Senator Barry M. Goldwater, K7UGA. Seating will be limited so please make reservations early.

If you have registered within the last 3 years you will receive a brochure in late February. If not write Box 44, Dayton, OH 45401.

Nominations are requested for Radio Amateur of the Year and Special Achievement Awards. Nomination forms are available from Awards Chairman, Box 44, Dayton, OH 45401.

For special motel rates and reservations write to Hamvention Housing, 1980 Winters Tower, Dayton, OH 45423. **NO RESERVATIONS WILL BE ACCEPTED BY TELEPHONE.**

All other inquiries write Box 44, Dayton, OH 45401 or phone (513) 296-1165 - 5-10 P.M. EST.

Rates for ALL 3 Days:

Admission: \$5 in advance, \$6 at door.
Flea Market Space: \$11 in advance, \$13 at gate.
Banquet: \$12 in advance, \$14 at door.

Make checks payable to Dayton HAMVENTION, Box 333, Dayton, OH 45405.

Bring your family and enjoy a great weekend in Dayton.

Sponsored by the Dayton Amateur Radio Association, Inc.

RTTY Loop

from page 18

Let's bop out of converter building long enough to consider a question sent in by Bob Bunn WA0LKE. Bob writes that he is setting up his RTTY station, but that a German amateur

told him that this equipment operates on 170-Hz shift, using tones of 1275 Hz and 1445 Hz. He wants to know how to buy, build, or modify a terminal unit to work the DA on these frequencies.

Well, Bob, it all boils down to

what you will be receiving. As we have stated here before, put AFSK into an SSB rig and FSK comes out. That is, it does not matter what frequency tones the DX station feeds into his transmitter; all you will see is plain old 170-Hz shift FSK RTTY. What frequency audio tones you recover depends only on your receiver. Any converter that works on anyone else would work on him. Okay?

Those of you in the mid-Atlantic area, be sure to come to Baltimore on March 30, 1980, for the Greater Baltimore Hambooree and Computerfest. Sponsored by the Baltimore Amateur Radio Club and Calvert Hall, it promises to be a whale of an event, with good ol' NSD, himself, speaking. I will be there, too, so hope to see you there. Check the "Social Events" section of 73 for details.

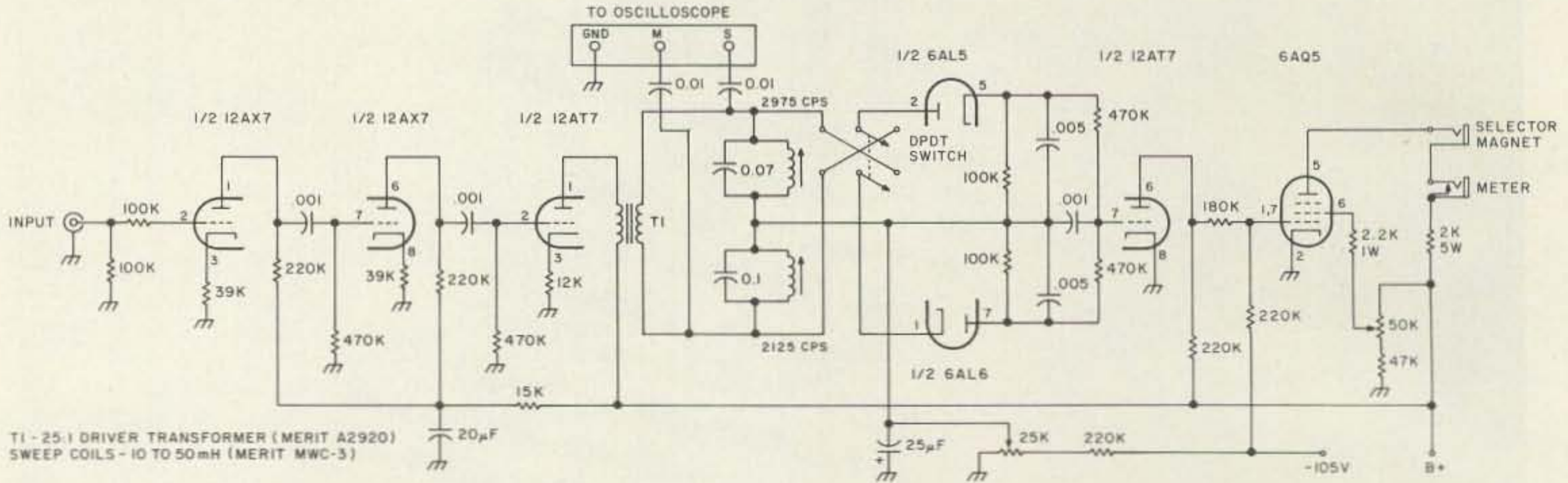

Fig. 3.

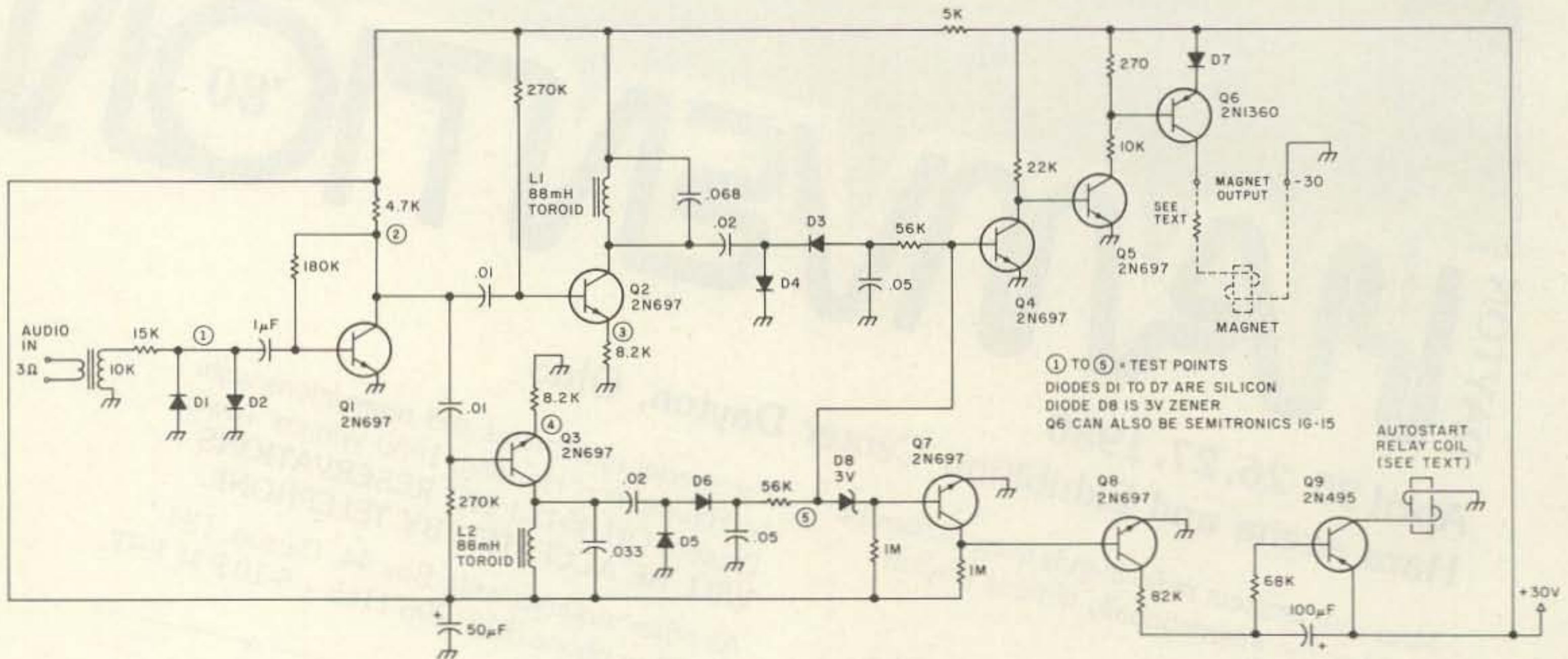

Fig. 4.

Contests

from page 130

continent. Non-member contacts count 1 point each.

For both contests: Only member stations' contacts count as multipliers. Count one multiplier for each state, country, YL/OM team, DX/WK team, partners

(when DX/WK partners contact each other).

AWARDS:

Extraordinary certificates will be issued to the highest individual score, DX/WK teams, YL/OM teams, and score for highest score for single-operator category. Regular certificates for

highest state and country winners.

ENTRIES:

Logs must show date/time in GMT, RS(T), SSBer number, partner's call, mode of operation, band, and period of rest time.

Summary sheets must be compiled and enclosed. All logs must be postmarked by May 15th. Send all compiled logs, along with your comments, to Lyle F. Shaw, 52340 Tallyho Drive, South Bend IN 46635.

1980 INTERNATIONAL SSTV CONTEST

See page 126

DX

from page 10

on 40 meters.

ZA3KL worked many stations on CW in December but is not legitimate. The beam heading from the east coast of the US was sometimes more in the direction of the South Pacific than toward Europe.

January 2 produced a severe earthquake in the Azores Islands, measuring 7.8 on the Richter scale. CT2AP appeared on 10 meters, operating from Angra at the Headquarters of the Security Police. The FCC was contacted regarding possible third party traffic with CT2, normally verboten, and the FCC Treaty Branch cabled the Portuguese government; nothing was forthcoming.

The ARRL's DX Advisory Committee voted on three items late in 1979. Voted down were "name changes" for the (formerly) VR1 islands, country status for Tierra del Fuego off the coast of Argentina, and implementation of a Board of Directors proposal for a new award based on IARU (International Amateur Radio Union) member societies/countries.

From March to September, 1979, OK3TAB/D2A made 18,000 contacts while VK0PK worked 3,300 during his stay on Macquarie, which ended in December. KG6SW changed his call to KH0AC on New Year's Day; Len has confirmed 30,000 contacts from the Marianas, through manager W7OM, since 1971. New manager for KH0AC is Jon Zabel K7ZA, 20711-231st Avenue SE, Maple Valley WA 98038.

Listen to the W6TI DX bulletin on 14002 at 0200 UTC Mondays. And, speaking of on-the-air bulletins...

"ARRL bulletin NR 2 from ARRL Headquarters, Newington CT January 3, 1980 to all radio amateurs. Because of lack of sponsorship for providing DX information, the weekly ARRL DX bulletin service has been temporarily discontinued. Clubs or individuals that (sic) may wish to provide information on a regular basis should leave a message with ARRL DX Editor..."

By the time you read this, the League's DX bulletin may be back in service, but as this is

written, it is kaput. They are apparently very particular from where and from whom they get their DX hot news, since there is certainly no lack of active DXers in Connecticut.

If you still need that "country" at the United Nations Headquarters on Manhattan Island, look for 4U1UN Thursday night/Friday morning 2200-0600 on 160, 80, 40, and 20. Primary operator seems to be N2KW.

K7JVR, AA7A, and N7CW made 7100 contacts between November 28 and December 3 from Antigua (VP2A). Their highlight was working PA0HIP on 160 for his 100th country on Top Band.

SV0AA's operation as /9 from Crete went off as planned in late November, but he didn't get on from Rhodes (Dodecanese). The IC-701 blew up and a borrowed Century 21 was pressed into service. It was not available for the Dodecanese.

A word to the wise: The FCC is cracking down on out-of-band operations by all license classes, particularly Generals in the Advanced portions of the HF bands. Many non-US amateurs do not know how the phone bands are divided among US license classes, and, consequently, they fail to listen above 14275 or 21350 when working split.

FR7ZL, who lives on Reunion, may be operating from either Glorioso or Tromelin by the time you read this. There has been trouble getting QSLs to Guy and trouble getting replies out. Try registered mail and have patience.

I0DUD spent much time at the Vatican during the winter signing HV3SJ on 15 SSB. W0BW was there in November and tried, without success, to stir up some CW activity among other potential operators.

C5ACG operates from the American Embassy using a TR7. He will be in The Gambia for several years.

All the information for this column was from *The DX Bulletin* out of Vernon CT. Please send input for this column c/o 73. We especially would like photographs, and your guest editorials will be considered for this column, also. Good DXing!

DX MYTHS DISPELLED

Author Anonymous

1. *DX stations are chased off the air by interference on their frequency.*

It may bother you, but the DX station working split isn't listening to his frequency. Almost always he has skipped to somewhere where the interference isn't being heard.

2. *I can't compete with these guys with eight elements at 150 feet.*

No one antenna system is the best for all conditions. A local with four elements at 75 feet on a hill used to get beaten out consistently to the Caribbean by lesser stations. Two local guys who are on top of the DX heap run three elements at 45-60 feet. After a kW and a properly tuned antenna, knowledge, skill, and dedication are most important.

3. *The bottom of the sunspot cycle is no time for DXing.*

Humbug! I got my DXCC at the bottom. Sure, signals were weaker and you had to watch openings more closely, but the receiver wasn't S9 from one end to the other of every band either. 40 and 80 bore lots of excitement.

4. *Lists ought to be outlawed.*

Not all DX stations are equipped with powerful transmitters or selective enough receivers to do the job. The operator may not be a contest-type who can or wishes to tackle a pileup. He's in the driver's seat and we do it his way. As for "Masters of Ceremonies," they are usually the fellows who have made friends with the DX operator and they are responsible for him being on the air at all. I can tell you from experience that any power or glory an MC might feel lasts no longer than one session. The headaches start early.

5. *The best way to QSL is direct, with no mention of radio on the envelope.*

If mail is being stolen, they'll probably steal first class mail first. They may be after stamps. Use common stamps, send the way the DX station suggests, and follow with a card through the Bureau.

6. *The exchange of signal reports constitutes a valid contact.*

Not necessarily so. If you put the DX callsign in your log and vice-versa, there must have been a contact. However, if there is an "MC" running the show, he probably has already passed your call to the DX station and the only way he can quickly confirm a valid contact is to hear you repeat your report. That's usually the only new info that's been passed directly between you and the DX station.

7. *Valid DXCC phone or CW contacts must be two-way phone or two-way CW.*

Not so. The award says *your* mode was CW or phone when you had contact with 100, etc., DXCC countries. It may excite many people with time delay changing to CW or the DX station may be so rusty on CW he can't recognize his own call, but those are different problems. The mode type DXCCs really credit the operator's expertise in a field, not so much in pure DXing.

8. *The poor W9s (or 1s, 2s, 3s, 4s, 5s, 6s, 7s, 8s, 0s, VEs).*

Stop complaining about this curtain, that disadvantage, or whatever. In the end, it's all equal.

9. *Those who work for a living have a disadvantage.*

Those who want to work something badly enough find a way. The best way is to have a ham for a boss.

10. *DXers are obnoxious loudmouths and/or stuffed shirts.*

No more so than anyone else, but they do tend to put a little extra in their stations, be on the air more, subscribe to bulletins, and in general be more informed. In our area, DXers are often club officers, involved in emergency work, mobile, VHF, and RTTY.

11. *DXers are nuts.*

Maybe, but they do respond, like almost everyone, to competition, whether against someone else or themselves. Seems like fishing is the best parallel hobby. Every time you throw in a line, you don't know what trophy you will come up with.

Lunar's new 2M 4-40P Linearized Amplifier makes your hand-held synthesized transceiver a GIANT!

1 to 4 WATTS IN— 10 to 40 WATTS OUT.

- Can be used with any 1-5 watt radio.
- Linearized so it's compatible with SSB.
- Has pre-amp for receiver portion to increase power and clarity of incoming signals.
- Amp and pre-amp functions independently controllable.
- Remote control capability.
- Regulated voltage output as required by the FT 207R and TR2400 to conserve battery pack.
- Turns your 1-4 watt transceiver into a higher powered base or mobile station.
- Made with the quality and care that has made Lunar the leader in linearized amps.

2785 Kurtz Street, Suite 10, San Diego, CA 92110
Telephone 714 299-9740
Telex 181747

Louis N. Anciaux
WB6NMT



NEW MFJ *DELUXE* Versa Tuner II

\$129.95 buys you one of the world's finest 300 watt antenna tuners with features that only MFJ offers, like . . . dummy load, SWR, forward, reflected power meter, antenna switch, balun. Matches everything from 1.8 thru 30 MHz: coax, random wires, balanced lines.



*MFJ's Best Versa Tuner II . . .
Solid American Quality*

\$129⁹⁵

✓ 47

This is MFJ's best Versa Tuner II. And one of the world's finest 300 watt (RF output) tuners.

The MFJ-949 *Deluxe Versa Tuner II* gives you a combination of quality, performance, and features that others can't touch at this price . . . or any price.

PERFORMANCE: You can run your full transceiver power output — up to 300 watts RF output — and match your transmitter to any feedline from 1.8 thru 30 MHz whether you have coax, balanced line or random wire.

FEATURES: A 200 watt 50 ohm dummy load lets you tune up for maximum performance.

A sensitive meter lets you read SWR with only 5 watts and both forward and reflected power in two ranges (300 and 30 watts).

A flexible antenna switch lets you select 2 coax lines direct or thru tuner, random wire or balanced line and dummy load.

A large efficient airwound inductor 3 inches in diameter gives you plenty of matching range and less losses for more watts out.

1:4 balun. 1000 volt capacitors. SO-239 coax connectors. Binding post for balanced line, random wire, ground. 10x3x7 inches.

QUALITY: Every single unit is tested for performance and inspected for quality. Solid American construction, quality components.

The MFJ-949 carries a full one year unconditional guarantee.

Order from MFJ and try it — no obligation. If not delighted, return it within 30 days for a re-

fund (less shipping).

To order, simply call us toll free 800-647-1800 and charge it on your VISA or Master Charge or mail us a check or money order for \$129.95 plus \$4.00 for shipping/handling.

Don't wait any longer to tune out that SWR and enjoy solid QSO's. Order your *Deluxe Versa Tuner II* at no obligation, today.

CALL TOLL FREE . . . 800-647-1800

Call 601-323-5869 for technical information, order/repair status. Also call 601-323-5869 outside continental USA and in Mississippi.

MFJ ENTERPRISES, INC.
BOX 494, MISSISSIPPI STATE, MS 39762

... at last ...
your shack organized!

A beautiful piece of furniture — your XYL will love it!

\$16450 S-F RADIO DESK
Deluxe - Ready to Assemble

Designed with **angled** rear shelf for your viewing comfort and ease of operation.

FINISHES: Walnut or Teak Stain.

Floor Space: 39" Wide by 30" Deep

Additional Information on Request.

Checks, Money Orders, BankAmericard
 and Master Charge Accepted.

F.O.B. Culver City. (In Calif. Add 6% Sales Tax.)

— DEALER INQUIRIES INVITED —

✓65



Radio equipment
 not included

Also Available

Floor Space: 51" Wide by 30" Deep
 \$192.50



S-f Amateur Radio Services

4384 KEYSTONE AVENUE • CULVER CITY, CALIF. 90230 — PHONE (213) 837-4870

THE BEST

DRAKE TR-7



TS-120S

YAESU FT-901

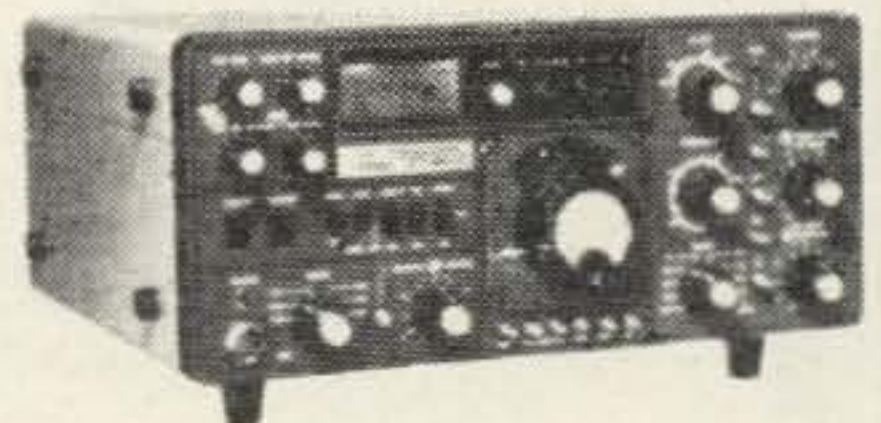

TOP OF THE LINE. NUMBER ONE. IF YOU'RE THE TYPE OF PERSON THAT WILL SETTLE FOR NOTHING LESS, WE'VE GOT WHAT YOU'RE LOOKING FOR. TOP OF THE LINE FROM THE THREE TOP LINES. AND WE OFFER MORE THAN JUST THE RIGS—SUPER SERVICE AFTER THE SALE. CALL US SOON FOR A QUOTE ON YOUR NEXT RIG.

ORDER TOLL FREE! 800-845-6183



G.I.S.M.O.

2305 CHERRY ROAD
 ROCK HILL, S.C. 29730

✓27

Service Department
 Call 803-366-7158

Awards

from page 12

Class 1—DX stations must work 2,000 European stations, of which 100 must be made on the 40- and/or 80-meter band. The requirement is the same for Europeans.

No QSL cards are required. General certification rules apply. Should all your contacts be on CW, DIG will provide a special "CW AWARD" sticker for this accomplishment. Fee for the WDXS Award is US \$5.00 or 10 IRCs.

EUROPEAN PREFIXES AWARD

The EU-PX-A is issued by DIG for contacts of 100 different European prefixes on or after January 1, 1969. There are no band or mode restrictions. Endorsement stickers are awarded for 150, 200, 250, and 300 prefixes claimed.

Should all your contacts be on CW, the sponsor has made a special "CW AWARD" sticker

available to recognize this accomplishment.

GCR apply and award fee is US \$5.00 or 10 IRCs.

THE ONE MILLION AWARD

The 1,000,000 Award is issued by DIG to those amateurs who can accumulate one million points by adding together the postal codes of each German station contacted. The same postal code may be claimed only once.

In making application for this award, your list of contacts would look something like that shown in Fig. 2.

As you will note, the list of contacts are made in order of the postal code number on the right hand column. Some postal codes may appear on your QSL or in the *Callbook* as a one-, two-, or three-digit number. In these instances, add zeros to make it a four-digit code (e.g., a postal code may appear as 41; add zeros to make it 4100).

| Call | Date | Band | QTH | Postal Code |
|-------|----------|------|------------|-------------|
| DL7IG | 18/8/69 | 80 | Berlin | 1000 |
| DL6TZ | 12/11/68 | 20 | Hamburg | 2000 |
| DL9KP | 11/10/69 | 40 | Duisburg | 4100 |
| DJ8OT | 27/11/69 | 80 | Velbert | 5620 |
| DL2JB | 13/1/68 | 40 | Laudenbach | 6941 |
| DL9XN | 15/6/67 | 15 | Boblingen | 7030 |

total at least 1,000,000

Fig. 2. Sample list of contacts for figuring score for the 1,000,000 Award.

GCR apply and the award fee is the same as with other DIG awards — \$5.00 or 10 IRCs.

WORKED DIG MEMBERS AWARD

The W-DIG-M Award is issued to those amateurs who submit proof of working DIG members on any band or mode with no restrictions as to date.

Three classes of this award are issued:

Class 3—DX stations work 15 DIG members; European stations work 50 DIG members.

Class 2—DX stations work 30 DIG members; European stations work 75 DIG members.

Class 1—DX stations work 50 DIG members; European stations work 100 DIG members.

A "CW ONLY" sticker is available for making all contacts on CW. GCR apply and the award fee is \$5.00 US or 10 IRCs.

INTERNATIONAL AIRPORT AWARD

The IAPA will be issued for contacts with amateur radio stations in 50 different cities with an international airport. All 6 continents must be worked and the applicant may claim only one contact from his or her own country; the remaining 49 contacts must be made outside your country. All contacts must be made after January 1, 1973, and there are no band or mode restrictions.

Fee for this diploma is US \$5.00 or 10 IRCs.

TWO MODES AWARD

This award requires the applicant to work 50 different countries on CW, including Germany and all six continents, and again the *same* 50 countries on phone. All contacts must be made on or after January 1, 1962, to qualify.

GCR apply and award fee is US \$5.00 or 10 IRCs.

WORKED GERMAN LARGE CITIES

The WGLC Award is available in three classes. There are no

restrictions as to modes. There are no band endorsements. All contacts must be made by using more than one band. Each city may be claimed only once regardless of band. All contacts must be made on or after January 1, 1962.

Class 3—DX stations work 10; Europeans must work 20 cities.

Class 2—DX stations work 20; Europeans must work 40 cities.

Class 1—DX stations work 30; Europeans must work 60 cities.

Should all your contacts be made on CW, DIG has prepared a special "CW ONLY" sticker made available upon your initial application.

German Large Cities are: Aachen, Augsburg, Berlin, Bielefeld, Bochum, Bonn, Bortrop, Braunschweig, Bremen, Bremerhaven, Darmstadt, Dortmund, Dusseldorf, Duisburg, Essen, Frankfurt/Main, Freiburg, Gelsenkirchen, Gottingen, Hagen, Hamburg, Hanover, Heidelberg, Heilbronn, Herne, Karlsruhe, Kassel, Kiel, Koblenz, Koln, Krefeld, Leverkusen, Ludwigshafen, Lubeck, Mainz, Mannheim, Monchengladbach, Mulheim/Ruhr, Munchen, Munster, Neuss, Nurnberg, Oberhausen, Offenbach/Main, Oldenburg, Osnabruck, Recklinghausen, Regensburg, Remscheid, Rhedyt, Saarbrucken, Salzgitter, Solingen, Stuttgart, Trier, Ulm, Wanne-Eickel, Wiesbaden, Wilhelmshaven, Witten, Wurzburg, Wuppertal.

And, at press time, I learned the following cities have been added to the list of Large German Cities: Erlangen, Furth, Kaiserslautern, and Wolfsburg.

GCR apply and award fee is the usual US \$5.00 or 10 IRCs.

As you can see, both DARC and DIG have very extensive award programs made available for you and me. Should you wish to inquire or for that matter submit application for one or more of the awards shown in this column thus far, may I suggest you write our good friend DJ8OT



directly: Eberhard Warnecke DJ8OT, Postfach 101244, 5620 Velbert 1, Federal Republic of Germany.

There remain two additional awards being sponsored by DIG; however, I wish to caution you not to apply for them through DJ8OT. The following awards have separate award custodians.

ACTION 40 AWARD

This diploma can only be applied for by licensed amateurs having proven contacts with at least 100 different amateur stations within one calendar month after November 1, 1977, on the 40-meter amateur band only.

All modes are accepted. Contest QSOs and crossband QSOs do not count. Split-frequency QSOs do count, however.

Your application must show the callsign worked, the name and QTH of the operator, mode, and date and time GMT. GCR apply and award fee is US \$5.00 or 10 IRCs. Mail your application and fee to: Klaus Kleine DJ1XP, Fasanenweg 22, D-4714 Selm-Bork, Federal Republic of Germany.

DIG DIPLOMA 77

This diploma requires applicant to work at least 77 DIG members from at least 7 different countries, but only 7 X 7 (49) DIG members out of one's own country after January 1, 1977. The award is made for phone only and mixed modes or bands are accepted. Fee is US \$5.00 or 10 IRCs. For further explanation of this award or for submitting application, write to: Henry Bielinski DC6JG, Werfstr, 245, D-2300 Kiel 14, Federal Republic of Germany.

ULSTER COUNTY AWARD

Today I received a very complimentary letter about our Awards column from Harold Twiss WA2RFX, who represents the Overlook Mountain ARC in Lake Katrine, New York. In his letter, Harold enclosed details of a very nice award being offered through his club.

This award requires applicants to contact other amateurs residing in the New York county of Ulster.

To qualify, DX stations must contact two amateurs in Ulster County, while amateurs in the continental US must make three contacts. There are no band or mode limitations, and there are no date restrictions either.

To apply, submit a list of contacts giving usual logbook data and enclosing the award fee of 50 cents or 4 IRCs to: Harold Twiss WA2RFX, Country Lane, Lake Katrine NY 12449.

WORKED A SHEBOYGAN AWARD

With activity on 10 meters at an all time high, now is your opportunity to earn the very attractive W.A.S. (Worked A Sheboygan) Award.

All that is required is that a contact be made with any station in Sheboygan County, Wisconsin, on the 10-meter band.

To apply, merely send your logbook information to the Awards Manager, Sheboygan County ARC, Inc., Farnsworth Jr. High School, Sheboygan, Wisconsin 53081. As a gesture, should you find that earning the award is impossible to do, why not drop the Jr. High School a letter and arrange for a schedule with one of their amateurs. Their club station is K9ERO.



NEW AWARD FROM PARS

The Poway Amateur Radio Society (PARS) has announced that a handsome new certificate is now available known as the "Distinguished PARS Communicator." The certificate has been issued to promote amateur radio contacts between PARS members and the amateur community at large. To qualify for the PARS certificate, operators must contact 5 PARS members (25 for San Diego county residents) and then submit their list of contacts in log form with an SASE to: Operations—PARS, PO Box 996, Poway CA 92064.

WHITE TAIL DEER AWARD

The Mid-Michigan Amateur Radio Club has announced the first of a series of awards featuring the wildlife of Michigan. The certificate is available to all licensed amateurs and shortwave listeners. The White Tail Deer Award requires contacts with two Mid-Michigan Amateur Radio Club stations, or contacts with one MMARC station and

three White Tail Deer Award certificate holders. For Novice applicants, the requirements are one contact with an MMARC station or one contact with a White Tail Deer Award certificate holder. For shortwave listeners, the requirements are one MMARC station heard or one White Tail Deer Award certificate holder. A detailed list showing name, call, and QTH of the station or stations worked or heard should be accompanied by one dollar US to cover postage and printing costs. Payment may be made by cash, check, money order, IRCs, or USA postage cards, although photocopies of QSLs will be accepted. Contacts may be made over any period of time, so dig back through your logs. Also, note any special endorsements that you want on your award. Repeater contacts cannot be used, but satellite contacts can. Send applications and information to: Gary Lorenz WD8JFF, Awards Manager, MMARC, 3210 N. County Line Rd., Farwell MI 48622.



Commission finds that amendment of Part 97 to allow Canadian Amateur licensees to operate without a permit is in the public interest, convenience and necessity. The specific rule amendments are set forth below. Authority for these amendments is contained in Sections 4(i) and 303 of the Communications Act of 1934, as amended, and Article III of TIAS 2508, Convention Between the United States of America and Canada Relating to the Operation by Citizens of Either Country of Certain Radio Equipment or Stations in the Other Country. Since the rule changes herein ordered serve the public interest by relieving an existing restriction, and further, since public comments, we believe, would be unlikely, we are dispensing with the prior notice and public procedure provisions of the Administrative Procedure Act as unnecessary, 5 U.S.C. 553(b). The effective date of the rule changes herein ordered is January 21, 1980, so that elimination of Amateur Reciprocal Permits will occur simultaneously in both the United States and Canada.

4. Accordingly, it is ordered, that Part 97 of the Commission's Rules is amended, effective January 21, 1980, as set forth below.

5. For further information on these rule changes contact Maurice J. DePont, (202) 254-6884.

(Secs. 4, 303, 48 Stat., as amended, 1066, 1082; 47 U.S.C. 154, 303.)

Federal Communications Commission.

William J. Tricarico,
Secretary.

Part 97 of Chapter I of Title 47 of the Code of Federal Regulations is amended, as follows:

1. In § 97.40, paragraph (a) is amended as follows:

§ 97.40 Station license required.

(a) No transmitting station shall be operated in the amateur radio service without being licensed by the Federal Communications Commission, except that an amateur radio station licensed by the Government of Canada may, in accordance with § 97.41, be operated in the United States without the prior approval of the Commission.

2. Section 97.41 is redesignated § 97.42, and a new § 97.41 is added, as follows:

§ 97.41 Operation of Canadian Amateur Stations in the United States.

(a) An amateur radio station licensed by the Government of Canada may be operated in the United States without the prior approval of the Federal Communications Commission.

(b) Operation of a Canadian amateur station in the United States must comply with all of the following:

(1) The terms of the Convention Between the United States and Canada (TIAS No. 2508) Relating to the Operation by Citizens of Either Country of Certain Radio Equipment or Stations in the Other Country. (See Appendix 4 to Part 97.)

(2) The operating terms and conditions of the amateur station license issued by the Government of Canada.

(3) The provisions of Subparts A through E of Part 97.

(4) Any further conditions the Commission may impose upon the privilege of operating in the United States.

(c) At any time the Commission may, in its discretion, modify, suspend, or cancel the privilege of any Canadian licensee operating an amateur radio station in the United States.

3. Sections 97.42 and 97.43 are redesignated §§ 97.43 and 97.44, respectively, and redesignated § 97.43 is revised to read as follows:

§ 97.43 Mailing address furnished by licensee.

Each application shall set forth and each licensee shall furnish the Commission with an address in the United States to be used by the

Commission in serving documents or directing correspondence to that licensee. Unless any licensee advises the Commission to the contrary, the address contained in the licensee's most recent application will be used by the Commission for this purpose.

[FR Doc. 79-38561 Filed 12-14-79; 8:45 am]

BILLING CODE 6712-01-M

47 CFR Part 97

[RM-2490; RM-2666; FCC 79-792]

Amateur Radio Service; Amending Rules Concerning Availability of Operator License

AGENCY: Federal Communications Commission.

ACTION: Memorandum Opinion and Order.

SUMMARY: The Commission grants a petition to allow an amateur radio operator to use a photocopy of an amateur license, while operating an amateur station. This action amends § 97.82 of the Amateur Radio Service, of the Commission's Rules and Regulations.

EFFECTIVE DATE: December 21, 1979.

ADDRESSES: Federal Communications Commission, Washington, D.C. 20554.

FOR FURTHER INFORMATION CONTACT: Private Radio Bureau, Personal Radio Branch, Attorney Roy C. Howell, (202) 254-6884.

Adopted: December 4, 1979.

Released: December 12, 1979.

1. The Commission has under consideration two petitions requesting amendment of § 97.82 and § 97.83. The first petition, RM-2490, was filed on November 25, 1974 by Mr. Ronald K. Long. Subsequently, on March 1, 1976, Mr. Robert L. Bingham petitioned in RM-2666 for an identical amendment to the Amateur Radio Rules.

2. Petitioners' request that the rules be amended to remove the requirement of having only the original amateur radio operators' license (pursuant to § 97.82), and station license (pursuant to § 97.83) in the possession of the control operator of an amateur radio station. Petitioners' argument for amendment of § 97.83 to allow station operators to have a photocopy of their station license in their possession, while operating an amateur radio station, is moot; and, the reason is because § 97.83 presently allows this practice, i.e.

The original license of each amateur station or a photocopy thereof shall be posted in a conspicuous place in the room occupied by the licensed operator while the station is being operated at a fixed location or shall be kept in his personal possession.

3. Petitioner, Mr. Robert L. Bingham, asserts that § 97.82 in its present form lacks any contemporary administrative justification, insofar as technological advancements have made this rule obsolete. According to petitioner (Mr. Bingham) § 97.82 was enacted during an era when portable or mobile radio operation was very minimum; and, therefore, amateur radio stations were generally at a fixed location. However, today with the advent of hand held portable units, transistorized mobile equipment, and the small QRP transceivers have made amateur radio operation away from a fixed location very easy.

Thus, as stated by petitioner (Mr. Bingham).

The idea of hanging the license up on the wall above the station equipment is no longer the proper way to do it if you are one of those who practice one of these three types of operations away from home.

4. Petitioner, Mr. Ronald K. Long, argues that § 97.82 is unduly restrictive; and, with the widely increasing mobile operation of amateur radio stations, § 97.82 effectively requires that the original license be carried in the personal wallet or purse where it may easily become damaged or lost. Hence § 97.82 causes great inconvenience to the amateur radio operator while operating a portable amateur radio

station. The only filed comment (filed by Mr. Philip A. Litchfield) likewise asserts that § 97.82 is unreasonably restrictive. The comment states,

Continual carrying of the original soon makes the original illegible, subject to mutilation and possible loss, and thus requiring replacement of same.

5. The Commission finds merit in petitioners' proposals to amend § 97.82. The administrative intent of § 97.82 is to provide the Enforcement Division of the Field Operations Bureau ready availability of the amateur operators' license to aid enforcement purposes. The ready availability interest of § 97.82 is satisfied if amateur radio operators produce a photocopy of their original license to an enforcement official. The Commission fully understands and agrees with petitioners, that with the incidence of portable and mobile radio station operations, the requirement of an amateur radio operator to carry the original license may result in unnecessary damage or loss to the document during the five year life of the license.

6. Since no party would be adversely affected by the rule changes, and adverse public comments would be unlikely, we are dispensing with prior notice and public procedure provisions of the Administrative Procedure Act as unnecessary, 5 U.S.C. 553(b). In view of the foregoing, it is ordered, effective December 21, 1979, that Part 97 of the Commission's Rules and Regulations is amended as shown below. Authority for this action is pursuant to Section 4(i) and 303 of the Communications Act of 1934, as amended. Further information about this action by the Commission may be obtained by contacting Roy C. Howell, Personal Radio Branch, Private Radio Bureau, FCC, 2025 M Street, NW., Washington, D.C. 20554, (202) 254-6884.

(Secs. 4, 303, 48 Stat., as amended, 1066, 1082; 47 U.S.C. 154, 303)

Federal Communications Commission.

William Tricarico,
Secretary.

Part 97 of Chapter I of Title 47 of the Code of the Federal Regulations is amended as follows:

1. Section 97.82 is amended to read as follows:

§ 97.82 Availability of operator license.

Each amateur radio operator must have the original or a photocopy of his or her operator license in his or her personal possession when serving as the control operator of an amateur radio station. The original license shall be available for inspection by any authorized Government official upon request made by an authorized representative of the Commission, except when such license has been filed with application for modification or renewal thereof, or has been mutilated, lost or destroyed, and request has been made for a duplicate license in accordance with § 97.57.

[FR Doc. 79-38562 Filed 12-14-79; 8:45 am]

BILLING CODE 6712-01-M

47 CFR Part 97

[Docket No. 20679; FCC 79-859]

Requiring Volunteer Examiners in the Amateur Radio Service To Submit Photocopies of Their Operator License With Their Requests for Examination Papers

AGENCY: Federal Communications Commission.

ACTION: Report and Order.

SUMMARY: This Report and Order terminates a Notice of Proposed Rulemaking which proposed to amend the Amateur Radio Service Rules. The proposed amendment would have required volunteer examiners to submit a photocopy of their own license to the Commission when requesting permission to examine others. This proceeding has been terminated because amendments already adopted by the

Commission have made the proposed amendment unnecessary.

EFFECTIVE DATE: Non-Applicable.

ADDRESSES: Federal Communications Commission, 1919 M Street NW., Washington, DC 20554.

FOR FURTHER INFORMATION CONTACT: Judith St. Ledger-Roty, Rules Division, Private Radio Bureau, (202) 634-2443.

Report and Order (Proceeding Terminated)

Adopted: December 19, 1979.

Released: January 7, 1980.

By the Commission:

In the matter of amendment of Part 97 of the Commission's Rules to require volunteer examiners in the Amateur Radio Service to submit photocopies of their operator license with their requests for examination papers.

1. On December 19, 1975, the Commission adopted a *Notice of Proposed Rulemaking* proposing amendment of § 97.29 (which is presently § 97.28) of the Amateur Radio Service Rules, 57 F.C.C. 2d 797 (1976), 40 FR 59602 (1975). At issue was the manner in which the Commission permitted license examinations by mail.

2. At the time the *Notice* was released, the examinations for the Novice, Technician, and Conditional class licenses were conducted by mail. Prospective licensees would select a qualified volunteer examiner who would then conduct the telegraphy portion of the exam for the applicant. If the applicant passed this portion, the volunteer examiner would submit a written request to the Commission for permission to administer the written portion of the examination. In order to qualify as an examiner, the Commission required each volunteer to state that he was 21 years old, and held an amateur license of a class higher than that sought by the applicant. The Commission would then forward the written examination to the volunteer examiner who in turn would administer the exam.

3. By December 1975, the Commission had discovered substantial abuses of this licensing procedure. Volunteer examiners had claimed qualifications they did not possess, and some names submitted as volunteers proved to be fictitious. However, the Commission did not have sufficient resources to verify every volunteer examiners' qualifications.

4. In order to limit abuse, and preserve the integrity and fairness of the mail examination program, the Commission proposed to amend Section 97.29 to require volunteer examiners to submit a photocopy of their amateur license when requesting examination papers. The Commission received five comments, four of which opposed the proposed amendment and suggested that the Commission improve its own internal procedures for verification rather than impose any additional burden on volunteer examiners. One participant pointed out that the added expense to the examiner might well dissuade would-be volunteers from participating in the licensing program. One volunteer examiner who filed comments felt that the need to maintain the integrity of the program outweighed any disadvantage to the examiners.

5. The problem of fraudulently obtained licenses was also, in part, the subject of the *Notice of Proposed Rulemaking in Docket 20282*, 49 F.C.C. 2d 1175 (1974). One of the broad objectives of this docket was to minimize any adverse impact on presently licensed amateurs while at the same time ensuring the vitality of the mail examination processes. In its *First Report and Order*, 59 F.C.C. 2d 877 (1976), the Commission, guided by the views of an estimated 4,000 participants, modified its proposals to assure that no amateur who already held a license would be harmed by new licensing procedures. The procedures adopted in the *First Report and Order* were designed to limit the availability of volunteer-administered examinations to

two categories of applicants:

(a) Applicants for the Novice license;¹ and

¹The Commission placed no restrictions on the Novice Class applicant because there is little incentive for that class to cheat. The examination for the Novice Class license is simpler than the examination for other amateur operator licenses.

(b) Applicants who show by a physician's certification that they are unable to appear at a Commission examination point because of a protracted disability preventing travel. 59 F.C.C. 2d at 879.

6. The amendments to the Amateur Rules adopted in the *First Report and*

Order in Docket 20282 provided a workable alternative to the proposals put forth in this docket. On the basis of these amendments, and the negative public reaction from the amateur community, the Commission believes that the public interest, convenience and necessity is best served by the termination of this proceeding.

Accordingly, by authority contained in Sections 4(i) and 303(r) of the Communications Act of 1934, as amended, IT IS ORDERED that this proceeding is TERMINATED.

Federal Communications Commission.
William J. Tricarico,
Secretary.

New Products

from page 27

all of which are programmable from the keyboard. Thus, CQs, test messages, station descriptions, etc., can be "canned" for smooth and easy operating.

There are also a number of nice-to-have technical and "housekeeping" features built into the Macrotronics unit. These include automatic carriage return and line feed (auto CR/LF), automatic unshift-on-space, "auto diddle" (in which the "LTRS" character is sent whenever the transmit buffer is empty), automatic scrolling (where lines of text move up the screen as it fills up), and automatic 10-minute ID in which the CW ID message is automatically inserted every 10 minutes from the start of the send mode to keep one legal during long-winded contacts.

Another handy feature is KOX, or keyboard operated transmit, analogous to the push-to-talk (PTT) of SSB operation, which keys the transmitter automatically on send and unkeys on receive. This highly desirable feature permits full station T/R control from the PET's keyboard. And, not to overlook any of the PET's capabilities, the M650's designers have allowed the unit to "piggyback" onto the digital clock that the computer contains. As long as the PET is left running continuously, you can even send the present time in UTC at the touch of a key!

The M650 contains a built-in phase locked loop (PLL) demodulator and an LED indicator for "visual cue" tuning. There is also provision for connecting an external TU (terminal unit) and an optional loop keyer module. No external power supply is required.

CW, Too

In addition to its RTTY capability, the M650 is also ready to go with Morse encode

and decode with the PET. The Morse program allows continuous speed adjustment from 1 to 100 wpm in any of three modes — receive, send, and code practice.

In the receive mode, a CW signal will be automatically decoded and be presented on the video monitor screen. Changes in the sending station's speed are automatically corrected for by means of an exponential smoothing technique. In the send mode, the M650 acts as a keyboard-actuated keyer — whatever is typed in is encoded and directly keys the transmitter, although the keyboard is buffered as in RTTY. This allows for "typing ahead" and overall smooth code transmission. In the code practice mode, the computer speed may be changed at any time by simply typing in the desired speed in wpm. A special feature is one that allows any key (or bug or electronic keyer) to be used with the unit. The decoded text is displayed on the video monitor. This provides a good means of monitoring and improving one's sending "fist." A sidetone oscillator allows for connection of a speaker for code practice or "processed audio" reception of received CW signals.

Interface and Software

The M650 includes an RS232 input (for use with an external TU), solid-state multiple keying circuits that will key positive or negative voltages, and necessary interconnecting cables and connectors for hookup to the PET.

The software consists of two computer programs, one for Morse code and one for RTTY, supplied on two cassette tapes. Both programs are written in BASIC for the PET, with machine-language subprograms. Each program requires 8K of RAM. This is easily accommodated on the PET, although only

one program — Morse or RTTY — can be stored at a given time. The RTTY software was designed by Wayne Reindollar and the Morse software by Ron Lodewyck N6EE. Lodewyck is the co-author of Radio Shack's Level I, Level II, and Disk BASIC instruction courses and Commodore's Basic BASIC tutorial.

Does It Work?

To borrow an old phrase — "as advertised." And more. The thick (28-page) user's manual was very well written and comprehensively covered installation and operating procedures. No major difficulty was encountered in setting up the unit, despite my never having operated on RTTY before.

Putting the unit on the air recalled days some 25 years ago when I put forth my first Novice CW "CQ". Feeling again like an unsure beginner, it was necessary to refer to the operating manual for the first few days to get the "hang" of making contacts and to keep from being "overrun and overwhelmed" by the many built-in automatic features. Learning just how to automatically send RTTY CQs, respond smartly to incoming calls, make use of the "instant" replay function, bring up the preprogrammed messages, and do other neat little "tricks" with the unit was an experience. I'm still exploring the M650's powerful capabilities and expect to be for some time to come.

Getting the Macrotronics/PET system on the air was strictly a matter of learning how to harness the system's potential. All the functions were run through and checked; there were no glitches or "bugs" detectable in either the RTTY or CW programs. Despite the newness of the product, Macrotronics has been running the programs for some time in pre-production and seems to have gotten the programs and hardware right before going public.

To be objective about my evaluation of the M650, it's only fair to pass along some comments regarding "hands-on" performance, operating character-

istics, and features. In no way are these intended to downgrade what is an excellent product, one that has forced a real breakthrough in ham RTTY and CW technology. Here's what I found:

1. The M650 *does* tie up the PET, which must be loaded and kept running if it's to be a full-time system. And, as mentioned, the program must be swapped out between the RTTY and CW modes. It takes about 4 minutes to load each program and another 30 seconds to initialize the variables and load the machine-language subprograms in the CW mode.

2. The 12-pin Molex® connectors at the two rear-panel user ports were fine, but RCA-type phono jacks would have been more convenient to hook into the transceiver's audio input/output jacks, keying circuit, AFSK input, etc. As it was, I installed single-hole mount RCA-type jacks (Radio Shack #274-346) on the rear apron rather than use the Molex connectors. Also, a longer cable could have been provided to reach the PET's ports.

3. With the PLL circuit of the M650, CW must be received in the transceiver's USB or LSB mode, using an SSB rather than a CW filter. The PLL has a lower limit of 800 Hz and thus can't work with the typical narrow bandpass CW filter, unless the rig happens to have an "i-f shift" circuit which can be used to increase the center frequency of the CW filter passband (the Kenwood TS-820 and TS-180 are rigs that have this feature). Obviously, this requirement presents an annoyance in trying to work two-way CW.

4. Some RFI is generated by the PET, and it's aggravated by the interconnections with the transceiver. This was only serious on weak signals in my shack. If you experience problems from RFI, use shielded interconnecting cables, be sure the equipment is well grounded, and feed the antenna with coaxial cable to prevent RFI from the computer from being picked up by the transmission line. If the

interference is especially severe, ferrite beads on the interconnecting cables should help.

5. The M650's CW function worked especially well. However, the operator-selected speed has a recognition range of approximately -30% to +40% of the set speed. If the incoming signal is outside this range, you have to reset the speed. Also, character-spacing "specs" are fixed, so that if the station you are in QSO with isn't sending letter-perfect, "swingless" Morse, reception will be garbled. The system is at its best when communicating between stations using machine- or electronic-keying systems. Taped code practice and CW bulletins from W1AW, for example, make excellent copy.

6. The PLL circuit was very difficult to "optimize" for solid RTTY copy, and the single LED didn't help too much in fine-tuning signals. I found that whereas a weak S4-S5 signal was enough to result in good copy on CW, an S7-S9 plus signal was required on RTTY for reasonably garble-free reception. The manufacturer makes no bones about the fact that for best results, a separate demodulator (TU), such as their accessory FSD-1, should be used. My experience confirmed their recommendation, and a demodulator will be high on my "nice-to-have" accessory list. Space is available inside the "oversize" M650 cabinet in which to mount the FSD-1 or a home-brew demodulator board. The front panel contains two DPDT switches for use with the FSD-1 or other accessories, and there is a meter cutout with a Macrotronics logo cleverly installed in its future position.

7. The instruction manual is well written, but what is needed are small plasticized cards—one each for RTTY and CW—to use as "cheat sheets" to remind the operator of all the functions at his command. I found it almost too much to try to remember how to "bring up" a certain function or to dig it out of the manual during a hot-and-heavy QSO.

About the only other "complaint" worth mentioning is that several months elapsed after the estimated delivery date before the PET interface adapter was available for shipment.

No PET? More hams own

TRS-80s than PETs, so if you do, you're also in luck. Macrotronics has introduced systems for other popular computers, including the TRS-80, Apple, and Exidy Sorcerer. The M80 and M800 are for the TRS-80, the latter being a super-deluxe system requiring a Level II 16K TRS-80. The A650 is designed to mate with the Apple, and the S80 harnesses the capabilities of the Sorcerer. In addition, a less-expensive PET interface, known as the M65, is also available. It's similar to the M650 but has fewer features and doesn't include the cabinet. At present, all of the interface units are sold in wired-and-tested form only (the M80 and M65 were once available as kits).

Other RTTY accessories and equipment offered by Macrotronics include a Baudot/ASCII interface for a printer and a plug-in loop keyer module. An AFSK tone module for use with SSB transmitters is also planned.

The M650 is sold by *Macrotronics, Inc.*, PO Box 518, Keyes CA 95328. Price is \$210 delivered. Reader Service number 44.

**Karl T. Thurber, Jr. W8FX
Ft. Walton Beach FL**

MFJ PHONE PATCHES

MFJ, famous for its quality line of amateur radio accessories, has just released two telephone patches for amateur radio applications. Since both patches (models 620 and 624) are identical except for the signal level meter, our review is applicable to both models.

The MFJ Telepatch is fundamentally a hybrid phone patch designed to transformer-interconnect a telephone line, receiver audio output, and transmitter microphone input.

To prevent the receiver audio from tripping the voice-actuated transmitter circuitry during VOX operation, an adjustable null circuit is provided, settable by a front panel control. This highlights one advantage which the 624 has over the meterless 620—touchups and trimming may be made while watching the meter response. Otherwise, initial setup of the 620 will require patience, trial and error, or the use of auxiliary test equipment.

As shown in the photo, the Telepatch has four controls. "Receiver Gain" accommodates



MFJ's Telepatch.

continuous level adjustment between the speaker output and the telephone line. Similarly, "Transmitter Gain" prevents overdriving the mike input of the transmitter from the telephone line.

For manual operation, the null control is unused, but with VOX, that provision is a real advantage. Obviously, receiver audio could be coupled back into the transmitter, keying it up each time a signal is received. By feeding the received audio into a balanced bridge, however, the audio signal does not appear at the microphone jack, only on the telephone line. A separate "Null Adjust" pot permits careful setting of this function. In some installations, the null circuit components will not provide a proper match for the audio load, and a change in circuit capacitance may be required. The technique is described in the literature included and extra solder pads are provided on the circuit board for additional capacitors.

When properly pruned, the null circuit will provide some 30 dB of attenuation, assuring good VOX operation.

The rear apron of the attractive Ten-Tec cabinet displays an array of jacks and terminals for custom requirements. Separate microphone and speaker jacks as well as transmitter input and receiver output jacks are accessible. They are standard RCA phono jacks. A two-screw terminal strip is used to interconnect the phone patch with the telephone line. Since some local public service regulations may require the use of a coupler between this accessory and the telephone line, it would be a good idea to contact your service representative to find out

whether there are special requirements for your telephone. Electrically, the Telepatch works fine without the additional Ma Bell hardware.

Low-pass RFI pi-section filters are provided on both sides of the phone line input to prevent stray rf coupling while transmitting. Two separate audio transformers are used in the Telepatch to ensure adequate input/output isolation.

Typical of previous products from MFJ which we have examined, construction of the Telepatch is clean and uncluttered. Component values are adequate for the job, and tolerances are well within range for the application.

The Telepatch is accompanied by several mimeographed instruction sheets, a complete schematic diagram, and block diagrams for typical installations. The diagrams provide virtually all the hookup information needed even without the text!

For the well-equipped ham shack—especially for the traffic operator—we would recommend a phone patch of the caliber of the MFJ Telepatch 620 or 624 (\$49.95 and \$59.95 plus \$3 shipping). MFJ, PO Box 494, Mississippi State MS 39762, or MFJ dealers nationwide. Reader Service number 47.

**Robert B. Grove
Brasstown NC**

AEA INTRODUCES NEW LOW-COST COMPUTERIZED MORSE KEYS

A new microprocessor-based Morse keyer—the MK-1—has been introduced by Advanced Electronic Applications (AEA) of Lynnwood, Washington.

The MK-1 incorporates more than 20 special features. It can

easily be programmed to send code at any rate between 2 and 99 wpm with precise full weighting control. The operator can adjust the dot to element space ratio from 0.5:1 to 1.5:1 and the dash to element space ratio from 2.0:1 to 4.0:1.

Other features incorporated in the MK-1 include: selectable semi-automatic "bug" mode, automatic stepped sidetone frequency selection, iambic keying, operation on 9 to 16 volts dc at 200 mA, and transmitter output for grid-block or transistor circuits.

All control of the keyer is performed with a keypad mounted on the top surface of the case. Mating connectors are supplied.

For more information on the MK-1, contact AEA, PO Box 2160, Lynnwood WA 98036; (206)-775-7373. Reader Service number 2.

KANTRONICS' FIELD DAY

Kantronics' Field Day is a Morse code and radioteletype reader with automatic CW-speed display. The unit is self-contained with built-in alphanumeric displays, power supply, and RTTY/CW demodulator. The heart of the Field Day is an Intel 8035 microcomputer with a special CW decoding program.

The Field Day is easy to install. Simply connect the power cord to 117 V ac and an audio cable between your receiver earphone jack and the Field Day audio input terminal. The Field Day is compact, measuring 3.44" high by 8.5" wide by 9.25" deep. It fits snugly beside or on top of your main station units. A tilt handle on the case is easy to adjust and allows for optimum viewing.

Special features on the Field Day include a speed display, code display, Morse copy, RTTY copy, a "smart" code editor,

automatic CW-speed tracking, a tuning eye (LED), input filtering, and an internal speaker. A switch on the back of the unit sets the Field Day for CW or RTTY. When receiving code, the characters travel across the screen from right to left. The characters are big (1/2 inch) and are easy to read.

The Field Day computes incoming code speed automatically. Once you've tuned in a station, the unit can adjust to the code being sent, and then it begins to display it properly. The speed display is optional; that is, you can turn it on or off. Speed is displayed on the two left-most readouts.

The input filter is about 200 Hz wide and it separates interfering signals well. It is usually possible to tune in one of three or four signals heard and get accurate copy. Two signals right on top of each other, in frequency and volume, could not be separated. Tuning of CW signals is made easier by the tuning eye. You must rotate the tuning dial on your receiver until the LED pulses with the incoming code. Once the eye is blinking, the Field Day automatically computes code speed and starts displaying the code on ten alphanumeric displays.

The smart code editor is engaged by pushing an EDIT button on the front panel. The editing program makes the Field Day an unusual code reader. The editor allows "sloppy" code (incorrect inter-character spacing or dot-dash weighting) to be copied. Really poor code can, however, fool the Field Day.

Field Day is a product of Kantronics, 1202 E. 23rd St., Lawrence KS 66044; (913)-842-7745.

PROTOTYPE BOARDS FROM OK TOOL

OK Machine and Tool Cor-

poration has introduced a new series of "Circuit Mount" boards for electronics projects and prototypes. All boards feature solderless insertion-type sockets on .100 inch centers. Each row has 5 common points. Larger boards also feature 40-point bus lines, while a separate bus strip module is also available. All boards can accept standard component leads including DIPs, while interconnections are

easily made using standard 22 AWG solid wire. "Circuit Mount" prototype boards are available in a range of sizes from small modules designed to hold a single IC up to 1020-point panel-mounted boards complete with binding posts. All separate modules are interlocking and also feature screw holes for permanent mounting. Delivery is from stock at local electronics retailers or directly from OK

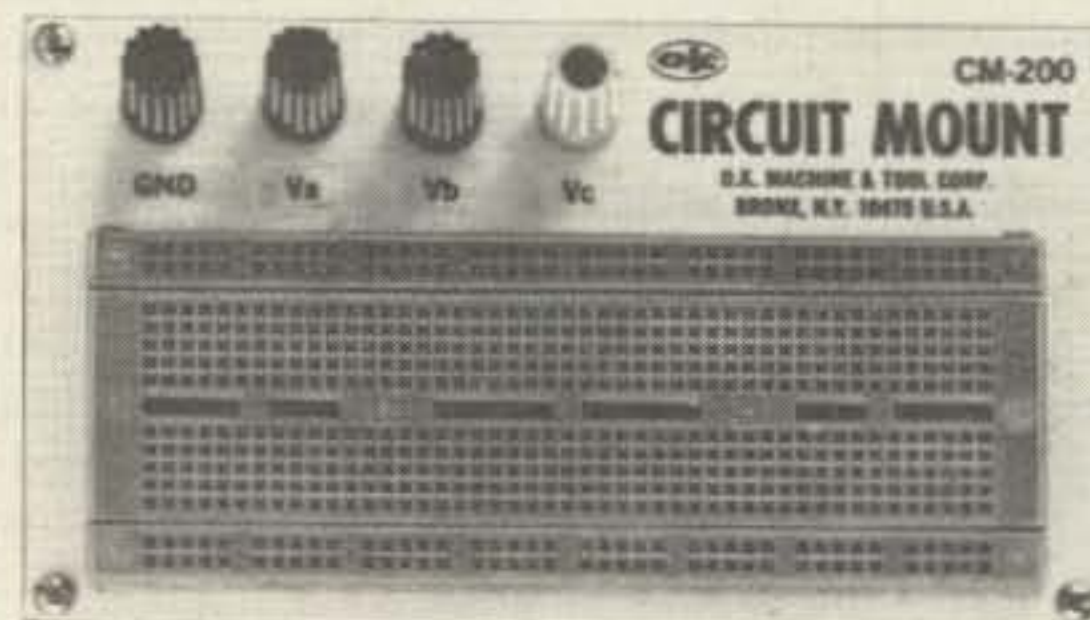
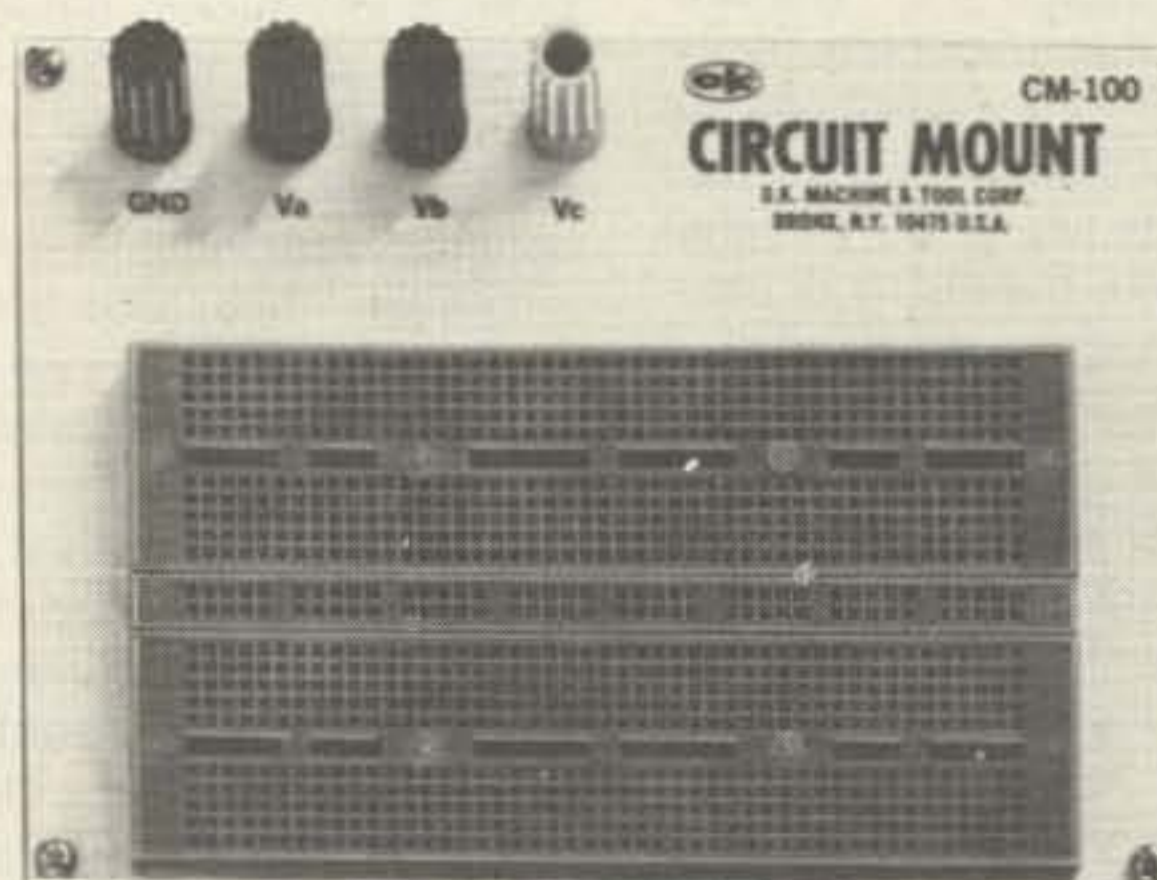
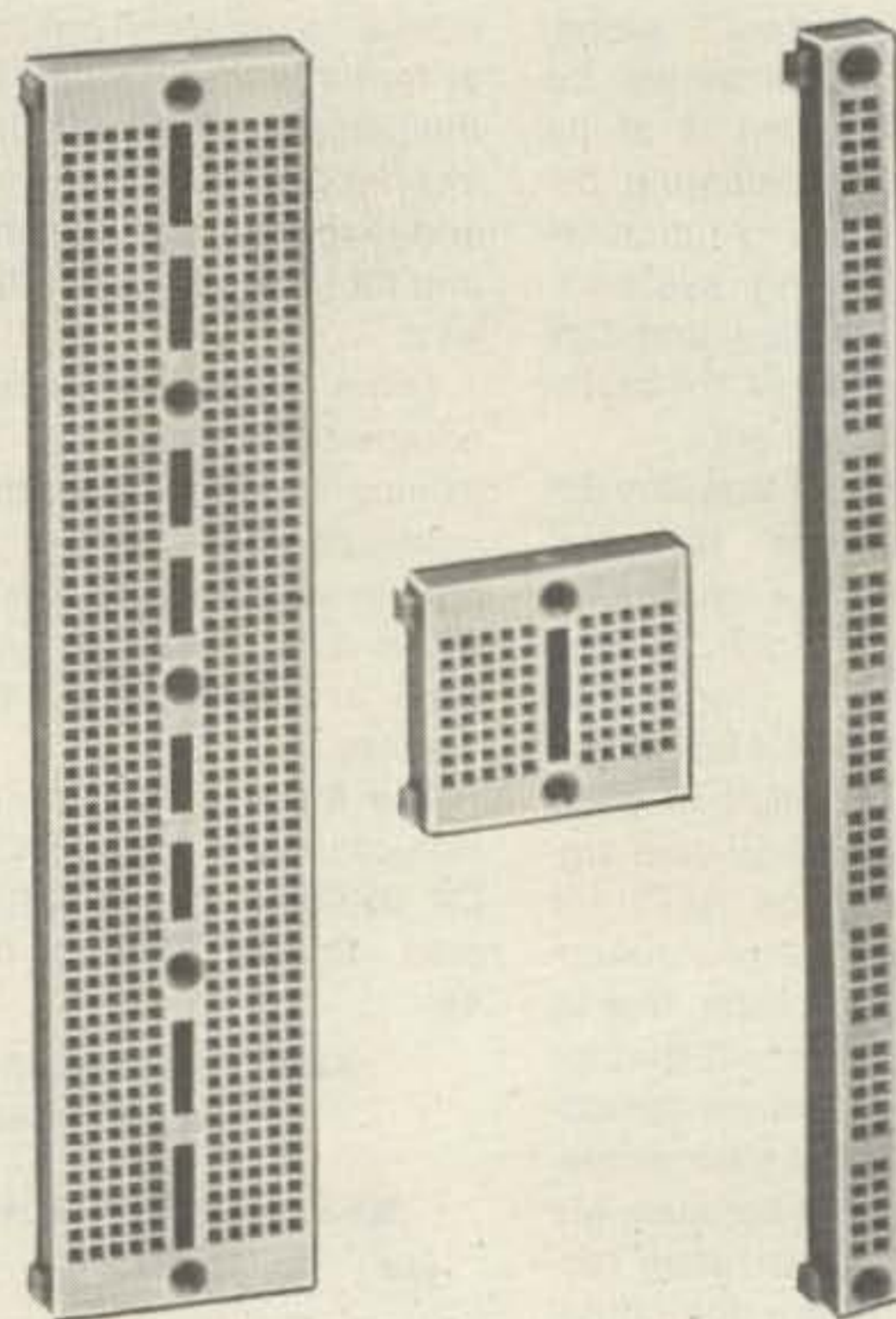

The Field Day from Kantronics.

"Circuit Mounts" from OK Tool.

Machine and Tool Corp., 3455 Conner Street, Bronx NY 10475. Reader Service number 54.

USER'S REPORT — THE SKYTEC CW SPEAKER

During these days of rapidly skyrocketing inflation, it's becoming increasingly difficult for one to truly get his money's worth when buying almost any item of an inexpensive nature. That single situation prompted me to write this report on a very outstanding and beneficial unit — the Skytec acoustically tuned CW speaker. Originally, this little gem captured my attention by its attractive and novel appearance. Once connected to my transceiver, however, I found this "single-frequency" speaker more practical than my FT-901DM's CW filter or audio peak filter . . . and that's a statement which will require substantiation.

Narrowband i-f filters, while providing very sharp selectivity to reduce adjacent channel interference, create a certain amount of "ringing" in the output. This is caused by propagation delays introduced by circuit components of the filter. Thus, the more narrow a bandpass, the more pronounced its ringing. An audio filter usually provides extreme selectivity and amplification at the reproduced audio frequency, resulting in a form of "tunnel vision" centered around one's operating frequency (some audio filters eliminate this problem by providing varying degrees of selectivity; some do not).

The Skytec CW speaker is an

ideal solution to both of these dilemmas. A desired signal can be sharply peaked by approximately 20 dB, yet adjacent channel signals can still be heard reduced in volume. This means the Skytec filter doesn't need to be removed for CW band scanning.

The Skytec unit filters directly at the room level, eliminating any ringing—a very pleasant change from i-f filters. One might wonder how effective audio-range filtering compares with i-f filtering, since it can't compensate for agc attacks by strong signals. Unless the interference is dead on frequency, only a slightly varying audio level is noticed with the Skytec. In fact, if one doesn't watch his S-meter, he probably will not be aware of that adjacent channel interference.

If the station transceiver employs a medium bandwidth i-f filter, its use in conjunction with the Skytec filter provides an unbeatable combination capable of filtering at both the i-f and audio levels . . . and it still reduces the tunnel-vision-type operation. I'm particularly pleased with my Skytec's ability to reduce band and power line noises. Since these raspy sounds fall outside the CW speaker's frequency range, I'm often unaware of their presence until disconnecting the Skytec unit. A tuning sleeve on the speaker's front allows the operator to set the desired frequency peak between 600 and 750 Hz, and the unit's attractiveness makes it a functional



The Skytec acoustically tuned CW speaker.

conversation piece for any CW operator's setup.

This report is being written following an enjoyable contact with VU2GO on 20-meter CW. VU2GO's signal was quite weak and there was QRM. The 901DM's bandpass was set at 1 kHz to prevent ringing from turning the signal into a mass of echos. The audio peak filter added too much ringing and prevented following small changes in VU2GO's signal. The Skytec speaker boosted the VU signal while permitting slight frequency changes to pass without attenuation. I hardly heard a UA0 and a JA2 off to the sides of our

QSO, and they didn't prove distracting. I would have given one of these fellows a call after the VU QSO, but there wasn't time . . . for that or for tuning the 901DM's audio peak filter if it had been in use. (It was also 7:00 am and time to leave for work.)

All aspects considered, the Skytec CW1 speaker is a true gem. It isn't heavily advertised in flashing lights, but it has all the merit of a DXer's secret weapon. The manufacturer is Skytec, Box 535, Talmage CA 95481. Reader Service number 477.

Dave Ingram K4TWJ
Birmingham AL

Corrections

In "What Do You Do When Your Rotator Dies?" (November, 1979, p. 149), the connection of the diodes shown across the electrolytic capacitors is in error. The diodes should be connected with their cathodes to the positive sides of the electrolytics.

Our thanks to K6WX and N4AHI for pointing this out.

Gene Smarte WB6TOV
News Editor

I'm sorry to report that the \$30 digital voltmeter (73, January, 1980, p. 83) is not available as a kit from Beckman Instruments.

Although it was planned as a kit when accepted for publication, time didn't allow me to provide one! I want to thank all those people who wrote for information on the kit, though.

I would also like to make some corrections to the article, "Build this \$50 Mini-Counter" (December, 1979, 73). In Fig. 3 (p. 60), the resistors going to the "b" and "g" pads on the IC are reversed. And the nearby "insulated jumper" connects in only two places. There's no connection in the center of the wire.

Gary McClellan
Fullerton CA

Ham Help

I have all issues of 73 from about 1964 to December, 1979, and I am just out of room for any more.

I will send all these issues to the individual or club that first gets a letter to me! Free!

David D. Blackmer WA6UNK
Route 3, Evergreen
Nipomo CA 93444

I need diagrams and operation manuals for the following equipment (all made by Link): Model 1623 test meter, 2552 test meter, 2210 transceiver, 1305-ED-2A receiver, and 2240-ED-2A

transmitter.

John C. White WB6BLV
560 N. Indiana St.
Porterville CA 93257

I have an old communications receiver made by RCA, a CR-88. It is not an AR-88. Nobody seems to know anything about this receiver; it was made about 1945. I'm looking for a schematic and an instruction book. Can anyone help me?

Guillermo Moreno Rivas
Sindicalismo #87-219
Escandon Z18. Mexico D.F.

LETTERS

from page 20

parties the ARRL throws. I've seen these all my life at the ARRL conventions where the macho thing was to get stupid drunk. They also have hosted these booze parties at electronics shows, with the membership paying the tab. It's your money, fellows! How on Earth does boozing up a bunch of people "promote ham radio"?

6. Having visited Geneva recently, I understand that it is expensive, but \$1,000 per day? Total insanity and an expense account vacation gone berserk! Sherry and I had no problem staying in Geneva for well under \$100 per day, complete... for the two of us. I'd also be interested in taking a look and seeing how many of the "representatives" were accredited and how many were over there on a nice expense account vacation courtesy of the League membership. I'll be surprised if more than three or four were accredited.

7. I've been hearing about me trying to destroy amateur radio for a long time, but the destruction never seems to come off. I think we will be hearing a lot more about the details on what actually happened at WARC and the place the ARRL played. If credit is due, I'll be glad to give credit.

10. Apparently the Chinese have made a complete change, and, instead of having the decisions made in Peking, as before, their delegation was given the power... and lost the battle with the ARRL when they got drunker than the League people. I have a feeling that there may be two sides to that story.

11. Hey! They said something nice about me! The future? Wait until you get the details on the two brand new modes of communications I'll be pushing... plus a little satellite scheme I have up my sleeve.

12. This one is really difficult to swallow.

13. Baloney. Why all this bad-mouthing of the FCC by the

League?

14. See #1.

15. I sure hope that hams don't get swept up in nationalistic politics. This stuff makes as much sense as a lot of the drivel from Iran and is aimed at getting the Archie Bunker set excited. Of course, if it comes to secession, how about New Hampshire breaking off? We have lots of wood to run our cars and an atomic power plant for electricity. Now, if they'd just let us have nuclear weapons so we could defend ourselves...

16. More nationalistic nonsense. Cooler heads, if there are any, will remind directors about the fact that there are more amateurs in Japan than in the U.S., so it is unlikely that Japan is going to oppose amateur radio.

17. What possible effect would it have for us to stop buying FM gear? With about a half million two-meter users in Japan, the 100,000 hams using it here are a drop in the bucket. What is wrong with you fellows out there? When you hear baloney, why don't you say something?

If the League is in favor of home-brewing, why do they have so few articles on it in QST... particularly as compared to 73? QST devotes extensive coverage to DX, contests, traffic handling, and CW... and relatively little to home-brewing.

The League did save money for years to invest in a new building; however, this was after WWII. Their real savings were in the '60s when Mort Kahn became a director. Mort, a shrewd New York businessman, was elected over Dannals (with my assistance) and he did a couple of good things. First, he engineered the forced retirement of Budlong. Second, he pointed out to the other directors that there was no reason to spend the money already put aside for the new building when the members could be talked into donating to a building fund. He set this up and he was right... they got the money donated

for the new building. The old building fund was kept in stocks and bonds. Then they turned around and sold their old building in East Hartford for about what the new building cost. This, too, was put into stocks... which is where the nearly \$2 million they have stashed away "for a rainy day" came from... not WWII. Note that I am not calling names or smearing anyone... just pointing out facts. If the League has any argument with what I have said, fine... let's see some of the details on expenses down through the years. These have been carefully kept a secret from the members. The "cannibal, chink, and gook" approach to clubs is aimed at getting the red-neck vote. Having recently visited the Asian area, I can assure you that we will do much better to appreciate their strengths and not indulge in an orgy of name-calling. — Wayne.

SHUT UP?

Since I was licensed as a Novice in January, 1978, with virtually no knowledge in electronics or amateur operating practices, I have been on a "learning spree" and enjoying every minute of it. I have tried to remain objective to the political throes of this hobby, but now feel compelled to speak out. Let me explain.

I have relied heavily on information in most of the amateur radio periodicals—73, QST, Ham Radio Horizons, CQ, an occasional Ham Radio—and have taken note of your repeated criticism of the ARRL and the supposed debacle they have gotten the amateur radio fraternity into, from FCC doctrines to WARC, but have at no time seen any truly constructive criticism or suggestions that may help the ARRL better represent the amateur community. Quoting your December, 1979, editorial: "About the only good thing you can say about our government is that, crummy as it is, we don't know of a better one anywhere." Likewise, we don't have a better official representative of the amateur population here in the good ol' USA.

73 Magazine offers a lot to the amateur. Its magnitude and scope are clearly a function of its editors' deep belief and love of this hobby, but, likewise, QST, as official representative of

amateur radio in this country, provides an enormous amount of information to its readers, specifically in areas which other magazines, 73 included, don't even consider.

The problem with the ARRL is that, crummy as it is, we don't know of a better one anywhere. You can quote me on that, too! As American citizens, we all have the opportunity to shape and make good our criticism of the American government. Its constitution provides for such criticism. Seems to me the ARRL has the same sort of process built in also. When was the last time you voted for any office of the ARRL, from SCM to Division Representative or even Director? My point is this: If right, stand behind and support it; if wrong, put it right, much the same as you would try to do with the American government. My guess is that you have been fighting for so long you have lost sight of your goal (notwithstanding your own accomplishments) of a truly representative body of people to make the plight of the radio amateur not only heard, but answered, fairly, in the best interests of all. If the fervor you have in your column could be used as a catalyst to unite the amateur community in support for needed changes in the ARRL, as opposed to merely a sounding board, just think how much better amateur radio would be for all. Your magazine has much clout and I would say is probably as well read as QST (I myself subscribe to both). If the ARRL is to be made better, we have to change it! So how about it, Wayne? Are you gonna put up or shut up?

Joe Silvasi KC2J
Wrightstown NJ

SUN BIRDS

Please forgive me for taking up your valuable time, but I think I have an idea worth looking into. In the cities and larger towns, the schools are full of electronic gear and anyone can join a class and learn radio or electronics. But in the smaller towns and villages, there is no way they can get this schooling except by reading books. And the places that have the least are the places that need the ham communications the most.

Each year there are thousands of "Sun Birds" who drive

south for the winter and back north for the summer. Of the thousands, I am sure that there are some hams who would be glad to stop and spend a few days helping a would-be ham, if we could just get the giver and receiver together. There should be a column in a magazine where they could write and publish their names and addresses. They would need a place to park a trailer, camper, or motor home. I know this works because I spent 5 days out on the road in Alaska with a Novice. At the end of the week, he went into Anchorage and upgraded to General.

William E. Johnston W6NYK
Tecopa CA

P.S. I am spending my spare

time, while out here in the desert, teaching a Novice class at the Death Valley High School at Shoshone CA.

HAM HELP

I wanted to let you know that *73 Magazine* is about the best in its field, if not the tops. I particularly enjoy the construction projects, even though I am handicapped.

A terrible thing happened. One gentleman answered one of my "Ham Help" pleas and a nurse (or myself) lost all of the info except that I believe it was a WD call from (I believe) the southeast. I hope that that OM, as well as others, will read this

and call or write to me.

Special thanks to the 73 staff for researching an article on a simple IC keyer circa 1973. I really appreciate the effort... it is above the call of duty and 73 is the only magazine that has done that for me.

John C. White WB6BLV
560 N. Indiana St.
Porterville CA 93257

VP1 QSLs

The Kansas City DX Club will have operated from VP1-land before, during, and after the 1980 ARRL DX Phone Contest. Our club call was VP1A. QSL to WB0TNY, Box 4798, Overland Park KS 66204. Following are other calls used and where to

QSL them: VP1AB/W0AR; VP1RLB/WB0TNY; VP1SWC/KA0BCW; VP1DD/W0AWA; VP1NLB/W0FNO; VP1CS/K0CS; VP1SAR/WB0ISW; VP1WG/W0DEL.

Rick Barnett WB0TNY
Overland Park KS

JUNK BOX HAM

I have tried a couple of your antenna projects with good results. The "Balun for a Buck" was really a saver. Being an old "junk-box" ham, I guess I enjoy making something work out of things discarded.

Please keep the issues coming. Thank you.

Harold L. Allison W5CZP
Paragould AR

Microcomputer Interfacing

from page 22

devices and the CPU. These signals are $\overline{IO/\overline{M}}$, \overline{RD} , and \overline{WR} . The $\overline{IO/\overline{M}}$ signal is used to indicate what type of device the 8085 is attempting to communicate with; logic 1 = I/O devices and logic 0 = memories. The \overline{RD} and \overline{WR} signals coordinate the reading or writing of data, respectively. These three signals are used directly by the 8085-compatible memory and I/O devices such as the 8155 and 8355. In other systems, you may have to use these signals to generate the \overline{MR} , \overline{MW} , \overline{IN} , and \overline{OUT} signals that we have discussed and used in previous columns. The necessary gating is shown in Fig. 2.

In almost all 8080-based systems, interrupts are implemented with an interrupt instruction port and restart instructions. The 8085 has four new interrupts that have been implemented on the chip. These are summarized in Table 1. The overall priority from highest to lowest is as follows: TRAP, RST 7.5, RST 6.5, RST 5.5, and INT. The INT input is the normal 8080-like interrupt input. These interrupts have their vector addresses placed within the address space 000 000 to 000 100, as is the case with the "normal" 8080 interrupts. Some of these addresses are placed between the usual 8080 vector addresses, leaving only four bytes of storage space between interrupt vector ad-

resses. Most programmers will use jump instructions to point to areas of memory that will allow for longer interrupt service programs. These new interrupts act in the same manner as the normal 8080-like interrupts, so a stack is still a necessity. If these interrupt inputs are not to be used, we suggest grounding them.

The 8085 also has a single input pin and a single output pin on the chip that can be controlled directly by software. Of course, the 256 addressable I/O port capability is still maintained. The two single I/O connections may be used for a single sense input and a single control output. They could also be used for serial I/O to a terminal or a teletypewriter, with the actual serialization being done in software.

There are two new, one-byte instructions that are implemented in the 8085. These allow you

to manage the new interrupts and the two I/O lines SID and SOD, Serial Input Data and Serial Output Data. These instructions are Set Interrupt Mask (SIM = 060) and Read Interrupt Mask (RIM = 040). The A register is used as the source or the destination of the data bytes for each operation. This is shown in Table 2.

These instructions are powerful, since they allow you to select certain devices for interrupts, check interrupts, and control an input and an output line. Remember, these instructions do not affect other 8080-type operations, except that the A register or accumulator is used.

These new functions mean that a small microcomputer-based controller can be configured with a few integrated circuits. You will see how this is done, and how 8085-compatible chips are used, in future columns.

Ham Help

I need answers to the following:

- I have a TRS-80 and M-80 interface connected to a FT-101EX. When the cables are connected, there is S-9+ rf interference on my receiver. Is there any way to isolate the TRS-80 from the receiver to stop the rf pickup?
- Is there anyone who has been able to figure out how to use a

frequency counter as a display readout for the FT-101?

- Is there anyone with information on using the TRS-80 for SSTV?
- Is there anyone out there who has any information on PC boards and home-brew information on building SSTV monitors, or who has an old monitor which they would like to pass on at a

fair price?

Thanks for any help.

John J. Apoka
DA2AW/WB5YHO
HHC 503 AVN BN
APO NY 09165

I need information, schematics, service manuals, etc., on a 713A Power Lab power supply manufactured by Precise Electronics, Mineola NY.

I will pay for reproducing and shipping. Thank you.

Bill Rhoades WD0FRB
Rt. 3, Box 89B
Northfield MN 55057

My friend, Linda, says she would get a ham license if she could talk to people about her interests. In particular, she would like to know if there is an astrology net.

Phil Hughes WA6SWR
PO Box 2847
Olympia WA 98507

I am interested in becoming a radio operator. Does anyone know of any radio classes near me?

Herbert E. Scott
84 Torrey St.
South Weymouth MA 02190

Social Events

from page 52

Talk-in on 146.52 simplex and the local repeater (147.03).

MAUMEE OH MAR 23

The Toledo Mobile Radio Association will hold its 25th annual auction and hamfest on Sunday, March 23, 1980, at the Lucas County Recreation Center, Key Street, in Maumee, Ohio. Hours are from 8:00 am to 5:00 pm. The free auction starts at 10:00 am. There will be ample free parking all day and overnight. Tickets are \$2 in advance and \$3 at the door. Flea-market tables are available and displays are limited to electronics and ham gear. There will be commercial exhibits, door prizes, refreshments, and a big raffle — all inside. Prizes include a Kenwood TS-120S with power supply, a Kenwood TR-2400, a Hy-Gain TH3 MK3 3-element tri-band beam, and many more. There will be an additional ladies' program. Bring your YL, XYL, or OM and make a day of it. Talk-in on 146.52/52. Area repeaters are 146.01/61, 146.19/79, 146.34/94, 147.87/27, and 147.975/375. For additional information, write: T.M.R.A., Inc., PO Box 24, Temperance MI 48182.

CENTREVILLE MI MAR 23

The Amateur Radio Public Service Association will hold its annual hamfest on Sunday, March 23, 1980, at Glen Oaks

Community College, Shimmel Road, Centreville MI. Doors open at 7:00 am. Tickets may be purchased in advance or at the door for admission and door prizes. Donation in advance is \$1.50, and \$2.00 at the door. Table reservations are \$2.00 per full table. Talk-in on 146.66/06 or 146.52. For further information and table reservations, contact Sharon Tilbury KA8EGJ, 607 Oak St., Three Rivers MI 49093, phone (616)-273-8301, or Dave McClain WD8RGR, 13926 Riverside Drive, Constantine MI 49042, phone (616)-435-7422.

MUSKEGON MI MAR 28-29

The Muskegon Area Amateur Radio Council will sponsor the ARRL Great Lakes Division Convention and Hamfest at Muskegon Community College on March 28-29, 1980. On Friday evening, March 28, the "Ham Hospitality" room is open to all at the Muskegon Holiday Inn. There will also be other entertainment that evening at the Inn. Saturday, March 29, doors and registration open at 8:00 am at the college. An interesting ladies' program will be presented as well as many other events. Saturday tickets are \$2.50 each, with no advance or mail ticket sales. Swap and Shop table space may also be purchased on Saturday. Advance reserva-

tions are required for the Saturday dinner program. Overnight reservations should be made directly. For additional information, write to MAARC, PO Box 691, Muskegon MI 49443, or contact Clarke Cooper K8BP at (616)-865-6198.

SIoux CITY IA MAR 29

The 3900 Club of the Sooland Repeater Association will hold its 4th annual hamboree on Saturday, March 29, 1980, at The Oasis, Sioux City Airport, Sioux City, Iowa. Advance registration, including the banquet, is \$6.75; \$7.75 at the door. Tickets for the hamboree only are \$2.00. Featured will be entertainment, exhibitors, a technical problems panel, a flea market, a CW contest, a Novice meeting, a 3900 Club quarterly meeting, technical programs, and a dinner banquet. Talk-in on .37/97. For advance tickets and motel reservations, write to Loren Barbee WB0YOW, 1518 W. 30th, Sioux City IA 51103.

UPPER SADDLE RIVER NJ MAR 29

The Chestnut Ridge Radio Club will hold a ham radio and computer flea market on March 29, 1980, at the Education Building, Saddle River Reformed Church, East Saddle River Road at Weiss Road (new site), in Upper Saddle River NJ. Tables will be available for \$5.00; tailgating \$3.00. There is no admission fee. Food and drink will be available. For further information, contact Jack Meagher W2EHD, (201)-768-8360, or Neil Abitabilo WA2EZN, (201)-767-3575.

STUART FL MAR 29

The Martin County Amateur Radio Association will hold its annual Stuart Hamfest on Saturday, March 29, 1980, from 8:00 am to 4:00 pm at the Knights of Columbus Hall. (From Route 1 in Stuart, go 6 miles southwest on State Road 76 to Gaines Ave.) Admission is only \$1.00 and swap tables will be \$5.00. For table reservations or other info, please contact Matt De Carlo KA4GPY, 1900 Palm City Rd., 35-F, Stuart FL 33494, (305)-283-1466.

MENTOR OH MAR 30

The Lake County Amateur Radio Association will hold its second annual Lake County Hamfest on Sunday, March 30, 1980, at Mentor High School, Mentor OH. The new location includes easy access, over 20,000 square feet, indoors, heated, on one floor, and 200 commercial and flea-market tables available. Doors open to exhibitors at 6:00 am and to the public at 8:00 am. Auction action begins at 12:00. Door prizes will be given away hourly. A computer raffle drawing will be held at 3:00. For county hunters and other collectors of rare and exotic places, special event station WD8IVL will be on the air from 1300-2100Z Saturday and Sunday near 7.25 and 21.375 MHz. Special commemorative QSLs and certificates will be issued. Tickets are \$3.00 at the door; \$2.50 in advance. For further details, send an SASE to LCARA Hamfest Committee, 37778 Lakeshore Blvd., Eastlake OH 44094, or call (216)-953-9784.

TIMONIUM MD MAR 30

The Baltimore Amateur Radio Club will hold its greater Baltimore Hamboree and Computerfest on March 30, 1980, at the Maryland State Fairgrounds, just off I-83, 2 miles North of I-695, Timonium, Maryland. There will be plenty of space for dealers, displays, tables, and commercial exhibits. Special events, lectures, and demonstrations will be held. Food service will be provided. There will be acres of space for tailgate sales. Door prizes will be awarded throughout the day. Admission is \$3.00 and tables are \$5.00. Talk-in on the BARC repeaters, 146.07/67 and 146.34/



Tempo Handheld!

800 CHANNEL
SYNTHESIZED
TRANSCEIVERS

S-1 299.00 2 Meter
S-1T 339.00 With Tone Pad
S-2 349.00 220 MHz
S-2T 399.00 With Tone Pad

Amateur equipment accessories & antennas.
Amateur & commercial repair service.



2317 Vance Jackson Rd. San Antonio, TX 78213
(512) 734-7793

Radio Shack DEALER COMPUTER CENTER



15% Discount
on
TRS-80's - I
AND ACCESSORIES

FAST 100 cps Centronics 730 PRINTER... \$800.00
HIGHLY RELIABLE LOBO DRIVES... \$375.00

MICRO MANAGEMENT SYSTEMS
DOWNTOWN PLAZA SHOPPING CENTER
115 C SECOND AVE. S.W.
CAIRO, GEORGIA 31728 313
912-377-7120

.94. For additional information, tickets, and space reservations, please write to Joseph A. Lochte, Jr., 2136 Pine Valley Drive, Timonium MD 21093, or for a recorded message, dial (301)-HAM-TALK.

**ROCHESTER MI
APR 12**

The Rochester Amateur Radio Club and the Rochester Repeater Society will sponsor the Rochester Area Hamfest on Saturday, April 12, 1980, at St. John's School gymnasium, 490 W. Center St., Rochester MN. Doors will open at 8:30 am. There will be a large indoor flea market for radio and electronic items, prize raffles, refreshments, and plenty of free parking. Talk-in on 146.22/.82 (WR0SFT). For further information, contact RARC, WB0YEE, 2253 Nordic Ct. N.W., Rochester MN 55901.

**WELLESLEY MA
APR 12**

The Wellesley Amateur Radio Society will hold its annual auction on Saturday, April 12, 1980, beginning at 11:00 am at the Wellesley High School cafeteria on Rice Street, Wellesley MA. Talk-in on .63/.03, .04/.64, and .52. Doors open at 10:00 am. For further information, contact Kevin P. Kelly WA1YHV, 7 Lawnwood Place, Charlestown MA 02129.

**MADISON WI
APR 13**

The Madison Area Repeater Association, Inc. (MARA), is pleased to announce its eighth annual Madison Swapfest which will be held on Sunday, April 13, 1980, at the Dane County Exposition Center Forum Building in Madison WI. Doors will be open at 8:00 am for sellers and exhibitors and at 9:00 am for the public. Commercial exhibitors and flea-market vendors will provide a large variety of equipment and components for hams, computer hobbyists, and experimenters. Door prizes will be awarded. An all-you-can-eat pancake breakfast and a barbecue lunch will be available, as well as free movies throughout the day. Admission is \$2.50 per person in advance and \$3.00 at the door. Children twelve and under are admitted free. Tables are \$4.00 each in advance and \$5.00 at the door. Be sure to reserve tables

early as tables were sold out last year. Talk-in on WR9ABT, 146.16/.76. For reservations, write to MARA, PO Box 3403, Madison WI 53704. For further information, contact Dick Victor WD9GRI, 2314 Rowley Avenue, Madison WI 53705, phone (608)-266-3527 (days) or (608)-238-0153 (evenings and weekends).

**DAYTON OH
APR 25-27**

The Dayton Amateur Radio Association, Inc., will hold its Hamvention on April 25-27, 1980, at the Hara Arena and Exhibition Center, Dayton OH. Admission is \$5.00 in advance; \$6.00 at the door. Flea-market space is \$11.00 in advance; \$14.00 at the gate. The Saturday evening banquet will be \$12.00 in advance; \$14.00 at the door. Senator Barry M. Goldwater K7UGA will be the banquet speaker. For additional information, write Box 44, Dayton OH 45401, or phone (513)-296-1165 5:00-10:00 pm EST. For special motel rates and reservations, write to Hamvention Housing, 1980 Winters Tower, Dayton OH 45423. There will be no reservations accepted by telephone. Make checks payable to: Dayton Hamvention, Box 333, Dayton OH 45405.

**DE KALB IL
MAY 4**

The Kishwaukee Radio Club and the De Kalb County Amateur Repeater Club will hold their annual indoor/outdoor hamfest on Sunday, May 4, 1980, from 8:00 am to 3:00 pm at the Notre Dame School (3 miles south of De Kalb, between Highway 23 and South 1st Street on Gurler Road). Tickets are \$1.50 in advance and \$2.00 at the door. Indoor tables are available, but if you bring your own, the setup is free. Talk-in on 146.13/.73 and .94 simplex. For further information, send an SASE to Howard WA9TXW, PO Box 349, Sycamore IL 60178.

**GREEN BAY WI
MAY 10**

The Green Bay Mike and Key Club will hold its swapfest from 8:30 am to 3:30 pm on May 10, 1980, at the Ashwaubenon Recreation Center. Admission will be \$1.50 advanced and \$2.00 at the door. Food and beverages will be served. There will be drawings for door prizes. For more information, contact Bob Duescher KA9BXG, 1011 13th Ave., Green Bay WI 54304. Talk-in on .72/.12.

**MICROWAVE
GUNN OSCILLATORS**

Inexpensive microwave power sources for amateur and experimental applications. Standard waveguide flanges. Removed from Police Radar units.

X-BAND: 10.525GHz, mech. tunable ±50MHz; Input +10VDC @600mA max.

| | | | |
|--------------|---------|---------|-------|
| OUTPUT (min) | 25mW | 50mW | 100mW |
| EACH | \$35.00 | \$40.00 | 45.00 |

K-BAND: 24.150GHz, mech. tunable ±50MHz; Input +6VDC @800mA

| | | | |
|--------------|---------|---------|---------|
| OUTPUT (min) | 40mW | 70mW | 100mW |
| EACH | \$60.00 | \$67.50 | \$75.00 |

**IN-LINE RF WATTMETER
Military Type TS - 3499 / URM**

Identical to ELECTRO IMPULSE DW - 1000

A rugged portable instrument for measuring forward or reflected CW power. Wide power range and broad coverage is accomplished by panel mounted switches; no plug-in elements required; Fwd Power 10, 50, 100, 500, 1000 watts; Refl. Power 10, 50, 100, 500 watts; Freq. 2 - 30 / 25 - 250 / 200 - 1000MHz; VSWR 1.10 max.; 50Ω; Accuracy ±5%FS; Connectors N(F); Size 10½ x 9¼ x 7"; Weight 13 lbs.

Brand New . . . \$299.00, 3 For \$750.00

PUSH-TO-TALK MICROPHONE: King Radio, hand held, low impedance, carbon push-to-talk microphone; with coiled cord & mounting bracket.

Brand New . . . \$5.95

Complete stock of microwave components for prompt delivery

We Buy surplus Test instruments, microwave components & equipment, and military electronic equipment.

Check or Money Order with order. C.O.D.'s enclose 25% deposit. Open Accounts to firms favorably rated in D & B. F.O.B. Camden, N.J., New Jersey residents add 5% sales tax.

ELECTRONIC RESEARCH LABS., INC.
1423 Ferry Ave., Camden, N.J. 08104
Phone 609 - 541 - 4200

✓ 315

ALL BAND TRAP ANTENNAS!

PRETUNED - COMPLETELY ASSEMBLED - ONLY ONE NEAT SMALL ANTENNA FOR UP TO 6 BANDS! EXCELLENT FOR CONGESTED HOUSING AREAS - APARTMENTS LIGHT - STRONG - ALMOST INVISIBLE!

FOR ALL MAKES & MODELS OF AMATEUR TRANSCEIVERS - TRANSMITTERS - GUARANTEED FOR 2000 WATTS SSB 1000 WATTS CW INPUT FOR NOVICE AND ALL CLASS AMATEURS!

COMPLETE AS SHOWN with 90 ft. RG58U-52 ohm feedline, and PL259 connector, insulators, 30 ft. 300 lb. test dacron end supports, center connector with built in lightning arrester and static discharge - molded, sealed, weatherproof, resonant traps 1" X 6" - you just switch to band desired for excellent worldwide operation - transmitting and receiving! WT. LESS THAN 5 LBS.

| | |
|---|---------|
| 160-80-40-20-15-10 bands 4 trap --- 169 ft. with 90 ft. RG58U - connector - Model 1060BU | \$99.95 |
| 80-40-20-15-10- bands 4 trap --- 91 ft. with 90 ft. RG58U coax - connector - Model 1080BU | \$95.95 |
| 40-20-15-10 bands 4 trap --- 45 ft. with 90 ft. RG58U coax - connector - Model 1040BU | \$92.95 |
| 20-15-10 bands 4 trap --- 23 ft. with 90 ft. RG58U coax - connector - Model 1002BU | \$89.95 |

SEND FULL PRICE FOR POST PAID INSURED DEL. IN USA. (Canada is \$5.00 extra for postage - clerical - customs - etc.) or order using VISA Bank Americard - MASTER CHARGE - AMER. EXPRESS. Give number and ex. date. Ph 1-308-236-5333 9AM - 6PM week days. We ship in 2-3 days. ALL PRICES WILL INCREASE . . . SAVE - ORDER NOW! All antennas guaranteed for 1 year. 10 day money back trial if returned in new condition! Made in USA. FREE INFO. AVAILABE ONLY FROM.

WESTERN ELECTRONICS ✓ 80 Dept. A7-3 Kearney, Nebraska, 68847

ALL BAND TRAP ANTENNAS!

JUST GETTING ON THE AIR?

See Adirondack for



- New Equipment
- Used Gear
- Friendly Advice

ADIRONDACK Radio Supply

185-191 West Main Street • P.O. Box 88
Amsterdam, N.Y. 12010 Tel. (518) 842-8350
Just 5 minutes from N.Y. Thruway - Exit 27

W2NSD/1 NEVER SAY DIE

editorial by Wayne Green

from page 6

radio, but it is annoying to hear that people have been sent out to tell ham clubs that I am intending to kill amateur radio. That's not consistent with their claim that I'm trying to make big bucks out of amateur radio... but then who is nitpicking about consistency?

The proposed new bands sound good... and I'm glad to see them getting more possible. I do hope that the credit for them goes where it belongs, which I think is with Prose Walker. He was the first one I ever heard propose them and I think we should set up a statue somewhere for his part in this accomplishment. Of course, with the projected date for the ham opening of these bands being 1989, we are not going to get a lot of immediate benefit. One hopes that hints that the U.S. will be able to forestall the promised shortwave broadcast WARC now set for 1985 will pan out. And if the U.S. is not able to pull this off, then the next hope is that we won't lose those new bands even before we get them. Leave it to me to be a worrywart.

It was not only amateur radio that made out like a bandit at WARC. Most of the shortwave users had gone into the conference with their fingers crossed and hoping for the best... but not expecting it. The recently past ITU meetings had been so filled with politics and strictly political decisions on frequencies that there were many expressions that this might well be the last ITU meeting. Indeed, if the African countries had continued with the course they had set with the satellite and marine conferences, this was a distinct possibility.

My input from those who participated at WARC was that for some reason, after the first few days, the Third World countries didn't get into further political lathers and all went incredibly smoothly. There are, of course, possibilities for trouble later on,

but the consensus of opinion is that all will run as planned if no one upsets the boat with rhetoric.

The shortwave broadcast conference scheduled for a few years hence will probably not entail frequency allocation hassles. The countries will be getting together to decide such matters as whether to shift to single sideband broadcasting, whether some limits should be placed on simultaneous broadcasting on several wavelengths, and administrative matters.

Should the SW broadcasters change to sideband, we might start getting more hams entering the hobby. Before CB, much of the entrance to amateur radio was via shortwave listening. After a few months of tuning in the BBC and Radio Moscow, one finds that, boring as they sometimes are, most of the interesting shortwave action is in the ham bands. A bit of listening and one starts thinking about participation... and soon we have a new ham in our ranks.

Since many of the telecommunications people in Third World countries are hams, it is incumbent upon all of us to watch our remarks and to present as good a face to the world as we can. Recent organized attempts to put down African countries as cannibals and Asians as chinks is about as far as one can get from the true spirit of amateur radio... though it may appeal to a few Americans with serious inferiority complexes.

You'll be hearing some stories about Geneva being expensive... and it is. I visited there recently and it is certainly a little worse than New York... but not much. Something goes wrong with some people when they are on an expense account. In business we watch for this syndrome and make sure that people are on very controlled expense accounts. The government has a similar approach. I should think that \$100 a day or so would be a reasonable ex-

pense for Geneva and much beyond that should call for an investigation by the tax people.

EXTRA CLASS OPPORTUNITY

When the promised new bands are finally available, I would suggest that they be restricted to Extra class licenses. This might, for the first time, offer something of value instead of a callsign change and make this class of license worthwhile. It might even get me to move up to Extra.

As I've mentioned before, I am perhaps unusual in that I will generally do just about anything for people who ask... and fight to the last ditch when people demand. The FCC's approach to forcing me to go for my Extra in order to get back frequencies I had before still has me resisting stubbornly. I don't want any new call. I've had W2NSD for some 40 years now and I like it, so the FCC can jam the Extra class license as far as I'm concerned.

I still have a disbelieving feeling that something will go wrong before we get any new bands, but should they come along and should they be made an Extra class preserve, I probably would rumble down to the FCC and upgrade.

MEANWHILE

With some assurance of stability in our shortwave bands, we can lay some plans for expanding and improving amateur radio. My own ideas for developing better communications do lie a good deal with mating amateur radio and computers. For instance, wouldn't it be nice if we could get away from the present ghastly systems for working rare DX?

Yes, I know that a few of the

big guns enjoy the pileup method of working DX. They have the huge towers, big beams, and enormous power amplifiers to whomp on top of the rest of us and get through first. But the pileup system ends up with very few stations being contacted per hour. There certainly must be a more efficient system. After all, if rare DX stations could get the instant contacts out of the way, they could spend a little more time talking and perhaps enjoying amateur radio more. It gets to be a bloody pest to be hounded by DX QSL card seekers every time you get on the air.

The list system is not much better. A bit faster, but still slow. I think we can come up with a system which will be fast and fun... and which will have a lot of side benefits which will more than repay us for the extra processing equipment we will have to build or buy to keep up. I'll be discussing the details of some proposed systems first with the ham manufacturers and then, once the system is decided upon, we'll be pushing through the magazine for fast development of the idea and its use all over the world.

If I can get even a couple of my ideas into action within the next few years, I promise you that amateur radio will be more fun than anything you've seen yet. You enjoyed FM and repeaters, didn't you? Wait for the next step.

NOVEMBER WINNER

To no one's real surprise, "The Satellite TV Primer" was voted November's most popular article, so author Bob Cooper W5KHT will receive our \$100 bonus check.

Ham Help

For research purposes, I wish to contact anyone who has operated from a country listed on the ARRL Deleted Countries (DXCC) List. Thank you.

Gary Mitchell WA1GXE
Box 1003
Fairfield CT 06430

The East Valley ARC needs equipment for aspiring amateurs and upgraders. All members of the club are disabled. Please contact me, the station trustee, at the address below.

Any gear or help will be appreciated. Thanks.

John C. White WB6BLV
East Valley ARC
Box 1809
Porterville CA 93258

Does anyone have any information on modifying the Yaesu CPU-2500R to automatically resume scanning after the absence of a signal?

Mike Larson WD0EZK
Box 307
Stanhope IA 50246

HAM-KEY™ RADIO TELEGRAPH SENDING DEVICES



Model **HK-3M**
\$19⁹⁵

- * Deluxe straight key
- * Anti-tip bracket. Can't tip
- * Heavy base. No need to attach to desk

Add \$2.00 Shipping & Handling.

- * Navy type knob
- * Smooth action

CC-3P shielded cable & plug for HK-3M \$2.49.

Add \$.50 Shipping & Handling.

Model AT-B anti-tip bracket only, to convert any HK-3 to HK-3M.
\$2.99 Postpaid



Model **HK-1** **\$29⁹⁵**

Add \$2.00 Shipping & Handling.

- * Dual lever squeeze paddle
- * For use with all electronic keyers
- * Heavy base with non-slip rubber feet
- * Paddles reversible for wide or close finger spacing

CC-1P shielded cable & plug for HK-1 \$3.75

Add \$.75 Shipping & Handling.

Model HK-2, same as HK-1 but less base for incorporation in your own keyer. **\$19.95**

Add \$1.00 Shipping & Handling.

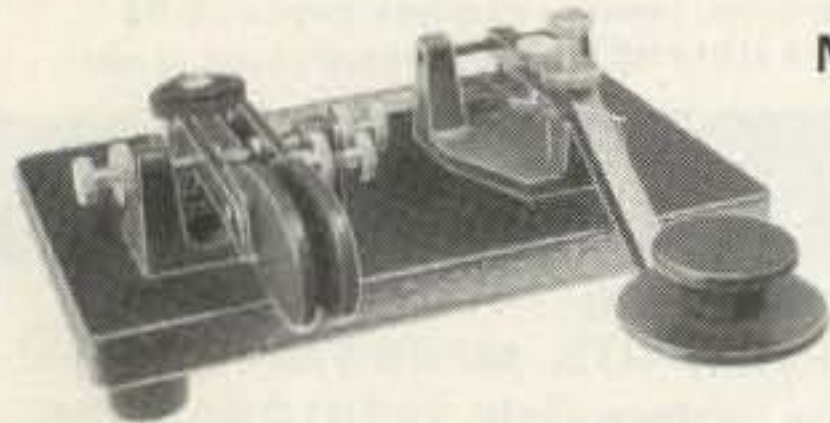

Model **HK-4**

\$44⁹⁵

Add \$2.00 Shipping & Handling.

- * Combination HK-1 & HK-3 on same base
- * Straight key may be used conventionally or as a switch to trigger a memory.

CC-1/3P Shielded cable with plugs for HK-4 \$5.99.

Add \$1.00 Shipping & Handling



Model **HK-5A** Electronic Keyer

\$69⁹⁵

Add \$2.00 Shipping & Handling.

- * Iambic circuit for squeeze keying
- * Self completing dots & dashes
- * Dot & dash memory
- * Built-in sidetone
- * Battery operated with provisions for external power

- * Uses Curtis 8044 keyer chip
- * Grid block or direct keying
- * Speed, volume, tone & weight controls on front panel
- * Use with HK-1 or HK-4

Order direct or from your favorite dealer. ✓ 30

The HAM-KEY Co.

P.O. Box 28271 St. Louis, MO 63132

Phone TOLL-FREE 1-800-325-3651



✓ 82

MONITOR \$149, 12" B&W

NEW
Terminal Unit
Keyboard & CRT
SKT-170

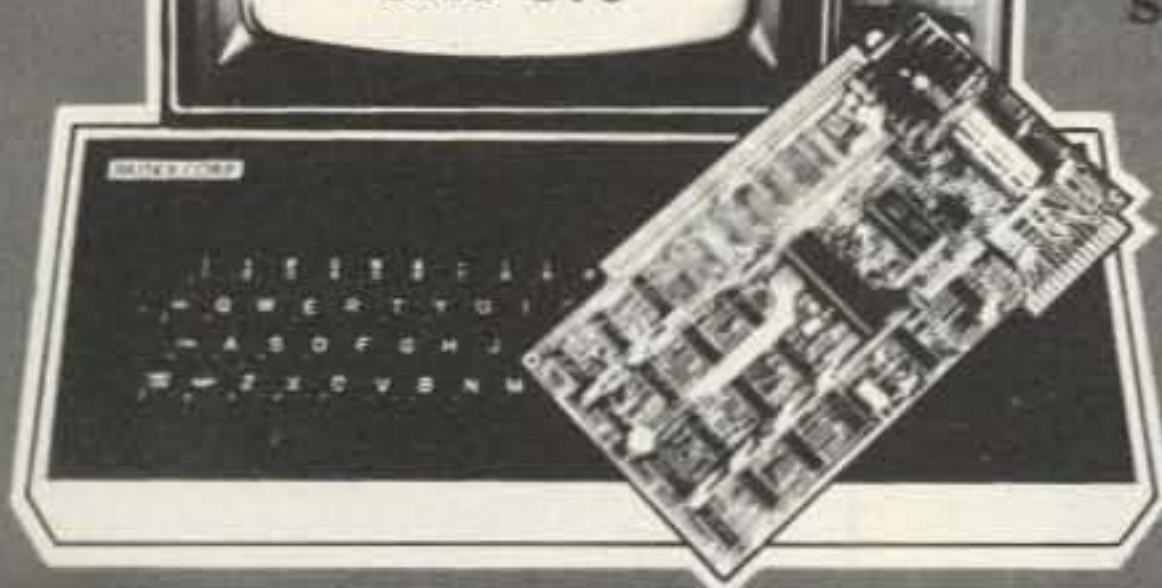

COMPLETE KEYBOARD TERMINAL \$375

Full Kit \$325 (includes SCT-100)

XITEX IS RTTY FOR ASCII

- ASCII • Baudot TU/CRT with Morse Compatibility (MRS-100)
- 170/850 Hz shift Modulator/Demodulator
- All TU controls front panel located for ease of operation
- AUTO IDENT/25 word message (optional in PROM)
- Available January.....Write for complete details

SCT-100 VIDEO BOARD FEATURES

- 64x16 line format with 128 displayable characters
- Serial ASCII or BAUDOT with multiple Baud rates
- \$197 Assembled or \$167 Kit (Partial Kit \$99)
- Full cursor control with scrolling and paging
- On board power supply
- Serial interface RS232 or current loop
- Purchase SCT-100 alone or complete terminal

XITEX CORP.

9861 Chartwell Drive
Dallas, Texas 75243 (214) 349-2490

ORDER BY PHONE/Overses orders & dealers welcome



XITEX MORSE TRANSCIEVER



MRS100 FEATURES:

- Connects directly with any ASCII or Baudot Teletype®/Terminal
- Operates from 1 to 150 WPM with Auto-Sync.
- Displays WPM rate of copied signal plus FIFO buffer status.
- Contains a built-in 80 Hz bandpass filter and sidetone oscillator.

\$295 Assembled & Tested • \$225 Complete Kit • \$95 Partial Kit

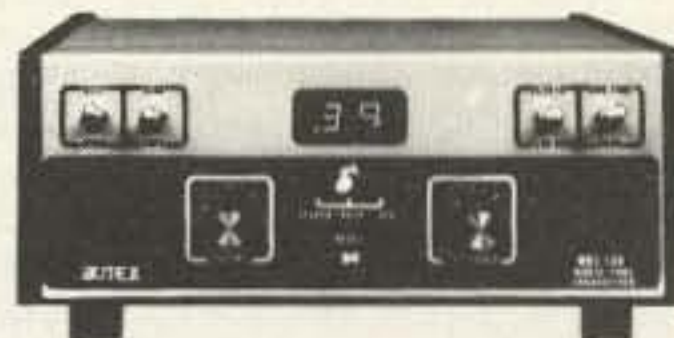

NEW FROM XITEX...ABM-100

Universal Converter ASCII • Baudot • Morse
The ABM-100 is a universal code converter for translating between ASCII and Baudot, or between Morse and ASCII (or Baudot). Also used as a TTY® speed converter. Assembled and tested the ABM will operate from a single +5V supply and sells for \$129. Write for complete details

★ For Sale ★

\$10,000,000 INVENTORY

The *ultimate* source for electronic components and equipment.

**PRODUCTION OVERRUNS
SURPLUS MATERIALS**

Send us your inquiries. Get on our exclusive mailing list. Inquire in writing or by Telex
TWX: 510-224-6539

Serving domestic and overseas markets.

**Ultima
Electronics, Ltd.**
(516) 423-3770

✓310

73 Sherwood Ct., Huntington, N.Y. 11743 U.S.A.

ATTENTION

EXPERIMENTER DESIGNER MANUFACTURER
HFT OFFERS YOU
ENGINEERING SERVICES - MINIMODULE PRODUCTS
AUDIO THROUGH 250 MHz

FULL SCALE DUAL GATE MIXER

RF PREAMPLIFIERS
DUAL GATE FET MIXERS
IF AMPLIFIERS
AUDIO AMPLIFIERS
WWV RECEIVERS
VIDEO AMPLIFIERS
COMPRESSIVE AUDIO AMP.
SSB GENERATOR
RF POWER AMPLIFIERS
POWER SUPPLIES

CATALOG ITEMS IN TWO WEEKS OR LESS
QUICK TURN AROUND ON SPECIALS

CATALOG & DESIGN MANUAL \$2.95 REFUND ON 1ST PURCHASE

DETAILED SPECIFICATIONS
APPLICATION NOTES
DESIGN DATA ON: RF PREAMPLIFIERS, MIXERS,
SPURIOUS SIGNALS, RECEIVER
PARAMETERS, AUDIO COMPRESSION,
& OTHER DATA

SHORT FORM CATALOG ON REQUEST

FULL SCALE RF PREAMP.

HFT INC ✓304

158 West 9th St
Deer Park NY 11729

HAM SCAN-1: YAESU MEMORIZER

*Scans 145-148 MHz in 10 sec., stops 3 sec. on active channels, simple 7 wire installation.
ORDER HAM SCAN-1.....\$39.95

HAM SCAN-2: K'WD 7625, 7600,

**7400A, KDK 2015R, 2016A, CLEGG FM-28
MIDLAND 13-510, HW-2036, Others soon.**

- * Adds one channel of memory to any above rig
- * Scan range selectable by position of radio's MHz switch. Up to full 4 MHz width.
- * Scan rate 200 kHz/sec at 10 kHz steps with a 3 second pause on all active channels
- * Mike-mounted switch provides 3 functions: start/stop, remote freq. incrementing and xmit interlock while actively scanning
- * Scanner mounts inside radio, no external box
- * Assembled, tested and guaranteed \$59.95

ORDER HAM SCAN-2 and specify type of radio

Technical Clinic

P.O. BOX 636 ✓312
STERLING HTS. MI 48078
Phone Orders Call: (313) 286-4836

URFI

**(UNIVERSAL RECEIVED
FREQUENCY INDICATOR)**

Digitize your receiver's dial with the DIAL SPOTTER. Adapts to most Communication Receivers with simple connection to VFO. From \$149.95 Write for Data Sheet.

**GEMINI
INSTRUMENTS
INCORPORATED**

Box 205 Larchmont, NY 10538 ✓24

UNBEATEN SIX BAND ANTENNA

THE JOYSTICK VFA

(Variable Freq. Antenna) claims unbeaten scoring over commercial and/or conventional antennae.

- Simple, rapid erection
- Not only 6-band but CONTINUOUS 0.5 - 30 Mhz., incl. BC & MARS
- Omni-directional
- Substantially Harmonic FREE
- 1,000,000 miles per watt, unbeaten record!
- Poor QTH's enhanced!
- CLIFF DWELLERS ANTENNA!
- QUOTE from CQ Mag. - "If you are high enough the antenna will operate (esp. at 15-20) as well as the well-known 3-element beam with which we compared it. The tests were operational, not theoretical! We find that if we can hear 'em we can work 'em"

SYSTEM 'A' \$110.00 Each System 3 sections easily assembled to make unit 7' 6" long. Matching ATU. Air mail cost included.
150 W.P.E.P. &/or Receiving only

SYSTEM 'J' \$130.00
500 W.P.E.P. &/or Improved Q Factor Receive

Rush Mastercharge/Visa no. or check or request FREE literature.

PARTRIDGE ELECTRONICS LTD
8 Partridge House,
Broadstairs, Kent, England.

G3CED Tel: 011 44 0843 62535 **G3VFA**

Please send all reader inquiries directly

AUTOMATIC CW COPIER

Now you can copy the fast CW stations. The NEW professionally designed DE-150 plugs into a transceiver's earphone jack & automatically displays Morse code as it is being received. New characters are entered from the right and shift left giving a continuous easy to read display of the latest code received. \$425.

One year warranty and 15 day return privilege. Add \$5 for shipping. VISA & MC cards welcome.

✓21

Dynamic
ELECTRONICS INC.

(205) 773-2758 Box 896 Hartselle, AL 35640

Radio Amateurs!

AZDEN PGS-2000
••• \$339.00 List. Ask For Quote

SWAN ASTRO 102BX
••• \$1195.00 List. Ask For Quote

TEN-TEC OMNI D
••• \$1119.00 List. Ask For Quote

Amateur equipment accessories & antennas.
Amateur & commercial repair service.

**Appliance
& Equipment
Company Inc.** ✓301

2317 Vance Jackson Rd. San Antonio, TX 78213
(512) 734-7793

142-163 Mhz BANDPASS F-194/U BANDPASS FILTER

gold-plated twin tuned cavity designed for the 142 to 163 Mhz range. Has tuning controls and type N connections. Size: 6 1/4 x 2 1/2 x 11 1/2", 6 lbs. sh. wt. Unused **\$17.95**

We have similar filters (listed below) which can be converted to amateur usage according to conversions by W4FXE (2/80 and 4/80 Ham Radio) used. **\$12.95** unused, **\$15.95:** F-192/U or F-193/U, used only, conversion to 2-meters. F-195/U (163-184 Mhz) or F-196/U (185-205 Mhz), conversion to 220-225 Mhz. F-202/U (314-344 Mhz), conversion to 420-450 Mhz.

R-644/URR RECEIVER: 20-237 Mhz, AM, FM, CW in seven continuously tunable bands. Same as R-220/URR but requires 24 VDC 10 amp. power input. 10 1/2 x 19 x 14 1/4", 96 lbs. net. Shipped in sealed gov't export crate with transit case, manuals, and spares — not checked. Crate sh. wt. **\$425.00**

J-37 KEY: with adjustable contacts. 3x6 base, and cord; used **\$7.95**

All Prices F.O.B. Lima, Ohio. Please Allow for Shipping. Use your VISA or MASTERCARD Card.

✓22 Write for our Big FREE CATALOG.
Address Dept. 73 • Phone 419/227-6573

FAIR RADIO SALES
1016 E. EUREKA • Box 1105 • LIMA, OHIO • 45802

Digitrex Electronics

PA-19 Wideband Preamp ✓18

- 2 to 200 MHz Bandwidth 3dB Points
- 19 dB Gain!
- 50 Ohms Input & Output Impedance
- Tiny PC Board Size (7/8" x 1-5/8")
- Absolutely No Tuning Required
- Extremely Stable
- Draws only 20mA @ 12VDC
- Great Way to Increase Sensitivity of Receivers, Counters, etc
- Fully Assembled and Tested
- Instructions Provided, Full Warranty

only **\$8.95** 50 Shipping/Handling

Portable 600 MHz Frequency Counter

- 1-600 MHz Range
- 1 KHz or 100 Hz Resolution
- Assembled and Tested
- Full Lifetime Warranty
- Size 5" L x 2 1/2" W x 1 1/2" H
- BNC Whip Antenna Opt. \$8.95

\$59.95 ppd. (less ant.)

C.O.D. Orders Welcome
Digitrex Electronics
4412 Fernlee, Royal Oak
Michigan 48073 313-651-9247

• 75 mV Sensitivity

LATEST ADDITIONS! ASSEMBLED AND TESTED:

| | | |
|-------------|---|-------|
| PS 300 | 300 MHz Prescaler ±10 Output | 14.95 |
| PS 600 | 600 MHz Prescaler ±10 and 100 | 28.95 |
| PS 1250 | 500 MHz / ±100, 1250 MHz / ±1000 (the cast case) | 79.95 |
| RD-320 | 4 Digit Rec. Display 100 Hz resolution works with any Rec. with 1MHz or less VFO range per band. Simple hook up | 49.95 |
| Model RT260 | 8 Digit Frequency Counter Range 2 1250 MHz ±1 Hz range. Smaller than Cognate's jack (less supply) | 99.95 |

New SATELLITE For the TV home.



Supersharp Reception—Color Like Never Before

Get over 50 channels of television directly from the satellite! HBO, Showtime, the Superstations, and sports from around the world!

Works Anywhere!

Buy complete or build and save. Our book tells everything! Send \$7.95 today or call our 24 hr. C.O.D. Hotline!

(305) 869-4283

SPACECOAST RESEARCH ✓ 309

P.O. Box 442, Dept. G, Altamonte Springs, FL 32701



SYNTHESIZED SIGNAL GENERATOR



- Covers 100 to 179.999 MHz in 1 kHz steps with thumb-wheel dial
- Accuracy .00001% at all frequencies
- Internal frequency modulation from 0 to over 100 kHz at a 1 kHz rate
- Spurs and noise at least 60dB below carrier
- RF output adjustable from 50 to 500mv across 50 ohms
- Operates on 12vdc @ 1/2 amp
- Price \$299.95 plus shipping.

In stock for immediate shipping. Overnight delivery available at extra cost. Phone: (212) 468-2720.

✓ 311

VANGUARD LABS

196-23 Jamacia Ave. Hollis, NY 11423

CB TO 10 METER

10 METER CONVERSION KITS FOR CB RADIOS AM-FM & SSB

- Kits for over 300 Models of CB Radios
- Low Cost from \$10.00
Easy to Install with All Instructions
Tune-Up Procedure Alignment
- KITS FOR MOST POPULAR UNITS
Over 5,000 Satisfied Customers
- Write or Call Today for Our Free 1980 Catalogue

AMERICAN CRYSTAL SUPPLY COMPANY

PO Box 638
W Yarmouth, MA 02673
(617) 771-4634 ✓ 7

Tired of High Prices?

Tired of playing roulette with "800" number specials? Forget the toll-free frustration. Take a shortcut and call Long Path Radio. We deliver low prices from the ground up—on towers, rotators, antennas, and accessories. Our goal is to have what you want in stock.

Take a look at the complete line:

| | | |
|----------------------------|-------------------------|-----------------------------------|
| HyGain Antennas | HDBX48 self | 16 element- |
| TH6DXX \$219.00 | supp. tower .. \$299.00 | 2 meter \$ 55.00 |
| TH5DX \$179.00 | HDBX56 self | CDE Rotators |
| TH3MK3 \$153.00 | supp. tower .. \$315.00 | Call or write for your low price. |
| TH2MK3 \$ 99.00 | 3/16 EHS guy wire, | Cushcraft Antennas |
| TH3JR \$113.00 | 500 ft. \$ 46.00 | ATB34 Tribander .. \$199.00 |
| 105BA \$ 86.00 | 3/16 CCM cable | 20-3CD \$133.00 |
| 155BA \$133.00 | clamp \$.30 | 20-4CD \$222.00 |
| 205BA \$219.00 | 1/8 turnbuckle, | 15-3CD \$ 76.00 |
| 204BA \$166.00 | eye & eye \$ 5.50 | 15-4CD \$ 87.00 |
| 402B \$159.00 | M200H 10 ft. | 10-3CD \$ 54.00 |
| DB1015A \$103.00 | H.D. galvanized | 10-4CD \$ 66.00 |
| 18AVT \$ 70.00 | mast \$ 33.95 | ATV-4 \$ 74.00 |
| 14AVQ \$ 46.00 | Tonna F9FT | ATV-5 \$ 82.00 |
| BN86 \$ 12.00 | 4 element- | ARX-2 \$ 30.00 |
| Rohn Towers | 2 meter \$ 21.95 | ARX-450 \$ 30.00 |
| and Accessories | 9 element- | A-147-11 \$ 30.00 |
| 25G section \$ 35.75 | 2 meter \$ 29.95 | 32-19 Boomer ... \$ 65.00 |
| 45G section \$ 62.00 | | |

Except for Rohn towers, all items shown are complete stock. Sorry, no other products available.

We're here to serve you from 8:30 to 5:00, Monday through Friday, at 1-214-369-3401. Ask for Long Path Radio.

LONG PATH RADIO, INC. ✓ 84

P.O. Box 29682/Dallas, Texas 75229/1-214-369-3401

TERMS:

All prices F.O.B. Dallas. C.O.D. requires 25% deposit. Money order, cashier's check, O.K. No personal checks. We ship freight collect. If you desire prepaid freight, a small Per Item charge will be made for shipping and handling.

Available May 1, 1980

Write for Features/Specs

★ TRS-80/RTTY ★

THE CROWNING TOUCH

ROM-116

THE COMPLETE AMATEUR RTTY OPERATING SYSTEM

✓ 16 **CROWN MicroProducts**

P. O. BOX 892
Marysville, Wa. 98270
206-659-4279/206-659-9512

50-144 REPEATERS - 220-450 Mhz

BASIC AUTO PATCH

*Access, #Disable and adjustable Timer.
COMPLETELY ASSEMBLED—\$75.00.

Now with courtesy
beep and beacon
capability

EXTENSION BOARD

Antifalsing, 3 digit sequential Touch Tone™ decoder with automatic reset, Antifalsing Ring detector, reverse auto patch capability for basic auto patch and two, two-watt audio amplifiers.

COMPLETELY ASSEMBLED—\$140.00

Available Separately:

COR Identifier: All on one board, programmable, Fully adjustable, time out (.5-7 min.), hang time (0-1 min.), identifier (1-10 min.), tone, speed, volume, L.E.D. outputs, low current drain CMOS logic, plugs for easy installation and removal plus much more. \$89.95 COMPLETELY ASSEMBLED

Basic Repeater \$499.95 COMPLETELY ASSEMBLED

2M 130-175 MHz Basic Repeater for 2 meters with all the features of the HI Pro Mki less the power supply and front panel controls and accessories.

Hi Pro Mk I REPEATERS

50 MHz \$789.95 450 MHz 799.95
144 + 220 MHz \$699.95

PA Res. add 6% tax
PLUS SHIPPING

Maggiore Electronic Laboratory

845 WESTTOWN RD.
WEST CHESTER, PA. 19380 PHONE 215 436-6051

7294 N.W. 54 STREET
MIAMI, FLORIDA 33166

SURPLUS ELECTRONICS CORP. ✓ 69

PHONE: (305) 887-8228
TWX: 810-848-6085
WHOLESALE - RETAIL

| <p>PL259 or SO239 Quality American Made 10/\$5.00 100/\$35.00 50/\$20.00 1000/\$300.00</p> | <p>CB SPECIAL Brand new printed circuit board assembly. Used in all HyGain 40 Channel CB transceivers. Fits many other manufacturers' units also. Squelch pot/volume control/channel selector switch not included. Board Dimensions 6" x 6 1/2" 1-9 - 7.50 ea. 50-99 - 6.00 ea. 10-49 - 6.50 ea. 100-up - 5.50 ea.</p> | | <p>TRIMMER CAPS Can fit in your watch 3.5-20 pF & 5-30 pF \$.75 ea., 2/\$1.25 5/\$3.00</p> | | | | | | | | | | | | | | | | | | | | | | | | | | | | | | | | | | | | | | | | | | | | | | | | | | | | | | | | | | | | | | | | | | | | | | | | | | | | | | | | | | | | | | | | | | | | | | | | | | | | | | | | | | | | |
|--|---|---|---|-------------------|-------------|-------------|-------------|--------------|--------------|----|-------------------|------------|-------------|-------------|------------|------------|--------|-------------------|-------------|--------------|--------------|----|-------------------|-------------|--------|---|-----|--------|-------|---------|-------|---|-----|--------|--------|---------|-------|---|-----|--------|----|---------|-------|---|-----|--------|--------|---------|--------|---|-----|----|----|---------|--------|---|-----|--------|----|---------|--------|---|-----|----|-------|---------|-------|---|-----|--------|--------|---------|--------|---|-----|----|--------|---------|-----|---|-----|--------|--------|---------|-----|---|------|--------|--------|---------|-----|---|------|--------|--------|---------|----|---|------|--------|----|---------|-----|---|------|--------|----|---------|---|---|---|
| <p>E. F. Johnson NICAD 12.0 V. 1.2 AH @ 10 hr rate 4 1/2" x 1 7/8" x 1 3/4" \$1495ea.</p> | <p>CB SPECIAL W/40 ch SW same as above 1-9 \$10.50 ea. 50-99 \$9.00 ea. 10-49 \$9.50 ea. 100-up \$8.50 ea.</p> | | <p>POLY FOAM COAX 50 Ohm Low Loss = to RG174 \$.495/100' \$3.00/50'</p> | | | | | | | | | | | | | | | | | | | | | | | | | | | | | | | | | | | | | | | | | | | | | | | | | | | | | | | | | | | | | | | | | | | | | | | | | | | | | | | | | | | | | | | | | | | | | | | | | | | | | | | | | | | | |
| <p>E. F. Johnson S Meter Edge Meter 250 UA. Fits in 5/8" x 1-3/8" hole. MTG holes on each end 1-1/4" behind panel. Black scale 0-5 bottom 1-20 top \$1.25 ea. 5/\$5.00</p> | <p>Serviceman Special New Hy Gain 40ch CB Less Case, Speaker & Knobs (as is) \$14.95 ea</p> | | <p>ULTRASONIC TRANSDUCER Detects sound above the range of human hearing! Transmits & receives \$2.50 ea. 5/\$10.00</p> | | | | | | | | | | | | | | | | | | | | | | | | | | | | | | | | | | | | | | | | | | | | | | | | | | | | | | | | | | | | | | | | | | | | | | | | | | | | | | | | | | | | | | | | | | | | | | | | | | | | | | | | | | | | |
| <p>E. F. Johnson Signal Strength Meter 200 UA 2 1/2" x 2 1/2" Sq. mounts in 1 1/4" hole 1" behind panel. Scale: 1-30 db top 0-5 bottom. \$4.95ea 5/\$20.00</p> | <p>NEW Hy-Gain Remote 40ch CB Less Case, Speaker & Control Mic (as is) \$14.95 ea</p> | <p>NEW E.F. Johnson Power Mic/Less Cord. Desktop Style \$19.95 ea</p> | <p>MAGNETIC PICK UP TRANSDUCER Converts motion to ac voltage without mechanical linkage 3/4" x 2" w/6' shielded cable \$4.95 ea.</p> | | | | | | | | | | | | | | | | | | | | | | | | | | | | | | | | | | | | | | | | | | | | | | | | | | | | | | | | | | | | | | | | | | | | | | | | | | | | | | | | | | | | | | | | | | | | | | | | | | | | | | | | | | | | |
| <p>PANEL METERS \$4.00 ea 2 for \$7.00</p> <p>25-0-25 dc volts } 2 1/4" x 3" 0-20 dc volts } 0-25 dc volts } 2 1/4" x 2 1/4" 0-50 ac volts } -Shunt Required-</p> | <p>ASTATIC T-UG8-D104 PREAMP Desktop microphone w/crystal element 3 Pin Plug \$35 ea.</p> | <p>CERAMIC IF FILTERS EFC L455K \$3.50 ea.</p> | <p>SOLDERLESS TEST PROD (BLACK) Threaded type, molded handle \$.40 ea. 10/\$3.50</p> | | | | | | | | | | | | | | | | | | | | | | | | | | | | | | | | | | | | | | | | | | | | | | | | | | | | | | | | | | | | | | | | | | | | | | | | | | | | | | | | | | | | | | | | | | | | | | | | | | | | | | | | | | | | |
| <p>Double Row/Wire Wrap .100</p> <p>25 pins \$3.49 ea 10/\$30.00 30 pins \$3.96 ea 10/\$32.00 50 pins \$5.43 ea 10/\$45.00</p> | <p>50' MODEM CABLES 13#22ga wire w/shield, DB25P conn & DB51226-1 cover on one end \$7.50 ea.</p> | <p>15' MODEM CABLES 10#22ga wire w/shield, DB25P conn & DB51226-1 cover on one end \$5.50 ea. 10/\$50.00</p> | <p>25' MODEM CABLES 13#22ga wire w/shield, DB25P conn & DB51226-1 cover on one end \$6.50 ea. 10/\$60.00</p> | | | | | | | | | | | | | | | | | | | | | | | | | | | | | | | | | | | | | | | | | | | | | | | | | | | | | | | | | | | | | | | | | | | | | | | | | | | | | | | | | | | | | | | | | | | | | | | | | | | | | | | | | | | | |
| <p>Double Row/Solder Eyelet .156</p> <p>6 pins \$1.10 ea 10/\$ 9.00 15 pins \$1.55 ea 10/\$12.50 22 pins \$2.08 ea 10/\$17.00 43 pins \$3.66 ea 10/\$30.00</p> | <p>12 Vdc RELAY SPST 35 Amp Contacts Open Frame Rugged, great for mobile use \$4.50 ea 5/\$20.00</p> | <p>12 Vdc RELAY SPST Open Frame 5 Amp Contacts Mfg-Magnecraft \$1.50 ea 4/\$5.00</p> | <p>USED MUFFIN FANS 3 blades, 110VAC, 4 1/4" sq. \$5.95</p> | | | | | | | | | | | | | | | | | | | | | | | | | | | | | | | | | | | | | | | | | | | | | | | | | | | | | | | | | | | | | | | | | | | | | | | | | | | | | | | | | | | | | | | | | | | | | | | | | | | | | | | | | | | | |
| <p>C & K SWITCHES</p> <p>PART # MOVEMENT 7101 ON/NONE/ON SPST 7103 ON/OFF/ON SPST 7108 ON/NONE/(ON) SPST 7201 ON/NONE/ON DPDT \$1.00 EA 6 FOR \$5.00</p> | <p>RECEIVER FRONT ENDS Made by EFJ 132-174 MHz \$12.00 ea.</p> | <p>100 ASSORTED DISC CAPS (FULL LEADS) 20 EA OF 5 DIFFERENT VALUES \$2.00 PER PACK</p> | <p>CW MINI SLIDE SW DPDT .15 ea. 10/\$1.25</p> | | | | | | | | | | | | | | | | | | | | | | | | | | | | | | | | | | | | | | | | | | | | | | | | | | | | | | | | | | | | | | | | | | | | | | | | | | | | | | | | | | | | | | | | | | | | | | | | | | | | | | | | | | | | |
| <p>6 TV GAMES ON (1) CHIP Gen Instr AY-3-8500-1 28 Pin Plastic Case EVERYDAY LOW PRICE \$7.50 ea</p> | <p>STANCOR TRANSFORMERS STEP-DOWN AUTO (3) COND LINE CORD W/RECPT GSD 200 (230V In/115V Out @ 200 Va) \$12.00 ea GSD 400 (230 In/115 V Out @ 400 Va) \$14.50 ea</p> | <p>White Porcelain Egg Insulator 1 1/2" x 1" 50c ea. 3 for \$1.25</p> | <p>ALL STAR AIR VARIABLE 24-275 pF .75 ea.</p> | | | | | | | | | | | | | | | | | | | | | | | | | | | | | | | | | | | | | | | | | | | | | | | | | | | | | | | | | | | | | | | | | | | | | | | | | | | | | | | | | | | | | | | | | | | | | | | | | | | | | | | | | | | | |
| <p>ASSORTED ELECTROLYTICS</p> <table border="1"> <thead> <tr> <th>VALUE/MFD</th> <th>@</th> <th>VOLTS</th> <th>DIA</th> <th>LENGTH</th> <th>PRICE</th> </tr> </thead> <tbody> <tr><td>250,000</td><td>@</td><td>5V</td><td>3"</td><td>53/4"</td><td>\$4.00 ea</td></tr> <tr><td>30,000</td><td>@</td><td>15V</td><td>3"</td><td>4 1/2"</td><td>4.00 ea</td></tr> <tr><td>63,000</td><td>@</td><td>15V</td><td>3"</td><td>5 1/2"</td><td>4.00 ea</td></tr> <tr><td>10,000</td><td>@</td><td>20V</td><td>1 1/2"</td><td>53/4"</td><td>3.00 ea</td></tr> <tr><td>2,700</td><td>@</td><td>25V</td><td>1 1/4"</td><td>2 1/4"</td><td>2.00 ea</td></tr> <tr><td>2,900</td><td>@</td><td>25V</td><td>1 1/4"</td><td>2"</td><td>2.00 ea</td></tr> <tr><td>3,000</td><td>@</td><td>25V</td><td>1 1/2"</td><td>4 1/2"</td><td>2.00 ea</td></tr> <tr><td>18,000</td><td>@</td><td>25V</td><td>2"</td><td>4"</td><td>3.00 ea</td></tr> <tr><td>21,000</td><td>@</td><td>25V</td><td>2 1/2"</td><td>3"</td><td>3.00 ea</td></tr> <tr><td>39,000</td><td>@</td><td>45V</td><td>3"</td><td>53/4"</td><td>3.00 ea</td></tr> <tr><td>1,000</td><td>@</td><td>50V</td><td>1 1/4"</td><td>3 1/4"</td><td>2.50 ea</td></tr> <tr><td>34,800</td><td>@</td><td>50V</td><td>3"</td><td>5 1/2"</td><td>3.00 ea</td></tr> <tr><td>450</td><td>@</td><td>75V</td><td>1 1/4"</td><td>2 1/4"</td><td>2.00 ea</td></tr> <tr><td>500</td><td>@</td><td>100V</td><td>1 1/2"</td><td>3 1/2"</td><td>2.00 ea</td></tr> <tr><td>240</td><td>@</td><td>300V</td><td>1 1/4"</td><td>3 1/4"</td><td>2.00 ea</td></tr> <tr><td>50</td><td>@</td><td>450V</td><td>1 1/4"</td><td>2"</td><td>2.00 ea</td></tr> <tr><td>140</td><td>@</td><td>450V</td><td>1 1/4"</td><td>3"</td><td>2.00 ea</td></tr> </tbody> </table> | VALUE/MFD | @ | VOLTS | DIA | LENGTH | PRICE | 250,000 | @ | 5V | 3" | 53/4" | \$4.00 ea | 30,000 | @ | 15V | 3" | 4 1/2" | 4.00 ea | 63,000 | @ | 15V | 3" | 5 1/2" | 4.00 ea | 10,000 | @ | 20V | 1 1/2" | 53/4" | 3.00 ea | 2,700 | @ | 25V | 1 1/4" | 2 1/4" | 2.00 ea | 2,900 | @ | 25V | 1 1/4" | 2" | 2.00 ea | 3,000 | @ | 25V | 1 1/2" | 4 1/2" | 2.00 ea | 18,000 | @ | 25V | 2" | 4" | 3.00 ea | 21,000 | @ | 25V | 2 1/2" | 3" | 3.00 ea | 39,000 | @ | 45V | 3" | 53/4" | 3.00 ea | 1,000 | @ | 50V | 1 1/4" | 3 1/4" | 2.50 ea | 34,800 | @ | 50V | 3" | 5 1/2" | 3.00 ea | 450 | @ | 75V | 1 1/4" | 2 1/4" | 2.00 ea | 500 | @ | 100V | 1 1/2" | 3 1/2" | 2.00 ea | 240 | @ | 300V | 1 1/4" | 3 1/4" | 2.00 ea | 50 | @ | 450V | 1 1/4" | 2" | 2.00 ea | 140 | @ | 450V | 1 1/4" | 3" | 2.00 ea | <p>15' MODEM CABLES 14#22ga wire w/shield, DB25P conn & DB51226-1 cover on one end \$6.00 ea. 10/\$55.00</p> <p>15' MODEM CABLES 10#22ga wire w/shield, DB25S conn & DB51226-1 cover on one end \$6.50 ea. 10/\$60.00</p> | <p>CAPS RADIAL LEADS 2200 uF @ 16V .25 ea. 10/\$2.00</p> | <p>RED SEVEN SEGMENT DISPLAY TIL 322P \$1.00 ea.</p> |
| VALUE/MFD | @ | VOLTS | DIA | LENGTH | PRICE | | | | | | | | | | | | | | | | | | | | | | | | | | | | | | | | | | | | | | | | | | | | | | | | | | | | | | | | | | | | | | | | | | | | | | | | | | | | | | | | | | | | | | | | | | | | | | | | | | | | | | | | | | |
| 250,000 | @ | 5V | 3" | 53/4" | \$4.00 ea | | | | | | | | | | | | | | | | | | | | | | | | | | | | | | | | | | | | | | | | | | | | | | | | | | | | | | | | | | | | | | | | | | | | | | | | | | | | | | | | | | | | | | | | | | | | | | | | | | | | | | | | | | |
| 30,000 | @ | 15V | 3" | 4 1/2" | 4.00 ea | | | | | | | | | | | | | | | | | | | | | | | | | | | | | | | | | | | | | | | | | | | | | | | | | | | | | | | | | | | | | | | | | | | | | | | | | | | | | | | | | | | | | | | | | | | | | | | | | | | | | | | | | | |
| 63,000 | @ | 15V | 3" | 5 1/2" | 4.00 ea | | | | | | | | | | | | | | | | | | | | | | | | | | | | | | | | | | | | | | | | | | | | | | | | | | | | | | | | | | | | | | | | | | | | | | | | | | | | | | | | | | | | | | | | | | | | | | | | | | | | | | | | | | |
| 10,000 | @ | 20V | 1 1/2" | 53/4" | 3.00 ea | | | | | | | | | | | | | | | | | | | | | | | | | | | | | | | | | | | | | | | | | | | | | | | | | | | | | | | | | | | | | | | | | | | | | | | | | | | | | | | | | | | | | | | | | | | | | | | | | | | | | | | | | | |
| 2,700 | @ | 25V | 1 1/4" | 2 1/4" | 2.00 ea | | | | | | | | | | | | | | | | | | | | | | | | | | | | | | | | | | | | | | | | | | | | | | | | | | | | | | | | | | | | | | | | | | | | | | | | | | | | | | | | | | | | | | | | | | | | | | | | | | | | | | | | | | |
| 2,900 | @ | 25V | 1 1/4" | 2" | 2.00 ea | | | | | | | | | | | | | | | | | | | | | | | | | | | | | | | | | | | | | | | | | | | | | | | | | | | | | | | | | | | | | | | | | | | | | | | | | | | | | | | | | | | | | | | | | | | | | | | | | | | | | | | | | | |
| 3,000 | @ | 25V | 1 1/2" | 4 1/2" | 2.00 ea | | | | | | | | | | | | | | | | | | | | | | | | | | | | | | | | | | | | | | | | | | | | | | | | | | | | | | | | | | | | | | | | | | | | | | | | | | | | | | | | | | | | | | | | | | | | | | | | | | | | | | | | | | |
| 18,000 | @ | 25V | 2" | 4" | 3.00 ea | | | | | | | | | | | | | | | | | | | | | | | | | | | | | | | | | | | | | | | | | | | | | | | | | | | | | | | | | | | | | | | | | | | | | | | | | | | | | | | | | | | | | | | | | | | | | | | | | | | | | | | | | | |
| 21,000 | @ | 25V | 2 1/2" | 3" | 3.00 ea | | | | | | | | | | | | | | | | | | | | | | | | | | | | | | | | | | | | | | | | | | | | | | | | | | | | | | | | | | | | | | | | | | | | | | | | | | | | | | | | | | | | | | | | | | | | | | | | | | | | | | | | | | |
| 39,000 | @ | 45V | 3" | 53/4" | 3.00 ea | | | | | | | | | | | | | | | | | | | | | | | | | | | | | | | | | | | | | | | | | | | | | | | | | | | | | | | | | | | | | | | | | | | | | | | | | | | | | | | | | | | | | | | | | | | | | | | | | | | | | | | | | | |
| 1,000 | @ | 50V | 1 1/4" | 3 1/4" | 2.50 ea | | | | | | | | | | | | | | | | | | | | | | | | | | | | | | | | | | | | | | | | | | | | | | | | | | | | | | | | | | | | | | | | | | | | | | | | | | | | | | | | | | | | | | | | | | | | | | | | | | | | | | | | | | |
| 34,800 | @ | 50V | 3" | 5 1/2" | 3.00 ea | | | | | | | | | | | | | | | | | | | | | | | | | | | | | | | | | | | | | | | | | | | | | | | | | | | | | | | | | | | | | | | | | | | | | | | | | | | | | | | | | | | | | | | | | | | | | | | | | | | | | | | | | | |
| 450 | @ | 75V | 1 1/4" | 2 1/4" | 2.00 ea | | | | | | | | | | | | | | | | | | | | | | | | | | | | | | | | | | | | | | | | | | | | | | | | | | | | | | | | | | | | | | | | | | | | | | | | | | | | | | | | | | | | | | | | | | | | | | | | | | | | | | | | | | |
| 500 | @ | 100V | 1 1/2" | 3 1/2" | 2.00 ea | | | | | | | | | | | | | | | | | | | | | | | | | | | | | | | | | | | | | | | | | | | | | | | | | | | | | | | | | | | | | | | | | | | | | | | | | | | | | | | | | | | | | | | | | | | | | | | | | | | | | | | | | | |
| 240 | @ | 300V | 1 1/4" | 3 1/4" | 2.00 ea | | | | | | | | | | | | | | | | | | | | | | | | | | | | | | | | | | | | | | | | | | | | | | | | | | | | | | | | | | | | | | | | | | | | | | | | | | | | | | | | | | | | | | | | | | | | | | | | | | | | | | | | | | |
| 50 | @ | 450V | 1 1/4" | 2" | 2.00 ea | | | | | | | | | | | | | | | | | | | | | | | | | | | | | | | | | | | | | | | | | | | | | | | | | | | | | | | | | | | | | | | | | | | | | | | | | | | | | | | | | | | | | | | | | | | | | | | | | | | | | | | | | | |
| 140 | @ | 450V | 1 1/4" | 3" | 2.00 ea | | | | | | | | | | | | | | | | | | | | | | | | | | | | | | | | | | | | | | | | | | | | | | | | | | | | | | | | | | | | | | | | | | | | | | | | | | | | | | | | | | | | | | | | | | | | | | | | | | | | | | | | | | |
| <p>IC SOCKETS Cambion Gold Plated Wire Wrap 14 pin .35 ea 10/\$3.00 16 pin .38 ea 10/\$3.30</p> | <p>SOLDER LUG-TYPE CAPS 50 UF @ 350V 1" D x 3" L 50 UF @ 450V 1" D x 2 1/2" L 50 UF @ 450V 1" D x 3" L 60c EA. 5 FOR \$2.50</p> | <p>BOURNS' EDGE MOUNTING 5K pot single turn 3345W series \$1.50 ea.</p> | | | | | | | | | | | | | | | | | | | | | | | | | | | | | | | | | | | | | | | | | | | | | | | | | | | | | | | | | | | | | | | | | | | | | | | | | | | | | | | | | | | | | | | | | | | | | | | | | | | | | | | | | | | | | |
| <p>COMCO XTAL FILTER 238" x 1" x 1/4" 13KC BW \$10.00 ea.</p> | <p>EFJ CRYSTAL OVENS 6V/12V 75° \$5.00 ea.</p> | <p>12 VOLTS @ 1/2 AMP Filament transformer 1 1/2" x 2" x 1" \$1.50 ea.</p> | | | | | | | | | | | | | | | | | | | | | | | | | | | | | | | | | | | | | | | | | | | | | | | | | | | | | | | | | | | | | | | | | | | | | | | | | | | | | | | | | | | | | | | | | | | | | | | | | | | | | | | | | | | | | |
| <p>Coax Connectors UG-273/U BNC-F/UHF-M 2.50 UG-255/U BNC-M/UHF-F 3.00 UG-146A/U N-M/UHF-F 4.50 UG-83B/U N-F/UHF-M 4.50 UG-175 RG-58 Adapt. .20 UG-176 RG-59 Adapt. .20</p> | <p>AXIAL LEAD ELECTROLYTIC CAPACITORS</p> <table border="1"> <tbody> <tr><td>2 uF @ 15V</td><td rowspan="5">}</td><td rowspan="5">12 ea. for \$1.00</td></tr> <tr><td>10 uF @ 15V</td></tr> <tr><td>20 uF @ 15V</td></tr> <tr><td>50 uF @ 15V</td></tr> <tr><td>2.2 uF @ 25V</td></tr> <tr><td>3.3 uF @ 25V</td><td rowspan="5">}</td><td rowspan="5">15 ea. for \$2.00</td></tr> <tr><td>1 uF @ 35V</td></tr> <tr><td>2 uF @ 150V</td></tr> <tr><td>25 uF @ 25V</td></tr> <tr><td>3 uF @ 50V</td></tr> <tr><td>5 uF @ 50V</td><td rowspan="3">}</td><td rowspan="3">10 ea. for \$2.00</td></tr> <tr><td>10 uF @ 50V</td></tr> <tr><td>250 uF @ 25V</td></tr> <tr><td>100 uF @ 50V</td><td rowspan="2">}</td><td rowspan="2">10 ea. for \$2.00</td></tr> <tr><td>50 uF @ 75V</td></tr> </tbody> </table> | 2 uF @ 15V | } | 12 ea. for \$1.00 | 10 uF @ 15V | 20 uF @ 15V | 50 uF @ 15V | 2.2 uF @ 25V | 3.3 uF @ 25V | } | 15 ea. for \$2.00 | 1 uF @ 35V | 2 uF @ 150V | 25 uF @ 25V | 3 uF @ 50V | 5 uF @ 50V | } | 10 ea. for \$2.00 | 10 uF @ 50V | 250 uF @ 25V | 100 uF @ 50V | } | 10 ea. for \$2.00 | 50 uF @ 75V | | | | | | | | | | | | | | | | | | | | | | | | | | | | | | | | | | | | | | | | | | | | | | | | | | | | | | | | | | | | | | | | | | | | | | | | | | | | | | | | | | | | | | | |
| 2 uF @ 15V | } | 12 ea. for \$1.00 | | | | | | | | | | | | | | | | | | | | | | | | | | | | | | | | | | | | | | | | | | | | | | | | | | | | | | | | | | | | | | | | | | | | | | | | | | | | | | | | | | | | | | | | | | | | | | | | | | | | | | | | | | | | | |
| 10 uF @ 15V | | | | | | | | | | | | | | | | | | | | | | | | | | | | | | | | | | | | | | | | | | | | | | | | | | | | | | | | | | | | | | | | | | | | | | | | | | | | | | | | | | | | | | | | | | | | | | | | | | | | | | | | | | | | | | | |
| 20 uF @ 15V | | | | | | | | | | | | | | | | | | | | | | | | | | | | | | | | | | | | | | | | | | | | | | | | | | | | | | | | | | | | | | | | | | | | | | | | | | | | | | | | | | | | | | | | | | | | | | | | | | | | | | | | | | | | | | | |
| 50 uF @ 15V | | | | | | | | | | | | | | | | | | | | | | | | | | | | | | | | | | | | | | | | | | | | | | | | | | | | | | | | | | | | | | | | | | | | | | | | | | | | | | | | | | | | | | | | | | | | | | | | | | | | | | | | | | | | | | | |
| 2.2 uF @ 25V | | | | | | | | | | | | | | | | | | | | | | | | | | | | | | | | | | | | | | | | | | | | | | | | | | | | | | | | | | | | | | | | | | | | | | | | | | | | | | | | | | | | | | | | | | | | | | | | | | | | | | | | | | | | | | | |
| 3.3 uF @ 25V | } | 15 ea. for \$2.00 | | | | | | | | | | | | | | | | | | | | | | | | | | | | | | | | | | | | | | | | | | | | | | | | | | | | | | | | | | | | | | | | | | | | | | | | | | | | | | | | | | | | | | | | | | | | | | | | | | | | | | | | | | | | | |
| 1 uF @ 35V | | | | | | | | | | | | | | | | | | | | | | | | | | | | | | | | | | | | | | | | | | | | | | | | | | | | | | | | | | | | | | | | | | | | | | | | | | | | | | | | | | | | | | | | | | | | | | | | | | | | | | | | | | | | | | | |
| 2 uF @ 150V | | | | | | | | | | | | | | | | | | | | | | | | | | | | | | | | | | | | | | | | | | | | | | | | | | | | | | | | | | | | | | | | | | | | | | | | | | | | | | | | | | | | | | | | | | | | | | | | | | | | | | | | | | | | | | | |
| 25 uF @ 25V | | | | | | | | | | | | | | | | | | | | | | | | | | | | | | | | | | | | | | | | | | | | | | | | | | | | | | | | | | | | | | | | | | | | | | | | | | | | | | | | | | | | | | | | | | | | | | | | | | | | | | | | | | | | | | | |
| 3 uF @ 50V | | | | | | | | | | | | | | | | | | | | | | | | | | | | | | | | | | | | | | | | | | | | | | | | | | | | | | | | | | | | | | | | | | | | | | | | | | | | | | | | | | | | | | | | | | | | | | | | | | | | | | | | | | | | | | | |
| 5 uF @ 50V | } | 10 ea. for \$2.00 | | | | | | | | | | | | | | | | | | | | | | | | | | | | | | | | | | | | | | | | | | | | | | | | | | | | | | | | | | | | | | | | | | | | | | | | | | | | | | | | | | | | | | | | | | | | | | | | | | | | | | | | | | | | | |
| 10 uF @ 50V | | | | | | | | | | | | | | | | | | | | | | | | | | | | | | | | | | | | | | | | | | | | | | | | | | | | | | | | | | | | | | | | | | | | | | | | | | | | | | | | | | | | | | | | | | | | | | | | | | | | | | | | | | | | | | | |
| 250 uF @ 25V | | | | | | | | | | | | | | | | | | | | | | | | | | | | | | | | | | | | | | | | | | | | | | | | | | | | | | | | | | | | | | | | | | | | | | | | | | | | | | | | | | | | | | | | | | | | | | | | | | | | | | | | | | | | | | | |
| 100 uF @ 50V | } | 10 ea. for \$2.00 | | | | | | | | | | | | | | | | | | | | | | | | | | | | | | | | | | | | | | | | | | | | | | | | | | | | | | | | | | | | | | | | | | | | | | | | | | | | | | | | | | | | | | | | | | | | | | | | | | | | | | | | | | | | | |
| 50 uF @ 75V | | | | | | | | | | | | | | | | | | | | | | | | | | | | | | | | | | | | | | | | | | | | | | | | | | | | | | | | | | | | | | | | | | | | | | | | | | | | | | | | | | | | | | | | | | | | | | | | | | | | | | | | | | | | | | | |

TERMS: All material guaranteed. If for any reason you are not satisfied, our products may be returned within 10 days for a full refund (less shipping). Please add \$3 for shipping and handling on all orders. Additional 5% charge for shipping any item over 5 lbs. COD's accepted for orders totaling \$50.00 or more. All orders shipped UPS unless otherwise specified. Florida residents please add 4% sales tax. Minimum order \$15.00.

82.75
83.0000
84.0000
90.833
93.1346
93.535
93.9353
94.3
95.35
106.850
121.5
126.4
146.64
147.09
153.6

Polorad Model 1206
1.95 to 4.20 GHz
signal source
\$400.00
Model 1107 3.8 to 8.20
GHz signal generator
\$550.00

FETS
3N128 \$1.00
40673 1.39
MPF102 .45
MPF121 1.00
MPF131 1.00

TUNNEL DIODES
TYPE PRICE
TD261A \$10.00
TD263A 10.00
1N2930 7.65
1N3716 5.00
1N4396 7.50

Nicad battery charger . . . \$5.95
E.F. Johnson tube socket #122-0275-001
for 3-400Z, 3-500Z, 4-125A, 4-250A, 4-400A
\$29.95/pair

2300 MHz CONVERTER KIT

PC board and assembly instructions \$25.00
PC board with 13 chip caps - assembled \$44.50
PC board with all parts for assembly \$79.95
PC board assembled and tested \$119.95

| TYPE | PRICE | TYPE | PRICE | TYPE | PRICE |
|-------------|---------|---------------|--------|---------------|--------|
| 2N1561 | \$15.00 | 2N5216 | 47.50 | MM1500 | 32.20 |
| 2N1562 | 15.00 | 2N5583 | 4.43 | MM1550 | 10.00 |
| 2N1692 | 15.00 | 2N5589 | 4.60 | MM1552 | 50.00 |
| 2N1693 | 15.00 | 2N5590 | 6.30 | MM1553 | 56.50 |
| 2N2857JAN | 2.45 | 2N5591 | 10.35 | MM1601 | 5.50 |
| 2N2876 | 12.35 | 2N5637 | 20.70 | MM1602/2N5842 | 7.50 |
| 2N2880 | 25.00 | 2N5641 | 4.90 | MM1607 | 8.65 |
| 2N2927 | 7.00 | 2N5642 | 8.63 | MM1661 | 15.00 |
| 2N2947 | 17.25 | 2N5643 | 14.38 | MM1669 | 17.50 |
| 2N2948 | 15.50 | 2N5645 | 11.00 | MM1943 | 3.00 |
| 2N2949 | 3.90 | 2N5764 | 27.00 | MM2605 | 3.00 |
| 2N2950 | 5.00 | 2N5842 | 8.65 | MM2608 | 5.00 |
| 2N3287 | 4.30 | 2N5849 | 19.50 | MM8006 | 2.15 |
| 2N3294 | 1.15 | 2N5862 | 50.00 | MMCM918 | 1.00 |
| 2N3301 | .75 | 2N5913 | 3.25 | MMT72 | .61 |
| 2N3302 | 1.05 | 2N5922 | 10.00 | MMT74 | .94 |
| 2N3304 | 1.48 | 2N5942 | 46.00 | MMT2857 | 2.68 |
| 2N3307 | 10.50 | 2N5944 | 7.50 | MRF304 | 43.45 |
| 2N3309 | 3.90 | 2N5945 | 10.90 | MRF420 | 20.00 |
| 2N3553 | 1.45 | 2N5946 | 13.20 | MRF450A | 10.35 |
| 2N3818 | 6.00 | 2N6080 | 5.45 | MRF475 | 5.00 |
| 2N3866 | 1.09 | 2N6081 | 8.60 | MRF476 | 5.00 |
| 2N3866JAN | 2.70 | 2N6082 | 9.90 | MRF502 | .49 |
| 2N3866JANTX | 4.43 | 2N6083 | 11.80 | MRF504 | 6.95 |
| 2N3924 | 3.20 | 2N6084 | 13.20 | MRF509 | 4.90 |
| 2N3925 | 6.00 | 2N6094 | 5.75 | MRF511 | 8.60 |
| 2N3927 | 11.50 | 2N6095 | 10.35 | MRF517 | 20.70 |
| 2N3950 | 26.25 | 2N6096 | 19.35 | MRF8004 | 1.44 |
| 2N4072 | 1.70 | 2N6097 | 28.00 | PT4186B | 3.00 |
| 2N4135 | 2.00 | 2N6136 | 18.70 | PT4571A | 1.50 |
| 2N4261 | 14.60 | 2N6166 | 36.80 | PT4612 | 5.00 |
| 2N4427 | 1.09 | 2N6265 | 75.00 | PT4628 | 5.00 |
| 2N4429 | 7.50 | 2N6266 | 100.00 | PT4640 | 5.00 |
| 2N4430 | 20.00 | 2N6439 | 43.45 | PT8659 | 10.72 |
| 2N4957 | 3.50 | 2N6459/PT9795 | 18.00 | PT9784 | 24.30 |
| 2N4958 | 2.80 | A50-12 | 25.00 | PT9790 | 41.70 |
| 2N4959 | 2.12 | BFR90 | 3.00 | PT9847 | 26.40 |
| 2N4976 | 19.00 | BLY568C | 25.00 | SD1043 | 5.00 |
| 2N5090 | 6.90 | BLY568CF | 25.00 | SD1116 | 3.00 |
| 2N5108 | 3.90 | CD3495 | 15.00 | SD1118 | 5.00 |
| 2N5109 | 1.55 | HEP76/S3014 | 4.95 | SD1119 | 3.00 |
| 2N5160 | 3.34 | HEPS3002 | 11.30 | TA7993 | 75.00 |
| 2N5179 | .49 | HEPS3003 | 29.88 | TA7994 | 100.00 |
| 2N5184 | 2.00 | HEPS3005 | 9.95 | 40281 | 10.90 |
| | | HEPS3006 | 19.90 | 40282 | 11.90 |
| | | HEPS3007 | 24.95 | 40290 | 2.48 |
| | | HEPS3010 | 11.34 | | |
| | | HEPS5026 | 2.56 | | |

MHZ ELECTRONIC KITS:

kit #1
Motorola MC14410CP CMOS Tone Generator
CMOS Tone Generator uses 1MHZ crystal to produce standard dual frequency dialing signal. Directly compatible with 12 key Chomeric Touch Tone Pads. Kit includes the following:
1 Motorola MC14410CP Chip
1 PC Board
And all other parts for assembly, with 1 MHz crystal \$20.65

Kit #2
Fairchild 95H90DC Prescaler 350MHZ.
95H90DC Prescaler divides by 10 to 350 MHZ. This kit will take any 35MHZ Counter to 350 MHZ. Kit includes the following:
1 Fairchild 95H90DC Chip
1 2N5179 Transistor
2 UG-88/U BNC Connectors
1 PC Board
And all other parts for assembly. **NOW ONLY \$24.95**
Less 95H90 chip \$10.95

FAIRCHILD VHF AND UHF PRESCALER CHIPS

| | | |
|---------|---------------------------------------|---------|
| 95H90DC | 350MHZ Prescaler Divide by 10/11 | \$ 9.50 |
| 95H91DC | 350MHZ Prescaler Divide by 5/6 | 8.95 |
| 11C90DC | 650MHZ Prescaler Divide by 10/11 | 16.50 |
| 11C91DC | 650MHZ Prescaler Divide by 5/6 | 15.95 |
| 11C83DC | 1GHZ Divide by 248/256 Prescaler | 29.90 |
| 11C70DC | 600MHZ Flip/Flop with reset | 12.30 |
| 11C58DC | ECL VCM | 4.53 |
| 11C44DC | Phase Frequency Detector (MC4044P/L) | 3.82 |
| 11C24DC | Dual TTL VCM (MC4024P/L) | 3.82 |
| 11C06DC | UHF Prescaler 750MHZ D Type Flip/Flop | 12.30 |
| 11C05DC | 1GHZ Counter Divide by 4 | 74.35 |
| 11C01FC | High Speed Dual 5-4 Input NO/NOR Gate | 15.40 |

CRYSTAL FILTERS: Tyco 001-19880 same as 2194F
10.7MHZ Narrow Band Crystal Filter
3 db bandwidth 15khz minimum 20 db bandwidth 60khz minimum 40 db bandwidth 150khz minimum. Ultimate 50 db: Insertion loss 1.0db Max. Ripple 1.0db Max. Ct. 0+ - 5pf. Rt. 3600 Ohms.
NOW ONLY \$5.95

We bought 6,000 LED digital clocks, made by Spartus. All have alarms. Sold as is. (Some alarms don't work.)
\$7.95 each/2 for \$13.95
Have National clock module Model MA 1002 and 1023. Can be used for 12- or 24-hours.

TUBES

| | | | |
|-----------|--------|-------------|--------|
| 2E26 | \$5.00 | 4X150G | 70.00 |
| 3-500Z | 90.00 | 100TH | 144.00 |
| 3-1000Z | 225.00 | 572B | 39.00 |
| 3B28 | 5.00 | 811A | 12.95 |
| 3X2500A3 | 150.00 | 813 | 29.00 |
| 4.65A | 54.50 | 5894 | 39.00 |
| 4-125A | 68.75 | 6146A | 5.25 |
| 4-250A | 80.00 | 6146B | 6.25 |
| 4-400A | 81.50 | 6159 | 10.60 |
| 4-1000A | 255.00 | 6293 | 18.50 |
| 5-500A | 145.00 | 6360 | 6.95 |
| 4CX250B | 38.50 | 6907 | 35.00 |
| 4CX250F | 53.50 | 6939 | 14.75 |
| 4CX250G | 53.50 | 7360 | 10.60 |
| 4CX250K | 72.00 | 7984 | 10.40 |
| 4CX250R | 48.00 | 8072 | 45.00 |
| 4CX350A | 60.00 | 8156 | 7.85 |
| 4CX350FJ | 70.00 | 8226 | 127.70 |
| 4CX1000A | 289.00 | 8295A/PL172 | 328.00 |
| 4CX1500B | 285.00 | 8458 | 25.75 |
| 4CX15000A | 400.00 | 8560AS | 50.00 |
| 4X150A | 37.00 | 8950 | 7.80 |

TERMS:
All checks and money orders are in U.S. funds!
All orders sent first class or UPS.
Please include \$1.50 minimum for postage.
All prices are in U.S. dollars.
All parts prime/guaranteed.
5% service charge on all bank cards.



✓ 48

(602) 242-3037
2111 W. Camelback
Phoenix, Arizona 85015

BANK AMERICARD/VISA/MASTERCHARGE
Your Number (or equivalent)
Exp. Date
Your Signature:

SEMICONDUCTORS SURPLUS

2822 North 32nd Street/Unit -1 Phoenix, Arizona 85008 (602) 956-9423

We accept checks, MasterCharge, and Visa

Prices subject to change without notice



E.F. JOHNSON TUBE SOCKETS & PARTS

POWER TUBE SOCKET

for RCA 8072, 8021, 8122, and 8462
EIA base #E11-81
Will also fit CRT tubes 1EP11 and 1EP1 EIA base #E11-22

\$4.99 each

SCREEN GRID BY-PASS

CAPACITOR

1450pf @ 1000pf
Part No. 124-0113-001

\$9.95 each

POWER TUBE SOCKETS

for 4X150A and D, 4CX250B and R, 4CX350A
Part No. 124-0107-001

\$14.95

CHIMNEY for 4CX250B and R, 4X150A and D, and 4CX350A

Part No. 124-0111-001

\$3.99

POWER TUBE SOCKETS

for 4-125A, 4-250A, 4-400A/C etc., 3-400Z, and 3-500Z

Part No.

\$29.95 per pair only

SPRAGUE RF NOISE FILTERS

#JN17-4080A
100VDC @ 70Amps
.22mfd

\$2.99 each

CARBIDE DRILL BITS

for drilling P.C.B.

5 mix **\$6.00**

10 mix **\$10.00**

25AMP SCR's

| | |
|-------|--------|
| 2N681 | \$1.10 |
| 2N682 | 1.25 |
| 2N683 | 1.45 |
| 2N684 | 1.60 |
| 2N685 | 1.70 |
| 2N686 | 1.95 |
| 2N687 | 2.45 |
| 2N688 | 3.45 |
| 2N690 | 3.95 |

E.F. JOHNSON MINIATURE TYPE V AIR VARIABLE CAPS

| | |
|-------------|------------|
| 189-503-105 | 1.4-9.2pf |
| 189-504-4 | 1.8-5pf |
| 189-504-5 | 1.5-11.6pf |
| 189-505-5 | 1.7-14.1pf |
| 189-506-105 | 1.8-16.7pf |
| 189-507-5 | 2-19.3pf |
| 189-508-5 | 21.-22.9pf |
| 189-509-5 | 2.4-24.5pf |
| 189-1-1-4 | 1.2-4.2pf |
| 189-4-5 | 1.5-9.1pf |
| 189-5-8 | 1.1-11pf |
| 189-6-8 | 1.8-13pf |
| 189-503-5 | 1.4-9.2pf |

\$1.50 each

FET's

| | |
|---------------|-------------------|
| 3N128 | \$1.00 or 10/8.00 |
| 40673 | 1.39 or 10/10.00 |
| MPF102 | .45 or 10/3.50 |
| MFE131 | 1.00 or 10/8.00 |
| U2705/2N4416 | 1.00 or 10/8.00 |
| MFE2000 | 1.00 or 10/8.00 |
| MPF4391 | .80 or 10/6.00 |
| 2N4303 | .50 or 3/1.00 |
| 2N5484 | .50 or 3/1.00 |
| 2N5555 | .90 or 2/1.50 |
| 2N5639 | .48 or 3/1.00 |
| 2N5246 | .50 or 3/1.00 |
| 2N5248/MPF102 | .45 or 10/3.50 |
| 3N201 | 1.99 or 10/12.00 |
| 3N157A | 6.00 each |

MOTOROLA POWER TRIACS

TO-220 case
15Amps 600PRV
99¢ each or 10/\$7.50

TUBES

| | |
|--------------------------|---------|
| 2E26 | \$ 5.00 |
| 3-500Z | 90.00 |
| 3B28 | 4.00 |
| 3X2500A3 | 125.00 |
| 3X3000F1 | 200.00 |
| 4-65A | 30.00 |
| 4-125A | 40.00 |
| 4-250A | 60.00 |
| 4-400A | 80.00 |
| 4-1000A | 175.00 |
| 4CX250B | 38.50 |
| 4CX250R | 40.00 |
| 4CX350A | 50.00 |
| 4CX1000A | 150.00 |
| 4X150A | 20.00 |
| 4X150G | 30.00 |
| 572B/T160L | 39.00 |
| 811A | 9.95 |
| 6146 | 4.50 |
| 6146A | 5.25 |
| 6146B | 6.50 |
| 6146W | 7.50 |
| 6360 | 7.95 |
| 6939 | 8.00 |
| 8072 | 45.00 |
| 8295/PL172 | 300.00 |
| 8950 | 5.95 |
| 8877 | 300.00 |
| 7289 | 6.99 |
| 6KD6 | 4.00 |
| 6LF6 | 4.00 |
| 6LQ6/6JE6 | 5.99 |
| 8908 | 8.99 |
| 6550A | 8.00 |
| Other numbers on request | |

HIGH VOLTAGE CAPS

22mfd @ 500VDC
7/8 in. x 1 1/2 in.
\$1.99 each

330mfd @ 450VDC
Can Type
1 7/8 in. x 4 1/4 in.
\$4.99 each

SEMICONDUCTORS SURPLUS

2822 North 32nd Street/Unit #1 Phoenix, Arizona 85008 (602) 956-9423

We accept checks, MasterCharge, and Visa

Prices subject to change without notice



DIP TANTALUMS

.1 uf @ 10V
 .1 uf @ 35V
 .47 uf @ 35V
 1 uf @ 35V
 2.2 uf @ 25V
 2.2 uf @ 16V
 10 uf @ 35V
 22 uf @ 10V
 22 uf @ 16V
 100 uf @ 3V
49¢ each

CAPACITORS

.001/1000pf @ 100VDC
 1/8 in. round
**10/\$1.00, 50/\$4.00,
 100/\$7.00, 1000/\$40.00**

.01 @ 1KVDC
6/\$1.00

.01 @ 25VDC
10/\$1.00

.1 @ 25VDC
10/\$1.00

.01 @ 50VDC
10/\$1.00

.001 @ 50VDC
10/\$1.00

HAM MICROWAVE DOWNCONVERTER KIT

2100 to 2400MHz
 Power supply kit with
 P.C.B., downconverter
 kit with P.C.B. and
 antenna all for **\$159.95**
 Or assembled and tested
\$299.95 (specify frequency
 tuned to)
 All parts necessary
 included in kits.

DIP PLUGS

14 pin **25¢**
 28 pin **45¢**

IC SOCKETS - LOW PROFILE

8 pin **20¢**
 14 pin **17¢**
 16 pin **19¢**
 22 pin **25¢**
 24 pin **28¢**
 28 pin **30¢**
 40 pin **40¢**

IC SOCKETS - WIRE WRAP

40 pin **\$1.10**

CHOKES (U252)

2.5mh 150ma
69¢ each

MUFFIN FANS

Removed from equipment
 115VAC
\$4.99 each

MOTOROLA POWER TRANSISTORS

PNP MJE2955 **\$1.69**
 NPN MJE3055 **.99**
 60V @ 10Amps @ 90 Watts
 20/120HFE

MOTOROLA POWER DARLINGTONS

PNP MJ900 **\$1.69**
 NPN MJ1000 **1.29**
 60V @ 8Amps @ 90Watts @
 1000HFE min.

NEW SPST DIP SWITCHES

3 position **\$1.00**
 4 **1.25**
 5 **1.30**
 6 **1.35**
 7 **1.25**
 8 **1.50**
 10 **1.35**

UA703 RF/IF

limiting amp.
\$1.00 each

LIGHT ACTIVATED SCR's

TO-18 case
 400VDC @ 800MA
2/\$1.25

HIGH VOLTAGE CAPS

.02 @ 8000VDC
 2 1/2 in. x 1 in.
\$2.00 each

FEED THRU CAPACITORS

.0015 uf
 .0033 uf
 .1 uf
 .001 uf
 100 pf
 500 pf
 800 pf
 1000 pf
 1200 pf
 1500 pf
 6200 pf
99¢ each

MOTOROLA/RCA 2N3055

NPN TO-3 case
 115Watts, 100VCB,
 70VCE, 15Amps,
 20-70HFE min.
79¢ each

UA715 HIGH SPEED

OP AMP
\$1.00 each

C106B SCR

TO-92 case
 .8Amps, 200V
 200UA gate
10/\$1.00

HF & VHF BEAMS and VERTICALS



SPECTRONICS, INC.

1009 Garfield St., Oak Park, Illinois • 60304

(312) 848-6777 ✓67

the antenna
specialists



2 MTR DUCKIES

- Model HM-4. Has 5/16"-32 thread. Fits Motorola HT's, ICOM IC215 and Standard 146A \$7.00
- Model HM-5. Same as above, but with PL-259 connector \$7.00
- Model HM-226. Same, with TNC connector for Wilson 1405 \$18.50
- Model HM-227. Same, but with BNC connector termination \$12.00
- Model HM-228. With F connector for Wilson 1402 & Tempo \$11.50

- HM180 2mtr, 3db trunk lip ant. \$33.50 b
- HM179 2mtr, 3db hole mount ant. 29.00 b
- HM20 2mtr, 3db for marine use. 39.00 b
- HM176 440MHz 5db trunk lip ant. 33.00 b
- HM175 440MHz 5db hole mount ant. 29.00 b
- HM224 220MHz 4db trunk lip ant. 33.50 b

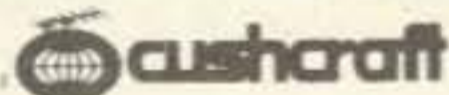

- AR2 2meter Ringo base ant. \$24.95 b
- ARX2 2mtr Ringo Ranger base ant. . . 39.95 c
- AR220 220MHz Ringo base ant. 24.95 b
- ARX220 220MHz Ringo Ranger. 39.95 c
- AR450 UHF Ringo base ant. 24.95 b
- ARX450 UHF Ringo Ranger base ant. . 39.95 c
- AR6 6 meter Ringo base ant. 36.95 c
- ARX2K Adapts 2M Ringo to Ranger . 16.95 b
- A147-4 4 ele 2M FM beam ant. 24.95 b
- A147-11 11 ele 2M FM beam. 36.95 c
- A147-20T 10 ele 2M vert/horz twist. . 62.95 d
- A144-7 7 ele 2M CW/SSB beam. 26.95 c
- A144-11 11 ele 2M CW/SSB beam. 36.95 d
- A144-10T 10 ele Twist OSCAR ant. 42.95 c
- A144-20T 20 ele Twist OSCAR ant. 62.95 d
- A220-7 7 ele 220MHz beam. 26.95 c
- A220-11 11 ele 220MHz beam. 34.95 c
- A449-6 6 ele UHF FM beam. 24.95 c
- A449-11 11 ele UHF beam. 34.95 c
- A432-11 11el 432MHz SSB/CW beam 34.95 c
- AFM4D 144-148MHz Four Pole. 69.95 c
- AFM24D 220MHz Four Pole. 64.95 c
- AFM44D 435-450MHz Four Pole. 64.95 c
- ASQ-2 2M Squalo horiz ant. 19.95 b
- LAC-1 Coax lightning arrester. 4.95 a
- LAC2- Coax lightning arrester. 4.95 a
- ATB34 ★ 4 ele 20-10mtr beam. 219.95 ★
- ATV3 20-10mtr trap vertical. 49.95 e
- ATV4 40-10mtr trap vertical. 69.95 e
- ATV5 80-10mtr trap vertical. 89.95 e
- A50-3 3 element 6 meter beam. 39.95 d
- A50-5 5 element 6 meter beam. 59.95 e
- A28-3 ★ 3 element 10 meter beam. . 69.95 ★
- A432-20T 432MHz 20 ele twist. 59.95 d

AVERAGE SHIPPING COST GUIDE

(Continental U.S.) Items sent UPS whenever possible.

Please estimate the shipping charges for your order. Any excess payment over 25c will be refunded or credited. Underpayment will be billed or sent collect. For insurance add 25c for each \$100.00 value over the first \$100.00.

| W/K CALL AREA | 1,2,3,4,5 | 6,7 | 8,0 | 9 |
|---------------|-----------|-------|------|------|
| 1 lb. | .90 | 1.00 | .90 | .85 |
| 5 lbs. | 1.50 | 2.00 | 1.35 | 1.20 |
| 10 lbs. | 2.25 | 3.20 | 1.95 | 1.70 |
| 20 lbs. | 3.80 | 5.60 | 3.20 | 2.60 |
| 30 lbs. | 5.30 | 8.05 | 4.40 | 3.50 |
| 50 lbs. | 8.40 | 12.90 | 6.80 | 5.35 |

ESTIMATED WEIGHT CODING

After the price of each item you will find a letter, i.e., 19.95 a. To make it easier to figure shipping costs, these letters indicate the approximate weight of the item as follows:

- a. Less than 1 lb.
- b. 1-3 lbs.
- c. 4-6 lbs.
- d. 7-10 lbs.
- e. 10-20 lbs.
- f. 20-30 lbs.
- g. 30-40 lbs.
- h. 40-50 lbs.

NOTE: INTERNATIONAL ORDERS write for Proforma Invoice. ITEMS MARKED ★ will be sent truck collect.

2M BASE ANT. PACKAGE



Here's what you get:

- Cushcraft AR2 Ringo South River.
- PFM71 Roof mount.
- A125-5P 5' alum mast.
- Lag bolts.
- 50' 8U foam coax.
- PL259 coax conn.

\$59⁹⁵

Wt. 16 lbs.



The most rugged 6 & 2 meter beams we've seen yet!!

- A 2-10 10 ele, 2M beam \$44.95 d
- A 2-5 5 ele, 2M beam, 9.5db gain. 27.95 c
- A 2-2 10 ele, 2M dual polarization. 46.50 e
- A62 6&2M antenna on one boom 74.95 e
- A6-5 5 element 6M beam, 11db 46.50 e
- A6-3 3 ele 6M beam, 7db gain 30.00 d
- A 1 1/4 220MHz 10 ele, 13.8db 32.95 d

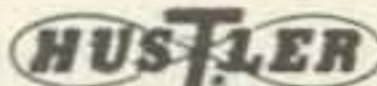

\$9⁹⁵ "BUCK-BUSTER" SF-2 ANTENNA

Fits all Hustler deluxe mobile mounts. 3/8"x24 base 5/8" wave two meters, 3.4 db gain. SWR at resonance: adj. to 1.5:1 or better. Bandwidth: 6 MHz, 2:1 or better SWR. 100 watts max.

\$79⁹⁵ NEW 4-BTV VERTICAL

One setting covers 10, 15, 20, 40M. Space restricted or unlimited, you get top signal reports, consistent contacts and complete coverage. Add 5th band with a 75M resonator. Use one feedline, any length. Requires no switching or matching devices. 15 lbs.

SF-2

4-BTV

- MO1 Mobile mast \$22.95 c
- MO2 Mobile mast 22.95 c
- RM10 10 Meter resonator. 6.95 b
- RM15 15 meter resonator. 7.95 b
- RM20 20 Meter resonator. 8.95 b
- RM40 40 Meter resonator. 14.95 b
- RM75 75 Meter resonator. 16.95 b
- RM80 80 Meter resonator. 17.95 b
- RM10S 10M resonator 2KW PEP 11.95 b
- RM15S 15M resonator 2KW PEP 12.95 b
- RM20S 20M resonator 2KW PEP 13.95 b
- RM40S 40M resonator 2KW PEP 16.95 b
- RM75S 75M resonator 2KW PEP 31.95 b
- RM80S 80M resonator 2KW PEP 31.95 b
- CG144 5.2db 2mtr ant 3/4 x 24 stud. . 26.95 b
- CGT144 Same but trunk lip mount. . . 42.95 c
- SF2 3db 2mtr ant 3/4 x 24 stud. 9.95 b
- SF220 3db 220MHz ant 3/4 x 24 stud. . 11.95 b
- 4BTU 40-10mtr vertical. 79.95 e
- G6-144 2mtr base ant 6db. 79.95 d
- BM1 Bumper mount 3/4 x 24 thread. . 15.95 d
- RSS2 Mobile resonator spring. 5.95 a
- QD1 Quick disconnect 3/4 x 24. 16.95 a

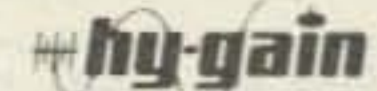

VERTICAL ANTENNAS

- Model 14AVQ/WB \$69.95
- SAVE \$10.00!
- List \$79.95

Self-supporting, automatic band switching vertical antenna. Omni-directional performance. Favorable L/C ratio. High Q. True 1/4 wave resonance on all bands. Low angle radiation pattern. Taper swaged seamless aluminum construction. 12" double-grip mast bracket. Full circumference compression clamps at tubing joints. Weight: 8.2 lbs.

Model 14AVQ/WB 59.95

- Model 18AVT/WB \$87.00
- SAVE \$18.00!
- List \$105.00

Three beefed-up Hy-Q traps permit automatic switching. 5 band capability. Favorable L/C ratio. Top loading coil. Across the band performance with one furnished setting for each band (10 thru 40). True 1/4 wave resonance on all bands. SWR of 2:1 or less at band edges. Low angle radiation pattern. Extra heavy duty tapered swaged seamless aluminum tubing with full circumference, corrosion resistant compression clamps at tubing joints. Antenna can be mounted without guide wires. 25' high. Weight: 10.7 lbs.

Model 18 AVT/WB 87.00

- BN86 Ferrite balun for 80-10mtrs. \$15.95 a
- 155 Center insulator for doublet. 5.95 a
- 156 End insul. for doublet (pair) 3.95 a
- 18HT ★ HyTower 80-10M vertical. . . 289.95 ★
- 18V Economy 80 tru 10M vertical. 29.95 c
- 12AVQ 20-10mtr trap vertical. 39.95 c
- 14AVQ 40-10mtr trap vertical. 59.95 d
- 18AVT/WB 80-10mtr trap vertical. . . 87.00 d
- 2BDQ Trap doublet for 80 & 40mtr. . . 49.95 d
- 5BDQ Trap doublet for 80-10mtrs. . . 89.95 e
- TH3 MkIII ★ 3 ele 20-10 tribander. . 189.95 ★
- TH6DXX ★ 6 ele 20-10M tribander. . 264.95 ★
- TH3 Jr 3 ele tribander (750W PEP) . 149.95 e
- HY QUAD ★ 2 ele quad 20-10 mtrs. . 229.95 ★
- 103BA 3 element 10Mtr beam. 64.95 e
- 153BA ★ 3 element 15mtr beam. 79.95 e
- 204BA ★ 4 element 20mtr beam. 214.95 ★
- 402BA ★ 2 element 40 mtr beam. 204.95 ★
- 64B ★ 4 element 6 meter beam. 49.95 b
- 270 6db fiberglass 2M antenna. 49.95 b
- 203 3 element 2 meter yagi. 21.95 b
- 205 5 element 2 meter yagi. 17.95 c
- 208 8 element 2 meter yagi. 29.95 c
- 214 14 element 2 meter yagi. 34.95 d

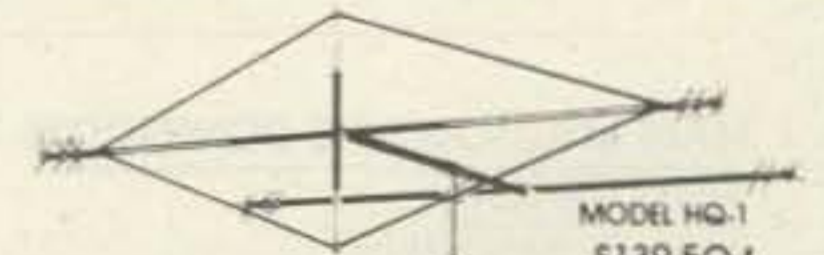

CRAMPED FOR SPACE?

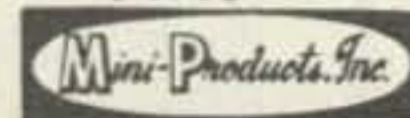

Then you want the antenna that's known around the world for its small size and superior performance. The Multiband HYBRID QUAD for 6-10-15 & 20 meters.

- WING SPAN-11 FT.
- BOOM-54 INCHES LONG
- WIND AREA-1.5 SQ. FT.
- 1200 WATTS PEP INPUT TO FINAL
- FEED LINE-50 OHMS



GIVE US A TRY ON YOUR MFJ NEEDS. MANY TIMES WE CAN GIVE QUICKER DELIVERY THAN WHEN YOU ORDER DIRECT.

Low Cost...High Performance

DIGITAL MULTIMETER



\$99.95 WIRED

Low cost, high performance, that's the DM-700. Unlike some of the hobby grade DMMs available, the DM-700 offers professional quality performance and appearance at a hobbyist price. It features 26 different ranges and 5 functions, all arranged in a convenient, easy to use format. Measurements are displayed on a large 3½ digit, ½ inch high LED display, with automatic decimal placement, automatic polarity, and overrange indication. You can depend upon the DM-700, state-of-the-art components such as a precision laser trimmed resistor array, semiconductor band gap reference, and reliable LSI circuitry insure lab quality performance for years to come. Basic DC volts and ohms accuracy is 0.1%, and you can measure voltage all the way from 100 μV to 1000 volts, current from 0.1 μA to 2.0 amps and resistance from 0.1 ohms to 20 megohms. Overload protection is inherent in the design of the DM-700, 1250 volts, AC or DC on all ranges, making it virtually goof proof. Power is supplied by four 'C' size cells, making the DM-700 portable, and, as options, a nicad battery pack and AC adapter are available. The DM-700 features a handsome, jet black, rugged ABS case with convenient retractable tilt bail. All factory wired units are covered by a one year limited warranty and kits have a 90 day parts warranty.

Order a DM-700, examine it for 10 days, and if you're not satisfied in every way, return it in original form for a prompt refund.

Specifications

DC and AC volts: 100 μV to 1000 Volts, 5 ranges
 DC and AC current: 0.1 μA to 2.0 Amps, 5 ranges
 Resistance: 0.1Ω to 20 megohms, 6 ranges
 Input protection: 1250 volts AC/DC all ranges fuse protected for overcurrent
 Input impedance: 10 megohms, DC/AC volts
 Display: 3½ digits, 0.5 inch LED
 Accuracy: 0.1% basic DC volts
 Power: 4 'C' cells, optional nicad pack, or AC adapter
 Size: 6"W x 3"H x 6"D
 Weight: 2 lbs with batteries

Prices

| | |
|------------------------------------|---------|
| DM-700 wired + tested | \$99.95 |
| DM-700 kit form | 79.95 |
| AC adapter/charger | 4.95 |
| Nicad pack with AC adapter/charger | 19.95 |
| Probe kit | 3.95 |

TERMS: Satisfaction guaranteed or money refunded, COD, add \$1.50. Minimum order \$6.00. Orders under \$10.00, add \$.75. Add 5% for postage, insurance, handling. Overseas, add 15%. NY residents, add 7% tax.



600 mHz COUNTER



\$99.95 WIRED

The CT-70 breaks the price barrier on lab quality frequency counters. No longer do you have to settle for a kit, half-kit or poor performance, the CT-70 is completely wired and tested, features professional quality construction and specifications, plus is covered by a one year warranty. Power for the CT-70 is provided by four 'AA' size batteries or 12 volts, AC or DC, available as options are a nicad battery pack, and AC adapter. Three selectable frequency ranges, each with its own pre-amp, enable you to make accurate measurements from less than 10 Hz to greater than 600 mHz. All switches are conveniently located on the front panel for ease of operation, and a single input jack eliminates the need to change cables as different ranges are selected. Accurate readings are insured by the use of a large 0.4 inch seven digit LED display, a 1.0 ppm TCXO time base and a handy LED gate light indicator.

The CT-70 is the answer to all your measurement needs, in the field, in the lab, or in the ham shack. Order yours today, examine it for 10 days, if you're not completely satisfied, return the unit for a prompt and courteous refund.

Specifications

Frequency range: 10 Hz to over 600 mHz
 Sensitivity: less than 25 mv to 150 mHz
 less than 150 mv to 600 mHz
 Stability: 1.0 ppm, 20-40°C; 0.05 ppm/°C TCXO crystal time base
 Display: 7 digits, LED, 0.4 inch height
 Input protection: 50 VAC to 60 mHz, 10 VAC to 600 mHz
 Input impedance: 1 megohm, 6 and 60 mHz ranges 50 ohms, 600 mHz range
 Power: 4 'AA' cells, 12 V AC/DC
 Gate: 0.1 sec and 1.0 sec LED gate light
 Decimal point: Automatic, all ranges
 Size: 5"W x 1½"H x 5½"D
 Weight: 1 lb with batteries

Prices

| | |
|------------------------------------|---------|
| CT-70 wired + tested | \$99.95 |
| CT-70 kit form | 75.95 |
| AC adapter | 4.95 |
| Nicad pack with AC adapter/charger | 14.95 |
| Telescopic whip antenna, BNC plug | 7.95 |
| Tilt bail assembly | 3.95 |

ramsey electronics

✓ 62

BOX 4072, ROCHESTER, N.Y. 14610
 PHONE ORDERS CALL
 (716) 271-6487

STOCK UP YOUR LAB WITH OUR SPECIALS!!

Now is the time to take advantage of some exceptional deals. These specials will be appearing soon in other electronics magazines, but 73 readers get first crack at the goodies. Please note that the following special items are first come, first served, and that quantities are limited.

| | | | |
|---------------------------|-----------|---------------------------|-----------|
| 14 pin soldertail sockets | 50/\$4.95 | 24 pin soldertail sockets | 30/\$4.95 |
| 16 pin soldertail sockets | 50/\$4.95 | 28 pin soldertail sockets | 30/\$4.95 |
| 18 pin soldertail sockets | 50/\$4.95 | 40 pin soldertail sockets | 20/\$4.95 |
| 20 pin soldertail sockets | 40/\$4.95 | | |

TO-92 or TO-18 (sorry, no choice) NPN transistors. General purpose, for small signal and switching use; similar to 2N3904. 100/\$7.95

TO-92 or TO-18 (sorry, no choice) PNP transistors. General purpose, for small signal and switching use; similar to 2N3906. 100/\$8.95

IMSAI spacing S-100 soldertail edge connectors. 2/\$5.00

& MORE!

IT PAYS TO READ 73...

Our MA1003 clock module/case combination has been very popular for mobile and home timekeeping applications. And why not? 12V DC operation, internal crystal timebase accurate to .01%, blue-green fluorescent readouts, and other outstanding features — along with documentation that shows how to use this module to maximum advantage in your car — combine to make an outstanding value. Our normal price is \$19.95 for the clock and case, but you can deduct \$1 from our already low price if you mention that you are a 73 reader. Please note: any orders that take the \$1 deduction but do not mention 73 will have to be returned.

Although not subject to the \$1 discount when purchased separately, the clock module is available without case for \$16.50.

16K Dynamic RAMS 8/\$87.20

Expand memory in TRS-80* -I and -II, Exidy, Apple, new PET, H89, etc. These are low power 250 ns chips that are compatible with 4 MHz systems.

Add \$3 for 2 dip shunts plus instructions for TRS-80* expansion.

*TRS-80 is a trademark of the Tandy Corporation

TERMS: Allow 5% for shipping (excess refunded). VISA®/Mastercharge® orders, call our 24 hour order desk at (415) 562-0636. COD OK with street address for UPS. Cal res add tax. Prices good through cover month of magazine and are subject to change without notice..

GODBOUT

GODBOUT ELECTRONICS
Bldg. 725, Oakland Airport, CA 94614

12V 8A Power Supply \$44.50

Handles 12V peaks with a 50% duty cycle. Includes crowbar overvoltage protection, current limiting, adjustable output 11-14V, custom wound transformer, RF suppression, and easy assembly (all parts except transformer, filter cap, and diodes mount on the circuit board). Ideal for powering transceivers, automotive tape decks and TVs, other 12V automobile accessories, bunches of floppy disks, and more. Please allow at least \$5 for shipping this supply; excess will be refunded.

MEMORY!!!!!!

Choose from unkit (sockets, bypass caps pre-soldered in place), assembled, or boards qualified under our high-reliability Certified System Component (CSC) program (200 hour burn-in, extensive testing, immediate replacement in event of failure within 1 year of invoice date).

| Name | Buss & Notes | Unkit | Assm | CSC |
|------------------------|--------------|-------|-------|--------|
| 8K Econoram**IIA | S-100 | \$149 | \$179 | \$239 |
| 16K Econoram IV | S-100 | \$289 | \$339 | \$429 |
| 16K Econoram VIIA-16 | S-100 | \$299 | \$349 | \$439 |
| 24K Econoram VIIA-24 | S-100 | \$419 | \$499 | \$605 |
| 16K Econoram IX-16 | Dig Grp | \$319 | \$379 | n/a |
| 32K Econoram IX-32 | Dig Grp | \$559 | \$639 | n/a |
| 32K Econoram X | S-100 | \$549 | \$669 | \$789 |
| 32K Econoram XI | SBC/BLC | n/a | n/a | \$1050 |
| 16K Econoram XIII A-16 | S-100 (1) | \$349 | \$419 | \$519 |
| 24K Econoram XIII A-24 | S-100 (1) | \$469 | \$539 | \$649 |
| 32K Econoram XIII A-32 | S-100 (1) | \$579 | \$699 | \$849 |
| 16K Econoram XIV | S-100 (2) | \$299 | \$359 | \$459 |
| 16K Econoram XV-16 | H8 (3) | \$329 | \$395 | n/a |
| 32K Econoram XV-32 | H8 (3) | \$599 | \$729 | n/a |

**Econoram is a trademark of Godbout Electronics

- (1) Compatible with all bank select systems (Cromemco, Alpha Micro, Etc.); addressable on 4K boundaries.
- (2) Extended addressing (24 address lines). Single block addressable on 4K boundaries.
- (3) Bank select option for implementing memory systems greater than 64K.

FREE FLYER: Our latest catalogue has lots of good stuff in it... parts, books, kits, computer equipment, music kits... and you can get one if you live in the USA by simply sending us your name and address (add 41¢ in stamps for 1st class delivery). Canada/international, send \$1 to cover postage costs.

ASSOCIATED RADIO

913-381-5900

8012 CONSER BOX 4327

OVERLAND PARK, KANSAS 66204



CALL US WITH YOUR REQUIREMENTS
AMERICA'S NO. 1 Real Amateur Radio Store



**Associated Wants to TRADE - BUY - SELL
GOT YOUR BEST DEAL? THEN CALL US AT
913-381-5900 - NO TRADE? ASK FOR EXT. 12**

**NOTE: SEND \$1.00 FOR OUR CURRENT CATALOG
OF NEW AND RECONDITIONED EQUIPMENT.**

*** ALSO WE PERIODICALLY PUBLISH A LIST OF
UNSERVICED EQUIPMENT AT GREAT SAVINGS.
A BONANZA FOR THE EXPERIENCED OPERATOR.
TO OBTAIN THE NEXT UNSERVICED BARGAIN LIST,
SEND A SELF ADDRESSED STAMPED ENVELOPE.**

1¢ SALE

58

WE'RE BACK WITH OUR WORLD FAMOUS

"ONE PENNY GETS U TWO"

*Buy any item on this page and get 2nd item of the same cat. no. for only one penny!

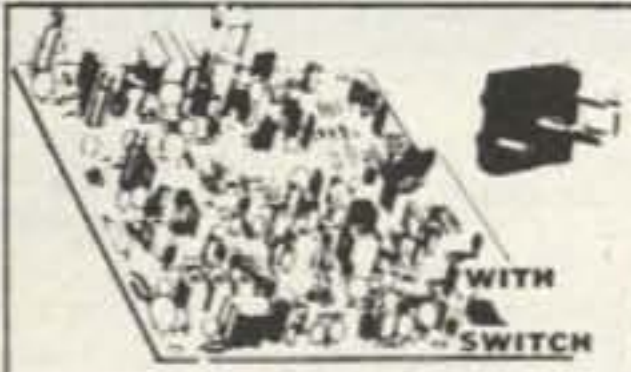

40 CHANNEL CB BOARDS
2 FOR \$15
 only \$14.99
 FROM Hy-Gain! Boards have: Heatsinked 9 Watt Amp Chip, RF & Mod. transistors, and PLL selector IC. May be used for 10 meter conversion, (see continuing series CB to 10" in 73 magazine. Size: 6" x 6" x 2" (h). Wt: 9 oz.
 Cat. No. 92CU5554



HY-GAIN ONE ARM BANDIT MIKES
2 FOR \$15
 \$14.99
 Places ON/OFF, VOLUME, SQUELCH, CHANNEL SELECTOR, SPEAKER, and DIGITAL DISPLAY, conveniently in the palm of your hand. Comes with 6' multi-conductor, coiled cable, (separate). Size: 4 1/2" x 2 1/4" x 1 1/4". Wt: 9 oz.
 Cat. No. 92CU5886



"TIE PIN" CONDENSER MIKE
2 for \$3.96
 EACH \$3.95
 Omnidirectional. Frequency response: 20-20K Hz. 600 ohm impedance. Less tie pin or lapel clip. 1.5 VDC. 3/4" (dia.) x 1/2"
 Cat. No. 92CU5730



4-DIGIT HY GAIN LED CLOCK KIT
2 FOR \$15
 \$14.99
 • Giant 0.4" high LED digits
 • Colon "pulsating" second indicator
 • AM-PM indicators!
 Cat. No. 92CU6320
 • 7 PC set

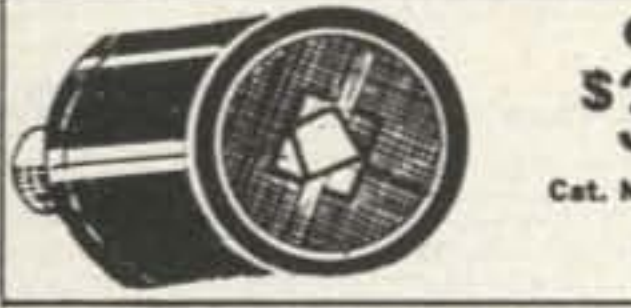

ULTRASONIC TRANSDUCER
2 for \$3.99
 Only \$3.98 each
 Cat. No. 92CU5375
 Sends & Receives! 1" (dia.) 1" dia. x 3/8" with RCA type phono jack. For remote control, alarms, etc. Wt: 2 oz.



CB-HAM NOISE CANCELLING COMMUNICATIONS MICROPHONE
2 FOR \$10
 each \$9.99
 WITH volume control
 The answer to the biggest mobile communication problem... automatic noise cancelling. Works more effectively than power tubes. A must for 2 meter hams. Doesn't "trip" repeaters. Low impedance, frequency response: 200-5000 Hz, sensitivity -65db, 6 foot coiled cord, case made of hi-impact black plastic. With wiring instructions for 100% of CB's. Spt. wt. 2 lbs. 92CU6333



5 WATT MONO AMPLIFIER
2 for \$7
 \$6.99 each
 Requires 12 VDC to produce 4.5W RMS, (5W max.) into 4 ohms from 20-40K Hz. THD: 0.8% @ 2W @ 1 KHz. Includes heatsinked SGS/ATES TBA-641B amp chip, and concentrically mounted OFF/ON, VOL. & TONE controls. Size: 2-1/8" x 4-1/2" x 1-1/4". Wt: 4 oz. w/hookup data. Cat. No. 92CU5681



THUMB WHEEL POTS
 ORDER BY CAT. NO. AND RATING
 6 for \$1.29 12 for \$1.30

| | | | | | |
|-----------------------------------|------------------------------|--------------------------------|-----------------------------------|-------------------------------|----------------------------------|
| <input type="checkbox"/> 100 ohm | <input type="checkbox"/> 1K | <input type="checkbox"/> 100K | <input type="checkbox"/> 100 ohm | <input type="checkbox"/> 10K | <input type="checkbox"/> 500K |
| <input type="checkbox"/> 150 ohm | <input type="checkbox"/> 5K | <input type="checkbox"/> 200K | <input type="checkbox"/> 250 ohm | <input type="checkbox"/> 20K | <input type="checkbox"/> 1 meg |
| <input type="checkbox"/> 200 ohm | <input type="checkbox"/> 10K | <input type="checkbox"/> 250K | <input type="checkbox"/> 500 ohm | <input type="checkbox"/> 25K | <input type="checkbox"/> 2 meg |
| <input type="checkbox"/> 250 ohm | <input type="checkbox"/> 20K | <input type="checkbox"/> 500K | <input type="checkbox"/> 1K | <input type="checkbox"/> 50K | <input type="checkbox"/> 2.2 meg |
| <input type="checkbox"/> 500 ohm | <input type="checkbox"/> 25K | <input type="checkbox"/> 1 meg | <input type="checkbox"/> 2K | <input type="checkbox"/> 100K | <input type="checkbox"/> 3 meg |
| <input type="checkbox"/> 2500 ohm | <input type="checkbox"/> 50K | <input type="checkbox"/> 5 meg | <input type="checkbox"/> 2500 ohm | <input type="checkbox"/> 150K | <input type="checkbox"/> 4 meg |
| | | | <input type="checkbox"/> 5K | <input type="checkbox"/> 250K | <input type="checkbox"/> 5 meg |

 SNAP-IN 92CU3364



3 ELEMENT 120 VAC HOTPLATE
2 FOR \$4
 \$3.99
 Cat. No. 92CU5723
 Top Quality, Multi-Purpose Hotplate generates up to 150 C., 120 watts. Features: Built-in Thermostat, Neon "Red" AC Indicator Lamp, and 1/8" Textured glass surface. Size: 10-3/8 x 6-3/8 x 1/8". Wt: 1 lb. 2 oz.

THIS ITEM NOT INCLUDED IN PENNY SALE.
 Now Only **\$119**
DELUXE 40 CHANNEL



CITIZENS BAND Base Station TRANSCEIVER
WAS \$250
WOW

FEATURES:

- 40 channel operation—PLL digital frequency synthesizer assures total reliability, perfect channel tracking. Eliminates frequency deviation, fuzzy reception, "off" channel problems.
- 3 ceramic filters provide high sensitivity with ultra low adjacent channel interference protection.
- 4 watts RF output power (FCC maximum limit).
- Rotary channel selector knob.
- LED digital readout.
- Controls: Power, volume, variable squelch, continuously variable fine tuning, tone, SWR calibrate.
- Switches: Noise Blanker (NB), Automatic Noise Limiter (ANL), PA/CB, Local/Distance.
- Illuminated S/R and SWR Meter.
- Illuminated modulation percentage meter.
- Built-in LED digital clock with five function control including memory capability for turning transceiver on at desired time.
- Transmit, receive and antenna warning indicator lights.
- Front firing 5" high performance speaker.
- External jacks: PA speaker, external speaker, headphones.
- Dynamic push-to-talk detachable microphone.
- Luxurious, contemporary styling—solid wood cabinetry.
- 117 Volt 60 cycle AC operation.
- UL listed and FCC approved.

Foly Paks buys out the entire distributors inventory of these Top of the Line 40 Channel Base Stations at a cost that defies comparison anywhere in the country! Manufactured by one of the worlds foremost electronics concerns, (sorry we can't name 'em) this set represents the epitome of engineering, design and performance standards as well as a polished Professional appearance that's characteristic of state-of-the-art equipment. Due to a last minute rush, our picture may be a bit fuzzy... but the features and specifications speak for themselves as testimony to Top Notch Quality at a Rock Bottom Price. Unit boasts rugged metal construction, rack mount case handles, and a brushed aluminum facade with offsetting Black trim that will enhance any communications installation. Units come Brand New in factory sealed cartons, 100% guaranteed and ready to go. Shop around... we dare you to compare. Our price is the lowest you'll find anywhere. Cat. No. 92CU6132

SPECIFICATIONS:
 Dimensions 15 1/2" W x 9 1/4" D x 5 1/2" H Weight 12 lbs. 11 oz.
 Frequency Range 26.965-27.405MHz Frequency Tolerance ±.005
 Modulation up to 100% Sensitivity (max.) .5uV
 Receiver Circuit Double conversion superheterodyne

SEND FOR FREE CATALOG
POLY PAKS®
 P.O. BOX 942-A3
 SO. LYNNFIELD, MA 01940

HOW TO ORDER
 We honor MASTERCHARGE, VISA, check, and COD, (25% down). Order by phone or mail. Minimum order \$8. Please state Cat. No. & description, name & month of magazine. Postage: Canadian; add \$5. Foreign; add \$10 (US funds). Excess will be returned. TERMS: add postage. RATED: Net-30. Phone: (617) 245-3828

TELEPHONE HANDSET
2 for \$9
 only \$8.99
 Removed from desk sets. Good condition, guaranteed. Size: 7 1/4 x 2 1/4". Wt: 2 lbs. Cat. No. 92CU6142



We now have available a bunch of goodies too good to bypass. Items are limited so order today

Call Your Phone Order in Today



TERMS: Satisfaction guaranteed or money refunded. COD add \$1.50. Minimum order \$6.00. Orders under \$10.00 add \$.75. Add 5% for postage, insurance, handling. Overseas add 15%. NY residents add 7% tax.

**MINI KITS - YOU HAVE SEEN THESE BEFORE NOW
HERE ARE OLD FAVORITE AND NEW ONES TOO.
GREAT FOR THAT AFTERNOON HOBBY.**

| | | | |
|---|---|--|--|
| <p>FM MINI MIKE</p> <p>A super high performance FM wireless mike kit! Transmits a stable signal up to 300 yards with exceptional audio quality by means of its built-in electret mike. Kit includes case, mike, on-off switch, antenna, battery and super instructions. This is the finest unit available.</p> <p>FM-3 Kit \$14.95 FM-3 Wired and Tested 19.95</p> | <p>Color Organ</p> <p>See music come alive! 3 different lights flicker with music. One light each for, high, mid-range and lows. Each individually adjustable and drives up to 300 W. runs on 110 VAC.</p> <p>Complete kit, ML-1 \$8.95</p> | <p>Video Modulator Kit</p> <p>Converts any TV to video monitor. Super stable, tunable over ch. 4-6. Runs on 5-15V. accepts std. video signal. Best unit on the market! Complete kit, VD-1 \$7.95</p> | <p>Super Sleuth</p> <p>A super sensitive amplifier which will pick up a pin drop at 15 feet! Great for monitoring baby's room or as general purpose amplifier. Full 2 W rms output, runs on 6 to 15 volts, uses 8-45 ohm speaker.</p> <p>Complete kit, BN-9 \$5.95</p> |
| | <p>Led Blinky Kit</p> <p>A great attention getter which alternately flashes 2 jumbo LEDs. Use for name badges, buttons, warning panel lights, anything! Runs on 3 to 15 volts.</p> <p>Complete kit, BL-1 \$2.95</p> | <p>CPO-1</p> <p>Runs on 3-12 Vdc 1 wall out, 1 KHZ good for CPO, Alarm, Audio Oscillator. Complete kit \$2.95</p> | |

CLOCK KITS

Your old favorites are here again. Over 7,000 Sold to Date. Be one of the gang and order yours today!

Try your hand at building the finest looking clock on the market. Its satin finish anodized aluminum case looks great anywhere, while six .4" LED digits provide a highly readable display. This is a complete kit, no extras needed, and it only takes 1-2 hours to assemble. Your choice of case colors: silver, gold, black (specify).

Clock kit, 12/24 hour, DC-5 **\$24.95**
Clock with 10 min. ID timer, 12/24 hour, DC-10 **\$29.95**
Alarm clock, 12 hour only, DC-8 **\$29.95**
12V DC car clock, DC-7 **\$29.95**

For wired and tested clocks add \$10.00 to kit price.

| | | |
|--|---|---|
| <p>FM Wireless Mike Kit</p> <p>Transmits up to 300' to any FM broadcast radio, uses any type of mike. Runs on 3 to 9V. Type FM-2 has added sensitive mike preamp stage.</p> <p>FM-1 kit \$3.95 FM-2 kit \$4.95</p> | <p>Whisper Light Kit</p> <p>An interesting kit, small mike picks up sounds and converts them to light. The louder the sound, the brighter the light. Includes mike, controls up to 300 W, runs on 110 VAC.</p> <p>Complete kit, WL-1 \$6.95</p> | <p>Tone Decoder</p> <p>A complete tone decoder on a single PC board. Features: 400-5000 Hz adjustable range via 20 turn pot, voltage regulation, 567 IC. Useful for touch-tone burst detection, FSK, etc. Can also be used as a stable tone encoder. Runs on 5 to 12 volts.</p> <p>Complete kit, TD-1 \$5.95</p> |
| <p>Universal Timer Kit</p> <p>Provides the basic parts and PC board required to provide a source of precision timing and pulse generation. Uses 555 timer IC and includes a range of parts for most timing needs.</p> <p>UT-5 Kit \$5.95</p> | <p>Mad Blaster Kit</p> <p>Produces LOUD ear shattering and attention getting siren like sound. Can supply up to 15 watts of obnoxious audio. Runs on 6-15 VDC</p> <p>MB-1 Kit \$4.95</p> | <p>Siren Kit</p> <p>Produces upward and downward wail characteristic of a police siren. 5 W peak audio output, runs on 3-15 volts, uses 3-45 ohm speaker.</p> <p>Complete kit, SM-3 \$2.95</p> <p>60 Hz Time Base</p> <p>Runs on 5-15 VDC. Low current (2.5ma) 1 min/month accuracy TB-7 Kit \$5.50 TB-7 Assy \$9.95</p> |

Car Clock

The UN-KIT, only 5 solder connections

Here's a super looking, rugged and accurate auto clock, which is a snap to build and install. Clock movement is completely assembled - you only solder 3 wires and 2 switches, takes about 15 minutes! Display is bright green with automatic brightness control photocell - assures you of a highly readable display, day or night. Comes in a satin finish anodized aluminum case which can be attached 5 different ways using 2 sided tape. Choice of silver, black or gold case (specify).

DC-3 kit, 12 hour format **\$22.95**
DC-3 wired and tested **\$29.95**

| | |
|---|---|
| <p>Calendar Alarm Clock</p> <p>The clock that's got it all: 6-5" LEDs, 12/24 hour, snooze, 24 hour alarm, 4 year calendar, battery backup, and lots more. The super 7001 chip is used. Size: 5x4x2 inches. Complete kit, less case (not available) \$34.95</p> | <p>Under Dash Car Clock</p> <p>12/24 hour clock in a beautiful plastic case features 6 jumbo RED LEDs; high accuracy (.001%); easy 3 wire hookup, display blanks with ignition, and super instructions. Optional dimmer automatically adjusts display to ambient light level.</p> <p>DC-11 clock with mtg. bracket \$27.95 kit DM-1 dimmer adapter \$2.50 Add \$10.00 Assy. and Test</p> |
| <p>Video Terminal</p> <p>A completely self-contained stand alone video terminal card. Requires only an ASCII keyboard and TV set to become a complete terminal unit. Features are single 5V supply, XTAL controlled sync and baud rates (to 9600); complete computer and keyboard control of cursor; parity error control and display. Accepts and generates serial ASCII plus parallel keyboard input. The 6416 is 64 char. by 16 lines with scrolling upper and lower case (optional) and has RS-232 and 20ma loop interlaces on board. Kits include sockets and complete documentation.</p> <p>RE 6416 terminal card kit (add \$60.00 for wired unit) \$189.95 Lower Case option \$13.95 Power Supply \$14.95 RF Modulator kit \$7.95</p> | |

PARTS PARADE

IC SPECIALS

| LINEAR | TTL |
|------------------|---------------|
| 301 \$.35 | 74S00 \$.40 |
| 324 \$ 1.50 | 7447 \$.65 |
| 380 \$ 1.50 | 7475 \$.50 |
| 555 \$.45 | 7490 \$.50 |
| 556 \$ 1.00 | 74196 \$ 1.35 |
| 565 \$ 1.00 | |
| 566 \$ 1.00 | |
| 567 \$ 1.25 | |
| 741 \$ 10/\$2.00 | |
| 1458 \$.50 | |
| 3900 \$.50 | |
| 3914 \$ 2.95 | |
| 8038 \$ 2.95 | |

| CMOS | SPECIAL |
|-------------|------------------|
| 4011 .20 | 11C90 \$13.50 |
| 4013 .25 | 10116 \$ 1.25 |
| 4046 \$1.85 | 7208 \$17.50 |
| 4049 .40 | 7207A \$ 5.50 |
| 4059 \$9.00 | 7216D \$21.00 |
| 4511 \$2.00 | 7107C \$12.50 |
| 4518 \$1.35 | 5314 \$ 2.95 |
| 5639 \$1.75 | 5375AB/G \$ 2.95 |
| | 7001 \$ 6.50 |

| READOUTS | Diodes |
|-----------------------------|-------------------------|
| FND 359 4" C.C. \$1.00 | 5.1 V Zener \$20/\$1.00 |
| FND 507/510 5" C.A. 1.00 | 1N914 Type \$5/\$1.00 |
| MAN 72/HP7730 33" C.A. 1.00 | 1KV 2Amp \$8/\$1.00 |
| HP.7651 43" C.A. 2.00 | 100V 1Amp \$15/\$1.00 |

| Resistor Ass't | Crystals |
|---|---|
| Assortment of Popular values - 1/4 watt. Cut lead for PC mounting. 1/8" center, 1/2" leads. bag of 300 or more. \$1.50 | 3.579545 MHZ \$1.50 |
| | 10.00000 MHZ \$5.00 |
| | 5.248800 MHZ \$5.00 |
| Switches | AC Adapters |
| Mini toggle SPDT \$1.00 | Good for clocks, nicad chargers, all 110 VAC plug one end |
| Red Pushbuttons N.O. 3/\$1.00 | 8.5 vdc @ 20 mA \$1.00 |
| | 16 vac @ 160mA \$2.50 |
| | 12 vac @ 250mA \$3.00 |
| Earphones | Mini 8 ohm Speaker |
| 3" leads, 8 ohm, good for small tone speakers, alarm clocks, etc. 10 for \$1.00 | Approx 2 1/4" diam. Round type for radios, mike etc. 3 for \$2.00 |
| Slug Tuned Coils | Solid State Buzzers |
| Small 3/16" Hex Slugs turned coil. 3 turns. 15/\$1.00 | small buzzer 450 Hz, 86 dB, sound output on 5-12 vdc at 10-30 mA. TTL compatible. \$1.50 |

| CAPACITORS | DC-DC Converter | Ceramic IF Filters |
|---|---|---|
| TANTALUM Dipped Epoxy 1.5 uF 25V \$6/\$1.00 | +5 vdc input prod. -9 vdc @ 30ma +9 vdc produces -15 vdc @ 35ma \$1.25 | Mini ceramic filters 7 KHz B.W. very sharp. \$1.50 ea. |
| 500 uF 20V Axial \$3/\$1.50 | | |
| 150 uF 16V Axial \$5/\$1.00 | | |
| 10 uF 15V Radial \$10/\$1.00 | | |

Audio Prescaler

Make high resolution audio measurements, great for musical instrument tuning, PL tones, etc. Multiplies audio UP in frequency, selectable x10 or x100, gives .01 HZ resolution with 1 sec. gate time! High sensitivity of 25 mv, 1 meg input z and built-in filtering gives great performance. Runs on 9V battery, all CMOS.

PS-2 kit **\$29.95**
PS-2 wired **\$39.95**

600 MHz PRESCALER

Extend the range of your counter to 600 MHz. Works with all counters. Less than 150 mv sensitivity, specify -10 or -100

Wired, tested, PS-1B **\$59.95**
Kit, PS-1B **\$44.95**

30 Watt 2 mtr PWR AMP

Simple Class C power amp features 8 times power gain. 1 W in for 8 out, 2 W in for 15 out, 4W in for 30 out. Max output of 35 W, incredible value, complete with all parts, less case and T-R relay.

PA-1, 30 W pwr amp kit **\$22.95**
TR-1, RF sensed T-R relay kit **6.95**

Power Supply Kit

Complete triple regulated power supply provides variable 6 to 18 volts at 200 ma and +5 at 1 Amp. Excellent load regulation, good filtering and small size. Less transformers, requires 6.3 V @ 1 A and 24 VCT.

Complete kit, PS-3LT \$6.95

RF actuated relay senses RF (1W) and closes DPDT relay. For RF sensed T-R relay TR-1 Kit \$6.95

OP-AMP Special

BI-FET LF 13741 - Direct pin for pin 741 compatible, but 500,000 MEG input z, super low 50 pa input current, low power drain.

50 for only **\$9.00** 10 for **\$2.00**

| | |
|-------------|-------------|
| 78MG \$1.25 | 7812 \$1.00 |
| 79MG \$1.25 | 7815 \$1.00 |
| 723 \$.50 | 7905 \$1.25 |
| 309K \$1.15 | 7912 \$1.25 |
| 7805 \$1.00 | 7915 \$1.25 |

Shrink Tubing Nubs

Nice precut pces of shrink size: 1" x 1/4" shrink to 1/8". Great for splices. 50/\$1.00

Mini TO-92 Heat Sinks

Thermalloy Brand **5 for \$1.00**
To-220 Heat Sinks **3 for \$1.00**

Opto Isolators - 4N28 type \$1.00 ea.
Opto Reflectors - Photo diode + LED \$1.00 ea.

Molex Pins

Molex already precut in length of 7. Perfect for 14 pin sockets. 20 strips for \$1.00

CDS Photocells

Resistance varies with light, 250 ohms to over 3 meg **3 for \$1.00**



SPECTRONICS, INC.

1009 Garfield St., Oak Park, Illinois • 60304

(312) 848-6777

BARGAIN FAVORITES!

OUR BEST-SELLING MULTI-BAND!



AS LOW AS
\$73⁷⁵

- One half the length of conventional half-wave dipoles
- Multi-band, Multi-frequency.
- Maximum efficiency — no traps, loading coils, or stubs.
- Fully assembled and pre-tuned — no measuring, no cutting.
- All weather rated — 1 KW AM, 2.5 KW CW or PEP SSB.
- Proven performance — more than 10,000 have been delivered.
- Permit use of the full capabilities of today's 5-band xcvsr.
- One feedline for operation on all bands.

| | |
|---|-----------|
| 40-10HD/A 40/20/15/10 Mtrs (36) | \$73.75 c |
| 80-40HD/A 80/40 Mtr bands (69) | 77.25 c |
| 75/40HD/A 75/40 Mtr bands (66) | 73.75 c |
| 75-10HD/A 75/40/20/15/10 Mtr (66) | 89.95 c |
| 80-10HD/A 80/40/20/15/10 Mtr (69) | 94.95 c |

Famous "W2AU" Balun

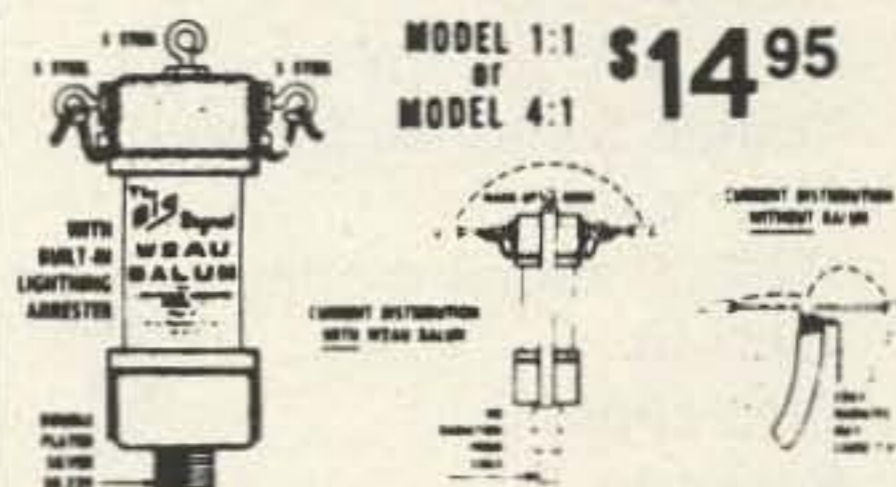

MODEL 1:1 **\$14⁹⁵**
BY
MODEL 4:1

- HANDLES FULL 2 KW PEP AND THEN SOME. Broad Banded 3 to 40 Mc.
- HELPS TVI PROBLEMS By Reducing Coax Line Radiation
- NOW ALL STAINLESS STEEL HARDWARE. SO239 Double Silver Plated
- IMPROVES F/B RATIO By Reducing Coax Line Pick Up
- REPLACES CENTER INSULATOR. Withstands Antenna Pull of Over 600 Lbs
- BUILT-IN LIGHTNING ARRESTER. Helps Protect Balun — Could Also Save Your Valuable Gear
- BUILT-IN HANG-UP HOOK. Ideal for Inverted Vees, Multi-Band Antennas, Dipoles, Beam and Quads

NOW BEING USED BY ALL BRANCHES OF THE U.S. ARMED FORCES, FAA, RCA, CIA, CANADIAN DEFENSE DEPT. PLUS THOUSANDS OF HAMS THE WORLD OVER

Comes in 2 models. 1:1 matches 50 or 75 ohm unbalanced (coax line) to 50 or 75 ohm balanced load. 4:1 model matches 50 or 75 ohm unbalanced (coax line) to 200 or 300 ohm balanced load

Model 1:1 \$14.95 Model 4:1 \$14.95

2 METER ANTENNAS at BARGAIN PRICES!!

NEW! 3 db GAIN
MAGNETIC MOUNT
ONLY

Model 287
Wt. 2.5 lbs.

\$19.⁹⁵

An economical alternative to drilling a hole. A magnetic antenna by a name you can trust at a low, low price.

Model 286 Same but trunk lid. \$15.95 b

NEW! **FINCO**
2.8 dbd GAIN
BASE ANTENNA

ONLY **\$9.⁹⁵**

Model A2-GP
Wt. 2 lbs.

At last! An inexpensive, omni directional, 144-148 MHz, 1/2 wave antenna. Fits 1 1/4" mast, 50 ohm imp. A good antenna at a very affordable price.

NEW! FROM
avanti antennas

ON GLASS MOBILE ANTENNAS

Modern technology lets you mount a mobile antenna right on the window. Ideal for tough installations. 3 models available

| | |
|--|-----------|
| AH151.3G 144-174 MHz, 3 db gn. | \$33.95 b |
| AH220.3G 220 MHz, 3 db gn. | 33.95 b |
| AH450.5G 406-512 MHz, 5 db gn. | 36.95 b |

IMPROVE YOUR RECEPTION!

AN AMECO ALL-BAND PREAMP!
• 6-160 Meters
• 20+ dB Gain
• Low Price



ONLY **\$49⁹⁵**

MODEL PLF-2 . . . Improves weak signals as well as image and spurious rejection of most receivers. Direct switching to rec. or preamp. Includes pwr. supp. 117 VAC wired & tested \$49.95.

DIPOLE HEADQUARTERS

CABLE

| | |
|---|-----------|
| 8U FOAM, hi dens braid 50 ft. | \$12.95 c |
| 8U FOAM, hi dens braid 100 ft. | 24.00 e |
| RG58A/U stranded center 50 ft. | 6.95 c |
| RG58A/U stranded center 100 ft. | 9.95 d |
| RG58 3 ft w/PL259 each end. | 3.35 b |
| RG58 5 ft w/PL259 each end. | 4.39 b |
| RG58 50 ft w/PL259 each end. | 9.95 c |

COPPER WIRE

| | |
|--|--------|
| #14 stranded, 100 ft spool. | 5.95 c |
| #14 solidcopper enameled 100'. | 5.95 c |

INSULATORS

| | |
|--|--------|
| Egg Ins, porcelain per pair | .99 a |
| DOG BONE, porcelain set of 3 | 1.50 a |
| HY GAIN #155 center insulator. | 5.95 b |
| HY GAIN Cycloc end ins per pair. | 3.95 b |
| MOSLEY dipole center insulator | 5.75 a |

CONNECTORS

| | |
|--|--------|
| PL259 UHF male, 2 per pkg | 1.59 a |
| SO239 UHF female chassis mt | .69 a |
| UG175 Adapts RG58 to PL259, pkg 2. | .59 a |
| UG176 Adapts RG59 to PL259, pkg 2. | .59 a |
| PL258 UHF double female | .99 a |
| DM-SP UHF double male | 1.69 a |
| M359 90 deg UHF elbow conn. | 2.10 a |
| UG88U BNC male for RG58 | 1.49 a |
| 1094 BNC female | 1.49 a |
| M358 UHF "T" connector | 3.95 a |
| UG255 UHF female to BNC male | 3.49 a |
| UG273 BNC female to UHF male | 2.45 a |

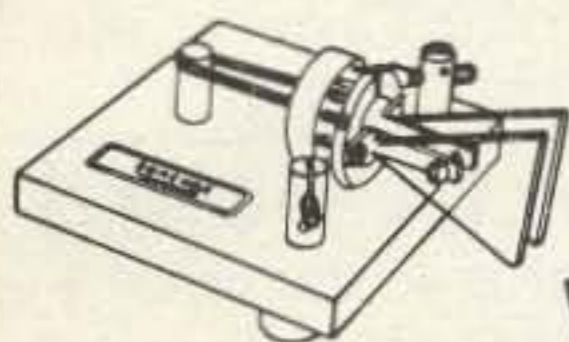

BENCHER

If it's the ultimate in paddles your looking for may we recommend the Bencher. It's simply the nicest one we've seen yet.

| | |
|---|-----------|
| BY1 paddle w/black base. | \$39.95 c |
| BY1 Deluxe model w/chrome base. | 49.95 c |

MODEL 595

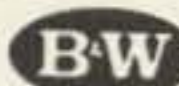

\$21⁵⁰

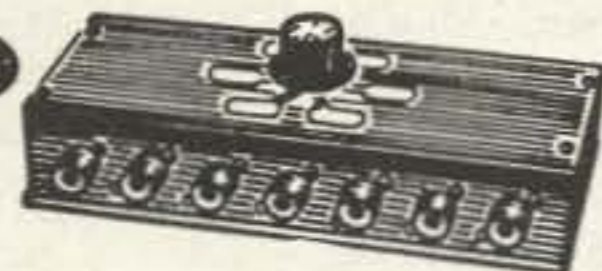

Our most popular switch. 6 position, grounds all except selected output circuit. Can be mounted on wall, on desk, or almost anywhere. Good to 150MHz. Wt. 2 lbs.

NEW from HY-GAIN!

A \$289.95 Value! **TH5DXX 5 El.**
ONLY **\$221⁵⁰** 10-15-20 Meter
Beam — Rated
Full Legal Power
TRUCK SHIP ONLY Output

AVERAGE SHIPPING COST GUIDE

(Continental U.S.) Items sent UPS whenever possible.

Please estimate the shipping charges for your order. Any excess payment over 25c will be refunded or credited. Underpayment will be billed or sent collect. For insurance add 25c for each \$100.00 value over the first \$100.00.

| W/K CALL AREA | | | | |
|---------------|-----------|-------|------|------|
| WEIGHT | 1,2,3,4,5 | 6,7 | 8,9 | 9 |
| 1 lb. | .90 | 1.00 | .90 | .85 |
| 5 lbs. | 1.50 | 2.00 | 1.35 | 1.20 |
| 10 lbs. | 2.28 | 3.20 | 1.95 | 1.70 |
| 20 lbs. | 3.80 | 5.60 | 3.20 | 2.60 |
| 30 lbs. | 5.30 | 8.05 | 4.40 | 3.50 |
| 50 lbs. | 8.40 | 12.90 | 6.80 | 5.35 |

ESTIMATED WEIGHT CODING

After the price of each item you will find a letter, i.e., 19.95 a. To make it easier to figure shipping costs, these letters indicate the approximate weight of the item as follows:

| | |
|--------------------|---------------|
| a. Less than 1 lb. | f. 20-30 lbs. |
| b. 1-3 lbs. | g. 30-40 lbs. |
| c. 4-6 lbs. | h. 40-50 lbs. |
| d. 7-10 lbs. | |
| e. 10-20 lbs. | |

NOTE: INTERNATIONAL ORDERS write for Proforma Invoice. ITEMS MARKED * will be sent truck collect.

ALARM CLOCK KITS: 4 Digit .5"

Here it is! The first of several quality kits we have been asked for: Here is what you get — unbelievable as it may sound...

- 1 National - 5375AA Clock Chip
- 1 Bowmar Clock Stick Readout (L.E.D.) 4 digit - 1/2"
- 13 Transistors
- 2 Push Buttons for time set
- 2 Toggle Switches for alarm
- 1 Filter cap
- 4 1N4000 series diodes
- 1 1N4148
- 2 Disc caps
- 29 Resistors
- 1 Transducer (Speaker) for Alarm
- 1 LED Lamp for alarm indicator

ORDER
KIT
CK-100AC

NEW!
\$9.99

P.C. Board \$2.25
Plug In
Transformer \$1.50

D.C. MODEL

Same as above except it includes 60 Hz timebase.

This Kit Includes:

- 1 National 5375AA Clock Chip
- 1 Bowmar Clock Stick Readout - (L.E.D.) 4 digit - 1/2"
- 12 Transistors
- 2 Push Buttons for time set
- 2 Disc caps
- 27 Resistors
- 1 MOV
- 1 60 Hz time base

ORDER
KIT
CK-100DC

NEW!
\$12.75

P.C. Board \$2.25

MICRO MINI
TOGGLE SWITCHES
6 for \$5 with hardware.



99¢
EACH

VARO FULL WAVE BRIDGE

6 AMPS 200 PIV
#VH248
3/4 IN. SQUARE NEW!



89¢ ea. 4 For \$2.99

RCA SENSITIVE GATE TRIAC

TO-5 CASE. HOUSE #40531
ALSO SAME AS T2300D.
2.5 AMPS 400 PIV



5 FOR \$1.19

Perfect for Dimmers, Color Organs, etc.
PC LEADS

Sonalert® on P.C. Board

Direct from a radar detector manufacturer! 4-741 on a board - plus 12 capacitors, trim pot and many useable components plus a Mallory Sonalert® - well worth the price of the board alone - while they last - **\$2.50 ea.**



We bought 350,000 LED's.
And you get the savings.

Reds, greens, yellows, orange, small, medium, large. Bags of 25 - mixed **\$2.75.** That's only 11¢ each. Compare this bargain up to twice our price.

FACTORY PRIME

BI - Polar LED 59¢ ea. or 10 for \$5

LAB-BENCH VARIABLE POWER SUPPLY KIT

5 to 20 VDC at 1 AMP. Short circuit protected by current limit. Uses IC regulator and 10 AMP Power Darlington. Very good regulation and low ripple. Kit includes PC Board, all parts, large heatsink and shielded transformer. 50 MV. TYP. Regulation. **\$15.99 KIT**

LED BAR GRAPH AND ANALOG METER DRIVER

New from National Semi. #LM3914. Drives 10 LED directly for making bar graphs, audio power meters, analog meters, LED oscilloscopes, etc. Units can be stacked for more LED's. A super versatile and truly remarkable IC. Just out!

SPECIAL PRICE: \$3.99 INCLUDES 12 Page Spec. Sheet

CLOCK MODULE OPTIONS MA1008 A and D MA1013

Switches and pot for all options.

Includes:

- 5 push buttons
- 1 toggle
- 1 10K pot **\$2.50**
- Alarm Parts (including high impedance transducer). Much more efficient than a speaker. **\$1.50**
- Transducer only (unbelievably loud!) **\$1.10**

16K DYNAMIC RAM CHIP WORKS IN TRS-80 OR APPLE II

16K X 1 Bits. 16 Pin Package. Same as Mostek 4116-4. 250 NS access. 410 NS cycle time. Our best price yet for this state of the art RAM. 32K and 64K RAM boards using this chip are readily available. These are new fully guaranteed devices by a major mfg.

VERY LIMITED STOCK!

"MAGAZINE SPECIAL" - 8/\$79.50

SONY 23 WATT AUDIO AMP MODULE

#STK-054. 23 WATTS SUPER CLEAN AUDIO. 20HZ to 100 KHZ ± 2 DB. HYBRID, SILICON, SELF-CONTAINED MODULE. ONLY 1 3/4 x 2 1/2 IN. WITH DATA.

COMPARE AT UP TO TWICE OUR PRICE! **\$6.50 each**

60 Hz CRYSTAL TIME BASE \$4.95 (Complete Kit)

Uses MM5369 CMOS divider IC with high accuracy 3.579545 MHZ Crystal. Use with all MOS Clock Chips or Modules. Draws only 1.5 MA. All parts, data and PC Board included. 100 Hz. same as above, except **\$5.95**

SILICON POWER SOLAR CELLS

2 Inch Dia. Approx. .5 VDC at 500 MA. in sunlight. Factory new units, not rejects as sold by others. Series for higher voltage, parallel for higher current. Converts solar energy directly to electricity.

LIMITED QUANTITY. \$5.99 ea

FAIRCHILD PNP

"SUPER TRANSISTOR"

2N4402. TO-92 Plastic. Silicon PNP Driver. High Current. VCEO-40 HFE-50 to 150 at 150 MA. FT-150 MHZ. A super "BEEFED-UP" Version of the 2N3906.

8 FOR \$1.19

SOUND ACTIVATED SWITCH

Not a kit. Already assembled. Clap your hands and turn on lights, music boxes, coffee pots, etc. Full spec. sheet with each unit.

69¢

10 for \$5.50

TOSHIBA POWER AUDIO AMP

5.8 WATTS RMS Typical Output. 50 to 30,000 HZ ± 3 DB. For CB's, tape decks, PA's, etc. Works off of a single supply voltage from 10.5 to 18 VDC. 10 Pin plastic DIP with special built in heat sink tab. Perfect for use on 12VDC. **\$3.99 each**

NATIONAL SEMICONDUCTOR "COLOSSUS JR." JUMBO CLOCK MODULE

**MA1013
BRAND NEW!**

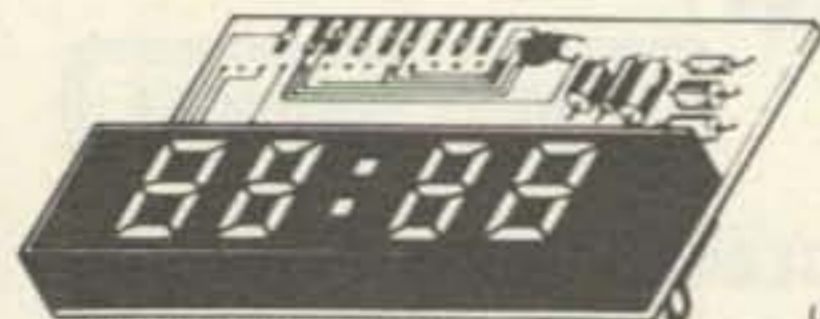

\$8.50

2 FOR
\$15

(AC XFMR \$1.95)

ASSEMBLED! NOT A KIT!

MANUFACTURER'S CLOSEOUT!

PERFECT FOR USE
WITH A TIMEBASE.

- Bright 4 digit 0.7" LED Display
- Complete-Add only Transformer and Switches
- 24 Hour Alarm Signal Output
- 12 Hour Real Time Format
- 50 or 60 Hz Operation
- Power Failure Indication
- LED Brightness Control
- Sleep and Snooze Timers
- Alarm "on" and PM Indicators
- Direct Drive - No RFI
- Direct Replacement for MA1012
- Comes with Full Data

Digital Research: Parts

(OF TEXAS)

P.O. BOX 401247 • GARLAND, TEXAS 75040 • (214) 271-2461

TERMS: Add 50¢ postage, we pay balance. Orders under \$15 add 75¢ handling. No C.O.D. We accept Visa, MasterCard and American Express cards. Tex. Res. add 5% Tax. Foreign orders (except Canada) add 20% P&H. 90 Day Money Back Guarantee on all items.

GET ON PHASE THREE FOR MUCH LESS THAN YOU THINK!

These Low Cost SSB TRANSMITTING CONVERTERS

Let you use inexpensive recycled 10M or 2M SSB exciters on UHF & VHF!

- Linear Converters for SSB, CW, FM, etc.
- A fraction of the price of other units; no need to spend \$300 - \$400!
- Use with any exciter; works with input levels as low as 1 mW.
- Use low power tap on exciter or simple resistor attenuator pad (instructions included).
- Link osc with RX converter for transceive.

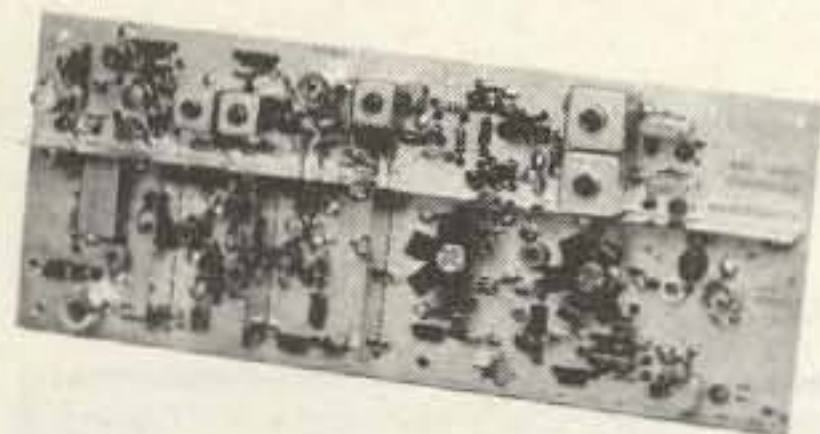

HAMTRONICS DOES IT AGAIN!

NEW XV4 UHF KIT - ONLY \$99.95

28-30 MHz in, 435-437 MHz out; 1W p.e.p. on ssb, up to 1½W on CW or FM. Has second oscillator for other ranges. Atten. supplied for 1 to 500 mW input, use external attenuator for higher levels.

Extra crystal for 432-434 MHz range..... \$5.95
XV4 Wired and tested \$149.95

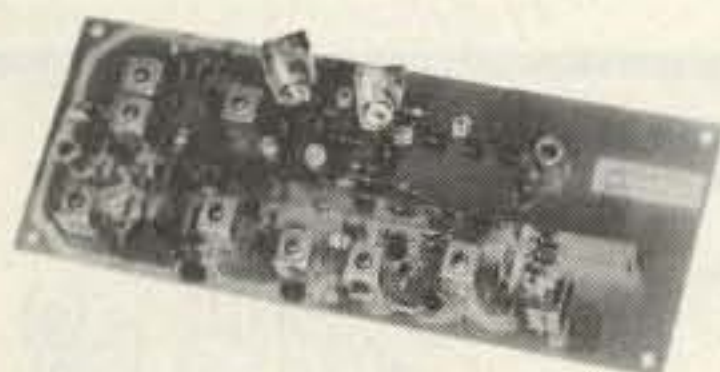

XV2 VHF KIT - ONLY \$69.95

2W p.e.p. output with as little as 1mW input. Use simple external attenuator. Many freq. ranges available.

| MODEL | INPUT (MHz) | OUTPUT (MHz) |
|-------------------------------------|--------------------|---------------------|
| XV2-1 | 28-30 | 50-52 |
| XV2-2 | 28-30 | 220-222 |
| XV2-4 | 28-30 | 144-146 |
| XV2-5 | 28-29 (27-27.4 CB) | 145-146 (144-144.4) |
| XV2-7 | 144-146 | 50-52 |
| XV2 Wired and tested \$109.95 | | |

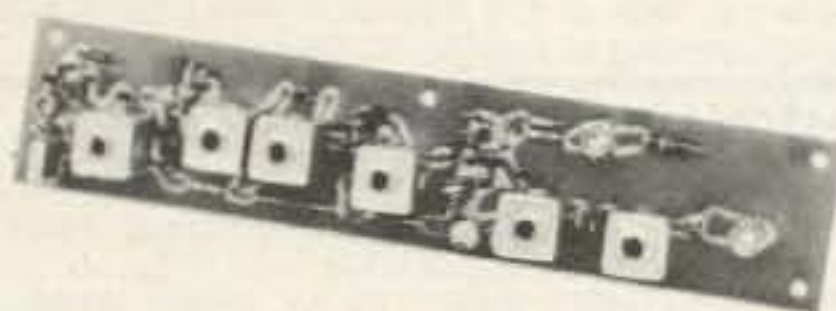

XV28 2M ADAPTER KIT - \$24.95

Converts any 2M exciter to provide the 10M signal required to drive above 220 or 435 MHz units.

Easy to Build FET RECEIVING CONVERTERS

Let you receive OSCAR and other exciting VHF and UHF signals on your present HF or 2M receiver



VHF KIT \$34.95
VHF Wired \$44.95

| MODEL | RF RANGE | OUTPUT RANGE |
|-----------------------------|---------------------------|----------------|
| CA28 | 28-32 MHz | 144-148 MHz |
| CA50 | 50-52 | 28-30 |
| CA50-2 | 50-54 | 144-148 |
| CA144 | 144-146 | 28-30 |
| CA145 | 145-147 | 28-30 |
| or | 144-144.4 | 27-27.4 (CB) |
| CA146 | 146-148 | 28-30 |
| CA220 | 220-222 | 28-30 |
| CA220-2 | 220-224 | 144-148 |
| CA110 (less xtal) | Any 2MHz of Aircraft Band | 26-28 or 28-30 |
| Kit less xtal \$29.95 | | |

UHF KIT \$34.95
UHF Wired \$44.95



| MODEL | RF RANGE | OUTPUT RANGE |
|-----------------------------|----------|--------------|
| C432-2 | 432-434 | 28-30 |
| C432-5 | 435-437 | 28-30 |
| C432-4 | 432-436 | 144-148 |
| Kit less xtal \$29.95 | | |

Professional Quality VHF/UHF FM/CW EXCITERS

- Fully shielded designs
- Double tuned circuits for spurious suppression
- Easy to align with built-in test aids

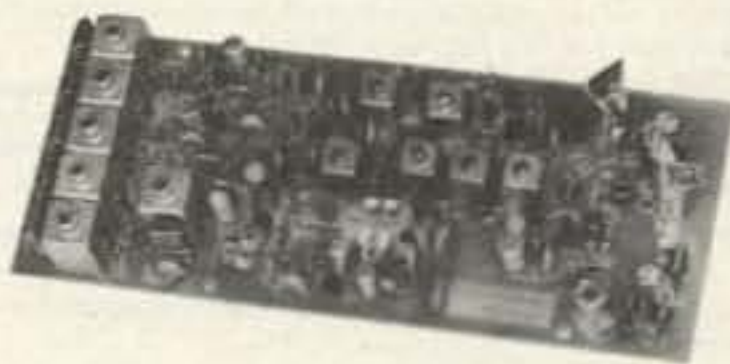

| | | |
|---------|-------------------------|---------|
| T50-50 | 6-chan, 6M, 2W Kit | \$44.95 |
| T50-150 | 6-chan, 2M, 2W Kit | \$44.95 |
| T50-220 | 6-chan, 220 MHz, 2W Kit | \$44.95 |
| T450 | 1-chan, 450 MHz, ¼W Kit | \$44.95 |

See our Complete Line of VHF & UHF Linear PA's

- Use as linear or class C PA
- For use with SSB Xmtg Converters, FM Exciters, etc.

| | | |
|---------|------------------------|----------|
| LPA2-15 | 6M, 2M, 220; 15 to 20W | \$59.95 |
| LPA2-30 | 6M, 2m; 25 to 30W | \$89.95 |
| LPA2-40 | 220 MHz; 30 to 40W | \$119.95 |
| LPA2-45 | 6M, 2M; 40 to 45W | \$119.95 |
| LPA4-10 | 430MHz; 10 to 14W | \$79.95 |
| LPA4-30 | 430MHz; 25 to 30W | \$119.95 |

See catalog for complete specifications

FAMOUS HAMTRONICS PREAMPS

Let you hear the weak ones too!
Great for OSCAR, SSB, FM, ATV. Over 14,000 in use throughout the world on all types of receivers.

P9 Kit \$12.95
P14 Wired \$21.95
Specify band when ordering

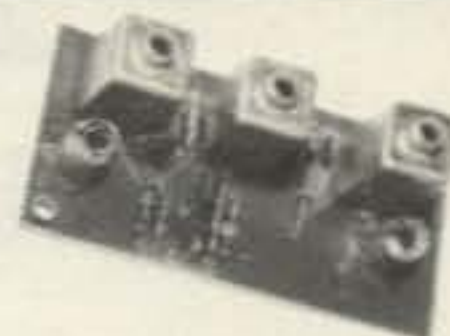

- Deluxe vhf model for applications where space permits ● 1½" x 3" ● Models available to cover any 4MHz band in the 26 to 230 MHz range ● 12 Vdc ● 2 stages ● Ideal for OSCAR ● 20 dB gain

P8 Kit \$10.95
Specify band when ordering



- Miniature vhf model for tight spaces—size only ½ x 2 ¾
- Models available to cover any 4MHz band in the range 20 to 230 MHz ● 20 dB gain ● 12 Vdc

P15 Kit \$18.95
P35 Wired \$27.95



- Covers any 10 MHz band in UHF range of 380 to 520 MHz ● 20 dB gain ● 2 stages ● 12 Vdc

NEW VHF/UHF FM RCVRs

Offer Unprecedented Range of Selectivity Options

- New generation
- More sensitive
- More selective
- Low cross mod
- Uses crystal filters
- Smaller
- Easy to align

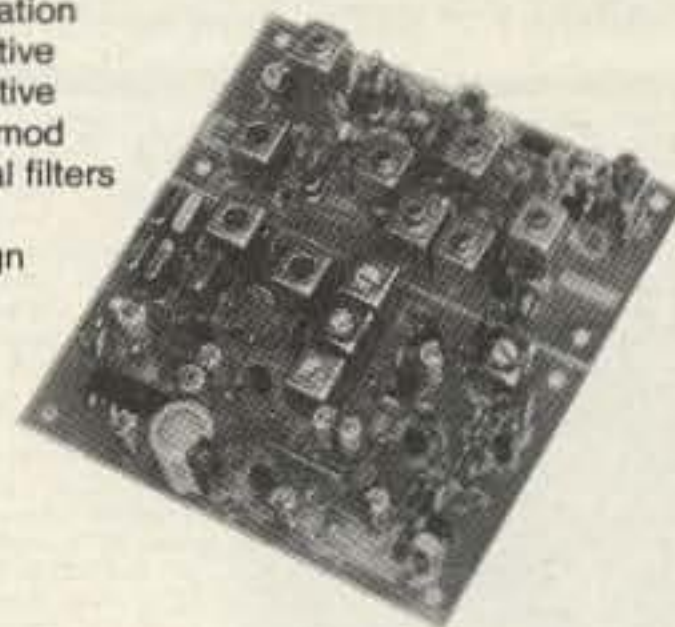

R75A* VHF Kit for monitor or weather satellite service. Uses wide L-C filter. -60dB at ± 30 kHz. \$69.95

R75B* VHF Kit for normal nbfm service. Equivalent to most transceivers. -60dB at ± 17 kHz, -80dB at ± 25 kHz... \$74.95

R75C* VHF Kit for repeater service or high rf density area. -60dB at ± 14kHz, -80dB ± 22kHz, -100dB ± 30kHz.... \$84.95

R75D* VHF Kit for split channel operation or repeater in high density area. Uses 8-pole crystal filter. -60dB at ± 9 kHz, -100dB at ± 15 kHz. The ultimate receiver!... \$99.95

* Specify band: 10M, 6M, 2M, or 220 MHz. May also be used for adjacent commercial bands. Use 2M version for 137 MHz WX satellites.

R85() UHF FM Receiver Kits, triple conversion, include C432 UHF Front End Module. Add \$20 to above prices. (Add selectivity letter to model number.)

A13-45A 6 Channel Adapter for receivers \$13.95
WX-25 Weather Tone Alert \$24.95

NEW R110 VHF AM RCVR

AM monitor receiver kit similar to R75A, but AM. Available for 10-11M, 6M, 2M, 220 MHz, and 110-130 MHz aircraft band. \$74.95

IT'S EASY TO ORDER!

- Write or phone 716-392-9430 (Electronic answering service evenings & weekends)
- Use Credit Card, UPS COD, Check, Money Order
- Add \$2.00 shipping & handling per order

Call or Write to get FREE CATALOG With Complete Details

(Send 4 IRC's for overseas mailing)

hamtronics, inc.

65 E MOUL RD • HILTON, NY 14468

X-RATED CLOCK!

ZULU II CLOCK KIT

WITH CALENDAR AND
NOX™ CIRCUIT

\$19⁹⁵
LESS CASE

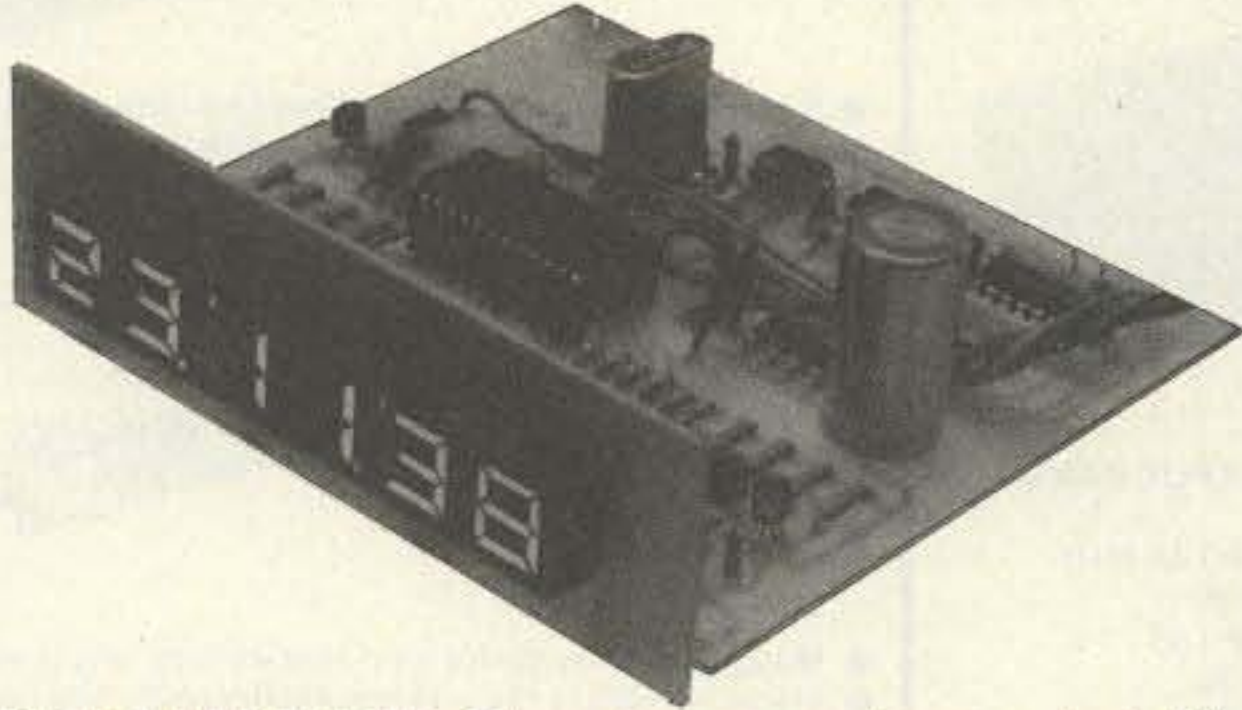

X-TRA VALUE: All the components and high quality plated G-10 PC Boards are provided.

X-TRA CARE IN DESIGN: No wires between readout board and clock board. Large open layout.

X-CELLENCE IN IDEAS: 5 years of designed products for the amateur radio market.

X-CELLENCE IN INSTRUCTIONS: Clear step-by-step instructions with quality illustrations. The assembly manual is not a read-between-the-lines afterthought!

X-TRA FEATURES: There has never been a clock kit with so many features — at any price!

- Unit operates on either 12 VAC or 12 VDC.
- On board QUARTZ XTAL TIMEBASE or 60Hz AC line freq. can be used.
- Automatic BATTERY BACKUP*. Never worry about power failures again!
- Reads true 24 HOUR TIME and 31 DAY CALENDAR.
- Unique NOX™ CIRCUIT activates readouts with a handclap or they can be turned on constantly.
- When used mobile readouts blank when ignition is off.
- Special NOISE SUPPRESSION and battery reversal circuits.
- Bright 1/2" LED's show hours, minute and seconds.

Just clap your hands and the time appears for 5 seconds followed by the date for 4 seconds. A low cost 9V transistor battery provides stand by power in the event of power failures up to 4 hours. With the addition of a low cost 12V 300 MA transformer, the unit will work on AC.

Custom High Impact Molded Case with Ruby Lens. Available in Blue or Tan.

6.50

117 VAC to 12 VAC Transformer.

1.35

ACCESSORIES

*9V Battery Not Included

SE 01 Sound Effects Kit \$16.95

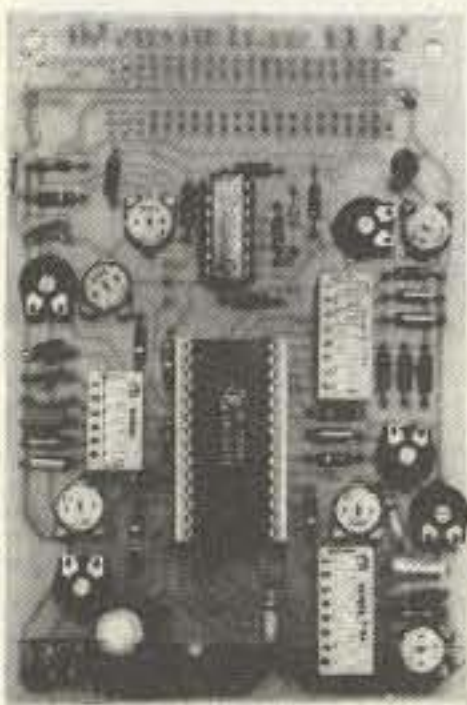

The SE-01 is a complete kit that contains all the parts to build a programmable sound effects generator. Designed around the new Texas Instruments SN76477 Sound Chip, the board provides banks of MINI DIP switches and pots to program the various combinations of the SLF Oscillator, VCO, Noise, One Shot, and Envelope Controls. A Quad Op Amp IC is used to implement an Adjustable Pulse Generator, Level Comparator and Multiplex Oscillator for even more versatility. The 3/4" x 5" PC Board features a prototype area to allow for user added circuitry. Easily programmed to duplicate Explosions, Phasor Guns, Steam Trains, or almost an infinite number of other sounds. The unit has a multiple of applications. The low price includes all parts, assembly manual, programming charts, and detailed 76477 chip specifications. It runs on a 9V battery (not included). On board 100MW amp will drive a small speaker directly, or the unit can be connected to your stereo with incredible results! (Speaker not included).

- 76477 CHIP IS INCLUDED. EXTRA CHIPS \$2.95 EACH
- \$16.95 LESS SPEAKER & BATTERY

From T.I.: TL490 BAR/DOT DRIVER IC. Drives 10 LED's with adjustable analog steps. Units are cascable up to 10 (100 steps). Drives LED's directly. Great for voltage, current, or audio displays. Similar in features to LM3914 with specs and circuit notes.

2.95

NEW!



NEW ITEMS

| | | |
|-----------|----------------------|--------|
| LM567 | Tone Decoder | .89 |
| RCA 40430 | 400V 6A TRIAC TO-66 | .75 |
| CA3086 | RCA Transistor Array | .80 |
| MC1438R | Power Op Amp/Driver | .50 |
| CD4046 | PLL CMOS | .99 |
| LM3302 | Quad Comparator | .89 |
| 2SC1849 | High Freq NPN TO-92 | 6/1.00 |
| MPS A20 | NPN GEN PUR | 8/1.00 |
| 723 | 14 PIN DIP | 3/1.00 |

XAN SUPER DIGITS

.6" JUMBO LED
7 SEGMENT
RED

99¢

6640 COMMON ANODE
6920 COMMON CATHODE



NOW A SUPER READOUT AT A SUPER BUY! These are factory fresh prime LED readouts, not seconds or rejects as sold by others. Compare our price and send for yours today, but hurry, the supply is limited!

SPECIFY: COMMON ANODE OR COMMON CATHODE

POTENTIOMETER ASSORTMENT

A mix of new, panel mount 3/8" bushing pots in various values. Some dual, some with switches.

10/2.00

1/2W RESISTOR ASSORTMENT

A good mix of 5% and 10% values in both full lead and PC lead devices. All new, first quality.

(Asst.) 200 pieces/2.00

SLIDE SWITCH ASSORTMENT

An outstanding bargain. Includes miniature and standard sizes and multi-position units. All new first quality, name brand switches. Try one pack and you'll reorder more: SPECIAL — 12 for \$1.20 (Assortment)

PARTS

| | |
|--|---------|
| 301 OP AMP 8 LEAD CAN | 3/1.00 |
| 723 VOLT REG. 10 LEAD CAN | .50 |
| *13741 FET INPUT 741 MINI DIP | 3/1.10 |
| 30.000 @ 15V COMPUTER GRADE | 2.10 |
| 2N4400 NPN GEN. PURPOSE | 8/1.00 |
| 2N4402 PNP COMPLIMENT | 8/1.00 |
| 2N6028 P.U.T. W/SPECS | .50 |
| LM380 2W AUDIO IC W/SPECS | 1.09 |
| LM377 DUAL LM380 W/SPECS | 2.50 |
| *7815 VOLT REG. 1A 15V | .69 |
| *78M05 5V 1/2A TO-5 REG. | .60 |
| IL-1 OPTO ISOLATOR MINI DIP | .60 |
| *MEM 631 DUAL GATE MOSFET. DIODE PROTECTED. SIMILAR TO 40673 | .50 |
| MV1624 VARICAP DIODE TO PFD | .49 |
| 1N4003 1A 200V DIODE | 15/1.00 |
| TIP30 TAB PNP POWER | 3/1.00 |
| *MC1351P FM IF. DISC IC | .50 |
| .25 ohm 3W RESISTOR | 8/1.00 |
| *INDICATES ITEM IS "HOUSE NUMBERED" | |

LED'S

| | |
|----------------------|-------|
| JUMBO GREEN | 4/.89 |
| JUMBO RED | 5/.89 |
| MEDIUM RED (1/4") | .15 |
| MEDIUM GRN OR YELLOW | .16 |

7 WATT AUDIO AMP KIT

SMALL SINGLE HYBRID IC AND COMPONENTS FIT ON A 2" x 3" PC BOARD (INCLUDED). RUNS ON 12 VDC. GREAT FOR ANY PROJECT THAT NEEDS AN INEXPENSIVE AMP. LESS THAN 3% THD @ 5 WATTS. COMPATIBLE WITH SE-01 SOUND KIT.

\$5.95

6 DIGIT AUTO/VAN CLOCK

- LARGE 1/2" CHARACTERS (LED)
- QUARTZ XTAL TIMEBASE
- ALARM & SNOOZE OPTIONS
- NOISE FILTERING
- EASY TO ASSEMBLE
- 4" x 3" x 1 1/2"
- DRILLED & PLATED PC BOARDS

\$16.95 COMPLETE KIT
12 VDC

ULTRASONIC RELAY KIT

INVISIBLE BEAM WORKS LIKE A PHOTO ELECTRIC EYE. USE UP TO 25 FT. APART. COMPLETE KIT. ALL PARTS & PC BOARDS.

\$21.50

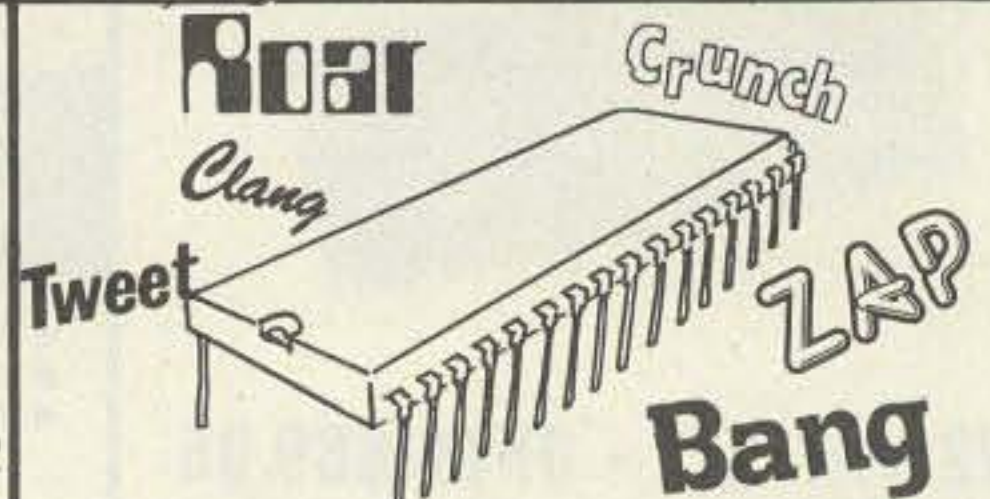

AY3-8910 PROGRAMMABLE SOUND GENERATOR

The AY3-8910 is a 40 pin LSI chip with three oscillators, three amplitude controls, programmable noise generator, three mixers, an envelope generator, and three D/A converters that are controlled by 8 BIT WORDS. No external pots or caps required. This chip hooked to an 8 bit microprocessor chip or Buss (8080, Z80, 6800 etc.) can be software controlled to produce almost any sound. It will play three note chords, make bangs, whistles, sirens, gunshots, explosions, bleets, whines, or grunts. In addition, it has provisions to control its own memory chips with two IO ports. The chip requires +5V @ 75ma and a standard TTL clock oscillator. A truly incredible circuit.

\$14.95 W/Basic Spec Sheet (4 pages)

60 page manual with S-100 interface instructions and several programming examples, **\$3.00 extra**

NPN HIGH VOLTAGE 2.00

VCEO = 450 VDC IC = 3A (5A Peak)

FOR TV HORIZONTAL SECTIONS; HIGH VOLTAGE REGULATORS
REPLACES: 2N5076, 2N5077, 2N5838, 2N5665, BDY94, BU126, 2SC2121, 2N5840, 2SC1046, 2N5466, TIP556 AND MANY OTHERS



HOUSE #

- * NO C.O.D.'s
- * SEND CHECK M.O. OR CHARGE CARD NO.
- * PHONE ORDERS ACCEPTED ON VISA AND MASTERCARD ONLY.

(214) 278-3553

- * ADD 5% FOR SHIPPING
- * TX. RES. ADD 5% STATE SALES TAX
- * FOREIGN ORDERS ADD 10% (EXCEPT CANADA) (20% AIRMAIL) U.S. FUNDS ONLY.

catalog free on request

RADIO BOOKSHOP

LICENSE STUDY GUIDES & TAPES

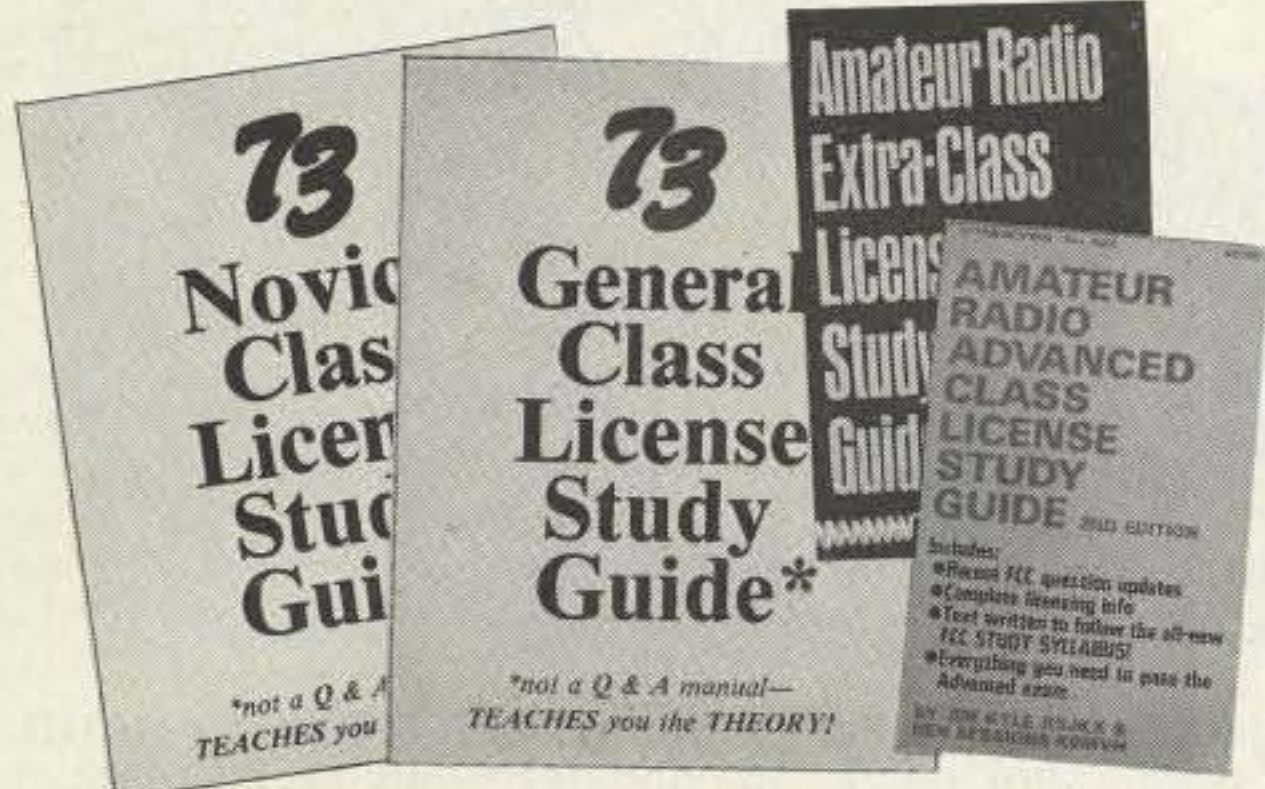

● **NOVICE STUDY GUIDE—SG7357**—Here is a completely new study guide and reference book for the potential ham. This is not a question/answer memorization course. Electronic and radio fundamentals are presented and explained in an easy-to-understand fashion, preparing the beginner for the Novice exam. Includes the latest FCC amateur regulations, as well as application forms. Easily the best path into the exciting world of ham radio! \$4.95.*

● **GENERAL CLASS STUDY GUIDE—SG7358**—A complete theory course for the prospective General or Technician. This reference explains transistor, amplifier, and general radio theory, while preparing the Novice for the "big" ticket. After getting your ticket, you'll use this guide again and again as an electronic reference source. Not a question/answer guide that becomes dated when the FCC updates the amateur exams. \$5.95.*

● **ADVANCED CLASS STUDY GUIDE—SG1081**—Ready to upgrade your license? To prevent retaking the FCC theory exam, you need the 73 Advanced theory guide. SSB, antenna theory, transmitters, and electronics measuring techniques are covered in detail in this easy-to-follow study guide. Special modes and techniques, such as RTTY, are also treated. An engineering degree is *not* necessary to master Advanced theory—try this book before visiting the examiner's office! \$6.95.*

● **EXTRA CLASS LICENSE STUDY GUIDE—SG1080**—Before going for your 1 x 2 call, it pays to be a master of the Extra class electronic theory. This study guide is the logical extension of the 73 theory course. All the theory necessary to pass the exam is presented. Antennas, transmission lines, swr are discussed, as well as noise, propagation, and specialized communication techniques. This book is not a classroom lecture or memorization guide, but rather a logical presentation of the material that must be *understood* before attempting the Extra exam. Save yourself a return trip to the FCC and try the 73 method first! \$6.95.*



NOVICE THEORY TAPES Startling Learning Breakthrough

● **NOVICE THEORY TAPES—CT7300**—Startling Learning Breakthrough. You'll be astounded at how really simple the theory is when you hear it explained on these tapes. Three tapes of theory and one of questions and answers from the latest Novice exams give you the edge you need to breeze through your exam. 73 is interested in helping get more amateurs, so we're giving you the complete set of our tapes for the incredibly low price of **ONLY \$15.95.***

Scientists have proven that you learn faster by listening than by reading because you can play a cassette tape over and over in your spare time—even while you're driving! You get more and more info each time you hear it.

You can't progress without solid fundamentals. These four hour-long tapes give you all the basics you'll need to pass the Novice exam easily. You'll have an understanding of the basics which will be invaluable to you for the rest of your life! Can you afford to take your Novice exam without first listening to these tapes? Set of 4—\$15.95.*



SSTV

● **SLOW SCAN TELEVISION TAPE—CT7350**—Prize-winning programs from the 73 SSTV contest. Excellent for Demo! \$5.95.*

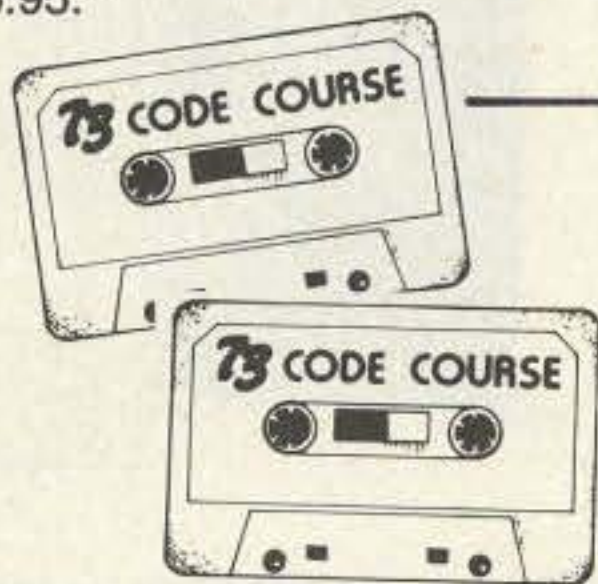

"GENESIS"

5 WPM—CT7305—This is the beginning tape for people who do not know the code at all. It takes them through the 26 letters, 10 numbers and necessary punctuation, complete with practice every step of the way using the newest blitz teaching techniques. It is almost miraculous! In one hour many people—including kids of ten—are able to master the code. The ease of learning gives confidence to beginners who might otherwise drop out.

"THE STICKLER"

6+ WPM—CT7306—This is the practice tape for the Novice and Technician licenses. It is made up of one solid hour of code, sent at the official FCC standard (no other tape we've heard uses these standards, so many people flunk the code when they are suddenly—under pressure—faced with characters sent at 13 wpm and spaced for 5 wpm). This tape is not memorizable, unlike the zany 5 wpm tape, since the code groups are entirely random characters sent in groups of five.

73 CODE TAPES

Any Four Tapes For \$15.95! *
\$4.95 Each! *

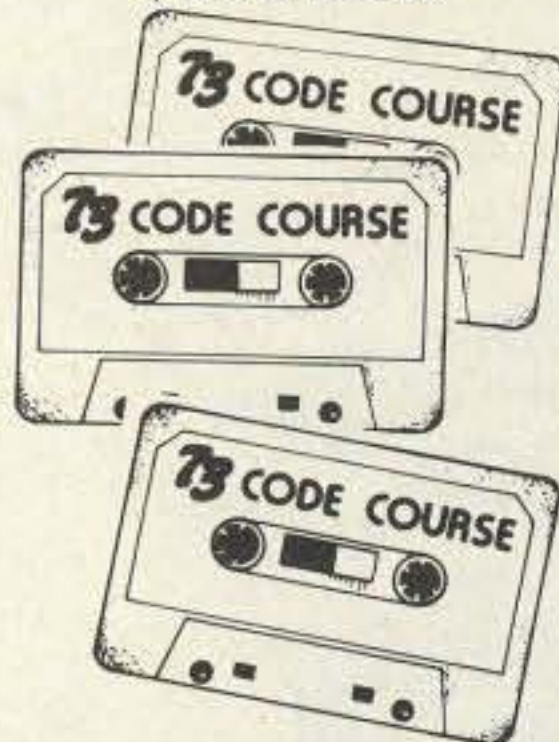

"BACK BREAKER"

13+ WPM—CT7313—Code groups again, at a brisk 13 per so you will be at ease when you sit down in front of the steely-eyed government inspector and he starts sending you plain language at only 13 per. You need this extra margin to overcome the panic which is universal in the test situations. When you've spent your money and time to take the test, you'll thank heavens you had this back-breaking tape.

"COURAGEOUS"

20+ WPM—CT7320—Code is what gets you when you go for the Extra class license. It is so embarrassing to panic out just because you didn't prepare yourself with this tape. Though this is only one word faster, the code groups are so difficult that you'll almost fall asleep copying the FCC stuff by comparison. Users report that they can't believe how easy 20 per really is with this fantastic one hour tape.

"OUTRAGEOUS"

25+ WPM—CT7325—This is the tape for that small group of overachieving hams who wouldn't be content to simply satisfy the code requirements of the Extra Class license. It's the toughest tape we've got and we keep a permanent file of hams who have mastered it. Let us know when you're up to speed and we'll inscribe your name in 73's CW "Hall of Fame."

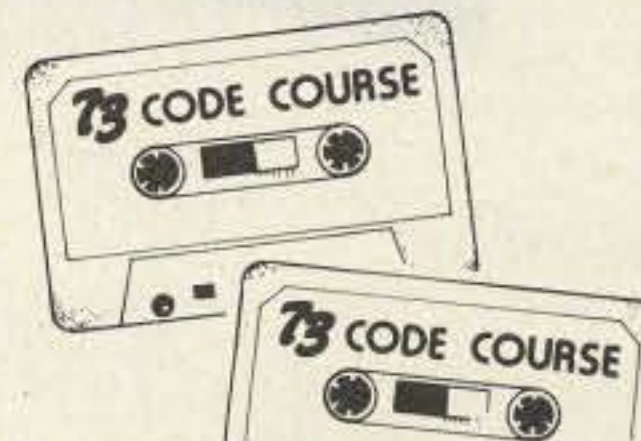

Use the order card in the back of this magazine or itemize your order on a separate piece of paper and mail to: 73 Radio Bookshop • Peterborough NH 03458. Be sure to include check or detailed credit card information. *Add \$1.00 handling charge. Note: Prices subject to change on books not published by 73 Magazine.

FOR CUSTOMER SERVICE CALL (603) 924-7298

RADIO BOOKSHOP

73 TECHNICAL LIBRARY

● **BEHIND THE DIAL**—BK7307—By Bob Grove. Get more fun out of shortwave listening with this interesting guide to receivers, antennas, frequencies and interference. \$4.95.*

● **THE CHALLENGE OF 160**—BK7309—is the newest book in the 73 technical library, dedicated to 160 meter operating. Si Dunn provides all necessary information to get started on this unique band. The all-important antenna and ground systems are described in detail. The introduction contains interesting photos of Stew Perry's (the King of 160) shack. This reference is a must for new and experienced "Top Band" operators. Price: \$4.95.*

● **IC OP-AMP COOKBOOK**—BK1028—by Walter G. Jung. Covers not only the basic theory of the IC op amp in great detail, but also includes over 250 practical circuit applications, liberally illustrated. 592 pages, 5½ × 8½, softbound. \$12.95.*

● **THE POWER SUPPLY HANDBOOK**—BK7305—Need a power supply for a gadget you're building? In the **POWER SUPPLY HANDBOOK** there are dozens ready-to-build, plus detailed steps for designing your own. There are circuits and parts lists for all kinds of supplies, ranging from simple DC types to highly stable regulated versions. If you need a circuit to convert a DC voltage to a higher or lower voltage, turn DC into AC, or AC to DC—then this is the book you need. With more than 400 pages, you should be able to find just the circuit you need. Without a doubt one of the best power supply source books available, compiled by the editors of 73. \$7.95.*



● **INTRODUCTION TO RTTY**—BK7380—A beginner's guide to radioteletype including teletypewriter fundamentals, signals, distortion and RTTY art. You can be a RTTY artist! A 73 publication. \$2.00.*

● **THE NEW RTTY HANDBOOK**—BK7347—is a new edition and the only up-to-date RTTY book available. The state of the art has been changing radically and has made all previous RTTY books obsolete. It has the latest circuits, great for the newcomer and expert alike. \$5.95.*

● **PROPAGATION WIZARD'S HANDBOOK**—BK7302—by J. H. Nelson. When sunspots riddled the worldwide communications networks of the 1940's, John Henry Nelson looked to the planets for an answer. The result was a theory of propagation forecasting based upon interplanetary alignment that made the author the most reliable forecaster in America today. The book provides an enlightened look at communications past, present, and future, as well as teaching the art of propagation forecasting. \$6.95.*

● **SSB . . . THE MISUNDERSTOOD MODE**—BK7351—by James B. Wilson. Single Sideband Transmission . . . thousands of us use it every day, yet it remains one of the least understood facets of amateur radio. J. B. Wilson presents several methods of sideband generation, amply illustrated with charts and schematics, which will enable the ambitious reader to construct his own sideband generator. A must for the technically-serious ham. \$5.50.*

● **SSTV HANDBOOK**—BK7354(hardcover), BK7355(softcover)—This excellent book tells all about it, from its history and basics to the present state-of-the-art techniques. Contains chapters on circuits, monitors, cameras, color SSTV, test equipment and much more. Hardbound \$7.00, softbound \$5.00.*

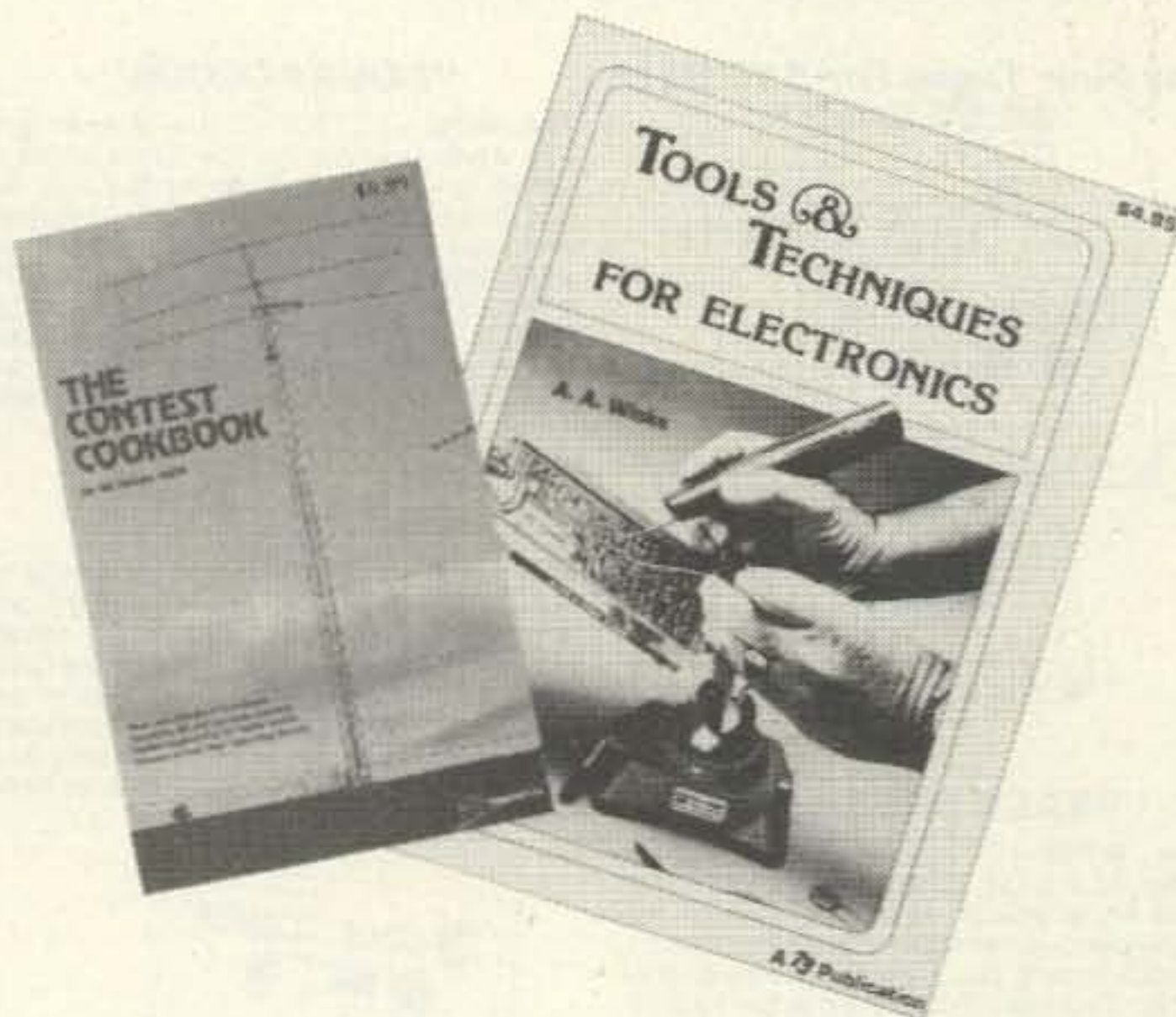

● **WEATHER SATELLITE HANDBOOK**—BK7370—Simple equipment and methods for getting good pictures from the weather satellite. Antennas, receivers, monitors, facsimile you can build, tracking, automatic control (you don't even have to be home). Dr. Taggart WB8DQT. \$4.95.*

● **TOOLS & TECHNIQUES FOR ELECTRONICS**—BK7348—is an easy-to-understand book written for the beginning kit builder as well as the experienced hobbyist. It has numerous pictures and descriptions of the safe and correct ways to use basic and specialized tools for electronic projects as well as specialized metal working tools and the chemical aids which are used in repair shops. \$4.95*

● **THE CONTEST COOKBOOK**—BK7308—reveals the secrets of the contest winners (Domestic, DX and specialty contests), complete with photos and diagrams of equipment used by the top scorers. Find out how to make 150 contacts in one hour. \$5.95*

Use the order card in the back of this magazine or itemize your order on a separate piece of paper and mail to:
Dept. F3 • 73 Radio Bookshop • Peterborough NH 03458. Include check or detailed credit card information.
*Add \$1.00 handling charge. Note: Prices subject to change on books not published by 73 Magazine.

FOR TOLL FREE ORDERING CALL 1-800-258-5473

Radio Bookshop

TEST EQUIPMENT

● **RF AND DIGITAL TEST EQUIPMENT YOU CAN BUILD**—BK1044—Rf burst, function, square wave generators, variable length pulse generators—100 kHz marker, i-f and rf sweep generators, audio osc, af/rf signal injector, 146 MHz synthesizer, digital readouts for counters, several counters, prescaler, microwave meter, etc. 252 pages. \$5.95.*

● **VOL. I COMPONENT TESTERS**—LB7359—... how to build transistor testers (8), diode testers (3), IC testers (3), voltmeters and VTVMs (9), ohmmeters (8 different kinds), inductance (3), capacity (9), Q measurement, crystal checking (6), temperature (2), aural meters for the blind (3) and all sorts of miscellaneous data on meters... using them, making them more versatile, making standards. Invaluable book. \$4.95.*

● **VOL. II AUDIO FREQUENCY TESTERS**—LB7360—... jam packed with all kinds of audio frequency test equipment. If you're into SSB, RTTY, SSTV, etc., this book is a must for you... a good book for hi-fi addicts and experimenters, too! \$4.95.*

● **VOL. III RADIO FREQUENCY TESTERS**—LB7361—Radio frequency waves, the common denominator of Amateur Radio. Such items as SWR, antenna impedance, line impedance, rf output and field strength; detailed instructions on testing these items includes sections on signal generators, crystal calibrators, grid dip oscillators, noise generators, dummy loads and much more. \$4.95.*

● **VOL. IV IC TEST EQUIPMENT**—LB7362—Become a troubleshooting wizard! In this fourth volume of the 73 TEST EQUIPMENT LIBRARY are 42 home construction projects for building test equipment to work with your ham station and in servicing digital equipment. Plus a cumulative index for all four volumes of the 73 TEST EQUIPMENT LIBRARY. \$4.95.*



THE WELL-EQUIPPED HAM SHACK

● **73 MAGAZINE BINDERS**—Preserve and protect your collection for your lifetime! There's no excuse for lost issues when you have these handsome red binders with gold lettering. Order 1—BN1001—for \$6.50*; 2 or more—BN1002—for \$6.00 each.* (specify 1978 or 1979 binders)

● **QSL CARDS**—73 turns out a fantastic series of QSL cards at about half the cost of having them done elsewhere because they are run as a fill-in between printing books and other items in the 73 Print Shop. 250 Style W—QW0250—for \$8.95*; 500 Style W—QW0500—for \$13.95*; 250 Style X—QX0250—for \$8.95*; 500 Style X—QX0500—for \$13.95*; 250 Style Y—QY0250—for \$8.95*; 500 Style Y—QY0500—for \$13.95.* Allow 6-12 wks. for delivery.

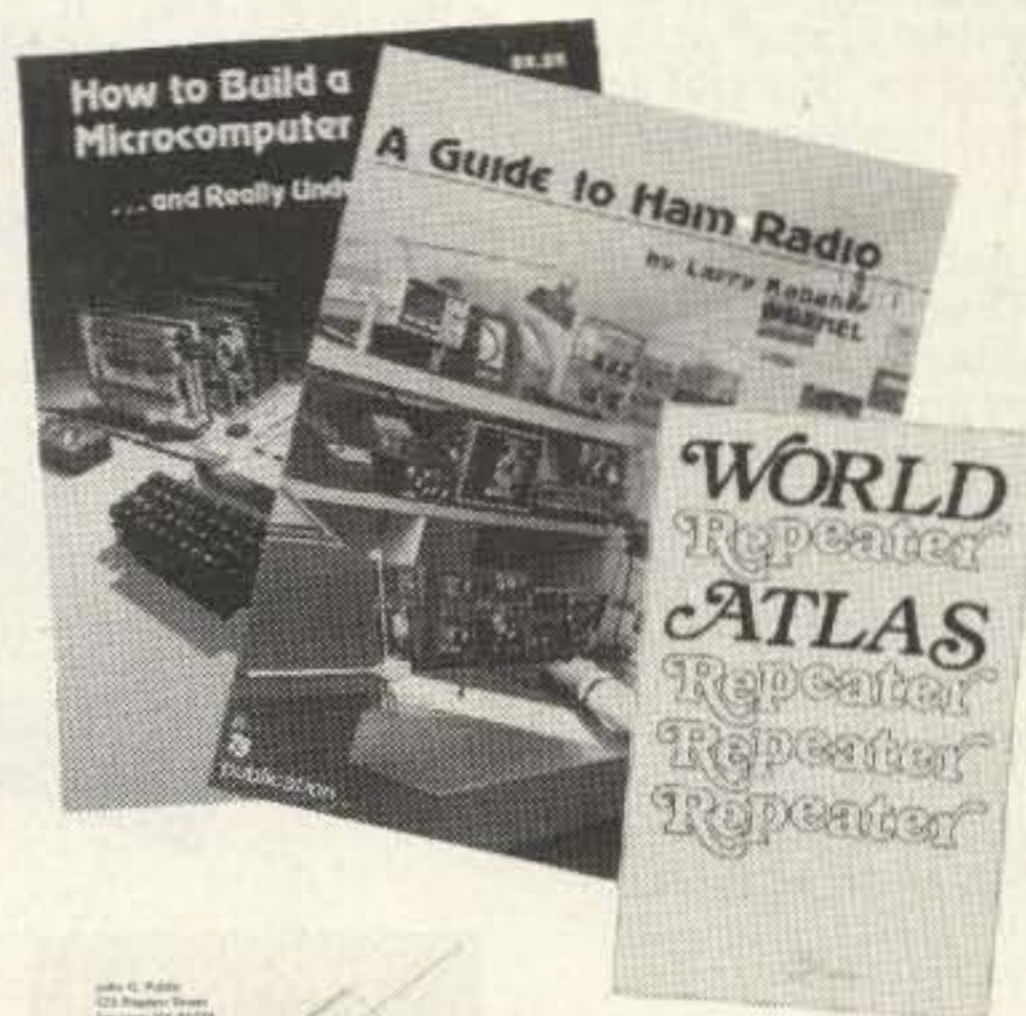

● **HOW TO BUILD A MICROCOMPUTER—AND REALLY UNDERSTAND IT**—BK7325—by Sam Creason. The electronics hobbyist who wants to build his own microcomputer system now has a practical "How-To" guidebook. Sam Creason's book is a combination technical manual and programming guide that takes the hobbyist step-by-step through the design, construction, testing and debugging of a complete microcomputer system. \$9.95.*

● **1980 WORLD REPEATER ATLAS**—BK1080—Completely updated for 1980, over 230 pages of repeater listings are indexed by location and frequency. More than 50 maps pinpoint 2000 repeater locations throughout the USA. Foreign listings include Europe, the Middle East, South America and Africa. \$4.95.*

● **BACK ISSUES**—Complete your collection; many are prime collectables now, classics in the field! A full collection is an invaluable compendium of radio and electronics knowledge!



Style X



Style Y



Style W

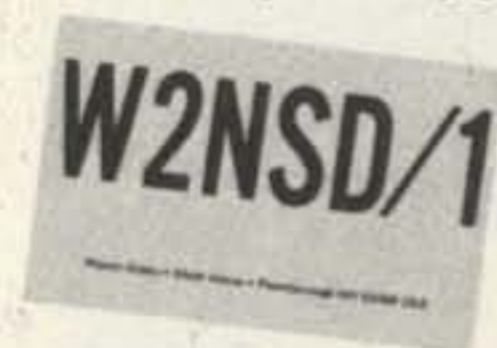

Single back issue—ST0000—\$3.00*;
25 our choice—ST2500—\$12.00*;
25 your choice—ST2501—\$25.00*;
5 your choice—ST0500—\$8.75*;
10 your choice—ST1000—\$14.00*.

● **OWNER REPAIR OF AMATEUR RADIO EQUIPMENT**—BK7310—Frank Glass shares over 40 years of operating, servicing, and design experience in this book which ranges from the elementary to the highly technical written for the top engineers in the field. It is written in narrative style on the subjects of electronic servicing, how components work, and how they are combined to provide communication equipment. This book will help you understand the concepts required to service station equipment. \$7.95.*

● **FREE BACK ISSUE CATALOGS** are yours for the asking... specify 73 Magazine and/or Kilobaud Microcomputing back issue catalog when you send your name and address to us on a postcard.

● **A GUIDE TO HAM RADIO**—BK7321—by Larry Kahaner WB2NEL. What's Amateur Radio all about? You can learn the basics of this fascinating hobby with this excellent beginner's guide. It answers the most frequently asked questions in an easy-going manner, and it shows the best way to go about getting an FCC license. A Guide to Ham Radio is an ideal introduction to a hobby enjoyed by people around the world. \$4.95.*

● **LIBRARY SHELF BOXES**—These sturdy white, corrugated, dirt-resistant boxes each hold a full year of 73 or Kilobaud Microcomputing. With your order, request self-sticking labels for any of the following: 73, Kilobaud Microcomputing, CQ, QST, Ham Radio, Personal Computing, Radio Electronics, Interface Age, and Byte. Order 1—BX1000—for \$2.00*; order 2-7—BX2002—for \$1.50 each*; order 8 or more—BX1002—for \$1.25 each*.

Use the order card in the back of this magazine or itemize your order on a separate piece of paper and mail to:
Dept. F3 • 73 Radio Bookshop • Peterborough NH 03458. Include check or detailed credit card information.

*Add \$1.00 handling charge. Note: Prices subject to change on books not published by 73 Magazine.

FOR CUSTOMER SERVICE CALL (603) 924-7298

Radio Bookshop

● **73 DIPOLE AND LONG-WIRE ANTENNAS**—BK1016—by Edward M. Noll W3FQJ. This is the first collection of virtually every type of wire antenna used by amateurs. Includes dimensions, configurations, and detailed construction data for 73 different antenna types. Appendices describe the construction of noise bridges, line tuners, and data on measuring resonant frequency, velocity factor, and swr. \$5.50.*

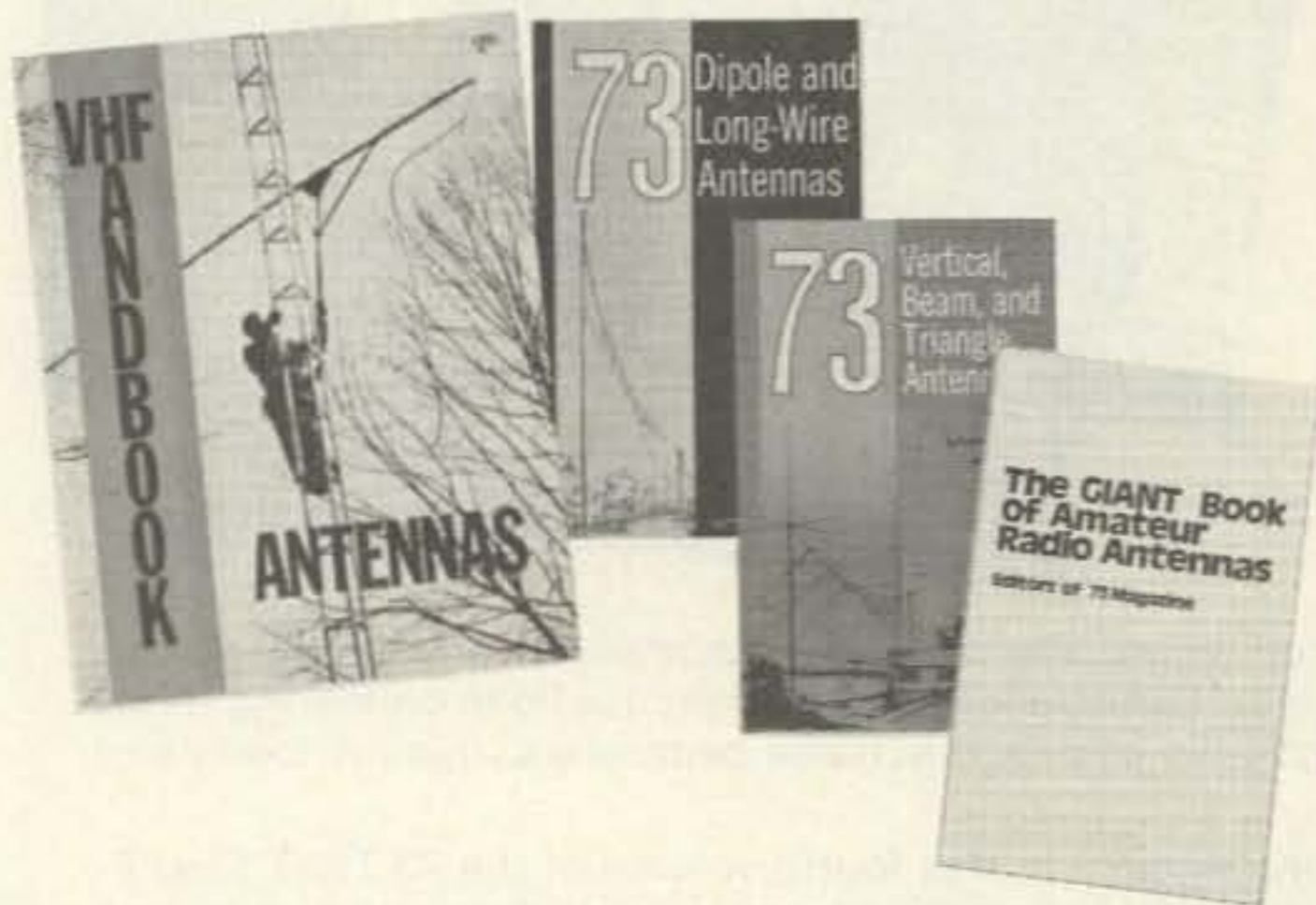

● **THE GIANT BOOK OF AMATEUR RADIO ANTENNAS**—With the **GIANT Book of Amateur Radio Antennas** by your side, antennas will become the least of your worries. Over 450 pages of design ideas, theory and reference data make this book live up to its title. The 7 chapters cover everything from basic antenna theory through designs for DIY accessories, as well as dozens of antenna designs. Whether planning to build or buy, design or admire, test or enjoy a ham antenna—this is the book for you. From the editors of 73; published by Tab Books. \$12.95* hardback—BK7304, \$8.95* paper—BK1104.

● **73 VERTICAL, BEAM AND TRIANGLE ANTENNAS**—BK1069—by Edward M. Noll W3FQJ. Describes 73 different antennas for amateurs. Each design is the result of the author's own experiments covering the construction of noise bridges and antenna line tuners, as well as methods for measuring resonant frequency, velocity factor, and standing-wave ratios. 160 pages. \$5.50.*

● **VHF ANTENNA HANDBOOK**—BK7368—The **NEW VHF Antenna Handbook** details the theory, design and construction of hundreds of different VHF and UHF antennas... A practical book written for the average amateur who takes joy in building, not full of complex formulas for the design engineer. Packed with fabulous antenna projects you can build. \$4.95.*

● **PRACTICAL ANTENNAS FOR THE RADIO AMATEUR**—BK1015—A manual describing how to equip a ham station with a suitable antenna. A wide range of antenna topics, systems, and accessories are presented giving the reader some food for thought and practical data for construction. Designed to aid the experienced ham and novice as well. Only \$9.95.*

● **TTL COOKBOOK**—BK1063—by Donald Lancaster. Explains what TTL is, how it works, and how to use it. Discusses practical applications, such as a digital counter and display system, events counter, electronic stopwatch, digital voltmeter and a digital tachometer. \$9.50.

● **CMOS COOKBOOK**—BK1011—by Don Lancaster. Details the application of CMOS, the low power logic family suitable for most applications presently dominated by TTL. Required reading for every serious digital experimenter! \$10.50.*

● **TVT COOKBOOK**—BK1064—by Don Lancaster. Describes the use of a standard television receiver as a microprocessor CRT terminal. Explains and describes character generation, cursor control and interface information in typical, easy-to-understand Lancaster style. \$9.95.*



● **BASIC NEW 2ND EDITION**—by Bob Albrecht. Self-teaching guide to the computer language you will need to know for use with your microcomputer. This is one of the easiest ways to learn computer programming. \$6.95.* (BK1081)

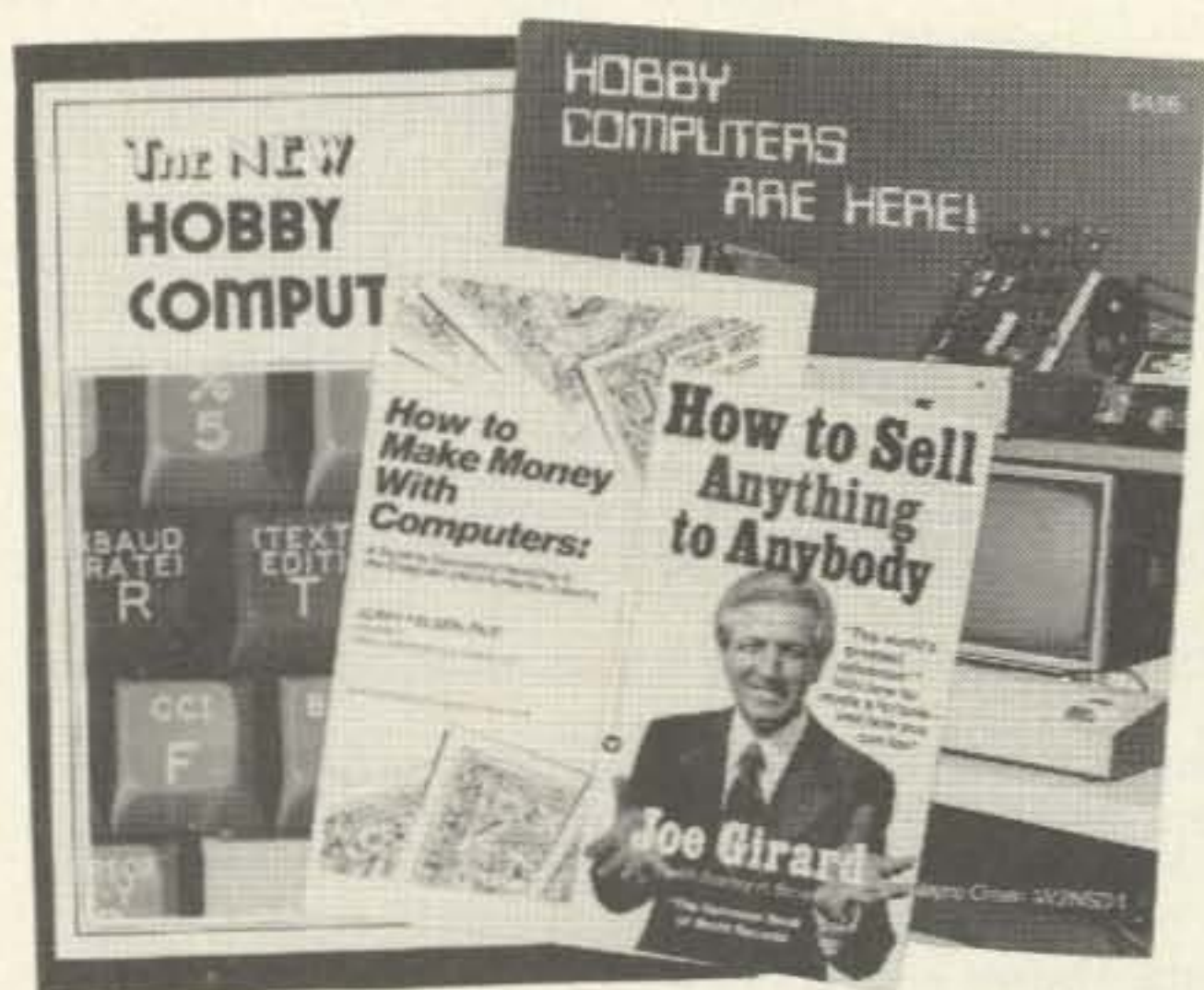

● **HOBBY COMPUTERS ARE HERE!**—BK7322—If you want to come up to speed on how computers work... hardware and software... this is an excellent book. It starts with the fundamentals and explains the circuits, the basics of programming, along with a couple of TVT construction projects, ASCII-Baudot, etc. This book has the highest recommendations as a teaching aid for newcomers. \$4.95.*

● **THE NEW HOBBY COMPUTERS**—BK7340—This book takes it from where **Hobby Computers Are Here!** leaves off, with chapters on Large Scale Integration, how to choose a microprocessor chip, an introduction to programming, low cost I/O for a computer, computer arithmetic, checking memory boards, a Baudot monitor/editor system, an audible logic probe for finding those tough problems, a ham's computer, a computer QSO machine... and much, much more! \$4.95*

● **HOW TO MAKE MONEY WITH COMPUTERS**—In 10 information-packed chapters, Jerry Felsen describes more than 30 computer-related, money-making, high profit, low capital investment opportunities. \$15.00.* (BK1003)

● **HOW TO SELL ANYTHING TO ANYBODY**—According to *The Guinness Book of World Records*, the author, Joe Girard, is "the world's greatest salesman." This book reveals how he made a fortune—and how you can, too. \$2.25.* (BK7306)

Use the order card in the back of this magazine or itemize your order on a separate piece of paper and mail to:
Dept. F3 • 73 Radio Bookshop • Peterborough NH 03458. Include check or detailed credit card information.
*Add \$1.00 handling charge. Note: Prices subject to change on books not published by 73 Magazine.

FOR TOLL FREE ORDERING CALL 1-800-258-5473

PROPAGATION

by
J. H. Nelson

kilobaud

MICROCOMPUTING™

for business . . . education . . . FUN!

save
up to 50%

Yes! Please send me Kilobaud
MICROCOMPUTING at a saving of
40% to 50% off the newsstand
price.

- 12 issues for \$18 (save 40%)
- 24 issues for \$30 (save 50%)
- 36 issues for \$45 (save 50%)
- New subscription Renewal
- Payment enclosed \$ _____
- VISA MC AE Bill me

Card# _____ Exp. date _____

Signature _____

Name _____

Address _____

City _____ State _____ Zip _____

—for even faster service call toll-free (800) 258-5473

Canada: same as US, in US funds.
Other foreign: \$23 one year only, US funds.

303B6

MICROCOMPUTING • POB 997 • Farmingdale NY 11737

MOVING?

Let us know 8 weeks in advance so that you won't miss a single issue of 73 Magazine. Attach old label where indicated and print new address in space provided. Also include your mailing label whenever you write concerning your subscription. It helps us serve you promptly. Write to:

73 magazine

Subscription Department
P.O. Box 931
Farmingdale NY 11737

- Address change only Payment enclosed
- Extend subscription
- Enter new subscription Bill me later
- 1 year \$18.00

If you have no label handy, print OLD address here.

AFFIX LABEL

Name _____ Call _____

Address _____

City _____ State _____ Zip _____

print NEW address here:

Name _____ Call _____

Address _____

City _____ State _____ Zip _____

301B55

EASTERN UNITED STATES TO:

| | GMT: | 00 | 02 | 04 | 06 | 08 | 10 | 12 | 14 | 16 | 18 | 20 | 22 |
|--------------|------|-----|----|----|----|----|-----|-----|-----|-----|-----|-----|----|
| ALASKA | 21 | 14 | 7A | 7 | 7 | 7 | 7 | 7 | 14 | 14 | 21 | 21A | |
| ARGENTINA | 21A | 14 | 14 | 14 | 7 | 7 | 21A | 21A | 21A | 21A | 21A | 21A | |
| AUSTRALIA | 21A | 21 | 14 | 7B | 7B | 7B | 7B | 14B | 14 | 21 | 21A | 21A | |
| CANAL ZONE | 21A | 14 | 14 | 7A | 7 | 7 | 14 | 21A | 21A | 21A | 21A | 21A | |
| ENGLAND | 7A | 7 | 7 | 7 | 7 | 7 | 14 | 21A | 21A | 21A | 14A | 14 | |
| HAWAII | 21A | 14 | 14 | 7 | 7 | 7 | 7 | 7 | 14 | 21A | 21A | 21A | |
| INDIA | 7A | 7A | 7B | 7B | 7B | 7A | 14 | 21 | 14A | 14 | 14 | 7A | |
| JAPAN | 21 | 14 | 7B | 7B | 7B | 7B | 7 | 7B | 7B | 7B | 14 | 21 | |
| MEXICO | 21 | 14 | 7 | 7 | 7 | 7 | 7A | 21 | 21A | 21A | 21A | 21A | |
| PHILIPPINES | 21 | 14 | 7B | 7B | 7B | 7B | 7B | 7B | 7 | 14 | 14 | 14A | |
| PUERTO RICO | 14A | 14 | 7A | 7 | 7 | 7 | 14 | 21 | 21A | 21A | 21A | 21A | |
| SOUTH AFRICA | 14 | 14 | 7 | 7B | 7B | 14 | 21A | 21A | 21A | 21A | 21A | 21A | |
| U. S. S. R. | 7B | 7 | 7 | 7 | 7 | 7B | 14 | 21A | 21A | 21 | 14 | 7B | |
| WEST COAST | 21A | 14A | 7A | 7 | 7 | 7 | 7 | 14 | 21A | 21A | 21A | 21A | |

CENTRAL UNITED STATES TO:

| | GMT: | 00 | 02 | 04 | 06 | 08 | 10 | 12 | 14 | 16 | 18 | 20 | 22 |
|--------------|------|-----|----|----|----|----|----|-----|-----|-----|-----|-----|----|
| ALASKA | 21 | 14A | 14 | 7 | 7 | 7 | 7 | 7 | 14 | 14 | 21A | 21A | |
| ARGENTINA | 21A | 21 | 14 | 14 | 7 | 7 | 14 | 21A | 21A | 21A | 21A | 21A | |
| AUSTRALIA | 21A | 21A | 21 | 14 | 7B | 7B | 7B | 7B | 14 | 21 | 21A | 21A | |
| CANAL ZONE | 21A | 14A | 14 | 7A | 7 | 7 | 14 | 21A | 21A | 21A | 21A | 21A | |
| ENGLAND | 7A | 7 | 7 | 7 | 7 | 7 | 7B | 14 | 21A | 21A | 14A | 14 | |
| HAWAII | 21A | 21A | 14 | 7 | 7 | 7 | 7 | 7 | 14 | 21A | 21A | 21A | |
| INDIA | 14 | 14 | 7B | 7B | 7B | 7B | 7B | 7A | 14 | 14 | 14 | 14 | |
| JAPAN | 21A | 21 | 14 | 7B | 7B | 7B | 7 | 7 | 7 | 14B | 14 | 21A | |
| MEXICO | 21 | 14 | 7 | 7 | 7 | 7 | 7 | 14 | 21 | 21A | 21A | 21 | |
| PHILIPPINES | 21A | 21 | 14 | 7B | 7B | 7B | 7B | 7B | 7 | 14 | 14 | 21 | |
| PUERTO RICO | 21 | 14 | 14 | 7 | 7 | 7 | 14 | 21A | 21A | 21A | 21A | 21A | |
| SOUTH AFRICA | 14 | 14 | 7 | 7B | 7B | 7B | 14 | 21A | 21A | 21A | 21A | 21A | |
| U. S. S. R. | 7B | 7 | 7 | 7 | 7 | 7B | 7B | 14 | 21 | 14 | 14B | 7B | |

WESTERN UNITED STATES TO:

| | GMT: | 00 | 02 | 04 | 06 | 08 | 10 | 12 | 14 | 16 | 18 | 20 | 22 |
|--------------|------|-----|-----|----|----|-----|----|-----|-----|-----|-----|-----|----|
| ALASKA | 21 | 21 | 14 | 7 | 7 | 7 | 7 | 7 | 7A | 14A | 21 | 21A | |
| ARGENTINA | 21A | 21A | 14A | 14 | 14 | 7 | 7B | 14 | 21A | 21A | 21A | 21A | |
| AUSTRALIA | 21A | 21A | 21A | 21 | 14 | 14B | 7B | 7B | 14 | 21 | 21A | 21A | |
| CANAL ZONE | 21A | 21 | 14 | 7A | 7 | 7 | 7 | 14A | 21A | 21A | 21A | 21A | |
| ENGLAND | 7A | 7 | 7 | 7 | 7 | 7 | 7B | 7B | 14 | 21A | 14A | 14 | |
| HAWAII | 21A | 21A | 21 | 14 | 7A | 7 | 7 | 7 | 14 | 21A | 21A | 21A | |
| INDIA | 14 | 14 | 14 | 7B | 7B | 7B | 7B | 7B | 14 | 14 | 14 | 14 | |
| JAPAN | 21A | 21A | 21 | 14 | 7B | 7B | 7 | 7 | 7 | 14 | 14 | 21A | |
| MEXICO | 21A | 21 | 14 | 14 | 7 | 7 | 7 | 14 | 21A | 21A | 21A | 21A | |
| PHILIPPINES | 21A | 21A | 21 | 14 | 7B | 7B | 7B | 7B | 7 | 14 | 14 | 21A | |
| PUERTO RICO | 21A | 14A | 14 | 7 | 7 | 7 | 7 | 14A | 21A | 21A | 21A | 21A | |
| SOUTH AFRICA | 14 | 14 | 7 | 7B | 7B | 7B | 7B | 14 | 21A | 21A | 21A | 21A | |
| U. S. S. R. | 7B | 7B | 7 | 7 | 7 | 7B | 7B | 7B | 14A | 14 | 14B | 7B | |
| EAST COAST | 21A | 14A | 7A | 7 | 7 | 7 | 7 | 14 | 21A | 21A | 21A | 21A | |

- A = Next higher frequency may also be useful
- B = Difficult circuit this period
- F = Fair
- G = Good
- P = Poor
- SF = Chance of solar flares

march '80

| sun | mon | tue | wed | thu | fri | sat |
|------------------|------------------|------------------|------------------|------------------|-------------------|----------------|
| | | | | | | 1 G |
| 2 G | 3 G | 4 F/SF | 5 F/SF | 6 F/SF | 7 F | 8 F |
| 9 G | 10 G | 11 G | 12 G | 13 G | 14 P/SF | 15 F |
| 16 F | 17 F | 18 F | 19 G | 20 G | 21 G | 22 G |
| 23 G/G | 24 F/F | 25 G | 26 G | 27 G | 28 G | 29 G |

READER SERVICE

| | | | |
|---|---|---|--|
| 1 Adirondack Radio Supply..... 151 | 24 Gemini Instrument Co..... 154 | 49 Micro Control Specialties..... 60 | 71 Tab Books..... 23 |
| 2 Advanced Electronic Applications 132, 145 | 25 Germantown Amateur Supply 114 | 50 Microcraft Corp..... 73 | 312 Technical Clinic..... 154 |
| 3 AED Electronics..... 53 | * Gilfer Shortwave..... 131 | 51 Microlog Corp..... 73, 101, 129 | 72 Tele-Tow'r Mfg. Co..... 132 |
| 300 Aldelco..... 53 | 27 G.I.S.M.O..... 139 | 313 Micro Management Systems... 150 | * Ten-Tec, Inc..... 9 |
| 314 Alliance Mfg. Co..... 13 | 28 Godbout Electronics..... 164 | 52 Mid Com Electronics, Inc..... 57 | 73 TET, USA..... 43 |
| 5 Amateur-Wholesale Electronics 119 | * Hal Communications Corp..... 19 | 307 Mil Industries..... 134 | 74 Texas Towers..... 128 |
| 6 AMC Engineering..... 127 | 31 Hal-Tronix..... 37 | 308 J W Miller Div Bell Industries 127 | 75 Thomas Communications..... 67 |
| 7 American Crystal Supply..... 155 | 30 The Ham-Key Co..... 153 | 53 MOM's..... 84, 85 | * Toledo Mobile Radio Association 100 |
| * AMSAT..... 64 | 32 Ham Radio Center..... 65 | 54 OK Machine & Tool..... 81, 83, 146 | 76 Trac Electronics, Inc..... 106 |
| 301 Appliance & Equipment Co., Inc. 150, 154 | 33 Hamtronics, NY..... 171 | 55 Optoelectronics, Inc..... 11 | 77 Tufts Radio Electronics 28, 29, 53 |
| 8 Apron Laboratories..... 47 | 303 Heath Co..... 7, 26 | 56 Outdoor Outfitters..... 131 | 310 Ultima Electronics, Ltd..... 154 |
| * Associated Radio..... 166 | 34 Henry Radio..... CII | * Palomar Engineers..... 106 | 311 Vanguard Labs..... 155 |
| 10 Avanti Research & Development 109 | 304 HFT, Inc..... 154 | * Partridge Electronics, Ltd..... 154 | 80 Western Electronics..... 151 |
| 11 Barker-Williamson..... 134 | 305 Hustler, Inc..... 100 | 57 P.C. Electronics..... 131 | * Wilson Systems, Inc..... 102-105 |
| 12 Bulet Electronics..... 172 | * ICOM..... 15 | 58 Poly Paks..... 167 | 81 Wilson Electronics..... 3 |
| 13 Clegg..... 13 | 37 IRL..... 42 | 59 Protronics, Inc..... 131 | * Xitex Corp..... 153 |
| 476 Cloverleaf Products..... 26 | 38 Jameco Electronics..... 165 | 69 Quest Electronics..... 157 | 82 Xitex Corp..... 153 |
| 14 Communications Center, NE..... 69 | 39 Jan Crystals..... 127 | 61 Radio Amateur Callbook..... 129 | 83 Yaesu Electronics Corp. CIII, 24, 61 |
| 15 Communications Specialists 16, 17 | * Kantronics..... 133, 146 | * Radio Shack..... 26 | From 73..... 99, 173-178 |
| 16 Crown Micro Products..... 155 | * Kenwood..... CIV, 5 | * Radio World..... 73 | From 80 Microcomputing..... 77 |
| * Dayton Hamvention '80..... 135 | 40 KLM Electronics..... 109 | 62 Ramsey Electronics..... 163, 168 | |
| 17 Dielectric Communications..... 64 | 41 LaRue Electronics..... 127 | 63 RF Power Labs, Inc..... 128 | |
| * Digital Research Parts..... 170 | 315 Lectronic Research Labs..... 151 | 64 Semiconductors Surplus 160, 161 | |
| 18 Digitrex Electronics..... 154 | 84 Long Path Radio..... 155 | 65 S-F Amateur Radio Services 139 | |
| 19 R. L. Drake Co..... 95 | 42 Long's Electronics..... 120-125 | 66 Signalcrafters, Inc..... 115, 133 | |
| 20 DSI Instruments..... 86, 87 | 43 Lunar Electronics..... 38, 138 | 477 Skytec..... 147 | |
| 21 Dynamic Electronics, Inc..... 154 | 44 Macrotronics..... 27, 134 | 309 Spacecoast Research..... 155 | |
| 22 Fair Radio Sales..... 154 | 45 Madison Electronics Supply 57, 118, 129 | 67 Spectronics, Inc..... 162, 169 | |
| 23 Flesher Corp..... 53 | 46 Maggiore Electronic Lab..... 155 | 68 Spectrum Communications..... 39 | |
| | 47 MFJ Enterprises 51, 131, 134, 138, 145 | 69 Surplus Electronics..... 156 | |
| | 48 MHz Electronics..... 158, 159 | 70 Swan Electronics..... 21 | |

*Reader Service inquiries not honored.
Please contact advertiser directly.

BOOKS, ETC.

| | | | | | |
|--------|---|---------|--------|--|-------------|
| BK1016 | 73 DIPOLE & LONG WIRE ANTENNAS..... | \$ 5.50 | BK7305 | POWER SUPPLY HANDBOOK..... | \$ 7.95 |
| ST0000 | 73 BACK ISSUE..... | \$ 3.00 | BK1015 | PRACTICAL ANTENNAS FOR THE RADIO AMATEUR..... | \$ 9.95 |
| ST2500 | 73 BACK ISSUES - 25 OUR CHOICE..... | \$12.00 | BK7302 | PROPAGATION WIZARD'S HANDBOOK..... | \$ 6.95 |
| ST0500 | 73 BACK ISSUES - 5 YOUR CHOICE..... | \$ 8.75 | QW0250 | QSL CARDS - STYLE W - 250..... | \$ 8.95 |
| ST1000 | 73 BACK ISSUES - 10 YOUR CHOICE..... | \$14.00 | QW0500 | QSL CARDS - STYLE W - 500..... | \$13.95 |
| ST2501 | 73 BACK ISSUES - 25 YOUR CHOICE..... | \$25.00 | QX0250 | QSL CARDS - STYLE X - 250..... | \$ 8.95 |
| BK1081 | BASIC NEW 2ND EDITION..... | \$ 6.95 | QX0500 | QSL CARDS - STYLE X - 500..... | \$13.95 |
| BK7307 | BEHIND THE DIAL..... | \$ 4.95 | QY0250 | QSL CARDS - STYLE Y - 250..... | \$ 8.95 |
| BN1001 | BINDER - 73 - 1..... | \$ 6.50 | QY0500 | QSL CARDS - STYLE Y - 500..... | \$13.95 |
| BN1002 | BINDER - 73 - 2 AND UP..... | \$ 6.00 | BK1080 | 1980 WORLD REPEATER ATLAS..... | \$ 4.95 |
| BK7309 | CHALLENGE OF 160..... | \$ 4.95 | BK1044 | RF DIGITAL TEST EQUIPMENT..... | \$ 5.95 |
| CT7305 | CODE TAPE - 5 WPM..... | \$ 4.95 | BK7347 | RTTY HANDBOOK..... | \$ 5.95 |
| CT7306 | CODE TAPE - 6+ WPM..... | \$ 4.95 | BX1000 | SHELF BOX - 1..... | \$ 2.00 |
| CT7313 | CODE TAPE - 13+ WPM..... | \$ 4.95 | BX1001 | SHELF BOXES - 2..... | \$1.50 each |
| CT7320 | CODE TAPE - 20+ WPM..... | \$ 4.95 | BX1002 | SHELF BOXES - 8 AND UP..... | \$1.25 each |
| CT7325 | CODE TAPE - 25+ WPM..... | \$ 4.95 | BK7351 | SSB THE MISUNDERSTOOD MODE..... | \$ 5.50 |
| CT7394 | CODE TAPES (ANY FOUR ABOVE)..... | \$15.95 | BK7354 | SSTV HANDBOOK (HARDCOVER)..... | \$ 7.00 |
| BK7308 | THE CONTEST COOKBOOK..... | \$ 5.95 | BK7355 | SSTV HANDBOOK (SOFTCOVER)..... | \$ 5.00 |
| BK7321 | GUIDE TO HAM RADIO..... | \$ 4.95 | CT7350 | SSTV TAPE..... | \$ 5.95 |
| BK7304 | GIANT BOOK OF AMATEUR RADIO ANTENNAS..... | \$12.95 | SG1081 | STUDY GUIDE - ADVANCED CLASS..... | \$ 6.95 |
| BK7322 | HOBBY COMPUTERS ARE HERE..... | \$ 4.95 | SG1080 | STUDY GUIDE - EXTRA CLASS..... | \$ 5.95 |
| BK7325 | HOW TO BUILD A MICROCOMPUTER & REALLY UNDER- STAND IT..... | \$ 9.95 | SG7358 | STUDY GUIDE - GENERAL CLASS..... | \$ 5.95 |
| BK1003 | HOW TO MAKE MONEY WITH COMPUTERS..... | \$15.00 | SG7357 | STUDY GUIDE - NOVICE CLASS..... | \$ 4.95 |
| BK7306 | HOW TO SELL ANYTHING TO ANYBODY..... | \$ 2.25 | LB7359 | TEST EQUIP LIB V1 - COMP TESTERS..... | \$ 4.95 |
| BK1028 | IC OP AMP COOKBOOK..... | \$12.95 | LB7360 | TEST EQUIP LIB V2 - AUDIO TESTERS..... | \$ 4.95 |
| BK7380 | INTRO TO RTTY..... | \$ 2.00 | LB7361 | TEST EQUIP LIB V3 - RADIO EQUIP..... | \$ 4.95 |
| BK7340 | THE NEW HOBBY COMPUTERS..... | \$ 4.95 | LB7362 | TEST EQUIP LIB V4 - IC TEST EQUIP..... | \$ 4.95 |
| CT7300 | NOVICE THEORY TAPES..... | \$15.95 | BK7348 | TOOLS & TECHNIQUES..... | \$ 4.95 |
| BK7310 | OWNER REPAIR OF AMATEUR RADIO EQUIP- MENT..... | \$ 7.95 | BK1063 | TTL COOKBOOK..... | \$ 9.50 |
| | | | BK1064 | TVT COOKBOOK..... | \$ 9.95 |
| | | | BK1069 | VERTICAL BEAM & TRIANGLE ANTNS..... | \$ 5.50 |
| | | | BK7368 | VHF ANTENNA HANDBOOK..... | \$ 4.95 |
| | | | BK7370 | WEATHER SATELLITE HANDBOOK..... | \$ 4.95 |

FT-707 is shown with optional FV-707DM VFO & Scanning Microphone



THE FT-707 "WAYFARER"

The introduction of the "WAYFARER" by Yaesu is the beginning of a new era in compact solid state transceivers. The FT-707 "WAYFARER" offers you a full 100 watts output on 80-10 meters and operates SSB, CW, and AM modes. Don't let the small size fool you! Though it is not much larger than a book, this is a full-featured transceiver which is ideally suited for your home station or as a traveling companion for mobile or portable operation.

The receiver offers sensitivity of .25 $\mu\text{V}/10$ dB SN as well as a degree of selectivity previously unavailable in a package this small. The "WAYFARER" comes equipped with 16 poles of IF filtering, variable bandwidth and optional crystal filters for 600 Hz or 350 Hz. Just look at these additional features:

FT-707 with Standard Features

- Fast/slow AGC selection
- Advanced noise blanker
- Built-in calibrator
- WWV/JJY Band
- Bright Digital Readout
- Fixed crystal position
- 2 auxiliary bands for future expansion
- Unique multi-color bar metering—monitors signal strength, power output, and ALC voltage.

FT-707 with Optional FV-707DM & Scanning Microphone

- Choice of 2 rates of scan
- Remote scanning from microphone
- Scans in 10 cycle steps
- Synthesized VFO
- Selection of receiver/transmitter functions from either front panel or external VFO
- "DMS" (Digital Memory Shift)

Impressive as the "WAYFARER" is its versatility can be greatly increased by the addition of the FV-707DM (optional). The FV-707DM, though only one inch high, allows the storage of 13 discrete frequencies and with the use of "DMS" (Digital Memory Shift) each memory can be band-spread 500 KHz. These 500 KHz bands may be remotely scanned from the microphone at the very smooth rate of 10 Hz steps.

The FT-707 "WAYFARER" is a truly unique rig. See it today at your authorized Yaesu Dealer.

YAESU
The radio.



New 2-meter direction.



PS-20

TR-9000

BO-9

SP-120

Subject to FCC Approval

A compact transceiver with FM/SSB/CW plus...

TR-9000

Kenwood's done it again! Now, it's the exciting TR-9000 2-meter all-mode transceiver... complete with a host of new features. Combining the convenience of FM with long distance SSB and CW in a very compact, very affordable package, the TR-9000 is the answer for any serious Amateur Operator! Versatile? You

bet! Because of its compactness, the TR-9000 is ideal for mobile installation. Add on its fixed station accessories and it becomes the obvious choice for your ham shack!

See your Authorized Kenwood Dealer now for details on the TR-9000... the new direction in 2-meter all-mode transceivers!



UP/DOWN microphone (standard)
... "beep" sounds with each frequency step.

Note: Price, specifications subject to change without notice and obligation.

 **KENWOOD**
...pacesetter in amateur radio

TRIO-KENWOOD COMMUNICATIONS INC.
1111 WEST WALNUT / COMPTON, CALIFORNIA 90220