

73 Magazine

for Radio Amateurs

- 32 **Sunspots . . . What Do They Mean?**
—your guess is as good as mine. G3WDI
- 36 **More on Jammer Nabbing**
—hints on equipment and strategy. WB0CMC
- 38 **Cheapy Scanner for the Memorizer**
—is \$5 cheap enough for you? WA2ORU
- 40 **Back to School**
—we can still learn a thing or two about basic
electricity. W6HDM
- 46 **Moving Display ASCII Readout**
—works with UARTs, keyboards, and
micros. W8VL
- 54 **Lab-Quality Hi I Supply**
—part II. McClellan
- 58 **A Better Car Regulator**
—improved reliability. Gelsing
- 62 **Test Gear Bargain from Heath**
—a multi-purpose RCL bridge. Staff
- 64 **Semiconductor Test Gadget**
—use with your scope. Truesdale
- 66 **Shoes and Socks for the IC-502**
—when your vacation ends, you'll appreciate
this amplifier/PS combo. N4QH
- 68 **Hams on the Trail of UFOs**
—the Army's "flying saucer" movie . . . did you
see it? K8NQN
- 70 **Hi-Fi CW for the TS-820**
—the SSB filter copes with numbing noise
. K3HBP
- 72 **Going 2m All-Mode with Yaesu's
FT-225RD**
—not just another pretty face. W6OJF
- 73 **The PL-259 Connection**
—reducing adapters need not try your patience
. AC5P
- 76 **IO A Micro-Controlled Ham Station**
—TRS-80 does it. W4UCH/2
- 80 **IO CW and the TRS-80**
—send Morse with a Level I. WB7TUG
- 88 **A Solid-State RTTY Keyboard**
—with auto-shift. K2BLA
- 92 **SWLing? Try This Souped-Up SSR-1**
—digital readout and more for Drake's fine
receiver. G3WDI
- 96 **Off to MARS with the S1**
—mod is also useful for oddball repeater
splits. K5EDS
- 98 **Field-Strength Fever**
—this simple meter eases antenna tuning
. W6DOB
- 100 **CB to 10**
—part XXIV: Penney's SSB rig. WA4UUV
- 104 **Build an Audio VOM**
—and keep your eyes where they belong
. AC5P
- 106 **Sound-Sensitive CW Sender**
—for hands-free Morse. W2GZ
- 108 **A Tightwad's FSK Demodulator**
—using the 567 PLL. WA5WPQ
- 115 **Measure Frequency on your DVM**
—this 3-chip circuit works to 10 kHz. W3HB



Never Say Die—4, Looking West—10, RTTY Loop—12, Contests—14, Leaky Lines—16,
Letters—20, Awards—22, DX—24, Microcomputer Interfacing—26, New Products—28,
Dealer Directory—86, Social Events—116, Ham Help—122, 123, 133, OSCAR Orbits—
123, Corrections—132, Review—162, FCC—170, Propagation—193



*Shown with accessory touch tone pad

**PROVEN
DEPENDABILITY**
...**THE TEMPO S-1**
GREET'S THE NEW YEAR
WITH A SPECIAL LOW PRICE

The **TEMPO S-2**... the world's first synthesized 220 MHz hand held transceiver. With an S-2 in your car or pocket you can use any 220 MHz repeater in the United States. It offers all of the advanced engineering, premium quality components and exciting features of the S-1. It is completely synthesized, offering 1000 channels in an extremely lightweight but rugged case. If you're not on 220 it's about time you try it and this is the perfect way to get started. With the addition of a matching Tempo solid state amplifier you can use your S-2 as a powerful mobile or base station as well. It's all you really need. And if you already have a 220 MHz rig, the S-2 will add versatility you never dreamed possible.

Also... the price is right. The ni-cad battery pack, charger, and telescoping whip antenna are included. Although not a necessary option, the touch tone pad shown in the illustration adds greatly to its convenience at a low price.

The time has never been better to expand your horizons... there has never been a better little rig for 220 than the S-2.

Price...\$349.00

With touch tone pad...\$399.00

By now most of you have heard the same words of praise on the air that we (gratefully) receive over and over. The quality that is built into the S-1 has been attested to by the outstanding performance and dependability of the thousands of units in daily use. It's simple to operate and the high level of innovative engineering that brought forth the Amateur world's first hand held synthesized radio also designed into this compact beauty exciting performance and features at a very affordable price. A price that also includes a ni-cad battery pack, charger, and a telescoping whip antenna. The optional touchtone pad shown in the illustration adds greatly to its convenience. In addition we offer superior quality 30 and 80 watt solid state matching power amplifiers that give the S-1 the flexibility of operating as a portable, mobile, or base station rig.

Remember...the Tempo S-1 is the original and proven 800 channel synthesized hand held transceiver. Don't be fooled by substitutes.

SPECIFICATIONS

Frequency Coverage: 144 to 148 MHz
Channel Spacing: Receive every 5 kHz, transmit Simplex or ±600 kHz
Power Requirements: 9.6 VDC
Current Drain: 17 ma-standby 500 ma-transmit
Batteries: 8 cell ni-cad pack included
Antenna Impedance: 50 ohms
Dimensions: 40 mm x 62 mm x 165 mm (1.6" x 2.5" x 6.5")
RF Output: Better than 1.5 watts
Sensitivity: Better than .5 microvolts

SUPPLIED ACCESSORIES

Telescoping whip antenna, ni-cad battery pack, charger.

OPTIONAL ACCESSORIES

Touch tone pad (not installed): \$39 • Tone burst generator: \$29.95 • CTCSS sub-audible tone control: \$29.95 • Rubber flex antenna: \$8 • Leather holster: \$16 • Cigarette lighter plug mobile charging unit: \$6 • Matching 30 watt output 13.8 VDC power amplifier (S30): \$89 • Matching 80 watt output power amplifier (S80): \$149

Price... ~~\$349.00~~ Reduced to \$299.00

With touch tone pad... ~~\$399.00~~ Reduced to \$339.00

The Tempo line also features a fine line of extremely compact UHF and VHF pocket receivers. They're low priced, dependable, and available with CTCSS and 2-tone decoders. The Tempo FMT-2 & FMT-42 (UHF) provide excellent mobile communication and features a remote control head for hide-away mounting.

The Tempo FMH-42 (UHF) and the NEW FMH-12 and FMH-15 (VHF) micro hand held transceivers provide 6 channel capability, dependability plus many worthwhile features at a low price. FCC type accepted models also available.

Please call or write for complete information. Also available from Tempo dealers throughout the U.S. and abroad.



NEW TOLL FREE ORDER NUMBER: (800) 421-6631

For all states except California. Calif. residents please call collect on our regular numbers.

H3

11240 W. Olympic Blvd., Los Angeles, Calif. 90064 213/477-6701
931 N. Euclid, Anaheim, Calif. 92801 714/772-9200
Butler, Missouri 64730 816/679-3127

Henry Radio

Prices subject to change without notice.

WILSON'S NEWEST TOWER

"77 ft. Freestanding ST-77B"

ST-77B SPECIFICATIONS

- Full Height..... 77' (80' with Base)
- Min. Height..... 24'
- Weight..... 700 lbs.
- Winch..... 1500 lbs.
- Cable..... 6400 lbs.
- Tubing Size:
 - 2"..... .095
 - 3½"..... .095
 - 4½"..... .125
 - 6"..... .125
 - 8"..... .134
- Conforms to ASTM specifications

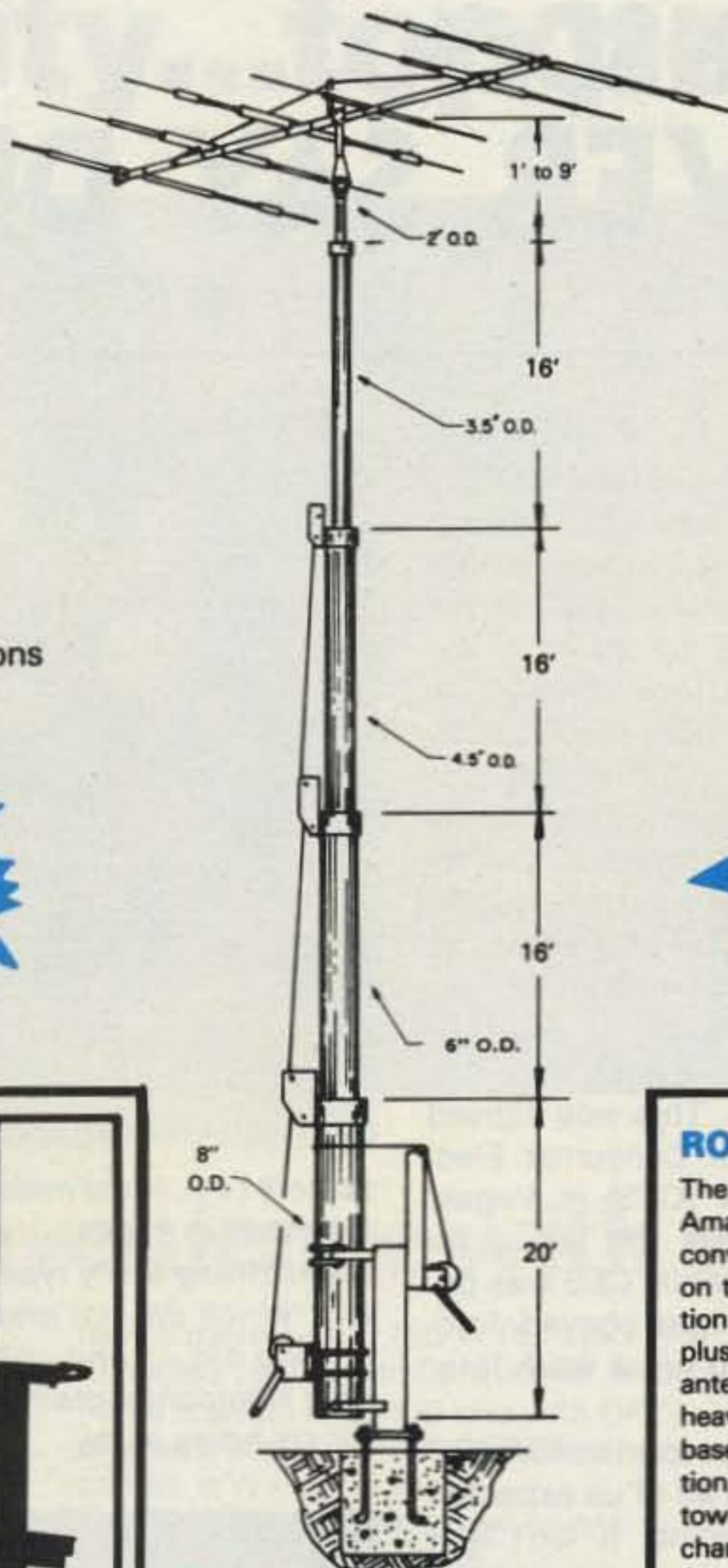

ST-77B FEATURES

- Our largest and tallest freestanding tower
- Hot dipped galvanized tubing
- Special high strength carbon steel (25% stronger than conventional pipe or tubing)
- Wind loading at 50 mph:
 - 69' high — 18 sq. ft.
 - 77' high — 12 sq. ft.
- Can handle 20 sq.ft. at 80 mph at 73' when used with one set of Guys at top of 3½" section
- 10' Push-up Mast

FACTORY DIRECT
\$949⁹⁵

NEW!

FIXED BASE

The **FB-77B** will provide an economical method of mounting the tower. It will support the tower in a completely freestanding vertical position, while also having the capabilities of tilting the tower over to provide an easy access to the antenna. The rotor mounts at the top of the tower in the conventional manner, and will not rotate the complete tower. Shown at right is FB-61B, the FB-77B is similar, except larger.



FB-77B..... 250 lbs..... \$289.95

MUST BE USED WITH EITHER FB-77B or RB-77B
Requires 3½' x 3½' x 6' Foundation (2½ yds of concrete)

ROTATING BASE

The **RB-77B** was designed for the Amateur who wants the added convenience of being able to work on the rotor from the ground position. This base will give that ease plus rotate the complete tower and antenna system by the use of a heavy duty thrust bearing at the base of the tower mounting position, while still being able to tilt the tower over when desiring to make changes on the antenna system. Shown at right is the RB-61B. The RB-77B is similar except larger.

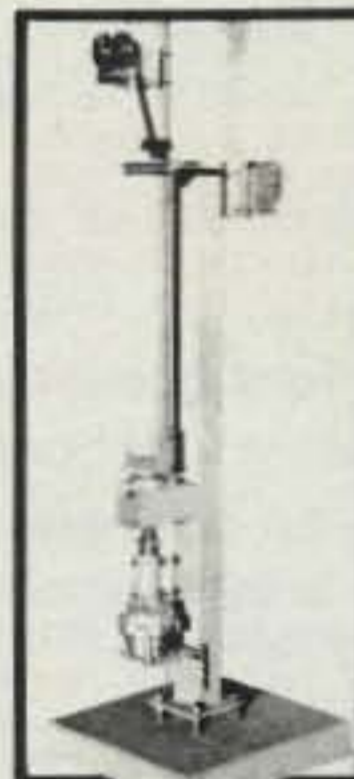

RB-77B..... 300 lbs..... \$449.95

WILSON SYSTEMS, INC. — 4286 So. Polaris
Las Vegas, Nevada 89103 — (702) 739-7401

FACTORY DIRECT ORDER BLANK

Toll Free Order Number
1-800-634-6898

QTY	MODEL	DESCRIPTION	SHIP	PRICE
	ST-77B	77' Tubular Crank Up Tower	TRUCK	949.95
	FB-77B	Fixed Base w/Tilt-Over feature	TRUCK	299.95
	RB-77B	Rotating Base w/Tilt-Over feature	TRUCK	449.95
ACCESSORIES				
	T*X	CDR Tailtwister Rotor	UPS	199.95
	RC-8C	8/C Rotor Cable	UPS	.12/ft.
	RG-8U	RG-8U Foam-Ultra Flexible Coaxial Cable, 38 strand center conductor, 11 gauge	UPS	.21/ft.

NOTE:

On Coaxial and Rotor Cable, minimum order is 100' with 50' multiples
Ninety (90) Day Limited Warranty. All Products FOB Las Vegas, Nevada

Nevada Residents Add Sales Tax

Ship C.O.D. Check Enclosed Charge to VISA M/C

Card No. _____

Expires _____ Bank No. _____

Signature _____

PRINT Name _____

Address _____

City _____

State _____ Zip _____

AVAILABLE MARCH 1, 1980

Prices and specifications subject to change without notice.



Tilting the tower over is a one-man task with the Wilson bases. Shown above is the RB-61B—(Rotor not included.) FB-77B similar.

Staff

EDITOR/PUBLISHER
Wayne Green W2NSD/1

EXECUTIVE VICE PRESIDENT
Sherry Smythe

CORPORATE CONTROLLER
Alan Thulander

ASSISTANT PUBLISHER
Jeffrey DeTray WB8BTH

ADMINISTRATIVE ASSISTANT
Dotty Gibson

MANAGING EDITOR
John Burnett

ASSISTANT MANAGING EDITOR
Susan Philbrick

NEWS EDITOR
Gene Smarte WB6TOV/1

EDITORIAL ASSISTANTS
Nancy Noyd
Richard Phenix

PRODUCTION MANAGER
Noel Self WB1ARP

ASSISTANT PRODUCTION MANAGER
Robin Sloan

ART DEPARTMENT
Steve Baldwin
Bob Drew
Bruce Hedin
Kenneth Jackson
Michael Murphy
Dion Owens
Nancy Salmon
Patrice Scribner
John White

BOOK PUBLICATIONS
Jim Perry

BOOK PRODUCTION
Emily Gibbs
Chris Brown N1AU1

PHOTOGRAPHY
Bill Heydolph
Tedd Cluff
Terrie Anderson

TYPESETTING
Barbara Latti
Sara Bedell
Sandie Gunseth

ACCOUNTING MANAGER
Knud Keller KV4GG/1

DATA ENTRY
Cathy DeSilva

CIRCULATION MANAGER
Debra Boudrieau

ASSISTANT CIRCULATION MANAGER
Barbara Block

CIRCULATION
Pauline Johnstone

BULK SALES MANAGER
Ginnie Boudrieau

SHIPPING
Mark Dendy
Bill Barry
Bryan Hastings KA1DXZ

RECEPTIONIST
Doni Jarvis

ASSOCIATES
Robert Baker WB2GFE
Sanger Green
Dave Ingram K4TWJ
Larry Kahaner WB2NEL
Joe Kasser G3ZCZ
Bill Pasternak WA6ITF
John Schultz W4FA
Peter Stark K2OAW

ADVERTISING
Aline Coutu, Mgr.
Kevin Rushalko
Nancy Ciampa
Marcia Stone
Louise Holdsworth
Jerry Merrifield
Lori Mugford
Rita Rivard
Hal Stephens
Phoebie Taylor

the ham business . . . past, present, and projections for the future.

The big event was my discussion of three proposed new modes of ham communications for the 80s and a new type of ham gear construction which would be geared to the new modes . . . and to working with microprocessors. The firms represented signed non-disclosure contracts which give those signers a six-month minimum lead over other firms toward design-

Continued on page 163



Other toys which Chuck brought along were a couple of the latest Sony stereo players, complete with earphones. The quality of the sound is beyond belief and these were very popular while skiing. Here's Curt getting an earful of Scott Joplin via the Sony during one of our workshop dinners. This, by the way, was at the Copper Kettle restaurant and our waiter was WB0FOR, as in past years. Curt is one hell of a skier . . . and his wife Marge does well, too.



Some of our people opted for breakfast on the sidewalk . . . despite the chilly temperature. Here we see pancakes being poured . . . part of the celebration of Winterskol each January. Actually, it wasn't all that cold, with temperatures into the 40s some days, making skiing hot work. We often find Aspen awash in slush in January, but



Here's Curt Childress W0MNK, the president of Midwest Scientific Industries, coming down the slope at Tiehack on Buttermilk at 42 mph. He is being timed by Eric Williams WA1HON. The radar speed detector is the same as the ones being advertised by JS&A and it works very well indeed. Chuck Martin WA1KPS, the president of Tufts Electronics, had brought the radar unit so we could damned near kill ourselves trying for higher and higher speeds.



Marshall on the left, Sandy Cole K1SC (who comes from my home town, Littleton, New Hampshire, and now lives in Tucson), Jim, Eric, and Chuck. Splendid meal at the Chart House restaurant in Aspen. Note the four HTs on the table . . . par for the course.



Despite rather substantial breakfasts, as well as lunches and dinners, I managed to go home lighter than I arrived in Aspen. This was

FM...SSB...CW...

ICOM Does it All!

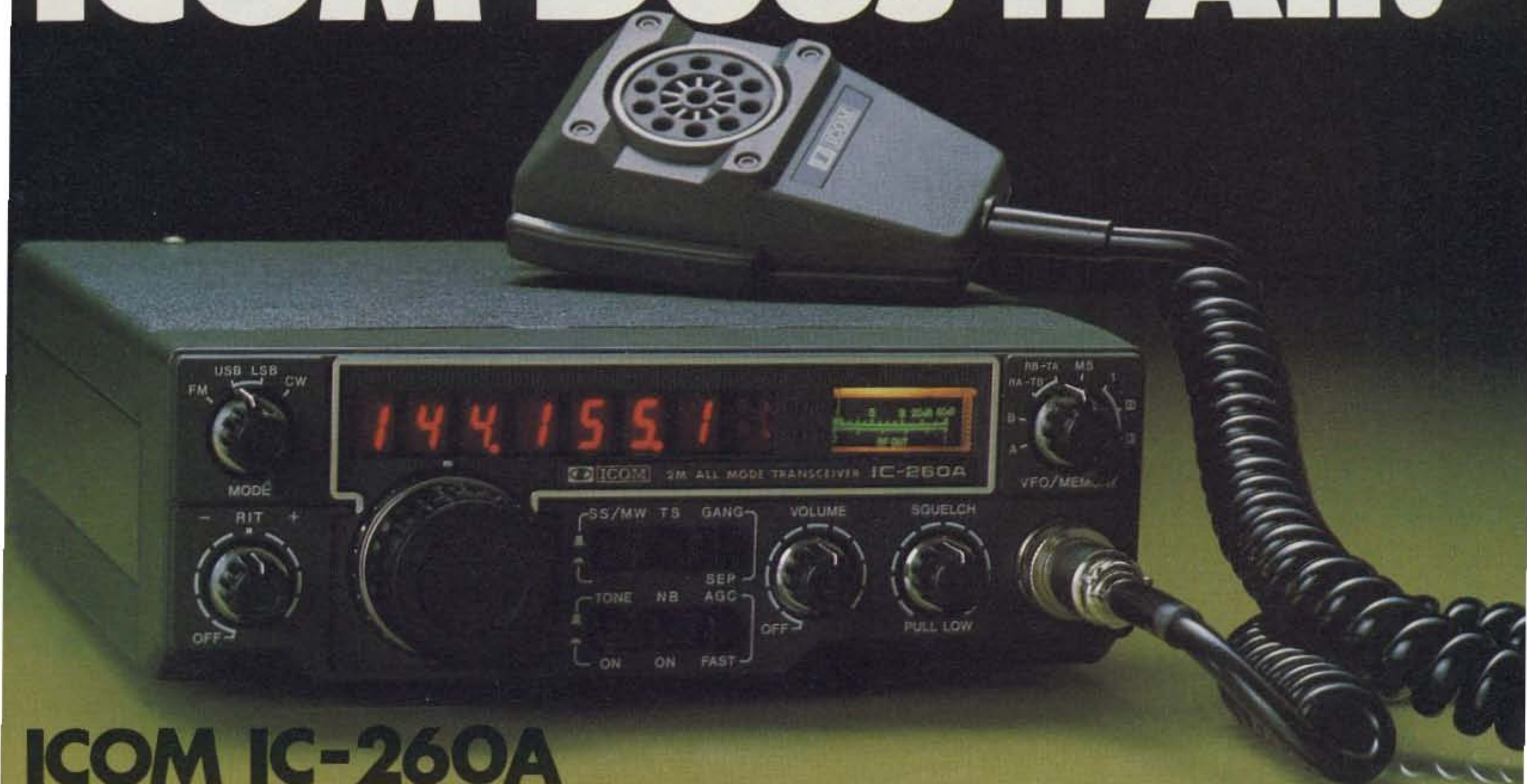

ICOM IC-260A

Enjoy VHF mobile at its best. Sideband, FM or CW, the ICOM IC-260A does it all. The ICOM IC-260A contains all the features a mobile operator would want in a compact 2 meter mobile package with FM, SSB, CW operation. Features customers ask for most including:

- 3 memories built in (quick access to your favorite frequencies).
- Memory scan — automatically stops on an active frequency programmed in the memories.
- Programmable band scan — scan the whole band, or any portion of it you desire (adjustable scanning speed).

- Squelch on SSB, the 260A will automatically and silently scan the SSB portion of the band seeking out the SSB activity on 2.
- 600kc repeater offset built in. Easy repeater operation on the FM portion of the band.
- Variable repeater split — with the 2 built in VFOs, it's possible to work the odd splits plus accommodate future repeater band plan changes.
- Multimode operation — USB, LSB, CW, and FM. Great for getting into OSCAR, plus enjoying SSB rag chewing as well as repeater operation (including the new subband).

- With optional 117/12V supply, the 260A makes a flexible functional base for SSB/OSCAR/FM operation

The RF amplifier and first mixer circuits using FETs, and other circuits provide excellent Cross Modulation and Intermodulation characteristics. The IC-260A has excellent sensitivity demanded especially for mobile operation, high stability, and with Crystal Filters having high shape factors, exceptional selectivity.

The transmitter uses a balanced mixer in a single conversion system, a band-pass filter and a high-performance low-pass filter. This system provides distortion-free signals with a minimum spurious radiation level.

HF/VHF/UHF AMATEUR AND MARINE COMMUNICATION EQUIPMENT



ICOM

ICOM AMERICA, INCORPORATED

Sales Service Centers located at:

2112 116th Avenue NE
Bellevue, WA 98004
Phone (206) 454-8155

3331 Towerwood Dr., Suite 307
Dallas, TX 75234
Phone (214) 620-2780

ICOM INFORMATION SERVICE

2112 116th Ave., N.E.
Bellevue, WA 98004

Please send me: IC-260A specifications sheet; full color ICOM Product Line Catalog; List of Authorized ICOM Dealers.

NAME _____ CALL _____

ADDRESS _____

CITY _____ STATE _____ ZIP _____

You may send a machine copy of this form

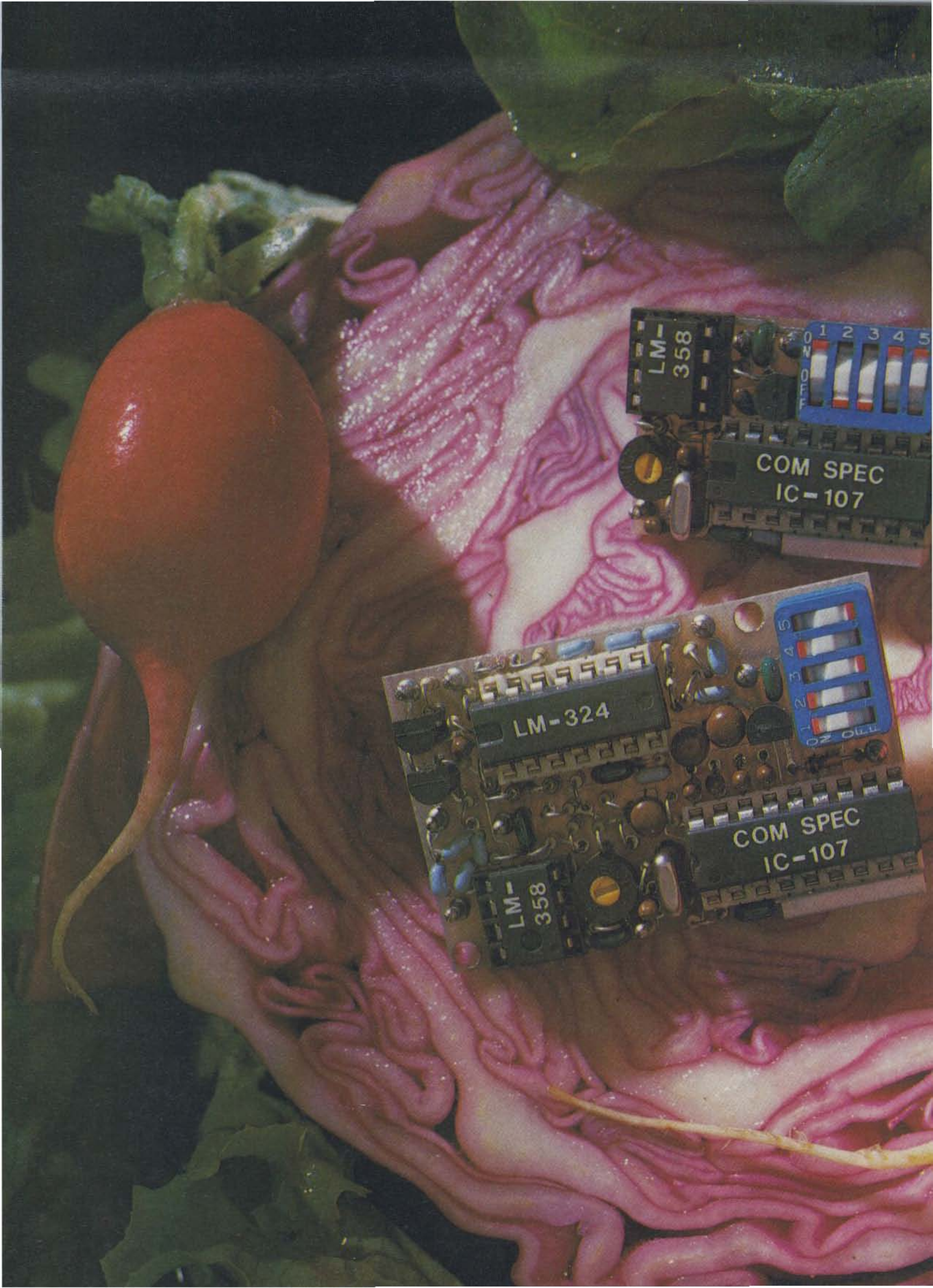

A fresh idea!

Our new crop of tone equipment is the freshest thing growing in the encoder/decoder field today. All tones are instantly programmable by setting a dip switch; no counter is required. Frequency accuracy is an astonishing $\pm .1$ Hz over all temperature extremes. Multiple tone frequency operation is a snap since the dip switch may be removed. Our SS-32 encode only model is programmed for all 32 CTCSS tones or all test tones, touch-tones and burst-tones.

And, of course, there's no need to mention our 1 day delivery and 1 year warranty.



TS-32 Encoder-Decoder

- Size: 1.25" x 2.0" x .40"
- High-pass tone filter included that may be muted
- Meets all new RS-220-A specifications
- Available in all 32 EIA standard CTCSS tones

SS-32 Encoder

- Size: .9" x 1.3" x .40"
- Available with either Group A or Group B tones

Frequencies Available:

Group A			
67.0 XZ	91.5 ZZ	118.8 2B	156.7 5A
71.9 XA	94.8 ZA	123.0 3Z	162.2 5B
74.4 WA	97.4 ZB	127.3 3A	167.9 6Z
77.0 XB	100.0 1Z	131.8 3B	173.8 6A
79.7 SP	103.5 1A	136.5 4Z	179.9 6B
82.5 YZ	107.2 1B	141.3 4A	186.2 7Z
85.4 YA	110.9 2Z	146.2 4B	192.8 7A
88.5 YB	114.8 2A	151.4 5Z	203.5 M1

- Frequency accuracy, $\pm .1$ Hz maximum - 40°C to +85°C
- Frequencies to 250 Hz available on special order
- Continuous tone

Group B					
TEST-TONES:	TOUCH-TONES:	BURST-TONES:			
600	697 1209	1600	1850	2150	2400
1000	770 1336	1650	1900	2200	2450
1500	852 1477	1700	1950	2250	2500
2175	941 1633	1750	2000	2300	2550
2805		1800	2100	2350	

- Frequency accuracy, ± 1 Hz maximum - 40°C to +85°C
- Tone length approximately 300ms. May be lengthened, shortened or eliminated by changing value of resistor

Wired and tested: TS-32 \$59.95, SS-32 \$29.95

 **COMMUNICATIONS SPECIALISTS** ✓15

426 West Taft Avenue, Orange, California 92667
(800) 854-0547 / California: (714) 998-3021

The following are excerpts from unsolicited letters and registration cards received from owners of the new TEN-TEC OMNI transceiver.

- "I sold a Yaesu to buy this and am very impressed" —WB5ULA
 "My first QSO with OMNI-A was LAISV on CW and second was EA8SK on SSB." —N2CC
 "Excellent rig, just as advertised." —WB5TMD
 "Very pleased with performance. QSK feature very slick." —WB0ELM
 "This is my 5th TEN-TEC transceiver in less than 2 years. I loved them all and still have 3." —WB0VCA
 "Through the years I have had complete Drake and Collins stations. I tried a 544 Digital and liked it the best so decided to purchase the 546 OMNI-D Digital." —WA4NFM
 "Your OMNI is the best rig I have had in 20 years of hamming." —K4IHI
 "As a owner of Collins rig, your OMNI-D is the best." —K9JLJ
 "I already have an OMNI-A, 544 and a TRITON IV. You may ask why I own so many TEN-TEC rigs. In case there is a great RF famine, I want to be ready!" —WD4HCS
 "You guys really know how to turn on an old timer!" —K8ELS
 "Best operating & most conveniences of any transceiver I've ever used." —W6LZI
 "I like CW. Compared OMNI against IC701 (rcvr) and OMNI won hands down. XYL WD6GSB really enjoys rig on SSB. Finds rig is very stable and digital readout accurate." —AC6B
 "Have checked it out on both modes from "top band" (160) all the way to 29 MHz. Terrific!!!!" —W4DN
 "Works well, parts layout and design much better for any possible servicing than other ham gear. The Japanese hybrid sets can't compare to TEN-TEC for audio. Audio reports excellent without special speech processors, etc., to distort the signal." —AG8K
 "I have been using the S-Line over 15 yrs and never thought anything could outperform it. I got the biggest surprise and THRILLED with this OMNI-D even though I have been a ham since 1936." —KV4GD

- "This must be the greatest. I've spent enough money on final tubes to almost pay for this." —KA4BIH
 "This transceiver was recommended to me by old time hams (Xtras) whom I have known for 40 yrs. Has excellent break-in." —N6AVQ
 "Best package job I've ever seen! First licensed 6AAV in 1926. Now in operation—a sweetheart!" —W7LUP
 "From a 32V2/SX115 to an OMNI is a big step!" —K6YD
 "Receiver prominent—transmitter likewise—working comfortable—pleasing design." —OE1FAA
 "First new rig for me in 10 years but seems to be very good." —W5GBY
 "The best transceiver I ever used or owned." —W3TS
 "I wouldn't swap my OMNI for anything on the market, regardless of price." —WD0HTE

OMNI/SERIES B FEATURES

All solid-state; 160-10 meters; Broadband design; Standard 8-Pole 2.4 kHz Crystal Ladder I-F Filter + Optional 1.8 kHz SSB Filter & 0.5 kHz 8-Pole CW Filter; 3-Bandwidth Active Audio Filter; Choice of readout — OMNI-A (analog dial), OMNI-D (digital); Built-in VOX and PTT, Selectable Break-in, Dual-Range Receiver Offset Tuning, Wide Overload Capabilities, Phone Patch Interface Jacks; Adjustable ALC; Adjustable Sidetone; Exceptional Sensitivity; 200 Watts INPUT; 100% Duty Cycle, Front Panel Microphone and Key Jacks; Zero-Beat Switch; "S"/SWR Meter; Dual Speakers; Plug-In Circuit Boards; Complete Shielding; Easier-to-use size: 5¼" h x 14¼" w x 14" d; Full Options: Model 645 Keyer \$85; Model 243 Remote VFO \$139; Model 252MO matching AC power supply \$139; Model 248 Noise Blanker \$49; Model 217 500 Hz 8-Pole Crystal Ladder CW Filter \$55; Model 218 1.8 kHz 8-Pole Crystal Ladder SSB Filter \$55.

Model 545 Series B OMNI-A . . . \$949
 Model 546 Series B OMNI-D . . . \$1119

To add your name to the fast-growing list of OMNI owners, see your TEN-TEC dealer, or write for full details.

TEN-TEC, INC.
 SEVIERVILLE, TENNESSEE 37862
 EXPORT: 5115 LINCOLN AVE., CHICAGO, ILL. 60646

OMNI OWNERS SAY:



RTTY Loop

Marc I. Leavey, M.D. WA3AJR
4006 Winlee Road
Randallstown MD 21133

We started looking at some published designs for demodulators last month and covered several which represented the "state of the art" up to the mid-'60s. This month, we will continue to move forward through time and see what progress has wrought.

Designs covered so far were either complex tube types or very simple semiconductor circuits. In August, 1967, 73 published an article by Ken Kokjer K0JXO/9 which used the

then-new silicon-controlled rectifier (SCR) as the keying element in his solid-state demodulator. Shown in Fig. 1, the basic design is pretty much as earlier units, with diode limiters, amplification, and non-toroidal inductors used for the filters. However, instead of a high-voltage transistor or tube being used to key the loop, two SCRs are used to form the keying pulses. Certainly a unique application!

Transistors were fine, but the advance of technology brought another new device to our benches: the integrated circuit. The earliest ICs to reach us were

linear, i.e., not digital, ICs, called "operational amplifiers" or "op amps." In July, 1969, 73 published an article by C. W. Andreasen WA6JMM which presented one of the first RTTY applications of ICs. This demodulator, diagrammed in Fig. 2, used two ICs, one as an amplifier in the front end and a "710" comparator to decode and feed the pulses to the keying transistor. This is a simple compact unit that appears to perform reasonably well under most conditions. With just two ICs, two toroids, and a few other components, it is quite a bit in a small package.

Integrated circuits were firmly entrenched over the next few years, and more and more projects used them. Complexity grew, and we can see how much

by looking back just a few years to the August, 1976, issue of 73 where Bernd Grossman DL2SX/ZS6GG and John S. Reid ZS6JR described their "Safari RTTY Terminal." Take a deep breath and give a look at Fig. 3! Now, we are up to a handful of ICs, transistors, and other odds and ends. What we end up with is a reasonably compact and efficient terminal unit that includes an AFSK generator. Again, op amps are used throughout as both amplifiers and comparators. If you are interested in working with this circuit, the referenced article shows both printed circuit layouts and describes test and setup procedures.

I can't close this month's survey with the monster mentioned above, so take a look at Fig. 4. Yes, this two-IC, one-transistor wonder is an honest-to-goodness demodulator, described by Allan S. Joffe W3KBM in the September, 1976, issue of 73. Now, with a circuit this simple, you might suspect there is some skulduggery in order to copy RTTY, and there is. This demodulator is set up to decode only the space tone. When it gets a space, it opens the loop. On mark or no signal, the loop is closed. This simulates "mark-hold" and allows copy on any reasonably clear signal.

Next month we will conclude our look at terminal units with a couple of recent designs. I have picked out a few that span the gap from super simple to complex and complicated. Hope you enjoy them!

Now, turning to a feature that many of you enjoy, let's look in the mailbag. Diane Deibert WA6MVD of Sunnymead, California, writes in concerning the 6800 published in the July, 1979, issue of 73. She notes that the stack load address, \$A070, interferes with her dual floppy system. Well, Diane, this is merely the address that the stack pointer is set to in order to preserve the program counter. In a non-disk system, this permits re-entry into the program after a reset or other exit merely by typing a "G". If you are going to store this program on disk, you will want to assign a "transfer address" in order to begin ex-

Continued on page 138

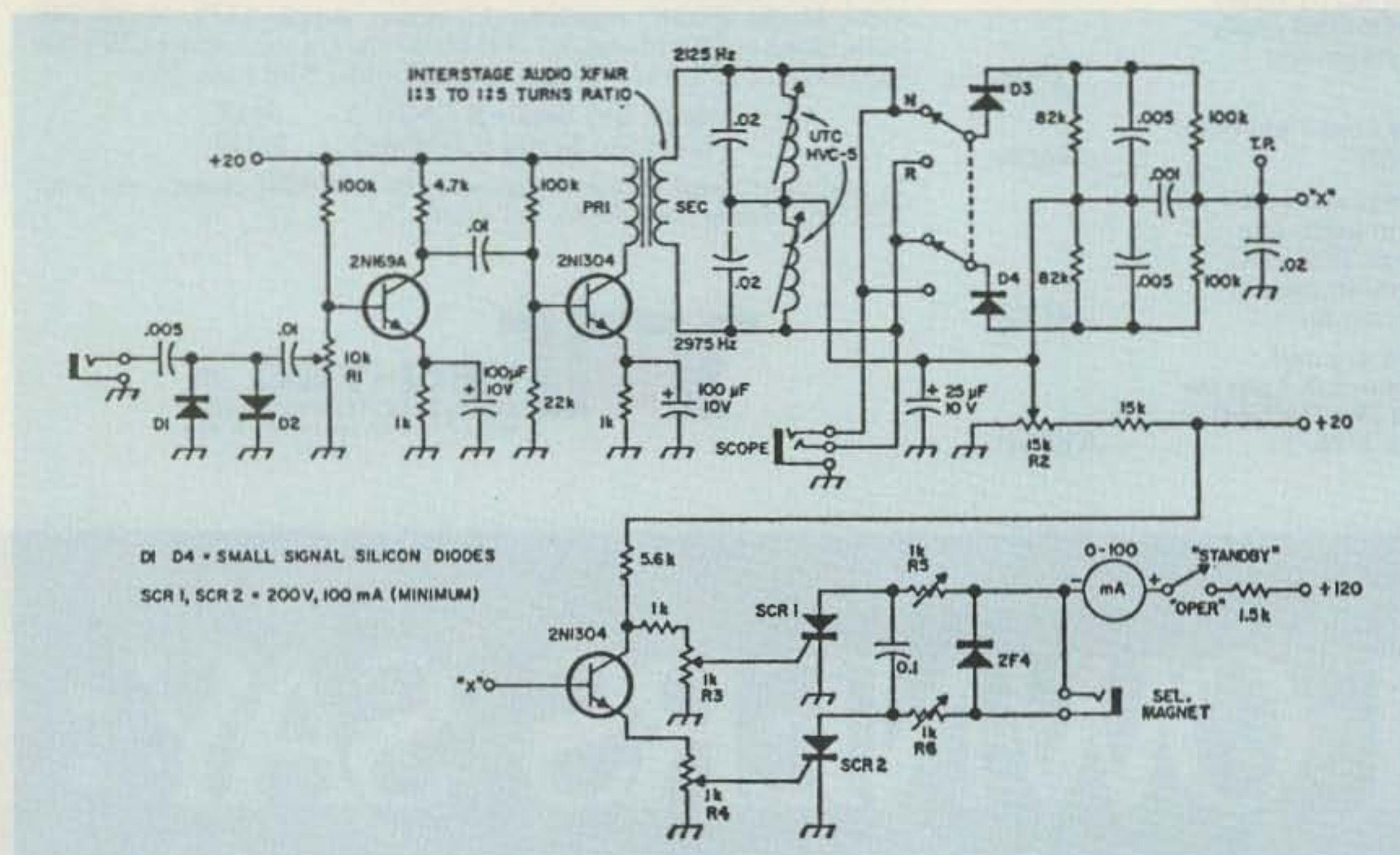

Fig. 1.

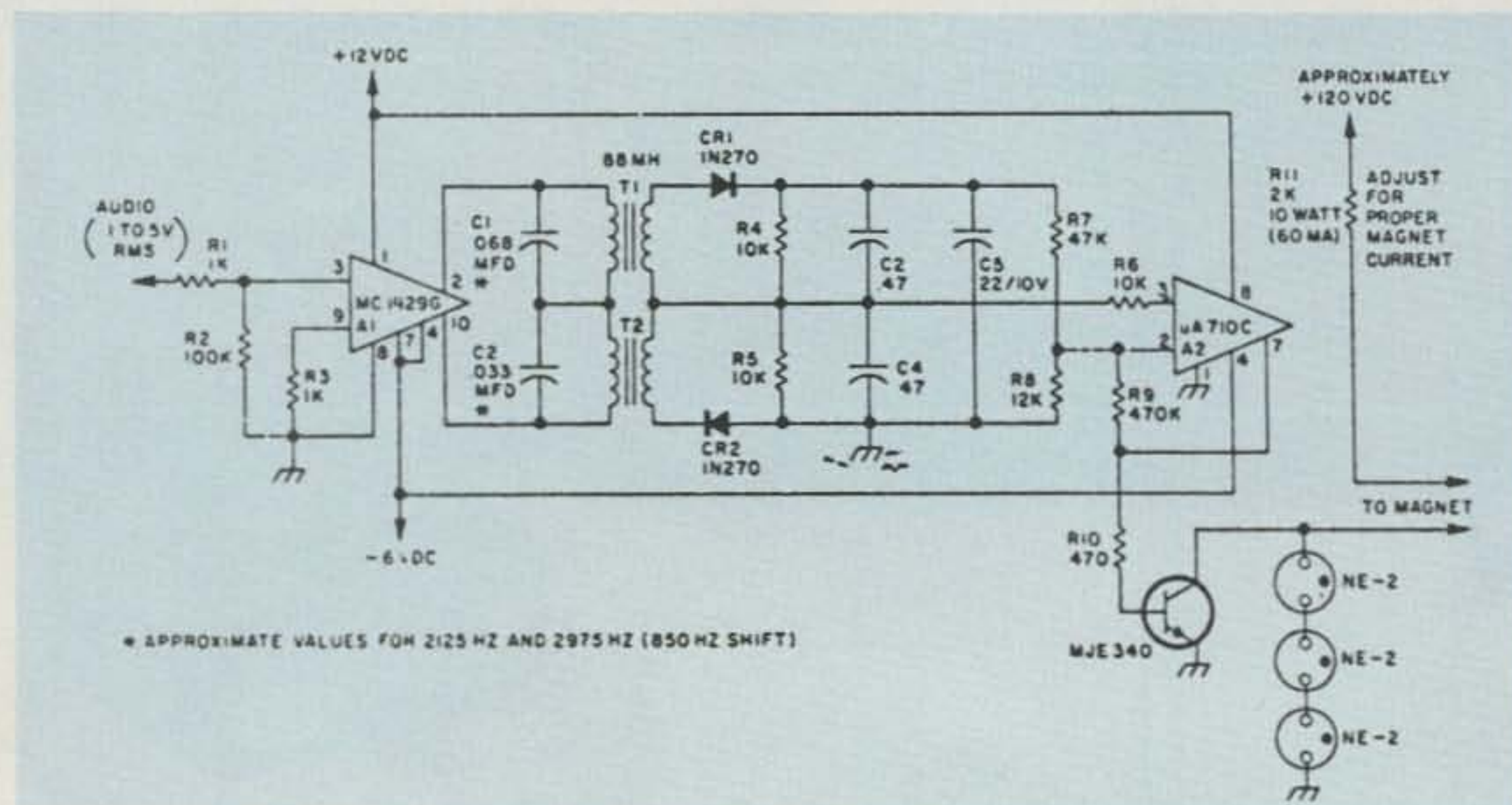

Fig. 2.

WHEN OUR CUSTOMERS TALK...WE LISTEN.

DS3100 ASR



We've Been Taking Notes.

Combining your ideas with some of our own, we've come up with what has to be the most advanced and convenient terminal available. These are some of the conveniences you can now enjoy by putting the DS3100 ASR in your RTTY and CW station:

ASR Operation (Compose your transmission WHILE receiving)

- 150-line Receiver Buffer
- 50-line Transmit Buffer
- Split Screen to Show Buffers
- Internal Real-Time Clock
- 10 Programmable Messages
- Automatic Answer-Back (WRU)
- Morse, Baudot, or ASCII Operation
- RTTY and CW Identification
- Full 128-Character ASCII
- 110-9600 baud ASCII
- 60-130 WPM Baudot
- 1-175 WPM Morse

Write or call for the DS3100 ASR specifications and see how YOU have helped design the new standard in amateur radio terminals.



HAL COMMUNICATIONS CORP.
Box 365
Urbana, Illinois 61801
217-367-7373

For our European Customers Contact:
Richter & Co., Hannover
I.E.C. Interelec, Bissone

Contests

Robert Baker WB2GFE
15 Windsor Dr.
Atco NJ 08004

QRP ARCI ANNUAL QSO PARTY

Starts: 2000 GMT April 5
Ends: 0200 GMT April 7

The contest is open to all amateurs and all are eligible for the awards. Stations may be worked once per band for QSO and multiplier credits.

EXCHANGE:

Members—RST, state/province/country, and QRP number.

Non-members—RST, state/province/country, power input.

SCORING:

Each member QSO counts 3 points. Non-member QSOs are 2 points and stations other than W/VE count 4 points each. Multipliers are as follows: more than 100 Watts input—x1; 25-100 Watts input—x1.5; 5-25 Watts input—x2; 1-5 Watts input—x3; less than 1 Watt input

—x5. Final score is total QSO points times total number of states/provinces/countries per band times the power multiplier.

FREQUENCIES:

Novice—3710, 7110, 21110, 28110.

SSB—1810, 3985, 7285, 14285, 21385, 28885, 50385.

CW—1810, 3560, 7060, 14060, 21060, 28060, 50360.

AWARDS:

Certificates to the highest-scoring station in each state, province, or country. Other places will be given depending on activity. One certificate for the station showing three "skip" contacts using the lowest power.

LOGS & ENTRIES:

Send full log data, including full name, address, and bands used plus equipment, antennas, and power used. Entrants desiring results sheet and scores, please enclose a business-size envelope with return postage.

Logs must be received by April 30th to qualify. Send all logs and data to: QRP ARCI Contest Chairman, Edwin R. Lappi WD4LOO, 203 Lynn Drive, Carrboro NC 27510.

COUNTY HUNTERS SSB CONTEST

Contest Periods:

0100 to 0800 GMT April 12

1200 GMT April 12 to

0800 GMT April 13

1200 to 2400 GMT April 13

Please note the two 4-hour rest periods.

Mobiles may be worked each time they change counties or bands. Mobiles that are worked again from the same county on a different band count for point credit only. Mobiles that are contacted on a county line count as one contact but 2 multipliers. Fixed stations may be worked by other fixed stations only once during the contest. Repeat QSOs between fixed stations on other bands are not permitted. Fixed stations may be worked by mobiles each time they change counties or bands. Repeat contacts between mobiles are permitted provided they are on a different band or from a different county. Mixed-mode contacts are permitted provided that one station is on SSB. Contacts made on net frequencies will not be allowed for scoring in this year's contest.

EXCHANGE:

Signal report, county, and state or country.

FREQUENCIES:

Suggested frequencies are as follows: 3920-3940, 7220-7240, 14275-14295, 21375-21395, 28575-28595.

There will be a "Mobile Window" of 10 kHz on the following frequencies: 3925-3935, 7225-7235, 14280-14290.

Mobiles will be in this 10-kHz segment and fixed stations are asked to refrain from calling "CQ Contest" in the mobile window. After working mobiles in the window, fixed stations are requested to QSY outside the window to work fixed stations in the contest. This will allow the mobiles running lower power a chance to be heard and worked in the contest.

SCORING:

Contact with a fixed US or Canadian station = 1 point. Contact with a DX station (KL7 and KH6 count as DX) = 5 points. Contact with a mobile station = 15 points. The multiplier is the total number of US counties plus Canadian stations worked. The final score is this multiplier times the total QSO points.

AWARDS:

MARAC plaques to the highest-scoring fixed US or Canadian station, DX station, and top 2 scoring mobile stations. Certificates to the top 10 fixed and mobile stations in the US and Canada and to the highest-scoring station in each DX country.

ENTRIES:

Logs must show date and time, station worked, reports exchanged, county, state, band, and claimed QSO points (1, 5, or 15), and each new multiplier must be numbered. Logs and summary sheets are free for a #10 SASE or SAE and appropriate IRCs. Write to: John Ferguson W0QWS, 3820 Stonewall Ct., Independence MO 64055. All entries must be received by June 1st to be eligible for awards. DX entries should use air mail. Winners will be announced at the 1980 Independent County Hunters Conven-

Continued on page 154

Calendar

Apr 5-6	ARRL Open CD Party
Apr 5-7	QRP ARC International QSO Party
Apr 8-9	DX to North American YL — Phone
Apr 12-13	County Hunters SSB Contest
Apr 15-16	DX to North American YL — CW
Apr 19-20	YL International SSBers QSO Party — Phone
Apr 19-20	ARRL EME Contest I
Apr 26-27	Helvetia Contest
May 3-4	SENARC Totem Pole Contest
May 10	DARC Corona 10-Meter RTTY Contest
May 17-18	Florida QSO Party
May 17-18	ARRL EME Contest II
May 17-19	Massachusetts QSO Party
May 24-25	CQ Worldwide WPX Contest — CW
Jun 14-15	ARRL VHF Contest
Jun 28-29	ARRL Field Day
Jul 12-13	IARU Radiosport Championship
Aug 2-3	ARRL UHF Contest
Aug 9-10	European DX Contest — CW
Sep 13-14	European DX Contest — Phone
Sep 13-14	ARRL VHF Contest
Sep 13-15	Washington State QSO Party
Sep 14	North American Sprint
Sep 27	DARC Corona 10-Meter RTTY Contest
Oct 4-5	California QSO Party
Oct 4-5	ARRL Simulated Emergency Test
Oct 11-12	ARRL CD Party
Nov 1-2	ARRL Sweepstakes — CW
Nov 8-9	European DX Contest — RTTY
Nov 9	International OK DX Contest
Nov 15	DARC Corona 10-Meter RTTY Contest
Nov 15-16	ARRL Sweepstakes — Phone
Dec 6-7	ARRL 160-Meter Contest
Dec 13-14	ARRL 10-Meter Contest

Results

YL HOWDY DAYS, 1979

Score	Call	Name	YLRL Member
156	WB2OHD	Peggy Arciero	yes
115	DL4GA	Christa Elksnat	non
114	DL1MS	Juliane Schuegger	yes
107	WD4NKP	Martha King	yes
98	WA2NFY	Lia Zwack	yes
85	K4RNS	Marge Campbell	yes
80	G4GAJ	Mary Adams	yes
79	DK9ZL	Ella Grindel	yes
71	N2LA	Joyce Euart	yes
71	DF2KG	Ursel Weiskirchen	yes

ATR-6800

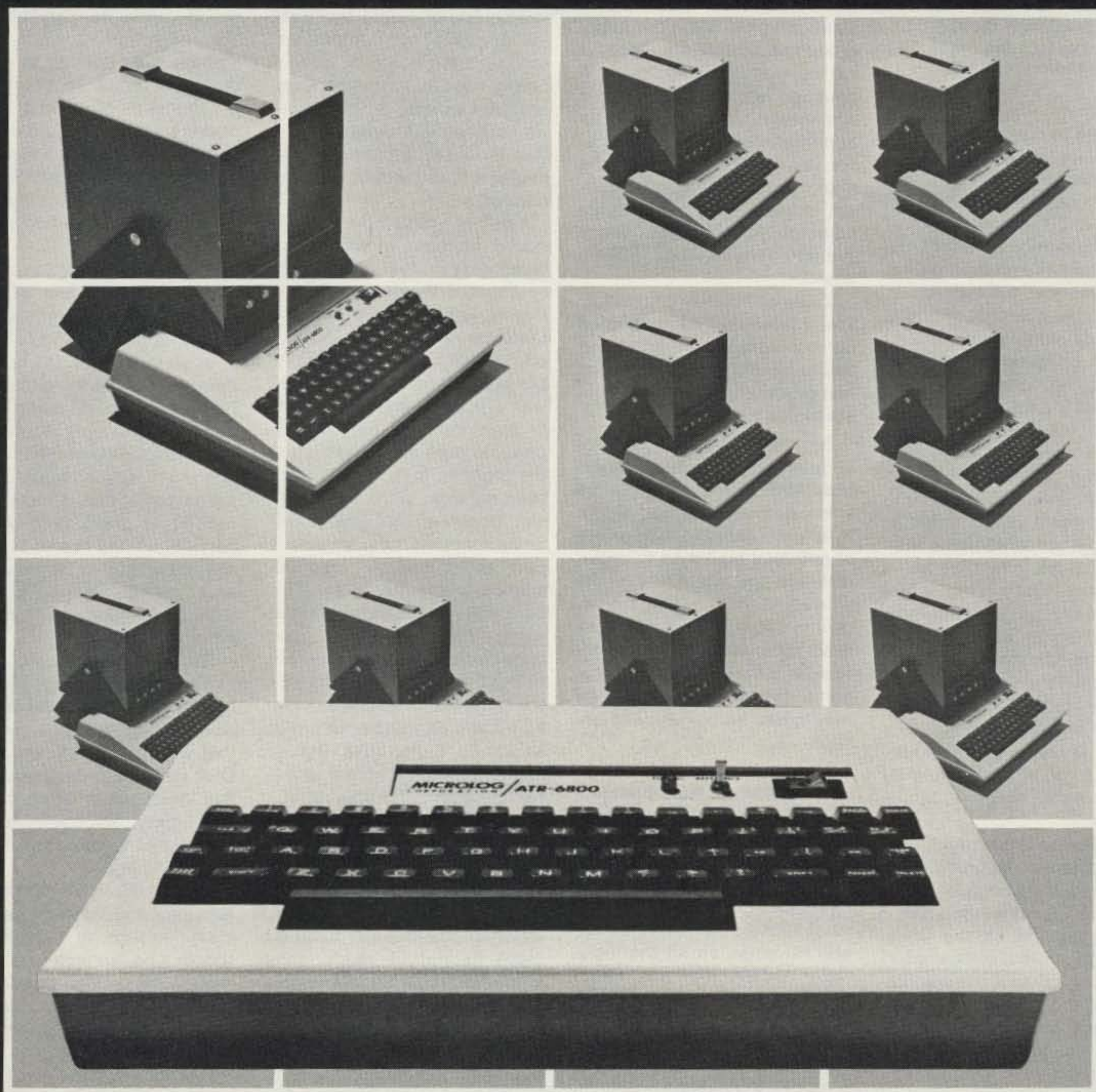

Truly a new dimension in digital communications, the ATR-6800 is more than a superb CW and RTTY machine. It includes a user programmable microprocessor designed to fully automate your station.

Your ATR-6800 is ready to run in a "real world" environment. A shielded metal box and extensive RFI filtering allow side by side operation with your kilowatt, and there is no need for extra attachments or cumbersome program loading.

Direct connection to your transceiver provides total capability on CW and all Baudot and ASCII speeds, both present and future.

For additional performance specs, just use your imagination . . . ATR-6800 with 9' monitor amateur net. \$1,995.

Ask your dealer for a full demo, or drop by. MICROLOG CORPORATION, 4 Professional Drive, Suite 119, Gaithersburg, MD. 20760. telephone (301)-948-5307.

MICROLOG ✓ 51

INNOVATORS IN DIGITAL COMMUNICATIONS

Leaky Lines

Dave Mann K2AGZ
3 Daniel Lane
Kinnelon NJ 07405

Now that WARC is over, what happened to all those dire predictions we heard on all sides? The conference ended without any acrimony or major disagreements. And the fight that had been expected between the have countries and the have-not countries never did materialize. Even on the question of orbital frequency slots, since no substantive compromise could be reached, the matter was simply tabled for the future.

There were no particularly vigorous moves to deprive amateur radio of present frequencies; the conference did little to revise present allocations. On the whole, we fared better than other services. In fact, we won a significant victory in that a proposal to deprive us of the 7100-7300 kHz portion of the 40-meter band failed to carry. Moreover, an explicit resolution was adopted, prohibiting fixed services from operating on the 7000-7100 kHz segment and enjoining those who are presently using it from continuing to use it.

As expected, this prohibition was vigorously opposed by the USSR and some of its stooges, but the Region 2 nations stood solidly together on the issue. Although it was somewhat in doubt until almost the adjournment of the conference, it was finally resolved in our favor, and we did not lose the 7100-7300 kHz portion.

From the amateurs' point of view, the most significant change is the new allocation of frequencies in the 10-, 18-, and 25-MHz bands. But it will take a number of years before we can use them, since the fixed stations now operating there must be assigned new frequencies.

One highly important result was the realization that all the paranoia that was expressed in various quarters concerning prejudice against amateur radio proved groundless. The gloomy predictions never did materialize. Prior to the conference, we were warned over and over again that anti-ham interests were sure to stampede the delegates into taking frequencies

away from us. Dire and dreary pronouncements appeared in all the magazines and were a constant topic of pessimistic conversation on our bands. The apprehensiveness was palpable; you could hardly broach the subject of WARC without hearing someone echoing those catastrophic bleatings of Henny Penny: "The sky is falling down!"

It was completely unjustified. The conference demonstrated no marked anti-ham bias, and amateur radio did not suffer the fate predicted by all the "prophets of doom."

But it would be a serious error to interpret this as a lifetime guarantee. There will always be some element of danger, and it is far more sensible to be aware of potential peril than to underestimate the possibility of its existence. Thus, while the recent conference may not have lived up to its advance billing, there is always a likelihood that some subsequent conference may indeed act to our disadvantage.

This is a very good time to point out that far more amateurs must become involved and interested in more than the mere operation of their ham stations. They must take a more active role in their radio clubs, and they must make sure that they are well informed on all the legislative matters that may affect the hobby. We cannot afford complacency at any time, but it is particularly essential to avoid it at moments of triumph. For in this world of constant and illogical change, no victory can be considered permanent.

In a "Leaky Lines" of some eight years ago, I had occasion to quote a small piece of philosophy often uttered during my childhood by my mother. It goes: "When everybody is somebody, nobody is anybody!" It happens to be one of those epigrams which, like a provable mathematical equation, shines with the brilliance of the sun. Truth is the most irresistible force on Earth or in heaven; it cannot be contravened.

Why, you might ask, do I repeat my mom's little bon mot? Because we have now virtually come to a point in amateur radio

when everybody is indeed somebody. Practically all of us now own linear amplifiers and directional antennas. And all but a relative few of us (and those are the ubiquitous non-conformists, rugged individualists, iconoclasts, and other hopeless idealists) are running all the power we can manage to generate... that is to say, all that we can manage to run without getting nabbed!

I do not wish to discuss the matter in terms of honesty or dishonesty... that is for others to concern themselves with. I merely want to point out that there is no absolute, demonstrable rule to prove that legally-powered stations are operated with efficiency and high quality of emission and that illegally-powered ones are operated just the opposite. In fact, it has often been my experience as an Official Observer that one sometimes hears the most abysmally poor audio quality... and frequency instability, key clicks, back wave, chirp, unsuppressed carrier, hash and hum... on transmitters which operate at or below the legal power limit. By the same token, one hears ultra-high-powered transmitters with audio so superlative that it might be coming from a broadcasting studio... with absolutely pure CW note... no hash, no hum, no carrier, no motor-boating.

It has always seemed to me that any definition of legality which is based solely upon dc input or output must leave something to be desired. It is as if they hired players for a band on the basis of the high polish of their instruments rather than their quality of musicianship... or they accepted ball players according to the way they looked in their uniforms rather than the way they could field and hit.

I know some hams who run high power (and I will never admit it or identify them under oath) who have never been guilty of deliberate interference or of rudeness and inconsiderate behavior on the air. And I know some who run below the legal limit who consistently interfere with others, either through deliberate intention or poorly adjusted equipment. It seems strange to me that the latter are permitted to continue without fear of penalty, while the former live under constant danger of discovery and punishment.

There is something terribly wrong with such a standard. We do not bar cars from our highways which are capable of great speed... the ordinary kitchen and bathroom contain substances toxic enough to cause death, but they are not outlawed... almost all of us carry in our pockets or handbags a single item that could cause a conflagration that could easily destroy a forest or a town - the ordinary match - but it is not declared illegal.

The operative criterion should be the manner in which all these things are used... or misused. The same criterion should be applied to radio gear. If I had the power to rewrite the radio regulations, I would make high power illegal only contingent upon absolute proof that it had been misused, and never on the single basis that it merely exceeded a given limit whose parameters had been arbitrarily set generations previously, when power was difficult to manage and equipment was inefficiently designed.

Recognizing that individual examples should never be used to substantiate general conclusions, I nonetheless must report that I have sometimes heard QRP stations running less than five Watts which emitted God-awful clicks which were audible fifteen and twenty kHz up and down the band.

I do not think that it is healthy for amateur radio when the principal violation in the eyes of those who enforce the radio regulations is high power. It is just as senseless as the view among certain police that high speed is the only basis for a traffic summons. What would happen if such a cop allowed cars with faulty brakes, bald tires, inoperable headlights, poor steering control, etc., to operate without regulation as long as they stayed within the speed limit?

High power, in and of itself, should not provoke a vendetta on the part of the licensing authority. Not unless it is used in such a way as to cause problems for others.

As I say, I have heard pairs of 8877s and 4-1000As which sound cleaner and far more acceptable than a single 6146 or sweep tube operated by some dumb space cadet driving the pants off it!

But don't get me wrong; I run an SB-220... strictly legal. Hi!

In 2 Meters Today...

ICOM Leads the Way!



ICOM IC-251A

ICOM has always been the amateur communications equipment industry's leader in 2 meter solid state digital technology. ICOM continues its established leadership with the all new IC-251A 2 meter multi-mode base transceiver. ICOM's advanced engineering incorporated a multi-memory system, 2 programmable scanning systems, 2 internal VFO's, and built in repeater offsets.

The New ICOM 251A is the most advanced, flexible 2 meter system on the market, incorporating features customers ask for most:

Memory scan — automatically stops on an active frequency programmed in the memory.

- 3 memories built in (quick access to your favorite frequencies)
- Programmable band scan — scan the whole band, or any portion of it you desire (adjustable scanning speed). Automatically resumes scanning after 16 seconds if desired.
- Squelch on SSB! The 251A will automatically and silently scan the SSB portion of the band seeking out the SSB activity on 2.
- Multi-mode operation — USB, LSB, CW, FM. Great for getting into Oscar, plus enjoying SSB rag chewing as well as repeater operation (including the new subband).

- 600kc Repeater offset built in. Easy repeater operation on the FM portion of the band.
- Variable repeater split — with the 2 built in VFO's, it's possible to work the odd splits plus accommodate future repeater band plan changes.

The RF amplifier and first mixer circuits using MOS FET's, and other circuits provide excellent Cross Modulation and Intermodulation characteristics. The IC-251A has excellent sensitivity demanded especially for mobile operation, high stability, and with Crystal Filters having the high shape factors, exceptional selectivity.

HF/VHF/UHF AMATEUR AND MARINE COMMUNICATION EQUIPMENT



ICOM

ICOM AMERICA, INCORPORATED

Sales Service Centers located at:

2112 116th Avenue NE
Bellevue, WA 98004
Phone (206) 454-8155

3331 Towerwood Dr., Suite 307
Dallas, TX 75234
Phone (214) 620-2780

ICOM INFORMATION SERVICE

2112 116th Ave., N.E.
Bellevue, WA 98004

Please send me: IC-251A specifications sheet; full color ICOM Product Line Catalog; List of Authorized ICOM Dealers.

NAME _____ CALL _____

ADDRESS _____

CITY _____ STATE _____ ZIP _____

You may send a machine copy of this form

DSI CONTINUES TO DO IT

Best Price to Quality Features Ratio

FACTORY WIRED 500 MHz or 1 GHz • 8 Digits 1 PPM • TCXO

109⁹⁵

5500 WIRED

50 Hz to 512 MHz

5510 WIRED

139⁹⁵ 50 Hz to 1 GHz



10 MHz OVEN TIME BASE 500 MHz or 1.2 GHz

169⁹⁵

5600 KIT

50 Hz to 512 MHz

199⁹⁵

5612 KIT

50 Hz to 1.2 GHz



TRUE RMS — 3 1/2 Digits — DMM — .1% Basic Accuracy

169⁹⁵

LC 5000

FACTORY
WIRED

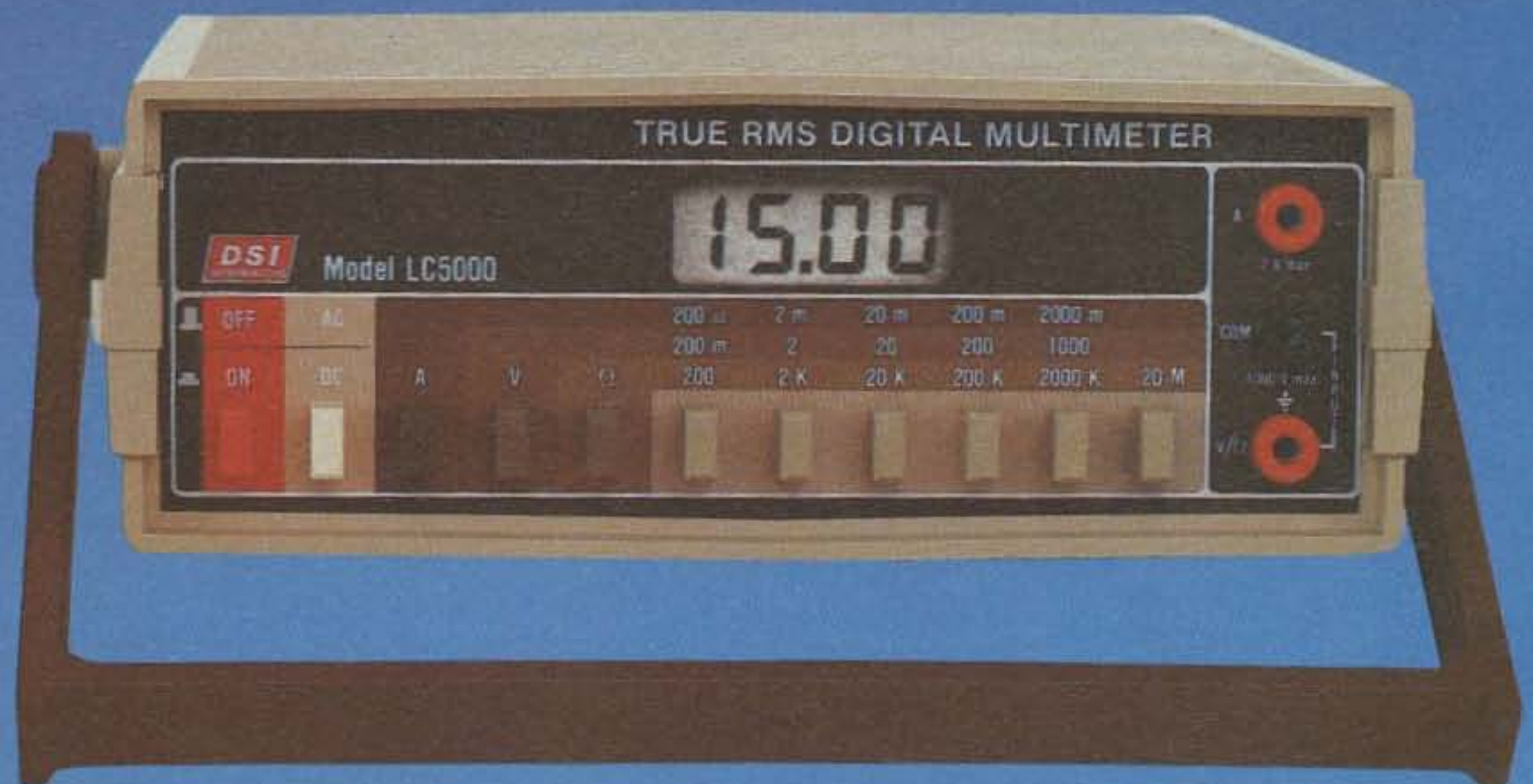

1GHz For Only \$139.95

Compare these features and you will buy *DSI*

5500/ 5510 STANDARD FEATURES

- 5510 - 50 Hz to 1GHz
- 5500 - 50Hz to 512MHz
- Made in U.S.A.
- 8 Digits not 6 or 7
- 1PPM TCXO not 1.5PPM or 10PPM
- Resolution 1Hz @ 50MHz not 10Hz

With the introduction of the 5510 *DSI* has filled a long standing void in the frequency counter market place. You now have the choice of selecting a 512 MHz model 5500 for around a \$100 or for only \$30.00 more you can buy an 8 digit 1GHz counter model 5510. With this 1GHz capability the new world of 960 MHz is immediately available to you. Both the 5500 and 5510 are available with a rechargeable battery pack which includes the AC adapter and battery charger for one low price. Whether you select the 5500 or the 5510 you will receive the best price to quality features ratio in the industry, no wonder *DSI* has become one of the world's largest manufacturers of high quality frequency counter instrumentation.

9 DIGITS 1.2 GHz FOR ONLY \$199.95

- 5612 - 50Hz to 1.2GHz
- 5600 - 50Hz to 512MHz
- External 10MHz inputs & outputs
- 10MHz 2PPM 10°-40° C Proportional oven
- 9 large 1/2 inch LED Readouts
- .1Hz Resolution to 50MHz

Why buy a 5600A or 5612 kit? Because 95% of the assembly is completed by *DSI* and you are only one hour away from solving all those difficult bench problems, from setting the frequency of an audio signal to within 1/10 of a Hz, to checking the frequency of a 960 MHz mobile radio. Whether you are servicing a VTR, trouble shooting a PLL circuit, the 5600A/5612 is the right counter with accuracy that will meet any FCC land mobile, broadcast, or telecommunications requirements. On the bench or in the field the 5600A/5612 will do the job you need. The 5600/5612 includes a self contained battery holder providing instant portability of *DSI* offers a 10 hour rechargeable battery pack option. In addition *DSI* offers an audio multiplier which allows you to resolve a 1/1000 of a Hz. The 5600A/5612 is perfect for communications, TV servicing, industrial testing or meeting your QSO on the correct frequency every time.

LARGE LCD READOUTS-PRECISION LASER TRIMMED RESISTOR NETWORKS

- AC TRUE RMS to 1000v — 200mv, 2v, 20v, 200v, 1000v
- DC VOLTAGE to 1000v — 200mv, 2v, 20v, 200v, 1000v
- DC CURRENT to 2 amps — 200ma, 2ma, 20ma, 200ma, 2a
- RESISTANCE to 20 megohms — 200, 2k, 20k, 2 meg, 20 meg
- AUTOMATIC POLARITY INDICATOR

FOR INFORMATION — DEALER LOCATION — ORDERS — OEM
 CALL 800-854-2049 CALIFORNIA RESIDENTS CALL 800-542-6253

Model	Price	Frequency Range Typ	Accuracy Over Temperature	Sensitivity Typ			Number of Readouts	Power Requirements	Size H W D
				@ 100Hz-25MHz	@ 50-250MHz	@ 250-450MHz			
5600A-Kit	\$169.95	50Hz-550MHz	Proportional Oven .2 PPM 10° - 40° C	5-10mv	5-10mv	5-50mv	9	*115 VAC or 8.2-14.5 VDC	3 1/4" x 9 1/2" x 9"
5600A-Wired	\$199.95								
5612Kit	\$199.95	50Hz-1.2 GHz	Proportional Oven .2 PPM 10° - 40° C	5-10mv	5-10mv	5-50mv	9	*115 VAC or 8.2-14.5 VDC	3 1/4" x 9 1/2" x 9"
5612 Wired	\$239.95								
5500 Wired	\$109.95	50Hz-512MHz	TCXO 1 PPM 17° - 40° C	10-25mv	10-15mv	15-50mv	8	115 VAC or 8.2-14.5 VDC or NICAD PAK.	1 1/2" x 5" x 5 1/2"
5510 Wired	\$139.95	50Hz-1GHz							

Factory wired units carry 1 year limited warranty kits carry a 90 day limited warranty.
 Prices and/or specifications subject to change without notice or obligation.

*With AC-9 Adapter

Prices effective
 Feb. 1, 1980

- 5510 Wired 139.95
- 5500 Wired 109.95
- 5510/BAC Wired 164.95
- 5500/BAC Wired 134.95
- T600 BNC ANT (all models) 7.95
- AC-9 AC Adapter(all models) 7.95
- LC 5000 169.95



DSI INSTRUMENTS, INC.

9550 Chesapeake Drive ✓ 20
 San Diego, California 92123
 (714) 565-8402

TERMS: MC — VISA — AE — CHECK — M.O. — COD
 in U.S. Funds. Please add 10% to a maximum of \$10.00
 for shipping, handling and insurance. Orders outside
 of USA & Canada, please add \$20.00 additional to
 cover air shipment. California residents add 6% Sales Tax

- 5612 Kit 199.95
- 5612 Wired 239.95
- 5600A Kit 169.95
- 5600A Wired 199.95
- BA56 Rechargeable
- 10 Hr. Bat. Pack 29.95
- AM-56 Audio Multiplier
- .001 Hz Resolution 34.95

LETTERS

AUTO-ALARM

I know you are interested in new things, so I thought I would write to tell you about the system which we have established in our county which provides 24-hour monitoring for emergency calls on the Goderich VE3GOD and Hensall VE3OBC two-meter repeaters. I call it the Auto-Alarm.

For several years, I have been testing different tone decoder/ alarm devices which mobile stations in our rural area could use to summon help in an emergency late at night when no one is on the repeater. Our group found a suitable circuit and we have a dozen units in service at the homes of various amateurs. The alarm is not connected to the repeater in any way and requires no modification to the two-meter receiver to which it is connected. Cost is around \$30.00. To my knowledge, ours was the first operational system in Canada.

I have established a standard tone and timing interval which is simple to generate and to decode but has good immunity to "falsing." I hope that this can become the Standard Canadian Auto-Alarm Tone (SCAAT).

To activate the alarm, one keys a tone of 941 Hz for 3 to 4 seconds over the radio channel. This is produced by pressing any 2 of the "bottom-line" Touchtone® digits—#, 0, or *. Once activated, the alarm remains latched on until manually reset.

I am presently working on a simple PLL single-tone encoder which will enable those without tone pads to access the alarm.

Other repeater clubs may wish to establish similar systems. A group in Saskatchewan has expressed interest in doing so. The London ARC has also introduced a version of the Auto-Alarm which uses the SCAAT. They have 25 operational units.

I propose that anyone setting up a system should use our established tone standard, as it

would be much simpler than having a different tone and procedure for each area. In an emergency, it would be easy to forget the access tone and fail to summon help. If participating clubs coordinate this venture now before it expands, we will have few problems in the future with non-standard tones.

I have a collection of reference material on various tone-alarm circuits and am willing to answer any questions readers might have about an Auto-Alarm system. SASE, please.

Glenn F. McMichael VE3CGU
Box 231
Goderich, Ontario
Canada N7A 3Z2

CAN YOU TOP THIS?

Here is a personal story which I think is unsurpassed in originality.

In December last, I received a card from Lydia Johnson W0KJZ of Rapid City, South Dakota, where she is an ARRL SCM. Lydia informed me that a local TV station, KOTA, had recently opened up a "satellite" station in Gillette, Wyoming, which was operating under the announced (sound and video) callsign of K6JM. My amateur callsign!

Lydia felt something was amiss, looked me up in the *Callbook*, and mailed me the advice.

Since my license was coming up for renewal in February, 1980, I got bad vibes that somehow I was about to be defranchised.

A telephone call to the engineer on duty at KOTA, Rapid City, brought prompt confirmation that their Gillette station was indeed operating under the call K6JM. They didn't know why, but it was on their license.

Immediately I shot off a letter to the KOTA station manager advising him of the callsign duplication and requesting an explanation—also pointing out this is not a call normally issued to a broadcaster. I sent a similar letter to the Chief, Personal Radio Services Division, FCC,

Washington.

To date, I have not received a reply from the station or the FCC. However, another communique from W0KJZ last weekend tells me that the Gillette TV station has just switched its announced call to K06JM—still not a regular broadcaster assignment.

I wonder if anyone else has had the dubious experience of sharing their ham call with a TV broadcast station. The assumption is that someone's computer readout goofed, I hope. Meanwhile, I want it known that K6JM Santa Monica accepts no responsibility for the editorial policies of K6JM Gillette, Wyoming, Hi.

Peter A. Lovelock K6JM
Santa Monica CA

NEW REPEATER

The Ottawa Area Radio Club of Ottawa, Ohio, is pleased to announce the operation of its new 2-meter repeater as of January 1, 1980. Located in Ottawa, Ohio, the repeater has an input frequency of 144.630 and an output frequency of 145.230. This repeater is carrier-operated accessed and operates under callsign K8BNS. All area hams and those visiting or traveling through the area are invited to make use of our repeater.

Robert Northrop AK8N
Ottawa OH

VOICE INTERFACE

The October, November, and December issues of *73 Magazine* have been outstanding and I wanted to let you know. I really enjoyed reading about "The Black Art of Antenna Design" in the November issue. *73* is by far the most interesting magazine I get.

I had an idea hit me about the width of voice transmissions. An SSB signal usually takes up about 5 kHz of spectrum. NBVM seems to have lost a lot of support lately, so nothing new is really happening as far as I can tell. I am also a computer nut and own an Apple computer. It seems to me that if a voice interface was used with the computer, you could talk to the computer and have it send out Morse code or RTTY to a similarly equipped station. On receive, a program could convert the

Morse back into speech using the computer voice box. With sharp audio filters, it would be possible for 4 to 5 stations to have voice contact in about 2.5 kHz of spectrum!

Arlan Henderson KA4HQI
Saltville VA

P.S. How about a simple 2-meter FM transmitter article someday?

MORE WOODPECKERS?

It is ironic that we have to live with the woodpecker. It seems to me that we have little or no choice. Reporting this deliberate source of interference to the FCC undoubtedly will do no good.

I say this due to a recent article in *Microwaves*, Sept., '79, pages 41-51, in which it was reported that the U.S. has a possible over-the-horizon radar in operation in Cypress and one under construction in Maine by GE, this one with operational tests reportedly to begin this fall.

The fact that this type of radar utilizes frequencies of 10-30 MHz means that our problems are about to be compounded. If the tests in Maine are successful and if a number of these monsters are deployed at a later date, then large segments of the already limited HF spectrum will undoubtedly become useless for normal use.

I do not believe that the FCC has any control over the agencies operating or developing these radars. This further leads me to believe that any complaints directed at the FCC concerning the woodpecker may just fall, or are falling, on deaf ears.

Johannes P. Fassotte WL7AGG
Fairbanks AK

20M CB

I am writing because of the mess on our HF bands. It seems that having to take a theory and code test no longer filters out the lids. In the past two years, I have become totally disgusted with the lack of respect on HF. Many people do not listen before they talk and how many times have you heard someone tuning up on an active frequen-

Continued on page 152

A SWAN FOR EVERY NEED

Talk State of the art, Versatility, or Economy — SWAN'S famous "world's best" Engineering team has designed a complete line of Transceivers to suit your need.

Take a look at the three hottest new SSB Transceivers this year. They're all made in America and they're all from Swan. Whatever your dreams—from a compact fully synthesized mobile to a full-blown base station with dual PTO's—one of these will bring them to reality today. They're all solid state, all 235 Watts PEP and CW on all frequencies, and most of all they're affordable.

Most Advanced HF Transceiver in the World—ASTRO 150

HF SSB Transceiver featuring "VRS" a knob with a new twist, and over 100,000 fully microprocessor-controlled frequencies on present or envisioned "ham" bands.

High Power — Full 235 Watts PEP & CW, all bands Truly Synthesized in accurate 100Hz steps Full CW Break-In with narrow XTAL Filter Standby Memory — ALL BANDS True PEP

output meter Model 150 — 80 thru 10 meters Model 151 — 160 thru 15 Meters



Most Versatile HF 160M-10M Transceiver in the World—ASTRO 102 BX

Dual PTO's, 235 Watts PEP & CW on all frequencies, IF Passband tuning, with LED position indicators and full break-in.

All solid state Modern design and styling Tunable notch filter 4 Function Meter Speech Processor VOX Adjustable AGC Decay 2 Position CW Wave Shaping 16 Pole IF Filter Crystal CW Filter PLL Synthesized Band Selection

Economy with top SWAN quality and mobility—100MX

235 Watts PEP & CW on all frequencies. The field-proven Rig the whole world's talking about.

All solid-state Modern design and styling VOX Noise Blanker Semi-CW Break-in RIT ± 1.5 KHz 25 KHz Calibrator, built-in CW side tone with adjustable pitch and level Internal speaker Jack for external counter



ASTRO 150



A division of Cubic Communications, Inc.

305 Airport Rd. • Oceanside, Ca. 92054
(714) 757-7525

Look to Swan for Quality Accessories . . . and Service

70



Awards

Bill Gosney WB7BFK
2665 North 1250 East
Whidbey Island
Oak Harbor WA 98277

Through the cooperation of Dr. John Allaway and C. R. Emary of the Radio Society of Great Britain, I was able to obtain complete details of this great organization's awards program.

The following rules and conditions apply to all HF certificates and awards issued by RSGB and should be read in conjunction with those governing awards and certificates individually.

All members of the RSGB will be afforded awards at no charge. Others must enclose at least 6 IRCs for each award. Applicants within the United Kingdom must submit QSL cards directly to RSGB to justify their claim. All others may use the general certification rule with an

affiliated society of a national organization.

Endorsements will be given for All Phone, All CW, and/or single-band accomplishments.

COMMONWEALTH DX CERTIFICATE (CDXC)

This certificate may be claimed by any licensed amateur who can produce evidence of having made two-way communication with stations located in at least 50 call areas listed on the Commonwealth call area chart shown in Fig. 1. All contacts have to be made on 14 MHz and an additional 50 contacts must be made in Commonwealth call areas on other bands. In the case of "other" bands, a particular call area may be claimed only once, irrespective of the band on which the call area was worked. The other call areas do not have to be the same as those worked on 14 MHz.

Mode	UK Stations	European Stations	DX Stations
CW/SSB/AM	1	2	5
FM	1/2	5	10
SSTV/RTTY/OSCAR	5	10	15

Fig. 2.

BRITISH COMMONWEALTH RADIO TRANSMISSION AWARD (BCRTA)

This award may be claimed by any licensed radio amateur who can produce evidence of having effected two-way communication with stations located in at least 50 of the call areas on any band or combination of bands. A five-band endorsement is available for 50 call areas on 5 bands.

WORKED BRITISH COMMONWEALTH CERTIFICATE (WBC)

This certificate requires the applicant to work at least one British Commonwealth station located in at least five of the recognized continental areas as defined by the ITU and noted on the chart shown in Fig. 1. For the purpose of this award, North and South America count as one continental area.

IARU REGION I AWARD

This award may be claimed by any licensed amateur who can produce evidence of having worked stations located in IARU Region I. There are three levels of operating achievement:

Class I requires contact with all countries in IARU Region 1.

Class II requires contact with 35 countries within IARU Region 1.

Class III requires contact with 20 IARU Region I countries.

To be eligible, all contacts must be made after January 1, 1979. Special endorsements are given for single band or mode achievements.

Members of IARU Region I are: Algeria, Austria, Bahrain, Belgium, Botswana, Bulgaria, Cyprus, Czechoslovakia, Denmark, Federal Republic of Germany, German Democratic Republic, Faeroes, Finland, France, Ghana, Gibraltar, Greece, Hungary, Iceland, Ireland, Israel, Italy, Ivory Coast, Jordan, Kenya, Lebanon, Liberia, Luxembourg, Malta, Mauritius, Monaco, Netherlands, Nigeria, Norway, Oman, Poland, Portugal, Rhodesia, Romania,

South Africa, Sierra Leone, Spain, Sweden, Switzerland, United Kingdom, USSR, Yugoslavia, and Zambia.

To apply for any of the awards sponsored by the Radio Society of Great Britain, forward your application along with the award fee of 6 IRCs to: C. R. Emary G5GH, Westbury End, Finmere, Buckingham Bucks, England.

Jeff Maynard G4EJA writes to inform us about a unique award made available by radio amateurs in the England County of Cheshire.

CHESHIRE AWARD

This award is issued in three categories: Applicants receive a gold award for accumulating 50 points, a silver award for accumulating 30 points, and a bronze award for accumulating 15 points.

Contacts must be made with only radio amateurs in the Cheshire County of England and there are no band or mode restrictions nor any date limitations.

Points can be claimed for all valid QSOs according to Fig. 2.

Should you contact an amateur who resides in the County Town of Cheshire in Cheshire County, you may claim double point value.

The fee for this award is US \$3.00 or 10 IRCs. This includes postage of the award which is attractively printed on parchment with an embossed seal signifying the category.

GCR apply; however, the Award Manager reserves the right to request QSLs prior to issuance of the award.

F. van Greunen ZS1IT recently wrote me on behalf of the South African Radio League (SARL) and provided details for their very popular African awards program. A detailed description follows.

ALL AFRICA AWARD (AAA)

This award, sponsored by SARL, is made available to DXers throughout the world. Below is a list of areas in Africa from which QSL cards will qualify to

EUROPE

British Isles
England (including Isle of Wight and Isles of Scilly) G
Channel Isles: Jersey GJ GC
Guernsey, Alderney & Sark GU GC
Isle of Man GD
Northern Ireland GI
Scotland (including Orkney, Shetland and Western Isles) GM
Wales GW
Gibraltar ZB2
Malta (ZB) 9H4
Corno and Comino 9H4

AMERICA

Canada
Maritime Provinces VE1
Sable Isle VE1
St. Paul Is. VE1
Province of Quebec VE2
Province of Ontario VE3
Province of Manitoba VE4
Province of Saskatchewan VE5
Province of Alberta VE6
Province of British Columbia VE7
Yukon Territories VE8
N.W. Territories VE8
Province of Newfoundland (including Labrador) VO
Bahama Islands (VP) O6
Barbados (VP) 8P6
Belize VP1
Bermuda VP9
Cayman Islands (VP) ZF1
Falkland Islands VP8
Grahamland VP8
Guyana (VP) 8R
Jamaica 6Y5

Leeward Islands

Anguilla VP2
Antigua and Barbuda VP2
British Virgin Is. VP2
Montserrat VP2
St. Kitts-Nevis VP2
Sandwich Group VP8
South Georgia VP8
South Orkney Islands VP8
South Shetland Islands VP8
Trinidad and Tobago Islands (VP) 8Y4
Turks and Caicos Islands VP5

Windward Islands

Dominica VP2
Grenada and Deps. VP2
St. Lucia VP2
St. Vincent VP2

CALL AREAS WITH RESTRICTED DATE LIMITS

BEFORE 1 JUNE 1961
Union of South Africa:
Cape District ZS1
Cape Province (excluding ZS1) ZS2
Marion and Prince Edward Is. ZS3
South West Africa ZS4
Orange Free State ZS4
Natal (including Zululand) ZS5
Transvaal ZS6

BEFORE 1 JULY 1960
British Somaliland VQ6

BEFORE 25 APRIL 1964
Zanzibar and Pemba VQ1

BEFORE 1 DECEMBER 1967
Aden VS9
Kuria Muru VS9
Kamaran VS9

BEFORE 1 FEBRUARY 1972
Pakistan AP

OCEANIA

Australia
Australian Capital Territory VK1
New South Wales VK2
Victoria VK3
Queensland VK4
South Australia VK5
Western Australia VK6
Tasmania VK7
Northern Territories VK8

New Zealand

Auckland District ZL1
Wellington District ZL2
Canterbury District ZL3
Otago District ZL4
ZL
Auckland and Campbell Is. ZL
Australian Antarctic Territory VK0
British Phoenix Islands VR1
British Solomon Islands VR4
Brunei VS5
Christmas Island (Indian Ocean) VK9
Cocos-Keeling Island VK9
Cook Islands (including Karatonga) ZK1
Fanning Is. (including Christmas and Washington Is) VR3
Fiji Islands (VR2) JD2
Gilbert and Ocean Islands VR1
Heard Island VK0
Kermadec Group (including Sunday Island) ZL1
Lord Howe Island VK2
Macquarie Island VK0
Malaysia, East (VS4, ZC5) 9M6 9M8
Manihiki Group ZK1
Nauru Island (VK9) C21
New Guinea (inc. Bismarck and Admiralty Islands) (VK9) P29
New Hebrides Condominium YJ8
New Zealand Antarctic Territory ZL5
Niue ZK2
Norfolk Island VK9
Papua (VK9) P29
Pitcairn Island VR6
Samoa (ZM6) SW1
Tonga or Friendly Islands (VR5) AJ
Tokelau or Union Islands ZM7
Tutuila VR8
Wallis Island VK4

AFRICA

Agalaga and St. Brandon (VQ8) 3B6 3B7
Aldabra Islands VQ9
Ascension Island ZD3
Lesotho (ZS8) 7P
Botswana (ZS9) A2
Chagos Archipelago (VQ8) VQ9
Des Roches VQ9 D
Farquar VQ9 F
Gambia (ZD3) C5
Ghana (ZD4) 9G1
Kenya (VQ4) 5Z4
Malawi (ZD6) 7Q7
Mauritius (VQ8) 3B8
Nigeria (ZD2) 5N2
Rhodesia ZE
Rodriguez Island (VQ8) 3B9
St. Helena ZD7
Seychelles (VQ8) 8T
Sierra Leone (ZD1) 9L1
Swaziland (ZS7) ZD5
Tanzania (VQ3) 5H3
Tristan da Cunha and Gough Island ZD9
Uganda (VQ5) 5X3
Zambia (VQ2) 9J2

ASIA

Anilaman and Nicobar Islands VU
Bangladesh 5U
Cyprus (ZC4) 5B4
Hong Kong VS6
India VU2
Laos VU4
Malaysia West 9M2 9M4
Maldiv Islands (Gan only) VS9M
Sikkim AC3
Singapore 9V1
Sri Lanka (VS7) 4B7

Fig. 1. List of British Commonwealth call areas.

obtain this award.

Confirmation must be submitted in respect to one contact from each of the six ZS call areas as well as one contact from Botswana (A2), Lesotho (7P8), and Swaziland (3D6), plus one contact from 25 different areas of the remaining groups of country prefixes shown below.

A list indicating callsigns, mode, date, and time must accompany QSL cards submitted. Applicants who belong to IARU affiliated clubs or societies may have their QSLs verified through their affiliated organization.

All stations contacted must be fixed land stations. Islands around Africa or its coast do not count for this award. All contacts must be made after November, 1945, with a minimum CW report of 338 or phone report of 33. This award is issued free to SARL members; it is \$.50 US or 10 IRCs for non-members.

Countries List: Algeria, Angola, Sudan, Congo Kinshasa, Burundi, Rwanda, Somali Rep., Camerouns, Egypt, Eritrea, Central Africa Rep., Rep. of Congo Brazzaville, Gabon, Chad, French Morocco, French Somaliland, Ivory Coast, Dahomey Rep., Volta Rep., Mauritania, Senegal, Niger Rep., Rep. of Guinea, Gambia, Ghana, Kenya, Liberia, Libya, Mozambique, Nigeria, Zambia, Malawi, Portuguese Guinea, Sierra Leone, Rhodesia, Spanish Morocco or Ifni or Rio de Oro or Spanish Guinea, Tangier, Tanzania, Tunisia, Togoland, Uganda, Botswana, Lesotho, Swaziland, South West Africa, Rep. of South Africa (ZS1-ZS6), Transkei, Bophuthatswana.

Applications and the appropriate award fee should be addressed to the attention of: F. van Greunen ZS1IT, Awards Manager, South African Radio League, PO Box 3911, Cape Town 8000, South Africa.

AWARDS FROM CERTIFICATE WORLD

I was very pleased to receive a letter from a new subscriber and also to learn of his new adventure of collecting various amateur operating awards. Meet Stu Herring WB5ULD from Fulton, Mississippi. Stu features some very attractive awards for the parchment pursuer.

Representing Certificate World, we find his awards are

Continued on page 161

headsets

New Headsets With Selectable Microphone Impedance

When traffic is heavy and the session is long, you need the comfort and efficiency of a Telex headset. The new ProCom 300 and ProCom 200 provide hands-free operation and the exact mike-to-mouth distance for consistent and reliable VOX operation.

ProCom 300

The ultimate in comfort, the ProCom 300 is an ultra-light, single-sided, aviation style headset with a powerful, electret noise-cancelling microphone. This dual impedance microphone has a 200 to 3500 Hz frequency response specifically tailored to the human voice. The earphone has a low impedance, dynamic element with a sensitive tailored frequency response of 300 to 3000 Hz.

ProCom 200

This dual muff headset has a powerful, dual-impedance, electret microphone with a typical frequency response of 200 to 3500 Hz. The dynamic, low impedance headphone has a very sensitive 200 to 12000 Hz frequency response.

Footswitch (FS-1) and handswitch (HS-1) accessories or the built-in VOX select switch provide total professional flexibility. Write for complete details today.

TELEX hy-gain

TELEX COMMUNICATIONS, INC.
DEPARTMENT 7-25

8601 NORTHEAST HIGHWAY SIX, LINCOLN, NE 68505 U.S.A.
EUROPE: 22, rue de la Légion d'Honneur, 93200 St. Denis, France

Tower shown is
The NEW Hy-Gain
HG-52SS
Self Supporting
Crank-Up Tower

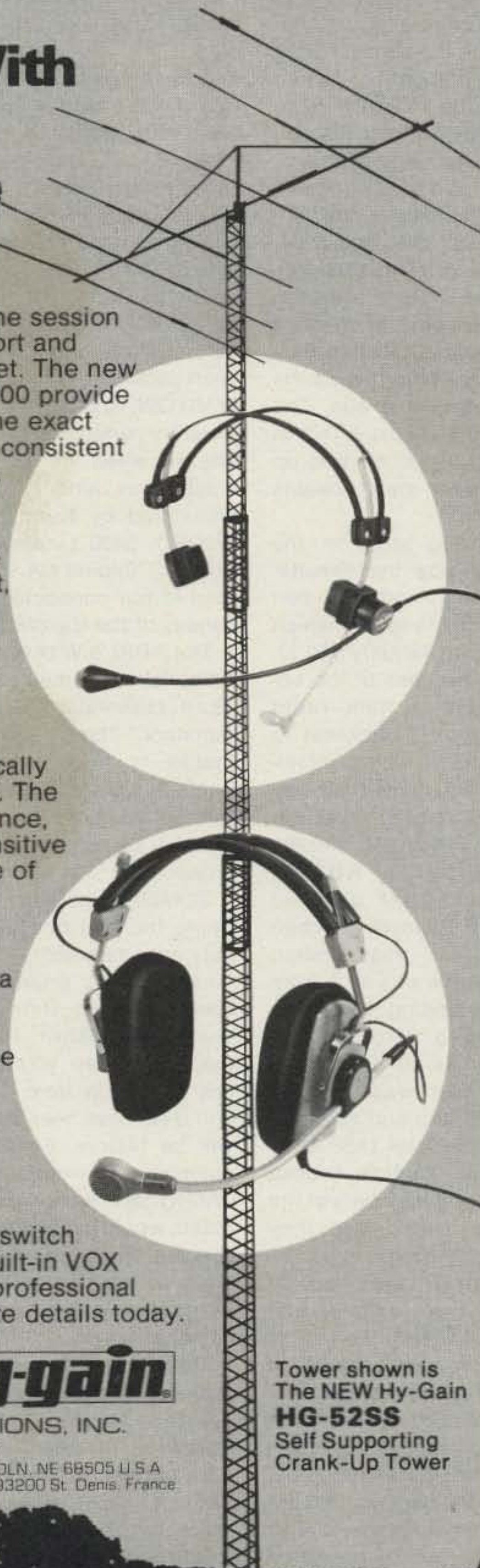

DX

James D. Cain K1TN
306 Vernon Avenue
Vernon CT 06066

January, 1980, not only ushered in a new decade (unless you're progressive and follow the decade-begins-in-'81 theory), but it also may have brought the bad news that the sunspot peak has come and gone. Ted Cohen N4XX says the monthly mean sunspot number from the Zurich observatory for December was 182.2, down from November's 185.0, and the figures for January were lower still. Boo. Hiss. Several more excellent propagation years are in store, however, since the sunspots are always lazier in dropping off than they were when climbing toward the summit, whenever it was. The next minimum is expected in 1986 or 1987, so don't fold up your six-and-ten-meter beams yet!

January's big story in the world of DX was the simultaneous operation from Kingman Reef and Palmyra Island which took place from January 5 to 10. The relative success of the operations from a ham radio standpoint took a backseat to the human drama which unfolded as the group made their way to these two isolated spots. On January 4, WA6YQW, K6LPL, WA2FIJ, W5VAH, KB5FU, WD5FJL, and K2HXF departed Honolulu for Palmyra by chartered plane. The grass landing strip on Palmyra was slick from rain and the landing resulted in a demolished aircraft and serious injuries to Jan Gould WA6YQW. She was airlifted back to Honolulu and hospitalized at the Tripler U.S. Army Hospital with multiple broken bones. No other members of the group were injured, and they went on with the expedition.

The Palmyra team, led by K6LPL, remained to set up and operate K6LPL/KH5; the rest of the group departed by boat for Kingman Reef where, on January 6, WA2FIJ/KH5K appeared on the bands. About 5,000 contacts were made from Kingman, 17,000 from Palmyra. Equipment difficulties on Kingman reduced the efficiency of the operation there; vertical antennas were used and did not work as

planned.

As the two groups were preparing to wrap up their operations, with Kingman shutting down for the boat trip back to Palmyra, disaster again befell the operation. Dave Gardner K6LPL, a neurosurgeon, fell and lacerated his hand on a piece of glass. The injury was serious, and once again the U.S. Coast Guard was called in to evacuate the entire party to Honolulu, where K6LPL was treated. He faces further surgery.

QSL card chores for these two operations are being handled by WA2FIJ and K6LPL; the Southern California DX Club will be assisting with K6LPL/KH5 confirmation. A fund has been established for Jan Gould WA6YQW, who faces a very long recovery period from the injuries she received in the landing crash. This fund is being administered by Norm Friedman W6ORD, 5400 Lindley Avenue, Apt. 312, Encino CA 91316. The fund is not connected with expenses of the trip per se.

The ARRL's W1AW on-the-air DX bulletin resumed on January 18 after several weeks without a "sponsor." The operation was thanks to the Southern New England DX Association, who offered to provide a weekly news item for the League's broadcast.

ZL1ADI expected to be in China the first of March, probably accompanied by ZL1AMO. This visit has prompted more speculation on the DX bands than any other in recent memory. When you read this, any operation from China (the call BY2F has been mentioned) will be history. Following last summer's one-hour operation by JA6HOZ/BY, word was that outsiders would not be permitted to operate from China until the Chinese themselves began getting on the air. But it doesn't hurt to hope...

Both the Andaman and Laccadive Islands were on last month's "Top 25" list of needed countries. In order for an amateur station to come on from either of those spots, it will require a native islander who has lived there for a period of time. So scratch those two from your DXpedition list. A West German

amateur recently received a letter from the Indian Ministry of Home Affairs saying "neither Indian nor foreign nationals are allowed operation from the Laccadives." Don't hold your breath for a VU7 on the bands.

Also on the "Top 25" is Burma, where VE3FXT is presently doing some scientific work and has a license for very low power commercial work, somewhere in the 15-meter band. No reports of anyone hearing him.

Have faith... things are looking up for a few of the countries on that list; although ZA3KL is still not verified as having been in Albania at all, much less with permission to operate (he was on the bands briefly in early January), there is hope for an operation from Australia's Heard Island, VK0, sometime this spring. A scientific expedition left for Heard on February 29 for a short visit, and Jim Smith P29JS contacted the leader of the group with an eye on some sort of operation from Heard. Jim was hoping for a "controlled" type of operation utilizing a non-amateur within the expedition group to provide a few contacts from the island. The time interval between this writing and publication will answer the question of whether the initiative bore fruit.

While we're on the subject, we might as well work our way down those 25 DXCC countries until we get to some positive things. No immediate hope for numbers 7, 8, 9, 10, which are 7O South Yemen, FB8W Crozet, XU Kampuchea, and 3Y Bouvet. Number eleven was the Andamans. And 3X Guinea doesn't look bright, either. But!!! 6O1 Somalia may appear. We had a call from a W6 the other day who needed just that one to have them all, and we tried to cheer him up. With talk of the U.S. establishing a military base of some sort in Somalia, a la Diego Garcia, the chances of amateur radio are increased immeasurably. Could be as early as the end of this year.

As for 14, Glorioso, and 20, Juan de Nova, both FR7-type-callsign islands, odds are against any activity until one of the resident amateurs on the "big" island, Reunion, is able to activate them. As this is written, N2KK, K5CO, and N5AU are on their way to Reunion with hopes of activating the outer islands, but the prospects are dim.

Talk continues of an operation from CE0X San Felix by Chilean amateurs, perhaps this year. But the Navy must be called in to transport a group to San Felix, and the cost is very high.

Number 16, Afghanistan, has seen all operation cancelled by the invasion by the U.S.S.R. Stations have been reported signing such things as UA0AA/YA and the like; even if they are real stations, the DXCC administrators will probably not allow credit. XV5 Viet Nam is, of course, off the air.

At present, at least two amateurs from Belgium are in 9U Burundi, with hopes of licensing. That might move Burundi down from its number 18 slot on the list. Not much hope for 4W N. Yemen, but S9 St. Thomas (formerly CR5 Sao Thome) may be on this spring thanks to D4CBS, who may make a business trip there in March or April. Angelo revealed these plans when he attended a meeting of the Southern New England DX Association in Boston on January 11.

Since we're this far along, we might as well finish out the 25 on the list. HK0 Malpelo is so difficult and dangerous to get to that it is probably out of the question for some time, especially after the problems encountered by the Kingman/Palmyra team. 5A Libya and 7Q Malawi have political circumstances precluding any operations soon. But Uganda could see a 5X5 operation any day, now that Idi Amin is out. It will be fun to look back at that list of 25 at the end of 1980 and mark off the countries which saw amateur radio operations happen. Let's hope for plenty!

During 1979, eleven countries had changes of government as despotic rulers were either exiled or assassinated. Can you name them? They are, by radio prefix, XU, EP, VP2G, 5X5, YN, 3C1, TL, YS, HM, TT, and YA. From the DXer's point of view, the changes were for the good in the cases of 5X5, 3C1, TL, and TT. The changes will not affect us as far as Grenada, Nicaragua, El Salvador, and Korea are concerned. Kampuchea was a lost cause as far as amateur radio goes, so no matter. There may be activity from Iran as time goes along, but YA is probably going to be silent for some time.

I0DUD activated the Vatican

station, HV3SJ, regularly early in the year; QSLs go to his Italian address. He was most often found on 15 SSB. ZS2MI leaves Marion Island at the end of April; he has been very active on 14240 around 04-0600 UTC on various days, often with assistance from his QSL manager, WA2IZN. The Long Island DX Association donated the ZS2MI cards.

More clubs report electing new officers for 1980: The Western Washington DX Club, whose *Totem Tabloid* is one of the finest local club bulletins around, tabbed W7YOZ, N7CY, WA7GRE, K7YDO, W7OTO, and WB7WEI for club duties. The 240-member Southern California DX Club elected W6SP, N6AHU, WA6WZO, and W6PN. The Texas DX Society out of Houston honored N5WW, K5BZU, KA5CHW, and K5NA with work slots.

If you work 4U1ITU, be sure to ask for the operator's own home callsign and send your QSL to him directly. That's the way things are run there in Geneva.

YASME operations by Iris Colvin W6QL and Lloyd Colvin W6KG moved from St. Lucia, where they signed J6LOO, to Dominica, J7DBB, during January. J6LOO made 9,000 contacts with 130 countries; the Colvins also worked all U.S. call areas on 160 from St. Lucia. Their plans to operate from FM7 Martinique following St. Lucia were thwarted. While in St. Lucia, two local amateurs, J6LHV and J6LIM (VE2EWS), dropped by the Colvins' operating site with busted rigs. When they left, the rigs were working again.

TF3SG's 6-meter privileges have been extended through 1980; he has been working up and down the East Coast of the U.S. since the first of January. Over 300 Worked All States awards have been awarded for contacts on 50 MHz. Compare that to over 700 5-band DXCC plaques engraved thus far and the relative difficulty of DX becomes apparent.

The ARRL's DX Advisory Committee has several new members, appointed by President W2HD for two-year terms beginning January 1. The entire committee is W1OT, W2QM, W3ZN, N4MM, K5YY (Chairman), N6RJ, K7LAY, WB8EUN,

Continued on page 159

hy-gain®

HG-52SS Self-Supporting Crank-Up Tower

The Hy-Gain Model HG-52SS is a 52 foot self-supporting crank-up tower designed for antenna loads of up to 9.0 square feet in winds up to 50 mph. This all steel constructed tower is hot dip galvanized after fabrication to ASTM specifications. Features include extra-strength diamond web bracing and an improved guide system for the telescoping sections, which provides rigid, close tolerance structural support while leaving the tube ends open for complete surface galvanizing and unrestricted moisture drainage. Rotators, including the Hy-Gain 300 and CDE Tailtwister, can be mounted inside the top section on the rotor mounting plate included with the tower. The HG-52SS is easily raised and lowered by manual or optional electric winch system. A thrust bearing is available which bolts to the top section and accommodates masts up to 2 inches in diameter. The HG-52SS is easily erected on a limited area site, and can be readily retracted to a 21 foot height for service of the antenna. Hy-Gain manufactures a complete line of Crank-Up towers from 33 to 70 feet. Write for complete details today.

Antenna shown
is Hy-Gain
TH6DXX
Tri-Band Beam

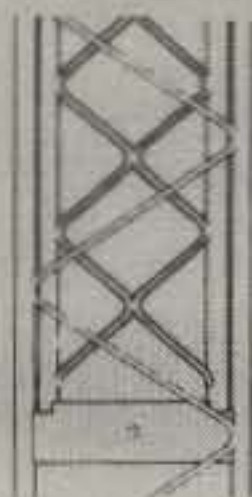

Hy-Gain
Diamond Web
Bracing for the
ultimate in
structural
strength.

TELEX hy-gain

TELEX COMMUNICATIONS, INC.
DEPARTMENT 7-25

8601 NORTHEAST HIGHWAY SIX, LINCOLN, NE 68505 U.S.A.
EUROPE: 22, rue de la Legion d'Honneur, 93200 St. Denis, France

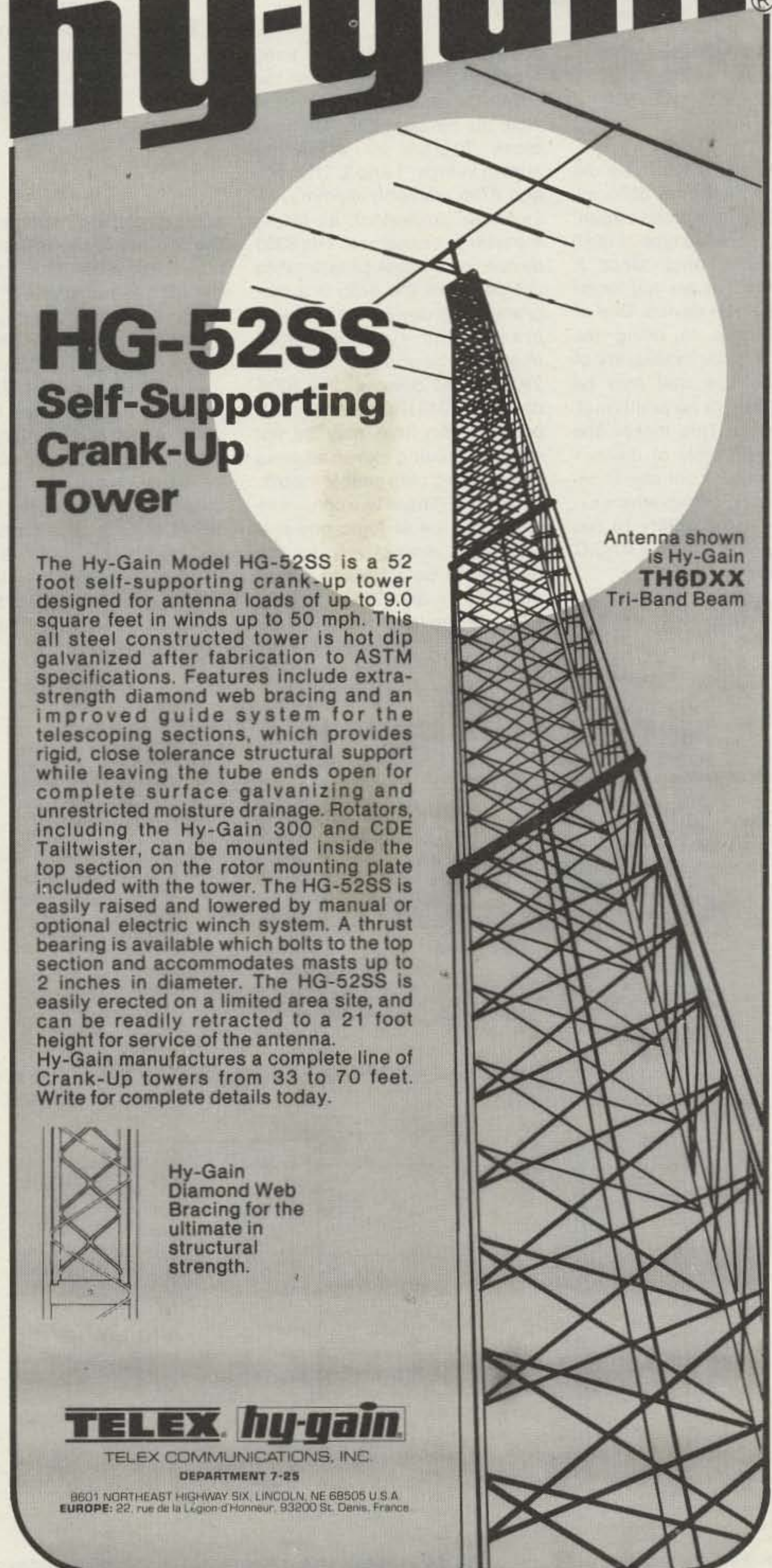

Microcomputer Interfacing

Jonathan A. Titus
 Christopher A. Titus
 David G. Larsen WB4HYJ
 Peter R. Rony

In a previous column, we described the new Intel 8085 microprocessor integrated circuit. This is an upgraded type of 8080 microprocessor chip, since it has features that are not found on the 8080-type device. One of the advantages in using the 8085 device is the availability of "family" devices that may be used with little or no additional, external logic. This makes the 8085 and its family of devices ideal for small controllers, instruments, and games where expansion and the ability to run large programs such as BASIC may not be required.

In this month's column, we will describe two of the

8085-family devices, the 8155 read/write memory chip and the 8355/8755 read-only memory device, the pin configurations and block diagram for which are shown in Figs. 1 and 2. The 8355 and 8755 read-only memory devices are equivalent, as far as the user is concerned. The 8355 device is a mask-programmed device, while the 8755 is a programmable device that may be erased and reprogrammed much like the popular 1702A and 2708 PROM devices. The 8755 contains 2048 (2K) bytes of read-only memory that may be accessed by using eleven address bits and two chip enable inputs, CE and \overline{CE} . These two control inputs must be at logic one and logic zero, respectively, for the memory to be accessed. Since the 8755 is an 8085-family device, the low address and data

M2	M1	Mode of Operation
0	0	Output a logic zero during the second half of the count.
0	1	Output a square wave, same as 00, above, but reload and restart the count at the end of each count sequence.
1	0	Output a single, short pulse at the end of the count sequence.
1	1	Output a single pulse at the end of the count, but reload and restart the count at the end of each count sequence.

Table 1.

bus signals are multiplexed on the bidirectional address-data bus lines, AD7-AD0. As such, the 8755 is not very exciting. It does contain, however, two eight-bit I/O ports that allow the chip a great deal of flexibility.

The I/O ports on the 8755, and the 8355 as well, may be programmed on a bit-by-bit basis so that the individual I/O bits may be either input bits or output bits. This allows you, the user, to select any combination of input and output bits, from 16 inputs to 16 outputs. Each of the two I/O ports on the 8355/8755 chip has a control register that is as-

sociated with it so that the bits may be easily programmed. To make our system fairly easy to understand, we have chosen to use the accumulator I/O technique to interface the two I/O ports on the 8355/8755 chip to the 8085. To do this, we have gated together the necessary 8085 control signals to generate the \overline{IN} and \overline{OUT} signals that are necessary for I/O control. These signals are applied to the 8355/8755 chip's \overline{IOR} and \overline{IOW} pins. The device addresses for the I/O ports and their control registers are shown below:

```

Port A           XXXXXX00
Port B           XXXXXX01
Port A Control Register XXXXXX10
Port B Control Register XXXXXX11
    
```

The X bits are "don't care" bits, since their states do not have to be known to select one of the four functions. We are allowed this flexibility since the chip is also controlled with the CE and \overline{CE} inputs; these two inputs must be in their proper state before the chip can operate on the ports or the port control registers. It is important for you to note that you cannot read the contents of either control register. The contents of the registers can only be updated and

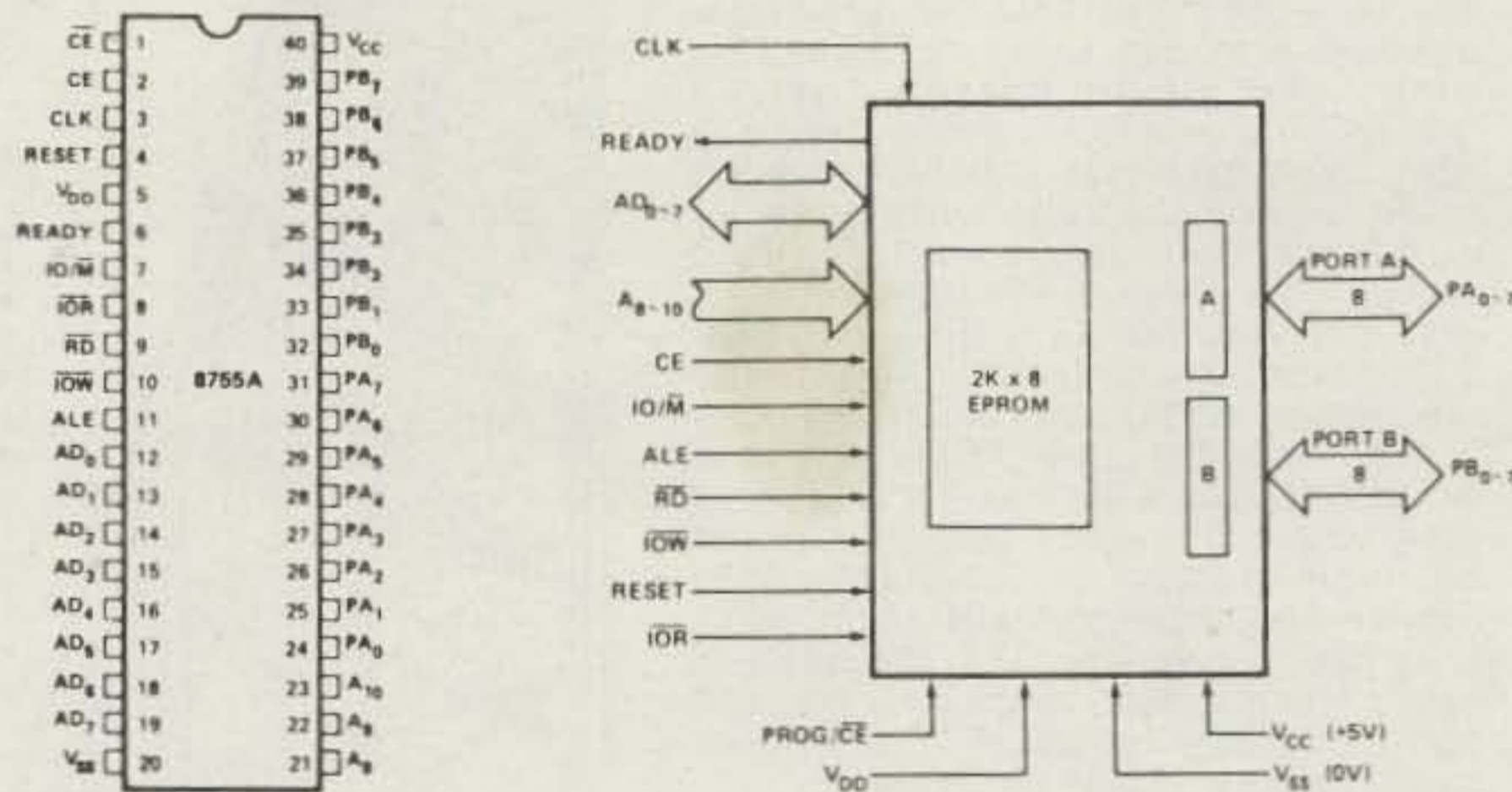

Fig. 1. Block diagram and pin configuration for the 8755 read-only memory used in 8085-based systems.

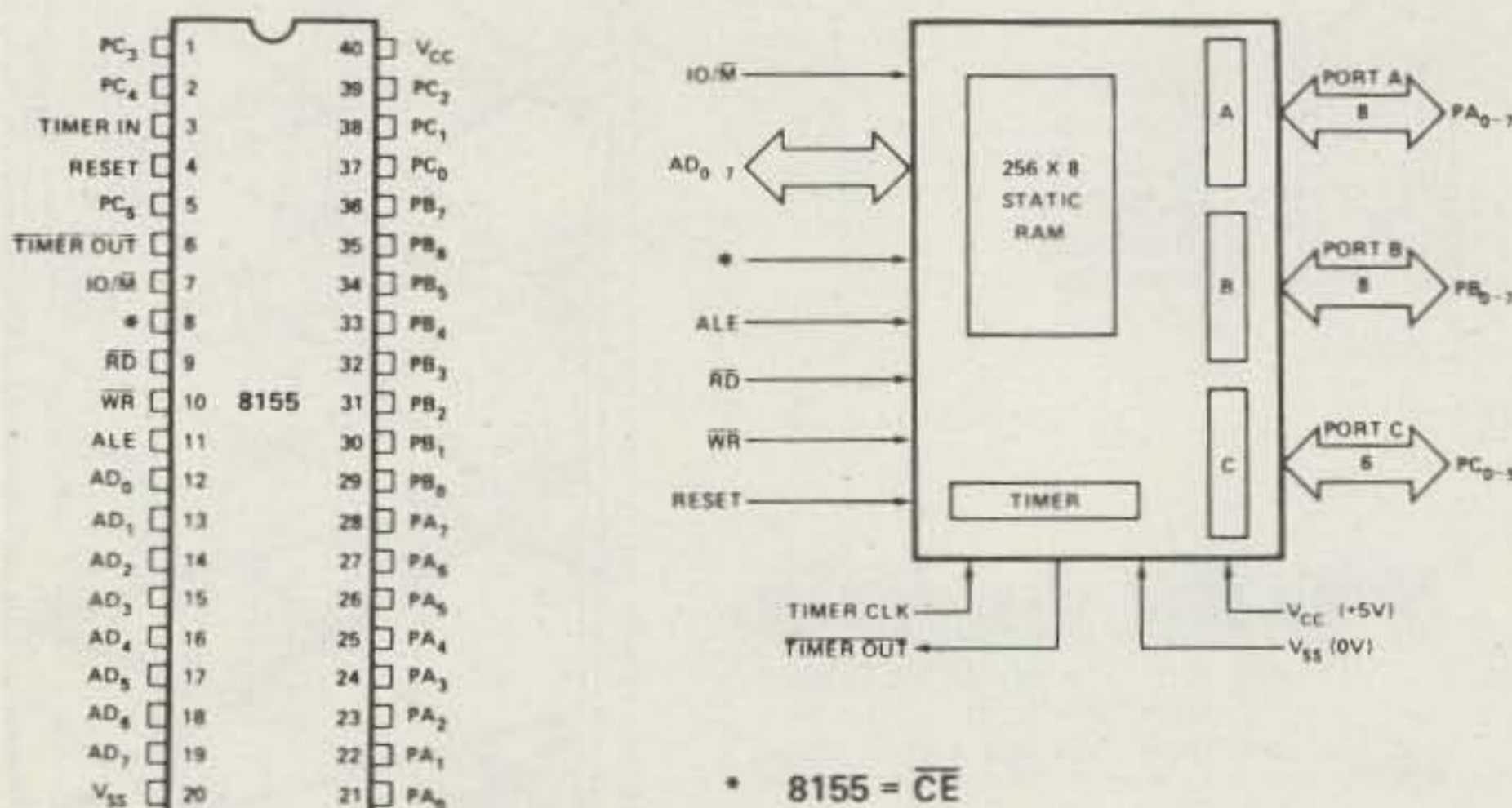

Fig. 2. Block diagram and pin configuration for the 8155 read/write memory used in 8085-based systems.

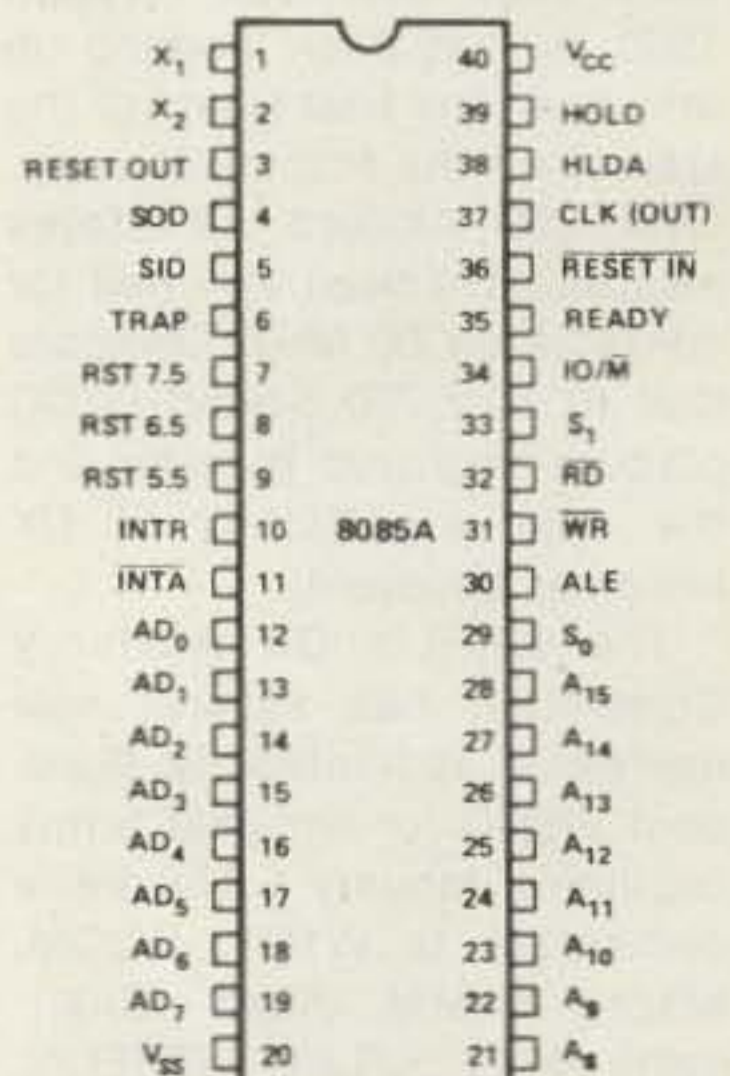

Fig. 3.

not checked.

In our small 8085-based system, we have configured the chips so that the read-only memory in the 8355 or the 8755 chip starts at address 000 000 and continues through address 007 377. The I/O ports have addresses 001 and 002, with the control registers having addresses 002 and 003. Our final system does not have *absolute addressing*, since some of the unused address bits are ignored. More decoding is necessary if you wish to expand the small system that is discussed in this column.

The 8155 read/write memory chip contains 256 bytes of memory, which is probably more than enough for a small system. In most cases, the read/write memory will be used for temporary storage of data or results, as well as register and address information. The 8155 is also bus-compatible with the 8085 system, through the use of the bidirectional address/data bus and standard control signals. In this case, the $\overline{IO/M}$, \overline{RD} , and \overline{WR} signals are all that are needed for memory control. The ALE, CLOCK, and RESET signals from the 8085 are also provided for internal control of the chip.

The 8155, like the 8355 and 8755 chips, has some I/O lines. In fact, there are two eight-bit I/O ports and one six-bit I/O port on the 8155 chip. The two eight-bit I/O ports may be operated in either the input or output mode. Individual bits can not be selected, as was the case with the 8355/8755 device. These two ports are called ports A and B. The six-bit I/O port, port G, may be operated in a number of ways, but these are beyond our present discussion. Let us just say that they allow the I/O ports to operate in a manner that is similar to that encountered in the mode 1 and mode 2 operation of the 8255 programmable peripheral interface chip.

The 8155 read/write memory chip also contains a 14-bit programmable counter, referred to as a timer. The timer may use either the 8085's clock output or an externally applied clock signal. The timer's output is available as a pin on the 8155 chip and it may be used in a number of ways, depending upon your needs. It could be connected to the Serial Input Data pin (SID,

hy-gain[®]

18HT The World's Finest Multiband Vertical

The 18HT "Hy-Tower" is the only full size, automatic band-switching vertical antenna for 80 thru 10 meters on the market today! It features a unique stub decoupling system which effectively isolates various sections of the antenna so that an electrical $\frac{1}{4}$ wavelength (or odd multiple of a $\frac{1}{4}$ wavelength) appears on all bands. As a result, the VSWR is less than 1.5:1 at resonance 80 thru 10 meters.

Typical 2:1 VSWR Bandwidths are:

- 700 kHz on 10 meters
- 300 kHz (or better) on 15, 20, and 40 meters
- 250 kHz on 80 meters

With the addition of a base loading coil, the 18HT also provides exceptional 160 meter performance!

Many 18HT's have been in service for 15 years or more and they still deliver "original spec" performance. This enviable record is the result of Hy-Gain's no-compromise attitude toward materials and construction. The 18HT is complete with a 24 foot galvanized tower that supports the entire system without guys in winds up to 75 mph. The top section consists of dependable 6063-T832 taper swagged aluminum tubing that extends the antenna to an overall height of 50 feet. A special hinged base allows complete assembly on the ground and permits easy raising and lowering.

Hy-Gain offers a wide selection of vertical antennas as well as a complete line of beams and crank-up towers. Write for detailed information today!

TELEX *hy-gain*

TELEX COMMUNICATIONS, INC.

DEPARTMENT 7-24

8601 NORTHEAST HIGHWAY SIX, LINCOLN, NE 68505 U.S.A.
EUROPE: 22, rue de la Légion d'Honneur, 93200 St. Denis, France

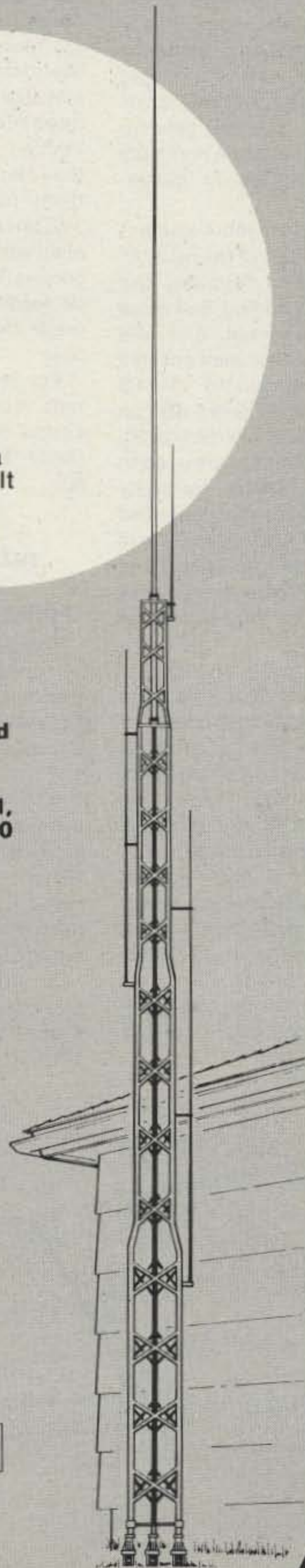

Continued on page 122

New Products

KLM'S KT-34XA

KLM Electronics' new KT-34XA tribander delivers broadband coverage on 20, 15, and 10 meters at performance levels equal to or exceeding many stacked monoband systems. With reduced weight and wind load, and tower and rotator requirements, overall system costs can be kept to a minimum with no sacrifice in performance.

KLM's field-proven 4-element KT-34 is the heart of the new "X" tribander. But, doubling the boom length, adding one more tri-resonant element, and one full-sized 10-meter element has increased the gain to 11-11.3 dBd on 10 meters, 9-9.5 dBd on 15 meters, and 8.5-9 dBd on 20. Two driven elements are used to make the KT-34XA unusually broadbanded (a concept applied to many KLM antennas). Gain is virtually flat across each band except for 10 meters which has been optimized for the DX'er at 28-29 MHz.

The traps, coils, and capacitors of conventional tribanders have been discarded in favor of integral linear loading and Hi-Q air capacitors, all composed of aluminum tubing. These give the KT-34XA a conservative power-handling capability of 4 kW PEP and a high level of operating efficiency. Linear loading also makes full $\frac{1}{4}$ -wave elements possible on 10 and 15 meters, and brings 20 meters much closer to the desirable $\frac{1}{4}$ -wavelength than any conventional tribander.

Mechanically, the KT-34XA has been built to survive. All aluminum, including the boom, is tough weather-resistant 6063-T832 alloy. All electrical hardware and guy cables are stainless steel. Virtually indestructible lexan insulators, just like those used on KLM's linear-loaded 40-meter Big Sticker, are used for mounting the elements and insulating them from the boom. KLM's 3-60-MHz 4:1 ferrite balun is supplied with the KT-34XA for direct connection to any 50-Ohm coaxial feedline. Special kits to upgrade the KT-34 are also available.

For more information, contact *KLM Electronics, 17025 Laurel Road, Morgan Hill CA 95037*. Reader Service number 40.

5820-437-1918 TRANSMITTER, RADIO T-1151 (V) / USQ FORKED STICK, PRAT MOSS

The disgustingly decrepit dab of doggie-doo distastefully depicted does indeed deceive. Delicately encapsulated within a husk of camouflaged epoxy is a VHF transmitter! Operating in the 150-MHz range, this aesthetically appealing little unit is actually a "seismic intrusion detector"—a sophisticated surveillance monitor which was used in Viet Nam to detect troop movements.

The luscious looking lump of fecal foolery contains several discrete transistors and a seismic detector. The instru-

ment is powered by three mercury cells and is armed by withdrawing a small plastic pin which closes a switch.

In actual use, seismic intrusion detectors are scattered throughout an area suspected of being in the route of the enemy; ground vibrations cause an inertial device to close a circuit, activating the transmitter. The pulse-coded signals are picked up by a remote VHF monitor receiver, alerting personnel to the presence of intruders.

Range of the radiated signal is approximately 300 meters, limited by its relatively low power (a few milliwatts) and its built-in copper-foil dipole. After 15 years, the batteries are dead, but the circuit is still very much active. Who will be the first to key up the local repeater with digital doo-doo?

Weighing only about an ounce, the detectors were made in several different sizes and shapes. Their cruddy appearance was deliberately designed to blend in with native ground litter. While some look like droppings from a passing puppy, others resemble nondescript globs of mud.

If anyone would like to own his very own transmitting atrocity, he may order one for only \$5 postpaid from *John Meshna, PO Box 62, 19 Allerton Street, East Lynn MA 01904*. Reader Service number 478.

**Robert B. Grove WA4PYQ
Brasstown NC**

JUST WRAP KIT

Complementing the introduction of its new Just Wrap wire wrapping tool, O.K. Machine and Tool Corp. has announced

its new Just Wrap Kit. The Just Wrap tool wraps 30 AWG wire onto standard .025"-square posts without stripping or slitting the insulation. The tool can daisy chain continuously through several points or can be used in the point-to-point mode. It contains a built-in wire cutoff device for terminating the final connection of each chain. The JWK-6 Kit contains the Just Wrap wrapping tool, the JUW-1 unwrapping tool, and four 50-ft. wire refill cartridges, 1 each in red, white, blue, and yellow, all packaged in a sturdy, reusable clear plastic box. The JWK-6 Just Wrap Kit is available from stock at local electronics retailer or directly from *O.K. Machine and Tool Corp., 3455 Conner Street, Bronx, NY 10475*. Reader Service number 54.

DENTRON ANNOUNCES NEW GLA-1000B LINEAR

DenTron Radio Company has introduced an improved model of its popular GLA-1000 linear amplifier, the GLA-1000B. Featuring a tuned input circuit for consistent 50-Ohm input impedances, the new unit is the smallest and most economical 1200-Watt SSB (800-Watt CW) linear amplifier ever offered to amateurs.

DenTron has also added a new innovation in amateur linear amplifiers, namely a front-panel antenna switch, designed to allow user selection of either a dummy load (such as a DenTron Big Dummy) or an alternate antenna system.

Additional improvements include the use of LED status indicators for standby and transmit, thus ending the need for replacement of incandescent light

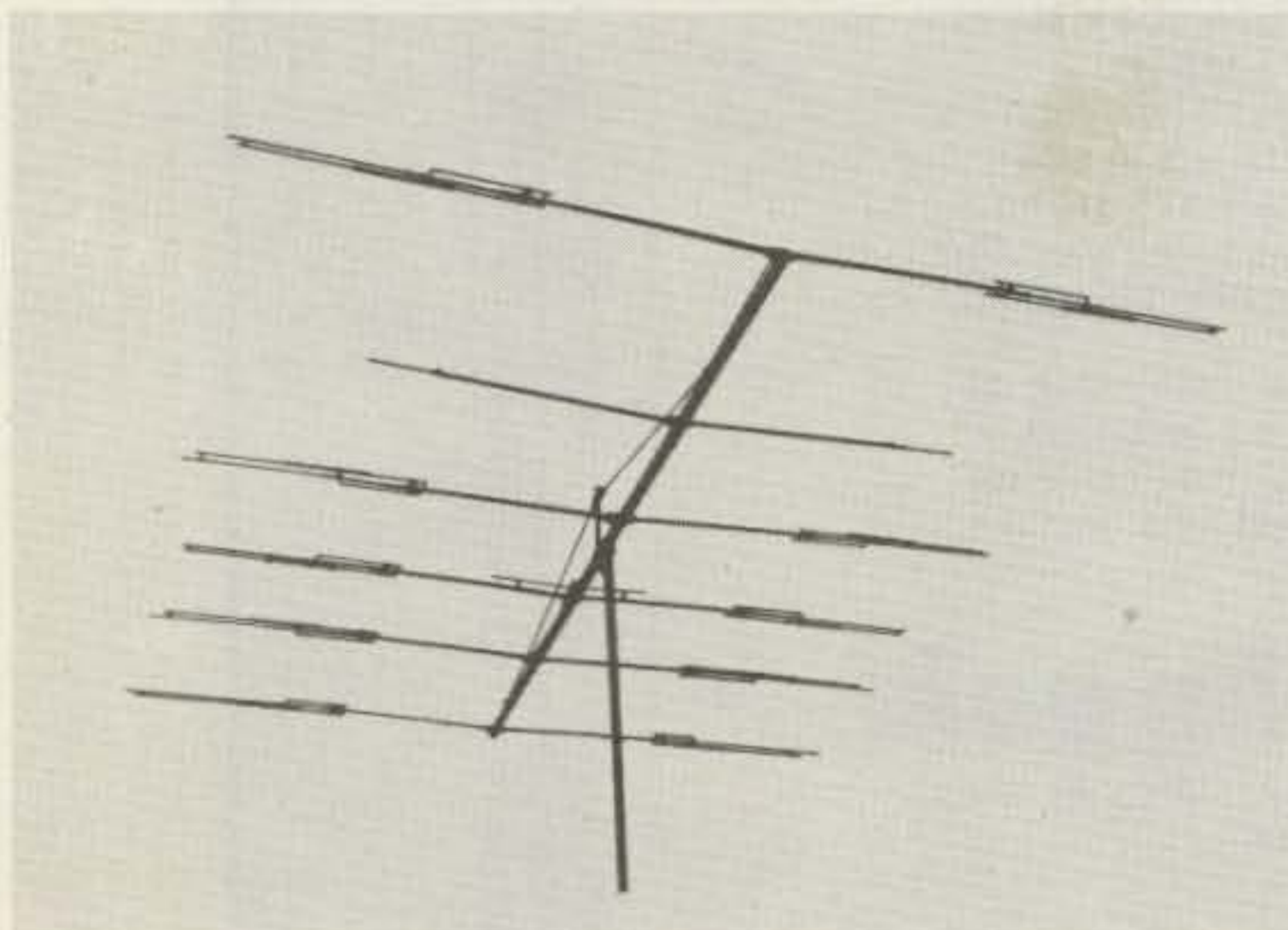

The new KLM KT-34XA.



5820-437-1918.

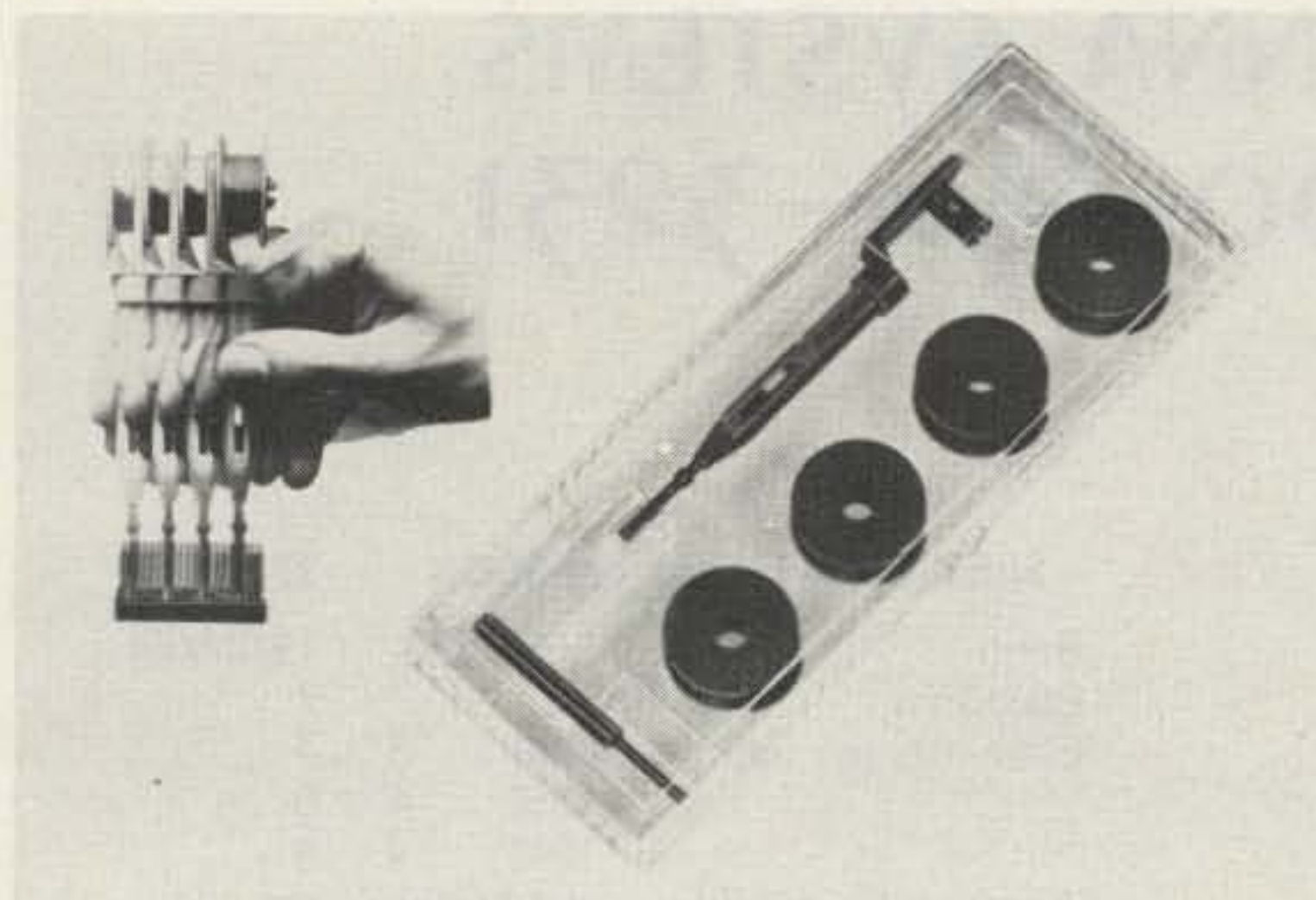

The Just Wrap Kit from O.K. Machine and Tool Corp.

bulbs, and greatly enhanced tube life through design refinements.

Retained in the new GLA are the basic features of the original unit: compact size, complete metering of essential voltages, currents, and relative power output with a large back-lite meter, easy conversion to 10 meters by a licensed amateur, economical D-50A finals that cost less than \$40.00 to replace the full complement, a built-in power supply, user selectable for 117 V ac or 234 V ac primary voltage, and FCC type acceptance.

The most exciting news, however, is the price, with DenTron offering the new GLA-1000B at a price which makes it the most economical linear amplifier of the decade! The new GLA-1000B is available now from DenTron Dealers worldwide. DenTron Radio Company, 1605 Commerce Drive, Stow OH 44224. Reader Service number 476.

HEATH INTRODUCES NEW REMOTE COAX SWITCH

Heath Company has announced a new remote coax switch. The Heathkit SA-1480 allows the amateur radio operator to select any of 5 antennas by simply turning a knob at his bench.

Used with the SA-1480, one feedline from the inside control box to the outside switching box replaces 5 separate antenna cables, saving coaxial cable. A special grounding position grounds all antennas for lightning protection.

A specially shielded switching box protects the switching circuitry from the elements. Silverplated switch contacts help reduce swr and the SA-1480 operates on frequencies up to 150 MHz at full legal power.

Heath engineers say the new remote coax switch can be easily assembled in 6 to 8 hours. A U-bolt assembly is included to facilitate mounting the outside



DenTron's new GLA-1000B.

switching box on an antenna mast or tower leg.

Heath Company, Benton Harbor MI 49022. Reader Service number 303.

DIGITAL RF WATTMETERS

A new era in rf power measurement was announced by THRULINE® wattmeter designer Bird Electronic Corp. with the introduction of the new series 4380 RF Power Analyst™. First of the series, portable model 4381 is a multi-purpose digital directional wattmeter for power levels from 100 mWatts to 10,000 Watts, an 1/2 to 2300 MHz. CW or FM modulation in both forward or reflected directions is displayed in Watts or dBm at the push of a button. Vswr is calculated continuously and indicated through a fifth button, as is dB return loss. Buttons seven and eight are for peak envelope power (as in SSB transmissions) in Watts, and the ninth button calls up percent

modulation. The final set of three buttons makes tuning a transmitter, matching an antenna, or tweaking rf components a fast and simple task: A delta (Δ) function identifies either rise or fall in displayed values, while a minimum or maximum memory recalls optimum conditions during adjustments. Other models in the 4380 series measure to 250 kW or are panel mounted.

This new generation of rf wattmeters with nine-mode system versatility was designed around existing Bird Plug-in Elements, which determine full-scale power and frequency range. Once a set of two Elements is chosen (for incident and reflected power), the large LED display places the decimal point correctly, making mental multipliers superfluous. Over-ranging of up to 120% in Watts, and 400% in dBm often obviates changing to a higher-power Element.

Continued on page 162



The Heathkit SA-1480 Remote Coax Switch.



The RF Power Analyst™ from Bird.

TET[®]

ANTENNA SYSTEMS 1-800-654-3231

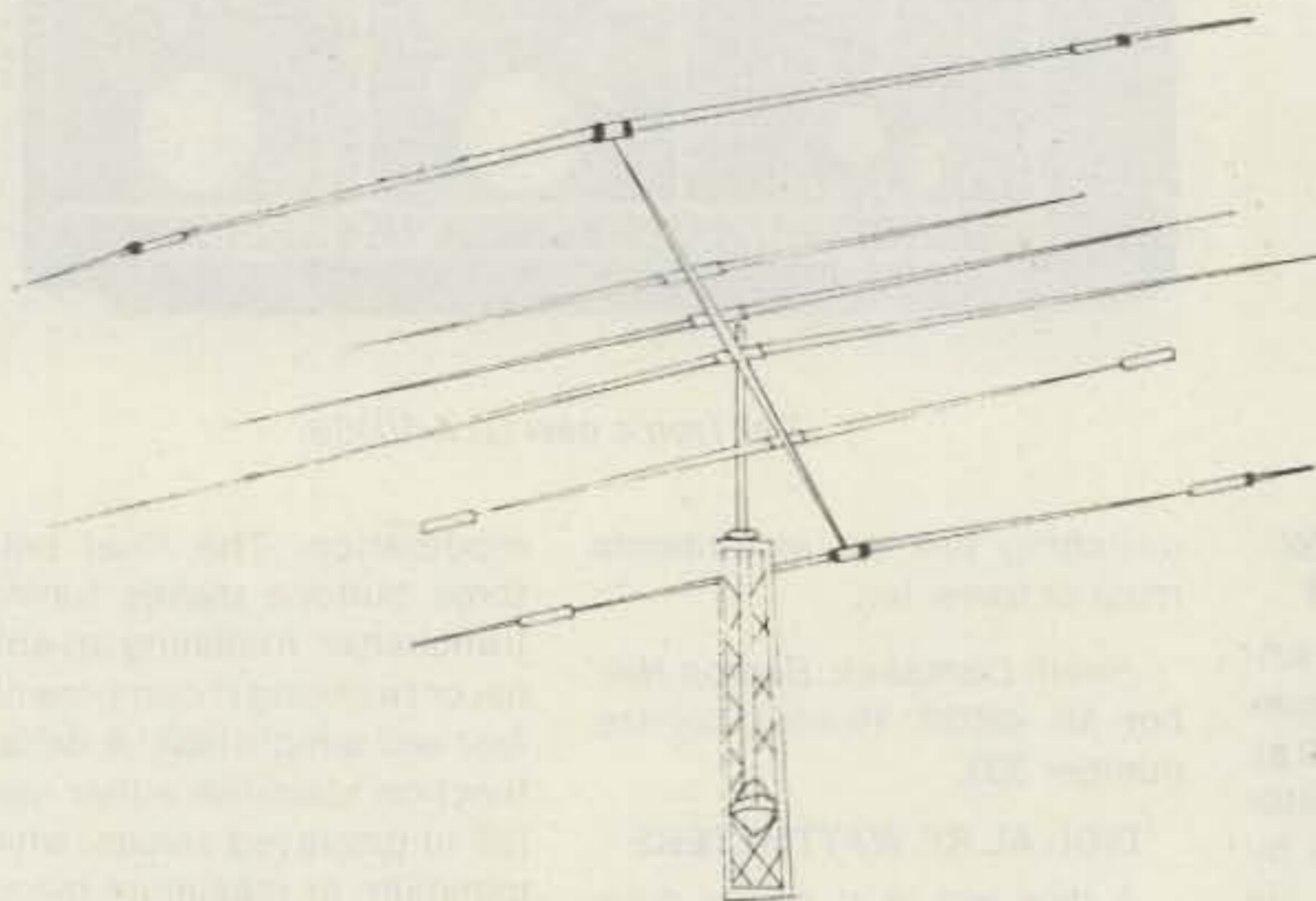

SPECIFICATIONS - 3F36DX 3F37DX

Band	14/21/28	14/21/28
Elements	6	7
Elements per band	20M 3	3
	15M 4	5
	10M 4	5
Antenna Gain dBd	call factory	-----
Front to Back ratio	call factory	-----
Maximum power	full legal	full legal
VSWR	Below 1.5:1	Below 1.5:1
Impedance	50 Ohm	50 Ohm
Max Element Length	34'5"	33'11"
Boom Length	16'5"	24'8"
Turning Radius	17'3"	17'5"
Wind Surface Area	9.58 sq. ft.	11.3 sq. ft.
Wind Load @ 80 mph	191 lbs.	226 lbs.
Mast Size	2"	2"
Weight	46.3 lbs.	55 lbs.
Shipping weight	52 lbs.	62 lbs.
TET DIRECT PRICE	\$ 199.95	\$ 234.95

TET Antenna Systems is proud to announce the addition of an all new six element triband beam, the 3F36DX. Following the proven world wide performance record of the 3F35DX the 3F36DX provides even greater performance on the 10 and 15 meter bands. The 3F36DX has three active elements on 20 meters; four active elements on 10 and 15 meters. Boom length remains the same at 16'5". The 3F36DX is a no compromise antenna designed to give maximum performance on all three bands. The parallel fed full sized driven elements contribute toward true wide band performance. No phone and CW band settings with the 3F36DX; full band coverage is possible even with modern all solid state transceivers. VSWR below 1.5:1 will be found across all of 20 and 15 meters. Ten meter coverage is greater than 1.5 MHz with VSWR below 1.5:1. The 3F36DX is fed directly with a single 50 ohm coaxial cable. No baluns are needed. No special matching networks are used. The 3F36DX employs a single direct feed to a common 50 ohm buss across the three full sized driven elements.

TET invites you to compare the 3F36DX performance data against that of other antenna manufacturers. TET the leader in wideband antenna design, offers superior performance at an affordable price. Order your own 3F36DX today and be prepared for those busy pile-ups in a few short days.

3F36DX \$ 199.95
3F37DX \$ 234.95
fob Norman, OK.

CALL TOLL FREE 1-800-654-3231



✓73

TET U.S.A., INC.



425 HIGHLAND PARKWAY, NORMAN, OKLAHOMA 73069 TEL: 405-360-6410

TET[®]

ANTENNA SYSTEMS

1-800-654-3231

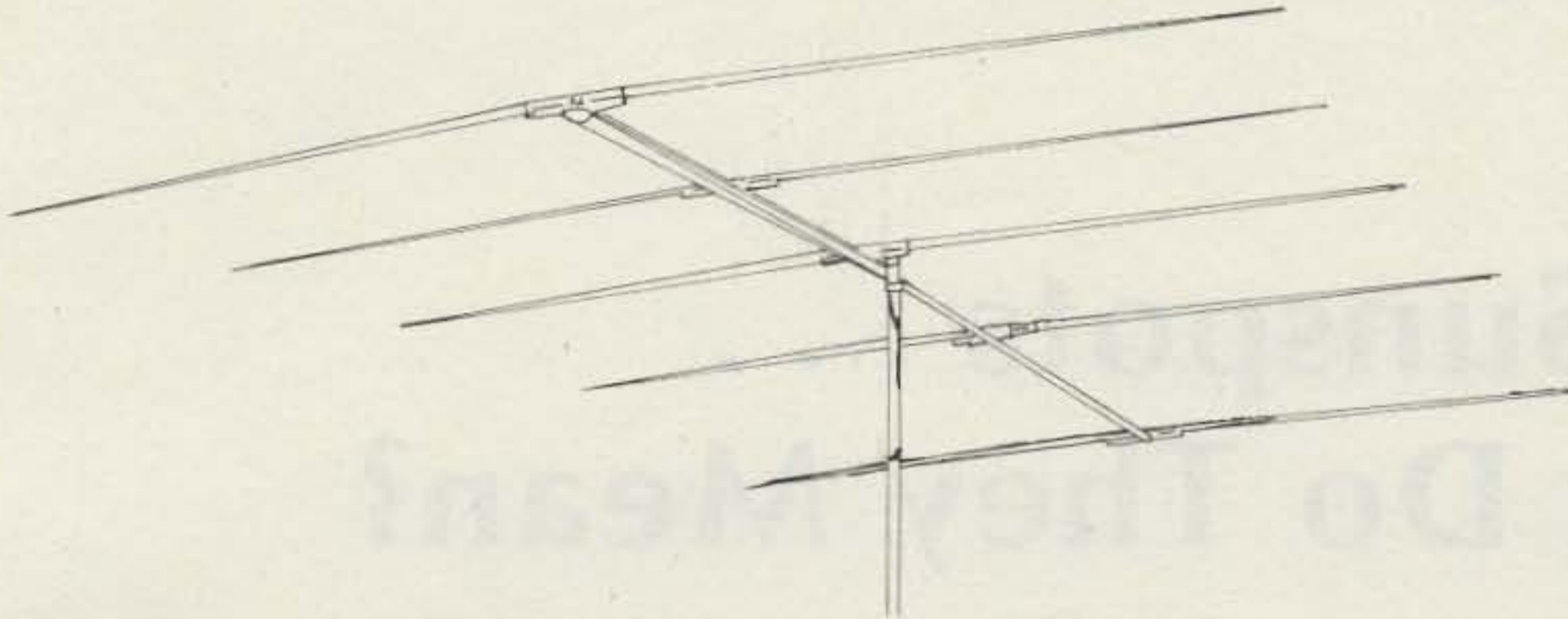

TET ANSWERS THE VSWR CRISIS

The first major development in yagi antenna technology in a generation has been accomplished by the research department of TET. No more Phone and CW assembly charts! No more compromise performance! Install a new TET SP Series Monobander and pick your frequency. From band edge to band edge, you will experience extremely low VSWR and high performance, unmatched by the competition.

The heart of the SP Series Monobander is a unique three element drive system (2 on three element models) employing a coaxial matching network INSIDE each of the driven elements. A rigid two conductor phasing harness couples energy directly to three elements. Each of these elements is pretuned for maximum power transfer and the lowest possible VSWR across the entire band. No baluns, chokes or other external devices are required. The TET SP Series Monobander uses a simple, direct connecting 50 ohm coaxial feed.



VSWR figures obtained with the new TET SP Series Monobander are substantially lower than previously obtainable. The figures shown in the specification table are for the ENTIRE BAND, and only reflect worst case conditions. Typically, for example, the 10F5SP demonstrated VSWR of 1.2:1 or less from 28 to 30 MHz! Don't delay; be the first in your neighborhood with the best antenna technology available. Order your superior performance SP Series Monobander today. You'll find yourself ahead of the crowd when that rare one you need comes on frequency. Order direct from TET, by mail, or TOLL FREE 1-800-654-3231;

KR400 Rotator 7½ sq. ft.	84.95
KR600 Rotator 16½ sq. ft.	139.95
KR2000 Rotator 32½ sq. ft.	289.95
KR500 Elevation Rotator	149.95
KS065 2½" thrust bearing	20.95
KS050 2" thrust bearing	14.95

MODEL	BAND	ELEMENTS	LONGEST ELEMENT	BOOM LENGTH	TURNING RADIUS	SURFACE AREA (sq. ft.)	WIND LOAD 80 MPH	MAST SIZE	WEIGHT (lbs.)	PRICE
10F3SP	10M	3	17'9"	9'11"	10'2"	3.18	62	2"	15.4	63.95
10F4SP	10M	4	18'10"	13'2"	11'6"	4.38	88	2"	18.7	77.95
10F5SP	10M	5	28'10"	19'10"	13'8"	5.41	108	2"	28	113.95
15F3SP	15M	3	23'7"	13'3"	13'6"	4.19	84	2"	17.6	72.95
15F4SP	15M	4	23'11"	19'10"	15'6"	5.70	114	2"	30	135.95
15F5SP	15M	5	23'11"	26'5"	17'10"	6.80	136	2"	46.3	189.95
20F3SP	20M	3	35'8"	16'6"	19'4"	8.61	114	2"	33	135.95
20F4SP	20M	4	35'8"	26'5"	23'1"	11.51	170	2"	52	199.95

TET U.S.A., INC. 1-800-654-3231



425 Highland Parkway, Norman, Oklahoma 73069
Oklahoma Residents Call (405) 360-6410

Sunspots . . . What Do They Mean? — your guess is as good as mine

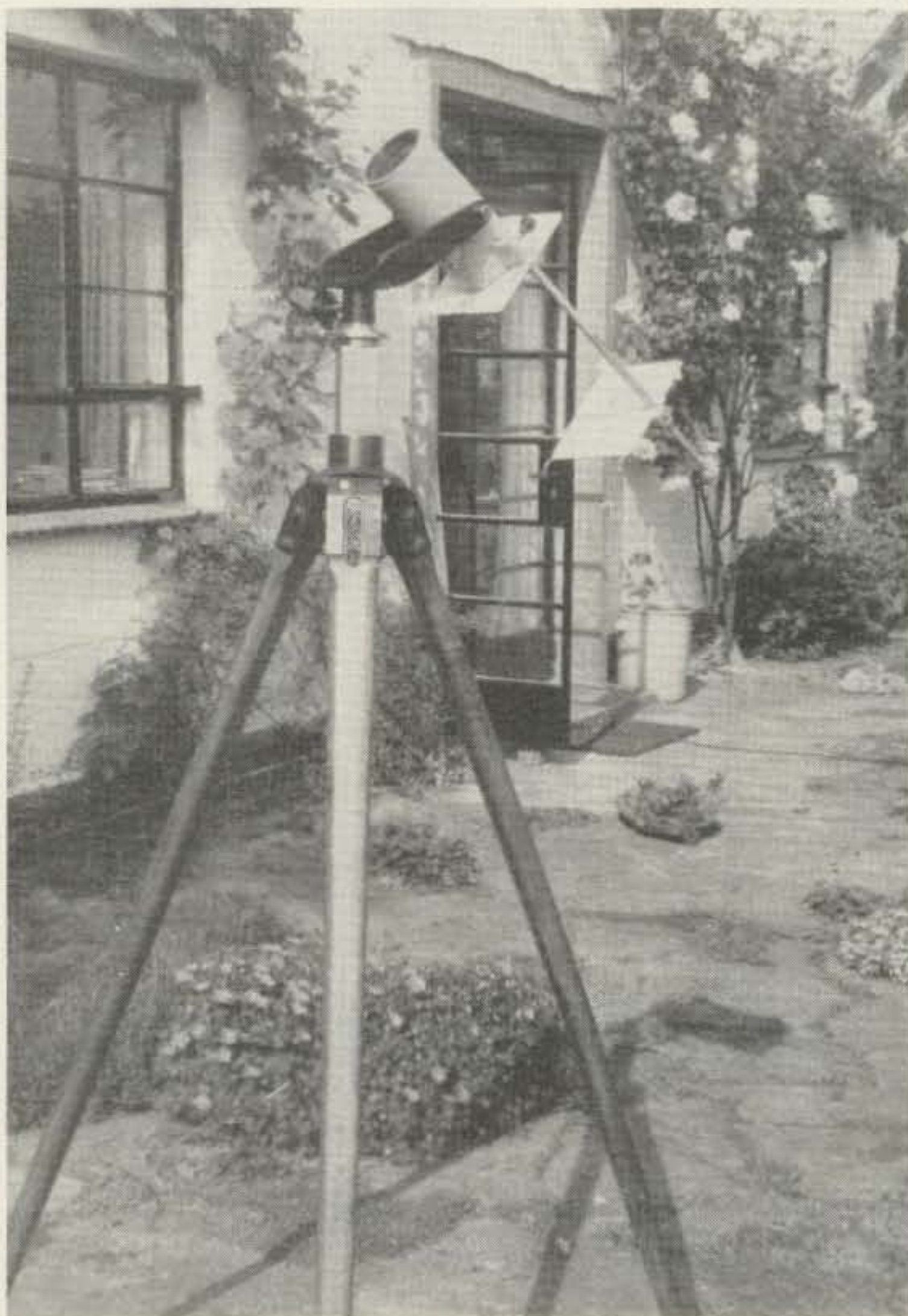

The setup at G2UK.

*Terry F. Weatherley G3WDI
16, Beverley Court
Carlton Colville
Lowestoft, Suffolk
Great Britain*

That the sun affects radio propagation has been known and taken advantage of for many years, and the radio amateurs' rule of thumb can be written: lots of spots = lots of DX.

The science (?) of predicting both the year of maximum and the number of spots at that time is a fascinating one. There are many false trails and intriguing features. Can there really be a connection between such diverse events as harsh winters in the US, monsoons in India, earthquakes in China, aurora, the number of runs scored by cricketers in the UK, and the position of Jupiter in the night sky? Scientists would have us believe that there is a connection and that it is the sun and its spots. If this be so, amateurs ought to have an easy

time predicting DX! This article will explore some of these theories, and the bibliography at the end will lead the interested reader to further fascinating reading.

It was in 1611 that Galileo turned his newly-invented telescope toward the sun and discovered sunspots. Being a cautious man, he did not announce this discovery until 1612 when he wrote, "Having made repeated observations I am at last convinced that the spots are objects close to the surface of the solar globe, where they are continually being produced and then dissolved, some quickly and some slowly; also that they are carried around the sun by its rotation, which is completed in a period of about one lunar month." This discovery was not universally popular or accepted. Some churchmen objected, notably Fr. Scheiner, who wrote that "spots were not a fit subject for the sun's surface."

What are sunspots? Simply defined, a sunspot is a disturbance on the sun's surface, which is connected in some way with the sun's magnetic field. Studies of groups of sunspots show that they tend to occur in pairs of opposite polarity. Two areas can be seen in a fully-developed spot: The uniformly dark central region, called the umbra, and the less-dark surrounding area, called the penumbra. The spots rotate with the sun. It is not uncommon for large spot-groups to reappear two or three times. The number of spots visible on the sun varies from day to day; for establishing long-term trends a formula was developed by the astronomer, R. Wolf, of the Zurich Observatory. The Wolf number is calculated as follows: relative Number (R) = 10 x number of sunspot groups + number of single spots.

Records of sunspot numbers have been kept yearly since 1610. Using these records it is easy to show that the mean sunspot-period is 11.1 years long, but that period variations are from as short as eight years to as long as 16 years. That is the prediction problem.

Other data can be discovered in the 450-year, 195-year, and 27-day cycles.

In the *Annals of the New York Academy of Sciences*, 1961, in his paper on "Sunspot Cycle Correlation," D. Williams states, "The use of mathematical techniques to derive cycles from data poses the question of whether the cycles are not introduced by the technique used." Various mathematicians obtained different results from the same data! In other words, your guess is as good as mine!

A recent spanner introduced into the works was

the suggestion that there was a period prior to 1610 when for many years there were no sunspots at all. There are notes in old manuscripts stating, "It is ten years since we saw a sunspot." This used to be put down to poor observation, but a recent report in the *Daily Telegraph* said that studies of ice cores from Antarctica seem to confirm these records. Whether or not this period was simply an allowable variable in a complex cycle has yet to be determined. Don't sell that HF gear yet!

Anyone can, of course, join in the prediction game, and in the next few paragraphs we will look at the data available and some of the conclusions drawn from it. From there, we will look at other apparently similar data drawn from different fields.

First, the raw data. Regular recording of yearly sunspot numbers has taken place since 1749, and the yearly mean Wolf numbers from 1749 to 1954 are shown in Table 1. These figures are plotted out in Fig. 1. They show quite clearly the 11.1-year periods.

This view is somewhat simplistic, and individual cycles are not as smooth as the yearly figures would suggest. If we take a closer look at the last cycle (Fig. 2), solar cycle 20 (from 1964 to 1976), and plot a three-monthly mean rather than a yearly one, considerable variations can be seen. This again highlights the unpredictability of the monthly sunspot number—even when we know the position of the month in question within a cycle.

The ultimate number of the sunspot maximum is also of interest to DXers. As can be seen from the figures, the value of the maximum increases and decreases over a period of

Year	R	Year	R	Year	R	Year	R
1749	80.9	1799	6.8	1849	95.9	1899	12.1
1750	83.4	1800	14.5	1850	66.5	1900	9.5
1751	47.7	1801	34.0	1851	64.5	1901	2.7
1752	47.8	1802	45.0	1852	54.2	1902	5.0
1753	30.7	1803	43.1	1853	39.0	1903	24.4
1754	12.2	1804	47.5	1854	20.6	1904	42.0
1755	9.6	1805	42.2	1855	6.7	1905	63.5
1756	10.2	1806	28.1	1856	4.3	1906	53.8
1757	32.4	1807	10.1	1857	22.8	1907	62.0
1758	47.6	1808	8.1	1858	54.8	1908	48.5
1759	54.0	1809	2.5	1859	93.8	1909	43.9
1760	62.6	1810	0.0	1860	95.7	1910	18.6
1761	85.9	1811	1.4	1861	77.2	1911	5.7
1762	61.2	1812	5.0	1862	59.1	1912	3.6
1763	45.1	1813	12.2	1863	44.0	1913	1.4
1764	36.4	1814	13.9	1864	47.0	1914	9.6
1765	20.9	1815	35.4	1865	30.5	1915	47.4
1766	11.4	1816	45.8	1866	16.3	1916	57.1
1767	37.8	1817	41.1	1867	7.3	1917	103.9
1768	69.8	1818	30.4	1868	37.3	1918	80.6
1769	106.1	1819	23.9	1869	73.9	1919	63.6
1770	100.8	1820	15.7	1870	139.1	1920	37.6
1771	81.6	1821	6.6	1871	111.2	1921	26.1
1772	66.5	1822	4.0	1872	101.7	1922	14.2
1773	34.8	1823	1.8	1873	66.3	1923	5.8
1774	30.6	1824	8.5	1874	44.7	1924	16.7
1775	7.0	1825	16.6	1875	17.1	1925	44.3
1776	19.8	1826	36.3	1876	11.3	1926	63.9
1777	92.5	1827	49.7	1877	12.3	1927	69.0
1778	154.4	1828	64.2	1878	3.4	1928	77.8
1779	125.9	1829	67.0	1879	6.0	1929	65.0
1780	84.8	1830	71.0	1880	32.3	1930	35.7
1781	68.1	1831	47.8	1881	54.3	1931	21.2
1782	38.5	1832	27.5	1882	59.7	1932	11.1
1783	22.8	1833	8.5	1883	63.7	1933	5.7
1784	10.2	1834	13.2	1884	63.5	1934	8.7
1785	24.1	1835	56.9	1885	52.2	1935	36.1
1786	82.9	1836	121.5	1886	25.4	1936	79.7
1787	132.0	1837	138.3	1887	13.1	1937	114.4
1788	130.9	1838	103.2	1888	6.8	1938	109.6
1789	118.1	1839	85.8	1889	6.3	1939	88.8
1790	89.9	1840	63.2	1890	7.1	1940	67.8
1791	66.6	1841	36.8	1891	35.6	1941	47.5
1792	60.0	1842	24.2	1892	73.0	1942	30.6
1793	46.9	1843	10.7	1893	84.9	1943	16.3
1794	41.0	1844	15.0	1894	78.0	1944	9.6
1795	21.3	1845	40.1	1895	64.0	1945	33.2
1796	16.0	1846	61.5	1896	41.8	1946	92.6
1797	6.4	1847	98.5	1897	26.2	1947	151.6
1798	4.1	1848	124.3	1898	26.7	1948	136.3
						1949	134.7
						1950	83.9
						1951	69.4
						1952	31.5
						1953	13.9
						1954	4.4

Table 1. Sunspot numbers (R) from 1749 through 1954 (Wolf numbers).

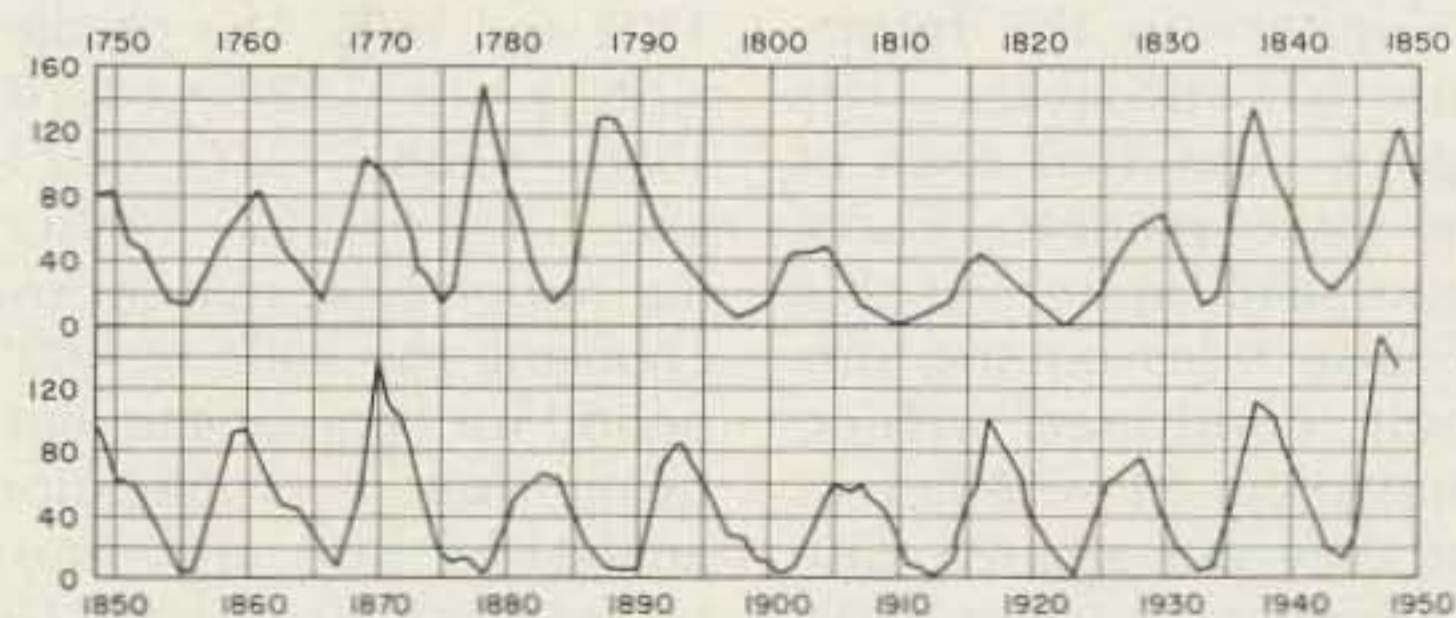

Fig. 1. The 11-year cycles of solar activity from 1750 to 1950. Ordinates: relative numbers, or Wolf numbers.

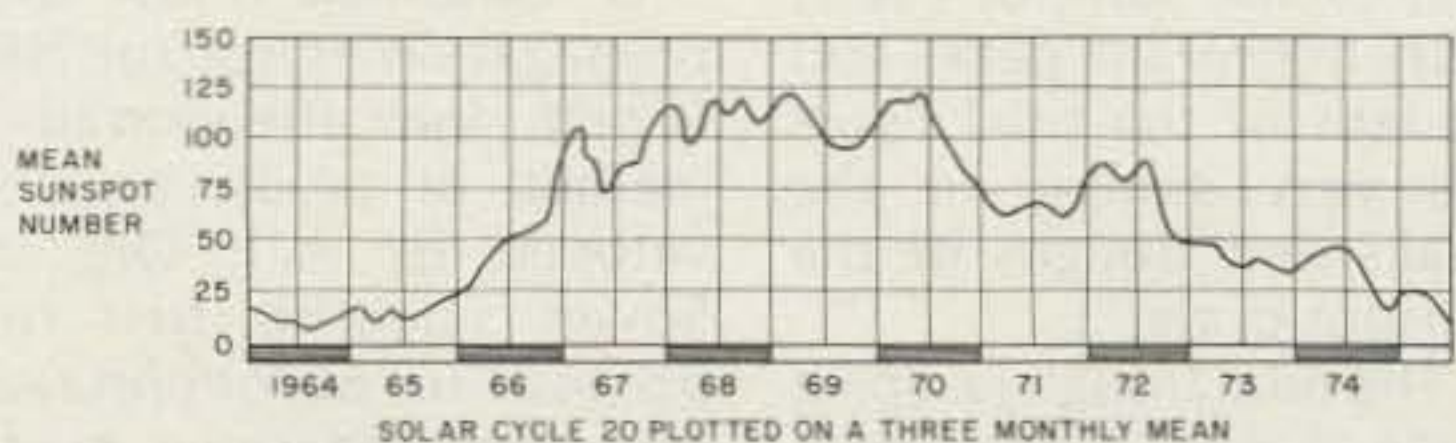

Fig. 2. Solar Cycle 20, plotted on a three-monthly mean.

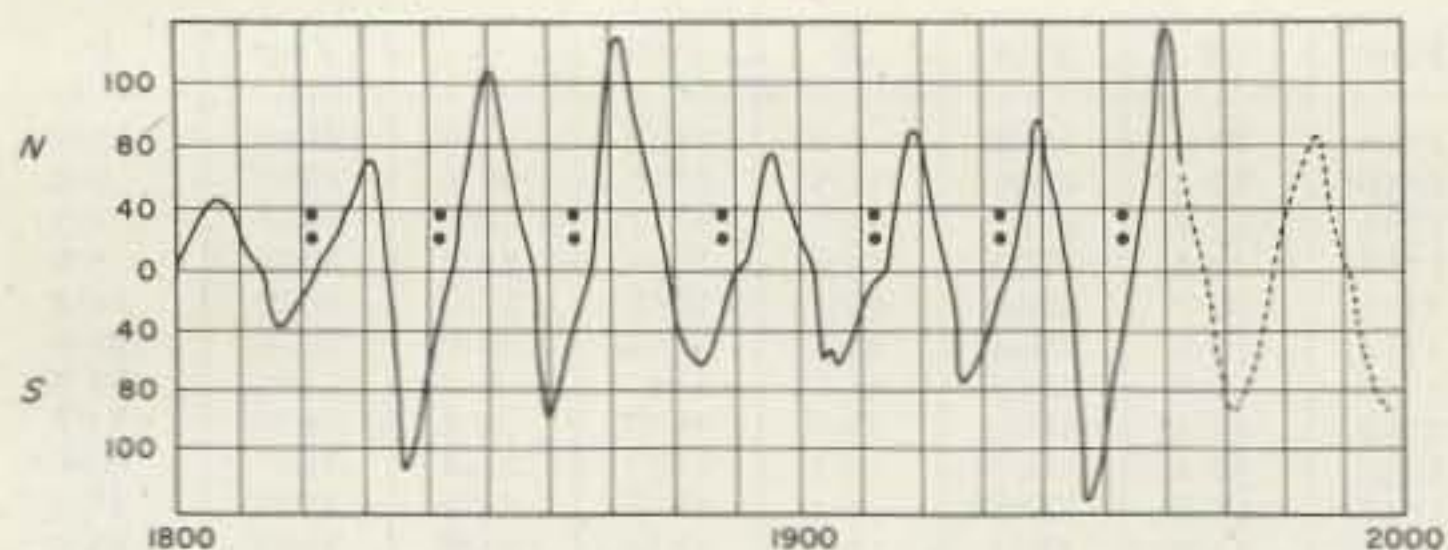
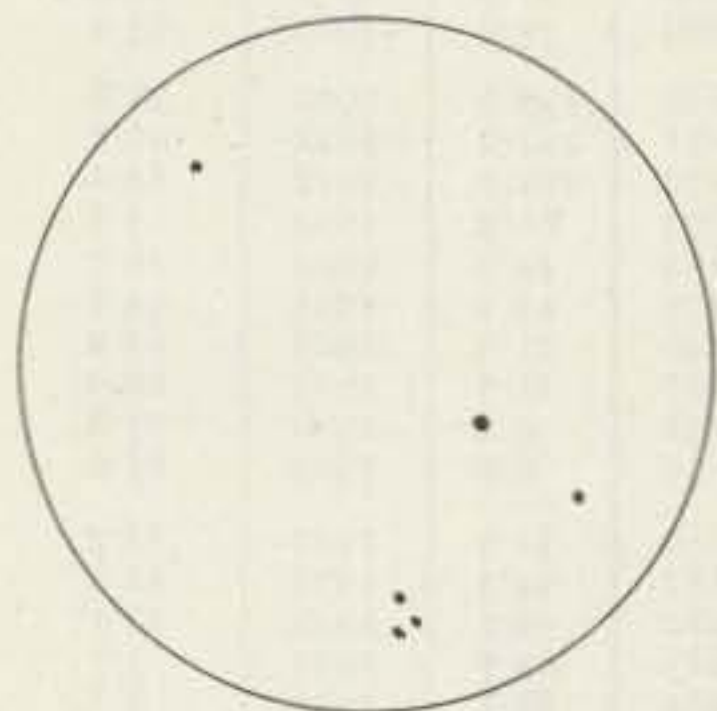

Fig. 3. Anderson's 22-year sunspot cycle. Spots of each new cycle appear in the N and S hemispheres alternately. The economic depressions of 1823, 1843, 1867, 1889, 1913, 1933, and 1954 are located by the twin dots.



One drawing of sunspots, made with the G2UK setup.

seven cycles with super-maximums occurring in 1778, 1860, and 1937.

Some recent research has tried to look beyond past records to predict both the length and height of future cycles. The work of K. D. Wood, of the University of Colorado, falls into this category. His research attempts to relate the tides raised on the sun by the planets—principally Jupiter—to the formation of sunspots. His figures show that each of the three planets—Earth, Venus, and Jupiter—is able to raise tides on the sun. Their combined effect, depending on whether or not they are aligned with each other, causes a variation in the height of the tide, with a period of 11.08 years. This is very close to that of the sunspot cycle. Furthermore, the peaks and troughs of the tidal cycle are very similar to the peaks and troughs of the sunspot cycle.

The tidal trough just past (1976.2) led F. M. Smith G8KG, in his article in

Radio Communication for July, 1976, to predict that the sunspot trough would occur in 1976.5—that is, July, 1976. We can now test that prediction against the data supplied by Zurich for July, 1976. This stated, "The provisional sunspot number was 2.1 following a month of virtually no solar activity, and the following months showed higher figures." All this seems to fit quite well. Smith then proceeded to attempt to predict date and height of the next maximum. He predicted a maximum of 150, at best, from late in 1980, for about two years.

John H. Nelson, writing in *73 Magazine* in March, 1977, suggested that the forthcoming cycle-high would be in 1979-82 and would be about 20-25 spots higher than the cycle-high that took place between 1802 and 1805. This prediction gave 1979—65/70, 1980—63/68, 1981—68/73, and 1982—62/67. Nelson did not give his reasons for choosing the 1802 to 1805 period for comparison, but, being from a propagation analyst for RCA, they must be scientifically based. He reiterated his prediction in a letter to *73* in February, 1978.

O. Okleshen W9RX, the propagation editor for *HR Report*, drew attention to a method of prediction developed by A. I. Ohl, a Soviet scientist, first reported in *Solnechnaya Dannye*, and since modified by H. H. Sargent, of

the Space Environment Services Center, Denver, Colorado. The theory is based upon using the regression of recurrent geomagnetic activity recorded from the prior cycle, to predict the sunspot maximum for the coming cycle. Thus, from the Ohl/Sargent predictions, the following emerge: predicted sunspot maximum—153.6; date of maximum—May 1980.

The theory also gave some 1978 monthly predictions which could be compared with the actual figures from Zurich:

January—prediction, 58.6; actual, 49.3;
 February—prediction, 64.4; actual, 89.8;
 March—prediction, 69.6; actual, 73.5
 April—prediction, 75.0; actual, 94.7;
 May—prediction, 80.6; actual, 79.3.

The Zurich Observatory also joined in the predictions game, and in the July, 1978, edition of *Radio Communication*, predicted the time of maximum for August, 1979, and the number of sunspots—150.

Other research points to other ways of predicting sunspot maxima than simply looking at the sun. The Williams paper, cited earlier, draws attention to some of them. Wolf reported in 1852 that the years 1000 to 1800, which were rich in solar spots, were in general drier and more fruitful. In 1933, Clough stated that 11-, 37-, 83-, and 300-year sunspot cycles correlate with frequency of severe winters, Chinese earthquakes, flood- and low-stages of the Nile, tree growth in Arizona, and wheat prices in England, over a 1400-year period. Wood suggests that it is the extremes of a sunspot cycle—the trough or the peak—that lead to ex-

treme weather conditions (either good or bad), and Williams links economic depressions in the US to 11-year cycle starts with spots in the opposite hemisphere.) This is shown in Fig. 3.

It might be useful here to discuss how the interested amateur can see these all-influential spots—the setup at G2UK is shown in the photograph.

Never, never, never look at the sun directly through a telescope or binoculars! The only safe way is to point the telescope towards the sun and project the image onto a white screen. A shield around the telescope is useful. If the sun's image is recorded on drawing paper, a permanent record can be kept. (A drawing by G2UK is shown.) If, at the same time, a note of band conditions is made, then some useful data can be accumulated.

It would appear from all available data that we are in for an interesting time. DX will be good, winters cold, summers hot (or wet, as in the UK!) But look out for more violent hurricanes and more earth tremors! Nothing is certain, however, and only time will tell! ■

Bibliography

- Abetti, G., *The Sun*.
- F. M. Smith G8KG, "Some New Insights into the Mechanism of the Sunspot Cycle," *Radio Communication* (RSGB), July, 1976.
- Wood, K. D., "Sunspots and the Planets," *Nature*, November, 1972.
- Waldmeier, M., "Sunspot Activity in the Years 1610-1960."
- Williams, D., "Sunspot Cycle Correlation," *Annals of the New York Academy of Sciences*, 1961.
- Nelson, J., "10 and 11 Meter Predictions," *73 Magazine*, March, 1977, and letter, February, 1978.
- Okleshen, O., "Sunspot Cycle 21," *HR Report*.
- Sargent, H. H., "Modified Ohl Theory."

FACTORY DIRECT SALE!!

Wilson Electronics



MARK II
Save \$105.90

MARK IV
Save \$112.90

- At greatly reduced prices.
- Mark II and IV accessories.
- Introducing the new Mobile Amplifier Charger.
- Battery and Five free Xtal pairs of your choice with radio.

Mobile Amplifier Charger and Amplifier Specifications

		POWER (Watts)			AMP* 13.8 Vdc
		Useable	In (Typ)	Out (Typ)	
WMH 440TT	Mobile Amplifier Charger	1-6	4	40	5.0
WMH 480TT	Mobile Amplifier Charger	1-6	4	85	15.6
WA 440	Broad Band Amplifier	1-6	4	40	4.8
WA 480	Broad Band Amplifier	1-6	4	85	15.5
WA 2080	Broad Band Amplifier	10-25	20	90	11.0

MOBILE AMPLIFIER FEATURES

- 5-watt audio amplifier for external speaker.
- Automatic fast/trickle charge.
- Front panel Touch-Tone® Pad which allows generation of DTMF tones.
- Over and under mounting bracket for under dash, floor mounting or base station use.
- A Key-locking feature for security.
- Mobile antenna connect.

(Detach Here)

MODEL NUMBER

MODEL NUMBER		SALE PRICE
<input type="checkbox"/> MARK II	1 and 2.5 Watt 2m HH	\$189.00
<input type="checkbox"/> MARK IV	1 and 4 Watt 2m HH Radios (Includes battery and 52/52 plus 5 Xtal pairs of your choice)	212.00
<input type="checkbox"/> BC-2	Desk Battery Charger	31.00
<input type="checkbox"/> BP-4	Extra Battery Pack	19.00
<input type="checkbox"/> LC-3	Leather Case	15.00
<input type="checkbox"/> LC-3P	Leather Case for Touch-Tone® Pad	15.00
<input type="checkbox"/> TTP	Touch-Tone® Pad (Factory Installed)	48.50
<input type="checkbox"/> MC-12	Mobile Charger Only	135.00
<input type="checkbox"/> WMH 440	40W Mobile Amplifier Charger	199.00
<input type="checkbox"/> WMH 480	80W Mobile Amplifier Charger	271.00
<input type="checkbox"/> WMH 440TT	40W Mobile Amplifier Charger with Touch-Tone® Pad	240.00
<input type="checkbox"/> WMH 480TT	80W Mobile Amplifier Charger with Touch-Tone® Pad	309.00
<input type="checkbox"/> WA 440	40W No Tuning Amplifier for Portable Radios	108.00
<input type="checkbox"/> WA 480	80W No Tuning Amplifier for Portable Radio	181.00
<input type="checkbox"/> WA 2080	80W No Tuning Amplifier for Mobile Units	147.00

TO: **Wilson Electronics** ✓ 81
4288 South Polaris Avenue
Las Vegas, Nevada 89103



Ship me all indicated on above chart.

Enclosed is \$ _____

Check Money Order MC VISA

Card Number _____

Expiration Date _____

Xtals 52/52 / / / / /

Name _____

Address _____

City _____

State _____ Zip _____

Signature _____

Shipping Prepaid — Nevada Residents Add 3% Sales Tax

More on Jammer Nabbing

— hints on equipment and strategy

After publication of my article, "How to Nab a Jammer," I have received many inquiries concerning our DF techniques. The following is in response to a letter which I received. The writer was not sure if the interference had been deliberate and malicious or was simply the kerchunking of a local repeater. It also contained a request for information about the types of antennas used in catching "Red Rider."

We didn't use any fancy antennas to find our turkey. The most exotic was a four-element beam on a broomstick; the simplest was a 5/8-wave Larsen magnetic mount held perpendicular to the belly button of a rotating body. With a bit of trial and error on 52, its pattern can be determined within a few degrees. A rubber ducky in a horizontal position works nearly as well. If you know you're within a few blocks of your turkey, you can turn to an adjacent channel. If he's on 34, go to 37, 31, or 40 receive, and home in on the white noise. Your antenna will have the same pattern. We helped ourselves by getting off 2m for coordination and by having a pair of 2m receivers per

team, one on the repeater input and one on the output. Fingerprints were probably the most important single aid in our search. They are especially helpful when the jammer is a ham. Every transmitter has its own set, and if one knows what to look for, they are as different as human prints. All one needs for this is an SSB receiver.

Things to look for in the sideband mode on an FM signal:

1. Exact frequency referenced to the SSB receiver if a better standard is not available.
2. Chirp: If a carrier has a characteristically bad CW chirp, it is a crystal radio, and every crystal has its own peculiar chirp or settling time. It is usually less than one hundred milliseconds, but may be as long as ten seconds.
3. Flutter: If the carrier has a slight frequency jitter (typically plus or minus 50 Hz at a random rate—sounds like a warble on SSB—the rig is a PLL type and therefore synthesized. These types may also chirp, but a well-designed one won't. (The Drake UV-3 is typically plus or minus 1.5 kHz.)
4. On longer transmissions: Frequency drift...does it

drift high or low?

5. Transmitter rise time: How long does it take the carrier to get to full strength? (This is best seen on a triggered scope hooked to the last i-f on the SSB receiver.)

6. If he has PL, what is the exact PL frequency? This can be measured to .01 Hz and the tolerance of most PL is plus or minus .5 Hz.

7. Signal strength: You will know (within a few blocks radius) where the turkey is by comparing his signal and distance to a known transmitter's power. The signal, distance, and estimate of his transmitter power can then be made.

8. On FM: Background sounds may give a clue to where he is. For example, if there is a baby crying, he's probably home.

Two or three base stations with SSB and beams (vertical or horizontal polarization makes little difference, as long as it's consistent) can make all of the above measurements for comparison to legal transmissions. If the guy's a ham, he probably will have fits of legal operation, and if you get a match, you will know where to set up a stake-out. If you intend to bring in the FCC, documen-

tation is the key word. Look for patterns of operation (the turkey may be an 8 to 5er) and note the times. If you ID a vehicle, get the tag numbers and run them through DMV. If audio is used, get tapes of the patterns. Retired, unemployed, disabled, or self-employed people are the best sleuths, because they can listen at all hours and adjust their schedules to fit any given situation.

The system you choose is also important. Our best system consisted of a base station with two operators, a set of city or area maps, and three to five mobile teams. Two mobile teams are adequate; more than five will clutter up the coordination channel and step on each other. If you have too many people for five teams, put three or four people on each team. Two people per team seems to be the minimum, having one drive and kibbitz and the other run all the gear. A three-person team also works well, with the third person running the coordination channel while the second is DFing. A fourth person can hold the coffee cups and take turns on the other tasks. There should be at least two base operators

per base station. One should run the strings, circles, markers, pins, etc., on the map while the other coordinates the mobile teams. Base DFing can be shared by a third person. It was also convenient to have a wife or sweetheart available to make sandwiches and coffee during the ordeal.

All situations are different. A friendly reminder (on the air) that button-pushing without ID is illegal may be sufficient to solve the problem for the average ham who wants to follow the rules. If your problem is simply kerchunking, a series of fingerprints will often reveal many different transmitters. Good PR can usually cut this problem drastically. We need wider publicity at ham meetings and in club publications to convince people that kerchunking a repeater with no call sign or ID: (a) is illegal;

(b) creates unnecessary wear and tear on the repeater; (c) is a nuisance and annoying to people who monitor; (d) is a crutch to the button-pusher to reassure him that the repeater is still there; and (e) is unnecessary.

An example: One Saturday I sat on 34 and 94 receive and in a ten-minute period the repeater kerchunked thirty-five times. Of that thirty-five, there were twenty-seven different transmitters. The last five occurred during a fifteen-second span and were all from the same transmitter. I simply picked up my mike, turned down the 34 receiver, and said, "If you like to push buttons so much, why don't you go into the bathroom and poke yourself in the navel; then you'll never have to ID." This had occurred about fifteen minutes earlier when I said something to the effect that

making transmissions without identification is illegal—will the button-pusher please give his call sign? After I signed clear of the repeater, I didn't hear anything for an hour and a quarter.

Another line that works well (if the first friendly warning is ignored) is, "When are you going to get a license, so that you can identify legally when you kerchunk the repeater?" The first friendly warning should be a mandatory courtesy, because the offender may be a newcomer and totally unaware that he is doing anything illegal.

Finally—if you know the offender—don't chew him out on the air. Phone him and inform him privately, and you'll get much more cooperation.

The club in Omaha found that kerchunking was cut approximately 70% by removing the hang time on

the repeater (no squelch tail).

I hope I've covered your situation. The procedures discussed here have solved all problems that were not electronically induced (intermod, equipment failure, etc.). Hopefully, your problem can be minimized with a good PR campaign. You will never eliminate it totally because hams are, after all, not perfect. I hear a lot on our local repeater that is fun to listen to, a lot that's boring, and a lot I just can't stand. As long as it's not illegal, I refuse to say anything or condemn anyone for any transmission (even "10-4 Good Buddy" lingo), because I don't have to listen to it. I simply use the VOL knob or the QSY switch and the problem, for me, is solved. This solution is all too often forgotten or doesn't even occur to the offended station. ■

INSTRUMENTS YOU CAN COUNT ON...

- 4½ DIGIT MULTIMETER/THERMOMETER
- FREQUENCY COUNTERS TO 1.3 GHz
- PRECISION DIGITAL THERMOMETER
- CAPACITANCE METER



FOR ORDERS, INFORMATION OR A CATALOG WRITE OR PHONE **800-327-5912**
FROM FLORIDA PHONE (305) 771-2050/771-2051



Optoelectronics inc

5821 N.E. 14 AVE. FT. LAUDERDALE, FL. 33334

Cheapy Scanner for the Memorizer

— is \$5 cheap enough for you?

Steve Laufer WA2ORU
2-15 34th St.
Fair Lawn NJ 07410

The Yaesu 227R Memorizer is an excellent rig with very few shortcomings. One of these shortcomings is the selector knob. It is quite a job to switch from, say, 144.9 to 147.9 while driving or when you are on a long trip and are forever turning the selector knob in hope of finding a live repeater. Help is on the way. For about \$5.00 and some scrounging around in your junk box,

you can build this excellent scanner.

About The Circuit

The circuit consists of an NE555 in the astable mode and four switches, some hookup wire, 10-conductor cable, one LED (optional) and one minibox. The output of the 555 (pin 3) is connected via a 1- μ F capacitor to the emitter of Q3 which, in turn, clocks the clock input of Q710 pin 5. Now, by switching the output from the emitter of Q2, which is the up or down input of Q710 pin 10, the counter will count either up or down, depending upon the position of switch 1. Switch

2 is the scan-rate switch and switches one of two capacitors in or out of the circuit. The speed can also be trimmed via R1. The push-button switch, S3 (normally closed), is connected to the collector of Q115 via a 500-Ohm resistor and the other wire to pin 4 of the 555. Whenever there is a signal present at the base of Q115, the device conducts and puts a low on pin 4 of the 555 which, in turn, disables the clock pulses. This will stop the scanning for as long as the signal is present. One can defeat this by depressing the defeat switch momentarily. This will cause pin 4 to go high again and the scanner will continue to scan until it sees another busy channel. One can stop the scanner by switching the on-off switch, S4, to the off position. (Note that for manual operation, the up-down switch must be in the up position.)

The objective of this project was to use a minimum number of parts, yet achieve the same results one might expect from commercial scanners. An auto-reverse feature can be added by decoding the

4 and 8 of the 144 and 148 and feeding them into a flip-flop. This is easily done by tapping into Q711 for high and Q712 for the low end.

Construction

Refer to the schematic. Work slowly and double-check all your connections before applying power to the rig. The 555 and associated components were placed on a small PC board about 1" x 1" and wrapped in non-conductive foam. This was tucked next to the speaker depression of the lower cover. Leave enough wire between the cover and the rig so that the cover can be easily removed for service. A small connector was used to exit from the rig to the control box. I used a Cinch No. DB25P, but any miniature 12-pin, or more, connector can be used. It is always good to have a few extra pins for future modifications like remote control of PLs, etc.

In conclusion, the scanner works like a charm and I am sure it will delight all you knob and switch nuts.

Good luck and happy scanning! ■

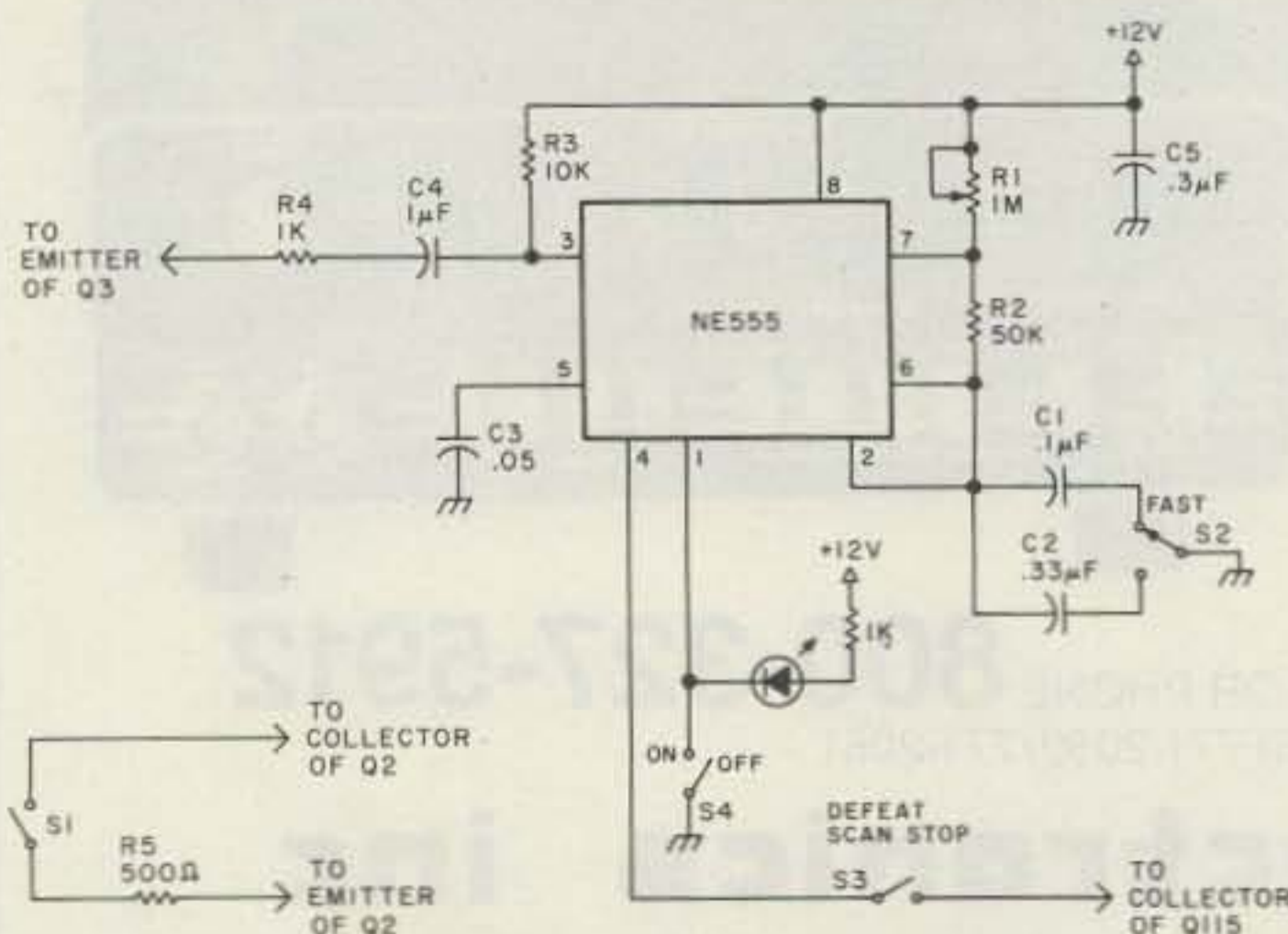

Fig. 1. Scanner schematic.

SOMETHING DIFFERENT

The FT-107 Series with "DMS"*

"It's A Cut Above The Rest"

* OPTIONAL DIGITAL MEMORY SHIFT ("DMS")
12 discrete memories. Stores individual frequencies
or use as 12 full coverage VFOs (500 kHz each)

- Solid State
- 240 watts DC SSB/CW
- 160-10 meters, WWV
(2 auxiliary band positions are available for future expansion)
- RF Speech Processor
- SSB, CW, AM, FSK
- Built-in SWR Meter
- Excellent Dynamic Range
- Audio Peak/Notch Filter
- Variable Bandwidth
- Full Line of Accessories



The FT-107 has been created as a result of a blending of technologies — computer, solid state and RF design. By careful utilization of these disciplines and the experience gained from our FT-301 series, YAESU has achieved an HF transceiver which offers unique features (e. g. "Digital Memory Shift"), efficient operation and a level of performance that has been previously unattainable.

(Receiver Section) FT-107 TRANSCEIVER SPECIFICATIONS (Transmitter Section)

Sensitivity: 0.25 μ V for 10dB S/N, CW/SSB, FSK
1.0 μ V for 10dB S/N, AM

Image Rejection: 60dB except 10 meters (50dB)

IF Rejection: 70dB

Selectivity: SSB 2.4 kHz at -6dB, 4.0 kHz at -60dB.
CW 0.6 kHz at -6dB, 1.2 kHz at -60dB.
AM 6 kHz at -6dB, 12 kHz at -60dB
Variable IF Bandwidth

20dB RF Attenuator

Peak/Notch Audio Filter

Audio Output: 3 watts (4-16 ohms)

Accessories: FV-107 VFO (standard not synthesized)

FTV-107 VHF (UHF Transverter)

FC-107 Antenna Tuner

SP-107 Matching Speaker

FP-107 AC Power Supply

Power Input: 240 watts DC SSB/CW
80 watts DC AM/FSK

Opposite Sideband Suppression: Better than 50dB

Spurious Radiation: -50dB.

Transmitter Bandwidth 350-2700 hz (-6dB)

Transmitter: 3rd IMD -31dB neg feedback 6dB

Transmitter Stability: 30 hz after 10 min. warmup
less than 100 hz after 30 min.

Antenna Input Impedance: 50 ohms

Microphone Impedance: 500 ohms

Power Required: 13.5V DC at 20 amps

100/110/117/200/220/234V AC at 650 VA

YAESU ⁸³ 
The radio.

Price And Specifications Subject To
Change Without Notice Or Obligation

1179R

YAESU ELECTRONICS CORP., 6851 Walthall Way, Paramount, CA 90723 • (213) 633-4007
YAESU ELECTRONICS Eastern Service Ctr., 9812 Princeton-Glendale Rd., Cincinnati, OH 45246

Back to School

— we can still learn a thing or two about basic electricity

Irving M. Gottlieb W6HDM
931 Olive Street
Menlo Park CA 94025

During a QSO the other evening, a ham was indulging in woeful lamentations as he speculated the worth of his fortune had he but deployed a different stratagem in the stock market. As for me, several successive market devastations finally illumined the path of absolute reliability for the avoidance of such mishaps on Wall Street—absolute absti-

nence!

Of course, my belated advice could not restore my ham friend's bank account. Indeed, I myself succumbed to the contagion of fantasizing lost economic opportunities. After we QRT'd, I began speculating about my tax bracket had I received a measly buck for every unheeded admonition I have sounded for the Young Squirt's benefit. For one thing, I have repeatedly urged him to pursue a vocation which commands popular respect and holds promise of se-

cure remuneration. He could have directed his quest for education to plumbing, barbering, or to truck piloting. As to whether it was pure perversity or not-so-pure rebellion, I confess ignorance. All I know is that he is adamantly chasing after an elusive degree in Electrical Engineering. (At times, I ponder my own guilt in the matter, having presented him with that birthday gift several years ago—a hi-fi kit!)

On second thought, there may well be a good measure of method in his madness. After all, he has his unemployed pop, an EE of venerable vintage, to assist with the homework. Be that as it may, my diligent efforts with job resume number 122 were rudely interrupted.

"Hey, Dad, these three problems should be right up your alley, especially this first one because you've been monkeying around with motors on that rotary beam of yours!"

I found myself scanning the problem sheet which he had disrespectfully but accurately cast into my field of vision. Of the three

problems presented, the first dealt with a dc shunt motor. An illustration such as indicated in Fig. 1 was provided. A slew of operating conditions was given, but I construed these to be so much smoke-screening intended to obscure the nitty-gritty of the problem. Suffice it to say the motor was lightly loaded and was operating well within its ratings in all other respects. The kindergartenish problem questioned how one should adjust the rheostat in the field circuit in order to cause the motor to run faster. I couldn't help reflect upon the soft life these Young Squirts had—for sure, my EE studies had been incomparably tougher!

After admonishing the Young Squirt that he would never cultivate the ability to analyze difficult problems if he was too lazy to apply his noggin to such cinch problems as this one, I authoritatively expounded the obvious answer.

"Naturally, you'd crank resistance out of the rheostat. Then there would be more current in the field winding, more field current

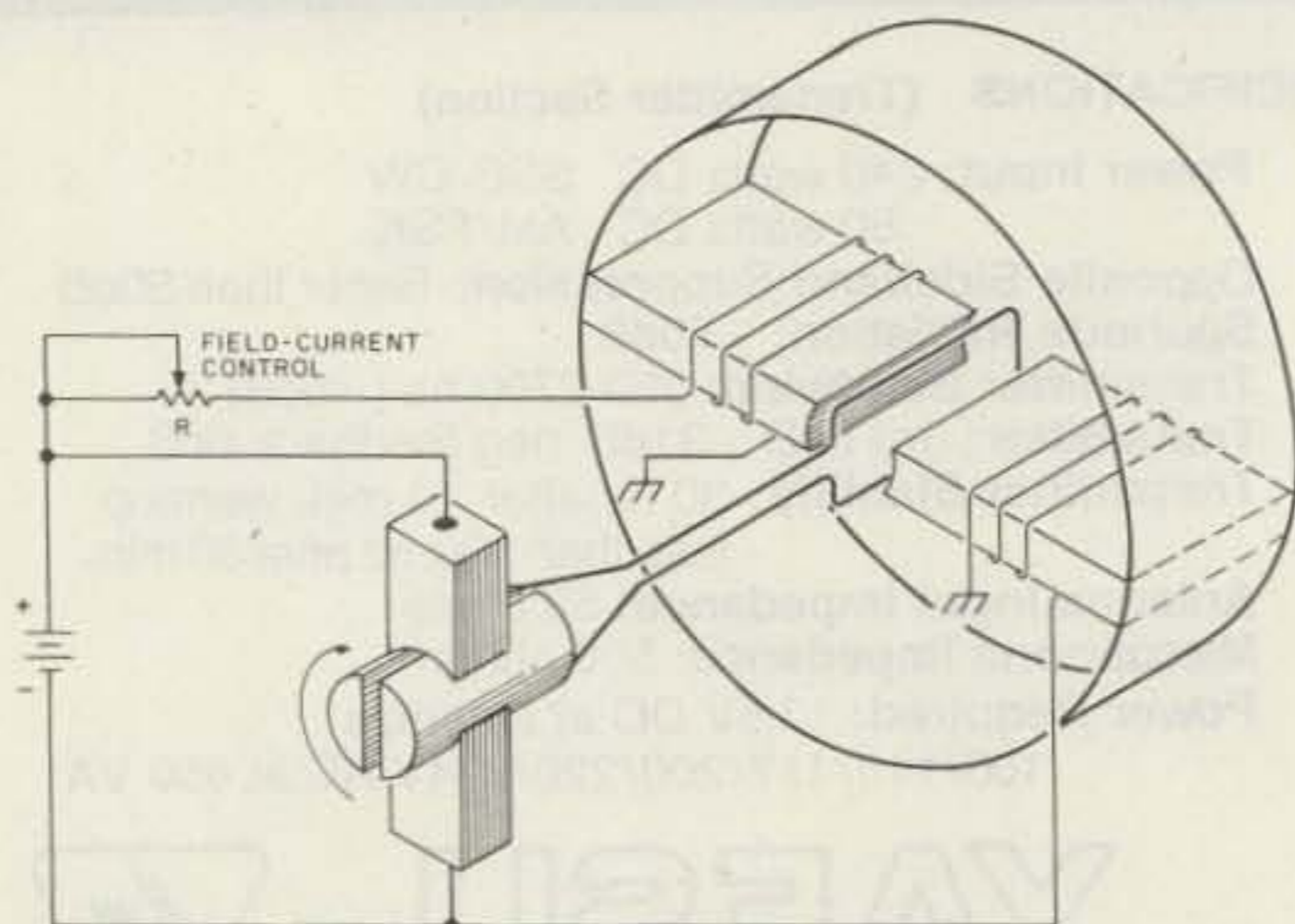

Fig. 1. Simple dc shunt motor with field-current rheostat for speed control. An elementary setup, to be sure, but which way should R be adjusted to increase motor speed?

in the field for the armature conductors to react with. Inasmuch as the rheostat is connected to adjust field current only, it follows that the interaction between the current-carrying armature conductors and the shunt field will be stronger, which is to say, more electromagnetic torque will be developed. And, since the mechanical load on the motor remains constant, this increased torque can do only one thing—speed up the rotation of the armature!”

A look of astonishment surfaced on the countenance of the Young Squirt. “But, Dad...” he protested.

Nipping his response in the bud lest the proverbial molehill grow into a mountain, I interrupted with, “There just aren’t any ifs, ands, or buts. Certainly, it must be clear to you that if you had no magnetic field at all, you wouldn’t even have a motor. In other words, the armature wouldn’t even rotate. If there is a field for the armature current to react with, you’d have some rate of rotation. Naturally, then, if the field is made stronger, you’d expect an even higher rate of rotation. What could be simpler?”

“Yeah, Dad,” replied the Young Squirt, apparently coming to his senses. “That sure is a simpler explanation than my Prof coughed up. Maybe you should go in for teaching.”

This compliment instantly dissolved any insecurity I might have harbored in recalling the behavior of those long-forgotten motors. So, with a burst of gusto, I plowed into the second problem. This brain teaser involved the elementary three-phase circuit shown in Fig. 2. As can be seen, a voltmeter and an ammeter are connected to indicate ac voltage and current of one phase of a

three-phase resistive load. (The load was stipulated to be balanced.) The question before the house: What is the total power consumed by the load? Here, I sniffed a rodent. But, if such a critter were indeed involved, its whereabouts eluded me.

Partially rescuing myself from having spent the better part of three minutes in deep meditation, I answered the question with another question: “Well, why don’t you just multiply the phase voltage by the phase current, then times three for the total power in all three phases?”

Inasmuch as my query wasn’t in the least wishy-washy, but resounded with boldness and much resolve, the Young Squirt limited his comments to a brief under-the-breath murmur of unintelligible gibberish. Assuming this to be some oral equivalent of “thank you,” I focused my attention on the third, and final, problem.

An inspection of Fig. 3 revealed a simple charging circuit in which a one-microfarad capacitor, C1, can be charged through a resistance from a 100-volt dc source. After capacitor C1 is fully charged, its charge may then be shared with a similar capacitor, C2. This is accomplished via switch SW by moving the blade from contact no. 1 to contact no. 2. (Once this has been done, the 100-volt source is no longer involved.) Actually, the problem had two parts. First, the amount of energy stored in C1 is required. Then the inquisitor wants to know what happens to this electrostatic energy when the switch is set in its no. 2 position.

With renewed confidence, I informed the Young Squirt that such problems weren’t often encountered outside of a physics class. From the vague recesses of my sub-

conscious mind, I managed to extricate the formula for electrostatic energy (which had been stored in “condensers” when I was a Young Squirt). That formula, $W = \frac{1}{2}CV^2$, expresses a “classical” relationship—the energy, W, is in joules, the capacitance, C, is in farads, and V is in volts.

“Duck soup,” I exclaimed. “Your instructor is just trying to see if he can snow you with that million-times-too-big a quantity of farads; also, he figures you will panic when you are forced to fool around with joules.”

To drive home the basic simplicity of the problem, I didn’t even resort to my highly-esteemed scientific calculator. (Much of the esteem stems from the high price I shelled out when these fancy gadgets first became available.) On a piece of scrap paper, I pencilled the following arithmetic: $W = \frac{1}{2} \times 1 \times 10^{-6} \times 100^2$. With a little crank-grinding, W came out to be .005 joules. “This,” I announced, “is the energy stored in C1 after it becomes fully charged with

the switch set in its no. 1 position.”

This time, the response from the now awe-stricken Young Squirt was a clearly audible “Wow!”

With the culmination of my tutorial activities in sight, I eagerly sought a face-to-face encounter with the second part of this problem. Its benign aspect evoked no need to muster latent resources of courage. What the heck! One simply dumps a charged capacitor into a like-sized uncharged one—where’s the problem? In an attempt to “dress up” the explanation so as to impress the Young Squirt, I groped for an elegant postulate of classical physics. Did not Einstein, Newton, Tesla, or some other scientific sage inform us that energy could be either piled up at one place or parcelled out in the same total amount elsewhere? Despite my strenuous efforts to pinpoint the relevant axiom or hypothesis, its origin and identity tantalizingly eluded me. Finally, falling back on good old common sense, I divulged my solution to the Young Squirt.

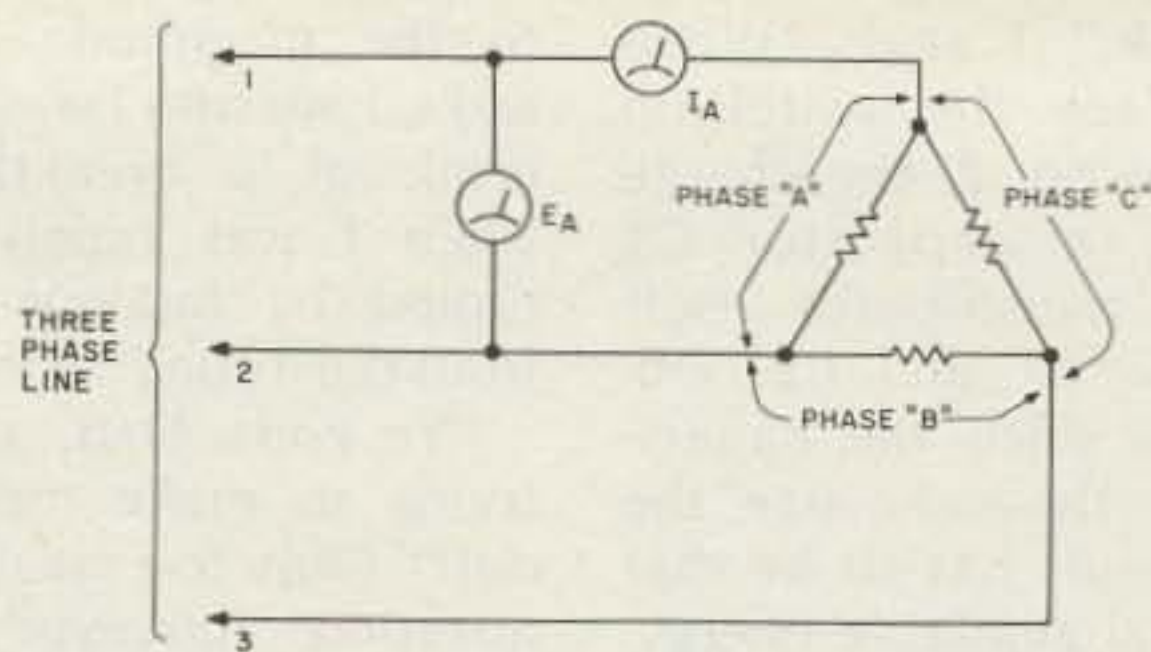

Fig. 2. A three-phase balanced load with a voltmeter and ammeter in one phase. A little common sense suggests that the total power consumed by the delta-connected load is $3 \times E_A \times I_A$. A more adequate dose of common sense refutes this simplistic solution!

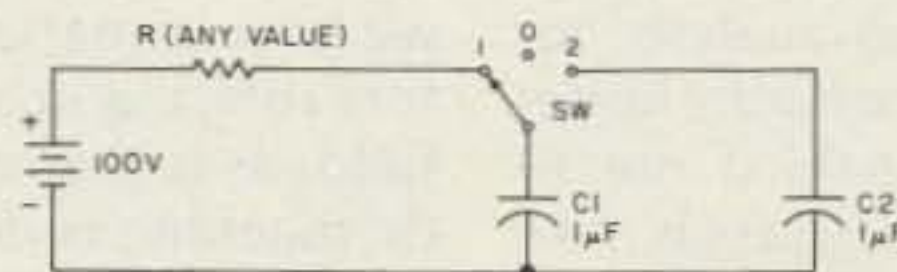

Fig. 3. Circuit for redistributing energy stored in a capacitor. After C1 is charged up, its energy is then shared with C2 by setting the switch in its no. 2 position. If the result is obvious, beware!

"Look," I said. "When you place the switch in position no. 2, the charge stored in capacitor C1 simply redistributes itself between C1 and C2. Obviously, since the capacitors are the same size, the final result has to be that the total available energy, .005 joules, remains .005 joules but now is stored on a 50-50 basis in the two capacitors. In other words, C1 and C2 each wind up with .0025 joules."

The Young Squirt's retort really made my day. "Gee, Dad, you old-timers sure do know your stuff. That Prof of mine took about ten times longer than you did to explain it and it just went in one ear and out the other."

And so this brief parley was terminated. I recalled how my own EE studies used to drive me up the wall those many moons ago, and I pondered with amazement that seemingly long-forgotten learning could be pulled out of the subconscious on demand! I peacefully returned to my job resumes. Then, after mailing a three-inch stack of these, I spent several days debugging my recently completed home-brew receiver. It appeared to be operable right off the bat, but closer scrutiny showed it to be plagued by numerous spurious responses. These were quite amenable to being moved around on the dial, but seemingly could not be eliminated. Neither theory nor cut-and-try sufficed to eradicate the offending signals. So challenging did this unexpected defect become that I became totally immersed in its interpretation and correction. The keen analysis, together with the earthy horse-sense that enabled me to promptly dispatch the Young Squirt's problems, were mysteriously proving ineffective now. Ever a seeker of challenge, I resolutely determined to measure up

to the magnitude of my tasks. I am sure I was on the brink of a breakthrough when I was rudely interrupted by raucous noises from the Young Squirt.

"Ye gods, Dad, are you trying to make me flunk out?" Only too clearly, the question conveyed more accusation than interrogation. "I was the only one who missed those three problems! The Prof says I'm not sharp enough to come up with such dumb answers, so he figures someone's been feeding me a bunch of baloney!"

As you probably suspect, the Young Squirt wasn't merely blowing bubbles through his beard! With appropriate manifestations of well-deserved embarrassment, I repented and apologized right then and there. What else could I do? With beautiful consistency, I had, indeed, swallowed the hook on all three "simple" problems!

And now, just in case your Young Squirt inflates your professional pride with similar "common-sense" problems, I herewith reproduce the correct answers as written by the Young Squirt's professor, beneath the large red "F" on the homework papers.

"1. In the dc shunt motor, there is some tendency for speed increase as the magnetic field is made stronger. However, this tendency is completely overshadowed by another effect accompanying the strengthened field. As you should know, such a machine simultaneously operates as a generator, even though we describe its function as that of a motor. This is true because we have armature conductors rotating in a magnetic field, as is the case when a dc machine is deliberately used as a generator (that is, when mechanical power is *supplied* to the shaft and electrical power is *extracted* from the armature).

The effect of such generator action during motor operation is to oppose the current delivered to the armature. Because of the iron in the magnetic 'circuit' of the machine, a little increase in field current produces a relatively large increase in the internally generated voltage, or counter EMF. The resultant opposition to the armature current then overwhelms the effect on speed of the stronger magnetic field per se. Inasmuch as the torque developed in the rotating armature is proportional to field strength and to armature current, the predominantly large reduction in armature current actually decreases the torque and thereby causes the speed to decrease. Accordingly, if we wish to *increase* motor speed, we must insert *more* resistance in the field circuit so that field current and field strength are decreased!

"Where were you when I requested anyone failing to grasp this aspect of motor operation to see me after class?

"2. It may appear correct to state that the product of E_A and I_A in Fig. 2 yields the power consumed by the phase A section of the load. Yet, caution is required in the interpretation of such a statement because phase B and phase C also make contributions to the line current, I_A . That is why one cannot solve for the total load power by merely multiplying the product of E_A and I_A by three! Rather, the total load power is given by $E_A \times I_A \times \sqrt{3}$.

"Where were you when I carefully explained this?

"Inasmuch as $\sqrt{3}$ is 1.73, we can write $P_{TOTAL} = E_A \times I_A \times 1.73$. And because we are dealing with a balanced three-phase system, it is also true that $P_{TOTAL} = E_B \times I_B \times 1.73$ as well as $E_C \times I_C \times$

1.73. All this comes about because the three-phase voltages differ from one another by 120 degrees. The three-phase currents also differ from one another by 120 degrees. That is why you can't use the logic of ordinary arithmetic in computing total power in this problem!

"Note that if connecting lead no. 3 is interrupted, phases B and C will no longer be active. Under this condition, three times the product $E_A \times I_A$ will give the total power in the load when phases B and C are restored by reconnecting lead 3.

"3. There is a certain mystique about this 'trap'—it never fails to catch prey! It is commonly recognized that the capacitance will be doubled when the switch, SW, is placed in its no. 2 position. And most students (but not you) perceive that the stored voltage will be halved. This derives from the relationship $V = Q/C$, where V is the voltage developed across the plates of a capacitor or a capacitance system, Q is the amount of charge, and C is the capacitance. We do not need to enumerate Q in this problem—it is sufficient to know that it remains the same whether stored in the signal capacitor, C1, or in the parallel capacitors, C1 and C2. That being so, the voltage across the parallel combination of capacitors must be one-half that originally developed across C1 alone.

"What is the significance, then, of the situation where we have half the original voltage and twice the original capacitance? Does the stored energy remain constant? It certainly does not. Consider the formula for electrostatic energy, $W = \frac{1}{2}CV^2$. A little arithmetical experimentation quickly shows that only one-half the initial

energy stored in C1 alone is available from the parallel combination of C1 and C2 after switch SW is placed in its no. 2 position.

"Where have you been? And, what became of the lost energy?"

"As your instructor, I find it easier to answer the second question. The lost energy dissipated itself as heat in the resistance of the connecting leads and in the resistance within the capacitors themselves. Also, some of the energy entered entropy, that land of no return, via the acoustics of the spark and through electromagnetic radiation.

"Interestingly, it is found that the ultimate result of this experiment is substantially the same whether the connecting leads have a small fraction of an Ohm or thousands of Ohms of resistance. In all cases, the

'new' storage system (SW position no. 2) will contain very close to one-half the stored electrostatic energy of the original system (SW position no. 1).

"Does such behavior appear strange? It very well might, for in most electrical circuits, increased resistance is accompanied by increased losses. How can you reconcile this apparently devious feature of our capacitor circuit?"

"Extra credit will be given for good answers to this paradox, providing reasonable proof can be tendered that no *outside assistance was obtained!!*"

Well, I'm sure we can agree that the Young Squirt's professor is a literary bug par excellence. And, I gotta hand it to him; those electrons don't put anything over on him. But, his sense of humor—that, I don't dig! ■



GREGORY ELECTRONICS
The FM Used
Equipment People.

Motorola Special X73LHT-1190 150MHz 110 Watts



12 Volts, 4 Freq. TX.,
2 Freq. RX., with a
separate 2 Freq.
RX. Front end on
170MHz, capable
of Simultaneous
Receive.

With accessories
(one set channel elements)

Was \$428
NOW \$398



GREGORY ELECTRONICS CORP.

251 Rt. 46, Saddle Brook, N.J. 07662

Phone: (201) 489-9000

FAST SCAN AMATEUR TELEVISION PRODUCTS FOR THE 420-450 MHz BAND

*ATV REPEATER
Model 1570B—a complete system with filters
ready to connect to antennas

*ATV REPEATER ANTENNA—a dual antenna system, omnidirectional,
vertical polarization

*ATV TRANSCEIVERS
Model TXR 15A—15 watt peak output, audio subcarrier, 2 frequency crystal controlled receiving converter
Model TXR 15T—15 watt peak output, audio subcarrier, tuneable receiving converter

*ATV TRANSMITTER
Model TX 15A—15 watt peak output, audio subcarrier

*IN-LINE DETECTOR
Model XD 25C—monitor your actual transmitted
picture

*ATV RECEIVING CONVERTERS
Model TR 70A—tuneable 420-450 MHz
Model XR 70A—crystal controlled, single frequency
Model XR 70B—crystal controlled, dual frequency

*AUDIO-VIDEO DEMODULATOR
Model TD 100A—connect a converter, speaker, and
video monitor and you have a commercial quality
receiving system

TELEVISION HANDBOOK FOR THE AMATEUR

*ANTENNAS—48 and 88 element models

*COMBLINE and INTERDIGITAL FILTERS— for repeater and base station use

EVERY APTRON ATV PRODUCT IS.....

COMPLETE, FACTORY ASSEMBLED AND TESTED...

PROVIDES COMMERCIAL QUALITY COLOR PERFORMANCE...

SOLD WITH A 30 DAY SATISFACTION OR MONEY BACK GUARANTEE—

AND A ONE YEAR WARRANTY

SEE US AT DAYTON....

FOR INFORMATION CALL 812-336-4775, OR WRITE TO—

APTRON LABS ✓8

PO BOX 323
BLOOMINGTON
INDIANA, 47402



G.I.S.M.O. ✓27

**2305 CHERRY ROAD
ROCK HILL, S.C. 29730**

Featuring



IN ADDITION TO THE PRODUCTS LISTED ABOVE, WE ARE ALSO FACTORY AUTHORIZED DEALERS OR DISTRIBUTORS FOR B & W, UNIVERSAL TOWERS, BERK-TEK CABLES, BENCHER PADDLES, THE NEW CES DIALER AND MANY OTHER ACCESSORIES. OUR SERVICE SHOP, STAFFED BY FIRST PHONE, EXTRA CLASS TECHNICIANS, OFFERS EXPERT SERVICE ON ALL MAKES AND MODELS AND FACTORY AUTHORIZED SERVICE ON SWAN, YAESU AND KENWOOD PRODUCTS.

**73 THE
GISMO
GANG**

SERVICE DEPT.
CALL
803-366-7158

**ORDER TOLL FREE!
800-845-6183**

New 2 Meter Avanti Mobile Antenna

Mounts on glass — no holes!

- Receives and transmits through glass.
- Superior performance equivalent to 5/8 wave.
- Superior radiation full Omni-Directional.

It's easy to install — No holes to drill, no magnet to scratch the paint, no clamps. Uses an especially developed epoxy adhesive that secures antenna to window like a 1/4" bolt. The capacity coupling box is simply attached with a special adhesive tape to inside of window. Worried about crimping or corroding coaxial cables? It's all inside and out of sight.

Models also available for 220 MHz and 450 MHz.

AH 151.3G SPECIFICATIONS

Gain	Equivalent to 5/8 wave
2 meter V.S.W.R. Band Width	Better than 1.5:1
Maximum power	150 watts
Nominal Impedance	50 Ohms
Chrome plated casting. Stainless Steel hardware. Swivel whip holder	
Height	33"
Performance and Mechanical Patents Pending	

Buy one from your nearest AVANTI dealer. If your dealer does not have one in stock, have him call the following toll free number and we will ship him one within 24 hours:

(800) 323-9429

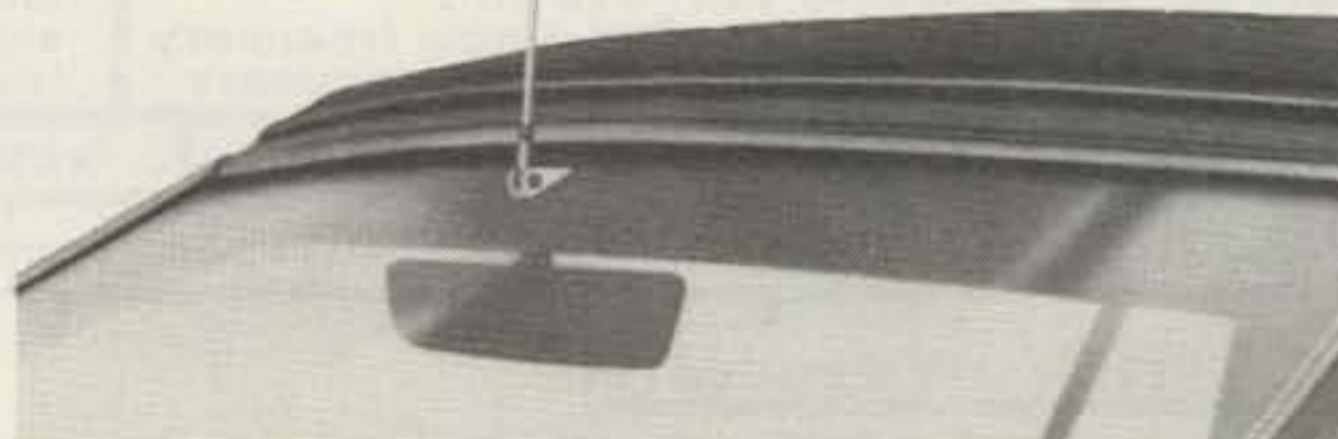
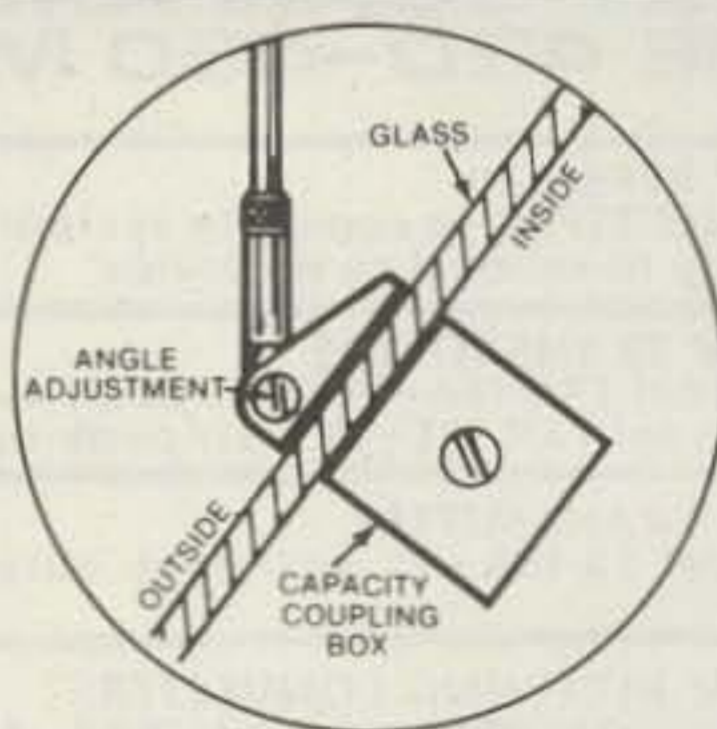

See Avanti's other new amateur mobile and base antennas. Write for new catalog today.

Send 50¢ for handling and postage.

avanti antennas

Avanti Research and Development, Inc.,
340 Stewart Ave., Addison, IL 60101
1979 In Canada: Lenbrook Ind., Scarborough, Ontario MIH IH5

FSK-500 RTTY Demodulator



Ham Net **\$197.00**

Here is an RTTY demodulator designed for interface with today's microcomputers and popular printers. A TU with a low price tag and high performance to give you solid copy of commercial stations, news services, and dependable interchange with other ham stations of communications and programs.

Designed for interface with the TRS-80, PET, Apple, Heath and other modern microcomputers

Includes bandpass preselector to fight ham band QRM
Wide = 145 Hz
Narrow = 75 Hz

Fully active filters in each channel

Receives 170, 425, and 850 Hz shifts

4 shift AFSK keyer with narrow shift for CW identification

Mark hold for prevention of run-ning open

RS-232 compatible or TTL mark high in and outputs

Autostart system built in

Normal or reverse switch to copy reversed shifts

117 volt, 60 Hz power supply

Operates in 60 or 20 Ma loop



700 Taylor Road
Columbus, Ohio 43230

Call (614) 864-2464

ALL-MODE VHF amplifiers

FOR BASE STATION & REPEATER USE

MODEL: V350



- ☆ Built-in 115/230 VAC Supply
- ☆ AM-FM-CW-SSB-RTTY
- ☆ 60dB Harmonics
- ☆ 60dB Spurious
- ☆ Heavy Duty Design

MODEL: V180

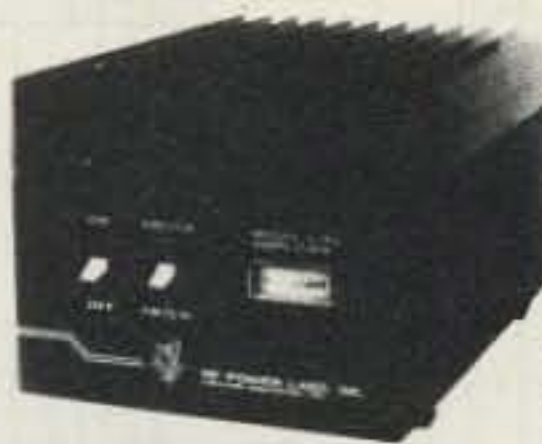

- ☆ Illuminated Panel Meter
- ☆ Automatic T/R Switching
- ☆ VSWR Protected
- ☆ +13V/3A Accessory Socket
- ☆ U.S. Manufactured

All Solid-State!

MODEL	FREQUENCY	INPUT	OUTPUT	SIZE WxDxH	WEIGHT	FAN KIT REQUIRED	PRICE
V76	50-54MHz	8-15W	100-120W	216x330x178mm	11.7 kg (26 lbs)	No	\$339.00
V360	50-54MHz	2-10W	400-450W	432x330x178mm	23.4 kg (52 lbs)	Yes	\$895.00
V70	144-148MHz	10-15W	75-90W	216x330x178mm	11.7 kg (26 lbs)	No	\$315.00
V71	144-148MHz	1-3W	75-90W	216x330x178mm	11.7 kg (26 lbs)	No	\$349.00
V180	144-148MHz	5-15W	170-200W	216x330x178mm	13.5 kg (30 lbs)	CW & FM	\$539.00
V350	144-148MHz	10-20W	350-400W	432x330x178mm	23.4 kg (52 lbs)	Yes	\$895.00
V130B	220-225MHz	10-15W	70-85W	216x330x178mm	11.7 kg (26 lbs)	No	\$329.00
V135B	220-225MHz	25-35W	140-160W	216x330x178mm	11.7 kg (26 lbs)	CW & FM	\$469.00
F110		Fan Kit, 115VAC		135x135x50mm	1 kg (2.2 lbs)	-	\$ 33.00
F220		Fan Kit, 230VAC		135x135x50mm	1 kg (2.2 lbs)	-	\$ 33.00
*F135		Fan Kit, 115VAC		381x140x89mm	3.2 kg (7 lbs)	-	\$ 59.00
*F235		Fan Kit, 230VAC		381x140x89mm	3.2 kg (7 lbs)	-	\$ 59.00
RM-1		19 Inch Rack Adaptor		483x3x178mm	1 kg (2.2 lbs)	-	\$ 25.00
*RM-2		19 Inch Rack Adaptor		197x32x28mm	5 kg (11.1 lbs)	-	\$ 12.00

*Used with the V360 & V350 Amplifiers

Other Frequencies Available on Request

Dealer Inquiries Invited

Meeting all applicable FCC Requirements.

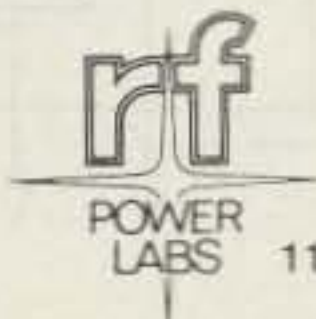

RF POWER LABS, INC.

11013-118th Place N.E. • Kirkland, Washington 98033 Telephone: (206) 822-1251 • TELEX No. 32-1042



Moving Display ASCII Readout

— works with UARTs, keyboards, and micros

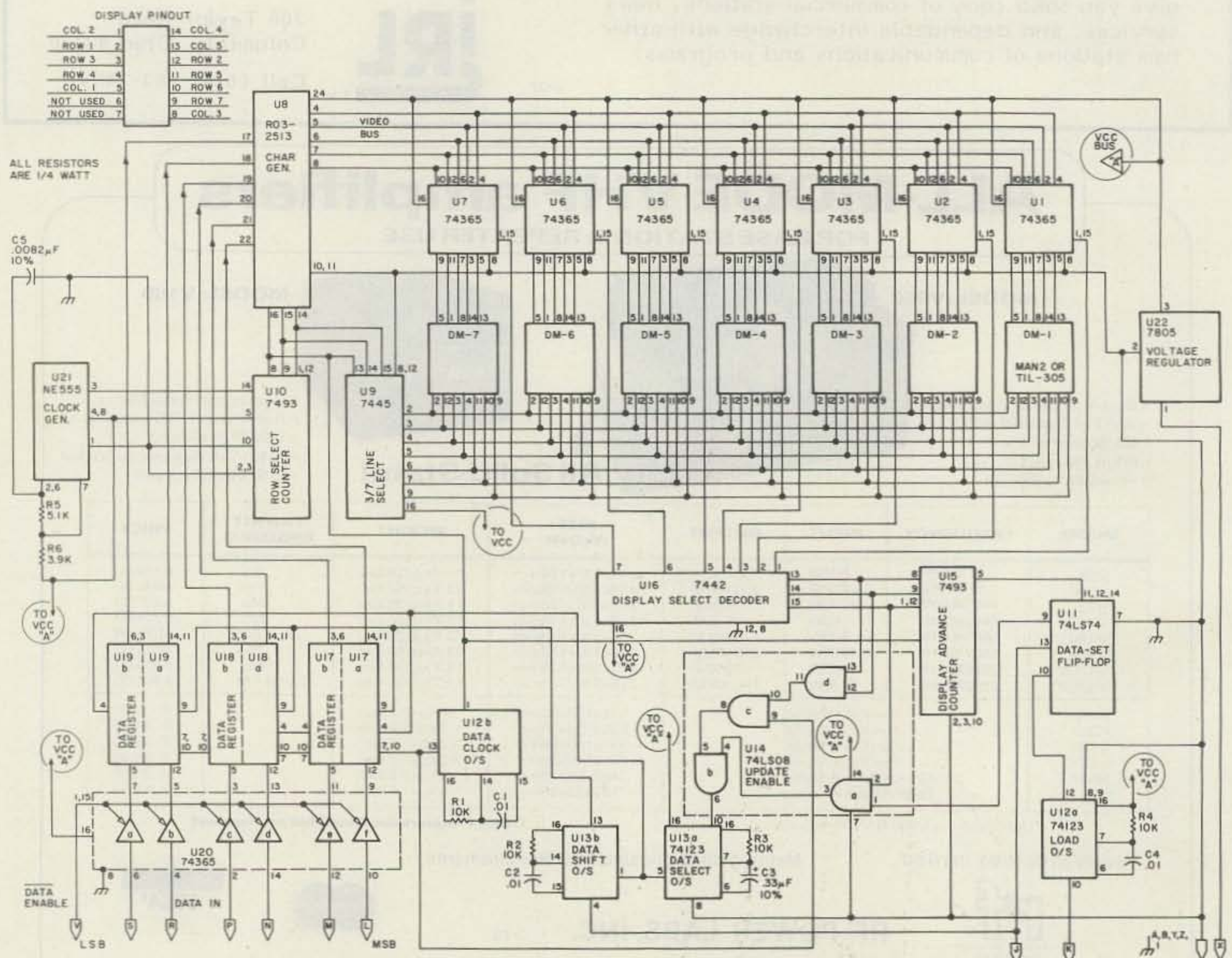

Fig. 1. Display schematic.

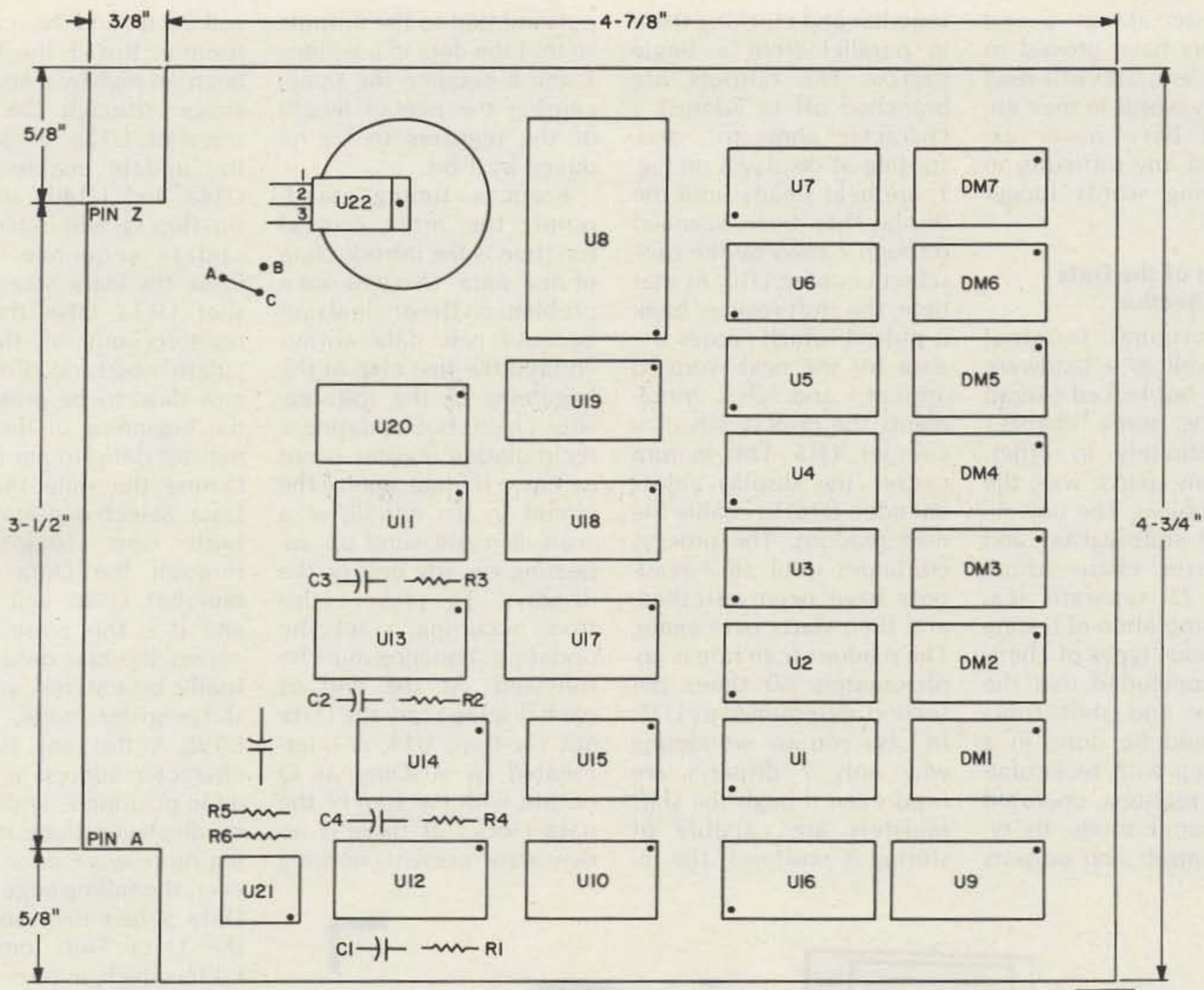

Fig. 2. Printed circuit board component layout and dimensions.

Francis J. Ferrara W8VL
 PO Box 56
 Enon OH 45323

The great deal of mail received in response to the article "Moving Display RTTY Readout," September, 1977, *73 Magazine*, gave me considerable food for thought concerning a redesign of the readout section.

A number of specific comments and suggestions regarding the original system have been incorporated into this new layout, which simplifies the display section by sharply reducing the chip count and eliminating all of the cumbersome drive transistors. The

end result is a compact, ASCII-compatible, almost stand-alone alphanumeric display board, which requires only a 5-volt power supply, a parallel data source, and a strobe pulse. Results obtained have been so encouraging that a printed circuit board has been laid out and is now available.

The first change made was a reduction in the number of readouts. At approximately \$5 for each readout, building a large display rapidly becomes an expen-

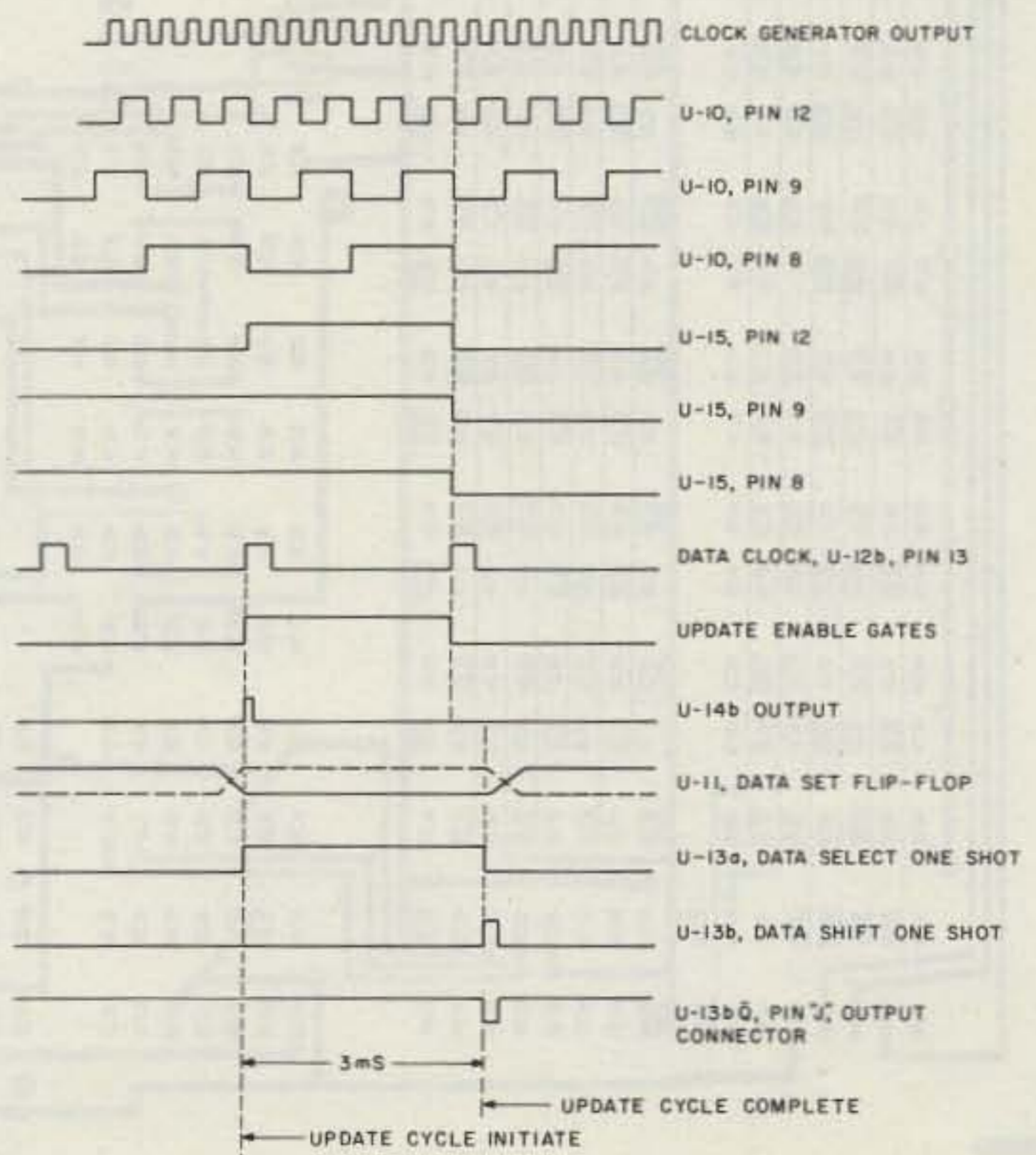

Fig. 3. System timing diagram.

sive undertaking. Seven characters have proved to be sufficient, and will read out many words in their entirety. I have never experienced any difficulty in deciphering words longer than this.

Redesign of the Data Register Section

The original terminal served well as a hardware test bed, but lacked overall efficiency; some changes were definitely in order. Too many parts was the main problem. The unit required a shift-register and multiplexer chain which totaled 22 separate ICs. Upon completion of testing with various types of chips, it was concluded that the multiplex and shift functions could be done in a single step with recirculating shift registers, operated in a dynamic mode, by tying the inputs and outputs

together and clocking them in parallel from a single source. The outputs are branched off to address a character generator, and, starting at display 1 on Fig. 1, are held steady until the display has been scanned through 7 rows by the row-select counter, U10. At that time, the shift-register bank is pulsed, which causes the data for the next word to appear, and also increments the display advance counter, U15. This in turn causes the display select decoder, U16, to enable the next readout. The process continues until all 7 readouts have been refreshed, and then starts over again. The readout scan rate is approximately 50 times per second, determined by U21. In case you are wondering why only 7 displays are used even though the shift registers are capable of storing 8 positions, the in-

puts are tied to the outputs so that the data in positions 1 and 8 become the same, causing the overall length of the registers to be reduced by 1 bit.

From a timing standpoint, the most critical function is the introduction of new data. This was not a problem on the original unit because new data always entered the first chip at the beginning of the shift-register chain, but updating a recirculating register is not as easy. If data enters the circuit in the middle of a scan, it might wind up appearing on any one of the displays. To prevent this from occurring, a specific updating sequence must be followed. At the end of each display scan, the Data Set flip-flop, U11, is interrogated by ANDing its Q output with the sum of the data clocks. If there is no new data present, nothing

will occur, and the scan will resume. But if the Q has been set high by a new data strobe through the Load one-shot, U12a, the sum of the update enable gates, U14a and U14d, and the flip-flop Q, will initiate the update sequence. Once fired, the Data Select one-shot, U13a, takes the shift registers out of the circulate mode and allows the new data to be present at the beginning of the shift-register data-stream inputs. During the time that the Data Select one-shot Q is high, one clock pulse through the Data Clock one-shot, U12b, will occur, and it is this pulse which causes the new data to actually be entered into the shift-register bank, U17a-U19b. At this time, the new character address is located in position 7, and would be displayed there if nothing more were done. However, the falling edge of the Data Select one-shot fires the Data Shift one-shot, U13b, which, in turn, pulses only the shift-register bank. The Display Select Decoder chip, U16, is unaffected. The net result of this operation is that the (new) data which had been present in position 7 is moved to position 1; that which was in 1 is moved to 2, 2 to 3, 3 to 4, etc., and the last character moves off the board. The entire update cycle occurs between scans; therefore, the movement of data being entered into position 7 and then shifted to position 1 is imperceptible.

The \bar{Q} of the Data Shift one-shot, U13b, is available at pin J of the board edge connector. It normally sits in the high state, and will pulse low when the update cycle is completed. It can be used to, say, reset the DAV flag on a UART. Once the update cycle has been initiated, incidentally, data present at the inputs must remain steady until this pulse occurs, which may

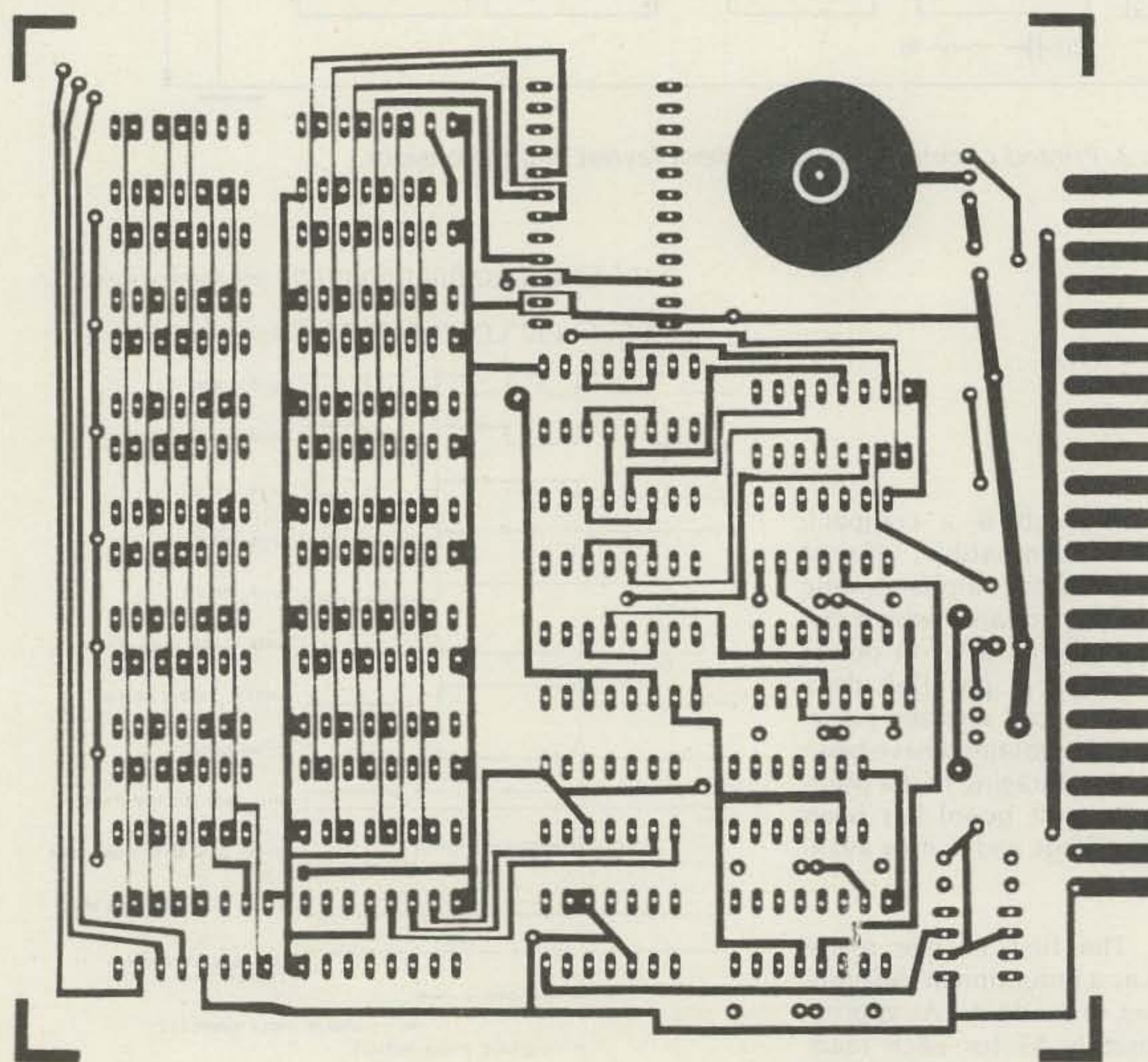

Fig. 4(a). Printed circuit board layout, top side.

take as long as 3 ms after the data strobe. Operating directly from the data bus of a microprocessor normally will require the use of an output port or a latch of the 74LS174 or 74LS374 variety.

The 9328/93L28 shift registers are manufactured by Fairchild, and are pin-for-pin compatible with the Signetics 8277. This chip was selected for ease of implementation, due to on-chip multiplexing between input sources, separate and common clocking, and two-register-to-a-chip packaging. Only three devices are required for the shift-register section.

Redesign of the Display Section

A little more experimentation resulted in the read-out section also being improved. The original unit required 87 drive transistors—a bit much. Playing around with some more chips and a suggestion from Bob Kissell WD8ILI resulted in discovering that ICs could directly handle the current requirements of the displays. The line-select chip, U9, a 7445, is a higher-power version of the original 7442, and also has open collector outputs. It is not necessary to tie the collectors to any voltage source, for when a particular line is selected it is switched to ground. The source current is supplied by the column drivers, U1-U7, 74365s, which are ideal for this application since they easily interface with the character-generator output bus. They are also tri-state, having neither output nor loading when de-selected. The character generator is the RO-3-2513, made by General Instruments, and requires only a single 5-volt power supply. Current-limiting for the display diode matrices, DM-1 through DM-7, has been found to be unnecessary, essentially because the

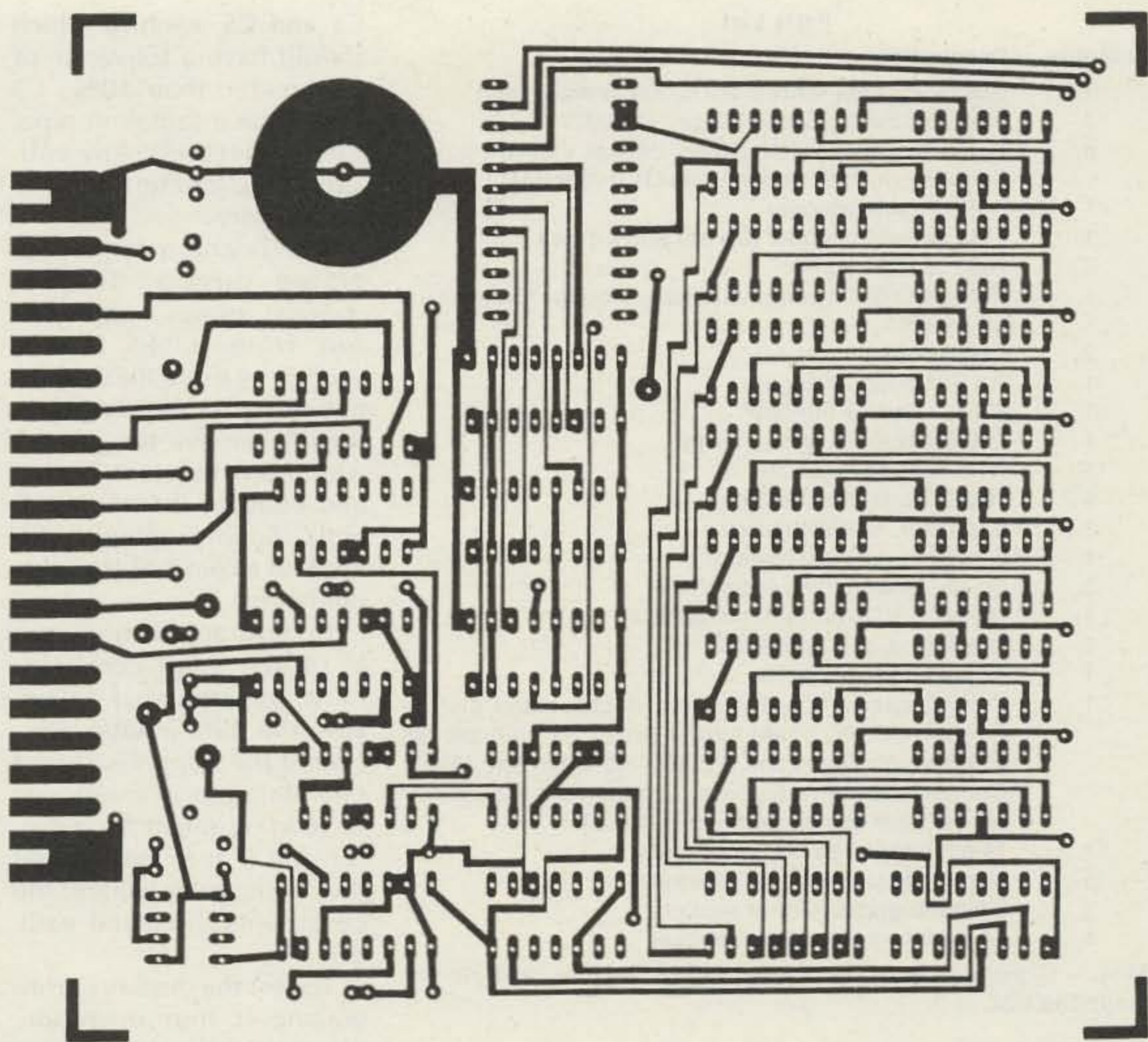

Fig. 4(b). Printed circuit board layout, bottom side.

driver chips are self-limiting due to the voltage drops across the internal output transistors. A prototype display board has been in operation for more than six months, and probably has more than a thousand hours of operating time on it. To this date, there have been no display failures.

Construction

The layout is relatively straightforward, and construction should not be difficult. Wire-wrap can be used for experimental units, with discrete parts mounted on component carriers. If the printed circuit board layout is used, care should be exercised to avoid solder bridges between traces. The use of sockets for mounting chips and the displays is highly recommended, as repairs to a board of this type can be very difficult.

The only two critical components are capacitors

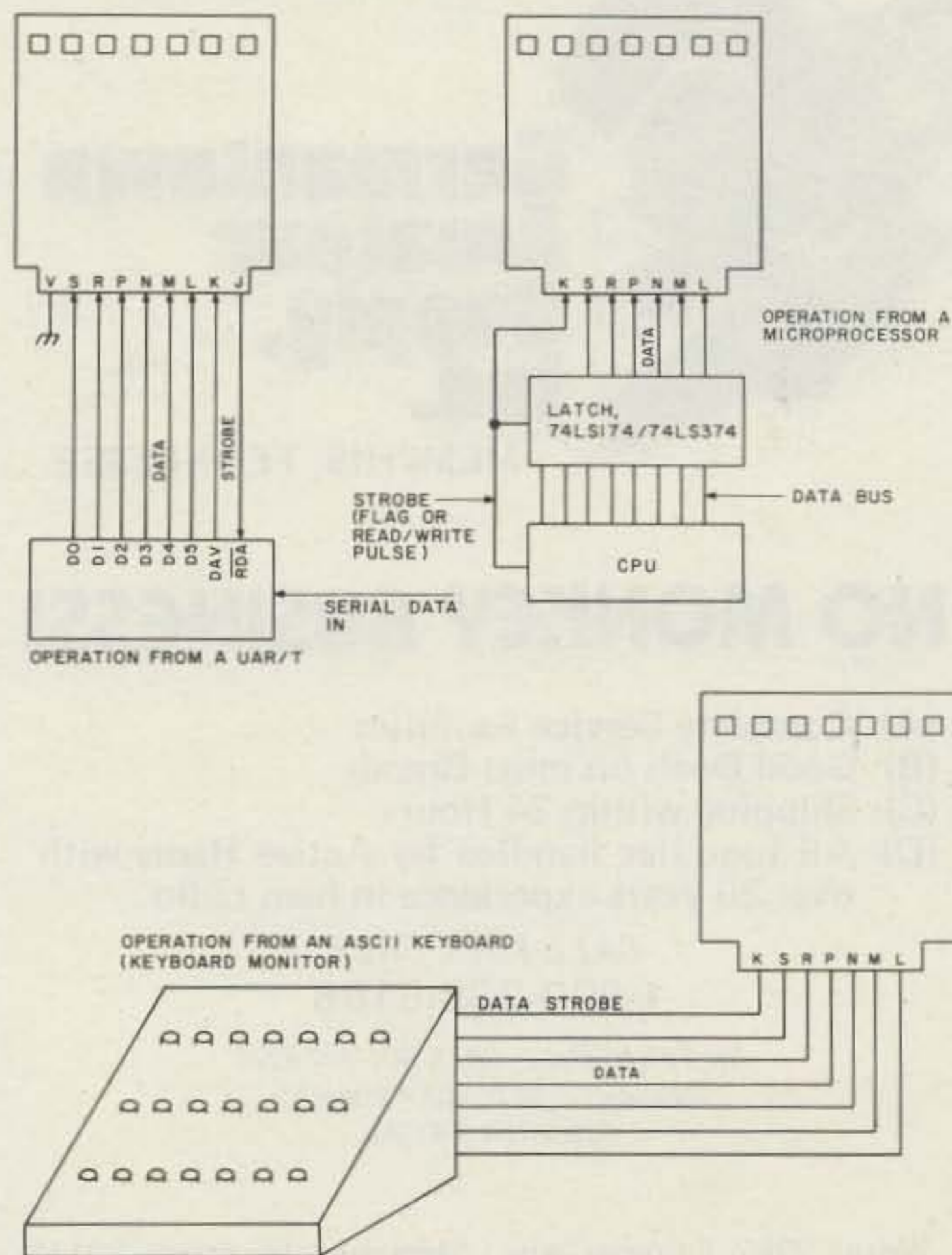

Fig. 5. Typical applications.

Parts List

Quantity	Description
7	Readouts, type MAN-2 or TIL-305 or equivalent
3	Shift registers, 9328/93L28 or type 8277
8	74365 tri-state buffer (Note: do <i>not</i> use low-power Schottky devices in positions U1 through U7.)
1	7442 decade decoder
1	7445 decade decoder (Do not substitute.)
2	7493 binary counter
1	RO-3-2513-001 5-volt character generator (General Instrument)
2	74123 dual one-shot
1	74LS08 quad AND gate
1	74LS74 dual-D flip-flop
1	LM555CN timer or equivalent
1	7805 voltage regulator
4	10k-Ohm, 1/4-Watt resistor
1	5.1k-Ohm, 1/4-Watt resistor
1	3.9k-Ohm, 1/4-Watt resistor
3	.01-uF ceramic disc capacitor
1	.33-uF ± 10% tantalum capacitor
1	.0082-uF ± 10% capacitor
1	44-pin edge connector
1	Printed circuit board (Note: a double-sided plated-through hole PC board for this project is available for \$30 through Digiscann, PO Box 56, Enon OH 45323. Contact the above address regarding the availability of the other components on this list.)
11	14-pin integrated circuit sockets
15	16-pin integrated circuit sockets
1	8-pin integrated circuit socket
1	24-pin integrated circuit socket

Misc.—1" piece of wire for jumper; screw, washer, and nut for mounting U22.

C3 and C5, each of which should have a tolerance of no greater than 10%. C3 should be a tantalum type, for compactness. Any voltage rating greater than 5 is satisfactory.

The board may be operated directly from a +5-volt power supply, or run from a +7-10-volt source, by using the on-card regulator. If this mode is selected, remove the jumper wire from points A and C and connect it to points B and C. Supply voltage is still applied to pin X of the edge connector.

In most applications, pin V of the edge connector must be grounded to enable the data inputs. However, if the display is placed on a data bus where timing or loading might be a factor, pin V may be strobed low, taking into account the constraints discussed earlier.

To test the display before placing it into operation, place all of the chips except U8, the character generator, into their respective sockets and apply power.

At this point, all of the displays should appear to be on. If not, check for defective components and/or soldering errors. If the board passes this test, insertion of the character generator should bring about normal operation.

The board itself can be mounted vertically in an edge connector and, if desired, it can be supported with circuit-card guides, spaced according to the dimensions in Fig. 2.

Incidentally, for the sake of economy, it is not necessary to use all 7 readout positions. Indeed, the display will function quite normally with just one readout in place. To run it in this manner, place all of the components on the board except for drivers U1 through U7 and diode matrices DM-1 through DM-7, and then, starting from the right, put on as many or as few displays as desired, making sure that each readout has a driver chip. Additional displays may be added to the board at any time. ■



**Germtown
Amateur
Supply,
Inc.**
MEMPHIS, TENNESSEE

NO MONKEY BUSINESS!

- (A) Complete Service Facilities
- (B) Good Deals on most Brands
- (C) Shipping within 24 Hours
- (D) All inquiries handled by Active Hams with over 20 years experience in ham radio

CALL TOLL FREE
1-800-238-6168

IN TENNESSEE, CALL 901-452-4276
MONDAY - SATURDAY 8:30-5:30
FOR YOUR SPECIAL.

Write: 3202 Summer Ave., Memphis, Tennessee 38112

ASCII Address Of:	Will Display:	ASCII Address Of:	Will Display:
000000-LSB	@	100000-LSB	(SPACE)
000001	A	100001	!
000010	B	100010	"
000011	C	100011	#
000100	D	100100	\$
000101	E	100101	%
000110	F	100110	&
000111	G	100111	'
001000	H	101000	(
001001	I	101001)
001010	J	101010	.
001011	K	101011	+
001100	L	101100	,
001101	M	101101	-
001110	N	101110	.
001111	O	101111	/
010000	P	110000	0
010001	Q	110001	1
010010	R	110010	2
010011	S	110011	3
010100	T	110100	4
010101	U	110101	5
010110	V	110110	6
010111	W	110111	7
011000	X	111000	8
011001	Y	111001	9
011010	Z	111010	:
011011	[111011	;
011100	\	111100	<
011101]	111101	=
011110	^	111110	>
011111	-	111111	?

Fig. 6. Address/display truth table.

HAM RADIO CENTER HAS BRANCH STORES ALL OVER THE COUNTRY



1-800-325-3636

FOR

BEST PRICE — FAST DELIVERY

HAM RADIO CENTER

8340-42 Olive Blvd. • P.O. Box 28271 • St. Louis, MO 63132



Signalcrafters Presents
**The Most Advanced
 Automatic Computing
 Power Meters
 In Amateur Radio!**



MODELS 31 and 32*

Our portable Models 31 and 32 feature the same state-of-the-art technology that is incorporated in their Big Brother, the Model 30. Never again will you have to bother with SWR "calibrate" controls and switches! Signalcrafters' custom integrated circuit makes power and SWR measurement a "hands-off" operation by automatically computing SWR. The result is unparalleled accuracy and ease of operation.

FEATURES:

- **CUSTOM IC**—Computes SWR from the level sensed on the transmission line independent of the power level. This analog computer operates over a range of only one watt to the full scale of the meter with unequalled accuracy.
- **RUGGED TAUT-BAND METERS**—Provide accuracy and readability that must be seen to be appreciated.
- **HEAVY DUTY CABINETS**—Handsome heavy duty metal cabinets complement virtually every transceiver on the market today.
- **TWO MODES—PEAK OR AVERAGE**—The amateur may choose between either peak or average power readings.
- **POWER REQUIREMENTS**—Due to the advanced low current design, battery life is truly outstanding, making this meter a natural for portable or field day operation. Uses standard 9 volt battery or 120V AC with optional AC adaptor.
- **ATTRACTIVE AFFORDABLE PRICING**
 *Model 31A (0 to 200w)
 31B (0 to 20w)
 only \$149.00

Model 32A (0 to 200w, 0 to 2000w)
 32B (0 to 20w,
 0 to 200w)
 ✓66 only \$169.00

SIGNALCRAFTERS, INC.
 5460 BUENA VISTA DRIVE
 SHAWNEE MISSION, KANSAS 66205
 913/262-6565; TELEX 42-4171

All Signalcrafters products are designed, engineered, and produced in the U.S.A. Prices include shipping to all U.S.A. VISA and Master Charge accepted. Kansas Residents please add 3% percent.

This MFJ RF Noise Bridge . . .

lets you adjust your antenna quickly for maximum performance. Measure resonant frequency, radiation resistance and reactance. Exclusive range extender and expanded capacitance range gives you much extended measuring range.



- Exclusive range extender • Expanded capacitance range
- Series Bridge

\$54⁹⁵

This new MFJ-202 RF Noise Bridge lets you quickly adjust your single or multiband dipole, inverted Vee, beam, vertical, mobile whip or random system for maximum performance.

Tells resonant frequency and whether to shorten or lengthen your antenna for minimum SWR over any portion of a band.

MFJ's exclusive range extender, expanded capacitance range (± 150 pf) gives unparalleled impedance measurements, 1 to 100 MHz. Simple to use. Comprehensive computer proven manual.

Works with any receiver or transceiver. SO-239 connectors. 2 x 3 x 4 inches. 9 volt battery.

Other uses: tune transmatch; adjust tuned circuits; measure inductance, RF impedance of amplifiers, baluns, transformers; electrical length, velocity factor, impedance of coax; synthesize RF impedances with transmatch and dummy load.

Order from MFJ and try it — no obligation. If not delighted, return it within 30 days for a refund (less shipping). This bridge is unconditionally guaranteed for one year.

To order, simply call us toll free 800-647-1800 and charge it on your VISA or MasterCard or mail us a check or money order for \$54.95 plus \$3.00 for shipping and handling.

Don't wait any longer to enjoy maximum antenna performance. Order today.

CALL TOLL FREE . . . 800-647-1800

Call 601-323-5869 for technical information, order/repair status. Also call 601-323-5869 outside continental USA and in Mississippi. ✓47

MFJ ENTERPRISES, INC.
 BOX 494, MISSISSIPPI STATE, MS 39762

**For your TRS-80
 send & receive
 CW/RTTY**



FEATURES

- Auto Send & Receive RTTY & CW
- Connects to TRS-80 User Port & Key/head phone jacks
- 10 message memories 255 char. ea.
- Uses builtin PLL or external TU

- Includes hardware, cassette & manual
- Morse tutorial-10 lessons-corrects mistakes. Simplest, fastest way to learn the code
- Morse practice-random 5 letter words
- Auto numbering contest keyer
- Interactive graphics custom PIX
- Autotransmitter control PTT
- Requires Level II Basic & 16K RAM
- CM80 In cabinet as illustrated \$279
- M80 As above minus cabinet \$149
- M800 Adds advanced RTTY features to M80 \$99
- PET, APPLE, SORCERER versions available

Write or call for complete catalog



MACROTRONICS, inc.® ✓44

1125 N. Golden State Blvd. / Suite G
 Turlock, CA 95380 (S)
 (209) 667-2888 / 634-8888



We are experiencing telephone difficulties,
 please keep trying.

California residents add 6% tax

ECONOMICAL RTTY

Flesher Corp offers a selection of compact, economical RTTY equipment and accessories unequalled in quality or function for the price. Flesher units

are designed with minimum space requirements in mind, too. Call or write today for our free 1980 catalog of affordable kits, wired units and accessories.



FLESHER CORP ✓ 23

P.O. Box 976 • Topeka, Kansas 66601 • 913 • 234 • 0198
Distributors in Canada and Australia

SCANNERS:

COMPTRONIX FM-80, FM-200 Kit \$49.95 Assm. \$64.95
KDK 2015R, KDK 2016A
MIDLAND 13-510, 13-513, CLEGG FM-28
YAESU FT227R, ICOM IC22S,
KENWOOD TR7400A, TR7600, & TR7625

- AED continues to expand its line of quality scanners. All of the above scanners are custom designed for their respective rigs.
- All scanners install completely inside the rig. No obtrusive external connections.
- All are easy to assemble and come complete with a detailed instruction manual.
- Scanned frequency displayed on digital readout (except IC22S).
- In the scanner OFF mode the rig operates normally. In the scanner ON mode the scanner locks on an occupied frequency, pauses for a preset time (about 5 secs.) and then resumes scanning.
- This gives you the ability to eavesdrop all over the band without lifting a finger. When you hear something interesting, you flip the switch to the LOCK mode and the rig is ready to transmit.

AED SCANNER SPECIFICATIONS

	KDK 2015R	KDK 2016A	KENWOOD TR7600 TR7625	KENWOOD TR7400A	YAESU FT227R	MIDLAND 13-510 13-513	CLEGG FM-28	ICOM IC22S
SCAN RATE	Adjustable 100kHz/sec-1mHz/sec		50kHz/sec	200kHz/sec	100kHz/sec	100kHz/sec	100kHz/sec	100kHz/sec
SWEEP WIDTH	144-148 or only the mHz segment you select on mHz switch	142-149.995	complete band or mHz you want	complete band or mHz you want	adjustable eg. 146-148 144-146 146-147	scans the mHz seg. selected by the mHz switch	same as Midland	145.35-147.99
SCAN CONTROLS	2 mini toggle switches mounted on rig — LOCK switch may be mounted on mic.		2 mini toggle switches mounted on rig.	2 mini toggle switches mounted on rig.	1 mini toggle switch mounted on mic or rig.	2 mini toggle switches mounted on rig.	same as Midland	1 mini toggle switch mounted on mic or rig.
PRICE FOR KIT	\$39.95							
PRICE PRE-ASSEMBLED	\$59.95							

AED ELECTRONICS

750 LUCERNE RD., SUITE 120
MONTREAL, QUEBEC, CANADA H3R 2H6
TEL. 514-737-7293

Add \$1.50 for postage & handling

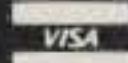

DEALER INQUIRIES INVITED



TRAC

DELUXE MESSAGE MEMORY KEYS



Features: Model TE-284

- State-of-the-art CMOS Circuitry
- Three choices of Message Storage
 - A. Two (50 character each) message storage
 - B. Four (25 character each) message storage
 - C. One (50 character and two (25 character message storage)
- Records at any speed—plays at any speed
- Memory operating LED
- Use for daily QSO or contests

PLUS:

- Self-completing dots and dashes
- Both dot and dash memory
- Iambic Keying with any squeeze paddle
- 5-50 w.p.m.
- Speed, volume, tone, tune and weight controls
- Sidetone and speaker
- Low current drain CMOS battery operation—portable
- Deluxe quarter-inch jacks for keying and output
- Keys grid block and solid state rigs
- WIRED AND TESTED FULLY GUARANTEED—LESS BATTERY

"BRAND NEW"

\$89.95

MESSAGE

MEMORY KEYS



Features:

- Advanced CMOS message memory
- Two (50 char. each) message storage
- Repeat function
- Records at any speed—plays back at any speed
- Longer message capacity
- Example: send CQ CQ CQ DX de WB2YJM WB2YJM K—then play second message on contact—de WB2YJM QSL NY NY 579 579 Paul Paul K
- Use for daily QSOs or contests

Model # TE201

\$69.95

PLUS:

- State-of-the-art CMOS keyer
- Self-completing dots and dashes
- Both dot and dash memory
- Iambic keying with any squeeze paddle
- 5-50 w.p.m.
- Speed, volume, tone, tune and weight controls
- Sidetone and speaker
- Low current drain CMOS battery operation—portable
- Deluxe quarter-inch jacks for keying and output
- Keys grid block and solid state rigs
- WIRED AND TESTED FULLY GUARANTEED—LESS BATTERY

"BRAND NEW"

Model # TE144

59.95



Features: Deluxe CMOS Electronic Keyer

- State-of-the-art CMOS circuitry
- Self-completing dots and dashes
- Both dot and dash memory
- IAMBIC keying with any squeeze paddle 5-50 w.p.m.
- Speed, weight, tone, volume tune controls & sidetone and speaker
- Semi-automatic "bug" operation & straight keying—rear panel switch
- Low current drain CMOS battery operation—portable
- Deluxe quarter inch jacks for keying and output
- Keys grid block and solid state rigs
- Wired and tested—fully guaranteed—less battery

MODEL TE133—same as TE144 with wgt and tone control internal, less semi-auto keying. \$49.95

MODEL TE122—same as TE133 less wgt, tune, solid state keying \$36.50

AT YOUR DEALER OR SEND CHECK OR MONEY ORDER. (plus \$2.00 s/h NY res. add tax)

TRAC ELECTRONICS, INC
1106 RAND BLDG.
BUFFALO NY 14203

Lab-Quality Hi I Supply

— part II

I hope that by now you have finished assembling your power supply as presented in part I of this article, and are ready to put the finishing touches on your project. In this installment, I will describe the construction of the digital panel meters (DPMs) used to display voltage and current

and describe a few circuit improvements. As mentioned in part I, the DPMs are optional, and if you used analog panel meters, simply skip to the "Improvements" section below.

First, a few words about the DPMs used in this project. They feature simple cir-

cuitry, high accuracy, and relatively low cost. We chose to "roll our own" because good commercial instruments cost almost twice as much to buy. Since the DPMs are the most expensive part of the project, this was the natural way to go.

As you can see from the schematic, the circuitry of the DPMs is quite simple. A single IC chip from Intersil contains an A/D converter

with a 3½-digit counter capable of directly driving an LED display. An input filter, consisting of R101 and C101, filters any noise off the input voltage being measured, and then the chip takes over. Analog signals appearing on pins 30 and 31 are internally processed by the chip. Resistor R103 and capacitor C105 determine the rate at which the processing takes place—normally about five times a second. Resistors R104, R105, and R106 form the meter calibration circuitry, and divide an internal reference to 1.000 volt for the A/D converter. These parts set the accuracy of the meter. Capacitors C106 and C107 serve as on-board noise filters, and the rest of the parts are related to the analog circuitry.

Inside the chip, the analog voltage is converted to a corresponding train of pulses and counted up by an internal 3½-digit counter. The counter section then drives LED displays. Not to be overlooked, diodes D101 and D102 serve to limit the voltage applied to the display. This sharply reduces the current drain required

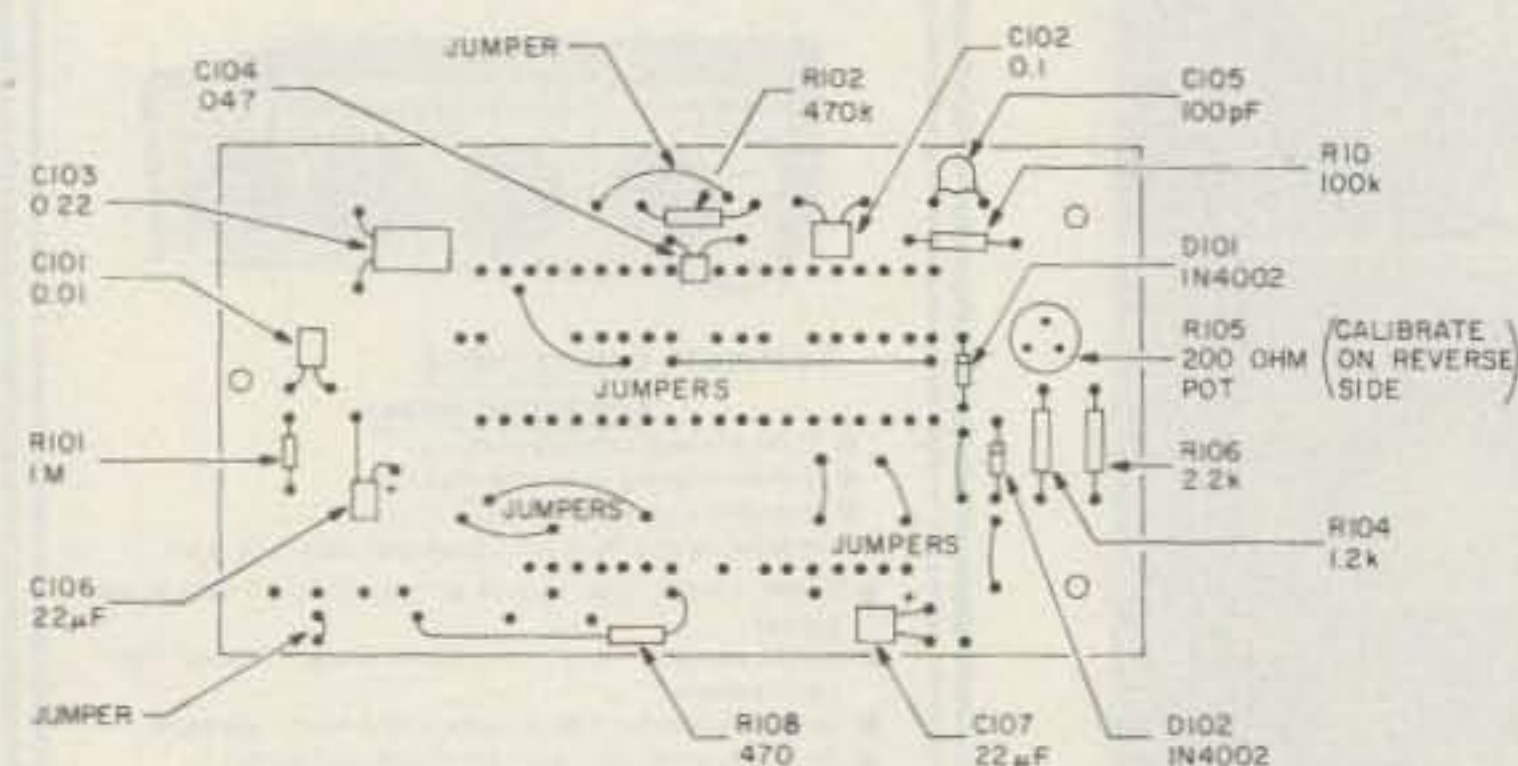

Fig. 1. Front view of the DPM showing how parts are installed.

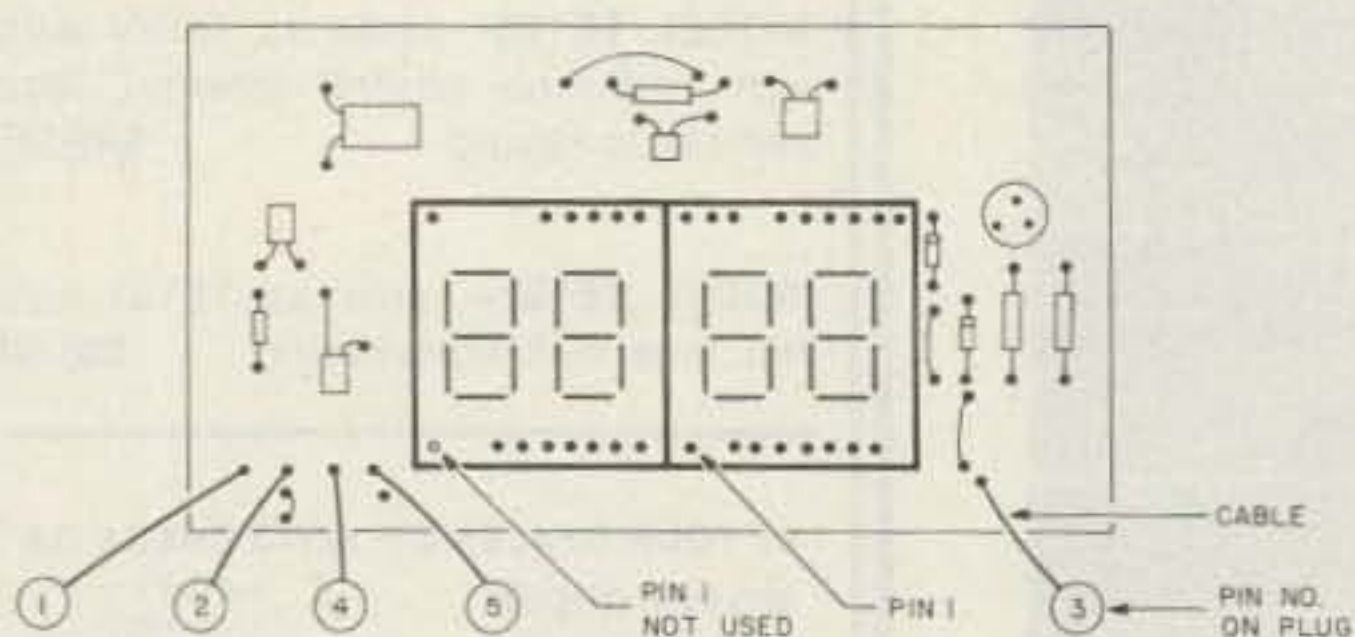

Fig. 2. Another view of the DPM, showing installation of the LEDs.

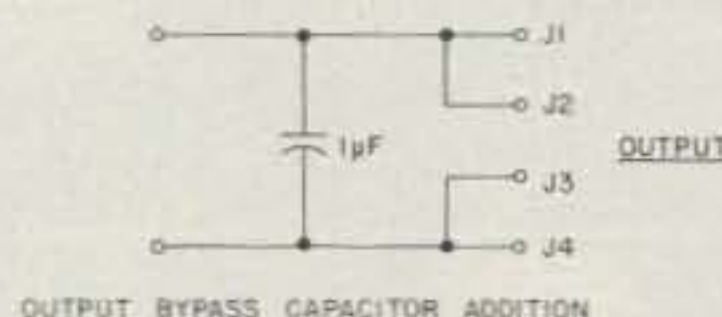
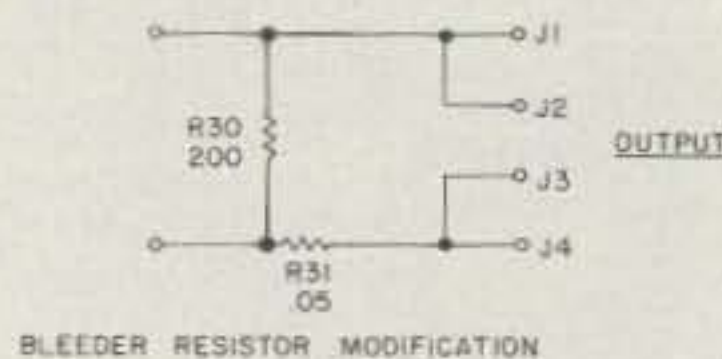
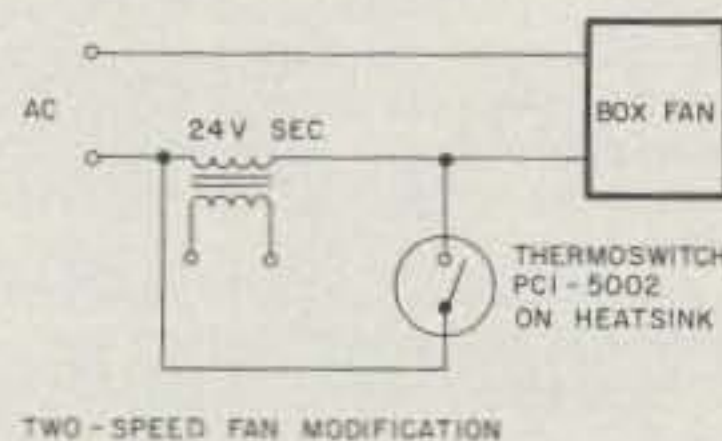

Fig. 3. Modifications you can make to your power supply.

by the DPM and results in cooler, more reliable operation. The theory has been simplified greatly to allow more room for discussing construction, but the basic operation of the DPMs has been described. Suffice it to say, that's enough for practical purposes!

The first step in putting the DPMs together is to find all the parts. Good sources for the National dual-digit common-anode LED display include the Digi-Key Corporation of Thief River Falls, Minnesota, and a good source for the Intersil DVM chip has been Poly Paks, of East Lynn, Massachusetts. The Poly Paks chips are prime units as of this writing, and sell for less than from most commercial distributors. The rest of the parts are standard and should be easy to get. Do not substitute capacitors C102 and C103 if you can help it. Use the green Japanese mylar® caps. If you substitute these caps, the DPMs will tend to give jittery readings and, in general, be less accurate. Pot R105 is a Beckman model 82PFR200 trimmer—a type often found on surplus PC boards. If desired, a conventional trimmer may be mounted on the rear of the board if the Beckman TO-5-sized unit can't be located.

The next step is to make up the PC board. As you can see, full-sized artwork has been provided for you to do this. Use transfer film such as PCP Type A, available from hobby electronics houses, to transfer the pattern to the board. Expose, develop, and etch the board according to manufacturer's instructions. Then cut to size and drill all holes with a no. 65 drill. Also, drill the three holes along the PC board edges with a 1/8" drill. These are the mounting holes. With that, let's turn to the construction.

Building the DPMs is easy if you follow instruc-

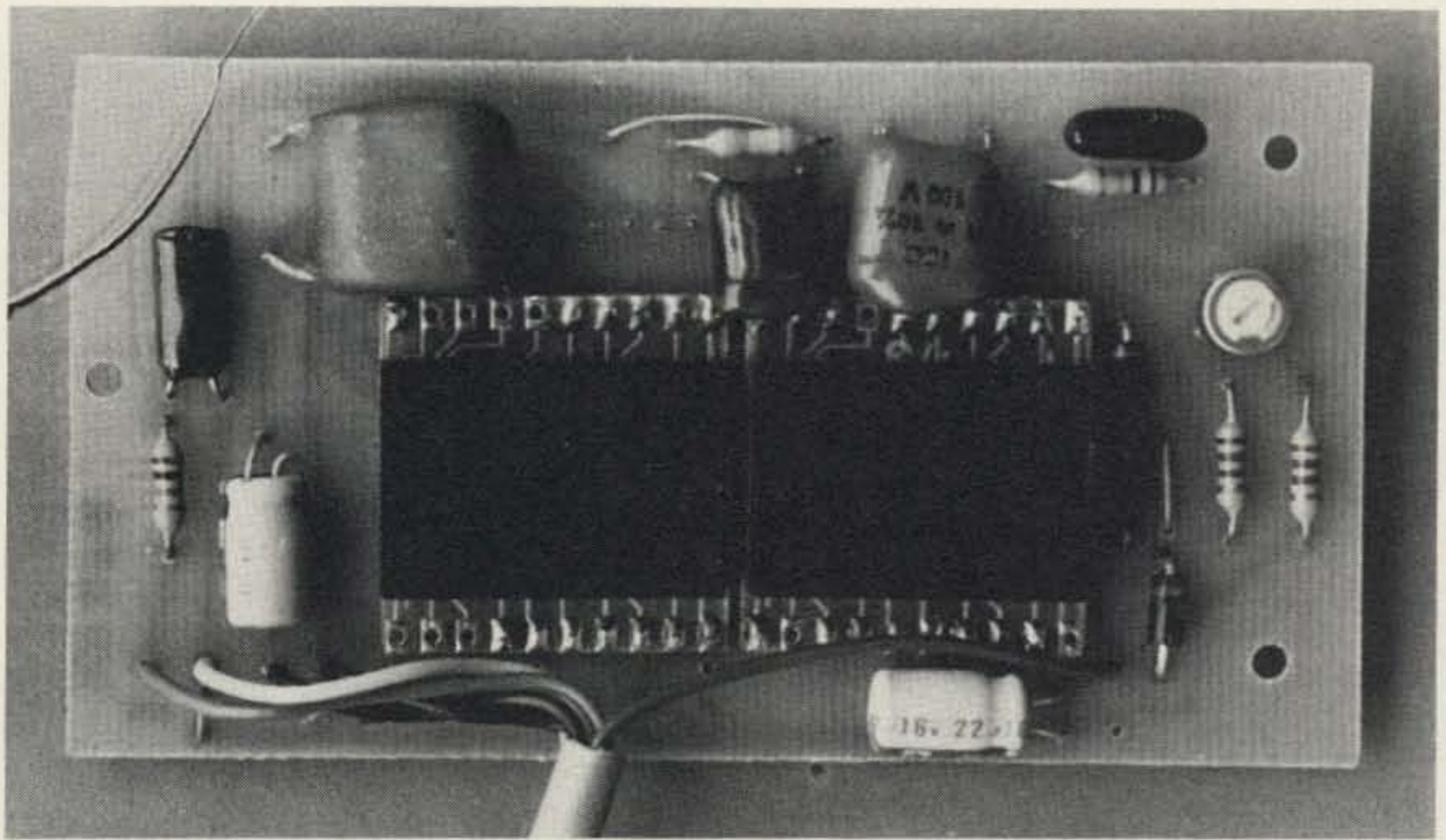

Photo A. DPM component side.

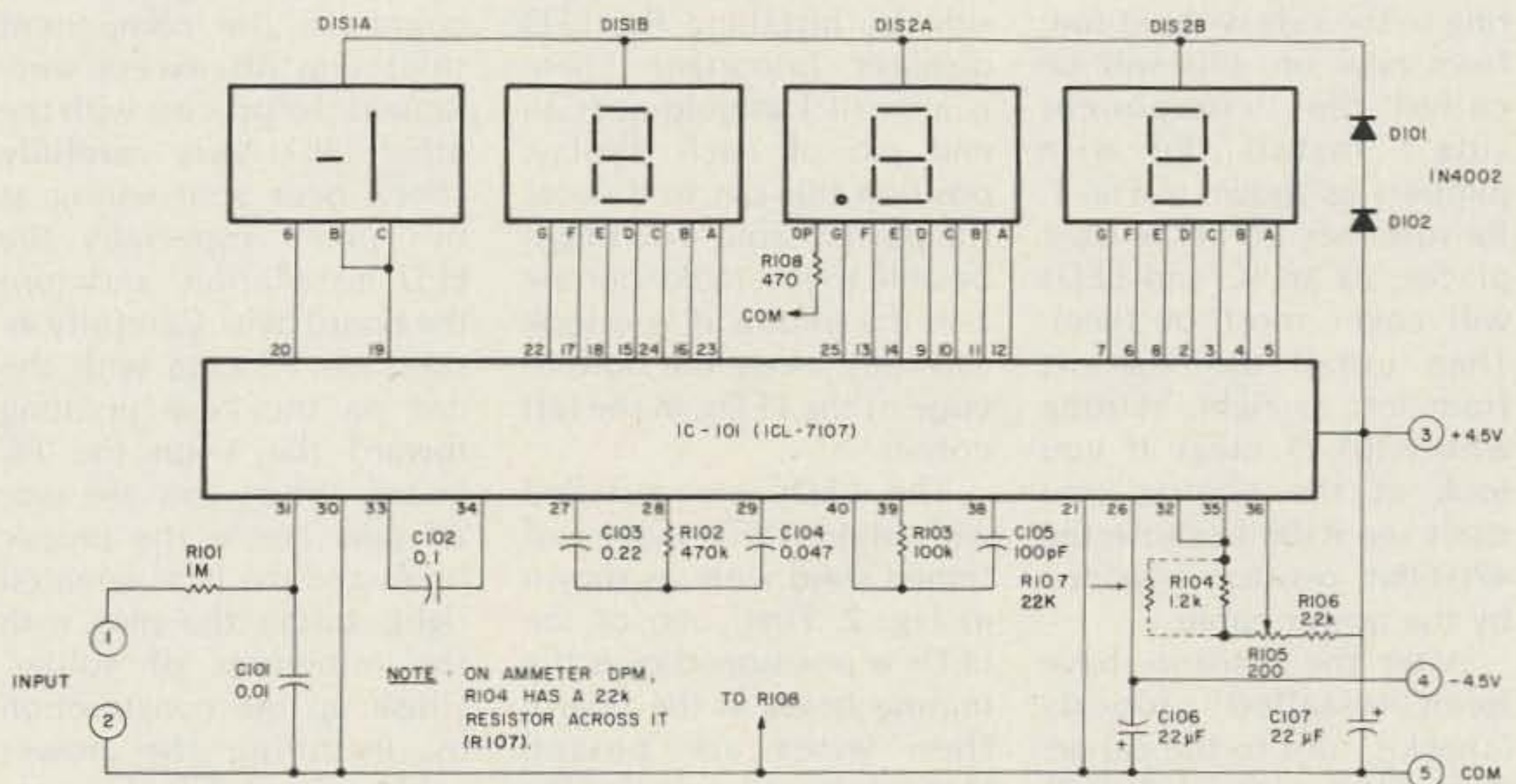

Fig. 4. DPM assembly. (DS1AB, DS2AB = NSN-584.)

Parts List

- C101 — 0.01- μ F, 50-volt mylar capacitor*
- C102 — 0.1- μ F, 50-volt mylar capacitor*
- C103 — 0.22- μ F, 50-volt mylar capacitor*
- C104 — 0.047- μ F, 50-volt mylar capacitor*
- C105 — 100-pF disc capacitor
- C106, C107 — 22- μ F, 6.3-volt electrolytic or disc capacitors
- D101, D102 — 1N4002 silicon diodes
- DIS1, DIS2 — National NSN-584 common-anode LED displays (Do not substitute.)
- IC1 — Intersil ICL-7107CPL DVM chip
- (All resistors, 1/4-Watt, 5% film.)
- R101 — 1-meg resistor
- R102 — 470k resistor
- R103 — 100k resistor
- R104 — 1.2k resistor
- R105 — 200-Ohm pot (See text.)
- R106 — 2.2k resistor
- R107 — 22k resistor (Connected across R104 in ammeter DPM only.)
- R108 — 470-Ohm resistor
- Misc: 5-pin plugs, PC boards, wire, etc.
- *Use imported, green-dipped capacitors

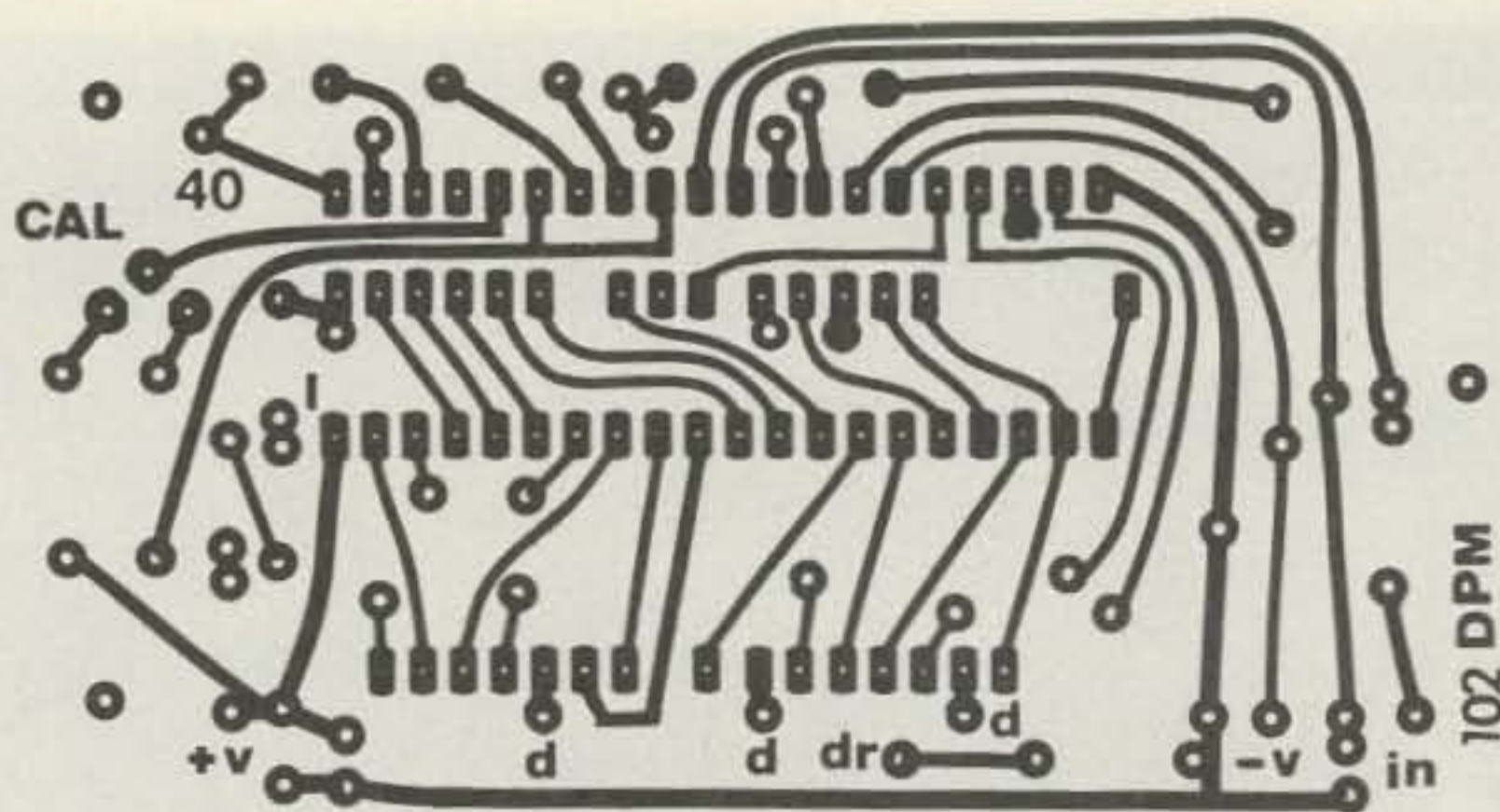

Fig. 5. PC board (foil side).

tions. This is important because there is a definite sequence of assembly steps for them. Goof up, and you might be running external jumper wires from one side to the other! Start by referring to the side without foil; from now on, this will be called the "component side." Install the wire jumpers as shown in Fig. 1. Be sure they go in the right places, as an IC and LEDs will cover most of them. Then install the resistors from left to right, starting with R101 (1 meg). If you look at the photos, you can't see R108 because the 470-Ohm resistor is hidden by the power cable.

After the resistors have been installed properly (check!), turn to the capacitors. Start with C101 (0.01

uF) and work your way to the right, referring to Fig. 1 often. Then install diodes D101 and D102, bands pointing up as in the photo and Fig. 1. Now you can finish up the component side by installing the LED displays. *Important:* There is a small 1 in gold near an end pin of each display; position this pin so it faces the power cable. You might be able to just make out the 1 in the photos if you look carefully along the bottom edge of the LEDs, in the left corner.

The LEDs are installed with short ($\frac{1}{2}$ ") pieces of tinned solid wire, as shown in Fig. 2. First, one of the LEDs is positioned over the mating holes in the board, then wires are passed through board and display

and then soldered quickly in both places. Note from the photos that not all of the pins are used. When the wires are installed and soldered (try to solder the wires flush against the board on the component side), clip off excess wire. Repeat the process with the other LED. Very carefully check over your wiring at this point, especially the LED installation, and turn the board over. Carefully install the IC chip with the dot on the case pointing toward the 1 on the PC board. When you are sure all pins are in the proper holes and the IC is oriented right, solder the pins with the minimum of solder. Finish up the construction by installing the power cable (about 6" of 5-con-

ductor wire) to the points along the bottom edge. Then connect a plug to the free end, with the wires going to the proper pin locations. That's it for the DPM construction! It generally won't take more than 2-3 hours for the first one, and under 2 hours for the second.

Just before installing the DPMs in the power supply cabinet and checking them out, pick up the unit reserved for the Amps display and solder a 22k film resistor across R104. Do this on the foil side. This modification allows you to read 20 Amps with only a 1-volt input; in effect you are doubling the sensitivity! Turn to the voltmeter and connect the power plug. Turn on the power supply and the meter should display voltage. Your supply should be working properly at this point; if not, fix it, and then test out the DPM.

Connect an external digital multimeter across the output terminals and set the power supply for 15 volts. Then adjust R105 for the same reading as the DMM you connected. That finishes calibration of the voltmeter. Turn next to the ammeter, and connect it to the supply. Connect a heavy load across the power supply and measure the voltage drop across R31 (0.05-Ohm resistor) with your DMM. Then adjust the ammeter calibration for the same reading. This is sufficient for most purposes. Or, if you prefer, draw a known current from the power supply with a known resistor (I used a 1-Ohm, 1%, 100-Watt resistor) and adjust the ammeter's R105 for the correct current reading. Install the DPMs in the cabinet if you haven't done so, and you are finished!

At this point you should be proud of your power supply; it works like some of the finest, cost a fraction of the best, and is extremely handy. But, if you are like

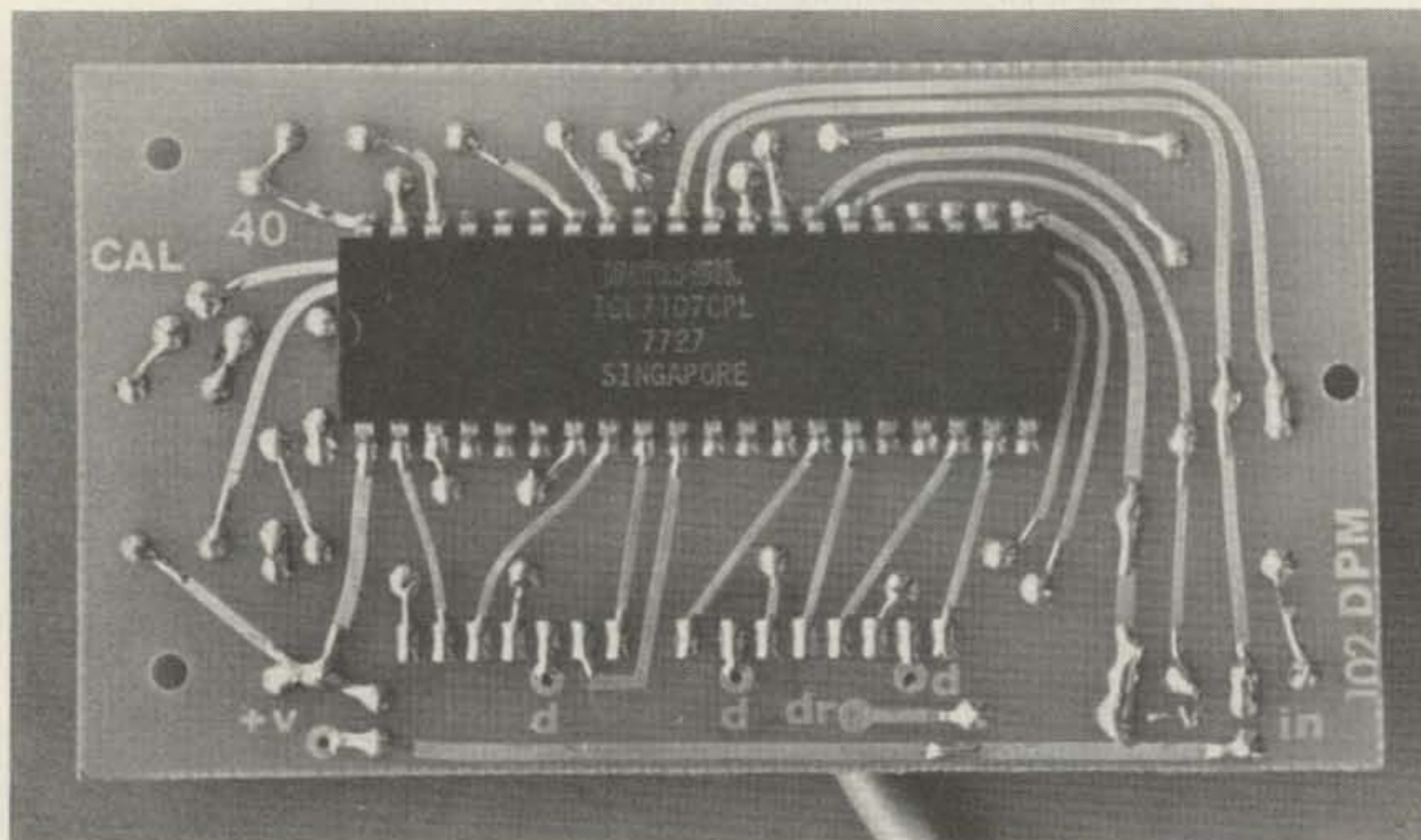

Photo B. DPM foil side.

me, you may want to tidy up a few loose ends.

Improvements

There are several things you can do to improve your power supply at little or no cost. These improvements were not included in part I of this article because they were made after it was written. The first improvement is to change the fan to a two-speed model, and is necessary only if you were unlucky enough to find a standard noisy-type fan. The drone of a standard fan is quite annoying after a time. The modification is simple, and is done as shown in Fig. 3. An old 24-volt, 1-Amp filament transformer serves as the voltage drop in series with the fan. Only the secondary winding is used. If you prefer, select an old filter choke from your junk box to do the same job. Connected across the trans-

former is a PCI (Protective Controls, Inc., Husky Park, Frederick MD 21701) model 5002 thermoswitch mounted on the heat sink. When the heat sink temperature rises to about 85° C, the switch closes and the fan runs at full speed providing extra cooling.

Another modification you can make is to the output circuitry. First, move the negative lead of R30, 200 Ohms, from J3/J4 as shown originally in the schematic, to the other side of R31, 0.05 Ohms. This will stop the current reading residual that shows up in the Amps display.

And one final modification you can make is to connect a 1-uF, 25-volt mylar capacitor across J1/J2 and J3/J4. This modification will decrease the rf output impedance of the power supply and possibly give better performance when working with critical rf circuitry. ■

DIGITAL MODERNIZATION KIT



\$96.45

Plus \$3.50 ship. & handling
U.S. and Canada - Wash. residents
include sales tax.

THE DMK IS A COMPLETELY WIRED AND TESTED DIGITAL READOUT UNIT, that translates the LMO frequency to a frequency referenced from the HET and BFO oscillators. The DMK has independent calibration for each band. The last two digits are programmed and controlled by the Mode Switch, to correct for the difference in the USB/LSB LMO shift frequency. Both the Counter Clock and the Translation Oscillator are Crystal Controlled. The accuracy of the DMK is determined by the accuracy of your calibration source (Receiver Crystal Calibrator and etc). Installation instructions and mounting hardware is available for the following units:

SB-102 USE DMK-102
SB-300 USE DMK-300
SB-303 USE DMK-303

SB-401 USE DMK-401
HW-101 USE DMK-101
HW-100 USE DMK-100

All DMK's are electronically identical, only the installation instructions and mounting hardware may be different, therefore the DMK will work in units other than those listed above.

Easy step-by-step installation instructions. We will install for \$23.45.

TECHNICAL INFORMATION & PHONE ORDERS:

AL STAGGS, P.E. 1-206-829-0056
Time 0900 - 0200 Local Time

PHONE ORDERS ONLY:

1-206-588-5804
Time 0800-2300 Local Time

PROTRONICS, INC.

✓59

MASTER CHARGE

BOX 778
BUCKLEY, WA 98321

VISA

HAM-KEY™ RADIO TELEGRAPH SENDING DEVICES



Model **HK-3M**

\$19⁹⁵

Add \$2.00 Shipping & Handling.

- * Deluxe straight key
- * Anti-tip bracket. Can't tip
- * Heavy base. No need to attach to desk

- * Navy type knob
- * Smooth action

CC-3P shielded cable & plug for HK-3M \$2.49.

Add \$.50 Shipping & Handling.

Model AT-B anti-tip bracket only, to convert any HK-3 to HK-3M.
\$2.99 Postpaid



Model **HK-1** **\$29⁹⁵**

Add \$2.00 Shipping & Handling.

- * Dual lever squeeze paddle
- * For use with all electronic keyers
- * Heavy base with non-slip rubber feet
- * Paddles reversible for wide or close finger spacing

CC-1P shielded cable & plug for HK-1 \$3.75

Add \$.75 Shipping & Handling.

Model HK-2, same as HK-1 but less base for incorporation in your own keyer. **\$19.95**

Add \$1.00 Shipping & Handling.

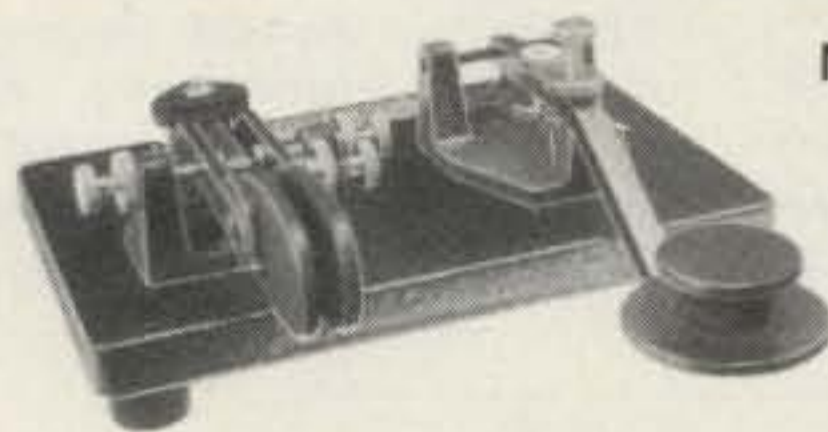

Model **HK-4**

\$44⁹⁵

Add \$2.00 Shipping & Handling.

- * Combination HK-1 & HK-3 on same base
- * Straight key may be used conventionally or as a switch to trigger a memory.

CC-1/3P Shielded cable with plugs for HK-4 \$5.99.

Add \$1.00 Shipping & Handling



Model **HK-5A** Electronic Keyer

\$69⁹⁵

Add \$2.00 Shipping & Handling.

- * Iambic circuit for squeeze keying
- * Self completing dots & dashes
- * Dot & dash memory
- * Built-in sidetone
- * Battery operated with provisions for external power
- * Uses Curtis 8044 keyer chip
- * Grid block or direct keying
- * Speed, volume, tone & weight controls on front panel
- * Use with HK-1 or HK-4

Order direct or from your favorite dealer. ✓30

The HAM-KEY Co.

P.O. Box 28271 St. Louis, MO 63132

Phone TOLL-FREE 1-800-325-3651



A Better Car Regulator

—improved reliability

Charles Gelsinger
4000 Camino Del Valle SW
Albuquerque NM 87105

The problem: In the March, 1977, issue of *73 Magazine*, an article appeared claiming a reliable, high performance automotive voltage regulator.¹

The regulator described has a major design flaw and is definitely not reliable. This design flaw caused my regulator to fail (putting 17 volts on my car's electrical system) after only 2 months of operation.

Subsequent circuit analysis and study of the LM723 specs² showed that the LM723 was being grossly overstressed and subject to catastrophic failure in the circuit as described in the original article.

The assumption that the

LM723 has a current output of 150 mA applies only to the output transistor, not the internal zener, Vz. The data sheet lists, under Absolute Maximum Ratings, that the current through the Vz zener is 25 mA, worst case. Mr. Prudhomme, in the original circuit, has over 130 mA flowing through this zener. The failure of the output stage, where Vz is located, was evident in my failed LM723 as the internal reference supply still operated properly, as measured at pin 6 of the DIP package.

The solution: Fig. 1 is the circuit I used to correct the design flaw. This improved design requires an additional transistor and resistor. I elected not to change the 51-Ω resistor used in the original article, so I placed a 6.2-volt, 1-Watt zener in series with the 51-Ω resistor

to substitute for the voltage drop of the Vz zener in the LM723.

Now the maximum current through the output transistor and the Vz zener is about 16 mA, well within the 25-mA rating of the Vz zener. This arrangement also allows the LM723 to run much cooler. The 51-Ω resistor in the original article should be a 1-Watt unit, not a 1/2-Watt one.

The original article suggests installing the regulator in a mini-box with barrier terminal connections and an additional relay to operate the dash ALT lamp. I suggest a saner, cheaper solution: Obtain a defunct regulator of the same general type as in your car. Disassemble the unit (mine is a Delco) and there will be two relay-type devices inside. The more complicated of the two is

the regulator and the other is the ALT lamp relay. The regulator can be removed by drilling out a rivet in the base of the housing. Also, remove the resistors mounted to the base of the housing by pulling them off.

Now you have a nice, watertight housing with a connector that mates to your car's electrical system with no modification, and a relay for operating the ALT lamp. All for free.

The space formerly filled by the regulator coil is filled with a small vectorboard (about 1" x 2") which has all the regulator circuitry except the pass transistor, which is mounted with an insulating washer to the base of the regulator housing. See Fig. 2 for a sketch of the mounting arrangement used.

I also changed the voltage divider values in my unit to eliminate the 500-Ω pot, a potential troublemaker in the harsh temperature environment of an automobile. I found that the .5-μF condenser normally used with the former mechanical regulator is not required and can be removed if desired.

My unit has been in operation for almost a year with no problem after the design was improved as described in this article. ■

Footnotes

1. "Build Your Own Car Regulator," W. J. Prudhomme, *73 Magazine*, March, 1977, p. 160.
2. *National Linear Data Book*, National Semiconductor Corp.

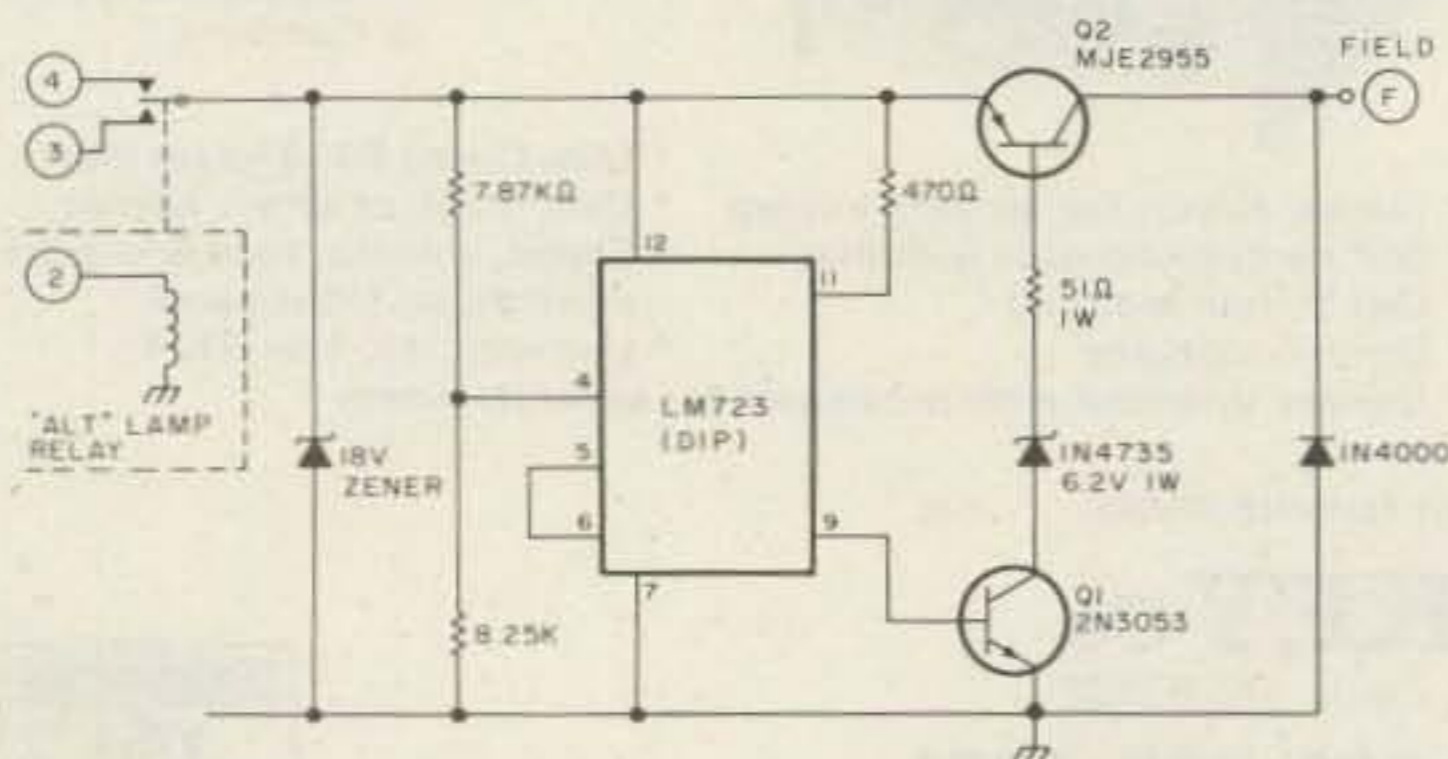

Fig. 1. Improved regulator.

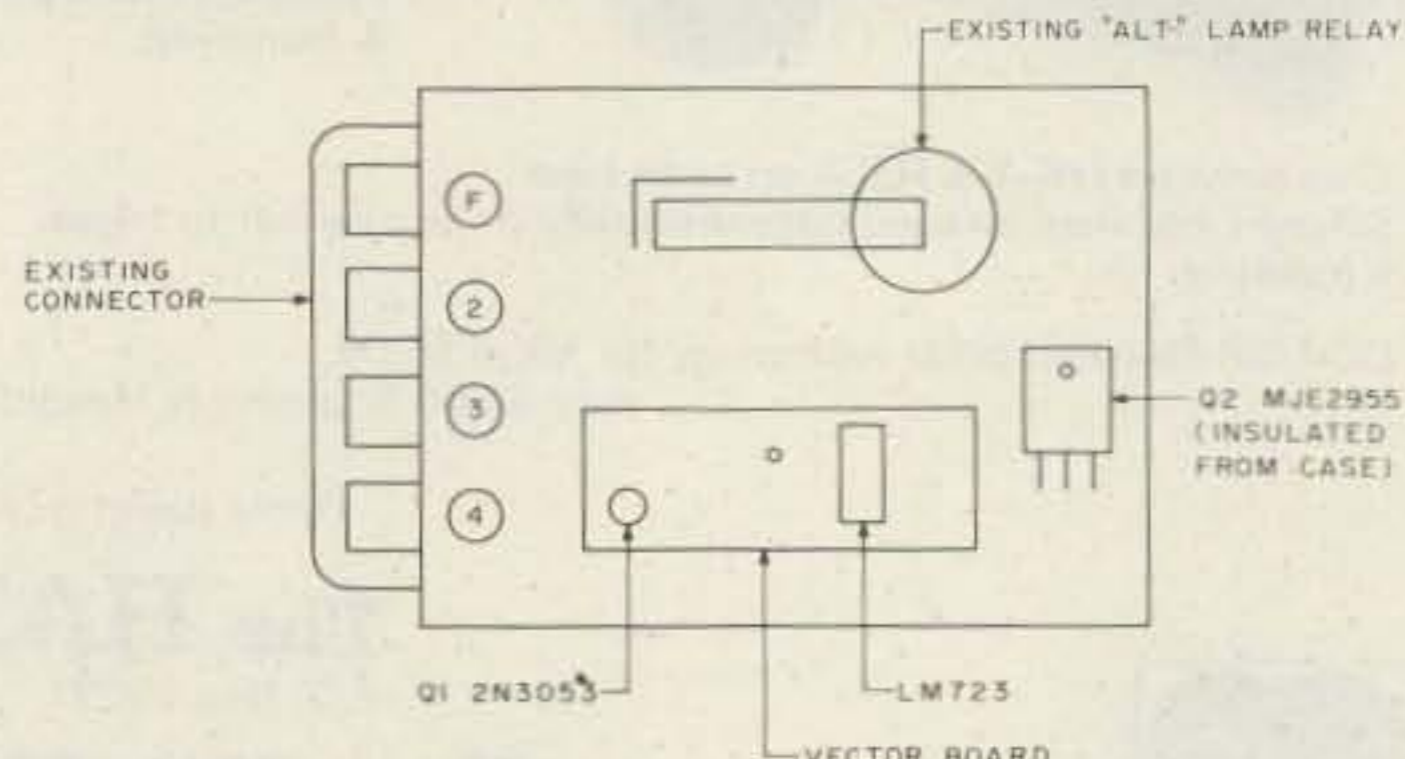

Fig. 2. Mounting arrangement in "stock" housing.

Call 1-203-667-0811

ORDER YOURS TODAY!

USED EQUIPMENT

ATLAS 210X (Special Edition) w/NB 215X w/DMK Mount 200PS Power Supply	\$429.00 399.00 69.00	HEATHKIT SB-303 Rcvr. HW-104 Xcvr. w/PS, Spkr., Filter, N. B., Mike SB-634 Console HM-102 SWR/Power Meter SB-614 Scope IM-4100 Freq. Counter	259.00 549.00 169.00 29.00 159.00 50.00
ALLIED A-2517 Xcvr w/PS/Spkr.	399.00	ICOM IC-22S 2 Meter Xcvr. IC-3PA D.C. Supply IC-245 2 Meter Xcvr.	189.00 49.00 299.00
COLLINS 75S-3B Rcvr. 75S-3 Rcvr. KWM-2 (round) Xcvr. w/516F- 2P.S. KWM-2A Xcvr. LC-1-32S Processor 516E-1 D.C. Supply	649.00 450.00 1199.00 749.00 69.00 69.00	KENWOOD TS-600 6 Meter Xcvr. TS-820S Xcvr. TS-820 (Digital Xcvr. w/CW Filter	529.00 799.00 799.00
CLEGG FM-27B 2 Meter Xcvr.	169.00	KLM I0-I60 BL 2 Meter Amp.	189.00
COMTRONIX FM-80 10 meter "FM" Xcvr.	149.00	NATIONAL NCX-5 Xcvr. w/P.S. & Spkr.	359.00
CTG Magnum Six Processor (Kenwood)	59.00	SWAN 800R Rcvr. 350 Rcvr. w/117XC P.S./ Spkr. 350A Rcvr. 250 6 Meter Xcvr. w/117XC P.S./Spkr.	399.00 349.00 349.00 289.00
DRAKE 2B Rcvr. 2BQ Q Multiplier/Spkr. R-4B Rcvr. 2C Rcvr. T-4X Xmtr. T-4XB Xmtr. TR-4CW W/RIT TR-3 W/NB RV-3 Remote VFO AC-4 Power Supply MS-4 Speaker TR-33C 2 Meter Port.	179.00 39.00 349.00 189.00 329.00 369.00 549.00 299.00 69.00 89.00 19.00 169.00	TEN TEC Triton II Xcvr. w/252P.S., CW Filter Triton IV Xcvr. w/CW Filter 540 Xcvr. w/252G P.S. 544 Xcvr. (digital) w/CW Filter	475.00 519.00 569.00 599.00
DENTRON HF200A Xcvr. w/HF-ACS P/S Spkr., Mike GLA-1000 Amp. Clipperton L Amp.	519.00 199.00 450.00	TEMPO Tempo One Xcvr. w/AC One P.S./Spkr.	3399.00
ELECTRONIC RESEARCH CORP. SL-55 Tunable Audio Filter	49.00	WILSON I402 2 meter handheld w/Xtals, Desk Charger, Nicads, Case WE-800 Synthesized Port. w/TTP	139.00 339.00
HALLICRAFTERS SX-101A w/Spkr. SX-111 Rcvr. FPM-300 Xcvr.	\$179.00 129.00 349.00	YAESU FT-301SD Xcvr. w/CW Filter, Processor FT-301D Xcvr. w/FP301 P.S. & Spkr. FT-301AD Xcvr. w/CW Filter, Mike, FP-301, P.S. & Spkr. FR-101S Rcvr. w/6 Meter Conv., FM, Xtals FT-901D Xcvr. "Demo" w/ warranty FT-901DE Xcvr. w/FM Option "Demo" w/warranty	499.00 659.00 699.00 499.00 999.00 1065.00
HENRY 100AL10 2 Meter Amp. w/PS 1220B Supply & Cabinet	229.00		

NEW EQUIPMENT SPECIALS

AZDEN PCS-2000 2 Meter Xcvr.	\$299.00	ICOM New Low Prices!	
ATLAS RX110 Rcvr. PS110H P.S. MM-110 Mobile Mnt. 215X w/N.B.	169.00 88.00 27.00 499.00	KLM I5-I60 BL 2 Meter Amp.	229.00
ALLIANCE HD-73 Rotor	119.00	KENWOOD Now in Stock! Call for Prices.	
BIRD Model 43 -	Call for Price	SWAN TB-3HA Tribander 10-40V 10-40 Meter Vertical	169.00 95.00
CDE CDE-44 Rotor	89.00	TEN TEC KR-20A Keyer KR-50 Keyer Omni A "B" Series	49.95 89.95 839.00
CUSHCRAFT ATB-34 ARX-2 ATV-5 A147-11 A50-5	199.00 31.00 89.00 32.00 54.95	YAESU FT-7B Xcvr. FT-127RA 220 Mhz Xcvr. YC-221 Display CPU2500R/K Xcvr. YO-901 W/Bandscope	589.00 399.00 99.00 419.00 449.00

We Sell and Service the Following New and Used Equipment:

Aida	DSI	Mirage
Alliance	ETO Alpha	Mosley
Ameco	Ham Key	Murch
ARRL	Hustler	PIPO
Atlas	Hy-Gain	Robot
Bencher	ICOM	Rohn
Bird	JW Miller	Saxton Wire
B & W	KDK	Shure
Callbook	KLM	SST Electronics
CDE	Larsen	Swan
CES	MFJ	Telex
Covercraft	Microlog	Ten Tec
Cushcraft		TET Antennas
Dentron		Trac
Drake		Unadilla
		VHF Engineering
		Vibroplex
		Wilson
		Wilson Commercial
		Yaesu



WE TAKE PHONE ORDERS OR SHIP C.O.D.

Call or Write for your super quote today!



WE EXPORT (Sub-Dealers wanted in foreign countries)



95 Kitts Lane, Newington, Conn. 06111
"Near ARRL Headquarters"

Connecticut Residents Call 203-667-0811
OPEN MON-FRI 10-6 • THURS 10-8 P.M. • SAT 10-4
EASY DIRECTIONS: Rt. 15 South - 2 blocks past McDonald's (Berlin Turnpike)

SUB-DEALER INQUIRIES INVITED! (Send letterhead for complete package)

When it comes to
**AMATEUR
RADIO QSL's...**



it's the
ONLY BOOK!
US or DX Listings

1980
callbooks
NOW READY!

Here they are! The latest editions. World-famous Radio Amateur Callbooks, the most respected and complete listing of radio amateurs. Lists calls, license classes, address information. Loaded with special features such as call changes, prefixes of the world, standard time charts, world-wide QSL bureaus and more. The new 1980 Radio Amateur Callbooks are available now. The U.S. Edition features over 400,000 listings, over 120,000 changes from last year. The Foreign Edition, over 315,000 listings, over 90,000 call changes. Place your order now.

	Each	Shipping	Total
<input type="checkbox"/> US Callbook	\$16.95	\$1.75	\$18.70
<input type="checkbox"/> Foreign Callbook	\$15.95	\$1.75	\$17.70

Order both books at the same time for \$34.65, includes shipping.

Order from your favorite electronics dealer or direct from the publisher. All direct orders add \$1.75 for shipping, Illinois residents add 5% Sales Tax.



SPECIAL LIMITED OFFER!
Amateur Radio
Emblem Patch
only \$2.50 postpaid

Pegasus on blue field, red lettering. 3" wide x 3" high. Great on jackets and caps. Sorry, no call letters.

ORDER TODAY!

✓61

RADIO AMATEUR
callbook INC.



925 Sherwood Drive
Lake Bluff, IL 60044

Tired of High Prices?

Tired of playing roulette with "800" number specials? Forget the toll-free frustration. Take a shortcut and call Long Path Radio. We deliver low prices from the ground up—on towers, rotators, antennas, and accessories. Our goal is to have what you want in stock.

Take a look at the complete line:

HyGain Antennas	HDBX48 self	16 element-
TH6DXX	supp. tower ..	2 meter
TH5DX	HDBX56 self	\$ 55.00
TH3MK3	supp. tower ..	CDE Rotators
TH2MK3	3/16 EHS guy wire,	Call or write for your low
TH3JR	500 ft.	price.
105BA	3/16 CCM cable	Cushcraft Antennas
155BA	clamp	ATB34 Tribander ..
205BA	1/4 turnbuckle,	\$199.00
204BA	eye & eye	20-3CD
402B	M200H 10 ft.	\$133.00
DB1015A	H.D. galvanized	20-4CD
18AVT	mast	\$222.00
14AVQ	Tonna F9FT	15-3CD
BN86	4 element-	\$ 76.00
	2 meter	15-4CD
	9 element-	\$ 87.00
	2 meter	10-3CD
Rohn Towers		\$ 54.00
25G section		10-4CD
45G section		\$ 66.00
		ATV-4
		\$ 74.00
		ATV-5
		\$ 82.00
		ARX-2
		\$ 30.00
		ARX-450
		\$ 30.00
		A-147-11
		\$ 30.00
		32-19 Boomer ...
		\$ 65.00

Except for Rohn towers, all items shown are complete stock. Sorry, no other products available.

We're here to serve you from 8:30 to 5:00, Monday through Friday, at 1-214-369-3401. Ask for Long Path Radio.

LONG PATH RADIO, INC. ✓84

P.O. Box 29682/Dallas, Texas 75229/1-214-369-3401

TERMS:

All prices F.O.B. Dallas. C.O.D. requires 25% deposit. Money order, cashier's check, O.K. No personal checks. We ship freight collect. If you desire prepaid freight, a small Per Item charge will be made for shipping and handling.

APPLE Owners
send & receive
CW/RTTY



FEATURES

- Send & Receive MORSE, BAUDOT, ASCII.
- Connects to APPLE game I/O port
- Split Screen - edit while receiving.
- Uses builtin PLL or external TU

- Includes hardware, cassettes & manual.
- Word Oriented Editor.
- Instant Break operation—preserve type-ahead buffer.
- Eight message memories—255 char. ea.
- Auto transmitter control—PTT.
- Diddle, Replay, Cassette Save, CW ID (RTTY only).
- Random Practice, Beacon, change spacing (Morse only).
- CA650 In cabinet as illustrated \$259
- TA650 FFD-1 active filter RTTY demodulator.
- XTL-1 xtal controlled AFSK and AC power supply installed in CA650 (assembled/tested) \$499

Write or call for complete catalog



MACROTRONICS, inc. ® ✓44

1125 N. Golden State Blvd. / Suite G
Turlock, CA 95380 (S)
(209) 667-2888 / 634-8888



We are experiencing telephone difficulties,
please keep trying.

California residents add 6% tax

Plug-in Transistor Oscillators

HIGH FREQUENCY (20 MHz — 160 MHz)

- Signal Generators For Receiver Alignment
 - Quick-Change Plug-In Oscillators
- Five transistor oscillators covering 20 MHz-160 MHz. Standard 77°F calibration tolerance $\pm .0025\%$. The frequency tolerance is $\pm .0035\%$. Oscillator output is .2 volts (min.) across 51 ohms. Power requirement: 9 vdc @ 10 ma. max.

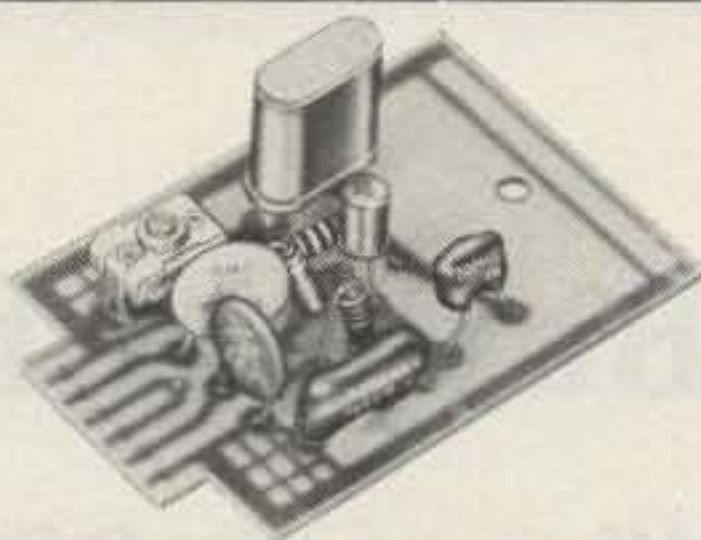

Catalog Number	Oscillator Type	Oscillator Range	Temperature Tol. -40°F to 150°F	Oscillator (Less Crystal) Price
035200	OT-124	20-40 MHz	$\pm .0035\%$	\$9.28
035201	OT-146	40-60 MHz	$\pm .0035\%$	9.28
035202	OT-161	60-100 MHz	$\pm .0035\%$	9.28
035203	OT-1140	100-140 MHz	$\pm .0035\%$	9.28
035204	OT-1160	145-160 MHz	$\pm .0035\%$	9.28

LOW FREQUENCY (70 KHz - 20,000 KHz)

- Band Edge Markers
- Frequency Markers For Oscilloscopes
- Portable Signal Standards
- Accessory Cases

Four transistor oscillators covering 70 KHz — 20,000 KHz. Trimmer capacitor for zeroing crystal. When oscillator is ordered with crystal the standard will be $\pm .0025\%$. Oscillator output is 1 volt (min.) across 470 ohms. Power requirement: 9 vdc @ 10 ma. max.

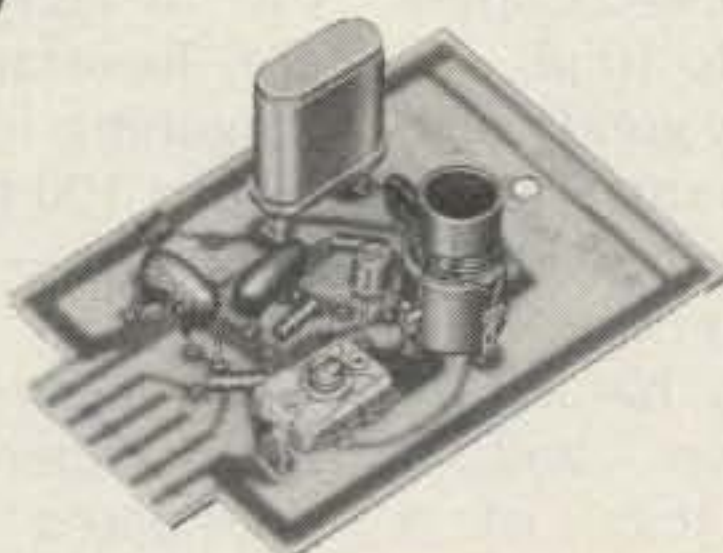

Catalog Number	Oscillator Type	Oscillator Range	Temperature Tol. -40°F to 150°F	Oscillator (Less Crystal) Price
035205	OT-11	70-150 KHz	$\pm .015\%$	\$9.28
035206	OT-12A	150-400 KHz	200-600 KHz $\pm .01\%$	9.28
035207	OT-12	400-5,000 KHz	600-5,000 KHz $\pm .0035\%$	9.28
035208	OT-13	2,000-12,000 KHz	$\pm .0035\%$	9.28
035209	OT-14	10,000-20,000 KHz	$\pm .0035\%$	9.28

SUPPLEMENTAL CRYSTAL ORDERING INFORMATION FOR ICM OSCILLATORS

Please refer to the "4" Series Crystal Specification Sheets. (Available on request.) Prices on crystals will vary with frequency being ordered.

CALIBRATION TEMPERATURE:

Customer's choice, usually 26°C.

RANGE: Depends on crystal frequency being ordered.

TYPE: CS ② is recommended.

HOLDER:

F-605 ① for all except crystals below 160 KHz.

F-13 ③ required for crystals below 160 KHz.

LOAD:

OT-11, OT-12, OT-12A ... 24PF ④
OT-13, OT-14 ... 20PF ③

OT-124, OT-146, OT-161, OT-1140, OT-1160 SERIES ①
ALIGNMENT OSCILLATORS,
Models 812, 814 32PF ⑤

Note: Circled numbers refer to numbers on Crystal Specification Sheets.

EXAMPLES

OT-11 Catalog Number = 4 1 1 2 8 4
(75 KHz*, CS, F-13 Holder, 24PF)

OT-14 Catalog Number = 4 3 3 2 1 3
(10.5 MHz*, CS, F-605 Holder, 20PF)

OT-1140 Catalog Number = 4 7 4 2 1 0
(120 MHz*, CS, F-605 Holder, Series)

*All "4" Series Catalog Numbers require crystal frequency specified by Customer.

FOR ADDITIONAL INFORMATION WRITE:



36

INTERNATIONAL CRYSTAL MFG. CO. INC. • 10 NORTH LEE • OKLAHOMA CITY, OKLA. 73102

MFJ KEYERS

Uses Curtis 8044 IC. All have dot-dash memories, weight control, solid state keying. RF proof.



BRAND NEW

\$69⁹⁵

The NEW MFJ-406 Deluxe Electronic Keyer sends iambic, automatic, semi-automatic, manual. Use squeeze, single lever or straight key.

Socket for external Curtis memory, random code generator, keyboard. Optional cable, \$3.00.

Iambic operation with squeeze key. Dot-dash insertion. Semi-automatic "bug" operation provides automatic dots and manual dashes.

Dot-dash memory, self-completing dots and dashes, jam-proof spacing, instant start. RF proof.

Solid-state keying: grid block, solid state xmtrs.

Front panel controls: linear speed, weight, tone, volume, function switch, 8 to 50 WPM.

Weight control adjusts dot-dash space ratio; makes your signal distinctive to penetrate ORM.

Tone control. Speaker. Ideal for classroom.

Function switch selects off, on, semi-automatic/manual, tune. Tune keys transmitter for tuning.

Uses 4 C-cells. 2.5 mm phone jacks for external power (6-9 VDC). Optional AC adapter \$7.95.

Eggshell white, walnut sides. 6x2x6 inches. Optional Bencher Iambic Paddle, \$39.95.

\$49⁹⁵



The MFJ-400 8044 IC Econo Keyer is a reliable, full feature economy keyer for squeeze, single lever or straight key.

Sidetone, speaker, volume, speed, internal weight and tone controls. Pull-to-tune switch. On-off. Iambic operation. Dot-dash memories. 8 to 50 WPM. Uses 9 V battery. 2x3x4 inches.

Reliable solid state keying: grid block, cathode solid state transmitters.



\$59⁹⁵



\$44⁹⁵

MFJ-404 8044 IC ECONO KEYER at \$59.95 has adjustable single paddle, sidetone, speaker, weight, tone, volume, speed controls. Dot-dash memories. 8 to 50 WPM. Solid state keying. 2x3x4 inches. Uses 9 V battery. Switch for TUNE, OFF, ON, SIDETONE OFF. Jacks for external key. Iambic with squeeze key.

MFJ-402 8044 IC ECONO KEYER. \$44.95. Paddle, weight, speed controls. Dot-dash memories. 8 to 50 WPM. 2x3x4 inches. Uses 9 V battery. No sidetone and jacks for external key.

Order from MFJ and try it. If not delighted, return within 30 days for refund (less shipping).

One year unconditional guarantee.

Order yours today. Call toll free 800-647-1800. Charge VISA, MC. Or mail check, money order. Add \$3.00 each for shipping and handling.

CALL TOLL FREE ... 800-647-1800

Call 601-323-5869 for technical information, order/repair status. Also call 601-323-5869 outside continental USA and in Mississippi.

MFJ ENTERPRISES, INC.
BOX 494, MISSISSIPPI STATE, MS 39762

Test Gear Bargain from Heath

— a multi-purpose RCL bridge

The new Heath 5280 series of test instruments appeared, at first glance, as probably not offering very much because of the low prices. One of the first pieces of the series that we noticed was the IB-5281 RCL Bridge. It claimed the following measurement ranges:

Resistance—10 Ohms to 10 megohms; Inductance—10 μ H to 10 henrys; and Capacitance—10 pF to 10 μ F.

This is a fairly good range of measurement. Much more expensive test equipment, such as even the Heath IB-3128, hardly offers much more, and in some cases less, of a

measurement range. The measurement ranges for the IB-3128, for example, are: Resistance—0.1 to 10 megohms; Inductance—0.1 mH to 100 henrys; and Capacitance—100 pF to 100 μ F.

Of course, there are many other factors to be considered than just the measurement ranges—the accuracy of measurement being an obvious one.

As it turns out, however, the IB-5281 is much more of a sophisticated little piece of test equipment than meets the eye. Perhaps the first thing one notices when looking at the kit is that there are a fair number of parts involved for the 10-transistor circuitry used.

In fact, the average amateur would probably find it difficult to buy the electronic parts for the cost of the whole kit.

The circuitry used in the kit is not new in basic principles, but it has been very neatly implemented. The bridge operates on the basic Wheatstone bridge applied to RCL components as shown in Fig. 1. A reference R, C, or L component is used which is compared with an unknown component by balancing a bridge circuit. When the bridge circuit is balanced, the meter reads zero. The balancing potentiometer's rotation can be calibrated in terms of how far in value the unknown component's value is above or below the value of the reference component. Theoretically, any value component can be measured, but in practice there are many limitations, particularly when either very small value or very large value components are involved.

A partial diagram of the Heath bridge is shown in Fig. 2 and illustrates some of the very interesting features found in the unit. The ac source, or oscillator, is a rather elaborate five-transistor FET type. Part of the

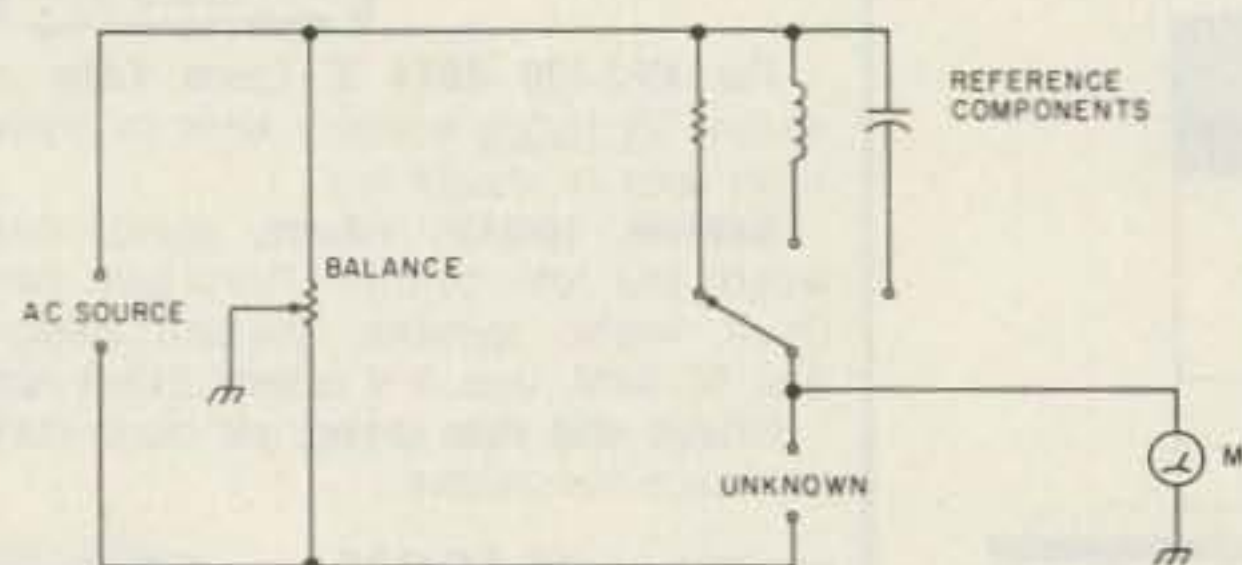

Fig. 1. Basic Wheatstone bridge type of circuit used with reference R, L, and C components compared to an unknown component to determine its value.

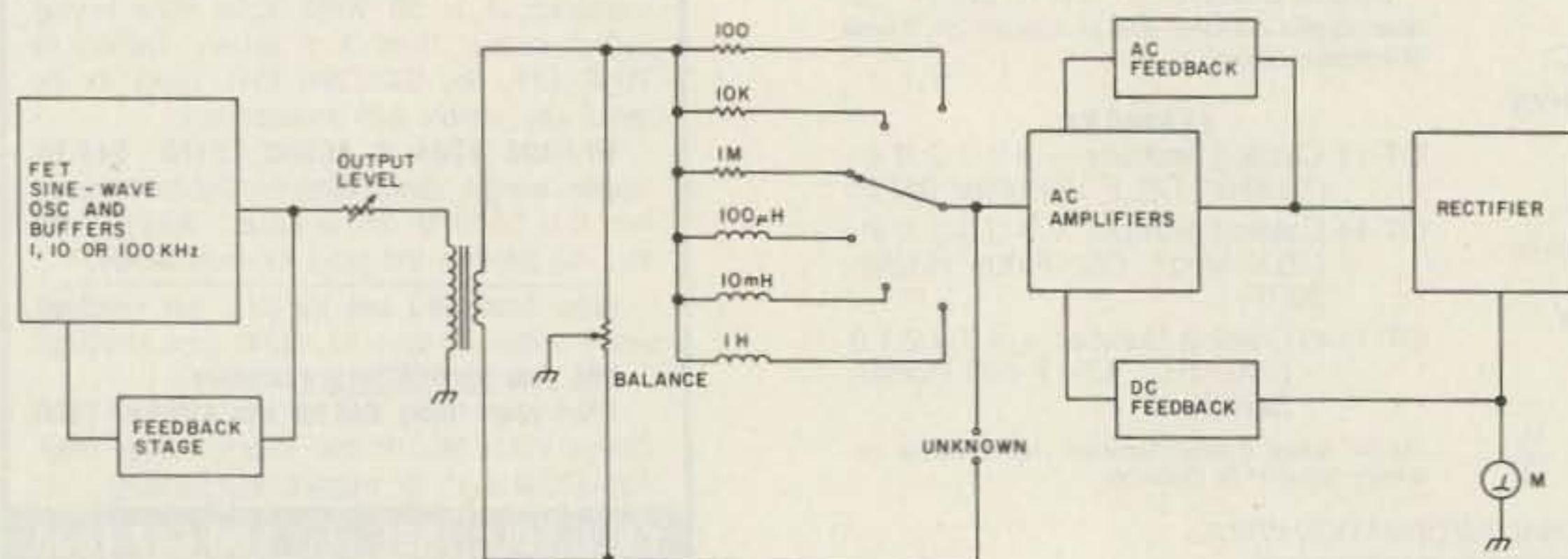

Fig. 2. As this partial diagram shows, quite a bit of design work has gone into the circuitry of the IB-5281. Only the R and L reference components are shown; there are also three reference capacitors in the actual circuit. In addition, provision is made for the use of an external reference R, L, or C component, if desired.

output is rectified, and a feedback arrangement is employed to control the gain of the oscillator. This provides better control than the usual lamp arrangement found in simpler oscillators. The oscillator also operates at three different frequencies: 1, 10, or 100 kHz, depending on the range selected for each R, L, or C component. This is a great improvement over simpler bridges which have just a 1-kHz oscillator. It becomes very difficult with such oscillators to measure small values of inductance or capacitance since one is basically trying to measure component values used at rf frequencies in a low-frequency audio-type test arrangement.

The oscillator output is coupled through the transformer, T1. The secondary of this transformer forms a balanced ac source arrangement for the actual bridge circuit. The transformer has a very low impedance, and this plays a major role in the good performance of the bridge. The actual bridge circuit is formed by the rest of the components shown. There are three ranges for each type of component. Although to simplify the diagram only three reference components are shown for resistance and inductance measurements, there are also three reference capacitors in the actual circuit.

The output of the bridge goes to a five-stage ac amplifier and rectifier which drive a meter for a null indication. The amplifier stages are relatively sophisticated in design, with both ac and dc feedback incorporated to enhance circuit stability.

The construction of the bridge is relatively straightforward. Most of the components mount on a single PC board. Perhaps the only

area where a newcomer should take time and be especially careful in construction is in wiring up the range switch. A number of components mount on the switch itself and if one doesn't get this four-wafer switch wired correctly, it could cost a lot of troubleshooting time to correct it.

If it were not for the switch, one could rate the construction as simple. However, the assembly manual is very detailed, and anyone who has a basic proficiency in soldering should be able to assemble the kit. An experienced builder can assemble the kit in two evenings, while others might take up to double that time.

Performance, considering the price of the bridge, can be termed as excellent. It is not a super-accurate bridge, where one can read the difference between 100 Ohms and 102 Ohms, for instance, but one certainly can find quickly the approximate value of any components. The bridge was tried with a variety of unmarked capacitors and coils, and the values obtained compared with those obtained on a laboratory bridge. In all

cases, the values checked out closely enough for most experimental uses, and there is absolutely no doubt about separating standard-size component values (.005-, .01-, .02-, .05-, and .1-uF capacitors, for example). The bridge was particularly good when measuring a variety of inductors. Air-wound coils, ferrite-core coils, slug-tuned coils, rf chokes, etc., all produced clear null indications quickly. In fact, some of the inductors tried could not be measured on the laboratory bridge (unless one wanted to spend hours at it) because of trying to compensate for their different Qs.

A look at the rear of the unit reveals that there is a lot of unused volume in the enclosure. Heath undoubtedly took the route of using a standard-size enclosure for all the IB-5280 series test instruments, for economy reasons. There is room in the enclosure to store two extra of the 9-volt transistor radio batteries which are needed to power the bridge. However, one could also easily build a dual 9-volt ac supply in the enclosure and have room to spare.

The bridge as it stands is a fine little test instrument and nicely fills the gap for those who like to do a bit of circuit experimenting where component values need to be measured, but do not have the need for a laboratory-grade bridge. In trying to think of ancillary uses for the bridge, the use of the audio oscillator and ac amplifier came to mind.

The audio oscillator probably could be made variable by the use of a dual potentiometer to augment the fixed value resistors which are switched in for 1-, 10-, or 100-kHz output. As it stands, the fixed frequencies could provide very stable sine-wave test signals with very low distortion. The ac amplifier/rectifier was measured to be able to detect rf signals all the way up to 17 MHz! So, it could be used as it stands as a tuning indicator for low-frequency rf signals and probably could be turned into a very sensitive field-strength meter by augmenting the bypassing for rf frequencies. The input to the amplifier/rectifier can be accessed from the front panel, without modification, via the "Z's" terminals. ■

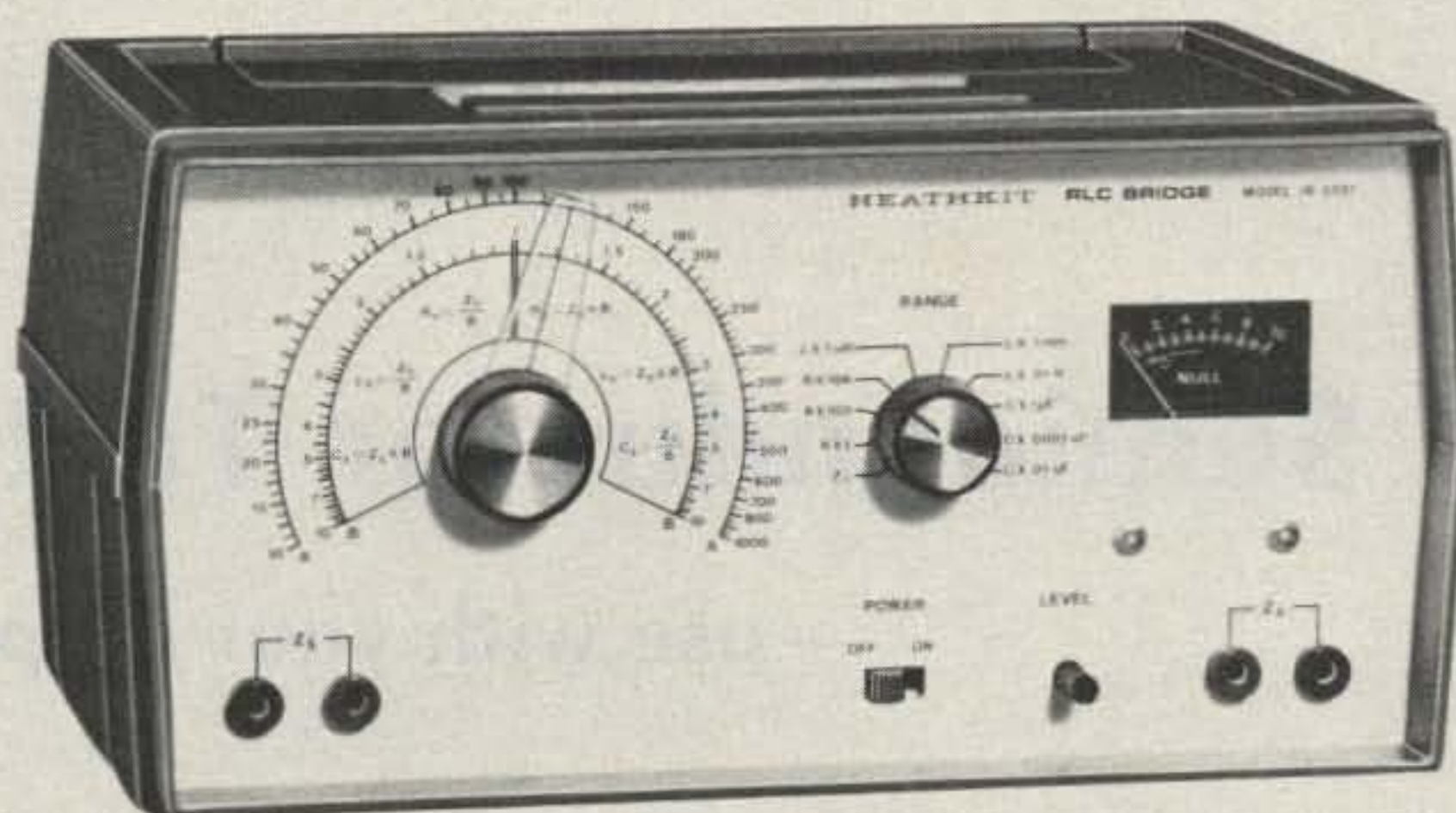

Photo A. The Heath IB-5281.

Semiconductor Test Gadget

— use with your scope

Transistor testers come in many assorted kits and variations providing confusing data such as BV_{cbo} , BV_{ces} , BV_{evo} , $R2D2$, $C3p0$, and so on. All I want to know is if the transistor or diode is good or bad.

This transistor/diode tester tells you just that. With a glance at an oscilloscope face, you can see shorts, opens, and leakage between collector and emitter and determine the overall quality of the transistor in a matter of seconds.

All you need is an oscilloscope that works reasonably well, a 110/6.3-volt transformer, 2 resistors, an SPST switch, and a set of probes.

The transformer provides low power to the transistor or diode to be tested and is read directly on the oscilloscope face.

An In-Circuit or Out-of-Circuit switch is provided so that the transistor or diode does not have to be

removed from the circuit to be checked. However, I feel the transistor is checked best if removed; this is a matter of personal preference.

At the In-Circuit position, both resistors are in series providing the lowest current applied to the circuit. This low current, 1 mA or less, should not harm surrounding components associated with the transistor or diode being tested.

This transistor/diode tester is to be used on de-energized circuits only. I have not used it on an energized circuit, but I feel it will be of no real value there.

I built two transistor/diode testers. The first was a portable model encased in a metal box which I hooked up to a friend's oscilloscope. When I got my own oscilloscope, I hooked to the filament transformer, installed an on/off switch, mounted the resistors, wired directly to the ver-

tical and horizontal inputs, and then ran the test probes out the side of the case. Now, with the flip of a switch, I have the transistor/diode tester ready to use.

After the tester is installed, touch the probes together. The scope will go from its normal horizontal line to a vertical line. Adjust the horizontal and vertical gains so that the line will be the same length both vertically and horizontally. Adjust the centering of both vertical and horizontal positioning so that the line will be in the center of the scope. You are now ready to check transistors and

diodes.

Select a transistor from the junk box; determine if it is silicon or germanium and hold one probe on the base and touch the other probe to the collector or emitter. If the transistor is good, the screen should show a right angle. (If it is inverted, it doesn't matter; just turn your probes around.) Now read from collector to emitter. A straight line should show. This is a good silicon transistor.

Germanium transistors give a reading that will be slightly different. From collector to emitter only, they will give some type of right angle. With germanium transistors, I recommend that you compare them with others of the same number out of the circuit.

Figs. 2 and 3 will give you an idea of what to expect on your oscilloscope. Some of them can be confusing when checking transistors or diodes at the In-Circuit position; this is why I feel that Out-of-Circuit is best used to check transistors and diodes. However, after some experience using this device and a little circuit tracing to find resistors and capacitors used in conjunction with the transistor or diode, you should be able to determine with some degree of accuracy if the circuit is operational. ■

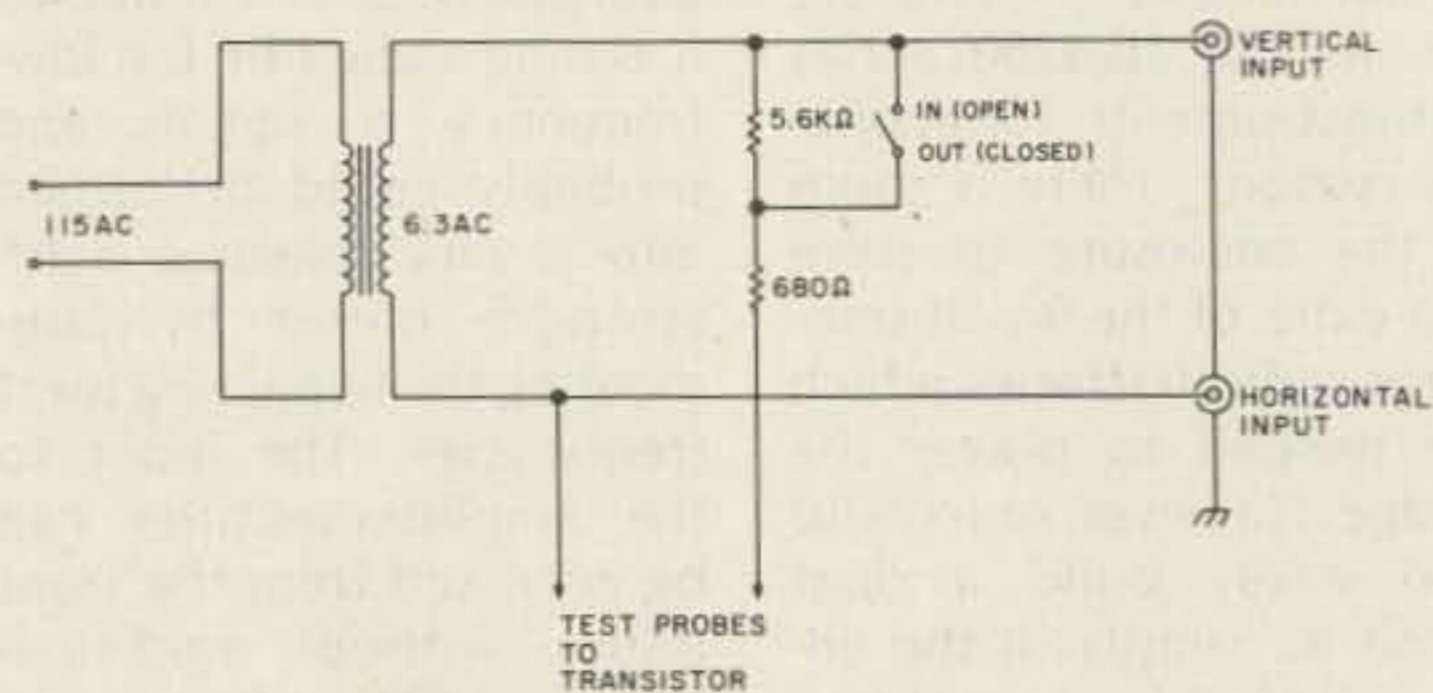

Fig. 1.

SHORT	
OPEN	-
RESISTIVE	/
CAPACITIVE	o o o
RESISTIVE / CAPACITIVE	o r
RESISTIVE / INDUCTIVE	l

Fig. 2. In-Circuit readings.

TRANSISTORS (GOOD)	
SILICON	GERMANIUM
BE	└
BC	└
CE	-
TRANSISTORS (BAD)	
BE	(SHORT) - (OPEN)
BC	(SHORT) - (OPEN)
CE	(SHORT) └ (LEAKAGE / SILICON)
	└ (LEAKAGE / GERMANIUM)
DIODES (GOOD)	
ALL DIODES EXCEPT ZENERS	
	└

Fig. 3. Out-of-Circuit readings.

CALL TOLL FREE
1-800-228-4097

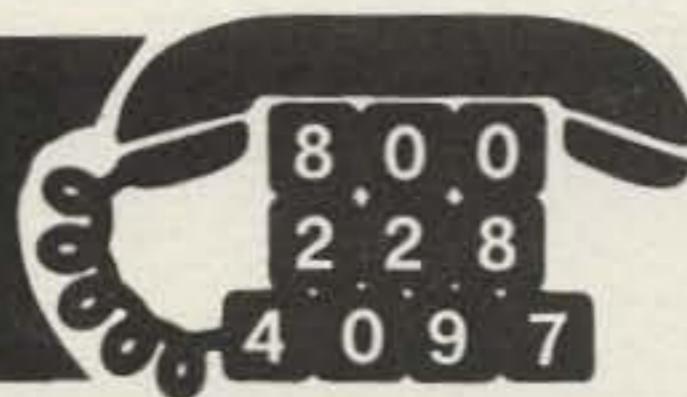

SPRING CLEANING SPECIALS



Telex Model 88
 Headset only \$49.95



NEW Kenwood R-1000
 Receiver
 List \$499.95
 Call for discount price

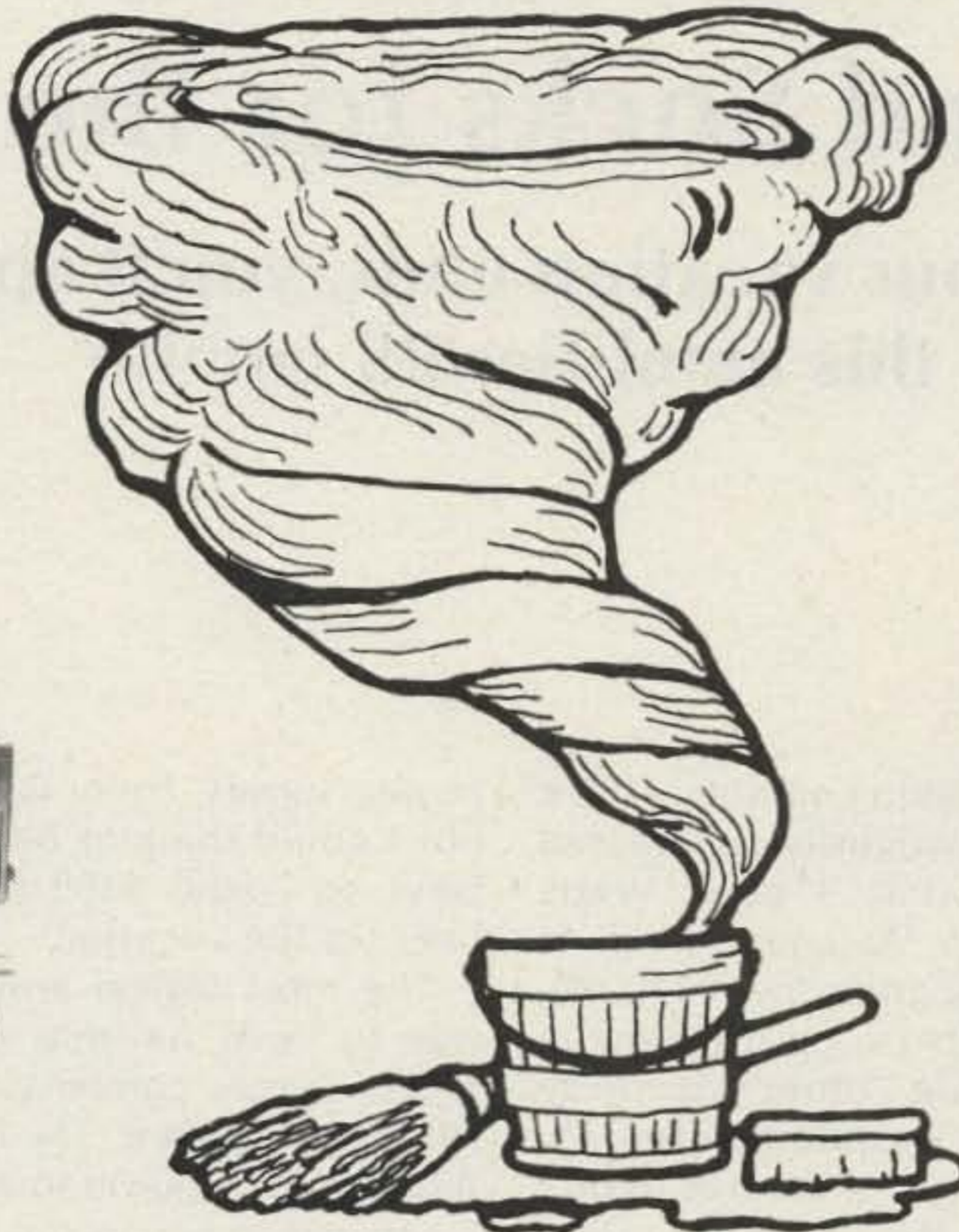

Dentron GLA-1000
 Amplifier
 Only \$299.95



Panasonic RF-4900
 General Coverage Receiver
 List \$549.95
 Ours - \$399.95

SPRING CLEANING SUPER SAVERS

		REGULAR	CLEAN OUT
Yaesu CPU-2500RK	FM Mobile	\$ 585.00	\$ 399.00
Yaesu FT-227RB	2 Mtr. Mobile	425.00	339.95
Yaesu FT-225RD	2 Mtr. Base	895.00	669.95
Yaesu FT-625RD	6 Mtr. Base	895.00	669.95
Yaesu FT-901DM	H.F. Transceiver	1459.00	1199.95
Yaesu FRG-7000	General Coverage Receiver	655.00	519.95
Midland 13-1510A	2 Meter Mobile	439.95	329.95
Drake MN-4C	Antenna Tuner	165.00	119.95
Swan MKII	2KW Linear Amp.	995.00	799.00
Avanti AH151.3	Thru the Glass Antenna	34.95	29.95
Tempo S-1	Synthesized hand held	299.95	269.95
Bencher BY-1	Paddle	39.95	36.95
Drake TR7/DR7	H.F. Transceiver	1395.00	1219.95
CDE Ham 4	Rotor	199.95	149.95
CDE Tailtwister	Rotor	299.95	199.95
Alliance HD-73	Rotor	154.95	109.95
Hygain 3750	H.F. Transceiver	1995.00	CALL
Kenwood TS-520SE	H.F. Transceiver	629.95	CALL
Kenwood TS-120S	H.F. Transceiver	699.95	CALL
Kenwood TS-180S	H.F. Transceiver	1149.95	CALL
Kenwood TR-7600	2 Mtr. Mobile	375.00	CALL

Antenna Sale!

		Regular	Special
HY-GAIN			
TH6DX	Super Thunderbird	\$329.95	\$259.95
TH3MK3	3 el. 10-15-20M beam	222.95	179.95
TH3JR	3 el. 10-15-20M beam	169.95	139.95
Hy-Quad	2 el. 10-15-20M Quao	274.95	219.95
205BA	5 el. "Long John" 20M beam	329.95	259.95
155BA	5 el. "Long John" 15M beam	199.95	159.95
105BA	5 el. "Long John" 10M beam	129.95	109.95
204BA	4 el. 20M beam	249.95	199.95
204MK5	5 el. conversion kit	99.95	79.95
153BA	3 el. 15M beam	89.95	79.95
103BA	3 el. 10M beam	74.95	59.95
402BA	2 el. 40M beam	239.95	189.95
BN-86	Balun for beam antennas	15.95	15.95
TH2MK3	2 el. 10-15-20M beam	149.95	119.95
18HT	Hy-Tower 80-10M vertical	\$359.95	\$289.95
18AVT/WB	80-10M Trap vertical	105.95	84.95
14AVQ/WB	40-10M Trap vertical	69.95	57.00
12AVQ	20-10M Trap Vertical	42.95	34.95
14RMQ	Roof Mounting kit (verticals)	33.95	29.95
58DQ	80-10M Trap doublet	109.95	89.95
28DQ	80-40M Trap doublet	59.95	49.95
66B	6 el. 6M beam	119.95	99.95
203	3 el. 2M beam	15.95	
205	5 el. 2M beam	21.95	
208	8 el. 2M beam	29.95	
214	14 el. 2M beam	34.95	
LA-1	Deluxe lightning arrestor	59.95	49.95
TH5DX		269.95	209.95

Call for discounts on Cushcraft, Mosley, Hustler

We Export

Communications Center

443 N. 48th, Lincoln, Nebraska 68504

In Nebraska Call (402)466-8402



Shoes and Socks for the IC-502

— when your vacation ends, you'll appreciate this amplifier/PS combo

Well, at last, my "vacation 6 meter special" radio had arrived—an Icom IC-502. I have now put it into action with my 6 meter beam (a Hilltopper) and have managed to work some good ground-wave from our local mountaintop and some occa-

sional skip contacts. I have been mightily impressed with what 3 puny Watts can do. As usual, back at the vacation special home, 3 Watts isn't putting me in the big time, so more power is contemplated. My first impression was to procure the 10-Watt amp/

power supply from Icom, but I could think of better ways to spend \$169 (like beer for the vacation).

The most logical answer was to build an amp and power supply combination. Now, how to do it. The first problem is the power source. I can remember in my CB

radio service days how many manufacturers used one transformer for the 12 V vibrator supply and 117 V ac. After scrounging one of these transformers from an old Gonset CB rig, I applied 117 V ac to the primary and discovered that the vibrator winding now had 19-20 V ac coming out—a center-tapped winding even! How perfect for obtaining 13 V dc from a full-wave rectifier. The other 2 windings had 12 V ac for filament and 250 V ac (no c-t). The 250 V ac with a full-wave bridge rectifier would net me 350 V dc at 80 mA—just perfect for a 30-Watt input amplifier! Now, with 350 V of B+, 12 V for filament, and 3 Watts of rf drive, I figured a 12JB6 tube would be perfect. They come cheap and I have plenty of spares from my Drake TR-3.

As one can see from Fig. 1, the circuit is simple and straightforward. A 12JB6 tube is used in a grounded-grid configuration with a shunt-fed tank output for ease of adjustment and

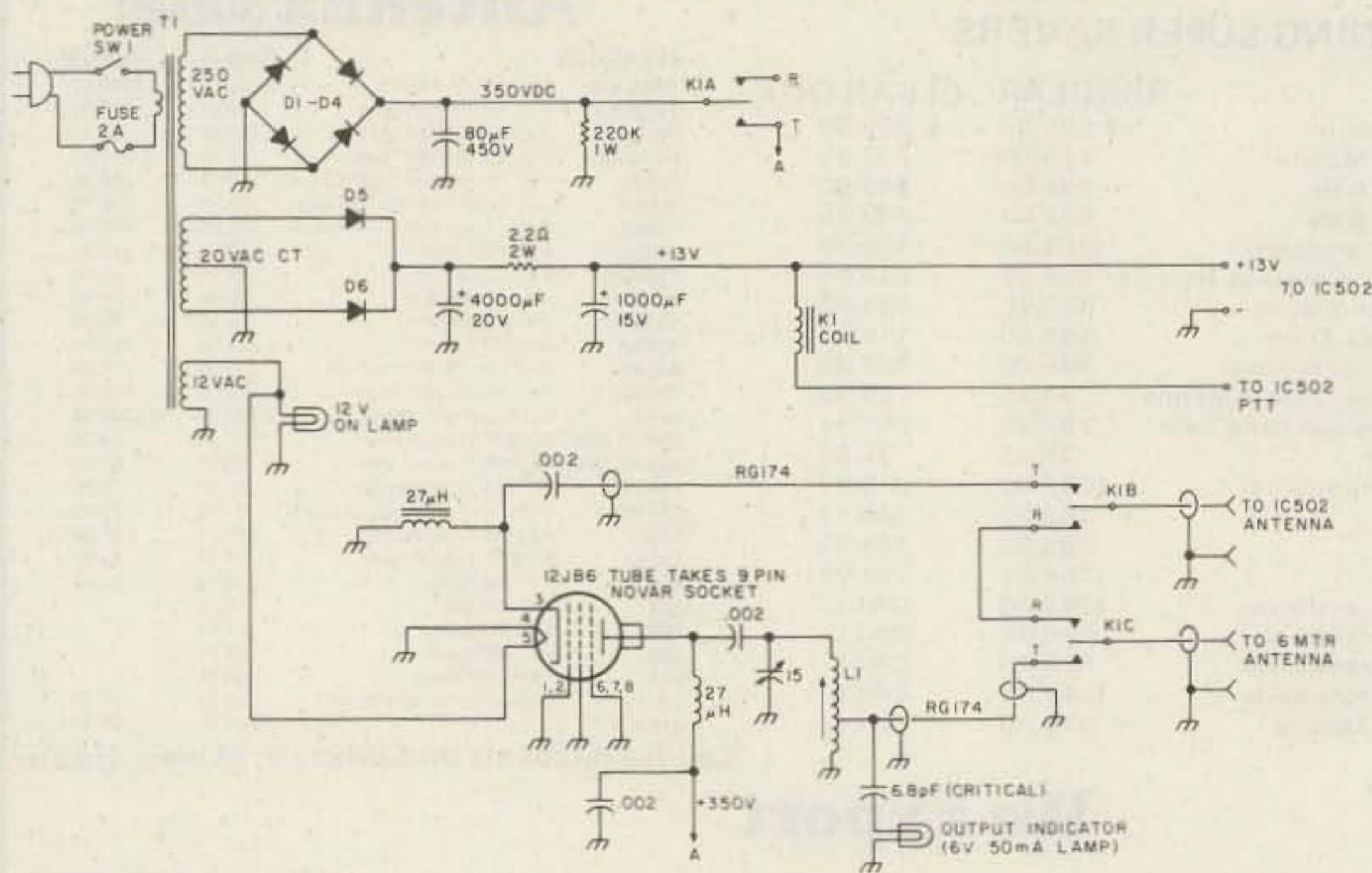

Fig. 1. Circuit diagram. T1—vibrator/ac power transformer from 12 V CB tube radio with 250 V ac, 20 V ac c-t, and 12 V ac secondaries. K1—3PDT miniature relay with 12 V dc coil. D1-4—1000 piv 1-Amp diodes. D5, 6—50 piv 3-Amp diodes. L1—8 turns #20 on 3/8" slug form tapped 1½ to 3 turns from ground end (adjust for max output).

simplicity. Mechanically, I used 2 chassis, 3" x 5" x 7" and 2" x 5" x 7". I bolted both chassis together top to top. I used 2 bottom plates, one for the bottom of the lower chassis (2" x 5" x 7") and one to cover the now top of the upper chassis (3" x 5" x 7"). This made a nice cabinet for the whole ball of wax. The 12JB6 stands upright into the 3" x 5" x 7" chassis from the 2" x 5" x 7" chassis, being countersunk about 3/4" to accommodate the plate cap of the tube. Parts placement is not critical, but keep rf leads short. The plate circuit was mounted on the now "front panel" of the upper 3" x 5" x 7" chassis, along with the output indicator lamp (meters are too expensive for me). Leads for 13 V dc are brought out the back of the cabinet for IC-502 power,

along with the keying lead. The keying lead goes into the IC-502 CW key jack and fastens to the mic jack inside the K502 at the PTT line. Obviously, you must open up the 502 to accomplish this task.

After building the amplifier, carefully check your wiring and solder joints. Apply 117 V ac, turn switch S1 on, and check all voltages. If the power supply passes the smoke test, hook up the IC-502 and apply drive. You should have immediate success. Peak the final plate for maximum output (maximum brilliance on output lamp). If the final plate capacitor doesn't peak near center mesh, adjust coil L1. With a full 3 Watts drive, you should obtain up to 16 big-time Watts output. One model I built netted me 20 Watts output. Good DX-ing. ■

★ YOU ASKED FOR IT ★

A COMPLETE REPEATER STARRING THE MARK 3C SUPERCONTROLLER

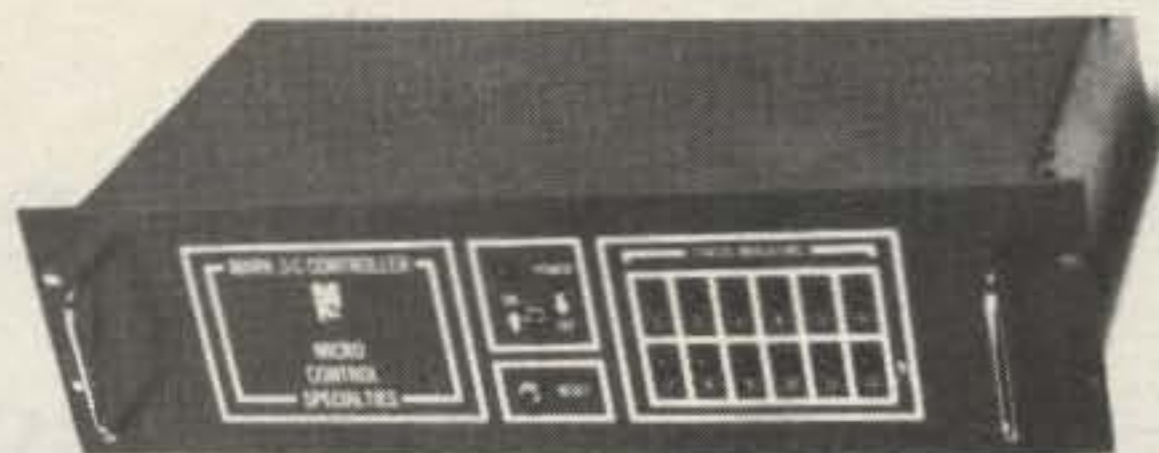

ALL the unique features which make Mark 3C the acclaimed leader in repeater control —

- Autopatch
- Reverse patch
- Autodial
- 40 Functions
- 13 Morse messages
- Custom tail messages
- Digital tone decoding
- Microprocessor control

MARK 3-C CONTROLLER \$995.

AND NOW, even the repeater is built in —

- Receiver sens. 0.25 UV
- Super crisp audio
- Transmitter output 2W

PLUS options —

- Power amplifiers (pick your level)
- Sub-audible tone
- Control receivers

MARK 3CR REPEATER

144-220 \$1495. Introductory price.

Call or write for specifications

MICRO CONTROL SPECIALTIES (617) 372-3442
23 Elm Park, Groveland, Ma. 01834

✓ 49

DIELECTRIC'S RF MEASUREMENT EQUIPMENT

Dielectric — the leader in RF measurement equipment offers a variety of RF products for the communications industry.

Dielectric's new 1000-A RF Directional Wattmeter, well



on its way to becoming the industry standard, accepts plug-in range elements for power measurements from 100 mW to 5000 watts at 2 MHz to 1 GHz. The 1000-A, with ± 5% full scale accuracy, offers the highest available resolution. The large 4½" mirrored-scale meter makes the 1000-A the

easiest to read of any wattmeter on the market.

Terminating Load Resistors range from a 5 W dry load to a 50 KW heat-exchanger load. Low power dry loads up to 150 watts are available as well as high power water-cooled or heat-exchanger loads up to 50 KW. In addition, liquid dielectric/air convection loads with a power range to 10 KW are available. Each of these resistors boasts



a VSWR specification of 1.1:1 or less over the frequency range from DC to 1 GHz.

These are just some of the products that have made Dielectric THE LEADER IN RF MEASUREMENT EQUIPMENT.



DIELECTRIC COMMUNICATIONS

A UNIT OF GENERAL SIGNAL
RAYMOND, MAINE 04071 • TEL. 207-655-4555 • 800-341-9678

✓ 17

Hams on the Trail of UFOs

— the Army's "flying saucer" movie . . . did you see it?

D. L. Dobbs K8NQN
6612 Pleasant Street
Cincinnati OH 45227

"The bodies appeared little by human standards. Most notable were the heads, all looking

alike, and all being large compared to their body sizes. They looked mongoloid, with small noses and mouths and eyes that were shut. Their skin was leathery, and ashen in color."

Len Stringfield, veteran UFO researcher and author

of *Situation Red, The UFO Siege*, held the audience spellbound and on the edge of its seat at the Ninth Annual Symposium of MUFON, the Mutual UFO Network. The place: Dayton, Ohio, Convention Center. Date: July 29, 1978. Other hams were in the crowd, listening as intently as I. After being part of

their UFO nets for more than a year, it had been great to eyeball W0NC and N1JS at last. I'd met K9PAW, and WA5RON was somewhere back in the crowd with my son, WD8IAM. Seated up on the stage was Walt Andrus W5VRN, director of MUFON.

Carefully, patiently, Stringfield was putting together for us a jigsaw puzzle of strange events which went back 31 years, building a possibility which was stranger than fiction. "Retrievals of the Third Kind," the title read in the *MUFON Symposium Proceedings* in which I was making marginal notes, "—A Case Study of Alleged UFOs and Occupants in Military Custody." Len was presenting Abstract 5, in which a civilian, now in a high technical position, related to him a fascinating experience which occurred in 1953.

A young radar specialist, Mr. T. was stationed at Fort Monmouth, New Jersey, at that time. It was in the spring of the year when he, along with a number of other radar specialists, were told to report to the base theater to view a special film.

When the group was seat-

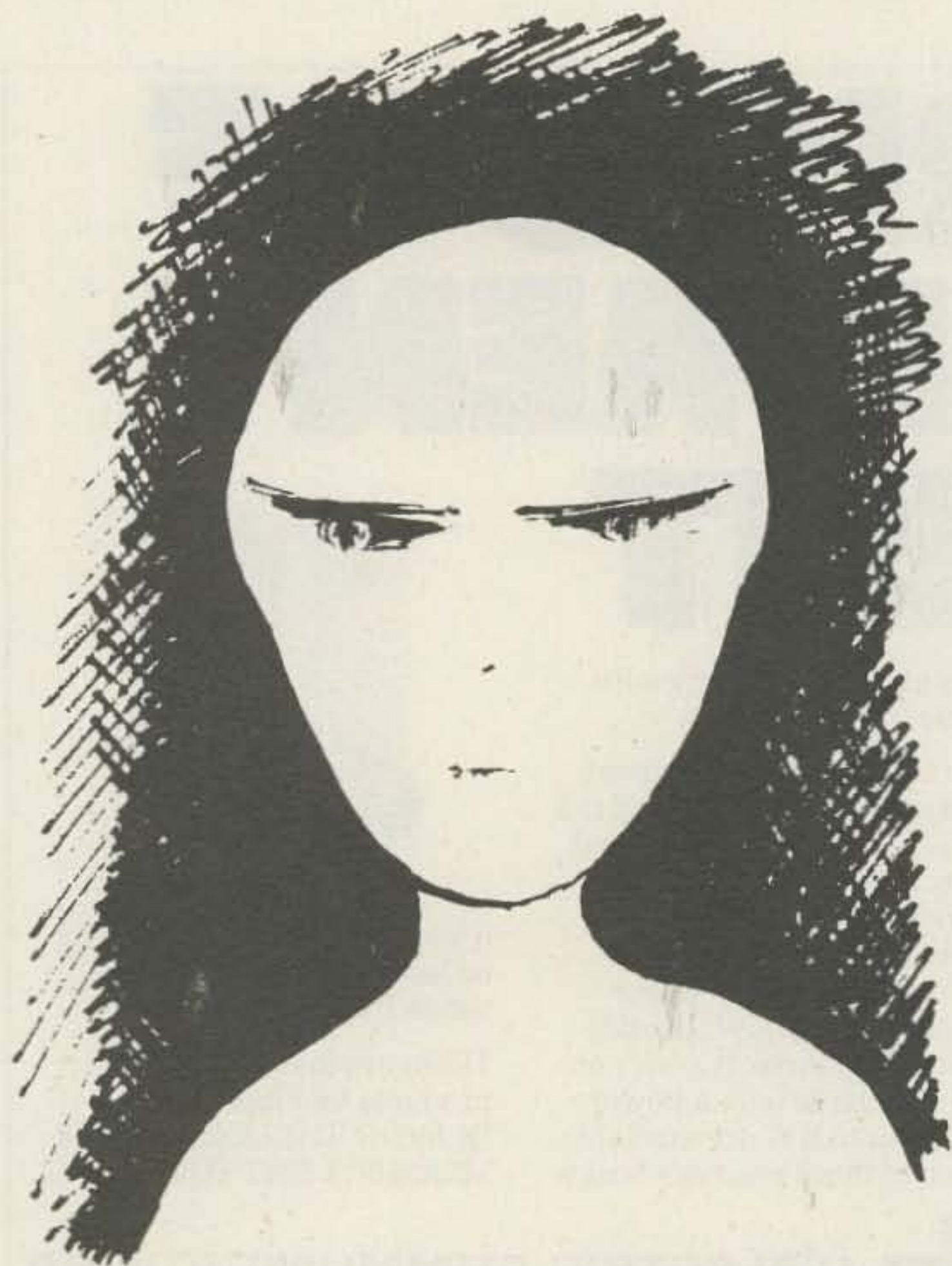

Fig. 1. Alien humanoid head, drawn by L. H. Stringfield, based on descriptions by witnesses, July, 1978.



Fig. 2. Alien humanoid hand, drawn by L. H. Stringfield, based on a description by a witness.

ed, the lights went out with no briefing. A 16 mm movie projector filled the screen with light, showing all the flaws and scratches generally common to combat film. "Suddenly," as Stringfield describes the revelation, "without any titles or credits or music, there appeared a desert scene dominated by a silver disc-shaped object imbedded in the sand, with a domed section at the top. At the bottom was a hatch or door that was open."

Mr. T. recalled the next scene as showing 10 to 15 military personnel in fatigues without identification patches, standing around the disabled craft. From their height relative to the disc, he estimated it to be 15 to 20 feet in diameter. The open hatch was judged to be about 2½ feet wide and about 3 feet high.

Puzzled about the purpose of the movie, the young soldier watched the scene switch to the interior of the object. A close-up showed a panel with a few simple levers. The observer recalled noting the muted colors and sudden glares of white which characterize poor photography.

Startled, the young man viewed the next scene. Inside what appeared to be a tent were two tables—with dead bodies lying on them! Two lay on one table, and one on the other. Len was continuing with the description of the bodies now, concluding, "Each wore a tight-fitting suit in a pastel color." Strangely, the sight of the dead bodies was the end of the movie!

Contrary to most military movies which credit the Signal Corps or some other source, this one just "stopped cold," Mr. T related. The lights came on, and the officer in charge told the men,

"Think about the movie. But don't relate its contents to anyone." Mr. T. didn't even tell his wife about it!

Two weeks later, he was approached by an intelligence officer on the base. "Forget the movie," he was told. "It was a hoax."

Commenting on the movie 23 years later, Mr. T. advised Stringfield that it was about five minutes long and that he felt that it in all probability was shot by an inexperienced cameraman because it was full of scratches and had poor coloring and texture. He believes that the craft and bodies he saw were real. As he put it, "The movie was certainly not a Walt Disney production." Although he has never been particularly interested in UFOs, he has always remained curious about the purpose of the film. This was accentuated when, years later, he met an old Army acquaintance who told him about seeing this same film at a different base under similar conditions.

Len Stringfield went on, abstract after abstract, to build a very impressive body of evidence, circumstantial though it may be at present, that there indeed may have been many "retrievals of the third kind" over the years.

What do you think? Was the movie reality or a hoax? And what purpose did it have?

I'd be willing to bet that a lot of young radar specialists, trained by the military in electronics, later became hams. Who knows, you may have one of them in the next QSO. "Break. KG1UR, this is NE1C. About that movie you guys were talking about. Back in '53, when I was stationed at ----."

Better reach for an 807. It's going to be a long evening, and an interesting one!

Section	Day	EST	CST	Control	QTH
40 meter	Saturday	0800	0700	N1JS	MA
75 meter	Saturday	0900	0800	WA9ARG	IL

Table 1. Mutual UFO Network amateur radio SSB nets.

Addendum

It has been learned that the ex-radar specialist who viewed this movie in 1953 is a member of the amateur radio fraternity. Stringfield also has received confirmation that the same movie was shown to a group of radar specialists at a Naval base in Maine at a somewhat later date. In this case, they were not subsequently told that it was a hoax.

There may have been other UFO movies shown as well. Ray Stanford, whose instrumented UFO research was described in "Close Encounters," 73 Magazine, December, 1978, alludes to this in his book, *Socorro "Saucer" in a Pentagon Pantry*. Several years prior to 1964, an of-

ficer informed Ray that his group of radar operators had been shown movies of UFOs so close that "we could see right into the windows."

This appears to be very strange treatment of a phenomenon which NASA declined to investigate because of "an absence of tangible evidence." That's my opinion, OM. What's yours? ■

References

1. *Situation Red, The UFO Siege*, Leonard H. Stringfield, Fawcett Crest Books, New York, 1977, 254 pps., paperback, \$1.75.
2. *1978 MUFON Symposium Proceedings*, MUFON, 103 Oldtowne Road, Seguin TX 78155, 131 pps., \$6.00.
3. Sketches by Leonard H. Stringfield, reproduced with permission.

NEW!!

ATTENTION MOBILE HAMS

15 METER MOBILE TRANSCEIVER CW & USB

NCG 15SB



THE QRP RIG WITH THE **BIG RIG SOUND** ACTIVE NOISE BLANKER—RF GAIN—CW SWITCH—SQUELCH—MIC GAIN—DIGITAL FREQUENCY DISPLAY—HI/LO POWER SWITCH—13.8 VDC 5A POSITIVE OR NEGATIVE GROUND.

DEALER INQUIRY INVITED.

NCG Co.

1275 N. GROVE ST.
ANAHEIM, CALIF. 92806 (714) 630-4541

Hi-Fi CW for the TS-820

— the SSB filter copes with numbing noise

Here is a modification for the Kenwood TS-820 that will allow you to use either the CW or SSB filter when you are on CW.

I have found the modification very useful at my QTH where I am plagued sometimes by an S5 line noise from leaky power-line insulators in my neighborhood. On 160 and 80 meters especially, this noise is very harsh when using the CW filter; after 30 or 45 minutes, my ear and brain would become numb from listening to it. I soon found it easier to copy the other fellow on the SSB filter—which reduced the harshness of the noise—and then switch back to the CW mode to transmit.

After using my 820 for a while, I was envious of

some of my friends who owned rigs such as the Drake TR4-CW, Heath SB-102, or HW-101, which have the switch-selectable i-f filter to use on CW. While using their rigs, I found it easier to hear a comeback to my CQ from someone slightly off-frequency (one you wouldn't have heard through the sharp CW filter), and I could enjoy a QSO on a "quiet" band where the QRM was not very bad and the CW filter was not really necessary.

Their rigs were also much easier to use while in a CW net. If you have ever been net control of a CW

net, or if you just check in once in a while, you know that not every station is exactly on the same frequency. The SSB filter allows you to copy most of the off-frequency stations without retuning. Of course, the CW filter on these rigs is available at the flip of a switch, if needed.

DXers using one of the new 250-Hz CW filters that are now available for their TS-820 also may find this mod useful. With it, you can tune around the bands looking for a new country while listening through the SSB filter. You might hear a rare one signing on a frequency about 2 kHz away (that the sharp CW filter wouldn't let through), quickly return to the DX station's frequency, and dump in your callsign. Then you can switch in

your CW filter if it is needed.

Operators who have one of the newer variable-bandwidth audio filters, such as the Autek QF-1, now can use the SSB filter on CW, and use the audio filter to reduce slight QRM. You now can enjoy a long QSO by tuning in the other station in the 1000-1400-Hz bandwidth range, which seems easier on the ears to listen to.

Cross-mode operation is now easier, of course. A DX station can be in the foreign phone band on SSB, and you can return to him on CW without having to change the mode switch on every turnover. On 160, 80, or 40 meters, you will have to ask the DX station to go to the upper sideband for you to copy him, but it shouldn't be any problem if the DX station is agreeable.

Now on to the modification. I purchased the repair manual for the TS-820, and studied the schematic diagram of the i-f board and band switch assembly. Fig.

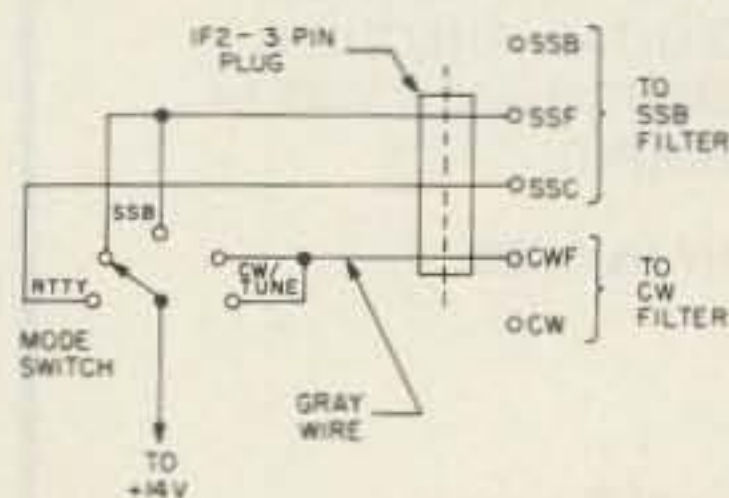

Fig. 1. Original wiring hook-up.

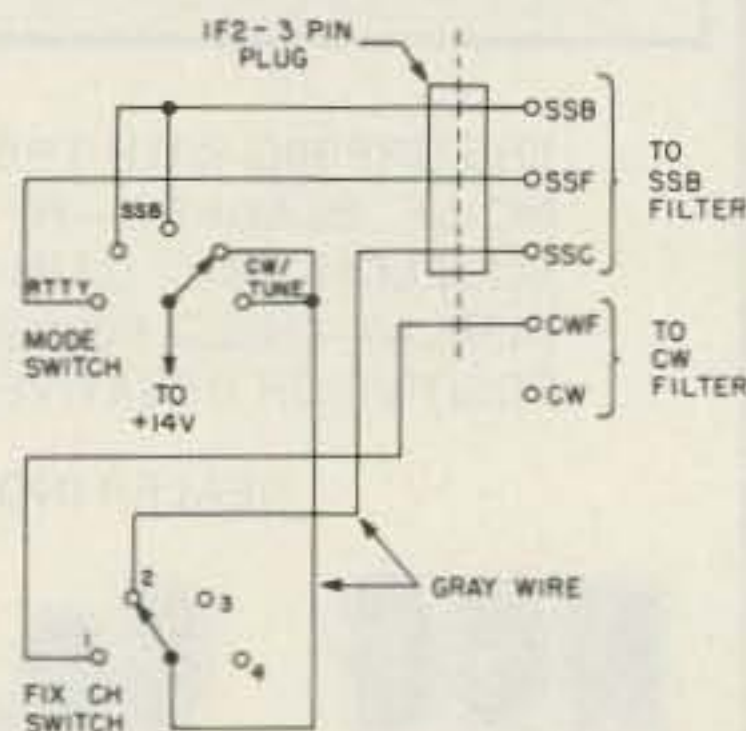

Fig. 2. Revised wiring hook-up.

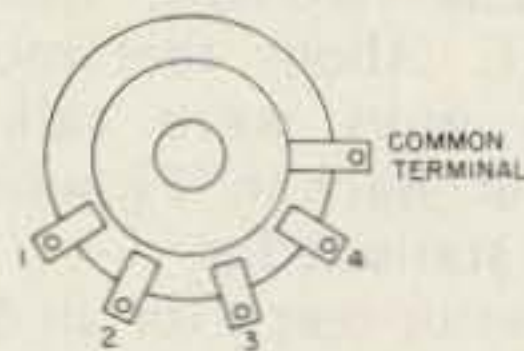

Fig. 3. FIX CH switch as seen from the front.

1 is the schematic diagram of the present hookup to the i-f board from the mode switch with the CW filter installed. In the CW mode, 14 volts is removed from the switching diodes on the SSB filter, and applied to the switching diodes on the CW filter. It appeared that all that was needed to utilize the SSB filter in the CW mode was a method to switch the 14 volts between the filters. Since I did not have any crystals installed in the FIX CH board, I decided to use the front panel FIX CH selector switch to do the switching.

Fig. 2 shows the revised hookup. The 3-pin plug is installed back to the original (no-CW filter) position. The wire carrying the 14-volt switching voltage, when in the CW mode (pin 3), is now sent to the FIX CH switch's common terminal. Selecting either CH1 or CH2 allows you to use the

filter of your choice—CH1 for CW, CH2 for SSB.

The modification involves unsoldering three wires, installing three wires, and cutting one wire. You may want to refer to Fig. 25 on page 34 of the TS-820 operating manual for the location of the 3-pin plug (IF2), and "position A" (referred to later). It took me about 45 minutes to complete the job, so it should not be a very long chore for anyone. Fig. 3 is a front panel view of the FIX CH switch to help you locate the proper pins.

(1) Remove the top and bottom covers of the TS-820. Be careful of the speaker leads.

(2) Unsolder the two red wires from the common terminal of the FIX CH switch. Solder the two wires together, wrap with tape, and dress neatly to one side.

(3) Unsolder the purple and blue wires from the

CH1 and CH2 terminals of the FIX CH switch. Cut off the exposed wire, twist together, and dress neatly to one side.

(4) Remove the 3-pin plug (IF2) from the i-f board. Cut the gray wire (pin 3) about 1½ inches from the plug.

(5) Solder a new wire from the common terminal of the FIX CH switch to the end of the gray wire that goes to the mode switch. There is a space between the chassis and front panel below the switch that the wire can be routed through.

(6) Solder a new wire to pin 2 (CH2) of the FIX CH switch. Route the same way as suggested in step 5. Solder the other end to the end of the gray wire from the 3-pin plug (IF2).

(7) Obtain a Molex® pin if possible. Solder it to the end of the third new wire. Push it on the CWF terminal of the i-f board (terminal 4). Route the wire the

same way as above. Solder it to pin 1 (CH1) of the FIX CH switch. If you cannot obtain a Molex pin or something similar, you can solder the new wire directly to the CWF terminal of the i-f board. The Molex pin makes removal of the i-f board easier at a later date.

(8) Install the 3-pin plug (IF2) back to the original no-CW filter position. This is position A in the operating manual. Wrap tape around all soldered connections on the wires to prevent shorts.

That's it! Now you can select either filter via the front panel switch. Install the top and bottom covers, (don't forget the speaker leads), and give it a test run.

I hope you find this mod as useful as I do. If you perform the mod, send me your QSL and let me know why you decided to try it. ■

ANTENNA SYSTEMS/TOWER HARDWARE

HY-GAIN ANTENNAS

TH5DX	New 5-Element Triband Beam	\$.195
TH6DXX	6-Element Triband Beam	\$.225
TH3MK3	3-Element Triband Beam	\$.165
TH3JR	3-Element Triband Beam	\$.119
TH2MK3	2-Element Triband Beam	\$.109
HY-QUAD	2-Element Triband Quad	\$.199
402BA	2-Element 40-mtr Beam	\$.175
205BA	5-Element 20-mtr "Long John"	\$.225
155BA	5-Element 15-mtr "Long John"	\$.145
105BA	5-Element 10-mtr "Long John"	\$.94
204BA	4-Element 20-mtr Beam	\$.175
153BA	3-Element 15-mtr Beam	\$.64
103BA	3-Element 10-mtr Beam	\$.54
DB1015A	3-Element 10/15-mtr Beam	\$.115
64B	4-Element 6-mtr Beam	\$.42
66B	6-Element 6-mtr Beam	\$.89
18HT	Hy-Tower 80-10 mtr. Vertical	\$.249
18AVT/WR	80-10 mtr Trap Vertical	\$.75
14AVQ/WB	40-10 mtr Trap Vertical	\$.55
208	8-Element 2-mtr Beam	\$.24
214	14-Element 2-mtr Beam	\$.29
2BDQ	80/40 mtr Trap Dipole	\$.49
5BDQ	80-10 mtr Trap Dipole	\$.85
BN86	80-10 mtr KW Balun	\$.14

KLM ANTENNAS

KT34A	4-El Tribander	\$.299
KT34XA	New 6-El Tribander	\$.449
160V	160-mtr Vertical	\$.89
7.0-7.3-4A	4-El 40-mtr Beam	\$.589
7.2-1	40-mtr Dipole	\$.139
10-30-7A-LP	7-El 10-30 MHz Beam	\$.599
13.9-14.4-6A	6-El 20-mtr Beam	\$.629
21.0-21.5-6A	6-El 15-mtr Beam	\$.379
28-30-6A	6-El 10-mtr Beam	\$.199
50-52-11	11-El 6-mtr Beam	\$.169
144-148-13LB	13-El 2-mtr Long Boomer	\$.69
219-226-14	14-El 220 MHz Beam	\$.49
432-16LB	16-El 432 MHz Beam	\$.59
3-60-1:1	1:1 4-KW PEP Balun	\$.24
3-60-4:1	4:1 4-KW PEP Balun	\$.24

CUSHCRAFT ANTENNAS

ATB-34	4-Element Triband Beam	\$.209
ATV-4	40-10 mtr Trap Vertical	\$.78
ATV-5	80-10 mtr Trap Vertical	\$.85
15-4CD	New 4-Element 15-mtr Beam	\$.89
10-4CD	New 4-Element 10-mtr Beam	\$.67
A50-5	5-Element 6-mtr Beam	\$.55
A617B	New 6-Element 6-mtr Beam	\$.149
ARX-2	2-mtr "Ringo Ranger"	\$.30
A-3219	19-Element 2-mtr "Boomer"	\$.66
A-214B	14-Element 2-mtr "Boomer"	\$.53
A-214FB	14-Element 2-mtr FM "Boomer"	\$.53
A-228FB	28-Element 2-mtr FM Power Pack	\$.165
A-147-11	11-Element 2-mtr FM Beam	\$.30
A-147-22	22-Element 2-mtr FM Power Pack	\$.90
DX120	20-Element 2-mtr Colinear	\$.45
ARX-450	450 MHz "Ringo Ranger"	\$.30
A-144-10T	10-Element 2-mtr "Oscar" ant.	\$.37
A-144-20T	20-Element 2-mtr "Oscar" ant.	\$.53
A-432-20T	20-Element 432 MHz "Oscar" ant.	\$.49
LAC-1	"Blitz-Bug" Male/Female	\$.5
LAC-2	"Blitz Bug" Female/Female	\$.5

ANTENNA ROTORS

Alliance HD-73	Rated for 10.7 sq. ft.	\$.99
Alliance U-100	Ideal for Elevation Rotor	\$.39
CDE CD-45	Rated for 9 sq. ft.	\$.115
CDE HAMIV	Rated for 15 sq. ft.	\$.149
CDE Tailtwister	Rated for 30 sq. ft.	\$.209
8 Conductor Rotor Cable		\$.15/ft.
Heavy Duty 8 Conductor Rotor Cable		\$.36/ft.

For a quote on your antenna system needs, call today!

TEXAS TOWERS

1309 Summit Ave. Plano, Texas 75074
 ✓ 74 9 a.m. - 6 p.m. Mon-Fri, 9 a.m. - 1 p.m. Sat

TELEPHONE: (214) 423-2376

A Texas Communications Products Company (TEXCOM)

ROHN TOWERS

20G \$29.50	25G \$38.50	45G \$67.50	55G \$104.50
HDBX48	Free-standing 48-ft. tower (18 sq. ft.)	\$.305	
HBX56	Free-standing 56-ft. tower (10 sq. ft.)	\$.335	
FK2548	48-ft 25G Foldover tower	\$.599	
FK2558	58-ft 25G Foldover tower	\$.666	
FK2568	68-ft 25G Foldover tower	\$.729	
FK4548	48-ft 45G Foldover tower	\$.839	
FK4558	58-ft 45G Foldover tower	\$.929	
FK4568	68-ft 45G Foldover tower	\$.999	

(Freight paid on all foldover towers. Prices 10% higher west of Rocky Mountain states.)

GALVANIZED STEEL TOWER HARDWARE

3/16" EHS (3990 lb rating)	\$.95/100 ft	\$.90/1000 ft.
1/4" EHS (6000 lb rating)	\$.12/100 ft	\$.111/1000 ft.
5/32" - 7 x 7 Aircraft cable (2700lb)		\$.8/100 ft
3/16 CCM cable clamps (3/16" or 5/32" cable)		\$.030
1/4 CCM cable clamps (1/4" cable)		\$.040
1/4 TH Thimble (fits all sizes)		\$.025
3/8 EE (3/8" Eye and eye turnbuckle)		\$.550
3/8 EJ (3/8" Eye and jaw turnbuckle)		\$.600
1/2 EE (1/2" Eye and eye turnbuckle)		\$.750
1/2 EJ (1/2" Eye and jaw turnbuckle)		\$.800
3/16" Preformed guy deadend		\$.145
1/4" Preformed guy deadend		\$.165
6"-dia. 4-ft long earth screw anchor		\$.10.50
2"-dia 10-ft long heavy duty mast		\$.35.00
500D Guy insulator (5/32" or 3/16" cable)		\$.085
502 Guy insulator (1/4" cable)		\$.180

COAXIAL CABLE AND CONNECTORS

RG-213/U (Mil-spec RG-8/u)	\$.29/ft
RG-8X new 1/4" diam. low loss foam	\$.15/ft
1/2" 50-ohm Polyjacketed Hardline	\$.65/ft
Male Hardline Connector (PL-259)	\$.800
Female Hardline Connector (SO-239)	\$.900
Male Hardline Connector (Type N)	\$.10.00
Female Hardline Connector (Type N)	\$.10.00

HY-GAIN TOWER MASTER AND TELE TOWER CRANK-UPS

Direct factory shipment to save freight expenses. Call for our competitive quote on these towers. We can ship tower bases from stock to allow you to complete foundation work while tower is being prepared for shipment.

Going 2m All-Mode with Yaesu's FT-225RD

— not just another pretty face

Glenn W. Malme W6OJF
9337 Gotham Street
Downey CA 90241

FM has been around since 1920, give or take a few years. It has been just in recent years that the current crop of hams discovered how extremely useful FM equipment is when used mobile. All the noise and racket that plagued AM mobile rigs is gone.

Actually, the amateur type of FM is really phase modulation, such as a lot of us old-timers used in the 1950s on ten meters to avoid buying or building a large and expensive modulator. The problem in those days, however, was that

the guy listening to us just had too much trouble slope-detecting our PM on his AM receiver, and so it was that phase modulation died on the HF bands.

Now, with two meters having been reborn, thanks to frequency modulation, it makes no difference whether it is true FM with an old Motorola unit or the latest amateur phase modulation. They are compatible.

So it was that I got into two-meter mobile activity. Then I decided that a base station would really be nice to have. I wanted SSB and CW capabilities also, because I intended to have one beam horizontal to be able to work two-meter DX. I also wanted AM because

I belong to the Golden Poppies net and the National Award Hunter's net—which keeps me out of the pool halls six nights a week. AM is a long way from being dead on two meters out here in the Los Angeles area.

This was how I came to discover a new Yaesu FT-225RD at the local candy store. I saw a bewildering array of two-meter transceivers, and it took some time for me to sort out the pluses and minuses of the competitive units.

I will admit that at first I fell for a pretty face. But after a thorough test over one weekend, the FT-225RD took root on my operating table. For one thing, it covers the entire two-meter band in 1-MHz segments and provides USB, LSB, CW, AM and FM. In the FM mode, you have the standard 600 kHz, up or down, depending upon which segment of the band you are working. And for those odd-ball repeaters that are not standard in their shift, you have 11 crystal positions to keep you happy. Repeater shift, which is normally 600 kHz, may be set to an alternative split of up to 1 MHz by the addition of an optional crystal or Yaesu's unique "memory system," also an optional feature.

The rig provides one- to

25-Watt variable output on all modes with 8 Watts on AM. The readout is digital. For example, suppose you are listening to an FM repeater on 147.09 MHz. As soon as you key your mike, the transmit frequency of 147.69 is shown on the digital dial, thus eliminating the problem some fellows have in forgetting to reset a panel switch from simplex to RPTR.

The Yaesu FT-225RD also offers something no one else's equipment does—plug-in printed circuit boards. This simplifies correcting any problems that might develop and makes it possible for you to do the work yourself instead of sending it out for repairs.

If, like me, you're a fussy guy on frequency readout, the transceiver will delight you. Readout is to 0.1 kHz; analog display resolution is better than 1 kHz. Receiver sensitivity is 0.3 microvolts for 10-dB S/N on SSB and CW. On FM it is 0.35 for 20-dB quieting and 1.0 for 10-dB S/N on AM. What this means, fellas, is that if the station is there, you will copy him.

Selectivity is ideal in all modes. On SSB and CW it is 2.3 kHz at 6 dB down and 4.1 kHz at 60 dB down. It is 12 kHz at 6 dB down on FM and 28 kHz at 60 dB down.



Photo A.

The transmitter is very clean, with spurious radiation better than a minus 60 dB and unwanted sideband suppression a minus 40 dB.

The audio reports I have been getting in all modes have been excellent. The 50 or so fellas on the Golden Poppies AM net (145.75 MHz weekday nights at 7:30 pm PST) gave audio-excellent reports, as was the case in SSB and FM as well.

A microphone properly tailored for voice frequencies, and matching the transceiver's requirements, comes with the equipment.

The large, illuminated meter can be set to serve as an FM discriminator read-out, or as an S-meter, as well as used for tune-up. Did I say transmitter tune-up? Once you have peaked your station to receive, a one-knob adjustment, the transmitter is all set to

go—no dipping and loading required. This makes it possible to scoot all over in just a split second.

To list all of the goodies would take many pages. Suffice it to say that the rig has a beautiful VOX as well as PTT. You can select slow or fast agc. And, if you want to go mobile with the unit, it's all set to connect to your car battery. The noise blanker really works when pulse-type noise

gives you trouble, and there is a clarifier which allows offset on both transmitter and receiver at your choice. This is handy when you want to stay on a net frequency but have to scoot off to pick up someone who isn't right on.

All in all, it is my opinion that the Yaesu FT-225RD is certainly state-of-the-art and is a completely satisfactory do-everything, two-meter transceiver. ■

The PL-259 Connection

—reducing adapters need not try your patience

Mike Maloney AC5P
Box 33
Bartlesville OK 74003

Since getting into ham radio, one of the minor hassles for me has been to assure myself of making a good shield connection to the standard PL-259 coax plug with the smaller RG-58 series coax feed-

lines. The first method, that of trying to solder through the holes of the PL-259 sleeve to the shield underneath, was quickly discarded as unsatisfactory to me since to ensure good solder flow on the shell, it has to be heated to the point where the dielectric would be melting.

The second method tried, which is much superior, was to cut a slot with a hacksaw in the UG-175/U reducing adapter, then separate the shield into two equal strands, pulling down into the slots and soldering. The excess shield was trimmed off, and then the PL-259 could be screwed on with only the center conductor to be soldered to complete the job.

The third method, shown

in the diagram, is a further improvement in that no soldering of the shield, thus no melting or changing of the dielectric, is required. A 3/8-inch length of 3/16-inch OD by 1/8-inch ID brass or stainless tubing is cut with a hacksaw. The sharp edges are deburred with a small screwdriver and sandpaper or fine file. Slip the UG-175 adapter over the coax and strip back about 1½ to 2 inches of the outer jacket. Slightly spread the shield down to about 1/8 inch or so from the outside jacket. Wedge the shield and sleeve down into the inside of the adapter.

In my case, it has been

necessary to clamp the adapter in a vise and, by using a longer piece of the same size tubing (slipped over the center conductor only) and gently tapping with a hammer, to drive the sleeve on down flush with the top of the adapter. The excess shield above the adapter is now carefully trimmed off with a sharp knife, and assembly is completed by stripping the center conductor and adding the PL-259 as above. You will find that the shield makes a good tight connection all the way around, compressed between the sleeve and the inside of the adapter. Be sure to tighten the adapter to the PL-259 with pliers to assure a reliable and good mechanical and electrical connection. ■



Fig. 1.

SCR1000 VHF—SCR4000 UHF

For Your New Repeater System, Or, to Replace Your Old "Klunker"

*Go First
Class!*

**2 Mtr.
220 MHz
450 MHz**

- 30W Output.
- Low Noise/Wide Dynamic Range Front End for Excellent Sensitivity & IM Rejection.
- Sensitivity: 0.35uV Typ.
- 8 Pole IF Crystal Filter.
- Full Metering, Lighted Status Indicators/Control Push-buttons, Btry. Power Input, AC Pwr. Supply, CW IDer, etc., etc.!

Made in USA

SCR1000 IS FCC
TYPE ACCEPTED
for Commercial
Services

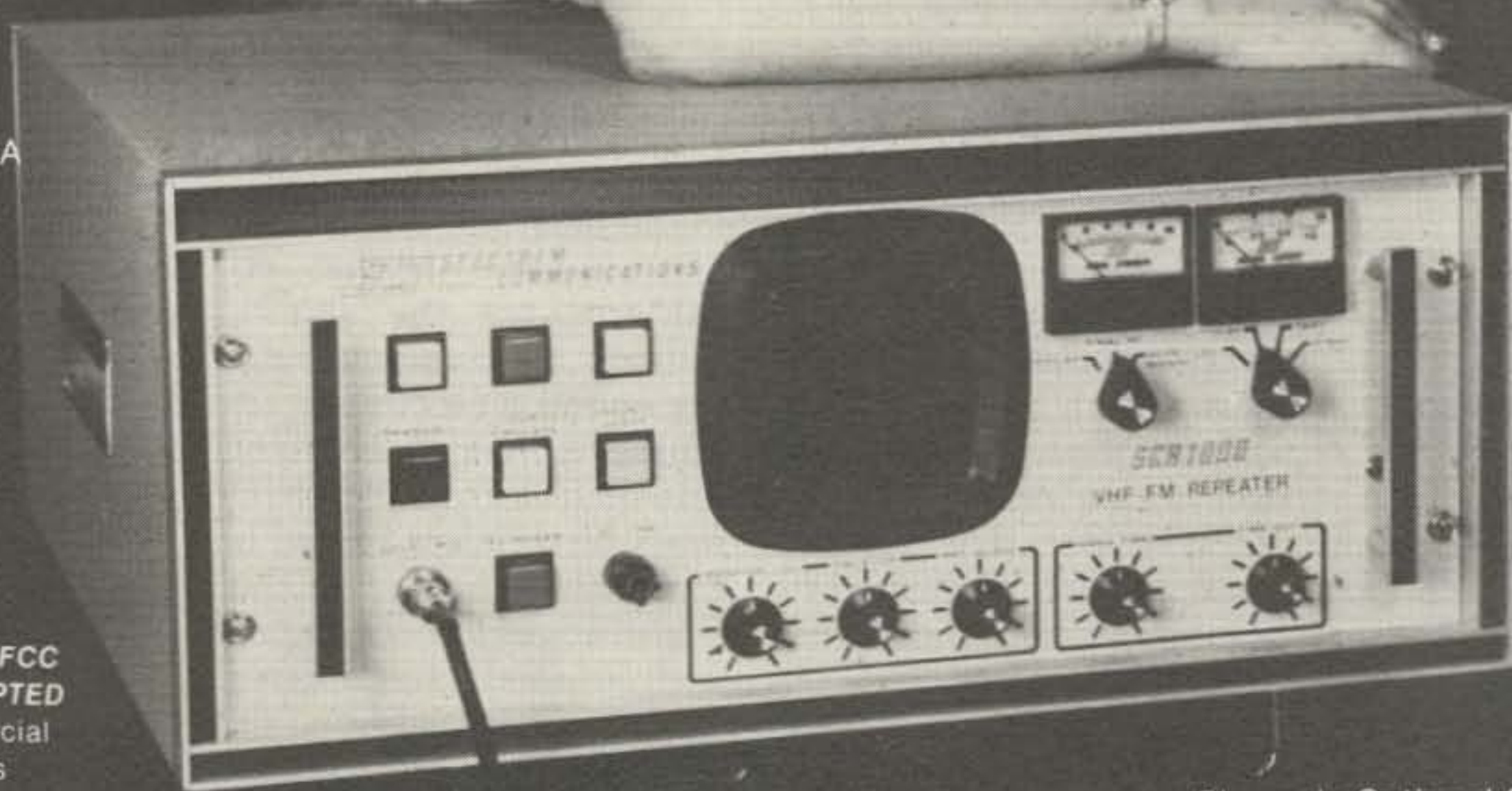

Shown in Optional Cabinet

**30 or 70 WATTS
on 2 Mtrs.!**

Available with Full Autopatch/Reverse Patch/Land-Line Control; Touch Tone Control of various repeater functions; "PL"; "Emergency Pwr. I.D."; various Tone & Timer Units, etc. PLUS—the finest Duplexers, Cabinets, Antennas, Cables, etc. Our Repeaters are sold factory direct only, or through Foreign Sales Reps. Get your order in A.S.A.P.!

180 Day Warranty

Call or write today and get the details!



SPECTRUM

Export Orders — Contact our International Dept.

1055 W. Germantown Pk., Dept. S4

new

COMMERCIAL MOBILE & BASE TRANSCEIVERS

Spec Comm "Professional Communications Line"

Features

- 136-174 MHz & 220-240 MHz (450 soon).
- 6 channels.
- 0.35 uV Rcvr.
- 6 or 8 Pole Crystal Filtr.
- Beautiful Audio—RX & TX.
- Very Reasonable Price!

PCL250 25 Wt. Mobile Unit

- "Super Rugged" Housing
- Solid 1/8" Thk. Aircraft Aluminum!



- Very attractive woodgrain housing.



PCL300 25 Wt. Base Station

- Built-in AC Power Supply.
- Front Panel Status Indicator Lights.
- Optional Rcvr. Scanning Function Available.

SPEC COMM REPEATER BOARD & SUB-ASSEMBLIES

These are Professional "Commercial Grade" Units—Designed for Extreme Environments (-30 to +60° C).

All equipment assembled & tested. For 2M, 220 MHz & New 450 MHz!

SCR450 BOARD

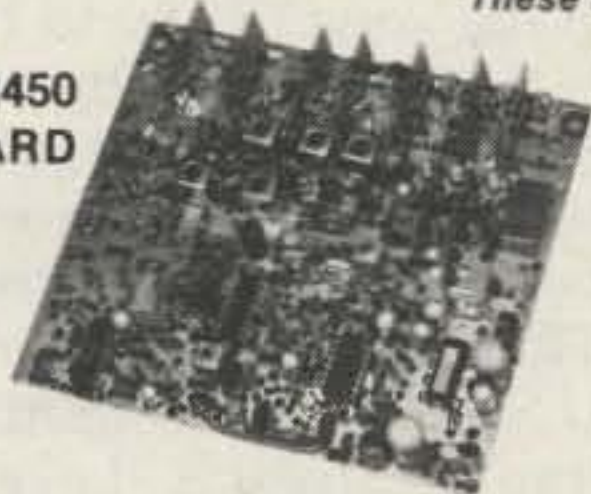

SCR100 VHF Receiver Board

- Wide dynamic range! Reduces overload, 'de-sense', and IM.
- Sens. 0.3 uV/20 dB Qt. typ.
- Sel. -6dB @ ± 6.5 KHz, -110dB @ ± 30KHz, (8 Pole Crystal Filtr.)
- 'S Meter' Output.
- Exc. audio quality! Fast squelch! w/xtal.

SCR100 Receiver Assembly

- SCR100 mounted in shielded housing
- Same as used on SCR1000
- Completely asmbld. w/F.T. caps, SO239 conn., AF GAIN POT, etc.

SCR450 UHF Receiver Bd. or Assy.

- Similar to SCR100, except with 12 Pole IF Filtr. & 8 Resonator Front End Filtr.!
- Discriminator & Deviation Mtr. Outputs
- **Totally New Advanced Design!**

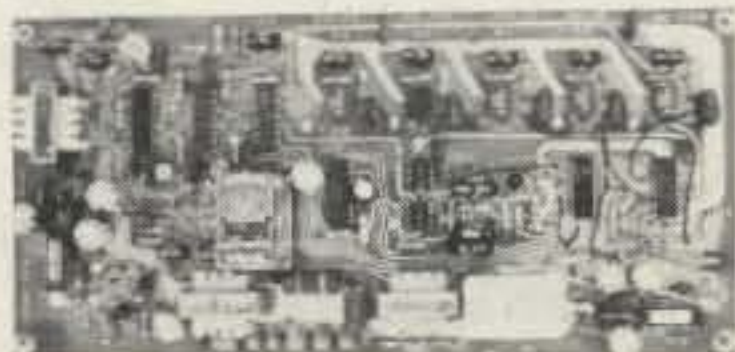

SCAP Autopatch Board

- Provides all basic autopatch functions
- 3 Digit Access; 1 Aux. On/Off function; Audio AGC; Built-in Timers; etc.
- 0/1 Inhibit bd. also available.
- Write/call for details and a data sheet.

RPCM Board

- Used w/SCAP board to provide "Reverse Patch and Land-Line Control of Repeater.
- Includes land line "answering" circuitry



FL-6

FL-6 Rcvr. Front-End Preselector

- 6 Hi Q Resonators with FET preamp (2M or 220 MHz).
- Provides tremendous rejection of "out-of-band" signals w/out the usual loss! Can often be used instead of large, expensive cavity filters.
- Extremely helpful at sites with many nearby VHF transmitters.
- Gain: apx. 10 dB.
- Selectivity: -20 dB @ ± 2.0 MHz; -60 dB @ ± 6 MHz (typ.)

TRA-1 Timer Reset Annunciator Board

- Puts out a tone "beep" on rptr. xmtr. apx. 1 sec. after rcvd. signal drops—thus allowing time for breakers.
- Resets rptr. time-out timer when tone is emitted.
- Adjustable time delay and tone duration.
- For use with CTC100 and ID100/250.

TMR-1 Timer Board

- Can be set up for 1 of 2 configurations.
- #1) Time Out Warning Tone.
- #2) "Kerchunker Killer"—initial Rptr. Xmtr. key-up delay.
- For use w/SCR1000, or CTC100/ID250.

CTC100 COR/Timer/Control Board

- Complete COR circuitry.
- Carrier 'Hang' & T.O. Timers.
- Remote xmtr. Inhibit/Reset control.
- Provision for panel control switches & lamps.
- 100% Solid State CMOS logic.
- Many other features.

ID250 CW ID & Audio Mixer Board

- Adjustable ID tone, speed, level, timing cycle.
- 4 Input AF Mixer & Local Mic amp.
- COR input & xmtr. hold circuits.
- CMOS logic; PROM memory—250 bits/channel.
- Up to 4 different ID channels!
- Many other features, Factory Programmed



SCT410 XMTR. ASSY.

SCT110 VHF Xmtr/Exciter Board

- 7 or 10 Wts. Output, 100% Duty Cycle!
- Infinite VSWR proof
- True FM for exc. audio quality
- New Design—specifically for continuous rptr. service
- Very low in "white noise"
- Spurious -70 dB, Harmonics -60 dB.
- With .0005% xtal.
- BA-10 30 Wt. Amp board & Heat Sink, 3 sec. LPF & rel. pwr. sensor.

SCT110 Transmitter Assembly

- SCT110 mounted in shielded housing
- Same as used on SCR1000
- Completely asmbld. w/F.T. caps, SO239 conn.
- 7, 10 or 30 Wt. unit.

SCT410 UHF Transmitter Bd. or Assy.

- Similar to SCT110. 8-10 Wts.
- Avail. w/ or w/o OS-18 Super High Stability Crystal Osc./Oven.
- BA-40 30W. min. UHF Amp. Bd.

new



TTC100 Touchtone

Control Board

- 3 digit ON, 3 digit OFF control of a single repeater function. Or, (optional) 2 functions (2 digits ON/OFF each).
- Can be used to pull in a relay, trigger logic, etc.
- Typically used for Rptr. ON/OFF, HI/LO Pwr., P.L. ON/OFF, Patch Inhibit/Reset, etc.
- Stable, anti-falsing design. 5s Limit on access.
- For Add'l Function(s)—Add a "Partial TTC" Board.

COMMUNICATIONS CORP.

Send for Data Sheets!

✓ 68

Norristown, PA 19401 • (215) 631-1710

A Micro-Controlled Ham Station

— TRS-80 does it

Having built a TTL chip CW and RTTY system, as described in *QST* and other ham magazines a few years ago, the system described here is our first effort at putting together a microcomputer controlled ham station. What began as only a very modest effort in writing a simple software program for our 16K memory Level II BASIC TRS-80, to send and receive RTTY, has grown like Topsy and now threatens to engulf the entire ham shack! Further, the recent availability of ready-to-plug-in, low-cost, ancillary ham-oriented modules specifically for the TRS-80 has lead us to abandon the "reinventing the wheel syndrome." We quit trying to write our own software for every function, and began to play the part of a systems-organizer by using off-the-shelf modules/kits/software.

This article is not a detailed how-to-do-it, or wire-point-A-to-point-B story. It is a general description of the approach we used to achieve our objectives, plus an appendix listing suppliers and prices. Also, our approach to the problems and choices of solutions are not necessarily the best or only way to go. Indeed, there are as many different approaches and solutions, probably, as there are licensed hams in the U.S.

Before getting into the nitty-gritty, parts-and-pieces of our system, a brief review of exactly what a TRS-80 microcomputer is and does is in order. It was introduced to the marketplace during August, 1977, by the Radio Shack Division of Tandy Corporation. The design and development team at Tandy Advanced Products was led by Steve Leininger, a relatively young genius who previously had been with National Semiconductor, where he designed the highly-regarded SC/MP microcomputer. Today, only a bit more than 2 years after its introduction, more TRS-80s have been sold and delivered than any other microcomputer in the world. Soon, Tandy will announce that more TRS-80s have been sold and delivered than *all* other microcomputers in the world! There must be a reason for this, when one considers the highly competitive marketplace, brimming-over with PETs, APPLes, and KIMs, to name a few. The answer is cost-effectiveness, plus the virtually unlimited growth capability that was designed into the TRS-80 from scratch.

The TRS-80 utilizes the Zilog Z-80 microprocessor, a third-generation chip that was designed and developed by another genius, Fred Faggin. He led the Intel design team that in-

vented the world's first microprocessor, and then went on to develop the world-famous second-generation microprocessor, the 8080. The Z-80 will do everything the 8080 does, but faster, and has an instruction set over 100 percent larger.

It is difficult to maintain perspective when discussing microcomputers today, when one remembers that only 12 years ago a computer with the same capability as a TRS-80, but with lower throughput (speed), cost over one million dollars.

This article is not long enough to describe all the versions and options available to a TRS-80 purchaser. It is enough to say that unless you are an experienced programmer, well versed in BASIC, you will be doing yourself a disservice not to start with the TRS-80 with Level I BASIC installed, as the self-programmed, self-teaching manual included with the Level I system is one of the finest computer texts ever written. It was authored by Dr. Dave Lien W6OVP and Dr. Ron Lodewyck N6EE, who have made your introduction to the TRS-80 and BASIC programming language truly a pleasure instead of hard work. Their "User's Manual For Level I" is recommended whether you are a high

school student, or graduate engineer writing college microwave textbooks.

Radio Shack will upgrade your TRS-80 to Level II BASIC (written by Micro Soft) for \$99.00, and guarantee two-day turnaround repair time at any of the 50 TRS-80 repair centers in the U.S. One comment on Radio Shack's Level II BASIC and Disk BASIC: These two programs will do everything, will do more than IBM's "VS BASIC," and do it faster, too, for about \$50k less! Hewlett-Packard BASIC and General Electric BASIC are certainly good programs, though on a cost-effective basis they are only runners-up to Radio Shack's Level II and Disc BASIC.

Let's get down to business and examine "Uncle Charlie How's" TRS-80-controlled ham station. See the block diagram. However: With a few exceptions, it is rather self-explanatory.

One: There is no noisy TTY machine (which the author abominates, and feels should be in a museum with steam cars).

Two: What is a word-processing system doing in the ham shack? Answer: Why not, since you already have a general-purpose computer and Selectric printer. The TRS-80 electric pencil software program,

written by Michael Shroyer, and adapted for the TRS-80 by Small System Software, will give your ham shack better word and text processing capability than if you had a zillion dollar IBM MT/ST or Mag Card system.

Three: What is an old Hallicrafters HT-37 transmitter doing there with all those goodies like the ITT #3021 digital tune receiver? Answer: The author has an on-going HT-37 love affair, and this is his third one. In phase two, what will serve the ITT #3021 digital receiver as a programmable vfo and drive? You guessed it. The venerable phase-quadrature SSB-generating HT-37. One does not kick one's wife or mistress out of the house because of grey hair. Same with the author's HT-37.

Four: Why are Radio Shack CTR-21A cassettes used instead of the CTR-41 cassettes that come with the TRS-80? Will not the CTR-21A extra current drain "melt" the TRS-80's Ry-1 which is only rated at 500 mA? Answer: A Radio Shack 6 V dc relay, 9 V dc transistor radio battery, and dropping resistor, serve to isolate the CTR-21A from Ry-1; the reason for using the CTR-21A cassette is that it has an S-meter built in which greatly simplifies loading cassette tapes into the TRS-80. It works the first time, instead of after 3 or 4 tries and much diddling with the cassette volume control.

Five: In the upper left corner of Fig. 1 are shown HA-160, HA-6, HA-2, HA-1¼, and HA-¾ transverters. Didn't Hallicrafters make only HA-6 and HA-2 transverters? Answer: You are correct. The author has been a VHF/UHF nut for 30 years; he buys over-the-hill HA-6s at hamfests and rebuilds them to the VHF/UHF bands. He even has an HA-¾; anyone with his ab-

erration for HT-37s and the matching decor the HA transverter cabinets offer, would be kooky enough to build an HA-160, too, even if he uses it only once every five years.

Before digging deeper into TRS-80-controlled subsystems, a few words about memory expansion that may or may not cause Radio Shack pain when they read this. 16K RAM memory kits go for \$120 each (installation included, at Radio Shack; for a "full house" 48K memory this comes to \$360 above the original 4K memory price. Our friends at Apparat, Inc. (see Appendix), sell exactly the same memory package, new from Mostek, with installation instructions, for \$79 per 16K memory. Installation time is approximately 10 minutes for the TRS-80 (including jumpers) and about 5 minutes for the 32K expansion interface (no jumpers). It appears that 15 minutes of your time can save you \$120. Even for heart and brain surgeons, this would be a considerable savings.

Comment on TRS-80 reliability: though our TRS-80 was one of the very first ever built, it has operated two years with NO failures of any variety. It often has run 4 or 5 days in a row, 24 hours a day, with no external cooling and never a failure. The TRS-80 is undoubtedly the Rolls-Royce Dart engine of the microcomputer community!

TRS-80-Controlled Subsystems

Microtronics Model M-80 CW/RTTY Software-Hardware Subsystem. This system designed by Dr. Ron Lodewyck N6EE, is about the ultimate any dedicated RTTYer could desire. It offers narrow- or wide-shift keyboard-selectable speeds of 60, 66, 75, and 100 wpm, plus ten preprogrammed message memories, plus

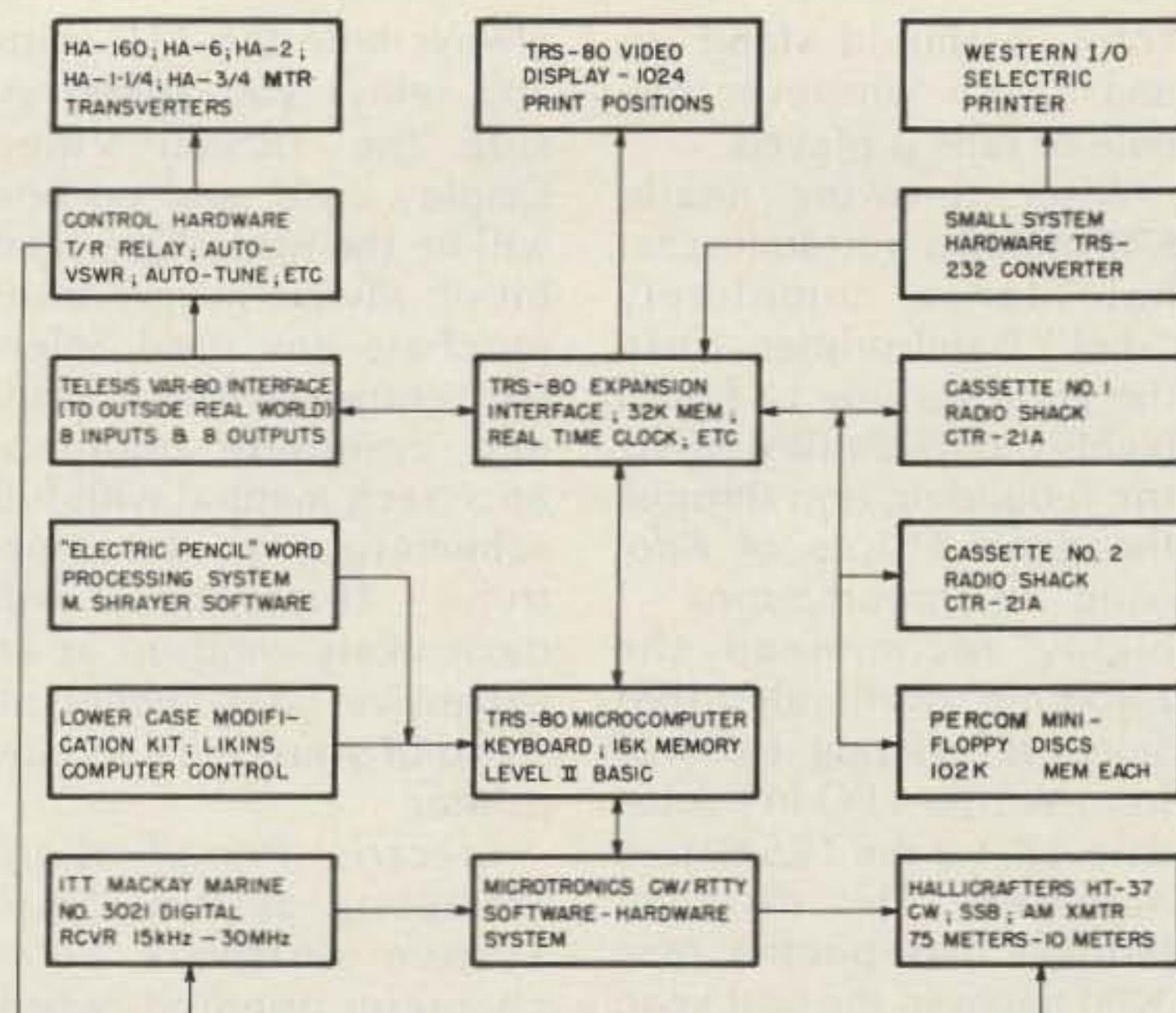

Fig. 1. Block diagram of a TRS-80 microcomputer-controlled ham station.

single-key actuation. Automatic shift, unshift, line feed, unshift-on-space, and automatic CW ID also are provided, as is provision for external TU, if more sophisticated TU is desired. Five separate keying circuits (2 relay contacts and 3 xstrs), allow maximum flexibility in interfacing FSK, AFSK, and TTY (ugh) equipment. In the CW mode, 3 options are provided the user: send, receive, and code practice. In the receive mode, the CW signal is automatically decoded and displayed on the screen. In all modes, the code speed is adjustable for 1-100 wpm and, when receiving, the sending station's speed may vary plus or minus 10 wpm with automatic compensation.

As icing on the cake for Dr. Ron's system, it also offers a code practice mode that will randomly generate characters or five letter groups at any desired speed, using the TRS-80's random number generator. Radio Clubs take note: no modifications to either the TRS-80, with or without Expansion Interface, or your xmtr/rcvr are required. Ten preprogrammed messages also are provided for

the CW operator.

Not to be outdone by HAL devices, Dr. Ron also offers these additional features: PLL adjustable to any receiver passband 800-2300 Hz, 115 V ac pwr supply, LED visual-tuning indicator, side-tone oscillator, TTL and RS232 inputs, all connectors, automatic scrolling (lines of text which move up on the video monitor), double-size characters (32/line) operator-selectable for those without glasses who need them, keyboard buffer that allows you to type up to 255 characters ahead regardless of CW or RTTY speed, and, lastly, if you have the Radio Shack Disk BASIC, an automatic "time-sending" feature.

Selectric Printer Terminals. This probably will be your most difficult (and expensive) decision to make. If cost is not an object, then by all means choose the Selecterm Selectric typewriter/printer. It is a brand new IBM Selectric mechanism, quite properly interfaced with all the solenoids and ASCII interface electronics to work directly with your TRS-80. At approximately \$2000 per

copy, it should stand up and salute whenever reveille or taps is played.

After throwing nearly \$700 down a bottomless rat hole for a completely "shot" Datel printer, I had the good fortune to find a highly reputable IBM Selectric rebuilding firm through the good offices of *Kilobaud Microcomputing*. I highly recommend the zero-time, overhauled IBM Selectric printing terminal from Western I/O in Scottsdale AZ, for the TRS-80 (see Appendix). This excellent terminal has printed over 3000 pages in the past year.

For those with small budgets and pocketbooks who are willing to gamble \$400 to \$700 for a used Selectric terminal/printer from any of the many surplus houses, *caveat emptor!* Most of these machines have run 24 hours a day for 7 to 10 years or more, and although advertised as LIKE NEW or OVERHAULED, are mostly junk. Only if the surplus dealer happens to be a relative or close personal friend who is located within an hour's driving time of your QTH is this avenue worth looking into.

Most of these used machines do not speak ASCII, which is the TRS-80's native language. As such, you will have to write a software program to convert your ASCII to EBCDIC, or IBM Selectric correspondence code, or whatever. It is at this stage you will discover that ASCII characters such as up arrow, greater than, and less than have no counterparts on your machine, and that the Selectric code was written by a crazy man. For instance, the combination of events that must transpire to effect a "space" in correspondence code usually can occur only on a Friday the 13th during leap year.

Amateur ingenuity will eventually win, and someday you will bring your Selectric on-line. You can

always hide the TTL chips and relays you added inside the TRS-80 Video Display case, and no one will be the wiser. One final bit of advice: never, never purchase any used Selectric terminal without a full and complete maintenance/tech manual with full schematics of the electronics. If you do, it will most likely wind up as an expensive boat anchor instead of your pride and joy printer.

Electric Pencil Word Processing System—Small System Software. This character-oriented word-processing system was written by Michael Shroyer Software and adapted for the TRS-80 by Small System Software. If you are familiar with the IBM Mag Card or IBM MT/ST word-processing systems, you know how a basic word processor works. The Electric Pencil does the same thing, using our TRS-80 computer and Selectric printer, only it does it in about an order of magnitude better and faster.

Here is how it works: Using your cassette recorder, the machine-language software program is automatically loaded into a high-memory location in about one minute. Being a character-oriented word-processing system, this means that text is entered as a series of continuous characters and is manipulated as such. This allows the operator exceptional freedom and ease in the movement and handling of text. Since line endings are never delineated, any number of characters, words, lines or paragraphs may be inserted or deleted anywhere in the text. The entirety of the text shifts and opens up or closes as needed, in full view of the operator. Neither the typing of carriage returns nor word hyphenation is required, since lines of text

are formatted automatically.

As text is typed in on the TRS-80 keyboard and the end of the 64 character video display line is reached, a partially completed word is shifted to the beginning of the following line. Whenever text is inserted or deleted, existing text is pushed down or pulled up in a wrap-around fashion. Everything appears on the video display screen as it occurs, eliminating any guesswork. Text may be reviewed at will by variable-speed scrolling in both forward and reverse directions. By using the search, or the search and replace function, any series of characters may be located and/or replaced with any other series of characters as desired. When text is printed, this software program automatically justifies the right margin by inserting extra spaces between words on the line, and also automatically inserts carriage returns where applicable. Operator-inserted combinations of line length, page length, line spacing and page spacing allow most any form and layout to be handled. Automatic page numbering and page title printing also is included.

Most of the foregoing paragraph has been pirated from Electric Pencil boilerplate, but, if anything, it is an understatement compared to what this system can do. It is a terribly efficient and addicting system. Once you have actually tried it and used it, you will find that you cannot do without it. Though your author is only a hunt-and-peck typist of the worst variety, it took only between 3 and 4 hours to get the hang of the system, utilizing most of the excellent features it offers. It will work with any TRS-80 printer whether upper case

only, or both upper and lower case. All of a sudden your letters will look as if they have been professionally typeset by a commercial printer.

One of the niceties of the Selectric printer is being able to change the printing element, and, thus, type styles, in a few seconds. If you are lucky enough (and wealthy enough) to have a new Selecterm printer with the dual-pitch option (printing either 10 or 12 characters per inch), you may select your printing element from a wide variety of type styles and spacing. For instance, you might use 12-pitch Script for personal letters, 10-pitch Delegate for business letters, and 10-pitch Orator for speeches to be read without your glasses.

TRS-80 Lower Case Modification Kit—Likins Computer Control or Small System Software. Yes, Nancy, there is a Santa Claus. He included lower case capability in the TRS-80, but Radio Shack forgot to hook it up. All TRS-80s have the capability, although some will position lower case characters such as "p" or "y" even with the line rather than in the normal position where the bottom half of such letters is below the line. For printing with your Selectric printer, though, it does not make a big difference, and the printed copy will appear entirely normal.

The Likins kit and Small System kit (to be available soon), are similar in that both add a 2102A memory chip piggyback on another 2101A video memory chip on the TRS-80 main PCB. Your author prefers the Small System hookup since it actuates the lower-case option only when using the Electric Pencil word processing system, and this really is the only time when you want to use it. It can be

installed in about 10 minutes, and involves only soldering the extra 2102A piggyback on a Z-45 chip, cutting one PCB trace and soldering in 5 wires, plus adding a SPDT switch and additional keyboard control key for turning on or off the lowercase function while running the Electric Pencil. Holding "down" the new keyboard control key and pressing BREAK will alternately turn-on and turn-off the lowercase function, much like the shift-lock on a regular typewriter. A good spot to install the additional lowercase control key is just to the right of the BREAK key on the TRS-80 keyboard so it is not actuated inadvertently. Taking only reasonable care, the key may be installed in about 15 minutes using only a hacksaw blade, file, 5-minute epoxy, and 1/8" balsa wood as an insulator/PCB switch mount.

VAR-80 Interface (to outside real world)—Telesis Laboratory. Here is a fascinating little black box that allows the TRS-80 to handle programmed instructions to and from the outside world. Eight outputs are provided, DBO 0 through DBO 7. The first two consist of relays with contacts rated at 3 Amps at 115 V ac. The last six outputs are TTL level, which easily will drive a 7406 or 7407 chip, either of which will handle and drive 6 Radio Shack 275-004 6 V dc relays. If 8 relays are not adequate to handle your ham station requirements, it is a simple matter to, for instance, hang the last four outputs onto a 74154 demultiplexer TTL chip which, through two 7407 buffer chips, will drive 16 relays each. The eight outputs of the VAR-80 are accessed by the TRS-80 using the OUT statement port value. The VAR-80 uses port number zero and

decodes the byte value sent to port zero to turn on or off the appropriate relays/TTLs, depending on whether or not any bit in the 8-bit byte of the value number (0 to 255) contains a 1.

A picture is worth a thousand words. Picture if you will, decimal 255 binary (11111111). Since the OUT 0, 255, from our TRS-80 contains eight each binary 1-bits, all eight outputs of the VAR-80 will be turned "on." If our OUT statement was written OUT 0, 63, port zero would have the binary number 00111111 addressed to it, and the VAR-80 would turn "on" its first six outputs, leaving its last two outputs "off." Easy isn't it? Counting the 8-bit binary number from right to left tells us the on or off status of each of the VAR-80's eight outputs, depending on whether a one or zero is in any of the 8 possible binary positions.

The VAR-80 also has eight inputs available to

the outside world. The first two are opto-isolated, should you be messing around with sensing kilovolt power supplies (yuk), and the last six are TTL. The TRS-80 INP (port) function is used to input data in similar fashion to the OUT statement: A binary one is "on" or "closed," and a binary zero is "off" or "open."

What does all this good stuff do for a ham station? Well, just about anything you want it to do. The only limits are your own imagination and ability to write a simple program in BASIC for your TRS-80 to execute. For real contest nuts, it is now almost feasible for the TRS-80 and its ancillary subsystems described in this article to enter a CW and/or a RTTY contest without your assistance. All the TRS-80 will do (almost!) is ask you to take its log off the Selectric terminal/printer, put the log in the envelope it printed for you, put a stamp on it, and mail it!

As mentioned earlier, the author's TRS-80 Microcomputer-Controlled Ham Station is only one way to go. The choice of subsystems, the choice of software versus hardware, and its implementation, is up to the individual. A very decided trend is worth noting, however. The days of the dedicated computer/processor in the ham shack are indeed numbered, as are the days of the growling-clanking TTY machine. How so, you say? Answer: "The cost-effectiveness of the general purpose microcomputer... especially the TRS-80."

Let us close this dissertation with a special "thank you" to Steve Leininger, Ed Juge W5TOO, and the late Mr. Tandy for successfully bringing the TRS-80 "online" at a price many amateurs can afford. Its impact will go far beyond amateur radio and computer hobbyists and even further beyond what our wildest imaginings today can conceive! ■

Appendix

Microtronics Model M-80
5943 Pioneer Road
Hughson CA 95326
(209) 634-8888

Apparat Incorporated
P.O. Box 10324
Denver CO 80210

Western I/O, Inc.
Attn: S. Mueller, Dir. Mktg.
8337 East San Miguel
Scottsdale AZ 85253
(602)-947-0070

Small System Software
P.O. Box 483
Newbury Park CA 91320

Likins Computer Control
3001 Red Hill Avenue—Bldg. 1
Costa Mesa CA 92626

Telesis Laboratory
Dept. VAR
P.O. Box 1843
Chillicothe OH 45601

Richcraft Engineering, Inc.
Attn: TRS-80 Programs Mgr.
#1 Wahmeda Industrial Park
Chautauqua NY 14722
(716)-753-2654

CW/RTTY Hardware and software for TRS-80
Assembled and tested \$129. pp
Kit \$99. pp

16K RAM memory for TRS-80 or Expansion
Interface \$79.

Zero-time overhauled IBM Selectric "heavy-duty" printer terminal for TRS-80; \$1100 plus \$30 cable. This is an IBM #2970 system that would cost \$4000+ today.

Electric Pencil for TRS-80 \$99.
TRS232 Interface for TRS-80 \$39.

TRS-80 lowercase modification kit \$13. pp

VAR-80 Interface for TRS-80 \$99.95 pp

TRS-80 Morse code transmit-receive program (no ancillary devices required): \$15 disk/cassette pp; TRS-80 Disassembled Handbook: \$10 pp; TRS-80 All-base conversion program: \$10 disk/cassette pp

CW and the TRS-80

— send Morse with a Level I

Mark Gillett WB7TUG
2925 N. 86th Drive
Phoenix AZ 85037

About a year ago, I bought a home computer. Because of limited finances (due to the fact that I am not old enough to get a job), I purchased a Level I 4K RAM TRS-80 from Radio Shack. I have become proficient in Level I programming and wish to advance into Level II. But,

like a lot of TRS-80 owners, I just don't have the money it takes to upgrade. So, I decided I would see just how much I could get out of my basic 4K Level I machine and share my findings with other computer owners who are in the same predicament.

One of the big breakthroughs actually was discovered by accident. One day I was programming Byge (the name of my computer) and I decided to turn my radio on to get some music. I turned it on, but

there was no music. All I heard was noise. Then it occurred to me that Byge was emitting rf noise across the whole AM band. Then I ran a program and the results were revealing. The computer was making all kinds of different tones.

I flipped over to FM and tuned to a spot where these tones were clear and strong. I found that for the TRS-80, the best setting was somewhere around 89 to 90 MHz. For other computers, however, it might be best to tune around until the tones are the clearest possible. Remember, there were no connections needed between the radio and the computer, but the radio had to be in close enough proximity to the computer to receive the rf produced by the computer.

After I discovered the audible capabilities of my

computer, I began working on all kinds of new programs. And what was even more stimulating was to run old programs and listen to how each one sounded. One of the programs that I began working on was a program for computer music. By mixing different commands together, I could vary the audible note. I'm sure that any experimentation with your different commands would be well worth the effort.

Months have gone by since I first realized that Byge was capable of "talking back." Now, every time I turn on my computer, I turn on my FM radio. It's just not the same without it.

Sending Morse Code

A few weeks ago, some friends who own 32K Level II machines with floppy disks told me that the TRS-80 could now send and receive RTTY and CW. Sure enough, they ordered the hardware and software that was needed and showed me that it was possible. There was only one catch: It required a system equipped with Level II in ROM and 16K in RAM. So that eliminated me, as it might other smaller system operators.

I was determined to show them that what I lacked in memory capabilities I made up for in intelligence.

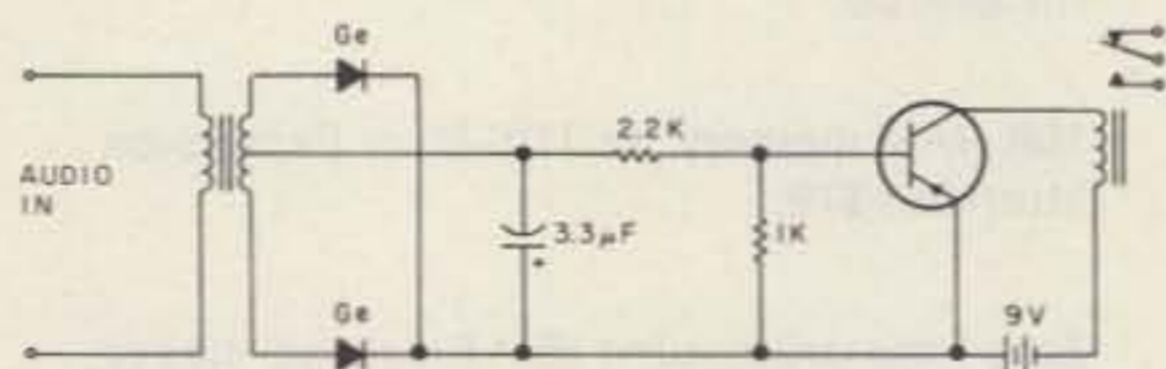

Fig. 1. A schematic of a simple circuit that plugs into the output of the radio. It closes the relay if a signal is present and opens the relay if a signal is not present.

9, 15, 18 Wpm #	2, 5, 6 Wpm #	0, 1, 3 Wpm #	0, 1, 3 Wpm #	0, 0, 1 Wpm #	0, 0, 1 Wpm #
1	11 208	21 104	31 54	41 31	51 14
2	12 182	22 99	32 50	42 29	52 12
3 875	13 161	23 91	33 47	43 27	53 11
4 625	14 143	24 85	34 44	44 25	54 10
5 450	15 124	25 79	35 41	45 23	55 9
6 345	16 107	26 74	36 37	46 21	56 8
7 245	17 96	27 69	37 34	47 20	57 7
8 180	18 85	28 64	38 31	48 18	58 6
9 135	19 75	29 60	39 29	49 17	59 5
10 90	20 65	30 57	40 28	50 15	60 4

Table 1. Converting a words-per-minute rate into the speed # required by the computer. At the top of each column is the recommended number of PRINT statements for each gap, pause, and space for that particular range of speeds.

I began working on a program that would input characters and output Morse code. Using one short loop and one long loop at a steady tone value gave me dits and dahs from my nearby radio. I used PRINT statements for the spaces, pauses, or gaps that are needed between letters and words because they had the least amount of audible tone.

About the Program

The program I have included was written in simple BASIC language. However, abbreviations had to be used in order to have enough memory left to use for array variables. If your system is equipped with more than 4K in RAM, these abbreviations may be spelled out.

Lines 3 through 7 are my two subroutines for dits and dahs. I put them in the beginning of the program because it takes a lot less memory to GOSUB 3 than it would to GOSUB 3000. The program actually begins on line 100. From 100 to 120 the letters from A to Z are assigned a numerical value. Now, since I have used up all my letter variables, I must resort to array variables.

The program now is ready to input characters from the keyboard and display them on the screen. Lines 130, 140, and 150 do just that. Line 130 inputs the character and moves the cursor over two, ready for the next input. It also erases the ? and produces a double-spacing effect. Line 140 calls a SUB at line 200. Line 200 allows backspacing to any place in the text. Line 220 detects a space character (which is a 0) and prints a space on the screen. The rest of the subroutine prints inputs that are greater than 38. These inputs are the four basic punctuation marks. Line 150 increments the array

variable and goes to 130 where the next letter is put in.

After the whole message is in memory, the computer must start at the beginning of the text and convert each character into the right sequence of dits and dahs. Line 160 starts the computer at the beginning of the message, then each number from a range of 1 to 42 (since all letters and punctuation are assigned numerical values) goes to the subroutine at 300. Lines 300 through 340 send any number from 1 to 42 to a specified location where a certain sequence of GOSUB produces the code for that number. For example, say an A was typed in. If you recall, each letter was placed at a numerical value. The value of A was 11. So line 310 would send control to line 400. At line 400 we have a GOSUB 3 and a GOSUB 6. GOSUB 3 produces the dit and GOSUB 6 produces the dah. Bingo!

Operational Procedures

When you run this Morse code program, the first thing you must do is tell the computer the speed # at which the code is to be sent. This number must not be mistaken for the wpm number. If you wish to send a certain number of words per minute, Table 1 converts wpm into the speed # required by the computer. This number sets the length of a dit and a dah but does not adjust the length of the spaces between dits and dahs, letters, and words. For good-sounding code, these lengths also must vary with the speed # entered. These lengths are changed by varying the number of PRINT statements at lines 4 and 7 for gaps between dits and dahs, at line 180 for pauses between letters, and at line 670 for spaces between words. At the top of the columns in Table 1, the

```

1 G 100
2 G 160
3 F N=16384T016384+A(2)/3:N,N
4 P :P :RET.
5 F N=16384T016384+A(2):N,N
7 P :P :RET.
100 CLS:A=11:B=12:C=13:D=14:E=15:F=16:G=17:H=18:I=19:J=20:K=21
110 L=22:M=23:N=24:O=25:P=26:Q=28:R=29:S=30:T=31:U=32:V=33
120 W=34:X=35:Y=36:Z=37:A(1)=3:IN,"SPEED #":A(2):CLS
130 P:ATA(1)*2-4:P:ATA(1)*2-2:IN:A(A(1)):IFA(A(1))=27G.160
140 GOS 200
150 A(1)=A(1)+1:G.130
160 A(1)=3
170 GOS 300
180 P:P:P:P:P
190 A(1)=A(1)+1:G.170
200 IFA(A(1))<0A(A(1))=A(1)-1+A(A(1)):RET.
210 IFA(A(1))=10P:ATA(1)*2-1,"0":RET.
220 IFA(A(1))=0P:ATA(1)*2-2," ":A(A(1))=38:RET.
230 IFA(A(1))<39RET.
240 P:ATA(1)*2-1
250 ONA(A(1))-38G.260,270,280,290
260 P:"?":RET.
270 P:" ":RET.
280 P:"," :RET.
290 P:"-":RET.
300 ONA(A(1))G.710,720,730,740,750,760,770,780,790,700
310 ONA(A(1))-18G.400,410,420,430,440,450,460,470
320 ONA(A(1))-18G.480,490,500,510,520,530,540,550
330 ONA(A(1))-26G.660,560,570,580,590,600,610,620
340 ONA(A(1))-34G.630,640,650,670,680,690,810,820
400 GOS 3:GOS 6:RET.
410 GOS 6:GOS 3:GOS 3:GOS 3:RET.
420 GOS 6:GOS 3:GOS 6:GOS 3:RET.
430 GOS 6:GOS 3:GOS 3:RET.
440 GOS 3:RET.
450 GOS 3:GOS 3:GOS 6:GOS 3:RET.
460 GOS 6:GOS 6:GOS 3:RET.
470 GOS 3:GOS 3:GOS 3:GOS 3:RET.
480 GOS 3:GOS 3:RET.
490 GOS 3:GOS 6:GOS 6:GOS 6:RET.
500 GOS 6:GOS 3:GOS 6:RET.
510 GOS 3:GOS 6:GOS 3:GOS 3:RET.
520 GOS 6:GOS 6:RET.
530 GOS 6:GOS 3:RET.
540 GOS 6:GOS 6:GOS 6:RET.
550 GOS 3:GOS 6:GOS 6:GOS 3:RET.
560 GOS 6:GOS 6:GOS 3:GOS 6:RET.
570 GOS 3:GOS 6:GOS 3:RET.
580 GOS 3:GOS 3:GOS 3:RET.
590 GOS 6:RET.
600 GOS 3:GOS 3:GOS 6:RET.
610 GOS 3:GOS 3:GOS 3:GOS 6:RET.
620 GOS 3:GOS 6:GOS 6:RET.
630 GOS 6:GOS 3:GOS 3:GOS 6:RET.
640 GOS 6:GOS 3:GOS 6:GOS 6:RET.
650 GOS 6:GOS 6:GOS 3:GOS 3:RET.
660 E
670 P:P:P:P:P:P:RET.
700 GOS 6:GOS 6:GOS 6:GOS 6:GOS 6:RET.
710 GOS 3:GOS 6:GOS 6:GOS 6:GOS 6:RET.
720 GOS 3:GOS 3:GOS 6:GOS 6:GOS 6:RET.
730 GOS 3:GOS 3:GOS 3:GOS 6:GOS 6:RET.
740 GOS 3:GOS 3:GOS 3:GOS 3:GOS 6:RET.
750 GOS 3:GOS 3:GOS 3:GOS 3:GOS 3:RET.
760 GOS 6:GOS 3:GOS 3:GOS 3:GOS 3:RET.
770 GOS 6:GOS 6:GOS 3:GOS 3:GOS 3:RET.
780 GOS 6:GOS 6:GOS 6:GOS 3:GOS 3:RET.
790 GOS 6:GOS 6:GOS 6:GOS 6:GOS 3:RET.
800 GOS 3:GOS 6:GOS 3:GOS 6:GOS 3:RET.
810 GOS 6:GOS 6:GOS 3:GOS 3:GOS 6:GOS 6:RET.
820 GOS 6:GOS 3:GOS 3:GOS 3:GOS 6:RET.
830 GOS 3:GOS 3:GOS 6:GOS 6:GOS 3:GOS 3:RET.

```

Listing 1. A simple BASIC program that allows Morse code output by the radio for any text entered by the keyboard. Abbreviations were used to save memory space.

recommended numbers of PRINT statements are listed in order for gaps, pauses, and spaces.

After entering the desired speed and adjusting the number of PRINT statements for gap, pause, and space, you are ready to start entering your message. You must enter one letter at a time, and each letter will be displayed after entering.

To correct a mistake after entering it, just enter minus (-) the number of spaces to the left you wish to backspace. For example,

```

130 A(A(1))=R:(42):IFA(A(1))=27G.130
140 A(1)=A(1)+1:IFA(1)<I:(M./4-1)G.130
150 A(A(1))=27

```

Listing 2. An option for the program in Listing 1 that converts it into a random code-practice sender.

if you type in CQ CQ CQ DR WB7TUG?, all you do is enter -8 and the cursor goes to the R and lets you input the correction and start from there.

Punctuation is limited to four basic marks: the question mark (enter 39), the period (enter 40), the comma (enter 41), and the dash

(enter 42). The character for a space is a 0.

After you have completed your text and want the computer to start sending, enter 27. If you want the computer to send the same message over, just enter RUN 2. (Note: With 4K RAM and without an excessive number of PRINT statements at lines 4, 7, 180, and 670, a text may be as long as 11 lines, or even more.)

Option: Making a Random Code-Practice Sender

To use this BASIC program as an aid in learning code, just change lines 130, 140, and 150 as shown in Listing 2. When running this program, there will be a slight delay before the code is sent. Just stand by.

Addition: Adding a Computer-Controlled Relay

You already have computer audio output capability from your FM radio, so

now you can harness the logic 0 (no audio tone) and the logic 1 (audio tone) to operate a relay.

Fig. 1 shows a schematic of a simple circuit that takes the raw ac input from the radio and converts it to dc. This dc voltage is then fed into a PNP transistor where it varies the current from the 9-V source to the relay. This activates the relay on a logic 1 and drops it on a logic 0. If the relay does not respond to a logic 1, try adjusting the volume control on the radio. Your computer can now control lights, oscillators, or any other circuit via the relay.

By using this FM radio method of producing audio tones from your computer, you should be able to find a lot of interesting new applications for your small system. The BASIC program I have come up with is just a starting point. The sky is the limit. ■

Practical Antennas for the Radio Amateur is a manual which describes how to go about equipping an amateur station with a suitable antenna, with the goal of on-the-air operation. The scope of this work is designed to aid not only the experienced amateur operator but the newcomer as well. A wide range of antenna topics, systems, and accessories are presented, both to give the reader some food for thought and as practical data for construction. Just \$9.95, catalog number BK1015.

**ORDER TODAY!
USE THE
POSTAGE PAID
CARD AT THE
BACK OF THIS ISSUE.**

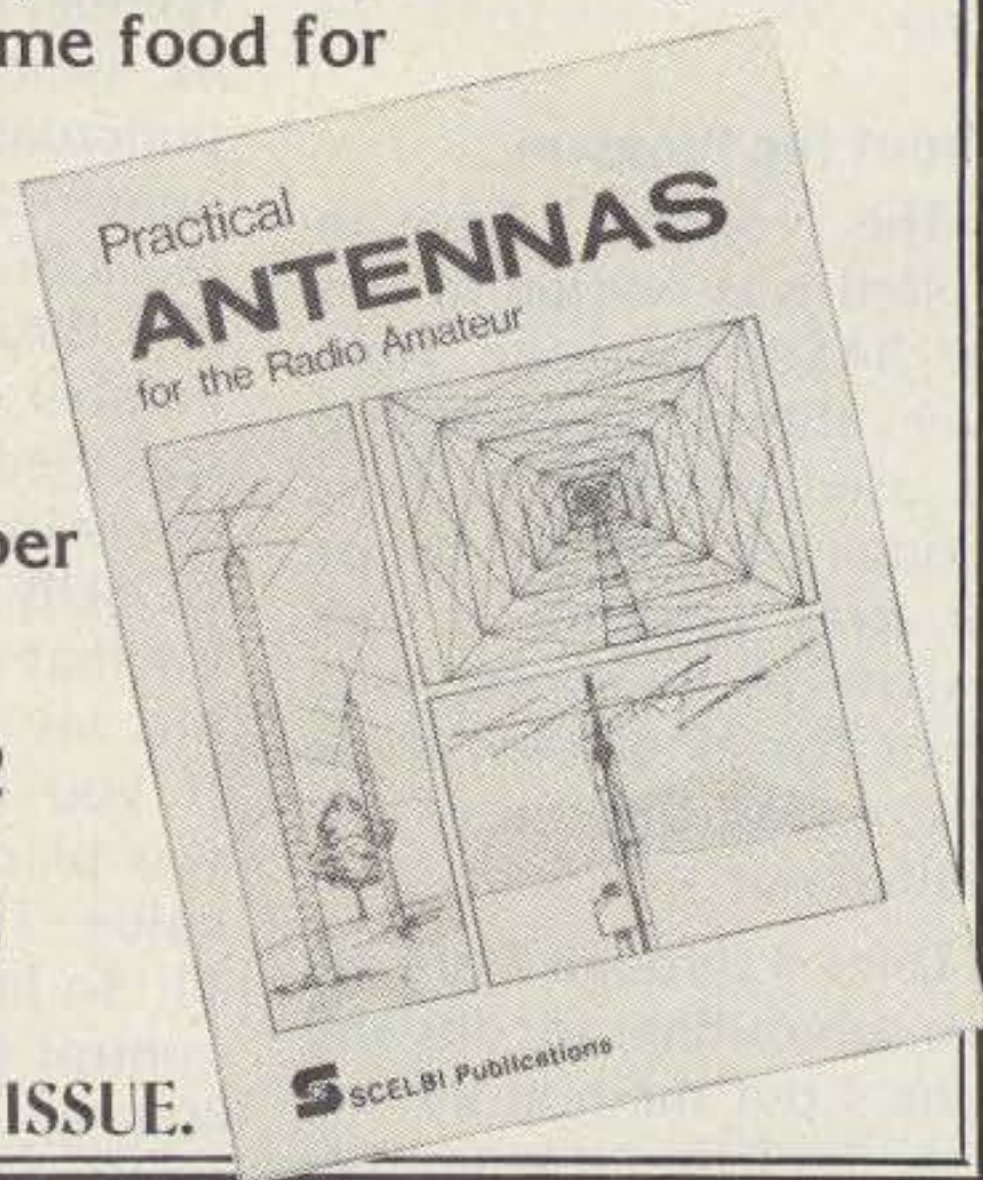

A.R.C.H. CONVENTION AMATEUR RADIO · COMPUTER HOBBYIST

ST. LOUIS, MO. MAY 24, 25, 1980

- FABULOUS FORUMS
- GIANT INDOOR FLEA MARKET
- EXHIBITS
- MAJOR MANUFACTURERS AND DEALER DISPLAYS
- PARKING
- THOUSANDS OF DOLLARS IN PRIZES
- SPECIAL MOTEL ACCOMMODATIONS
- MISSISSIPPI RIVER DINNER AND DANCE CRUISE
- LADIES AND FAMILY ACTIVITIES

OFFICIAL ARRL CENTRAL-MIDWEST CONVENTION

FEATURING: HARRY DANNA
LOU MCCOY

SATURDAY EVENING A.R.C.H. BANQUET AND CRUISE
WITH ROY NEAL, K6DUE, NBC NETWORK NEWS

ADMISSION: \$3.00 ADVANCE \$4.00 AT DOOR
RIVER CRUISE/BANQUET: \$16.00

SEND CHECK TO:
GATEWAY AMATEUR RADIO ASSOCIATION, INC.
P.O. Box 26
Marissa, Illinois 62257

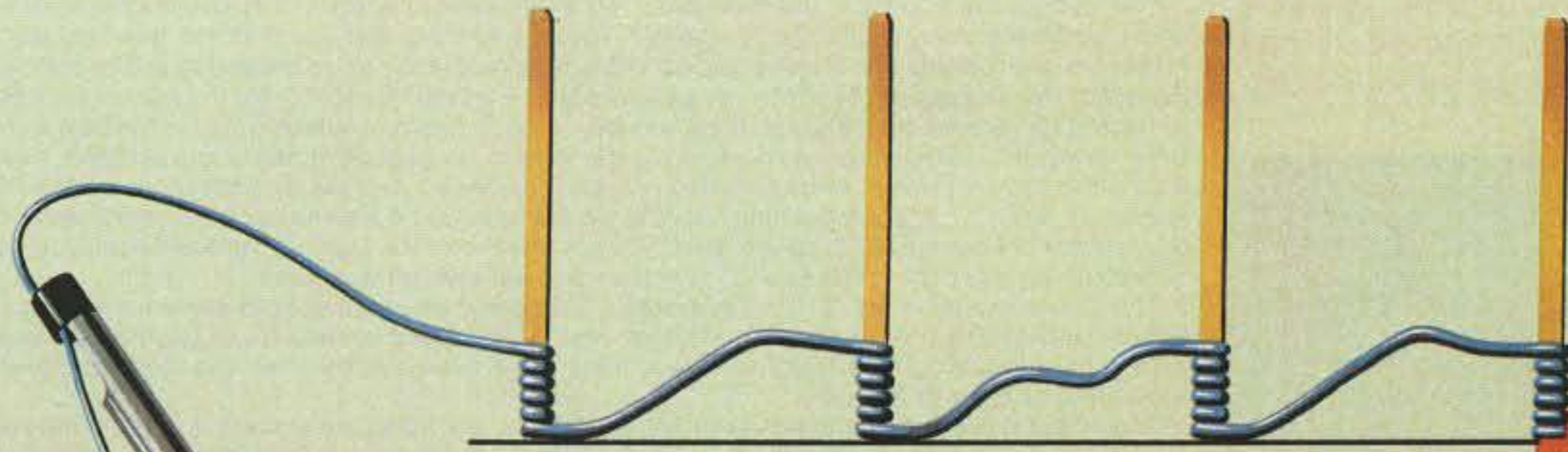

WHY CUT? WHY STRIP? WHY SLIT?
WHY NOT...

NEW

JUST WRAP™

WIRE WRAPPING TOOL

- AWG 30 Wire
- .025" Square Posts
- Daisy Chain or Point To Point
- No Stripping or Slitting Required
- Built In Cut Off
- Easy Loading of Wire
- Available Wire Colors: Blue, White, Red & Yellow

U.S.A., FOREIGN PATENTS PENDING

traditional Wire-Wrapping

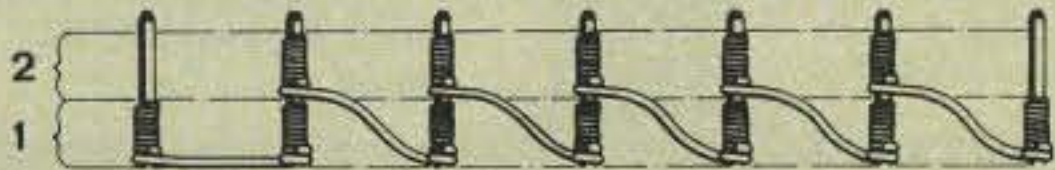

JUST WRAP Wire-Wrapping

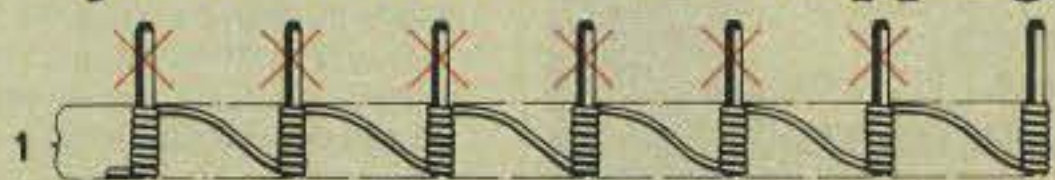

JUST WRAP TOOL WITH ONE 50 FT. ROLL OF WIRE		
COLOR	PART NO.	U.S. LIST PRICE
BLUE	JW-1-B	\$ 14.95
WHITE	JW-1-W	14.95
YELLOW	JW-1-Y	14.95
RED	JW-1-R	14.95
REPLACEMENT ROLL OF WIRE 50 FT.		
BLUE	R-JW-B	\$ 2.98
WHITE	R-JW-W	2.98
YELLOW	R-JW-Y	2.98
RED	R-JW-R	2.98
JUST WRAP-UNWRAPPING TOOL		
	JUW-1	\$ 3.49



OK MACHINE & TOOL CORPORATION 3455 CONNER ST.,
BRONX, N.Y. 10475 (212) 994-6600/TELEX 125091

✓ 54

*MINIMUM BILLING \$ 25.00/ADD SHIPPING CHARGE \$ 2.00/NEW YORK CITY/STATE RESIDENTS ADD APPLICABLE TAX.

If you enjoy driving, you're going to get a **COMPUCRUISE**. Once you see what it can do, you just won't be able to live without it.

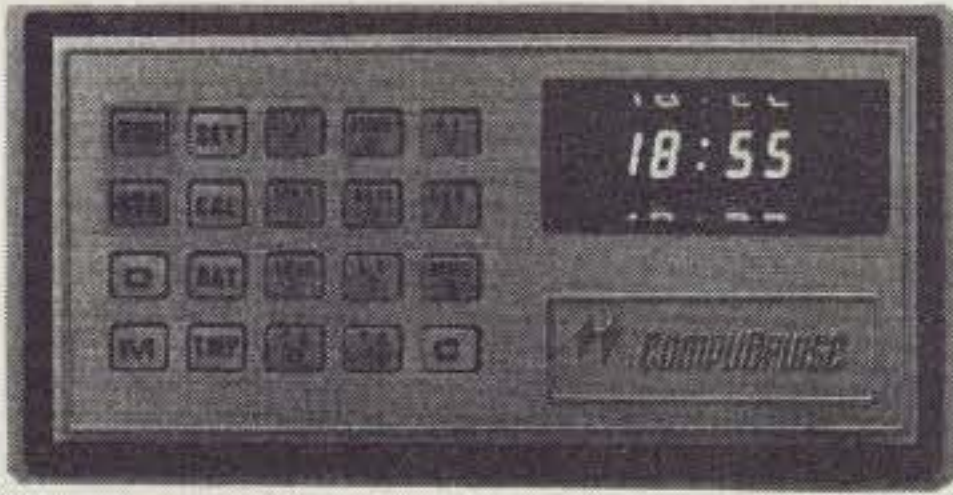

This gadget fits into most dashboards... no strain even in a tiny sports car like the Mazda RX-7... and once you have it, every trip is like flying a 747. The darned thing tells you the time, how fast you're going, how far you've been on this trip or since the last regassing, how many miles per gallon you're getting, either at the instant or the average on the trip... or gallons per hour at the moment or for the trip... temperature outside... inside (or coolant temperature, if you prefer)... oh, it has an elapsed time for the trip, a stop watch, lap time, an alarm... how much further for your trip, how many gallons more the trip will take, how much longer for the trip at your present average speed... yes, it gives you your average speed for the trip. You prefer it in metric, no strain... liters remaining, etc. Did we mention that it also has cruise control either at a speed set on the control board or at whatever speed you are traveling? The Compucruise will keep you busy and entertained during any trip... telling you more than you will ever want to know.

The Compucruise is not difficult to install... though it does connect to everything except the cigarette lighter. Until you've tried computerized travel, you haven't found out how much fun driving can be. It will work on any car not having fuel injection... and there is a front-wheel drive accessory gadget available for only \$4.40-#P001 (regularly \$5.50).

The price for the Compucruise is regularly \$199.95... and a bargain at that price. We'll sell you one of these fantastic gadgets for \$159.95 with cruise control (Model 44-#P002), and \$127.95 without (Model 41-#P003). Send money... and start having fun!

MOM'S

MAIL ORDER MICROS

Dept A73 • PO Box 427 • Marlboro NH 03455
Phone: (603) 924-3041



Steal Stopper

Ever had your car stolen?
The first reaction is one of disbelief...
... you know it was right there!

What you want is a modern combination lock on your ignition... The Steal Stopper. It's easy to install and almost impossible to defeat. You can by-pass it, if you want, for parking attendants or a car wash. Other than that, you set up a secret four digit code and only will then be able to start the car... even if you leave the keys in the ignition.

This protection retails for \$50... but we have a special for you at \$39.95. Don't procrastinate. Order #P004.

Note: This product works best on Detroit cars. Mazda RX7 owners must order additional module, #P008, which costs \$8. The Steal Stopper can be modified for Mercedes, Porsche, Ferrari, or other high performance European cars by returning unit to manufacturer with \$3. They promise quick modification and return.

PROCESSOR TECH HARDWARE

- 9 Processor Tech Video Display Module—Memory mapped video for S-100, excellent condition. #D009-\$144 each.

PROCESSOR TECH SOFTWARE

- 2 Processor Tech Extended Disk BASIC—This is full disk BASIC on 8" disk for HELIOS II disk controllers with PTDOS and greater than 16K. #D015-\$80 each.
- 1 Extended Disk BASIC on cassette—This is the same as previously mentioned for the Disk BASIC from Processor Tech. Needs more than 16K. #D017-\$72.
- 8 Extended Cassette BASIC—This includes all file operations, advanced functions for doing more than playing games; for SOLOS, CUTTER, and CONSOL Monitors. #D016-\$22 each.
- 19 BASIC 5 from Processor Tech—This is a simple BASIC for a SOLOS, CUTTER, or CONSOL Monitor and 8K of RAM. #D013-\$11.60 each.
- 4 Processor Tech GAMEPAC—Various simple games. #D014-\$11.60 each

ASTROLOGICAL COMPUTER AND 4-FUNCTION CALCULATOR

ASTRO®

Gives you a fascinating look into your personality traits. Compares 16 different combinations. Matches your astrological influences to any day—past, present, or future. Gives in-depth analysis of your compatibility with your boss, your spouse, your lover, your child. Regularly \$49.95. #P0020—\$39.95 SPECIAL PRICE.

PROCESSOR TECH SOL

- 4 SOL Computers—8K RAM Monitor, S-100, excellent condition. #D004-\$980 each.
- 19 TREK-80 on cassette for SOL—This is one of the best real time space games available today; needs 8K. #D005-\$11 each.
- 9 Electric Pencil on cassette for SOL—Word processor, needs 8K. #D006-\$80 each.

MICRO TERM ACT TERMINAL

- 2 MicroTerm ACT Terminal—Need a video monitor, up to 600 Baud, good condition. #S035-\$200 each. SPECIAL PRICE.

COMPUCOLOR HARDWARE

- 2 Compucolor Computer 8001 (use as computer or 75 MHZ Color Monitor)—8K RAM, BASIC and DOS in ROM, good condition. #S025-\$1500 each. SPECIAL PRICE.
- 2 Compucolor MiniFloppy—5 1/4 inch, good condition. #S026-\$525 each. SPECIAL PRICE.
- 4 Compucolor 8K RAM card—Static RAM, good condition. #S027-\$200 each. SPECIAL PRICE.
- 3 Compucolor Floppy Tape Drive—Uses eight track cartridges, good condition. #S028-\$70 each. SPECIAL PRICE.

PANASONIC TAPE DECKS

Panasonic RS261 US Stereo Cassette Decks—with auto-stop, record level adjust, VU meters, used condition; all have had heads replaced and aligned. #T001-\$50.
Panasonic RS260 US Stereo Cassette Decks—same as above, but also has bias switch for chrome tapes. #T002-\$50.

POLYMORPHIC HARDWARE

- 6 PolyMorphic Video Terminal Interface—Memory mapped video for S-100 bus, good to excellent condition. #S044-\$150 each. SPECIAL PRICE
- 1 PolyMorphic S-100 Cabinets—Nice 5-slot S-100 mainframe, good to excellent condition. #D049-\$248 each.

POLY-88 ACCESSORIES

- 1 Software on 5 1/4"—This is system software that requires a PolyMorphic Disk Controller in a System 88 Cabinet. #D002-\$100.
- 1 Electric Pencil—#D003-\$80.

LIMITED SUPPLY 73 MAG. AUG. '79

Contains controversial article "You Can Watch Those Secret TV Channels." Order #M001-\$5 each. (Plus shipping and handling.)

ALS-80

- 14 ALS-80 Operating system—This system requires 12K RAM from D000 to FFFF; as well as either the SOLOS or CUTTER monitor; it includes an Assembler/Editor. #D018-\$11.60 each.

NORTH STAR HARDWARE

- 1 North Star Floating Point BASIC card—With special BASIC, new. #D0059-\$287.
- 2 North Star Floating Point BASIC card (kit)—With special BASIC, S-100, new. #D0060-\$207.
- 8 North Star Floppy Disk Controller card—Single density, S-100, new. #D0061-\$248.
- 120 S-100 Edge Connector—Gold Contacts, new. #D050-\$2 each.
- 6 Extender Card for S-100 (kit)—New. #D051-\$24 each.

BALLY GAMES

- 2 Bally VideoCode Cassettes—They consist of two games: Speed Math and Bingo Math. #D029-\$16 each.

ABACUS

- 112 Abacus Paperweight—Hefty, brass, excellent condition. #S024-\$3 SPECIAL PRICE.

MUSIC

- 2 Software Technology S-100 Music system on cassette—This is an S-100 Music system; contains the proper hardware. #D0058-\$19.60 each.

COMPUTER TRAINER

- 1 IASIS COMPUTER-IN-A-BOOK—8080 Microcomputer, comes built into training manual, excellent condition. #D020-\$240

ICOM DISK DRIVE ACCESSORIES

- 1 ICOM Dual Disk Drive—Single density, 512K storage, S-100 controller, includes CP/M ROM, good condition. #S030-\$1500. SPECIAL PRICE.
- 1 ICOM PROM and 8" Disk for SOL FDOS—This disk requires an ICOM S-100 Disk Controller installed in an S-100. #D031-\$160.
- 1 ICOM CP/M on 8" Disk for S-100—Requires an ICOM S-100 controller in an S-100 cabinet, #D032-\$100.
- 2 ICOM FDOS-II on 8" Disk for S-100—Requires an ICOM S-100 controller in an S-100 cabinet, no documentation. #D033-\$180 each.
- 1 ICOM FDOS-II on 5 1/4" Disk for S-100—Requires an ICOM S-100 Mini-Floppy Controller in an S-100 cabinet. #D034-\$168.

MOM'S

MAIL ORDER MICROS
Dept A73 • PO Box 427 • Marlboro NH 03455
Phone: (603) 924-3041

20% OFF Inventory Clearance SALE

IMSAI HARDWARE

- 1 IMSAI 8800 Mainframe S-100—Excellent condition. #D0087-\$839.
- 1 IMSAI 80/15 S-100 Development System—Partially assembled, needs a CPU card, excellent condition. #S0088-\$525 as is. **SPECIAL PRICE.**
- 1 IMSAI 80/15 S-100 Development System—Kit, mainframe cover missing, needs a CPU card, excellent condition. #S0089-\$500 as is. **SPECIAL PRICE.**
- 2 IMSAI 4K RAM card—S-100, good condition. #D0055-\$89.60

IMSAI SERIAL I/O CARDS

- 1 IMSAI Serial I/O card
- 2 IMSAI Serial I/O card 2-2 (kit)—Two serial ports, full RS-232 control, S-100, good condition. #D0090-\$188.
- 5 IMSAI Serial I/O card 2-2 (kit)—Two serial ports, full RS-232 control, S-100, new. #D0091-\$124.
- 2 IMSAI Serial I/O card 2-1 (kit)—One serial port, full control RS-232 control, S-100, new. #D0092-\$100.

IMSAI PARALLEL I/O CARDS

- 1 IMSAI Parallel I/O card 4-4—Four parallel ports, S-100, excellent condition. #D0093-\$186.
- 1 IMSAI Parallel I/O card 4-1 (kit)—One parallel port, S-100, new. #D0094-\$74.40.

IMSAI SOFTWARE

- 2 IMSAI IMDOS V2.02 on 8" Disk for S-100—No documentation, but this is apparently IMSAI's version of CP/M for S-100 systems with an IMSAI Disk Controller. #D0056-\$96 each.
- 2 IMSAI BASIC 9A—This BASIC is on a TARSELL cassette interface. #D0057-\$22.
- 1 TARSELL Cassette Interface (kit)—Kansas City Interface, Tarbell Phase encoding, S-100, new. #D0064-\$96.

HEAD ALIGNMENT KIT

Best cassette recorder tape head alignment kit available. Solves loading problems. #K001-only \$9.95.

PHONE INTERFACE

- 6 Novation Modem #3102A—Connects to any phone, originate only, good condition. #S021-\$165 each. **SPECIAL PRICE.**
- 1 Novation Modem #43—Connects to any phone, originate only, good condition. #S023-\$165. **SPECIAL PRICE.**

VECTOR GRAPHIC S-100

- 3 Vector Graphic ROM/RAM card—12K empty ROM sockets, 1K RAM, excellent condition. #D0078-\$119.60.
- 5 Vector Graphic Analog Interface—Allows hobbyist to interface analog experiments, S-100, new. #D0079-\$79.20.

TDL ZAPPLE

- 2 TDL Z-80 8K RAM—This is for a Z-80 with a ZAPPLE monitor. #D0071-\$36.
- 3 TDL ZAP 1K Monitor—Simple monitor. #D0073-\$12.

INSTANT SOFTWARE HALF PRICE SPECIAL CLOSEOUT—ONLY \$4

- TRS-80, Level I, Games
Knights Quest/Robot Chase 4K-#SI0003.
Cave Exploring 16K-#SI0010.
Doodles and Displays 16K-#SI0030.
Fun Package I 16K-#SI0041.
- TRS-80, Level I, Finance
Status of Homes 4K-#SI0012.
- TRS-80, Level II, Hobby
Model Rocketry Analyzer-#SI0024.

BOOK CLEARANCE UP TO 50% OFF

Take a Chance with Your Calculator (Lithium-publisher) #BK1002—was \$8.95, now \$4.50.
Chemistry with a Computer (Educamp-publisher) #BK1010—was \$9.95, now \$5.00.
Computer Dictionary (Camelot-publisher) #BK1018—was \$5.95, now \$3.00.
FORTRAN Programming (Camelot-publisher) #BK1019—was \$7.95, now \$4.00.
FORTRAN Workbook (Camelot-publisher) #BK1020—was \$4.95, now \$2.50.
A Quick Look at BASIC (Camelot-publisher) #BK1043—was \$4.95, now \$2.50.

TDL SOFTWARE-DISK

- 1 TDL FDOS & SuperBASIC on 8" Disk—This requires an ICOM Disk Controller and at least 20K of memory, plus a ZAPPLE Monitor in an S-100 Cabinet (Altair, IMSAI, etc.). #D0065-\$137.
- 1 TDL System Software on 5 1/4" disk—This set of system software requires a North Star Disk Controller, a TDL Systems Monitor Board I, and consists of 12K BASIC, Relocator/Linking Loader, Z-80 Editor, and Text Processor. #D0066-\$183.
- 1 TDL System Software on 5 1/4" disk—This is the same as above, but does not require the Systems Monitor Board I. #D0067-\$200.
- 1 TDL System Software on 5 1/4" disk—Again, as above, but requires a HELIOS Disk Controller and the TDL Systems Monitor Board II (not I). #D0068-\$183.

HONEYWELL

15 Honeywell ASR-33 Communications Consoles with TTY, paper tape reader and punch. Used, working when removed from service. Shipped freight collect or you pick up. Weight 300 lbs. \$395. Order #P006.

MOUNTAIN HARDWARE

- 7 Mountain Hardware AC Controller—Remote AC outlet control, S-100, new. #D040-\$100 each.
- 4 Mountain Hardware remote outlet—Remote AC outlet for ab channels, new. #D041-\$72 each.

HEURISTICS SPEECH LAB

- 1 Heuristics Speech Lab—S-100, used, fair condition. #S042-\$100 as is. **SPECIAL PRICE.**
- 4 Heuristics Speech Labs—S-100, new. #D043-\$151 each.

CALLBOOKS 10% OFF

US-#CX01—was \$16.95, now \$15.25
DX-#CX02—was \$15.95, now \$14.35

SHUGART

- 4 Shugart MiniDisk Drives—No cabinet, good condition. #S037-\$300 each. **SPECIAL PRICE.**
- 4 Power Supplies—above condition. #D0069-\$72 each. **SPECIAL PRICE.**

Prices include 20% discount. **SPECIAL PRICE** includes more than 20% discount.

Quantities are limited, immediate refund if ordered item is no longer available. *Phone answered by machine. Orders taken with credit cards. Questions answered by mail.

TERMS: FOB Marlboro, NH USA. Limited stock; everything guaranteed as described; you pay postage on returns. PRINT orders clearly. Minimum order \$10 plus \$2.50 shipping and handling charge in USA only. DOUBLE THAT ELSEWHERE. Orders over \$50 add 5% for shipping in USA; 10% elsewhere (we will refund excess). Orders shipped UPS or insured mail only. No CODs please. Send US funds by check or money order. For credit card purchases, add 4%, list AE, MC or VISA, number, and expiration date. Mail to MOM's, Department A73, PO Box 427, Marlboro NH 03455.

Condition of Inventory:
New = original container
Excellent = new, but not in original container
Good = tested or used in store

Qty	Catalog #	Description	Unit Price	Total

Delivery: 3 to 6 weeks. Personal checks take about 2 weeks to clear bank before we ship.
Enclosed \$ _____

Bill: AE MC VISA

Card no. _____

Name _____

Address _____

City _____

Ship: UPS

Insured mail Signature _____

MOM'S

MAIL ORDER MICROS
Dept A73 • PO Box 427 • Marlboro NH 03455
Phone: (603) 924-3041

Shipping & Handling _____

Credit Card (+ 4%) _____

Total _____

Exp Date _____

State _____ Zip _____

QUALITY THAT SPEAKS FOR ITSELF!

Hustler fixed station two meter gain antennas.

Hustler is the choice of those who know quality. Because we're known for precision engineering and electronic expertise.

Only the finest materials are used to make a Hustler amateur antenna. And each model is the result of years of design excellence.

From easy and precise assembly to outstanding long-range transmitting and receiving, Hustler quality speaks for itself. See your dealer and find out why!



3275 North B. Ave., Kissimmee, Florida 32741

✓305 *Clearly the choice of those who know quality.*



DEALER DIRECTORY

Fontana CA

We carry the following: ICOM, Midland, Amcom, DenTron, KLM, Swan, Drake, Ten-Tec, Wilson, SST, MFJ, Hy-Gain, Lunar, Nye-Viking, B&W, Redi-kilowatt, CushCraft, Mosley, Big Signal, Pipa, etc. Full Service Store Fontana Electronics, 8628 Sierra Ave., Fontana CA 92335, 822-7710.

San Jose CA

Bay area's newest Amateur Radio store. New & used Amateur Radio sales & service. We feature Kenwood, ICOM, KDK, Yaesu, Ten-Tec, VHF Engineering & many more. Shaver Radio, Inc., 1378 So. Bascom Ave., San Jose CA 95128, 998-1103.

San Leandro CA

Specializing in Amateur Radio Test Guides. F.C.C. Advanced Class test is a snap with our manual. Bash Educational Services, 15373 Edgemoor St., P.O. Box 382, San Leandro CA 94577.

Denver CO

Experimenter's paradise! Electronic and mechanical components for computer people, audio people, hams, robot builders, experimenters. Open six days a week. Gateway Electronics Corp., 2839 W. 44th Ave., Denver CO 80211, 458-5444.

New Castle DE

ICOM, Ten-Tec, Swan, KDK, NDI, Tempo, Wilson; Authorized dealer: 1 mile off I-95. No sales tax. Delaware Amateur Supply, 71 Meadow Road, New Castle DE 19720, 328-7728.

Columbus GA

KENWOOD—YAESU—DRAKE
The world's most fantastic amateur show-room! You gotta see it to believe it! Radio Wholesale, 2012 Auburn Avenue, Columbus GA 31906, 561-7000.

Boise ID

Adzen, Amidon, Ameco, ARRL, B&W, Callbook, Collins, CushCraft, Dentron, Hustler, ICOM, Jim-Pak, KDK, MFJ, NPC, Nye, Sams, SST, Swan, Ten-Tec, Wanzer, Wilson. Custom Electronics, 1209 Broadway, Boise ID 83706, Bob W7SC 344-5084.

Preston ID

Ross WB7BYZ, has the Largest Stock of Amateur Gear in the Intermountain West and the Best Prices. Call me for all your ham needs. Ross Distributing, 78 So. State, Preston ID 83263, 852-0830.

Terre Haute IN

Your ham headquarters located in the heart of the midwest. Hoosier Electronics, Inc. Q 43B Meadows Shopping Center, P.O. Box 2001, Terre Haute IN 47802, 238-1456.

Littleton MA

The ham store of N.E. you can rely on. Kenwood, ICOM, Wilson, Yaesu, DenTron, KLM amps, B&W switches & wattmeters, Whistler radar detectors, Bearcat, Regency, antennas by Larsen, Wilson, Hustler, GAM. TEL-COM Inc. Communications & Electronics, 675 Great Rd., Rt. 119, Littleton MA 01460, 486-3040.

Laurel MD

Kenwood, Drake, ICOM, Ten-Tec, Swan, Dentron, Tempo and many ham accessories. Also computers by Apple and Exidy. Call toll free 1-800-638-4486. The Comm Center, Inc., Laurel Plaza—Rt. 198, Laurel MD 20810.

St. Louis MO

Experimenter's paradise! Electronic and mechanical components for computer people, audio people, hams, robot builders, experimenters. Open six days a week. Gateway Electronics Corp., 8123-25 Page Blvd., St. Louis MO 63130, 427-6116.

Camden NJ

X-band (& other frequencies) Microwave Components & Equipment. Laboratory Grade Test Instruments, Power Supplies, 1000's in stock at all times, BUY & SELL all popular makes—HP, GR, FXR, ESI, Sorensen, Singer, etc. Lectronic Research Labs, 1423 Ferry Ave., Camden NJ 08104, 541-4200.

Syracuse—Central NY

We deal, we trade, we discount, we please! Yaesu, Ten-Tec, Cushcraft, Drake, Dentron, KLM, Midland, B&W, ICOM, Hygain, Swan, Amcom, Telco, Mirage, DSI etc. Complete 2-way service shop! Ham-Bone Radio (Div. Stereo Repair Shop) 3206 Erie Blvd. East, Syracuse NY 13214, 446-2266.

Syracuse—Rome—Utica NY

Featuring: Yaesu, ICOM, Drake, Atlas, Dentron, Ten-Tec, Swan, Tempo, KLM, Hy-Gain, Mosley, Wilson, Larsen, Midland Southwest Technical Products. You won't be disappointed with equipment/service. Radio World, Oneida County Airport-Terminal Building, Oriskany NY 13424, 337-2622.

Phila. PA/Camden NJ

Waveguide & coaxial microwave components & equipment. Laboratory grade test instruments, power supplies. Buy, sell & trade all popular makes, HP, GR, FXR, ESI, Sorensen, Singer, etc. Lectronic Research Labs., 1423 Ferry Ave., Camden NJ 08104, 541-4200.

Columbus OH

All major brands featured in the biggest and best ham store for miles around. Come in and twist the knobs before you buy. We ship U.P.S. too. Universal Amateur Radio, Inc., 1280 Aida Dr., Reynoldsburg (Columbus) OH 43068, 866-4267.

Houston TX

Experimenter's paradise! Electronic and mechanical components for computer people, audio people, hams, robot builders, experimenters. Open six days a week. Gateway Electronics Inc., 8932 Clarkcrest, Houston TX 77063, 978-6575.

San Antonio TX

Complete 2 way service shop. Call Dee, W5FSP. Selling Antenna Specialists, Avanti, Azden, Bird, Hy-gain, Standard communications, Genave, Henry, CushCraft, Hustler, ICOM, KDK, MFJ, Nye, Shure, Swan, Tempo, Ten-Tec and others. Appliance & Equipment Co., Inc., 2317 Vance Jackson Road, San Antonio TX 78213, 734-7793.

Davenport WA

Preassembled all band antennas 160m/10m. Trap models start at \$36.50, no trap models start at \$54.50. Complete ham radio repair and parts. Electronic Communications Service Co., Rt. 1-78K, Davenport WA 99122, 725-6822.

Port Angeles WA

Mobile RFI shielding for elimination of ignition and alternator noises. Bonding straps. Components for "do-it-yourself" projects. Plenty of free advice. Estes Engineering, 930 Marine Drive, Port Angeles WA 98362, 457-0904.

DEALERS

Your company name and message can contain up to 25 words for as little as \$150 yearly (prepaid), or \$15 per month (prepaid quarterly). No mention of mail-order business or area code permitted. Directory text and payment must reach us 60 days in advance of publication. For example, advertising for the June issue must be in our hands by April 1st. Mail to 73 Magazine, Peterborough NH 03458. ATTN: Aline Coutu.

X-RATED

**OUTPERFORMS
ALL commercially
available tribanders
AND many monoband
systems, too!**

KLM's KT-34X

20, 15, & 10M — FOR THE MATURE HAM ONLY

KT-34 UPGRADE KITS AVAILABLE

WRITE FOR COMPLETE DETAILS OR
SEE YOUR LOCAL KLM DEALER

KLM 17025 LAUREL RD., MORGAN HILL, CA 95037, (408) 779-7363 ✓40

DAYTON

HAMVENTION[®] '80

April 25, 26, 27, 1980

Hara Arena and Exhibition Center Dayton, Ohio

Meet your amateur radio friends from all over the world at the internationally famous Dayton HAMVENTION.

Banquet speaker Saturday evening will be Senator Barry M. Goldwater, K7UGA. Seating will be limited so please make reservations early.

If you have registered within the last 3 years you will receive a brochure in late February. If not write Box 44, Dayton, OH 45401.

Nominations are requested for Radio Amateur of the Year and Special Achievement Awards. Nomination forms are available from Awards Chairman, Box 44, Dayton, OH 45401.

For special motel rates and reservations write to Hamvention Housing, 1980 Winters Tower, Dayton, OH 45423. **NO RESERVATIONS WILL BE ACCEPTED BY TELEPHONE.**

All other inquiries write Box 44, Dayton, OH 45401 or phone (513) 296-1165 — 5-10 P.M. EST.

Rates for ALL 3 Days:
Admission: \$5 in advance, \$6 at door.
Flea Market Space: \$11 in advance, \$13 at gate.
Banquet: \$12 in advance, \$14 at door.
Make checks payable to Dayton HAMVENTION, Box 333, Dayton, OH 45405.

Bring your family and enjoy a great weekend in Dayton.
Sponsored by the Dayton Amateur Radio Association, Inc.

- Technical Forums
- ARRL and FCC Forums
- ARRL 3-Day Flea Market
- GIANT 3-Day Products and Exhibits
- New Products and Exhibits
- Grand Banquet
- Women's Activities
- Grand Group Meetings
- Special Group Prizes
- Special Group Meetings
- Hundreds of Prizes
- CW Proficiency Tests
- CW Proficiency Awards
- Amateur of Year Award
- Special Achievement and parking
- Expanded Exhibits and parking

A Solid-State RTTY Keyboard

— with auto-shift

It is generally agreed that state-of-the-art operation on RTTY is the use of an electronic keyboard for transmission and a CRT display for reception. Both of these items are expensive station accessories and, because of their complexity, leave the average homebuilder with the alternatives of laying out the necessary sum to purchase a commercially-made unit or continuing to use the old but reliable mechanical equipment. Clearly, the

display unit is a very complicated system, but the keyboard can, if properly designed, be a relatively easy project for the average home shop. The growth of the home computer hobby has produced a wealth of sources for obtaining the keyboards, logic, and other necessary ingredients for constructing a solid-state RTTY keyboard.

A few goals and compromises were made before the design was attempted. The design requirements

were: (1) The keyboard must be simple and easy to construct; (2) The keyboard must be inexpensive and constructed from readily-available components; (3) The keyboard must send 60 and 100 wpm, and (4) The keyboard must have full keyswitch interlocking, two-key roll-over, and send the entire Baudot character set.

Only one significant compromise was required. The stop pulse in this keyboard is 44 ms instead

of the usual 31 ms. This has the effect of reducing the maximum rate of the keyboard. Very few operators can send at a sustained 60 wpm rate, so the reduction in maximum speed will go unnoticed. However, the keyboard is fully compatible with all printers in spite of the long stop pulse.

Several other differences exist between the electronic keyboard and its mechanical counterpart. These are considered differences and not compromises. Most of the departures were required because most of the available keyswitch assemblies were made for transmitting the ASCII code rather than Baudot code. In the Baudot code, numbers and punctuation are in the uppercase. That is, each number or punctuation shares a code and a key with a letter. In order to print a number or punctuation, the figures key must be sent to shift the printer into the figures case. In the ASCII system, the letters do not share keys or codes with numbers or punctuation.

It would be possible to use the ASCII keyboard for transmitting Baudot by simply paralleling the letter-switch connections to the corresponding number or punctuation key. This is not desirable since

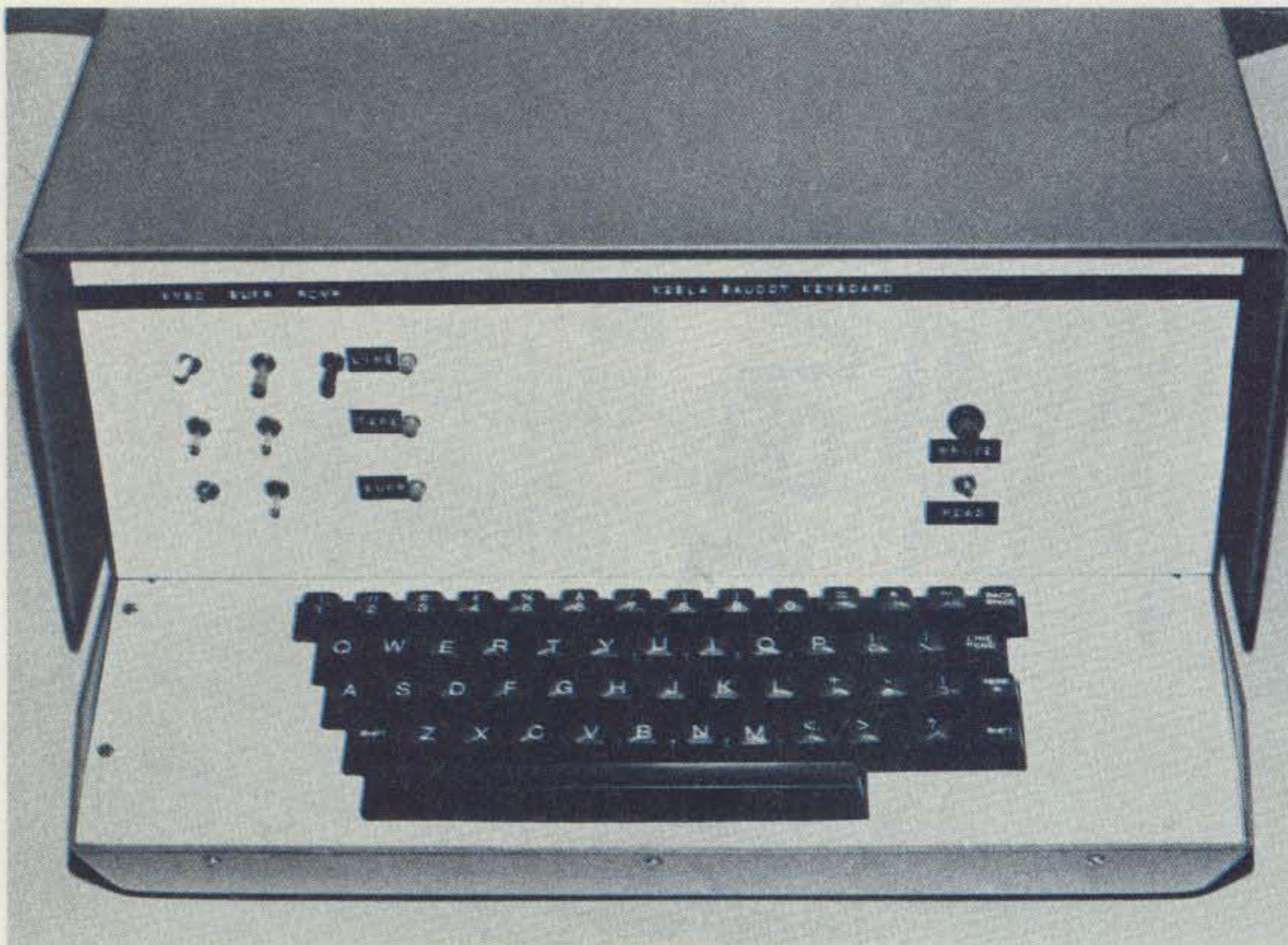

Here is a front view of the keyboard.

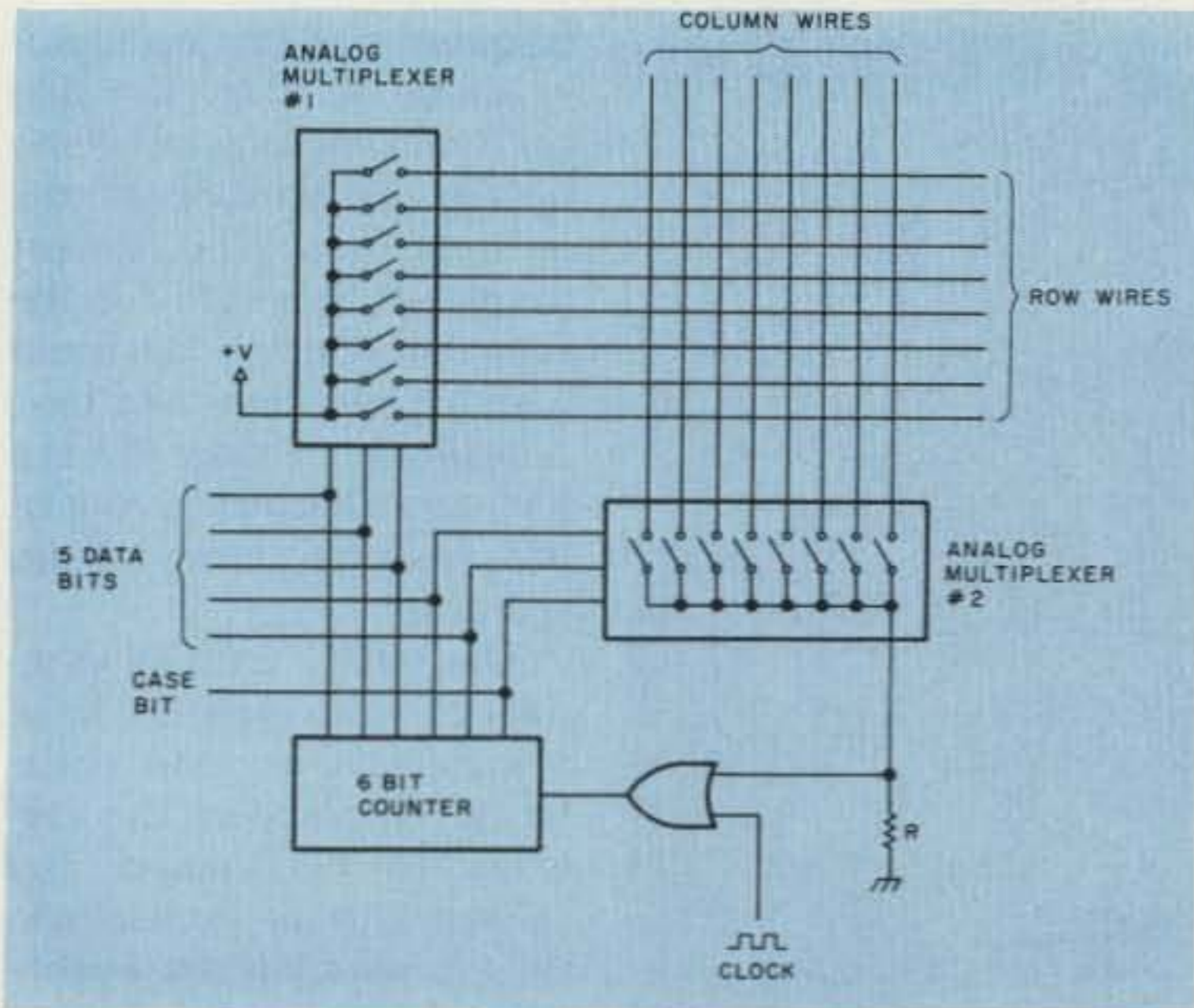

Fig. 1.

	B0	B1	B2	B3	B4	B5	B6	B7
A0	ltrs*	X	V	M	/	:	-	
A1	K	F	C	N	(\$:	,
A2	Q	Y	P	H	1	6	0	#
A3	U	S	I	space	7	'	8	
A4	figs*	B	G	O		?	&	9
A5	J	D	R	CR			4	
A6	W	Z	L	T	2	")	5
A7	A	LF	E	blank*	-		3	

Table 1. Keyswitches connect between row wires and column wires as shown. Those functions shown with an asterisk are not required, but may be wired if keyswitches are available.

the key would appear as a separate code on the keyboard when in actuality it is an uppercase of another key on the keyboard. Pressing either key would send the same letter or number/punctuation unless separated by a figures or letters key. Another problem is that on most ASCII keyboards, neither letters nor figures keys are available.

These shortcomings of the ASCII keyboard were overcome by automatically sending the figures or letters code as required. A one-bit memory keeps a running account of whether the keyboard is sending figures or letters. If a key is pressed that differs from the case being sent, the keyboard automatically inserts the proper figures or letters code before sending the different case figure(s) or letter(s). For example, if the keyboard is

sending in the letters case and an amateur call is sent which includes a number, such as K2BLA, the operator presses the keys k, 2, b, l, and a. The conventional keyboard requires the following keys; k, figs, 2, letters, b, l, and a. Since with my unit the letters/figures function is completely automatic, no figures or letters keys are required.

On the standard communications keyboard, several keys operate the same on both upper- and lowercase, such as line feed, carriage return, space, and blank. This electronic keyboard treats these as lowercase only. This will affect the speed of the keyboard only in rare cases, such as groups of numbers separated by spaces.

The heart of this circuit is a scanned keyboard. The actual encoding is ac-

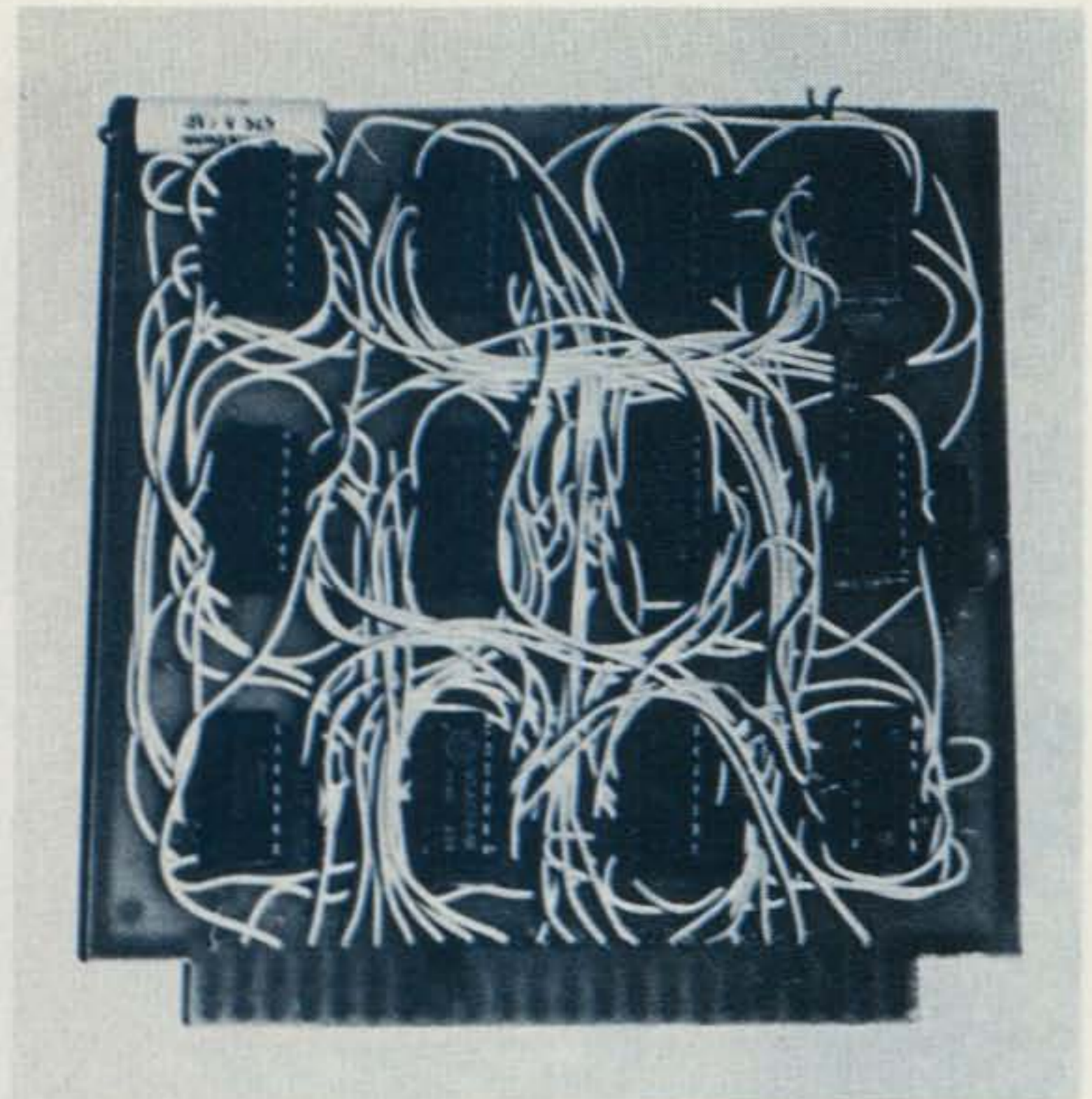

The entire keyboard is contained on one 12-chip prototype board, as shown here.

complished by wiring the keyswitches to the appropriate intersection of the scanning matrix (see Table 1). The scanning system allows each switch to be sampled one at a time at some rapid rate, looking for a closed switch.

When a closed switch is found, the scanning process stops until the RTTY character has been sent, after which the scanning continues. If only one switch has been closed, the keyboard will send the Baudot code for the selected key while the scanning remains disabled until the closed switch has been released. If two keys were pressed and held, only the first key down will be sent. If one key is depressed, released before the completion of the first character, and a second key is then depressed, the keyboard will send both characters complete with the proper stop pulses and figures and/or letters characters where necessary. It is because of this two-key roll-over that the electronic keyboard will tolerate a very uneven typ-

ing rhythm.

Fig. 1 shows a simplified schematic of the scanned keyboard. The six-bit counter operates at the clock frequency, causing an analog switch in each multiplexer to be closed at any one given time. Sixty-four clock pulses are required to complete a cycle of all possible analog switch states. Keyboard switches are connected between row wires and column wires. If a keyboard switch is closed, a current path will exist from +V, through analog multiplexer 1, the keyswitch, analog multiplexer 2, and the resistor, R. Since the counter will advance through all possible analog switch states, the current path will exist in less than 64 clock pulses after a switch closure, causing +V to be applied to the resistor, R, thus stopping the counter. Each keyboard switch will stop the counter at a different counter state. The keyswitches are connected to the intersection of row and column wires so that the counter will contain the correct Baudot code

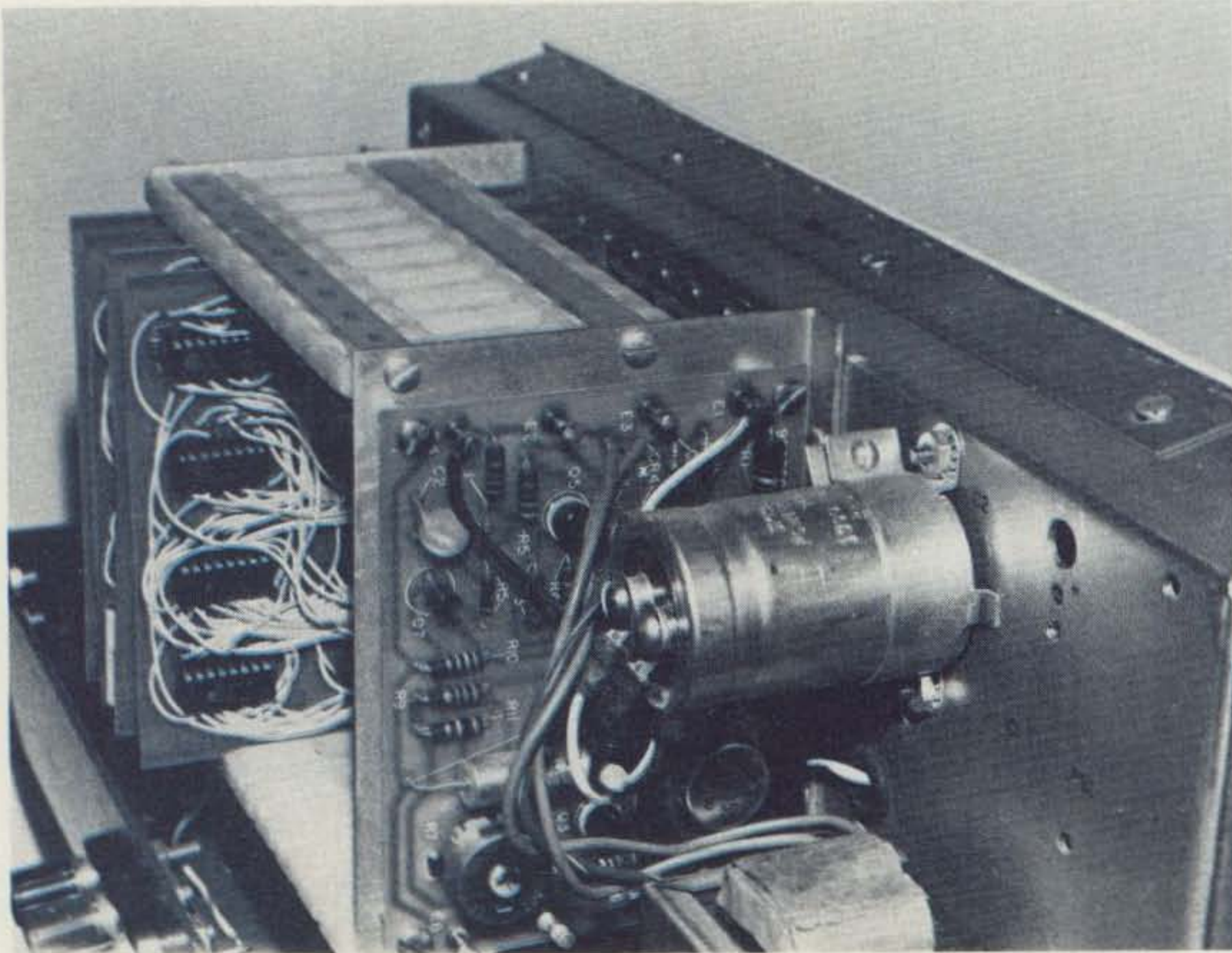

Only one of the four plug-in boards visible in this photo is for the keyboard. The others are for accessories mentioned in the text.

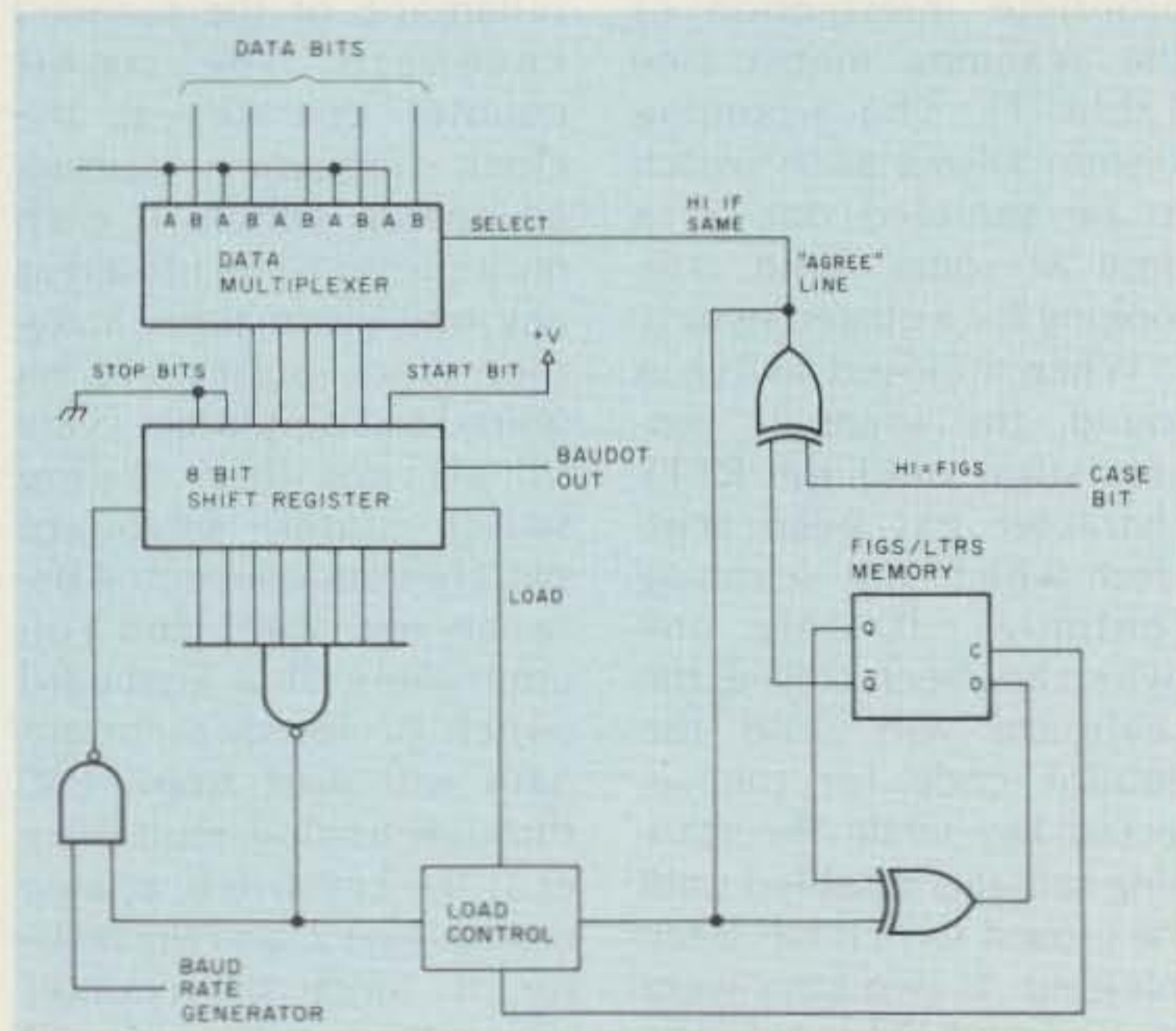

Fig. 2.

plus a sixth bit indicating the case, either figures or letters.

Before any key closure is sent, it must be determined whether it should be preceded by a figures or letters code. A flip-flop (see Fig. 2) serves as a one-bit memory to remember if the keyboard is sending figures or letters. Whenever a keyswitch closure is

detected, the status of the case bit, the sixth bit, is compared to the content of the one-bit memory. If they are the same, the "agree" line is high and the 8-bit shift register is loaded with a start bit, the 5 data bits contained in the counter, and two stop bits, in that order, from right to left. This digital word is shifted out as Baudot code.

If the state of the one-bit memory and the case bit disagree, then the shift register is first loaded with 00100 if a figures character is to be sent, or 00000 if a letters character is to be sent. After the figures or letters character has been sent, the shift register is loaded with the data from the scan counter along with the necessary start and stop bits and is shifted out. During this time, the keyboard has been locked out so that any key closures will not disrupt the sending of the data. Also during this time, the state of the one-bit memory has been reversed, indicating that the keyboard is sending the opposite case.

Fig. 3 is the actual schematic of the CMOS Baudot keyboard. U9 and U10 are the analog multiplexers driving the keyboard matrix from the six-bit counter, U11. The 4024 is actually a seven-stage counter, but the last stage is not used. The scan oscillator is U12C and U12D. The

frequency of this oscillator is about 32 kHz, allowing for a maximum access time for the keyboard of about 2 milliseconds. The lowest frequency possible for the scan oscillator, consistent with a good keyboard feel, is desirable in order to keep the higher harmonics out of the high-frequency radio spectrum.

The 4035 parallel-in/serial-out shift registers have a synchronous load capability. This allows the registers to be loaded and shifted with the same clock, thus producing an evenly spaced serial output with a minimum of external circuitry. An eight-input NAND gate, U6, determines the state of the shift register and provides a low output when the shift register is empty and ready for a new character.

The keyboard requires an accurate frequency source known as a baud-rate generator. The baud rate of any teleprinter operation is equal to $1/t$, where t is the time duration of the data bits. At sixty words per minute, the data bit time is 22 milliseconds, so therefore the baud rate is $1/0.022 = 45.45$ Hz. Almost any stable oscillator capable of supplying the baud rate at better than one percent is acceptable. Several single-chip baud-rate generators are available that supply a number of common baud rates from a single crystal. Fig. 4 shows a simple baud-rate generator that supplies 45.5 and 74.2 baud for operation on 60 wpm and 100 wpm.

The electronics for the keyboard was assembled on a 12-IC universal DIP board. The baud-rate generator was constructed on a small portion of another board. The parts placement is not critical for either board. The cabinet is a cut-down IC test set. Almost any type of cabinet will do, but it is desirable to tilt the

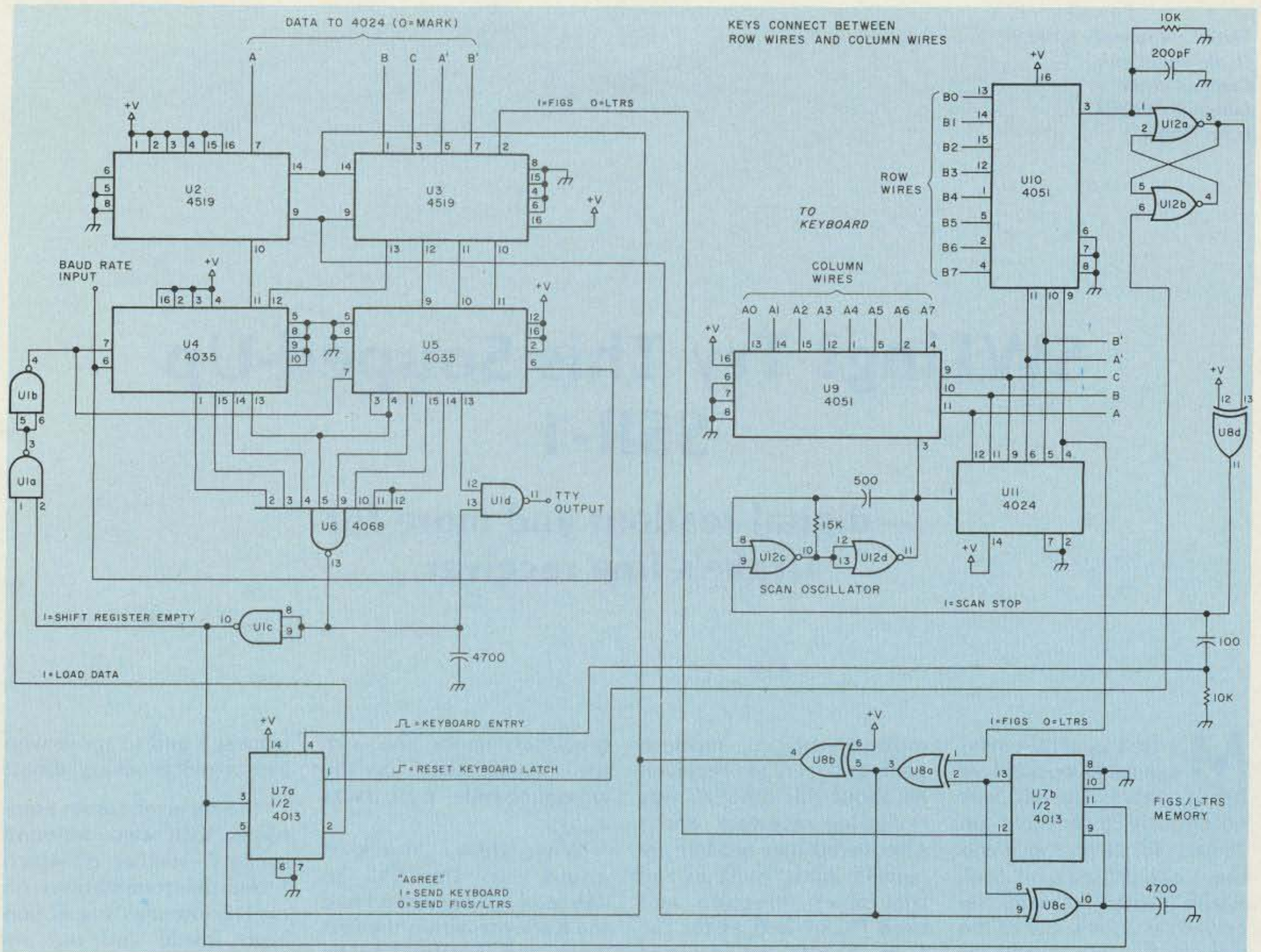

Fig. 3.

keyboard between ten and thirty degrees from the horizontal. A flat chassis or box could be used by attaching oversized feet to the rear. The extra room in my cabinet is used to house a CW ID generator, an audio cassette interface, a signal switcher, and a 1024-character buffer memory. The power supply was made oversized and can accommodate about 10 more boards. The baud-rate generator is shared among all of the systems.

All of the parts required for the keyboard are available by mail order at reasonable prices. Almost any type of keyboard will work since the scanned keyboard circuit is very tolerant of all types of keyswitch arrangements. It would be best to obtain a keyboard with separate unencoded

switches. If this is not available, an encoded keyboard may be utilized by removing the encoding electronics. If the electronics are to be removed from an encoded keyboard, be sure that the keyswitches will stand alone, that is, that the printed circuit board is not required for mechanical support. A few very cheap keyboards used this type of construction and are worthless for the Baudot keyboard unless another PC board is constructed. Also, beware of keyboard switches that give only momentary closures. Although these switches will work, the 2-key roll-over and the interlocking features of the scanned keyboard will be lost.

The keyboard is a worthwhile addition to any RTTY shack, even when the sta-

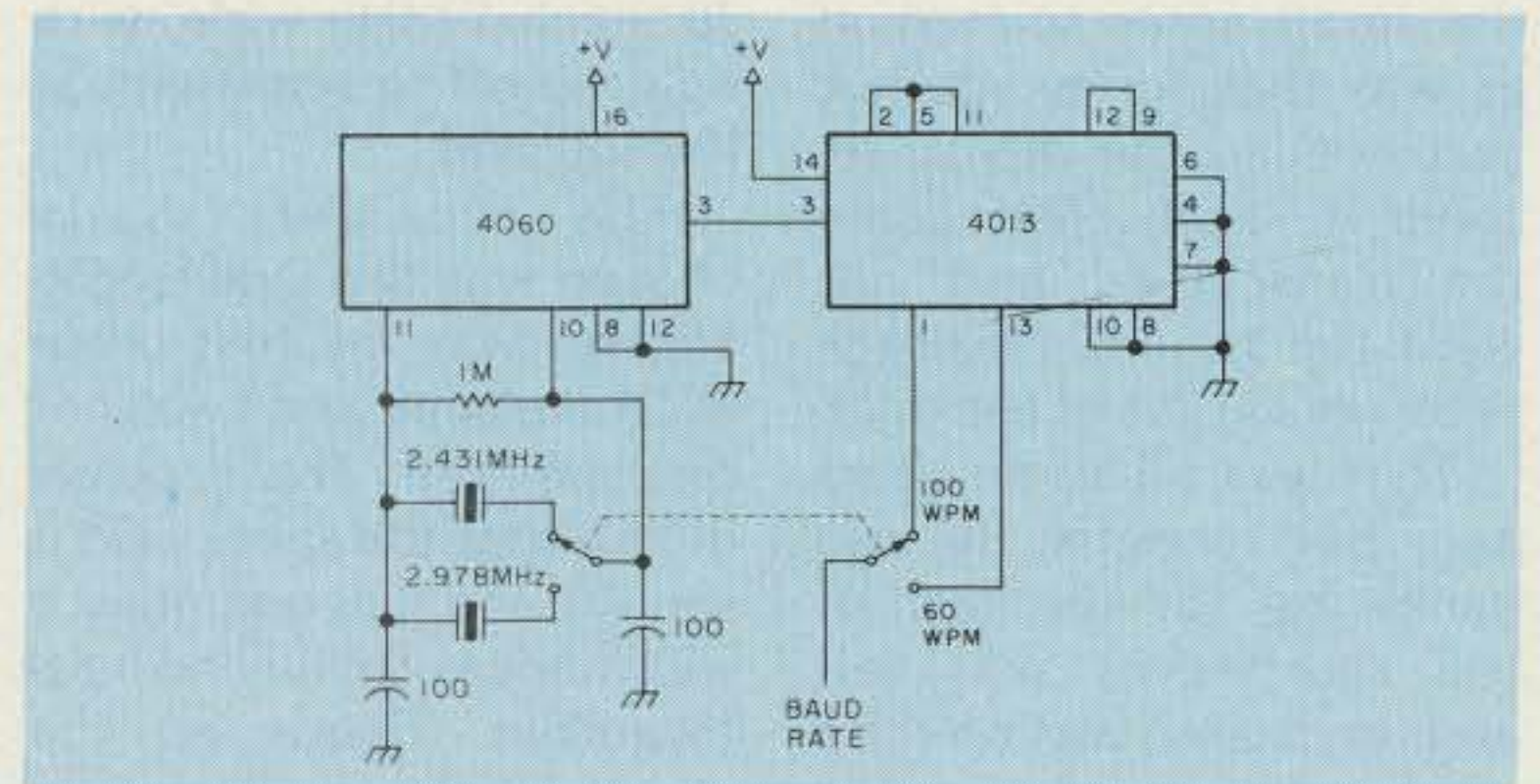

Fig. 4.

tion may be already equipped with a mechanical keyboard. The light action and the automatic upshift/downshift are such a delight to use that the old cement mixer probably will be relegated to printing only or replaced with a CRT display. ■

References

1. William I. Orr W6SAI, *Radio Handbook*, 21st edition, page

14. 15 (general description of RTTY signal generation).

2. Albert D. Helfrick K2BLA, "An Inexpensive Morse Keyboard," *QST*, January, 1978 (describes a Morse code keyboard using a scanned keyboard).

3. ARRL staff, *Specialized Communications Techniques for the Radio Amateur*, page 99 (general description of RTTY communications).

4. Motorola, Inc., *McMOS Handbook*, chapter 6 (general rules for using CMOS circuits).

Terry F. Weatherley G3WDI
16, Beverley Court
Carlton Colville
Lowestoft, Suffolk
Great Britain

SWLing? Try This Souped-Up SSR-1

— digital readout and more for
Drake's fine receiver

My first general-coverage receiver had five bands, valves (tubes), was notoriously insensitive on 28 MHz (or 28 Mcs as it was then), and drifted a bit. Still, Radio Australia was received, as were some of the easier Pacific stations. Amateurs were received on the small areas so-marked as was that funny squawk that needed the bfo to resolve it—SSB. Next came the transceiver, and out went the general-coverage receiver as part of the deal.

That was all some years ago, but recently the old hankering for the rest of the shortwaves was felt and the search was on for a

modestly-priced, modern general-coverage receiver. At about this time, 73 was reviewing receivers, and I discovered that modern receivers had "synthesized first-mixer injection and used PLLs," and as for the five bands of distant memory, there were now 30, each 1 MHz wide, with no drop-off in sensitivity at the top end.

The receiver finally chosen was the Drake SSR-1'. This was my first piece of Drake gear, and I was not disappointed. The receiver did all that the specs said it should, and reacquaintance was made with old and half-forgotten friends on the

broadcast bands and with the "woodpecker" on the amateur bands. In all, it was a joy.

Why, then, "muck it about," as the XYL so delicately put it when I had the back off within the first week and appeared to be attacking it wildly with drill and chassis punch? Why indeed? In my defense, I muttered something about "extras" and pointed out that these did not affect the performance of the receiver. Indeed, these mods are offered as extras for the consideration of those who like cream with their peaches (I don't know the equivalent in Amer-

icanese!) and to those who can't resist mucking about!

The receiver comes complete with two antenna sockets—neither of which fitted the terminations on my HF antennas. Inspection both inside and out revealed that there was plenty of room to fit a UHF-type socket, and this was done as can be seen in Fig. 2. I decided that I did not require the second antenna socket, two terminal plugs, so the feed from these was removed and the terminals wired to provide a 12-volt supply from the receiver's own.

Further inspection of the



Fig. 1.

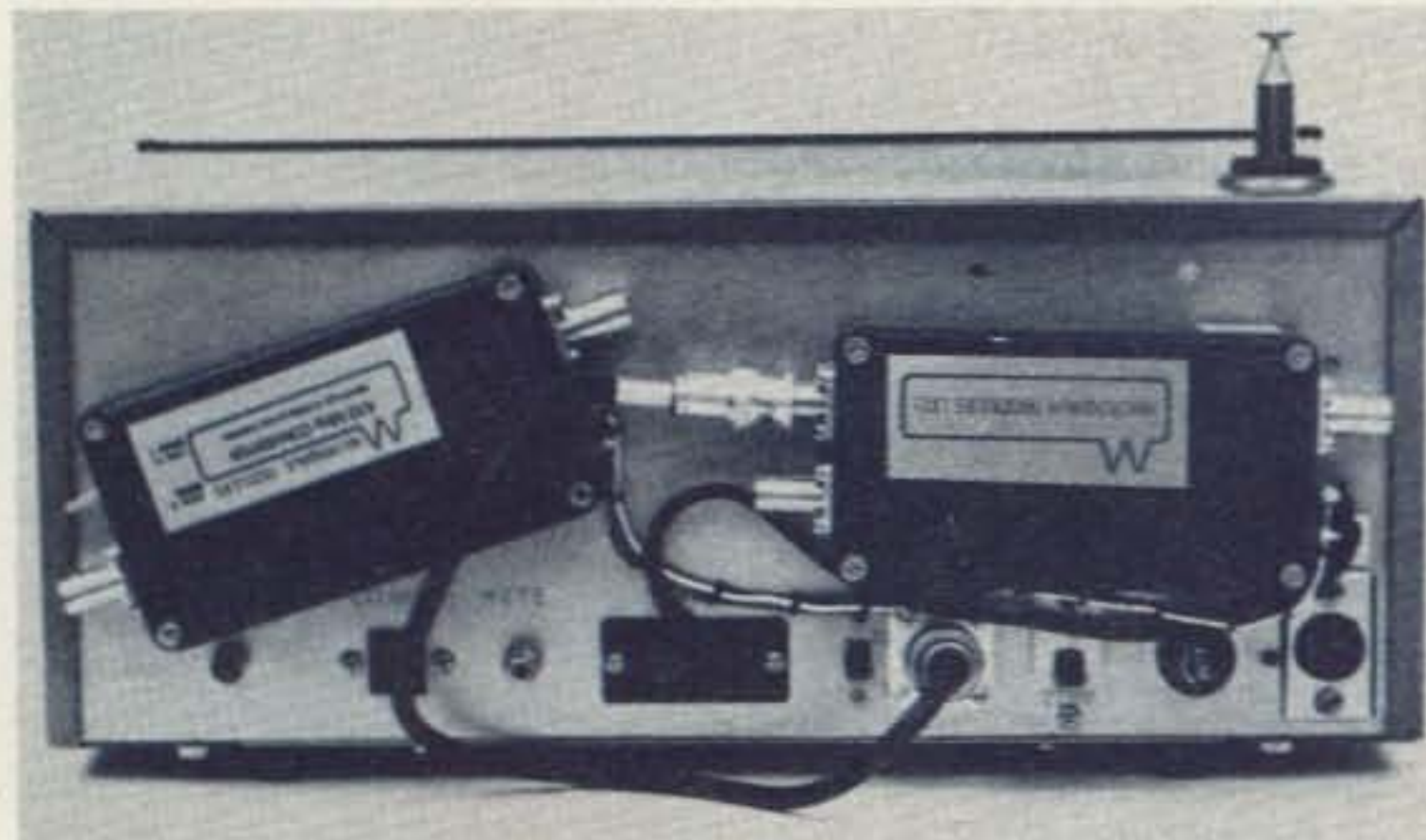

Fig. 2.

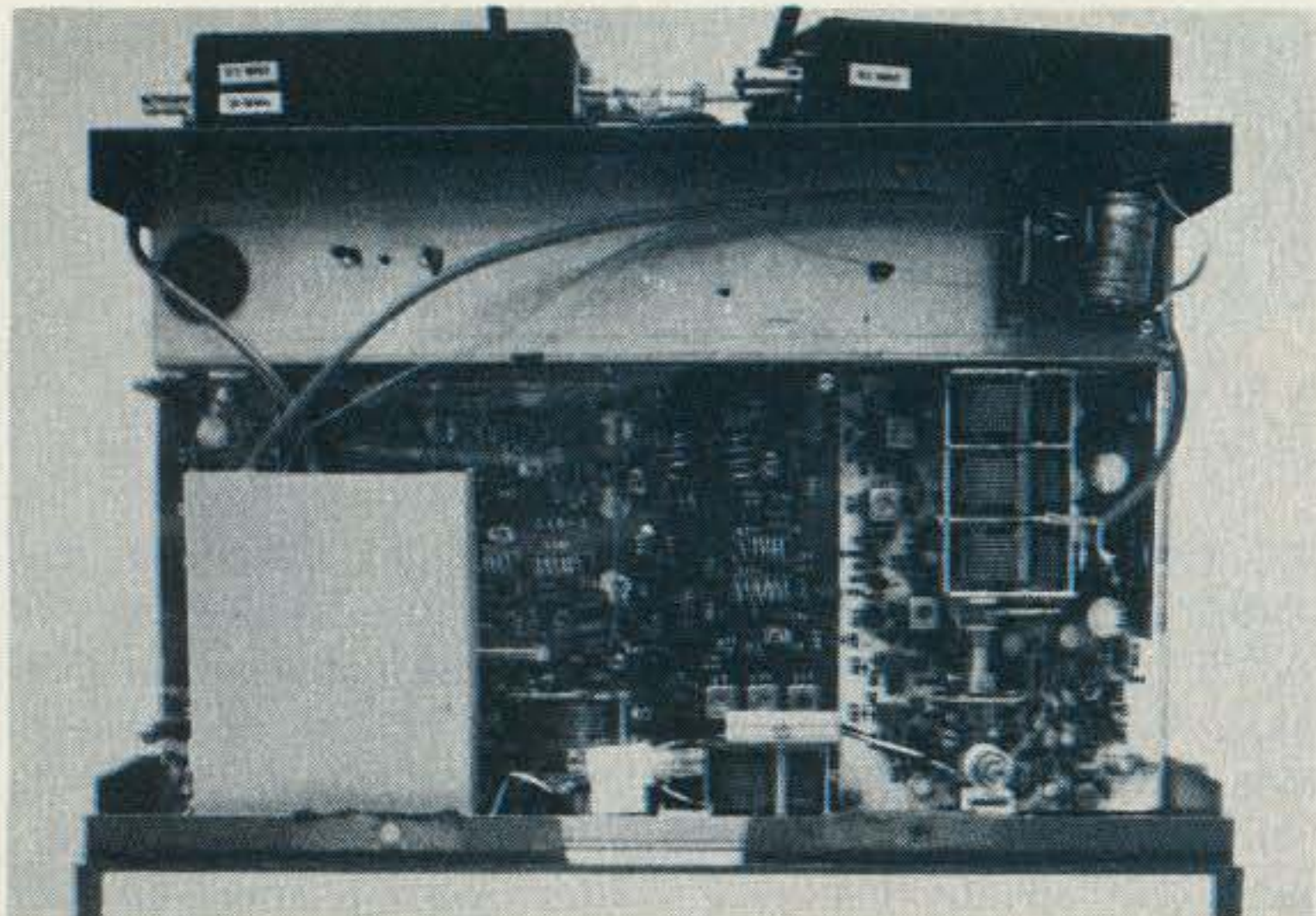

Fig. 3.

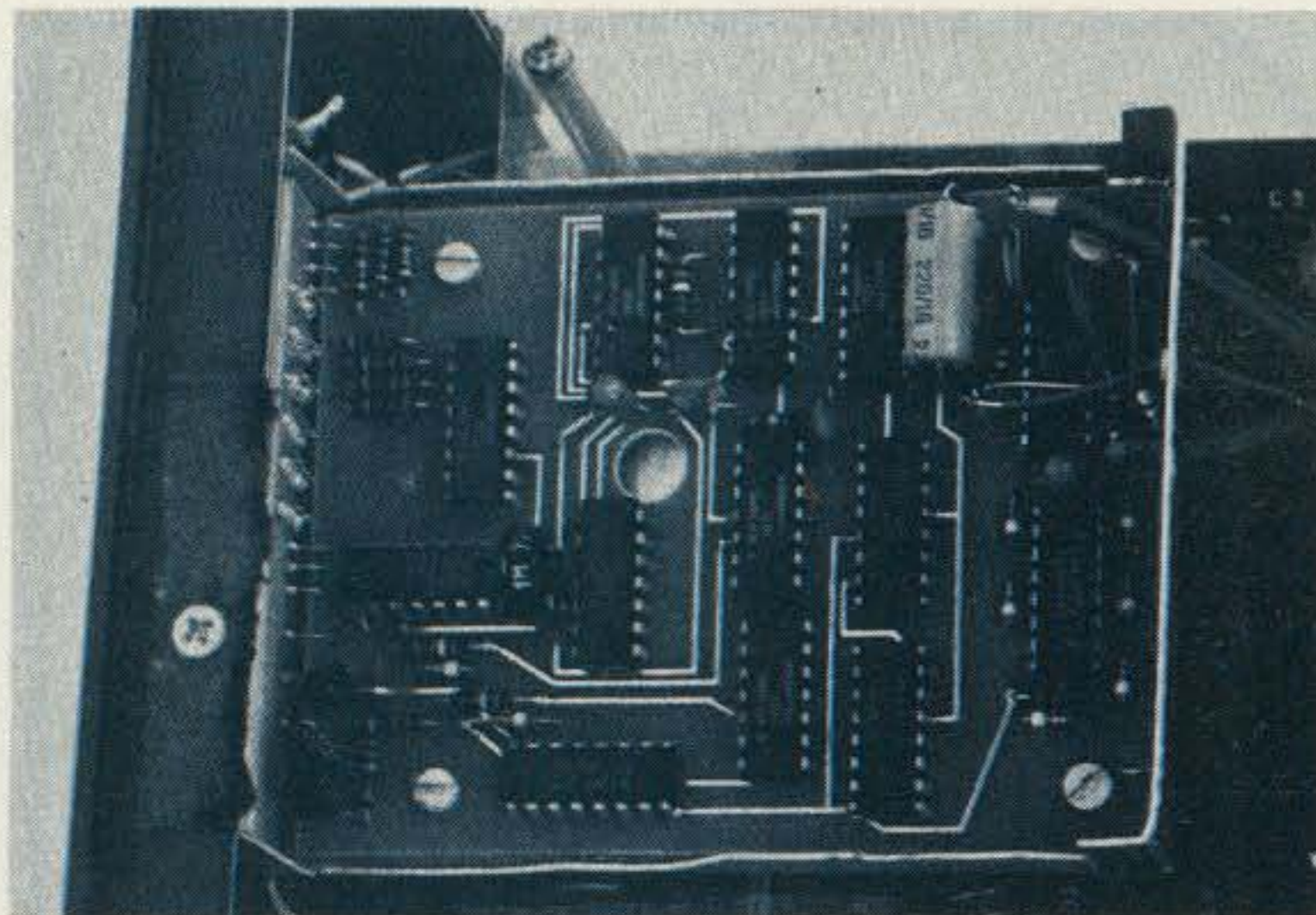

Fig. 4.

back panel showed that there was room to mount a converter for 432 MHz for OSCAR reception. This, together with the same manufacturer's ten-meter preamp, was bolted onto the back and the power supply was taken from the terminals as previously explained.

Encouraged by this instant success, I next looked inside to see how much room there was to spare. Once the battery compartment has been removed, there is quite a lot. Towards the rear is a metal shelf, and the circuit boards are covered by a plastic shield which makes an excellent shelf. See Fig. 3.

A feature of all modern rigs seems to be digital readout. This was one thing

that the SSR-1 did not have. At about this time, 73 carried an article about digital readout,² and I was just about to order the TTLs and have a go when an ad was discovered in the British amateur radio press (we do have some) which saved me time and frustration, if not cash. The ad offered a CMOS digital readout board designed for the SSR-1 and giving a count of 0-999 on each of the 1-MHz bands.³ It required 7-9 volts and only two connections to the SSR-1.

With immodest speed the cheque was written, and within two days (Norwich is only 25 miles away) the wired and tested board arrived. Fig. 4 shows that the unit is a small board with three 7-segment LEDs

mounted vertically at one end. The keen-eyed will notice that it contains a 12-bit binary counter, 3 pre-settable up-down counters, and a 4511 display chip. (Incidentally, the board is double-sided.) One coax lead went to the 10-MHz signal line and the other to the front gang of the tuning capacitor.

The unit also required 7-9 volts dc. It was decided to build a small power supply inside the SSR-1 to power this unit. A small 12-volt transformer was fixed under the back shelf (Fig. 5), and the components for the smoothing and stabilization were mounted on a piece of matrix board and fixed to the shelf. The circuit is conventional and uses a 7805 with resistors to raise the supply to 8-9 volts

(Fig. 7).

The paperwork supplied with the unit said that its operation might give rise to rf noise, so a small aluminum box was made to house the unit. This box conveniently sits on the plastic cover (Fig. 3).

The next stage was to remove the front panel. Quite an operation, as it was soon discovered that some of the fixing screws are underneath the foam lining and must be probed for. (See Fig. 5.) A hole is then cut to accommodate the LED display in the metalwork above the loudspeaker cut-out (see Fig. 6). When this hole has been cut (or, in my case, hacked), the surrounding area is painted with matte black paint. If at this point the front panel is replaced, it will be seen that

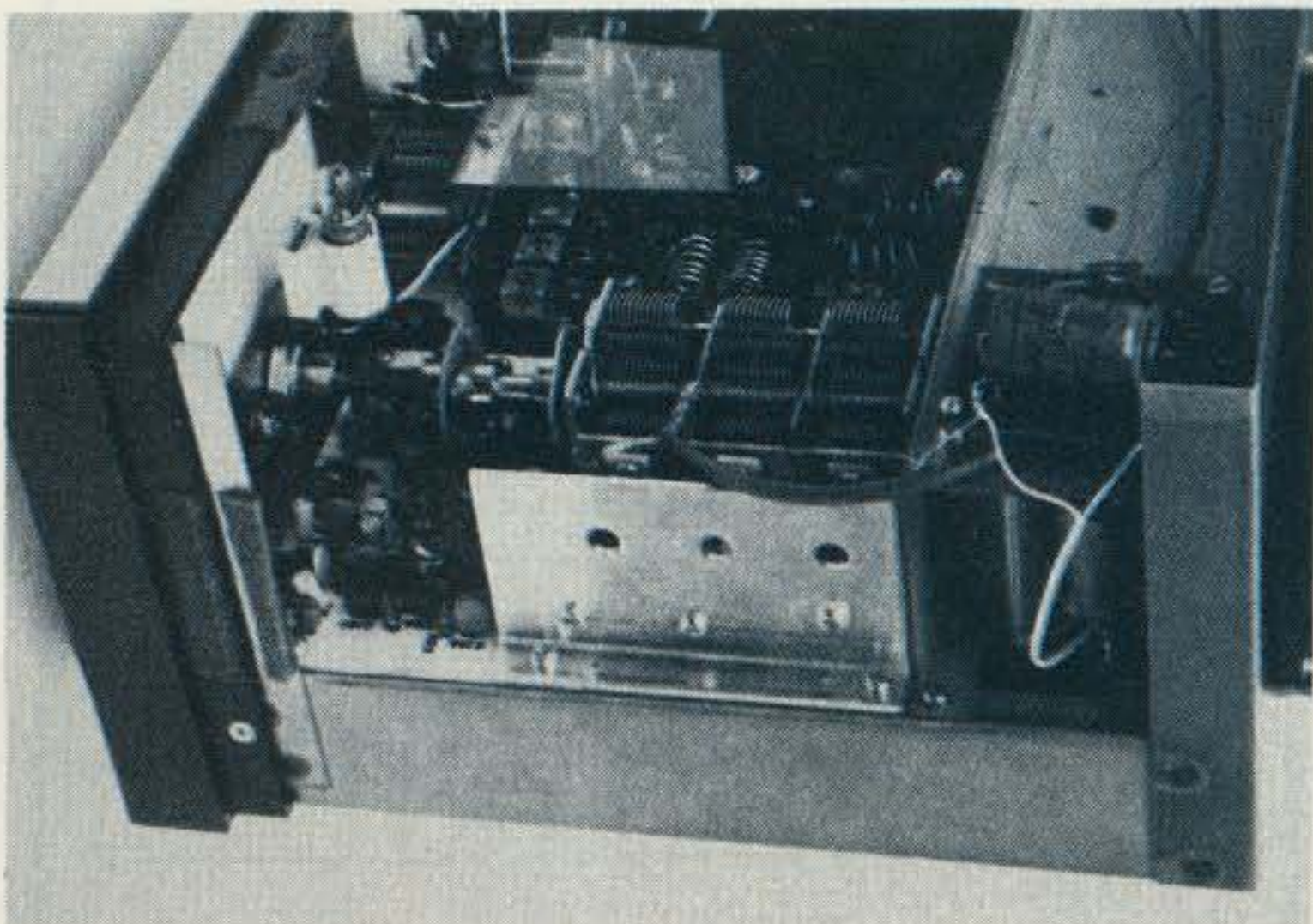

Fig. 5.

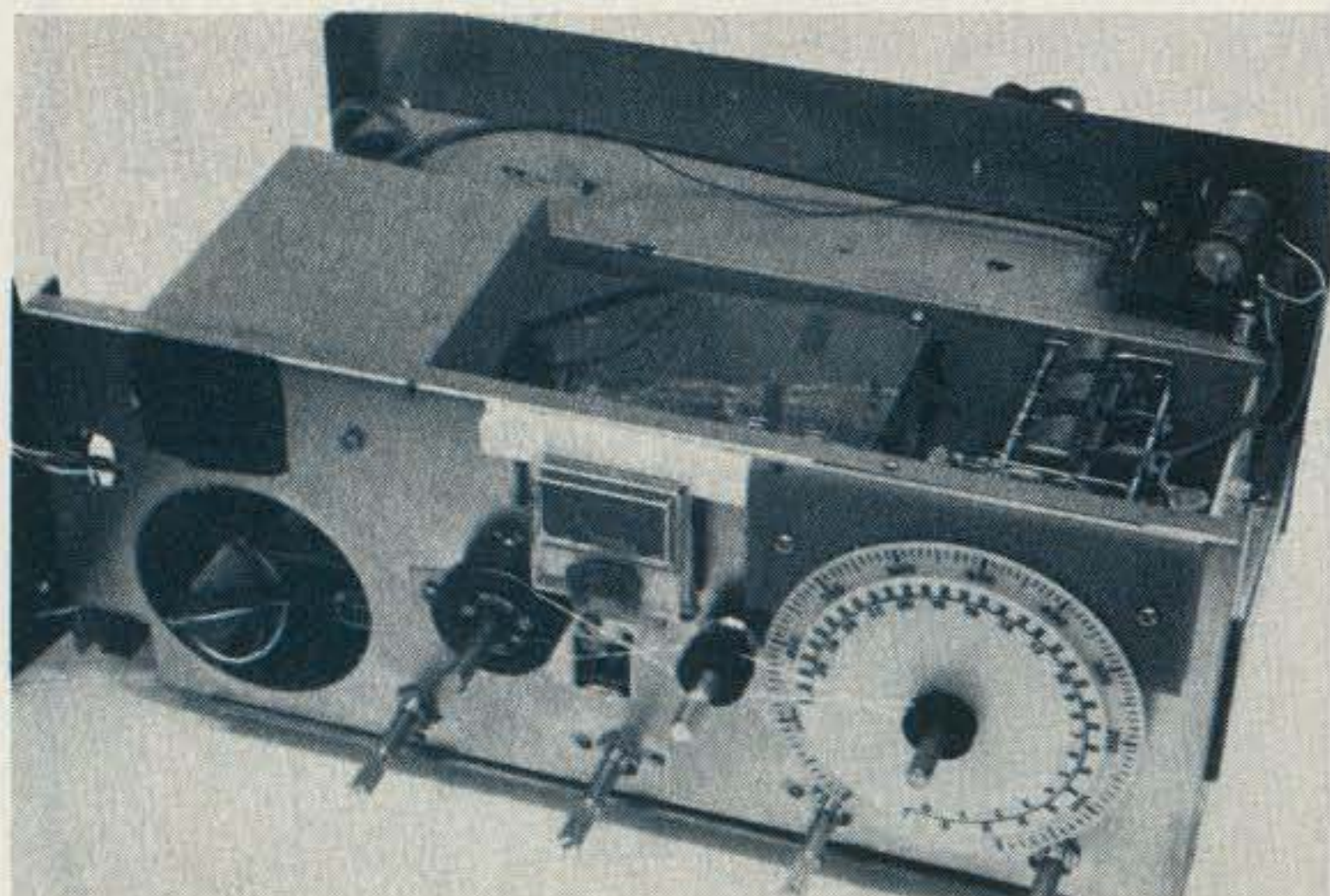
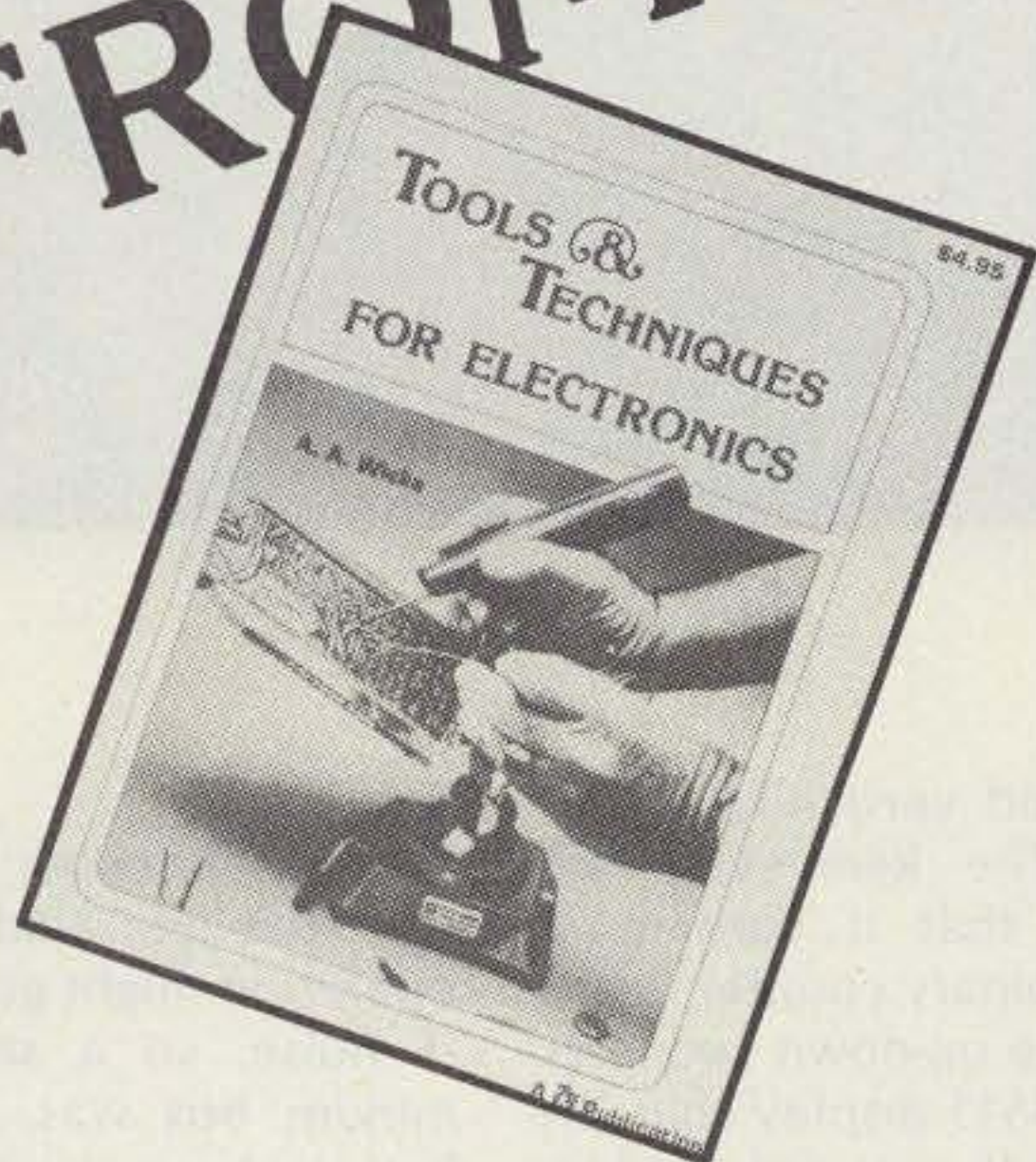

Fig. 6.

NEW FROM 73



Tools and Techniques for Electronics (BK7348) is a comprehensive guide to the tools and construction practices used by today's electronics hobbyist. This new 73 Magazine publication should be a part of the library of anyone who has ever built or fixed any electronic gear. The text and numerous pictures and illustrations provide an easy-to-understand description of the safe and correct way to use the basic and specialized tools needed for electronics work.

The first part of Tools and Techniques for Electronics covers the basic tools that will assist the amateur Novice, CB operator, or beginning computer kit builder. It is also an excellent review for more experienced hobbyists. The second portion of the text will be of interest to the advanced tool user. It explains specialized metal working tools as well as the chemical aids that are used in repair shops. The final chapters of Tools and Techniques for Electronics discuss the construction skills that result in a professional-looking project.

Handy reference data on English/metric conversions, machine screw data, and the like will be found in the appendices. The contents of basic and advanced tool kits are outlined, and the book includes a list of suppliers.

Whether you are interested in working with tubes or the latest wire-wrap techniques, a great deal of pride and satisfaction can be gained by building or repairing your own equipment. 73's Tools and Techniques for Electronics shows you the way.

Order your copy today! Only \$4.95 from the Radio Bookshop. Use the handy order form on the Reader Service Card at the back of the magazine or phone toll free 1-800-258-5473.

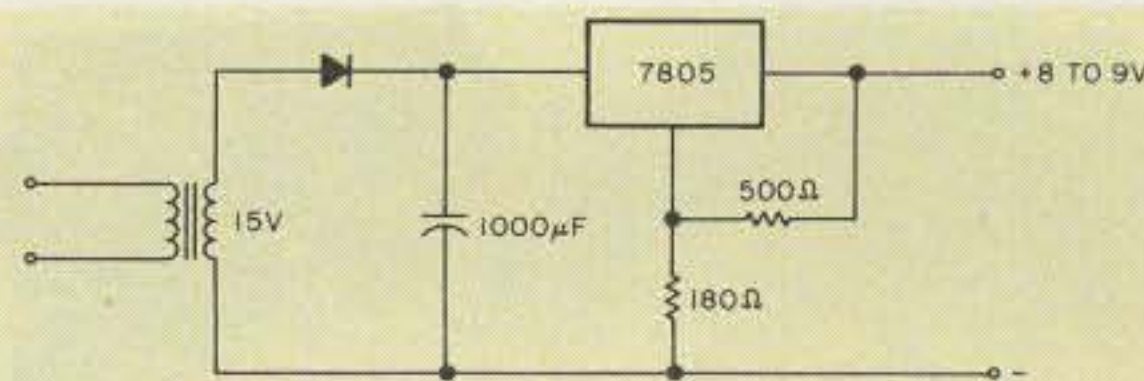

Fig. 7.

the digital display is now completely covered by the plastic strip bearing the legend, "SSR-1." Since this is obviously a handicap to efficient operation, the black paint and white lettering should be removed, using automobile cleaner to remove the paint without scratching the plastic. It is then a simple matter to mask the strip and re-spray the black, leaving an area of clear plastic in front of the display LEDs.

The finished result can be seen in Fig. 1. The display in no way spoils the appearance of the front panel; the clean lines of the original are still there.

Those, to date, are my mods to the SSR-1. There is room inside for more. Perhaps a micro-controlled CW decoder with VDU output via the phone socket. There also is room for an audio filter. The possibilities are endless. See what you can do—and I'd be interested to hear from you. ■

References

1. "Review of the SSR-1," 73, April, 1977.
2. "Build Your Own Digital Dial," W10OP, 73, July, 1978.
3. Digital display from B. Brookes Electronics, 69 Leicester Street, Norwich, Norfolk, G.B. Complete unit, but kits and boards may be available.

MOVING?

Let us know 8 weeks in advance so that you won't miss a single issue of 73 Magazine.

Attach old label where indicated and print new address in space provided. Also include your mailing label whenever you write concerning your subscription. It helps us serve you promptly. Write to:

73 magazine

Subscription Department
P.O. Box 931
Farmingdale NY 11737

- | | |
|---|---|
| <input type="checkbox"/> Address change only | <input type="checkbox"/> Payment enclosed |
| <input type="checkbox"/> Extend subscription | <input type="checkbox"/> Bill me later |
| <input type="checkbox"/> Enter new subscription | |
| <input type="checkbox"/> 1 year \$18.00 | |

If you have no label handy, print OLD address here.

AFFIX LABEL Name _____ Call _____

Address _____

City _____ State _____ Zip _____

print NEW address here:

Name _____ Call _____

Address _____

City _____ State _____ Zip _____

301B55

THE GIANT **AZDEN** COMPANY

REVOLUTIONIZES THE STATE OF THE ART

AWE AND AZDEN, INTRODUCE THE BRILLIANT NEW PCS-2000

**MICROCOMPUTER
CONTROLLED**

**SUPERIOR COMMERCIAL GRADE
2 METER FM TRANSCEIVER**

**NOT \$550.00
SPRING
SALE**

\$299⁰⁰

REG. \$369.00

**NOT \$550.00
SPRING
SALE**

\$299⁰⁰

REG. \$369.00



COMPARE THESE FEATURES WITH ANY UNIT AT ANY PRICE

- **FREQUENCY RANGE:** Receive and transmit: 144.00 to 147.995 MHz, 5Khz steps + MARS-CAP and MULTIPLE OFFSET BUILT IN.
- **ALL SOLID STATE-CMOS PL DIGITAL SYNTHESIZED.**
- **SIZE:** UNBELIEVABLE! ONLY 6 3/4" x 2 3/8" x 9 3/4". **COMPARE!**
- **MICROCOMPUTER CONTROLLED:** All scanning and frequency-control functions are performed by microcomputer.
- **DETACHABLE HEAD:** The control head may be separated from the radio for use in limited spaces and for security purposes.
- **SIX-CHANNEL MEMORY:** Each memory is re-programmable. Memory is retained even when the unit is turned off.
- **MEMORY SCAN:** The six channels may be scanned in either the "busy" or "vacant" modes for quick, easy location of an occupied or unoccupied frequency. **AUTO RESUME. COMPARE!**
- **FULL-BAND SCAN:** All channels may be scanned in either "busy" or "vacant" mode. This is especially useful for locating repeater frequencies in an unfamiliar area. **AUTO RESUME. COMPARE!**
- **INSTANT MEMORY-1 RECALL:** By pressing a button on the microphone or front panel, memory channel 1 may be recalled for immediate use.
- **MIC-CONTROLLED VOLUME AND SQUELCH:** Volume and squelch can be adjusted from the microphone for convenience in mobile operation.
- **ACCESSORY OFFSET:** Provides three additional offset values: +0.4 MHz, +1 MHz and +1.6 MHz. Other offsets may also be obtained.
- **25 WATTS OUTPUT:** Also 5 watts low power for short-distance communication.
- **DIGITAL S/R F METER:** LEDs indicate signal strength and power output. No more mechanical meter movements to fall apart!
- **LARGE 1/2-INCH LED DISPLAY:** Easy-to-read frequency display minimizes "eyes-off-the-road" time.
- **PUSHBUTTON FREQUENCY CONTROL FROM MIC OR FRONT PANEL:** Any frequency may be selected by pressing a microphone or front-panel switch.
- **SUPERIOR RECEIVER SENSITIVITY:** 0.28 uV for 20-dB quieting. The squelch sensitivity is superb requiring less than 0.1 uV to open. The receiver radio circuits are designed and built to exacting specifications, resulting in unsurpassed received-signal intelligibility.
- **TRUE FM, NOT PHASE MODULATION:** Transmitted audio quality is optimized by the same high standard of design and construction as is found in the receiver. The microphone amplifier and compression circuits offer intelligibility second to none.
- **OTHER FEATURES:** Dynamic Microphone, built in speaker, mobile mounting bracket, external remote speaker jack (head and radio) and much, much more. All cords, plugs, fuses, microphone hanger, etc. included. Weight: 6 lbs.
- **ACCESSORIES:** 15' REMOTE CABLE.....\$29.95. CS-6R A/C POWER SUPPLY.....\$49.95. TOUCHTONE MIC. KIT.....\$39.95. EXTERNAL SPEAKER.....\$18.00.

AMATEUR-WHOLESALE ELECTRONICS ORDER NOW TOLL FREE

3817 S.W. 129th Terrace, Miami, Florida 33176

Telephone (305) 233-3631 • Telex: 80-3356

U.S. DISTRIBUTOR

DEALER INQUIRIES INVITED

1-800-327-3102

CREDIT CARD HOLDERS MAY USE OUR TOLL FREE ORDERING NUMBER.

Off to MARS with the S1

— mod is also useful for oddball repeater splits

The Tempo S1 represents a great step for portability and flexibility in the two-meter band. For a traveler or someone who lives in an area like Los Angeles, it sure beats buying crystals.

One day, while playing with a Bird Wattmeter, I found out that the little rig put out 2.1 Watts from 140.00 to 149.99. Being active in Air Force MARS and getting tired of carrying a GE Portamobile everywhere, I thought about using the S1 on MARS. As it sat, I could use it simplex,

but I also wanted to use the repeater. The S1 is fairly straightforward, so it didn't look too difficult. The rig has ± 600 kHz already built in by using 10.1 and 11.3 MHz crystals to provide offset. I called Bonnie at Cal Crystal Labs (1142 N. Gilbert St., Anaheim CA 92801, (714)991-1580) and ordered a crystal for the MARS split. She didn't know the formula, but said she would do her best to get it. Three weeks later, my crystal arrived and I was ready to dig into my S1. If you could live without your

— 600 kHz split, it would be a simple matter of putting the crystal in the place of the 10.1 MHz rock. Not wanting to do that, I started looking for ways to have this extra split without losing any of the standard features.

Taking the S1 apart is a simple matter of taking off four screws and pulling the battery plug and board-interconnection plug. Once inside, I saw that Tempo had thoughtfully left plenty of room for their optional PL mods. I also decided that my extra offset switch

would fit nicely where the seldom (if ever) used ear-phone jack is located.

I desoldered the ear-phone jack and bridged the normally-closed portion of the circuit to keep the speaker operating. I then placed a subminiature on-on switch in the hole left by the ear jack.

Next, I removed the wire going from the offset switch to crystal E on the transmitter board. I ran a wire from the offset switch to the center pole on my new subminiature switch. I ran

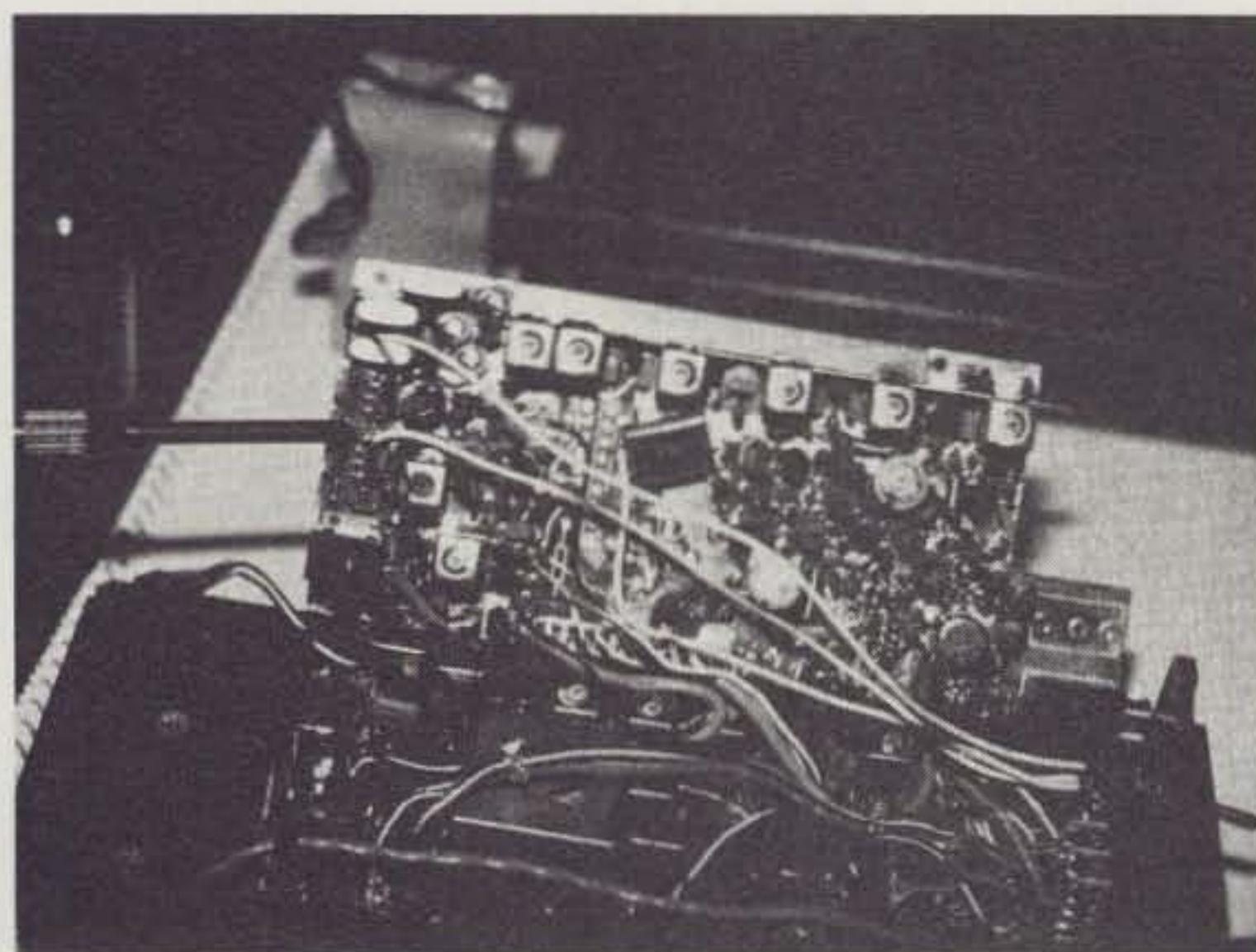

Wire from offset switch.

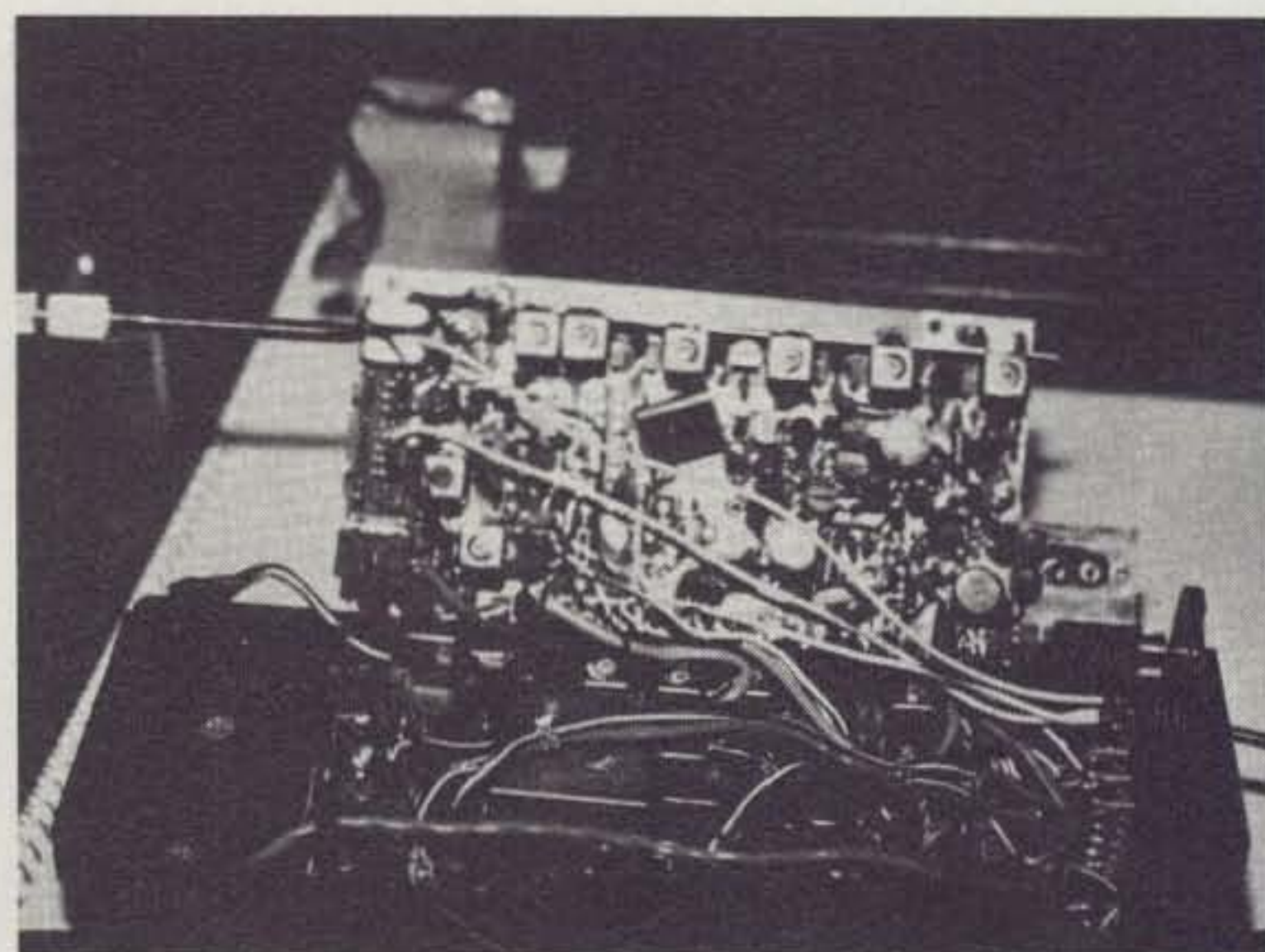

Wire from crystal E.

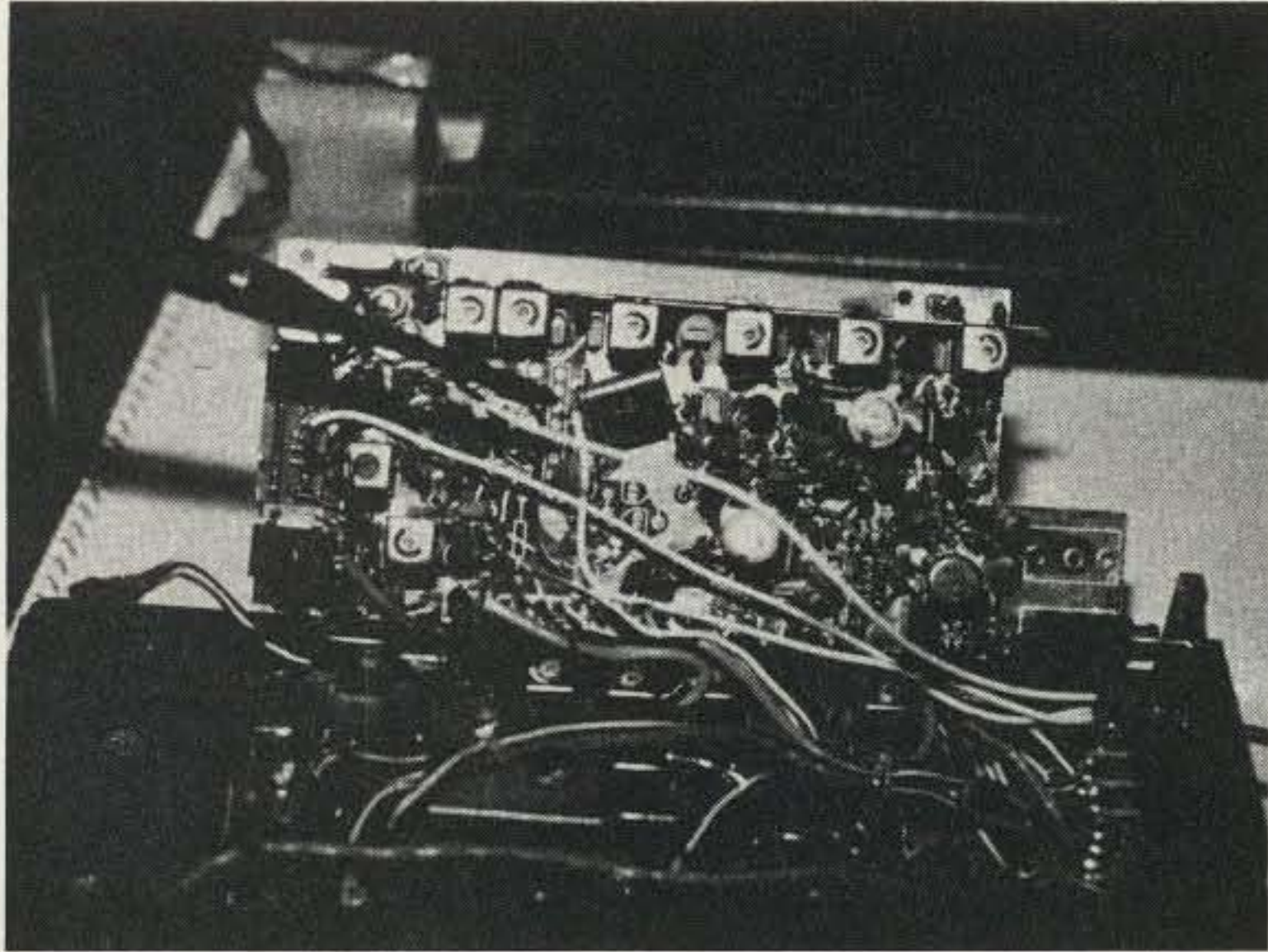

New crystal.

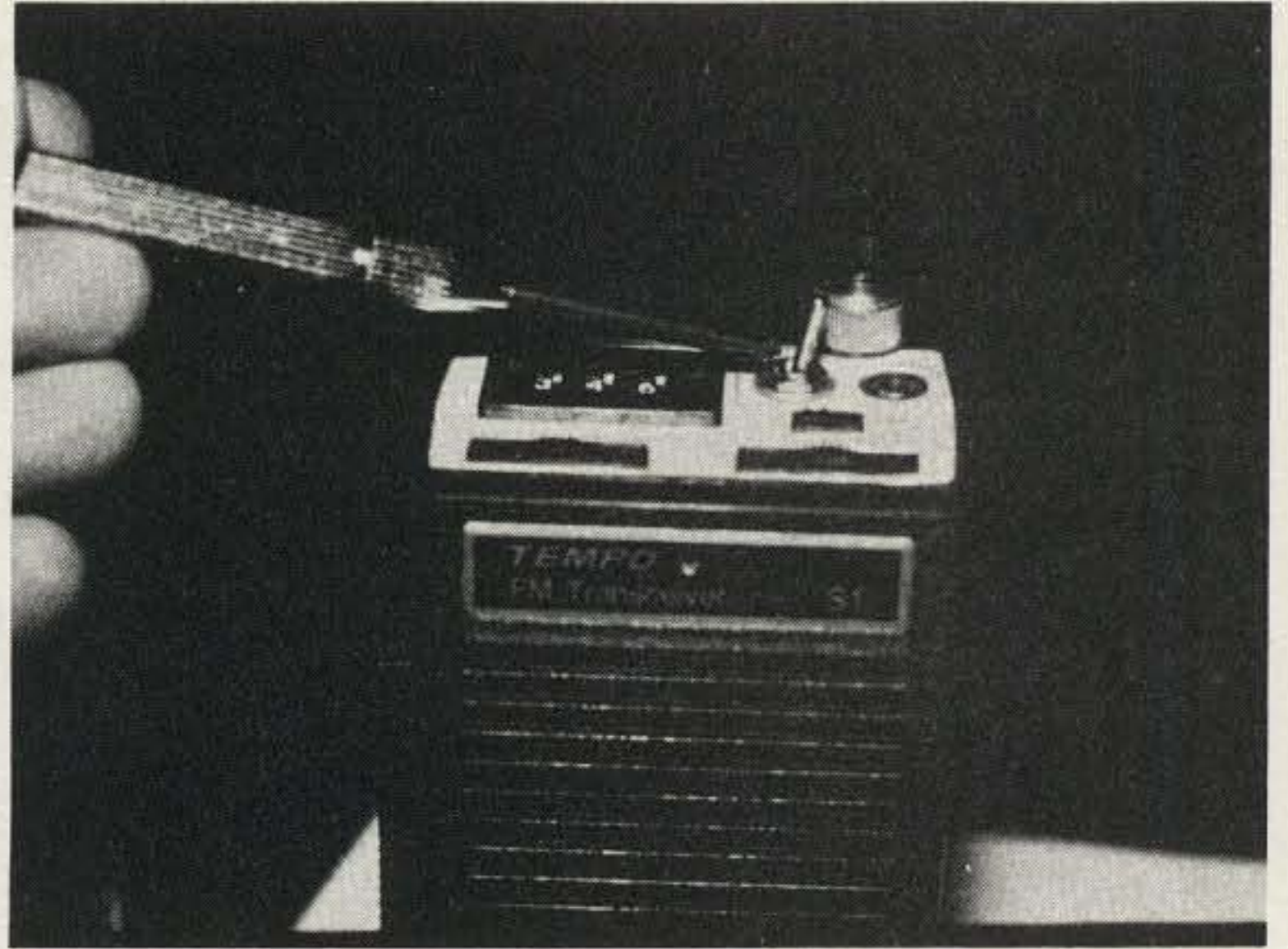

Completed product showing new switch.

another wire from the now vacant hole at crystal E to one pole on the new switch.

The final steps depend on how fancy you want to get. I simply ran my third wire from the switch to one side of the new crystal. I then tacked the other crystal lead to ground with solder to give it the prover-

bial "smoke test." It worked! My frequency counter lit up at 142.152, which was only 3 kHz from the desired 142.155. From that point, I simply started putting capacitors in series to ground with the crystal until the counter read the desired frequency. The first on-the-air test gave full-

quieting results with good audio. Good-bye, Portable!

This mod would work well with oddball split repeaters so that you can have it all. There is actually enough room to put quite a few crystals inside the S1 if you so desire. I also tried the first change with shield-

ed wires, but found them unnecessary. When dialing out of the amateur band, always go out on the high side and come back in on the low side. You will find little resistance and the wear on the BCD switch is minimal. I know that I enjoy my S1 more now that it's "gone to MARS." ■

the direct connection

AVANTI • ASTRON • ALLIANCE • ATLAS • ALPHA • BIRD • CUSHCRAFT • COLLINS • CDE • DRAKE • DENTRON • HY-GAIN • HUSTLER • ICOM • KLM • KENWOOD • MOSLEY • MICRO-LOG • MOR-GAIN • MIRAGE • MFJ • PALOMAR ENG. • SWAN • TEN-TEC • TAYLOR • TRI-EX • TELE-TOW'R • UNIVERSAL • UNARCO-ROHN ... ALL THESE AND MORE

MIDCOM ELECTRONICS, INC.
2506 S. BRENTWOOD BOULEVARD
ST. LOUIS, MISSOURI 63144



1-800-325-3609

MO. RESIDENTS CALL COLLECT 314-961-9990

Lloyd M. Jones W6DOB
 17779 Vierra Canyon
 Salinas CA 93907

Field-Strength Fever

— this simple meter eases antenna tuning

For many years I have used two field-strength meters, and they are still in use. I shall give credit to Jo Jennings W6EI (deceased), for he is the person who showed me the simple circuit. This little gadget is non-frequency selective. I have used it from 2 meters through 160 meters. The

telescoping antenna may be adjusted to its shortest length when working with 2 meters to keep the needle on scale. I use this field-strength meter to adjust all my 2 meter Js, base-loaded 5/8 wavelengths, beams, etc.

The meter used should be a 100 microamp up to a

500 microamp movement. The diodes may be any germanium type, such as 1N34, etc. Silicon diodes will also work, but are a bit less sensitive. The diode leads may be left their normal length. The sloped meter box is ideal. The box does NOT have to be metal. ■

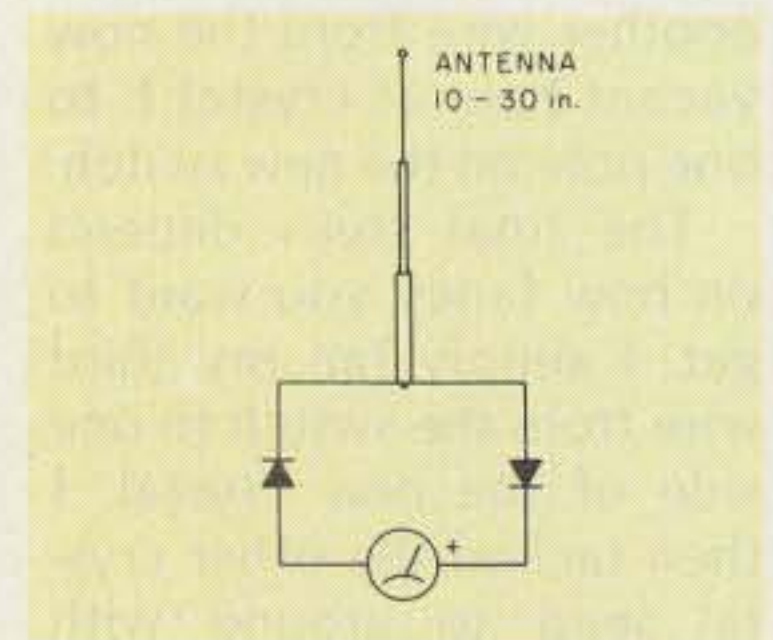

Fig. 1.

save up to 50%

kilobaud
MICROCOMPUTING™
 for business... education... FUN!

Yes! Please send me Kilobaud MICROCOMPUTING at a saving of 40% to 50% off the newsstand price.

12 issues for \$18 (save 40%)
 24 issues for \$30 (save 50%)
 36 issues for \$45 (save 50%)
 New subscription Renewal
 Payment enclosed \$ _____
 VISA MC AE Bill me

Card # _____ Exp. date _____
 Signature _____
 Name _____
 Address _____
 City _____ State _____ Zip _____

—for even faster service call toll-free (800) 258-5473

Canada: same as US, in US funds.
 Other foreign: \$23 one year only, US funds.

303B6

MICROCOMPUTING • POB 997 • Farmingdale NY 11737

the TRS-80* magazine

Send me one year of 80 Microcomputing for just \$15. (I save over 37%.)

I prefer 2 years for \$24. (I save 50%.)

I prefer 3 years for \$36. (I save 50% off the newsstand price.)

80 MICROCOMPUTING
The magazine for today's biggest selling computer.

New subscription Renewal
 Payment enclosed \$ _____ Bill me
 Visa Master Charge Am Express

Card # _____ Exp. date _____
 Signature _____
 Name _____
 Street _____
 City _____ State _____ Zip _____

Canada: same as US rates, in US funds. (*TRS-80 is a trademark of Tandy Corp.)
 Other foreign: \$20 one year only, US funds.

304B6

80 Microcomputing • POB 981 • Farmingdale NY 11737

INNOVATION IN AMATEUR RADIO

73

For over 18 years, 73 Magazine has been the innovator in amateur radio. 73 led the way to developing the use of solid-state circuitry, and was the first to promote such things as SSTV, radioteletype, computer applications for radio communications, and single sideband.

Radio electronics has changed as 73 has changed. Ever notice how other magazines published in the field of radio electronics are just like the ones before them? Same old subjects in every issue, same predictable views, same old editorials . . . try to find it in 73 . . . you won't. In one issue you might find building projects and information on antennas, moonbouncing and mountaintopping; in the next issue you might read about computers, radioteletype, or traffic handling.

FREE TRIAL COPY

Write today and we'll send you your first copy with absolutely no obligation . . . that's right, if you're not completely satisfied after you've read your first issue, just write "CANCEL" on your invoice and send it back to us . . . the first issue is yours to keep — on us! In addition, we'll guarantee every issue of your subscription . . . if you're not satisfied with your first — or your eleventh — issue, we'll refund your money on all remaining issues. Call in your order today and get your new subscription started for \$15 . . . half the price you'd pay on the newsstand. Have your credit card handy and call us toll-free at (800) 258-5473.

**or . . .
use
this
coupon
and
subscribe
today . . .**

Please send me my trial copy of 73 at no obligation. I understand that you'll start my subscription and bill me later . . . if I'm not completely satisfied I'll mark the invoice "CANCEL" and mail it back within 10 days.

One year—\$15

Three years—\$45

Bill me

Payment Enclosed

Bill my: Visa

Master Charge

Card # _____ Exp. date _____

Signature _____

Name _____

Address _____

City/State/Zip _____

Canada: \$15 in US funds. Other foreign \$26 one year only, in US funds.

304B6

73 Magazine • POB 931 • Farmingdale NY 11737

CB to 10

— part XXIV: Penney's SSB rig

Want a 10-meter rig that is cheap, easy to use, and provides up to 1.7-MHz coverage? If so, read on and see how you can change a 40-channel SSB CB into a convenient mobile package for just a few bucks and an hour's time.

The J.C. Penney Model no. 6246 (catalog #981-8378)

and the Sears Roadtalker 40 (934.38260700) are 40-channel AM/SSB transceivers using the same phase locked loop (PLL) circuitry. The J.C. Penney model has an excellent instruction manual which contains a good explanation of how PLL circuits work, as well as alignment instructions. By all means, try to obtain this

manual if you don't already have it. The methods described for these sets can be applied to other Sears and J.C. Penney sets with similar circuits. You'll have to do some figuring, though, because of some circuit changes and a different schematic numbering system. The following conversion instructions include how to change the 40 AM/USB channels to ten meters, three ways to double the number of channels available, and two ways to change the fine-tuning control to swing the transmit frequency as well as the receive frequency.

How To Start the Conversion

Frequency Selection

1. Select the starting frequency for the portion of the band you wish to use. My selection was 28.510 MHz because I intended to work sideband and as much DX as possible.

2. Derive the new AM/USB local-oscillator crystal (X701) frequency. To the frequency you have chosen, add 11.275, subtract 1.28, and divide by 3. Example: $(28.510 + 11.275 - 1.28) / 3 = 12.835$ MHz.

3. Replace X701. This crystal is located in a metal

box behind the channel switch (see Fig. 1). It will be necessary to remove the three screws securing it to the main PCB and then to unsolder the sides of the box from the bottom of the box. This is no problem with the aid of a solder wick. Remove the local oscillator board from the can and replace X701 with the new crystal.

PLL Adjustments

1. Refer to Fig. 1 for component locations. A frequency counter and oscilloscope will make the job easier if problems develop, but if you don't have these instruments, don't worry. With the set tuned to channel 18, adjust T702 to obtain a dc voltage across TP5 and TP6 (ground) of $3.0 \pm 0.1V$ and proceed to *Transmitter Alignment* instructions, below.

2. If you want to be more scientific and check things as you go along, or if step one didn't work, get out your frequency counter and proceed with step three.

3. Check the frequency of the new crystal by measuring it between the top of trimmer CT702 and the crystal box. It should be about 12.835 MHz.

4. Check the frequency

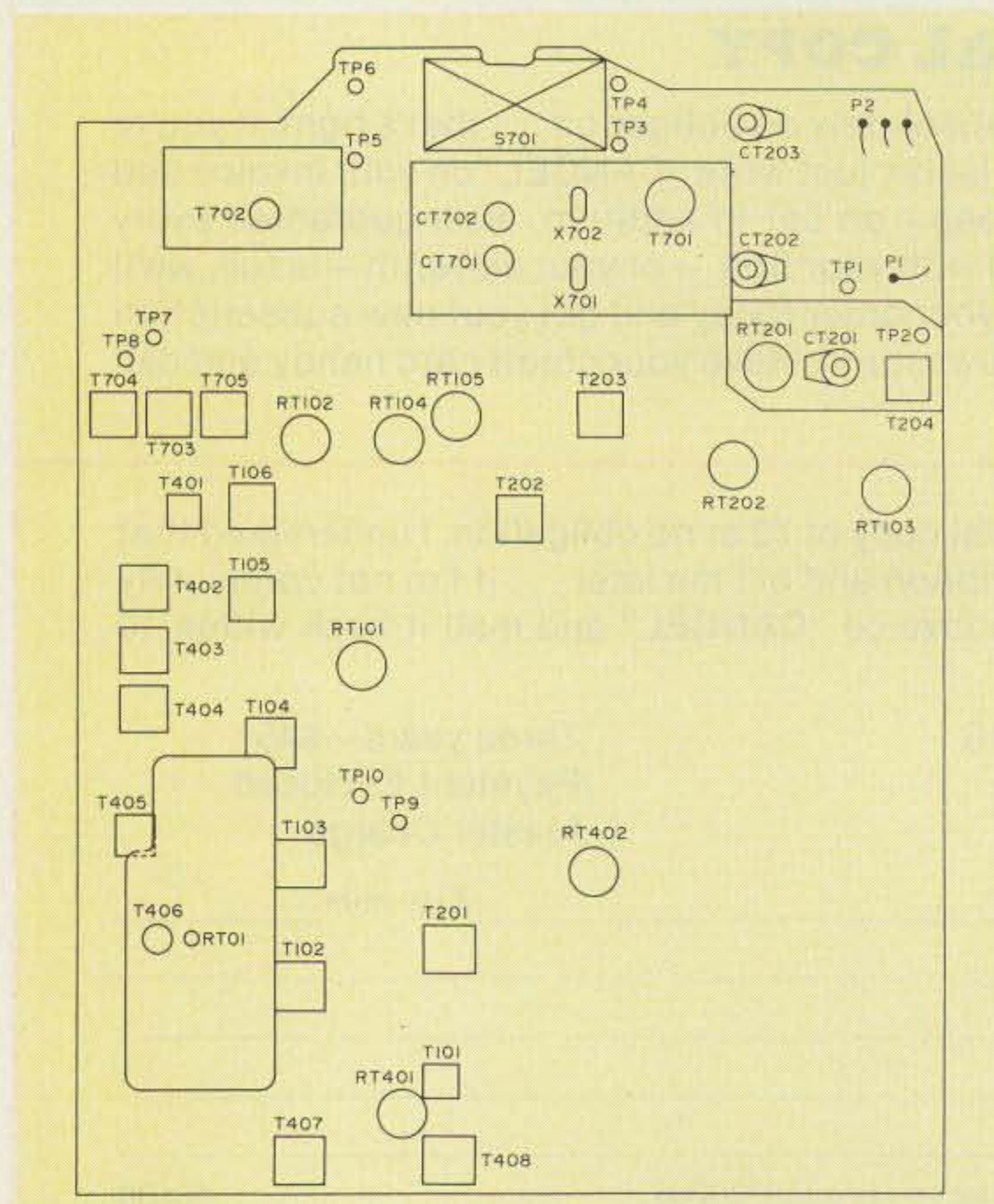

Fig. 1. Component location diagram.

from the output of the local-oscillator circuitry by unplugging from the board the white wire leading to the main printed circuit board. This is one of a pair, the other one being white with a stripe. This is the output from the tripler, and the frequency output at this point should be about 38.505 MHz. Plug the white wire back on the board terminal.

5. Connect an oscilloscope to TP3 and TP4 (ground) and adjust T701 for maximum amplitude.

6. Now, with the set tuned to channel 18, adjust T702 for a dc output of 3.0 ± 0.1 V across TP5 and TP6 (ground).

7. Measure the frequency across the collector of Q708 and any of the metal shields on the foil side of the board. The frequency should be about 39.995 MHz for channel 18 if you used an X701 frequency of 12.835 MHz ($X701 \times 3 + 1.49$). This completes PLL adjustments and checks.

Transmitter Alignment

1. Alignment of the transmitter section is accomplished by attaching an antenna to the rig (a 104" piece of wire), and, with the help of your HF SSB receiver tuned for about 28.720 MHz, keying the rig (AM, channel 18) and listening for a weak heterodyne whistle. Adjust T703 and T704 for maximum deflection of your HF receiver's S-meter. After this step, place a wattmeter and dummy load on the rig and key the set again. If no output is seen, go back to the wire antenna and adjust T401 and T402 for maximum S-meter reading, again using your HF SSB receiver to detect the peak output position. Once an output is seen on the wattmeter, final adjustment of T401-T408 can be made.

2. Turn RT402 fully counterclockwise. With

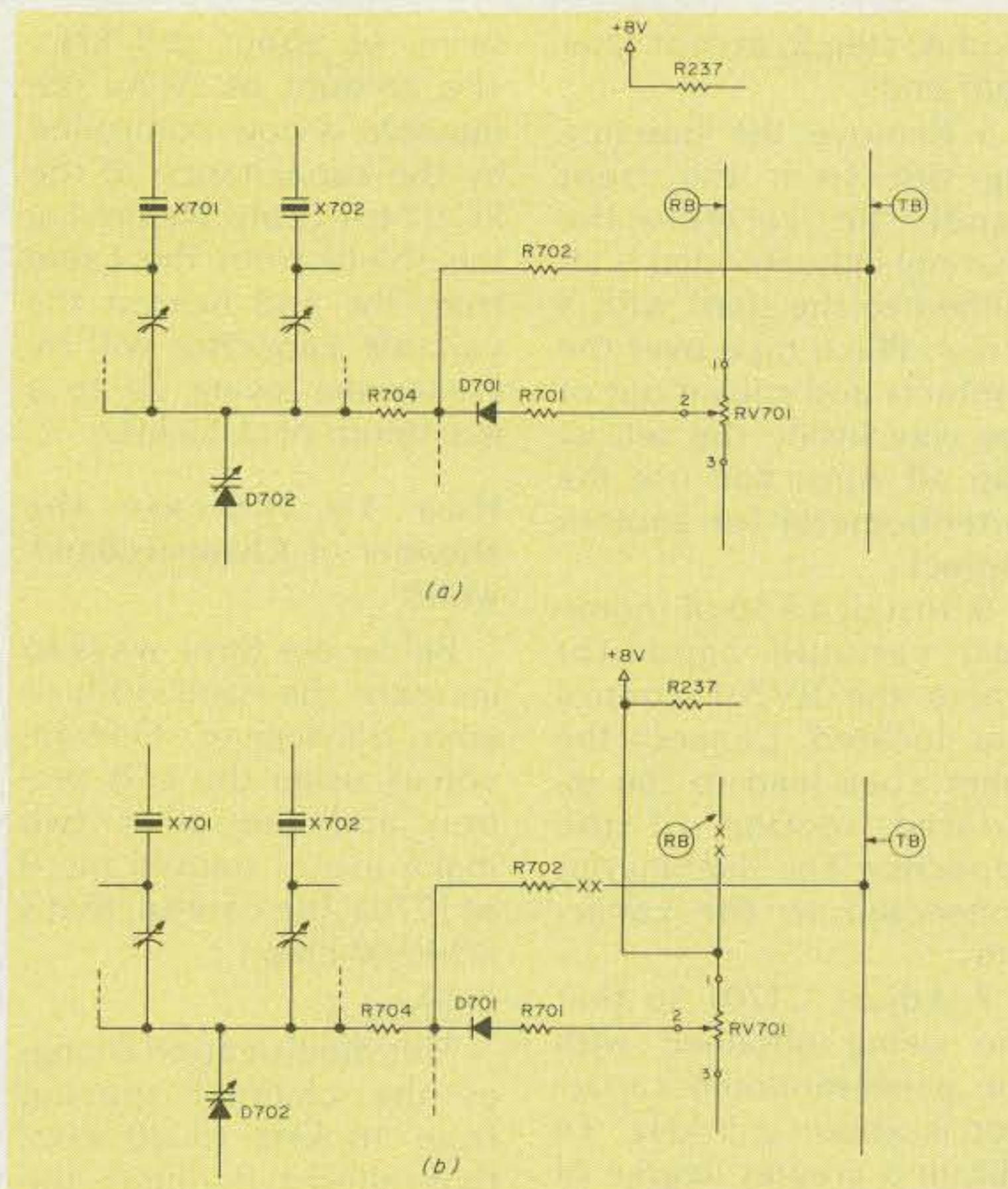

Fig. 2. Mod A—varactor circuit modification: (a) before modification; (b) after modification.

the function switch in SSB-USB, hold your mike next to the sidetone of your keyer, use the marker tone from your HF receiver, or, if you're really well equipped, use an audio frequency generator and key the rig. Readjust T703, T704, and T401-T408 for maximum power output.

3. Check the set's output on each channel. On sideband, mine was about 7 Watts. If the output falls off to 0 Watts at either end, readjust T702 very slightly to lock the PLL.

Modifications to the Fine-Tuning Control

This rig has an RIT but is fixed on transmit. The RIT has a range of ± 2 kHz. The Mod A changes, below, will enable the transmit frequency to also be shifted ± 2 kHz. Mod B will give a swing of ± 5 kHz to ± 15 kHz.

Mod A—Varactor Circuit

Refer to Fig. 2. This CB rig is designed to provide a ± 2 -kHz swing on receive

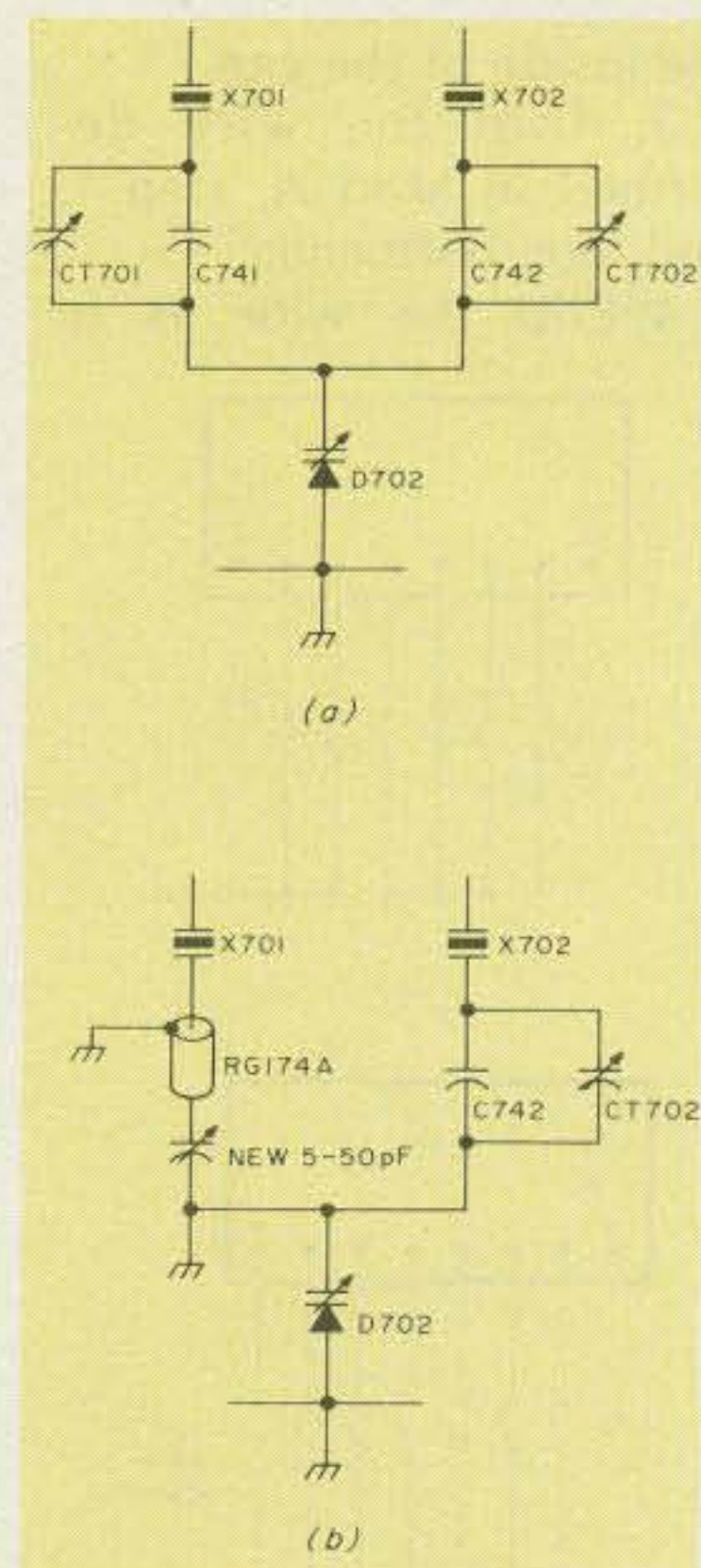

Fig. 3. Mod B—How to obtain a ± 5 -to-15-kHz swing: (a) before modification; (b) after modification.

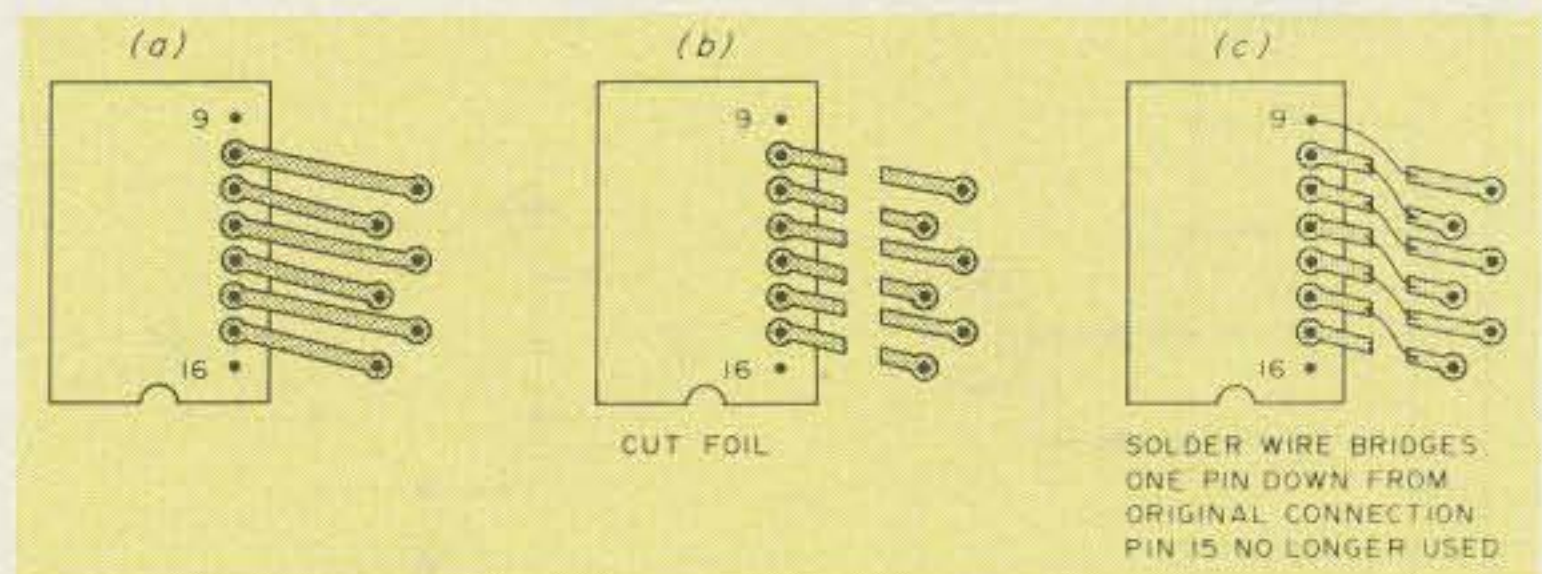

Fig. 4. Modifications to IC701 to obtain 20-kHz channel spacing.

by varying the voltage across varactor D702 by means of potentiometer RV701. A +8-V dc potential is applied to RV701 (fine-tuning control) only during receive. During transmit, +8 V dc is applied to the varactor through a fixed resistance, R702. This modification simply supplies +8 V dc continuously to RV701, thus enabling it to function on transmit as well as receive.

1. Clip the wire originating from the local oscillator board which terminates at C752 and R702. Tape both ends.

2. Clip the wire from terminal 1 of the fine-tuning

control near the socket which plugs into the main PCB. Tape the end going to the socket. Solder the other end to the foil side of the PCB to the R237 termination nearest the edge of the PCB. This is a +8-V dc source which is on during both transmit and receive.

Mod B—How to Obtain a ± 5 -to-15-kHz Swing

Refer to Fig. 3.

1. Remove C741, the 22-pF capacitor in parallel with CT701.

2. Run a 4" length of coax (RG-174/A) from where C741 was connected (center lead to hole nearest crystal) through a hole in the side of the oscillator can. Solder the shield to

the inside of the can.

3. Clip the wire described in Mod A, step 1, and tape both ends.

4. Clip the wire as in

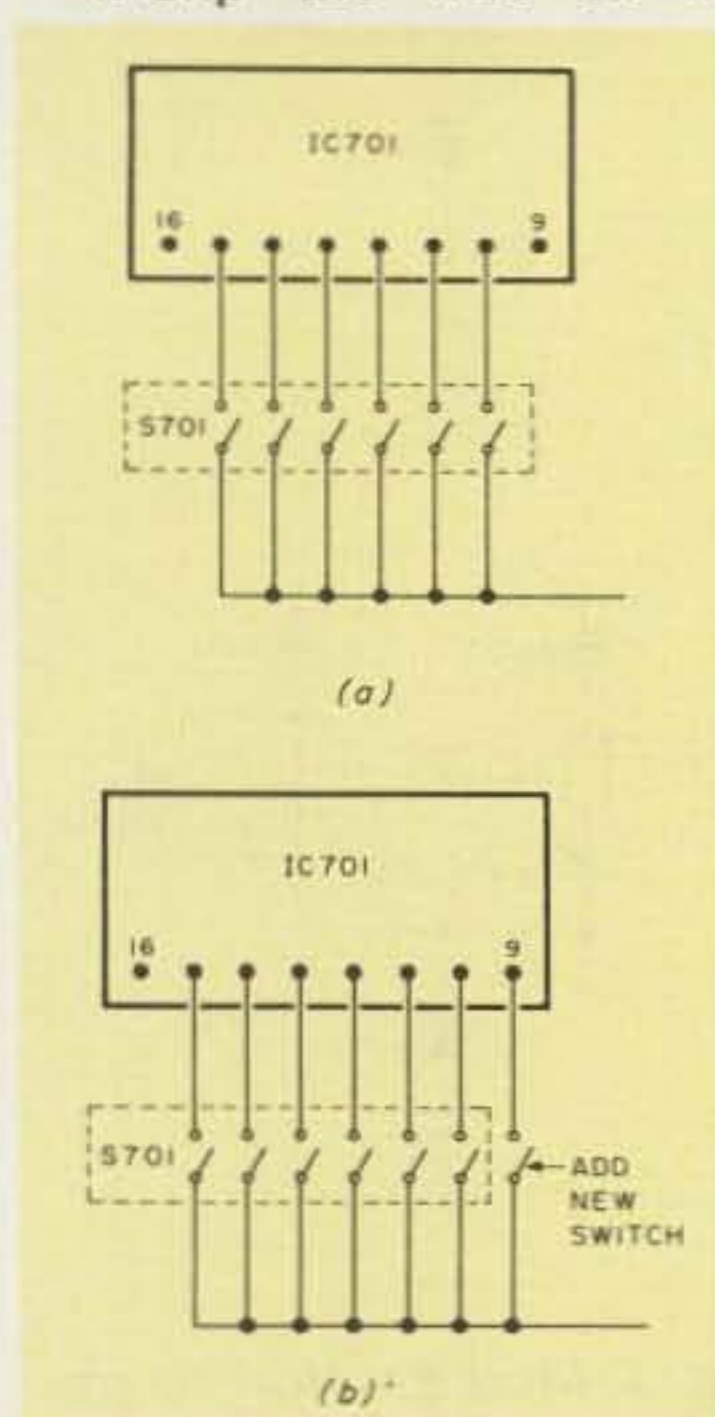

Fig. 5. 640-kHz jump modification: (a) before; (b) after.

Mod A, step 2, except tape both ends.

5. Remove the fine-tuning pot from the front panel. Be careful—the channel indicator dial is attached to the shaft with a screw. Place tape over the contacts and stick it out of the way inside the set, or clip all wires and use the potentiometer for another project.

6. Install a 5-50-pF (nominal) variable capacitor where the RV701 control was located. Connect the inner coax lead to the insulated section of the capacitor. The shield is not connected to the capacitor.

7. Adjust CT701 so that the swing obtained with the panel-mounted capacitor is about ± 5 kHz. To obtain a greater degree of swing, remove CT701 from the board. This will yield a

swing of about ± 8 kHz. The amount of swing obtainable is now controlled by the capacitance of the RG-174/A cable. Removing the shield from the cable from the end nearest the variable capacitor will increase the swing up to a maximum of ± 15 kHz.

How To Increase the Number of Channels/Bandwidth

Below are three ways to increase the bandwidth of your transceiver. One involves using the LSB section and the other two make use of unused pin 9 of IC701. (Be careful, that's a \$40.00 chip.)

Method A

This modification changes the channel spacing from 10 kHz to 20 kHz, thus almost doubling the bandwidth available. My rig covers 28.500 to 29.400 MHz.

1. Cut foil as shown in Fig. 4(a) and (b). This is done easily with a Dremel tool. Sand the varnish from the foil and solder wire bridges, as shown in Fig. 4(c).

2. Perform the Mod B swing, using the instructions to obtain a swing of ± 12 kHz. This will provide enough swing to cover the gaps between most of the channels.

Method B

Pin 9 of IC701 can also be used to jump each channel 0.640 MHz up from its original frequency, so that 28.510 MHz becomes 29.150 MHz when this pin is activated. If the rig will tune 28.510-28.950 with pin 9 switched off, it will tune 29.150-29.550 MHz with the pin switched on.

Refer to Fig. 5.

1. Run a wire from unused pin 9 of the programmable divider to a front-panel-mounted switch. (Suggestion: Remove wires from the ANL switch, solder them together, and use the ANL switch.)

2. Run another wire from the switch to the common leg of the channel selector switch. Try the foil side of the board where R722 is attached nearest to the channel switch. With this switch in the on position, each channel will be 640 kHz higher in frequency than it was originally.

Note on the Programmable Frequency Divider: Pins 9-15 on IC701 are the inputs to this device. Energizing pin 15 adds 10 kHz to the base frequency. Pin 14 adds 20 kHz, pin 13—40 kHz, pin 12—80 kHz, pin 11—160 kHz, pin 10—320 kHz, and pin 9—640 kHz. Thus, if channel 1 is 28.505 MHz, energizing pins 15 and 11 will yield a frequency of $28.505 + .010 + .160 = 28.675$ MHz. Some hams have replaced the channel switch with seven small switches and "program in" the desired frequency. This IC701 chip is available from New-Tone Electronics International, PO Box 1738, Bloomfield NJ 07003, for under \$10. Sylvania's ECG 1255 does not work, and the IC from Sears of J.C. Penney listed for around \$40 when I checked.

Method C

Change the LSB local-oscillator crystal for 40 more. Refer to Fig. 6.

1. Select the portion of the band you wish to cover. Using the lowest frequency, calculate the LSB crystal frequency by using the formula in step 2 of the conversion instructions. Example: Additional bandwidth desired, 28.960-29.400 MHz. $(28.960 + 11.275 - 1.28)/3 = 12.985$ MHz.

2. Install the new crystal in place of X702.

3. Cut the red/black wire attached to P2 near the plug end.

4. Cut the wire to P1 about $\frac{3}{4}$ " from the plug.

5. Remove C742 and CT702, and tie both crystals into the fine-tuning

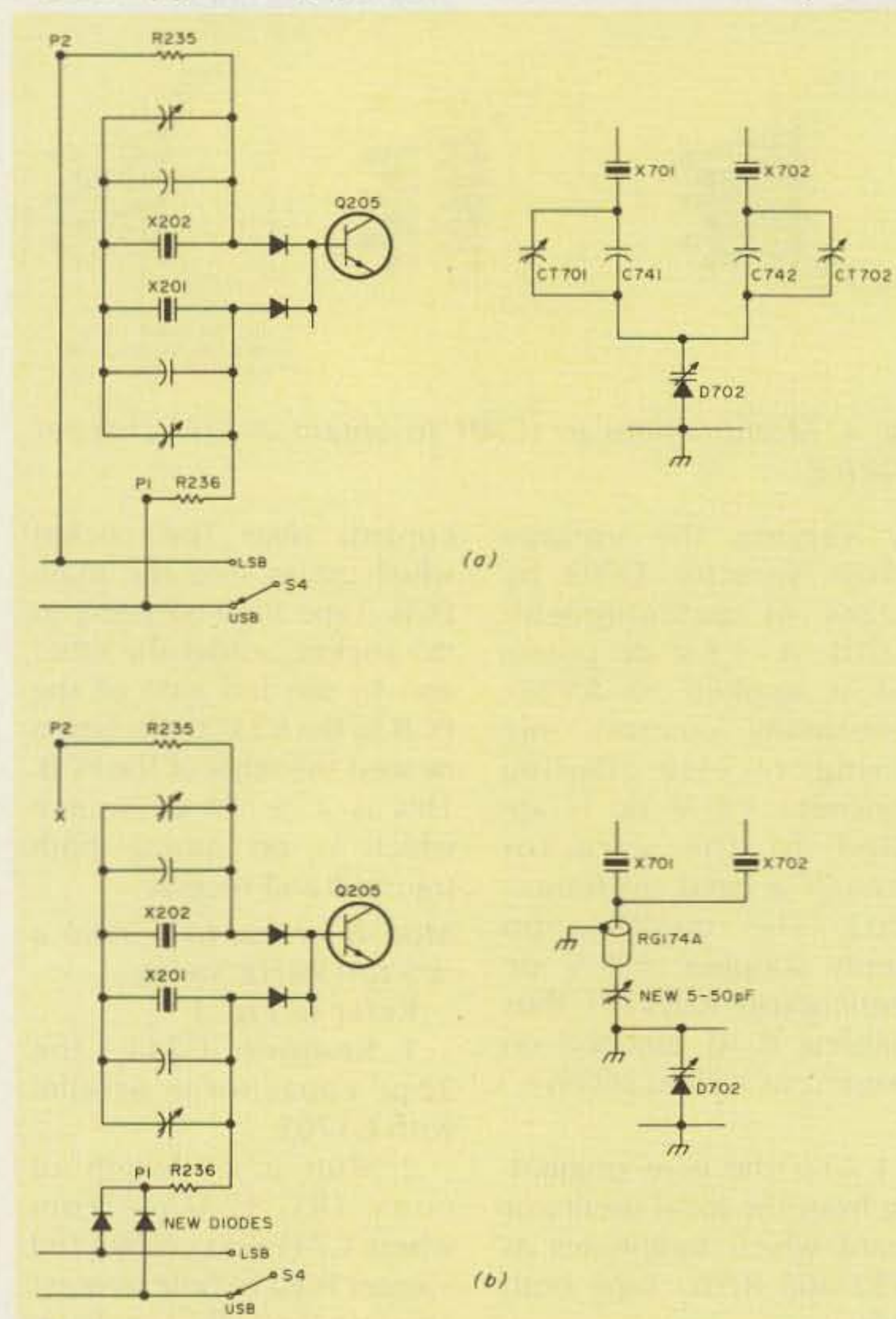

Fig. 6. LSB oscillator crystal modification for 40 more: (a) before; (b) after.

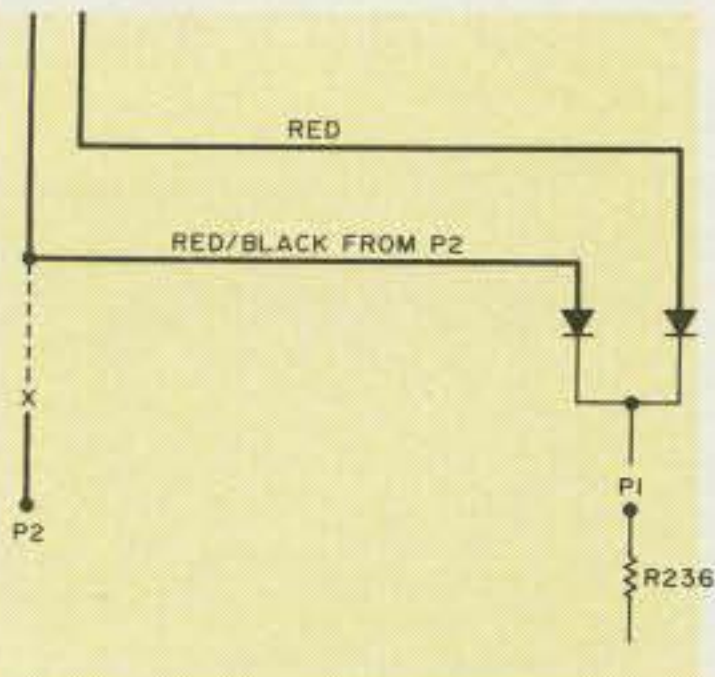

Fig. 7. Adding diodes for conversion of LSB to USB.

capacitor with a short jumper from the crystal side of where CT702 was to the coax going to the air-variable capacitor.

6. Place diodes in series with the wires and reconnect both diodes as shown in Fig. 7.

This modification should give you 1.7 MHz coverage of the band, assuming all the stages are broad enough.

Receiver Alignment

1. Adjust T705, T101,

T201, and T102-T106 so that the output is maximum on channel 20 with the set on a convenient AM signal.

2. With the set on channel 20 and a convenient SSB station or signal, adjust T201, T202, and T203 for maximum output.

Conclusion

On-the-air tests from the car have been great. Almost any station heard can be worked if the "biggies" don't pile on. Mobile contacts into Europe are routine from this QTH, and with the rig hooked to the tribander at the house, Asia and Australia are no problem. Signal reports generally run 5 by 5 to 5 by 8, which is solid copy on 10 meters. The receiver is decent and is well balanced with the transmitter's abilities. All in all, the rig is easy to convert and performs very well. ■

Order Your Collins KWM-380 NOW!

and receive FREE ONE of the following

(+ old pricing, deposit only required)

- 1) Noise Blanker — \$195.00
- 2) 2 Filters, your choice — \$96.00 ea.
- 3) Blower Kit — \$195.00



Get on with the Best!



MADISON

Electronics Supply, Inc. ✓ 45

1508 McKinney • Houston, Texas 77002 • (713) 658-0268

SEE YOU IN DAYTON

Redesigned and new cabinetry. Watch for new showing in this space.

COMPLETE KITS: CONSISTING OF EVERY ESSENTIAL PART NEEDED TO MAKE YOUR COUNTER COMPLETE. **HAL-600A** 7-DIGIT COUNTER WITH FREQUENCY RANGE OF ZERO TO 600 MHz. FEATURES TWO INPUTS: ONE FOR LOW FREQUENCY AND ONE FOR HIGH FREQUENCY; AUTOMATIC ZERO SUPPRESSION. TIME BASE IS 1.0 SEC OR .1 SEC GATE WITH OPTIONAL 10 SEC GATE AVAILABLE. ACCURACY ± .001%, UTILIZES 10-MHz CRYSTAL 5 PPM.

COMPLETE KIT..... \$129

HAL-300A 7-DIGIT COUNTER WITH FREQUENCY RANGE OF ZERO TO 300 MHz. FEATURES TWO INPUTS: ONE FOR LOW FREQUENCY AND ONE FOR HIGH FREQUENCY; AUTOMATIC ZERO SUPPRESSION. TIME BASE IS 1.0 SEC OR .1 SEC GATE WITH OPTIONAL 10 SEC GATE AVAILABLE. ACCURACY ± .001%, UTILIZES 10-MHz CRYSTAL 5 PPM.

COMPLETE KIT..... \$109

HAL-50A 8-DIGIT COUNTER WITH FREQUENCY RANGE OF ZERO TO 50 MHz OR BETTER. AUTOMATIC DECIMAL POINT, ZERO SUPPRESSION UPON DEMAND. FEATURES TWO INPUTS: ONE FOR LOW FREQUENCY INPUT, AND ONE ON PANEL FOR USE WITH ANY INTERNALLY MOUNTED HALTRONIX PRE-SCALER FOR WHICH PROVISIONS HAVE ALREADY BEEN MADE. 1.0 SEC AND .1 SEC TIME GATES. ACCURACY ± .001%. UTILIZES 10-MHz CRYSTAL 5 PPM.

COMPLETE KIT..... \$109

PRE-SCALER KITS

HAL 300 PRE..... \$19.95
(Pre-drilled G10 board and all components)

HAL 300 A/PRE..... \$24.95
(Same as above with preamp)

HAL 600 PRE..... \$34.95
(Pre-drilled G10 board and all components)

HAL 600 A/PRE..... \$39.95
(Same as above but with preamp)

TOUCH TONE DECODER KIT

HIGHLY STABLE DECODER KIT. COMES WITH 2 SIDED, PLATED THRU AND SOLDER FLOWED G-10 PC BOARD, 7-567's, 2-7402, AND ALL ELECTRONIC COMPONENTS. BOARD MEASURES 3 1/2 x 5 1/2 INCHES. HAS 12 LINES OUT. ONLY \$39.95

DELUXE 12-BUTTON TOUCHTONE ENCODER KIT utilizing the new ICM 7206 chip. Provides both VISUAL AND AUDIO indications! Comes with its own two-tone anodized aluminum cabinet. Measures only 2 3/4 x 3 3/4". Complete with Touch-Tone pad, board, crystal, chip and all necessary components to finish the kit.

PRICED AT..... \$29.95

For those who wish to mount the encoder in a hand-held unit, the PC board measures only 9/16" x 1 3/4". This partial kit with PC board, crystal, chip and components.

PRICED AT..... \$14.95

ACCUKEYER—MEMORY OPTION KIT THIS ACCUKEYER MEMORY KIT PROVIDES A SIMPLE, LOW COST METHOD OF ADDING MEMORY CAPABILITY TO THE WB4VVF ACCUKEYER. WHILE DESIGNED FOR DIRECT ATTACHMENT TO THE ABOVE ACCUKEYER, IT CAN ALSO BE ATTACHED TO ANY STANDARD ACCUKEYER BOARD WITH LITTLE DIFFICULTY. \$16.95

ACCUKEYER (KIT) THIS ACCUKEYER IS A REVISED VERSION OF THE VERY POPULAR WB4VVF ACCUKEYER ORIGINALLY DESCRIBED BY JAMES GARRETT, IN QST MAGAZINE AND THE 1975 RADIO AMATEURS HANDBOOK. \$16.95

ACCUKEYER—MEMORY OPTION KIT—TOGETHER ONLY \$32.00

6-DIGIT CLOCK • 12/24 HOUR

COMPLETE KIT CONSISTING OF 2 PC G10 PRE-DRILLED PC BOARDS, 1 CLOCK CHIP, 6 FND 359 READOUTS, 13 TRANSISTORS, 3 CAPS, 9 RESISTORS, 5 DIODES, 3 PUSH-BUTTON SWITCHES, POWER TRANSFORMER AND INSTRUCTIONS. DON'T BE FOOLED BY PARTIAL KITS WHERE YOU HAVE TO BUY EVERYTHING EXTRA.

PRICED AT \$12.95

CLOCK CASE Available and will fit any one of the above clocks. Regular Price ... \$6.50 But Only \$4.50 when bought with clock

SIX-DIGIT ALARM CLOCK KIT for home, camper, RV, or field-day use. Operates on 12-volt AC or DC, and has its own 60-Hz time base on the board. Complete with all electronic components and two-piece, pre-drilled PC boards. Board size 4" x 3". Complete with speaker and switches. If operated on DC, there is nothing more to buy.*

PRICED AT \$16.95

Twelve-volt AC line cord for those who wish to operate the clock from 110-volt AC. \$2.95

SHIPPING INFORMATION

ORDERS OVER \$15.00 WILL BE SHIPPED POSTPAID EXCEPT ON ITEMS WHERE ADDITIONAL CHARGES ARE REQUESTED. ON ORDERS LESS THAN \$15.00 PLEASE INCLUDE ADDITIONAL \$1.00 FOR HANDLING AND MAILING CHARGES. SEND SASE FOR FREE FLYER.

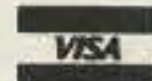

"HAL" HAROLD C. NOWLAND
WBZXH

HAL-TRONIX ✓ 31

P. O. BOX 1101
SOUTHGATE, MICH. 48195
PHONE (313) 285-1782

Build an Audio VOM

—and keep your eyes where they belong

There are many cases where one desires simply to check a circuit or device for continuity, contact, or the presence of voltage, without needing any quantitative measurements. Also, there are times when it is not easy to eyeball a meter while making these checks. If you have ever tried tracing down a wire or checking out a switch in your automobile electrical system, you know what I mean.

The simple circuit described here will produce an audio output in proportion to the level of voltage (ac or dc) and will check continuity.

This unit will detect ac or dc voltage to at least 300 volts and down to as low as approximately 6 volts. It will distinguish be-

tween ac and dc, with the audio from ac sounding a bit raspy and the dc producing a more pure note. Checking for dc voltage is further simplified by not having to worry about the polarity of the test leads. The sound intensity is proportional to the level of voltage applied.

The lower limit of voltage detection depends on the value of R1, the sensitivity of the device, and your ears. With the circuit shown, I have no problem "hearing" as little as six volts. In the Ohms position, the circuit will detect resistance from a short up to approximately 40k Ohms or more, with a fresh 9-V transistor radio battery. Shorting the test leads together produces the loudest signal in the Ohms mode.

The circuit is quite basic, consisting of a full-wave bridge rectifier with a Mallory Sonalert® transducer connected to the dc terminals, observing polarity, of course. The model SC628 Sonalert has a range of 6-28 V dc using only 3 to 14 mA of current, so the device is fairly sensitive. With the series resistor, R1, or the battery as shown in the circuit, the range of input voltage, or resistance that produces a sound output, will surprise you. Switch S1 selects either an internal 9-V battery for Ohms or series resistor R1 for voltage.

The value of the resistor was determined experimentally to permit a range of voltage to be checked that would most likely be encountered by the average person, and limit the voltage drop across the device to a safe level. At 300 volts, the Sonalert has about 20 volts across it which is still within its range. Finally, a 1/8-Amp fuse is included in series with one of the leads, in case someone goofs and tries to hear voltage with the switch in the Ohms position.

The unit was built to fit into a small plastic instru-

ment case, with the test leads brought out directly to alligator clips for maximum convenience and economy. Just about any small box or enclosure that will hold the parts should work nicely, however.

One word of caution when using this tester—which holds true for any VOM. Always make sure the circuit is de-energized before checking resistance or continuity either by disconnecting all sources of voltage and/or checking for no voltage first. Always return the instrument to the voltage position after using the Ohms position, and you should never have to replace the fuse inside. Also, it is not recommended for voltages in excess of 300.

You will find this little unit as handy as a button on a shirt, for checking for blown fuses, panel lamps, tracing wires, connections, relay coils and contacts, switches and so on. It will check diodes for short or open condition and transformers and coils for continuity; there is a host of other applications too numerous to list here. After using the unit a few times, you will find yourself wondering how you ever got along without it. ■

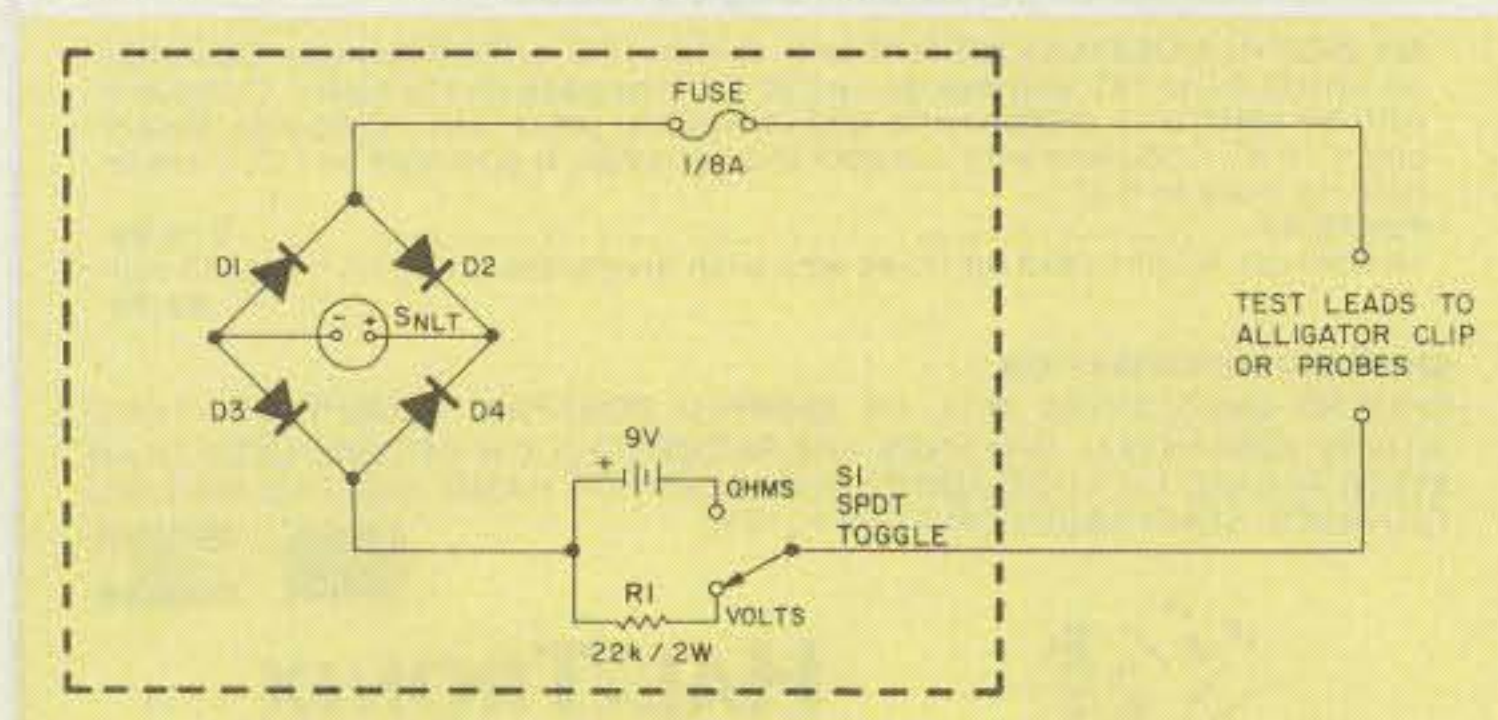

Fig. 1. Simple audio volt-Ohm detector. S_{NLT} —Mallory SC628 Sonalert.® D₁ through D₄—1N5061 or equivalent. (Any general-purpose diode or package bridge rectifier with a piv rating of 500 V or more should work.)

Completely Free
Standing Towers

TELE TOW'R

PAT. NO. 4,151,534

40' MODEL

Model 40 (extends
from 21' to 40')
List \$259.10

55' MODEL

Model 55 (extends
from 21' to 55')
List \$473.97

Breakover Model

40 (extends from
23' to 40' with
breakover at
ground level)
List \$440.62

Breakover Model

55 (extends from
23' to 55' with
breakover at
ground level)
List \$661.75

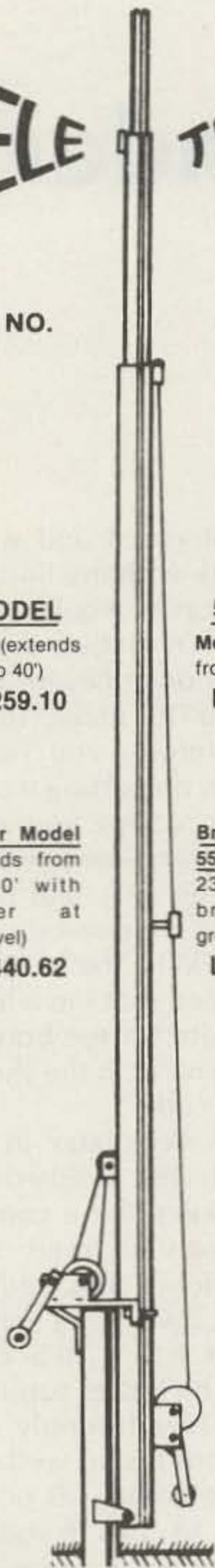

All steel constructed.

Concrete sleeve available for all
models.

✓72

TELE-TOW'R MFG. CO., INC.
P.O. Box 3412 • Enid, OK 73701
405-233-4412

Touch-Tone Decoders

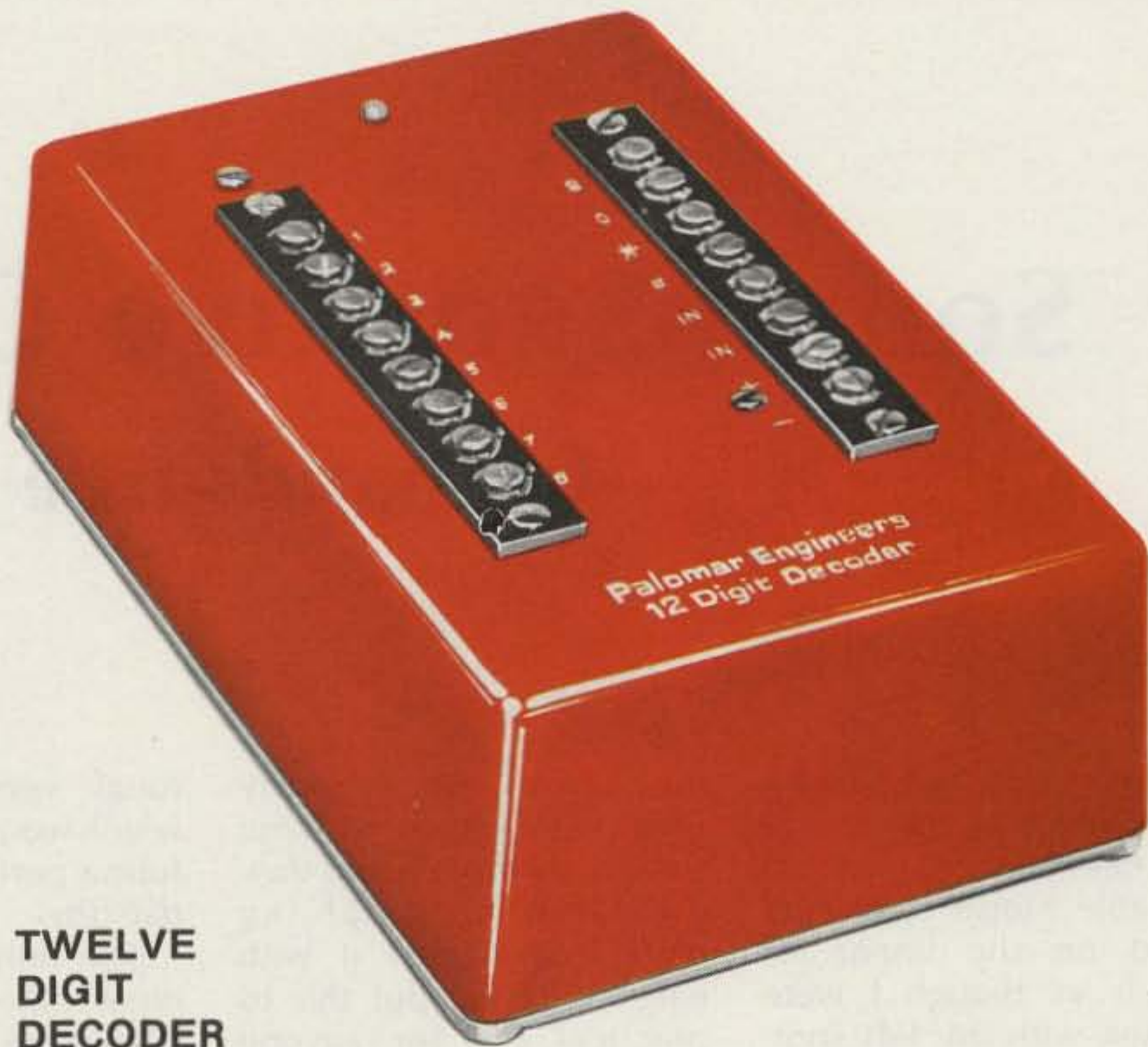

**TWELVE
DIGIT
DECODER**
\$155.00

- Decodes digits 1, 2, 3, 4, 5, 6, 7, 8, 9, 0, * and #.
- Twelve 5-volt output lines.
- Isolated 5000 ohm input.
- Operates from any DC voltage +12 to +30 volts.
- Output drives TTL logic or relays.



Model T2 \$59.95

- Decodes one Touch-Tone digit.
- Available for digits 1, 2, 3, 4, 5, 6, 7, 8, 9, 0, *, and #. Also for digits A, B, C, D.
- Relay output SPST 1/2 amp.
- Operates on any DC voltage +12 to +30 volts.



Model AR-3 \$59.95

- Sequence decoder.
- Connects to 12-digit decoder.
- Three digits must appear in correct order and timing to close output relay.
- For foolproof secure signalling.

Send for free brochure. ORDER TO-DAY. Add \$3 shipping/handling.
Add sales tax in California.

Palomar Engineers

Box 455, Escondido, CA. 92025 • Phone: [714] 747-3343

Sound-Sensitive CW Sender

— for hands-free Morse

A few years ago I had a slight stroke, and since then have sent the most improbable Morse code ever heard on the bands. It sounds as though I were sending with my left foot. I'm not exactly a serious CW operator, but occasionally I like to keep in practice.

An idea occurred to me which I have never seen in 40 years of perusing ham

magazines. How many times have you heard some slaphappy ham *dah-dit-dah-dit-dah-dah-dit-dah-ing* away and copied it with ease? Why not put this to practical use for anyone who can't send with his hands?

I passed this idea along to Ed Jados WA2TYA, who put the wheels in motion, did all the brain work, and a week later had made a

rough version of a keyer which would key my rig and follow perfectly my audible *dah-dits*.

The only critical adjustment is the volume control, so that the keyer won't pull in with breathing or extraneous noise, but will prove to key solidly with voice tones. Naturally, talking close to the mike is essential.

Any inexpensive mike is coupled into a 741 IC. The amplified audio is then fed to a bridge rectifier. The resulting dc voltage, which must not be over-filtered so that time lag won't be too long to follow the dots at 20 wpm or so, is then fed to a pair of NPN transistors. Any low-cost transistors such as 2N2222s will work perfectly to pull in a reed relay that will nicely key my Drake TR-4 transceiver.

This first, rough version was completely open and

unshielded and would not work with my linear turned on, as it would remain on from rf pick-up as soon as it was once keyed. If you intend to make this keyer, therefore, you had better plan on putting it in a metal box, unless you intend to run very low power.

The only real problem I have is a domestic one with the XYL. She is firmly convinced that I'm a likely candidate for the booby hatch when I'm in the shack sending code.

A week later, in came Ed with the finished product looking like a commercially-manufactured item. It is enclosed in a Radio Shack box 2 x 3 1/4 x 4 inches deep (5 x 8.1 x 10.5 cm).

The power supply, a simple 12-volt supply, was built in, but just as well could be an external CB power supply or two 6-volt lantern batteries in series. It is not seen in Fig. 2, the schematic of the completed keyer.

With this final product, there is no problem keying a full kilowatt rig as there was with the unshielded version.

We have been hearing a great deal lately about CW for the handicapped. I hope this will be the answer for a good many, as it has been for me. ■

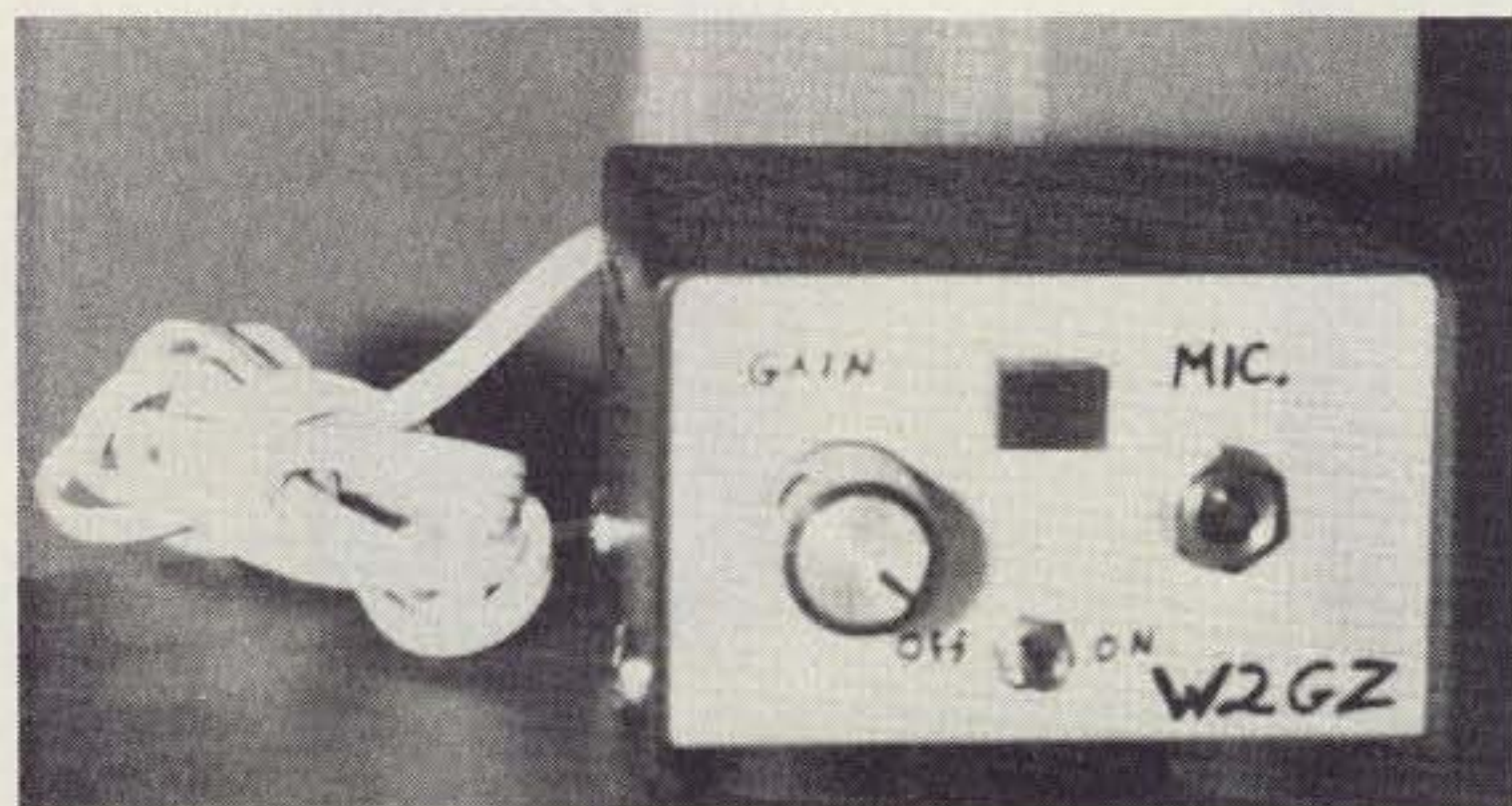

Fig. 1.

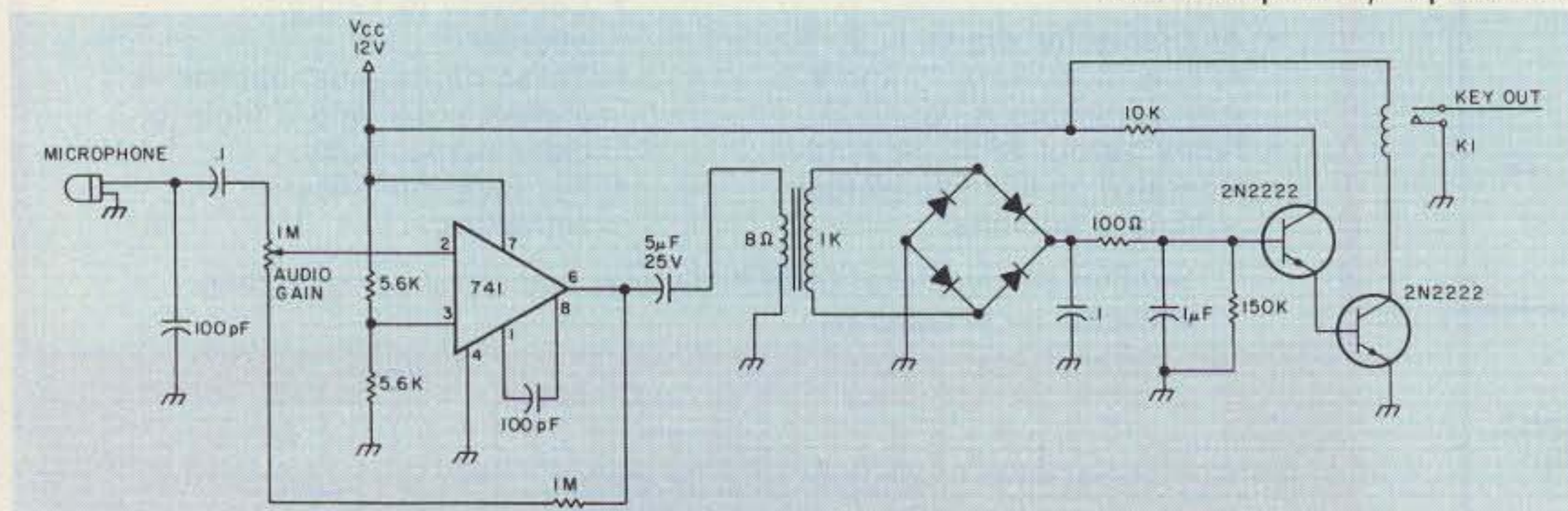

Fig. 2.

KLM's PA15-160BL POWER AMPLIFIER . . .



For those
who recognize
excellence . . .

There are many reasons the KLM PA15-160BL Power Amplifier is used and respected by hams "in the know." Real-world **PERFORMANCE** is one. When we rate it at 160 watts out for 15 watts in, that's not "downhill with a tailwind" or "designer's prototype," that's 160 watts out **minimum** in every production unit. Each PA15-160BL must prove itself a clean, efficient performer, across the band, in all modes, or it doesn't go out the door.

RELIABILITY is another reason. Each KLM PA15-160BL amplifier is put through a tough series of tests that **ensure** years of trouble-free service. Power out is maximized against minimum current drain for cool, efficient operation. Spectrum analyzers are used to eliminate spurious emissions and reduce harmonics to less than 60 dB. VSWR, linearity, and thru-loss are checked against "spec." Circuit protection devices, such as the on-the-board thermal sensor and circuit breaker are cycled and checked. In the two-tone test, bias is adjusted to minimum IMD. In the SSB voice test proper keying and delay are verified, and the output is spectrum analyzed. The amp must meet specification in each test or it goes no farther.

Each KLM PA15-160BL spends a lot of time at the test bench before it is shipped. But we know the extra time spent there is valuable insurance against problems later in the field . . . And, we back up this belief with a full one year warranty that includes the output transistors

If there is no place for 2nd rate in **your** system; if you need clean, reliable, hi-performance power, then KLM's PA15-160BL is the **only** way to go!

KLM has been a leader in power amplifier development, right from the beginning. When a better amp can be made, KLM will be building it.

SPECIFICATIONS

PA15-160BL

Nominal Drive Power: 5-15 watts
Power out @ 15 watts: 160 watts minimum
Frequency of Operation: 144-148 MHz
Modes of Operation: AM, CW, FM, SSB
Relay Switching: Automatic or remote
Relay Delay: Adjustable
Input VSWR: 1.4:1 or less
Impedance: 50 ohms, input and output
Supply Voltage: 13.5 VDC
Current @ 13.5 VDC: 22 amps typical
Circuit Breaker: 25 amps
R.F. Connectors: SO-239

Preamp PRA-144C

N/F: less than 2.5 dB
Gain: 10 dB
Operation: Switchable

Contact KLM for complete information.

POWER RESPONSE

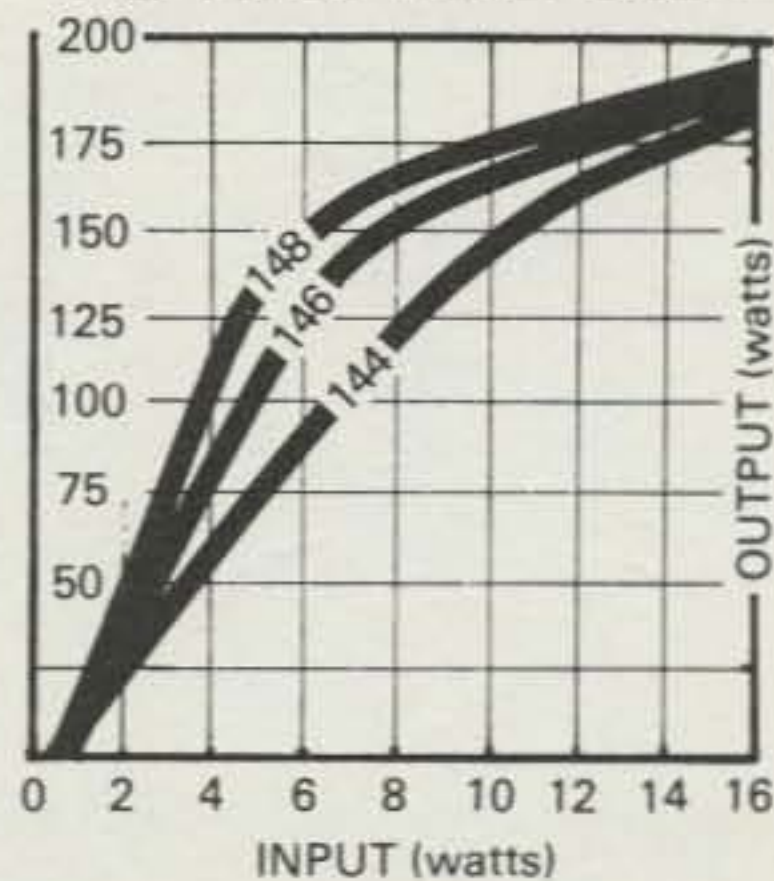

See your KLM Dealer.

KLM • P. O. Box 816 • Morgan Hill, CA 94037 • (408) 779-7363

40

A Tightwad's FSK Demodulator

— using the 567 PLL

FSK demodulation can be accomplished easily and inexpensively using the 567 tone decoder chip. The applications described in this article were developed for use with a CRT terminal requiring TTL-compatible signals. Only a few external components are required in setting the center lock frequency, bandwidth, and output delay.

The design philosophy of the demodulator establishes a reliable circuit utilizing only the MARK tones. The concept of demodulation provides input conditioning such that all signals except the MARK frequencies are rejected. We can, therefore, assume that the absences of MARK tones constitute SPACE tones. Several advantages in this approach, as compared with circuits

demodulating both MARK and SPACE tones, make this circuit appealing to both the beginner and experienced RTTYer.

One advantage is a component (as well as cost) reduction of more than 50 percent. Another is that constraints are reduced since high Q circuits with narrow passbands centered around the MARK frequency are employed. There is no longer a requirement for a wide front-end bandpass filter since the SPACE tones are not decoded. This also permits narrow-shift as well as wide-shift signals to be demodulated without any adjustments. Additionally, the MARK-SPACE summation circuitry has been eliminated. The output of the demodulator can be

coupled directly into computers, video boards, or to almost any keyer circuit to drive Teletype[®] machines.

Functional Description

Refer to Fig. 1 for the basic block diagram. A two-section, two-pole bandpass active filter precedes the tone decoder. This filter conditions the audio input to the decoder, providing 20 dB of gain with a shape factor of 20 dB per decade. With a 100-mV input signal to the filter, the tone decoder would see approximately 1 V, well above the threshold of the tone decoder. The SPACE tone should be at least 6-dB down from the MARK tone providing greater SPACE rejection and improved signal-to-noise ratio. The Q of the filter is 21, estab-

lishing an approximate bandwidth of 100 Hertz.

The output of the active filter drives the tone decoder. The decoder is actually a PLL (phase locked loop) which consists of a quadrature phase detector, low-pass filter, and voltage-controlled oscillator. The vco establishes the reference frequency. When the input signal changes phase (frequency) with respect to the vco reference, the phase detector produces an "error" voltage. This error voltage is proportional to the phase difference of the input and reference signals. The error voltage is used to control the vco frequency, thereby preserving the locked condition.

Circuit Description

The FSK demodulator circuit is shown in Fig. 2. U2A, U2B, and associated components comprise the four-pole active filter. Good quality components such as metal film resistors and mica capacitors should be used in the filter circuit to guarantee an adequate shape factor centered around the MARK frequency. The operational amplifier provides maximum amplification around 2.1 kHz providing best signal-to-noise ratio of MARK tones. Audio from the receiver speaker is injected into the filter input through

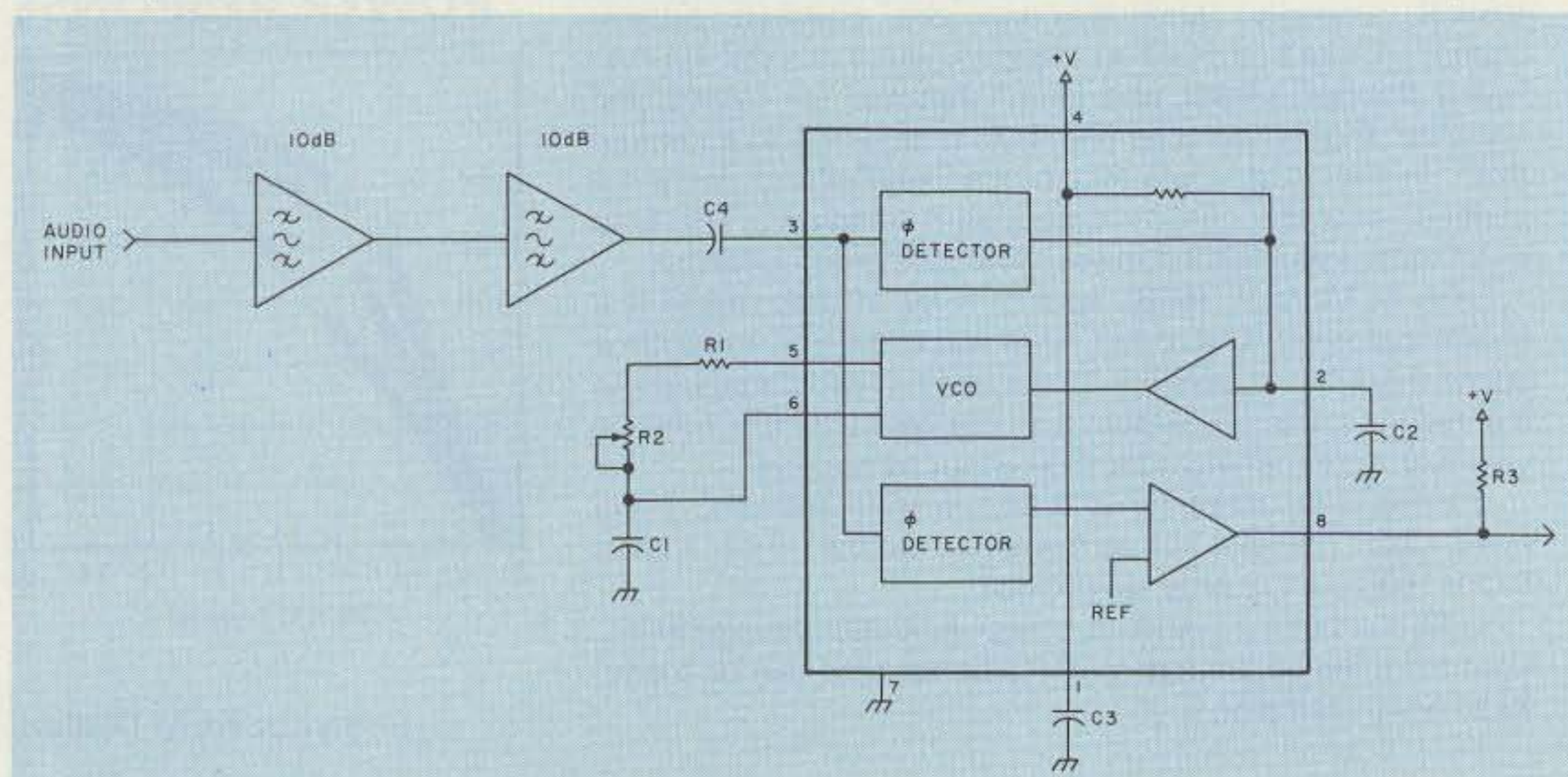

Fig. 1. Block diagram.

R4 and C6, amplified, and capacitively coupled through C4 to pin 3 of the tone decoder. Amplitude distortion due to overdriving the filter is unimportant since the tone decoder is frequency-sensitive only.

The free-running frequency of the vco is established by R1, R2, and C1. R2 should be a multi-turn pot to provide adequate resolution for setting the lock frequency. The bandwidth is set by the lowpass filter capacitor, C2. With the values shown, the passband is approximately 400 Hertz. The output of the tone decoder is open-collector and pulled up to 5 V through R3. When the audio at pin 3 from the filter falls within the passband of the decoder, the output goes low, indicating that a MARK has been decoded.

The speed of operation may be improved by decreasing the value of C3. However, it was found that the output tends to chatter if the value of C3 is lower than 0.8 uF. This is due to high-frequency components causing excessive ringing, thereby driving the output stage through its threshold several times. On the other hand, if C3 is too large in value, the charge time increases making the vco unable to lock fast enough.

Alignment Procedure

With the values shown in Fig. 2, the lock frequency should be in the range of 1 kHz to 3 kHz. Probably anywhere in this range should work quite well if used with vfo-operated receivers. However, for best SPACE rejection, and especially if the circuit is to be used without vfo-controlled receivers (2-meter FM), then it becomes necessary to effect alignment as follows:

1) Inject a test-tone of

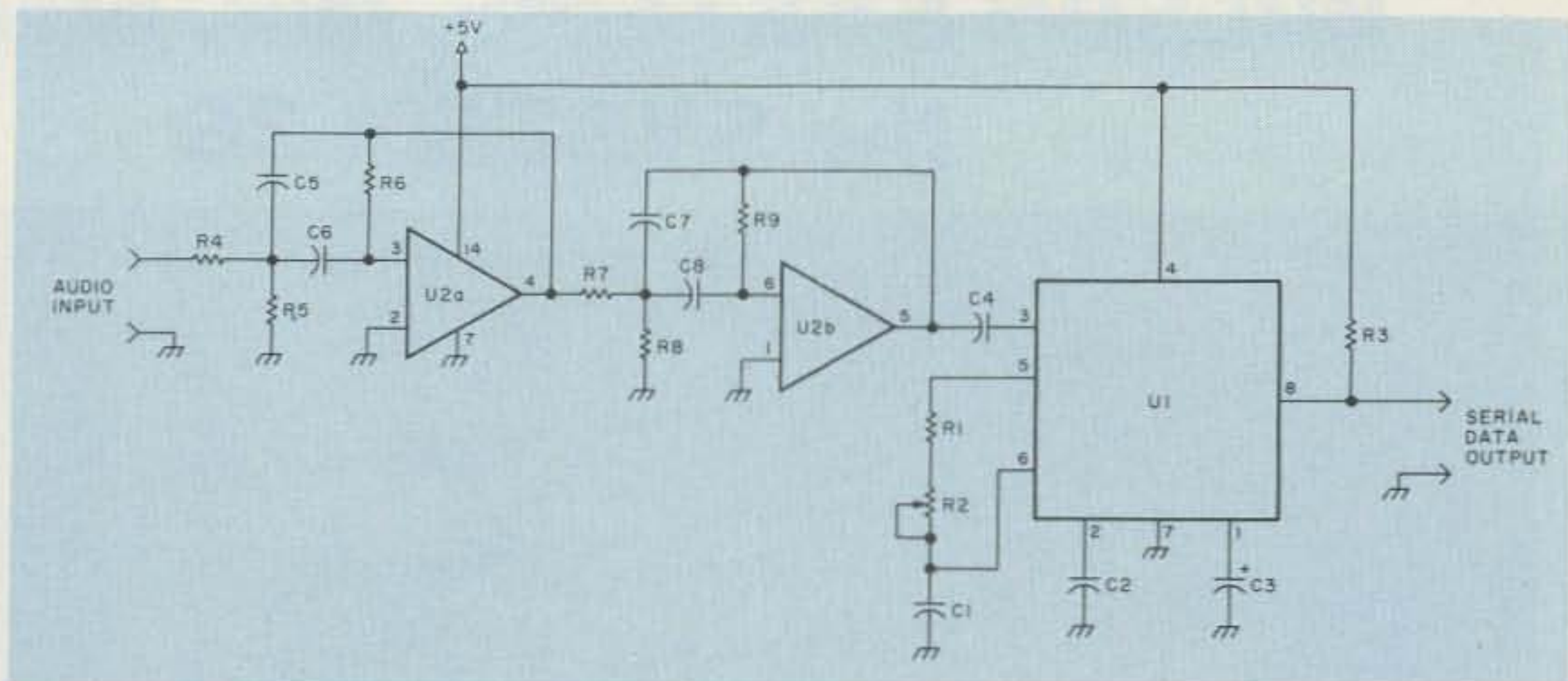

Fig. 2. Schematic diagram.

2125 Hertz at a level of 100 mV p-p to the filter input.

2) Connect oscilloscope at U1 pin 3 and verify the test tone to be approximately 1-V p-p.

3) Connect oscilloscope to U1 pin 8 and verify a TTL low. If the output is not low, adjust R2 until pin 8 goes low.

4) Change the test-tone frequency to 2200 Hertz. Adjust R2 slightly until the output of the 567 changes from one state to another. This establishes the vco unlock frequency.

5) Change the test-tone frequency to 2295 Hertz and verify the output of the 567 to be a TTL high.

Summary

The demodulator circuit in Fig. 2 has been successfully used to decode FSK data on 80, 40, 20, and 2 meters. The active input filter provides substantial interference rejection, improving the signal-to-noise ratio as well as increasing the lock sensitivity by 20 dB. Since only MARK decoding circuitry is utilized, an increase in tracking bandwidths is achieved providing easier tuning with vfo receivers. Moreover, this technique enables narrow-shift and wide-shift demodulation without additional tuning or adjustments.

The output of the demodulator is TTL-compatible and can be directly interfaced to most computer systems through an RS-232

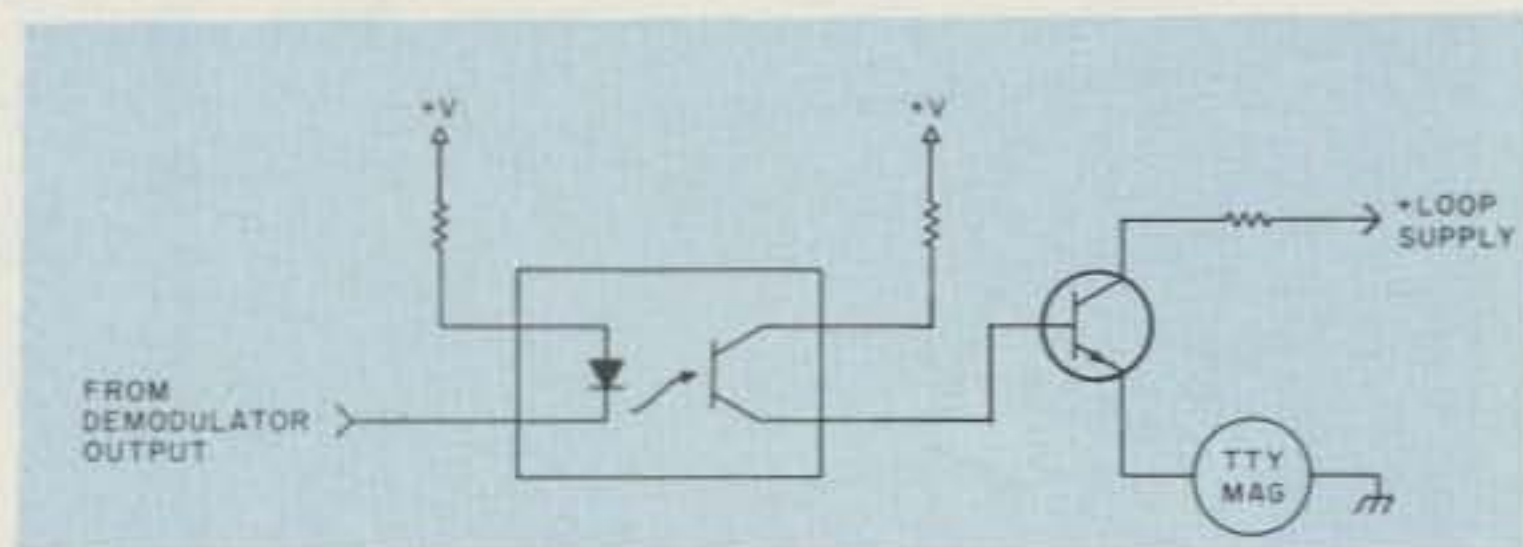

Fig. 3. Typical keyer circuit.

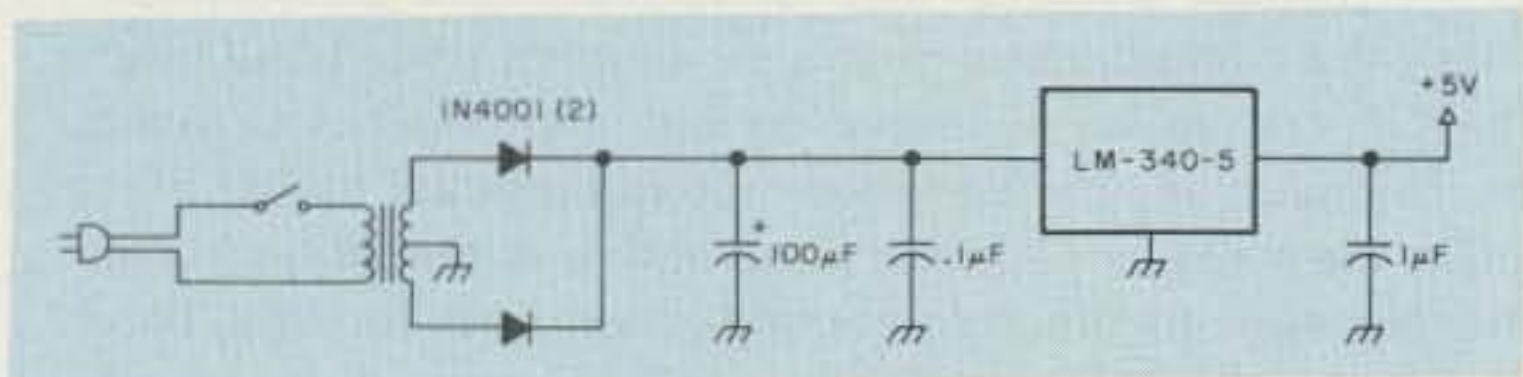

Fig. 4. Regulated power supply.

serial I/O port. Interfacing with mechanical teletype machines may be accomplished with an external keyer circuit. A typical keyer circuit using an optical isolator is shown in Fig. 3. When the output of the demodulator goes low indicating a MARK, the input diode becomes forward biased. As this happens, the output transistor in the isolator turns on causing the switch transistor in the teletype loop to turn on. The optical isolator is used to provide ac as well as dc isolation from the loop supply and the demodulate supply. Current spikes induced into the low-voltage supply from the TTY could cause damage to the demodulator.

A suggested power supply is shown in Fig. 4. The IC

regulator provides excellent regulation and will source up to 1 A if an adequate heat sink is used. The demodulator requires only a fraction of the regulator's capability, but its low cost and ruggedness make it an attractive device. These regulators may be purchased for under a dollar and will enable additional loads other than the demodulator. ■

Parts List

U1	NE567
U2	LM3900
R1	3.9k, 1/4 Watt
R2	5k pot
R3	5k, 1/4 Watt
R4, R7	16k, 1/4 Watt
R5, R8	178, 1/4 Watt
R6, R9	320k, 1/4 Watt
C1, C4	.1 uF mica
C2	.047 uF mica
C3	1 uF tantalum
C5-C8	.01 uF mica

WILSON SYSTEMS, INC. presents the SYSTEM 36

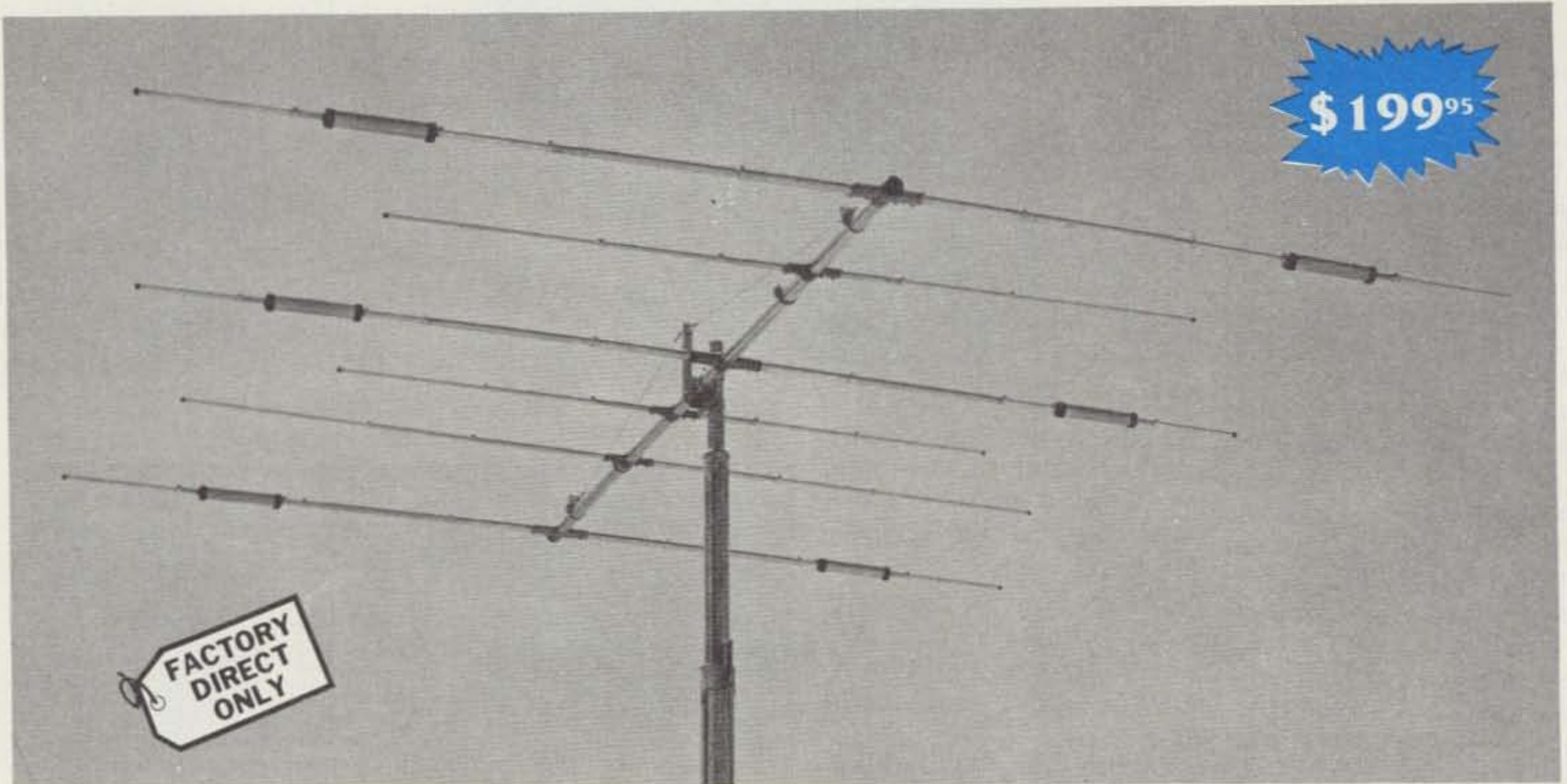

A trap loaded antenna that performs like a monobander! That's the characteristic of this six element three band beam. Through the use of wide spacing and interlacing of elements, the following is possible: three active elements on 20, three active elements on 15, and four active elements on 10 meters. No need to run separate coax feed lines for each band,

as the bandswitching is automatically made via the High-Q Wilson traps. Designed to handle the maximum legal power, the traps are capped at each end to provide a weather-proof seal against rain and dust. The special High-Q traps are the strongest available in the industry today.

SPECIFICATIONS

Band MHz 14-21-28
Maximum power input . Legal limit
Gain (dBd) Up to 9 dB
VSWR @ resonance . . . 1.3:1
Impedance 50 Ω
F/B ratio 20 dB or better

Boom (O.D. x Length) . . 2" x 24'2 1/2"
No. of elements 6
Longest element 28'2 1/2"
Turning radius 18'6"
Maximum mast diameter . 2"
Surface area 8.6 sq. ft.

Wind loading @ 80 mph . . 215 lbs.
Maximum wind survival . . 100 mph
Feed method Coaxial Balun
Assembled weight (approx.) . 53 lbs.
Shipping weight (approx.) . 62 lbs.

Compare the SY-36 with others . . .

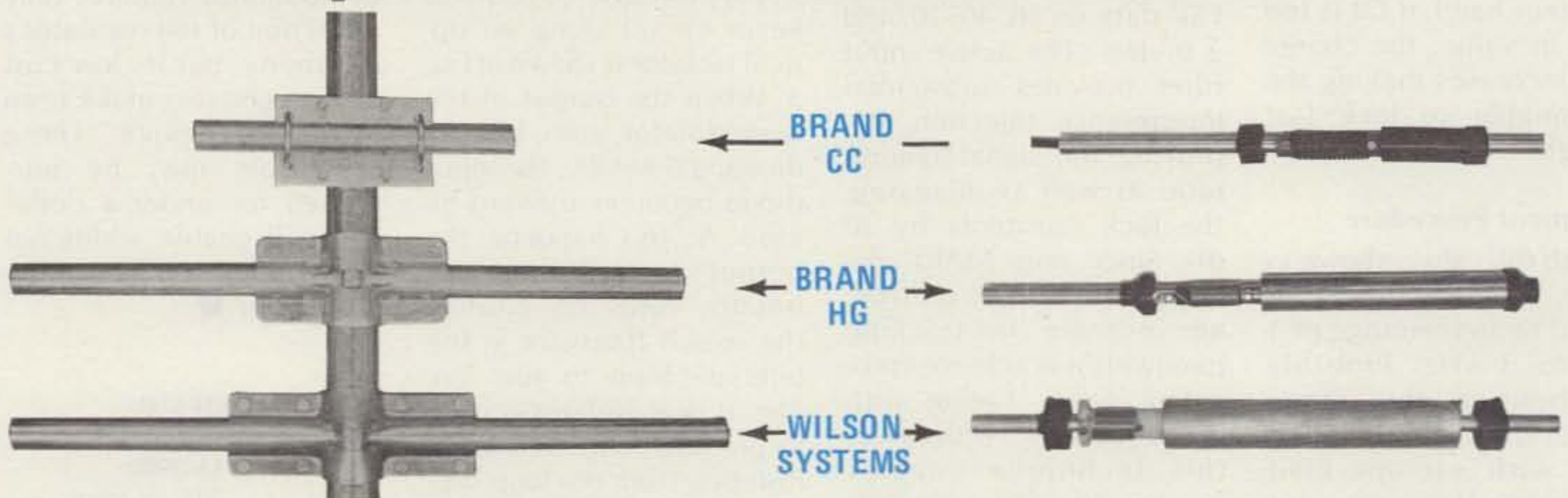

Compare the size and strength of the boom to element clamps. See who offers the largest and heaviest duty. Which would you prefer?

Wilson Systems traps offer a larger diameter trap coil and a larger outside housing, giving excellent Q and power capabilities.

**CALL
FACTORY DIRECT
1-800-634-6898**

**W S I WILSON
SYSTEMS, INC.**

4286 S. Polaris Ave., Las Vegas, Nevada 89103

Prices and specifications subject to change without notice.

WILSON SYSTEMS TOWERS

— IN STOCK —

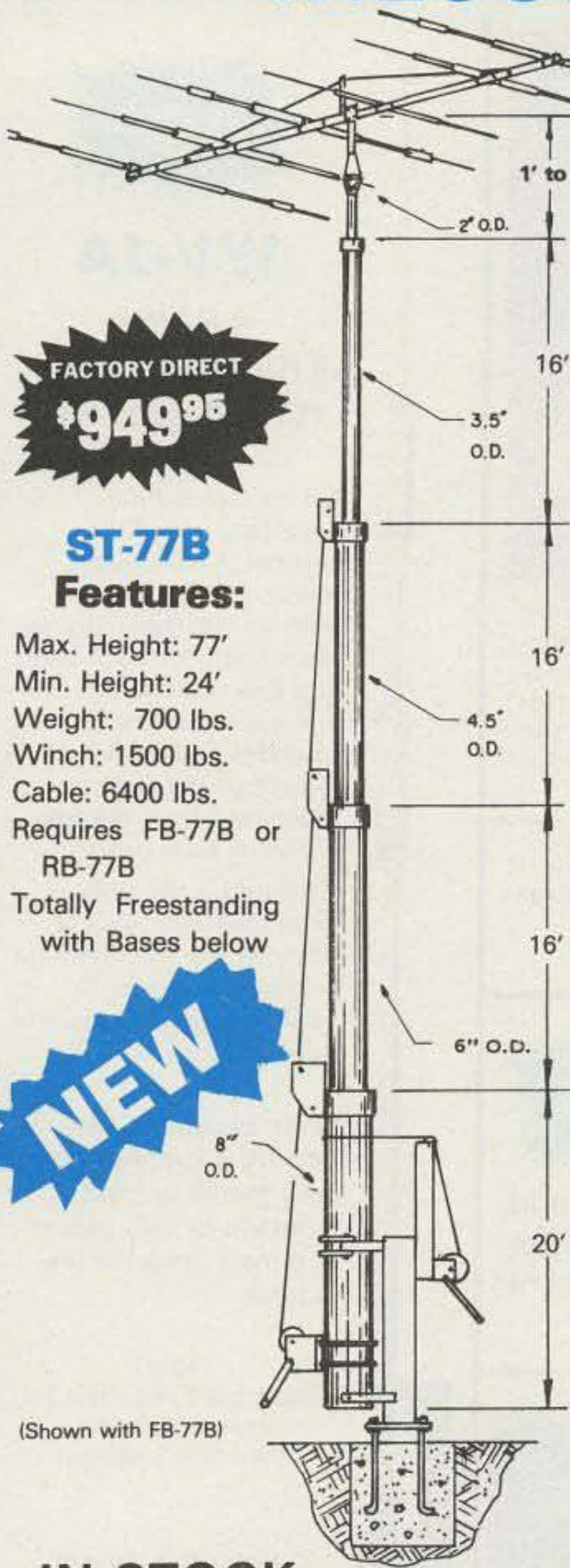

FACTORY DIRECT
\$949⁹⁵

ST-77B

Features:

Max. Height: 77'
Min. Height: 24'
Weight: 700 lbs.
Winch: 1500 lbs.
Cable: 6400 lbs.
Requires FB-77B or RB-77B
Totally Freestanding with Bases below

FACTORY DIRECT
\$549⁹⁵

MT-61B

Features:

Max. Height: 61'
Min. Height: 23'
Weight: 450 lbs.
Winch: 1200 lbs.
Cable: 4200 lbs.
No Guys required when mounting against house.
For completely freestanding installation, use RB-61B or FB-61B below.

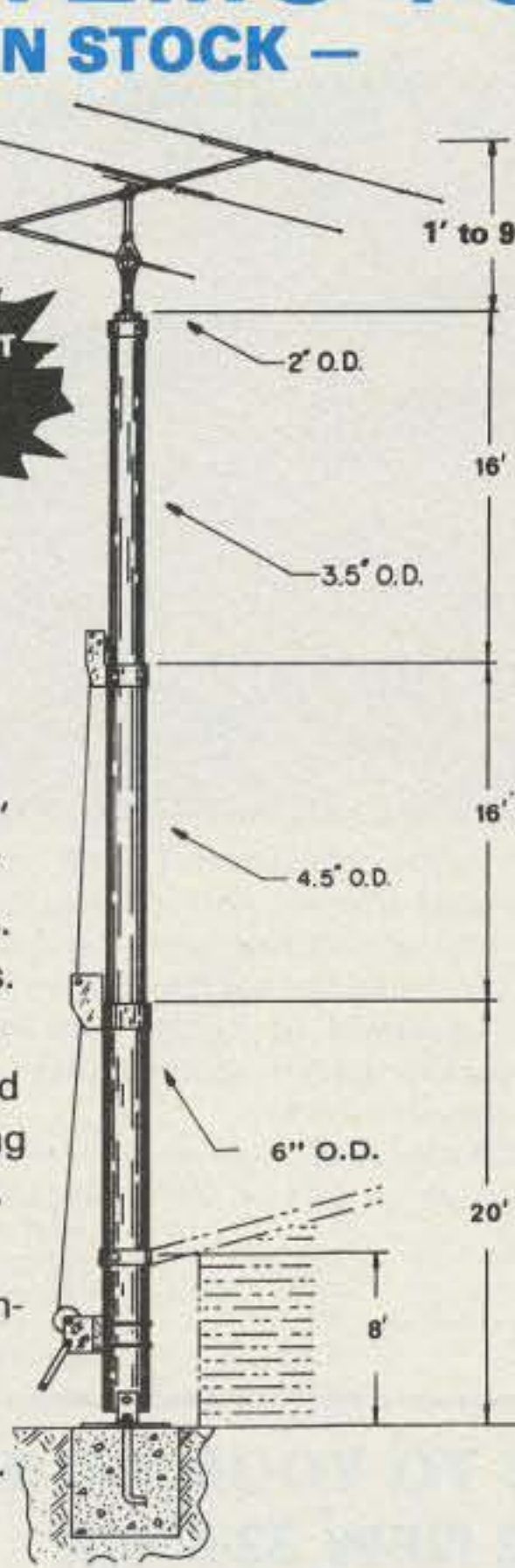

FACTORY DIRECT
\$314⁹⁵

TT-45B

Features:

Max Height: 45'
Min. Height: 22'
Weight: 250 lbs.
Winch: 1200 lbs.
Cable: 4200 lbs.

No Guys required when mounting against eave of house.

For completely freestanding installation, use RG-45B or FB-45B below.

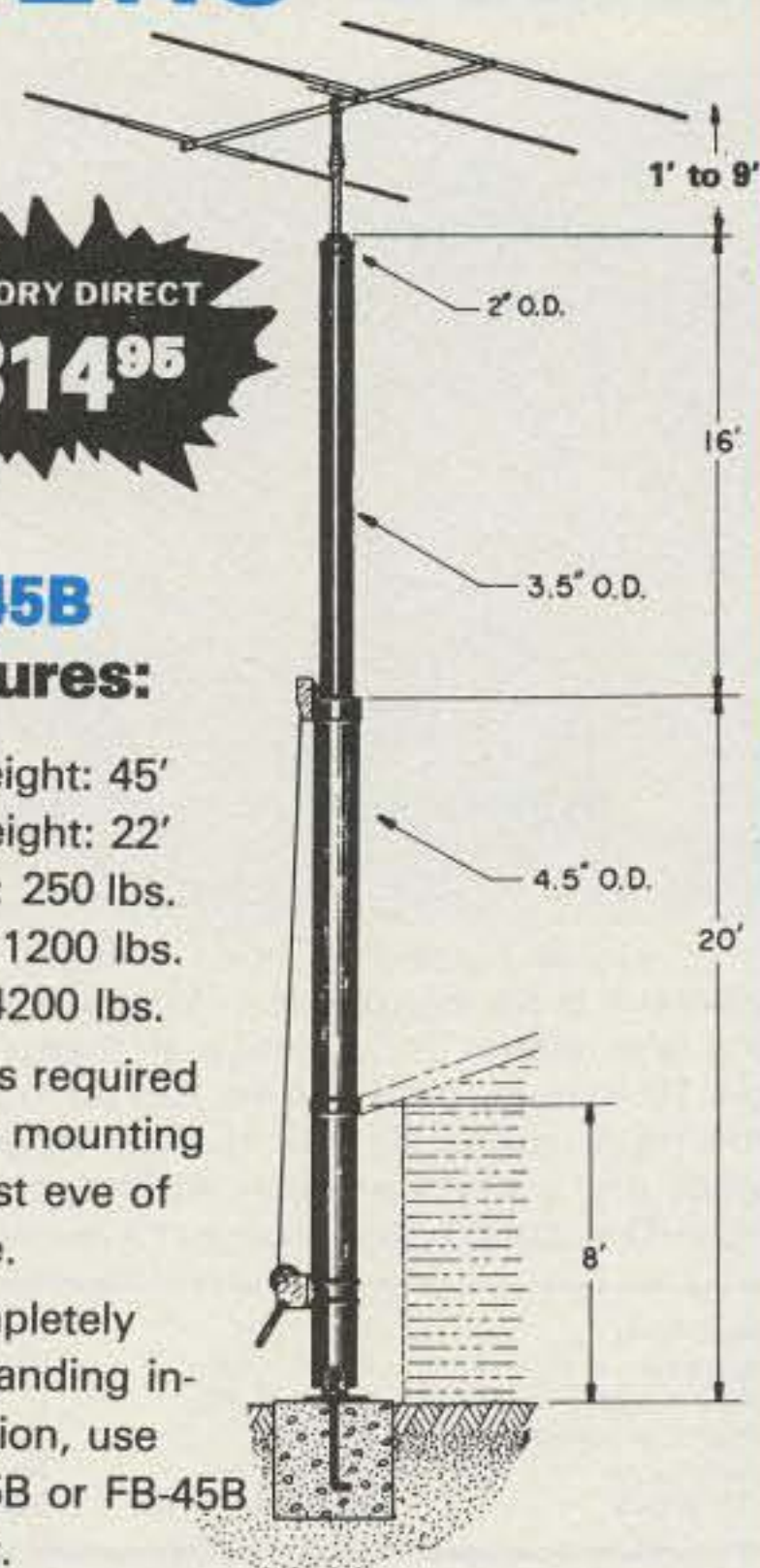

WIND LOADING			
Tower	Height	Sq. Ft.	Square Footage Based on 50 MPH Wind
ST-77B	69	18	
	77	12	
MT-61B	53	18	
	61	12	
TT-45B	37	18	
	45	12	

BASE CHART		
TOWER	WIDTH	DEPTH
TT-45B	12" x 12"	30"
FB-45B	30" x 30"	4 1/2'
RB-45B	30" x 30"	4 1/2'
MT-61B	18" x 18"	4'
FB-61B	3' x 3'	5 1/2'
RB-61B	3' x 3'	5 1/2'
ST-77B	See Below	Bases
FB-77B	3 1/2' x 3 1/2'	6'
RB-77B	3 1/2' x 3 1/2'	6'

Wilson Systems uses a new high strength carbon steel tube manufactured especially for Wilson Systems. It is 25% stronger than conventional pipe or tubing. The tubing size used is: 2" & 3 1/2"-.095; 4 1/2" & 6"-.125, 8"-.134. All tubing is hot dip galvanized. Top section is 2" O.D. for proper rotor and antenna mounting.

The TT-45B and MT-61B come complete with house bracket and hinged base plate for against-house mounting. For totally freestanding installation, use either of the tilt-over bases shown below.

The ST-77B can not be mounted against the house and must be used with the tilt-over base FB-77B or RB-77B shown below.

All three towers above are able to handle large arrays of up to 20 sq. ft. at 80 mph WHEN GUYED with one set of 4-point Guys at the top of the 3 1/2" section. Guying Kits are available at the following prices: GK-45B—\$59.95; GK-61B—\$79.95; GK-77B—\$99.95. When using the Guy System with RB Series Rotating Base, an additional thrust bearing at the top is required. The WTB-1 is available for \$49.95.

IN STOCK

TILT-OVER BASES FOR TOWERS

FIXED BASE

The FB Series was designed to provide an economical method of moving the tower away from the house. It will support the tower in a completely free-standing vertical position, while also having the capabilities of tilting the tower over to provide an easy access to the antenna. The rotor mounts at the top of the tower in the conventional manner, and will not rotate the complete tower.

FB-45B... 112 lbs... \$154.95
FB-61B... 169 lbs... 214.95
FB-77B... 250 lbs... 299.95

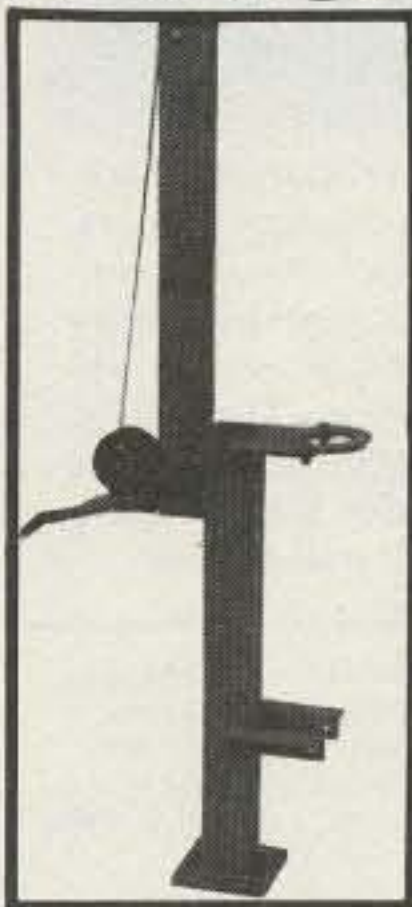

ROTATING BASE

The RB Series was designed for the Amateur who wants the added convenience of being able to work on the rotor from the ground position. This series of bases will give that ease plus rotate the complete tower and antenna system by the use of a heavy duty thrust bearing at the base of the tower mounting position, while still being able to tilt the tower over when desiring to make changes on the antenna system.

RB-45B... 144 lbs... \$219.95
RB-61B... 229 lbs... 299.95
RB-77B... 300 lbs... 449.95

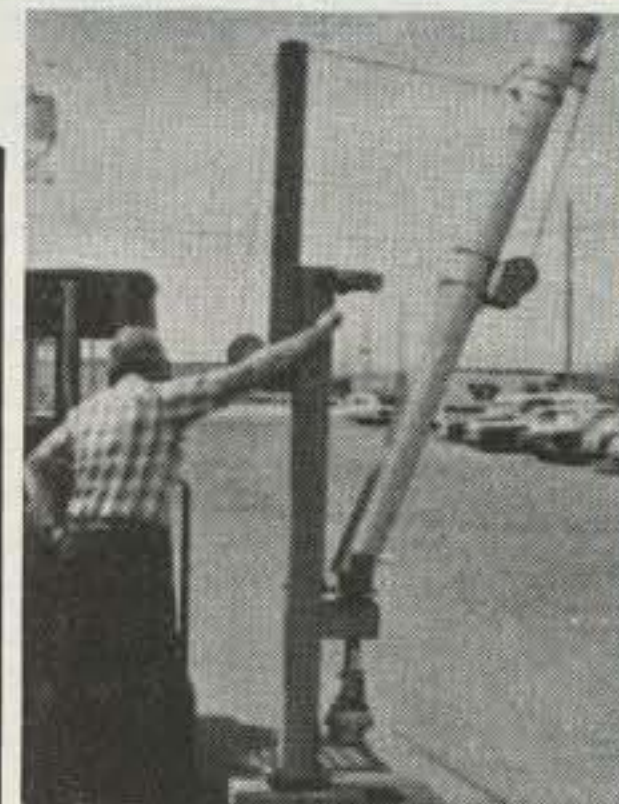
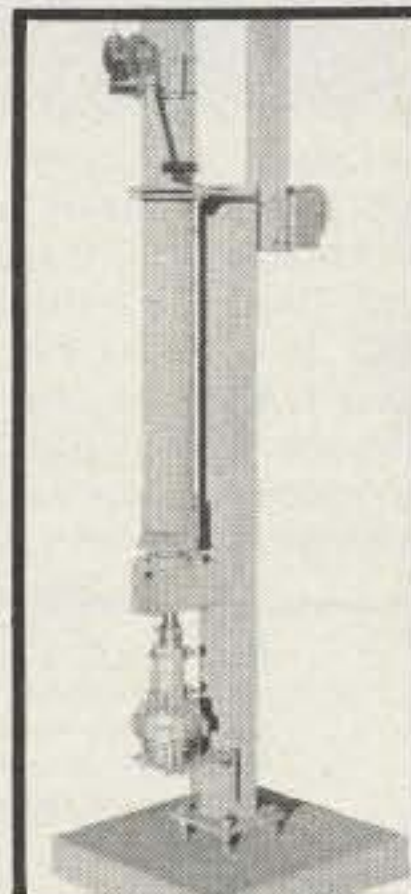

Tilting the tower over is a one-man task with the Wilson bases. (Shown above is the RB-61B. Rotor is not included.)

ORDER
FACTORY DIRECT
1-800-634-6898

W S I WILSON
SYSTEMS, INC.

4286 S. Polaris Ave., Las Vegas, Nevada 89103

WILSON SYSTEMS INC. MULTI-BAND ANTENNAS

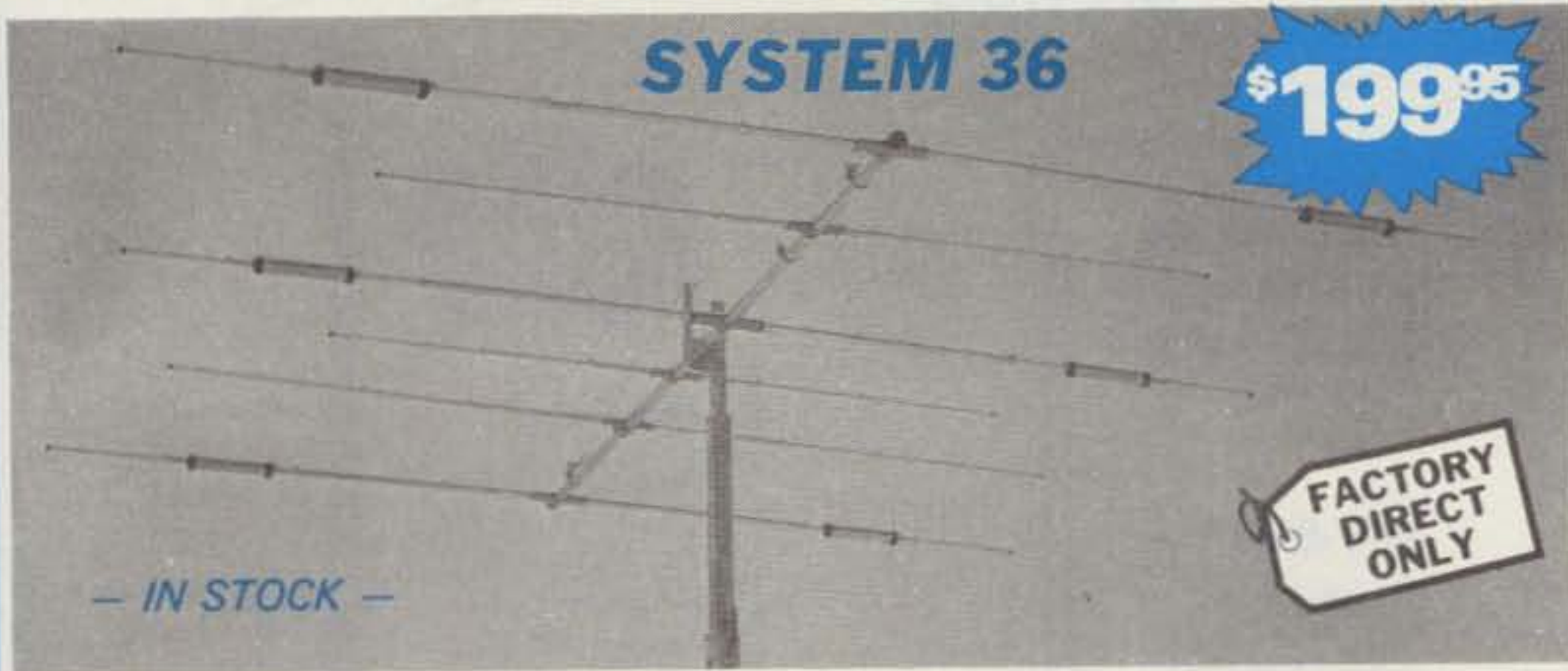

SYSTEM 36

\$199⁹⁵

FACTORY DIRECT ONLY

— IN STOCK —

A trap loaded antenna that performs like a monobander! That's the characteristic of this six element three band beam. Through the use of wide spacing and interlacing of elements, the following is possible: three active elements on 20, three active elements on 15 and four active elements on 10 meters. No need to run separate coax feed lines for each band, as the bandswitching is automatically made via the High-Q Wilson traps. Designed to handle the maximum legal power, the traps are capped at each end to provide a weather-proof seal against rain and dust. The special High-Q traps are the strongest available in the industry today.

SPECIFICATIONS

Band MHz	14-21-28	Boom (O.D. x Length)	2" x 24' 2 1/2"	Wind Loading @ 80 mph	215 lbs.
Maximum power input	Legal Limit	No. of Elements	6	Maximum wind survival	100 mph
Gain (dBd)	Up to 9 dB	Longest Element	28' 2 1/2"	Feed method	Coaxial Balun
VSWR @ resonance	1.3:1	Turning Radius	18' 6"	Matching Method	Beta
Impedance	50 ohm	Maximum mast diameter	2"	Assembled weight (approx)	53 lbs.
F/B Ratio	20 dB or better	Surface area	8.6 sq. ft.	Shipping weight (approx)	62 lbs.



NEW! ADD 40 METERS TO YOUR TRI-BAND WITH THE NEW 33-6 MK

\$49⁹⁵

— IN STOCK —

Now you can have the capabilities of 40-meter operation on the System 36 and System 33. Using the same type high quality traps, the 40-meter addition will offer 200HKZ of bandwidth at less than 2:1 SWR. The new 33-6 MK will fit your present SY36 or SY33, and using the same single feed line.

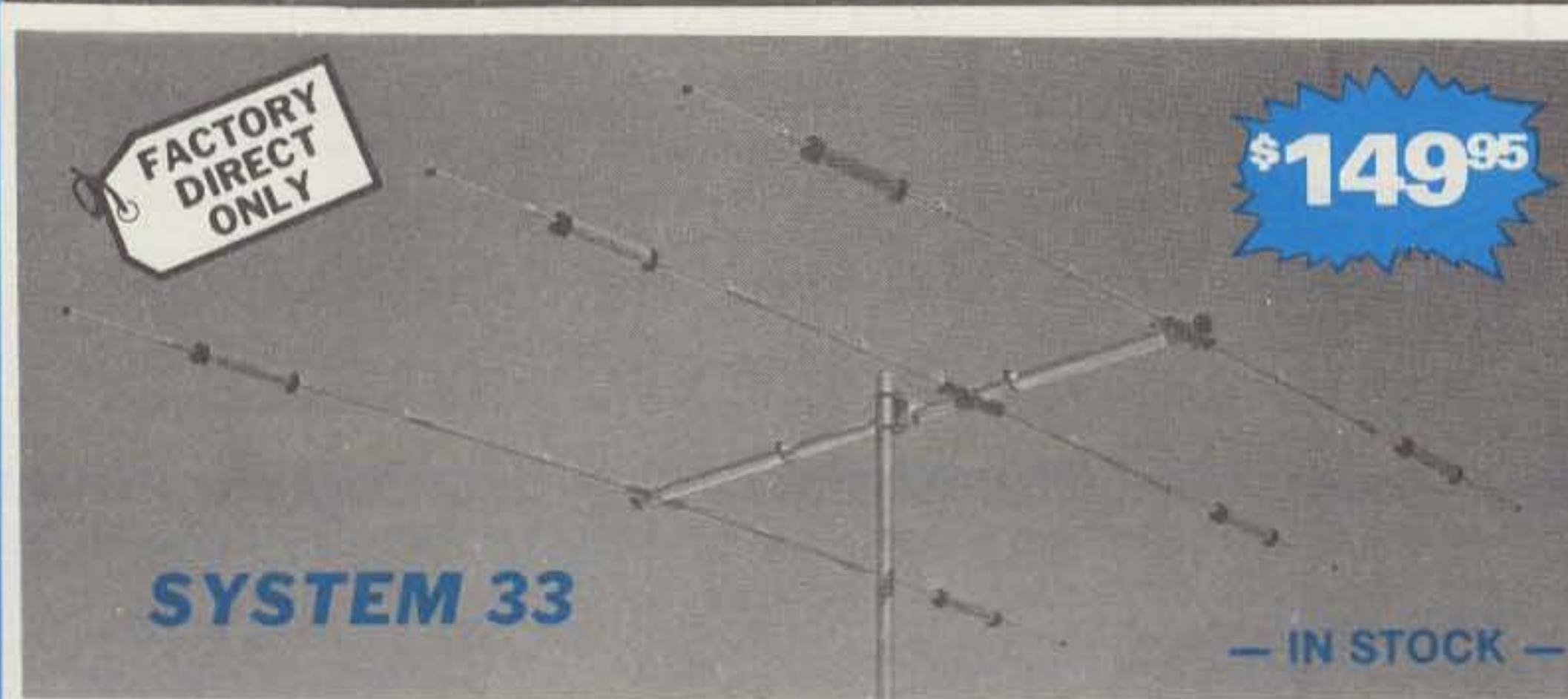

SYSTEM 33

\$149⁹⁵

FACTORY DIRECT ONLY

— IN STOCK —

Capable of handling the Legal Limit, the "SYSTEM 33" is the finest compact tri-bander available to the amateur. Designed and produced by one of the world's largest antenna manufacturers, the traditional quality of workmanship and materials excels with the "SYSTEM 33". New boom-to-element mount consists of two 1/8" thick formed aluminum plates that will provide more clamping and holding strength to prevent element misalignment. Superior clamping power is obtained with the use of a rugged 1/4" thick aluminum plate for boom to mast mounting. The use of large diameter High-Q traps in the "SYSTEM 33" makes it a high performing tri-bander and at a very economical price. A complete step-by-step illustrated instruction manual guides you to easy assembly and the lightweight antenna makes installation of the "SYSTEM 33" quick and simple.

SPECIFICATIONS

Band MHz	14-21-28	Boom (O.D. x length)	2" x 14' 4"	Wind loading at 80 mph	114 lbs.
Maximum power input	Legal Limit	No. of elements	3	Assembled weight (approx)	37 lbs.
Gain (dbd)	Up to 8 dB	Longest element	27' 4"	Shipping weight (approx)	42 lbs.
VSWR at resonance	1.3:1	Turning radius	15' 9"	Direct 52 ohm feed — no balun required	
Impedance	50 ohms	Maximum mast diameter	2" O.D.	Maximum wind survival	100 mph
F/B Ratio	20 dB or better	Surface area	5.7 sq. ft.		

W S I WILSON SYSTEMS, INC.

4286 S. Polaris Ave., Las Vegas, Nevada 89103

Prices and specifications subject to change without notice.

ORDER FACTORY DIRECT 1-800-634-6898

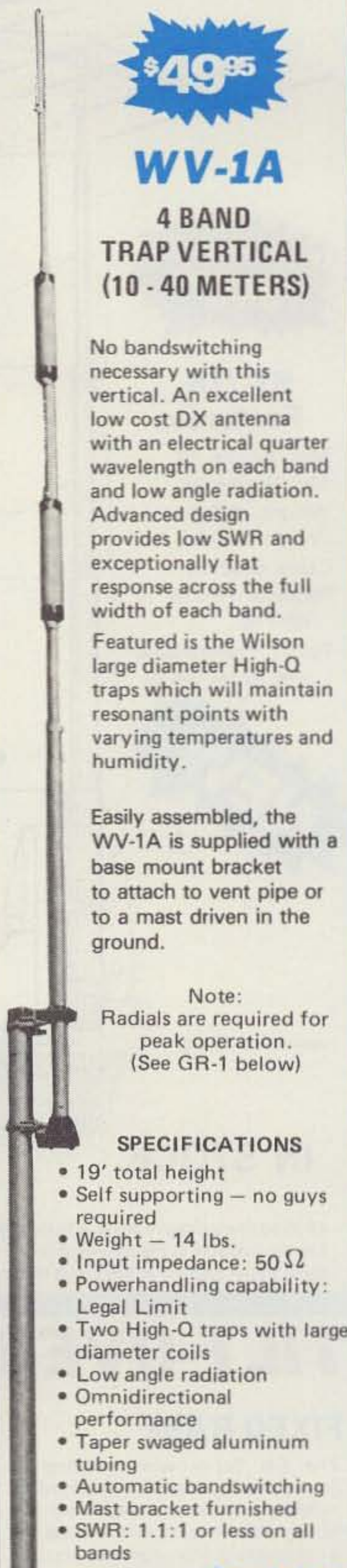

\$49⁹⁵

WV-1A

4 BAND TRAP VERTICAL (10 - 40 METERS)

No bandswitching necessary with this vertical. An excellent low cost DX antenna with an electrical quarter wavelength on each band and low angle radiation. Advanced design provides low SWR and exceptionally flat response across the full width of each band.

Featured is the Wilson large diameter High-Q traps which will maintain resonant points with varying temperatures and humidity.

Easily assembled, the WV-1A is supplied with a base mount bracket to attach to vent pipe or to a mast driven in the ground.

Note: Radials are required for peak operation. (See GR-1 below)

SPECIFICATIONS

- 19' total height
- Self supporting — no guys required
- Weight — 14 lbs.
- Input impedance: 50 Ω
- Powerhandling capability: Legal Limit
- Two High-Q traps with large diameter coils
- Low angle radiation
- Omnidirectional performance
- Taper swaged aluminum tubing
- Automatic bandswitching
- Mast bracket furnished
- SWR: 1.1:1 or less on all bands



GR-1

\$12⁹⁵

The GR-1 is the complete ground radial kit for the WV-1A. It consists of: 150' of 7/14 stranded copper wire and heavy duty egg insulators, instructions. The GR-1 will increase the efficiency of the WV-1A by providing the correct counterpoise.

WILSON MONO-BAND BEAMS

FACTORY DIRECT ONLY

\$229.95



M520A
THE ALL NEW 5 ELEMENT 20 METER BEAM

At last, the antennas that you have been waiting for are here! The top quality, optimum spaced, and newest designed monobanders. The Wilson System's new Monoband beams are the latest in modern design and incorporate the latest in design principles utilizing some of the strongest materials available. Through the select use of the current production of aluminum and the new boom-to-element plates, the Wilson Systems' antennas will stay up when others are falling down due to heavy ice loading or strong winds. Note the following features:

- 1. Taper Swaged Elements** — The taper swaged elements provide strength where it counts and lowers the wind loading more efficiently than the conventional method of telescoping elements of different sizes.
- 2. Mounting Plates — Element to Boom** — The new formed aluminum plates provide the strongest method of mounting the elements to the boom that is available in the entire market today. No longer will the elements tilt out of line if a bird should land on one end of the element.
- 3. Mounting Plates — Boom to Mast** — Rugged 1/4" thick aluminum plates are used in combination with sturdy U-bolts and saddles for superior clamping power.
- 4. Holes** — There are no holes drilled in the elements of the Wilson HF Monobanders. The careful attention given to the design has made it possible to eliminate this requirement as the use of holes adds an unnecessary weak point to the antenna boom.

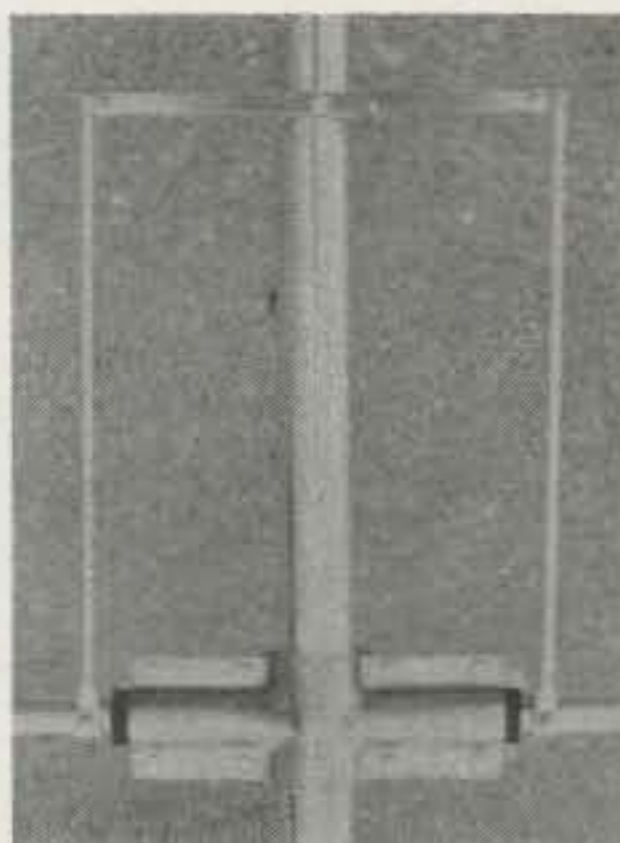

Wilson's Beta match offers maximum power transfer.

With the Wilson Beta-match method, it is a "set it and forget it" process. You can now assemble the antenna on the ground, and using the guide-lines from the detailed instruction manual, adjust the tuning of the Beta-match so that it will remain set when raised to the top of the tower.

The Wilson Beta-match offers the ability to adjust the terminating impedance that is far superior to the other matching methods including the Gamma match and other Beta matches. As this method of matching requires a balanced line it will be necessary to use a 1:1 balun, or RF choke, for the most efficient use of the HF Monobanders.

The Wilson Monobanders are the perfect answer to the Ham who wants to stack antennas for maximum utilization of space and gain. They offer the most economical method to have more antenna for less money with better gain and maximum strength. Order yours today and see why the serious DXers are running up that impressive score in contests and number of countries worked.

SPECIFICATIONS

Model	Band Mtrs	Gain dBd	F/B Ratio	Resonance & 1.5VSWR Bandwidth	VSWR @ Resonance	Impedance	Matching	Elements	Longest Element	Boom O.D.	Boom Length	Turning Radius	Surface Area (Sq. Ft.)	Windload @ 50 mph (Lbs.)	Maximum Mast	Assembled Weight (Lbs.)
M520A	20	11.5	25 dB	500 KHz	1.1:1	50 Ω	Beta	5	36'6"	2"	34'2 1/2"	25'1"	8.9	227	2"	68
M420A	20	10.0	25 dB	500 KHz	1.1:1	50 Ω	Beta	4	36'6"	2"	26'0"	22'6"	7.6	189	2"	50
M515A	15	12.0	25 dB	400 KHz	1.1:1	50 Ω	Beta	5	25'3"	2"	26'0"	17'6"	4.2	107	2"	41
M415A	15	10.0	25 dB	400 KHz	1.1:1	50 Ω	Beta	4	24'2 1/2"	2"	17'0"	14'11"	3.1	54	2"	25
M510A	10	12.0	25 dB	1.5 MHz	1.1:1	50 Ω	Beta	5	18'6"	2"	26'0"	16'0"	2.8	72	2"	36
M410A	10	10.0	25 dB	1.5 MHz	1.1:1	50 Ω	Beta	4	18'3"	2"	12'11"	11'3"	1.4	36	2"	20

WILSON SYSTEMS, INC. — 4286 S. Polaris
Las Vegas, NV 89103 — (702) 739-7401

FACTORY DIRECT
ORDER BLANK

Toll-Free Order Number
1-800-634-6898

WILSON SYSTEMS ANTENNAS

WILSON SYSTEMS TOWERS

Qty	Model	Description	Shipping	Price	Qty.	Model	Description	Shipping	Price
	SY40	10 Ele. Tribander for 10, 15, 20 Mtrs.	UPS	274.95		TT-45B	Freestanding 45' Tubular Tower	TRUCK	314.95
	SY36	6 Ele. Tribander for 10, 15, 20 Mtrs.	UPS	199.95		RB-45B	Rotating Base for TT-45B w/tilt over feature	TRUCK	219.95
	SY33	3 Ele. Tribander for 10, 15, 20 Mtrs.	UPS	149.95		FB-45B	Fixed Base for TT-45B w/tilt over feature	TRUCK	154.95
	33-6 MK	40 Mtr. Mod Kit for SY33 & SY36	UPS	49.95		MT-61B	Freestanding 61' Tubular Tower	TRUCK	549.95
	WV-1A	Trap Vertical for 10, 15, 20, 40 Mtrs.	UPS	49.95		RB-61B	Rotating Base for MT-61B w/tilt over feature	TRUCK	299.95
	GR-1	Ground Radials for WV-1A	UPS	12.95		FB-61B	Fixed Base for MT-61B w/tilt over feature	TRUCK	214.95
	M-520A	5 Elements on 20 Mtrs.	TRUCK	229.95		ST-77B	Freestanding 77' Tubular Tower	TRUCK	949.95
	M-420A	4 Elements on 20 Mtrs.	UPS	159.95		RB-77B	Rotating Base for ST-77B w/tilt over feature	TRUCK	449.95
	M-515A	5 Elements on 15 Mtrs.	UPS	129.95		FB-77B	Fixed Base for ST-77B w/tilt over feature	TRUCK	299.95
	M-415A	4 Elements on 15 Mtrs.	UPS	84.95		GK-45B	Guying Kit for TT-45B	UPS	59.95
	M-510A	5 Elements on 10 Mtrs.	UPS	84.95		GK-61B	Guying Kit for MT-61B	UPS	79.95
	M-410A	4 Elements on 10 Mtrs.	UPS	69.95		GK-77B	Guying Kit for ST-77B	UPS	99.95
		ACCESSORIES				WTB-1	Thrust Bearing for Top of Tower	UPS	49.95
	T*X	Tail Twister Rotor	UPS	199.95					
	HD-73	Alliance Heavy Duty Rotor	UPS	109.95					
	RC-8C	8/C Rotor Cable	UPS	.12/ft.					
	RG-8U	RG-8U Foam-Ultra Flexible Coaxial Cable. 38 strand center conductor, 11 gauge	UPS	.21/ft.					

ACCESSORIES NOTE:

On Coaxial and Rotor Cable, minimum order is 100' and 50' multiples.
Prices and specifications subject to change without notice.
Ninety (90) Day Limited Warranty — All Products FOB Las Vegas, Nevada

Prices Effective April 1-30, 1980 Nevada Residents add Sales Tax
Ship C.O.D. Check enclosed Charge to VISA MasterCard

Card No. _____ Expires _____

Bank No. _____ Signature _____

Name _____ Phone _____

Street _____

City _____ State _____ Zip _____

Prices and specifications subject to change without notice.

Tomorrow's Technology—Here Today!

THE YAESU FT-207R

The "horse-and-buggy" days of crystal-controlled handies are gone! Yaesu's engineers have harnessed the power of the microprocessor, bringing you 800 channels, digital display, memory, and scanning from a hand-held package. Only with Yaesu can you get these big performance features in such a compact package.

- 4 bit CPU chip for frequency control.
- Keyboard entry of all frequencies
- Digital frequency display.
- 800 channels across 144-148 MHz.
- Up/Down manual scan, or auto scan for busy/clear channels. 10 kHz scanning steps.
- Five channels of memory
- Priority channel with search-back feature.
- Keyboard lock to prevent accidental frequency change.
- Memory backup
- \pm 600 kHz or odd repeater splits.
- Display ON/OFF switch for battery conservation.
- Equipped with rubber flex antenna, wallmount battery charger, earphone, shoulder strap, and belt clip.
- Switchable RF output 2.5 watts (minimum) or 200 mW
- Earphone for private listening
- 2 Tone (Touchtone®) Input from Keyboard
- Highly reliable LED frequency display (works in cold temperatures and does not fade with age)

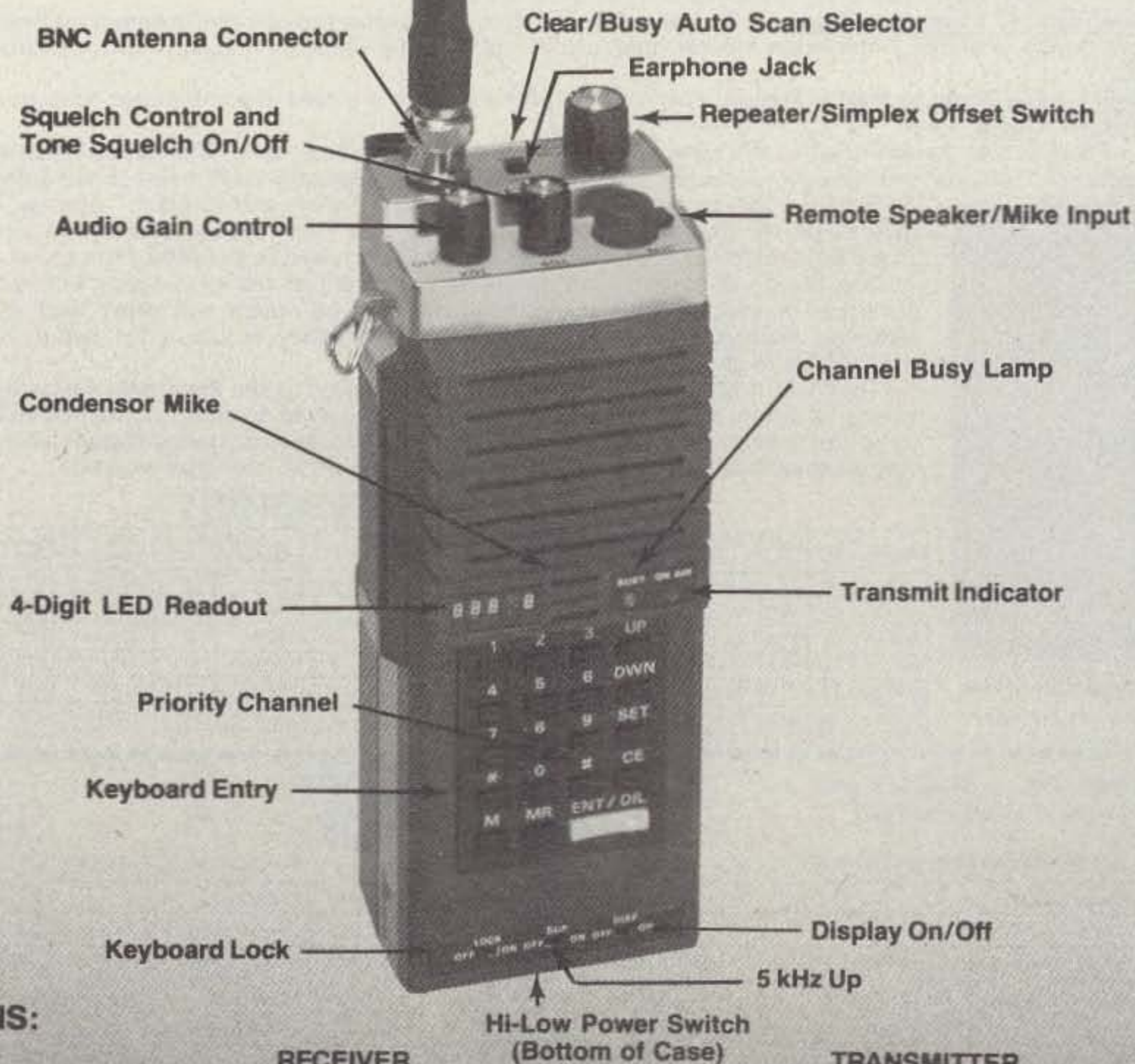

SPECIFICATIONS:

GENERAL

Frequency coverage: 144-148 MHz
Number of channels: 800
Emission type: F3
Batteries: NiCd battery pack
Voltage requirement: 10.8 VDC
 \pm 10%, maximum
Current consumption:
 Receive: 35 mA squelched (150 mA unsquelched with maximum audio)
 Transmit: 800 mA (full power)
Case dimensions: 68x181x54 mm (HWD)
Weight (with batteries): 680 grams

RECEIVER

Circuit type: Double conversion superheterodyne intermediate frequencies.
 1st IF = 10.7 MHz
 2nd IF = 455 kHz
Sensitivity: 0.32 μ V for 20 dB quieting
Selectivity: \pm 7.5 kHz at 60 dB down
Audio Output: 200 mW at 10% THD

Price And Specifications Subject To Change Without Notice Or Obligation

TRANSMITTER

Power Output: 2.5 watts minimum / 200mW
Deviation: \pm 5 kHz
Spurious radiation: -60 dB or better
Microphone: Condenser type (2000 ohms)

OPTIONS

LC-C7 Leather Carrying Case
 YM-24 Remote Speaker/Microphone
 Tone Squelch Unit
 NB-P9 Battery Pack
 NC-2 Quick Charger

YAESU
The radio.



180

Measure Frequency on your DVM

— this 3-chip circuit works to 10 kHz

Howard M. Berlin W3HB
519 Dougfield Road
Newark DE 19713

The type 4151 integrated circuit, manufactured by Raytheon, can be wired as a frequency-to-voltage (F/V)

converter enabling a digital voltmeter to measure frequencies from 10 Hz to 10 kHz.

The circuit shown used op amp U1 as a non-inverting comparator¹ which acts as a square wave converter for any periodic input waveform. The comparator's output is limited at

5.1 volts by the zener diode. The 50k Ω pot serves as a dc threshold adjustment to compensate for those inputs that have a periodic waveform superimposed on a dc level.

The square wave output then feeds U2, wired as a F/V converter, followed by an op amp integrator, U3.² The integrator is used to increase the circuit's response, linearity, and accuracy, while at the same time minimizing the amount of output ripple.

The 10k Ω "offset" pot is first adjusted to give a -10-mV output with a 10-Hz input signal. The 5k Ω "full-scale" pot is then adjusted to give a -10.0-V reading with a 10-kHz input. Consequently, the conversion gain for the entire circuit is -1 mV/Hz.

This circuit will work satisfactorily with peak input voltages ranging from 0.3 to 13 volts over the 10-Hz to 10-kHz frequency range. In actual operation, I used a 3½ digit voltmeter connected to the output of the integrator. Consequently, the resolution of the measurement depends on the voltmeter's scale, as shown in Table 1.

When the circuit is properly adjusted, the displayed reading was found to be accurate to within 0.5% at 10 kHz. ■

Maximum Scale Voltage	Maximum Frequency	Resolution
200 mV	200 Hz	± 0.1 Hz
2 V	2 kHz	± 1 Hz
20 V	10 kHz	± 10 Hz

Table 1.

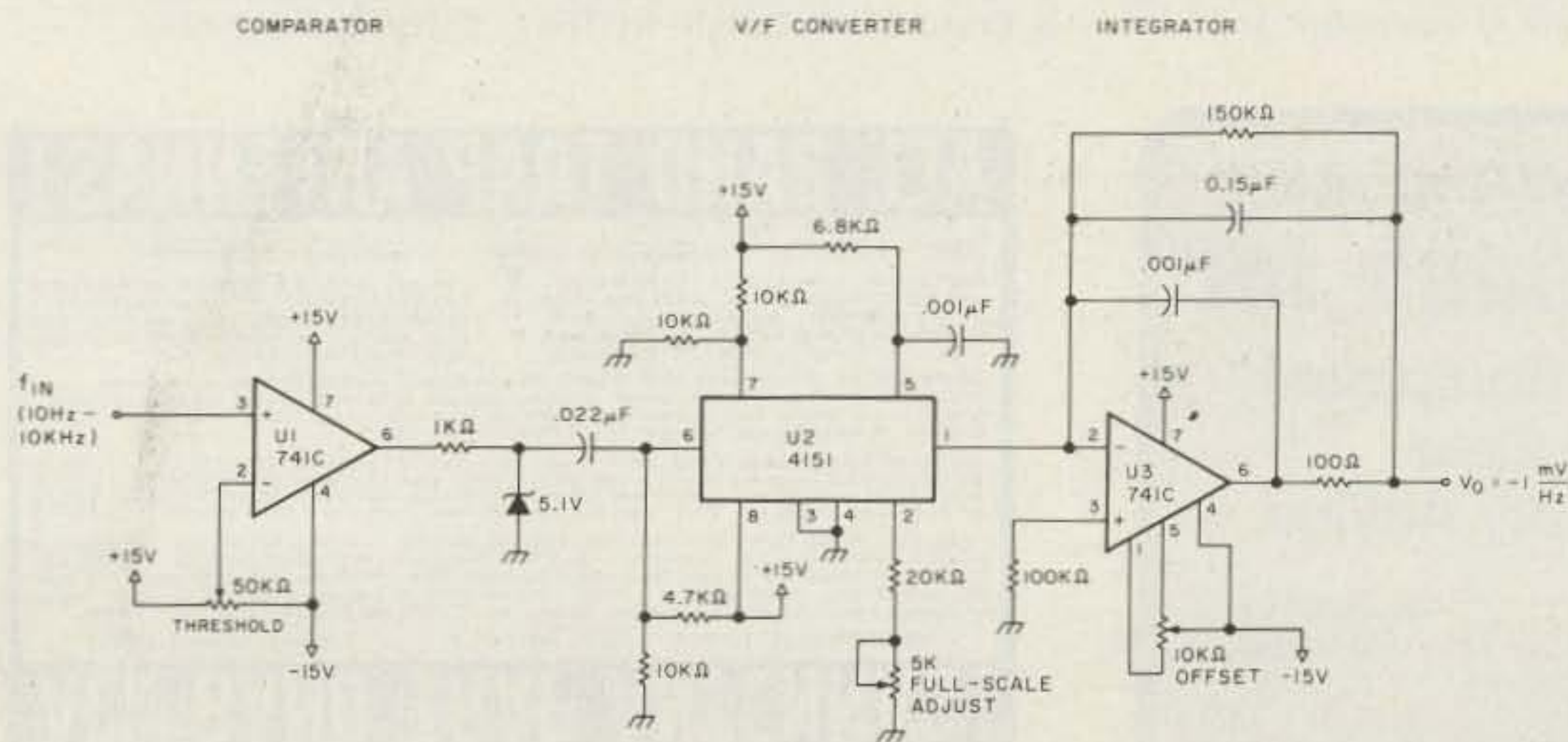

Fig. 1.

Footnotes

- Berlin, Howard M., *The Design of Operational Amplifier Circuits, with Experiments*, E&L Instruments, Inc., 1977.
- 4151 data sheet, Raytheon Semiconductor Division, 1976.

Social Events

Listings in this column are provided free of charge on a space-available basis. The following information should be included in every announcement: sponsor, event, date, time, place, city, state, admission charge (if any), features, talk-in frequencies, and the name of whom to contact for further information. Announcements must be received two months prior to the month in which the event takes place.

ROCHESTER MN APR 12

The Rochester Amateur Radio Club and the Rochester Repeater Society will sponsor the Rochester Area Hamfest on Saturday, April 12, 1980, at St. John's School gymnasium, 490 W. Center St., Rochester MN. Doors will open at 8:30 am. There will be a large indoor flea market for radio and electronic items, prize raffles, refreshments, and plenty of free parking. Talk-in on 146.22/.82 (WR0AFT). For further information, contact RARC, WB0YEE, 2253 Nordic Ct. N.W., Rochester MN 55901.

WELLESLEY MA APR 12

The Wellesley Amateur Radio Society will hold its annual auction on Saturday, April 12, 1980, beginning at 11:00 am at the Wellesley High School cafeteria on Rice Street, Wellesley MA. Talk-in on .63/.03, .04/.64, and .52. Doors open at 10:00 am. For further information, contact Kevin P. Kelly WA1YHV, 7 Lawnwood Place, Charlestown MA 02129.

ST. CLAIR SHORES MI APR 13

The South Eastern Michigan Amateur Radio Association will hold its 22nd annual hamfest on April 13, 1980, from 8:00 am to 3:00 pm at South Lake High School, 21900 E. Nine Mile Road (at Mack Ave.), St. Clair Shores, Michigan.

LANGHORNE PA APR 13

The Penn Wireless Association, Inc., will hold its Tradefest '80 on Sunday, April 13, 1980 at the National Guard Armory, Southampton Rd. and Roosevelt Blvd. (Rte. 1), a half-mile south of Pennsylvania Turnpike Exit 28. Sellers space, 6' x 8', is \$5; bring your own tables. There are a limited number of power connections (\$3). General admission is \$3. There will be prizes, refreshments, a rest area, displays, and surprises. Talk-in on 146.715 and .52. For further information, contact Robert L. Daut, Jr. WB3KRV, PO Box 734, Langhorne PA 19047.

MADISON WI APR 13

The Madison Area Repeater Association, Inc. (MARA), is pleased to announce its eighth annual Madison Swapfest which will be held on Sunday, April 13, 1980, at the Dane County Exposition Center Forum Building in Madison WI. Doors will be open at 8:00 am for sellers and exhibitors and at 9:00 am for the public. Commercial exhibitors and flea-market vendors will provide a large variety of equipment and com-

ponents for hams, computer hobbyists, and experimenters. Door prizes will be awarded. An all-you-can-eat pancake breakfast and a barbecue lunch will be available, as well as free movies throughout the day. Admission is \$2.50 per person in advance and \$3.00 at the door. Children twelve and under are admitted free. Tables are \$4.00 each in advance and \$5.00 at the door. Be sure to reserve tables early as tables were sold out last year. Talk-in on WR9ABT, 146.16/.76. For reservations, write to MARA, PO Box 3403, Madison WI 53704. For further information, contact Dick Victor WD9GRI, 2314 Rowley Avenue, Madison WI 53705; phone (608)-266-3527 (days) or (608)-238-0153 (evenings and weekends).

AMBOY IL APR 13

The Rock River Radio Club will hold its 14th annual hamfest on Sunday, April 13, 1980, at the Lee County 4H Center in Amboy IL, one mile east of the junction of routes 52 and 30, south of Dixon IL. There will be free coffee and donuts from 8:00 am to 8:30 am. Camping and tables are available at a nominal charge, as well as breakfasts and dinners. Advance tickets are \$1.50; gate tickets are \$2.00. Talk-in on 146.52 simplex or 146.37/.97 repeater. For more details, contact Chas. W. Randall W9LDU, 1414 Ann Avenue, Dixon IL 61021.

GRIFFITH IN APR 19

The Lake County Amateur Radio Club will hold its 27th annual Herbert S. Brier Memorial Banquet on April 19, 1980, starting at 6:00 pm at the Griffith Knights of Columbus Hall, 1400 S. Broad Street, Griffith IN. The

evening will feature a famous surprise guest speaker, door prizes, awards, and lots of good food. Tickets are \$10 each. There will be no tickets sold at the door. For tickets, contact LCARC, PO Box 1909, Gary IN 46409.

LITTLE ROCK AR APR 19-20

The Central Arkansas Radio Emergency Net amateur radio club of Little Rock will hold its annual hamfest on Saturday and Sunday, April 19-20, 1980, at the North Little Rock Community Center on Pershing Blvd., Little Rock AR. Activities include a covered flea market, air-conditioned dealer area, forum rooms, a cafeteria, and a Saturday night banquet. Harry Dannels W2HD will be guest speaker. There will be several door prizes along with a main prize. Talk-in on .34/.94. For information, contact Dale Temple W5RXU, 1620 Tarrytown, Little Rock AR 72207, (501)-225-5868.

KANSAS CITY MO APR 19-20

The PHD Amateur Radio Association, Inc., will hold its eleventh annual Northwest Missouri Hamfest and Missouri State ARRL Convention on Saturday and Sunday, April 19-20, 1980, at the Kansas City Trade Mart, from 10:00 am to 5:30 pm, in Kansas City MO. The 1980 directory of all amateurs in the 20-county metropolitan Kansas City, Missouri/Kansas area will be on sale at the hamfest. For further information, contact L. Charles Miller WA0KUH, 7000 Northeast 120th Street, Kansas City MO 64166, (816)-781-7313, or Thomas L. Bishop K0TLM, 4936 North Kansas, Kansas City MO 64119, (913)-342-4939.

JUST GETTING ON THE AIR?

See Adirondack for



- New Equipment
- Used Gear
- Friendly Advice

ADIRONDACK Radio Supply

185-191 West Main Street • P.O. Box 88
Amsterdam, N.Y. 12010 Tel. (518) 842-8350
Just 5 minutes from N.Y. Thruway - Exit 27

ALL BAND TRAP ANTENNAS!

PRETUNED - COMPLETELY ASSEMBLED - ONLY ONE NEAT SMALL ANTENNA FOR UP TO 6 BANDS! EXCELLENT FOR CONGESTED HOUSING AREAS - APARTMENTS LIGHT - STRONG - ALMOST INVISIBLE!

COMPLETE AS SHOWN WITH 90 FT. RG58U-52 OHM FEEDLINE, AND PL259 CONNECTOR, INSULATORS, 30 FT. 300 LB. TEST DACRON END SUPPORTS, CENTER CONNECTOR WITH BUILT IN LIGHTNING ARRESTER AND STATIC DISCHARGE - MOLDED, SEALED, WEATHERPROOF, RESONANT TRAPS "X6" - YOU JUST SWITCH TO BAND DESIRED FOR EXCELLENT WORLDWIDE OPERATION - TRANSMITTING AND RECEIVING! WT. LESS THAN 5 LBS.

160-80-40-20-15-10 bands 4 trap --- 169 ft. with 90 ft. RG58U - connector - Model 1060BU ... \$99.95
80-40-20-15-10 bands 4 trap --- 91 ft. with 90 ft. RG58U coax - connector - Model 1080BU ... \$95.95
40-20-15-10 bands 4 trap --- 45 ft. with 90 ft. RG58U coax - connector - Model 1040BU ... \$92.95
20-15-10 bands 4 trap --- 23 ft. with 90 ft. RG58U coax - connector - Model 1002BU ... \$89.95

SEND FULL PRICE FOR POST PAID INSURED DEL. IN USA. (Canada is \$5.00 extra for postage - clerical - customs - etc.) or order using VISA Bank Americard - MASTER CHARGE - AMER. EXPRESS. Give number and ex. date. Ph 1-308-236-5333 9AM - 6PM week days. We ship in 2-3 days. ALL PRICES WILL INCREASE ... SAVE - ORDER NOW! All antennas guaranteed for 1 year. 10 day money back trial if returned in new condition! Made in USA. FREE INFO. AVAILABLE ONLY FROM:

WESTERN ELECTRONICS 80 Dept. A7-4 Kearney, Nebraska, 68847

ALL BAND TRAP ANTENNAS!

**RALEIGH NC
APR 20**

The Raleigh Amateur Radio Society is sponsoring its eighth annual hamfest on Sunday, April 20, 1980, at the Crabtree Valley Mall, US 70 west, Raleigh NC. Activities begin at 9:00 am. General admission is \$3.00. There will be many prizes, including a first-prize choice of a TS-120S and power supply or a TS-700SP. Second prize is a tri-band beam; third prize is a heavy-duty CDR rotator. The drawings will be held all day Sunday. A covered flea market will also be featured. There will be a hospitality room on Saturday evening. Talk-in on 146.04/146.64 and 146.28/146.88. For additional information or reservations, write to RARS Hamfest, PO Box 17124, Raleigh NC 27619.

**IRVINGTON NJ
APR 20**

The Irvington Radio Amateur Club will hold its annual hamfest on Sunday, April 20, 1980, from 9:00 am to 4:00 pm at the P.A.L. Building, 285 Union Avenue, Irvington NJ. Take the Garden State Parkway to exit 143 north or 143B south. Admission is \$1.00; tables are \$3.00. Refreshments will be available. Talk-in on .34/.94 and .52. For information, call Pete WB2FAS, (201)-763-8220, or write IRAC, PO Box 894, Union NJ 07083.

**LINDEN PA
APR 20**

The 16th annual Penn Central Hamfest will be held on Sunday, April 20, 1980, at the Woodward Township Fire Hall (Route 220, north of Williamsport PA), Linden PA, from 11:00 am to 5:00 pm. Talk-in on 146.52 and 146.13/.73. For more information, write Kathy Wehr, R.D. #1, Watson-town PA 17777, or phone KA3CXB at (717)-323-7311.

**TRENTON NJ
APR 20**

The Delaware Valley Radio Association, W2ZQ, assisted by the Lawrenceville Amateur Repeater Group, will hold their annual flea market on Sunday, April 20, 1980, from 8:00 am to 4:00 pm, at the New Jersey National Guard 112th Field Artillery Armory, Eggerts Crossing Road, in Lawrence Township, Trenton, New Jersey. Advance registration is \$2.00, or \$2.50 at the gate. There will be an adequate indoor and outdoor flea market area. Sellers are asked

to provide their own tables. Door prizes, raffles, refreshments, and FCC examinations will be provided. Talk-in on 146.52, 146.07/67, and 147.84/24. For further information and reservations, write DVRA, PO Box 7024, West Trenton NJ 08628.

**DAYTON OH
APR 25**

The 11th annual FM B*A*S*H will be held on Friday night of the Dayton Hamvention, April 25, 1980, at the convention center, Main and Fifth Streets, Dayton OH. Parking is available in adjacent city garage. Admission is free to all. Sandwiches, snacks, and a COD bar will be available. Live entertainment will be provided. Awards include a new synthesized HT. For further information, contact the Miami Valley FM Association, PO Box 263, Dayton OH 45401.

**WORCESTER MA
APR 25**

The Central Massachusetts Amateur Radio Association will hold its ham radio auction and flea market on April 25, 1980, at the Main South American Legion Post 341, Main Street at Webster Square, next to Atamian Motors, Worcester MA. The doors open at 6:00 pm, with the auction beginning at 7:30 pm. At the auction, 15% of the profits will go to CMARA. The flea market tables are \$5.00 (items \$5.00 and less only). Refreshments and door prizes will be available. Talk-in on .37/.97 and .52/.52. For more information, contact Rene Brodeur WA1LEA, (617)-753-7480, or Dave Penttila K1COW, (617)-885-4995.

**DAYTON OH
APR 25-27**

The Dayton Amateur Radio Association, Inc., will hold its Hamvention on April 25-27, 1980, at the Hara Arena and Exhibition Center, Dayton OH. Admission is \$5.00 in advance; \$6.00 at the door. Flea-market space is \$11.00 in advance; \$14.00 at the gate. The Saturday evening banquet will be \$12.00 in advance; \$14.00 at the door. Senator Barry M. Goldwater K7UGA will be the banquet speaker. For additional information, write Box 44, Dayton OH 45401, or phone (513)-296-1165 5:00-10:00 pm EST. For special motel rates and reservations, write to Hamvention Housing, 1980 Winters Tower, Dayton OH 45423. There will be

no reservations accepted by telephone. Make checks payable to: Dayton Hamvention, Box 333, Dayton OH 45405.

**AGUADILLA PR
APR 26-27**

The Puerto Rico Amateur Radio Club will hold its 1980 convention and hamfest on Saturday and Sunday, April 26-27, 1980, at the Montemar Inn, Aguadilla, Puerto Rico. For additional information and reservations, write to the Radio Club de Puerto Rico, GPO Box 693, San Juan PR 00936.

**NEWINGTON CT
APR 27**

The Pioneer Valley Repeater Association will hold its third annual flea market on Sunday, April 27, 1980, from 10:00 am to 5:00 pm at Newington High School, Newington CT. General admission is \$1.00; table rental is \$7.50 each, including admission. Chairs and electricity will be provided. There will be a flea market, planned family activities, dealer displays and sales, door prizes, and free parking. Refreshments will be available. For more details, contact Arnie DePascale K1NFE, Post Office Drawer M, Plainville CT 06062, or Evangelo Demetriou, 38 Volpe Court, New Britain CT 06053.

**NEENAH WI
MAY 3**

The 3-F Amateur Radio Club will hold its swapfest on Saturday, May 3, 1980, at the Neenah Labor Temple, 157 South Green Bay Road, Neenah WI. Admission is \$1.50 in advance for tickets and \$1.50 for tables. Admission at the door will be \$2.00 for tickets and \$2.00 for tables. Facilities include a large parking area, and large indoor and outdoor swap area, with a free auction provided at the conclusion of the day. Food and beverages will be available. For further information, write Mark Michel W9OP, 339 Naymut Street, Menasha WI 54952, or phone (414)-722-4034.

**MEADVILLE PA
MAY 3**

The sixth annual Northwestern Pennsylvania Hamfest will be held on May 3, 1980, at the Crawford County Fairgrounds, Meadville PA. The gates will open at 8:00 am. Admission is \$3.00; children under 12 are free.

Indoor table spaces are \$5.00 and outside car spaces are \$2.00. Bring your own tables. Refreshments will be available. Talk-in on .04/.64, .81/.21, and .63/.03. For information, write CARS, PO Box 653, Meadville PA 16335, Attention: Hamfest Committee.

**WARMINSTER PA
MAY 4**

The Warminster Amateur Radio Club will hold the sixth annual Ham-Mart on Sunday, May 4, 1980, from 9:00 am to 4:00 pm at the William Tennent Intermediate High School, Route 132 (Street) and Newtown Roads, Warminster PA. There will be door prizes, a flea market, an auction, and a free FM clinic. There will be food, drink, and tables available. Registration is \$2.00 per person (children under 14 free), \$3.00 per space for sellers, and \$5.00 per space for one indoor table. Tickets for the Wilson HT drawing are additional. Talk-in on 146.52 simplex or 146.16/.76 on the PARA repeater. For more information, write WARC, PO Box 113, Warminster PA 18974, or call Pat Cawthorne W3DNI, (215)-672-5289.

**FALL RIVER MA
MAY 4**

The fourth annual Bristol County Amateur Radio Association flea market and radio auction will be held on Sunday, May 4, 1980, from 9:00 am until 5:00 pm at the Knights of Columbus Hall, Meridian Street, Fall River MA. Talk-in on 146.31/.91. For more information, write to Gerald P. DiChiara AA1Q, 35 Central Avenue, Assonet MA 02702.

**STIRLING NJ
MAY 4**

The Tri-County Radio Association will hold its annual indoor hamfest/flea market on May 4, 1980, at the Passaic Township Youth Center, Valley Road, Stirling NJ, from 9:00 am to 4:00 pm. Admission is \$2.00 and tables are \$5.00. Food will be served. There will be many door prizes. Talk-in on 147.855/.255 or 146.52. For information, write TCRA, Box 412, Scotch Plains NJ 07076, or phone Herb Klawunn at (201)-647-3461.

**DE KALB IL
MAY 4**

The Kishwaukee Radio Club

and the De Kalb County Amateur Repeater Club will hold their annual indoor/outdoor hamfest on Sunday, May 4, 1980, from 8:00 am to 3:00 pm at the Notre Dame School (3 miles south of De Kalb, between Highway 23 and South 1st Street on Gurler Road). Tickets are \$1.50 in advance and \$2.00 at the door. Indoor tables are available, but if you bring your own, the setup is free. Talk-in on 146.13/.73 and .94 simplex. For further information, send an SASE to Howard WA9TXW, PO Box 349, Sycamore IL 60178.

FRESNO CA MAY 9-11

The Fresno Amateur Radio Club, Inc., will hold the 38th annual Fresno Hamfest on May 9-11, 1980, at the Hacienda Inn, Clinton and 99, Fresno CA. Full registration is \$20.00 in advance; \$23.00 at the door. Partial registration is \$5.00. The ladies' program is \$7.00. Advance registration closes May 2, 1980. There are many activities planned, including a prime rib banquet. Talk-in on 146.34/.94. For more information, write to Fresno Hamfest, PO Box 783, Fresno CA 93712.

SANTA BARBARA CA MAY 9-11

The 25th annual West Coast VHF Conference will be held on May 9-11, 1980, at the Miramar Hotel, Santa Barbara CA. Highlights will include a hospitality room on Friday evening (May 9), technical sessions on Saturday (May 10), a program featuring key participants in the VHF-UHF propagation breakthroughs of 1979-80, noise-figure measurements on Saturday evening, antenna gain measurements on Sunday morning, plus technical exhibits, door prizes, and a drawing. Pre-registration is \$4.00 per person until May 1, 1980, and registration at the door is \$6.00. Registration forms, hotel information, and further details may be obtained by writing to Wayne Overbeck N6NB, Conference Coordinator, 5818 Woodlake Avenue, Woodland Hills CA 91367; (213)-347-3456 (home) or (213)-446-4311 (office).

DEERFIELD NH MAY 10

The Hosstraders Net will hold its 7th annual tailgate swapfest

on Saturday, May 10, 1980, at the Deerfield Fairgrounds, Deerfield NH. There will be covered buildings, in case of rain. Admission is \$1.00, with no commission or percentage. Commercial dealers are welcome at the same rate. Excess revenues will benefit the Boston Burns Unit of the Shriner's Hospital for Crippled Children. Last year we donated \$1,355. Talk-in on .52 and 146.40/147.00. For information or map, send an SASE to Joe Demaso K1RQG, Star Route, Box 56, Bucksport ME 04416, or Norm Blake WA1IVB, PO Box 32, Cornish ME 04020.

GREEN BAY WI MAY 10

The Green Bay Mike and Key Club will hold its swapfest from 8:30 am to 3:30 pm on May 10, 1980, at the Ashwaubenon Recreation Center. Admission will be \$1.50 advanced and \$2.00 at the door. Food and beverages will be served. There will be drawings for door prizes. For more information, contact Bob Duescher KA9BXG, 1011 13th Ave., Green Bay WI 54304. Talk-in on .72/.12.

ROCHESTER NY MAY 16-17

The Rochester Hamfest and New York State ARRL Convention will be held on Friday and Saturday, May 16-17, at the Monroe County Fairgrounds Dome Center, Route 15A, Rochester, New York. Indoor and outdoor flea-market space will be available. Forums, technical programs, and other meetings will be held on Saturday. Equipment displays and flea market will open on Friday afternoon. Hamfest headquarters is the Rochester Marriott Inn at the NY State Thruway. Send a QSL to Rochester Hamfest, Box 1388, Rochester NY 14603, to have your name added to the mailing list, or call us at (716)-424-1100 for specific information.

COEUR D'ALENE ID MAY 17

The Kootenai Amateur Radio Society will hold its annual Ham Meet on May 17, 1980, at the Northern Idaho Fairgrounds, Government Way, Coeur d'Alene ID. There will be commercial displays, auctions, a swap and shop, contests, and a snack bar. On Friday evening there will be entertainment. Doors will open at 7:00 am and the show will start at 9:00 am. Parking will be available at the fairgrounds. Talk-in on 146.52 simplex and 146.37/.97, club repeater

W7LQT/R. For information on free table reservations or tickets, write KARS, Route 1, Box 87, Rathdrum ID 83858.

WABASH IN MAY 18

The Wabash County Amateur Radio Club will hold its 12th annual hamfest on Sunday, May 18, 1980, from 6:00 am until 3:00 pm at the Wabash County 4-H Fairgrounds, Wabash IN. Admission will be \$3.00 at the gate or \$2.50 in advance and will include a chance in the major prize drawing. There will be plenty of food, door prizes, and parking. Camping space is available for Saturday night. Talk-in on 147.63/.03 and 146.52 simplex. For tickets or more info, send an SASE to Dave Spangler N9ADO, 45 Grant St., Wabash IN 46992.

EASTON MD MAY 18

The sixth annual Easton Amateur Radio Society hamfest will be held on May 18, 1980, rain or shine, at the Easton Senior High School cafetorium on Route 50, just south of Easton at mile marker 66, from 10:00 am until 4:00 pm. Donation is \$2.00, with an additional \$2.00 for tables or tailgaters. Talk-in on .52 simplex and 146.445/147.045 on the repeater in Easton. For more details, write R. C. Thompson KA3BKW, PO Box 1473, Easton MD 21601, or Easton Amateur Radio Society, Inc., Box 781, Easton MD 21601.

YAKIMA WA MAY 18

The Yakima Amateur Radio Club, W7AQ, will hold its annual hamfest on Sunday, May 18, 1980, in Yakima WA. Breakfast and lunch will be served, starting at 7:00 am. There will be door prizes, a swap shop, and new product dealers will be present. A free parking area for self-contained vehicles at the hamfest site will be available. Talk-in on .34/.94, .25/.85, and .01/.61. For further information, call Walt Hart at 575-4488 or Kenneth Zahn at 452-7982.

ISLIP LI NY MAY 18

The Long Island Mobile Amateur Radio Club, Inc., will hold the ARRL Hamfair '80 on May 18, 1980, from 9:00 am to 4:00 pm at the Islip Speedway, on Islip Avenue (Rte. 111), one block south of the Southern State

Parkway, Exit 43. There will be over 300 exhibitors and no reservations are needed. General admission is \$2.00 and exhibitors' admission is \$3.00 per space. There will be many door prizes awarded and plenty of parking space. Food and refreshments will be available at the track. The rain date will be June 1, 1980. For additional information, phone Sid Wolin K2LJH (516)-379-2861 nights, or Hank Wener WB2ALW (516)-484-4322 days.

EVANSVILLE IN MAY 18

The Tri-State Amateur Radio Society will hold its annual hamfest on May 18, 1980, at the Vanderburg County 4-H Center, Evansville IN. Grounds for the hamfest will be open at 8:00 am CST Sunday morning. There will be no admission charge. Tickets will be on sale for door prizes. In addition, there will be many other lesser prizes awarded for hamfest attendance. Exhibit tables inside the hall will be \$2.50 each, and a 4-by-8-foot space in a covered area adjacent to the hamfest will be available for \$1.00 per space. Food and beverage will be available. Saturday overnight camping space is available for those so equipped. Talk-in will be on the Evansville 147.75/.15 repeater. For further details, contact Dave Bradford N6ACP/9, 313 E. Franklin Street, Evansville IN 47711.

WASHINGTON DC MAY 24

The Maryland FM Association will hold its third hamfest on Saturday, May 24, 1980, 8:00 am to 4:00 pm at the Greenbelt Armory at the intersection of Greenbelt Road (MD Route 193) and the Baltimore-Washington Parkway, NE of Washington DC, just off I-95/495. Activities include cash prizes, catered food, indoor displays and flea market, and a separate outdoor tailgating area. Donations are \$3.00, tailgating is \$2.00, and tables are \$5.00. Talk-in on 52.525 simplex, 146.161.76, 146.28/.88, and 146.52 simplex, and 449.1/444.1. Tables may be reserved by paying in advance to Fred Siebert K3PNL, 8357 Reservoir Road, Fulton MD 20759. If acknowledgement is desired, please include an SASE.

GORHAM ME MAY 24

The Portland Amateur Wire-

SIGNALCRAFTER INTRODUCES

The Most Advanced Automatic Computing RF Measuring Instrument in Amateur Radio!



MODEL 30

This new Signalcrafters SWR/Power Meter is in a class by itself. Signalcrafters custom-designed integrated circuits compute SWR automatically, thus eliminating need for "set" or "sensitivity" controls. The built-in analog computer operates over the power range of only one watt to several kilowatts with unparalleled accuracy. Our auto-ranging feature automatically selects the proper range of 0 to 20, 0 to 200, or 0 to 2,000 watts according to the RF level detected on the transmission line and indicates the proper range on one of three front panel LED's. The operator can assume manual control of this feature by selecting one of the three basic ranges on the front panel switches. Two large taut-band meters indicate forward power and SWR. Complete hands-off operation! The amateur may also choose between either average or peak RF power. Self-indicating push buttons allow selection of any of three antennas or a dummy load when used with external 12-volt coaxial relays or our Model 50 Antenna Relay/Dummy Load. The 1.5 to 30 mhz coupler is plug-in mounted on the rear apron and can be unplugged and remote-mounted for convenience. The attractive, heavy-duty, low profile metal cabinet complements the latest transceiver designs. DC output receptacles supply analog voltages that track the meter readings. These outputs can be used to control many different accessories, such as analog to digital converters, remote meters, control and alarm devices, as well as the Signalcrafter Model 40 Audio-Tuner for the blind amateur. Operates from 110 volt 60 hz AC. Width: 8½" (216 mm), Height: 4½" (108 mm), Depth: 6" (152 mm).....\$225.00

® **SIGNALCRAFTERS, INC.** ✓ 66

5460 Buena Vista Drive
Shawnee Mission, Kansas 66205
913/262-6565; Telex: 42-4171

All Signalcrafters products are designed, engineered and produced in the U.S.A.
Prices include shipping to all U.S.A. — VISA and Master Charge accepted.
Kansas residents please add 3½ percent.

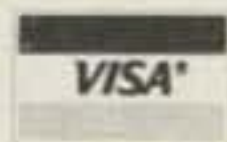

less Association and the University of Southern Maine Radio Club will hold a flea market on May 24, 1980, from 9:00 am to 5:00 pm on the campus of the University of Maine, Gorham ME. Admission is \$1.00 per person. Indoor and outdoor sites will be available. Talk-in on .52, .73, and .06. For further information, contact Jon Taylor N1SD, 44 Mitton Street, Portland ME 04102, or phone (207)-773-2651.

ST. LOUIS MO MAY 24-25

The ARRL Midwest and Central Divisions will hold their amateur radio and computer hobbyist convention on May 24-25, 1980, at the Cervantes Convention Center, St. Louis, Missouri. Featured will be prominent speakers, information forums, equipment displays and demonstrations, and an indoor flea-market sale. Friday night, May 23rd, will be "Amateur Radio Night" at Busch Memorial Stadium, where the St. Louis Cardinals will play the San Diego Padres. On Saturday night, May 24th, the convention banquet and dance will be held on the riverboat *Admiral*. On Memorial Day, May 26th, there will be an all-day visit to Six Flags Over Mid-America. For more information, write to the Gateway Amateur Radio Association, Inc., Box 68, Marissa IL 62257.

FREMONT OH MAY 25

The Sandusky Valley Amateur Radio Club will hold its third annual hamfest on Sunday, May 25, 1980, at the Sandusky County Fairgrounds, Fremont OH. Doors open at 7:00 am. Admission is \$1.00, and all tables are free. Talk-in on .52/.52 and 146.31/.91. For tickets or additional information, send an SASE to Ron Winke WB8NMK, 1200 Stilwell Avenue, Fremont OH 43420.

HAMBURG PA MAY 25

The Reading Radio Club will hold its second annual hamfest on Sunday, May 25, 1980, in the Hamburg PA Fieldhouse (take Rte. 22 from east or west, Rte. 61 from north or south). There are indoor as well as outdoor sites. Cash and equipment prizes will be awarded. Talk-in on 146.31/.91 and 146.52. For information, write W3BN, PO Box 124, Read-

ing PA 19603.

ST. PAUL MN MAY 31

The North Area Repeater Association, Inc., will hold its Amateur Fair on Saturday, May 31, 1980, at the Minnesota State Fairgrounds, St. Paul MN. This is a swapfest and exposition for amateur radio operators and computer enthusiasts. There will be free overnight parking for self-contained campers on May 30th. Exhibits, booths, and prizes will be featured. Admission is \$3.00. For information or reservations, write Amateur Fair, PO Box 30054, St. Paul MN 55175.

MANASSAS VA JUN 1

The Ole Virginia Hams Amateur Radio Club, Inc., will hold its seventh annual Manassas Hamfest on Sunday, June 1, 1980, at the Prince William County Fairgrounds, Route 234, Manassas VA. Booths are available. Admission is \$3.00, children under 12 are free, and tailgaters are \$2.00. Talk-in on 146.37/146.97 repeater (WB4HHN) and 146.52 simplex. For further information, contact Joseph A. Schlatter K4FPT, Ole Virginia Hams ARC, Inc., PO Box 1255, Manassas VA 22110.

WILMINGTON OH JUN 1

Clinton County area amateurs will sponsor the first annual Clinton County area Hamfest 1980 on June 1, 1980, 8:00 am to 5:00 pm, at the Clinton County Fairgrounds, Wilmington OH. Admission will be \$3.00; 12 and under are free. Flea-market space is free. There will be door prizes and free parking. Food and drinks will be available. Talk-in on .72/.12. For more info, send an SASE to CCARA c/o Russ Eidemiller WD8NPZ, 310 Bethel Lane, Wilmington OH 45177.

GRANITE CITY IL JUN 8

The Egyptian Radio Club will hold a hamfest and flea market on June 8, 1980, beginning at 8:00 am at the ERC Clubhouse, Slough Road, Granite City IL. Tickets are \$1.50. Refreshments, activities for women and children, and overnight camping are available. Prizes will be awarded. Talk-in on 146.16/.76 and 146.52.

JEFFERSON CITY MO JUN 8

The Missouri Single Side Band Net Picnic will be held on Sunday, June 8, 1980, at Binder Lake, Jefferson City MO. There will be a covered dish dinner served at noon and drinks will be furnished by the Net. For information, contact Benton C. Smith K0PCK, net manager, Prairie Home MO 65068.

BARRIE ONT CAN JUN 13-15

The Lake Simcoe Hamfest will be held on June 13-15, 1980, at Molson's Park, Barrie, Ontario, Canada. Doors will open at 12:00 noon on Friday, June 13. Registration at the gate is \$5.00 and pre-registration is \$4.00, with children under the age of 18 admitted free. Talk-in on VE3LSR 146.85, 146.52 simplex, and 3780 kHz. For information, reservations, or tickets, write to Lake Simcoe Hamfest, PO Box 2283, Orillia ONT, Canada L3V 6S1.

OXFORD ME JUN 28

The Yankee Radio Club, Inc., of Maine, will hold its Yankee Hamfest '80 on Saturday, June 28, 1980, at the Oxford County Fairgrounds in Oxford ME. Featured will be computer displays, talks on selected subjects, a ladies program, a youth program, swap tables, door prizes, and a buffet dinner in the evening. Registration will be \$8.00, complete with a dinner and door prize chances; \$7.00 for early registrations. For admission only, at the gate, the cost is \$2.50. Camper hookups will be available for Friday and Saturday nights at \$2.00 per night. Talk-in will be on 146.28/.88 and on 146.52. For information and registration, send an SASE to Lynda Mount, 198 Cony Extension, Augusta ME 04330.

BURLINGTON ONT CAN JUL 5

The Burlington Amateur Radio Club will hold its 6th annual Ontario Hamfest 1980 on Saturday, July 5, 1980, at the Milton Fairgrounds, just south of the intersection of Highways 401 and 25 (Exit 39). General admission is \$3.00; children and ladies are free. Pre-registration before June 15, 1980, is \$2.00. Gates will open Friday, July 4, 1980, at 12:00 noon and Saturday, July 5, 1980, at 7:00 am. The

flea market opens at 8:00 am and tables are free. There will be camping available and food and prizes. Talk-in on 147.81/.21 VE3RSB. For information, write BARC, Box 836, Burlington ONT CAN L7R 3Y7.

WAUKESHA WI JUL 19

The Kettle Moraine Radio Amateur Club (KMRA) will hold its annual hamfest on Saturday, July 19, 1980, beginning at 7:00 am, at the Badger Raceway, Waukesha WI. The Badger Raceway is located west of Dousman on U.S. 18, 3½ miles from the intersection of I-94 and State Highway 67. There will be overnight camping on the grounds on Friday. Tickets are \$1.50 in advance and \$2.00 at the door. Talk-in on 146.52, 52.525, and 28.650 MHz. For additional information and advance tickets, write KMRA Hamfest, 108 Shepard Ct., Mukwonago WI 53149.

WEST FRIENDSHIP MD JUL 27

The Baltimore Radio Amateur Television Society will hold its annual BRATS Maryland Hamfest on Sunday, July 27, 1980, at the Howard County Fairgrounds, just off I-70 and Route 32 at Route 144, West Friendship MD. Beginning at 8:00 am, activities will be held rain or shine. Talk-in on .63/.03, .16/.76, and .52 simplex. For information or table reservations, write BRATS, Box 5915, Baltimore MD 21208.

GEORGETOWN IL AUG 30-31

The Illiana Repeater System, Inc., amateur radio club will hold its 11th annual Danville, Illinois, Hamfest, Saturday and Sunday, August 30-31, 1980, at the Georgetown, Illinois, Fairgrounds. Advance gate donations are \$1.50 per adult; \$2.00 at the gate, with children 14 years and younger free. Activities will include two days of flea markets, commercial exhibitors, RTTY setups, an Antique Wireless Association display, a home-brew builders contest, a USAF MARS station, and other interests. Meals and refreshments will be served both days and overnight camping facilities are available. For more information or advance tickets, send an SASE to Illiana Repeater System, Inc., PO Box G, Catlin IL 61817.



INEXPENSIVELY SUPERIOR

The DS2000 KSR is the lowest priced RTTY terminal available with these advanced features:

- TX/RX operation on Baudot and ASCII RTTY plus Morse Code (Morse RX optional)
- Integrated keyboard and video generator allows editing of transmit text
- Full 24 line by 72 characters per line display
- Bright/dim display of characters differentiates between TX and RX display
- Morse receive option may be added at any time
- Separate CW identification key for RTTY operation
- Status line on top of screen shows terminal operating conditions
- Pretype transmit message into 255 character buffer; edit before transmitting
- 2 programmable "Here Is" messages
- Word-wrap-around prevents word splitting at end of display line
- Word mode allows editing of text to be transmitted
- Quick Brown Fox and RYRY test message keys
- Small size metal cabinet gives effective RFI shielding from transmitters
- Loop compatible RTTY connections and plus or minus CW key connections
- 110 and 300 baud ASCII
- 45,50,57,74,100 baud Baudot
- 1-175 wpm Morse transmit
- 1-175 wpm optional Morse receive
- 120/240 v, 50/60 Hz power
- Internal CW side-tone
- UnShift On Space for Baudot
- Keyboard Operated Switch
- SYNC idle for RTTY
- One year warranty

HAL Communications and amateur radio serving the 1980 Winter Olympics through W.O.R.A.N. (Winter Olympics Radio Amateur Network)

Write or give us a call. We'll be glad to send you our new RTTY catalog.



HAL COMMUNICATIONS CORP.
 Box 365
 Urbana, Illinois 61801
 217-367-7373

For our European customers, contact: Richter & Co. D3000
 Hannover 1 • I.E.C. Interelco, 6816 Bissone/Lugano • Radio
 Shack Ltd., London NW6 3AY • Erik Torpdahl Telecom, DK 3660
 Stenlose Denmark

DS2000 KSR.....	\$499.00
ESM-914 Video Monitor...	\$169.00
MR2000	
Morse receive option....	\$159.00

Microcomputer Interfacing

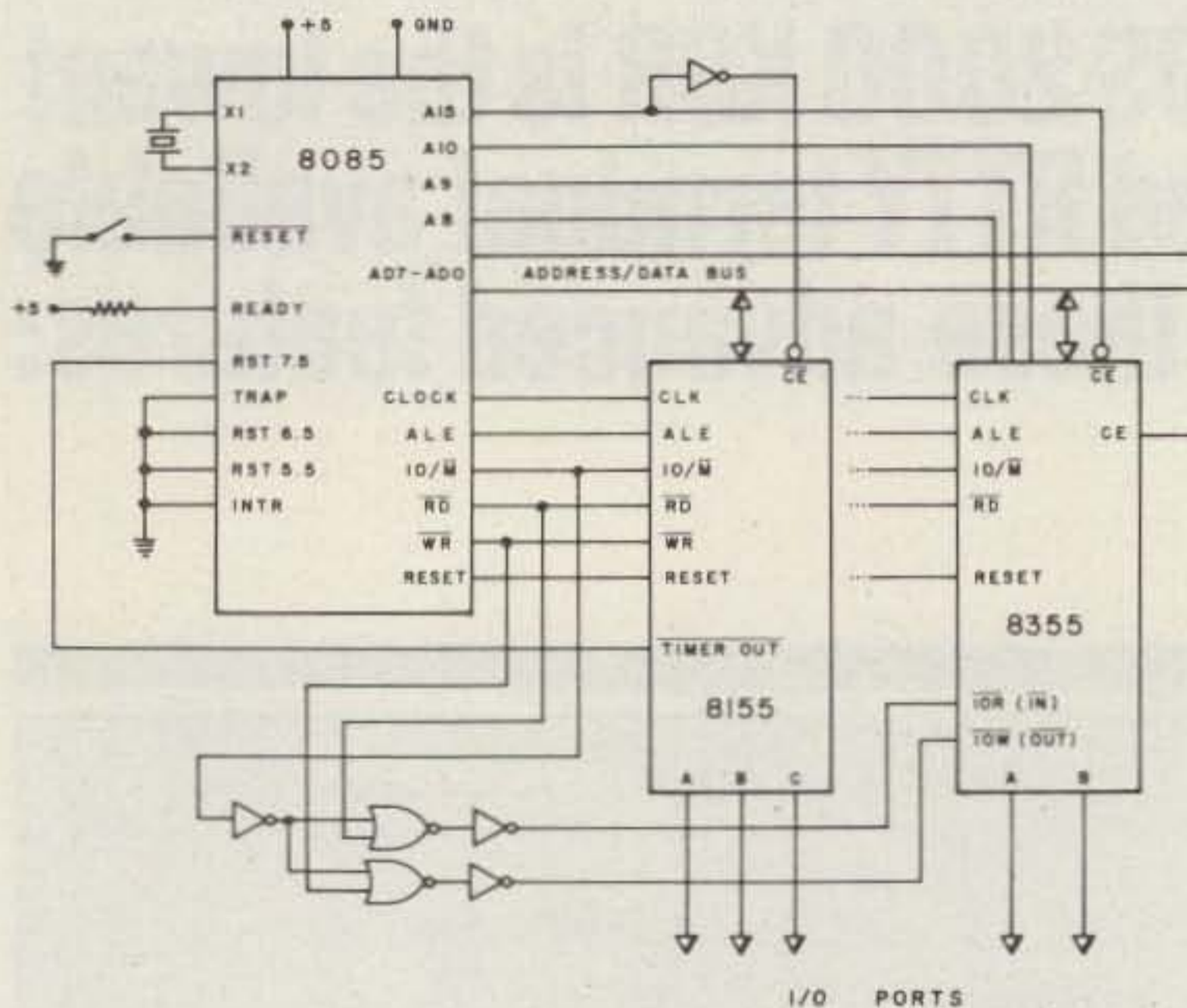

Fig. 4. Pin configuration for the 8085 central processor unit or micro-processor chip.

from page 27

pin 5) so that it could be sensed by the RIM instruction, or it could be connected to one of the 8085's interrupt pins, RST 7.5, for example, so that the end of the timer's period could be detected through an interrupt action. The timer's output is fairly flexible, being programmed to operate in one of four ways shown in Table 1.

These control bits, M2 and M1, are the most significant bits in the 16-bit count value that is programmed into the counter. Since the counter is only 14 bits long, the control bits are not included in the count itself, but

are used by the counter's control logic to determine the state of the counter's output when the count has been finally decremented to zero. Whenever a new 14-bit count value is reprogrammed into the counter, these two control bits also must be included in the new 16-bit word.

The 8155 read/write memory chip also has an internal control register that is loaded with an eight-bit byte that is used to determine the operation of the I/O ports and 14-bit counter. The various control register bits and their functions are shown in Table 2.

There are six device ad-

Bit	Function
D0	Defines Port A
D1	Defines port B
D2	Defines port C
D3	Defines Port C
D4	Port A Interrupt Enable
D5	Port B Interrupt Enable
D6	Timer Control
D7	Timer Control

Timer Control Bits	Function
D7 D6	
0 0	No effect upon the counter
0 1	Stop counting
1 0	Stop after this count has been completed
1 1	Load counter and start counting. If the counter is running, load and restart after the current count has finished.

Table 2. Control bit designations and their functions. These bits are used to program the 8155's control register to control the various 8155 I/O ports, interrupts, and timer.

Function	Address
Command/Status Register	XXXXX000
Port A	XXXXX001
Port B	XXXXX010
Port C	XXXXX011
Counter bits D7-D0	XXXXX100
Counter bits D13-D8 and Counter	XXXXX101

Table 3.

resses that are associated with the 8155 in an 8085-based system. These addresses control the I/O ports, the timer, and the control register. The control register's address may be used in a read operation to read various conditions or various status bits. We shall not discuss this further. The individual addresses and their functions are shown in Table 3.

In our 8085-based system, these devices have addresses 200 through 205. Remember that the 8155's chip enable input, \overline{CE} , must be at a logic zero for the memory or I/O devices to operate properly. The final, minimum system that we have configured

is shown in Fig. 3. Two additional integrated circuits, an SN7404 hex inverter and an SN7402 quad NOR, are needed to provide gating and inverting functions. (See Fig. 4 for 8085 pin configuration.) Note the use of address bit A15 to select between the 8155 and 8355 chips. We have chosen the 8355 as the read-only memory chip in this system. In our next column, we will explore the use of this system and the development of some software examples that may be used in small control systems.



Ham Help

Recently I got a Mite UGL-41 teleprinter, which works from 110-volt, 400-Hz mains. I'm looking for someone who is experienced in such power supplies, has a supply for sale, or maybe has a surplus unit. We have 220-volt, 50-Hz mains here, but this is not the real problem. I am also looking for a manual and a spare parts source for my Mite.

Thank you.

Detlev-R. Flegner DL7VS
Glockenblumenweg 28 a
1000 Berlin 47 West Germany

Our Apple computer net meets every Sunday night 0100Z on 14.329 MHz \pm QRM. If you have a problem in programming, this may be the place to find answers, or give help to someone

else. SWLs may mail questions to me for airing on the net.

James E. Hassler WB7TRQ
129 Park Ave.
Orchard Valley
Cheyenne WY 82001

I would like hams who live within 100 miles of the San Andreas Fault on the west coast of North America and who would like to participate in an earthquake prediction project to please send an SASE to me. This is a bona fide project to cooperate with the U.S. Geolog-

ical Survey to supply data on band conditions to a scientist who is studying the electromagnetic field of the San Andreas Fault.

Lawrence I. Cotariu KA6GVI
8041 N. Hamlin Avenue
Skokie IL 60076

I need an operation or service manual for a Clegg FM-27B. I will copy and return or pay for copies. Thanks.

Jung Y. Lem KB6BO
5222 Coringa Drive
Los Angeles CA 90042

OSCAR Orbits

Courtesy of AMSAT

Any satellite placed into a near-Earth orbit suffers from the cumulative effects of atmospheric drag. The much publicized descent of the Skylab space station was a graphic demonstration of these effects.

The OSCAR satellites are subject to atmospheric drag, of course, and the present period of intense solar activity has accentuated the problem. During this period, our sun has been expelling huge numbers of charged particles, some of which find their way into the Earth's upper atmosphere, increasing the density (and thus the drag) there. It is through this region that the OSCARs must pass. OSCAR 8, in a lower orbit than OSCAR 7, is the more seriously affected of the two.

If the drag factor is not considered when OSCAR calculations are performed, long-range orbital projections will be in error. For example, by the end of 1979, OSCAR 8 was more than 20 minutes ahead of some published schedules. The nature of orbital mechanics is such that extra drag on a satellite causes it to move into a lower orbit, resulting in a shorter orbital period. Thus, the satellite arrives above a given Earthbound location earlier than predicted.

Using data supplied to us by Dr. Thomas A. Clark W3IWI of AMSAT, the equatorial crossing tables shown here were generated with the aid of a TRS-80™ microcomputer. The tables take into account the effects of atmospheric drag and should be in error by a few seconds at most.

The listed data tells you the time and place that OSCAR 7 and OSCAR 8 cross the equator in an ascending orbit for the first time each day. To calculate successive OSCAR 7 orbits, make a list of the first orbit number and the next twelve orbits for that day. List the time of the first orbit. Each successive orbit is 115 minutes later (two hours less five minutes). The chart gives the longitude of the day's first ascending (northbound) equatorial crossing. Add 29° for each succeeding orbit. When OSCAR is ascending on the other side of the world from you, it will descend over you. To find the

equatorial descending longitude, subtract 166° from the ascending longitude. To find the time OSCAR 7 passes the North Pole, add 29 minutes to the time it passes the equator. You should be able to hear OSCAR 7 when it is within 45 degrees of you. The easiest way to determine if OSCAR is above the horizon (and thus within range) at your location is to take a globe and draw a circle with a radius of 2450 miles (4000 kilometers) from your QTH. If OSCAR passes above that circle, you should be able to hear it. If it passes right overhead, you should hear it for about 24 minutes total. OSCAR 7 will pass an imaginary line drawn from San Francisco to Norfolk about 12 minutes after passing the equator. Add about a minute for each 200 miles that you live north of this line. If OSCAR passes 15° east or west of you, add another minute; at 30°, three minutes; at 45°, ten minutes. Mode A: 145.85-95 MHz uplink, 29.4-29.5 MHz downlink, beacon at 29.502 MHz. Mode B: 432.125-175 MHz uplink, 145.975-925 MHz downlink, beacon at 145.972 MHz.

At press time, OSCAR 7 was scheduled to be in Mode A on odd numbered days of the year and in Mode B on even numbered days. Monday is QRP day on OSCAR 7, while Wednesdays are set aside for experiments and are not available for use.

OSCAR 8 calculations are similar to those for OSCAR 7, with some important exceptions. Instead of making 13 orbits each day, OSCAR 8 makes 14 orbits during each 24-hour period. The orbital period of OSCAR 8 is therefore somewhat shorter: 103 minutes.

To calculate successive OSCAR 8 orbits, make a list of the first orbit number (from the OSCAR 8 chart) and the next thirteen orbits for that day. List the time of the first orbit. Each successive orbit is then 103 minutes later. The chart gives the longitude of the day's first ascending equatorial crossing. Add 26° for each succeeding orbit. To find the time OSCAR 8 passes the North Pole, add 26 minutes to the time it crosses the equator. OSCAR 8 will cross the imaginary San Francisco-to-Norfolk line about 11 minutes after crossing the equator. Mode A: 145.85-95 MHz uplink, 29.4-29.50 MHz downlink, beacon at 29.40 MHz. Mode J: 145.90-146.00 MHz uplink, 435.20-435.10 MHz downlink, beacon on 435.090 MHz.

OSCAR 8 is in Mode A on Mondays and Thursdays, Mode J on Saturdays and Sundays, and both modes simultaneously on Tuesdays and Fridays. As with OSCAR 7, Wednesdays are reserved for experiments.

OSCAR 7 ORBITAL INFORMATION FOR APRIL

ORBIT #	DATE	TIME (GMT)	EQ. CROSSING (DEGREES WEST)
24596	1	0001:32	69.8
24609	2	0055:48	83.4
24622	3	0150:04	97.0
24634	4	0049:23	81.9
24647	5	0143:39	95.5
24659	6	0042:59	80.3
24672	7	0137:15	93.9
24684	8	0036:34	78.8
24697	9	0130:50	92.3
24709	10	0030:09	77.2
24722	11	0124:25	90.8
24734	12	0023:44	75.6
24747	13	0118:00	89.2
24759	14	0017:20	74.1
24772	15	0111:35	87.7
24784	16	0010:55	72.5
24797	17	0105:11	86.1
24809	18	0004:30	71.0
24822	19	0058:46	84.5
24835	20	0153:02	98.1
24847	21	0052:21	83.0
24860	22	0146:37	96.6
24872	23	0045:56	81.4
24885	24	0140:12	95.0
24897	25	0039:32	79.9
24910	26	0133:48	93.5
24922	27	0033:07	78.3
24935	28	0127:23	91.9
24947	29	0026:42	76.7
24960	30	0120:58	90.3

OSCAR 8 ORBITAL INFORMATION FOR APRIL

ORBIT #	DATE	TIME (GMT)	EQ. CROSSING (DEGREES WEST)
10565	1	0116:13	69.5
10579	2	0121:11	70.8
10593	3	0126:08	72.1
10607	4	0131:05	73.3
10621	5	0136:03	74.6
10635	6	0141:00	75.8
10648	7	0002:45	51.3
10662	8	0007:42	52.6
10676	9	0012:39	53.8
10690	10	0017:36	55.1
10704	11	0022:33	56.3
10718	12	0027:30	57.6
10732	13	0032:28	58.9
10746	14	0037:25	60.1
10760	15	0042:22	61.4
10774	16	0047:19	62.6
10788	17	0052:15	63.9
10802	18	0057:12	65.2
10816	19	0102:09	66.4
10830	20	0107:06	67.7
10844	21	0112:03	68.9
10858	22	0117:00	70.2
10872	23	0121:56	71.5
10886	24	0126:53	72.7
10900	25	0131:50	74.0
10914	26	0136:47	75.2
10928	27	0141:43	76.5
10941	28	0003:27	51.9
10955	29	0008:24	53.2
10969	30	0013:20	54.5

OSCAR 7 ORBITAL INFORMATION FOR MAY

ORBIT #	DATE	TIME (GMT)	EQ. CROSSING (DEGREES WEST)
24972	1	0020:17	75.2
24985	2	0114:33	88.8
24997	3	0013:52	73.6
25010	4	0108:08	87.2
25022	5	0007:28	72.1
25035	6	0101:44	85.7
25047	7	0001:03	70.5
25060	8	0055:19	84.1
25073	9	0149:35	97.7
25085	10	0048:54	82.5
25098	11	0143:10	96.1
25110	12	0042:29	81.0
25123	13	0136:45	94.6
25135	14	0036:04	79.4
25148	15	0130:20	93.0
25160	16	0029:39	77.9
25173	17	0123:55	91.4
25185	18	0023:14	76.3
25198	19	0117:30	89.9
25210	20	0016:50	74.7
25223	21	0111:05	88.3
25235	22	0010:25	73.2
25248	23	0104:41	86.8
25260	24	0004:00	71.6
25273	25	0058:16	85.2
25286	26	0152:31	98.8
25298	27	0051:51	83.6
25311	28	0146:07	97.2
25323	29	0045:26	82.1
25336	30	0139:42	95.7
25348	31	0039:01	80.5

OSCAR 8 ORBITAL INFORMATION FOR MAY

ORBIT #	DATE	TIME (GMT)	EQ. CROSSING (DEGREES WEST)
10983	1	0018:17	55.7
10997	2	0023:13	57.0
11011	3	0028:10	58.2
11025	4	0033:06	59.5
11039	5	0038:03	60.7
11053	6	0042:59	62.0
11067	7	0047:55	63.3
11081	8	0052:52	64.5
11095	9	0057:48	65.8
11109	10	0102:44	67.0
11123	11	0107:40	68.3
11137	12	0112:37	69.5
11151	13	0117:33	70.8
11165	14	0122:29	72.1
11179	15	0127:25	73.3
11193	16	0132:21	74.6
11207	17	0137:17	75.8
11221	18	0142:13	77.1
11234	19	0003:56	52.5
11248	20	0008:52	53.8
11262	21	0013:48	55.0
11276	22	0018:44	56.3
11290	23	0023:40	57.5
11304	24	0028:36	58.8
11318	25	0033:32	60.1
11332	26	0038:27	61.3
11346	27	0043:23	62.6
11360	28	0048:19	63.8
11374	29	0053:15	65.1
11388	30	0058:10	66.3
11402	31	0103:06	67.6

Ham Help

I am looking for a bimetallic thermostatic heater, 60° to 70° centigrade, for a crystal oven, or a successful electronic temperature control for same, working off of 5 to 12 volts.

I am also looking for a schematic and/or alignment data for a Wells Gardner Co. receiver, model CWQ 46229. Any help will be appreciated.

Rex D. Faulkner
3416 Brinkley Road, Apt. 102
Temple Hills MD 20031

For informational purposes, I'm interested in locating amateurs who have operated in former European colonies or territories.

Gary Mitchell WA1GXE
Box 1003
Fairfield CT 06430

I am interested in obtaining information regarding any modifications to the Heathkit HW-101 transceiver or the Heathkit

Mono-Bander transceivers, HW-12, HW-22, or HW-32.

Doug Limbaugh WA9GPH/8
2030 Riverside Court
Lansing MI 48906

I need a repair/service manual and pattern pictures for a Central Electronics, Inc., R.F. Distortion Indicator, model DI-1, serial #2056, manufactured by P&H Electronics of Lafayette, Indiana. I will pay reasonable copying charges if a manual is not available.

James F. Hartley W1DIS
US Route #302, Box 11
Raymond ME 04071

In May, I'm being transferred to Ft. Polk, Louisiana, and need some information on clubs and activities in the Ft. Polk area. Can anyone help?

SSG Gene Slaten
3 BDE LDRSP SCH
APO NY 09074

I need a schematic for a Hy-Gain model 628G hand-held VHF-UHF monitor-scanner. It is a discontinued model and any help will be appreciated.

John Ward WB9EDI
2811 Schumacher Drive
Mishawaka IN 46544

FAST SCAN ATV

WHY GET ON FAST SCAN ATV?

- You can send broadcast quality video of home movies, video tapes, computer games, etc, at a cost that is less than slocan.
- Really improves public service communications for parades, RACES, CAP searches, weather watch, etc.
- DX is about the same as 2 meter simplex - 15 to 100 miles.



ALL IN ONE BOX

TC-1 Transmitter/Conv
Plug in camera, ant, mic and you are on the air \$399 ppd



HITACHI HV-62 TV CAMERA
High performance closed circuit camera just right for atv. with lens \$239 ppd

PUT YOUR OWN SYSTEM TOGETHER

"SEE US IN DAYTON"

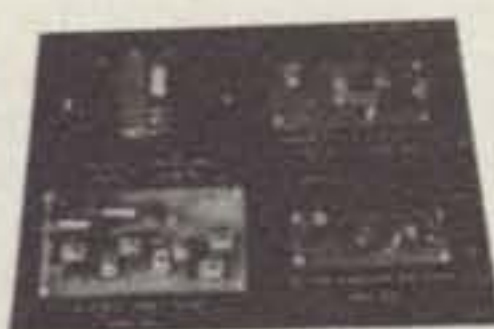

TVC-1B CONVERTER tunes 420 mhz down to ch 2 or 3.. \$49.50 ppd
TXA5 EXCITER \$69 ppd
PA5 10 WATT LINEAR . . \$79 ppd
FMA5 Audio Subcarrier . \$24.50 ppd

SEND FOR OUR CATALOG, WE HAVE IT ALL

Modules for the builder, complete units for the operator, antennas, color cameras, repeaters, preamps, linears, video ider and clock, and more. 19 years in ATV.

Call 213-447-4565

✓57



P.C. ELECTRONICS

Maryann
WB6YSS

2522 DAXSON
ARCADIA, CA 91006

Tom
W6ORG



"CALL FOR QUOTE"

KENWOOD TS-520SE



MADISON ELECTRONICS SUPPLY, INC. ✓45

1508 McKinney • Houston, TX 77002
(713) 658-0268

MASTERCARD • VISA

PRIME STRIKES AGAIN

After removing most of our data processing work from our Prime computer, we were hoping that it would be able to at least keep up with the Reader Service requests for literature. Several thousand readers suffered through our tussles with the Prime when we tried to have it handle subscriptions . . . a battle we lost, leaving thousands of readers angry in the process.

Now that the Reader Service processing is over two months behind, we admit that the Prime seems to have totally defeated our best intentions. We are moving the data processing involved to an outside agency, so it should get back on schedule in short order. This service is going to be handled by the nationally famous A. C. Nielsen Company.

Subscriptions are now being processed by Fulfillment Associates on Long Island and our complaint department has been dropped from twelve full-time people to one part-timer.

You might think that a magazine which deals in part with computers would know better than to get into a fix like that, but the sad fact is that it is difficult to know for sure with a new system such as the Prime. We depended mostly on the people from Prime . . . and believed them.

Readers who have requested information in recent months and not gotten it should try again . . . Nielsen will get it done, and quickly. Please don't blame the advertisers . . . just us. We are sending the big jobs we had planned for the Prime out to service bureaus such as Nielsen and FAI, and turning most of the other data processing we need over to in-house MSI and TRS-80 systems. We have been finding them easy to use, surprisingly dependable, easy to program, and capable of handling an astounding amount of work.

All New HF/SSB 5 Band Transceiver The SS-105

A newly developed all solid state transceiver that offers performance you wouldn't expect from a miniature unit this size. Features superb sensitivity on all bands, multi-mode operation including USB, LSB, CW and FM, and its light weight and compact size make it truly portable.

- Covers the 80M, 40M, 20M, 15M and 10M bands.
- Includes separate transceiver input and output connections.
- Power output: Model SS-105S 10 watts
Model SS-105D 100 watts.
- Weight: 3 kg (6.6 pounds).
- Dimensions: 17.8W x 12.4H x 27.2cm D.
(7 x 4.9 x 10.7 inches)
- Accessories available include Noise Blanker, 500Hz CW filter, FM, RX and TX Modules, Clip-on rechargeable battery pack.



Model SS-105S

\$499⁹⁵

Model SS-105D
\$599⁹⁵

M&M DOES IT!

**COMING
SOON!**

ATLAS 210x/215x 200 WATT SSB TRANSCEIVER

One of the most popular transceivers ever made (over 18,000 sold in 4 years) will soon be available in limited quantities from M & M. And the new price will truly amaze you!

We'll have a few samples on display at Dayton, so be sure to visit our booth.



M&M RF DISTRIBUTORS

2785 Kurtz Street, Suite 4, San Diego, CA 92110
P.O. Box 82183, San Diego, CA 92138

CALL (714) 299-9741

"See us at Dayton! We'll have some great bargains!"

New from Longs . . . Kenwood R-1000 compact communications receiver KENWOOD

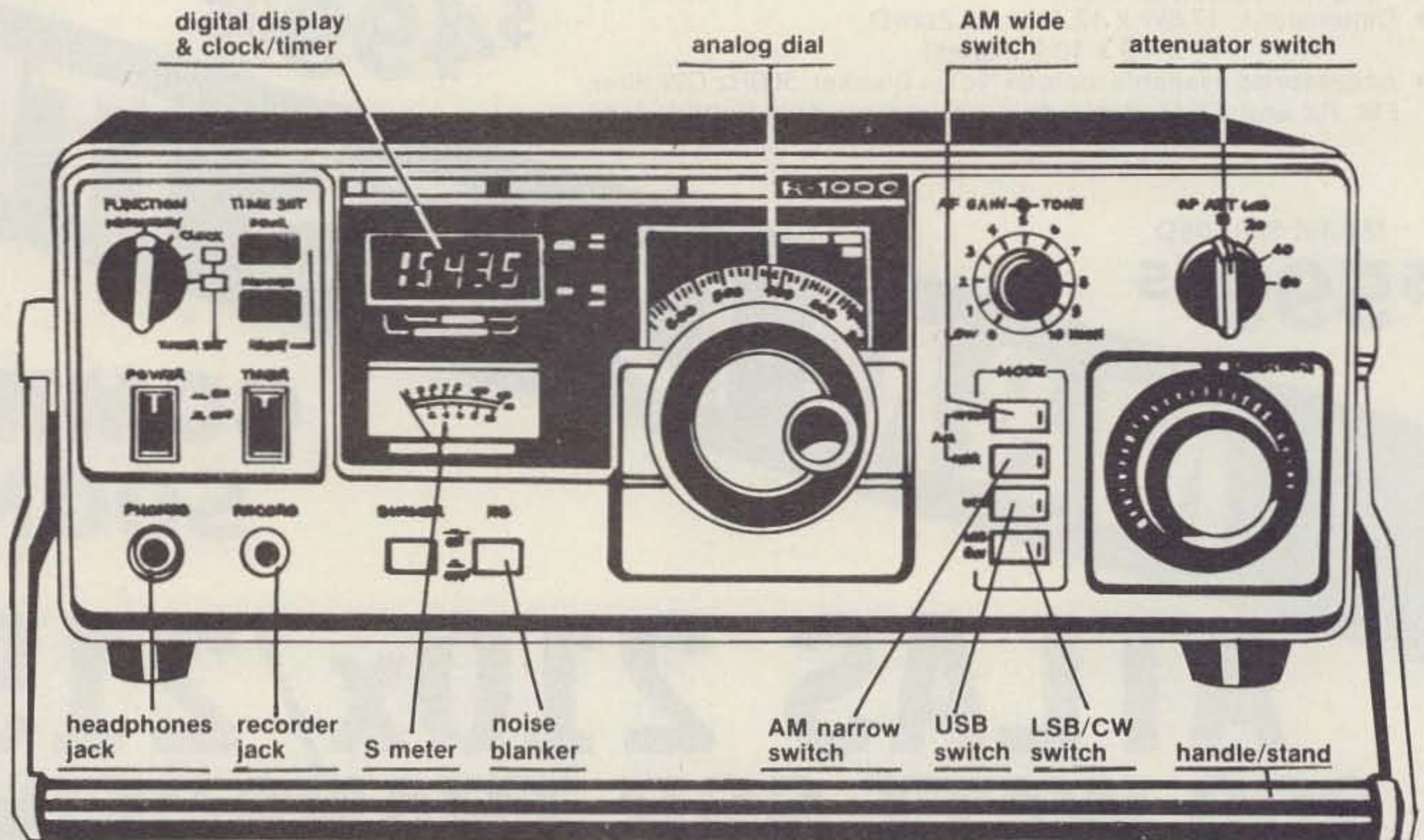

The new, compact (12 $\frac{3}{4}$ "W x 4 $\frac{1}{2}$ "H x 8-9/16"D) R-1000 is a high class general coverage receiver covering 30 bands from 200 KHz to 30 MHz. It features: PLL synthesizer, digital display readout (1 KHz step) and analog dial calibrated at 10 KHz intervals from 0 to 1,000 KHz. The 12 hr. quartz digital clock with timer can be set to go on or off at any time. A stepped RF attenuator provides 20, 40, and 60 dB attenuation to protect the unit from damage by high input power signals. Also features: 3 stage IF filter, tone control, built-in noise blanker, dimmer switch, recording terminal, selectable AC power voltage (100, 120, 220 or 240 VAC), wire antenna terminals and UHF connector (SO-239 for coax cable), large 10 cm built-in speaker, external speaker jack, 2 position antenna selector switch, accessory terminals for timer and muting circuit. Has calibrated S meter, AF gain control, 4 mode switches. Selects LSB/CW, USB, narrow AM or wide AM.

Sensitivity (S + N/N 10 dB or more): SSB 200 KHz - 2 MHz: 5 micro V, AM 50 micro V. SSB 2 MHz - 30 MHz 0.5 micro V, AM 5 micro V. Frequency stability: ± 2 KHz Max. from 1-60 min. after power on, + 300 Hz max. in every subsequent 30 min. Selectivity: AM (wide) 12 KHz at -6dB, 25 KHz at -50dB. AM (narrow) 6 KHz at -6dB, 18 KHz at -50dB. SSB/CW 2.7 KHz at -6dB, 5 KHz at -60dB.

499.00

List Price. Call for quote.

42
Long's



Use your Master Charge or BankAmericard/VISA when you order.

Ham Radio Department Store

MAIL ORDERS: P.O. BOX 11347 BIRMINGHAM, AL 35202 • STREET ADDRESS: 2808 7TH AVENUE SOUTH BIRMINGHAM, ALABAMA 35233

A full 2KW PEP amplifier at a price you can afford — The DENTRON Clipperton L linear amplifier! *Dentron*

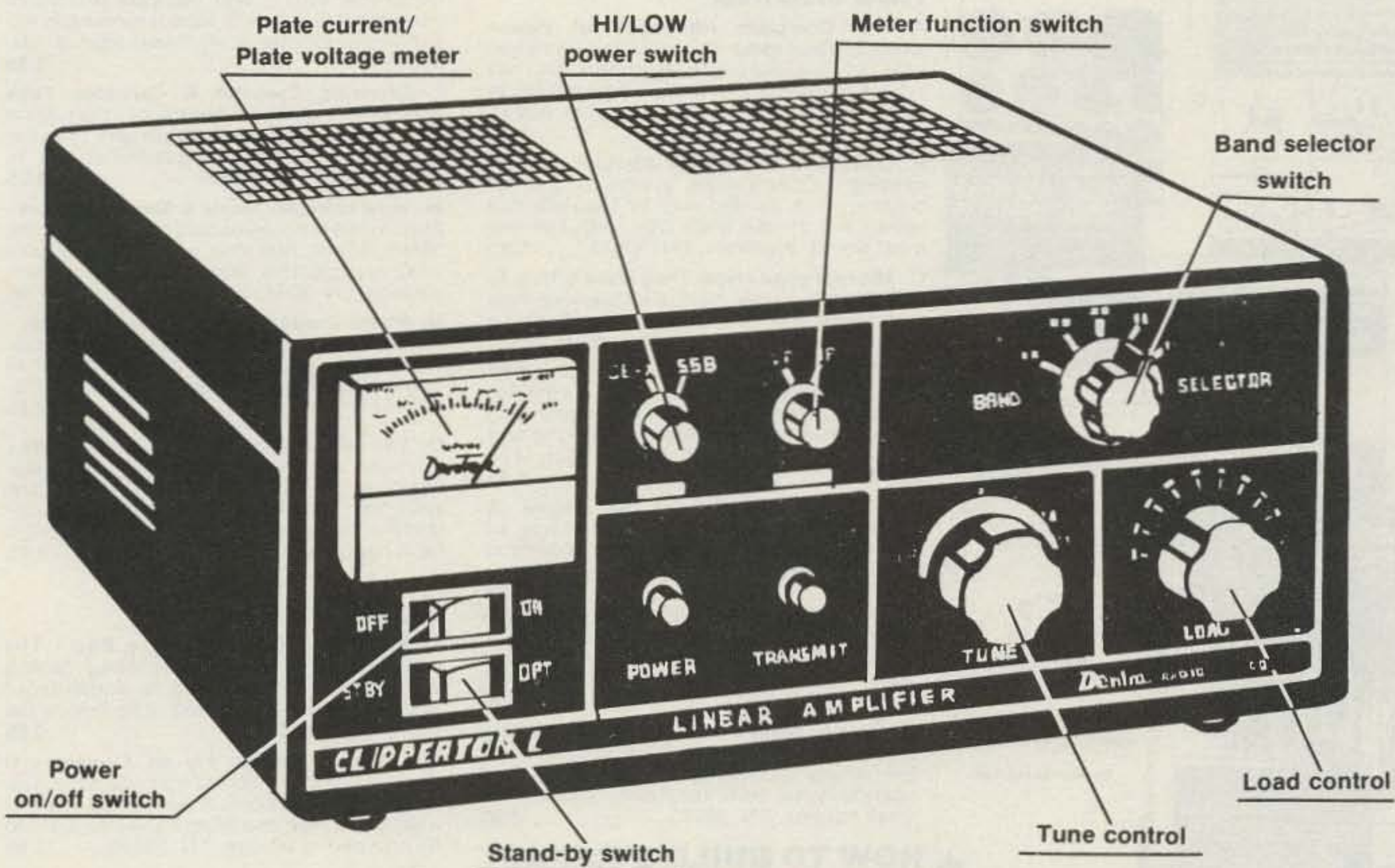

The Clipperton L linear amplifier covers 160-15 meters and most MARS frequencies. It delivers 2000 watts PEP input on SSB and 1000 watts DC input on CW, RTTY, or SSTV; all continuous duty. There are four 572B triodes operating in grounded grid, hi/lo power switching and linear bypass from the front panel, a large illuminated meter for monitoring plate current and plate voltage, a built-in continuous duty power supply—2500 volt idle SSB — 1800 volt idle CW approximately with rear panel selection of 117 volts or 234 volts primary transformer taps and adjustable ALC. The Clipperton L also features forced air cooling for longer tube life, harmonic suppression that meets or exceeds FCC requirements, 50 ohm impedance unbalanced at better than 1.5 to 1 VSWR and 50 ohm output impedance. Size: 6"H x 14½"W x 14½"D. Weight: 42 lbs.

CALL NOW!

699.50

List Price. Call for quote.

Call Toll Free **1-800-633-3410**

IN ALABAMA CALL 1-800-292-8668 9 AM TIL 5:30 PM CST, MONDAY THRU FRIDAY



AUDIO & VIDEO RECORDING

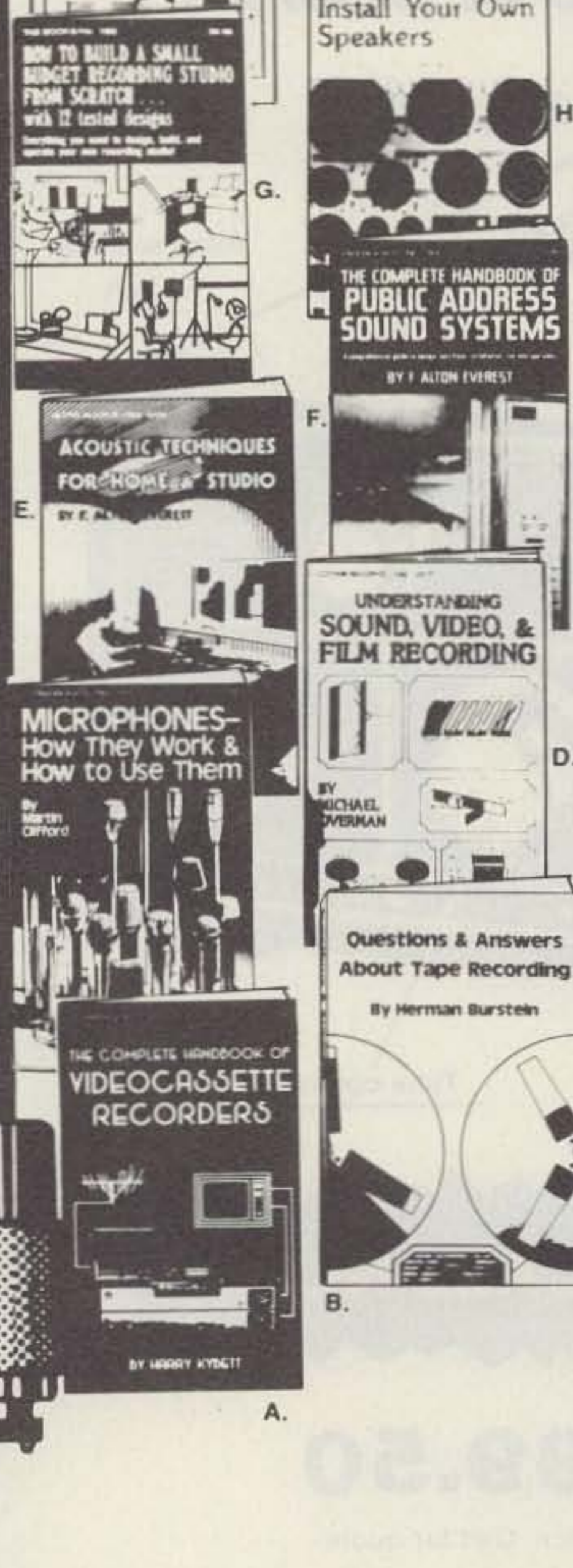

- A. The Complete Handbook of Videocassette Recorders** - For the non-technical user of videocassette recorders. It has simple language and practical examples to make clear common situations. I.N. 30639. **5.95**
- B. Questions & Answers About Tape Recording** - Covers every aspect of tape recording. It is divided into 19 chapters and answers in simple every day language, the most asked questions. I.N. 30635. **5.95**
- C. Microphones--How They Work & How to Use Them** - A new manual for learning how mics work and how to use them. Explains technical terms, applications and problems. I.N. 30641. **5.95**
- D. Understanding Sound, Video, & Film Recording** - Tells how they work, what's best for you and describes the background and the virtues and limitations for each. I.N. 30649. **5.95**
- E. Acoustic Techniques for Home & Studio**—A book that points the way to reasonable solutions for many common problems in home acoustics. I.N. 30634. **6.95**
- F. The Complete Handbook of Public Address Sound Systems** - A total guide to design, purchase, installation, use and operation. Covers church, hall, school PA systems. I.N. 30551. **7.95**
- G. How to Build a Small Budget Recording Studio from Scratch** - 12 tested designs. Everything you need to design, build, and operate your own recording studio. For small studios. I.N. 30655. **8.95**

HOW TO BUILD & REPAIR

- H. How to Select and Install Your Own Speakers** - How to get the best sound reproduction from any audio system. A thorough understanding of speakers & how to install them. I.N. 30650. **5.95**
- I. Mimeograph Operation, Maintenance & Repair** - A guide to understanding, operating and servicing every kind of school, office, church, club mimeograph. Detailed information on all aspects of use. I.N. 30647. **6.95**
- J. How to Design, Build, & Test Complete Speaker Systems** - Contains a variety of ready to build speaker projects plus all the info a beginner needs to design and build his own. I.N. 30652. **7.95**

- K. Cassette Tape Recorders How They Work - Care and Repair** - A cassette handbook with a well rounded picture of equipment and how to keep it running in top condition. Covers some basic repairs. I.N. 30636. **5.95**
- L. Servicing Cassette & Cartridge Tape Players** - A practical source of information on cartridge and cassette players of every description. Testing, adjustments are in each chapter. I.N. 30637. **6.95**
- M. How to Repair Movie & Slide Projectors** - Step by step do-it-yourself repairs for 8mm, 16mm, 35mm, film strip, slide, overhead and opaque projectors, and silent and sound film viewers. I.N. 30648. **7.95**
- N. Photo Guide to AM/FM Stereo Repair** - An easy to use troubleshooting guide. Covers the most popular stereos in down to earth language and step by step illustrations. I.N. 30646. **7.95**
- O. The ABC Book of Hi-Fi/Audio Projects** - A make it yourself book for hobbyists, beginner or advanced. Design and build your own equipment. Each project has detailed instructions to make it easy enough for a beginner. I.N. 30658. **4.95**

FLYING

- P. Hang Gliding - Fly Like a Bird** - The complete flight manual for hang gliding enthusiasts. All you need to know about weather, construction and activities in the sport. I.N. 30615. **5.95**
- Q. Learning How to Fly an Airplane** - If you're thinking of taking flying lessons, you should read this book. A detailed account of what's required and what it's like to learn to fly and earn a license. I.N. 30565. **5.95**

CRAFTS

- R. Sewing With Scraps** - An easy to follow guide that shows you how to turn left-over scraps and bargain remnants into beautiful and stylish clothing and gifts. I.N. 30642. **4.95**
- S. Crafts for Kids** - A book full of easy to make projects for children. Inexpensive and easy to find materials and clear explanations with illustrations. I.N. 30638. **7.95**

Call today for shipping and handling charges.

Long's

Ham Radio Department Store



Use your Master Charge or BankAmericard/VISA when you order.

MAIL ORDERS: P.O. BOX 11347 BIRMINGHAM, AL 35202 • STREET ADDRESS: 2808 7TH AVENUE SOUTH BIRMINGHAM, ALABAMA 35233



HOME ENERGY

A. How to Make Your Own Solar Electricity - This book will show you how to build your own solar energy conversion system to make electricity to heat or cool your home and operate appliances. I.N. 30656 ... **5.95**

B. Homeowner's Guide to Saving Energy - A lot of the best and simplest ways for you to save both energy and money. For the average person using basic tools. Instructions & diagrams. I.N. 30644 ... **5.95**

C. Wood Heating Handbook - Here's how to use, select, install and maintain fireplaces and wood stoves and save up to 50%! Plus how to cut, store, season, split and burn wood. I.N. 30640 ... **5.95**

D. Adding Solar Heat to Your Home - Step by step instructions for using solar heat in your home. A complete guide to the practical aspects of solar heating. I.N. 306577.95

E. Homeowner's Guide to Solar Heating & Cooling - How to purchase, install, and maintain solar heating/cooling and hot-water systems. A step by step analysis. I.N. 30645 ... **4.95**

F. How to Cut Your Electric Bill and Install Your Own Emergency Power System - Shows how to cut power waste and how to buy and operate a portable power generator. I.N. 30651 ... **2.95**

G. The Family Handyman Practical Book of Saving Home Energy - Hundreds of tested ideas to save your energy dollars without giving up comfort. Easy to read charts & diagrams. I.N. 30653 ... **5.95**

H. Do It Yourself's Guide to Modern Energy Efficient Heating & Cooling Systems - How to choose, install, maintain, troubleshoot, and repair solar, radiant, hot water and hot air systems... and how to cut down on energy costs. I.N. 30643 ... **5.95**

I. How to Make Home Electricity From Wind, Water & Sunshine - A complete guide to nature's forces to make your own electricity. Lots of practical data to apply to your own needs. I.N. 30654 ... **5.95**

COMPUTERS

J. Microprocessor Programming for Computer Hobbyists - 24 chapters of solid information covering the basics of computer programming in simple, easy to understand language. I.N. 30511 ... **8.95**

K. 57 Practical Programs & Games in BASIC Programs - For everything from space war games to black jack. All programs will run on any floating point BASIC. I.N. 30501. ... **7.95**

L. Beginner's Guide to Microprocessors - Everything you need to know to get started with personal computers and microprocessors. An in-depth introduction. I.N. 30502 ... **5.95**

M. Getting the Most Out of Your Electronic Calculator - Numerous practical examples and shortcuts and how to get the right answer in the least time. Uses every day calculations. I.N. 30528 ... **4.95**

N. The "Compulator" Book - Building super calculators & minicomputer hardware with calculator chips. Includes many projects with easy-to-understand instructions. I.N. 30509 ... **7.95**

O. Understanding Micro Computers and Small Computer Systems - Easy reading book with all the fundamental concepts behind micro computers. Includes glossary. 300 pages of no nonsense text. I.N. 32404. ... **9.95**

AMATEUR RADIO

P. Ameco Novice Class Radio Amateur License Guide - The fastest way to a ham ticket... Includes FCC questions, easy-to-understand answers and an FCC type multiple choice practice exam. I.N. 24828. ... **1.00**

Q. The Complete Shortwave Listener's Handbook - A total explanation of the hobby of shortwave listening. Packed with little known facts and a lot of interesting shortwave history. I.N. 30532 ... **9.95**

R. How to Be A Ham - Includes the latest FCC rules. All you need to know about the fascinating world of amateur radio. Tells you the basics of a hobby that can take you around the world! I.N. 30533 ... **3.95**

S. Better Shortwave Reception - How your radio receiver works, how to adjust it for best performance, all about VHF-FM scanning receivers, in short, all about shortwave reception and how to make it your hobby. I.N. 26204 ... **4.95**

T. ARRL Code Kit - Boost your code speed from 5 to 13 wpm quickly, easily and enjoyably. 2 hrs. of random code groups on cassettes, 5, 7½, 10, and 13 wpm plus an illustrated guide. I.N. 10046 ... **8.00**

Call today for shipping and handling charges.



Call Toll Free **1-800-633-3410**

IN ALABAMA CALL 1-800-292-8668 9 AM TIL 5:30 PM CST, MONDAY THRU FRIDAY

Power to the mobile operators! ICOM IC-255A 25 watt 2 meter FM transceiver!

CALL NOW!

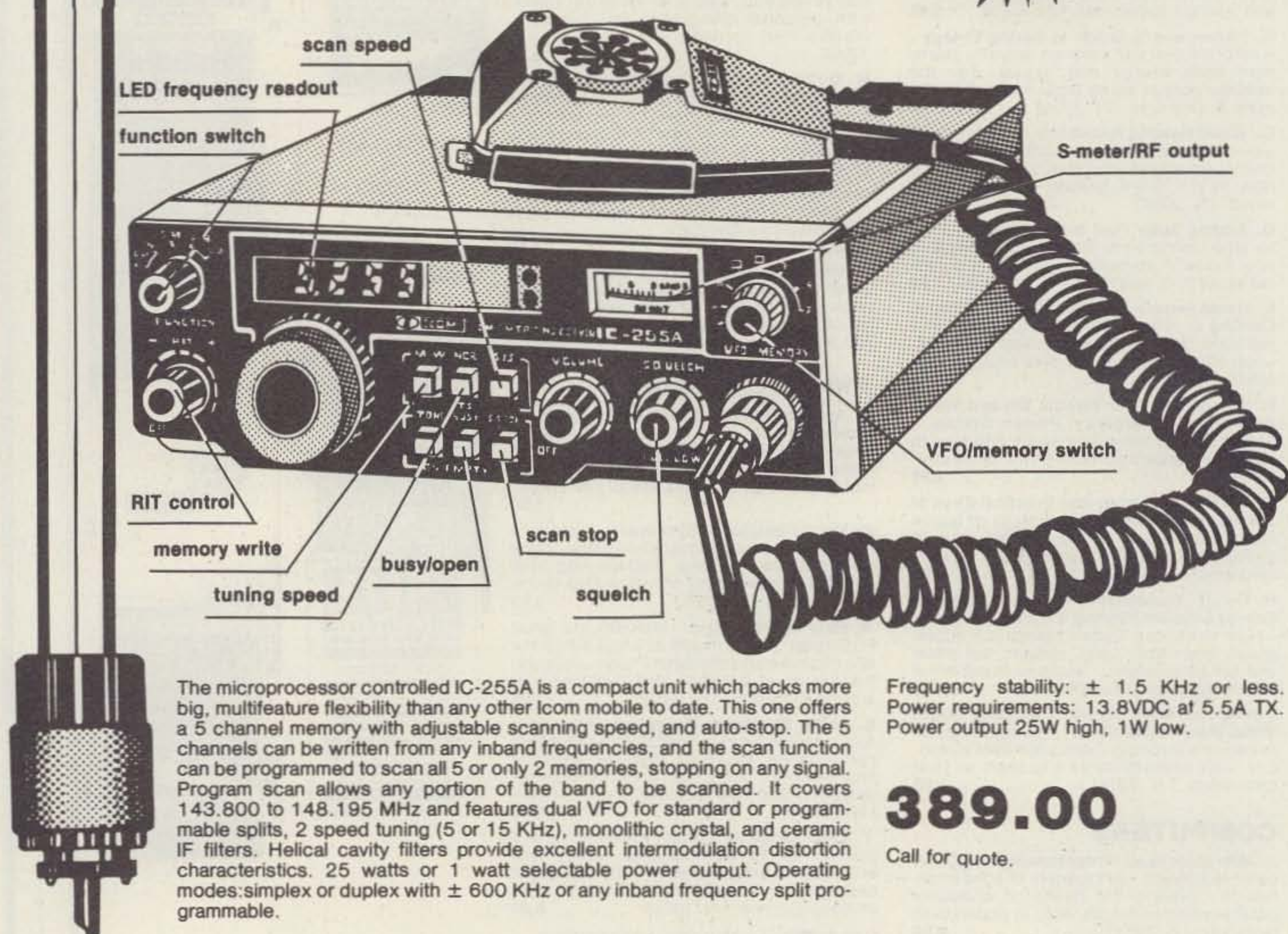

The microprocessor controlled IC-255A is a compact unit which packs more big, multifeature flexibility than any other Icom mobile to date. This one offers a 5 channel memory with adjustable scanning speed, and auto-stop. The 5 channels can be written from any inband frequencies, and the scan function can be programmed to scan all 5 or only 2 memories, stopping on any signal. Program scan allows any portion of the band to be scanned. It covers 143.800 to 148.195 MHz and features dual VFO for standard or programmable splits, 2 speed tuning (5 or 15 KHz), monolithic crystal, and ceramic IF filters. Helical cavity filters provide excellent intermodulation distortion characteristics. 25 watts or 1 watt selectable power output. Operating modes: simplex or duplex with ± 600 KHz or any inband frequency split programmable.

Frequency stability: ± 1.5 KHz or less.
Power requirements: 13.8VDC at 5.5A TX.
Power output 25W high, 1W low.

389.00

Call for quote.

Long's



Use your Master Charge or BankAmericard/VISA when you order.

Ham Radio Department Store

MAIL ORDERS: P.O. BOX 11347 BIRMINGHAM, AL 35202 • STREET ADDRESS: 2808 7TH AVENUE SOUTH BIRMINGHAM, ALABAMA 35233

ICOM IC-551 compact 50 MHz all mode transceiver

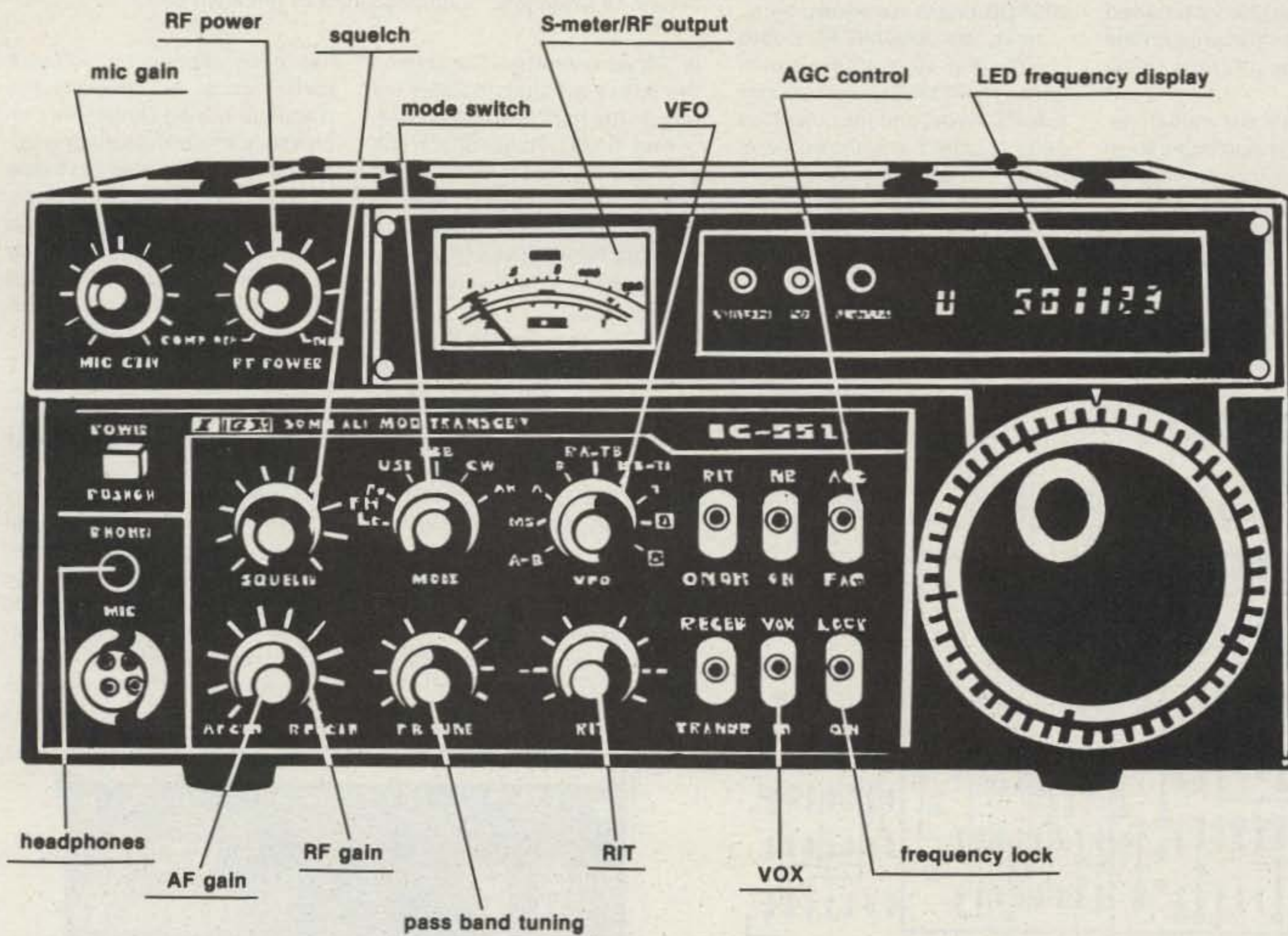

Icom's IC-551 is an all mode 6 meter unit in a compact, easy to use instrument which uses a built-in microprocessor for frequency control and scanning. The no backlash, no delay dual VFO light chopper system is included as a standard feature and provides split frequency operation as well as completely variable offsets. It covers 50.000 MHz to 53.999.9 MHz and features a 6 digit frequency readout, 2 digital VFO's, built-in AC/DC power supply, variable output from 1 to 10 watts, dial lock switch for mobile use, noise blanker, variable scan speed, and 3 memories. It can scan memories and scan the entire 6 meter band or any selected segment of the band. Modes:SSB, CW, AM, FM (optional). FF speech processor and variable bandpass module optional. VOX unit available. Power output: SSB 10W PEP (1-10W adjustable), CW 10W (1-10W adjustable), AM 4W (1-4 adjustable), FM 10W (1-10W adjustable).



Sensitivity: SSB, CW, AM less than 0.5 microvolts for 10 dB S+N/N FM. More than 30 dB S+N+D/N+D at 1 microvolt. Less than 0.6 microvolts for 20 dB noise quieting.

449.00

Call for quote.

Call Toll Free **1-800-633-3410**

IN ALABAMA CALL 1-800-292-8668 9 AM TIL 5:30 PM CST, MONDAY THRU FRIDAY

Corrections

In "The Dollar-Saver DVM" (73, January, 1980, p. 83), we incorrectly listed Beckman Instruments, Inc., of Fullerton, California, as the source of the parts kit for the DVM in the article.

Payment for the parts kit should be directed to the author, not Beckman Instruments, Inc. Additionally, all checks received by Beckman Instruments for the parts kit will be returned to the senders.

We regret this unfortunate error and offer our apologies to all who have been inconvenienced by it.

Gene Smarte WB6TOV
News Editor

There are several errors in my article, "An LED Display for the

HW-2036" (October, 1979), and I hope that this will help solve the problems encountered by those readers who attempted to construct the display.

First, Fig. 9 (p. 40), top view, is correct. However, the PC layout in the bottom view is not. PC layouts for both sides of the 2036-DB board are shown here.

Next, the 2036-MB PC board layouts (Fig. 10, p. 40) are also in error. The 2036-MB component side PC layout and the corrected parts location are shown here. Note that, as mentioned in the original article, the 1-MHz crystal and neighboring 0.01- μ F capacitors are not mounted on the component side.

The designations for the pin-outs of the chips shown in Fig. 8

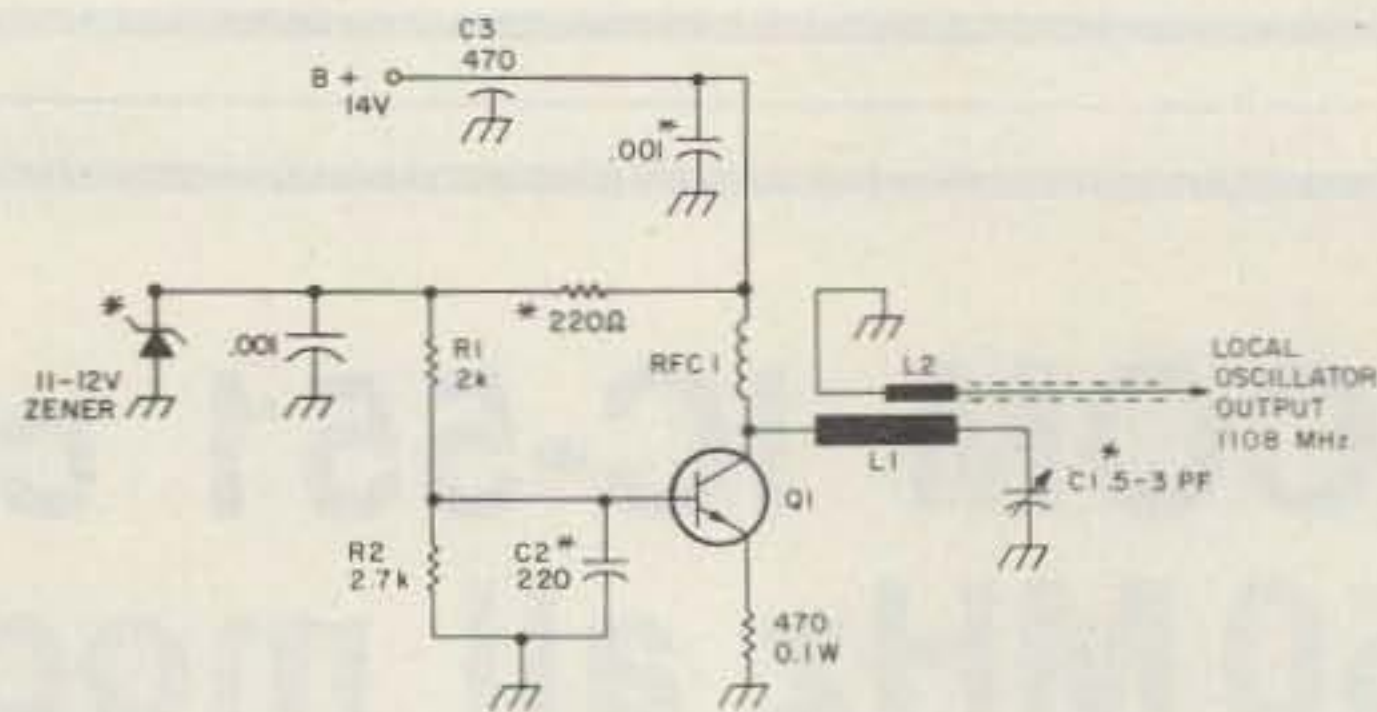

Revised local oscillator circuit, Fig. 5 (b), of "You Can Watch Those Secret TV Channels." * indicates new or changed part.

(p. 39) were omitted. The chip on the left is a Fairchild 9368; the one on the right is an SN74LS48.

And, finally, Radio Shack has changed the part number of the 24-conductor mike cable to W-1870. It can be ordered by phoning Radio Shack Customer Service in Ft. Worth at (817)-531-0274.

Tom French WA4BZP
1161 Lane Park Road
Tavares FL 32778

Here are some updates to the microwave TV downconverter circuit that was originally described in the August, 1979, 73 Magazine article entitled, "You Can Watch Those Secret TV Channels."

- The value of the capacitor between S1 and J3 in the power supply is 0.001 μ F.
- The local oscillator circuit

has been changed to improve performance and increase the electrical tuning range. This increase in electrical tuning is especially nice during extreme outside temperature changes. The improved oscillator circuit is shown in the accompanying schematic diagram. The original PC board may be modified with careful use of a sharp knife to incorporate the changes. Be sure that the two 0.001- μ F capacitors are located as close to the B+ end of R1 and RFC1 as possible.

• If the above LO change is made, then smoother electrical tuning will result by lowering the maximum power supply voltage to about 15.5 volts. This can be done by replacing the 910 Ω resistor, R1, with 1500 Ω .

• It was found that when in direct sunlight the temperature

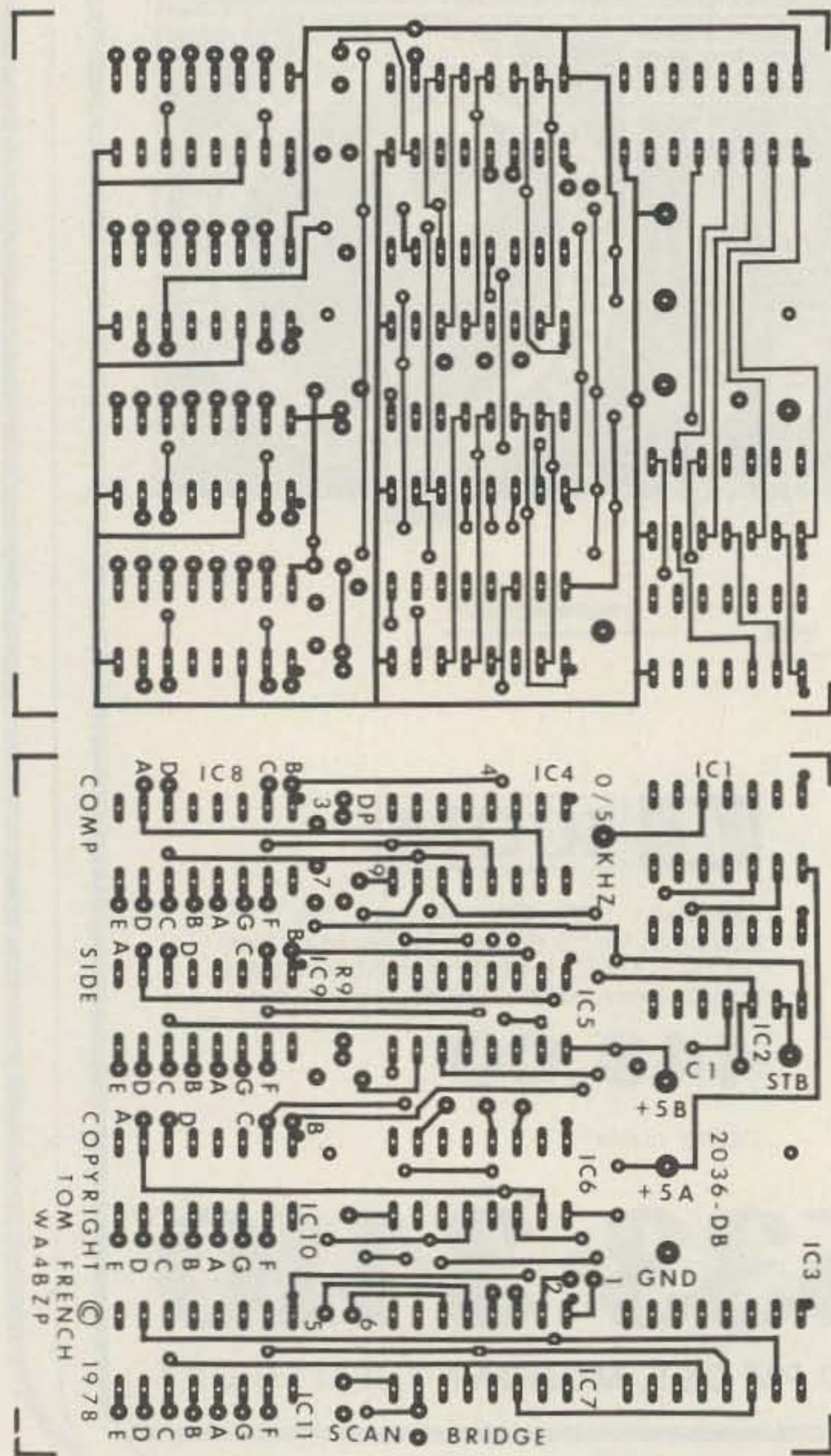

Revised Fig. 9, "An LED Display for the HW-2036."

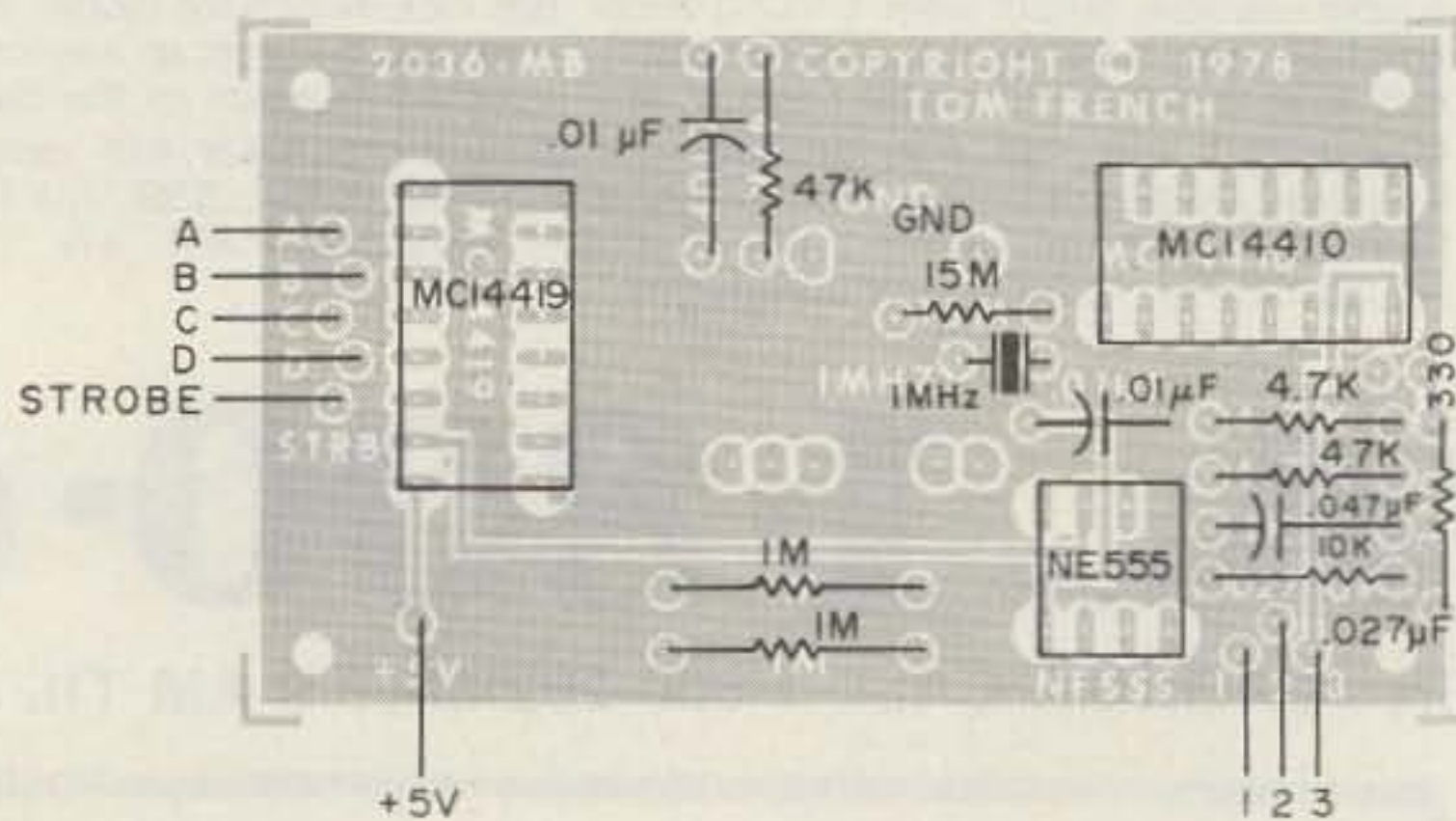
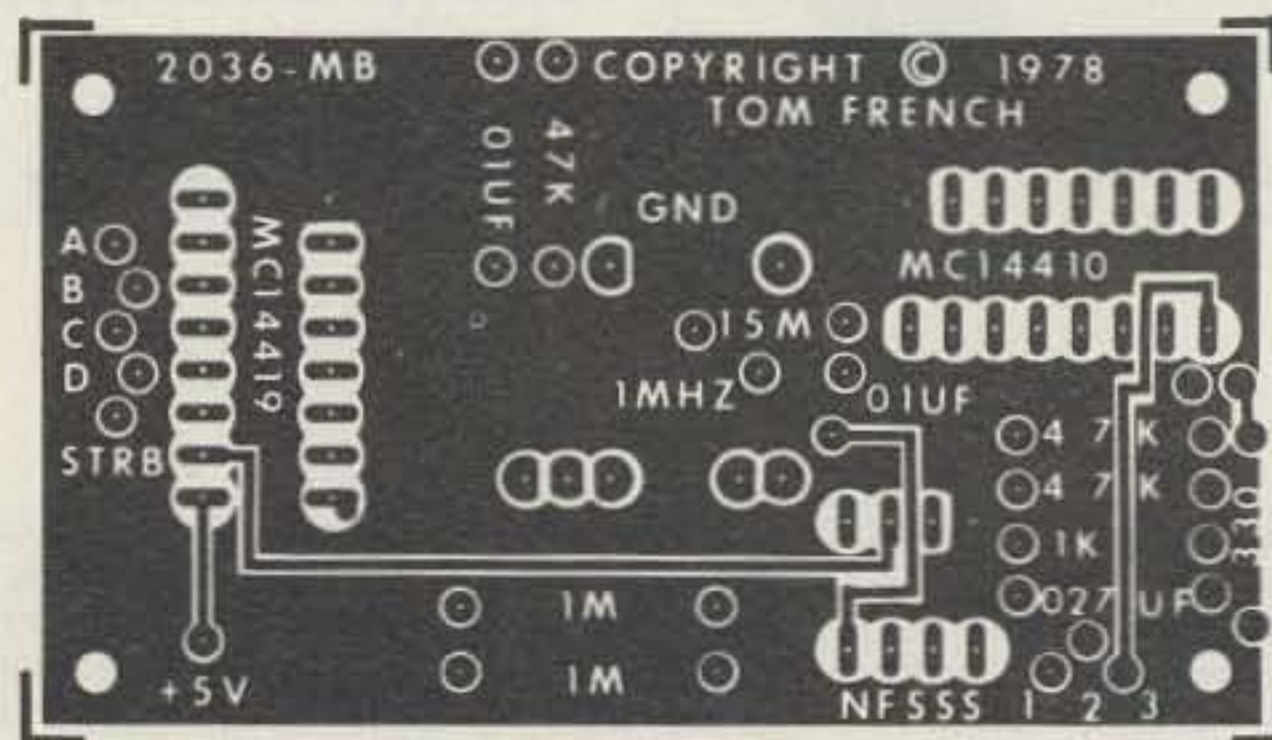

Revised Fig. 10, "An LED Display for the HW-2036."

in the downconverter box can get excessively high. Painting the box white and, if possible, positioning it to be shaded by the antenna will keep its temperature at a more reasonable level.

● Use *very small* drops of epoxy to attach the mixer lines to the base board.

● The length of the piece of small coaxial cable between the LO and the mixer line should not

exceed 5 cm (2 in.).

● Even after careful assembly and tune-up of the converter, a few of them seemed to lack sensitivity. The cause of this has been found to be a bad impedance match between the antenna and the mixer. A significant improvement can sometimes be made by replacing the 5-pF antenna coupling capacitor (C1) with a "gimmick" capacitor

made from a piece of bare solid hook-up wire, about 22 AWG or so.

Make the "gimmick" by forming a loop about 1/8" in diameter on one end of the wire and filling it with solder to give it a little extra surface area. Attach the other end to the antenna connector, suspending the looped end over the diode end of L2 where the 5-pF capacitor was

previously attached. Space it above about 1/32" at first, then carefully adjust the spacing with an insulated stick for best signal.

Parts and PC boards for this project can be obtained from the authors. Send an SASE to me for a list.

Jim Barber K0JB
22518 97th Avenue N
Rogers MN 55374

Ham Help

The Atlanta Radio Club is offering two cash scholarships of \$500 each this year. Applicants must be licensed amateurs and must be high-school graduates entering an accredited college or university as freshmen in the fall of 1980. All applications must be completed and post-marked not later than midnight, May 15, 1980. Write to the Atlanta Radio Club Scholarships, PO Box 77171, Atlanta GA 30357, for application forms and additional information.

Phil Latta W4GTS
Secretary, Atlanta Radio Club
Scholarship Committee
259 Weatherstone Parkway NE
Marietta GA 30067

I need schematics or technical info on the following: Triplett model 3433 AM/FM signal generator, Deltron model C5-10.5C B power supply (s.n. 34983), and Navy surplus receiver, AN/URR 35B. I'm interested in conversion of the latter to two meters. Thank you.

George H. Potts
113 7th Avenue
Roebing NJ 08554

I have 3 UHF oscillators which I would be happy to donate to an individual or club.

The units are about 4" high and 3" in diameter and look like gold-plated (gad!) brass—complete with lighthouse-type tubes and marked "freq 1.71-1.73 GC." These were manufactured by Trak in 1963.

All these tubes have filament continuity, but there is no guarantee that they will oscillate. The units have grid- and plate-tuning slugs. Any takers?

David D. Blackmer WA6UNK
Route 3, Evergreen
Nipomo CA 93444

I have acquired a Bell System Star Set, model KS-20778, series B headphone and mike. It is designed for use with telephone operations. I would like to be able to use the set with an SB-104A from Heath. Any schematics, modifications, advice, etc., would be greatly appreciated.

Michael D'Antignac
908 Alpha Street
Inglewood CA 90302

I need help in obtaining repair/service information or at least a complete schematic for a Telequipment Servicescope oscilloscope, type S-32. I will be happy to pay for the manual or for copies or will borrow and return the manual after copying it myself. Any help will be sincerely appreciated.

John R. Parke WA2JYA
125 Hempstead Road
Trenton NJ 08610

I wish to purchase, in any condition, a Heathkit Ham-Scan Panoramic Adapter, model HO-13.

Kenneth Hunt WB7OVU
6519 Valhalla Ave.
Klamath Falls OR 97601

I have need for schematic diagrams and any other available information for a Link model 150T1 FM transmitter and a model 150FR1 FM receiver. I would be happy to compensate for copying costs, etc., or be willing to buy the service manuals involved.

Jerry Van W9VOW
1150 Kellogg St.
Green Bay WI 54303

I would like to buy or borrow a manual and schematic for a

McMurdo Silver signal generator, model 906, which covers 90 kHz to 170 MHz.

H. W. Brown K1TQ
1015 Concord Circle
Haddonfield NJ 08033

I need a front glass, scaled for a Hallicrafters SX-111 receiver. Thank you.

Kirt Damon KA5GSI
6027 Chef Mentour Hwy
Suite 202A
New Orleans LA 70126

I have just been put in charge of my club's hamfest for this fall and would like any newsletters or other information from readers which can help me make it a good one. In fact, I would appreciate a copy of any club newsletter that might have meeting ideas, etc., which I can pass along. Thanks.

Matt Beha, Jr. KA4DYM/8
3752 Lane Court
St. Joseph MI 49085

I need help in converting a Royce model 639 SSB CB radio to 10 meters. The SSB generator uses two crystals, LSB—9.7875 and USB—9.7825. The PLL circuit uses three crystals, LSB—10.2385, USB—10.2415, and AM—10.240. The unit also uses a 27-MHz ceramic filter before the driver and final in the transmitter.

I would appreciate any information from anyone who has converted the 639 or a unit that uses a similar circuit. Thank you.

Jon W. Krannawitter WB0RNN
514 W 21st
Hays KS 67601

I'm Looking for *Radio Boys with the Flood Fighters* and *Radio Boys in Gold Valley*, by Chapman, to complete a series.

R. Randall K6ARE
1263 Lakehurst Road
Livermore CA 94550

I need schematics, alignment instructions, voltage readings, etc., for an HRO 5TA1 (pre-WWII) and an 1155-series receiver (WWII R.A.F.). The HRO and 1155 have external power packs and the 1155B has a built-in power pack.

I will shortly be a licensed ZE and will certainly appreciate any help. Thank you very much.

Brian W. Legg
9 Wingate Road, Highlands
Salisbury, Zimbabwe Rhodesia

I need a schematic diagram for a Gonset Communicator II 2-meter AM transceiver. I will repay any reasonable photocopying charges or copy and return. I need only the schematic, not the operation manual.

Tim McDonough WD9EDT
1800 Pickett Street
Springfield IL 62703

I need a schematic and manual for an Eico scope, Model 435. I will copy and return and pay all postage.

Jim Spivey KB4DQ
Rt. 1, Box 23-B
Cusseta GA 31805

I am in need of diagrams, schematics, alignment instructions, and info on any mods to the Hammarlund HQ-140-X. I will copy and return.

John A. Poplawski WB2GFR
9 East 15th Street
Bayonne NJ 07002

I have acquired a National NC-88 receiver in poor working condition. If anyone can supply a schematic diagram, I will gladly pay for copying and mailing costs.

I would also like any references to any articles that would be useful for repairing old receivers. Thank you.

Marc S. Webb WB1FPB
566 Washington St., #17
Weymouth MA 02188

Radio Amateurs!

AZDEN PGS-2000

••• \$339.00 List. Ask For Quote

SWAN ASTRO 102BX

••• \$1195.00 List. Ask For Quote

TEN-TEC OMNI D

••• \$1119.00 List. Ask For Quote

Amateur equipment accessories & antennas.
Amateur & commercial repair service.



✓ 301

2317 Vance Jackson Rd. San Antonio, TX 78213
(512) 734-7793

NOW! NOW! NOW! NOW! NOW!

The ultimate answer for eliminating the damaging effects of antenna weight on your rotor . . . it's the

"UDM THRUSTOR"



- Fits any taper tower or can be used with flat top.
- Accepts 1 1/4" mast pipe
- All steel construction.
- Utilizing precision ground & hardened ball-type thrust bearing.
- Comes ready to install.
- Eliminates the damaging effect on your rotor.
- Shipped prepaid UPS (U.S.A.)
- Check, cash, money order, Visa, MasterCard. \$49.95 complete.
- Also available for 2" mast pipe for \$59.95

UDM ENTERPRISES ✓ 319

P.O. Box 2037, Sandusky, Ohio 44870

CB TO 10 METER

10 METER CONVERSION KITS FOR CB RADIOS AM-FM & SSB

- Kits for over 300 Models of CB Radios
- Low Cost from \$10.00
Easy to Install with All Instructions
Tune-Up Procedure Alignment
- KITS FOR MOST POPULAR UNITS
Over 5,000 Satisfied Customers
- Write or Call Today for Our Free
1980 Catalogue

AMERICAN CRYSTAL SUPPLY COMPANY

PO Box 638
W Yarmouth, MA 02673
(617) 771-4634 ✓ 7

New SATELLITE For the TV home.



Supersharp Reception—Color Like Never Before
Get over 50 channels of television directly from the satellite! HBO, Showtime, the Superstations, and sports from around the world!



Works Anywhere!

Buy complete or build and save. Our book tells everything! Send \$7.95 today or call our 24 hr. C.O.D. Hotline!

(305) 869-4283

SPACECOAST RESEARCH ✓ 309
P.O. Box 442, Dept. G, Altamonte Springs, FL 32701

SYNTHESIZED SIGNAL GENERATOR

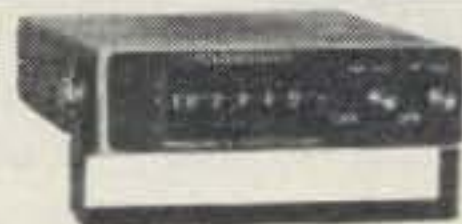

- Covers 100 to 179.999 MHz in 1 kHz steps with thumb-wheel dial
- Accuracy .00001% at all frequencies
- Internal frequency modulation from 0 to over 100 kHz at a 1 kHz rate
- Spurs and noise at least 60dB below carrier
- RF output adjustable from 50 to 500mv across 50 ohms
- Operates on 12vdc @ 1/2 amp
- Price \$299.95 plus shipping.

In stock for immediate shipping. Overnight delivery available at extra cost. Phone: (212) 468-2720.

✓ 311

VANGUARD LABS

196-23 Jamacia Ave. Hollis, NY 11423

Radio Shack DEALER COMPUTER SPECIALISTS



15% Discount on
TRS-80's - I
AND ACCESSORIES

POPULAR 16K LEVEL 2 SYSTEM.....\$722.00
FAST 100 cps Centronics 730 PRINTER.....\$800.00
HIGHLY RELIABLE LOBO DRIVES.....\$375.00

MICRO MANAGEMENT SYSTEMS

DOWNTOWN PLAZA SHOPPING CENTER
115 C SECOND AVE. S.W.
CAIRO, GEORGIA 31728 ✓ 313
912-377-7120

TRS-80 is a Registered Trademark of Tandy Corp.

50 144 REPEATERS 220 450 Mhz

Hi Pro Mk I

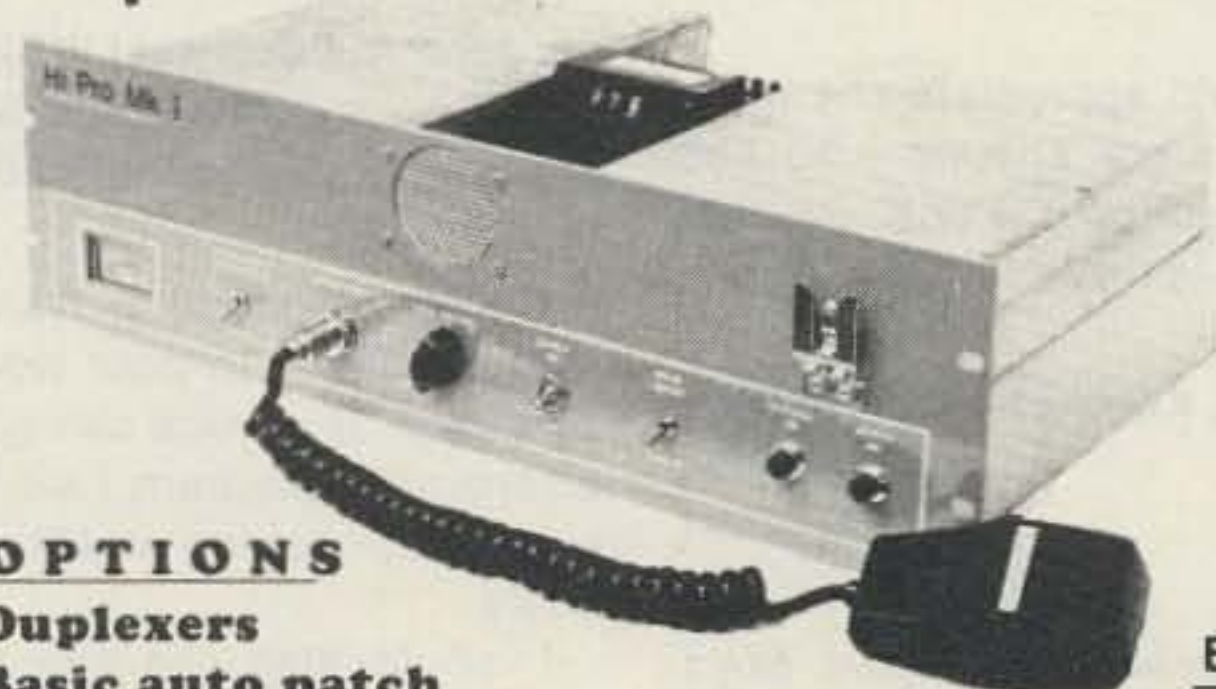

OPTIONS

- Duplexers
- Basic auto patch
- Matching cabinet
- .0005% High stability crystals

50 MHz \$889.95 450 MHz 899.95
144 or 220 MHz 799.95

PA Res. add 6% tax
PLUS SHIPPING

New and Improved
Receiver
and Transmitter

Available Separately:

COR Identifier: All on one board, programmable, Fully adjustable, time out (.5-7 min.), hang time (0-1 min.), identifier (1-10 min.), tone, speed, volume, L.E.D. outputs, low current drain CMOS logic, plugs for easy installation and removal plus much more. \$89.95

Basic Repeater \$599.95

2M 130-175 MHz Basic Repeater for 2 meters with all the features of the Hi Pro Mkl less the power supply and front panel controls and accessories.

Maggiore Electronic Laboratory

845 WESTTOWN RD. ✓ 46
WEST CHESTER, PA. 19380 PHONE 215 436-6051

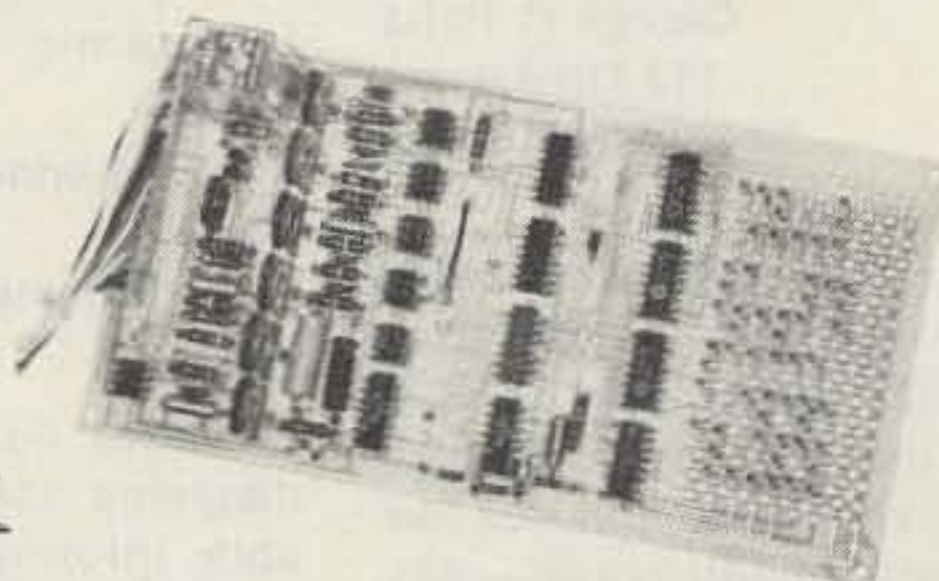

New MFJ 3 & 1.5 KW Versa Tuners

Run up to 3 KW or 1.5 KW PEP and match everything from 1.8 thru 30 MHz: coax, balanced line, random wire. Built-in balun.

3 KW VERSA TUNER IV's

1.5 KW VERSA TUNER III's



NEW MFJ KW VERSA TUNERS HAVE THESE FEATURES IN COMMON

These 6 new MFJ KW Versa Tuners let you run up to 3 KW or 1.5 KW PEP (depending on the model) and match any feedline continuously from 1.8 to 30 MHz: coax, balanced line or random wire. Gives maximum power transfer. Harmonic attenuation reduces TVI, out of band emissions. All metal, low profile cabinet gives RFI protection, rigid construction, sleek styling. Black. Rich anodized aluminum front panel. 5x14x14 inches.

Flip down stand tilts tuner for easy viewing.

Efficient, encapsulated 4:1 ferrite balun. 250 pf, 6000 volt capacitors. 18 position dual inductor, 17 amp, 3000 V ceramic rotary switch (3 KW version). 12 position inductor, ceramic rotary switch (1.5 KW version). 2% meters. SO-239 coax connectors, ceramic feedthru for random wire and balanced line. One year limited warranty. Made in U.S.A.

3 KW VERSA TUNER IV's

1 MFJ-984 3 KW VERSA TUNER IV
\$299⁹⁵ *EXCLUSIVE RF AMMETER*
insures maximum power to antenna at minimum SWR. Built-in dummy load.

This is MFJ's best 3 KW Versa Tuner IV. The MFJ-984 Deluxe 3 KW Versa Tuner IV gives you a combination of quality, performance, and features that others can't touch at this price.

An exclusive 10 amp RF ammeter insures maximum power to antenna at minimum SWR. A separate meter gives SWR, forward, reflected power in 2 ranges (2000 and 200 watts).

Versatile antenna switch lets you select 2 coax lines thru tuner and 1 thru or direct, or random wire, balanced line or dummy load.

A 200 watt 50 ohm dummy load lets you tune your exciter off air for peak performance. Efficient, encapsulated 4:1 ferrite balun.

2 MFJ-981 3 KW VERSA TUNER IV
\$199⁹⁵ *Accurate meter gives SWR, forward and reflected power in 2 ranges: 2000 and 200 watts. 4:1 ferrite balun.*

The MFJ-981 3 KW Versa Tuner IV is one of MFJ's most popular Versa Tuners. An accurate meter gives you SWR, forward and reflected power in 2 ranges: 2000 and 200 watts. Encapsulated 4:1 ferrite balun.

3 MFJ-982 3 KW VERSA TUNER IV
\$199⁹⁵ *Antenna switch lets you select 1 coax thru tuner and 2 coax thru tuner or direct, or random wire and balanced line.*

The MFJ-982 3 KW Versa Tuner IV gives you a versatile 7 position antenna switch that lets you select 1 coax thru tuner and 2 coax thru tuner or direct, or random wire and balanced line. Encapsulated 4:1 balun.

If you already have a SWR/wattmeter, the MFJ-982 is for you.

4 MFJ-980 3 KW VERSA TUNER IV
\$169⁹⁵ *Heavy duty encapsulated 4:1 ferrite balun for balanced lines.*

The MFJ-980 is MFJ's lowest priced 3 KW Versa Tuner IV but has the same matching capabilities as the other 3 KW Versa Tuner IV's.

Features an efficient, encapsulated 4:1 ferrite balun for balanced lines.

1.5 KW VERSA TUNER III's

5 MFJ-962 1.5 KW VERSA TUNER III
\$169⁹⁵ *SWR, dual range forward and reflected power meter, 6 position antenna switch, encapsulated 4:1 ferrite balun.*

The MFJ-962 1.5 KW Versa Tuner III is an exceptional value. An accurate meter gives SWR, forward and reflected power in 2 ranges (2000 and 200 watts).

A versatile six position antenna switch lets you select 2 coax lines thru tuner or direct, or random wire and balanced line. Encapsulated 4:1 balun. Black front panel has reverse lettering.

6 MFJ-961 1.5 KW Versa Tuner III
\$149⁹⁵ *6 position antenna switch lets you select 2 coax lines thru tuner or direct, or random wire and balanced line.*

The MFJ-961 1.5 KW Versa Tuner III gives you a versatile six position antenna switch. It lets you select 2 coax lines thru tuner or direct, or random wire and balanced line. Encapsulated 4:1 ferrite balun.

If you already have a SWR/wattmeter, the MFJ-961 is for you. Black front panel has reverse lettering.

FOR YOUR NEAREST DEALER OR FOR ORDERS

CALL TOLL-FREE **800-647-1800**

Why not visit your dealer today? Compare these 3 KW and 1.5 KW Versa Tuners to other tuners. You'll be convinced that its value, quality and features make it a truly outstanding value. If no dealer is available, order direct from MFJ and try it. If not delighted, return it within 30 days for a prompt refund (less shipping). Charge VISA, MC. Or mail check, money order plus \$10 shipping/handling.

For technical information, order/repair status, in Mississippi, outside continental USA, call 601-323-5869.

Order By Mail or Call TOLL FREE 800-647-1800 and Charge It On



MFJ ENTERPRISES, INC.

P. O. BOX 494

✓ 47

MISSISSIPPI STATE, MISSISSIPPI 39762

LARUE ELECTRONICS CUSHCRAFT ANTENNA HEADQUARTERS ✓41

CUSHCRAFT ANTENNAS: 2-METER: A32-19, A144-11, A147-4, A147-11, A147-20T, A147-22, AFM-4D, AR-2, ARX-2, AMS-147, ATS-147, 214B, 214FB, A11-SK, A14-SK, A14-VPK, A22-SK, A32-SK, A147-VPK, ARX-2K AND 228-VPK. 6-METER: A50-3, A50-5, A50-6, A50-10, A535-SK AND AR-6. 220-MHZ.: A220-7, A220-11, AFM-24D, AMS-220, ARX-220 AND ATS-220. 450-MHZ.: A430-11, A449-11, AFM-44D AND ARX-450. OSCAR: A14T-MB, A144-10T, A144-20T AND A432-20T. HF: 10-3CD, 10-4CD, 15-3CD, 15-4CD, 20-3CD, A28-3, ATB-34, ATV-3, ATV-4 AND ATV-5. BLITZ BUGS: LAC-1 AND LAC-2. ICOM TRANSCEIVERS: IC-22S, IC-202S, IC-215, IC-251A, IC-255A, IC-260A, IC-280, IC-402, IC-502, IC-551, IC-551D AND IC-701AC. ICOM ACCESSORIES ALSO IN STOCK. BIRD MODEL 43 AND 4431 WATTMETERS, TABLE-1 ELEMENTS AND CC-1/EC-1 CARRYING CASES. ANTENNA SPECIALISTS 2-METER AND 450-MHZ., AMATEUR AND COMMERCIAL, MOBILE AND FIXED STATION ANTENNAS. CDE ROTATORS: T2X TAILTWISTER \$219.00, HAM-IV \$159.00, CD-45 \$115.00 AND AR-22-XL \$59.00. BELDEN COAX AND ROTOR CABLE. W2AU/W2VS ANTENNA PRODUCTS. BARKER & WILLIAMSON COAX SWITCHES AND DIPOLE KITS. VHF ENGINEERING 2-METER BLUE LINE AMPLIFIERS, POWER SUPPLIES AND MANY OTHER KITS AND W/T UNITS AVAILABLE. HAM-KEYS: HK-1 \$29.95, HK-2 \$19.95, HK-3M \$19.95, HK-4 \$44.95 AND HK-5A ELECTRONIC KEYS \$69.95. CES 230A MICROPAD \$44.95 AND 235 MICRODIALER \$69.95. THE NEW AVANTI "ON-GLASS" 2-METER, 220-MHZ. AND 450-MHZ. MOBILE ANTENNAS IN STOCK. NEW ITEM: THE ELECTRONICS MODEL PA 1-10 [1-WATT IN, 10-WATTS OUT] 2-METER FM RF AMPLIFIER, GREAT FOR HANDIE-TALKIES AND PORTABLES, \$69.95. 1980 RADIO AMATEUR CALLBOOKS: U.S. \$16.95, FOREIGN \$15.95. COMING SOON: THE NEW ICOM IC-2A 2-METER SYNTHESIZED HANDIE-TALKIE! 73, L. GENE LARUE K3HAM.

LaRue Electronics, 1112 GRANDVIEW STREET, SCRANTON, PA. 18509 - Ph. [717]343-2124

Info-Tech's Great New M-200E TRI-MODE CONVERTER

Converts
MORSE, RTTY
& ASCII to
video.



This advanced model in the M-200 Series extends the horizons of capability and performance:

- **Morse Reception:**
6-60 wpm with automatic speed & wordspace
- **RTTY Reception:**
4 speeds 3 shifts unshift on space select. automatic threshold select auxiliary baudot loop output. tuning meter. auto speed readout
- **ASCII Reception:**
110 Baud with built-in T.U.
- **Video Outputs:**
32 character line x 16 line video with scrolling
72 character line x 16 line video with scrolling
- **Special Feature:**
ASCII. Loop or RS232 output on all modes

M-200E (32).....\$500.00
M-200E (72).....\$525.00

Order direct or from these dealers:

A-1 Technik

Blumberg 3
D-5882 Mönnerstragen 2
West Germany

Cohon Amateur Supply, Inc.

307 McJannet Avenue
Hopkinton, Kentucky 42140
502-886-4534

Dialta Amateur Radio Supply

212 48th Street
Rapid City, S. Dakota 57701
605-343-6127

Emona Electronics

Suite 208 7 661 George Street
Sydney NSW 2000 Australia

Germantown Supply

3202 Summer Avenue
Memphis, Tenn 38142
901-452-4276

Gilfer Associates, Inc.

52 Park Avenue
Park Ridge, New Jersey 07656
201-391-7887

Global Communications

636 Cocoa Isles Blvd
Cocoa Beach, Florida 32917
407-785-3624

Ham Radio Center

8342 Olive Blvd
St. Louis, Missouri 63137
314-993-6060

Marcucci-SPA

Via F.lli Bronzetti
37 20129
Milan, Italy

N & G Distributing Corp.

7285 NW 12th Street
Miami, Florida 33126
305-592-9685

Panacom

P.O. Box 76093
Caracas 107, Venezuela

Radio World

Oneda Co. Airport
Terminal Bldg
Oriskany, New York 13424
800-448-7914 or
315-337-2627

Universal Amateur Radio Inc.

1280 Ada Drive
Reynoldsburg, Ohio 43068
614-866-4267



INFO-TECH INCORPORATED

Specializing in Digital Electronic Systems ✓35

2349 Weldon Parkway • St. Louis, Missouri 63141 • (314) 576-5489

JAN CRYSTALS
HOLD THE FREQUENCY

- CB
- CB standard
- 2 meter
- Scanners
- Amateur Bands
- General Communication
- Industry
- Marine VHF
- Micro processor crystals

Send 10¢ for our latest catalog. Write or phone for more details.

2400 Crystal Drive
Ft. Myers, Florida 33907
all phones (813) 936-2397

NOW - THE NEW AMCODER

IT'S EVEN BETTER!!!

4" x 2 3/8" x 6"

- Still only 40hz wide. Single signal - no QRM/QRN reception. Immune to impulse (ignition) noise.
- Still tape quality audio with TTL compatible signal for computer interface applications. No noise appears in the AMCODER output.
- NOT A FILTER!! Its CW regeneration.
- NOW - dig into the noise for the weak ones without front end overload with our new AGC module. No locking on noise.
- No mods to your gear. Just plug into phone jack. Speaker or phone outputs with bypass switching when not in use. No external power required.
- 26DB dynamic range (5 to 6S unit fade margin) with AGC module when properly adjusted.
- Constant level input to the AMCODER regardless of receiver audio level with either S-1 or 30 over 9 signals. (Works on phone signal levels too) with the AGC module.
- Still reduced operator fatigue, variable frequency acquisition, 400-1400hz and variable frequency output tone (and smoother).
- Still variable output level for station speaker or head phones.

Complete kit (Less AGC option) (Cabinet included)	\$79.95
AGC Module (only FWT) for older AMCODERS	29.95
AGC Module (Only FWT) for new AMCODERS	29.95
New AMCODER Factory wired & tested	94.95
With AGC Module installed	119.95
Foreign - Add \$20.00 - all in U.S. Funds.	
Ship your old AMCODER to AMC for updating and installation of AGC module - we pay for return shipping	32.50

VISA & Mastercharge Accepted
Maryland residents - add 5% Sales Tax.
Write for brochure or check reader info card.

AMC ENGINEERING
P.O. Box 427
Jessup, Md. 20794 ✓6

Phone: 301-799-7741



Radio World



CENTRAL NEW YORK'S FASTEST GROWING HAM DEALER



Featuring Yaesu, Icom, Drake, Ten-Tec, Swan, DenTron, Midland, KDK, MFJ, Microwave Module, Tempo, Astron, KLM, Hy-Gain, Mosley, Larsen, Cushcraft, Hustler, Mini Products, Bird, DSI, Mirage, Vibroplex, Bencher, Info-Tech, Universal Towers, Callbook, ARRL, Astatic, Shure. We service everything we sell! Write or call for quote. You Won't be Disappointed. We are just a few minutes off the NYS Thruway (I-90) Exit 32

Warren K2IXN Call Toll Free: 1-800-448-7914
ONEIDA COUNTY AIRPORT TERMINAL BUILDING ORISKANY, NEW YORK 13424
Bob WA2MSH New York State Residents Call: 315-337-2622 or 315-337-0203

Microcraft's New Morse-A-Word

- Eight character moving display.
- Built-in code practice oscillator.
- Excellent for learning Morse Code. ✓50
- Complete — no CRT or expensive extras needed.
- Decodes audio CW signals from your receiver's speaker and displays letters, numbers, punctuation and special Morse characters as the code is received.



- MORSE-A-WORD Kit with 4 character readout MAWK-4 \$149.95
- MORSE-A-WORD Kit with 8 character readout MAWK-8 \$169.95
- MORSE-A-WORD wired & tested with 8 character readout . . . MAWF \$249.95

Send check or money order. Use your VISA or Master Charge. Add \$3.50 shipping and handling for continental U.S. Wisconsin residents add 4% State Sales Tax.

Microcraft Corporation Telephone: (414) 241-8144
P. O. Box 513G, Thiensville, Wisconsin 53092

The UDT 170

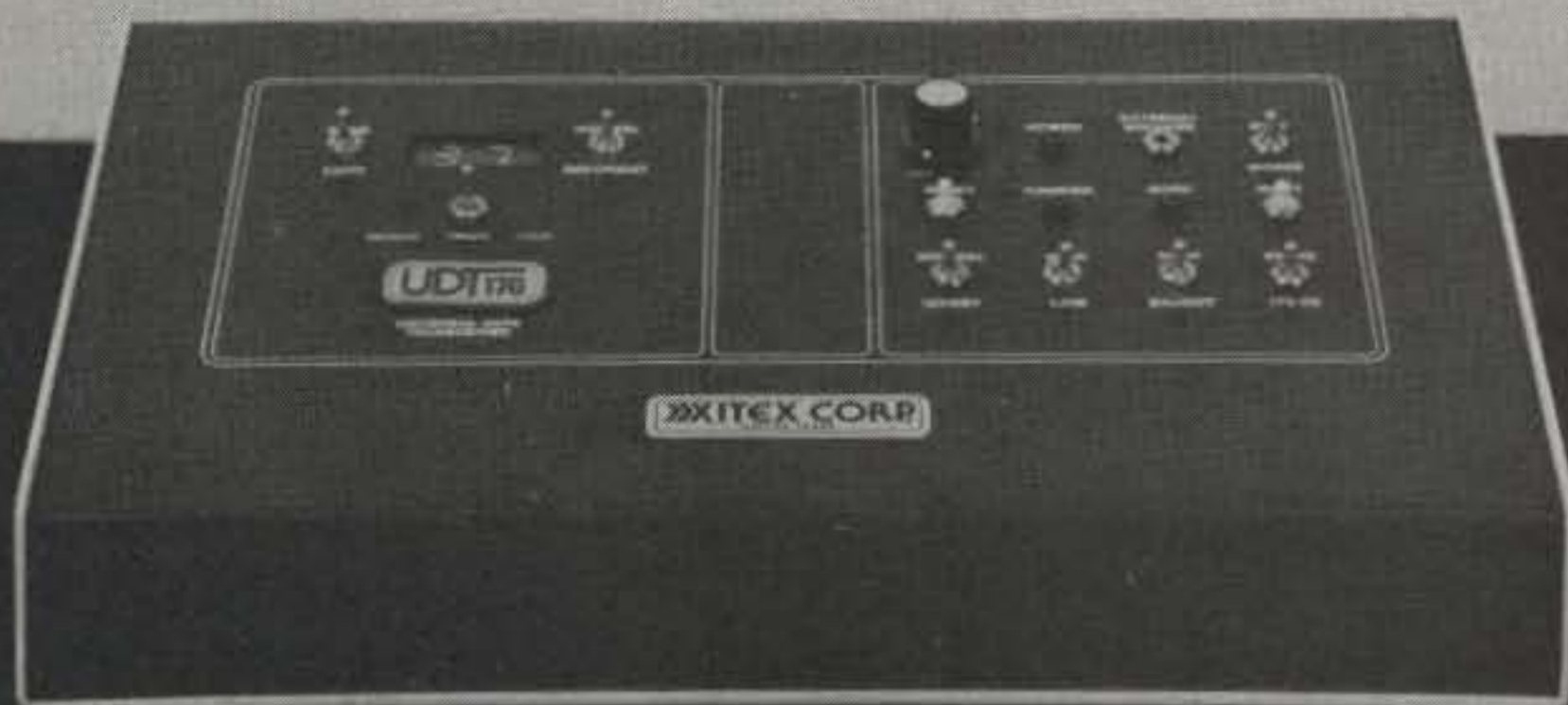

The SMART TU for RTTY & MORSE

The UDT 170 Universal Data Transceiver will instantly convert any ASCII or Baudot teletype or video terminal into a multiple baud rate data transceiver for ASCII, Baudot or Morse operation. It features ...

- 170/850 HZ Shift
- Dual 6 pole active filters for weak signal operation
- ASCII/Baudot Regeneration with multiple baud rates
- CW Auto Ident (optional)
- 1-150 WPM Morse with Auto-track
- Computes & Displays WPM copy rate & Buffer Status
- Selectable line length from 40 to 80 characters
- Metal Enclosure 12"x7 1/4"x3 1/2"

For more information write or phone

Cost Complete and Assembled **\$479**

Price subject to change without notice

XITEX CORP. ✓82

9861 Chartwell Drive
Dallas, Texas 75243
(214) 349-2490



S-F Amateur Radio Services
(213) 837-4870
4384 KEYSTONE AVE.,
CULVER CITY, CA. 90230

the **W6TOG**
RECEIVER MODIFICATION KITS
INCREASE SELECTIVITY
IMPROVE SENSITIVITY
LOWER INTERNAL NOISE
COMBAT BLOCKING
FROM LOCAL SIGNALS

TS-520 KIT	\$27.50
TS-520S KIT	32.50
TS-820 & 820S KIT	34.50
TS-820 MIXER KIT	27.50
TS-120S KIT	32.50
R-820 KIT	34.50
FRG-7000 KIT	32.50
FT-101 SERIES KIT	32.50
FT-101ZD KIT	34.50
FR-101 SERIES KIT	34.50
FT-301 SERIES KIT	34.50
FT-901 SERIES KIT	34.50
ATLAS-210 OR 215X KIT	34.50
ALDA-103 OR 105 KIT	32.50

MAGICOM PROCESSOR MODIFICATION KIT

INCREASES AUDIO PUNCH
IMPROVES
PROCESSED SPEECH QUALITY

TS-520/S	42.50
TS-820/S	27.50

NEW

TS-120/S	42.50
DRAKE T4XC	52.50
DRAKE TR7	42.50

The "MAGICOM" provides up to 6dB increase in output with smooth, clean, non-distorted audio and more penetration for those pile-ups. Easy installation. (No front panel alteration)

HI POWER KITS

INCREASE OUTPUT POWER BY 30%

Set of (2) 6146-W final tubes
Plate rating 40W per tube

GET MORE DRIVE FOR
THOSE HI POWER AMPLIFIERS!!!
TS-520 / 520S QRO KIT . . . \$39.50
TS-820 / 820S QRO KIT . . . 39.50

10% OFF ON KIT ORDERS
TOTALING \$75.00 OR MORE

SEND FOR PRICING
AND INFORMATION ✓65

ALL PRICES POSTPAID
IN CALIF. ADD 6% SALES TAX
MASTERCHARGE & VISA ACCEPTED
SATISFACTION GUARANTEED
OR MONEY REFUNDED

RTTY Loop

from page 12

cution, rather than setting the program counter. The beginning of the program would then be:

```
0100      ORG $0100
0100 4F    START CLR A
0101 B7 801D STA A PIACA
... etc.
```

The transfer address would be \$0100, and the program would be reassembled, taking three fewer bytes. Of course, you could leave it alone, execute from \$0103, and fill the first three bytes with NOPs. Do hope this helps things along.

Also from out west, Clay Abrams K6AEP passes along the information that he has a TV camera hooked up to a MicroWorks DS-68 Digitizer and can send pictures either on SSTV or RTTY. Some of the software he has written for this system has appeared in the pages of 73, and it looks like he has a fine setup. Both he and I wonder if anyone

else has tried this combination. Anyone?

While I'm on the topic of computers and RTTY, one more letter came in. Felton Mitchell WA4OSR of Mobile, Alabama, addresses himself to the problem of the "software UART" discussed in the above RTTY programs. Mitch points out that a 555 timer set to interrupt the processor can provide for the timing external to a delay loop, this freeing the processor to do other tasks. This removes many of the objections voiced to the program. I agree, Mitch, that using an interrupt, such as the IRQ vector in the 6800, would be a simple way to provide for outputting the Baudot bits. However, my intention with the program was to show how to send and receive RTTY with a minimum of external devices. An interrupt timer must first be built and then calibrated to provide exactly the right interval, and if you want to change speed, a hardware change is needed.

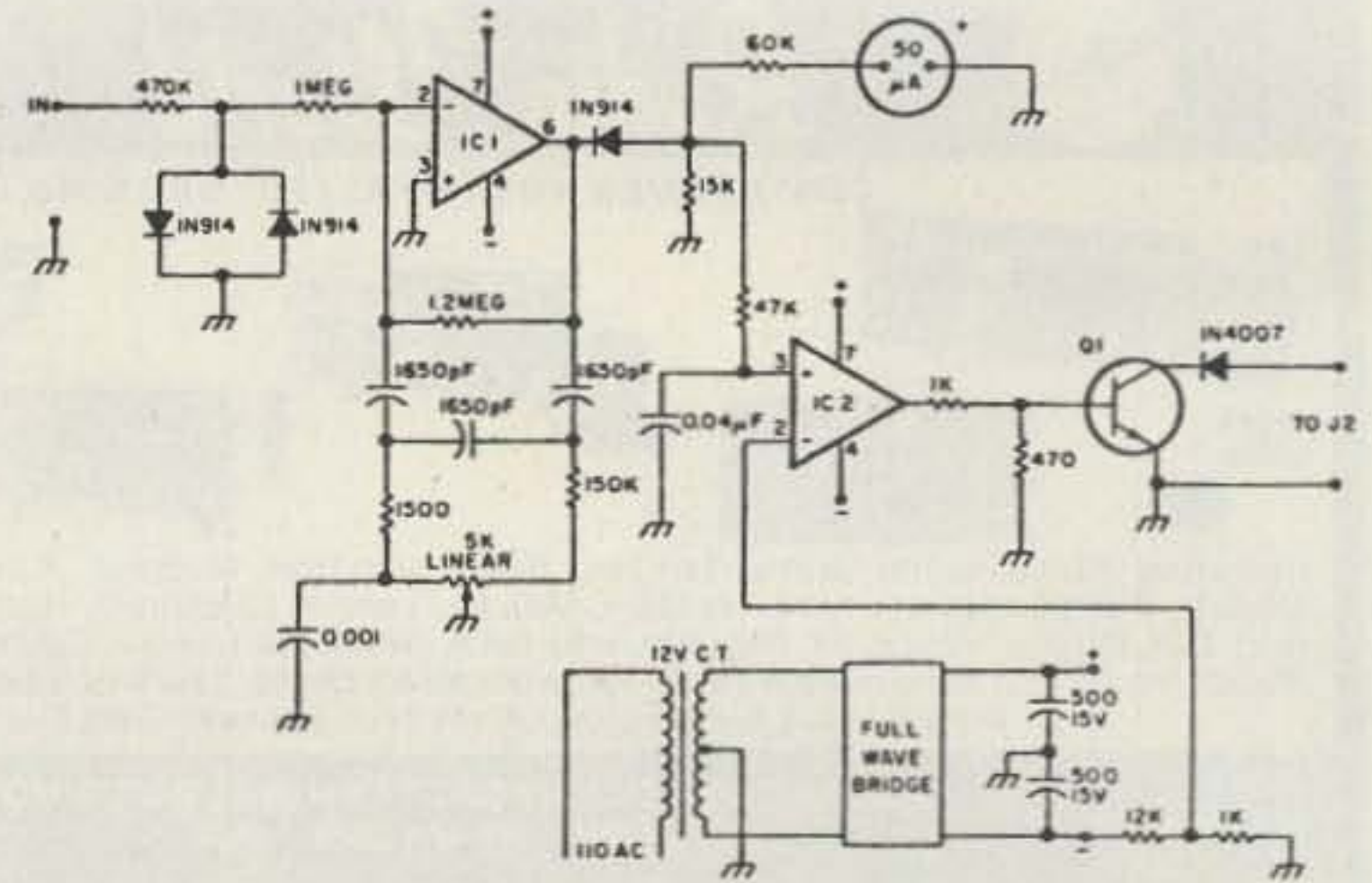

Fig. 4. IC1, IC2—741 op amps; Q1—MJE-340.

With timing loops, changing constants is easy, quick, and painless. If you had a software-controlled interrupt timer, things would be different, but, again, we would be getting into additional hardware, which is one area I attempted to avoid.

And now... April update. Still no word on Teleprinter Art, Ltd. Neither has a response to my nor anyone else's letter been received. I am forwarding material to the proper authorities and ask anyone who has had deal-

ings with the firm in the past to please send me details, good or bad, for inclusion. I will let you all know what gives, as soon as I find out.

Next month holds some more on demodulators you can build, as well as a look at some more mail. Following that, I hope to provide some insight as to commercial equipment offered for use on ham RTTY: demodulators, video terminals, and more. Stay with us, and see it all here in RTTY Loop!

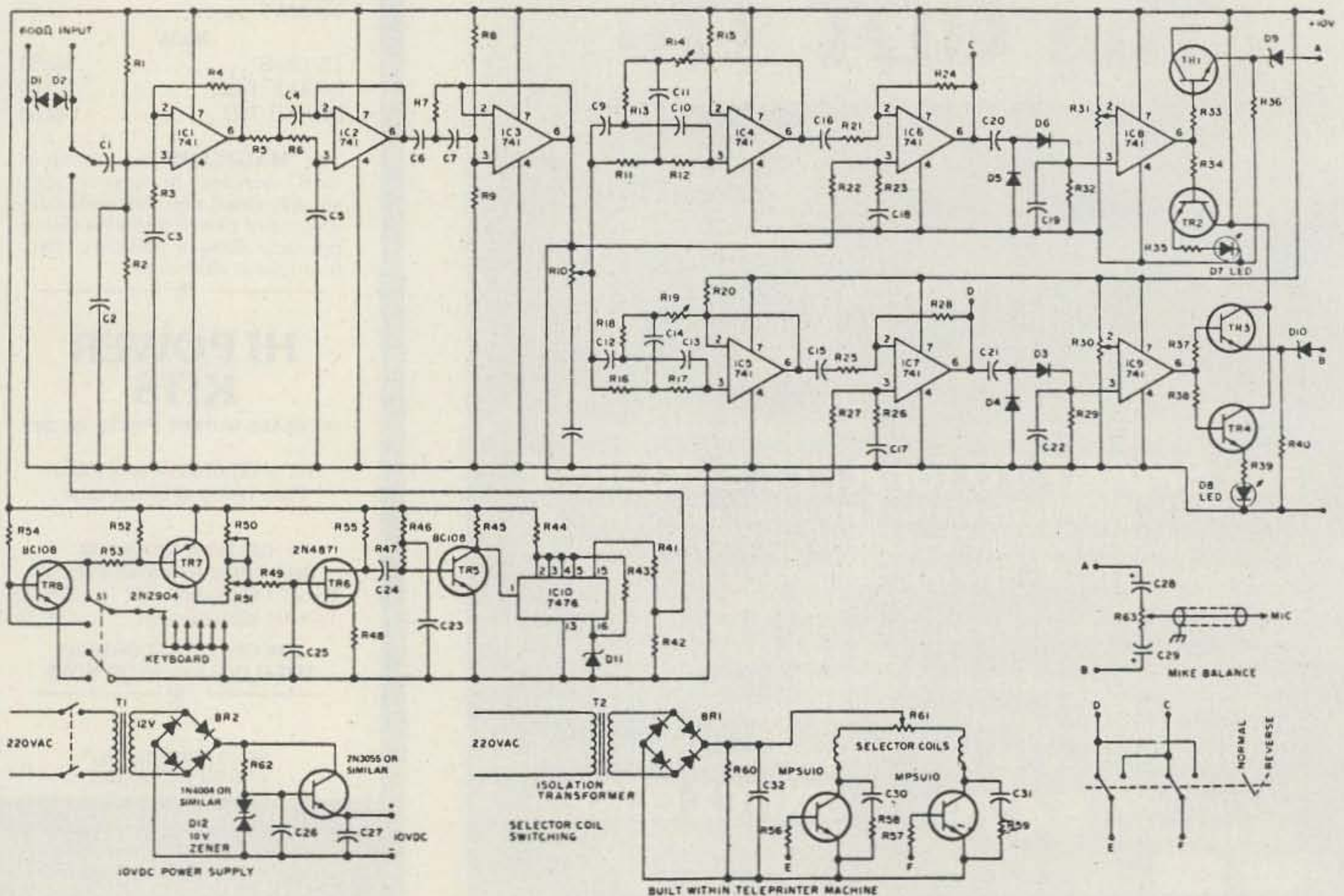
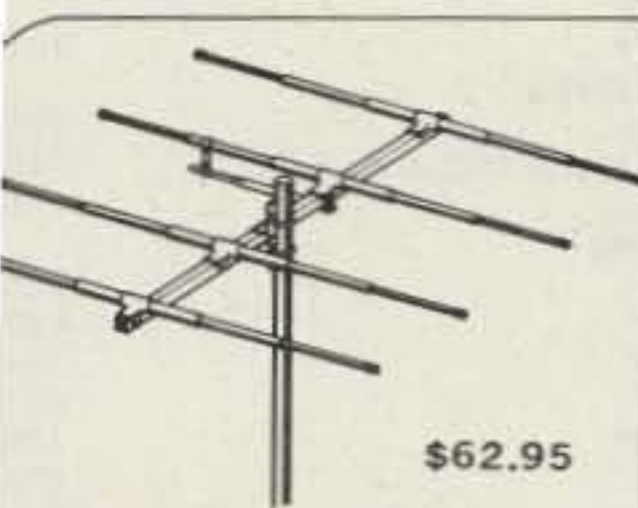

Fig. 3.

FINCO STINGER VHF/UHF Antennas

On this page Tufts brings you . . .
Finco Stinger Ham-Key Hitachi
Ham-Key Alliance



10 meter

STINGER A 10-4 DESCRIPTION
The model Stinger A 10-4 is a wide spaced, full size, high gain four element 10-meter monobander designed for optimum DX performance. Utilizing the exclusive Stinger Series square boom construction, the A 10-4 is light enough to be easily stacked for an additional 3 dB gain yet strong enough to withstand the most adverse weather conditions. The highly efficient gamma match system easily withstands 2,000 watts P.E.P. of power and maintains a relatively low V.S.W.R. across the entire 10-meter amateur band.

SPECIFICATIONS - A 10-4	
ELECTRICAL-	MECHANICAL-
Forward Gain 10dB	Boom Length 16 ft.
Front-to-Back Ratio 25dB	Longest Element 18.2 ft.
V.S.W.R. (at resonance) 1.1:1	Turning Radius 7.4 ft.
Half Power Beam Width 55°	Maximum Surface Area 4.4 sq. ft.
Bandwidth 28 to 30 MHz	Wind Load at 80 MPH 118 lbs.
Impedance 50 Ohms	Weight 17.5 lbs.
Matching System Adjustable Gamma	

\$62.95

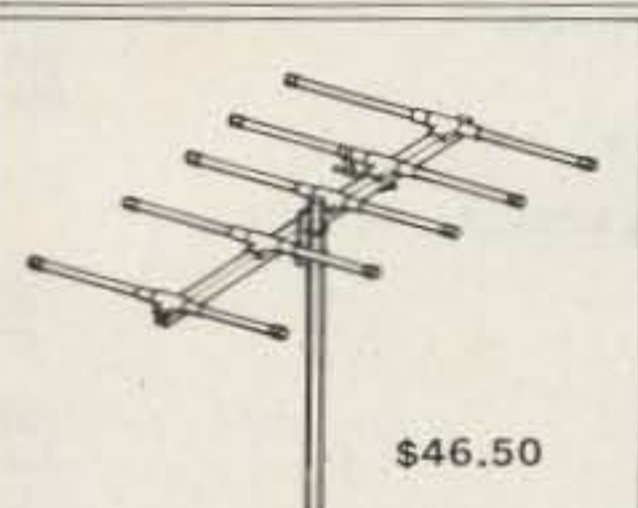

6 meter

STINGER A 6-5 DESCRIPTION
The model Stinger A 6-5 is a highly directional 6-meter five element beam specifically designed for maximum forward gain with a "no compromise" front to back ratio. The elements are constructed of high tensile strength seamless aluminum tubing plus the exclusive Stinger square boom and bracket assemblies. For maximum power transfer and low V.S.W.R., a carefully designed gamma matching assembly capable of withstanding 2,000 watts P.E.P. is incorporated. Wide element spacing assures optimum DX performance and good operating efficiency across the entire 50 to 54 MHz 6-meter band. The square boom allows optional vertical mounting for accessing 6-meter repeaters.

SPECIFICATIONS - A 6-5	
ELECTRICAL-	MECHANICAL-
Forward Gain 11dB	Boom Length 13 ft.
Front-to-Back Ratio 25dB	Longest Element 10 ft.
V.S.W.R. (at resonance) 1.1:1	Turning Radius 8.3 ft.
Half Power Beam Width 52°	Maximum Surface Area 3.23 sq. ft.
Bandwidth 50 to 54 MHz	Wind Load at 80 MPH 40.2 lbs.
Impedance 50 ohms	Weight 11.5 lbs.
Matching System Adjustable Gamma	

\$46.50

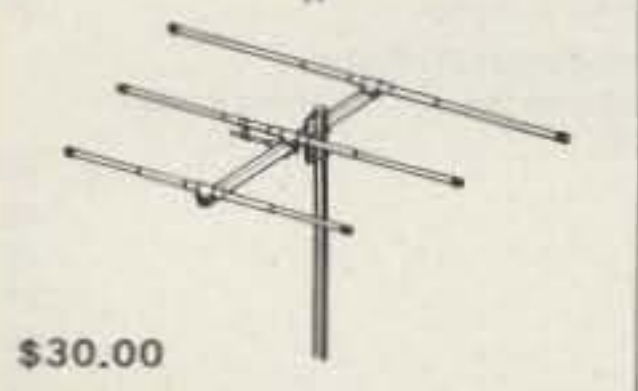

6 and 2 meter

STINGER A 6-3 DESCRIPTION
The model Stinger A 6-3 is a 3-element high gain 6-meter beam similar to the A 6-5 but expressly designed for the casual 6-meter enthusiast. The A 6-3 also finds excellent application for portable use as it disassembles into a compact package. Due to the units light weight and minimal wind load, the antenna is ideal for double stacked and quad stacked arrays for the real 6-meter DXer. The A 6-3 is rated at 2,000 watts P.E.P. and incorporates a square boom and high tensile strength aluminum elements.

SPECIFICATIONS - A 6-3	
ELECTRICAL-	MECHANICAL-
Forward Gain 7.0dB	Boom Length 6.0 ft.
Front-to-Back Ratio 21.0dB	Longest Element 10 ft.
V.S.W.R. (at resonance) 1.1:1	Turning Radius 5.4 ft.
Half Power Beam Width 60°	Maximum Surface Area 1.75 sq. ft.
Bandwidth 50 to 54 MHz	Wind Load at 80 MPH 17.6 lbs.
Impedance 50 Ohms	Weight 7 lbs.
Matching System Adjustable Gamma	

\$30.00

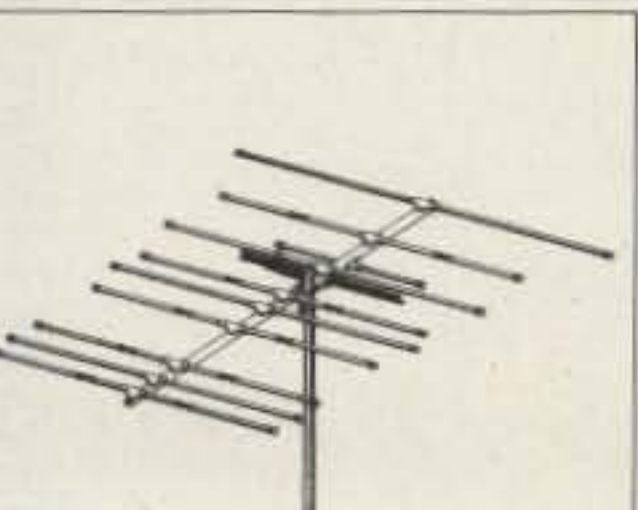

6 and 2 meter

STINGER A 62 DESCRIPTION
The model Stinger A 62 is a truly remarkable combination 6 and 2-meter beam designed for optimum performance on both bands yet only requiring ONE transmission line. This is accomplished through the use of exclusive phasing elements to accomplish dual band operation with no sacrifice to either band - NO SWITCHING REQUIRED!
On 2-meters, the A 62 has 6 collinear elements - equivalent to three 1/2 A 6-element yagis stacked side by side - thus giving outstanding performance. Maximum forward gain is assured on 6-meters through the use of four wide spaced elements. The heavy duty Stinger construction is used throughout so that the antenna will withstand 100 mph plus wind loads.
The A 62 is ideal for mounting on the same mast as your tri-bander or other antenna thus easily opening up the world of 6 and 2-meter VHF communication.

SPECIFICATIONS - A 62	
ELECTRICAL-	MECHANICAL-
Forward Gain 6 meters 9.5dB	Boom Length 10.1 ft.
2 meters 12.0dB	Longest Element 10 ft.
Front-to-Back Ratio 6 meters 13.0dB	Turning Radius 5.7 ft.
2 meters 22.0dB	Maximum Surface Area 4.48 sq. ft.
V.S.W.R. (6 & 2 meters) 1.1:1	Wind Load at 80 MPH 43 lbs.
Half Power Beam Width 40° to 55°	Weight 13.8 lbs.
Bandwidth 6 meters 50 to 54 MHz	
2 meters 144 to 148 MHz	
Impedance 50 ohms	
Matching System Adjustable Gamma	

\$74.95

2 meter

STINGER A 2-10 DESCRIPTION
The model Stinger A 2-10 is a high performance wide spaced ten-element 2-meter yagi designed for the serious VHF operator. Utilizing the Stinger construction features, the A 2-10 is almost indestructible no matter what weather conditions are encountered. Complete coverage of the 2-meter band and low V.S.W.R. is assured through the use of non-linear spaced elements thus also achieving maximum forward gain. Power rating - 2,000 watts P.E.P.
The A 2-10 can be mounted for vertical polarization, thereby making the antenna quite useful in repeater accessing, or mounted for horizontal polarization for station to station VHF DX work. Additional bays of the A 2-10 can be easily stacked for even greater gain and front-to-back ratio.

SPECIFICATIONS - A 2-10	
ELECTRICAL-	MECHANICAL-
Forward Gain 13.8dB	Boom Length 10 ft.
Front-to-Back Ratio 25dB	Longest Element 42 in.
V.S.W.R. (at resonance) 1.1:1	Turning Radius 71 in.
Half Power Beam Width 40°	Maximum Surface Area 2.36 sq. ft.
Bandwidth 144 to 148 MHz	Wind Load at 80 MPH 26.2 lbs.
Impedance 50 Ohms	Weight 9.8 lbs.
Matching System Adjustable Gamma	

\$44.95

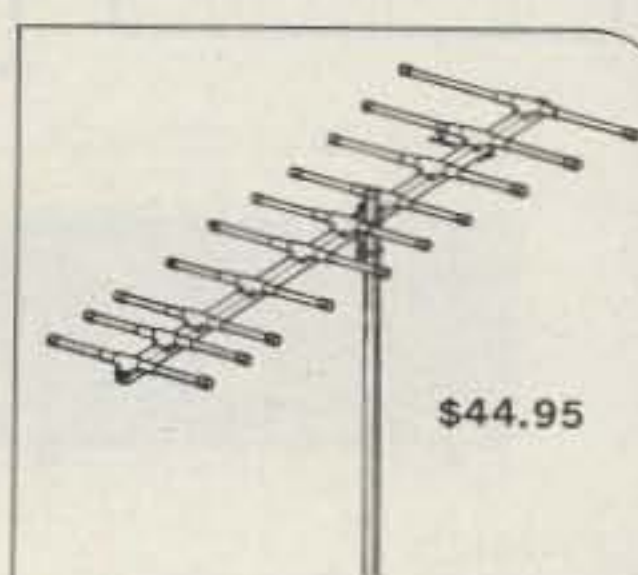

2 meter

STINGER A 2-5 DESCRIPTION
The model Stinger A 2-5 is a five-element high gain antenna similar to the A 2-10 but having physically less of a profile. The A 2-5 finds excellent application as a portable antenna as it disassembles into a very compact package. Like the A 2-10, the antenna can be mounted for vertical or horizontal polarization for repeater or general coverage work. Constructed of the Stinger heavy duty materials, the A 2-5 is ideal for locations encountering adverse weather conditions. Power rating 2,000 watts P.E.P.

SPECIFICATIONS - A 2-5	
ELECTRICAL-	MECHANICAL-
Forward Gain 9.5dB	Boom Length 5.5 ft.
Front-to-Back Ratio 22dB	Longest Element 41 in.
V.S.W.R. (at resonance) 1.1:1	Turning Radius 42 in.
Half Power Beam Width 51°	Maximum Surface Area 1.23 sq. ft.
Bandwidth 144 to 148 MHz	Wind Load at 80 MPH 13.3 lbs.
Impedance 50 Ohms	Weight 6.5 lbs.
Matching System Adjustable Gamma	

\$27.95



2 meter

STINGER A 2+2 DESCRIPTION
The model Stinger A 2+2 is a ten-element, dual polarization 2 meter antenna designed for OSCAR communications or where switching from horizontal to vertical polarization is required. The A 2+2 can even be phased to operate on both horizontal and vertical polarization at the same time. This is not only ideal for OSCAR work but gives your station versatility for ground communications.

Wide, non-linear element spacing gives the A 2+2 superior gain, however, since it is a five element beam in one given plane, the half power beam width does not make satellite tracking difficult because of sharp directivity. The dual gamma match assemblies provide for a very low V.S.W.R. and will withstand 2,000 watts P.E.P.

SPECIFICATIONS - A 2+2	
ELECTRICAL-	MECHANICAL-
Forward Gain 9.5dB	Boom Length 6 ft.
Circular Gain 10.5dB	Longest Element 41 in.
Front-to-Back Ratio 22dB	Turning Radius 5.5 ft.
Half Power Beam Width 52°	End Mount 5.5 ft.
Horizontal Polarization 57°	Center Mount 3.4 ft.
E Plane 57° H Plane 52°	Maximum Surface Area 1.51 sq. ft.
Vertical Polarization 52°	Wind Load at 80 MPH 13.4 lbs.
E Plane 52° H Plane 57°	Weight 11 lbs.
Circular Polarization 52°	
Bandwidth 144 to 148 MHz	
Impedance 50 Ohms	
Matching System Adjustable Gamma	

\$46.50

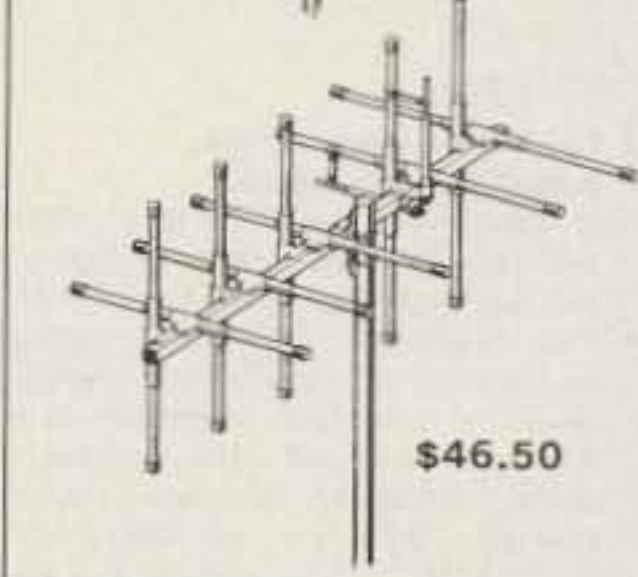

1 1/4 meter

STINGER A 1 1/4 - DESCRIPTION
The model Stinger A 1 1/4 is a ten element 1 1/4-meter (220 MHz) high performance yagi designed for all 220 MHz communication needs. Designed to be mounted in either the vertical or horizontal plane, the A 1 1/4 is adaptable for OSCAR, repeater, or general communication work. Incorporating the Stinger heavy duty elements, boom and boom to mast assemblies, the antenna easily withstands 120 mph wind loads under 1/4" ice conditions. A low loss gamma matching system assures a low V.S.W.R. and is power rated at 1,000 watts.

SPECIFICATIONS - A 1 1/4	
ELECTRICAL-	MECHANICAL-
Forward Gain 13.8dB	Boom Length 8 ft.
Front-to-Back Ratio 25dB	Longest Element 28 in.
V.S.W.R. (at resonance) 1.1:1	Turning Radius 4.3 ft.
Half Power Beam Width 40°	Maximum Surface Area 1.33 sq. ft.
Bandwidth 220 to 226 MHz	Wind Load at 80 MPH 17.9 lbs.
Impedance 50 Ohms	Weight 8 lbs.
Matching System Adjustable Gamma	

\$32.95

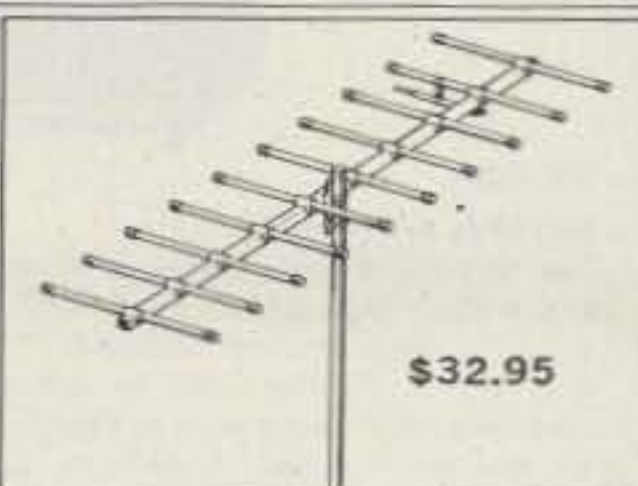

HITACHI OSCILLOSCOPES



Single and dual trace, 15 and 30 MHz. All our high sensitivity Hitachi oscilloscopes are built to demanding Hitachi quality standards and are backed by a 2-year warranty. They're able to measure signals as low as 1mV/division (with X5 vertical magnifier). It's a specification you won't find on any other 15 or 30 MHz scope. Plus: Z-axis modulation, trace rotation, front panel X-Y operation for all four scope models, and X10 sweep magnification. And, both 30 MHz oscilloscopes offer internal signal delay lines. For ease of operation, functionally-related controls are grouped into three blocks on the color coded front panel.

- V-302 30 MHz Dual Trace \$945
- V-301 30 MHz Single Trace \$745
- V-152 15 MHz Dual Trace \$695
- V-151 15 MHz Single Trace \$545

HAM-KEY

Model HK-3M



\$19.95

- Deluxe straight key
- Anti-tip bracket. Can't tip
- Heavy base. No need to attach to desk
- Navy type knob
- Smooth action

Model HK-4

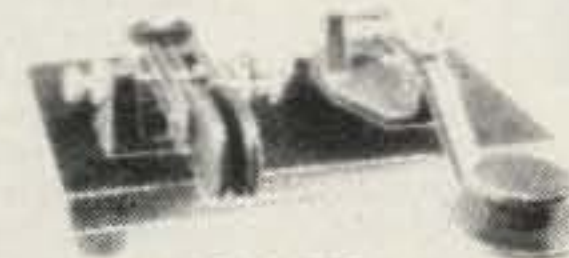

\$44.95

- Combination HK-1 & HK-3 on same base
- Straight key may be used conventionally or as a switch to trigger a memory.

CC-1/3P Shielded cable with plugs for HK-4 \$5.99.

RADIO TELEGRAPH SENDING DEVICES

Model HK-1



\$29.95

- Dual lever squeeze paddle
- For use with all electronic keyers
- Heavy base with non-slip rubber feet
- Paddles reversible for wide or close finger spacing

CC-1P shielded cable & plug for HK-1 \$3.75
Model HK-2, same as HK-1 but less base for incorporation in your own keyer \$19.95

Model HK-5A Electronic Keyer



\$69.95

- Tambic circuit for squeeze keying
- Self completing dots & dashes
- Dot & dash memory
- Built-in wdtone
- Battery operated with provisions for external power
- Uses Curtis 8044 keyer chip
- Grid block or direct keying
- Speed, volume, tone & weight controls on front panel
- Use with HK-1 or HK-4

ALLIANCE



\$119.95

HD-73 HEAVY-DUTY ROTATOR

with exclusive Dual-Speed Control!

For antennas up to 10.7 sq. ft. of wind load area. Mast support bracket design permits easy centering and offers a positive drive no-slip option. Automatic brake action cushions stops to reduce inertia stresses. Unique control unit features DUAL-SPEED rotation with one five-position switch. SPECIFICATIONS: Max. wind load bending moment - 10,000 in.-lbs. (side-thrust overturning); Starting torque - 400 in.-lbs.; Hardened steel drive gears; Bearings - 100-3/8" diameter (hardened); Meter - D'Arsonval, taut band (back-lighted). There's much, much more.

TUFTS Electronic Department Store TUFTS

On this page Tufts
brings you . . .
YAESU

YAESU



FT-101ZD

High-Performance HF Transceiver

Today's technology, backed by a proud tradition, is yours to enjoy with the all new FT-101ZD HF SSB/CW transceiver. This no-compromise rig includes variable IF bandwidth, digital plus analog frequency display, a built-in RF speech processor, and a wide receiver dynamic range. The FT-101ZD may be used with all of the FT-901 series accessories, providing such exciting features as a scanning external VFO, memory, VHF and UHF coverage, and extensive monitoring capability.

FT-101Z

Top Performance for the Budget-Minded Amateur

If economy is an important consideration, and you don't need the frequency counter and digital display, then choose the FT-101Z. The precision VFO gear mechanism is coupled to an easy-to-read analog display, providing resolution to greater than 1 kHz. All other features — the variable IF bandwidth, rf speech processor, superb noise blanker, VOX — are identical to the FT-101ZD.



YC-500

500 MHz Frequency Counter

The YC-500 utilizes advanced IC techniques and a dual range system to provide accurate 8 digit readout to cover 500 MHz. Both MHz and kHz indications can be selected with ease over this range with a flip of a switch on the front panel. A built-in ac and dc supply enables complete portability, and a double-sided epoxy circuit board ensures stable and accurate operation with reliability for many years.



- FT-127RA — 220 MHz FM
- FT-227RB — 144 MHz FM
- FT-627RA — 50 MHz FM

Scanning Memorizers

The FT-127RA, FT-627RA, and FT-227RB FM transceivers allow scanning and expanded memory coverage for the demanding VHF FM operator. Both feature up/down scanning capability, with control from the microphone; the scanner will also search for a busy or clear channel, if you wish. Four memory channels are also available — two for simplex channels, three for repeater channels, and one for a split of up to 4 MHz.



FT-7B

HF Mobile Transceiver

The all-solid-state FT-7B provides power and performance for the amateur on the move. The rugged transistor final amplifier stage operates at an input power of 100W for SSB and CW, 25W for AM. The FT-7B optional frequency display provides safe indication of your operating frequency from your dash board, steering column, or other convenient location.



FT-901 DM

Our Top-of-the-line Transceiver

Unparalleled receiver performance, combined with state-of-the-art transmitter features, makes our top-of-the-line FT-901DM the ham's dream, at home or away. The receiver features continuously variable IF bandwidth, rejection tuning, a CW audio peak filter, and industry-leading dynamic range. The transmit side includes a built-in Curtis 8044 IC keyer, RF speech processor, and a 10-second "TUNE" mode timer, which prevents damage to your finals caused by excessive key-down time while tuning.



FRG-7000

Digital Display Communications Receiver with CPU Digital Clock and Timer

- 0.25 Thru 29.9 MHz Coverage with 1 kHz Readout

Computer technology and convenience features are brought together in the FRG-7000, a digital-display general coverage receiver for the discriminating SWL. The digital clock and timer, controlled by a CPU (Central Processing Unit) chip, will read out both local and GMT time, and will control peripheral station equipment such as a tape recorder.



FT-625RD

All-Mode 6m Transceiver

The FT-625RD is designed for today's demanding 6m operator. Built into every FT-625RD are an rf speech processor, a high-performance noise blanker, and ±1 MHz repeater split for FM buffs. Available as an option is Yaesu's exciting memory unit, allowing storage and recall of any frequency.



FRG-7

General Coverage Receiver

- 0.5-29.9 MHz Coverage with 10 kHz Readout

The FRG-7 is a precision-built all-purpose communications receiver, featuring all solid state construction for long life and high performance. Utilizing the Wadley Loop drift cancellation system, in conjunction with a triple conversion superheterodyne circuit, the FRG-7 boasts high sensitivity along with excellent stability.



CPU-2500R

2m FM Transceiver with CPU

The age of computers has exploded onto the amateur scene with the announcement of the new CPU-2500R 2m FM transceiver. Controlled by a 4-bit central processing unit (CPU), the CPU-2500R contains a scanner, 4 memory channels, manual or automatic tone burst generation, an optional sub-audible tone squelch, and 25W output across the band.

MODEL	DESCRIPTION	PRICE
FT-901DM	160-10m xcvr	\$1459.00
FT-101ZD	160-10m xcvr	895.00
FT-101Z	Analog Version	749.00
FT-720RU	UHF TRANSCEIVER 440-450 FM xcvr	499.00
FT-7B	SOLID STATE HF XCVRS 80-10m 100W	675.00
FT-107M	160-10m SSB/CW/AM w/o DMS & memory	1045.00
FT-707	80-10m 200W	TB
CPU2500RK	VHF TRANSCEIVERS FM mobile keyboard	585.00
FT-127RA	200 MHz AutoScan	479.00
FT-207R	2m Syn. 3W Handie	399.00
FT-225RD	2m with Digital	895.00
FT-227RB	2m/4 Mem. w/YM-22	425.00
FT-625RD	6m All Mode xcvr	895.00
FT-627RA	6m 4 Memory xcvr	399.00
FRG-7	SOLID STATE RECEIVERS Communications	370.00
FRG-7000	All Band HF	655.00
FL-2100ZA	LINEAR AMPLIFIER 160-15m	599.00
YH-55	ACCESSORIES ALL MODELS Headset	15.00
FF501dx	Lo pass filter	34.00
QTR-24D	Quartz Clock	49.00
YC-500J	TEST EQUIPMENT 500 MHz 10 PPM	239.00
YC-500S	500 MHz 1 PPM	399.00
YC-500E	500 MHz 0.02 PPM	537.00
YS-2000	2000W Peak Reading SWR Bridge	95.00
FA-9	Fan	\$ 20.00
FM-901*	FM Adapter	45.00
KY-901*	Keyer Unit	45.00
MU-901*	Memory Unit	124.00
DC-901*	DC-DC Converter	60.00
SP-901	Speaker	35.00
SP-901P	Speaker/Patch	74.00
FTV-901R	Transverter w/2m	455.00
"	2m adapter only	154.00
"	6m adapter only	110.00
"	70 cm adapter only	255.00
YO-901	Monitor w/scope	515.00
YR-901	Code/RTTY Decoder	730.00
FV-901DM	Synthesized VFO	415.00
FC-901	Antenna Tuner	199.00
XF8.9HC	CW Filter	45.00
XF8.9B*	AM Filter	45.00
DC-101ZD	DC-DC Converter	60.00
ZD-1	Analog Readout	150.00
FV-101Z	Remote VFO	175.00
PB-1424	ACCESSORIES FOR VHF EQUIPMENT Marker Unit	50.00
PB-1555	Tone Squelch Unit	30.00
MMB-4	Mobile Unit for (620B & FT-221)	23.00
MMB-5	Mobile Mount (227R)	8.00
FP-4	4 Amp Pwr. Supply	50.00
FP-12	12 Amp Pwr. Supply/Spkr (2500RK)	132.00
MU225/625	Memory Unit for (225RD & 625RD)	165.00
XF10.8HC	CW Filter (625RD)	45.00
XF10.8HS	SSB Filter (625RD)	45.00
FSP-1	Remote Speaker	21.00
FTS-64	64 Tone Switchable CTCSS/Burst Encoder	80.00
FTS-32ED	32 Tone CTCSS Programmable Encoder/Decoder	TBA
FTV-250	ACCESSORIES FOR 101 SERIES 2m Transverter	275.00
FA-9	Fan	20.00
XF-30B	AM Filter	40.00
XF-30C	CW Filter	40.00
DC-1	DC-DC Converter	50.00
YO-101	Monitor Scope	320.00
YC-601B	Digital Readout	235.00
SP-101B	Speaker	25.00
NC-1A	ACCESSORIES FOR HAND-HELD XCVRS 15 hr. Drop-in Charger	\$ 46.00
NC-2	3 hr. Drop-in with Power Supply	90.00
PA-1	Mobile Battery Eliminator	39.00
LCC202	Leather Carry Case	35.00
TC-202	Top Cover	3.95
NBP-9	Battery Pack	23.00
NC-9B	15 hr. Wall Mount Charger	10.00
YM-24	Speaker Mic	32.00
FBA-1	Battery Sleeve	8.00
LCC-7	Leather Carry Case	35.00
TA-2	Telescope Antenna	8.50
FTS-32E	Syn. 32 Tone CTCSS/Burst Encoder	40.00
FP-12	ACCESSORIES FOR SOLID STATE XCVRS 12 Amp Speaker with Power Supply	132.00
YC-7B	Digital Readout Counter	110.00
FP-107	Internal Power Supply	139.00
FP-107E	External Power Supply	145.00
DMS-107	Digital Memory Shift	125.00
FC-107	Antenna Tuner	139.00
FV-107	Remote VFO	125.00
SP-107	Speaker	29.00
SP-107P	Speaker/Patch	67.00
FTV-107R	Transverter w/2m	284.00
"	6m Adapter only	110.00
"	70 cm Adapter Only	255.00

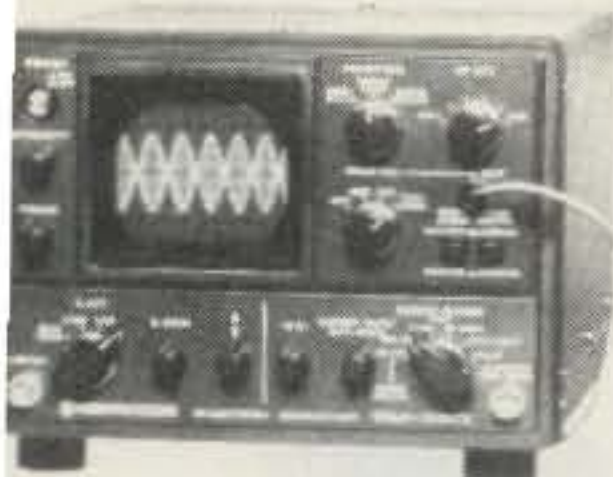

SM-220

The SM-220 Station Monitor is capable of various monitoring functions, and performs as a wideband oscilloscope, and is expandable for pan-display operation.

SM-220 FEATURES:

- Monitors transmitted SSB and CW waveforms from 1.8 to 150 MHz.
- High-sensitivity, wide-frequency-range (up to 10 MHz) oscilloscope.
- Monitors received signals in IF stage.
- Tests linearity of linear amplifiers (provides trapezoid pattern).
- Allows observation of RTTY tuning points (cross pattern).
- Built-in two-tone (1000-Hz and 1575-Hz) generator.
- Expandable to pan-display capability for observing the number and amplitude of stations within a switchable ± 20 kHz/ ± 100 kHz bandwidth.

OPTIONAL ACCESSORIES:

- BS-8 pan-display module for TS-180S and TS-820 series.
- BS-5 pan-display module for TS-520 series.



TL-922A

The TL-922A linear amplifier for all Kenwood HF equipment provides maximum legal power on the 160m-15m Amateur bands, employing a pair of EIMAC 3-500Z high-performance transmitting tubes.

TL-922A FEATURES:

- 2000W PEP (SSB)/1000W dc (CW, RTTY) input power on 160m-15m, with 80W drive.
- Excellent IMD characteristics.
- Safety protection.
- Blower with automatic delay circuit.
- Variable threshold level type ALC.



TR-7600 / TR-7625

The TR-7600 and TR-7625 are Kenwood's popular synthesized 2m FM mobile transceivers. Combined with the RM-76 Microprocessor Control Unit, several memory and scanning capabilities are provided.

TR-7600 / TR-7625 FEATURES:

- One memory channel.
- Mode switch for simplex or repeater operation. Repeater mode shifts the transmit frequency +600 kHz or -600 kHz or to the memory frequency.
- Full 5-kHz coverage with 144.000 to 147.995 MHz.
- Adaptable to any one MARS simplex or repeater channel between 143.7 and 148.3 (with modification kit).



TS-120S

Truly a "big little rig," the TS-120S has created a new excitement in HF communications for highly versatile Amateur operation. The compact, all solid-state 80m-10m transceiver, with up to 200W PEP input, requires no tuning and includes a large digital readout, making it ideal for mobile operation. IF shift and other important features make it a high-quality rig for the ham shack as well.

OPTIONAL ACCESSORIES:

- YK-88CW 500-Hz filter.
- MB-100 mobile mount.



TS-520SE

The TS-520SE is an economical version of the TS-520S... the world's most popular 160m-10m Amateur transceiver. Now, any Amateur can afford a high-quality HF transceiver for his ham shack.

TS-520SE FEATURES:

- Covers 160m-10m and receives WWV on 15 MHz.
- 200W PEP input on SSB and 160W dc on CW.
- CW WIDE/NARROW bandwidth switch, for use with the optional CW-520 500-Hz CW filter.
- Digital display with optional DG-5, showing actual frequency.
- Speech processor, effective in DX pileups.
- VOX and semi-break-in CW with sidetone.
- Built-in 25-kHz calibrator.

OPTIONAL ACCESSORIES:

- CW-520 500-Hz CW filter.
- AT-200 antenna tuner.

On this page
Tufts brings
you...
Kenwood

TR-2400

The TR-2400 synthesized 2m hand-held transceiver features a large LCD frequency readout, 10 memories, scanning, and much more.

TR-2400 FEATURES:

- Large, illuminated LCD digital frequency readout. Readable in direct sunlight, and a lamp switch makes it readable in the dark. Shows receive and transmit frequencies and memory channels, and indicates "ON AIR," memory recall, battery status, and lamp switch on.
- 10 memories, with battery backup.

OPTIONAL ACCESSORIES:

- Attractive leather case.
- Model ST-1 base stand, which provides 1.5-hour quick charge, trickle charge, and base-station operation with microphone connector and impedance-conversion circuit for using MC-30S microphone.
- Model BC-5 dc quick charger.



KPS-7

The KPS-7 is a matching ac power supply for the TR-7600 and TR-7625. Output is 13.8 Vdc at 7 A ICS (50% duty cycle).

ORDER NO.	DESCRIPTION	PRICE	ORDER NO.	DESCRIPTION	PRICE
NEW ALL SOLID-STATE HF EQUIPMENT					
	180S "DFC" (Digital Frequency Control) Series				
TS-180S w/DFC	160m-10m all solid-state rig, 4 tuning memories	\$1,149.95	TS-520SE	160m-10m transceiver with CW filter switch; no DC-DC converter or transverter terminals	\$ 629.95
TS-180S wo/DFC	HF rig, digital/differential display, IF shift	984.95	R-300	170 kHz-30 MHz receiver	279.00
DF-180	DFC (Digital Frequency Control)	164.95	AT-200	200-W antenna tuner, SWR/power meter, switch	159.00
VFO-180	Remote VFO	179.95	TL-922A	160m-15m linear amplifier, 2 kW PEP	1,199.00
SP-180	External speaker with selectable audio filters	69.95	SM-220	Station monitor, 10-MHz scope, two-tone generator	349.00
AT-180	Antenna tuner/SWR and RF power meter/antenna switch	179.95	BS-8	SM-220 pan display for TS-820 series	75.00
YK-88SSB	IF crystal SSB filter (for dual filter system)	59.95	BS-5	SM-220 pan display for TS-520 series	75.00
YK-88CW	500-Hz CW filter	59.95	DS-1A	DC-DC converter for TS-820/TS-520S series	69.00
PS-30	Base-station power supply, 13.8 VDC, 20A	139.00	VHF/UHF EQUIPMENT		
	120 Series		TR-2400	2m synthesized hand-held with LCD, 10 memories, scanning, 5 kHz steps, nicad pack, charger, and rubberized antenna	395.00
TS-120S	80m-10m solid-state rig, 200 W PEP, digital display	699.95		Extra battery pack for TR-2400	TBA
VFO-120	Remote VFO	159.95	2400		
SP-120	External speaker	39.00	NICAD		
AT-120	Antenna tuner	99.95	ST-1	Base Stand quick/trickle charger with mic connector for TR-2400	TBA
MB-100	Mobile mounting bracket	29.00	BC-5	Mobile quick charger for TR-2400	TBA
YK-88CW	(See 180S "DFC" Series)		2400 Case	Leather case for TR-2400	TBA
PS-30	(See 180S "DFC" Series)		TS-600	6m SSB/CW/FM/AM 10W transceiver	799.00
TRADITIONAL HF EQUIPMENT					
	820 Pacesetter Series		TS-700 SP	2m SSB/CW/FM/AM transceiver, digital, all subbands	799.00
TS-820S	Deluxe transceiver, digital display, 160m-10m	1,299.00	VFO-700S	External VFO for TS-700S/SP	135.00
TS-820	Deluxe transceiver, 160m-10m, IF shift	1,100.00	SP-70	External speaker for TS-600 and TS-700SP	33.00
R-820	Deluxe receiver, 160m-10m, notch filter, VBT	1,099.00	TR-7600	2m FM transceiver with memory, 10W, synthesized	375.00
DG-1	Digital frequency display for TS-820	199.00	TR-7625	2m FM transceiver with memory, 25W synthesized	425.00
VFO-820	Remote VFO for TS-820 series	175.00	RM-76	Microprocessor Control Unit for TR-7600/7625	125.00
SP-820	External speaker with selectable audio filters	65.00	TR-8300	70 cm FM transceiver, 10W, 23 channels	369.00
CW-820	500-Hz CW filter for TS-820 series	59.00	TV-502S	2m transverter for TS-520/820 series, 10W	279.00
YG-88A	6-kHz AM filter for R-820	59.00	TV-506	6m transverter for TS-520/820 series, 10W	279.00
YG-455C	500-Hz CW filter for R-820	85.00	VOX-3	VOX unit for TS-700A and TS-600	25.00
YG-455CN	250-Hz CW filter for R-820	109.00	RSK-7	Repeater subband (144.5-145.5 MHz) kit for TS-700A/S	14.00
	520S Series		OTHER ACCESSORIES		
TS-520S	160m-10m transceiver, noise blanker	849.00	HS-5	Deluxe Headphone set	39.95
DG-5	Digital frequency display for TS-520S	199.00	HS-4	Headphone set	19.50
DK-520	Adaptor for DG-5 to TS-520 and R-599	20.00	PC-1	Phone patch	59.95
VFO-520S	Remote VFO for TS-520S	155.00	MB-1A	Mobile bracket for TR-2200A	13.00
SP-520	External speaker for TS-520S	33.00	MC-50	Dynamic base microphone, high/low impedance	45.00
CW-520	500-Hz CW filter for TS-520S	59.00	MC-30S	500 Ohm noise-cancelling mobile microphone	29.00
			MC-35S	50 kilohm noise-cancelling mobile microphone	29.00
			MC-45	500 Ohm touch-tone mobile microphone, automatic PTT	49.95
			PS-6	AC power supply for TR-8300, 12 VDC, 3.5A	79.00
			KPS-7	AC power supply for TR-7600/7625, 12 VDC, 7A	79.95

TUFTS Electronic Department Store TUFTS

On this page Tufts brings you . . .
ICOM and Amphenol

IC-202S, IC-502, IC-402

ICOM Portables

All ICOM portables are designed with performance and features that allow for external power, and external antenna hookup (UHF connector); and the quickchange fold away mobile mount makes them ideal for mobile operation. All controls, including single-knob tuning dials and lighted "S" meters, are located on the front panel, as are mic and external speaker plugs.

In addition to dry cell type "C" battery operation and the optional IC-3PS power supply, ICOM offers a nicad battery pack and charger, which fits totally within the internal battery compartments of all ICOM portables. The nicad rechargeable cells accept full charge from a 12V electrical system, the IC-3PS or ICOM's new, low cost ac wall charger unit.

The IC-202S, IC-502, and IC-402 put out a full 3W PEP to get through when the band is open or to drive a class AB1 amp to full output. The IC-215 FM portable delivers an output of 3W in the high power mode and 0.5W in a low power position. The IC-215's low power conserves "C" cell battery life, and 3W from the portables jumps to 10W through our optional amp, the IC-20L for 2m.



IC-202S

This sideband transceiver operates lower sideband. It uses a special VXO circuit to provide smooth tuning and crystal stability needed for SSB operation on the 2m band. Each of the four band positions is a 200 kHz band within the 144.0-145.99 range of the 2m band.

IC502

The VFO used in this unit covers the first 800 kHz of the 6m band where most of the activity is.

IC-402

Utilizing a tunable second oscillator, this unit provides the stability and band spread needed for SSB operation on 430. Crystals are provided for two of the four bands which can be selected from the 26 200 kHz segments between 430 and 435.2. Listen to the signals from OSCAR VIII, mode "J", with the superb 0.5 μ V receiver on either lower or upper sideband. Most accessories for the IC-202S and the IC-502 can also be used on the IC-402.



ICOM



IC-215 FM

The versatile IC-215 provides continuous contact for even the busiest FM enthusiast. The IC-215's three narrow filters provide quality not usually found in portable VHF equipment. With 15 channel capacity (12 on the dial and 3 on priority) and an MOS FET rf amp with five tuned circuits on the front end, the IC-215 offers optimum FM portable performance.

The fully collapsible antenna is removable for accommodating the flexible "rubber duck", and the IC-215 comes supplied with five popular channels at no extra cost (52/52, 34/94, 28/88, 22/82, 16/76).



IC-701

The HF Maximizer

ICOM's superior LSI technology takes the lead in Amateur HF. The extremely compact IC-701 delivers 100W output from completely solid state, no tune (bro band design) final, on all modes and bands, from 160m-10m. Continuously variable bandwidth on filter widths for SSB RTTY, and even SSTV.

The single frequency control knob provides fully synthesized instant tuning at a single fingertip. Wide bandspread, with 100 Hz per division and 5 kHz per turn, is instant co-ordinated between the smooth turn knob and the synthesizer's digital readout with positively no time lag or backlash. At the push of the electronic high speed tuning button, the synthesizer flies through megacycles at 10 kHz per step (500 kHz per turn).

AMPHENOL BUNKER RAMO

SERIES 31 - BNC CONNECTORS

Amphenol's BNC connectors are small, lightweight, weatherproof connectors with bayonet action for quick disconnect applications.

Shells, coupling rings and male contacts are accurately machined from brass. Springs are made of beryllium copper. All parts in turn are ASTRO-plated[®] to give you connectors that can take constant handling, high temperatures and resist abrasion.

BNC BULKHEAD RECEPTACLE 31-221-385 UG-1094 Mates with any BNC plug. Receptacle can be mounted into panels up to 104" thick. \$1.25



BNC (M) TO UHF (F) ADAPTER 309-2900-385 UG-255 Adapts any BNC jack to any UHF plug. \$3.63

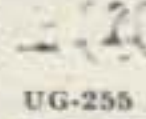

DOUBLE MATE ADAPTER 83-877-385 Both coupling rings are free turning. Connects 2 female components. \$2.72



JACK ADAPTER 575-102-385 Adapts 83-15P-385 to Motorola type auto antenna jack or pin jack. \$1.95

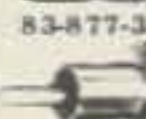

PANEL RECEPTACLE 83-1R-385 SO239 Mounts with 4 fasteners in 21/32" diameter hole. \$1.17

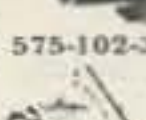

BNC (F) TO UHF (M) ADAPTER 31-028-385 UG-273 Adapts any BNC plug to any UHF jack. \$2.39



PUSH-ON 83-5SP-385 Features an unthreaded, springy shell to push fit on female connectors. \$2.27

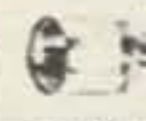

LIGHTNING ARRESTOR 575-105-385 Eliminates static build-up from antenna. Protects your valuable equipment against lightning damage. \$4.80



BNC PLUG 31-002-385 UG-88 Commonly used for communications antenna lead cables. For RG 55/U & RG 58/U cables. \$1.59

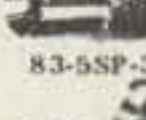

BNC STRAIGHT ADAPTER 31-219-385 UG-914 1 9/32" long, allows length of cables to be joined. Mates with BNC plugs. \$2.12



BNC PANEL RECEPTACLE 31-003-385 UG-290 Mounts with 4 fasteners in 29/64" diameter hole. \$1.74



83-878-385 SO239SH Mounts in single 21/32" diameter hole. Knurled lock nuts prevent turning. \$1.59



BNC ANGLE ADAPTER 31-009-385 UG-306 Adapts any BNC plug for right angle use. \$4.23



BNC TEE ADAPTER 31-008-385 UG-274 Adapts 2 BNC plugs to 31-003-385 or other female BNC type receptacle. \$4.56

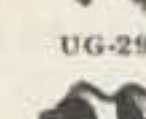

IC-551D

The IC-551D is the high-powered brother to the IC-551. With an 80+W output, you have all the punch you need. The IC-551D has the same no-backlash no-delay dual VFO light chopper system coupled to the microprocessor for split frequency as well as completely variable offsets. Pass band tuning and VOX are included at no extra cost.

IC-2A

Synthesized 2m Handie Talkie

- 800 T/R channels, synthesized.
- 1.5W output high/low power battery saving switch to .15W
- Separate built-in speaker and mic. Excellent audio quality.
- Compact. About the size of a dollar bill.
- Variable size nicad power pack, 3 sizes available to suit your needs (250 mA standard). Makes the IC-2A the most compact synthesized HT on the market.
- Optional tone pad, desk charger, speaker/mic available.
- With slip on/slip off bottom nicad pack, you can vary the size of the HT from about 116 mm high to 175 mm high. Easy to carry extra snap-on packs with you for extended trips.



IC-251A

The IC-251A is the newest addition to ICOM's all mode transceiver line. Like the matching IC-551, the IC-251A has dual digital VFO's, three memories, scanning (even SSB). Both units include the no backlash, no delay light chopper, similar to the IC-701, as a standard feature at no cost. Coupled to the microprocessor, this provides split frequency operation as well as completely variable offsets.

ICOM PRICE LIST

MODEL	DESCRIPTION	PRICE
BASE STATION EQUIPMENT		
215A	2m AC & 12V, FM, SSB, CW, 10W	\$ 699.00
551	6m 10W, Syn. AC & 12V Pwr	449.00
551D	6m 80W, 12V, W/EX107, EX108	669.00
551D & PS	551D and AC supply	849.00
701	HF Transceiver, 12V DC	1195.00
701 & PS	HF Transceiver, AC & 12V Supply	1375.00
MOBILE TRANSCEIVERS		
22S	2m FM, 10W, 22 channel Programmable	289.00
255A	2m FM, 25W Synthesized 12V	389.00
260A	2m MBL, SSB, FM, CW, W/Mem	489.00
280	2m FM, 10W, Syn. Remotable, 12V	359.00
PORTABLE TRANSCEIVERS		
202S	2m SSB Portable	249.00
215	2m FM Portable	189.00
402	430 MHz SSB Portable	349.00
502	6m SSB Portable	229.00
POWER SUPPLIES		
3PE	AC to 12V supply 3A/Spkr;	85.00
3PS	AC to 12V supply for Portable	85.00
701PS	12V Power Supply for 701	190.00
PS20	20A Power Supply, 551D, 701	190.00
ATTENDANT ACCESSORIES		
20L	2-10W 2m linear amplifier	98.00
30L	3-10W 430 MHz linear amplifier	105.00
EX106	FM Option, 551, 551D	115.00
EX107	VOX Option, 551 (Incl w/551D)	49.00
EX108	PBT, 551 (Incl w/551D)	98.00
RM2	Controller, 701, 211, 245	125.00
BC15	Nicad Supply, Portable, AC adapter	54.50
BC20	Nicad Supply, Portable	54.50
SP2	Matching Base Station Speaker	49.50
CF1	Cooling fan, 701PS or PS20	39.00
HM3	Microphone, 3 or 4 pin, specify model	16.00
HM5	Microphone, 4 pin, noise cancelling	32.00
HM7	Microphone, amplifier, 8 pin	25.00
HM8	8 Pin mic (251A, 255A, 260A) w/tone encoder	39.50
DC Pwr	DC power cord, specify radio	3.50
DC HD	DC power cord, 551D, 701	10.00
EX-1	701 "Y" interface	29.50
HP-1	Headphone	29.50
CK28SC	280 remote kit, Mount, 5' cable	31.25
CK28LC	280 remote kit, Mount, 17' cable	41.25
LC	Long cable 17', only used in CK28LC	18.75
SM2	Desk mic, 4 pin	32.50
SM5	8 pin base mic for 251A, 255A, 260A	32.50
MMB	Mobile mounting bracket, specify radio	16.25
24PP	24 pin molex plug and pins	3.75
24PK	24 pin molex plug, pins, mated pair	7.50
WC215	117V to 12V power unit for BC-20	11.95
Manual	Any manual (except 701), specify radio	7.50
Man701	701 Manual	20.00
RRD	Reverse dial for 22A, 22S, 30A	2.00
FA1	"Rubber Duckie" 2m Helical Antenna	5.50
MIC-P	3, 4, or 8 pin mic plug	1.75
MIC-B	3, 4, or 8 pin chassis mount (base)	1.75

DRAKE



Drake R-7

Synthesized, General Coverage Receiver

Fully synthesized with a permeability tuned oscillator (PTO) for smooth, continuous tuning.

Covers complete range 0-30 MHz. Both digital and analog readout.

Special low distortion "synchro-phase" AM detector provides superior international shortwave broadcast reception.

Tunable IF notch filter effectively reduces heterodyne interference from nearby stations.

Multi-function antenna selector/50 Ohm splitter is switch-selected from the front



panel. Provides simultaneous dual receive with the TR-7, making possible the reception of two different frequencies at the same time.

- Built-in power supply operates from 100, 120, 200, 140 Vac, 50/60 Hz, or nominal 13.8 Vdc.
- Much more!



Drake L-7

2kW Linear Amplifier

10m-160m coverage. 2kW PEP, 1kW CW, RTTY, SSTV operation - all modes, full rated input, continuous duty cycle. Accurate built-in rf wattmeter, with forward/reverse readings, is switch selected. By-pass switching for straight through, low power operation without having to turn off amplifier. Bandpass tuned input circuitry for low distortion and 50 Ohm input impedance. Operates from 120/240 Vac, 50/60 Hz primary line voltage.

On this page Tufts

brings you . . .

Drake



Drake UV-3

UHF-VHF FM Transceiver

- Fully synthesized on each band, 5 kHz steps, digital readout.
- FM coverage on complete 144, 220 and 440 Amateur bands, depending on model purchased. Completely band-switched from front panel.
- Four extra diode programmable fixed channels, with offsets, available for each band, in addition to the synthesizer.
- Diode programmable non-standard offsets available for each band.
- Separate SO-239 Antenna Connector for each band.
- Scan a programmed fixed channel from any synthesizer frequency. Scan any synthesizer frequency from a programmed fixed channel. Scan a specific programmed fixed channel from another programmed fixed channel.

UV-3 OPTIONAL ACCESSORIES:

- Removable control head will operate radio in trunk compartment from driver's seat.
- PS-3 - companion ac power supply.
- Drake 1525EM Encoding Mike.

DRAKE PRICE LIST

MODEL NUMBER	MODEL	DESCRIPTION	PRICE
COMMUNICATIONS RECEIVERS AND ACCESSORIES			
1242	DSR-2	VLF-HF Digital Synthesized SSB, AM, CW, RTTY, ISB Laboratory Communications Receiver	\$3400.00
1240	R7-/DR-7	0-30 MHz General Coverage, Digital Synthesized Receiver	1299.00
1548	R-7/TR-7	Cable Interface Kit	24.50
1532	NB-7A	Noise Blanker for R-7	90.00
7021	SL-300	300 Hz CW Filter for 7-line	55.00
7022	SL-500	500 Hz CW Filter for 7-line	55.00
7023	SL-1800	1800 Hz RTTY Filter for 7-line	55.00
7026	SL-4000	4000 Hz AM Filter for R-7	55.00
7024	SL-6000	6000 Hz AM Filter for 7-line	55.00
1531	MS-7	Speaker for 7-line	39.00
1217	4-NB	Noise Blanker for R-4C	74.00
7011	FL250	250 Hz CW Filter for R-4C	55.00
7013	FL-500	500 Hz CW Filter for R-4C	55.00
7015	FL-1500	1500 Hz RTTY Filter for R-4C	55.00
7017	FL-4000	4000 Hz AM Filter for R-4C	55.00
7019	FL-6000	6000 Hz AM Filter for R-4C	55.00
VHF-FM TRANSCEIVERS AND ACCESSORIES			
1346	UV-3	144-220-440 Transceiver 12 VDC	995.00
1330	UMK-3	Remote Trunk Kit for UV-3	69.95
1339		Extra Control Head for UV-3	90.00
1525	1525EM	Encoder Microphone for UV-3	49.95
AMPLIFIERS			
1528	L-7	160-15m Amplifier, Power Supply, and Tubes	1199.00
1578	L-7E	160-10m Amplifier, Power Supply, and Tubes	1199.00
ANTENNA TUNERS AND ACCESSORIES			
1538	MN-7	250W, 160-10m Tuner	175.00
1539	MN-2700	2KW, 160-10m Tuner	299.00
1510	B-1000	4:1 Balun for MN-7/MN-2700	26.95
1533	CS-7	Remote Controlled Antenna Switch	169.00
1514	WH-7	1.8-54 MHz 20/200/2000 Wattmeter	89.00
1550	DL-300	300W Dummy Load	26.95
1551	DL-1000	1000W Dummy Load	53.00
1529	FA-7	Fan for DL-1000/TR-7/PS-7	29.00
HF TRANSCEIVERS AND ACCESSORIES			
1336	TR-7/DR-7	Digital HF transceiver 160-10m (receives 1.5-30MHz)	1495.00
1537	NB-7	Noise Blanker for TR-7	90.00
7021	SL-300	300 Hz CW Filter for 7-line	55.00
7022	SL-500	500 Hz CW Filter for 7-line	55.00
7023	SL-1800	1800 Hz RTTY Filter for 7-line	55.00
7024	SL-6000	6000 Hz AM Filter for 7-line	55.00
1536	AUX-7	Auxiliary Range Program Board for TR-7 (for out of band coverage)	45.00
1546	RRM-7	Range Receive Modules	8.50
1547	RTM-7	Range Transceive Modules	8.50
1529	FA-7	Fan for TR-7/PS-7/DL-1000	29.00
1338	RV-7	Remote VFO for TR-7	195.00
1531	MS-7	Speaker for 7-line	39.00
1335	MMK-7	Mobile Mount for TR-7	49.95
7073	7073	Dynamic Mobile mic. w/Plug TR-7	24.50
7077	7077	Dynamic Desk mic. w/Plug TR-7	49.00
7037	7037	TR-7 Service Kit	50.00
POWER SUPPLIES AND ACCESSORIES			
1501	AC-4	Power Supply for 4-line, 110/220V	\$ 150.00
1505	DC-4	12 VDC Power Supply for 4-line	195.00
1504	PS-3	Power Supply for UV-3, 110/220V	89.95
1502	PS-7	Power Supply for TR-7, 110/220V	259.00
1529	FA-7	Fan for PS-7/TR-7/DL-1000	29.00
LOW PASS AND HIGH PASS TVI FILTERS			
1605	TV-42LP	100W Low Pass Filter	14.60
1608	TV-3300LP	1000W Low Pass Filter	26.60
1603	TV-300HP	High Pass Filter for 300 Ohm Twin Lead	10.60
1610	TV-75HP	High Pass Filter for 75 Ohm	13.25
ACCESSORY CRYSTALS			
		Crystals for 2C/R4B/R4C/SW4A/SPR4/ML2/T4XB/T4XC/TR4C/TR4CW	9.50
		Crystals for fixed frequency operation of tunable units/2NT	10.50
		Crystals for TR22/TR22C	9.50
		Crystals for TR72/TR33C	9.50

TR 7 TRANSCEIVER



In the past few years, several amateur transceivers have appeared on the market boasting features and techniques considered to be "state-of-the-art" in regards to communications technology. More often than not, these features and techniques have been incorporated without the initial expense of the development time necessary to assure that the resulting equipment represented an advancement in communications technology with respect to both performance and operator convenience.

The Drake TR7 Transceiver represents a unique blend of proven state-of-the-art techniques culminating in the first truly state-of-the-art transceiver presently available.

A product of the Drake "anything worth doing is worth doing right" philosophy, the TR7's many new techniques and operational features complement each other producing performance and convenience which will remain unexcelled for many years to come.

High Pass Filters for TV Sets

provide more than 40 dB attenuation at 52 MHz and lower. Protect the tv set from amateur transmitters 6-160 meters.



DRAKE TV-300-HP

Model No. 1603
For 300 Ohm twin lead. New terminals for easy installation.



DRAKE TV-75-HP

Model No. 1610
For 75 Ohm tv coaxial cable; tv type "F" connectors installed.

Low Pass Filters for Transmitters

have four pi sections for sharp cut off above the hf amateur bands and to attenuate transmitter harmonics falling in any tv channel and FM band. 52 Ohm. SO-239 connectors built in.



DRAKE TV-3300-LP

Model No. 1608
1000W max. below 30 MHz. Attenuation better than 80 dB above 41 MHz. Helps tv i-f interference, as well as harmonic interference.



DRAKE TV-42-LP

Model No. 1605
A four section filter designed with 43.2 MHz cut-off and extremely high attenuation in all tv channels for transmitters operating at 30 MHz and lower. Rated 100W input.

TUFTS Electronic Department Store TUFTS

CSC breaks the professional instrument price barrier!

On this page Tufts brings you . . .
CSC
Beckman



NEW!
DIGITAL PULSE GENERATOR 4001

- 0.5Hz-5MHz Frequency range
- 100mV-10V positive output; less than 30 nanosecond rise/fall times
- Independent TTL-compatible output (rise-fall times less than 25 nsec.)
- Square wave output mode
- Complement (polarity inverted) output
- Independent pulse width and spacing controls
- 10⁷:1 duty cycle range
- Continuous and manual one-shot operation
- External triggering, DC to 10MHz
- Synchronous output gating

ACCESSORIES

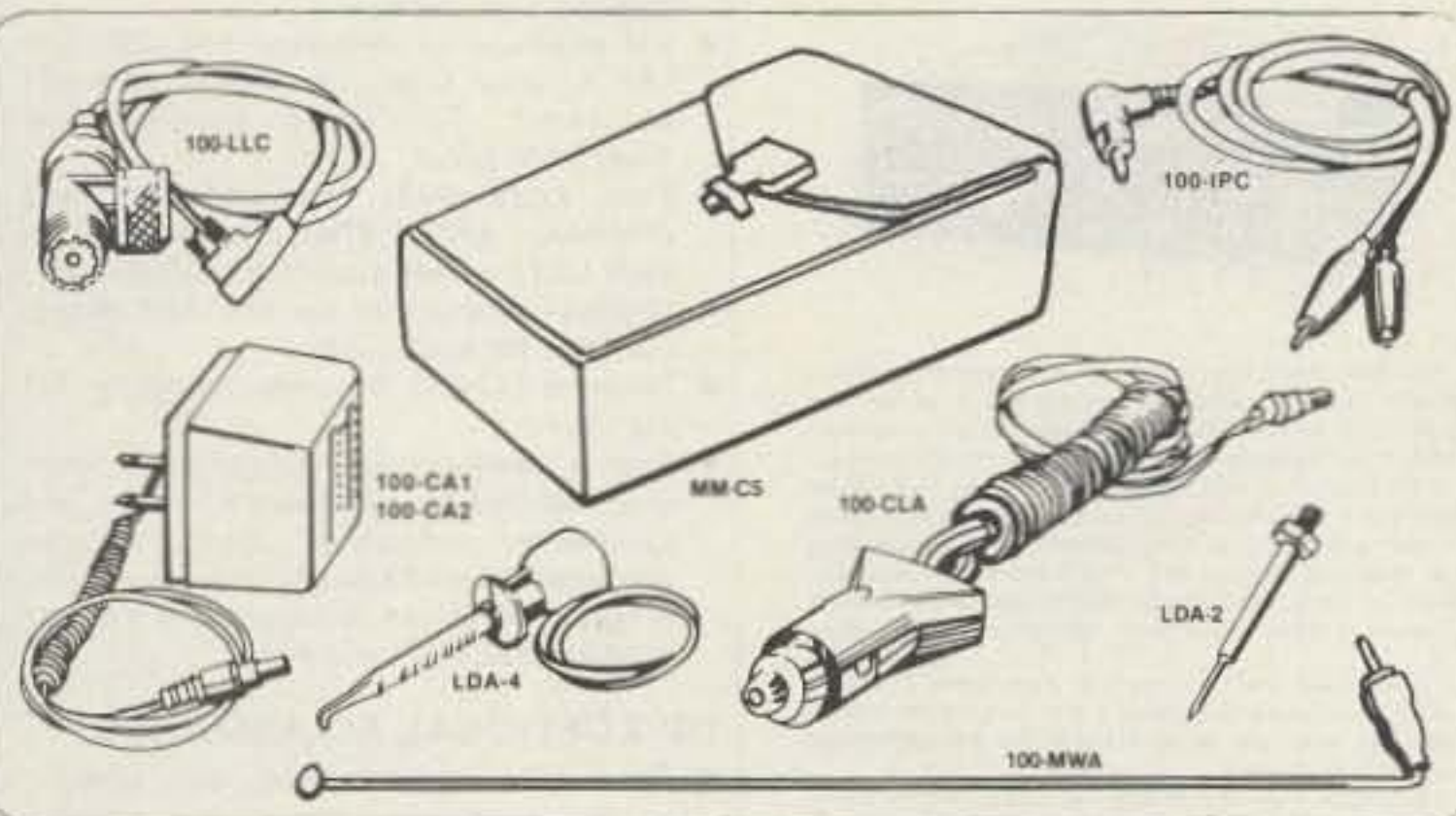

ACCESSORIES ADD EVEN GREATER FLEXIBILITY TO CSC INSTRUMENTS . . . ECONOMICALLY!

PRODUCT	STOCK NO.	DESCRIPTION	PRODUCT	STOCK NO.	DESCRIPTION
Max-100:					
100-IPC	11-0006	input cable with allig. clip	100-CA2	11-0005	AC charger/adaptor 220VAC, 50/60 Hz
100-CA1	11-0004	AC charger/adaptor 110VAC, 50/60 Hz	100-CLA	11-0003	auto cigarette light adapter
100-CA2	11-0005	AC charger/adaptor 220VAC, 50/60 Hz	Max-550:		
100-MWA	11-0007	mini-whip antenna when direct coupling is impractical	M1-IPC	11-0031	3' min RF to min RF cable
100-CLA	11-0003	Auto cigarette lighter/adaptor	M2-IPC	11-0032	min RF jack to BNC adapter
100-LLC	11-0008	in-line tap for monitoring transmission line, rated >4 watts	MM-IPC	11-0021	input cable with alligator clips (<50 MHz)
100-CC	11-0002	vinyl carrying case	MMAC2	11-0022	AC adapter - 110VAC, 50/60 Hz
Max-50:					
MM-IPC	11-0021	input cable with allig. clip	MMAC3	11-0023	AC adapter - 220VAC, 50/60 Hz
MMAC2	11-0022	AC adapter - 110VAC, 50/60 Hz	MMA4	11-0024	mini-antenna, when direct coupling is impractical
MMAC3	11-0023	AC adapter - 220VAC, 50/60 Hz	MMC5	11-0029	hard leather carrying case
MMA4	11-0024	mini-antenna, when direct coupling is impractical	PS-500:		
MMC5	11-0029	hard leather carrying case	PSA-1	11-0019	input power cable with allig. clip
PS-500 (cont'd):					
PSA-1	11-0019	input power cable with allig. clip	LDA-1	11-0009	1.5" probe tip
PSA-2	11-0027	3' BNC to BNC cable	LDA-2	11-0010	2.5" long probe tip
PSA-3	11-0028	18" phono to phono cable (Max-100 to Prescaler)	LDA-3	11-0011	3" mini-hook to use (in place of probe tip)
PSA-4	11-0030	18" phono to mini-phone cable (Max-50 to Prescaler)	LDA-4	11-0012	3" ground wire with mini-hook
100-CA1	11-0004	AC charger/adaptor 110VAC, 50/60 Hz	LDA-5	11-0013	3" ground wire with allig. clip
			LDA-6	11-0014	tip adapter, converts probe tip to mini-hook
			LDA-7	11-0015	banana plug adapter to use in place of probe tip
			LDA-8	11-0019	36" power cord with allig. clips
			LDA-9	11-0020	36" power cord with mini-hooks
			LDA-A	11-0018	all accessories except LDA-1 and LDA-8

BECKMAN

If you've ever been troubled by a faulty multimeter — or had one that wasn't quite up to the tougher jobs — your troubles are over

...Beckman Multimeters keep going.

Choice of Models
The TECH 310 has all above features, 7 functions, 29 ranges, plus 0.25% Vdc accuracy.
The TECH 300 has a 0.5% Vdc accuracy and all the above features, but without Insta-Ohms™ continuity function or the 10 amp current ranges.

Complete Multimeter Capability
DC volts: 100 μ V to 1500V
AC volts: 100 μ V to 1000V rms
Resistance: 0.1 Ω to 20M Ω
DC current: 100 μ A to 10A (TECH 310)
100 μ A to 2A (TECH 300)
AC current: 100 μ A to 10A (TECH 310)
100 μ A to 2A (TECH 300)
Diode/Semiconductor test function
Continuity function (TECH 310)

TECH 300 — \$110
TECH 310 — \$140



ONLY CSC COULD PROVIDE SUCH AN UNUSUAL VALUE: A SET OF MATCHED, PROFESSIONAL-GRADE GENERATORS, PERFECT FOR SHOP OR LABORATORY, YET PRICED FAR BELOW COMPARABLE UNITS.

LOGIC PROBES: HIGH-PRECISION, STIMULUS-RESPONSE, CIRCUIT-POWERED DIGITAL TESTING.

LP-1 MEMORY PROBE

With a guaranteed minimum detectable pulse width of 50 nanoseconds and a maximum input frequency of 10 MHz, this probe is an inexpensive workhorse for any shop, lab or traveling tool kit. It detects high-speed pulse trains or one-shot events and stores pulse or level transitions indefinitely, replacing separate level detectors, pulse stretchers, pulse detectors and pulse-memory devices. And, it's reverse-voltage protected to 36V over-voltage protected to $\pm 50V$ continuous.
Stock No: 07-0002

\$44.95

LP-2 ECONOMY PROBE

Same basic design as the LP-1, but for slower-speed circuits and without the memory capability. Handling a minimum pulse width of 300 nanoseconds, this 300 K Ω input probe is the economical way to test circuits up to 1.5 MHz. Detecting pulse trains or single-shot events in TTL, DTL, HTL and CMOS circuits, it replaces a separate pulse detector, pulse stretcher and node state analyzer. The unit is over-voltage protected to $\pm 50V$ continuous, and operates from 5 to 15 Vcc at 30mA max.
Stock No: 07-0003

\$24.95

LP-3 HIGH-SPEED MEMORY PROBE

All the features of the LP-1 PLUS high-speed capabilities that let this probe capture pulses as narrow as 10 nsec, monitoring pulse trains to 50 MHz. LP-3 offers the capability of a high quality memory scope at about 1/100th the cost, capturing one-shot or low-rep-rate events that are all but impossible to detect any other way. All, without the weight, bulk, inconvenience or power consumption of other methods. Over-voltage protected to $\pm 50V$ continuous, reverse voltage to 36V, the unit simplifies testing, debugging and servicing with capabilities not available in other instruments.
Stock No: 07-0004

\$69.95

LABORATORY PRECISION. VERSATILE AND RUGGED, FOR USE IN THE FIELD.

Faster, easier, and more economical digital testing: CSC Logic Probes were developed to meet the increased need for portable, compact logic-state-oriented test equipment. These precision, pocket-sized instruments instantly locate and analyze problems at the integrated-circuit level, allowing you to:

- Determine the logic state of any node — high, low, invalid
- Catch fast pulses and store them, if desired
- Find low-rep-rate glitches — impossible to detect, even with a fast scope
- Trace signals through circuits
- Check levels, pulse transitions, duty cycles . . . and more

- Simply connect the clip leads to the test circuit's power supply, set the Logic Family switch and touch the probe's tip to the node in question.
- Dual level indicator LED's, fed by precision window comparators, display Hi (Logic "1"), LO (Logic "0") tracing pulses through TTL/DTL or CMOS/HTL/HINILMOS logic circuits.
- Depending upon the setting of the PULSE/MEMORY Switch, a third LED stretches pulse transitions or latches on first transition, for easy "tracking" of "0" and "1" states up to 50 MHz. Unlike other designs, CSC Logic Probes respond to both positive and negative level transitions.
- When high frequency signals are unsymmetrical, and duty cycle is less than 30%, LO LED lights, while duty cycles above 70% light the HI LED.

NOW, LABORATORY-QUALITY PULSE AND FUNCTION GENERATORS THAT SET NEW STANDARDS IN ECONOMY WITHOUT SACRIFICING PERFORMANCE.

NEW!

FUNCTION GENERATOR 2001



- Sine-, square-, triangle- and separate TTL square wave output
- Frequency range, 1Hz-100KHz
- Frequency Sweepable over 100:1 range
- Pushbutton range, function and DC offset selection
- Low distortion
- Variable output to 10V P-P
- Shortproof outputs

NEW!

MAX-550: POCKET-SIZED 1 KHz-550 MHz COUNTER.

A wide-range frequency measuring instrument in a calculator-sized case.

- Measures 1000 Hz to 550 MHz, guaranteed
- No larger than a pocket calculator
- Full 8-digit display with Lead-Zero blanking
- Crystal timebase accurate to 3 ppm
- Compact, rugged low-drain design
- Choice of two power sources





BARKER &
WILLIAMSON, INC.

On this page Tufts
brings you . . .
B&W

5-BAND TRAP DIPOLE (80 thru 10 Meters)

Power rated 2k WPEP, approx. 110 ft. span

Complete with: wire, traps, end insulators, 50 ft. RG-8/U, PL-259 connector, heavy-duty cast aluminum and statite center connector.



Pre-assembled: Model 370-11 Kit (illustrated):
- \$64.95 Model 370-12 - \$54.95

Model Number	Dia.	TPI	Wire Size (AWG)	Length of Coils (Inches)	PRICE	Model Number	Dia.	TPI	Wire Size (AWG)	Length of Coils (Inches)	PRICE
404T	1/2	4	18	2	\$2.20	1404T	13/4	4	14	10	\$7.10
406T	1/2	6	18	2	2.33	1406T	13/4	6	14	10	5.01
408T	1/2	8	18	2	2.33	1408T	13/4	8	14	10	5.12
410T	1/2	10	18	2	2.42	1410T	13/4	10	16	10	5.23
416T	1/2	16	20	2	2.53	1416T	13/4	16	18	10	5.36
432T	1/2	32	24	2	2.75	1432T	13/4	32	24	10	5.65
504T	5/8	4	16	2	2.20	1604T	2	4	12	10	9.60
506T	5/8	6	18	2	2.27	1606T	2	6	14	10	9.71
508T	5/8	8	18	2	2.33	1608T	2	8	14	10	9.82
510T	5/8	10	18	2	2.46	1610T	2	10	16	10	9.94
516T	5/8	16	20	2	2.53	1616T	2	16	18	10	10.14
532T	5/8	32	24	2	2.66	2004T	2 1/2	4	12	10	10.90
604T	3/4	4	16	2	2.10	2006T	2 1/2	6	12	10	11.01
606T	3/4	6	18	2	2.17	2008T	2 1/2	8	12	10	11.12
608T	3/4	8	18	2	2.30	2010T	2 1/2	10	16	10	11.23
610T	3/4	10	18	2	2.37	2404T	3	4	10	10	13.17
616T	3/4	16	20	2	2.42	2406T	3	6	12	10	13.28
632T	3/4	32	24	2	2.61	2408T	3	8	14	10	13.40
804T	1	4	16	3	2.31	2410T	3	10	14	10	13.50
806T	1	6	18	3	2.45	195-1	3	---	---	---	52.38
808T	1	8	18	3	2.52	195-2	3	---	---	---	61.02
810T	1	10	18	3	2.56	3204T	4	4	8	10	69.39
816T	1	16	20	3	2.73	3206T	4	6	10	10	70.74
832T	1	32	24	3	2.78	3208T	4	8	12	10	67.23
1004T	1 1/4	4	14	10	6.17	3210T	4	10	12	10	68.58
1006T	1 1/4	6	14	10	6.33	4004T	5	4	8	10	83.16
1008T	1 1/4	8	16	10	7.17	4006T	5	6	10	10	84.78
1010T	1 1/4	10	18	10	7.33	4008T	5	8	12	10	86.94
1016T	1 1/4	16	20	10	7.48	4010T	5	10	12	10	90.45
1032T	1 1/4	32	24	10	7.89	4804T	6	4	8	10	92.34
1204T	1 1/2	4	14	10	6.36	4806T	6	6	10	10	99.36
1206T	1 1/2	6	14	10	6.79	4808T	6	8	12	10	100.98
1208T	1 1/2	8	16	10	7.17	4810T	6	10	12	10	108.00
1210T	1 1/2	10	18	10	7.24						
1216T	1 1/2	16	20	10	7.50						
1232T	1 1/2	32	24	10	7.82						

PI-DUX® Coils
High-precision, air-wound coils for band-switching, pi-network final amplifiers.

AIR-DUX® Air Wound Coils
Uniform-pitch coils from 1/2 inch to 6 inches diameter, 2 inches to 10 inches long, 4 to 32 turns per inch, no. 8 to no. 24 AWG.



Model 195-1 rated to 1 KW PEP
Model 195-2 rated to 2 KW PEP

COAXIAL SWITCHES AND ACCESSORIES

for antenna selection and RF switching

Model 376



Model 375



Model 550A-2



Model 551A



Model 592

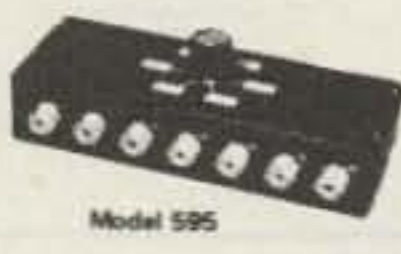

Model 595



Model 550A



Model 377



Model 593



Model 594



Model 590



Model 590G

MODEL	DESCRIPTION	PRICE
SWITCHES		
375	PROTAX switch. Grounds all except selected output circuit. 6 Outputs.	\$19.75
376	PROTAX switch. Grounds all except selected output circuit. Sixth switch position grounds all outputs. 5 Outputs.	19.75
377	Coaxial Antenna Relay	22.50
550A	Antenna/RF Coax Switch. 5 Outputs.	17.50
550A-2	Antenna/RF Coax Switch. 2 Outputs.	14.95
551A	Special 2-pole, 2-position switch used to switch any RF device in or out of series connection in a coaxial line. 2 Outputs.	17.95
556	Bracket only, for wall mounting of radial connector switches.	.95
590	Antenna/RF Coax Switch. 5 Outputs.	18.50
590G	Grounds all except selected output circuit. 5 Outputs.	18.50
592	Antenna/RF Coax Switch. 2 Outputs.	17.75
593	Single pole, 3 position Antenna RF/Coax Switch.	17.50
594	D.P.D.T. Antenna /RF Coax Switch. Interchanges two outputs between two inputs.	18.25
595	Grounds all except selected output circuit. 6 Outputs.	21.50



Model 333 dummy load wattmeter - Favorite Lightweight Portable-250 WATT RATING - Air Cooled. Ideal field service unit for mobile 2-way radio - CB, marine, business band. Best for QRP amateur use, CB, with zero to 5 watts full scale low power range.

Frequency Range: DC to 300 MHz
VSWR: Less than 1.3:1 to 230 MHz
Power Range: 250 watts intermittent
Wattmeter Ranges: 0.5, 0.50, 0.125, 0.250
Connector: SO 239
Size: 4" x 7" x 8"
Shipping Weight: 2 lbs.
Price: \$98.50



Model 374 dummy load wattmeter - Top of the Line - 1500 WATT RATING - Oil Cooled. Our highest power combination unit. Rated to 1500 watts input (intermittent). Meter ranges are individually calibrated for highest accuracy.

Frequency Range: DC to 300 MHz
VSWR: Less than 1.3:1 to 230 MHz
Power Range: 1500 watts DC intermittent.
Warning light* signals maximum heat limit.
Wattmeter Ranges: 0.15, 0.50, 0.300, 0.1500
Input Connector: SO 239 (hermetically sealed)
Size: 4 1/2" x 9" x 10 1/2"
Shipping Weight: 12 lbs.
Price: \$235.00



High Power - 1000 WATT RATING - Oil Cooled - model 334A dummy load wattmeter. Our most popular combination unit. Handles full amateur power. Meter ranges individually calibrated. Can be panel mounted.

Frequency Range: DC to 300 MHz
VSWR: Less than 1.3:1 to 230 MHz
Power Range: 1000 watts CW intermittent.
Warning light* signals maximum heat limit.
Wattmeter Ranges: 0.10, 0.100, 0.300, 0.1000
Input Connector: SO 239 (hermetically sealed)
Size: 4 1/2" x 5" x 10 1/2"
Shipping Weight: 12 lbs.
Price: \$195.00



Wide range attenuator - Model 371-1. Seven rocker switches provide attenuation from 1 dB to 61 dB in 1-dB steps. Switches are marked in dB, 1-2-3-5-10-20-20. Sum of actuated switches (IN position) gives attenuation. With all switches in OUT position, there is NO insertion loss. Attenuator installs in coaxial line using UHF connectors.

Power Capacity: 1/2 watt
VSWR: 1.3:1 maximum, DC to 225 MHz
Impedance: 50 ohms
Attenuation: 1 dB/dB, DC to 60 MHz
0.1 dB/dB to 0.5 dB, DC to 160 MHz
0.1 dB/dB to 1.0 dB, DC to 225 MHz
Size: 8 1/2" x 2 1/2" x 2 1/4"
Shipping Weight: 1 1/2 lbs.
Price: \$59.50

TUFTS Electronic Department Store TUFTS

On this page Tufts brings you . . .

Telex
NPC
Unarco-Rohn



Headphone Jack Box

Ham Clubs, field day contest operation. No more jury rigs for multiple headphones. Six 1/4" phone jacks with individual volume controls, 4 foot cord with 1/4" phone plug. **\$14.30**

PROFESSIONAL HEADPHONES & HEADSETS BOOM MIC HEADSETS

For the ultimate in communications convenience and efficiency select a boom mic headset. Long-time favorites of professional communications, boom mic headsets allow more personal mobility while always keeping the mic properly positioned for fast, precise voice transmission. Boom microphones are completely adjustable to allow perfect positioning. And, boom headsets leave both hands free to perform other tasks.

All models are supplied with "close talking" microphones to limit ambient noise pick-up and provide superior intelligibility. Each model as a convenient, inline push-to-talk switch, which can be wired for either push-to-talk relay control or mic circuit interrupt for voice operated transmitters. The switch may be used as a momentary push-button or it can be locked in the down position. All models have tough, flexible, 8 foot cords which are stripped and tinned, unterminated.

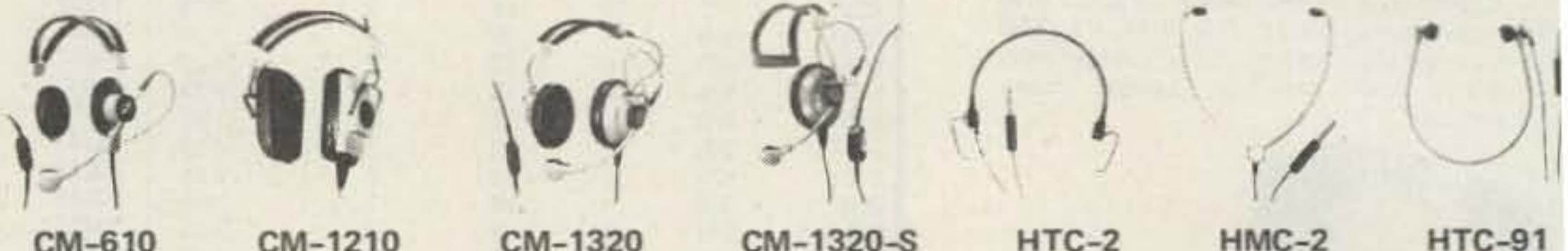

TELEX



MODEL	C-610	SWL-610	C-1210	C-1320	CM-610	CM-1210	CM-1320	CM-1320S	PC-100	HTC-2	HMC-2	HFC-91
Headphone Sensitivity Ref 0002 Dynes/cm ² @ 1mW input, 1kHz	103dB SPL ±5dB	103dB SPL ±5dB	103dB SPL ±3dB	105dB SPL ±5dB	103dB SPL ±5dB	103dB SPL ±3dB	105dB SPL ±5dB	105dB SPL ±dB				
Headphone Impedance	3.2 20 ohms	2000 ohms	3.2 20 ohms	3.2 20 ohms	3.2 20 ohms	3.2 20 ohms	3.2 20 ohms	3.2 20 ohms	8 200 ohms	3.2 20 ohms	3.2 20 ohms	3.2 20 ohms
Microphone Frequency Response					50 8000 Hz	50 8000 Hz	50 8000 Hz	50 8000 Hz	50 1200 Hz	100 3000 Hz	100 3000 Hz	100 3000 Hz
Microphone Impedance					High	High	High	High	Low	Low	Low	Low
Microphone Sensitivity Below 1 volt/microbar at 1 kHz					51 dB ±5 dB	51 dB ±5 dB	51 dB ±5 dB	51 dB ±5 dB				
PRICE:	\$10.45	\$12.25	\$29.70	\$41.80	\$47.20	\$62.75	\$75.25	\$59.95	\$16.95	\$24.50	\$15.50	\$9.90



MODEL	NET PRICE
12V4	\$19.95
102	\$24.95
107	\$28.95
103R	\$39.95
104R	\$49.95
108RA	\$79.95
108RM	\$99.95
109R	\$149.95



MODEL 109R
NPC 25 Amp Regulated Power Supply, 4 Way Protected. Output Voltage and Current Meters.
Extra heavy duty unit quietly converts 115 volts AC to 13.6 volts DC - 200 millivolts, 10 amps continuous, 25 amps max. All solid state. Features dual current overload, overvoltage and thermal protection. Ideally suited for operating mobile Ham radio and linear amplifier in your home or office. Excellent bench power supply for testing and servicing of mobile communications equipment.

TYPICAL	MAXIMUM
Output Voltage	13.6 - 2VDC
Line/Load Regulation	50 mV
Ripple/Noise	5 mV RMS
Transient Response	20 uSec
Current Continuous	10 Amp
Current Limit	26 Amp
Overvoltage Protection	14.5 V
Thermal Overload	180 °F

Case: 4" (H) x 9" (W) x 8" (D) Shipping Weight: 15 lbs

MODEL 108RM



NPC 12 Amp Regulated Power Supply, Solid State, 3 Way Protected, Current Meter.
This heavy duty unit quietly converts 115 volts AC to 13.6 volts DC - 200 millivolts, 8 amps continuous, 12 amps max. All solid state. Features dual current overload, overvoltage protection. Ideally suited for operating mobile Ham radio, 2 meter, AM/FM SSB transceivers in your home or office. Can also be used to trickle charge 12 volt car batteries.

TYPICAL	MAXIMUM
Output Voltage	13.6 - 2VDC
Line/Load Regulation	20 mV
Ripple/Noise	2 mV RMS
Transient Response	20 uSec
Current Continuous	8 Amp
Current Limit	12 Amp
Current Feedback	2.5 Amp
Overvoltage Protection	14.5 V

Case: 4" (H) x 7" (W) x 5" (D) Shipping Weight: 9.5 lbs

ALSO AVAILABLE AS MODEL 108RA WITHOUT METER AND OVERVOLTAGE PROTECTION.



MODEL 104R
NPC 6 Amp Power Supply Regulated, Solid State, Dual Overload Protection.
Converts 115 volts AC to 13.6 volts DC - 200 millivolts. Handles 4 amps continuous and 6 amps max. Ideally suited for applications where excellent DC stability is important, such as CB transmission, small Ham radio transmitter, and high quality eight-track car stereos. Can be used to trickle charge 12 volt car batteries.

TYPICAL	MAXIMUM
Output Voltage	13.6 - 2VDC
Line/Load Regulation	20 mV
Ripple/Noise	2 mV RMS
Transient Response	20 uSec
Current Continuous	4 Amp
Current Limit	8 Amp
Current Feedback	2 Amp

Case: 3" (H) x 5" (W) x 6" (D) Shipping Weight: 6 lbs



MODEL 103R
NPC 4 Amp Regulated Power Supply, Solid State, Dual Overload Protection.
Converts 115 volts AC to 13.6 volts DC - 200 millivolts. Handles 2.5 amps continuous and 4 amps max. Ideally suited for applications where no hum and DC stability are important such as CB transmission, small Ham radio transmitter, and high quality eight-track car stereos. Can also be used to trickle-charge 12 volt car batteries.

TYPICAL	MAXIMUM
Output Voltage	13.6 - 2VDC
Line/Load Regulation	20 mV
Ripple/Noise	2 mV RMS
Transient Response	20 uSec
Current Continuous	2.5 Amp
Current Limit	4 Amp
Current Feedback	1 Amp

Case: 3" (H) x 4" (W) x 5" (D) Shipping Weight: 4 lbs



MODEL 102
NPC 2.5 Amp Power Supply, 4 Amp Max., Solid State, Overload Protected.
Functions silently in converting 115 volts AC to 12 volts DC. 2.5 amps continuous, 4 amps max. Enables anyone to enjoy CB radio, car 8-track cartridge, cassette tape player or car radio in a home or office.

TYPICAL	MAXIMUM
Output Voltage	12 V
Output Voltage (No Load)	15 V max
Output Voltage (Full Load)	12 V min
Filtering Capacitor	5,000 uF
Ripple (Full Load)	5 V RMS
Short Circuit Protection	Thermal Breaker

Case: 2" (H) x 4" (W) x 5" (D) Shipping Weight: 4 lbs

MODEL 107

NPC 4 Amp Power Supply, 6 Amp Max. Solid State, Overload Protected.



Functions silently in converting 115 volts AC to 12 volts DC. 4 amps continuous, 6 amps max. Enables anyone to enjoy CB radio, car 8-track cartridge, cassette player or car radio in a home or office.

TYPICAL	MAXIMUM
Output Voltage	12 V
Output Voltage (No Load)	15 V max
Output Voltage (Full Load)	12 V min
Filtering Capacitor	10,000 uF
Ripple (Full Load)	5 V RMS
Short Circuit Protection	Thermal Breaker

Case: 3" (H) x 4" (W) x 5" (D) Shipping Weight: 5 lbs

MODEL 12V4

NPC 1.75 Amp Power Supply, 3 Amp Max.



Functions silently in converting 115 volts AC to 12 volts DC. Ideally suited for most applications including 8-track stereo, burglar alarm, car radio and cassette tape player within power rating.

TYPICAL	MAXIMUM
Output Voltage	12 V
Output Voltage (No Load)	15 V max
Output Voltage (Full Load)	12 V min
Filtering Capacitor	5,000 uF
Ripple (Full Load)	4 V RMS
Short Circuit Protection	Thermal Breaker

Case: 3" (H) x 4" (W) x 5" (D) Shipping Weight: 3 lbs

Unarco-Rohn

COMPLETE 25G TOWER PACKAGES

50' Guyed Tower: Includes top section, 4 regular sections, base plate, rotor plate, 50' guy wire, 2 guy assemblies with torque bars, 3 concrete guy anchors and other miscellaneous hardware.

TOTAL REGULAR PRICE \$594.02
SALE PRICE 464.02

SAVE \$130.00

50' Bracketed Tower: Includes top section, 4 regular sections, base plate, rotor plate and universal house bracket.

TOTAL REGULAR PRICE \$366.15
SALE PRICE 266.15

SAVE \$100.00



Bearcat®

\$329.00



BEARCAT 220
Aircraft, Marine, Public Service. The 220 has features and advanced sophistication. Aircraft and Marine - press button to search entire Aircraft Band, another for Marine
7 Bands - Low, High, UHF, UHF-T, 2m amateur and 75 CM Ham - plus the Aircraft Band
20 Channels - scan up to 20 frequencies or either of two banks of 10 channels each
Automatic Search - Selective Scan Delay - Automatic Lock-Out - Patented Track Tuning - Manual Scan Control - Single Antenna
Priority - automatically samples designated channel every two seconds
AC/DC operation

\$129.95



BEARCAT Four-Six
More bands, more channels - more scanning capabilities than other Hand-Helds.
• 4 Bands (Low, High, UHF and UHF-T)
• 6 Channels - more monitoring capacity
• "Rubber Ducky" Antenna
• Belt Clip frees hands while monitoring
• 8 channels per second scan speed
• Automatic or manual scanning
• Individual channel lock-outs
• Portable - weighs only 12 ounces
• Battery operated (6 Vdc)

BEARCAT 211
More capabilities - more refinements. The 211 sets a new standard for synthesized scanners.
• 6-Band coverage - Low, High, Gov't., UHF, UHF-T and the amateur Ham Band.
• 18 channel monitoring.
• Digital Electronic Clock
• Variable Scan Speed - 5 or 15 channels per second
• Deluxe Keyboard, Synthesized Programming
• Automatic Search - Selective Scan Delay - Automatic Lock-Out - Patented Track Tuning - Manual Scan Control - Hold for stopping on frequencies while searching - Single Antenna
• Decimal Display
• Auto Squelch factory-set for optimum reception
• AC/DC operation

\$279.00



BEARCAT 300 \$499.95

Service Search
Over 2100 pre-programmed frequencies.
• 11 Service Search categories arrange stored frequencies into "interest" groups - Police, Fire, Marine, HAM, Emergency, Telephone, Government, Forestry, Industrial, Transportation and Aircraft.
• 50 Channels/5 bands
• 7 Bands (Low & High VHF, UHF, and UHF-T, AM Aircraft, 2m & 75 CM Amateur)
• Non-volatile memory, AC/DC
• Automatic Search with Hold & Resume functions
• Patented Selective Scan Delay
• Vacuum Fluorescent Decimal-Display with Dimmer Control
• Speed Control
• Quartz Clock
• Patented Track Tuning
• Direct Channel Access
• Automatic Squelch

On this page Tufts brings you . . .
Bearcat
DAIWA (J. W. Miller)



BEARCAT 250 \$299.00

The most advanced synthesized scanner in Bearcat history.
• 50 channels can be programmed in 5 banks of 10 channels each; 6 Bands
• Search/Store locates and remembers active frequencies
• Search/Recall displays "found" frequencies in sequence
• Automatic Count of action on each channel
• Search Direction for easy operations
• LED Clock
• Non-Volatile Memory - Priority - Auxiliary Control - Twin Scan Speeds - Manual Scan - Automatic Squelch - Scan Delay - Track Tuning - LED Clock - more.
• AC/DC operation

\$79.95



BEARCAT Alert
Warning Radio
More than a weather radio - it automatically activates to broadcast emergency weather information.
• Touch bar for monitoring continuous weather forecast from National Weather Bureau.
• Audio and visual warnings for emergency bulletins.
• Automatically switches to batteries when power fails, AC/DC

\$65.95

DAIWA



RF-660



RF-440 \$135.95

RF Speech Processor
Models RF-400 & RF-660
Increases talk power with splatter free operation. RF clipping assures low distortion. Simply install between microphone and transmitter.
Talk Power: Better than 6 dB.
Frequency Response: 300-3000 Hz at 12 dB down.
Distortion: Less than 3% at 1 kHz, 20 dB clipping.
Power Requirement: RF-440 self contained. AC power supply: RF-660 13.5Vdc external supply.

CN-720 and CN-620
Frequency Range: 1.8-150 MHz
SWR Detection Sensitivity: 5W min.
Power: 3 Ranges (Forward, 20/200/100W) (Reflected, 4/40/200W)

\$140.50



CN-620

Interference Filters from J. W. Miller

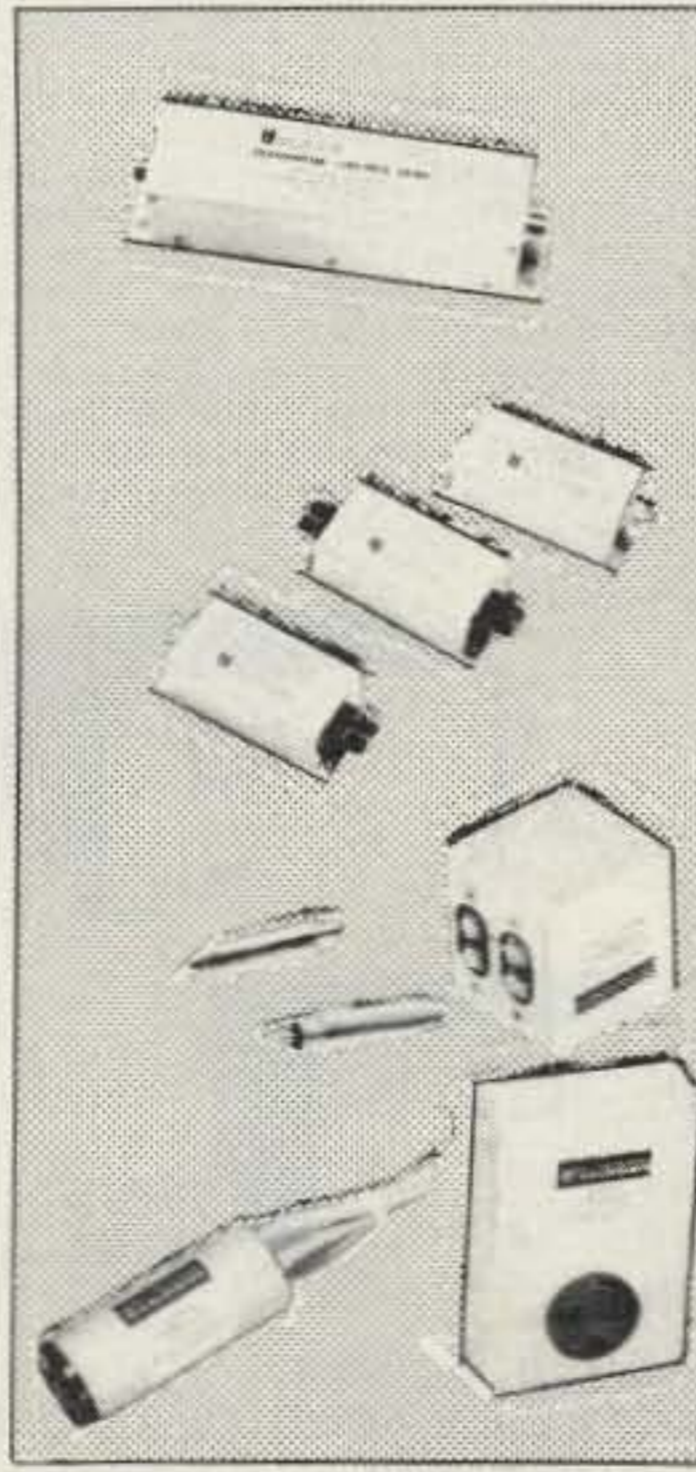

Low Pass Filters
Eliminate or greatly reduce interference to TV receivers by radio amateur stations when installed in antenna lines of those transmitters. Input and output impedance 50 ohms. Insertion loss .3 dB max.; VSWR 1.2:1
Attenuation greater than 75 dB above 41 MHz
C-511-T: 25 W AM 50 W PEP SSB \$19.50
C-514-T: 1000 W AM 2000 W PEP SSB \$26.80

High Pass Filters
When installed in the antenna, eliminate or greatly reduce front end overload interference to TV or FM receivers caused by amateur radio transmitters and other high frequency radio services. Filter attenuates signals below 40 MHz by a power factor greater than 1,000,000:1. Impedance C-513-T1: 75/300 ohm \$10.18
C-513-T2: 75/75 ohm; C-513-T3: 300/300 ohm \$10.18

Audio Interference Filters
Eliminate interference caused in your audio equipment by radio amateur transmitters and other radio services. C-505-R installs in the input lines of audio equipment. Consists of 1 pair. C-506-R installs in speaker lines. Unit will take care of stereo speaker system. \$5.07
C-506-R \$6.67

AC Power Line Filters
Eliminate or reduce interference to radio amateur receivers, TV's and radios, and prevent radio signals from entering power line.
C-508-L: 3-section LC filter, 3 A max. \$ 8.33
C-509-L: 5-section LC filter (for more severe interference), 5 A max. \$18.35

CN-630
Frequency Range: 140-450 MHz
Power: 2 Ranges (Forward 20/200W) (Reflected 4/40W)

CN-630



Coaxial Switches
2 Position/Model CS-201
4 Position/Model CS-401

\$20.95

SWR & Power Meters
Models CN-720, CN-620 and CN-630

Professionally engineered cavity construction. Power Rating: 2.5kW PEP, 1kW CW
Impedance: 50 Ohms
Connectors: SO-239
Insertion Loss: Less than 2 dB
VSWR: 1:1.2
Maximum Frequency: 500 MHz
Isolation: Better than 50 dB at 300 MHz; better than 45 dB at 450 MHz; adjacent terminal.
Unused Terminals grounded.



CN-720 \$166.95

TUFTS Electronic Department Store TUFTS

On this page Tufts brings you . . .
Ten-Tec

OMNI



Designed to give you every advantage, every capability, whatever your operating specialty. Totally solid-state, 8 bands, broad-band design, analog and digital readouts, built-in VOX and PTT, built-in adjustable squelch, built-in 4-position CW/SSB filter, 8-pole crystal SSB filter, 2-speed break-in, WWV reception, front panel control of linear or antenna bandswitching, built-in phone patch jacks, built-in "timed" crystal calibrator, built-in zero beat switch, separate receiving antenna capability, built-in SWR bridge, front panel microphone and phone jacks, adjustable automatic level control, built-in adjustable sidetone, dual compression-loaded speakers, automatic sideband selection, plug-in circuit boards, 12VDC, 117VAC (external supply is required for fixed station use), accessories available, much more.

OMNI SPECIFICATIONS:
Frequency Bands: 1.8-2.3, 3.5-4.0, 7.0-7.5, 14.0-14.5, 21.0-21.5, 28.0-28.5, 28.5-29.0, 29.0-29.5, 29.5-30.0 MHz transceiver; 10.0-10.5 MHz receive only.
 Permeability tuned VFO and receiver rf amplifier.
Vernier Tuning: 18 kHz per revolution, typical.
OMNI-A Accuracy: ±1kHz from nearest 25 kHz calibration point.
 Pulsed 25 kHz crystal calibrator in OMNI-A.
OMNI-D Accuracy: ±100 Hz.
OMNI-A Readout: Slide rule dial indicates 100 kHz segment, dial skirt increment to 1 kHz. Three dial scales.
OMNI-D Readout: Six digit, 0.43" LED numerals. Least significant digit indicating 100 Hz green, all others red.
VFO Stability: Less than 15 Hz change per F°, averaged over a 40° change from 70° to 110°, after 30 minute warmup. Less than 10 Hz change from 105 to 125 VAC line voltage when using TEN-TEC power supply.
 Automatic sideband selection, reversible. Provisions for remote VFO, Model 243. Power switch remotely controls power supply.

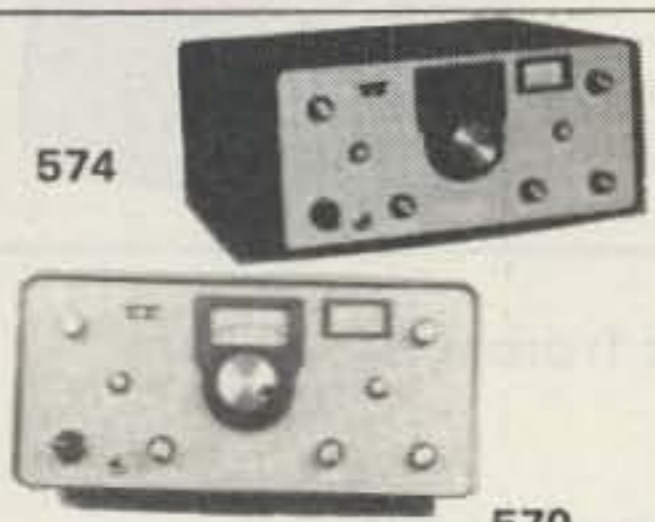

Century 21 (570 or 574)
Novice Exclusive
 Purchase your Century 21 (570 or 574) from us and have up to one year to apply the full purchase price towards a model 540, 544, 545, or 546 when you upgrade your station.

ADDITIONAL CRYSTALS
 Extend 10m coverage to 30MHz. Model 212 29.0 to 29.5 MHz. Model 213 29.5 to 30.0 MHz.

MODEL 249 - Noise Blanker
 Plug-in PC assembly for either model. Effectively blanks most impulse noise. Blanker is inserted into receiving i-f channel. Disabling switch on front panel.

MODEL 245 - CW Filter
 Plug-in PC assembly consists of four active, low Q op-amps. Center frequency of 750 Hz, bandwidth of 150 Hz. Two selectivity responses available with front panel control. Shape factor of 7.2 @ 6/60 dB.



MODEL 240 - 160m Converter
 Provides 160m operation at 75% power level. In addition to using 540/544 VFO for variable transceive operation, one of two owner-selected crystal positions can be used for transmitting while the VFO is used for receiving. This is useful for listening in the DX window and transmitting outside of it. Housed in matching enclosure.



MODEL 242 - Remote VFO
 Duplicate of 540/544 VFO for operation on two frequencies. Switch, with LED indicators, allows selection of six possible modes. TRANSCIEVER transmit and receive; REMOTE transmit and receive; TRANSCIEVER transmit-REMOTE receive; REMOTE transmit-TRANSCIEVER receive; TRANSCIEVER transmit-both receive; REMOTE transmit-both receive. Full break-in is preserved for all modes. Two crystal positions, selected from front panel, for spot frequency or out of band use. Matching enclosure. Plugs into accessory socket on either Model 540 or 544.



MODEL 262M/262M/E
MODEL 252M/252M/E (115-230 VAC)
AC Power Supplies
 Fully voltage regulated to provide highly stable, pure DC (225W) from 117 VAC. Panel DC ammeter. Instantaneous overload protection circuit prevents damage caused by excessive current drain; reset by momentary turn-off. Model 262M has, in addition, a complete VOX system. VOX controls are located on front panel. Low frequency components in voice, below cut-off frequency of speaker, actuate T/R function.

TEN-TEC

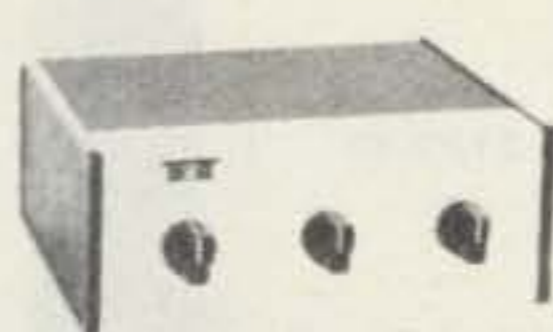

MODEL 247 - Antenna Tuner
 Matches 50 ohm unbalanced output from transmitter to a variety of balanced or unbalanced antenna impedances. Popular universal Transmatch circuit with one kV capacitor spacing and 46-tap silver plated inductor (pat. pending) allows vernier adjustment up to 200W rf rating. Handsome enclosure matches 540/544 transceivers.



MODEL 215P - Microphone Stand
 Designed for optimum articulation - free from power limiting peaks. Impervious to extremes of temperature, humidity and rough handling. Convenient as a hand-held mike yet nests in an attractive base for desk use. Four foot cable, PTT switch, stereo type phone plug and die cast base.



MODEL 645 - Electronic Keyer
 The 645 keyer uses transistor switching and is powered by the transceiver (so it is compatible with any TEN-TEC transceiver). Adjustable magnetic paddle return. Self completing characters. Dit and dah memories with defeat switches.

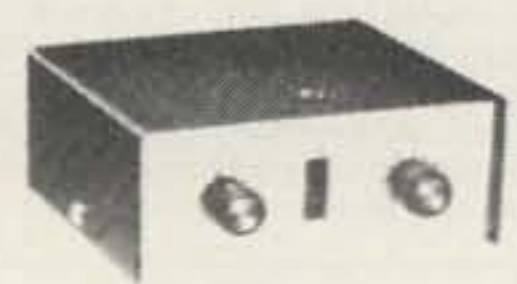

MODEL 241 - Crystal Oscillator
 Six crystal positions allow operating spot frequencies in or out of bands. Will extend range 100 kHz from 80 and 40 meter band edges and 200 kHz on remaining bands. Cannot be used with Models 242 or 244. Plugs into accessories socket. Matching enclosure.

MODEL	DESCRIPTION	PRICE
ACCESSORIES		
206A	Crystal Calibrator	\$34.50
208	CW Filter, for Model 509	34.50
212	Crystal, for Models 540/544, 29.0-29.5 MHz	5.00
213	Crystal, for Models 540/544, 29.5-30.0 MHz	5.00
214	Electret Microphone, for Model 234	39.00
215P	Microphone, Ceramic with plug	29.50
215PC	Microphone, Ceramic with plug and coil-cord	34.50
217	500 Hz 8 Pole Ladder Filter	55.00
218	1.8 kHz 8 Pole Ladder Filter	55.00
234	Speech Processor	124.00
240	One-Sixty Converter, for Models 540/544	110.00
241	Crystal Oscillator, for Models 540/544	35.00
242	Remote VFO, for Models 540/544	179.00
243	Remote VFO, for Models 545/546	139.00
244	Digital Readout/Counter for Models 540/544	197.00
245	CW Filter, for Models 540/544	25.00
247	Antenna Tuner	69.00
248	Noise Blanker, for Models 545/546	49.00
249	Noise Blanker, for Models 540/544	29.00
273	Crystal, for Models 570/574, 28.5-29.0	5.00
276	Crystal Calibrator, for Model 570	29.00
277	Antenna Tuner/SWR Bridge, for Model 570	85.00
1102	Snap-up Legs (pair)	1.00
1140	DC Circuit Breaker, for Models 540/544 and 545/546	8.75
1145	Knob Set for Models 540, 509	5.00
1150	Overvoltage Protector, for Models 252/262 Series	15.00
1170	DC Circuit Breaker, for Model 570	8.75
POWER SUPPLIES		
210	117 VAC, 13 VDC, 1 A	34.00
210/E	Same as Model 210, but 115/230 VAC	39.00
252M	117 VAC, 13 VDC, 18 A	139.00
252M/E	Same as Model 252M, but 115/230 VAC	146.00
252MO	Same as Model 252M, but matches OMNI	139.00
252MO/E	Same as Model 252MO, but 115/230 VAC	146.00
262M	117 VAC, 13 VDC, 18 A, Deluxe, with VOX	159.00
262M/E	Same as Model 262M, but 115/230 VAC	166.00
TRANSCIEVERS		
509	Argonaut, 5 W. SSB/CW, 3.5-30 MHz	389.00
540	Transceiver, 200 W. SSB/CW, 3.5-30 MHz	699.00
544	Transceiver, Digital, 200 W. SSB/CW, 3.5-30 MHz	869.00
545	OMNI-A, Analog, Series B, SSB/CW, 1.8-30 MHz	1119.00
570	Century/21, 70 W. CW, 3.5-29 MHz	349.00
574	Century/21, Digital, 70 W. CW, 3.5-29 MHz	449.00
KEYERS		
645	Ultramatic, Dual Paddle for 545/546	85.00
670	Single Paddle Keyer, for Model 570/574	34.50
KR-5A	Single Paddle Keyer, 6-14 VDC	39.50
KR-20A	Single Paddle Keyer, 117 VAC/6-14 VDC	69.50
KR-50	Ultramatic Keyer, Dual Paddle, 117 VAC/6-14 VDC	110.00

TUFTS

Electronic Department Store

OPEN DAILY 9-9
SATURDAY 9-6



ORDER BLANK



P. O. Box 75, Somerville, Mass., 02145, 1-617-391-3200

Prices FOB Medford, Mass. Mass. residents add 5% sales tax. Minimum \$3.00 for shipping and handling on all orders.

CAT. NO.	PAGE NO.	DESCRIPTION	QUANTITY ORDERED	UNIT PRICE	TOTAL PRICE

Name _____ Call _____
 Address _____
 City _____ State _____ Zip _____
 Order: _____
 Check Enclosed Visa Master Charge Send Free Catalog
 PRICES SUBJECT TO CHANGE WITHOUT NOTICE
 Card no. _____ Card exp. date _____
 Signature _____

5% Sales Tax (Mass. Residents)	
Shipping and Handling	\$3.00 Min.
Amount Enclosed	

SPECIAL PRICING NOTICE

Many of the major items, such as transceivers, are available at special discount prices. A complete list of these special discount prices may be obtained by writing or calling our mail order department. If your order contains one of the items on the current discount list our sales staff will make sure that you receive the lower prices. You may call us at (617) 391-3200 for quotes off our discount list.

SST T-3 MOBILE IMPEDANCE TRANSFORMER



All bands (160m-10m) with any wire
 • 200W output • Any transceiver • Home or portable • Neon tune-up indicator.
 \$29.95

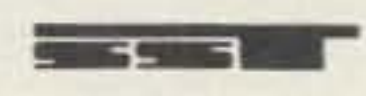

SST T-2 ULTRA TUNER



Tunes out SWR on any antenna - coax fed or random wire (160m-10m). Any rig - up to 200W RF output. Rugged, yet compact: 5 1/4" x 2 1/4" x 2 1/2".
 \$37.95

SST T-4 ULTRA TUNER DELUXE



ULTRA TUNER DELUXE Matches any antenna - coax fed or random wire on all bands (160m-10m). Tune out the SWR on your antenna for more efficient operation of any rig. Home, mobile, portable - only 9" x 2 1/2" x 4 1/4". • 300W rf output capability • SWR meter with 2-color scale • Antenna Switch selects between two coax fed antennas, random wire, or tuner bypass • Pi-network design. Attractive black.
 \$64.95

SST T-6 ULTRA TUNER



Matches 52 Ohm coax to the lower impedance of a mobile whip. Taps between 3 and 50 Ohms. 3-30 MHz. 300W output. 2 1/4" x 2" x 2 1/4".
 \$19.95

SST T-1 RANDOM WIRE ANTENNA TUNER



Most versatile antenna tuner available. Any antenna - coax fed or random wire (160m-10m). Front panel function switch selects between two circuits - a Pi or L network - or tuner bypass. Front panel antenna switch. Relative output meter. 200W output - will work with virtually any transceiver. 6 1/2" x 3" x 3". Attractive bronze finished enclosure.
 \$59.95

SST A-1 Amplifier Kit. 1W in 15 out. All parts, circuit board, instructions. Easy to build.
 \$22.95

SST DL-1 K4RLJ DUMMY LOAD. 1000W PEP. 1.5:1 1-225 MHz. Scaled.
 3-1/8" x 4-3/8".
 \$19.95

SST B-1 Balun for using T-2, T-4, T-6, or similar tuner with balanced open wire lines.
 300W.
 \$5



EASTER EGGS

ALPHA 76, 374, 78 In Stock.....	Call
Cushcraft "boomer".....	69.95
OMNI-J 2 Meter Antenna.....	39.95
Bird 43 and slugs. UPS paid in USA.....	stock
Microwave Modules. Less 10% off list. stock	
Telrex TB5EM, in stock.....	415.00
TB6EM.....	520.00
Monobanders in stock	
New Telrex TB5ES. 2KW Pep version.....	315.00
New Palomar Transceiver Preamp.....	89.50
Bench Paddles.....	39.95
chrome.....	49.95
Vibroplex Paddles in stock, & bugs.....	call
Lunar 6M-2M-220 In-line Preamps.....	stock
Janel QSA-5.....	41.95
HAM-X Tailtwister Rotor.....	189.00
HAM-4 Rotor.....	139.00
Cetron or GE 572B.....	32.00/ea
GE, AMPGREX, Raytheon G146B.....	9.95
Motorola HEP170.....	0.29
Mallory 2.5A/1000 PIV Epoxy diode.....	0.19
Sprague 100MFD/450VDC Cap.....	2.00
Aerovox 1000PF/500V Feedthru Cap.....	1.95
Adel Nibbling Tool.....	8.45
Technical books: Ameco, ARRL, Sams, TAB, Rider, Radio Pub., Callbook, Cowan, WRTVH, etc.....	Call
New Belden 9405 (2#16)(6#18) 8 wire Rotor cable, heavy duty for long runs.....	0.32/ft
8448 8 wire Rotor Cable.....	0.20/ft
9888 Double Shield RG8 Foam.....	0.46/ft
8214 RG8 Foam.....	0.26/ft
8237 RG8 Regular.....	0.23/ft
8267 RG213.....	0.30/ft
9251 RG8 A/U.....	0.35/ft
Belden #8000 14GA Stranded Antenna wire.....	0.06/ft
Amphenol Silverplate PL259 (8315P).....	0.69
Berktex RG8X 52ohm. KW.....	0.16/ft
Robot "Slow Scan" 400.....	499.00

Telrex antennas?
In Stock!

Monobanders?
You bet!

Looking for antique parts?
Write specific need to W5GJ.

THIS MONTH'S SPECIALS:

New IC701, AC, MIC \$1195.00;
New ICOM, IC251A — 2M \$599.00;
IC551D -6M-100W \$599.00;
IC551 \$399.00.

Dentron GLA1000B.....	295.00
Dentron Clipperton L.....	499.00
Bearcat 250, 220.....	299.00
300.....	399.00

MASTERCARD • VISA

All prices fob Houston except where indicated. Prices subject to change without notice, all items guaranteed. Some items subject prior sale. Send letterhead for Dealer price list. Texas residents add 6% tax. Please add postage estimate \$1.00 minimum.

 **MADISON**
Electronics Supply, Inc.
1508 McKinney • Houston, Texas 77002 • (713) 658-0268
✓ 45

MFJ ✓ 47

ANTENNA TUNERS



\$69⁹⁵

NEW MFJ-940 VERSA TUNER II matches coax and random wire 1.8 to 30 MHz.

Up to **300 watts RF OUTPUT**. SWR, dual range wattmeter (300 and 30 watts full scale).

Six position antenna switch on rear. Select 2 coax lines direct or thru tuner, random wire, and tuner bypass for dummy load.

New efficient airwound inductor (12 positions) gives you less losses than tapped toroid for more watts out, 8x2x6 inches. SO-239 coax connectors. 208 pf, 1000 volt capacitors.

Optional mobile mounting bracket, add \$3.00.

Beware of imitators. When you buy MFJ you buy proven MFJ quality . . . and a one year unconditional guarantee.



\$39⁹⁵

MFJ-900 ECONO TUNER matches coax, random wires. Full band coverage 1.8 to 30 MHz.

Up to **200 watts RF OUTPUT**. Efficient airwound inductor gives more watts out than tapped toroid.

SO-239 coax connectors. 5x2x6 inches. One year unconditional guarantee.

MFJ-901 Versa Tuner available. Same as MFJ-900 but has 4:1 balun for balanced lines, \$49.95.

Beware of imitators. Some are still copying our earlier models. MFJ has made improvements.

For example, a new efficient airwound inductor gives you less losses than a tapped toroid for more watts out and plenty of inductance for full band coverage 1.8 to 30 MHz.

\$29⁹⁵



MFJ-16010 RANDOM WIRE TUNER lets you operate 1.8 to 30 MHz with random wire. Up to **200 watts RF OUTPUT**. Small enough to carry in your hip pocket. Ultra compact 2x3x4 inches.

Match low and high impedances by interchanging input and output. SO-239 coax connectors.

One year unconditional guarantee.

Order from MFJ and try it. If not delighted, return within 30 days for refund (less shipping).

Order yours today. Call toll free 800-647-1800. Charge VISA, MC. Or mail check, money order. Add \$3.00 each for shipping.

CALL TOLL FREE . . . 800-647-1800

For technical information, order/repair status, in Miss., outside continental USA, call 601-323-5869.

MFJ ENTERPRISES, INC.
BOX 494, MISSISSIPPI STATE, MS 39762

What does it
really cost to
get on RTTY?



**No Economy models,
no extras**

. . . its *all* there. The Microlog "Split Screen Package" will get you on silent RTTY and CW with any rig, any mode; and with features you will find most desirable. \$999 for complete AKB-1 keyboard and AVR-2 decoder using your TV (\$1099 with 9" monitor shown). Compare on quality, features and price; we're sure you'll stay with MICROLOG. 4 Professional Drive, Suite 119, Gaithersburg, Maryland 20760, 301-948-5307.

✓ 51
MICROLOG
CORPORATION

Innovators in Digital Communication

LETTERS

from page 20

cy? A lot of people just do not obey the rules. Whatever happened to using minimum power necessary? When did they come out with the rule allowing someone to own a frequency? Our HF bands are sounding more like 11 meters every day.

I do not claim to know it all, but I do try to obey the rules. I ran a Ten-Tec Argonaut for six months and worked the world on two Watts. So do not cry to me about your busted kW! I am a bit of a pessimist. I predict that in ten years our HF bands will be a lost cause. They will undoubtedly be just like 11 meters.

My personal cure for HF was VHF and UHF. There you can tinker and converse without being jammed. Our 450-MHz band does not yet have a lot of readily available equipment. Thus, most of the people there are tinkers and experimenters. Most of these people respect their privilege of being able to operate at all.

So someday when you turn on your rig, you will hear garbage on our HF bands that surpasses even CB. I have already given up on HF and sold all my HF gear. So everybody have fun on 20-meter CB.

Michael Crumpton
Orlando FL

WHAT A LETDOWN

Today, after reading your January editorial, I feel like a teenage boy who idealized the athletic man across the street and just found out that he was as queer as a three-dollar bill. Boy! What a letdown!

I don't know of any ham who wants the code requirements dropped. It appears to me that only certain people would stand to gain financially from canceling the code requirements.

If there is a great number of people who find the code requirements too difficult, we could go to the present CB licensing procedures. I am sure

that this system would satisfy those people who want to make money at our expense.

By the way, Wayne, I bring people into amateur radio the right way. I teach Novice classes through the Adult Education System in our community.

David W. Wilcox WA1YOC
Caribou ME

NEW RFI PROBLEM

May I provide a word of warning to any ham using a 1978 LeBaron with a "lean burn" engine who contemplates using more than 30 Watts output? The original computer is not shielded and high rf can really send it into a tailspin. My problem included 18 months of rough engine performance and mileage variation from 25 mpg to 10 mpg on an intermittent basis! Three new computers, 5 sets of plugs, 3 new PCV valves, a carb boil-out, and at least a dozen engine scopes offered no help! Finally, a hot-line call from Florida to Chrysler Engineering revealed that they had indeed had problems with police, vets, and other users of high-output 2-way radios (no tech bulletins had been issued, nor was Sales warned of problems to prospective users). The cure—simply wrap the computer case in aluminum foil—not very professional, but it seems to work!

Anyone having problems is advised to insist on a call to Detroit—the field service people have not been advised!

Lowell C. Stanley WA9OLL
Lantana FL

BUY AMERICAN

Thank you for printing the Joe Feagans W9HCI letter in the December issue. He saved me the time and effort of expressing the same sentiments myself.

Yes, you do have the best amateur radio magazine going. I agree with about 90% of your editorials, but the rest has be-

come pure drivel.

The honorable mention you have given lately to the CB HFers is unbecoming of an otherwise excellent publication. Within their own 10½-meter subculture, they obviously can no longer differentiate between right and wrong. Future hams? Where would they operate then in crowded band conditions? Would MARS frequencies become funny channels?

Unlike most hams who think this type of problem will go away by remaining ignorant about it, the Novices on 10 CW do an admirable job on any idiot who ventures above 28.000 MHz into their, that is to say our, frequency spectrum.

Further, you have implied that most Yaesu and Kenwood equipment is CB-bound. I tend to agree. Albeit even a Collins KWM-2 can be modified for 10½ meters, it does not appear that Rockwell has actively gone after that market. This then becomes a personal matter of ethics for all hams when they decide who to patronize when buying amateur gear. I would like to see more business given to our people at Atlas, Drake, etc.

Lowell Loughary K7LFT
Portland OR

TELENETICS/TELARIS

Just a quick note about the fine article on the 7516 chip written by Bill Hosking W7JSW in the October, 1979, issue of 73.

Your readers will have a hard time locating the manufacturer of these devices, as they changed names as well as addresses.

They are now: Telaris Telecommunications, Inc., 2772 Main St., Irvine CA 92714.

Thanks to the efforts of a couple of the users of our repeater, WB6FUB/RPT, we managed to find them again.

Mike DeHart WB6KRU
Walnut CA

FEEDING FRENZY

While listening to the recent Kingman Reef DXpedition, I was extremely disturbed by the actions of our fellow hams in the United States. The only proper analogy I can give this fiasco is a "feeding frenzy."

I realize that in a pileup, especially of a rare country, there will be a bit of anxiety involved,

but this was ridiculous. I hope this never happens again.

In conclusion, I don't wish to repeat any of the unidentified comments or imply degrees of intelligence of the hams who made the comments, but I cannot resist the temptation to interject on one of the most used phrases. This was in reference to CBers. Now, being an upgrade from eleven meters, I can truthfully say that CBers have much more self-control than that referred to. My regards to W2FIJ and those who were trying their best at 2200Z on January 9, 1980, 28.594 ±.

Sorry, gentlemen, I did turn the dial.

F. C. LaMont, Jr. KA6AAE
Modesto CA

GREAT DISSERVICE

I read with interest your views expressed in the January, 1980, issue of 73 Magazine. I have been quite impressed with your publication and opinions for some time now, but, by the same token, I also support the ARRL. I believe they have a valid function in our hobby. I enjoy reading all available ham publications because I feel it is necessary to hear more than one viewpoint on an issue.

I must say that I'm inclined to agree with you on your statements concerning lack of participation by younger amateur prospects. However, I don't feel eliminating the code requirement is going to help anybody. Speaking for myself and other hams (at least in the Toledo area), it would be a great disservice to the good of the hobby to do away with code. I, for one, am proud to have achieved the code knowledge I have (and, incidentally, Wayne, I used your 73 code cassettes to do it).

As a matter of fact, I am now using your 21 wpm cassette as well as your old enemy, the ARRL W1AW code practice. Not only am I studying your Extra Class book, but I am also using the ARRL manual plus several other sources. Sorry, Wayne, but there is no such thing as a complete study guide. This is partially the fault of the FCC itself, and I don't blame your organization or the ARRL. You do have fine publications, so please, keep up the good work.

Steve Lewis KA8CXT
Russford OH

new COAX SWITCHES

from Barker & Williamson

Model 593

- **Single Pole 3** Position with grounding of all unused positions
- **Crosstalk** (measured at 30 MHz) is -45db between adjacent outlets and 60 db between alternate outlets



Model 594

- **2 Pole 2 Position**
- **Crosstalk** 45db (measured at 30 MHz)



Specifications for both switches

- **Power** 1 KW-2 KW PEP
- **Impedance** 50-75 ohms
- **VSWR** 1.2:1 up to 150 MHz
- **Dimensions** 1 3/4" high, 5" wide, 3" deep
- **Weight** 1 lb.
- **Mount** Wall or desk

✓ 11 Available at your B&W dealer



Barker & Williamson, Inc.
10 Canal St. Bristol, Pa. 19007
Telephone: (215) 788-5581

Microlog AKB-1 memory keyboard. . .



. . . famous for its smooth and reliable operation, now with special option packages tailored to suit your needs:

AKB-1 Memory Keyboard for CW **\$299**

AKB-1 with RTTY, AFSK Generator and T/R Relay (Save \$51) **\$449**

Add 2000 character expanded memory and brag tape (Save \$151) **\$599**

Limited time offer.

4 Professional Drive, Suite 119,
Gaithersburg, MD 20760,
301-948-5307 ✓ 51

MICROLOG
CORPORATION

Innovators in Digital Communication

ALDELCO ELECTRONICS COMPANY

RF DEVICES			
2N5913 1.7W 175 MHz	\$1.70	2N6080 4W 175 MHz	5.40
2N3866 1W 400 MHz	1.25	2N6081 15W 175 MHz	8.45
2N5589 3W 175 MHz	4.75	2N6082 25W 175 MHz	10.95
2N5590 10W 175 MHz	7.80	2N6083 30W 175 MHz	11.75
2N5591 25W 175 MHz	10.95	2N6084 40W 175 MHz	13.30

OVERVOLTAGE PROTECTION OV-12 Provides protection from runaway Power Supply Voltage. Triggers @ 16V 25 Amp rated, 1 piece moulded unit for 12 Volt DC fused Power Supply **\$8.95** OV-5 for 5 Volt PS triggers at 7V **\$9.95**

ACCUKEYER KIT. Similar to Handbook version. Includes PC Board, IC's, Sockets & all parts. Includes sidetone on board, lmbic operation dot dash memory. Only **\$21.95**

NEW MEMORY KIT. 1056 bit memory expandable to 4224 bits. 1 2102 supplied. Additional chips \$1.25 each. Led indicator. Adaptable to other keyers. Uses 5VDC. Only **\$21.95**

Dual digital 12 or 24 HOUR CLOCK KIT. NOW WITH A NEW WALNUT WOOD GRAIN CABINET Model ALD 5-W Six Big 0.5 Displays Only **\$52.95** 12 or 24 Hour Operation —

Each Clock controlled separately
Freeze Feature for Time Set — Easy assembly for clock and Cabinet



5 x 7.3 dot matrix display **3.95**
Handie Talkie collapsible whip ant. BNC **8.95**

ALARM CLOCK KIT Six 0.5 LED Display Readouts, Elapsed Time indicator, 12 Hour Format with 24 Hour Alarm Snooze feature, AM/PM indicator, Power Supply power failure indicator. Only **\$21.95**
12 or 24 Hour Clock Kit, 0.5 Display LED's **\$19.95**
Wood Grain Cabinet **\$4.95**

TUNABLE AMATEUR TV CONVERTER Receive Fast Scan ATV in the 420 MHz Band with any TV Set. Low noise high gain Amplifier stage with Varactor Tuned input and output. Built-in 110 VAC Supply. Two Tone Walnut & Beige Cabinet measuring 1-7/8" x 4-1/4" x 4-1/8". Factory Wired & Tested. 2 Year Guaranty. Only **\$59.95**

Lunch Counter Kit (boards & front panel only) **\$14.50**
11C90 Prescaler **\$19.95** 1 MHz crystal **\$ 7.95**
74C925 Multiplex **\$15.95** 10-60 PF trimmer **\$.60**
F9368 Drivers (2) **\$15.95** 704 displays, each **\$ 1.25**
Resistor Kit **\$ 1.75** Capacitor Kit **\$ 6.00**

Add 6% for Shipping. Min. Order \$10.00. Out of USA send Certified Check or Money Order. Include Postage.

ALDELCO

2789 A Milburn Avenue, Baldwin, NY 11510
(516) 378-4555

✓ 300 Send 1st class stamp for our catalog

The Ultimate QRM Killer

DATONG MODEL FL-1



FREQUENCY-AGILE
AUDIO FILTER

\$219.⁹⁵

Including Pre-Paid
Shipping & Full Insurance

- Made in England
- 90 Day Warranty
- Reviewed in QST Aug. 1979
- VISA-MASTERCHARGE accepted

Model FL 1 is a versatile add-on audio filter for communications receivers. It gives great flexibility in helping to extract the desired signal (SSB, CW, RTTY, etc.) from background interference and yet simply connects between loudspeaker and receiver output.

- Fully automatic search/lock/track operation for notching out unwanted heterodynes.
- Selectable bandpass or band-reject modes.
- Bandwidth smoothly variable from 20 Hz to 1000 Hz.
- Center frequency smoothly variable from 280 to 3000 Hz.
- Built-in 2 watt power output stage.
- Uses internal 9-volt battery or external source of 6 to 12 volts DC.

Application to CW

Model FL 1 is superb for CW reception. As an extra refinement automatic frequency control can be switched, which enables the filter to tune itself onto a CW station over a 100 Hz range. This way the 20 Hz minimum bandwidth becomes as easy to tune in as if it were 100 Hz.

Application to SSB and RTTY

For SSB or RTTY reception Model FL 1 can be used to give either a fully adjustable audio "window" to pass the wanted signal and to reject others, or as a variable notch to remove unwanted narrow band signals. Tuning in the notch mode can be fully automatic or manual. Auto-notching allows routine "hands off" use of a notch only 20 Hz wide so that the wanted signal is completely unaffected.

Dedicated to Excellence (Exclusive importers of DATONG ASP's)

AR Technical
Products
Corp.

Box 62
Birmingham, Michigan 48012
Telephone 313/644-5698

✓ 9

WANTED WRITERS AUTHORS

The *Blacksburg Group*, originators of the *BUGBOOKS*, is interested in working with authors who would like to have their book ideas published in the popular "Blacksburg Series." Our 30+ titles cover many aspects of electronics, and there is always room for exciting new topics.

Meet with W3HB (Howard Berlin), WB4HYJ (Dave Larsen), and other series authors at the *Dayton Hamfest* in April. We'll have all of the "Blacksburg Series" titles on sale, and we will be interviewing people who have new book ideas. Be sure to bring your outlines and manuscripts. In the meantime, write for an author packet and book list, and make an appointment to meet with us in Dayton.

- Microcomputer Applications
- Telephone Applications
- PET Interfacing
- Software (All types)
- IEEE-488 Bus
- Robotics
- Word Processing
- Home/Satellite TV
- TRS-80 Interfacing
- 16-Bit Micros
- Home/Solar Control
- AND OTHERS . . .

The Blacksburg Group
Box 242, Blacksburg, VA 24060
(703) 951-9030

✓ 320



Contests

from page 14

tion during July in Denver and in the MARAC newsletter.

ARRL EME CONTEST I

Starts: 0001 GMT April 19
Ends: 2359 GMT April 20

Briefly, the rules are as follows: All amateurs worldwide are invited to participate. The object is to conduct two-way communication via the Earth-moon-Earth path on any authorized amateur frequency above 50 MHz. Stations must exchange call signs and a signal report and acknowledge all information. Contacts may be made on CW or SSB. Only one contact per station on each band regardless of mode. Each station can have only one signal per band on the air at all times. Fixed or portable operation is permitted, but portable stations outside their licensed call areas must sign portable and identify the operating call area. Each

station can use only one call sign during the entire contest. Entry classes include single- and multi-operator. Score 100 points per EME contact. The multiplier is the total number of DXCC countries and US and Canadian call areas. Contacts with KH6, KL7, and so on carry multiplier credit as DXCC countries but not as call areas. Entries must be postmarked not later than June 2. For complete rules and additional information, see the February issue of QST.

HELVETIA CONTEST

Starts: 1500 GMT April 26
Ends: 1500 GMT April 27

Use all bands, 1.8 to 28 MHz, on CW or phone. Each station can be worked once per band regardless of mode.

EXCHANGE:

RS(T) plus three-figure serial number starting at 001. Swiss stations will also give their canton.

Results

YL ANNIVERSARY PARTY, 1979 COMBINED SCORES CW & SSB

Station	CW	SSB	Total
N1YL	1,728.0	12,006.0	13,734.0
WD5FQX	297.5	10,296.0	10,593.5
WB4PRM	2,200.0	5,812.5	8,012.5
KI4W	552.5	5,757.5	6,310.0
WA2NFY	567.0	4,263.0	4,830.0

WINNERS

Corcoran Award (plaque) – N1YL
Hagar Award (cup) – VK3KS

YLAP SSB CONTEST

DX

DJ1TE	10,780.0
DL1MS	9,690.0
G4GAJ	6,944.0
DK5TT	4,407.0
DK9ZL	4,112.5
G4EZI	3,636.0

YLAP CW CONTEST

DX

VK3KS	637.5
LZ1QG	506.25
DF2SL	228.0
YC1BZ	212.5
DK5TT	152.0
JA1AEQ	32.0

North America

N1YL	12,006.0	WB4PRM	2200.0
WA1KKP	10,647.0	N1YL	1728.0
WD5FQX	10,296.0	K1QFD	1674.0
WB2OHD	9,821.0	W8YL	1248.75
K6KCI	8,387.0	N9AIB/4	968.75
KA5AZT	6,875.0	W3CDQ	621.0
WB9ZBE	6,519.0	WA2NFY	567.0
K6DLL	6,490.0	KI4W	552.5
W2GLB/5	6,270.0	W2HFR	546.0
W8DUV	6,042.0	WD0ELR	525.0

SCORING:

Each contact with an HB station counts 3 points. The multiplier is the sum of Swiss cantons worked on each band, 26 maximum per band. Final score is sum of QSO points multiplied by the sum of cantons worked on each band.

ENTRIES & AWARDS:

Certificates will be given to the highest scorer in each country. USA and Canadian call areas are considered as separate countries. Logs must be postmarked not later than 30 days after the contest and sent to: TM USKA K. Bindschedler

Results

1979 CAN-AM CONTEST

TROPHY WINNERS

Canadian Champion Combined – VE5DX
American Champion Combined – K6LL/7
Canadian Phone Trophy – VE7BGK
American Phone Trophy – AG7M
Canadian CW Trophy – VE7CC
American CW Trophy – N4ZZ
Multi-Operator Champion – VE4VV
Club Competition – Ontario Contest Club

SINGLE-OPERATOR

Canadians

Americans

	Phone		
VE5DX	952,271	K6LL/7	870,177
VE7BGK	872,894	AG7M	550,368
CZ6OU	506,106	WB4OSN	385,530
VE3BVD	435,860	N4TO	249,291
VE3DLR	214,985	AG9S	194,850
VE3KZ	112,922	N0AQK	144,275
VE7VX	95,694	WA6TOE	139,018
VE3DUS	73,140	N0JW	127,310
VE1CCC	58,520	KB5FU	126,799
VE3DAP	52,576	WA0LKL	108,675

CW

VE5DX	598,000	K6LL/7	371,424
VE7CC	560,637	N4ZZ	324,213
VE3BVD	411,382	N7ZZ	313,110
VE3KZ	379,638	AA6DX	280,692
VE1AIH	233,920	K0JW	275,500
VE3DAP	178,924	N4TO	265,000
VE3DZV	166,553	AG7M	250,101
VE1BGD	129,168	WB4OSN	243,945
VE1ANU	117,180	WA0LKL	241,428
VE8TM	105,164	N4OW	220,968

Combined

VE5DX	1,550,271	K6LL/7	1,241,601
VE7BGK	872,894	AG7M	800,469
VE3BVD	847,242	WB4OSN	629,475
VE7CC	560,637	N4TO	514,291
CZ6OU	506,106	WA0LKL	350,103
VE3KZ	492,560	N4ZZ	324,213
VE1AIH	233,920	N7ZZ	313,110
VE3DAP	231,500	N0AQK	307,084
VE3DLR	214,985	AA6DX	280,692
VE3DZV	166,553	K0JW	275,500

MULTI-OPERATOR

	Phone		CW
VE4VV	562,122	VE4VV	561,144
VE2FU	526,962	VE2FU	427,630
VE1AWN	434,076	VE1DXA	312,660
AA6DX	403,970	VE1AWN	302,220
VE1DXA	398,497	N4UF	231,168
N4UF	377,460	VE3UDO	185,283

CLUB COMPETITION

Ontario Contest Club – 1,662,754
South Florida DX Assn. – 1,620,716
Halifax ARC – 1,062,257

DUPLEXERS

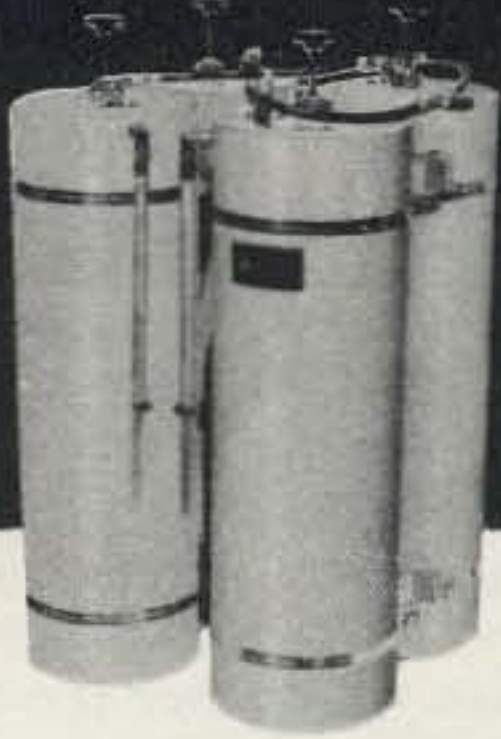

US PATENT
4080601

✓ 79

OUR NEW BANDPASS-REJECT DUPLEXERS WITH OUR EXCLUSIVE

BpBr CIRCUIT*

... provides superior performance, especially at close frequency spacing.

Models available for all Ham bands. Special price for Amateur Repeater Clubs

CALL OR WRITE FOR DETAILS:

WACOM PRODUCTS, INC.



P. O. Box 7127
Waco, Texas 76710
817/848-4435 ✓ 79

THE FAMOUS CLEGG TWINS



MARK-3 144-148 MHz* 15 Watts \$185
FM-76 220-225 MHz 10 Watts \$175

For 2 meters & 220 MHz

12 channel operation at unbelievable price—plus the performance & reliability you have learned to expect from Clegg.

Special quantity pricing is available on both models. Get your group together & call 1-800-233-0250 for a quote on your requirements.

*MARK-3 can be supplied with special modification for CAP or MARS!

Call or write today for descriptive brochure.

Clegg Communications Corp.

1911 Old Homestead Lane
Greenfield Industrial Park East
Lancaster, PA 17601 ✓ 13
(717) 299-7221

Our smart machine reads sloppy copy.

New! Includes 24-hour UTC clock, 110 and 300 baud ASCII, & tuning eye!



Kantronics

Field Day®

\$449.95

If someone tells you they offer the same features we do, check them out with the list below. Kantronics offers the finest in state-of-the-art technology through over 35 dealerships in the United States, Canada and West Germany.

- Morse copying ability
- 3 to 80 WPM Morse range
- Computer programs for improving sloppy Morse
- Radioteletype copying ability - 60, 67, 75 and 100 WPM Baudot
- ASCII radioteletype ability - 110 and 300 WPM baud
- Copies any shift of RTTY
- 24-hour UTC clock available in any mode
- Entire unit contained in one package
- Automatic code-speed tracking
- Full 10-character, large-size display
- Displays code speed
- Tuning eye for faster tuning
- Full year limited warranty
- Internal speaker
- Requires no TV set for use
- Advanced demodulator circuits
- Internal 200 Hz bandwidth filter
- All letters, numbers and punctuation plus 8 special Morse characters and 5 special RTTY characters
- 15-day trial period.

Send for our free brochure that explains the Field Day system of Morse and RTTY decoding. Or you can order from one of our dealers or our factory today. Our number is below, give us a call.

Special SWL model - \$464.95

Free

Code Reading Made Simple

Okay, tell me more.

Name
Address
City

State
Zip

Kantronics
1202 E. 23rd Street (913) 842-7745
Lawrence, Kansas 66044

HB9MX, Strahleggweg 28, 8400 Winterthur, Switzerland.

Canton abbreviations are: ZH, BE, LU, UR, SZ, OW, NW, GL, ZG, FR, SO, BS, BL, SH, AR, AI, SG, GR, AG, TG, TI, VD, VS, NE, GE, and JU.

H26 AWARD

For contacts made after January 1, 1979.

Send a list and QSL for each of the 26 cantons worked on CW and/or phone, RTTY, and SSTV to: Walter Blattner, Postbox 450, 6601 Locarno, Switzerland.

USS NORTH CAROLINA MEMORIAL STATION

The Azalea Coast Amateur Radio Club (WD4ORA) will be operating from the battleship USS North Carolina Memorial, Wilmington, North Carolina, on April 12 and 13 from 0930 to 1700

EST. Operating frequencies will be 25 kHz up from the lower edge of the General phone bands.

QSL to ACARC, PO Box 4044, Wilmington, North Carolina 28403. SASE, please.

Looking West

from page 10

remains the same: the special allure of the rails. Now, after many years, I think I understand the meaning of the song.

TRAINS AND HAMCONS DEPARTMENT

On the return leg of our journey, the three of us spent quite a bit of time discussing rail travel and how it might be applicable to amateur radio in light of the ever increasing cost of fuel and other alternate methods of transportation. It's no secret that many amateur radio conventions, even the biggies, are suffering from the fuel crunch. As with everything else, amateurs seem to think twice before taking the family mobile for a few-hundred-mile ride these days. As we talked, an idea popped into our collective heads which I might share with you. The train car we were in holds 88 people. According to AMTRAK, they have cars that hold more but most are 88-seaters. Let's hypothesize that a fairly good convention is being planned for, say, the San Francisco area. In the old days, when gasoline was 20¢ or even 30¢ a gallon, it was nothing for southern Californians to make a long weekend trip north to such an event. Today, most of us cannot afford such a trip.

What if alternate transportation were available at a reasonable price. How about a package which included transportation, hotel rooms and convention entry fee? Here might be a chance for an enterprising convention planner to make some friends and, possibly, some extra bucks. Suppose that our hypothetical San Francisco convention rented three coach cars, a club/dining car, and a baggage car from AMTRAK. The baggage car and one coach would originate in San Diego and would be tagged onto the

regular San Diego-to-Los Angeles run. Meanwhile, in Los Angeles, the club/dining car and two other coaches are loaded with the LA contingent. When the San Diego train arrives, the two cars carrying the convention-goers are added to the cars from Los Angeles and all are hooked to the regular train headed to San Francisco. When the train arrives, the planner has buses ready to whisk the new arrivals to their respective reserved hotel rooms, and when they check into the hotel, they are handed their convention ID. On the return leg, the process is simply reversed.

As an added attraction, the sponsor might get a well-known manufacturer to host the club car, set up an operational display of his equipment and let those on board operate "train mobile," and let the manufacturer pick up the entire tab for that car. Obviously, the car would probably be limited to VHF operation, but there is nothing to keep whoever is sponsoring the club car from showing his entire line of equipment. Remember, I operated using only a rubber ducky and made a myriad of contacts. Possibly it could be arranged to install a 1/4-wave mag mount atop the car for even a better signal. Anyhow, if this type of package could be put together, it might well make for a rather enjoyable trip and, moreover, ensure good attendance at the particular convention. I have run my hypothetical San Francisco convention and its associated transportation, lodging and admittance package past numerous local amateurs and most agree that it sounds like fun. So, you who are planning a show in the near future might take this idea under advisement. AMTRAK does rent out cars for those who want them, and the prices I have been quoted for certain runs seem very realistic. Think about it. It might be a way

to save a faltering show or add a new dimension to one doing well already.

THE CES DEPARTMENT

As many of you already know, I have been and still am deeply involved in consumer electronics. I have been since I fixed my first TV set at age five. We had a 10" RCA 630 in those days, and annually it required a 6AC7 sync amplifier. Well, television and all other aspects of consumer electronics have come a long way since that RCA 630. Today, I proudly claim ownership of a complete Sony home video entertainment center including a videotape recorder and will shortly be adding a portable Beta VCR and camera to expand on what I already have. No, I am not trying to brag. It's just that I have become as addicted to video as I have to amateur radio. Both hobbies have the ability to complement one another as was described in past columns. Anyhow, ever since it was decided to hold the winter CES in Las Vegas, I have become an annual attendee.

The train arrived on time, and we took a cab to the Landmark Hotel, where we had reservations. We had chosen the Landmark for a number of reasons, but the most important was that it was only across the street from the Las Vegas Convention Center, where the major part of CES takes place. In regard to the Landmark, I would like to express our collective sincere gratitude to the people who run it—especially to Mr. Bill Snyder for making our stay a most enjoyable one. I'd recommend that hotel anytime, especially if you are attending CES without access to an automobile. For a real treat, the next time you go to Las Vegas, have dinner in their sky-top restaurant. It has a most breathtaking view of the city, especially at night. Also, the prime rib is terrific!

Enough about the frills; on to the 1980 winter CES. Though I have no official figures as to attendance, it seemed a little less crowded this year. I judge this

mainly by the much smaller crowds at the food lines and smaller groups around each booth. Also, the overall atmosphere seemed far more businesslike than in years past; however, this is only a personal observation. For the second year in a row, home video and video-related products were in the forefront, followed closely by home audio, telephone equipment, and auto sound (auto radios, tape players, etc.), with personal radio communications taking a back seat to just about everything else. To my eye, it appears that CB has lost a lot of ground and, most unfortunately, has taken amateur radio along with it.

Last year, I estimated that amateur radio and amateur-related products accounted for around 1% of what was shown. This year I would say that it was down to about .1%—maybe less—not that CB fared all that much better. It appears that CB radio manufacturers are wising up and concentrating on making a smaller number of superior-quality radios rather than hordes of poor ones. Many of the new CB sets are very advanced and feature such niceties as microprocessor control, digital readouts, better quality receive and transmit audio, and, in general, a better, more professional look about them. Low-end merchandise was scant when compared to mid-market and top-end radios, with a definite emphasis on SSB. As the year progresses, you will see what I mean as these new models start appearing in local stores.

On the amateur radio scene, there were a few companies such as Antenna Specialists, Avanti, Midland, Fijitsu-Ten, Pathcom, and others who either showed amateur radio products or at least had information to hand out regarding them, but the numbers that we had last year were definitely down this year. In no way do I blame the manufacturers for this. Actually, if there is a "blame" at all, it must be laid at the feet of the overall economy of the nation

Available May 1, 1980

★ TRS-80/RTTY ★

Write for Features/Specs

THE CROWNING TOUCH

ROM-116

REAL-TIME CLOCK • BAUDOT OR ASCII • CONTINUOUS STATUS CONDITION • STANDARD BAUD RATES FROM 45.45-9600 • WRU/QBF • 2 SERIAL PORTS • PLUS MANY MORE FEATURES • COMPLETE HARDWARE/SOFTWARE PACKAGE.

INTRODUCTORY PRICE \$240

THE COMPLETE AMATEUR RTTY OPERATING SYSTEM

CROWN MicroProducts

16 P. O. BOX 892
Marysville, Wa. 98270
206-659-4279/206-659-9512

master charge

VISA

NOW - THE NEW

AMCODER

IT'S EVEN BETTER!!!

4" x 2 3/8" x 6"

- Still only 40hz wide. Single signal - no QRM/QRN reception. Immune to impulse (ignition) noise.
- Still tape quality audio with TTL compatible signal for computer interface applications. No noise appears in the AMCODER output.
- NOT A FILTER!! Its CW regeneration.
- NOW - dig into the noise for the weak ones without front end overload with our new AGC module. No locking on noise.
- No mods to your gear. Just plug into phone jack. Speaker or phone outputs with bypass switching when not in use. No external power required.
- 26DB dynamic range (5 to 6S unit fade margin) with AGC module when properly adjusted.
- Constant level input to the AMCODER regardless of receiver audio level with either S-1 or 30 over 9 signals. (Works on phone signal levels too) with the AGC module.
- Still reduced operator fatigue, variable frequency acquisition, 400-1400hz and variable frequency output tone (and smoother).
- Still variable output level for station speaker or head phones.

Complete kit (Less AGC option) (Cabinet Included)	\$79.95
AGC Module (only FWT) for older AMCODERS	29.95
AGC Module (Only FWT) for new AMCODERS	29.95
New AMCODER Factory wired & tested With AGC Module installed	94.95
Foreign - Add \$20.00 - all in U.S. Funds.	119.95
Ship your old AMCODER to AMC for updating and installation of AGC module - we pay for return shipping	32.50

VISA & Mastercharge Accepted
Maryland residents - add 5% Sales Tax.
Write for brochure or check reader info card.

AMC ENGINEERING
P.O. Box 427
Jessup, Md. 20794

Phone: 301-799-7741

... at last ...

your shack organized!

A beautiful piece of furniture - your XYL will love it!

\$16450 S-F RADIO DESK

Deluxe - Ready to Assemble

Designed with angled rear shelf for your viewing comfort and ease of operation.

FINISHES: Walnut or Teak Stain.
Floor Space: 39" Wide by 30" Deep

Additional Information on Request.

Checks, Money Orders, BankAmericard and Master Charge Accepted.

F.O.B. Culver City. (In Calif. Add 6% Sales Tax.)
DEALER INQUIRIES INVITED

S-f Amateur Radio Services

4384 KEYSTONE AVENUE • CULVER CITY, CALIF. 90230 — PHONE (213) 837-4870

Radio equipment not included

Also Available
Floor Space: 51" Wide by 30" Deep
\$192.50

65

UNADILLA

FULL POWER - QUALITY

HAM ANTENNA ACCESSORIES
at your dealer

the Big Signal **W2AU Balun**

the Old reliable **W2VS Traps**

For over 20 years, the choice of Hams, Armed Forces and Commercial Communications - world-wide.

5-Band Antenna Kit

- Lo-Pass Filter 2000W
- Quad Parts
- Baluns / Traps
- Insulators
- Wire & Cable
- Connectors

HAMS - call for our free catalog PC-80

DEALERS - join over 400 dealers world-wide. Call us today for no-risk deal.

HAMFEST MANAGERS - UNADILLA cooperates! Call us.

US - TOLL-FREE 1-800-448-1666
NY & Canada - COLLECT - 1-315-437-3953

Ask for Hugh Gunnison, WA2ZOT, or Bonnie, or Emily.

UNADILLA / REYCO Division Microwave Filter Co., Inc., E. Syracuse, NY 13057

right now. Some of the smaller companies probably couldn't afford it this year, I suspect.

There were no amateur radio magazines with booths this year. During 1979, Cowan Publishing divested itself of *CQ*, and though they were in attendance, they were showing only their CB and industry-related periodicals. *CB Magazine* also had a booth, manned by the magazine's new editor, Gordon West WB6NOA. Under Gordon's guiding hand, *CB Magazine* is slowly but surely becoming a cut above anything else in its field. In the past few months, it has taken up the cause of amateur radio with regular features and an ongoing amateur radio training program as an integral part. I feel it's becoming somewhat of a "transition magazine," a publication aimed at the CBER who wants more than just ratchet-jawing on channel 19. Gordon, along with Leo Sands, is doing some truly amazing things with *CB Magazine*. They're going in directions that no CB magazine has ever gone before and are seemingly meeting with a positive response. I personally wish them well in their new direction. They were the closest thing to an amateur radio oriented publication to be seen at CES.

Another publication which drew a lot of interest was *Omni* magazine. *Omni* had two attractions named "Omni" and "Huggy." Both were robots who roamed the convention floor, stopping now and then to chat with passersby. Needless to say, they drew crowds. By the way, if you are at all interested in sci-fi, science fantasy, and the like, then *Omni* is definitely a magazine you have to see at least once. I've been hooked on it since issue one. It's one of the most beautifully appointed magazines ever produced, in my humble opinion.

While people may be buying smaller, more economical to operate automobiles these days, auto sound is doing well. If people are economizing on the size of their new auto purchase, they seem to be making up for it with luxury interior sound systems. There are now high-end systems available which give close to 200 Watts rms per channel of audio with quality that rivals high-priced home stereo systems. Most of the better-quality auto sound systems now feature ap-

proximately 20 Watts per channel, digital AM-FM tuning, and built-in cassette record/play features. Again, much of the equipment shown at CES will be available quite soon.

Home video, which includes recorders, videodisc, projection television, and home microprocessors, also has come a long way this year. Many new companies are entering the market and the competition is making for some fascinating items. Almost everyone now has a full line of home video recorder/players. Last year VHS had at least a 6-to-1 margin over Beta, but that lead seems to be dwindling a bit with the introduction of the new 5-hour Beta format and extended length L-840 tape. Theoretically, the L-840 tape is not supposed to be used on anything but Beta III machines, but somebody seems to have forgotten to tell my Sony SL-7200 this fact. At least in my particular machine, I have had no problem using either it or the L-750 cartridges, but you are on your own in this one. I have spoken to others who have had problems doing what I do, and have paid a lot of bucks in repair costs. So, beware of the consequences if you try either L-750- or L-840-length tape in an older Beta I machine.

Sony now has a battery-powered portable Beta-format recorder which looks very much like a pint-sized version of their portable 3/4" U-Matic EJ unit. The playback quality was excellent and this will probably be the unit I will procure later this year. They also have a neat little roll-around cabinet that houses the recorder, a switcher/character effects generator, and accessories for the system. It is literally a compact roll-around mini home-production facility. Add a camera, and you are ready to go make some rather professional-looking home movies... er... tapes. Speaking of color cameras, Sharp had a real knockout with its XC-32OU. Now, this is not a cheapie camera by any standards. It was meant for industrial and EJ use, and was only recently made available in Sharp's consumer line because the company saw a growing trend by home video enthusiasts towards higher quality reproduction. The XC-32OU is a 3-tube camera, which means that it has separate red, green, and blue pickup tubes. In this

camera, the tubes and optics for them are mounted in a pre-aligned sealed unit, thus affording minimal registration readjustment over prolonged time periods. It boasts a horizontal resolution of 500 lines at center and a vertical resolution of 400 lines at center, in addition to a 46-dB S/N ratio at standard 2,500 lux, F4, 3,200 K illumination. The camera weighs only 9.9 pounds, though it is bigger than most home cameras, measuring 5.2" wide by 14.76" long by 7" high. The best part is the price. The Sharp rep at the booth told me that a complete package, which included AC adapter, an F2, 8X lens, 1.5" electronic viewfinder, pistol grip, and shoulder pad, could be purchased for under \$5000. Other accessories including a 4" electronic viewfinder and a shotgun-type mike are also available. Needless to say, I was very impressed by the XC-32OU. It's definitely a cut above the average single-tube camera at a price that's only a little more than the cost of a top-line single-tube unit.

Computers and microprocessors abounded this year. It's no secret that everyone, including the "Big 3" department store chains, is getting into the home-computer business, but they are not alone. This year you will be seeing many traditional home entertainment companies offering their version of the home computer as another add-on to the TV set. Many of these are both utility- and entertainment-oriented, with the ability to do the "books," keep track of the bills, and also play a myriad of games. By the end of 1980, I suspect that the term "mini-floppy" will be a part of everyone's vocabulary. Both Apple and Ohio Scientific pulled large crowds, though the smaller companies did equally well.

So, there you have CES '80 Las Vegas. It was a good show. A bit more businesslike than in years past, but, nonetheless, a worthwhile show to attend. There were no earth-shattering developments this year, but rather a continuation of the refinement of existing product lines with a definite emphasis on high-end merchandise in all aspects of consumer electronics—a definite indication that today's consumer wants better quality for his dollar.

DATELINE: IRAN

Alan Kaul W6RCL is a field producer for the NBC Network News. He was among the 100 US journalists sent to cover the Iranian situation, and was among those that Iran expelled when it ordered all US journalists out in January. Upon his return to Los Angeles, Alan filed the following report for the Westlink News about amateur radio in third-world nations in general and Iran in particular. It was first played the week of January 20th, and I am reprinting it here for those of you who do not hear the Westlink News on your local repeater.

"It's difficult to say what's happening to amateur radio in third-world countries such as Iran. Under the Shah, American hams were encouraged to bring in equipment and apply for licenses, but native Iranians with ham tickets probably numbered fewer than a dozen. Also under the Shah, Iranian citizens who wanted to own shortwave receivers could, provided that these radios were not equipped with beat frequency oscillators. A young man I met who owns such a radio said that the secret police there didn't realize what he had, because when he bought his radio, he wisely purchased a shortwave set which had a built-in cassette player and a not-so-noticeable bfo.

"When you drive through Tehran these days, you see a city of more than three million people, but you don't see a single amateur-only antenna. There are no quads and no beams; nothing to advertise that a ham lives here or there. Yet, I was told that there are six licensed amateurs in the country and that their equipment is either home-built or purchased from Americans who made hasty departures during the revolution a year ago. One ham I met, who was licensed in another third-world country, told me that he has tried unsuccessfully for 4 years to obtain an Iranian license. He's just about given up hope. There's no such thing as reciprocal licensing these days.

"Unlike Islamic Jordan, where amateur radio is encouraged and even propagated by government-sponsored radio clubs, there is nothing comparable in Iran. Officially, the government seems to be moving toward the dark ages. That's because the government's official position is

that modernization is bad. So, don't look for things to get any better, don't look for reciprocal licensing, and don't look for permission for a DXpedition."

220 ON THE MOVE DEPARTMENT

While two meters continues to stagnate in southern California, plagued by ever-increasing episodes of malicious interference and seemingly endless rounds of on-the-air profanity sessions, things on the 220-MHz band are moving quite smoothly. Unlike two meters, where repeater owner-operators are an unseen commodity, the opposite holds true on the 220-MHz band. Repeater owners are usually active users on their systems and available for consultation by user groups. In my five years on that band, I have yet to hear a single profane word uttered or witness a massive attack against the established norm by outsiders who want things their way. Simply, the inhabitants of 220 won't tolerate the false "liberation" that these windbags who now plague two extoll. But 220 has something going for it that two meters hasn't: intercommunication between all aspects of the spectrum's usership. This intercommunication comes in the form of an organization known as the 220 MHz Spectrum Management Association of Southern

California.

Unlike its two-meter counterpart, which has only a handful of repeater owners and a small number of users as members these days, the 220 SMA continues to grow and widen its scope. From the outset, the 220 SMA was a "spectrum users" organization, and this led to a rather tightly knit operation. While FM and repeater people make up the majority in numbers, they do not dominate the organization. In fact, 220 SMA was structured in a way that permits no one person or special interest group to dominate either that organization or the band. By and large, they are a highly technical organization which places politics in a secondary position, and technical advancement, rather than political prowess, has been the key to successful development of the 220 band for all modes and all users.

At a recent meeting, the 220 SMA came forth with a proposal to establish two national weak signal CW/SSB calling frequencies. They are 220.01 MHz and 222.0 MHz. The reason for two channels is simply that amateurs on the east coast prefer 220.01 for such operations, while out west, 222 has taken root as the home for such operations. By establishing both, the needs of all amateurs can be met, while, at the same time,

both coasts and everyone in between will know where to look for such activities.

Another 220 SMA recommendation is the establishment of 223.74 MHz as a national ASCII and packet radio calling channel to give amateurs who are oriented toward such communication a reserved spot in which to operate and locate one another. While it may be a year before the first ASCII stations are in operation, nonetheless, the 220 SMA feels that now is the time to plan for the future and avoid a crisis situation later on. By far, the 220 SMA is the leader in the development of the 220-MHz spectrum. They fought hard to protect it against Class E CB, fought for its survival at WARC, and are now working toward its overall technological development under the guiding hand of its current chairman, Ray Von Neumann K6PUW. So, while two meters wallows in the mire of its own decay, searching for a solution to problems it brought to itself by the uncaring aloofness of those who own and operate repeaters, by those who shun any organized attempt to change things by again becoming active in their spectrum management organization and taking an active part in the efforts to rid both two meters and the amateur service of those who willfully violate the terms of their licenses, the 220 band

moves ahead quietly and on sound footing, picking up the pieces and continuing where two meters left off. The technology of tomorrow is on 220.

LINEAR TRANSLATION DEPARTMENT

Northern California now has an operational two-meter in-band linear translator. The following report from Neil Lewis WB6VIV tells the story:

"On Sunday, January 6, 1980, narrowband communicators activated a 2-meter SSB-CW linear translator. The SSB-CW translator, with a 600-kHz offset, is being operated at an interim site in the hills of Oakland, California, approximately 800 feet above sea level. Signal quality reports from amateurs throughout the San Francisco Bay area were excellent. The 100-milliwatt translator was also worked by stations in the San Joaquin-Sacramento Valley and Sierra Nevada Mountains. The translator was even worked by a station over 100 miles away. This demonstrates the efficiency of narrowband communications. The system is working great, far better than our wildest dreams. Sunday was a very exciting day for all of the NBC members who worked so hard on this project. WB6JNN deserves much of the credit for designing and building the 2-meter linear translator circuitry."

DX

from page 25

N9MM, W0SR, and VE3QA. Board liaison is W4UG and HQ liaison is W3AZD.

Speaking of the ARRL Board of Directors, they met in Hartford CT on January 17 and 18, 1980, and several topics of interest to the world of DX came up. Referring to the official meeting minutes, here are the items directly affecting us DXers:

9. Noel Eaton, who led the IARU WARC team, has been elected to a newly created office—International Affairs Vice President. Noel is VE3CJ.

11. Membership Affairs Committee Chairman Wicker reported "thumbs down" to the July, 1979, "100 IARU Countries Award" proposal.

20. Contest Advisory Committee Board Liaison Olson "commented orally on changes in the 1980 DX Test rules which he felt were not made in compliance with Standing Order 65 and which accordingly *should be reexamined after the 1980 Test*" (emphasis added).

21. DX Advisory Committee Board Liaison Milius gave the DXAC report.

33. W0BWJ was elected First Vice President and W4RA was elected Vice President. Both are DXers.

40. President W2HD is to appoint a committee to study possible uses and subdivision of the new 10-MHz amateur band and report at the July, 1980, Board meeting.

44. On Director W3KT's motion, the Board unanimously

directed the general manager "to announce in the next possible issue of *QST* that the rules for the ARRL DX Contest will be reexamined for possible restoration in whole or in part to their previous status and that *comment is solicited* prior to June 15, 1980" (emphasis added).

45. The Membership Affairs Committee will study and report on "consideration be given to the publication of a bi-weekly DX publication by the ARRL."

55. The Membership Affairs Committee will study the incoming QSL Bureau organization; its objective is to increase efficiency and decrease workload.

61. The Plans and Programs Committee is to study petitioning the FCC to change the 20-meter phone allocations as follows: 14150-14350 Extra Class; 14175-14350 Advanced; 14200-14350 General.

65. President W2HD is to appoint a special committee to formulate guidelines for combat-

ting the increasing malicious interference on the amateur bands.

78. QSL Bureau managers are authorized \$4000 total for travel to hamfests, etc.

87. Dave Bell W6AQ, who is chairman of the committee organizing this year's Fresno Convention in April, for his work in making amateur radio films for the public, was awarded the title "The Cecil B. DeMille of the airwaves."

89. President W2HD was directed to "seek the elimination of the existing restrictions on operations in the 1.8-2.0 MHz band at the earliest possible date" (in light of the fact that LORAN-A in Region 2 will be gone no later than Dec. 31, 1982).

Between December, 1978, and May, 1979, and again from August to December, 1979, JA7JT operated from Ogasawara Island as JA7JT/JD1; he made 9435 contacts. In be-

Call	Via	Call	Via
AP2AD	K1KNQ	T3LA	W7OK
AP5HQ	N0RR	UK1PGO	UA1OSM
AH8A	WD5EKM	VK0KH	VK5WV
A4XGY	K2RV	VP1KT	WB4INC
A4XID	G8HOR	VP2AG	WB2TSL
A7XA	DJ9ZB	VP2ML	K1RH
CN8AK	WA3HUP	VP2VDU	WD8BVG
CT2CB	KB5GL	VP2VEJ	WB3KGY
CX5RV	G5RV	VP8AI	WD4AHZ
C5ACG	K4YT	VP8QG	WA4JQS
VE2WII/C6A	VE2UN	VP8WA	WA4JQS
DU6RH	W7HPI	VQ9DM	K1BZ
WB5LBJ/DU2	W7HPI	VQ9KK	WA3HUP
W7LPP/DU2	N2CW	VQ9TC	W3HNK
OK3TAB/D2A	OK3ALE	VR6TC	W6HS
D68AP	WB2OHD	VU2CK	K3GL
EA8OR	DJ6JI	VU2KMK	N7UT
FB8XV	F5VU	VU2RX	W2LOG
FB8ZO	F6EYB	VU2UH	SP9AJT
FG0FJD	W2GHK	VU2XX	VE3HDC
FG7AS	W7RUK	XT2AU	WA1ZEZ
FK8CR	W7OK	XT3AA	ON5GN
FM7WE	K4FJ	YB9X	JA1UT
FY7YE	W5JLU	YK1AN	DJ9ZB
HC5EE	K8LJG	ZB2BL	W9JVF
HC8GI	W3HNK	ZB2EO	K3MNV
HH2VP	N4XR	ZD7HH	W4FRU
HI7XWL	W2GHK	ZF1MA	VE3GCO
HK0BKX	WB4QFH	ZF1MT	K9XJ
HL9UX	WA4RVO	ZK2VE	W7PHO
HP2XRX	WB2DCP	ZS2MI	WA2IZN
HS1ABD	K3EST	3D6BP	W1OX
HS5AID	AG6D	3D6BW	G4AVA
HZ1AB	K8PYD	4S7DA	W3HNK
JT1AN	W7PHO	4S7DJ	W4BAA
J3AAG	K1EM	4U1UN	W2MZV
J3ABX	DF3GX	4Z4US	WA2KGY
J6LCT	WA1ZXF	5B4IJ	OE8HFL
J6LIM	VE2EWS	5H3FW	DF4TA
KC4AAC	K7ODK	5L1A	WA4DPF
KC4USR	K9Vfy	5L2AV	N6FL
KC6MJ	W7PHO	5N0DOG	W4FRU
KG6SL	WA6AHF	5T5AY	W4LZZ
KH2AD	W6TPC	5Z4AA	OE6MBG
W6ENK/KH4	WB9MFC	5Z4YV	JA2AJA
K6LPL/KH5	K6LPL	5Z4YW	VE3ACY
WA2FIJ/KH5K	WA2FIJ	6W8AR	WB4LFM
W8NMK/KH0	K4AVU	6W8DY	VE4SK
KP2A	WB2VFT	7Z2AP	I8YCP
KV4AA	K6PBT	WA4LRB/8R1	N4BPP
KX6PP	WD4NVH	K9EF/8R1	K1RH
OY5NS	W3HNK	9G1AP	I0LCJ
OY9J	K2IJL	9H1ED	WA1YYX
PZ2AC	WB4RRK	9H4L	W3HNK
P29DI	W4KXF	9H79EU	9H1EU
VE3BVD/ST2	VE3FRA	9H79GL	W3HNK
S2BTF	W5RU	9J2TJ	N8JW
TA2KS	G3SCP	9N1MM	N7EB
TF3YH	WA8AEE	9Q5GB	W7KTI
TG9ML	K5BDX	9V1TK	JA6RIL
TR8DX	F6ESH	9V1TX	N5FN
TZ4AQS	ON6BC	9X5LG	DL8AO

QSL Managers—Lists of QSLing information are available everywhere, and we do mean everywhere. We have tried to make this list useful in a special way by listing stations actively worked on the bands during the month of January. This should become a regular part of this DX column in 73. You will note some listings which are the same as they have been for years. The idea is to provide you with useful information for your recent DXing.

tween, a stint from Minami Torishima yielded 3570 QSOs, broken down as follows: 628 in North America, 30 in South America, 49 in Oceania, 444 in Europe, 14 in Africa, and 2,405 in Japan (many there on 6 meters).

Many strange callsigns began filtering out of the U.S.S.R. around the first of the year, beginning with the letter R or with the letter U followed by a numeral. Some of the special calls are in preparation for the Olympic Games to be held in Moscow this summer, while some are for centennials of various cities in the Soviet Union. The only way to figure out where the station is located is to ask (just like in the U.S. after the FCC finished eliminating all geographic significance of callsigns).

Those on the Newington staff responsible for the changes in the ARRL International DX Competition (just run in February and March) came under fire at the January Board of Directors meeting. QST was ordered to run a prominent announcement of solicitation of comments concerning the changes so an evaluation can be made before the 1981 affair. The new rules for this year's Contest appeared on page 94 of the December, 1979, QST. They bear reading carefully with consideration being given to whether the DX contesters of the world want another contest which is essentially a carbon copy of the CQ Worldwide DX Contest, which has run in October and November for 30 years.

Oh, yes, during the CQ CW Contest last November, PJ2CC set a new world record in the multi-transmitter class, with 11,786 contacts, 154 zones, and 522 countries. Operators were K4BAI, W1BIH, W1GNC, K3EST, WB4SGV, K3KU, K4VX, and YU3EY/KA3EHD. QSLs to K4BAI.

New operators from Equatorial Guinea are Alberto 3C1AB and friends 3C1s NE, NM, and JP, all operating from the same station.

All the information for this column was from *The DX Bulletin* out of Vernon CT. Please send input for this column c/o 73... especially photos and guest editorials. Thanks, and good DXing!

Awards

from page 23

made available to all US and foreign amateurs for two-way communication in the separate award areas. All modes of communications are accepted with the exception of those contacts via repeater.

All awards have a fee of \$1.00 each or 6 IRCs. GCR apply. Apply by sending your list of contacts to: Certificate World, Rt. 2, Box 72, Fulton, Mississippi 38843.

THE OLD SOUTH AWARD

This certificate depicts a scroll listing the ten states of the Old South. It is awarded for contact from each of the states of Alabama, Arkansas, Florida, Georgia, Louisiana, Mississippi, North Carolina, South Carolina, Tennessee, Texas, and Virginia.

OLD MAN RIVER AWARD

A certificate picturing the mighty Mississippi River and the ten states bordering the river can be yours for contacting the states of Arkansas, Illinois, Iowa, Kentucky, Louisiana, Minnesota, Mississippi, Missouri, Tennessee, and Wisconsin.

MISSISSIPPI STATE AWARD

If you thought your first Mississippi QSO was hard to get, try making a total of ten to earn this award. A state outline and statistics add up to an interesting award for your hard work.

CAPITOLS OF THE UNITED STATES

This one will not come easy. You must have two-way communication with all 50 US state capitols plus Washington DC. Fifty-one QSOs will earn you an award listing some facts about

the US Capitol and proof of a lot of hard work and fun.

There's a good chance you may have already qualified for some of these awards. If not, good luck on earning them. Let Certificate World hear from you and be sure to tell our friend Stu WB5ULD that you read about it in 73 Magazine's Awards column.

SMIRK AWARDS

Ray Clark K5ZMS, representing the Six-Meter International Radio Klub (SMIRK) has forwarded some very impressive achievement awards for fellow six-meter enthusiasts to pursue.

To become a member of SMIRK, applicants must make 2-way contact by any normal emission with other members of SMIRK. US stations must log 6 contacts, while stations outside the US must log at least 3 member stations. All contacts must be made after October 14, 1973. Once this is accomplished, forward your claim along with \$4.00

for a lifetime membership certificate.

Once a member, you then become eligible to apply for the other awards sponsored by this six-meter group. Separate awards are given for making contacts with 100, 250, 500, and 1000 SMIRK members utilizing the same guidelines as already mentioned. Cost is free to members of SMIRK.

And for those who want the ultimate challenge on 6 meters, SMIRK offers the DX Decade Award for having contacted ten DX countries on six meters. Endorsements are given for 15, 20, 25, etc., in increments of 5 DX country contacts.

To apply for the DX Decade Award, list all logbook information and enclose \$3.00 for ten countries and \$1.00 for each 5-country endorsement seal being applied for. For all correspondence with the SMIRK group, write: WA1KYH, SMIRK Award Manager, 18 Laurel Drive, Medfield MA 02052 USA.

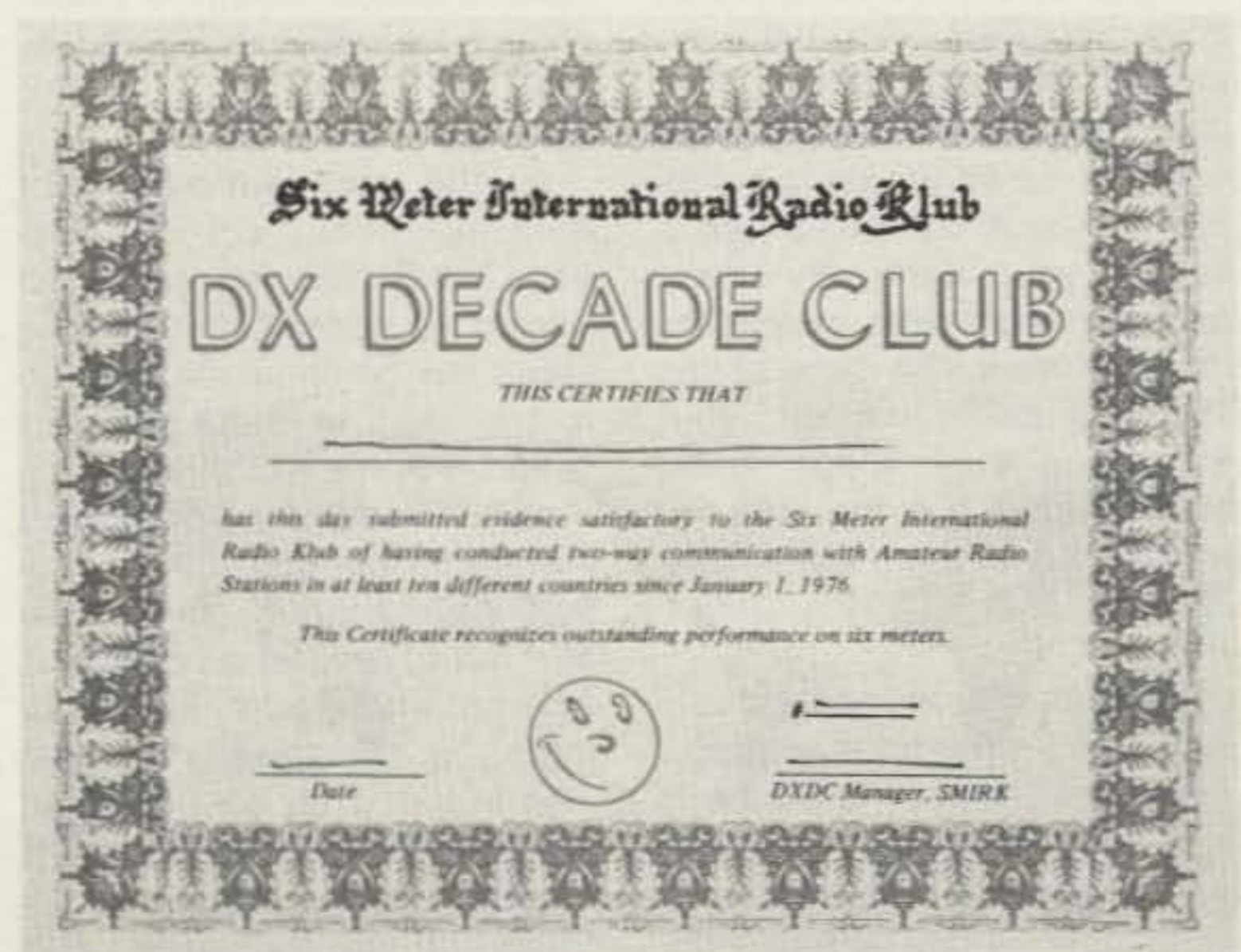
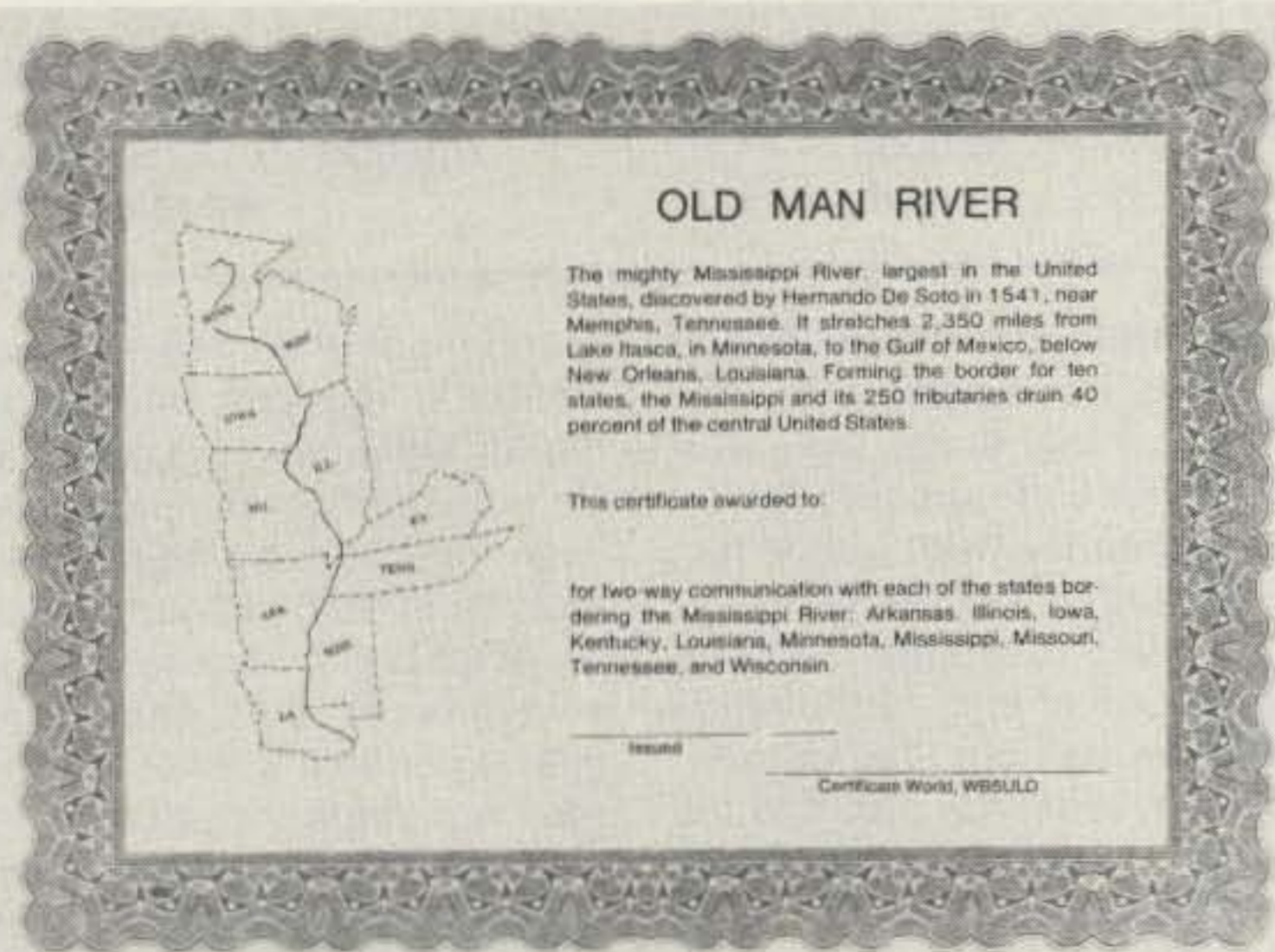

New Products

from page 29

ment and retains up-scale accuracy. The accuracy of the model 4381 is $\pm 5\%$ of nominal full scale and the vswr is a low 1.05 max to 1 GHz in 50-Ohm systems. *Bird Electronic Corporation, 30303 Aurora Road, Cleveland (Solon) OH 44139. Reader Service number 477.*

THE BULLET ELECTRONICS SE-01 SOUND EFFECTS GENERATOR

As a boy, the ability to make the sound of a six-shooter or of a machine gun was a prerequisite for growing up on the west side of town! Today's children, however, do not need to strain their vocal chords; instead, they can use the Bullet Electronics SE-01 Sound Effects Generator.

The SE-01 is a complete sound effects kit which is built around the Texas Instruments SN76477 integrated circuit. The SN76477 is a complex sound generator which employs analog and digital circuitry in one 28-pin dual inline package. The

chip includes a noise generator, a voltage-controlled oscillator (vco), and a super-low-frequency oscillator (SLF) which, when coupled with a noise filter, a mixer, attack/decay circuitry, and associated control circuitry, can produce a wide variety of entertaining sounds. So versatile is this chip, in fact, that it finds major applications in such equipment as arcade and home video games, as well as in a number of home and industrial timers, alarms, indicators, and controls.

While the SN76477 is readily available (e.g., from Radio Shack), only Bullet Electronics appears to offer a complete kit of parts with which to exercise this chip. Thus, I didn't waste a minute in securing the SE-01 kit!

The kit comes complete with a compact printer circuit (PC) board and all of the parts necessary (except for the battery and a speaker) to utilize the functions in the SN76477. Included in the kit are numerous switches and potentiometers which allow

the user to program various sounds. The kit also comes with a complete set of instructions on how to build the kit as well as with documentation on tests to be performed to ensure that the kit has been properly assembled.

The components are of high quality, though the markings on a few of the capacitors were somewhat inadequate. Nevertheless, the kit went together quickly (even given the fact that my 9- and 11-year-old daughters did most of the soldering). Best of all, the kit worked from the first time it was turned on.

Our first attempts to program sounds such as white noise and a siren were highly successful and only served to whet our appetites! Thus, it was not long before the room was filled with the sounds of birds, running water, a rapid-fire ray gun, a horse galloping, and a two-tone warble. Other sounds followed and included a steam train (with whistle) and a female scream (the girls' favorite!).

But the fun did not stop there. By experimenting with the controls, we discovered that we could make the sound of a person walking or running through

a grassy field. And delight of delights, the burning of a little midnight oil produced the sounds of a two-engine airplane (one could hear the engines beating against one another), a machine gun, and the screaming dive of an airplane out of control.

Because of the chip's unique capabilities, a cult of sound-effect addicts has developed among the users of the SN76477. This group is best represented, perhaps, by the SE-01 Users Group. Using Bullet Electronics as a clearinghouse, the users group will share information on the kit and the sounds it can produce through a set of published notes. Information on the Users Group is included with the SE-01 kit.

The kit, including a 5% shipping charge, sells for \$17.80, and it makes a fine little project for those cool spring nights... that is, of course, if you can get the kit away from your children! The SE-01 Sound Effects Generator is available in kit form from *Bullet Electronics, PO Box 401244-A, Garland TX 75040. Reader Service number 12.*

**Theodore J. Cohen N4XX
Alexandria VA**

Review

1980 RADIO AMATEUR'S HANDBOOK American Radio Relay League, 1979

By now most amateurs have probably recovered from the shock they suffered when the new, large size, revised 1979 ARRL *Radio Amateur's Handbook* appeared. The 1980 version of the *Handbook* does not outwardly appear much different than the 1979 edition, but as the new look continues into a second year, more refinement and a few changes in content can be found. The price of the 1980 *Handbook*, like just about everything else, didn't stand still. Ten dollars is the list price for the fifty-seventh edition, up 25¢ from 1979.

Inflation may not be entirely to blame for the price increase, since this year's *Handbook* is slightly longer and has what is advertised as better paper. Among the other improvements

a sharp reader might notice is improved layout and graphics. Highly detailed diagrams have been enlarged while less important sketches have been shrunk. The fuzzy photos that plagued last year's edition are gone, and the only smeared artwork is a printed circuit template in the chapter on VHF and UHF receiving.

As the "standard manual of amateur radio communications," the new edition is expected to contain information about the components and circuitry used in state-of-the-art gear. Discussion of digital logic is still limited to a few pages and there is no mention of the microprocessor and its role in amateur radio. Several construction projects make use of digital logic, but the League has not recognized it as an important part of the current technology. Most of the new gear is digitally oriented, yet the ARRL has

made little effort to universally educate its members to this trend. In other areas, the *Handbook* does try to stress recent innovations. The 1980 edition has a section on the use of VMOS field-effect transistors and a discussion of high-performance receiver design. Technically-minded hams may also find the design tables for Chebyshev filters useful.

Many hams were dismayed by the deletion of all the material on "specialized communications techniques" from last year's ARRL guide. The editors apparently decided that such modes as RTTY, slow scan, and fast scan amateur television are indeed legitimate amateur pastimes and they once again have a special place in the *Handbook*. The discussion of satellite techniques has been greatly expanded and improved, perhaps in expectation of interest in the AMSAT phase III program. ATV has been allotted several additional paragraphs with schematics and block diagrams, but the SSTV and RTTY sections no longer have

descriptions of home-brew gear.

Several chapters have been heavily edited and projects that were favorites in the past have been replaced by ones seen recently in *QST*. These changes are especially noticed in the sections on antennas and mobile/portable operation. The tube and semiconductor tables that were conspicuously absent in last year's *Handbook* have been reinstated. Special emphasis is given to rf and low-noise transistors, and, for the first time, a package overview diagram is included.

Providing a book that covers all aspects of amateur radio is not a simple task. The diverse nature of the hobby combined with the inevitability of rapid technological change makes the *Handbook* susceptible to criticism from all sides. The 1980 *Radio Amateur's Handbook* shows that the shortcomings of previous editions can be remedied and that a practical, up-to-date, comprehensive manual can still be published.

**Tim Daniel N8RK
Terre Haute IN**

W2NSD/1 NEVER SAY DIE

editorial by Wayne Green

from page 6

ing equipment to work on the new modes. I don't have any delusions that we will be plunging into the new modes in strength this year... I think it will take several years, as it did when I promoted FM and repeaters. But I do think that the new modes have as much possibility for popularity as FM and that they will bring a new bunch of fun to amateur radio.

In all, the Ham Industry Conference was a fine opportunity for manufacturers, dealers, and the media to get together and talk at length, getting to understand each other's problems, getting ideas, mulling over the things which have not worked, and agreeing to work together toward a better amateur radio in the future.

SCHEDULED TALKS

The first talk I have scheduled for 1980 is at the Baltimore Ham-boree and Computerfest at the Maryland State Fairgrounds at Timonium on March 30th. The only other talk so far scheduled for 1980 is at the Tri-City Ham-fest in Pasco, Washington, in June.

That's right... nothing planned for Dayton, Atlanta, St. Louis, and points north and south for this year. It's not a

JOB LOT BIDDING

Manufacturers or dealers with job lots of merchandise, systems, software, publications, parts, test equipment, printers, terminals, disks, tapes, monitors, etc., can do worse than contact Sherry Smythe at (603)-924-3873. *Kilobaud Microcomputing*, *80 Microcomputing*, and *Instant Software, Inc.*, need these for the lab and we would like to bid on your job lot. You could do better than an auction... a lot better.

question of not being asked in most cases; it's a matter of the time involved. Despite claims to the contrary from Connecticut, I am human and find that there are only so many things which I can do in a given amount of time.

If I were to plan to get to more hamfests and conventions, this would take away from the time which I perhaps could better spend on working towards the development of the new ham communications modes... working with the FCC toward better regulations... working towards developing amateur radio in some more developing nations. The demands of my three monthly computer magazines and the very rapidly growing software publishing business, which is worldwide in scope, are formidable.

After thinking quite a bit about the new ham bands which have generated so much enthusiasm, I suspect that they will be of minor importance because of their narrow width and thus their inability to support much ham activity. There are several other developments which seem to have vastly more to offer the 99% of us who won't be able to get a word in edgewise on the new bands and I'll be working toward developing these ideas.

To those amateurs who feel that because we came out of WARC okay, the end justifies the means, I'll have some words at my talks. I feel that we have been granted a blessed reprieve and that we should not squander it on the usual backbiting, which seems to be in vogue right now. We should use the time we've won to make sure that amateur radio has an established place in the spectrum for all time. It's time we started working seriously toward getting back, if possible, satellite allocations so amateur radio can successfully cope with the communications needs of the '80s and '90s. In just one generation, it will be the year 2000, and how much planning has

been made for amateur radio at that time?

I'm working with my community toward developing the town and services that we want Peterborough to have in the year 2000. This means planning for growth in housing, business, roads, water, sewers, and all of the regular community services such as snow clearance, police, hospitals, fire, etc. It is an exciting project and it has many parallels with the need for planning for amateur radio growth, new modes, technological advances, and (perhaps most important) ways to get the FCC to provide us with rules which are needed and in a timely manner.

In the computer field, I've given talks for several years on the economic opportunities this exploding industry is providing. This has not abated and the opportunities are even better than before... which I probably will be talking about at both Maryland and Washington... if you're interested. The real growth in the microcomputer industry is just now getting started and the opportunities to make really big money are just sitting there, waiting for entrepreneurs to grab 'em.

At my June talk, I'll be revealing, for the first time in public, some of my plans for developing a completely new mode of ham communications. This will be a mode which I think will be as popular as FM and repeaters are today and which will generate an enormous amount of ham building and experimentation. At first we will be adding accessories to accomplish my new mode... but it won't be long before commercial rigs will be available with the new mode built in. This has to remain a trade secret at present, but I can give you a small hint... it has a lot to do with microprocessors... and it is going to be a lot of fun. I think it will do a lot to help generate interest in amateur radio just by virtue of the improvement it will bring to ham communications. Those few who have been privy to my ideas seem to be most enthusiastic and the general feeling is that this could well revolutionize much of amateur radio communications.

Since I have agreed to give the manufacturers who have signed a contract to keep my secrets a lead of at least six months for the design of the new equip-

ment, I won't be able to discuss these ideas until June, at the earliest.

Dayton. At the present time it is not definite whether I will even be going out to the Dayton Hamvention this year. I skipped it in 1978, but did have a booth to sell 73 subscriptions. In 1979, I had planned on not even having a booth, but they called and had me on the program to talk about microcomputers, so we did have a booth. We have no plans for a booth this year, but I might fly out for a day just to see the manufacturers and talk with them briefly.

I gather that the slowdown in ham sales has thrown a blanket on the Hamvention and that many of the firms will be waiting for better times. Some of the dealers, heretofore at Dayton in force, will be running smaller booths with fewer salespersons, more to show the flag than anything. There may be some good bargains on esoteric equipment as dealers strain to get rid of inventory which does not move fast. With the cost of money depreciating ham gear at about 2.5% per month, dealers can no longer afford to carry items which do not sell quickly. I suspect many of them will be bringing the slow-moving stuff to Dayton with prices which should clear this stuff out.

WARC CREDITS

The initial barrage of self-congratulation is remarkably reminiscent of the orgy we experienced over the 220-MHz situation. Oddly enough, in reading reports on WARC in non-amateur journals, though I have read some very in-depth reports on what happened and "why the sky didn't fall," those most deserving credit have yet to even get a mention in the ham publications.

The key to the surprising turn away from politics at Geneva seems to involve not amateurs or their representatives, who merely benefitted from the situation, but one Frank Urbany of the National Telecommunications and Information Administration (one of the 65-member U.S. delegation) and Algeria's chief of delegation, Noureddine Bouhired. By coming to an agreement to clear out reserved, but unused, frequencies registered with the International Frequency Registration Board (IFRB), the Third World nations

were able to see substantial cooperation on the part of the developed nations in making frequencies available for them ... and it broke the political stalemate which was about to stall the whole conference.

Algeria had been the spokesman for the Third World in pushing the concept of a 70-30 split of frequencies, with the large share going to the developing nations. The compromise on the IFRB changes got the conference off the developing political battle and on to technical matters, where agreement was much easier to attain. The published reports on WARC give credit to Urbany and Bouhired for preventing politics from getting into almost every later decision.

I hope the amateurs who had a wonderful trip to Geneva and who came back with 50 kHz of new ham bands which we may see in a couple of years or so and other frequencies which are due much, much later will now turn their efforts to helping amateur radio achieve Third World growth and thus make future conferences hinge less on strokes of good luck and more on long-range planning.

MAY IN L.A.

Since the National Computer Conference (NCC) will be in Anaheim again this year, I'll be in the L.A. area around May 20-25th. If there are any clubs which would like to cook up a special meeting for an evening of creative thinking about amateur radio, get in touch and let's see what we can organize.

This is also an invitation for my old friends in the area to plan to come out to a dutch dinner with Sherry and me on Wednesday the 21st, 8 pm, at the Red Onion in Palos Verdes. This is a ham-run restaurant with one of the best Mexican cuisines I've found. It is an old favorite with Sherry, who lived in Palos Verdes a few years back. In order to make sure that we have table room, please drop me a note or give me a call and let me know that you are going to be there.

WHAT HAPPENED AT HR?

Much as I deplore the politics of *Ham Radio* magazine, I do hate to see them going into what appears to be a terminal nose dive. The hobby needs a publication which concentrates

on abstruse design articles and *HR* has certainly filled this need for our elite.

Perhaps I am overstating the seriousness of the problem. A look at a chart of the number of pages of advertising per year for the last eight years may put this into perspective.

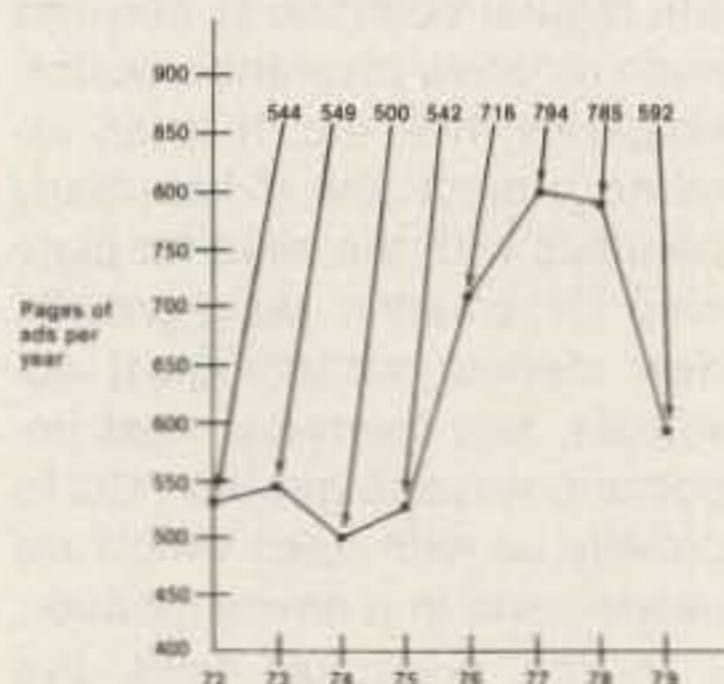

Oddly enough, in 1972, *HR* had more pages of ads than *QST*, but by 1979, *QST* was running almost 700 more pages of advertising than *HR*. In fact, with the exception of *HR* and its sister magazine, *Ham Radio Horizons*, most ham magazines did very well in 1979, showing good growth. What went wrong?

It looks to me as if there were a number of contributing factors. The part *HR* played in shooting down the Amateur Radio Manufacturer's Association (ARMA) soured many advertisers. This was a serious blunder. The article on how to screw ham dealers was another massive blow to advertiser confidence in the publisher. Only a handful of advertisers are still supporting the magazine.

A couple years ago, *HR* published far more construction articles, but today the magazine looks more like an engineering journal and is over the head of most hams. I like construction articles to explain the considerations which went into the design, but I balk at extensive calculus and math proofs. Did you see the matrices equations in the recent *HR* article on designing a yagi antenna?

Dealers, who are a potent advertising force, also have been very upset over the aggressiveness of the *HR* bookstore, which they feel is taking money away from them. The massive *HR* booths at hamfests selling books in competition with the dealers aggravated this situation. I think *HR* finally saw the light on that and may have stopped this scam.

When you get the dealers mad at you, they also put pres-

ures on the manufacturers to cut advertising, so they get you twice.

Another factor which has hurt *HR* has been their limited support of repeaters. During the 1970s, the use of repeaters grew from the preserve of a few hundred pioneer hams to the most popular amateur activity in the world. While *73* was publishing hundreds of articles on the subject, *HR* was largely ignoring this revolution, with the result that most VHF amateurs turned to *73* for information. This meant that advertisers of VHF products got relatively little results from *HR* ads, particularly as compared to the same ad in *73*. About the only major VHF manufacturer presently still advertising in *HR* is one who has never tried *73*, or any other ham magazines, as far as I recall.

The torpedoing of both the manufacturers and dealers has cut advertising, which has in turn reduced the articles, and this has reduced ham interest. This is a downward spiral which is difficult to stop. Where they used to run around 80 pages of articles, now it is half that! With immediate changes in management and perhaps a new editor, things might turn around. It will be a long hard climb back up. The magazine has to be more responsive to the readers... and to the industry, upon which it depends for life.

DOGGIE-DOO

The other day, an article came in on the modification of a war surplus transmitter for the amateur two-meter band. I might not have paid much attention to the article if there hadn't been a photo with it of the unmodified rig... in the shape of... er... dog... er... well, you know.

It seems that Meshna has rounded up a bunch of little transmitters which were made for use in Viet Nam. These are in the shape of... er... animal droppings. Other similar rigs are shaped like mud or little wads of clay. When you break 'em open, you find a miniature transmitter on about 150 MHz, a stack of those little batteries we use in watches, a foil antenna, and a movement sensor. The idea was to strew these turdlets along the Ho Chi Minh Trail. They would then start transmitting when anything shook the ground, letting us know by remote receiver when any cars or trucks or even

troops were moving along the trail.

The batteries are long dead, but they can be replaced and these little rigs can be used for experimenting or even for doing what they were intended to do... put around the house to let you know when you have unwanted visitors.

I got right on the phone and made sure that John Meshna had plenty of the rigs. Then I drove down and picked up a couple to use for further pictures and some playing around. They are certainly realistic! I keep one on my desk, on a piece of Kleenex, and you should see people shy away from it. The jokes started right away, too... perhaps encouraged by a bunch of QSL cards we received lately. Someone around Japan has been signing SH1T, giving the location as Crap Island and the operator's name as O. M. Turd, and telling the stations which are worked to QSL via W2NSD. We've gotten quite a few cards and were about to print up some responding cards when the new rigs arrived. If we can get an exact mailing address for the DX station, we'll send some appropriate rigs.

It is kind of a shame that some joker is taking advantage of the naivete of the Russian amateurs by pulling this dirty trick on 'em. In all innocence, they have been sending us the QSLs for working this "DXpedition."

You may be sure that we'll be wide open for further modifications of the camouflaged transmitters. They're available for \$4 each from Meshna. I can think of some interesting awards for the better conversions. Let's see what you can do... do-do.

Having haunted electronic surplus stores for years, a visit to Meshna's was almost traumatic. I got that old feeling which resulted in me buying ten of everything I wanted, just in case. This filled up a whole barn and brought on two major auctions of all this debris. I bought parts and surplus stuff for thirty years before finally reforming. Still, I can feel the subconscious pressures to buy a dozen of this and a box of that. The Meshna store is so packed with fantastic goodies that I managed to escape only by massive use of my resolve to not fill up the car... and an alarmed tugging at my

sleeve by Sherry worried by the look in my eyes and the compulsive reaching for my wallet.

Just a few weeks ago, I was in New York and stopped off to say hello to my old friend Sy Denby at Metro Electronics. Sy remembers me well over 30 years ago when I used to haunt his surplus store on Cortlandt Street and buy prop pitch motors, BC-654s, and items like that. I was in there every Saturday for years. I'm sure I toted home several tons of surplus from Sy's place. In those days, I was building ham gear day and night, converting surplus, and having a ball.

My cellar ham shack eventually got so full of ham gear and parts that I had to operate my rigs by remote control from the living room . . . there just wasn't room to get into the shack any more. Yes, the visit to Meshna brought back memories. Thirty years ago, I had the time to sit down, break open one of the surplus delights, and bring it into a ham band. Today, I can just dream of that as I work on the pile of mail from readers, think up plans for dealing with the FCC, solve problems for four magazines, and try to keep up with the literature in two different fields.

FCC DEBACLE

In late January, the FCC finally adopted rules permitting the use of ASCII on the ham bands. That's the good part . . . the bad news is the restrictions.

One of these days, some outfit is going to take the FCC to task for consistent violation of the FCC rules. This rule is just another example of how the Commission violates its own rules whenever it pleases, with amateurs having no voice in the matter. What rule? As I have pointed out many times before, and have even testified before the FCC, this new rule is in direct violation of Part 97.1c.

The basis and purpose of amateur radio regulations state that the Commission has the responsibility to provide us with rules which will "provide for skills in both the communication and technical phases of the art." This means that the FCC is supposed to encourage amateur inventing, experimenting, and pioneering . . . and this new rule change certainly does not do that by even the wildest use of the imagination.

This new rule finally allows

amateurs to use techniques and standards which are years old. Amateurs have not been permitted, even when requesting special temporary authority, to keep up with the commercial developments. And here we are again, just as we were when the Commission finally broke down and permitted radioteletype communications some thirty years ago, with restrictive rules which prohibit amateur experimenting and pioneering. One of the basic reasons for allowing amateur radio has been as a means to experiment and devise new modes of communications . . . new techniques. Yet these are exactly the things which the FCC prohibits.

I think that the FCC should be sued and thus forced to abide by their own regulations. Sure, they have phoney excuses for hobbling amateurs and prohibiting us from doing what the rules say we should be doing. In the name of monitoring our transmissions, the Commission has virtually brought amateur experimentation to a halt for over thirty years. I think we should sue and ask for extensive punitive damages . . . in the name of the United States . . . and in the name of every licensed amateur.

Just look at the benefits the amateur development of single sideband has brought to our country and the world! And this happened in spite of the Commission, not because of any help from it. Many amateurs have wanted to develop other novel systems of communications, but have been prohibited from even experimenting with them by the Commission. Is \$10,000 per licensed amateur too little to ask for the incalculable damages we have suffered? That would come to some \$3 billion and that figure just might be enough to get the attention of Congress and bring about some desperately needed changes.

When CBers caused a lot of TVI as a result of the FCC rules on linear amplifiers, who got it in the neck? CBers? You bet not . . . it was the hams. Now that CB has died down and the amplifier people have gone out of business, we are still stuck with the stupid rules which keep us from having a decent signal on ten meters.

About ten years ago, amateurs started putting on pressure to get permission to use

ASCII on the ham bands. There were no good reasons for delaying this for all these years . . . just the usual glacial movement of stuff through our government agency and a complete lack of any lobby effort on the part of amateur radio to speed up the process.

So here we are with a 300 baud speed limit, and we have just barely managed to get permission for that. This in a day when 300 baud is like driving a car at 10 miles per hour. The fact is that 300 baud is even considered as ridiculously slow for telephone communications. 1200 baud phone data exchange is coming about rapidly, and radio communications should enable us to work on data links of 9600 baud and above. We are being restrained to the antiquated bandwidth limits of old AM phone signals, and I see no good reason why we should have to live by bandwidth standards which are over fifty years old in a time when new techniques might make vast changes in radio communications if they were permitted to happen.

What would happen if we took off the bandwidth limitations on the ham bands? We could insist only that all signals stay within the ham bands. Bandwidth is a function of rate of exchange of information, so what we would be doing is trading off bandwidth for time. Do we care if a signal is broad if it is only on a short time? Or are we still geared to the old concepts of stations going on the air and transmitting continuously until it is time for the other station to transmit? I think we should be able to experiment with new modes of communications . . . that we should be able to use RTTY, SSTV, FAX, and SSB on the same frequencies.

How can we come up with packet transmissions, time-slice transmissions, and other ideas which might or might not work if we can't try them out? The FCC used to be able to get off the hook on restrictive regulations by pointing out that, well, if any ham really wanted to try out new ideas, he could get an STA . . . a special temporary authority . . . and go ahead. But the FCC has routinely been denying these for the last few years, so that avenue of developing new ideas is closed to us.

Until the time that we get

some clout in Washington, we are going to be so emasculated by the FCC that amateur radio will be able to provide only a fraction of the inventing that it used to be able to provide. We need a lobby in Washington which can put pressures on the Commission to get them to stop spiking the guns of amateur radio . . . pressures to let us be free.

Back in 1974, when amateurs really got fed up with the insane repeater regulations which tied us up in red tape, slowed down new repeater licenses to a point where it took months to process them, and brought the development of new repeater ideas completely to a halt, we protested with a formal hearing before the FCC Commissioners. I organized a committee representing repeater groups from all over the country which went to Washington (no help from the ARRL) and testified. The result was the biggest change in amateur regulations in the history of the Commission. Well, the Commission got a good start on the deregulation of ham radio, but they eventually stopped and a regulation era has come back again.

If we need to have another hearing, okay, we can arrange it. But I think it is time for amateurs to let the Commission know that the new ASCII rules are asinine and that we want to be free of restrictions and over-regulation. We want the Commission to get on with deregulation and to stop hemming us in with rules forcing us to use communications standards which are a generation old. We want to be able to be in the vanguard of development, not the clean-up squad.

The new ASCII regulations stink.

There is no valid reason why every FCC monitoring station has to be able to copy every amateur transmission 100%. As long as we sign our calls in a way they can copy, they should butt out of our communications. They can get their jollies on the 99.9% of ham communications which will be using time-honored standards. But if we want to try out ASCII at 3247 baud, then we should be able to. If we want to send some other digital code, leave us alone.

That's what I think . . . now the pages are open for any coherent arguments, pro or con.

CIVIL DEFENSE

The recent events in Afghan-

istan and Iran have moved the country substantially in the direction of again taking on the responsibility for opposing Russia and its expansionism. This was one of the ideas we had in mind when we bogged down in Viet Nam.

If we are going to put up some resistance to the Russian takeover of the world's main supply of oil, we have to be prepared in many ways. Oh, we can go about it in the same way we did in Viet Nam, turning to our military and asking them what we should do. If we do this, as we did in Viet Nam, we have to be prepared for their standard answer: Fight. Perhaps one of the greater problems facing our country is the lack of any high-level group dedicated to out-thinking our enemies.

We have our military, dedicated to fighting enemies. We seem to have a State Department, dedicated to placating our enemies. And then we have the politicians, vacillating between the two extremes, going first one way and then the other, confusing everyone, including themselves.

Back just before the war in Viet Nam, I made a visit to the country and many of the neighboring countries. As a result, I came up with a plan for avoiding the conflict and still winning the war. I wrote this up in 73 and have had many letters of agreement on the plan, but there was no way to ever get the idea where it would do any real good. Letters to Congress didn't get beyond administrative assistants.

The basic concept was to use the time-honored system of bribing. We were spending about a half million dollars each to kill the Viet Cong. For a tiny fraction of that expense, we could have set up a toll booth on the Ho Chi Minh Trail and issued a parcel of farm land, a house, some furniture, food chits for a year, and the opportunity to get a job in a nearby factory.

The factories would make the prefab homes, the furniture, goods for export... and, most important, small cars for local sale and television sets. TV tamed the wars on New Caledonia. The natives had to go to work to earn money to buy TV sets and this stopped the wars. Then, the products advertised on TV meant more work, so it was an endless cycle... no

more wars between tribes.

If low-cost cars, perhaps not much more than go-karts, were made available, most people would work their asses off to get one, and again the people would be started towards working instead of fighting. The investment to get all this started would have been miniscule as compared to the cost of fighting... not to mention the loss of American lives involved.

We have a different situation in the Middle East these days, but that doesn't mean that we can't come up with some ways of outsmarting the enemy instead of trying to outfight 'em. For instance, suppose we sat down with the chaps in Pakistan and, instead of offering to ship billions of dollars in arms with no strings attached, we offered to help them only if they would set up a buffer zone between Afghanistan and Pakistan... perhaps five miles wide. This zone would be deeded to the U.S. for 99 years and we would guarantee free travel across it. But this would be American land and would set up a situation wherein Russia would have to go through our land in order to attack Pakistan. This would also give us an area from which to monitor radio communications within Russia and Afghanistan... and room for airports and military bases.

If that worked, we might suggest the same for the borders of Saudi Arabia and other worried oil states. Thus, for any aggressor to get at a country, they would have to cross U.S. soil and get us directly and immediately involved.

I can just see future surplus camel-dung radios.

One of the ways Russia has really taken advantage of us has been via the past SALT agreements. This was one reason why I was pleased to see interest in a new SALT agreement fading. It seems to me that Russia fights for every concession they can wangle on these treaties and then goes ahead and ignores them completely, laughing at us for taking them seriously.

According to the earlier SALT agreement, neither the U.S. nor Russia would attempt to protect the populations of their cities against nuclear attack. We went right ahead and essentially dismantled our civil defense system. Russia went ahead and built the most comprehensive

system of civil defense of their populations in history. Their people can be holed up safely in a matter of minutes and their estimates are that much of the population of Russia cannot be touched by atomic warfare.

Their industry is underground or else so spread out through Siberia that it would be impractical to try to knock off much of it. Ours is gathered in a few easily-removed areas... like around Route 128 in Boston, in Silicon Valley, etc.

Okay, supposing that some of the above is true... what can we do about it? Well, the one big thing that radio amateurs can do is to get set up for any possible emergency. We need to get cracking on some sort of civil defense communications network and we certainly don't want to wait for word from Washington before we get going on this. This is a matter, as I see it, for our radio clubs to tackle.

In time of emergency, we will need massive communications capability. We'll have to be able to provide local, medium range, and even long-range communications. We'll need emergency repeaters and cross-band operation to the low bands. We'll also need to be able to intercommunicate with all of the other users of two-way radio such as taxis, doctors, trucks, police, fire, road crews, CB, etc.

There are a few clubs which have set up vans with emergency communications equipment along these lines. I'd like to see every major club work in this direction, setting up mobile emergency communications centers. It takes a lot of work, some expense, and dedication, but the results are worth it. Not only is the resulting communications center a good advertisement for the club and for amateur radio, but it is also good public relations in many more ways. A well-advertised emergency unit can help local amateurs get cooperation from the citizens, from the local government and police.

In addition to a mobile communications center, clubs also want to build up their ability to cope with emergencies. This means having an up-to-date inventory of the ham gear which is available for use in emergencies... where it is and how to get it. This gear has to be used every now and then, for nothing ever works right the first time out.

How many HTs do the members of your club have? How many are synthesized and how many are on fixed channels? Does anyone in your club have a portable emergency repeater? What about power sources?

73 Magazine will look most favorably on articles on emergency preparation for clubs... on pictures of mobile communications centers... on photos of club projects. Let's get club work started on this and help each other with letters and articles on how you're doing.

I have some later plans for a VHF linkup which might enable repeater groups to interconnect with any other repeater group on a 24-hour-per-day basis. We'll see how plans for this come along. It would make a superb emergency communications system if it can be attained.

1940

One of the very few benefits of getting old is the ability to remember "the way it was" many years ago. Unfortunately, there is very little call for this talent. On the off chance that there are a few relative newcomers to amateur radio who have sucked in on the romanticized recollections of old-timers, let me regress for you and give you an idea of what hamming was like forty years ago.

With the start of the war in Europe on September 3, 1939, most of the DX disappeared from 20m. Ten meters was a relatively new band, with hams just discovering techniques for building equipment to use this band. I remember hearing GM6RG pouring through on ten with solid signals every day for hours back before the war started.

And what ham band was the most used... by far? You'll miss that guess probably... it was forty meters, and no phone allowed. Everyone was crystal controlled, and, with crystals costing around \$50 each in terms of today's dollar, few hams had more than one crystal. This meant that when you went on the air, you checked out the band very carefully to try to find a frequency which didn't have too many active stations on it... particularly the powerhouse stations.

Once you bought your crystal, you were stuck with it. The receivers were, by today's standards, broad as a barn door, so

any strong signals within a few kilocycles would wipe you out. Fortunately, few stations had high power, with 50 Watts being considered a good average. The magazines of the times, *Radio* and *QST*, published articles on building one-tube transmitters. I remember the QSL-40 rig with a single 6L6G, crystal controlled, 40 Watts... on a chassis the size of a QSL card.

Hams were very proud in those days to get as much power as possible out of receiving-type tubes. Of course, you didn't dare hold the key down for long if you didn't want to melt the plate of your final... but the glass tubes made it so you could see what was going on and take your finger off the key before the plate got quite white hot.

With crystal control, the system was to call a CQ and then tune the band, usually starting from one end or the other. The higher-powered stations tended to be close to the band edges. There was nothing surprising about hearing someone calling you 200 kc away from your frequency. We get so used to using vfos that we forget what it is like not to have one. Forty years ago, there was no real thought of being any particular place in the band... you just had a frequency and you tuned the band without regard to where your frequency was.

What about phone? The most popular phone band, by a very wide margin, was 160m. In those days, we only had two classes of license, effectively. These were Class A and Class B. Only a small percentage of the hams had the Class A ticket, and they were privileged to operate on 20- and 75-meter phone. This was not as big a plus as you might imagine. Those bands were each 100 kc wide and held about nine big signals since AM was the phone mode at that time. On 75m, most of the band was occupied by a handful of nets and they did not welcome newcomers.

A kilowatt phone rig was a very big deal then. I don't think you could build one for much less than \$25,000 in today's dollars, so they were for the wealthy... and these hams lorded it over their less fortunate brethren. It was an attempt by a few surviving members of this group which pulled off the so-called "Incentive Licensing" pro-

posal in the early 1960s. This was an attempt to get all the "kids" off the phone bands.

One-sixty was the big phone band, with more phone activity than all other ham phone bands combined. It was packed from 1800-2050 kc, almost entirely with low-powered rigs. The big deal then was the 6L6 oscillator modulated by a 6L6... a two-tube transmitter, running around 10 Watts or so, and a ball to use.

Those amateurs today who are having problems with mental cases jamming repeaters or making them difficult to use should know that we had their grandfathers doing essentially the same thing forty years ago. These jerks would get on 160m and play phonograph records by the hour... bringing about an FCC rule against broadcasting music or any one-way communications. Attempts to reason with these guys got nowhere, despite some antenna-cutting and black eyes.

There was a lot of pressure for more phone frequencies at that time. The League was flatly opposed to phone operation and would have none of it. This brought about the formation of the National Amateur Radio Council (NARC); it quickly grew into a very big national organization and soundly defeated the ARRL over the matter, getting the FCC to okay a phone band for 40 meters. Once the phone bands had been expanded, the NARC need died down, as did NARC.

A tiny group of experimenters was playing around with 2½- and 5-meter rigs, but they were in the strict minority. I built a little 1G4/1H5 transceiver for 2½ meters in a box about the size of a Gonset Communicator and had a ball with it at that time. I was also quite active on 40m and 160m phone. If you'll check your old *QSTs*, you'll find that I won the Sweepstakes phone contest for 1941 for Eastern New York!

Just before the war, there were about 50,000 licensed amateurs in the U.S. There were few enough so I was able to take a map of Brooklyn and make a mark for every ham in the *Callbook*... and then set out to visit all of them. This was around 1938-39 and I made the visits on bicycle or skates. I think Ed Pillar W2KPK has forgotten my visit in 1938 to his station...

down near Coney Island Avenue. Ed is still very active... with ATV repeaters these days.

When the war came along, we were put off the air immediately. I was on 160 that fateful Sunday and got the news of Pearl Harbor on that band. A couple of hours later, W1AW was broadcasting word to get off the air, and within a couple of days the last hams were off the air... for almost five years.

Some 40,000 of our 50,000 licensed hams joined the armed forces. Without this body of technicians, the military would have been in very deep trouble. Our hams were first put into blitz training schools as teachers to qualify radio operators and radio technicians. Virtually every teacher I ran into during my time in the Navy was a ham... as were many of the radio-men and technicians.

Much has been made of the amount of ham building in the pre-war period. I would like to put that into perspective. In the 1920s, hams built their equipment... they had to since little was available commercially. In the early 1930s, the first commercial communications receivers were put on the market and this stopped the ham building of receivers almost completely. There were not enough hams to make it profitable to build commercial transmitters, so hams still had to build their own. My visits to hams all over Brooklyn... hundreds of them... showed me that though hams built their equipment from articles in the ham magazines, they had little understanding of what they were doing. We had one or two real technicians and these chaps were the "experts" who were able to find out what had gone wrong during construction and get the rigs working.

In my estimation, 90% of the hams today know far more about radio than 10% of the hams did forty years ago. Tube sockets were often wired upside down so the grid connections went to the plate circuit. Ask anyone who was there. The top technician for much of Brooklyn was Sy W2IXJ... now retired as W4IXJ. With a small light bulb as an rf detector, he fixed and tuned up transmitters. I'm not sure he even owned a VOM... and he was the best we had!

It was around January, 1940, that the music rule came

through. It was phrased in a way to make it illegal to transmit for other than purposes of communications. The FCC hadn't thought about this affecting duplex operation, which was very popular on 160m at that time. During the afternoons, when interference was low, stations all over the major cities would group together into duplex nets and sit talking with each other. It was incredible fun to do and very popular. It hurt nothing. Stations with crystals on one end of the band would relay stations from the other end of the band. All were using low power, so it was not difficult... calling mostly for separate antennas.

It didn't take long after the new rule went through for a ham at one of the FCC monitoring stations to decide that the use of six carriers on the band at once for a six-way duplex round table conversation was no longer permitted. The ARRL, hating phone, did nothing to stop this, so duplex disappeared... forever.

COLORADO SPRINGS

One of the reasons I would like to see a ham manufacturer's organization with some real strength is our need for lobbying for amateur radio on a three-level basis. We need to have a strong lobby in Washington to see that we get the rules we need to keep amateur radio growing and the freedom we need to allow amateurs to invent new systems and modes and then pioneer them. With little clout in Washington, we are pushed around by any group which does have an organization.

We saw that very clearly when amateur manufacturers went to the FCC to testify against the ten-meter linear ban and saw their lack of organization losing the battle. EIA walked in, testified for five minutes, and won hands down.

We also need lobbying on a national basis to get grass-roots support for hamming... and to help bring newcomers into our clubs to participate in our license study classes. The supply of newcomers has almost dried up, due in a large part to a lack of persistent publicity by ham clubs and a lack of any national organization to coordinate such publicity.

The third level is interna-

tional. We need to work continually to get amateur radio going in more and more Third World countries. We want to be able to go to an ITU conference in the future and know that we have

done our homework and not have to rely on blind luck and the good will of some chap from Algeria.

In line with the need for good PR for amateur radio, one of the

best examples I can think of happened a few months ago out in Colorado Springs. The amateurs there got together and pro-

vided the communications for the National Sports Festival... and they provided superb communications. It was a perfect



In the Field House at the Air Force Academy, I found Frank Freiler WB0PAJ (L) and Mint Tanner WA0YTK providing the communications for the wrestling events. All of the communications were on 146.52 MHz. They passed along the names of the winners of each event and kept all of the Sports Festival officials in close touch with each other.



Not far from the yachting event we found the softball competition. Here are Bob Poirier K0DJ (L) and Ron Seats K0LZD (R) with HT providing the communications.



Not too far from town, at the Garry Barry Stadium, we found the soccer games going full tilt. The communications here were being provided by Dennis Smith WB0YKH.



The base station was set up at the Olympic Headquarters in Colorado Springs. Here we see Art Mayer WA0AEH at the mike and Dave Vierling N0DV helping him. This was the center of all communications as well as a liaison to low-band relaying of messages from contestants to their families.



Don Lohse KA0CHA (L) and Barbara Remy WB0NUW handled the equestrian events, working through the local repeater, which was reserved just for the Sports Festival events for the duration of the show.



At the volleyball event, I found Karl Perry WB0YEO keeping Headquarters informed on scores... passing along scores from other events to officers at this event, etc.



The base station at the Air Force Academy, several miles from town, was mostly on 146.52 and used the call WA0RFB. Seen operating are David Stivers WB0SSG (L), Jerry Farkasofsky WB0HZG (center), and Allen Bailey AD0Z (R). This station coordinated all of the events taking place at the Academy and relayed the results to the Olympic Headquarters in town. They also handled a lot of messages from contestants sending word of winnings to parents and friends.



Jim Wilkinson N0AIN passed along the yachting winners and times to Headquarters from Prospect Lake.

lesson in what amateur radio can do and one which should be repeated in every part of the country.

The club bit off a big chunk. The Sports Festival was spread out over 400 square miles, making communications far more complex than just one repeater could handle. They fielded 112 members to handle the commu-

nications needed for thirty different events spread out over a six-day period. During that time, they kept every part of the Sports Festival people in communications. They found missing people, got ticket counts to headquarters, got scores and winners' names to everyone, and in general held the entire Festival together.



Later, at the same lake, Tom Purdon AB0A (L) and Jim Mullikin AE0H (R) kept track of the sailboat events. Those round badges hanging from strings allowed the club members to get into all of the events without hassles from the gate watchers. Note that most of the members are wearing the official National Sports Festival hats ... supplied by Coca Cola.



Mike Stansberry K0TER kept the officials up to date on the weather. Every now and then, a rain squall would head through the area, making some events stop for a while until things cleared up. Mike kept close track of these squalls and their probable path over the various events.

Sherry and I flew out to see how they were managing and I was most impressed by the or-

ganization, the willingness of everyone to cooperate, and the hard work and hours they put in,



At the conclusion of the Festival, the club got together for a dinner at Guiseppi's Old Depot Restaurant. Here Sherry and I had an opportunity to meet many of the other club members who were involved in the six-day effort, but who were not on duty at the exact time that I was taking pictures. For instance, here we see Kim Schlueter WB0UUW (14 years old, on left), father Dick Schlueter WB0PNX, mom Lorna WD0BTF, and daughter Susie WD0FXR (12 years old, on right).



Here we see (left to right) Bob Card AE0W, Gordon Denno WB0TIC (a very well-known foot surgeon ... tops in his field), Jim Mullikin AE0H, and Louie Preller W0PCZ.



Dave Acree W0MBZ is standing; seated (left to right) are Ken Keyte W0TGL (known as Two-Guy Louie, a very well-known sideband pioneer), Oak Stockton K0ROL, who made the arrangements for Sherry and me to watch the club in action (including the trip from Denver out to Colorado Springs), Oak's XYL, Ruth, and an unknown W4 visitor. Gordon Denno got us back to Denver after the show ... and a very interesting trip that was.

with many events starting at 8 am and others running until late into the night.

The coordination of all of the communications teams was a job in itself. I found myself shuttling from one area to another, often having to drive several miles to the next sports event, and always finding the club members there with everything under control. They even had one chap out at the weather station to pass along word of rain squalls which might interfere with outside events.

The main club communications center was set up near the Olympic Headquarters buildings. I visited these buildings, watching communications sort out ticket problems and locate some missing officials. Nearby was the hockey field, where I watched some field hockey. From there, we drove to the lake in Prospect Park where the yachting competition was in full swing. Then off to the middle of

town and a roller-skating competition at Skate City. From there out to Broadmoor Arena for ice hockey. Then a long drive to the Air Force Academy to see the archery competition, wrestling, and water polo.

As you can see, I took some pix of the club in action.

One of the props the club found necessary was signs which identified the ham stations as being amateur so credit would go toward amateur radio rather than commercial or even Citizen's Band. We've now made such signs and they are available for clubs setting up communications centers.

The job done by the Colorado Springs amateurs in providing communications for this Sports Festival was superb. I only hope that their example will be followed by ham clubs all around the country.

If you see an opportunity to provide community service, get your club organized and have at



Jerry Haberer WA0WSY on left, Chuck Myers W0RNT, Dave Acree W0MBZ, and Dick Thompson WB0DUL on right.

it. Be sure to get credit for the job, too. That's most important. Get information to the local papers and to the radio and television stations about what you are doing. You can perhaps help these media to gather news or the names of winners of

events.

Part of the charter of amateur radio is for us to provide communications in emergencies and to help our communities. Think in these terms and have at it. Remember that 73 would like pictures and a story.

FCC

Reprinted from the Federal Register.

47 CFR Part 97

[SS Docket No. 79-22; FCC 80-14]

Amateur Radio Service; Telegraphy Examination Credit

AGENCY: Federal Communications Commission.

ACTION: Report and Order.

SUMMARY: This Report and Order amends the Amateur Radio Service Rules to delete Section 97.25(d). This Section allowed credit for the telegraphy portion of the Amateur Extra Class examination to those who presented proof of having continuously held the Amateur Extra First Class license and its successor licenses. The Commission deleted the Section because it had proved to be obsolete.

EFFECTIVE DATE: August 1, 1980.

ADDRESSES: Federal Communications Commission, 1919 M Street NW., Washington, DC 20554.

FOR FURTHER INFORMATION CONTACT: Judith St. Ledger-Roty, Rules Division, Private Radio Bureau, (202) 634-2443.

Report and Order

Adopted: January 16, 1980.

Released: January 22, 1980.

By the Commission:

In the matter of deletion of § 97.25(d) from the Amateur Radio Service Rules. SS Docket No. 79-22, RM-3001.

1. On February 14, 1979, the Commission adopted a *Notice of Proposed Rulemaking in Docket No. 79-22*, 70 F.C.C. 2d 1918 (1979), 44 Fed. Reg. 12473 (1979), to consider the deletion of Section 97.25(d) of the Amateur Radio Service Rules. That Section presently provides that: "[a]n applicant for the Amateur Extra Class operator license will be given credit for examination element 1(c) if he so requests and submits evidence of having held the Amateur Extra First Class license, [and] having continuously held its successor license." It was proposed that the

effective date for this amendment be set for six months after approval by the Commission in order to give any persons affected one last chance to apply for the Amateur Extra Class license under the current rules.

2. From June 1923 to June 1933, the Department of Commerce and subsequently the Federal Radio Commission issued Amateur Extra First Class operator licenses. The Federal Communications Commission, upon its creation, issued the equivalent license, designating it a "Class A" license, and then later, an "Advanced" license.

3. In 1952, the Commission created the Amateur Extra Class license. To obtain this license, the applicant must successfully complete a written examination testing nine areas of basic, general, intermediate and advanced amateur practice. These written examination requirements are far more stringent than those that were associated with the Amateur Extra First Class license. The telegraphy proficiency requirement for the Amateur Extra First Class license was twenty words per minute; the telegraphy requirement for the Amateur Extra Class license is also twenty words per minute.

4. In recognition of this identical telegraphy requirement, the Commission amended Section 97.25(d) to allow credit for the telegraphy portion of the Amateur Extra Class examination to those who presented proof of having continuously held the Amateur Extra First Class license and its successor licenses. *Report and Order in Docket No. 19163*, 37 F.C.C. 2d 202 (1972).

5. Section 97.25(d) was adopted in order to eliminate any inequity that mandatory repetition of the telegraphy examination might create for former holders of the Amateur Extra First Class license who have remained active. In the *Notice* released in this docket, the Commission noted that the number of persons seeking examination credit pursuant to this Section has declined to such an extent that it might well be

considered obsolete. In fact, the Commission has averaged less than one applicant per year over the last few years. It therefore appears that Section 97.25(d) has fulfilled its purpose and should now be deleted.

6. In response to the Notice proposing deletion of Section 97.25(d), the Commission received only one comment. That participant agreed that Section 97.25(d) should be omitted if it was no longer useful, but requested that we delay the effectiveness of any order for one year so that remaining applicants might have time to study for and take the examination under the current provisions.

7. Section 97.25(d) has been in effect since 1972. Because of the lack of applications for credit, and the apparent lack of interest in this rule, we must assume that those who were eligible have applied for and received credit during the past seven years. It does not appear necessary to delay the effectiveness of the amendment for any more than the six month period originally proposed. Six months should be ample time to study for and take the examination, especially considering that prospective applicants for credit have already had several years for preparation.

8. The Commission also has under consideration a petition for rulemaking, RM-3001, submitted by Mr. Frank Carman of Otis, Oregon. Mr. Carman petitions the Commission to amend its rules to provide that applicants for the Amateur Extra Class license who were licensed amateurs prior to 1925 and currently hold General of Advanced Class licenses be granted credit for the 1 (C), 4 (A) and 4 (B) examination elements.

9. Mr. Carman's petition expresses views similar to those considered and rejected in Docket No. 19163. *Report and Order*, 37 F.C.C. 2d 202 (1972). At that time, we clearly expressed our views with regard to the Amateur Extra Class license, stating that:

As the highest grade amateur license, the Extra Class signifies that its holder has clearly demonstrated his technical qualifications based on both minimum licensing time and passage of a rigorous examination. Although the Commission

realizes that length of licensed operation can be a valuable asset toward establishing one's eligibility for the Extra Class license, this in itself is not considered sufficient basis for determining the amateur's total qualifications. In addition, to allow attainment of the Extra Class license on the basis of age or term of license tenure alone, would, we believe, discourage amateurs from studying toward license achievement in keeping with the Commission's incentive licensing program. 37 F.C.C. 2d at 204.

The Commission is unable to discern any benefit which would accrue to the Amateur Radio Service if this petition were adopted. Rather, we remain of the belief that the only appropriate basis for issuing an amateur operator license is the successful completion of the examination elements designed to establish the qualifications prescribed for a particular class of license.

10. In view of the foregoing, the Commission finds that the amendment to Part 97 of the Amateur Radio Service Rules, as set forth in the Appendix, is in the public interest. Authority for promulgating this amendment is contained in Sections 4(i) and 303 of the Communications Act, as amended.

11. Accordingly, it is ordered that, effective August 1, 1980, Part 97 of the Commission's Rules is amended as set forth in the appendix.

12. It is further ordered, that the petition of Mr. Frank Carman, RM-3001, is denied after due consideration.

13. It is further ordered that this proceeding be terminated.

(Secs. 4, 5, 303, 48 Stat., as amended, 1066, 1068, 1082; 47 U.S.C. 154, 155, 303)

Federal Communications Commission.

William J. Tricarico,

Secretary.

Appendix

1. The Federal Communications Commission amends Chapter 1, Part 97 of the Code of Federal Regulations as follows:

§ 97.25 [Amended]

(a) Paragraph 97.25(d) is deleted, and paragraph 97.25(e) is redesignated as paragraph (d).

HAM SCAN-1: YAESU MEMORIZER

*Scans 145-148 MHz in 10 sec., stops 3 sec. on active channels, simple 7 wire installation.
ORDER HAM SCAN-1.....\$39.95

HAM SCAN-2: K'WD 7625, 7600,

7400A, KDK 2015R, 2016A, CLEGG FM-28 MIDLAND 13-510, HW-2036, Others soon.
*Adds one channel of memory to any above rig
*Scan range selectable by position of radio's MHz switch. Up to full 4 MHz width.
*Scan rate 200 kHz/sec at 10 kHz steps with a 3 second pause on all active channels
*Mike-mounted switch provides 3 functions: start/stop, remote freq. incrementing and xmit interlock while actively scanning
*Scanner mounts inside radio, no external box
*Assembled, tested and guaranteed \$59.95
ORDER HAM SCAN-2 and specify type of radio

Technical Clinic

P.O. BOX 636 ✓312
STERLING HTS. MI 48078
Phone Orders Call: (313) 286-4836

URFI

(UNIVERSAL RECEIVED FREQUENCY INDICATOR)



Digitize your receiver's dial with the DIAL SPOTTER. Adapts to most Communication Receivers with simple connection to VFO. From \$149.95 Write for Data Sheet.

GEMINI INSTRUMENTS INCORPORATED

Box 205, Larchmont, NY 10538 ✓24

★ For Sale ★

\$10,000,000 INVENTORY

The *ultimate* source for electronic components and equipment.

PRODUCTION OVERRUNS SURPLUS MATERIALS

Send us your inquiries. Get on our exclusive mailing list. Inquire in writing or by Telex
TWX: 510-224-6539

Serving domestic and overseas markets.

Ultima
Electronics, Ltd.
(516) 423-3770

✓310

73 Sherwood Ct., Huntington, N.Y. 11743 U.S.A.

ATTENTION

EXPERIMENTER DESIGNER MANUFACTURER
HFT OFFERS YOU
ENGINEERING SERVICES - MINIMODULE PRODUCTS
AUDIO THROUGH 250MHZ

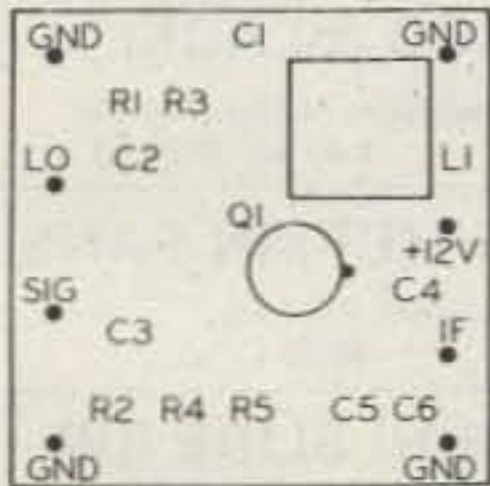

RF PREAMPLIFIERS
DUAL GATE FET MIXERS
IF AMPLIFIERS
AUDIO AMPLIFIERS
WWW RECEIVERS
VIDEO AMPLIFIERS
COMPRESSIVE AUDIO AMP.
SSB GENERATOR
RF POWER AMPLIFIERS
POWER SUPPLIES

FULL SCALE DUAL GATE MIXER

CATALOG ITEMS IN TWO WEEKS OR LESS
QUICK TURN AROUND ON SPECIALS

CATALOG & DESIGN MANUAL \$2.95 REFUND ON 1ST PURCHASE
DETAILED SPECIFICATIONS
APPLICATION NOTES
DESIGN DATA ON:

RF PREAMPLIFIERS, MIXERS,
SPURIOUS SIGNALS, RECEIVER
PARAMETERS, AUDIO COMPRESSION,
& OTHER DATA

SHORT FORM CATALOG ON REQUEST

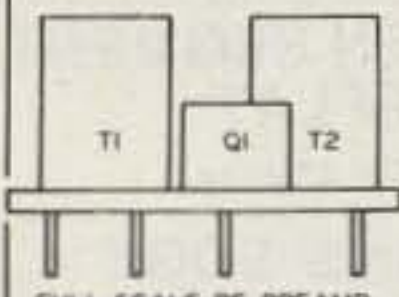

FULL SCALE RF PREAMP.

HFT INC ✓304
158 West 9th St
Deer Park NY 11729

UNBEATEN SIX BAND ANTENNA

THE JOYSTICK VFA

(Variable Freq. Antenna) claims unbeaten scoring over commercial and/or conventional antennae.
• Simple, rapid erection • Not only 6-band but CONTINUOUS 0.5 - 30 Mhz., incl. BC & MARS • Omni-directional • Substantially Harmonic FREE • 1,000,000 miles per watt, unbeaten record! • Poor QTH enhanced! CLIFFDwellers ANTENNA! • QUOTE from CQ Mag. - If you are high enough the antenna will operate (esp. at 15-20) as well as the well-known 3-element beam with which we compared it. The tests were operational, not theoretical! We find that if we can hear 'em we can work 'em.

SYSTEM 'A' \$110.00
150 W.P.E.P. &/or Receiving only

Each System 3 sections easily assembled to make unit 7" 6" long. Matching ATU. Air mail cost included.

SYSTEM 'J' \$130.00
500 W.P.E.P. &/or Improved
Q Factor Receive

Rush Mastercharge/Visa no. or check or request FREE literature.

PARTRIDGE ELECTRONICS LTD
8 Partridge House,
Broadstairs, Kent, England.

G3CED Tel: 011 44 0843 62535 **G3VFA**

Please send all reader inquiries directly

AUTOMATIC CW COPIER



Now you can copy the fast CW stations. The NEW professionally designed DE-150 plugs into a transceiver's earphone jack & automatically displays Morse code as it is being received. New characters are entered from the right and shift left giving a continuous easy to read display of the latest code received. \$425.

One year warranty and 15 day return privilege. Add \$5 for shipping. VISA & MC cards welcome.

Dynamic ELECTRONICS INC. ✓21

(205) 773-2758 Box 896 Hartselle, AL 35640



Tempo Handheld!

800 CHANNEL SYNTHESIZED TRANSCEIVERS

S-1 299.00 2 Meter
S-1T 339.00 With Tone Pad
S-2 349.00 220 MHz
S-2T 399.00 With Tone Pad

Amateur equipment accessories & antennas.
Amateur & commercial repair service.

Appliance & Equipment Company Inc. ✓301

2317 Vance Jackson Rd. San Antonio, TX 78213
(512) 734-7793

MILITARY SURPLUS WANTED

Highest prices ever on recent U.S. Military surplus, especially on Collins equipment or parts. We Pay freight. Call collect for high offer. (201) 440-8787. 35 Ruta Court, S. Hackensack, N.J. 07606

SPACE ELECTRONICS CO. ✓317

Subscription Problem?

73 Magazine does not keep subscription records on the premises, therefore calling us only adds time and doesn't solve the problem.

Please send a description of the problem and your most recent address label to:

73 Magazine
Subscription Dept.
PO Box 931
Farmingdale, NY 11737

Thank you and enjoy your subscription.

7294 N.W. 54 STREET
MIAMI, FLORIDA 33166

SURPLUS ELECTRONICS CORP.

PHONE: (305) 887-8228
TWX: 810-848-6085
WHOLESALE - RETAIL

<p>PL259 or SO239 Quality American Made 10/\$5.00 100/\$35.00 50/\$20.00 1000/\$300.00</p>	<p>CB SPECIAL Brand new printed circuit board assembly. Used in all HyGain 40 Channel CB transceivers. Fits many other manufacturers' units also. Squelch pot/volume control/channel selector switch not included. Board Dimensions 6" x 6 1/2" 1-9 - 7.50 ea. 50-99 - 6.00 ea. 100-up - 5.50 ea.</p>		<p>TRIMMER CAPS Can fit in your watch 3.5-20 pF & 5-30 pF \$.75 ea., 2/\$1.25 5/\$3.00</p>																																																																																																												
<p>E. F. Johnson NICAD 12.0 V. 1.2 AH @ 10 hr rate 4 1/2" x 1 7/8" x 1 3/4" \$1495ea.</p>	<p>CB SPECIAL W/40 ch SW same as above 1-9 \$10.50 ea. 50-99 \$9.00 ea. 10-49 \$9.50 ea. 100-up \$8.50 ea.</p>		<p>POLY FOAM COAX 50 Ohm Low Loss = to RG174 \$.495/100' \$3.00/50'</p>																																																																																																												
<p>E. F. Johnson S Meter Edge Meter 250 UA. Fits in 5/8" x 1-3/8" hole. MTG holes on each end 1-1/4" behind panel. Black scale 0-5 bottom 1-20 top \$1.25 ea. 5/\$5.00</p>	<p>Serviceman Special New Hy-Gain 40ch CB Less Case. Speaker & Knobs (as is) \$14.95 ea</p>		<p>ULTRASONIC TRANSDUCER Detects sound above the range of human hearing! Transmits & receives \$2.50 ea. 5/\$10.00</p>																																																																																																												
<p>E. F. Johnson Signal Strength Meter 200 UA 2 1/2" x 2 1/2" Sq. mounts in 1 1/4" hole 1" behind panel. Scale: 1-30 db top 0-5 bottom. \$4.95ea 5/\$20.00</p>	<p>NEW Hy-Gain Remote 40ch CB Less Case. Speaker & Control Mic (as is) \$14.95 ea</p>	<p>NEW E.F. Johnson Power Mic/Less Cord. Desktop Style \$19.95 ea</p>	<p>MAGNETIC PICK UP TRANSDUCER Converts motion to ac voltage without mechanical linkage 3/8" x 2" w/6" shielded cable \$4.95 ea.</p>																																																																																																												
<p>PANEL METERS \$4.00 ea 2 for \$7.00</p> <p>25-0-25 dc volts } 2 1/4" x 3" 0-20 dc volts } 0-25 dc volts } 2 1/4" x 2 1/4" 0-50 ac volts } -Shunt Required-</p>	<p>ASTATIC T-UG8-D104 PREAMP Desktop microphone w/crystal element 3 Pin Plug \$35 ea.</p>	<p>CERAMIC IF FILTERS EFC L455K \$3.50 ea.</p>	<p>SOLDERLESS TEST PROD (BLACK) Threaded type, molded handle \$.40 ea. 10/\$3.50</p>																																																																																																												
<p>Double Row/Wire Wrap .100</p> <p>25 pins \$3.49 ea 10/\$30.00 30 pins \$3.96 ea 10/\$32.00 50 pins \$5.43 ea 10/\$45.00</p>	<p>ILEX COPY LENS F:5.6,6.1 Focal Length (155MM) 1 1/4" D, 2 1/16" L, 1 1/16" Fixed Iris. \$7.50 ea.</p>	<p>50' MODEM CABLES 13#22ga wire w/shield, DB25P conn & DB51226-1 cover on one end \$7.50 ea.</p> <p>15' MODEM CABLES 10#22ga wire w/shield, DB25P conn & DB51226-1 cover on one end \$5.50 ea. 10/\$50.00</p> <p>25' MODEM CABLES 13#22ga wire w/shield, DB25P conn & DB51226-1 cover on one end \$6.50 ea. 10/\$60.00</p>	<p>USED MUFFIN FANS 3 blades, 110VAC, 4 1/4" sq. \$5.95</p>																																																																																																												
<p>Double Row/Solder Eyelet .156</p> <p>6 pins \$1.10 ea 10/\$ 9.00 15 pins \$1.55 ea 10/\$12.50 22 pins \$2.08 ea 10/\$17.00 43 pins \$3.66 ea 10/\$30.00</p>	<p>12 Vdc RELAY SPST 35 Amp Contacts Open Frame Rugged, great for mobile use \$4.50 ea 5/\$20.00</p>	<p>12 Vdc RELAY SPST Open Frame 5 Amp Contacts Mfg-Magnecraft \$1.50 ea 4/\$5.00</p>	<p>CW MINI SLIDE SW DPDT .15 ea. 10/\$1.25</p>																																																																																																												
<p>C & K SWITCHES</p> <p>PART # MOVEMENT 7101 ON/NONE/ON SPST 7103 ON/OFF/ON SPST 7108 ON/NONE/(ON) SPST 7201 ON/NONE/ON DPDT \$1.00 EA 6 FOR \$5.00</p>	<p>RECEIVER FRONT ENDS Made by EFJ 132-174 MHz \$12.00 ea.</p>	<p>100 ASSORTED DISC CAPS (FULL LEADS) 20 EA OF 5 DIFFERENT VALUES \$2.00 PER PACK</p>	<p>ALL STAR AIR VARIABLE 24-275 pF .75 ea.</p>																																																																																																												
<p>6 TV GAMES ON (1) CHIP Gen Instr AY-3-8500-1 28 Pin Plastic Case EVERYDAY LOW PRICE \$7.50 ea</p>	<p>STANCOR TRANSFORMERS STEP-DOWN AUTO (3) COND LINE CORD W/RECT GSD 200 (230V In/115V Out @ 200 Va) \$12.00 ea GSD 400 (230 In/115 V Out @ 400 Va) \$14.50 ea</p>	<p>White Porcelain Egg Insulator 1 1/2" x 1" 50¢ ea. 3 for \$1.25</p>	<p>RED SEVEN SEGMENT DISPLAY TIL 322P \$1.00 ea.</p>																																																																																																												
<p>ASSORTED ELECTROLYTICS</p> <table border="1"> <thead> <tr> <th>VALUE/MFD</th> <th>@</th> <th>VOLTS</th> <th>DIA</th> <th>LENGTH</th> <th>PRICE</th> </tr> </thead> <tbody> <tr><td>250,000</td><td>@</td><td>5V</td><td>3"</td><td>5 3/4"</td><td>\$4.00 ea</td></tr> <tr><td>30,000</td><td>@</td><td>15V</td><td>3"</td><td>4 1/2"</td><td>4.00 ea</td></tr> <tr><td>63,000</td><td>@</td><td>15V</td><td>3"</td><td>5 1/2"</td><td>4.00 ea</td></tr> <tr><td>10,000</td><td>@</td><td>20V</td><td>1 1/2"</td><td>5 3/4"</td><td>3.00 ea</td></tr> <tr><td>2,700</td><td>@</td><td>25V</td><td>1 1/4"</td><td>2 1/4"</td><td>2.00 ea</td></tr> <tr><td>2,900</td><td>@</td><td>25V</td><td>1 1/4"</td><td>2"</td><td>2.00 ea</td></tr> <tr><td>3,000</td><td>@</td><td>25V</td><td>1 1/2"</td><td>4 1/2"</td><td>2.00 ea</td></tr> <tr><td>18,000</td><td>@</td><td>25V</td><td>2"</td><td>4"</td><td>3.00 ea</td></tr> <tr><td>21,000</td><td>@</td><td>25V</td><td>2 1/2"</td><td>3"</td><td>3.00 ea</td></tr> <tr><td>39,000</td><td>@</td><td>45V</td><td>3"</td><td>5 3/4"</td><td>3.00 ea</td></tr> <tr><td>1,000</td><td>@</td><td>50V</td><td>1 1/4"</td><td>3 1/4"</td><td>2.50 ea</td></tr> <tr><td>34,800</td><td>@</td><td>50V</td><td>3"</td><td>5 1/2"</td><td>3.00 ea</td></tr> <tr><td>450</td><td>@</td><td>75V</td><td>1 1/4"</td><td>2 1/4"</td><td>2.00 ea</td></tr> <tr><td>500</td><td>@</td><td>100V</td><td>1 1/2"</td><td>3 1/2"</td><td>2.00 ea</td></tr> <tr><td>240</td><td>@</td><td>300V</td><td>1 1/4"</td><td>3 1/4"</td><td>2.00 ea</td></tr> <tr><td>50</td><td>@</td><td>450V</td><td>1 1/4"</td><td>2"</td><td>2.00 ea</td></tr> <tr><td>140</td><td>@</td><td>450V</td><td>1 1/4"</td><td>3"</td><td>2.00 ea</td></tr> </tbody> </table>	VALUE/MFD	@	VOLTS	DIA	LENGTH	PRICE	250,000	@	5V	3"	5 3/4"	\$4.00 ea	30,000	@	15V	3"	4 1/2"	4.00 ea	63,000	@	15V	3"	5 1/2"	4.00 ea	10,000	@	20V	1 1/2"	5 3/4"	3.00 ea	2,700	@	25V	1 1/4"	2 1/4"	2.00 ea	2,900	@	25V	1 1/4"	2"	2.00 ea	3,000	@	25V	1 1/2"	4 1/2"	2.00 ea	18,000	@	25V	2"	4"	3.00 ea	21,000	@	25V	2 1/2"	3"	3.00 ea	39,000	@	45V	3"	5 3/4"	3.00 ea	1,000	@	50V	1 1/4"	3 1/4"	2.50 ea	34,800	@	50V	3"	5 1/2"	3.00 ea	450	@	75V	1 1/4"	2 1/4"	2.00 ea	500	@	100V	1 1/2"	3 1/2"	2.00 ea	240	@	300V	1 1/4"	3 1/4"	2.00 ea	50	@	450V	1 1/4"	2"	2.00 ea	140	@	450V	1 1/4"	3"	2.00 ea	<p>15' MODEM CABLES 14#22ga wire w/shield, DB25P conn & DB51226-1 cover on one end \$6.00 ea. 10/\$55.00</p> <p>15' MODEM CABLES 10#22ga wire w/shield, DB25S conn & DB51226-1 cover on one end \$6.50 ea. 10/\$60.00</p>	<p>CAPS RADIAL LEADS 2200 uF @ 16V .25 ea. 10/\$2.00</p>	<p>BOURNS' EDGE MOUNTING 5K pot single turn 3345W series \$1.50 ea.</p>
VALUE/MFD	@	VOLTS	DIA	LENGTH	PRICE																																																																																																										
250,000	@	5V	3"	5 3/4"	\$4.00 ea																																																																																																										
30,000	@	15V	3"	4 1/2"	4.00 ea																																																																																																										
63,000	@	15V	3"	5 1/2"	4.00 ea																																																																																																										
10,000	@	20V	1 1/2"	5 3/4"	3.00 ea																																																																																																										
2,700	@	25V	1 1/4"	2 1/4"	2.00 ea																																																																																																										
2,900	@	25V	1 1/4"	2"	2.00 ea																																																																																																										
3,000	@	25V	1 1/2"	4 1/2"	2.00 ea																																																																																																										
18,000	@	25V	2"	4"	3.00 ea																																																																																																										
21,000	@	25V	2 1/2"	3"	3.00 ea																																																																																																										
39,000	@	45V	3"	5 3/4"	3.00 ea																																																																																																										
1,000	@	50V	1 1/4"	3 1/4"	2.50 ea																																																																																																										
34,800	@	50V	3"	5 1/2"	3.00 ea																																																																																																										
450	@	75V	1 1/4"	2 1/4"	2.00 ea																																																																																																										
500	@	100V	1 1/2"	3 1/2"	2.00 ea																																																																																																										
240	@	300V	1 1/4"	3 1/4"	2.00 ea																																																																																																										
50	@	450V	1 1/4"	2"	2.00 ea																																																																																																										
140	@	450V	1 1/4"	3"	2.00 ea																																																																																																										
<p>TERMS: All material guaranteed • If for any reason you are not satisfied, our products may be returned within 10 days for a full refund (less shipping). Please add \$3 for shipping and handling on all orders. Additional 5% charge for shipping any item over 5 lbs. COD's accepted for orders totaling \$50.00 or more. All orders shipped UPS unless otherwise specified. Florida residents please add 4% sales tax. Minimum order \$15.00.</p>	<p>IC SOCKETS Cambion Gold Plated Wire Wrap 14 pin .35 ea 10/\$3.00 16 pin .38 ea 10/\$3.30</p>	<p>SOLDER LUG-TYPE CAPS 50 UF @ 350V 1" D x 3" L 50 UF @ 450V 1" D x 2 1/2" L 50 UF @ 450V 1" D x 3" L 60¢ EA. 5 FOR \$2.50</p>	<p>12 VOLTS @ 1/2 AMP Filament transformer 1 1/4" x 2" x 1" \$1.50 ea.</p>																																																																																																												
<p>EQUIPMENT / COMPONENTS / WIRE & CABLE / ACCESSORIES</p>	<p>COMCO XTAL FILTER 23/8" x 1" x 1/4" 13KC BW \$10.00 ea.</p>	<p>EFJ CRYSTAL OVENS 6V/12V 75° \$5.00 ea.</p>	<p>CTS DP6P ROT SWITCH .50 ea. 5/\$2.00</p>																																																																																																												
<p>Coax Connectors UG-273/U BNC-F/UHF-M 2.50 UG-255/U BNC-M/UHF-F 3.00 UG-146A/U N-M/UHF-F 4.50 UG-83B/U N-F/UHF-M 4.50 UG-175 RG-58 Adapt. .20 UG-176 RG-59 Adapt. .20</p>	<p>AXIAL LEAD ELECTROLYTIC CAPACITORS</p> <p>2 uF @ 15V } 10 uF @ 15V } 20 uF @ 15V } 50 uF @ 15V } 2.2 uF @ 25V } 3.3 uF @ 25V } 1 uF @ 35V } 2 uF @ 150V } 25 uF @ 25V } 3 uF @ 50V } 5 uF @ 50V } 10 uF @ 50V } 250 uF @ 25V } 100 uF @ 50V } 50 uF @ 75V }</p> <p>12 ea. for \$1.00 15 ea. for \$2.00 10 ea. for \$2.00</p>	<p>12 Vdc RELAY SPST 35 Amp Contacts Open Frame Rugged, great for mobile use \$4.50 ea 5/\$20.00</p>	<p>RED SEVEN SEGMENT DISPLAY TIL 322P \$1.00 ea.</p>																																																																																																												

Low Cost...High Performance

DIGITAL MULTIMETER



\$99.95 WIRED

Low cost, high performance, that's the DM-700. Unlike some of the hobby grade DMMs available, the DM-700 offers professional quality performance and appearance at a hobbyist price. It features 26 different ranges and 5 functions, all arranged in a convenient, easy to use format. Measurements are displayed on a large 3½ digit, ½ inch high LED display, with automatic decimal placement, automatic polarity, and overrange indication. You can depend upon the DM-700, state-of-the-art components such as a precision laser trimmed resistor array, semiconductor band gap reference, and reliable LSI circuitry insure lab quality performance for years to come. Basic DC volts and ohms accuracy is 0.1%, and you can measure voltage all the way from 100 μ V to 1000 volts, current from 0.1 μ A to 2.0 amps and resistance from 0.1 ohms to 20 megohms. Overload protection is inherent in the design of the DM-700, 1250 volts, AC or DC on all ranges, making it virtually goof proof. Power is supplied by four 'C' size cells, making the DM-700 portable, and, as options, a nicad battery pack and AC adapter are available. The DM-700 features a handsome, jet black, rugged ABS case with convenient retractable tilt bail. All factory wired units are covered by a one year limited warranty and kits have a 90 day parts warranty.

Order a DM-700, examine it for 10 days, and if you're not satisfied in every way, return it in original form for a prompt refund.

Specifications

DC and AC volts:	100 μ V to 1000 Volts, 5 ranges
DC and AC current:	0.1 μ A to 2.0 Amps, 5 ranges
Resistance:	0.1 Ω to 20 megohms, 6 ranges
Input protection:	1250 volts AC/DC all ranges fuse protected for overcurrent
Input impedance:	10 megohms, DC/AC volts
Display:	3½ digits, 0.5 inch LED
Accuracy:	0.1% basic DC volts
Power:	4 'C' cells, optional nicad pack, or AC adapter
Size:	6"W x 3"H x 6"D
Weight:	2 lbs with batteries

Prices

DM-700 wired + tested	\$99.95
DM-700 kit form	79.95
AC adapter/charger	4.95
Nicad pack with AC adapter/charger	9.95
Probe kit	3.95

TERMS: Satisfaction guaranteed or money refunded. COD, add \$1.50. Minimum order \$6.00. Orders under \$10.00, add \$.75. Add 5% for postage, insurance, handling. Overseas, add 15%. NY residents, add 7% tax.



600 mHz COUNTER



\$99.95 WIRED

The CT-70 breaks the price barrier on lab quality frequency counters. No longer do you have to settle for a kit, half-kit or poor performance, the CT-70 is completely wired and tested, features professional quality construction and specifications, plus is covered by a one year warranty. Power for the CT-70 is provided by four 'AA' size batteries or 12 volts, AC or DC, available as options are a nicad battery pack, and AC adapter. Three selectable frequency ranges, each with its own pre-amp, enable you to make accurate measurements from less than 10 Hz to greater than 600 mHz. All switches are conveniently located on the front panel for ease of operation, and a single input jack eliminates the need to change cables as different ranges are selected. Accurate readings are insured by the use of a large 0.4 inch seven digit LED display, a 1.0 ppm TCXO time base and a handy LED gate light indicator.

The CT-70 is the answer to all your measurement needs, in the field, in the lab, or in the ham shack. Order yours today, examine it for 10 days, if you're not completely satisfied, return the unit for a prompt and courteous refund.

Specifications

Frequency range:	10 Hz to over 600 mHz
Sensitivity:	less than 25 mv to 150 mHz less than 150 mv to 600 mHz
Stability:	1.0 ppm, 20-40°C; 0.05 ppm/°C TCXO crystal time base
Display:	7 digits, LED, 0.4 inch height
Input protection:	50 VAC to 60 mHz, 10 VAC to 600 mHz
Input impedance:	1 megohm, 6 and 60 mHz ranges 50 ohms, 600 mHz range
Power:	4 'AA' cells, 12 V AC/DC
Gate:	0.1 sec and 1.0 sec LED gate light
Decimal point:	Automatic, all ranges
Size:	5"W x 1½"H x 5½"D
Weight:	1 lb with batteries

Prices

CT-70 wired + tested	\$99.95
CT-70 kit form	75.95
AC adapter	4.95
Nicad pack with AC adapter/charger	14.95
Telescopic whip antenna, BNC plug	7.95
Tilt bail assembly	3.95

ramsey electronics

62 BOX 4072, ROCHESTER, N.Y. 14610
PHONE ORDERS CALL
(716) 271-6487



SPECTRONICS, INC.

1009 Garfield St., Oak Park, Illinois • 60304
(312) 848-6777

BARGAIN FAVORITES!

OUR BEST-SELLING MULTI-BAND!



AS LOW AS
\$73⁷⁵

- One half the length of conventional half-wave dipoles
- Multi-band, Multi-frequency.
- Maximum efficiency — no traps, loading coils, or stubs.
- Fully assembled and pre-tuned — no measuring, no cutting.
- All weather rated — 1 KW AM, 2.5 KW CW or PEP SSB.
- Proven performance — more than 10,000 have been delivered.
- Permit use of the full capabilities of today's 5-band xcvrs.
- One feedline for operation on all bands.

- 40-10HD/A 40/20/15/10 Mtrs (36) \$73.75 c
 80-40HD/A 80/40 Mtr bands (69) 77.25 c
 75/40HD/A 75/40 Mtr bands (66) 73.75 c
 75-10HD/A 75/40/20/15/10 Mtr (66) 89.95 c
 80-10HD/A 80/40/20/15/10 Mtr (69) 94.95 c

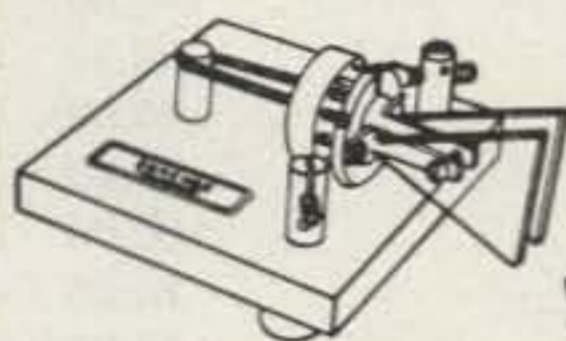

BENCHER

If it's the ultimate in paddles your looking for may we recommend the Bencher. It's simply the nicest one we've seen yet.

- BY1 paddle w/black base \$39.95 c
 BY1 Deluxe model w/chrome base 49.95 c

MODEL 595 **BW**
\$21⁵⁰

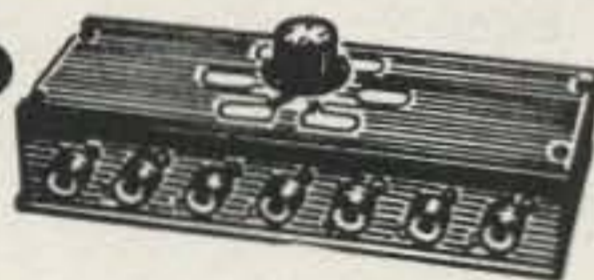

Our most popular switch. 6 position, grounds all except selected output circuit. Can be mounted on wall, on desk, or almost anywhere. Good to 150MHz. Wt. 2 lbs.

NEW from HY-GAIN!

A \$269.95 Value! **TH5DXX 5 El.**
ONLY **10-15-20 Meter**
\$221⁵⁰ Beam — Rated
Full Legal Power
TRUCK SHIP ONLY Output

AVERAGE SHIPPING COST GUIDE (Continental U.S.) Items sent UPS whenever possible.

Please estimate the shipping charges for your order. Any excess payment over 25c will be refunded or credited. Underpayment will be billed or sent collect. For insurance add 25c for each \$100.00 value over the first \$100.00.

Wt. Call Area	1,2,3,4,5	6,7	8,9
1 lb.	.90	1.00	.90 .85
5 lbs.	1.50	2.00	1.95 1.20
10 lbs.	2.25	3.20	1.95 1.70
20 lbs.	3.80	5.60	3.20 2.80
30 lbs.	5.30	8.05	4.40 3.50
50 lbs.	8.40	12.90	6.90 5.35

ESTIMATED WEIGHT CODING

After the price of each item you will find a letter, i.e., 12.95 a. To make it easier to figure shipping costs, these letters indicate the approximate weight of the item as follows:

- a. Less than 1 lb. l. 20-30 lbs.
 b. 1-3 lbs. m. 7-10 lbs. g. 30-40 lbs.
 c. 4-6 lbs. n. 10-20 lbs. h. 40-50 lbs.

NOTE: INTERNATIONAL ORDERS write for Proforma Invoice. ITEMS MARKED ★ will be sent truck collect.

IMPROVE YOUR RECEPTION!

AN AMECO ALL-BAND PREAMP!
• 6-160 Meters
• 20+ dB Gain
• Low Price

ONLY
\$49⁹⁵



MODEL PLF-2 . . . Improves weak signals as well as image and spurious rejection of most receivers. Direct switching to rec. or preamp. Includes pwr. supp. 117 VAC wired & tested \$49.95.

DIPOLE HEADQUARTERS

CABLE

- 8U FOAM, hi dens braid 50 ft. \$12.95 c
 8U FOAM, hi dens braid 100 ft. 24.00 e
 RG58A/U stranded center 50 ft. 6.95 c
 RG58A/U stranded center 100 ft. 9.95 d
 RG58 3 ft w/PL259 each end. 3.35 b
 RG58 5 ft w/PL259 each end. 4.39 b
 RG58 50 ft w/PL259 each end. 9.95 c

COPPER WIRE

- #14 stranded, 100 ft spool. 5.95 c
 #14 solidcopper enameled 100' 5.95 c

INSULATORS

- Egg Ins, porcelain per pair99 a
 DOG BONE, porcelain set of 3 1.50 a
 HY GAIN #155 center insulator. 5.95 b
 HY GAIN Cycloc end ins per pair 3.95 b
 MOSLEY dipole center insulator 5.75 a

CONNECTORS

- PL259 UHF male, 2 per pkg 1.59 a
 SO239 UHF female chassis mt69 a
 UG175 Adapts RG58 to PL259, pkg 2 59 a
 UG176 Adapts RG59 to PL259, pkg 2 59 a
 PL258 UHF double female99 a
 DM-SP UHF double male 1.69 a
 M359 90 deg UHF elbow conn 2.10 a
 UG88U BNC male for RG58 1.49 a
 1094 BNC female 1.49 a
 M358 UHF "T" connector 3.95 a
 UG255 UHF female to BNC male 3.49 a
 UG273 BNC female to UHF male 2.45 a

Famous "W2AU" Balun

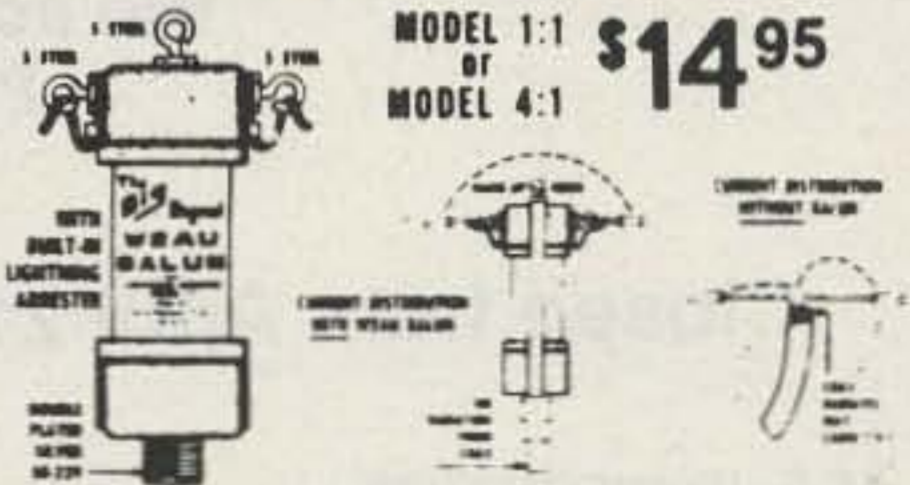

MODEL 1:1 OF MODEL 4:1 **\$14⁹⁵**

1. HANDLES FULL 2 KW PEP AND THEN SOME. Broad Banded 3 to 40 Mc
2. HELPS TVI PROBLEMS By Reducing Coax Line Radiation
3. NOW ALL STAINLESS STEEL HARDWARE: SO239 Double Silver Plated
4. IMPROVES F/B RATIO By Reducing Coax Line Pick Up
5. REPLACES CENTER INSULATOR Withstands Antenna Pull of Over 600 Lbs
6. BUILT IN LIGHTNING ARRESTER Helps Protect Balun — Could Also Save Your Valuable Gear
7. BUILT IN HANG-UP HOOK. Ideal for Inverted Vees, Multi-Band Antennas, Dipoles, Beam and Quads

NOW BEING USED BY ALL BRANCHES OF THE U.S. ARMED FORCES, FAA, RCA, CIA, CANADIAN DEFENSE DEPT. PLUS THOUSANDS OF HAMS THE WORLD OVER

Comes in 2 models. 1:1 matches 50 or 75 ohm unbalanced (coax line) to 50 or 75 ohm balanced load. 4:1 model matches 50 or 75 ohm unbalanced (coax line) to 200 or 300 ohm balanced load

Model 1:1 \$14.95 Model 4:1 \$14.95

2 METER ANTENNAS at BARGAIN PRICES!!

NEW! **hygain** 3 db GAIN MAGNETIC MOUNT
ONLY **\$19.⁹⁵**
Model 287
Wt. 2.5 lbs.

An economical alternative to drilling a hole. A magnetic antenna by a name you can trust at a low, low price.

Model 286 Same but trunk lid. \$15.95 b

NEW! FINCO 2.8 dbd GAIN BASE ANTENNA

ONLY **\$9.⁹⁵**
Model A2-GP
Wt. 2 lbs.

At last! An inexpensive, omni directional, 144-148 MHz, 1/2 wave antenna. Fits 1 1/4" mast, 50 ohm imp. A good antenna at a very affordable price.

NEW! FROM avanti antennas

ON GLASS MOBILE ANTENNAS
Modern technology lets you mount a mobile antenna right on the window. Ideal for tough installations. 3 models available

- AH151.3G 144-174 MHz, 3 db gn. . . . \$33.95 b
 AH220.3G 220 MHz, 3 db gn. 33.95 b
 AH450.5G 406-512 MHz, 5 db gn. . . . 36.95 b

SEMICONDUCTORS SURPLUS

2822 North 32nd Street/Unit -1 Phoenix, Arizona 85008 (602) 956-9423

We accept checks, MasterCharge, and Visa

Prices subject to change without notice



Closed from April 21st through May 6th for the Dayton Ohio Hamfest.

E.F. JOHNSON TUBE SOCKETS & PARTS

POWER TUBE SOCKET

for RCA 8072, 8021, 8122, and 8462
EIA base #E11-81
Will also fit CRT tubes 1EP11 and 1EP1 EIA base #E11-22
\$4.99 each

SCREEN GRID BY-PASS

CAPACITORS
1450 100pf
Part No. 124-0113-001
\$9.95 each

POWER TUBE SOCKETS

for 4X150A and D, 4CX250B and R, 4CX350A
Part No. 124-0107-001
\$14.95

CHIMNEY for 4CX250B and R, 4X150A and D, and 4CX350A
Part No. 124-0111-001
\$3.99

POWER TUBE SOCKETS

for 4-125A, 4-250A, 4-400A/C etc., 3-400Z, and 3-500Z
Part No.
\$29.95 per pair only

SPRAGUE RF NOISE FILTERS

#JN17-4080A
100VDC @ 70Amps
.22mfd
\$2.99 each

CARBIDE DRILL BITS

for drilling P.C.B.
5 mix **\$6.00**
10 mix **\$10.00**

25AMP SCR's

2N681	\$1.10
2N682	1.25
2N683	1.45
2N684	1.60
2N685	1.70
2N686	1.95
2N687	2.45
2N688	3.45
2N690	3.95

E.F. JOHNSON MINIATURE TYPE V AIR VARIABLE CAPS

189-503-105	1.4-9.2pf
189-504-4	1.8-5pf
189-504-5	1.5-11.6pf
189-505-5	1.7-14.1pf
189-506-105	1.8-16.7pf
189-507-5	2-19.3pf
189-508-5	21.-22.9pf
189-509-5	2.4-24.5pf
189-1-1-4	1.2-4.2pf
189-4-5	1.5-9.1pf
189-5-8	1.1-11pf
189-6-8	1.8-13pf
189-503-5	1.4-9.2pf

\$1.50 each

FET's

3N128	\$1.00 or 10/8.00
40673	1.39 or 10/10.00
MPF102	.45 or 10/3.50
MFE131	1.00 or 10/8.00
U2705/2N4416	1.00 or 10/8.00
MFE2000	1.00 or 10/8.00
MPF4391	.80 or 10/6.00
2N4303	.50 or 3/1.00
2N5484	.50 or 3/1.00
2N5555	.90 or 2/1.50
2N5639	.48 or 3/1.00
2N5246	.50 or 3/1.00
2N5248/MPF102	.45 or 10/3.50
3N201	1.99 or 10/12.00
3N157A	ea.00

MOTOROLA POWER TRIACS

TO-220 case
15Amps 600PRV
99¢ each or 10/\$7.50

TUBES

2E26	\$ 5.00
3-500Z	90.00
3B28	4.00
3X2500A3	125.00
3X3000F1	200.00
4-65A	30.00
4-125A	40.00
4-250A	60.00
4-400A	80.00
4-1000A	175.00
4CX250B	38.50
4CX250R	40.00
4CX350A	50.00
4CX1000A	150.00
4X150A	20.00
4X150G	30.00
572B/T160L	39.00
811A	12.95
6146	5.00
6146A	5.25
6146B	6.50
6146W	12.95
6360	7.95
6939	8.00
8072	45.00
8295/PL172	300.00
8950	5.95
8877	300.00
7289	6.99
6KD6	4.99
6LF6	4.00
6LQ6/6JE6	5.99
8908	8.99
6550A	8.00

Other numbers on request

HIGH VOLTAGE CAPS

22mfd @ 500VDC
7/8 in. x 1 1/2 in.
\$1.99 each

330mfd @ 450VDC
Can Type
1 7/8 in. x 4 1/4 in.
\$4.99 each

See you in Dayton!

SEMICONDUCTORS SURPLUS

✓ S63

2822 North 32nd Street/Unit -1 Phoenix, Arizona 85008 (602) 956-9423

We accept checks, MasterCharge, and Visa

Prices subject to change without notice



Closed from April 21st through May 6th for the Dayton Ohio Hamfest.

HIGH VOLTAGE CAPs

150uf @ 450VDC
Can Type
1 3/8 in. x 3 1/2 in. high
\$3.99 each

50uf @ 450VDC
Can Type
1 in. x 3 in. high
\$2.99 each

MINI TRIM POTS

5 Ohm	5 K
10 Ohm	10 K
17 Ohm	20 K
50 Ohm	25 K
100 Ohm	50 K
150 Ohm	100 K
200 Ohm	200 K
500 Ohm	250 K
1 K	500 K
2 K	1 Meg
2.5 K	5 Meg
4.7 K	

49¢ each

MINI RF CHOKES

.2 uh	33 uh
.5 uh	39 uh
.56 uh	47 uh
.68 uh	100 uh
1.5 uh	680 uh
2.2 uh	1000 uh
3.3 uh	1 mh
6.8 uh	1.1 mh
10 uh	2.5 mh
22 uh	6.8 mh
27 uh	10 mh

79¢ each

PRESS FIT RECTIFIERS

DO-21 500VDC @ 25Amps
2/\$1.00

MAN 3's
4/\$1.00

FULL WAVE BRIDGES

Motorola MDA 204/3N256	2Amps @ 400VDC	\$.69 each
Varo VH147	6Amps @ 100VDC	1.00 each
Varo VS148	2Amps @ 100VDC	.69 each
Varo VS647	2Amps @ 600VDC	1.29 each
Motorola and GI	25Amps @ 600VDC	2.99 each

RF TRANSISTORS

2N2270	\$.78	2N6084	\$13.20
2N2857	1.80	2N6094	5.75
2N2857JAN	2.45	2N6095	19.35
2N2947	17.25	2N6097	28.00
2N3261	2.10	2N6166	36.80
2N3375	7.99	2N6439	43.45
2N3553	1.80	40280	2.00
2N3866	1.09	40281	10.90
2N3866JAN	2.70	40282	11.90
2N3866JANTX	4.43	40894	.99
2N3925/M9477	6.00	FT3551C/2N6082NS	4.00
2N3948	2.00	(no stud)	
2N3950	26.25	PT3563	5.00
2N3818	6.00	PT4132D/2N5641	4.90
2N4072	1.70	PT4571A	1.50
2N4427	1.09	MRF216	20.00
2N4429	7.50	MRF221	10.00
2N4877	.90	MRF227	2.00
2N4959	2.12	MRF240	price on request
2N5108	3.90	MRF245	31.05
2N5109	1.55	MRF247	39.95
2N5179	.69	MRF314	14.00
2N5177	20.70	MRF412	price on request
2N5190	1.50	MRF422A	42.30
2N5583	4.43	MRF426A	price on request
2N5214	20.00	MRF450	10.35
2N5589	4.60	MRF450A	10.35
2N5590	6.30	MRF454/568BLYCF	17.95
2N5591	10.35	MRF454A	20.00
2N5637	20.70	MRF475	2.90
2N5645	11.00	MRF476	1.38
2N5842/MM1607	8.65	MRF477	2.00
2N5919	30.00	MRF479	price on request
2N5946	13.20	MRF485	price on request
2N5849/MM1620	20.00	MRF502	.49
2N5862	50.00	MRF629	3.00
2N6080	5.45	MRF901	3.99
2N6081	8.60	MRF911	3.99
2N6082	9.90	MRF5176	13.00
2N6083	11.80	MRF8004	1.44
		Other numbers on request	

Minimum order of \$10.00.

AZDEN ★ NEW! ★ AZDEN ★ NEW! ★ AZDEN ★ NEW! ★ AZDEN

THE GIANT **AZDEN**® COMPANY
REVOLUTIONIZES THE STATE OF THE ART
AWE AND AZDEN. INTRODUCE THE BRILLIANT NEW **PCS-2800**
MICROCOMPUTER CONTROLLED
SUPERIOR COMMERCIAL GRADE
10 METER — **INTRODUCTORY**
FM TRANSCEIVER **PRICE**

\$299⁰⁰



COMPARE THESE FEATURES
WITH ANY UNIT AT ANY PRICE

- **FREQUENCY RANGE:** Receive and transmit: 28.000 to 29.995 MHz, 10KHz steps with built-in - 100 KHz repeater offset.
- **ALL SOLID STATE-CMOS PL DIGITAL SYNTHESIZED.**
- **SIZE: UNBELIEVABLE! ONLY 6 3/4" x 2 3/8" x 9 3/4". COMPARE!**
- **MICROCOMPUTER CONTROLLED:** All scanning and frequency-control functions are performed by microcomputer.
- **DETACHABLE HEAD:** The control head may be separated from the radio for use in limited spaces and for security purposes.
- **SIX-CHANNEL MEMORY:** Each memory is re-programmable. Memory is retained even when the unit is turned off.
- **MEMORY SCAN:** The six channels may be scanned in either the "busy" or "vacant" modes for quick, easy location of an occupied or unoccupied frequency. **AUTO RESUME. COMPARE!**
- **FULL-BAND SCAN:** All channels may be scanned in either "busy" or "vacant" mode. This is especially useful for locating repeater frequencies in an unfamiliar area. **AUTO RESUME. COMPARE!**
- **INSTANT MEMORY-1 RECALL:** By pressing a button on the microphone or front panel, memory channel 1 may be recalled for immediate use.
- **MIC-CONTROLLED VOLUME AND SQUELCH:** Volume and squelch can be adjusted from the microphone for convenience in mobile operation.
- **DIRECT FREQUENCY READOUT:** LED display shows operating frequency, **NOT** channel number. **COMPARE!**
- **TEN (10) WATTS OUTPUT:** Also 1 watt low power for shorter distance communications. LED readout displays power selection when transmitting.
- **DIGITAL S/RF METER:** LEDs indicate signal strength and power output. No more mechanical meter movements to fall apart!
- **LARGE 1/2-INCH LED DISPLAY:** Easy-to-read frequency display minimizes "eyes-off-the-road" time.
- **PUSHBUTTON FREQUENCY CONTROL FROM MIC OR FRONT PANEL:** Any frequency may be selected by pressing a microphone or front-panel switch.
- **SUPERIOR RECEIVER SENSITIVITY:** 0.28 uV for 20-dB quieting. The squelch sensitivity is superb, requiring less than 0.1 uV to open. The receiver audio circuits are designed and built to exacting specifications, resulting in unsurpassed received-signal intelligibility.
- **TRUE FM, NOT PHASE MODULATION:** Transmitted audio quality is optimized by the same high standard of design and construction as is found in the receiver. The microphone amplifier and compression circuits offer intelligibility second to none.
- **OTHER FEATURES:** Dynamic Microphone, built in speaker, mobile mounting bracket, external remote speaker jack (head and radio) and much, much more. All cords, plugs, fuses, microphone hanger, etc. included. Weight 6 lbs.
- **ACCESSORIES:** 15' REMOTE CABLE...\$29.95. FMPS-4R A/C POWER SUPPLY...\$39.95. TOUCHTONE MIC. KIT...\$39.95. EXTERNAL SPEAKER...\$18.00.

AMATEUR-WHOLESALE ELECTRONICS ORDER NOW TOLL FREE

8817 S.W. 129th Terrace, Miami, Florida 33176
 Telephone (305) 233-3631 • Telex: 80-3356
 U.S. DISTRIBUTOR DEALER
 INQUIRIES INVITED

1-800-327-3102

CREDIT CARD HOLDERS MAY USE OUR TOLL FREE ORDERING NUMBER.

Bargains GALORE !!

SOLDERTAIL SOCKET SPECIAL

14 pin 50/\$4.95 16 pin 50/\$4.95 18 pin 50/\$4.95
 20 pin 40/\$4.95 24 pin 30/\$4.95 28 pin 30/\$4.95
 40 pin 20/\$4.95

TRANSISTORIZED SPECIAL

If you ever needed to stock up on transistors, you had better do it now. General purpose NPN transistors (similar to the 2N3904) are now 100/\$7.95, while general purpose PNP transistors (similar to the 2N3906) are now 100/\$8.95. Quantities are limited at this special price.

THE CLOCK AND CASE SPECIAL CONTINUES

The MA1003 is a great car clock module; it includes a built-in crystal controlled timebase, runs off +12V DC, and features blue-green fluorescent readouts for easy visibility. The case has an optical filter to bring out the best of the readouts, along with mounting hardware to attach the clock under (or on) your dashboard. \$19.95

16K DYNAMIC RAMS: 8/\$87.20

Ideal for expanding memory in TRS-80* -I and -II, as well as machines made by Apple, Exidy, Heath, newer PETs, etc. Low power, 250 ns (4 MHz) parts. Add \$3 for two DIP shunts plus TRS-80* installation instructions.

*TRS-80 is a trademark of the Tandy Corporation

WE HAVE THE VOLTAGE REGULATORS YOU NEED

Positive 1A, TO-220 package, 78 series only \$1.38 each. Choose from +5, +6, +8, +12, +15, +18, and +24 Volts. Negative 1A, TO-220 package, 79 series only \$1.49 each. Choose from -5, -6, -8, -12, -15, -18, and -24 Volts.

transistors & FET's

2N2221	NPN TO-18, unmarked	7/\$1.00
2N2222	PNP TO-18, unmarked	5/\$1.00
2N2907A	PNP plastic case, house number	5/\$1.00
2N3055	NPN TO-3, house no. power type	1/\$0.75
2N3904	NPN TO-105, house number	5/\$1.00
2N3906	PNP TO-105, house number	5/\$1.00
2N4124	30V, 200 mA, 350 mW, TO-92 w/ min hFE 120 to 360	3/\$1.00
2N4304	TO-18 plastic N-JFET, gen purp.	2/\$1.00
2N4400	NPN plastic, house number	5/\$1.00
2N4917	PNP TO-106 case	5/\$1.00
2N4946	NPN TO-106 case	6/\$1.00
2N5227	Ideal small signal 3 lead, silicon transistor, PNP, TO-92, 30V	6/\$1.00
2N5306	Silicon transistor, TO-92, Darling- ton NPN 25V, 300 mA, 400 mW, hFE 7000 to 70000	3/\$1.00
2N5449	Silicon NPN transistor	6/\$1.00
2N5484	RF N-FET	3/\$1.00
D41D1	PNP TO-202, 1A max power type	1/\$0.50
D44C4	TO-220, 4A, 30W, 55V, NPN, minimum hFE 25	1/\$0.75
D45C4	TO-220, 4A, 30W, 55V, PNP, minimum hFE 25	1/\$0.75
D45H8	TO-220, house number, PNP, 10A, 50W, 60V, hFE 60 min.	3/\$2.00
TIP3055	Silicon NPN power, tab case elect.	1/\$0.75
MPS3694	NPN/general purpose	4/\$1.00
FPT100	Phototransistors	1/\$0.50
FET-1	Dual N-JFET VHF/UHF, TO-18	3/\$1.00
FET-2	Dual N-JFET VHF/UHF amp, sim. to 2N4416, TO-18	3/\$1.00
FET-3	Dual N-JFET low noise audio amp, TO-18	2/\$1.00
FET-6	House number, general purpose 631 type dual gate MOSFET. Ideal for RF amp/mixer applications with a dB NF at 200 MHz	3/\$2.00

SPECIAL SPECIAL SPECIAL SPECIAL SPECIAL
 .01 ceramic disc capacitors, with full leads (not cut for
 PC insertion). Ideal for bypassing TTL and other logic
 circuits, audio coupling, and audio bypass applications.
 Available in quantity only: 500/\$16.95 or for even
 greater savings, 1000/\$30.00. Stock up now!
 SPECIAL SPECIAL SPECIAL SPECIAL SPECIAL

resistors

¼ Watt only; may be 5% or 10%. All resistors may only be
 ordered in multiples of 100 (i.e. you cannot purchase one
 2.7k resistor; you must order 100, 200, 300, etc.).

EACH VALUE: \$1.70/hundred (1 pkg)

TEN VALUES: \$15.30/thousand (10 pkgs)

1.0 Ohms	47 Ohms	2.0k	82k
1.2	51	2.2k	91k
1.3	56	2.4k	100k
1.5	62	2.7k	110k
1.6	68	3.0k	120k
1.8	75	3.3k	130k
2.0	82	3.6k	150k
2.2	91	3.9k	160k
2.4	100	4.3k	180k
2.7	110	4.7k	200k
3.0	120	5.1k	220k
3.3	130	5.6k	240k
3.6	150	6.2k	270k
3.9	160	6.8k	300k
4.3	180	7.5k	330k
4.7	200	8.2k	360k
5.1	220	9.1k	390k
5.6	240	10k	430k
6.2	270	11k	470k
6.8	300	12k	510k
7.5	330	13k	560k
8.2	360	15k	620k
9.1	390	16k	680k
10	430	18k	750k
11	470	20k	820k
12	510	22k	910k
13	560	24k	1.0M
15	620	27k	1.1M
16	680	30k	1.2M
18	750	33k	1.3M
20	820	36k	1.5M
22	910	39k	1.6M
24	1k	43k	1.8M
27	1.1k	47k	2.0M
30	1.2k	51k	2.2M
33	1.3k	56k	5.6M
36	1.5k	62k	6.8M
39	1.6k	68k	22M
43	1.8k	75k	

TERMS: Cal res add tax. Allow 5% shipping; excess refunded. VISA/Master-
 charge call our 24 hour order desk at (415) 562-0636. COD OK with street ad-
 dress for UPS. Special prices good through cover month of magazine while
 supplies last; other prices subject to change without notice. Add \$1 handling
 to orders under \$15. Thanks for your business!

SEND FOR OUR CATALOG TODAY!

GODBOUT

GODBOUT ELECTRONICS
 Bldg. 725, Oakland Airport, CA 94614

ASSOCIATED RADIO

913-381-5900

8012 CONSER BOX 4327

OVERLAND PARK, KANSAS 66204



CALL US WITH YOUR REQUIREMENTS
AMERICA'S NO. 1 Real Amateur Radio Store



**Associated Wants to TRADE - BUY - SELL
GOT YOUR BEST DEAL? THEN CALL US AT
913-381-5900 - NO TRADE? ASK FOR EXT. 12**

**NOTE: SEND \$1.00 FOR OUR CURRENT CATALOG
OF NEW AND RECONDITIONED EQUIPMENT**

*** ALSO WE PERIODICALLY PUBLISH A LIST OF
UNSERVICED EQUIPMENT AT GREAT SAVINGS.
A BONANZA FOR THE EXPERIENCED OPERATOR.
TO OBTAIN THE NEXT UNSERVICED BARGAIN LIST
SEND A SELF ADDRESSED STAMPED ENVELOPE.**

BACK BY POPULAR DEMAND OUR WORLD FAMOUS POLY PAKS 'ONE CENTERS'



Buy any item on this page and get 2nd item of the same cat. no. for only one penny!



"HALL EFFECT" MAGNETIC FIELD TRIGGERS DIGITAL SENSORS

2 FOR \$1.99
4 FOR \$2

Cat. No. 92CU6117

Unusual device in a 3-pin TO-92 package is used in position sensing and contactless switching, where the "Hall Effect" detects a magnetic field. Device consists of a silicon Hall generator, differential amplifier, trigger, dual open collector output stages and a voltage regulator. By placing a small PM magnet or any magnetic field over device (750 gauss maximum and 100 gauss minimum) will trigger to "ON" or operating point @ 20 mils each. VCC operates from 5V to 16VDC. DUAL OUTPUTS, "ON" current 20 ma. Drives acrs, triacs, TTL and DTL compatible, drive line operated loads, etc. Similar to UGN3201M.

"KLH" FM TUNER MODULE

\$9.99
2 FOR \$10

Cat. No. 92CU6234

- Printed circuit construction.
- KLH precision engineered.
- Ready to go!
- Tunes complete FM range 88 to 108 MHz.
- Can be used with any IF strip or an IF integrated circuit.

WORLD'S SMALLEST JOYSTICK

\$7.99 2 for \$8

Cat. No. 92CU6347

Tiny 1-1/8" square cube with 3/4" long metal handle that controls miniature 40K and 46K pots. Cube is removable from plastic case, as is SPST data entry type push switch. Resistance varies with angle of the handle. Ideal for micro-circuitry projects. With 5 conductor, 5' insulated cord.

- Mounted In 2-3/8 x 4-1/4 x 1-3/8" Plastic Enclosure
- With Data Entry Control switch

OPTO-ISOLATOR REFLECTIVE OBJECT SENSOR

2 FOR \$1.99
4 FOR \$2

Cat. No. 92CU5787

- High Sensitivity
- High Reliability

Manufactured by Monsanto, this MCA7 type Optoisolator consists of a GaAsLiTE emitting diode that generates infrared light and a silicon planar photo darlington. Because the on-axis radiation of the emitter, and the on-axis response of the detector are both Perpendicular to the face of the device, the photo-darlington responds to the radiation emitted from the diode only when a reflective object or surface is in the field of view of the detector. SPECS: VF:1.25V (typ.) BVCEO: 55V (typ.) Max. Forward DC Current: (input diode) 75mA. Rise/Fall time: (output darlington): 0.6 mS. Includes data sheet. Size: .50" x .10" x .375" with .50" PC leads.

5 WATT MONO AMPLIFIER

\$6.99 each
2 for \$7

Cat. No. 92CU5681

Requires 12 VDC to produce 4.5W RMS; (5W max.) into 4 ohms from 20-40K Hz. THD: 0.8% @ 2W @ 1 KHz. Includes heatsinked SGS/ATES TBA-641B amp chip, and concentrically mounted OFF/ON, VOL. & TONE controls. Size: 2-1/8" x 4-1/2" x 1-1/4". Wt: 4 oz. w/hookup data.

THUMB WHEEL POTS

ORDER BY CAT. NO. AND RATING

6 for \$1.29			12 for \$1.30		
<input type="checkbox"/> 100 ohm	<input type="checkbox"/> 250K	<input type="checkbox"/> 100K	<input type="checkbox"/> 100 ohm	<input type="checkbox"/> 20K	<input type="checkbox"/> 250K
<input type="checkbox"/> 150 ohm	<input type="checkbox"/> 5K	<input type="checkbox"/> 200K	<input type="checkbox"/> 250 ohm	<input type="checkbox"/> 25K	<input type="checkbox"/> 500K
<input type="checkbox"/> 200 ohm	<input type="checkbox"/> 20K	<input type="checkbox"/> 250K	<input type="checkbox"/> 500 ohm	<input type="checkbox"/> 50K	<input type="checkbox"/> 1 meg
<input type="checkbox"/> 250 ohm	<input type="checkbox"/> 25K	<input type="checkbox"/> 500K	<input type="checkbox"/> 1K	<input type="checkbox"/> 100K	<input type="checkbox"/> 2 meg
<input type="checkbox"/> 500 ohm	<input type="checkbox"/> 50K	<input type="checkbox"/> 5 meg	<input type="checkbox"/> 2500 ohm	<input type="checkbox"/> 150K	<input type="checkbox"/> 2.2 meg
			<input type="checkbox"/> 5K	<input type="checkbox"/> 200K	<input type="checkbox"/> 3 meg
			<input type="checkbox"/> 10K	<input type="checkbox"/> 5 meg	

UPRIGHT 92CU3363 SNAP-IN 92CU3362

ULTRASONIC TRANSDUCER

\$3.98 EACH
2 for \$3.99

Cat. No. 92CU5375

Sends & Receives! 1" (dia.) 1" dia. x 3/4" with RCA type phono jack. For remote control, alarms, etc. Wt: 2 oz.

4-DIGIT HY GAIN LED CLOCK KIT

\$14.99
2 FOR \$15

Cat. No. 92CU6320

- Giant 0.8" high LED digits
- Colon "pulsating" second indicator
- AM-PM indicators!

7 PC set

3 ELEMENT 120 VAC HOTPLATE

\$3.99 2 FOR \$4

Cat. No. 92CU5723

Top Quality, Multi-Purpose Hotplate generates up to 150 C., 120 watts. Features; Built-in Thermostat, Neon "Red" AC Indicator Lamp, and 1/8" Textured glass surface. Size: 10-3/8 x 5-3/8 x 1/8". Wt: 1 lb. 2 oz.

WORLD'S SMALLEST MIKE/SPEAKER

\$1.49 EACH
2 FOR \$1.50

Cat. No. 92CU6335

- Dynamic
- Low impedance

1" diameter element performs equally well as microphone with low impedance, (350 ohms) for smooth bass reproduction, or as a speaker, where it's small size and crisp response makes it suitable for headphone replacement. Frequency Response: 100-30,000 Hz. (approx.)

25 AMP FULL WAVE SILICON BRIDGE RECTIFIERS

Type	Case	Cat. No.	PRV	SALE	2 for
A	ROUND lugs	92CU2273 A	25	\$.99	1.00
			50	1.19	1.20
			100	1.39	1.40
			200	1.69	1.70
			400	2.25	2.26
			600	2.95	2.96
			800	3.50	3.51
			1000	3.95	3.96

CB-HAM NOISE CANCELLING COMMUNICATIONS MICROPHONE

\$9.99 each
2 FOR \$10

Cat. No. 92CU6333

WITH volume control

The answer to the biggest mobile communication problem... automatic noise canceling. Works more effectively than power mikes. A must for 2 meter hams. Doesn't "trip" repeaters. Low impedance. Frequency response: 300-5000 Hz, sensitivity -65db. 6 foot coiled cord, case made of hi-impact black plastic. With wiring instructions for 100% of CB's. Spt. wt. 2 lbs.

12 VOLT ROTARY SOLENOID

\$6.99 each
2 for \$7

Cat. No. 92CU6052

Combines SPST, SP3T, & DP3T, in a single, 12-step device. Unit switches one step with the application of a 12 volt surge. Uses standard rotary contact wafer system. Rated 12 VDC @ 1.25 amps, only 1-3/8" (dia.) x 2-3/8". Wt: 7 oz.

HY-GAIN ONE ARM BANDIT MIKES

\$14.99
2 FOR \$15

Cat. No. 92CU5886

Places ON/OFF, VOLUME, SQUELCH, CHANNEL SELECTOR, SPEAKER, and DIGITAL DISPLAY, conveniently in the palm of your hand. Comes with 6' multi-conductor, coiled cable, (separate). Size: 4 1/2 x 2 1/4 x 1 1/4". Wt: 9 oz.

"FLIP-OVER" DIGITAL CLOCK

\$6.99 EACH
2 for \$7.00

Cat. No. 92CU6336

- 115 VAC Operation
- Built-In Alarm Function With 24 Hour Dial Indicator
- 3/4" High White Numerals

TELEPHONE HANDSET

only \$8.99
2 for \$9

Cat. No. 92CU6142

Removed from desk sets. Good condition, guaranteed. Size: 1 1/2 x 2 1/4". Wt: 2 lbs.

SEND FOR FREE CATALOG
POLY PAKS
P.O. BOX 942-A4
SO. LYNNFIELD, MA 01940

HOW TO ORDER
We honor MASTERCHARGE, VISA, check, and COD. (25% down). Order by phone or mail. Minimum order \$8. Please state Cat. No. & description, name & month of magazine, postage: Canadian; add \$5, Foreign; add \$10 (US funds). Excess will be returned. TERMS: add postage, RATED: Net-30. Phone: (617) 245-3828

Polorad Model 1206
1.95 to 4.20 GHz
signal source
\$400.00
Model 1107 3.8 to 8.20
GHz signal generator
\$550.00

FETS
3N128 \$1.00
40673 1.39
MPF102 .45
MPF121 1.00
MPF131 1.00

MHZ ELECTRONIC KITS:

kit #1
Motorola MC14410CP CMOS Tone Generator
CMOS Tone Generator uses 1MHZ crystal to produce standard dual frequency dialing signal. Directly compatible with 12 key Chomeric Touch Tone Pads. Kit includes the following:
1 Motorola MC14410CP Chip
1 PC Board
And all other parts for assembly, with 1 MHz crystal \$20.65

Kit #2
Fairchild 95H90DC Prescaler 350MHZ.
95H90DC Prescaler divides by 10 to 350 MHZ. This kit will take any 35MHZ Counter to 350 MHZ. Kit includes the following:
1 Fairchild 95H90DC Chip
1 2N5179 Transistor
2 UG-88/U BNC Connectors
1 PC Board
And all other parts for assembly. **NOW ONLY \$24.95**
Less 95H90 chip \$10.95

FAIRCHILD VHF AND UHF PRESCALER CHIPS

95H90DC	350MHZ Prescaler Divide by 10/11	\$ 9.50
95H91DC	350MHZ Prescaler Divide by 5/6	8.95
11C90DC	650MHZ Prescaler Divide by 10/11	16.50
11C91DC	650MHZ Prescaler Divide by 5/6	15.95
11C83DC	1GHZ Divide by 248/256 Prescaler	29.90
11C70DC	600MHZ Flip/Flop with reset	12.30
11C58DC	ECL VCM	4.53
11C44DC	Phase Frequency Detector (MC4044P/L)	3.82
11C24DC	Dual TTL VCM (MC4024P/L)	3.82
11C06DC	UHF Prescaler 750MHZ D Type Flip/Flop	12.30
11C05DC	1GHZ Counter Divide by 4	74.35
11C01FC	High Speed Dual 5-4 Input NO/NOR Gate	15.40

CRYSTAL FILTERS: Tyco 001-19880 same as 2194F
10.7MHZ Narrow Band Crystal Filter
3 db bandwidth 15khz minimum 20 db bandwidth 60khz minimum 40 db bandwidth 150khz minimum. Ultimate 50 db: Insertion loss 1.0db Max. Ripple 1.0db Max. Ct. 0 + - 5pf. Rt. 3600 Ohms.
NOW ONLY \$5.95

We bought 6,000 LED digital clocks, made by Spartus. All have alarms. Sold as is. (Some alarms don't work.)
\$7.95 each/2 for \$13.95
Have National clock module Model MA 1002 and 1023. Can be used for 12- or 24-hours.

TUBES

2E26	\$5.00	4X150G	70.00
3-500Z	90.00	100TH	144.00
3-1000Z	225.00	572B	39.00
3B28	5.00	811A	12.95
3X2500A3	150.00	813	29.00
4.65A	54.50	5894	39.00
4-125A	68.75	6146A	5.25
4-250A	80.00	6146B	6.25
4-400A	81.50	6159	10.60
4-1000A	255.00	6293	18.50
5-500A	145.00	6360	6.95
4CX250B	38.50	6907	35.00
4CX250F	53.50	6939	14.75
4CX250G	53.50	7360	10.60
4CX250K	72.00	7984	10.40
4CX250R	48.00	8072	45.00
4CX350A	60.00	8156	7.85
4CX350FJ	70.00	8226	127.70
4CX1000A	289.00	8295A/PL172	328.00
4CX1500B	285.00	8458	25.75
4CX15000A	400.00	8560AS	50.00
4X150A	37.00	8950	7.80

TERMS:
All checks and money orders are in U.S. funds!
All orders sent first class or UPS.
Please include \$1.50 minimum for postage.
All prices are in U.S. dollars.
All parts prime/guaranteed.
5% service charge on all bank cards.

BANK AMERICARD/VISA/MASTERCHARGE

Your Number:
(or equivalent)

Exp. Date

Your Signature:

TUNNEL DIODES

TYPE	PRICE
TD261A	\$10.00
TD263A	10.00
1N2930	7.65
1N3716	5.00
1N4396	7.50

Nicad battery charger . . . \$5.95

E.F. Johnson tube socket #122-0275-001
for 3-400Z, 3-500Z, 4-125A, 4-250A, 4-400A
\$29.95/pair

2300 MHz CONVERTER KIT

- PC board and assembly instructions \$25.00
- PC board with 13 chip caps - assembled \$44.50
- PC board with all parts for assembly \$79.95
- PC board assembled and tested \$119.95

RF TRANSISTORS

TYPE	PRICE				
2N1561	\$15.00	2N5590	6.30	MM1550	10.00
2N1562	15.00	2N5591	10.35	MM1552	50.00
2N1692	15.00	2N5637	20.70	MM1553	56.50
2N1693	15.00	2N5641	4.90	MM1601	5.50
2N2632	45.00	2N5642	8.63	MM1602/2N5842	7.50
2N2857JAN	2.45	2N5643	14.38	MM1607	8.65
2N2876	12.35	2N5645	11.00	MM1661	15.00
2N2880	25.00	2N5764	27.00	MM1669	17.50
2N2927	7.00	2N5842	8.65	MM1943	3.00
2N2947	17.25	2N5849	19.50	MM2605	3.00
2N2948	15.50	2N5862	50.00	MM2608	5.00
2N2949	3.90	2N5913	3.25	MM8006	2.15
2N2950	5.00	2N5922	10.00	MMCM918	1.00
2N3287	4.30	2N5942	46.00	MMT72	.61
2N3294	1.15	2N5944	7.50	MMT74	.94
2N3301	.75	2N5945	10.90	MMT2857	2.68
2N3302	1.05	2N5946	13.20	MRF304	43.45
2N3304	1.48	2N6080	5.45	MRF420	20.00
2N3307	10.50	2N6081	8.60	MRF450	10.35
2N3309	3.90	2N6082	9.90	MRF450A	10.35
2N3375	8.75	2N6083	11.80	MRF454	20.10
2N3553	1.45	2N6084	13.20	MRF458	18.95
2N3755	7.20	2N6094	5.75	MRF475	5.00
2N3818	6.00	2N6095	10.35	MRF476	5.00
2N3866	1.09	2N6096	19.35	MRF502	.49
2N3866JAN	2.70	2N6097	28.00	MRF504	6.95
2N3866JANTX	4.43	2N6136	18.70	MRF509	4.90
2N3924	3.20	2N6166	36.80	MRF511	8.60
2N3925	6.00	2N6265	75.00	MRF901	5.00
2N3927	11.50	2N6266	100.00	MRF5177	20.70
2N3950	26.25	2N6439	43.45	MRF8004	1.44
2N4072	1.70	2N6459/PT9795	18.00	PT4186B	3.00
2N4135	2.00	2N6603	10.00	PT4571A	1.50
2N4261	14.60	2N6604	10.00	PT4612	5.00
2N4427	1.09	A50-12	25.00	PT4628	5.00
2N4429	7.50	BFR90	3.00	PT4640	5.00
2N4430	20.00	BLY568C	25.00	PT8659	10.72
2N4957	3.50	BLY568CF	25.00	PT9784	24.30
2N4958	2.80	CD3495	15.00	PT9790	41.70
2N4959	2.12	HEP76/S3014	4.95	PT9847	26.40
2N4976	19.00	HEPS3002	11.30	SD1043	5.00
2N5090	6.90	HEPS3003	29.88	SD1116	3.00
2N5108	3.90	HEPS3005	9.95	SD1118	5.00
2N5109	1.55	HEPS3006	19.90	SD1119	3.00
2N5160	3.34	HEPS3007	24.95	TA7993	75.00
2N5179	.49	HEPS3010	11.34	TA7994	100.00
2N5184	2.00	HEPS5026	2.56	TRWMRA2023-1.5	42.50
2N5216	47.50	HP3583IE/		40281	10.90
2N5583	4.43	HXTR5104	50.00	40282	11.90
2N5589	4.60	MM1500	32.20	40290	2.48

MHz
electronics

(602) 242-3037

2111 W. Camelback
Phoenix, Arizona 85015

ALARM CLOCK KITS: 4 Digit .5"

Here it is! The first of several quality kits we have been asked for: Here is what you get — unbelievable as it may sound...

- 1 National - 5375AA Clock Chip
- 1 Bowmar Clock Stick Readout (L.E.D.) 4 digit - 1/2"
- 13 Transistors
- 2 Push Buttons for time set
- 2 Toggle Switches for alarm
- 1 Filter cap
- 4 1N4000 series diodes
- 1 1N4148
- 2 Disc caps
- 29 Resistors
- 1 Transducer (Speaker) for Alarm
- 1 LED Lamp for alarm indicator

ORDER
KIT
CK-100AC

NEW!
\$9.99

P.C. Board \$2.25

Plug In

Transformer \$1.50

D.C. MODEL

Same as above except it includes 60 Hz timebase.

This Kit Includes:

- 1 National 5375AA Clock Chip
- 1 Bowmar Clock Stick Readout - (L.E.D.) 4 digit - 1/2"
- 12 Transistors
- 2 Push Buttons for time set
- 2 Disc caps
- 27 Resistors
- 1 MOV
- 1 60 Hz time base

ORDER
KIT
CK-100DC

NEW!
\$12.75

P.C. Board \$2.25

**MICRO MINI
TOGGLE SWITCHES**
6 for \$5 with hardware.



**99¢
EACH**

VARO FULL WAVE BRIDGE

6 AMPS 200 PIV
#VH248
3/4 IN. SQUARE **NEW!**



89¢ ea. 4 For \$2.99

RCA SENSITIVE GATE TRIAC

TO-5 CASE. HOUSE #40531
ALSO SAME AS T2300D.
2.5 AMPS 400 PIV



5 FOR \$1.19

Perfect for Dimmers, Color Organs, etc.
PC LEADS

5 VOLT REED RELAY

An absolutely fantastic item. Compare this price with any advertiser. **While They Last.**

\$1.10

Turns on at 10 MA.

Drops out at 5 MA.



**We bought 350,000 LED's.
And you get the savings.**
Reds, greens, yellows, orange, small, medium, large. Bags of 25 - mixed **\$2.75.**
That's only 11¢ each. Compare this bargain up to twice our price.

FACTORY PRIME

BI - Polar LED 59¢ ea. or 10 for \$5

TOSHIBA POWER AUDIO AMP

5.8 WATTS RMS Typical Output. 50 to 30,000 HZ ± 3 DB. For CB's, tape decks, PA's, etc. Works off of a single supply voltage from 10.5 to 18 VDC. 10 Pin plastic DIP with special built in heat sink tab. Perfect for use on 12VDC. **\$3.99 each**

CLOCK MODULE OPTIONS MA 1008 A and D MA1013

Switches and pot for all options.
Includes:
5 push buttons
1 toggle
1 10K pot
Alarm Parts (including high impedance transducer). Much more efficient than a speaker
Transducer only (unbelievably loud)

\$2.50

\$1.50

\$1.10

LAB-BENCH VARIABLE POWER SUPPLY KIT \$15.99 KIT

5 to 20 VDC at 1 AMP. Short circuit protected by current limit. Uses IC regulator and 10 AMP Power Darlington. Very good regulation and low ripple. Kit includes PC Board, all parts, large heatsink and shielded transformer. 50 MV. TYP. Regulation.

16K DYNAMIC RAM CHIP WORKS IN TRS-80 OR APPLE II

16K X 1 Bits. 16 Pin Package. Same as Mostek 4116-4. 250 NS access. 410 NS cycle time. Our best price yet for this state of the art RAM. 32K and 64K RAM boards using this chip are readily available. These are new fully guaranteed devices by a major mfg.

VERY LIMITED STOCK!

"MAGAZINE SPECIAL"

8/\$79.50

60 Hz CRYSTAL TIME BASE \$4.95 (Complete Kit)

Uses MM5369 CMOS divider IC with high accuracy 3.579545 MHZ Crystal. Use with all MOS Clock Chips or Modules. Draws only 1.5 MA. All parts, data and PC Board included. 100 Hz, same as above, except \$5.95

SILICON POWER SOLAR CELLS

2 Inch Dia. Approx. 5 VDC at 500 MA. in sunlight. Factory new units, not rejects as sold by others. Series for higher voltage, parallel for higher current. Converts solar energy directly to electricity. **LIMITED QUANTITY. \$5.99 ea**

NATIONAL SEMICONDUCTOR

"COLOSSUS JR." JUMBO CLOCK MODULE

**MA1013
BRAND NEW!**

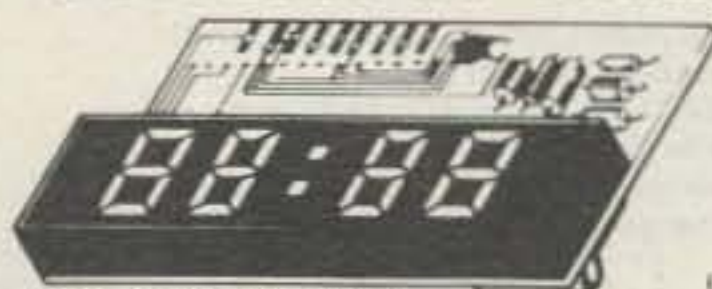

\$8.50

2 FOR
\$15

(IAC XFMR \$1.95)

ASSEMBLED! NOT A KIT!

MANUFACTURER'S CLOSEOUT!

PERFECT FOR USE
WITH A TIMEBASE

- Bright 4 digit 0.7" LED Display
- Complete-Add only Transformer and Switches
- 24 Hour Alarm Signal Output
- 12 Hour Real Time Format
- 50 or 60 Hz Operation
- Power Failure Indication
- LED Brightness Control
- Sleep and Snooze Timers
- Alarm "on" and PM indicators
- Direct Drive - No RF!
- Direct Replacement for MA1012
- Comes with Full Data

SONY 23 WATT AUDIO AMP MODULE

#STK-054. 23 WATTS SUPER CLEAN AUDIO. 20 HZ to 100 KHZ ± 2 DB. HYBRID, SILICON, SELF-CONTAINED MODULE. ONLY 1 3/4 x 2 1/2 IN. WITH DATA. **COMPARE AT UP TO TWICE OUR PRICE! \$6.50 each**

FAIRCHILD PNP "SUPER TRANSISTOR"

2N4402. TO-92 Plastic. Silicon PNP Driver. High Current. VCEO-40 HFE-50 to 150 at 150 MA. FT-150 MHZ. A super "BEEFED-UP" Version of the 2N3906.

8 FOR \$1.19

SOUND ACTIVATED SWITCH

Not a kit. Already assembled. Clap your hands and turn on lights, music boxes, coffee pots, etc. Full spec. sheet with each unit.

69¢

10 for \$5.50

Digital Research: Parts

(OF TEXAS)

P.O. BOX 401247 • GARLAND, TEXAS 75040 • (214) 271-2461

TERMS: Add 50¢ postage, we pay balance. Orders under \$15 add 75¢ handling. No C.O.D. We accept Visa, MasterCard and American Express cards. Tex. Res. add 5% Tax. Foreign orders (except Canada) add 20% P&H. 90 Day Money Back Guarantee on all items.

GET ON PHASE THREE FOR MUCH LESS THAN YOU THINK!

These Low Cost SSB TRANSMITTING CONVERTERS

Let you use inexpensive recycled 10M or 2M SSB exciters on UHF & VHF!

- Linear Converters for SSB, CW, FM, etc.
- A fraction of the price of other units; no need to spend \$300 - \$400!
- Use with any exciter; works with input levels as low as 1 mW.
- Use low power tap on exciter or simple resistor attenuator pad (instructions included).
- Link osc with RX converter for transceive.

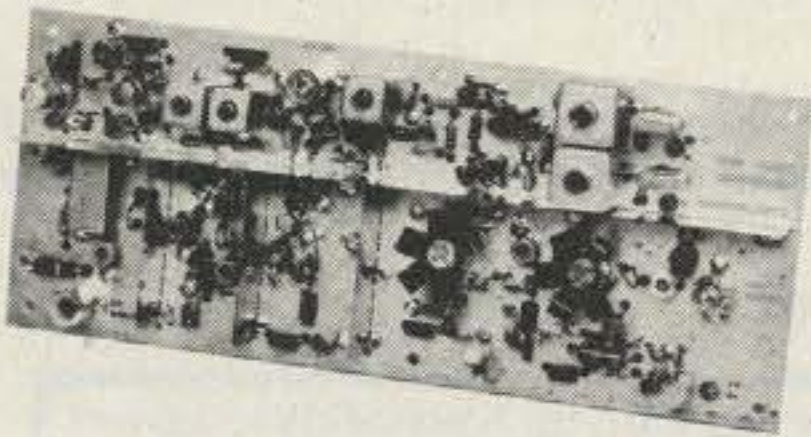

HAMTRONICS DOES IT AGAIN!

NEW XV4 UHF KIT - ONLY \$99.95

28-30 MHz in, 435-437 MHz out; 1W p.e.p. on ssb, up to 1½W on CW or FM. Has second oscillator for other ranges. Atten. supplied for 1 to 500 mW input, use external attenuator for higher levels.

Extra crystal for 432-434 MHz range \$5.95
XV4 Wired and tested \$149.95

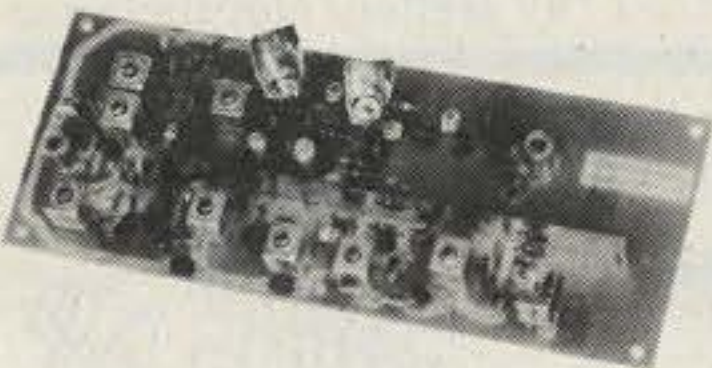

XV2 VHF KIT - ONLY \$69.95

2W p.e.p. output with as little as 1mW input. Use simple external attenuator. Many freq. ranges available.

MODEL	INPUT (MHz)	OUTPUT (MHz)
XV2-1	28-30	50-52
XV2-2	28-30	220-222
XV2-4	28-30	144-146
XV2-5	28-29 (27-27.4 CB)	145-146 (144-144.4)
XV2-7	144-146	50-52
XV2 Wired and tested		\$109.95

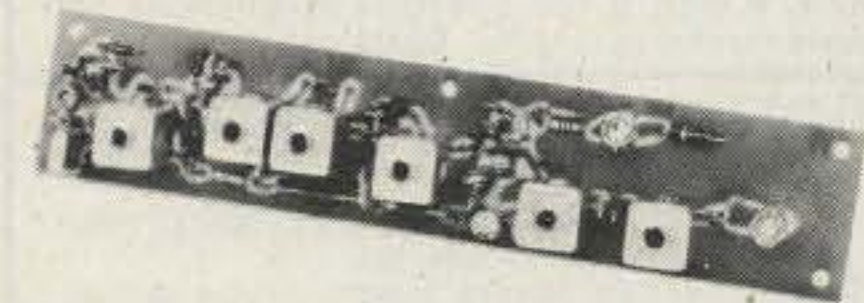

XV28 2M ADAPTER KIT - \$24.95

Converts any 2M exciter to provide the 10M signal required to drive above 220 or 435 MHz units.

Easy to Build FET RECEIVING CONVERTERS

Let you receive OSCAR and other exciting VHF and UHF signals on your present HF or 2M receiver

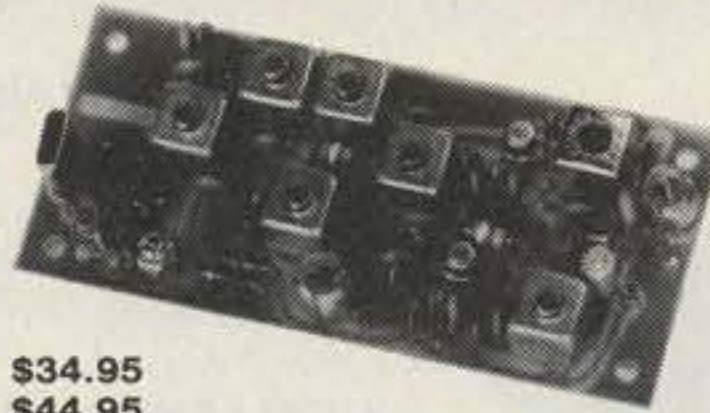

VHF KIT \$34.95
VHF Wired \$44.95

MODEL	RF RANGE	OUTPUT RANGE
CA28	28-32 MHz	144-148 MHz
CA50	50-52	28-30
CA50-2	50-54	144-148
CA144	144-146	28-30
CA145	145-147	28-30
or	144-144.4	27-27.4 (CB)
CA146	146-148	28-30
CA220	220-222	28-30
CA220-2	220-224	144-148
CA110 (less xtal)	Any 2MHz of Aircraft Band	26-28 or 28-30
Kit less xtal		\$29.95

UHF KIT \$34.95
UHF Wired \$44.95



MODEL	RF RANGE	OUTPUT RANGE
C432-2	432-434	28-30
C432-5	435-437	28-30
C432-4	432-436	144-148
Kit less xtal		\$29.95

Professional Quality VHF/UHF FM/CW EXCITERS

- Fully shielded designs
- Double tuned circuits for spurious suppression
- Easy to align with built-in test aids



T50-50	6-chan, 6M, 2W Kit	\$44.95
T50-150	6-chan, 2M, 2W Kit	\$44.95
T50-220	6-chan, 220 MHz, 2W Kit	\$44.95
T450	1-chan, 450 MHz, ¾W Kit	\$44.95

See our Complete Line of VHF & UHF Linear PA's

- Use as linear or class C PA
- For use with SSB Xmtg Converters, FM Exciters, etc.

LPA2-15	6M, 2M, 220; 15 to 20W	\$59.95
LPA2-30	6M, 2m; 25 to 30W	\$89.95
LPA2-40	220 MHz; 30 to 40W	\$119.95
LPA2-45	6M, 2M; 40 to 45W	\$119.95
LPA4-10	430MHz; 10 to 14W	\$79.95
LPA4-30	430MHz; 25 to 30W	\$119.95

See catalog for complete specifications

FAMOUS HAMTRONICS PREAMPS

Let you hear the weak ones too!
Great for OSCAR, SSB, FM, ATV. Over 14,000 in use throughout the world on all types of receivers.

P9 Kit \$12.95
P14 Wired \$21.95
Specify band when ordering

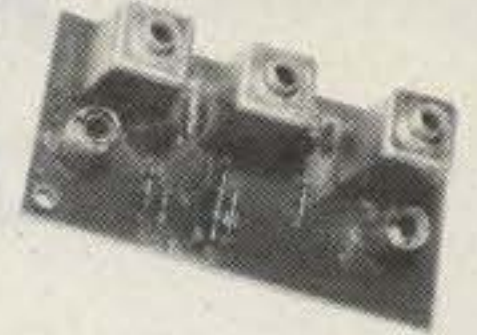

- Deluxe vhf model for applications where space permits • 1½" x 3"
- Models available to cover any 4MHz band in the 26 to 230 MHz range • 12 Vdc
- 2 stages • Ideal for OSCAR • 20 dB gain

P8 Kit \$10.95
Specify band when ordering



- Miniature vhf model for tight spaces—size only ½ x 2 ¾"
- Models available to cover any 4MHz band in the range 20 to 230 MHz • 20 dB gain • 12 Vdc

P15 Kit \$18.95
P35 Wired \$27.95



- Covers any 10 MHz band in UHF range of 380 to 520 MHz • 20 dB gain • 2 stages • 12 Vdc

NEW VHF/UHF FM RCVRs Offer Unprecedented Range of Selectivity Options

- New generation
- More sensitive
- More selective
- Low cross mod
- Uses crystal filters
- Smaller
- Easy to align



R75A* VHF Kit for monitor or weather satellite service. Uses wide L-C filter. -60dB at ± 30 kHz. \$69.95

R75B* VHF Kit for normal nbfm service. Equivalent to most transceivers. -60dB at ± 17 kHz, -80dB at ± 25 kHz. \$74.95

R75C* VHF Kit for repeater service or high rf density area. -60dB at ± 14kHz, -80dB ± 22kHz, -100dB ± 30kHz. \$84.95

R75D* VHF Kit for split channel operation or repeater in high density area. Uses 8-pole crystal filter. -60dB at ± 9kHz, -100dB at ± 15 kHz. The ultimate receiver! ... \$99.95

*Specify band: 10M, 6M, 2M, or 220 MHz. May also be used for adjacent commercial bands. Use 2M version for 137 MHz WX satellites.

R85() UHF FM Receiver Kits, triple conversion, include C432 UHF Front End Module. Add \$20 to above prices. (Add selectivity letter to model number.)

A13-45A 6 Channel Adapter for receivers \$13.95
WX-25 Weather Tone Alert \$24.95

NEW R110 VHF AM RCVR

AM monitor receiver kit similar to R75A, but AM. Available for 10-11M, 6M, 2M, 220 MHz, and 110-130 MHz aircraft band. \$74.95

IT'S EASY TO ORDER!

- Write or phone 716-392-9430 (Electronic answering service evenings & weekends)
- Use Credit Card, UPS COD, Check, Money Order
- Add \$2.00 shipping & handling per order

Call or Write to get FREE CATALOG With Complete Details

(Send 4 IRC's for overseas mailing)

hamtronics, inc.

65 E MOUL RD • HILTON, NY 14468

X-RATED CLOCK!

ZULU II CLOCK KIT WITH CALENDAR AND NOX™ CIRCUIT

\$19.95
LESS CASE

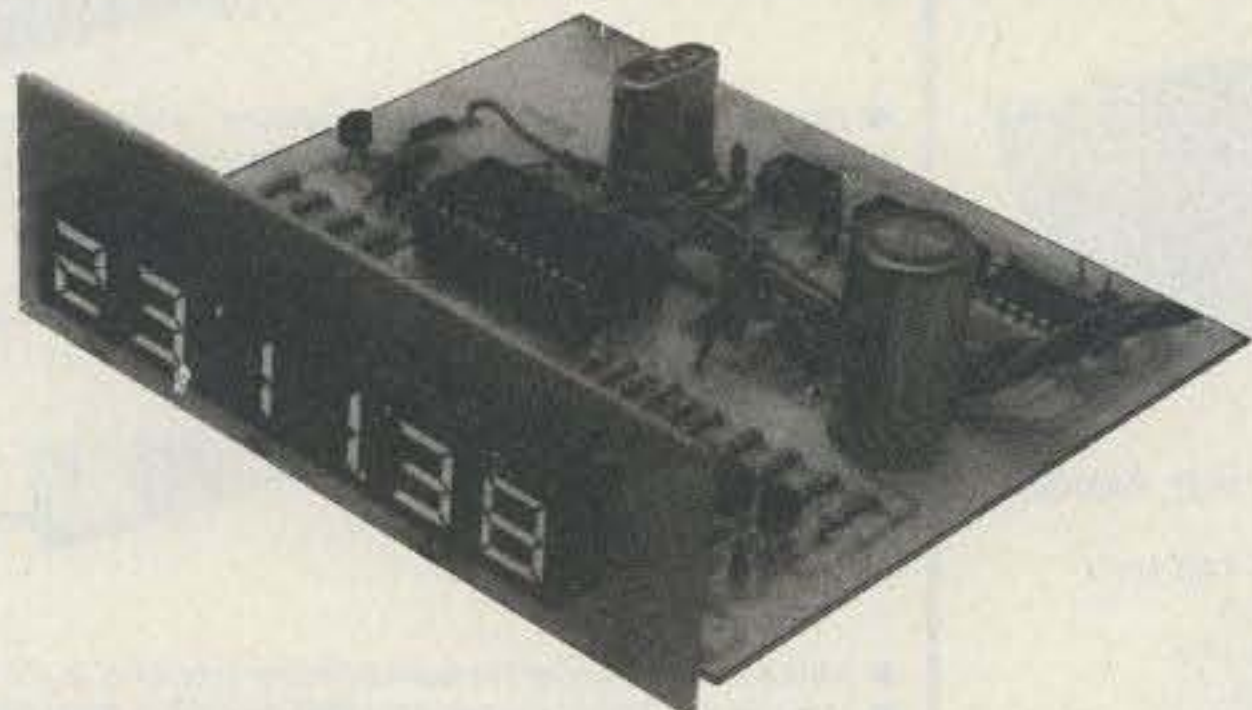

X-TRA VALUE: All the components and high quality plated G-10 PC Boards are provided.

X-TRA CARE IN DESIGN: No wires between readout board and clock board. Large open layout.

X-CELLENCE IN IDEAS: 5 years of designed products for the amateur radio market.

X-CELLENCE IN INSTRUCTIONS: Clear step-by-step instructions with quality illustrations. The assembly manual is not a read-between-the-lines afterthought!

X-TRA FEATURES: There has never been a clock kit with so many features — at any price!

- Unit operates on either 12 VAC or 12 VDC.
- On board **QUARTZ XTAL TIMEBASE** or 60Hz AC line freq. can be used.
- Automatic **BATTERY BACKUP***. Never worry about power failures again!
- Reads true **24 HOUR TIME** and **31 DAY CALENDAR**.
- Unique **NOX™ CIRCUIT** activates readouts with a handclap or they can be turned on constantly.
- When used mobile readouts blank when ignition is off.
- Special **NOISE SUPPRESSION** and battery reversal circuits.
- Bright 1/2" LED's show hours, minute and seconds.

Just clap your hands and the time appears for 5 seconds followed by the date for 4 seconds. A low cost 9V transistor battery provides stand by power in the event of power failures up to 4 hours. With the addition of a low cost 12V 300 MA transformer, the unit will work on AC.

Custom High Impact Molded Case with Ruby Lens. Available in Blue or Tan.

6.50

117 VAC to 12 VAC Transformer.

1.35

ACCESSORIES

*9V Battery Not Included

SE 01 Sound Effects Kit \$17.50

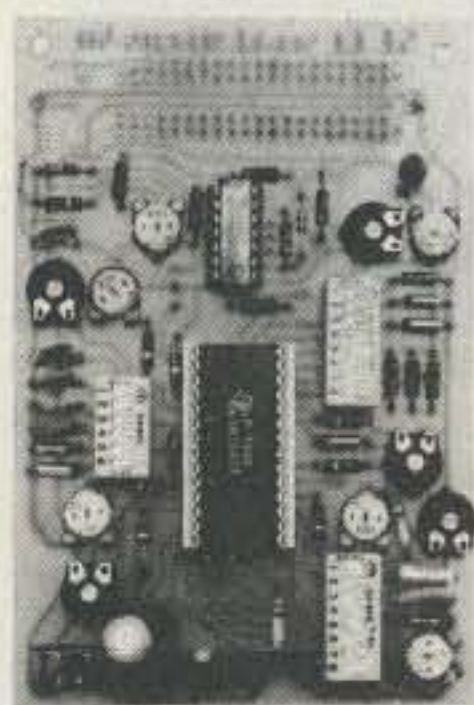

The SE-01 is a complete kit that contains all the parts to build a programmable sound effects generator. Designed around the new Texas Instruments SN76477 Sound Chip, the board provides banks of MINI DIP switches and pots to program the various combinations of the SLF Oscillator, VCO, Noise, One Shot, and Envelope Controls. A Quad Op Amp IC is used to implement an Adjustable Pulse Generator, Level Comparator and Multiplex Oscillator for even more versatility. The 3 1/2" x 5" PC Board features a prototype area to allow for user added circuitry. Easily programmed to duplicate **Explosions, Phasor Guns, Steam Trains**, or almost an infinite number of other sounds. The unit has a multiple of applications. The low price includes all parts, assembly manual, programming charts, and detailed 76477 chip specifications. It runs on a 9V battery (not included). On board 100MW amp will drive a small speaker directly, or the unit can be connected to your stereo with incredible results! (Speaker not included).

- 76477 CHIP IS INCLUDED. EXTRA CHIPS \$2.95 EACH
- \$17.50 LESS SPEAKER & BATTERY**

From T.I.: **TL490 BAR/DOT DRIVER IC**. Drives 10 LED's with adjustable analog steps. Units are cascadable up to 10 (100 steps). Drives LED's directly. Great for **voltage, current, or audio displays**. Similar in features to LM3914 with specs and circuit notes.

2.95

NEW!



NEW ITEMS

LM567	Tone Decoder	.89
RCA 40430	400V 6A TRIAC TO-66	.75
CA3086	RCA Transistor Array	.80
MC1438R	Power Op Amp/Driver	.50
CD4046	PLL CMOS	.99
LM3302	Quad Comparator	.89
2SC1849	High Freq NPN TO-92	6/1.00
MPS A20	NPN GEN PUR	8/1.00
723	14 PIN DIP	3/1.00

XAN SUPER DIGITS

.6" JUMBO LED
7 SEGMENT
RED

99¢

6920 COMMON ANODE
6640 COMMON CATHODE



NOW A SUPER READOUT AT A SUPER BUY! These are factory fresh prime LED readouts, not seconds or rejects as sold by others. Compare our price and send for yours today, but hurry, the supply is limited! **SPECIFY: COMMON ANODE OR COMMON CATHODE**

POTENTIOMETER ASSORTMENT

A mix of new, panel mount 3/8" bushing pots in various values. Some dual, some with switches.

10/2.00

1/2W RESISTOR ASSORTMENT

A good mix of 5% and 10% values in both full lead and PC lead devices. All new, first quality.

(Asst.) 200 pieces/2.00

SLIDE SWITCH ASSORTMENT

An outstanding bargain. Includes miniature and standard sizes and multi-position units. All new first quality, name brand switches. Try one pack and you'll reorder more: **SPECIAL — 12 for \$1.20** (Assortment)

PARTS

301 OP AMP 8 LEAD CAN	3/1.00
723 VOLT REG. 10 LEAD CAN	.50
*13741 FET INPUT 741 MINI DIP	3/1.10
30.000 @ 15V COMPUTER GRADE	2.10
2N4400 NPN GEN. PURPOSE	8/1.00
2N4402 PNP COMPLIMENT	8/1.00
2N6028 P.U.T. W/SPECS	.50
LM380 2W AUDIO IC W/SPECS	1.09
LM377 DUAL LM380 W/SPECS	2.50
*7815 VOLT REG. 1A 15V	.69
*78M05 5V 1/2A TO-5 REG.	.60
IL-1 OPTO ISOLATOR MINI DIP	.60
*MEM 631 DUAL GATE MOSFET, DIODE PROTECTED. SIMILAR TO 40673	.50
MV1624 VARICAP DIODE 10 PFD	.49
1N4003 1A 200V DIODE	15/1.00
TIP30 TAB PNP POWER	3/1.00
*MC1351P FM IF. DISC IC	.50
25 ohm 3W RESISTOR	8/1.00
*INDICATES ITEM IS "HOUSE NUMBERED"	

LED'S

JUMBO GREEN	4/.89
JUMBO RED	5/.89
MEDIUM RED (1/4")	.15
MEDIUM GRN OR YELLOW	.16

7 WATT AUDIO AMP KIT

SMALL SINGLE HYBRID IC AND COMPONENTS FIT ON A 2" x 3" PC BOARD (INCLUDED). RUNS ON 12 VDC. GREAT FOR ANY PROJECT THAT NEEDS AN INEXPENSIVE AMP. LESS THAN 3% THD @ 5 WATTS. COMPATIBLE WITH SE-01 SOUND KIT.

\$5.95

6 DIGIT AUTO/VAN CLOCK

- LARGE 1/2" CHARACTERS (LED)
- QUARTZ XTAL TIMEBASE
- ALARM & SNOOZE OPTIONS
- NOISE FILTERING
- EASY TO ASSEMBLE
- 4" x 3" x 1"
- DRILLED & PLATED PC BOARDS

\$16.95 COMPLETE KIT
12 VDC

ULTRASONIC RELAY KIT

INVISIBLE BEAM WORKS LIKE A PHOTO ELECTRIC EYE. USE UP TO 25 FT. APART. COMPLETE KIT. ALL PARTS & PC BOARDS.

\$21.50

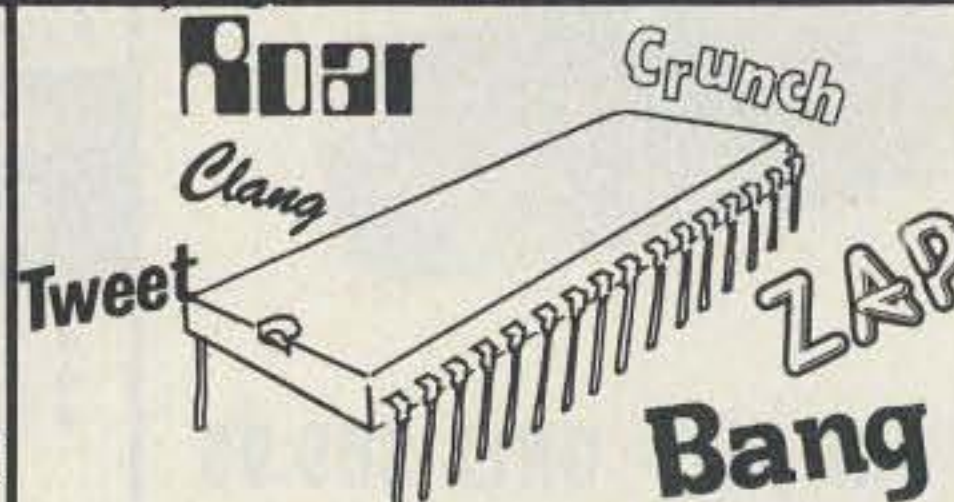

AY3-8910 PROGRAMMABLE SOUND GENERATOR

The AY3-8910 is a 40 pin LSI chip with three oscillators, three amplitude controls, programmable noise generator, three mixers, an envelope generator, and three D/A converters that are controlled by 8 BIT WORDS. No external pots or caps required. This chip hooked to an 8 bit microprocessor chip or Buss (8080, Z80, 6800 etc.) can be software controlled to produce almost any sound. It will play three note chords, make bangs, whistles, sirens, gunshots, explosions, bleets, whines, or grunts. In addition, it has provisions to control its own memory chips with two IO ports. The chip requires +5V @ 75ma and a standard TTL clock oscillator. A truly incredible circuit.

\$14.95 W/Basic Spec Sheet (4 pages)

60 page manual with S-100 interface instructions and several programming examples. **\$3.00 extra**

NPN HIGH VOLTAGE 2.00

VCEO = 450 VDC IC = 3A (5A Peak)
FOR TV HORIZONTAL SECTIONS, HIGH VOLTAGE REGULATORS
REPLACES: 2N5076, 2N5077, 2N5838, 2N5665, BDY94, BU126, 2SC2121, 2N5840, 2SC1046, 2N5466, TIP556 AND MANY OTHERS.



HOUSE #

- * NO C.O.D.'s
- * SEND CHECK M.O. OR CHARGE CARD NO.
- * PHONE ORDERS ACCEPTED ON VISA AND MASTERCARD ONLY.

(214) 278-3553

- * ADD 5% FOR SHIPPING
- * TX. RES. ADD 5% STATE SALES TAX
- * FOREIGN ORDERS ADD 10% (EXCEPT CANADA)

(20% AIRMAIL) U.S. FUNDS ONLY
catalog free on request

Radio Bookshop

LICENSE STUDY GUIDES & TAPES

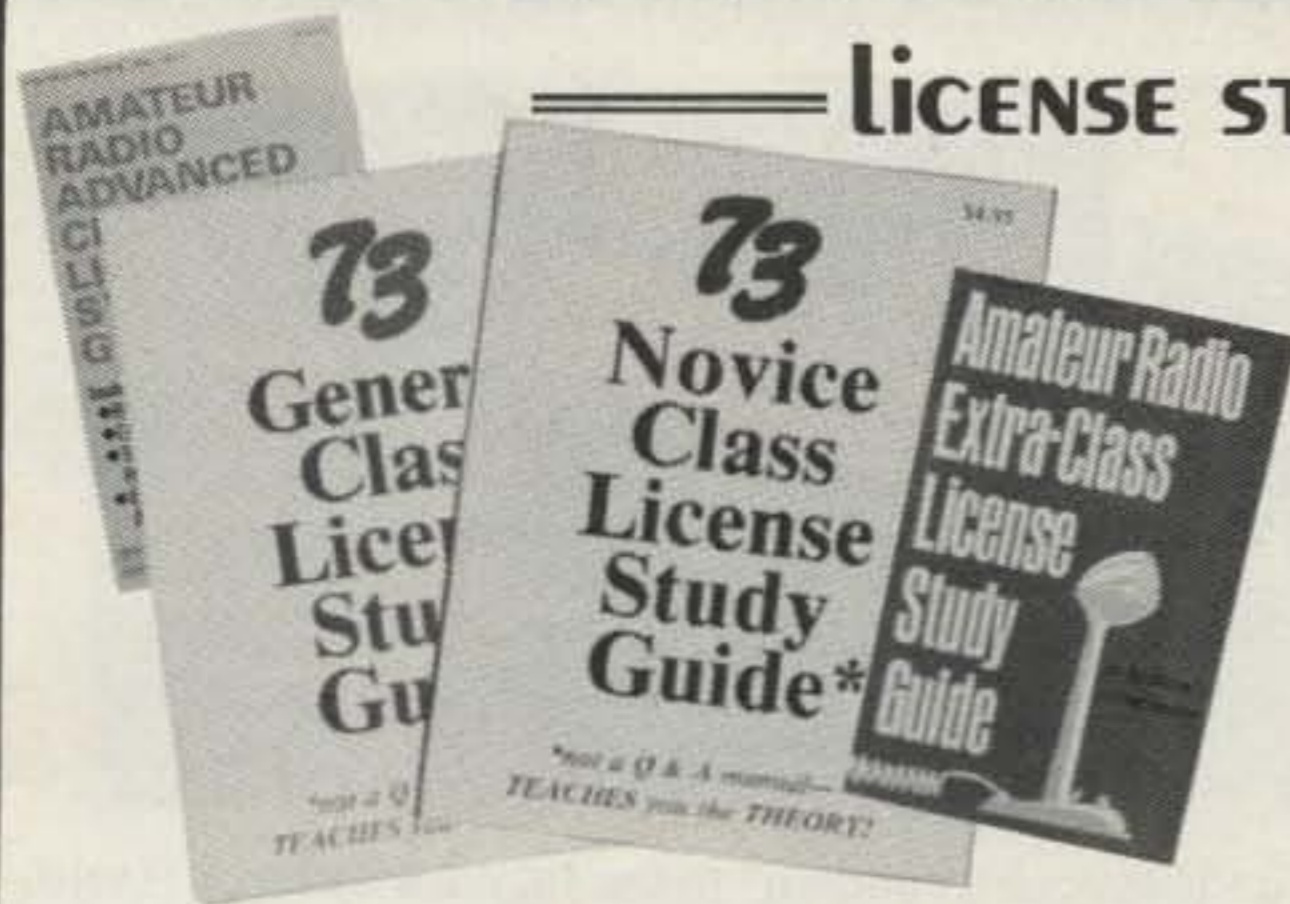

● **NOVICE STUDY GUIDE**—SG7357—Here is a completely new study guide and reference book for the potential ham. This is not a question/answer memorization course. Electronic and radio fundamentals are presented and explained in an easy-to-understand fashion, preparing the beginner for the Novice exam. Includes the latest FCC amateur regulations, as well as application forms. Easily the best path into the exciting world of ham radio! \$4.95.*

● **GENERAL CLASS STUDY GUIDE**—SG7358—A complete theory course for the prospective General or Technician. This reference explains transistor, amplifier, and general radio theory, while preparing the Novice for the "big" ticket. After getting your ticket, you'll use this guide again and again as an electronics reference source. Not a question/answer guide that becomes dated when the FCC updates the amateur exams. \$5.95.*

● **ADVANCED CLASS LICENSE STUDY GUIDE**—SG1081—Ready to upgrade your license? To prevent retaking the FCC theory exam, you need the 73 Advanced theory guide. SSB, antenna theory, transmitters, and electronics measuring techniques are covered in detail in this easy-to-follow study guide. Special modes and techniques, such as RTTY, are also treated. An engineering degree is *not* necessary to master the Advanced theory—try this book before visiting the examiner's office! \$6.95.* (Published by TAB Books previous to recent changes in FCC exam material.)

● **EXTRA CLASS LICENSE STUDY GUIDE**—SG1080—Before going for your 1 x 2 call, it pays to be a master of the Extra class electronics theory. This study guide is the logical extension of the 73 theory course. All the theory necessary to pass the exam is presented. Antennas, transmission lines, swr are discussed, as well as noise, propagation, and specialized communication techniques. This book is not a classroom lecture or memorization guide, but rather a logical presentation of the material that must be *understood* before attempting the Extra exam. Save yourself a return trip to the FCC and try the 73 method first! \$5.95.*

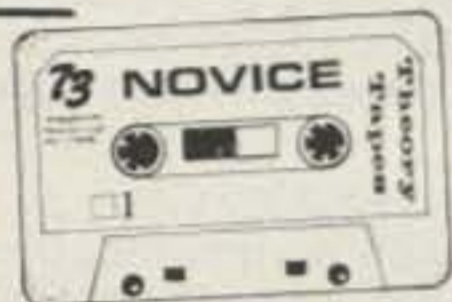

NOVICE THEORY TAPES Startling Learning Breakthrough



● **NOVICE THEORY TAPES**—CT7300—Startling Learning Breakthrough. You'll be astounded at how really simple the theory is when you hear it explained on these tapes. Three tapes of theory and one of questions and answers from the latest Novice exams give you the edge you need to breeze through your exam. 73 is interested in helping get more amateurs, so we're giving you the complete set of our tapes for the incredibly low price of **ONLY \$15.95.***

Scientists have proven that you learn faster by listening than by reading because you can play a cassette tape over and over in your spare time—even while you're driving! You get more and more info each time you hear it. You can't progress without solid fundamentals. These four hour-long tapes give you all the basics you'll need to pass the Novice exam easily. You'll have an understanding of the basics which will be invaluable to you for the rest of your life! Can you afford to take your Novice exam without first listening to these tapes? Set of 4—\$15.95.*

These tapes were made previous to recent changes in FCC rules. These minor changes do not affect the theory involved. A new set of tapes reflecting these rule changes is being developed. Expected availability is June 1980.



SSTV

● **SLOW SCAN TELEVISION TAPE**—CT7350—Prize-winning programs from the 73 SSTV contest. Excellent for Demo! \$5.95.*

73 CODE TAPES

Any Four Tapes For \$15.95! *
\$4.95 Each! *

"GENESIS"

5 WPM—CT7305—This is the beginning tape for people who do not know the code at all. It takes them through the 26 letters, 10 numbers and necessary punctuation, complete with practice every step of the way using the newest blitz teaching techniques. It is almost miraculous! In one hour many people—including kids of ten—are able to master the code. The ease of learning gives confidence to beginners who might otherwise drop out.

"THE STICKLER"

6+ WPM—CT7306—This is the practice tape for the Novice and Technician licenses. It is made up of one solid hour of code, sent at the official FCC standard (no other tape we've heard uses these standards, so many people flunk the code when they are suddenly—under pressure—faced with characters sent at 13 wpm and spaced for 5 wpm). This tape is not memorizable, unlike the zany 5 wpm tape, since the code groups are entirely random characters sent in groups of five.

"BACK BREAKER"

13+ WPM—CT7313—Code groups again, at a brisk 13 per so you will be at ease when you sit down in front of the steely-eyed government inspector and he starts sending you plain language at only 13 per. You need this extra margin to overcome the panic which is universal in the test situations. When you've spent your money and time to take the test, you'll thank heavens you had this back-breaking tape.

"COURAGEOUS"

20+ WPM—CT7320—Code is what gets you when you go for the Extra class license. It is so embarrassing to panic out just because you didn't prepare yourself with this tape. Though this is only one word faster, the code groups are so difficult that you'll almost fall asleep copying the FCC stuff by comparison. Users report that they can't believe how easy 20 per really is with this fantastic one hour tape.

"OUTRAGEOUS"

25+ WPM—CT7325—This is the tape for that small group of overachieving hams who wouldn't be content to simply satisfy the code requirements of the Extra Class license. It's the toughest tape we've got and we keep a permanent file of hams who have mastered it. Let us know when you're up to speed and we'll inscribe your name in 73's CW "Hall of Fame."

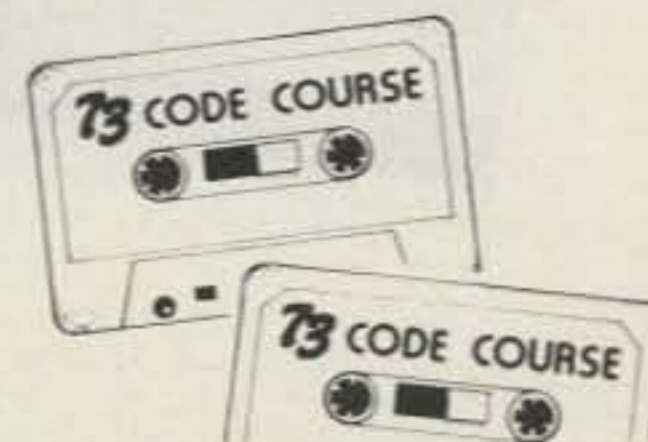

Use the order card in the back of this magazine or itemize your order on a separate piece of paper and mail to: 73 Radio Bookshop • Peterborough NH 03458. Be sure to include check or detailed credit card information. * Add \$1.00 handling charge. Note: Prices subject to change on books not published by 73 Magazine. Questions regarding your order? Please write to Customer Service at the above address. Please allow 4-6 weeks for delivery.

FOR TOLL FREE ORDERING CALL 1-800-258-5473

Radio Bookshop

73 TECHNICAL LIBRARY

● **BEHIND THE DIAL**—BK7307—By Bob Grove. Get more fun out of shortwave listening with this interesting guide to receivers, antennas, frequencies and interference. \$4.95.*

● **THE CHALLENGE OF 160**—BK7309—is the newest book in the 73 technical library, dedicated to 160 meter operating. Si Dunn provides all necessary information to get started on this unique band. The all-important antenna and ground systems are described in detail. The introduction contains interesting photos of Stew Perry's (the King of 160) shack. This reference is a must for new and experienced "Top Band" operators. Price: \$4.95.*

● **IC OP-AMP COOKBOOK**—BK1028—by Walter G. Jung. Covers not only the basic theory of the IC op amp in great detail, but also includes over 250 practical circuit applications, liberally illustrated. 592 pages, 5½ × 8½, softbound. \$12.95.*

● **THE POWER SUPPLY HANDBOOK**—BK7305—Need a power supply for a gadget you're building? In the **POWER SUPPLY HANDBOOK** there are dozens ready-to-build, plus detailed steps for designing your own. There are circuits and parts lists for all kinds of supplies, ranging from simple DC types to highly stable regulated versions. If you need a circuit to convert a DC voltage to a higher or lower voltage, turn DC into AC, or AC to DC—then this is the book you need. With more than 400 pages, you should be able to find just the circuit you need. Without a doubt one of the best power supply source books available, compiled by the editors of 73. \$7.95.*



● **INTRODUCTION TO RTTY**—BK7380—A beginner's guide to radioteletype including teletypewriter fundamentals, signals, distortion and RTTY art. You can be a RTTY artist! A 73 publication. \$2.00.*

● **THE NEW RTTY HANDBOOK**—BK7347—is a new edition and the only up-to-date RTTY book available. The state of the art has been changing radically and has made all previous RTTY books obsolete. It has the latest circuits, great for the newcomer and expert alike. \$5.95.*

● **PROPAGATION WIZARD'S HANDBOOK**—BK7302—by J. H. Nelson. When sunspots riddled the worldwide communications networks of the 1940's, John Henry Nelson looked to the planets for an answer. The result was a theory of propagation forecasting based upon interplanetary alignment that made the author the most reliable forecaster in America today. The book provides an enlightened look at communications past, present, and future, as well as teaching the art of propagation forecasting. \$6.95.*

● **SSB . . . THE MISUNDERSTOOD MODE**—BK7351—by James B. Wilson. Single Sideband Transmission . . . thousands of us use it every day, yet it remains one of the least understood facets of amateur radio. J. B. Wilson presents several methods of sideband generation, amply illustrated with charts and schematics, which will enable the ambitious reader to construct his own sideband generator. A must for the technically-serious ham. \$5.50.*

● **SSTV HANDBOOK**—BK7354(hardcover), BK7355(softcover)—This excellent book tells all about it, from its history and basics to the present state-of-the-art techniques. Contains chapters on circuits, monitors, cameras, color SSTV, test equipment and much more. Hardbound \$7.00, softbound \$5.00.*

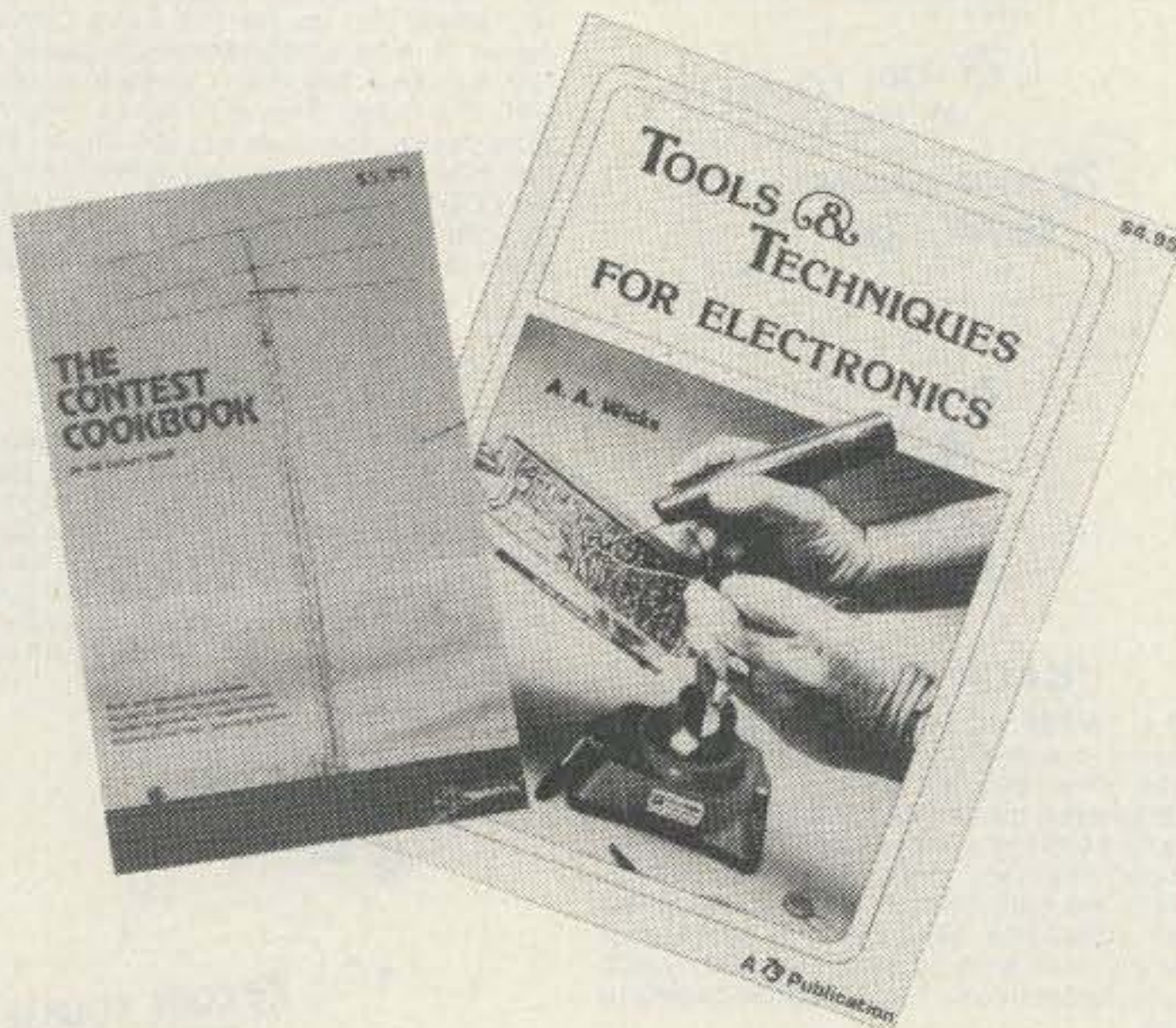

● **WEATHER SATELLITE HANDBOOK**—BK7370—Simple equipment and methods for getting good pictures from the weather satellite. Antennas, receivers, monitors, facsimile you can build, tracking, automatic control (you don't even have to be home). Dr. Taggart WB8DQT. \$4.95.*

● **TOOLS & TECHNIQUES FOR ELECTRONICS**—BK7348—is an easy-to-understand book written for the beginning kit builder as well as the experienced hobbyist. It has numerous pictures and descriptions of the safe and correct ways to use basic and specialized tools for electronic projects as well as specialized metal working tools and the chemical aids which are used in repair shops. \$4.95*

● **THE CONTEST COOKBOOK**—BK7308—reveals the secrets of the contest winners (Domestic, DX and specialty contests), complete with photos and diagrams of equipment used by the top scorers. Find out how to make 150 contacts in one hour. \$5.95*

Use the order card in the back of this magazine or itemize your order on a separate piece of paper and mail to: 73 Radio Bookshop • Peterborough NH 03458. Be sure to include check or detailed credit card information. *Add \$1.00 handling charge. Note: Prices subject to change on books not published by 73 Magazine. Questions regarding your order? Please write to Customer Service at the above address. Please allow 4-6 weeks for delivery.

FOR TOLL FREE ORDERING CALL 1-800-258-5473

Radio Bookshop

TEST EQUIPMENT

● **RF AND DIGITAL TEST EQUIPMENT YOU CAN BUILD**—BK1044—Rf burst, function, square wave generators, variable length pulse generators—100 kHz marker, i-f and rf sweep generators, audio osc, af/rf signal injector, 146 MHz synthesizer, digital readouts for counters, several counters, prescaler, microwave meter, etc. 252 pages. \$5.95.*

● **VOL. I COMPONENT TESTERS**—LB7359—... how to build transistor testers (8), diode testers (3), IC testers (3), voltmeters and VTVMs (9), ohmmeters (8 different kinds), inductance (3), capacity (9), Q measurement, crystal checking (6), temperature (2), aural meters for the blind (3) and all sorts of miscellaneous data on meters... using them, making them more versatile, making standards. Invaluable book. \$4.95.*

● **VOL. II AUDIO FREQUENCY TESTERS**—LB7360—... jam packed with all kinds of audio frequency test equipment. If you're into SSB, RTTY, SSTV, etc., this book is a must for you... a good book for hi-fi addicts and experimenters, too! \$4.95.*

● **VOL. III RADIO FREQUENCY TESTERS**—LB7361—Radio frequency waves, the common denominator of Amateur Radio. Such items as SWR, antenna impedance, line impedance, rf output and field strength; detailed instructions on testing these items includes sections on signal generators, crystal calibrators, grid dip oscillators, noise generators, dummy loads and much more. \$4.95.*

● **VOL. IV IC TEST EQUIPMENT**—LB7362—Become a troubleshooting wizard! In this fourth volume of the 73 TEST EQUIPMENT LIBRARY are 42 home construction projects for building test equipment to work with your ham station and in servicing digital equipment. Plus a cumulative index for all four volumes of the 73 TEST EQUIPMENT LIBRARY. \$4.95.*



THE WELL-EQUIPPED HAM SHACK

● **73 MAGAZINE BINDERS**—Preserve and protect your collection for your lifetime! There's no excuse for lost issues when you have these handsome red binders with gold lettering. Order 1—BN1001—for \$6.50*; 2 or more—BN1002—for \$6.00 each.* (specify 1978 or 1979 binders)

● **QSL CARDS**—73 turns out a fantastic series of QSL cards at about half the cost of having them done elsewhere because they are run as a fill-in between printing books and other items in the 73 Print Shop. 250 Style W—QW0250—for \$8.95*; 500 Style W—QW0500—for \$13.95*; 250 Style X—QX0250—for \$8.95*; 500 Style X—QX0500—for \$13.95*; 250 Style Y—QY0250—for \$8.95*; 500 Style Y—QY0500—for \$13.95.* Allow 6-12 wks. for delivery.

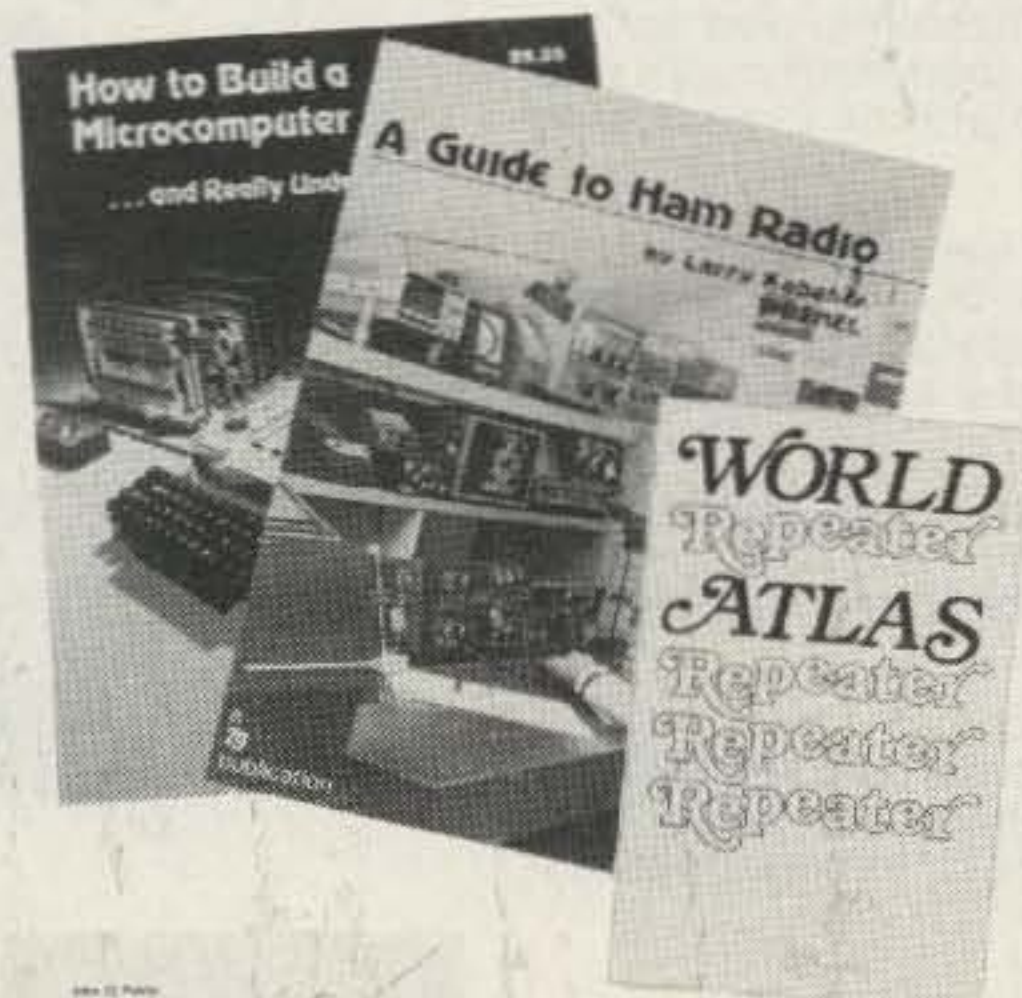

● **HOW TO BUILD A MICROCOMPUTER—AND REALLY UNDERSTAND IT**—BK7325—by Sam Creason. The electronics hobbyist who wants to build his own microcomputer system now has a practical "How-To" guidebook. Sam Creason's book is a combination technical manual and programming guide that takes the hobbyist step-by-step through the design, construction, testing and debugging of a complete microcomputer system. \$9.95.*

● **1980 WORLD REPEATER ATLAS**—BK1080—Completely updated for 1980, over 230 pages of repeater listings are indexed by location and frequency. More than 50 maps pinpoint 2000 repeater locations throughout the USA. Foreign listings include Europe, the Middle East, South America and Africa. \$4.95.*

● **BACK ISSUES**—Complete your collection; many are prime collectables now, classics in the field! A full collection is an invaluable compendium of radio and electronics knowledge!

WA6JYB

Style X

Style Y

W2NSD/1

Style W

Single back issue—ST0000—\$3.00*;

25 our choice—ST2500—\$12.00*;
25 your choice—ST2501—\$25.00*;
5 your choice—ST0500—\$8.75*;
10 your choice—ST1000—\$14.00.*

● **OWNER REPAIR OF RADIO EQUIPMENT**—BK7310—Frank Glass K6RQ shares over 40 years of operating, servicing, and design experience in this book which ranges from the elementary to the highly technical written for the top engineers in the field. It is written in narrative style on the subjects of electronic servicing, how components work, and how they are combined to provide communication equipment. This book will help you understand the concepts required to service your own station equipment. \$7.95.*

● **FREE BACK ISSUE CATALOGS** are yours for the asking... specify 73 Magazine and/or Kilobaud Microcomputing back issue catalog when you send your name and address to us on a postcard.

● **A GUIDE TO HAM RADIO**—BK7321—by Larry Kahaner WB2NEL. What's Amateur Radio all about? You can learn the basics of this fascinating hobby with this excellent beginner's guide. It answers the most frequently asked questions in an easy-going manner, and it shows the best way to go about getting an FCC license. A Guide to Ham Radio is an ideal introduction to a hobby enjoyed by people around the world. \$4.95.*

● **LIBRARY SHELF BOXES**—These sturdy white, corrugated, dirt-resistant boxes each hold a full year of 73 or Kilobaud Microcomputing. With your order, request self-sticking labels for any of the following: 73, Kilobaud Microcomputing, CQ, QST, Ham Radio, Personal Computing, Radio Electronics, Interface Age, and Byte. Order 1—BX1000—for \$2.00*; order 2-7—BX2002—for \$1.50 each*; order 8 or more—BX1002—for \$1.25 each*.

Use the order card in the back of this magazine or itemize your order on a separate piece of paper and mail to: 73 Radio Bookshop • Peterborough NH 03458. Be sure to include check or detailed credit card information. *Add \$1.00 handling charge. Note: Prices subject to change on books not published by 73 Magazine. Questions regarding your order? Please write to Customer Service at the above address. Please allow 4-6 weeks for delivery.

FOR TOLL FREE ORDERING CALL 1-800-258-5473

Radio Bookshop

● **73 DIPOLE AND LONG-WIRE ANTENNAS**—BK1016—by Edward M. Noll W3FQJ. This is the first collection of virtually every type of wire antenna used by amateurs. Includes dimensions, configurations, and detailed construction data for 73 different antenna types. Appendices describe the construction of noise bridges, line tuners, and data on measuring resonant frequency, velocity factor, and swr. \$5.50.*

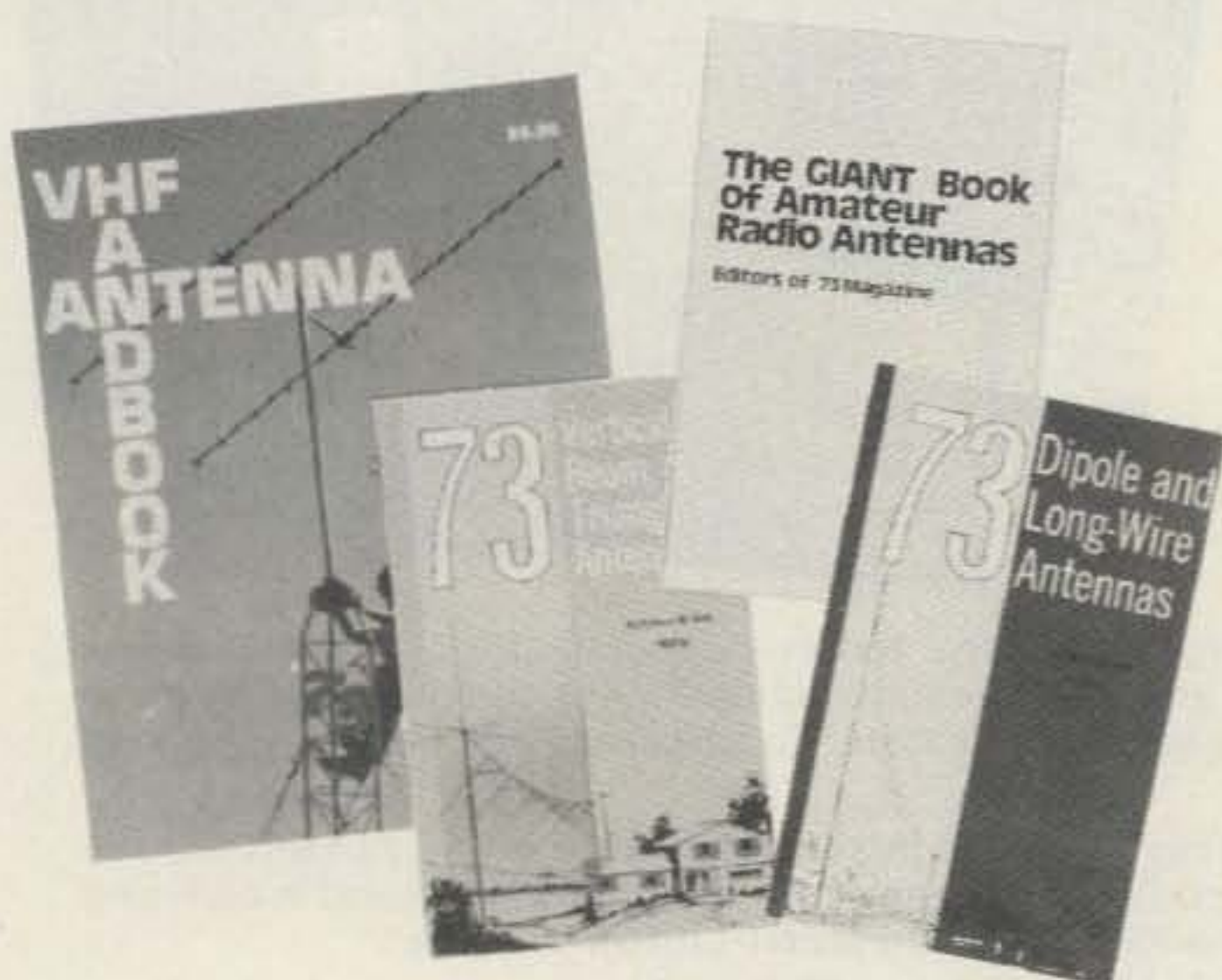

● **THE GIANT BOOK OF AMATEUR RADIO ANTENNAS**—With the **GIANT Book of Amateur Radio Antennas** by your side, antennas will become the least of your worries. Over 450 pages of design ideas, theory and reference data make this book live up to its title. The 7 chapters cover everything from basic antenna theory through designs for DIY accessories, as well as dozens of antenna designs. Whether planning to build or buy, design or admire, test or enjoy a ham antenna—this is the book for you. From the editors of 73; published by Tab Books. \$12.95* hardback—BK7304.

● **73 VERTICAL, BEAM AND TRIANGLE ANTENNAS**—BK1069—by Edward M. Noll W3FQJ. Describes 73 different antennas for amateurs. Each design is the result of the author's own experiments covering the construction of noise bridges and antenna line tuners, as well as methods for measuring resonant frequency, velocity factor, and standing-wave ratios. 160 pages. \$5.50.*

● **VHF ANTENNA HANDBOOK**—BK7368—The **NEW VHF Antenna Handbook** details the theory, design and construction of hundreds of different VHF and UHF antennas... A practical book written for the average amateur who takes joy in building, not full of complex formulas for the design engineer. Packed with fabulous antenna projects you can build. \$5.95.*

● **PRACTICAL ANTENNAS FOR THE RADIO AMATEUR**—BK1015—A manual describing how to equip a ham station with a suitable antenna. A wide range of antenna topics, systems, and accessories are presented giving the reader some food for thought and practical data for construction. Designed to aid the experienced ham and novice as well. Only \$9.95.*

● **TTL COOKBOOK**—BK1063—by Donald Lancaster. Explains what TTL is, how it works, and how to use it. Discusses practical applications, such as a digital counter and display system, events counter, electronic stopwatch, digital voltmeter and a digital tachometer. \$9.50.

● **CMOS COOKBOOK**—BK1011—by Don Lancaster. Details the application of CMOS, the low power logic family suitable for most applications presently dominated by TTL. Required reading for every serious digital experimenter! \$10.50.*

● **TVT COOKBOOK**—BK1064—by Don Lancaster. Describes the use of a standard television receiver as a microprocessor CRT terminal. Explains and describes character generation, cursor control and interface information in typical, easy-to-understand Lancaster style. \$9.95.*



● **BASIC NEW 2ND EDITION**—by Bob Albrecht. Self-teaching guide to the computer language you will need to know for use with your microcomputer. This is one of the easiest ways to learn computer programming. \$6.95.* (BK1081)

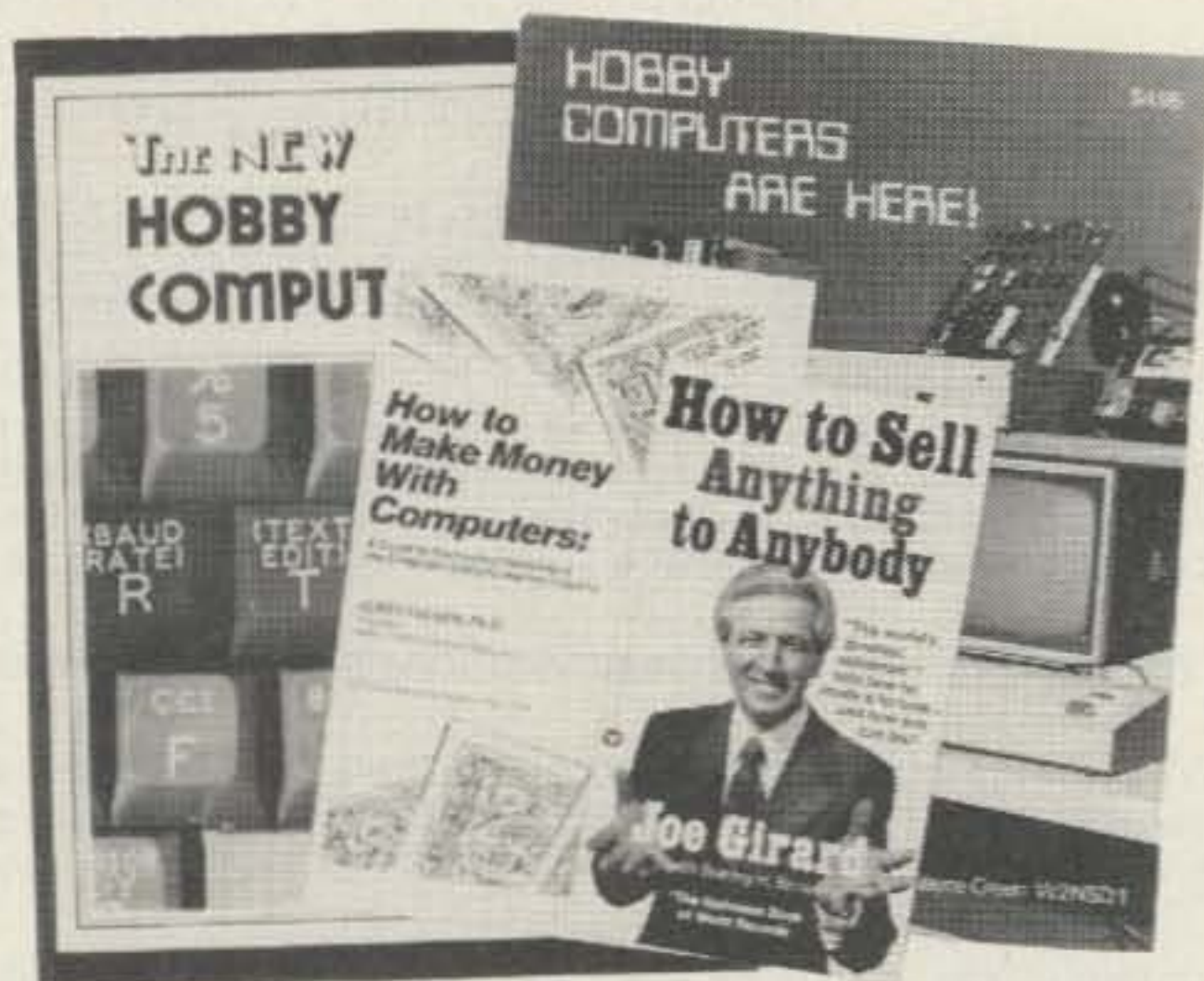

● **HOBBY COMPUTERS ARE HERE!**—BK7322—If you want to come up to speed on how computers work... hardware and software... this is an excellent book. It starts with the fundamentals and explains the circuits, the basics of programming, along with a couple of TVT construction projects, ASCII-Baudot, etc. This book has the highest recommendations as a teaching aid for newcomers. \$4.95.*

● **THE NEW HOBBY COMPUTERS**—BK7340—This book takes it from where **Hobby Computers Are Here!** leaves off, with chapters on Large Scale Integration, how to choose a microprocessor chip, an introduction to programming, low cost I/O for a computer, computer arithmetic, checking memory boards, a Baudot monitor/editor system, an audible logic probe for finding those tough problems, a ham's computer, a computer QSO machine... and much, much more! \$4.95*

● **HOW TO MAKE MONEY WITH COMPUTERS**—In 10 information-packed chapters, Jerry Felsen describes more than 30 computer-related, money-making, high profit, low capital investment opportunities. \$15.00.* (BK1003)

● **HOW TO SELL ANYTHING TO ANYBODY**—According to *The Guinness Book of World Records*, the author, Joe Girard, is "the world's greatest salesman." This book reveals how he made a fortune—an how you can, too. \$2.25* (BK7306)

Use the order card in the back of this magazine or itemize your order on a separate piece of paper and mail to: 73 Radio Bookshop • Peterborough NH 03458. Be sure to include check or detailed credit card information. *Add \$1.00 handling charge. Note: Prices subject to change on books not published by 73 Magazine. Questions regarding your order? Please write to Customer Service at the above address. Please allow 4-6 weeks for delivery.

FOR TOLL FREE ORDERING CALL 1-800-258-5473

73 magazine

The world's most comprehensive guide to the subject of ham radio.



The back issues of 73 are a gold mine of interesting articles. Unlike the other magazines, which fill their pages with activity reports, there's little to go stale in 73. You'll find pioneering articles on SSTV, FM, repeaters, ICs, and computers. Even the editorials are fun as Wayne Green's dire predictions, like the debacle of incentive licensing, have come to pass.

Clip the coupon below and send for 73's new back issue catalogue.

YES! Rush me 73's FREE Back Issue Catalogue!

Name _____

Address _____

City _____

State _____ Zip _____

73 Magazine • Subscription Dept • Peterborough NH 03458

PROPAGATION

by
J. H. Nelson

EASTERN UNITED STATES TO:

GMT:	00	02	04	06	08	10	12	14	16	18	20	22
ALASKA	14	14	14	7	7	7	7	7	14	14	14	14
ARGENTINA	21A	21	14	14	7A	7A	21	21A	21A	21A	21A	21A
AUSTRALIA	21A	21	14	7A	7B	7B	7B	14	14	14	21A	21A
CANAL ZONE	21A	21	14	14	7	7	14	21	21A	21A	21A	21A
ENGLAND	14	7	7	7	7	14	14	21	21A	21	14	14
HAWAII	21A	21	14	7	7	7	7	14	21	21	21A	21A
INDIA	14	14	7B	7B	7B	7B	14	14	14A	14A	14	14
JAPAN	21	14	7B	7B	7B	7	7G	7	14	14B	14	21
MEXICO	21	14	14	7A	7	7	7A	21	21	21A	21A	21A
PHILIPPINES	21	14	7A	7B	7B	7B	7B	7B	14B	14	14	14A
PUERTO RICO	21A	14	14	7	7	7	14	21	21A	21A	21A	21
SOUTH AFRICA	21	14	7	7	14	14	21A	21A	21A	21A	21A	21A
U. S. S. R.	7B	7	7	7	7	14	14	14	21	21	14	7B
WEST COAST	21A	14A	14	14	7	7	7	14A	21	21	21A	21A

CENTRAL UNITED STATES TO:

ALASKA	14A	14A	14	14	7	7	7	7	14	14	14	14
ARGENTINA	21A	21	14	14	7A	7A	14	21A	21A	21A	21A	21A
AUSTRALIA	21A	21	21	14	14	7B	7B	14	14	14	21A	21A
CANAL ZONE	21A	14A	14	7A	7	7	14	21A	21A	21A	21A	21A
ENGLAND	14	7	7	7	7	7	14	14	14	21	14	14
HAWAII	21A	21	14	14	7	7	7	14	21	21	21A	21A
INDIA	14	14	14	7B	7B	7B	7B	7B	14	14	14	14
JAPAN	21	21	14	7B	7B	7	7	7	14	14	14	21
MEXICO	21	14	7	7	7	7	7	14	14	21	21A	21A
PHILIPPINES	21	14A	14	7B	7B	7B	7B	7B	14B	14	14	14A
PUERTO RICO	21A	21	14	7A	7	7	14	21	21A	21A	21A	21A
SOUTH AFRICA	21	14	7	7	7B	7B	14	21A	21A	21A	21A	21A
U. S. S. R.	7B	7	7	7	7	7	7	14	14	21	14	7B

WESTERN UNITED STATES TO:

ALASKA	14A	14A	14	7	7	7	7	7	14	14	14	14
ARGENTINA	21A	21A	14	14	14	7A	14	21	21A	21A	21A	21A
AUSTRALIA	21A	21A	21A	21	14	14	14	14	14	14	21A	21A
CANAL ZONE	21A	21	14	7A	7	7	7	14A	21A	21A	21A	21A
ENGLAND	14	7B	7	7	7	7	7	14	14	14	14	14
HAWAII	21A	21A	21A	21	14	14	7	14	21	21	21A	21A
INDIA	14	14	14	14	7B	7B	7B	7B	14	14	14	14
JAPAN	21	21A	21	14	7B	7	7	7	14	14	14A	21
MEXICO	21A	21	14	7A	7	7	7	14	21	21	21A	21A
PHILIPPINES	21	21A	21	14	14B	7B	7B	7B	14B	14	14A	21
PUERTO RICO	21A	14A	14	7	7	7	7	14A	21A	21A	21A	21A
SOUTH AFRICA	21	14	7	7	7B	7B	7B	14	21	21	21A	21A
U. S. S. R.	7B	7B	7	7	7	7	7B	7B	14	14	14	7B
EAST COAST	21A	14A	14	14	7	7	7	14A	21	21	21A	21A

- A = Next higher frequency may also be useful
- B = Difficult circuit this period
- F = Fair
- G = Good
- P = Poor
- SF = Chance of solar flares

april

sun	mon	tue	wed	thu	fri	sat
		1	2	3	4	5
		G	G	G	G	G/SF
6	7	8	9	10	11	12
G/SF	G/SF	G/SF	G/SF	F/SF	F/SF	G
13	14	15	16	17	18	19
G	G	F	F	P	F/SF	F/SF
20	21	22	23	24	25	26
F/SF	G	G	G	G	G	G
27	28	29	30			
G	G	F	G			

READER SERVICE

R.S. No.	Page	R.S. No.	Page	R.S. No.	Page	R.S. No.	Page	
1	Adirondack Radio Supply.....	116	27	G.I.S.M.O.....	44	51	Microlog Corp.....	15, 151, 153
3	AED Electronics.....	53	28	Godbout Electronics.....	180	313	Micro Management Sys.....	134
300	Aidelco.....	153	29	Gregory Electronics.....	43	52	Mid Com Electronics, Inc.....	97
5	Amateur-Wholesale Electronics.....	95, 178	*	Hal Communications Corp.....	13, 121	26	M&M RF Distributors.....	125
6	AMC Engineering.....	136	31	Hal-Tronix.....	103	318	National Communication Group Co.....	69
7	American Crystal Supply.....	134	30	The Ham-Key Co.....	57	53	MOM'S.....	84, 85
301	Appliance & Equipment Co., Inc.....	134, 171	32	Ham Radio Center.....	51	54	OK Machine & Tool.....	28, 83
8	Apron Laboratories.....	43	33	Hamtronics, NY.....	187	55	Optoelectronics, Inc.....	37
9	AR Technical Products Corp.....	153	303	Heath.....	29	*	Palomar Engineers.....	105
*	Associated Radio.....	182	34	Henry Radio.....	Cov II	*	Partridge Electronics, Ltd.....	171
10	Avanti Research & Development.....	44	304	HFT, Inc.....	171	57	P.C. Electronics.....	124
11	Barker-Williamson.....	153	305	Hustler, Inc.....	86	58	Poly Paks.....	183
477	Bird.....	29	316	Hy-Gain Div. of Telex Comm., Inc.....	23, 25, 27	59	Protronics, Inc.....	57
320	Blacksburg Group.....	153	*	ICOM.....	7, 17	69	Quest Electronics.....	173
12	Bullet Electronics.....	162, 188	35	Info-Tech, Inc.....	136	61	Radio Amateur Callbook.....	60
13	Clegg.....	155	36	International Crystal Mfg.....	61	*	Radio World.....	137
14	Communications Ctr, NE.....	65	37	IRL.....	45	62	Ramsey Electronics.....	174, 179
15	Communications Specialists.....	8, 9	38	Jameco Electronics.....	181	63	RF Power Labs, Inc.....	45
16	Crown Micro Products.....	157	39	Jan Crystals.....	136	64	Semiconductors Surplus.....	176, 177
*	Dayton Hamvention.....	87	*	Kantronics.....	155	65	S-F Amateur Radio Services.....	137, 157
476	DenTron.....	28	*	Kenwood.....	Cov IV, 5	66	Signalcrafters, Inc.....	52, 119
17	Dielectric Communications.....	67	40	KLM Electronics.....	28, 87, 107	317	Space Electronics.....	171
*	Digital Research Parts.....	186	41	LaRue Electronics.....	136	309	Spacecoast Research.....	134
20	DSI Instruments.....	18, 19	84	Long Path Radio.....	60	67	Spectronics, Inc.....	175
21	Dynamic Electronics, Inc.....	171	42	Long's Electronics.....	126-131	68	Spectrum Communications.....	74, 75
23	Flesher Corp.....	53	44	Macrotronics.....	52, 60	69	Surplus Electronics.....	172
*	Gateway Amateur Radio Association.....	82	45	Madison Electronics Supply.....	103, 124, 151	70	Swan Electronics.....	21
24	Gemini Instrument Co.....	171	46	Maggiore Electronic Lab.....	134	312	Technical Clinic.....	171
25	Germantown Amateur Sup.....	50	478	Meshna.....	28	72	Tele-Tow'r Mfg. Co.....	105
			47	MFJ Enterprises.....	52, 61, 135, 151	316	Telex Communications, Inc.....	23, 25, 27
			48	MHz Electronics.....	184, 185	*	Ten-Tec, Inc.....	11
			49	Micro Control Specialties.....	67			
			50	Microcraft Corp.....	137			

*Reader Service inquiries not honored. Please contact advertiser directly.

From 73..... pages 99, 189-194
From 80 Microcomputing..... page 98
From KB Microcomputing..... page 98

BOOKS, ETC.

BK1016	73 DIPOLE & LONG WIRE ANTENNAS.....	\$ 5.50	BK1015	PRACTICAL ANTENNAS FOR THE RADIO AMATEUR.....	\$ 9.95
ST0000	73 BACK ISSUE.....	\$ 3.00	BK7302	PROPAGATION WIZARD'S HANDBOOK.....	\$ 6.95
ST2500	73 BACK ISSUES - 25 OUR CHOICE.....	\$12.00	QW0250	QSL CARDS - STYLE W - 250.....	\$ 8.95
ST0500	73 BACK ISSUES - 5 YOUR CHOICE.....	\$ 8.75	QW0500	QSL CARDS - STYLE W - 500.....	\$13.95
ST1000	73 BACK ISSUES - 10 YOUR CHOICE.....	\$14.00	QX0250	QSL CARDS - STYLE X - 250.....	\$ 8.95
ST2501	73 BACK ISSUES - 25 YOUR CHOICE.....	\$25.00	QX0500	QSL CARDS - STYLE X - 500.....	\$13.95
BK1081	BASIC NEW 2ND EDITION.....	\$ 6.95	QY0250	QSL CARDS - STYLE Y - 250.....	\$ 8.95
BK7307	BEHIND THE DIAL.....	\$ 4.95	QY0500	QSL CARDS - STYLE Y - 500.....	\$13.95
BN1001	BINDER - 73 - 1.....	\$ 6.50	BK1080	1980 WORLD REPEATER ATLAS.....	\$ 4.95
BN1002	BINDER - 73 - 2 AND UP.....	\$ 6.00	BK1044	RF DIGITAL TEST EQUIPMENT.....	\$ 5.95
BK7309	CHALLENGE OF 160.....	\$ 4.95	BK7347	RTTY HANDBOOK.....	\$ 5.95
CT7305	CODE TAPE - 5 WPM.....	\$ 4.95	BX1000	SHELF BOX - 1.....	\$ 2.00
CT7306	CODE TAPE - 6+ WPM.....	\$ 4.95	BX1001	SHELF BOXES - 2.....	\$1.50 each
CT7313	CODE TAPE - 13+ WPM.....	\$ 4.95	BX1002	SHELF BOXES - 8 AND UP.....	\$1.25 each
CT7320	CODE TAPE - 20+ WPM.....	\$ 4.95	BK7351	SSB THE MISUNDERSTOOD MODE.....	\$ 5.50
CT7325	CODE TAPE - 25+ WPM.....	\$ 4.95	BK7354	SSTV HANDBOOK (HARDCOVER).....	\$ 7.00
CT7394	CODE TAPES (ANY FOUR ABOVE).....	\$15.95	BK7355	SSTV HANDBOOK (SOFTCOVER).....	\$ 5.00
BK7308	THE CONTEST COOKBOOK.....	\$ 5.95	CT7350	SSTV TAPE.....	\$ 5.95
BK7321	GUIDE TO HAM RADIO.....	\$ 4.95	SG1081	STUDY GUIDE - ADVANCED CLASS.....	\$ 6.95
BK7304	GIANT BOOK OF AMATEUR RADIO ANTENNAS.....	\$12.95	SG1080	STUDY GUIDE - EXTRA CLASS.....	\$ 5.95
BK7322	HOBBY COMPUTERS ARE HERE.....	\$ 4.95	SG7358	STUDY GUIDE - GENERAL CLASS.....	\$ 5.95
BK7325	HOW TO BUILD A MICROCOMPUTER & REALLY UNDERSTAND IT.....	\$ 9.95	SG7357	STUDY GUIDE - NOVICE CLASS.....	\$ 4.95
BK1003	HOW TO MAKE MONEY WITH COMPUTERS.....	\$15.00	LB7359	TEST EQUIP LIB V1 - COMP TESTERS.....	\$ 4.95
BK7306	HOW TO SELL ANYTHING TO ANYBODY.....	\$ 2.25	LB7360	TEST EQUIP LIB V2 - AUDIO TESTERS.....	\$ 4.95
BK1028	IC OP AMP COOKBOOK.....	\$12.95	LB7361	TEST EQUIP LIB V3 - RADIO EQUIP.....	\$ 4.95
BK7380	INTRO TO RTTY.....	\$ 2.00	LB7362	TEST EQUIP LIB V4 - IC TEST EQUIP.....	\$ 4.95
BK7340	THE NEW HOBBY COMPUTERS.....	\$ 4.95	BK7348	TOOLS & TECHNIQUES.....	\$ 4.95
CT7300	NOVICE THEORY TAPES.....	\$15.95	BK1063	TTL COOKBOOK.....	\$ 9.50
BK7310	OWNER REPAIR OF RADIO EQUIPMENT.....	\$ 7.95	BK1064	TVT COOKBOOK.....	\$ 9.95
BK7305	POWER SUPPLY HANDBOOK.....	\$ 7.95	BK1069	VERTICAL BEAM & TRIANGLE ANTNS.....	\$ 5.50
			BK7368	VHF ANTENNA HANDBOOK.....	\$ 5.95
			BK7370	WEATHER SATELLITE HANDBOOK.....	\$ 4.95

READER SERVICE

This card is valid until July 31, 1980.

Please help us to bring you a better magazine—by answering these questions:

I. What is your age?

- A. under 18
- B. 18-22
- C. 23-40
- D. 41-60
- E. over 60

II. ARRL

- 1. Love it
- 2. Don't care
- 3. Hate it

III. If you are not a subscriber please circle number 500.

Reader Service: Return this card to receive full information on the products advertised in this issue. Refer to the ad. You will find numbers near the logo of each advertiser. Each represents the advertiser's individual Reader Service Number. Circle the corresponding numbers on one of the cards on this page, include your name, address & zip, and drop in a mailbox. In 4-6 weeks you'll hear from the advertiser directly.

1	6	11	16	21	126	131	136	141	146	251	256	261	266	271	376	381	386	391	396
2	7	12	17	22	127	132	137	142	147	252	257	262	267	272	377	382	387	392	397
3	8	13	18	23	128	133	138	143	148	253	258	263	268	273	378	383	388	393	398
4	9	14	19	24	129	134	139	144	149	254	259	264	269	274	379	384	389	394	399
5	10	15	20	25	130	135	140	145	150	255	260	265	270	275	380	385	390	395	400
26	31	36	41	46	151	156	161	166	171	276	281	286	291	296	401	406	411	416	421
27	32	37	42	47	152	157	162	167	172	277	282	287	292	297	402	407	412	417	422
28	33	38	43	48	153	158	163	168	173	278	283	288	293	298	403	408	413	418	423
29	34	39	44	49	154	159	164	169	174	279	284	289	294	299	404	409	414	419	424
30	35	40	45	50	155	160	165	170	175	280	285	290	295	300	405	410	415	420	425
51	56	61	66	71	176	181	186	191	196	301	306	311	316	321	426	431	436	441	446
52	57	62	67	72	177	182	187	192	197	302	307	312	317	322	427	432	437	442	447
53	58	63	68	73	178	183	188	193	198	303	308	313	318	323	428	433	438	443	448
54	59	64	69	74	179	184	189	194	199	304	309	314	319	324	429	434	439	444	449
55	60	65	70	75	180	185	190	195	200	305	310	315	320	325	430	435	440	445	450
76	81	86	91	96	201	206	211	216	221	326	331	336	341	346	451	456	461	466	471
77	82	87	92	97	202	207	212	217	222	327	332	337	342	347	452	457	462	467	472
78	83	88	93	98	203	208	213	218	223	328	333	338	343	348	453	458	463	468	473
79	84	89	94	99	204	209	214	219	224	329	334	339	344	349	454	459	464	469	474
80	85	90	95	100	205	210	215	220	225	330	335	340	345	350	455	460	465	470	475
101	106	111	116	121	226	231	236	241	246	351	356	361	366	371	476	481	486	491	496
102	107	112	117	122	227	232	237	242	247	352	357	362	367	372	477	482	487	492	497
103	108	113	118	123	228	233	238	243	248	353	358	363	368	373	478	483	488	493	498
104	109	114	119	124	229	234	239	244	249	354	359	364	369	374	479	484	489	494	499
105	110	115	120	125	230	235	240	245	250	355	360	365	370	375	480	485	490	495	500

Name _____

Address _____

City _____

State _____

Zip _____

73 Magazine • April 1980

BOOKS

Please send me the following 73 products:

Qty.	Catalog #	Title	Unit Price	Total

Add \$1 shipping/handling _____

Total _____

Please allow 4-6 weeks for delivery.

Enclosed \$ _____ Check M.O.

Bill: AE MC Visa

Card # _____ Exp. date _____

Name _____

Address _____

City _____

State _____ Zip _____

SUBSCRIPTION

**73 subscribers
save 50%
off the
newsstand price.**

New subscription Renewal

1 year—\$15

2 years—\$30

3 years—\$45

Enclosed \$ _____ Check M.O.

Bill: MC Visa AE me

Card # _____ Exp. date _____

Name _____

Address _____

City _____ State _____ Zip _____

Canada: \$15 per year, US funds
Other foreign: \$26 one year only, US funds

304B9

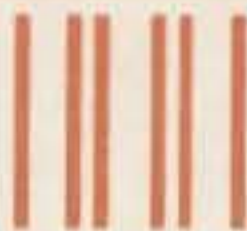

NO POSTAGE
NECESSARY
IF MAILED
IN THE
UNITED STATES

BUSINESS REPLY CARD

FIRST CLASS PERMIT NO. 73 PETERBOROUGH NH 03458

POSTAGE WILL BE PAID BY ADDRESSEE

73 MAGAZINE
Subscription Dept.
POB 931
Farmingdale NY 11737



NO POSTAGE
NECESSARY
IF MAILED
IN THE
UNITED STATES

BUSINESS REPLY CARD

FIRST CLASS PERMIT NO. 73 PETERBOROUGH NH 03458

POSTAGE WILL BE PAID BY ADDRESSEE

73 MAGAZINE
Peterborough
NH 03458



BUSINESS REPLY CARD

FIRST CLASS PERMIT NO. 217 CLINTON IA 52735

POSTAGE WILL BE PAID BY ADDRESSEE

73 MAGAZINE
POB 2739
Clinton IA 52735



NO POSTAGE
NECESSARY
IF MAILED
IN THE
UNITED STATES

Att. Mail Order

FT-707 is shown with optional FV-707DM VFO & Scanning Microphone



THE FT-707 "WAYFARER"

The introduction of the "WAYFARER" by Yaesu is the beginning of a new era in compact solid state transceivers. The FT-707 "WAYFARER" offers you a full 100 watts output on 80-10 meters and operates SSB, CW, and AM modes. Don't let the small size fool you! Though it is not much larger than a book, this is a full-featured transceiver which is ideally suited for your home station or as a traveling companion for mobile or portable operation.

The receiver offers sensitivity of .25 μ V/10 dB SN as well as a degree of selectivity previously unavailable in a package this small. The "WAYFARER" comes equipped with 16 poles of IF filtering, variable bandwidth and optional crystal filters for 600 Hz or 350 Hz. Just look at these additional features:

FT-707 with Standard Features

- Fast/slow AGC selection
- Advanced noise blanker
- Built-in calibrator
- WWV/JJY Band
- Bright Digital Readout
- Fixed crystal position
- 2 auxiliary bands for future expansion
- Unique multi-color bar metering—monitors signal strength, power output, and ALC voltage.

FT-707 with Optional FV-707DM & Scanning Microphone

- Choice of 2 rates of scan
- Remote scanning from microphone
- Scans in 10 cycle steps
- Synthesized VFO
- Selection of receiver/transmitter functions from either front panel or external VFO
- "DMS" (Digital Memory Shift)

Impressive as the "WAYFARER" is its versatility can be greatly increased by the addition of the FV-707DM (optional). The FV-707DM, though only one inch high, allows the storage of 13 discrete frequencies and with the use of "DMS" (Digital Memory Shift) each memory can be band-spread 500 KHz. These 500 KHz bands may be remotely scanned from the microphone at the very smooth rate of 10 Hz steps.

The FT-707 "WAYFARER" is a truly unique rig. See it today at your authorized Yaesu Dealer.

YAESU
The radio.



Easy selection.

15 memories/offset recall, scan, Touch-Tone[®], priority



TR-7800

Kenwood's remarkable TR-7800 2-meter FM mobile transceiver provides all the features you could desire for maximum operating enjoyment. Frequency selection is easier than ever, and the rig incorporates new memory developments for repeater shift, priority, and scan, and includes a

built-in autopatch Touch-Tone[®] encoder. Ask your Authorized Kenwood Dealer about the exciting TR-7800.

NOTE: Price, specifications subject to change without notice and obligation.

 **KENWOOD**
...pacesetter in amateur radio

TRIO-KENWOOD COMMUNICATIONS INC.
1111 WEST WALNUT / COMPTON, CA 90220

Subject to FCC Approval